



# VETERINARY MEDICINE

EDITION

11

A Textbook of the Diseases of  
Cattle, Horses, Sheep, Pigs, and Goats

PETER D. CONSTABLE    KENNETH W. HINCHCLIFF  
STANLEY H. DONE    WALTER GRÜNBERG



ELSEVIER

# VETERINARY MEDICINE

**A Textbook of the Diseases of  
Cattle, Horses, Sheep, Pigs, and Goats**



This page intentionally left blank

# VETERINARY MEDICINE

EDITION

11

A Textbook of the Diseases of  
Cattle, Horses, Sheep, Pigs, and Goats

VOLUME ONE

PETER D. CONSTABLE  
KENNETH W. HINCHCLIFF  
STANLEY H. DONE  
WALTER GRÜNBERG

ELSEVIER



ELSEVIER

3251 Riverport Lane  
St. Louis, Missouri 63043

VETERINARY MEDICINE: A TEXTBOOK OF THE DISEASES OF CATTLE, HORSES, SHEEP, PIGS, AND GOATS, ELEVENTH EDITION

Copyright © 2017 Elsevier Ltd. All Rights Reserved.  
Previous editions copyrighted: 2007, 2000, 1999, 1994, 1983, 1979, 1974  
First published 1960

No part of this publication may be reproduced or transmitted in any form or by any means, electronic or mechanical, including photocopying, recording, or any information storage and retrieval system, without permission in writing from the publisher. Details on how to seek permission, further information about the Publisher's permissions policies and our arrangements with organizations such as the Copyright Clearance Center and the Copyright Licensing Agency, can be found at our website: [www.elsevier.com/permissions](http://www.elsevier.com/permissions).

This book and the individual contributions contained in it are protected under copyright by the Publisher (other than as may be noted herein).

#### Notices

Knowledge and best practice in this field are constantly changing. As new research and experience broaden our understanding, changes in research methods, professional practices, or medical treatment may become necessary.

Practitioners and researchers must always rely on their own experience and knowledge in evaluating and using any information, methods, compounds, or experiments described herein. In using such information or methods they should be mindful of their own safety and the safety of others, including parties for whom they have a professional responsibility.

With respect to any drug or pharmaceutical products identified, readers are advised to check the most current information provided (i) on procedures featured or (ii) by the manufacturer of each product to be administered, to verify the recommended dose or formula, the method and duration of administration, and contraindications. It is the responsibility of practitioners, relying on their own experience and knowledge of their patients, to make diagnoses, to determine dosages and the best treatment for each individual patient, and to take all appropriate safety precautions.

To the fullest extent of the law, neither the Publisher nor the authors, contributors, or editors, assume any liability for any injury and/or damage to persons or property as a matter of products liability, negligence or otherwise, or from any use or operation of any methods, products, instructions, or ideas contained in the material herein.

Main ISBN: 9780702052460  
Volume 1 ISBN: 978-0-7020-7057-0

Content Strategist: Penny Rudolph  
Content Development Specialist: Laura Klein  
Content Development Manager: Jolynn Gower  
Publishing Services Manager: Hemamalini Rajendrababu  
Senior Project Manager: Kamatchi Madhavan  
Design Direction: Renee Duenow

Printed in China

Last digit is the print number: 9 8 7 6 5 4 3 2 1



Working together  
to grow libraries in  
developing countries

[www.elsevier.com](http://www.elsevier.com) • [www.bookaid.org](http://www.bookaid.org)

**Dr. Otto M. Radostits, August 31, 1934-December 15, 2006,  
Senior Author, Fifth to Seventh Editions; Lead Author, Eighth to Tenth Editions**

Otto Martin Radostits was a veterinary educator, clinician, and researcher who had a profound influence on students and practicing veterinarians throughout the world through his writings, not the least this text. Otto was closely involved with writing and editing the Fifth to Tenth Editions of *Veterinary Medicine*.

Otto, the eldest son of Austrian immigrants, was raised on a small mixed farm in Alberta, Canada. His early farm experiences and those obtained from working with a local veterinarian while attending high school sparked an interest in pursuing a career in veterinary science and were the beginning of his lifelong passion for large-animal veterinary medicine. He was admitted to the Ontario Veterinary College in 1954, at that time the only English-speaking veterinary school in Canada. During his undergraduate years, his clinical interests and potential were recognized such that following graduation, he was invited to join the faculty as a member of the ambulatory clinic practice of the college—at that time a vigorous practice in a rural area. Otto spent the next 5 years teaching in this position, with the exception of a year spent at the veterinary school at Purdue University in West Lafayette, Indiana.

The Western College of Veterinary Medicine in Saskatchewan, Canada, was established under the leadership of Professor D. L. T. Smith in the mid-1960s, and Otto was one of the founding faculty members. He established the ambulatory practice and helped design the college clinical buildings and finalize the curriculum. He remained a faculty member at the Western College of Veterinary Medicine until he retired in June 2002 and was awarded the title Emeritus Professor. Here he matured as a clinical teacher to influence students and veterinarians locally and internationally through his writings and presentations at veterinary meetings.

Otto's international recognition in large-animal veterinary medicine rests mainly on the strength of his writing and authorship of veterinary texts. These span the spectrum of large-animal veterinary medicine, from the clinical examination of the individual animal to the epidemiology, diagnosis, treatment, and control of livestock diseases, to herd health and preventive medicine.

The most notable are his contributions to this textbook, which has been used by veterinary students and practicing veterinarians around the world for over 50 years and through 11 editions, for 6 of which Otto was a senior or lead author. Otto joined the original authors, Doug Blood and Jim Henderson, for the Fifth Edition of this text in 1979 and, in 1994, became the senior author for the Eighth, Ninth, and Tenth Editions. During his sojourn as senior author, the text continued its original design as a student textbook with many student-friendly features. It also continued its importance as a reference book including the available information on all of the diseases of large animals, a truly formidable task. Otto did a large part of the work and would surely have been very proud of this new Eleventh Edition.

In the writing of these and his other texts, Otto read the veterinary literature and was a firm believer in evidenced-based medicine. He insisted that all statements in these texts were supported by references in the literature, and he maintained the format of a very large bibliography at the end of each disease description. He believed that other veterinary educators should also be current with the veterinary

literature and had little regard for those who were not. He could be a forceful presence in discussions, but Otto was also one of the quickest to recognize new information that negated previous theories concerning a disease, and he was always responsive to reasoned argument.

Otto taught that making a correct diagnosis was the crux to the solution of a disease problem, and he had a passion for the art and science of clinical examination. Many of his students affectionately remember his admonition, “We make more mistakes by not looking than by not knowing.” Otto's insistence on the need for accurate diagnosis did not preclude this realization that what the practicing veterinarian needed as the final message from his books was the best current information on what to do to cure or prevent the disease in question.

Otto has authored other texts. In the late 1990s he became concerned that the traditional skills of physical clinical examination were being supplanted by laboratory and instrumental analysis. As a consequence, he consulted with veterinary clinicians around the world and in 2000 was a senior author of the text *Veterinary clinical examination and diagnosis*. From his work on farms, Otto recognized that disease in farm animals commonly was a population concern, and he recognized the limitations of “fire brigade” medicine. He authored the first major text in herd health and preventive medicine with its first edition in 1985. Otto published many other works of significance to global veterinary medical education and presented more than 250 invited lectures and seminars in veterinary medicine in countries around the world.

Dr. Radostits's contributions have been recognized by many awards. For him, probably the most important were the award of Master Teacher from his university and, nationally, the Order of Canada.

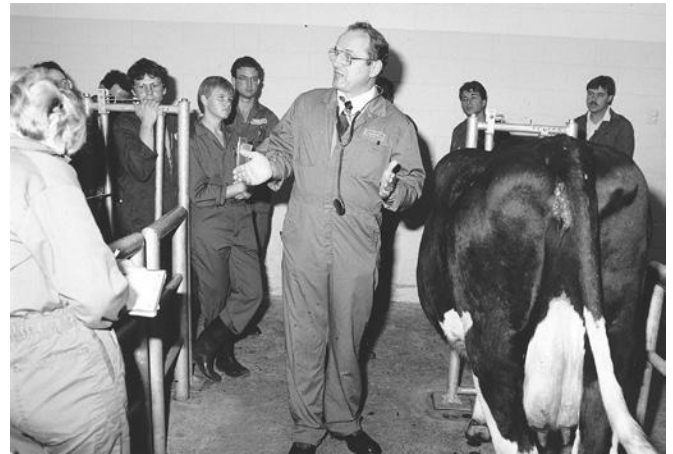

Dr. Otto Radostits teaching at the Western College of Veterinary Medicine in Saskatchewan, Canada. (Image courtesy of Mrs. Ruth Radostits and family.)



## Dr. Clive Collins Gay

Dr. Clive Collins Gay, DVM (Guelph, 1960), MVSc (Guelph, 1962), MVSc (*Ad Uendam Statum*, Melbourne, 1970), FACVSc (1977), Diplomate of the American College of Veterinary Internal Medicine (honorary, 2008), and Doctor of Veterinary Science (*Honoris Causa*, Melbourne, 2008) has a distinguished career as an agricultural animal veterinarian, scientist, author, and educator spanning five decades.

After graduating from Guelph in 1960, he was appointed as an assistant lecturer in the Department of Veterinary Medicine at the University of Glasgow from 1962 to 1964. In 1964, he was a George Aitken Pastoral Research Fellow (Sheep) and worked at the Veterinary Investigation Centre, Edinburgh University (Scotland); the Veterinary Investigation Centre, Ministry of Agriculture, Penrith (England); and the Nuffield Institute for Medical Research, Oxford University.

In 1965, Dr. Gay was recruited by his mentor Professor Douglas Blood to the newly reestablished veterinary school at the University of Melbourne as a senior lecturer in agricultural animal medicine. Ken Hinchcliff was one of Dr. Gay's students at the University of Melbourne. Dr. Gay was a genuinely gifted clinician, with an enthusiasm for veterinary science that inspired generations of undergraduate and postgraduate students and staff alike. His teaching attributes were recognized by various student accolades over the years, both in Australia and North America, and by the Washington State University (WSU) Faculty Award in 2000 from the Washington State Veterinary Medical Association (WSVMA).

In 1979, Dr. Gay became a professor of food animal medicine at WSU, where he concentrated on agricultural animals, establishing the Field Disease Investigation Unit in 1982 and leading the unit until his retirement in 2005. The approach used by the Field Disease Investigation Unit was groundbreaking at the time it was implemented in that it applied a multidisciplinary approach including university and private veterinarians, animal scientists, extension agents, and producers to tackle economically important livestock diseases. Dr. Gay was also one of the earliest proponents of evidenced-based medicine. He served on several committees of the U.S. Department of Agriculture (USDA). In recognition of his extensive contribution in this area, he received the prestigious Calvin W. Schwabe Award for lifetime achievement in veterinary epidemiology and preventive medicine from the American Association of Veterinary Epidemiology and Preventive Medicine in 2007. Dr. Gay became Professor Emeritus at WSU in 2005. His extensive contribution to veterinary medicine was recognized with a Distinguished Achievement Award from the Washington State Veterinary Medical Association in 2006, and he was made an Honorary Diplomat of the American College of Veterinary Internal Medicine in 2008.

Dr. Gay's research activities covered the breadth of veterinary science in regard to both species and systems, including topics as diverse as colic in horses, cardiology in dogs, diarrhea in pigs, colostrum immunity in calves, and trace-element deficiency in ruminants. He supervised 13 PhD students and 14 master's degree students. This work resulted in more than 90 articles in journals, more than 100 proceedings and abstracts, and the delivery of more than 150 invited presentations to scientific groups, veterinary conferences, and agricultural groups. The latter reflected his commitment to "knowledge

transfer" (extension work), which was a cornerstone of his approach to epidemiological studies and preventive medicine.

Reflecting his international standing, Dr. Gay had been a Visiting Research Fellow in the following areas: the Department of Veterinary Microbiology, University of Guelph, in 1971; the Department of Veterinary Clinical Studies, University of Cambridge, in 1972; the Department of Veterinary Clinical Sciences, Massey University, in 1993; the Central Veterinary Laboratory, Ministry of Agriculture Fisheries and Food, Pirbright, in 1994; and the Department of Geospatial Science, RMIT University (Melbourne), in 2001.

Over the years, Dr. Gay contributed actively to national and state veterinary associations, serving as a committee member of the Victorian Division of the Australian Veterinary Association (1968–1971); and editor of the *Victorian Veterinary Proceedings* (1968–1971); and an executive committee member of the Washington State Veterinary Medical Association (1999–2005), where he held the positions of vice president (2000), and president (2003–2004).

Dr. Gay was a contributing author of *Veterinary Medicine*, edited by Blood, Henderson, and Radostits in 1979, 1983, and 1989, and an author and editor for the Eighth (1994), Ninth (2000), and Tenth (2007) Editions. His most important contributions to those editions included diseases of the newborn, infectious diseases of sheep and goats, prion diseases, practical antimicrobial therapy, and selected metabolic and protozoan diseases, emphasizing the important roles that environment, management, host factors, and pathogen virulence factors play in disease occurrence and severity. Dr. Gay was largely responsible for bringing the Tenth Edition to print when Dr. Radostits, the lead author and editor, became ill during the final stages of preparation of the text.



Dr. Clive Gay and Professor Doug Blood, Veterinary Clinical Centre, University of Melbourne, 1978. (Courtesy of D. Blood's family.)

## Professor Douglas Blood

### 1920–2013

Professor Douglas Blood came to Australia in 1926 from East Ham, London. His family settled in Richmond, New South Wales, and toughed out the Great Depression. Through a scholarship, he attended Hurlstone Agricultural High School, where he enjoyed studying animals, especially cows and dogs. Following high school, Doug entered the Bachelor of Veterinary Science program at the University of Sydney. During World War II, he and a group of colleagues convinced the university to allow them to complete an accelerated course so that they could graduate in 1942 and then enlist in the armed services. Doug became a captain in a surveillance unit called Curtin's Cowboys in the Northern Territory. He returned to teach at the University of Sydney Veterinary School for 12 years. Then, from 1957 to 1962, Doug taught large-animal medicine at the Ontario Veterinary College at Guelph. It was during this time that he taught and mentored Otto Radostits and Clive Gay, both of whom were subsequently to become authors, along with Doug, of this text.

In 1962, Doug was appointed Professor of Veterinary Medicine and Founding Dean of Veterinary Science at the University of Melbourne. Doug passed on the deanship in 1968, but he continued to teach, retiring in 1985 after 23 years of service. During his time at the University of Melbourne, Doug recruited Clive Gay to a faculty (academic) position in the School of Veterinary Science and taught both Ken Hinchcliff and Peter Constable, both of whom followed him as authors of this text and deans of veterinary faculties—Hinchcliff at the University of Melbourne and Constable at the University of Illinois.

In recognition of his service to veterinary science, Doug was the recipient of many awards and honorary degrees, including the Schofield Medal from the University of Guelph, the Gilruth Prize for Meritorious Service to Veterinary Science from the Australian Veterinary Association, and an Order of the British Empire. He was involved in the formation of the Australian and New Zealand College of Veterinary Scientists. He also served as a committee member of the Victorian Division of the Australian Veterinary Association and as a board member of the Veterinary Surgeons Registration Board of Victoria.

In the early years, Doug Blood revolutionized the teaching of clinical veterinary medicine. For those of us privileged to have been taught by him at this time, he was a superlative teacher. Doug was one of the first teachers in clinical veterinary medicine to recognize that pathophysiology was the basis for teaching the disease processes in large animals. He also concentrated on the principles of pathophysiology in his explanations of disease syndromes and in teaching clinical examination and diagnosis. This was an approach that he developed from the teaching of his mentor, Oxford veterinary scientist H. B. Parry, to whom the first edition of this text was dedicated. This approach to clinical teaching was in marked contrast to the rote learning that was common in many of the disciplines taught at that time and in stark contrast to the teaching method in clinical examination and diagnosis, which primarily relied on pattern recognition.

Doug Blood also taught that the method of clinical examination should be system based, that it should be conducted in a systematic manner, and that it should be conducted using all available senses and techniques. He further taught that the intellectual diagnostic rule-out process should also incorporate a consideration of the presenting epidemiology of the disease problem, an examination of the environment, and an estimation of the probability of disease occurrence, summarized with his often repeated adage “common diseases occur commonly.” Although these approaches might seem obvious to recent graduates, in the 1950s and early 1960s, they were revolutionary. In fact, they set the foundation for current teaching principles in large-animal clinical veterinary medicine. Students of that older vintage recall with great appreciation the understanding of clinical veterinary medicine imparted by Doug Blood and his particular contribution to



Professors Ken Hinchcliff, Peter Constable, and Doug Blood (Werribee, Australia, 2008). (Source: Hinchcliff K.)

their education. Throughout subsequent years in his teaching career, Doug had the ability to inspire students and is viewed with respect, admiration, and even veneration by the generations of students he has taught.

The First Edition of this text was published in 1960 and authored by D. C. Blood and J. A. Henderson. It was entitled *Veterinary Medicine: A Textbook of the Diseases of Cattle, Horses, Sheep, Pigs and Goats* and was based on Doug Blood's and Jim Henderson's lectures and Doug's teaching and philosophical approach. At that time, there were few textbooks in the disciplines of veterinary science and up-to-date texts published in English that were primarily concerned with clinical veterinary medicine and diseases in agricultural animal species were not available. The original text was divided into two major sections. One section, “General Medicine,” covered system dysfunction, and the other, “Special Medicine,” covered the specific diseases of the large-animal species. This format was followed until the Eleventh Edition. The Second Edition was published in 1963 and had an additional two chapters covering parasitic diseases. Subsequently, new editions have been published approximately every 5 years, with major or minor changes in format in most editions, such as the addition of chapters dealing with new subjects or the addition of material in specific sub-headings to highlight, for example, the epidemiology or zoonotic implications of disease. However, always, with each edition, there was an extensive revision of disease descriptions based on current literature. Professor Henderson's involvement with the text ceased with the Fifth Edition, and that edition recruited Professor O. M. Radostits as senior author and others as contributing authors. Blood coauthored nine editions over a span of 45 years, with coauthors including Radostits, Gay, Hinchcliff, and Constable.

In the preface to the First Edition, it was stated that the book was directed primarily to students of veterinary medicine, although it was expected that the book would be of value to practicing veterinarians and field workers. The latter expectation has certainly proved true, and the book has come to be extensively used as a reference by veterinarians in large- and mixed-animal practice around the English-speaking world. Editions of the text have also been translated into French, Italian, Spanish, Portuguese, Japanese, Chinese, and Russian.

In addition to his passion for the method and accuracy of diagnosis of disease in individual animals and herds, Doug Blood also had a passion for preventive medicine and was a firm proponent of the thesis that subclinical disease is economically more important than clinical disease in agricultural animal populations. With other



colleagues at the University of Melbourne, he developed health programs for dairy cattle, beef cattle, and sheep and conducted practical trials of these programs in private herds and flocks. These programs were based on a whole-farm approach and centered on the concept that performance targets could be tracked through computer-based productivity monitoring to detect deviation from target performance. Doug Blood was a very early proponent of the use of computers to manage and analyze data in clinical diagnosis and herd health man-

agement. These herd health programs have been successfully commercially adopted in several countries.

Doug had a formidable intellect combined with an inexhaustible work ethic. He was a generous family man who had a zest for life and dry wit and who was so proud of his family and their achievements. He loved his morning runs/walks with his beloved Border Collies, music, and literature, and Doug had a passion for baking bread, brewing beer, photographing birds, and wearing bow ties.

# Contributors

The authors' names, degrees, and contact emails are below.

## Authors

**Peter D. Constable** BVSc(Hons), MS, PhD, *Docteur Honoris Causa* (Université de Liège), Dipl.ACVM, Dipl.ACVM (Honorary), AssocMember.ECBHM; (constabl@illinois.edu) Professor and Dean, College of Veterinary Medicine, University of Illinois, Urbana, Illinois, **USA**

**Kenneth W. Hinchcliff** BVSc(Hons), MS, PhD, Dipl.ACVM; hkww@unimelb.edu.au; President and Chief Executive Officer, Trinity College, University of Melbourne, Royal Parade, Parkville, Victoria, 3052, Australia; past Dean Faculty of Veterinary and Agricultural Sciences, University of Melbourne, Werribee, Victoria, **Australia**

**Stanley H. Done** BA, BVetMed, DVetMed, Dipl.ECPHM, FRCVS, FRCPath; (stanleydone70@icloud.com) Animal Health and Veterinary Laboratories Agency (AHVLA), Thirsk, **United Kingdom**. Contact Norma.Souter@ahvla.gsi.gov.uk

**Walter Grünberg** DrMedVet, MS, PhD, Dipl.ECBHM, Dipl.ECAR, AssocDipl.ACVM; (walter.gruenberg@tiho-hannover.de) Farm Animal Internal Medicine Specialist, University of Veterinary Medicine Hannover, Foundation Clinic for Cattle, Hannover, **Germany**

## Contributing Authors

**D.D. (Doug) Colwell** BSc, MSc, PhD; (Doug.Colwell@AGR.GC.CA) Livestock Parasitology/Parasitologie du bétail, Agriculture and Agri-Food Canada/Agriculture et Agroalimentaire Canada, Lethbridge Research Centre, Alberta, **Canada**

**Sara Connelly**, DVM, MS, Dipl.ACVCVP; (sconnoll@illinois.edu) Clinical Assistant Professor, Department of Pathobiology and Veterinary Diagnostic Laboratory, College of Veterinary Medicine, University of Illinois, Illinois, **USA**

**Levent Dirikolu** DVM, MVSc, PhD; (ldirikolu@lsu.edu) Professor and Director of the Equine Medication Surveillance Laboratory, School of Veterinary Medicine, Louisiana State University, Baton Rouge, Louisiana, **USA**

**Robin Gasser** Tierarzt, DVM, PhD, DVSc; (robinbg@unimelb.edu.au) Professor in Veterinary Parasitology, Veterinary Preclinical Centre, Faculty of Veterinary Science, University of Melbourne, Parkville, Victoria, **Australia**

**Lynn Hovda** RPh, DVM, MS, Dipl.ACVM; (lhovda@safetycall.com) Adjunct Professor, University of Minnesota College of Veterinary Medicine, Director of Veterinary Services, SafetyCall International and Pet Poison Helpline, Bloomington, Minnesota, **USA**

**Basil Ikede** DVM, PhD, Diagn Path, FCVSN; (ikede@upe.ca) University of Prince Edward Island, Charlottetown, Prince Edward Island, **Canada**

**John Larsen** BVSc, PhD, Grad Dip Bus Admin; (j.larsen@unimelb.edu.au) Associate Professor of Ruminant Production Medicine and Director, The Mackinnon Project, Veterinary Clinical Centre, Faculty of Veterinary and Agricultural Sciences, University of Melbourne, 250 Princes Highway, Werribee, Victoria, **Australia**

**William Witola** BVetMed, MSc, PhD; (whwit35@illinois.edu) Assistant Professor of Parasitology, Department of Pathobiology, College of Veterinary Medicine, University of Illinois, Urbana, Illinois, **USA**

**Amelia R. Woolums** DVM, MVSc, PhD, Dipl.ACVM, Dipl.ACVM; (amelia.woolums@msstate.edu) Professor, Department of Pathobiology and Population Medicine, College of Veterinary Medicine, Mississippi State University, Mississippi, **USA**



# Preface to the Eleventh Edition

We are delighted to present the Eleventh Edition of *Veterinary Medicine*, 56 years since the first “Blood and Henderson” *Veterinary Medicine* was published in 1960 and 9 years since the Tenth Edition was published in 2007. *Veterinary Medicine* focuses on diseases of ruminants, horses, and swine, and it is the most extensively cited textbook in veterinary medicine, with a recent total of 4,267 citations (Google Scholar, May 2016). Because the demand for this book remains strong, we assume that we have developed a philosophy, format, and price that are attractive and meet the demands of undergraduate veterinary students and graduate veterinarians working in the field of large-animal medicine.

Substantial changes were made to the format of the book for the Eleventh Edition to keep current with the continuing expansion of knowledge about the diseases of large animals. The book has been extensively revised and reorganized based on the major organ system affected. The **organ systems approach** reflects the profound impact that Dr. D. C. Blood had on the practice of large-animal medicine worldwide (see Foreword); he emphasized that the clinical examination procedure should be a systems-based method. We have extended the systems approach implemented in the First Edition through the assignment of diseases to the primary organ system affected or the most obvious clinical sign referable to an organ system. As a result, the Eleventh Edition contains 21 chapters, compared with 36 chapters in the Tenth Edition. Thirteen chapters deal with specific organ systems, including the alimentary tract of ruminants and nonruminants; the liver and pancreas; and the cardiovascular, hemolymphatic/immune, respiratory, urinary, nervous, musculoskeletal, and reproductive systems; in addition to metabolic/endocrine abnormalities, diseases of the mammary gland, and, finally, diseases of the skin, eye, and ear. Each of these chapters is organized in the following manner: general diseases; infectious diseases, listed in order of cause (bacterial, viral, prion, protozoal, fungal, metazoan) and species affected (all large animals, ruminants, horses, pigs); metabolic diseases; nutritional diseases; toxicologic diseases and environmental agents; neoplastic diseases; congenital and inherited diseases; and, finally, diseases of unknown etiology. The remaining eight chapters deal with specific medicine topics, as follows: clinical examination and making a diagnosis; examination of the population; biosecurity and infection control; general systemic states; disturbances of free water, electrolytes, acid-base balance, and oncotic pressure; practical antimicrobial therapeutics; perinatal diseases, and systemic and multi-organ diseases. A comprehensive index permits the reader to easily access relevant information in different chapters of the book.

We have attempted to ensure that the book continues to have an **international scope** by including clinically important diseases occurring in large animals **worldwide**. The book notes the eradication of Rinderpest in 2011 and includes new or extensively revised sections on a variety of topics, such as biosecurity and infection control; the Schmallenberg and bluetongue viral epidemics of ruminants in Europe; Wesselsbron disease in cattle and hypokalemia in adult cattle; equine multinodular pulmonary fibrosis; Hendra virus infection; multisystemic, eosinophilic, epitheliotropic disease of horses; hypoglycin A intoxication and equine metabolic syndrome; porcine reproductive and respiratory syndrome; porcine epidemic diarrhea and circovirus, and malignant catarrh in pigs; Torque teno, Menangle, and Japanese B viruses in pigs; and numerous recently identified congenital and inherited disorders of large animals.

Reflecting the international scope of the book, the four authors and nine coauthors were educated or have practiced veterinary medicine in 12 countries covering five continents, including Australia, Austria, Canada, Germany, Japan, the Netherlands, Nigeria, Turkey, Switzerland, the United Kingdom, the United States, and Zambia.

We continue to emphasize the **epidemiology** and **pathophysiology** of each disease, which are important in understanding the rationale for the **diagnosis**, **treatment**, and **control**. This means that we strive to maintain an optimum balance between published research and what field veterinarians find useful in their daily work. To make it easier for the reader to find particular pieces of information, long passages of prose have been divided into smaller sections using **headings** and **subheadings**. Key words, terms, and phrases have been emboldened for emphasis and to make it easier for the reader to identify important points. We also continue to include the **zoonotic** and **bioterrorism implications** of many diseases and how the large-animal veterinarian is becoming more involved in the control of diseases transmissible to humans. The use of individual diagnostic tests, described under *Clinical Pathology* for each disease, continues to be a challenge for all of us, especially with the increased availability of genomic or genetic testing and point-of-care testing. We have continued to concentrate on those tests that are accepted through common use, to discuss their limitations if they are known, and to provide a reference to newer tests that have future promise in diagnosis. A common limitation of publications describing new diagnostic tests is the absence of, or inadequate, information on the characteristics (sensitivity, specificity, accuracy) of the test in the population of animals in which it will be used.

Consistent with our deep commitment to practicing **evidenced-based veterinary medicine**, relevant references from 2006 onward have been cited, and important review and scientific papers, including Internet sites, are identified as Further Reading. We refer readers to previous editions of the book for references to earlier works.

When permitted by the quality and number of peer-reviewed publications, we have applied the Grading of Recommendations Assessment, Development and Evaluation (**GRADE**) process (see Foreword) to provide a summary of treatment and control recommendations in a box at the end of the section. This process distills information down to one of four recommendations that reflect “a judgment that most well-informed people would make”: R1, “do it”; R2, “probably do it”; R3, “probably don’t do it”; and R4, “don’t do it.” We believe that the GRADE approach will prove helpful to large-animal veterinarians, and we look forward to expanding this approach in future editions of this book.

Constraining the size of the book has been a constant preoccupation and a difficult task with the ever-increasing volume of published information and the constantly growing list of diseases. Our intention has always been to provide information on all recorded diseases. Despite reductions in reference lists and extensive editing to minimize repetition, the book is still large, necessitating a move to two volumes. More than 150 new figures have been added to the book to assist in presenting information.

We continue to subscribe to the practice and philosophy of earlier editions of this book in having a small number of authors contribute the majority of the text, with contributions from content specialists for particular topics. We believe that analysis and review of the relevant literature by a small number of authors with a broad knowledge and global perspective of large animal medicine assures a consistency of approach to each topic. Our authors are based in the United States, Australia, Europe, the United Kingdom, and Canada and have extensive experience in international veterinary medicine.

**Dr. Peter Constable**, Dean of the College of Veterinary Medicine, University of Illinois, USA, has assumed the responsibilities of senior author. He revised a number of sections related to specific ruminant diseases, in addition to major sections of the chapters on general systemic states and diseases of the ruminant alimentary tract, cardiovascular system, urinary system, musculoskeletal system, nervous system, and mammary gland. Dr. Constable also revised the chapters

on examination of the population and disturbances of free water, electrolytes, and acid-base balance.

**Dr. Kenneth Hinchcliff**, CEO of Trinity College, University of Melbourne, and former Dean of the Faculty of Veterinary and Agricultural Sciences, University of Melbourne, Australia, revised all the equine diseases and major sections of the chapters on diseases of the respiratory system, nonruminant alimentary tract, hemolymphatic and immune systems, endocrine abnormalities, and diseases of the neonate. Dr. Hinchcliff also revised the chapter on clinical examination and making a diagnosis and the Foreword of the book. Dr. Hinchcliff acknowledges the support of St. John's College, Cambridge, in appointing him as Overseas Visiting Scholar in 2013 during preparation of parts of this text. Drs. Constable and Hinchcliff are responsible for the revised format of the book.

**Dr. Stanley Done**, recently retired from the Animal Health and Veterinary Laboratories Agency, Thirsk, United Kingdom, joined our book as a coauthor and revised all the sections on diseases of pigs. This was a major task given the very large literature base on infectious diseases of pigs on a worldwide basis.

**Dr. Walter Grünberg**, Farm Animal Internal Medicine Specialist, Tierärztliche Hochschule, University of Veterinary Medicine, Hannover, Germany, is also a new coauthor. He revised a number of sections related to specific ruminant diseases and extensive sections of the chapters on diseases of the liver and pancreas and the skin, eye, conjunctiva, and ear.

The legacies of **Drs. D. C. Blood, C. C. Gay, J. A. Henderson,** and **O. M. Radostits** continue in this edition of *Veterinary Medicine*. **Dr. Doug Colwell**, Principal Research Scientist at Agriculture and Agri-Food Canada, once again revised the sections on diseases caused by arthropod ectoparasites. **Dr. Sara Connelly**, Clinical Assistant Professor of Clinical Pathology, College of Veterinary Medicine, University of Illinois, USA, revised the appendices dealing with conversion tables and reference laboratory values. **Dr. Levent Dirikolu**, Professor of Pharmacology, School of Veterinary Medicine, Louisiana

State University, USA joined our book as a contributor by revising the chapter on practical antimicrobial therapeutics. **Dr. Robin Gasser**, Professor of Veterinary Parasitology, Faculty of Veterinary and Agricultural Sciences, University of Melbourne, Australia, is a new contributor who revised the coverage of protozoal diseases. **Dr. Lynn Hovda**, Director of Veterinary Services, PLLC and Pet Poison Helpline, Minnesota, USA also joined our book by revising the sections related to diseases caused by toxins in plants, fungi, cyanophytes, clavibacteria, and venoms in ticks and vertebrate animals. **Dr. Basil O. Ikede**, recently retired from the Atlantic Veterinary College in Prince Edward Island, Canada, once again revised the sections on the major exotic viral and protozoan diseases. **Dr. John Larsen**, Director of the Mackinnon Project, Faculty of Veterinary and Agricultural Sciences, University of Melbourne, Australia, is a new contributing author and revised many chapters related to diseases of sheep and goats. **Dr. William Witola**, Assistant Professor of Parasitology, College of Veterinary Medicine, University of Illinois, USA, is also a new contributor to the book, revising chapters related to nematode, trematode, and tapeworm parasitic infection. **Dr. Amelia Woolums**, Professor of Pathobiology and Population Medicine, College of Veterinary Medicine, Mississippi State University, USA, joined the Eleventh Edition by authoring a new chapter on biosecurity.

We believe that we have completed another authoritative and comprehensive review of the peer-reviewed literature of large-animal medicine, at a standard at least equal to that of the previous 10 editions. We hope that the Eleventh Edition of *Veterinary Medicine* provides the information necessary to meet the needs of veterinary students and large animal clinicians for the next 5 to 8 years.

**P. D. Constable**  
**K. W. Hinchcliff**  
**S. H. Done**  
**W. Grünberg**

# Introduction

The first edition of this book established its role as a textbook of the diseases of traditional farm animals in the Western world, those being cattle, horses, sheep, pigs, and goats. The primary objective of this book was to offer the veterinary student and the practitioner the knowledge and information necessary to provide animal health management for farm animals. Although this intent has not changed, the context of veterinary medicine and large-animal practice has changed markedly in the 56 years since publication of the first edition.

## VETERINARY MEDICINE IN THE ANTHROPOCENE

*Anthropocene* is the proposed name for a new, and the current, geological epoch following on from the Holocene and demarcated as the time when human activities began to have a substantial global effect on the Earth's systems.<sup>1,2</sup> Although not universally accepted, the proposal recognizes that human activity has become the primary determinant of Earth's biophysical conditions, influencing global systems and having profound effects on local and regional environments. The Anthropocene is also associated with marked political and economic changes, including regional instability and reductions in political or economic barriers to trade. All of these factors have influenced, and will continue to influence, veterinary practice and the management of the health, well-being, and productivity of animals used for production of fiber and human food.<sup>3</sup>

The concept of the Anthropocene allows veterinarians to consider how the veterinary profession will adapt to our changing environment and associated social, political, environmental, and economic challenges to animal and human health. The challenges include, but are not limited to the following:<sup>4</sup>

- A changing climate with flow-on effects on the geographic distribution of diseases, emergence or reemergence of infectious and noninfectious diseases, and extension of diseases into species not historically affected
- Altered farming patterns, and hence use of animals, as climatic changes force farmers to abandon decades or centuries old land and animal management practices
- Increasing internationalization of trade and freedom of movement of people, animals, and potential fomite, with important implications for the biosecurity of countries, regions, and industries
- Political instability, with subsequent loss of animal health monitoring and disease control
- Economic pressures to produce more and safer food with no increase in water or land use
- Societal expectations for increased animal welfare and the associated mandated changes in farm animal management practices, for example, housing of dairy cattle or mulesing of lambs

As noted by the “Safeguarding Human Health in the Anthropocene Epoch: Report of the Rockefeller Foundation-Lancet Commission on Planetary Health,”<sup>2</sup> the scale of human impact on the planet is immense and includes the following changes:

- About a third of the ice-free and desert-free land surface of the planet has been converted to cropland or pasture.
- Annually, roughly half of all accessible freshwater is appropriated for human use.
- More than 2.3 million km<sup>2</sup> of primary forest has been cleared since 2000.
- More than 60% of the world's rivers are dammed, affecting in excess of 0.5 million km of river.
- Extinction rate of species is more than 100 times that observed in the fossil record, and many remaining species are decreasing in number.

- Concentrations of major greenhouse gases—carbon dioxide, methane, and nitrous oxide—are at their highest levels for at least the past 800,000 years.
- The global temperature continues to rise above long-term historic levels, driving changes in climate and weather patterns.

These changes have a profound impact on human and animal health, as evidenced by altered geographic distributions of diseases, emergence of new diseases, and reemergence of previously controlled or repressed diseases. Anthropogenic changes in the environment influence animal health by affecting the productivity of agricultural and animal production systems and increasing the likelihood of spread of diseases from animals to humans. One-half of the global emerging infectious disease events of zoonotic origin between 1940 and 2005 are estimated to be the result of changes in land use, agricultural practices, and food production practices.<sup>5</sup> There is evidence of an increased risk of zoonotic disease transmission in disturbed and degraded habitats, as exemplified by the emergence of two diseases caused by henipaviruses in animals and humans. Both Nipah and Hendra henipaviruses “spill over” from bats to pigs and horses, respectively, and subsequently infect humans. In both instances, disease is associated with altered habitats, including land clearing that creates a pathway for the repeated transmission of virus from fruit bat reservoirs, emphasizing the role of intact ecosystems and the suitability of climatic conditions in regulating the transmission of diseases.<sup>6-8</sup>

Change in weather systems and climate can profoundly influence the distribution of vectors for important pathogens. Climate is a major factor in determining the geographic and temporal distribution of arthropods, characteristics of arthropod life cycles, dispersal patterns of associated arboviruses, the evolution of arboviruses, and the efficiency with which arboviruses are transmitted from arthropods to vertebrate hosts.<sup>9</sup> For example, emergence of bluetongue virus infection and disease in Europe has been attributed to climate change-induced alterations in distribution of hematophagous midges that transmit the virus, although this concept is disputed, and the importance of other anthropogenic, vector, or virus factors in the spread of the disease is unclear.<sup>10-13</sup>

There is concern that changes in land-use patterns and climate might provide for the spread of Rift Valley fever into new locations, including more frequent or deeper incursions into the Arabian Peninsula.<sup>14</sup> The emergence of Schmallenberg virus, an orthobunyavirus, as a cause of disease in ruminants in Germany and the Netherlands in late 2011, and its subsequent rapid spread across Europe, highlights the potential for emergence of new diseases. The virus is apparently spread by *Culicoides* midges, but its origin remains unknown. Its roughly concurrent occurrence with new strains of bluetongue virus (e.g., BTV-6) in the same region might be more than a coincidence.<sup>15</sup>

International transport of animals and animal products has the proven potential to introduce disease into areas in which it was not present. Introduction of African horse sickness into regions with populations of susceptible horses and competent midge (*Culicoides* spp.) vectors can result in spread of the disease, as occurred in the Iberian Peninsula in 1987.<sup>16-18</sup> Equine influenza virus was inadvertently introduced into Australia in August 2007 by importation of infected horses from Japan, with spread occurring because of apparently inadequate quarantine procedures.<sup>19</sup> Incursion of the virus, which was subsequently eliminated from the continent, had an adverse economic impact.<sup>20</sup>

Similarly, political instability and conflict, which might or might not be associated with climate change but in either case is clearly human-related, results in altered patterns of human movement, loss of control and eradication programs, and absence of surveillance, with

resultant resurgence of previously repressed diseases. Examples include the incursion of rinderpest into Turkey from Iraq in the aftermath of the first Gulf War in the early 1990s, and spread of bovine contagious pleuropneumonia in Angola and the Horn of Africa as a result of civil wars.<sup>21</sup>

It is not just in infectious diseases that we will see changes in the Anthropocene. Increasing global temperatures and altered rainfall conditions will increase the potential for heat- and drought-associated illnesses in farm animals and for disruption to social systems by altered rainfall patterns causing flooding, droughts, and an increase in extreme weather events.<sup>4</sup> For instance, heat stress profoundly influences milk production, weight gain, and fertility of cattle, with these effects extending beyond the period of actual exposure to heat.<sup>4</sup> Heat stress is a concern for dairy, feedlot, and range cattle in temperate and tropical regions of much of the world and has led to the introduction of management systems to accommodate the changes in weather.<sup>3,22,23</sup> Increases in mean global temperature will increase the number of days annually, in some instances by over 100%, on which cattle are exposed to conditions that will cause heat stress.<sup>4</sup>

Veterinary input to animal production systems will need to reflect these complex and changing climatic, political, social, and economic environments that represent the nature of contemporary livestock production of fiber and food for human consumption.

## CONTEMPORARY LIVESTOCK PRODUCTION

Although traditional farms incorporating multiple livestock systems still exist, much more important economically and in terms of the numbers of animals involved are farms that concentrate on one or two livestock systems or species. For example, witness the almost absence in developed countries of farms on which pigs are run in extensive systems on pastures or fields shared with cattle, horses, or sheep. Much more common, and economically important, are the large piggeries that house hundreds to thousands of pigs, often with farms focusing on breeding pigs that are then transferred to other farms or facilities for finishing. Or consider the ascension of feedlots in which sometimes massive numbers of cattle are aggregated from the many individual farms on which they were bred, or the change in dairies from small (50–100 cows) farms to large operations with thousands of cows. The disease issues confronting managers and their veterinary advisors in these facilities are much different from those encountered by a veterinarian responding to a call for a sick cow in a small dairy herd on a family-run farm that also produces sheep, pigs, and poultry. This edition of *Veterinary Medicine* reflects these changing circumstances, which are discussed in more detail in this Introduction.

Another important change confronting veterinarians is the increasing value of some individual animals, particularly horses. The manner in which this book deals with medicine of horses is discussed in detail during the planning of each edition. Increasing value of individual horses and desire by owners to protect the health or performance of these animals have driven the veterinary profession to develop sophisticated, and expensive, diagnostic and therapeutic modalities and interventions directed toward care of individuals. However, this is offset by the recognition that preservation of the health of bands of horses on studs or in stables, or in whole populations in a country, is economically important and based on a thorough understanding of epidemiology and biosecurity—just as for food- and fiber-producing animals. For this latter reason, equine medicine in this book is dealt with as much from a population perspective as it is from the perspective of diagnosis and treatment of an individual horse.

It is stating the obvious that veterinary medicine has advanced in ways that were unimaginable 56 years ago. For example, our understanding of the genetic, and increasingly the genomic, basis of production and susceptibility to disease is something that is now included in discussions of almost every disease, and not just those diseases with a clear monogenetic basis. Associated with this is the incalculable value of use of diagnostic tests based on detection of all or part of the

genome of a pathogen. Polymerase chain reaction tests now allow detection of infinitesimally small quantities of DNA or RNA with great rapidity and absolute specificity, often permitting detection of the presence of pathogen genetic material on the same working day as the samples were collected. Additionally, analysis of part (such as single-nucleotide polymorphisms, or SNIPs) or all of the genome of an animal or pathogen provides information critical to understanding the pathogenesis, pathogenicity, or epidemiology of the organism. The utility of this type of information is evident in discussion of many of the diseases—from detection of mutations in the genome of animals that cause them to display particular diseases, for example, bovine leucocyte adhesion deficiency, or, conversely, decrease their susceptibility to infectious diseases, such as occurs with scrapie in some breeds of sheep; to understanding of the pathogenicity of microbes, such as equine herpesvirus 1 neuropathic and less neuropathic strains, or their epidemiology, such as in strain typing of equine influenza H3N8 viruses.

## VETERINARY CLINICAL EPIDEMIOLOGY

Important to our understanding of the basis of disease has been the emergence of clinical epidemiology as a means of interrogating the patterns of disease and disease spread and identifying risk factors for development of disease. Understanding patterns of disease spread is fundamental to developing and implementing sensible and effective biosecurity and control measures. Similarly, knowing the risk factors for development of disease and quantifying the relative importance of each (“relative risk” or “odds ratio,” depending on the context) are key to determining which of these factors can be modified to reduce risk of the disease and whether it is economical to do so.

The importance of use of applied and analytical epidemiology in large-animal practice and veterinary medicine is clear. The tools of epidemiology are now readily available to allow the veterinarian to identify and quantify the risk factors associated with the disease, to provide a more accurate prognosis, to accurately assess treatment responses and not depend on clinical impressions, to scientifically evaluate control procedures, and to conduct response trials. There is a large and challenging opportunity for veterinarians to become involved in clinical research in the field where the problems are occurring. It will require that they become knowledgeable about the use of computerized databases. These now provide an unlimited opportunity to capture and analyze data and generate useful information, which heretofore was not considered possible. The technique of decision analysis is also a powerful tool for the veterinarian who is faced with making major decisions about treatment and control procedures.

## VETERINARY SCIENTIFIC LITERATURE AND HOW TO USE IT

Perhaps the single greatest advance in veterinary medicine has been the collective increase in knowledge. The large increase in knowledge of animal diseases and animal health, including information about efficacy of diagnostic and therapeutic techniques and interventions, coupled with the ease of access of this information through online databases and web-based search engines, presents challenges in assessing the quality of information and in collating the information into a useable form.

Development of formal methods for assessing information and providing a recommendation have led to the term *evidence-based veterinary medicine*.<sup>24–26</sup> Evidence-based veterinary medicine is defined as the use of best relevant evidence in conjunction with clinical expertise to make the best possible decision about a veterinary patient, taking into account the circumstances of each patient and the circumstances and values of the owner/carer.<sup>27</sup> The questions related to use of an evidence-based approach can be summarized as follows:

- Why do we need evidence of effectiveness of our clinical actions (assessment of clinical signs, diagnostic tests, interventions, prognostication)?



- What are the levels of evidence, and how good are they?
- How does one translate evidence into a recommendation or decision?
- What factors contribute to the weighting of evidence?
- Does weak evidence allow us to make a strong recommendation?
- Does strong evidence not always allow us to make a strong recommendation?
- How do I use this in practice?

There are five steps to evidence-based veterinary medicine:<sup>27</sup>

1. Ask the pertinent question and thereby define what it is that needs to be known to allow for the most appropriate action.
2. Acquire the evidence, usually by a review of the available literature or, less commonly, performing a new research study.
3. Appraise the quality of evidence and its external validity (evidentiary value for the question being asked).
4. Apply the evidence to practice, where appropriate. See comments that follow about the GRADE process.
5. Audit—Assess whether the application of the new evidence has affected the outcome of interest.

### Quality of Evidence

The confidence we have in our evidence-based approach to veterinary practice depends on our assessment of the quality of the evidence available to us.<sup>28</sup> Not all evidence is of equal merit or utility, and although there are slight differences in the ratings of quality of evidence from different sources, an approximate hierarchy of evidence from lowest to highest in terms of value of evidence for practical use is as follows:

- Expert opinion/editorials/nonstructured consensus statements or opinion pieces
- Case reports and case series
- In vitro studies with an appropriate control group
- Animal models of the disease of interest (induced disease in species other than the species in which the disease occurs naturally, e.g., mouse model of a disease in horses)
- Case-control or cross-sectional studies
- Nonrandomized trials, cohort studies, or models of induced disease in the species of interest (target species, e.g., induction of viral diarrhea in calves)
- Randomized controlled trials under field conditions
- Systematic review of randomized controlled trials
- Systematic review, including meta-analysis

The higher the quality of evidence, the greater is our confidence in making decisions based on this evidence. The highest-quality evidence is provided by systematic reviews, which might include a meta-analysis. Systematic reviews differ from narrative reviews, which have much lower evidentiary value, in that systematic reviews are approached in a manner and with methodology designed to ensure the validity of the conclusions.<sup>29</sup> Systematic reviews should be based on a clearly defined question and prespecified criteria for inclusion and evaluation of the literature, among other factors. Criteria and methodology for performing systematic reviews are available.<sup>30-32</sup>

Assessment of the quality of evidence provided by scientific articles is dependent on the authors of the article reporting exactly what they did and how they did it. It is clear from studies in human medicine and small animals that poorer reporting of methodology in articles is associated with a greater proportion of positive outcomes, leading one to suspect that reports that are less well documented are more likely to provide unreliable evidence of efficacy.<sup>33</sup> There are increasing numbers of guidelines that provide advice for authors on how to adequately report on trials, and these guidelines are also useful as checklists for readers of articles. Available guidelines are CONSORT, REFLECT, STARD, STROBE, and others, which are available through the EQUATOR website (<http://www.equator-network.org/reporting-guidelines/>).<sup>34</sup>

### From Evidence to Recommendation

The approach of using evidence to guide clinical decision making has been formalized in the last two decades in human medicine and is gaining traction in veterinary practice. As veterinary clinicians, we have ethical and legal obligations to use methods and practices that are most likely to provide the “best” outcomes for the animals we treat and their owners. A traditional approach to deciding on the “best” treatments, diagnostic tests or methods, and preventative measures has been to identify the highest-quality evidence of effectiveness and to adopt the approach with the strongest evidence of efficacy. The Cochrane Collaboration and the Cochrane Reviews exemplify and lead this approach in human medicine (<http://www.cochrane.org/cochrane-reviews>).

This “evidence-based” approach has the implicit assumption that one should rely on the highest-quality evidence and that high-quality evidence of efficacy necessarily leads to the adoption of that treatment, diagnostic test, or prophylaxis. However, this approach falls short when formulating recommendations for use in clinical practice. What practitioners need is recommendations that are based on the available evidence but that also take into account the other factors that must be considered when advising an owner or trainer on the “best” approach to dealing with their animal’s (and their) problem. This methodology has been developed in human medicine as the GRADE (Grading of Recommendations Assessment, Development, and Evaluation) process.<sup>35</sup> GRADE fundamentally works by providing a framework to determine a final recommendation on an intervention through use of the following:

1. The quality of evidence (Cochrane and similar evaluations of quality of evidence stop here),
2. Seriousness of the outcome,
3. Magnitude of the treatment effect,
4. Precision of the treatment effect,
5. Risk of the target event (how frequent),
6. Risk of adverse events associated with the intervention,
7. Cost of the intervention, and
8. The values and preferences of the end users (patients).

All of these criteria have at least some applicability in veterinary medicine. Briefly, judgments about the quality of recommendations require consideration of the following factors:

- **The quality of evidence on which the recommendation is based.** The quality of evidence is assessed on the type of study (with systematic reviews being designated *a priori* as the highest level of evidence and observational studies providing a lower quality of evidence), imprecision of the results over a number of studies, inconsistency of the studies, indirectness, reporting bias, magnitude of the effect, biological plausibility, and strength of association.<sup>36-40</sup>
- **The balance between benefits and harms.** Will the intervention do more good than harm? What is the extent of the benefit and of the potential harm?
- **Feasibility of translating the evidence into the circumstance in which the intervention will be made.** Can I apply this in my practice? Is it affordable?
- **Certainty of the baseline risk.** How important is the problem?
- **Cost.** Both monetary costs and expenditures in terms of resources must be considered.

The balance between benefit and harm (the trade-off) can be categorized as follows:

- Net benefits = the intervention clearly does more good than harm.
- Trade-off = there are important trade-offs between the benefits and harms.
- Uncertain trade-offs = it is unclear whether the intervention does more good than harm.
- No net benefits = the intervention clearly does more harm than benefit.

The quality of evidence informing the recommendation can be categorized as follows:



- **High:** We are very confident that the true effect lies close to that of the estimate of the effect. In other words, we can be very confident that both the direction of the effect and its magnitude are known with reasonable certainty and that the magnitude of the effect is clinically relevant.
- **Moderate:** We are moderately confident in the effect estimate. The true effect is likely to be close to the estimate of the effect, but there is a possibility that it is substantially different. In other words, the direction of the effect is likely known, although the magnitude might change with further research. The magnitude of the effect is likely clinically significant.
- **Low:** Our confidence in the effect estimate is limited. The true effect could be substantially different from the estimate of the effect. In other words, both the direction of the effect and its magnitude are very likely to change with further research.
- **Very low:** Any estimate of the effect is very uncertain, and the direction and magnitude of the real effect of the intervention are unknown.

Finally, all of the considerations just described can be distilled down to the following recommendations being “a judgement that most well-informed people would make”:<sup>41</sup>

- “Do it”—there is high-quality evidence of net benefits within appropriate resource constraints (costs) for a problem that has significant importance (a judgment that most well-informed people would make).
- “Probably do it” = when the strength of evidence is moderate or when the benefit:harm trade-off is unclear or marginal.
- “Probably don’t do it” = when the strength of evidence is low or very low, when the benefit:harm trade-off is unclear or marginal, or when the baseline risk is low.
- “Don’t do it” = there is high-quality evidence of harm clearly exceeding benefits, the cost is too great compared with benefits, or the baseline risk is very low (i.e., the problem is not important).

The GRADE guidelines, although not well established for veterinary medicine, have been used and provide the opportunity to make evidence-based recommendations to practitioners.<sup>42</sup>

## FOOD- AND FIBER-PRODUCING ANIMALS

Veterinary practice with food-producing animals provides service primarily to the owners of the meat-, milk-, and fiber-producing animals such as dairy and beef cattle, pigs, sheep, and goats. Veterinarians also provide service to owners of captive ungulates, such as red deer, elk, and bison, which are being raised under farm conditions for the production of meat and byproducts such as hides. Although some commercially processed horsemeat is consumed by humans, the market is small compared with that for beef and pork, and horses are not usually included in discussions about food-producing animal veterinary practice. Poultry, fish, and rabbits are also important sources of human food but are not the subject of this book.

For the past several decades, the major activity in food-producing-animal practice, and a major source of income for veterinarians, was the provision of **emergency veterinary service** to the owners of herds or flocks in which a single animal was affected with one of the common diseases. Occasionally, outbreaks of disease affecting several animals occurred. In addition, routine elective veterinary services, such as castration, vaccination, dehorning, and deworming; the testing for diseases, such as brucellosis and tuberculosis; and the dispensing of veterinary drugs, pharmaceuticals, and biologicals accounted for a significant source of revenue for the veterinarian. Since about the early 1970s, there has been a shift from emphasis and dependence on emergency veterinary medicine and routine procedures to more attention being paid by the veterinarian and the producer to **planned animal health and production management** using the whole-farm approach. Livestock producers are now much more knowledgeable about animal agriculture and are concerned about the cost-effectiveness and the scientific basis of the recommendations made by veterinarians and agricultural advisors. More and more producers are doing the routine

elective procedures themselves. From firsthand experience and extension courses provided for them, they have also learned how to diagnose and treat many of the common diseases of farm livestock. Many veterinary pharmaceuticals antimicrobials and biologicals can now be purchased by producers from either veterinary or nonveterinary sources.

## INDUSTRIALIZED ANIMAL AGRICULTURE

The intensification of animal agriculture has created complex animal health and production problems for which there are no simple and reliable therapeutic and preventive procedures, and this has made the task of the veterinarian much more challenging. For example, acute undifferentiated respiratory disease is a common disease of feedlot cattle that is difficult to treat and control effectively because the etiology and epidemiology are complex. Acute diarrhea of calves under 30 days of age may be caused by several different enteropathogens, but a knowledge of the risk factors or epidemiologic determinants, such as colostral immunity and population density, is probably more important for effective clinical management and control of the disease. The rearing of pigs intensively and in complete confinement has exaggerated a number of disease problems, many exacerbated by inadequacies of the environment.

Suboptimal reproductive performance resulting from a variety of management and environmental factors is common, and pneumonia in growing and finishing pigs may be almost impossible to eradicate unless the herd is depopulated and repopulated with minimal-disease breeding stock. Infectious diseases such as porcine reproductive and respiratory syndrome are difficult to control. The solutions to these complex problems are not always readily apparent, in part because of insufficient research on etiology and epidemiology and different control strategies in the herds where the problems are occurring. The veterinarian must be knowledgeable and skillful in the principles of epidemiology, applied nutrition, and animal housing; the education and training of animal attendants; and the analysis of production indices, including profit and loss, which includes the use of computers, in addition to being skilled in the traditional veterinary disciplines of medicine, reproduction, pharmacology, and pathology. Thus, the food-producing-animal practitioner must become more skilled in the simultaneous management of animal health and production; the modern livestock producer is cost-conscious, and anything veterinarians do or recommend must be cost-effective.

## COMPANION-ANIMAL PRACTICE

In contrast, developments in companion-animal medicine (small animals) have followed in the footsteps of human medicine, with an ever-increasing emphasis and reliance on extensive use of clinical pathology for the in-depth evaluation of the hematology, clinical chemistry, enzymology, immune status, and many other body functions of the individual animal.

Diagnostic techniques such as ultrasonography, endoscopy, nuclear imaging, and computed tomography are being used both in veterinary teaching hospitals and in referral veterinary practices. These in-depth “diagnostic workups” presumably lead to a greater understanding of the etiology and pathophysiology of disease, with the ultimate aim of a more accurate and early diagnosis that allows much more effective medical and surgical therapy than is economically possible or necessary in food-producing animals. There is not the same emphasis on the efficiency of production, epidemiology, and cost-effectiveness that constantly faces the food-producing-animal practitioner. More and more companion-animal owners, because of the sentimental value of their animals and the growing importance of the human-companion animal bond, are willing to pay for the costs associated with extensive laboratory and sophisticated diagnostic tests and intensive and prolonged veterinary hospital care. Palliative care for dogs and cats affected with diseases that may not be curable over the long term is now a recognized fact in small-animal practice.

## EQUINE PRACTICE

Equine practice has evolved along similar lines to small-animal practice. Some aspects of it, such as reproduction, intensive clinical care of the newborn foal, and the treatment of medical and surgical diseases of valuable athletic and competitive horses, have advanced a great deal. The great strides that have been made in our understanding of the diagnosis, prognosis, and medical and surgical therapy of colic in the horse are a result of the in-depth diagnostic laboratory work and the medical and surgical expertise that have been used. Our improved understanding of the prognosis of equine colic is in part attributable to prospective studies of the clinical and laboratory findings in horses with colic. However, the large advances in improvement in survival made in the early years of surgical and intensive medical treatment of colic have not continued, and there is an urgent need for appropriately designed prospective clinical trials to determine optimal treatment regimes in these horses. The same is true for intensive treatment of sick foals. In addition to the advanced diagnostic and therapeutic procedures being done on valuable horses at veterinary teaching hospitals, there are now many privately owned equine veterinary centers that provide the same service. Undoubtedly the high financial value of some horses has provided the impetus for the development of these services.

Although the increasingly sophisticated diagnostic and therapeutic techniques used in equine practice are readily noted, advances in the understanding of infectious and contagious diseases of horses have also increased markedly. This is particularly true for economically important diseases that have the potential to affect large numbers of horses, consequently causing disruption to important athletic events and the sale and shipment of horses. These diseases are typically the infectious respiratory diseases and those diseases, such as African horse sickness, that are exotic to most of the horse population worldwide. The economic incentive to control these diseases has resulted in considerable increases in knowledge of their etiology (and consequently vaccinology), epidemiology, immunology, diagnosis, and prevention. Few advances have been made in treatment of what are, for the most part, self-limiting diseases with low case-fatality rates.

## CONTRASTING OBJECTIVES

It is clear that there are major differences between the objectives and principles of companion-animal practice and those of food-producing-animal practice. In companion-animal practice, the objective is the restoration of the clinically ill animal to a normal state, if possible, or in some cases a less-than-normal state is acceptable provided it is a quality life, using all the readily available diagnostic and therapeutic techniques that can be afforded by the client. In sharp contrast, in food-producing-animal practice, the objective is to improve the efficiency of animal production using the most economical methods of diagnosis, treatment, and control, including the disposal by culling or slaughter of animals that are difficult to treat and are economic losses.

This growing dichotomy in the delivery of veterinary services to the food-producing-animal owner and to the companion-animal owner prompted us to present a short introductory commentary on the objectives and principles of food-producing-animal practice.

### The Objectives of Food-Producing-Animal Practice

#### EFFICIENCY OF LIVESTOCK PRODUCTION

The most important objective in food-producing-animal practice is the continuous improvement of the efficiency of livestock production by the management of animal health. This involves several different but related activities and responsibilities, which include the following:

- **Providing the most economical method of diagnosis and treatment** of sick and injured animals and returning them to an economically productive status, or to a point where slaughter for salvage is possible, in the shortest possible time. The financially conscious producer wants to know the probability of success following treatment of a disease in an animal and to minimize the costs of prolonged convalescence and repetitive surgery.
- **Monitoring animal health and production** of the herd on a regular basis so that actual performance can be compared with targets and the reasons for the shortfalls in production or increases in the incidence of disease can be identified as soon as possible, so that appropriate and cost-effective action can be taken. The routine monitoring of production records and the regular monitoring of bulk-tank milk somatic cell counts in dairy herds are examples.
- **Recommending specific disease control and prevention programs**, such as herd biosecurity, vaccination of cattle against several important infectious diseases that occur under a variety of conditions, and the strategic use of anthelmintics in cattle and sheep.
- **Organizing planned herd and flock health programs** for the individual farms with the objective of maintaining optimum productivity through animal health management.
- **Advising on nutrition, breeding, and general management practices.** Food-producing-animal practitioners must be interested in these matters when they affect animal health. It is a large part of production-oriented health management, and it is now common for veterinarians to expand their health-oriented animal husbandry advisory service to include an animal-production advisory service. To do so is a matter of individual preference, an option that some veterinarians take up and others do not. Some veterinarians will rely on consultation with agricultural scientists. However, veterinarians still require a working knowledge of the relevant subjects, at least enough to know when to call in the collaborating advisor for advice. Members of both groups should be aware of the extensive list of subjects and species-oriented textbooks on these subjects, which should be used to support this kind of service.

## ANIMAL WELFARE

Encouraging livestock producers to maintain standards of animal welfare that comply with the views of the community is emerging as a major responsibility of the veterinarian. The production of food-producing animals is an animal welfare concern that practitioners face and an area in which they must become proactive.<sup>43,44</sup> Increasing public concern for the welfare of animals, including those that produce food and fiber for human consumption, must be addressed using high-quality scientific evidence and a sound understanding of the arguments of individuals and groups opposed to such use of animals.

## ZOONOSSES AND FOOD SAFETY

Promoting management practices that ensure that meat and milk are free of biological and chemical agents capable of causing disease in humans must also become a preoccupation for food-producing-animal veterinarians. This is because the general public is concerned about the safety of the meat and milk products it consumes, and the most effective way to minimize hazards presented by certain infectious agents and chemical residues in meat and milk is to control these agents at their point of entry into the food chain, namely, during the production phase on the farm. Veterinarians will undoubtedly become involved in the surveillance of the use of antimicrobial compounds and other chemicals that are added to feed supplies to promote growth or prevent infections, and they will be expected to minimize the risk

of the occurrence of zoonotic disease agents in farm-animal populations.

## Principles of Food-Producing Animal Practice

### REGULAR FARM VISITS

A unique feature of a food-producing animal veterinary practice is that most of the service is provided by the veterinarian who makes emergency or planned visits to the farm. In some areas of the world, where veterinarians had to travel long distances to farms, large-animal clinics were established, and producers brought animals that needed veterinary attention to the clinic. For the past 25 years these clinics have provided excellent facilities in which, for example, surgical procedures such as cesarean sections could be done and intensive fluid therapy for dehydrated diarrheic calves could be administered much more effectively and at a higher standard than on the farm. However, much less veterinary service is being provided in these clinics now because of the high operating costs of providing hospital care and the limited economic returns that are possible for the treatment of food-producing animals, which have a fixed economic value. Producers have also become less enthusiastic about transporting animals to and from a veterinary clinic because of the time and expertise involved, and because of increasing concern about biosecurity and the potential impact of pathogen introduction on the health and productivity of their animals.

### CLINICAL EXAMINATION AND DIAGNOSIS

The diagnosis, treatment, and control of diseases of food-producing animals are heavily dependent on the results of the clinical examination of animals on the farm and the careful examination of the environment and management techniques. This means that the veterinarian must become highly skilled in obtaining an accurate and useful history on the first visit to an animal or group of animals and in conducting an adequate clinical examination to make the best diagnosis possible, and economically, so that the treatment and control measures can be instituted as soon as possible. On the farm, during the day or in the middle of the night, the veterinarian will not have ready access to a diagnostic laboratory for the rapid determination of a cow's serum calcium level if milk fever is suspected. The practitioner must become an **astute diagnostician** and a skillful user of the physical diagnostic skills of visual observation, auscultation, palpation, percussion, succussion, ballottement, and olfactory perception. On the farm, the clinical findings, including the events of the recent disease history of an animal, are often much more powerful, diagnostically, than laboratory data. It therefore becomes increasingly important that the clinical examination should be carefully and thoughtfully carried out so that all clinically significant abnormalities have been detected.

An outline of the clinical examinations of an animal and the different methods for making a diagnosis are presented in [Chapter 1](#). Becoming efficient in clinical examination requires the diligent application of a systematic approach to the task and, most importantly, evaluation of the outcome. A most rewarding method of becoming a skillful diagnostician is to retrospectively correlate the clinical findings with the pathology of those cases that die and are submitted for necropsy. The correlation of the clinical findings with the clinical pathology data, if available, is also an excellent method of evaluation but is not routinely available in most private practices. The food-producing-animal practitioner must also be a **competent field pathologist** and be able to do a useful necropsy in the field, usually under less-than-desirable conditions, and to make a tentative etiologic diagnosis so that additional cases in the herd can be properly handled or prevented. Doing necropsies on the farm or having them done by a local diagnostic laboratory can be a major activity in a specialty pig or beef feedlot practice, where clinical examination of

individual animals is done only occasionally, compared with dairy practice.

### EXAMINATION OF THE HERD

The clinical examination of the herd in which many animals may be affected with one or a number of clinical or subclinical diseases, or in which the owner's complaint is that performance is suboptimal but the animals appear normal, has become a major and challenging task. This is particularly true in large dairy herds, large pig herds, beef feedlots, lamb feedlots, and sheep flocks where the emphasis is on health management of the herd. Intensified animal agriculture may result in an increased frequency of herd **epidemics** or **outbreaks** of diseases such as bovine respiratory disease syndrome, bloat, and acute diarrhea in beef calves and peracute coliform mastitis in dairy cattle. Such well-known diseases are usually recognizable, and a definitive etiologic diagnosis can usually be made, and in some cases the disease can be controlled by vaccination. However, in some cases of herd epidemics of respiratory disease, salmonellosis, or John's disease, for example, the veterinarian may have to make repeated visits to the herd to develop effective treatment and control procedures. The steps involved in the examination of the herd affected by a clinical disease or suboptimal performance are presented in [Chapter 1](#).

### COLLECTION AND ANALYSIS OF ANIMAL HEALTH DATA

With the shift in emphasis to the problems of the herd, the collection, analysis, and interpretation of animal health and production data will be a major veterinary activity. Livestock producers must keep and use good records if the veterinarian is to make informed decisions about animal health and production. The once tedious and unpopular work of recording and analyzing animal health and production data is now done by the computer. Veterinarians will have to move in the direction of developing a computer-based animal health and production profile of each herd for which they are providing a service. Veterinary colleges will also have to provide leadership and provide undergraduate and graduate student education in the collection, analysis, and interpretation of animal health data. This activity will include methods of informing the producer of the results and the action necessary to correct the herd problem and to improve production.

### PUBLIC HEALTH AND FOOD SAFETY

Veterinarians have a major responsibility to ensure that the meat and milk produced by the animals under their care are free from pathogens, chemicals, antimicrobials, and other drugs that may be harmful to humans. The prudent use of antimicrobials, including adherence to withdrawal times for meat and milk, are becoming major concerns of the veterinary associations, such as the American Association of Bovine Practitioners, the American Association of Small Ruminant Practitioners, and the American Association of Swine Practitioners. Traditionally, veterinary public health was not a career option considered by new or recent graduates. However, because of the recent concern about the contamination of meat supplies by pathogens and **xenobiotics** (any substance foreign to an animal's biological system), and the potentially serious economic effects of such contamination on the export markets of a country, it is now clear that veterinarians, using a variety of testing techniques, will become increasingly involved in monitoring the use of veterinary drugs so that treated animals are not placed in the food chain until the drugs have been excreted. The same principles apply to the contamination of milk supplies with antimicrobials, prevention of which is a major responsibility of the veterinarian.

### ECONOMICS OF VETERINARY PRACTICE

The successful delivery of food-producing-animal practice will depend on the ability of the veterinarian to provide those services that



the producer needs and wants at a price that is profitable to both the producer and veterinarian. Several constraints interfere with this successful delivery. Maximizing net profit is not a high priority for many farmers. Being independent and making a living on the farm are commonly ranked higher. Consequently, when veterinarians make recommendations to control a disease, their subsequent enthusiasm for giving advice may be dampened if farmers do not adopt the control procedures even though the advice is based on good information about expected economic returns.

The frustrations that many veterinarians experience in attempting to get dairy producers to adopt the principles of an effective and economical mastitis control program are well known. In some cases, producers do not use modern methods of production and disease control because they are unaware of their importance. The variable financial returns that farmers receive for their commodities, particularly the low prices received during times of oversupply of meat and milk, may also influence whether they purchase professional veterinary service or attempt to do the work themselves.

## VETERINARY EDUCATION

We have described our views on the state of food-producing-animal medicine and what it requires of veterinarians who practice it. Traditionally, veterinary colleges have provided undergraduate students with the knowledge and clinical skills necessary to enter veterinary practice and begin to engage in food-producing-animal practice. Field-service units and large-animal in-clinics devoted to clinical teaching have been an integral part of most veterinary colleges. The clinical caseload is for the students, clinicians, and those in the paraclinical sciences such as microbiology, toxicology, clinical pathology, and pathology. However, recently, it seems that veterinary colleges have not maintained their farm-animal teaching clinics, and in fact, some of these teaching clinics have ceased to exist. The demise of in-house food-producing-animal practice in veterinary teaching hospitals, as opposed to the care of agricultural animals from hobby farms, is contributed to by the increasing use of stringent biosecurity measures on medium- and large-scale operations. Animals brought to veterinary teaching hospitals for diagnosis and possible treatment cannot be returned to the farm because of the fear of introducing infectious disease. Regardless, the demise of in-house food-producing-animal practice in some universities should be of major concern to the veterinary profession because universities have an obligation to serve the veterinary needs of animal agriculture. Some veterinary colleges have developed extensive programs in which undergraduate students spend time in private veterinary practice to gain clinical experience. However, the failure to maintain and support viable farm-animal teaching clinics will diminish the clinical experience of clinicians and those in the paraclinical sciences who have a primary responsibility for teaching. In addition, the lack of clinical cases will adversely affect the clinical research activities of clinicians. Clinicians must experience a critical number of clinical cases to maintain credibility as a veterinary scholar.

*To study the phenomena of disease without books is to sail an uncharted sea, while to study books without patients is not to go to sea at all.*

**Sir William Osler (Books and Men, Boston Surgical Journal, 1901)**

The practicing veterinarian must become knowledgeable about various aspects of **farm animal management**, especially those that cause or contribute to clinical or subclinical disease and impaired animal production. Such veterinarians will become **species-industry specialists** who can provide totally integrated animal health and production management advice to those managing a dairy herd, a beef cow-calf herd, a beef feedlot, a pig herd, or a sheep flock. To be able to do this, veterinarians will need to undertake a postgraduate clinical residency program or develop the expertise on their own by diligent self-education in a veterinary practice that is committed to the concept of a total animal health management and allows the veterinarian the time and the resources to develop the specialty.

## OPTIMAL UTILIZATION OF THE FOOD-PRODUCING-ANIMAL PRACTITIONER

All that we have said in this Introduction is related to enhancing and improving the performance of the professional food-producing-animal veterinarian. In developed countries, this could mean greater utilization of each veterinarian by farmers and improved financial viability of their farming enterprises. In developing countries, it could mean a greater volume of production at a time when malnutrition appears to be the fate of so many groups of the world community. These could be the outcomes if the world's agricultural situation was a stable one. As it is, there is currently a great upheaval in agriculture; developed countries are heavily overproduced, and there is a sharp decline in farming as an industry and way of life. In developing countries, the decisions governing the health and welfare of animals and the people that depend on them often seem to depend more on political expediency than on the basic needs of humans and their animals. In these circumstances we do not feel sufficiently courageous and farsighted to predict our individual futures, but with the hindsight of how far the human population and the attendant agricultural and veterinary professions have come in the past 56 years, we are confident that you will have an opportunity to properly pursue the objectives and principles that we have described.

### FURTHER READING

- Animal agriculture in a changing climate. Cornell University. <<http://climatechange.cornell.edu/animal-agriculture-in-a-changing-climate/>>.
- Centre for Evidence-Based Veterinary Medicine. University of Nottingham. <<http://www.nottingham.ac.uk/cevm/index.aspx>>.
- Quammen D. *Spillover: Animal Infections and the Next Human Epidemic*. London: Vintage Books; 2013.
- Thornton PK, van de Steeg J, Notenbaert A, et al. The impacts of climate change on livestock and livestock systems in developing countries: a review of what we know and what we need to know. *Ag Syst*. 2009;101:113-127.

### REFERENCES

- Crutzen PJ. *Nature*. 2002;415:23.
- Whitmee S, et al. *Lancet*. 2015;386:1973.
- Gauly M, et al. *Animal*. 2013;7:843.
- Thornton PK, et al. *Ag Syst*. 2009;101:113.
- Keesing F, et al. *Nature*. 2010;468:647.
- Plowright RK, et al. *Proc Royal Soc B*. 2015;282.
- Plowright RK, et al. *Proc Royal Soc B*. 2011;278:3703.
- Pulliam JRC, et al. *J R Soc Interface*. 2012;9:89.
- Gould EA, et al. *Trans R Soc Trop Med Hyg*. 2009;103:109.
- MacLachlan NJ, et al. *Vet Res*. 2010;41.
- MacLachlan NJ, et al. *Rev Sci Tech*. 2015;34:329.
- Wilson A, et al. *Parasitol Res*. 2008;103:S69.
- Jacquet S, et al. *Mol Ecol*. 2015;24:5707.
- Paweska JT. *Rev Sci Tech*. 2015;34:375.
- Doceul V, et al. *Vet Res*. 2013;44.
- Gale P, et al. *J Appl Microbiol*. 2009;106:1409.
- Thompson GM, et al. *Ir Vet J*. 2012;65:(3 May 2012).
- Faverjon C, et al. *BMC Vet Res*. 2015;11.
- Webster WR. *Aust Vet J*. 2011;89:3.
- Smyth GB, et al. *Aust Vet J*. 2011;89:151.
- Roeder P, et al. *Philos Trans R Soc Lond B Biol Sci*. 2013;368.
- Cool cows: dealing with heat stress in Australian dairy herds. Dairy Australia, 2016. Accessed May 1, 2016, at <<http://www.coolcows.com.au/>>.
- Animal agriculture in a changing climate. Cornell University, 2016. Accessed May 1, 2016, at <<http://climatechange.cornell.edu/animal-agriculture-in-a-changing-climate/>>.
- Holmes M, et al. *In Pract*. 2004;26:28.
- Cockcroft P, et al. *In Pract*. 2004;26:96.
- Holmes M, et al. *In Pract*. 2004;26:154.
- Evidence-based veterinary medicine. University of Nottingham. Accessed April 2, 2016, at <<https://www.nottingham.ac.uk/cevm/index.aspx>>.
- Sargeant JM, et al. *Zoonoses Pub Health*. 2014;61:10.
- O'Connor A, et al. *Vet J*. 2015;206:261.
- O'Connor AM, et al. *Zoonoses Pub Health*. 2014;61:28.
- O'Connor AM, et al. *Zoonoses Pub Health*. 2014;61:52.
- Sargeant JM, et al. *Zoonoses Pub Health*. 2014;61:39.
- Sargeant JM, et al. *J Vet Intern Med*. 2010;24:44.

34. O'Connor AM, et al. *J Vet Intern Med.* 2010;24:57.
35. Guyatt G, et al. *J Clin Epidemiol.* 2011;64:383.
36. Guyatt GH, et al. *J Clin Epidemiol.* 2011;64:1283.
37. Guyatt GH, et al. *J Clin Epidemiol.* 2011;64:1303.
38. Guyatt GH, et al. *J Clin Epidemiol.* 2011;64:1294.
39. Guyatt GH, et al. *J Clin Epidemiol.* 2011;64:1311.
40. Guyatt GH, et al. *J Clin Epidemiol.* 2011;64:407.
41. Guyatt GH, et al. *Br Med J.* 2008;336:1049.
42. Hinchcliff KW, et al. *J Vet Intern Med.* 2015;29:743.
43. Coetzee JF. *Appl Anim Behav Sci.* 2011;135:192.
44. Marley CL, et al. *Animal.* 2010;4:259.



This page intentionally left blank

# Contents

Contributors, ix  
Preface to the Eleventh Edition, x  
Introduction, xii  
List of Tables, xxiv  
List of Illustrations, xxvii

## 1 Clinical Examination and Making a Diagnosis, 1

Introduction, 1  
Making a Diagnosis, 2  
Clinical Examination of the Individual Animal, 5  
Prognosis and Therapeutic Decision Making, 26

## 2 Examination of the Population, 29

Approach to Examining the Population, 29  
Examination Steps, 30  
Techniques in Examination of the Herd or Flock, 32  
Role of the Integrated Animal Health and Production Management Program, 34

## 3 Biosecurity and Infection Control, 36

Definitions and Concepts, 36  
Development of a Biosecurity Plan, 37  
Practices to Aid in Maintaining Biosecurity, 38

## 4 General Systemic States, 43

Hypothermia, Hyperthermia, and Fever, 43  
Acute Phase Response, 56  
Sepsis, Septicemia, and Viremia, 57  
Toxemia, Endotoxemia, and Septic Shock, 59  
Toxemia in the Recently Calved Cow, 67  
Hypovolemic, Hemorrhagic, Maldistributive, and Obstructive Shock, 71  
Localized Infections, 76  
Pain, 78  
Stress, 84  
Disturbances of Appetite, Food Intake, and Nutritional Status, 87  
Weight Loss or Failure to Gain Weight (Ill-Thrift), 90  
Physical Exercise and Associated Disorders, 96  
Sudden or Unexpected Death, 99  
Diseases Associated With Physical Agents, 103  
Diagnosis of Inherited Disease, 111

## 5 Disturbances of Free Water, Electrolytes, Acid-Base Balance, and Oncotic Pressure, 113

Dehydration, 113  
Water Intoxication, 115  
Electrolyte Imbalances, 116  
Acid-Base Imbalance, 123  
Oncotic Pressure and Edema, 128  
Naturally Occurring Combined Abnormalities of Free Water, Electrolyte, Acid-Base Balance, and Oncotic Pressure, 130  
Principles of Fluid and Electrolyte Therapy, 137

## 6 Practical Antimicrobial Therapeutics, 153

Principles of Antimicrobial Therapy, 153  
Antibiotic Resistance, 156  
Antibiotic Metaphylaxis to Control Respiratory Disease, 158  
Practical Usage of Antimicrobial Drugs, 158  
Classification of Antimicrobial Agents: Mechanisms of Action and Major Side Effects, 169  
 $\beta$ -Lactam Antibiotics: Penicillins, Cephalosporins, and  $\beta$ -Lactamase Inhibitors, 170

## 7 Diseases of the Alimentary Tract: Nonruminant, 175

Principles of Alimentary Tract Dysfunction, 176  
Manifestations of Alimentary Tract Dysfunction, 178  
Special Examination, 183  
Principles of Treatment in Alimentary Tract Disease, 190  
Diseases of the Buccal Cavity and Associated Organs, 192  
Diseases of the Pharynx and Esophagus, 196  
Diseases of the Nonruminant Stomach and Intestines, 203  
Diseases of the Peritoneum, 215  
Abdominal Diseases of the Horse Including Colic and Diarrhea, 220  
Abdominal Diseases of the Pig Including Diarrhea, 287  
Noninfectious Intestinal Disease of Swine, 290  
Bacterial and Viral Diseases of the Alimentary Tract, 292  
Parasitic Diseases of the Alimentary Tract, 397  
Control, 421  
Toxins Affecting the Alimentary Tract, 421  
Neoplasms of the Alimentary Tract, 431

Congenital Defects of the Alimentary Tract, 432  
Inherited Defects of the Alimentary Tract, 434

## 8 Diseases of the Alimentary Tract—Ruminant, 436

Diseases of the Forestomach of Ruminants, 436  
Special Examination of the Alimentary Tract and Abdomen of Cattle, 445  
Diseases of the Rumen, Reticulum and Omasum, 457  
Diseases of the Abomasum, 500  
Diseases of the Intestines of Ruminants, 523  
Bacterial Diseases of the Ruminant Alimentary Tract, 531  
Viral Diseases of the Ruminant Alimentary Tract, 572  
Parasitic Diseases of the Ruminant Alimentary Tract, 603  
Toxic Diseases of the Ruminant Alimentary Tract, 618  
Diseases of the Ruminant Alimentary Tract of Unknown Cause, 621

## 9 Diseases of the Liver, 622

Diseases of the Liver: Introduction, 622  
Principles of Hepatic Dysfunction, 622  
Manifestations of Liver and Biliary Disease, 623  
Special Examination of the Liver, 625  
Principles of Treatment in Diseases of the Liver, 629  
Diffuse Diseases of the Liver, 629  
Diseases Characterized by Systemic Involvement, 639  
Hepatic Diseases Associated With Trematodes, 641  
Diseases Associated With Major Phytotoxins, 645  
Poisoning by Mycotoxins, 649  
Focal Diseases of the Liver, 655  
Diseases of the Pancreas, 656

## 10 Diseases of the Cardiovascular System, 657

Principles of Circulatory Failure, 657  
Manifestations of Circulatory Failure, 659  
Special Examination of the Cardiovascular System, 663  
Arrhythmias (Dysrhythmias), 675  
Diseases of the Heart, 685  
Cardiac Toxicities, 697  
Cardiac Neoplasia, 703  
Congenital Cardiovascular Defects, 703  
Inherited Defects of the Circulatory System, 706  
Diseases of the Pericardium, 707  
Diseases of the Blood Vessels, 709  
Vascular Neoplasia, 715

**11 Diseases of the Hemolymphatic and Immune Systems, 716**

Abnormalities of Plasma Protein Concentration, 716  
 Hemorrhagic Disease, 718  
 Lymphadenopathy (Lymphadenitis), 751  
 Diseases of the Spleen and Thymus, 752  
 Immune-Deficiency Disorders (Lowered Resistance to Infection), 753  
 Amyloidoses, 755  
 Enzootic Bovine Leukosis (Bovine Lymphosarcoma), 785  
 Nutritional Deficiencies, 814  
 Toxins Affecting the Hemolymphatic System, 823  
 Neoplasia, 834  
 Congenital Inherited Diseases, 837  
 Inherited Immunodeficiency, 839  
 Diseases of Unknown Etiology, 842

**12 Diseases of the Respiratory System, 845**

Principles of Respiratory Insufficiency, 846  
 Principal Manifestations of Respiratory Insufficiency, 848  
 Special Examination of the Respiratory System, 855  
 Principles of Treatment and Control of Respiratory Tract Disease, 868  
 Diseases of the Upper Respiratory Tract, 874  
 Diseases of the Lung Parenchyma, 880  
 Diseases of the Pleural Cavity and Diaphragm, 895  
 Diseases of the Bovine Respiratory Tract, 901  
 Diseases of the Ovine and Caprine Respiratory Tract, 969  
 Diseases of the Equine Respiratory Tract, 981  
 Diseases of the Swine Respiratory Tract, 1047  
 Respiratory System Toxicoses, 1087  
 Neoplastic Diseases of the Respiratory Tract, 1088  
 Congenital and Inherited Diseases of the Respiratory Tract, 1090

**13 Diseases of the Urinary System, 1095**

Introduction, 1095  
 Clinical Features of Urinary Tract Disease, 1097  
 Special Examination of the Urinary System, 1099  
 Principles of Treatment of Urinary Tract Disease, 1108  
 Diseases of the Kidney, 1110  
 Infectious Diseases of the Kidney, 1115  
 Toxic Agents Affecting the Kidney, 1135  
 Renal Neoplasia, 1137  
 Congenital and Inherited Renal Diseases, 1137

Diseases of the Ureters, Bladder, and Urethra, 1139  
 Diseases of the Prepuce and Vulvovaginal Area, 1152

**14 Diseases of the Nervous System, 1155**

Introduction, 1156  
 Principles of Nervous Dysfunction, 1157  
 Clinical Manifestations of Diseases of the Nervous System, 1158  
 Special Examination of the Nervous System, 1164  
 Diffuse or Multifocal Diseases of the Brain and Spinal Cord, 1178  
 Focal Diseases of the Brain and Spinal Cord, 1189  
 Plant Toxins Affecting the Nervous System, 1194  
 Fungal Toxins Affecting the Nervous System, 1201  
 Other Toxins Affecting the Nervous System, 1202  
 Diseases of the Cerebrum, 1219  
 Bacterial Diseases Primarily Affecting the Cerebrum, 1224  
 Viral Diseases Primarily Affecting the Cerebrum, 1227  
 Prion Diseases Primarily Affecting the Cerebrum, 1286  
 Parasitic Disease Primarily Affecting the Cerebrum, 1301  
 Metabolic Diseases Primarily Affecting the Cerebrum, 1302  
 Metabolic and Toxic Encephalomyelopathies, 1321  
 Inherited Diseases Primarily Affecting the Cerebrum, 1322  
 Congenital and Inherited Encephalomyelopathies, 1324  
 Diseases Primarily Affecting the Cerebellum, 1328  
 Diseases Primarily Affecting the Brainstem and Vestibular System, 1329  
 Diseases Primarily Affecting the Spinal Cord, 1337  
 Parasitic Diseases Primarily Affecting the Spinal Cord, 1341  
 Toxic Diseases Primarily Affecting the Spinal Cord, 1346  
 Inherited Diseases Primarily Affecting the Spinal Cord, 1346  
 Diseases Primarily Affecting the Peripheral Nervous System, 1358

**15 Diseases of the Musculoskeletal System, 1371**

Principal Manifestations of Musculoskeletal Disease, 1372  
 Diseases of Muscles, 1377  
 Diseases of Bones, 1388  
 Diseases of Joints, 1406  
 Infectious Diseases of the Musculoskeletal System, 1425  
 Nutritional Diseases Affecting the Musculoskeletal System, 1458

Toxic Agents Affecting the Musculoskeletal System, 1503  
 Congenital Defects of Muscles, Bones, and Joints, 1510  
 Inherited Diseases of Muscles, 1514  
 Inherited Diseases of Bones, 1530  
 Inherited Diseases of Joints, 1538

**16 Diseases of the Skin, Eye, Conjunctiva, and External Ear, 1540**

Introduction, 1541  
 Principles of Treatment of Diseases of the Skin, 1543  
 Diseases of the Epidermis and Dermis, 1543  
 Diseases of the Hair, Wool, Follicles, and Skin Glands, 1552  
 Diseases of the Subcutis, 1555  
 Non-Infectious Diseases of the Skin, 1559  
 Bacterial Diseases of the Skin, 1564  
 Viral Diseases of the Skin, 1580  
 Dermatomycoses, 1600  
 Protozoal Diseases of the Skin, 1607  
 Nematode Infections of the Skin, 1608  
 Cutaneous Myiasis, 1611  
 Mite Infestations, 1618  
 Ked and Louse Infestations, 1623  
 Miscellaneous Skin Diseases Caused by Flies, Midges, and Mosquitoes, 1625  
 Tick Infestations, 1631  
 Deficiencies and Toxicities Affecting the Skin, 1634  
 Cutaneous Neoplasms, 1640  
 Congenital and Inherited Defects of the Skin, 1643  
 Eye and Conjunctival Diseases, 1648  
 External Ear Diseases, 1660

**17 Metabolic and Endocrine Diseases, 1662**

Introduction, 1662  
 Metabolic Diseases of Ruminants, 1662  
 Inherited Metabolic Diseases of Ruminants, 1727  
 Metabolic Diseases of Horses, 1727  
 Disorders of Thyroid Function (Hypothyroidism, Hyperthyroidism, Congenital Hypothyroidism, Thyroid Adenoma), 1739  
 Diseases Caused by Nutritional Deficiencies, 1747  
 Deficiencies of Energy and Protein, 1753  
 Diseases Associated with Deficiencies of Mineral Nutrients, 1754

**18 Diseases Primarily Affecting the Reproductive System, 1758**

Infectious Diseases Primarily Affecting the Reproductive System, 1758  
 Infectious Diseases Primarily Affecting the Reproductive System, 1761

Toxic Agents Primarily Affecting the Reproductive System, 1821  
 Congenital and Inherited Diseases Primarily Affecting the Reproductive System, 1828

## 19 Perinatal Diseases, 1830

Introduction, 1830  
 Perinatal and Postnatal Diseases, 1830  
 Perinatal Disease—Congenital Defects, 1835  
 Physical and Environmental Causes of Perinatal Disease, 1840  
 Failure of Transfer of Passive Immunity (Failure of Transfer of Colostral Immunoglobulin), 1848  
 Clinical Assessment and Care of Critically Ill Newborns, 1856  
 Neonatal Infectious Diseases, 1874  
 Neonatal Neoplasia, 1903

## 20 Diseases of the Mammary Gland, 1904

Introduction, 1904  
 Bovine Mastitis, 1904  
 Diagnosis of Bovine Mastitis, 1914  
 Mastitis Pathogens of Cattle, 1930

Mastitis of Cattle Associated With Common Contagious Pathogens, 1930  
 Mastitis of Cattle Associated With Teat Skin Opportunistic Pathogens, 1942  
 Mastitis of Cattle Associated With Common Environmental Pathogens, 1943  
 Mastitis of Cattle Associated With Less Common Pathogens, 1960  
 Control of Bovine Mastitis, 1964  
 Miscellaneous Abnormalities of the Teats and Udder, 1985  
 Mastitis of Sheep, 1991  
 Mastitis of Goats, 1993  
 Contagious Agalactia in Goats and Sheep, 1994  
 Mastitis of Mares, 1996  
 Postpartum Dysgalactia Syndrome of Sows, 1996

## 21 Systemic and Multi-Organ Diseases, 2002

Diseases of Complex or Undetermined Etiology, 2003  
 Multi-Organ Diseases Due to Bacterial Infection, 2011

Multi-Organ Diseases Due to Viral Infection, 2058  
 Multi-Organ Diseases Due to Protozoal Infection, 2137  
 Multi-Organ Diseases Due to Trypanosome Infection, 2150  
 Multi-Organ Diseases Due to Fungal Infection, 2158  
 Multi-Organ Diseases Due to Metabolic Deficiency, 2161  
 Multi-Organ Diseases Due to Toxicity, 2176

## APPENDICES, 2215

Appendix 1  
 Conversion Tables, 2215  
 Appendix 2  
 Reference Laboratory Values, 2217  
 Appendix 3  
 Drug doses and intervals for horses and ruminants, 2220  
 Appendix 4  
 Drug doses and intervals for pigs, 2232

## Index, 2235

# List of Tables

- 1-1 Normal average temperatures with critical points, [15](#)
- 1-2 Resting pulse rates, [15](#)
- 1-3 Method for determining sensitivity, specificity, likelihood ratio for positive and negative tests, positive predictive value, and negative predictive value of a test, [24](#)
- 1-4 Effect of changes in prevalence (pretest probability of disease) on the positive predictive value and negative predictive value of tests with 95% sensitivity and specificity (Test A) and 60% sensitivity and specificity (Test B), [25](#)
- 3-1 Examples of online risk calculators that can help veterinarians and producers estimate the risk of introducing diseases onto facilities in which animals are maintained, [36](#)
- 3-2 Examples of online sources of information regarding biosecurity practices appropriate for agricultural animal species, [36](#)
- 3-3 Examples of some classes of disinfectants with some of their benefits and drawbacks, [40](#)
- 4-1 A simple method of categorizing livestock affected by burns and appropriate actions for each category, [111](#)
- 5-1 Representative laboratory values (mean  $\pm$  sd) in body water and electrolyte disturbances, [133](#)
- 5-2 Summary of disturbances of body water, electrolytes, and acid-base balance in some common diseases of cattle and horses, and suggested fluid therapy, [137](#)
- 5-3 Summary of effective strong ion difference and osmolarity of parenterally administered crystalloid solutions, [138](#)
- 5-4 Estimated daily energy requirements of fasting cattle, [140](#)
- 5-5 Composition (mmol/L) and indications for use of electrolyte solutions used in fluid therapy, [144](#)
- 5-6 Examples of approximate amounts of fluid required for rehydration and maintenance therapy, [145](#)
- 6-1 The four major categories of penicillin: Narrow spectrum, broad spectrum, penicillinase resistant, and extended spectrum, [170](#)
- 7-1 Medications with potential prokinetic actions in horses (see text for references), [181](#)
- 7-2 Guidelines for the classification and interpretation of bovine peritoneal fluid, [187](#)
- 7-3 Characteristics of equine peritoneal fluid in selected diseases of horses, [187](#)
- 7-4 Epidemiological and clinical features of diseases of cattle in which diarrhea is a significant clinical finding, [205](#)
- 7-5 Epidemiological and clinical features of horses with diarrhea, [206](#)
- 7-6 Epidemiological and clinical features of diseases of the pig in which diarrhea is a significant clinical finding, [206](#)
- 7-7 Epidemiological and clinical features of the diseases of sheep and goats in which diarrhea is a significant clinical finding, [207](#)
- 7-8 Fluid deficits (L) in horses, foals and calves with 10% dehydration, [213](#)
- 7-9 Origin and examples of visceral pain in the horse, [221](#)
- 7-10 Etiological classification of equine colic, [222](#)
- 7-11 Disorders of the equine gastrointestinal tract causing colic, by anatomical site, [222](#)
- 7-12 Criteria for evaluation of pain in horses, [226](#)
- 7-13 Rectal findings and associated causes of equine colic, [228](#)
- 7-14 Method for brief examination of the abdomen of a horse with colic, [230](#)
- 7-15 Analgesics and spasmolytics for use in equine colic, [233](#)
- 7-16 Promotility agents, lubricants, and fecal softeners for use in horses with colic, [235](#)
- 7-17 Diseases causing colic in foals, [238](#)
- 7-18 Differential diagnosis of common foal colics, [240](#)
- 7-19 Differential diagnosis of common equine colics, [242](#)
- 7-20 Drugs used in the treatment of *clinically important* gastroduodenal ulcer disease of foals and adult horses and recommendations for treatment (not prophylaxis), [246](#)
- 7-21 Agents used to treat ileus in horses with duodenitis and proximal jejunitis, [257](#)
- 7-22 Epidemiological and clinical features of suckling foals with diarrhea, [274](#)
- 7-23 Proportion of samples testing positive for one of the listed organisms, [294](#)
- 7-24 Biochemical characteristics of species of *Brachyspira* isolated from pigs, [327](#)
- 7-25 Importance of fomites and animals in spread of *Brachyspira* sp. on one farm, [328](#)
- 7-26 Antibiotic therapy in use for swine dysentery, [332](#)
- 7-27 Differential diarrhea: Most likely causes of acute neonatal diarrhea in farm animals, [373](#)
- 7-28 Calf diarrhea risk factors: Risk factors and their role in acute undifferentiated diarrhea of newborn calves, [374](#)
- 7-29 Calf enteropathogens: Age occurrence of the common enteropathogens in calves, [376](#)
- 7-30 Chemotherapeutics recommended for treatment and control of coccidiosis in calves and lambs, [406](#)
- 8-1 Effects of some common clinical excitatory and inhibitory influences on primary cycle movements of the reticulorumen, [438](#)
- 8-2 Differential diagnosis of causes of gastrointestinal dysfunction of cattle, [442](#)
- 8-3 Differential diagnosis of abdominal distension in cattle, [447](#)
- 8-4 Pathogenesis and interpretation of clinical findings associated with diseases of the digestive tract and abdomen of cattle, [454](#)
- 8-5 Diseases of the digestive tract and abdomen of cattle in which a laparotomy is indicated if the diagnosis can be made, [455](#)
- 8-6 Clinical and laboratory indications for an exploratory laparotomy in cattle when the diagnosis is not obvious, [455](#)
- 8-7 Differential diagnosis of diseases of the digestive tract and abdomen of young calves presented with distension of the abdomen, [456](#)
- 8-8 Guidelines for the use of clinical findings in assessing the severity of grain overload in cattle for the selection of the treatment of choice, [466](#)
- 8-9 The relationship between the stages in the pathogenesis of Johne's disease, the presence of clinical disease and the results of diagnostic test, [557](#)
- 8-10 Differential diagnosis of diseases of cattle in which there are either oral lesions or diarrhea alone or together in the same animal, [590](#)
- 8-11 Anatomical distribution of trichostrongylid worms in ruminants, [604](#)
- 10-1 Base-apex electrocardiographic parameters in cattle and horses (mean  $\pm$  standard deviation), [668](#)
- 10-2 Mean ( $\pm$  standard deviation) cardiopulmonary values for adult horses, cattle and calves, and pigs, [674](#)
- 10-3 Results of sequential blood gas analysis from a 2-year-old Holstein-Friesian heifer with a large ventricular septal defect, [674](#)
- 10-4 Common arrhythmias and conduction disturbances in the horse and cow, [675](#)



- 10-5 Evaluation of pulmonary arterial pressure scores in cattle examined at high altitude, 695
- 11-1 Differential diagnosis of anemia, with or without edema, in horses, 729
- 11-2 Differential diagnosis of diseases of cattle characterized by acute hemolytic anemia with or without hemoglobinuria, 730
- 11-3 Characteristic or expected changes in hematological and serum biochemical variables in anemic animals, 733
- 11-4 Acute hemorrhage: estimated blood loss, 735
- 11-5 Method for performing the jaundiced foal agglutination test, 744
- 11-6 Protocols for treatment of lymphoma and lymphosarcoma in adult equids, 749
- 11-7 Defects of acquired immunity causing disease in foals and horses, 754
- 11-8 Algorithm for testing horses for infection by equine infectious anemia virus, 798
- 11-9 Ticks reported to transmit protozoan disease, 800
- 11-10 Major *Babesia* species infective to domestic animals, their tick vectors, and their geographic distribution, 801
- 11-11 Differential diagnosis of diseases of cattle in which red urine is a principal manifestation, 807
- 12-1 Identification and clinical significance of breath sounds, 851
- 12-2 Guidelines for radiographic pulmonary pattern recognition in foals, 858
- 12-3 Representative results of cytology of bronchoalveolar lavage fluid of cattle, sheep, pigs, and horses, 863
- 12-4 Changes in blood gas tensions in various disease states compared with values in normal animals breathing air at sea level, 866
- 12-5 Effects of unilateral or bilateral nasal insufflation of oxygen at flow rates of 50 mL O<sub>2</sub> per kg bodyweight per minute to 5- to 7-day-old healthy foals on inspired oxygen tension (measured in the thoracic trachea), arterial oxygen tension and measures of acid:base balance. (Reproduced from Wong et al.2010.), 870
- 12-6 Major pathogenic *Mycoplasma* spp. of ruminants, swine, and horses, 885
- 12-7 Differential diagnosis of bovine respiratory disease, 904
- 12-8 Contagious pleuropneumonia-1: Members of the *Mycoplasma mycoides* cluster, 926
- 12-9 Summary of systemic mycoplasmoses of sheep and goats, 971
- 12-10 Preferred terms for describing findings on endoscopic examination of the upper airway of horses (modified from), 982
- 12-11 Antimicrobial agents and recommended doses for treatment of pleuropneumonia in horses, 994
- 12-12 Causes of epistaxis in horses, 1001
- 12-13 Drugs used in the treatment of heaves in horses, 1010
- 12-14 Frequency and prevalence of extrapulmonary manifestations of infection by *R. equi* in 150 foals. (Reproduced with permission.), 1015
- 12-15 Differential diagnosis of respiratory diseases of older (not newborn) foals, 1017
- 12-16 Differential diagnosis of diseases of the upper respiratory tract of horses, 1023
- 12-17 Aims and associated measures used to control transmission of *Streptococcus equi* in affected premises and herds, 1025
- 13-1 Indices of renal function in healthy adult horses and foals less than 30 days of age, 1106
- 13-2 Forms of leptospirosis in the animal species, 1120
- 13-3 Differential diagnosis of diseases of cattle characterized by acute hemolytic anemia with or without hemoglobinuria, 1126
- 14-1 Correlation between clinical findings and location of lesions in the nervous system of farm animals: abnormalities of mental state (behavior), 1165
- 14-2 Correlation between clinical findings and location of lesion in the nervous system of farm animals: involuntary movements, 1166
- 14-3 Correlation between clinical findings and location of lesion in the nervous system of farm animals: abnormalities of posture, 1166
- 14-4 Correlation between clinical findings and location of lesion in the nervous system of farm animals: abnormalities of gait, 1167
- 14-5 Correlation between clinical findings and location of lesion in the nervous system of farm animals: abnormalities of the visual system, 1168
- 14-6 Correlation between clinical findings and location of lesion in the nervous system of farm animals: disturbances of prehension, chewing, or swallowing, 1168
- 14-7 Needle length gauge for lumbosacral cerebrospinal fluid collection, 1173
- 14-8 Relative diffusion of gram-negative antimicrobials, 1183
- 14-9 Diseases of horses characterized by signs of intracranial or disseminated lesions of the central nervous system, 1233
- 14-10 Differential diagnosis of diseases of cattle with clinical findings referable to brain dysfunction, 1235
- 14-11 Viruses causing encephalomyelitis in horses. reproduced with permission., 1259
- 14-12 Commercial vaccines against alphaviral equine encephalomyelitis available for equines, 1272
- 14-13 Three-tiered approach to managing an outbreak of equine herpesvirus myeloencephalopathy., 1281
- 14-14 Transmissible spongiform encephalopathies in animals and humans, 1286
- 14-15 PrP genotype and susceptibility to scrapie in national scrapie program in Great Britain, 1297
- 14-16 Scrapie susceptibility and genotype as defined by the U.S. Scrapie Eradication Plan, 1297
- 14-17 Daily dietary allowances of vitamin A, 1320
- 14-18 Diagnostic taxonomy of congenital tremor in pigs, 1327
- 14-19 Key features of the six types of congenital tremor described in pigs, 1327
- 14-20 Association of horse factors associated with a diagnosis of cervical stenotic myelopathy in 811 horses with cervical stenotic myelopathy and 805 control horses, 1352
- 14-21 Differential diagnosis of disease causing spinal ataxia in adult horses, 1356
- 14-22 Ticks reported to cause paralysis in livestock, 1367
- 15-1 Differential diagnosis of diseases of the musculoskeletal system, 1373
- 15-2 Common or well-characterized myopathies of equids, 1383
- 15-3 Laboratory evaluation of synovial fluid in diseases of the joints, 1409
- 15-4 Differential diagnosis of lameness accompanied by foot lesions in sheep, 1445
- 15-5 Virulence of strains, 1453
- 15-6 Antimicrobial resistance in Spain and the UK., 1454
- 15-7 Glutathione peroxidase (GSH-PX) activity and selenium concentration in blood and body tissues of animals deficient in selenium, 1472
- 15-8 Selenium reference range to determine selenium status of sheep and cattle in New Zealand, 1472
- 15-9 Examples of estimated daily requirements of calcium, phosphorus, and vitamin D, 1486
- 15-10 Inherited skeletal diseases of livestock with known mutations and proposed mechanisms., 1531
- 15-11 Differential diagnoses for inherited skeletal diseases of animals, 1533
- 16-1 Terms used to identify skin lesions, 1542
- 16-2 Differential diagnosis of diseases of swine with skin lesions, 1578
- 16-3 Differential diagnosis of diseases of horses characterized by discrete lesions of the skin only, 1598
- 16-4 Differential diagnosis of diseases of horses characterized by lesions of the skin of the lower limbs only, 1599
- 16-5 Single- and multiple-host ticks, 1631

- 16-6 Diseases associated with bacteria, viruses, and rickettsia and reported to be transmitted by ticks, 1632
- 17-1 Salient features of metabolic diseases of farm animals, 1663
- 17-2 Metabolic profile parameters in cattle—optimum values, 1672
- 17-3 Annual (April–March) percentages outside optimum ranges of metabolite results in blood plasma in adult dairy cows, 1673
- 17-4 Relationship between the 10-point BCS scale used in New Zealand and the 5-point BCS scale used in Ireland and the United States, and the 8-point scale used in Australia, 1675
- 17-5 Parturient paresis: Differential diagnosis of common causes of recumbency in parturient adult cattle, 1682
- 17-6 Parturient paresis: Molecular weights, equivalent weights, and conversions from percent to milliequivalents (%-mEq) of anions and cations used in calculating dietary cation–anion difference, 1687
- 17-7 To convert from the SI unit to the conventional unit, divide by the conversion factor; to convert from the conventional unit to the SI unit, multiply by the conversion factor, 1712
- 17-8 Diagnostic Testing Methods for Equine pituitary pars intermedia dysfunction (PPID), 1729
- 17-9 Criteria for estimating body condition in light-breed horses, 1733
- 17-10 Grading system for assessing regional adiposity in the neck of ponies and horses, 1733
- 17-11 Serum or plasma concentrations of thyroid hormones and thyroid-stimulating hormone in foals, horses, donkeys, and cattle, 1741
- 17-12 Principal pathologic and metabolic defects in essential trace-element deficiencies, 1755
- 18-1 Diagnostic summary of infectious abortion in ewes, 1777
- 18-2 Diagnostic summary of causes of abortion in cattle, 1788
- 18-3 Cytokines and porcine reproductive and respiratory syndrome, 1802
- 18-4 Nursey depopulation and cleanup protocol for elimination of PRRS, 1811
- 19-1 Scoring system for assessing vigorosity of newborn lambs, 1848
- 19-2 Definitions for lamb behaviors, 1848
- 19-3 Failure of transfer of passive immunity; concentrations and relative percentage of immunoglobulins in serum and mammary secretions of cattle and pigs, 1849
- 19-4 Criteria to assess stage of maturity of the newborn foal, 1859
- 19-5 Hematologic values of normal foals and calves, 1861
- 19-6 Serum biochemical values of normal foals and calves, 1862
- 19-7 Antimicrobials used in neonatal foals, 1866
- 19-8 Method for calculating survival score in hospitalized neonatal foals, 1867
- 19-9 Probability of survival for hospitalized neonatal foals with survival scores calculated according to table 19-8, 1867
- 19-10 Differential diagnosis of comatose (“sleeper”) neonatal foals, 1873
- 19-11 Worksheet for calculating a sepsis score for foals less than 12 days of age, 1877
- 19-12 Degree of dehydration in calves with experimentally induced diarrhea, 1886
- 19-13 Possible causes of bacteremia/septicemia and acute neonatal diarrhea in farm animals, 1888
- 20-1 Estimated prevalence of infection and losses in milk production associated with bulk tank milk somatic cell count, 1915
- 20-2 Sensitivities and specificities for diagnosing an intramammary infection based on the culture of a single milk sample from a quarter using a 10- $\mu$ L volume, 1916
- 20-3 Calculating somatic cell score (previously called linear score) from the somatic cell count, 1918
- 20-4 Conversion of somatic cell scores (previously called linear scores) to somatic cells counts (cells/mL) and predicted loss of milk, 1918
- 20-5 California mastitis test reactions and equivalent somatic cell counts and somatic cell scores for bovine milk and somatic cell counts for bovine colostrum, 1918
- 20-6 Summary of three-compartment model for anatomic location of infection caused by mastitis pathogens in cattle, 1923
- 20-7 Scale used in rating udder edema, 1989
- 20-8 Diagnosis of free electricity problems based on voltage difference between two points that can be accessed by an animal with resultant current flow, 1991
- 21-1 Causes and diagnostic features of recumbency of more than 8 hours in duration in adult horses, 2004
- 21-2 Species of streptococci isolated from the pig with principal locations, 2045
- 21-3 Differentiation of acute vesicular disease, 2064
- 21-4 Test methods available for the diagnosis of equine viral arteritis and their purpose, 2090
- 21-5 Definitive and intermediate hosts for *Sarcocystis* spp.–associated infections in agricultural animals, 2138
- 21-6 Summary of the theilerioses of domestic ruminants, 2144
- 21-7 Summary of the trypanosomoses of domestic animals and humans, 2150
- 21-8 Conditions associated with secondary copper deficiency, 2163
- 21-9 Copper levels of soils and plants in primary and secondary copper deficiency, 2166
- 21-10 Concentrations of copper in plasma, liver, milk, and hair; dietary intake and ratios of copper and its antagonists in normal, marginal, and copper-deficient situations, 2170
- 21-11 Venomous snakes of importance: taxonomy, geographic range, and major venom effects (Prepared by Daniel E Keyler, Pharm. D., FAACT), 2177
- 21-12 Plants causing glucosinolate poisoning, 2202

# List of Illustrations

- 1-1 Making a diagnosis., 3
- 1-2 Effect of prevalence on positive and negative predictive values of a test with set sensitivity and specificity. The prevalence in this example is prevalence of failure to recover by recumbent cows (i.e., to stand), and the curves represent the consequent NPV and PPV for a serum aspartate aminotransferase activity of 171 U/L. (Reproduced with permission from Shpigel et al. *Vet Rec* 2003; 152:773.), 25
- 1-3 A decision tree for choosing between two interventions. (With permission from Fetrow J et al. *J Am Vet Med Assoc* 1985; 186:792-797.), 27
- 1-4 Example of the construction and use of a decision tree. The sources of probabilities and dollar values are discussed in the text. (a) The skeleton of the decision tree with a decision [treat (*Tx*) versus do not treat] and chance outcomes [recovery (*REC*) or spontaneous recovery (*SPREC*) versus continued cyst (*CYST*)]. (b) Probabilities and previously calculated outcome values are placed on the tree. (c) Expected costs of decision alternatives have been calculated and written in balloons above the chance nodes. (d) At this decision node, the correct choice is no treatment because it is cheaper (\$72.96 versus \$78.12). Double bars mark the pathway that is not chosen (treatment). The value \$72.96 is then the outcome cost for this decision node. The value is used in the calculation of the best alternative to the previous decision node, because the process is repeated from right to left (not shown). (With permission from White ME, Erb HN. *Comp Cont Educ Pract Vet* 1982; 4:S426-S430.), 28
- 2-1 Examination of the herd with the objective of making a diagnosis., 31
- 4-1 Relationship between environmental temperature, heat production rate, and body core temperature in agricultural animals. *LCT*, lower critical temperature; *UCT*, upper critical temperature. (Adapted from Kadzere et al. *Livestock Prod Sci*, 2002; 77:59-91.), 46
- 4-2 The nociceptive pathway in cattle, identifying the anatomic location of analgesic drug activity. Effective analgesia is best achieved using a multimodal approach that incorporates the administration of two or more pharmaceutical agents that attenuate or abolish the transmission, modulation, and perception of pain. (Reproduced with permission from Coetzee JF. *Vet Clin North Am Food Anim Pract* 2013;29:13.), 81
- 4-3 Summary of system to estimate body condition scoring (BCS) in dairy cattle, ranging in score from 1.0 (could not be skinnier) to 5.0 (could not be fatter)., 91
- 4-4 Body condition scoring system modified from earlier work. (From Isensee A et al. *Animal* 2014; 8(12):1971-1977.), 92
- 4-5 Location of the site for ultrasonographic measurement of backfat thickness in dairy cattle from the left lateral and dorsal views (top two panels) and ultrasound image from an overconditioned cow with a back fat thickness of 34 mm. (Reproduced with permission from Schroder UJ, Staufenbiel R. *J Dairy Sci* 2006;89:1-4.), 93
- 5-1 Etiology and pathogenesis of dehydration., 114
- 5-2 **A**, Association between eye recession into the orbit and dehydration as a percent of body weight in milk-fed calves with experimentally induced diarrhea and dehydration. The filled circles in the left panel are individual data points, the solid line is the linear regression line, and the dashed lines are the 95% confidence interval for prediction. Intravenous fluid is recommended when dehydration is estimated at 8% or more of body weight, equivalent to an eye recession into the orbit of 4 mm or more. **B**, The calf has an 8-mm eye recession into the orbit, equivalent to being 14% dehydrated. (Reprinted with permission from Constable PD et al. *J Am Vet Med Assoc* 1998;212(7):991-996.), 115
- 5-3 Hemoglobinuria in a Holstein-Friesian heifer calf that had not been provided free access to water. The calf voluntarily drank 5 L in 5 minutes and voided red-tinged urine (on floor and in white container) 30 minutes later., 116
- 5-4 Etiology and pathogenesis of hyponatremia., 117
- 5-5 Types of dehydration., 117
- 5-6 Calf with neurologic signs of hypernatremia, including abnormal mentation and posture and fasciculation of facial muscles. (From Byers SR, Lear AS, Van Metre DC: Sodium balance and the dysnatremias, *Vet Clin Food Anim* 2014;30:333-350.), 118
- 5-7 Etiology and pathogenesis of hypochloremia., 118
- 5-8 Etiology and pathogenesis of hypokalemia., 119
- 5-9 Spider plot revealing the association between changes in two variables of the Henderson-Hasselbalch equation, plasma bicarbonate concentration ( $\text{cHCO}_3^-$ ) and carbon dioxide tension ( $\text{Pco}_2$ ), on venous blood pH in 231 sick calves, most of which had diarrhea. The spider plot was obtained by systematically varying one input variable ( $\text{cHCO}_3^-$  or  $\text{Pco}_2$ ) while holding the remaining input variables at their reference values for calf venous plasma. Reference values for the two input variables for calf plasma were 29.5 mmol/L for  $\text{cHCO}_3^-$  (large open circles) and 53 mm Hg for  $\text{Pco}_2$  (open squares). The solid vertical and horizontal lines indicate that venous blood pH = 7.38 when  $\text{cHCO}_3^-$  and  $\text{Pco}_2$  are at their reference values. Note that the individual data points are displaced from the predicted pH- $\text{cHCO}_3^-$  relationship. This displacement indicates that changes in plasma  $\text{cHCO}_3^-$  do not account for all of the changes in blood pH in sick calves. (Reproduced with permission from Constable PD, *Vet Clin North Am Food Anim Pract* 2014;30:295-316.), 124
- 5-10 Evaluation of acid-base balance using the traditional Henderson-Hasselbalch equation (**A**) and strong ion difference (SID) theory (**B**). The Henderson-Hasselbalch equation posits that blood pH is dependent on the respiratory system, as assessed by the partial pressure of carbon dioxide ( $\text{Pco}_2$ ), and metabolism, as assessed by the bicarbonate concentration ( $\text{cHCO}_3^-$ ) or base excess. **A**, It highlights one of the fundamental flaws with using the Henderson-Hasselbalch equation in that blood pH cannot be dependent on  $\text{cHCO}_3^-$  because bicarbonate concentration is calculated from blood pH and  $\text{Pco}_2$ . **B**, For comparison, this conveys that the strong ion approach to acid-base balance posits that blood pH is dependent on the respiratory system, assessed by  $\text{Pco}_2$ , and on metabolism, assessed by the SID and concentration of nonvolatile buffers ( $\text{A}_{\text{tot}}$ , such as albumin, globulin, and phosphate) in plasma. (Reproduced with permission from Constable PD: Clinical assessment of acid-base status: Strong ion difference theory, *Vet Clin North Am Food Anim Pract* 1999;15:447-71.), 125

- 5-11 Spider plot revealing the association among changes in three independent variables of the simplified strong ion equation, strong ion difference (SID, open circles), carbon dioxide tension ( $P_{CO_2}$ , open squares), and the plasma concentration of nonvolatile buffers ( $A_{tot}$ , open triangles), on venous blood pH in 231 sick calves, most of which had diarrhea. The spider plot was obtained by systematically varying one input variable (SID,  $P_{CO_2}$ , or  $A_{tot}$ ) while holding the remaining input variables at their reference values for calf venous plasma (42 mEq/L for SID), 53 mm Hg for  $P_{CO_2}$ , and 18.5 mmol/L for  $A_{tot}$ . The solid vertical and horizontal lines indicate that venous blood pH = 7.38 when SID,  $P_{CO_2}$ , and  $A_{tot}$  are at their reference values. Note that the individual data points are located more centrally around the predicted pH–SID relationship than for the pH– $CHCO_3^-$  relationship identified in Figure 5.9. This is because changes in plasma protein concentration (and therefore  $A_{tot}$ ) caused by changes in hydration status account for some of the change in blood pH. The plot also indicates the six primary acid-base disturbances (respiratory, strong ion, or nonvolatile buffer ion acidosis and alkalosis) and the relative effect of each disturbance on blood pH in the neonatal calf. Note that changes in SID have the greatest relative effect on blood pH. (Adapted from Constable PD, Stämpfli HR, Navetat H, et al.: Use of a quantitative strong ion approach to determine the mechanism for acid-base abnormalities in sick calves with or without diarrhea. *J Vet Intern Med* 2005;19:581-9. IN Constable PD: Acid-Base Assessment When and How to Apply the Henderson-Hasselbalch Equation and Strong Ion Different theory, *Vet Clin Food Anim*. 2014;30:295-316.), 126
- 5-12 Etiology and pathogenesis of acidemia., 127
- 5-13 Etiology and pathogenesis of alkalemia., 129
- 5-14 The interrelationships among the changes in body water, electrolytes, and acid-base balance that can occur in diarrhea., 131
- 5-15 Relationship between venous blood pH and anion gap (AG) in 806 neonatal calves with diarrhea. The thick line represents the result of nonlinear regression analysis:  $pH = \log_{10} (39.7 - AG) + 5.92$ . (Reproduced with permission from Trefz FM, Constable PD, Lorenz I. *J Vet Intern Med* 2015;29:678-687.), 135
- 5-16 Relationship between venous blood pH and strong ion gap (SIG) in 806 neonatal calves with diarrhea. The thick line represents the result of nonlinear regression analysis:  $pH = \log_{10} (SIG + 32.4) + 5.84$ . (Reproduced with permission from Trefz FM, Constable PD, Lorenz I. *J Vet Intern Med* 2015;29:678-687.), 136
- 5-17 Optimized decision tree for treating neonatal calves with diarrhea in a field setting. Examination of the ability to stand is evaluated by lifting recumbent animals. Enophthalmos reflects a visible gap of 3 to 4 mm between the corneal surface of the eye and the caruncula lacrimalis or normal position of the lower eyelid. (From Trefz FM et al. *BMC Vet Res* 2012;8:238.23), 144
- 5-18 Securing a 14-gauge 14-cm catheter into the jugular vein of a cow. The site of venipuncture is clipped and scrubbed for aseptic placement of a catheter. A 1-mL bleb of 2% lidocaine is placed intradermally at the proposed site of catheter insertion and a 5-mm long stab incision made through the skin, including the dermis. **A**, The catheter is then placed into the lumen of the vein and carefully advanced until the hub of the catheter is level with the skin. The catheter is secured by placing sutures through the skin using an 18-gauge needle and a synthetic multifilament suture material. The suture does a loop around the extension tubing near where it attaches to the hub of the catheter so that the catheter cannot back out. **B**, The 18-gauge needle is then passed through the ventral skin fold adjacent to the catheter, and the suture tightened to create a tunnel. **C**, Additional sutures are placed through the upper and lower skin folds to lengthen the tunnel and prevent excessive movement at the junction of the catheter with the hub., 146
- 5-19 Administering large-volume isotonic crystalloid solutions to Holstein–Friesian cows by the jugular vein (**A**) and auricular vein (**B**)., 147
- 5-20 Placement of a 22-gauge 2.5-cm over the stylet butterfly catheter into the auricular vein of a calf. The ear is clipped and scrubbed for aseptic placement of a catheter, and a tourniquet is placed at the base of the ear to facilitate visualization of the auricular veins (**A**). The catheter is then placed into the lumen of the vein and carefully advanced (**B**). The tourniquet is removed and the catheter is secured to pinna by placing a 20-gauge needle through the pinna and butterfly section and tying, taking care not to distort the ear (**C**). Intravenous fluids are then attached and the ear bandaged, taking care not to bandage below the end of the catheter (**D**). (Pictures generously provided by Dr. Joachim Berchtold, Germany.), 148
- 6-1 Diagram of the approximate locations of the major arteries of the posterior ear and the recommended needle insertion locations. Administration of EXCEDE Sterile Suspension into ear arteries is likely to be fatal. EXCEDE can also be administered SC at the base of the ear in a rostral direction toward the eye on the same side of the head as the ear, or administered SC at the base of the ear in a ventral direction. (Courtesy of Zoetis, Inc., [https://www.zoetis.com/products/pages/excede\\_beef/TechnicalResources.aspx](https://www.zoetis.com/products/pages/excede_beef/TechnicalResources.aspx) EXCEDE® (Cefiofur Crystalline Free Acid) Sterile Suspension.), 160
- 6-2 Relationship between minimum bactericidal concentration (MBC) and minimum inhibitory concentration (MIC) for bacteriostatic and bactericidal agents., 165
- 7-1 **A**, Ultrasonographic image obtained at site 1: an abnormal amount of anechoic fluid is visible. **B**, Ultrasonographic image showing nonturgid fluid-filled small-intestinal loops. **C**, Ultrasonographic image showing turgid small-intestinal loops without wall thickening in a horse with small-intestinal obstruction. **D**, Ultrasonographic image showing turgid small-intestinal loops with marked wall thickening in a horse with strangulated small-intestinal obstruction., 229
- 7-2 **A**, Left lateral view of abdomen of a normal horse. **B**, Left dorsal displacement of the left colon, left lateral view. The left ventral and dorsal colon is displaced lateral and dorsal to the spleen and occupies the renosplenic space. 1, liver; 2, stomach; 3, left dorsal colon; 4, left ventral colon; 5, spleen; 6, left kidney and renosplenic ligament; 7, pelvic flexure. (With permission from Johnston JK, Freeman DE. *Vet Clin North Am Equine Pract* 1997;13:317.), 260
- 7-3 Right dorsal displacement of the colon, right lateral view. The colon has passed lateral to the cecum, the pelvic flexure is displaced cranially, and the sternal and diaphragmatic flexures are displaced caudally. 1, right dorsal colon; 2, base of cecum; 3, right ventral colon; 4, liver; 5, cecum; 6, left ventral colon; 7, pelvic flexure. (With permission from Johnston JK, Freeman DE. *Vet Clin North Am Equine Pract* 1997;13:317.), 261
- 7-4 A 360 clockwise volvulus of the colon viewed from the right side. The volvulus has occurred in the direction of the arrow. 1, cecum; 2, right dorsal colon; 3, right ventral colon. (With

- permission from Johnston JK, Freeman DE. *Vet Clin North Am Equine Pract* 1997;13:317., 261
- 7-5 Steps in correction of left dorsal displacement of the colon (renosplenic entrapment). **A**, Caudal view of abdomen of horse with left dorsal displacement of the colon. Entrapped colon is shown in black. *K*, left kidney; *S*, spleen. **B**, Injection of phenylephrine and contraction of spleen. **C**, Horse anesthetized and placed in right lateral recumbency. **D–H**, Horse rolled through dorsal recumbency to left lateral recumbency. Entrapped colon moves ventrally and then medially to the contracted spleen. (Modified with permission from Kalsbeek HC. *Equine Vet J* 1989;21:442.), 263
- 7-6 Enterolith in the large colon of a horse with colic. The scale marker is 10 cm. (Reproduced with permission from Kelleher ME, et al. *JAVMA*. 2014;245:126.<sup>4</sup>), 266
- 7-7 Lateral abdominal radiograph of a Miniature horse with severe sand accumulation. (Reproduced with permission from Hart KA, et al. *Equine Vet J*. 2013;45:465.<sup>1</sup>), 267
- 7-8 Percutaneous ultrasonographic image of an 8-month-old filly with enteritis caused by *Lawsonia intracellularis* and demonstrating markedly thickened small-intestinal wall (9 mm; normal <3 mm). (Reproduced with permission. Arroyo LG, et al. *Can Vet J*. 2013;54:853.<sup>18</sup>), 381
- 8-1 **A and B**, Two-year-old Holstein Friesian heifer demonstrating dropped cuds while being retained in a head-gate. The heifer had a tooth root abscess., 441
- 8-2 Silhouettes of the contour of the abdomen of cattle, viewed from the rear, with different diseases of the abdominal viscera. *a*, normal; *b*, left flank filled; *c*, free-gas bloat; *d*, frothy bloat; *e*, dilated rumen (vagus indigestion); *f*, hydrops; *g*, paralytic ileus; *h*, pneumoperitoneum; *i*, right-side abomasal dilation/volvulus; *j*, abomasal impaction. (From Stober M, Dirksen G. *Bovine Pract* 1977; 12:35-38.), 446
- 8-3 Schematic illustration of the rectal findings in cattle affected with different diseases of the abdominal viscera. *a*, normal; *b*, L-shaped rumen; *c*, cecocolic volvulus; *d*, abomasal volvulus; *e*, abomasal impaction; *f*, left displaced abomasum (LDA); *g*, intussusception; *h*, mesenteric volvulus; *i*, intestinal incarceration; *j*, peritonitis; *k*, lipomatosis; *l*, omental bursitis; *m*, hydrops; *n*, enlarged kidney; *o*, palpation lymph nodes; *p*, cystitis, ureteritis. (From Stober M, Dirksen G. *Bovine Pract* 1977; 12:35-38.), 450
- 8-4 Some common causes of physical and functional obstruction of the alimentary tract of cattle., 451
- 8-5 Ultrasonographic findings and interpretation with respect to stratification of the rumen contents of pasture-fed domestic cattle. *a*, 1, abdominal wall; 2, rumen wall; 3, reverberation lines indicative of a gas-filled space (gas dome); *b*, abrupt transition from gas dome (3) to fiber mat (4); *c*, ingesta with gaseous inclusions; fiber mat; (4) at the rumen wall; *d*, transition from fiber mat (4) to a comparatively sharp demarcating ruminal wall with no signs of gaseous ingesta (fluid layer, 5). (Reproduced, with permission from Tschuor A, Clauss M. *Eur J Wildl Res* 2008; 54:627-633.), 452
- 8-6 Rope rumen foreign body removed during a rumenotomy on a dairy cow with chronic weight loss, weakness, and clinical signs of vaginal indigestion., 460
- 8-7 Rumenotomy of a beef bull with grain overload. Forty kilograms of barley was removed and 10 L of fresh rumen fluid and some chopped grass hay was placed back into the rumen., 469
- 8-8 Ruminal parakeratosis in the dorsal rumen of a 3-month-old Holstein Friesian calf with recurrent free gas bloat and poor weight gain. Note the clumping of rumen papilla and excessive cornification of papilla., 473
- 8-9 Sequelae of traumatic perforation of the reticular wall., 482
- 8-10 **A, and B**, Ultrasonogram and schematic of a reticular abscess in a cow with chronic traumatic reticuloperitonitis. The abscess is between the reticulum and the ventral abdominal wall. The ultrasonogram was obtained from the sternal region with a 5.0-MHz linear transducer. 1, Ventral abdominal wall; 2, abscess; 3, capsule of the abscess; 4, reticulum; *Cr*, cranial; *Cd*, caudal. (Reproduced with permission of U. Braun.), 487
- 8-11 **A, and B**, Ultrasonogram and schematic of the reticulum in a cow with chronic traumatic reticuloperitonitis. The reticulum is covered with fibrinous deposits. The ultrasonogram was obtained from the sternal region with a 5.0-MHz linear scanner. 1, Lateral abdominal wall; 2, fibrinous deposits; 3, anechoic fluid; 4, reticulum; *Cr*, cranial; *Cd*, caudal. (Reproduced with permission from U. Braun.), 487
- 8-12 Causes of grunting in cattle., 488
- 8-13 **A**, Classic papple shaped abdominal profile of vagal indigestion in a Holstein Friesian cow, with an apple on the left and a pear on the right. **B**, Figure depicting the rumen enlargement that causes the classic papple-shaped abdominal profile of vagal indigestion (pear on the right side, apple on the left side). *R*, rectum. (Reproduced with permission from Constable PD, Hoffsis GF, Rings DM. *Compend Contin Educ Pract Vet* 1990; 12:1169-1174.), 493
- 8-14 **A**, Passage of a large-diameter tube through a wooden mouth gag to decompress the rumen in a Guernsey cow with vagal indigestion. **B**, Rapid emptying of ruminal contents through a large-diameter tube., 495
- 8-15 Holstein Friesian dairy cow with right-sided heart failure (brisket edema) caused by traumatic reticulopericarditis., 497
- 8-16 Left-lateral radiograph of the caudoventral thorax and cranioventral abdomen in a cow with traumatic reticulopericarditis. The reticulum with a vague honeycomb pattern is on the right and contains a magnet with a vertically aligned wire that does not appear attached to the magnet. This is consistent with a diagnosis of traumatic reticuloperitonitis. A separate foreign body is present cranial to the reticulum and diaphragm (not visible) with a dorsal gas pocket. This is consistent with a diagnosis of traumatic reticulopericarditis, although traumatic reticulopleuritis could not be ruled out. (Reproduced with permission from Braun U. *Vet J* 2009; 182:176-186.), 498
- 8-17 Schematic diagram of a cross-sectional view of the bovine abdomen at the level of the ninth intercostal space. 1, Rumen; 2, Liver; 3, gallbladder; 4, omasum; 5, small intestine. The distance between the abdominal wall and the dorsal limit of omasum (*A1*), the closest distance to the omasum (*A2*), and the ventral limit of the omasum (*A3*) are identified. (Reproduced with permission from Braun U, Blessing S. *Vet Rec* 2006; 159:812.), 499
- 8-18 Illustration of transabdominal ultrasonographic measurements of abomasal margins on the ventral abdominal wall (dorsal view) in Holstein Friesian heifers and cows. The numbers indicate anatomic landmarks and measurements: 1, xiphoid process; 2, cranial abomasal margin; 3, caudal abomasal margin; 4, right lateral extension in cranial region; 5, left lateral extension in cranial region; 6, right lateral extension in caudal region; 7, left lateral extension in caudal region. (Reproduced with permission from Wittek T, Constable PD, Morin DE. *J Am Vet Med Assoc* 2005; 227:1469-1475.), 500



- 8-19 Dorsal view of abomasal position and shape (modeled as an ellipse in the horizontal plane) of Holstein Friesian cows at the beginning of the last 3 months of gestation (dashed line), immediately before parturition (solid line), immediately after parturition (dotted line), and during the third month of lactation (dashed and dotted line). The abomasum moves cranially and to the left in late gestation. *X*, Center of the abomasal body projection in nonpregnant cows. (Reproduced with permission from Wittek T, Constable PD, Morin DE. *J Am Vet Med Assoc* 2005; 227: 1469-1475.), 501
- 8-20 Jejunal intussusception in an adult Holstein Friesian cow. The cow is in sternal recumbency with the head to the right. A right flank incision was made and much of the small intestine exteriorized. The surgeon is holding the jejunal flange, which is empty, as is the cecum (*top*). Most of the jejunum is markedly distended with fluid, and the mesentery is tied up into a knot in the center of the picture, which is the location of a large intussusception., 524
- 8-21 Entrapment of the jejunum by a remnant of the ductus deferens (“gut tie”) in an Angus steer (remnant being held by the surgeon). The steer was standing with its head to the right and a right flank laparotomy was performed. An incision was made in the right flank under regional analgesia and much of the jejunum was distended., 525
- 8-22 Simmental cow exhibiting signs of subacute abdominal pain with ears forward, and alert expression, and a slight sawhorse stance (**A**). The jejunal mesentery contained multiple areas of hard fat, which occluded the intestinal lumen (**B**)., 526
- 8-23 Contents present in the rectum of a cow with acute intestinal obstruction caused by intussusception of the jejunum. There is very little fecal material evident, and the rectal contents are predominately mucus., 527
- 8-24 Cecocolic volvulus in a Holstein Friesian cow. The cow's head is to the right and a right flank laparotomy is being performed with the cow standing. The cecum is markedly distended and has a bluish color suggestive of ischemia. The ileum is also markedly distended (smaller luminal structure caudal to the cecum., 530
- 8-25 **A**, Polled Hereford cow with actinomycosis of the left mandible. **B**, Brown Swiss cow with actinomycosis of the left mandible with a draining tract., 531
- 8-26 Holstein Friesian cow with jejunal hemorrhage syndrome. **A**, Indicates the typical lesion in the jejunum as visible through a right flank laparotomy with the cow standing. The cow's head is to the right. **B**, Organized blood clot that was removed from the intestinal lumen from an enterotomy distal to the lesion., 550
- 8-27 **A and B**, Ultrasonogram and schematic of the abdomen in a cow with ileus caused by obstruction of the jejunum with coagulated blood (hemorrhagic bowel syndrome). The jejunal loops are dilated and there is anechoic fluid (transudate) between the dilated loops. The ultrasonogram was obtained from the right abdominal wall caudal to the last rib using a 5.0-MHz linear scanner. 1, Lateral abdominal wall; 2, dilated jejunal loops; 3, anechoic fluid between the jejunal loops; *Ds*, dorsal; *Vt*, ventral. (Reproduced with kind permission of U. Braun.), 551
- 8-28 Objectives of herd testing for bovine viral diarrhea virus (BVDV)., 593
- 8-29 Flow chart for testing a beef herd prebreeding to detect and eliminate bovine viral diarrhea virus carrier (BVDV) cattle., 594
- 8-30 Flow chart for testing a dairy herd to detect and eliminate bovine viral diarrhea virus persistently infected (PI) carrier cattle. *PCR*, polymerase chain reaction., 595
- 9-1 Severe jaundice in a Holstein Friesian cow, 623
- 9-2 **A**, Ultrasonogram and schematic of the liver in a cow with obstructive cholestasis caused by fasciolosis. The intrahepatic bile ducts are dilated. Normally, they are not visible. **B**, The ultrasonogram was obtained from the 11th intercostal space on the right side using a 5.0-MHz linear transducer. 1, Lateral abdominal wall; 2, Liver; 3, Dilated intrahepatic bile ducts. *Ds*, dorsal; *Vt*, ventral. (Reproduced with kind permission of U. Braun.), 627
- 9-3 Current distribution of pithomycotoxicosis (facial eczema) in New Zealand (left) and predicted distribution with 3°C climate warming (right). (Reproduced with permission from Di Menna ME. *New Zeal J Agr Res* 2009;52:345-376.), 653
- 9-4 Acutely affected crossbred Merino with severe secondary photosensitization caused by pithomycotoxicosis (facial eczema). Note the presence of erythema and severe ulceration with crusting around the eyes and mouth, corneal edema, drooping ears, and puffy periorcular and facial skin. (Reproduced with permission from Ozmen O, Sahinduran S, Haligur M, Albay MK. *Trop Anim Health Prod* 2008;40:545-551.), 653
- 10-1 Brisket and preputial edema caused by right-sided congestive heart failure in a Charolais bull. Heart failure was caused by infiltration of the atrial and ventricular myocardium by lymphosarcoma (see Chapter 11 for more details)., 661
- 10-2 Typical base–apex lead electrocardiogram (ECG) from a healthy Holstein-Friesian cow. The waves, segments, and intervals are identified. The morphology is similar for the base–apex lead recording of the ECG in sheep, goats, horses, and pigs. Recorded at 25 mm/s. (Reprinted with permission from DeRoth L. *Can Vet J* 1980;21:271-277.), 667
- 10-3 Typical base–apex lead electrocardiogram (ECG) from a healthy Holstein-Friesian cow. The ST peak interval is the interval between the apex of the S wave and the apex of the T wave in seconds. The SS interval is the interval between consecutive S waves in seconds. The corrected ST peak interval (STc) is calculated by dividing the ST peak interval in seconds by the square root of the SS interval in seconds. (Reprinted with permission from Itoh M, Sakurai Y, Nakajima Y, Kawamoto S. *J Vet Med Sci* 2016;77(12):1655-7.), 667
- 10-4 The Poincaré plot from an adult cow. The duration of an interbeat interval (IBI) in milliseconds is plotted against the duration of the preceding IBI in milliseconds. An ellipse is then fitted along the line of identity that summarizes the variability perpendicular to the line of identity (SD1) and along the line of identity (SD2). (Reproduced with permission from Kovacs L, Jurkovich V, Bakony M, Szenci O, Poti P, Tozser J. *Animal* 2014;8(2):316-330.), 669
- 10-5 Base–apex electrocardiograms (ECGs) of large animals with normal sinus rhythm (**A and B**), supraventricular arrhythmias (**C-H**), hyperkalemia (**H and I**), or ventricular arrhythmias (**J-L**). All ECGs were recorded at 25 mm/s and 10 mm = 1 mV. Base–apex ECGs of large animals with normal sinus rhythm (**A and B**), supraventricular arrhythmias (**C-H**), hyperkalemia (**H and I**), or ventricular arrhythmias (**J-L**). All ECGs were recorded at 25 mm/s and 10 mm = 1 mV., 676
- 10-6 Base–apex electrocardiograms (ECGs) of horses with selected arrhythmias. All ECGs were recorded at 25 mm/s and 10 mm = 1 mV. **A**, An ECG (base–apex configuration) of a horse with atrial fibrillation. The typical characteristics include an irregularly irregular rhythm,

absence of P waves, coarse baseline irregularity called fibrillation (“f”) waves, and “QRS” complexes of normal width and morphology. Note that for short RR intervals the T wave (arrow) has opposite polarity to the QRS complexes that follow longer diastolic intervals; the same phenomenon occurs in ECGs recorded during exercise compared with at rest. In the same horse, even in the same ECG trace, coarse and fine fibrillation waves can be present, representing the chaotic nature of the underlying electrical activation of the atria. **B**, Base–apex ECG obtained from a 5-year-old trotter with a 14-day history of reduced athletic performance. The ECG shows atrial flutter with a cycle length of 268 ms (rate 224 beats/min). **C**, During exercise and during periods of excitement 1:1, 1:2, and 1:3 atrioventricular (AV) conduction of the flutter waves occurred and the horse’s heart rate rhythm sounded regular by auscultation. This ECG recording was obtained during and immediately after pulling up from a trot on the lunge. A 1:1 conduction of F waves as parasympathetic tone is withdrawn results in an excessively high heart rate for the work being undertaken, but the horse’s cardiac rhythm is now completely regular. The horse was subsequently converted by transvenous electrical cardioversion at the first 125-J shock, after which he returned to his previous level of exercise. **D**, Junctional ventricular premature depolarization in a horse presented with poor performance. The normal rhythm is broken by a ventricular premature depolarization (VPD) with a morphology that is only slightly different from the normal sinus beats (QRS). Within the QT interval of the VPD a P wave can be identified (P wave indicated by *arrow*) because the normal sinus rhythm is not interrupted. The P wave does not result in a QRS complex because the ventricle is still refractory. This AV dissociation is a hallmark of ventricular prematurity. Although the complex is not noticeably wider than the sinus beats, it is still ventricular in origin. Its configuration suggests that it originates from the AV junctional, or His-Purkinje system, and has been conducted using (part of) the normal conduction pathways. Note that the T wave preceding the VPD is exactly the same as the other sinus T waves, so that an ectopic P’ wave could not have been hidden within it. **E**, Third-degree AV block in a 15-year-old Grand Prix dressage horse. There is complete AV dissociation because of third-degree AV block. PQ

interval is highly variable because they have no relation; the fourth QRS complex occurs simultaneously with a P wave. Bifid “P” waves occur at a rapid rate because of associated hypotension. In this case the QRS morphologies are similar but their rate is slow and rhythm is irregular; they are junctional ventricular escape complexes. The gelding presented acutely after multiple episodes of collapse in a single day. The referring veterinarian administered antibiotics and corticosteroids and referred the horse for pacemaker implantation. At presentation, third-degree AV block was present but ventricular escape rhythm was sufficiently high to prevent collapse. Within 48 hours he reverted to normal sinus rhythm. No pacemaker was implanted. The gelding was closely monitored and returned to dressage after 6 months. He was retired 2.5 years later because of chronic tendinitis. (Reproduced with permission from Hinchcliff KW, Kaneps A, Geor R. *Equine Sports Medicine and Surgery*. 2nd edition. St. Louis, MO: Elsevier; 2013.), 678

10-7 Persistent right aortic arch in a foal. Lateral positive contrast esophagram of the thorax of a 9-day-old pony foal that was observed to have milk coming from both nostrils when in lateral recumbency. The esophagus is distended proximally to the asterisk at the third intercostal space with barium. The trachea is narrowed at this site of esophageal narrowing. (Reproduced with permission from Coleman MC, Norman TE, Wall CR. *J Am Vet Med Assoc* 2014; 244:1253-1255.), 706

11-1 Schematic diagram of a representative thromboelastogram depicting coagulation time (CT), clot formation time (CFT), angle ( $\alpha$ ), and maximum clot firmness (MCF). (Reproduced with permission from Paltrinieri et al. 2008.<sup>8</sup>), 720

11-2 Extremely pale bulbar conjunctiva in an anemic Holstein–Friesian cow. The cow had a packed cell volume of 13% secondary to massive acute hemorrhage into the lactating mammary gland., 736

11-3 Lactating Brown Swiss cow with massive persistent proteinuria and severe hypoalbuminemia (serum albumin concentration, 0.7 g/dL) as a result of advanced renal amyloidosis. Note the ventral abdominal and submandibular edema secondary to the marked hypoalbuminemia. An enlarged left kidney was detected per rectal palpation, and renal biopsy confirmed the diagnosis of renal amyloidosis., 756

11-4 **A** and **B**, Urticaria in a Holstein–Friesian cow following antibiotic administration. Note the presence of multiple small raised bumps in multiple areas of the skin and the edema of the eyelid., 759

11-5 Cheviot ewes with caseous lymphadenitis of the submaxillary lymph nodes., 763

11-6 **A**, Ultrasonographic image of a liver abscess identified using a 5-MHz sector transducer. The characteristic “onion peel” appearance is highly suggestive of the presence of a *Corynebacterium pseudotuberculosis* abscess (caseous lymphadenitis). **B**, Cross-sectional image of the liver from the same sheep obtained at necropsy., 763

11-7 Possible pathways after exposure to bovine leukosis virus (percentage figures indicate proportion of seroconverted animals that develop the particular form referred to<sup>2</sup>)., 789

11-8 Clinical diagnosis frequency of predominant signs of bovine leukemia—1100 field cases. (Courtesy of Canadian Veterinary Journal), 790

11-9 The developmental life cycle of *Babesia bigemina* in cattle and the ixodid tick vector *Boophilus microplus*. (Adapted from Mehlhorn H, Schein E. The piroplasms - life-cycle and sexual stages. *Adv Parasitol*. 1984;23:37-103; Gough JM, Jorgensen WK, Kemp DH. Development of tick gut forms of *Babesia bigemina* *in vitro*. *J Eukaryot Microbiol*. 1998;45:298-306; Mackenstedt U, Gauer M, Fuchs P. et al. DNA measurements reveal differences in the life-cycles of *Babesia bigemina* and *B. canis*, 2 typical members of the genus *Babesia*. *Parasitol Res*. 1995;81:595-604.), 802

11-10 **A**, Ventral view from the front of a basketball-sized mass in the thoracic inlet of an 18-month-old Holstein–Friesian heifer with thymic lymphosarcoma. **B**, Dorsal view from the front of the same heifer exhibiting chronic mild ruminal tympany., 835

11-11 Cutaneous lymphoma in a 2-year-old Holstein–Friesian heifer., 836

11-12 Transcutaneous ultrasound image of thymic lymphosarcoma obtained from the ventrolateral region of the caudal neck of the heifer pictured in [Figure 11-1](#). A 3.5-MHz sector scan transducer was used to identify a well-encapsulated tumor., 836

12-1 Decision tree for assessing thoracic radiographs of horses. RAO is recurrent airway obstruction or heaves. (Reproduced from Dunkel et al. 2013.<sup>14</sup>), 857

12-2 Horse wearing equipment for overground endoscopy, including endoscope and water pump and

- control, recording, and telemetry units. (Reproduced with permission van Erck 2011.<sup>7</sup>), [868](#)
- 12-3 Endoscopic view of a progressive ethmoidal hematoma in a horse. (Reproduced with permission.<sup>12</sup>), [876](#)
- 12-4 Lateral radiograph of the head of a horse with progressive ethmoidal hematoma (black arrow) and related hemorrhage into the paranasal sinuses (white lines). (Reproduced with permission.<sup>12</sup>), [876](#)
- 12-5 Computed tomographic image of the head of a horse with advanced ethmoidal hematoma revealing extension into the paranasal sinuses (white arrow). (Reproduced with permission.<sup>12</sup>), [876](#)
- 12-6 Lateral radiograph of the cervical region of an American Miniature horse revealing extensive tracheal collapse. (Reproduced with permission.<sup>2</sup>), [880](#)
- 12-7 Ventrodorsal radiograph of the chest of a 7-day-old foal immediately after ~30 minutes of enforced lateral recumbency. Note the consolidation of the previously dependent lung. Repeat radiographic examination 24 hours later, and without a period of recumbency, did not reveal lesions in the lungs., [883](#)
- 12-8 Epistaxis and hemoptysis in a cow with pulmonary hemorrhage and vena caval thrombosis. (Reproduced with permission from Braun 2008.<sup>2</sup>), [883](#)
- 12-9 Marked subcutaneous emphysema on the dorsal midline of a Holstein Friesian cow with acute respiratory disease. The cow's head is to the right. The skin can be depressed 5 cm with a forefinger, creating a crinkling feeling that is slightly painful to the cow. The emphysema gradually disappeared over a few days after antimicrobial treatment for bacterial pneumonia was implemented., [884](#)
- 12-10 Mechanisms of failure of the respiratory defenses. The center column illustrates the layered arrangement of the respiratory defenses. At left is a partial summary of causes and mechanisms whereby each of these respiratory defenses is comprised of factors that predispose to bacterial pneumonia. At right is a partial summary of how pathogens further contribute to failure of the lung defenses. BVDV, bovine viral diarrhea virus; IFN, interferon; TLR, toll-like receptor. (Data from: Couetil, L.L. (2014) In Hinchcliff KW, Kaneps AJ, and Geor RJ (eds): *Equine Sports Medicine and Surgery: Basic and clinical sciences of the equine athlete*, ed. 2. Elsevier Health Sciences. p 614.), [887](#)
- 12-11 Pleural lavage of the right pleural cavity of a Holstein Friesian cow with septic pleuritis secondary to a localized abomasal perforation and subsequent development of an abomasal diaphragmatic fistula. Note the dorsal ingress chest tube that is clamped and pleural fluid drainage via the ventral egress chest tube. Ten liters of warmed sterile 0.9% NaCl solution was infused dorsally, and 20 L of pleural fluid was removed via the ventral tube., [899](#)
- 12-12 Lateral thoracic radiograph in a foal demonstrating presence of gas-filled intestinal loops in the caudodorsal thorax. (Reproduced with permission.<sup>4</sup>), [901](#)
- 12-13 Ultrasonogram of intrahepatic vena cava of an adult cow demonstrating presence of a thrombus (white arrow) and dilated intrahepatic vessels (white arrowhead). (Reproduced with permission.<sup>4</sup>), [902](#)
- 12-14 Cow with cranial vena cava thrombosis causing jugular vein distension and edema of the brisket. (Courtesy of Dr. Christian Gerspach, Vetsuisse Faculty University of Zurich)., [903](#)
- 12-15 Holstein Friesian heifer with enzootic pneumonia. Notice the poor body condition, anxious look, conjunctivitis, nasal discharge, open-mouth breathing with blood-tinged foamy saliva, and extended neck in an attempt to facilitate breathing., [943](#)
- 12-16 Development of the immune response in the calf from conception to puberty. The window of susceptible is the optimal time for vaccination against enzootic pneumonia and represents the time during which passive (maternal) immunity is waning and active immunity is increasing. (Reproduced, with permission, from Chase CCL, Hurley DJ, Reber AJ. Neonatal immune development in the calf and its impact on vaccine response. *Vet Clin Food Anim* 2008; 24:87-104.), [946](#)
- 12-17 **A**, Nasal adenocarcinoma in a Suffolk ewe. Notice the seropurulent nasal discharge (left greater than right). Very little air movement was detected from the right nostril. **B**, Endoscopic view of a nasal adenocarcinoma (dorsal pink gray spherical mass) in a Suffolk ram with clinical signs of an upper respiratory tract obstruction., [970](#)
- 12-18 Endoscopic view of dorsal displacement of the soft palate in a resting Thoroughbred racehorse., [982](#)
- 12-19 Normal airway of a horse during exercise. (Reproduced with permission.<sup>1</sup>), [983](#)
- 12-20 Palatal instability with no rima glottidis obstruction. The epiglottis has a flattened appearance, and the soft palate appears flaccid with no concave depression caudally. (Reproduced with permission.<sup>1</sup>), [983](#)
- 12-21 Palatal instability with obstruction of the rima glottidis. The soft palate is billowing in front of the rima glottidis. (Reproduced with permission.<sup>1</sup>), [983](#)
- 12-22 Chondroids removed at postmortem from the guttural pouch of a horse., [984](#)
- 12-23 Lateral radiograph of the head of a horse with rupture of the longus capitis muscle after rearing and falling over backward. There is loss of radiolucency of the guttural pouches and evidence of an avulsion fracture of the basisphenoid bone (white arrow)., [987](#)
- 12-24 Endoscopic view of the pharynx and larynx of a horse with entrapment of the epiglottis by the aryepiglottic folds., [988](#)
- 12-25 Lateral radiograph of the head of a yearling horse demonstrating presence of a retropharyngeal mass (identified by white arrow)., [989](#)
- 12-26 Thoroughbred racehorse with epistaxis secondary to exercise-induced pulmonary hemorrhage during racing., [999](#)
- 12-27 Grading of EIPH in Thoroughbred racehorses—Grades 1 (A), 2 (B), 3 (C), and 4 (D). (Reproduced with permission Hinchcliff et al. 2005.<sup>21</sup>), [1000](#)
- 12-28 Proportion of horses in Great Britain with recurrent airway obstruction (RAO) that display clinical signs of respiratory disease in each month. (Reproduced with permission.<sup>12</sup>), [1005](#)
- 12-29 Endoscopic grading of tracheal mucus in horses. (Modified from Gerber V, Straub R, Marti E et al. Endoscopic scoring of mucus quantity and quality: observer and horse variance and relationship to inflammation, mucus viscoelasticity and volume, *Equine Vet J* 2004;36: 576–582 with permission from the *Equine Veterinary Journal*.), [1008](#)
- 12-30 Abscess score based on ultrasonographic examination of foals on a farm with endemic *R. equi* infection administered a placebo, tulathromycin, doxycycline, doxycycline and rifampin, or azithromycin and rifampin. There was no effect of antimicrobial treatment on resolution of the abscess score. (Modified from Venner M, Asstheimer K, et al.: Efficacy of Mass Antimicrobial Treatment of Foals with Subclinical Pulmonary Abscesses Associated with *Rhodococcus equi*, *J Vet Int Med* 27:171, 2013.), [1018](#)
- 12-31 Phylogenetic tree illustrating evolving nature of equine influenza virus N3H8 from the virus originally detected in 1963. Note that there are two lineages

- (Eurasian and American) that diverged in the early 1980s; that the American lineage further evolved into Kentucky, Argentinian, and Florida sublineages (clades 1 and 2); and that these continue to evolve. Strains causing substantial outbreaks are highlighted in green, dates of large outbreaks are identified in the boxes, and vaccine strains are identified in yellow. (Reproduced with permission.<sup>11</sup>), 1031
- 12-32 Radiograph of the caudal thorax of an adult horse with pulmonary aspergillosis secondary to acute enterocolitis. Note the military and interstitial densities., 1046
- 12-33 Granulomatous lesion caused by *R. seeberi* in a Belgian Warmblood horse. (Reproduced with permission.<sup>1</sup>), 1046
- 12-34 Endoscopic view of a granular cell tumor in a horse., 1089
- 12-35 Lateral thoracic radiograph of an adult horse demonstrating presence of a granular cell tumor (outline by black arrows)., 1089
- 13-1 Lateral view of the urethra (a), vagina (b), and suburethral diverticulum (c) in adult female cattle as viewed from the left. A finger is inserted into the suburethral diverticulum on the ventral aspect to direct the tip of the catheter over the diverticulum and into the external urethral orifice. (Reprinted with permission from Rosenberger G. *Clinical examination of cattle*. Berlin: Parey; 1979; 453.), 1099
- 13-2 Relationship between urine pH and net base excretion (equivalent to the negative value for net acid excretion) for cows fed diets of different dietary cation-anion difference. The dashed lines indicate that net base excretion = 0 mEq/L (by definition) when pH 7.40. Notice that urine pH is poorly associated with net base excretion at pH <6.3 (dotted line); at this urine pH renal ammonium ion concentration ( $[NH_4^+]$ ) becomes markedly increased. (Reproduced with permission from Constable PD, Gelfert CC, Fülll M et al. *Am J Vet Res* 2009; 70(7):915-925.), 1101
- 13-3 Ultrasonographic image (left) and drawing (right) that illustrates a bovine left kidney imaged from the right paralumbar fossa obtained by placing the transducer parallel to the longitudinal axis of the cow just below the transverse processes of the lumbar vertebrae 3 to 5. The kidney is moved toward the right paralumbar fossa by palpation per rectum. 1, caudal vena cava; 2, renal cortex; 3, medullary pyramid; 4, renal sinus; a, hyperechoic line representing the perirenal fat; b, hypoechoic line representing the medial wall of the rumen; c, hyperechoic line (internal reverberation artifact) reflecting from the tissue-gas interphase superimposed on the image of the medial wall of the rumen; Cr, cranial; Cd, caudal; M, medial. (Reproduced with permission from Imran S, Sharma S. *Veterinarni Medicina* 2014; 59:29-32.), 1106
- 13-4 Drawing of the system for continuous-flow peritoneal dialysis in an adult horse. TPN, total parenteral nutrition. (Reproduced with permission from Gallatin LL et al. *J Am Vet Med Assoc* 2005; 226:756-759.), 1109
- 13-5 Change in urine appearance during voiding in a Holstein-Friesian cow with chronic cystitis. Top left is from the initial urine stream, followed by the bottom left, and bottom right, and the top right is the last urine voided. Notice the presence of blood clots in the last urine sample., 1130
- 13-6 Bilateral, severe, chronic pyelonephritis and ureteritis in an old Holstein-Friesian cow with profound azotemia and severe renal failure. Notice the extensive cortical thinning in response to hydronephrosis, particularly in the left kidney (left)., 1131
- 13-7 Severe chronic cystitis in the same animal. The bladder is opened and focal areas of cystitis are evident., 1131
- 13-8 Extensive precipitation of crystals on the preputial hairs of a steer with obstructive urolithiasis., 1146
- 13-9 Holstein-Friesian steer with obstructive urolithiasis, urethral rupture, and urine collecting ventrally to the site of rupture., 1147
- 13-10 Luminal surface of bladders from cattle with bovine enzootic hematuria. **A**, The bladder contains multiple tumors, with the two tumors (arrows) diagnosed as hemangiosarcoma. **B**, The bladder contains a transitional cell carcinoma. (Reproduced with permission from Carvalho T, Pimto C, Peleteiro MC. *J Comp Pathol* 2006; 134:336-346.), 1152
- 14-1 Abnormal mentation in Simmental calf with bacterial meningitis. The calf is exhibiting opisthotonus and is acting inappropriately for its surroundings., 1165
- 14-2 **A**, Holstein Friesian calf with hydrocephalus caused by in utero infection with bovine viral diarrhea virus. The calf was able to suckle but appeared to have diminished responsiveness to its environment. **B**, Piglet with meningocele secondary to in utero hydrocephalus., 1181
- 14-3 Holstein Friesian steer with acute lead toxicity. Notice the abnormal mentation, contraction of facial muscles, and marked dilatation of the pupils. The bandage around the neck protected an intravenous catheter that was used for daily intravenous Ca-EDTA treatment. The steer recovered following treatment., 1205
- 14-4 A 3-month-old Toggenburg kid with advanced progressive neurologic signs caused by infection with caprine arthritis encephalitis virus. The goat has normal mentation but exhibits asymmetric weakness (hindlimbs worse than forelimbs) and proprioceptive abnormalities., 1255
- 14-6 Transmission cycle of Japanese encephalitis virus between amplifiers (pigs and wild birds) and mosquito vectors (especially *Culex tritaeniorhynchus*), including the infection of dead-end hosts (humans, horses, cattle). (reproduced with the permission of the World Organisation for Animal Health (OIE, [www.oie.int](http://www.oie.int)). Fig. 3 of Morita K., et al., Japanese encephalitis. *In* New developments in major vector-borne diseases. Part II: Important diseases for veterinarians (S. Zientara, D. Verwoerd & P.-P. Pastoret..., eds). *Rev. Sci. Tech. Off. Int. Epiz.*, 34 (2), page 444. doi: 10.20506/rst.34.2.2370.), 1263
- 14-5 Distribution of Japanese Encephalitis Virus as of 2015. Viral genome has been detected in dead birds and mosquitos in Italy, but the virus has not been isolated nor disease consistent with Japanese encephalitis detected in that country. (reproduced with the permission of the World Organisation for Animal Health (OIE, [www.oie.int](http://www.oie.int)). Fig. 2 of Morita K., et al., Japanese encephalitis. *In* New developments in major vector-borne diseases. Part II: Important diseases for veterinarians (S. Zientara, D. Verwoerd & P.-P. Pastoret..., eds). *Rev. Sci. Tech. Off. Int. Epiz.*, 34 (2), page 443. doi: 10.20506/rst.34.2.2370.), 1263
- 14-7 Transmission cycles for infection with Western Equine Encephalitis Virus and Eastern Equine Encephalitis Virus in the Americas. (reproduced with the permission of the World Organisation for Animal Health (OIE, [www.oie.int](http://www.oie.int)). Adapted from Fig. 1 of Arechiga-Ceballos N. & A. Aguilar-Setién, Alphaviral equine encephalomyelitis (Eastern, Western and Venezuelan). *In* New developments in major vector-borne diseases. Part II: Important diseases for veterinarians (S. Zientara, D. Verwoerd & P.-P. Pastoret..., eds). *Rev. Sci. Tech. Off. Int. Epiz.*, 34 (2), page 492. doi: 10.20506/rst.34.2.2374.), 1266
- 14-8 Epidemiology of Venezuelan Equine Encephalitis virus in enzootic (endemic) and epizootic (epidemic) cycles. Note the need for mutation of the virus for development and establishment of epizootics. (reproduced with the



- permission of the World Organisation for Animal Health (OIE, [www.oie.int](http://www.oie.int)). Adapted from Fig. 1 of Arechiga-Ceballos N. & A. Aguilar-Setièn, Alphaviral equine encephalomyelitis (Eastern, Western and Venezuelan). *In* New developments in major vector-borne diseases. Part II: Important diseases for veterinarians (S. Zientara, D. Verwoerd & P.-P. Pastoret..., eds). *Rev. Sci. Tech. Off. Int. Epiz.*, 34 (2), page 492. doi: 10.20506/rst.34.2.2374., 1269
- 14-9 Methodology for rapid antemortem diagnosis of equine herpesvirus-1 (EHV-1) myeloencephalopathy in horses with signs of nervous system disease. Solid lines represent a diagnostic pathway. EDTA, ethylenediaminetetraacetic acid. (Reproduced, with permission, from Pusterla N, Wilson WD, Madigan JE, Ferraro GL. Equine herpesvirus-1 myeloencephalopathy: a review of recent developments. *Vet J* 2009;180:279-289.), 1277
- 14-10 The number of reported bovine spongiform encephalopathy (BSE) cases in cattle and variant Creutzfeldt–Jakob (vCJD) cases in humans by date of onset in the UK and in the European Union (EU) excluding the UK from 1988 to 2013. Note the different multiplier for BSE and vCJD cases in the UK and EU non-UK. (Published with permission from the European Centre for Disease Prevention and Control. [http://ecdc.europa.eu/en/healthtopics/Variant\\_Creutzfeldt-Jakob\\_disease\(vCJD\)/Pages/factsheet\\_health\\_professionals.aspx](http://ecdc.europa.eu/en/healthtopics/Variant_Creutzfeldt-Jakob_disease(vCJD)/Pages/factsheet_health_professionals.aspx).), 1288
- 14-11 **A**, Clinical signs of scrapie in Suffolk ewes located in the midwest region of the United States. The ewe on the left is pruritic, which is manifested as rubbing against the tree. The same ewe is also showing a positive nibble reflex (scrapie scratch reaction) with an upper lip curl and protruded tongue. The ewe on the right is losing weight and has an abnormally low head carriage. **B**, A positive result to the scrapie scratch reaction test. Rubbing/scratching the back over the thoracic vertebrae results in a slight elevation of the head, an upper lip curl, licking of the lips, and a pleasing look in the eyes of sheep with scrapie., 1299
- 14-12 Weaned Polled Hereford calf with polioencephalomalacia. The calf has been walking in the same direction in the stall for many hours (as indicated by the straw). The diameter of the circle is determined by the width of the stall. The calf was blind and depressed, but was neurologically normal 48 hours later after aggressive treatment with intramuscular thiamine., 1306
- 14-13 **A**, Weanling sheep with acute polioencephalomalacia demonstrating slow progressive walking that is interrupted by a wall. This is mistakenly called head-pressing. **B**, The same weanling sheep 24 hours later after repeated intravenous thiamine injections. The sheep has stopped progressive walking and the appetite has partially returned; however, the sheep is not fully aware and could not identify that it was still eating. It made a full recovery., 1307
- 14-14 Lens dislocation (**A**) and ocular rupture (**B**) in Simmental calves with hypovitaminosis A. (Reproduced with permission from Anon. *Vet Rec* 2014;174:244.), 1317
- 14-15 Otitis media/interna on the right side of a recently weaned Suffolk sheep. Notice the marked deviation of the line between the two eyes from horizontal., 1330
- 14-16 **A**, Two-year-old Holstein Friesian heifer with listeriosis. The heifer is exhibiting clinical signs of a left brainstem lesion in the vicinity of the vestibulocochlear nerve nucleus (cranial nerve VIII) manifested as extensor thrust from the right side and tight circles to the left (circling is impeded by placement in the headgate). **B**, Three-year-old Simmental cow with listeriosis. The cow is exhibiting depression, weakness of the tongue and jaw muscles, and lack of sensation that she has hay in her mouth. Some of these clinical signs are also seen in cattle with rabies or esophageal obstruction (choke). Both animals responded well to intravenous oxytetracycline treatment., 1335
- 14-17 Two-year-old goat with listeriosis. The goat has depression of the right corneal branch of the trigeminal nerve (cranial nerve V) because it does not detect the straw on its right eye, and the right facial nerve (cranial nerve VII) because it has a right ear droop, deviation of the philtrum to the left, and flaccid right upper lip. The goat was unable to stand and appeared depressed., 1335
- 14-18 **A**, Bilateral posterior paresis in a 5-year-old Holstein Friesian cow with spinal lymphosarcoma caused by infection with enzootic bovine leukosis virus. **B**, Caudal view of the same cow, demonstrating marked paresis of the tail and hindlegs and poor milk production., 1339
- 14-19 Spastic paresis in an 8-month-old Holstein Friesian heifer. Both hindlegs are excessively straight, the left hindleg is held caudally and above the ground, and the tail is characteristically held away from the body., 1347
- 14-20 Simplified drawing of the  $\gamma$ -motor neuron system. In cattle with spastic paresis, spinal cord neurons are thought to provide defective control to the  $\gamma$ -motor neuron system, most likely by overstimulation or sufficient inhibition. During the normal stretch reflex the extrafusal skeletal muscle fibers are lengthened, stretching the muscle spindle. This stretch is detected and a signal sent via the afferent axon to the dorsal root. The signal is then sent directly to the  $\alpha$ -motor neurons, resulting in muscle contraction.  $\gamma$ -Motor neurons in the ventral spinal cord that are controlled by the central nervous system appear to inappropriately modulate the sensitivity of the stretch reflex system, resulting in sustained and excessive contraction. (Reproduced with permission from De Vlamynck C. *Vet J* 2014; 202:229-235.), 1348
- 14-21 Inherited periodic spasticity in a Holstein Friesian bull. The signs are apparent only on rising; the hindlimbs are stretched out behind and the back depressed., 1350
- 14-22 Violin plot of the variation in individual ratings grouped by the median rating for each horse during live scoring only. To align the ratings around 0, each score was subtracted from the median score of the horse. A violin plot is similar to a boxplot, with the addition of the density of data points illustrated by an increase in width. This figure reveals that most grades have a fluctuation of 1 degree more or less than the median; however, grades 0 and 3 are condensed around the median illustrating better agreement, whereas grade 2 stretches from -2 to + 1 grades from the median. (From Olsen E, Dunkel B, Barker WHJ, et al. Rater Agreement on Gait Assessment During Neurologic Examination of Horses. *J Vet Int Med* 2014;28:630.), 1354
- 14-23 Schematic drawing of the cervical vertebrae illustrating the sagittal ratios: the intravertebral sagittal ratio is calculated as the ratio of the minimum sagittal diameter of the spinal canal (green line) to the maximum sagittal diameter of the vertebral body, taken at the cranial aspect of the vertebra and perpendicular to the spinal canal (black line). The intervertebral sagittal ratio is the ratio of the minimal distance taken from the most cranial aspect of the vertebral body to the most caudal aspect of the vertebral arch of the more cranial vertebra (blue line) and the maximal sagittal diameter of the vertebral body (black line). (Reproduced with permission from Van Biervliet J. An evidence-based approach to clinical



- questions in the practice of equine neurology. *Vet Clin Nth Am Equine Pract* 2007;23(2):317-328., 1354
- 14-24 Schematic drawing of cervical myelogram illustrating the dural diameter reduction (green lines) and the dorsal myelographic column reduction (pink lines). (Reproduced with permission from Van Biervliet J. An evidence-based approach to clinical questions in the practice of equine neurology. *Vet Clin Nth Am Equine Pract* 2007;23(2):317-328.), 1355
- 14-25 Three-year-old Holstein Friesian cow with mild paresis of the right sciatic nerve. The hock is dropped relative to the normal unaffected left leg, and the fetlock has the characteristic knuckling. The cow has had a left displaced abomasum surgically corrected by a right flank incision and is being treated for concurrent mastitis., 1359
- 14-26 Mild radial nerve paresis in a Holstein Friesian bull. Swelling is present over the lateral aspect of the elbow. Paresis was present immediately after taking the animal off a foot table for corrective foot trimming., 1359
- 14-27 One-week-old kid with brachial plexus avulsion of the right forelimb. The right limb "appears" longer than the unaffected left limb and the right elbow appears dropped. The right front leg cannot support weight and is not advanced in a normal manner during walking. The right leg received excessive traction during correction of a dystocia., 1359
- 14-28 Polled Hereford cow exhibiting early signs of tetanus with healthy calf. The tail is held slightly away from the perineum, the ears are back, the eyes have a surprised expressed with slight prolapse of the nictitating membrane, and saliva is drooling from the mouth. The cow calved 7 days previously and had a retained placenta and metritis., 1361
- 14-29 Suffolk lamb with tetanus after castration using a band. The lamb is exhibiting a sawhorse stance caused by generalized muscle rigidity and drooling of saliva., 1361
- 14-30 Corriedale lamb with tetanus after tail docking. Note the ear and eyelid retraction and generalized stiffness., 1362
- 15-1 Diagnostic approach to horses with exertional myopathy or persistent increases in serum activity of creatine kinase and aspartate aminotransferase. The approach differs depending on the breed of horse (and hence pretest probability of disease and documented genetic abnormalities). MH, malignant hyperthermia; RER, recurrent exertional rhabdomyolysis (Reproduced with permission from Piercy RJ and Rivero J. Muscle disorders of equine athletes. In Hinchcliff KW, Kaneps AJ, and Geor RJ (eds): *Equine Sports Medicine and Surgery: Basic and clinical sciences of the equine athlete*, 2nd edition. W.B. Saunders. London. 2014:109.), 1386
- 15-2 Myositis centered in the right lateral distal femur region of a lactating dairy cow as a result of a penetrating wound. The cow also has a fractured and shortened tail as a result of a traumatic injury when a calf., 1387
- 15-3 Holstein-Friesian heifer with a sequestrum of the left distal third metacarpal bone with draining tract associated with a hard swelling., 1392
- 15-4 Palmar-dorsal radiograph of the limb of the heifer in Figure 15-3 showing involucrum laterally and medially (thick sheath of periosteal new bone surrounding a sequestrum) and marked bone proliferation on the cortical surface., 1393
- 15-5 Depiction of the structure of a hemidesmosome and lamina densa, which provide the connection between the basal cell and basement membrane. Note the variety of proteins, including glycoproteins and collagen, that provide tight attachment of the distal phalanx to the hoof. (Reproduced with permission from Pollit C. The anatomy and physiology of the suspensory apparatus of the distal phalanx. *Vet Clin North Am Equine* 2010; 26:29-49.), 1395
- 15-6 Radiograph of a horse demonstrating rotation of the distal phalanx with likely penetration of the sole. The coronary band is indented, and there is no evidence of sinking. There is not osteolysis of the distal phalanx. (Reproduced with permission.<sup>75</sup>), 1400
- 15-7 Diagrams showing the normal radiologic distances and proportions in the front feet of sound horses. Care must be taken in interpretation of these values because there is marked individual (breed and size) variability, and many can also be altered by farriery; the measurements in these diagrams do not represent the absolute minimum and maximum of normal values; rather, they are representative of the center of the range. (Reproduced with permission.<sup>74</sup>), 1401
- 15-8 Bilateral tarsitis in a lactating Holstein-Friesian cow. Note the marked joint effusion centered on both tarsal joints and the excessively straight hindlimbs., 1409
- 15-9 Very early signs of septic arthritis of the left hock joint in a 7-day-old Shorthorn calf. The calf did not suckle colostrum and had a slightly enlarged and painful umbilicus of 2 days in duration. Decreased weight-bearing on the left leg with palpable joint distention of the left hock has just become evident., 1413
- 15-10 Through-and-through needle lavage of the left hock joint of the Shorthorn calf in Figure 15-9. Warmed lactated Ringer's solution is lavaged through the joint with periodic joint distention (present) to facilitate lavage of the entire joint. The calf made a complete recovery., 1417
- 15-11 Progression of a painful M2 lesion (**A**) to a mature M4 lesion accompanied by heel horn erosion (**B**) 4 weeks later on the same foot of a 3-year-old Holstein-Friesian cow. Pictures generously provided by Dr. Tessa Marshall, United States., 1437
- 15-12 Subacute enzootic muscular dystrophy in a recently weaned Merino lamb. The weaning is bright, alert, and responsive, with a good appetite, but it is unable to stand for more than a few seconds., 1469
- 15-13 Calcium and phosphate homeostasis. A decrease in extracellular  $\text{Ca}^{2+}$  concentrations or an increase in phosphate ( $\text{PO}_4$ ) concentrations leads to a parathyroid hormone (PTH) release from the parathyroid gland, which in turn increases renal reabsorption of  $\text{Ca}^{2+}$ , renal activation of vitamin D, urinary  $\text{PO}_4$  excretion, and bone resorption. In turn, vitamin D increases intestinal absorption and renal reabsorption of  $\text{Ca}^{2+}$  and  $\text{PO}_4$ . An increase in  $\text{Ca}^{2+}$  concentration stimulates the thyroid gland to secrete calcitonin to inhibit osteoclastic bone resorption. (Courtesy of Ramiro E. Toribio, DVM, MS, PhD, and Tim Vojt, Columbus, OH; Reproduced with permission.<sup>6</sup>), 1483
- 15-14 Degenerative joint disease (arrow) affecting P2 to P3 of a calf. (Reproduced with permission.<sup>6</sup>), 1500
- 15-15 Myofiber hyperplasia in a Belgian Blue cow., 1516
- 15-16 Spider lamb syndrome in two yearling Suffolk lambs. **A**, A wether with marked angular limb abnormalities and disproportionately long, thin legs. **B**, A wether with a roman nose, shortening of the mandible, and kyphoscoliosis., 1536
- 16-1 Lesions of seasonal allergic dermatitis in a Hampshire Down sheep. (Reproduced with permission from Correa TG et al. *Vet Parasitol* 2007; 145:181.<sup>6</sup>), 1561
- 16-2 Warts on the face of a yearling Belgian Blue bull., 1582
- 16-3 **A**, Warts (papillomas) on the neck and shoulders of a Holstein-Friesian heifer. **B**, Extensive warts (papillomas) on the

- face, neck, and shoulder of a yearling Hereford bull., 1583
- 16-4 Coalescing plaques covered with a keratinous crust occupying most of the concave aspect of the horse's left ear, as viewed from the front. (Reproduced from Torres SMF et al. *Vet Dermatol* 2010; 21:503.), 1583
- 16-5 Survival of horses with penile or preputial papilloma, or squamous-cell carcinoma (G1, well differentiated; G2, moderately differentiated; and G3, poorly differentiated. PIN, penile intraepithelial neoplasia). (Reproduced from van den Top JGB et al. *Equine Vet J* 2015; 47:188.), 1584
- 16-6 Contagious ecthyma on the teat of an ewe. The ewe contracted the infection by being suckled by a lamb with orf lesions on the commissures of its mouth., 1594
- 16-7 Extensive chronic lesions as a result of chronic orf infection in a Suffolk ewe lamb. These facial lesions are often accompanied by similar lesions on the distal limbs., 1595
- 16-8 Muzzle of an affected mare during acute disease associated with infection by vaccinia-like virus. Multiple, confluent papules and proliferative lesions in the muzzle, between and surrounding the nares, and extending aborally. (Reproduced with permission, Brum MCS et al. *J Vet Diagn Invest* 2010; 22:143.), 1597
- 16-9 A, Body strike on a wether as viewed from above. The wether is depressed, and maggots (white) are visible on the surface of the struck area (blackened area of wool). B, Body strike on a weaned sheep as viewed from above. The wool has been clipped away from the edges of the lesion before application of treatment., 1613
- 16-10 Infectious bovine keratoconjunctivitis (IBK) in a beef steer. Note the extensive lacrimation and blepharospasm and the centrally located corneal ulcer with keratitis and conjunctivitis., 1651
- 16-11 **A**, Advanced plaque on the lateral limbus of the right eye from a Simmental cow. This is a precursor to ocular squamous-cell carcinoma. **B**, Advanced papilloma on the third eyelid of the right eye from a Simmental cow. This is a precursor to squamous-cell carcinoma. Note the small amount of periocular eyelid pigmentation. **C**, Advanced squamous-cell carcinoma of the right lower eyelid of a Simmental cow. The tumor mass is large enough that metastasis to the regional lymph node was likely., 1656
- 16-12 Advanced case of bilateral convergent strabismus with exophthalmos in a German Brown cow. (Reproduced, with permission, from Mömke S, Distl O. Bilateral convergent strabismus with exophthalmus [BCSE] in cattle. An overview of clinical signs and genetic traits. *Vet J* 2007; 173:272-277.), 1659
- 16-13 Ocular dermoid cyst on the ventral corneal and limbus of the left eye of a Simmental calf., 1660
- 17-1 **A**, Total disease incidence (sum of mastitis, ketosis, digestive disorders, and laminitis) relative to days from calving for first- and third-lactation cows in Danish dairy herds that calved in 1998. **B**, Acceleration in milk yield through lactation for cows peaking at 30 kg or 60 kg (bold line) of milk daily. (Reproduced with permission from Ingvarsen KL. *Anim Feed Sci Technol* 2006; 126:175-213.), 1664
- 17-2 Least-squares means and 95% confidence interval (error bars) for plasma nonesterified fatty acid concentration and  $\beta$ -hydroxybutyrate concentration in 269 multiparous Holstein-Friesian cows from 21 days prepartum to 21 days postpartum. (Reproduced with permission from McCarthy MM, Mann S, Nydam DV, Overton TR, McArt JAA. *J Dairy Sci* 2015; 98:6284-6290.), 1669
- 17-3 Body-condition scoring chart. (Adapted from Edmonson AJ, Lean IJ, Weaver LD, Farver T, Webster G. A body condition scoring chart for Holstein dairy cows. *J Dairy Sci*. 1989; 72:68-78.), 1674
- 17-4 Friesian cow with stage 2 periparturient hypocalcemia. The cow is unable to stand without assistance., 1680
- 17-5 Vitreous humor is sampled from a recently deceased animal by inserting a 14-gauge needle perpendicular and caudal to the limbus. The needle tip can be observed through the pupil. Aqueous humor is obtained by inserting a 21-gauge needle horizontally rostral to the limbus and into the anterior chamber. Vitreous humor is required to evaluate magnesium concentrations. (Reproduced, with permission, from Edwards G, Foster A, and Livesey C. *In Practice* 2009; 31: 22-25.), 1703
- 17-6 Holstein-Friesian cow with nervous ketosis, manifest as excessive and sustained licking behavior., 1711
- 17-7 Appearance of light-breed horses at each of the body-condition scores described by Henneke et al. (1983). Henneke DR, et al. *Equine Vet J*. 1983;15:371. (Reproduced with permission from Carter RA, et al. In: Geor RJ, et al., eds. *Equine Applied and Clinical Nutrition*. W.B. Saunders; 2013:393.), 1734
- 17-8 Radiographs of a stillborn lamb from a flock with severe iodine deficiency revealing lack of mineralization of the epiphyses of long bones and vertebral bodies and presence of incompletely ossified cuboidal bones of the carpus and tarsus. (Reproduced with permission from Campbell AJD, et al. *Aust Vet J*. 2012;90:235.), 1745
- 17-9 Marked goiter in a neonatal lamb as a result of in utero iodine deficiency. A palpable thrill was present in the ventral cervical region., 1745
- 17-10 Plot of probability that a flock of ewes will respond to iodine supplementation based on lamb thyroid-weight:body-weight ratios. A ratio of 0.40 g/kg (95% confidence interval [CI] = 0.29 to 0.47) predicted with 35% probability, and a ratio of 0.80 g/kg (95% CI = 0.70 to 0.99) predicted with 90% probability, that a lamb came from an unsupplemented (i.e., iodine-deficient) flock. (Reproduced with permission from Knowles SO, et al. *N Z Vet J*. 2007;55:314.), 1746
- 17-11 The sequence of pathophysiological changes that can occur in mineral-deprived livestock, commencing with depletion and ending with clinical disease, and their relation to the body pools of that nutrient. (Reproduced with permission from Suttle NF. *Mineral Nutrition of Livestock*. 4th ed. Wallingford, Oxon, UK: CAB International; 2010 [Chapter 1].), 1756
- 19-1 Heart rate of mare and fetus from 270 days of gestation until foaling. The heart rate of the mare increases, whereas that of the foal declines, as the duration of gestation increases. (Reproduced from Nagel et al., 2011.<sup>16</sup>), 1841
- 19-2 Measurement of ultrasonographic indices of pregnant mare. **A**, Transrectal images in the ventral part of the uterine body, near the cervix. Headers show the combined thickness of the uterus and placenta (CTUP). **B**, Transrectal image of crown rump length (CRL) (header). **C**, Transrectal image of fetal eye orbit. Eye length (=) and width (x) measurements are shown. Eye length is measured from the maximum length of the inner margins of the vitreous body, and eye width is measured from the margin of the anterior portion of the capsule of the lens to the inner margin of the optic disc. **D**, Transabdominal image of the fetal abdomen at the level of the kidney. Kidney cross-sectional length (=) and width (x) measurements are shown. (Reproduced with permission from Murase et al., 2014.<sup>6</sup>), 1842
- 19-3 Predicted death rate for neonatal lambs as a function of wind chill. (Data generated from LambAlive. Horizon Agriculture [[www.hzn.com.au/lambalive.php](http://www.hzn.com.au/lambalive.php)] and courtesy of Dr.

- John Larsen, University of Melbourne.<sup>6,7</sup>), 1845
- 19-4 Examples of forms used to document and record historical aspects and findings on physical examination of foals less than 1 month of age., 1857
- 20-1 The environmental bacterial challenge can be formidable in confinement dairy operations, as demonstrated from a Midwest dairy in the United States., 1909
- 20-2 Increased hock-to-hock distance in a Holstein Friesian cow with clinical mastitis in the right rear quarter., 1914
- 20-3 Mean deviation (in log<sub>10</sub>) of selected milk constituents from the overall means in relation to somatic cell count (*n* = 9326 quarter milk samples). (Reproduced with permission from Hamann J. *XXII World Buiatrics Congress*, Hannover, August 18-23, 2002, 334-345.), 1917
- 20-4 Schematic representation of the development of mastitis in an infected udder. Contagious and environmental pathogens invade the udder via the streak canal and teat cistern. The pathogens then multiply in the udder in which they are attacked by neutrophils. Epithelial cells lining the alveoli are damaged during bacterial multiplication and subsequent immunologic response, with release of enzymes such as NAGase and lactate dehydrogenase (depicted). The tissue response to infection varies based on pathogen, infective dose, immunologic state, and response of the cow, as well as other factors. (Reproduced with permission from Viguier C, Arora S, Gilmartin N, Welbeck K, O Kennedy R (2009) Mastitis detection: current trends and future perspectives. *Trends Biotechnol* 27:486-493.), 1919
- 20-5 Scatter plot of blood leukocyte count (left panel) and segmented neutrophil count (expressed on a logarithmic scale; right panel) for 108 lactating dairy cattle with acute clinical mastitis caused by Gram-negative bacteria or Gram-positive bacteria. The hatched area represents the reference range, and data are expressed as mean ± standard deviation. Cattle with acute Gram-negative mastitis are much more likely to be leukopenic and neutropenic. (Reproduced with permission from Smith GW, Constable PD, Morin DE. *J Vet Intern Med* 2001;15(4):394-400.), 1949
- 20-6 New infection rate in cows by stage of lactation. (Reproduced with permission from Natzke RP. *J Dairy Sci* 1981;64:1431-1441.), 1966
- 20-7 A summary of the possible outcomes for individual quarters during the dry period. IMI, intramammary infection. (Reproduced with permission from Bradley A, Barkema H, Biggs A, et al. *Dairy Herd Health*, Wallingford, UK: CAB International 2012;144.), 1966
- 20-8 Vesicles on the left foreteat of a Holstein heifer with acute herpes mammillitis infection. The vesicles are fragile and appear as the first sign of infection., 1987
- 20-9 Healing udder cleft dermatitis in the caudodorsolateral aspect of the udder of a Holstein Friesian heifer. The heifer is in dorsal recumbency. Smooth beds of granulation tissue are developing 1 week after aggressive debridement of the focal areas of dermatitis., 1988
- 20-10 Udder edema in a 2-year-old Holstein Friesian heifer that calved a few days previously. Note the extension of edema cranial to the udder. This is a grade 5/10 udder edema score., 1989
- 21-1 A, The right eye of an adult cow with early clinical signs of malignant catarrhal fever. Moderate corneal edema is present. Intraocular structures can be seen but not in detail. B, The left eye of an adult cow with advanced malignant catarrhal fever. Severe corneal edema is present, and intraocular structures cannot be observed. (Reproduced with permission from Zemljič T, Pot SA, Haessig M, Spiess BM. Clinical ocular findings in cows with malignant catarrhal fever: ocular disease progression and outcome in 25 cases [2007-2010]. *Veterinary Ophthalmology* 2012; 15:46-52.), 2078
- 21-2 Seasonal occurrence of outbreaks of African horse sickness in central Ethiopia (2007–2010).<sup>1</sup> (Reproduced with permission from Aklilu N, Batten C, Gelaye E, et al: African Horse Sickness Outbreaks Caused by Multiple Virus Types in Ethiopia. *Transboundary & Emerging Diseases* 2014;61:185-192.), 2094
- 21-3 Lesions of blastomycosis in horse demonstrating combination of verrucous, raised, hairless lesions (black arrow) and subcutaneous lesions (white arrow). (Reproduced with permission from Funicello B, et al. *Equine Vet Educ* 2014;26: 458.), 2161
- 21-4 The biochemical changes that lead to copper deficiency and disease. (From Suttle NF. *The mineral nutrition of livestock*, 4th ed., Wallingford, Oxon: CAB International, 2010: 255-305.), 2169

This page intentionally left blank

# Clinical Examination and Making a Diagnosis

# 1

## INTRODUCTION 1

## MAKING A DIAGNOSIS 2

Diagnostic Methods 2

## CLINICAL EXAMINATION OF THE INDIVIDUAL ANIMAL 5

History Taking 5

Examination of the Environment 8

Examination of the Animal 10

Interpretation of Laboratory Data 22

Computer-Assisted Diagnosis 25

## PROGNOSIS AND THERAPEUTIC DECISION MAKING 26

Systematic Reviews 26

Decision Analysis 26

## Introduction

Illness is the situation of being unhealthy or having poor health and is caused by disease. One must recognize illness and then determine the disease causing poor health. The focal point of any investigation of animal disease is the making of a diagnosis, and the critical part in making that decision is the clinical examination of the individual animal or group of animals. Similar to human medicine,<sup>1</sup> the diagnostic act is actually a process to categorize the animal's illness. It is an attempt to recognize the group or class of the animal's illness so that one can, based on prior individual or collective experience, determine the likely disease and what further acts or interventions are required to resolve or mitigate the effects of the illness. Collective experience refers to information about diseases assembled in scholarly articles, accumulated in texts, and generally available to the relevant professional. The diagnostic act not only provides information about the identity of the illness, but also its severity and, with repeated examinations, progression of the disease. This information can then be used to determine a prognosis and for monitoring efficacy of interventions, if any.

Disease can be defined as the "inability to perform physiologic functions at normal levels even though nutrition and other environmental requirements are provided at adequate levels."<sup>2</sup> Traditionally, a disease was defined by a specific combination of clinical signs and pathologic and clinicopathologic abnormalities; for example, pneumonia was defined by a combination of fever, cough, increased respiratory rate, abnormal lung sounds, presence of inflammatory exudate in tracheal mucus, radiographic evidence of abnormalities in the lungs, an inflammatory leukogram, and distinctive lesions in lungs at postmortem examination. The definition has been widened to include those animals or herds that are not clinically ill but do not perform as expected, for example, suboptimal growth rates in piglets, failure to perform

to expectation for an athletic horse, or lower than anticipated reproductive rates. Veterinarians working with food-producing animals and horses are required to recognize individual animals that are affected with a particular, recognizable pathologic lesion, or biochemical or metabolic deficit, or nutritional deficiency, which results in recognizable clinical signs such as fever, dyspnea, convulsions, or lameness. This is traditional veterinary medicine based on a transposition of attitudes and behavior from human medicine. However, it is also necessary to investigate disease that the owner recognizes simply as failure to perform or to reach predetermined objectives. This is not necessarily subclinical disease: it is recognizable clinically but perhaps only as poor performance, such as unthriftiness, without any specific system-oriented clinical signs. In other situations, the owner might not recognize any abnormality unless productivity is measured, e.g., milk production or growth rate per day.

There has been considerable emphasis on the clinical and laboratory examination of individual animals affected with clinical disease or that have not performed normally, and the large body of information now available in laboratory medicine testifies to this preoccupation. Its greatest importance is in animals, such as companion and racing animals, which are kept as singles and, unless the diagnosis is simple and readily obvious, if a laboratory is available there can be a tendency to make one or more laboratory examinations. The more valuable the animal, the greater is the tendency toward some laboratory work. Many biochemical, hematologic, and biophysical examinations of each body system can yield valuable clues about system or organ function, which usually lead to more accurate and detailed examination of that system or organ. In animals kept in herds or flocks, these laboratory tests are also important but are equaled in importance overall by epidemiologic investigations.

Epidemiologic information deals with the distribution and determinants of health and disease in groups,<sup>1</sup> and by extrapolation it

provides diagnostically, therapeutically, and prognostically useful information for individual animals. Clinical epidemiology uses data regarding causes of disease, efficacy (sensitivity, specificity, etc.) of diagnostic acts and therapeutic interventions, and prognosis in the management of disease in individuals, herds, or flocks.

With a herd of animals affected with clinical disease or failing to achieve expected objectives, an epidemiologic investigation, in addition to the clinical examination of individual animals, can make a valuable contribution to the diagnostic process. Epidemiologic investigations in these situations imply or involve the collection of data related to risk factors for disease, quantitative evidence of production shortfalls, clinicopathologic data from a large number of animals, and quantitative assessment of the outcomes of the disease. This is not to suggest that clinical and laboratory examinations are deemphasized in the examination of herd problems. In some instances, the clinical and laboratory examinations assume major importance to ensure that animals in a herd that is not performing normally are not clinically ill. When the presenting complaint is poor performance, it is necessary to collect all the pertinent epidemiologic data, including accurate production measurements, and to decide whether or not an abnormality is present and, if so, its magnitude. It is at this point that veterinarians become the arbiters of what is *health* and what is *illness*. In herd health programs this is a continuing and positive service provided by veterinarians to farmer clients.

In this chapter the standard procedure for the clinical examination of an individual animal followed by some guidelines for the examination of the herd are described. The level of the examination is sufficient to enable the clinician to determine the nature of the abnormality and the system involved. For more detailed examination it is recommended that subsequent chapters, which deal with individual systems, be consulted. Each of them describes a method for a special examination of the particular system.



## Making a Diagnosis

The practice of clinical veterinary medicine consists of two major facets: the making of a diagnosis and the provision of treatment and control measures. For treatment and control to be of optimum value the diagnosis must be as accurate as possible; thus, the diagnosis is the crux of all medical problems.

A diagnosis is the identification of the disease affecting the animal, and to be complete should include three parts:

1. Identification of the clinical manifestation of that abnormality produced by the causative agent—classification of the animal's illness
2. Abnormality of structure or function (the disease) produced by the causative agent
3. The above two then usually allow identification of the specific cause of the illness

The illness should be classified as precisely as possible and should, ideally, include the animal species (and if possible more detail), the causative agent, and the predominant body system affected, for example, equine *Rhodococcus equi* pneumonia and lung abscess or bovine neonatal colibacillosis. Many diagnoses fall short of this objective because of a lack of confirmatory laboratory assistance and are assigned a classification (diagnosis) based on clinical signs, such as bovine chronic diarrhea or necropsy lesions (such as bovine polioencephalomalacia).

### DIAGNOSTIC METHODS

At least five distinctly recognizable methods are used and are presented here in order of increasing complexity.<sup>1</sup> Generally, the experienced clinician uses more of the simpler strategies, and the novice clinician uses more of the complex ones. This occurs because the simple method omits several steps in the clinical reasoning process or the appropriate and safe *cutting of corners* that it is possible to perform with confidence only after gaining wide experience and after paying a good deal of attention to assessing one's own personal competence as a clinician, especially as a diagnostician.

#### METHOD 1: THE SYNDROME OR PATTERN RECOGNITION

Sometimes referred to as the *Aunt Minnie* or gestalt diagnostic technique, this method involves the rapid, almost instantaneous, arrival at a diagnosis.<sup>1</sup> It is gestalt because it involves the recognition of a pattern among apparently chaotic or confused information and Aunt Minnie because one instantly recognizes a close acquaintance without the need to thoughtfully identify and assimilate their distinctive attributes. The diagnosis is made instantaneously and intuitively in the

first few moments of viewing the animal, e.g., the behavior of a horse with abdominal pain or the skin lesions of ecthyma in a sheep or papillomatosis in a cow. The same experience can occur while taking the history—in fact most diagnoses in human medicine are made during collection of the history—in which the description of the clinical situation and signs are pathognomonic or highly suggestive of a disease. This recognition is based on the comparison of the subject case and previous cases in the clinician's memory or training, and one is recognized as a replica of the other. There is no need to seek further supporting advice, and the definitive diagnosis is made then and there. In the hands of experienced or well-trained clinicians this method is quick and accurate.

#### METHOD 2: HYPOTHETICO-DEDUCTIVE REASONING

As soon as the client begins to relate the presenting signs, usually commencing with the key clinical sign, the clinician begins to draw up a short list (usually three or four) of diagnostic possibilities. This is the process of generating multiple plausible **hypotheses** from initial cues. The clinician then begins to ask questions and conduct clinical examinations that test the hypotheses. The questions and examinations should be directed at supporting or discounting the tentative diagnoses (the confirm/exclude technique) but can lead to the addition of more hypotheses and the deletion of some others. (The questions used here are search ones, aimed at supporting a hypothesis, and are distinctly different from scanning questions, which are *fishing* expeditions looking for more key signs about which search questions to ask.) This process of hypothesis and deduction is continued until one diagnosis is preferred over the others. The original list of hypotheses can be expanded but not usually to more than seven, and in the final stages it is usually reduced to two or three. These are then arranged in order of preference and become the list of **diagnostic possibilities**.

In farm animal medicine there is usually a general absence of both hard primary data and ancillary data, such as clinical pathology; thus the clinician might be in the position of having to provide treatment for two or three possible illnesses. An example is the parturition syndrome of recently calved dairy cows in which the treatment of subacute mastitis, metritis, and acetonemia is standard procedure because the clinician is uncertain about which disease is most accountable for the illness. In the more resource-rich arena of a veterinary hospital it might still be necessary to proceed in this way in the first instance but then to narrow down the list of hypotheses when additional information is received from the laboratory. This *polypharmacy* approach is inefficient and has a number of disadvantages, among which are the additional expense and the increased possibility

of contamination of food products of animal origin by medications, especially antibiotics.

One of the important characteristics of this strategy is the dependence on the selection of a critical or key clinical sign or cue on which to base the original hypotheses. The selection of the key sign and additional supporting clinical findings is done instinctively by experienced clinicians on the basis of prior experience in similar situations. For novice clinicians it might be necessary to examine two or more key signs.

#### METHOD 3: THE ARBORIZATION OR ALGORITHM METHOD

This is really an extension of Method 2, but the hypothetico-deductive reasoning method is formalized and performed according to a preplanned program. This reasoning method depends on the clinician remembering and being aware of an all-inclusive list of diagnostic possibilities in the case under consideration. Because memory is unreliable and impressionistic, the hypothetico-deductive method is subject to error by omission. The arborization or algorithmic method similarly approaches a listed series of diagnoses and examines each one in turn with supporting or disproving questions; if they pass the proving test they stay in, if they fail the test then they are deleted. For example, a key sign of red urine in a cow promotes the question: Has the cow had access to plant substances that color the urine red? If the answer is no, the next question is: Is the red color caused by hemoglobinuria or hematuria? If the answer is hemoglobinuria, all the diagnoses on the hematuria branch of the algorithm are deleted and the questioner proceeds to the next question, which will attempt to determine whether the cow has postparturient hemoglobinuria or any of the diseases characterized by intravascular hemolysis.

This method works well provided the list of possible diagnoses is complete, is frequently updated as new diagnoses become available, and, just as importantly, new ways of supporting or discounting each hypothesis are added as soon as they are published. These algorithms are eminently suited to computerization and use of *apps* on smart phones or personal digital devices. The number of apps for personal digital devices is increasing almost daily, and readers are urged to consider these tools after appropriately considering their efficacy and accuracy.

The arborization method is well suited to the clinician who has not had the necessary experience memorizing long lists of potential diagnoses and the critical tests that confirm or exclude each of them. Because the algorithms are likely to include **all** the recorded diagnoses that have that particular key sign, error by omission is not a risk. Thus they are also valuable to the specialist, who is less able to afford an omission than the general practitioner and certainly cannot

really afford to miss even the most obscure and unlikely diagnosis. Another major advantage is that they provide a system of tests that should be performed and clinical findings that should be searched for, which is really a form of clinical protocol, acting as a reminder of the sequential diagnostic steps to be taken. The arrangement of the algorithm represents the clinical reasoning of the person who designed it and it should have considerable merit, assuming that the designer was an expert. This characteristic does arouse the comment that the method does away with the need for clinicians to do their own clinical reasoning. That might be so, but the interests of optimum clinical care of animals are probably better served by having inexperienced clinicians apply the clinical reasoning of a specialist and, consequently, achieve better results.

**METHOD 4: THE KEY ABNORMALITY METHOD**

This is a more time-consuming method than the previous ones that requires clinicians to rely on their knowledge of normal structure

and function to select the key abnormality or clinical cue. This method consists of five steps and is summarized in Fig. 1-1.

**Determination of the Abnormality of Function Present**

Disease is an abnormality of function that is harmful to the animal. The first step is to decide what abnormality of function is present. In pursuing a diagnosis using this technique one should be aware of the parsimony principle, sometimes referred to as Occam's razor, which is the principle that the simplest of several hypotheses is always the best when accounting for unexplained facts, i.e., always try first to explain the animal's clinical signs as being caused by the fewest number of diseases. However, one should also be aware of Hickam's dictum: "that patients (animals) can have as many diseases as they damn well please." The practice attempts to explain the animal's illness with as few diseases as possible while not definitively excluding any plausible explanations. Finally, there can be more than one abnormality detected, but some will be clinically

unimportant, e.g., a physiologic cardiac murmur in a newborn foal.

Definition of the abnormality is usually in general terms, such as paralysis, diarrhea, bloat, edema, and so on. These terms are largely clinical, referring to abnormalities of normal physiologic function, and their use requires a foreknowledge of normal physiology. It is at this point that the preclinical study of physiology merges with the clinical study of medicine.

The necessary familiarity with the normal, combined with observation of the case at hand, makes it possible to determine the physiologic abnormality, e.g., hypoxia. The next step is to determine the body system or body as a whole or organ involved in the production of the hypoxia.

**Determination of the System or Body as a Whole or Organ Affected**

Having made a careful physical examination and noted any abnormalities, it is then possible to consider which body system or organ is the cause of the abnormality. In some cases the body as a whole can be involved. This

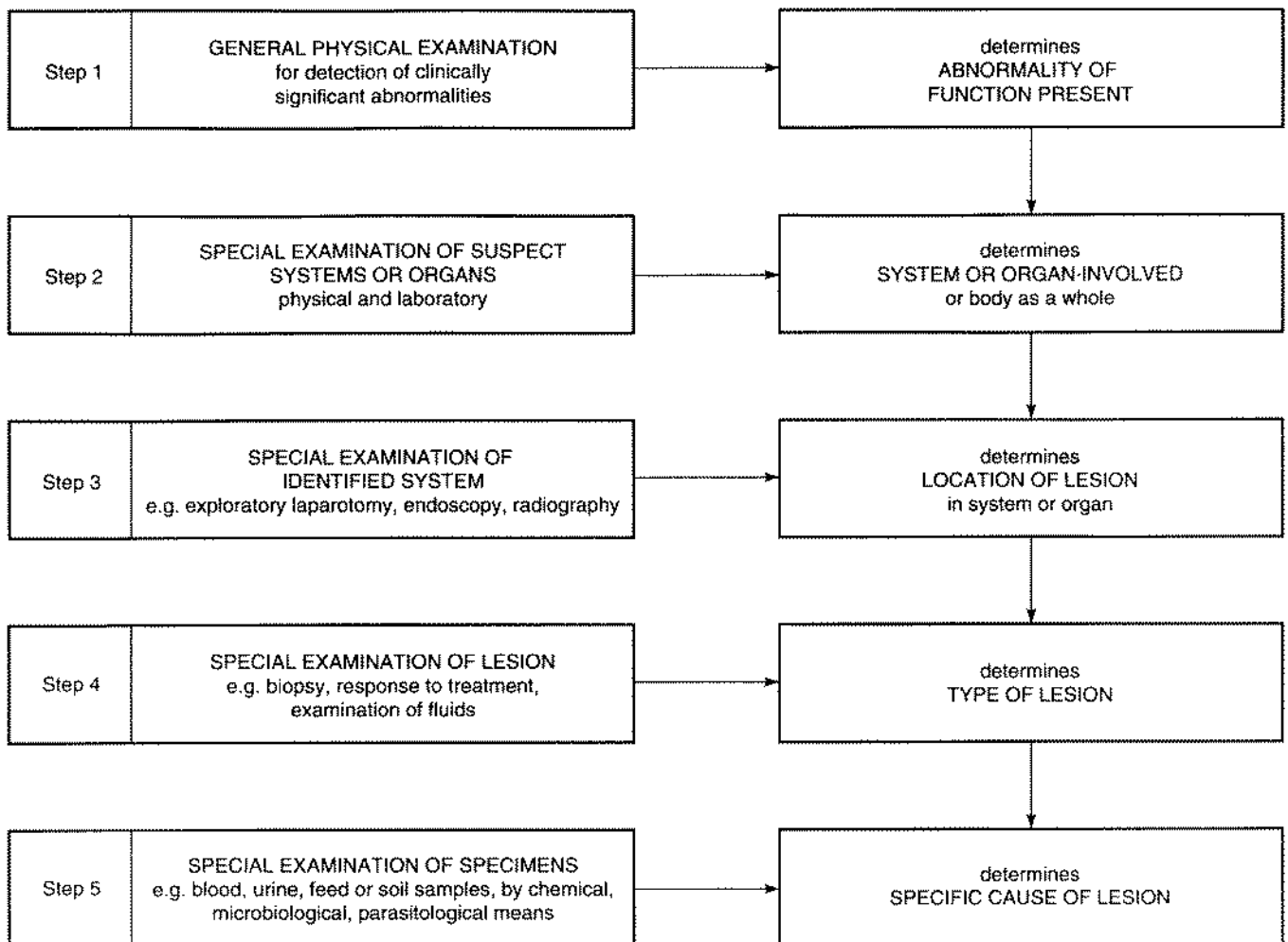

Fig. 1-1 Making a diagnosis.

might not be difficult with some systems; for example, hypoxia can be caused by failure of the respiratory or circulatory systems, and examination of these is not difficult. However, special problems arise when attempting to examine the nervous system, the liver, kidney, endocrine glands, spleen, and hemopoietic systems. Here, routine physical examination by palpation, auscultation, and percussion is not very rewarding; special ancillary examination techniques with the aid of a laboratory are usually necessary. These are described in the special examination methods done for the various systems. As a guiding principle, all functions of the organ under examination should be observed and any abnormalities noted. For example, if the integrity of the central nervous system is to be examined, the clinician would look for abnormalities of mental state, gait, posture, muscle and sphincter tone and involuntary movements, abnormal posture, and paralysis. Knowing the normal physiologic functions of systems, during examination one looks for aberrations.

When only a simple physical examination is available, it can be difficult to choose between two or more systems as the possible location of the abnormality. For example, when an animal is unable to rise from the recumbent position it can be difficult to decide whether the nervous system or the musculoskeletal system or generalized weakness from a systemic illness is the origin of the clinical recumbency. If special diagnostic techniques and laboratory evaluations are inconclusive or not available, it can be necessary to resort to probability as a guide. For example, paresis caused by diseases of the muscles is most common in young calves, lambs, and foals and generally uncommon in mature farm animals, with the exception of the myopathy associated with the downer cow syndrome in dairy cattle. However, paresis is common in mature cows affected with parturient hypocalcemia, peracute coliform mastitis, and acute diffuse peritonitis.

### Determination of the Location of the Lesion Within the System or Organ Affected

The location of the lesion within the body system involved is not always obvious and might require special physical and laboratory examination techniques. For example, a detailed neurologic examination will be necessary to localize the lesion in an animal with manifestation of disease of the nervous system. This might be combined with radiographic techniques such as myelography. An exploratory laparotomy with or without biopsy techniques might be necessary to determine the location of an intestinal lesion thought to be the cause of chronic diarrhea. Endoscopy is standard practice for the localization of lesions of the respiratory tract of the horse. Radiography is often necessary to

localize lesions of the musculoskeletal system and diseases of the feet of horses and cattle.

### Determination of the Type of Lesion

The abnormality observed may be produced by lesions of different types. Generally, lesions can be divided into anatomic or physical lesions and functional disturbances. The physical lesions can be further subdivided into inflammatory, degenerative, or space occupying. These classifications are not mutually exclusive because a lesion may be both inflammatory and space occupying, for example abscesses in the spinal cord or lung. In these circumstances it is necessary to modify the diagnosis and say that such and such a lesion is space occupying and may or may not be inflammatory.

The differentiation between functional disturbances and physical lesions is often extremely difficult because the abnormalities produced may be identical. For example, in a case of hypomagnesemia in a cow there is no physical lesion but differentiation from the encephalitis of furious rabies may be impossible. As a rule, functional disturbances are transient, often recurrent or fluctuating, and are readily reversible by treatment, whereas structural lesions cause changes that are relatively static or at least change slowly and are affected only gradually by treatment. This is by no means a regular rule: the acute abdominal pain of intestinal obstruction usually fluctuates but the lesion is a physical one, whereas the paralysis of parturient paresis in cattle is static but the disturbance is functional.

Differentiation among inflammatory, degenerative, and space-occupying lesions is usually simpler. Space-occupying lesions produce signs characteristic of pressure on surrounding organs and can often be detected by physical means. Inflammatory lesions are characterized by heat, pain, swelling, and a local or general leukocytosis and, in severe cases, a systemic toxemia. A total white blood cell count and differential is a **sensitive** but **nonspecific** test for the presence of an infection. A leukopenia, neutropenia, and a degenerative left shift suggest a severe infection. A neutrophilia and regenerative shift suggest an active chronic infection. The most common infections of cattle, which are often not readily obvious, are in the thoracic and abdominal cavities (pleuritis, pulmonary abscesses, pericarditis, and peritonitis). Degenerative lesions produce the same loss or abnormality of function as lesions of the other types but are not usually accompanied by evidence of inflammation unless they are extensive. If the lesion is accessible, biopsy should be considered as a means of determining its nature.

### Determination of the Specific Cause of the Lesion

If the nature of the abnormality and the type of lesion can be satisfactorily determined,

then the specific causative agent remains to be found. If, for example, it could be said that a particular case of paralysis in a calf was caused by a degenerative lesion of the musculature, only a few specific etiologic agents would have to be considered to make a final diagnosis. In many cases it is impossible to go beyond this stage without additional techniques of examination, particularly laboratory examinations, and it is general practice to make a diagnosis without this confirmatory evidence because of limitations of time, finances, or facilities.

It is at this stage that a careful history taking and examination of the environment show their real value. It is only by a detailed knowledge of specific disease entities, the conditions under which they occur, the epidemiology, and the clinical characteristics of each disease that an informed judgment can be made with any degree of accuracy. If the diagnostic possibilities can be reduced to a small number, confirmation of the diagnosis by laboratory methods becomes so much easier because there are fewer examinations to be made and confirmation by response to treatment is easier to assess. If it is necessary to treat with many drugs serially or in combination to achieve a cure, the expense is greater and the satisfaction of both the client and the veterinarian is diluted in proportion to the range of treatments. Accuracy in diagnosis means increased efficiency, and this is the final criterion of veterinary practice.

### METHOD 5: THE DATABASE METHOD

The basis of this method (also called the **Weed** or **problem-oriented method**) is to conduct a complete clinical and clinicopathologic examination of the animal to acquire a comprehensive animal database. The problems (key signs) in this database are then matched with the diagnostic database, in which collections of signs or syndromes are labeled with diagnoses, to select the best fit with the animal's data.

This method also uses the **problem-oriented veterinary medical record system**, which is an excellent system for the daily recording of clinical and laboratory data in an orderly, systematic, and consistent manner that can be easily followed by clinicians and their colleagues. This system is now used widely by veterinary teaching hospitals. It has four components based on the four phases of veterinary medical action:

- Database
- Problem list
- Initial plans
- Progress notes

The progress notes are created daily and divided into four parts known collectively by the acronym SOAP to designate the following:

- Subjective information
- Objective data
- Assessment of problem

- Plans, which may include diagnostic, therapeutic, or client education

The method requires clinicians to be very painstaking in their examination and recording. It places great demands on the time spent by clinicians and clinical pathologists, on laboratory resources, and on clinical record storage. Much of the data have no diagnostic importance because the diagnostic decisions are made largely on the presence or absence of relatively few key signs. It also has the disadvantage that there is a tendency to make the animal fit a category. It is the opposite of the **key abnormality** method, in which only the signs and other indicants relevant to the proposed diagnosis are sought and recorded. Because of its requirement of time and data recording and storage this method is not suitable for use in food animal medicine, in which speed is a vital component of the diagnostic process. As mentioned in the next section, it is an excellent system for the teaching clinical veterinary medicine (i.e., taught how to do it, but then taught never to do it).

The method is really an expanded version of the hypothetico-deductive method, in which the hypotheses are made sequentially as further information becomes available. In the database method all the hypotheses are pursued in parallel because all the possible data have been put into the animal's database. The source of error in the method is the possibility of undue importance being attached to a chance abnormality in, say, the clinical biochemistry. If the abnormality cannot be matched to a clinical sign, it should be weighted downward in value or marked for comment only. The same error can result from inclusion of a sign that is important, e.g., diarrhea, but that happens to be present at low intensity.

## Clinical Examination of the Individual Animal

A clinical examination has three parts:

- History
- Animal
- Environment

The usual admonition is that one should collect a comprehensive history and perform a complete physical examination (a diagnosis by exhaustion<sup>1</sup>) when investigating disease in an individual animal. This approach, in which one gathers all pertinent or potentially pertinent information before attempting to arrive at a diagnosis, is often taught to veterinary students as well as medical colleagues, but does not represent the behavior of experienced clinicians. One authority in human medicine states that all medical students should be taught how to do a complete historical and physical examination, but once they have mastered its components they should be taught never to do use this exhaustive methodology.<sup>1</sup>

Inadequate examination of any of these can lead to error. The examination of the affected animal represents only a part of the complete investigation. Careful questioning of the owner or attendant can yield information about the diet or the prior diet, about recent vaccinations or surgery, or about the introduction of animals into the group, which will provide the clues for a successful diagnosis. However, the most detailed examination of the animal and the most careful questioning of the owner might fail to elicit the evidence necessary for a correct diagnosis, for example, in lead poisoning of cattle. Only a careful physical search of the environment for a source of lead can provide this information. Thus neglect of one aspect of the clinical examination can render valueless a great deal of work on the other aspects and lead to an error in diagnosis.

### HISTORY TAKING

In veterinary medicine, history taking is often the most important of the three aspects of a clinical examination. The importance of the results obtained by examination of the animal and the environment is liable to be modified by a number of factors. Animals are unable to describe their clinical symptoms (they have clinical signs, which are noticeable to an observer, but it can only be assumed that animals have symptoms or the subjective sensation of illness); they vary widely in their reaction to handling and examination, and a wide range of normality must be permitted in the criteria used in a physical examination. These variations are much greater in some species than in others. Dairy cattle, horses, sheep, and goats are usually easy to examine, whereas beef cattle and pigs can be difficult to examine adequately under some conditions. A satisfactory examination of the environment can prove difficult because of lack of knowledge of the factors concerned or because of the examiner's inability to assess their significance. Problems such as the measurement of the relative humidity of a barn and its importance as a predisposing factor in an outbreak of pneumonia or the determination of pH of the soil with reference to the spread of leptospirosis can present virtually insuperable difficulties to the veterinarian in the field. On the other hand, a search for a specific factor (a known poison), such as a pasture walk to detect toxic yew (*Taxus* spp.) offcuts in a field, can be relatively simple.

Nevertheless, history taking is an important key to accurate diagnosis in veterinary medicine, and to be worthwhile it must be accurate and purposeful. A fit for purpose history requires the focused collection of data that progressively increase or decrease the likelihood of a diagnosis. Collection of information that does not address a clinically relevant question (hypothesis) is a waste of

time and resources. Admittedly, human fallibility must be taken into consideration: there might be insufficient time, the importance of particular factors might not be appreciated, and there could be misunderstanding. Although these are excusable up to a point, failure to recognize the importance of the history can lead only to error. To avoid being misled, it is essential that the veterinarian assesses the accuracy of the history by careful examination of what the owner relates about his or her animals.

The history should suggest not only the diagnostic possibilities but also the probabilities: a 1-year-old heifer is unlikely to have clinical John's disease, and an adult cow is more likely to have parturient paresis than a first-calf heifer, which in turn is more likely to have maternal obstetric paralysis than is the adult cow. The history can often indicate that special attention should be paid to the examination of a particular system in the animal or a particular factor in the environment. For example, in hypovitaminosis A in beef calves from 6 to 10 months of age, the animals might be seen when they are clinically normal, and the only means of reaching a diagnosis might be a consideration of the history of the clinical findings and the nutritional status.

### HISTORY-TAKING METHOD

Good communication skills are an essential component of successful history taking and are increasingly taught as part of a veterinary curriculum.<sup>3</sup> Some suggestions are presented here as guidelines that might prove useful to the clinician.

The veterinarian should establish the context for the consultation and ensure that the environment in which it occurs is safe, professional, and allows for effective interaction with the client and examination of the animal.<sup>3</sup> This includes an introduction so that both parties are aware of the other's roles and responsibilities. For example, the veterinarian might be consulting with the sole owner, one of several owners, the farm manager or animal trainer, or a stable hand or farm worker. Each of these might have different levels of authority (the sole owner presumably has the most authority) or knowledge (a stable hand might have better insight into the horse's condition than a geographically distant part-time owner).

The next step is to establish rapport with the client. How can I help you today? is an effective opening question that provides the owner the opportunity to relate his or her concerns about the animals. Importantly, this allows the client to identify the reasons for the consultation. Recall that the role of a veterinarian in clinical practice is, in most instances, to solve the owner's problems or address his or her concerns. A focus solely on the animal will not necessarily result in a good outcome for the owner.



The owner or attendant must be handled with diplomacy and tact. The use of non-technical terms is usually essential, because livestock owners can be confused by technical expressions or reluctant to express themselves when confronted with terms they do not understand. The veterinarian must be aware of the vernacular associated with particular breeds or uses of animals and should be able to communicate in these terms. Statements, particularly those concerned with time, should be tested for accuracy and precision. Such terms as *not long ago* or *a little while ago* should be used to ascertain the number of hours, days, or weeks involved. One person's perception of *recently* might be considerably different to another person. Owners, and more especially herds-men and agents, can attempt to disguise their neglect by condensing time or varying the chronology of events. If a detailed cross-examination of the owner seems likely to arouse some antagonism, it is advisable for the veterinarian to forego further questioning and be content with his or her own estimate of the dependability of the history. The clinician must try to separate owners' observations from their interpretations. A statement that the horse had a bout of bladder trouble may, on closer examination, mean that the horse had an attack of abdominal pain in which it assumed a posture usually associated with urination. Often, however, it is impossible to avoid the use of leading questions—Did the pigs scour?, Was there any vomiting?—but it is necessary to weigh the answers in accordance with the general veracity of the owner.

Absence of a sign can only be determined by inquiring whether or not it occurred. Simply asking for a complete history of what has happened almost invariably results in an incomplete history. The clinician must know the right questions to ask; this knowledge comes with experience and familiarity with disease. Owners seldom describe clinical signs in their correct time sequence, and part of the clinician's task is to establish the chronology of events.

For completeness and accuracy in history taking the clinician should conform to a set routine. The system outlined next includes animal data, disease history, and management history. The order in which these parts of the history are taken will vary. Generally it is best to take the disease history first. The psychological effect is good: the owner appreciates the desire to get down to the facts about his or her animal's illness.

### ANIMAL DATA

If records are to be kept at all, even if only for financial purposes, accurate identification of the animal is essential. An animal's previous history can be referred to, the disease status of a herd can be examined, and specimens for laboratory examination can be dispatched with the knowledge that

the results can be related to the correct animal. Accurate records are also necessary for the submission of accounts for veterinary services rendered, and the details of the owner's address and of the animals examined and treated must be accurate. These points might have no importance in establishing the diagnosis, but they are of primary importance in the maintenance of a successful practice.

The relevant data include the following:

- Owner's name and initials
- Postal address and telephone number
- Species, type, and breed (or estimate of parentage in a crossbreed)
- Sex, age, name or number, and body weight
- If necessary, a description, including color markings, polledness, and other identifying marks, of the animal

Such a list can appear formidable but many of the points, such as age, sex, breed, and type (use made of animal, e.g., beef, dairy, mutton, wool), are often important to the diagnosis. A case history of a particular animal might suggest that further treatment is likely to be uneconomic because of age, or that a particular disease is assuming sufficient importance in a herd for different control measures to be warranted.

Computers are routinely veterinary practices for recording the details of farm calls, the animals examined and treated, the amounts charged for travel and professional services, the costs of laboratory services, the drugs used and dispensed, and the diseases that occur on a particular farm on an ongoing basis. It is now possible for veterinary practices to provide regular and annual health reports to herd owners so that planned health management programs can be assessed and evaluated. The ability to retrieve and summarize this information on an individual farm basis is a major step forward in providing optimal veterinary service to livestock herds, regardless of their size and complexity.

### DISEASE HISTORY

History taking will vary considerably depending on whether one animal or a group of animals is involved in the disease problem under examination. Generally, in large animal work, all disease states should be considered as herd problems until proved to be otherwise. It is often rewarding to examine the remainder of a group and find animals that are in the early stages of the disease.

### Present Disease

Attempts should be made to elicit the details of the clinical abnormalities observed by the owner in the sequence in which they occurred. If more than one animal is affected, a typical case should be chosen and the variations in history in other cases should then be noted. Variations from the normal in the physiologic functions, such as intake of

food or drink, milk production, growth, respiration, defecation, urination, sweating, activity, gait, posture, voice, and odor, should be noted in all cases. There are many specific questions that need to be asked in each case, and for the most part they are variations on the questions already suggested.

If a number of animals are affected, information could be available from clinical pathologic examinations performed on living animals or necropsy examinations on fatal cases. The behavior of animals before death and the period of time elapsing between the first observable signs and death or recovery are important items of information. Prior surgical or medical procedures, such as castration, docking, shearing, or vaccination, may be important factors in the production of disease.

### Morbidity, Case Fatality, and Population Mortality Rates

The morbidity rate is usually expressed as the percentage of animals that are clinically affected compared with the total number of animals exposed to the same risks. The case fatality rate is the percentage of affected animals that die. The population cause-specific mortality rate is the percentage of all exposed animals that die of the disease of interest. The population mortality rate is the proportion of animals in the population of interest that die of any cause during the specified period (a rate always includes a time element in the denominator). The estimates can be important in diagnosis because of the wide variations in morbidity, case fatality, and cause-specific mortality rates that occur in different diseases. An equally important figure is the proportion of animals at risk that are clinically normal but show abnormality on the basis of laboratory or other tests (so-called *subclinical disease*).

### Prior Treatment

It is important to determine whether the animal has had any previous treatment for this condition administered by the owner or another veterinarian. Exact details of the preparations used and doses given can be of value in eliminating some diagnostic possibilities. They could be of importance when assessing the probable efficiency of the treatment and the significance of clinical pathologic tests, and in prescribing additional treatment. Drug withdrawal regulations now require that treated animals or their products, such as milk, be withheld from slaughter or market for varying lengths of time to allow drug residues to reach tolerable limits. This necessitates that owners reveal information about recent treatments.

### Prophylactic and Control Measures

It should be ascertained whether preventive or control procedures have already been attempted. There could have been clinical pathologic tests; the introduction of artificial



insemination to control venereal disease; vaccination; or changes in nutrition, management, or hygiene. For example, in an outbreak of bovine mastitis careful questioning should be pursued regarding the method of disinfecting the cows' teats after each milking, with particular reference to the type and concentration of the disinfectant used and whether or not back-flushing of teat cups is practiced. Spread of the disease can result from failure of the hygiene barrier at any one of a number of such points. When written reports are available they are more reliable than memory.

### Previous Exposure

The history of the group relative to additions is of particular importance in establishing the animal's exposure to the following risk factors:

- Is the affected animal an established member of the group, or has it been introduced, and if so how long ago?
- If the affected animal has been in the group for some time, have there been recent additions?
- Is the herd a *closed herd* or are animals introduced at frequent intervals?

Not all herd additions are potential carriers of disease: they might have come from herds in which control measures are adequate, they could have been tested before or after sale or kept in quarantine for an adequate period after arrival, or they could have received suitable biological or antibiotic prophylaxis. Herd additions might have come from areas in which a particular disease does not occur, although a negative history of this type is less reliable than a positive history of derivation from an area in which a particular disease is enzootic.

A reverse situation may occur in which imported animals have no resistance to endemic infection in the home herd or have not become adapted to environmental stressors, such as high altitudes, high environmental temperatures, and particular feeding methods, or are not accustomed to poisonous plants occurring in the environment.

### Transit

The possibility of infection during transit is always a potential risk, and presale certificates of health may be of little value if an animal has passed through a sale barn, a show, or communal trucking yards while in transit. Highly infectious diseases may be transmitted via trucks, railroad cars, or other accommodation contaminated by previous inhabitants. Transient introductions, including animals brought in for work purposes, for mating, or on temporary grazing, are often overlooked as possible vectors of disease. Other sources of infection are wild fauna that graze over the same area as domestic livestock and inanimate objects such as human footwear, car tires, and feeding utensils.

### Culling Rate

There may be considerable diagnostic importance in the reasons for culling and the number of animals disposed of for health reasons. Failure to grow well, poor productivity, and short productive life suggest the possible occurrence of a number of chronic diseases, including some associated with infectious agents, caused by nutritional deficiencies, or caused by poisons.

### Previous Disease

Information elicited by questioning on previous history of illness can be helpful. If there is a history of previous illness, inquiries should be made along the usual lines, including clinical observations, necropsy findings, morbidity, case fatality rates, the treatments and control measures used, and the results obtained. If necessary, inquiries should be made about herds from which introduced animals have originated and also about herds to which other animals from the same source have been sent.

### MANAGEMENT HISTORY

The management history includes nutrition, breeding policy and practice, housing, transport, and general handling. It is most important to learn whether or not there has been any change in the prevailing practice before the appearance of disease. Because a disease has occurred when the affected animals have been receiving the same ration, deriving from the same source over a long period, suggests that the diet is not at fault, although errors in preparation of concentrate mixtures, particularly with the present-day practice of introducing additives to feeds, can cause variations that are not immediately apparent.

### Nutrition

The major objective in the examination of the nutritional history is to determine how the quantity and quality of the diet the animals have been receiving compares with the nutrient requirements recommended for a similar class of animal. Attention should be paid to both the macronutrients (protein, roughage, carbohydrate, and fat) and micronutrients (minerals and trace elements). Malnutrition can involve underfeeding (starvation), overfeeding (obesity), or deficiency or excess of micronutrients. In some situations it will be necessary to submit feed and water samples for analyses to assess quality and adequacy of feed.

### Livestock at Pasture

Pastured livestock present a problem different from those being stall fed because they receive a diet that is less controlled and thus more difficult to assess. The risk of parasitic infestation and, in some cases, infectious disease is much greater in grazing animals. Inquiries should be made about the composition of the pasture, its probable nutritive

value with particular reference to recent changes brought about by rain or drought, whether rotational grazing is practiced, the fertilizer program, and whether or not minerals and trace elements are provided by top-dressing or mineral mixtures. The origin of mineral supplements, particularly phosphates, which can contain excess fluorine, and homemade mixtures, which can contain excessive quantities of other ingredients, should receive attention. Actual examination of the pasture area is usually more rewarding than a description of it.

### Hand-Fed/Stall-Fed Animals

Hand-fed or stall-fed animals are subjected to a controlled feed supply but, because of human error, they are frequently exposed to dietary mistakes. Types and amounts of feeds should be determined. Examples of disease caused by inadequate hand-fed diets include osteodystrophia fibrosa in horses on diets containing excess grain, azoturia in the same species when heavy-carbohydrate diets are fed during periods of rest, and lactic acid indigestion in cattle introduced to high-level grain diets too rapidly. The sources of the dietary ingredients can also be important. Grains from some areas are often much heavier and contain a much greater proportion of starch to husk than grains from other areas; thus when feed is measured, rather than weighed, overfeeding or underfeeding can occur.

Because the digestive enzyme capacity of newborn farm animals is most efficient in the digestion of whole milk, the use of nonmilk sources of carbohydrates and proteins in the formulation of milk replacers can result in indigestion and nutritional diarrhea.

Exotic diseases can be imported in feed materials; anthrax, foot-and-mouth disease, and hog cholera are well-described examples.

Variations in the preparation of ingredients of rations can produce variable diets. Overheating, as in pelleting or the cooking of feeds, can reduce their vitamin content; contamination with lubricating oil can result in poisoning by chlorinated naphthalene compounds; and pressure extraction of linseed can leave considerable residues of hydrocyanic acid in the residual oil cake.

Feeding practices may contribute to the production of disease. Pigs fed in large numbers with inadequate trough space or calves fed from communal troughs are likely to be affected by overeating or inanition, depending on their size and vigor. High-level feeding and consequent rapid growth may create deficiency states by increasing the requirement for specific nutrients.

In both hand-fed and grazing animals changes in diet should be carefully noted. Movement of animals from one field to another, from pasture to cereal grazing, and from unimproved to improved pasture may

all precipitate the appearance of disease. Periods of sudden dietary deficiency can occur as a result of bad weather or transportation or a change to unfamiliar feeds. Rapid changes are more important than gradual alterations, particularly in pregnant and lactating ruminants when metabolic diseases, including those caused by hypocalcemia, hypoglycemia, and hypomagnesemia, are likely to occur.

The availability of **drinking water** must be determined and is ideally done by direct examination of the watering facilities.

### Reproductive Management and Performance

In the examination of a single animal the breeding and parturition history might suggest or eliminate some diagnostic possibilities. For example, pregnancy toxemia occurs in sheep in late pregnancy, whereas ketosis in dairy cows occurs primarily 2 to 6 weeks after parturition. Acute septic metritis is a possibility within a few days after parturition in any species but unlikely several weeks later.

### Breeding History

The breeding history can be important regarding inherited disease. The existence of a relationship between sires and dams should be noted. Hybrid vigor in crossbred animals should be considered when there is apparent variation in resistance to disease between groups maintained under similar environmental conditions. A general relationship between selection for high productivity and susceptibility to certain diseases is apparent in many breeds of animal and even in certain families. The possibility of genotrophic disease, i.e., the inheritance of a greater than normal requirement for a specific nutrient, should be considered.

### Reproductive History

The examination of the herd reproductive history involves comparing past and present reproductive performances with certain optimum objectives. The mean length of the interval between parturition and conception, the mean number of services per conception, and the percentage of young animals weaned relative to the number of females that were originally exposed for breeding (calf or lamb crop and pigs weaned) are general measures of reproductive performance and efficiency.

Using cattle as an example, certain observations can assist in determining the cause of failure to reach reproductive performance objectives. These include the following:

- Percentage of abortions
- Length of breeding season
- Percentage of females pregnant at specified times after the onset of the breeding period
- Bull/cow ratio
- Size and topography of breeding pastures

- Fertility status of the females and males at breeding time

The percentage of females that need assistance at parturition and the percentage of calves that die at birth are also indices of reproductive performance indicative of the level of reproductive management provided.

### Climate

Many diseases are influenced by climate. Foot rot in cattle and sheep reaches its peak incidence in warm, wet summers and is relatively rare in dry seasons. Diseases spread by insects are encouraged when climatic conditions favor the proliferation of the vector. Internal parasites are similarly influenced by climate. Cool, wet seasons favor the development of hypomagnesemia in pastured cattle. Anhidrosis in horses is specifically a disease of hot, humid countries. The direction of prevailing winds is important in many disease outbreaks, particularly in relation to the contamination of pasture and drinking water by fumes from factories and mines and the spread of diseases carried by insects.

### General Management

There are so many items in the proper management of livestock that, if neglected, can lead to the occurrence of disease that they cannot be related here; animal management in the prevention of disease is a subject in its own right and is dealt with in all parts of this book. Some of the more important factors include the following:

- Hygiene, particularly in milking parlors and in parturition and rearing stalls
- Adequacy of housing in terms of space, ventilation, draining, and situation and suitability of troughs
- Opportunity for exercise
- Proper management of milking machines to avoid udder injury

The class of livestock under consideration is also important; for example, enterotoxemia is most common in finishing lambs and pigs, parturient paresis in milking cows, obstructive urolithiasis in lambs and steers in feedlots, and pregnancy toxemia in ewes used for fat lamb production.

## EXAMINATION OF THE ENVIRONMENT

An examination of the environment is a necessary part of any clinical investigation because of the possible relationship between environmental factors and the incidence of disease. A satisfactory examination of the environment necessitates an adequate knowledge of animal husbandry and, with the development of species specialization, it will be desirable for the veterinarian to understand the environmental needs of a particular species or class of farm animal.

Depending on the region, some animals are kept outside year round, some are housed for part of the year during the winter months,

and some are kept under total confinement. For animals raised on pasture, the effects of topography, plants, soil type, ground surface, and protection from extremes of weather assume major importance. For animals housed indoors, hygiene, ventilation, and avoiding overcrowding are of major concern. Some of these items will be briefly presented here as guidelines. Each observation should be recorded in detail for preparation of reports for submission to the owners. Detailed records and even photographs of environmental characteristics assume major importance when poisonings are suspected and where litigation proceedings appear possible.

## OUTDOOR ENVIRONMENT

### Topography and Soil Type

The topography of grasslands, pastures, and wooded areas can contribute to disease or inefficient production and reproduction. Flat, treeless plains offering no protection from wind predispose cattle to lactation tetany in inclement weather. Low, marshy areas facilitate the spread of insect-borne diseases and soil-borne infections requiring damp conditions, such as leptospirosis; Johne's disease and diseases associated with liver fluke infestation and lungworm pneumonia are more prevalent in such areas. Rough grasslands with extensive wooded areas can have an adverse effect on reproductive performance in beef herds because of the difficulty the bulls have in getting to the females during peak periods of estrus activity.

The soil type of a district may provide important clues to the detection of nutritional deficiencies; copper and cobalt deficiencies are most common on littoral sands, and the copper deficiency/molybdenum excess complex usually occurs on peat soils. The surface of the ground and its drainage characteristics are important in highly intensive beef feedlots and in large dairy herds where fattening cattle and dairy cows are kept and fed under total confinement. Ground surfaces that are relatively impermeable and/or not adequately sloped for drainage can become a sea of mud following a heavy rainfall or snowstorm. Constant wetting of the feet and udders commonly results in outbreaks of foot rot and mastitis. Dirty udders increase the time required for udder washing before milking and can seriously affect a mastitis control program.

In some regions of the world, beef cows are calved in outdoor paddocks in the spring when it is wet and cold with an excess of surface water; this increases the spread of infectious disease and results in a marked increase in neonatal mortality. A lack of sufficient protection from the prevailing winds, rain, snow, or the heat of the sun can seriously affect production and can exacerbate an existing disease condition or precipitate an outbreak. Dusty feedlots during the hot

summer months may contribute to an increase in the incidence of respiratory disease or delay the response to treatment of disease such as pneumonia.

### Stocking Rate (Population Density)

Overcrowding is a common predisposing cause of disease. There may be an excessive buildup of feces and urine, which increases the level of infection. The relative humidity is usually increased and more difficult to control. Fighting and cannibalism are also more common in overcrowded pens than when there is adequate space for animals to move around comfortably. The detection and identification of animals for whatever reason (illness and estrus) can be difficult and inaccurate under crowded conditions.

### Feed and Water Supplies

#### Pasture and Feed

In pastures the predominant plant types, both natural and introduced, should be observed because they are often associated with certain soil types and may be the cause of actual disease; the high estrogen content of some clovers, the occurrence of functional nervous diseases in pastures dominated by *Phalaris aquatica* (syn. *P. tuberosa*) and perennial rye grass, and the presence of selective absorbing *converter* plants on copper-rich and selenium-rich soils are all examples of the importance of the dominant vegetation. The presence of specific poisonous plants, evidence of overgrazing, and the existence of a bone-chewing or bark-chewing habit can be determined by an examination of the environment.

Vital clues in the investigation of possible poisoning in a herd may be the existence of a garbage dump or ergotized grass or rye in the pasture, or the chewing of lead-based painted walls in the barn, or careless handling of poisons in the feed area. The possibility that the forage has been contaminated by environmental pollution from nearby factories or highways should be examined. In some cases the physical nature of the pasture plants may be important; mature, bleached grass pasture can be seriously deficient in carotene, whereas lush young pasture can have rachitogenic potency because of its high carotene content or it may be capable of causing hypomagnesemia if it is dominated by grasses. Lush legume pasture or heavy concentrate feeding with insufficient roughage can cause a serious bloat problem.

The feed supplies for animals raised in confinement outdoors must be examined for evidence of moldy feed, contamination with feces and urine, and excessive moisture caused by lack of protection from rain and snow. Empty feed troughs may confirm a suspicion that the feeding system is faulty.

#### Water

The drinking water supply and its origin may be important in the production of disease.

Water in ponds can be covered with algae containing neurotoxins or hepatotoxic agents, and flowing streams might carry effluent from nearby industrial plants. In a feedlot, water can suddenly become unavailable because of frozen water lines or faulty water tank valves. This should not go unnoticed if one recognizes the anxiety of a group of cattle trying to obtain water from a dry tank.

### Waste Disposal

The disposal of feces and urine has become a major problem for large intensified livestock operations. Slurry is now spread on pastures and may be important in the spread of infectious disease. Lagoons can provide ideal conditions for the breeding of flies, which can be troublesome to a nearby livestock operation. The inadequate disposal of dead animals also can be an important factor in the spread of certain diseases.

### INDOOR ENVIRONMENT

There are few aspects of livestock production that have aroused more interest, development, and controversy in the last few years than the housing and environmental needs of farm animals. Several textbooks on the subject have been written, and only some of the important items will be mentioned here, with the aid of some examples. The effects of housing on animal health have not received the consideration they deserve, partly because of insufficient knowledge of animals' environmental needs and partly because there has been a failure to apply what is already known.

Generally, it can be said that inadequate housing and ventilation, overcrowding, and uncomfortable conditions are considered to have detrimental effects on housed animals that make them not only more susceptible to infectious disease but also less productive. Moreover, this reduction in productive efficiency may be a greater cause of economic loss than losses caused by infectious disease. For this reason, the veterinarian must learn to examine and assess all aspects of an indoor environment, which may be the primary cause of, or a predisposing factor to, disease. For example, the major causes of preweaning mortality of piglets are chilling and crushing of piglets in the first few days of life and not infectious disease. These physical causes are commonly related to a combination of poorly designed farrowing crates, slippery floors, inadequate heating, and perhaps overcrowding of the farrowing facilities.

### Hygiene

One of the first things to observe is the level of sanitation and hygiene, which is usually a reliable indicator of the level of management; poor hygiene is often associated with a high level of infectious disease. For example, the incidence of diarrhea in piglets may be high because the farrowing crates are not suitably

cleaned and disinfected before the pregnant sows are placed in them. A similar situation applies for lambing sheds, calving pens, and foaling boxes. An excessive buildup of feces and urine with insufficient clean bedding will result in a high level of neonatal mortality. The methods used for cleaning and disinfection should be examined carefully. The removal of dried feces from animal pens that have been occupied for several months is a difficult and laborious task and often not done well. Undue reliance may be placed on the use of chemical disinfectants.

The total length of time that animals have occupied a pen without cleaning and disinfection (occupation time) should be noted. As the occupation time increases, there is a marked increase in the infection rate and the morbidity and mortality from infectious disease often increase.

### Ventilation

Inadequate ventilation is considered to be a major risk factor contributing to the severity of swine enzootic pneumonia in finishing pigs. The primary infection has a minimal effect on the well-housed pig, but inadequate ventilation results in overheating of the barn in the summer months and chilling and dampness during the winter months. This commonly results in subclinical and clinical pneumonia, which severely affects productive efficiency. Similarly, in young calves, which are raised indoors in most of the temperate zones of the world, protection from the cold during the winter is necessary. The effects of enzootic pneumonia of housed calves are much more severe when ventilation is inadequate than when the calves are comfortable and have clean, fresh air.

Evaluating the adequacy of the ventilation of a farm animal barn filled to economic capacity with animals is a difficult task and a major subject. Ventilation is assessed by a determination of the number of air changes per unit of time, the relative humidity during the day and night, the presence or absence of condensation on the hair coats of the animals or on the walls and ceilings, the presence of drafts, the building and insulation materials used, the positions and capacities of the fans, and the size and location of the air inlets. The measurement of the concentration of noxious gases in animal barns, such as ammonia and hydrogen sulfide, may be a valuable aid in assessing the effectiveness of a ventilation system.

Animals raised indoors are frequently overcrowded, which may predispose them to disease, and measurements of population density and observations of animal behavior in such conditions assume major importance. When pigs are raised indoors in crowded conditions with inadequate ventilation, their social habits may change drastically and they begin to defecate and urinate on the clean floor and on their penmates rather than over the slatted floor over the



gutter. This can result in outbreaks of diseases that are transmitted by the fecal–oral route.

### Flooring

The quality of the floor is often responsible for diseases of the musculoskeletal system and skin. Poorly finished concrete floors with an exposed aggregate can cause severe foot lesions and lameness in adult swine. Recently calved dairy cows are very susceptible to slipping on poor floors in dairy barns, which is a common cause of downer cow syndrome. Loose-housing systems, particularly those with slatted floors, have resulted in a new spectrum of diseases of the feet of cattle because of the sharp edges of some of the slats. The quality and quantity of bedding used should be noted. Bedding is now rarely used in intensified swine operations. The use of sawdust or shavings in loose-housing systems for dairy cattle may be associated with outbreaks of coliform mastitis. Wet bedding, particularly during the winter months, is commonly associated with endemic pneumonia in calves.

### Floor Plan

The floor plan and general layout of an animal house must be examined for evidence that the routine movements of animal attendants, the movements of animals, and feeding facilities may actually be spreading disease. Communal gutters running through adjacent pens may promote the spread of disease through fecal or urinary contamination. The nature of the partitions between pens, whether a solid or open-grid type, may assist the control or spread of infectious disease. The building materials used will influence the ease with which pens, such as farrowing crates and calf pens, can be cleaned and disinfected for a new batch of piglets or calves.

### Lighting

The amount of light available in a barn should be noted. With insufficient light it may be difficult to maintain a sufficient level of sanitation and hygiene, sick animals may not be recognized early enough, and errors in management are likely to occur.

When investigating a herd problem of mastitis in dairy cattle the veterinarian should visit the farm at milking time and observe how the cows are prepared for milking, examine the teats and udders before and after they are washed, observe the use of the milking machine, and rate the level of sanitation and hygiene practiced. Several successive visits may be necessary to reveal possible weaknesses in a mastitis control program.

## EXAMINATION OF THE ANIMAL

Clinical examination is a key component in any diagnostic process. More is missed by

not looking than by not knowing, and care should be taken to ensure that clinical examinations are appropriate for the task at hand. Clinical examinations aid in the identification of abnormalities in form and function of the animal, provide invaluable information regarding the cause of the disease, help to define the severity of the disease, and aid in monitoring the progression of the disease. Increasingly the utility of abnormalities detected on clinical examination is improving. For instance, determining the severity of the clinical abnormality and not just its presence or absence is useful in establishing a prognosis. A simplistic example of this is equine colic, in which the heart rate of affected horses is directly correlated with the likelihood of death. More sophisticated examples include objective assessment of the severity of the neurologic grade made with knowledge of the interobserver agreement about severity and use of the FAMACHA (FAffa MALan CHArt) scoring system for anemia in small ruminants. To be useful, these signs of clinical abnormality have to be repeatable both within and between observers and must have a demonstrated relationship with either the likelihood of diagnosis or outcome of the disease.

A complete clinical examination of an animal includes, in addition to history taking and examination of the environment, physical and laboratory examinations. A complete clinical examination of every animal is unnecessary because of the simplicity of some diseases and, as with history taking, a more targeted approach is favored by experienced clinicians. However, a general clinical examination of every animal is necessary, and the inexperienced clinician should spend as much time and effort as is practicable and economical in carrying it out. This will help to avoid the sort of embarrassing error in which a calf is operated on for umbilical hernia when it also has a congenital cardiac defect.

As **learned** experience develops, the clinician will know the extent to which a clinical examination is necessary. All the laboratory tests that are likely to be informative and that are practical and economical should be used. Because of the cost of laboratory tests, the clinician must be selective in the tests used. The most economical method is to examine the animal and then select those laboratory tests that will support or refute the tentative clinical diagnosis. In this section a system for the examination of an animal is outlined in a general way. There is a great deal of difference between species in the ease with which this examination is done and the amount of information that can be collected. Additional detailed examination techniques are described under the individual body systems.

The examination of an animal consists of a **general inspection** done from a distance (the **distant examination**, and the particular

**distant examination of body regions**) followed by a **close physical examination** of all body regions and systems. Only the major body systems that are routinely examined are presented here as part of the general examination.

### GENERAL INSPECTION (DISTANT EXAMINATION)

The importance of a distant examination of the animal cannot be overemphasized, and yet it is often overlooked. Apart from the general impression gained from observation at a distance, there are some signs that can best be assessed before the animal is disturbed. The proximity of the examiner is particularly disturbing to animals unaccustomed to frequent handling.

#### Behavior and General Appearance

The general impression of the health of an animal obtained by an examination from a distance should be assessed according to the following sections.

#### Behavior

Separation of an animal from its group is often an indication of illness. The behavior is also a reflection of the animal's health. If it responds normally to external stimuli, such as sound and movement, it is classified as **bright**. If the reactions are sluggish and the animal exhibits relative indifference to normal stimuli, it is said to be **dull** or **apathetic**. Cattle with carbohydrate engorgement are commonly reluctant to move unless coaxed. A pronounced state of indifference in which the animal remains standing and is able to move but does not respond at all to external stimuli is the **dummy syndrome**. This occurs in subacute lead poisoning, listeriosis, and some cases of acetonemia in cattle, and in encephalomyelitis and hepatic cirrhosis in horses. The terminal stage of apathy or depression is **coma**, in which the animal is unconscious and cannot be roused.

#### Excitation States

Excitation states vary in severity. A state of anxiety or apprehension is the mildest form: here the animal is alert and looks about constantly but is normal in its movements. Such behavior is usually expressive of moderate constant pain or other abnormal sensation, as in early parturient paresis or in recent blindness. A more severe manifestation is restlessness, in which the animal moves about a good deal, lies down and gets up, and may go through other abnormal movements such as looking at its flanks, kicking at its belly, and rolling and bellowing. Again, this demeanor is usually indicative of pain.

More extreme degrees of excited demeanor include **mania** and **frenzy**. In mania, the animal performs abnormal movements with vigor: violently licking at its own body, licking or chewing inanimate objects, and pressing forward with the head

are typical examples. In frenzy the actions are so wild and uncontrolled that the animals are a danger to anyone approaching them. In both mania and frenzy there is usually excitation of the brain, as in rabies, acute lead poisoning, and some cases of nervous acetoneemia.

### Voice

Abnormality of the voice should be noted. It may be hoarse in rabies or weak in gut edema; there may be continuous lowing in nervous acetoneemia or persistent bellowing indicative of acute pain. Soundless bellowing and **yawning** are commonly seen in rabid cattle, and yawning is a common sign in animals affected with hepatic insufficiency.

### Eating

The appetite of the animal can be assessed by observing its reaction to the offering of feed or by the amount of feed available that has not been eaten. It is important to determine the total amount of feed that the animal is eating per day. In an animal that has retained its appetite, there may be abnormality of **prehension**, **mastication**, or **swallowing** and, in ruminants, of belching and regurgitation.

Prehension may be interfered with by inability to approach feed, paralysis of the tongue in cattle, in cerebellar ataxia, and osteomyelitis of cervical vertebrae and other painful conditions of the neck. When there is pain in the mouth prehension may be abnormal, and affected animals may be able to take only certain types of feed. Mastication may be slow, one-sided, or incomplete when mouth structures, particularly teeth, are affected. Periodic cessation of chewing when feed is still in the mouth is common in the dummy syndrome, when there are space-occupying lesions of the cranium, or an encephalomyelitis exists.

Swallowing can be painful because of inflammation of the pharynx or esophagus, as is found in strangles in the horse, in calf diphtheria, and where improper use of bailing and drenching guns or bottles has caused laceration of the pharyngeal mucosa. Attempts at swallowing followed by coughing up of feed or regurgitation through the nostrils can also be the result of painful conditions but are most likely caused by physical obstructions such as esophageal diverticula or stenosis, a foreign body in the pharynx, or paralysis of the pharynx. It is important to differentiate between material that has reached the stomach and ingesta regurgitated from an esophageal site. Partial esophageal obstruction resulting in difficult swallowing is usually manifested by repeated swallowing movements often with associated flexion of the neck and grunting.

In ruminants there may be abnormalities of **ruminantion** and **eructation**. Absence of cudging occurs in many diseases of cattle and sheep; violent efforts at regurgitation with grunting suggests esophageal or cardiac

obstruction. There may be inability to control the cud (cud-dropping) caused by pharyngeal paralysis or painful conditions of the mouth. Failure to eructate is usually manifested by the appearance of bloat.

### Defecation

In constipation and rectal paralysis or stenosis, the act of defecation may be difficult and be accompanied by straining or tenesmus. When there is abdominal pain or laceration of the mucocutaneous junction at the anus, defecation may cause obvious pain. Involuntary defecation occurs in severe diarrhea and when there is paralysis of the anal sphincter. Consideration of frequency, volume, and character of feces is given later. Constipation must not be mistaken for scant feces, particularly in mature cattle with diseases of the forestomachs and failure of movement of ingesta in a caudad direction.

### Urination

This may be difficult when there is partial obstruction of the urinary tract and painful when there is inflammation of the bladder or urethra. In cystitis and urethritis there is increased frequency with the passage of small amounts of fluid, and the animal remains in the urination posture for some time after the flow ceases. Incontinence, with constant dribbling of urine, is usually caused by partial obstruction of the urethra or paralysis of its sphincter. If the animal urinates during the visual inspection, a sample of urine should be obtained, examined grossly, and submitted for urinalysis.

### Posture

Abnormal posture is not necessarily indicative of disease, but when associated with other signs it may indicate the site and severity of a disease process. One of the simplest examples is resting of a limb in painful conditions of the extremities; if a horse continually shifts its weight from limb to limb it may indicate the presence of laminitis or early osteodystrophia fibrosa. Arching of the back with the limbs tucked under the body usually indicates mild abdominal pain; downward arching of the back and *saw horse* straddling of the legs is characteristic of severe abdominal pain, usually spasmodic in occurrence; and a *dog-sitting* posture in the horse associated with rolling and kicking at the belly is usually associated with abdominal pain and pressure on the diaphragm, such as occurs in acute gastric dilatation after engorgement on grain. This posture is commonly adopted by normal cattle but will occur in painful conditions of the pelvic limbs such as degenerative osteoarthritis in young cattle. Abduction of the elbows is usually synonymous with chest pain or difficulty in breathing. Elevation and rigidity of the tail and rigidity of the ears and limbs are good indications of tetanus in animals. The carriage of the tail in pigs is a useful barometer of their state of health.

Sheep that are blind, as in early pregnancy toxemia, are immobile but stand with the head up and have an expression of extreme alertness.

When the animal is recumbent there also may be abnormalities of posture. In cattle affected by dislocation of the hip or by sciatic nerve paralysis, the affected limb is not held flexed next to the abdomen but sticks straight out in an awkward position; unilateral pain in the chest may cause an animal to lie habitually on the other side; and a weak hindleg may be kept under the animal. The head may be carried around toward the flank in parturient paresis in cows and in horses with colic. Sheep affected with hypocalcemia and cattle with bilateral hip dislocation often lie in sternal recumbency with the hindlegs extended behind in a froglike attitude. Inability or lack of desire to rise are usually indicative of muscle weakness or of pain in the extremities such as in enzootic muscular dystrophy or laminitis.

### Gait

Movements of the limbs can be expressed in terms of rate, range, force, and direction of movement. Abnormalities may occur in one or more of these categories. For example, in true cerebellar ataxia all qualities of limb movement are affected. In louping-ill in sheep it is the range and force of movement that are excessive, resulting in a high-stepping gait and a bounding form of progression; in arthritis, because of pain in the joints, or in laminitis, because of pain in the feet, the range is diminished and the animal has a shuffling, stumbling walk. The direction of progress may be affected. Walking in circles is a common abnormality and is usually associated with rotation or deviation of the head; it may be a permanent state as in listeriosis or occur spasmodically as in acetoneemia and pregnancy toxemia. Compulsive walking or walking directly ahead regardless of obstructions is part of the dummy syndrome mentioned earlier and is characteristic of encephalomyelitis and hepatic insufficiency in the horse.

### Body Condition

The animal may be in normal bodily condition, or obese, thin, or emaciated. The difference between thinness and emaciation is one of degree: the latter is more severe but there are additional signs that are usually taken into consideration. In an emaciated (cachectic) animal the coat is poor, the skin is dry and leathery, and work performance is reduced. Thin animals, on the other hand, are physiologically normal. The difference between fatness and obesity is of the same order. Most beef cattle prepared for the show ring are obese. To inject some degree of numerical assessment it is now customary in all farm animal species and in horses to use body condition on a scale of 1 to 5 or preferably 1 to 10.



## Body Conformation

The assessment of conformation or shape is based on the symmetry and the shape and size of the different body regions relative to other regions. An abdomen that is very large relative to the chest and hindquarters can be classified as an abnormality of conformation. To avoid repetition, points of conformation are included in the description of body regions.

## Skin

Skin abnormalities can usually be seen at a distance. They include changes in the hair or wool, abnormal sweating, the presence of discrete or diffuse lesions, and evidence of soiling by discharges and of itching. The normal luster of the coat may be absent. It may be dry as in most chronic debilitating diseases or excessively greasy as in seborrheic dermatitis. In debilitated animals the long winter coat may be retained past the normal time. Alopecia may be evident: in hyperkeratosis it is diffuse, and in ringworm it may be diffuse but more commonly occurs in discrete areas. Sweating may be diminished, as in anhidrosis of horses; patchy as in peripheral nerve lesions; or excessive as in acute abdominal pain. Hypertrophy and folding of the skin may be evident, and hyperkeratosis is the typical example. Discrete skin lesions range in type from urticarial plaques to the circumscribed scabs of ringworm, pox, and impetigo. Diffuse lesions include the obvious enlargements caused by subcutaneous edema, hemorrhage, and emphysema. Enlargements of lymph nodes and lymphatics are also evident when examining an animal from a distance.

## INSPECTION OF BODY REGIONS (PARTICULAR DISTANT EXAMINATION)

As a general rule, as much of a clinical examination as possible should be performed before the animal is handled. This is partly to avoid unnecessary excitement of the animal but also because some abnormalities are better seen at a distance and in some cases cannot be discerned at close range. The general appearance of the animal should be noted and its behavior assessed. Some time should also be devoted to an inspection of the various body regions, which is a particular distant examination.

## Head

The facial expression may be abnormal. The rigidity of tetanus, the cunning leer or manic expression of rabies, and acute lead poisoning are cases in point. The symmetry and configuration of the bony structure should be examined. Doming of the forehead occurs in some cases of congenital hydrocephalus and in chondrodysplastic dwarfs, and in the latter there may be bilateral enlargement of the maxillae. Swelling of the maxillae and mandibles occurs in osteodystrophia fibrosa;

in horses swelling of the facial bones is usually caused by frontal sinusitis; in cattle enlargement of the maxilla or mandible is common in actinomycosis. Asymmetry of the soft structures may be evident and is most obvious in the carriage of the ears, degree of closure of the eyelids, and situation of the muzzle and lower lip. Slackness of one side and drawing to the other are constant features in facial paralysis. Tetanus is accompanied by rigidity of the ears, prolapse of the third eyelid, and dilatation of the nostrils.

The carriage of the head is most important. Rotation is usually associated with defects of the vestibular apparatus on one side and deviation with unilateral involvement of the medulla and cervical cord. Opisthotonus is an excitation phenomenon associated with tetanus, strychnine poisoning, acute lead poisoning, hypomagnesemic tetany, polioencephalomalacia, and encephalitis.

The eyes merit attention. Visible discharge should be noted. Protrusion of the eyeball, as occurs in orbital lymphomatosis, and retraction of the bulb, as occurs commonly in dehydration, are important findings; spasm of the eyelids and excessive blinking usually indicate pain or peripheral nerve involvement; and prolapse of the nictitating membrane usually characterizes central nervous system derangement, generally tetanus.

Dilatation of the nostrils and nasal discharge suggest the advisability of closer examination of the nasal cavities at a later stage. Excessive salivation or frothing at the mouth denotes painful conditions of the mouth or pharynx or is associated with tremor of the jaw muscles caused by nervous involvement. Swellings below the jaw may be inflammatory, as in actinobacillosis and strangles, or edematous, as in acute hypoproteinemia, protein starvation, or congestive heart failure. Unilateral or bilateral swelling of the cheeks in calves usually indicates necrotic stomatitis.

## Neck

If there is enlargement of the throat this region should be more closely examined later to determine whether the cause is inflammatory and whether lymph nodes, salivary glands (or guttural pouches in the horse), or other soft tissues are involved. Goiter leads to local enlargement located further down the neck. A jugular pulse, jugular vein engorgement, and edema should be looked for, and local enlargement caused by esophageal distension should be noted.

## Thorax

Respiration should be examined from a distance, preferably with the animal in a standing position, because recumbency is likely to modify it considerably. Allowance should be made for the effects of exercise, excitement, high environmental temperatures, and fatness of the subject: obese cattle may have

respiratory rates two to three times that of normal animals. The rate, rhythm, depth, and type of respiration should be noted.

## Respiratory Rate

In normal animals under average conditions the rate should fall within the following limits:

- Horses, 8 to 16 per minute
- Cattle, 10 to 30 per minute
- Sheep and pigs, 10 to 20 per minute
- Goats, 25 to 35 per minute

An increased respiratory rate is designated as polypnea, decreased rate as oligopnea, and complete cessation as apnea. The rate may be counted by observation of rib or nostril movements, by feeling the nasal air movements, or by auscultation of the thorax or trachea. A significant rise in environmental temperature or humidity may double the normal respiratory rate. Animals acclimated to cold outdoor temperatures are susceptible to heat stress when exposed suddenly to warmer temperatures. When brought indoors the respiratory rate may increase to six or eight times the normal, and panting open-mouth breathing may be evident within 2 hours.

## Respiratory Rhythm

The normal respiratory cycle consists of three phases of equal length: inspiration, expiration, and pause. Variation in the length of one or all phases constitutes an abnormality of rhythm. The breathing pattern of the neonatal foal is markedly different from that of the adult horse and similar to that of other neonates. It has a higher respiratory rate, a higher airflow rate, and a higher minute ventilation on a body weight basis. In addition, in the standing neonatal foal, both the inspiratory and expiratory airflow patterns are essentially monophasic, whereas the adult horse typically has a biphasic inspiratory and expiratory airflow pattern. The transition from monophasic to biphasic flow patterns occurs within the first year of life.

## Prolongation of Phases

Prolongation of inspiration is usually caused by obstruction of the upper respiratory tract; prolongation of expiration is often caused by failure of normal lung collapse, as in emphysema. In most diseases of the lungs there is no pause and the rhythm consists of two beats instead of three. There may be variation between cycles: Cheyne–Stokes respiration is a gradual increase and then a gradual decrease in the depth of respiration, and Biot's breathing, which occurs in meningitis affecting the medullary region, is characterized by alternating periods of hyperpnea and apnea, and the periods often are of unequal length. Periodic breathing also occurs commonly in animals with electrolyte and acid-base imbalances. There are periods of apnea followed by short bursts of hyperventilation.

## Respiratory Depth

The amplitude or depth of respiratory movements may be reduced in painful conditions of the chest or diaphragm and increased in any form of anoxia. Moderate increase in depth is referred to as hyperpnea and labored breathing as dyspnea. In dyspnea, the accessory respiratory movements become more prominent. There is extension of the head and neck, dilatation of the nostrils, abduction of the elbows, and breathing through the mouth plus increased movement of the thoracic and abdominal walls. Loud respiratory sounds, especially grunting, may also be heard.

## Type of Respiration

In normal respiration there is movement of the thorax and abdomen. In painful conditions of the thorax, e.g., acute pleurisy, and in paralysis of the intercostal muscles, there is relative fixation of the thoracic wall and a marked increase in the movements of the abdominal wall. There also may be an associated pleuritic ridge caused by thoracic immobility with the thorax expanded. This syndrome is usually referred to as an abdominal-type respiration. The reverse situation is thoracic-type respiration, in which the movements are largely confined to the thoracic wall, as in peritonitis, particularly when there is diaphragmatic involvement.

## Thorax Symmetry

This can also be evaluated by inspection. Collapse or consolidation of one lung may lead to restriction of movements of the thoracic wall on the affected side. The *rachitic rosary* of enlarged costochondral junctions is typical of rickets.

## Respiratory Noises or Stridors

These include the following:

- Coughing caused by irritation of the pharynx, trachea, and bronchi
- Sneezing caused by nasal irritation
- Wheezing caused by stenosis of the nasal passages
- Snoring when there is pharyngeal obstruction, as in tuberculous adenitis of the pharyngeal lymph nodes
- Roaring in paralysis of the vocal cords
- Grunting is a forced expiration against a closed glottis, which happens in many types of painful and labored breathing

An important part of the clinical examination of a horse that produces an externally audible noise, usually a grunt, while working is to determine when the noise occurs in the respiratory cycle. This can be related to limb movement, such as expiration occurring as the leading foot hits the ground at the canter or gallop. Flexion of the head by the rider will exacerbate the noise.

## Abdomen

Variations in abdominal size are usually appreciated during the general inspection of

the animal. An increase in size may be caused by the presence of excessive feed, fluid, feces, flatus, or fat and the presence of a fetus or a neoplasm. Further differentiation is usually possible only on close examination. In advanced pregnancy, fetal movements may be visible over the right flank of cattle. In severe distension of the intestines with gas, the loops of intestine may be visible in the flank, especially in calves. Intestinal tympany usually results in uniform distension of the abdomen, whereas fluid tends to result in increased distension ventrally.

The term *gaunt* is used to describe an obvious decrease in the size of the abdomen. It occurs most commonly in starvation, in severe diarrhea, and in many chronic diseases in which appetite is reduced. An umbilical hernia, omphalophlebitis, or dribbling of urine from a previous urachus may be apparent on visual inspection of the ventral abdominal wall. Ventral edema is commonly associated with approaching parturition, gangrenous mastitis, congestive heart failure, infectious equine anemia, and rupture of the urethra caused by obstructive urolithiasis. A grossly enlarged asymmetric swelling of the flank may suggest herniation of the abdominal wall. Ruminal movements can be seen in the left paralumbar fossa and flank of cattle, but a complete examination of the rumen requires auscultation, palpation, and percussion, which are described later.

## External Genitalia

Gross enlargements of the preputial sheath or scrotum are usually inflammatory in origin, but varicocele or tumors can also be responsible. Degenerative changes in the testicles may result in a small scrotum. Discharges of pus and blood from the vagina indicate infection of the genitourinary tract.

## Mammary Glands

A disproportionate size of the udder suggests acute inflammation, atrophy, or hypertrophy of the gland. These conditions can be differentiated only by further palpation and examination of the milk or secretions.

## Limbs

General abnormalities of posture and gait have been described. Symmetry is important, and comparison of the various aspects of pairs of limbs should be used when there is doubt about the significance of an apparent abnormality. Enlargement or distortion of bones, joints, tendons, sheaths, and bursae should be noted as well as any enlargement of peripheral lymph nodes and lymphatic vessels.

## CLOSE PHYSICAL EXAMINATION

Some of the techniques used in making a close physical examination are set out in the following sections.

## Palpation

Direct palpation with the fingers or indirect palpation with a probe is aimed at determining the size, consistency, temperature, and sensitivity of a lesion or organ. Terms used to describe palpation findings include the following:

- **Doughy:** When the structure pits on pressure, as in edema
- **Firm:** When the structure has the consistency of normal liver
- **Hard:** When the consistency is bonelike
- **Fluctuating:** When the structure is soft, elastic, and undulates on pressure but does not retain the imprint of the fingers
- **Tense:** When the structure feels like a viscus distended with gas or fluid under some considerable pressure
- **Emphysematous:** When the structure is puffy and swollen and moves and crackles under pressure because of the presence of gas in the tissue

## Percussion

In percussion, the body surface is struck to set deep parts in vibration and cause them to emit audible sounds. The sounds vary with the density of the parts set in vibration and may be classified as follows:

- **Resonant:** The sound emitted by organs containing air, e.g., normal lung
- **Tympanitic:** A drumlike note emitted by an organ containing gas under pressure such as a tympanitic rumen or cecum
- **Dull:** The sound emitted by solid organs such as heart and liver

Percussion can be performed with the fingers using one hand as a plexor and one as a pleximeter. In large animals a pleximeter hammer on a pleximeter disk is recommended for consistency.

The quality of the sound elicited is governed by a number of factors. The strength of the percussion blow must be kept constant because the sound volume increases with stronger percussion. Allowances must be made for the thickness and consistency of overlying tissues; for example, the thinner the thoracic wall, the more resonant is the lung. Percussion on a rib must not be compared with percussion on an intercostal space. The size and body condition score of the animal are also important considerations. The technique may be relatively ineffective in a fat animal. Pigs and sheep are of a suitable size, but the fatness of the pig and the wool coat of the sheep plus the uncooperative nature of both species make percussion impracticable. In mature cattle and horses the abdominal organs are too large and the overlying tissue too thick for satisfactory outlining of organs or abnormal areas, unless the observer is highly skilled. The lungs of cattle and horses can be satisfactorily examined by percussion, but this requires practice and experience to become skillful and accurate.

Percussion is a valuable aid in the diagnosis of diseases of the lungs and abdominal viscera of all large animals. Increased dullness over the thorax indicates consolidation of the lung, a pleural effusion, or space-occupying lesion such as tumor or abscess. Increased resonance over the thorax suggests emphysema or pneumothorax.

### Ballottement

Ballottement is a technique used to detect floating viscera or masses in the abdominal cavity. Using the extended fingers or the clenched fist the abdominal wall is palpated vigorously with a firm push to move the organ or mass away and then allow it to rebound on to the fingertips. Ballottement of a fetus is a typical example; the fetal prominences can be easily felt by pushing the gravid uterus through the abdominal wall over the right flank in pregnant cattle. Impaction of the abomasum, large tumors, and abscesses of the abdominal cavity may also be detected by ballottement. Ballottement and auscultation of the flanks of cattle is also useful to detect fluid-splashing sounds. Their presence on the left side suggests carbohydrate engorgement and excessive quantities of fluid in the rumen or left-side displacement of the abomasum. Over the right flank, fluid-splashing sounds may indicate intestinal obstruction, abomasal volvulus, cecal dilatation and torsion, and paralytic ileus.

Ballottement and auscultation of the abdomen of the horse with colic may elicit fluid-splashing sounds indicative of intestines filled with fluid, as in intestinal obstruction or paralytic ileus. A modification of the method is tactile percussion, when a cavity containing fluid is percussed sharply on one side and the fluid wave thus set up is palpated on the other. The sensation created by the fluid wave is called a fluid thrill. It is felt most acutely by the palm of the hand at the base of the fingers. Diseases that cause ascites and accumulation of fluid in the peritoneal cavity are examples in which this technique is useful.

### Auscultation

Direct listening to the sounds produced by organ movement is performed by placing the ear to the body surface over the organ. Indirect auscultation by a stethoscope is the preferred technique. A considerable amount of work has been done to determine the most effective stethoscopic equipment, including investigation of such things as the shape and proportions of bell chest pieces, the thickness of rubber tubes, and the diameter and depth of phonendoscope chest pieces. A comparatively expensive unit from a reputable instrument firm is a wise investment. For large animal work, a stethoscope with interchangeable 5-cm diameter phonendoscope and rubber (to reduce hair friction sounds) bell chest pieces is all that is required. The details of the sounds heard on

auscultations of the various organs are described in their respective sections. Auscultation is used routinely to assess heart, lung, and gastrointestinal sounds.

### Percussion and Simultaneous Auscultation of the Abdomen

Percussion and simultaneous auscultation of the left and right sides of the abdomen is a useful technique for examination of the abdomen of large animals. The stethoscope is placed over the area to be examined, and the areas around the stethoscope and radiating out from it are percussed. This is a valuable diagnostic aid for the detection and localization of a gas-filled viscus in the abdomen of cattle with left-side displacement of the abomasum, right-side dilatation and volvulus of the abomasum, cecal dilatation and torsion, intestinal tympany associated with acute obstruction or paralytic ileus, or pneumoperitoneum.

Simultaneous percussion and auscultation of the abdomen of the horse with colic is useful to detect pings indicative of intestinal tympany associated with intestinal obstruction or paralytic ileus. In diaphragmatic hernia the presence of gas-filled intestines in the thorax may be determined by this method. To elicit the diagnostic ping, it is necessary to percuss and auscultate side by side and to percuss with a quick, sharp, light, and localized force. The obvious method is a quick tap with a percussion hammer or similar object. Another favored method is a flick with the back of a forefinger suddenly released from behind the thumb. A gas-filled viscus gives a characteristic clear, sharp, high-pitched ping, which is distinctly different from the full, low-pitched note of solid or fluid-filled viscera. The difference between the two is so dramatic that it is comparatively easy to define the borders of the gas-filled viscus.

The factors that determine whether a ping will be audible are the force of the percussion and the size of the gas-filled viscus and its proximity to the abdominal wall. The musical quality of the ping is dependent on the thickness of the wall of the viscus (e.g., rumen, abomasum, small or large intestines) and the amount and nature of the fluid and gas in the intestines or viscus.

### Succussion

This technique, which involves moving the body from side to side to detect the presence of fluid, is an adaptation of the previously mentioned method. By careful auscultation while the body is moved, free fluid in the intestines or stomach will result in fluid-splashing or tinkling sounds.

### Other Techniques

Special physical techniques including biopsy and paracentesis are described under special examination of the various systems to which they apply. With suitable equipment and

technique, one of the most valuable adjuncts to a physical examination is a radiographic examination. The size, location, and shape of soft tissue organs are often demonstrable in animals of up to moderate size. Radiology, other than of limbs and neonates, is not commonly practiced in larger animals. Ultrasound appears to have much more general application but is beyond the scope of this book.

### SEQUENCE USED IN THE CLOSE PHYSICAL EXAMINATION

The close physical examination should be performed as quietly and gently as possible to avoid disturbing the animal and increasing the resting heart and respiratory rates. At a later stage it may be necessary to examine certain body systems after exercise, but resting measurements should be performed first. If possible the animal should be standing, as recumbency is likely to cause variation in heart and pulse rates, respiration, and other functions.

The sequence used in the close physical examination will vary with the species being examined, the results of the distant examinations, the history obtained, and the diagnostic hypotheses that the clinician has generated. The various parts of the close physical examination that are described here can be modified according to individual circumstances, but it is important to do a thorough clinical examination based on the circumstances.

Following the distant examination, and the particular distant examination, it is recommended that the vital signs are determined before the animal is handled for examination of body regions such as the oral cavity.

Generally, an appropriate sequence for the close physical examination would be as follows:

- Vital signs: Temperature, heart and pulse rates, respirations, and state of hydration
- Thorax: Heart sounds (rate, rhythm, and intensity) and lung sounds
- Abdomen: Nasogastric intubation
- Head and neck: Including eyes, oral cavity, facial structures, and the jugular veins
- Rectal examination
- Urinary tract
- Reproductive tract
- Mammary gland
- Musculoskeletal system
- Nervous system
- Skin: Including ears, hooves, and horns

The important principle is to determine the vital signs before handling and examining other body systems, which may distort the vital signs. The sequence that follows taking the vital signs can vary, based on individual circumstances; the urgency of the case, if any; and the ease of doing the particular examinations. For example, it may be very

**Table 1-1** Normal average temperatures with critical points

Species	Normal temperature	Critical point
Horse	38.0°C (100.5°F)	39.0°C (102.0°F)
Cattle	38.5°C (101.5°F)	39.5°C (103.0°F)
Pig	39.0°C (102.0°F)	40.0°C (103.5°F)
Sheep	39.0°C (102.0°F)	40.0°C (104.0°F)
Goat	39.5°C (103.0°F)	40.5°C (105.0°F)

*Temperature conversions are approximate.*

important to pass a nasogastric tube as one of the first diagnostic techniques in a horse with severe colic associated with gastric distension. When presented with a lactating dairy cow with peracute mastitis, the sequence will be recording the temperature, heart rate and sounds, respirations and status of the lungs, and status of the rumen, followed by careful examination of the mammary gland. The close physical examination of each body region or body systems is outlined in the following sections.

### Vital Signs Temperature

Normally the temperature is taken per rectum. When this is impossible the thermometer should be inserted into the vagina. Ensure that the mercury column is shaken down, moisten the bulb to facilitate entry and, if the anus is flaccid or the rectum full of hard feces, insert a finger also to ensure that the thermometer bulb is held against the mucosa. When the temperature is read immediately after defecation, or if the thermometer is stuck into a ball of feces or is left in the rectum for insufficient time, a false, low reading will result.

As a general rule the thermometer should be left in place for 2 minutes. If there is doubt as to the accuracy of the reading, the temperature should be taken again. The normal average temperature range for the various species at average environmental temperature is shown in [Table 1-1](#).

The reference values in [Table 1-1](#) indicate the average resting temperature for the species and the critical temperature above which hyperthermia can be said to be present. Normal physiologic variations occur in body temperature and are not an indication of disease: a diurnal variation of up to 1°C (2°F) may occur, with the low point in the morning and the peak in the late afternoon. There may be a mild rise of about 0.6°C (1°F) in late pregnancy, but a precipitate, although insignificant, decline just before calving is not uncommon in cows and ewes and lower temperatures than normal occur just before estrus and at ovulation. The degree of change [about 0.3°C (0.6°F)] is unlikely to attract clinical attention.

In sows the body temperature is subnormal before farrowing, and there is a significant rise in body temperature coinciding with parturition. This rise is commonly high enough to exceed the critical temperature of 40°C and may be considered erroneously as evidence of disease. The elevation of temperature that occurs in sows at the time of parturition, of the order of 1°C, is maintained through lactation and disappears at weaning.

High environmental humidity and temperature and exercise will cause elevation of the temperature. The deviation may be as much as 1.6°C (3.0°F) in the case of high environmental temperatures and as much as 2.5 to 3°C (4.5°F) after severe exercise. In horses, after racing, 2 hours may be required before the temperature returns to normal.

If animals that have been acclimatized to cold outside temperatures are brought indoors to a warmer temperature their body temperatures may exceed the critical temperature within 2 to 4 hours. Marked temperature variations are an indication of a pathologic process:

- **Hyperthermia** is the simple elevation of the temperature past the critical point, as in heat stroke
- **Fever or pyrexia** is the state in which hyperthermia is combined with toxemia, as in most infectious diseases
- **Hypothermia**, a subnormal body temperature, occurs in shock, circulatory collapse (as in parturient paresis and acute rumen impaction of cattle), hypothyroidism, and just before death in most diseases.

### Pulse

The pulse should be taken at the middle coccygeal or facial arteries in cattle, the facial artery in the horse, and the femoral artery in sheep and goats. With careful palpation a number of characters may be determined, including rate, rhythm, amplitude, tone, maximum and minimum pulse pressures, and the form of the arterial pulse. Some of these characters are more properly included in special examination of the circulatory system and are dealt with under that heading.

### Rate

The pulse rate is dependent on the heart alone and is not directly affected by changes in the peripheral vascular system. The pulse rate may or may not represent the heart rate; in cases with a pulse deficit, in which some heartbeats do not produce a pulse wave, the rates will differ. Normal resting rates (per minute) for the various species are shown in [Table 1-2](#).

Although there are significant differences in rates between breeds of dairy cow and between high- and low-producing cows, the differences would not be noticeable to a clinician performing a routine examination. In newborn thoroughbred foals the pulse rate is

**Table 1-2** Resting pulse rates

Species	Pulse rate per minute
Adult horses	30–40
Foals up to 1 year	70–80
Adult cattle	60–80
Young calves	100–120
Sheep and goats	70–90

30 to 90 beats per minute in the first 5 minutes, then 60 to 200 during the first hour, and then 70 to 130 during the first 48 hours after birth. Draught horses have heart rates slightly higher than those quoted, which are based on a light horse population. The pulse is not readily palpable in the pig but the comparable heart rate is 60 to 100 per minute. The same techniques are used in intensive clinical examinations for horses afflicted with poor performance syndrome.

**Bradycardia**, or marked slowing of the heartbeat, is unusual unless there is partial or complete heart block, but it does occur in cases of space-occupying lesions of the cranium, in cases of diaphragmatic adhesions after traumatic reticulitis in cattle, or when the rumen is much emptier than normal.

**Tachycardia**, or increased pulse rate, is common and occurs in most cases of septicemia, toxemia, circulatory failure, and in animals affected by pain and excitement. Counting should be performed over a period of at least 30 seconds.

### Rhythm

The rhythm may be regular or irregular. All irregularities must be considered as abnormal except sinus arrhythmia, the phasic irregularity coinciding with the respiratory cycle. There are two components of the rhythm, the time between peaks of pulse waves and the amplitude of the waves. These are usually both irregular at one time with variations in diastolic filling of the heart causing variation in the subsequent stroke volume. Regular irregularities occur with constant periodicity and are usually associated with partial heart block. Irregular irregularities are caused by ventricular extrasystoles or atrial fibrillation. Most of these irregularities, except that caused by atrial fibrillation, disappear with exercise. Their significance lies chiefly in indicating the presence of myocardial disease.

### Amplitude

The amplitude of the pulse is determined by the amount of digital pressure required to obliterate the pulse wave. It is largely a measure of cardiac stroke volume and may be considerably increased, as in the *water hammer* pulse of aortic semilunar valve incompetence, or decreased, as in most cases of myocardial weakness.



## State of Hydration

The state of hydration is assessed by inspection of the eyes for evidence of dehydration and evaluating the elasticity of the skin. Dehydration is characterized by sunken eyes of varying degrees, and the skin will *tent* when lifted with the fingers and remain tented for varying lengths of time.

## EXAMINATION OF BODY REGIONS

After the examination of the temperature, pulse, and respirations the physical examination proceeds with an examination of the various body regions.

### Thorax

Examination of the thorax includes palpation, auscultation, and percussion of the cardiac area (precordium) and the lung area. The wide variations between species in the thickness of the thoracic wall, the size of the animal, and the respiratory rate require careful and methodical examination. For example, in the adult horse the thick thoracic wall and the normally slow respiratory rate contribute to an almost soundless respiration on auscultation of the thorax. There is also the need to detect minor pulmonary lesions, which may reduce the work performance of the horse only slightly but, because of the importance of perfect fitness in a racing animal, may have major significance. Another important factor that emphasizes the care that must be taken with the examination of the respiratory system of the horse is the ability of racing animals to compensate for even major pulmonary lesions from their immense functional reserve. Because of this, one is likely to encounter horses with massive pulmonary involvement with little obvious impairment of respiratory function.

### Cardiac Area

Auscultation of the heart is aimed at determining the character of normal heart sounds and detecting the presence of abnormal sounds. Optimum auscultation sites are the fourth and fifth intercostal spaces and, because of the heavy shoulder muscles that cover the anterior border of the heart, the use of a flat phonendoscope chest piece pushed under the triceps muscles is necessary. Extension of the forelimb may facilitate auscultation if the animal is quiet. Areas in which the various sounds are heard with maximum intensity are not directly over the anatomic sites of the cardiac orifices, because conduction of the sound through the fluid in the chamber gives optimum auscultation at the point where the fluid is closest to the chest wall.

The first (systolic) sound is heard best over the cardiac apex, and the tricuspid closure is most audible over the right apex and mitral closure over the left apex. The second (diastolic) sound is heard best over the base of the heart, the aortic semilunar

closure posteriorly, and the pulmonary semilunar anteriorly, both on the left side.

In auscultation of the heart, the points to be noted are the rate, rhythm, intensity, and quality of sounds and whether abnormal sounds are present. Comparison of the heart and pulse rates will determine whether there is a pulse deficit caused by weak heart contractions failing to cause palpable pulse waves; this is most likely to occur in irregular hearts. Normally the rhythm is in three time and can be described as

*LUBB – DUPP – pause,*

with the first sound being dull, deep, long, and loud and the second sound sharper and shorter. As the heart rate increases the cycle becomes shortened, mainly at the expense of diastole, and the rhythm assumes a two-time quality. More than two sounds per cycle is classified as a *gallop* rhythm and may be caused by reduplication of either the first or second sounds. Reduplication of the first sound is common in normal cattle, and its significance in other species is discussed in [Chapter 10](#).

The rhythm between successive cycles should be regular except in the normal sinus arrhythmia associated with respiration. With irregularity, there is usually variation in the time intervals between cycles and in the intensity of the sounds—louder sounds coming directly after prolonged pauses and being softer than normal sounds after shortened intervals, as in extrasystolic contractions. The intensity of the heart sounds may vary in two ways, absolutely or relatively: absolutely when the two sounds are louder than normal, and relatively when one sound is increased compared with the other in the cycle. For example, there is increased absolute intensity in anemia and in cardiac hypertrophy.

The intensity of the first sound depends on the force of ventricular contraction and is thus increased in ventricular hypertrophy and decreased in myocardial asthenia. The intensity of the second sound depends on the semilunar closure, i.e., on the arterial blood pressure, and is therefore increased when the blood pressure is high and decreased when the pressure is low.

Abnormal sounds may replace one or both of the normal sounds or may accompany them. The heart sounds are muffled when the pericardial sac is distended with fluid. Sounds that are related to events in the cardiac cycle are murmurs or bruits and are caused mainly by endocardial lesions such as valvular vegetations or adhesions and by insufficiency of closure of valves and by abnormal orifices such as a patent interventricular septum or ductus arteriosus. Interference with normal blood flow causes the development of turbulence with resultant eddying and the creation of murmurs. When attempting to determine the site and type of the lesion it is necessary to identify its time

of occurrence in the cardiac cycle: it may be presystolic, systolic, or diastolic, and it is usually necessary to palpate the arterial pulse and auscultate the heart simultaneously to determine accurately the time of occurrence. The site of maximum audibility may indicate the probable site of the lesion, but other observations, including abnormalities of the arterial pulse wave, should be taken into account. In many cases of advanced debility, anemia, and toxemia, soft murmurs can be heard that wax and wane with respiration (hemic murmurs) and are probably caused by myocardial asthenia. In cases of local pressure on the heart by other organs, for example, in diaphragmatic hernia in cattle, loud systolic murmurs may be heard and are probably caused by distortion of the valvular orifices.

Abnormal sounds not related to the cardiac cycle include pericardial friction rubs, which occur with each heart cycle but are not specifically related to either systolic or diastolic sounds. They are more superficial, more distinctly heard than murmurs, and have a to-and-fro character. Local pleuritic friction rubs may be confused with pericardial sounds, especially if respiratory and cardiac rates are equal.

Palpation of the heart beat has real value: the size of the cardiac impulses can be assessed and palpable thrills may on occasion be of more value than auscultation of murmurs. It is best performed with the palm of the hand and should be performed on both sides. An increased cardiac impulse, the movements of the heart against the chest wall during systole, may be easily seen on close inspection of the left precordium and can be felt on both sides. It may be caused by cardiac hypertrophy or dilatation associated with cardiac insufficiency or anemia or to distension of the pericardial sac with edema or inflammatory fluid. Care should be taken not to confuse a readily palpable cardiac impulse caused by cardiac enlargement with one caused by contraction of lung tissue and increased exposure of the heart to the chest wall.

Normally, the heart movements can be felt as distinct systolic and diastolic thumps. These thumps are replaced by thrills when valvular insufficiencies or stenoses or congenital defects are present. When the defects are large the murmur heard on auscultation may not be very loud, but the thrill is readily palpable. Early pericarditis may also produce a friction thrill. The cardiac impulse should be much stronger on the left than the right side and reversal of this situation indicates displacement of the heart to the right side. Caudal or anterior displacement can also occur.

Percussion to determine the boundaries of the heart is of little value in large animal work because of the relatively large size of the heart and lungs and the depth of tissue involved. The area of cardiac dullness is increased in cardiac hypertrophy and



dilatation and decreased when the heart is covered by more than the usual amount of lung, as in pulmonary emphysema. More detailed examination of the heart by electrocardiography, radiographic examination, test puncture, and blood pressure are described under diseases of the heart in [Chapter 10](#).

### Lung Area

**Auscultation, percussion, and palpation** are the major methods used for examination of the lungs.

The lung area available for satisfactory auscultation is slightly larger than that available for percussion. The normal breath sounds are heard over most of the lungs, particularly in the middle third anteriorly over the base of the lung, and consist of a soft, sipping VEE-EFF, the latter, softer sound occurring at expiration. The sounds are heard with variable ease depending on the thickness of the chest wall and the amplitude of the respiratory excursion. In well-fleshed horses and fat beef cattle the sounds may not be discernible at rest. The amplitude or loudness of the breath sounds is increased in dyspnea and in early pulmonary congestion and inflammation. The amplitude of the breath sounds is decreased or totally inaudible when there is pleural effusion and in space-occupying lesions in the lung or pleural cavity. Abnormal lung sounds include crackles, wheezes, and pleuritic friction rubs. They are the result of interference with the free movement of air in and out of the lungs, and of the presence of lesions that interfere with the normal movement of the lung creating additional respiratory sounds, which are an indication of disease. The descriptions and interpretations of the normal and abnormal lung sounds, and other respiratory noises, are described in [Chapter 12](#).

The intensity of abnormal lung sounds may be increased and their clarity improved by measuring the rate and depth of respirations with forced mild exercise such as walking for a few minutes followed by immediate auscultation. If exercise is undesirable the occlusion of both nostrils for 30 to 45 seconds will be followed by some deep inspirations and accentuation of abnormal lungs. An alternative maneuver, which is effective in both horses and cattle, is to pull a plastic bag over the muzzle and lower face. When respiratory movements become exaggerated the bag is removed and the lungs auscultated immediately.

Sounds of peristalsis are normally heard over the lung area on the left side in cattle and in horses. In cattle, these sounds are caused by reticular movement and in horses caused by movements of the colon. Their presence is not of much significance in these species unless there are other signs. Also in cattle the sounds of swallowing, eructation, and regurgitation may be confused with peristaltic sounds; ruminal movements and the esophagus should be observed for the

passage of gas or a bolus to identify these sounds. Other techniques for examination of the thorax are described in [Chapter 12](#).

Palpation of the thoracic wall may reveal the presence of a pleuritic thrill, bulging of the intercostal spaces when fluid is present in the thoracic cavity, or narrowed intercostal spaces and decreased rib movement over areas of collapsed lung.

Percussion may be done by the usual direct means or indirectly by tracheal percussion when the trachea is tapped gently and the sound is listened for over the lung area. By direct percussion within the intercostal spaces the area of normal lung resonance can be defined and abnormal dullness or resonance detected. Increased dullness may indicate the presence of a space-occupying mass, consolidated lung, edematous lung, or an accumulation of fluid. In a pleural effusion the upper limit of the area of dullness can be determined by percussion and the **fluid line** can be delineated and identified and used to assess the progress of therapy.

An overloud normal percussion note is obtained over tissue containing more air than usual, e.g., emphysematous lung. A definite tympanitic note can be elicited over pneumothorax or a gas-filled viscus penetrating through a diaphragmatic hernia. For percussion to be a satisfactory diagnostic aid, affected areas need to be large with maximum abnormality, and the chest wall must be thin.

### Abdomen

Clinical examination of the abdomen includes the following:

- **Visual inspection** of the abdominal contour for evidence of distension or gauntness
- **Auscultation** of the gastrointestinal sounds
- **Palpation** and **percussion** through the abdominal wall
- **Rectal palpation**
- **Passage of the nasogastric tube**
- **Paracentesis** of the abdomen

### Auscultation

Auscultation of the abdomen is an essential part of the clinical examination of cattle, horses, and sheep. It is of limited value in pigs. The intestinal or stomach sounds will indicate the nature of the intraluminal contents and the frequency and amplitude of gastrointestinal movements, which are valuable aids in clinical diagnosis. The intensity, duration, and frequency of the sounds should be noted. All these characteristics will be increased in animals that have just eaten or immediately following excitement.

### *Auscultation of the Rumen of Cattle and Sheep*

This is a very useful part of the clinical examination. In normal animals there are one to two primary contractions per minute involving the reticulum and the dorsal and ventral

sacs of the rumen; the frequency depends on the amount of time that has elapsed since feeding and the type of food consumed. Secondary contractions of the dorsal and ventral sacs of the rumen occur at about 1 per minute and are commonly associated with eructation. The examination is made in the left paralumbar fossa and a normal sequence of sounds consists of a lift of the flank with a fluid gurgling sound, followed by a second more pronounced lift accompanied by a booming, gassy sound. Auscultation over the lower left ribs will reveal the fainter fluid sounds of reticular contractions just before the contractions of the dorsal and ventral ruminal sacs described earlier. The reticular and ruminal sounds are the predominant abdominal sounds in the normal ruminant.

A grunt, detectable by auscultation over the trachea, may occur during the reticular contraction phase of a primary contraction in cattle with traumatic reticuloperitonitis. The factors that result in a decrease in the intensity and frequency of ruminal sounds are discussed in detail in [Chapter 8](#).

The intestinal sounds that are audible on auscultation of the right flank of cattle and sheep consist of frequent faint gurgling sounds, which are usually difficult to interpret. Contraction of the abomasum and the intestines results in a mixture of sounds that are difficult to distinguish.

### *Intestinal Sounds of the Horse*

These sounds are clearly audible and their assessment is one of the most vital parts of the clinical examination and surveillance of the horse with suspected abdominal disease. Over the right and ventral abdomen there are the loud, booming sounds (borborygmi) of the colon and cecum, which are at peak intensity about every 15 to 20 seconds. Over the left abdomen there are the much fainter rushing fluid sounds of the small intestines. An increase in the intensity and frequency of sounds with a distinct fluid quality are heard in enteritis and loud, almost crackling, sounds in spasmodic colic. In impaction of the large intestine there is a decrease in the intensity and frequency of the borborygmi, and in thromboembolic colic caused by vermiform aneurysm and infarction of the colon there may be complete absence of sounds. In intestinal obstruction the intestinal sounds caused by peristalsis are markedly decreased and usually absent, and fluid tinkling sounds occur infrequently. In intestinal stasis in the horse, auscultation in the right flank often detects the tinkling sound of fluid dropping from the ileocecal valve through gas into the dorsal sac of the cecum.

### **Palpation and Percussion Through the Abdominal Wall**

Because of the thickness and weight of the abdominal wall in mature cattle and horses, deep palpation of viscera and organs through the abdominal wall has limited value in these

species compared with its usefulness in small animals. No viscera or organ, with the exception of the fetus, can be palpated with certainty through the abdominal wall in the horse. In cattle, the rumen and its contents can usually be palpated in the left paralumbar fossa. Ruminal distension is usually obvious, whereas an inability to palpate the rumen may be caused by a small, relatively empty rumen or to medial displacement, as in left-side displacement of the abomasum.

#### *Percussion and Simultaneous Auscultation*

In left-side displacement of the abomasum, percussion and simultaneous auscultation over the upper third of the costal arch between the 9th and 12th ribs of the left side will elicit the typical high-pitched musical-quality sounds or ping. These may be mistaken for similar sounds present in ruminal atony. A markedly enlarged liver in a cow may be palpable by ballottement immediately behind the right costal arch. Using a combination of palpation, percussion, and simultaneous auscultation over the right paralumbar fossa and caudal to the entire length of the right costal arch, it may be possible to detect any of the following in cattle:

- Dilatation and torsion of the abomasum
- Cecal dilatation and torsion
- Impaction of the abomasum and omasum
- Intestinal obstructions, including torsion of the coiled colon

Percussion and auscultation over viscera that are distended with fluid and gas may be undertaken, and the size and location of the tympanic area will provide some indication of the viscera likely to be involved.

#### *Tactile Percussion of the Abdomen*

This technique aids detection of an excessive quantity of fluid in the peritoneal cavity: ascites caused by a ruptured bladder, transudate in congestive heart failure, and exudate in diffuse peritonitis. A sharp blow is struck on one side of the abdomen and a fluid wave, a *blip* or undulation of the abdominal wall, can be seen and felt on the opposite side of the abdomen. The peritoneal cavity must be about one-third full of fluid before a fluid wave can be elicited.

#### *Abdominal Pain*

The location of abdominal pain may be located by deep external palpation of the abdominal wall in cattle. Deep palpation with a firm uniform lift of the closed hand or with the aid of a horizontal bar held by two people under the animal immediately caudal to the xiphoid sternum is a useful aid for the detection of a grunt associated with traumatic reticuloperitonitis in cattle. Superficial pain may be elicited by a firm poke of the hand or extended finger in cattle or horses. In cattle, pain may be elicited over the right costal arch when there are liver lesions or

generally over the abdomen in diffuse peritonitis.

The response to palpation of a focus of abdominal pain in cattle is a grunt, which may be clearly audible without the aid of a stethoscope. However, if there is doubt about the audibility of the grunt, the simultaneous auscultation of the trachea will detect a perceptible grunt when the affected area is reached. In calves with abomasal ulceration, a focus of abdominal pain may be present on deep palpation over the area of the abomasum.

In cases of severe abdominal distension (ruminal tympany in cattle and torsion of the large intestine) it is usually impossible to determine, by palpation and percussion, the viscera that are distended. Pneumoperitoneum is rare; thus gross distension of the abdomen is usually caused by distension of viscera with gas, fluid, or ingesta. A combination of rectal examination, passage of a stomach tube, paracentesis, and exploratory laparotomy may be necessary to determine the cause.

The abdomen of pigs is difficult to examine by palpation because pigs are seldom sufficiently quiet or relaxed and the thickness of the abdominal wall limits the extent of deep palpation. In late pregnancy in sows the gravid uterus may be ballotted but it is usually not possible to palpate fetal prominences.

In sheep, the rumen, impacted abomasum, and the gravid uterus are usually palpable through the abdominal wall. Positioning the sheep on its hindquarters will shift the viscera to a more easily palpable position.

#### *Nasogastric Intubation*

An important part of the examination of the abdomen and gastrointestinal tract of large animals, especially cattle and horses, is the passage of the nasogastric tube into the rumen of cattle and into the stomach of horses. Gastric reflux occurs commonly in the horse with colic, and it is important to determine whether the stomach is distended with fluid and to relieve it as necessary. This topic is presented in detail in [Chapter 7](#). In cattle, when disease of the rumen is suspected, the nasogastric tube is passed into the rumen to relieve any distension and to obtain a sample of rumen juice for determination of rumen pH and the presence or absence of rumen protozoa.

#### *Head and Neck*

##### *Eyes*

Any discharge from the eyes should be noted: it may be watery in obstruction of the lacrimal duct, serous in the early stages of inflammation, and purulent in the later stages. Whether the discharge is unilateral or bilateral is of considerable importance. A unilateral discharge may be caused by local inflammation, and a bilateral discharge may denote a systemic disease. Abnormalities of

the eyelids include abnormal movement, position, and thickness. Movement may be excessive in painful eye conditions or in cases of nervous irritability including hypomagnesemia, lead poisoning, and encephalitis. The lids may be kept permanently closed when there is pain in the eye or when the eyelids are swollen, for instance, in local edema caused by photosensitization or allergy. The membrana nictitans may be carried across the eye when there is pain in the orbit or in tetanus or encephalitis. There may be tumors on the eyelids.

#### *Examination of the Conjunctiva*

This examination is important because it is a good indicator of the state of the peripheral vascular system. The pallor of anemia and the yellow coloration of jaundice may be visible, although they are more readily observed on the oral or vaginal mucosa. Engorgement of the scleral vessels, petechial hemorrhages, edema of the conjunctiva as in gut edema of pigs or congestive heart failure, and dryness caused by acute pain or high fever are all readily observable abnormalities.

#### *Corneal Abnormalities*

These include opacity, varying from the faint cloudiness of early keratitis to the solid white of advanced keratitis, often with associated vascularization, ulceration, and scarring. Increased convexity of the cornea is usually caused by increased pressure within the eyeball and may be caused by glaucoma or hypopyon.

#### *Size of the Eyeball*

Eyeball size does not usually vary, but protrusion is relatively common and when unilateral is caused by pressure from behind the orbit in most cases. Periorbital lymphoma in cattle, dislocation of the mandible, and periorbital hemorrhage are common causes. Retraction of the eyeballs is a common manifestation of reduction in volume of periorbital tissues, e.g., in starvation when there is disappearance of fat and in dehydration when there is loss of fluids.

#### *Abnormal Eyeball Movements*

Abnormal movements occur in nystagmus caused by anoxia or by lesions of the cerebellum or vestibular tracts. In nystagmus there is periodic, involuntary movement with a slow component in one direction and a quick return to the original position. The movement may be horizontal, vertical, or rotatory. In paralysis of the motor nerves to the orbital muscles there is restriction of movement and abnormal position of the eyeball at rest.

#### *Examination of the Deep Structures*

Assessment of the deep structures of the eye necessitates an ophthalmoscope but gross abnormalities may be observed by direct vision. Pus in the anterior chamber,

hypopyon, is usually manifested by yellow to white opacity often with a horizontal upper border obscuring the iris. The pupil may be of abnormal shape or abnormal in position caused by adhesions to the cornea or other structures. An abnormal degree of dilatation is an important sign, and unilateral abnormality usually suggests a lesion of the orbit.

Bilateral excessive dilatation (mydriasis) occurs in local lesions of the central nervous system affecting the oculomotor nucleus, or in diffuse lesions including encephalopathies, or in functional disorders such as botulism and anoxia. Peripheral blindness caused by bilateral lesions of the orbits may have a similar effect. Excessive constriction of the pupils (miosis) is unusual unless there has been overdose with organic phosphatic insecticides or parasympathomimetic drugs. Opacity of the lens is readily visible, especially in advanced cases.

### Vision Tests

Several tests of vision and of ocular reflexes are easily performed, and when warranted should be done at this stage of the examination. Tests for blindness include the menace reflex and an obstacle test. In the former a blow at the eye is simulated with care being taken not to cause an air current. The objective is to elicit the eye preservation reflex manifested by reflex closure of the eyelids. This does not occur in peripheral or central blindness, and in facial nerve paralysis there may be withdrawal of the head but no eyelid closure. An obstacle test in unfamiliar surroundings should be arranged and the animal's ability to avoid obstacles assessed. The results are often difficult to interpret if the animal is nervous. A similar test for night-blindness (nyctalopia) should be arranged in subdued light, either at dusk or on a moonlit night. Nyctalopia is one of the earliest indications of avitaminosis-A. Total blindness is called amaurosis, and partial blindness is called amblyopia. The pupillary light reflex—closure and dilatation of the iris in response to lightness and darkness—is best tested with a strong flashlight.

### Nostrils

Particular attention should be paid to the odor of the nasal breath. There may be a sweet sickly smell of ketosis in cattle or a fetid odor, which may originate from any of a number of sources including gangrenous pneumonia, necrosis in the nasal cavities, or the accumulation of nasal exudate. Odors originating in the respiratory tract are usually constant with each breath and may be unilateral. The sour smell of alimentary tract disturbance is detectable only periodically, coinciding with eructation. Odors originating in the mouth from bad teeth or from necrotic ulcers associated with *Fusobacterium necrophorum* in calves may be smelled on the nasal breath but are stronger on the oral breath.

In certain circumstances it may be important to note the volume of the breath expelled through the nostrils: it may be the only way of determining whether the animal is breathing and, in some cases, of counting the respiratory rate. Variation in volume between nostrils, as felt on the hands, may indicate obstruction or stenosis of one nasal cavity. This can be examined further by closing off the nostrils one at a time; if obstruction is present in one nostril, closure of the other causes severe respiratory embarrassment.

Any nasal discharge should receive special attention and its examination should be performed at the same time as an inspection of the nasal mucosa. Discharges may be restricted to one nostril in a local infection or be bilateral in systemic infection. The color and consistency of the exudate will indicate its source. In the early stages of inflammation the discharge will be a clear, colorless fluid, which later turns to a white to yellow exudate as leukocytes accumulate in it. In Channel Island cattle the color may be a deep orange, especially in allergic rhinitis. A rust or prune juice color indicates blood originating from the lower respiratory tract, as in pneumonia and in equine infectious anemia in the horse. Blood clots derived from the upper respiratory tract or pharynx may be present in large quantities or appear as small flecks. Generally, blood from the upper respiratory tract is unevenly mixed with any discharge, whereas that from the lower tract comes through as an even color.

The consistency of the nasal discharge will vary from watery in the early stages of inflammation, through thick, to cheesy in longstanding cases. Bubbles or foam may be present. When the bubbles are coarse it signifies that the discharge originates in the pharynx or nasal cavities; fine bubbles originate in the lower respiratory tract. In all species, vomiting or regurgitation caused by pharyngitis or esophageal obstruction may be accompanied by the discharge of food material from the nose or the presence of food particles in the nostrils. In some cases the volume of nasal discharge varies from time to time, often increasing when the animal is feeding from the ground, leading to infection of the cranial sinuses.

Inflammation of the nasal mucosa varies from simple hyperemia, as in allergic rhinitis, to diffuse necrosis, as in bovine malignant catarrh and mucosal disease, to deep ulceration as in glanders. In hemorrhagic diseases variations in mucosal color can be observed and petechial hemorrhages may be present.

### Mouth

Excessive salivation with ropes of saliva hanging from the mouth and usually accompanied by chewing movements occurs when a foreign body is present in the mouth and also in many forms of inflammation of the oral mucosa or of the tongue.

Actinobacillosis of the tongue, foot-and-mouth disease, and mucosal disease are typical examples. Excessive salivation may also occur in diseases of the central nervous system, as in acute lead poisoning in young cattle. Hypersalivation is a characteristic sign in epidemic hyperthermia associated with the mycotoxins of *Acremonium coenophialum* and *Claviceps purpurea* and by the fungus *Rhizoctonia leguminicola* sometimes found on red clover. Dryness of the mouth occurs in dehydration and poisoning with belladonna alkaloids, or when fed high levels of urea.

Abnormalities of the buccal mucosa include local lesions, hemorrhages in purpuric diseases, the discolorations of jaundice and cyanosis, and the pallor of anemia. Care must be taken to define the exact nature of lesions in the mouth, especially in cattle; differentiation between vesicles and erosive and ulcerative lesions is of diagnostic significance in the mucosal diseases of this species.

### Teeth

Examination of the teeth for individual defects is a surgical subject, but a general examination of the dentition can yield useful medical information. Delayed eruption and uneven wear may signify mineral deficiency, especially calcium deficiency, in sheep; excessive wear with mottling and pitting of the enamel is suggestive of chronic fluorosis.

### Tongue

The tongue may be swollen by local edema or by inflammation as in actinobacillosis of cattle or shrunken and atrophied in postinflammatory or nervous atrophy. Lesions of the lingual mucosa are part of the general buccal mucosal response to injury.

### Pharynx

Examination of the pharyngeal region in large animals requires some dexterity and the use of a speculum of appropriate size. The oral cavity and pharynx of calves, lambs, and goat kids is examined by holding the mouth open; depressing the base of the tongue with the fingers or a tongue depressor; and viewing the pharynx, the glottis, and the proximal part of the larynx and arytenoid cartilages. In adult cattle, a metal or Plexiglas cylindrical speculum, 45cm in length and 4cm in diameter, placed in the oral cavity and over the base of the tongue will allow viewing of the pharynx and the larynx. Foreign bodies, diffuse cellulitis, and pharyngeal lymph node enlargement can also be detected this way. The use of a speculum wedged between the upper and lower molar teeth in cattle allows manual exploration and evaluation of lesions of the pharynx and proximal part of the larynx. In the horse, the pharynx cannot be viewed from the oral cavity and manual exploration of the pharynx requires general anesthesia. Endoscopy is a useful method of



examination in this species, and the modern fiberscope has made it possible to visualize lesions in the posterior nares and pharynx-esophagus and larynx-trachea in the standing, conscious horse or ox.

### Submaxillary Region

Abnormalities of the submaxillary region that should be noted include enlargement of lymph nodes caused by local foci of infection, subcutaneous edema as part of a general edema, local cellulitis with swelling and pain, and enlargement of salivary glands or guttural pouch distension in the horse. Thyroid gland enlargement is often missed or mistaken for other lesions, but its site, pulsation, and surrounding edema are characteristic.

### Neck

The most important part of the examination of the neck of cattle and horses is to determine the state of the jugular veins. Bilateral engorgement of the jugular veins may be caused by obstruction of the veins by compression or constriction or by right-sided congestive heart failure. A jugular pulse of small magnitude moving up the jugular vein about one third of the way up the neck is normal in most animals but it must be differentiated from a transmitted carotid pulse, which is not obliterated by compression of the jugular vein at a lower level. Variations in size of the vein may occur synchronously with deep respiratory movements but bear no relation to the cardiac cycles. When the jugular pulse is associated with each cardiac movement it should be determined whether it is physiologic or pathologic. The physiologic pulse is presystolic and caused by atrial systole and is normal. The pathologic pulse is systolic and occurs simultaneously with the arterial pulse and the first heart sound; it is characteristic of an insufficient tricuspid valve.

Local or general enlargement of the esophagus associated with vomiting or dysphagia occurs in esophageal diverticulum, stenosis and paralysis, and in cardiac obstructions. Passage of a stomach tube or probang can assist in the examination of esophageal abnormalities.

Tracheal auscultation is a useful diagnostic aid. Normally, the sounds that are audible are louder and more distinct than breath sounds audible over the lung. In upper respiratory tract disease, such as laryngitis and tracheitis, the sounds are louder and harsher and may be whistling in the presence of stenosis. Very loud stenotic tracheal sounds are characteristic of calves with tracheal collapse. Abnormal tracheal sounds, regardless of their cause, are usually transferred down the major bronchi and are audible on auscultation over the thorax, primarily during inspiration. They are commonly confused with abnormal lung sounds caused by pneumonia, but in pneumonia the abnormal

sounds are usually present both on inspiration and on expiration.

### Rectal Examination

Rectal exploration of the abdomen is a vital part of the complete examination of the abdomen of large animals, especially cattle and horses. Abnormalities that are completely unexpected can be present and may be the cause of illness in animals in which no other significant clinical abnormalities were detected on clinical examination. Special care is necessary to avoid injuring the animal and causing it to strain. Suitable lubrication and avoidance of force are the two most important factors. Rectal examination enables observations to be made on the alimentary, urinary, and genital tracts and on the vessels and peritoneum and pelvic structures. The amount and nature of the feces in the rectum should be determined.

Palpable abnormalities of the digestive tract include paralysis and ballooning of the rectum, distension of the loops of the intestine with fluid or gas, the presence of hard masses of ingesta such as in cecal and colonic impactions in the horse, and intestinal obstruction caused by volvulus, intussusception, or strangulation. The detection of tight bands of mesentery leading to displacement segments may be a valuable guide. In cattle, the caudal sacs of the rumen are readily palpable. When the rumen is distended as in bloat or vagus indigestion they may push well into the pelvis or be only just within reach when the rumen is empty. A distended abomasum may be felt in the right half of the abdomen in cases of abomasal torsion and occasionally in vagus indigestion. In healthy animals there is little to feel because of the space occupied by normal intestines. Palpable objects should be carefully examined.

The left kidney in the cow can be felt in the midline and distinct lobulations are evident. In the horse, the caudal pole of the left kidney is easily palpable, but the right kidney is not. There may be abnormalities of size and pain on pressure caused by pyelonephritis, and abnormalities of size caused by hydronephrosis and amyloidosis. The ureters and empty bladder are not normally palpable. A distended bladder or chronic cystitis with thickening of the wall can be felt in the midline at the anterior end of the pelvic cavity. Abnormalities of the bladder and ureters in cattle are also palpable through the ventral aspects of the vagina. Large calculi have a stonelike hardness and are occasionally observed in horses in the same position. Pain with spasmodic jerking of the penis on palpation of the urethra occurs in urinary obstruction caused by small calculi, cystitis, and urethritis. Enlarged, thickened ureters such as occur in pyelonephritis can be felt between the kidney and the bladder.

On the peritoneum and mesentery one may feel the small, grapelike lesions of tuberculosis; the large, irregular, hard masses of fat

necrosis; and the enlarged lymph nodes of lymphomatosis. The abdominal aorta is palpable, and in horses the anterior mesenteric artery and some of its branches can be felt. This may be an important examination if a verminous aneurysm is suspected, in which case the vessels are thickened but still pulsate and have an uneven rough surface and may be painful. In horses the caudal edge of the spleen is usually palpable in the left abdomen. During a rectal examination in a horse it is advantageous in some cases to palpate the inguinal ring from inside the abdomen and, by pushing the other hand between the horse's thighs, to palpate the external ring simultaneously. It is then easier to decide whether any abnormal structures are passing through the ring.

### Feces and Defecation

Examination of the feces may provide valuable information on the digestive and motor functions of the tract. They should be examined for volume, consistency, form, color, covering, odor, and composition. A note should be made of the frequency and the time taken for material to pass through the tract. Laboratory examinations may be advisable to detect the presence of helminth eggs, occult blood, bile pigments, pathogenic bacteria, or protozoa.

The volume of feces is usually described as scant, normal, or copious but, in certain circumstances, it may be advisable to weigh or measure the daily output. The normal output for each species is as follows:

- Horses: 15 to 20 kg/day
- Cattle: 25 to 45 kg/day
- Pigs: 1 to 2.5 kg/day
- Sheep and goats: 0.5 to 1 kg/day

There is an increased bulk when fed too much fiber or during attacks of diarrhea. The consistency and form of the feces vary with each species and vary widely within a normal range, depending particularly on the nature of the food. Variations in consistency not explainable by changes in the character of the feed may indicate abnormalities of any of the functions of the tract. The consistency is more fluid in diarrhea and less fluid than normal in constipation. The consistency and form of the feces may provide some indication of the location of the dysfunction of the gastrointestinal tract. Generally, large quantities of liquid feces suggest a dysfunction of the small intestine where normally most of the fluid is absorbed. Feces that contain large quantities of undigested feed could suggest overfeeding, incomplete mastication, a digestive enzyme deficiency, or an acute disorder of the small intestine or stomachs. Large quantities of soft feces that contain well-digested ingesta suggest a dysfunction of the large intestine. However, these are only guidelines and are subject to error.

**Color of the Feces.** This also varies widely with the color of the food, but feces of a

lighter color than normal may be caused by an insufficient secretion of bile or by simple dilution of the pigments, as occurs in diarrhea. The effect of blood on the appearance of feces has already been described. Discoloration by drugs should be considered when the animal is undergoing treatment.

**Fecal Odor.** This depends largely on the nature of the food eaten, but in severe enteritis the odor is characteristically one of putrefaction.

**Composition.** The composition of the feces should be noted. In herbivorous animals there is always a proportion of undigested fiber, but excessive amounts suggest incomplete digestion caused by, for example, bad teeth and faulty mastication. Excessively pasty feces are usually associated with a prolonged sojourn in the tract such as occurs in vagal indigestion or abomasal displacement in cattle. Foreign material of diagnostic significance includes sand or gravel, wool, and shreds of mucosa. Mucus is a normal constituent but, in excessive amounts, indicates either chronic inflammation, when it is associated with fluid, copious feces, or constipation when the feces are small in volume and hard. Mucosal shreds or casts always indicate inflammation.

**Frequency of Defecation.** Frequency and the length of sojourn in the gastrointestinal tract are usually closely allied, and increased frequency and decreased sojourn occur in diarrhea and the reverse in constipation. Most animals defecate eight to 12 times a day but the sojourn varies widely with the species. Omnivores and carnivores with simple stomachs have an alimentary sojourn of 12 to 35 hours, in ruminants it is 2 to 4 days, and in it is horses 1 to 4 days, depending on the type of feed.

#### *Other Observations*

Observation of other acts associated with the functions of the alimentary tract may provide information of diagnostic value. Prehension, mastication, swallowing, vomiting, and defecation should be observed and an attempt made to analyze the behavior of the animal when there is evidence of abdominal pain.

#### **Paracentesis of the Abdomen**

Paracentesis of the abdomen includes obtaining a sample of peritoneal fluid when peritonitis or inflammation of the serosae of the intestines or other viscera of the abdomen is suspected. Aspiration of fluid from a distended abdominal viscus is also possible and is often a useful aid in the diagnosis (see [Chapter 7](#)).

#### **Urinary System**

Examination of the urinary tract consists of observations of the **act of urination**,

evidence of **difficult and painful urination**, **abnormal urine**, collection of urine and urinalysis, and, depending on the species, **palpation of the kidneys, bladder, and urethra**. Details of the examination of the urinary tract are presented in [Chapter 13](#).

#### **Reproductive Tract**

Examination of the reproductive tract is usually performed at this stage but is not discussed here because it is beyond the scope of this book. In the immediate postpartum period, the vagina, cervix, and uterus should be examined thoroughly for evidence of gross abnormalities such as metritis, retained placenta, and ruptured uterus, which may be the cause of illness not obvious on examination of other body systems.

#### **Mammary Gland**

The mammary gland(s) of all species is examined by inspection and palpation of the udder and teats and gross examination of the milk or abnormal secretions of the glands. Details of this examination are presented in [Chapter 20](#).

#### **Musculoskeletal System and Feet**

Examination of the musculoskeletal system and feet is necessary when there is lameness, weakness, or recumbency. Inspection of the gait during the walk and trot is used to determine the origin of the lameness. The muscles, joints, ligaments, tendons, and bones are inspected and palpated to determine abnormalities associated with lameness, weakness, or recumbency. The feet are examined by inspection, palpation, and the trimming of hooves in farm animals to identify lesions associated with lameness. Medical imaging is commonly used to define lesions not readily recognizable by routine clinical examination. Details of examination of the musculoskeletal system and feet are presented in [Chapter 15](#).

#### **Nervous System**

In routine veterinary practice, veterinarians will commonly include several components of a neurologic examination in a complete clinical examination. Most often a diagnosis and differential diagnosis can be made from consideration of the history and the clinical findings. However, if the diagnosis is uncertain it may be necessary to conduct a complete neurologic examination, which may uncover additional clinical findings necessary to make a diagnosis and give a prognosis.

A complete neurologic examination includes examination of the mental status, head and posture, cranial nerve function, gait and posture, function of the neck and forelimbs, function of the trunk and hindlimbs, palpation of the bony encasement of the central nervous system, examination of cerebrospinal fluid, and medical imaging of the bony skeleton of the head and vertebral

column. The details of the neurologic examination are presented in [Chapter 14](#).

#### **Skin Including Ears, Hooves, and Horns**

A systematic method for the examination of the skin is necessary to avoid misinterpretation of the lesions. Inspection of the behavior of the animal and of the skin and hair and palpation and smelling of the skin are the most common physical methods used for clinical examination of the skin. The important prerequisites for an adequate examination of the skin are good lighting such as natural light or day-type lamps, clipping the animal's hair when necessary to adequately visualize lesions, magnification of the lesions with a hand lens to improve visualization of the changes, and adequate restraint and positioning of the animal. Palpation can be used to assess the consistency of lesions, the thickness and elasticity of skin, and to determine the presence of pain associated with diseases of the skin.

**Close inspection and palpation** of the skin and hair coat are necessary to identify and characterize lesions. Magnifying spectacles or an illuminated magnifying glass may prove useful. The dorsal aspect of the body is inspected by viewing it from the rear, as elevated hairs and patchy alopecia may be more obvious from that angle. All parts of the head including the nose, muzzle, and ears are examined. The lateral trunk and the extremities are then examined. The feet of large animals need to be picked up to examine the interdigital clefts and parts of the coronary bands. The skin of the udder and teats of cattle, sheep, goats, and horses must be observed. The ventral aspect of the body is carefully examined using a source of light to illuminate the underside of adult cattle and horses. The external and internal aspects of the ears and the hooves and horns must be examined by inspection and palpation.

Every centimeter of the skin needs to be examined for the presence of lesions in different stages of development. The **visual**, **tactile**, and **olfactory senses** are used to see, feel, and smell the lesions. The presence or absence of some ectoparasites can be determined by direct inspection. For example, lice and ticks of cattle are usually easily visible. The odor of the skin in some diseases may be abnormal; dermatophilosis in cattle is characterized by a foul and musty odor. Parting the hairs with the fingers or by gently blowing them is necessary to evaluate the length of the hair shafts. Broken hairs, changes in hair color, and the accumulation of exudative material on hair shafts are noted. The texture and elasticity of the skin must be assessed by rolling the skin between the fingers. Careful digital palpation of the hair coat which appears normal on visual inspection may reveal underlying lesions such as pustules, which may be covered by the hair coat. In



some cases, tufts of hairs may be seen protruding through an accumulation of exudate. A combination of visual inspection of the wool coat of sheep is done carefully and systematically by parting the wool coat and evaluating the condition of the wool fibers and the underlying skin. The hair coat should not be clipped, groomed, or washed before the lesions have been identified and characterized.

## DIAGNOSTIC IMAGING

Use of advanced diagnostic imaging is increasing in large animal practice. Once the domain of university-associated veterinary teaching hospitals, imaging modalities such as digital radiography, computed tomography, fluoroscopy, and sophisticated ultrasonography are increasingly available in ambulatory practice or hospital-based private practices. Magnetic resonance imaging continues to be limited to veterinary teaching hospitals or major private referral hospitals.

Routine ultrasonography is now an accepted part of most large animal practices and is essentially a continuation of the clinical examination usually performed by clinicians rather than imaging specialists. Ultrasonography has developed into a valuable imaging technique in almost all animal species because of the rapid development of technically improved portable units and their potential for use on farms and stables.

The ultrasonographic examination is unique in its animal application because it is a dynamic examination technique with minimal risk to the animal or the sonographer. Ultrasonography is noninvasive and well tolerated in unsedated animals. It enables serial examinations to monitor the progression of an abnormality or response to treatment. Ultrasonography requires skill and experience to make a diagnosis, but this is readily and rapidly obtained by veterinarians. Continuing education courses and workshops are becoming more common and they provide excellent training and the latest concepts. Ultrasonography can be valuable in examining the contents of cavitory lesions, synovial cavities, cysts, or other fluid-filled lesions for the presence of liquid, semisolid, or solid contents and/or effusion. Centesis of synovial cavities or body cavities and biopsy of organs, such as the liver or kidney, are now frequently done as part of the clinical examination. Ultrasonography enables accurate needle placement following ultrasonographic examination of the designated structure, assisting with the measurement of the distance from the skin surface to the structure when, for example, a freehand biopsy technique is to be performed.

During a routine ultrasound examination, real-time B-mode provides information regarding the physical form and structure of tissues, allows subjective assessment of movement such as peristaltic contractions

within the intestine, and provides an overview that guides the application of other ultrasound modes. M-mode is now an integral part of echocardiographic examinations.

The benefits of ultrasound as a veterinary diagnostic imaging procedure are numerous. Routine ultrasound examinations have no harmful biological effects. It is a safe procedure for the animal, the operator, and nearby personnel, which allows it to be done in any location without the need for specific safety precautions.

The ability of ultrasound to distinguish fluid from soft tissue and differentiate between soft tissues on the basis of their composition makes it more suited than radiography for examining soft tissue structures. Ultrasonography can often provide information that was previously only available through exploratory laparotomy. Ultrasound is limited by its inability to penetrate gas-filled or bony structures; therefore *acoustic windows* must be found that avoid the interposition of bone or gas between the transducer and the region of interest, although this can often be achieved by judicious positioning of the animal. Transcutaneous examinations in animals can require removal of the hair overlying the region of interest by clipping, because the beam cannot penetrate the air trapped between the hairs, or application of an acoustic coupling material such as gel or 70% alcohol in short-coated animals (horses, foals, cattle, and calves).

Examples of the use of ultrasonography in bovine practice include the diagnosis of gastrointestinal disease, diseases of the mammary gland, thoracic disease, splenic disease, ruptured gallbladder in cows, and the blood flow patterns in the common carotid artery and external jugular vein for cardiac and blood vessel disease.

The use of ultrasonography as a reproductive management aid in dairy cattle practice represents a major advance in understanding their reproductive biology. The literature on veterinary ultrasound equipment, imaging the bovine ovary (ovarian follicles, corpora lutea, and ovarian cysts), the bovine uterus (early pregnancy diagnosis, early embryonic loss, identification of cows carrying twins, and determination of fetal sex), and the diagnostic limitations of ultrasonic imaging has been reviewed. Because nonpregnancy can be established 7 to 14 days earlier after artificial insemination (AI) using ultrasound compared with rectal palpation, nonpregnant cows can be detected earlier and returned to AI service, improving the pregnancy rate through an increased AI service rate.

The use of ultrasonography to examine various body systems is described in a number of chapters in this textbook. Readers are encouraged to consult textbooks dealing with ultrasonography. Short

courses and laboratory workshops are now commonplace and readily available and highly recommended. The development of extension education programs to train bovine practitioners is a critical step toward rapid implementation of this technology into the dairy industry.

## FURTHER READING

Radostits OM, Mayhew IG, Houston DM. *Veterinary Clinical Examination and Diagnosis*. London: WB Saunders; 2000.

## REFERENCES

1. Sackett DL, et al. *Clinical Diagnostic Strategies. Clinical epidemiology: a basic science for clinical medicine*. 1st ed. Boston: Little Brown; 1985.
2. Studdert VP, et al. *Comprehensive Veterinary Dictionary*. London: Elsevier; 2012.
3. Gray C, et al. *Handbook of Veterinary Communication Skills*. Oxford: Wiley-Blackwell; 2010.

## INTERPRETATION OF LABORATORY DATA

### WHY COLLECT LABORATORY DATA?

Collection of a full history and performance of a purposeful physical examination are the most powerful tools available to the veterinarian in determining the nature of an animal's disease and its likely cause, although as noted previously not all of these should be done for every case. However, laboratory data, including results of clinical, biochemical, hematologic, serologic, radiographic, electrocardiographic, ultrasonographic, and other examinations, are often obtained from individual animals or groups of animals. The reasons for collecting paraclinical or laboratory data are to

- Confirm the presence or cause of a disease
- Rule out the presence of a disease
- Assess the severity of a disease
- Predict the clinical course of a disease or to determine a prognosis
- Estimate the likely response to therapy
- Determine the response to therapy or monitor progression of a disease
- Satisfy regulatory requirements
- Determine the disease or immune status of an animal, herd, or flock

Collection of laboratory data should not be viewed as a fishing expedition performed in the hope that "something will turn up." The decision to collect laboratory data should always be made with one or more of the previously listed aims, with the intention that the data collected will answer a particular, clearly stated question. It is very easy, when faced with a sick animal with clinical signs that are not clearly diagnostic or indicative of the organ system involved, to request a "serum biochemical profile" and complete blood count without having a clear idea of the usefulness of the information provided by the results of these tests. Although the

usefulness of these tests in most cases is very clear, the results of the tests are most informative when used to address a particular question, for instance: Does the animal have evidence of kidney disease?

A test should never be performed unless one can anticipate all the likely results and provide a meaningful interpretation for each. Collecting laboratory data for the sake of running a test or as an act of **diagnostic desperation** is wasteful of resources and will not, in all likelihood, contribute to the management of the animal or group of animals. It is more likely that the results of the test will be uninterpretable and will muddy the diagnostic picture.

### PROPERTIES OF DIAGNOSTIC TESTS

Reporting of new diagnostic tests or refinement of current tests should be complete to permit the reader to determine the usefulness of the test. Guidelines for determining whether the utility of a diagnostic test is adequately reported are provided as part of the **standard for the reporting of diagnostic accuracy (STARD)** document.<sup>1</sup> The following properties of a test, and of the population to which it is applied, should be known before it is considered to be reliable.

- The test should be developed and validated in the population of interest. Tests developed in one population might not be valid in an animal from another population. For instance, tests developed for use in one species might not be reliable if used in another species.
- The accuracy of the test should be known in the situation in which its use is intended. The test must be able to distinguish between animals with the disease and those that are disease free. This involves knowledge of the sensitivity, specificity of the test, its receiver operating curve characteristics, and likelihood ratios.<sup>2</sup>
- The specificity of the test, i.e., the ability of a positive result of the test to rule in the disease of interest, should be known. Although this is a property of the test that is usually independent of the prevalence of the disease in the population being tested, this might not always be the case.
- The sensitivity of the test, i.e., the ability of a negative result of the test to rule out the disease of interest, should be known. Although this is a property of the test that is usually independent of the prevalence of the disease in the population being tested, this might not always be the case.
- The pretest likelihood of the disease in the population should be known (i.e., the prevalence of the disease in the population of the animal being tested). This permits calculation of posttest odds of the animal having (positive predictive

value) or not having (negative predictive value) the disease for which it is being tested.

- The likelihood ratios of the various test results should be known for the population of animals being tested.
- The reliability of the laboratory performing the test should be known. There should be considerable confidence in the quality control of the laboratory such that test results are repeatable and reliable.
- Are the reference ranges (values in animals without the disease or condition of interest) known and with what certainty are they known? The meaning of an abnormal test result should be clear.
- The test should allow the clinician to rule in or rule out one of the differential diagnoses, or markedly influence the likelihood of the presence or absence of the target disorder, in the instance in which a test is being used for diagnostic, as opposed to monitoring or other purposes.
- All test results should be interpretable. In other words, all results should provide information that will be of use in diagnosis or monitoring.

### Utility

To be useful, a diagnostic test must be accurate. An accurate test reliably differentiates between normal and diseased animals, contributing to effective management of the animal or its disease. Inaccurate diagnostic tests provide unreliable data, which in the best scenario are useless and in the worst scenario cause mismanagement of the animal or its disease. The diagnostic accuracy of a test should be known before it is used in clinical practice, and a test of unknown diagnostic accuracy should be assumed to be inaccurate until proven otherwise.

The usefulness of a test to a veterinarian depends on a number of factors. First, the test must be accurate, as discussed earlier. Second, it should be technically feasible and reliable, i.e., the test must be readily performed and its characteristics (listed previously) must be known. A test that cannot be readily performed has minimal usefulness, and unreliable tests are inaccurate. For testing of analytes, such as serum biochemical analysis or serology, it is important that the analysis yields results that are accurate and precise. Laboratory tests that are accurate yield results that are the same or very close to the true value of the variable being measured. Precise tests yield results that have very little variability around the expected value. Note that a test can be precise without being accurate, i.e., it has little variability but yields a value different from the actual value. Tests that are inaccurate or are highly variable (have poor precision) are not useful because the results are unreliable.

Third, the test must have diagnostic utility in that the results of the test should enable the veterinarian to make a decision that will affect the subsequent management of the animal or its disease. If the results of the test will not alter the animal's management or treatment of its disease or improve its production or prognosis, then the test has no diagnostic utility and should not be performed. The diagnostic utility depends on the characteristics of the test in the population of animals being tested. The important characteristics, which should be known before the test is widely used, are the sensitivity and specificity of the test and the likelihood ratios associated with the possible results, in the population in which it will be used. That a test has sensitivity and specificity implies that there is a range of values expected in normal animals—the so-called *reference range*.

### Reference Range (Interval)

An important aspect of evaluating laboratory data is to decide whether or not the result of a test is consistent with the animal being healthy or diseased. Healthy animals are assumed to have values within a certain range, whereas diseased animals will have values that differ from that expected in a healthy animal. The range of values in healthy animals is often referred to as in the *normal range*, although, because of the statistical connotation of this term, reference range or reference interval is preferred.

The reference range represents the range of values of a test that are expected in a group of healthy animals. Animals with values outside the reference range are at increased risk of having the disease compared with animals with values within the reference range. The actual increase in risk of being diseased depends on the way in which the reference range was determined, the sensitivity and specificity of the test, and the prevalence of the disease in the population from which the animal was selected. Calculation of likelihood ratios, both positive and negative, is a useful means of quantitatively assessing the results of a test provided that the pretest probability (prevalence) of the disease is known.

The reference range for a particular test is usually developed by collecting values from a large number of healthy or *normal* animals and performing a statistical analysis of the values. For variables that have a range of possible values (e.g., serum urea nitrogen concentration), as opposed to being either present or absent (e.g., seropositive or seronegative for antibodies to a disease), the range of values in normal animals will have a characteristic spread. For the range of values of the variable in normal animals, an upper and a lower value are chosen that represent the upper and lower limits of the reference range. These values are usually chosen to include 95% of the values from normal

animals. This can be calculated on the assumption (or after demonstration) that the distribution of values in a population of healthy animals is Gaussian (“normal” distribution) or when transformations of raw data are used to approximate a Gaussian distribution or when nonparametric statistics are used.

### Problems With Reference Ranges

There are problems with using the reference range of normal animals to diagnose diseased animals. First, and depending on the statistical methodology used to determine the reference range, approximately 5% of normal animals will have values for the test that are outside the reference range, and these animals can be incorrectly diagnosed as being diseased (**false positive**). Although a 5% false-positive rate is relatively low, the error is compounded when batteries of tests are run at the same time. This is a potentially serious problem when interpreting data from a serum biochemical profile analysis, in which 20 or more analytes are measured simultaneously from one animal. The risk of the value of any one analyte being outside the normal range is only 5%, but when 20 analytes are measured simultaneously the chance of finding one analyte of the 20 with a value outside the reference range is almost 66% ( $100(1 - 0.95^{20})$ ).

This problem can be mitigated in several ways. First, serum biochemical profiles often contain more than one variable that is indicative of a particular disorder. If disease affecting a particular organ system is present, then there should be appropriate changes in all variables indicative of disease in this system. For instance, most serum biochemical profiles measure both serum creatinine and urea nitrogen concentrations. An elevation in the serum urea nitrogen concentration might be indicative of renal disease, but if the serum creatinine concentration is not also increased, then the likelihood of important renal dysfunction is much less than if both analytes were above the reference range. Second, disease can be associated only with marked increases in value of the variable such that unusually low values could be disregarded. For example, a serum creatinine concentration below the reference range is very unlikely to indicate the presence of renal disease, and a serum creatinine activity below the reference range has almost no diagnostic value. Third, the extent to which the variable is outside the reference range should be considered. A small difference from the reference range is much less likely to indicate the presence of disease than is a much larger difference—calculation of likelihood ratios is one way of expressing this effect of variables that are markedly abnormal.

Another problem with using the reference range to detect disease is that not all diseased animals will have a value for the

variable of interest that is outside the normal range. Some diseased animals will have values of useful variables that are within the reference range and these animals can be falsely diagnosed as not having the disease (**false negative**). This problem can be mitigated by reducing the size of the reference range, although this will increase the false-positive rate, or by measuring other variables that are also useful in detecting the suspected disease. For instance, an animal with liver disease might have a value of the serum activity of a hepatic enzyme that is within the reference range, suggesting the lack of liver disease (a false-negative result, and not uncommon in animals with chronic liver disease). However, the same animal might have marked increases in serum bilirubin and bile acid concentrations, which are findings strongly suggestive of liver disease.

### Sensitivity and Specificity

The **sensitivity** of a test is a measure of the test's ability to detect animals that are diseased, and its numerical value represents the proportion of animals with the disease that are detected by the test (Table 1-3). A test with high sensitivity will detect most diseased animals within a population. The specificity of a test is a measure of the test's ability to detect animals that are not diseased, and its numerical value represents the proportion of normal animals detected by the test. A positive result with a highly specific test will rule in the disease in most diseased animals (a low false-positive rate), and a negative result for a test with high sensitivity effectively rules out the disease being tested for (a low false-negative rate).

Sensitivity and specificity are intrinsic properties of the test, and their values are not markedly influenced by the likelihood before the animal is tested that it has the disease for which it is being tested. The ability of a test to detect whether an animal has a particular disease depends on the likelihood that the animal has the disease at the time it is tested (the prevalence of disease in the population from which the animal being tested is drawn) as well as on the sensitivity and specificity of the test. The sensitivity and specificity can be combined to produce a single number, which is called the likelihood ratio.

### Likelihood Ratio

The likelihood ratio is an overall measure of the efficiency of the diagnostic test, combining both sensitivity and specificity (see Table 1-3) and permitting the calculation of posttest odds of the disease from the pretest odds of disease. The likelihood ratio is a quality of the test and is not influenced in most instances by the prevalence of the disease in the population. The likelihood ratio is useful for quantifying the posttest odds of an animal having the disease. For instance, in hospitalized neonatal foals, a positive stall-side test for failure of transfer of passive immunity has a likelihood ratio of 4.86. A foal with a 50% pretest probability of having the disease that has a positive test (i.e., indicative of lack of passive immunity) therefore has a 81% posttest probability of having the disease.

### Positive and Negative Predictive Value

The usefulness of the test depends on animal characteristics, the probability that it has the disease (prevalence) and the intrinsic characteristics of the test. The combined effects on the prevalence of the disease and the sensitivity and specificity of the test can be calculated and are called the **positive predictive value** (PPV) and **negative predictive value** (NPV), respectively. These are important values because they determine the usefulness of the test in detecting diseased or normal animals. The PPV is the likelihood that a positive test is from an animal with the disease. The NPV is the likelihood that a negative test is from an animal that does not have the disease.

Both the PPV and NPV are inextricably linked to the prevalence of the disease in the population being tested. Reports of the PPV and NPV are therefore only useful for populations of animals similar to those in which the values of these variables were determined, especially regarding the prevalence of the disease in the population. The prevalence of the disease can also be viewed as the probability that an animal selected at random from the population has the disease—it is the pretest probability of disease in the animal. For a test of given sensitivity and specificity, the likelihood that a positive test correctly

**Table 1-3** Method for determining sensitivity, specificity, likelihood ratio for positive and negative tests, positive predictive value, and negative predictive value of a test

True disease status	Disease present	Disease absent
Test positive	True positive (TP)	False positive (FP)
Test negative	False negative (FN)	True negative (TN)

$Sensitivity = (TP / (TP + FN)) \times 100$   
 $Specificity = (TN / (FP + TN)) \times 100$   
 $Likelihood\ ratio\ positive\ test = Sensitivity / (1 - Specificity)$   
 $Likelihood\ ratio\ negative\ test = Specificity / (1 - Sensitivity)$   
 $Positive\ predictive\ value = TP / (TP + FP)$   
 $Negative\ predictive\ value = TN / (TN + FN)$

predicts the presence of disease (the PPV) increases as the proportion of diseased animals in the population increases (the disease has higher prevalence). Conversely, the NPV increases as the prevalence of the disease decreases.

The effect of changes in prevalence on the PPV and NPV of two tests with differing sensitivities and specificities is illustrated in Table 1-4 and Fig. 1-2. The probability that either test will detect the presence of disease in an animal with a high pretest likelihood of having the disease is very high. Similarly, the probability that a negative result is indicative of the absence of disease in an animal from a population with very low prevalence of disease is also very high. Importantly, the ability of a very good test (sensitivity and specificity both 95%) to correctly predict the presence of disease in an animal with a positive test from a population with a low prevalence (1% of animals affected) of the disease is very poor. Applied to an individual animal, this means that even a very good test is more likely to yield an incorrect result than a

correct result in an animal that is unlikely to have the disease.

Conversely, a positive result in an animal with a very high pretest probability of having the disease yields little further information; in other words, the test is inefficient in that it adds little additional information. The test result does not increase the likelihood of the animal having the disease by a clinically useful margin. The diagnostic test has its greatest utility when the pretest probability of disease is approximately 50% and the increase in PPV and NPV is much greater for a test with higher sensitivity and specificity.

The pretest probability of disease, and thus the positive predictive value of the test, can be increased by selecting animals to be tested through careful physical examination and collection of an appropriate history. The PPV of a test in an animal that has signs of the disease it is being tested for is much higher than the PPV of a test in an animal without signs of the disease. Testing clinically normal animals is more likely to yield

false-positive than true-positive results, and such indiscriminate testing is not wise.

## FURTHER READING

- Cockcroft P, Holmes M. *Handbook of Evidence-Based Veterinary Medicine*. Oxford: Blackwell; 2003.  
Sackett DL, et al. *Clinical Epidemiology. A Basic Science for Clinical Medicine*. Boston: Little, Brown & Co.; 1991:3-170.

## REFERENCES

1. Towards complete and accurate reporting of studies of diagnostic accuracy: the STARD initiative. Standards for Reporting of Diagnostic Accuracy. 2014. (Accessed at <<http://www.equator-network.org/reporting-guidelines/stard/>>.)
2. Newman TB, et al. *Evidence-Based Diagnosis*. Cambridge, UK: Cambridge University Press; 2009.

## COMPUTER-ASSISTED DIAGNOSIS

In the 1980s there was considerable interest in computer-assisted diagnosis. The entry of the clinical and laboratory data from an animal into a computer program could yield a differential diagnosis list of diseases in order of highest to lowest probability. However, despite over 30 years of activity and interest in the use of computers for diagnosis, the impact of computer-assisted diagnosis in medical practice has been slight. Computerized programs have been useful in circumscribed areas such as the differential diagnosis of abdominal pain in humans and the diagnosis and treatment of meningitis. However, no program developed for use in a specific localized area of the body has been successfully adapted for generalized use. Theoretically, the computer could be expected to be useful to aid the clinician with the workup to make multiple and complex diagnoses.

Research on clinical decision making has confirmed the importance of creating the list of differential diagnoses or diagnostic hypotheses. A clinician faced with a diagnostic problem must use clinical findings to develop a list of possible diagnoses. With knowledge of the epidemiologic and clinical characteristics of each disease, the veterinarian can confirm or exclude certain diagnostic possibilities. Diagnostic acumen depends on the ability to recognize the most important clinical abnormalities and to generate a list of differential diagnoses—a task that becomes more efficient with experience.

Specialists can generate many differential diagnoses in a narrow area of expertise, but the breadth of knowledge required in general practice makes it difficult for generalists to keep current on rare or unusual conditions. If a disease is not considered by the clinician faced with a presenting problem, it is frequently overlooked as a possibility and may not be “stumbled-on” during the diagnostic process. This problem is complicated in veterinary education by the common practice of

**Table 1-4** Effect of changes in prevalence (pretest probability of disease) on the positive predictive value and negative predictive value of tests with 95% sensitivity and specificity (Test A) and 60% sensitivity and specificity (Test B)

Prevalence or pretest probability of disease (%)	Test A PPV (%)	NPV (%)	Test B PPV (%)	NPV (%)
1	17	99	1	99
10	67	99	14	92
25	85	98	33	82
50	95	96	60	60
75	98	86	83	31
90	99	65	94	12
99	99	19	99	1

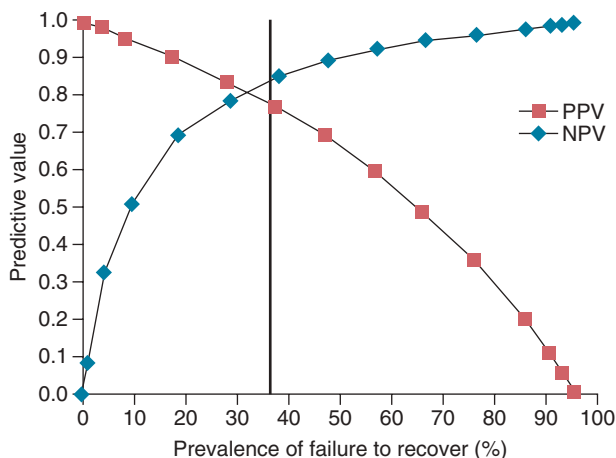

**Fig. 1-2** Effect of prevalence on positive and negative predictive values of a test with set sensitivity and specificity. The prevalence in this example is prevalence of failure to recover by recumbent cows (i.e., to stand), and the curves represent the consequent NPV and PPV for a serum aspartate aminotransferase activity of 171 U/L. (Reproduced with permission from Shpigel et al. *Vet Rec* 2003; 152:773.)



teaching according to disease entity. All the nosology of a disease is presented in a standard format, but the information must then be used in reverse order in clinical practice: the clinician generates a list of diseases based on the history and clinical findings. Textbooks that feature lists of differential diagnoses for animals with similar clinical findings assist in this task, but rapidly become outdated because of the many major and minor clinical findings that can be associated with a disease. The large storage capacity of computer databases and the ease of access to stored data make the computer useful for handling this sort of information.

The success of a computer-assisted diagnosis will depend first on the clinician determining the important finding or **forceful feature** or **pivot** of the case, which can be useful in separating possible look-alike diseases. The second most important requirement is to know the propensity for a certain clinical finding to occur in a disease syndrome. The algorithm is the center of a computer-aided diagnostic system. Statistical algorithms calculate the most likely diagnosis from explicit statistical analysis of disease probabilities and the frequency of clinical findings in a particular disease. A statistical algorithm is based on the Bayes theorem. The posterior probability that an animal has a given disease can be calculated if one has access to the

- Incidence (prior probability) of the disease
- Probability of a given clinical finding if the animal has the disease
- Probability of the same clinical finding occurring if the animal has the disease

After receiving the data, the computer uses this theory to calculate the likelihood of various diseases. However, a major problem of a Bayesian system is the nonavailability of an order of probabilities of the incidence of diseases and clinical findings associated with them. There is a need in veterinary medicine to generate comprehensive databases from which the probabilities of incidence and clinical finding for each disease can be determined from actual clinical practice.

In spite of these limitations, some progress is being made in the development of computer-assisted diagnosis in veterinary medicine. One computer-assisted diagnostic system for veterinary medicine was developed at the College of Veterinary Medicine, Cornell University, Ithaca, New York. The CONSULTANT program designed by M. E. White and J. Lewkowicz is a web-based program facilitating compilation of differential diagnoses based on presenting signs or by disease.<sup>1</sup>

The data bank contains a description of several thousand diseases of dogs, cats, horses, cattle, sheep, pigs, and goats. For each disease there is a short description including information on diagnostic testing, a list of current references, and a list of the clinical

findings that might be present in the disease. The clinician enters one or more of the clinical findings present in an animal. The computer supplies a list of the diseases in which that clinical finding or combination of clinical findings are present. The complete description can be retrieved for any disease in the list of differential diagnoses. A major limitation of the program to date is that the list of differential diagnoses is not in order of probability from highest to lowest. This is because the program does not include the probability of incidence and clinical findings for each disease, information that, as mentioned earlier, is not yet available.

Experience with the Cornell CONSULTANT program has shown that computer-assisted diagnosis is not used in day-to-day management of routine cases but is used primarily when faced with an unusual problem, to provide assurance that a diagnosis was not overlooked. Computerized databases also offer a mechanism for the generalist to search through a complete list of differential diagnoses compiled from the recorded experience of many specialists and kept current as new information is published.

## REFERENCE

1. CONSULTANT: a diagnostic support program for veterinary medicine. 2015. (Accessed June 25, 2015, at <<http://www.vet.cornell.edu/consultant/>>.)

## Prognosis and Therapeutic Decision Making

### SYSTEMATIC REVIEWS

Decision making, whether for diagnostic, therapeutic, or prognostic purposes, should involve consideration of the evidence contributing to the decision. Evidence-based medicine is the name given the process of using the best available evidence to arrive at a decision regarding health care in animals (or humans). In many instances, this involves consideration of evidence from a number of studies, often with conflicting outcomes and recommendations. This process can be challenging for nonexperts not least because of the difficulty in maintaining familiarity with the scientific literature and more so because of the need for expertise in assessing trial design and quality of scientific reporting.

An increasingly important contribution of evidence-based medicine to veterinary and human medicine is the process of developing and publishing **systematic reviews** (see<sup>1-4</sup> for recent examples). These reviews differ from the more historically common narrative review that systematic reviews explicitly define a specific review question, use methods to reduce bias in the selection and inclusion of studies that address the review question (including a systematic and specified search strategy and selection of

studies based on explicit eligibility criteria), an assessment of the risk of bias for included studies, and objectively summarizing the results qualitatively or quantitatively such as by meta-analysis.<sup>5</sup> Detailed guidelines are available for preparing such reviews.<sup>5-12</sup> Systematic reviews provide readers with a transparent report and assessment of the scientific literature addressing a particular well-defined clinical question. The number of these reviews is limited and not all provide unequivocal outcomes or recommendations. An extension of the systematic review is the **GRADE** approach in which evidence is then used to make recommendations (systematic reviews typically provide only an assessment of the quality of evidence and not how or whether it should be used).<sup>13,14</sup>

The dilemma of whether or not to administer a certain drug or perform a certain operation in an animal with or without an established diagnosis, or when the outcome is uncertain, is familiar to veterinarians. Owners of animals with a disease, or merely a minor lesion, expect to receive a reasonably accurate prediction of the outcome and the cost of treatment, but often considerable uncertainty exists about the presence or absence of a certain disease, or its severity, because confirmatory diagnostic information is not available.

The information required for a reasonably accurate prognosis includes the following:

- The expected morbidity and case fatality rates for the disease
- The stage of the disease
- Whether or not a specific treatment or surgical operation is available or possible
- The cost of the treatment

If success is dependent on prolonged and intensive therapy, the high cost can be prohibitive to the owner who might then select euthanasia of the animal as the optimal choice. Veterinarians have an obligation to keep their clients informed about all possible outcomes and the treatment that is deemed necessary and should not hesitate to make clear recommendations regarding the options for treatment or disposal of a case. There are also different levels of outcome, which may affect the prognosis and therapeutic decision making. In the case of breeding animals, mere survival from a disease is insufficient and treatment is often not undertaken if it is unlikely that it will result in complete recovery and return to full breeding capacity. Slaughter for salvage may be the most economical choice. In other cases, e.g., a pleasure horse, the return of sufficient health to permit light work might satisfy the owner.

### DECISION ANALYSIS

Veterinarians must routinely make decisions that have economic consequences for the client and the veterinarian. Questions, such



as whether to vaccinate or not, whether to treat an animal or recommend slaughter for salvage value, whether or not to perform surgery, or even which surgical procedure to use to correct a case of left-side displacement of the abomasum, are common. Many of these questions are complex, requiring several successive decisions, and each decision may have more than one outcome. Clinical decisions are not only unavoidable but also must be made under conditions of uncertainty. This uncertainty arises from several sources and includes the following:

- Errors in clinical and laboratory data
- Ambiguity of clinical data and variations in interpretations
- Uncertainty about the relationships between clinical information and presence of disease
- Uncertainty about the effects and costs of treatment
- Uncertainty about the efficacy of control procedures such as vaccination or the medication of feed and water supplies in an attempt to control an infectious disease

The process of selecting a management plan from a range of options involves a mental assessment of the available options and their probable outcomes. Decision analysis provides a framework for handling complex decisions so that they can be more objectively evaluated. Decision analysis is a systematic approach to decision making under conditions of uncertainty. Because the technique can be so useful in sorting out complex questions associated with the treatment and control of disease in individual animals and in herds, it is almost certain to become more commonly used by large-animal practitioners.

Decision analysis involves identifying all available choices and the potential outcomes of each and structuring a model of the decision, usually in the form of a decision tree. Such a tree consists figuratively of nodes, which describe choices and chances and outcomes. The tree is used to represent the strategies available to the veterinarian and to calculate the likelihood that each outcome will occur if a particular strategy is used. A probability value must be assigned to each possible outcome, and the sum of the probabilities assigned to the branches must equal 1.0. Objective estimates of these probabilities may be available from research studies or from a veterinarian's own personal records or it may be necessary to use subjective estimates. The monetary value associated with each possible outcome is then assigned, followed by calculation of the expected value at each node in the tree. At each decision node the value of the branch with the best expected value is chosen and that becomes the expected value for that node. The expected value establishes a basis for the decision. An example of a decision tree without probability values assigned is shown in Fig. 1-3.

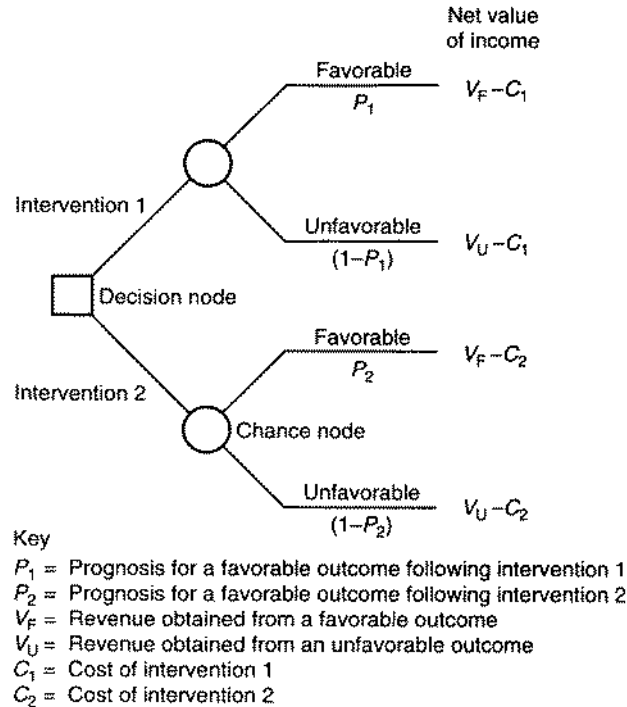

**Fig. 1-3** A decision tree for choosing between two interventions. (With permission from Fetrow J et al. *J Am Vet Med Assoc* 1985; 186:792-797.)

In the decision tree, choices such as the decision to use Intervention Number 1 or Intervention Number 2 are represented by squares called **decision nodes**. Chance events, such as favorable or unfavorable outcomes, are represented by circles called **chance nodes**. When several decisions are made in sequence, the decision nodes must be placed from left to right in the same order in which the decisions would have to be made, based on information available at that time. The tree may become very complicated, but the basic units of choice and chance events represented by squares and circles remain the same. Lines, or **branches**, follow each node and lead to the next event. The branches following each decision node must be exhaustive; for example, they must include all possible outcomes, and the outcomes must be mutually exclusive. After each chance node there is a probability that an event occurs. The probabilities following a chance node must add up to 1.0. The probabilities are placed on the tree following the chance node. The expected outcomes ( $V_F$  and  $V_U$  in Fig. 1-3) are entered at the far right of the tree. The outcomes represent the value that would result if the events preceding them on the tree were to take place and must include the costs of the intervention.

When a complete tree accurately representing the problem has been constructed, the next step is to solve it for the best decision to follow. This is done by starting at the right of the tree, in which outcome values are multiplied by the probabilities of outcome at the preceding chance node. The figures

derived from this procedure are added together to obtain the equivalent of a weighted average value at the chance node, known as the **expected value**, which by convention is circled with an oval. This procedure is repeated from right to left on the tree at each chance node. When a decision node is reached when moving from right to left, the most profitable path is chosen and a double bar is drawn across the branches leading to the lesser cost-effective decisions. When the first decision node at the left of the tree is reached, a single path will remain that leads from left to right and has not been blocked by double bars. This path represents the best way to handle the problem according to the available information, including the outcome at the end of that path.

An example of the construction and use of a decision tree to assist in deciding at what day postpartum an ovarian cyst should be treated, as opposed to waiting for spontaneous recovery, is illustrated in Fig. 1-4. In structuring the problem, over time, the clinician knows that the cyst can be treated or left to be treated later. Retreatment is possible if the first treatment is ineffective. The structure must include all alternatives. The other information needed to solve the problem includes the following:

- The incidence or chances of spontaneous recovery
- The response to treatment, both initially and following repeated treatments
- When the response occurs
- The cost of treatment and the cost of the disease

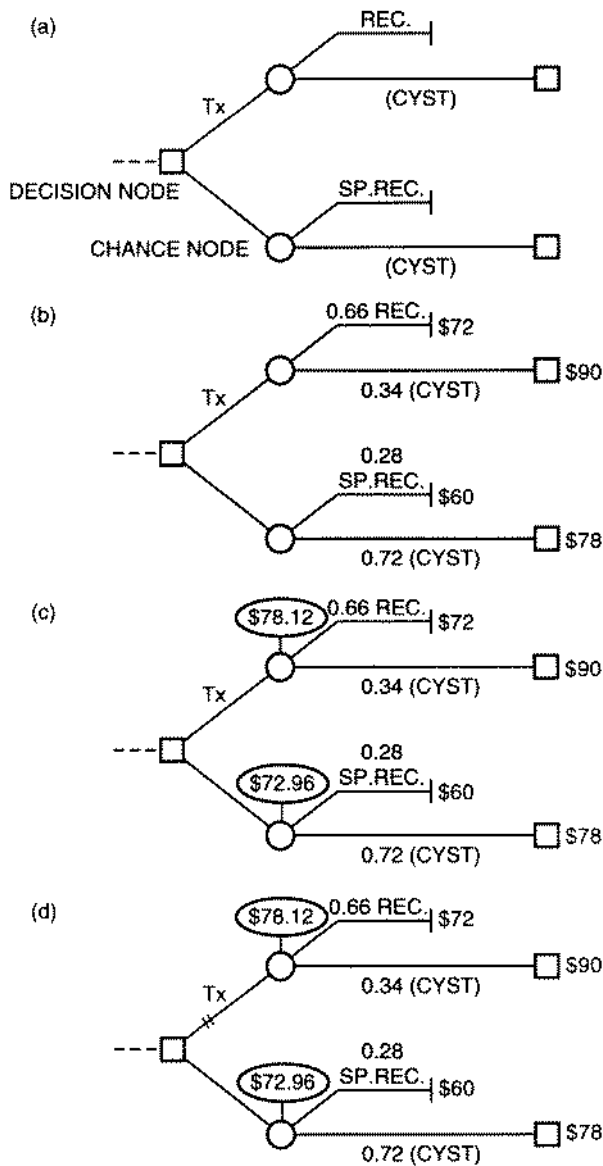

**Fig. 1-4** Example of the construction and use of a decision tree. The sources of probabilities and dollar values are discussed in the text. (a) The skeleton of the decision tree with a decision [treat (*Tx*) versus do not treat] and chance outcomes [recovery (*REC*) or spontaneous recovery (*SPREC*) versus continued cyst (*CYST*)]. (b) Probabilities and previously calculated outcome values are placed on the tree. (c) Expected costs of decision alternatives have been calculated and written in balloons above the chance nodes. (d) At this decision node, the correct choice is no treatment because it is cheaper (\$72.96 versus \$78.12). Double bars mark the pathway that is not chosen (treatment). The value \$72.96 is then the outcome cost for this decision node. The value is used in the calculation of the best alternative to the previous decision node, because the process is repeated from right to left (not shown). (With permission from White ME, Erb HN. *Comp Cont Educ Pract Vet* 1982; 4:5426-5430.)

The details of the steps used in decision analysis of several different problems in food-animal practice have been described, and the reader is referred to the publications for further information. There are some limitations to using decision analysis in animal health programs, and the technique requires time and effort, which practitioners are reluctant to provide unless the benefits are obvious. The estimates of the probabilities associated with the respective branches of the tree are seldom readily available.

A number of techniques that can be used to derive these probabilities and incorporate them in decision making have been recorded. The rapidly developing use of analytical veterinary clinical epidemiology can now provide the tools to generate the numerical data necessary to make reliable decisions. There is a need to apply epidemiologic principles to prospective clinical studies to determine the most effective therapy or the efficacy of control procedures for the commonly occurring economically important diseases of food-producing animals. The inputs and outputs of a given strategy may not have a market value, or the market value may not be an appropriate measure, or they may not be tangible or measurable in the usual monetary units. For example, the market value of a dairy cow may not represent the true or real value of the cow to the farmer. The farmer may consider the value of the cow in relation to cattle replacement determinants such as herd size, the availability of replacements, and the genetic potential of the animal. The final selection of one option or the other is usually a complex process that will also vary from individual to individual depending on the decision criterion used.

In summary, decision analysis provides a systematic framework for making rational decisions about major questions in animal health, and it is hoped that some veterinarians will adopt the technique for field use.

#### FURTHER READING

O'Connor A, Sargeant J. Research synthesis in veterinary science: narrative reviews, systematic reviews and meta-analysis. *Vet J*. 2015;206:261-267.

#### REFERENCES

- Baltzell P, et al. *J Vet Int Med*. 2013;27:760.
- Dore E, et al. *J Vet Int Med*. 2012;26:32.
- Grissett GP, et al. *J Vet Int Med*. 2015;29:770.
- Sullivan SL, et al. *Eq Vet J*. 2015;47:341.
- O'Connor A, et al. *Vet J*. 2015;206:261.
- O'Connor AM, et al. *Zoonoses Pub Health*. 2014;61:28.
- O'Connor AM, et al. *Prev Vet Med*. 2014;113:313.
- O'Connor AM, et al. *Anim Health Res Rev*. 2014;15:3.
- O'Connor AM, et al. *Zoonoses Pub Health*. 2014;61:52.
- Sargeant JM, et al. *Zoonoses Pub Health*. 2014;61:10.
- Sargeant JM, et al. *Zoonoses Pub Health*. 2014;61:39.
- Sargeant JM, et al. *Zoonoses Pub Health*. 2014;61:2.
- Neumann I, et al. *J Clin Epi*. 2016;72:45.
- Guyatt GH, et al. *Brit Med J*. 2008;336:1049.

The critical factor in each tree is the probability value for each possible outcome. The monetary value of each outcome can be estimated on a daily basis but, unless the probability of the outcome can be assessed as accurately as possible, the decision analysis will be unreliable. Decision analysis has been used to determine the cost-effectiveness of heat mount detectors, the time at which to treat bovine ovarian cysts, the effectiveness of three alternative approaches to the control of

*Haemophilus* meningoencephalitis in feedlot cattle, the economically optimal control strategy among several alternatives for the control of infection with *Brucella ovis* in a sheep flock, and the relative merits of testing or not testing calves entering a feedlot with a metabolic and cellular profile test as predictors of performance in the feedlot. Decision analysis can now be done on a microcomputer, which makes the process highly suitable for assisting the veterinarian in daily decision making.

# Examination of the Population

APPROACH TO EXAMINING THE  
POPULATION 29  
EXAMINATION STEPS 30

TECHNIQUES IN EXAMINATION OF  
THE HERD OR FLOCK 32

ROLE OF THE INTEGRATED ANIMAL  
HEALTH AND PRODUCTION  
MANAGEMENT PROGRAM 34

The examination of the herd or flock assumes importance where there are outbreaks of disease or problems of population productivity caused by subclinical disease. The purpose of a herd examination is to define the exact nature of the problem and to identify those dysfunctions within the herd environment that are associated with its occurrence. The ultimate objective in the examination of a herd is to establish strategies for the treatment, correction, and control of the disease problem at the herd level. This may involve strategies to increase the resistance of the animals or strategies that change adverse factors in the herd environment.

There are a number of ways in which these objectives can be achieved, and they are not mutually exclusive. The methods for examination of the population include the following:

- Initial definition of the problem to be examined
- Clinical examination of individual animals in the population
- Analysis of records of performance and disease
- Examinations of the environment
- Laboratory examination of the animal and nutritional and environmental sampling
- Necropsy examinations of dead or sacrificed animals
- Descriptive and analytical epidemiologic examinations

Methods for correction of the problem include the following:

- Treatment of individual sick animals
- Selective or strategic prophylactic medication of the impacted group (metaphylaxis)
- Immunoprophylaxis
- Alterations to the nutrition, the environment, or the management of the herd or of selected groups within it

One or several of these methodologies may be used in dealing with herd problems depending on the nature of the disease under consideration.

Herd examinations can be expensive, and in clinical settings the depth of investigation must be justified by the degree of economic importance of the problem. Some diseases are well defined, they are easily and definitively recognized by clinical or postmortem

examination, their determinants are well established, and there are established effective methods for their control. In these instances a herd examination in a clinical setting would be limited to the initial examinations that establish the diagnosis and to the implementation of corrective strategies.

Other diseases are less well defined. There may be several determinants of their occurrence and, consequently, all facets of the examination methods may be needed to determine the most appropriate method for control. It is for this type of disease that **epidemiologic investigations** are of particular importance and, where there is an economic justification, an in-depth epidemiologic investigation should be considered to determine the appropriate method of intervention.

## Approach to Examining the Population

Chapter 1 discussed the approach to clinical examination of the individual animal and the methods for determining the presence of an organ system dysfunction and for reaching a diagnosis as to cause. Basically, these consist of a physical examination to assess the function of each body system coupled with laboratory or other ancillary diagnostic methods and information that can assist in this assessment and in the establishment of cause. In the individual animal, disease is usually diagnosed and classified by the system involved and the inciting agent, for example, pneumonia associated with *Pasteurella multocida* and myopathy caused by a deficiency of selenium. Subsequent treatment is based on this knowledge and usually consists of therapy directed against the cause and therapy aimed at correcting the system dysfunction. The **traditional approach** therefore emphasizes diagnosis and treatment of individual animals, with the **assumption that a healthy individual leads to a healthy herd** because **a herd is composed of individuals**.

The approach to the examination of the herd has a similar logical and systematic approach, but it is obviously expanded beyond the examination of individual animals and involves different systems. It

also involves different approaches to the cause of disease. Herd examinations are conducted because there is an outbreak of disease or a problem of production inefficiency. By definition this involves a group or a population of animals. Most outbreaks of this type in groups of animals result from faults or dysfunctions in the complex of interactions that occur within groups of animals and between the groups of animals and their management, environment, and nutrition. Thus the characteristics of the group of animals that are affected become the focus of the examination and the management, environment, and nutrition are the broad systems that are examined in relation to this group of animals. The **integrated animal health and production management program** therefore emphasizes the management system, with the **assumption that an optimized production system leads to a healthy herd**. During the examination of the herd the following questions are asked:

- What is the disease problem present?
- What are the characteristics of the animals involved?
- Why has this group of animals developed the disease?
- Why are they at increased risk in relation to others within the herd?
- What are the factors in their management, nutrition, or other environment that have led to his increased risk?
- What intervention strategies can be used to correct the problem?

A major objective of the examination is to establish a diagnosis of cause. In particular, the objective is to establish a diagnosis of cause that can be altered by an intervention. The diagnosis of cause in a herd disease problem is often different from the diagnosis of cause established in the examination of an individual. Disease occurrence in groups of animals is often multifactorial in cause and the result of the interaction of several risk factors, which may be characteristics of the animals, their environment, or of an inciting agent. In the context of the herd the cause or *etiology* of a disease can be a management fault. In making a diagnosis of cause, the clinician establishes and ranks the major determinants of the problem from among the various risk factors.

### EXAMPLES OF MULTIFACTORIAL ETIOLOGY OF A DISEASE

The examination of an individual animal that is representative of a group of young calves with respiratory disease may lead to a diagnosis of pneumonia associated with *P. multocida*. The diagnosis of the cause of the same problem following a herd examination that evaluates the numerous risk factors for pneumonia in calves might include the following:

- Inadequate ventilation in the calf house
- Failure of adequate transfer of colostral immunoglobulins
- Lack of a vaccine program against respiratory pathogens
- Failure to use all in, all out, housing changes
- Presence of a calf that is persistently infected with bovine virus diarrhoea
- Most probably, a combination of one or more of these risk factors, plus other additional factors

In making a diagnosis of cause, the clinician establishes and ranks the major determinants of the problem from among the various risk factors. With many diseases one progresses to an examination of cause in the herd using the recognized risk factors for the disease. These risk factors usually have a logical relation to the disease being examined, such as with the previous example of calf pneumonia. With other diseases the logic of these relationships may be less apparent. This occurs particularly with newly developing or recently recognized diseases, in which the pathogenesis of the disease is poorly understood but epidemiologic examinations have established certain relationships that have a causal association. The definition of circumstances of occurrence for a disease can lead to a method of control even though the cause of the disease, in the traditional sense, is not known and the relationship between the inciting or associated circumstance and the disease is obscure. A current example would be the developing recognition of an association between dry cow nutrition in dairy cattle and metabolic and infectious diseases that occur early in lactation.

### EXAMPLE OF THE CONTROL OF A DISEASE WITHOUT KNOWLEDGE OF ITS ETIOLOGIC CAUSE

It is now known that facial eczema in sheep is a toxicosis from fungal toxins produced in pastures. However, long before the toxic nature of this disease was fully understood, the epidemiologic circumstances of its occurrence were defined, and it was prevented by removing sheep from pastures at risk for the disease during predicted risk periods.

Problems of disease and production inefficiency encountered in herds can present a considerable challenge in diagnosis and correction. In part this is because disease in groups or herds is commonly multifactorial in cause and, for this reason, when examining the herd all the factors that influence the behavior of a disease in that herd are important. The obvious approach is a quantitative definition of the disease and a quantitative examination of the relative importance of these risk factors. However, this approach can be difficult in practice.

In clinical settings there is usually no difficulty in achieving a quantitative definition of the animals affected and their characteristics. In large, well-recorded herds it is usually possible to conduct a quantitative examination of risk factors if the records contain information that relates to them. In small herds, a quantitative examination of the relative importance of risk factors may be limited by small numbers of animals. Knowledge of risk factors and their relative importance in disease causation is improving with epidemiologic research studies that involve large numbers of animals and several herds. The role of the clinician in the approach to a herd disease problem is to know and to be able to detect these established influences, to be able to quantify them where possible, and to be able to choose which influences are best corrected by intervention from both a practical and an economic standpoint.

## Examination Steps

There is no single protocol that can be used for the examination of the herd, because this will depend on the type of disease problem and the type of herd. For example, the methods of examination that would be used in the examination and definition of a problem of ill-thrift in a flock of weaned lambs would be different from those used for a problem of lameness in dairy cattle. Most herd investigations will follow certain broad principles and steps, which are outlined in Fig. 2-1. A given herd examination does not necessarily follow all of these steps and does not necessarily proceed in the exact order given; however, the general principles apply to most investigations.

### Step 1: Defining the Abnormality

It is essential first to define the abnormality in either clinical or subclinical terms. This definition must be accurate because this step of the examination determines the focus of the examination and the types of cases that will be included in the examination and analytical procedures. The definition must also address the producer's concerns because they must implement change, and will be reluctant to do so if they feel their concerns have not been addressed. A **case** is defined as an animal or a group of animals that have the

characteristics of the disease or a defined deviation from targets of production. With some investigations the problem will have obvious clinical manifestations and the primary definition of cases will be made by clinical examination of affected individuals. With others the primary complaint may be lowered production in the absence of clinical disease. An apparent problem in production efficiency can be found by examining the records. In many herds this will prove to be an immediate major limitation to the investigation because of a lack of sufficient records on reproduction, production, and associated management to define the complaint. In these circumstances the criteria of the production inefficiency considered in the examination will need to be determined and some form of measurement established.

### Step 2: Defining the Pattern of Occurrence and Risk Factors

This step of the examination is often conducted in conjunction with Step 1. It defines the characteristics of the animals that are affected in the disease problem and that have been established as cases. It also determines the differences between them, as individuals or as a group, and the nonaffected animals within the herd. These differences may be attributes of the animals themselves or of environmental influences that affect them.

The initial examination is usually directed toward the determination of the characteristics of the animals involved and the **temporal** (when) and **spatial** (where) patterns of the disease. Generally, the information that allows these examinations is collected at the same time and consists of the following factors:

- A listing of the cases that have occurred
- The date when disease was first observed in each case
- The age, breed, and other individual information for each case, which may include information such as source, family association, vaccination history, and previous medication
- Management group membership, which may be pen membership, milking string, pastoral group, and so forth
- Type of ration and nutritional data
- Management and other environmental information relevant to the problem

To compute **risk group analysis** the number of animals present in both sick and well groupings must be recorded as well as any similarities and differences in their management and environment. After the identity of the abnormality has been established, all the available clinical, production, and laboratory data are examined according to the affected subgroups in the herd and according to time occurrence, management differences, nutritional and environmental influences, and factors such as vaccination history.

In most herd examinations the analysis of these data is restricted to a cross-sectional



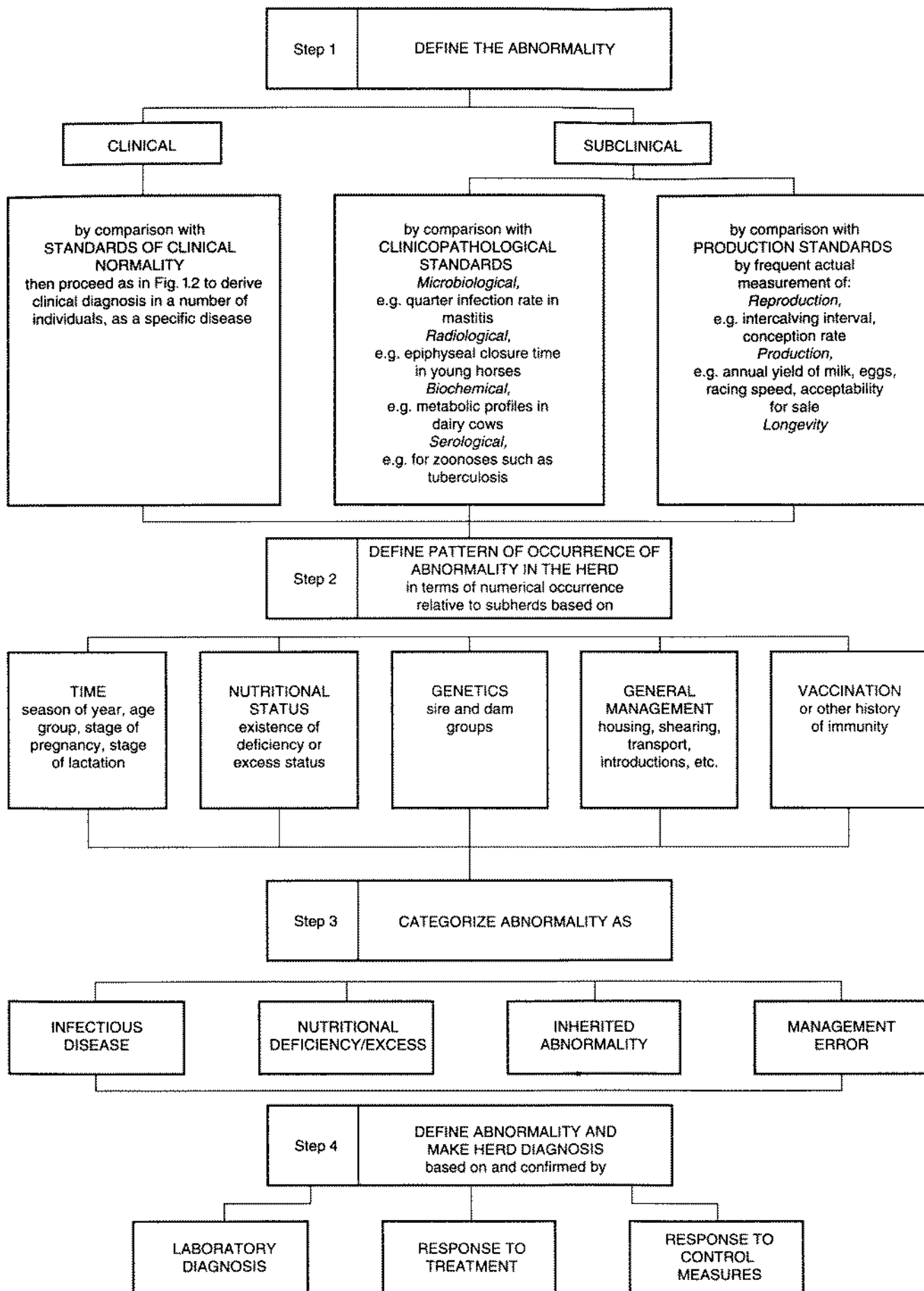

Fig. 2-1 Examination of the herd with the objective of making a diagnosis.



study. Prevalence rates within the various groups are calculated and the population at risk can be determined. Animals or groups can be examined as those with and without disease and those with and without hypothesized risk factors using a  $2 \times 2$  contingency table generated for each variable. Relative risk, odds ratios, or rate ratios can be calculated as a measure of association of the variable with chi-square and Mantel-Haenszel procedures used for evaluation of the significance of the risk. These procedures attempt to determine whether any associations exist between certain groups of animals and those factors that can influence the behavior of disease.

In some herds, in which there has been extensive historical recording, it may be possible to examine the nature of the problem on the basis of a case-control study. However, in most herds this will not be possible because the factors important for defining the disease problem are less extensively recorded. Because the economic viability of the herd is very important, it may be necessary to establish recording systems that allow a prospective examination of disease problems.

### Temporal Pattern

The temporal pattern of distribution of a disease in a population can be important in suggesting the type of disease that is occurring and its possible causes. Temporal recording and graphing of cases is valuable in indicating possible portals of entry of an infectious agent or sources of a toxic influence. For this analysis the temporal occurrence of the disease is determined by the collection and graphing of the time of onset of clinical cases (hours, days, and weeks) and by relating this information to management or environmental changes.

Generally two types of epidemic curves are graphed. A **point source** epidemic curve is characterized by a rapid increase in the number of cases over a short period of time. This type of epidemic curve occurs when all the animals in a population are exposed at one time to a common agent. This may be a toxin or a highly infectious agent, with many animals affected at approximately the same time and, depending on the variation in the incubation period, a sharply rising or a bell-shaped curve of short time duration. The graphing of a sporadic outbreak suggests the occasional introduction of a disease agent into a susceptible population or the sporadic occurrence of factors suitable to the clinical manifestation of an endemic agent, as opposed to the relatively continual occurrence of an endemic disease.

When the infection has to be transferred from animal to animal after undergoing multiplication in each animal, delay results and the epidemic curve develops a flatter bell-shaped occurrence of much longer duration and with varying peaks depending on temporal differences in, and opportunities for,

transmission. This is known as a **propagative** epidemic. Although the occurrence and identification of an index case has considerable value in epidemiologic examinations of this nature, it often cannot be identified in veterinary clinical settings.

### Spatial Examination

The spatial examination of a disease problem requires gathering information on affected and nonaffected animals relating to housing environment, or pastures, or animal movements. A cluster of cases associated with a specific area may indicate the source of the problem. This is best analyzed by plotting the frequency of cases on maps of the environment that include possible risk factors, such as pen locations within buildings, buildings themselves, water sources, pastures, rubbish dumps, roads, implement storage areas, and so forth. When spatial associations are established, further detailed examination of the location is indicated.

### Step 3: Defining the Etiologic Group

Following characterization of the abnormality according to groups within the herd, and having made comparisons of the prevalence rates between groups, it may be possible to discern to which etiologic category the abnormality most logically belongs. In many instances considerable difficulty may be encountered in deciding in which of the general areas of etiology the major determinant is located. In many cases herd problems are not the result of a single error but are multifactorial, with several determinants contributing to a greater or lesser degree, and the problem may fall into several categories.

An example might be a problem of mortality in calves in which examinations have determined that population mortality rates are highest in the winter period, that most mortality occurs between 4 days and 1 month of age, that calves that die early in this period have septicemia or have scours associated with rotavirus and cryptosporidial infections, that the body condition scores of the calves fall during the third and fourth weeks of life, and that calves that die later in the time period appear to die of starvation. Probable causes include improper feeding of colostrum, a poor environment leading to a high infection pressure and possibly also to excess cold exposure, and malnutrition resulting either from the residual effects of enteric disease on intestinal absorption of nutrients or from an inadequate caloric intake or both. This complex could be placed in the categories of infectious disease, nutritional disease, and management error, and further definition is the next step.

The use of **path models** that summarize current knowledge of the causality of the disease under consideration can help in this aspect of the herd examination. Path models specific to the problem at hand can be constructed and can show the interrelationships

between various risk factors. These models can give some indication of the dependence of any one factor on the occurrence of another. This information can be used to estimate the relative contributions of the various etiologic categories and to give guidance as to the area where intervention is most likely to be effective.

### Step 4: Defining the Specific Etiology

The final step is to select the probable most important determinant or combination of determinants from within one or more of the general areas and to make corrective interventions based on this diagnosis. In many instances the primary cause may be clear, and the correction (alterations in nutrition, alterations in management, vaccination, etc.) can be made at this stage. In other cases further prospective examinations may be conducted for a better definition before an intervention is attempted. In the previous example, failure of transfer of colostrum immunoglobulins and inadequate caloric intake would have been suspect or even identified as underlying determinants of the problem. However, with most farm recording systems there is likely to be no available data that would help delineate the specific reasons and the specific management deficiencies that require correction; thus a prospective study to provide these data would need to be established.

It can be very difficult to obtain a clearly defined diagnosis of disease in a herd because of its complexity, but the known important relationships are given for the individual diseases in each chapter. Methods for practical clinical quantitative assessment of the level of management expertise or, more importantly, the intensity with which it is applied, are not available. Consequently, this must be assessed qualitatively for most management practices. Surrogates such as the percentage of cows presented for pregnancy diagnosis but not pregnant, bulk tank somatic count, rates of failure of passive transfer of colostrum immunoglobulins, and so forth, can provide some indication.

## Techniques in Examination of the Herd or Flock

In the following sections are some of the techniques used in examining a group or herd of animals. Any one or combination of the techniques may be used at the same time, depending on the nature of the problem and the availability of support facilities such as diagnostic laboratories and data analysis laboratories and their cost. Fundamental requirements for success are the veterinarian's communication skills<sup>1</sup> and willingness to collaborate with other animal health professionals,<sup>2</sup> such as agricultural engineers, agricultural economists, nutritionists, crop scientists, and soil scientists.

## CLINICAL EXAMINATION

A clinical examination is essential if clinical illness is a feature of the disease, and a representative sample of animals should be examined. The importance of this component of the examination cannot be overemphasized. When there is clinical disease an accurate definition by clinical examination may lead to a diagnosis of a disease with known and specific determinants, and further examination of the herd can focus specifically on these factors. When clinical examination does not lead to a finite definition of the cause of the disease but gives a diagnosis of a disease of multifactorial determinants, the examination will still lead to the identification of risk factors that need to be included in the herd examination.

Recording the findings is important and is greatly assisted by a structured report form so that the same clinical features are recorded for each animal. Often clinically affected animals are enrolled as cases in an investigation on the basis of the presence of certain defined signs or clinical abnormalities, and a recording form aids in this selection. This is especially important when several veterinarians in a practice may be involved in the herd examination over time.

Selection of the animals to be examined is vital. This should not be left to the farmer because that selection may be biased to include the sickest, the thinnest, and the oldest, and not necessarily the animals that are representative of the disease under examination. This is particularly important if a group of animals is to be brought from the farm to a central site for detailed clinical examination as part of the workup of the problem. Strict instructions should be given to the owner to select 10 to 12 animals as a minimum. The groups should include eight sick animals, if possible four advanced and four early cases, and four normal animals as controls. If the situation permits, the inclusion of animals that can be sacrificed for necropsy examination is an advantage. Ideally, unless facilities will not allow it, the clinical examinations should be on the farm and the veterinarian should select the animals for examination.

In outbreaks of disease in which there is mortality, necropsy examination and associated sampling is an extremely valuable investigative and diagnostic tool. Necropsy examination should not be ignored as the primary method of establishing a diagnosis of problems of disease or production inefficiency in larger herds and flocks. With many diseases in swine herds and larger sheep flocks the costs associated with the sacrifice of a few animals for this purpose are far outweighed by the benefits of an early and accurate diagnosis and the ability to intervene quickly with corrective strategies. Even in cattle herds, owners are willing to sacrifice affected cattle if it can facilitate a more accurate definition of their problem. It must also

be recognized that some diseases cannot be accurately defined on the basis of their clinical manifestation and epidemiology and a necropsy is required as part of the examination system.

## SAMPLING AND LABORATORY TESTING

Laboratory examination is conducted for a number of legitimate reasons. It may be conducted to aid in the establishment of a diagnosis or it may be conducted following the establishment of a diagnosis to aid in the definition of risk factors or in the evaluation or the efficacy of treatment and control strategies.

The validity of laboratory testing in the investigation of disease is only as good as the quality and relevance of the samples submitted. Frequently samples that can be most conveniently obtained are not the best for this purpose, and a **sampling strategy** specifically directed to the question may need to be established.

Laboratory analysis of samples is expensive and should not be undertaken unless there is a specific objective. Before submitting samples for examination the following questions should be asked:

- Is the sampling strategy structured to answer specific questions or is it a random fishing expedition?
- Has a sampling strategy been established that will allow a comparison of animals in the at-risk category with those thought not at risk for the disease or the exposure factor? Is pooling of samples appropriate, and if so, what is the optimal number of samples to be pooled and what impact does pooling have on overall test sensitivity?
- Is there a gold standard for the analysis and its interpretation?
- What information will be gained from the results of the laboratory examination that could not be gained by other examinations or logically inferred without these examinations?
- What are the specific steps to be taken that depend on the results of these examinations, or will the steps be taken regardless of the results?

This type of questioning may limit laboratory examination to situations where it is most cost-effective.

The ideal laboratory test should provide immediate on-farm results and be low cost, widely available, simple to use and interpret, and have appropriate sensitivity and specificity. Six excellent examples of extremely useful laboratory tests are the California Mastitis Test (CMT) for detecting subclinical mastitis on a quarter or cow level, the urine nitroprusside test for detecting subclinical or clinical ketosis, daily milk production on an individual cow and herd level that provides immediate feedback on nutrition and environmental stress, milk fat percentage that provides insight into rumen pH and diet

formula, urine pH that provides information on the adequacy of acidogenic diet formulation in the late dry period, and body condition score using morphologic parameters or back-fat thickness determined ultrasonographically. Successful implementation of an integrated animal health and production management program requires more on-farm tests like these, and more validated indices of health based on behavior, such as rumination time per day and activity level based on pedometers.

Laboratory examination of samples taken in association with clinical examination is usually conducted to help establish the presence and severity of organ dysfunction, which generally cannot establish cause. The value and use of laboratory examinations in the assessment of organ function is discussed in the sections in this text that deal with system diseases relevant chapters of this text. Similarly the nature and value of sampling to establish the etiologic association of toxic or infectious agents with disease is discussed under specific disease headings.

Laboratory testing can also be conducted to determine risk and exposure factors. When used for this purpose the sampling strategy must be directed and should be conducted after the preliminary diagnosis has been made. It must be aimed at answering the specific questions listed earlier, otherwise it will be inordinately expensive. An example would be the examination of specific feeds that have been implicated as potential sources for a toxin following the epidemiologic examination and risk factor analysis in a herd in which a specific toxicity was established as the cause of mortality. Without this prior epidemiologic examination a mass sampling of the herd and its environment for the presence of the toxin would be extremely expensive and of limited value.

At the time of the initial farm visit, it is advisable to collect samples that are pertinent to the problem and its differential diagnosis but are not of primary analytical significance in the initial definition of the problem. These can be stored and, depending on the results of initial laboratory examinations, may be discarded or used to further define the problem. Duplicate samples are often desirable so that second thoughts on tests can be accommodated. This is particularly important in serologic work in which hindsight may occur much later and extra samples might be useful when one is attempting a retrospective examination.

In many outbreaks it is usually wise to collect samples from controls that are established specifically to evaluate the problem under investigation. These may be clinically normal animals that have not experienced the suspect exposure factor, animals that are clinically normal but have been exposed and are possibly in an incubation or subclinical stage, and from a third group of clinically affected animals. This system approximates the protocol for the Compton Metabolic

Profile, which is described in detail in Chapter 17.

The other consideration is the number of animals to be included in each sampling group. The sample size required for the detection of an attribute varies with the confidence of detection that is desired and with the size of the population and the prevalence or frequency of the attribute in that population. There can be no set recommendation even for one disease. For example, the sample size required to confirm a diagnosis of copper deficiency in a group of animals with overt clinical deficiency disease will be much smaller than that required to establish a developing deficiency state or the risk for clinical disease in the face of deficient intakes when grazing pasture. Unfortunately, cost severely limits the size of the sample that can be tested in most circumstances, and the small size that is common can place severe restrictions on any meaningful interpretation. The commonly recommended 10 animals or 10% of the group would appear to have little validity in most examinations.

### Numerical Assessment of Performance

Productivity indexes can be used as indicators of health; they can also be used to measure response to treatment or control measures. More and more they are used as guides to husbandry and management questions to meet the present-day farmer's concerns with costs and returns. If recording systems are present on the farm they can be invaluable data sources in the investigation of herd problems with disease. Monitors of production efficiency are used extensively in performance or production management veterinary practice and are detailed in texts on that subject in the reference sections.

### Intervention Strategies and Response Trials

As the result of a herd examination, a clinician formulates a hypothesis concerning the disease. This may include hypotheses on the population of animals at risk, the determinants of the disease, and the source of the problem and its methods of transmission or propagation. There may be sufficient confidence in these hypotheses that they may result in **intervention strategies** to correct the problem without further analysis. In other outbreaks the hypotheses may be less secure and may require further examination of response trials.

**Response trials** are often used in an approach to herd disease problems and problems of production inefficiency. They have several purposes: they may be used to establish or confirm a diagnosis, and when used for this purpose it is usually because of the difficulty in confirming the diagnosis by other methods. This may result from the lack of a suitable laboratory test or because the result of the test is supportive for the

diagnosis but not confirmatory. Response trials can also be used to determine the degree of intervention that is required and the efficacy of the level of intervention that has been used.

#### EXAMPLE OF REASON FOR RESPONSE TRIALS

The finding of hypocupremia in a group of poorly growing calves would support a diagnosis of growth retardation caused by copper deficiency but does not confirm it, because calves with normal growth can also be hypocupremic. The only way to confirm the association and the diagnosis is to conduct a response trial with copper treatment as the variable.

#### AN EXAMPLE OF MONITORING EFFICACY OF INTERVENTIONS

Response trials can be used to determine the degree of intervention required and the efficacy of the level of intervention that has been used. Copper deficiency in grazing calves may occur as a simple deficiency or as a conditioned deficiency. Simple copper deficiency can usually be prevented by a single subcutaneous treatment of copper glycinate and this may protect the calves for several months. On the other hand, a conditioned copper deficiency may require treatment every 4 to 6 weeks.

Some prediction as to the required treatment frequency can be made by pasture element analysis. A response trial with 6-week-interval monitoring of blood copper concentrations and weight gain can monitor the efficacy of the treatment used and allow a corrective intervention, if indicated. In the absence of a treatment response trial, a nonresponse caused by an incorrect decision on treatment frequency could result in discarding the correct diagnosis.

There are many limitations to conducting response trials in clinical situations in private herds, and their structure may not always meet the strict requirements of those conducted in research. It is not always possible to establish a controlled response trial in clinical practice but the efficacy of intervention strategies should still be monitored. The ultimate interest is in whether the disease or production problem is corrected; however, the efficacy of the individual strategies should be specifically monitored where possible. In the earlier example of calf mortality a decision might have been made to change the method of feeding colostrum and to improve the caloric intake of the calves. There can be various ways that either of these changes could be achieved. The overall efficacy of these changes will be determined by improved survival of the calves. However, the efficacy of the colostrum management

change in improving passive transfer should be determined specifically by measurements of serum immunoglobulin concentrations in the serum of a proportion of calves and the efficacy of caloric improvement by weight measurements. Should calf mortality drop, these latter measures are of limited value, but if it does not then there are ways to predict whether the failure was caused by misdiagnosis of the problem or poor efficacy of the suggested corrective strategies in correcting their respective target areas.

A diagnosis made on the basis of a response trial is often presumptive, and it has become customary to couch the diagnosis in terms of response to a treatment, for instance, selenium-responsive infertility in sheep. This is not a diagnosis in terms of satisfying the original concepts of Koch's postulates, although it does satisfy the subsequent modifications of these postulates that are now generally accepted and have been based on a broader interpretation of disease causation. In populations of animals, diseases are largely the result of a number of interacting factors of different genres, including management, nutrition, and environmental factors, and interacting with traditional agent-causes of disease, including microbiological and toxic agents. The answer for the practical problem may be most economically derived by finding the cure rather than the cause. This is especially desirable if that course is cost-effective and finding the cause is more expensive than the wastage caused by the disease.

A simple example would be mortality in a group of cattle that followed a change of feed to a more concentrated ration. An epidemiologic examination, including a temporal examination of cause or determinants, might closely link the mortality to the change in ration. This should be sufficient to indicate that the ration should be withdrawn or its method of feeding modified. The alternative approach would be to defer any decision for correction of the problem until the exact problem with the ration was established. This could involve a ration analysis and an examination for unknown toxic components. These examinations would take considerable time, would involve considerable costs, and could give no additional information that would modify the immediate initial intervention strategy.

## Role of the Integrated Animal Health and Production Management Program

Properly conducted integrated animal health and production management programs maintain accurate records on all matters of production and health. These are maintained against a background of epidemiologic data, including number of animals in the herd and

numbers of animals in the reproductive cycle segment group or age group that are at risk. In many instances all the data required to effectively diagnose a disease or monitor its prevalence are already in the records of these herds. It does put the veterinarian and the farmer in the position of almost being able to do a herd examination simply by consulting the records. Goal setting and production evaluation are important components of the integrated animal health and production management program and are both highly valued by producers. The approach is detailed in texts on herd health and production medicine, such as those listed in Further Reading.

An important issue yet to be clarified is whether integrated animal health and production programs provide a suitable return on investment for both the producer and veterinarian. Such programs must do more than increase production; they must improve profitability and sustainability of the agricultural enterprise while addressing animal welfare issues. Very few studies have evaluated the economic aspects of integrated animal health and production programs. The first such analysis, conducted by the pioneering preventive medicine program at the

University of Melbourne in Australia led by Blood, Morris, and Williamson, concluded that “the dairy health and management program tested in this study represents a highly profitable investment for dairy farmers.”<sup>3</sup> Similar detailed studies documenting the return on investment of integrated animal health and production programs in other production systems and countries are scarce. Recent studies from The Netherlands examining dairy farms that participated or did not participate in veterinary herd health management programs failed to identify a beneficial effect of such programs on overall farm efficiency.<sup>4,5</sup>

#### FURTHER READING

- Atkinson O. Guide to the rumen health visit. *In Pract.* 2009;31:314-325.
- Cook N, Oetzel G, Nordlund K. Modern techniques for monitoring high-producing dairy cows. 1. Principles of herd-level diagnoses. *In Pract.* 2006;28:510-515.
- Cook N, Oetzel G, Nordlund K. Modern techniques for monitoring high-producing dairy cows. 2. Practical applications. *In Pract.* 2006;28:510-515.
- Derks M, van de Ven LMA, van Werven T, et al. The perception of veterinary herd health management by Dutch dairy farmers and its current status in the

Netherlands: a survey. *Prev Vet Med.* 2012;104:207-215.

- LeBlanc SJ, Lissemore KD, Kelton DF, et al. Major advances in disease prevention in dairy cattle. *J Dairy Sci.* 2006;89:1267-1279.
- Mulligan FJ, O'Grady L, Rice DA, Doherty ML. A herd health approach to dairy cow nutrition and production diseases of the transition cow. *Anim Reprod Sci.* 2006;96:331-353.
- Nickell JS, White BJ. Metaphylactic antimicrobial therapy for bovine respiratory disease in stocker and feedlot cattle. *Vet Clin North Am Food Anim Pract.* 2010;26:285-301.
- Penry JF, Brightling PB, Dyson RS, Paine MS. Developing new veterinary services in milk quality: a review of a recent mastitis risk management co-development in Australia. *N Z Vet J.* 2011;59:24-27.
- Radostits OM. Herd health. *Food Animal Production Medicine.* 3rd ed. Philadelphia, PA: WB Saunders; 2001.
- van Winden S, Pfeiffer D. Sampling programmes to establish and monitor the infectious disease status of cattle herds. *In Pract.* 2008;30:30-35.

#### REFERENCES

1. Cipolla M, Zecconi A. *Res Vet Sci.* 2015;99:60.
2. Pothmann H, et al. *J Dairy Sci.* 2014;97:851.
3. Williamson NB. *Aust Vet J.* 1980;56:1.
4. Derks M, et al. *Prev Vet Med.* 2014;117:478.
5. Derks M, et al. *J Dairy Sci.* 2014;97:1336.



**DEFINITIONS AND CONCEPTS 36****DEVELOPMENT OF A BIOSECURITY PLAN 37**

Initial Planning 37

**PRACTICES TO AID IN MAINTAINING BIOSECURITY 38**

Testing and/or Isolation of Newly Introduced Animals 38

Controlling Contact by Visitors to the Operation 39

Controlling Contact by Wildlife, Neighboring Livestock, and Pets 39

Separating Groups of Animals Based on Risk 39

Cleaning and Disinfection 40

Disease Monitoring and Record Keeping 41

Communication, Training, and Assessment 41

**Definitions and Concepts**

**Biosecurity** has been defined in various ways; one informative definition is “the outcome of all activities undertaken by an entity to preclude the introduction of disease agents into an area that one is trying to protect.”<sup>1</sup> Thus biosecurity is the intended result of efforts to protect animals and humans from disease-causing materials of biological origin. Preventing infection of animals by various agents by preventing transmission of infectious agents between animals and the people who contact them is the most common focus of veterinary biosecurity planning. A useful distinction can be made in applying the term biosecurity to efforts intended to prevent introduction of infectious agents onto an operation in which the agents are not present, and the term **biocontainment** to practices intended to minimize transmission of disease-causing agents that are already present. **Biohazard** is a general term for any material of biological origin that may be hazardous to animals or humans that contact the material; biosecurity or biocontainment planning can be aimed at limiting or preventing infection or disease caused by any biohazard. For the sake of brevity, the remainder of this section will focus on biosecurity and biocontainment to prevent infections that cause disease in animals on a single operation (farm, ranch, feedlot, or birthing or rearing facility). The term biosecurity will be used to refer to practices that are relevant to either biosecurity or biocontainment. Readers are referred elsewhere for information on national biosecurity, on biosecurity for veterinary hospitals, and on control of agents that may cause foodborne illness in humans but not animal disease.

Disease caused by infectious agents can have a negative effect on the health, welfare, and productivity of animals; therefore, some degree of attention to biosecurity is likely warranted on any operation in which animals are maintained, either permanently or transiently. However, determination of

the exact biosecurity plan that is appropriate for an operation first requires an assessment of the **risks** for infection for animals on the operation in question. In recent years, increased recognition of the possible impact of infectious disease on domestic animal populations has led to the development of risk calculators for certain livestock species or diseases to be used in the assessment of the risk of introduction of specific diseases or infectious diseases in general. Many of these are available online through the World Wide Web. See examples of some websites providing risk calculators in **Table 3-1**. General information on biosecurity for animal operations can also be found on the

World Wide Web, and some examples of sites with useful information are shown in **Table 3-2**. Like all information accessed via the Web, the qualifications and agenda of the person or group providing biosecurity information should be considered and determined to be trustworthy before the information is used. Generally, information provided by regional or national organizations of animal health experts or animal producers should be reliable.

Determination of the biosecurity plan will require identification of the infectious agents likely to cause important disease in the animals on the operation, and this will depend on the species and geographic

**Table 3-1** Examples of online risk calculators that can help veterinarians and producers estimate the risk of introducing diseases onto facilities in which animals are maintained

Species	Infectious agent or disease	Source of information	Website
Swine	Not specific	U.S. Pork Board	<a href="http://www.pork.org/filelibrary/Biosecurity/BiosecurityBook.pdf">http://www.pork.org/filelibrary/Biosecurity/BiosecurityBook.pdf</a>
Cattle	Bovine viral diarrhea virus (BVDV)	Kansas State University, College of Veterinary Medicine	<a href="http://www.bvdconsult.com">http://www.bvdconsult.com</a>
Cattle	Bovine leukosis virus (BLV)	New York State Cattle Health Assurance Program	<a href="https://ahdc.vet.cornell.edu/Sects/NYSCHAP/docs/RiskAssessment.pdf">https://ahdc.vet.cornell.edu/Sects/NYSCHAP/docs/RiskAssessment.pdf</a>
Cattle	<i>Salmonella</i>	New York State Cattle Health Assurance Program	<a href="https://ahdc.vet.cornell.edu/Sects/NYSCHAP/docs/SalmonellaRiskAssessment.pdf">https://ahdc.vet.cornell.edu/Sects/NYSCHAP/docs/SalmonellaRiskAssessment.pdf</a>

**Table 3-2** Examples of online sources of information regarding biosecurity practices appropriate for agricultural animal species

Species	Source of information	Website
Swine	American Association of Swine Veterinarians	<a href="http://www.aasv.org/aasv/PRRSV_BiosecurityManual.pdf">http://www.aasv.org/aasv/PRRSV_BiosecurityManual.pdf</a>
Cattle and sheep	University of Nebraska, Great Plains Veterinary Education Center	<a href="http://www.farmandranchbiosecurity.com">http://www.farmandranchbiosecurity.com</a>
Cattle, swine, and horses	Iowa State University, Center for Food Security and Public Health	<a href="http://www.cfsph.iastate.edu/Infection_Control/index.php">http://www.cfsph.iastate.edu/Infection_Control/index.php</a>
Horses	American Association of Equine Practitioners	<a href="http://www.aeep.org/info/infectious-disease-control">http://www.aeep.org/info/infectious-disease-control</a>

**Box 3-1 Diseases or agents that may be appropriate targets for biosecurity planning****Dairy cattle**

Bovine herpesvirus-1 (BHV-1)  
 Bovine leukosis virus (BLV)  
 Bovine viral diarrhea virus (BVDV)  
*Brucella abortus* (brucellosis)  
 Leptospirosis  
 Mastitis: contagious causes  
*Mycobacterium avium* ssp. *paratuberculosis* (Johne's disease)  
*Mycobacterium bovis* (tuberculosis)  
*Neospora caninum*  
*Salmonella enterica* (including numerous serotypes)

**Beef cattle**

Bovine herpesvirus-1 (BHV-1)  
 Bovine leukosis virus (BLV)  
 Bovine viral diarrhea virus (BVDV)  
*Brucella abortus* (brucellosis)  
*Campylobacter fetus* ssp. *venerealis*  
 Leptospirosis  
*Mycobacterium bovis* (tuberculosis)  
*Trichomonas foetus*

**Horses**

Equine herpesvirus-1 and -4 (EHV-1 and EHV-4)  
 Equine infectious anemia virus (EIAV)

Equine influenza virus (EIV)  
*Salmonella enterica* (including numerous serotypes)  
*Streptococcus equi* ssp. *equi* (strangles)

**Sheep or goats**

Caprine arthritis and encephalitis virus (CAEV)  
*Corynebacterium pseudotuberculosis* (caseous lymphadenitis)  
*Mycoplasma mycoides* ssp. *mycoides* (large colony type)  
 Ovine progressive pneumonia virus (OPPV)  
 Scrapie

**Swine**

*Brucella suis*  
 Leptospirosis  
 Porcine parvovirus  
 Porcine respiratory and reproductive syndrome virus (PRRSV)  
 Pseudorabies virus (Aujeszky's disease)  
 Swine dysentery  
 Swine influenza virus (SIV)

*Some examples of diseases or infectious agents that may be appropriate targets for biosecurity planning, by livestock species. This list is not exhaustive. Other agents or diseases not listed may also be appropriate to target in biosecurity planning.*

location of the animals in question as well as the degree to which the operation is *open* (receiving new animals either permanently or transiently from sources outside the operation), because new introductions are an important source of biosecurity risk. Some examples of agents or diseases that may be the focus of animal biosecurity planning are shown in **Box 3-1**. Development of a biosecurity plan also requires an evaluation of the **cost of biosecurity relative to the cost of the disease** in the absence of biosecurity. Biosecurity measures, particularly when performed properly, cost time and money and can be seen as inconvenient. Time and money are limiting factors on all operations in which animals are maintained, but the degree to which this is true will vary among operations. Lack of information regarding the cost and benefit of biosecurity practices limits the willingness of farmers to undertake biosecurity practices.<sup>2</sup> Thus it is evident that there is no “one size fits all” biosecurity plan that can be applied to all operations; rather, the veterinarian and the owner or manager must work together to define the important infectious disease risks for the operation and then to develop a biosecurity plan that is cost-effective and feasible. On some operations, the manager may elect to undertake efforts to prevent introduction of

an infectious agent or to eliminate an agent from the operation; on other operations, the manager may elect to tolerate a level of disease or production loss caused by an agent when exclusion is deemed to be too costly. Although veterinarians must be prepared to defend the welfare of animals by helping producers recognize when a level of disease is inconsistent with animal well-being, they must also recognize that efforts to exclude certain infectious agents may not be financially feasible for some producers. In such cases, biocontainment efforts that minimize disease on the operation, combined with timely identification of affected animals and appropriate treatment, culling, or euthanasia, may be the most appropriate approach to ensuring animal well-being.

A biosecurity plan may be comprehensive, or it may be simple and focused on only a few high-risk areas. To be effective, the biosecurity plan should include a plan for periodic assessment of the efficacy of biosecurity through monitoring and record keeping to identify infection or disease events that should be impacted by the plan. Additionally, communication of the biosecurity plan to all parties involved in animal care, through training and written protocols, is necessary to ensure consistency of biosecurity practices.

**Development of a Biosecurity Plan****INITIAL PLANNING**

For a given operation, development of a biosecurity plan requires assessment and determination of the following<sup>1</sup>:

**WHAT ARE THE INFECTIOUS DISEASE RISKS FOR THE OPERATION?****Are these infectious agents already present on the operation? If so**

What are the costs from these agents? Consider treatment expenses, loss associated with animal deaths or early culling, decreased animal value, and decreased animal welfare. For zoonotic agents, costs associated with possible human infection should also be considered.

**How or where are these agents transmitted to susceptible animals?**

- What measures can be put into place to decrease or stop transmission at these points?
  - What is the likely cost in time and money of implementing these measures?
  - Can these measures be implemented on this operation?
- If introduction of all possible control measures is not feasible, which control measures are likely to have the most impact? Which measures are the most feasible and cost-effective?
  - Can the most impactful and cost-effective subset of control measures be implemented on this operation?

**WHAT ARE THE INFECTIOUS DISEASE RISKS FOR THE OPERATION?****For infectious agents not currently present on the operation, what is the likelihood of their introduction?**

If introduced, what are the likely costs? How can these infectious agents be introduced to the operation?

- What measures can prevent introduction?
  - What is the likely cost of these measures?
  - Can these measures be implemented on this operation?
- If introduction of all possible control measures is not feasible, which measures are likely to have the most impact? Which measures are the most feasible and cost-effective?
  - Can the most impactful and cost-effective measures be implemented on this operation?

Such an assessment is similar to the Hazard Analysis and Critical Control Point system used to ensure food safety by minimizing the contamination of food by

hazardous materials or agents.<sup>3</sup> Although this list of questions may seem daunting, at least a superficial evaluation of these issues will help to determine whether the cost and inconvenience of biosecurity practices are worthwhile to the producer. The cost of various biosecurity practices have not been thoroughly estimated, and they are likely to vary considerably for different operations based on the local cost and availability of materials and labor and the value of the animals in question. Although some producers may be willing to undertake a thorough economic assessment of the costs and benefits of various biosecurity practices before deciding on a plan, in many cases the assessment will likely depend on rough estimates of the major costs and benefits. The veterinarian and producer should be able to help each other in making these estimates, with each bringing their knowledge and experience to the assessment.

## Practices to Aid in Maintaining Biosecurity

### TESTING AND/OR ISOLATION OF NEWLY INTRODUCED ANIMALS

Bringing animals from outside sources onto an operation, either permanently or transiently, is an important means by which infectious agents can be introduced into the resident population. Although new introductions may appear healthy at entry, they may manifest signs of disease within days, brought on in part by the stress and exposure to infectious agents that can occur during transport. Animals that have passed through competitions or sales have the added risk of recent exposure to many animals from other sources, amplifying their potential for contact with infectious agents. New introductions may also be chronic shedders of infectious agents, even if they remain persistently healthy in appearance. *Streptococcus equi* ssp. *equi*, *Mycobacterium avium* ssp. *paratuberculosis*, BVDV, PRRSV, and some serotypes of *Salmonella enterica* are a few examples of transmissible agents that can be shed for weeks to months or years by carrier animals who may appear completely healthy.

It is recognized that isolating new introductions for some time after arrival should help decrease the chance of transmitting infectious agents to the resident population. In spite of this, it has been shown that a minority of cattle and horse producers observe this practice.<sup>4-7</sup> The exact length of time that new introductions should be isolated has not been well defined, and this depends on the agent in question. For diseases with short incubation periods caused by infectious agents that are shed only

temporarily, such as many viral respiratory pathogens, a quarantine period of 14 to 28 days is likely adequate to usefully decrease risk of infecting animals in the resident population. For diseases in which agents are shed for several weeks or longer, a quarantine period of a practical length is not likely to be helpful. Ideally, the isolated animals should be housed at a site remote from the resident population; if that is not feasible, then the isolated animals should have no possibility of direct contact with the resident herd, contact with feed or water consumed by the resident animals, or shared airspace. People caring for the newly introduced animals should wear different clothing and footwear than what is worn when caring for the resident herd, and they should clean their hands with antimicrobial soap and water or alcohol-based hand sanitizer after contacting the new introductions or associated materials. Feed troughs, water buckets, tools, and tack used with the new introductions should not be used with animals in the resident population, or they should be cleaned thoroughly and disinfected appropriately before such use.

Testing animals for the presence of infectious agents before introduction, or while they are in isolation after introduction, is one method of decreasing the chance of introducing infectious agents. However, the veterinarian and producer must consider carefully how to use such testing so that it is reliable and cost-effective. It is not likely to be practical or cost-effective to test all new introductions for all infectious agents they could possibly be shedding. Also, the reliability of a test result is related to the sensitivity and specificity of the diagnostic test used as well as the prevalence of disease in the population of animals tested. When testing an individual animal of unknown status to determine whether that individual is infected, the veterinarian is relying on the **positive predictive value** (PPV) and the **negative predictive value** (NPV) of the test being used; that is, the probability that the animal is infected, given a positive test result (PPV), and the probability that the animal is not infected, given a negative test result (NPV). The PPV and NPV of a test are related to the prevalence of disease in the population being tested; when the prevalence of disease is low in a population of animals being tested, the PPV of any test will be lower than the PPV of the same test when it is used to test animals in a population in which the prevalence of disease is high. This is an important point to consider when deciding whether to test new introductions to exclude infectious disease, because a newly introduced animal is usually an animal that has no clinical signs of disease. Such an animal can be thought of as a member of the population of all animals that have no clinical signs of disease, in which the prevalence of any infectious disease is lower than it is in

the population of all animals with signs of that disease. (In other words, an animal with no clinical signs of disease is less likely to be infected with an infectious agent than an animal that has signs of disease caused by that agent, generally speaking.) Therefore, the PPV of any diagnostic test run on an animal that appears completely healthy will be lower than the PPV for the same test if it is run on an animal with signs of the disease in question. Thus testing is more likely to give an erroneous result when animals that appear healthy are tested for any infectious disease. However, the degree to which an erroneous result is likely depends on the sensitivity and specificity of the test in question. A highly sensitive test will have a better PPV than a less sensitive test in a population with a low prevalence of disease. Therefore the decision to test new introductions to exclude infectious agents should be based on the reliability of the testing strategy, given the sensitivity and specificity of the test to be used and the likelihood of the disease being present in the animals tested, as well as the cost of testing relative to the cost of introducing the infectious agent in question. Diagnostic specialists at veterinary diagnostic laboratories should be able to give veterinarians information about the sensitivity and specificity of tests they offer to aid them in making such decisions. A helpful review of these points is available for further information.<sup>8</sup>

Another way to help decrease the likelihood of introducing infectious disease with new introductions is to introduce animals only from herds known to be free of disease, if possible. An animal originating from a herd certified to be free of a given infectious disease and transported directly from that herd of origin to the new operation, without contact with any other animals in transit, is less likely to bring that disease onto the new operation than an animal purchased from a herd of unknown status. Although it may not always be possible to obtain accurate and complete information about the presence of infectious diseases on source herds, when that information is available, selecting animals from such herds will help decrease the likelihood of introducing particular diseases. For infections that are not permanent and for which vaccines are available, requiring that animals be vaccinated before introduction should help decrease the chance that they will shed the agent around the time of introduction. For vaccination to be useful in this regard it is important that the animals are vaccinated when they have time to develop protective immunity before shipment. The length of time required varies for different vaccines, but generally the animal should receive an initial vaccine followed by a booster, with the booster occurring no less than 2 weeks before shipment.

## CONTROLLING CONTACT BY VISITORS TO THE OPERATION

Visitors to the operation, which includes workers bringing materials (such as feed or fuel) or taking materials to and from the operation (such as manure or carcasses), animal health professionals such as farriers and veterinarians, and those coming to the operation just to observe, can all introduce infectious agents to resident animals. Additionally, employees, family members, and others who are on the operation routinely can introduce infectious agents when they return from visits to outside operations in which animals are maintained. The importance of visitors, vehicles driven by visitors, or visits by workers to outside farms as a source of infectious disease introduction has been shown in multiple research studies.<sup>9-11</sup> Visits by trucks from rendering facilities coming to pick up dead animals are a particularly important risk, because dead animals on these trucks are likely to have been ill and shedding infectious agents before death, leaving their carcasses and the truck transporting them contaminated. Vehicles from outside sites should not be allowed on the operation if possible. In the example of visits by the rendering truck, carcasses should be placed for pick up at a site outside the operation, or at least at a site on the operation that is remote from resident animals. On-site disposal of carcasses is an alternative that removes the need for visits by the rendering truck, but the various methods for carcass disposal also have biosecurity risks that need to be addressed; this has been reviewed in detail.<sup>12</sup>

If visiting vehicles cannot be kept off the operation entirely, they should be directed to drive and park in areas that resident animals are unlikely to contact. If it is not possible to keep visiting vehicles away from resident animals, all parts of the vehicle that contact anything on the operation should be washed and disinfected before entry. However, in one study washing wheels was not protective against introduction of foot-and-mouth disease virus, but parking visitor vehicles away from areas in which animals were housed was protective,<sup>9</sup> suggesting that washing and disinfecting vehicles may not be sufficiently protective. Workers should shower and change their clothes after visiting outside sites and before contacting resident animals. High levels of biosecurity practiced by certain operations mandate that workers or visitors should not come into contact with resident animals for a particular period of time (usually 48 to 72 hours) after visiting other animal operations. Visitor access is best controlled by having all visitors enter the operation through monitored entry points; ideally visitors are met by someone representing the operation to make sure contacts that could introduce infectious disease are prevented or minimized.

## CONTROLLING CONTACT BY WILDLIFE, NEIGHBORING LIVESTOCK, AND PETS

Neighboring livestock and wildlife (including birds and rodents) are an important potential source for introducing infectious disease. Multiple research studies have shown that proximity to another farm is an important risk factor for introduction of certain infectious diseases, and this may be caused by direct contact between animals across fences or on shared range; common visits for the delivery or pick up of materials; shared use of equipment; or transmission of infectious agents among farms by wildlife, running water, or wind currents.<sup>10,13,14</sup> Contact with neighboring animals across fence lines or on open range can nullify biosecurity efforts; therefore such contact should be prevented if possible. Pet animals (dogs, cats, or other species) can transmit infectious agents among livestock, so their contact with livestock should be controlled or prevented. Because birds and rodents can shed pathogens such as influenza (birds), *Salmonella*, and *Leptospira* (rodents), access of wild birds, poultry, and rodents to areas in which livestock eat or drink should be prevented. This is done by fencing off areas in which birds may congregate and by undertaking efforts to limit access of wild birds and rodents to feed-stuffs and animal-housing areas.

## SEPARATING GROUPS OF ANIMALS BASED ON RISK

A useful practice to decrease transmission of infectious agents if they are introduced, or to decrease transmission of agents already present on the operation, is to separate animals into groups based on their likelihood of shedding infectious agents and their susceptibility to infection. For example, sick animals are more likely to be shedding infectious agents than healthy animals, and this is particularly true for sick animals showing signs of acute respiratory disease or acute gastrointestinal disease, especially diarrhea. Therefore sick animals should be housed separately from healthy animals, and designated workers should be assigned to care only for sick animals; or those who care for sick animals should change their clothes and footwear and clean their hands with antimicrobial soap and water afterward. Materials (tools, tack, feed, water, and bedding) from sick animal housing should not be used for healthy animals, unless it is possible to first clean them thoroughly and disinfect them properly.

Neonates and young animals (under 1 year of age) are more likely to be susceptible to infection because of their naive immune status and waning maternal antibody, so these individuals should be separated from sick animals and, ideally, from other older animals who are not sick but who may

shed infectious agents inapparently. Pregnant females should not come into contact with juvenile animals (6 months to 2 years of age), because juvenile animals are commonly infected by acute respiratory viruses such as EHV-1 or BHV-1, which can cause disease and possibly induce abortion. Peripartum animals are also at increased risk for shedding infectious agents because the events around parturition can be immunosuppressive; their newborns are also at high risk for infection, especially before they consume colostrum. Thus birthing areas should be separate from areas in which sick animals are kept and separate from juvenile animals that are likely to shed infectious agents. Birthing stalls or pens should also be cleaned and disinfected between uses to minimize the exposure of newborns to infectious agents. Animals that give birth on pasture should not be crowded, and accumulation of mud and manure should be prevented, because these can be sites in which enteric pathogens persist for weeks or months.

It is important not only to prevent direct contact between subpopulations on an operation but also to prevent or limit sharing of airspace, feed, water, and materials between these groups. For example, it has been shown that calves are more likely to develop respiratory disease if they are housed early in life in the same building as adult cows.<sup>15</sup> On dairy farms, feed refused by the lactating cows is sometimes fed to young animals to minimize waste.<sup>16</sup> However, this practice can expose susceptible young animals to infectious agents shed by the lactating cows; therefore, the practice should be avoided, or refused feed should only be fed to older juveniles that will likely have better immunity to any infectious agents in the feed, compared with younger animals. Pasteurization of colostrum and waste milk fed to calves is another practice that can decrease transmission of infectious agents from adult cows to young calves on dairies.

Contact by human caretakers can also be an important means of transmission of infectious agents among subpopulations on an operation. Thus different workers should be assigned to care for different subgroups, if possible. This may be feasible on large operations in which the number of animals justifies the employment of several people. On smaller operations it may instead be necessary to have workers start each day caring for the most susceptible individuals (e.g., young animals and postpartum females) and then moving to the care of more resistant individuals, or those more likely to be shedding infectious agents (e.g., sick animals). This order of care should help decrease the transmission of agents from high-risk animals to animals of high susceptibility. It may be helpful to have coveralls and boots dedicated for wear only in areas in which susceptible and sick animals are housed and to make a hand-cleaning station with water, soap, and



alcohol-based hand sanitizer available. This all makes it easy for workers to minimize the possibility of transmitting infectious agents among subpopulations.

Manure from animals is an important source of many infectious agents, and fecal-oral transmission is a major route of infection. Therefore feed troughs and water tanks should be constructed and situated so they are not inadvertently contaminated with feces from resident animals or wildlife such as birds or rodents. Moreover, equipment used to remove manure and soiled bedding from animal-housing areas should not be also used to transport feed. If the use of shared equipment cannot be avoided, the equipment must be cleaned thoroughly and effectively disinfected before use with feedstuffs.

### CLEANING AND DISINFECTION

A helpful review of cleaning and disinfection in the context of animal care is available.<sup>17,18</sup> To summarize briefly, cleaning and disinfection are practices of major importance to biosecurity, but if they are not practiced properly they will not be effective. Protocols for cleaning and disinfection should be established, communicated clearly to people responsible for cleaning and disinfecting, and written and placed where they are easy to reference so people can remind themselves how to complete the protocol correctly. Proper technique for cleaning and disinfection should be made as easy as possible to maximize compliance.

There is no single disinfectant that is appropriate for all uses; therefore, the choice of disinfectant to be used will depend on the

site that requires disinfection and the type of infectious agents that must be removed. Also, disinfectants vary in their efficacy against different types of agents. In order of increasing resistance, disinfectants may kill or inactivate enveloped viruses, bacteria (nonmycobacterial agents), fungi, nonenveloped viruses, mycobacteria, bacterial spores, and prions. Many disinfectants are effective against enveloped viruses, but fewer are effective against mycobacteria and bacterial spores, and very few inactivate prions. Some chemicals can remove all infectious agents from a surface (sterilize), whereas others decrease the number of infectious agents of one or more types (disinfect), but they do not sterilize. Chemicals that can be sterilizing are also the most toxic and caustic to humans and animals; therefore, on most operations in which animals are maintained, disinfectants that do not actually sterilize will be used, for reasons of safety. Examples of some commonly used classes of disinfectants with some of their benefits and drawbacks are presented in Table 3-3.

Important principles for effective cleaning and disinfecting include the following:

- Surfaces and items to be disinfected must be completely cleaned with detergent and water before disinfection, because organic material such as manure, nasal secretions, or feed on a surface can inactivate some disinfectants and can prevent any disinfectant from contacting the surface to be disinfected.
- After cleaning, detergent should be rinsed completely from the surface with clean water, because detergent residue can inactivate some disinfectants.

- Porous surfaces (such as unpainted wood) are difficult or impossible to disinfect thoroughly, because infectious agents can persist in microscopic crevices on such surfaces. Surfaces and items used around animals should be made only of smooth plastic, metal, concrete, or completely painted wood. If it is not possible for all surfaces to be made of such materials, they should at least be used consistently around animals that are isolated because of recent introduction or illness to allow for effective disinfection of materials contacting high-risk individuals.
- Dirt floors in animal-housing areas cannot be disinfected, although it is possible to decrease pathogen load with thorough cleaning and scraping of dirt floors. Calcium oxide (lime) is often applied to dirt floors for disinfection, and although this may decrease pathogen numbers, evidence also indicates that lime may prolong survival of anthrax spores.<sup>19</sup> This suggests that lime should not be used in areas in which anthrax is a significant risk.
- Disinfectant must be diluted to the appropriate concentration and applied to the surface for the required contact time for effective disinfection. The label on the container of the disinfectant product will indicate the concentration and contact time that must be used.
- After the appropriate contact time, disinfectant should be rinsed off the disinfected surface with clean water, because many disinfectants can be toxic or can leave an unpleasant taste on

**Table 3-3** Examples of some classes of disinfectants with some of their benefits and drawbacks<sup>17,18</sup>

Disinfectant class	Benefits	Drawbacks	Notes
Alcohols	Rapid acting, not very toxic, no residue	Inactivated by organic material	Most appropriate for skin prep and for objects that come in direct contact with patient skin
Aldehydes	Very broad spectrum, including sporicidal	Relatively toxic, carcinogenic	
Biguanides (including chlorhexidine)	Not very toxic, broad antibacterial spectrum but less consistent against viruses	Inactivated by organic material	As for alcohols
Halogen chlorine compounds (including bleach)	Effective against many bacteria including mycobacteria, also viruses and fungi Inexpensive	Inactivated by organic material, some soaps, and sunlight Irritating and corrosive	Appropriate for environmental disinfection of clean surfaces
Iodophors	Effective against many bacteria including mycobacteria, also viruses and fungi Rapid acting, not very toxic	Inactivated by organic material, not inexpensive, may stain tissues or materials	Products for skin prep are not appropriate for disinfection of objects or surfaces
Quaternary ammonium compounds	Antimicrobial spectrum of different formulations variable, not effective against nonenveloped viruses	Inactivated by organic material and some soaps	
Phenols	Broad antimicrobial spectrum including many nonenveloped viruses, retain activity in the presence of organic material	Inactivated by some detergents, toxic to some animals	Avoid using on surfaces used to deliver milk, water, or food
Oxidizing agents (hydrogen peroxide based or peroxygen compounds)	Broad antimicrobial spectrum including many nonenveloped viruses and some spores, relatively nontoxic, retain activity in the presence of organic material	Can be corrosive to materials	Some products: good choice for footbaths because of prolonged stability efficacy in the presence of organic matter

items used to deliver water, milk, or food. Disinfectants can also be irritating if they come into contact with human or animal skin, and they can be corrosive to surfaces of buildings and tools.

Note that disinfectants are required to be labeled with detailed information regarding their chemical class, the infectious agents against which the product is effective, and the directions for effective use, including the concentration at which the product must be used and the required contact time for disinfection. People devising cleaning and disinfection protocols should read the label on the disinfectants they use to ensure that the protocol is consistent with the product label and to ensure effective disinfection.

Footbaths containing disinfectant are often used on operations so that caretakers can step into a footbath to disinfect their footwear when moving between areas of animal housing in which transmission of infectious agents is likely. The evidence supporting footbath efficacy is mixed; footbaths have been shown to be associated with decreased risk of introduction of infectious agents in some research studies but not in others. One research study showed that footmats containing phenolic disinfectant did not prevent transmission of *Salmonella* from a large animal clinic to the adjacent small animal clinic presumably on the feet of people walking between these areas.<sup>20</sup> Similarly, disinfection of footwear did not have a consistent impact on floor bacterial counts in another hospital.<sup>21</sup> Various disinfectants can decrease the number of bacteria on the soles of footwear significantly, but they do not sterilize footwear.<sup>22-24</sup> A footbath does not decrease bacterial counts significantly if footwear is contaminated with feces.<sup>23</sup> For a footbath to significantly decrease bacteria on footwear, the soles of the footwear should be scrubbed free of feces and other organic matter in water, or in a primary footbath intended for cleaning footwear, before the wearer then steps into a second disinfecting footbath. People who are expected to use footbaths should be required to wear footwear that is nonporous and impervious to water or they are unlikely to step into the footbath completely, nullifying the value of the footbath. A footbath becomes less effective with repeated use, likely because of contamination of the footbath with organic matter and inactivation of the disinfectant by chemical change occurring over time. Because traces of organic material are likely to persist on footwear even after scrubbing, only disinfectants that retain efficacy in the presence of organic matter should be used for footbaths (see [Table 3-3](#)). The length of time a disinfectant is effective at the working concentration should be indicated on the product label, and the disinfectant solution in footbaths should be changed regularly at an interval that ensures the disinfectant retains efficacy.

People may be more likely to step on footmats containing disinfectant, which only contact the soles of footwear. These have been shown to be equally efficacious at decreasing bacterial counts on the footwear soles compared with footbaths.<sup>22</sup> Disposable plastic boots can effectively protect footwear from contamination,<sup>25</sup> but because holes can form in the bottom of such boots when they are worn for long, they should only be used for short episodes. In summary, footbaths and footmats can decrease the number of microorganisms on the soles of footwear, and their use may decrease transmission of infectious agents, but they must be used properly to be effective. Proper use includes scrubbing footwear free of manure and other organic material before use of footbaths or footmats, use of disinfectants that retain efficacy in the presence of organic matter, and regular replacement of used disinfectant solution when it becomes heavily contaminated with organic matter or when the expiration period has been met.

Proper hand hygiene is another important component of biosecurity. Detailed information regarding effective hand hygiene, materials to support worker training regarding hand hygiene, and guidelines for monitoring worker compliance are available.<sup>26</sup> Briefly, hand hygiene should be practiced after any interaction with an animal likely to be shedding infectious agents, or after contacting any object or material that has contacted such an animal. If hands are visibly soiled with dirt, manure, urine, or secretions or excretions, they should be washed thoroughly with antimicrobial soap and water. However, if hands are not visibly soiled, the use of alcohol-based hand sanitizer is more effective than hand washing. Moreover, because effective hand washing takes longer than effective use of hand sanitizer, and repeated hand washing can lead to chapped hands, the availability of hand sanitizer may improve hand hygiene compliance by people working with animals. Disposable examination gloves should be worn when undertaking activities in which hands are likely to become heavily contaminated with infectious agents, but it is important to note that hands must still be cleaned by washing or use of hand sanitizer after gloves are removed, because microscopic holes in gloves can allow hand contamination.

### **DISEASE MONITORING AND RECORD KEEPING**

Regular and consistent disease monitoring and record keeping are necessary for accurate assessment of the biosecurity risks for an operation and for evaluation of the efficacy of biosecurity practices. Caretakers should be trained to identify signs of common diseases, and they should know how sick or injured animals should be handled and treated and who should be informed when

sick or injured animals are identified. On large operations written protocols outlining the criteria for identification of some common health problems may be established. Ideally all animals on an operation should be identified by some form of unique permanent identification, which allows accurate identification of diseased animals for monitoring and treatment. Unique animal identification also facilitates accurate record keeping, which is particularly important to ensure that appropriate withdrawal (withholding) times are observed before treated animals or their products are marketed for human consumption.

Records of animal disease and treatment events should be periodically reviewed by the veterinarian who serves the operation, because this will facilitate identification of patterns of disease occurrence that reveal breakdowns in biosecurity or evidence of new biosecurity risks. Periodic assessment of records also provides the opportunity to track improvements in animal health and productivity that should result from effective biosecurity.

### **COMMUNICATION, TRAINING, AND ASSESSMENT**

People caring for animals are more likely to implement biosecurity practices if they think the practices are effective, which is logical. If people working with livestock do not understand or think in the efficacy of biosecurity practices, it follows that efforts to establish a biosecurity plan may be fruitless, because individuals will not be motivated to observe biosecurity protocols consistently and effectively. Therefore veterinarians can help improve biosecurity by explaining the reason for biosecurity practices in clear and simple terms and by helping responsible parties to develop protocols that are accurate and complete, yet easy to understand and follow. It will likely be useful to develop written protocols for at least the most critical biosecurity practices and to have these displayed prominently in areas in which the protocol should be followed. This is because people often forget the steps of a protocol, and a protocol performed incorrectly may be ineffective or may even lead to the harm of animals or people.

Training and periodic review of training should be provided for animal caretakers and their supervisors to make sure that biosecurity protocols are being performed properly. Periodic assessment of protocols is important, because it has been shown that compliance deteriorates over time, even for people who understand why biosecurity is necessary.<sup>27,28</sup> Regular review of animal health records may lead to identification of either biosecurity breakdowns or biosecurity successes, and communicating these results to everyone working with animals may help reinforce the need for biosecurity.

**FURTHER READING**

- Caveney L, Jones B, Ellis K, eds. *Veterinary Infection Prevention and Control*. Ames, IA: Wiley-Blackwell; 2011.
- Dargatz DA. Biosecurity of cattle operations. *Vet Clin North Am Food Anim Pract*. 2002;18:1-5.
- Gwyther CL, Pryor Williams A, Golyshin PN, et al. The environmental and biosecurity characteristics of livestock carcass disposal methods: a review. *Waste Manag*. 2011;31:767-778.
- Weese JS. Infection control and biosecurity in equine disease control. *Equine Vet J*. 2014;46:654-660.

**REFERENCES**

- Dargatz DA, et al. *Vet Clin North Am Food Anim Pract*. 2002;18:1.
- Laanen M, et al. *Prev Vet Med*. 2014;115:1.
- <http://www.fda.gov/Food/GuidanceRegulation/HACCP/ucm2006801.htm>.
- Rogers CW, et al. *N Z Vet J*. 2010;58:64.
- Negrón M, et al. *Prev Vet Med*. 2011;99:130.
- Can MF. *Vet Q*. 2014;34:67.
- Schembri N, et al. *Prev Vet Med*. 2015;118:104.
- Smith DR. *Vet Clin North Am Food Anim Pract*. 2002;18:157.
- Ellis-Iversen J, et al. *Vet Rec*. 2011;168:128.
- Volkova V, et al. *Avian Dis*. 2012;56:521.
- Fasina FO, et al. *Prev Vet Med*. 2011;98:204.
- Gwyther CL, et al. *Waste Manag*. 2011;31:767.
- Firestone SM, et al. *Prev Vet Med*. 2011;100:53.
- <http://www.pork.org/filelibrary/Biosecurity/BiosecurityBook.pdf>.
- Gulliksen SM, et al. *J Dairy Sci*. 2009;92:5139.
- Maunsell F, et al. *Vet Clin North Am Food Anim Pract*. 2008;24:155.
- Caveney L. Guidelines for effective cleaning and disinfection. In: Caveney L, Jones B, Ellis K, eds. *Veterinary Infection Prevention and Control*. Ames, IA: Wiley-Blackwell; 2011:10.
- Caveney L. Chemical disinfectants. In: Caveney L, Jones B, Ellis K, eds. *Veterinary Infection Prevention and Control*. Ames, IA: Wiley-Blackwell; 2011:129.
- Himsworth CG. *Can Vet J*. 2008;49:1208.
- Hartmann FA, et al. *J Am Vet Med Assoc*. 2013;242:682.
- Stockton KA, et al. *J Am Vet Med Assoc*. 2006;228:1068.
- Dunowska M, et al. *J Am Vet Med Assoc*. 2006;228:1935.
- Amass SF, et al. *Swine Health Prod*. 2000;8:169.
- Amass SF, et al. *J Swine Health Prod*. 2001;9:121.
- Dee S, et al. *Can J Vet Res*. 2004;68:19.
- <http://www.who.int/gpsc/5may/tools/9789241597906/en/>.
- Ssematiba A, et al. *Prev Vet Med*. 2013;109:106.
- Dorea FC, et al. *Avian Dis*. 2010;54:1007.

# General Systemic States

## HYPOTHERMIA, HYPERTHERMIA, AND FEVER 43

Body Temperature 43  
Hypothermia 44  
Cold Injury (Frostbite and Chilblains) 50  
Hyperthermia (Heat Stroke or Heat Exhaustion) 51  
Fever (Pyrexia) 54

## ACUTE PHASE RESPONSE 56

## SEPSIS, SEPTICEMIA, AND VIREMIA 57

## TOXEMIA, ENDOTOXEMIA, AND SEPTIC SHOCK 59

## TOXEMIA IN THE RECENTLY CALVED COW 67

Puerperal metritis in cattle 67

## HYPOVOLEMIC, HEMORRHAGIC, MALDISTRIBUTIVE, AND OBSTRUCTIVE SHOCK 71

## LOCALIZED INFECTIONS 76

## PAIN 78

## STRESS 84

## DISTURBANCES OF APPETITE, FOOD INTAKE, AND NUTRITIONAL STATUS 87

Thirst 87  
Polyphagia 88  
Anorexia or Aphagia 88  
Pica or Allotriophagia 88  
Starvation 89  
Inanition (Malnutrition) 89

## WEIGHT LOSS OR FAILURE TO GAIN WEIGHT (ILL-THRIFT) 90

Shortfalls in Performance 94  
Unthriftiness in Weaner Sheep (Weaner Ill-Thrift) 94  
Porcine Failure to Thrive 96

## PHYSICAL EXERCISE AND ASSOCIATED DISORDERS 96

Exercise-Associated Diseases 97  
Poor Racing Performance and Exercise Intolerance In Horses 97

## SUDDEN OR UNEXPECTED DEATH 99

Sudden or Unexpected Death in Single Animals 99  
Sudden Death in Horses 100  
Sudden or Unexpected Death in a Group of Animals 100  
Procedure for Investigation of Sudden Death 101  
Cyanobacteria (Blue-Green Algae) Toxicosis 101  
Plants Causing Sudden Death Without Cardiomyopathy 103

## DISEASES ASSOCIATED WITH PHYSICAL AGENTS 103

Lightning Strike and Electrocution 103  
Stray Voltage 105  
Environmental Pollutants and Noise 106  
Wind Farms and Electric and Magnetic Fields 106  
Radiation Injury 107  
Volcanic Eruptions 109  
Bushfire (Grass Fire) Injury (Thermal Burns) 110

## DIAGNOSIS OF INHERITED DISEASE 111

Several systemic states contribute to the effects of many diseases. Because these systemic states are common to many diseases they are considered here as a group to avoid unnecessary repetition. Hyperthermia, fever, septicemia, toxemia, and the acute phase response are closely related in their effects, and an appreciation of them is necessary if they are not to be overlooked in the efforts to eliminate the causative agent. Likewise, hypovolemic, hemorrhagic, maldistributive, and obstructive shock are best examined together. Anaphylactic shock is covered in [Chapter 11](#). This chapter will also briefly introduce pain and stress as it relates to disease. Syndromes of poor performance, decreased appetite, and sudden and unexpected death are also covered.

## Hypothermia, Hyperthermia, and Fever

Hypothermia, hyperthermia, and fever—characterized by physiologically significant changes in core body temperature—are presented here together, along with an introduction to thermoregulation mechanisms of the body.

## BODY TEMPERATURE

Farm animals maintain a relatively constant body core temperature (**homeothermy**) during extreme ranges of thermal environments. This **homeothermic** state is achieved by physiologic and behavioral mechanisms that modify either rates of heat loss from the body or the rate at which heat is produced by the metabolism of feed or body energy reserves. For the body temperature to remain constant in changing thermal environments, the rate of heat loss must equal the rate of heat gain. The body temperature is a reflection of the balance between **heat gain** from the environment (radiation, conduction, and convection) or caused by metabolic activity (maintenance, exercise, growth, lactation, gestation, and feeding) and **heat loss** to the environment (radiation, conduction, convection, and evaporation) or caused by metabolic activity (milk removal, fecal elimination, and urinary elimination). Absorption of heat from the environment occurs when the external temperature rises above that of the body.

## HEAT PRODUCTION

Heat production occurs as a result of metabolic activity and the digestion of feed, muscular movement, and the maintenance of muscle tone. **Shivering thermogenesis** is

a response to sudden exposure to cold and is a major contributor to enhanced heat production. **Nonshivering thermogenesis** is also induced by exposure to cold and is the mechanism by which heat is produced by the calorogenic effect of epinephrine and norepinephrine. In the neonate, heat is produced by the metabolism of brown adipose tissue, which is present in newborn farm animals and is a particularly important mechanism of heat production to prevent neonatal hypothermia.

## HEAT LOSS

Heat is transferred to or from an animal by the four standard physical phenomena of **convection**, **conduction**, **radiation**, and **evaporation**. Convection is a transfer of heat between two media at different temperatures such as the coat surface and the air. As such, convective heat transfer depends on the temperature gradient between the coat surface and air, the surface area, and the air speed over the surface. Conduction is the transfer of heat between two media that are in direct contact such as the skin and water. Radiation is the absorption or emission of electromagnetic radiation at the body surface and depends on the skin surface temperature and area. Evaporative heat transfer is a process by which heat is lost by the evaporation of water



and is dependent on the water vapor pressure gradient between the epithelial surface and the environment and the air speed over the surface.

Evaporation occurs by sweating, salivation, and respiration, with the relative importance of each varying between species. Losses by evaporation of moisture vary between species depending on the development of the sweat gland system and are less important in animals than in humans, beginning only at relatively high body temperatures. Horses sweat profusely, but in pigs, sheep, goats, New World camelids, and European cattle sweating cannot be considered to be an effective mechanism of evaporative heat loss. In zebu cattle the increased density of cutaneous sweat glands suggests that sweating may be more important. Profuse salivation and exaggerated respiration, including mouth breathing, are important mechanisms in the dissipation of excess body heat in animals. The tidal volume is decreased and the respiratory rate is increased at high body temperatures so that heat is lost but alkalemia caused by respiratory alkalosis is avoided.

### BALANCE BETWEEN HEAT LOSS AND GAIN

The balance between heat gain and heat loss is controlled by the heat-regulating functions of the hypothalamus. The afferent impulses derive from peripheral hot and cold receptors and the temperature of the blood flowing through the hypothalamus. The efferent impulses control respiratory center activity, the caliber of skin blood vessels, sweat gland activity, and muscle tone. Heat storage occurs and the body temperature rises when there is a decrease in rate and depth of respiration, constriction of skin blood vessels, cessation of perspiration, and increased muscle tone. Heat loss occurs when these functions are reversed. These physiologic changes occur in, and are the basis of, the increment and decrement stages of fever.

### BREED DIFFERENCES

Differences exist between breeds and races of cattle in coat and skin characters that affect heat absorption from solar radiation and heat loss by evaporative cooling; differences also exist in the metabolic rate, which influences the basic heat load. Interest in this subject has been aroused by the demands for classes of animal capable of high production in the developing countries of the tropical zone. Detailed information on the physiologic effects of, and the mechanisms of adaptation to, high environmental temperatures are therefore available elsewhere but are not dealt with in this book because they appear to be minimally related to the development of clinical illness.

**Hypothermia**, caused by exposure to low environmental temperatures, and **hyperthermia (heat stroke or heat exhaustion)**, caused by exposure to high environmental

temperatures, are the major abnormalities of body temperature associated with extremes of environmental temperatures. **Anhidrosis**, occurring primarily in horses in hot humid climates and associated with the inability to sweat, is described in Chapter 16.

### HYPOTHERMIA

Hypothermia is a lower than normal body temperature, which occurs when **excess heat is lost or insufficient heat is produced**. Neonatal hypothermia is a major cause of morbidity and mortality in newborn farm animals within the first few days of life. Cold injury and frostbite are presented under that heading in Chapter 4.

#### ETIOLOGY

##### Excessive Loss of Heat

Exposure to excessively cold air temperatures causes heat loss if increased metabolic activity, shivering and sustained muscular contraction, and peripheral vasoconstriction are unable to compensate.

##### Insufficient Heat Production

Insufficient body reserves of energy and insufficient feed intake result in insufficient heat production. Hypothermia also occurs secondary to many diseases in which there may be a decrease in the ability to shiver and skeletal muscle contraction associated with decreased cardiac output, decreased peripheral perfusion, and shock. Examples include parturient paresis, acute ruminal acidosis (grain overload), during anesthesia and sedation, and the reduction of metabolic activity that occurs in the terminal stages of many diseases. A sudden fall in body temperature in a previously febrile animal, the so-called premortal fall, is an unfavorable prognostic sign.

##### Combination of Excessive Heat Loss and Insufficient Heat Production

A combination of excessive heat loss and insufficient heat production is often the cause of hypothermia. Insufficient energy intake or starvation of newborn farm animals in a cold environment can be a major cause of hypothermia. This may not occur under the same environmental conditions if the animals receive an adequate energy intake. Fatal hypothermia may also occur in other circumstances such as in certain breeds of pig (pot-bellied) following general anesthesia or sedation with higher doses of azaperone. Mature pot-bellied pigs deprived of feed and kept outdoors during cooler months of the year may develop hypothermia, which would not normally occur in these conditions if the pigs were receiving adequate food.

#### EPIDEMIOLOGY

##### Neonatal Hypothermia

Newborn farm animals are prone to hypothermia in cool environments, and

hypothermia is a major cause of neonatal mortality. Neonates cannot maintain their core body temperatures at normal values during the first few hours after birth under cold environmental conditions. Hypothermia and environmental thermoregulatory interactions are of particular importance in piglets and lambs because of their surface to volume ratio but are also relevant in calves and sick foals.

At birth, the neonatal ruminant moves from a very stable thermal environment, of similar temperature to its core body temperature, to a variable and unstable thermal environment that is 10 to 50°C colder than its core temperature. The coat is wet with placental fluids, and energy loss is increased by evaporation and the low insulative value of a wet coat. The newborn calf becomes hypothermic in the first 6 hours after birth and only limited tissue substrates are available as energy sources. Neonates also are exposed to a variety of environmental pathogens against which they have little specific immunity. Thus the neonatal period is one of the most critical to the survival of an animal, and during this period the morbidity and mortality can be high under adverse environmental conditions.

The continued emphasis in modern agriculture on the production of neonates throughout the year, including times of inclement weather and limited feed (late winter and early spring calving in beef herds in northern climates); the emphasis on short calving seasons; the use of high stocking densities; and the production of animals with high muscle growth potential, which may be associated with an increased incidence of dystocia resulting in decreased vitality of newborn animals at birth; all appear to combine to increase the incidence of mortality caused by hypothermia and related diseases of the neonate.

In lambs, more than 30% of deaths occur in the first few days of life, and mortalities may be greater than 10%, with more than half of the losses caused by hypothermia from either exposure or starvation. In calves, approximately 50% of deaths occur within 48 hours of birth, and most losses are either directly caused by, or follow, dystocial parturitions in which stillbirths and early postnatal mortality rates are about 20% compared with less than 5% in calves born without dystocia (eutocial).

### Thermoregulation in Neonatal Farm Animals

#### Response to Cold Stress

Neonatal ruminants, compared with many altricial neonatal mammals, are **precocial** in their development, with well-developed thermoregulatory mechanisms that allow them to maintain homeothermy in many environments. Prolonged exposure to heat or cold induces hormonal and metabolic changes specific to each stress. This involves

secretion of glucocorticoid hormones and increased activity of the sympathetic nervous system augmented by increased secretion of catecholamines. The principal metabolic effect of these increases is greater availability and utilization of substrates (fat, glycogen, and protein) for catabolism, with increased production of heat.

### Cold-Induced Thermogenesis

This is achieved by shivering thermogenesis in skeletal muscle tissue and nonshivering thermogenesis in brown adipose tissue. **Shivering thermogenesis** consists of involuntary, periodic contractions of skeletal muscle. Heat is produced during contraction of muscle bundles in skeletal muscle tissue that has increased in tone as well as in skeletal muscle contracting in overt tremors. Increased heat production in neonatal calves in the first several hours after birth can be significant when the animals first stand for 10 minutes; this effect is reproduced later when the calves are stronger and stand for longer periods. The principal site of cold-induced nonshivering thermogenesis in animals is brown adipose tissue, which is present in neonatal lambs, kids, and calves but not in piglets. In neonatal lambs, approximately 40% of the thermogenic response during summit metabolism is attributed to **nonshivering thermogenesis**, with the balance of about 60% attributed to shivering thermogenesis.

### Control of Heat Loss

The insulative nature of the external hair coat and cutaneous tissues to resist nonevaporative heat loss during cold exposure is critical in maintaining homeothermy. Total thermal insulation is the sum of tissue insulation and external insulation.

**Tissue Insulation.** This is the resistance of cutaneous tissue to conductive heat loss from the body core to the skin surface. Tissue insulation is influenced by subcutaneous fat depth, which is minimal in neonates, and by vasoconstriction. Tissue insulation increases with age.

**External Insulation.** This is the thermal resistance of the hair coat and air interface to radiative, convective, and conductive heat losses from the skin surface to the environment. External insulation is a function of length and type of hair coat and the air interface. When exposed to dry, cold still air environmental conditions, external insulation as a proportion of total thermal insulation in neonatal calves ranges from 65% to 75%. Moisture and mud in the coat decrease the value of external insulation; wind and rain can also decrease external insulation.

The neonate's total thermal resistance to heat loss is a function of the physical properties of the skin and hair coat and the ability to induce vasoconstriction of cutaneous

blood vessels and piloerection of the hair coat. Neonatal calves are remarkably cold tolerant in a dry, still air environment. The thermal demand of an outdoor cold environment is a function of **wind** and **precipitation** as well as **ambient temperature**.

**Conductive heat loss** is controlled by sympathetic regulation of blood vessels that supply cutaneous tissues, especially the ears and lower extremities. In response to cold, vessels constrict, peripheral blood flow diminishes, and heat transfer is limited. Vasoconstriction of cutaneous vessels during cold exposure occurs first in the ears, followed by the lower extremities, and then the skin surrounding the trunk. **Phasic vasodilation** in the skin of the ears and distal extremities at a point near freezing occurs by the sudden opening of arteriovenous anastomoses to permit **intermittent warming** (called the **hunting reaction**). Phasic vasodilation does not occur on the skin of the trunk.

### Thermoregulating Mechanisms

Heat exchange between any homeotherm and the environment is the result of the following:

- Heat production by metabolism
- Insensible heat loss by evaporation of moisture from the respiratory tract and skin
- Sensible heat transfer by conduction, convection, and radiation

There is a range in the effective thermal environment, called the **thermoneutral zone**, over which an animal maintains body temperature with minimal metabolic effort. Within this zone, body temperature is maintained primarily by varying blood flow to the body surface, piloerection of the hair coat, and behavioral and postural changes. These responses adjust the physical processes of heat transfer to balance the body's heat production. The lower limit of the thermoneutral zone (the **lower critical temperature**) is the minimum temperature that an animal can tolerate without actually increasing its rate of metabolic heat production to maintain thermal balance (Fig. 4-1). The lower critical temperature of an animal is determined by the animal's ability to resist heat loss (thermal insulation) and the animal's resting, thermoneutral heat production through metabolism. An increase in thermal insulation or an increase in thermoneutral metabolic rate decreases the lower critical temperature, improving cold tolerance.

Estimates of lower critical temperatures of calves during the first day of life are not available, but some estimates for older calves include 13°C for 2-day-old Ayrshire calves and 8 to 10°C for dairy and crossbred calves at 1 to 8 weeks of age. In lambs, estimates are 37 and 32°C for light (2-kg) and heavy (5-kg) birth weights immediately after birth while still wet with amniotic fluid, and 31 and 22°C when these lambs are more than 1 day old.

The thermoneutral zone for lactating dairy cows is 5 to 25°C. Adult cattle are very cold tolerant, with lower critical temperatures of 0°C for 1-month-old calves, -16 to -37°C for lactating dairy cows depending on their level of milk production, and -36°C for finishing feedlot cattle. At the lower border of the cold zone is the **cold lethal limit**, the ambient temperature below which the calf is unable to generate sufficient heat to offset heat losses required to maintain thermal balance, and at which hypothermia begins. Prolonged periods of exposure below the cold lethal limit will result in death. The cold lethal limit also can be defined as the ambient temperature below which heat loss exceeds the animal's summit or maximal metabolism. Because published values for lower critical temperatures assume **still air**, **dry clean coats**, **standard radiation**, and a **standing animal given a maintenance level of feeding**, there continue to be limitations to their use. Insulation of extremities decreases, and heat loss increases, at temperatures below freezing. Thus some lower critical temperatures for cattle are too low, which means that neonates may be affected by cold temperatures not normally considered harmful. External insulation can change because of changes in air velocity and long-wave radiation. Behavioral changes of animals may occur to minimize heat loss. For example, animals may orient toward the wind to decrease their profile, and they may seek shelter, huddle, and change their posture. Solar radiation varies throughout the daylight hours depending on the quantity of cloud. Generally, radiation balance is positive in the day, whereas at night, when the skies are clear, the radiation balance is usually negative. Heat production varies with the time of day and time since the last meal and physical activity. Rain will often depress intake of feed and illness, hypothermia severely depresses feed intake, and cold stimulates intake.

### Heat Production

Heat produced by metabolism varies directly with the level of feed intake, particularly in adult ruminants in which the heat increment produced by forestomach fermentation is considerable. The more an animal eats, the greater the heat increment of feeding, and this results in an increase in core temperature of up to 0.3°C in lactating dairy cows, compared with dry cows. Animals subjected to cold environmental temperatures will increase their feed intake if given the opportunity, with proportionate dry matter increases of up to 35% being typical. Heat is also generated from physical activity. When newborn calves stand for the first time and are able to stand for 10 minutes, the energy expenditure is increased proportionately 30 to 100%. As calves become stronger and are able to stand for more than 30 minutes, heat production increases by 40%.

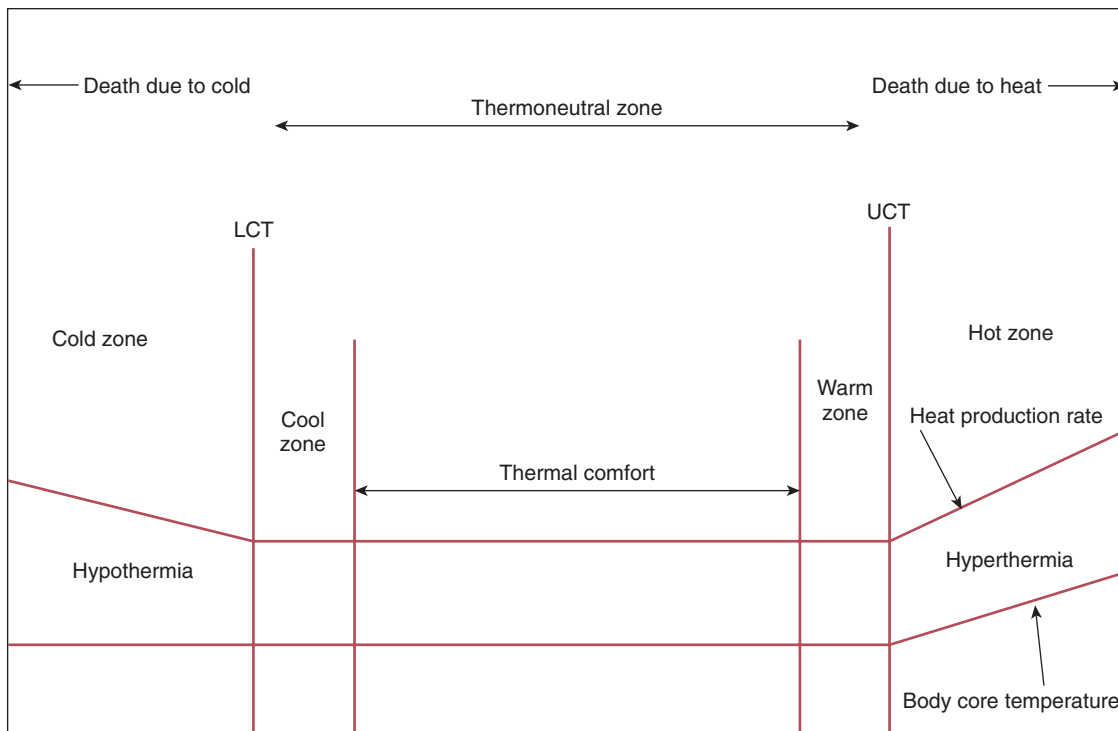

**Fig. 4-1** Relationship between environmental temperature, heat production rate, and body core temperature in agricultural animals. *LCT*, lower critical temperature; *UCT*, upper critical temperature. (Adapted from Kadzere et al. *Livestock Prod Sci*, 2002; 77:59-91.)

### Cold Thermogenesis

The major source of heat in cold thermogenesis, whether it is induced by either shivering thermogenesis or by nonshivering thermogenesis, is lipid. Glycogen is also important for maximum metabolic rates and for lipid metabolism. For the neonate, in the first 24 hours there is little digestion of colostrum proteins and little catabolism of amino acids.

**Shivering Thermogenesis.** This is the most obvious sign of increased heat production of cold thermogenesis.

**Nonshivering Thermogenesis.** Functional brown adipose tissue is present in newborn calves, lambs, and kids, and its primary function is to generate heat by nonshivering thermogenesis. The release of norepinephrine during cold exposure in neonatal ruminants stimulates increased blood flow to brown adipose tissue. Thyroid hormones also have an essential role in regulating cold thermogenesis. Glucocorticoids are essential for cold thermogenesis through the mobilization of lipid and glycogen to supply energy substrates. Large deposits of brown adipose tissue are present in the abdominal cavity (perirenal), around large blood vessels, and in the inguinal and prescapular areas. In calves, brown fat may represent 20 g/kg body weight (BW) and in lambs from well-fed ewes, brown fat may represent 6g/kg BW. At parturition, marked changes occur in both the neonate's supply and demand for

nutrients. In utero the fetal ruminant is provided with high levels of carbohydrate and low levels of fat, whereas after birth it is provided with colostrum high in fat and low in carbohydrate. Before colostrum is fed, the neonatal ruminant depends on mobilization of tissue glycogen and lipids to provide energy substrates for basal metabolism as well as thermogenesis in shivering muscle tissue and in brown adipose tissue. The major sources of energy substrates for thermogenesis in neonatal ruminants include glycogen and lipid in liver and muscle because protein catabolism is minimal during the early postnatal period.

**Summit Metabolism.** This is the maximal rate of metabolism that occurs in response to cold without a decline in body temperature. The time for which summit metabolism can be maintained is usually short, e.g., a few minutes in neonatal lambs. Summit metabolism is approximately five times the resting metabolic rate and is associated with increased sympathetic activity, development of metabolic acidosis, and increased plasma concentrations of glucose, glycerol, free fatty acids, and L-lactate. Prepartum hypoxia is likely associated with postpartum depression of sympathetic nervous activity and of thermogenic responses to cold.

**Birth Weight and Summit Metabolism.** The principal factor that determines an animal's resting, thermoneutral metabolism is

body size. In newborn animals, thermoneutral metabolic rates and summit metabolic rates are proportional to their weight ( $W^1$ ) rather than  $W^{0.75}$ , which means that summit metabolism per unit of  $W$  is similar for all neonates regardless of size, but lightweight animals have more surface area per unit of  $W$  than heavyweight neonates. Therefore lightweight neonates have a lower summit metabolic rate per unit of surface area and, consequently, lightweight neonates will be less cold tolerant than heavyweight neonates. Lightweight neonates therefore have a more difficult time maintaining thermal balance during cold stress because of a lower cold-induced thermogenic rate per unit of skin surface area than heavier animals. This, in part, explains the higher incidence of neonatal mortality in smaller piglets and lambs, and in smaller calves born to first-calf heifers, and even to mature cows.

### Factors Affecting Cold Thermogenesis

Several factors affect the ability of the newborn calf to avoid hypothermia. Prompt activation of thermogenic mechanisms must occur immediately after birth when the demand for heat production is usually highest. The development of functional brown adipose tissue must occur in fetal life to enable calves to have maximal nonshivering thermogenesis during the early postnatal period. Most of the functional brown adipose tissue is deposited in late gestation in lambs and calves.

Ambient temperature and nutrition during pregnancy can affect cold thermogenesis of lambs. Maternal cold exposure by winter shearing of sheep increases lamb birth weight and the amount of perirenal adipose tissue independent of changes in prepartum feed intake. Thus newborn lambs from cold-exposed ewes are more cold tolerant. Acute cold exposure during late gestation increases glucose supply to the fetus, which stimulates insulin secretion, which in turn promotes fetal growth; recruitment and proliferation of brown adipose tissue occurs to enhance cold tolerance of the newborn lamb. There is some evidence that prepartum exposure of pregnant cows to a cold environment may result in heavier calf weights.

**Malnutrition of the Dam During Late Gestation.** This can adversely affect neonatal calf survival. Prepartum energy restriction beginning at day 90 of gestation of ewes can also reduce the proportional weight of perirenal adipose tissue and reduce the nonshivering ability of newborn lambs. The influence of prepartum nutritional restriction on cold thermogenesis in newborn calves is unknown, but prepartum protein restriction during the last trimester reduced thermoneutral thermogenic rates by 12% without affecting birth weights, resulting in an estimated increase in the lower critical temperature. Maternal malnutrition also adversely affects the availability of energy substrates required by the neonate for cold thermogenesis. Nutritional restriction of pregnant ewes reduces total body lipid in fetal lambs but not muscle or liver glycogen. Thus nutritional restriction of the fetus impairs cold tolerance of the neonate by reducing body substrate reserves available for cold thermogenesis and reduces nonshivering thermogenic capabilities.

European or British breeds of cattle are also more cold tolerant and more adaptable to temperate climates, whereas zebu cattle are more adaptable to subtropical climates because of greater heat tolerance. The lack of cold tolerance of the newborn *Bos indicus* calf is associated with a higher mortality rate in purebred Brahman herds in the United States. These calves are less cold tolerant and more susceptible to the weak calf syndrome.

#### *Postnatal Changes in Cold Thermogenesis*

As calves and lambs grow during the early postnatal period, heat loss per unit of body weight declines because of improved thermal insulation and a decrease in the ratio of skin surface area to body weight. Nonshivering thermogenesis decreases during the first month of age in lambs and calves, which is associated with a decrease in summit metabolism. This coincides with the conversion of brown adipose tissue to white adipose tissue by about 10 days after birth. Postnatal

exposure to cold delays the disappearance of brown adipose tissue, which enhances cold tolerance of the lamb and calf by delaying the normal decline in nonshivering thermogenesis.

#### **Risk Factors for Neonatal Hypothermia**

##### **Calves**

Beef calves born outdoors during cold weather are susceptible to hypothermia. Wind, rain, and snow decrease the level of insulation and increase the lower critical temperature. Dairy calves born indoors are not usually exposed to cold environments that cause hypothermia; however, hypothermia has been recognized in dairy calves reared outdoors in cold climates and in some calves affected with enteritis.

Dystocia can affect cold thermogenesis. During a normal delivery, fetal hypoxemia may occur, causing anaerobic glycolysis, the production of lactic acid, and a mixed respiratory–metabolic acidosis that the calf can usually compensate for within hours after birth. In prolonged dystocia, a metabolic acidosis may occur, which will inhibit nonshivering thermogenesis and impair cold tolerance immediately after birth. Dystocia may result in a weak calf that has weak teat-seeking activity, a poor suck reflex, and a poor appetite for colostrum, resulting in colostrum deprivation and hypogammaglobulinemia.

**Colostrum** supplies **passive immunity** to the calf and the **nutrients** to meet energy demands during the immediate postpartum period. For the calf to maintain thermal balance during cold exposure, it is critical that the calf ingests colostrum early to provide enough energy reserves to sustain cold thermogenesis. Thus it is vitally important that newborn calves consume adequate colostrum to ensure adequate passive immunity and to aid in the maintenance of thermal stability during the early postnatal period when rates of heat loss are greatest. The limited availability of energy substrates from body reserves also requires that adequate quantities of colostrum are ingested during long periods of cold exposure, especially in neonatal calves at higher risk for developing hypothermia. The thermoneutral maintenance requirements of a 40-kg calf can be met with about 2.4 L of cow colostrum; an additional 125 mL of colostrum is required to supply the energy requirements for every 1°C decrease in effective environmental temperature below the lower critical temperature.

Young calves to be reared for veal are usually transported for 1 to 2 days during the first 2 weeks of life. These calves are prone to cold stress because they are very young and are being fed at a low level directly after transport. Veal calves arriving in a veal calf unit are dependent on body reserves to meet their energy requirement because of limited feed allowances, and ambient temperatures

should not be below 14°C immediately after arrival to prevent extra mobilization of energy reserves. The thermal requirements of these calves are higher during standing than during lying, and the provision of bedding that stimulates lying will have a positive effect on thermal requirements.

##### **Lambs**

Cold exposure resulting in hypothermia is a primary cause of lamb mortality, as seen when large numbers of lambs die during or soon after periods of a few hours of low temperatures (<5°C) with wind and rain, or after prolonged rain. Deaths in “bad” weather cannot necessarily be attributed with certainty to exposure as a primary cause, because lambs debilitated for other reasons, such as starvation, are highly susceptible to chilling and conditions such as low birth weight, birth injury, and sparse hair coat, which all predispose lambs to cold exposure. Under less harsh conditions such lambs may survive.

**Colostrum intake** is also critical in lambs. Under field conditions in the United Kingdom it is estimated that lambs require 180 to 210 mL colostrum per kilogram BW in the first 18 hours after birth to provide sufficient energy substrate for heat production. This colostrum requirement exceeds that for adequate transfer of colostral immunoglobulins. The thermoneutral and summit metabolic rates are much higher in lambs fed colostrum compared with unfed lambs at 4 to 5 hours of age. The increased metabolic rates are attributed to increased availability of energy substrates from colostrum: plasma concentrations of glucose and nonesterified free fatty acids are doubled from birth to 4 hours of age in colostrum-fed lambs but remain unchanged in colostrum-deprived lambs.

The heaviest losses in Australian sheep flocks, which occur in the form of *outbreaks* when the weather is very bad, are caused by hypothermia. The high mortality rates in newborn lambs caused by the effects of cold exposure and starvation occur because many of these lambs are born during the late winter and early spring, when adverse conditions are most likely to occur. This is also true in the northern United States and Canada. The lambs are often born outdoors in unprotected pens designed to accommodate a large number of ewes. Under these circumstances, the lambs may be severely cold stressed because the ambient air temperatures outside and within the lambing sheds are often 15°C or less, which is considerably lower than the critical temperatures described for heavy-weight (32°C) and lightweight (37°C) lambs. Cold-stressed lambs often become hypothermic because of excessive heat loss from exposure to inclement weather and because of heat production caused by severe hypoxia at birth or to starvation. Factors that further increase the susceptibility of lambs to hypothermia include the following:



- Lambs from ewes in poor condition
- Lambs from young or aged ewes
- Lambs from multiple births
- Lambs from dystocias
- Lambs with a low birth weight or born prematurely
- Breed differences in susceptibility to cold, and genetic differences within a breed
- Length of the birth coat
- Wetting of the birth coat
- Exposure to wind

The effects of experimental cold stress (0°C and -10°C) on pregnant ewes during the last weeks of gestation and their lambs of up to 3 days of age have been examined. Generally, ewes were unaffected by treatment. Cold-induced changes in lambs included physical weakness, depression, and poor nursing response. Serum concentrations of glucose and insulin decreased and cortisol increased. The mortality rate was 40% in stressed lambs and 10% in lambs kept at the warmer temperatures. Cold-exposed lambs had reduced amounts of adipose tissue in perirenal areas and extensive subcutaneous hemorrhages and edema in the distal portions of the thoracic and pelvic limbs.

**Wetness of the fleece** is a major factor in determining whether or not lambs become hypothermic. Wet lambs suffer a reduction in coat insulation, primarily as a result of reduced coat depths, but this effect is small compared with the increase in the evaporative heat loss that occurs as a result of wetting. Lambs exposed to experimental air movement from a fan produce more body heat than those in still air, and differences in resistance to cold stress between single and twin lambs are largely caused by the corresponding differences in body weight and coat depth.

The relative importance of environmental and maternal factors is not easy to determine. Lamb mortality is typically related to birth weight by a U-shaped curve, with an optimal birth weight for survival between 4.5 and 5.5 kg. Inclement weather kills many lambs, probably more than would otherwise die, but principally those that are at risk because of reduced vigor (dependent on poor preceding nutrition) or because of poor mothering (itself as dependent on poor nutrition of the ewe as on her inherited lack of mothering ability). The vigor of the lamb, principally manifested as *sucking drive*, is reduced by lack of reward, so that a vicious cycle is created if the ewe will not stand. Vigor is also greatly reduced by cold discomfort, giving inclement weather two points at which it influences lamb survival rates. The lamb dies of hypothermia and inanition.

#### Piglets

At birth, the newborn piglet experiences a sudden and dramatic 15 to 20°C decrease in its thermal environment. Because the newborn pig is poorly insulated, maintenance

of homeothermia depends almost exclusively on its capacity to produce heat. Unlike most other mammals the newborn pig does not possess brown adipose tissue. Consequently, neonatal pigs are assumed to rely essentially on muscular thermogenesis for thermoregulatory purposes. Newborn pigs shiver vigorously from birth because it is the main heat-producing mechanism and the thermogenic efficiency of shivering increases during the first 5 days of life.

Thermoregulation in the newborn piglet is important in the first 2 days. Metabolic heat production and rectal temperature increase and the development of adequate thermal insulation helps to withstand the effects of a cold environment. Body reserves are important for the piglet to survive in the first few hours, and glycogen and fat reserves are used as major energy substrates for heat production within the first 12 to 24 hours. Thus ingestion of colostrum and a high ambient temperature in the first several days of life are crucial. Application of 0.5 to 1 kg of chopped straw on a daily basis combined with 2 kg for nest building when the sow was about to farrow decreased the percentage of stillbirths by 27% but increased the number of piglets that were crushed.<sup>1</sup> Coldness impairs the development of thermostability and induces hypothermia, which diminishes the vigor of the piglet and reduces colostrum intake and immunoglobulins.

#### Foals

Newborn foals that are premature, dysmature, or affected with neonatal maladjustment syndrome cannot maintain their rectal temperatures at normal values during the first few hours after birth under the environmental conditions usually encountered within foaling boxes in the United Kingdom. Their overall mean metabolic rate is about 25% below the mean value for recumbent healthy foals.

This difference in resting metabolic rate affects the lower critical temperature or the air temperature below which heat loss exceeds resting heat production. The lower critical temperature for healthy foals is estimated to be about 10°C and for sick foals is about 24°C. When wet with amniotic fluid, the lower critical temperature probably will be much higher. Covering these foals with rugs and providing thermal radiation using radiant heaters would increase the lower critical temperature.

Premature foals are the most compromised compared with dysmature and those with neonatal maladjustment syndrome. They have small body masses, the lowest rates of metabolism, and the lowest rectal temperature. Premature foals are also likely to be deficient in energy reserves and thermal insulation, in addition to immaturity of organ systems, which could limit further energy availability. **Colostrum intake** is also crucial to their survival.

#### Postshearing Hypothermia in Sheep

Cold, wet, and windy weather can cause high mortality caused by hypothermia in newly shorn sheep; a fall in body weight in the period immediately preceding shearing is a major risk factor for mortality. In outbreaks in Australia in January the mean temperature can be 10°C, with a high rainfall and high wind velocity, accounting for a **wind chill factor** (a function of temperatures, rain, and wind velocity). Other factors that increase heat loss include sunshine versus cloud and the depth of the wool cover. The speed of the wind at the location of the animals varies greatly depending on the presence of protective windbreaks such as trees.

#### Cold Environments and Animal Production

Farm animals maintain a relatively constant body core temperature during exposure to the extreme range of thermal environments experienced in countries such as Canada. The severity of the winter is particularly challenging. Homeothermy is achieved by physiologic and behavioral mechanisms that modify either rates of heat loss from the body or the rate at which heat is produced by metabolism of feed or body energy reserves. Despite the extremely cold temperatures that occur in most of the agricultural regions of Canada, the effective severity of extremely cold temperatures is reduced because of the dryness of the frozen environment and the effective external insulation of the animal's hair coat. The influence of wind can add to cold stress, and the provision of shelter from wind by natural tree shelter belts or manmade structures such as porosity fences is required.

Prolonged exposure to cold results in subtle adaptation of hormonal and metabolic responses. Acclimatization to cold and winter conditions generally has little long-term effect on energy metabolism but increases thermal insulation and appetite. During prolonged exposure of cattle and sheep to cold environments down to -10 to -20°C there is a reduction in the apparent digestibility of the diet. To offset the lowered digestibility, the animals would accordingly need to consume more feed to achieve a similar digestible energy intake when kept outdoors during winter than if they were kept in a heated barn.

#### PATHOGENESIS

Sudden exposure of neonatal animals at birth and during the first few days of life to cold ambient temperature results in subnormal body temperature and shivering as well as decreased cardiac output, heart rate, and blood pressure. This results in muscular weakness and mental depression, respiratory failure, recumbency, and a state of collapse and, eventually, coma and death. The entire body, especially the extremities, becomes cold and the rectal temperature is below

37°C and may drop to 30°C or lower in neonates. Cold injury or frostbite of the extremities may occur in extremely cold conditions. Nonshivering-induced thermogenesis may occur, resulting in depletion of brown adipose tissue deposits. The neurologic signs of convulsions seen in some cases of hypothermia have not been adequately explained. The nervous signs observed in piglets with an inadequate intake of milk and exposed to cold environmental temperatures are probably caused by a marked hypoglycemia rather than hypothermia.

In newborn lambs carbohydrate and lipid are the major energy substrates for heat production because protein catabolism is minimal during the first day after birth. Liver glycogen concentrations increase markedly during the last few days before normal parturition. The amount of liver and skeletal muscle glycogen available in the newborn lamb at birth determines how long it can avoid hypoglycemia and hypothermia if not fed. The amount of lipid present in the newborn lamb can also affect the duration of the glycogen reserves. In growth-retarded lambs, lipid availability is decreased and glycogen exhaustion occurs earlier than normal. Such lambs are highly susceptible to hypothermia but this can be minimized by the early ingestion of colostrum, which is rich in lipid and extends the availability of glycogen.

Death results from excessive body cooling caused by low temperature, driving winds, and starvation. Wetness may or may not be involved. The starvation results indirectly from poor mothering by the ewe, either because she is a poor mother, because the weather interferes with mothering, or because the lamb is weak from poor antepartum nutrition. These lambs often walk after birth but at postmortem examination there is little to see. They may have sucked but there is little digestion and the intestine on the recumbent side is flaccid. There are also subcutaneous hemorrhages of the limbs and depletion of brown fat stores.

Hypothermia secondary to other diseases is caused by failure of the thermoregulation mechanism and is usually accompanied by varying degrees of shock and the inability to invoke shivering thermogenesis.

### CLINICAL FINDINGS

A decrease in body temperature to below 37°C represents hypothermia for most farm animal species. Weakness, decreased activity, cold extremities, and varying degrees of shock are common. Bradycardia, weak arterial pulse, and collapse of the major veins are characteristic. The mucous membranes of the oral cavity are cool and there is a lack of saliva.

### Neonatal Hypothermia

Body temperatures may be as low as 35°C in neonatal calves, piglets, lambs, and foals

exposed to a cold environment within hours after birth or following 12 to 24 hours of profuse diarrhea accompanied by marked dehydration and acidemia. However, acute dehydration in a thermoneutral environment is accompanied by a mild increase in rectal temperature. In the early stage of hypothermia, affected animals may be shivering and trembling and the skin of their extremities and ears feels cool to touch. Hypothermic piglets will attempt to huddle together, are lethargic, do not suck, and eventually become recumbent and die. Hypothermic calves exposed to a cold environment will assume sternal recumbency, lie quietly, will have a weak suck reflex, and will die in a few hours. In later stages further weakness leading to coma is common. The mucous membranes of the oral cavity are cool and may be dry. The heart rate is slower than normal and the intensity of the heart sounds decreased. Death is common when the body temperature falls below 35°C, but field observations indicate that the temperature may fall below 30°C and animals still survive if treated intensively.

### Shorn Sheep Hypothermia

Sheep with hypothermia associated with recent shearing and inclement weather have a range of body temperatures from 35 to 38°C. They huddle in tight groups and the animals that cannot maintain sufficient heat will become weak, recumbent, and die within a few hours. They may be found in lateral or sternal recumbency with their heads back over their shoulders. Palpebral reflexes are decreased, skin and extremities are cold, mucous membranes are pale to white, and generalized weakness similar to circulatory collapse is common.

### Hypothermia Secondary to Other Diseases

Hypothermia secondary to other diseases is usually not marked, and there are clinical findings related to the underlying illness. Hypothermia is common in diseases, such as milk fever in cattle, but returns to normal within a few hours after successful treatment with calcium salts. Successful treatment of the primary disease will usually return the temperature to within the normal range.

### CLINICAL PATHOLOGY

Clinical pathologic examinations are usually not done because the diagnosis is frequently obvious and the variability in biochemical changes makes them of limited value in reaching a diagnosis of hypothermia. The serum concentrations of glucose, nonesterified fatty acids, and immunoglobulins are commonly reduced, and hypoglycemia may be profound. However, the glucose concentration depends on the level of starvation that coexisted with the hypothermia. In starvation-induced depletion of body lipid and glycogen reserves, there is a depression

in cold thermogenesis and subsequent hypothermia. In neonatal calves and lambs with hypothermia caused by excessive heat loss during short cold exposure, the serum concentrations of glucose, nonesterified fatty acids, and immunoglobulins may be at adequate levels. Hemoconcentration, azotemia, and metabolic acidosis may occur.

### Necropsy Findings

Lesions associated with hypothermia depend on the duration and severity of the hypothermia. Fatal hypothermia in lambs and calves is characterized by an absence of lesions. A relative absence of milk in the abomasum is common. Experimental cold stress may result in subcutaneous edema of the ventral body wall and subcutaneous edema and hemorrhages of the extremities. Marked reductions in the amount of perirenal adipose tissue may be obvious. However, intense cold exposure of short duration may cause death of calves with no significant changes in the visual appearance of perirenal and pericardial adipose tissue depots.

### TREATMENT

#### Hypothermic Newborn Lambs

A standardized approach for the detection and treatment of hypothermia in newborn lambs can improve the survival rate. Most lambs become hypothermic within 5 hours or at more than 12 hours after birth. Hypothermia in the first 5 hours of life is most commonly caused by a high rate of heat loss from the wet newborn lamb, whereas a depressed rate of heat production consequent to starvation is the most common cause in the older lamb. Twin and triplet lambs are more susceptible to hypothermia than singles because of lower body energy reserves; the ewe takes longer to lick dry two or three lambs, and the milk requirement of two or three lambs is higher than that of a single lamb and starvation is more likely.

Using an electronic thermometer, the body temperature of any weak or suspect lamb is taken. Lambs of any age with mild hypothermia (37–39°C) are dried off if necessary to reduce heat loss, given ewe or cow colostrum by stomach tube, and placed in a sheltered pen with the ewe. Lambs less than 5 hours of age with severe hypothermia (<37°C) are dried off and given an intraperitoneal injection of 20% glucose at a temperature of 39°C. A large lamb (>4.5 kg) is given 50 mL, a medium lamb (3.0–4.5 kg) 35 mL, and a small lamb (<3.0 kg) 25 mL. Hypothermic lambs are then placed in warming pens, measuring 2 × 2 m and made of horizontally laid straw bales, two bales high. The pen is divided horizontally into two chambers by a sheet of weld mesh upon which the lambs lie. Warm air, at 38 to 40°C, is blown into the lower chamber from a domestic heater, and a sheet of polythene fitted over the entire pen retains the heat. When the lamb's temperature reaches 37°C, it is

removed from the warmer and immediately fed ewe or cow colostrum by stomach tube at a rate of 50 mL/kg BW. Any lamb that is vigorous and able to suck is returned to its ewe in a sheltered pen and monitored over the next several hours. Colostrum can be hand milked from the ewe after administration of oxytocin.

The immersion of hypothermic lambs in water at 38°C can result in the recovery to a euthermic state in about 28 minutes at a reduced expense in metabolic effort by lambs. However, this requires extra labor and lambs must be quickly dried, otherwise the heat loss is exaggerated after removal from water because of the wet fleece.

### Hypothermic Newborn Calves

Clinical management of hypothermic newborn calves is similar to that of lambs. Supplemental heat must be provided immediately. Rewarming can be done in small, enclosed boxes bedded with blankets and heat provided by infrared heat lamps. Colostrum or milk should be warmed to 40°C and intubated using an esophageal feeder. Fluids given intravenously must be warmed but their temperature usually decreases to the ambient environmental temperature before entering the jugular vein. Submersion of the intravenous line in a sustained source of hot water and ensuring an appropriate environmental temperature can mitigate the cooling of intravenously administered fluids before they reach the calf. Intravenous dextrose (1 mL of 50% dextrose per kilogram BW) should be routinely administered to all hypothermic calves because most have moderate to severe hypoglycemia. This dosage rate of 50% dextrose will increase the serum glucose concentration of the calf by approximately 100 mg/dL, assuming that the extracellular fluid space is 50% of the calf's body weight. The rectal temperature should be taken every 30 minutes during rewarming to assess progress.

A more aggressive rewarming technique involves the repeated administration of warm (40°C) 0.9% NaCl enemas via a flexible soft tube; a 20 to 30 Fr Foley catheter works well in this regard when it is advanced through the anus and the bulb inflated to maintain the catheter in the rectum. Rectally administered fluid should be aspirated before infusing additional fluid volumes via the Foley catheter to maximize the warming ability of enema fluids. Use of enema fluids as part of the rewarming protocol makes it more difficult to monitor the increase in body temperature. Whether immersion of hypothermic calves in water at 38 to 40°C is beneficial has not been determined, but immersion presents practical difficulties.

### Hypothermic Newborn Foals

The clinical management of sick foals that are prone to hypothermia is presented in the section [Control](#).

### Hypothermic Newborn Piglets

Hypothermic piglets must be placed in a warming box with a heat lamp and treated with intraperitoneal administration of glucose for the hypoglycemia (see Chapter 19).

### CONTROL

Control and prevention of hypothermia is dependent on providing the necessary surveillance at the time of parturition in animals being born in cold environments. Early recognition and treatment of animals with diseases leading to hypothermia is also necessary.

### Lambs and Calves

Prevention of hypothermia in calves depends on the planning and implementation of effective management strategies that will limit the risk factors known to predispose newborn calves to hypothermia and starvation. Management strategies to prevent hypothermia from excessive heat loss are most important in the first 24 hours after birth. These include changing the calving season to a warmer time of the year to minimize exposure to severe weather. Measures to minimize excessive heat loss include providing a dry, draft-free environment for calving and lambing. Providing a protective shelter for beef cow/calf pairs for calving and during the first week after birth can reduce mortality from hypothermia. In extensive beef cow/calf herds, calf huts large enough for 8 to 10 calves provide excellent shelter from wind, rain, and snow.

The provision of adequate surveillance and assistance at the time of lambing or calving is necessary to minimize the incidence of dystocia and its consequences for the neonate. The ingestion of adequate quantities of colostrum, beginning as soon after birth as possible, is important to provide immunoglobulin and energy sources for the neonate.

### Piglets

The newborn piglet requires an adequate intake of colostrum within a few hours after birth, continued intake of milk after the colostrum period, a warm external environment of 30 to 34°C for at least the first 3 days of life (with heat lamps), and protection from traumatic injuries such as crushing by the sow. Sows do not instinctively remove the amniotic fluid from the surface of piglets; it is removed by contact with other surfaces or by evaporation. Smaller than normal piglets and weak piglets should be dried manually after birth to minimize excessive heat loss. Cross-fostering is used when gilts or sows have large litters that they cannot nurse adequately.

### Sick Foals

Sick foals are prone to hypothermia, but cold stress can be reduced by good management procedures, including the following:

- The foal should be housed in an environment with minimal drafts, in which the air temperature is controlled at a steady value and set according to the foal's needs. Air temperature should be at, or a few degrees above, the lower critical temperature. This temperature may exceed 24°C for a sick, uncovered recumbent foal. Radiant heaters are useful but should not be placed too close to the foal.
- Excessive moisture should be removed from the foal's hair coat immediately after birth. A sick foal that cannot increase its metabolic rate is particularly susceptible to cold stress when wet with amniotic fluid.
- Additional insulation with foal rugs and leg bandages will reduce heat loss from the dry body surface. The dry sick foal needs an additional 10 mm of insulation for each 10°C decline in air temperature below 24°C. Because sick foals are recumbent, they should lie on a heated pad or on thick bedding material to minimize heat loss by conduction to the floor.
- Energy intake should be sufficient to sustain resting metabolism and can be given by the oral or parenteral route.
- Frequent monitoring of both rectal and air temperature, as well as energy intake, will assist in the diagnosis of thermal stress, so that appropriate action can be taken. A lack of shivering does not indicate an absence of cold stress.

### FURTHER READING

- Carstens GE. Cold thermoregulation in the newborn calf. In: perinatal mortality in beef herds. *Vet Clin North Am Food Anim Pract.* 1994;10:69-106.
- Hinch GN, Brien F. Lamb survival in Australian flocks: a review. *Anim Product Sci.* 2014;54:656-666.

### REFERENCE

1. Westin R, et al. *Prev Vet Med.* 2015;119:141.

## COLD INJURY (FROSTBITE AND CHILBLAINS)

### SYNOPSIS

**Etiology** Exposure of extremities to cold temperatures, usually below freezing, without adequate protection.

**Epidemiology** Cooler seasons of the year, primarily in young animals, especially beef calves, debilitated from other disease. Teats of lactating dairy cows also susceptible.

**Clinical findings** Lesions can occur on extremities of limbs, especially hindfeet, ears, and tail. Demarcated lesions with initial swelling with edema followed by necrosis and sloughing. Teats and udder of adult cows can be affected.

**Clinical pathology** None specific.



**Necropsy findings** Subcutaneous edema and hemorrhage in affected areas.

**Diagnostic confirmation** Clinical findings and history of exposure to cold.

**Treatment** Warm, dry environment. Improve peripheral circulation.

**Control** Remove debilitated calves from cold environments. Adequate and dry bedding.

## ETIOLOGY AND EPIDEMIOLOGY

Injury occurs during cold weather in the winter or spring months and is most common in **calves** that are weak or in which the peripheral circulation of the limbs is impaired, usually because of diarrhea and dehydration. In a retrospective study of frostbite in calves, 80% of cases were associated with a concurrent disease such as pneumonia, diarrhea, omphalitis, septicemia, and ocular disease. Hypothermia (<37.5°C) was present in about 50% of the calves. The disease in calves appears more common in beef breeds, possibly because of management risk factors.

In **dairy herds** with loose housing, access to outdoor exercise yards without adequate bedding can be a risk factor. There can be a high incidence of teat lesions in drylot-housed herds in temperate areas when freak cold weather fronts invade the region. Regional differences in teat chapping in winter are associated with regional differences in winter temperature.

## PATHOGENESIS

Physiologically, body heat is lost from the skin surface by radiation and convection and by conduction and evaporation when the skin and hair coat are wet. **Newborn calves** are particularly susceptible to cold because of their inadequate insulation and high ratio of body surface area (through which heat is lost) to body volume (in which heat is generated). The core and trunk body temperature is preferentially conserved during cold stress at the expense of the peripheral tissues, which are most susceptible to cold injury.

**Peripheral tissues** are also most susceptible because of their contact with the ambient temperature and wet environments. When cattle are in sternal recumbency, the uppermost pelvic limb is fully exposed and the distal aspect of the opposite limb from the hoof to above the fetlock joint is exposed to the environment. The distal extremities of the thoracic limbs are usually covered by the thorax. Thus any situation that results in prolonged sternal recumbency will allow the distal extremities of the pelvic limbs to cool excessively, and if there is impairment of circulation because of preexisting dehydration, varying degrees of cold injury can occur. Field observations suggest that if a weak calf does not move from a sternally recumbent position for several hours then the cold injury can progress to the stage of severe

irreversible frostbite before the clinical signs are recognized by the owner.

The **teats of dairy cows** are also exposed when standing and lying. Residual teat dip after milking predisposes to cold injury.

Cold injuries of extremities vary from mild to severe. Exposure to cold results in vasoconstriction and coolness of the affected part. Most dry-cold injury is superficial and the skin may become gangrenous resulting in a hard shell or carapace over healthier tissue. Deeper cold injury causes inflammation, redness or cyanosis, local swelling, and pain or loss of sensation.

## CLINICAL FINDINGS

Frostbite of the **feet** of calves is not readily obvious, even to the experienced observer. The normal hair covering and pigmentation of the skin often mask the early changes of frostbite. Commonly, cases are identified during the treatment with fluids of scouring, recumbent calves, when further clinical examination reveals that the hindfeet are cool and clammy.

In the **early stages** of frostbite of the distal parts of the limbs, the tissues are swollen, edematous, and may have well-demarcated limits. After several hours of warming indoors, the feet remain cool and close examination reveals some moistness and dark red to bluish coloration of the skin. There may be a line of demarcation between normal and affected tissue at about the level of the fetlock joints. If the injury is not severe, complete recovery can occur in a few days.

In more **severe cases**, within 24 to 48 hours, necrosis and sloughing of the skin occur and the hooves become detached several days later. There is pain on palpation of affected tissues, especially at the line of demarcation.

When there is avascular necrosis of the affected part, the skin will be hard like a shell (known as a carapace) and moderate palpation will elicit pain.

Freezing of the **ears** results in loss of pliability of the ears, gangrene, and loss of the affected parts and curling of the affected skin adjacent to the affected parts. Some sloughing of affected parts will occur, and after several days the ears appear shortened.

Freezing of the **tail** occurs most commonly at the distal end, resulting in stiffness and loss of flexibility because of a carapace. Varying portions of the tail may be affected, but usually 5 to 10 cm of the distal end is involved. The distal parts of the tail of adult cattle may freeze in very cold weather.

In adult cattle, freezing of the **teats** and **base of the udder** can occur in lactating cattle that have inadequate bedding and shelter from wind and snow. Affected teats are swollen and cold and the skin begins to vesiculate and peel. Freezing of the teats of cows may result in permanent injury, chronic thelitis, and the possibility of mastitis with

gangrene. Less severe lesions predispose to mastitis.

Freezing of the **scrotum** occurs in yearling beef bulls kept outdoors during the cold winter months, but the lesions are not commonly recognized until the spring of the year.

## NECROPSY FINDINGS

Necrosis of the skin of the affected area with severe diffuse hemorrhagic subcutaneous edema is typical of frostbite.

## TREATMENT

Affected calves should be moved to a warm, well-bedded **dry environment** and circulation should be improved by providing **fluid therapy** as necessary. In early cases, affected calves will recover in a few days and the swelling and pain will regress. Field observations suggest that superficial freezing of the skin between the fetlock and coronets will heal over a period of several weeks providing the lesion does not extend into the coronary bands and the laminae of the feet, which commonly results in sloughing of the hoof.

In severe cases with extensive necrosis, the skin will begin to slough. Such open wounds should be treated with suitable antibiotic ointments and bandaged for several days. Calves with extensive freezing of the hindlimbs extending from the feet up to hock joints are incurable and should be euthanized.

There is no specific treatment for freezing of the ears and tails of calves or the teats of cows.

## CONTROL

The prevention of cold injury in newborn **calves** requires daily surveillance of calves to ensure that any animal that is inactive for any reason is examined for evidence of illness and treated immediately and placed in a protected environment.

When an exceptional cold period is forecast for **dairy cows** at risk, teat dipping should be temporarily suspended during the cold period. Additional bedding should be provided for loose-housed cows, and bedding with some manure can be piled in the center of drylot yards to provide composting heat upon which the cows can bed.

## HYPERTHERMIA (HEAT STROKE OR HEAT EXHAUSTION)

Hyperthermia is the elevation of core body temperature caused by excessive heat production or absorption, or to deficient heat loss, when the causes of these abnormalities are purely physical. Heat stroke (heat exhaustion) is the most commonly encountered clinical entity.

## ETIOLOGY

The major causes of hyperthermia are the physical ones of high environmental



temperature and prolonged, severe muscular exertion, especially when the humidity is high, the animals are fat, have a heavy hair coat, or are confined with inadequate ventilation such as on board ship or during road transportation. Fat cattle, especially British beef breeds, can be overcome by the heat in feedlots. Brahman cattle in the same pen may be unaffected. Angora goats are much more sensitive to high environmental temperatures than sheep, especially when they are young.

### High Environmental Temperature

The upper border of the thermoneutral zone (the **upper critical temperature**) is the effective ambient temperature above which an animal must increase heat loss to maintain thermal balance (see Fig. 4-1). The upper critical limit for dairy cows is 25 to 26°C. The upper critical temperature in sheep with a light wool coat on board ship appears to be 35°C (95°F) at a humidity of 33 to 39 mm Hg (4.4–5.2 kPa) vapor pressure. Differences between breeds of animal in their tolerance to environmental high temperatures, exposure to sunlight, and exercise are important in animal management and production. Holstein cows carrying the *slick hair* gene (phenotypically having a short, sleek and sometimes glossy hair coat) are better able to regulate body temperature during heat stress than wild-type Holsteins, with slick-haired animals having an increased sweating rate.<sup>1</sup> Water buffalo have been shown to be less heat tolerant than Shorthorn steers, which were less tolerant than Javanese Banteng and Brahman crossbreeds (the last two appear to be equally tolerant). The differences appear to be at least partly caused by the capacity to increase cutaneous evaporation under heat stress.

There are similar differences in heat tolerance between lactating and nonlactating cows; lactating animals show significantly greater increases in rectal temperature and heart and respiratory rates when the environmental temperature is raised. This is primarily a result of the greater dry matter intake and heat of fermentation in dairy cattle that must be dissipated. Heat stress is therefore an important production-limiting disease when dairy cattle are kept in conditions of high heat and humidity.

Rested, hydrated horses are well able to maintain homeothermy in the hottest environmental conditions. Their most efficient mechanism in ensuring that body temperature is kept low is their capacity for heavy sweating.

### Other Causes of Hyperthermia

- Neurogenic hyperthermia: Damage to hypothalamus, e.g., spontaneous hemorrhage, may cause hyperthermia or poikilothermia
- Dehydration: Caused by insufficient tissue fluids to accommodate heat loss by evaporation

- Excessive muscular activity: For example, strychnine poisoning
- Miscellaneous poisonings, including levamisole and dinitrophenols
- Malignant hyperthermia in the porcine stress syndrome
- Malignant hyperthermia in Quarter Horses<sup>2,3</sup>
- Hyperkalemic periodic paresis in horses
- Fescue toxicity in ruminants and horses
- Cattle with hereditary bovine syndactyly
- Administration of tranquilizing drugs to sheep in hot weather
- Specific mycotoxins, e.g., *Claviceps purpurea* and *Acremonium coenophialum*, are causes of epidemic hyperthermia; bovine idiopathic hyperthermia in cattle in Australia may be caused by *Claviceps purpurea*
- Iodism
- Sylade (possibly) poisoning

### PATHOGENESIS

The means by which hyperthermia is induced have already been described. The physiologic effects of hyperthermia are important and are outlined briefly here.

Unless the body temperature reaches a critical point, a short period of hyperthermia is advantageous in an infectious disease because phagocytosis and immune body production are facilitated and the viability of most invading organisms is impaired. These changes provide justification for the use of artificial fever to control bacterial disease. However, the metabolic rate may be increased by as much as 40 to 50%, liver glycogen stores are rapidly depleted, and extra energy is derived from increased endogenous metabolism of protein. Feed intake is decreased and there is a change in postabsorptive carbohydrate metabolism in cattle, characterized by increased plasma insulin concentration and insulin release to a glucose tolerance test. If anorexia occurs because of respiratory embarrassment and dryness of the mouth, there will be considerable loss of body weight and lack of muscle strength accompanied by hypoglycemia and an increase in plasma urea nitrogen concentration caused by the use of skeletal muscle for energy.

There is increased thirst caused in part by dryness of the mouth. An increase in heart rate occurs directly because of the rise in blood temperature and indirectly to the fall in blood pressure resulting from peripheral vasodilatation. An increased respiratory rate cools by increasing salivary secretion and the rate of air flow across respiratory epithelial surfaces, increasing the rate of evaporative cooling. Urine secretion is decreased because of the reduced renal blood flow resulting from peripheral vasodilatation and because of physicochemical changes in body cells that result in retention of water and chloride ions.

When the critical temperature is exceeded, there is depression of nervous system activity and depression of the respiratory center usually causes death by respiratory failure. Circulatory failure also occurs caused by myocardial weakness and the heart rate becoming fast and irregular. If the period of hyperthermia is unduly prolonged, rather than excessive in degree, the deleterious effects are those of increased endogenous metabolism and deficient food intake. There is often an extensive degenerative change in most body tissues, but this is more likely to be caused by metabolic changes than by the direct effects of elevation of the body temperature.

Malignant hyperthermia is an autosomal dominant trait in Quarter Horse lineages caused by a single missense point mutation in the ryanodine receptor 1 (*RyR1*) gene. Dysfunction of the *RyR1* gene leads to excessive release of calcium into the cytosol and a hypermetabolic state of the skeletal muscle cells, which in severe cases can result in rectal temperatures exceeding 43°C. Malignant hyperthermia is potentially fatal in horses carrying the genetic defect, with an estimated mortality rate of 34%.<sup>2,3</sup>

### CLINICAL FINDINGS

An elevation of body temperature is the primary requisite for a diagnosis of hyperthermia, and in most species the first observable clinical reaction to hyperthermia occurs when the rectal temperature is increased by 3 to 4°C (4–7°F) above normal. In most instances the temperature exceeds 42°C (107°F) and may reach 43.5°C (110°F). An increase in heart and respiratory rates with a weak pulse of large amplitude, sweating, and salivation occur initially, followed by a marked absence of sweating. The animal may be restless but soon becomes dull, stumbles while walking, and tends to lie down.

In the early stages there is increased thirst and the animal seeks cool places, often lying in water or attempting to splash itself. Additional increases in rectal temperature lead to labored respiration and general distress is evident. Beyond this point the respirations become shallow and irregular, the pulse becomes very rapid and weak, and these signs are usually accompanied by collapse, convulsions, and terminal coma. Death occurs in most species when the core temperature exceeds the normal value by approximately 5 to 7°C (8–10°F). Abortion may occur if the period of hyperthermia is prolonged, and a high incidence of embryonic mortality has been recorded in sheep that were 3 to 6 weeks pregnant. In cattle, breeding efficiency is adversely affected by prolonged heat stress and in intensively housed swine a syndrome known as summer infertility, manifested by a decrease in conception rate and litter size and an increase in anestrus, occurs during and following the hot summer months in most countries. A

case series of 4- to 6-month-old lambs examined in summer with clinical signs of high rectal temperature, tachypnea, and neurologic disease has been reported in Texas.<sup>4</sup> Neurologic signs included postural kyphosis and limb hyperextension to sternal recumbency and was attributed to hyperthermia-induced spinal cord injury.

Respiratory rate at the lower end of the thermoneutral zone is 20 breaths per minute in cattle and 25 to 30 breaths per minute in sheep and goats. An increase in respiratory rate above 40 breaths per minute in adult ruminants represents panting, which has the homeostatic goal of facilitating cooling by respiratory evaporation. The respiratory rate is therefore the most practical indicator of heat stress in adult ruminants, with respiratory rates of 40 to 60, 60 to 80, and 80 to 120 breaths per minute representing low, moderate, and severe heat stress, respectively. It is not uncommon in hot humid climates to see cattle open-mouth breathing with respiratory rates exceeding 80 breaths per minute during periods of heat stress. In summary, the progression of changes in cattle with heat stress is increased respiratory rate, rectal temperature, and heart rate; followed by decreased urine concentration (caused by increased water intake); and finally decreased appetite and milk production.

Heat stress in horses and donkeys is associated with increased respiratory rate and depth, flared nostrils, nodding of the head, and apathy.<sup>5</sup> Hyperthermic horses are fatigued and have profound fluid and electrolyte losses, characterized by hypotonic dehydration caused by excessive sweating. The resultant clinical signs include decreased performance, depression, weakness, increased heart and respiratory rates, and marked increases in rectal temperature (usually exceeding 42°C). Because of the hyponatremia, affected horses may lose the stimulus to drink, exacerbating their dehydration. In advanced cases, the skin is dry and hot because sweating is impaired. Hyperthermic horses that have been participating in an endurance event may have synchronous diaphragmatic flutter as a result of hypocalcemia and metabolic alkalosis. Coma and death can occur in extreme cases of hyperthermia that are not identified and treated until the condition is advanced.

### CLINICAL PATHOLOGY

No important clinicopathologic change is observed in simple hyperthermia. However, horses with advanced hyperthermia typically have hyponatremic dehydration and azotemia. Horses with synchronous diaphragmatic flutter are typically hypocalcemic.

### Necropsy Findings

At necropsy there are only poorly defined gross changes. Peripheral vasodilatation may be evident, clotting of the blood is slow and incomplete, and rigor mortis and

putrefaction occur early. There are no constant or specific histopathologic changes.

### TREATMENT

The presence of adequate drinking water is essential and, together with shade and air movement, is of considerable assistance when multiple animals are exposed to high air temperature.

If treatment of individual animals is necessary because of the severity or duration of the hyperthermia, affected animals should be immediately placed in the shade and hosed on the midline of the back with cold water so that their coats are saturated. Fans should be immediately placed in front of the animal to promote evaporative cooling, and cooled water, with and without added electrolytes, should be made available for the animal to drink. In severe cases of hyperthermia in which large volumes of water are not available, very cold water (2–8°C) should be applied and immediately scraped off because the water becomes warm almost immediately. The application of very cold water does not induce a clinically relevant degree of peripheral vasoconstriction and has not been associated with clinically relevant side effects. Water applied by hose does not need to be scraped off because heat is conducted to the applied water stream. Placement of wet sheets or towels over the head or neck is not recommended because they provide unneeded insulation.

The rectal temperature should be monitored frequently during cooling, and water application should be stopped when the rectal temperature has returned to normal. Because affected animals may not be interested in or capable of drinking, the intravenous administration of fluids such as 0.9% NaCl is indicated in animals that are weak, recumbent, or dehydrated. Horses often need 20 to 40 L of intravenous fluids over the first few hours of treatment. Horses with synchronous diaphragmatic flutter should be treated with intravenous calcium after verifying the presence of hypocalcemia.

Fluids can also be administered orally to horses, but care should be taken to ensure that gastrointestinal motility is not impaired. A practical oral electrolyte solution is obtained by dissolving 20 g of table salt (NaCl) and 20 g of Litesalt (NaCl and KCl) in 5 L of water; this provides 107, 28, and 132 mmol/L of sodium, potassium, and chloride, respectively. Five liters of this fluid can be administered to an adult horse each hour by nasogastric tube.

### CONTROL

Shade alone is the most important factor in maintaining the comfort of livestock and preventing heat stress. Shade reduces the heat gain from solar radiation and can be provided by trees or artificially by roofs or shades made from cloth or artificial material. Shades should be placed over feed and where

the producer wants the animals to spend their time. The efficiency of metal shades can be increased by painting metal shades white on the topside and black on the underside. A north-south orientation will permit drying under the shades as the shaded area moves throughout the day; this may be helpful in decreasing the incidence of coliform mastitis if sprinklers are used under the shades and cattle prefer to lie under the shades than in freestalls.

In dairy and feedlot cattle, the following measures should be taken to manage heat stress:

- Provide cool clean water and plenty of trough space for drinking.
- Use shades and intermittent sprinkler systems (wet time of 1–2 min with an adequate dry off time of 20–30 min); continuous application of water increases the local humidity and decreases the effectiveness of evaporative cooling.
- Enhance airflow by fans or by providing mounds for cattle to stand on.
- Adjust rations and feed a larger percentage of the ration in the evening when it is cooler.
- Minimize handling during periods of greatest heat stress.
- Select cattle based on breed and coat characteristics, and house the most susceptible cattle (heavy, black) on east-sloping lots with the most shade; genetic studies have identified genes associated with resistance to heat stress in dairy cattle.<sup>1,6</sup>

In exercising horses, periodic rests in the shade with fans and water sprinklers and maintaining a normal hydration status can be very helpful in preventing heat stress. Monitoring the heart rate is a useful and practical method of assessing the degree of heat stress in horses, because heart rates remain elevated for a longer period of time in horses undergoing heat stress.

If animals have to be confined under conditions of high temperatures and humidity, the use of tranquilizing drugs has been recommended to reduce unnecessary activity. However, care is needed because blood pressure falls and the animals may have difficulty losing heat if the environment is very hot and in some cases may gain heat. Chlorpromazine, for example, has been shown to increase significantly the survival rate of pigs exposed to heat and humidity stress.

### FURTHER READING

- Foreman JH. The exhausted horse syndrome. *Vet Clin North Am Equine Pract.* 1998;14:205-219.
- Kadzere CT, Murphy MR, Slianiakove N, Maltz E. Heat stress in lactating dairy cows: a review. *Livestock Product Sci.* 2002;77:59-91.
- Leon LR, Bouchama A. Heat stroke. *Compr Physiol.* 2015;5:611-647.
- Marai IFM, El-Darawany AA, Fadiel A, Abdel-Hafez MAM. Physiological traits as affected by heat stress in sheep—a review. *Small Rumin Res.* 2007;71:1-12.

- O'Brien MD, Rhoads RP, Sanders SR, Duff GC, Baumgard LH. Metabolic effects to heat stress in growing cattle. *Domest Anim Endocrinol*. 2010;38:86-94.
- Sevi A, Caroprese M. Impact of heat stress on milk production, immunity, and udder health in sheep: a critical review. *Small Rumin Res*. 2012;107:1-7.
- Silanikove N. Effects of heat stress on the welfare of extensively managed domestic ruminants. *Livestock Product Sci*. 2000;67:1-18.

## REFERENCES

- Dikmen S, et al. *J Dairy Sci*. 2008;91:3395.
- Aleman M, et al. *J Vet Intern Med*. 2009;23:329.
- Nieto JE, Aleman M. *J Vet Intern Med*. 2009;23:619.
- Sprake PM, et al. *J Vet Intern Med*. 2013;27:1242.
- Pritchard JC, et al. *Equine Vet J*. 2006;38:433.
- Dikmen S, et al. *PLoS ONE*. 2013;8(7):e69202.

## FEVER (PYREXIA)

Fever is an elevation of core body temperature above that normally maintained by an animal and is independent of the effects of ambient conditions on body temperature. It is important to realize that fever is a combination of hyperthermia and infection or inflammation that results from an elevated set point for temperature regulation.

## ETIOLOGY

Fevers may be septic, the more common type, or aseptic, depending on whether or not infection is present.

### Septic Fevers

These include infection with bacteria, viruses, protozoa, or fungi as

- Localized infection such as abscess, cellulitis, and empyema
- Intermittently systemic, as in bacteremia and endocarditis
- Consistently systemic, as in septicemia

### Aseptic Fevers

- Chemical fevers, caused by injection of foreign protein and intake of dinitrophenols
- Surgical fever, caused by breakdown of tissue and blood
- Fever from tissue necrosis, e.g., breakdown of muscle after injection of necrotizing material
- Severe hemolytic crises (hemoglobinemia)
- Extensive infarction
- Extensive necrosis in rapidly growing neoplasms such as multicentric lymphosarcoma in cattle
- Immune reactions such as anaphylaxis and angioneurotic edema

## PATHOGENESIS

Most fevers are mediated through the action of endogenous pyrogens produced by granulocytes, monocytes, and macrophages. The most important and best known **endogenous pyrogen** is interleukin-1 (IL-1), produced by monocytes and macrophages. The

febrile response is initiated by the introduction of an **exogenous pyrogen** into the body. Exogenous pyrogens include pathogens such as bacteria, viruses, bacterial endotoxins, antigen-antibody complexes, hemoglobine-mia in a hemolytic crisis, and many inorganic substances. In hypersensitivity states, soluble antigen-antibody complexes may act as mediators. One of the most potent exogenous pyrogens is the lipopolysaccharide of gram-negative bacteria.

## Endogenous Pyrogens

Endogenous pyrogens are proteins released from monocytes and, to a lesser extent, lymphocytes. These proteins were originally designated as **monokines** and **lymphokines**, respectively, but are now more commonly referred to under the more general term of **cytokines**. One of the pyrogenic cytokines is IL-1, formerly known as lymphocyte activating factor. **IL-1** stimulates T-lymphocyte proliferation in the presence of antigen, enhancing the immune response. The mediators between endogenous pyrogen and the hypothalamus appear to be prostaglandins, and the level of calcium in the hypothalamus appears to regulate its activity.

Interleukin-1 initiates fever by inducing an abrupt increase in the synthesis of **prostaglandins**, particularly prostaglandin E<sub>2</sub>, in the anterior hypothalamus. The elevated prostaglandin levels in the hypothalamus raise the thermostatic set point and induce the mechanisms of heat conservation (vasoconstriction) and heat production (shivering thermogenesis) until the blood and core temperature are elevated to match the hypothalamic set point.

Prostaglandin precursors are thought to be the chemical mediators of fever according to the following sequence:

1. Endogenous pyrogens cause the release of arachidonic acid, with subsequent synthesis of prostaglandins.
2. Arachidonic acid breakdown products modulate the hypothalamic thermoregulatory mechanism, resulting in an increase in the set point value.
3. Prostaglandin synthetase-inhibitor antipyretics lower fever by blocking the synthesis of prostaglandins or prostaglandin precursors from arachidonic acid.

A cytokine known as **tumor necrosis factor- $\alpha$**  (TNF- $\alpha$ ) reproduces many of the physiologic derangements observed in septic shock and mediates many of the deleterious effects of gram-negative bacterial infection, including fever.

In addition to their pyrogenic activity, cytokines mediate the acute phase response, which is a term now being used to describe the reaction of animals to pathogen invasion, tissue injury, immunologic reactions, and inflammatory processes. The physiologic mechanisms involved in the production of fever after stimulation by pyrogens must be

matured or sensitized by previous exposure to pyrogen. Injection of pyrogens into newborn lambs does not cause fever but subsequent injections do.

## Effect of Pyrogens on the Hypothalamus

The effect of bacterial and tissue pyrogens is exerted on the thermoregulatory center of the hypothalamus so that the thermostatic level of the body is raised. The immediate response on the part of organs involved in heat regulation is the prevention of heat loss and the increased production of heat. This is the period of **increment**, or chill, which is manifested by cutaneous vasoconstriction, resulting coldness and dryness of the skin, and an absence of sweating. Respiration is reduced and muscular shivering occurs, and urine formation is minimal. The extremities are cold to the touch, the rectal temperature is elevated, and the pulse rate increased. When the period of heat increment has raised the body temperature to a new thermostatic level the second period of fever, the **fastigium**, or period of constant temperature, follows. In this stage the mechanisms of heat dissipation and production return to normal. Cutaneous vasodilatation causes flushing of the skin and mucosa, sweating occurs and may be severe, and diuresis develops. During this period there is decreased forestomach motility in ruminants, metabolism is increased considerably to maintain the body temperature, and tissue wasting may occur. There is also an inability to maintain a constant temperature when environmental temperatures vary.

When the effect of the pyrogenic substances is removed, the stage of **decrement**, or fever defervescence, appears and the excess stored heat is dissipated. Vasodilatation, sweating, and muscle flaccidity are marked and the body temperature falls. The fall in body temperature after the initial rise is accompanied by a decline in plasma zinc and plasma total iron concentrations. If the toxemia accompanying the hyperthermia is sufficiently severe, the ability of tissues to respond to heat production or conservation needs may be lost and as death approaches there is a precipitate fall in body temperature.

## Febrile Response

The febrile response, and the altered behavior that accompanies it, are thought to be part of a total mechanism generated to conserve the resources of energy and tissue being wasted by the causative infection. The febrile response has major effects on immune mechanisms. Endogenous pyrogens stimulate T-cell proliferation. The increased body temperature causes increases in leukocyte mobility, leukocyte bactericidal and phagocytic activities, and lymphocyte transformation as well as enhances the effects of interferon and IL-1.



Some possible adverse effects of fever include anorexia, which can lead to excessive catabolism if prolonged. Rarely, extremely high fevers can result in disseminated intravascular coagulation and effects on the central nervous system (CNS) that may lead to convulsions.

### CLINICAL FINDINGS

The effects of fever are the combined effects of hyperthermia and infection or inflammation. There is elevation of body temperature, an increase in heart rate with a diminution of amplitude and strength of the arterial pulse, hyperpnea, wasting, oliguria often with albuminuria, increased thirst, anorexia, scant feces, depression, and muscle weakness. The temperature elevation is always moderate and rarely goes above 42°C (107°F).

The **form of the fever may vary**. Thus the temperature rise may be

- Transient
- Sustained, without significant diurnal variation
- Remittent, when the diurnal variation is exaggerated
- Intermittent, when fever peaks last for 2 to 3 days and are interspersed with normal periods
- Atypical, when temperature variations are irregular

A biphasic fever, consisting of an initial rise, a fall to normal, and a secondary rise, occurs in some diseases, e.g., in strangles in the horse and in erysipelas in swine. The outstanding example of intermittent fever in animal disease is equine infectious anemia.

In farm-animal practice the most common cause of a fever is the presence of an inflammatory process such as pneumonia, peritonitis, mastitis, encephalitis, septicemia, viremia, etc. The clinical abnormalities that are typical of the particular disease must be detected and differentiated in the process of making a diagnosis. In the absence of physical causes of hyperthermia, the presence of a fever indicates the presence of inflammation, which is not always readily apparent. A **fever of unknown origin** occurs commonly in farm animals and requires repeated clinical and laboratory examinations to elucidate the location and nature of the lesion.

In **horses**, a **fever of unknown origin** is characterized by prolonged, unexplained fever associated with nonspecific findings such as lethargy, inappetence, and weight loss. In a series of horses with fever of unknown origin, the cause was found to be infection in 43%, neoplasia in 22%, immune mediated in 7%, and miscellaneous diseases in 19%. The cause remained undetermined in 10%.

The **magnitude of the fever** will vary with the disease process present, and it is often difficult to decide at what point the elevated temperature is significant and represents the presence of a lesion that requires

specific treatment. This is especially true when examining groups of animals with nonspecific clinical findings including an elevated temperature. The typical example is a group of feedlot cattle affected with depression, inappetence, dyspnea, and fever ranging from 39.5 to 40.5°C. The suspected disease may be pneumonic pasteurellosis but it may be impossible to make that diagnosis based on auscultation of the lungs of all the affected animals. Some of the animals may have a fever of unknown origin from which they will recover in a few days and specific therapy is not required. Under these circumstances and based on clinical experience, the tendency is to make a diagnosis of **acute undifferentiated bovine respiratory disease** or **undifferentiated fever** in animals with a temperature  $\geq 40.5^\circ\text{C}$  for 2 days in succession. This emphasizes the need to select an upper threshold value that indicates a clinically and physiologically significant fever. Infrared thermography offers great promise as a noninvasive method of identifying pyrexia in group housing, particularly pigs raised in confinement housing and feedlot cattle.

### CLINICAL PATHOLOGY

There are no clinicopathologic findings that are specific for fever. The hemogram will reflect the changes associated with the cause of the fever. Inflammation is characterized by marked changes in the total and differential leukocyte count characteristic for each disease. A wide variety of tests can be performed to identify the location and nature of the lesion causing the fever. The most common tests include the following:

- Microbiologic testing of blood samples
- Analysis of serous fluids from body cavities
- Cerebrospinal fluid analysis
- Milk sample analysis
- Reproductive tract secretion analysis
- Joint fluid analysis
- Biopsies
- Exploratory laparotomy

Medical imaging may be necessary to detect deep abscesses.

### Necropsy Findings

The necropsy findings will be characteristic of the individual disease process and are commonly characterized by varying degrees of peracute, acute, and chronic inflammation depending on the severity of the disease, the length of illness, and whether or not treatment had been given. In the case of long-standing fevers, these findings are still characteristic but they may fluctuate in severity daily or over longer periods.

Fever must be differentiated from hyperthermia caused by a physical cause such as **heat stroke** or **exhaustion** or **malignant hyperthermia** of pigs and Quarter Horses. In **fever of unknown origin**, the history, physical examination, laboratory findings,

and epidemiologic setting should be reviewed. Localizing clinical findings may provide a clue to the body system or organ involved. Common inflammatory processes include the following:

- Abscesses of the peritoneum, pleura, and lungs
- Septic metritis
- Endocarditis
- Polyarthritis
- Pyelonephritis

Many animals are placed in the category of fever of unknown origin because the veterinarian overlooks, disregards, or rejects an obvious clue. No algorithms or computer-assisted diagnostic programs are likely to solve this diagnostic challenge. To improve the diagnostic accuracy veterinarians will have to work harder. This requires obtaining a detailed history, repeated physical examinations, reconsideration of the epidemiologic characteristics of the affected animal, requesting consultations from colleagues, and the investment of time to consider the diagnosis and the circumstances.

### TREATMENT

#### Antimicrobial Agents

The most important aspects of the clinical management of fever should be directed at its cause. The main objective is to identify and treat the primary disease. Antimicrobial agents are indicated for the treatment of bacterial infections. The selection of antimicrobial, the route of administration, and the duration of treatment depend on the cause of the infection, its severity, and the accessibility of the lesion to the drug. The use of antimicrobial agents to prevent secondary bacterial infections in animals with viral diseases (e.g., viral interstitial pneumonia) is controversial and of doubtful benefit.

In animals with a **fever of unknown origin**, broad-spectrum antimicrobial agents seem rational. However, blind therapy is not recommended because it may lead to drug toxicity, superinfection caused by resistant bacteria, and interference with subsequent accurate diagnosis by cultural methods. In addition, the fall of the temperature following treatment may be interpreted as a response to therapy, with the conclusion that an infectious disease is present. If such a trial is begun the response should be monitored daily to determine effectiveness, and continued efforts should be made to determine the cause of the fever. In some cases it may be necessary to surgically remove by drainage techniques the source of the infection located in abscesses or body cavities such as the pleural cavity.

#### Antipyretics

Because fever ordinarily does little harm and usually benefits the animal's defense mechanism, antipyretic agents are rarely essential and may actually obscure the effect of a specific therapeutic agent or of the natural



course of the disease. If the fever is high enough to cause discomfort or inappetence, or is so high that death from hyperthermia is possible, then nonsteroidal antiinflammatory drugs (NSAIDs) should be administered. Most NSAIDs, such as flunixin meglumine, are inhibitors of prostaglandin synthesis and act centrally to lower the thermoregulatory set point. Rectal temperatures start to decline within 30 minutes of parenteral NSAID administration but usually do not completely return to within the normal physiologic range.

### FURTHER READING

Evans SS, Repasky EA, Fisher DT. Fever and the thermal regulation of immunity: the immune system feels the heat. *Nat Rev Immunol*. 2015;15:335-349.

Soerensen DD, Pedersen LJ. Infrared skin temperature measurements for monitoring health in pigs: a review. *Acta Vet Scand*. 2015;57:5.

## Acute Phase Response

Acute phase proteins are plasma proteins that change their concentration when animals are subjected to external stressors, such as transportation, or internal stimuli, such as inflammation, bacterial infection, neoplasia, and surgical trauma.<sup>1</sup> Acute phase proteins have been categorized as positive or negative dependent on whether their concentration increases (positive) or decreases (negative) in response to an external or internal stimulus. There has been increased interest in measuring the serum concentration of acute phase reactants to monitor the severity of an infectious disease, assist in making a diagnosis, and to verify that an animal produced for food is healthy and fit for slaughter. During the hepatic acute phase response, the liver increases the synthesis of specific proteins (**positive acute phase proteins**) in response to release of IL-1 $\beta$ , IL-6, and TNF- $\alpha$  (proinflammatory cytokines) from macrophages and monocytes, whereas albumin synthesis is reduced (negative acute phase protein). Interleukin-1 $\beta$  induces type 1 acute phase proteins (serum amyloid A [SAA] and C-reactive protein) within 4 hours. Interleukin-6 induces haptoglobin at a later stage with serum concentrations remaining elevated for up to 2 weeks. A clinically important issue is that IL-1 $\beta$  is the primary initiator of fever as well as an important upstream initiator of the acute phase response; therefore, it remains to be determined whether laboratory measurement of acute phase reactant concentration in plasma provides practical information beyond that provided by rectal temperature alone. It should be recognized that although the liver plays a central role in the acute phase response, extrahepatic tissues, such as the bovine mammary gland, can also synthesize acute phase reactants.

**Fibrinogen** is the most widely studied positive acute phase protein in large animals.

The interpretation of plasma fibrinogen concentration is complicated by its involvement in the clotting cascade (and potentially decreasing in animals with severe coagulopathies such as disseminated intravascular coagulation) and its relatively narrow range of increase (typically no more than a three- to fourfold increase). Moreover, the plasma fibrinogen concentration is slower to increase in inflammatory conditions than other acute phase reactants, typically taking 24 hours to increase with peak values at 2 to 3 days.

The **SAA** is a positive acute phase protein (apolipoprotein) that is rapidly synthesized and released primarily by hepatocytes in response to inflammation or bacterial infection. The specific role of SAA in the inflammatory response is incompletely understood, but amyloid A is thought to have immune-related functions including opsonization of gram-positive and gram-negative bacteria, increased chemotaxis of neutrophils and monocytes, and the clearance of plasma endotoxin and high-density lipoproteins including cholesterol.

**Haptoglobin** is a positive acute phase protein and is thought to provide an exquisitely sensitive screening test for the release of endogenous glucocorticoids and proinflammatory cytokines. Haptoglobin is the principal scavenger of free hemoglobin in plasma and therefore decreases growth of most bacteria by decreasing the availability of iron. A major confounder for the interpretation of an increased serum haptoglobin concentration is that trauma, and increased plasma cortisol and estradiol concentrations associated with parturition, increase serum haptoglobin concentrations.<sup>2</sup>

**Lipopolysaccharide binding protein (LBP)** is an antiinflammatory in low concentrations and proinflammatory in high concentrations. It binds to the lipopolysaccharide portion of gram-negative bacteria and the bound complex then attaches to membrane or soluble CD14 receptors, initiating a signaling cascade. **C-reactive protein** and  **$\alpha$ 1-acid glycoprotein** are also positive acute phase proteins that have been extensively investigated in humans but have not been well investigated in large animals.

Several positive acute phase proteins have been evaluated in horses including SAA, C-reactive protein, haptoglobin, and fibrinogen. The most clinically relevant acute phase reactant in the horse appears to be SAA, because SAA concentrations are extremely low in healthy horses, increase markedly and rapidly during the acute phase of inflammation, and decrease rapidly after recovery because of its short half-life.<sup>1,3,4</sup> The clinical utility of SAA as a marker of infection is decreased in neonatal foals because SAA concentrations increase for up to 7 days in response to inflammation associated with vaginal delivery and absorption of amyloid A present in colostrum.<sup>5</sup>

Serum amyloid A, haptoglobin, and fibrinogen are important positive acute phase proteins in cattle and are produced by the liver in response to endogenous release of glucocorticoids and proinflammatory cytokines. Of these acute phase reactants, SAA is considered to have the most diagnostic utility in cattle. A potential confounder for the interpretation of SAA concentration in cattle is that its concentration normally increases at calving.<sup>6</sup> This means that an increased SAA concentration is not specific for inflammation or bacterial infection in the postparturient dairy cow and may be more associated with the extent of hepatic lipidosis than the presence of an inflammatory process in early lactation.<sup>6,7</sup>

Serum or plasma haptoglobin concentration is increased in cows with hepatic lipidosis, displaced abomasum, traumatic reticuloperitonitis, respiratory disease, mastitis, metritis, pododermatitis, and renal amyloidosis.<sup>6,8-12</sup> More research is needed to increase our understanding of changes in the concentration and kinetics of haptoglobin in cattle. C-reactive protein does not appear to be an acute phase reactant in cattle. The increase in SAA and haptoglobin in cattle appears to be dose dependent; therefore, the magnitude of the increase reflects the severity of the underlying inflammatory process.<sup>13,14</sup>

Important **negative acute phase proteins** in cattle include **albumin**, transferrin, and **paraoxonase**.<sup>8</sup> Albumin does not appear to be as sensitive an acute phase reactant as SAA in cattle. Moreover, serum albumin concentrations are decreased for 2 weeks after calving in lactating dairy cattle, partly as a result of increased plasma volume and decreased albumin synthesis,<sup>6</sup> further decreasing the clinical utility of serum albumin concentration as an acute phase reactant in postparturient cattle. The acute phase response in sheep appears similar to that in cattle.<sup>15</sup>

Plasma or serum iron concentrations decrease as part of the acute phase response; this has been attributed to sequestration of iron stores by the animal to make less iron available for bacterial growth.<sup>16</sup> Inflammation causes the release of IL-6 that stimulates hepatocytes to release the peptide hormone **hepcidin**, which blocks iron efflux from macrophages, directly resulting in hypoferrremia.<sup>16</sup> Plasma iron concentration appears to be a better acute phase reactant than fibrinogen concentration in horses.<sup>16</sup>

### FURTHER READING

Ceciliani F, Ceron JJ, Eckersall PD, Sauerwein H. Acute phase proteins in ruminants. *J Proteomics*. 2012;75:4207-4231.

Eckersall PD, Bell R. Acute phase proteins: biomarkers of infection and inflammation in veterinary medicine. *Vet J*. 2010;185:23-27.

Jacobsen S, Andersen PH. The acute phase protein serum amyloid A (SAA) as a marker of inflammation in horses. *Equine Vet Educ*. 2007;19:38-46.

- Lomborg SR, Nielsen LR, Heegard PM, et al. Acute phase proteins after exposure to complex stress. *Vet Res Commun*. 2008;32:575-582.
- Tothova C, Nagy O, Kovac G. Acute phase proteins and their use in the diagnosis of diseases in ruminants: a review. *Vet Med (Praha)*. 2014;59:163-180.

## REFERENCES

- Jacobsen S, et al. *Vet Surg*. 2009;38:762.
- Tothova CS, et al. *Acta Vet Brno*. 2008;77:51.
- Jacobsen S, et al. *Equine Vet J*. 2005;37:552.
- Pader K, et al. *Vet Sur*. 2011;40:998.
- Paltrinieri S, et al. *Vet J*. 2008;176:393.
- Guzelbektes H, et al. *J Vet Intern Med*. 2010;24:213.
- Katoh N. *J Vet Med Sci*. 2002;64:293.
- Bionaz M, et al. *J Dairy Sci*. 2007;90:1740.
- Suojala L, et al. *Acta Vet Scand*. 2008;13:50.
- Ganheim C, et al. *Vet J*. 2007;173:645.
- Suojala L, et al. *Acta Vet Scand*. 2008;50:18.
- Hajimohammadi A, et al. *Comp Clin Pathol*. 2013;22:227.
- Jacobsen S, et al. *J Dairy Sci*. 2004;87:3330.
- Tothova C, et al. *Berl Munch Tierarztl Wochenschr*. 2010;123:307.
- Kabaroff LC, et al. *Vet Immunol Immunopathol*. 2006;113:113.
- Borges AS, et al. *J Vet Intern Med*. 2007;21:489.

## Sepsis, Septicemia, and Viremia

**Sepsis** is a suspected or proven bacterial infection in conjunction with the presence of **systemic inflammatory response syndrome (SIRS)**, which is defined as systemic inflammation in response to injury, being caused by infectious agents (e.g., bacteria, viruses, protozoa, fungi) or by noninfectious causes (e.g., trauma, toxins, hyperthermia, burns). Accurate criteria for SIRS have yet to be identified in domestic animals, but the presence of at least two of the following abnormalities is used to identify the presence of SIRS in humans:

- Hyperthermia or hypothermia
- Tachycardia
- Tachypnea or hyperventilation
- Leukopenia, leukocytosis, or >10% band neutrophils

These criteria for SIRS should not be applied when environmental conditions impact the measurement (such as heat stress or environmental cold or the presence of pain).

**Severe sepsis** is sepsis accompanied by organ dysfunction. **Septic shock** is defined as severe sepsis with hypotension (mean arterial blood pressure <65 mm Hg) despite aggressive intravenous fluid therapy. **Septicemia** is the acute invasion of the systemic circulation by pathogenic bacteria accompanied by septic shock with possible bacterial localization in various body systems or organs. It is a common cause of morbidity and mortality in newborn farm animals that have not received a sufficient quantity of colostrum in the first 24 hours after birth.

**Bacteremia** is different from septicemia in that bacteremia is not accompanied by sepsis or septic shock. The difference between

septicemia and bacteremia is one of degree. In bacteremia, bacteria are present in the bloodstream for only transitory periods and do not produce clinical signs; for example, a clinically unimportant bacteremia probably occurs frequently after rectal examination or other manipulations in which the mucosa is disturbed. In septicemia, the pathogen is present throughout the course of the disease and is directly responsible for initiation of the disease process. There is a current movement to eliminate the term septicemia from use and use the term **multiple organ dysfunction syndrome**, which indicates dysfunction to two or more organ systems, but the definitions stated earlier are clinically useful.

**Viremia** is the invasion of the systemic circulation by pathogenic viruses with localization in various body tissues and in which the lesions produced are characteristic of the specific virus. Many infections associated with rickettsias, protozoa, and fungi are also spread hematogenously throughout the body but usually do not initiate a systemic inflammatory response syndrome.

## ETIOLOGY: ALL SPECIES

Many different infectious agents can result in septicemia or viremia. Some of the notable examples of septicemias and viremias are outlined next. Anthrax, pasteurellosis, and salmonellosis are found in all species of food animal.

## Neonatal Septicemias

Neonatal septicemias are caused most commonly by gram-negative bacteria.

### Calves

Bacteremia and septicemia are often associated with *Escherichia coli* and *Salmonella* spp. *E. coli* is most frequently isolated from the blood of calves, but gram-positive infections may be found in 10% of septicemic calves and polymicrobial infections in 28%. Calf septicemia is infrequently caused by bacteria similar to *Actinobacillus suis* bacteria. Thirty percent of severely ill calves with or without diarrhea are bacteremic, and the risk of bacteremia is higher in calves with failure of transfer of colostral immunoglobulins.

### Piglets

Septicemia caused by *E. coli* is possible along with septicemia with localization in the joints, endocardium, and meninges associated with *Streptococcus suis* type 1.

### Foals

Septicemia with localization associated with *E. coli*, *A. equuli*, *Klebsiella pneumoniae*,  $\alpha$ -hemolytic *Streptococcus*, and *Salmonella* spp. are seen.

### Lambs

Septicemia associated with *E. coli* occurs most frequently.

## Cattle

*Histophilus somni*, *Pasteurella multocida*, *Mannheimia haemolytica*, *Pasteurella (Yersinia) pseudotuberculosis*, acute and chronic infections with bovine virus diarrhea virus, and bovine malignant catarrh are encountered.

## Sheep (Young Lambs)

*H. somni* is the main pathogen.

## Pigs

Hog cholera and African swine fever viruses and *Erysipelothrix insidiosa* are encountered.

## Horses, Donkeys, and Mules

African horse sickness and *M. haemolytica* infection are implicated.

## Secondary Septicemias

The principal cause of death in subacute radiation injury is septicemia resulting from loss of leukocyte production because of injury to bone marrow. Septicemia may also result when there is a congenital defect in the immune system or when immunosuppression occurs in older animals as a result of corticosteroid therapy or toxin such as bracken.

## EPIDEMIOLOGY

Systemic infections associated with bacteria, viruses, rickettsia, protozoa, and other pathogens occur in animals of all ages and under many different circumstances. The epidemiologic characteristics for each entity are presented under each disease described in this book. The risk factors for each infectious disease are categorized according to

- Animal risk factors
- Environmental risk factors
- Pathogen risk factors

For example, colostrum-deprived newborn animals are highly susceptible to septicemia.

**Failure of transfer of passive immunity (FTPI)** in foals is defined by serum IgG<sub>1</sub> concentrations of <400 mg/dL and partial failure of transfer of passive immunity between 400 and 800 mg/dL. Serum IgG concentrations of  $\geq 800$  mg/dL are less frequently associated with sepsis in foals, and this is considered the threshold concentration for prophylaxis in foals.

## PATHOGENESIS

Two mechanisms operate in septicemia: the **exotoxins** or **endotoxins** produced by the infectious agents initiate a profound toxemia and high fever because of their initiation of the release of host mediators and because of the rapidity with which the agents multiply and spread to all body tissues (see also Toxemia, Endotoxemia, and Septic Shock). The clinical manifestations are the result of the effect of the pathogens on monocytes and lymphocytes, which initiate **SIRS**. TNF- $\alpha$  is associated with clinical septicemia in

newborn foals and calves, and plasma TNF- $\alpha$  concentration is associated with the severity of clinical signs.

Localization of certain pathogens occurs in many organs and may produce severe lesions in animals that survive the toxemia. Direct endothelial damage and hemorrhages may also be caused. The same general principles apply to a viremia, except that toxins are not produced by viruses. It is more likely that the clinical manifestations are the result of direct injury of the cells invaded by the virus. **Transplacental infection** can occur, resulting in fetal **mummification**, **abortion**, or **infection of the fetus that may be carried to term**.

### Disseminated Intravascular Coagulation

Progression of SIRS can result in disseminated intravascular coagulation (DIC) caused by intravascular fibrin formation, particularly in severe septicemic diseases. Disseminated intravascular coagulation is initiated by vascular injury with partial disruption of the intima, caused by the circulation of foreign materials such as bacterial cell walls, antigen-antibody complexes, and endotoxin, with subsequent platelet adherence and the formation of platelet thrombi. Severe, uncontrolled hypercoagulation results in a high mortality rate caused by MODS. Once coagulation proceeds, the initial hypercoagulable state changes to hypocoagulation as clotting factors and platelets are consumed. The activation of the fibrinolysis system can be a major cause of the hemorrhagic diathesis present in this syndrome.

### CLINICAL FINDINGS

The major clinical findings in septicemia are **fever**, **cardiovascular dysfunction and shock**, and **submucosal and subepidermal hemorrhages** that are usually petechial and occasionally ecchymotic. The hemorrhages are best seen under the conjunctiva and in the mucosae of the mouth and vulva. Tachycardia, tachypnea, and shock-induced organ dysfunction with cardiovascular hypotension, myocardial asthenia, and respiratory distress may occur in severe cases if the pathogen initiates the release of the host mediators, causing **SIRS**. These features are described under **Toxemia**, **Endotoxemia**, and **Septic Shock**.

Specific signs may occur as the result of localization of the infection in joints, heart valves, meninges, eyes, or other organs. The clinical findings characteristic of each disease in which septicemia and viremia occur are presented under each disease heading in this book.

### Neonatal Septicemia

Neonatal septicemia is common in all farm animal species from a few hours up to several days of age. The following features are common:

- Recumbency
- Depression
- Absence or marked depression of the suck reflex
- Dehydration
- Fever
- Diarrhea
- Injected or congested mucous membranes
- Weakness
- Rapid death

Colostrum-deprived foals are commonly very ill and become comatose and die within several hours. Localized infections in the joints and lungs are frequent in foals that survive for several days. Septic polyarthritis is common and is characterized by heat, pain, synovial distension, and lameness, and occurs in 14% to 38% of neonatal foals with sepsis. About half the foals with septic arthritis have two or more joints clinically infected, with the femoropatellar and tarsocrural joints being most commonly involved. Pneumonia is often observed and is characterized by dyspnea and abnormal lung sounds. The survival rate of foals with confirmed septicemia in one series was 70%.

In calves under 30 days of age with septicemia clinical findings can include evidence of shock with cold extremities, dehydration, weak pulse, prolonged capillary refill time, weakness, and recumbency. Findings indicative of localization include ophthalmitis, neurologic abnormalities, omphalophlebitis, and polyarthritis.

### Clinical Sepsis Score

A **clinical sepsis score** for the early diagnosis of septicemia in newborn foals has been evaluated and validated. It should be recognized that application of such scoring systems is statistically flawed, even if they assign different weights to predictors, because they assign equal weights to the change in severity within a given predictor. Nevertheless, such sepsis scores have been adopted by some and do have the value of facilitating the identification of neonates at risk for being septicemic. A score for predicting bacteremia in neonatal dairy calves from 1 to 14 days of age has also been suggested to predict clinically whether a sick calf has bacteremia. The calves are scored according to degrees of **hydration status**, **fecal appearance**, **general attitude**, **appearance of scleral vessels**, and **umbilical abnormality**. However, the sensitivity, specificity, and positive predictive value are too low to be of diagnostic value.

### CLINICAL PATHOLOGY

#### Blood Culture

Isolation of the causative bacteria from the bloodstream should be attempted by culture. Ideally, blood cultures should be obtained just before the onset of fever and from a major vein or any artery. The standard is three blood cultures or animal inoculation at the height of the fever. A minimum of

10 mL of blood (preferably 30 mL) should be collected anaerobically after aseptic preparation of the venipuncture site by clipping and scrubbing with povidone iodine scrub. Blood samples should be inoculated into a broth medium with the ratio of blood to broth being 1:10 to 1:20, and the culture bottles should be examined for growth daily for up to a week. Growth is manifested as turbidity and possibly by the presence of hemolysis.

### Hemogram

The presence of **leukopenia** or **leukocytosis** is an aid in diagnosis and the type and degree of leukocytic response may be of prognostic significance, particularly the presence of band neutrophils, metamyelocytes, or toxic neutrophils.<sup>1</sup>

Plasma fibrinogen concentrations may be increased. Consumption coagulopathy is detected by falling platelet counts, prothrombin and fibrinogen concentrations, and by the presence of fibrin-linked degradation products such as **D-dimer**. In neonatal calves, plasma activated partial thromboplastin time was prolonged in calves suspected to have septic shock.<sup>1</sup>

### Immunoglobulin Status

Low concentrations of serum protein and immunoglobulins are associated with failure of transfer of colostral immunoglobulins in newborn farm animals with consequent septicemia caused, most commonly, by gram-negative bacteria.

### Biomarkers

Biomarkers of sepsis are becoming increasingly used to guide diagnosis and treatment in humans. The main challenges with the use of biomarkers of sepsis in domestic animals are their availability, cost, and time required to obtain a result. Calves with abnormal coagulation profile results indicating the presence of severe hemostatic dysfunction were much more likely to die despite intensive therapy.<sup>1</sup> Plasma or serum biomarkers that show promise for diagnosing sepsis in foals or adult horses are SAA,<sup>2</sup> a soluble form of the CD14 molecule that binds endotoxin in plasma,<sup>3,4</sup> adrenomedullin,<sup>5</sup> arginine vasopressin,<sup>6</sup> and adrenocorticotropin hormone (ACTH).<sup>6</sup> C-reactive protein<sup>7</sup> and haptoglobin<sup>7</sup> do not currently appear to be useful biomarkers for sepsis in foals.

### Serology

Serologic tests are available for most infectious diseases described in this book; however, the rapid onset of septicemia in most instances precludes the use of immunoglobulin tests, with the possible exception of IgM.

### Necropsy Findings

The lesions will reflect the specific disease causing the septicemia. Subserous and submucosal hemorrhages may be present, together with embolic foci of infection in



various organs accompanied by the lesions typical of the specific pathogen.

## TREATMENT

The principles of treatment are similar to those described for the treatment of toxemia, endotoxemia, fever, and septic shock, and treatment should focus on broad-spectrum antimicrobial agents and general supportive measures. For neonatal septicemia the provision of a source of immunoglobulins by plasma or blood transfusion is thought to be advantageous when there is FTPI. Whether such treatment alters the mortality rate is uncertain. Intensive care of the newborn with septicemia is described in Chapter 19. The frequency of bacteremia (approximately 30%) is sufficiently high in calves with diarrhea that are severely ill (as manifested by reduced suckle reflex, >6% dehydration, weakness, inability to stand, or clinical depression) that affected calves should be routinely treated for bacteremia, with emphasis on treating potential *E. coli* bacteremia. Strict hygienic precautions to avoid spread of infection are also necessary.

## FURTHER READING

- Dunkel B, Corley KTT. Pathophysiology, diagnosis and treatment of neonatal sepsis. *Equine Vet Educ.* 2015;27:92-98.
- Lewis DH, Chan DL, Pinheiro D, et al. The immunopathology of sepsis: pathogen recognition, systemic inflammation, the compensatory anti-inflammatory response, and regulatory T cells. *J Vet Intern Med.* 2012;26:457-482.
- Osterbur K, Mann FA, Kuroki K, DeClue A. Multiple organ dysfunction syndrome in humans and animals. *J Vet Intern Med.* 2014;28:1141-1151.
- Palmer J. Update on the management of neonatal sepsis in horses. *Vet Clin Equine.* 2014;30:317-336.
- Taylor S. A review of equine sepsis. *Equine Vet Educ.* 2015;27:99-109.
- Werners AH, Bryant CE. Pattern recognition receptors in equine endotoxemia and sepsis. *Equine Vet J.* 2012;44:490-498.

## REFERENCES

- Irmak K, et al. *Vet Res Commun.* 2006;30:497.
- Belgrave RL, et al. *J Am Vet Med Assoc.* 2013;243:113.
- Wagner B, et al. *Vet Immunol Immunopathol.* 2013;155.
- Silva A, et al. *Vet Immunol Immunopathol.* 2013;155:264.
- Toth B, et al. *J Vet Intern Med.* 2014;28:1294.
- Hurcombe SDA, et al. *J Vet Intern Med.* 2008;22:639.
- Zabrecky KA, et al. *J Vet Intern Med.* 2015;29:673.

## Toxemia, Endotoxemia, and Septic Shock

**Toxemia** is a clinical systemic state caused by widespread activation of host defense mechanisms to the presence of toxins produced by bacteria or injury to tissue cells. Toxemia does not include the diseases caused by toxic substances produced by plants or insects or ingested organic or inorganic poisons. Theoretically, a diagnosis of toxemia can be

made only if toxins are demonstrable in the bloodstream. Practically, toxemia is often diagnosed when the endotoxemia is present. In most cases there is contributory evidence of a probable source of toxins, which in many cases are virtually impossible to isolate or identify.

The most common form of toxemia in large animals is **endotoxemia**, caused by the presence of lipopolysaccharide cell-wall components of gram-negative bacteria in the blood and characterized clinically by abnormalities of many body systems. Because of the overwhelming importance of endotoxemia in large animals with gram-negative bacterial infections, the focus of this discussion will be on endotoxemia. The abnormalities of endotoxemia include the following:

- Marked alterations in cardiopulmonary function
- Abnormalities in the leukon (neutropenia and lymphopenia) and thrombocytopenia that may lead to coagulopathies
- Increased vascular permeability
- Decreased organ blood flow and metabolism, leading to heart and renal failure
- Decreased gastrointestinal motility
- Decreased perfusion of peripheral tissues, leading to shock
- The need for intensive and complex therapy
- A high case fatality rate

Current therapeutic regimens are only moderately successful in treating endotoxic large animals with clinical signs of **septic shock** (severe sepsis with hypotension [mean arterial blood pressure <65 mm Hg] despite aggressive intravenous fluid therapy).

Gram-negative bacteria such as *E. coli*, *Salmonella* spp., *Pasteurella* spp., and *H. somni*, as examples, cause many diseases of ruminants in which endotoxemia is common. Varying degrees of severity of toxemia occur in diseases such as mastitis, peritonitis, pneumonia and pleuritis, pericarditis, septic metritis, septicemia of neonates, myositis, meningoencephalitis, and some enteritides. Endotoxemia is also one of the most common causes of death in horses affected with gastrointestinal disease from a physical obstruction causing strangulation and ischemic necrosis.

## ETIOLOGY

Toxins can be classified as antigenic or metabolic.

### Antigenic Toxins

These are produced by bacteria and to a lesser extent by helminths. Both groups of pathogens act as antigens and stimulate the development of antibodies. Antigenic toxins are divided into exotoxins and endotoxins.

### Exotoxins

These are protein substances produced by bacteria that diffuse into the surrounding

medium. They are specific in their pharmacologic effects and in the antibodies that they induce. The important bacterial exotoxins are those produced by *Clostridium* spp., for which commercial antitoxins are available. They may be ingested preformed, as in botulism, or produced in large quantities by heavy growth in the intestines, such as in enterotoxemia, or from growth in tissue, as in blackleg and black disease.

### Enterotoxins

These are exotoxins that exert their effect principally on the mucosa of the intestine, causing disturbances of fluid and electrolyte balance. The most typical example is the enterotoxin released by enterotoxigenic *E. coli*, which causes a hypersecretory diarrhea in neonatal farm animals.

### Endotoxins

The endotoxins of several species of gram-negative bacteria are a major cause of morbidity and mortality in farm animals. The endotoxins are lipopolysaccharides found in the outer wall of the bacteria. Endotoxins are released into the immediate surroundings when the bacteria undergo rapid proliferation with production of unused sections of bacterial cell wall or, most commonly, when the bacterial cell wall breaks. Endotoxin gains access to the blood when there is a severe localized infection, such as a coliform mastitis in dairy cattle, or a disseminated infection, such as coliform septicemia in newborn calves.

Gram-negative bacteria are present in the intestinal tract as part of the normal microflora and endotoxins are also present. The endotoxins are not ordinarily absorbed through the intestinal mucosa unless it is injured, as in enteritis or more particularly in acute intestinal obstruction. Ordinarily, small amounts of endotoxin that are absorbed into the circulation are detoxified in the liver but, if hepatic efficiency is reduced or the amounts of toxin are large, a state of endotoxemia is produced. Endotoxins may also be absorbed in large amounts from sites other than the intestine including the mammary gland, peritoneum, abscesses and other septic foci, or from large areas of injured or traumatized tissue. The best known endotoxins are those of *E. coli*, which have been used extensively as models for experimental endotoxemia, and *Salmonella* spp.

The most common causes of endotoxemia in horses are associated with diseases of the gastrointestinal tract including colitis, intestinal strangulation, or obstruction and ileus. Complications associated with foaling and grain overload are also common causes.

### Metabolic Toxins

These may accumulate as a result of incomplete elimination of toxic materials normally produced by body metabolism, or by abnormal metabolism. Normally, toxic products



produced in the alimentary tract or tissues are excreted in the urine and feces or detoxified in the plasma and liver. When these normal mechanisms are disrupted, particularly in hepatic dysfunction, the toxins may accumulate beyond a critical point and the syndrome of toxemia appears. In obstruction of the lower alimentary tract there may be increased absorption of toxic phenols, cresols, and amines that are normally excreted with the feces, resulting in the development of the syndrome of autointoxication. In ordinary circumstances in monogastric animals these products of protein putrefaction are not absorbed by the mucosa of the large intestine but when regurgitation into the small intestine occurs there may be rapid absorption, apparently because of the absence of a protective barrier in the wall of the small intestine.

In liver diseases, many of the normal detoxification mechanisms, including oxidation, reduction, acetylation, and conjugation with such substances as glycine, glucuronic acid, sulfuric acid, and cysteine, are lost and substances that are normally present in insufficient quantity to cause injury accumulate to the point where illness occurs. The production of toxins by abnormal metabolism includes the production of histamine and histamine-like substances in damaged tissues. Ketonemia caused by a disproportionate fat metabolism, and lactic acidemia caused by acute ruminal acidosis (grain overload), are two common examples of toxemia caused by abnormal metabolism.

### **PATHOGENESIS**

The specific effects of the particular bacterial exotoxins and metabolic toxins are presented in the relevant sections of specific bacterial diseases in this book. The principles of the effects of bacterial endotoxemia will be presented here.

The total toxic moiety of the lipopolysaccharide molecule is generally similar regardless of the bacterial source. Endotoxemia results in an extraordinary array of pathophysiologic effects, involving essentially all body systems. Of the endotoxins produced by bacteria, the most is known of those produced by *E. coli*.

**Endotoxins are normally present in the intestine** and, although the intestinal mucosa provides a highly efficient barrier, limiting transmural movement of endotoxins, small quantities are absorbed into the portal blood. These endotoxins are removed by the liver and do not reach the peripheral blood. In hepatic failure the level of endotoxins in plasma is increased. Significantly greater quantities of endotoxins escape the intestine when the mucosal barrier is disrupted by intestinal ischemia, trauma, ionizing radiation, bacterial overgrowth, reduced luminal pH, or inflammatory intestinal disease. These conditions not only temporarily overwhelm the capacity of the liver to remove

endotoxin from the portal circulation but also allow transmural movement of endotoxins into the peritoneal cavity from which they reach the peripheral blood.

**Endotoxemia** may also occur when gram-negative bacteria gain access to tissues and/or blood. Most of these organisms liberate endotoxin during rapid growth and gain access to the blood from primary foci of systemic or superficial tissue infections. One example is coliform septicemia in newborn farm animals. Once the endotoxins gain access to the blood, they are removed from the circulation by the mononuclear phagocyte system, and the response of these phagocytes to the lipopolysaccharides determines the severity of the clinical illness.

### **Biochemical Mediators**

Endotoxins do not cause their effects via direct toxic effect on host cells; instead they induce the production of soluble and cell-bound mediators from a broad range of host cells, including endothelial and smooth muscle cells, polymorphonuclear granulocytes, platelets, thrombocytes, and cells of the monocyte/macrophage lineage. These cells release a series of phlogistic biochemical mediators, which include cytokines, platelet-activating factor, thromboxane A<sub>2</sub>, prostaglandins, leukotrienes, proteinases, toxic oxygen metabolites, and vasoactive amines. Macrophages become highly activated for enhanced secretory, phagocytic, and cidal functions by the lipopolysaccharide. The cytokines derived from the macrophages are responsible for many of the pathophysiologic consequences of endotoxemia. Pulmonary intravascular macrophages are the most important producers of cytokines in large animals.

Animals have evolved to recognize and respond to the lipopolysaccharide of gram-negative bacteria. Although lipopolysaccharides may directly injure the host tissue, many of its effects are indirectly mediated through inappropriate activation of host defense mechanisms, culminating in multiple organ dysfunction and failure. Importantly, the response to endotoxin can be attenuated with certain substances. Experimentally, the use of detergents, such as a nonionic surfactant, can attenuate the response of the horse given endotoxin. There is a large individual variability in the response to endotoxin administration. Much of the variability remains unexplained but appears to have a genetic component.<sup>1</sup> Circulating lipopolysaccharide forms complexes in plasma with high-density lipoproteins or a unique plasma protein termed LBP and bound lipopolysaccharide is cleared from plasma within a few minutes by fixed and circulating macrophages in the bovine lung and liver that recognizes the lipopolysaccharide-LBP complex. The lipopolysaccharide-LBP complex binds to a membrane-bound receptor (**mCD14**) on mononuclear cells via a secreted linking

protein called MD-2 and then attaches to **toll-like receptor-4** (TLR-4) on the mononuclear cell membrane; the lipopolysaccharide-LBP-mCD14-MD-2 complex is then internalized and lipopolysaccharide is thought to be destroyed in the process. Internalization of lipopolysaccharide activates the intracellular signaling pathway via nuclear factor  $\kappa$ B (**NF- $\kappa$ B**), which translocates to the nucleus and causes the transcription of many cytokine genes and release of proinflammatory cytokines, of which **TNF- $\alpha$** , **IL-1**, and **IL-6** are the most important. Some of the genes activated include those that code for cyclooxygenase 2 (**COX-2**, the inducible form of cyclooxygenase); inducible nitric oxide; **endothelial adhesion molecules**, which promote the adhesion of neutrophils to endothelial surfaces; and chemokines. Some of the membrane-bound receptors (mCD14) are shed from the cell surface into the plasma; in plasma the shed receptors are termed soluble CD14 receptors (sCD14), which play a crucial role in the pathophysiology of endotoxemia. This is because sCD14 receptors can transfer bound lipopolysaccharide directly to mCD14 or the MD-2/TLR-4 complex, activating the intracellular signaling pathway. Increased serum concentrations of sCD14 are associated with the severity of some clinical signs in critically ill horses.<sup>2</sup>

The plasma concentrations of the **arachidonic acid metabolites**, **thromboxane A<sub>2</sub>** and **prostacyclin**, increase in several species during endotoxemia, and these eicosanoids are probably responsible for the hemodynamic abnormalities caused by endotoxin. Endotoxin initiates cellular events that activate a cell-membrane enzyme known as phospholipase A<sub>2</sub>. Activation of this enzyme leads to the hydrolysis of membrane-bound phospholipids; arachidonic acid is released from the phospholipid portion of damaged mammalian cell membranes. The enzyme cyclooxygenase converts arachidonic acid into intermediate endoperoxides, which are substrates for the formation of prostaglandins, thromboxane, and prostacyclin, by specific synthetases. Platelets are the principal source of thromboxane, which acts as a potent vasoconstrictor and induces platelet aggregation. Most prostacyclins are synthesized in vascular endothelial cells and cause vasodilation and inhibit platelet aggregation. The generalized endotoxin-induced production of cyclooxygenase products may contribute to the multisystemic organ dysfunction, shock, and disseminated coagulopathy that culminates in death.

**Tumor necrosis factor- $\alpha$**  is released by macrophages and monocytes in a dose-dependent manner early in the course of endotoxemia, and circulating TNF- $\alpha$  activity correlates with the severity and outcome of disease. Infusion of TNF induces an endotoxemic-shock-like syndrome and TNF- $\alpha$  blockade confers marked protection against the effects of gram-negative sepsis and

lipopolysaccharide administration. Experimentally, pretreatment of horses with monoclonal antibody to TNF- $\alpha$  can reduce the hematologic and clinical effects of endotoxin-induced TNF activity and IL-6 activity can be reduced by neutralization of TNF- $\alpha$ . Interleukin-1 release is proinflammatory and leads to pyrexia and the hepatic **acute phase response**. Interleukin-6 contributes to the hepatic acute phase response and promotes B-lymphocyte proliferation. Interleukin-6 may have value as a prognostic indicator, because its plasma concentration appears to be a better predictor of mortality in humans than TNF- $\alpha$  or IL-1.

The systemic effects of endotoxemia can be demonstrated experimentally by parental injection of purified endotoxin, TNF- $\alpha$ , or IL-1. In naturally occurring disease, however, the total effect includes those of bacterial toxins plus those of mediators produced by tissues in response to the toxins and the counterbalancing effects of anti-inflammatory molecules that are also secreted during sepsis such as IL-4, IL-10, IL-11, and IL-13, and soluble CD14 receptors. The pathophysiologic effects of endotoxemia associated with gram-negative bacteria are summarized here according to their effects on various body systems or functions.

### Cardiopulmonary Function

The hemodynamic effects of endotoxemia are manifested in two phases. In the early stages, heart rate and cardiac output commonly increase, although systemic blood pressure remains near or slightly less than normal. This is known as the **hyperdynamic phase** of endotoxemia. Oxygen demands of peripheral tissues are increased during the hyperdynamic phase, resulting in compensatory mechanisms that increase blood flow in an attempt to meet the increased metabolic demands. However, despite the absolute increase in cardiac output and oxygen delivery during this hyperdynamic phase, blood flow still may be inadequate to meet the needs of tissues in a hypermetabolic state. During the hyperdynamic state, affected animals hyperventilate and have decreased capillary refill time and red, congested mucous membranes. Microcirculatory shunting of blood continues in organs such as the gastrointestinal tract and kidney. Ischemia of intestinal mucosa is manifested clinically by ileus and diarrhea may occur. Decreased renal perfusion will result in decreased urine output.

With uncontrolled endotoxemia, the hyperdynamic phase progresses to the **hypodynamic phase** of shock. Changes include decreased cardiac output, systemic hypotension, increased peripheral resistance, and decreased central venous return. Hypothermia, rapid irregular pulses, prolonged capillary refill time, pale to cyanotic mucous membranes, acidemia, and hypoxemia provide clinical evidence of this advanced

stage of endotoxemia. The skin and extremities are cool. Severe pulmonary edema and increasing pulmonary hypertension occur. In horses, administration of endotoxin at high dosages can induce circulatory shock with increased heart rate, decreased cardiac output and stroke volume, and concomitant increases in peripheral vascular resistance. The slow intravenous infusion of low doses of endotoxin into conscious horses results in pulmonary hypertension without causing hypotensive hypovolemic shock. Intestinal vasoconstriction occurs as part of the compensatory response to endotoxemia following slow infusion of low dosages of endotoxin.

Infusion of endotoxin into swine induces widespread changes including intense pulmonary vasoconstriction and hypertension, bronchoconstriction, increased vascular permeability, hypovolemia, systemic hypotension, pulmonary edema, hypoxemia, granulocytopenia, and thrombocytopenia. The vascular changes in endotoxemia include increased vascular permeability, changes in vascular tone, and microvascular obstruction. Increased capillary permeability promotes transmural movement of albumin and other colloids that carry water to the interstitial space. The result is hypoalbuminemia, hypoproteinemia, interstitial edema, pulmonary edema, relative hypovolemia, decreased return to the heart, and further decreases in cardiac output. Arterial and arteriolar vasoconstriction develops in the systemic and pulmonary circulations. Prolonged infusion of endotoxin into sheep causes systemic hypotension, pulmonary hypertension, and acute lung injury with progressive respiratory failure.

### Activation of the Renin–Angiotensin–Aldosterone System and Dysfunction of the Hypothalamic–Pituitary–Adrenal Axis

The renin–angiotensin–aldosterone system (RAAS) system is activated in critically ill foals, characterized by increased plasma angiotensin-II and aldosterone concentrations. Critically ill foals also have hypothalamic–pituitary–adrenal (HPA) axis dysfunction, which was originally called **relative adrenal insufficiency** (defined as an inappropriately low plasma cortisol concentration or a low ACTH to cortisol ratio).<sup>3</sup> In 2008 a consensus statement developed by human critical care specialists recommended that the preferred term for the HPA axis dysfunction in septic shock is critical illness-related corticosteroid insufficiency, which reflects an inadequate corticosteroid activity for the severity of the patient's illness.

### Leukocytes and Platelets

Foals in septic shock most commonly have gram-negative septicemia, but a minority have gram-positive septicemia or mixed bacterial isolates identified on blood culture.

The presence of leukopenia or lymphopenia in a foal with presumed sepsis makes it more likely that a gram-negative septicemia is present.<sup>4</sup> Endotoxemia causes an acute and severe neutropenia, which precedes neutrophilia and hemoconcentration. Neutropenia is caused mainly by leukocyte margination and sequestration; persistence of severe neutropenia is a poor prognostic indicator. Hemoconcentration is caused by movement of fluid from the vascular to extravascular spaces. Endotoxin administration causes an immediate accumulation, margination, and activation of leukocytes in the microcirculation, particularly in the alveolar capillaries. This is followed by degranulation and leukocyte migration into the interstitium and endothelial cell damage. Pulmonary sequestration of neutrophils is preceded by endotoxin uptake by pulmonary intravascular macrophages, indicating that the pulmonary macrophage response is pivotal to the subsequent inflammatory response. Leukopenia appears to be an immediate response to endotoxin administration and is observed as early as 5 minutes after infusion. The rebound leukocytosis is caused by humoral effects on the bone marrow; a neutrophil-releasing factor that promotes release of neutrophils from bone marrow; and macrophage colony-stimulating factor, which stimulates granulopoiesis. Colostrum-fed calves have a greater neutrophilia in response to endotoxin than colostrum-deprived calves, possibly because of absorption of a granulopoietic factor from colostrum. Endotoxemia also induces a lymphopenia that is secondary to the release of endogenous corticosteroids and redistribution of lymphocytes from peripheral blood and the spleen to lymphatic tissue.

Thrombocytopenia is consistently observed after endotoxin administration, but occurs later than neutropenia, although it is sustained for a longer period of time. Endotoxin affects platelet function by a number of different mechanisms.

### Hemostatic System

Endotoxins cause endothelial injury directly or indirectly, exposing subendothelial collagen and tissue thromboplastin, initiating the intrinsic and extrinsic coagulation cascades, respectively. Endotoxin can initiate the coagulation cascade directly by activation of factor XII or by inducing platelet release of thromboxane and other procoagulant substances. Endotoxin may induce coagulopathy indirectly by endothelial damage with secondary factor XII activation, or through the effects of complement activation. Macrophages and leukocytes have been shown to release a procoagulant substance in response to endotoxin, which functions similarly to factor VII and may also have a role in perpetuating coagulopathy in endotoxemia via the extrinsic pathway.

Disseminated intravascular coagulation is the cause of diffuse microvascular

thrombosis and eventual organ failure subsequent to endotoxemia. The experimental injection of endotoxin can cause diffuse microthrombosis in multiple organ systems. The principal clinical finding of DIC in horses is petechial and/or ecchymotic hemorrhages on mucous membranes and sclerae with a tendency to bleed from venipuncture sites. Spontaneous epistaxis or prolonged hemorrhage after nasogastric intubation may also occur. The result of exaggerated thrombin formation during DIC is widespread fibrin deposition in the microcirculation causing circulatory obstruction and organ hypoperfusion that may lead to ischemic necrosis and failure. The ultimate consequences are multiple organ failure and death.

### Thermoregulation

Bacterial endotoxins are potent stimulators of macrophage interleukins, which belong to a family of polypeptides functioning as key mediators of various infectious, inflammatory, and immunologic challenges to the host. Interleukin-1 induces fever, an increase in the number and immaturity of circulating neutrophils, muscle proteolysis through increased prostaglandin  $E_2$  production, hepatic acute phase protein production, and reduced albumin synthesis. Interleukin-1 participates in the acute phase response, which is characterized by fever, hepatic production of acute phase proteins, neutrophilia, and procoagulant activity.

Endotoxins commonly cause a fever followed by hypothermia. Serum IL-6 concentrations are lower in endotoxin-induced colostrum-deprived foals and take longer to reach peak levels compared with colostrum-fed foals. The higher and more rapid concentrations in colostrum-fed foals may be part of a resistance factor in equine neonates. Interleukin-6 plays a key role in host defense, regulating antigen-specific immune responses, hematopoiesis, cellular differentiation, and the acute phase reaction subsequent to an inflammatory insult. Serum TNF- $\alpha$  responds in a similar pattern in colostrum-deprived and colostrum-fed foals given endotoxin, and the mean rectal temperature in colostrum-deprived foals is significantly less than in colostrum-fed foals.

### Gastrointestinal Function

Endotoxemia can cause a profound inhibition of gastrointestinal motility, including the stomach and small and large intestines. Postoperative ileus is a frequent and serious complication of equine colic surgery, and there is a good correlation between the incidence of ileus and the presence of ischemic intestine. Low doses of endotoxin infused into ponies produced profound disruption of normal fasting intestinal motility patterns, with an inhibition of gastric contraction amplitude and rate, left dorsal colon contraction product, and small-colon spike rate. In

the small intestine, there is an increase in abnormally arranged regular activity and a decrease in irregular activity. Experimental endotoxemia in the horse causes cecal and proximal colonic hypomotility (ileus) by a mechanism involving  $\alpha$ -adrenergic receptors, which is reversible by yohimbine. Numerous mediators may interact with the sympathetic nervous system to induce this effect.

The administration of endotoxin to adult dairy cows can reduce the frequency of reticulorumen contractions; this is caused by endotoxin-induced mediators and the effect can be abolished by flunixin meglumine. Endotoxemia also decreases the abomasal emptying rate in cattle and is suspected to play a role in the development of left displaced abomasum.

### Carbohydrate Metabolism

The effects on carbohydrate metabolism include a fall in plasma glucose concentration, the rate and degree varying with the severity of endotoxemia; a disappearance of liver glycogen; and a decreased glucose tolerance of tissues so that administered glucose is not used rapidly. Endotoxic shock can result in lactic acidemia and both hyperglycemic and hypoglycemic responses. **Hyperglycemia** occurs early and transiently in endotoxic shock,<sup>5</sup> is accompanied by increased rates of glucose production, and is dependent on mobilization of hepatic glycogen. **Hypoglycemia** is very common in prolonged or severe endotoxemia caused by decreased suckle and septicemia, and hypoglycemia, hypertriglyceridemia, and low plasma insulin concentrations are commonly present in septic foals.<sup>6</sup> Plasma insulin and leptin concentrations may have predictive utility of clinical outcome in critically ill foals.<sup>6</sup> Experimental infusion of endotoxin into sheep results in transient hyperglycemia associated with increased hepatic glucose production followed by hypoglycemia 3 to 8 hours later, when hepatic glucose production decreases. Sympathetic activation occurs early in endotoxemia and is probably responsible for the initial hyperglycemia and glycogenolysis. Blood pyruvate and lactate concentrations increase as a result of poor tissue perfusion and the anaerobic nature of tissue metabolism.

### Protein Metabolism

There is an increase in tissue breakdown (catabolism) and a concomitant increase in serum urea nitrogen concentration. The changes observed include alterations in individual plasma amino acid concentrations, increased urinary nitrogen excretion, and increased whole-body protein turnover. The time course changes in the concentrations of plasma amino acids and other metabolites during and after acute endotoxin-induced fever in mature sheep have been described. Rapid and extensive changes occur in the

patterns of tissue protein metabolism in the ruminant in response to endotoxin administration, and these changes may contribute to economic losses incurred during infectious disease outbreaks. There is also an alteration in the aminogram (the relative proportions of the amino acids present in blood) and the electrophoretic pattern of plasma proteins. The globulins are increased and albumin decreased as part of the acute phase reaction.

### Mineral Metabolism

Negative mineral balances occur. These include hypoferrremia and hypozincemia as part of the acute phase reaction as the animal attempts to sequester these microminerals from invading bacteria, but blood copper concentrations are commonly increased concurrently with an increase in blood ceruloplasmin levels.

### Reproduction and Lactogenesis

Endotoxemia can cause pregnancy failure in domestic animals, particularly when pregnancy is corpus luteum-dependent. In horses and cattle, experimentally induced endotoxemia causes an immediate and pronounced release of prostaglandin  $F_{2\alpha}$ . The intravenous administration of endotoxin may influence luteal function by the activation of the arachidonic acid cascade, by a direct effect of prostaglandin  $F_{2\alpha}$  on the corpus luteum. The administration of endotoxin to mares pregnant 21 to 35 days results in a decrease in progesterone and fetal death, which can be prevented by daily treatment with a progesterone compound. Similar results have been produced in pregnant dairy cows during the first 150 days of lactation, and coliform mastitis in the first 5 months of lactation is becoming an increasingly important cause of early embryonic death and return to estrus. The uterus of the early postpartum cow is capable of absorbing endotoxin, which may provoke changes in the serum concentrations of prostanoids and is thought to contribute substantially to the systemic signs of toxic metritis in cows. Endotoxin has a negative effect on the genital functions of the ram; the changes in luteinizing hormone and testosterone are similar to those seen after heat-induced stress.

In recently farrowed swine with the mastitis-metritis-agalactia syndrome, it is suggested that the endotoxin from the mammary glands affected with mastitis may be important in the pathogenesis of theagalactia.

### Combined Effects on Body Systems

The combined effects of the hypoglycemia, hyper L-lactatemia, and acidemia interfere with tissue enzyme activity and reduce the functional activity of most tissues. Of these factors, acidemia is probably the most important in adult animals; in neonates low plasma glucose concentrations are probably



as important as acidemia because profound hypoglycemia is more commonly encountered in neonatal animals.<sup>5</sup> Experimental endotoxemia in calves at 24 to 36 hours of age causes severe hypoglycemia, lactic acidemia, and hypotension commonly associated with moderate to severe sepsis. The myocardium is weakened, the stroke volume decreases, and the response to cardiac stimulants is diminished. There is dilatation and in some cases damage to capillary walls, so that the effective circulating blood volume is decreased; this decrease, in combination with diminished cardiac output, leads to a fall in blood pressure and the development of circulatory failure. The resulting decline in the perfusion of tissues and oxygen consumption contributes greatly to the animal's decline and to the clinical signs, such as the dark red coloration of the oral mucosa. Respiration is little affected except as it responds to the failing circulation.

There is decreased liver function, and the damage to renal tubules and glomeruli causes a rise in plasma nonprotein nitrogen and the appearance of albuminuria. The functional tone and motility of the alimentary tract is reduced and the appetite fails; digestion is impaired, with constipation usually following. A similar loss of tone occurs in skeletal muscle and is manifested by weakness and terminally by prostration.

Apart from the effects of specific toxins on the nervous system, such as those of *Clostridium tetani* and *C. botulinum*, there is a general depression of function attended by dullness, depression, and finally coma. Because of the suspected role of *E. coli* in the etiology of edema disease of swine, it is noteworthy that some of the characteristic nervous system lesions of that disease are missing from experimentally induced porcine colitoxicosis. Changes in the hemopoietic system include depression of hemopoiesis and an increase in the number of leukocytes—the type of cell that increases often varies with the type and severity of the toxemia. Leukopenia may occur but is usually associated with aplasia of the leukopoietic tissue associated with viruses or specific exogenous substances such as radioactive materials. Most of these pathophysiologic effects of endotoxemia have been produced experimentally, and it is apparent that very small amounts of endotoxin can contribute greatly to the serious effects of intestinal disease, especially in the horse.

### Endotoxin Tolerance

The repeated administration of lipopolysaccharide results in attenuation of the host response, which is known as endotoxin tolerance. This refractoriness to endotoxin-mediated effects comprises two phases. Early phase tolerance is transient, occurs within hours or days, and is not associated with antiendotoxin antibody production. Late phase tolerance requires several days to

develop and is long lasting, antigen specific, and the result of antibody production. By this mechanism it is possible for individual animals to survive a dose of endotoxin lethal to the nontolerant individual. Experimentally, horses develop endotoxin tolerance following sequential sublethal infusions of endotoxin.

### Hypersensitivity

A secondary effect produced by some toxins is the creation of a state of hypersensitivity at the first infection so that a second infection, or administration of the same antigen, causes anaphylaxis or an allergic phenomenon such as purpura hemorrhagica. Also, a generalized Schwartzman reaction can be induced in pigs by an injection of *E. coli* endotoxin, especially if there are two injections properly spaced (in time). Pigs on a vitamin E-deficient diet are much more severely affected than pigs on a normal diet. Vitamin E is protective, but selenium is not.

### Other Infectious Toxins

In mycoplasmosis (*Mycoplasma mycoides* var. *mycoides*), at least part of the toxic effect is attributable to galactans contained in the toxins. These have a noticeably local effect in causing hemorrhages in alveolar ducts and pulmonary vessel walls so that pulmonary arterial blood pressure rises as systemic blood pressure falls. Later lesions are pulmonary edema and capillary thrombosis, which are characteristic of the natural disease of pleuropneumonia. Disseminated intravascular coagulation is also a characteristic of the lesions associated with the toxin of *Pseudomonas* spp.

## CLINICAL FINDINGS

### Acute Toxemia

The clinical findings of acute toxemia in most nonspecific toxemias are similar. The syndrome varies with the speed and severity of the toxic process but the variations are largely of degree. **Depression, anorexia, and muscular weakness** are common in acute endotoxemia. **Calves do not suck voluntarily** and may not have a suck reflex. Scant feces are common but a low-volume diarrhea may also occur. The heart rate is increased and initially the intensity of the heart sounds is increased, but later as the toxemia worsens the intensity may decrease. The pulse is weak and rapid but regular. A **fever** is common in the early stages of endotoxemia but later the temperature may be normal or subnormal. In neonatal calves, foals, and lambs a fever may not occur because of failure of thermoregulation or deprivation of colostrum. Terminally, there is muscular weakness to the point of collapse, and death occurs in a coma or with convulsions.

Anterior uveitis, manifested as lacrimation, blepharospasm, photophobia, corneal edema, conjunctival hyperemia, and fibrin in the anterior chamber are commonly present

in septicemic foals.<sup>7</sup> Posterior segment lesions, such as multifocal hemorrhages, exudates, and focal retinal detachments may also be visible during ophthalmic examination in foals with minor anterior segment changes. The presence of uveitis is associated with a lower survival rate in foals.<sup>7</sup>

### Endotoxemia

When toxin formation or liberation into the circulation is rapid and the toxicity of the toxin high enough, the onset of cardiovascular collapse is rapid enough to cause a state of *toxic* or *septic* shock. The remarkable clinical findings are

- Severe **peripheral vasodilatation** with a consequent fall in blood pressure
- **Pallor of mucosa**
- **Hypothermia**
- **Tachycardia**
- **Pulse of small amplitude**
- **Muscle weakness**

The syndrome is discussed also in the section on Shock, Endotoxemia, and Septic Shock. Endotoxemia is most commonly associated with bacteremia or septicemia caused by infection with gram-negative organisms, especially *E. coli*.

The clinical findings of severe endotoxemia include the following:

- Depression
- Hyperthermia followed by hypothermia
- Tachycardia followed by decreased cardiac output
- Decreased systemic blood pressure
- Cool skin and extremities
- Diarrhea
- Congested mucosae with an increased capillary refill time
- Muscular weakness, leading to recumbency

Renal failure is common and is characterized by anuria. If DIC develops, it is characterized by petechial and ecchymotic hemorrhages on mucous membranes and sclerae with a tendency to bleed from venipuncture sites.

### Chronic Toxemia

Lethargy, separation from the group, inappetence, failure to grow or produce, and emaciation are characteristic signs of chronic toxemia.

### Localized Infection

With localized infections there are, in addition to the general signs of toxemia, the clinical effects of a space-occupying lesion. These are presented under Localized infections.

## CLINICAL PATHOLOGY

### Hematology

Changes in total and differential leukocyte numbers occur in endotoxemia. Leukocytosis and neutrophilia occur with mild endotoxemia and leukopenia, neutropenia, and lymphopenia increase in severity and duration with increasing severity of endotoxemia. Endotoxin-induced rebound neutrophilia



may occur and is attributed to an accelerated release of neutrophils from the bone marrow reserve into the circulation through generation of the neutrophil-releasing factor.

In experimental sublethal endotoxemia in foals 3 to 5 days of age, there is leukopenia followed by leukocytosis, hypoglycemia, increased prothrombin time and partial thromboplastin time, and mild hypoxemia.

Coagulopathies are common in critically ill foals, particularly those with sepsis and septic shock.<sup>8,9</sup> Clinical evidence of bleeding is associated with severity of shock in neonatal foals, and is present in 67% of septic shock foals, 39% of septic foals, and 13% of non-septic foals.<sup>8</sup> Septic foals demonstrate marked activation of the coagulation and fibrinolytic systems, and many meet the criteria for DIC. As a consequence, plasma concentration of D-dimer, a fibrin-linked degradation product from fibrinolysis, is increased in septic foals, with a normal plasma D-dimer concentration having clinical utility as a predictor for the absence of sepsis.<sup>9</sup>

### Serum Biochemistry

A low plasma glucose concentration, high serum urea concentration, and a low serum albumin and total protein concentration are usually present in acute endotoxemia. Decreased albumin and total protein concentrations are in response to increased capillary permeability, whereas the azotemia reflects a decreased glomerular filtration rate. Adult herbivores have a mild hypocalcemia, hypomagnesemia and hypokalemia, and hypophosphatemia, which most likely reflects inappetence and decreased gastrointestinal tract motility. Plasma iron concentration is decreased, which reflects redistribution of iron to intracellular storage sites, particularly in the liver. Plasma zinc concentration is decreased via a cytokine-mediated redistribution of zinc to the intracellular compartment, possibly through the zinc transporter Zip14.<sup>10</sup> Hypoferremia and hypozincemia are focused on decreasing the availability of important mineral elements for bacterial replication. High plasma cortisol concentrations are associated with a higher mortality rate in sick neonatal foals.<sup>11</sup>

In more chronic toxemic states, a high serum total protein concentration, with globulins noticeably increased on electrophoretic examination, is more common.

### Endotoxin

Endotoxin can be detected in the platelet-rich plasma of critically ill horses and cattle using the chromogenic *Limulus amoebocyte lysate* (LAL) assay, which is a biologic test using the hemolymph of the horseshoe crab. The results of most studies indicate that higher plasma endotoxin concentrations in critically ill animals are associated with an increased mortality rate.<sup>12</sup> However, the LAL assay is not widely available and is usually run as a research test.

### NECROPSY FINDINGS

Gross findings at necropsy are limited to those of the lesion that produces the toxin. Microscopically, there is degeneration of the parenchyma of the liver and the glomeruli and tubules of the kidney and the myocardium. There may also be degeneration or necrosis in the adrenal glands.

### TREATMENT

The principles of treatment of endotoxemia or septic shock include (1) removal of the foci of infection; (2) administration of antimicrobial agents with a gram-negative spectrum; (3) aggressive fluid and electrolyte therapy to combat the relative hypovolemia, systemic hypotension, hypoglycemia, and electrolyte and acid-base disturbances; and (4) NSAIDs or glucocorticoids for the inhibition of products of the cyclooxygenase pathway. These four treatments are routinely applied and are called goal-directed therapy. Other treatments that may be applied in selected cases include the administration of inotropic agents or vasopressors, intravenous or intramammary administration of polymyxin B, continuous rate infusion of lidocaine, and intravenous administration of hyperimmune plasma containing antibodies directed against core lipopolysaccharide antigens. Potential therapeutic agents under investigation (such as pentoxifylline, dimethyl sulfoxide,<sup>12a</sup> tyloxapol, and insulin) cannot be currently recommended for treating endotoxemic animals because of the lack of clinical studies in animals with naturally acquired endotoxemia.

Endotoxemic or septic shock occurs when the animal is overwhelmed by an infection or endotoxemia. This is a complex disease that requires a rapid and comprehensive treatment plan, including those interventions in the following sections.

### Removal of Foci of Infection

Removal of endotoxin before it can be absorbed is an important cornerstone of treatment in foals and calves with omphalophlebitis, horses with ischemic or necrotic bowel, and lactating dairy cattle with coliform mastitis.

### Antimicrobial Agents

**Bactericidal gram-negative antimicrobial agents** are always indicated whenever there is evidence of septicemia or a localized infection causing endotoxemia. The choice and route of administration will depend on the pathogens suspected of causing the infection and endotoxemia and the site of infection. The speed of kill of gram-negative bacteria may be an important clinical issue, because antimicrobial agents with a rapid kill (such as moxalactam) can produce a bolus release of endotoxin into the bloodstream by punching multiple holes in the bacteria, causing a rapid explosion of the bacteria caused by osmotic fluid shifts and bolus release of

endotoxin. Antimicrobial agents that alter the cell wall of gram-negative bacteria can theoretically produce a bolus release of endotoxin when administered to animals with gram-negative septicemia. On this basis,  $\beta$ -lactam antibiotics effective against gram-negative bacteria should theoretically be avoided; however, clinical experience has not indicated deleterious effects following administration of  $\beta$ -lactam antibiotics. Moreover, coadministration of aminoglycosides blocks the potential bolus release of endotoxin by  $\beta$ -lactam antibiotics. However, it is clinically prudent to ensure that whenever antimicrobial treatment is initiated in endotoxemic animals that NSAIDs are administered concurrently. It is also important to adjust dosage rates of water-soluble antibiotics in neonatal animals because some antibiotics, such as gentamicin in foals and ceftiofur in calves, have a larger volume of distribution and slower clearance in neonatal animals.<sup>13</sup>

### Aggressive Fluid Therapy

The intravenous infusion of large quantities of fluids and electrolytes is a high priority in the management of endotoxemia. Maintenance of peripheral perfusion is essential to any therapeutic regimen for treatment of endotoxic shock. Large volumes of isotonic fluids have been standard practice. Recent studies have identified concerns with bolus fluid resuscitation in septic patients, such as 20 to 40 mL/kg in the first hour.<sup>14,15</sup> These findings suggest that rapid resuscitation should focus on the use of low-volume hypertonic saline, and that traditional high-volume crystalloid solution resuscitation should not use bolus administration. Instead, traditional high-volume crystalloid fluid resuscitation should focus on slower rates of administration (<20 mL/kg/h); lactated Ringer's solution or other balanced electrolyte solution should therefore be administered over several hours. A beneficial response is noted by the following:

- Correction of peripheral vasoconstriction
- Restoration of an acceptable pulse quality
- Return of urine output
- Increase in the central venous pressure
- Restoration of mean arterial blood pressure to >65 mm Hg
- Restoration of cardiac output
- Restoration of oxygen delivery to acceptable levels

It may be necessary to deliver fluids in amounts equivalent to 0.5 to 1.0 times the estimated blood volume of the animal over a period of several hours.

### Hypertonic Solutions

The use of hypertonic saline, 7.5% NaCl, may enhance tissue perfusion and decrease the volume of subsequent fluids required for a beneficial response. Experimentally, the use

of hypertonic saline in sublethal *E. coli* endotoxemia in mature horses was associated with a more effective cardiovascular response than was an equal volume of isotonic saline solution. Cardiac output is increased and peripheral vascular resistance is decreased compared with results for isotonic saline controls. Hypertonic saline rapidly expands the plasma volume and increases preload by acting as an effective osmotic agent in the extravascular compartment, causing a translocation of fluid from the intracellular space and gastrointestinal tract.

Hypertonic sodium bicarbonate is widely used for the initial treatment of metabolic acidosis in endotoxemic adult horses. However, in horses with experimental endotoxemia, hypertonic sodium bicarbonate did not normalize blood pH, and it increased blood L-lactate concentrations and caused hypokalemia, hypernatremia, and hyperosmolality.

### Glucose and Insulin Administration

Glucose should always be included in the infusion fluids because hypoglycemia, increased glucose utilization, and inappetence are usually present in endotoxemic animals. The appropriate target range for plasma glucose concentration in septic humans and domestic animals is unknown. Hyperglycemia, hyperinsulinemia, and low leptin concentrations are associated with increased morbidity and mortality in horses, and endotoxemic horses have impaired glucose metabolism and decreased insulin sensitivity.<sup>6,16</sup> Originally, blood glucose concentration was maintained at <180 to 200 mg/dL, but recent approaches have focused on maintaining blood glucose concentrations within the reference range for each species.<sup>17</sup> Coadministration of glucose (37 mg/kg/h, equivalent to 30 kcal/kg/day) and insulin (0.07 U/kg/h) as continuous rate infusions is effective in preventing hypoglycemia in healthy adult horses and adult horses with experimentally induced endotoxemia.<sup>17</sup> Continuous rate infusions of insulin appear to provide better glycemic control than intermittent subcutaneous insulin injections.<sup>17</sup> It should be noted that insulin has an affinity for binding to fluid administration lines.

### Inotropic Agents, Vasopressors, and Local Anesthetics

Critically ill neonates and adults may require the administration of positive inotropic agents and vasopressor agents. Inotropic agents increase cardiac contractility, increasing cardiac output and oxygen delivery. Vasopressor agents increase systemic arterial blood pressure. Inotropic and vasopressive agents are usually administered for short periods of time during anesthesia or recovery from anesthesia.

**Dobutamine** (0.5–1 µg/kg BW/min in adults and 1–3 µg/kg BW/min in neonates)

is the inotropic agent of choice in large animals, although human studies prefer dopamine and norepinephrine. Dobutamine should be diluted in 0.9% NaCl, 5% dextrose, or lactated Ringer's solution and the dose carefully titrated by monitoring heart rate and rhythm and blood pressure. **Norepinephrine** (0.01–1 µg/kg BW/min) is the vasopressor agent of choice in hypotensive animals that have not responded to intravenous fluid loading or dobutamine. Norepinephrine should be diluted in 5% dextrose and the dose titrated because there is marked individual variability in the response to norepinephrine administration.

**Lidocaine** 1.3 mg/kg as bolus intravenous injection followed by a continuous rate infusion of 0.05 mg/kg/minute mitigated some of the effects of endotoxin administration in healthy adult horses, but the effects were not profound and lidocaine was administered 20 minutes after endotoxin administration.<sup>18</sup> Clinical studies of animals with naturally acquired endotoxemia or septic shock are needed before lidocaine administration can be recommended.

### Nonsteroidal Antiinflammatory Drugs

The NSAIDs have been in general use for the treatment of endotoxemia because of their analgesic, antiinflammatory, and antipyretic properties. They suppress production of thromboxane and prostaglandins and reduce the acute hemodynamic response to endotoxemia. Although NSAIDs are routinely administered to endotoxemic animals, a large-scale study in humans with severe sepsis failed to demonstrate an effect of ibuprofen on mortality, despite improvement in a number of clinical indices and decreased production of arachidonic acid metabolites.

**Flunixin meglumine** is the NSAID most commonly used in the treatment of endotoxemia in horses and cattle and remains the NSAID of choice for treating this condition. It is a potent inhibitor of cyclooxygenase and its action on this enzyme to inhibit the synthesis of eicosanoids, such as prostaglandin E<sub>2</sub>, may explain the antiinflammatory action of the drug. Flunixin meglumine also modulates the acute hemodynamic changes and hyper L-lactatemia commonly seen during endotoxemia, which may increase survival rate. Endotoxin-stimulated production of thromboxane B<sub>2</sub> (a metabolite of thromboxane) and prostaglandin F<sub>1α</sub> are blocked by flunixin meglumine at 0.25 and 0.1 mg/kg, respectively, which resulted in a widespread clinical use of an antiendotoxemic dose of 0.25 mg/kg. However, the term *antiendotoxemic effect* should be discouraged because it is misleading, and a dose rate of 1.1 mg/kg BW IV every 12 hours is recommended in horses. Care should be taken to ensure adequate hydration in endotoxemic animals receiving multiple doses of flunixin meglumine. It is usually given intravenously US

label is only for IV use in cattle at 1.1 to 2.2 mg/kg BW every 24 hours. The oral administration of flunixin meglumine at 2.2 mg/kg BW before experimentally induced endotoxemia in cattle exerted an effect equal to that after intravenous administration by minimizing the fever and prostaglandin F<sub>2α</sub> metabolite concentration induced by the endotoxin administration. However, flunixin meglumine did not prevent the decrease in peripheral mononuclear cells and polymorphonuclear leukocytes seen after endotoxin administration. The bioavailability of flunixin meglumine in cattle ranges from 53% to 60% in cattle and 80% to 86% in horses.

Flunixin meglumine was superior to prednisolone and dimethylsulfoxide in providing protection and mitigating the effects of experimental endotoxemia in calves, but it was only partially protective against the hypotension and hyper L-lactatemia and failed to alter the hypoglycemic effect. Although flunixin meglumine is the most widely used NSAID in endotoxemia, there is little experimental evidence demonstrating its efficacy over other NSAIDs. Ketoprofen, flunixin meglumine, ketorolac, and phenylbutazone have been compared for treating experimental endotoxemia in calves. Each drug modified the response to endotoxin but none was clearly superior to the others in modulating the clinical signs. Phenylbutazone given to calves at 5 mg/kg BW/day intravenously for 5 days suppressed the clinical response to experimental endotoxin in neonatal calves with progressively increasing amounts of endotoxin until large amounts were given. There were no significant differences between ketoprofen and flunixin meglumine in *in vitro* studies of the effects of the drugs on equine peripheral blood monocytes. An interesting finding in adult dairy cows with experimentally induced endotoxemia was that flunixin meglumine and phenylbutazone delayed the plasma clearance of endotoxin by 2 to 3 and 6 to 12 times, respectively, suggesting that both NSAIDs may prolong the clinical signs of endotoxemia in cattle, possibly by interfering with hepatic metabolism. The clinical significance of this finding is unknown. Flunixin meglumine has been associated with impaired healing of the intestinal tract, injury to the gastrointestinal tract and kidneys, and increased intestinal permeability to lipopolysaccharide.<sup>19</sup>

### Glucocorticoids

Glucocorticoids (corticosteroids) have been used extensively in the past for the treatment of endotoxemia and shock. The rationale for the use of glucocorticoids includes the following:

- Organelle and cell-membrane stabilization
- Improved cellular metabolism and gluconeogenesis
- Improved microcirculation

- Decreased production of endogenous toxins such as myocardial depressant factor
- Decreased leukocyte activation and degranulation
- Minimal reticuloendothelial depression and histologic organ damage

The corticosteroids most commonly used in endotoxic shock were hydrocortisone, prednisolone, methylprednisolone, and **dexamethasone**. However, these corticosteroids have been most beneficial therapeutically when given as a pretreatment in experimental situations. Published evidence, based on controlled clinical trials, that corticosteroids are efficacious in naturally occurring cases of endotoxemic shock in humans and farm animals is lacking.

Glucocorticoids improve capillary endothelial integrity and tissue perfusion, decrease activation of complement and the clotting cascade, decrease neutrophil aggregation, stabilize lysosomal membranes, protect against hepatic injury, and improve survival rate. However, there are concerns about their use in septicemic animals because they may cause immunosuppression. Large doses are required, which are cost-prohibitive in farm animals when they are used most commonly in acute cases and in doses such as 1 mg/kg BW of dexamethasone intravenously every 24 hours. It is currently thought that glucocorticoids, if they are to be clinically effective, **must be given as early as possible** to endotoxemic animals. Glucocorticoids are less frequently administered to endotoxemic animals as a result of a number of studies supporting the use of NSAIDs.

### Polymyxin B

**Polymyxin B** is a cationic antibiotic that has an appropriate charge distribution to stoichiometrically bind to the lipid A moiety of lipopolysaccharide. Parenteral administration of antimicrobial doses of polymyxin can lead to nephrotoxicity, neurotoxicity, and ototoxicity, but lower, nonnephrotoxic doses are effective in ameliorating the effects of endotoxin in horses. Specific endotoxin binding agents, such as intravenous polymyxin B, are therefore theoretically beneficial and have shown some efficacy in endotoxemic foals and adult horses when administered at a recommended dose of 1 mg (6000 U)/kg BW administered at 8-hour intervals.<sup>20,21</sup> The benefits attributed to polymyxin B administration in endotoxemic animals are not profound, and definitive efficacy studies have not been completed in endotoxemic calves or horses with naturally acquired endotoxemia. In particular, because the efficacy of polymyxin B is focused against circulating lipopolysaccharide before it is bound to LBP, it is currently thought that polymyxin B, like glucocorticoids, must be given as early as possible to endotoxemic animals if it is to be clinically effective. Attractive features of polymyxin B

are its shelf-life and ease of storage, ease of administration (intravenous bolus), cost, and 8-hour duration of effect.

### Hyperimmune Serum and Plasma Transfusion

**Hyperimmune serum** is commercially available for the treatment of endotoxemia in the horse. The rationale is that antilipid A antibodies bind circulating lipopolysaccharide, preventing the subsequent inflammatory cascade. On theoretical grounds it is difficult for an antibody to competitively inhibit the strong binding affinity and high specificity between lipopolysaccharide and LBP. There are also difficulties with spatial hindrance between IgG and the R-core subfraction of lipopolysaccharide that contains lipid A. It is therefore difficult to think that antiserum against core lipopolysaccharide antigens will ever be therapeutically successful in animals with naturally acquired endotoxemia, and large-scale studies in septic humans have failed to observe a decrease in mortality following the administration of hyperimmune core-lipopolysaccharide plasma. However, the administration of plasma containing antiserum has many theoretical advantages separate from those of endotoxin neutralization, and it may be that plasma transfusion alone is beneficial.

The use of antiserum to the rough mutant of *E. coli* 0111:B4(J-5) as a treatment of experimental or naturally acquired endotoxemia has been demonstrated in some, but not all, studies in adult horses but not in foals and calves. One study in foals indicated that the administration of hyperimmune serum resulted in a worsening of the clinical signs and augmented release of TNF- $\alpha$  and IL-6. A later study identified a higher survival rate to discharge for septic and critically ill foals receiving hyperimmune plasma rich in anti-endotoxin antibodies; however, survival rate in a subset of the foal population that had gram-negative septicemia was not significantly altered by plasma administration.<sup>22</sup> Antiserum does not appear as rational a treatment for neutralizing circulating lipopolysaccharide as polymyxin B and, for this reason, the administration of hyperimmune plasma or serum should probably be reserved for animals that fail to improve after polymyxin B administration.

### Pentoxifylline and Ethyl Pyruvate

Pentoxifylline is a methylxanthine derivative that has been used in foals with septicemia because it has been shown to suppress production of TNF- $\alpha$  in a dose-dependent manner. Oral administration of pentoxifylline at 10 mg/kg BW produces serum concentrations similar to those achieved at therapeutic levels in humans when administered every 12 hours.<sup>23</sup> Clinical trials administering pentoxifylline in large animals with naturally occurring endotoxemia or septic shock have not been performed.

Ethyl pyruvate is a stable derivative of pyruvate that has been shown to diminish the clinical effects of endotoxemia when rapidly administered to horses intravenously at 150 mg/kg BW in lactated Ringer's solution immediately after endotoxin administration.<sup>15,24</sup> The mechanism of action is thought to be via binding to NF- $\kappa$ B and diminished expression of proinflammatory cytokines. There is a potential for synergism between ethyl pyruvate and flunixin meglumine in the treatment of endotoxemia in horses, but clinical trials have not been performed.

### Anticoagulants

Disseminated intravascular coagulation (hypercoagulable states) can be treated with heparin in an attempt to impair intravascular coagulation. Much of the knowledge regarding DIC in endotoxemia has been extrapolated from species other than large animals, and there is little objective information available to guide the clinical use of anticoagulants in endotoxemic large animals. Instead, the focus of treatment should be aggressive intravenous fluid administration to maximize microcirculation.

### CONTROL OF ENDOTOXEMIA

The hallmarks of a control program are to decrease the risk or prevent neonatal septicemia, institute early and aggressive treatment of gram-negative bacterial infections, and ensure prompt surgical removal of ischemic and damaged intestine. Vaccines based on core lipopolysaccharide antigens are widely used in North America to decrease the incidence and severity of gram-negative mastitis in lactating dairy cows (see Chapter 20) and gram-negative infections in pigs, but similar vaccination protocols have not been developed for horses, small ruminants, and New World camelids, which are also at risk for endotoxemia.

### FURTHER READING

- Dellinger RP, Levy MM, Carlet JM, et al. Surviving sepsis campaign: international guidelines for management of severe sepsis and septic shock: 2008. *Crit Care Med*. 2008;36:296-327.
- Dunkel B, Corley KTT. Pathophysiology, diagnosis and treatment of neonatal sepsis. *Equine Vet Educ*. 2015;27:92-98.
- Lewis DH, Chan DL, Pinheiro D, et al. The immunopathology of sepsis: pathogen recognition, systemic inflammation, the compensatory anti-inflammatory response, and regulatory T cells. *J Vet Intern Med*. 2012;26:457-482.
- Moore JN, Vandenplas ML. Is it the systemic inflammatory response syndrome or endotoxemia in horses with colic? *Vet Clin Equine*. 2014;30:337-351.
- Osterbur K, Mann FA, Kuroki K, DeClue A. Multiple organ dysfunction syndrome in humans and animals. *J Vet Intern Med*. 2014;28:1141-1151.
- Patel GP, Balk RA. Systemic steroids in severe sepsis and septic shock. *Am J Resp Crit Care Med*. 2012;185:133-139.
- Russell JA. Management of sepsis. *N Engl J Med*. 2006;355:1699-1713.



Taylor S. A review of equine sepsis. *Equine Vet Educ.* 2015;27:99-109.

Werners AH, Bryant CE. Pattern recognition receptors in equine endotoxemia and sepsis. *Equine Vet J.* 2012;44:490-498.

## REFERENCES

1. Elasser TH, et al. *J Appl Physiol.* 2005;98:2045.
2. Silva A, et al. *Vet Immunol Immunopathol.* 2013;155:264.
3. Dembek KA, et al. *J Vet Intern Med.* 2013;27:331.
4. Corley KTT, et al. *Equine Vet J.* 2007;39:84.
5. Ballou MA, et al. *Vet Immunol Immunopathol.* 2011;141:76.
6. Barsnick RJIM, et al. *J Vet Intern Med.* 2011;25:123.
7. Leiva M. *J Vet Intern Med.* 2010;24:391.
8. Bentz AI, et al. *J Vet Intern Med.* 2009;23:161.
9. Armengou L, et al. *J Vet Intern Med.* 2008;22:411.
10. Wang J, et al. *Am J Vet Res.* 2007;68:529.
11. Armengou L, et al. *J Vet Intern Med.* 2013;27:567.
12. Senior JM, et al. *Equine Vet J.* 2011;43:585.
- 12a. Kelmer G, et al. *Equine Vet J.* 2008;40:358.
13. Burton AJ, et al. *Equine Vet J.* 2013;45:507.
14. Maitland K, et al. *N Engl J Med.* 2011;364:2483.
15. Hilton AK, Bellomo R. *Crit Care.* 2012;16:302.
16. McGovern KF, et al. *J Vet Intern Med.* 2013;27:347.
17. Han JH, et al. *Am J Vet Res.* 2011;72:522.
18. Peiro JR, et al. *J Vet Intern Med.* 2010;24:940.
19. Jacobs CC, et al. *Equine Vet J.* 2013;45:333.
20. Wong DM, et al. *J Am Vet Med Assoc.* 2013;243:874.
21. Morresey PR, et al. *Am J Vet Res.* 2006;67:642.
22. Peek SF, et al. *J Vet Intern Med.* 2006;20:569.
23. Liska DA, et al. *Am J Vet Res.* 2006;67:1621.
24. Schroeder EL, et al. *Equine Vet J.* 2011;43:341.

## Toxemia in the Recently Calved Cow

A special occurrence of toxemia of major importance in food-animal practice is that caused by several diseases in the period immediately after calving in the dairy cow (and less frequently the beef cow). The syndrome is characterized clinically by lack of appetite, marked reduction in milk yield, reduced ruminal and intestinal activity, dullness, lethargy, and a fever. The term *parturition syndrome* has been used in the past but is no longer recommended, because its general adoption could dissuade clinicians from seeking more accurate identification of the component disease.

The diseases commonly included in the broad category of periparturient toxemia are as follows:

- Acetonemia
- Fat cow syndrome and pregnancy toxemia
- Mastitis
- Peritonitis
- Puerperal metritis

A brief account of puerperal metritis in cattle is provided here because of the common occurrence of puerperal metritis and the profound nature of the systemic signs of illness in affected cattle. All the other diseases are described under their respective headings in this book.

## PUERPERAL METRITIS IN CATTLE

**Puerperal metritis** occurs primarily in dairy cows within the first 7 days after parturition (but up to 21 days after parturition) and is characterized clinically by systemic signs of sickness including fever ( $\geq 39.5^{\circ}\text{C}$ ); dullness; inappetence; increased heart rate; low milk production; an enlarged uterus for the number of days postpartum with poor uterine tone; and a copious, foul-smelling red-brown watery uterine discharge, with or without retention of the fetal membranes. Puerperal metritis is one of the most costly diseases of dairy cattle, with an estimated total cost per case of \$329 to \$386. **Clinical metritis** is defined as the presence of an abnormally enlarged uterus and a purulent uterine discharge detectable in the vagina within 21 days postpartum in an animal that is not systemically ill. This should be compared with **clinical endometritis**, which is characterized by the presence of a purulent ( $>50\%$  pus) uterine discharge detectable in the vagina 21 days or more after parturition, or the presence of a mucopurulent (approximately 50% pus and 50% mucus) discharge detectable in the vagina 26 days or more after parturition.

### ETIOLOGY

The etiology is multifactorial. It is assumed that a combination of impaired neutrophil function; abnormal postpartum uterine involution, often with retained fetal membranes; and infection of the uterus precipitates the disease. A mixed bacterial flora is common, which includes organisms such as *Trueperella* (*Arcanobacterium* or *Actinomyces* or *Corynebacterium*) *pyogenes*, *Fusobacterium necrophorum*, *Prevotella melaninogenica*, *Bacteroides* spp. *Streptococcus uberis*; these commonly predominate as a mixed flora in cows with retained placenta and postpartum metritis, particularly after 5 to 7 days postpartum. Other observations found that *E. coli* predominates in cows with retained placenta, particularly in the first 5 to 7 days postpartum. *Staphylococcus* spp., *Streptococcus* spp., *Pseudomonas aeruginosa*, *Proteus* spp., and occasionally *Clostridium* spp. are also present; the last can occasionally result in tetanus if *C. tetani* proliferates. High-throughput automated DNA pyrosequencing of uterine fluid from dairy cows with metritis on postpartum days 1 to 3 and 8 to 10 indicated that *Fusobacterium* and *Bacteroides* accounted for more than 83% of all bacterial DNA.<sup>1</sup> Slow-growing facultative anaerobic gram-positive bacteria (*Helcococcus kunzii* and *H. ovis*) have also been cultured from the uterine fluid in dairy cows with puerperal metritis.<sup>2</sup>

The current view is that *E. coli* colonization within the first 3 days after parturition creates a suitable intrauterine environment that leads to puerperal metritis by facilitating the establishment and persistence

of *F. necrophorum* and other gram-negative anaerobic bacteria in the endometrium and uterine lumen. Early intrauterine colonization with *E. coli* strains that carry the virulence factor *fimH* that facilitate adhesion to endometrial epithelial and stromal cells increases the odds of developing metritis by 4.6 to 4.7.<sup>3</sup> Clinical signs of puerperal metritis are most likely caused by intrauterine colonization with the strict anaerobic bacteria *F. necrophorum* and the facultative anaerobe *T. pyogenes*, which are the most likely source for the fetid odor of affected cattle. Another important virulence factor for developing metritis appears to be *lktA* (leukotoxin) of *F. necrophorum*.<sup>3</sup> Together, this sequential colonization pathway suggests that decreasing fecal contamination of the vagina and uterine lumen (and therefore the colonization by *E. coli*) in the immediate postpartum period should decrease the incidence of puerperal metritis in cattle. Interestingly, it appears that uterine colonization by *E. coli* in the early postpartum period increases the risk of puerperal metritis but decreases the risk of clinical endometritis, whereas uterine colonization by *S. uberis* in the early postpartum period increases the risk of clinical endometritis.<sup>4</sup>

### EPIDEMIOLOGY

The disease occurs in cows of all ages but is most common in mature dairy cows within 2 to 10 days of parturition. Factors strongly associated with an increased incidence of puerperal metritis include:

- Large herds
- Dystocias
- Retained fetal membranes
- Decreased feed intake in the last 2 weeks before parturition<sup>5</sup>
- Overconditioning or underconditioning of cows

Puerperal metritis is most common in cows with fetal membranes retained for more than 24 hours following parturition. Several cause and effect relationships have been implicated for retained placenta in cattle, with impaired neutrophil function being the most likely underlying cause.

Retention of fetal membranes is associated most commonly with abortion, dystocia, and multiple births. The most commonly used definition is the presence of fetal membranes 12 hours or more following parturition but retention for more than 6 to 8 hours is the time limit set, particularly in older cows. Approximately 10% of dairy cows have retained fetal membranes after parturition. The incidence between herds ranges from 3% to 27%. In single calvings the incidence is about 10% and in twin calvings 46%. Puerperal metritis occurs in about 50% of cows with retained placenta, and puerperal metritis is 25 times more likely to occur with retained placenta than without. Other less common risk factors for retained placenta include the following:



- Old age
- Increased gestation length
- Hormone-induced parturition
- Fetal anasarca
- Uterine prolapse
- Fetotomy

The factors that are associated with retention of the placenta are indirectly associated with the development of puerperal metritis. The forceful removal of retained placenta, particularly in the first 4 days postpartum, is also considered to be a major predisposing factor to puerperal metritis. Recent work indicates that the fundamental cause of retained placenta is impaired neutrophil function, in which the ability of the maternal immune system to recognize the placenta as “foreign” tissue is impaired. Specifically, the separation of a placenta from healthy caruncles in a normal calving depends on incompatibility between maternal and fetal major histocompatibility complex Class I expressed on the epithelium within the fetomaternal unit.<sup>5</sup> In other words, retained placenta is an indication of an impaired immune system, which may be secondary to periparturient deficiency of vitamin E or selenium, or a greater degree of negative energy balance prepartum. Lack of uterine motility is thought to play a minimal to no role in the development of retained placenta and puerperal metritis.

Uncomplicated cases of retained fetal membranes in cattle have no significant effect on subsequent fertility and the calving-to-conception interval. However, it is significantly increased in cows that develop puerperal metritis as a sequel to retained fetal membranes. Vitamin E and selenium deficiency, placentitis, and vitamin A deficiency have also been suggested as factors.

### PATHOGENESIS

Failure of normal uterine involution combined with retention of the fetal membranes and infection of the uterus with a mixed bacterial flora results in puerperal metritis and a severe toxemia. There is diffuse necrosis and edema of the mucosa and wall of the uterus. There is marked accumulation of foul-smelling fluid in the uterus and enlargement of the uterus. Absorption of toxins results in severe toxemia, particularly in fat cows, which may develop irreversible fatty degeneration of the liver.

### CLINICAL FINDINGS

Affected cows become acutely anorexic and toxemic within 2 to 10 days after parturition. There is a marked drop in milk production. The temperature is usually elevated, in the range of 39.5 to 41.0°C, but may be normal in the presence of severe toxemia. A consensus has not been reached on the threshold rectal temperature cut point for a diagnosis of toxic metritis, because increased ambient temperatures in summer also increase core body temperature, and dystocia-related trauma in primiparous cattle appears to

increase rectal temperature. The optimal rectal temperature cut point indicating a cow has puerperal metritis during the first 10 days in milk in dairy cattle is approximately  $\geq 39.5^\circ\text{C}$  (range is  $>39.2^\circ\text{C}$  to  $>39.7^\circ\text{C}$ ), with the cut point higher for primiparous than multiparous cattle.<sup>6,7</sup> It has become popular on some large dairies to measure the rectal temperature each morning for the first 10 days of lactation, primarily as a screening test for puerperal metritis. One study suggested that rectal temperature measurement from day 5 to 10 of lactation was sufficient, because this protocol did not negatively impact the ability to successfully treat cases of puerperal metritis that are diagnosed before day 5 of lactation.<sup>8</sup> Although an elevated rectal temperature is considered a requirement for a diagnosis of **puerperal metritis**, it is important to recognize that some cows can have systemic signs of illness and a serosanguinous uterine discharge and a normal rectal temperature. An elevated rectal temperature in the 5 to 10 day postpartum period should not be used as the sole criteria for a diagnosis of **clinical metritis**, because this will lead to overtreatment of healthy cows. For example, 14% to 66% of healthy cattle exhibit at least one rectal temperature  $\geq 39.5^\circ\text{C}$  in the first 10 days of lactation, 59% of cows with clinical metritis maintain a rectal temperature  $<39.5^\circ\text{C}$ , and rectal temperature is impacted by the age of the animal, environmental conditions, and the method used to measure rectal temperature.<sup>9</sup>

The heart rate is usually elevated and may range from 96 to 120 beats/min. The respiratory rate is commonly increased to 60 to 72 breaths/min, and the breath sounds may be louder than normal. Rumen contractions may be markedly depressed or absent. A foul-smelling fluid diarrhea may occur. Mild to moderate dehydration is common because affected cows do not drink normally.

Retention of the fetal membranes is common, and manual examination of the vagina reveals the presence of copious quantities of foul-smelling, dark brown to red fluid containing small pieces of placenta pooled in the vagina. When the fetal membranes are retained and protruding through the cervix, the hand can usually be inserted through the cervix and into the uterus. Manual exploration of the uterine cavity will usually reveal the state of adherence of the fetal membranes. Often the fetal cotyledons are firmly attached to the maternal caruncles, but occasionally they have separated from the caruncles and the placenta can be removed by simple traction.

Rectal examination usually reveals that the uterus is large, flaccid and lacks the longitudinal ridges that indicate normal rate of involution. In large cows the enlarged, flaccid uterus may be situated over the pelvic brim extending into the ventral part of the abdomen and thus may not be easily palpable and examined. This is an important finding because the fetal membranes may be

fully retained in the uterus and no evidence of their presence may be detectable on examination of the vagina and the cervix, which may be almost closed, making examination of the uterus impossible.

The presence of viscid, nonodorous mucus in the cervix and anterior part of the vagina usually, but not always, indicates that the fetal membranes have been expelled. When evidence of a retained placenta and puerperal metritis cannot be found on examination of the reproductive tract, either by rectal palpation or vaginal examination, and if the history indicates some uncertainty about the disposition of the placenta, a retained placenta and puerperal metritis should be considered until proven otherwise. Persistent toxemia, tachycardia (100–120 beats/min), anorexia, and rumen stasis that cannot be explained by any other disease should arouse suspicion of septic metritis until proved otherwise.

Tenesmus occurs most commonly when the fetal membranes are retained and this causes irritation in the vagina. Manual examination of the vagina may also stimulate tenesmus.

The course of the disease varies from 2 to 10 days. Those cases with retained fetal membranes may be toxemic and not return to normal appetite until the membranes are fully expelled, which may take up to 10 days. Necrotic pieces of placenta may be passed for 10 to 14 days after treatment is begun.

## CLINICAL PATHOLOGY

### Hematology

Leukopenia, neutropenia, and a degenerative left shift occur in acute cases and the degree of change parallels the severity of the disease and reflects the absorption of endotoxin from the uterine lumen. Bacteremia caused by *Bacillus* spp. has been identified in 53% (9/17) of cattle with puerperal metritis; however, bacteremia did not reflect the most common isolates from the uterus of affected cattle.<sup>10</sup> The prevalence of bacteremia in healthy dairy cattle at the same stage of lactation (53%, 8/15) was similar to that of cattle with puerperal metritis.

### Vaginal/Uterine Fluid

**Samples of fluid from the vagina and uterus** reveal a mixed bacterial flora including *E. coli*, *F. necrophorum*, *T. pyogenes*, *Proteus* spp., *Staphylococcus* spp. and *Streptococcus* spp., with the predominant bacteria varying mainly with time since parturition. Generally, *E. coli* predominates in the first 5 days after parturition, whereas *F. necrophorum* and *T. pyogenes* predominate after the first 5 days in cattle with retained placenta. Uterine lochia of cattle with retained placenta had a much higher endotoxin concentration in the first 2 days postpartum than did lochia of healthy cattle or cattle that had undergone a dystocia but did not have retained placenta. Endotoxin was not detected in the plasma of cattle with high

lochial endotoxin concentrations, indicating effective systemic clearance.

### Other Samples and Tests

**Ketonuria** may occur in animals that are overconditioned and mobilize excessive quantities of depot fat, resulting in ketosis. **Liver function tests** reveal a decrease in liver function, which may be irreversible in excessively fat cows. A study evaluating the detection of the fetid smell of puerperal metritis indicated considerable subjectivity into the classification of healthy and diseased animals, whereas an instrument that acted as an “electronic nose” was more repeatable but not sufficiently accurate for on-farm use.<sup>11</sup> A subsequent reanalysis focusing on days 2, 5, and 10 using a proprietary algorithm suggested that test performance could be improved.<sup>12</sup>

### NECROPSY FINDINGS

The uterus is enlarged, flaccid and may contain several liters of dark brown, foul-smelling fluid with decomposed fetal membranes. The uterine mucosa is necrotic and hemorrhagic and the wall of the uterus is thickened and edematous. In severe cases, fibrin may be present on the serosal surface of the uterus. The liver may be enlarged and fatty and there is usually mild degeneration of the myocardium and kidneys. The presence of perineal, perivulvar, and perivaginal gelatinous or hemorrhagic edema along longitudinal vulvar, vaginal, cervical, and uterine body tears is suggestive of infection with *C. septicum*.<sup>13</sup>

### Fat Cow Syndrome

This is characterized by excessive body condition, anorexia to inappetence, ketonuria, a marked loss in milk production, decreased rumen movements, and delayed involution of the uterus. The temperature is usually normal but the heart and respiratory rates may be increased. The prognosis is poor in cows that are totally anorexic; those that are inappetent will usually recover after 5 to 7 days of supportive therapy.

### Acute Diffuse Peritonitis

This may occur in cows within a few days postpartum and is characterized by anorexia, toxemia, a spontaneous grunt, or one that can be elicited by deep palpation, rumen stasis, fever and the presence of an inflammatory exudate in the peritoneal fluid.

### Peracute and Acute Mastitis

This occurs in cows within a few days after parturition and is characterized by severe toxemia, swelling of the affected quarters, and abnormal milk.

## TREATMENT

### Conservative Therapy

Uncomplicated cases of retained fetal membranes without any evidence of clinical toxemia usually do not require parenteral or intrauterine treatment. The placenta is

typically retained for an average of 7 days. Cows with retained fetal membranes and tenesmus should be examined vaginally to ensure that there is no evidence of injury to the vagina or cervix. In cows with tenesmus, if the placenta is detached and loose it should be removed by careful traction. Forceful removal of the placenta should be avoided.

### Antimicrobial Agents

Cows with retained fetal membranes but **without systemic illness** should be monitored, but treatment with antimicrobial agents is not indicated. Antibiotic treatment with IV or IM oxytetracycline (10 mg/kg BW, daily) before placental shedding delays detachment of the placenta; this finding is consistent with the concept that intrauterine bacterial infection facilitates placental detachment.

Cows with retained fetal membranes **complicated by septic metritis and toxemia** should be treated with antimicrobial agents daily for several days or until recovery occurs. Death can occur in untreated animals. Because of the mixed bacterial flora in the postpartum uterus with a retained placenta, broad-spectrum antimicrobials are recommended. Procaine penicillin (22,000 U/kg BW intramuscularly every 12–24 h) and ceftiofur (1–2.2 mg/kg BW intramuscularly every 24 h) for 3 to 5 days are preferred treatments, with some support from clinical trials for the administration of ampicillin (10–11 mg/kg BW intramuscularly)<sup>14</sup> or oxytetracycline (11 mg/kg BW intravenously every 24 h) for 3 to 5 days. Ceftiofur increases the cure rate and milk yield and decreases rectal temperature when administered to dairy cows with fever and vaginal discharge or dystocia. Subcutaneous administration of ceftiofur (1 mg/kg BW) achieves concentrations of ceftiofur derivatives in uterine tissue and lochial fluid that exceeded the reported minimal inhibitory concentrations for common metritis pathogens. Treatment with a longer acting formulation of ceftiofur (ceftiofur crystalline free acid) subcutaneously into the base of the ear at 6.6 mg/kg may not provide an adequate duration of antibiotic concentration in endometrial tissue and lochia in cows with puerperal metritis, and current data do not support using this one-dose ceftiofur treatment regimen instead of daily subcutaneous ceftiofur injections for 3 to 5 days.<sup>15</sup> A recent randomized clinical trial indicated that the administration of ceftiofur crystalline free acid (6.6 mg/kg) subcutaneously twice into the base of the ear on days 0 and 3 was effective in treating puerperal metritis, with the second dose given in the opposite ear.<sup>16</sup> Care should be exercised when injecting ceftiofur crystalline free acid subcutaneously into the base of the ear because acute death has been associated with neurologic sequelae caused by intraarterial injection. Ampicillin increased the pregnancy rate and decreased the cure rate, compared with ceftiofur, in cattle that were also treated with intrauterine

ampicillin and cloxacillin. Generally, oxytetracycline use should be confined to the first 5 to 7 days postpartum when *E. coli* predominates, because it is likely to be ineffective against *T. pyogenes* in the endometrium. Oxytetracycline at 30 mg/kg BW intravenously as a single dose in cows with retained fetal membranes resulted in concentrations of the antimicrobial in uterine secretions, placenta, and cotyledon for 32 to 36 hours. Two intramuscular injections of regular formulations of oxytetracycline at 25 mg/kg BW resulted in lower peak concentrations, but these were maintained for 144 hours. Parenteral oxytetracycline appears to decrease endotoxin production, as indicated by the severity of leukopenia in cattle with retained placenta.

In **severely affected cases**, large amounts of balanced isotonic crystalloid fluids, electrolytes, and glucose by continuous intravenous infusion may be necessary and often result in a marked beneficial response within 24 to 48 hours. The uterus should always be examined by palpation per rectum and vaginally to determine the degree of uterine involution, the thickness of the uterine wall, the volume of the uterus, the nature of the luminal contents, and the degree of attachment of the placenta to the cotyledons. This can be done daily to assess progress. Uterine fluids should be drained by creating a siphon if sufficiently liquid in nature, although care must be taken to ensure that the tube does not penetrate a friable uterine wall. The placenta will invariably be expelled within 6 to 8 days, and usually within 4 to 6 days, if parenteral antimicrobial and supportive therapy is provided. The use of antimicrobial agents must be accompanied by appropriate withdrawal periods for the milk produced by treated animals.

### Intrauterine Medication

The necessity for intrauterine medication is controversial. There is limited evidence, if any, that the intrauterine infusion of antimicrobial agents with or without lytic enzymes and estrogens has any beneficial effect on the treatment of puerperal metritis. Nevertheless, a wide variety of antimicrobial agents have been used for intrauterine medication for retained placenta and metritis in cows, although generally  $\beta$ -lactam-resistant antibiotics should be administered because the uterine lumen can contain  $\beta$ -lactamase-producing bacteria. Intrauterine infusion of 0.5 g of the first-generation cephalosporin cephapirin improved the reproductive performance of cows with metritis, but only when administered after 26 days in milk. Intrauterine infusion of 1 g of the third-generation cephalosporin ceftiofur in 20 mL of sterile water once between 14 and 20 days of lactation had no effect on reproductive performance but decreased the risk of culling and increased the time to culling.

Tetracycline products (5–6 g) are commonly administered but should be administered as a powder dissolved in an appropriate volume of 0.9% NaCl, because vehicles such

as propylene glycol can irritate the endometrium. Intrauterine infusion of oxytetracycline decreases lochial odor and the incidence of fever in cattle with retained placenta. The combination of 8 g of oxytetracycline dehydrate (40 ml of solution) by intrauterine infusion through a disposable uterine catheter twice at 72 to 96 h apart and amoxicillin trihydrate (15 mg/kg BW intramuscularly every 48 hours for a total of three injections) increased conception rate at first insemination and percent pregnant at 150 days in milk compared with treatment with amoxicillin alone.<sup>17</sup> In cattle with retained placenta, intrauterine administration of a povidone-based oxytetracycline solution (5 g daily until expulsion) combined with fenprostalene (1 mg subcutaneously) did not alter the time to detachment of the placenta but increased the frequency of pyometra; this finding was consistent with the concept that intrauterine bacterial infection facilitates placental detachment. Milk from cows treated by intrauterine infusion of antimicrobial agents should be discarded for an appropriate period of time to avoid illegal residues. Generally, intrauterine treatment may achieve effective endometrial antibiotic concentrations, but antibiotic concentrations in deeper myometrial tissue are usually too low to be effective, hence, the preference for systemic treatment in cattle with puerperal metritis.

Intrauterine administration of antiseptics (0.5% povidone iodine, 0.1% chlorhexidine), hyperosmotic agents (7.2% NaCl solution, 50% dextrose), and proprietary organic formulations<sup>18</sup> as a lavage or infusion has been done, particularly on organic dairies, but studies with a negative control group demonstrating efficacy are lacking.

### Ancillary Treatment and Control

Portions of retained placenta protruding from the vagina should be wrapped in a plastic rectal sleeve to minimize wicking of fecal bacteria after defecation, although this supposition has not been verified. Alternatively, protruding remnants of placenta can be excised, although this may prolong to the time to expulsion because the decreased placental weight may interfere with traction on the remaining placenta in the uterine lumen. Complete manual removal is often requested by the producer but is not recommended because studies have not demonstrated its efficacy.

Nonsteroidal antiinflammatory drugs are often administered as part of the initial treatment of toxic metritis, purportedly to address fever and clinical signs of endotoxemia. The administration of one dose of the NSAID flunixin meglumine (2.2 mg/kg intravenously) at the start of treatment of puerperal metritis in dairy cows in addition to antibiotics did not improve the outcome compared with administration of antibiotics alone.<sup>19</sup> The addition of flunixin meglumine (1.1 mg/

kg, route not stated, daily for 3 days) to the treatment of puerperal metritis in dairy cows with parenteral ceftiofur (1 mg/kg, subcutaneously or intramuscularly [route of administration not clear] daily for 5 days) did not improve the clinical cure rate, serum or blood concentrations of inflammatory biomarkers such as serum amyloid A and fibrinogen, or the elimination of bacteria from the uterus.<sup>20</sup>

The infusion of collagenase solution (200,000 U dissolved in 1 L of 0.9% NaCl containing 40 mg calcium chloride and sodium bicarbonate) into the umbilical arteries within 12 hours of parturition is an effective treatment for retained placenta. Collagenase injection therefore provides an effective method for preventing septic metritis in cattle with retained placenta. However, the collagenase solution is expensive and not widely available, and the technique is difficult in some animals because of difficulty in identifying intact umbilical arteries for injection. As a result, collagenase injection is rarely performed in clinical veterinary practice. The efficacy of umbilical artery infusion with antimicrobial agents has not been adequately evaluated.

Ecbolic drugs have been proposed for the prevention and treatment of retained placenta in cattle. These include prostaglandins, ergot derivatives, oxytocin, and  $\beta_2$ -adrenoceptor antagonists. The rationale for their use is that they stimulate uterine contractions and physically aid in the expulsion of the fetal membranes. Generally, the consensus is that they are ineffective after the diagnosis of a retained placenta is recognized. However, their use may be effective if used immediately after calving. In particular, the frequent intramuscular administration of oxytocin appears to provide the most effective means of preventing metritis, with a recommended protocol of 20 IU every 3 hours for postpartum days 0 to 3, 30 IU every 2 hours for postpartum days 4 to 6, and 40 IU every 2 hours for postpartum days 7 to 10. A large study found that intramuscular injection of oxytocin (30 IU) immediately after parturition and 2 to 4 hours later decreased the incidence of retained placenta and the calving-to-conception interval. Fenprostalene at 1 mg subcutaneously, 25 mg dinoprost tromethamine intramuscularly, or 20 IU oxytocin given to a large number of dairy cows in five commercial dairy herds did not reduce the incidence of retained fetal membranes or improve reproductive performance. A detailed review failed to identify any evidence supporting the use of estrogen or prostaglandins in the first 7 to 10 days postpartum.<sup>21</sup>

The finding that retained placenta can be caused by neutrophil dysfunction at calving provides the basis for epidemiologic evidence that deficiency of trace minerals or vitamins (such as selenium and vitamin E) is associated with an increased incidence of

retained placenta. In regions deficient in selenium, supplementation of the diet up to 0.3 ppm can decrease the incidence of retained placenta in herds that are fed a total mixed ration. Selenium can also be administered by intraruminal boluses or parenteral administration of vitamin E/selenium preparations during the dry period.

Subcutaneous vaccination with protein subunits or inactivated bacterial components of *E. coli* (expressing the *fimH* virulence factor), *F. necrophorum* (producing the protein leukotoxin), and *T. pyogenes* (producing the protein pyolysin) can prevent puerperal metritis and result in improved reproductive performance.<sup>22</sup> It is anticipated that a commercial vaccine will be produced incorporating one or more of these agents.

### Identification of Affected Cows

Cows affected with retained placenta and puerperal metritis should be identified and recorded in the records system and examined 30 to 40 days after parturition for evidence of further complications such as pyometra.

## TREATMENT AND CONTROL

### Treatment

For cows with fetid smelling metritis and rectal temperature  $\geq 39.5^\circ\text{C}$ :

- Procaine penicillin (22,000 U/kg body weight [BW] intramuscularly [IM] every 12–24 h for 3–5 days). (R-1)
- Ceftiofur (1.1–2.2 mg/kg BW IM every 24 h for 3–5 days). (R-1)
- Ceftiofur crystalline free acid (6.6 mg/kg BW subcutaneously every 3 days for two treatments). (R-2)
- Ampicillin (10–11 mg/kg BW IM every 24 h for 3–5 days). (R-2)
- Oxytetracycline (11 mg/kg BW IV every 24 h for 3–5 days). (R-2)
- Oxytetracycline dihydrate (8 g) by intrauterine infusion twice at 72 to 96 h apart combined with amoxicillin trihydrate (15 mg/kg BW IM every 48 hours for a total of three injections). (R-2)
- Carefully siphon off voluminous uterine fluid. (R-2)
- Administer intrauterine treatment and manual removal of placenta. (R-3)
- Parenteral administration of nonsteroidal antiinflammatory drugs. (R-3)

For cows with metritis and rectal temperature  $< 39.5^\circ\text{C}$ :

- Monitor rectal temperature daily, institute treatment when temperature  $> 39.5^\circ\text{C}$ . (R-1)

### Control

- Ensure adequate vitamin E and selenium status. (R-1)
- Wrap retained placenta with palpation sleeve or remove placenta hanging from perineum. (R-2)



## FURTHER READING

- Beagley JC, Whitman KJ, Baptiste KE, Scherzer J. Physiology and treatment of retained fetal membranes in cattle. *J Vet Intern Med.* 2010;24:261-268.
- De Boer MW, LeBlanc SJ, Dubuc J, et al. Invited review: systematic review of diagnostic tests for reproductive-tract infection and inflammation in dairy cows. *J Dairy Sci.* 2014;97:3983-3999.
- LeBlanc SJ. Postpartum uterine disease and dairy herd reproductive performance: a review. *Vet J.* 2008;176:102-114.
- Reppert EJ. Evidence for the use of ceftiofur for treatment of metritis in dairy cattle. *Vet Clin North Am Food Anim Pract.* 2015;31:139-149.
- Sheldon IM, Lewis GS, LeBlanc S, Gilbert RO. Defining postpartum uterine disease in cattle. *Theriogenology.* 2006;65:1516-1530.

## REFERENCES

- Santos TM, Bicalho RC. *PLoS ONE.* 2012;7:e53048.
- Locatelli C, et al. *J Gen Appl Microbiol.* 2013;59:371.
- Bicalho MLS, et al. *Vet Microbiol.* 2012;157:125.
- Wagener R, et al. *Vet J.* 2014;202:527.
- Huzzey JM, et al. *J Dairy Sci.* 2007;90:3220.
- McNaughton AP, Murray RD. *Vet Rec.* 2009;165:615.
- Benzaquen ME, et al. *J Dairy Sci.* 2007;90:2804.
- Wenz JR, et al. *J Dairy Sci.* 2011;94:1864.
- Sannmann I, et al. *Theriogenology.* 2013;79:961.
- Burfeind O, et al. *Theriogenology.* 2014;82:121.
- Credille BC, et al. *J Vet Intern Med.* 2014;28:1606.
- Sannmann I, et al. *J Dairy Sci.* 2013;96:5773.
- Burfeind O, et al. *Theriogenology.* 2014;82:64.
- Odani JS, et al. *J Vet Diagn Invest.* 2009;21:920.
- Lima FS, et al. *J Dairy Sci.* 2014;97:5401.
- von Krueger X, et al. *J Dairy Sci.* 2013;96:1054.
- McLaughlin CL, et al. *J Dairy Sci.* 2012;95:4363.
- Armengol R, Fraile L. *Theriogenology.* 2015;83:1344.
- Pinedo PJ, et al. *J Dairy Sci.* 2015;98:3120.
- Drillich M, et al. *J Dairy Sci.* 2007;90:3758.
- Jeremejeva J, et al. *Acta Vet Scand.* 2012;54:45.
- Machado VS, et al. *PLoS ONE.* 2014;9(3):e91734.

## Hypovolemic, Hemorrhagic, Maldistributive, and Obstructive Shock

### SYNOPSIS

**Etiology** Shock caused by a reduction in venous return (circuit failure) secondary to hypovolemia, hemorrhage, maldistribution of blood or obstruction, to venous return.

**Clinical findings** Depression and weakness, subnormal temperature, elevated heart rate with weak thready pulse, cold skin and extremities, prolonged capillary refill time. Progressive development without aggressive fluid therapy and collapse and death from irreversible shock.

**Clinical pathology** Increased blood or plasma L-lactate concentration, decreased venous oxygen tension, evidence of multiple organ dysfunction. Decreased central venous pressure, low mean arterial blood pressure terminally. Changes in heart rate, activity level, and blood or plasma L-lactate

concentration indicate the efficacy of treatment.

**Necropsy findings** None specific for hypovolemic or maldistributive shock; the source of hemorrhage may be apparent in hemorrhagic shock.

**Diagnostic confirmation** Clinical signs, blood or plasma L-lactate concentrations, venous oxygen tension.

**Treatment** Aggressive fluid therapy based on intravenous isotonic crystalloid solutions and possibly colloid solutions. Blood transfusion or stroma-free hemoglobin administration for hemorrhagic shock. Initial treatment by rapid infusion with small-volume hypertonic saline solutions gives rapid but transient resuscitative effect. Antimicrobial agents and nonsteroidal antiinflammatory drugs in maldistributive shock caused by endotoxemia.

## ETIOLOGY

The circulatory system consists of a pump (the heart) and a circuit (the vasculature). Circulatory shock can result from abnormal functioning of the pump or circuit, or both. It is clinically very important to differentiate **pump failure** (cardiogenic shock caused by acute or chronic heart failure) from **circuit failure**, because the diagnosis and treatment of cardiogenic shock is vastly different from that of circuit shock. Cardiogenic shock is covered in detail in [Chapter 10](#), whereas circuit failure is addressed in the following section.

Circuit failure occurs whenever the cardiac output is reduced below a critical point because of inadequate venous return to the heart. There are four main ways that circuit failure occurs:

- Hypovolemic shock** occurs when there is a reduction in circulating blood volume caused by loss of blood, plasma, or free water.
- Hemorrhagic shock** occurs when there is a reduction in circulating blood volume caused by the rapid loss of blood.
- Maldistributive shock** occurs when there is a reduction in circulating blood volume caused by increased capillary permeability, pooling of blood in capacitance vessels (such as the veins in the splanchnic circulation), or pooling of plasma in a large third space such as the thoracic or abdominal cavities.
- Obstructive shock** occurs when there is an acute reduction in venous return caused by a mechanical obstruction, such as pericardial tamponade or pulmonary artery thrombosis. Obstructive shock is extremely rare in large animals.

Regardless of the initiating cause for circuit failure and inadequate venous return, tissue hypoperfusion results, leading to impaired oxygen uptake and anaerobic metabolism.

The end result of inadequate tissue perfusion is the development of multiple organ failure, L-lactate acidemia, and strong ion (metabolic) acidosis, manifested as the **hypodynamic stage** of shock. Hypovolemia and poor tissue perfusion result in cold extremities, elevated heart rate, a weak thready pulse, decreased capillary refill times, and altered mental status. Cardiac arrhythmias may occur because of myocardial ischemia and electrolyte and acid-base disturbance. There is anorexia and gastrointestinal stasis. Signs of renal failure include anuria or oliguria and azotemia.

Common causes of circuit failure in large animals are as follows.

### Hypovolemic Shock

- Fluid loss and dehydration, such as in neonatal calf diarrhea and burn injury, especially when fluid loss is severe and rapid
- Fluid loss into the gastrointestinal tract caused by acute intestinal obstruction

### Hemorrhagic Shock

Acute hemorrhage with loss of 35% or more of total blood volume, equivalent to an acute blood loss of 2.8% of BW (assuming blood volume is 8% of BW) will lead to clinical signs of severe hemorrhagic shock. In contrast, acute hemorrhage with loss of less than 10% of total blood volume (equivalent to an acute blood loss of less than 0.8% of BW) produces minimal detectable clinical changes.

Traumatic injury or spontaneous rupture of a large blood vessel are common reasons for acute hemorrhage. Any sort of minor surgical wound, e.g., castration or dehorning, may lead to excess hemorrhage after which there is a hemorrhagic tendency caused by defects of clotting. Some of the more common causes of hemorrhagic shock are as follows.

### Cattle, Sheep, and Goats

- Spontaneous pulmonary hemorrhage associated with caudal vena caval syndrome
- Abomasal ulcer, sometimes originating from a bovine viral leukosis lesion (cattle)
- Enzootic hematuria with bleeding from a bladder lesion (cattle)
- Pyelonephritis with bleeding from a renal lesion (cattle)
- Intraabdominal hemorrhage as a result of arterial aneurysm, possibly associated with copper deficiency (cattle)
- Laceration of arteries in the wall of the vagina as a result of dystocia
- Ruptured middle uterine artery during uterine prolapse or torsion of uterus
- Cardiac tamponade caused by rupture of the coronary artery or ventricular chamber, rupture of the aorta (see [Chapter 1](#))



- Rupture of liver associated with dystocia in lambs, and in older lambs possibly associated with vitamin E deficiency

### Horses

- Ethmoidal hematoma
- Exercise-induced pulmonary hemorrhage
- Rupture of the middle uterine, uteroovarian (especially right side), or iliac artery associated with parturition, more commonly in aged mares
- Nasal bleeding from hemorrhage into the guttural pouch, from carotid or maxillary arteries with guttural pouch mycosis or associated with rupture of the longus capitis muscle following trauma
- Rupture of mesenteric arteries secondary to strongyle larval migration
- Splenic hematoma or rupture following blunt trauma
- Rupture of liver with hyperlipemia
- Hemangioma, hemangiosarcoma, squamous cell carcinoma of the stomach, and other neoplasia
- Persistent bleeding from the vulva in association with ulcerated varicose veins on the dorsal wall of the vagina
- Congenital venous aneurysm (rare)

### Pigs

- Esophagogastric ulceration
- Proliferative hemorrhagic enteropathy
- Rupture of liver in hepatosis dietetica
- Congenital neonatal bleeding, e.g., umbilical hemorrhage

### Maldistributive Shock

- Endotoxemia in neonatal septicemia, salmonellosis, coliform mastitis in lactating dairy cattle, toxic metritis in cattle
- Septic shock caused by gram-positive bacterial septicemia
- Too sudden reduction of pressure in a body cavity, e.g., by rapid withdrawal of ascitic fluid

### Obstructive Shock

- Pericardial tamponade

## PATHOGENESIS

### Hypovolemic Shock

When cardiac output falls as a result of decreased venous return, the carotid and aortic baroreceptors stimulate the sympathetic nerves and adrenal medulla to release catecholamines resulting in vasoconstriction in vessels with  $\alpha$ -adrenergic receptors. Vasoconstriction leads to **decreased renal perfusion**, which activates the RAAS, inducing sodium and water retention. The decrease in renal perfusion can result in renal ischemia and nephrosis if the ischemia is sufficiently severe and prolonged (see Chapter 13). Hypovolemia also stimulates the release of antidiuretic hormone (vasopressin). There is

contraction of the spleen and venous capacitance vessels, an increased peripheral vascular resistance, and an increase in heart rate in an attempt to maintain cardiac output and blood perfusion through the coronary and cerebral blood vessels.

Water shifts from the interstitial space to the vascular space in response to the contraction of precapillary arterioles. In the initial stages of hypovolemic failure the primary signs are those of interstitial fluid depletion and dehydration, with dry mucous membranes, sunken eyes, and decreased skin turgor. Peripheral vasoconstriction in the face of continued hypovolemia and falling cardiac output results in the opening of arteriovenous shunts and decreased perfusion of organ systems, with resultant damage from hypoxia and tissue acidosis and the development of clinical signs of peripheral vascular failure and shock. Arterial blood pressure falls terminally, and a decrease in mean arterial pressure indicates a complete lack of cardiovascular reserve. The rate at which hypovolemia develops profoundly affects the outcome because compensatory mechanisms are more readily overcome by acute than chronic changes.

### Hemorrhagic Shock

The major effects of hemorrhage are loss of blood volume (hypovolemic shock), loss of plasma protein (decreased plasma oncotic pressure), and loss of erythrocytes (decreased oxygen-carrying capacity and buffering capacity).

With acute and severe hemorrhage, the rapid loss of blood volume results in hypovolemic shock and the loss of erythrocytes in anemic anoxia. The combination of these two factors is termed hemorrhagic shock and is often fatal. With less severe hemorrhage, the normal compensatory mechanisms, including release of blood stored in the spleen and liver and the withdrawal of fluid from the tissue spaces, may maintain a sufficient circulating blood volume, but the anemia is not relieved and the oncotic pressure of the blood is reduced by dilution of residual plasma protein. The resulting anemia and edema are repaired with time provided the blood loss is halted.

### Maldistributive Shock

In normal animals the healthy intestinal mucosa is an effective barrier to the absorption of endotoxin that is present in the gut, and the small amounts of endotoxin that are absorbed into the portal blood are cleared by the liver and do not reach the systemic circulation. When the integrity of the intestine is compromised by factors such as ischemia, trauma, or inflammation, sufficient endotoxin can be absorbed to overwhelm the clearance mechanisms of the liver, and endotoxin may also leak to the peritoneal cavity, gaining access to the systemic circulation. Endotoxin can also be absorbed from sites of

local infection, as with diffuse peritonitis, coliform mastitis, and toxic metritis, or released from gram-negative bacteria in the bloodstream. Intestinal mucosal integrity is lost in the terminal stages of circulatory shock caused by tissue hypoxia, and endotoxin translocation from the intestinal tract is markedly increased in the terminal stages of shock, independent of the initiating cause.

Endotoxin and other bacterial toxins cause direct endothelial damage. Endotoxin also activates macrophages and neutrophils provoking the release of a multitude of **inflammatory mediators**, including TNF, IL-1, IL-6, and platelet-activating factor, which lead to endothelial damage, leaky vessels, hypotension and vasculitis, and eventually decreased intravascular volume. Inadequate perfusion of tissue with appropriately oxygenated blood impedes oxidative cellular metabolism and leads to the release of arachidonic acid, which is metabolized by the cyclooxygenase pathway to yield prostaglandins and thromboxane  $A_2$  or by the lipoxygenase pathway to yield leukotrienes. These **eicosanoids** are potent vasoactive compounds. They can act locally or be carried in the circulation to act at distant sites to further adversely affect vascular reactivity and vascular permeability. Endotoxin itself also provokes increased synthesis and release of eicosanoids, and many of the early effects of endotoxin are mediated by these metabolites of arachidonic acid.

A further consequence to tissue hypoxia is damage to endothelium with exposure of collagen; tissue thromboplastin can initiate the intrinsic and extrinsic coagulation cascades, leading to damage to other organ systems and further complications from the development of coagulopathies, including DIC, which may be central to the development of irreversible shock.

In the early **hyperdynamic stage** of endotoxemia and sepsis, there is an increased oxygen demand by peripheral tissue and an increase in heart rate and cardiac output with pulmonary and systemic vasoconstriction. Pulmonary hypertension increases transvascular fluid filtration in the lung, and pulmonary edema can develop when hypertension is accompanied by increased vascular permeability. There is systemic arterial hypoxemia caused by ventilation-perfusion inequalities in the lung and, despite the increase in cardiac output, blood flow may be inadequate to meet the needs of tissue in a hypermetabolic state. The **late hypodynamic stage** of endotoxemia and sepsis is characterized by decreased venous return, decreased cardiac contractility, decreased cardiac output and oxygen delivery, systemic arterial hypoxemia, and decreased mean arterial pressure.

### Obstructive Shock

In severe pericardial tamponade, the rapid increase in pericardial fluid volume impedes

diastolic filling of the heart, resulting in decreased cardiac output. A similar response occurs in advanced traumatic reticulopericarditis in cattle that have ingested a wire; however, in the latter condition the obstruction is slow to develop.

### CLINICAL FINDINGS

Depression, weakness, and listlessness are accompanied by a fall in temperature to below normal. The skin is cold and skin turgor is decreased. The mucosae are pale gray to white and dry, and capillary refill time is extended beyond 3 to 4 seconds.

There is an increase in heart rate to 120 to 140 beats/min in horses and cattle, with abnormalities of the pulse including small and weak pressure amplitudes (manifested as a “thready” pulse). Cardiac arrhythmias are present terminally. Venous blood pressure is greatly reduced in hypovolemic and hemorrhagic shock and the veins are difficult to raise in response to obstruction. Arterial blood pressure, measured either directly by arterial puncture or by indirect oscillometric methods, is decreased terminally and fails to provide an early indicator of the severity of the circulatory failure.

Anorexia is usual but thirst may be evident and there is anuria or oliguria. Nervous signs include depression, listlessness and obtusion, and coma in the terminal stages.

**During the early hyperdynamic stage** of maldistributive shock the temperature is normal or elevated, mucous membranes are injected and brick-red in color, there is tachycardia but normal capillary refill time, and the extremities (particularly ears) are cool to the touch. Although these signs are not specific for shock, the recognition of this stage in animals that are at risk for maldistributive shock, such as the neonate or animals with early signs of acute intestinal accident, can allow the early institution of therapy, which will frequently result in a better outcome than therapy instituted when the later stages of shock have manifested.

**Therapeutic reversal** of maldistributive shock in its later stages is difficult. In contrast, circulatory failure that is a result of hypovolemic or hemorrhagic shock is relatively easily treated and can be successfully reversed, even at stages of profound depression.

### CLINICAL PATHOLOGY

The use of clinical pathology is directed at determining the cause and severity of shock and at monitoring the effectiveness of therapy. Volume expansion and restoration of tissue perfusion will usually correct acid-base and strong ion (metabolic) acidosis in the majority of animals with shock, and abnormalities are addressed once fluid balance is established.

Examination of the blood to determine the hematocrit and plasma protein

concentration is invaluable in indicating the magnitude of the blood loss in hemorrhagic shock and providing a clinically useful index to the progress of the disease. However, there can be a **delay in the fall** of the hematocrit following hemorrhage for up to 4 to 6 hours because splenic contraction temporarily augments circulating red cell numbers. The hematocrit and plasma protein concentrations usually fall to their lowest levels 12 to 24 hours following hemorrhage, and determination at this time provides a clinically useful index of the amount of blood lost. Signs of a regenerative response (increased hematocrit, presence of reticulocytes, and increased red blood cell volume) should be seen within 4 days of an acute hemorrhage in ruminants and pigs but cannot be used as a guide in the horse. Generally, the hematocrit increases by 1% per day following acute hemorrhage in ruminants.

**Abdominocentesis, thoracocentesis, and ultrasound** are used to identify sites of internal bleeding. **Thrombocyte and clotting factor** examinations are indicated in cases in which unexplained spontaneous hemorrhages occur.

### Monitoring in Shock

**Clinical parameters** of heart rate, pulse character, mucous membrane color, temperature of the extremities (particularly the ears), and activity level provide extremely useful guides to the efficacy of treatment when performed serially over time. The single most valuable index is the **heart rate**, although, in animals housed in a stable ambient temperature, **peripheral skin temperature** is also a useful clinical guide but not during rapid intravenous fluid administration, because there is a thermal lag of at least 30 minutes before increased blood and heat flow to the periphery is manifested as an increase in skin surface temperature. **Blood or plasma L-lactate concentration** and **venous oxygen tension** provide the most useful measures of the adequacy of oxygen delivery and tissue perfusion and therefore the efficacy of treatment. These two laboratory parameters are much more informative than measurement of **central venous pressure** or **mean arterial blood pressure**, and blood pressure measurement is discussed mainly for historical interest.

**Blood or plasma L-lactate concentration**, preferably measured in arterial blood or blood from a large vein such as the jugular vein, provides an indication of prognosis and an even more valuable serial measure of the efficacy of treatment. In general terms, plasma L-lactate concentrations are normally less than 1.5 mmol/L and fluctuate slightly depending on diet and time since feeding. Plasma L-lactate concentrations of more than 4 mmol/L indicate the presence of widespread anaerobic metabolism and the need for aggressive therapy, and plasma L-lactate concentrations above 10 mmol/L

are associated with a high mortality in humans, pigs, cattle, and horses. Blood L-lactate concentrations are increased in cows with abomasal volvulus; however, blood lactate concentration did not provide an accurate prognostic indicator for survival. Generally, it is the **change in plasma L-lactate concentration after initiation of therapy** that provides the most useful guide to treatment. This change may be monitored by the actual plasma L-lactate concentration or the area under the plasma L-lactate concentration-time relationship. In particular, failure to decrease the plasma L-lactate concentration despite aggressive and appropriate therapy is a poor prognostic sign.

**Venous blood oxygen tension ( $P_{O_2}$ )**, preferably measured in a large vein such as the jugular vein, provides an indication of the adequacy of oxygen delivery and is a useful guide to the efficacy of treatment. In general terms, venous  $P_{O_2}$  is normally 35 to 45 mm Hg, arterial  $P_{O_2}$  is normally 90 mm Hg, and the difference between the venous and arterial  $P_{O_2}$  depends on the amount of oxygen extracted by tissues. The oxygen extraction ratio increases in tissues receiving inadequate blood flow as a consequence of the inadequate oxygen delivery; this results in an increased difference between arterial  $P_{O_2}$  and venous  $P_{O_2}$  and a lower value for venous  $P_{O_2}$ . **Venous  $P_{O_2}$  below 30 mm Hg** indicates inadequate oxygen delivery and the need for aggressive therapy, such as hemoglobin in erythrocytes or stroma-free solution in hemorrhagic shock and plasma volume expansion in hypovolemic and maldistributive shock. A venous  $P_{O_2}$  below 25 mm Hg indicates severe abnormalities in oxygen delivery, and venous  $P_{O_2}$  below 20 mm Hg indicates impending death. Aggressive resuscitation should always increase venous  $P_{O_2}$  to more than 40 mm Hg, and failure to substantially increase venous  $P_{O_2}$  despite aggressive and appropriate therapy is a poor prognostic sign.

**Central venous pressure (CVP)** is another measure of hypovolemia, but individual measurements can be misleading and serial measurements should be used. By definition, CVP can only be measured by a catheter placed in a blood vessel within the thorax (typically the cranial vena cava), because this permits measurement of negative values for CVP. Central venous pressure is frequently measured in the jugular vein through a short intravenous catheter; this pressure is more correctly termed jugular venous pressure and, because it cannot be negative, is of much less clinical value than measuring CVP in shocked animals. A general rule of thumb in horses is to administer fluids as long as the CVP remains below 2 cmH<sub>2</sub>O (0.2 kPa), and to immediately discontinue fluid administration whenever CVP exceeds 15 cmH<sub>2</sub>O (1.5 kPa). The main clinical utility of CVP measurement is

ensuring that volume overload is not occurring. More details on measuring CVP are available in [Chapter 10](#).

**Mean arterial blood pressure** is an insensitive but specific method for determining the severity of shock and the efficacy of therapy, because mean arterial blood pressure only decreases in the terminal stages of shock, indicating a complete lack of cardiovascular reserve. More details on measuring mean arterial blood pressure are available in [Chapter 10](#).

## NECROPSY FINDINGS

In **hemorrhagic shock** there is extreme **pallor** of all tissues, and a thin **watery appearance of the blood** may be accompanied by large extravasations of blood if the hemorrhage has been internal. When the hemorrhage has been **chronic**, anemia and edema are characteristic findings. In obstructive shock there is a large increase in pericardial fluid (usually blood), or the presence of a large thrombus in the cranial or caudal vena cava or pulmonary circulation, or evidence of severe abdominal distension (such as in ruminal tympany). There are **no specific findings** in hypovolemic or maldistributive shock, although in maldistributive shock the capillaries and small vessels of the splanchnic area may be congested and there may be evidence of pulmonary edema. With death from septic shock the major findings relate to the changes as evidence of pulmonary edema. With death from septic shock the major findings relate to the changes associated with the infectious disease. Dehydration is evident in animals dying from hypovolemic shock.

## DIFFERENTIAL DIAGNOSIS

Circulatory failure caused by a circuit abnormality can be diagnosed when there is no detectable primary cardiac abnormality and when a primary cause such as hemorrhage, dehydration, or endotoxemia is known to be present. Ideally, endotoxemic or septic shock should be diagnosed in its early hyperdynamic stage and aggressively treated at this stage. This requires knowledge of the risks for shock with various conditions in each of the animal species. Hypovolemic, hemorrhagic, or maldistributive shock should be anticipated:

- In septicemic disease, especially of the neonate
- In acute localized infections
- With intestinal disease, but especially with those in the horse that have acute intestinal accident as part of the differential diagnosis
- When severe trauma occurs
- Where there is severe fluid loss for any reason
- Where decompression of an area is to be practiced (i.e., removal of fluid from a body cavity)
- When there is to be a significant surgical procedure

## TREATMENT

### Identification of Cause

The identification and, if possible, the immediate elimination of the precipitating cause of the shock is important in cases in which circulatory failure is initiated by conditions that are amenable to surgical correction. Prompt surgical intervention coupled with aggressive fluid therapy may save an animal, whereas delaying surgery until shock is advanced is almost always followed by fatality. This requires a full clinical examination and often ancillary laboratory examination to accurately identify the cause.

The identification of cause will also give some indication of the likelihood of success in treatment. Generally, there is greater success in the treatment and management of hypovolemic and hemorrhagic shock, especially if treatment is instituted early in the clinical course. Effective treatment and management of maldistributive shock is less successful unless the sepsis can be controlled and the source of the endotoxemia eliminated.

### Hypovolemic and Maldistributive Shock

The rapid administration of intravenous fluids is the single most important therapy in animals with hypovolemic or maldistributive shock. The goal is to increase venous return, restoring circulatory function and tissue perfusion. Crystalloid solutions (fluids that contain electrolytes) and colloid solutions (fluids that increase the plasma oncotic pressure and expand plasma volume) can be used. The general principles and practice of fluid therapy are extensively discussed in [Chapter 5](#).

### Isotonic Crystalloid Solutions

These are the least expensive and most commonly used treatments for hypovolemic and maldistributive shock in large animals. Balanced electrolyte solutions, such as lactated Ringer's solution, are preferable to 0.9% NaCl solutions. Fluids for the restoration of the extracellular fluid volume must contain sodium, but glucose solutions (fluids that provide free water when the glucose is metabolized) are not indicated in the treatment of shock. **Large volumes** of isotonic crystalloid fluids are required. There is no set dose and each case needs to be assessed individually; an initial administration of 1\00 mL/kg by rapid intravenous infusion is not unusual and 50 mL/kg is probably the minimum. Isotonic crystalloid solutions expand the interstitial fluid volume and promote urine flow; however, beneficial responses are absent shortly after the cessation of fluid administration unless the syndrome is resolved.

More fluids are administered as required on the basis of clinical response and the monitoring measures discussed earlier; generally, this involves continuous intravenous

infusion during the clinical course. In calves, ruminants, and horses the reestablishment of adequate tissue perfusion by intravenous fluid therapy can often be sustained by oral administration of large volumes of electrolyte solutions.

The disadvantages of the use of isotonic crystalloid solutions are the large volume required for treatment, the requirement for repeated treatment, and a sustained increase in pulmonary artery pressure with the risk for production of pulmonary edema in animals with maldistributive shock caused by endotoxemia. Moreover, the delivery of large volumes of isotonic fluid to large animals takes time and is difficult to accomplish in the field. This has led to the widespread use of **small-volume hypertonic saline solutions** for the initial resuscitation of shocked animals. The intravenous administration of small volumes of hypertonic salt solutions results in a transcompartmental and transcellular shift of fluid into the vascular compartment, with an increase in the circulating volume, cardiac output, and stroke volume and an increase in blood pressure with a reduction in peripheral and pulmonary vascular resistance. However, there is little improvement in renal function, the improvement in hemodynamic function is very **short lived**, and their use must be followed by intravenous isotonic crystalloid fluids.

### Hypertonic Saline Solution

This has been used successfully in fluid therapy of hypovolemic, maldistributive, and hemorrhagic shock and is of value for the rapid resuscitative effect and the lower risk for induction of pulmonary edema in animals with endotoxemia. Small volumes (4–5 mL/kg) of hypertonic saline (7.2%, 2400 mOsm/L) are infused intravenously over 4 to 5 min, and the animal is allowed access to fresh water immediately upon completion of the injection.<sup>1</sup> Too rapid an infusion will result in vasodilation and death and too slow an infusion will diminish the resuscitative effect. There is a risk of phlebitis if there is perivascular deposition of hypertonic fluid. Hypertonic sodium lactate solution has been shown to improve fluid balance and mean arterial pressure in pigs with experimentally induced endotoxemic shock.<sup>2</sup>

### Colloids

The intravenous administration of colloid solutions (plasma, dextran, gelatin polymers, and hydroxyethyl starches) induces a more sustained increase in plasma volume than crystalloid solutions and smaller volumes are required for therapy, but colloid solutions are expensive and are rarely used in cattle and occasionally used in horses, with the exception of blood transfusion. Hydroxyethyl starches, such as hetastarch and tetrastarch, can interfere with coagulation but for the most part the effects are minor and clinically



inapparent.<sup>3</sup> Colloid solutions also have a risk for the induction of pulmonary edema and may also increase risk for coagulopathy. For horses, equine plasma is available commercially but is expensive. The use of hypertonic saline in combination with colloids or infusions containing albumin gives a more sustained response and hypertonic saline-dextran solution (2400 mOsm/L sodium chloride with 6% Dextran 70) at a dose of 5 mL/kg is more effective than hypertonic saline alone.

### Hemorrhagic Shock

The source of the hemorrhage should be determined and the cause corrected. The other immediate concern is to replenish the blood volume and a decision must be made if this will be with fluids, whole blood, or stroma free hemoglobin solutions. Blood transfusion replaces all elements of the blood and in cases of severe hemorrhage blood transfusion is the most satisfactory treatment. However, a decision for **blood transfusion** should not be made lightly because the procedure is time-consuming, costly, and carries some risk. The decision to use whole blood in addition to fluids for treatment is based on the need to replace erythrocytes. The hematocrit can be a guide, in combination with clinical assessment, if the hemorrhage started at least 4 hours previously. With acute hemorrhage (<4 hours), transfusion is indicated solely on the basis of the severity of clinical signs. In the period immediately following hemorrhage a hematocrit of 20% is indicative of a significant loss of erythrocytes and the hematocrit should be monitored over the next 24 to 48 hours. If there is a fall to less than 12%, a transfusion of blood is indicated, but a stable packed cell volume (PCV) between 12% and 20% is not usually an indication for transfusion.

The best **anticoagulant** for immediate **blood transfusion** is **sodium citrate**, which is widely available and inexpensive. Citrate complexes calcium and inhibits coagulation; as such the amount of sodium citrate mixed with a volume of blood must be accurately known because excess sodium citrate will induce hypocalcemia when collected blood is transfused into the recipient. Sodium citrate (purchased as a white powder) is dissolved in sterile water to provide a stock solution of 3.85% (weight/volume), which can be autoclaved; the stock solution is subsequently mixed at one part solution to nine parts blood. As an example, 500 mL of 3.85% stock sodium citrate solution is placed at the bottom of a glass bottle and 4.5 L of blood collected to provide a final blood volume of 5 L. Approximately 20 mL of blood for each kg BW can be safely collected from a healthy blood donor (equivalent to 10 L from a 500-kg horse or cow). Do not exceed this volume of collection from the donor, because 40 mL of blood for each kg BW can be lethal. Heparinized blood is not recommended for

immediate transfusion because heparin has a much longer half-life in domestic animals than citrate; consequently, if hemorrhage is not controlled there is the potential for heparin to facilitate additional blood loss.

If blood transfusion is to be delayed, then **acid citrate dextrose (ACD)** also known as anticoagulant citrate dextrose is widely recommended based on the addition of dextrose, which purportedly supports erythrocyte metabolism. The beneficial effect of dextrose has probably been overemphasized in domestic animals relative to humans, because human erythrocytes have a similar glucose concentration to plasma. In contrast, erythrocytes from adult domestic animals have a glucose concentration that is much lower than that in plasma and, consequently, a much lower rate of glucose metabolism,<sup>4</sup> potentially minimizing the need for additional glucose. Enthusiastic supporters of using ACD solution can purchase commercial plastic collection kits (usually 450 mL) with the appropriate volume of ACD solution present, but this becomes expensive when contemplating transfusion of an adult horse or cow. Alternatively, 3.6 mL of 50% dextrose solution, 1.6 g of sodium citrate, and 0.5 g citric acid can be dissolved in distilled water to a total volume of 50 mL, which is sufficient to collect 450 mL of blood.

The blood donor should be healthy and easily restrained during collection and free of infectious agents that can be transferred during blood transfusion, including prions. Crossmatching is not routinely performed in cattle, sheep, goats, or alpacas/llamas because these species have a large number of blood group factors and transfusion reactions are rare on the first transfusion. Consideration regarding crossmatching is required in these species if the animal in hemorrhagic shock has been previously transfused; however, often the results are not available fast enough to impact the decision to transfuse animals in shock. Crossmatching is routinely performed in horses if available in a timely manner because the incidence of incompatibility on the first transfusion is much higher in this species. The incidence of adverse events during transfusion in horses was 16% (7/44), characterized by mild urticarial reactions, acute anaphylactic shock, and exacerbation of intravascular hemolysis.<sup>5</sup> Five of the seven horses had some level of incompatibility on major or minor crossmatching, confirming that crossmatching would be beneficial if there is sufficient time and the test is available.

The jugular vein (or both veins) should be aseptically prepared and a bleb of 2% lidocaine placed under the skin to facilitate creating a 5-mm long stab incision through the skin over the site of the jugular vein in the midcervical region (the skin is moved dorsally away from the vein while making the incision). The jugular vein should be

distended by application of a knotted rope around the distal cervical region so the knot occludes the jugular vein and facilitates sustained venous distention. A sterilized **12-gauge bleeding trocar** is then placed through the incision and advanced into the lumen of the jugular vein until the hub of the trocar is at skin level. Blood is collected directly into the glass jar as it flows freely, with gentle swirling of the jar contents to mix collected blood with citrate and minimize clot formation. The addition of a connecting tube from the bleeding trocar to the glass jar is not recommended because such tubes usually result in a narrowing of the blood flow with marked slowing of blood collection. Collection of blood into plastic bags is preferred to collection into glass bottles because hemolysis is decreased and clotting factors are maintained and the plastic bag is not easily broken when dropped; however, suitably sized plastic bags may not be readily available. At the completion of blood collection, sustained venous distention is released, the bleeding trocar removed, and one or more sutures are placed in the skin over the site of venipuncture to facilitate hemostasis. The bleeding trocar must be thoroughly cleaned and sterilized after use because plasma adheres tenaciously to the lumen of the trocar; the presence of foreign plasma protein will promote clotting and decreased luminal volume and flow rate when the trocar is used to collect blood from a different animal.

Blood should be administered to the recipient intravenously with an in-dwelling 14-gauge catheter through a commercially available in-line filter that will trap small blood clots. A test administration of 20 mL of blood should be administered and the animal monitored for clinical signs of anaphylaxis, including tachypnea, tachycardia, urticaria, and edema. If these signs are observed the blood transfusion should be immediately stopped. Administration of blood at too rapid a rate may cause overloading of the circulation and acute heart failure, particularly in animals with both circuit and pump failure. An infusion rate of 10 to 20 (mL/kg BW)/h is recommended and 5 to 10 L of blood usually requires an hour to administer to a cow or horse.

**Hypertonic saline** solution is recommended in the initial treatment of hemorrhagic shock and has been shown to be effective in the treatment of experimental hemorrhagic shock in large animals. Hypertonic saline can be of particular value to the ambulatory clinician, because this therapy can be used in emergency situations for the initial resuscitation of cases of hemorrhagic shock pending transfusion. A further advantage to the ambulatory clinician is the ease of portability of this fluid. The use of hypertonic saline is contraindicated when the hemorrhage has not been controlled, because its use in these cases will result in more protracted bleeding.



Drugs to assist coagulation and arrest hemorrhage are used in some cases, but there is limited information on their efficacy. **Aminocaproic acid** (10 g in 1 L of saline for an adult horse, administered intravenously) has been recommended for the management of hemoperitoneum in the horse. **Formalin** has traditionally been used to control hemorrhage and 10 mL of a 37% solution of formaldehyde or 30 to 150 mL of buffered 10% formalin in 1 L of 0.9% NaCl solution administered rapidly intravenously through an intravenous catheter has been recommended for the control of hemorrhage in horses; however, administration of formaldehyde at levels that did not induce an adverse reaction did not alter measured hemostatic variables in healthy horses. Formaldehyde treatment for hemostasis cannot be recommended for use in horses with the current available data. However, administration of a 5% solution of formalin to healthy goats (at 1.1 mL/kg intravenously) had a transient but detectable effect on decreasing both clotting time and bleeding time. This suggests that the effect of intravenous formalin on hemostasis may be dose dependent, and the optimal dose has yet to be identified in horses. **Ergonovine maleate**, 1 to 3 mg intramuscularly at 3-hour intervals, has also been used to control hemorrhage in the postparturient mare.

Animals should be kept quiet and in a dark stall to minimize excitement and the risk of further hemorrhage. Analgesic drugs should be given with hemorrhagic disease when there is pain, such as rupture and hemorrhage of the broad ligament of the uterus.

### Obstructive Shock

The source for the obstruction should be identified and specific remedies applied. Obstructive shock is a rare cause of shock in large animals.

### Ancillary Treatment

A large number of drugs have been shown to influence various components of the inflammatory response in septic shock, but none has been shown to alter the eventual outcome, and the interference of one aspect of the inflammatory cascade triggered by endotoxin should not be expected to improve overall survival. The specific treatment of maldistributive shock has been discussed earlier in this chapter.

### Corticosteroids

There is considerable controversy over the use of corticosteroids in shock. Experimental studies have shown that they may have value in the prevention of maldistributive shock, but for this to occur corticosteroids must be given before the bacterial or endotoxin challenge. There is little evidence that they are of value in the treatment of hypovolemic, hemorrhagic, or maldistributive shock in animals once clinical signs have developed. Despite

this, corticosteroids are frequently used in the treatment of shock in animals. The dose that is used is considerably higher than that used for other indications, for example, a dose of 1 to 2 mg/kg BW of dexamethasone intravenously, which is expensive in adult cattle and horses.

### Cyclooxygenase Inhibitors

The use of cyclooxygenase inhibitors such as IV flunixin meglumine (0.25 mg/kg BW) and IM ketoprofen (0.5–2.2 mg/kg BW) has attractions in that they inhibit the production of the vasoactive prostaglandins and thromboxane A<sub>2</sub>. This may not be entirely advantageous because the alternate path of metabolism of arachidonic acid is to leukotrienes, which are also potent mediators of inflammation. Treatment of horses with endotoxemia with cyclooxygenase inhibitors does result in a better maintenance of blood pressure and tissue perfusion but does not influence the eventual mortality. Tirilazad mesylate suppresses eicosanoid production and TNF- $\alpha$  activity and has been shown to be of benefit in the treatment of experimental endotoxemia in calves.

### Antibiotic Therapy

With maldistributive shock the appropriate antibiotic therapy should be immediately instituted. Antibiotic therapy will not counteract the immediate effects of endotoxin and may theoretically increase the release of endotoxin in the short term, but this should not be a contraindication to antibacterial therapy. Pending the result of bacterial culture and susceptibility testing a broad-spectrum bactericidal antibiotic, or a combination of antibiotics to achieve a broad spectrum, should be used. Gram-negative septicemia in calves or foals, or acute–diffuse peritonitis, must be treated with antibiotics as well as by aggressive fluid therapy if there is to be any chance of survival.

### Vasoconstrictors and Vasodilators

The administration of vasoconstrictors and vasodilators in cases of shock remains problematic unless the patient's cardiovascular status is accurately known and can be continuously monitored. Generally, their use is not currently recommended. The administration of a vasoconstrictor substance in a case of low-pressure distributive shock might seem rational because blood pressure would be elevated but it could reduce tissue perfusion still further.  $\alpha$ -Adrenergic blockers improve tissue perfusion and cardiac function once the circulating blood volume has been restored, but if hypotension is already present it will be further exacerbated. Dopaminergic agonists may be useful in the early stages of maldistributive shock as long as monitoring is adequate. This is seldom possible in large-animal ambulatory practice and their use in large animals is confined to referral hospitals.

### Immunotherapy

Immunotherapy with antibody directed against the **core lipopolysaccharide antigens** of gram-negative bacteria may be of value in the therapy or prevention of shock produced by endotoxin in some diseases but not in others. Immunotherapy has shown some promise in the treatment of shock associated with experimental endotoxemia in horses but none for the control of maldistributive shock associated with gram-negative sepsis in the neonate. Hyperimmune serum is available commercially and may be indicated in those cases when endotoxemia is a risk, in which case it is given before the onset of severe signs. Vaccination with these antigens has proved of value in the reduction of clinical disease produced by endotoxemia and in a reduction of the occurrence of endotoxin-induced shock associated with gram-negative mastitis in cows, although it does not reduce the occurrence of infection of the udder.

### FURTHER READING

- Balcomb C, Foster D. Update on the use of blood and blood products in ruminants. *Vet Clin North Am Food Anim Pract.* 2014;30:455-474.
- Bell G. Blood transfusions in cattle. *UK Vet.* 2006;11:1-4.
- Constable PD. Fluids and electrolytes. *Vet Clin North Am Food Anim Pract.* 2003;19:1-40.
- Mudge MC. Acute hemorrhage and blood transfusion in horses. *Vet Clin Equine Pract.* 2014;30:427-436.
- Tennent-Brown B. Blood lactate measurement and interpretation in critically ill equine adults and neonates. *Vet Clin Equine.* 2014;30:399-413.

### REFERENCES

- Sickinger M, et al. *Vet J.* 2014;201:338.
- Duburcq T, et al. *Crit Care.* 2014;18:467.
- Epstein KL, et al. *J Vet Intern Med.* 2014;28:223.
- Megahed A, et al. *J Vet Intern Med.* 2015;29:1718.
- Hurcombe SD, et al. *J Am Vet Med Assoc.* 2007;231:267.

## Localized Infections

Localized infections are common in farm animals and many are bacterial infections secondary to traumatic injuries. Because most of them have a surgical outcome, by incision and drainage or by excision or amputation, they are not usually included in medical textbooks. They are presented briefly here because of their importance in the differential diagnosis of causes of toxemia and also because of their space-occupying characteristics, which cause compression of other structures. Also, the initial treatment is often medical, especially if the location of the lesion cannot be identified.

### ETIOLOGY

Abscesses and similar aggregations of pyogenic material in certain anatomic locations are described elsewhere in this book. The common ones include pharyngeal,

submandibular,<sup>1</sup> retroperitoneal, hepatic,<sup>2,3</sup> splenic, pulmonary, cerebral, pituitary, spinal cord, and subcutaneous abscesses. Other similar lesions include embolic nephritis, guttural pouch empyema, lymphadenitis, pharyngeal phlegmon, osteomyelitis tooth root abscesses, and infections of the umbilicus and associated vessels.

More widespread accumulations of necrotic/toxic pyogenic debris occur and are described under the headings of pericarditis, pleurisy, peritonitis, metritis, mastitis, meningitis, and pyelonephritis.

Other pyogenic lesions worthy of note include the following:

- **Inguinal abscess in horses.** Some of these probably originate as postcastration infections, but some obviously have other origins, possibly as a lymphadenitis arising from drainage of a leg with a chronic skin infection.
- **Traumatic cellulitis and phlegmon in soft tissue,** especially skeletal muscle. The neck is a common site of infection in the horse, with lesions resulting from infected injection sites or the injection of escharotic materials, e.g., iron preparations intended only for intravenous administration. Penetrating traumatic wounds, often severely infected, are among the serious occurrences to the legs and hooves of horses and cattle. These commonly penetrate joint capsules, bursae, and tendon sheaths, and underrun periosteum. In cattle, the common causes are agricultural implements; in horses they are more commonly caused by running into protruding objects, including stakes and fencing material.
- **Abscessation and cellulitis of the tip or the proximal part of the tail.** This occurs in steers in feedlots and rarely extends to the hindquarters and the scrotum; the cause is presumed to originate from the presence of an aggregate of feces on the tip of the tail (manure ball) that gets caught in fencing material. Bacteria isolated from the lesion indicates a mixed infection.
- **Perirectal abscess** occurs in horses, caused usually by minor penetrations of the mucosa during rectal examination. Some of these rupture into the peritoneal cavity, causing acute, fatal peritonitis. Others cause obstruction of the rectum and colic because of the pain and compression that result. They are readily palpable on rectal examination.
- **Perivaginal abscess** occurs in heifers and cows, caused by vaginal tears during parturition, particularly after dystocia. Occasionally these rupture into the peritoneal cavity, causing acute, fatal peritonitis. More commonly, the abscess causes obstruction of the rectum and urethra, with the animal exhibiting signs of abdominal pain and stranguria

because of the resultant pain and compression during posturing for defecation and urination. Perivaginal abscesses are readily palpable on rectal and vaginal examination.

- **Urachal abscess.** See omphalitis.
- **Pituitary abscess** occurs in cattle, sheep, and goats<sup>4</sup> as a single entity or in combination with other lesions. Pituitary abscesses cause a wide range of signs with emphasis on dysphagia caused by jawdrop, blindness, and absence of a pupillary light reflex, ataxia, and terminal recumbency with nystagmus and opisthotonus.
- **Facial abscess in cattle and goats.** Facial abscesses secondary to injury of the cheek mucosa caused by plant awns are common in beef cattle being fed hay containing a variety of awns that may penetrate the oral mucosa. *T. pyogenes* (formerly *Arcanobacterium* or *Actinomyces* or *Corynebacterium pyogenes*) is the commonly isolated bacterium. Localized abscesses of the face and neck are common in some flocks of goats and sheep.<sup>5,6</sup> *Corynebacterium pseudotuberculosis* is most commonly isolated, followed by *T. pyogenes* and *Staphylococcus* spp. The abscesses are most common on the jaw and sternal, facial, and cervical regions.
- **Tooth root abscesses in llamas, alpacas, goats, and sheep.** Tooth root abscesses are a common dental disease of llamas and alpacas and are thought to be caused by ingestion of rough or stemmy forages when permanent molars are erupting.<sup>7</sup> Tooth root abscesses can arise without a known cause or may result from trauma, foreign body migration (such as grass seeds), malocclusion and abnormal tooth wear, and periodontal disease. *T. pyogenes* and *F. necrophorum* are most commonly isolated from tooth root abscesses in New World camelids. Tooth root abscesses are most frequently found in mandibular molar teeth in New World camelids,<sup>7</sup> the mandibular incisors in pigs, and the first maxillary molar in horses.

### Bacterial Causes of Localized Infection

These include those bacteria that are common skin contaminants in animals, including *T. pyogenes*, *F. necrophorum*, streptococci, and staphylococci. Clostridial infections are common but occur sporadically. They are described under Malignant edema. *Clostridium pseudotuberculosis* is common as a cause of local suppuration in horses and is the specific cause of caseous lymphadenitis of sheep. *Rhodococcus equi* also causes pulmonary and subcutaneous abscesses in horses and cervical lymphadenitis in pigs. Strangles (*Streptococcus equi* subsp.

*equi*), *R. equi* infection in foals, melioidosis, and glanders are all characterized by extensive systemic abscess formation. *Histophilus somni* causes systemic abscess formation in sheep. *Mycobacterium phlei* and other atypical mycobacteria are rare causes of local cellulitis and lymphadenitis/lymphangitis manifesting as “skin tuberculosis” in cattle. Streptococcal cervical abscess in pigs is another specific abscess-forming disease.

### PORTAL OF ENTRY

Most localized infections begin as penetrating wounds of the skin, caused accidentally or neglectfully because of failure to disinfect the skin adequately before an injection or incision, as in castration, tail docking, and so forth.

Metastatic implantation from another infectious process, especially endocarditis, carried by blood or lymph, is the next most common cause. In this way a chain of lymph nodes can become infected. Cranial and caudal vena caval syndromes produce similar embolic showers in the lungs.

### PATHOGENESIS

The local infection may take the form of a circumscribed aggregation of bacterial debris and necrotic tissue, known as an **abscess**. This may be firmly walled off by a dense fibrotic capsule or be contiguous with normal tissue. When such an abscess occurs in a lymph node it is called a **bubo**; when the infective material is purulent but diffusely spread through tissues, especially along fascial planes, it is known as a **phlegmon**; and when it is inflammatory but not purulent the same lesion is called **cellulitis**.

The species of bacteria in the abscess determines the type of pus present and its odor. Staphylococci produce large quantities of thick yellow pus, and streptococci produce less pus and more serous-like exudates. Pus associated with *T. pyogenes* is deep-colored, yellow or green in color and very thick and tenacious. The pus of *F. necrophorum* is very foul-smelling and usually accompanied by the presence of gas.

Deposition of bacteria in tissues is sufficient to establish infection there in most instances. Conditions that favor abscess development include ischemia, trauma, and the presence of a cavity or a hematoma. A continuing process of pus formation results in enlargement to the stage of pointing and rupturing of an abscess, or spread along the path of least resistance into a nearby cavity or vessel, or discharge to the exterior through a sinus. Continuing discharge through a sinus indicates the persistence of a septic focus, usually a foreign body, such as a grass seed, a sequestrum of necrotic bone, or an osteomyelitis lesion.

### CLINICAL FINDINGS

The clinical signs of abscesses and other local aggregations of pyogenic lesions were

described earlier. General clinical findings that suggest the presence of a localized infection, which is not readily obvious clinically, include the following:

- Fever, depression, lack of appetite, all are signs of toxemia.
- Pain resulting in abnormal posture, e.g., arching of the back, or gait abnormality, including severe lameness.
- Weight loss, which can be dramatic in degree and rapidity.
- Obstruction of lymphatic and venous drainage, which can cause local swelling and edema. Sequels to these developments include extensive cellulitis if there is a retrograde spread of infection along lymph drainage channels and phlebitis and thrombophlebitis when there is stasis in the veins.
- Careful palpation under anesthesia or heavy sedation may be necessary to overcome the muscle spasm caused by pain. Calves with extensive abscessation emanating from the navel, and horses with inguinal abscesses, can only be satisfactorily examined by deep abdominal and rectal palpation.
- Radiologic examination may elicit evidence of osteomyelitis, and examination of a fistulous tract may be facilitated in this way, especially if a radiopaque material is infused into the tract.

## CLINICAL PATHOLOGY

### Hemogram

A complete blood count is helpful in supporting a diagnosis of local abscess. Unless the infection is completely isolated by a fibrous tissue capsule or is small in size relative to the size of the animal (tooth root abscess or osteomyelitis), there will be a leukocytosis with a left shift and an elevation of polymorphonuclear leukocytes in acute lesions or of lymphocytes and monocytes in more chronic ones. A moderate normochromic anemia is usual in chronic lesions, and mild proteinuria is common.

### Sample of Lesion for Culture and Staining

Attempts to identify the presence of an infectious agent and to establish its identity are usually undertaken, but care is necessary to avoid spreading infection from a site in which it is presently contained. Techniques used include paracentesis, careful needle aspiration from an abscess, blood culture (with the chances of isolation of bacteria being very small unless there is phlebitis or endocarditis), and aspiration of cerebrospinal fluid. Ultrasonographic guidance is helpful for percutaneous aspiration of deeper seated abscesses.<sup>8</sup>

The isolation of bacteria from a well-contained abscess may be difficult because of the paucity of organisms. Special techniques

may be necessary and examination of a smear stained with Gram stain, and perhaps also with Ziehl–Neelsen stain if the circumstances suggest it, is an essential part of the examination. Determination of sensitivity of the bacteria to antibiotics is usually undertaken.

### Necropsy Findings

The presence and location of the local infection can be demonstrated at necropsy.

## TREATMENT

### Drainage of Abscesses

Surgical drainage of readily accessible intact abscesses is the treatment of choice and in most cases the only effective method of therapy. A needle aspirate may be indicated when the nature of the lesion is uncertain. The site is prepared surgically and the abscess is drained, flushed, and topically medicated, usually with a roll of gauze soaked in a 1% povidone iodine solution, which is a stable chemical complex of polyvinylpyrrolidone and elemental iodine, for the first 24 to 48 hours. One roll is used to ensure that all the gauze is removed from the abscess. If the abscess is large then gauze rolls should be tied together to ensure all gauze is removed at the same time. If the abscess has not yet pointed with a soft spot, hot fomentations and hydrotherapy may aid in the maturation of a superficial abscess. An analgesic may be required during this stage of therapy. Deep-seated abscesses may benefit from ultrasonographic-guided aspiration, lavage of the abscess cavity with 0.9% NaCl solution, removal of the remaining saline solution, and injection of potassium penicillin into the abscess cavity.<sup>8</sup> Some abdominal abscesses may only be accessible by surgery.<sup>4,9</sup> Tooth root abscesses require extraction of the affected tooth to effect a cure.

### Antimicrobial Agents

Antimicrobial agents given parenterally can be used for the treatment of deep abscesses not readily accessible to surgical drainage. Ideally, a sample of the contents of the abscess should be cultured and antimicrobial susceptibility determined. The agent must achieve high plasma concentrations to facilitate penetration into an abscess, and daily treatment for several days is usually necessary. However, antimicrobial agents alone may be ineffective, even if the organism appears sensitive to the drug in vitro in cases when the abscess is surrounded by a dense capsule—presumably the capsule prevents diffusion of the drug into the abscess cavity. Lipophilic antibiotics, such as rifampin, florfenicol, or macrolides, are theoretically advantageous in penetrating into abscesses. Rifampin should be administered with another antimicrobial agent to delay the development of antibiotic resistance.

## REFERENCES

1. Fielding CL, et al. *Vet Rec.* 2008;162:18.
2. Dore E, et al. *J Vet Intern Med.* 2007;21:853.
3. Arnold CE, Chaffin MK. *J Am Vet Med Assoc.* 2012;241:1659.
4. Allen AL, et al. *J Vet Diagn Invest.* 2013;25:482.
5. Ural K, et al. *Small Rumin Res.* 2008;77:84.
6. Washburn KE, et al. *J Am Vet Med Assoc.* 2009;234:1162.
7. Niehaus AJ, Anderson DE. *J Am Vet Med Assoc.* 2007;231:284.
8. Mohamed T, Oikawa S. *J Vet Med A Physiol Pathol Clin Med.* 2007;54:512.
9. Mair TS, Sherlock CE. *Equine Vet J.* 2011;43(suppl 39):123.

## Pain

### THE PROBLEM OF PAIN

Pain has been described in animals as “an aversive sensory and emotional experience representing an awareness by the animal of damage or threat to the integrity of its tissues.” Pain is basically a protective mechanism to ensure that the animal moves away from noxious (damaging) influences, but endogenous pain, arising from internal damaging influences, causes its own physiologic and pathologic problems that require the veterinarian’s intervention. In humans, there is an additional psychological parameter to pain and, although it is customary to transpose attitudes from pain in humans to animals, this is a courtesy rather than an established scientific principle.

A major difficulty with pain in animals is the difficulty of pain measurement. Pain is a subjective sensation known by experience that can be described by illustration, but measurement of pain is an indirect activity related to its effects and is an objective phenomenon. A panel report on recognition and alleviation of pain in animals proposed a simplified classification for animal pain and distress as pain, anxiety and fear, stress, suffering, comfort, discomfort, and injury. The recommendations are directed at academics, teachers, and researchers using laboratory animals, as well as the pharmaceutical industry.

Pain is assessed in animals by three methods: (1) **observation of behavior**; (2) measurement of physiologic parameters, including heart rate, blood pressure, sweating and polypnea, that indicate **sympathetic activation**; and (3) measurement of the plasma concentration of factors that indicate sympathetic activation, such as plasma cortisol, epinephrine, norepinephrine, and nonesterified fatty acid concentrations. Behavioral changes are increasingly being used as indirect indicators of pain, but studies lack standardization with respect to definition of behaviors, frequency and duration of monitoring, and interpretation of results. More objective indirect techniques for quantifying pain include the use of force meters, vocalization measures, stride length, and activity using pedometers and



accelerometers.<sup>1</sup> Because of the lability and expense of epinephrine and norepinephrine analyses, and the poor specificity of increased plasma nonesterified fatty acid concentration for pain, the most commonly used laboratory measure of pain is **plasma cortisol concentration**. Cortisol concentrations have also been measured in saliva, urine, and feces to provide a more accurate indicator of basal stress, because plasma cortisol concentrations increase rapidly in response to handling and restraint for blood sampling.

Pain in agricultural animals is a matter of ever-increasing concern, and there is an obvious need to identify, evaluate, prevent, and manage pain in large animals. Many agricultural practices that are thought to be necessary to avoid later painful disease or injury (e.g., disbudding or dehorning of cattle, sheep, and goats;<sup>2</sup> tail docking in piglets and lambs;<sup>3</sup> the Mules operation in Merino sheep;<sup>4</sup> and tooth clipping in baby pigs), to improve animal production and minimize fighting or reproductive-related injuries (e.g., castration, spaying), or to facilitate in animal identification (branding, eartagging, tattooing, or ear notching) are performed by producers without provision of an analgesic agent. It is not our purpose to engage in a discussion on the subject of animal welfare or the prevention of cruelty.

## ADVANCES IN ATTITUDE TOWARD PAIN

There is now a greater awareness of the existence and detrimental effects of pain in animals, which has led to widespread implementation of postoperative pain control. New and improved analgesics are being developed and marketed as a result of increased basic and clinical research in pain. The detrimental effects of pain include the following:

- Suffering and stress resulting in delayed healing
- Increased catabolism and decreased feed intake
- Prolonged recovery and longer recumbency, with a greater risk of postoperative complications
- The potential to cause ineffective respiratory ventilation with the development of respiratory acidosis and acidemia
- Self-mutilation
- The potential of acute pain to lead to chronic pain

Pain may be clinically beneficial by acting as a protective mechanism by moving the animal away from the noxious stimulus and providing immobility of the affected part, promoting healing. Pain is a valuable diagnostic aid but, once identified, it is necessary to treat the pain and remove or modify its source if possible.

Once it is accepted that pain is detrimental it then becomes important to recognize and evaluate the severity of the pain. In the

past, veterinary science has used an anthropomorphic approach to the assessment of whether or not an animal is in pain. It is a reasonable elementary approach to compare the effects of pain in animals with those in humans because there are many more similarities in the neuroanatomical, physiologic, and behavioral data between humans and animals than there are differences. However, because of the inherent behavioral and social differences between humans and animals, this approach is limited.

Current research on pain in animals includes visual and subjective assessment of pain supported by physiologic and clinicopathologic measurements. These studies have increased the awareness of the problem of pain in veterinary medicine and resulted in improved information on the use of appropriate analgesics. Analgesics are now more commonly used perioperatively in food-producing animals and horses in New Zealand, Scandinavia, the United Kingdom, and the United States undergoing surgical and painful procedures.<sup>5-8</sup> More research is needed to develop optimal analgesic protocols.

## ETIOLOGY

Pain sensations are aroused by different stimuli in different tissues, and the agents that cause pain in one organ do not necessarily do so in another. In animals there are three types of pain:

1. Cutaneous (or superficial)
2. Visceral
3. Somatic (or musculoskeletal)

The causes of each type of pain are listed in the following sections.

### Cutaneous or Superficial Pain

Cutaneous or superficial pain is caused by agents or processes that damage the skin, such as burning, freezing, cutting, and crushing. Fire burns, frostbite, severe dermatitis, acute mastitis, laminitis, infected surgical wounds, foot rot, crushing by trauma, conjunctivitis and foreign body in the conjunctival sac are all common causes of pain.

### Visceral Pain

Examples of visceral pain include the following:

- Inflammation of serosal surfaces, as in peritonitis, pleurisy, and pericarditis
- Distension of viscera, including the stomach, intestines, ureters, and bladder
- Swelling of organs as in hepatomegaly and splenomegaly
- Inflammation, as in nephritis, peripelvic cellulitis, and enteritis
- Stretching of the mesentery and mediastinum

In the nervous system, swelling of the brain caused by diffuse edema, or of the meninges caused by meningitis, are potent causes of pain. Inflammation of (neuritis) or

compression of (neuralgia) peripheral nerves or dorsal nerve roots are also associated with severe pain.

### Musculoskeletal (Somatic) Pain

Muscular pain can be caused by lacerations and hematomas of muscle, myositis, and space-occupying lesions of muscle. Osteomyelitis, fractures, arthritis, joint dislocations, and sprains of ligaments and tendons are also obvious causes of severe pain. Among the most painful of injuries are swollen, inflamed lesions of the limbs or joint caused by deep penetrating injury or, in cattle, by extension from foot rot. Amputation of a claw, laminitis, and septic arthritis are in the same category. Ischemia of muscle and generalized muscle tetany, such as occurs in electroimmobilization, also appear to cause pain.

The trauma of surgical wounds is a controversial topic in animal welfare, especially that associated with minor surgical procedures such as dehorning, tail docking, and castration in farm animals. From clinical observation supported by some laboratory examinations, e.g., salivary cortisol concentrations after castration in calves and lambs, it appears that pain after these procedures is short-lived, up to about 3 hours, and the perception of pain is age dependent.<sup>1,9</sup>

### PATHOGENESIS

Pain receptors are distributed as end organs in all body systems and organs. They are connected to the CNS by their own sensory nerve fibers with their cell bodies in the dorsal root ganglion of each spinal nerve and via some of the cranial nerves. Intracord neurons connect the peripheral neurons to the thalamus, where pain is perceived, and to the sensory cerebral cortex, where the intensity and localization of the pain are appreciated and the responses to pain are initiated and coordinated.

The stimuli that cause pain vary between organs. The important causes include the following:

- **Skin:** cutting, crushing, freezing, burning
- **Gastrointestinal tract:** distension, spasm, inflamed mucosa, stretching of mesentery
- **Skeletal muscle:** ischemia, traumatic swelling, tearing, rupture, hematoma
- **Synovial membranes and cartilage of joints:** inflammation

Nociception is the normal physiologic process by which pain is perceived. When a tissue is injured by mechanical, thermal, or chemical means, **peripheral nociceptors** (specialized free nerve endings of afferent neurons) are depolarized and the initial stimulus is felt as pain.

Peripheral nociceptors are located in skin, fascia, muscles, tendons, blood vessels, joint capsules, periosteum, subchondral bone, pleura, peritoneum, and viscera. Five



classes of peripheral nociceptor are currently recognized: (1) thermal nociceptors activated by temperatures above 52°C or below 5°C, (2) mechanoheat nociceptors activated by pressure and temperature, (3) polymodal nociceptors, (4) visceral nociceptors, and (5) silent nociceptors. The **first pain** or initial sharp stinging following injury is caused by activation of large-diameter fast-conduction myelinated nerve fibers called **Type IA $\delta$  fibers** (thermal nociceptors) or **Type IIA $\delta$  fibers** (mechanoheat nociceptors). The **second pain** or slow pain following injury is caused by activation of small-diameter unmyelinated slow-conduction fibers called **C-fibers**; these fibers transmit a painful stimulus that is perceived as a sustained burning sensation that persists past cessation of the initial sharp painful sensation. Visceral nociceptors are activated by diffuse stimulation instead of direct local noxious stimuli. Silent nociceptors are mechanoheat nociceptors activated when sensitized by release of pro-inflammatory mediators (such as bradykinin, histamine, leukotrienes, eicosanoids, serotonin, substance P, adenosine triphosphate [ATP], low tissue pH, and other constituents of inflammation) into damaged tissues, establishing **peripheral hyperalgesia**. The hyperalgesia during acute pain is thought to promote healing at the injured site.

### Central Hypersensitivity and Preemptive Analgesia

A state of altered central processing can also occur in response to chronic activation of peripheral nociceptors, which is called **central hypersensitivity** or “wind up.” This central hypersensitivity results in a modified response to subsequent afferent inputs, which last between 10 and 200 times the duration of the initiating stimulus. The net result is that stimuli previously perceived as innocuous, such as touch or pressure, become perceived as painful after the system is sensitized. Preinjury treatment with opioids or local anesthetics prevents or decreases the development of central hypersensitivity and behavioral indicators of pain, but opioids and local anesthetics are less effective if administered after the injury is initiated. It is the establishment of central hypersensitivity that makes pain much more difficult to control once it is established and why analgesics are less effective at this time. Thus the combination of peripheral hyperalgesia (particularly associated with substance P) and central hypersensitivity results in what is called clinical pain.

It has been suggested that by preventing the surgical afferent stimuli from entering the spinal cord, the facilitation of spinal nociceptive processing could be prevented and this would decrease the severity of postoperative pain. This is known as the concept of **preemptive analgesia**. Preoperative administration of an analgesic is more

effective than postoperative administration of the same dose; this is relevant to the control of pain associated with elective surgery. Many studies (primarily in humans) have demonstrated that preoperative administration of local anesthetic agents and the administration of NSAIDs or opioids before the patient is recovered from anesthesia are appropriate methods for instituting preemptive analgesia.

The physiologic responses to pain are described in the following sections. Normal responses include the release of the morphine-like endorphin from the brain, providing an endogenous analgesic system, and also cortisol release from the adrenal cortex in response to any stress. The clinical response to pain varies not only with the personality of the patient (some are more stoic than others) but also with various other influences. For example, distraction, as in walking a horse with colic, application of an alternative pain in the forced elevation of the tail of a cow (tail jack), and application of local anesthetic agents all tend to relieve pain. In agricultural animals pain elicits behavioral, physiologic, and clinicopathologic changes. The behavioral responses can be interpreted as a form of distraction, a displacement activity, or as providing an alternative pain. The physiologic and clinicopathologic responses are part of the fight or flight phenomena and reflect sympathetic activation.

### CLINICAL FINDINGS

The general clinical findings of pain are described here and the indications of pain associated with individual body systems or organs are described within each category.

#### Physiologic Responses

Physiologic responses to pain are manifested by the following signs, and the severity of the pain determines the degree of response:

- Tachycardia
- Polypnea
- Pupillary dilatation
- Hyperthermia
- Sweating

The cardiovascular responses of tachycardia and hyperthermia may contribute to a fatal outcome in animals with reduced cardiovascular reserve, for example, when dehydration, acid-base imbalance, and endotoxic shock are also present.

#### Behavioral Responses

These include abnormal posture and gait when the pain is musculoskeletal (e.g., somatic). The gait abnormalities include lameness, a shuffling gait, and rapid shifting of weight from one leg to another. These are subjects of importance in orthopedic surgery.

The behavioral responses to pain may also include unrelated activities such as **rolling, pawing, crouching, or grinding of teeth** when the pain is visceral. However, the

behavioral activities may also be related to the site of the pain, e.g., the horse with colic that looks at its abdomen, or to a particular function, such as pain manifested on coughing, walking, defecating, urinating, and so forth. The behavioral aspects of severe pain are very important in the horse with severe unrelenting visceral pain caused by colic. The rolling, falling, and lunging upward and backward (often falling against walls) can result in severe injury and causes panic in many owners.

Generally, somatic pain is more localized and easily identified than visceral pain. Injuries to limbs are usually identifiable by fractures or localized tendon strain or muscle injury. With severe somatic pain, as with a fracture or septic arthritis, the limb is carried off the ground and no weight is taken on the limb. With lesser lesions more weight-bearing activity is undertaken.

One of the notable factors affecting pain in animals is the analgesic effect of the animal lying on its back or of its adopting a defeated, supine posture. This may be related to the release of endorphins.

More general behavioral responses to pain include **decreased appetite** and average daily rate of gain, adoption of an anxious expression (ears retracted), disinclination to be examined, and aversion to returning to a particular location in which pain has been experienced previously. **Moaning, grunting, and grinding of the teeth** (odontoprisis or bruxism) are generally indicative of pain. If vocalization occurs with each respiration or rumination, the pain appears likely to arise from a lesion in the thoracic or abdominal cavities. When teeth grinding is associated with head pressing it is thought to indicate increased intracranial pressure such as occurs with brain edema or lead poisoning. Grinding of the teeth as a sole sign of pain is usually associated with subacute distension of segments of the alimentary tract. More extreme kinds of vocalization caused by pain include moderate bellowing by cattle, bleating in sheep and goats, and squealing in pigs.

### Elicitation of Pain by the Veterinarian

This is an essential part of a clinical examination. The techniques include the following:

- Pressure by palpation, including firm ballottement with the fist and the use of a pole to depress the back in a horse or to arch the back upward from below in a cow
- Pressure by compression, as with hoof testers for detecting the presence of pain in the hoof
- Movement by having the animal walk actively or by passively flexing or extending limbs or neck
- Stimulation of pain related to coughing by eliciting the cough reflex
- Relief of the pain by correction of the lesion

## Periodicity and Duration of Pain

Limited duration of pain can be the result of natural recovery or of surgical or medical correction of the problem. Constant pain results from a static state, whereas periodic or intermittent pain is often related to periodic peristaltic movement. In humans and in companion animals some importance also attaches to observing the time of onset of pain, whether it is related to particular functions or happenings and whether the patient gains relief by adopting particular postures or activities. These factors are unlikely to be of importance as an aid to a diagnosis in agricultural animals.

## TREATMENT

Several aspects concerning the relief of pain in agricultural animals are important. Cost has always been a deterrent to the use of local anesthetics and analgesics. However, with changing attitudes toward animal pain, this issue is more frequently examined. Treatment of the causative lesion is a major priority, but the treated lesion may remain painful for varying lengths of time. Relief and the control of pain should be a major consideration and the following principles require consideration:

- Relief of pain is a humane act. Improved, less painful methods of castration,<sup>9</sup> dehorning,<sup>2</sup> tail docking,<sup>3</sup> Mules operation in sheep,<sup>4</sup> spaying cattle, and treating painful lesions of the hooves of farm animals must be explored and implemented. Surgical operations, such as laparotomies, must be performed using appropriate analgesia.
- Analgesia may obscure clinical findings that may be necessary to observe, properly diagnose, or maintain surveillance of a case. This is of major importance in equine colic.
- Control of pain is necessary to prevent animals from inflicting serious self-injury associated with uncontrollable behavior as a result of severe visceral pain.
- Analgesics for visceral pain are readily available and relatively effective.
- A major problem in the clinical management of pain is for cases of severe, slowly healing, infected traumatic wounds of the musculoskeletal system. Pain is likely to be very severe, continuous, and to last for periods of up to several weeks. Affected animals cannot bear weight with the affected limb, have great difficulty in moving, lose a great deal of weight, and prefer prolonged recumbency. At the present time, there are no effective analgesics available that can be administered easily and daily for a few weeks without undesirable side effects. The development of such products is urgently required.

## Analgesia

The analgesic agents and techniques available include the following:

- Surgical procedures, e.g., neurectomy by section of peripheral nerves, as practiced in horses
- Local destruction of peripheral nerves by chemical means, e.g., the epidural injection of agents such as ethyl alcohol may prevent straining
- Local destruction of peripheral nerves by thermal means, e.g., cautery of the wound edge after gouge dehorning in calves
- Analgesia using nonopioid drugs when sedation is not required or is contraindicated
- Opioid analgesics (narcotic analgesics)

## Analgesic Agents

There are seven main types of analgesic agent administered parenterally or topically to large animals:

1. **Local anesthetic agents** such as lidocaine (lignocaine), mepivacaine, and bupivacaine
2. **NSAIDs** such as flunixin meglumine, ketoprofen, phenylbutazone, carprofen, and meloxicam
3.  **$\alpha_2$ -Agonists** such as xylazine and detomidine
4. **Opioids** such as morphine, fentanyl, butorphanol, and buprenorphine
5. **N-methyl-D-aspartate receptor antagonists** such as ketamine
6. **Vanilloids** such as capsaicin
7.  **$\gamma$ -Aminobutyric acid analogs** such as gabapentin

Generally, local anesthetic agents,  $\alpha_2$ -agonists, and opioids are used to provide short-term analgesia (hours), parenteral NSAIDs and topical vanilloids are used to provide long-term analgesia (days to months), and  **$\gamma$ -aminobutyric acid analogs are investigational**. Effective analgesia is best achieved using a **multimodal approach** that incorporates the administration of two or more pharmaceutical agents that attenuate or abolish the transmission, modulation, and perception of pain, providing optimal pain relief (Fig. 4-2). Standard anesthesiology texts should be consulted regarding techniques for local analgesia using regional or peripheral nerve blocks and local anesthetic agents, or for general analgesia using  $\alpha_2$ -agonists and opioids.

## Local Anesthetic Agents

Lidocaine, mepivacaine, and bupivacaine exert their analgesic effect by addressing both the first pain and second pain after injury by blocking the voltage-gated sodium channels in peripheral nerves, preventing propagation of depolarization. Types IA $\delta$  and IIA $\delta$  and C-fibers are blocked before other sensory and motor fibers, meaning that it is possible (but sometimes a clinical challenge) to selectively block pain while maintaining the animal's normal motor function. The main advantages of local anesthetic agents are their cost and predictable and local effect, and the main disadvantage is short duration of action. They are usually administered by perineural infiltration in specific or regional nerve blocks. One challenge with lidocaine injection is that formulations are acidic and, consequently,

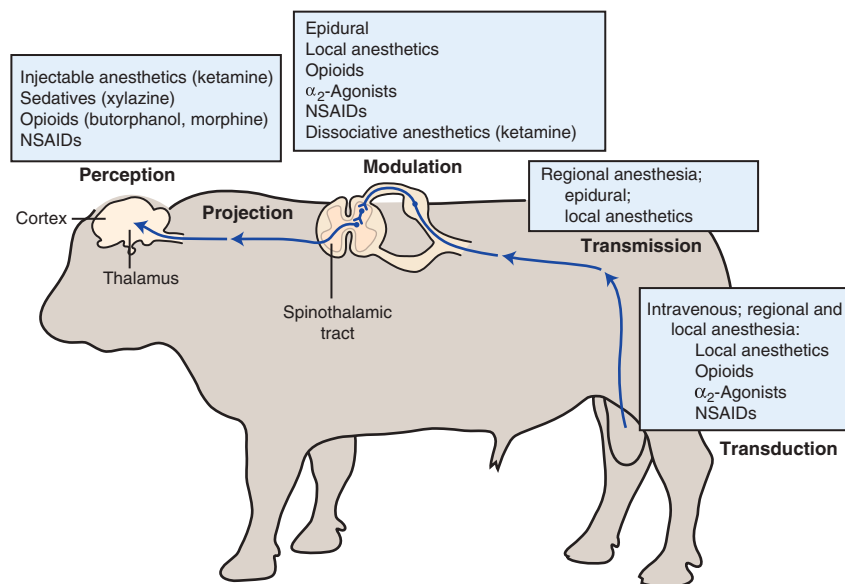

**Fig. 4-2** The nociceptive pathway in cattle, identifying the anatomic location of analgesic drug activity. Effective analgesia is best achieved using a multimodal approach that incorporates the administration of two or more pharmaceutical agents that attenuate or abolish the transmission, modulation, and perception of pain. (Reproduced with permission from Coetzee JF. *Vet Clin North Am Food Anim Pract* 2013;29:13.)

burn when injected. The injection pain can be mitigated by mixing 1 mL of 8.4% sodium bicarbonate solution with 10 mL of 2% lidocaine in a 12-mL syringe; this increases the solution pH and reportedly decreases the immediate pain associated with lidocaine injection. The bicarbonate–lidocaine mixture should be used immediately and not stored because the higher pH causes the lidocaine to come out of the solution. Topical formulations of lidocaine (2.5%) and prilocaine (2.5%) are available that appear to be useful for transdermal administration of a local anesthetic in large animals before intravenous catheter placement, venipuncture, arthrocentesis, or collection of cerebrospinal fluid. There is concern in the European Union regarding the use of lignocaine (lidocaine) in food-producing animals because of mutagenic activity and genotoxic characteristics of a lignocaine metabolite, 2,6-xylylidine. Procaine is not metabolized to the same metabolite and offers a suitable alternative if lignocaine use is curtailed in food-producing animals.

### Nonsteroidal Antiinflammatory Drugs

These drugs appear to exert most of their analgesic effect by addressing the **second pain** (slow pain) caused by sensitization of C-fibers by eicosanoids; NSAIDs are not currently thought to exert a central analgesic effect. Animals receiving NSAIDs should be normally hydrated to minimize potential renal effects such as tubular nephrosis and papillary necrosis (see diseases of the kidney). Combined administration of a systemic NSAID with an intraarticular corticosteroid appeared to be more successful in the treatment of joint pain in horses than single treatment of either agent alone.<sup>10</sup>

Although parturition is painful, current data do not support the routine administration of NSAIDs at parturition because most of the studies completed in cattle have reported an increased incidence of retained placenta in animals treated with NSAIDs; this result is consistent with the current understanding that  $PGF_{2\alpha}$  plays an important role in placental detachment.<sup>11</sup> Whether NSAIDs are beneficial in cattle experiencing dystocia remains to be determined.<sup>12,13</sup>

#### Flunixin Meglumine

This NSAID has excellent antiinflammatory, antipyretic, and analgesic properties, and is the preferred NSAID for acute soft tissue or visceral pain, although it is also efficacious against musculoskeletal pain. Flunixin meglumine provides excellent analgesia in equine colic and postoperative pain. In a comparison of three NSAIDs used to minimize postsurgical pain in horses, flunixin meglumine (1 mg/kg BW), phenylbutazone (4 mg/kg BW), or carprofen (0.7 mg/kg BW) were administered once intravenously. All three NSAIDs were effective in controlling postoperative pain, but the duration of

clinical effect was longer for flunixin meglumine (12.8 hours) than carprofen (11.7 hours) or phenylbutazone (8.4 hours). Flunixin meglumine (1.1 mg/kg intravenously) was an effective analgesic in 2- to 3-month-old bull dairy calves undergoing surgical castration; flunixin meglumine administration attenuated the cortisol response and avoided some of the behavioral changes observed in calves castrated without drugs or with lidocaine infusion alone.<sup>1</sup>

The usual loading dose for flunixin meglumine is 1.1 to 2.2 mg/kg BW IV (ruminants) or 1.1 mg/kg BW (horses) followed by a maintenance dose of 1.1 mg/kg BW every 24 hours, although some studies have administered repeated injections at 8 to 12 hours. Flunixin meglumine is usually administered once or twice a day for its analgesic effect and is usually administered parenterally (preferably intravenously because of the rare instances of myonecrosis following intramuscular injections, particularly in horses), although oral formulations exist. Intramuscular doses are rapidly absorbed, with the maximal concentration occurring within 1 hour. Large doses given to individual ponies may, however, be toxic. Toxic effects are similar to those with phenylbutazone and include ulceration of the colon, stomach, and mouth; the latter two are most evident when administered orally. The major disadvantage with flunixin meglumine is the relatively short duration of action and label requirements for intravenous injection in the United States.<sup>14</sup>

#### Ketoprofen

This NSAID has antiinflammatory, antipyretic, and analgesic properties and is labeled in Europe for the treatment of pain in cattle associated with mastitis, lameness, and trauma (3.3 mg/kg BW intravenously or intramuscularly, every 24 hours for 3 days). Oral formulations are also available in Europe for the treatment of suckling calves. On theoretical grounds, ketoprofen may have analgesic properties superior to currently available NSAIDs because it blocks both the cyclooxygenase and 5-lipoxygenase branches of the arachidonic acid cascade as well as potentially having antibradykinin activity. However, the latter two effects have not been demonstrated in large animals at recommended dose rates. Ketoprofen has been shown to provide analgesia for several hours after gouge dehorning of calves and surgical castration of calves.

#### Phenylbutazone

This NSAID is used extensively as an oral analgesic for horses, especially for long-term treatment of musculoskeletal pain. It is most effective for the relief of mild to moderate musculoskeletal pain. The half-life of the drug in plasma is about 3.5 hours so that repeated treatment is recommended. A plasma concentration of 20  $\mu$ g/mL appears to

be clinically effective in horses, whereas a plasma concentration of 60 to 90  $\mu$ g/mL appears to be clinically effective in cattle. After oral use in horses the peak levels in plasma are reached at 2 hours, but after intramuscular injection this does not occur until after 6 hours; thus, the oral or intravenous routes are the usual routes of administration. Unless care is taken to inject the drug slowly when using the intravenous route, severe phlebitis, sometimes causing complete obstruction of the jugular vein, may result. For horses the recommended dose rate is 4.4 mg/kg BW daily for 5 days orally or intravenously. Treatment on day 1 may be at 4.4 mg/kg BW twice, constituting a loading dose. Treatment beyond 5 days may be continued at minimal effective dose rates. However, prolonged use, especially in ponies, at a dose of 10 to 12 mg/kg BW daily for 8 to 10 days, may be followed by ulceration of alimentary tract mucosa, including the oral mucosa, and fatal fluid retention caused by hypoproteinemia. The pathogenesis of these lesions is thought to be caused by a widespread phlebopathy. Phenylbutazone should not be used if there is preexisting gastrointestinal ulceration, clotting deficits, or cardiac or renal dysfunction. Its use should be under close veterinary supervision so that the dose rate may be kept to a minimal effective level and so that it is used only when there is a clear clinical indication to do so. It should be withdrawn if there is no indication of a therapeutic response or if signs of toxicity appear. If there is doubt about toxicity or a prolonged course is advised, periodic hematologic examinations are recommended.

For cattle, the recommended oral dose is 10 to 20 mg/kg BW initially followed by daily doses of 4 to 6 mg/kg BW or every other day dose of 10 to 14 mg/kg BW. Clearance is slowed in neonates, so the dosage protocol would need to be adjusted in suckling calves. The general clinical impression is that phenylbutazone is the most effective analgesic available for the treatment of cattle with painful musculoskeletal conditions. Phenylbutazone is no longer permitted to be administered to female dairy cattle > 20 months of age in the United States because of concerns about meat and milk residues; phenylbutazone is known to induce blood dyscrasias in humans, including aplastic anemia, leukopenia, agranulocytosis, thrombocytopenia, and death. In addition, phenylbutazone is a carcinogen, as determined by the National Toxicology Program. Because of these concerns, phenylbutazone should not be administered to food-producing animals.

#### Meloxicam

Meloxicam is a longer acting NSAID than flunixin meglumine and has the additional advantage that it can be administered intramuscularly. Meloxicam preferentially binds to COX-2 (the inducible isoform) and



therefore theoretically has decreased side effects in large animals that may result from constitutive COX-1 isoform inhibition, including gastric or abomasal ulceration and proximal tubular injury of the kidneys. Meloxicam has been shown to be an effective analgesic in ruminants undergoing surgical procedures such as dehorning or castration, and it is effective when administered at 0.5 to 1 mg/kg BW orally every 1 to 2 days. However, based on prescription guidelines in the United States, oral meloxicam should only be administered to ruminants when sustained analgesia (>3 days) is needed.

### Salicylates

Aspirin or acetylsalicylic acid is the most commonly administered analgesic in cattle but is not very effective, and there is limited clinical evidence of its efficacy. The recommended dose rate is 100 mg/kg BW orally every 12 hours, and oral administration is most common. Because there may be limited absorption from the small intestine, the salicylates may be given intravenously (35 mg/kg BW every 6 hours in cattle; 25 mg/kg BW every 4 hours in horses), but this is no longer practiced with the widespread availability of flunixin meglumine and phenylbutazone.

### Carprofen

This is the safest NSAID, because of its weak inhibition of peripheral prostaglandins.

### Diclofenac

This NSAID, when given to lambs before castration with bloodless castrators, significantly reduced the time spent trembling or in abnormal postures following the castration procedure. Diclofenac was widely administered to cattle and water buffalo in south Asia until catastrophic declines in the local vulture populations was identified. It was determined that vultures scavenging on cattle carcasses that had been unsuccessfully treated with diclofenac were dying from diclofenac-induced renal failure. Diclofenac was subsequently banned for veterinary use across south Asia in 2006, and since that time vulture populations have made a remarkable comeback.

### $\alpha_2$ -Agonists

#### Xylazine

Xylazine was the first widely used  $\alpha_2$ -agonist in large animals and remains the most commonly administered  $\alpha_2$ -agonist in ruminants. Xylazine has been shown to be the most effective analgesic for the relief of experimentally induced superficial, deep, and visceral pain in ponies when it was compared with fentanyl, meperidine (pethidine), methadone, oxymorphone, and pentazocine. However, its short duration of action and the accompanying sedation and decreased gastrointestinal motility, respiratory activity, and increased urine formation limit its use as a short-term analgesic. Xylazine appears

to produce minimal sedation and analgesia in pigs when administered as a sole agent.

Xylazine is widely used in the horse. Medetomidine and dexmedetomidine are used in the horse when a longer duration of analgesia is required.<sup>15</sup>

### Narcotic Analgesics

Meperidine (Demerol, pethidine) is extensively used as an analgesic for visceral pain in the horse. Methadone hydrochloride and pentazocine are also used, to a limited extent, and their use is detailed in the treatment of colic in the horse. Butorphanol, a synthetic narcotic used alone or in combination with xylazine, provides highly effective analgesia in horses.<sup>16</sup>

Generally, narcotic analgesics are not as effective in ruminants as in horses and pigs because they have a distribution of  $\mu$  and  $\kappa$  receptors different from monogastric animals. In ruminants, opioids produce brief analgesia or no analgesia (depending on the type of stimulus) and higher doses are needed for an effect than in monogastric animals. Opioids also produce behavioral side effects in ruminants. Concern that most opioids are scheduled drugs necessitating extensive record keeping and secure storage, and about meat and milk residues in food-producing animals, further limit the use of opioids in ruminants.

Narcotic agents are used in somatic pain in humans and may have wider applicability in animals. A recent clinical application has been transdermal delivery of fentanyl, which is a potent  $\mu$  and  $\kappa$  agonist opioid analgesic drug that is highly lipid soluble. Fentanyl patches have been applied to the skin of horses, pigs, sheep, goats, and llamas. The rate and magnitude of uptake is dependent on core temperature and environmental temperature (and therefore blood flow to the skin at the site of the patch), thickness of the skin at the site of the patch, and adherence of the patch to the skin. A significant limitation to the use of opioids is their addictive nature in humans, necessitating storage under strict control with written records of their usage required in most countries.

### N-methyl-D-aspartate receptor antagonists

The prototype N-methyl-D-aspartate receptor antagonist is ketamine, which modulates central sensitization at subanesthetic doses exerting an antihyperalgesic effect. The analgesic effects of ketamine are most evident in animals with moderate to severe pain or those animals that appear hypersensitive to pain.

### Vanilloids

Capsaicin is derived from hot chili peppers (*Capsicum annuum*) and is the main vanilloid used in horses; these agents are characterized by their ability to activate a subpopulation of nociceptor primary afferent neurons. Capsaicin induces a transient

primary hyperalgesia that is followed by a sustained period of desensitization that is species, age, dose, and route of administration dependent. The sustained desensitization is responsible for capsaicin's efficacy as an analgesic agent. Capsaicin therefore has dual effects: initial transient primary hyperalgesia (manifested as a burning sensation) and long-term desensitization. Topical application of capsaicin ointment over the site of the palmar digital nerves has been used in horses as an adjunctive method of analgesia in equine laminitis, with demonstrated efficacy. The major clinical disadvantage of using capsaicin is the initial transient primary hyperalgesia.

### $\gamma$ -Aminobutyric Acid Analogs

Gabapentin is the class representative and was originally developed as an antiepileptic agent in humans because it is a structural analog of the inhibitory neurotransmitter  $\gamma$ -aminobutyric acid (GABA). The analgesic effect of gabapentin is focused primarily at chronic or neuropathic pain or as part of multimodal therapy, particularly with NSAIDs. The pharmacokinetics of gabapentin has been determined in horses,<sup>17</sup> beef cattle,<sup>18</sup> and dairy cattle.<sup>19</sup> Generally, gabapentin is rapidly but poorly absorbed in horses when administered orally at 5 mg/kg BW and is rapidly cleared in the horse with an apparent plasma elimination half-life of 3.4 hours. This suggests that gabapentin must be administered frequently (at least every 8 hours) when administered orally to horses.

### Balanced (Multimodal) Analgesia

Because multiple mechanisms for pain modulation all act together, the concept of **balanced or multimodal analgesia** has been proposed, similar to the way in which the use of different combinations of sedative and anesthetic agents results in the best aspects of each agent producing balanced anesthesia. Among horses receiving NSAIDs at the end of an anesthetic, those that received butorphanol during surgery required less additional analgesia compared with those that did not receive any opioid. Thus combinations of drugs can be used to produce sequential blocks in nociceptive pathways.

Acupuncture is a popular complementary treatment option for pain in human medicine. Adequate randomized clinical trials that have an appropriate control group, use blinding, and have clinically relevant primary endpoints have yet to be conducted in large animals to determine whether acupuncture is an effective analgesic agent.

### Administration Routes

The main routes used for administration of analgesics have been local infiltration, subcutaneous, intramuscular, and intravenous. Other routes, including **oral**, **epidural**, **intraarticular**, and **topical**, are now being explored.



**Xylazine** and **lidocaine** given as **epidural analgesia** abolished pain and tenesmus in cows with acute tail-head trauma, which was characterized by acute, intense pain and discomfort, severe tenesmus, and a limp tail. Extended pain relief was required for up to 3 weeks. Xylazine in the epidural space has also been used to provide analgesia for the castration of bulls. In the horse epidural analgesia using a combination of butorphanol and local anesthetics has been used to provide perineal analgesia.

### Supportive Therapy

The application of moist heat to a local lesion causing pain is effective and makes medical sense. Its value depends on how frequently and for how long it can be applied. Providing adequate bedding is important for an animal that is recumbent for long periods or that is likely to injure itself while rolling. A thick straw pack is most useful if it can be kept clean and densely packed. Sawdust is most practical but gets into everything, especially dressings and wounds. Rubber floors and walls, as in recovery wards, are effective but are usually available only for short periods. Distracting a horse with colic by walking it continuously is a common practice to prevent the animal from behavioral activities such as rolling, which may cause self-inflicted injuries. Walking is valuable, but has obvious limitations.

The provision of adequate amounts and quality of feed and water is essential, especially if the animal is immobilized and because appetite is often poor.

### FURTHER READING

- Anderson DE, Edmondson MA. Prevention and management of surgical pain in cattle. *Vet Clin North Am Food Anim Pract.* 2013;29:157-184.
- Coetzee JF. A review of pain assessment techniques and pharmacologic approaches to pain relief after bovine castration: practical implications for cattle production within the United States. *Appl Anim Behav.* 2011;135:192-213.
- Habacher G, Pittler MH, Ernst E. Effectiveness of acupuncture in veterinary medicine: systematic review. *J Vet Intern Med.* 2006;20:480-488.
- Lizarraga I, Chambraers JP. Use of analgesic drugs for pain management in sheep. *N Z Vet J.* 2012;60:87-94.
- Mainau E, Manteca X. Pain and discomfort caused by parturition in cows and sows. *Appl Anim Behav.* 2011;135:241-251.
- Muir WW. Pain: mechanisms and management in horses. *Vet Clin North Am Equine Pract.* 2010;26:467.
- Plummer PJ, Schleining JA. Assessment and management of pain in small ruminants and camelids. *Vet Clin North Am Food Anim Pract.* 2013;29:185-208.
- Sanchez LC, Robertson SA. Pain control in horses: what do we really know? *Equine Vet J.* 2014;46:517-523.
- Sneddon LU, Elwood RW, Adamo SA, Leach MC. Defining and assessing animal pain. *Anim Behav.* 2014;97:201-212.
- Stock ML, Coetzee JF. Clinical pharmacology of analgesic drugs in cattle. *Vet Clin North Am Food Anim Pract.* 2015;31:113-138.

Walker KA, Duffield TF, Weary DM. Identifying and preventing pain during and after surgery in farm animals. *Appl Anim Behav.* 2011;135:259-265.

### REFERENCES

- Webster HD, et al. *J Dairy Sci.* 2013;96:6285.
- Stafford KJ, Mellor DJ. *Appl Anim Behav Sci.* 2011;135:226.
- Sutherland MA, Tucker CB. *Appl Anim Behav Sci.* 2011;135:179.
- Fisher AD. *Appl Anim Behav Sci.* 2011;135:232.
- Waran N, et al. *N Z Vet J.* 2010;58:274.
- Thomsen PT, et al. *Vet Rec.* 2010;167:256.
- Huxley JN, Whay HR. *Vet Rec.* 2006;159:662.
- Fajt VR, et al. *J Am Vet Med Assoc.* 2011;238:755.
- Rault JL, et al. *Appl Anim Behav Sci.* 2011;135:214.
- Brommer H, et al. *Vet Rec.* 2012;171:527.
- Laven R, et al. *Vet J.* 2012;192:8.
- Richards BD, et al. *Vet Rec.* 2009;165:102.
- Newby NC, et al. *J Dairy Sci.* 2013;96:3682.
- Smith GW, et al. *J Am Vet Med Assoc.* 2008;232:697.
- Valverde A. *Vet Clin North Am Equine Pract.* 2010;26:515.
- Clutton RE. *Vet Clin North Am Equine Pract.* 2010;26:493.
- Dirikolu L, et al. *J Vet Pharmacol Ther.* 2008;31:175.
- Coetzee JF, et al. *Vet J.* 2011;190:98.
- Malreddy PR, et al. *J Vet Pharmacol Ther.* 2013;36:14.

## Stress

Stress is a systemic state that develops as a result of the long-term application of stressors. It includes pain, which was discussed earlier. **Stressors** are environmental factors that stimulate homeostatic, physiologic, and behavioral responses in excess of normal. The most objective measures of the presence and magnitude of acute stress are activation of the **sympathoadrenal medullary system** and the **HPA axis**, manifested as increases in the plasma concentrations of catecholamines and cortisol, respectively. The importance of stress is that it may

- Lead to the development of psychosomatic disease
- Increase susceptibility to infection
- Represent an unacceptable level of consideration for the welfare of animals
- Reduce the efficiency of production

**The general adaptation syndrome**, described in humans, has no counterpart in animals, and it is lacking in accurate definitions, precise pathogenesis, and general credibility.

### CAUSES OF STRESS

For animals, a satisfactory environment is one that provides thermal comfort, physical comfort, control of disease, and behavioral satisfaction. An environment that is inadequate for these factors will lead to stress. The environmental influences that elicit physiologic responses from animals are outlined next and some can be classified as stressors. The effects of most of these influences on production or performance indices have

been measured quantitatively, and many of them have been equated with blood levels of adrenal corticosteroids, which quantify them as stressors in the different species:

- **Road transportation** for prolonged periods, especially during inclement weather and when overcrowded, is considered to be a major stress associated with an increased incidence of infectious disease in all farm animal species. The effects of prolonged road transportation have been measured in young calves, cattle, sheep, and horses.
- **Climate**, especially temperature, either as excessive heat or cold, is a stressor. In particular, a change of climate places great pressure on heat production and conservation mechanisms in, for example, conditions of sudden wind and rain, which affect the comfort of animals.
- **Excessive physical effort**, as in endurance rides for horses, struggling in restrained animals, fear, and the excitement and fear in capture myopathy syndrome in wildlife, are all potential stressors.
- **Pain**, especially analgesia-masked pain in severe colic in horses, is a stressor. The pain of dehorning and castration of farm animals is also a transient stressor, depending on the species and method used.
- **Crowding factors**, such as temperature, humidity, the physical exhaustion associated with standing up for long periods, being walked on, difficulty in getting to food and water, and so forth, are relevant. Two other factors could be important. One is the effect of crowding on behavior; for example, pigs in overcrowded pens appear to bite one another more than when they are housed at lower densities, and are more restless than normal when temperatures in the pens are high. The biting is much more severe between males than between females. Also, it is known that pigs bite each other when establishing precedence in a group, e.g., after mixing of batches, and that this is more severe when feed is short. The other possible factor that might affect the animal's response to crowding is a psychological appreciation of the unattractiveness of crowding (or of isolation). This, however, is an unknown phenomenon in animals.
- **Presence or absence of bedding.** This is a comfort factor separate from temperature and wetness. Whether comfort affects physiologic mechanisms is not currently known.
- **Housing** generally includes the matter of comfort as well as that of maintaining moderate temperatures, but whether there is a factor other than the physical is not known.

- **Nutritional deficiencies** including lack of energy, bulk, and fluid.
- **Quietness versus excitement.** Harassment by humans or other animals sufficient to cause fear does elicit stress response in animals, and this is thought to be one of the significant causes of stress-related diseases in animals. Thus transportation, entry to saleyards, feedlots, fairs, and shows, and simply the mixing of several groups so that competition for superiority in the social order of the group is stimulated, are causes of stress. Entry to an abattoir, which has the additional fear-inspiring factors of noise and smell, is likely to be very stressful for those reasons, but it is unlikely that a fear of impending death is relevant. Such situations are stressful to the point of causing marked elevation of plasma epinephrine concentrations.
- **Herding and flocking instincts.** Animal species that are accustomed to be kept as herds or flocks may be distressed for a period if they are separated from the group.

## PATHOGENESIS

Stress is thought to develop when the animal's mechanisms concerned with adapting its body to the environment are extended beyond their normal capacities. The daily (circadian) rhythm of homeostatic and physiologic changes in response to normal daily changes in environment requires the least form of adaptation. Marked changes in environment, such as a dramatic change in weather, on the other hand, place a great strain on adaptation and are classified as stressors.

The body systems that are principally involved in the process of adaptation to the environment are the endocrine system for the long-term responses and the nervous system for the sensory inputs and short-term responses. The endocrine responses are principally the adrenal medullary response, related to the "flight or fight" situation, which requires immediate response, and the adrenal cortical response, which becomes operative if the stressful situation persists.

In humans, a large part of the "stress" state is the result of stimuli arising in the cerebral cortex and is dependent on the capacity to develop fear and anxiety about the effect of existing or anticipated stressful situations. Whether or not these psychological inputs play any part in animal disease is important, but undecided. The evidence seems to suggest that psychic factors do play such a part but that it is relatively minor.

The critical decision in relating stress to disease is to decide when an environmental pressure exceeds that which the animal's adaptive mechanisms can reasonably accommodate, in other words, to define when each of the pressures outlined earlier does, in fact, become a stressor. There is a great dearth of

definition on the subject. Probably the most serviceable guideline is "stress is any stimulus, internal or external, chemical or physical or emotional, that excites neurons of the hypothalamus to release corticotrophin-releasing hormone at rates greater than would occur at that time of the day in the absence of the stimulus." This definition uses stress where stressor would have been more commonly used. Other than that, it is acceptable. The critical threshold of stress occurs in the adrenal cortex, and its physical determination is subject to a chemical assay of ACTH. This was the basis of the original "stress and the general adaptation syndrome" as set down by Selye in 1950. The original concept is still attractive because of its simplicity and logic. However, evidence supporting the hypothesis remains limited. The importance of the concept for our animals is unproven. The deficiency in evidence is that of obtaining a standard response to a standard application of a stimulus. There is a great deal of variation between animals, and stimuli that should be significant stressors appear to exert no effect at all on adrenocortical activity.

## Stress and Road Transportation

The response of different farm animal species to the effects of road transportation has been examined. In unaccustomed cattle that are forced to run and are then herded together, there are increases in the hematocrit and blood concentrations of catecholamines, cortisol, total lipid, glucose, and lactose. Transportation of calves, 4 to 6 months of age, for only 4 hours results in a leukocytosis with neutrophilia, a decrease in T-lymphocyte population, a suppression of lymphocyte blastogenesis, and enhancement of neutrophil activity. The effect of road transportation on cattle varies according to age: the transportation of 1- to 3-week-old calves for up to 18 hours was not as stressful as in older calves. The lack of response of the younger calves to transport may be caused by their lack of physiologic adaptation to coping with the transportation. During transportation, plasma cortisol concentrations and serum creatine kinase (CK) activities increase. There is clinical evidence of dehydration and increases in serum nonesterified fatty acid,  $\beta$ -hydroxybutyrate, and urea concentrations, which reflect changes in normal feeding patterns. Based on the physiologic measurements and subjective measurements of behavior, a 15-hour transportation period under good conditions is not unacceptable regarding animal welfare. Transportation is exhausting and causes dehydration, but lairage facilitates recovery from both. When sheep are subjected to a journey of up to 24 hours it is best to be done as an uninterrupted trip, because it is the initial stages of loading and transport that are most stressful. In a 15-hour road journey with sheep, the major change in hormone release occurs

during the first 3-hour period and is much less in the remaining 12 hours.

The effects of road transport on indices of stress in horses have been examined. A road journey lasting up to 24 hours is not particularly stressful for horses, if they are healthy, accustomed to the trailer and their travel companions, permitted to stop at least as frequently as every 3.75 hours, and traveling in a well-ventilated trailer. There was no indication that road transport was a risk factor for pulmonary disease; however, confinement of horses with their heads elevated for up to 24 hours (similar to during transportation) results in bacterial colonization and multiplication within the lower respiratory tract. Horses are also less physically stressed when facing backward in a trailer.

Based on plasma cortisol concentrations, confinement of young bulls on a truck and motion are considered stressful factors in road transport. Transport stress increases fecal, urine, and tissue losses, with most of the increased loss taking place during the first 5 to 11 hours of transport. During transportation of feeder calves (195 kg) the major portion of transport stress occurs during the early phases of transport; longer periods may not add significantly to the overall stress imposed on the calf. It is possible that the major stress may be related to the handling of the animals during loading and unloading.

## Other Possible Sources of Stress

Dehorning dairy calves at 8 weeks of age resulted in an increase in plasma cortisol concentration within 1 hour after the procedure but there was no evidence of prolonged stress.

The effects of maternal dietary restriction of protein and/or metabolizable energy on the humoral antibody response in cows and the absorption of immunoglobulins by their cold-stressed calves indicates that there were no major or sustained differences compared with controls.

Different types of stress also result in distinctive changes in the plasma concentrations of metabolites and hormones. An environmental stress, such as noise, will stimulate a hypothalamic-adrenal-cortex response, whereas a sympathetic-adrenal-medulla response occurs with a stressor such as transportation.

## CLINICAL PATHOLOGY

The direct criterion of stress is the assay of plasma ACTH; stress may be indirectly assayed using plasma cortisol concentration, which is a less expensive and more widely available assay. Salivary or fecal cortisol concentration is a good indicator of stress in sheep and cattle. Salivary and fecal samples are easy to collect, and the laboratory assay is simple to perform. Remember that elevation of plasma, salivary, and fecal cortisol concentrations are a normal physiologic

response and do not necessarily imply the existence of a damaging state in the environment. Assays of plasma catecholamines (epinephrine and norepinephrine) are confined to the research setting because these hormones are unstable using standard storage conditions.

Stressors such as weaning, placement in solitary housing or with a new group, and transportation lead to an acute phase response, which is manifested as an immediate increase in serum amyloid A concentration and a slightly delayed increase in serum haptoglobin concentration.<sup>1</sup> The mechanism of the increase is not directly linked to an increased plasma cortisol concentration. Endogenous cortisol release also results in an acute neutrophilia with no left shift.<sup>1</sup>

During prolonged periods of road transportation of cattle and sheep, there are significant changes in serum concentrations of total proteins, nonesterified fatty acids (NEFAs), glucose, CK,  $\beta$ -hydroxybutyrate, and urea. These changes can be used to assess the degree of nutritional stress and the deprivation from feed and water during transportation.<sup>2</sup> Prolonged feed deprivation reduces liver glycogen stores and increases concentrations of NEFAs and ketones in the plasma. Dehydration will elevate the concentrations of plasma proteins and the osmolality of the blood. Physical stress, such as fatigue or exercise, will result in increases in CK. Psychological stressors such as fear result in elevations of cortisol and corticosterone.

## STRESS SYNDROMES

### Stress-Related Psychosomatic Disease

In humans there is a significant neuronal input from the cerebral cortex to the hypothalamus in response to the psychological pressure generated by stress. The inability to monitor anxiety and feelings of harassment in our animals makes it impossible to determine the presence of psychological stress in them. However, psychosomatic diseases as they occur in humans are almost unknown in farm animals. The pathogenesis of psychosomatic disease appears to be based on the ability of the cerebral cortex to effectively override the normal feedback mechanisms by which the pituitary gland regulates the secretion of corticosteroids from the adrenal cortex. In other words, the normal adaptive mechanisms do not operate and hyperadrenocorticism and adrenal exhaustion develop.

### Stress and Susceptibility to Infection

Field observations support the view that stress reduces resistance to infection. This seems to be logical in the presence of higher than normal adrenocortical activity. The most intensively explored relationship of this kind has been that of exposure of calves to weaning and transportation and their subsequent susceptibility to shipping fever. The prevalence appears to be increased and is still

further enhanced by the introduction of other stress factors.

### Stress and Animal Welfare

The perceived harassment of domesticated animals by humans has become a matter of great concern for the community at large. Intensive animal housing has become an accepted part of present-day agribusiness, but sections of the consuming public are inclined to the view that these practices are cruel. The literature that has built up around this argument sets out to demonstrate that environmental stress in the shape of intensive housing, debeaking, tail docking, and so on, is sufficient to cause a stress reaction as measured by increased corticosteroid secretion. This has not turned out to be the case, and it is understandable in the light of the known variation among animals in their response to environmental circumstances requiring their physiologic adaptation. If it could be shown that this relationship did exist and that the increased adrenocortical activity caused reduction in resistance to infection, the task of the responsible animal welfare person would be much easier. The absence of this experimental data makes the continuing argument less resolvable, but it is now generally accepted that producers have a responsibility to their animals and to society generally to maintain an acceptable standard of humane care of animals. These arguments are usually expressed as codes of animal welfare, to which most concerned people conform. However, they are not statutory directives and are not capable of active enforcement. Some courts of law accept them as guidelines on what the human-animal relationship in agriculture should be. Many aspects of the codes are arbitrary and are understandably heavily sprinkled with anthropomorphic sentiments. The study of ethology, which has expanded greatly during the recent past, may eventually provide some answers to this active, often bitterly fought-over field.

There has been increased adoption of the belief that an animal's welfare, whether on a farm, during transportation, or at a market or slaughterhouse, should be considered in terms of **five freedoms** that reflect ideal states rather than legal standards. The Five Freedoms concept originated with the Brambell Report released in 1965 (Report of the Technical Committee to Enquire into the Welfare of Animals kept under Intensive Livestock Husbandry Systems). This report indicated that livestock should have the freedom "to stand up, lie down, turn around, groom themselves and stretch their limbs." The five freedoms are currently stated as follows:

- **Freedom from Hunger and Thirst:** Ready access to fresh water and a suitable diet that maintains full health and vigor.

- **Freedom from Discomfort:** Provide an appropriate environment including shelter and a comfortable resting area.
- **Freedom from Pain, Injury, or Disease:** Prevent or rapidly diagnose and treat disease.
- **Freedom to Express Normal Behavior:** Provide sufficient space, proper facilities, and an appropriate group structure.
- **Freedom from Fear and Distress:** Ensure that conditions and treatment avoid mental suffering.

Animal welfare can also be viewed using a conceptual framework, with three such frameworks being widely advocated (biological functioning, affective state, and natural living). In the **biological functioning** framework, animals use a variety of behaviors and physiologic responses to cope with the environment; poor production or injury occurs in severe circumstances in which they are unable to adapt to the environment. This framework has been criticized because it does not include an emotional component, although such activation may be inferred by evaluating the magnitude of sympathoadrenal medullary and HPA axes. In the **affective state** framework, animal welfare is viewed as the "net sum of the magnitude of pleasant and unpleasant experiences." Although this is a useful concept, it has been difficult to quantify. Finally, the **natural living** framework is based on the concept that welfare is improved whenever animals can express their normal behaviors; this is best illustrated by "welfare-friendly" production systems, such as free range grazing of sheep flocks and beef cattle herds. When practiced to extremes, natural living can result in animal welfare concerns, such as increased neonatal losses caused by hypothermia in ruminants exposed to cold and windy weather.

The status of animals used in research has always been a bone of contention between the experimenters and some sections of the general public. Generally, these arguments revolve around anthropomorphic propositions that animals are subject to fear of pain, illness, and death in the same way as humans. There is no consistent evidence in physiologic terms that supports these views. However, the public conscience has again achieved a good deal of acceptance to the view that animal experimentation should be controlled and restricted and carefully policed to avoid unnecessary experiments and hardship in animals under our control.

### Stress and Metabolic Disease

There is an inclination to label any disease caused by a strong pressure from an environmental factor as a stress disease, for instance, hypocalcemia of sheep and hypomagnesemia of cattle in cold weather, acetoneuria and pregnancy toxemia of cattle and sheep on deficient diets, and white muscle disease of



calves and lambs after vigorous exercise. These diseases do have environmental origins, but their causes are much simpler than a complex interaction of the cerebral-cortical-hypothalamic-adrenocortical axis. They can be prevented and cured without any intervention in the stress disease pathogenesis. This is not to say that there is no adrenocortical basis for the pathogenesis of the previously listed diseases, but attempts to establish the relationship have so far been unsuccessful.

### Stress and Its Effect on Economic Performance

The constant struggle for domination of other animals in an animal population is most marked in chickens and pigs, and the relationship between status in the hierarchy and productivity in these species has been established with the low-status animals producing less well. It is also known that birds that are highly sensitive and easily startled are poor producers, and they are easily identified and culled.

The relationship between stress and production appears to be a real one. For example, heat stress in the form of high environmental temperatures reduces roughage intake and hence milk production in lactating dairy cows, and the relationships between stress and infertility and stress and mastitis in cattle are also well documented. The sensitivity of animals to environmental stress is greatest at times when they are already affected by metabolic stresses, e.g., during late pregnancy and early lactation. The adoption of a policy of culling erratic, excitable animals appears to have an economic basis.

### MANAGEMENT OF STRESS

The widespread public debate about the welfare of food-producing domestic animals dictates that veterinarians, animal scientists, and the livestock industry must develop systems of handling and housing that will minimize stressors and provide an environment that makes the animals most content and at the same time most productive. In civilized human society it should be realistic to expect that the animals that are used for food production or as companions should live their lives free from abuse or adverse exploitation. It will be necessary to determine how best to monitor the well-being of animals and determine whether or not they are under stress. Guidelines dealing with codes of practice for livestock production are available in many countries. In addition to housing, handling, and experimental intervention, it will also be important to give due care to the appropriate selection and use of anesthetics and analgesics when pain is being inflicted, such as in dehorning and castration. The effect of sedatives, such as acepromazine and xylazine on the stress response in cattle, has been examined but the results are inconclusive.

The welfare of animals during transportation is a major issue that has resulted in legislation governing the transport of animals and to define acceptable and unacceptable procedures. Welfare is determined by the length of the trip and the conditions under which animals are transported, including stocking density, ventilation, temperature and humidity, noise, and vibration. Prolonged deprivation of feed and water during long transportation results in hunger and thirst, and methods to minimize these consequences have been developed.

### FURTHER READING

- Hart KA. The use of cortisol for the objective assessment of stress in animals: pros and cons. *Vet J.* 2012;192:137-139.
- Hemsworth PH, Mellor CJ, Cronin GM, Tilbrook AJ. Scientific assessment of animal welfare. *N Z Vet J.* 2015;63:24-30.
- Sutherland MA. Welfare implications of invasive piglet husbandry procedures, methods of alleviation and alternatives: a review. *N Z Vet J.* 2015;63:52-57.

### REFERENCES

1. Lomborg SR, et al. *Vet Res Commun.* 2008;32:575.
2. Saco Y, et al. *Vet J.* 2008;177:439.

## Disturbances of Appetite, Food Intake, and Nutritional Status

**Hunger** is a purely local subjective sensation arising from gastric hypermotility caused in most cases by lack of distension by food.

**Appetite** is a conditioned reflex depending on past associations and experience of palatable foods, and is not dependent on hunger contractions of the stomach. The term appetite is used loosely regarding animals and really expresses the degree of hunger as indicated by the food intake. When variations from normal appetite are mentioned, it means variations from normal food intake, with the rare exception of the animal that demonstrates a desire to eat but fails to do so because of a painful condition of the mouth or other disability. Variation in appetite includes increased, decreased, or abnormal appetite.

**Hyperorexia**, or increased appetite, caused by increased hunger contractions, is manifested by **polyphagia** or increased food intake. Partial absence of appetite (**inappetence**) and complete absence of appetite (**anorexia**) are manifested by varying degrees of decreased food intake (**anophagia**). **Undernutrition** can be defined as a prolonged inadequate supply of nutrients to sustain good health and, in the case of immature or underweight animals, growth potential. For comparison, **malnutrition** is a deficit, imbalance, or excess of nutrients with consequential adverse effects on health and growth potential.<sup>1</sup>

Abnormal appetites include cravings for substances, often normally offensive, other than usual foods. The abnormal appetite may be perverted, a temporary state, or depraved, the permanent or habit stage. Both are manifested by different forms of **pica** or **allotriophagia**.

### THIRST

Thirst is an increased desire for water manifested by excessive water intake (polydipsia). The two main stimuli for thirst are increased plasma osmolality and hypovolemia/hypotension. Osmolality is monitored by receptors in the anterior hypothalamus that are outside the blood-brain barrier, whereas "pressure" is monitored by high- and low-pressure baroreceptors in the vascular system and heart. Clinically, diabetes insipidus produces by far the most exaggerated polydipsia.

Specific observations in ponies have shown that water intake is increased in response to either an increase in the osmotic pressure of tissue fluid (from previous water deprivation) or a decrease in the volume of their body fluids (such as from intravenous furosemide administration). Equidae can accommodate and rapidly recover after 72 hours of water deprivation, particularly donkeys and burros, and, consequently, can be considered desert-adapted animals.

The clinical syndrome produced by water deprivation is not well defined. Animals supplied with saline water will drink it with reluctance and, if the salinity is sufficiently great, die of salt poisoning. Cattle at pasture that are totally deprived of water usually become quite excited and are likely to knock down fences and destroy watering points in their frenzy. On examination they exhibit a hollow abdomen, sunken eyes, and the other signs of dehydration. There is excitability with trembling and slight frothing at the mouth. The gait is stiff and uncoordinated and recumbency follows. Abortion of decomposed calves, with dystocia caused by failure of the cervix to dilate, may occur for some time after thirst has been relieved and cause death in survivors. At necropsy there is extensive liquefaction of fat deposits, dehydration, and early fetal death in pregnant cows.

Experimental water deprivation has been recorded in camels, lactating and nonlactating dairy cows, and sheep. In camels death occurred on the seventh to ninth day of total deprivation; BW loss was about 25%. Lactating cows allowed access to only 50% of their regular water supply become very aggressive about the water trough, spend more time near it, and lie down less. After 4 days milk yield is depressed to 74% and body weight to 86% of original figures. There is a significant increase in serum osmolality with increased concentrations of urea, sodium, total protein, and copper. The PCV is increased, as are



activities of creatinine kinase and serum aspartate aminotransferase (AST) activity. With complete deprivation for 72 hours, the changes are similar but there are surprisingly few clinical signs at that time. The composition of the milk does not change markedly and plasma electrolyte concentrations return to normal in 48 hours. Sheep, even pregnant ewes, are capable of surviving even when access to water is limited to only once each 72 hours, but there is a significant loss (26%) of BW. Deprivation of water that allows access to water only once every 96 hours is not compatible with maintaining the pregnancy.

### **POLYPHAGIA**

Starvation, functional diarrhea, chronic gastritis, and abnormalities of digestion, particularly pancreatic deficiency, may result in polyphagia. Metabolic diseases, including diabetes mellitus and hyperthyroidism, are rare in large animals but are causes of polyphagia in other species. Internal parasitism is often associated with poor growth response to more than adequate food intakes.

Although appetite is difficult to assess in animals, it seems to be the only explanation for the behavior of those that grossly overeat on concentrates or other palatable feed. The syndromes associated with overeating are dealt with in [Chapter 8](#).

### **ANOPHAGIA OR APHAGIA**

Decreased food intake may be caused by physical factors, such as painful conditions of the mouth and pharynx, or to lack of desire to eat. Hyperthermia, toxemia, and fever all decrease hunger contractions of the stomach. In species with a simple alimentary tract a deficiency of thiamin in the diet will cause atony of the gut and reduction in food intake. In ruminants a deficiency of cobalt and a heavy infestation with *Trichostrongylidae* helminths are common causes of anophagia, and low plasma levels of zinc have also been suggested as a cause. In fact alimentary tract stasis from any cause results in anophagia. Some sensations, including severe pain, excitement, and fear, may override hunger sensations and animals used to open range conditions may temporarily refuse to eat when confined in feeding lots or experimental units. Some sheep that have been on pasture become completely anophagic if housed. The cause is unknown and treatment, other than turning out to pasture, is ineffective.

A similar clinical sign is feed aversion, seen most commonly in pigs, which is rejection of particular batches of feed that are contaminated by fungal toxins, e.g., *Fusarium* spp., or by the plant *Delphinium barbeyi*.

One of the important aims in veterinary medicine is to encourage adequate food intake by sick and convalescing animals.

Alimentary tract stimulants applied either locally or systemically are of no value unless the primary disease is corrected first. To administer parasympathomimetic drugs parenterally when there is digestive tract atony caused by peritonitis is unlikely to increase food intake. In cattle, the intraruminal administration of 10 to 20 L of rumen juice from a normal cow will often produce excellent results in adult cattle that have been anorexic for several days, provided the primary cause of the anorexia is corrected. The provision of the most palatable feed available is also of value.

Parenteral or oral fluid and electrolyte therapy is indicated in animals that do not eat or drink after a few days. For animals that cannot or will not eat, or in those with intractable intestinal disease, the use of total intravenous feeding (parenteral nutrition) may be indicated. The subject of therapeutic nutrition for farm animals that cannot or will not eat appears to have been ignored. However, in most cases farm animals will begin to eat their normally preferred diets when the original cause of the anophagia or aphagia is removed or corrected. Intensive fluid therapy may be necessary during the convalescence stage of any disease that has affected feed intake and that may result in a mild depression of serum electrolytes.

A reduced feed intake in high-producing dairy cattle during the first few days or weeks of lactation and in fat beef cattle in late pregnancy may result in fatty infiltration and degeneration of the liver and high mortality. Treatment with glucose parenterally and propylene glycol orally to minimize the mobilization of excessive amounts of body fat is indicated.

In nervous anophagia the injection of insulin in amounts sufficient to cause hypoglycemia without causing convulsions is used in human practice, and in animals the use of tranquilizing drugs may achieve the same result.

In ruminants the effects of blood glucose levels on food intake are controversial, but it seems probable that neither blood glucose nor blood acetate levels are important factors in regulating the appetite. The anorexia that is characteristic of acetonemia and pregnancy toxemia of ruminants appears to be the result of the metabolic toxemia in these diseases. Electrolytic lesions in the hypothalamic region can stimulate or depress food intake depending on the area affected. This indicates the probable importance of the hypothalamus in the overall control of appetite.

### **FURTHER READING**

Sartin JL, Daniel JA, Whitlock BK, Wilborn RR. Selected hormonal and neurotransmitter mechanisms regulating feed intake in sheep. *Animal*. 2010;4:1781-1789.

### **REFERENCE**

1. Hogan JP, et al. *Nutr Res Rev*. 2007;20:17.

### **PICA OR ALLOTRIOPHAGIA**

**Pica** is the ingestion of materials other than normal food and varies from licking to actual eating or drinking. It is associated in most cases with dietary deficiency, either of bulk or, in some cases, more specifically fiber, or of individual nutrients, particularly salt, cobalt, or phosphorus. It is considered as normal behavior in rabbits and foals, where it is thought to be a method of dietary supplementation or refection of the intestinal bacterial flora. Boredom, in the case of animals closely confined, often results in the development of pica. Chronic abdominal pain caused by peritonitis or gastritis and CNS disturbances, including rabies and nervous acetonemia, are also causes of pica.

The type of pica may be defined as follows: **osteophagia**, the chewing of bones; **infantophagia**, the eating of young; **coprophagia**, the eating of feces. Other types include wood eating in sheep, bark eating, the eating of carrion, and cannibalism. Salt hunger can result in coat licking, leather chewing, earth-eating, and the drinking of urine. Urine drinking may also occur if the urine is mixed with palatable material such as silage effluent. Bark eating is a common vice in horses, especially when their diet is lacking in fiber, e.g., when they are grazing irrigated pasture.

### **CANNIBALISM**

**Cannibalism** may become an important problem in housed animals, particularly swine, who bite one another's tails, often resulting in severe local infections. Although some cases may be caused by dietary deficiencies in protein, iron, or bulk, many seem to be the result of boredom in animals given insufficient space for exercise. A high ambient temperature and generally limited availability of food also appear to contribute. Male castrates are much more often affected than females, and the bites are also much more severe in males. Provision of larger pens or a hanging object to play with, removal of incisor teeth, and the avoidance of mixing animals of different sizes in the same pen are common control measures in pigs. In many instances only one pig in the pen has the habit and his removal may prevent further cases. One common measure that is guaranteed to be successful in terms of tail biting is surgical removal of all tails with scissors during the first few days of life, when the needle teeth are removed. Unfortunately the cannibalistic tendency may then be transferred to ears. As in all types of pica, the habit may survive the correction of the causative factor.

### **INFANTOPHAGIA**

**Infantophagia** can be important in pigs in two circumstances. In intensively housed sows, especially young gilts, hysterical savaging of each pig as it is born can cause heavy

losses. When sows are grazed and housed at high density on pasture it is not uncommon to find “cannibal” sows who protect their own litters but attack the young pigs of other sows. This diagnosis should be considered when there are unexplained disappearances of young pigs.

### SIGNIFICANCE OF PICA

Pica is defined as a depraved or abnormal appetite and may result from a nutritional deficiency or boredom. It may have serious consequences: cannibalism may be the cause of many deaths; poisonings, particularly lead poisoning and botulism, are common sequelae; foreign bodies leading to reticulo-peritonitis<sup>1</sup> or lodging in the alimentary tract leading to a luminal obstruction; accumulations of wool, fiber, or sand may cause obstruction; perforation of the esophagus or stomach may result from the ingestion of sharp foreign bodies; and grazing time is often reduced and livestock may wander away from normal grazing. In many cases the actual cause of the pica cannot be determined and corrective measures may have to be prescribed on a trial and error basis.

The majority of observational studies identify a relationship between phosphorus deficiency and pica, particularly in ruminants. Horses exhibiting pica may have iron or copper deficiencies.<sup>2</sup>

### STARVATION

Complete deprivation of food causes rapid depletion of glycogen stores and a change-over in metabolism to fat and protein. In the early stages there is hunger, increase in muscle power and endurance, and a loss of body weight. In sheep there is often a depression of serum calcium levels sufficient to cause clinical hypocalcemia. The development of ketosis follows associated with increased fat utilization and an increased serum concentration of NEFAs. Plasma and urine concentrations of allantoin are decreased in goats and sheep during fasting as a result of depressed microbial protein production in the forestomach.<sup>3</sup>

A marked reduction in feed intake in pony mares in late pregnancy is often a precursor of hyperlipemia, a highly fatal disease discussed in Chapter 17. In a case series of chronically starved horses, a low body condition score was accompanied with a lower serum urea nitrogen concentration (caused by low protein intake), a normocytic and normochromic anemia, and an increased serum total bilirubin concentration.<sup>4</sup> The serum urea nitrogen to creatinine concentration ratio is considered a better index of protein wasting than serum albumin or total protein concentrations, with a ratio <15 mg/dL being indicative of protein deprivation or starvation in horses.<sup>4</sup> The most pronounced biochemical changes in ponies and mares occurring as a result of experimental food

deprivation is increased serum concentrations of triglycerides, cholesterol, and glutamate dehydrogenase,<sup>5</sup> which reach a peak by the eighth day of fasting but quickly return to normal when feeding is resumed. This degree of change in blood lipids appears to be a characteristic of ponies and horses; it is much higher than that in pigs.

In lactating cows, a short period of starvation results in depression of plasma glucose and an increase in plasma lipid concentrations. Milk yield falls by 70%. On refeeding most levels return to normal in 5 days but blood lipid and milk yield may take as long as 49 days to recover to normal levels. In horses, fecal output falls to zero at day 4 and water intake is virtually zero from that time on, but urine volume is maintained. In spite of the apparent water imbalance there is no appreciable dehydration, and plasma protein levels and PCV stay at normal levels. A significant loss of skin turgor (increase in skin tenting) caused by the disappearance of subcutaneous fat as cachexia develops may occur. Muscular power and activity decrease and the loss of body weight may reach as high as 50% to 60%. The metabolic rate falls and is accompanied by a slowing of the heart and a reduction in stroke volume, amplitude of the pulse, and blood pressure. The circulation is normal as indicated by mucosal color and capillary refill.

In the final stages, when fat stores are depleted, massive protein mobilization occurs and a premortal rise in total urinary nitrogen is observed, whereas blood and urine ketones are likely to diminish from their previous high level. Great weakness of skeletal and cardiac musculature is also present in the terminal stages and death is caused by circulatory failure. During the period of fat utilization there is a considerable reduction in the ability of tissues to use glucose and its administration in large amounts is followed by glycosuria. In such circumstances readily assimilated carbohydrates and proteins should be given in small quantities at frequent intervals but fatty foods may exacerbate the existing ketosis. Diets for animals that have been through a period of great nutritional stress because of deprivation of food or because of illness are described in the following section.

**Starvation of farm livestock is an animal welfare issue** with economic and ethical considerations. When starving animals are identified by a neighboring farmer or veterinarian they are commonly reported to the appropriate authorities, which may be provincial or state-appointed inspectors (animal care officers) who have the authority to take appropriate action. The animals are examined and corrective action is taken, including possession of the animals and relocating them to a commercial feeding facility. Predicting survival of starved animals is a major challenge. Economics becomes an important aspect because the financial costs

of stabilizing a group of starved horses may exceed their free market price. Responsible management of chronically starved commercial animals should include options for immediate euthanasia. Ethical considerations include deciding if certain severely starved animals should be euthanized. In some cases, enforcement officers may be reluctant to recommend mass euthanasia of otherwise healthy horses based on personal aversion.

Chronically starved horses lose body weight, become weak, and their body condition score may decline to below 2 on the basis of 1 to 9, and death is common, especially during cold weather. Chronically starved horses frequently respond poorly to refeeding. About 20% of severely malnourished horses can be expected to die in spite of attempts at refeeding. Recovery of severely malnourished horses to an average body condition score may require 6 to 10 months.

### INANITION (MALNUTRITION)

Incomplete starvation—inanition or malnutrition—is a more common field condition than complete starvation. The diet is insufficient in quantity; all essential nutrients are present but in suboptimal amounts. This condition is compatible with life, and generally the same pattern of metabolic change occurs as in complete starvation but to a lesser degree. Thus ketosis, loss of body weight and muscular power, and a fall in metabolic rate occur. As a result of the reduction in metabolic activity there is a fall in body temperature and respiratory and heart rates. In addition there is mental depression, anestrus in cows but not ewes, and increased susceptibility to infection. This increased susceptibility to infection that occurs in some cases of malnutrition cannot be accepted as a general rule. In the present state of knowledge it can only be said that *some* nutritional influences affect resistance to *some* forms of infection.

A significantly reduced food intake also increases susceptibility to some poisons, and this has been related to the effects of starvation on hepatic function. In ruminants, the effects of starvation on the activity of liver enzymes is delayed compared with the effects in monogastric animals, apparently because of the ability of the ruminal store of feed to cushion the effect of starvation for some days. The most striking effect of short-term malnutrition in sheep and cattle compared with rats was the very rapid and large accumulation of neutral fat in hepatocytes. If there is a relative lack of dietary protein over a long period of time, anasarca occurs, particularly in the intermandibular space.

Malnutrition makes a significant contribution to a number of quasispecific diseases, “weaner ill-thrift” and “thin sow syndrome” among them, and these are dealt with in the following section.

Controlled malnutrition in the form of providing submaintenance diets to animals during periods of severe feed shortage is now a nutritional exercise with an extensive supporting literature. For pastured animals it is a fact of economic life that significant loss of body weight is planned and tolerated for some parts of each year because the well-known phenomenon of compensatory growth enables the animal to make up the lost weight, with no disadvantage, during the times of plenty. Animals fed on submaintenance diets undergo metabolic changes reflected in blood and tissue values as well as the more significant changes in weight. Experimental restriction of feed intake to 65% of normal levels in nonlactating, nonpregnant heifers does not cause significant falls in serum calcium and phosphorus levels, nor in plasma AST, lactate dehydrogenase (LDH), or CK activities. Serum alkaline phosphatase (ALP) activity was also maintained. In sheep that are losing weight because of undernutrition there is a significant decrease in plasma creatinine concentration.

Experimental feed restriction, followed by fasting, followed by *ad libitum* access to feed, such as might occur in nature, had no serious ill effects on goats. The goats lost weight significantly but did not overeat on being allowed access to feed.

A deficiency of one or more specific dietary essentials also causes a form of partial starvation (see Chapter 4).

**Outbreaks of incomplete starvation may occur in cattle, sheep, and horses** that are kept outdoors during the cold winter months in regions of the Northern Hemisphere. The feed usually consists of poor-quality grass hay or cereal grain straw and no grain supplementation. During prolonged exposure to the cold environment the animals will increase their daily intake in an attempt to satisfy maintenance requirements and, in cattle, abomasal impaction with a high case of mortality may occur. Field and postmortem findings indicate complete mobilization of fat in affected animals, including serous atrophy of fat in the bone marrow, and an inability to maintain core body temperature in cold ambient temperatures. The fat percentage in the bone marrow of the femur offers an excellent test to quantify whole-body fat reserves. The test requires drying a bone marrow sample to constant temperature; bone marrow percent fat = (dry weight  $\times$  100)/wet weight. Normal animals have a percent fat of 70% to 80% in femur bone marrow; animals dying of starvation usually have a bone marrow percent fat <10% and very low body condition score.<sup>6</sup> Serous atrophy can also be quantified by magnetic resonance imaging of bone marrow fat in the distal limbs,<sup>7</sup> but this appears to provide a complicated and expensive method compared with weighing to constant weight. Animals affected with severe inanition are

usually weak and recumbent and may or may not eat when offered a palatable feed.

**Malnutrition and starvation may occur in calves** under 1 month that are fed poor-quality milk replacers containing excessive quantities of nonmilk carbohydrates and proteins. The diet is not well digested by young calves and chronic diarrhea and gradual malnutrition occur. Affected calves recover quickly when fed cows' whole milk for several days. At necropsy there is a marked reduction in muscle mass, lack of depot fat, and serious atrophy of fat. Starvation may also occur in beef calves sucking poorly nourished heifer dams with an insufficient supply of milk. The mortality will be high during cold weather when the maintenance requirements are increased. Affected calves will initially suck vigorously and persistently, they will attempt to eat dry feed, drink surface water and urine, and bawl for several hours. Eventually they lie in sternal recumbency with their head and neck turned into their flanks and die quietly. The response to therapy is usually unsatisfactory and the case fatality rate is high. The convalescence period in survivors is prolonged and treatment is usually uneconomic. Affected animals must be brought indoors and kept warm and well bedded during treatment and realimentation. Initially, fluid therapy using balanced electrolyte solutions containing glucose and amino acids may be necessary to restore the animal's strength and appetite. This is followed by the provision of controlled amounts of a highly palatable digestible diet. High-quality legume hay is excellent, small amounts of ground grain are of value, and the daily administration of a multiple B vitamin and mineral mixture will replenish those lost during inanition. Skim-milk powder is an excellent source of carbohydrate and protein for young animals that have been partially starved. Adult animals cannot digest large quantities of milk powder because of the relative lack of appropriate digestive enzymes.

Horses that have been ill with a poor appetite should be tempted with green grass first, and failing that tried with good-quality hay, preferably alfalfa. It is best to dilute it with good grass hay to begin with, and increase the mix to 100% legume hay over a week. An average horse will require 1.5 to 2 kg BW/day. Grain can be added mixed with molasses or as a mash. Low-fiber diets are recommended to ensure maximum digestibility. A supplement of B vitamins may be advantageous until full appetite and intake are regained. Horses with broken jaws or that are unable to eat at all for some reason can be allowed to go without food for 3 days, but beyond that time they should be fed by stomach tube. A suitable ration is as follows:

- Electrolyte mixture (NaCl, 10 g; NaHCO<sub>3</sub>, 15 g; KCl, 75 g; K<sub>2</sub>HPO<sub>4</sub>, 60 g; CaCl<sub>2</sub>, 45 g; MgO, 24 g): 210 g
- Water: 21 L

- Dextrose, increased from 300 g/day in 7 days to 900 g
- Dehydrated cottage cheese, increased from 300 g/day in 7 days to 900 g

The ration is divided into two or three equal amounts and fed during 1 day. Adult horses that are weak and recumbent may be supported in a sling to avoid decubitus ulceration and other secondary complications associated with prolonged recumbency.

#### FURTHER READING

- Hogan JP, Petherick JC, Phillips CJ. The physiological and metabolic impacts on sheep and cattle of feed and water deprivation before and during transport. *Nutr Res Rev.* 2007;20:17-28.
- Schott HC. Water homeostasis and diabetes insipidus in horses. *Vet Clin North Am Equine Pract.* 2011;27:175-195.

#### REFERENCES

1. Ocal N, et al. *J Anim Vet Adv.* 2008;7:651.
2. Aytakin I, et al. *Biol Trace Elem Res.* 2011;139:301.
3. Fujihara T, et al. *Anim Sci J.* 2007;78:129.
4. Munoz A, et al. *J Equine Vet Sci.* 2010;30:581.
5. Hospes R, Bleul U. *J Equine Vet Sci.* 2007;27:542.
6. Whiting TL, et al. *Can Vet J.* 2012;53:1173.
7. Sherlock CE, et al. *Vet Radiol Ultrasound.* 2010;51:607.

## Weight Loss or Failure to Gain Weight (Ill-Thrift)

This section is concerned with the syndrome of weight loss, or low body condition score (BCS), in the presence of an apparently adequate food supply and a normal appetite. In the absence of any primary disease, an animal or group of animals that presents with this as the problem is a major diagnostic dilemma. Several poorly identified diseases in this category are weaner ill-thrift, thin sow syndrome, thin ewe syndrome, and weak calf syndrome (see other sections of this chapter).

Body weight and BCS are sometimes used interchangeably and regarded as synonymous. This is incorrect as body weight, per se, is not a good indicator of BCS because it is closely related to the height and girth of the animal and provides only limited information about body composition.<sup>1</sup> Body weight (live weight) reflects changes in protein and in fat but is influenced by the relative percentages of protein, fat, and water in the body, which can vary depending on physiologic status. Body weight is not a good indicator of energy content per kilogram of body weight, and proportions of fat, protein, and water are highly variable in animals of the same weight.<sup>2</sup> For example, when body mass is depleted there can be selective depletion of fat mass with partial replacement by water so that the amount of mobilized fat can be larger than the loss of body weight.<sup>1-3</sup> Additionally, body weight is substantially influenced by gut fill, and short periods of feed or water withholding, or feed supplementation, can result in marked changes in

body weight without similar changes in body energy content.<sup>2,4</sup> Pregnancy can increase body weight, especially during mid to late gestation, solely because of the growing fetus.

Body condition score is a more useful indicator of both fat-free mass and fat mass in many species. These variables, and in particular fat mass, are closely associated with nutrient requirements, reproductive efficiency, cull value, and risk of disease (for example, laminitis in fat horses) of animal, and estimation of body fat from the BCS or back fat thickness is increasingly important in management of animals.<sup>1,2,4-9</sup> The ideal body condition of an animal must be determined while considering many factors including species, sex, age, reproductive status, lactation status, disease risk, and intended use. For example, the ideal body condition of dairy cows during each stage of lactation is that which optimizes milk production, minimizes reproductive and health disorders, and maximizes economic returns.<sup>2,8</sup>

Body condition score is determined subjectively by observers using a standardized grading system. These grading systems were not developed to assess the fat content (proportion) of the animal but rather to assess “flesh” or the general body condition and are

limited because of their subjective nature.<sup>10</sup> Additionally, body condition scoring systems do not provide an assessment of regional adiposity, which might have greater clinical relevance in some species, including horses.<sup>5</sup> Body condition scoring systems have not been validated in all major breeds and uses of animals (validation determines the relationship between BCS and a gold standard measure of body fat, such as deuterium dilution space or carcass analysis) nor has their reliability (intrarater and interrater agreement/repeatability expressed as an intraclass correlation coefficient or, less optimally, a  $\kappa$  or weighted  $\kappa$  statistic) been demonstrated over large numbers of raters. There are reports of an intraclass correlation coefficient of 0.74 for four raters of 21 mares and 75 ponies, and of 0.92 (without details).<sup>11,12</sup> Interrater agreement (weighted  $\kappa$  statistic) among three trained observers for dairy cattle was 0.67 for exact agreement, 0.82 for  $\pm 0.25$ , and 0.96 for  $\pm 0.5$  BCS, based on a <2 to 5 scale.<sup>13</sup> Training of observers markedly improved both interobserver and intraobserver repeatability.<sup>13</sup>

Furthermore, differing rating systems might be used within an industry or between countries such as the use of different body

condition scoring methodologies in the United Kingdom (UKBCS) and the United States (USBCS) resulting in the need to develop conversion factors ( $R^2 = 0.56$ ):<sup>14</sup>  $USBCS = 1.182 + 0.816 \times UKBCS$  and,  $UKBCS = 0.131 + 0.681 \times USBCS$ .

A rating system for dairy cattle developed by Elanco Animal Health and subsequently modified is used in the United States (Fig. 4-3) and a methodology for equids is described in Chapter 17.<sup>13</sup> A similar BCS system in dairy cattle is depicted in Fig. 4-4.

Estimation of body composition, including proportions of fat and fat-free mass, can be made using tracer dilution technologies (isotopes or chemical traces such as urea or antipyrine) or ultrasonographic imaging. The gold standard is the analysis of carcass composition, but this technique requires the death of the animal and is time-consuming and expensive. Use of tracer technologies and in particular deuterium oxide has become more common in experimental studies but has limited utility in clinical practice situations.<sup>4</sup> More practical is the use of ultrasound to determine subcutaneous fat thickness, or retroperitoneal fat depth (usually perirenal), as an indicator of body energy stores. This methodology has been well

BCS	3.0	2.75	2.5	2.25	2.0	< 2.0
Pelvic area	V	V	V	V	V	V
Hook bones	Rounded	Angular	Angular	Angular	Angular	Angular
Pin bones	Padded	Padded	Angular, fat palpable	Angular, no fat palpable	Angular, no fat palpable	Angular, no fat palpable
Ribs	Corrugations non visible	Corrugations non visible	Corrugations non visible	Corrugations visible 1/2 way between tips and short ribs	Corrugations visible 3/4 way between tips and short ribs	Corrugations visible 3/4 way between tips and short ribs
					Thurl non prominent	Thurl prominent

BCS	3.25	3.5	3.75	4.0	4.25	4.5	4.75	5.0
Pelvic area	U	U	U	U	U	U	U	U
Tailhead ligament	Visible	Barely visible	Not visible	Not visible	Not visible	Not visible	Not visible	Not visible
Sacral ligament	Visible	Visible	Barely visible	Not visible	Not visible	Not visible	Not visible	Not visible
Thurl	Non flat	Non flat	Non flat	Non flat	Flat	Flat	Flat	Flat
Tips short ribs	Visible	Visible	Visible	Visible	Barely visible	Barely/not visible	Barely/not visible	Barely/not visible
Pin bones	Visible	Visible	Visible	Visible	Visible	Buried	Buried	Buried
Hook bones	Visible	Visible	Visible	Visible	Visible	Visible	Barely visible	Barely/not visible
								All bony prominences well bounded

Fig. 4-3 Summary of system to estimate body condition scoring (BCS) in dairy cattle, ranging in score from 1.0 (could not be skinnier) to 5.0 (could not be fatter).



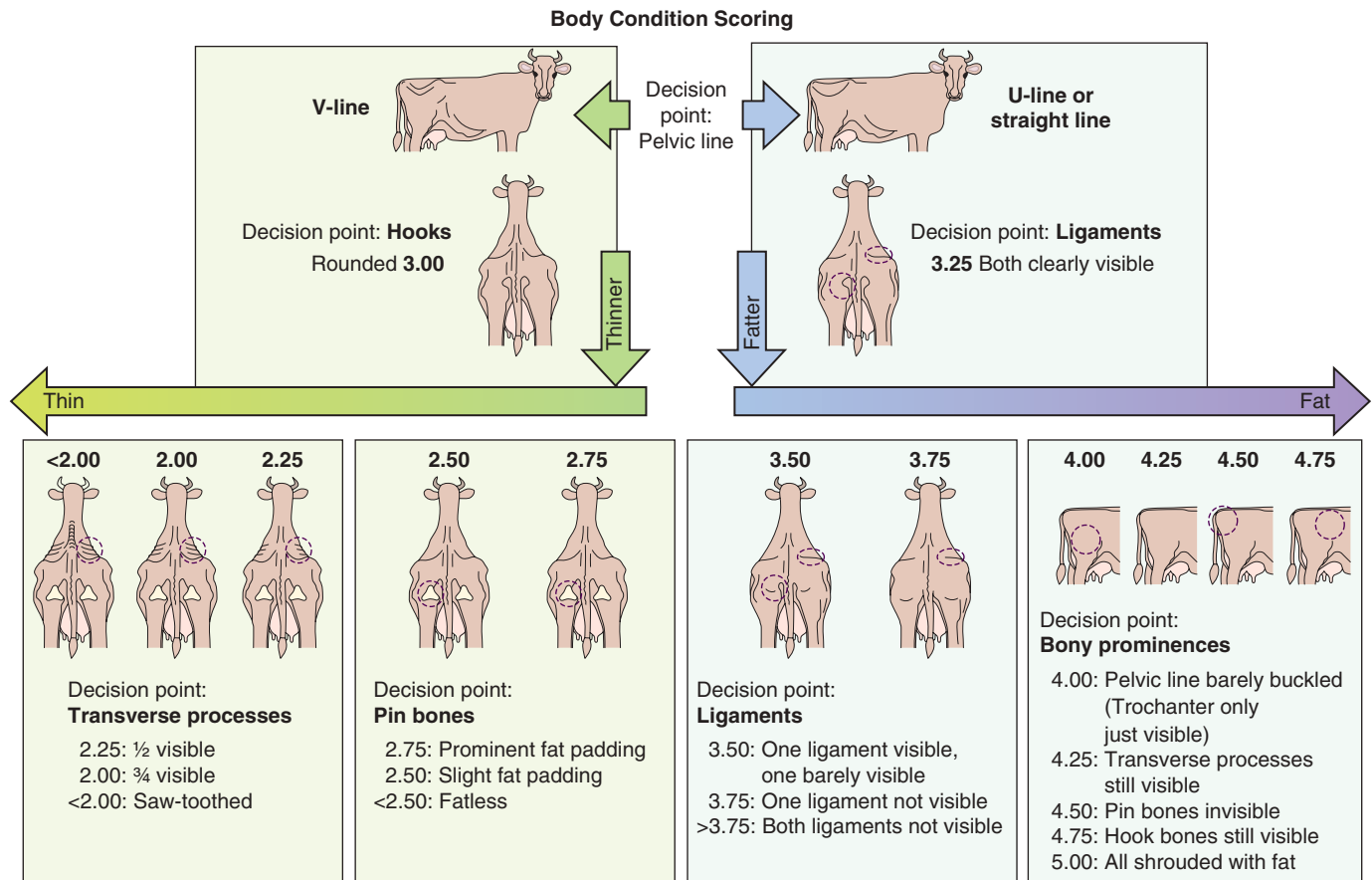

Fig. 4-4 Body condition scoring system modified from earlier work. (From Isensee A et al. *Animal* 2014; 8(12):1971-1977.)

developed in cattle (Fig. 4-5) and pigs and less so in horses.<sup>3,5,7,16-18</sup>

Measurement of bioelectrical impedance is used to assess carcass composition of cattle and to estimate changes in body water in horses.<sup>19-21</sup> Thermal imaging and use of digitized images have been investigated for the assessment of BCS in dairy cows, with a view toward developing automated systems.<sup>17,22</sup>

Detailed next is a checklist of causes that should be considered when an animal has a weight loss problem in the absence of signs indicative of a primary wasting disease.

### NUTRITIONAL CAUSES

“Hobby farm malnutrition” is a surprisingly common cause of poor body condition, especially in companion horses. Inexperienced owners keep their animals where they are not able to graze pasture and are entirely dependent on stored feed but underfed for economy’s sake or out of ignorance of the nutritional requirements of the animal. Knowledge of the animals’ needs and of the approximate energy and protein values of feeds is necessary to prepare an appropriate ration.

The feed and feeding conditions must be inspected as the first step in the diagnostic process to rule out malnutrition (broadly defined as either provision of insufficient

feed or of feed that is not appropriate for the species, age, reproductive status, and use of the animal) as a cause of poor body condition. Mature meadow hay might not provide sufficient calorie or protein intake for some animals and “shy” animals or those low in the hierarchy (pecking order) in group-fed animals can be physically prevented from getting a fair share of available feed, especially if **trough space** is inadequate.

This problem is also common when urban people try to raise a few veal calves or sheep to help defray the costs of their rural acreage. It is common in these circumstances to equate rough meadow grass with proper nutrition for young or pregnant ruminants.

- Other considerations are as follows:
- Diets that are inadequate in total energy because they cannot replace the energy loss caused by the animal’s level of production can be important causes of weight loss in heavy producing animals. This subject is discussed under the heading of production disease. An example is acetonemia of high-producing cows in which body stores of fat and protein are raided to repair the energy deficiency of the diet.
  - Malnutrition as a result of a ration that is deficient in an essential trace element

is unusual in the management situation being discussed. A nutritional deficiency of cobalt does cause weight loss in ruminants but is likely to have an area effect rather than cause weight loss in single animals. Copper, salt, zinc, potassium, selenium, phosphorus, calcium, and vitamin D deficiencies are also in this category. Experimental nutritional deficiencies of riboflavin, nicotinic acid, pyridoxine, and pantothenic acid in calves and pigs can also be characterized by ill-thrift.

- Inadequate intake of an adequate supply of feed is dealt with under diseases of the mouth and pharynx and is not repeated here, but it is emphasized that the first place for a clinician to look in a thin animal is its mouth. The owner might have forgotten just how old the animal is and one often finds a cow without any incisor teeth attempting to survive on pasture.
- Other factors that reduce an animal’s food intake when it is available in adequate amounts include anxiety, the excitement of estrus, new surroundings, loss of a newborn, bad weather, tick or other insect worry, and abomasal displacement.

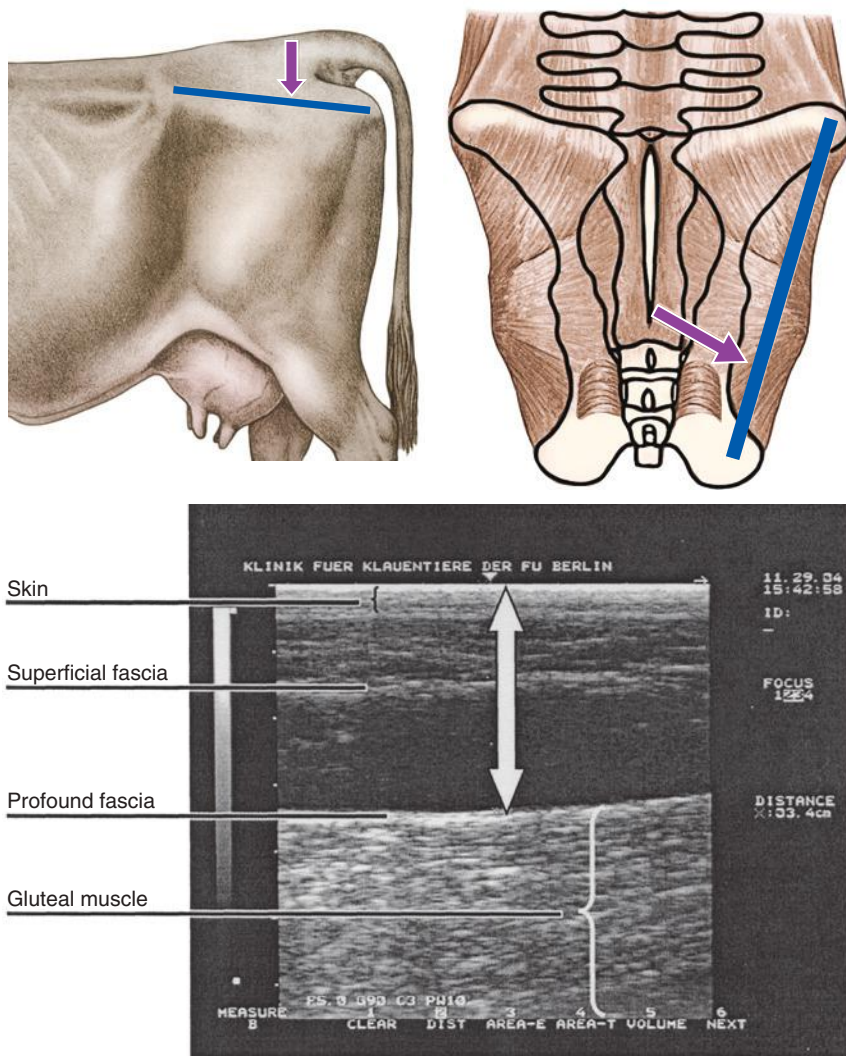

**Fig. 4-5** Location of the site for ultrasonographic measurement of backfat thickness in dairy cattle from the left lateral and dorsal views (top two panels) and ultrasound image from an overconditioned cow with a back fat thickness of 34 mm. (Reproduced with permission from Schroder UJ, Staufenbiel R. *J Dairy Sci* 2006;89:1-4.)

### EXCESSIVE LOSS OF PROTEIN AND CARBOHYDRATES

- **Protein loss in the feces.** Cases of protein-losing gastroenteropathy are not unusual and can be caused by diseases as common as gastrointestinal parasitism or bovine or ovine paratuberculosis (Johne's disease). The loss can occur through an ulcerative lesion, via a generalized vascular discontinuity, or by exudation through intact mucosa as a result of hydrostatic pressure in blood vessels, e.g., in verminous aneurysm, or lymphatics in cases of lymphangiectasia of the intestine. The identification of a neoplasm (lymphosarcoma or intestinal or gastric adenocarcinoma are the usual ones) or of granulomatous enteritis is not possible without laparotomy and biopsy of the alimentary segment. One is usually led to the possibility of this as

a diagnosis by either a low serum total protein or low albumin level in a normal total protein level, and in the absence of other protein loss.

- **Proteinuria** for a lengthy period can cause depletion of body protein stores, resulting in weight loss. Chronic glomerulonephritis is the usual cause. Examination of the urine should be part of every clinical examination of an animal being investigated for weight loss.
- **Internal and external parasitoses** in which blood sucking is a part of the pathogenetic mechanism can result in severe protein loss, as well as anemia per se.

### FAULTY DIGESTION, ABSORPTION, OR METABOLISM

Faulty digestion and absorption are commonly manifested by diarrhea, and diseases

that have this effect are dealt with under the heading of malabsorption syndromes (see Chapter 7). In grazing ruminants, the principal causes are the nematode worms *Ostertagia*, *Teladorsagia*, *Nematodirus*, *Trichostrongylus*, *Chabertia*, *Cooperia*, and *Oesophagostomum* and the flukes *Fasciola* and *Paramphistomum*. In cattle the additional causes are tuberculosis, coccidiosis, sarcosporidiosis, and enzootic calcinosis. In sheep and goats there are Johne's disease, viral pneumonia without clinical pulmonary involvement, and hemonchosis. In horses there are strongylosis, habronemiasis, and heavy infestations with botfly larvae. In pigs there are stephanuriasis, hyostromylosis (including the thin sow syndrome), infestation with *Macracanthorhynchus hirudinaeus*, and ascariasis. Gastrointestinal neoplasia must also be considered as a possible cause.

- Chronic villous atrophy occurs most severely with intestinal parasitism or as a result of a viral infection.
- Abnormal physical function of the alimentary tract, as in vagus indigestion of cattle and grass sickness in horses, is usually manifested by poor food intake and grossly abnormal feces.
- Inadequate utilization of absorbed nutrients is a characteristic of chronic liver disease. It is usually distinguishable by a low serum albumin concentration (although this is an uncommon manifestation of liver diseases in horses), by liver function tests, and by measurement of activity in serum of liver-derived enzymes. A clinical syndrome including edema, jaundice, photosensitization, and weight loss is a common accompaniment.
- Neoplasia in any organ. The metabolism of the body as a whole is often unbalanced by the presence of a neoplasm so that the animal wastes even though its food intake seems adequate.
- Chronic infection, including specific diseases such as tuberculosis, sarcocystosis, East Coast fever, trypanosomiasis (nagana), maedi-visna, caprine arthritis-encephalitis, enzootic pneumonia of swine, metastatic strangles in horses, and nonspecific infections such as atrophic rhinitis of pigs, abscess, empyema, and chronic peritonitis reduce metabolic activity generally as well as reducing appetite. Both effects are the result of the toxemia caused by tissue breakdown and of toxins produced by the organisms present. Less well understood are the means by which systemic infections, e.g., equine infectious anemia, scrapie in sheep, and other slow viruses, produce a state of weight loss progressing to emaciation.
- Food refusal is a well-recognized syndrome in pigs, which in some cases

is caused by mycotoxins in the feed, and “off feed effects” are similarly encountered in feedlot cattle on rations containing a large proportion of wheat grain.

- Many diseases of other systems, e.g., congestive heart failure, are manifested by weight loss.
- Determination of the **specific cause of weight loss in an individual animal** depends first on differentiation into **one of the three major groups**:
  - Nutritional causes, diagnosed by assessment of the animal's total food intake
  - Protein or carbohydrate loss in the animal's excretions, diagnosed by clinicopathologic laboratory tests
  - Faulty absorption of the food ingested diagnosed by tests of digestion, as set out in [Chapter 7](#).

## SHORTFALLS IN PERFORMANCE

The need for economically efficient performance by farm animals introduces another set of criteria, besides freedom from disease, to be taken into consideration when deciding an animal's future. The same comment applies, and much more importantly, when a herd's productivity is being assessed. This is usually done by comparing the subject herd's performances to that of peer herds, or animals in similar environmental and management conditions.

It is usual to use the production indexes that are the essential outputs of the particular enterprise as the criteria of productivity. Thus in dairy herds the criteria could be as follows:

- Milk or butterfat production per cow per lactation (liters per cow or liters per hectare)
- Reproductive efficiency as the mean intercalving interval
- Percentage calf survival to 1 year of age
- Longevity as percentage mortality per year or average age of cows in herd plus culling rate per year
- The culling rate needs to differentiate between sale because of disease or poor production and sale as a productive animal
- Acceptability of product at sale, as indicated by bulk tank milk somatic cell count and rejection of milk because of poor-quality, low-fat content, and low solids-not-fat content

If it is decided that performance falls too far short of the target, an investigation is warranted. Some targets for productivity in each of the animal industries are available, but they vary a great deal between countries depending on the levels of agriculture practiced and the standards of performance expected. For this reason, they are not set down here and neither is the degree of

shortfall from the target that is acceptable, which depends heavily on the risk aversion or acceptability in the industry in that country. For example, if the enterprise is heavily capitalized by high-cost housing and land, the standard of performance would be expected to be higher than in a more exploitative situation in which cattle are pastured all year. In the latter, a reasonable flexibility could be included in the assessment of productivity by permitting it to fall within the scope of 2 standard deviations of the mean productivity established by peer herds.

If the performance is below permissible standards, then an investigation should be conducted that should include the following groups of possible causes:

- **Nutrition:** Its adequacy in terms of energy, protein, minerals, vitamins, and water
- **Inheritance:** The genetic background of the herd and the quality of its heritable performance
- **Accommodation:** To include protection from environmental stress by buildings for housed animals and terrain and tree cover for pastured animals; also consideration of population density as affecting access to feed, water, and bedding areas
- **General managerial expertise:** The degree of its application to the individual flock or herd; this is difficult to assess and then only indirectly, e.g., the efficiency of heat detection and achievement of planned calving pattern
- **Disease wastage:** As clinical disease or, more particularly, subclinical disease; the latter may include such things as quarter infection rate as an index of mastitis, fecal egg counts relative to parasite burden, metabolic profile relative to metabolic disease prevalence rate, and so forth

These investigations tend to require special techniques in addition to the clinical examination of individual animals. They are mostly self-evident, but attention is drawn to the section on examination of a herd or flock in [Chapter 2](#). It will be apparent that there is a great deal of merit in having herds and flocks under constant surveillance for productivity and freedom from disease, such as is practiced in modern herd health programs. Monitoring performance and comparing it with targets is the basis of that system.

The specific syndromes that fall within this category of disease, and which are dealt with elsewhere in this book, are ill-thrift of weaner sheep, thin sow syndrome, weak calf syndrome, poor performance syndrome of horses, and low butterfat syndromes and summer slump of milk cows. Two performance shortfalls encountered commonly by field veterinarians are ill-thrift in all species and poor performance syndrome in horses.

## FURTHER READING

- Kenyon PR, Maloney SK, Blache D. Review of sheep body condition score in relation to production characteristics. *N Z J Agric Res.* 2014;57:38-64.
- Roche JR, Friggens NC, Kay JK, et al. Invited review: body condition score and its association with dairy cow productivity, health and welfare. *J Dairy Sci.* 2009;92:5769-5801.
- Schroder UJ, Staufenbiel R. Methods to determine body fat reserves in the dairy cow with special regard to ultrasonographic measurement of backfat thickness. *J Dairy Sci.* 2006;89:1-4.

## REFERENCES

1. Dugdale AHA, et al. *Vet J.* 2012;194:173.
2. Schroder UJ, et al. *J Dairy Sci.* 2006;89:1.
3. Dugdale AHA, et al. *Equine Vet J.* 2010;42:600.
4. Dugdale AHA, et al. *Equine Vet J.* 2011;43:562.
5. Dugdale AHA, et al. *Equine Vet J.* 2011;43:552.
6. Dugdale AHA. *Equine Vet J.* 2013;45:259.
7. Emenheiser JC, et al. *J Anim Sci.* 2014;92:3868.
8. Roche JR, et al. *J Dairy Sci.* 2009;92:5769.
9. Corner-Thomas RA, et al. *Small Rumin Res.* 2014;119:16.
10. Kenyon PR, et al. *N Z J Agric Res.* 2014;57:38.
11. Carter RA, et al. *Vet J.* 2009;179:204.
12. Carter RA, et al. *Am J Vet Res.* 2009;70:1250.
13. Vasseur E, et al. *J Dairy Sci.* 2013;96:4725.
14. Bewley JM, et al. *J Dairy Res.* 2010;77:95.
15. Isensee A, et al. *Animal.* 2014;8:1971.
16. Dugdale AHA, et al. *Vet J.* 2011;190:329.
17. Weber A, et al. *Livestock Sci.* 2014;165:129.
18. Jiao S, et al. *J Anim Sci.* 2014;92:2846.
19. Thomson BC, et al. *Aust J Exp Agric.* 1997;37:743.
20. Latman NS, et al. *Res Vet Sci.* 2011;90:516.
21. Lindinger MI. *Comp Exerc Physiol.* 2014;10:3.
22. Halachmi I, et al. *Comp Elect Agric.* 2013;99:35.

## UNTHRIFTINESS IN WEANER SHEEP (WEANER ILL-THRIFT)

### ETIOLOGY

Several factors have been associated with this syndrome in lambs, goat kids, and calves. Contributing causes include intestinal parasitism, coccidiosis, infection with *Mycoplasma ovis* (eperythrozoosis), suboptimal animal husbandry, and nutritional deficiencies. The latter can be in the form of inadequate gross nutrition (a lack of energy or protein) or a deficiency of trace elements (copper, cobalt, selenium, and zinc) or vitamins (thiamin, vitamin A, vitamin D, and vitamin E).

The syndrome is often multifactorial, with a combination of management, nutritional, and infectious causes involved that can be a challenge to identify and correct.<sup>1</sup>

### SYNOPSIS

**Etiology** Several, often interacting causes, including poor management and animal husbandry; parasitism; trace element and vitamin deficiencies; the amount, quality, and palatability of pasture and fungal infestations of pasture.

**Epidemiology** Loss of weight after weaning, hence failure to achieve target



weights for adequate survival and mating. This is often despite the presence of ample feed and at times when adult sheep are faring well.

**Clinical findings** Poor body condition and wool growth, failure to thrive, and gradually accumulating mortalities.

**Lesions** Inanition; little body fat, involution of rumen papillae, and poor mineralization of long bones and ribs, often with evidence of healing fractures.

**Diagnostic confirmation** Examination of weight profile of mob and pastures being grazed. Laboratory testing for contributing causes, such as worm egg counts for internal parasitism or blood and tissue tests for trace element status. Response to treatment or provision of the required nutritional supplement, such as energy (usually most cost-effectively in the form of cereal grains), protein (legume grains such as field peas or lupins), trace elements, or vitamins.

**Treatment and control** Correction of gross nutritional or trace element deficiencies and review of the management calendar, including length of mating period, month of lambing, and proactive monitoring of body weights and worm egg counts at and after weaning. "Imprint feeding" of cereal grains to lambs while they are still on the ewes; 20 g per head on at least three occasions will help weaner sheep recognize and start consuming supplementary grain rations before they start losing excessive weight.

Poor quality or unpalatable pasture can be a cause of ill-thrift, or at least associated with it, and moving animals to a better quality pasture will often help alleviate the problem. This has been observed with many pasture species, especially rank or senescent swards, including phalaris (*Phalaris aquatica*), perennial rye grass (*Lolium perenne*), setaria grass (*Setaria sphacelata*), tall fescue (*Festuca arundinaceae*), and turnips (*Brassica repens*). Infestation of pasture grasses with endophyte fungi may be a contributing factor to ill-thrift and poor growth rates, such as with *Acremonium lolii* in perennial rye grass and "summer syndrome" of calves associated with *A. coenophialum* infestation of tall fescue. Infection of pasture species with toxicogenic *Fusarium* spp. has been associated with ill-thrift in lambs in South Africa, New Zealand, and Australia. Pasture and soil fungi have also been suspected of being associated with ill-thrift in sheep in eastern Canada.

## EPIDEMIOLOGY

The syndrome appears to be most severe in the Southern Hemisphere, but this may be because Merino sheep are more prevalent. The disease is most common in this breed, which may be due in part to their timorous nature, which makes weaning, and the need

to graze as a mob by themselves, more stressful and traumatic than for most other breeds. For example, the average postweaning mortality in a national survey of 1400 sheep producers in Australia was 4.6%, with 44% of farms having "high" mortalities (exceeding a benchmark of 4% per annum).<sup>1</sup> High mortality was reported on 50% of farms with predominantly Merino sheep, but also on 32% of farms with predominantly cross-breeds, and there was a postweaning mortality >10% on 14% of farms.

Factors that contribute to weaner ill-thrift include the following:

- Overstocking (overcrowding) on pasture.
- Poor quality or an inadequate amount of pasture.
- Lambs that are light (<20 kg) at weaning, with the lightest 20% of a mob having three times the risk of mortality than the middle 20%. A target for a weaning weight of at least 22 kg for Merinos, or 45% of mature weight, is commonly used.<sup>2,4</sup>
- Merino ewes often have poor milk production, hence management of the ewe flock, such as maintaining ewes at target condition scores from mating and throughout pregnancy, is critical to achieve target weaning weights.<sup>4</sup>
- Postweaning growth rate: Increasing growth from 10 to 20 g/day reduces the risk of mortality by 70%<sup>3</sup> and a target for growth in the immediate postweaning period of 30g/day (1 kg/month) is sufficient to significantly reduce the risk of mortality.<sup>2,4</sup>
- Other management factors likely to lead to low weaning weights and subsequent unthriftiness are extended mating periods (lambs born late in the season), ewes in low condition score (light lambs and poor milk supply), and multiple birth lambs.

Weaner ill-thrift does occur in breeds other than the Merino<sup>1</sup> and is also reported in the Northern Hemisphere. The economic effects can be disastrous for individual flocks and have been estimated at up to USD\$58M over the entire industry in Australia.<sup>5</sup> Decreased growth and delayed maturation can mean a poor performance at the first (maiden) lambing. A high proportion of weaner deaths in wool flocks reduces the ability to select replacement ewes, decreasing the rate of genetic gain (although ram genetics are overwhelmingly more important in a wool flock). There is also a substantial decrease in the amount and quality of weaner wool which, in Merino flocks, is usually the finest and most valuable from any age group.

## CLINICAL AND NECROPSY FINDINGS

As the name indicates, this syndrome in weaned sheep is manifested primarily by poor body condition and a failure to thrive.

Within an affected group not all lambs are equally affected and there will be a range of weight or condition scores. Those lambs in very poor condition are often anemic, may have diarrhea, and there are sporadic but continuing mortalities. The sheep will often have been treated with anthelmintics with no favorable response. There are often no abnormal findings at gross postmortem, other than those associated with emaciation. Poor development of rumen papillae may be obvious grossly, villous atrophy is often found on histologic examination of the small intestine, and the mineralization of long bones and ribs may be reduced because of chronic malnutrition. This can lead to thin cortices and fractures when sheep are handled, such as for shearing or crutching.

## DIFFERENTIAL DIAGNOSIS

When faced with this problem the initial approach should be to examine for the most likely cause, namely a deficiency in energy or protein intake. A physical examination of affected sheep should include an examination of the teeth to ensure that there is no excessive wear, or even breaking of the incisors (e.g., if the sheep are being fed roots).

The internal parasite status of the group should be examined by appropriate techniques, such as worm egg counts or total worm counts. Clinical or subclinical infestations with nematodes are common occurrences at this time in the sheep's life, before immunity is properly developed and when pasture contamination can be high.

Infections with coccidia, cryptosporidia, or *Mycoplasma (Eperythrozoon) ovis* are significant causes of ill-thrift and should be examined by fecal flotation and blood smears, respectively.

The trace element status of the group should be examined if the cause cannot be attributed to gross nutritional deficiencies (inadequate energy or protein) or internal parasites. The most common trace element deficiencies are copper, selenium, and cobalt. These are typically associated with specific geographic areas, soil types, and differing patterns of soil ingestion through wet and dry seasons. If trace element deficiency is a contributing factor it is likely that there will be some prior history of this problem in the area. Diagnosis by response to supplementation is a common approach, and the diagnostic aspects of the trace element deficiencies are outlined under their specific headings.

Examination of the previously mentioned possible causes can be time-consuming and costly, and there are a proportion of cases in which no clear cause can be identified.

Infectious agents can produce enteric lesions and ill-thrift (e.g., coronavirus and yersiniosis), with the malabsorption of nutrients manifested by weight loss and by chronic diarrhea. These can be differentiated on the initial gross postmortem or in samples submitted for culture and histopathology.



## FURTHER READING

Radostits O, Gay C, Hinchcliff K, Constable P. Unthriftness in weaner sheep (weaner illthrift). In: *Veterinary Medicine: A Textbook of the Diseases of Cattle, Horses, Sheep, Pigs, and Goats*. 10th ed. London: W.B. Saunders; 2007:1997.

## REFERENCES

1. Campbell AJD, et al. *Anim Prod Sci*. 2014;54:4.
2. Hatcher S, et al. *Aust J Exper Agric*. 2008;48:966.
3. Campbell AJD, et al. *Aust Vet J*. 2009;87:305.
4. Thompson AN, et al. *Anim Prod Sci*. 2011;51:784.
5. Sacket D, et al. Final report project AHW.087, MLA Sydney, 2006.

## PORCINE FAILURE TO THRIVE

This is a clinical syndrome recognized in the United States and Canada since 2007<sup>1</sup> and in Spain.<sup>2</sup> It has also been called porcine cachectic syndrome or porcine cachexia. It is characterized by anorexia of nursery piglets, progressive loss of bodily condition, and lethargy over the next 1 to 3 weeks. Morbidity may be low but the case mortality is high and many require culling.

## ETIOLOGY

The etiology for porcine failure to thrive has not yet been established. It may include both infectious and noninfectious factors. This syndrome was first identified in a high-health herd and all the usual culprits were ruled out, although both viral and bacterial agents were found.<sup>3,4</sup> Some eminent pig veterinarians think that the disease is related mainly to suboptimum management before weaning.

## EPIDEMIOLOGY

It occurs around weaning not just postweaning. Villous atrophy and enteritis are the main features.

## PATHOGENESIS

Some think porcine failure to thrive is a postweaning location issue, whereas others think it is a source farm issue. There are no infectious, nutritional, managerial, or environmental factors to explain the clinical signs.

## CLINICAL SIGNS

At weaning affected pigs are of average to above average weight. Within 60 to 72 hours of weaning they are still active, alert, and without fever, but they are flat-sided and have an empty abdomen. Within 7 days they are anorectic with rough hair coats and lethargic. Their heads are down and their muscles are slack. They are unwilling to move and often sneeze. The pigs deteriorate and die within 2 to 3 weeks.

Some groups from the same source are affected but not others. It may occur several times and then disappear for a long period. Some pigs on the affected farms show repetitive oral behavior such as licking, chewing, or chomping. The crucial time appears to be

around 96 hours postweaning. At this time the pigs rest their heads on the backs of their fellows and start chomping.

## PATHOLOGY

It is difficult to say whether the lesions are the cause of the condition or are the result of inappetence and starvation. Subgross pathology shows a severe villous atrophy, rhinitis, and gastritis but not in the *pars esophagea*. There are no fat reserves remaining in the carcass.

In the early cases in 2007, the most obvious lesions were histologic and included superficial lymphocytic fundic gastritis, atrophic enteritis with many immature cells, villous atrophy, superficial colitis, lymphocytic and neutrophilic rhinitis, mild nonsuppurative meningoencephalitis, and thymic atrophy.

## TREATMENT

Until a cause is found it is difficult to work out a reliable treatment, and in many cases pigs are too badly affected for anything other than euthanasia. It is essential that pigs find food and water and it may be necessary to introduce gruel feeding. Few pigs respond to the special care they might have in hospital accommodation (supplemental heat, electrolytes, special high-milk feed supplements, moistened feed, and individual pig feeding).

## CONTROL

There is none at the moment.

## REFERENCES

1. Dufresne L, et al. *Proc Allen Leman Swine Conf*. 2008;79.
2. Segales J, et al. *Vet Rec*. 2012;170:499.
3. Huang Y, et al. *J Swine Health Prod*. 2011;19:331.
4. Huang YJ, et al. *J Vet Diagn Invest*. 2012;24:96.

## Physical Exercise and Associated Disorders

The act of performing physical work requires expenditure of energy at rates above the resting metabolic rate. Increases in metabolic rate can be supported by anaerobic metabolism through the use of intramuscular ATP stores and conversion of glycogen or glucose to lactate for short periods of time. Ultimately, however, all energy is derived by aerobic metabolism and is limited by the rate of delivery of oxygen to tissue and its utilization in mitochondria. To support the increased energy expenditure required to perform work, such as racing, carrying a rider, or pulling a cart, the metabolic rate is increased. Increases in metabolic rate are supported by increases in oxygen delivery to tissue and carbon dioxide removal. Increased oxygen consumption is dependent on an

increase in oxygen delivery to tissues, which is possible by increases in cardiac output, muscle blood flow and, in horses, an increase in hemoglobin concentration with a concomitant increase in the oxygen-carrying capacity of blood. The increased transport of oxygen from the air to the blood is accomplished principally by increases in respiratory rate and tidal volume. Factors that affect oxygen transport from the air to the mitochondria have the potential to impair performance. For instance, laryngeal hemiplegia reduces minute ventilation and exacerbates the normal exercise-associated hypoxemia in horses, atrial fibrillation decreases cardiac output and hence oxygen delivery to tissues, and anemia reduces the oxygen-carrying capacity of the blood.

The increase in cardiac output with exercise of maximal intensity in horses is very large; horses have a cardiac output of about 75 (mL/min)/kg at rest and 750 (mL/min)/kg (300 L/min for a 400-kg horse) during maximal exercise. Associated with the increase in cardiac output are increases in right atrial, pulmonary arterial, and aortic blood pressures. Systemic arterial blood pressure during exercise increases as the intensity of exercise increases with values for systolic, mean, and diastolic pressures increasing from 115, 100, and 80 mm Hg (15.3, 13.3, and 10.6 kPa) at rest to 205, 160, and 120 mm Hg (27.3, 21.3, and 16 kPa), respectively, during intense exercise.

Pulmonary artery pressure increases from a mean of approximately 25 mm Hg (3.3 kPa) to almost 100 mm Hg (13.3 kPa) during intense exercise. The increase in pulmonary artery pressure with exercise may contribute to exercise-induced pulmonary hemorrhage.

The increase in metabolic rate during exercise causes a marked increase in metabolic heat generation with a subsequent increase in body temperature. The increase in body temperature is dependent on the intensity and duration of exercise and the ability of the horse to dissipate heat from the body. Intense exercise of short duration is associated with marked increases in body temperature but such increases rarely cause disease. However, prolonged exercise of moderate intensity, especially if performed in hot and humid conditions, may be associated with rectal temperatures in excess of 42.5°C (108.5°F). Heat is dissipated primarily by evaporation of sweat from the skin surface. Sweating results in a loss of body water and electrolytes, including sodium, potassium, calcium, and chloride. The size of these losses can be sufficient to cause dehydration and abnormalities of serum electrolyte concentrations and also impaired cardiovascular and thermoregulatory function.

Recovery from exercise is influenced by the fitness of the individual, with fitter horses recovering more rapidly; the intensity and

duration of the exercise bout; and activity during recovery. Horses allowed to walk after a bout of intense exercise recuperate more quickly than do horses that are not allowed to walk. Recovery is delayed if the horse cannot drink to replenish body water or in hot and humid conditions.

### FURTHER READING

- Hinchcliff KW, Kaneps AJ, Geor RJ. *Equine Sports Medicine and Surgery: Basic and Clinical Sciences of the Equine Athlete*. Edinburgh, UK: Saunders; 2014.
- Votion DM, Navet R, Lacombe VA, et al. Muscle energetic in the exercising horse. *Comp Exerc Physiol*. 2007;4:105-118.

## EXERCISE-ASSOCIATED DISEASES

Many exercise-induced diseases are associated with specific activities. For instance, heat stroke and exhaustion are very rare in Standardbred and Thoroughbred horses raced over distances of up to 3 miles (5km) but common in horses participating in endurance races (50–100km) or the second day of 3-day event competitions. Conversely, exercise-induced pulmonary hemorrhage occurs only in horses that race or compete at high speed and is very uncommon in draft breeds. The exercise-associated diseases exertional rhabdomyolysis, synchronous diaphragmatic flutter, hyperthermia, and exercise-induced pulmonary hemorrhage are dealt with in other sections of this book.

### EXHAUSTION

All physical work, if of sufficient intensity and duration, causes fatigue. The mechanisms underlying fatigue vary with the type of work or exercise performed. Thus fatigue in a racehorse running 3 km at high speed has a different genesis from fatigue than an endurance horse that has run 100 km at low speed. Typically, Standardbred and Thoroughbred racehorses recover quickly and exhaustion rarely occurs. However, horses performing endurance exercise require longer to recover, and the processes associated with fatigue may progress to the extent that recovery is delayed or impossible without treatment.<sup>1</sup> This results in illness in some competitors after racing and elimination of some horses from competition during the endurance race.<sup>2</sup> The failure to recover and the clinical and clinicopathologic signs associated with this have been labeled *exhausted horse syndrome*.

The exhausted horse syndrome is associated with endurance races, 3-day eventing, trail riding, and fox and bird hunting; these are all activities in which there is prolonged submaximal exercise. The likelihood of the disorder is increased in unfit horses or when horses are exercised in hot and humid conditions, especially if they are not accustomed to such conditions.

### PATHOGENESIS

The pathogenesis of exhaustion is complicated but probably involves depletion of body glycogen and electrolytes, especially sodium, chloride, and potassium; hypovolemia caused by large losses of water in sweat; hyperthermia; and acid-base disturbances. Endurance exercise is associated with the production of large amounts of heat, which are dissipated primarily by evaporation of sweat. Approximately 11 L of sweat are lost each hour during submaximal exercise, and this loss causes a significant decline in total body water, sodium, potassium, and chloride content and serum concentrations of these ions. Loss of chloride causes a metabolic alkalosis. Hypovolemia impairs thermoregulation by reducing blood flow to the skin and probably results in a reduction in gastrointestinal blood flow contributing to intestinal ischemia and development of ileus. Body temperature increases to dangerous levels (43°C; 109°F), and the horse cannot continue to exercise. Excessive increases in body temperature can overwhelm mechanisms to ensure that the brain of horses does not overheat, resulting in signs of CNS dysfunction.<sup>1</sup> If the exercise-induced abnormalities are sufficiently severe then the combination of hyperthermia and dehydration can initiate a cascade of events terminating in shock, multiple organ failure, and death.

### CLINICAL SIGNS

The clinical signs of the exhausted horse syndrome include failure to continue to exercise, depression, weakness, failure to eat and drink, delayed return of heart rate and rectal temperature to normal values, poor skin turgor and capillary refill time, a stiff stilted gait consistent with rhabdomyolysis, and decrease or absent borborygmi. Urine is concentrated and the horse ceases to urinate.

Colic occurs in horses after endurance racing and can be related to abnormalities in gastrointestinal motility secondary to fluid and electrolyte abnormalities and hyperthermia.<sup>3-6</sup> Lesions in horses taken to surgery most commonly involve the small intestine, and affected horses have signs typical of acute small intestinal obstruction compounded by signs of exhaustion.<sup>3</sup> Most endurance horses with postracing colic respond to cooling and correction of fluid and electrolyte abnormalities with development of surgical lesions.<sup>4</sup>

Clinicopathologic examination reveals hemoconcentration, hypochloremia, hypokalemia, and variable changes in serum sodium concentration. There is usually a metabolic alkalosis (increased blood bicarbonate concentration), although some severely affected horses will also have a metabolic acidosis associated with increased blood lactate concentration. Serum creatinine and urea nitrogen concentrations are increased because of dehydration and/or renal disease. Serum

creatinine kinase activity is markedly increased in horses with rhabdomyolysis.

### TREATMENT

Treatment consists of rapid restoration of hydration status, correction of electrolyte and acid-base abnormalities, and reduction in body temperature. Fluid therapy is addressed in detail in [Chapter 5](#). Suitable fluids for administration to exhausted horses are Ringer's solution, isotonic sodium chloride with added potassium chloride (10 mEq/L), and calcium gluconate (10–20 mL of 24% solution per liter). Theoretically, lactated Ringer's solution should not be given to horses with metabolic alkalosis, but clinical experience indicates its safety and efficacy.

Horses should be aggressively cooled by application of cold water or water and ice. In spite of folklore to the contrary, application of ice cold water to hyperthermic horses is not dangerous or associated with rhabdomyolysis. The NSAIDs for pain relief can be given when the horse is no longer hypovolemic. Horses with colic should have a full examination for that condition, including passing of a nasogastric tube to ensure that there is no distension of the stomach.

### PREVENTION

Prevention rests in ensuring that participating horses are adequately trained for the event and acclimated to the environmental conditions. Horses should be healthy, preferably as determined by a veterinary examination before the race, and should be monitored during the event for signs of excessive fatigue, dehydration, or hyperthermia.

### REFERENCES

1. Foreman JH. *Comp Exerc Physiol*. 2012;8:81.
2. Nagy A, et al. *Equine Vet J*. 2014;46:294.
3. Alexander GR, et al. *Equine Vet Educ*. 2012;24:193.
4. Fielding CL, et al. *Equine Vet J*. 2012;44:472.
5. Banse HE, et al. *Comp Exerc Physiol*. 2013;9:125.
6. Walker WT, et al. *Can Vet J*. 2014;55:765.

## POOR RACING PERFORMANCE AND EXERCISE INTOLERANCE IN HORSES

The definition of poor racing performance is difficult. Horses that have a proven record of performing well and then fail to perform at their previous level are readily apparent, and a physical cause of the reduction in performance can often be identified. More difficult are the horses that do not have a history of satisfactory performance and are best labeled as *failure to perform to expectation*. Horses in this group might indeed have a clinical abnormality, but commonly the reason is lack of innate ability or inadequate training. Both of these causes must be raised with the owner and trainer carefully and tactfully, and only after a thorough examination of the horse.

Exercise intolerance in racehorses is best defined as the inability to race at speeds previously attained by that horse or attained by peers. In its most extreme form exercise intolerance is evident as failure to complete the race, whereas its mildest form is evident as a slight decrement in performance, such as losing a race by several lengths or 1 or 2 seconds, or failure to perform to expectation.

### APPROACH TO THE HORSE WITH EXERCISE INTOLERANCE

Horses with a history of a recent decrement in performance or those that are not performing to expectation should be examined in a systematic fashion.

#### History

A detailed history should be collected that focuses on documenting the reduction in performance, its time course, and the presence and evolution of any clinical signs. This can be accomplished by asking the following questions of the owner or trainer:

- **What evidence is there of poor performance?** This query should focus on providing objective evidence of a reduction in performance through examination of race times or results. This also allows the severity of the reduction in performance to be documented.
- **What is the horse's training schedule?** The training regimen should be appropriate for the horse's level of competition.
- **Describe the horse's exercise intolerance.** Does it start the race strongly and "fade" in the last part of the race, or is it unable to maintain a suitable speed for the complete race? Is the horse slow to recover its normal respiratory rate after exercise? Can it sweat? Does it consistently veer or "pull" toward one side?
- **Is there any history of illness in this horse or other horses in the same stable or at the race track?** Has the horse had a fever or been inappetent? Is the horse on any medication? Specific attention should be paid to any history of respiratory disease.
- **Does the horse make an unusual noise associated with respiration when running?** Horses with upper airway obstructions almost always make an abnormal noise during exercise.
- **Does the horse cough either at rest, during, or after exercise?** Coughing can be an indication of lower respiratory tract disease.
- **Has the horse ever had blood at the nostrils after exercise or has it been diagnosed as having exercise-induced pulmonary hemorrhage?**
- **Is the horse lame?** Does it ever show signs of muscle stiffness or abnormal gait?

- **What is the history of anthelmintic administration?**

#### Clinical Examination

A thorough clinical examination should be performed. The physical examination should include a detailed examination of the musculoskeletal, cardiovascular, and respiratory systems and should include the collection of samples of body fluids for laboratory analysis as indicated by the historical data or clinical examination. Ancillary testing, such as radiography, endoscopy, nuclear scintigraphy, and stress testing, are available at larger centers and might be indicated in some cases.

The horse should be examined at rest for evidence of musculoskeletal disease and then should be observed at the walk and trot for signs of lameness. Subtle lameness that is sufficient to impair performance can be difficult to detect in a horse slowly trotting, and other examinations, such as observation during and after high-speed running at a track, radiography, and nuclear scintigraphy, can be necessary. The major muscle groups, including the quadriceps, should be palpated for firmness or pain suggestive of rhabdomyolysis.

The heart should be auscultated carefully for evidence of valvular incompetence or arrhythmias. Mild (grade II–III/VI) systolic ejection murmurs heard loudest on the left thorax are common in fit racehorses and should not be mistaken for evidence of valvular disease. Electrocardiography to diagnose abnormalities of rhythm (for example, atrial fibrillation) or echocardiography to demonstrate the extent of valvular lesions are indicated if abnormalities are detected on cardiac auscultation.

The respiratory system should be carefully examined by auscultation of the thorax in a quiet area. The thorax should be auscultated initially with the horse at rest; if no abnormalities are detected the horse's tidal volume should be increased by rebreathing air from a large bag held over its nose, or by exercise. Radiography of the thorax may demonstrate changes consistent with exercise-induced pulmonary hemorrhage, recurrent airway obstruction, or pneumonia. Aspirates of tracheal fluid or bronchoalveolar lavage fluid should be examined for evidence of inflammation or hemorrhage.<sup>1,2</sup> The upper respiratory tract, including pharynx, larynx, trachea, and carina, should be examined with a flexible endoscope.

#### Laboratory Testing

Collection of blood and urine samples for laboratory analysis is indicated if specific abnormalities are detected on physical examination or there is historical data suggesting the need to more closely examine some body systems. For instance, exercise-associated rhabdomyolysis can be confirmed by measurement of serum CK and AST activity.

However, blood samples are often submitted for analysis as a matter of routine. Specific attention should be paid to the hemogram, in particular the white blood cell count, for evidence of inflammation and the hematocrit for evidence of anemia. Care should be taken to not assign minor abnormalities an undue importance until corroborating evidence is obtained. Tracheal or bronchoalveolar lavage fluid can provide evidence of lower respiratory tract disease.<sup>2</sup> Examination of feces for helminth ova might demonstrate parasitism.

#### Exercise Stress Testing

Examination of horses during and after high-speed exercise is now routine in many referral centers and practices specializing in sports medicine. Such examinations in the past had to be conducted on a treadmill if dynamic endoscopic examinations or electrocardiographic examinations were to be performed, but this is no longer the case. Endoscopic and electrocardiographic examinations of horses exercising in the field, and ideally undertaking exercise tasks that mimic their day-to-day activities and competition, are now readily achieved in real time.<sup>3–8</sup> Dynamic endoscopy allows visualization of the upper airway of horses under actual working conditions (racing, dressage, and reining) and avoids the risks and limitations of horses exercising on a treadmill,<sup>3,7,9</sup> although this risk is comparatively small with 0.6% of horses sustaining an important injury during examination.<sup>10</sup> Examination of ridden horses under saddle also provides the opportunity to examine the horse–saddle–rider interaction, including saddle fit and girth tension, which is an important cause of poor performance in some classes of equitation.<sup>11</sup>

Values of a number of performance-related variables have been determined for Standardbred and Thoroughbred racehorses, with better athletes having greater aerobic capacity. However, at this time the main use of high-speed exercise testing is the detection of exercise-induced arrhythmia (such as paroxysmal ventricular tachycardia or atrial fibrillation), rhabdomyolysis, and upper airway obstruction. Upper airway obstruction is a common cause of poor performance that can often be diagnosed by rhinolaryngoscopic examination of horses at rest or after brief nasal occlusion. However, some causes of obstruction are best diagnosed using rhinolaryngoscopy during exercise.<sup>12</sup>

### CAUSES OF EXERCISE INTOLERANCE OR POOR PERFORMANCE

Any disease that adversely affects the normal function of a horse has the potential to impair performance, and these are dealt with extensively in textbooks on equine sports medicine. Listed in the following sections are some common causes of exercise intolerance in racehorses.



## Musculoskeletal System

- Lameness is a common cause of poor performance. Subtle lameness can be difficult to detect but be sufficient to cause a decrement in performance. Causes and diagnosis of lameness are discussed in textbooks on that topic and are not further covered here.
- Rhabdomyolysis (see Chapter 15)

## Cardiovascular System

Poor performance attributable to cardiovascular disease can be caused by the following:

- Atrial fibrillation is usually readily detected on examination of heart sounds or pulse and confirmed by electrocardiographic examination. Paroxysmal atrial fibrillation induced by exercise that resolves soon after exercise ceases causes poor performance and is difficult to diagnose.
- Ventricular arrhythmias<sup>4,5</sup>
- Valvular incompetence, such as mitral or tricuspid regurgitation secondary to acquired or congenital disease; endocarditis is rare in horses.
- Congenital anomalies including ventricular septal defect
- Myocarditis or myocardial disease (rare)
- Aortoiliac thrombosis

## Respiratory System

### Upper Airways (See Obstructive Diseases of the Equine Larynx)

- Laryngeal hemiplegia
- Intermittent dorsal displacement of the soft palate
- Epiglottic entrapment
- Epiglottic hypoplasia
- Arytenoid chondritis
- Pharyngeal cysts
- Upper air obstruction associated with hyperkalemic periodic paralysis
- Guttural pouch empyema
- Retropharyngeal abscesses
- Redundant or flaccid alar folds

### Lower Airways

- Pneumonia secondary to influenza virus or equine herpesvirus-1 or equine herpesvirus-4 infection
- Parasitic pneumonia caused by *Dictyocaulus arnfieldi*
- Severe exercise-induced pulmonary hemorrhage
- Lower airway inflammatory disease and recurrent airway obstruction
- Granulomatous pneumonia

## Hematologic and Biochemical Abnormalities

### Anemia

- Parasitism, especially caused by *Strongylus* sp. and cyathostomes
- Chronic disease, such as the presence of an abscess

- Equine infectious anemia
- Piroplasmosis
- Gastric ulceration (anemia is an unusual manifestation of this disease)
- Iron deficiency (which is rare)
- Administration of inhibitors of folic acid synthesis or prolonged oral administration of inactive folic acid
- Phenylbutazone toxicity
- Excessive phlebotomy
- Gastric squamous cell carcinoma
- Administration of recombinant human erythropoietin

### Hypoproteinemia

- Parasitism, especially caused by *Strongylus* sp. and cyathostomes
- Malnutrition, especially inadequate protein intake
- Protein-losing enteropathy such as lymphosarcoma or granulomatous enteritis

### Electrolyte Abnormalities

- Hypokalemia and hyponatremia secondary to excessive losses in sweat and inadequate intake

### Nervous System Disease

- Spinal ataxia caused by cervical compressive myelopathy (static or dynamic), equine protozoal myeloencephalitis, and equine degenerative myelopathy
- Sweeney
- Stringhalt

### Miscellaneous

- Hypothyroidism (very rare)
- Pituitary tumor (equine Cushing's disease)
- Iatrogenic hypoadrenocorticism
- Hepatic disease of any cause, but beware of iron overload
- Renal disease
- Secondary nutritional hyperparathyroidism
- Malnutrition
- Performance-altering drug administration such as  $\beta$ -adrenergic antagonists (beta blockers) or sedatives

## TREATMENT

Treatment should be directed toward correcting the underlying disease. Routine administration of hematinics to horses with a normal hemogram is unnecessary. If after careful and comprehensive examination an organic cause for the poor performance is not found, attention should be given to the horse's training program. Training programs for horses are described in Further reading (see below).

## FURTHER READING

Hinchcliff KW, Kaneps AJ, Geor RJ. *Equine Sports Medicine and Surgery: Basic and Clinical Sciences of the Equine Athlete*. Edinburgh, UK: Elsevier Health Sciences; 2014.

## REFERENCES

1. Richard EA, et al. *Vet J*. 2010;184:282.
2. Nolen-Walston RD, et al. *JAVMA*. 2013;242:1138.
3. Pollock PJ, et al. *Equine Vet J*. 2009;41:354.
4. Barbesgaard L, et al. *Equine Vet J*. 2010;42:202.
5. Trachsel DS, et al. *Equine Vet J*. 2010;42:208.
6. Davidson EJ, et al. *Equine Vet J*. 2011;43:3.
7. Van Erck E. *Equine Vet J*. 2011;43:18.
8. Strand E, et al. *Equine Vet J*. 2012;44:518.
9. Van Erck-Westergren E, et al. *Equine Vet J*. 2013;45:376.
10. Franklin SH, et al. *Equine Vet J*. 2010;42:70.
11. Greve L, et al. *Vet J*. 2013;195:275.
12. Allen KJ, et al. *Equine Vet J*. 2010;42:587.

## Sudden or Unexpected Death

When an animal is found dead without having been previously observed to be ill, a diagnosis, even after necropsy examination, is often difficult because of the absence of a detailed history and clinical findings. A checklist of diseases for consideration when sudden or unexpected death occurs in a single animal or group of animals is provided later. All death is sudden, but the focus on an investigation of sudden death is that it was unexpected. Details of each of the diseases listed are available in other sections of this book. This list applies particularly to cattle, but some occurrences in other species are noted. It is necessary to point out the difference between "found dead" and "sudden and unexpected death."

When animals are observed infrequently, for example, at weekly intervals, it is possible for them to be ill with obvious clinical signs for some days without being observed. In these circumstances the list of possible diagnoses is very large. It is also correspondingly large when animals are kept together in large groups and are not observed as individuals. This is likely to happen in beef cattle, especially in feedlots or as calves with dams at pasture, when the animals are unaccustomed to human presence and move away when approached.

## SUDDEN OR UNEXPECTED DEATH IN SINGLE ANIMALS

### SPONTANEOUS INTERNAL HEMORRHAGE

This condition could be caused by cardiac tamponade in cows, ruptured aorta or atrium, inherited aortic aneurysm, or vermiform mesenteric arterial aneurysm in horses and esophagogastric ulcer or intestinal hemorrhagic syndrome in pigs. Aortic rupture and aortopulmonary fistulation should be considered as a potential cause of sudden death in Friesian horses.<sup>1</sup>

### RUPTURE OF INTERNAL CAROTID ARTERY ANEURYSM

This condition may occur secondary to mycosis of the guttural pouch of the horse.



In one survey of sudden deaths in horses while racing, most (68%) were undiagnosed, although it was assumed that they died of exercise-associated ventricular arrhythmias. Of those that were diagnosed, most deaths were caused by spontaneous hemorrhage. Similar conclusions have resulted from other surveys. Most reported cases of sudden death in the horse are the result of cardiovascular accidents. Fracture of the pelvis can result in fatal hemorrhage within the gluteal muscles of the horse and rupture of the middle uterine artery at parturition in cattle may occur with uterine prolapse.

### PERACUTE ENDOGENOUS TOXEMIA

Peracute endogenous toxemia can arise from rupture of the stomach of horses, abomasum of cows, and the colon in mares at foaling. Large amounts of gastrointestinal contents are deposited rapidly into the peritoneal cavity. In newborn animals, especially foals, fulminating infections are the commonest cause.

**Peracute exogenous toxemia** in a single animal could be as a result of snakebite, but the snake would have to be very poisonous and the animal of small body weight (such as an adult sheep or goat) to cause death without any observable illness.

### TRANSPORTATION STRESS

Transportation can result in sudden death in stress-susceptible animals. The best known example of this is porcine stress syndrome (PSS), during which stress appears to be the sole causative factor in death. Transportation results in a death rate from PSS of 2.0 per 1000 slaughter age pigs in Germany and 0.6 to 3.4 per 1000 slaughter age pigs in the Czech Republic.<sup>2</sup>

### TRAUMA

Trauma may cause death by either internal hemorrhage or damage to the CNS, especially the brain or atlantooccipital joint sufficient to damage the medulla oblongata. In most cases the trauma is evident: there has been fighting, or a fall has occurred, or the animal has attempted to jump an obstacle. In horses a free gallop downhill may result in a serious fall or collision with, for example, a wall, especially if the ground is slippery.

Inapparent trauma usually occurs when animals are tied up by halter and rush backward when frightened or are startled by an electric fence and the halter shank is long. Sometimes the animal will plunge forward and hit its forehead between the eyes on a protruding small object such as a bolt used in a fence. Sadism, especially by the insertion of whip handles or pitchfork handles into the anus or vulva, may also be inapparent.

### GASTROINTESTINAL CONDITIONS

Gastric rupture in the horse may occur following overeating highly fermentable feed,

administration of excessive quantities of fluids by nasogastric tube, gastric impaction, or when gastric motility is markedly reduced in acute grass sickness or gastric distension with fluid. Peracute enteritis in the horse can cause rapid unexpected death.

Volvulus or gastrointestinal accidents account for almost 50% of sudden deaths in sows, followed next by gastric ulceration, retained fetuses, and toxemia.

Recumbent cattle that become lodged in a small hollow in the ground may die of bloat because the cardia becomes covered with ruminal fluid and eructation is not possible.

### IATROGENIC DEATHS

Iatrogenic deaths may be caused by overdose with intravenous solutions of calcium salts in an excited cow, too-rapid fluid infusion in an animal with pulmonary edema, intravenous injection of procaine penicillin suspension, and intravenous injections of ivermectin in horses. These are not hard to diagnose and the producer or veterinarian is usually obviously embarrassed.

One of the most sudden death occurrences is the anaphylactoid reaction in a horse to an intravenous injection of an allergen such as crystalline penicillin. Death occurs in about 60 seconds. Intraarterial injections of ceftiofur, penicillin, or phenothiazine tranquilizers have also been reported to cause sudden death. This has been documented in a small number of cattle given subcutaneous injections of ceftiofur crystalline free acid suspension at the base of the ear; 0.1% of cattle in one report died suddenly and unexpectedly because of inadvertent intraarterial injection with migration to the cerebral vasculature.<sup>3</sup>

### SUDDEN DEATH IN HORSES

An analysis of the cause of sudden death over a 20-year period was completed in Victoria, Australia. The risk in flat starts was 0.08 to 0.10 per 1000 starts, whereas the risk in jump starts was three to four times higher at 0.26 to 0.36 per 1000 starts.<sup>4</sup> An analysis was made of the causes of death in horses and ponies over 1 year of age that died suddenly and unexpectedly. No cause of death was found in 31% of cases and 16% died from the following causes: hemorrhage in the respiratory tract and CNS and adverse drug reactions. Cardiovascular lesions were the cause in 14% and the remaining 3% had lesions of the gastrointestinal tract.

Sudden death in racehorses is commonly caused by massive hemorrhage into the lungs, abdomen, or brain. In horses that were found dead but appeared normal when last seen, the cause of death was not determined in 33% of cases. Lesions of the gastrointestinal tract were the cause of death in 39% and respiratory tract lesions in 9%. Lesions of both the CNS and cardiovascular system

were the cause of death in 5%, and the remaining 10% had miscellaneous causes.

Hyperkalemic periodic paralysis should be considered as a potential cause of sudden death in certain lines of Quarter Horses, Appaloosas, and Paints because of a single point mutation in the  $\alpha$ -subunit of the muscle sodium gene.

### SUDDEN OR UNEXPECTED DEATH IN A GROUP OF ANIMALS

The following diseases could affect single animals if the animals were housed or run singly.

#### LIGHTNING STRIKE OR ELECTROCUTION

This usually affects a number of animals that are found together in a pile or group. Rarely, electrical current only electrifies a contact object intermittently and deaths will be intermittent. In most cases the history and an examination of the environment reveals the cause.

#### NUTRITIONAL DEFICIENCY AND POISONING

At pasture, sudden death may come from the sudden exposure of the cattle to plants that cause bloat, hypomagnesemia, cyanide or nitrite poisoning, fluoroacetate poisoning, microcystins (produced by algae in a stagnant lake or pond), or acute interstitial pneumonia.<sup>5</sup> Acute myocardialopathy in young animals on diets deficient in vitamin E or selenium is in this group, as is inherited myocardialopathy in Herefords. Gross nutritional deficiency of copper in cattle causes "falling disease," which is a manifestation of acute myocardialopathy.

Acute myocardialopathy and heart failure is associated with poisons in *Phalaris* spp. pasture; grass nematodes on *Lolium rigidum*; the hemlocks *Cicuta* and *Oenanthe* spp.; and the weeds *Fadogia*, *Pachystigma*, *Pavetta*, *Asclepius eriocarpa*, *Cryptostegia* and *Albizia*, and *Cassia* spp. The trees oleander and yew (*Taxus* spp.) may also be causes, and those species containing fluoroacetate, such as the gidgee tree and the weeds *Gastrolobium*, *Oxylobium*, *Dichapetalum*, and *Ixiolaena* spp., may be implicated. There are a number of plants that cause cardiac irregularity and some sudden deaths, e.g., *Urginea* and *Kalanchoe* spp., but more commonly congestive heart failure is caused. Monensin, lasalocid, and salinomycin toxicities are increasingly common causes in horses and, to a less extent, cows.<sup>5</sup>

#### ACCESS TO POTENT POISONS

Access to potent poisons may occur in housed animals or in those fed prepared feeds. A select number of herbicides, insecticides, rodenticides, and metals

account for the majority of poisonings, with country to country variation and species differences.<sup>6,7</sup>

There are few poisons that cause sudden death without premonitory signs. Cyanide is one, but is an unlikely poison in these circumstances. Monensin, mixed in a feed for cattle that is then fed to horses, or fed in excess to cattle, does cause death by heart failure. Organophosphates are more likely, but clinical signs are usually apparent. Lead is in a similar category; however, very soluble lead salts can cause death quickly in young animals.<sup>8</sup>

### DISEASES ASSOCIATED WITH INFECTIOUS AGENTS

These diseases cause septicemia or toxemia, and include anthrax, blackleg, hemorrhagic septicemia, and (especially in sheep, but occasionally in cattle) peracute pasteurellosis. In pigs, mulberry heart disease and perhaps gut edema should be considered. In horses, colitis is probably the only disease that will cause sudden death. In sheep and young cattle, enterotoxemia associated with *Clostridium perfringens* should be included and this may be involved in rumen overload in feedlot cattle on heavy grain feed. Circumstances, feeding practices, climate, and season of the year usually give some clue as to the cause of death.

### NEONATAL AND YOUNG ANIMALS

In very young, including neonatal, animals, congenital defects that are incompatible with life—prematurity, septicemia because of poor immune status or toxemia associated with particular pathogens, especially *E. coli*, and hypothyroidism—are important causes of sudden death.

### ANAPHYLAXIS

Anaphylaxis after injection of biological materials, including vaccines and sera, is usually an obvious diagnosis, but its occurrence in animals at pasture can cause obscure deaths. In these circumstances it usually affects one animal and clinical illness is often observed. A similar occurrence is sudden death in a high proportion of piglets injected with an iron preparation when their selenium–vitamin E status is low.

### PROCEDURE FOR INVESTIGATION OF SUDDEN DEATH

The procedure for investigating sudden death is as follows:

- Keep excellent records because of the probability of insurance enquiry or litigation.
- Take a careful history, which may indicate changes of feed composition or source, exposure to poisons, or administration of potentially toxic preparations.

- Make a careful examination of the environment to look for potential sources of pathogens. Be especially careful if electrocution is possible; wet concrete floors can be lethal when combined with electrical current unless rubber boots are worn.
- Carefully examine dead animals for signs of struggle, frothy nasal discharge, unclotted blood from natural orifices, bloat, pallor or otherwise of mucosae, burn marks on the body (especially on the feet), or signs of trauma or of having been restrained. Pay particular attention to the forehead by palpating the frontal bones, because these may have been fractured with a heavy blunt object without much damage to the skin or hair.
- Ensure that typical cadavers are examined at necropsy, preferably by specialist pathologists at independent laboratories, in which opinions are more likely to be considered authoritative and unbiased.
- Collect samples of suspect materials for analysis. Preferably, collect two samples, one to be analyzed and one to be made available to a feed company, if indicated.

### FURTHER READING

Lyle CH, Uzal FA, McGorum BC, et al. Sudden death in racing Thoroughbred horses: an international multicentre study of post mortem findings. *Equine Vet J.* 2001;43:324-331.

### REFERENCES

1. Ploeg M, et al. *Equine Vet J.* 2013;45:101.
2. Vecerek V, et al. *Vet Med.* 2006;51:21.
3. McLaughlin CL, et al. *J Dairy Sci.* 2012;95:4363.
4. Boden LA, et al. *Equine Vet J.* 2006;38:312.
5. Varga A, Puschner B. *Vet Med Res Rep.* 2012;3:111.
6. Berny P, et al. *Vet J.* 2010;183:255.
7. Guitart R, et al. *Vet J.* 2010;183:249.
8. Nikolaidis E. *Small Rumin Res.* 2010;92:84.

### CYANOBACTERIA (BLUE-GREEN ALGAE) TOXICOSIS

#### SYNOPSIS

**Etiology** Toxins from cyanobacteria in blooms on stagnant fresh or brackish water in lakes, ponds, reservoir, billabongs

**Epidemiology** Outbreaks with high mortality when sole source of drinking water is polluted by toxigenic algae

**Clinical pathology** Elevation of liver enzymes, electrolyte abnormalities, hypoglycemia (microcystins), or possible acetylcholinesterase depression [anatoxin-a(s)]

**Lesions** Sudden death caused by massive hepatic necrosis (microcystins) or respiratory arrest (anatoxins). Hepatomegaly and hepatic necrosis (microcystins); no lesions

(anatoxins); cyanobacteria in alimentary tract (both).

**Diagnosis confirmation** Positive identification of toxin(s) in water source and animal fluids or tissue confirms diagnosis; liquid chromatography mass spectrometry using animal tissue available for some toxins (microcystins)

**Treatment** None

**Control** Avoidance of contaminated water; judicious use of algaecides; watershed management

### ETIOLOGY

There are over 2000 species of cyanobacteria with at least 80 known to be toxigenic.<sup>1</sup> The cyanobacteria, commonly referred to as blue-green algae, form dense blooms in fresh or brackish bodies of warm, stagnant water. Ingestion of cyanobacteria or their toxins liberated from ruptured cells results in clinical signs. Toxicity is species specific and some species, such as *Anabaena flos-aquae*, produce more than one toxin. Cyanotoxins associated with large-animal poisonings include:<sup>1-3</sup>

- **Microcystins.** These are potent hepatotoxins produced by many different cyanobacteria including several species of *Anabaena*, *Anabaenopsis*, *Microcystis*, *Planktothrix*, *Nostoc*, and *Oscillatoria*.
- **Anatoxins.** Toxins in this group are potent neurotoxins produced primarily by several species of *Anabaena* and a few species of *Planktothrix*.
- **Various freshwater toxins.** Included in this group are cyanotoxins known to cause toxicity in animals. Toxins, produced by a variety of cyanobacteria, include saxitoxins, cylindrospermopsin, nodularins, and most recently  $\beta$ -N-methylamino-L-alanine (BMAA).<sup>4,5</sup>

### EPIDEMIOLOGY

#### Occurrence

Cyanobacterial toxins are associated with outbreaks of poisoning in farm animals that drink contaminated water. Lakes, reservoirs, ponds, waterholes, and other nonturbulent water sources are all affected, especially when the organisms are concentrated by onshore winds so that large quantities may be ingested. Typically the surface of the water has a bluish green sheen or pea green to iridescent neon green streaks. Often the algae accumulate along the shoreline where animals have easy access and the water is shallow and more stagnant. In small waterholes and reservoirs the surface water is often completely covered with a very thick coat of gelatinous organisms (algae bloom), and animals are unable to drink without ingesting some of the algae. Cyanobacteria are found in every continent except Antarctica and toxicoses has been recorded in most

countries, especially the United States, Canada, Scandinavia, Japan, South Africa, Australia, and New Zealand.<sup>2,3,6,7</sup> The cyanobacterial toxins affect all animals and birds and those found in brackish and marine waters are associated with mortalities in fish.<sup>3</sup> Death, while the normal outcome, occasionally does not occur, especially if animals are able to avoid ingesting large amounts of contaminated water.

### Risk Factors

Heavy growth commonly occurs in the late summer to autumn period. Factors promoting growth of the organisms and increasing the chances of animals being poisoned include warm water temperatures, low water depths, sunshine, and onshore winds.<sup>1,3</sup> In addition, a high concentration of other nutrients such as nitrogen and phosphorus associated with fertilizer runoff or feces/urine contamination may play a role.<sup>2,8</sup>

## PATHOGENESIS

### Microcystins

These toxins are potent hepatotoxins affecting virtually every animal species as well as some plant species. The toxins are found inside the cyanobacteria and released by cell damage or death. When an animal drinks contaminated water, the acid pH of the stomach liberates microcystins from the algae and toxicosis occurs. The toxin enters hepatocytes via the bile acid carriers and inhibits protein phosphatases 1 and 2A resulting in cytoskeleton and actin filament changes, hepatocyte necrosis, and cell death.<sup>1</sup> Other mechanisms such as free radical induction and mitochondrial changes affect the liver as well.<sup>1</sup> Animal death occurs from intrahepatic hemorrhage.

### Anatoxins

Three important subgroups of anatoxins, all potent neurotoxins, have been identified in animal poisonings. One subgroup, homoanatoxin-a, has not yet been associated with large-animal poisonings, but with neurotoxicosis and death in New Zealand dogs.<sup>9</sup>

#### Anatoxin-a

This neurotoxin is a potent agonist at nicotinic acetylcholine receptors both at the neuromuscular junctions and neurons.<sup>1,6</sup> Prolonged and continuous stimulation at the neuromuscular junction results in weakness, respiratory paralysis, and death. Dopamine and norepinephrine are released secondary to modulation at the neuronal nicotinic acetylcholine receptors.<sup>10</sup>

#### Homoanatoxin-a

Toxicologic properties of this toxin are similar to anatoxin-a.<sup>9</sup>

#### Anatoxin-a(s)

The chemical structure and mechanism of action of this toxin are different from the

other two anatoxins. Anatoxin-a(s) is an irreversible acetylcholinesterase inhibitor with a mechanism of action similar to organophosphorus containing pesticides.<sup>1,11</sup> Continued nicotinic receptor stimulation from increased amounts of acetylcholine result in ataxia, seizures, respiratory arrest, and death. Unlike organophosphorus compounds, anatoxin-a(s) affects only the peripheral nervous system (i.e., no central effects).<sup>11</sup>

### Various Freshwater Toxins

The toxins listed next are not as common as microcystins and anatoxins but worthy of note because they have been associated in some manner with large-animal poisonings.

- **Saxitoxins.** Toxins in this group are generally associated with paralytic shellfish poisoning in small animals, but a group of Australian sheep became symptomatic and died after exposure to *Anabaena circinalis*.<sup>3</sup> Saxitoxin, a potent neurotoxin, selectively blocks voltage-gated sodium channels causing neuromuscular weakness, respiratory arrest, and death.<sup>1,6</sup>
- **Cylindrospermopsin.** This toxin, produced by several species of cyanobacteria including *Cylindrospermopsis raciborskii*, has been implicated in the death of cattle. It inhibits protein synthesis and thus affects several organs in the body including the heart, lungs, liver, and kidneys.
- **Nodularins.** This potent hepatotoxin is produced primarily by the cyanobacteria *Nodularia spumigena* and has caused death in sheep and other livestock.<sup>1,3,12</sup> The mechanism of action is similar to microcystins with death the normal outcome.
- **BMAA.** This potent neurotoxin produced by the cyanobacteria *Hydrilla verticillata* was recently associated with the development of avian vacuolar myelinopathy.<sup>4,5</sup> The toxin has also been associated with several degenerative human neurologic diseases, and it has been hypothesized that BMAA may play a role in the onset of equine motor neuron disease.<sup>13</sup>

## CLINICAL FINDINGS

### Microcystins

The clinical picture has been well described in livestock, swine, and horses.<sup>1,3,8</sup> Most are found dead or die within a few hours. Vomiting, diarrhea, ataxia, and shock occur in early deaths; those that live for a few hours show agitation and irritability, ataxia, recumbency, and seizures before death. In the less acute cases there is severe liver damage manifested by anorexia, stupor or hypersensitivity, ruminal atony, dehydration, recumbency, jaundice, and photosensitization in cattle and sheep. Many apparently unaffected and recovered animals die in the ensuing 3

months. Affected pigs are anorexic and show dullness, vomiting, lethargy, tremor, frothing at the mouth, coughing, sneezing, dyspnea, and dysentery.

### Anatoxins

Affected animals are commonly found dead. Clinical signs may become apparent within 15 minutes after exposure. In acute cases the affected animals have muscle tremor, stupor, staggering, recumbency, and in some cases hyperesthesia to touch so that slight stimulation provokes a seizure with opisthotonus. Death is from respiratory arrest. Animals exposed to anatoxin-a(s) also have excess salivation as well as lacrimation, vomiting, and diarrhea.

## CLINICAL PATHOLOGY

### Microcystins

Chemical analysis shows increased liver enzymes, electrolyte abnormalities (hyperkalemia), hypoglycemia, and hypoalbuminemia in all species.<sup>1,3</sup> Clinical pathologic findings rated in order of frequency in sheep exposed to microcystins are high serum concentrations of bile acids, glutamate dehydrogenase,  $\gamma$ -glutamyl transferase and serum bilirubin, and reduced serum concentration of albumin.

### Anatoxins

There are no anatoxins.

## NECROPSY FINDINGS

Necropsy findings in microcystin toxicity vary depending on when death occurred. Gross postmortem examinations show enlarged livers with dark-brown to a bluish parenchyma.<sup>14</sup> Microscopic lesions are consistent with centrilobular hepatic necrosis.<sup>1</sup> Other lesions include generalized petechiation, plasma transudates in body cavities, and congestion of most viscera. Severe gastroenteritis with intestinal hemorrhage and severe bloody diarrhea has also been observed in some outbreaks. There are no specific necropsy findings in animals dying of anatoxin toxicity.

## Diagnosis

The presence of cyanobacteria in the source water and gastrointestinal tract is not diagnostic. Identification of the specific toxin in the water and animal tissues or fluids is needed to make a diagnosis. The toxins may disappear from the water within 2 to 3 days so samples should be taken as soon as possible after the poisonings occur. A specimen of the bloom material should be immediately preserved for identification, because degeneration of cells is rapid during transport to the laboratory. Laboratory examination for the presence of high concentrations of known toxic cyanobacteria is required. Many assays, including ELISAs, are available to routinely confirm the presence of microcystins in suspect water, but few are useful for



anatoxins.<sup>15</sup> Within the past few years, liquid chromatography mass spectrometry (LC/MS/MS) has been successfully used to measure the microcystin concentration found in body tissues. No such test is routinely available for anatoxins.<sup>16,17</sup> The diagnosis of anatoxin a(s) intoxication may be supported by acetylcholinesterase testing, although the presence of organophosphorus and carbamate pesticides needs to be ruled out.<sup>1</sup>

### DIFFERENTIAL DIAGNOSIS

Diagnosis confirmation is made by positive assay for the algal toxins in suspect water and animal body tissues or fluids.

#### Microcystins

- Alfatoin toxicosis
- Carbon disulfide ingestion
- Hepatotoxic chemicals (chlorinated hydrocarbons, phenols, etc.)
- Mushroom ingestion (amatoxins)
- Paraquat toxicosis
- Pyrrolizidine alkaloids, other hepatotoxic plants
- Phomopsin toxicosis
- Sporidesmin toxicosis

#### Anatoxins

- Anthrax
- Atrial fibrillation
- Cyanide toxicosis
- Electrocutation or lightning strike
- Ionophore toxicosis
- Plant poisonings
- Rupture of major vessel (aorta, uterine arteries)
- Trauma

### TREATMENT

There are no specific antidotes, and treatment is unrewarding.

### CONTROL

The two principles involved are prevention of ingestion of floating bloom material by animals and preventing the addition of nutrients that promote cyanobacterial growth to the water.<sup>2,8</sup>

#### Prevent the Ingestion of Toxins

- Prevent access to contaminated water. Move livestock to a clean water source or draw drinking water from a site away from the bloom.
- Keep bloom away from water intake by use of a floating boom.
- Add precipitants, e.g., lime, ferric alum, and gypsum, which remove algae without release of toxin and remove phosphates (see later).
- Algaecides such as copper sulfate are still used but the routine, unregulated use is no longer recommended. The killed cyanobacteria release toxins into the water, so it cannot be used as drinking water for at least 5 days. The

algaecides also damage other vegetation and may ultimately promote further cyanobacterial blooms.

#### Prevent the Addition of Nutrients to Water

- Fence off water sources from direct livestock access so no manure or urine is added to the watershed or directly to the water.
- Precipitate phosphates with lime, gypsum, and ferric alum. This is useful only for small reservoirs or ponds.
- Mechanically aerate bottom layers of water body; this is useful only for large water reservoirs.
- Exert catchment control and minimize use of phosphate fertilizers and inflow of sewage.
- Filter the inflow by enhancing reed bed and wetland growth.
- Buffer afforestation and vegetation generally along the banks of watercourses.

#### FURTHER READING

Puschner B, Galey FD, Johnson B, et al. Blue-green algae toxicosis in cattle. *J Am Vet Med Assoc.* 1998;213:1571, 1605-1607.

Toxic Cyanobacteria (Blue-Green Algae). An emerging concern. At <[http://www.envirologix.com/library/KU\\_Manuscript\\_Toxic\\_Algae.pdf](http://www.envirologix.com/library/KU_Manuscript_Toxic_Algae.pdf)>; Accessed 08.10.13.

Walker SR, Lund JC, Schumacher DG, et al. Nebraska experience. *Adv Exp Med Biol.* 2008;619:139-152.

#### REFERENCES

1. Puschner B, et al. Gupta RC, ed. *Veterinary Toxicology*. 2nd ed. Elsevier, London; 2012:953.
2. Linkov I, et al. *Managing Critical Infrastructure Risks*. Linkov I, Wenning RJ, Kiker GA, eds. Netherlands: Springer; 2007:207.
3. Stewart I. *Adv Exp Med Biol.* 2008;619:613.
4. Bidigare RR, et al. *Amyotroph Lateral Scler.* 2009;10(S):7.
5. Wiley FE, et al. *J Wildl Dis.* 2007;43:337.
6. Finnie JW, et al. *Aust Vet J.* 2011;89:24.
7. Handeland K, et al. *Toxicol.* 2010;56:1076.
8. Morgan SE. *Vet Clin North Am Food Anim Pract.* 2011;27:285.
9. Wood SA, et al. *Toxicol.* 2007;50:292.
10. Campos F, et al. *Neurochem Int.* 2010;56:850.
11. Patocka J, et al. *Mil Med Sci Lett.* 2011;80:129.
12. Simola O, et al. *Vet Pathol.* 2012;49:755.
13. Brenner SR. *Med Hypotheses.* 2013;80:103.
14. Kupper J. *Prakt Tierarzt.* 2009;90:162.
15. Humbert JF. *Anal Bioanal Chem.* 2010;397:1653.
16. Ott JL, et al. *Toxicol.* 2006;47:734.
17. Frias HV, et al. *Biochem Biophys Res Commun.* 2006;344:741.

### PLANTS CAUSING SUDDEN DEATH WITHOUT CARDIOMYOPATHY

In many plant poisonings the identity of the toxin is unknown. The more common of these plants associated with sudden death without evidence of cardiomyopathy are listed next. Because the information about most of them is meager, no attempt is made

to provide a complete picture of each of them.

*Arrabidaea bilabiata*

*Burttia prunoides*

*Eupatorium wrightii*

*Lamium amplexicaule*/dead nettle

*Laurelia novae-zealandiae*/ pukatea

*Nicandra physalodes*/apple of Peru

*Viguiera annua*/ annual goldeneye

## Diseases Associated With Physical Agents

### LIGHTNING STRIKE AND ELECTROCUTION

#### SYNOPSIS

**Etiology** Exposure to high-voltage electric currents

**Epidemiology** Single or multiple cases.

Following a thunderstorm dead animals at pasture may be under trees or along fence lines. Posterior paralysis in housed pigs

**Clinical findings** Bone fractures, temporary unconsciousness, or immediate death. In recovered animals residual nervous signs may persist. Posterior paralysis in pigs

**Necropsy findings** Singe and burn marks with some cases. Fractures of long bones in some cases and of lumbar vertebrae in swine

**Diagnostic confirmation** Difficult. History and environmental evidence of lightning or electric shock exposure and no postmortem lesions of other causes of disease

#### ETIOLOGY

The three common causes are flashes of linear lightning during thunderstorms, broken overhead electrical transmission wires that usually carry very high voltages, and faulty electrical wiring in cowsheds and barns.

Lightning-related injury or death can occur through five primary mechanisms<sup>1,2</sup>:

1. Direct strikes
2. Side flashes emanating from tall objects such as trees hit by lightning
3. Ground currents (step potentials or step voltages) occur with each strike and are the most common mechanism in four-legged species because after injection of current into the earth, a potential gradient develops that can initiate current entering the animal from one set of feet, leaving the body by the other set of feet. In contrast to humans, this current crosses essential organs, such as the heart and liver, causing death.
4. Contact, from touching long conductors, such as railings, cables, and fences can be fatal.



5. Upward leaders that emanate from high ground and tall objects when downward leaders approach ground

During lightning strike trees, fences, barns, and pools of water may become electrified, and it is not unusual for damp ground to act as a conductor for electricity passing along the roots of stricken trees. Animals electrocuted by standing on electrified earth are unlikely to show burn marks on the body. Oak trees are particularly prone to lightning strike and because of their spreading foliage and extensive root system, are common mediators of electrocution deaths in pastured animals. Poplar, elm, walnut, beech, ash, and conifers are also mediators of electrocution to animals that shelter under them.

**Electrical transmission wires** are most dangerous when they fall into pools of water, as they are likely to do during the storms that bring the wires down. In such cases, the entire pool is electrified and animals passing through it may be killed instantly. Electrocution can also occur from this source without obvious evidence of line fault.

In accidents caused by **faulty wiring**, voltages of 110 to 220 V are sufficient to kill adult cattle provided they make good contact with the source and the ground. Water pumps and milking machines are the common sources of electricity that may electrify water pipes or the milk line through the earth wire or a short circuit. The use of very heavy fuse wire (30–60 A) may cause continuance of the trouble, which could be avoided if lower capacity fuses were used. In situations of electrical fault, certain farm owners will choose to try to circumvent it by improper use of fuse breakers that can lead to substantial risk of electrocution hazard.

### EPIDEMIOLOGY

The area incidence is never high but heavy mortalities may occur on individual farms when a barn or a group of animals sheltering under a tree is struck. Approximately 90% of deaths occur in cattle in Belgium.<sup>2</sup> Risk factors include documented cloud-to-ground lightning strikes at about the time of death of animals and the presence of open water and tall trees.<sup>2</sup> As many as 20 head of cattle may be killed by one lightning flash. Most fatalities caused by lightning strike occur during the summer months when the animals are at pasture.<sup>2,3</sup>

Behavioral abnormalities of housed animals may indicate the presence of faulty wiring in barns. Deaths caused by electrocution in barns can occur at any time.

### PATHOGENESIS

Tissue damage from electrical trauma is induced by the direct effects of the electric current and the development of heat and tissue ischemia. Exposure to high-voltage electrical currents causes severe **nervous shock** with complete unconsciousness and flaccid paralysis. In some instances, focal

destruction of nervous tissue occurs and **residual signs of damage** to the nervous system persist after nervous shock disappears. Death when it occurs is usually caused by paralysis of vital medullary centers. Ventricular fibrillation can also occur and contribute to death. **Superficial burns** may be evident at the site of contact with the current or along the path of flow from the point of contact to ground. The burn is produced by heat generated from the resistance of tissues to the passage of the electricity. **Fractures** are thought to be the result of sudden and profound muscular contraction.

### CLINICAL FINDINGS

Deaths caused by lightning strike can be detected by an examination of the dead animal and its environment with additional information provided by lightning location data.<sup>2</sup>

Varying degrees of shock occur. With high-voltage currents and good earth contacts such as wet concrete floors, water, and damp earth, the animal may fall dead without a struggle. Singeing and burning are likely to occur because of the severity of the shock. The burns may be localized to the muzzle or feet and be in the form of radial deposits of carbon with or without disruption of tissue, or they may appear as treelike, branching patterns of singeing running down the trunk and limbs. Acute blindness linked to lightning flash injury has occurred in a horse. The injuries were consistent with acute and severe flash injury.<sup>4</sup>

In less severe shocks, the animal falls unconscious, **suddenly collapses**, or may struggle, followed by a period of unconsciousness varying from several minutes to several hours. When consciousness is regained, or the animal is removed from the electric field, the animal may rise and be perfectly normal, or show depression, blindness, ataxia, posterior paralysis, monoplegia, and cutaneous hyperesthesia. In some cases there may be more local signs including nystagmus and unilateral paralysis. Sloughing of the skin at the sites of burns may occur after a few days. These signs may persist or disappear gradually over a period of 1 to 2 weeks. With electrocution in **pigs** caused either by lightning strike or wiring faults, the major signs are related to spinal injury or to fracture of the ileum, ischium, and the transverse processes of the lumbar vertebrae with a large number of animals exhibiting apparent lameness and especially posterior paralysis. Vestibular disease is described as a sequela to lightning strike in horses.

The actual occurrence of electric shock often is not observed and electrocution should always be considered in the differential diagnosis of spinal or pelvic fracture or injury in pigs.

With minor shocks, especially as they occur in barns on low-voltage domestic current, the animal may be knocked down

or remain standing. Consciousness is not lost and the clinical picture is one of restlessness. The animal may kick violently at the stanchion or the dividing rail. The attacks may be intermittent and occur only when the cattle supply a good ground contact such as standing in the gutter, when they are drinking, or when they are wet. Dairy farmers are often unaffected in the same environment because their boots provide effective insulation.

### CLINICAL PATHOLOGY

Laboratory examinations are of no value in diagnosis.

### NECROPSY FINDINGS

If electrocution is suspected it is best to ensure that possible **sources of electric power** are shut off before proceeding with a postmortem examination.

Diagnostic lesions are often minimal but singe marks on or under the skin, or damage to the environment, or both, occur in about 90% of lightning deaths. Rigor mortis develops but passes quickly.

In cattle, anthrax is often a consideration as the carcass decomposes rapidly and blood may exude from the external orifices. The pupils are usually dilated and the anus relaxed. All viscera are congested and the blood is dark and unclotted. Petechial hemorrhages may occur throughout the body, including the trachea, endocardium, meninges, and CNS. The superficial lymph nodes, particularly the prescapular and the interior cervical, are often hemorrhagic. Superficial singeing of the hair, burn marks on the feet or muzzle, and internal or subcutaneous extravasations of blood in arboreal patterns also occur.

In some cases of electrocution there are longitudinal **fractures** of long bones and in incidents involving pigs, local hemorrhage and extensive fractures of the bones in the pelvic area are observed. Fractures of the lumbar vertebrae have also been described in electrocuted swine.

Theoretically, the passage of electric current through tissue may cause cell nuclei to elongate and assume orientations parallel to one another. Skin lesions can be examined histologically for this change and hyperconcentration of skeletal muscle fibers may also be observed.

### DIFFERENTIAL DIAGNOSIS

Great care must be taken in accepting an owner's suggestion that an animal has been killed or injured by lightning strike. Insurance against loss by lightning is commonly carried and the many other causes of sudden death or injury are seldom covered by insurance. To minimize the possibility of conflict and potential future legal problems it is wise to have a representative of the insurance

company present at the autopsy so that all may agree on the diagnosis.

To make the diagnosis, there should be a history of exposure and evidence of sudden injury or death. In the latter case, half-chewed food may still be present in the mouth. Burns on the skin, scorching of the grass, and tearing of the bark on nearby trees are also accepted as contributory evidence. The possibility of electrocution caused by faulty wiring should be considered when sudden shocks or death occur in animals confined in stanchions. Differentials include:

- Other causes of sudden death
- In pigs, other causes of posterior paresis/paralysis

## DIAGNOSIS

A model to predict the likelihood that death of an animal at pasture was caused by lightning strike has been developed. Factors significantly associated with lightning strike death in the multivariable model were age, presence of a tree or open water in the near surroundings, tympany, and presence of feed in the oral cavity at the time of investigation.<sup>2</sup> This basic model had a sensitivity (Se) of 54% and a specificity (Sp) of 88%. The predictive value was improved by combining the model based on the veterinary expert investigation (circumstantial evidence and pathologic findings), together with the detection of cloud-to-ground (CG) lightning at the time and location of death (Se 89%; Sp 67%).<sup>2</sup>

## TREATMENT

Central nervous system stimulants and artificial respiration should be provided for unconscious animals, but in most instances the animals are dead or recovered before treatment can be instituted.

## CONTROL

Precautions taken to avoid lightning strike in animals are largely ineffective, but proper installation of all electric equipment in barns and milking parlors is essential to prevent losses. All motors should be earthed to a special iron spike or pipe driven at least 2.5 m into the ground, preferably in a damp spot, and electrical machinery that has potential contact with animals should be shielded. Earthing to water pipes should not be permitted. Minimum amperage fuses should be used to provide protection in cases of short-circuiting.

## FURTHER READING

Gomes C. Lightning safety of animals. *Int J Biometeorol.* 2012;56:1011-1023.

## REFERENCES

1. Gomes C. *Int J Biometeorol.* 2012;56:1011.
2. Vanneste E, et al. *Vet J.* 2015;203:103.
3. Poelman DR, et al. *J Atmos Ocean Technol.* 2013;30:942.
4. Evans PM, et al. *Vet Ophthalmol.* 2012;15:276.

## STRAY VOLTAGE

### SYNOPSIS

**Etiology** Minor voltage (<10 V) in the animal environment causing mild electric shock

**Epidemiology** Risk with any electrified housing system but most recognized in dairy cattle and pig housing

**Clinical findings** Behavioral changes in feeding or eating patterns, reluctance to move freely in some areas of buildings at levels of 2 V or higher in some but not all animals. Claims for increased disease incidence and decreased production not substantiated experimentally

**Diagnostic confirmation** Demonstration of stray voltage with amelioration of the problem when this is corrected

## ETIOLOGY

The term *stray voltage* is used to denote minor (<10 V) electrical voltage between two points that can be accessed by an animal resulting in a current flow through the animal. **Other terms** that have been used for stray voltage include *free electricity*, *tingle voltage*, and *transient voltage*. The terms *neutral to earth voltage* or *neutral to ground voltage* usually apply to the voltage measured between the service entrance neutral bus and a reference ground rod. **Cow contact voltage** refers to voltage measured between a potential cow contact, such as a drinker, and the ground.

The source and cause of the problem is complex. Stray voltage can be caused by leakage of current from electrical installations, electric and magnetic induction from high voltage lines, or faulty connections between the electrical circuit and earth.<sup>1</sup>

Depending on the current, exposure to stray voltage can produce minor electrical shock and discomfort to animals. Voltages occurring in barns at the level of the animal are usually low and are not felt by humans because of the insulation provided by clothing and footwear.

## EPIDEMIOLOGY

The potential presence of stray voltage has been recognized for many years. The possible relation to production and disease gained particular attention in the 1980s when different surveys indicated that over 50% of dairy farms had significant cow contact voltage, and more current studies indicate a continuing problem. Deteriorating wiring, poor wire insulation, and older buildings are **risk factors**. Heavy milking cows are thought more sensitive to electric shock; scratched, infected, and sore muzzles and hooves may increase sensitivity.

## PATHOGENESIS

The reaction of the animal to stray voltage will depend on the current flow, or shock,

which is related directly to the voltage and inversely to the **impedance** to flow in the animal.<sup>2</sup> The impedance decreases as body weight increases because of an increase of the surface of contact and the pressure exerted by the hooves on the floor and, with pigs, current flow at the same voltage is higher through a gilt or sow than through a piglet. There are some differences in impedance between different pathways in animals (e.g., mouth to hooves or udder to hooves), but there can also be individual animal **variation in sensitivity** to stray voltage.<sup>3</sup> Generally, the problem will only be suspected if the stray voltage is high enough so that a significant proportion of the herd shows signs.

The reactivity of **cows** to different voltage levels has been studied, and the **lowest behavioral perception** is observed at 1 to 2 V for the most sensitive cows and moderate behavioral responses at 1.5 to 3 V. With **pigs**, feeding and drinking behavior is affected at 5 V but not at 2 V, and resting time is disturbed at 8 V.

## CLINICAL FINDINGS

### Behavioral Changes

The behavioral responses exhibited by **cows** exposed to stray voltage depend on the site at which the voltage occurs and the strength of the current flow. Stray voltage in the **milking parlor** results in a reluctance to enter the parlor, a reluctance to cross the floor grids, extreme nervousness while in the parlor, and rapid exit or stampeding from the parlor. Where stray voltage occurs at **drinkers** cows may show reluctance to drink, with lapping of water rather than full drinking and crowding at the drinker resulting in one cow being the ground while others drink. Cows that are experiencing current flow are restless, they may tremble, the back is arched and the head is elevated with the ears held back rigidly, and there is frequent urination and defecation.

In **pigs**, restlessness, increased aggressiveness, and changes in drinking and feeding patterns have been associated with stray voltage.

### Effects on Production and Disease

Field observations suggested that stray voltage in the milking parlor at milking time may result in incomplete milk letdown, increased milking times, elevated somatic cell counts, an increased incidence of clinical mastitis, and poor production. However, **controlled trials** have consistently reported behavioral changes, as well as transiently elevated blood cortisol levels in cows exposed to stray voltage above a certain threshold, but failed to identify any effect on somatic cell counts, mastitis incidence, or milk production.<sup>1,2,4</sup> Similarly no effect of stray voltage on the incidence of disease in pigs could be identified. It was concluded that exposure to stray voltage at the levels of 2 to 4 V may be

a mild stressor but does not impair productivity or increase the occurrence rate of production diseases.

### DIFFERENTIAL DIAGNOSIS

The presence of stray voltage should be suspected where animals exhibit behavioral abnormalities and for the present, it is probably wise to consider it as part of the differential of problems of production inefficiency.

Cow contact voltage can be measured with a sensitive voltmeter, but the ground must be well established. The measurement of the neutral to earth voltage does not give a good prediction of cow contact voltage and is not recommended as the sole measure for the risk of stray voltage on the farm. In most instances a qualified electrician is required to correct the problem. The use of a commercially available tingle voltage filter has been recorded to significantly reduce stray levels.

### FURTHER READING

Reinemann DJ. Stray voltage and milk quality. A review. *Vet Clin North Am Food Anim Pract.* 2012;28:321-345.

### REFERENCES

- Rigalma K, et al. *J Dairy Sci.* 2010;93:3542.
- Reinemann DJ. *Vet Clin North Am Food Anim Pract.* 2012;28:321.
- Rigalma K, et al. *Anim Welfare.* 2011;20:385.
- Erbreich LS, et al. *J Dairy Sci.* 2009;92:5951.

## ENVIRONMENTAL POLLUTANTS AND NOISE

### Pollution From Outside the Farm

Deposition of contaminants in soil and water and on plants can derive from a large number of sources including atmospheric pollution, residues from the petroleum and metalliferous industries (both mining and smelting), persistent pesticides, and the application of sludge. Deposition in soil, but not on plants, does not preclude poisoning of animals because soil can comprise a significant proportion of the dry matter intake of grazing ruminants. Pollutants exert their effect through direct toxicity, immunosuppression or, in the case of some heavy metals, by the competitive induction of trace element deficiencies.

**Mine spills and smelter emissions** have been associated with soil and water contamination with a number of different heavy metals. Aluminum smelter emissions result in fluorosis in Easter Grey Kangaroos in Australia.<sup>1,2</sup> Cattle grazing near lead, zinc, or vanadium mines have increased concentrations of lead, cadmium, and vanadium in body tissues and biochemical evidence of intoxication.<sup>3-7</sup> Cattle grazing pasture and drinking water near former uranium mines have elevated concentrations of radionuclides.<sup>8</sup> Water from mines is also potentially

toxic to livestock that drink it. Pastures adjacent to **major roads** and animals grazing them are also contaminated by heavy metals from vehicle emissions. Blood and tail hair can be analyzed to detect abnormal concentrations of many pollutants, including heavy metals.<sup>9,10</sup> Cattle grazing near a lead and zinc industrial processing area had higher blood concentrations of lead, lower hematocrit and hemoglobin concentration, and higher serum activity of alanine transaminase and AST than did cattle from an uncontaminated area.<sup>11</sup> Similarly, young cattle grazing near a zinc and lead mine had evidence of subclinical toxicosis (blood lead 6–35 µg/dL and elevated blood aminolevulinic acid dehydrogenase activity) compared with reference ranges.<sup>6</sup>

Cattle will readily ingest petroleum products, and the toxicology of **oil field pollutants** has been reviewed. Another important group of compounds is the polychlorinated biphenyls and the **polybrominated biphenyls** and the chlorinated hydrocarbons. These substances are extensively used in agriculture and in industry. They have very long half-lives and, although they are not in themselves dangerous, they cause a great deal of trouble if they get into the human food chain and become deposited in fatty tissues.

### Pollution From Farms

Pollution of the environment by animal feces and urine is now a matter of great importance, especially to intensive animal farmers located near population centers. There are increasing regulations governing livestock farming, effluent disposal, nitrogen and mineral cycles, and odor emission, and there are increasing regulatory actions or private lawsuits against farms that offend. This is not a subject for a text on veterinary medicine, although efforts to minimize nitrogen, phosphorus, and potassium fecal outputs by dietary manipulation and water restriction have potential veterinary and welfare implications.

**Slurry** application to pastures and runoff to streams and groundwater introduce health problems such as salmonellosis, cryptosporidiosis, leptospirosis, and mycobacteriosis. Shallow wells near animal accommodation are also likely to contain high levels of nitrates derived from nitrogen filtering through surrounding earth. Such water is a potential source of nitrate poisoning, especially in pigs.

One of the important pollutants for housed animals is **ammonia** from urine.<sup>12</sup> When it is combined with dust, it can cause severe inflammation of the respiratory mucosae. **Dust** may be the carrier of pathogenic bacteria or viruses or antigens that provoke a hypersensitivity reaction, e.g., interstitial pneumonia. Carbon monoxide and hydrogen sulfide from **slurry pits** can cause mortality in both animals and humans. The highest risk is during agitation of the

slurry, when they are released. Sulfur dioxide is also an environmental contaminant capable of causing respiratory tract irritation in animals.

### Noise

Animals are more susceptible to high-pitched noise than are humans, and the elimination of such noises in working facilities improves the **orderly handling** of cattle and sheep. Pollution by noise, a matter of increasing importance for veterinarians who police codes of practice for animal welfare and for those who are called upon to act as expert witnesses in cases involving excessive noise and its effects on animals, is also an important subject.

The effects of a sonic bang from **aircraft** are short-lived and are caused by fear reactions but include injury from sudden flight, killing of young by mink and rabbits, suffocation in panic-stricken chickens, and reduced egg production. Cattle and goats are unaffected and the effect on livestock and wildlife from the noise produced by low-flying aircraft appears minimal.<sup>13</sup>

### REFERENCES

- Clarke E, et al. *J Zoo Wildl Med.* 2006;37:477.
- Hufschmid J, et al. *Ecotoxicology.* 2011;20:1378.
- Gummow B, et al. *Prev Vet Med.* 2006;76:167.
- Ikenaka Y, et al. *Environ Toxicol Chem.* 2012;31:2300.
- Pareja-Carrera J, et al. *Ecotoxicol Environ Saf.* 2014;108:210.
- Rodriguez-Estival J, et al. *Environ Pollut.* 2012;160:118.
- Swarup D, et al. *Res Vet Sci.* 2007;82:16.
- Strok M, et al. *J Environ Radioact.* 2012;110:64.
- Patra RC, et al. *Ecotoxicol Environ Saf.* 2007;66:127.
- Patra RC, et al. *J Vet Med A Physiol Pathol Clin Med.* 2006;53:511.
- Mohajeri G, et al. *Bull Environ Contam Toxicol.* 2014;92:693.
- Weeks CA. *Anim Welfare.* 2008;17:275.
- van der Staay FJ, et al. *BMC Vet Res.* 2011;7:16.

## WIND FARMS AND ELECTRIC AND MAGNETIC FIELDS

Electric and magnetic fields are generated from the transmission of electricity through high tension lines. Electrical transmission lines and electrically powered devices generate an **extremely low frequency magnetic field** (50–60 Hz), whereas electronic devices emit a **high-frequency electromagnetic radiation** (300 MHz to 300 GHz). Livestock are exposed to these fields when high-voltage lines pass through rural areas. German veterinarians have expressed concern for livestock health from the effect of radiofrequency electromagnetic fields associated with the establishment of a national mobile phone network. Current work suggests the major biological effect of high-frequency electromagnetic radiation is localized heating, which is usually very minor relative to diurnal temperature changes and changes in



core temperature in response to different ambient conditions. The evidence supporting an effect of electromagnetic fields on circadian rhythms in a variety of species such as cows and lambs, via alteration in melatonin or cortisol secretion, is contradictory and the consensus view is one of no effect.

There is no apparent effect of high-voltage transmission lines on any health outcome in humans, with the possible exception of an increased risk of childhood leukemia. There appears to be no effect on the behavioral or feeding patterns or the reproductive performance of cattle grazed under or near high-voltage transmission lines. There is no consistent detectable effect of high-voltage transmission lines on reproductive performance or growth rate in animals.

**Wind farms** have become commonplace in parts of Europe, North America, and Australia as society is becoming increasingly interested in using alternative energy sources to fossil fuels. The environmental concern about wind farms is focused on four alterations produced by wind turbines: (1) an extremely low frequency magnetic field; (2) a high-frequency electromagnetic radiation; (3) a low-frequency noise and shadow flicker; and (4) infrasound, which is a sound wave inaudible to humans because of its extremely low frequency (1–20 Hz). No adverse health effects of exposure to wind farms have been identified, except for increased mortality of specific migrating bird species and bats by hitting rotating wind turbine blades and population shifts as a result of habitat alteration; the latter is primarily the result of building access roads and preparing ground to support large wind farms.

## FURTHER READING

- Kurpas D, Mroczek B, Karakiewicz B, et al. Health impact of wind farms. *Ann Agric Environ Med.* 2013;20:595-605.
- Lerchl A. Animal studies on growth and development. *Prog Biophys Mol Biol.* 2011;107:404-407.
- Lewczuk B, Redlarsko G, Zak A, et al. Influence of electric, magnetic, and electromagnetic fields on the circadian system: current stage of knowledge. *Biomed Res Int.* 2014;2014:169459.
- Repacholi M. Concern that "EMF" magnetic fields from power lines cause cancer. *Sci Total Environ.* 2012;426:454-458.
- Schüz J. Exposure to extremely low-frequency magnetic fields and the risk of childhood cancer: update of the epidemiological evidence. *Prog Biophys Mol Biol.* 2011;107:339-342.
- Sterze J, Pogacnik M. The impacts of wind farms on animal species. *Acta Vet (Beograd).* 2008;58:615-632.

## RADIATION INJURY

### SYNOPSIS

**Etiology** Ionizing radiation from radionuclides in environment or feed resulting from

exploded nuclear bombs or nuclear power plant accidents

**Epidemiology** Type, severity, and extent of exposure will depend on atmospheric conditions and the radionuclides released.

**Clinical findings** Anorexia, depression, and severe diarrhea in acute sickness. Bone marrow depression with anemia and septicemic disease

**Clinical pathology** Neutropenia and thrombocytopenia, bone marrow depression

**Necropsy findings** Hemorrhagic and ulcerative lesions in the alimentary tract. Pneumonia, general septicemia

**Diagnostic confirmation** Radiation exposure from nuclear disaster

**Public health considerations** Animals exposed to radioactive material also serve as reservoirs for radioactive material that could be passed to humans in meat, milk, and other animal products. This hazard to humans is a problem of public health and is primarily addressed by establishing tolerance limits for contamination in animal products for human food and by changes in agronomic practices and policy.<sup>1-5</sup> The following discussion is restricted to the effects of irradiation on the health of animals exposed to it.

## ETIOLOGY

Radiation injury can be caused in a number of ways including nuclear bombs, contamination from nuclear power plant accidents, and exposure to x-rays, but the effects on the tissues are the same, with differences occurring only in the depth of penetration and the degree of injury caused. The radiation emitted by radionuclides has a similar biological effect to external irradiation by x-rays because both sources are **ionizing**—they remove electrons from their orbits causing atoms within animal tissue to produce pairs of charged ions, which are the instruments of the biological damage. Atomic explosions can also injure through the effects of blast and heat.

## EPIDEMIOLOGY

### Incidence and Case Fatality

There is considerable variation in the effects of an atomic explosion, or a nuclear power plant accident, depending on the distance from and the time after the blast, whether the explosion occurs in the air or on the ground surface, and the types of radionuclides released. With nuclear explosions, animals within the range of immediate irradiation are more severely affected than those exposed only to the "fallout" of radionuclides on pasture. However, grazing animals are exposed to very great risk because of this fallout. The area in which direct radiation effects occur is significantly smaller than that where "intervention levels" for radionuclides are exceeded.

## Risk Factors

### Animal

Radiosensitivity differs between animal species when death is defined as the endpoint. Horses are more resistant to whole-body radiation than other animal species. Sheep appear the most susceptible and die earlier than cattle at equivalent exposure doses. Pigs are the least susceptible to low radiation. Age is also a risk factor and calves are more susceptible than adult cattle and are prone to develop respiratory and enteric disease, effects that are uncommon in adult cattle that commonly show hemorrhagic disease.

### Nature of Radiation

Of the radioactive materials produced by an atomic explosion, a number of **radionuclides**, including iodine-131, barium-140, strontium-89 and strontium-90, and cesium-134 and cesium-137 are likely to enter biological systems. Of these, radioactive iodine, barium, and strontium-89 are of less importance because of their short **half-lives**. On the other hand, strontium-90, cesium-134, and cesium-137 may occur in very large quantities and have long half-lives and are therefore of greatest biological significance.<sup>6</sup> If a sufficient amount of these radionuclides is ingested and tissue levels of them reach critical points, injury similar to that produced by external irradiation will occur. Cesium-134 and cesium-137 are of particular concern because of their biological mobility. They behave metabolically like potassium and are distributed widely through the body.<sup>6</sup> Both are beta and gamma emitters and effectively will administer a dose of whole-body radiation to an animal ingesting pasture contaminated with them. Iodine-131 behaves like stable iodine and is concentrated in the thyroid gland.

**Soil type** can influence radionuclide intake by animals grazing contaminated pastures. Persisting concentrations of radiocesium in plants are associated with acid soils with high organic and low clay content. In mineral soils, cesium is strongly bound to clay particles, which limits its uptake by plants; clay minerals, such as bentonite, fed to ruminants will reduce the alimentary absorption of radiocesium. Animal contamination is further influenced by **differences in uptake** of radionuclides by different pasture species and animal breed differences in **grazing behavior**.

### Zoonotic Implications

Radionuclides are excreted in the **milk**<sup>2</sup> of animals and are present in the **meat**,<sup>1</sup> posing a risk for humans consuming them. Radioiodine transfer to the milk of sheep and goats is considerably greater than to that of cows. The half-life of radioiodine is sufficiently short that contaminated milk could be diverted to stored dairy products, although this would not have public acceptance. The



**maximum permissible concentration** of radioactive substances in meat is reached at much lower levels of pasture contamination than would be required to cause physical injury to the cattle or sheep; in most countries it is set at around 1000 to 2000 Becquerels (Bq) per kg fresh weight.<sup>4</sup>

## PATHOGENESIS

The acute radiation syndromes from acute radiation usually occur within the first few days after exposure to whole-body radiation to 30 to 60 days depending on the radiation dose. Based on the dose, the major manifestations have been divided into three major presentations, central nervous system (CNS), gastrointestinal, and hemorrhagic, but there is considerable overlap in clinical signs at all but the high doses that result in the peracute CNS syndrome.

Doses greater than 80 to 100 Gray (Gy) induce rapid damage to blood vessels, changes in permeability, and an increase in intracranial pressure with death in 2 to 5 days. Gastrointestinal disease results when the radiation dose ranges between 10 and 80 Gy and results from damage to the rapidly dividing undifferentiated cells in crypts of intestinal villi, which are the progenitor cells to the differentiated enterocytes of the intestinal villi. Damage to bone marrow stem cells is the main cause of death at whole-body doses between 2 and 10 Gy with death in large animals occurring 6 to 8 weeks after exposure. Clinical disease is slow in development after exposure because the effect of this damage is not evident until the death of existing circulating blood cells. The effects are the result of decreased granulocytes, platelets, and red cells and are manifested with increased susceptibility to infection, bleeding syndromes, and anemia.

Initially there is a lymphopenia followed by a depression of granulocyte and platelet counts. The leukopenia permits invasion by bacteria from the alimentary tract and **bacteremia** and septicemia develop 1 to 4 weeks after irradiation. The clotting mechanism and antibody production are impaired and facilitate the invasion. Progressive necrosis of the gut wall without inflammation is characteristic. Thrombocytopenic hemorrhage into the lymphatic system and other tissues leads to the development of a profound anemia.

The activity of **germinative epithelium** is also profoundly depressed; if the animal survives the early stages listed earlier, the hair commences to shed, the skin to ulcerate, and a gross reduction in fertility occurs. Degenerative changes in the lens of the eye, particularly cataract, may also occur. **Long-term effects** in animals are of less concern than in man because of the short life span of animals and any genetic damage can be removed by selective breeding. Very long-term effects of irradiation include a high rate of **mutations** and a high incidence of tumors, mostly of the hemopoietic system,

and an increased risk for squamous cell carcinoma of the skin.

**Thyroid damage** by iodine-131 does not appear a major risk for ruminants. The thyroid gland of the sheep is more radiosensitive than that of the cow but very high and sustained doses of iodine are required to produce damage, and clinical signs in thyroid-damaged ruminants are minimal.

## CLINICAL FINDINGS

### Acute Syndrome

After immediate irradiation with high doses death occurs from damage to the CNS. At lesser doses damage to the alimentary tract occurs and, particularly in young animals, there is a resulting intense, refractory diarrhea. Death occurs in a few days from dehydration and electrolyte imbalance. Local contact of radioactive materials to skin causes changes within a few hours. Observable lesions vary from depilation and slight desquamation to extensive necrosis, depending on the irradiation dose.

### Subacute Syndrome

Immediately after irradiation with median doses there is an **initial phase** of “radiation sickness” characterized by anorexia, vomiting in pigs, and profound lethargy, which lasts from several hours to several days.

The **second phase** is one of apparent normality lasting until 1 to 4 weeks after irradiation. This is followed by a **third phase** in which most deaths occur associated with damage to stem cells in bone marrow and secondary infections. Clinical signs vary with the nature of the infection and the age of the animal. Calves commonly develop respiratory and enteric disease with fever, weakness, and diarrhea developing to melena and dysentery, sometimes with tenesmus. Anorexia is complete but there is great thirst. Weakness, recumbency, and hyperirritability are present. Respiration is rapid with panting and there is a profuse sometimes blood-stained nasal discharge. In adult cattle severe anemia and septicemia occur.

Generally, if the animal survives this period, there is a **long period of convalescence**, which is accompanied by failure to make normal weight gains, alopecia, sterility, and lenticular defects. The sterility may be permanent, or normal fertility may be restored by the end of 8 months in pigs and 2 years in cattle. During the ensuing years, recovered animals may produce mutant offspring. Tumors, especially of the hemopoietic system and of areas of skin that suffer radiation injury, are also likely to occur.

Experimental irradiation of pregnant animals causes fetal death and resorption, defects of individual organ and limb development, decreased survival of young born alive, and depressed growth rate and fertility of surviving young. The type of abnormality depends on the stage of pregnancy at which exposure is experienced.

## Chronic Exposure

Chronic exposure to gamma and mixed neutron-gamma radiation for several years produces lenticular opacities. Levels of irradiation that cause lesions in the human lens are the same levels that create similar opacities in the lens of cattle, but are not the same for pigs or burros.

## CLINICAL PATHOLOGY

In cattle receiving median somatic doses, the **total leukocyte count** falls precipitately during the first few days after irradiation with the peak of fall at the 15th to 25th post-irradiation (PI) day. In this species, the most sensitive leukocyte is the **neutrophil**, in contrast to the lymphocyte, which is most seriously affected by irradiation in humans.

**Platelet counts** begin to decrease from a normal of 500,000/mm on PI day 7 to 40,000/mm at about PI day 21.

**Erythrocyte counts** and hematocrit levels also fall and prothrombin times increase in parallel to the other changes mentioned. The return to preirradiation levels requires about a year for granulocytes and platelets and from 4 to 5 years for agranulocytes.

## NECROPSY FINDINGS

Gastroenteritis, varying from hemorrhagic to ulcerative, is constant and ulceration of the pharyngeal mucosa and pulmonary edema occur commonly. Hemorrhages into tissues are also characteristic and include all degrees from petechiae and ecchymoses to hematomas and large extravasations. In experimentally produced irradiation sickness, severe fibrinous pneumonia, pleuropneumonia, and pericarditis are common. Degeneration of many tissues, but especially bone marrow, intestinal mucosa, and lymphoid tissue, is evident histologically. Evidence of secondary bacterial invasion is usually seen. Confirmation of the diagnosis usually requires documentation of exposure to radiation.

## Samples for Confirmation of Diagnosis

Histology samples from the jejunum, lymph node, and bone marrow are used for confirmation.

### DIFFERENTIAL DIAGNOSIS

The subacute syndrome closely resembles poisoning by bracken fern in cattle and by trichloroethylene-extracted soybean meal, but the diagnosis will usually depend on a knowledge of exposure to irradiation.

## CONTROL

The problems of veterinary civil defense in the event of thermonuclear warfare are too extensive to discuss here, and the necessary information is provided by most

governments. The use of clay minerals and iron-hexacyanoferrates in the feed can bind and **restrict the uptake** of radiocesium from the alimentary tract of ruminants but is impractical for widespread use. Long-term control of exposure rests can be accomplished with changes in agronomic practices.

## REFERENCES

1. Fukuda T, et al. *Anim Sci J*. 2015;86:120.
2. Lettner H, et al. *J Environ Radioact*. 2007;98:69.
3. Ohmori H, et al. *Livestock Sci*. 2014;159:156.
4. Okada K, et al. *Anim Sci J*. 2013;84:798.
5. Sasaki K, et al. *Biosci Biotechnol Biochem*. 2012;76:1596.
6. Rabitsch H, et al. *J Environ Radioact*. 2008;99:1846.

## VOLCANIC ERUPTIONS

Active and potentially active volcanic chains exist in several countries in close proximity to significant livestock production areas. Major volcanic eruptions are rare, but the experiences of the eruptions of Mount Hecla in Iceland, Mount St. Helens in the United States, the Lonquimay complex in the Southern Andes, Mount Ruapehu in New Zealand, and in Eyjafjallajökull, Iceland<sup>1</sup> suggest that while most are inconvenient to orderly livestock production, and usually have minimal effects on animal health, some can cause catastrophic losses of livestock, long-term destocking, and have a large economic impact. The 1991 eruption of the Vulcan Hudson in South America directly killed over one million livestock through deposition of ash on pasture resulting in severe continuing economic loss to the sheep grazing areas of Patagonia.<sup>2</sup> There is also the potential for volcanic ash to leach important mineral nutrients, such as sulfur, from soils, affecting productivity of grazing enterprises.<sup>3</sup>

### Blast and Gas Damage

Volcanic eruption can result in devastation of land areas from the effects of lateral blast and pyroclastic, laval, and mudflows. Livestock losses that occur in this way can be total, but the affected areas are restricted to the immediate vicinity of the eruption. Toxic gases from the eruption may accumulate in close low-lying areas and result in the death of animals in those areas.

### Ash Hazards

Significantly greater land areas can be affected by tephra fallout consisting of ash and rock fragments from the volcanic eruption. The size of the sector affected by ash fallout will be determined by the strength and direction of winds at the altitude reached by the ash column at the time of the eruption, but several thousand square kilometers can receive ash fallout varying from a light dusting to falls several centimeters in depth.

The hazards to livestock during the fallout period appear minimal, although in areas where the ash fall is heavy, there is virtually total darkness. Animals, particularly sheep, mill about excessively and some die of **suffocation** or **misadventure**, including drowning.

The immediate effect of the fallout is to blanket pastures with ash, and in heavy fallout areas taller succulents may become lodged and unavailable for grazing.<sup>2</sup> Livestock may be forced to graze more robust, but toxic, plant species if stored feeds are not provided, and loss from **plant poisoning** was observed following the Mount St. Helens eruption. **Hypocalcemia**, apparently resulting from food deprivation, was also observed in the immediate postfallout period with Mount St. Helens and was also recorded following the Mount Hecla eruption.

Ash fallout may have a devastating effect on insect life, and this may be followed soon afterward by death from starvation of **insectivorous avian species**. This might be misinterpreted by the public as evidence of ash toxicity.

### Toxic Chemicals

Potential hazards to livestock health exist in the chemical composition of ash. In the fallout from Mount St. Helens and from Mount Ruapehu several potentially toxic heavy metals and trace elements were present, but none in a concentration sufficient to be a hazard to livestock health. During the airborne stage, wind sorting of the dust into particles of varying size, shape, and density results in area variation in the composition of the fallout. Consequently, area variations in chemical analysis over the fallout area can occur. Analyses based on acid-leachable or water-soluble analysis are more relevant to immediate animal health than those reporting total content.

Death resulted from acute **fluorine poisoning** in association with high fluoride levels in ash and ash-contaminated grasses and water in the period immediately following the Mount Hecla, Lonquimay, and other eruptions.<sup>4,5</sup> It is therefore advisable to remove livestock from ash-contaminated pastures until this hazard is determined. In most circumstances, this will necessitate removal to indoor housing and **feeding of stored feed and well water if they are available**.

### Physical Properties

The ash particulate count in air and the respiratory exposure to livestock is highest during the fallout period, but can remain high for long periods following the fallout when ground ash is disturbed by animal movement, winds, and normal farming practices. A significant proportion of this material is of **small particulate size** and is **respirable**. Chemical and/or physical irritation of the respiratory tract, with a significant increase

in the prevalence of respiratory disease, might be expected in these circumstances. This did not occur following the Mount St. Helens eruption, even in animals with known preexisting respiratory disease, and it was not a reported problem following the eruption of Mount Hecla. Signs of irritation such as lacrimation were observed widely but with no untoward sequelae.

### Long-Term Effects

Volcanic ash is composed predominantly of pumiceous volcanic glass and crystalline mineral silicates such as feldspar. These materials have no innate pulmonary toxicity. Volcanic ash may also contain variable amounts of free crystalline silica such as quartz, cristobalite, and tridymite which, if present in respirable-sized particles for prolonged exposure periods, can induce pulmonary fibrosis.

**Silicosis** is primarily a human health concern, although spontaneous silicosis is recorded in livestock. While it is a concern with all eruptions, the long-term health history of animals and man following volcanic eruptions suggests this hazard is minimal.

In the vicinity of Mount St. Helens there have been two appreciable effects on livestock health:

- There has been a marked increase in the incidence of **hypomagnesemia** in cattle in the semiarid channeled scab lands of central Washington. This has possibly resulted from the reflective nature of the ash layer on the soil reducing soil temperature increase during early grass growth and thus reducing magnesium uptake. Grass magnesium concentrations are low and potassium levels are high, but there are no preeruption values for comparison.
- There has been an increase in the severity of **selenium deficiency**. The association between selenium deficiency and recent volcanic origin soils is well recognized. Problems have been corrected by additional and more intensive selenium supplementation.

Animals might ingest considerable quantities of ash from grazing contaminated pastures or from hay subsequently prepared from these areas. There is little field evidence for disturbance of **digestive function** in livestock following the Mount St. Helens or Mount Ruapehu eruptions, and feeding trials of ash to cattle and sheep have shown no clinical or postmortem evidence of untoward effects or any depression of production except that associated with decreased feed palatability at high ash feed levels. There is evidence that long-term inhalation of volcanic gases exacerbates the lesions caused by lung worm infestation in sheep in Hawaii.<sup>6</sup>

## REFERENCES

1. Saltykovskii AY. *Izvestiya, Atmos Oceanic Phys*. 2012;48:683.

2. Wilson T, et al. *Nat Haz*. 2011;57:185.
3. Cronin SJ, et al. *J Vulcan Geotherm*. 2014;286:233.
4. Flueck WT. *Eur J Wildl Res*. 2014;60:699.
5. Flueck WT, et al. *J Wildl Dis*. 2013;49:355.
6. Powers JG, et al. *Pacific Sci*. 2014;68:65.

## BUSHFIRE (GRASS FIRE) INJURY (THERMAL BURNS)

### SYNOPSIS

**Etiology** Thermal or smoke inhalation injury from fire

**Epidemiology** Large numbers of livestock with thermal burns in bush and grass (prairie) fires. Smoke inhalation injury more common in horses rescued from barn fires

**Clinical findings** Edema and thermal injury in skin. Upper respiratory signs in the short term and lower respiratory disease in the longer term, with smoke inhalation

**Treatment** Palliative local therapy, fluid therapy to prevent shock with superficial thermal injury. Maintenance of airway and lower respiratory function with smoke inhalation. The major dilemma with treatment is the conflict between the welfare of the animals and the responsibility to the owner.

### ETIOLOGY

Heat, carbon monoxide, and toxic gases are the cause of injury and death in fires. Most fire victims have thermal burns. The treatment of burns is usually a surgical subject, but there are aspects of bushfire or forest fire injury that warrant discussion in a textbook of large-animal medicine. For example, when large numbers of animals are affected the most important questions are whether to treat them and what to treat them with. Alternatively, if they are not to be treated a decision must be made as to whether they are humanely destroyed or salvaged for meat. When large numbers of animals are burned there is also often a problem with pastures and supplementary feed, such as hay, being destroyed by the fire. There is also a moral conflict for the veterinarian between the welfare of the animals and his or her responsibility to the owner.

### EPIDEMIOLOGY

#### Forest Fires

Although no written information is readily available about forest fires in softwood forests it is assumed that few animals would survive the suffocating effects of intense heat and high smoke concentration. The intensity of the heat arises from the fact that the entire forest from leaves to trunks is burned.

In hardwood forests, such as eucalyptus forests in Australia, the heat may not be so severe if only the tops of the trees are destroyed. Underbrush is burned but the tree trunks may only be scorched and usually survive to regrow. Depending on the density

of the forest and the amount of underbrush, many badly burned animals may survive and will need to be assessed. The most severe burns are on the lower surfaces and undersurfaces of the body and are caused by burning of the litter on the forest floor.

#### Grass Fires

The most serious situation is caused by a grass or prairie fire which, because of the short period of intense heat generated by the wind-driven fire, will burn but not necessarily kill animals. The fires can be extensive and involve contingent farms and large numbers of animals. Many animals will die of suffocation, especially sheep, but a majority will often survive with various states of burn injury.

#### Barn Fires

Animals may die of carbon monoxide poisoning and asphyxiation, or be burned all over, but some may be rescued without burns but with the risk of smoke-induced respiratory injury. Animals trapped, but subsequently rescued, in barn fires are usually horses.

There are a number of problems for veterinarians created by a large number of burned livestock:

- National or regional disaster services are usually responsible for dealing with the damage to property and welfare problems of humans. They are often poorly equipped to deal with animal problems, yet assume authority over their fate in the temporary absence of the owners. The normal reaction of the average person is to judge that burn injuries are much more serious than in fact they are, hence many burned animals are often unnecessarily destroyed.
- Facilities for penning and treating burned animals will often have been partially or completely destroyed by the fire, so mustering to inspect the affected animals may need improvised or temporary yards.
- The presence and amount of insurance also exerts an influence on the owner's decision on the course to be followed. If most livestock are protected by fire insurance there will be no argument with a veterinarian's decision that severely burned animals should be immediately destroyed for humane reasons.
- Salvage for slaughter is often difficult to arrange at short notice for such large numbers and often has logistical problems in the form of burned yards and fencing. Public sentiment is also often against this practice, and the quality of meat from burned animals can be severely downgraded. However, subsequent slaughter must be kept in mind as an option for animals that will

have impaired functions because of burns, such as ewes and cows with teat injuries and rams and bulls with preputial and scrotal burns.

### CLINICAL FINDINGS

#### Burn Injury

The parts most affected by burning are the face, especially the eyelids; conjunctivae and lips; the undersurface of the body, especially udder, teats, and perineum; and the coronets. Badly damaged corneas take many weeks to heal, but badly swollen lips and eyelids can appear almost normal within 48 hours. Marked edema is always a feature of skin burns in animals, but badly burned skin will be dry and ready to slough in a week.

The teats of dairy cows may be damaged to the point where they will not be milkable by machine, with heifers usually having the worst prognosis. Burns to the prepuce of wethers and rams may induce urethral obstruction. This will usually not be apparent until some days later; thus reinspection of groups assessed as not needing immediate destruction should always be a priority.

Separation of the coronary band from the hoof is commonly seen after burns from grass fires. There is usually a serous exudate at the separation of the hoof and coronet, which can become struck by blowflies. Footbathing in appropriate insecticides, which may be an off-label use, can effectively prevent or treat strikes. Sloughing of the entire hoof may occur, especially following fires that generate intense heat, and secondary infections can exacerbate these lesions.

### TREATMENT

#### Decision Criteria

An accurate assessment and prognosis for survival is essential if suffering is to be kept to a minimum, while at the same time allowing as many livestock that can be economically salvaged the chance to recover. The extent of burns varies widely, depending on the nature of the fire and location of individuals within a mob of sheep or cattle as the fire passes. Except for recently shorn sheep, the fleece, although charred, protects the sheep's body from intense heat. Critical areas for burns are the bare areas of skin, such as on the legs, udder, and breech.

Burned skin is inflamed and hot immediately after the fire, then blackens over the next 2 to 3 days and goes hard and dry, with a leathery feel. Thus burns inspected within 24 hours of a fire will appear progressively worse over the next few days.

A major decision must be made at the outset whether to treat each affected animal or whether to destroy it on humane grounds. This decision is more easily made when assessing individual animals rather than mobs or whole flocks/herds.

Recommended criteria for deciding the fate of sheep burned by pasture fire depend



**Table 4-1** A simple method of categorizing livestock affected by burns and appropriate actions for each category

	Prognosis	Action
Group 1	Survival unlikely	Immediate humane destruction. If large numbers they are usually shot and buried in a pit.
Group 2	Better than a 50–75% chance of survival	Treat and monitor in smaller paddocks on the farm; check every 1–2 days for dyspnea and recumbency; some may need to be subsequently destroyed and/or some sent for salvage slaughter at an abattoir; remainder retained in flock
Group 3	Minimal skin damage: often scorched wool and face/ears (check feet)	Minimal supervision; let out into a larger paddock and check for dyspnea and lameness (initially at 4–7 days)

on the presence of burns to the hooves and legs below the carpal and tarsal joints, which cause local swelling and a dry leathery appearance of the skin. Such sheep are often recumbent or immobile, unable to graze, and likely to die and should be humanely destroyed as soon as practicable. Burns that do not cause swelling of the lower limbs, or to other parts of the body, are not likely to be fatal or to produce chronic ill health, unless they affect a large part (more than 15% to 20%) of the body surface. A simple key for categorizing large numbers of sheep into three groups after a fire is shown in Table 4-1.

Animals that are unconscious or very distressed, cannot walk, or have severe difficulty in breathing are poor prospects for recovery and are best euthanized as soon as possible. It may be necessary to monitor sheep after a fire before deciding what to do with them. Several reinspections of a mob at 7 to 14 days, and then progressively longer intervals, may be required. It is necessary at all times to consider the need to avoid inflicting suffering on the animals and to consider the farmer's need to retrieve his assets and recover his business after the fire. If the animals are insured against fire it is also highly desirable to keep written records and advise the insurer of what recommendations have been made.

Animals that have been trapped in a burning building are likely to be burned all over and to have upper and lower respiratory damage from smoke inhalation. With individual animals of high value, bronchoscopy can aid in establishing the severity of this injury. Burning insulation and material from the ceiling can fall on animals and inflict severe (third-degree) burns along the back.

The disposal of euthanized livestock also requires appropriate planning. In large events this is often in a pit constructed by local authorities on the farm or on nearby public land.

### Skin Burns

Extensive skin burns are accompanied by fluid shifts, vascular leakage, protein loss,

and the potential for hypovolemia. The initial therapy is with crystalloid and colloid fluids as discussed earlier. Tetanus prophylaxis and topical antibiotics, silver sulfadiazine, and aloe vera gel are appropriate therapies. Nonsteroidal antiinflammatory agents can decrease the inflammatory response and help in pain management, but glucocorticoids may potentiate burn sepsis and so prophylactic antibacterial treatments are often advisable. In horses, euthanasia is recommended if greater than 50% of the body surface is affected.

### Smoke Inhalation

Tracheostomy may be required to maintain the upper airway. Bronchodilators such as aminophylline or terbutaline sulfate are used to relieve reflex bronchoconstriction and humidified oxygen and local hydration by fluid nebulization to relieve hypoxemia. Corticosteroids are used to reduce airway inflammation in animals with minimal cutaneous burns.

### FURTHER READING

- Assessing sheep after a bushfire. <<http://agriculture.vic.gov.au/agriculture/emergencies/recovery/livestock-after-an-emergency/assessing-sheep-after-a-bushfire>>; Accessed 30.04.16.
- Assessing bushfire burns in livestock. NSW Department of Primary Industries Prime Fact no. 399. <<http://www.dpi.nsw.gov.au/agriculture/emergency/bushfire/animals/assess-bushfire-burns-livestock>>; Accessed 30.04.16.
- Radostits O, Gay C, Hinchcliff K, Constable P, et al. Bushfire (Grassfire) injury (thermal burns). In: *Veterinary Medicine: A Textbook of the Diseases of Cattle, Horses, Sheep, Pigs, and Goats*. 10th ed. London: W.B. Saunders; 2007:1792-1793.

## Diagnosis of Inherited Disease

Genetic disorders are a small but important cause of wastage in farmed animals and, with increasing access to genomic analysis and technology, are more readily recognized and categorized. Most occur in purebred animals

and the simplest to understand and control are inherited as autosomal recessive traits with a clear phenotype and expression in the young animal. The recessive mode of inheritance means that heterozygotes can, in the absence of available testing, remain in the population, with disease only occurring when homozygous-affected animals are produced as a result of mating of heterozygous parents. An example of this situation is that of severe combined immunodeficiency syndrome in Arabian foals.

Dominant disorders tend to be self-limiting because of lack of viability of affected offspring or because affected animals are readily identified and excluded from the breeding pool.

A more complex situation is when heterozygotic animals have characteristics that are desired and when the homozygotic animal is severely or lethally affected. In this situation there is an imperative to select for the mutation by breeding desired heterozygotes. An example is Quarter Horses with hyperkalemic periodic paralysis (see Chapter 15) in which the heterozygote is favored because it performs better in halter class competitions. Another example is in the original Dexter cattle in which the slightly dwarfed Dexter phenotype is dominant to the normal and is selected for. Animals homozygous for the gene abort with a nonviable “bulldog” type fetus. Sex-linked disorders may occur but are uncommon. Some monogenic disorders may arise de novo because of new mutations of germ plasma. Those with a dominant mode of inheritance are present in offspring of the animal in question, usually affecting genes for structural proteins such as collagen. A new mutation should be considered with disorders such as osteogenesis imperfecta or skin fragility. The proportion of offspring with the defect may vary depending on what stage of gametogenesis the mutation occurred.

Inbreeding, knowingly or unknowingly practiced, is an important feature in the manifestation of most outbreaks of a recessive disorder. Founder effect is an aspect of this that has been important when new breeds have been introduced to a country by importation of genetic material from a small number of individuals. Artificial breeding on a large and international scale has sometimes exacerbated this, particularly in cattle but also in horses.

Genetic disorders can be manifested as disease or bodily malformation. When diagnosed, an entity may reflect the tip of an iceberg only, and it can be expected that many other cases go undiagnosed. Spread across an industry their economic importance may be limited, but as particular disorders tend to be concentrated in certain herds/flocks they may have considerable importance to an individual breeder, particularly those involved with pedigree breeding. Animal welfare is also a concern to be



addressed, which is driven by a greater awareness of ethical standards in livestock production and by potential market access requirements.

The advent of genome-wide association studies has allowed the detection of polygenic associations with production traits or propensity for disease.<sup>1-3</sup> Examples include double muscling in Belgium Blue cattle,<sup>3</sup> recurrent laryngeal neuropathy<sup>4,7</sup> and guttural pouch tympany in horses,<sup>7</sup> and mastitis<sup>2</sup> and resistance to mycobacterial disease in cattle.<sup>2</sup> Although these analyses are useful, the emphasis on genetic disease remains the determination of associations with mutations in single genes. This situation is changing as more complex genomic analyses become more widely available.

The two main problems for the clinician investigating a suspected inherited disorder are to confirm a primary genetic cause and then to institute control in a cost-effective manner.

## DIAGNOSIS

For a number of inherited diseases or malformations known to occur in a breed, morphology or histopathology may be so characteristic as to be essentially pathognomonic. However, for some disorders environmental agents (teratogens) may cause similar morphologic anomalies, e.g., arthrogryposis, so care should be taken. Pedigree analysis may help if there are sufficient animals of known breeding to show that the incidence of the disorder follows a Mendelian pattern. However, in many herds/flocks animals may be closely related and pedigree analysis can sometimes be misleading and produce a fictitious relationship between inheritance and disease. As the biochemical anomaly is now known for many diseases, or perhaps can be deduced from histopathologic lesions, laboratory tests may confirm a presumptive diagnosis. Test mating of a sire to daughters, related females, or females that have given birth to an affected animal is the ultimate confirmation of the genetic nature of a disorder, provided the appropriate numbers of progeny are generated. Disproving a genetic cause of a disorder may be as important as proving it. Matings of a sire to produce a minimum of 24 progeny from his daughters or 12 from putative heterozygotes (females that have given birth to affected individuals) are usually considered satisfactory numbers to exclude a likely inherited cause if no affected individuals are born ( $P < 0.5$ ). The birth of a proportion of affected offspring is strong evidence of inheritance.

The use of superovulation and embryo transfer techniques may facilitate this, particularly if insufficient daughters or putative heterozygotes are available. The time to accomplish this may be decreased by caesarian section of the surrogate dams if the defect can be detected in the fetuses.

The degree of inbreeding is an important indicator of whether a congenital disorder is inherited or not. Consistency of the defect is a characteristic of inherited disorders, but there may be some variation in age of onset or expressivity of lesions. Other epidemiologic factors include the occurrence of the defect over more than 1 year and occurrence or repetition of it in the same mating group, but not in others on the property.

## CONTROL OF INHERITED DISEASE

Appropriate control measures may vary, depending on the importance of the disorder, and may be aimed at the herd/flock level or at the breed as a whole. It may be prospective but, at the farm level, it is mainly reactive with the purpose of preventing further losses by immediate action. This should include not breeding from putative heterozygous sires or females that should preferably be culled. Replacement sires are best acquired from another breeder but, if the defect is common in the breed, then the risk may remain and crossbreeding with a sire from another breed may be considered if the type of farm operation permits it. If a test is available for detecting heterozygous animals then this can be used in new sire selection.

Control of genetic disorders in pedigree herds is more complex and to be effective depends on ability to detect heterozygotes or prove animals do not carry the recessive gene in question. Test mating is time-consuming, expensive, and of limited application. The explosion of knowledge concerning the biochemical and molecular genetic basis of inherited diseases across species has opened up effective means of diagnosing genotype for many of them. Control may be at an individual herd/flock level or applied to all at risk. It is best instigated with the help of breed societies who may exert control over the fate of animals diagnosed as heterozygous through control of registrations. Apart from the accuracy of genetic tests in genotype diagnosis, there is the added advantage that particularly valuable animals may be kept within the herd/flock for breeding because their offspring can in turn be tested as normal or heterozygous.

The first generation of tests for heterozygotes was biochemical based on knowledge

of the enzyme deficiency and the gene dosage phenomenon. Heterozygous animals with one normal and one mutant gene have enzyme values midway between normal and diseased values, although there may be some overlap. Supplementary tests or knowledge of the parents' genotype may assist with clarification of equivocal results. Such tests were used to control the economically important lysosomal storage diseases  $\alpha$ -mannosidosis in Angus and Murray Grey cattle in New Zealand and Australia and glycogen storage disease type II in Shorthorn and Brahman cattle in Australia. These have now given way to more accurate second-generation technology based on DNA for these diseases as well as a number of others.

The genome for the major farm species is known and genome-wide analyses now routine. When the abnormal gene or genes is known then it is much simpler to define the mutation and through molecular diagnostics detect affected or carrier animals.

Artificial breeding techniques have the capacity to spread undesirable genotypes widely before they are recognized. Many artificial breeding organizations involved in the dairy industry prospectively screen for genetic disorders by mating prospective sires over a proportion of their daughters. This is possible because of the time taken to prove a sire before he enters the industry on a large scale.

## ONLINE MENDELIAN INHERITANCE IN ANIMALS

Online Mendelian Inheritance in Animals (OMIA) is a database of genes, inherited disorders, and traits in animal species (other than human and mouse) authored by Professor Frank Nicholas of the University of Sydney, Australia, with help from many people over the years.<sup>8</sup> The database contains textual information and references as well as links to relevant records from Online Mendelian Inheritance in Man (OMIM), PubMed, Gene, and soon to be NCBI's phenotype database.

## REFERENCES

1. Sahana G, et al. *J Dairy Sci.* 2014;97:7258.
2. Thompson-Crispi KA, et al. *BMC Genom.* 2014;15.
3. Sartelet A, et al. *BMC Genom.* 2015;16.
4. Dupuis MC, et al. *Anim Genet.* 2013;44:206.
5. Boyko AR, et al. *BMC Genom.* 2014;15.
6. Gerber V, et al. *Equine Vet J.* 2015;47:390.
7. Metzger J, et al. *PLoS One.* 2012;7.
8. Online Mendelian Inheritance in Animals, OMIA. Faculty of Veterinary Science, University of Sydney, 2015. At <<http://omia.angis.org.au/>>; Accessed August 14, 2015.

# Disturbances of Free Water, Electrolytes, Acid-Base Balance, and Oncotic Pressure

# 5

## DEHYDRATION 113

## WATER INTOXICATION 115

## ELECTROLYTE IMBALANCES 116

Hyponatremia 116

Hypernatremia 118

Hypochloremia 118

Hypokalemia 119

Hyperkalemia 120

Hypocalcemia 121

Hypophosphatemia 122

Hypomagnesemia 123

## ACID-BASE IMBALANCE 123

Acidemia 126

Alkalemia 128

## ONCOTIC PRESSURE AND EDEMA 128

## NATURALLY OCCURRING COMBINED ABNORMALITIES OF FREE WATER, ELECTROLYTE, ACID-BASE BALANCE, AND ONCOTIC PRESSURE 130

## PRINCIPLES OF FLUID AND ELECTROLYTE THERAPY 137

There are many diseases of farm animals in which there are disturbances of body fluids (free water), electrolytes, and acid-base balance. A disturbance of body water balance in which more fluid is lost from the body than is absorbed results in reduction in circulating blood volume and in **dehydration** of the tissues. In contrast, the rapid ingestion of large quantities of water can lead to over-hydration (**water intoxication**).

**Electrolyte imbalances** occur commonly as a result of loss of electrolytes, shifts of certain electrolytes, or relative changes in concentrations caused by loss of water. Common electrolyte imbalances include hyponatremia, hypokalemia, hyperkalemia, hypocalcemia, hypochloremia, and hypophosphatemia.

**Acid-base imbalances**, either **acidemia** or **alkalemia**, occur as a result of the addition of acid and depletion of alkali reserve, or the loss of acid with a relative increase in alkali reserve.

Decreased **oncotic pressure** is caused by hypoalbuminemia or hypoproteinemia and results from severe gastrointestinal disease, renal glomerular disease, peritonitis, pleuritis, extensive burns, hepatic failure, chronic malnutrition, and severe starvation (increased loss of plasma protein, decreased production of plasma protein, or third spacing of plasma protein). The most common clinical sign of decreased oncotic pressure is generalized edema. Increased oncotic pressure occurs less frequently, and the most common cause is decreased free water from dehydration.

Under most conditions, disturbances of free water, electrolyte, acid-base balance, and oncotic pressure occur simultaneously, in varying degrees, depending on the initial cause. Each major abnormality will be described separately here with an emphasis on etiology, pathogenesis, clinical pathology, and treatment. However, it is important to remember that actual disease states in animals in which treatments with fluids and electrolytes are contemplated are rarely caused by single abnormalities. In most cases it is a combination of dehydration together

with an electrolyte deficit, and often without a disturbance of the acid-base balance, that necessitates treatment.

## Dehydration

### ETIOLOGY

There are two major causes of dehydration (decrease in free water):

- Inadequate water intake
- Excessive fluid loss

Deprivation of water, a lack of thirst caused by toxemia, and the inability to drink water as in esophageal obstruction are examples of dehydration from inadequate water intake. The most common cause of dehydration is when excessive fluid is lost. Diarrhea is the most common reason for excessive fluid loss, although vomiting, polyuria, and loss of fluid from extensive skin wounds or by copious sweating may be important in sporadic cases. Severe dehydration also occurs in acute carbohydrate engorgement in ruminants, acute intestinal obstruction and diffuse peritonitis in all species, and in dilatation and volvulus of the abomasum. In most forms of dehydration (deprivation of drinking water being an exception), the serious loss, and the one that needs correction, is not the fluid but the electrolytes (Fig. 5-1).

The ability to survive for long periods without water in hot climates represents a form of animal adaptation that is of some importance. This adaptation has been examined in camels and in Merino sheep. In the latter, the ability to survive in dry, arid conditions depends on a number of factors, including the insulating ability of the fleece, the ability to carry water reserves in the rumen and extracellular fluid space, the ability to adjust electrolyte concentrations in several fluid locations, the ability of the kidney to conserve water, and the ability to maintain the circulation with a lower plasma volume. Dehydrated mammals in hot environments can save water by reducing the rate of panting and sweating and regulating body

temperature above hydrated levels. Sweating is a significant avenue of evaporative heat loss in goats when they are hydrated and when exposed to high ambient temperatures above 40°C.

Observations of drinking behavior of cattle transported to the abattoir indicate that those animals that had been sold in live-stock markets before arrival at the abattoir are thirstier and more tired than cattle sent directly from farms. This indicates inadequate water intake and dehydration.

### PATHOGENESIS

Two factors are involved in the pathogenesis of dehydration:

- Depression of tissue water content with resulting interference in tissue metabolism
- Reduction in the free water content of blood

The initial response to negative water balance is the withdrawal of fluid from the tissues and the maintenance of normal blood volume. The fluid is drained primarily from the intracellular and interstitial fluid spaces. Essential organs, including the CNS, heart, and skeleton, contribute little and the major loss occurs from connective tissue, muscle, and skin. The loss of fluid from the interstitial and intracellular spaces results in loss of skin elasticity, dryness of the skin and mucosa, and a reduction and retraction of the eyeball (enophthalmia) caused by reduction in the volume of the postorbital fat deposits. In the goat, total body water may be reduced as much as 44% before death occurs.

The secondary response to continued negative water balance is a reduction in the fluid content of the blood causing a reduction in circulating blood volume (**volume depletion**) and an increase in the concentration of the blood (**hemoconcentration**). Because of the hemoconcentration, there is an increase in the viscosity of the blood, which impedes blood flow and may exacerbate peripheral circulatory failure. The loss in circulating blood volume also contributes to the mental depression of dehydrated animals, which is

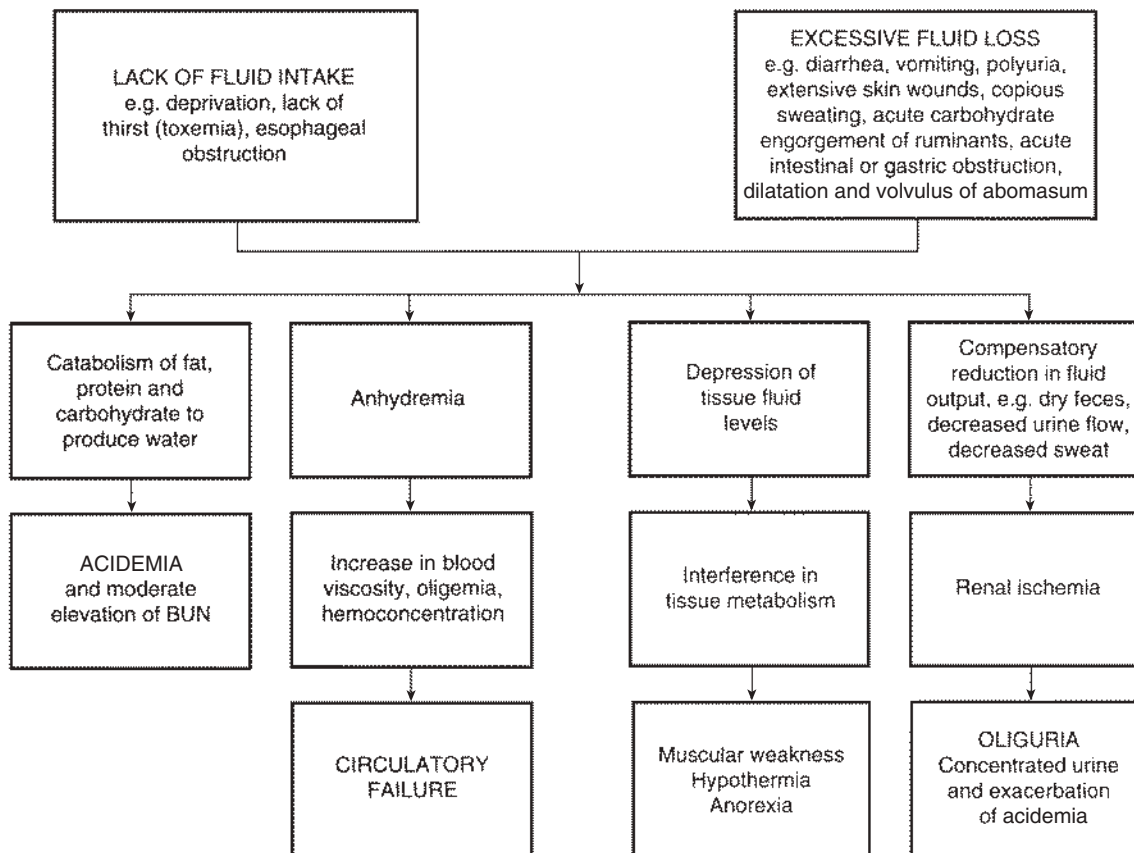

Fig. 5-1 Etiology and pathogenesis of dehydration.

also caused by varying degrees of acidemia and toxemia depending on the cause of the dehydration. In deprivation of water and electrolytes or in deprivation of water alone or inability to consume water in an otherwise normal animal (e.g., esophageal obstruction), the dehydration is minimal because the kidney compensates effectively by decreasing urine output and increasing urine osmolality. In addition, water is preserved by reduced fecal output and increased absorption, which results in dehydration of the contents of the rumen and large intestine, which in turn results in dry, scant feces.

In calves with acute diarrhea there is increased fecal output of water compared with normal calves, but the total water losses are not much greater than in normal calves. In the diarrheic calf the kidney compensates very effectively for fecal water loss, and the plasma volume can be maintained if there is an adequate oral fluid intake. Urine excretion decreases, the urine becomes progressively more concentrated, and the renal insufficiency may accentuate preexisting acidemia and electrolyte imbalance, hence, the importance of restoring renal blood flow and renal function. The newborn calf is able to concentrate urine at almost the same level as the adult. This illustrates the importance of oral fluid and electrolyte intake during diarrhea to compensate for continuous losses. However, it is possible for metabolic acidosis

to occur in diarrheic calves and goat kids that are not dehydrated.

Goats are more sensitive to water deprivation during pregnancy and lactation than during anestrus. Water deprivation for 30 hours causes a marked increase in the plasma osmolality and plasma sodium concentration in pregnant and lactating goats, which drink more than goats in anestrus.

The dehydration in horses used for endurance rides is hypotonic, in which both sodium and water are lost through sweating. This may account for the lack of thirst in some dehydrated horses with exhaustion syndrome. Weight losses of 10 to 15 kg/h may occur in horses exercising in high environmental temperatures exceeding 32°C (89°F), and a horse weighing 450 kg can lose 45 L of fluid in a 3-hour ride.

Dehydration exerts important effects on tissue metabolism. There is an increase in the breakdown of fat, then carbohydrate, and finally protein to produce water of metabolism. The increased endogenous metabolism under relatively anaerobic conditions results in the formation of acid metabolites and the development of metabolic acidosis. Urine formation decreases because of the restriction of renal blood flow and this, together with the increased endogenous metabolism, causes a moderate increase in plasma concentration of urea nitrogen. The body temperature may increase slightly initially (as

in dehydration hyperthermia) because of insufficient fluid to maintain the loss of heat by evaporation. The onset of sweating in steers after exposure to high environmental temperatures has been shown to be delayed by dehydration.

Dehydration may cause death, especially in acute intestinal obstruction, vomiting, and diarrhea, but it is chiefly a contributory cause of death when combined with other systemic states, such as acidosis, electrolyte imbalances, toxemia, and septicemia.

### CLINICAL FINDINGS

The first and most important clinical finding in dehydration is **dryness and wrinkling of the skin**, which gives the body and face a shrunken appearance. The eyes recede into the sockets, and the skin subsides slowly after being picked up into a fold. The dehydration is usually much more marked if water and electrolyte losses have been occurring over a period of several days. Peracute and acute losses may not be obvious clinically because major loss will have occurred from the intravascular compartment and only minor shifts have occurred from the interstitial spaces. Sunken eyes and inelastic skin are not remarkable clinical findings of dehydration in the horse.

The best indicator of hydration status in dairy calves has been demonstrated to be the **degree of recession of the eye into the orbit**.

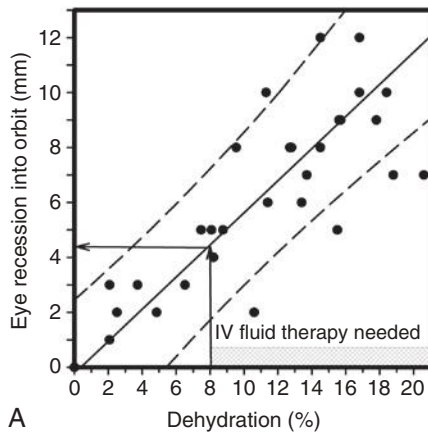

A

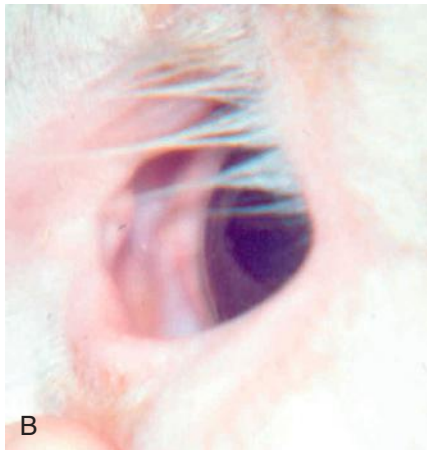

B

**Fig. 5-2** **A**, Association between eye recession into the orbit and dehydration as a percent of body weight in milk-fed calves with experimentally induced diarrhea and dehydration. The filled circles in the left panel are individual data points, the solid line is the linear regression line, and the dashed lines are the 95% confidence interval for prediction. Intravenous fluid is recommended when dehydration is estimated at 8% or more of body weight, equivalent to an eye recession into the orbit of 4 mm or more. **B**, The calf has an 8-mm eye recession into the orbit, equivalent to being 14% dehydrated. (Reprinted with permission from Constable PD et al. *J Am Vet Med Assoc* 1998;212(7):991-996.)

Hydration status is assessed by gently rolling the lower eyelid out to its normal position and estimating the distance of eye recession in millimeters. This distance is multiplied by 1.7 to provide an estimate of the degree of dehydration as a percentage of euhydrated body weight (BW; Fig. 5-2). The second best indicator of hydration status in calves is the elasticity of the skin of the neck and lateral thorax, which are assessed by pinching the skin between the fingers, rotating the skin fold 90°, and noting the time required after release of the skin fold for the skin fold to disappear (normally <2 s). The elasticity of the skin fold on the upper or lower eyelid is a poor indicator of hydration status in calves and is not recommended. The best method

for assessing hydration status in adult cattle and other large animals has not been determined, but it is likely that eye recession and skin tent duration in the neck region provide the most accurate and sensitive methods for estimating hydration status. The presence or absence of mucous membrane moistness may provide a sensitive indication of dehydration in dairy calves, but it was not useful as a predictor of hydration status in Brahman-cross calves housed in a hot environment.<sup>1</sup> Hydration status may also be more difficult to clinically evaluate in sheep.<sup>2</sup>

In diarrheic calves, the severity of dehydration, hypothermia, and metabolic acidosis are associated with the degree of mental depression. The combined effects of acidemia and dehydration also contribute to hypothermia.

Loss of BW occurs rapidly in dehydration, and muscular weakness and inappetence or anorexia is common. In horses deprived of water for 72 hours there is a mean BW loss of about 15%, and 95% of the animals have a urine specific gravity of 1.042, a urine osmolality of 1310 mOsm/kg, and a urine osmolality/serum osmolality ratio of 4:14. Prerenal azotemia also develops.

The degree of thirst present will depend on the presence or absence of other diseases causing an inflammatory response or endotoxemia. In primary water deprivation, dehydrated animals are very thirsty when offered water. In dehydration secondary to enteritis associated with severe inflammation, acidemia, and electrolyte imbalance there may be no desire to drink. Horses that become dehydrated in endurance rides may refuse to drink, and the administration of water by oral intubation and enemas may be necessary. In cattle on pasture and deprived of water for up to 9 days and then given access to water, there will be staggering, falling, convulsions, and some death—signs similar to salt poisoning in pigs. Experimental restriction of the water intake in lactating dairy cattle for up to 4 days may reduce milk yield by 75% and decrease BW by 14%. A 10% reduction in water intake causes a drop in milk production that may be difficult to detect. Behavioral changes are obvious: cows spend considerable time licking the water bowls. In cold climates, cattle are often forced to eat snow as a source of water. The snow must be soft enough so that it can be scooped up by the cattle and 3 to 5 days are necessary for the animals to adjust to the absence of water and become dependent on snow. During this time there is some loss of BW. Lactating ewes relying on snow as a source of free water reduce their total water turnover by approximately 35%.

### CLINICAL PATHOLOGY

Dehydration is characterized by an increase in the packed cell volume (PCV) and total serum protein concentration, although the latter response may be modified by the

presence of severe enteritis, peritonitis, or proteinuria.

## Water Intoxication

### SYNOPSIS

<b>Etiology</b>	Rapid ingestion of large quantities of water
<b>Epidemiology</b>	Access to water by thirsty calves, or calves that have been marginally deprived of water for some time
<b>Clinical findings</b>	Dark red urine, weakness, and depression
<b>Clinical pathology</b>	Hemoglobinuria, hemoglobinemia, hyposmolality, hyponatremia, and hypochloremia
<b>Necropsy findings</b>	Hemoglobinuria and renal cortical necrosis
<b>Diagnostic confirmation</b>	Epidemiologic, presence of hyponatremia and hypochloremia; rule out other causes of intravascular hemolysis
<b>Treatment</b>	Time, possibly intravenous hypertonic saline but usually too late to be effective

The rapid ingestion of large amounts of water by young calves with normal serum sodium concentrations may result in intravascular hemolysis, hemoglobinemia, and hemoglobinuria. In contrast, water ingestion in hypernatremic animals may result in cerebral edema, but it does not produce hemoglobinuria. The cerebral edema syndrome is described in sodium chloride poisoning. Water intoxication (acute overhydration) is described here.

### ETIOLOGY

The ingestion of excessive quantities of water when animals are very thirsty may result in overhydration, which is also called water intoxication. The primary cause of acute overhydration is a rapid decrease in the osmolality of the small intestinal contents, which are normally isotonic to plasma. Such a rapid decrease in luminal osmolality occurs within 5 minutes of water ingestion because thirsty calves close their esophageal groove when drinking. This results in a large volume of water in the abomasum, which is subsequently emptied into the duodenum. Free water rapidly moves from the small intestinal lumen into the intravascular compartment because of the large surface area for absorption in the small intestine and development of an osmotic gradient between the small intestinal lumen and intestinal capillary bed. The end result is a rapid decrease in plasma osmolality and expansion and rupture of erythrocytes, leading to intravascular hemolysis, hemoglobinemia, hemoglobinuria, hyponatremia, hypochloremia, and a decrease in plasma protein concentration from pregestion.



## EPIDEMIOLOGY

The syndrome has been reported from several countries but is uncommon. Calves 2 to 4 months of age are most commonly affected, but the disease is also recorded in adult cattle, sheep, and pygmy goats. Water intoxication occurs in calves in normal husbandry systems when animals that have had limited access to water are suddenly given free access. Commonly water intoxication occurs when calves previously fed a milk-replacer diet but no other fluid, or weaned calves that have been on a starter diet but limited water, are turned out to pasture or to yards where water is freely available. Calves that are not fed supplementary salt or that have lost salt as a result of severe exercise or high environmental temperatures may be at higher risk, but the syndrome also occurs where salt has not been restricted. The majority of calves show clinical signs within minutes to hours of access to water.

The condition has been reproduced in calves by gavage with water at 12% of BW.

## CLINICAL FINDINGS

Hemoglobinuria as a result of intravascular hemolysis is prominent, and there may be a moderate to severe hemolytic anemia. Dark red urine is passed shortly following access to water. Additional signs include tachycardia and hypothermia if the temperature of the water ingested is below body temperature. Affected animals are usually depressed and weak. (Fig. 5-3)

## CLINICAL PATHOLOGY

Hemoglobinuria and hemoglobinemia are evident and there is hyposmolality, hyponatremia, and hypochloremia. Serum total



**Fig. 5-3** Hemoglobinuria in a Holstein-Friesian heifer calf that had not been provided free access to water. The calf voluntarily drank 5 L in 5 minutes and voided red-tinged urine (on floor and in white container) 30 minutes later.

protein and albumin concentration may be decreased, but are usually within the normal range, because animals are usually mildly dehydrated and thirsty before ingesting large volumes of water.

## Postmortem Findings

Marked pallor of the carcass and renal cortical necrosis caused by hemoglobinemic nephrosis may be evident histologically.

## DIFFERENTIAL DIAGNOSIS

- Other causes of intravascular hemolysis and hemoglobinuria

## TREATMENT

Treatment of affected animals is usually not attempted because hyposmotic lysis has already occurred when clinical signs have manifested, and serum osmolality is usually gradually increasing as the distal convoluted tubules eliminate excessive free water. Hypertonic saline (7.2% NaCl, 5 mL/kg BW over 5 minutes intravenously) is usually administered to correct the hyponatremia and hypochloremia, but treatment is not necessary in mild cases. Case fatality is low, and hemoglobinuria persists for only a few hours.

## CONTROL

Water intoxication is not common and can be avoided by preventing thirsty animals from having unlimited access to water. Calves should have free access to water as soon as they are born.

## FURTHER READING

Angelos SM, van Metre DC. Treatment of sodium balance disorders: water intoxication and salt toxicity. *Vet Clin North Am Food Anim Pract.* 1999;15:609-618.

## REFERENCES

1. Fordyce G, et al. *Aust Vet J.* 2015;93:214.
2. Combs MDA, et al. *Aust Vet J.* 2014;92:107.

## Electrolyte Imbalances

Most electrolyte imbalances are caused by a net loss of electrolytes associated with diseases of the alimentary tract. Sweating, excessive salivation and vomiting, and exudation from burns also result in electrolyte losses, but are of minor importance in farm animals, with the exception of sweating in the horse and dysphagia in ruminants. The electrolytes of major concern are sodium, chloride, potassium, calcium, phosphorus, and magnesium. Losses of bicarbonate are presented later.

## HYPONATREMIA

Sodium is the most abundant ion in the extracellular fluid and is chiefly responsible

for the maintenance of osmotic pressure of the extracellular fluid. The most common cause of hyponatremia is increased loss of sodium through the intestinal tract in enteropathies (Fig. 5-4). This is particularly marked in the horse with acute diarrhea and to a moderate extent in calves with acute diarrhea. The sodium is lost at the expense of the extracellular fluid. In calves with acute diarrhea caused by enterotoxigenic *Escherichia coli* the sodium concentration of the intestinal fluid secreted in response to the enterotoxin is similar to that of plasma, and hyponatremia usually occurs (**hypotonic dehydration**). Animals affected with diarrhea of several days' duration continue to lose large quantities of sodium, and the hyponatremia may become severe. Hyponatremia can become severe when sodium-free water or 5% dextrose are used as the only fluid therapy in animals already hyponatremic. Hyponatremia can also occur in animals with proximal tubular dysfunction.

Hyponatremia causes an increase in the renal excretion of water in an attempt to maintain normal osmotic pressure, which results in a decrease in the extracellular fluid space, leading to a decreased circulating blood volume, hypotension, peripheral circulatory failure, and ultimately renal failure. Muscular weakness, hypothermia, and marked dehydration are common findings.

**Isotonic dehydration** occurs when there is a parallel loss of sodium and water. **Hypertonic dehydration**, which is uncommon, occurs when there is a loss or deprivation of water with minor losses or deprivation of sodium. Hypertonic dehydration can occur in animals that are unable to consume water because of an esophageal obstruction. The dehydration in isotonic and hypertonic dehydration is mild compared with the marked clinical dehydration that can occur in hypotonic dehydration accompanied by marked loss of water and concentration of the extracellular space (Fig. 5-5).

There are no clinical signs that are characteristic of hyponatremia. There is usually dehydration, muscular weakness, and mental depression, which occur with other disturbances of both water and electrolytes and with acid-base imbalance. Similarly, there are no clinical signs that are characteristic of hypochloremia. However, hyponatremia affects the osmotic pressure of the extracellular fluid, and hypochloremia promotes the reabsorption of bicarbonate and further development of alkalosis. Polyuria and polydipsia occur in cattle with dietary sodium chloride deficiency.

Hypotonic hyponatremia results in **cerebral edema** caused by water entry to the brain; however, if hyponatremia is slow to develop, solutes can leave brain tissue at a sufficiently fast enough rate to mitigate the development of cerebral edema. Clinical neurologic sequelae of hyponatremia are primarily determined by the speed of onset of

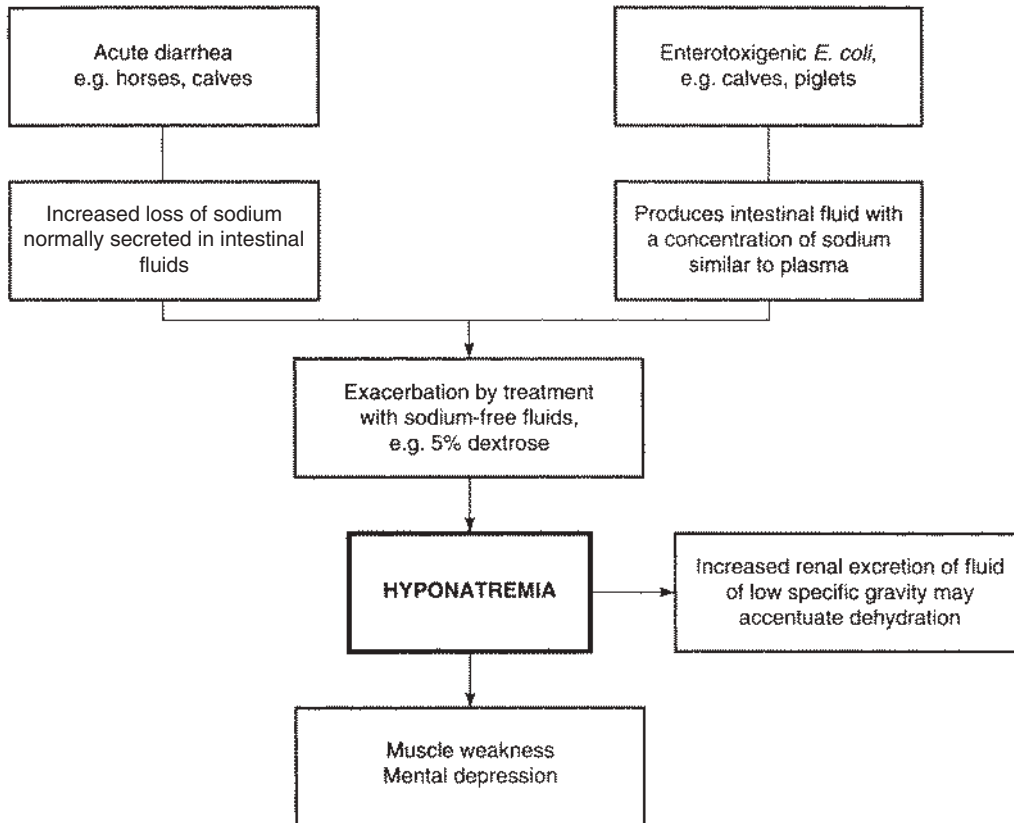

Fig. 5-4 Etiology and pathogenesis of hyponatremia.

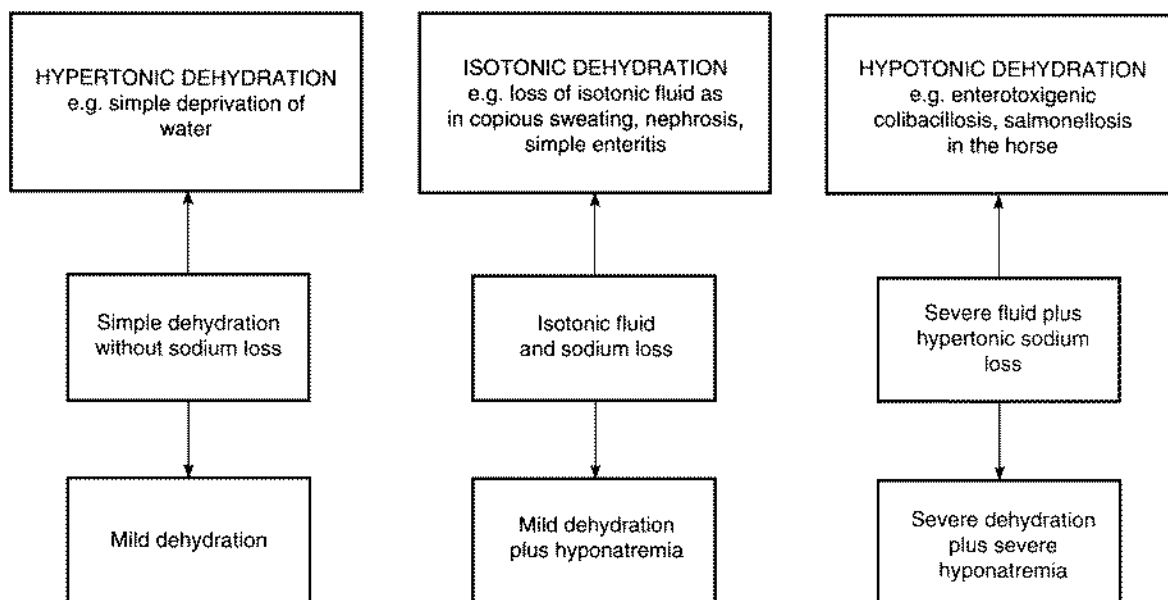

Fig. 5-5 Types of dehydration.

hyponatremia and the rapidity by which marked hyponatremia (serum sodium concentration  $<120$  mEq/L) is corrected. Too rapid correction of chronic hyponatremia (defined as hyponatremia  $>48$  hours) should be avoided because of the potential for **demyelination of pontine and extrapontine**

**neurons** that can produce severe neurologic deficits. These deficits are not well described in agricultural animals, but in humans, rapid correction of chronic hyponatremia has been associated with improvement of neurologic abnormalities within 1 to 2 days, followed by the development of progressive ataxia,

dysphagia, myoclonus, spastic tetraparesis, and death within 2 to 5 days. Current recommendations are to increase serum sodium concentration by 8 mEq/L/day in large animals with chronic hyponatremia. This is clinically managed by infusing 1 L of a mixture of 7.2, 5.0, and 0.9% NaCl solutions

(all commercially available), which are assumed to distribute 100% within the extracellular space.<sup>1</sup> To estimate the effect of 1 L of the NaCl infusate on serum sodium concentration ([Na]), the following formula is applied:

$$\text{Change in serum [Na]} = \frac{(\text{infusate [Na]} - \text{serum [Na]})}{(\text{total body water} + 1)}$$

where total body water is estimated in liters from the BW in kilograms using a standard formula of 60% BW for adult animals. With a targeted increase of 8 mEq/L over 24 hours and an infusion volume of 1 L, this equation can be rearranged to calculate the required infusate [Na] in mEq/L to be administered intravenously over 24 hours in 1 L of fluid:

$$\text{Infusate [Na]} = 8 \times (0.6 \times \{\text{BW in kg}\} + 1) - \text{serum [Na]}$$

## HYPERNATREMIA

Hypernatremia is most commonly caused by water restriction or mixing errors in neonatal animals, particularly in milk-replacer solutions or oral electrolyte formulations administered to neonatal calves with diarrhea as part of the treatment of dehydration. Hypernatremia appears to be increasing in North America in dairy calves fed milk replacer because milk-replacer formulations are increasingly dependent on whey from cheese manufacture, and whey has a high sodium concentration. Less common causes of hypernatremia include high-salinity water.<sup>2</sup> Hypernatremia occurs transiently after hypertonic saline (7.2% NaCl) administration, but serum sodium concentrations never exceed 170 mEq/L and may occasionally exceed 160 mEq/L for a few minutes. Transient episodes of mild hypernatremia caused by intravenous hypertonic saline administration are not thought to have any clinical consequences.

Clinically relevant hypernatremia occurs when serum sodium concentrations exceed 160 mEq/L, with significant mortality occurring whenever serum sodium concentrations exceed 180 to 190 mEq/L before treatment is instituted. The clinical signs of hypernatremia are nonspecific and include weakness, depression, inappetence, abnormal posture, recumbency, apparent blindness, and muscle twitching, particularly of the facial muscles (Fig. 5-6). Some animals may convulse shortly before death. Cerebral depression is caused by inhibition of neuronal cell glycolysis. Less severely affected animals may exhibit a mania for water. Hypernatremia has been associated with persistent hyperglycemia in New World camelids, in which it has been assumed that hyperglycemia-induced diuresis has resulted in excessive free water loss with inadequate water intake.

Correction of hypernatremia is challenging because too rapid a rate of correction can result in cerebral edema and brain herniation through the foramen magnum, particularly in animals with chronic hypernatremia. Treatment of hypernatremia focuses on identifying and removing the underlying cause (such as incorrectly mixed milk

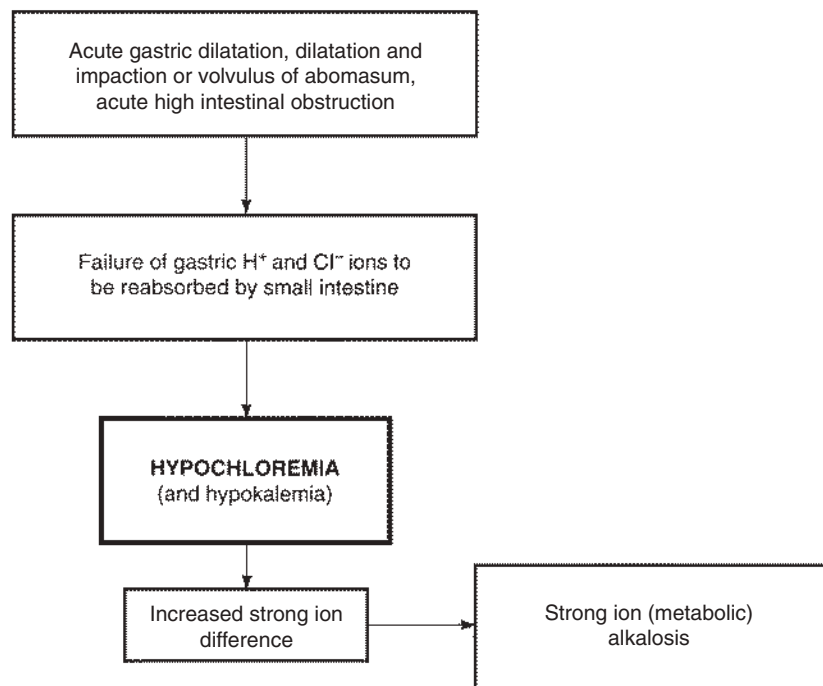

**Fig. 5-6** Calf with neurologic signs of hypernatremia, including abnormal mentation and posture and fasciculation of facial muscles. (From Byers SR, Lear AS, Van Metre DC: Sodium balance and the dysnatremias, *Vet Clin Food Anim* 2014;30:333-350).

replacer) and slowly reducing the serum sodium concentration, with a reduction of serum [Na] of 0.5 to 1.0 mEq/L/h being a goal (10 mEq/L decrease per day representing an ideal goal). The preferred method for decreasing serum [Na] concentration is by oral administration of sodium containing electrolytes. The first equation presented earlier can be applied to the use of intravenous fluids for correction of hypernatremia.

## HYPOCHLOREMIA

Hypochloremia occurs as a result of an increase in the net loss of the electrolyte in the intestinal tract in acute intestinal obstruction, dilatation and impaction, and volvulus of the abomasum and in enteritis (Fig. 5-7). Normally a large amount of chloride is secreted in the abomasum by the mucosal cells in exchange for bicarbonate, which moves into the plasma. The hydrogen, chloride, and potassium ions secreted in gastric juice are normally absorbed by the small intestine. Failure of abomasal emptying and obstruction of the proximal part of the small intestine will result in the sequestration of large quantities of chloride, hydrogen, and potassium ions, which leads to a **hypochloremic hypokalemic metabolic alkalosis**. A severe hypochloremia can be experimentally produced in calves by feeding them a low-chloride diet and daily removal of abomasal contents. Clinical findings include anorexia, weight loss, lethargy, mild polydipsia, and polyuria. A marked metabolic alkalosis occurs resulting in hypokalemia, hyponatremia, azotemia, and death.



**Fig. 5-7** Etiology and pathogenesis of hypochloremia.

## HYPOKALEMIA

Hypokalemia may occur as a result of decreased dietary intake, increased renal excretion, abomasal stasis, intestinal obstruction and enteritis, and repeated administration of corticosteroids with mineralocorticoid activity (Fig. 5-8). The prolonged use of potassium-free solutions in fluid therapy for diarrheic animals may result in excessive renal excretion of potassium and hypokalemia. Calves with neonatal diarrhea can have marked depletion of their body potassium stores, particularly when a marked acidemia and metabolic acidosis is present, and the calves have had a low milk intake and a long history of diarrhea.<sup>3</sup> Alkalosis may result in an exchange of potassium ions for hydrogen ions in the renal tubular fluid, resulting in hypokalemia. Hypokalemia can cause muscle weakness, prolonged unexplained recumbency, inability to hold up the head, anorexia, muscular tremors and, if severe enough, coma. The treatment of ketosis in lactating dairy cows with multiple dosages of isoflupredone, a glucocorticoid with some mineralocorticoid activity, can cause hypokalemia and recumbency, with a high case fatality rate.

Hypokalemia (defined as serum or plasma potassium concentration <3.9 mEq/L) is common in lactating dairy cows with left

displaced abomasum (LDA), right displaced abomasum (RDA), abomasal volvulus (AV), abomasal impaction, clinical mastitis, dystocia, retained placenta, and hepatic lipidosis.<sup>4</sup> The high prevalence of hypokalemia in sick lactating dairy cows is most likely caused by a combination of decreased dry matter intake; alkalemia from sequestration of chloride in the gastrointestinal tract in cattle with LDA, RDA, AV, or decreased abomasal emptying rate; hyperinsulinemia secondary to hyperglycemia;<sup>5,6</sup> the obligatory loss of potassium in milk (1.4 g of potassium per liter of milk); sympathetic nervous system activation; aldosterone release in response to hypovolemia and the need for sodium retention; and decreased whole-body potassium stores caused by the relatively low muscle mass in dairy cows. Whole-body depletion of potassium may be present in healthy dairy cattle immediately after calving, based on the results of potassium balance studies, studies documenting decreased skeletal muscle potassium content at calving, and decreased urine potassium concentrations immediately after calving. A low serum potassium concentration was a significant predictor of nonsurvival in cattle undergoing surgical correction of LDA or treatment of hepatic lipidosis.<sup>4</sup>

Metabolic alkalosis and hypokalemia in cattle are often accompanied by muscular

weakness and **paradoxical aciduria**. Hypokalemia causes muscle weakness by lowering the resting potential of membranes, resulting in decreased excitability of neuromuscular tissue. Thus the differential diagnosis of the animal with muscle weakness should always include hypokalemia.

Hypokalemia and alkalemia also are often directly related because of the renal response to either. Hypokalemia from true body deficits of potassium will cause decreased intracellular concentration of this ion. The intracellular deficit of potassium and excess of hydrogen will cause hydrogen secretion into the urine when distal sodium reabsorption is required. This situation exists in alkalemia and metabolic alkalosis, in which sodium bicarbonate reabsorption in the proximal nephron is decreased because of the excess of plasma bicarbonate. Distal nephron avidity for sodium is increased to protect extracellular fluid volume, and the increased distal sodium reabsorption is at the expense of hydrogen secretion, although it is contrary to the need of acid retention in the presence of alkalosis. In other words, the kidney prioritizes maintenance of plasma volume above that of acid-base balance, presumably because respiratory compensation can usually keep blood pH within the normal physiologic range. Because electroneutrality of extracellular fluid must be maintained by

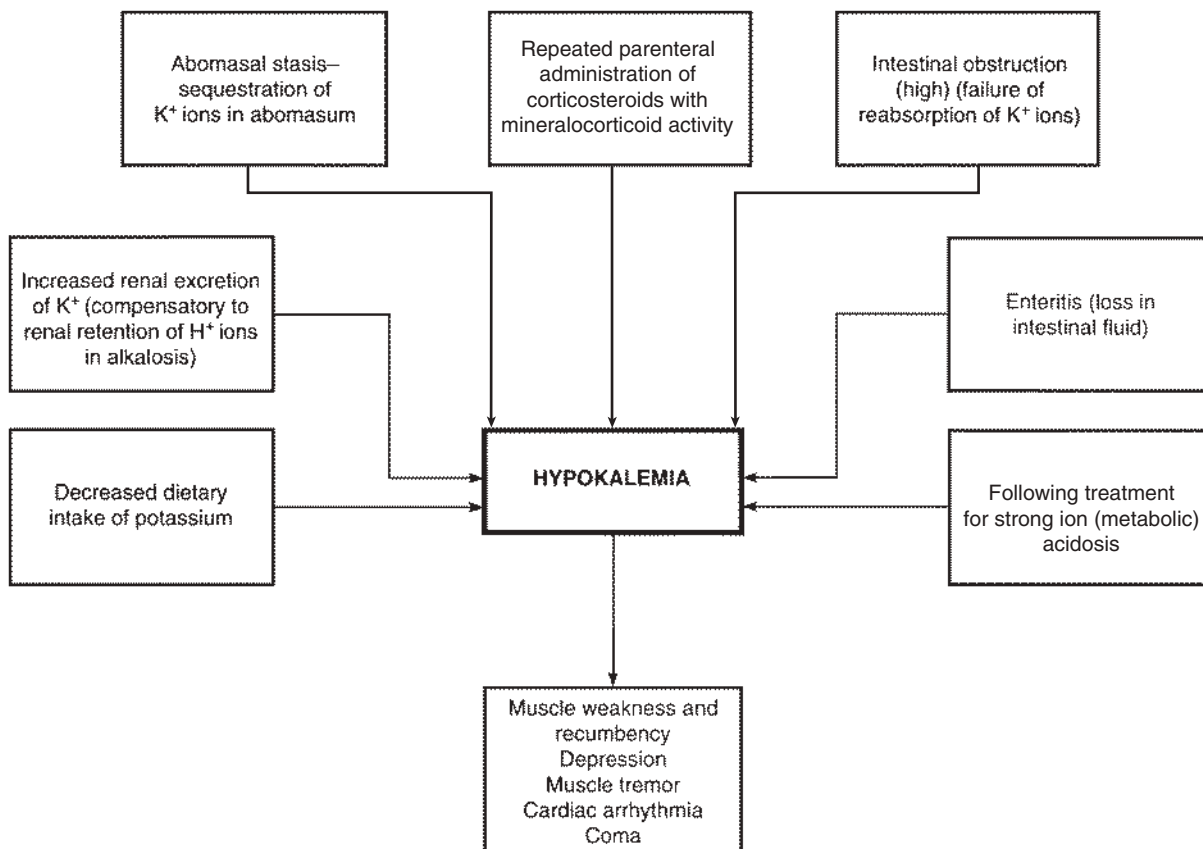

Fig. 5-8 Etiology and pathogenesis of hypokalemia.



reabsorbing an equivalent charge of cations and anions, the reabsorption rates of chloride and bicarbonate in the kidneys are inversely proportional to each other. Thus with excess trapping of chloride in the abomasum, the kidneys will compensate for the resulting hypochloremia by increasing bicarbonate reabsorption, which may proceed until metabolic alkalosis and alkalemia develop.

Because potassium is the major intracellular cation, the measurement of plasma or serum potassium is not a reliable indication of whole-body potassium status. Extremely low plasma or serum concentrations or high concentrations are usually indicative of a potassium imbalance often associated with other electrolyte and acid-base imbalances. In alkalemia, for example, potassium leaves the extracellular space and becomes concentrated in the cells. This may result in low serum potassium concentrations when there might not be potassium depletion of the body. Conversely, in severe acidemia and metabolic acidosis of calves with acute diarrhea, the potassium leaves the cells and moves into the extracellular fluid. This results in hyperkalemia in some cases in which the body potassium is normal or even decreased. When changes occur in the concentration of intracellular and extracellular potassium, the ratio of intracellular to extracellular potassium may decrease by as much as 30% to 50%, which results in a decrease in the resting membrane potential. This is thought to be the explanation for the effects of hypokalemia and hyperkalemia on muscle function.

The potassium concentration of red blood cells does not appear to provide a more accurate indicator of whole-body potassium deficit in horses and ruminants than the actual plasma or serum concentration.<sup>4</sup> There is marked cow-to-cow variability in the erythrocyte potassium concentration (7–70 mmol/L) and sodium concentration (15–87 mmol/L) of healthy cattle that has a genetic basis with no breed influence. Moreover, no relationship between plasma and erythrocyte potassium concentrations could be identified in a study of 180 cows. Milk potassium concentration is theoretically more sensitive than serum or plasma potassium concentration in detecting whole-body potassium depletion in individual cows because milk potassium concentration is constant for an individual cow over a short time period. However, milk potassium concentration changes during lactation, being 42 mmol/L in early lactation, 40 mmol/L in midlactation, and 27 mmol/L in late lactation, with a mean bulk milk tank potassium concentration of 37 mmol/L. Milk potassium concentration also increases in quarters with clinical or subclinical mastitis. As a consequence of these two factors, there is marked individual variation in milk potassium concentration in healthy cattle, with variations of up to 50% occurring among cows. The

large cow-to-cow variability in milk potassium concentration makes it difficult to identify a suitable cut point that accurately predicts whole-body potassium depletion in sick lactating dairy cows.<sup>4</sup> However, monitoring milk potassium concentration in individual cows without clinical or subclinical mastitis may have clinical utility as a monitoring tool to gauge the response to therapy with KCl.

Skeletal muscle potassium content provides the most sensitive and specific method for assessing whole-body potassium status.<sup>4,7</sup> Skeletal muscle is considered the best tissue to sample because it contains approximately 75% of the whole-body stores of potassium. A standardized muscle should be obtained for analysis in cattle because differences in potassium content of greater than 15% are present in individual animals, and this muscle-to-muscle variation is greater than that produced by breed.<sup>7</sup>

The treatment of hypochloremic, hypokalemic alkalosis requires correction of extracellular fluid volume and sodium and chloride deficits with 0.9% NaCl infusions and oral KCl. The provision of adequate chloride ion allows sodium to be reabsorbed without bicarbonate. Increased proximal reabsorption of sodium will decrease distal acid secretion because less sodium is presented to the distal nephron. As less bicarbonate is reabsorbed and less acid secreted, the metabolic alkalosis is resolved. Specially formulated solutions containing potassium are necessary in cases of severe hypokalemia and small-intestinal obstruction.

Potassium should be administered intravenously or orally. The intravenous route is used only for the initial treatment of recumbent ruminants with severe hypokalemia and rumen atony because it is much more dangerous and expensive than oral treatment. The most aggressive **intravenous treatment** protocol is an isotonic solution of KCl (1.15% KCl), which should be administered at less than 3.2 mL/kg/h, equivalent to a maximal delivery rate of 0.5 mEq of K<sup>+</sup>/kg BW per hour. Higher rates of potassium administration run the risk of inducing hemodynamically important arrhythmias, including ventricular premature complexes that can lead to ventricular fibrillation and death. A less aggressive intravenous treatment is an isotonic equimolar mixture of NaCl (0.45% NaCl) and KCl (0.58% KCl), and the least aggressive intravenous treatment is the addition of 10 mmol of KCl/L of Ringer's solution, which will increase the solution osmolarity to 329 mOsm/L. Clinical experience with oral administration of KCl has markedly decreased the number of adult ruminants treated with intravenous KCl.

**Oral potassium administration** is the method of choice for treating lactating dairy cattle with hypokalemia. The absorption efficiency of potassium on a typical lactating dairy cow diet ranges from 74% to 88%, with

potassium absorbed in the forestomach and small intestine and forestomach absorption predominating. Rumen fluid in cattle usually has a potassium concentration of 24 to 85 mEq/L, and rumen fluid potassium concentration and potassium absorption are strongly and linearly dependent on potassium intake. This indicates that increasing rumen potassium concentration by the oral administration of KCl will directly lead to increased potassium absorption. Oral administration of KCl therefore provides the optimal salt formulation for treating cattle with hypokalemia because potassium is needed in cattle with whole-body potassium depletion, and chloride is needed in cattle with alkalemia and pH-induced compartmental shift of potassium to the intracellular space.<sup>7</sup>

Current treatment recommendations are to administer 120 g of feed grade KCl orally twice at a 12-hour interval to inappetent dairy cattle with hypokalemia, providing a total 24-hour dose of 240 g of KCl; this dose is equivalent to a daily KCl dose of 0.4 g/kg BW for a 600-kg dairy cow.<sup>4,7</sup> Daily oral doses of KCl exceeding 0.4 g/kg BW are not currently recommended, except in cattle with profound hypokalemia, because they have the potential to result in diarrhea, excessive salivation, muscular tremors of the legs, labored breathing, convulsions, and death.<sup>4,7</sup> Oral administration of 0.58 g of KCl/kg BW was toxic in 6-month-old Holstein calves, manifested by excessive salivation, muscular tremors of the legs and excitability, and a peak plasma potassium concentration of 9.0 mEq/L. Extrapolating this toxic dose in normokalemic calves to hypokalemic 600-kg cows suggests that a daily dose of 240 g KCl approaches the upper limit of safety.

Hypokalemia also occurs following treatment of the horse affected with metabolic acidosis and hyponatremia, and probably reflects whole-body potassium depletion. Horses used for endurance rides may be affected by hypokalemia, hypocalcemia, and alkalosis caused by loss of electrolytes during the competition. Synchronous diaphragmatic flutter also occurs, which may be the result of the electrolyte imbalance (particularly hypocalcemia) causing hyperirritability of the phrenic nerve. Inappetent horses often have whole-body potassium depletion and would benefit from supplementary dietary potassium (25–50 g/day KCl).

## HYPERKALEMIA

Hyperkalemia is not as common in farm animals as hypokalemia, and is most common in severe metabolic acidosis and acidemia. The classic description for the development of hyperkalemia in metabolic acidosis involves a purported redistribution of potassium from the intracellular space to the extracellular space because a large

proportion of the excess hydrogen ions are buffered intracellularly. Thus potassium is supposedly exchanged with hydrogen ions across the cell membrane to maintain electroneutrality. Although widely accepted, this purported mechanism has never had a sound physicochemical basis because a decrease in plasma pH from 7.4 to 7.0 (equivalent to an increase in plasma hydrogen ion activity from 40 to 100 nEq/L) would decrease plasma [K] from 7.0 to 6.99994 mEq/L on the basis of electrochemical exchange of cations. Not only is such a decrease physiologically irrelevant, but the decrease is undetectable using current laboratory equipment.<sup>8</sup> An attractive hypothesis for the development of hyperkalemia in acidemic animals is that the low intracellular pH slows Na-K-ATPase activity causing potassium ions to leak down a concentration gradient from the intracellular to the extracellular space; however, there is no experimental data indicating that Na-K-ATPase activity is directly influenced by pH within the physiologic range. Low intracellular pH does exert a marked effect on phosphofructokinase activity in the glycolytic pathway; with Na-K-ATPase activity dependent on ATP availability, decreased phosphofructokinase activity presents a potential pathway for acidemia-induced hyperkalemia. Hampered insulin-dependent cellular potassium uptake in states of acidemia presents a second potential mechanism for the association between hyperkalemia and acidemia; mild declines in blood pH can induce insulin resistance. Because insulin triggers a transcellular shift of glucose and potassium, tissue resistance to insulin has the potential to contribute to hyperkalemia. A third potential mechanism for acidemia-induced hyperkalemia is activation of a cell membrane potassium channel called TREK-1 by low intracellular pH, resulting in potassium efflux from the cell.<sup>8</sup> An interesting recent finding is that hyperkalemia is much less common in neonatal calves with acidemia caused by hyper D-lactatemia than in calves with acidemia and plasma D-lactate concentrations within the reference interval.<sup>9</sup>

Hyperkalemia is potentially more life-threatening than hypokalemia. Hyperkalemia (when over 7–8 mmol/L) has a profound effect on cardiac function. There is usually marked bradycardia and arrhythmia, and sudden cardiac arrest may occur. Electrocardiogram (ECG) changes in experimentally induced hyperkalemia in the horse have been described. The changes include four successive stages as hyperkalemia increased. There was a widening and lowering of amplitude followed by inversion and disappearance of the P wave; an increase in the amplitude of the T wave; an increase in the QRS interval, with some irregularity in the ventricular rate; and periods of cardiac arrest that became terminal or were followed by ventricular fibrillation. The minimum

plasma potassium concentration required to induce ECG changes was 6 to 7 mmol/L, and severe cardiotoxic effects occurred at levels between 8 and 11 mmol/L. The effects of hyperkalemia on the ECG are exacerbated by the presence of hyponatremia, which is common in neonatal calves with diarrhea.

Hyperkalemia has traditionally been treated by intravenous administration of sodium bicarbonate, glucose, insulin, and sometimes calcium. Because hyperkalemia is most strongly associated with a decreased glomerular filtration rate, the primary treatment goal in hyperkalemia is to reestablish normal renal blood flow and rate of urine formation by the administration of sodium-containing fluids,<sup>9</sup> particularly sodium containing fluids that also produce rapid alkalization, such as 1.3% sodium bicarbonate.<sup>10</sup> Hypertonic saline has been shown to be just as effective as hypertonic sodium bicarbonate in decreasing hyperkalemia and hyperkalemia-associated bradyarrhythmias as a result of sodium-induced intracellular movement of potassium, extracellular volume expansion, and the strong ion effect of increasing the serum concentration of a strong cation.<sup>8</sup> Calcium counteracts the effect of hyperkalemia on the resting membrane potential by increasing the threshold potential to a higher value, returning an appropriate difference between resting and threshold potentials. Calcium can be administered intravenously at 0.2 to 0.4 mL of a 23% calcium gluconate solution/kg BW. In summary, the focus of treatment in hyperkalemia should be optimizing renal blood flow and glomerular filtration rate by plasma volume expansion, correction of acidemia, and increasing the serum sodium concentration. Glucose and insulin are not routinely needed to correct hyperkalemia, but can be administered to animals not responding to reestablishment of a normal rate of urine production and correction of acidemia.

**Hyperkalemic periodic paralysis** occurs in heavily muscled Quarter Horses. Affected horses become weak, may stand base-wide, and are reluctant to move. Sweating commonly occurs and generalized muscle fasciculations are apparent. Affected horses remain bright and alert but may yawn and do not eat or drink. Some horses become recumbent and may appear to be in a state of flaccidity. Attacks may occur in a rest period following exercise or at random. During the episode the serum potassium concentration is elevated by up to twofold and returns to normal values when the animal recovers. Treatment consists of sodium bicarbonate, hypertonic saline, or 5% dextrose given intravenously, possibly with insulin.

## **HYPOCALCEMIA**

The calcium fractions in plasma are in equilibrium and exist in three forms: free (43% of total); bound to proteins in a salt-type

manner (49%); and complexed to other compounds in plasma such as bicarbonate, lactate, citrate, sulfate, and phosphate (8%). The ionized (free) calcium fraction is the biologically active form of calcium and therefore is the preferred method of calcium measurement. The ionized calcium concentration ( $cCa^{2+}$ ) in bovine plasma is primarily dependent on the total calcium concentration, with total protein concentration explaining 85% of the variation in  $cCa^{2+}$ . Ionized calcium concentration is dependent to a lesser extent on pH, the plasma concentration of albumin (and therefore total protein), lactate, and chloride, and the temperature and ionic strength.

Ionized calcium concentration should be measured on an anaerobically collected blood sample, and should be reported as the measured  $cCa^{2+}$  at the actual pH of the patient. Correction of the measured ionized calcium concentration to a pH of 7.40 is routinely applied in experimental studies to assist in the interpretation of measured values relative to a reference range. This should only be done in samples that were not anaerobically collected and where there is loss of carbon dioxide from the sample (such as in a vacutainer tube). In this case a pH-corrected  $cCa^{2+}$  is used only to correct for CO<sub>2</sub> loss. The formula most commonly used for pH correction of  $cCa^{2+}$  in ruminant and equine plasma is  $cCa^{2+}_{corrected} = cCa^{2+} \times 10^{(-0.24 \times [7.40 - pH])}$ . Small differences in the measured value for  $cCa^{2+}$  exist, depending on whether the blood sample is anaerobically collected using sodium heparin or calcium-balanced heparin.

Hypocalcemia or milk fever may occur in recently calved mature dairy cows that have been inappetent or anorexic for a few days. Hypocalcemia can be caused by a reduction in dry matter intake because of illness or it may be the earliest stages of hypocalcemic parturient paresis. The clinical findings include anorexia; mild tachycardia with a reduction in the intensity of the heart sounds and occasionally an arrhythmia; a decrease in the frequency and amplitude of rumen contractions or complete ruminal stasis; and a decrease or complete absence of feces, which may last from 6 to 36 hours if untreated.

Hypocalcemia cases often mimic intestinal obstruction and create problems in the differential diagnosis. Affected cattle may not exhibit any evidence of muscular weakness, and the detection of the hypocalcemic state can be elusive. The total serum calcium concentrations range from 1.5 to 2.0 mmol/L and the response to intravenous therapy is usually good, although recovery may require several hours before the appetite returns to normal and feces are passed.

Calcium can be administered by the intravenous, subcutaneous, or oral route. **Calcium gluconate** and **calcium borogluconate** are the preferred forms for intravenous

and subcutaneous administration because  $\text{CaCl}_2$  causes extensive necrosis and sloughs of tissue when administered perivascularly. Compared with calcium gluconate, calcium borogluconate has improved solubility and shelf-life. Plasma ionized calcium concentrations are increased to a greater extent following  $\text{CaCl}_2$  treatment when high equimolar solutions of  $\text{CaCl}_2$  and calcium gluconate are administered, leading to more cardiac arrhythmias during  $\text{CaCl}_2$  administration. A typical treatment for an adult lactating dairy cow with periparturient hypocalcemia is 500 mL of 23% calcium borogluconate by slow intravenous injection with cardiac auscultation; this provides 10.7 g of calcium. Although the calculated calcium deficit in a recumbent periparturient dairy cow is 4 g, additional calcium should be provided to overcome the continued loss of calcium in milk. A field study comparing the effectiveness of different doses of calcium for treating periparturient milk fever determined that 9 g of calcium was superior to 6 g. A good rule of thumb for administering 23% calcium borogluconate solutions (2.14 g calcium/100 mL) to cows with periparturient hypocalcemia is therefore to administer 1 mL/kg BW. There do not appear to be any clinically important advantages to slow administration of the solution over 6 hours, compared with over 15 min.

The normal cardiac response to **intravenous calcium administration** is an increase in the strength of cardiac contraction and a slowing of the heart rate. Intravenous administration is continued until the first arrhythmia is detected (a bradyarrhythmia such as a prolonged pause); the rate of intravenous administration is then slowed until a second arrhythmia is detected, at which time intravenous administration is discontinued and the remainder of the solution is placed subcutaneously over the lateral thorax. This treatment method individually titrates the calcium dose required for each animal. Auscultation of the heart is an absolute requirement during treatment: visual monitoring of the jugular pulse at the base of the neck does not allow the early detection of bradyarrhythmias, making it more likely that the cow will receive a toxic and possibly lethal dose of calcium. The maximum safe rate of calcium administration in cattle is 0.07 mEq of  $\text{Ca}^{2+}$ /kg BW per minute, which is equivalent to 0.065 mL 23% calcium borogluconate per kilogram BW per minute. For a 500-kg normocalcemic dairy cow, this corresponds to a maximum safe rate of administration of 33 mL/min. Typical rates of administration through a 14-gauge needle are 50 mL/min; this rate of administration is safe for cows with hypocalcemia, provided cardiac auscultation is performed during administration. Intravenous administration of calcium gluconate or calcium chloride to horses increased serum calcium concentrations by approximately 35% and resulted in hypomagnesemia, hypokalemia,

and hyperphosphatemia, induced diuresis, and increased excretion of calcium, magnesium, potassium, sodium, phosphate, and chloride.<sup>11</sup>

**Subcutaneous administration** of calcium solutions has been practiced for many years as part of the treatment of hypocalcemic cattle. To facilitate calcium absorption, it is preferable to administer no more than 125 mL at a site. A 14-gauge needle is placed subcutaneously over the lateral thorax, 125 mL is administered, and the needle is redirected and another 125 mL is administered. The process is then repeated on the other side of the cow. The effectiveness of subcutaneous administration of calcium has been documented in healthy normal cows, and subcutaneous calcium injections appear to be absorbed by cows with periparturient hypocalcemia at a fast enough rate to be clinically effective. Subcutaneous administration of calcium gluconate in recumbent cows can therefore be expected to have some efficacy in improving plasma calcium concentrations; such treatment can be administered by producers until a veterinarian can arrive to administer intravenous calcium gluconate. Calcium chloride is not recommended for subcutaneous administration because of extensive tissue damage; the addition of dextrose to the administered calcium is also not recommended because it increases the tonicity of the solution and propensity for bacterial infection and development of abscesses. Rectal calcium administration is not recommended because it causes severe mucosal injury and tenesmus and does not increase plasma concentrations of calcium.

**Oral administration** of calcium has also been practiced for many years, usually by ororuminant intubation of calcium borogluconate solutions designed for parenteral administration. Over the past decade there has been increased interest in improving the efficacy of oral calcium formulations. The results of a number of studies indicate that oral calcium salts are effective at increasing plasma calcium concentration; orally administered calcium is absorbed by a dose-dependent passive diffusion process across ruminal epithelium and a dose-independent calcium-binding protein mechanism in the small intestine that is modulated by vitamin D. Rapid correction of hypocalcemia by oral calcium administration is predominantly by passive ruminal diffusion because small intestinal absorption is too slow to be of clinical value.

Two calcium formulations are currently recommended for oral administration to ruminants,  $\text{CaCl}_2$  and calcium propionate, but most commercially available products contain 50 g of  $\text{CaCl}_2$ . Calcium lactate does not appear to be absorbed in appreciable quantities when administered orally to cows in a large volume of water (20 L) followed immediately by oral administration of

sodium phosphate; this result may have been caused by formation of calcium-phosphate complexes in the rumen.<sup>12</sup> Calcium chloride has the advantage of low cost and low volume (because of its high solubility), but  $\text{CaCl}_2$  can severely damage the pharynx and esophagus in ruminants with reduced swallowing ability, can lead to necrosis of the forestomach and abomasum when administered in high doses, and can lead to aspiration pneumonia when administered as a drench. Calcium propionate has the advantage that it is less irritating than  $\text{CaCl}_2$  while providing a gluconeogenic substrate (propionate), but the disadvantages of calcium propionate are higher volumes and cost. Oral calcium solutions should only be administered to cattle that have normal swallowing ability, precluding their administration to animals with advanced clinical signs of hypocalcemia. Higher plasma calcium concentrations are obtained more quickly when calcium solutions are drenched after administration of vasopressin to induce esophageal groove closure, or when the calcium solution is administered as a drench instead of ororuminant intubation. Calcium solutions are suspected to have a higher likelihood of aspiration pneumonia than calcium gels (with a consistency similar to toothpaste), although this supposition does not appear to have been verified. Commercially available formulations of calcium gels contain 50 g of  $\text{CaCl}_2$  and increase plasma calcium concentrations within 30 to 60 minutes and for at least 6 hours. Retreatment at 12-hour intervals (if needed) therefore appears to be indicated and provides 100 g of  $\text{CaCl}_2$  and 37 g of calcium over 24 hours, but more aggressive treatment protocols are not recommended.

## HYPOPHOSPHATEMIA

Hypophosphatemia occurs in cattle under conditions similar to those of hypocalcemia. A decrease in feed intake or alimentary tract stasis will result in a decrease in serum inorganic phosphate concentration. Acute recumbency in lactating dairy cattle may be associated with marginal phosphorus deficiency, although a cause-and-effect relationship between hypophosphatemia and recumbency has not been established. However, many inappetent and weak cows have marginal hypophosphatemia and clinically appear to benefit from normalization of their plasma concentration of phosphate. As such, it is currently recommended that ruminants with marked hypophosphatemia and signs of illness should be treated with phosphorus-containing solutions.

Almost all commercially available intravenous solutions for treating hypophosphatemia use **phosphite** ( $\text{PO}_2^{2-}$ ) or **hypophosphite** ( $\text{PO}_3^{3-}$ ) salts as the source of phosphorus because these salts are very soluble, even in the presence of calcium and



magnesium. However, the phosphorus in phosphite and hypophosphite is unavailable to mammals, meaning that the vast majority of “phosphate”-containing solutions are not efficacious in treating hypophosphatemia.<sup>13</sup> Instead, the **monobasic monophosphate form of sodium phosphate** ( $\text{NaH}_2\text{PO}_4$ ) should be administered. The pH of the solution should be mildly acidic (pH 5.8) to maintain phosphate solubility in cold weather, but this is not needed when solutions are stored in warm ambient temperatures. A recommended treatment to an adult lactating dairy cow with severe hypophosphatemia is 300 mL of 10%  $\text{NaH}_2\text{PO}_4$  (monohydrate) solution by slow intravenous injection; this provides 7 g of phosphate (2.3 g of inorganic phosphate), and increases plasma phosphate concentrations for at least 6 hours. Human enema formulations that contain a mixture of monobasic sodium phosphate monohydrate and dibasic sodium phosphate heptahydrate in a buffered solution have also been administered intravenously to cattle with hypophosphatemia but are not recommended. This human enema solution is extremely hypertonic and must be diluted before administration. A major drawback with intravenous administration of phosphate solutions is that they should not be administered within 2 hours of intravenous calcium administration because of concerns that calcium-phosphate precipitates may be formed in the plasma of cattle with treatment-induced hypercalcemia and hyperphosphatemia. This has traditionally been evaluated by calculating the **calcium-phosphorus product**, in which metastatic calcification may occur if the product of serum calcium concentration and serum phosphate concentration (both in mg/dL) exceeds 70.

Hypophosphatemia is more safely treated by administration of **oral monosodium phosphate**, and this is the preferred method of administration in ruminants with rumen motility. Oral administration also results in a more prolonged increase in plasma phosphorus concentration. Recommended dose is 200 to 350 g of feed grade monosodium phosphate ( $\text{NaH}_2\text{PO}_4 \cdot 2\text{H}_2\text{O}$ , contains 50–70 g of phosphate) administered in gelatin boluses, drench, or by ororuminant intubation.<sup>12</sup> Phosphorus in other feed grade minerals (such as bone meal or dicalcium phosphate) is poorly available and is not recommended for the treatment of hypophosphatemia.

## HYPOMAGNESEMIA

Magnesium is usually administered parenterally only when a ruminant exhibits clinical signs of hypomagnesemia. Treatment of hypomagnesemia is more dangerous (to the animal and clinician) and less satisfying than treatment of periparturient hypocalcemia; the response to treatment is much slower in hypomagnesemia presumably because

magnesium concentrations must be normalized in cerebrospinal fluid (CSF), which turns over at approximately 1% per minute.

Treatment of hypomagnesemia has historically used 25% Epsom salts solution (magnesium sulfate heptahydrate;  $\text{MgSO}_4 \cdot 6\text{H}_2\text{O}$ ); this solution concentration was selected because it provided approximately 1 mmol of magnesium per liter. It should be noted that 25% Epsom salts solution is markedly hypertonic (2028 mOsm/L). A typical treatment for an adult cow has been slow intravenous administration (over at least 5 min) of 100 mL of the 25% Epsom salts solution, which provides 2.5 g of magnesium (25 mg of magnesium per mL of solution). More recently, hypomagnesemia has been treated using commercially available combined calcium and magnesium solutions; 500 mL of these solutions typically contain 1.6 to 2.7 g of magnesium in the form of a borogluconate, chloride, or hypophosphite salt. Although the calculated extracellular deficit in a cow with hypomagnesemia is 2 g of magnesium, additional magnesium should be provided to correct presumed intracellular deficiencies and to overcome the anticipated urinary loss of magnesium. Combined calcium and magnesium solutions are preferred for intravenous administration to 25% Epsom salts solution because ruminants with hypomagnesemia frequently have hypocalcemia, and hypercalcemia provides some protection against the toxic effects of hypermagnesemia. Moreover, administration of solutions containing magnesium as the only cation increases the risk of developing cardiac and respiratory failure during treatment. The maximum safe rate of administration of magnesium in cattle is 0.08 mEq  $\text{Mg}^{2+}$ /kg of BW per minute, which is equivalent to 0.04 mL 25% Epsom salts per kilogram of BW per minute. For a 500-kg beef cow with hypomagnesemia, this corresponds to a maximum safe rate of administration of 20 mL/min.

Magnesium-containing solutions (such as 25% Epsom salts solution) can also be administered subcutaneously, although this frequently leads to necrosis of the skin, particularly when 50% Epsom salts solution is administered. Only combined calcium and magnesium solutions should therefore be administered subcutaneously.

The oral bioavailability of magnesium is low and much lower than that of calcium. Accordingly, oral administration of magnesium is not recommended for the treatment of hypomagnesemia, but is essential for the prevention of hypomagnesemia. Magnesium absorption from the rumen is facilitated by volatile fatty acids but decreased by potassium and the ammonium ion.

Rectal administration may be the only practical and safe method for treating a convulsing hypomagnesemic beef cow. After evacuating the rectal contents, an enema

containing 60 g of Epsom salts (magnesium sulfate heptahydrate) or magnesium chloride in 200 mL of water can be placed in the descending colon (and not the rectum) and the tail held down for 5 minutes; this increases plasma magnesium concentrations within 10 minutes. However, enema solutions can be prematurely evacuated, eliminating the chance for therapeutic success, and some degree of colonic mucosal injury is expected because of the high osmolality of 30% solutions (approximately 2400 mOsm/L). The safety of this treatment protocol does not appear to have been evaluated, although a 50-mL enema of a 30%  $\text{MgCl}_2 \cdot 6\text{H}_2\text{O}$  solution rapidly and effectively increased serum magnesium concentration in 7- to 10-week-old calves and relieved clinical signs of hypomagnesemia.

Oral administration of magnesium hydroxide and magnesium oxide excessively alkalinizes the rumen and can create a severe metabolic alkalosis (strong ion alkalosis), as absorption of magnesium leads to hypermagnesemia and increased plasma strong ion difference (SID). Because oral administration of sodium bicarbonate causes expansion of the plasma volume and creates a metabolic alkalosis (strong ion alkalosis) without hypermagnesemia, it is likely that oral sodium bicarbonate is a more effective treatment for grain overload in ruminants.

## FURTHER READING

- Androgué HJ, Madias NE. Hyponatremia. *N Engl J Med.* 2000;342:1493-1499.
- Androgué HJ, Madias NE. Hyponatremia. *N Engl J Med.* 2000;342:1581-1589.
- Byers SR, Lear AS, Van Metre DC. Sodium balance and the dysnatremias. *Vet Clin North Am Food Anim Pract.* 2014;30:333-350.
- Constable PD. Fluids and electrolytes. *Vet Clin North Am Food Anim Pract.* 2003;19:1-40.

## REFERENCES

1. Wong DM, et al. *J Vet Emerg Crit Care.* 2007;17:275.
2. Ollivett TL, McGuirk SM. *J Vet Intern Med.* 2013;27:592.
3. Trefz FM, et al. *J Vet Intern Med.* 2015;29:688.
4. Constable PD, et al. *J Am Vet Med Assoc.* 2013;242:826.
5. Grünberg W, et al. *J Vet Intern Med.* 2006;20:1471.
6. Grünberg W, et al. *J Am Vet Med Assoc.* 2006;229:413.
7. Constable PD, et al. *J Dairy Sci.* 2014;97:1413.
8. Constable PD, Grünberg W. *Vet J.* 2013;195:271.
9. Trefz FM, et al. *J Dairy Sci.* 2013;96:7234.
10. Trefz FM, et al. *J Vet Intern Med.* 2015;29:696.
11. Toribio RE, et al. *Am J Vet Res.* 2007;68:543.
12. Braun E, et al. *Schweiz Arch Tierheilk.* 2012;381:388.
13. Braun U, Jehle W. *Vet J.* 2007;173:379.

## Acid-Base Imbalance

The pH of mammalian blood is maintained within the normal range of 7.35 to 7.45 by its buffer systems, of which hemoglobin (Hb) is the most important, because it has the greatest buffering capacity. However, because the



blood Hb concentration is regulated on the basis of oxygen delivery instead of acid-base balance, rapid changes in Hb concentration occur only with marked changes in hydration status or splenic contraction associated with exercise, and the bicarbonate system is an open buffering system via carbon dioxide loss through the respiratory system. The **bicarbonate system** has traditionally been considered to be the most important buffer. Other buffers in blood are plasma proteins and phosphate. The addition of relatively large amounts of acid or alkali to the blood is necessary before its buffering capacity is exhausted and its pH changed. Changes from normal acid-base balance toward alkalemia or acidemia are common in sick animals and make a significant contribution to the observed clinical signs.

**The traditional approach for assessing acid-base balance** focuses on how plasma carbon dioxide tension ( $P_{CO_2}$ ), plasma bicarbonate concentration ( $[HCO_3^-]$ ), the negative logarithm of the apparent dissociation constant ( $pK_1'$ ) for plasma carbonic acid ( $H_2CO_3$ ), and the solubility of  $CO_2$  in plasma ( $S$ ) interact to determine plasma pH. This relationship is most often expressed as the **Henderson–Hasselbalch equation**:  $pH = pK_1' + \log([HCO_3^-]/S \times P_{CO_2})$ . The evaluation of acid-base balance using the Henderson–Hasselbalch equation has historically used pH as an overall measure of acid-base status,  $P_{CO_2}$  as an independent measure of the respiratory component of acid-base balance, and extracellular base excess and actual  $HCO_3^-$  concentration or standard  $HCO_3^-$  as a measure of the nonrespiratory (also called metabolic) component of acid-base balance.

When using the traditional Henderson–Hasselbalch approach, **four primary acid-base disturbances** can be distinguished: **respiratory acidosis** (increased  $P_{CO_2}$ ), **respiratory alkalosis** (decreased  $P_{CO_2}$ ), **metabolic acidosis** (decreased extracellular base excess or actual  $HCO_3^-$  concentration), and **metabolic alkalosis** (increased extracellular base excess or actual  $HCO_3^-$  concentration). The anion gap (AG) is easily calculated from the results of serum biochemical analysis and is used to determine whether unmeasured anions (UAs) are present. The Henderson–Hasselbalch equation has a long history of use and remains widely and routinely used in the clinical management of acid-base disorders. These advantages should not be overlooked. The principal disadvantage of the Henderson–Hasselbalch equation is that it is more descriptive than mechanistic, decreasing the value of the approach in explaining the cause of acid-base changes during disease. This is because the Henderson–Hasselbalch equation fails to distinguish among the effects of independent and dependent variables on plasma pH.

**Actual plasma  $HCO_3^-$  concentration** in units of mmol/L is not measured but

calculated using the Henderson–Hasselbalch equation and measured values for pH and  $P_{CO_2}$ :

$$[HCO_3^-] = S \times P_{CO_2} \times 10^{(pH - pK_1')}$$

The values for  $pK_1'$  and  $S$  at  $37^\circ C$  are 6.105 and 0.0307 per mm Hg, respectively, for normal mammalian blood. The equation at  $37^\circ C$  is

$$[HCO_3^-] = 0.0307 \times P_{CO_2} \times 10^{(pH - 6.105)}$$

Because actual  $HCO_3^-$  concentration is calculated from pH and  $P_{CO_2}$ , it can never provide an independent measure of the nonrespiratory component of an acid-base disturbance. A primary decrease in  $P_{CO_2}$  (respiratory alkalosis) at normal pH always is accompanied by a decrease in plasma  $HCO_3^-$  concentration (which would be interpreted as a metabolic acidosis). Likewise, a primary increase in  $P_{CO_2}$  (respiratory acidosis) at normal pH always produces an increase in plasma  $HCO_3^-$  concentration (which would be interpreted as a metabolic alkalosis). In both cases, the actual  $HCO_3^-$  concentration is dependent on the pH and  $P_{CO_2}$ , providing no additional information as to the cause of the acid-base imbalance other than that obtained by knowledge of the pH

and  $P_{CO_2}$ . It is therefore illogical to use the actual  $HCO_3^-$  concentration to define the nonrespiratory (metabolic) component of an acid-base disturbance.

The current use of actual  $HCO_3^-$  concentration in the evaluation of acid-base status results from Van Slyke's work in 1924, in which pH and total  $CO_2$  (which is highly correlated with actual  $[HCO_3^-]$ ) could be measured more accurately than  $P_{CO_2}$ . This led to the graphical depiction of the curvilinear  $HCO_3^-$ –pH relationship, the so-called Davenport diagram, to represent acid-base disturbances (Fig. 5-9). With the later development of accurate and practical laboratory methods in the 1950s to measure  $P_{CO_2}$ , acid-base derangements were graphically depicted as approximately linear  $\log(P_{CO_2})$ –pH relationships. This development led directly to the **base excess** concept.

The normal range of plasma bicarbonate in large animals is 24 to 30 mmol/L (this should be compared with the normal range in humans, which is 22–24 mmol/L). In mild metabolic acidosis the bicarbonate concentration is in the range of 20 to 24 mmol/L, moderate metabolic acidosis is 14 to 18 mmol/L, and in severe cases the values are below 10 mmol/L and carry a grave

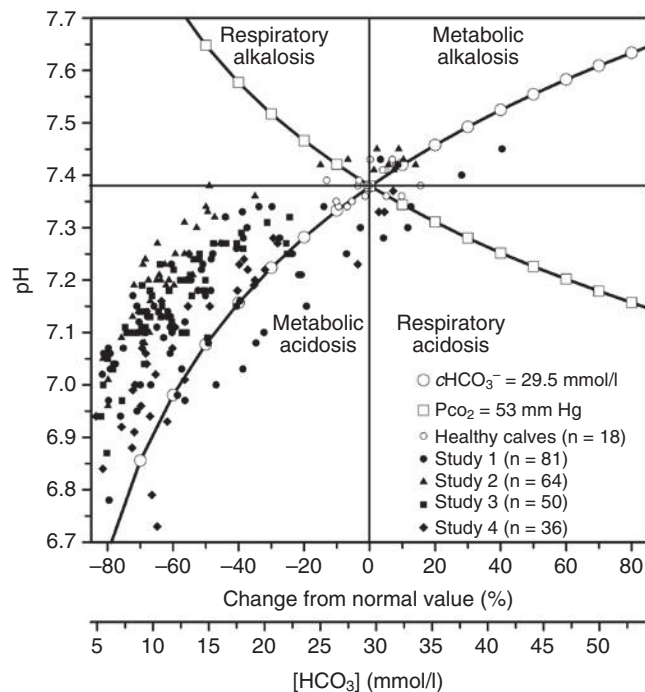

**Fig. 5-9** Spider plot revealing the association between changes in two variables of the Henderson–Hasselbalch equation, plasma bicarbonate concentration ( $HCO_3^-$ ) and carbon dioxide tension ( $P_{CO_2}$ ), on venous blood pH in 231 sick calves, most of which had diarrhea. The spider plot was obtained by systematically varying one input variable ( $cHCO_3^-$  or  $P_{CO_2}$ ) while holding the remaining input variables at their reference values for calf venous plasma. Reference values for the two input variables for calf plasma were 29.5 mmol/L for  $cHCO_3^-$  (large open circles) and 53 mm Hg for  $P_{CO_2}$  (open squares). The solid vertical and horizontal lines indicate that venous blood pH = 7.38 when  $cHCO_3^-$  and  $P_{CO_2}$  are at their reference values. Note that the individual data points are displaced from the predicted pH– $cHCO_3^-$  relationship. This displacement indicates that changes in plasma  $cHCO_3^-$  do not account for all of the changes in blood pH in sick calves. (Reproduced with permission from Constable PD, *Vet Clin North Am Food Anim Pract* 2014;30:295-316.)

prognosis. The levels of  $PCO_2$ ,  $PO_2$ , plasma bicarbonate, and blood pH can be used to determine the degree of compensation, if any, that has taken place. In metabolic acidosis there may be a compensatory decrease in  $PCO_2$  caused by hyperventilation; in metabolic alkalosis there may be an increase in  $PCO_2$  caused by hypoventilation. In respiratory acidosis caused by severe pneumonia the arterial  $PO_2$  will be markedly decreased.

The **base excess** value directly expresses the amount (usually expressed in units of mEq/L) of strong base (or acid) added per liter of blood or plasma, when the normal mean base excess value is arbitrarily fixed at zero. As such, the base excess is defined as the amount of strong acid (such as HCl) needed to titrate the pH of 100% oxygenated human blood to 7.40 at 37°C and at a  $PCO_2$  of 40 mm Hg. By definition, the normal base excess value for humans is 0 mEq/L (range is -2 to +2 mEq/L), and a base excess of more than +2 mEq/L indicates metabolic alkalosis, whereas a value of less than -2 mEq/L (negative base excess value or base deficit) reflects metabolic acidosis. The **normal range of base excess** in large animals is 0 to 6 mEq/L.

Mathematical formulas and nomograms are available to calculate base excess from measured pH,  $PCO_2$ , and blood Hb concentration. Base excess is usually expressed as  $BE_{ECF}$  (also called **standard base excess** or **in vivo base excess**). Extracellular base excess is the preferred measurement because this formulation provides the best clinical estimate of the required mmol/L of  $HCO_3^-$  required to correct metabolic acidosis and because it assumes a fixed Hb concentration of 5 g/dL. Clearly, the  $BE_{ECF}$  value will be incorrect when applied to animals with anemia or polycythemia; however, the error introduced by this approximation is small and usually clinically insignificant.

Most blood gas analyzers calculate base excess in units of mEq/L using Siggaard-Andersen's empirical equation derived from his nomogram with Hb concentration [Hb] and actual  $HCO_3^-$  concentrations in mmol/L:

$$BE_{blood} = (1 - 0.023 \times [Hb]) \times ([HCO_3^-] - 24.4) + (7.7 + 2.3 \times [Hb]) \times (pH - 7.40),$$

which is equivalent to the following expression when [Hb] = 3.1 mmol/L = 5 g/dL:

$$BE_{ECF} = 0.93 \times ([actual HCO_3^-] - 24.4) + 14.83 \times (pH - 7.40)$$

The calculated  $BE_{ECF}$  value assumes normal serum protein concentration (7.2 g/dL) providing an inaccurate estimate of the magnitude of a metabolic acidosis or alkalosis in domestic animals with hypoproteinemia or hyperproteinemia. The ability of  $BE_{ECF}$  and actual  $HCO_3^-$  concentration to accurately characterize the metabolic component of

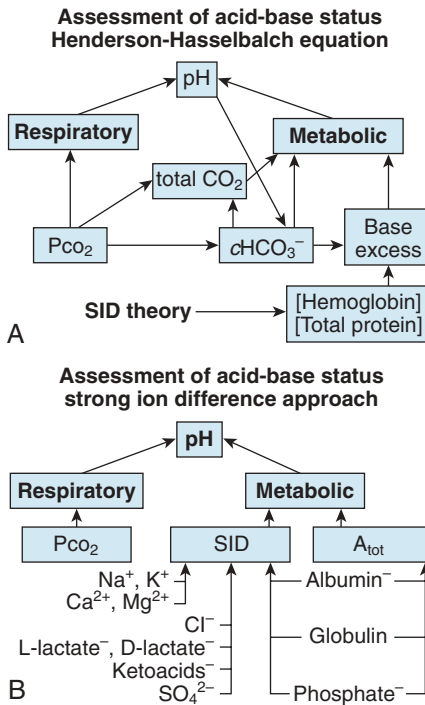

**Fig. 5-10** Evaluation of acid-base balance using the traditional Henderson-Hasselbalch equation (A) and strong ion difference (SID) theory (B). The Henderson-Hasselbalch equation posits that blood pH is dependent on the respiratory system, as assessed by the partial pressure of carbon dioxide ( $PCO_2$ ), and metabolism, as assessed by the bicarbonate concentration ( $cHCO_3^-$ ) or base excess. A, It highlights one of the fundamental flaws with using the Henderson-Hasselbalch equation in that blood pH cannot be dependent on  $cHCO_3^-$  because bicarbonate concentration is calculated from blood pH and  $PCO_2$ . B, For comparison, this conveys that the strong ion approach to acid-base balance posits that blood pH is dependent on the respiratory system, assessed by  $PCO_2$ , and on metabolism, assessed by the SID and concentration of nonvolatile buffers ( $A_{tot}$ , such as albumin, globulin, and phosphate) in plasma. (Reproduced with permission from Constable PD: Clinical assessment of acid-base status: Strong ion difference theory, *Vet Clin North Am Food Anim Pract* 1999;15:447-71).

acid-base status has been controversial for many years, although  $BE_{ECF}$  has advantages compared with actual  $HCO_3^-$  concentration. The major advantages of the base excess approach are that  $BE_{ECF}$  is theoretically related to SID and is independent of respiratory activity. On this basis, when using the traditional Henderson-Hasselbalch approach to acid-base balance, the recommended approach is to use pH as an overall index of acid-base status,  $PCO_2$  as an index of the respiratory component, and standard (in vivo) base excess as an index of the nonrespiratory (metabolic) component (Fig. 5-10).

The **strong ion approach** to acid-base balance provides a revolutionary method to

assess acid-base balance, which is becoming more widely adopted. In particular, the strong ion model is thought to provide a more accurate assessment of acid-base status than the traditional Henderson-Hasselbalch approach and can identify complex mixed acid-base disorders.<sup>1,2,3,4</sup> This strong ion approach differs in three important areas from the traditional bicarbonate-centered application of the Henderson-Hasselbalch equation: (1) acid-base balance is examined using a systems approach, (2) a clear conceptual distinction is made between dependent variables (such as pH and  $[HCO_3^-]$ ) and the independent variables, and (3) the effects of protein concentration on acid-base balance are considered.

The strong ion approach reduces the chemical reactions in plasma to that of simple ions in solution. This assumption can be made because the quantitatively important plasma cations ( $Na^+$ ,  $K^+$ ,  $Ca^{2+}$ , and  $Mg^{2+}$ ) and anions ( $Cl^-$ ,  $HCO_3^-$ , protein, lactate, sulfate, and ketoacids) bind each other in a saltlike manner. Plasma ions (such as  $Cu^{2+}$ ,  $Fe^{2+}$ ,  $Fe^{3+}$ ,  $Zn^{2+}$ ,  $Co^{2+}$ , and  $Mn^{2+}$ ) that enter into oxidation-reduction reactions, complex ion interactions, and precipitation reactions are not categorized as simple ions but are assumed to be quantitatively unimportant in determining plasma pH, primarily because their plasma concentrations are low.

Simple ions in plasma can be differentiated into two main types, nonbuffer ions (strong ions or strong electrolytes) and buffer ions. Strong ions are fully dissociated at physiologic pH and therefore exert no buffering effect. Strong ions do, however, exert an electrical effect because the sum of completely dissociated cations does not equal the sum of completely dissociated anions. Stewart termed this difference the SID. Because strong ions do not participate in chemical reactions in plasma at physiologic pH, they act as a collective positive unit of charge.

In contrast to strong ions, **buffer ions** are derived from plasma weak acids and bases that are not fully dissociated at physiologic pH. The conventional dissociation reaction for a weak acid (HA), conjugate base ( $A^-$ ) pair is

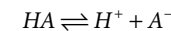

and, at equilibrium, an apparent weak acid dissociation constant ( $K_a$ ) can be calculated adopting the accepted convention regarding hydrated solutes as  $K_a = [H^+][A^-]/[HA]$ . For a weak acid to act as an effective buffer, its  $pK_a$  (defined as the negative logarithm of the weak acid dissociation constant  $K_a$ ) lies within the range of  $pH \pm 1.5$ .

Conceptually, the buffer ions can be subdivided into volatile buffer ions ( $HCO_3^-$ ) and nonvolatile buffer ions (non- $HCO_3^-$ ). Bicarbonate is considered separately because this buffer system is an open system in arterial plasma; rapid changes in carbon dioxide

tension and hence arterial plasma  $\text{HCO}_3^-$  concentration can be readily induced through alterations in respiratory activity. In contrast, the non- $\text{HCO}_3^-$  buffer system is a closed system containing a fixed quantity of buffer. Another important physiologic distinction between these two buffer systems is that an open buffer system such as  $\text{HCO}_3^-$  can be effective beyond the limits of  $\text{pH} = \text{pK}_a \pm 1.5$ . Finally, it should be appreciated that  $\text{HCO}_3^-$  is a homogeneous buffer ion, whereas the nonvolatile buffer ion ( $\text{A}^-$ ) represents a diverse and heterogeneous group of plasma buffers (albumin, globulin, and phosphate) that is being modeled as a single buffer. Another assumption in Stewart's strong ion model is that  $\text{HA}$  and  $\text{A}^-$  do not take part in plasma reactions that result in the net destruction or creation of  $\text{HA}$  or  $\text{A}^-$ . This is because when  $\text{HA}$  dissociates it ceases to be  $\text{HA}$  (therefore decreasing plasma  $[\text{HA}]$ ) and becomes  $\text{A}^-$  (therefore increasing plasma  $[\text{A}^-]$ ). The sum of  $[\text{HA}]$  and  $[\text{A}^-]$  (called  $\text{A}_{\text{TOT}}$ ) therefore remains constant through conservation of mass:

$$[\text{A}_{\text{TOT}}] = [\text{HA}] + [\text{A}^-]$$

In summary, the strong ion approach assumes that plasma ions act as either strong ions, volatile buffer ions ( $\text{HCO}_3^-$ ), or nonvolatile buffer ions ( $\text{A}^-$ ). Plasma therefore contains three types of charged entity: SID,  $\text{HCO}_3^-$ , and  $\text{A}^-$ . The requirement for electroneutrality dictates that at all times the SID equals the sum of bicarbonate buffer ion activity ( $\text{HCO}_3^-$ ) and nonvolatile buffer ion activity ( $\text{A}^-$ ), such that  $\text{SID} - \text{HCO}_3^- - \text{A}^- = 0$ . This equation obviously assumes that all ionized entities in plasma can be classified as either a strong ion (SID), a volatile buffer ion ( $\text{HCO}_3^-$ ), or a nonvolatile buffer ion ( $\text{A}^-$ ; see Fig. 5-9).

An equation relating plasma pH to three independent variables ( $\text{PCO}_2$ , SID, and  $\text{A}_{\text{TOT}}$ ) and three constants ( $K_a$ ,  $K_1$ , and  $S$ ) has been developed based on these assumptions. The most important factors that determine plasma pH are  $\text{PCO}_2$ , SID, and the concentrations of individual nonvolatile plasma buffers (albumin, globulins, and phosphate). A change in any one of these variables will produce a direct and predictable change in plasma pH. Using the strong ion approach, six primary acid-base disturbances can be distinguished (Fig. 5-11) instead of the four primary acid-base disturbances (respiratory acidosis, respiratory alkalosis, metabolic acidosis, and metabolic alkalosis) differentiated when using the traditional Henderson-Hasselbalch approach. The strong ion approach indicates that acidemia results from an increase in  $\text{PCO}_2$  and nonvolatile buffer concentration, or from a decrease in SID. Alkalemia results from a decrease in  $\text{PCO}_2$  and nonvolatile buffer concentration, or from an increase in SID. The unmeasured strong anion concentration is quantified by calculating the strong ion gap (SIG).

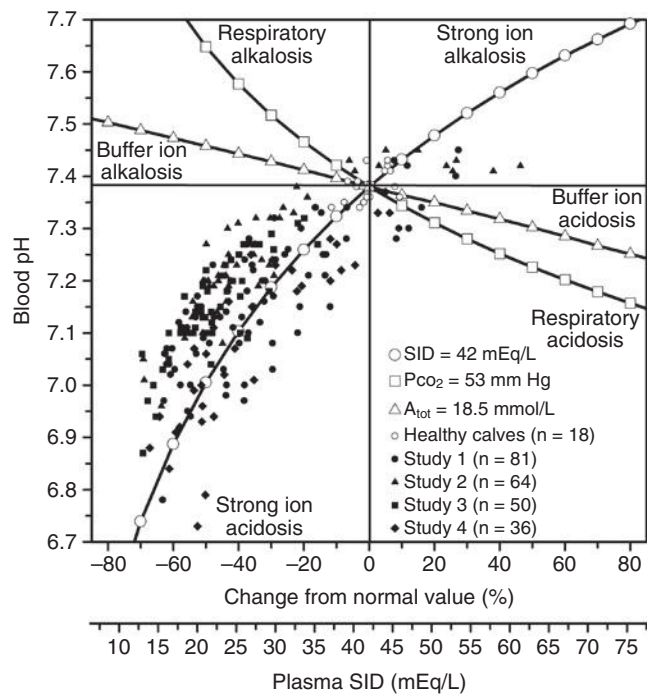

**Fig. 5-11** Spider plot revealing the association among changes in three independent variables of the simplified strong ion equation, strong ion difference (SID, open circles), carbon dioxide tension ( $\text{PCO}_2$ , open squares), and the plasma concentration of nonvolatile buffers ( $\text{A}_{\text{TOT}}$ , open triangles), on venous blood pH in 231 sick calves, most of which had diarrhea. The spider plot was obtained by systematically varying one input variable (SID,  $\text{PCO}_2$ , or  $\text{A}_{\text{TOT}}$ ) while holding the remaining input variables at their reference values for calf venous plasma (42 mEq/L for SID, 53 mm Hg for  $\text{PCO}_2$ , and 18.5 mmol/L for  $\text{A}_{\text{TOT}}$ ). The solid vertical and horizontal lines indicate that venous blood pH = 7.38 when SID,  $\text{PCO}_2$ , and  $\text{A}_{\text{TOT}}$  are at their reference values. Note that the individual data points are located more centrally around the predicted pH–SID relationship than for the pH– $\text{HCO}_3^-$  relationship identified in Figure 5.9. This is because changes in plasma protein concentration (and therefore  $\text{A}_{\text{TOT}}$ ) caused by changes in hydration status account for some of the change in blood pH. The plot also indicates the six primary acid-base disturbances (respiratory, strong ion, or nonvolatile buffer ion acidosis and alkalosis) and the relative effect of each disturbance on blood pH in the neonatal calf. Note that changes in SID have the greatest relative effect on blood pH. (Adapted from Constable PD, Stämpfli HR, Navetat H, et al.: Use of a quantitative strong ion approach to determine the mechanism for acid-base abnormalities in sick calves with or without diarrhea. *J Vet Intern Med* 2005;19:581-9. IN Constable PD: Acid-Base Assessment When and How to Apply the Henderson-Hasselbalch Equation and Strong Ion Different theory, *Vet Clin Food Anim*. 2014;30:295-316.)

## ACIDEMIA

### ETIOLOGY

The traditional Henderson-Hasselbalch approach to acid-base balance indicates that general causes of nonrespiratory (metabolic) acidosis can be divided into three categories on the basis of pathogenesis (Fig. 5-12):

- Excessive loss of base (bicarbonate)
- Accumulation of endogenous or exogenous acid
- Combination of both of these processes

For comparison, the strong ion approach indicates that general causes of nonrespiratory (metabolic) acidosis can be divided into two categories: strong ion acidosis caused by a decrease in strong cation concentration (hyponatremia) or increase in strong anion concentration (hyperchloremia, hyper L-lactatemia, hyper D-lactatemia, and ketoacidosis), and nonvolatile buffer ion

acidosis caused by an increase in albumin, globulin, and phosphate concentration.

Some common specific causes include acute diarrhea in newborn animals, acute enteritis in adult cattle and horses, and carbohydrate engorgement in ruminants and horses. Metabolic acidosis without dehydration, which is probably caused by hyper D-lactatemia, has been described in neonatal goat kids and neonatal calves.<sup>4</sup> Respiratory acidosis also occurs when there is retention of carbon dioxide in the blood as a result of interference with normal respiratory exchange. Thus pneumonia, severe pulmonary emphysema, depression of the respiratory center, and left-sided heart failure may all be accompanied by respiratory acidosis. Metabolic acidosis occurs in the newborn at the time of parturition if this is prolonged and difficult. It is also common in shock with peripheral circulatory failure and anaerobic oxidation. A decrease in renal excretion of



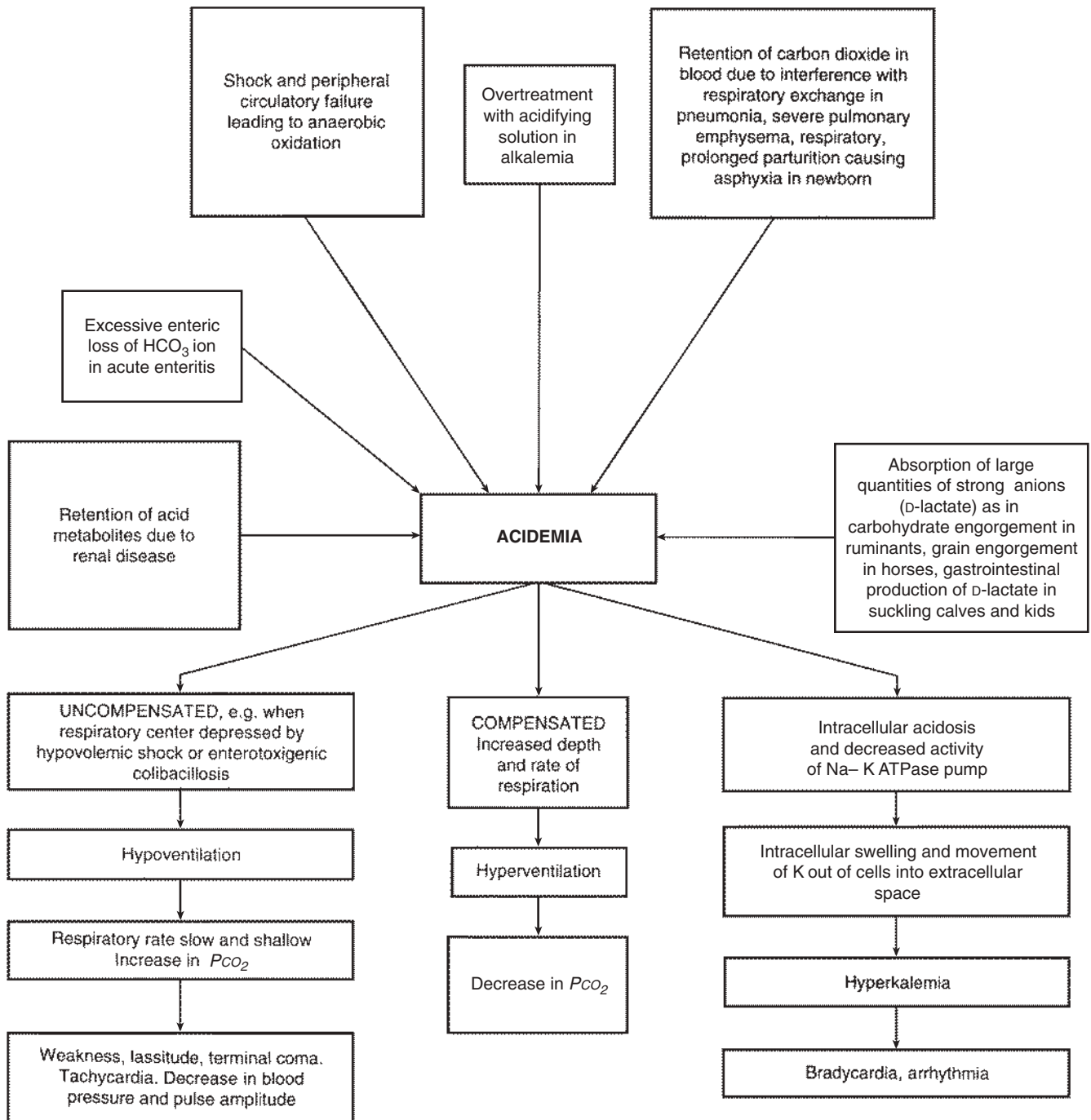

Fig. 5-12 Etiology and pathogenesis of acidemia.

acid in renal insufficiency or renal failure also contributes to a metabolic acidosis. The administration of excessive quantities of acidifying solutions for the treatment of metabolic alkalosis also may cause acidosis. Acute intestinal obstruction in the horse is commonly accompanied by metabolic acidosis, whereas in adult ruminants it is accompanied by alkalosis, at least initially.

### PATHOGENESIS

The traditional Henderson-Hasselbalch approach indicates that metabolic acidosis is

characterized by a low arterial blood pH and a low plasma bicarbonate concentration, following the loss of bicarbonate or the addition of hydrogen ions. Extracellular and intracellular buffering and respiratory compensation minimize the change in pH until the kidney can excrete sufficient hydrogen ions to correct the acid-base imbalance. Generally, the body will tolerate a pH range of 7.0 to 7.6, although survival has been reported at pH values beyond these limits for short periods, particularly in neonatal animals with diarrhea.

Acidemia generally depresses cardiac contractility and cardiac output in the dener-vated heart. In the intact animal, however, activation of the sympathetic nervous system in response to acidemia causes increased cardiac contractility, increased heart rate, and increased cardiac output. In acidemia, the myocardial response to catecholamines is not depressed until the blood pH is below 7.0 to 7.1. The increased carbon dioxide tension of the blood and depletion of bicarbonate causes an increase in the depth and then the rate of respiration by stimulation of the



respiratory center (**Kussmaul breathing**). However, when hypovolemic shock is severe enough, there is often depressed respiratory function, resulting in the additional accumulation of hydrogen ions; thus the acidemia is accentuated.

Acidemia causes varying degrees of depression of the central nervous system (CNS) and muscular weakness. Central nervous abnormalities may develop in neonatal foals that develop severe respiratory compromise, resulting in hypoxemia and hypercapnia, because of the reduced ability of the CSF to buffer acid-base changes. Carbon dioxide concentration within the CNS may have an effect on respiratory rate, neurotransmitter activity, CNS activity, cerebral blood flow, and cerebral extracellular fluid volume. If the blood-CSF and brain-CSF interfaces in the neonate are immature and unable to adequately compensate for vascular changes in CO<sub>2</sub>, the hypercapnia may contribute to the CNS abnormalities that are often seen in sick newborn foals. The increased cerebral blood flow may be associated with cerebral edema, resulting in the depression of cerebral activity observed in these same foals.

The increased urinary excretion of acids in acidosis also causes polyuria, which may be sufficiently severe to cause dehydration or accentuate concomitant dehydration. Urine pH is also likely to be decreased in herbivores; however, aciduria may not always be present because of concurrent electrolyte and free water abnormalities.

### CLINICAL FINDINGS

The major clinical manifestation of metabolic acidosis is mental depression and varying degrees of muscular weakness, depending on the mechanism for acidemia. Newborn calves, lambs, and goat kids with profound acidemia and metabolic acidosis are depressed, weak, and reluctant to suck. In severe acidemia, affected animals may be in lateral recumbency and appear to be in a state of coma. The depth and rate of respirations may be increased because of the increased PCO<sub>2</sub>. Respiratory compensation is normally evident when the bicarbonate level is diminished to 50% of normal. Calves affected with severe acidemia and dehydration caused by acute diarrhea may be unable to compensate because of depressed respiratory function. Their respiratory rate will be much slower and the depth of respiration much more shallow than normal. There is usually tachycardia, which becomes worse as the acidosis becomes more severe, and the amplitude of the pulse and blood pressure both decrease. A concomitant hyperkalemia will cause bradycardia, heart block, sudden collapse, and rapid death. This is particularly evident when animals with acidosis and hyperkalemia are transported and handled for treatment. The increased muscular activity appears to accentuate the abnormalities, and sudden death is

not uncommon. Weakness, lassitude, and terminal coma are frequent observations. An interesting recent observation is that experimentally induced acute acidemia and metabolic acidosis (jugular venous blood pH 6.96; base excess -22 mEq/L) in healthy neonatal calves, following intravenous administration of 4 L of a mixture of HCl and NaCl solutions, produced no clinically detectable abnormalities.<sup>5</sup> This finding suggests acidemia must be chronic to produce clinically apparent abnormalities, or that most of the clinical abnormalities observed in acidemic patients are caused by their disease process and concurrent electrolyte and energetic abnormalities.

A syndrome of metabolic acidosis with minimal signs of dehydration or diarrhea has been described in calves from 1 to 4 weeks of age.<sup>4</sup> Affected calves are depressed, weak, and ataxic, and the suck and menace reflexes may be weak or absent. Some calves appear comatose. Similar clinical presentations have also occurred in lambs and goat kids with no apparent history of previous diarrhea.<sup>6-8</sup> The abnormal laboratory findings include a reduced venous blood pH, PCO<sub>2</sub> and bicarbonate ion concentration, marked hyper D-lactatemia, elevated blood urea nitrogen, increased AG, and a neutrophilic leukocytosis with a left shift. Many of the clinical signs appear to be primarily the consequence of hyper D-lactatemia. The intravenous administration of 2.5 to 4.5 L of isotonic (1.3%) sodium bicarbonate solution, the amount depending on the severity of the condition, is necessary to return the neonatal calf to health.

## ALKALEMIA

### ETIOLOGY AND PATHOGENESIS

Alkalemia is caused by an increased absorption of alkali, excessive loss of acid, or a deficit of carbon dioxide (Fig. 5-13). Abomasal atony caused by dilatation, impaction, or torsion of the abomasum is one of the most common causes of alkalemia in cattle. There is continuous secretion of hydrochloric acid and potassium into the abomasum, with failure of evacuation of the abomasal contents into the duodenum for absorption. Sequestration of hydrochloric acid and potassium occurs in the abomasum, along with reflux into the rumen, all of which results in a hypochloremic, hypokalemic alkalosis. In metabolic alkalosis, potassium will shift from the extracellular to the intracellular space, resulting in a hypokalemia when there may not be depletion of total body potassium. In cattle with metabolic alkalosis there is a paradoxical aciduria, which is not well understood but may be caused by severe electrolyte depletion placing limits on the kidney to regulate acid-base balance. Paradoxical aciduria must be differentiated from postparturient aciduria, which has been reported to occur in dairy cows.

Metabolic alkalosis has been recorded in cows with severe coliform mastitis, but the pathogenesis is unknown.

### CLINICAL FINDINGS

The clinical findings of alkalosis are not characteristic enough to be recognized reliably. Alkalosis results in slow, shallow respirations in an attempt to preserve carbon dioxide. Muscular tremors and tetany with tonic and clonic convulsions may occur in extreme alkalemia (pH > 7.60) because of marked pH changes and possibly depression of the ionized fraction of serum calcium. Hyperventilation and dyspnea may also occur in the terminal stages.

## Oncotic Pressure and Edema

### ETIOLOGY

**Decreased plasma oncotic pressure** caused by hypoalbuminemia or hypoproteinemia is the most common cause of generalized symmetric edema. However, edema can also result from three other causes: **increased hydrostatic pressure** in capillaries and veins caused by chronic (congestive) heart failure or obstruction to venous return; **increased capillary permeability** in endotoxemia, part of the allergic response, vasculitis, and damage to the vascular endothelium; or **obstruction to lymphatic flow**.

### Decreased Plasma Oncotic Pressure

Decreased total protein concentration in plasma, and particularly decreased plasma albumin concentration, will result in symmetric ventral edema. Hypoalbuminemia is more important than hypoglobulinemia in inducing edema formation because albumin provides the largest contribution to plasma oncotic pressure. Hypoalbuminemia can result from **increased loss** (caused by blood-sucking parasites or across the gastrointestinal tract, kidneys, or into a large third space such as the pleural or peritoneal cavities), **decreased production** (as in chronic hepatic failure), or **decreased intake**:

- Chronic blood loss, especially in heavy infestations with blood-sucking parasites such as *Strongylus* spp. in the horse; *Fasciola* spp. in ruminants; *Haemonchus* spp. in ruminants of all ages, especially goats; and *Bunostomum* spp. in calves
- Protein-losing gastroenteropathies as in Johne's disease and amyloidosis in adult cattle and right dorsal colitis in horses; proliferative enteropathy in foals caused by *Lawsonia intracellularis*; heavy infestation with nematode parasites in ruminants, particularly *Ostertagia* spp. in young cattle and cyathostomiasis in horses
- Glomerulonephropathies, such as amyloidosis in adult cattle and inherited

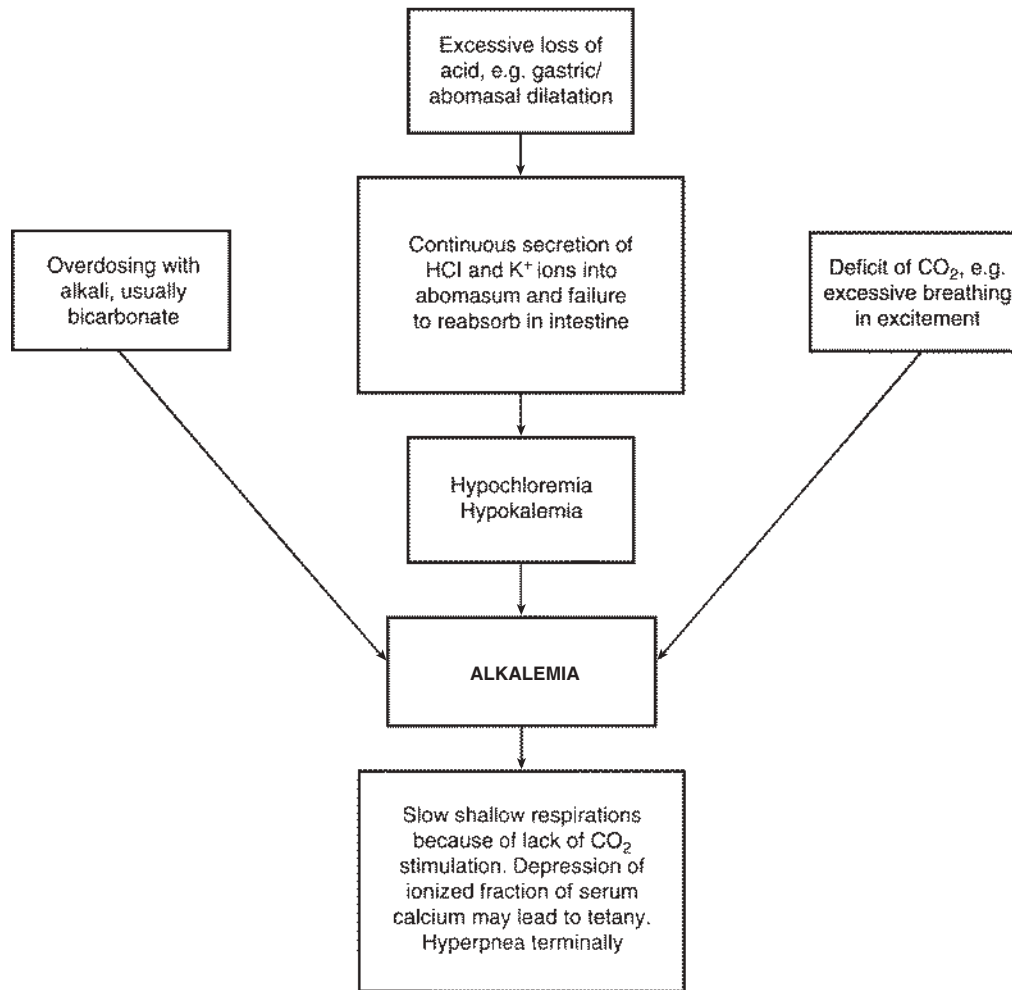

Fig. 5-13 Etiology and pathogenesis of alkalemia.

glomerulonephritis in Finnish Landrace lambs

- Chronic liver damage causing failure of plasma protein synthesis (rare and terminal in large animals)
- Terminally in prolonged malnutrition with low dietary protein intakes, e.g., ruminants at range in drought time

#### Increased Hydrostatic Pressure

Increased hydrostatic pressure can be caused by the following:

- Symmetric ventral edema in chronic (congestive) heart failure and symmetric pulmonary edema in acute heart failure
- Generalized edema in enzootic calcinosis of cattle
- Local symmetric ventral edema in udder edema in late pregnancy from compression of veins and lymphatics by the developing mammary gland (and possibly the enlarging fetus and uterus), causing mammary or ventral edema in cows (particularly heifers), mares, and occasionally ewes. Sodium and potassium intakes and cation-anion

differences in the diet contribute to the severity of udder edema. Edema resolves 5 to 10 days following parturition.

- Local edema by compressive lesions on veins (as in thymic lymphosarcoma with compression of the cranial vena cava) draining other anatomic locations
- Local edema in portal hypertension caused by hepatic fibrosis causing ascites (rare in large animals)

#### Increased Capillary Permeability

Increased capillary permeability can be caused by the following:

- Endotoxemia
- Allergic edema as in urticaria and angioneurotic edema caused by local liberation of vasodilators
- Toxic damage to vascular endothelium or vasculitis such as in anthrax, gas gangrene, and malignant edema in ruminants; edema disease of pigs; mulberry heart disease in pigs; equine viral arteritis, equine infectious anemia, and purpura hemorrhagica in horses; and heartwater (cowdriosis) in ruminants

#### Obstruction to Lymphatic Flow

- Part of the edema caused by tumors or inflammatory swellings is lymphatic obstruction. Extensive fluid loss also originates from granulomatous lesions on serous surfaces. Ascites or hydrothorax may result.
- Congenital in inherited lymphatic obstruction edema of Ayrshire and Hereford calves
- Sporadic lymphangitis (big leg) of horses
- Edema of the lower limbs of horses immobilized because of injury or illness

#### PATHOGENESIS

Edema is the excessive accumulation of fluid in the interstitial space of tissue caused by a disturbance in the mechanism of fluid interchange among capillaries, the interstitial space, and the lymphatic vessels. At the arteriolar end of the capillaries the hydrostatic pressure of the blood is sufficient to overcome its oncotic pressure, and fluid tends to pass into the interstitial space. At the venous end of the capillaries the position is reversed

and fluid tends to return to the vascular system. The pressure differences are not great, but there is a large area for exchange, and a small increase in hydrostatic pressure or a small decrease in oncotic pressure leads to failure of the fluid to return to the capillaries.

Increased fluid passage into the interstitial space can also occur where there is increased vascular permeability caused by vascular damage. Under these circumstances, fluid accumulates in the interstitial space when the fluid flux across the endothelium is greater than the ability of the lymphatic system to drain it. Alternatively, capillary hydrostatic pressure, oncotic pressure, and vascular permeability might be normal, but fluid and vascular permeability can accumulate in the interstitial space when lymphatic drainage is occluded.

Edema of the lower limbs of immobilized horses (*filling*) is usually ascribed to poor lymphatic or venous return caused by inactivity of the *foot pump*. Lower limb edema in horses may also be related to changes in the hematocrit and plasma protein concentration in the distal limb vasculature as a result of inactivity.

### CLINICAL FINDINGS

Accumulation of edematous transudate in subcutaneous tissues is referred to as **anasarca**, in the peritoneal cavity as **ascites**, in the pleural cavities as **hydrothorax**, and in the pericardial sac as **hydropericardium**. Anasarca in large animals is usually confined to the ventral wall of the abdomen and thorax, the brisket and, if the animal is grazing, the intermandibular space because of the large hydrostatic pressure gradient between the submandibular space and heart. Intermandibular edema may be less evident in animals housed because they do not have to lower their heads to feed. Edema of the limbs is uncommon in cattle, sheep, and pigs but is quite common in horses when the venous return is obstructed or there is a lack of muscular movement. Hydrothorax is not common with generalized edema and is usually an indication of an obstructive intrathoracic lesion. Local edema of the head in the horse is a common lesion in African horse sickness and purpura hemorrhagica.

Edematous swellings are **soft**, **painless**, and **cool to the touch** and **pit on pressure**. In ascites there is distension of the abdomen and the fluid can be detected by a fluid thrill on tactile percussion, fluid sounds on succussion, and by paracentesis. A level top line of fluid may be detectable by any of these means. In the pleural cavities and pericardial sac the clinical signs produced by the fluid accumulation include restriction of cardiac movements, embarrassment of respiration, and collapse of the ventral parts of the lungs. The heart sounds and respiratory sounds are muffled, and the presence of fluid may be

ascertained by percussion and thoracocentesis or pericardiocentesis.

More localized edemas cause more localized signs: pulmonary edema is accompanied by respiratory distress and in some cases by an outpouring of froth from the nose; cerebral edema is manifested by severe nervous signs of altered mentation. A not uncommon entity is a large edematous plaque around the umbilicus in yearling horses. The plaque develops rapidly, causes no apparent illness, and subsides spontaneously after about 7 days. Thrombophlebitis is a common cause of localized edema, particularly of the head in horses and cattle with thrombophlebitis of both jugular veins. Head edema usually occurs in affected animals only when there is rapid and complete occlusion of both jugular veins by thrombophlebitis; a slower rate of jugular vein occlusion permits development of collateral veins for venous drainage of the head.

### CLINICAL PATHOLOGY

Cytologic examination of a sample of fluid reveals an absence of inflammatory cells in which edema is the result of decreased plasma oncotic pressure (hypoalbuminemia), increased hydrostatic pressure, and increased vascular permeability or obstruction to lymphatic flow. Thoracocentesis or abdominocentesis is useful to differentiate the causes of fluid accumulation, in conjunction with measurement of serum albumin concentration and mean central venous pressure.

Examinations should always be directed toward determining the mechanism for hypoalbuminemia; in particular, the renal and gastrointestinal systems and liver are examined for evidence of disease and altered function. Generally, the serum albumin concentration is usually less than 15 g/L in animals with generalized edema caused by decreased plasma oncotic pressure. Generalized edema should always be expected whenever serum albumin concentration is less than 10 g/L.

### NECROPSY FINDINGS

The nature of the accumulation of fluid in most cases is obvious on gross postmortem examination, but the determination of the cause of the disease that has resulted in hypoalbuminemia may require further histologic and cultural examination. Necropsy findings for the specific diseases in which edema is a feature are given in later chapters.

#### DIFFERENTIAL DIAGNOSIS

- Rupture of urethra or bladder for differentiation of ascites
- Peritonitis or pleuritis for accumulation of fluid in abdominal or pleural cavities
- Cellulitis for local edema

### TREATMENT

The treatment of edema should be aimed at correcting the cause, whether it is decreased plasma oncotic pressure, increased hydrostatic pressure, increased endothelial permeability, or obstruction to lymphatic drainage. Hypoalbuminemia may require the administration of colloids such as plasma or Dextran 70, although this is only a short-term measure and is expensive. Chronic (congestive) heart failure may need to be treated with digoxin and thrombophlebitis of the jugular veins may need specific treatment (see Chapter 10). Parasitic gastroenteritis requires administration of the appropriate anthelmintic, obstructive edema requires removal of the physical cause, and increased permeability edema requires resolution of the cause of endothelial damage.

Ancillary nonspecific measures include restriction of the amount of salt in the diet and the use of diuretics. Diuretics may relieve the effects of pressure temporarily, but the primary cause needs to be addressed for a satisfactory outcome. Aspiration of edema fluid is rarely successful and is not routinely recommended but usually provides temporary relief because the fluid rapidly accumulates.

### FURTHER READING

- Constable PD. Fluids and electrolytes. *Vet Clin North Am Food Anim Pract.* 2003;19:1-40.
- Constable PD. Acid-base assessment: when and how to apply the Henderson-Hasselbalch equation and strong ion difference theory. *Vet Clin North Am Food Anim Pract.* 2014;30:295-316.
- Constable PD, Sen I. General overview to treatment of strong ion (metabolic) acidosis in neonatal calves with diarrhea. *Eurasian J Vet Sci.* 2013;29:121-126.

### REFERENCES

1. Gomez DE, et al. *J Vet Intern Med.* 2013;27:548.
2. van Galen G, et al. *J Vet Intern Med.* 2013;27:186.
3. Gomez DE, et al. *J Vet Intern Med.* 2013;27:1604.
4. Trefz FM, et al. *J Dairy Sci.* 2013;96:7234.
5. Gentile A, et al. *J Vet Intern Med.* 2008;22:190.
6. Bleul U, et al. *J Vet Intern Med.* 2006;20:1003.
7. Angell JW, et al. *Vet Rec.* 2013;172:154.
8. Lorenz I, Lorch A. *Vet Rec.* 2009;164:174.

## Naturally Occurring Combined Abnormalities of Free Water, Electrolyte, Acid-Base Balance, and Oncotic Pressure

These abnormalities are seldom primary and are usually secondary to a serious disease state such as abomasal volvulus, rumen overload, or acute intestinal obstruction—diseases that are in themselves life-threatening. Fluid and electrolyte abnormalities are also life-threatening and simple correction of the primary abnormality, for example, removal of a large section of a horse's small intestine, is valueless unless the dehydration,

hyponatremia, and acidosis are also corrected. The variation that can occur in these naturally occurring errors of fluid, electrolyte, and acid-base balance is what makes their diagnosis and treatment so difficult. If it were possible to have instant clinicopathologic advice on what the abnormalities were and how they were progressing as determined by constant laboratory monitoring, there

would be little clinical challenge. The increased availability of point-of-care devices have made real-time clinicopathologic values rapidly available; however, economics may preclude use of such equipment. It is therefore necessary to have an understanding of the basic physiology and pathology of these diseases to be able to predict, by clinical examination and examination of the history, the

likely deficiencies and imbalances and their degrees of severity.

In the preceding paragraphs the individual abnormalities of fluid and electrolyte homeostasis were described. In most naturally occurring diseases, the abnormalities are complex. For example, the probable events in a case of acute diarrhea are set out diagrammatically in Fig. 5-14. It is important

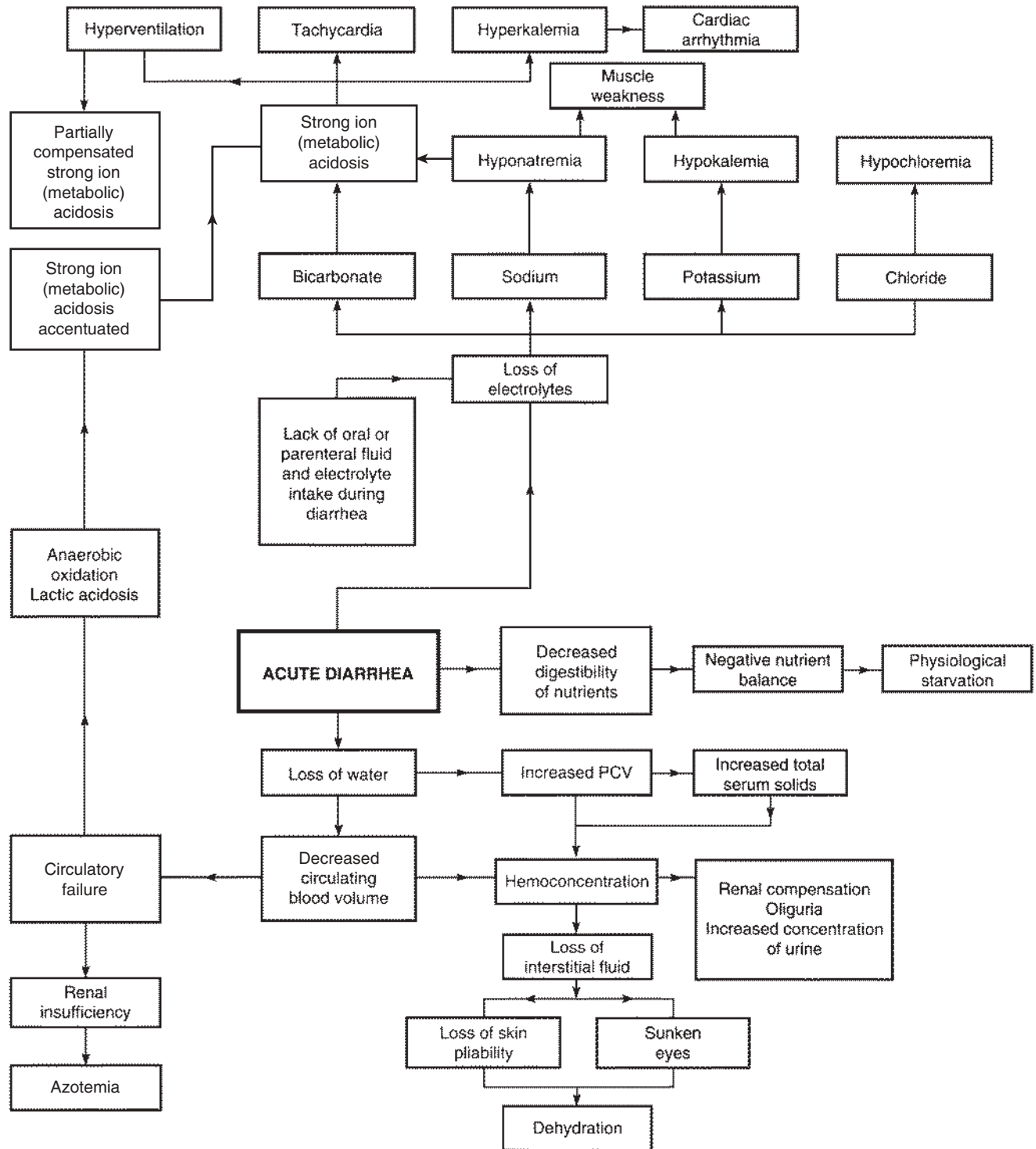

Fig. 5-14 The interrelationships among the changes in body water, electrolytes, and acid-base balance that can occur in diarrhea.



to remember that the variation in fluid and electrolyte imbalance is **dynamic** as a result of the compensatory changes occurring in various organs, especially the respiratory and circulatory systems and the kidneys. It is this volatility that makes clinicopathologic monitoring so important. Some generalizations on the dynamics of fluid and electrolyte status are as follows:

- Total body water and electrolytes are maintained at a homeostatic level by the buffering system of the blood, the lungs, and the kidneys.
- In disturbances of body water and electrolytes, the changes that occur are also dynamic, and there is constant reaction by the homeostatic mechanism to restore the water and electrolyte relationship to normal.
- With some exceptions, it is unusual to find an uncompensated alkalemia or acidemia. A partial compensation in the opposite direction of the primary acid-base imbalance is usually in progress, and it is important to determine the nature of the primary disturbance for the selection of rational therapy. A useful rule of thumb is that the primary disturbance (acidosis and alkalosis) is indicated by whether the blood pH is increased (alkalosis) or decreased (acidosis) relative to the mean value for the species examined.
- Often, the nature of the primary disturbance can be determined from a consideration of the history and the clinical findings.
- Dehydration caused by deprivation of water and electrolytes (lack of water or inability to drink) is mild and animals may appear only mildly dehydrated even after several days of water deprivation. The feces are hard and dry, the rumen contents are firm and dry, and urine volume is considerably decreased.
- With the exception of clinical dehydration, the clinical findings of electrolyte and acid-base imbalances are not characteristic.
- Without laboratory evaluation, the nature and degree of electrolyte and acid-base imbalance must be assumed and estimated based on the history of the affected animal and the changes that are most likely to have occurred.

### NATURE OF THE DISEASE AND HISTORY

The **history of the case**, the **length of time** the animal has been affected, and the **tentative diagnosis** will provide a clinical assessment of the possible nature and degree of electrolyte and acid-base imbalance. Animals affected with acute diarrhea caused by infectious enteritis are likely to be in a state of metabolic acidosis and hyponatremia. In intestinal obstruction of the horse, there are varying degrees of dehydration and

metabolic acidosis. Obstruction of the upper intestinal tract, or abomasal stasis, is characterized by varying degrees of dehydration and metabolic alkalosis with hypochloremia and hypokalemia. Chronic renal disease is characterized by hyponatremia and hypochloremia. Chronic inappetence in herbivores is characterized by hypokalemia, particularly in lactating ruminants. A combination of the clinical assessment and the available laboratory evaluation will allow the clinician to make the most rational approach to treatment.

The information on the duration of illness must be accurate or it will be misleading. The sequence of clinical findings in the history may indicate the trend in severity. Animals that have had a profuse watery diarrhea for 18 to 24 hours may be severely acidemic. Acute intestinal obstruction in cattle is not as severe as in the horse. Acute gastric or intestinal rupture in the horse or in cattle is usually rapidly fatal. Acidosis in grain overload in cattle may be fatal in 24 to 48 hours; acidosis in the horse with grain overload may be much more rapidly fatal because electrolyte disturbances are more severe in the horse.

### CLINICAL FINDINGS

**Dehydration** is usually obvious clinically and determination of the PCV and serum or plasma total protein concentration will improve the assessment and provide values for daily comparison of response to treatment.

A normal rectal **temperature** is not a good prognostic guide, but a subnormal temperature suggests a worsening situation.

A gradually progressive **tachycardia** indicates that the patient is deteriorating. Generally, in the horse, a heart rate up to 60 beats/min suggests a minor lesion (but not always), a heart rate of 60 to 80 beats/min is in the danger area, 80 to 100 beats/min is serious, and more than 100 beats/min is commonly premortal (except in intestinal tympany that may be relieved).

A **cold clammy skin** that remains tented for more than 30 seconds suggests severe dehydration. **Cyanosis of the oral mucous membranes and a capillary refill time of more than 4 seconds** suggests a poor prognosis, as does rapid respiration (three to four times normal) with intermittent hyperpnea and apnea.

**Muscular tremors and leg buckling are grave signs in the horse** and are commonly followed by collapse and death. The inability of any dehydrated animal to stand (other reasons being eliminated) is ominous. **Severe depression** and dullness are commonly observed in acute conditions, and coma is usually terminal.

**Metabolic acidosis** is characterized by varying degrees of mental depression, decreased or absent suckle in neonatal animals, weakness, and ataxia. Some of the

depression and weakness will be caused by dehydration, acidemia, or hyper D-lactatemia, although interestingly, acute and profound acidemia (jugular venous blood pH 6.96) in neonatal calves was not associated with depression or muscular weakness.<sup>1</sup> This is in contrast to the results of other studies in calves with more chronic and profound acidemia that profound acidemia is associated with decreased suckle and other clinical signs.<sup>2,3</sup> In newborn animals with metabolic acidosis associated with diarrhea, a failure to suck and the lack of a suck reflex are common.<sup>4,5</sup> Hyper D-lactatemia should be suspected in neonatal calves with a slowed or absent palpebral reflex, and profound acidemia and metabolic acidosis should be suspected in neonatal calves that stand unsteadily or have an inability to stand or have a delayed or absent reaction to acoustic, optical, or painful stimuli such as venipuncture.<sup>4</sup> Hyper D-lactatemia should also be suspected in neonatal lambs and goat kids with decreased or absent suckle that appear somnolent with varying degrees of ataxia.<sup>6-8</sup>

### CLINICAL PATHOLOGY

Some representative laboratory values in examples of body water and electrolyte disturbances are given in [Table 5-1](#).

#### Packed Cell Volume and Total Serum Protein or Plasma Protein

The PCV and the **total serum protein** or **plasma protein concentration** (historically called **total solids**) will indicate the severity of water loss. Anemic animals and those affected with diseases causing hypoproteinemia may provide misleading values. Neonatal animals often provide misleading values because of the variability of PCV in newborn animals and large differences in the transfer of colostral immunoglobulins.

The normal range depends on the age and species of animal, previous excitement, and the presence of anemia or hypoproteinemia. A PCV of 30% to 40% is considered normal; between 40% and 50%, fluid therapy may or may not be necessary; between 50% and 60%, fluids are necessary for recovery; and above 60% intensive fluid therapy is necessary and the prognosis is unfavorable. A total serum protein concentration of 6.0 to 7.5 g/dL is usually considered normal, at 8 to 10 g/dL fluids are needed and the prognosis is favorable, and above 10 g/dL the prognosis is unfavorable.

#### Total CO<sub>2</sub>

A useful screening test for acid-base status in animals without evidence of respiratory disease is the total CO<sub>2</sub>. Total CO<sub>2</sub> is defined as the amount of total carbon dioxide in plasma that can be liberated with a strong acid, and it can be calculated from the results of routine blood gas analysis as total CO<sub>2</sub> = [HCO<sub>3</sub><sup>-</sup>] + dissolved CO<sub>2</sub> + [H<sub>2</sub>CO<sub>3</sub>]. The [HCO<sub>3</sub><sup>-</sup>] is calculated using the

**Table 5-1** Representative laboratory values (mean  $\pm$  sd) in body water and electrolyte disturbances

Clinical pathology	Acute diarrhea in horse	Acute diarrhea in calf	Metabolic alkalosis caused by abomasal dilatation impaction/volvulus in cattle	Acute intestinal obstruction in horse	Acute carbohydrate engorgement in ruminants
Packed cell volume (%)	60 $\pm$ 7	45.3 $\pm$ 7.0	42 $\pm$ 6	64 $\pm$ 5	45 $\pm$ 6
Total serum solids (g/dL)	10 $\pm$ 2	8.6 $\pm$ 1.5	8.2 $\pm$ 1.5	11.5 $\pm$ 1.5	8.5 $\pm$ 1.8
Blood pH (venous)	7.10 $\pm$ 0.15	7.08 $\pm$ 0.12	7.49 $\pm$ 0.15	7.15 $\pm$ 0.04	7.10 $\pm$ 0.05
Plasma bicarbonate (mmol/L)	12 $\pm$ 3	13.7 $\pm$ 4.2	35.4 $\pm$ 5.7	18 $\pm$ 6	12.5 $\pm$ 3.5
Partial pressure of carbon dioxide (mm Hg)	45 $\pm$ 8	46.8 $\pm$ 6.4	46.4 $\pm$ 7.5	48 $\pm$ 6	40 $\pm$ 6
Serum sodium (mmol/L)	126 $\pm$ 3	138 $\pm$ 9.4	138.5 $\pm$ 5.4	135 $\pm$ 5	132 $\pm$ 4
Serum chloride (mmol/L)	99 $\pm$ 3	101.4 $\pm$ 7.5	88.6 $\pm$ 12.8	98 $\pm$ 4	93 $\pm$ 3
Serum potassium (mmol/L)	3.0 $\pm$ 1.2	7.4 $\pm$ 1.6	3.4 $\pm$ 0.6	3.8 $\pm$ 0.6	5.0 $\pm$ 2.5
Blood urea nitrogen (mg/dL)	60 $\pm$ 30	50.1 $\pm$ 30.5	40 $\pm$ 15	65 $\pm$ 35	55 $\pm$ 25

Henderson–Hasselbalch equation and the dissolved  $\text{CO}_2$  is equal to  $S \times \text{PCO}_2$ , whereas  $[\text{H}_2\text{CO}_3]$  is negligible.

Many automatic serum biochemical analyzers directly measure total  $\text{CO}_2$  (instead of calculating its value from the results of blood gas analysis), but for total  $\text{CO}_2$  measurement it is important that blood collection tubes are completely filled before serum is harvested: failure to completely fill the blood tubes promotes escape of  $\text{CO}_2$  from serum into the partial vacuum above, resulting in measured total  $\text{CO}_2$  values that underestimate true serum total  $\text{CO}_2$ . It is also important that large partially evacuated tubes are used to collect the blood sample; this is because the air to blood sample ratio is higher in small tubes (3 mL or less in sample volume), leading to lower measured values for total  $\text{CO}_2$  even with complete filling of the tube. As a consequence, total  $\text{CO}_2$  is most accurately measured when partially evacuated tubes of 4- to 10-mL sample volume are used,<sup>9</sup> and samples are stored at 4°C.<sup>10</sup> Because changes in total  $\text{CO}_2$  reflect changes in actual bicarbonate concentration, total  $\text{CO}_2$  can never provide an independent measure of the nonrespiratory component of an acid-base disturbance. Total  $\text{CO}_2$  does, however, provide a useful screening test for the presence of acid-base disturbances in

domestic animals without clinical evidence of respiratory disease. In the absence of respiratory disease, a decrease in total  $\text{CO}_2$  indicates a metabolic acidosis, whereas an increase in total  $\text{CO}_2$  indicates metabolic alkalosis. Total  $\text{CO}_2$  has historically been measured using the Harleco apparatus, although this methodology is no longer used because of the wide availability of point-of-care analyzers for blood gas and pH assessment.

### Blood Gas and pH Analysis

Blood collected anaerobically into a glass syringe and stored in iced water represents the reference method for blood gas and pH analysis, but glass syringes are no longer used clinically because of their cost, fragility, and inability to be sterilized. Polypropylene syringes have replaced glass syringes for blood gas and pH analysis; however, clinicians should be aware that small differences exist in blood pH and gas measurements when syringes from different manufacturers are used.<sup>11</sup>

The method used for collection of an anaerobically collected blood sample for blood gas and pH analysis differs depending on whether the clinical interest is on the **respiratory system** (which requires collection of an **arterial blood sample**) or

**metabolic status** (usually best evaluated using a blood sample from a large vein such as the **jugular vein**). Because respiratory disease that is clinically relevant can usually be detected during the physical examination of large animals,<sup>12</sup> most blood samples collected for blood gas and pH analysis are collected from the jugular vein.

If the primary clinical interest is an acid-base assessment of a large animal, then a jugular venous blood sample should be anaerobically obtained in a 3-mL polypropylene syringe that has been previously coated internally with sodium heparin (by drawing sodium heparin into the syringe barrel and then expelling all heparin from the syringe into the barrel before blood collection). Three milliliters of air should then be drawn into the syringe and forcibly expelled; this process is repeated three times. Evacuating the syringe in this manner ensures that minimal heparin is retained to dilute the blood sample, but a sufficient quantity is still present to prevent coagulation. Alternatively, commercially available polypropylene syringes that contain lyophilized lithium heparin can be used, but these syringes are considerably more expensive than standard polypropylene syringes.<sup>13</sup> Air bubbles should be immediately removed from the blood in the syringe after collection by holding the syringe vertically and tapping the syringe forcefully with a finger so that bubbles are dislodged and float upward. Once all visible bubbles are removed, a small amount of blood is expelled with the syringe still held vertically so that the syringe hub and needle lumen no longer contain air bubbles. A cork is then placed on the end of the needle to prevent loss of  $\text{CO}_2$  and addition of  $\text{O}_2$  to the blood sample. Jugular venous blood samples can predict arterial blood gas values of pH,  $\text{PCO}_2$ , bicarbonate concentration, total  $\text{CO}_2$ , and base excess in animals that do not have respiratory disease, but only accurately predict blood pH in animals with respiratory disease.<sup>14,15</sup> Changes in jugular venous  $\text{PO}_2$  over time are reflective of the direction and magnitude of the change in arterial  $\text{PO}_2$ .<sup>16</sup>

Generally, the blood sample should be analyzed as soon as possible and preferably within 30 minutes of collection. The method used for **storage** of an anaerobically collected blood sample for blood gas and pH analysis differs depending on whether the sample was collected from an artery or large vein. Venous blood samples should be stored in ice water (0°C) until analysis.<sup>17</sup> This will minimize any time-related changes in the measured values for pH and  $\text{PCO}_2$  and therefore the calculated values for base excess and total  $\text{CO}_2$ , which occur when blood is held at room temperature (20°C) or higher ambient temperatures, particularly in blood samples with high white blood cell concentrations. If the primary interest is evaluation of the respiratory system, an arterial blood sample should

be obtained in the same manner as a venous sample; however, the sample should be kept at body temperature (preferable) or room temperature before blood gas and pH analysis is performed, which should be completed as soon as possible. This is because storing 3-mL polypropylene syringes in ice water (0°C) facilitates oxygen diffusion through the barrel of the syringe, causing a preanalytical increase in  $P_{O_2}$ . Partially evacuated blood collection tubes should never be used for blood gas and pH analysis because they are not completely evacuated; consequently, an anaerobic blood sample cannot be obtained for analysis. Use of partially evacuated tubes always results in higher values for blood  $P_{O_2}$  and lower values for blood  $P_{CO_2}$  because oxygen and carbon dioxide in the blood equilibrate with the oxygen-rich and carbon dioxide-poor air within the tube.<sup>18</sup>

Use of point-of-care clinical analyzing systems has greatly facilitated routine evaluation of acid-base status in domestic animals and, generally, point-of-care systems are sufficiently accurate for clinical use.<sup>19</sup> A thorough assessment of acid-base status requires blood gas analysis and serum biochemical analysis, with blood samples obtained from a major vein or any artery. If serum total protein, albumin, and phosphate concentrations are approximately normal, then acid-base status should be evaluated using blood pH,  $P_{CO_2}$ , and extracellular base excess concentration. This is the traditional Henderson-Hasselbalch approach. The presence of unidentified anions should be investigated by calculating the AG. If serum total protein, albumin, and phosphate concentrations are markedly abnormal, then acid-base status should be evaluated using blood pH,  $P_{CO_2}$ , measured SID, and  $A_{TOT}$ . This is the simplified strong ion approach. The presence of unidentified strong ions should be investigated by calculating the SIG.

**Normal blood pH** for most domestic animals varies from 7.35 to 7.45 (venous blood). The degree of acidemia encountered includes moderate acidemia (pH 7.30–7.25), severe acidemia (pH 7.25–7.20), and grave acidemia (pH 7.10–7.00), which is associated with a high fatality rate, except in neonatal animals.

### Blood or Plasma L-Lactate Concentration

The blood or plasma L-lactate concentration provides valuable information about the adequacy of oxygen delivery to the tissues, providing a means for assessing the severity of cardiovascular or pulmonary dysfunction, monitoring the response to treatment, and formulating a prognosis for survival. The normal plasma L-lactate concentration in large animals is generally considered to be less than 1.5 mmol/L. Increases in plasma L-lactate concentration have been categorized as mild (2.5–4.9 mmol/L), moderate (5.0–9.9 mmol/L), and severe ( $\geq 10$  mmol/L),

with L-lactate concentrations greater than 10 mmol/L associated with a high mortality in humans, pigs, and horses.

A number of inexpensive handheld point-of-care devices are now available to measure blood L-lactate concentration. Most devices measure L-lactate concentration in whole blood through a two-step process on a specialized reagent strip. The L-lactate concentration is measured by placing a drop of blood onto the reagent strip; the blood seeps through a protective mesh on which the erythrocytes are retained and only plasma reaches the detection area. A chemical reaction takes place, and a change in color or current is rapidly detected and converted to an L-lactate concentration using a proprietary algorithm. Values can be displayed as whole blood or plasma based on a mathematical function of the analyzer. A number of method comparison studies have shown these units to be clinically useful, particularly when blood L-lactate concentrations are  $< 15$  mmol/L.

Studies in critically ill human patients have shown excellent correlations between blood L-lactate concentration in arterial blood, pulmonary arterial blood, central venous blood, and blood obtained from a peripheral vein, indicating that jugular venous blood L-lactate concentration provides an accurate reflection of pulmonary arterial or systemic arterial blood L-lactate concentrations, which are regarded as the gold standard sites for measuring blood L-lactate concentration. Consequently, jugular venous blood L-lactate concentrations are now routinely measured in critically ill large animals, with the clinical emphasis on evaluating the change in L-lactate concentration over time.<sup>20–22</sup> This is because the change in L-lactate concentration over time (particularly to an intervention) has greater prognostic ability than the actual L-lactate concentration at one point in time.

### Serum Electrolytes

**Serum electrolyte** concentrations indicate the severity of the electrolyte losses and the necessity for replacement with either balanced electrolyte solution or specific electrolyte solution. Serum concentrations of **sodium, chloride, and potassium** are usually determined. The total deficit for each electrolyte can be estimated using the standard formula presented under calculation of electrolyte requirements.

Serum electrolyte concentrations depend on the initial cause and the severity of the disease. For example, in most cases of acute diarrhea there is hyponatremia and metabolic acidosis, which are usually marked in the horse with acute diarrhea. The serum concentration of chloride may be normal or subnormal in acute diarrhea. The serum concentration of potassium will be below normal initially, but as acidemia develops and becomes severe **hyperkalemia** may occur. In cattle with **abomasal hypomotility** there will

be a **hypochloremic hypokalemic metabolic alkalosis**.

**Water and electrolyte abnormalities** are classified into three types based on the measurement of electrolytes and osmolality (assuming plasma osmolality in healthy large animals approximates 285 mosm/kg):

- **Hypertonic dehydration** (true dehydration/desiccation): Osmolality greater than 300 mosm/kg, associated with water deprivation, some acute gastrointestinal problems, and some types of diarrhea
- **Hypotonic dehydration** (acute desalting water loss): Osmolality less than 270 mOsm/kg, associated with acute diarrhea, particularly secretory diarrheas such as salmonellosis
- **Isotonic dehydration**: Normal electrolyte and osmolality levels, as in horses losing electrolytes and water in almost equal proportions

### Urea and Creatinine

**Urea** and **creatinine** are metabolic breakdown constituents that can be used to assess the degree of dehydration and to distinguish among prerenal, renal, and postrenal uremia. The plasma/serum concentrations of urea and creatinine concentration will be elevated, depending on the severity of the dehydration and decrease in circulating blood volume. Following treatment with fluids and electrolytes in prerenal uremia, the concentrations of urea and creatinine will decline. Plasma creatinine concentration varies directly with the muscle mass in healthy animals, and, consequently, is much higher in beef bulls than dairy cows. Plasma urea concentration varies directly with the protein intake in healthy animals, and, consequently, is increased in ruminants on a high-protein diet.

### Blood or Plasma Glucose

Plasma glucose concentration can be determined using conventional laboratory techniques (hexokinase assay), which require submission of heparinized blood samples to a laboratory as soon as possible to avoid erroneous results caused by erythrocyte glycolysis. Quantitative, rapid, low-cost point-of-care methods for determining blood glucose concentrations are now widely available, but many units are designed for analysis of human blood and are not suitable for use in large animals because they incorrectly assume intraerythrocyte glucose concentration is the same as plasma glucose concentration (which is the case in most primates). In all of the domestic animals examined, intraerythrocyte glucose concentration is lower than plasma glucose concentration, and, consequently, the measured blood glucose value depends on the hematocrit, which is usually assumed to be fixed and approximately 44%. Consequently, preferred point-of-care glucose meters should use a species-specific algorithm for correcting the



measured whole blood value, or should also measure hematocrit and use an additional algorithm to correct the measured whole blood value for deviations of hematocrit from the assumed value of 44%.

### Anion Gap

Acid-base balance has traditionally been evaluated by using the Henderson-Hasselbalch equation to characterize four primary acid-base disturbances (i.e., respiratory acidosis and alkalosis, metabolic acidosis, alkalosis) and by calculating the AG to estimate the UA concentration. Evaluation of the AG has become routine in many medical institutions. The calculation takes little time, is essentially without cost, and is valuable in assessing a variety of clinical conditions in which electrolyte imbalances occur.

The reference range for AG depends partly on the formula used for calculation. Some investigators prefer not to include the potassium concentration when calculating the AG on the basis that  $[K^+]$  varies to a much smaller degree than does  $[Na^+]$ ,  $[Cl^-]$ , and  $[HCO_3^-]$ ; therefore it exerts minimal influence on the AG. However, the consensus is that  $[K^+]$  should be included in the calculation of AG in large animals. Other investigators substitute the measured total  $CO_2$  value for  $[HCO_3^-]$ , permitting calculation of the AG from serum or plasma biochemical analysis without the need for blood gas determination.

The AG represents the difference between the concentration of  $[UA]$  and  $[UC]$  in serum (with square brackets representing concentration), which can be expressed in the equation:

$$[Na^+] + [K^+] + [UC] = [Cl^-] + [HCO_3^-] + [UA],$$

which can be rearranged to

$$[UA] - [UC] = AG = ([Na^+] + [K^+] - ([Cl^-] + [HCO_3^-]))$$

A change in  $[UA]$  or  $[UC]$  will cause a change in the AG. Under normal circumstances, approximately two thirds of the AG originates from the net negative charge of serum proteins, and the remainder represents the serum concentration of phosphate and strong anions, such as L-lactate, sulfate,  $\beta$ -OH butyrate, aceto-acetate, and anions associated with uremia.

The reference range for an AG depends on the age and species. The normal range for 2- to 3-week-old foals is 9 to 22 mEq/L, which is higher than that for 2-year-old horses (range 8–13 mEq/L). The 95% confidence interval for the range of AG for adult animals varies for different species: 8 to 13 mEq/L (horse), 14 to 20 mEq/L (cow), and 17 to 29 mEq/L (sheep). The AG values greater than 30 mEq/L have been observed in critically ill cattle; the increase is attributed to an increase in blood lactate and keto-acid concentration as well as to anions associated with uremia (Fig. 5-15).

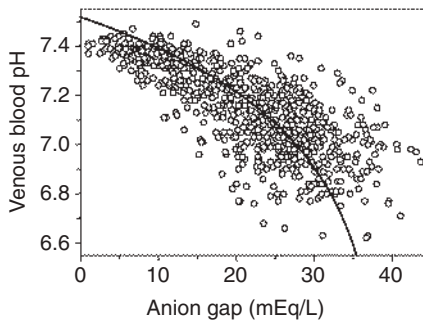

**Fig. 5-15** Relationship between venous blood pH and anion gap (AG) in 806 neonatal calves with diarrhea. The thick line represents the result of nonlinear regression analysis:  $pH = \log_{10}(39.7 - AG) + 5.92$ . (Reproduced with permission from Trefz FM, Constable PD, Lorenz I. *J Vet Intern Med* 2015;29:678-687.)

A potentially valuable clinical use for the AG is in estimating a value for plasma L-lactate concentration, and this is why calculation of the AG has been considered a “poor man’s plasma L-lactate concentration.” The correlation between AG and plasma L-lactate concentrations is excellent in horses with intestinal disease. The AG in adult cattle is only moderately correlated with L-lactate concentrations and is similarly correlated with serum phosphate and creatinine concentrations in neonatal calves and adult cattle, as well as with serum albumin and total protein concentrations in adult cattle.<sup>24</sup> The AG determination is of limited usefulness in predicting blood L-lactate concentration in sick cattle, whereas the correlation between AG and serum concentration in sick cattle suggests that an increased AG should suggest the potential presence of uremic anions.

In summary, the determinants and utility of the AG in predicting hyperlactatemia are as follows:

- The AG in critically ill cattle is influenced by at least three factors: blood L-lactate concentration and the serum concentrations of phosphate and creatinine.
- There is a substantial quantity of UAs in sick cattle (approximately 7 mEq/L), which implies that either unidentified cations or anions other than chloride, bicarbonate, L-lactate, pyruvate,  $\beta$ -OH butyrate, or phosphate are present in critically ill cattle or that the formula used to assign protein charge was inaccurate.
- The correlation coefficient between AG and blood L-lactate concentration is similar to that observed in human patients and less than that seen in sick horses.
- The AG appears to predict blood L-lactate concentration more accurately in neonatal calves with experimental

diarrhea than that in adult cattle with spontaneously occurring abomasal volvulus. The effects of acidemia on the AG and electrolyte concentration can vary depending on the cause of the acidosis and the species involved. Experimentally in horses, the infusion of L-lactic acid and D- and L-lactic acid results in acidosis with a high AG. An infusion of hydrochloric acid causes metabolic acidosis with a decreased AG. Infusions of isotonic saline (0.9% NaCl) cause mild acidosis with no significant change in AG.

### Strong Ion Gap

The SIG represents the concentration of unmeasured strong ions in plasma and is more specific in detecting the presence of unmeasured strong ions in plasma than the AG. Moreover, the results of every study that has compared SIG with AG have demonstrated that SIG has greater explanatory power.

The SIG concept is a logical extension of the AG concept and was developed using the SID approach to express SIG in terms of other factors:

$$SIG = \{A_{TOT} / (1 + 10^{(pK_a - pH)})\} - AG$$

where SIG represents the difference between unmeasured strong cation concentration and unmeasured strong anion concentration in plasma or serum. Calculation of the SIG requires species-specific values for the total plasma concentration of nonvolatile weak acids ( $A_{TOT}$ ; i.e., the total concentration of plasma nonvolatile buffers such as albumin, globulin, and phosphate) and the negative logarithm to the base 10 ( $pK_a$ ) of the effective dissociation constant ( $K_a$ ) for plasma nonvolatile buffers. Values for  $A_{TOT}$  and  $pK_a$  have been determined for the plasma of horses ( $A_{TOT}$ , 15.0 mmol/L = 0.22 mmol/g of total protein or 0.47 mmol/g of albumin;  $pK_a$ , 6.66) and calves ( $A_{TOT}$ , 23.1 mmol/L = 0.41 mmol/g of total protein or 0.75 mmol/g of albumin;  $pK_a$ , 7.08).

The reference range for SIG is generally -5 to +5 mEq/L. An increase in SIG above 5 mEq/L (which occurs rarely) reflects an increase in unmeasured strong cations or a decrease in unmeasured strong anions. A decrease in SIG below -5 mEq/L (a common occurrence) reflects a decrease in unmeasured strong cations or, more likely, an increase in unmeasured strong anions (Fig. 5-16).

The SIG offers a more accurate approach to identifying unmeasured strong ions in plasma than does the AG. The critical difference between the AG and SIG is that the SIG provides an estimate of the difference between unmeasured strong cations and strong anions, whereas AG provides an estimate of the difference between UCs and anions (including strong ions and nonvolatile buffer ions such as albumin, globulin,



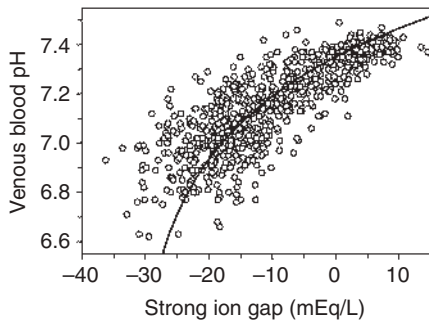

**Fig. 5-16** Relationship between venous blood pH and strong ion gap (SIG) in 806 neonatal calves with diarrhea. The thick line represents the result of nonlinear regression analysis:  $\text{pH} = \log_{10}(\text{SIG} + 32.4) + 5.84$ . (Reproduced with permission from Trefz FM, Constable PD, Lorenz I. *J Vet Intern Med* 2015;29:678-687.)

and phosphate). A change in SIG therefore provides a more specific method for detecting a change in unmeasured strong ions (such as lactate) than a change in AG.<sup>23,24</sup>

### Osmolal Gap

**Evaluation of the osmolal gap** is a means of detecting an increased amount of abnormal osmotically active solute in the blood. The osmolal gap is the difference between the measured plasma osmolality and the osmolality calculated from the plasma concentration of normally measured solutes. Sodium and potassium and their associated anions, along with glucose and urea, constitute the majority of normal osmotically active solutes. The following formula is recommended with plasma/serum glucose and urea measured in units of mg/dL,<sup>25</sup> although many clinicians disregard the contribution of urea on the basis that it is an ineffective osmole that easily crosses cell membranes:

$$1.90 \times ([\text{Na}^+] + [\text{K}^+]) + (\text{glucose}/18) + (\text{urea}/2.8) + 5.0.$$

Examination of the triad of **calculated osmolality, measured osmolality, and the osmolal gap** is beneficial in the diagnosis and prognosis of a number of diseases.

### Arterial, Jugular, or Central Venous Blood Pressure

Arterial blood pressure is occasionally measured in referral centers in which the technical assistance and instrumentation are readily available. Mean arterial blood pressure provides a rough guide for the presence and severity of terminal shock but not for the severity or extent of the initiating lesion. Methods for measuring mean arterial blood pressure are summarized in [Chapter 10](#).

Jugular venous pressure (or preferably central venous pressure) is occasionally measured in referral centers to monitor the response to fluid administration. Normal pressure is 2 to 10 cmH<sub>2</sub>O (0.3–1.0 kPa),

referenced to the point of the shoulder (scapulohumeral joint). Below 2 cmH<sub>2</sub>O (0.3 kPa) requires fluid therapy; above 15 cmH<sub>2</sub>O (1.5 kPa) indicates cardiac failure and volume overload. Mean central venous pressure provided a sensitive method for detecting hypovolemia in horses having blood removed at 16 mL/kg; the significant reduction in mean central venous pressure occurred in the absence of a change in heart rate.<sup>17</sup> Methods for measuring jugular venous pressure or central venous pressure are summarized in [Chapter 10](#).

### Total Body Water

The most practical way to measure change in body water is to measure the **change in BW** by weighing the animal on admission and at a standard time each day, usually before the morning feeding. This is most valuable in animals admitted to a hospital with clinical signs consistent with severe dehydration. Simultaneous measurement of hematocrit and plasma protein concentration using refractometry provides a low-cost but clinically valuable method for monitoring changes in extracellular fluid volume from admission. The clinical utility of frequent weighing can be improved by periodically weighing the food offered and eaten as well as determining the weight of feces produced. More exact estimates are provided if urine is collected and weighed, although this is usually only feasible in neonatal calves and small ruminants. Losses in milk volume also need to be accounted for if the method is used in lactating dairy cattle.

**Bioelectrical impedance** analysis has been used in horses to detect acute changes in fluid volume in horses, although impedance analysis appears to have more applications in research studies than in the critical care of dehydrated or shocked animals. The method uses a head–tail configuration (although other configurations have been used) and requires shaving two areas of skin over the right cranial border of the first cervical vertebra and over the caudal aspect of the right tuber ischia and cleaning the skin with alcohol. Subdermal platinum electrodes are then fixed in place.<sup>27,28</sup> These electrodes provide the best signal-to-noise ratio but are not practical for use in the field; noninvasive carbon fiber electrodes appear to provide a good option for field work. Adhesive electrodes are used for humans but do not work well in horses. A multifrequency bioimpedance analyzer measures the resistance and reactance between the electrodes at multiple frequencies at the two sites and uses proprietary algorithms to calculate extracellular fluid volume, intracellular fluid volume, and total body water. As currently used, the method does not appear to have sufficient sensitivity for routine clinical use because it was unable to detect a 20% change in blood volume caused by hemorrhage and underestimated the actual contraction and

expansion of the extracellular fluid volume in adult horses administered furosemide and intravenous large-volume crystalloid solutions.<sup>27</sup> In addition, when applied to 48 kg BW neonatal foals with an estimated extracellular fluid volume of 17.4 L, the 95% confidence interval for the volume estimated by bioelectrical impedance was 20% of the actual value with the estimate ranging from 15.6 to 19.2 L.<sup>28</sup>

The sodium dilution principle has also been used to estimate changes in extracellular and intracellular volume in horses. The method requires measurement of serum sodium concentration, urine sodium concentration, and BW, and makes the assumption that sodium ions and water remain constant over time in physiologic fluids, except for measured “ins” and “outs” that reflect intravenous fluid administration and urine production. The method requires validation in clinically ill horses before recommending its use.<sup>29</sup>

The reference method for measuring total body water in horses before and after exercise uses orally administered deuterium oxide followed by a series of blood samples taken for analysis. Mean total body water content is about 62%. This method is not used clinically.

### FURTHER READING

- Constable PD. Acid-base assessment: When and how to apply the Henderson–Hasselbalch equation and strong ion difference theory. *Vet Clin North Am Food Anim Pract.* 2014;30:295-316.
- Constable PD. Fluids and electrolytes. *Vet Clin North Am Food Anim Pract.* 2003;19:1-40.
- Lindinger MI. Determining dehydration and its compartmentation in horses at rest and with exercise: A concise review and focus on multi-frequency bioelectrical impedance analysis. *Comp Exercise Physiol.* 2014;10:3-11.
- Neil K. How to use lactate in equine practice. *Aust Equine Vet.* 2008;27:34-48.
- Tennent-Brown B. Lactate production and measurement in critically ill horses. *Compend Contin Educ Vet.* 2011;33:E1-E7.
- Tennent-Brown B. Blood lactate measurement and interpretation in critically ill equine adults and neonates. *Vet Clin North Am Equine Pract.* 2014;30:399-413.

### REFERENCES

1. Gentile A, et al. *J Vet Intern Med.* 2008;22:190.
2. Abeysekara S, et al. *Am J Physiol Endocrinol Metab.* 2007;293:E558.
3. Schwedhelm L, et al. *J Dairy Sci.* 2013;96:2464.
4. Bellino C, et al. *J Am Vet Med Assoc.* 2012;240:312.
5. Trefz FM, et al. *J Vet Intern Med.* 2012;26:160.
6. Lorenz I, Lorch A. *Vet Rec.* 2009;164:174.
7. Angell JW, et al. *Vet Rec.* 2013;173:193.
8. Bleul U, et al. *J Vet Intern Med.* 2006;20:1003.
9. Tinkler SH, et al. *J Am Vet Med Assoc.* 2012;241:922.
10. Tinkler SH, et al. *Equine Vet J.* 2012;44(S43):57.
11. Lima-Oliveira G, et al. *Clin Biochem.* 2012;45:683.
12. Šoltésová A, et al. *Acta Veterinaria-Beograd.* 2015;65:111.
13. Kennedy SA, et al. *Am J Vet Res.* 2012;73:979.
14. Gunes V, Atalan G. *Res Vet Sci.* 2006;81:148.
15. Parker AJ, Fitzpatrick LA. *Aust Vet J.* 2006;84:349.
16. Bleul UT, et al. *J Am Vet Med Assoc.* 2008;233:289.

17. Bleul U, Götz E. *Comp Clin Pathol*. 2015;24:117.
18. Noël PG, et al. *Equine Vet J Suppl*. 2010;42:91.
19. Bleul U, Götz E. *J Vet Emerg Crit Care*. 2014;24:519.
20. Tennent-Brown BS, et al. *J Vet Intern Med*. 2010;24:198.
21. Castagnetti C, et al. *Theriogenology*. 2010;73:343.
22. Borchers A, et al. *Equine Vet J*. 2012;(suppl 41):57.
23. Gomez D, et al. *J Vet Intern Med*. 2014;28:1122.
24. Trefz FM, et al. *J Vet Intern Med*. 2015;29:678.
25. Rasouli M, Kalantari KR. *Clin Chem Lab Med*. 2005;43:635.
26. Magdesian KG, et al. *J Am Vet Med Assoc*. 2006;229:1458.
27. Fielding CL, et al. *J Vet Intern Med*. 2007;21:176.
28. Fielding CL, et al. *Am J Vet Res*. 2011;72:1390.
29. Fielding CL, et al. *Am J Vet Res*. 2008;69:1506.

## Principles of Fluid and Electrolyte Therapy

The most important principle is to prevent or minimize dehydration and electrolyte loss whenever possible. This means the provision of an adequate water supply, adequate drinking space, and a continuous supply of salt and the necessary minerals. The next most important principle is to treat potential losses of fluid and electrolytes as quickly as possible to minimize the degree of dehydration and acid-base imbalance that may occur in animals with diseases in which losses are occurring.

The **major therapeutic objectives** are to **correct the abnormalities** that already exist

and to monitor and **provide maintenance therapy** until the animal has recovered. Correction of the abnormalities may require 4 to 6 hours, and maintenance therapy may be necessary for 2 to 4 days, depending on the cause of the disease. Recent studies have identified concerns with bolus fluid resuscitation in septic patients, such as 20 to 40 mL/kg in the first hour.<sup>1-3</sup> These findings suggest that rapid resuscitation should focus on the use of low-volume hypertonic saline, and that traditional high-volume crystalloid solution resuscitation should not use bolus administration. Instead, traditional high-volume crystalloid fluid resuscitation should focus on slower rates of administration (<20 ml/kg/h).

There are at least five possible free water, electrolyte, acid-base, and oncotic pressure abnormalities that could exist at the same time and must be corrected:

- **Fluid volume deficit (free water)**
- **Plasma osmolar deficits**
- **Specific electrolyte imbalances**
- **Acid-base imbalance**
- **Oncotic pressure imbalances**

The two major problems are to determine the nature and degree of the abnormalities present and to decide which fluid and electrolyte replacement solution should be used.

The ideal situation would be to make both a clinical and laboratory evaluation of the animal as described earlier. The history and the diagnosis will suggest the possibility

of acidemia or alkalemia and the electrolyte imbalances that are likely to be present. The degree of dehydration can usually be recognized clinically. Severe dehydration and acidemia should be treated as quickly as possible. A summary of the disturbances of fluid and electrolyte balance that occur in some common diseases of cattle and horses, and the suggested fluid therapy, is presented in [Table 5-2](#).

### Calculation of Electrolyte Requirements

The electrolyte deficits can be estimated using the serum electrolyte values of the affected animal. The total deficit of the electrolyte in mEq is the product of the deficit of the electrolyte in mEq per liter ( $\Delta\text{mEq/L}$ ) and the distribution space for the electrolyte. For sodium, chloride, and bicarbonate, the distribution space is the extracellular fluid volume, which approximates 30% of BW in normally hydrated adults and 50% in normally hydrated neonates. In other words, for sodium, chloride, and bicarbonate, the total milliequivalent deficit = ( $\Delta\text{mEq/L}$ )  $\times$  (estimated euhydrated BW in kg)  $\times$  (0.3 or 0.5).

There is much less certainty about the size of the potassium space because potassium is predominantly an intracellular ion.

### Types of Intravenous Fluid

Fluids are categorized on the basis of their physical nature (**crystalloid** or **colloid**)

**Table 5-2** Summary of disturbances of body water, electrolytes, and acid-base balance in some common diseases of cattle and horses, and suggested fluid therapy

Disease	Major abnormalities and deficits	Flue and electrolyte requirements
Neonatal calf diarrhea (including piglets and lambs)	Metabolic acidosis, low plasma bicarbonate, severe dehydration, loss of sodium, hyperkalemia when acidosis severe	Equal mixtures of isotonic saline and isotonic sodium bicarbonate with 5% dextrose, balanced electrolytes, intravenous and orally
D-lactic acidosis (carbohydrate engorgement of ruminants)	Metabolic acidosis, low plasma bicarbonate, severe dehydration	Sodium bicarbonate initially followed by balanced electrolytes, intravenously
Acute diffuse peritonitis	Dehydration, slight metabolic alkalosis caused by paralytic ileus	Balanced electrolyte solutions in large quantities intravenously for hydration and maintenance
Right-side dilatation/abomasal volvulus of cattle, abomasal impaction (dietary or vagal nerve injury).	Metabolic alkalosis, marked hypochloremia, hypokalemia, severe dehydration	Balanced electrolyte solutions or high-potassium and chloride-acidifying solution, intravenously; may give acidifying solutions orally; can also use mixture of 2 L of isotonic saline (0.9%), 1 L isotonic potassium chloride (1.1%), and 1 L isotonic dextrose (5%)
Peracute coliform mastitis	Severe dehydration, mild electrolyte deficits including mild hypocalcemia, metabolic acidosis if diarrhea present	Balanced electrolyte solutions intravenously in large quantities for hydration and maintenance for 24–48 hours (100–150 mL/kg BW per 24 hours)
Acute diarrhea in the horse (enteric salmonellosis)	Severe dehydration, marked hyponatremia, metabolic acidosis, hypokalemia occurs following bicarbonate therapy.	Hypertonic sodium bicarbonate (5%) 3–5 L/500 kg BW followed by high-sodium, high-potassium alkalizing solution to correct hypokalemia following bicarbonate therapy, all by the intravenous route
Acute grain engorgement in the horse	Metabolic acidosis, dehydration, and shock	Hypertonic sodium bicarbonate (5%) 3–5 L/500 kg BW followed by balanced electrolytes intravenously
Water and electrolyte deprivation, esophageal obstruction in horses	Moderate dehydration	Balanced electrolytes intravenously, when obstruction relieved, provide electrolyte solution orally
Acute intestinal obstruction	Metabolic acidosis or alkalosis dependent on level of obstruction, severe dehydration in horse, moderate in cow	Isotonic sodium bicarbonate initially, 3–5 L/500 kg BW followed by balanced electrolytes intravenously, horses may develop hypokalemia following bicarbonate therapy and must be given potassium chloride

and osmolarity (**hypotonic**, **isotonic**, or **hypertonic**). Isotonic or slightly hypotonic crystalloid solutions are most commonly administered parenterally, although under specific circumstances hypertonic crystalloid solutions or isotonic colloid solutions are preferred.

### Crystalloid Solutions

A crystalloid is a substance that forms a true solution and is capable of being crystallized. Examples of crystalloid solutions are Ringer's solution, lactated Ringer's solution, acetated Ringer's solution, 0.9% NaCl, 7.2% NaCl (hypertonic saline), 1.3% NaHCO<sub>3</sub>, 8% NaHCO<sub>3</sub>, calcium gluconate, and 50% dextrose. Sodium chloride is the classic example of a crystalloid solution, as table salt (NaCl) exists as a crystal but dissolves completely when placed in water. Because crystalloids dissolve completely in water, crystalloid solutions containing sodium distribute throughout the entire extracellular fluid space; therefore they are not confined to the intravascular space. Sodium-containing crystalloid solutions are always indicated in hypovolemia (circulation problem) but are contraindicated in congestive heart failure (pump problem) because they provide an additional sodium load, and animals with heart failure have already retained too much sodium. Sodium-containing crystalloid solutions are also contraindicated in the presence of severe hypoalbuminemia because sodium-containing crystalloids will further decrease plasma albumin concentration and oncotic pressure, resulting in the movement of fluid into the interstitial spaces and exacerbating tissue edema.

Crystalloid solutions are characterized in terms of the number of molecules (numerator) per volume of solution (denominator). The number of molecules is expressed in moles (abbreviated as mol), where 1 mol of compound is equivalent to the molecular weight of the compound in grams (formula weights for NaCl, NaHCO<sub>3</sub>, and KCl are 58.5, 85, and 74 g, respectively). Because body fluids are dilute, moles are expressed as millimoles (mmol = mol/1000) to facilitate readability.

Crystalloid solutions are commonly expressed in terms of the number of charged components (numerator) per volume of solution (denominator). The number of charged components is expressed in equivalents (abbreviated as Eq), where 1 Eq is the number of each charged component that combines with or replaces 1 mol of hydrogen ion (this means that Eq is always a positive number). Because body fluids are dilute, equivalents are expressed as milliequivalents (mEq = Eq/1000) to facilitate readability. To calculate the number of mEq from mmol, simply multiply the number of millimoles by the valence (charge) or mEq/L = (mmol/L) × valence. For instance, 1 mmol of NaCl in solution provides 2 mEq: 1 mEq of Na<sup>+</sup> (1 ×

**Table 5-3** Summary of effective strong ion difference and osmolarity of parenterally administered crystalloid solutions

Solution	Effective SID (mEq/L)	Osmolarity (mOsm/L)
<b>Hypertonic solutions (&gt;312 mOsm/L)</b>		
<i>Alkalinizing</i>		
8.4% NaHCO <sub>3</sub>	1000	2000
5.0% NaHCO <sub>3</sub>	595	1190
10% NaH <sub>2</sub> PO <sub>4</sub>	145	1150
<i>Acidifying</i>		
50% dextrose	0	2500
7.2% NaCl	0	2460
25% magnesium sulfate	0	2028
23% calcium borogluconate	0	1069
<b>Isotonic solutions (300–312 mOsm/L)</b>		
<i>Alkalinizing</i>		
Tromethamine	210	300
1.3% NaHCO <sub>3</sub>	155	310
Carbicarb	75	300
McSherry's solution	54	312
Darrow's solution	53	312
<i>Acidifying</i>		
Ringer's solution	0	309
0.9% NaCl	0	308
1.15% KCl	0	308
<b>Hypotonic solutions (&lt;300 mOsm/L)</b>		
<i>Alkalinizing</i>		
Acetated Ringer's	27	294
Lactated Ringer's	<14	275
<i>Acidifying</i>		
5% dextrose	0	250

The effective strong ion difference (SID) is the difference between the strong cation and strong anion concentration after metabolizable anions (such as lactate or acetate) have been completely metabolized to produce bicarbonate. Electrolyte solutions with an effective SID of more than 27 mEq/L are alkalinizing because they create a strong ion alkalosis. Electrolyte solutions with an effective SID = 0 are acidifying because they create a strong ion acidosis.

1) and 1 mEq of Cl<sup>-</sup> (1 × 1), assuming that NaCl acts as a strong electrolyte in water (i.e., it completely dissociates into Na<sup>+</sup> and Cl<sup>-</sup> in water). In comparison, 1 mmol of CaCl<sub>2</sub> in solution provides 4 mEq: 2 mEq of Ca<sup>2+</sup> (1 × 2) and 2 mEq of Cl<sup>-</sup> (2 × 1), and 1 mmol of dextrose provides 0 mEq, because dextrose does not dissociate into charged components in water.

The principal reason constituents of plasma are defined in terms of mEq instead of mmol is because electroneutrality must be preserved at all times; the difference between the charge assigned to all strong cations (Na<sup>+</sup>, K<sup>+</sup>, Ca<sup>2+</sup>, and Mg<sup>2+</sup>) and strong anions (Cl<sup>-</sup>, lactate, sulfate, ketoacids, nonesterified fatty acids, etc.) in plasma is called the SID, and this factor independently and directly alters blood pH and therefore acid-base status. The normal SID of plasma is approximately 40 mEq/L, although there are species differences in the actual value. Electrolyte solutions with an effective SID greater than 40 mEq/L are therefore alkalinizing because they create a strong ion alkalosis. Electrolyte solutions with an effective SID = 0 are acidifying because they create a strong ion acidosis. Electrolyte solutions of intermediate SID may be alkalinizing or acidifying, depending

on the change in plasma SID relative to the decrease in plasma protein concentration (which is alkalinizing; Table 5-3).

### Isotonic, Hypertonic, and Hypotonic Crystalloid Solutions

The tonicity of the solution is an important clinical issue. Complete understanding of the tonicity concept requires differentiation of two terms, **osmolality** and **osmolarity**. Osmolality is the number of dissolved particles per kilogram of solution and is expressed as mOsm/kg of solution. The normal plasma osmolality in large animals is approximately 285 mOsm/kg, and plasma osmolality is aggressively defended by increasing water intake (osmolality >285 mOsm/kg) or promoting free water excretion (osmolality <285 mOsm/kg). The correct term in plasma and extracellular fluid is osmolality, because this factor is measured in the laboratory; however, frequently the term osmolarity is used because 1 L of lactated Ringer's solution closely approximates 1 kg of lactated Ringer's solution and because osmolarity can be easily calculated from the concentration of electrolytes in the fluid solution. Osmolarity is the number of particles per liter of solution and is expressed as mOsm/L of solution.



One kilogram (1 L) of plasma from an adult large animal has two components, 70 g of protein and 930 g of plasma water. Accordingly, the osmolality of normal plasma (285 mOsm/kg) is equivalent to a plasma water osmolality of 306 mOsm/L ( $\{285 \text{ mOsm/kg}\}/\{0.93 \text{ L/kg}\}$ ). Ringer's solution, 0.9% NaCl, and 1.3% NaHCO<sub>3</sub> are therefore considered isotonic solutions because they distribute in plasma water and have calculated osmolalities of 309, 308, and 310 mOsm/L, respectively.

The normal plasma osmolality for solutions to be administered to large animals is approximately 306 mOsm/L; solutions can therefore be defined as isotonic (300–312 mOsm/L), hypertonic (>312 mOsm/L), or hypotonic (<300 mOsm/L). Using this categorization, it is readily apparent that some routinely used crystalloid solutions are hypotonic; in particular, lactated Ringer's solution (275 mOsm/L) is mildly hypotonic and 5% dextrose (250 mOsm/L) is moderately hypotonic, although, as glucose is metabolized, 5% dextrose becomes an increasingly hypotonic solution. Erythrocytes are resistant to increases in plasma osmolality, whereas they are susceptible to mild decreases in osmolality; this is the basis of the red blood cell fragility test in which red blood cell suspensions are placed in solutions of decreasing osmolality. Because of hypotonic-induced hemolysis, parenterally administered fluids should ideally be isotonic or hypertonic.

#### Hypotonic Crystalloid Solutions

**Lactated Ringer's solution** is a balanced, polyionic, alkalinizing, and hypotonic (275 mOsm/L) crystalloid solution containing physiologic concentrations of Na<sup>+</sup>, K<sup>+</sup>, Ca<sup>2+</sup>, Cl<sup>-</sup>, and L- and D-lactate (CH<sub>3</sub>CH(OH)COO<sup>-</sup>). Lactated Ringer's solution alkalinizes because lactate is predominantly metabolized to the bicarbonate ion:

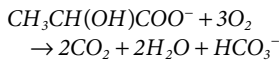

The lactate in lactated Ringer's is a racemic, approximately equimolar mixture of L- and D-lactate. In healthy animals L-lactate is rapidly metabolized; however, animals have negligible D-lactate dehydrogenase activity, leading to slow clearance of D-lactate, which is primarily through the urinary system. DL-lactate solutions, such as lactated Ringer's, therefore have approximately half the alkalinizing ability of L-lactate solutions. The effective SID of lactated Ringer's solution is therefore less than the calculated value of 28 mEq/L. Lactated Ringer's solution is the standard intravenous fluid for neonates and adult horses, because these animals tend to become acidemic when inappetent. However, lactated Ringer's solution is theoretically inferior to acetated Ringer's solution, because critically ill animals may have increased blood L-lactate concentrations and it is

incongruous to add L-lactate in this situation.

There has been recent interest in increasing the L-lactate concentration of lactated Ringer's and decreasing the chloride concentration to increase the alkalinizing effect. The inclusion of L-lactate at 56 or 84 mEq/L to an isotonic sodium solution provided a similar alkalinizing effect in healthy calves to the inclusion of bicarbonate at 56 or 84 mEq/L.<sup>4</sup>

**Acetated Ringer's solution** is a balanced, polyionic, alkalinizing, and hypotonic (294 mOsm/L) crystalloid solution. Commercially available formulations of acetated Ringer's solution contain physiologic concentrations of Na<sup>+</sup>, K<sup>+</sup>, Mg<sup>2+</sup>, Cl<sup>-</sup>, acetate (CH<sub>3</sub>COO<sup>-</sup>), and gluconate (CH<sub>2</sub>(OH){CH(OH)}<sub>4</sub>COO<sup>-</sup>); the gluconate is problematic because calves (and presumably all large animals) slowly metabolize gluconate.<sup>5</sup> Acetated Ringer's solution alkalinizes because acetate is metabolized to the bicarbonate ion:

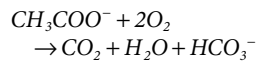

The strong ion approach to acid-base balance states that acetated Ringer's solution is alkalinizing because it contains a metabolizable strong anion (acetate) that, when metabolized, increases the SID. Two acetated Ringer's solution formulations are commercially available in North America, Plasma-Lyte A and Normosol-R. Both have the same formulation, except Plasma-Lyte has a pH of 7.4 when administered compared with Normosol-R, which has a pH of 6.6 when administered. The difference in solution pH is unlikely to be of clinical significance. The main advantage of acetated Ringer's solution is that the sodium concentration (140 mEq/L) is approximately the same as that of livestock animals, whereas the sodium concentration in lactated Ringer's (130 mEq/L) is appreciably lower.

**Five percent dextrose** is 250 mOsm/L as administered, but plasma osmolality decreases below 250 mOsm/L as the glucose is metabolized, leaving free water. Because 5% dextrose has no sodium to expand the extracellular volume and has much less energy content than 50% dextrose on a volume basis, the only application of 5% dextrose is to provide free water or as a vehicle for pharmacologic agents.

#### Isotonic Crystalloid Solutions

**Ringer's solution** is a balanced polyionic nonalkalinizing isotonic crystalloid solution that contains physiologic concentrations of Na<sup>+</sup>, K<sup>+</sup>, Ca<sup>2+</sup>, and Cl<sup>-</sup>. This solution is mildly acidifying because its effective SID = 0 mEq/L. Addition of a fluid with a SID of 0 mEq/L to plasma (normal SID ≈ 40 mEq/L) will decrease plasma SID and therefore directly and independently decrease plasma pH because a 1 mEq/L decrease in SID

decreases plasma pH by approximately 0.016. Ringer's solution is the standard intravenous fluid for adult ruminants because these ruminants tend to get alkalemic when inappetent.

**Isotonic saline (0.9% NaCl solution)** is an isotonic crystalloid solution that has little merit in the routine treatment of sick ruminants, principally because ruminants usually develop hypocalcemia and hypokalemia when inappetent. Accordingly, the use of 0.9% NaCl should be confined to horses, the irrigation of surgical sites and wounds, or as a vehicle for adding other electrolytes and dextrose. Like Ringer's solution, 0.9% NaCl is mildly acidifying because effective SID = 0 mEq/L.

**Isotonic sodium bicarbonate (1.3% NaHCO<sub>3</sub> solution)** is an alkalinizing isotonic crystalloid solution that is used to treat severe acidemia (indicated whenever blood pH < 7.20 as a result of metabolic acidosis). This solution is alkalinizing because it buffers hydrogen ion, HCO<sub>3</sub><sup>-</sup> + H<sup>+</sup> ↔ CO<sub>2</sub> + H<sub>2</sub>O, and increases SID (effective SID = 155 mEq/L). Sodium bicarbonate is superior to sodium L-lactate and sodium acetate for the treatment of metabolic acidosis because it provides an immediate source of bicarbonate. On theoretical grounds, sodium bicarbonate (NaHCO<sub>3</sub>) should not be used to treat severe respiratory acidosis, because additional CO<sub>2</sub> generated may worsen the respiratory acidosis. However, studies in critically ill large animals have failed to identify a clinically important effect of sodium bicarbonate infusion on increasing arterial PCO<sub>2</sub>, inducing respiratory acidosis and further decreasing blood pH. Moreover, concern has been raised that rapid large-volume sodium bicarbonate administration can result in systemic alkalinization but not **paradoxical CSF acidosis**, which may produce adverse neurologic sequelae. An in-depth review of the studies on this topic indicates that paradoxical CSF acidosis has only been observed in anesthetized animals with controlled ventilation. In other words, when sodium bicarbonate is administered to animals that control their own ventilation, even under anesthesia, paradoxical CSF acidosis does not occur because the animal detects the increase in arterial PCO<sub>2</sub> and reflexively increases minute volume to combat the bicarbonate-induced respiratory acidosis.<sup>6</sup>

**Tromethamine** (THAM, Tris-hydroxymethyl aminomethane, 300 mmol/L) is an isotonic solution of an organic amine that is a safe and effective buffer. After administration, 70% of the neutral compound (CH<sub>2</sub>(OH)<sub>3</sub>C-NH<sub>2</sub> in tromethamine is immediately protonated to the strong cation (CH<sub>2</sub>(OH)<sub>3</sub>C-NH<sub>3</sub><sup>+</sup> in plasma, with the net equation:

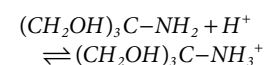



The remaining 30% of the administered tromethamine remains unprotonated, and can therefore cross cell membranes and potentially buffer the intracellular compartment. Tromethamine provides an alternative alkalinizing agent to sodium bicarbonate; however, tromethamine does not currently appear to offer any important clinical advantages over sodium bicarbonate in spontaneously breathing animals.

Isotonic formulations are available for intravenous administration with or without electrolytes; administration of tromethamine without electrolytes leads to hyponatremia, and it would appear preferable to administer tromethamine in conjunction with electrolytes.

**Carbicarb** is an isotonic buffer (300 mOsm/L) made from equimolar disodium carbonate ( $\text{Na}_2\text{CO}_3$ ) and sodium bicarbonate; carbonate avoids generation of  $\text{CO}_2$  when buffering acidemic blood:

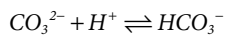

Carbicarb was suspected to decrease the incidence and magnitude of hypercapnia when rapid alkalinization was needed in animals with mixed metabolic and respiratory acidosis. Despite numerous studies comparing Carbicarb with sodium bicarbonate, the potential clinical advantages of Carbicarb have only been demonstrated in animals being ventilated or with extremely limited ventilatory ability. Carbicarb has been administered intravenously to diarrheic calves; however, these studies have failed to identify a clinically important advantage over conventional isotonic sodium bicarbonate administration. Accordingly, there does not appear to be a compelling reason to prefer Carbicarb to isotonic sodium bicarbonate when rapid alkalinization of conscious animals is required.

**Darrow's solution** is an isotonic polyionic solution formulated by Darrow in 1946 for use in human infants; the solution has been administered to calves. Compared with other isoosmotic polyionic solutions, Darrow's solution is hyponatremic, hyperkalemic, and hyperlactatemic and does not contain calcium or magnesium. As such, Darrow's solution is not recommended for administration to large animals.

**McSherry's balanced electrolyte solution** is an isotonic polyionic solution formulated by McSherry and Grinyer in 1954 for intravenous and intraperitoneal administration to dehydrated diarrheic calves. On theoretical grounds, this is an excellent parenteral fluid for resuscitating dehydrated diarrheic calves that deserves more frequent use. Unfortunately, commercial formulations are currently unavailable.

#### Hypertonic Crystalloid Solutions

**Fifty percent dextrose** is 2500 mOsm/L (approximately eight times normal osmolarity). Fifty percent dextrose solutions are

**Table 5-4** Estimated daily energy requirements of fasting cattle

Body weight (kg)	Metabolic body size (kg $\text{W}^{0.73}$ )	Metabolizable energy requirements (kcal)	Glucose 50% (L/day)
45 (1-month-old calf)	16	1760	7
90	27	2970	1.2
180	45	4950	2.0
360	74	8140	3.3
454	87	9519	3.8
544	100	12100	4.8

commonly administered to ruminants with ketosis or hypoglycemia and produce a transient increase in cardiac contractility. Some commercially available formulations in Europe contain an equimolar mix of dextrose and fructose, although the addition of fructose does not appear to produce a more sustained increase in plasma glucose concentration than that produced by glucose alone.

The necessity for glucose in fluid therapy has been controversial. Hypoglycemia occurs commonly in septicemic neonates and calves with diarrhea, but is uncommon in most other common diseases in which there is an acute fluid and electrolyte disturbance. Dextrose will promote the movement of extracellular potassium into the cell, will provide metabolic water, and is a source of carbohydrate. If glucose is indicated, large quantities of parenteral glucose are necessary to meet the maintenance energy requirements, and every effort must be made to restore the animal's appetite and to provide the necessary requirements through dietary intake. The energy requirements for maintenance are calculated on the basis of metabolic body size,  $\text{kg}^{0.73}$ , which is a measure of the fasting metabolism in an animal not eating and not doing any muscular work. If 1 g of dextrose given intravenously will provide 5 kcal (2.1 kJ) of energy, the approximate amounts of dextrose solution needed to meet the energy needs for maintenance in cattle are shown in Table 5-4. Table 5-4 provides a rough estimate of the requirements and should be used as a general guideline only. Every effort should be made to supply the energy needs through oral intake of energy-containing foods.

**NaCl 7.2% (hypertonic saline)** is 2460 mOsm/L (approximately eight times normal osmolarity), and is used for the rapid resuscitation of animals with hypovolemia. Hypertonic saline should be administered at 4 to 5 mL/kg BW intravenously over 4 to 5 min (1 mL/kg BW/min). Faster rates of administration lead to hemodynamic collapse caused by vasodilation and decreased cardiac contractility, whereas slower rates of administration provide no advantages over isotonic crystalloid solutions. Like high-volume 0.9% NaCl, small-volume hypertonic saline consistently induces a mild strong ion acidosis as its effective SID = 0 mEq/L.

Generally, the decrease in pH following hypertonic saline administration is less than 0.08 pH units and rapidly dissipates with time. The effect of hypertonic saline on acid-base balance is therefore clinically inconsequential.

The use of small volumes (4–5 mL/kg BW) of hypertonic saline solution, ranging in concentration from 7.0% to 7.5%, has been extensively evaluated for the treatment of various forms of hemorrhagic, septic, and endotoxic shock. Plasma volume is increased by the movement of free water from the intracellular space, increasing cardiac output, mean arterial blood pressure, systemic oxygen delivery, and glomerular filtration rate. Total peripheral vascular resistance and pulmonary vascular resistance decrease, and mean circulatory filling pressure increases. Urine output is restored and acid-base equilibrium returns toward normal in conjunction with improved tissue perfusion.

Hypertonic saline (7.2–7.5%), with or without Dextran 70, has been used successfully in the initial resuscitation of diarrheic calves that have moderate to severe dehydration.<sup>7-9</sup> When used in this manner, resuscitation is optimized if calves receive 3 L of an isotonic oral electrolyte solution by esophageal intubation immediately before hypertonic saline is administered intravenously into the jugular vein through an 18-gauge needle at 4 to 5 mL/kg over 4 to 5 minutes. Combined intravenous hypertonic saline and oral electrolyte solution provides the fastest rate of resuscitation of dehydrated calves, as characterized by cardiac output and mean central venous pressure. It is important to note that the rate of resuscitation with hypertonic saline is even faster than that provided by administration of an equivalent sodium load of lactated Ringer's solution at 80 mL/kg over the first hour. The rapid infusion of small volumes of hypertonic saline should therefore be considered the preferred treatment for the initial resuscitation of severely dehydrated diarrheic calves. Moreover, more of the administered sodium in hypertonic saline is retained by the calf, resulting in more sustained resuscitation, whereas urinary sodium and free water loss is increased in calves administered lactated Ringer's solution or 0.9% NaCl solution.<sup>7,8,10</sup> Although the first studies to

demonstrate efficacy of hypertonic saline in resuscitating dehydrated calves also administered dextran to assist in sustained plasma volume expansion,<sup>7,8</sup> subsequent studies have demonstrated that the addition of dextran is not required for a beneficial response.<sup>9,10</sup>

Hypertonic saline solution is widely used for the treatment of dairy cattle with endotoxic shock and endotoxemia associated with coliform mastitis. Affected cows are given 2 L of hypertonic saline (4–5 mL/kg BW) intravenously, followed by immediate access to drinking water and other supportive therapy. The small volume of hypertonic saline followed by the oral water load increases circulatory volume rapidly, induces slight metabolic acidosis, increases renal perfusion and glomerular filtration rate, and induces homeostatic changes in serum calcium and phosphorus. In experimental endotoxin-induced mastitis of cattle, small volumes of hypertonic saline given intravenously (7.5%, 5 mL/kg BW) resulted in expanded plasma volume and increased the cows' voluntary water intake by about 12 times compared with cows treated with isotonic saline. The rapid intravenous administration of hypertonic saline successfully, but transiently, resuscitates calves in experimental endotoxic shock.<sup>11</sup> Hypertonic saline (7.2% NaCl, 2400 mOsm/L), 4 mL/kg BW intravenously over 4 minutes can be safely administered to endotoxic calves. On a comparative basis, the rapid infusion of large-volume isotonic saline is superior to small-volume hypertonic saline for initial resuscitation of experimentally induced acutely endotoxemic calves.

Hypertonic saline (7.2% NaCl, 2 L intravenously over 10 minutes) has been administered to cattle with RDA, followed by 10 L of 0.9% NaCl intravenously, and the resuscitative effects compared with cattle receiving an equivalent sodium load of 0.9% NaCl (26 L). Hypertonic saline produced a faster rate of initial resuscitation, based on mean central venous pressure and changes in plasma volume.<sup>12</sup> Hypertonic saline (7.5% NaCl, 5 mL/kg intravenously over 15 minutes) has been administered to cattle with experimentally induced acute ruminal acidosis, and the resuscitative effects compared with isotonic saline solution (0.9% NaCl). The response to both fluids appeared equivalent, except for a slighter larger reduction in blood pH in cattle treated with hypertonic saline.<sup>13</sup> It should be noted that hypertonic saline should not be administered to ruminants with acute ruminal acidosis on theoretical grounds. This is because rumen osmolality is markedly increased in acute ruminal acidosis, which minimizes the osmotic gradient that is generated following rapid intravenous small-volume hypertonic saline administration and the volume of free water translocated from the forestomach.

Hypertonic saline solutions have been extensively studied in horses and are widely used for the initial resuscitation of critically ill horses that are undergoing abdominal surgery for colic. Hypertonic saline has been associated with greater and more prolonged improvement in cardiopulmonary function and survival in horses with experimentally induced hemorrhagic and endotoxemic shock and in halothane-induced hypotension in horses. When given intravenously to normal conscious horses at 5 mL/kg BW, there are increases in plasma osmolality and serum sodium and chloride, but clinically normal horses rapidly regulate variable sodium loads. In horses with experimentally induced acute endotoxemia, horses resuscitated with intravenous hypertonic saline (5 mL/kg) and hydroxyethyl starch (10 mL/kg) had a higher cardiac output, lower mean pulmonary artery pressure and mean central venous pressure, higher ionized plasma calcium concentration, and improved respiratory gas exchange and arterial oxygenation than horses resuscitated with high-volume isotonic acetated Ringer's solution.<sup>14,15</sup> These results were consistent with increased interstitial water in the lung and volume overload as a result of conventional rapid high-volume isotonic solution administration.<sup>14</sup> Similar findings were reported earlier in the resuscitation of endotoxemic calves.<sup>11</sup> Hypertonic saline (7.2%) at 4 mL/kg provided a superior resuscitative solution than equivolume isotonic saline (0.9%) in horses eliminated from an endurance event because of dehydration. Dehydrated horses administered hypertonic saline had a greater plasma volume expansion and shorter time to first urination than horses receiving isotonic saline.<sup>16</sup>

Hypertonic solutions of sodium bicarbonate are highly effective for the initial treatment of acidosis associated with D-lactic acidosis in calves, acute diarrhea in calves, and strong ion (metabolic) acidosis in newborn calves. **Sodium bicarbonate 8.4%** is 2000 mOsm/L (approximately seven times normal osmolality). This solution is used for rapid alkalization, particularly in the presence of severe acidemia (pH <7.20). The solution osmolality was selected because it provides 1 mEq of HCO<sub>3</sub><sup>-</sup>/mL of solution, which facilitates calculation of the volume to be administered. The speed of intravenous administration of 8.4% sodium bicarbonate should not exceed 1 (mL/kg BW)/min. There is one report of the intravenous administration of 8.4% sodium bicarbonate to normovolemic calves with experimentally induced mixed respiratory and metabolic acidosis; the study found that rapid administration of sodium bicarbonate (5 mL/kg intravenously over 5 min) rapidly corrected the metabolic acidosis, increased blood pH, and improved cardiovascular status without inducing paradoxical CSF acidosis, suggesting that this treatment may be of value in treating dehydrated diarrheic calves.<sup>17</sup> A study in

dehydrated calves with naturally acquired diarrhea has been conducted comparing intravenous hypertonic sodium bicarbonate (8.4%, 10 mL/kg over 8 minutes) and hypertonic saline (5.9%, 5 mL/kg over 4 minutes); calves receiving either treatment also received 3 L of an oral electrolyte solution 5 minutes after injection. As expected, the hypertonic sodium bicarbonate solution was more effective in correcting profound acidemia and metabolic acidosis than hypertonic saline.<sup>18</sup> The results of a study that compared the intravenous administration of equivalent sodium loads of 8.4% to 1.3% NaHCO<sub>3</sub> to neonatal calves with naturally acquired diarrhea and severe dehydration indicated that isotonic sodium bicarbonate was more effective in rehydrating the calf, whereas the rapid administration of hypertonic sodium bicarbonate was more effective in rapidly correcting the acidemia and strong ion (metabolic) acidosis.<sup>19</sup>

There are recent studies evaluating the effect of hypertonic solutions of **sodium lactate** (11.2% at 5 mL/kg/h administered over 270 minutes); lactate provides an energy substrate that can be used by most cells in the body, while being alkalizing after metabolism to bicarbonate. In a pig endotoxemia model, infusion of hypertonic sodium lactate increased mean arterial blood pressure and cardiac output and improved oxygenation, relative to hypertonic sodium bicarbonate or 0.9% NaCl solution.<sup>20</sup>

**Sodium bicarbonate 5%** is 1190 mOsm/L (approximately four times normal osmolality). This solution is also used for rapid alkalization in the presence of severe acidemia (pH <7.20). The speed of intravenous administration of 5.0% sodium bicarbonate should not exceed 2 (mL/kg)/min. Three to five liters of 5% sodium bicarbonate may be necessary as initial therapy to correct the severe hyponatremia and strong ion (metabolic) acidosis that occurs in the horse with acute diarrhea. Following this initial treatment, hypokalemia characterized by muscular weakness commonly occurs, which can be treated using a high-sodium, high-potassium, alkalizing solution.

**Calcium gluconate 23% or calcium borogluconate** are 1069 mOsm/L (approximately three and a half times normal osmolality). Calcium borogluconate is the standard treatment for milk fever (hypocalcemia) in cattle. D-gluconate is an aldose sugar produced by oxidation of D-glucose, and is the preferred salt for calcium-containing parenteral solutions because it does not cause tissue necrosis as severe as does CaCl<sub>2</sub>. Calcium gluconate should not be added to sodium bicarbonate solutions because a white precipitate (CaCO<sub>3</sub>) forms immediately that interferes with normal fluid administration. Likewise, calcium gluconate should not be administered with tetracycline antibiotics because a yellow precipitate forms.

### Colloid Solutions

A colloid is a substance that is too large to pass through a semipermeable membrane. Examples of colloid solutions administered to ruminants are whole blood, stroma-free Hb, plasma, dextrans, hydroxyethyl starches, and gelatins. As a group, colloid solutions are excellent for sustained expansion of plasma volume, which is in marked contrast to the effect of crystalloid solutions. Colloid solutions are contraindicated in congestive heart failure because these animals have increased plasma volume. Colloid solutions are also contraindicated in the presence of oliguric or anuric renal failure because the sustained volume overload may lead to pulmonary edema. Although initial studies using colloid solutions appeared promising, influential studies promoting the use of commercially available solutions have been recently retracted from major journals,<sup>21</sup> and the majority of smaller reviews evaluating the safety and efficacy of colloid solutions were written by investigators that had or have since established ties to the manufacturers of colloid solutions.<sup>22</sup> Moreover, questions are being raised about the relative importance of the difference between plasma oncotic and interstitial oncotic pressures and transcapillary fluid dynamics in patients with normal or decreased capillary pressures. The net result of these recent developments is decreased enthusiasm for the administration of commercially formulated colloid solutions.

**Whole blood** is the perfect balanced colloid/crystalloid solution, with great O<sub>2</sub>-carrying capacity. It has a short shelf-life (<24 hours at 4°C) and is expensive to obtain. Whole blood administration runs the risk of disease transmission and allergic reactions; the latter are extremely rare in ruminants with the first blood transfusion but common enough in horses for blood typing or cross-matching to be required. Descriptions for collecting, storing, and administering blood are available in [Chapter 4](#).

**Stroma-free Hb** is a blood substitute containing a purified Hb glutamer-200 solution (13 g Hb/dL) derived from cattle blood. A commercially available solution has a 2-year shelf-life at 20°C, an osmolarity of 300 mOsm/L, and an oncotic pressure of 43 mm Hg; the solution is therefore isotonic but hyperoncotic. Stroma-free Hb solutions are excellent at increasing oxygen delivery and carrying capacity while providing similar plasma volume expansion to dextrans and hydroxyethyl starches. The major theoretical concerns regarding administration of stroma-free Hb solutions are potent vasoconstriction and hemoglobinuric nephrosis. Some of the original experimental studies examining the effects of stroma-free Hb administration were completed in sheep, and there are occasional reports of its successful administration to critically ill horses in a clinical situation. It is likely that the high cost of this product

will minimize its administration to large animals.

**Plasma (fresh or frozen)** is an excellent balanced colloid/crystalloid solution. Compared with blood, plasma has a much longer shelf-life (at least 1 year at -20°C) but is more expensive to obtain. Details for collection, harvesting, storing, and administering plasma are available elsewhere, and bovine, equine, and New World camelid plasmas are commercially available. Like blood, administration of plasma runs the risk of disease transmission and allergic reactions, although these risks are less than with blood transfusion.

Plasma is routinely administered to foals with inadequate transfer of passive immunity. Hyperimmune plasma is occasionally administered to neonatal foals and adult horses with gram-negative septicemia and endotoxemia. There appears to be only one report documenting the efficacy of plasma administered to neonatal calves with diarrhea, and these calves were probably colostrum deprived. The 14-day survival rate in diarrheic calves that received 600 to 800 mL of bovine plasma (5 g protein per dL) and electrolytes intravenously was 93% (37/40), which was significantly greater than the survival rate of calves receiving intravenous electrolytes alone (54%, 7/13). Another study failed to identify a beneficial effect of blood transfusion in treating diarrheic calves. Because blood is cheaper to obtain than plasma, whole blood transfusions are usually administered when a neonatal ruminant needs plasma. Human albumin solutions (5% or 25% human albumin in 0.9% NaCl) are available, but are very expensive relative to the use of other colloids such as plasma, blood, or Dextran 70. Consequently, there does not appear to be a persuasive reason for the administration of human albumin solutions to large animals.

**Dextran preparations** (such as Dextran 70 and Dextran 40) are high molecular weight glucose polymers obtained by bacterial fermentation of sucrose; the fermentation metabolites then undergo acid hydrolysis and fractionation. The molecular weight of dextran can therefore be “selected,” and two dextran products, Dextran 70 (mean molecular weight 70,000 g) and Dextran 40 (mean molecular weight 40,000 g), are commercially available. Because the molecular weight of Dextran 70 is similar to albumin (molecular weight 65,000 g), there is limited diffusion of dextran into the interstitial space. Therefore Dextran 70 acts clinically as a plasma volume expander; this is in contrast to isotonic crystalloid solutions, which act as extracellular fluid volume expanders. Dextran 70 has been the most widely used dextran formulation in large animals, and is therefore the recommended product for administration. It is supplied as a 6% concentration in 0.9% NaCl, which provides a hyperoncotic but isotonic solution. Reported administration rates of Dextran 70 are 5 to

40(mL/kg)/h, but it is safer to administer Dextran 70 at less than 20(mL/kg)/h. One milliliter of Dextran 70 expands the plasma volume by 0.8 to 1.2 mL, but 50% of the administered dose is gone by 24 hours. Dextran administration runs the risk of exacerbating preexisting coagulopathies, although the clinical significance of dextran-induced prolongation of activated partial thromboplastin time (APTT) by decreasing factor VIII:C is probably minimal. The risk of coagulopathy is dependent on the administration rate, total dose administered (20 mL/kg is maximum 24-hour dose in humans), and the molecular weight of dextran. The deleterious effects of dextrans are usually associated with large doses or prolonged administration.

The use of **hypertonic saline-dextran solution** (4 mL/kg, 2400 mOsm/L sodium chloride in 6% Dextran 70 administered intravenously once over 4 minutes) combined with an isotonic oral alkalinizing solution containing sodium chloride (3.22 g/L), potassium chloride (1.12 g/L), sodium acetate trihydrate (4.76 g/L), and glucose anhydrous (16.22 g/L), providing 300 mOsm/kg of water and administered at 55 mL/kg BW, was superior to either solution alone for the treatment of experimentally induced hypovolemic diarrhea in calves. The combined treatment resulted in immediate and sustained increases in plasma volume, cardiac output, and stroke volume, improving tissue perfusion. Rapid and sustained rehydration after the combined treatment was indicated by improvement in hydration and clinical depression scores and decreases in hematocrit; blood lactate concentration; and serum creatinine, albumin, and phosphate concentrations. Resuscitation with oral electrolyte solution alone was slower but was complete within 24 hours. Resuscitation with the hypertonic saline-dextran solution alone resulted in only transient benefit.

The administration of hypertonic saline-dextran solution (7.2% NaCl solution with 6% dextran at the rate of 4 mL/kg BW, intravenously during a 4-minute period, combined with oral administration of isotonic electrolyte solution at the rate of 50–60 mL/kg BW) provided a rapid and effective method for resuscitating severely dehydrated calves with experimentally induced diarrhea or with naturally acquired diarrhea.

**Hydroxyethyl starch** is a high molecular weight glucose polymer (mean molecular weight 450,000 g) that is chemically synthesized from amylopectin, producing a highly branched glucose polymer with a structure similar to that of glycogen. Hydroxyethyl starch is hydrolyzed in blood by  $\alpha$ -amylase, and the addition of hydroxyethyl groups slows hydrolysis and prolongs the duration of plasma volume expansion. Hydroxyethyl starch solutions are categorized by the mean molecular weight and a molar substitution ratio (usually stated after a back slash) that



reflects the number of hydroxyethyl substitutions per glucose unit, with a higher number indicating more substitutions and a slower rate of degradation.<sup>23</sup> A variety of hydroxyethyl starch formulations have been developed world wide; Hetastarch (hydroxyethyl starch at 600,000 g/0.75 in 0.9% NaCl solution or 670,000 g/0.75 in lactated Ringer's solution), Pentastarch (200,000 g/0.4 in 0.9% NaCl solution), and Tetrastarch (130,000 g/0.4 or 130,000 g/0.42 in 0.9% NaCl solution). Pentastarch (200,000 g/0.4 in 0.9% NaCl solution), and Tetrastarch (130,000 g/0.4 in 0.9% NaCl solution). Because the molecular weight of hydroxyethyl starch is much greater than that of albumin (65,000 g), hydroxyethyl starch in Hetastarch preparations decreases endothelial permeability by sealing separations of endothelial cells. Hydroxyethyl starch is supplied as a 6% concentration in 0.9% NaCl; this provides a hyperoncotic but approximately isotonic solution. Reported administration rates are 5 to 40(mL/kg BW)/h but, like Dextran 70, it is safer to administer hydroxyethyl starch at less than 20(mL/kg BW)/h. Like Dextran 70, hydroxyethyl starch administration runs the risk of exacerbating preexisting coagulopathies. The risk of coagulopathy is dependent on the administration rate, total dose administered (20 mL/kg BW is the maximum 24-hour dose in humans), and size of the hydroxyethyl starch particles. Administration of 6% hydroxyethyl starch to anesthetized horses at 5 to 15 mL/kg over 90 minutes increased mean central venous pressure and cardiac output but did not correct inhalation anesthetic-induced systemic hypotension.<sup>24</sup> The rapid administration of 6% hydroxyethyl starch to horses with naturally occurring gastrointestinal disease at 10 mL/kg increased colloid osmotic pressure by approximately 20%, but did not return values to within the reference range.<sup>25</sup> High molecular weight hydroxyethyl starch formulations have been recently linked to nephrotoxicity, acute renal failure, and mortality in humans, particularly in septic patients or patients with preexisting renal disease, and the U.S. Food and Drug Administration recommended in 2013 that they not be used in critically ill adults and patients with preexisting renal dysfunction or severe liver disease. Low molecular weight hydroxyethyl starch formulations do not seem to demonstrate similar adverse effects, but are cleared at a faster rate because of their small size, resulting in a shorter duration of action. The relevance of these findings to the use of hydroxyethyl starch formulations in large animals is uncertain, because clinically relevant coagulation abnormalities caused by hydroxyethyl starch were not identified when administered to horses with experimentally induced acute endotoxemia at 10 mL/kg.<sup>15</sup> Hydroxyethyl starch solutions do exert dose-dependent in vitro effects on coagulation in horse blood, as assessed by platelet aggregation and function.<sup>23</sup> The

clinical relevance of these in vitro findings has not been determined.

Pentastarch has two important differences to Hetastarch (hydroxyethyl starch) formulations: it appears to have a less exacerbating effect on preexisting coagulopathies and the rate of elimination is faster (elimination half-life of 5.6 hours in healthy horses and possibly 2 hours in critically ill horses); however, similar to hydroxyethyl starch, pentastarch has been associated with an increased incidence of acute kidney injury in humans.<sup>26</sup> Pentastarch has been administered preoperatively to horses with colic at 4 mL/kg, and this infusion produced a higher cardiac output in anesthetized horses for 150 minutes compared with the same volume of hypertonic saline (7.2% NaCl).<sup>27</sup> It should be noted that Pentastarch is considerably more expensive than 7.2% hypertonic saline when compared on a volume basis.

Tetrastarch has been the most recently introduced colloid and, consequently, there are fewer studies examining its efficacy and safety. In vitro studies suggest Tetrastarch produces less impairment of coagulation caused by its lower molecular weight and lower molar substitution formulation. Studies in healthy adult horses indicated Tetrastarch caused plasma volume expansion but a shorter duration of adverse effects on platelet function than a similar dose of Hetastarch.<sup>28</sup> The clinical significance of this difference remains to be determined.

**Gelatins (modified bovine collagens)** are available for veterinary use. The formulation uses gelatin with a mean molecular weight of 30,000 g and is a 5.6% suspension in NaCl. Compared with dextrans and hydroxyethyl starches, gelatins have a shorter plasma half-life but appear to have less effect on coagulation. Generally, gelatins have not been evaluated as completely as dextrans and hydroxyethyl starches and, on this basis, are not currently preferred.

### Practical Administration of Electrolyte Solutions

Under ideal conditions, with laboratory evaluation of the animal, the deficits can be accurately assessed and fluids containing the deficient electrolytes can be formulated. However, under most practice conditions this is not possible and **polyionic crystalloid solutions** are in general use. These usually contain sodium, potassium, chloride, and calcium or magnesium at a concentration similar to the electrolyte composition of extracellular fluid; the solutions may also contain lactate or acetate as bicarbonate precursors. Dextrose may be added to the solution to make an initial mildly hypertonic solution.

Polyionic crystalloid solutions are safe and can be used in large quantities without inducing electrolyte disturbances provided that circulating blood volume and renal function have been restored and

are maintained. They can be used for most situations of dehydration and moderate acidemia or alkalemia and moderate electrolyte imbalances. They are not usually adequate for the treatment of severe acidemia or alkalemia, or severe hyponatremia, hypokalemia, or hypochloremia.

For the treatment of severe acidemia or alkalemia, and severe hyponatremia, hypokalemia, and hypochloremia, specific electrolyte solutions are necessary. Generally, they consist of a mixture of the common simple solutions with supplemented electrolytes to correct some major abnormality. These are considered necessary to correct abnormalities quickly that could not be corrected using balanced electrolyte solutions. These solutions are summarized in [Tables 5-3 and 5-5](#). Many intravenous solutions for fluid therapy in calf diarrhea are available, and it is recommended that they should contain 150 mmol/L of sodium, 5 mmol/L of potassium, and about 50 mmol/L of a mixture of bicarbonate and precursors.

When acidemia is not present it is not necessary to use a fluid containing bicarbonate.

Mature cattle affected with metabolic alkalosis associated with diseases of the abomasum are usually hypokalemic, hypochloremic, and dehydrated. For such cases, a balanced electrolyte solution containing sodium, chloride, and potassium is satisfactory. A solution containing sodium (135–155 mEq/L), chloride (150–170 mEq/L), and potassium (10–20 mEq/L) is effective. In recently calved dairy cattle, calcium borogluconate is commonly added to the mixture.

Solutions containing potassium have been recommended for the treatment of the potassium depletion that occurs in calves with acute diarrhea and in inappetent ruminants and horses. However, in calves with severe acidemia and hyperkalemia, it is important to expand circulating blood volume, restore renal function, and correct the strong ion (metabolic) acidosis before providing additional potassium, which may be toxic. Solutions containing potassium may be indicated following correction of the acidosis and dehydration. However, if the animal's appetite is returned to normal, the oral potassium intake will usually correct any existing deficiencies.

In neonatal calves with dehydration caused by diarrhea, optimized decision trees for treatment have been developed based on clinical signs of hydration status and the presence of varying degrees of acidemia caused by metabolic acidosis (suckling strength, degree of enophthalmos, ability to stand, and presence or absence of palpebral reflex).<sup>3,29</sup> The decision tree is followed to determine the need for oral fluids or intravenous administration of isotonic solutions of sodium bicarbonate containing 250 mmol, 500 mmol, or 750 mmol of sodium bicarbonate, with supplemental glucose added when indicated<sup>30</sup> ([Fig. 5-17](#)).



**Table 5-5** Composition (mmol/L) and indications for use of electrolyte solutions used in fluid therapy

Solution	Na <sup>+</sup>	K <sup>+</sup>	Cl <sup>-</sup>	Mg <sup>2+</sup>	Ca <sup>2+</sup>	HCO <sub>3</sub> <sup>-</sup>	Lactate or acetate	Dextrose	Gluconate	Major indications
0.9% sodium chloride (isotonic saline)	155		155							Expansion of circulation blood volume
1.3% sodium bicarbonate (isotonic)	155					156				Metabolic acidosis
1.3% sodium bicarbonate in 5% dextrose	155					156		5%		Metabolic acidosis
5% sodium bicarbonate (hypertonic)	600					600				Severe metabolic acidosis
Equal mixture of isotonic saline and isotonic sodium bicarbonate	155		78			78				Metabolic acidosis and dehydration
Balanced electrolyte solution (i.e., McSherry's solution)	138	12	100	5	3		50 (acetate)			Metabolic acidosis electrolyte losses and dehydration
Lactated Ringer's solution	130	4	111		3		28 (lactate)			Metabolic acidosis
Normosol-R	140	5	98				27	23		Metabolic acidosis
Plasma-Lyte A	140	5	98				27	23		Metabolic acidosis
High sodium, alkalinizing solution, lactated Ringer's solution plus sodium bicarbonate (5 g/L)	190	4	111			60	27 (lactate)			Metabolic acidosis and hyponatremia
High-sodium, high-potassium, alkalinizing sodium, lactated Ringer's solution plus 1 g/L potassium chloride and 5 g/L sodium bicarbonate	190	18	125			60	27 (lactate)			Metabolic, acidosis, hyponatremia, hypokalemia
High-potassium acidifying solution, isotonic saline plus 2.5 g potassium, chloride per liter, mixture of 1 L isotonic potassium chloride (1.1%), 2 L isotonic saline (0.9%), and 1 L dextrose 9%	154	35	189							Metabolic alkalosis, hypochloremia, hypokalemia Metabolic alkalosis in cattle with abomasal disease

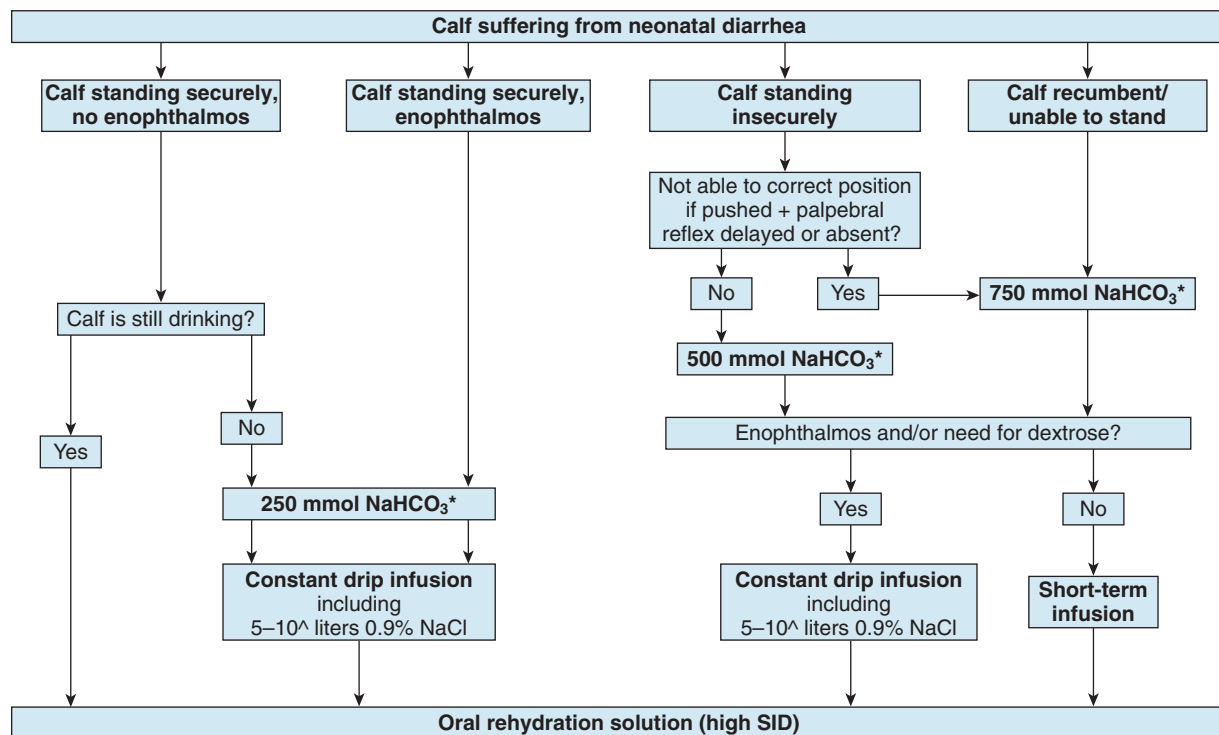

\* Represents the intended amount of sodium bicarbonate

^ An infusion volume of 10 liters is recommended for calves with estimated enophthalmos  $\geq 7$  mm.

**Fig. 5-17** Optimized decision tree for treating neonatal calves with diarrhea in a field setting. Examination of the ability to stand is evaluated by lifting recumbent animals. Enophthalmos reflects a visible gap of 3 to 4 mm between the corneal surface of the eye and the caruncula lacrimalis or normal position of the lower eyelid. (From Trefz FM et al. *BMC Vet Res* 2012;8:238.23).

For the treatment of hypochloremic hypokalemic metabolic alkalosis, acidifying solutions can be used but preferably only if constant laboratory evaluation of the animal is possible. Without laboratory evaluation, the use of Ringer's solution, 0.9% NaCl, or hypertonic saline for correction of strong ion (metabolic) alkalosis in adult cattle is recommended, along with the oral administration of potassium in animals that are inappetent. In experimentally induced hypochloremic hypokalemic metabolic alkalosis in 40 to 50 kg BW sheep, replacement of the chloride deficit using 2 L of hypertonic saline (1.8% sodium chloride) was effective in returning plasma sodium and chloride concentrations to normal within 12 hours, and the plasma potassium concentrations and acid-base balance returned to normal within 36 hours of treatment without providing potassium. Small volumes of hypertonic saline are also effective for the treatment of experimentally induced hypochloremic hypokalemic metabolic alkalosis in sheep.

In summary, five different kinds of solutions are used in large-animal practice:

- **Polyionic crystalloid solutions**, such as lactated Ringer's solution and acetated Ringer's solution, are indicated for dehydration and moderate degrees of acid-base and electrolyte imbalance.
- **Hypertonic saline solution and an oral water load** represent a practical and inexpensive alternative to parenteral administration of large fluid volumes.
- **Hypertonic or isotonic sodium bicarbonates**, such as 8.4, 5.0 (hypertonic), or 1.3% (isotonic) solutions of sodium bicarbonate, are used for severe strong ion (metabolic) acidosis and hyponatremia, particularly in dehydrated depressed calves with diarrhea.
- **Chloride-containing acidifying solutions**, such as Ringer's solution, are used for treatment of strong ion (metabolic) alkalosis.
- **Colloid solutions**, such as plasma or blood, are administered more frequently than Dextran 70 or hydroxyethyl starch solutions.

Because cost is a major consideration in large-animal fluid therapy, it may not be possible to use sterile solutions. Most of the previously mentioned solutions can be formulated using the necessary salts mixed with distilled water, boiled water, or ordinary tap water and are therefore prepared inexpensively.

### Quantity of Fluids Required and Routes of Administration

The amount of fluid required depends on the degree of dehydration (an estimate of the volume losses that have already occurred); the continuous losses that occur during treatment; and the maintenance requirements of the animal during treatment presuming its

dietary intake of water, electrolytes, and nutrients is minimal. The fluids are usually given in two stages:

- **Hydration therapy** in the first 4 to 6 hours at a rate of 100 to 150 mL/kg BW intravenously.
- **Maintenance therapy** (a combination of **continuous losses** and **maintenance requirements**) in the next 20 to 24 hours, depending on the severity and the course of the disease, at 60 to 80 mL/kg BW per 24 hours intravenously (approximately 3–4 mL/kg BW per hour). In some cases of profuse diarrhea, the continuous losses and maintenance requirements will be about 150 mL/kg BW over a 24-hour period. The daily maintenance water requirements of adult horses range from 54 to 83 mL/kg BW, with a mean of 64 mL/kg BW.

Some examples of the large quantities of fluid required for hydration and maintenance therapy in cases of acute diarrhea are outlined in Table 5-6.

### Parenteral Fluid Therapy

The total amount of the estimated necessary hydration therapy should be given intravenously using indwelling intravenous catheters in the first 4 to 6 hours to expand and maintain circulating blood volume. If acidemia or alkalemia is present, it also should be treated immediately. Thus the most important abnormalities—decreased circulating blood volume and acid-base imbalance—are treated first. Restoring circulating blood volume will restore renal function, which will assist in correcting acid-base and electrolyte balance. The immediate correction of acidemia will return the tissues to their normal physiologic activity. The intravenous route is preferred for hydration therapy and for the correction of severe acid-base and electrolyte imbalances. All other routes (intraperitoneal, subcutaneous, and oral) are unsatisfactory in the presence of decreased circulating blood volume.

During the intravenous administration, the animal must be monitored for clinical and laboratory evidence of improvement or deleterious effects. A **favorable response** is

indicated by urination within 30 to 60 minutes, an improvement in mental attitude, and some evidence of hydration. **Unfavorable responses** include **dyspnea** because of preexisting pneumonia or pulmonary edema because of too rapid administration, **failure to urinate** because of renal failure or paralysis of the bladder, and **tetany** because of the excessive administration of alkali. Unusual responses such as sweating, trembling, and depression within several hours following the intravenous administration of electrolytes or other substances such as commercial amino acids may occur if the infusion is contaminated during administration. If a laboratory is available, the determination of PCV, bicarbonate, and blood pH will provide an excellent monitoring system during the administration of the fluids.

### Rate of Administration

The rate of administration will depend on the size of the animal, the severity of the illness, the type of fluids administered, and the response of the animal to the fluids. In calves, isotonic saline (0.9% NaCl) and sodium bicarbonate solutions can be given at the rate of 1 to 3 L/h; in a mature horse, fluids may be given at the rate of 10 to 12 L/h. Hypertonic solutions such as 5% sodium bicarbonate can be given to a mature horse at the rate of 3 to 5 L/h, followed by balanced electrolytes at 10 to 12 L/h. Solutions containing added potassium should be given cautiously, at the rate of 3 to 5 L/h. In a cow with severe dehydration and acidosis caused by carbohydrate engorgement, fluids may be given at the rate of 10 to 12 L/h.

**Adverse reactions** to intravenous fluid administration include **sudden muscle weakness** (suggests hypokalemia) and **sudden tachycardia and hyperventilation**, which suggest **overhydration**. When these occur the fluids should be stopped and the clinical findings assessed. If laboratory assistance is available, the determination of blood pH and bicarbonate may provide an explanation for the reaction.

Special care is needed when administering intravenous fluids to **hypothermic** animals because intravenous fluid therapy has the potential to further decrease core

**Table 5-6** Examples of approximate amounts of fluid required for rehydration and maintenance therapy

Animal	Degree of dehydration (% BW)	FLUID REQUIRED FOR	
		Rehydration (L)	Maintenance (L/24 hours)
Mature horse (500 kg)	8	40	25–50
	12	60	25–50
Newborn calf (50 kg)	8	4	2.5–5
	12	6	2.5–5
Mature cow (700 kg)	8	56	35–70
	12	84	35–70

body temperature. Cooling is inevitable during intravenous fluid therapy whenever animals are housed at temperatures below their core body temperature. It is important to note that fluids initially warmed to 37°C are cooled after going through the fluid administration set. Placing commercially available heaters around the fluid administration line as close as possible to the catheter insertion site is effective in warming intravenous fluids to >36°C at flow rates between 60 and 300 mL/h.<sup>31</sup> When treating hypothermic neonates, many veterinarians place the distal part of the fluid administration set in a bucket of hot water to ensure that the fluid is as warm as possible when administered. The efficacy of this heating approach has not been evaluated, and because of the distance between the bucket and catheter insertion site, it is likely that this approach will not be as effective as use of commercially available heaters around the fluid line.

### Intravenous Catheters and Complications

The administration of large quantities of fluids intravenously to farm animals is best done with an indwelling **jugular vein** flexible catheter (10–14 gauge) that is appropriately secured to the animal's neck to prevent withdrawal from the vein (Fig. 5-18). Standard aseptic technique must be used. A plastic, springlike coiled tube and suitable rubber tubing are used to deliver the fluids from large 20- to 25-L plastic containers (Fig. 5-19). The coiled plastic tubing allows the animal to lie down or stand up without disrupting the catheter and tubing. The use of a drip chamber in the rubber tubing system assists in determining the flow rate, which can be adjusted with a clamp. With a 14-gauge catheter, 20 L of fluids can be delivered as hydration therapy to a mature horse or cow over 4 hours.

#### *Auricular Vein of Cattle and Calves*

Intravenous fluids are commonly administered to adult cattle and calves in northern Europe using the auricular vein. The short neck, thick skin, and, in some breeds, pendulous dewlap of cattle make it difficult to introduce and secure indwelling jugular catheters for long-term use. The auricular vein of adult cattle can be successfully catheterized with an over-the-needle, 5-cm long, 14-gauge catheter, permitting 20 L of rehydration solution to be delivered over 4 hours. The auricular vein of neonatal calves can be successfully catheterized with an over-the-needle, 2.5-cm long, 22-gauge butterfly catheter, after clipping the external pinna and applying a tourniquet at the base of the ear to facilitate visualization of blood vessels and catheter advancement (Fig. 5-20).

#### *Cecal Catheters in Horses*

Percutaneous cecal catheters have been used to deliver fluid solutions in ponies. The

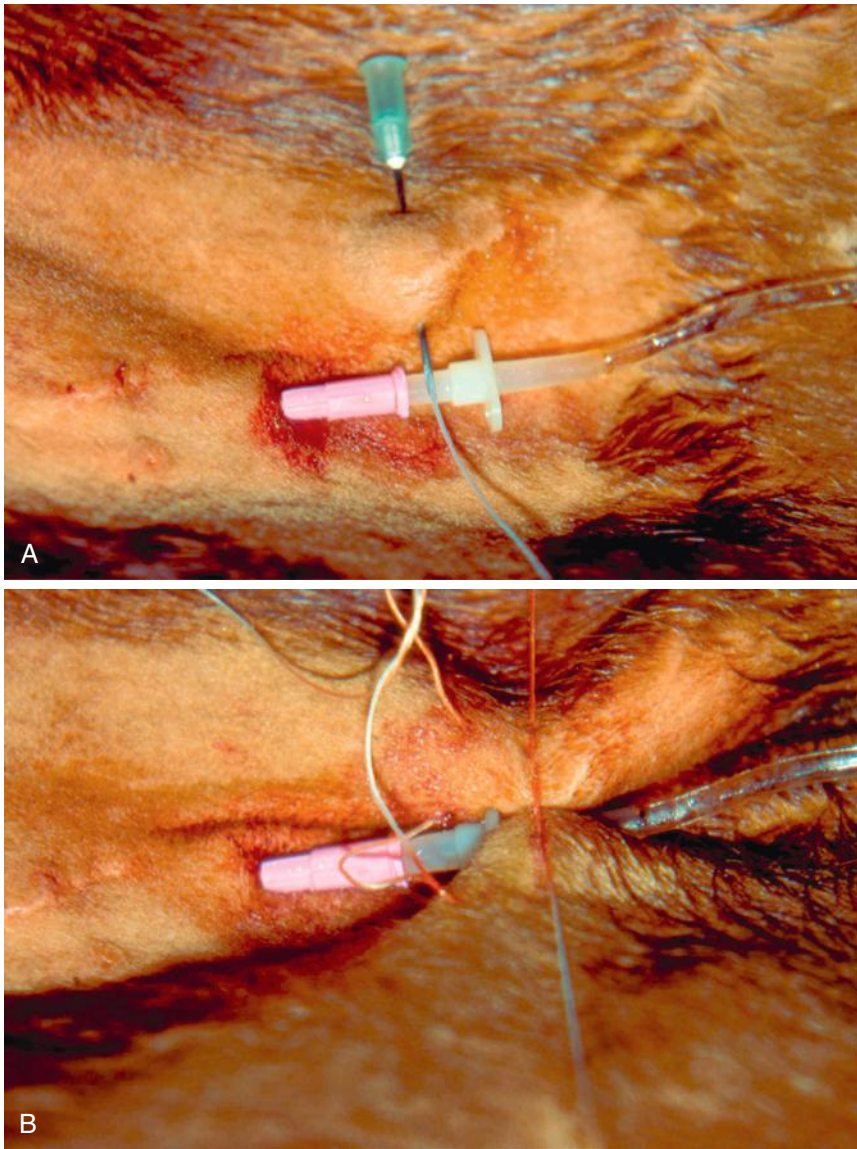

**Fig. 5-18** Securing a 14-gauge 14-cm catheter into the jugular vein of a cow. The site of venipuncture is clipped and scrubbed for aseptic placement of a catheter. A 1-mL bleb of 2% lidocaine is placed intradermally at the proposed site of catheter insertion and a 5-mm long stab incision made through the skin, including the dermis. **A**, The catheter is then placed into the lumen of the vein and carefully advanced until the hub of the catheter is level with the skin. The catheter is secured by placing sutures through the skin using an 18-gauge needle and a synthetic multifilament suture material. The suture does a loop around the extension tubing near where it attaches to the hub of the catheter so that the catheter cannot back out. **B**, The 18-gauge needle is then passed through the ventral skin fold adjacent to the catheter, and the suture tightened to create a tunnel.

advantages include less cost, but complications include peritonitis, diarrhea, laminitis, and hypocalcemia.

#### *Thrombophlebitis*

Long-term jugular vein catheterization (over a period of a few days) in adult cattle and particularly horses can result in thrombophlebitis, suppurative phlebitis, and catheter sepsis. Inspection of the affected jugular vein reveals swelling, firmness, and moderate pain. Careful digital and visual inspection is

necessary to determine the patency of the vein; in about 50% of cases the vein is completely thrombosed and occluded and cannot be used for intravenous administration for 2 to 3 weeks. The extent and severity of the thrombophlebitis can be determined by ultrasonography of the neck, and patency of the vein can be assessed by compressing the vein with the transducer head.

The development of thrombophlebitis is dependent on the method used for skin preparation and the catheterization



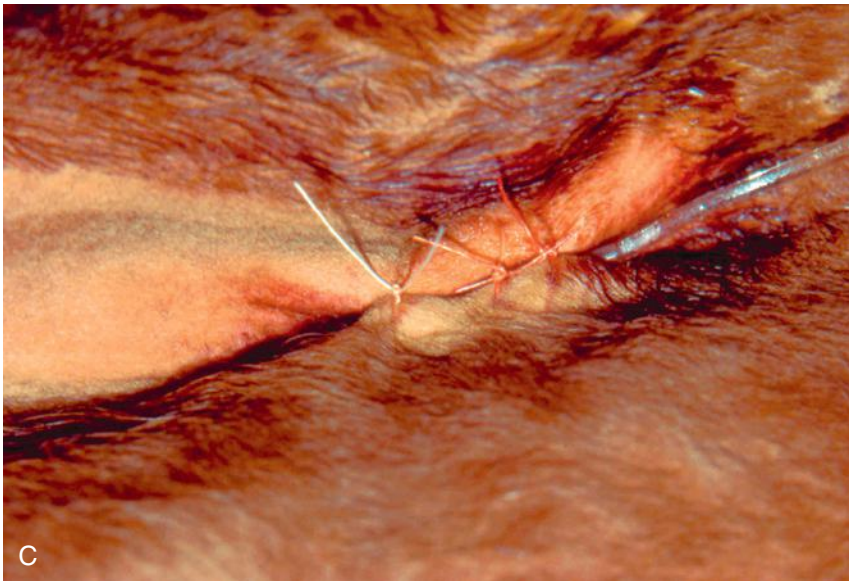

**Fig. 5-18, cont'd C**, Additional sutures are placed through the upper and lower skin folds to lengthen the tunnel and prevent excessive movement at the junction of the catheter with the hub.



**Fig. 5-19** Administering large-volume isotonic crystalloid solutions to Holstein-Friesian cows by the jugular vein (A) and auricular vein (B).

technique. Careful preparation of the skin and aseptic technique during insertion and placement of the catheter are crucial in preventing this complication. Heparin subcutaneously, 150 IU/kg BW immediately after insertion of the catheter and repeated every 12 hours, has been used prophylactically, but this is not deemed necessary with good technique. Alternating catheters between jugular veins every 48 to 72 hours is standard practice in equine fluid therapy, but despite this precaution complications occur in 20% to 50% of horses whose jugular veins are catheterized for 48 hours. By using catheters made of materials that are less thrombogenic, inserting them in an aseptic manner, and observing simple management practices, the duration of catheter survival increases to about 14 days. The least reactive catheter is Silastic followed by polyurethane; polytetrafluoroethylene causes the most reaction. Catheters that are soft are superior to stiff and rigid ones.

Intravenous fluids for large animals are often stored in a carboy (a Persian and Arabic term meaning *big jug*), which is used to describe a rigid container that can hold 20 to 40 L of fluids. A retrospective study of the risk factors associated with vein thrombosis in horses treated with intravenous fluids in a veterinary teaching hospital found that the use of carboy fluids and diarrhea and fever were related; the incidence was lower in horses that had general anesthesia, surgery, and received antimicrobial agents. A variety of aerobic bacteria were cultured from about 50% of the intravenous catheters removed from horses. Bacteria were isolated from 7% of skin swabs taken from the area around the catheter after surgical preparation with iodine soap and before and after removal of the catheter. However, there was no correlation between bacterial culture and venous thrombophlebitis.

### Oral Fluid Therapy

Whenever possible, the oral route can be used to deliver the maintenance requirements. Provided there are no abnormalities of the digestive tract that interfere with oral administration or the absorption of the fluids, the oral route is preferred for maintenance therapy. In ruminants such as adult cattle rumen function must be present for significant absorption of fluids and electrolytes. The oral administration of large quantities of fluid to cattle with rumen atony results in sequestration of the fluid in the rumen and the development of metabolic hypochloremic hypokalemic alkalosis.

### Oral Fluid Therapy in Calves and Adult Cattle

A variety of oral electrolyte replacement solutions are available commercially. Most preparations are in the form of powders to be mixed with water or directly with milk. The formulations vary in their composition



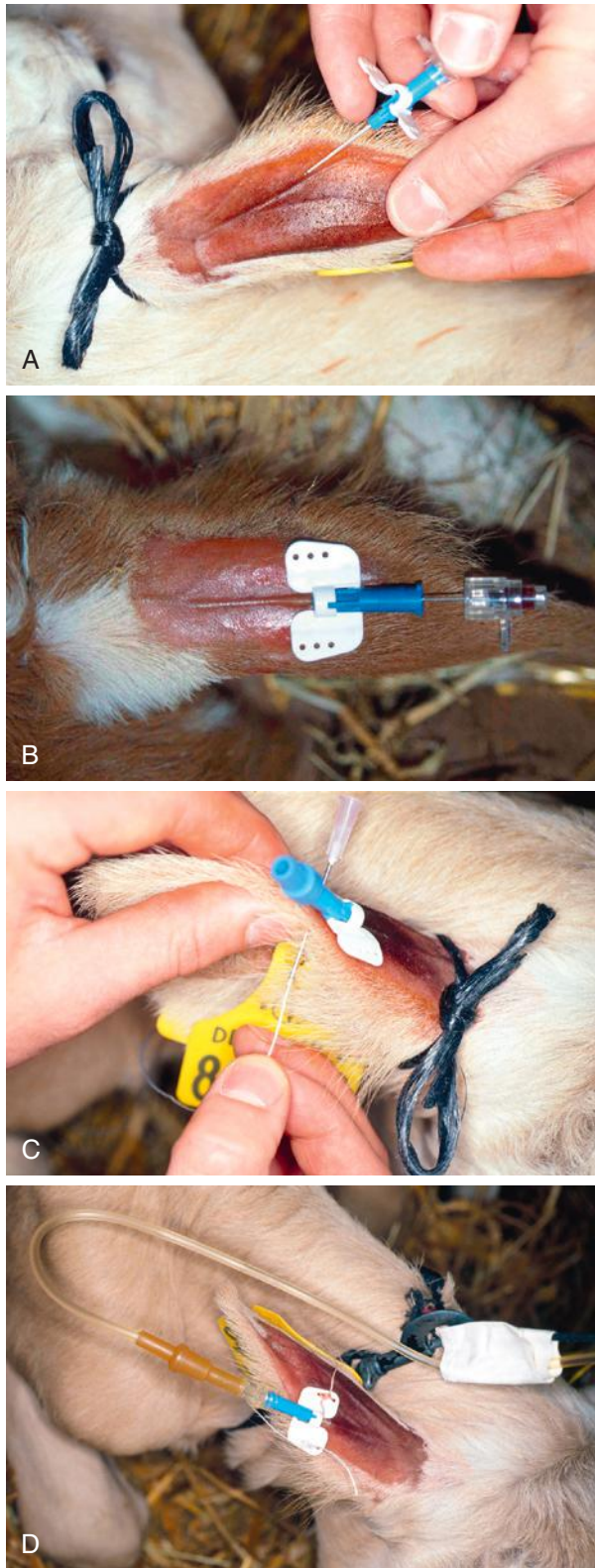

**Fig. 5-20** Placement of a 22-gauge 2.5-cm over the stylet butterfly catheter into the auricular vein of a calf. The ear is clipped and scrubbed for aseptic placement of a catheter, and a tourniquet is placed at the base of the ear to facilitate visualization of the auricular veins (A). The catheter is then placed into the lumen of the vein and carefully advanced (B). The tourniquet is removed and the catheter is secured to pinna by placing a 20-gauge needle through the pinna and butterfly section and tying, taking care not to distort the ear (C). Intravenous fluids are then attached and the ear bandaged, taking care not to bandage below the end of the catheter (D). (Pictures generously provided by Dr. Joachim Berchtold, Germany.)

but typically contain sodium, chloride, potassium, glucose, glycine, and bicarbonate or its precursors (acetate, propionate, or citrate). Some formulations contain other agents such as lecithin-coated pectin fiber that is reported to decrease the proliferation of *E. coli* and *Salmonella* spp., or other agents that facilitate normalization of the enteric bacterial population. Knowledge of the requirements for the ideal oral electrolyte solution for diarrheic calves continues to evolve. However, much progress has been made over the last 30 years, and the critical issues in formulating the ideal oral electrolyte solution are osmolality, sodium concentration, source of the alkalinizing agent, and the energy content (which is intimately tied to osmolality). It remains to be determined whether oral electrolyte solutions should contain agents such as glutamine that may facilitate repair of damaged intestinal epithelium. This issue is being actively researched at the moment and a clear consensus has not yet been reached.

Oral electrolyte solutions should be routinely administered to all neonatal calves <21 days of age at the first signs of diarrhea because it cannot be accurately predicted how quickly the calf will become dehydrated. Calves with a 4-mm or greater recession of the eye or calves that are unable to stand should receive intravenous fluids (small-volume hypertonic saline, small-volume sodium bicarbonate, or conventional large-volume isotonic crystalloid solution) in addition to an oral electrolyte solution. The initial treatment of a dehydrated calf should use an oral electrolyte solution that is not added to milk replacer because this provides superior plasma volume expansion.<sup>32</sup> The **osmolality** of the oral electrolyte solution should range from isotonic (300 mosm/kg) to hypertonic (700 mOsm/kg). The effective osmolality at the tip of the intestinal villus is approximately 600 mOsm/kg because of the presence of a countercurrent exchange mechanism. Although markedly hypertonic fluids should be avoided in animals with severe villous damage, it is currently not possible to predict which calves have severe villous damage on the basis of the physical examination findings and measurement of fecal pH or other body parameter. Low osmolality fluids (300 mosm/kg) have inadequate energy content because they have insufficient glucose. For this reason, if milk is withheld, then hypertonic oral electrolyte solutions (~600 mosm/kg) should be administered.<sup>33,34</sup> If milk is fed, then isotonic oral electrolyte solutions (300 mosm/kg) should be administered because inadequate energy content is no longer an issue.<sup>34,35</sup> Ideally fresh milk should be fed to diarrheic calves after 24 hours of treatment; fresh cow's milk is preferred to milk replacer or pasteurized waste milk because fresh milk contains trophic factors that facilitate repair of damaged intestinal

epithelium, and the energy content of milk is required to maintain BW. Generally, milk should not be withheld from diarrheic calves for more than 24 hours.<sup>37</sup>

The **sodium concentration** or the oral electrolyte solution should be between 90 and 130 mmol/L. Adequate sodium absorption is the fundamental determinant of successful expansion of the extracellular space, and is the main reason that oral electrolyte solutions are administered (the sodium concentration of milk is very low with an average value of 28 mmol/L). Sodium concentrations <90 mmol/L provide an inadequate sodium load, whereas sodium concentrations >130 mmol/L can lead to hypernatremia and additional free water loss.

The oral electrolyte solution should also contain **glucose** and either **acetate**, **propionate**, or **glycine** to facilitate sodium absorption and provide energy. There are cotransport mechanisms for sodium and glucose, sodium and volatile fatty acids such as acetate and propionate, sodium and citrate, and sodium and amino acids (such as glycine) in the luminal membrane of villous epithelial cells. Administration of glucose, acetate, propionate, glycine, or citrate therefore facilitates sodium absorption. These transport mechanisms are unimpaired in enterotoxigenic *E. coli* and are at least partially functional in malabsorptive/maldigestive diarrheas. A recent study in healthy normally hydrated neonatal calves raised questions about the relative importance of glucose-coupled sodium transport in rehydrating diarrheic calves with diarrhea, and suggested that the ratio of glucose to sodium (which is thought to range between 1.0 and 3.0 with an optimum ratio of 1.4 based on human infant oral rehydration solutions) may not be an important component of treatment efficacy in neonatal calves.<sup>38</sup> The choice of glycine in oral electrolyte solutions as an amino acid coupled sodium transport was based primarily on its low cost and wide availability, and because glycine was included in early human infant oral rehydration solutions.

The oral electrolyte solution must contain an **alkalinizing agent**, such as acetate, propionate, or bicarbonate, at a concentration range of 40 to 80 mM/L.<sup>39-41</sup> Acetate-containing fluids are as effective as bicarbonate-containing solutions at correcting mild to moderate acidosis:  $[\text{acetate} = \text{CH}_3\text{COO}^-] + \text{H}^+ + 2\text{O}_2 \leftrightarrow 2\text{CO}_2 + 2\text{H}_2\text{O}$ . Acetate must be metabolized to be effective, and metabolism may be impaired in severely dehydrated or acidemic animals, although this has not been proven in severely dehydrated calves. Acetate- or propionate-containing fluids can be fed with milk as acetate and propionate do not raise abomasal pH or inhibit milk clotting. In comparison, bicarbonate containing oral electrolyte solutions, when fed without milk, excessively alkalinize the abomasum and proximal small intestine, decreasing the effectiveness of the

“abomasal sterilizer” in killing ingested enteric pathogens, and potentially promoting enterotoxigenic *E. coli* attachment to epithelial cells and STa enterotoxin production. Moreover, bicarbonate does not inhibit growth of *Salmonella* in the intestinal lumen, whereas acetate and propionate both inhibit *Salmonella* growth. However, it is important to note that bicarbonate-containing oral electrolyte fluids are theoretically more effective at rapidly correcting severe acidemia than acetate and propionate, because bicarbonate reacts directly with  $\text{H}^+$  ions ( $\text{HCO}_3^- + \text{H}^+ \leftrightarrow \text{H}_2\text{CO}_3 \leftrightarrow \text{H}_2\text{O} + \text{CO}_2$ ). The main disadvantage of bicarbonate-containing oral fluids is that the pH of the abomasum (a natural defense mechanism) is increased, raising concerns that bicarbonate may decrease the ability to form a clot in the abomasum. This theoretical disadvantage regarding bicarbonate does not appear to be true, at least when low concentration bicarbonate solutions (25 mmol/L) are fed.<sup>37</sup>

The alkalinizing potential of an oral electrolyte solution can be estimated by calculating the **effective SID** of the formulation as fed. Because electroneutrality must be preserved at all times, the difference between the charge assigned to all strong cations in an oral electrolyte solution (usually only sodium and potassium) and strong anions in an oral electrolyte solution (usually only chloride) is called the effective SID and reflects the concentration of metabolizable strong anions, such as acetate, propionate, and citrate, as well as the concentration of bicarbonate.<sup>39</sup> Oral electrolyte solutions should have an effective SID of approximately 40 to 80 mmol/L. Electrolyte solutions with an effective SID = 0 are acidifying because they create a systemic strong ion acidosis; such solutions are not recommended for the treatment of dehydrated calves with diarrhea.

The **rate of abomasal emptying** influences the rate at which an oral electrolyte solution is delivered to the small intestine, which is the major site of fluid absorption. The rate of abomasal emptying is therefore an important determinant of the rate of rehydration in a dehydrated calf with diarrhea. The volume and caloric content of an ingested fluid meal are the most important determinants of abomasal emptying rate.<sup>40</sup> Other important determinants of emptying rate are the type of protein or fat, osmolality, and duodenal pH, with a solution osmolality of 600 mosm/kg or a luminal pH of <2.0 or >10.0 decreasing the abomasal emptying rate in suckling calves.<sup>40</sup> Studies in healthy calves suggest that oral electrolyte solutions that provide >2.4 g of glucose per kilogram BW may lead to a slower rate of rehydration as a result of a slower delivery of free water, sodium, and glucose to the small intestine, although it has been difficult to detect clinically important differences in the rate of resuscitation when oral electrolyte solutions

are fed to calves with naturally acquired diarrhea.

For diarrheic calves, the total 24-hour maintenance requirement is calculated and given orally in divided doses, ideally three times a day. Compared with parenteral therapy, there is less danger from overhydration and electrolyte toxicity, and in acute diarrhea the maintenance of oral fluid and electrolyte intakes will replace continuous losses that occur during the diarrhea. Live-stock owners should be informed of the value of providing newborn animals affected with diarrhea associated with dehydration, depression, inactivity, or failure to suck with oral fluids and electrolytes as soon as possible and of the value of continuing this treatment until the animal has returned to normal. Oral electrolyte solutions and water should be made available at all times to animals affected with diarrhea and other diseases in which there is continuous loss of fluid and electrolytes.

The **continued feeding of milk to diarrheic calves** while they are receiving oral fluids and electrolytes has been controversial. In the past, it was conventional to withhold milk from diarrheic calves for 1 to 2 days and then gradually reintroduce milk over the next few days when there is evidence of recovery. An extreme practice was to totally deprive the calf of milk until the diarrhea ceased. The rationale for this practice was that the ability of the calf's intestine to digest milk was impaired, particularly lactose digestion in the rotavirus and coronavirus diarrheas of young calves. It was also thought that the presence of milk in the intestine would provide a substrate for continued growth of enteric pathogens. Recent studies in calves with naturally acquired and experimentally induced diarrhea have demonstrated the benefit of feeding milk to diarrheic calves receiving oral electrolyte solutions<sup>35</sup>; such practice results in more rapid recovery from diarrhea (fewer days of diarrhea), less debilitation, continued weight gain, greater fat stores, faster rate of regeneration of the intestinal mucosa, and less thymic atrophy than calves deprived of milk. Adding the oral electrolyte solution to the milk of calves with diarrhea is effective and practical; this treatment approach requires that water be readily available to treated calves at all times.<sup>36</sup>

In adult ruminants, both water and sodium must be absorbed to produce sustained expansion of the extracellular fluid space. Acetic, propionic, and butyric acids are absorbed rapidly from the forestomach in their nonionized form but are absorbed more slowly in conjunction with a sodium ion in their ionized form. Cattle produce up to 180 L of saliva per day with a sodium concentration of 126 mEq/L, and approximately half of the sodium secreted with saliva is reabsorbed by the forestomach primarily through active transport mechanisms. Based on this physiology, orally administered



sodium is well absorbed in adult ruminants, and sodium absorption is accompanied by the passive movement of water from the rumen into the extracellular space.

Oral sodium bicarbonate administration can be an important part of treating adult ruminants with grain overload. The oral administration of sodium bicarbonate to adult ruminants (2.5 g/kg BW) causes a profound metabolic alkalosis (strong ion alkalosis). Drenching of dairy cows with 700 mL of 40% sodium bicarbonate solution or 46% sodium propionate solution (both markedly hyperosmotic) increases blood pH to an equivalent degree. Oral administration of sodium salts with a high effective SID therefore causes a metabolic alkalosis (strong ion alkalosis) in adult ruminants, as they do in neonatal ruminants.

The vast ruminal capacity for sodium and water absorption can be used by administering hypotonic oral electrolyte solutions to dehydrated adult ruminants. The optimal formulation of an oral electrolyte solution for adult ruminants is unknown, but such a solution should contain sodium, potassium, calcium, magnesium, phosphate, and propionate to facilitate sodium absorption and provide an additional source of energy to the animal. Provided that the osmolality of the rumen contents remains hypotonic to plasma, there will be a slow but sustained absorption of electrolytes and water in an oral electrolyte solution because of the reservoir function of the rumen. An isotonic fluid containing 6.17 g of NaCl, 0.34 g of KCl, and 2.89 g of NaHCO<sub>3</sub> (providing 140 mmol/L of sodium, 4.5 mmol/L of potassium, and 110 mmol/L of chloride) was effective in treating dehydrated goats when administered by nasoruminal intubation.<sup>42</sup> Another recommended formulation for adult ruminants, particularly those with **hypochloremic hypokalemia metabolic alkalosis**, contains 7 g of NaCl, 1.5 g of KCl, and 1 g of CaCl<sub>2</sub> (providing 120 mmol/L of sodium, 20 mmol/L of potassium, 9 mmol/L of calcium, and 158 mmol/L of chloride).<sup>44</sup> Formulation of a practical, effective, inexpensive, and commercially available oral electrolyte solution for adult ruminants remains an important need in fluid and electrolyte therapy.

### Oral Fluid Therapy in Horses

Intravenous fluid and electrolyte therapy has been used extensively for the treatment of dehydration and electrolyte disturbances in the horse with diarrhea. However, oral fluid therapy, as used in calves and adult cattle, has not been used to the same extent. Oral fluid therapy offers may be an effective, practical, and economical method of rehydration of horses with diarrhea that has not yet been fully explored.

In the horse with acute diarrhea, several factors contribute to the nature of the fluid and electrolyte losses. There are increases in

fecal sodium and water loss, but the fecal potassium excretion may remain unchanged. The lack of feed intake, which affects primarily the potassium intake, can result in losses of 2500 to 3000 mmol of potassium per day. Although urinary water and potassium losses are reduced, potassium depletion continues; thus potassium losses are very high and need to be replaced, especially in the anorexic horse. The large potassium deficit in diarrheic horses should also be considered when formulating the composition of oral fluids. Administration of 30 to 40 g of potassium chloride or, if chloride administration is inappropriate, 30 to 40 g of potassium bicarbonate in 2 to 4 L of water given by nasogastric tube several times daily to an inappetent horse with diarrhea, can complement intravenous fluid therapy and replace the potassium deficit.

The optimum electrolyte composition of oral fluids and the amount to be used have not yet been determined for the horse. The amount given depends on the degree of dehydration. Dehydration in horses becomes clinically apparent when about 5% of BW has been lost. In a 500-kg horse, assuming 90% water loss, the fluid deficit is about 23 L. Abdominal discomfort may occur following the nasogastric tube administration of a series of 8- to 10-L doses of oral rehydration fluid. The administration of large amounts may result in rapid transit through the stomach and intestines and decreased absorption. A slower rate of administration, such as 8 to 10 L every few hours, may be tolerated more effectively and the transit time in the intestine may be decreased, enhancing absorption. Volumes of 6 to 8 L can be given by nasogastric tube as often as every 15 to 20 minutes by funnel; as much as 20 to 30 L is possible during the first hour and 40 L is possible during a 2-hour period. Oral fluids may also be administered through a small-diameter indwelling nasogastric tube, as is used for prolonged enteral nutrition of horses with dysphagia.

Commercially available **oral electrolyte solutions** are inadequate for horses because the concentrations of sodium and potassium are too low to adequately replace losses. When treating horses with acute diarrhea, the ratio of sodium to chloride ions in the oral solution should be approximately 1.4:1, and the need for glucose in an oral rehydration solution for adult horses has not been clearly demonstrated. One formulation contained 5.27 g of NaCl, 0.37 g of KCl, and 3.78 g NaHCO<sub>3</sub> per liter of tap water; this produced a suitable electrolyte composition for oral administration (Na 135 mmol/L, K 5 mmol/L, Cl 95 mmol/L, and HCO<sub>3</sub> 45 mmol/L).

Oral administration of bicarbonate will result in a pronounced alkalemia within 3 to 6 hours, with the maximum change in pH occurring at a sodium bicarbonate dose of 1 g/kg BW (which represents 40% of normal

extracellular sodium). Doses above this level do not induce additional alkalization, presumably because of limited absorption of bicarbonate from the intestinal tract. The oral administration of sodium bicarbonate to normal mature resting horses without ad libitum access to water induces metabolic alkalosis, hypernatremia, hypokalemia, and hyperosmolality for at least 8 hours. The oral doses were 0.25, 1, and 1.5 g/kg BW in 3 L of water; the intravenous dose was 0.25 g/kg BW in 3 L of water. The effects were dose dependent: in the horses given the 1 and 1.5 g/kg BW oral doses the hypercapnia persisted for 12 hours, whereas hypercapnia lasted 2 hours in horses given the 0.25 g/kg BW dose orally or intravenously. The effects of these large doses of sodium bicarbonate on the renal function of horses indicated increases in urine flow, fractional clearance of electrolytes and bicarbonate, electrolyte-free water reabsorption, urine concentrations of sodium and bicarbonate, urine excretion, clearance of sodium and bicarbonate, urine pH, and AG.

The temperature or glucose concentration of the fluid does not appear to be important because the rate of fluid absorption was similar in dehydrated horses administered an oral rehydration solution at 5°C, 21°C, or 37°C or containing glucose at 0%, 2.5%, or 3.5%. The tonicity of the oral rehydration solution is of minor clinical importance; however, oral administration of hypertonic solutions (628 mOsm/kg BW) to dehydrated horses caused a transient increase in plasma protein concentration that was attributed to movement of water into the bowel lumen. **Continuous flow administration** of a hypotonic solution at 15 (mL/kg)/h through a **small-diameter nasoesophageal tube** is effective in increasing plasma glucose concentration in healthy adult horses, with maltodextrin (15 g/L) providing a greater glycemic response to that provided by glucose (15 g/L). This treatment protocol appears to provide a useful low-cost method for treating horses that are slightly dehydrated and hypoglycemic, but safety studies using a larger number of horses are required.<sup>43</sup> A practical limitation of oral rehydration solutions in horses is that they should be ingested voluntarily rather than by nasogastric intubation. This limitation has led to recent interest in the oral administration of pastes.

The oral administration of an **electrolyte paste** has been shown to be effective in correcting mild to moderate dehydration in horses, provided animals are monitored to ensure that they drink water. Oral electrolyte pastes may be formulated as follows: 30 g of 1:1 mixture of sodium chloride and potassium chloride, potassium chloride and sodium bicarbonate, or potassium chloride and potassium carbonate, and administered every 6 hours; 120 g of the latter mixture provides 1400 mmol or more of potassium

in a 24-hour period. Administration of higher doses of oral pastes (0.5 g of NaCl/kg BW, 0.5 g of KCl/kg BW, or a mixture of 0.25 g of NaCl/kg BW and 0.25 g of KCl/kg BW) to dehydrated horses induced a transient period of hyperhydration and apparent plasma volume expansion that lasted 12 hours. Although the absorbed electrolytes from an oral paste are subsequently eliminated via the urine, this treatment is potentially of benefit in horses with disease processes associated with ongoing fluid loss, such as diarrhea.

There is no published information on the use of oral fluid therapy in horses that are diarrheic as a result of disease of the small intestine such as enteritis or proximal enteritis (duodenitis). It would seem unlikely that oral fluid therapy would be indicated or effective for anterior duodenitis. In horses with colitis, the small intestinal absorptive capacity is probably intact and oral fluid therapy before transport of the horse to a clinical center for intensive fluid therapy may delay the onset of more serious complications. Horses with mild dehydration can be rehydrated effectively with oral fluid therapy. Horses treated with oral fluid therapy must be monitored clinically, and the hematocrit, total plasma protein concentration, and serum electrolytes should be measured.

Oral fluid therapy provides an effective and inexpensive treatment in horses with impaction of the large colon and dorsal displacement of the colon. An absolute requirement for oral fluid therapy in the horse is that there is no gastric reflux. Generally, although 6 to 8 L of water can be administered by nasogastric tube and funnel (gravity flow) every 15 to 20 minutes, and the administered fluid is rapidly transported to the large intestine, some horses do not tolerate oral fluid administration at 10 L/h and exhibit mild signs of abdominal discomfort. Accordingly, oral fluid rates are more commonly administered at 8 to 10 L every 2 hours using a nasogastric tube and a funnel.<sup>45</sup> Volumes exceeding 10 L should be administered over at least 15 minutes,<sup>46</sup> even though 90% of 10 L of an electrolyte solution is emptied from the stomach within 15 minutes.

It is generally recommended that the osmolality of the fluids should be isotonic, ranging from 280 to 360 mOsm/L; the upper range of tonicity that is safe to administer is unknown. Plain water has been administered at 50 to 150 mL/kg BW over 24 hours in four treatments to horses with experimentally induced dehydration. The administration of water was safe and effective in hydrating the large intestinal luminal contents.<sup>46</sup> One isotonic formulation that was successful in a case series involving 108 horses contained 6 g of sodium chloride and 3 g of potassium chloride per liter of tap water, equivalent to the following electrolyte concentration: 103 mEq/L of Na, 40 mEq/L of K, and 143 mEq/L of Cl.<sup>45</sup> Potassium is an important

component of the isotonic formulation in horses with impaction of the large colon or dorsal displacement of the colon. Oral administration of 60 L of lactated Ringer's solution or an isotonic solution over 12 hours was superior in hydrating the contents of the right dorsal colon compared with intravenous administration of an equivalent volume of lactated Ringer's solution or enteral administration of 1g/kg BW of MgSO<sub>4</sub>·7H<sub>2</sub>O (Epsom salts) or anhydrous Na<sub>2</sub>SO<sub>4</sub> as a 1-L solution. Moreover, enteral administration of Epsom salts has been associated with hypermagnesemia, and anhydrous Na<sub>2</sub>SO<sub>4</sub> has been associated with hypocalcemia.

### Fluid and Electrolyte Therapy in Newborn Piglets and Lambs

The most common cause of fluid and electrolyte imbalance in newborn piglets and lambs is acute neonatal diarrhea. There is severe dehydration, acidemia, hyponatremia and, in some cases, hyperkalemia caused by the acidosis. Balanced electrolyte solutions or isotonic saline and sodium bicarbonate initially followed by balanced electrolytes are indicated and successful. These are given subcutaneously or intraperitoneally at the rate of 15 mL per piglet every 2 hours plus the same amount orally. The safe amount of sterilized porcine serum or saline and 5% dextrose that can be given to piglets is equivalent to about 8% BW intraperitoneally, in two divided doses given 8 hours apart. Lambs are also treated subcutaneously (30–40 mL) and orally (50–100 mL) every 2 hours.

### Parenteral Nutrition

Parenteral nutrition is used to provide adequate nutrition intravenously, as long as necessary, when feeding by the gastrointestinal tract is impractical, inadequate, or impossible. The term parenteral nutrition is preferred to total parenteral nutrition because the complete nutritional requirements of large animals are either not completely known or not addressed by intravenous fluid administration. It should be recognized that enteral nutrition represents state-of-the-art medicine because enteral nutrition supports the repair, maintenance, and growth of the gastrointestinal tract to a much greater extent than parenteral nutrition. It should also be recognized that parenteral nutrition should only be contemplated after at least 5 days of inappetence.

The technique is used to supply the nutrient requirements, most importantly protein, of the animal until it returns to normal. In calves affected with persistent diarrhea caused by chronic disease of the alimentary tract, or that cannot or will not eat, total intravenous feeding may be indicated. High concentrations of glucose, protein hydrolysates, lipid emulsions, and electrolytes are given by continuous slow intravenous infusion over a period of several days. Some encouraging results in calves have been

published, but the cost-effectiveness of the technique has not been examined.

Parenteral nutrition is an acceptable method of maintaining nutrition in the healthy horse over a period of 10 days. Body weight was maintained at 94% of initial values without clinical evidence of dehydration. No problems were encountered with the long-term intravenous catheterization. The total daily amounts given are calculated on the basis of daily caloric requirement. The intravenous catheter must be inserted down into the cranial vena cava, in which a large volume of blood will dilute the hypertonic concentration of the solution. The potential problems associated with parenteral nutrition include difficulty in the maintenance of a steady intravenous drip, hypertonicity of the solutions used, venous thrombosis, excessive diuresis, catheter sepsis, and bacterial contamination of the solutions.

Parenteral nutrition in foals usually starts with a parenteral daily initial digestible energy of 50 to 55 kcal/kg BW that is designed to address resting energy requirements; the daily energy intake is increased gradually up to a daily target of 120 kcal/kg using a combination of parenteral and enteral nutrition.<sup>47</sup> Because of the cost of components, energy density, and availability of products, there are two philosophical approaches to parenteral nutrition in foals: (1) intravenous dextrose and lipid emulsion with 30% to 40% of the caloric intake provided by lipids or (2) intravenous dextrose, amino acids in a nonelectrolyte solution, and lipid emulsion. The latter formulation has been used for parenteral nutrition in alpacas.<sup>48</sup> B-complex vitamins are usually added to the final parenteral nutrition solution, and there is no clear consensus on the need for concurrent insulin administration. Typical commercially available products administered in North America are designed for use in humans in a critical care setting and include 50% dextrose solution, an 8.5% amino acid solution without electrolytes, and a 20% lipid emulsion solution, with the lipid solution as the most expensive component. In a retrospective study of 53 foals that received parenteral nutrition including lipids, 32% developed hypertriglyceridemia (>200 mg/dL), and this development was significantly associated with nonsurvival.<sup>47</sup> This finding suggests that parenteral nutrition in foals should use limited amounts of lipid for energy, and current recommendations in septic human patients are to provide no more than 5% of the caloric intake from lipid emulsions. Fifteen percent of the 53 foals developed catheter-related complications such as thrombophlebitis or sepsis.<sup>47</sup> This emphasizes the need for strict aseptic technique whenever attaching or flushing fluid administration lines and catheters in animals receiving parenteral nutrition.

A practical and effective parenteral nutrition solution for sheep, goats, and New



World camelids contains the following components and is administered at a rate of 5% of BW per day:<sup>43,44</sup>

- 5 L of a commercial balance electrolyte solution (such as lactated Ringer's solution)
- 1 L of 8.5% amino acids (commercially available)
- 500 mL of 50% dextrose
- 20 mL of B-complex vitamins
- Potassium chloride (20–40 mEq/L) and calcium gluconate 23% (20–50 mL/L) as indicated

The components should be mixed aseptically in this order. Administration is best performed using a centrally located catheter and strict attention should be given to aseptic technique. **Hyperglycemia** is a common finding in neonatal animals undergoing parenteral nutrition, and the occurrence of hyperglycemia (glucose >180 mg/dL, equivalent to >10 mmol/L) has been associated with an increased likelihood of nonsurvival.<sup>49</sup> The widespread availability of low-cost blood glucose point-of-care units has made it much easier to monitor blood glucose concentration every 1 to 2 hours and adjust the fluid administration rate accordingly.

Parenteral nutrition in adult cattle focuses on the administration of 50% dextrose as a continuous rate infusion as part of the treatment of ketosis and hepatic lipidosis and in the supportive treatment in cows that are inappetent or recumbent or have gastrointestinal or infectious diseases.<sup>50</sup> Concentrated (50%) dextrose solutions are administered to keep the infused volume low and minimize plasma volume expansion and diuresis. Cows with hepatic lipidosis or prolonged anorexia sometimes require continuous intravenous infusion of dextrose for several days until they can maintain energy balance. The continuous intravenous infusion of 50% dextrose (0.3 g/kg/h) to healthy lactating dairy cows resulted in hyperglycemia and hyperinsulinemia and a marked reduction in plasma phosphorus concentration. Other

effects of intravenous dextrose infusion included decreased plasma potassium concentration, decreased dry matter intake and fecal production, and a transient increase in milk production followed by a sustained decrease. All of these effects were reversed after dextrose infusion was stopped.<sup>50</sup> The results suggest a slower rate of glucose administration (0.1–0.2 g/kg/h) is more appropriate in lactating dairy cattle.

#### FURTHER READING

- Berchtold J. Treatment of calf diarrhea: Intravenous fluid therapy. *Vet Clin North Am Food Anim Pract.* 2009;5:73–99.
- Constable PD. Acid-base assessment. When and how to apply the Henderson-Hasselbalch equation and strong ion difference theory. *Vet Clin North Am Food Anim Pract.* 2014;30:295–316.
- Constable PD. Fluids and electrolytes. *Vet Clin North Am Food Anim Pract.* 2003;19:1–40.
- Ewaschuk JB, Naylor JM, Zello GA. D-lactate in human and ruminant metabolism. *J Nutr.* 2005;135:1619–1625.
- Fielding L. Crystalloid and colloid therapy. *Vet Clin North Am Equine Pract.* 2014;30:415–425.
- Grove-White D. Practical intravenous fluid therapy in the diarrhoeic calf. *In Pract.* 2007;29:404–408.
- Hilton AK, Bellomo R. A critique of fluid bolus resuscitation in severe sepsis. *Crit Care.* 2012;16:302.
- Jones M, Navarre C. Fluid therapy in small ruminants and camelids. *Vet Clin North Am Food Anim Pract.* 2014;30:441–453.
- Rainger JE, Dart AJ. Enteral fluid therapy in large animals. *Aust Vet J.* 2006;84:447–451.
- Roussel AJ. Fluid therapy in mature cattle. *Vet Clin North Am Food Anim Pract.* 2014;30:429–439.
- Smith GW, Berchtold J. Fluid therapy in calves. *Vet Clin North Am Food Anim Pract.* 2014;30:409–427.

#### REFERENCES

1. Maitland K, et al. *N Engl J Med.* 2011;364:2483.
2. Hilton AK, Bellomo R. *Crit Care.* 2012;16:302.
3. Bellino C, et al. *J Am Vet Med Assoc.* 2012;240:312.
4. Junqueira JRC, et al. *Arq Bras Med Vet Zootec.* 2015;67:15.
5. Müller KR, et al. *J Vet Intern Med.* 2012;26:674.
6. Abeysekara S, et al. *Can J Vet Res.* 2012;76:16.
7. Constable PD, et al. *Am J Vet Res.* 1996;57:97.
8. Walker PG, et al. *J Am Vet Med Assoc.* 1998;213:113.

9. Leal MLR, et al. *J Vet Intern Med.* 2012;26:1042.
10. Flores RV, et al. *Comp Clin Pathol.* 2006;15:131.
11. Constable PD, et al. *Am J Vet Res.* 1991;52:981.
12. Sickinger M, et al. *Vet J.* 2014;201:338.
13. Rodrigues FAML, et al. *Braz J Vet Res Anim Sci.* 2011;48:446.
14. Pantaleon LG, et al. *J Vet Intern Med.* 2006;20:1422.
15. Pantaleon LG, et al. *J Vet Intern Med.* 2007;21:1374.
16. Fielding CL, Magdesian KG. *J Vet Intern Med.* 2011;25:1138.
17. Berchtold J, et al. *J Vet Intern Med.* 2005;19:240.
18. Koch A, Kaske M. *J Vet Intern Med.* 2008;22:202.
19. Coskun A, et al. *J Am Vet Med Assoc.* 2010;236:1098.
20. Duburcq T, et al. *Crit Care.* 2014;18:467.
21. Anon. *Br J Anaesth.* 2011;107:116.
22. Hartog CS, et al. *Intensive Care Med.* 2012;38:1258.
23. Blong AE, et al. *Am J Vet Res.* 2013;74:712.
24. Ohta M, et al. *J Vet Med Sci.* 2013;75:841.
25. Bellezzo F, et al. *BMC Vet Res.* 2014;10(suppl 1):S8.
26. Rioux JP, et al. *Crit Care Med.* 2009;37:1293.
27. Hallowell GD, Corley KTT. *J Vet Intern Med.* 2006;20:980.
28. Epstein KL, et al. *J Vet Intern Med.* 2014;28:223.
29. Trefz FM, et al. *J Vet Intern Med.* 2012;26:162.
30. Trefz FM, et al. *BMC Vet Res.* 2012;8:238.
31. Lee RA, et al. *J Am Vet Med Assoc.* 2014;244:1423.
32. Kirchner D, et al. *Vet J.* 2014;199:251.
33. Nouri M, Constable PD. *J Vet Intern Med.* 2006;20:620.
34. Sen I, et al. *J Am Vet Med Assoc.* 2009;234:926.
35. Goodell GM, et al. *J Dairy Sci.* 2012;95:6677.
36. Wenge J, et al. *Livestock Sci.* 2014;159:133.
37. Constable PD, et al. *J Dairy Sci.* 2009;92:296.
38. Grünberg W, et al. *J Dairy Sci.* 2013;96:1.
39. Smith GW, et al. *J Am Vet Med Assoc.* 2012;241:1075.
40. Sen I, et al. *Am J Vet Res.* 2006;67:1377.
41. Marshall TS, et al. *Am J Vet Res.* 2008;69:824.
42. Atoji-Henrique K, et al. *Pesq Vet Bras.* 2012;32:1281.
43. Filho JDR, et al. *J Equine Vet Sci.* 2014;34:759.
44. Jones M, Navarre C. *Vet Clin North Am Food Anim Pract.* 2014;30:441.
45. Monreal L, et al. *Vet Rec.* 2010;166:259.
46. Lester GD, et al. *J Vet Intern Med.* 2013;27:554.
47. Lyers CJ, et al. *Vet J.* 2009;181:137.
48. Clore ERS, et al. *J Vet Intern Med.* 2011;25:598.
49. Krause JB, McKenzie HC. *Equine Vet J.* 2007;39:74.
50. Grünberg W, et al. *J Am Vet Med Assoc.* 2006;229:413.

# Practical Antimicrobial Therapeutics

## PRINCIPLES OF ANTIMICROBIAL THERAPY 153

### ANTIBIOTIC RESISTANCE 156

### ANTIBIOTIC METAPHYLAXIS TO CONTROL RESPIRATORY DISEASE 158

### PRACTICAL USAGE OF ANTIMICROBIAL DRUGS 158

Antibiotic Dosage: the Recommended Dose 158

Routes of Administration 159

Drug Distribution 162

Pharmacokinetic Principles for Antimicrobial Usage 163

Duration of Treatment 164

Drug Combinations 164

Additional Factors Determining Selection of Agents 165

Drug Deterioration 166

Unfavorable Response to Therapy 166

Drug Withdrawal Requirements and Residue Avoidance 167

### CLASSIFICATION OF ANTIMICROBIAL AGENTS: MECHANISMS OF ACTION AND MAJOR SIDE EFFECTS 169

Aminoglycosides and

Aminocyclitols 169

$\beta$ -Lactam Antibiotics: Penicillins, Cephalosporins, and  $\beta$ -Lactamase Inhibitors 170

Chloramphenicol 171

Chloramphenicol Analogs 171

Fluoroquinolones 171

Lincosamides 171

Macrolides 172

Sulfonamides 172

Tetracyclines 172

Miscellaneous Antibiotics 173

This chapter is not intended as a treatise on pharmacology, pharmacodynamics, and antibacterial activity of antimicrobial agents. Other textbooks are available that deal with those subjects. However, antimicrobials are the most commonly used group of drugs in large-animal practice, and their use is recommended on many occasions in the following chapters. To avoid repetition, the principles of usage and considerations for dose schedules and for the selection of antimicrobial agents for certain circumstances are given here and in the formulary.

Some of the information or opinions presented are based on clinical use rather than experimental evidence. However, this is often unavoidable because, unfortunately, many antimicrobial agents have in the past been released for use in large animals with minimal pharmacologic or clinical evaluation in the species concerned. As a result it has been assumed, often erroneously, that information obtained from studies in laboratory animals, dogs, and humans can be directly applied to the ruminant, horse, and pig.

## Principles of Antimicrobial Therapy

The success of antimicrobial therapy depends on **attaining and maintaining**, at the site of infection, a drug concentration that will result, directly or indirectly, in the death or control of the infectious organism with minimal deleterious effect to the host. To achieve these aims the antimicrobial agent must have activity against the organism at its **site of infection** and it must be administered in such a way as to maintain an **effective inhibitory or lethal concentration**. These

principles apply to therapy in all species and dictate the choice of antimicrobial agent to be used. However, in farm animal veterinary practice there are also other important considerations:

- **Cost** is critical. This consideration includes not only the primary cost of the drug but also related factors such as the ease and frequency of administration and the duration of treatment.
  - **Tissue residue problems** and **withdrawal periods** must also be taken into consideration and are a primary determinant of treatment strategy.
  - **Animal welfare** becomes a consideration when a decision is made not to treat an animal because of concerns about cost or the occurrence of residues that would preclude marketing of the animal or its products in the future.
  - **Antimicrobial resistance** and the risk of contributing to the emergence and problem of antimicrobial resistance is an increasing concern, not so much with the therapeutic use of antimicrobials but certainly with the prolonged administration of antimicrobials in animal feeds for disease prevention.
- In the theoretically ideal situation, the following steps would be taken before selecting an antimicrobial agent for therapy:
- First, the site of infection would be located and the identity of the infecting organism established by culture.
  - Second, the minimal inhibitory concentration (MIC) of each antimicrobial agent for the infecting organism would be identified.
  - Third, an initial selection would be made based on the susceptibility of the

organism and the knowledge of the capacity of the individual antimicrobial agents to penetrate the site of infection and to achieve and exceed these concentrations at nontoxic dose rates.

- Fourth, the dose rates, route of administration, and frequency of administration required to achieve these concentrations for each of the selected antibiotics, in the particular animal species being treated, would then be considered.
- Finally, selection of a particular drug would be based on a consideration of the potential toxicity to the host, on the likely relative efficiency of each drug, on the cost and ease of administration and, in food animals, on costs associated with the relative withholding periods.

For many clinical situations all of these steps cannot be followed before therapy is instituted. It may take several days to establish the identity of the infectious agent unless it can be ascertained by clinical diagnosis. The identification of the organism helps in determining its potential susceptibility, but even without identification the establishment of exact MICs by tube dilution for each antimicrobial agent takes several days, and the results would frequently be historical by the time that they were received. Also, knowledge about each antimicrobial agent and of the varying tissue and organ levels achieved following varying doses given by different routes of administration is not easily remembered and, therefore, not easily available in large-animal field situations. Unfortunately, complete information of this type also is not available for each antimicrobial agent in all large-animal species.

Because of this uncertainty, some expedients are adopted in clinical antimicrobial therapy. One of them is the concept of the **recommended dose** and another is the use of disk susceptibility testing, both of which are discussed later in this chapter. Regardless of these expedients, it should be recognized that rational antimicrobial therapy is based upon the principles outlined earlier. These important principles in antimicrobial therapy are discussed in greater detail individually.

### IDENTIFICATION OF THE INFECTION BY CLINICAL EXAMINATION

In infectious disease, clinical examination aims to identify the nature and site of the infection and its cause. The importance of making an accurate clinical diagnosis cannot be overemphasized as the first prerequisite for successful antimicrobial therapy. The establishment of a diagnosis in many instances immediately identifies the pathogen, and previous clinical experience may suggest the specific antibiotic to be used and allow a confident prediction of success of the therapy. Equally, it may indicate the likelihood of unsuccessful or prolonged therapy. For example, the diagnosis of erysipelas in pigs or strangles in horses immediately identifies the etiologic cause of the infection and the type of antimicrobial agent that will be required. It also gives some indication of the likely ease or difficulty of successful therapy and of the duration of therapy that might be required.

The establishment of an accurate diagnosis is also important in animals in which chemotherapeutic control of further disease may be required. Thus in pigs an accurate differentiation between the diarrhea of swine dysentery and that associated with coliform gastroenteritis is essential for effective prophylactic medication.

It is often not possible to establish an exact diagnosis at the first examination; yet in almost every instance it is essential that treatment be instituted at that time, not only for the well-being of the patient but also for the maintenance of good client relationships. The lack of a definitive etiologic diagnosis should never preclude the initiation of therapy during the period when further tests are being performed. Rational therapy in these circumstances depends very much on clinical acumen. A detailed examination leading to a determination of the site and nature of the infection can frequently allow an educated guess at the likely pathogen and allow rational therapy during the period that specific diagnosis is being determined by culture.

This approach is frequently used initially in field situations in large-animal medicine, but it requires good clinical knowledge. Clinicians should be familiar not only with the individual diseases of large animals but also with their **differential diagnosis** and with the **relative prevalence** of each condition in

their area. They should also be familiar with the types of organism that may produce infections in various body areas with similar clinical manifestations and the relative prevalence of each of these. Thus peracute mastitis in recently calved cows is most commonly associated with infection by staphylococci but can also be associated with coliform organisms or, more rarely, *Trueperella* (*Actinomyces* or *Corynebacterium*) *pyogenes* or *Pasteurella multocida*. Treatment must be initiated immediately if the gland or even the cow is to be saved. There are subtle clinical and epidemiologic differences that may allow some clinical differentiation between these agents, but frequently treatment must begin with no sure knowledge of which agent is involved. There are **two approaches** in this type of situation:

1. Therapy may be directed at the most prevalent or likely agent and, in situations where one particular infectious agent is the most prevalent cause of the condition, this is a rational approach.
2. In other situations, when a disease could be associated with any one of several different organisms, each with a different susceptibility, and when clinical experience suggests that no one organism is the predominant infectious agent, it is more common to initiate therapy with a broad-spectrum antimicrobial agent or a combination that will have activity against all the possibilities. If indicated, the antibacterial agent used for therapy may have to be changed to a more specific one once the actual pathogen and its susceptibility have been determined.

There are also clinical situations in which therapy must begin when there is little knowledge of the site of infection and, consequently, **no knowledge of the identity** of the infecting agent. This occurs when infection, such as abscessation, occurs in deep-seated and clinically inaccessible organs such as the liver or spleen. In these situations it also may not be possible to determine the nature and cause of the disease by laboratory examination, although biochemical examinations and ultrasound may give some indication of the site. In these cases, therapy is generally started with a broad-spectrum antimicrobial agent or a combination of lesser ones, and the accuracy of the selection is determined by subsequent clinical response.

### TAKING SAMPLES FOR DIAGNOSIS

In teaching hospitals, there is ready access to bacteriology laboratories, which frequently contain automated and rapid systems for susceptibility testing. However, in practice the taking of samples for this purpose is generally restricted and limited by such factors as the availability of a diagnostic laboratory and by cost. Furthermore, in many cases the results of culture and susceptibility are historical by

the time they are received. Nevertheless, information of this type is of value for future similar cases, and it provides prevalence data and data of antimicrobial susceptibility that can be used for background clinical knowledge and justification for extralabel drug use in food-producing animals.

The recognition of when samples should be taken for microbiological examination and susceptibility testing comes with clinical experience. Generally, the approach to dealing with individual sick animals is different from dealing with groups of animals that have a contagious disease. In individual animals, cost and the time for processing usually limit sample taking to valuable stud animals and to horses. They should be taken from **individual sick animals** with life-threatening conditions so that, if a response is not obtained during initial therapy, the subsequent choice of antimicrobial agent can be based on laboratory data. They should also be taken from animals with disease syndromes that may be caused by one of several agents or by an organism that may show **variable resistance patterns**. Examples would be infective arthritis in foals or gram-negative sepsis. The increasing emergence of variable resistance patterns in veterinary pathogens places an increasing importance on sampling and susceptibility testing, and many practices have now established their own laboratories for this purpose.

Samples are also frequently taken from chronic, **poorly responsive conditions** to determine the best course of treatment. In groups of animals where there is **contagious** disease, the taking of samples to establish or confirm the etiologic diagnosis and to determine the best drug for chemotherapy is most important. Where there are **a large number of animals at risk** it is important to confirm the initial choice of therapy as soon as possible so that remedial steps can be taken if the choice was incorrect. It is also important in these situations to have a confirmed accurate etiologic diagnosis so that control measures can be instigated to prevent future problems. Thus an outbreak of diarrhea in postweaned pigs may be caused by coliform gastroenteritis, salmonellosis, or swine dysentery. Clinical and pathologic examination may eliminate swine dysentery but not allow complete differentiation between salmonellosis and coliform gastroenteritis. An aminoglycoside could be used for the initial therapy of the outbreak but, at the same time, samples are taken for culture and susceptibility to determine the exact antimicrobial susceptibility of the infectious agent in case there is resistance to this antibiotic. Also, by this procedure the exact etiologic diagnosis will be determined, which will then determine recommendations for future control of the disease.

Consideration should be given to the **nature of the sample** for examination. In outbreaks of diarrhea there is little point in

taking fecal samples from chronically scouring and runted animals. Samples should be taken from animals at the onset of diarrhea. The site of sampling can also have an influence that may affect the relevance of the results. In animals with pneumonia, the nasal flora may not reflect that in the lung and cultures are best taken as transtracheal aspirates of the lower respiratory system.

Similarly, fecal *Escherichia coli* strains are not always representative of small-intestinal strains in scouring calves.

## ANTIMICROBIAL SUSCEPTIBILITY TESTS

### Rationale

Antimicrobial susceptibility testing is not required with all infections because many organisms are invariably sensitive to one or more antimicrobial agents, and in most cases these can be used for therapy. The clinician should be familiar not only with the spectrum of each antimicrobial drug, but also with the spectrum of susceptibility for the common organisms involved in diseases of large animals. **Susceptibility testing** is generally reserved for members of those groups of organisms that show considerable variation in sensitivity to individual antimicrobial agents.

There can be considerable area-to-area variation and spatial and temporal clustering in the susceptibility patterns of individual organisms. It is wise to establish the broad patterns of general susceptibility or resistance for these groups in any practice area, and to monitor any change periodically so that therapy can be guided by this information. This also can provide information justifying the extralabel use of antimicrobials in food-producing animals.

The **purpose of susceptibility testing** is to attempt to determine whether the organism under consideration is likely to be susceptible to the action of an antimicrobial agent at the drug levels that can be achieved using the usual therapeutic dose rates. In clinical terms, organisms are considered to be either **susceptible** or **resistant** to the action of an antimicrobial. However, with many organism–antimicrobial associations, resistance or susceptibility is **not an all-or-none phenomenon**; it is dependent on drug concentration. Organisms that may be resistant to low levels of an antimicrobial agent are frequently susceptible to its action at higher concentrations. Thus an organism that is susceptible to the action of benzylpenicillin at a concentration of 0.1 µg/ml would be considered susceptible because equivalent levels of benzylpenicillin can be easily achieved in the blood and tissues. One that was susceptible only at a concentration above 5 µg/ml might be considered resistant, even though it is possible to achieve and maintain this concentration of benzylpenicillin in the tissues with high and frequent dosing.

## Susceptibility Test Methods

### Tube Susceptibility Tests

Susceptibility tests may be quantitative or qualitative. **Tube susceptibility tests**, using serial dilutions of the antimicrobial drug against a standard dose of the test organism, provide quantitative information in terms of an exact MIC of the drug being tested. The MIC is the lowest antibiotic concentration that prevents the growth of bacteria within a defined period of time and under the conditions of the test. Tube susceptibility testing is the gold standard. With most antibiotics a mean plasma level two to five times the MIC needs to be sustained through the dosing interval for effective therapy. These tests are laborious and time-consuming and are seldom used in practice situations for these reasons.

### Disk Susceptibility Tests

**Disk susceptibility tests** provide more limited qualitative information. They are generally a valuable adjunct in the choice of an antimicrobial agent for therapy, particularly for systemic diseases. However, the limitations of the usual method of testing and the limitations of interpretation should be recognized by the clinician.

The **Kirby–Bauer** technique is the most commonly used method of disk diffusion susceptibility testing. With this technique, disks are impregnated with a standard amount of antibiotic that diffuses into the media to produce a zone of inhibition of growth. With a standard concentration of antibiotic in the disk and standard antibiotic sensitivity test media and test conditions, the concentration of the diffused antibiotic at any given distance from the disk is relatively predictable and constant. There is a linear relationship between the diameter of the zone of inhibition and the  $\log_2$  of the MIC. For each antibiotic MIC, breakpoints have been established and corresponding zone size breakpoints established above or below that which an organism is classified as resistant, susceptible, or of intermediate susceptibility.

Although the Kirby–Bauer disk susceptibility testing system has a quantitative genesis, the results are qualitative, especially as used in most practice laboratories. The MIC breakpoints are specific values used to assign bacteria to one of three classifications: susceptible, intermediate, and resistant.

The MIC breakpoints and thus the published reference zone sizes for resistance and susceptibility are often based on the pharmacokinetic properties of each antimicrobial in humans. These frequently have a limited relationship to their pharmacokinetic properties in animals, particularly ruminants.

Also, a single antimicrobial considered to be representative of its class is used to test susceptibility to that class of antimicrobials, but this representative is not always the antibiotic agent present in commercially

available antibiotic treatments for livestock. Further, the use of specific zone diameters to establish resistance and susceptibility assumes a standard test with standard media and under standard conditions. These conditions are frequently not met in veterinary practice laboratories.

Despite these limitations, disk susceptibility tests can be used as a guide to the selection of antimicrobials for therapy in large-animal veterinary practice. They are of particular value in selecting a choice of antibiotic with organisms that exhibit variable patterns of resistance and where this pattern for any one antibiotic is essentially bimodal in distribution. They may have limited value in the testing of organisms in which the sensitivities are clustered around the MIC breakpoint. However, there is a lack of validation for susceptibility testing being predictive for treatment outcome in almost all large-animal diseases because the breakpoints have not been validated. There should not be overreliance on the results of testing for sulfonamide susceptibility because these are frequently misleading and a good clinical response can be achieved with therapy, even though the sensitivity test suggests resistance.

Frequently, with disk susceptibility tests, the organism proves sensitive to a number of different antimicrobial agents. The selection of one of these for therapy is based on such factors as **ease of administration** and **cost**. The relative efficacy of any one of the agents cannot be determined by comparison of the size of the zones of inhibition.

### Microtiter Techniques

The development of semiautomated microtiter methodology for direct MIC determinations allows many reference diagnostic laboratories and teaching hospitals to determine MIC concentrations directly in bacterial susceptibility testing. The results are more directly applicable to rational therapy and, in particular, have more relevance than disk diffusion tests for determining the susceptibility of organisms that cluster around the MIC breakpoint for a given antibiotic.

### Other Considerations

The antimicrobial susceptibility of an organism can **vary** considerably depending on the **species of animal** from which it is isolated. *E. coli* isolates from pigs generally show a greater degree of antibiotic resistance than those isolated from adult cattle. Similarly, *Campylobacter* spp. isolates from pigs show substantially different antibiotic susceptibility patterns from those isolated from sheep. Isolates from the same species may also vary significantly in susceptibility so that *E. coli* isolated from mastitis in cattle generally have a broader susceptibility pattern than those isolated from enteric disease in calves. In addition, there are area differences and changes with time. Low levels of antibiotic



fed for growth-promoting purposes may influence susceptibility patterns, and in herds where growth promoters are used it is generally wise not to use the same drug or members of the same group for therapeutic purposes without prior testing.

### Flaws and Limitations of Culture Susceptibility Testing

Culture and susceptibility data (pharmacodynamics) increasingly are becoming an important tool in the selection of an antimicrobial. Culture and susceptibility testing might identify the target organisms, help to confirm the need for therapy, and confirm the susceptibility of the isolate to drugs of interest. Therefore culture and susceptibility testing is useful; on the other hand, this test represents an *in vitro* testing system and the results must then be applied to an *in vivo* situation. As such, culture and susceptibility results must be interpreted in the context of potential host and microbial factors that can alter concentrations achieved at the tissue site. It is extremely important to use proper technique for culture samples because culture data are only as good as the sampling method used for their collection. The following include the limitation of the application of the *in vitro* data to some patients:

- Time, space, and other limitations exclude testing of all drugs. For some drug classes, one drug serves as a model for other members in the class.
- Many laboratories include model drugs approved for use in humans but not in other animals.
- For any culture and susceptibility method, active metabolites may not be included in the interpretive standards when some metabolites can contribute markedly to activity.
- **Culture and susceptibility testing may fail to represent *in vivo* behavior of bacterial organism.**
- **The pharmacokinetics contributing to interpretative criteria of culture and susceptibility testing are largely based on total plasma concentrations. Culture and susceptibility testing does not take into account binding of the drug to plasma proteins, which overestimates efficacy of protein bound drugs. (Box 6-1)**

### FURTHER READING

- Boothe DM. Principles of antimicrobial therapy. *Vet Clin North Am Small Anim Pract.* 2006;1003-1047.
- Constable PD, Morin DE. Treatment of clinical mastitis: using antimicrobial susceptibility testing profiles for treatment decisions. *Vet Clin North Am Food Anim Pract.* 2003;19:139-155.
- Lubbers B. Using individual animal susceptibility test results in bovine practice. *Vet Clin North Am Food Anim Pract.* 2015;31:163-174.
- Lubbers BV, Turnidge J. Antimicrobial susceptibility testing for bovine respiratory disease: getting more from diagnostic results. *Vet J.* 2015;203:149-154.

### Box 6-1 Pros and cons of empirical therapy versus culture and susceptibility-based antibiotic therapy

Empirical choice	Susceptibility-based choice
<b>Advantages</b> <ul style="list-style-type: none"> <li>• Quicker</li> <li>• Cheaper</li> </ul> <b>Disadvantages</b> <ul style="list-style-type: none"> <li>• More likely to have the wrong antibiotics (up to 50% of cases)</li> <li>• More likely to have the wrong dosing regimen</li> <li>• Potential waste of time</li> <li>• Potential waste of money</li> <li>• Potential for resistance (50% of isolates resistant to antibiotics commonly used empirically)</li> </ul>	<b>Advantages</b> <ul style="list-style-type: none"> <li>• Very likely to have the right antibiotic</li> <li>• More likely to have correct dosing regimen</li> <li>• Save time and money if wrong antibiotics are chosen empirically</li> </ul> <b>Disadvantages</b> <ul style="list-style-type: none"> <li>• Takes 24–48 h</li> <li>• Cost</li> <li>• One to two member(s) of each class tested (assumption of similar results with other members)</li> <li>• Laboratory protocol might not perfectly represent reality</li> </ul>

## Antibiotic Resistance

Development of antimicrobial resistance by microbial pathogens and commensals represents a major threat to animal health and public health. Current concerns relating to antimicrobial resistance arise principally from the rapid rate of development of resistance relative to the slow rate at which new mechanistic groups of antibiotics are introduced, and the conviction that development of resistance is accelerated by overuse of antibiotics. Antibiotic resistance can be categorized in three types:

1. Natural or intrinsic resistance (predictable resistance)
2. Mutational resistance (unpredictable resistance)
3. Extrachromosomal or acquired resistance

Microorganisms generally resist the actions of antimicrobial agents by (1) interfering with the specific targets necessary for binding of the drug to its target site, such as development of altered receptors or enzyme for antibiotics (altered penicillin binding proteins [PBPs] for  $\beta$ -lactams and DNA gyrase for fluoroquinolones); (2) destroying or altering the conformational integrity of the drug (hydrolysis of the  $\beta$ -lactam ring of penicillins and cephalosporins by  $\beta$ -lactamases); and (3) preventing the drug from attaining an effective concentration at its site of action (alteration of porin channels or induction of efflux of drug).

Antimicrobial resistance is a natural biological phenomenon, and the introduction of

antibiotics into clinical use has almost invariably been followed by the emergence of resistance to these drugs in bacterial populations. When a microbial population is exposed to an antibiotic, the more susceptible organisms will succumb, and antimicrobial use in human medicine and in agriculture naturally must result in the selection of antimicrobial-resistant phenotypes. This occurs in nonpathogens as well as pathogens. Resistance is generally slow to reverse or is irreversible.

There are a number of mechanisms in which resistance is engendered. Resistance that results from spontaneous mutation of chromosomal genes encoding a target site is probably of limited importance in clinical settings. It occurs more frequently with certain antibacterials, *i.e.*, rifampin, and may be combated by the inclusion of a second antibacterial in the treatment regimen. Plasmid- and transposon-determined drug resistance is much more important in clinical situations and has led to widespread multiresistance patterns in certain bacterial populations.

Plasmids are extrachromosomal genetic elements that replicate independently of the chromosome. They can be transferred within, and in some cases between, bacterial species and may also act as vectors for transposons. They may encode for single or multiple patterns of antibiotic resistance and, increasingly, multiple patterns of resistance are emerging. With veterinary pathogens, plasmid-determined resistance is particularly important in the Enterobacteriaceae, *Staphylococcus aureus* and to some extent in *Pasteurella* spp.

Virtually all antibiotics given in therapeutic doses cause marked changes in the microflora of sites in the host normally colonized by bacteria. There is suppression of the sensitive flora with subsequent selection and colonization by resistant bacteria. In pigs, there is some evidence that therapeutic use of antibiotics in individual animals does not greatly influence herd flora resistance patterns, but in-feed medication of post-weaned pigs selects for antibiotic resistance that maintains in finisher pigs. The feeding of antibiotics for growth promotion and the feeding of antibiotic-treated milk to calves will select for resistance among organisms within the alimentary tract. These resistant organisms can persist in the animal and in the environment and subsequently form part of the normal colonizing flora of other animals. Thus it is not unusual to isolate organisms, *E. coli*, for example, that are resistant to one or more antibiotics even though the animal from which they were isolated had never received antibiotic medication.

There is a higher prevalence of antibiotic-resistant *E. coli* in the normal intestinal flora of young animals than adults. The prevalence is higher in young animals reared intensively, such as veal calves and pigs, and in

environments in which antibiotic usage has exerted selection pressure. The prevalence falls with increasing age, and the intestinal flora of adults generally shows a broader susceptibility pattern. Although many of these resistant organisms are not pathogens, they contribute a pool of R plasmids that can be transmitted to pathogens, and therapy decisions should take into account what antibiotics are in routine use on the farm as growth-promoting additives. Tetracyclines and neomycin are commonly incorporated in calf milk replacers with the label claim that they are growth promoters and aid in the control of calf diarrhea. However, there are no published studies that support health benefits. There are studies that show improved growth of calves on medicated milk replacers compared with control calves, but this difference is lost after weaning and not of any production benefit.

Feeding antimicrobials to livestock and poultry to reduce disease and promote weight gain has been standard practice in developed countries for several decades but is engendering increasing concern, and the occurrence of antimicrobial resistance is beginning to be considered to be a societal issue. The concern is that antimicrobial use in food-producing animals may affect human health by the presence of drug residues in foods and by promoting the presence of antibiotic-resistant strains in animals that can subsequently infect humans through food or from effluent contamination of the environment. The consequences of this also include an increased risk for resistant pathogens to be transferred to humans by direct contact with animals. Although many of the growth-promoting antibiotics used in animals are not the same as those used for human therapy, antimicrobial exposure can initiate bacterial resistance to compounds of dissimilar structures.

There is a particular risk to farmers, farm workers, and veterinarians from exposure to contamination in the farm environment and a risk from transfer of resistant bacteria through farm food and via environmental contamination from farm effluents.

Public and medical concern about the ways in which antimicrobials are used in agriculture has particularly been aroused by the development of vancomycin-resistant enterococci (VRE) in humans associated with the use of the related drug avoparcin as a growth-promoter in animal feeds. In response to concerns about the emergence of antimicrobial resistance, Sweden banned all growth-promoting antibiotics in 1986. This was followed by a ban on avoparcin and virginiamycin in Denmark in 1995 and 1998, respectively. Finally, the European Union banned the use of avoparcin in 1997 and bacitracin, spiramycin, tylosin, and virginiamycin for growth promotion in 1999. Following the 1995 ban on avoparcin, several investigators reported a decline in animal

VRE. In Denmark, frequencies peaked at 73% to 80% and fell to 5% to 6% in poultry. In Italy, VRE prevalence in poultry carcasses and cuts decreased from 15% to 8% within 18 months of the 1997 ban, and in Hungary a 4-year study showed not only a decline in prevalence of VRE among slaughtered cattle, swine, and poultry after removal of avoparcin but also a decrease in vancomycin MICs. Increased virginiamycin use in Danish broilers during the mid-1990s correlated with a rise in resistant *Enterococcus faecium* prevalence, from 27% to approximately 70%. Following the ban, resistance declined to 34% in 2000. Likewise, in Denmark the 1998 ban on the use of tylosin in swine resulted in a decline in erythromycin (a structurally related macrolide) resistance from 66% to 30%. Avilamycin use in 1995 and 1996 increased resistance in broiler *E. faecium* strains, from 64% to 77%, while declining applications after 1996 lowered the prevalence to 5% in 2000. There has been an apparent reduction in vancomycin resistance in fecal enterococci isolated from humans and animals. There has also been an apparent increase in morbidity and mortality among pigs, associated with enteric infections, diarrhea, and chronic infections caused by *Lawsonia intracellularis*. This increase in animal disease since the ban has resulted in a substantial increase in the use of therapeutic antibiotics for food animals in Europe, primarily tetracyclines, trimethoprim/sulfonamides, and macrolides.

With respect to the emergence of antibiotic resistance in zoonotic organisms, a particular concern has been plasmid-determined multiple antibiotic-resistant strains of salmonella that have emerged and caused rapidly spreading epidemics of disease in young calves in England and throughout Europe. These multiple resistance patterns have been associated with particular phage types and biotypes of *Salmonella typhimurium* and *S. dublin*.

Preventing the spread of multiresistant organisms is not easily achieved, and there are examples of spread involving virtually every major pathogenic bacterial group. An example is the emergence and spread of *S. typhimurium* DT104, in which multiple antibiotic resistance is chromosomally determined. A pathogen of a variety of different animal species, including humans, this organism spread globally in the 1990s. Because of the advanced salmonella surveillance system in the United Kingdom, this organism was first recognized as causing outbreaks of disease in cattle and humans in the United Kingdom and its emergence was initially attributed to the use of antimicrobials in cattle. There is, however, no evidence in support of this and its spread was caused by its colonizing ability and not to selection by the feeding of antimicrobials. The history of the emergence and spread of this organism, which was unrelated to the use of

antimicrobials in livestock and related more to the colonizing ability of DT104, should act as a brake on proposals to use changing patterns of antimicrobial resistance as a measure of the risk of the use of antimicrobials in livestock.

Plasmid-determined multiple patterns of resistance are likely to increase in organisms in environments in which selection pressure is high as a result of frequent antibiotic usage. The use of antibiotics in agriculture is an obvious target to reduce this selection, and is frequently blamed for the problem of developing antibiotic resistance in human pathogens. Nosocomial infection with antibiotic-resistant animal pathogens is an emerging problem in veterinary hospitals, and procedures for limiting their spread are available.

Although the major concern has been directed at antibiotic use for growth promotion, there are also moves, in some countries, to restrict the use of certain antimicrobials, e.g., fluoroquinolones, from therapeutic use in farm animals. However, a European survey of antimicrobial susceptibility among zoonotic and commensal bacteria from food-producing animals found that, although there was variation among European countries in the resistance of enteric organisms, this largely involved the older antimicrobials, and that resistance to the newer compounds used to treat humans was low. Equally, a study of mastitis pathogens over a 7-year period in the United States showed no trend toward increased resistance and reported a reduction of resistance to  $\beta$ -lactam antimicrobials for several gram-positive mastitis pathogens.

#### FURTHER READING

- Barton MD. Impact of antibiotic use in the swine industry. *Curr Opin Microbiol.* 2014;19:9-15.
- Marshall BM, Levy SB. Food animals and antimicrobials. Impacts on human health. *Clin Microbiol Rev.* 2011;24:718-733.

#### WAYS TO MINIMIZE OR AVOID THE DEVELOPMENT OF ANTIMICROBIAL RESISTANCE

Strategies considered effective in delaying development of resistance involve minimizing the use of antimicrobial agents, and using dosage regimens to achieve drug concentrations at the site of infections that eliminate pathogenic organisms without promoting survival of more resistant microbial subpopulations. The guidelines of antimicrobial usage have been published by a variety of agencies, and these guidelines adhere to the following principles:

- Use antibiotics whenever bacterial infection is confirmed.
- Start treatment early: Logarithmic growth phase of infection
- Dose adequately: Low dose (resistance) and high dose (cost and toxicity)

- Avoid prolonged use of antibiotics.
- When possible, select narrow-spectrum agents, based on definitive identification of the infectious agent, rather than broad-spectrum agents.
- Maintain the dosage: The general rule is to maintain dosing for 7 to 10 days or for 4 to 5 days after resolution of fever. Patients that have compromised host defenses should be treated for 10 to 14 days. Chronic infections may require 4 to 6 weeks of treatment.
- Susceptibility tests: Not practical for each case, periodic testing will help establish a trend for a particular disease or on a particular premise.
- Evaluate clinical effectiveness: Improvement by 4 days after initiation of treatment
- Prevention and good management: As simple as controlling ventilation, humidity, sanitary environment, and avoiding stress

### AVOIDING ANTIMICROBIAL RESISTANCE (THREE DS APPROACH)

- **De-escalate:** No antibiotic usage when alternate therapy is available, limit duration of treatment (shortest course of therapy clinically acceptable), rotate the usage of antibiotics on a regular schedule
- **Design:** Effective dosing regimen, selection of most appropriate antibiotic for the organism while narrowing spectrum of activity
- **Decontaminate:** Reduce bacterial exposure (wearing gloves, hand washing, proper bandaging, strict asepsis during surgery, etc.).

Investigations with fluoroquinolones resulted in the **mutant prevention concentration** (MPC) concept, which represents a novel in vitro measurement of fluoroquinolone potency. The MPC is the concentration of the drug necessary to prevent (inhibit) the emergence of the first-step mutants. In other words, MPC represents the highest MIC of the isolates in patient. It was also reported that the MPC values combined with the pharmacokinetic (PK) profiles could be used to optimize the dosing regimen to prevent the emergence of resistant mutants. When MPC data are applied to achievable and sustainable serum drug concentrations in the body, estimation of the time the serum drug concentration exceeds both MIC and MPC values can be determined. These data, along with kill data, allow for an estimate of the amount of time drug concentration needs to exceed MIC/MPC values to not only result in significant kill, but also to minimize resistance development. On the other hand, there is little correlation between MIC and MPC, and the MIC/MPC ratio is both drug and pathogen specific. Currently, limited data are available to conclude if the MPC concept

does or does not apply to other antimicrobial agents.

## Antibiotic Metaphylaxis to Control Respiratory Disease

**Metaphylaxis** (mass medication) to manage respiratory disease in newly received high stress or recently weaned cattle is a common practice. Metaphylaxis is a newer term used to describe the treatment of an entire group of calves with an antibiotic upon arrival at the farm before the onset of overt illness. Several viruses and bacteria have been associated with acute bovine respiratory disease (BRD). This disease syndrome was originally termed *shipping fever*, because signs often occur shortly after arrival in the feedlot. Consistent prevention and control of BRD is costly and difficult. Metaphylaxis can be considered as prevention and a curative treatment because cattle arriving to a stocker or feedlot facility may be at risk for developing BRD as well as currently experiencing various stages of the disease process. Interactions among the respiratory pathogens and compromise of the innate respiratory defense mechanisms, especially as a result of environmental and management stresses such as heat or cold and weaning and transportation, seems to be critical to the development of clinical BRD. This results in considerable economic loss from deleterious effects on cattle health and performance.

The decision to metaphylactically administer any class of pharmaceutical product is based on clinical signs, expected illness rates in the group, and prior evidence of product efficacy. General guidelines that impact the decision to administer metaphylactic treatment for BRD include the following:

- The clinical appearance of the cattle on arrival
- Current (and expected) morbidity/mortality patterns
- Feed consumption
- Elevated body temperature
- Efficacy of products labeled for the control of BRD

Metaphylaxis is most commonly administered within a few days of arrival at the feedlot. Many antimicrobial products are labeled for metaphylactic administration to aid in control of BRD. Many antibiotics are used in metaphylaxis in calves considered *high risk*. When considering metaphylaxis, it is necessary to know that not all antibiotics used in therapy have a beneficial effect in reducing BRD; therefore only approved antibiotics should be used. Antimicrobial drugs currently labeled for metaphylactic administration to cattle for control of BRD include the following:

- Ceftiofur (Excede)
- Chlortetracycline (Aureomycin)

- Chlortetracycline/sulfamethazine (AS-700)
- Florfenicol (Nuflor)
- Oxytetracycline (Tetradure)
- Tilmicosin (Micotil)
- Tulathromycin (Draxxin)

Clinical signs most commonly observed with BRD include high fever, depression, decreased appetite, nasal and ocular discharge, coughing, and varying degrees of dyspnea. The aim of metaphylaxis is to reduce the incidence of acute-onset BRD in highly stressed and newly received calves. An important strategy used to decrease the incidence of BRD is the preventative health program referred to as *preconditioning*, which is a planned management program used before shipment to the feedlot. Generally, preconditioning programs ensure that the animals have been weaned for a predetermined amount of time (usually 30–45 days), vaccinated for various infectious agents (bacterial and viral vaccines), treated with anthelmintics, castrated, dehorned, and acclimated to feed bunks and water troughs before being shipped to feedlots. The cattle health industry should continue to identify means of BRD control though the development of and use of new technologies with the aim of enhancing resistance, reducing risk factors, and decreasing pathogen exposure.

### FURTHER READING

- Chmiel-Urban R, Grooms DL. Prevention and control of bovine respiratory disease. *J Livestock Sci.* 2012;3:27-36.
- Clarke CR. Antimicrobial resistance. *Vet Clin North Am Small Anim Pract.* 2006;36:987-1001.
- Duff GS, Galyean ML. Recent advances in management of highly stressed newly received feedlot cattle. *J Anim Sci.* 2007;85:823-840.
- Griffin D. Antibiotics metaphylaxis to control respiratory disease. Accessed at <<http://www.4cattlemen.com/ncba2007/newsroom/PR102GriffinAntibiotic.pdf>>; 2014.
- Nickell JS, White BJ. Metaphylactic antimicrobial therapy for bovine respiratory disease in stocker and feedlot cattle. *Vet Clin North Am Food Anim Pract.* 2010;26:285-301.

## Practical Usage of Antimicrobial Drugs

### ANTIBIOTIC DOSAGE: THE RECOMMENDED DOSE

Theoretically, there is no set dose for any antimicrobial agent. The concentration of an antimicrobial drug required for effective activity against different microorganisms varies, and these requirements could be met by varying the dose rate of the drug. However, this is an impractical situation and in practice one works from the **recommended dose**, which will give blood and tissue levels that will be effective against very susceptible organisms with minimal side effects to the host. In this respect the recommended dose



should be considered as a minimum dose. If one is dealing with organisms that require higher concentrations of the drug for therapeutic effectiveness, the recommended dose can be exceeded. With low-toxicity antibacterials this dose may be exceeded severalfold, and with drugs such as benzylpenicillin this is a frequent therapeutic ploy. However, with antibacterials that have toxic potential the recommended dose should only be exceeded with caution and frequently it is wise to search for a different antimicrobial agent to which the organism is more sensitive.

Similarly, the recommended dose may be exceeded in an attempt to increase the concentration gradient in sensitive infections in which necrotic tissue produces long diffusion paths. The recommended dose may also be exceeded for management reasons, as in the case of the treatment of sheep with foot rot or mycotic dermatitis, where only a single treatment is administered for practical purposes.

The **label dose** is the dose stated on the label of the drug and is the legal dose that can be used for that product. The label states the required **withdrawal periods** for avoidance of tissue or milk residues. The recommended doses given in the sections on individual diseases are based on our expectations of therapeutic efficiency, and may exceed the label dose recommendations for certain drugs. The problem of persisting tissue residues should be recognized when label recommendations are exceeded and withdrawal periods should be adjusted accordingly.

Label dose levels and dose intervals for many of the antimicrobial agents used in large animals are frequently too low and too long. In many cases, there are no obvious pharmacologic reasons for these dosing regimens. Unfortunately, pharmacokinetic studies of the earlier antimicrobial agents released for use in large-animal species were limited at the time of their release and it would appear that in many instances the label dose established at that time was inadequate. Some estimate of the dose required for an antimicrobial drug can be obtained by a comparison of the MICs required for activity against various organisms with the blood and tissue levels of the drug obtained at various dose levels. Usually, levels three to five times the MIC are considered necessary for effective therapy, and it is generally considered desirable to maintain these levels over the treatment period, especially with bacteriostatic antimicrobials, although this is probably not essential.

The ultimate proof for dose levels and dose intervals of an antimicrobial is by clinical trials of its efficacy in the treatment of infectious disease. It is apparent that antimicrobial drugs are effective in many diseases in large animals at the dose rates and intervals currently in use. Nevertheless, as the results of pharmacokinetic studies in farm

animals become available it is quite probable that they will suggest changes in the dose levels and intervals for several of the antimicrobial drugs in use. This may result in more efficacious therapy and lead to label doses that have a broader spectrum of activity against disease.

## ROUTES OF ADMINISTRATION

### INTRAVENOUS INJECTION

Intravenously administered antibiotics attain high and immediate blood and tissue levels. This route should be used in the treatment of **septicemia** and other life-threatening diseases. The concentrations obtained are much higher than those obtained with equivalent doses of the same drug given intramuscularly or orally, and, consequently, greater **diffusion concentrations** are achieved at sites of infection. For this reason, this route of administration may also be used in an attempt to increase the drug concentration in areas where the antibiotic normally achieves only low concentrations and where areas of necrosis increase the length of the diffusion pathway. Intravenous (IV) administration may also be indicated in **chronic infections** such as corynebacterial pneumonia in foals, in which diffusion concentrations are required to penetrate the abscess areas and the capsular material of the organism.

An initial IV loading dose (LD) may combat the development of **stepwise resistant mutants**. Because of the initial higher blood and tissue levels, the IV route may also be used for the treatment of infections that are only moderately sensitive to the antibacterial drug being used. This is because effective concentrations may be achieved by repeated IV dosing that would not be achieved by equivalent doses given intramuscularly or orally.

For practical reasons the IV route of administration is used for **low-concentration**, high-volume antimicrobial agents such as sulfamethazine and oxytetracycline. It is also preferred to the intramuscular route in racehorses when there is a need to avoid muscular soreness. The need to avoid **muscle damage** in beef cattle close to marketing may also dictate IV administration.

Administration by this route is not without its dangers. Inadvertent intracarotid injection can occur whenever IV injection is attempted into the jugular vein. Acute **toxic reactions** either to the drug or to its vehicle are more common when intravenous administration is used. Drugs specifically formulated for IV use should be used, or the manufacturer's recommendations on the advisability of the use of this route for any preparation should be followed. Severely toxemic terminal cases may die immediately following injection, and in the owner's mind death may be attributed to the therapy.

Injections should be given **slowly** and not as a bolus. Therapy by repeated IV

administration is generally restricted to hospital situations and can be expensive because of the added **cost** of the IV preparations. In field situations an initial **IV LD** followed by sustaining intramuscularly administered doses is frequently indicated in the treatment of infectious diseases and is sound therapeutic policy.

The jugular vein is used in all species except the pig, in which the inaccessibility of superficial veins other than the ear veins makes the jugular route of administration generally impractical. **Perivascular reactions** and intravascular thrombosis are a hazard with this route, especially following the administration of irritant drugs such as sulfonamides and tetracyclines.

### INTRAMUSCULAR INJECTION

Intramuscular injection is the most commonly used method for antimicrobial administration in large animals. Where possible this route should be **avoided in meat-producing animals**, especially with irritant preparations. Lesions can be detected at slaughter 12 months after the intramuscular injection of long-acting tetracyclines. If the drug must be given intramuscularly in a meat-producing animal it should be given in the **muscles of the neck**, because scar tissue and blemish are more likely to be detected at this site in the cutting process after slaughter and they can be trimmed. With certain antibiotics, drug residues may persist at these sites for long periods, and the label recommendation for withdrawal or withholding time should be followed.

Irritant drugs should be used with care in **horses**, or avoided, as this species more commonly develops severe reactions at the site of injection. The development of such reactions is usually an indication to change to alternative therapy. Oil-based vehicles frequently produce severe reactions at the site of injection in horses and should not be used.

There is evidence, for some antibiotics at least, that the site of intramuscular administration can influence the rate of absorption, the **bioavailability**, and the subsequent pharmacokinetics of the administered antibiotic. In both cattle and horses, injection in the neck gives more favorable pharmacokinetic parameters than does injection into the gluteal or shoulder muscles. Injection into the dewlap gives the poorest bioavailability. These differences presumably result from differences in the spread of the injected drug within and between the muscles and differences in blood supply. With intermuscular spread there is a greater absorption area and less compromise of capillary and lymphatic structures. Injection into the side of the neck of horses is considered to be malpractice in some countries. When irritant preparations must be given to horses it is wise to inject them into the muscle of the chest between the forelegs, as reactions in this area have less tendency to spread



and are more accessible to drainage and treatment.

At all sites, care should be taken to ensure that the injection is not inadvertently given intravascularly by applying negative pressure to the syringe before injection. In adult animals no more than 10 mL should be given at any injection site. Large injection volumes can result in the formation of encapsulated antibiotic-filled cysts in muscle. Label directions of the maximum amount to be given at any one site should not be exceeded.

With most antimicrobial drugs, excepting the repository forms and drugs of an irritant nature, peak blood concentrations are obtained within 30 to 120 minutes of injection. However, the bioavailability of drugs given by intramuscular injection is markedly influenced by their formulation and irritant nature. This is especially marked with oxytetracycline preparations.

### INTRAPERITONEAL INJECTION

Intraperitoneal injection is occasionally used for antimicrobial administration, especially in cattle close to market size, and where IV administration for various reasons may be impractical. It is also occasionally used in pigs with diarrhea, during which the antibacterial drug is combined with fluids for rehydration. In cattle the injection is given in the right flank midway between the last rib and the tuber coxae and at least 10 cm ventral to the lateral processes of the lumbar vertebrae. This is done to avoid retroperitoneal and perirenal deposition of the drug. An aseptic injection technique should be used. Animals with peritonitis are also occasionally additionally treated by this route of injection. In horses with peritonitis the peritoneal cavity can be drained through a cannula inserted in the ventral midline as used for abdominal paracentesis, and the antimicrobial agent is injected via this route. Intraperitoneal injection may also be used for the parenteral administration of the tetracycline group in acutely toxemic animals or in animals with severe respiratory distress when IV injection may result in collapse and even death.

### SUBCUTANEOUS INJECTION

Subcutaneous injection has not been commonly used in large-animal practice, but concerns regarding lesions in meat following intramuscular injections are leading to a greater use of this route. Providing the drug is not deposited in a fat depot, this route provides a reasonable alternative to intramuscular injection. With irritant preparations there is a danger of excessive reaction and the occurrence of sterile abscesses. Very small animals (piglets) are often treated by this route. A long-acting formulation of ceftiofur is labeled in North America for subcutaneous administration in the pinna of the ear of cattle. This location was selected because of ease of access and potential for decreased trim of injection site at slaughter. Widespread

field use identified rapid death in a very small number of cattle after subcutaneous administration in the ear pinna. Subsequent investigation identified that the cause of sudden death was most likely inadvertent and rapid injection into the auricular artery, with the injection rapidly reaching the cerebral circulation. Recommendations are now available regarding the correct site of the ear pinna to inject to minimize the potential for intraauricular artery injection. One example is subcutaneous injection of the sterile suspension of ceftiofur free acid crystalline (Excede) into the posterior aspect of the ear where it attaches to the head or in the middle third of the posterior aspect of the ear (Fig. 6-1).

### ORAL ADMINISTRATION

Oral administration of antimicrobial agents is generally restricted to **preruminant animals, young foals, and pigs**. The blood and tissue levels achieved following oral administration are considerably less than those achieved by an equivalent dose of the same antimicrobial agent given parenterally, and for this reason the oral dose rate is generally two to five times greater than the parenteral dose. Oral drugs are less reliable because **absorption characteristics** may vary with the volume of ingesta, the presence or absence of gastric and intestinal stasis, or hypermotility and the nature of the ingesta, which variably bind the orally administered drug. For example, oxytetracycline and trimethoprim have a much lower **bioavailability** to calves when administered in milk, rather than in water, because of the high degree of binding to milk. There is some evidence that the oral administration of antibiotics to calves in glucose-glycine-electrolyte solutions is associated with more favorable absorption characteristics. The aminoglycoside and polymyxin groups of antimicrobial agents are not absorbed from the alimentary tract, and benzylpenicillin is largely destroyed within the stomach.

The oral route is the easiest method for administration, and where the cost of revisits is a significant consideration this route is often chosen for **continuing medication**, because it is within the capability of any owner. Generally, however, systemic infections are better treated by parenteral injection and certainly treatment should be initiated by this route. The oral route is the one of choice for the treatment of enteric infections. Experimental studies have shown that the oral administration of antibiotics to healthy neonatal calves may induce villous atrophy within the intestine and malabsorption diarrhea. This occurred particularly with neomycin and to a lesser extent with tetracycline and ampicillin. Although this does not negate the use of antibiotics for specific therapy of enteritis in young calves (when this is indicated), it does suggest that prophylactic use of oral antibiotics has a risk in young calves.

**Prolonged oral medication** at therapeutic levels may result in **superinfection** in all animal species. Commonly a yeast, *Staphylococcus*, or *Pseudomonas aeruginosa* is involved. It occurs most commonly in calves given courses of differing antimicrobial agents. It is more common following medication involving tetracyclines, and usually a treatment period of at least 2 weeks is required for its development.

Antimicrobial drugs are seldom given orally to ruminant animals. Exceptions are the use of sulfonamides, especially as a sustaining medication following initial parenteral treatment, and low-level antibiotic therapy to feedlot animals to reduce the incidence of liver abscess and respiratory disease. Blood levels following oral administration in ruminants are variable and frequently not achieved until 12 to 18 hours after dosing. Also, many antibacterials are destroyed or inactivated within the rumen. Orally administered antimicrobials cause a significant disruption of the ruminal flora and by itself this

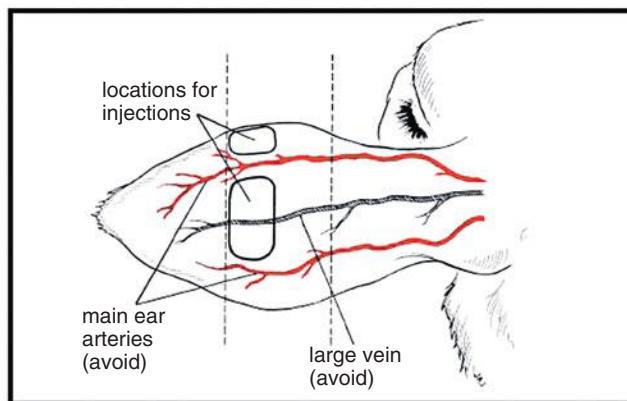

**Fig. 6-1** Diagram of the approximate locations of the major arteries of the posterior ear and the recommended needle insertion locations. Administration of Excede Sterile Suspension into ear arteries is likely to be fatal. Excede can also be administered SC at the base of the ear in a rostral direction toward the eye on the same side of the head as the ear, or administered SC at the base of the ear in a ventral direction. (Courtesy of Zoetis, Inc., [https://www.zoetis.com/products/pages/excede\\_beef/TechnicalResources.aspx](https://www.zoetis.com/products/pages/excede_beef/TechnicalResources.aspx) Excede® (Ceftiofur Crystalline Free Acid) Sterile Suspension.)

may result in a syndrome of ruminal stasis, anorexia, and depression. If antibacterial agents are given orally to ruminants, the course should be followed by reestablishment of the ruminal flora by cud transfer.

### Contamination of Feedstuffs

**Antibiotic contamination of rations** is a potential problem in feed mills that process medicated and nonmedicated feeds consecutively. The inadvertent feeding of antibiotics to cattle and horses can result in **clinical disease**, and the cause may not be immediately apparent to the investigating clinician. This can occur when cattle and horses are fed medicated pig feed, but may also occur when regular rations become contaminated with antibiotics. Residual carryover of medicated material into other feedstuffs can occur with feed mixers of various types and also via residues in conveyors, hoppers, and trucks. The risk for feedstuffs being contaminated can be quite high, and the most common contaminating drugs are chlortetracycline, sulfonamides, penicillin, and ionophores.

Within 24 hours of being fed medicated feed, dairy cattle show anorexia, rumen stasis, and subsequently pass custard-consistency feces containing undigested fiber. There is a precipitous fall in milk production. Dullness, muscle fasciculation, ketosis, hypocalcemia, and recumbency have also been observed. Affected cattle usually recover when placed on nonmedicated feed, but milk production may be adversely affected for the remainder of the lactation. Feeds contaminated with dimetridazole, lincomycin, and tylosin have been incriminated, although there is debate as to the role of tylosin in this syndrome. The **carryover** of medicated material into other feeds can also create violative **tissue residues** at slaughter. Sulfonamide contamination of swine rations is a particular problem.

The use of orally administered antimicrobial agents in horses over 3 months of age should be approached with great care. Their use can be followed by diarrhea, which is often intractable and results in chronic debilitation or death. Clindamycin and lincomycin carry a high risk and are probably totally contraindicated, and macrolides, tetracyclines, tylosin, and metronidazole are associated with risk in stressed horses.

### Water Medication of Pigs

The oral route is the most common and convenient one for group medication of pigs. The antibacterial agent may be incorporated in the water or in the feed. For the treatment of disease in pigs, water medication is preferred as **sick pigs may drink**, whereas they frequently will not eat. Also, water medication can usually be **started immediately**, whereas the mixing of an antibacterial agent with the diet for piggeries purchasing prepared diets may take 1 to 2 days. Antibiotic bioavailability is also less in pelleted feeds.

In outbreaks of contagious disease in pigs, the sick pigs within the group are usually initially treated individually by parenteral injection followed by mass medication of the water supply. Large swine units usually have facilities for in-line medication, and small swine units may not. With pigs using troughs, water medication is no problem. However, with automatic watering systems, medication must be through the header tank, if this can be isolated, or more commonly the water is turned off and medicated water is provided for the pigs via portable 200-L drums with a drinking bowl or nipple drinker inserted in the side.

In determining the **concentration of antibiotic** required in the water, the total daily dose of the drug is computed by multiplying the total weight of the group of pigs in kilograms by the daily dose of the drug in milligrams per kilogram. This dose must then be added to the amount of water that will be consumed in 1 day. It is obvious that this amount will vary according to climatic conditions and to the nature of the disease in the pigs. For example, diarrhetic pigs may drink more than normal quantities. In practice, a rule of thumb of 10% body weight water consumption of pigs between weaning and market age has been found to be satisfactory, with estimates of 15% for situations in which high water consumption can be expected. The total daily dose is thus added to the number of liters of water equivalent to 10% to 15% of the estimated total body weight of the group. In pregnant sows, water consumption is usually 5 to 8 L/day, but lactating sows may drink 15 to 20L/day. When there is doubt as to the exact water consumption the medication can be added to the lower estimate and, when consumed, fresh water provided for the remainder of the day. Water medication is generally continued for a period of at least 5 days. Antibiotics may deteriorate rapidly in water, and a fresh mix should be prepared each day. Most drugs for water medication have label directions.

### Water Medication in Cattle

There are some major limitations in the mass medication of water supplies of cattle. The daily amount of water consumed is usually directly proportional to the amount of dry matter intake. Anorexia or inappetence will result in a marked decrease in water intake to mere maintenance requirements. Depending on the drug used, the palatability of the medicated water may affect intake. With large drinking water tanks that are replenished on a continuous basis, or even two or three times daily, it is difficult to determine how much drug should be added on a daily basis to maintain a reasonably steady concentration. On a theoretical basis, automatic in-line water medicators should provide a uniform concentration of drug in the water supply. However, some medicators are extremely unreliable and regular surveillance

and servicing may be necessary. In countries where below-freezing temperatures occur during the winter months, the medication of water supplies may be difficult and impractical under certain management conditions.

### Dietary Medication

This is generally used for long-term disease control. In many countries, the amount of an antimicrobial that can be added to a feed is restricted to the **approved label level** and the veterinarian has no legal right to alter this concentration. The drug is usually added at the feed mill.

### Ionophores

Ionophores are feed additives used in cattle diets to increase feed efficiency and body weight gain. They are compounds that alter rumen fermentation patterns. Ionophores have been used widely in the beef and poultry industry for improved feed efficiency and control of coccidiosis. Similar to many other feed additives, ionophores are fed in very small amounts and supplied via another feedstuff as carrier for intake. Some argued that ionophore resistance poses the same public health threat as conventional antibiotics.

Commercially available ionophores include monensin (Coban and Rumensin), lasalocid (Avatec and Bovatec), salinomycin (Bio-cox and Sacox), narasin (Monteban and Maxiban), maduramicin (Cygro), semduramicin (Aviax), and laidlomycin propionate (Cattlyst). Ionophores are classified as carboxylic polyether antibiotics, and they disrupt the ion concentration gradient ( $\text{Ca}^{2+}$ ,  $\text{K}^+$ ,  $\text{H}^+$ , and  $\text{Na}^+$ ) across microorganisms, causing them to enter a futile ion cycle. Some ionophores (e.g., valinomycin) only move a single ion, but ionophores fed to cattle act as antiporters. The disruption of the ion concentration prevents the microorganism from maintaining normal metabolism and causes the microorganism to expend extra energy. Ionophores function by selecting against or negatively affecting the metabolism of gram-positive bacteria and protozoa in the rumen. The affected bacteria are those that decrease efficient rumen digestive physiology and the energy supplied from the ruminal digestion of feedstuffs. By controlling certain protozoa and bacteria in the rumen, less waste products (methane) are generated. The shift in ruminal bacteria population and metabolism allows beneficial bacteria to be more efficient through an increase in the amount of propionic acid and a decrease in the production of acetic acid and lactic acid. Therefore cattle experience an increase in the overall energy status and use feed resources more efficiently.

Ionophores are classified as an antibiotic, but they are not therapeutic antibiotics. Antibiotic resistance is an increasing concern in public discourse. However, the increase in antibiotic-resistant bacteria as a result of ionophore use is not well supported for a

number of reasons: (1) ionophores have never been (nor are likely to be) used as antimicrobials for humans; (2) ionophores have a very different mode of action from therapeutic antibiotics; (3) ionophore resistance in bacteria seems to be an adaptation rather than a mutation or acquisition of foreign genes; (4) ionophores can translocate across cell membranes of animals, which limits their use as therapeutic antibiotics; and (5) ionophore resistance in targeted bacteria shows complexity and a high degree of specificity.

In vivo and in vitro experiments indicate that only some ruminal bacteria are inhibited by ionophores. Susceptibility and resistance of ruminal bacteria to ionophores are more closely correlated with differences in the cell envelope. Bacteria that produce ionophores are naturally resistant with an unknown mechanism of resistance action. There are few toxicologic reports regarding toxicologic effects of ionophores in target animals and off-target animal species. Ionophores are generally safe and effective if used at recommended doses. However, accidental overdose, misuse, mixing errors, and accidental ingestion in nontarget species could result in toxicity in a number of animals. Horses, cattle, avian species, dogs, cats, and rats are sensitive to ionophore toxicity. Toxic effects of ionophores are thought to be mediated by disrupting the normal ionic gradients of cells leading to mitochondrial damage and lack of cellular energy. A well-known toxic effect of ionophores is cardiac toxicity and muscle degeneration in suspected species; however, the specific tissues affected and resulting clinical signs vary from species to species. However, one less commonly known effect of ionophores is associated with the nervous system, leading to neuropathy, which is manifested with myelin degeneration and ataxia. Cardiac muscles are primarily affected in cattle, and both myocardium and skeletal muscles are damaged in horses. Of the off-target species, the horse appears to be the most sensitive to ionophore toxicosis.

### OTHER ROUTES

Other routes of administration may be used to increase the level of antibacterial drug in areas in which diffusion following parenteral administration of the drug may be limited and when high local levels are required. These include intraarticular, intrapleural, and subconjunctival injection. Nonirritant preparations should be used with strict aseptic technique. In most cases these treatments should be supported by parenteral treatment.

Intramammary infusion of drugs is dealt with in Chapter 20. Intratracheal administration of antibiotics has its advocates for the treatment of pneumonia in cattle. In theory, this could result in higher levels of antibiotics at the site of infection, although with many

pneumonias diffusion through the affected lung must be minimal. The antibiotics are administered in sterile physiologic saline equivalent to 2 mL/kg body weight. An extensive study has shown variation in absorption and persistence between antibiotics administered by this route, compared with parenteral administration, but has concluded that there is no potentially useful advantage to its use.

The local administration of antibiotics may not always be the preferred route despite historical precedence. For example, in the treatment of the **genital tract**, it has been shown that parenteral administration of antibiotics achieves tissue concentrations of drug in all areas of the genital tract, whereas intrauterine infusion results in comparable concentrations only in the endometrium and uterine secretions. Local and/or parenteral administration may be indicated in different cases of genital tract infection.

### FURTHER READING

Guan H, Wittenberg KM, Ominski KH, Krause DO.

Efficiency of ionophores in cattle diets for mitigation of enteric methane. *J Anim Sci*. 2006;84:1896-1906.

Hersom M, Thrift T. Application of ionophores in cattle diet. 2012. Accessed June 2015, at <<http://edis.ifas.ufl.edu/pdf/AN/AN28500.pdf>>.

Kart A, Bilgili A. Ionophore antibiotics: toxicity, mode of action and neurotoxic aspect of carboxylic ionophores. *J Anim Vet Adv*. 2008;7(6):748-751.

## DRUG DISTRIBUTION

### ABSORPTION

Antibiotics of the aminoglycoside group and polymyxins are not absorbed from the alimentary tract, and if circulating levels of these antibiotics are required they must be given by parenteral injection. Where both intestinal and systemic levels are required, as may be the case in neonatal colibacillosis, these drugs should be given both orally and parenterally. Benzylpenicillin and methicillin are destroyed by acid pH and significant blood levels are not achieved following oral administration, but blood levels are achieved with ampicillin and amoxicillin. Certain sulfonamides (phthalylsulfathiazole, phthalylsulfacetamide, sulfaguandine, and succinylsulfathiazole) are not absorbed from the alimentary tract. The remaining antibiotics and sulfonamides are absorbed following oral administration in preruminant calves and lambs and in pigs and horses. However, generally, blood and tissue levels obtained are considerably lower than those achieved with equivalent doses given parenterally. Whey feeding (calcium) will inhibit the absorption of tetracyclines in pigs.

### DISTRIBUTION

Factors governing the distribution of antimicrobial agents in the body fluids are complex, and distribution should be considered as involving a multicompartmental system with

all body compartments being in contact directly or indirectly with the blood. The occurrence of exchange, and its rate, between the blood and the various tissue compartments is governed by the factors that influence the diffusion of solutes, such as the concentration of the drug and the volume of blood flow through the tissues and the volume of the tissue. It is also considerably influenced by the extent of protein binding of the drug in blood and in the tissues, the ionization constant of the drug, pH differences in the compartments, and the lipid solubility of the drug. Drug distribution is also influenced by age and the disease state of the animal.

In most diseases infection occurs in the extravascular tissue compartments, and it is the concentration of the unbound drug at these sites that determines the efficacy of therapy. The majority of antibiotics diffuse relatively freely in extracellular fluids, but sulfonamides, the chloramphenicol group, tetracyclines, fluoroquinolones, and macrolides have a distribution that more closely approximates total body water, and they can enter cells.

There are several so-called **barriers** to antimicrobial diffusion and these include the brain and cerebrospinal fluid, serous cavities, joints and synovial fluid, the eye, and the placenta and fetus. Generally, sulfonamides, tetracyclines, and chloramphenicol have some ability to penetrate these barriers in the normal state, whereas penicillin may not. Erythromycin has the ability to penetrate intracellularly and across most barriers but will not produce effective levels in the brain or cerebrospinal fluid. Members of the aminoglycoside group of antibiotics generally achieve effective levels in synovial fluid and the pleural and peritoneal fluid but not in the brain or eye. The importance of these barriers, especially those of serous cavities and synovia, in the presence of inflammation is open to doubt and effective therapy can often be achieved by the use of antibiotics that do not in normal situations reach these areas unless they are inflamed. An exception to this rule is infections involving the eyes where, to achieve effective levels, high circulating levels of the antimicrobial agent are required and IV injection to achieve this is usually necessary. Lipophilic drugs diffuse into tears and parenterally administered erythromycin, oxytetracycline, and gentamicin, for example, may achieve bacteriostatic concentrations in tears. In many areas, especially joints and the peritoneal, pleural, and pericardial cavities, high levels of the required antimicrobial agent can be achieved by local administration.

Almost all antimicrobial agents are **excreted** via the kidney, and the urine usually contains high levels of them. This feature is not of great significance in large animals, in which urinary tract infections are comparatively rare, but violative residue levels can



persist in the kidney for long periods with aminoglycosides. Penicillins and tetracyclines have a significant enterohepatic cycle, and erythromycin also may obtain significant levels in bile.

## PHARMACOKINETIC PRINCIPLES FOR ANTIMICROBIAL USAGE

A fundamental therapeutic concept is that the right drug must be selected for the right disease. An accurate diagnosis of the disease, knowledge of the clinical situation of the patient, and a sound understanding of the pharmacotherapeutics management of the disease is essential. Recently a second important aspect of therapeutics has emerged emphasizing that clinicians must do more than simply choose the proper drug. They must also select the dose, route of administration, and frequency of administration that will achieve and maintain an appropriate drug concentration at the site of action. Pharmacokinetics is a quantitative study of the time course of drug **absorption, distribution, metabolism, and excretion**. The ultimate goal of pharmacokinetics is to optimize the therapeutic management of individual patients through development of safe and effective drug-dosing regimens. The application of pharmacokinetic principles allows a more rational choice of therapeutic dosage regimen. In many cases, patient characteristics or specific disease states are known to alter the pharmacokinetic properties of a particular drug within the body. If appropriate adjustments in the dosage regimen are made to compensate for these changes, then potential problems of drug ineffectiveness and/or toxicity may be avoided. The following pharmacokinetics parameters are discussed briefly to help clinicians better establish an appropriate dosing regimen for antimicrobial compounds.

**Area under the curve (AUC)** represents an estimated area under the plasma drug concentration versus time curve. The AUC provides a measure of the extent of drug exposure and has little clinical relevance. Its therapeutic interpretation rests on comparing it with other AUC values or to some other therapeutic measure (such as the MIC of antimicrobial agents). The AUC of an extravascular dose may be compared with the AUC following intravascular administration for the determination of bioavailability. Bioavailability represents the rate and extent of drug absorption following extravascular administration of drugs. The AUC is also used during therapeutic drug monitoring to help identify factors that may affect drug pharmacokinetics, such as disease, food consumption, sex, age, breed, pregnancy, and lactation. It is also used in clinical pharmacology to calculate systemic clearance (systemic clearance  $[Cl_s] = \text{Dose IV}/\text{AUC IV}$ ).

**Volume of distribution (V)** is the constant that relates the amount of drug in the

body (A) to the plasma drug concentration (C) (i.e.,  $V = A/C$ ), but does not necessarily correspond to any actual anatomic volume or compartment. By definition V is the proportionality rate constant between a plasma concentration and the corresponding amount of drug in the body. It is a characteristic of a drug rather than of the biological system, although it may change in the presence of disease, pregnancy, obesity, and other states. Among the antibacterial drugs,  $\beta$ -lactams are ionized at physiologic pH and generally have a low V, whereas macrolides are concentrated in cells and have a high V. Three volumes of distribution are reported in the literature including volume of central compartment ( $V_c$ ), the volume of distribution during terminal elimination phase ( $V_{area}$ ), and the steady-state volume of distribution ( $V_{ss}$ ). In clinical pharmacology,  $V_c$  is rarely used, but sometimes this parameter is useful to predict maximum plasma concentration after IV bolus injection. When administering an IV loading dose (LD) to achieve immediate steady-state drug concentrations, the peak concentration associated with the LD can be estimated as how an IV dose/ $V_c \cdot V_{area}$  relates the plasma drug concentration during the terminal elimination phase to the corresponding amount of drug remaining in the body.  $V_{area}$  is primarily used in clinical pharmacology to estimate the residual amount of drug in the body when drug decreases according to its elimination phase.  $V_{ss}$  is useful in clinical pharmacology for calculation of an LD and also for predicting the fluctuation of plasma concentrations during a dosage interval. The  $V_{ss}$  provides an estimate of drug distribution that is independent of elimination process. By knowing the value of  $V_{ss}$ , it is possible to calculate the dose necessary to obtain a target plasma concentration (i.e.,  $\text{LD} = V_{ss} \cdot C_{ss}/F$ ), where  $C_{ss}$  represents steady-state plasma concentrations and F represents bioavailability. The greater the volume of distribution of a drug, the higher the dose necessary to achieve a desired concentration (e.g., the larger the  $V_{ss}$ , the smaller the fluctuation between peak and trough plasma concentrations).

The  $Cl_s$  describes the efficiency of irreversible elimination of a drug from the body (principally by the major organs of biotransformation and elimination, the liver and kidney) and is defined as the volume of blood cleared of drug per unit time. Clearance determines the maintenance dose (MD) rate required to achieve a target plasma concentration at steady state, because at steady state there is an equilibrium in which the rate of drug elimination is matched by the rate and extent of drug absorption (e.g.,  $\text{MD} = Cl_s \times C_{ss}/F$ ).  $Cl_s$  can only be calculated following IV injection of drugs (e.g.,  $Cl_s = \text{IV dose}/\text{AUC}$ ).

**First-pass effect** is a type of drug clearance and is defined as the extent to which an enterally administered drug is removed

before reaching the systemic circulation by prehepatic and hepatic metabolism. First-pass effects are important as a possible source of variability in clinical response to a drug and in explaining a component of the difference in response between parenteral and enteral administration of the same drug.

**Half-life ( $t_{1/2}$ )** is the time taken for the amount of drug in the body (or the plasma concentration) to fall by half. In most cases it is the elimination half-life that is used to distinguish it from the absorption half-life, a parameter that describes the rate of drug absorption and increase in plasma concentration. Half-life is a function of V and  $Cl_s$  ( $t_{1/2} = 0.693 \times V/Cl_s$ ) and frequently determines the duration of action after a single dose of a drug, the time taken to reach steady state with repeated dosing (generally three to five half-lives), and the dosing frequency required to avoid large fluctuations in peak and trough plasma concentration during the dosing interval (dosing at intervals of one half-life will lead to plasma concentrations covering a twofold range). The terminal elimination half-life is obtained as  $t_{1/2} = 0.693/\lambda_z$ , where 0.693 is the natural logarithm of 2 and  $\lambda_z$  is the slope of the terminal phase. Because  $t_{1/2}$  is a derived parameter, compounds with similar  $t_{1/2}$  values may have markedly different rates of  $Cl_s$  and vice versa. For this reason,  $t_{1/2}$  is considered a poor indicator of the pharmacokinetics changes that can accompany disease, pregnancy, lactation, and aging.

**Time to peak plasma concentration ( $T_{max}$ )** represents the time after dosing at which the maximum plasma concentration is observed and indicates the time at which the rate of absorption equals the rate of disposition (distribution and elimination).

**Maximum plasma concentration ( $C_{max}$ )** represents the maximum concentration of the drug observed (or calculated) in plasma after administration and occurs at  $T_{max}$ .

**Bioavailability (F)** is defined as the rate and extent to which the active constituent or active moiety of a drug is absorbed from a drug product and reaches the circulation. For systemically active drugs, absolute (100%) bioavailability is assigned to intravenously administered drug (unless the drug is likely to precipitate in blood). The bioavailability of alternative formulations of the same drug administered by other routes is compared with that of the IV route. In this case relative bioavailability is assessed by determining the AUC and comparing it with the AUC following IV administration. For nonsystemically active drugs, bioavailability is frequently determined by nonpharmacokinetic means, often by comparing the time course and degree of clinical response or effect of a test drug with a standard (or reference) drug preparation.

**Bioequivalence** is a clinical term referring to formulations of a drug with rates and extents of absorption that are sufficiently



similar so that there are not likely to be any clinically important differences with respect to either efficacy or safety. To demonstrate bioequivalence for systemically active drugs, a comparative pharmacokinetic study is generally undertaken, and the similarity (defined by statistical and biological criteria) of  $C_{max}$  and AUC of the formulations is assessed. For drugs not acting systemically, comparisons of clinical or other pharmacologic endpoints may be necessary.

## DURATION OF TREATMENT

For certain infectious diseases there is an established regimen of therapy that is known from clinical experience to be therapeutically effective. Where such regimens are known they are stated in the treatment section for the individual diseases in subsequent chapters. As a rule of thumb in undifferentiated diseases, therapy should be continued for at least a 3- to 5-day period or longer if there is evidence of chronic infectious disease with localization. An alternative rule of thumb is that treatment should be continued for at least 1 day beyond the return of body temperature to normal, especially if bacteriostatic antibiotics are being used. Chronic pyogenic processes may require treatment for a 2- to 4-week period or even longer.

## DRUG COMBINATIONS

Combinations of antimicrobial drugs are frequently used in veterinary practice. Combinations of antimicrobial agents are used either to achieve a **synergistic effect** in the case of a single infection or to achieve a **broad spectrum of activity** in the case of infections involving more than one agent. Combinations may also be of value in combating the **emergence of resistant** mutants during therapy.

The combination of two drugs may result in **indifference**, in which the effect is either that of the single most effective drug or is equal to the sum of the effects of the two individual drugs, or it may result in **synergism** or **antagonism**. There are, however, no hard and fast rules for combinations that will result in any of these effects. Knowledge of these effects results largely from laboratory animal studies and from some human therapeutic trials. From these trials it is evident that the occurrence of **synergism** is very dependent on the type of infectious organism, and to some extent the site of infection, and, whereas two drugs may show a synergistic effect with one type of infection, the effect may be indifferent or even occasionally antagonistic with other infective agents. **Antagonism** is equally not easily predictable, but the drugs that most commonly result in an antagonistic effect when combined with others are the tetracyclines, chloramphenicol, and macrolides.

A traditional approach has been that combinations of bactericidal drugs will generally result in an indifferent effect or in synergism; combinations of bacteriostatic drugs generally give an indifferent effect, whereas combinations of a bactericidal with a bacteriostatic drug may result in antagonism (Box 6-2). This approach is, however, too general for validity, because interactions are specific to individual infections and are dose dependent.

In farm animals, **synergistic activity** between penicillin and streptomycin has been demonstrated in the therapy of mycotic dermatitis and foot rot in sheep.

The synergism between aminoglycoside and  $\beta$ -lactam antimicrobials is widely used in the approach to the therapy of sepsis in neonates. Carbenicillin and gentamicin in combination can be of value in therapy against *P. aeruginosa*, *Klebsiella*, and *Proteus* spp., and tylosin and oxytetracycline can be of value in treating infection with *Mannheimia* and *Pasteurella* spp. Trimethoprim and sulfonamide combinations are of special value in treating several infectious diseases in large

animals. Rifampin and erythromycin show in vitro synergism against *Rhodococcus equi*, as does a combination of gentamicin and penicillin. Tiamulin and tetracycline show in vitro synergism against several swine respiratory pathogens, and herd studies show a measured response in the control of respiratory disease greater than that achieved by chlortetracycline alone.

Drug combinations are also used for **broad-spectrum therapy**. An accurate diagnosis with consequent recognition of the likely infectious organism allows specific antibacterial therapy and obviates the need for broad-spectrum antibacterial therapy. However, there are clinical situations in which broad-spectrum therapy, including the possibility of combined drug therapy, is indicated. These include such problems as acute septicemia, in which a number of different organisms, with differing antibacterial sensitivities, can produce identical clinical disease, and those infections associated with organisms that have a varying sensitivity depending on the isolate. The requirement for immediate treatment without knowledge of the bacterial sensitivity dictates the use of antimicrobial drugs designed to obtain a broad spectrum of activity.

The availability of **broad-spectrum drugs**, such as ampicillin or amoxicillin and trimethoprim-potentiated sulfonamides, has lessened the need to use drug combinations, but the latter may still be necessary in certain situations and are fully indicated. Although antagonism has not been demonstrated in clinical veterinary situations, it is wise to avoid bacteriostatic and bactericidal drug combinations.

**Fixed-dose combinations** are available commercially for some antibiotics, but they are **not recommended** for use and are gradually being withdrawn from the market or being declared not legal for use in food-producing animals. Fixed-dose combinations suffer from the deficiency that the dose level of any one of the drugs in the combination is dictated by the level of the other. Also, the excretion rates of the two drugs may be markedly different. The most common of these, fixed-dose penicillin/streptomycin combinations, suffers from this deficiency.

Where combinations of antibacterial drugs are used they should be given individually and at their respective recommended doses and repeats. Some antibiotics are **physically incompatible** when mixed together. The incompatibility may rest with the drugs or their vehicles and may be visible, as with crystalline benzylpenicillin and neomycin, or it may be inapparent, as with gentamicin and carbenicillin. The two drugs should be given separately at separate sites. Incompatibilities can also occur with antibiotics and intravenous fluid solutions, especially those containing protein hydrolysates.

Antibiotics may influence the **activity of other drugs**. In particular, chloramphenicol

### Box 6-2 Mode of action of antimicrobial drugs

#### Bactericidal antimicrobials

$\beta$ -Lactams  
 Penicillin  
 Cephalosporins  
 Semisynthetic penicillins  
 Ampicillin  
 Amoxicillin  
 Cloxacillin  
 Methicillin  
 Carbenicillin  
 Aminoglycosides  
 Streptomycin  
 Neomycin  
 Gentamicin  
 Paromomycin  
 Tobramycin  
 Glycopeptides  
 Vancomycin  
 Rifampin  
 Bacitracin  
 Polymyxins  
 Fluoroquinolones

#### Bacteriostatic antimicrobials

All sulfonamides  
 Trimethoprim  
 Methotrexate  
 Pyrimethamine  
 Tetracyclines  
 Macrolides  
 Erythromycin  
 Oleandomycin  
 Spiramycin  
 Tylosin  
 Carbomycin  
 Lincomycin  
 Chloramphenicol  
 Florfenicol

and tetracyclines inhibit liver microsomal metabolism and may significantly increase the half-life of drugs metabolized by this mechanism, such as digitalis or barbiturates, with resultant potential toxicity.

#### FURTHER READING

Toutain PL, Bousquet-Melou A. Plasma clearance. *J Vet Pharmacol Ther.* 2004;27:415-425.

Toutain PL, Bousquet-Melou A. Plasma terminal half-life. *J Vet Pharmacol Ther.* 2004;27:427-439.

Toutain PL, Bousquet-Melou A. Volume of distribution. *J Vet Pharmacol Ther.* 2004;27:441-453.

### ADDITIONAL FACTORS DETERMINING SELECTION OF AGENTS

In addition to the considerations of bacterial sensitivity to the antimicrobial agent, there are other important factors that dictate the selection of the antimicrobial agent to be used in a particular case. In most clinical situations several agents would be effective and a choice needs to be made among them.

#### COST

This is a major factor and includes not only the primary cost of the drug but also the ancillary costs that may be associated with its administration. This is a most important factor in agricultural animals but of less importance with pleasure horses. The importance of the primary cost of the drug is obvious. For example, in most countries a 5-day course of treatment with procaine benzylpenicillin will cost considerably less than one with, for example, oxytetracycline. If there is no specific indication for the use of the more expensive drug then the less expensive one should be used. The **ancillary costs** associated with repeat visits to administer the drug may also be important. The practice of dispensing drugs for continuing intramuscular therapy varies between countries and veterinary practices and has an influence on this consideration.

#### EASE OF ADMINISTRATION

This is a further factor that influences the nature of the drug and treatment used. Generally, one avoids starting a course of therapy with an antibacterial such as tetracycline, which may require daily IV administration, in favor of one that can be administered more simply, unless there are good therapeutic reasons for choosing the former. In situations where facilities are poor, where **mustering or yarding** is difficult, or where mass medication is required, long-acting repository preparations may be indicated. Irritant preparations are avoided where possible.

#### TOXICITY

This is always a consideration when dealing with infections that may require high dose rates of antimicrobial drugs, or in chronic

infections that require a prolonged course of therapy. When a choice is available, antimicrobial agents with a low incidence of toxic side effects at high doses are chosen. As in all clinical situations involving large animals, it is essential to make an assessment of the case and to attempt a **prognosis**. The possible cost and duration of treatment should be estimated and the owner advised of this. When examined in this light the decision may be against treatment and for salvage slaughter.

### BACTERICIDAL OR BACTERIOSTATIC ANTIMICROBIALS

Antibiotics are either primarily bactericidal or primarily bacteriostatic in their activity (see **Box 6-2**). A given antibiotic may be **bactericidal** (i.e., the organisms are killed) and **bacteriostatic** (i.e., the organisms are prevented from growing) depending on the concentration and the target bacteria. Bacteriostatic drugs temporarily inhibit the growth of organisms, but the effect is reversible once the drug is removed. For these drugs to be clinically effective, the drug concentration should be maintained above the MIC throughout the dosing interval. Many bacteriostatic drugs can be bactericidal if drug exposure is sufficiently high or prolonged, and some of the bactericidal groups are bacteriostatic at low concentrations. Both classes rely on intact and **effective body defense mechanisms** for full effect. Although in terms of clinical response little if any difference can be detected between the two groups in most diseases, in certain situations it is probably advisable to choose a bactericidal antibiotic for therapy. This is especially true when dealing with acute septicemic infection, in which there is frequently a significant leukopenia, and a quick maximal bactericidal effect is required and there is also the need to prevent subsequent localization.

Bactericidal drugs cause the death of microbes. These are preferred in infections that cannot be controlled or eradicated by host mechanisms alone because of the nature or site of infection (e.g., bacterial endocarditis) or because of reduced immunocompetence of the host (e.g., patient with immunosuppressive illness or receiving immunosuppressive therapy). Bactericidal antimicrobials are also indicated for antibacterial treatment of secondary infection

in **granulocytopenic syndromes** such as bracken fern poisoning or chronic furazolidone poisoning in calves. Bactericidal antibiotics are also preferable in the treatment of heavily **capsulated organisms**, such as *Klebsiella* spp. and *R. equi*, which show anti-phagocytic activity. Infections in which significant **intracellular parasitism** occurs are a problem. The majority of antimicrobials that diffuse relatively freely into cells are bacteriostatic in activity and, although the disease may be controlled by their use, infection may still persist in a latent carrier state.

The MIC is the lowest concentration of antibiotic that prevents visible growth after 18- to 24-hour incubation. The minimal bactericidal concentration is the minimal concentration that kills 99.9% of the cells.

Antimicrobial susceptibility is based on these assumptions: MIC > local drug concentration: no effect: resistant (R); MIC = local drug concentration: doubtful: intermediate (I); MIC < local drug concentration: successful therapy: susceptible (S). The S, I, and R designations are assigned by laboratories based on safely achievable plasma concentrations. Breakpoint is an MIC (MIC<sub>BP</sub>) selected to predict clinical outcome for a specific pathogen, in a specific disease, in a specific species, given a specific regimen (dose, route, duration, and frequency). The MIC<sub>BP</sub> incorporates pharmacokinetic and pharmacodynamic considerations. Two breakpoints are provided for each drug. An isolate inhibited at a concentration at or below the lower threshold or susceptible MIC breakpoint is designated S, whereas an isolate that is able to grow after in vitro exposure to a drug concentration that equals to the upper threshold or the resistant MIC breakpoint is designated R. The MPC is the concentration of the drug necessary to prevent (or inhibit) the emergence of the first-step mutants. An alternative definition of the MPC is the highest MIC of isolates in the patient (**Fig. 6-2**).

#### Postantibiotic Effect

The persistent suppression of bacterial growth following the removal of an antimicrobial agent is called the postantibiotic effect (PAE). Persistence of the antimicrobial effect exists after brief exposure to an antimicrobial agent.

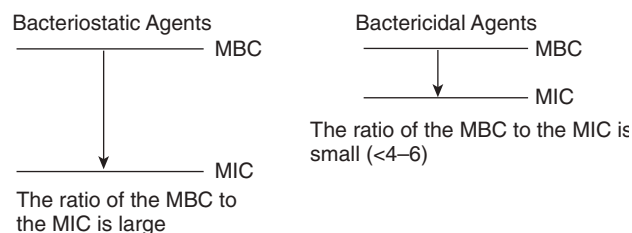

**Fig. 6-2** Relationship between minimum bactericidal concentration (MBC) and minimum inhibitory concentration (MIC) for bacteriostatic and bactericidal agents.

Bacterial killing curve studies show that antimicrobial agents exhibit either **concentration-dependent** or **time-dependent** bacterial killing. The relationship among efficacy, MIC, and the magnitude and time course of plasma drug concentration (PDC) is categorized as either concentration dependent (sometimes referred to as dose dependent) or time dependent (sometimes referred to as concentration independent). A third classification has emerged with characteristics from each of these classes (e.g., fluoroquinolones).

### Concentration-Dependent Killing

High plasma concentration ( $C_{max}$ ) relative to the MIC is the major determinant of clinical efficacy. These drugs also have prolonged PAE values, allowing long dosing intervals that maximize clinical efficacy and minimize side effects (e.g., aminoglycosides, fluoroquinolones, metronidazole).

- Rate and extent of killing increase with increasing drug concentrations
- Maximizing peak concentrations increases efficacy and decreases selection of resistant bacteria
- Some can be both time and concentration dependent (AUC is a better predictor of efficacy)
- Ratio of the AUC or  $C_{max}$  to the MIC (AUC/MIC or  $C_{max}/MIC$ ) correlates best with efficacy (ratio of at least 8–10)
- Some antibiotics (e.g. macrolides) can be either time- or concentration dependent based on organism

### Time-Dependent Killing

The time that the antimicrobial concentration exceeds the MIC determines the clinical efficacy ( $T > MIC$ ). Once the MIC of the bacteria has been exceeded, further increases in the plasma concentrations do not increase the activity of these agents. The objective is to keep the average PDC above the MIC of the pathogen for the significant portion (at least 50%) of the dosing interval (e.g., penicillins, cephalosporins, vancomycin, other bacteriostatic agents).

- Increasing concentrations above MIC does not result in proportionate increases in killing, but increasing the dose may be necessary to ensure that  $PDC > MIC$  severalfold.
- Antimicrobial action continues as long as concentrations are above MIC and lack PAE.
- PDC should be two to four times the MIC of the pathogen.
- Variable  $T > MIC$ : 25% for carbapenems, 50% to 70% extended spectrum penicillins, and 100% for aminopenicillins and penicillins
- For most time-dependent agents, exceeding MIC by 1 to 5 multiples for between 40 and 100% of the interdosing interval is appropriate.

### ANTIMICROBIALS PROHIBITED FROM USE IN ANIMALS INTENDED FOR FOOD IN THE UNITED STATES

- Chloramphenicol
- Dimetridazole
- Iprnidazole
- Other nitroimidazoles
- Furazolidone, nitrofurazone, other nitrofurans
- Sulfonamide drugs in lactating dairy cattle (except approved use of sulfadimethoxine, sulfabromomethazine, and sulfamethoxypridazine)
- Fluoroquinolones
- Glycopeptides (e.g., vancomycin)

### DRUG DETERIORATION

Many antibacterials lose their activity rapidly when kept under adverse conditions. **Quality control** in terms of purity, efficacy, and freedom from toxicity costs money, but for these reasons it is preferable to purchase from known reputable companies and follow their recommendations with respect to storage and expiration periods. The use of cheap antibacterial preparations, often purchased in bulk and simply packaged, and distributed with little consideration for factors influencing drug stability, often results in poor therapeutic results. **Crystal-line** or dry preparations that require reconstitution to a solution before parenteral administration are frequently presented this way because their activity degenerates rapidly once they are in solution. Therefore once they have been prepared they should be used immediately, or the manufacturer's recommendations should be followed regarding storage. Attention should be paid to the length of activity expected following reconstitution. **Temperature** and exposure to **sunlight** can be important factors in antibiotic stability and become especially important in farm ambulatory practice: car cold boxes should be used to store antibiotic preparations and other sensitive drugs.

### UNFAVORABLE RESPONSE TO THERAPY

In clinical cases that do not respond to antimicrobial therapy, the initial consideration should be that the wrong antimicrobial agent has been chosen for therapy. This is especially true of infectious conditions of undetermined etiology in which the drug has been chosen on the basis of an educated guess. In these circumstances adequate time should be given for an evaluation of the efficacy of the treatment before a change is made. Generally, a **3-day period of treatment** is allowed for this evaluation provided there is no marked deterioration in the clinical state or further elevation of temperature

during this period. If there is no response to initial therapy then, in the case of conditions of undetermined etiology, it is generally best to change to an entirely different class of antimicrobial agent. However, the possibility of viral or noninfectious etiology should always be considered in these cases, and the case and diagnosis should be reviewed before any change is made.

In any situation in which there is a poor response to therapy the usual causes of this failure should be considered in any further adjustments to therapy or future therapy of similar cases. The first and most obvious of these is that the organism is either **insensitive to the drug** or that it is **not susceptible to the level of the drug** that is being used for therapy. There are two possible approaches. The first is to increase the dose rate and dose frequency and/or to change the route of administration so that higher and possibly effective levels will be achieved, bearing in mind the possible toxic consequences. The second, and safer, approach is to change the antimicrobial agent being used. This problem can be avoided if the organism and its potential **susceptibility** can be identified, either by clinical examination or by appropriate sampling with culture and susceptibility testing. The development of resistance during antimicrobial treatment of an individual animal is not a recognized problem in large-animal medicine.

Another common cause of poor response is that the infection is situated in an area to which the drug is **poorly accessible**. If this is associated with an area behind a barrier to the entry of the antibiotic, such as the joints or the eye, it may be necessary to resort to **higher dose rates** and frequency, or intravenous administration of the drug, or to ancillary local treatment into this area. Alternatively, another drug with **superior penetrability** may be used.

Organisms must be actively metabolizing for antimicrobial agents to exert their effect. This feature can result in poor response to therapy or relapse following discontinuation of therapy in **chronic infections** such as endocarditis or where there is excessive necrotic or fibrotic tissue associated with the infection. In these instances, dormant organisms and the long diffusion tracks make effective cure difficult and high antimicrobial levels sustained over longer periods are required. In **purulent conditions** surgical drainage, where possible, is an essential adjunct to antimicrobial therapy.

The importance of ancillary and **supportive therapy** to counteract the effects of shock, toxemia, and dehydration that may be associated with infection cannot be overemphasized, and frequently such therapy may markedly influence the outcome of a case. It is obvious, for example, that 3 mL of antibiotic will do little to counter the effects of a 4-L fluid deficit in a scouring calf.



## DRUG WITHDRAWAL REQUIREMENTS AND RESIDUE AVOIDANCE

In most countries there are requirements for the withdrawal of antimicrobial agents from the feed for specified periods before slaughter, and animals or their milk cannot be marketed for certain periods following antimicrobial therapy.

Antibiotic contamination of food products can be a **public health risk**, although proven risk for toxicity or allergy from antibiotics in humans is minuscule. An example would be allergic reactions to antibiotic residues, particularly penicillin. There are also **commercial considerations** in which residues of antibiotics in milk can cause considerable problems in the manufacture of milk products. Effects on starter cultures for cheese and yogurt can be particularly deleterious and can result in downgrading or total loss of large quantities of manufacturing milk.

The purpose of withdrawal requirements is to ensure that meat and milk for human consumption is wholesome and does not contain violative residues of drugs. The public's concern for the wholesomeness of the food that it consumes will determine the food that it buys. Cooperative quality assurance programs involving both the producer and the veterinarian are a major answer to this concern.

A **withdrawal period** is the time during which the animal must be held free of the drug before it can be marketed. For milk the term **withholding period** is commonly used and defines the period during which milk cannot be sent for human consumption following the treatment of the animal with a drug. A **tolerance** for the pharmacologically active ingredient in tissues is set by regulatory authorities for each drug. The **tolerance level** is the level below which tissue concentrations must fall before they are considered safe for human consumption, and there is a large margin of safety.

The required withdrawal and withholding periods will vary between antimicrobial agents and also with the same antimicrobial agent depending on the amount of drug given; factors such as age and the disease state of the animal are also important. Unfortunately, the required withdrawal and withholding periods to ensure freedom of food products from violative drug residues are not known for the variety of dose concentrations and dose intervals of the various antimicrobials that could be used in clinical practice, and they not likely to be known in the near future. In many countries this has led to regulations that limit the quantity of antibiotics in drug products. **Label instructions explaining product usage and drug withdrawal times are required.** These label instructions include what is generally called the **label dose**.

### Label Dose and Extralabel Use

The label dose (and dose interval) is a dose of an antimicrobial for which the specific withdrawal and withholding periods have been established, and these are stated in conjunction with the label dose. The label dose is the officially approved or legal dose rate for that drug.

When an antimicrobial is used, it is incumbent upon the practitioner to notify the owner that the animal cannot be marketed (or milk sent for human consumption) before the accompanying withdrawal (or withholding) period has expired. The practitioner may be legally liable if a violation occurs and this notification has not been given.

In the **United States** the **label dose** of a drug also includes use only in the species of animal for which the drug is labeled, the class of animal (lactating versus nonlactating dairy cow), the disease conditions indicated by the label, the route of injection, the amount of drug to be injected at one site, and the number of repeat treatments that can be given. These **label directions**, and the need to follow them, are directed primarily at lay users of these drugs and lay users may not use the drug in a nonlabel fashion. The label directions should also be followed by the veterinarian whenever possible.

#### REQUIREMENTS FOR EXTRALABEL USE OF DRUGS IN THE UNITED STATES

- Extralabel use of drugs (ELDU) is permitted only by or under the supervision of a veterinarian.
- ELDU is allowed only for U.S. Food and Drug Administration (FDA)-approved animal and human drugs.
- A valid veterinarian–client–patient relationship is a prerequisite for all ELDU.
- ELDU must be for therapeutic purposes only (animal's health is suffering or threatened), not drugs for production use.
- Rules apply to dosage form drugs and drugs administered in water—ELDU in feed is prohibited.
- ELDU is not permitted if it results in a violative food residue or any residue that may present a risk to public health.
- FDA prohibition of a specific ELDU precludes such use.

### Extralabel Use

There are times where **extralabel use** of drugs is necessary and veterinarians can do this where they have established a proper veterinarian–client–patient relationship. It is the intention that the label dose should be one that is therapeutically effective for that drug. However, this is not always the case, and the label dose should not be confused with the term *recommended dose* as used elsewhere in this book. There are also circumstances where, although the label dose may be therapeutically efficient in many

cases, it is not for the particular case in hand. Optimal therapeutic dose regimens often require extralabel use of the drug. In these situations, antimicrobial drugs may need to be used at dose concentrations and dose intervals different from the label dose. Extralabel use of the drug may be therapeutically necessary for the successful treatment of the problem, but it is not officially approved and the establishment of the required withdrawal period is entirely incumbent upon the veterinarian. The withdrawal period in these circumstances cannot always be extrapolated from that for the label dose.

#### DEFINITION OF VALID VETERINARIAN–CLIENT–PATIENT RELATIONSHIP (AMERICAN VETERINARY MEDICAL ASSOCIATION)

An appropriate veterinarian–client–patient relationship will exist when

1. The veterinarian has assumed the responsibility for making medical judgments regarding the health of the animal(s) and the need for medical treatment, and the client (owner or other caretaker) has agreed to follow the instructions of the veterinarian.
2. There is sufficient knowledge of the animal(s) by the veterinarian to initiate at least a general or preliminary diagnosis of the medical condition of the animal(s). This means that the veterinarian has recently seen and is personally acquainted with the keeping and care of the animal(s) by virtue of an examination of the animal(s) and/or by medically appropriate and timely visits to the premises where the animal(s) are kept.
3. The practicing veterinarian is readily available for follow-up in case of adverse reactions or failure of the regimen of therapy.

### WITHDRAWAL PERIODS

**Label dose withdrawal periods** are determined from pharmacokinetic studies of excretion following administration of the label dose. However, the rate of drug elimination from the body can be influenced by drug dose and dose frequency. For example, the metabolism and excretion half-life of sulfonamides in cattle is dose dependent. With repeated dosing of antibiotics, such as tetracycline and the aminoglycosides, there is deposition of the antibiotic in certain tissues, and following cessation of drug administration there is a slow release from these tissues and a long **washout period**. During this washout period there are decreasing concentrations of the drug in tissues and in milk, which, although not of therapeutic importance, are sufficiently high to be violative. This presents a dilemma to the veterinarian trying to establish withdrawal periods. The occurrence of significant washout periods following prolonged therapy with antibiotics



has only recently been recognized, and there are few data on their duration at different dose concentrations and dose frequencies. A further problem is that most pharmacokinetic parameters have been determined in healthy animals, and altered physiology in diseased animals can markedly alter elimination half-lives; there is also considerable animal-to-animal variation. Rather than trying to guess the possible withdrawal period for an extralabel use, computer-based data information banks with easy access are established to provide this information. One of these is the Food Animal Residue Avoidance Databank ([www.farad.org](http://www.farad.org)), which provides recommendations for withdrawal intervals for extralabel drug use based on analysis of published pharmacokinetic data, foreign and domestic label drug withdrawal intervals, and established maximum residue limits.

### RESIDUE TESTING

Currently, the only way to attempt to ensure nonviolation with extralabel use of antimicrobials is to test for residues. There are a very large number of testing systems becoming available that vary in their method of detection of the presence of antibiotics. Tests such as the Swab Test on Premises (STOP), Calf Antibiotic and Sulfa Test (CAST), Live Animal Swab Test (LAST), Fast Antimicrobial Screen Test (FAST) (which has a higher sensitivity and shorter analytical time and has largely replaced the use of STOP and CAST), the Delvotest P, the Charm Inhibition Assay, and the Charm Farm and Disk Assays are based on the inhibition of growth of *Bacillus stearothermophilus* var. *calidolactis* or *B. stearothermophilus*. Although relatively cheap and easy to perform, they have a risk for false-positive results due to inhibition of growth by inhibitory substances other than antibiotics in milk, particularly substances in milk from inflamed mammary glands. They are sensitive for detecting penicillin and its derivative compounds but less sensitive to other classes of antibiotic. Other commercially available tests use a variety of different immunologic detection methods and test for a single antibiotic or class of antibiotics.

### TESTING FOR COMPLIANCE

Most countries have a monitoring program to detect the occurrence of residues in meat. In the United States, sampling provides a 95% probability of finding a violative residue when 1% of the population is violative. The occurrence of violative residues in red meat is very low because the prevalence of infectious disease is low in the period before slaughter. Feedlot cattle can have a high prevalence of disease in the early feeding period, but there is a substantial subsequent period on-feed before the animals are slaughtered, which exceeds the withholding period of most drugs used for treatment of

disease occurring during the early feeding period. Violative drug residues occur predominantly in cull dairy cows and in bob veal calves.

The concentrations for the various antibiotics that are violative are not stated in this chapter for two reasons: they vary from country to country and the violative concentrations tend to be set by the sensitivity of the detection assay used by the regulatory authority and, as assay technology improves, legally acceptable minimal concentrations will be lowered. Local regulatory publications should be consulted for current requirements.

Assay techniques can be remarkably sensitive. An example is the occurrence of violative residues of chloramphenicol in the milk, blood, and urine of cows that had teat or skin lesions sprayed with a 5% chloramphenicol solution, which is an illegal drug for use in animals for food in most countries.

### CAUSES OF RESIDUE VIOLATIONS IN MILK

In a retrospective study of reasons for the presence of violative antibiotic residues in milk, **failure to withhold milk** for the full withdrawal period and **accidental inclusion of treated milk** in the shipment were the most common. Accidental inclusion of treated milk can occur when there is **inadequate identification** of treated cows. The veterinarian should work with the producer to establish a system that easily identifies cows whose milk is subject to a withholding period. Colored leg markers are one system and are immediately visible to the milker.

**Contamination of recorder jars and milking equipment** with the high concentration of antibiotic secreted in milk in the first milking after treatment is a further reason for residue violations. Treated cows should be **milked last** in large dairies, or milked with separate equipment, and are preferably kept separate as a hospital string.

#### COMMON CAUSES OF ANTIBIOTIC RESIDUES IN MILK

- Extended usage or excessive dosage
- Failure to observe withdrawal times
- Poor records of treatment
- Prolonged drug clearance
- Failure to identify treated animals
- Contaminated milking equipment
- Milker or producer mistakes
- Products not used according to label directions
- Lack of advice on withdrawal period
- Withholding milk from treated quarters only
- Early calving or short dry periods
- Purchase of treated cows
- Use of dry cow therapy for lactating cows
- Milking dry cows

Other reasons for residue violations include **short dry periods**, in which dry cow therapy has been used but the cow has calved earlier than expected. The infusion of **dry cow treatments** into the udder of heifers before calving for the prevention of summer mastitis has also been followed by the presence of violative residues for as long as 26 days. A less common cause is the **accidental milking of dry cows**, in which the latter are not kept as a separate group, and the withholding of milk from only treated quarters. The use of dry cow infusion preparations for treatments during lactation can occur by mistake if drugs intended for the treatment of lactating cows are not kept in a **separate storage area** from other drugs.

The **risk** for residues is higher for farms that have higher frequency of antibiotic usage and for those that use part-time labor. The use of **records** to document treatments and the day of exit from the withholding period is an important preventive measure. Sulfonamides, tetracyclines, penicillins, aminoglycosides, cephalosporin, and chloramphenicol have been found in milk in the United States.

### CAUSES OF RESIDUE VIOLATIONS IN BEEF CATTLE

Violative drug residues occur predominantly in cull dairy cows and in bob veal calves. In one study the primary reasons for violations in this group were as follows:

- Failure to observe the withdrawal periods (61%)
- Use of an unapproved drug (10%)
- Feeding calves milk or colostrum from a treated cow (9%); a greater risk for residues occurs in herds that feed larger volumes of colostrum, possibly reflecting contamination from dry cow therapy; waste milk, discarded from treated cows and fed to calves, is also a risk especially if extralabel doses of antimicrobials are used for udder infusions
- Exceeding the label dose (6%)

The major drugs involved with residues in meat are neomycin, streptomycin, penicillin, oxytetracycline, gentamicin, and sulfamethazine. Intramuscular injection is the route of administration in 60% of the residue cases, oral administration in 28%, and intramammary infusion in 9%. The use of orally administered antimicrobial boluses in calves that were subsequently slaughtered as bob veal calves is also a problem.

### CAUSES OF RESIDUE VIOLATIONS IN SWINE

Similar causes are recorded for the occurrence of violative residues in pigs, but an additional problem in pigs is the tissue residues resulting from **antibiotic inclusions in feeds** for growth promotion and disease control. Sulfonamides are a particular problem. Nonobservance of the required

withdrawal period can result in the rejection of market batches of animals with a substantial financial loss to producers. If feed inclusions have been for the purposes of medication, the prescribing veterinarian may be liable if adequate information on withdrawal periods has not been given.

There is also a problem with **sulfonamide residues** resulting from carryover of sulfonamides from medicated to nonmedicated feeds at the feed mill or on the farm. Mistakes in feed **delivery**, feed-**mixing** sequences, ingredient **contamination** and contamination within the bulk feed **distribution system**, and **delivery augers** can cause residual contamination. **Carryover concentrations** of sulfamethazine (sulfadimidine) of greater than 2 g/t in the finisher ration can result in violative residues in the liver at slaughter. The use of granular forms of sulfamethazine markedly reduces the potential for carryover.

A further source of contamination in the piggyery is **environmental contamination**. Manure and pooled urine from swine fed 100 g/t of sulfamethazine contain sufficient drug to contaminate swine to violative levels when contact with the material is maintained, and this can continue for 6 to 7 weeks when pens are not cleaned after a drug is withdrawn from the feed. **Dried urine** has the potential for airborne contamination of pigs. Sulfamethazine is stable in manure and flush water for long periods and **coprophagy** by pigs can lead to significant intake of the drug. To avoid the risk of this occurring, it is recommended that 3 days after the medicated feed has been withdrawn, the pens should be thoroughly cleaned or the pigs moved to new housing. Water medication can also lead to buildup of residues in the water delivery system, so the watering systems should be flushed. Pigs destined for slaughter can be tested on the farm before shipping using commercially available testing systems, which can also be used for detection of the occurrence of sulfonamides in feed and water.

### TYPE OF THERAPY

In the United States veterinarians are responsible for a very minor proportion of detected residue violations. Possible causes of violations resulting from veterinary therapy include the selection of an inadequate withdrawal period following extralabel use of an antimicrobial and treatment modalities that may not be considered a risk. The local infusion of antibiotic solutions into the uterus of cows may result in circulating concentrations of antibiotic and residues in body tissues and in milk. This results from the absorption of the antibiotic through the endometrium and from the peritoneal cavity following passage through the fallopian tubes. Similarly, following infusion of antibiotic solutions into one quarter of the udder, low concentrations of the antibiotic can

occur in milk secreted from the remaining quarters. Gentamicin is generally considered not to be absorbed from the mammary gland, but more than 87% of an intramammary dose of gentamicin is absorbed from the *inflamed* udder.

### APPROVED DRUGS

Whenever possible, approved antimicrobials should be used for therapy at label dose and a known withdrawal time to comply with regulatory requirements and to minimize the possibility of antibiotic residues in meat and milk. It may be necessary to use nonapproved antimicrobial drugs in certain circumstances and in minor species. The use of an approved antibiotic in a minor species for which it is not approved constitutes an extralabel use of the drug. The legality of the use of unapproved drugs, or of approved drugs in minor species for which they are not approved, is questionable. If such use is contemplated, it is probably wise to have culture and sensitivity data indicating that the use of the unapproved drug is therapeutically necessary. Certain nonapproved antibiotics are **totally banned** for use in food-producing animals in some countries (e.g., in the United States chloramphenicol, nitroimidazoles, sulfamethazine in dairy cattle over 20 months of age, furazolidone, the use of fluoroquinolones in an extralabel fashion) and local regulations should be followed. The use of sulfamethazine in food-producing animals may be banned in some countries. The American Association of Bovine Practitioners has passed a voluntary moratorium on the use of aminoglycosides in cattle.

## Classification of Antimicrobial Agents: Mechanisms of Action and Major Side Effects

### AMINOGLYCOSIDES AND AMINOCYCLITOLS

Aminoglycosides are a class of bactericidal antimicrobial compounds (e.g., amikacin, tobramycin, apramycin, streptomycin, gentamicin, neomycin, kanamycin, dihydrostreptomycin, spectinomycin) produced from strains of *Streptomyces* spp., *Micromonospora* spp., and *Bacillus* spp. They are the drugs of choice for the treatment of serious aerobic gram-negative infections in animals.

### MECHANISM OF ACTION

Aminoglycosides exert a bactericidal action by entering the bacterial cell and inhibiting protein synthesis. They are transported into bacteria based on an ionic association between cationic aminoglycosides and the anionic surface of the cell. Aminoglycosides

penetrate through aqueous channels (porins) of gram-negative bacteria or the water-filled peptidoglycan wall of gram-positive bacteria into the periplasmic space. Transport across the cytoplasmic membrane (inner) is caused by an electrical potential gradient generated by an oxygen-requiring transport process linked to an electron transport system, which causes the bacterial cytoplasm to be negatively charged. This transport process is an energy-requiring aerobic step that does not occur in an anaerobic environment. The efficacy of aminoglycosides therefore depends on a high oxygen tension in the environment, and, consequently, anaerobic bacteria are resistant to aminoglycosides. The transport mechanism can also be inhibited by divalent cations (i.e.,  $\text{Ca}^{2+}$ ,  $\text{Mg}^{2+}$ ).

Aminoglycosides bind to one or more receptor proteins on the 30S subunit of bacterial ribosome. This binding interferes with protein synthesis via restricting polysome formation and causing disaggregation to monosomes, misreading mRNA, nonsense and frameshift mutations of proteins, and cell death.

### TOXICITY

Ototoxicity and nephrotoxicity are common side effects of aminoglycoside administration because cellular matrixes in these organs contain large amounts of phospholipids (anionic aminoglycoside receptors) compared with other tissues of the body. As a result, aminoglycosides should not be used with other ototoxic or nephrotoxic drugs (i.e., furosemide, amphotericin B).

Ototoxicity results from progressive damage to cochlear cells (more common with amikacin and neomycin) and can result in deafness in dogs, as well as damage to vestibular cells (more common with streptomycin and gentamicin) and can cause ataxia in cats. Ototoxicity is largely irreversible but has rarely been documented in large animals administered aminoglycosides.

Nephrotoxicity (occurring most commonly during prolonged therapy, longer than 10 days) is caused by the damage of the membranes of proximal tubular cells that have a high metabolic rate, resulting in a loss of brush border enzymes, proteinuria, decreased glomerular filtration rate, and azotemia. The mechanism of renal toxicity is not fully understood. Risk factors for nephrotoxicity include high doses, long duration of treatment, preexisting renal dysfunction or dehydration, concurrent administration of nephrotoxic drugs or diuretics, persistently elevated trough concentrations, and very young or old age.

Renal toxicity is largely reversible because of regeneration of tubules after the drug is cleared. Metabolic acidosis and electrolyte disturbances (e.g., hyponatremia, hypokalemia) increase renal toxicity of aminoglycosides. High-protein diets increase the glomerular filtration rate and renal blood

flow, promoting aminoglycoside excretion and protecting against nephrotoxicity.

Aminoglycosides cross the placental barrier and can produce nephrotoxicity and ototoxicity in a pregnant animal and its developing fetus. All aminoglycosides given rapidly IV cause bradycardia, decreased cardiac output, and lower blood pressure through an effect on calcium metabolism. Neuromuscular blockade is uncommon following administration of aminoglycosides and is caused by prejunctional blockage of acetylcholine release caused by impaired calcium release at myoneural junctions (muscle paralysis and apnea). The IV administration of calcium salt is used as a treatment for this toxicity. Because of this potential toxicity, it is best not to administer an aminoglycoside when neuromuscular blocker administration is considered.

Spectinomycin is much less toxic than the aminoglycosides; as much as 400 mg/kg IV can be tolerated. There are few important side effects of spectinomycin administration including no ototoxicity or nephrotoxicity. However, pain at the injection site; dizziness, nausea, and insomnia; and urticaria, chills, and fever have been reported. Administration of lincomycin-spectinomycin oral preparations, by parenteral injection to cattle, has produced heavy losses associated with severe pulmonary edema.

## β-LACTAM ANTIBIOTICS: PENICILLINS, CEPHALOSPORINS, AND β-LACTAMASE INHIBITORS

β-Lactam antibiotics are **bactericidal**. There are many congeners in this group of drugs. Members of this group differ in the

- Organisms against which they can be used (spectrum of activity)

- Pharmacokinetics, stability, and suitable route of administration
- Type and extent of bacterial resistance encountered

There are four major groups of penicillins: narrow spectrum, broad spectrum (aminopenicillins), extended spectrum, and penicillinase resistant (Table 6-1). Penicillin-β-lactamase inhibitor combinations (potentiated penicillins) include amoxicillin-clavulanate (orally, PO), ampicillin-sulbactam (IV), ticarcillin-clavulanate (IV), and piperacillin-tazobactam (IV).

### Mechanism of Action

Penicillins and cephalosporins induce their mechanism of action by inhibiting bacterial cell wall synthesis by interfering with the final stage of peptidoglycan synthesis. The peptidoglycan component of the cell wall is essential to the integrity of the bacterial envelope. The peptidoglycan is composed of glycan chains, which are linear strands of two amino sugars (*N*-acetyl glucosamine and *N*-acetylmuramic acid) and pentapeptides that are cross-linked by peptide chains. Formation of a rigid cell wall is through cross-linking between chains of peptidoglycan catalyzed by transpeptidase enzymes (PBP) in cell membrane). Penicillin occupies the D-alanyl-D-alanine substrate site of transpeptidase and becomes linked to the enzymes by a covalent bond, inhibiting transpeptidation or cross-linkage. Penicillin is most effective against actively dividing bacterial colonies and should not be used with bacteriostatic agents. Differences in susceptibility of gram-positive and gram-negative bacteria to penicillins results from structural differences in cell walls, differences in receptor sites (PBPs) and binding affinity for the target PBP, the relative amount of peptidoglycan present, and to different types of β-lactamase produced by bacteria. The composition of cell wall differs between

gram-positive and gram-negative bacteria. The gram-positive cell wall is between 50 and 100 molecules thick, whereas the gram-negative cell wall is one to two molecules thick. The lipopolysaccharide outer membrane forms a barrier to water-soluble penicillins, but porins inserted in this layer permit entry to some extended-spectrum penicillins, depending on size, charge, and hydrophobicity of R groups. As a result, many gram-negative bacteria are resistant to penicillins.

### Toxicity and Clinical Considerations

Allergic reactions to penicillin and its metabolites (penicilloic acid) occur when penicillin acts as a hapten to evoke antibody reactions, including hypersensitivity skin eruptions, hemolytic anemia, and anaphylaxis. As a result, penicillin residues in food-producing animals constitute a public health risk.

Superinfection can be a clinical problem during penicillin administration, reflecting the appearance of bacteriologic and clinical evidence of a new infection during the chemotherapy of a primary one. Penicillins can promote a single resistant microorganism to become dominant, invading the host and producing infection. Penicillins can alter normal intestinal flora and bowel function (anorexia, vomiting, and diarrhea) and can result in death in some species such as guinea pigs, hamsters, and rabbits.

Central nervous system seizures and cardiac arrest can occur in humans with epileptogenic foci that receive large doses of penicillin G. To avoid the induction of fatal ventricular arrhythmias, care should be taken with the rate at which potassium penicillin G is injected IV because of the potassium content of the injection.

Cephalosporins are β-lactam antimicrobials that have a mechanism of action similar to that of the penicillins (inhibition of bacterial cell wall synthesis). Different side chains exist in cephalosporins to create individual drugs (four generations of cephalosporins now exist). Unlike penicillins, cephalosporins contain a dihydrothiazine ring instead of a thiazolidine ring.

### TOXICITY

Cephalosporins cause fewer hypersensitivity reactions than penicillins. Cephalosporins should not be used in animals with a known sensitivity to penicillins (cross-reactivity). Cephalosporins are potentially nephrotoxic and, consequently, caution should be used when administered with other nephrotoxic drugs such as aminoglycosides (e.g., gentamicin, amikacin, neomycin) and amphotericin B. Cephalosporins in the urine can cause a false-positive reaction for glucosuria (copper-reduction technique) and proteinuria (sulfosalicylic turbidimetric test).

Superinfection has been associated with oral administration of first-generation

**Table 6-1** The four major categories of penicillin: Narrow spectrum, broad spectrum, penicillinase resistant, and extended spectrum

Narrow-spectrum penicillins	Aminopenicillins (broad spectrum)	Penicillinase-resistant penicillins (antistaphylococcal penicillins)	Extended-spectrum penicillins (antipseudomonal penicillins)
Crystalline penicillin G (IV)	Amoxicillin (PO)	Methicillin (IV)	Ureidopenicillins
Penicillin V (PO)	Ampicillin (IV or PO)	Nafcillin (IV)	Piperacillin (IV)
Aqueous penicillin G (IM)	Hetacillin	Isoxazolyl penicillins (IV or PO)	Azlocillin (IV)
		Cloxacillin	Mezlocillin (IV)
		Dicloxacillin	Carboxypenicillins
		Oxacillin	Ticarcillin (IV)
		Flucloxacillin	Carbenicillin (IV)

IV, intravenous; PO, orally; IM, intramuscular.



cephalosporins. Orally administered cephalosporins may cause anorexia, vomiting, and diarrhea.

## CHLORAMPHENICOL

Chloramphenicol inhibits protein synthesis by binding to the 50S ribosomal subunit near the site of action of macrolides and lincosamides; antimicrobials in the latter two classes interfere with the binding of chloramphenicol and may therefore interfere with each other's actions if given concurrently. Chloramphenicol is usually bacteriostatic with a broad-spectrum activity (gram-positive, gram-negative, aerobic, and anaerobic bacteria).

### MECHANISM OF ACTION

Chloramphenicol binding to the 50S bacterial ribosomal subunit inhibits peptide bond formation and protein synthesis by interfering with peptidyl transferase enzyme activity. This may affect mammalian mitochondrial protein synthesis, because mammalian mitochondrial ribosomes have a strong resemblance to bacterial ribosomes.

### TOXICITY

**Dose-dependent anemia** can occur in animals (especially in cats) and humans and is reversible. The anemia is caused by inhibition of mitochondrial protein synthesis in bone marrow, as well as inhibition of iron uptake by erythrocytes, which slows the rate of maturation of erythrocytes in bone marrow. **Dose-independent anemia (aplastic anemia)** occurs in humans and is independent of treatment duration. The mechanism of toxicity is thought to involve nitroreduction of a para-nitro group, leading to the production of nitrosochloramphenicol and other toxic metabolites that trigger stem cell damage. Because of the occurrence of rare but fatal aplastic anemia in humans, **the use of chloramphenicol in food-producing animals is banned by the Food and Drug Administration (FDA)**. As a result, humans should use gloves and eye protection when administering chloramphenicol and avoid repeated contact with or inhalation of the powder.

Other side effects are uncommon but occur mainly in young animals because of impaired glucuronidation pathways. Depression, dehydration, reduced fluid intake, weight loss, emesis, diarrhea, and anorexia have been reported with high or prolonged dosages of chloramphenicol. Administration is not recommended in lactating animals because of excretion in milk and possible toxicity risk in offspring (liver is not fully functioning in neonates and fetus). Drug interactions can occur, usually caused by inhibiting the activity of cytochrome P-450 enzymes in the liver, resulting in impaired hepatic metabolism of drugs such as

phenobarbital, pentobarbital, primidone, and phenytoin.

## CHLORAMPHENICOL ANALOGS

**Florfenicol** and **thiamphenicol** are chloramphenicol derivatives. They were synthesized because of the rare occurrence of chloramphenicol-induced aplastic anemia in people and also the ban on the use of chloramphenicol in food-producing animals. Attempts were made to synthesize chloramphenicol analogs to maintain broad-spectrum antimicrobial activity and eliminate the induction of aplastic anemia in people. The mechanism of the antimicrobial activity and antimicrobial spectrum are similar to that of chloramphenicol.

### TOXICITY

Signs of toxicity are varied and include diarrhea and hyperbilirubinemia in horses, diarrhea and decreased feed consumption and rumen activity in cattle, local tissue reaction following intramuscular and subcutaneous administration, and perianal inflammation and rectal eversion/prolapse in swine. Fatal bone marrow suppression with overdose or prolonged florfenicol administration has been reported.

## FLUOROQUINOLONES

Fluoroquinolones are a class of synthetic antimicrobial compounds with broad-spectrum antimicrobial activity (enrofloxacin, orbifloxacin, difloxacin, ciprofloxacin, marbofloxacin, danofloxacin, etc.). Fluoroquinolones exhibit good activity against many gram-negative bacteria (e.g., *E. coli*, *Enterobacter* species, *Klebsiella* species, *Pasteurella* species, *Proteus* species, *Salmonella* species). Some gram-positive bacteria are also susceptible to fluoroquinolones (primarily *Staphylococcus intermedius* and *S. aureus*, including  $\beta$ -lactamase producing gram-positive bacteria; however, the MIC values for staphylococci are typically higher than those for gram-negative bacteria. Poor activity in general against anaerobes and fluoroquinolones should not be used to treat anaerobic infections. *Chlamydia*, *Rickettsia*, *Mycoplasma*, *Mycobacteria*, *Ehrlichia*, *Coxiella*, and *Ureaplasma* sp. can also be susceptible to fluoroquinolones. New-generation fluoroquinolones, such as grepafloxacin, trovafloxacin, and premafloxacin, have increased activity against gram-positive cocci and anaerobic bacteria. They are bactericidal, potent, and are well tolerated by animals and can be administered with a variety of routes (orally, subcutaneously, intramuscularly, and intravenously).

### MECHANISM OF ACTION

Fluoroquinolones are bactericidal and exhibit good antibacterial activity, especially against gram-negative bacteria. They inhibit bacterial **DNA gyrase** or **topoisomerase IV**

**enzyme** activity, which is necessary for the DNA supercoiling, because the replicating strands separate inhibiting bacterial DNA replication and transcription. Mammalian cells are resistant to the killing effects because topoisomerase II activity is only inhibited at much higher concentrations.

### TOXICITY

Fluoroquinolones are relatively safe with no allergic and teratogenic activity in animals. They do not alter the anaerobic flora of the gastrointestinal (GI) tract, but high doses might generate reversible GI tract disturbances (e.g., nausea, vomiting, diarrhea). Central nervous system toxicity (e.g., convulsion, seizure) caused by inhibition of the GABA neurotransmitter has been reported primarily in humans but has also been reported in horses.

Arthropathy, characterized by formation of vesicles on the articular surface of the chondrocyte, has been reported to occur at recommended dosages in young dogs and foals, with other domestic animals appearing to be more resistant. This toxicity is thought to be caused by the ability of drugs to bind magnesium ions, which are necessary for the proper development of the cartilage matrix (loss of proteoglycan in the articular cartilage). No effect on pregnancy has been observed, but it is better to avoid using fluoroquinolones in pregnant animals unless no other antimicrobials are effective. Although enrofloxacin and orbifloxacin have been used in horses (in an unapproved manner), these drugs should not be used in young horses because of potential cartilage damage (enrofloxacin and orbifloxacin should not be administered to horses less than 3 years of age, except as a last resort for severe infections not treatable with other medications).

Inhibition of the activity of hepatic microsomal enzymes can alter the metabolism of certain drugs such as theophylline. Crystalluria has been reported in humans (primarily with ciprofloxacin) but not in animals.

## LINCOSAMIDES

There are three antibiotics in the lincosamide group: lincomycin, pirlimycin and clindamycin. Like the macrolides, lincosamides are primarily used to treat gram-positive bacterial infections (including  $\beta$ -lactamase-producing gram-positive bacteria, *Staphylococcus* spp., and *Streptococcus* spp.), in which there is resistance or intolerance to penicillins. Lincosamides are highly effective against anaerobes with poor activity against gram-negative aerobes.

### MECHANISM OF ACTION

Lincosamides bind to the 50S ribosome in which they inhibit protein synthesis. Because this binding site is similar to that of



chloramphenicol and the macrolides, concurrent use of these antimicrobials decreases overall efficacy; therefore combination therapy should be avoided.

### TOXICITY

Severe side effects in humans include pseudomembranous colitis, and this has also been reported in animals with fermenting GI tracts (horses, ponies, ruminants, hamsters, rabbits, guinea pigs, and chinchillas). Oral administration is contraindicated because of severe, often fatal, diarrhea. In cattle, oral administration of lincomycin at concentrations as low as 7.5 parts per million in feed has resulted in inappetence, diarrhea, ketosis, and decreased milk production. Intramuscular clindamycin injection is very painful. No serious side effects have been observed following intramammary injection of pirlimycin in dairy cows.

### MACROLIDES

Erythromycin is one of the macrolide antibiotics (tylosin, spiramycin, tilmicosin, tulathromycin, gamithromycin, tildipirosin, azithromycin, clarithromycin, etc.). Macrolides are usually regarded as being bacteriostatic, but they can be bactericidal in high concentrations against susceptible organisms. Macrolides are highly effective against aerobic gram-positive cocci and bacilli and also against gram-positive anaerobes and *Mycoplasma* species.

### MECHANISM OF ACTION

Macrolides bind to the 50S ribosomal subunit interfering with the binding of aminoacyl-tRNA to 50S and block peptide bond formation. This inhibits the translocation of a newly synthesized peptidyl tRNA molecule from the acceptor site to the peptidyl site.

### TOXICITY

Macrolides are relatively safe, with toxicity most often reported in humans. Studies have been conducted documenting the prokinetic effects of erythromycin, spiramycin, tilmicosin, tulathromycin, and tylosin in cattle.

There can be **pain and irritation** following intramuscular injection that is formulation dependent. Macrolides and lincosamides such as tylosin are associated with causing colitis and fatal diarrhea in horses, so their use is usually restricted to oral erythromycin for the treatment of *R. equi* infections in foals. Erythromycin has been associated with hyperthermia in foals; treated foals that are turned out on hot, sunny, humid days develop fever, tachypnea, and distress, which may result in fatal heat stroke. Diarrhea has been reported in horses and cattle.

**Cardiovascular toxicity** has been reported in animals other than cattle, and has been particularly associated with tilmicosin. Deaths have been reported in humans

related to accidental tilmicosin exposure. Tylosin and spiramycin may induce contact dermatitis in veterinarians. The intravenous administration of tylosin in cattle can cause shock, dyspnea, and depression, and fatal adverse events have been reported following the use of tildipirosin in swine.

### SULFONAMIDES

The sulfonamides are synthetic antimicrobial agents with a wide spectrum encompassing most gram-positive and many gram-negative organisms. Sulfonamides are the oldest group of antibiotics used therapeutically. These drugs were the first efficient treatment to be used systematically for the prevention and cure of bacterial infections. Sulfonamides are derived from the first sulfonamide, sulfanilamide. The long-term use of these drugs may have resulted in resistance that now limits their use. **To increase the efficacy of sulfonamides and convert them from bacteriostatic to bactericidal drugs (most of the time they function as bacteriostatic antimicrobials), they are sometimes combined with other compounds such as trimethoprim and ormetoprim (also pyrimethamine) to potentiate their antibacterial effects.**

### MECHANISM OF ACTION

Folic acid is an essential nutrient necessary for protein and nucleic acid synthesis (DNA and RNA). Folic acid is synthesized by bacteria from the substrate, para-amino-benzoic acid (PABA), and all cells require folic acid for growth. Folic acid (as a vitamin in food) diffuses or is transported into mammalian cells. However, folic acid cannot cross bacterial cell walls by diffusion or active transport. For this reason, bacteria must synthesize folic acid from PABA. Sulfonamides act by competing with PABA as a substrate for the enzyme dihydropteroate synthase, which incorporates PABA into dihydropteroic acid, the immediate precursor of folic acid.

Sulfonamides are bacteriostatic. Trimethoprim, ormetoprim, and pyrimethamine are bacteriostatic, inhibiting dihydrofolate reductase activity necessary for purine and pyrimidine nucleotide synthesis. They also inhibit folic acid synthesis but at a different point in the metabolic pathway from sulfonamides. Dihydropteroate synthase is not present in mammalian cells, whereas pyrimethamine and trimethoprim are more active against the parasite's dihydrofolate reductase than against the mammalian enzyme.

### TOXICITY AND CLINICAL CONSIDERATIONS

Sulfonamides can cause toxicity of multiple organs, including the liver, but there is no difference among the various sulfonamides in the risk of toxicity. Use can be limited

in a small number of patients because of hypersensitivity drug reactions (Type II and III hypersensitivity reactions). Idiosyncratic reactions, including immune-mediated reactions such as drug fever, urticaria, skin rashes, anemia, leukopenia, thrombocytopenia, nonseptic polyarthritides, focal retinitis, and hepatitis, are reported in some species.

Immune-mediated diseases of skin, kidney, liver, and eye (keratoconjunctivitis sicca) are not dose dependent and occur in response to any of the sulfonamides. Fortunately, these adverse reactions are rare when sulfonamides are used at recommended doses and for less than 2 weeks.

High doses of sulfonamides (30 mg/kg twice a day) can alter thyroid function, especially in dogs, causing decreased levels of thyroxine and thyronine (hypothyroidism). Decreases are clinically significant after 3 weeks of administration and will return to normal by 3 weeks after the drug is discontinued.

Renal crystalluria has been reported when administering high doses, and as a consequence it is important to ensure that the animal is well hydrated to avoid renal damage caused by precipitation of the sulfonamide (crystalluria). Because herbivores generally have alkaline urine, crystallization is not as much a concern in herbivores as in carnivores with their acidic urine.

Congenital defects are possible in foals born to mares treated for equine protozoal myeloencephalitis during pregnancy.

### Precautions and Contraindications

As a general rule, sulfonamides should be used with caution or avoided in animals with liver disease, kidney disease, blood dyscrasia, or a history of hypersensitivity to sulfonamides.

Although commonly administered orally to horses, potentiated sulfonamides are not for use in horses intended for food. Potentiated sulfonamides have been associated with inducing diarrhea in horses. The injectable formulations of potentiated sulfonamides are suspensions; rapid IV administration causes hypotension and collapse.

### TETRACYCLINES

Tetracyclines (tetracycline, chlortetracycline, oxytetracycline, doxycycline, minocycline, etc.) possess a broad-spectrum bacteriostatic activity against aerobic and anaerobic gram-positive (not  $\beta$ -lactamase-producing gram-positive bacteria) and gram-negative bacteria. They are also effective against microorganisms that are resistant to other antibiotics, such as several *Rickettsiae* (*Anaplasma*, *Ehrlichia* and *Haemobartonella*), *Spirochetes* (including Lyme disease), *Mycoplasma pneumoniae*, *Chlamydia* spp., and *Plasmodium* spp. Superinfections are rare with prolonged tetracycline administration.

## MECHANISM OF ACTION

Tetracyclines cross the outer bacterial cell membrane by diffusion through aqueous channels (porins). They enter the cytoplasm by a protein carrier system in gram-negative bacteria and by an energy-dependent process in gram-positive bacteria. Tetracyclines then bind to the 30S ribosomal subunit of bacteria; binding interferes with bacterial protein synthesis in growing or multiplying organisms. This binding prevents the attachment of the aminoacyl-tRNA to the acceptor site on the mRNA ribosomal complex.

## TOXICITY

Tetracyclines are considered relatively safe. The clinically most important toxicity occurs in animals administered high doses or animals administered with impaired renal function that are administered typical therapeutic doses (except for doxycycline and minocycline). In addition, expired tetracycline and oxytetracycline can decompose to form a nephrotoxic compound that results in Fanconi syndrome and glucosuria because reabsorption of glucose from the glomerular filtrate is impaired.

Most tetracyclines, except oxytetracycline, are too irritating to be administered intramuscularly or subcutaneously (sterile abscess), and great care is applied in the formulation of intramuscular products to minimize tissue damage. As a result, tetracyclines are often administered intravenously or orally. Rapid IV administration can cause the animal to collapse; to avoid this, the tetracycline should be injected slowly over a period of several minutes or administered diluted in normal saline solution free of polyvalent cations (as they bind tetracyclines and result in precipitation). Collapse is attributed to transient cardiovascular dysfunction such as atrioventricular block, ventricular bradycardia, and hypotension. The IV use of doxycycline in horses is associated with deleterious side effects on the cardiovascular system, which may result in fatalities. Undiluted propylene glycol-based oxytetracycline products can cause intravascular hemolysis and hemoglobinuria when administered by rapid IV injection.

Impaired bone development in fetus and young animals (tetracyclines pass the placental barrier readily and are administered for research purposes to monitor the rate of bone growth). As a result, tetracyclines should not be used in pregnant animals during the last half of gestation. Tooth mottling (discoloration of tooth enamel) also occurs if tetracyclines are administered during pregnancy (especially the last 2–3 weeks of pregnancy) and during the first postnatal month when tooth development is occurring. This effect is caused by chelation of tetracyclines to the calcium deposits in the developing teeth. Tetracyclines are antianabolic because they decrease protein synthesis at high concentrations.

## MISCELLANEOUS ANTIBIOTICS

### Bacitracin

Bacitracin is a complex labile polypeptide produced by *Bacillus subtilis*. It inhibits peptidoglycan synthesis during the second step of bacterial cell wall synthesis by interfering with the activity of phosphorylase and is bactericidal.

Bacitracin has activity against gram-positive bacteria and is often combined with antibiotics that have gram-negative spectrum of activity (such as polymyxin B, neomycin, or both). Bacitracin is not absorbed orally; systemic usage is associated with the development of nephrotoxicity in addition to pain, induration, and petechiae at the site of injection. As a result, bacitracin is most commonly applied topically in ointments.

### Carbadox

Carbadox is a newer synthetic antibiotic agent that is primarily effective against gram-positive bacteria with little efficacy against some gram-negative bacteria. The mechanism of antimicrobial action is not known, but carbadox is bactericidal.

Carbadox is most commonly used as a feed additive to promote growth in swine and also to control swine dysentery (*Serpulina hyodysenteriae*, formerly known as *Treponema hyodysenteriae*), bacterial enteritis (particularly *Salmonella* spp.), and nasal infections (*Bordetella bronchiseptica*). It is carcinogenic and genotoxic in rodents and, consequently, the usage of carbadox is prohibited in Europe and Canada.

Carbadox stimulates the renin-angiotensin system and suppresses aldosterone production by inducing morphologic changes in adrenal cortex (plasma Na↓ and K↑). Clinical signs of reduced aldosterone production in pigs include growth retardation, dry feces, wasting, dehydration, urine drinking, and a strong interest in salt-containing products.

### Dapsone

Dapsone is a chemical class different from sulfonamides but its mechanism of action is similar to sulfonamides via inhibition of bacterial synthesis of dihydrofolic acid by competing with para-aminobenzoate for the active site of dihydropteroate synthase. Dapsone is rapidly and well absorbed following oral administration and is primarily eliminated via the urine as conjugates and unidentified metabolites.

There is no veterinary approved form of dapsone. It is potentially useful for the oral treatment of some protozoal infections in horses. Dapsone is carcinogenic and should be used with caution in pregnant and nursing animals. Toxic effects include hepatotoxicity, anemia, thrombocytopenia, neutropenia, and GI effects.

### Metronidazole

Metronidazole is a bactericidal agent that is also effective against protozoa that cause

intestinal disease such as *Giardia* organisms, *Entamoeba histolytica*, *Trichomonas* organisms, and *Balantidium coli*. It is effective against most obligate anaerobes including *Bacteroides* spp., *Fusobacterium*, *Veillonella*, *Clostridium* spp., *Peptococcus*, and *Peptostreptococcus*. Metronidazole is primarily used as part of the treatment of anaerobic bacterial infections. It is taken up by anaerobic bacteria and protozoa and reduced to a cytotoxic metabolite that disrupts DNA synthesis, which results in bacterial cell death.

There is no veterinary-approved form of metronidazole, and its use is prohibited in food-producing animals in many countries because laboratory studies have demonstrated mutagenicity and carcinotoxicity. Human formulations are used for treatment of enteric bacterial infections caused by anaerobic bacteria in horses such as giardiasis and clostridiosis. Metronidazole may be teratogenic; therefore the drug should be avoided if possible in pregnant animals, especially during the first few weeks of gestation, and also in nursing animals. Metronidazole should not be used in debilitated animals.

The most severe adverse effect is dose-related central nervous system toxicity including loss of balance, head tilt, nystagmus, disorientation, tremors, and seizures with high doses of metronidazole in horses.

### Nitrofurans (e.g., Nitrofurantoin, Nitrofurazone, Furazolidone)

Nitrofurans are derived from 5-nitrofurans, and more than 3500 nitrofurans have been synthesized. The use of nitrofurans in food-producing animals is banned in many countries because of potential carcinogenic effects in laboratory animals. Nitrofurans are broad-spectrum antibiotics that are highly effective against gram-negative bacteria, with some activity against gram-positive bacteria. Furazolidone also has activity against protozoa, *Giardia*, *Trichomonas*, and coccidia.

Nitrofurans are bacteriostatic and inhibit bacterial carbohydrate synthesis by interfering with the conversion of pyruvate to acetyl coenzyme A. They have been administered orally and topically, with oral bioavailability improved when administered with feed. Nitrofurans are no longer commonly used for the treatment of systemic infections because the effective MIC often approximates the toxic concentration. Nitrofurans are also rapidly eliminated so it is difficult to achieve and sustain therapeutic concentrations in tissues. Nitrofurans (primarily nitrofurantoin) are very occasionally used in horses for the treatment of lower urinary tract infections because they are highly concentrated in urine.

The most common use of nitrofurans is in topical preparations for the eye, ear, mucous membrane, and skin.

### Novobiocin

Novobiocin is a dibasic acid derived from coumarin and is clinically used as a mono- ( $\text{Na}^+$ ) or dibasic ( $\text{Ca}^{2+}$ ) salt form. The mechanism of antibacterial activity is not known but is bactericidal. Several mechanisms of action have been proposed including non-specific inhibition of bacterial wall synthesis; inhibition of DNA, RNA, and protein synthesis; inhibition of respiration and oxidative phosphorylation; and induction of intracellular magnesium deficiency.

Novobiocin has activity against gram-positive and gram-negative bacteria with higher efficacy against the gram-positive bacteria (most gram-negative bacteria are resistant), especially *S. aureus*. Other susceptible organisms include *Neisseria* spp., *Haemophilus* spp., *Brucella* spp., and some strains of *Proteus* spp. Novobiocin is used occasionally as an alternative to penicillins against penicillin-resistant *Staphylococcus* spp. It has synergistic activity with tetracyclines, and combination novobiocin-tetracycline therapy has been used in an attempt to broaden the spectrum of activity and decrease the development of resistance.

Toxic reactions to novobiocin include skin rashes, leukopenia, thrombocytopenia, agranulocytosis, anemia, nausea, vomiting, and diarrhea. Novobiocin is less toxic when used topically; its use in large animals is limited to topical application and intramammary administration in lactating dairy cattle.

### Polymyxins

Polymyxin A, B, C, D, E, and M represent a group of *N*-monoacetylated decapeptide antimicrobial agents produced by *Bacillus polymyxa*. Sulfate salt forms of polymyxin B (mixture of polymyxin B<sub>1</sub> and B<sub>2</sub>) and E (also called Colistin) are used clinically. The usage is primarily limited to oral (Colistin) or topical (polymyxin B) use because of their systemic toxicity, although short-term IV administration of polymyxin B has been used as part of the initial treatment of endotoxemia in horses.

Polymyxins are surface-active cationic detergents and are bactericidal by interfering with bacterial cell membrane phospholipids and disrupting their structure. Development of bacterial resistance is rare for susceptible bacteria.

Polymyxins and Colistin are primarily used in topical skin, mucous membrane, eye, and ear preparations and intramammary formulations for lactating dairy cattle. Antimicrobial activity is markedly reduced in the presence of pus, in tissues containing acidic phospholipids, and in the presence of anionic detergents. Polymyxins have been used orally

in cattle and swine for the treatment of gram-negative enteric infections, but they have a narrow safety margin. Toxic effects include nephrotoxicity, respiratory paralysis (rapid IV injection), and central nervous system dysfunction including anorexia, pyrexia, and depression.

### Rifampin

Rifampin is a complex macrocyclic semi-synthetic antibiotic derived from rifamycin B. It is highly active against gram-positive bacteria (*Staphylococcus* spp.), *Mycobacterium* spp., *Haemophilus* spp., *Neisseria* spp., and *Chlamydia* spp., but has limited activity against gram-negative bacteria because of differences in the ability of the antibiotic to pass through the bacterial cell wall. Rifampin also has some antifungal and antiviral (poxviruses and adenoviruses) activity. In large animals, rifampin is most commonly administered orally in conjunction with other antibiotics to treat deep-seated abscesses such as liver abscesses in sheep caused by *Corynebacterium pseudotuberculosis* (caseous lymphadenitis) or pulmonary abscesses in foals caused by *R. equi*. Rifampin has also been used to treat individual valuable cattle with Johne's disease. Combined administration with another antibiotic is strongly advised because coadministration slows the development of resistance to rifampin.

Rifampin is bactericidal and inhibits the activity of DNA-dependent RNA polymerase, preventing the initiation of RNA synthesis by interfering with the activity of the  $\beta$ -subunit of DNA-dependent RNA polymerase. Rifampin metabolites may impart a red-orange color to the urine, feces, saliva, and tears.

Rifampin is a potent inducer of hepatic microsomal enzymes (hepatotoxicity) and is also teratogenic, so the use in pregnant animals should be restricted. Rifampin administration accelerates the metabolism of chloramphenicol and corticosteroids (prednisone and dexamethasone). The most common toxic effect is hepatotoxicity, and animals on long-term administration should have a periodic serum biochemical analysis performed to monitor for signs of hepatic injury and dysfunction.

### Vancomycin

Vancomycin is a glycopeptide bactericidal antibiotic that inhibits peptidoglycan synthesis in the bacterial cell wall during replication. A variety of *n*-alkyl vancomycin forms have been synthesized with some forms being more active and with some having longer elimination half-lives than that of vancomycin. Vancomycin is primarily

effective against gram-positive bacteria (in particular, *Staphylococcus* spp. and streptococci), enterococci (*E. faecium* and *E. faecalis*), and *Neisseria* spp. It is also effective against gram-positive anaerobic cocci with no activity against anaerobic gram-negative bacteria. Its most important use in veterinary medicine is for the treatment of life-threatening methicillin-resistant *S. aureus* infections.

Extralabel usage of vancomycin in food-producing animals is prohibited by the FDA. Vancomycin is not absorbed orally, intramuscular and subcutaneous injections are painful and irritating, and, consequently, vancomycin must be administered with slow IV infusion over at least 30 minutes as a dilute solution. Rapid IV administration has been associated with flushing of the skin, pruritus, tachycardia, severe hypotension, cardiac arrest, and other signs associated with histamine release. Nephrotoxicity and ototoxicity are possible. Newer formulations are safer but might be associated with histamine release following IV injection.

### Virginiamycin

Virginiamycin is a peptolide antibiotic consisting of a predominant M fraction ( $\text{C}_{28}\text{H}_{35}\text{N}_3\text{O}_7$ ) and the lesser S fraction ( $\text{C}_{43}\text{H}_{49}\text{NO}_{10}$ ). The S and M fractions have bacteriostatic and bactericidal activities when they are used separately and together, respectively. Virginiamycin is not known to have synergistic activity with other classes of antibiotics.

Virginiamycin inhibits protein synthesis by binding to the 23S ribosomal subunit and blocking the translation process, with no effect on transcription. It is not commonly used to treat bacterial infections in domestic animals despite possessing a broad-spectrum antimicrobial activity. Most often it is used as a feed-additive formulation for growth promotion in animals such as swine, turkey, and broiler chickens.

### FURTHER READING

- Giguere S, Prescott JF, Dowling PM, eds. *Antimicrobial Therapy in Veterinary Medicine*. 5th ed. Ames, IA: Wiley-Blackwell; 2013.
- Hsu WH, ed. *Handbook of Veterinary Pharmacology and Therapeutics*. 1st ed. Ames, IA: Wiley-Blackwell; 2008.
- Oakes J, Seifert S. American association of poison control centers database characterization of human tilmicosin exposures, 2001-2005. *J Med Toxicol*. 2008;4:225-231.
- Plumb DC, ed. *Plumb's Veterinary Drug Handbook*. Ames, IA: Blackwell; 2015.
- Riviere JE, Papich MG, eds. *Veterinary Pharmacology and Therapeutics*. 9th ed. Ames, IA: Wiley-Blackwell; 2009.

# Diseases of the Alimentary Tract: Nonruminant

# 7

## PRINCIPLES OF ALIMENTARY TRACT DYSFUNCTION 176

Motor Function 176  
Secretory Function 177  
Digestive Function 178  
Absorptive Function 178

## MANIFESTATIONS OF ALIMENTARY TRACT DYSFUNCTION 178

Abnormalities of Prehension,  
Mastication, and Swallowing 178  
Drooling of Saliva and Excessive  
Salivation 178  
Vomiting and Regurgitation 179  
Diarrhea, Constipation, and Scant  
Feces 179  
Ileus (Adynamic and Dynamic  
Ileus) 180  
Alimentary Tract Hemorrhage 181  
Abdominal Pain 182  
Tenesmus 182  
Shock and Dehydration 182  
Abdominal Distension 182  
Abnormal Nutrition 183

## SPECIAL EXAMINATION 183

Nasogastric Intubation 183  
Medical Imaging 183  
Endoscopy 184  
Exploratory Laparotomy (Celiotomy) 184  
Tests of Digestion and Absorption 184  
Abdominocentesis for Peritoneal  
Fluid 186  
Intestinal and Liver Biopsy 190

## PRINCIPLES OF TREATMENT IN ALIMENTARY TRACT DISEASE 190

Relief of Abdominal Pain 191  
Relief of Distension 191  
Replacement of Fluids and  
Electrolytes 191  
Correction of Abnormal Motility 191  
Relief of Tenesmus 192  
Reconstitution of Rumen Flora  
and Correction of Acidity or  
Alkalinity 192

## DISEASES OF THE BUCCAL CAVITY AND ASSOCIATED ORGANS 192

Diseases of the Muzzle 192  
Stomatitis 192  
Diseases of the Teeth 194  
Diseases of the Parotid Salivary  
Glands 195

## DISEASES OF THE PHARYNX AND ESOPHAGUS 196

Pharyngitis 196  
Pharyngeal Obstruction 197

Pharyngeal Paralysis 197  
Esophagitis 198  
Esophageal Rupture 198  
Esophageal Obstruction 199

## DISEASES OF THE NONRUMINANT STOMACH AND INTESTINES 203

Gastritis 203  
Enteritis (Including Malabsorption,  
Enteropathy, and Diarrhea) 204  
Intestinal Hypermotility 213  
Dietary Diarrhea 213  
Abdominal Fat Necrosis  
(Lipomatosis) 215

## DISEASES OF THE PERITONEUM 215

Peritonitis 215

## ABDOMINAL DISEASES OF THE HORSE INCLUDING COLIC AND DIARRHEA 220

Colic in the Pregnant and Postparturient  
Mare 236  
Colic in Foals 237  
Gastric Dilation in the Horse 240  
Gastric Impaction in Horses 243  
Gastric (Gastroduodenal) Ulcer in  
Foals 244  
Gastric Ulcer in Adult Horses 246  
Intestinal Obstruction in Horses 252  
Small-intestinal Obstruction in  
Horses 252  
Duodenitis-proximal Jejunitis  
(Anterior enteritis, Proximal  
Enteritis) 255  
Diseases of the Cecum 257  
Displacement and/or Volvulus of the  
Large (Ascending) Colon 259  
Impaction of the Large (Ascending)  
Colon of Horses 263  
Enteroliths and Fecaloliths 264  
Sand Colic 266  
Right Dorsal Colitis 267  
Small Colon Obstruction 268  
Spasmodic Colic 269  
Intestinal Tympany in Horses 269  
Verminous Mesenteric Arteritis  
(Verminous Aneurysm and  
Thromboembolic Colic) 270  
Retroperitoneal Abscess (Internal  
Abdominal Abscess, Chronic  
Peritonitis, and Omental  
Bursitis) 270  
Rectal Tears 271  
Acute Diarrhea of Suckling Foals 273  
Acute Diarrhea of Adult (Nonsuckling)  
Horses 276  
Chronic Undifferentiated Diarrhea of  
Horses 280

Idiopathic Chronic Inflammatory Bowel  
Diseases of Horses 282  
Granulomatous Enteritis of  
Horses 282  
Lymphocytic-plasmacytic  
Enterocolitis 283  
Idiopathic Focal Eosinophilic  
Enteritis 283  
Equine Grass Sickness (Equine  
Dysautonomia, Grass Disease, and  
Mal Secco) 283  
Intestinal Hyperammonemia 286

## ABDOMINAL DISEASES OF THE PIG INCLUDING DIARRHEA 287

Acute Gastric Dilatation in Pigs 287  
Acute Gastric Volvulus in Sows 287  
Gastric Ulcers and Hyperkeratosis of  
Swine 287

## NONINFECTIOUS INTESTINAL DISEASE OF SWINE 290

Intestinal Reflux 290  
Intestinal Obstruction in Pigs 290  
Impaction of the Large Intestine of  
Pigs 291  
Intestinal Tympany in Pigs 291  
Osseus Metaplasia 291  
Intestinal Hemorrhage  
Syndrome 291  
Diverticulitis and Ileitis of Pigs 291  
Rectal Prolapse 291  
Rectal Prolapse in Pigs 291  
Rectal Stricture 292

## BACTERIAL AND VIRAL DISEASES OF THE ALIMENTARY TRACT 292

Salmonellosis in Swine  
(Paratyphoid) 292  
Intestinal Clostridiosis in the Pig 308  
*Escherichia coli* Infections in Weaned  
Pigs 311  
Edema Disease (Gut Edema, *Escherichia  
coli* Enterotoxemia) 312  
Postweaning Diarrhea of Pigs (Coliform  
Gastroenteritis) 315  
Campylobacteriosis in Pigs 320  
Porcine Proliferative Enteropathy 322  
Brachyspiral Colitis (Swine Dysentery,  
Porcine Spirochetal Colitis) and  
Nonspecific Colitis 327  
Swine Dysentery 327  
*Brachyspira hamptonii* 334  
Nonspecific Colitis in Pigs 334  
Porcine Intestinal Spirochetosis  
(Spirochetal Colitis, Porcine  
Colitis, and Porcine Colonic  
Spirochetosis) and Nonspecific  
Colitis 335



Yersiniosis in Pigs 337  
 Viral Diarrhea in Neonatal Pigs 337  
 Porcine Rotaviruses 338  
 Porcine Hemagglutinating Encephalomyelitis Virus 340  
 Porcine Adenoviruses 341  
 Porcine Calciviruses 341  
 Porcine Sapoviruses 341  
 Porcine Norovirus 342  
 Porcine Astroviruses 342  
 Porcine Torovirus 342  
 Porcine Orbiviruses 342  
 Porcine Picobirnaviruses 342  
 Porcine Kobuviruses 342  
 Porcine New Virus 342  
 Porcine Bocavirus 343  
 A New Neonatal Diarrhea Syndrome 343  
 Transmissible Gastroenteritis in Pigs 343  
 Porcine Epidemic Diarrhea 350  
 Swine Vesicular Disease 353  
 Vesicular Exanthema of Swine 356  
 Salmonellosis in Ruminants and Horses 357  
 Acute Undifferentiated Diarrhea of Newborn Farm Animals (Particularly Calves and Piglets) 373  
 Enterocolitis Associated with *Clostridium difficile* 377  
 Proliferative Enteropathy in Horses 379  
 Equine Neorickettsiosis (Equine Monocytic Ehrlichiosis, Equine Ehrlichial Colitis, and Potomac Horse Fever) 382  
 Equine Coronavirus Infection 384

Viral Diarrhea in Calves, Lambs, Kids, Piglets, and Foals 384  
 Vesicular Stomatitis (Sore Mouth, Indiana Fever) 393

#### PARASITIC DISEASES OF THE ALIMENTARY TRACT 397

Cryptosporidiosis 397  
 Coccidiosis 401  
 Giardiasis 408  
 Ascariasis in Pigs, Horses, and Cattle 409  
 Strongylosis (Cyathostomiasis) in Horses 411  
*Oxyuris equi* (Pinworm) 415  
 Strongyloides (Threadworm) 416  
*Trichuris* (Whipworm) 416  
 Parasitic Gastritis in Pigs 417  
*Gasterophilus* spp. Infestation (Botfly) 418  
 Thorny-headed Worm in Pigs (*Macracanthorhynchus hirudinaceus*) 419  
 Tapeworm Infestations 419  
 Adult Tapeworm Infestation 420

#### TOXINS AFFECTING THE ALIMENTARY TRACT 421

Phosphorus Toxicosis 421  
 Arsenic Toxicosis 421  
 Molybdenum Toxicosis (Molybdenosis) 425  
 Amitraz Toxicosis 426  
 Propylene Glycol Toxicosis 427  
 Plant Materials Causing Physical Damage 427  
 Plant Toxins Affecting the Alimentary Tract 427

Plants (Unidentified Toxins) Affecting the Gastrointestinal Tract 429  
 Slaframine Toxicosis (Slobbers, Black Patch Disease) 429  
 Cantharidin Toxicosis (Blister Beetle Poisoning, Cantharidiasis) 430

#### NEOPLASMS OF THE ALIMENTARY TRACT 431

Mouth 431  
 Pharynx and Esophagus 431  
 Stomach and Rumen 431  
 Intestines 432  
 Tumors of the Peritoneum 432

#### CONGENITAL DEFECTS OF THE ALIMENTARY TRACT 432

Harelip and Cleft Palate 432  
 Atresia of the Salivary Ducts 433  
 Agnathia, Micrognathia, and Brachygnathia 433  
 Persistence of the Right Aortic Arch 433  
 Choanal Atresia 433  
 Congenital Atresia of the Intestine and Anus 433

#### INHERITED DEFECTS OF THE ALIMENTARY TRACT 434

Inherited Defects of the Mouth and Jaw 434  
 Inherited Rectovaginal Constriction 434  
 Inherited Atresia of Alimentary Tract Segments 434  
 Lethal White Syndrome in Foals and Lambs (Intestinal Aganglionosis) 435

## Principles of Alimentary Tract Dysfunction

The primary functions of the alimentary tract are the **prehension, digestion and absorption of food and water**, and the **maintenance of the internal environment** by modification of the amount and nature of the materials absorbed.

The primary functions can be divided into four major modes and, correspondingly, there are four major modes of alimentary dysfunction. There may be abnormality of **motility, secretion, digestion, or absorption**. The procedure in diagnosis of alimentary tract dysfunction should be to determine which mode or modes of function are disturbed before proceeding to the determination of the site and nature of the lesion and ultimately of the specific cause.

## MOTOR FUNCTION

### NORMAL GASTROINTESTINAL MOTILITY

The form and function of the small intestine of farm animals are similar between species, but the stomachs and large intestines vary considerably. The motility patterns in both the small and large intestine are similar among the species. In the small intestine, the fundamental unit of electrical activity is the slow wave, which is a subthreshold fluctuation in membrane potential. Slow waves are constantly propagated from the stomach to the rectum. When an additional stimulus causes the membrane potential to exceed the excitation threshold, a spike or electrical response activity occurs, which is usually accompanied by contraction. Almost all spike activity in the intestine is superimposed on slow waves, which are important in controlling frequency and velocity at which

spiking events occur. The spiking activity, also known as the migrating myoelectric complex, is the myoelectric pattern in the stomach and small intestine of fasted nonruminants, fed and fasted ruminants, and pigs and horses fed ad libitum.<sup>1</sup> There are three phases of the migrating myoelectric complex:

- **Quiescent phase**, in which very little spike activity occurs
- **Irregular phase**, characterized by intermittent spike activity
- **Activity front**, characterized by intense, continuous spike activity

There is very little muscle contraction or transit of gut contents during the quiescent phase. During the irregular phase, contractions mix the intestinal contents and propel them in an aboral direction. The activity front is accompanied by intense muscular contraction that obliterates the lumen, preventing backflow of content as it propagates, or migrates, down the intestine.

In nonruminants, and pigs and horses fed periodically, feeding abolishes the migrating myoelectric complex for several hours. It is replaced by the fed pattern, characterized by intermittent spike activity resembling the irregular phase.

Normal cecal and colonic myoelectric activities, like those of the small intestine, are characterized by slow waves and spikes. However, unlike the small intestine, the patterns of spikes vary greatly with the species and the area of the large intestine.

Abnormalities of stomach and intestinal motility represent the most common consequence of gastrointestinal tract disease. Disruption in gastrointestinal tract motility can result in the following:

- Hypermotility or hypomotility
- Distension of segments of the tract
- Abdominal pain
- Dehydration and shock

### HYPERMOTILITY AND HYPOMOTILITY

The most important functions of alimentary tract motility are the peristaltic movements that move ingesta from the esophagus to the rectum, the segmentation movements that churn and mix the ingesta, and the tone of the sphincters. In ruminants these movements are of major importance in the forestomach. Prehension, mastication, and swallowing are the other functions of alimentary tract motility that are essential for normal function. Eructation of ruminal gases is an additional crucial function of motility in ruminants.

**Abnormal motor function** can take the form of **increased or decreased motility**. Peristalsis and segmenting movements are usually affected equally and in the same manner. Motility depends on stimulation via the sympathetic and parasympathetic nervous systems, and is thus dependent on the activity of the central and peripheral parts of these systems and on the intestinal musculature and its intrinsic nervous plexuses. Autonomic imbalance, resulting in a relative dominance of one or other system, is manifested by hypermotility or hypomotility, and can arise as a result of stimulation or destruction of hypothalamic centers, the ganglia, or the efferent or afferent peripheral branches of the system. Debility, accompanied by weakness of the musculature, or severe inflammation, such as occurs in acute peritonitis or after trauma, or infarction, results in atony of the intestinal wall. Less severe inflammation, such as occurs in mild gastritis and enteritis, can result in an increase in muscular activity and increased propulsive activity. Abnormalities in intestinal motility can result in diarrhea or constipation and adversely affect digestion and absorption of ingesta.

Increased irritability at a particular intestinal segment increases its activity, and disturbs the normal downward gradient of

activity that ensures the ingesta are passed from the esophagus to the rectum. Not only is the gradient toward the rectum made steeper, increasing the rate of passage of ingesta in that direction, but the increased potential activity of an irritated segment may be sufficiently high to produce a reverse gradient to the oral segments so that the directions of the peristaltic waves are reversed orally to the irritated segments.

### DISTENSION

One of the major results of abnormality of motility is distension of one or more segments of the gastrointestinal tract. Distension can be the result of accumulation of gas, fluid, or ingesta. Much of the accumulated fluid represents saliva and gastric and intestinal juices secreted during normal digestion. Gas distension occurs as a result of failure to expel gas, by eructation or as flatulence, which is produced either as a result of normal digestive processes or abnormal fermentation.

Distension causes pain and, reflexively, increased spasm and motility of adjoining gut segments. Distension also stimulates further secretion of fluid into the lumen of the intestine, and this exaggerates the distension. When the distension passes a critical point, the ability of the musculature of the wall to respond diminishes, the initial pain disappears, and a state of paralytic ileus develops in which much muscle tone is lost.

### ABDOMINAL PAIN

Visceral pain can arise in any abdominal viscus or organ, but the mode of its development is always the same, and alimentary tract disease is the major cause of visceral and, more specifically, of abdominal pain. The **most important mechanism is stretching of the wall of the viscus**, which stimulates free pain endings of the autonomic nerves in the wall. Contraction does not itself cause pain but does so by causing direct and reflex distension of neighboring segments. Thus spasm, an exaggerated segmenting contraction of one section of intestine, will result in distension of the immediately oral segment of intestine when a peristaltic wave arrives. When there is increased motility for any reason, excessive segmentation and peristalsis cause abdominal pain, and the frequent occurrence of intermittent bouts of pain depends on the periodic increases in muscle tone that are typical of the alimentary tract wall. Other factors that have some stimulating effect on the pain of end organs are edema and failure of local blood supply, such as occurs in local embolism or in intestinal accidents accompanied by twisting of the mesentery. A secondary mechanism in the production of abdominal pain is the stretching and inflammation of serous membranes.

Clinically, abdominal pain can be detected by palpation and the eliciting

of pain responses. However, it is unknown if the response elicited is caused by involvement of underlying organs or by referred pain. It is difficult to decide if referred pain occurs in animals. In humans it is largely a subjective sensation, although often accompanied by local hyperalgesia. There are no known examples of referred pain that are of diagnostic importance in animals, and a local pain response on palpation of the abdomen is accepted as evidence of pain in the serous membranes or viscera that underlie the point of palpation.

### DEHYDRATION AND SHOCK

An immediate effect of distension of the stomach or small intestine by the accumulation of saliva and normal gastric and intestinal secretions is the stimulation of further secretion of fluid and electrolytes into the oral segments. The stimulation is self-perpetuating, and creates a vicious cycle resulting in loss of fluid and electrolytes to the point where fatal dehydration can occur. The dehydration is accompanied by acidosis or alkalosis, depending on whether the obstruction is in the intestine and accompanied by loss of alkali, or in the stomach and accompanied by a large loss of acid radicals. The net effect is the same whether the fluid is lost by vomiting or is retained in the gut.

The same cycle of events occurs in ruminants that gorge on grain, but here the precipitating mechanism is not distension but a gross increase in osmotic pressure of the ingesta caused by the accumulation of osmotically active compounds, including lactic acid. Dehydration is also of major importance in diarrhea, irrespective of the cause. An important additional factor in the production of shock, when there is distension of alimentary segments, is a marked reflex depression of vasomotor, cardiovascular, and respiratory functions. In diarrhea in calves in which there is no septicemia or toxemia associated with bacteria, the endpoint in the phase of dehydration can be cardiac failure caused by severe metabolic acidosis and electrolyte abnormalities. Renal ischemia leading to azotemia or uremia can result from decreased circulating blood volume and also contribute to a fatal outcome. These matters are discussed in detail in [Chapters 5 and 6](#).

### SECRETORY FUNCTION

Diseases caused by abnormalities of secretion of digestive enzymes are not generally recognized in farm animals. In humans, and to a lesser extent in small animals, defects of gastric and pancreatic secretion produce syndromes that are readily recognized, but they depend on clinical pathologic examination for diagnosis. If they do occur in farm animals, they have so far only been recognized as aberrations of motility caused by the defects of secretion. However, it is reasonable to assume that some neonates are deficient

in lactase activity, which results in dietetic diarrhea. Undigested lactose causes diarrhea by its hyperosmotic effect, and some of the lactose can be fermented in the large intestine, the products of which fermentation exaggerates the diarrhea. A deficiency of lactase activity has been suspected in foals affected with diarrhea of undetermined origin when the definitive diagnosis has not been made. The intestinal lactase activity of foals is at its highest level at birth, gradually declines until the fourth month of age, and then disappears from adults before their fourth year.

## DIGESTIVE FUNCTION

The ability of the alimentary tract to digest food depends on its motor and secretory functions and, in herbivores, on the activity of the microflora that inhabits the forestomachs of ruminants or cecum and colon of Equidae. The flora of the forestomachs of ruminants is capable of digesting cellulose, of fermenting the end products of other carbohydrates to volatile fatty acids, and of converting nitrogenous substances to ammonia and protein. In a number of circumstances, the activity of the flora can be modified so that digestion is abnormal or ceases. Failure to provide the correct diet, prolonged starvation or inappetence, and hyperacidity such as occurs in engorgement on grain all result in impairment of microbial digestion. The bacteria, yeasts, and protozoa may also be adversely affected by the oral administration of antibiotic and sulfonamide drugs or drugs that drastically alter the pH of the rumen content.

Diseases of the stomach of ruminants are presented in [Chapter 8](#). Information about the digestive and absorptive capacities of the equine gut is not exhaustive, but some basic data are available. The rate of passage of ingesta through the stomach and intestines is rapid but varies widely depending on the physical characteristics of the ingesta and dissolved material passing more rapidly than particulate material; 75% of a liquid marker can be emptied from the stomach in 30 minutes and be in the cecum in 2 hours. Passage through the large bowel is much slower, especially in the latter part of the colon in which much of the fluid is absorbed. There is an obvious relationship between the great activity of the small intestine and the effect of a complete obstruction of it: the pain is very severe and often uncontrollable with standard analgesics; fluid loss into the obstructed parts is rapid; and dehydration, loss of electrolytes, and disturbances of acid-base balance are acute, severe, and life-threatening.

## ABSORPTIVE FUNCTION

Absorption of fluids and the dissolved end products of digestion can be adversely

affected by increased motility or by disease of the intestinal mucosa. In most instances, the two occur together but, occasionally, as with some helminth infestations, lesions occur in the intestinal wall without accompanying changes in motility.

## Manifestations of Alimentary Tract Dysfunction

Inanition is the major physiologic effect of alimentary dysfunction when the disease is chronic, dehydration is the major effect in acute diseases, and shock is the important physiologic disturbance in hyperacute diseases. Some degree of abdominal pain is usual in most diseases of the alimentary tract, with the severity varying with the nature of the lesion. Other manifestations include abnormalities of prehension, mastication, and swallowing; and vomiting, diarrhea, hemorrhage, constipation, and scant feces.

## ABNORMALITIES OF PREHENSION, MASTICATION, AND SWALLOWING

Prehension is the act of grasping for food with the mouth (lips, tongue, and teeth). It includes the ability to drink. Causes of faulty prehension include:

- Paralysis of the muscles of the jaw or tongue
- Malposition of incisor teeth caused by the following:
  - Inherited skeletal defect (inherited displaced molar teeth, inherited mandibular prognathism, inherited congenital osteopetrosis)
  - Rickets

Absence of some incisor teeth  
Pain in the mouth caused by the following:

- Stomatitis, glossitis
- Foreign body in mouth
- Decayed teeth, e.g., fluorosis

Congenital abnormalities of tongue and lips:

- Inherited harelip
- Inherited smooth tongue of cattle

A simple examination of the mouth usually reveals the causative lesion. Paralysis is indicated by the behavior of the animal as it attempts to ingest feed without success. In all cases, unless there is anorexia caused by systemic disease, the animal is hungry and attempts to feed but cannot do so.

Mastication may be painful and is manifested by slow jaw movements interrupted by pauses and expressions of pain if the cause is a bad tooth, but in a painful stomatitis there is usually complete refusal to chew. Incomplete mastication is evidenced by the dropping of food from the mouth while eating and the passage of large quantities of undigested material in the feces.

Swallowing is a complex act governed by reflexes mediated through the glossopharyngeal, trigeminal, hypoglossal, and vagal nerves. It has been described endoscopically and fluoroscopically in the horse. The mechanism of the act includes closure of all exits from the pharynx, the creation of pressure to force the bolus into the esophagus, and involuntary movements of the musculature of the esophageal wall to carry the bolus to the stomach. A defect in nervous control of the reflex or a narrowing of the lumen of the pharynx or esophagus may interfere with swallowing. It is difficult to differentiate clinically between physical and functional causes of dysphagia (difficulty in eating/swallowing).

Dysphagia is manifested by forceful attempts to swallow accompanied initially by extension of the head, followed by forceful flexion and violent contractions of the muscles of the neck and abdomen. Inability to swallow is usually caused by the same lesions as dysphagia, but to a greater degree. If the animal attempts to swallow, the results depend on the site of the obstruction. Lesions in the pharynx cause regurgitation through the nostrils or coughing up of the material. In the latter instance, there is danger that some of the material is aspirated into the lungs and could cause acute respiratory and cardiac failure or aspiration pneumonia. When the obstruction is at a low level in the esophagus, a large amount of material can be swallowed and then regurgitated. It is necessary to differentiate between material regurgitated from the esophagus and vomitus: the former is usually slightly alkaline and the latter is acid.

## CAUSES OF DYSPHAGIA AND INABILITY TO SWALLOW

- Foreign body, tumor, or inflammatory swelling in pharynx or esophagus
- Painful condition of pharynx or esophagus
- Esophageal obstruction by impacted feed material
- Esophageal dilatation caused by paralysis
- Esophageal diverticulum
- Esophageal spasm at site of mucosal erosion (achalasia of cardia not encountered)

## DROOLING OF SALIVA AND EXCESSIVE SALIVATION

Drooling saliva from the mouth, distinct from frothing such as occurs during convulsions, can be caused by pain in the mouth and by an inability to swallow. Excessive salivation is caused by stimulation of saliva production by systemic toxins, especially fungal toxins, or by hyperthermia. With systemic poisonings the increased salivation is often accompanied by lacrimation.

## LOCAL CAUSES OF DROOLING

- Foreign body in mouth or pharynx
- Ulceration, deep erosion or vesicular eruption of the oral mucosa
- Inability to swallow (esophageal abnormality)

## SYSTEMIC CAUSES OF EXCESSIVE SALIVATION

- Poisonous trees: *Oleander* spp., *Andromeda* spp. (rhododendron)
- Other poisonous plants: kikuyu grass (or an attendant fungus)
- Fungal toxins, e.g., slaframine and those causing hyperthermia, e.g., *Claviceps purpurea* and *Acremonium coenophialum*
- Iodism
- Watery mouth of lambs
- Sweating sickness
- Methiocarb poisoning

## VOMITING AND REGURGITATION

### VOMITING

Vomiting is the forceful ejection of contents of the stomach and the proximal small intestine through the mouth, and is a complex motor disturbance of the alimentary tract. It is a vigorously active motion signaled by hypersalivation, retching, and forceful contractions of the abdominal muscles and diaphragm. Vomiting is essentially a protective mechanism with the function of removing excessive quantities of ingesta or toxic materials from the stomach. Note that vomition is exceedingly rare in horses and is usually a terminal event. Vomition occurs in two forms: **projectile** and **true vomiting**.

### Projectile Vomiting

This is not accompanied by retching movements, and large amounts of fluid material are ejected with little effort. It is almost always as a result of overloading of the stomach or forestomach with feed or fluid.

### True Vomiting

As it occurs in monogastric animals like the dog and cat, true vomiting is accompanied by retching movements including contraction of the abdominal wall and of the neck muscles and extension of the head. The movements are commonly prolonged and repeated, and the vomitus is usually small in amount and of porridge-like or pasty consistency. It is usually a result of irritation of the gastric mucosa. Vomiting is commonly designated as being either peripheral or central in origin depending on whether the stimulation arises centrally at the vomiting center or peripherally by overloading of the stomach or inflammation of the gastric mucosa, or by the presence of foreign bodies in the pharynx, esophagus, or esophageal groove. Central stimulation of vomiting by apomorphine and in nephritis and hepatitis are typical

examples, but vomiting occurs rarely, if at all, in these diseases in farm animals.

Vomiting can have serious effects on fluid and electrolyte balance because of the losses of gastric and intestinal contents. Aspiration pneumonia and laryngeal obstruction are potentially serious consequences of vomiting. Examination of any suspected vomitus to determine its site of origin should always be performed.

**True vomiting is rare in farm animals** except in pigs with gastroenteritis and some systemic diseases. True vomiting does not occur in ruminants but abnormal regurgitation does (see later). **True vomiting is not a feature of gastric disease in the horse for two reasons.** First, the strong cardiac sphincter inhibits the release of stomach contents; in horses rupture of the stomach is more likely to occur before vomiting takes place. Second, the soft palate and epiglottis combine to affect a seal between the oral and nasal parts of the pharynx so that any vomited stomach contents must be discharged through the nasal cavities and not through the mouth. Spontaneous nasal regurgitation or vomiting does occur occasionally, as manifested by the production of green stomach contents at the nostrils. This suggests extreme gastric distension or a dilated esophagus and cardiac sphincter and perhaps some underlying neurologic deficit. Thus vomiting of large quantities of material in the horse is usually a terminal event and suggests gastric rupture.

### REGURGITATION

Regurgitation is the expulsion through the mouth or nasal cavities of feed, saliva, and other substances that have not yet reached the stomach. In most cases it is caused by abnormalities of the esophagus that interfere with swallowing. A common example in large animals is the regurgitation of feed, saliva, and perhaps bloodstained fluid from the esophagus of the horse with esophageal obstruction. Esophagitis is also a common cause of regurgitation.

Ruminants regurgitate rumen contents as part of rumination, but the material is not expelled from the mouth or into the nasal cavities. The regurgitation of rumen contents through the mouth does occur in cattle occasionally, is abnormal, and is a dramatic event. It is usually associated with loss of tone of the cardia or inflammation of the cardia (see examples in the following sections).

**Nasogastric regurgitation or gastric reflux** occurs in the horse. Stomach contents flow into the esophagus, and usually into the nasopharynx and nasal cavities, as a result of distension of the stomach with fluid (which usually originates in the small intestine). This involuntary process is usually slow and gradual, unlike true vomiting. Gastric reflux in the horse can be elicited by nasogastric intubation. Spontaneous efflux of stomach contents is indicative of high-volume and

high-pressure fluid distension of the stomach. On other occasions the presence of sequestered gastric fluids can be confirmed only by the creation of a siphon, using the nasogastric tube to infuse a volume of fluid then disconnecting its supply to retrieve the **nasogastric reflux**.

Causes of vomiting and regurgitation include the following:

- Terminal vomiting in horses with acute gastric dilatation
- “Vomiting” in cattle is really *regurgitation* of large quantities of rumen contents through the mouth. Causes include the following:
  - Third-stage milk fever (loss of tone in the cardia)
  - Arsenic poisoning (acute inflammation of the cardia)
  - Poisoning by plants including *Eupatorium rugosum*, *Geigeria* spp., *Hymenoxys* spp., *Andromeda* spp., *Oleander* spp., and *Conium maculatum*
  - Veterinary administration of large quantities of fluids into the rumen (regurgitation occurs while the stomach tube is in place)
  - Use of a large-bore stomach tube
  - Cud-dropping: a special case of regurgitation usually associated with abnormality of the cardia
- Vomiting in pigs may be caused by the following:
  - Transmissible gastroenteritis (TGE)
  - Acute chemical intoxications
  - Poisoning by the fungus *Fusarium* spp., which also causes off-feed effects suspected to be analogous to nausea in humans
- Regurgitation in all diseases causing dysphagia or paralysis of swallowing

## DIARRHEA, CONSTIPATION, AND SCANT FECES

Diarrhea and constipation are the most commonly observed abnormalities in **fecal consistency, composition, and frequency of defecation**.

### DIARRHEA

**Diarrhea** is the increased frequency of defecation accompanied by feces that contain an increased concentration of water and decrease in dry matter content. The consistency of the feces varies from soft to liquid.

Abnormalities of peristalsis and segmentation usually occur together, and when there is a general increase in peristaltic activity there is increased caudal flow, resulting in a decrease in intestinal transit time and diarrhea. Because of a lack of absorption of fluid the feces are usually softer than normal, the dry matter content is below the normal range, and the total amount of feces passed per day is increased. The frequency of



defecation is usually also increased. Common causes of diarrhea are

- Enteritis, including secretory enteropathy
- Malabsorption, e.g., caused by villous atrophy and in hypocuprosis (caused by molybdenum excess)
- Neurogenic diarrhea as in excitement
- Local structural lesions of the stomach or intestine, including the following:
  - Ulcer, e.g., of the abomasum or stomach
  - Tumor, e.g., intestinal adenocarcinoma
- Indigestible diet, e.g., lactose intolerance in foals
- Carbohydrate engorgement in cattle
- In some cases of ileal hypertrophy, ileitis, diverticulitis, and adenomatosis
- Terminal stages of congestive heart failure (visceral edema)
- Endotoxic mastitis in cattle (splanchnic congestion)
  - Small colon impaction in horses
  - Sand colic in horses
- Chronic and acute undifferentiated diarrhea in horses
- Vagus indigestion in cows causes pasty feces but bulk is reduced; these cases may be mistaken initially for other causes of diarrhea

### Malabsorption Syndromes

**Malabsorption syndromes** are being recognized with increased frequency in monogastric farm animals. For example, in recently weaned pigs, there is villous atrophy with a resulting loss in secretory and absorptive function. Inefficient digestion originating in this way may or may not be manifested by diarrhea, but in malabsorption there is usually diarrhea. There is always failure to grow or maintain body weight (BW), in spite of an apparently normal appetite and an adequate diet. In horses, the lesions associated with malabsorption, which can be with or without diarrhea, include villous atrophy, edema and/or necrosis of the lamina propria of the gut wall, and nodular tracts and aggregations of eosinophils indicating damage by migrating strongyle larvae. Special tests are now detailed for the examination of digestive efficiency in the horse. These are listed in the next section. Increased venous pressure in the portal circuit caused by congestive heart failure or hepatic fibrosis also causes diarrhea.

The question of whether or not enteritis in animals causes intestinal hypermotility and increased peristalsis, resulting in diarrhea, remains unresolved. If hypermotility and increased peristalsis cause diarrhea, antimotility drugs may be indicated in some causes of acute infectious diarrhea. Current concepts on the pathophysiology of the common diarrheas associated with infectious agents (such as enterotoxigenic *Escherichia coli*) indicate that there is a net increase in

the flow of intestinal fluid into the lumen and a decrease in outflow back into the systemic circulation, which causes distension of the intestine with fluid. The hydraulic effect of the distension can cause diarrhea, and hypermotility is probably not necessary. In addition, because of the temporary malabsorption that exists in infectious enteritides, and the presence of infectious agents and enterotoxins in the lumen of the intestine, the emphasis should be on evacuation of the intestinal contents and not on the use of anticholinergic drugs to inhibit evacuation. Furthermore, it is unlikely that the anticholinergics will have any significant effect on the secretory-absorptive mechanisms that have been altered by an enteropathogen.

### CONSTIPATION

**Constipation** is the **decreased frequency of defecation** accompanied by feces that contain a decreased concentration of water. The feces vary in consistency from being hard to dry and of small bulk. True constipation, as it occurs in humans, is usually characterized by failure to defecate and impaction of the rectum with feces. When the motility of the intestine is reduced, the alimentary transit time is prolonged and constipation or scant feces occurs. Because of the increased time afforded for fluid absorption, the feces are dry, hard, of small bulk, and are passed at infrequent intervals. Constipation may also occur when defecation is painful, such as in cattle with acute traumatic reticuloperitonitis.

### SCANT FECES

**Scant feces** are small quantities of feces, which may be dry or soft. Scant feces are most common in cattle with abnormalities of the forestomach or abomasum resulting in the movement of only small quantities of ingesta into the small and large intestines (**an outflow abnormality**). The details are available in [Chapter 8](#). When there is complete intestinal stasis the rectum may be empty except for blood-tinged, thick, pasty material.

Common causes of constipation or scant feces are as follows:

- Diseases of the forestomach and abomasum causing failure of outflow
- Impaction of the large intestine in the horse and the sow
- Severe debility, as in old age
- Deficient dietary bulk, usually fiber
- Chronic dehydration
- Partial obstruction of large intestine
- Painful conditions of the anus
- Paralytic ileus
- Grass sickness in horses
  - Cauda equina syndrome in any species
  - Polyneuritis equi
- Chronic zinc poisoning in cattle
- Terminal stages of pregnancy in cows.

### ILEUS (ADYNAMIC AND DYNAMIC ILEUS)

Ileus is a state of **functional obstruction** of the intestines or failure of peristalsis. It is also known as **paralytic ileus** or **adynamic ileus**. **Dynamic or mechanical ileus** is a state of physical obstruction. In paralytic ileus there is loss of intestinal tone and motility as a result of reflex inhibition. This can occur in acute peritonitis, excessive handling of viscera during surgery, and prolonged and severe distension of the intestines as in intestinal obstruction or enteritis. Ileus can also be caused by acid-base imbalance, dehydration, electrolyte imbalances such as hypocalcemia and hypokalemia, and toxemia. Ileus can affect the stomach, causing delayed gastric emptying and subsequent dilatation with fluid and gas. The effect of ileus on the intestines is to cause failure of orocaudal movement of fluid, gas, and ingesta and accumulation of these substances, which results in intestinal distension and varying degrees of abdominal pain, dehydration, and a marked reduction in the amount of feces. Distension of the abdomen, fluid-tinkling, fluid-splashing sounds, and pings on percussion of the abdomen are common clinical findings. Impaction of the large intestine of horses is a form of ileus.

**Postoperative ileus** of the small and large intestines is a common complication of surgical treatment for colic in the horse.<sup>2-5</sup> The clinical findings include gastric reflux because of gastric distension with fluid, absence of or minimal intestinal peristaltic sounds, an absence of feces, abdominal pain, distended loops of intestine palpable per rectum, and varying degrees of shock and dehydration as a result of intestinal fluid sequestration and a decrease in fluid absorption. **Infarction of the intestinal wall** associated with an acute mechanical obstruction of the intestine also results in ileus. In thromboembolic colic caused by verminous mesenteric arteritis in the horse, large segments of the large colon and cecum can become infarcted, resulting in irreversible ileus.

The etiology and pathogenesis of ileus in farm animals are not well understood. Sympathetic hyperactivity is thought to be a factor. The gastroileal reflex is one example of the influence of the activity of one part of the digestive tract on that of another; inhibition of gastric motility when the ileum is distended is called ileogastric reflex. Immediate cessation of all intestinal movement (adynamic ileus) follows distension of an intestinal segment, rough handling of the intestine during abdominal surgery, or peritoneal irritation. Adynamic ileus operates through three pathways: general sympathetic discharge of the peripheral reflex pathway through the iliac and mesenteric plexuses and the intramural plexuses. The treatment of ileus depends on the original

**Table 7-1** Medications with potential prokinetic actions in horses (see text for references)

Drug	Mechanism of action	Proposed dose	Potential indications
<b>Parasympathomimetics</b>			
Bethanechol	Direct acting muscarinic receptor agonist	0.025 mg/kg BW, IV or SC every 4–6 h	Disorders requiring promotion of gastric or cecal emptying. Postoperative ileus, gastroesophageal reflux in foals
Neostigmine	Indirect acting cholinesterase	0.0044–0.022 mg/kg BW, IV, IM or SC; 4 mg SC every 6 h; 2 mg SC every 2 h	Caecal and large colon impactions inhibitor
<b>Benzamides</b>			
Metoclopramide	5-HT <sub>4</sub> agonist, 5-HT <sub>3</sub> and D <sub>2</sub> antagonist	0.04 mg/kg BW/h, IV CRI	Disorders requiring promotion of gastric and small intestinal motility, post-operative ileus, anterior enteritis
Cisapride	5-HT <sub>4</sub> agonist, 5-HT <sub>1</sub> antagonist	0.1–0.25 mg/kg BW/h, IV over 60 min; 0.1 mg/kg BW, IM	Disorders requiring promotion of gastric and small intestinal motility, post-operative ileus, anterior enteritis
Mosapride	5-HT <sub>4</sub> agonist	1–2 mg/kg BW, PO, every 24 h	Gastric impactions, small intestinal ileus, cecal impactions
Tegaserod	5-HT agonist	0.27 mg/kg BW, PO every 12 h	Large colon impactions
<b>Sodium channel blockers</b>			
Lidocaine	Unknown	1.3 mg/kg BW, IV (loading dose) followed by 0.05 mg/kg BW/min CRI	Post-operative ileus, anterior enteritis
<b>Macrolide antimicrobials</b>			
Erythromycin	Stimulation of motilin receptors	0.5–1 mg/kg BW in saline, IV over 60 min	Disorders requiring promotion of gastric and small intestinal motility, post-operative ileus, cecal impactions
<b>Dopamine antagonists</b>			
Domperidone	D <sub>2</sub> -receptor antagonist	0.2 mg/kg BW, IV	Disorders requiring promotion of gastric and small intestinal motility, post-operative ileus
<b>α-Adrenergic antagonists</b>			
Yohimbine	α <sub>2</sub> -Adrenergic receptors antagonist	0.15 mg/kg BW, IV every 3 h 0.25 mg/kg BW in saline, IV over 60 min	Post-operative ileus
Tolazoline	α <sub>2</sub> -Adrenergic receptors antagonist	1 mg/kg BW in saline, IV	Unknown over 60 min
Atipamezole	α <sub>2</sub> -Adrenergic receptors antagonist	0.03–0.06 mg/kg BW, IM	Unknown; possible prevention of α-adrenergic-induced ileus
Acepromazine	Nonspecific α-adrenergic receptors antagonist	0.01 mg/kg BW, IV or IM 4 h	Post-operative ileus
<b>Opioid antagonists</b>			
Naloxone	Opioid antagonist	0.05 mg/kg BW, IV	Unknown, possible large colon impactions, opioid-induced ileus
N-methylnaloxone	Opioid antagonist	0.75 mg/kg BW, IV every 12 h	Unknown, possible large colon impactions, opioid-induced ileus

BW, body weight; IM, intramuscularly; IV, intravenously; PO, orally; SC, subcutaneously; CRI, constant rate infusion.

cause. Physical obstruction of the intestines and torsion of the stomach must be corrected surgically.

**Management of postoperative ileus** and ileus associated with proximal duodenitis-jejunitis (anterior enteritis) includes correction of fluid and electrolyte abnormalities, relief of gastric distension, and administration of prokinetic drugs. Lidocaine (lignocaine, loading dose 1.5 mg/kg followed by 0.033 mg/kg/min intravenously) administered prophylactically to horses undergoing exploratory laparotomy because of abdominal pain reduces the severity and duration of postoperative ileus.<sup>4,6</sup>

Motility of the gastrointestinal tract can be modified by administration of a number of

compounds (Table 7-1).<sup>7–11</sup> Clinical utility is documented for administration of lidocaine to horses with postoperative ileus (see earlier information) and for erythromycin in cattle following surgery for abomasal disease.<sup>7,8</sup>

### ALIMENTARY TRACT HEMORRHAGE

Hemorrhage into the stomach or intestine is a common occurrence in farm animals. The main causes include the following:

- Gastric or abomasal (rarely duodenal) ulcers
- Severe hemorrhagic enteritis
- Structural lesions of the intestinal wall, e.g., adenomatosis, neoplasia

- Infestation with blood-sucking nematodes, e.g., bunostomiasis,
- Local vascular engorgement or obstruction as in intussusception and verminous thrombosis

Hemorrhage into the stomach results in the formation of **acid hematin**, which makes vomitus a dark brown color like coffee grounds, and feces have a black or very dark brown, tarry appearance (**melen**). The change in appearance of the feces caused by hemorrhage into the intestine varies with the level at which the hemorrhage occurs. If the blood originates in the **small intestine**, the feces may be **brown-black**, but if it originates in the **colon or cecum**, the blood is unchanged and gives the feces an **even red**

**color.** Hemorrhage into the **lower colon and rectum** may cause the voiding of feces containing or consisting entirely of **clots of whole blood (hematochezia)**.

If there is any doubt about the presence of blood in the feces or vomitus, biochemical tests should be performed. The hemorrhage may be sufficiently severe to cause anemia and, in particularly severe cases, acute peripheral circulatory failure. In cattle the most sensitive test is one using a dilute alcoholic solution of guaiac as the test reagent. It is capable of detecting a daily blood loss into the abomasum of as small a volume as 70 mL. Transit time of blood from abomasum to rectum in normal cows varies from 7 to 19 hours.

### ABDOMINAL PAIN

The pain associated with diseases of the abdominal viscera causes similar signs regardless of the viscus or organ involved and careful clinical examination is necessary to locate the site of the lesion. The manifestations of abdominal pain vary with the species, with horses being particularly sensitive, but they are comprised largely of abnormalities of behavior and posture. Pain as a systemic state is presented in general terms in [Chapter 5](#), including its effects on body systems and methods for its detection.

Readily identifiable syndromes of abdominal pain referable to the alimentary tract include the following.

#### Horses

- Acute pain: Pawing, flank-watching, rolling
- Subacute pain: Lesser degree of flank-watching, often excessive pawing, lying down frequently without rolling, stretching out as if to urinate, males may extrude the penis, walking backward, dog-sitting posture, lying on back, impulsive walking
- Peritoneal pain: Rigidity of the abdominal wall, pain on palpation.

#### Cattle

- Acute pain: Downward arching of back with treading of the hind feet, lying down (rolling is uncommon), calves will lie down and bellow with severe abdominal pain, as in abomasal torsion
- Subacute pain, including peritoneal pain: Back arched upward, grunting on walking or lying down, grunting on deep palpation of the abdomen, immobility

#### DIFFERENTIAL DIAGNOSIS

The disease states likely to be mistaken for the above categories of alimentary tract pain are

- Acute pain: Paresthesia, e.g., in photosensitive dermatitis of cows;

pleuropneumonia in the horse; uterine torsion in the mare and cow; urticaria as in milk allergy in cows; renal and urethral colic; compulsive walking, e.g., in hepatic disease; lead poisoning; dysuria or obstruction of urinary tract generally; laminitis; and lactation tetany in mares

- Subacute pain: Encephalopathy, possibly hepatic insufficiency

### COMMON CAUSES OF ALIMENTARY TRACT PAIN

#### Horses

- Acute pain: All causes of intestinal obstruction, gastric dilatation, enteritis generally, acute colitis, rarely salmonellosis
- Subacute pain: Thromboembolic colic, impaction of the large intestine, ileal hypertrophy

#### Cattle

- Acute pain: Intestinal obstruction, especially by phytozoars; poisoning by kikuyu grass, *Andromeda* sp., *Oleander* sp., and water hemlock (*Cicuta* sp.)
- Subacute pain: Traumatic reticuloperitonitis and peritonitis generally, abomasal volvulus

### TENESMUS

Tenesmus, or persistent straining, is common in many diseases of the organs of the pelvic cavity; therefore, it is not necessarily a diagnostic sign of disease in the lower alimentary tract. It is sometimes associated with frequent defecation caused by neurologic stimulation of peristalsis. Common causes of tenesmus are listed by species in the following sections.

#### Cattle

- Lower alimentary tract disease, e.g., colitis and proctitis caused by coccidiosis
- Genital tract disease, e.g., severe vaginitis, retained placenta
- Estrogen toxicity in steers, e.g., estrogen implantation, fusariotoxicosis
- 4-Aminopyridine poisoning, methiocarb poisoning
- Lower spinal cord lesions: spinal cord abscess, rabies
- Idiopathic

#### Horses

- Tenesmus does not usually occur except during parturition.

#### Pigs

- Constipation in parturient sows; also dystocia

### SHOCK AND DEHYDRATION

Acute rapid distension of the intestine or stomach causes reflex effects on the heart, lungs, and blood vessels. The blood pressure falls abruptly, the temperature falls below normal, and there is a marked increase in heart rate. In acute intestinal accidents in horses that terminate fatally in 6 to 12 hours, shock is the major cause of death. There appears to be some species difference in the susceptibility to shock because similar accidents in cattle rarely cause death in less than 3 to 4 days; acute ruminal tympany is an exception and may exert its effects rapidly, causing death in a very short time after its onset. Less severe distension, vomiting, and diarrhea cause clinically recognizable dehydration and abnormalities of electrolyte concentration and acid-base balance. Determination of the relative importance of shock and dehydration in a particular case at a particular time is one of the challenges in gastroenterology. The subject is considered in detail in a later section.

### ABDOMINAL DISTENSION

Distension of the abdomen is a common manifestation of disease of the alimentary tract. Generally, abdominal distension associated with the alimentary tract is caused by **distension of viscera with gas or fluid**. The degree of abdominal distension depends on the viscera that are distended, the species involved, and the age of the animal. Abdominal distension is most pronounced when large viscera of adult cattle and horses are distended. Distension of the small intestines in adult cattle and horses is not reliably detected on rectal examination but can be detected by percutaneous ultrasound examination of the abdomen.<sup>12-14</sup>

Occasional cases of abdominal distension are caused by **pneumoperitoneum**, which usually follows abdominal surgery. In ruminants the most common causes are distension of the rumen, abomasum, cecum, and large intestine, and the details of which are presented in [Chapter 8](#). Abdominal distension in horses and pigs is usually caused by distension of the large intestine. Gastric dilatation of the horse does not cause abdominal distension. Ascites is a cause of abdominal distension in all species but can be difficult to detect in horses.

Abdominal distension can be symmetric, asymmetric, or more pronounced dorsally or ventrally on one or both sides. The severity can vary from mild and barely detectable to so severe that the skin over the abdominal wall has sufficient tension that it cannot be picked up or "tented." Determination of the cause of the distension requires careful examination of the abdomen by inspection, palpation, percussion, and simultaneous auscultation. Rectal palpation is used to determine the location and nature of

distended viscera. Diseases of other body systems that cause abdominal distension and must be considered in the differential diagnosis include advanced pregnancy and hydrops allantois.

The alimentary tract diseases of simple-stomached animals in which abdominal distension can be a manifestation include the following:

- Intestinal tympany: Caused by excessive gas production caused by abnormal fermentation in the large intestine of horses and pigs
- Obstruction of the large intestine: In horses and pigs as a result of their torsion or miscellaneous constrictions caused by adhesions, usually as a result of peritonitis
- Retention of the meconium: In foals this is often accompanied by severe distension of the colon and abdomen

Obstruction of the small intestine may cause abdominal distension but not to the degree that occurs in distension of the large intestine. In all the previously mentioned diseases, acute abdominal pain is common.

## ABNORMAL NUTRITION

Failure of normal motor, secretory, digestive, or absorptive functions causes impairment of the nutrient supply to body tissues. Inanition or partial starvation results, and the animal fails to grow, loses BW, or shows other signs of specific nutritional deficiencies. Ancillary effects include decreased appetite when gut motility is decreased; in many cases in which motility is increased and there is no toxemia, the appetite is increased and may be voracious.

## Special Examination

The general aspects of the clinical examination of the alimentary tract and abdomen of farm animals are described in [Chapter 1](#). Some additional or special examination techniques and procedures are included in the following sections.

## NASOGASTRIC INTUBATION

### RUMEN OF CATTLE

Examination of the rumen contents is often essential to assist in determination of the state of the rumen environment and digesta. Passage of a stomach tube into the rumen will determine the patency of the esophagus and if there is increased intraruminal pressure associated with a frothy or free-gas bloat. In a free-gas bloat, large quantities of gas are usually released within a minute. In a frothy bloat, the ruminal end of the tube may become occluded by the froth and very little if any gas is released. Moving the tube back and forth within the rumen and blowing

air into the tube to clear the ruminal end may result in the release of some gas.

When the tube is in the rumen, some **rumen juice** can be siphoned or pumped out and collected in an open beaker for field and laboratory analysis. The **color**, depending on the feed to a limited extent, will be green, olive-green or brown-green. In cattle on **pasture** or being fed good quality hay, the color is **dark green**. When **silage or straw** is the diet the color is **yellow-brown**. In grain overload the color is **milky gray**, and in rumen stasis of long duration with putrefaction, the color is **greenish-black**. The **consistency of the rumen contents** is normally slightly viscid, and watery rumen content is indicative of inactive bacteria and protozoa. **Excess froth** is associated with frothy bloat as in primary ruminal tympany or vagus indigestion. The **odor** of the rumen contents is normally aromatic and, although somewhat pungent, not objectionable to the nose. A **moldy, rotting odor** usually indicates protein putrefaction, and an intensely sour odor indicates an excess of lactic acid formation caused by grain or carbohydrate engorgement. The **pH of the rumen juice** varies according to the type of feed and the time interval between the last feeding and taking a sample for pH examination. The normal range, however, is between 6.2 and 7.2. The pH of rumen juice should be examined immediately after the sample is obtained, using a wide range pH (1–11) paper. **High pH values (8–10)** will be observed when putrefaction of protein is occurring in the rumen or if the sample is mixed with saliva. Low pH values (4–5) are found after the feeding of carbohydrates. Generally, a **pH below 5** indicates **carbohydrate engorgement**; this pH level will be maintained between 6 and 24 hours after the animal has actually consumed the carbohydrate diet. Microscopic examination of a few drops of rumen fluid on a glass slide with a low-power field will reveal the level of protozoan activity. Normally five to seven protozoans are active per low-power field. In lactic acidosis the protozoa are usually absent or a few dead ones are visible.

### DECOMPRESSION OF DISTENDED RUMEN

In adult cattle with severe abdominal distension caused by gross distension of the rumen it is difficult, if not impossible, to assess the status of the abdomen. To determine whether the rumen is distended and/or to relieve the pressure a large-bore stomach tube should be passed (Colorado Kingman tube: 2 m long and 3-cm inside diameter). In vagus indigestion, the rumen may be grossly distended with fluid contents, which will gush out through a large-bore tube. In some cases 100 to 150 L of rumen contents may be released. If no contents are released the contents may be frothy or mushy and the rumen end of the

tube will plug almost instantly. Rumen lavage may then be attempted using a water hose to deliver 20 to 40 L of water at a time followed by back drainage using gravity flow. After the rumen is partially emptied it is usually possible to more accurately assess the rumen and the abdomen.

### DECOMPRESSION OF THE HORSE'S STOMACH

Attempts to pass a nasogastric tube in the horse will usually detect complete or partial obstruction of the esophagus. In gross distension of the stomach in the horse, there is an immediate rush of fluid contents as soon as the cardia is passed (**gastric reflux**). The technique of gastric decompression is therapeutic and diagnostic. Gastric distension is a highly painful feature of some colic cases, and the mere pain relief of gastric decompression facilitates the clinical examination. The retrieval of significant volumes (2 L or more) of sequestered gastric fluid is also an extremely specific indicator of intestinal obstruction, especially small-intestinal obstruction, and a reasonably specific indicator that surgical intervention is necessary.

## MEDICAL IMAGING

### RADIOGRAPHY

Because of their large size, and the presence of substantial amounts of gas in the large intestine, abdominal radiography has not been used routinely as a diagnostic aid in mature horses with abdominal pain. Similarly, in mature cattle the sheer size of the abdomen and the gas in the rumen has not favored abdominal radiography except for identifying the presence of metal objects in the reticulum. **Esophageal radiography** is, however, useful for the diagnosis of disorders of swallowing in horses.

Foals, calves, and small horses are too small to be palpated per rectum, and abdominal radiography, with and without contrast media, has been used diagnostically in colic of foals. A standard lateral abdominal radiography is a valuable diagnostic aid in the foal with colic. The site of the lesion, whether gastric, small, or large intestinal, or a combination of all three, can be determined from the radiographs. The **sensitivity of radiography** in detecting gastrointestinal lesions in neonatal foals was found to be 96%, and the specificity was 71%.

Knowledge of the radiographic appearance of the normal neonatal abdomen is important before lesions can be reliably detected. The standing lateral radiographic of the normal abdomen of the neonatal foal is characterized by the following:

- A gas cap over fluid and ingesta in the stomach
- Small collections of gas in the small intestine in the cranial and midcentral abdomen



- Gas caps over fluid and ingesta in the cecum and large colon, seen in the caudodorsal abdomen
- Small amounts of gas in the small colon and inconsistent gas in the rectum, seen at the pelvic inlet

Abdominal radiography has also been used for the diagnosis of enterolithiasis and sand accumulation as causes of colic.<sup>15-18</sup> The technique provides a high positive predictive value and is cost-effective in high-prevalence areas.

### ABDOMINAL ULTRASONOGRAPHY

Abdominal ultrasonography has been used to identify small intestine intussusceptions, large-colon displacements, abdominal viscera, and neoplasms. The technique requires only several minutes in the hands of an experienced clinician.<sup>14</sup>

#### Horse

Abdominal ultrasonography is a diagnostic aid that is used for evaluation of equine colic and to assist in differentiation of medical from surgical colics.<sup>19-21</sup>

It is accurate in identifying horses with abnormal small intestines. Completely distended small intestine is associated with an increased risk of strangulating obstruction (odds ratio [OR] 6.3), inability to visualize the left kidney (OR 31 for left dorsal displacement), and thickened large colon (OR 12 for large-colon strangulating volvulus).<sup>22</sup> Detecting increased thickness of the wall of the large intestine during ultrasonography is a reproducible and accurate preoperative test for large-colon torsion in horses with surgical colic localized to the large colon.<sup>20</sup> The duodenum of the horse can be evaluated by ultrasonography. The technique has been used to detect large-intestinal sand accumulations.<sup>23</sup> Gastrointestinal activity patterns have been evaluated in healthy horses using B-mode and Doppler ultrasonography.<sup>24</sup> The anatomy and biometric analysis of the thoracic and abdominal organs in healthy foals from birth to age 6 months have been evaluated with ultrasonography.<sup>25</sup>

#### Cattle

Abdominal ultrasonography is an ideal diagnostic aid for the investigation of gastrointestinal diseases, the most common of which include traumatic reticuloperitonitis, left and right displacement of the abomasum, duodenal obstruction, hemorrhagic bowel syndrome, omasal disease, ileus of the small intestine, and dilatation and displacement of the cecum.<sup>12,13,26</sup> The various divisions of the small intestine can be differentiated from one another with the exception that the ileum cannot be differentiated from the jejunum. In normal cows, in which the intestine is full of ingesta, all parts of the intestine have a relatively large diameter. In cows with ileus, the loops of intestine proximal to the

ileus are distended, and those distal to the ileus are empty.

### ENDOSCOPY

Gastroscopic examination is limited to monogastric animals and has particular utility in horses and foals. It is useful in confirming the presence or absence of gastric ulcers, impaction, neoplasia, and inflammatory disease. The procedure involves passage of a flexible endoscope of at least 3 m in length for the adult horse and approximately 13 mm in diameter.<sup>27</sup> Case preparation is important to ensure that the stomach and proximal duodenum can be completely visualized. Feed should be withheld for approximately 16 hours and water for no less than 1 hour. Horses are usually sedated before commencing the examination. Insufflation of the stomach is essential for a thorough examination, although it has been associated with segmental volvulus in a small number of cases.<sup>28</sup>

A complete examination of the stomach is important, and the presence or absence of squamous ulceration cannot be used as a predictor for the presence or absence of glandular ulceration.<sup>27</sup> Observation of the squamous mucosa is relatively easy, whereas passage through to the pyloric antrum is more technically demanding. However, observation of the pyloric antrum is critical because the majority of glandular ulceration occurs in this region.<sup>29-31</sup> Observation of the most ventral portion of the fundus is typically not possible because of the presence of fluid. The fluid can be suctioned out via the biopsy channel of the gastroscope; however, this is usually not necessary because ulceration in this region is rare.<sup>27</sup>

### LAPAROSCOPY

In this procedure a laparoscope is passed through an incision in the abdominal wall of either the left or right paralumbar fossa. Feed must be withheld for 36 hours, analgesia is provided during the procedure, and abdominal insufflation with carbon dioxide is required to separate the viscera for viewing. Laparoscopy in standing horses is a valuable diagnostic aid for examination of the structures in the dorsal regions of the abdomen. In the standing horse, the anatomic structures of importance that can be viewed in the left half of the abdomen are the hepatic duct, left lateral and quadrate lobes of the liver, stomach, left kidney with associated nephrosplenic ligament, segments of the jejunum, descending colon and ascending colon, left side of the male and female reproductive tracts, urinary bladder, vaginal ring, and mesorchium. The important structures observable in the right side of the abdomen are the common hepatic duct, left lateral, quadrate and right lobes of the liver, caudate process of the liver, stomach, duodenum, right dorsal colon, epiploic foramen, omental

bursa, right kidney, base of the cecum, segments of jejunum, descending colon and ascending colon, urinary bladder, right half of the male and female reproductive tracts, and rectum.

In the dorsally recumbent horse under general anesthesia, with laparoscopy the main structures of diagnostic relevance in the caudal region of the abdomen are the urinary bladder, mesorchium, ductus deferens (left and right), left and right vaginal rings, insertion of the prepubic tendon, random segments of jejunum and descending colon, the pelvic flexure of the ascending colon, body of the cecum, and cecocolic fold. The main structures observed in the cranial region of the abdomen are the ventral surface of the diaphragm; falciform ligament and round ligaments of the liver; ventral portion of the left lateral, left medial, quadrate, and right lateral lobes of the liver; spleen; right and left ventral colons; sternal flexure of the ascending colon; apex of the cecum; and stomach. Alterations in cardiovascular and respiratory functions in response to the pneumoperitoneum and various positional changes indicated a need for continuous and thorough anesthetic monitoring and support.

### EXPLORATORY LAPAROTOMY (CELIOTOMY)

An exploratory laparotomy is useful for palpating and inspecting the abdominal viscera as a diagnostic aid in cattle, sheep, and horses of all ages. Cost and time are important factors, but if abdominal disease is suspected and other diagnostic techniques cannot identify the location and nature of the abnormality, a laparotomy is highly desirable.

### TESTS OF DIGESTION AND ABSORPTION

Digestion and absorption of nutrients are complex, interrelated functions of the gastrointestinal tract. Failure in one or more of normal motility and enzymatic digestion of food and absorption of simple sugars, fat, and protein by the small intestine can result in inadequate assimilation of nutrients from the gastrointestinal tract. Tests of small-intestinal digestion, absorption, or both have been devised for use in monogastrics. These tests take advantage of the rapid appearance in blood of products of digestion, or of compounds that are readily absorbed without digestion.

**Indications** for these tests include the following:

- Weight loss of undetermined cause suspected to be from failure of absorption of food by the small intestine
- Diarrhea of suckling foals suspected to be from failure of the foal to digest lactose (lactase deficiency)

- Suspected protein-losing enteropathy of older foals and adult horses

Low serum protein and albumin concentrations with small-intestinal disease can be caused by failure of digestion of proteins and absorption of amino acids or leakage of plasma proteins into the intestine. Some horses with protein-losing enteropathy have abnormal tests of intestinal digestion and absorption of sugars. **Contraindications** include the presence of obstructive lesions of the gastrointestinal tract, risk of worsening the disease process by the period of fasting required for most of the tests (such as in ponies with hyperlipemia), or known adverse reactions of the animal to any of the test substances.

**Interpretation** of the test is based on the concentration of the variable of interest (usually glucose or xylose) in blood over a period of time after administration of the test meal (usually by nasogastric intubation). Concentration of the metabolite or marker of interest in blood is plotted against time, and the shape of the curve, highest concentration attained, time to attain the highest concentration, and elevation over baseline values (i.e., those measured immediately before administration of the test meal) are compared against values obtained from clinically normal horses or foals. Blood concentrations of glucose or xylose that are lower than expected (so called “flat curve”) can be indicative of alterations in gastrointestinal function that hinder propulsion, digestion, or absorption of nutrients. Thus tests of digestion and absorption alone rarely provided sufficient information to make a definitive diagnosis of the functional disorder. The exception to this rule is the modified lactose tolerance test in foals (see later). Interpretation of the results of oral tests of absorption is often confounded by factors that alter gastrointestinal function, such as feed withholding or enteritis or conditions that alter removal of the test compound from blood like reduced insulin sensitivity. This is particularly the case for tests that depend on measurement of blood glucose concentration. Blood glucose concentrations are determined in the absorptive state by the difference in rates of absorption of glucose from the small intestine into blood and removal of glucose from blood by uptake into muscle, adipose tissue, and metabolically active tissues. Conditions that enhance glucose uptake from the blood can result in low peak blood glucose concentrations, and conditions that decrease insulin sensitivity (as is seen in fat horses) can result in high blood glucose concentrations. The use of D-xylose as an indicator of small-intestinal absorption is intended to avoid these effects of variable glucose disposal. Therefore the values obtained with oral tests of absorption and digestion should be interpreted with caution and should be considered in light of all clinical and laboratory data available for

the animal. Sedation does not affect D-xylose uptake in horses.<sup>32</sup>

### GLUCOSE ABSORPTION TEST

The oral glucose tolerance test is one of the simplest tests of small-intestinal absorptive capacity to perform. However, because of the many factors that affect blood glucose concentration, including factors not related to small-intestinal absorptive capacity, results of the test can on occasion be difficult to interpret. Oral glucose tolerance testing can produce abnormal results in horses with diseases that do not involve the small intestine, such as lower motor neuron disease or polysaccharide storage myopathy. On the other hand, the oral glucose tolerance test is often used because of the ready availability of glucose for oral administration and routine nature of measurement of blood glucose concentrations.

The main indications for performing oral glucose tolerance testing include unexplained weight loss believed to be associated with gastrointestinal disease and suspected protein-losing enteropathy. Contraindications are those listed previously. In addition, care should be exercised in performing the test in horses at increased risk of laminitis, because rapid passage of unabsorbed glucose into the large colon and cecum can cause laminitis.

Horses undergoing oral glucose tolerance testing are first fasted for 12 to 18 hours. Access to water should be provided. Glucose is given by stomach tube at 1 g/kg BW of anhydrous glucose (or comparable) as a 10% to 20% solution in water. Blood for measurement of glucose concentration is collected immediately before and every 30 minutes for 4 to 6 hours after glucose administration. Some protocols involve less frequent (hourly) collection of blood. One protocol requires collection of blood samples before and 120 minutes after administration of glucose. This last protocol is not recommended because early or delayed peaks in blood concentration are not detected. The blood glucose concentration in the normal horse increases by at least 85% (from 90 up to 180 mg/dL [5.0–10.0 mmol/L]) with peak blood concentrations attained 90 to 150 minutes after administration of glucose. Horses with partial malabsorption have increases in blood glucose concentration of 15% to 85% of baseline values, and horses with complete malabsorption have no increase or less than 15% increase in blood glucose concentration by 2 hours. Blood concentrations of glucose in normal horses return to resting values in approximately 6 hours. The shape of the curve is affected by the horse's previous diet, and the curve is much lower in horses fed on stored feeds such as hay and grain compared with horses eating pasture of clover and grass.

Horses with weight loss and complete failure of absorption of glucose are likely to

have extensive infiltrative disease of the small intestine such as lymphosarcoma or granulomatous enteritis. Of 25 horses with partial failure of glucose absorption, 18 (62%) had structural abnormalities of the small intestine. Clearly abnormal results of the oral glucose tolerance test appear to be fairly specific for severe and widespread small-intestinal disease. Care should be taken when interpreting results that deviate only marginally from normal values.

### STARCH DIGESTION TEST

A suitable test for the evaluation of gastric, small-intestinal, and pancreatic function is the starch digestion test. The test relies on the presence of amylase in the small intestine with subsequent cleavage of starch into glucose, which is then absorbed into the blood. The horse is fasted for 18 hours and then given corn starch (1 kg in 4 L of water or 2 g/kg BW) by stomach tube. A pretreatment blood sample is matched with others taken at 15, 30, 60, 90, and 120 minutes and then hourly to 6 hours.

In the normal horse there is an increase in blood glucose levels of about 30 mg/dL (1.7 mmol/L; from 90 up to 120 mg/dL [5.0–6.7 mmol/L]), with the peak occurring at 1 to 2 hours and the curve returned to pretreatment level at 3 hours. The test can be affected by the diet of the horse before testing.

### LACTOSE DIGESTION TEST

Newborn animals rely on ingestion of milk sugar (lactose) as an important source of energy until weaning. Lactose is digested in the proximal small intestine by lactase, a disaccharidase present in the brush border of intestinal epithelial cells that cleaves lactose into glucose and galactose. Loss of small-intestinal production of lactase, such as occurs in some bacterial and viral enteritides including rotavirus infection, results in failure to cleave lactose and passage of the sugar to the hind gut. Fermentation of lactose in the hind gut causes acute and sometimes severe osmotic diarrhea. A prime indication for the oral lactose tolerance test is therefore acute diarrhea in neonates being fed milk. The test is also important because a positive test (i.e., demonstration of lactose intolerance) provides a clear indication for feeding lactose-free milk or providing supplemental lactase in the animal's diet.

An oral lactose digestion test has been devised for foals. Lactose (1 g/kg BW) is given by stomach tube in a 20% solution to a foal that has been fasted for 2 to 4 hours. In foals and young horses up to 3 years of age there is a rise in blood glucose levels from  $86 \pm 11$  mg/dL ( $4.8 \pm 0.1$  mmol/L) up to  $153 \pm 24$  mg/dL ( $8.5 \pm 1.3$  mmol/L), with a peak achieved in 90 minutes, and the level returns to pretreatment levels in 5 hours. In foals of 1 to 12 weeks of age the plasma glucose concentration should rise by at least 35 mg/dL.

(1.9 mmol/L) and peak within 40 minutes of the administration of the lactose. With this test no changes in blood sugar levels occur in horses over 4 years of age. Instead there is abdominal discomfort followed by diarrhea, with feces the consistency of cow feces for the next 24 hours. Sucrose and maltose are readily digested by the intestine of the adult horse, but not by newborn foals. Maximum levels of the relevant intestinal disaccharidases (sucrase and maltase) are not achieved until 7 months of age. The oral lactose digestion test is likely to be of value as a monitor of epithelial damage in young horses. In humans the ability to hydrolyze lactose is one of the first functions of the intestinal mucosa to be lost in which there is epithelial damage in the gut. It is also one of the last functions to return in the recovering patient. The loss of intestinal lactase may be the pathogenetic basis of the diarrhea that occurs in rotavirus infections in neonates. Lactase digestion is impaired in calves with mild diarrhea. Calves with acute diarrhea are in a catabolic state and respond with a larger increase in plasma glucose concentration to a given amount of glucose than do healthy calves.

A modification of the oral lactose tolerance test in foals includes a second evaluation in foals in which there is failure of blood glucose concentrations to increase by the appropriate amount after oral administration of lactose. At least 8 hours after the first test, foals are fed a meal of lactose-free milk, or of milk to which lactase has been added. Blood glucose concentrations are measured, and an increase of at least 35 mg/dL (1.9 mmol/L) is interpreted as evidence of lactase deficiency. Such animals can then be maintained on a diet of lactose-free milk. Diarrhea usually resolves in 24 hours but returns within hours of feeding milk containing lactose.

An alternative to the lactose tolerance tests described earlier is to simply feed the foal lactose free milk for several days. The foal must not have access to mare's milk or milk-based feed supplements during this time. Some foals have prompt resolution of diarrhea when fed only lactose-free milk.

### XYLOSE ABSORPTION TEST

D-Xylose is used to evaluate small-intestinal absorptive function because it is not metabolized by tissues, which is an advantage over the oral glucose tolerance test. D-xylose absorbed from the intestinal tract is excreted unchanged in the urine within 15 hours of dosing. Concentrations of D-xylose in blood are therefore dependent only on the rate of absorption from the intestine and rate of excretion into the urine. However, the compound is more expensive than glucose, and measurement of D-xylose in blood requires a particular analysis that might not be readily available. Indications for the test are the same as those for the oral glucose tolerance test described earlier.

D-Xylose, at a dose rate of 0.5 g/kg BW as a 10% solution, is administered by stomach tube after a starve of 18 hours. A maximum blood xylose level of 30 mg/dL (2.0 mmol/L) at 1.5 hours is a normal result in adult horses. In normal foals the peak blood concentration of xylose is reached in 30 to 60 minutes, and the level attained varies with age, being highest (47 mg/dL [3.14 mmol/L]) at 1 month of age and lowest (19 mg/dL [1.25 mmol/L]) at 3 months (the pretreatment reading should be zero). In abnormal horses the xylose curve is flat (a peak of 7–13 mg/dL [0.5 mmol/L] at 60 to 210 minutes) contrasted with a peak of 20 mg/dL [1.3 mmol/L] at 60 minutes in normal horses. As an initial checking test, one post-dosing sample at 2 hours is recommended.

Interpretation of the test is influenced by the customary diet of tested animals and feed deprivation. Horses receiving a high-energy diet have a lower absorption curve than horses on a low-energy diet. The test is also affected by the duration of deprivation of feed. In mares deprived of feed for 72 and 96 hours, the rate of D-xylose absorption and the maximum concentrations of D-xylose in plasma were reduced. For example, apparent low absorption can be caused by increased transit time through the gut, perhaps from excitement.

Low blood concentrations of xylose occur in horses with small-intestinal infiltrative disease, such as lymphosarcoma or granulomatous enteritis. The test appears to be quite specific (low false-positive rate) for small-intestinal disease, but the sensitivity (false-negative rate) is unknown. Peak xylose concentration is significantly ( $P = 0.048$ ) higher in horses with suspected inflammatory bowel disease that survive ( $1.36 \pm 0.44$  mmol/L) than nonsurvivors ( $0.94 \pm 0.36$  mmol/L).<sup>33</sup>

A D-xylose absorption curve has been determined for cattle. The xylose (0.5 g/kg BW) is deposited in the abomasum by abomasocentesis, and a peak of blood glucose is attained in about 90 minutes.

### SUCROSE ABSORPTION TEST

The sucrose absorption test differs from the other tests in this section in that abnormal results are associated with detection of sucrose in blood or urine of horses. Sucrose is not normally absorbed intact; it is usually cleaved by disaccharidases in the small intestine into glucose and fructose, which are then absorbed. Intact sucrose is absorbed across compromised gastric mucosa, and detection of sucrose in blood or urine indicates the presence of gastric ulceration, because mammals neither synthesize nor metabolize sucrose. The sucrose absorption test involves administration of 250 g of sucrose to an adult horse that has been fasted overnight. Blood samples for measurement of serum sucrose concentration are collected at 0, 15, 30, 45, 60, and 90 minutes after

dosing. Alternatively, a urine sample is collected 2 hours after dosing (the bladder must be emptied immediately before dosing). Peak serum sucrose concentrations occur 45 minutes after administration, and peak values correlate with the severity of gastric ulceration. Horses with minimal lesions have serum sucrose concentrations of 103 pg/ $\mu$ L, whereas horses with the most severe lesions have concentrations of 3400 pg/ $\mu$ L.

### RADIOACTIVE ISOTOPES

A technique used for determining whether a protein-losing enteropathy is present is based on the examination of feces for radioactivity after the intravenous administration of a radioactive agent. <sup>51</sup>Cr <sup>13</sup>C-labeled plasma protein has been used for this purpose. Similarly, administration of radioactively labeled leukocytes reveals the presence of small-intestinal inflammatory disease in horses. The test is quite specific, in that false-positive tests are uncommon, but not very sensitive.

### ABDOMINOCENTESIS FOR PERITONEAL FLUID

Peritoneal fluid reflects the pathophysiological state of the parietal and visceral mesothelial surfaces of the peritoneum. Collecting a sample of peritoneal fluid is useful in the diagnosis of diseases of the peritoneum and the abdominal segment of the alimentary tract. It is of vital importance in horses in the differential diagnosis and prognosis of colic and in cattle in the diagnosis of peritonitis.

### EQUINE AND BOVINE PERITONEAL FLUID

Normal peritoneal fluid is a transudate with properties as summarized in Tables 7-2 and 7-3. It has functions similar to those of other tissue fluids. It contains mesothelial cells, lymphocytes, neutrophils, a few erythrocytes, and occasional monocytes and eosinophils. The following general comments apply:

- It can be examined in terms of physical characteristics, especially color, translucence, specific gravity, clotting time, biochemical composition, cell volume, cell morphology, and cell type.
- Examination of the fluid may help determine the presence in the peritoneal cavity of
  - Peritonitis (chemical or infectious)
  - Infarction of a segment of gut wall
  - Perforation of the alimentary tract wall
  - Rupture of the urinary bladder
  - Leakage from the biliary system
  - Intraperitoneal hemorrhage
  - Peritoneal neoplasia
- The reaction of the peritoneum varies with time, and a single examination can be dangerously misleading. A series of examinations may be necessary, for example, in acute cases at intervals of as short as an hour.

**Table 7-2** Guidelines for the classification and interpretation of bovine peritoneal fluid

Classification of fluid	Physical appearance	Total protein (g/dL)	Specific gravity	Total RBC × 10 <sup>6</sup> /μL	Total WBC × 10 <sup>6</sup> /μL	Differential WBC count	Bacteria	Particulate matter (plant fiber)	Interpretation
Normal	Amber, crystal clear 1–5 mL per sample	0.1–3.1 (1.6) Does not clot	1.005–1.015	Few from puncture of capillaries during sampling	0.3–5.3	Polymorphonuclear and mononuclear cells, ratio 1:1	None	None	Increased amounts in late gestation, congestive heart failure
Moderate inflammation	Amber to pink, slightly turbid	2.8–7.3 (4.5) May clot	1.016–1.025	0.1–0.2	2.7–40.7 (8.7)	Nontoxic neutrophils, 50%–90%; macrophages may predominate in chronic peritonitis	None	None	Early stages of strangulation, destruction of intestine; traumatic reticuloperitonitis; ruptured bladder; chronic peritonitis
Severe inflammation	Serosanguineous, turbid, viscous 10–20 mL per sample	3.1–5.8 (4.2) Commonly clots	1.026–1.040	0.3–0.5	2.0–31.1 (8.0)	Segmented neutrophils, 70%–90%; presence of (toxic) degenerate neutrophils containing bacteria	Usually present	May be present	Advanced stages of strangulation obstruction; acute diffuse peritonitis; perforation of abomasal ulcer; rupture of uterus, stomachs, or intestine

RBC, red blood cell; WBC, white blood cell.

**Table 7-3** Characteristics of equine peritoneal fluid in selected diseases of horses

Disease	Protein concentration	Total nucleated cell count	Cytological comments	Other variables	Comments
Normal horse	<2.1 g/dL <21 g/L	<9 × 10 <sup>9</sup> cells/L <9 × 10 <sup>3</sup> cells/μL (TNCC is usually substantially lower in clinically normal horses)	Approximately 50% each of nondegenerate neutrophils and mononuclear cells	Lactate <1 mmol/L (always < plasma (lactate)); Glucose <2.0 mmol/L different from blood glucose; pH > 7.45; fibrinogen < 300 mg/dL (3 g/L) Creatinine = serum creatinine No red blood cells	Clear and slightly yellow Not malodorous Culture does not yield growth
Normal late gestation mare	<2.5 g/dL <25 g/L	<0.9 × 10 <sup>9</sup> cells/L <900 cells/μL	<40% neutrophils; no degenerative changes. <20% lymphocytes	Fluid usually readily obtained; clear and slightly yellow	
Normal postpartum (<7 days) mare	<2.5 g/dL <25 g/L	<5.0 × 10 <sup>9</sup> cells/L <5.0 × 10 <sup>3</sup> cells/μL	<50% neutrophils; no degenerative changes <10% lymphocytes	Fluid usually readily obtained; clear and slightly yellow	
Dystocia but clinically normal mare (1 day)	<2.5 g/dL <25 g/L	2.7 × 10 <sup>9</sup> (3.9) cells/L* 2.7 × 10 <sup>3</sup> (3.9) cells/μL	50%–90% nondegenerate neutrophils; 40% mononuclear cells and 10% lymphocytes	Fluid clear and yellow Essentially normal fluid with small increases in TNCC and protein concentration	
Dystocia and clinically abnormal mare (uterine rupture, vaginal tear)	4.4 (1.3) g/dL* 44 (13) g/L	27 × 10 <sup>9</sup> (35) cells/L* 27 × 10 <sup>3</sup> (35) cells/μL	70%–100% neutrophils, some of which are degenerate, <10% mononuclear cells and <10% lymphocytes	Increased red blood cell count	Fluid yellow or serosanguinous and cloudy; can be malodorous; culture can yield variety of bacteria; red cell count in mares with middle uterine artery rupture is high with normal TNCC

Continued



Table 7-3 Characteristics of equine peritoneal fluid in selected diseases of horses—cont'd

Disease	Protein concentration	Total nucleated cell count	Cytological comments	Other variables	Comments
Peritonitis, septic	5.2 (4.0–6.0) g/dL <sup>†</sup> 50 (40–60) g/L	131 (7–700) × 10 <sup>9</sup> cells/L <sup>†</sup> 131 (7–700) × 10 <sup>3</sup> cells/μL	Almost all neutrophils, many of which have degenerative changes Some neutrophils contain bacteria in many cases; plant material with rupture of intestine	pH < that of blood; glucose < blood (difference < 2.0 mmol/L or 50 mg/dL); peritoneal glucose < 30 mg/dL (1.5 mmol/L); fibrinogen > 200 mg/dL (2.0 g/L)	Fluid usually dark yellow, brown, or serosanguinous Can be green if severe rupture of intestine or stomach; cloudy. Malodorous; culture yields bacteria
Peritonitis, nonseptic (e.g., nonstrangulating, nonischemic obstructive lesion of the bowel)	2.7 (0.7–4.9) g/dL <sup>†</sup> 27 (7–49) g/L	13 (0.4–516) × 10 <sup>9</sup> cells/L <sup>†</sup> 13 (0.4–516) × 10 <sup>3</sup> cells/μL	Mostly neutrophils (>50%) Nondegenerate No bacteria detected No plant or foreign material	No abnormalities pH ≥ that of blood	Fluid yellow and clear Not malodorous; no bacteria isolated on culture
Strangulating intestinal lesion or ruptured intraabdominal viscus	5.2 (4.0–6.0) g/dL <sup>†</sup> 50 (40–60) g/L	131 (7–700) × 10 <sup>9</sup> cells/L <sup>†</sup> 131 (7–700) × 10 <sup>3</sup> cells/μL	Almost all neutrophils, many of which have degenerative changes Some neutrophils contain bacteria in many cases; plant material with rupture of intestine	Lactate 8.5 ± 5.5 mmol/L	Serosanguinous fluid Cloudy if ruptured
Nonstrangulating obstruction				Lactate 2.1 ± 2.1 mmol/L	
Peritonitis caused by <i>Actinobacillus equuli</i>	2.5–8.4 g/dL 25–84 g/L	46–810 × 10 <sup>9</sup> cells/L 46–810 × 10 <sup>3</sup> cells/μL	>80% neutrophils, most of which do not have signs of degeneration Low numbers of gram-negative pleomorphic rods, both intracellular and extracellular		Cream, orange, brown or red fluid; turbid; not malodorous; growth of <i>Actinobacillus equuli</i> on culture
Intraabdominal abscess	>2.5 g/dL >25 g/L	>10 × 10 <sup>9</sup> cells/L >10 × 10 <sup>3</sup> cells/μL	>80% nondegenerate neutrophils; usually no bacteria detected on Gram stain		Yellow to white; slightly cloudy; culture will occasionally yield × causative bacteria (usually <i>Streptococcus equi</i> )
Hemoperitoneum	3.2–6.3 g/dL 32–63 g/L	<10 × 10 <sup>9</sup> cells/L <10 × 10 <sup>3</sup> cells/μL	Differential similar to blood Mostly nondegenerate neutrophils, erythrophages, and hemosiderophages as hemorrhage resolves	High red cell count (2.4–8.6 × 10 <sup>12</sup> cells/L, 2.4–8.6 × 10 <sup>6</sup> cells/μL)	Serosanguinous to frankly bloody
Intraabdominal neoplasia (lymphosarcoma, gastric squamous cell carcinoma)	<2.5 g/dL <25 g/L	<10 × 10 <sup>9</sup> cells/L <10 × 10 <sup>3</sup> cells/μL	Abnormal cells not detected in most cases Care should be taken not to mistake reactive lymphocytes for neoplastic lymphocytes		Clear and yellow; often subjective assessment of increased quantity (increased ease of collection of a large quantity of fluid)
Uroperitoneum	<2.5 g/dL <25 g/L	<10 × 10 <sup>9</sup> cells/L <10 × 10 <sup>3</sup> cells/μL	Normal differential, might see calcium carbonate crystals in adult horses with uroperitoneum	Creatinine > serum creatinine concentration Urea nitrogen > serum urea nitrogen concentration Potassium > serum potassium concentration	Large amount of fluid Clear to very pale yellow Uriferous odor

Data from Frazer G. et al. *Theriogenology* 1997; 48:919; van Hoogmoed L. et al. *J Am Vet Med Assoc* 1996; 209:1280; van Hoogmoed L. et al. *J Am Vet Med Assoc* 1999; 214:1032; Pusterla N et al. *J Vet Intern Med* 2005; 19:344; Latson KM et al. *Equine Vet J* 2005; 37:342; Matthews S et al. *Aust Vet J* 2001; 79:536.

TNCC, Total nucleated cell count.  
\*Mean (standard deviation [SD]).

<sup>†</sup>Median (range).

- A significant reaction in the peritoneal cavity may be quite localized, so a normal sample of fluid collected at one point in the cavity may not be representative of the entire cavity.
- Changes in peritoneal fluid, especially its chemical composition, e.g., lactate level, may be a reflection of a systemic change. The examination of a concurrently collected peripheral blood sample will make it possible to determine whether the changes are in fact restricted to the peritoneal cavity.
- As in any clinicopathologic examination the results must be interpreted with caution and only in conjunction with the history and clinical findings.

### Specific Properties of Peritoneal Fluid (Normal and Abnormal)

#### Color

**Normal fluid is crystal clear, straw-colored to yellow.** Turbidity indicates the presence of increased leukocytes and protein, which may include fine strands of fibrin.

A **green color** suggests food material; intense orange-green indicates rupture of the biliary system. A **pink-red color** indicates presence of hemoglobin; degenerated erythrocytes; entire erythrocytes; and damage to the vascular system by infarction, perforation, or hydrostatic pressure. A **red-brown color** indicates the late stages of necrosis of the gut wall, the presence of degenerated blood and hemoglobin, and damage to gut wall with hemorrhage.

**Whole blood, clear fluid streaked with blood,** or heavily bloodstained fluid indicates that the sample has been collected from the spleen or a blood vessel or that there is hemoperitoneum. Rupture of the uterus or bladder or dicoumarol poisoning are also possibilities.

A **dark green sample** containing motile protozoa with very few leukocytes and no mesothelial cells indicates that the sample has been collected from the gut lumen. Enterocentesis has little apparent clinical effect in normal horses, although an occasional horse will show a transient fever. However, puncture of a devitalized loop of intestine may lead to extensive leakage of gut contents and fatal peritonitis. The effect of enterocentesis of normal gut on peritoneal fluid is consistently to increase the neutrophilic count, which persists for several days.

#### Cellular and Other Properties

Surgical manipulation of the intestinal tract during exploratory laparotomy or intestinal resection and anastomosis in the horse results in a significant and rapid postoperative peritoneal inflammatory reaction. Manipulation of the viscera causes injury to the mesothelial surfaces. Total and differential nucleated cell counts, red blood cell numbers, and total protein and fibrinogen concentrations were all elevated on the first day after

the surgery and remained elevated for up to 7 days in a study of this phenomenon.

In cattle, exploratory celiotomy and omentopexy result in an increase in the total nucleated cell count by a factor of 5 to 8, minor increases in specific gravity, and increases in total protein concentration by a factor of up to 2. These changes appear by 2 days after surgery and continue to increase through to day 6.

**Particulate matter** in peritoneal fluid suggests either fibrin clots/strands or gut contents caused by leakage from a perforated or ruptured gut wall.

**High specific gravity and high protein content** are indicative of vascular damage and leakage of plasma protein, as in peritonitis or mural infarction.

The **volume** and viscosity of fluid varies. A normal flow is 1 to 5 mL per sample. A continuous flow with 10 to 20 mL per sample indicates excess fluid caused by a ruptured bladder or ascites (clear yellow), acute diffuse peritonitis (yellow, turbid), and infarction or necrosis of gut wall (thin, red-tinged). The higher the protein content, as the peritoneal fluid shifts from being a transudate to an inflammatory exudate, the higher the viscosity becomes. Highly viscous fluid may clot.

#### Cells

A rapid staining method, using a modified Wright's stain, makes a stained slide ready for examination within 5 minutes. The value of the technique is in indicating the number of leukocytes and other cells present, and in differentiating the types of cell.

An **increase in total white cell count** of the fluid including a disproportionate number of polymorphonuclear cells indicates acute inflammation, which may have an infectious origin or else be sterile. An increase in mononuclear phagocytes from the peritoneum is an indication of chronic peritonitis. **Degenerate and toxic neutrophils** suggest the probability of infection being present. An increase in the number of **mesothelial cells** with the distinctive presence of actively dividing mitotic figures suggests neoplasia.

**Bacteria** found as **phagocytosed inclusions in leukocytes**, or by culture of fluid, indicate an infective peritonitis, which may arise by hematogenous spread, in which case the infection is likely to be a specific one. If there has been leakage from a peritoneal abscess the same comment applies, but if there is leakage through a segment of devitalized or perforated bowel wall there is likely to be a mixed infection and possibly particulate matter from bowel contents.

**Entire erythrocytes**, often accompanied by some hemoglobin, indicate either hemoperitoneum, in which case there should be active phagocytosis of erythrocytes, or that the sample has been inadvertently collected from the spleen. The blood is likely to be

concentrated if there has been sufficient time for fluid resorption across the peritoneum. Splenic blood has a higher packed cell volume (PCV) also, but there is no erythrophagocytosis evident in the sample. A **PCV of less than 5%** in peritoneal fluid suggests extravasation of blood from an infarcted or inflamed gut wall; a PCV of more than 20% suggests a significant hemorrhage.

### Abdominocentesis in Horses

In the horse the recommended site for paracentesis is on the ventral midline, 25 cm caudal to the xiphoid (or midway between the xiphoid and the umbilicus). Following surgical preparation and subcutaneous infiltration of an anesthetic, a stab incision is made through the skin and subcutaneous tissues and into the linea alba. A 9-cm long blunt-pointed bovine teat cannula, or similar metal catheter, with the tip wrapped in a sterile swab to avoid blood and skin contamination, is inserted into the wound and manipulated until the incision into the linea alba can be felt. With a quick thrust the cannula is pushed through the linea alba into the peritoneal cavity. A "pop" is often heard on entry into the peritoneal cavity. Failure to incise into the linea alba first will cause many cannulas to bend and break.

In most horses (about 75%) a sample of fluid is readily obtained. In others it takes a moment or two before the fluid runs out, usually spurting synchronously with the respiratory movements. Applying suction with a syringe may yield some fluid if there is no spontaneous flow. Normal fluid is clear, yellow, and flows easily through an 18-gauge needle. Two samples are collected, one in a plain tube and one in a tube with an anticoagulant. If the fluid clots readily a few drops should be placed and smeared out on a glass slide and allowed to dry for staining purposes.

In peritonitis, the total leukocyte count will increase markedly, but wide variation in the total count can occur between horses with similar conditions, and in the same horse within a period of hours. Variations are caused by the nature and stage of the lesion and by the total amount of exudate in the peritoneal cavity, which has a diluting effect on the total count. Total leukocyte counts ranging from 10,000 to 150,000  $\mu\text{L}$  have been recorded in peritonitis and in infarction of the intestine in horses. Experimentally, the intravenous injection of endotoxin into horses causes marked changes in the peripheral blood cellular components, but there are no changes in the total white cell count of the peritoneal fluid.

In **healthy foals** the reference values for peritoneal fluid are different from adult horses. The maximum peritoneal fluid nucleated cell counts in foals are much lower than in adult horses ( $1.5 \times 10^6/\text{L}$  versus  $5.0 \times 10^6/\text{L}$ ). Nucleated cell counts greater than  $1.5 \times 10^6/\text{L}$  should be interpreted as elevated.

Peritoneal fluid abnormalities in mares within a week of foaling should be attributed to a systemic or gastrointestinal abnormality and not to the foaling event. The nucleated cell count, protein concentration, fibrinogen concentration, and specific gravity of peritoneal fluid from recently foaled mares should be normal; however, differential cell counts may be abnormal for up to 1 week after foaling.

### Risks

**Abdominocentesis is not without some danger**, especially the risk of introducing fecal contents into the peritoneal cavity and causing peritonitis. This appears to be of major importance only if there are loops of distended atonic intestine situated on the ventral abdominal wall. This is a common occurrence in the later stages of intestinal obstruction that is still amenable to surgery. Puncture of a devitalized loop of intestine may cause a leakage of intestinal contents and acute diffuse peritonitis, which is rapidly fatal. Penetration of a normal loop of intestine occurs often enough to lead to the conclusion that it appears to have no ill effects. If a sample of peritoneal fluid is an important diagnostic need in a particular case, and the first attempt at paracentesis causes penetration of the gut, it is recommended that the attempt be repeated, if necessary two or three times, at more posterior sites. Repeated abdominocentesis does not cause alterations in peritoneal fluid constituents, and any significant changes are likely caused by alterations in the disease state present. The technique most likely to cause bowel penetration is the use of a sharp needle instead of the blunt cannula recommended, and forcibly thrusting the cannula through the linea alba without a prior incision. When the suggested incision is made in the linea alba, the cannula can be pushed gently through while rotating it.

### Abdominocentesis in Cattle

The choice of sites for paracentesis is a problem, because the rumen covers such a large portion of the ventral abdominal wall, and avoiding penetration of it is difficult. Cattle have a low volume of peritoneal fluid, and failure to obtain a sample is not unusual. The most profitable sites are those that, on an anatomic basis, consist of recesses between the forestomachs, abomasum, diaphragm, and liver. These are usually caudal to the xiphoid sternum and 4 to 10 cm lateral to the midline. Another recommended site is left of the midline, 3 to 4 cm medial, and 5 to 7 cm cranial to the foramen for the left subcutaneous abdominal vein. A teat cannula similar to the one described for use in the horse is recommended but, with care and caution, a 16-gauge 5-cm hypodermic needle may also be used. The needle or cannula is pushed carefully and slowly through the abdominal wall, which will twitch when the peritoneum is punctured. When this happens the fluid

will usually run out into a vial without the aid of a vacuum. However, if it does not, a syringe may be used and the needle may be moved backward and forward in a search for fluid, with the piston of the syringe withdrawn. A further site is the right caudoventral abdominal wall medial to the fold of the flank, using a 3.8-cm 15-gauge needle.

In calves, a reliable technique includes the use of sedation with intravenous xylazine hydrochloride and diazepam. The animal is placed in left lateral recumbency with the right hindlimb pulled dorsally and caudally. One site slightly dorsal and caudal to the umbilicus is prepared together with another site in the center of the inguinal region. The site is prepared with local anesthetic, and a 14-gauge needle is introduced and directed slightly caudally and toward the midline while keeping it parallel to the inner abdominal wall once the peritoneal cavity is entered. A 3.5-gauge urinary catheter (1.2 mm × 56 cm sterile feeding tube) is inserted through the needle, and a 3-mL sterile syringe is attached to the catheter. Gentle suction is applied. The fluid is placed in a 2-mL tube containing tripotassium ethylenediaminetetraacetic acid (EDTA). A 14-gauge over-the-needle catheter can also be used, followed by insertion of a 3.5 French feeding tube. If fluid cannot be obtained from the first site, the inguinal site is used using the same basic technique and with the catheter directed slightly cranially toward the midline.

Failure to obtain a sample does not preclude the possibility that peritonitis may be present: the exudate may be very thick and contain large masses of fibrin, or the peritonitis may be localized. Also, animals that are dehydrated may have less peritoneal fluid than normal. Most animals from which samples cannot be obtained, however, are in fact normal. In animals in which peritonitis is strongly suspected for clinical reasons, up to four attempts at paracentesis should be made before aborting the procedure. The fluid should be collected into an anticoagulant, preferably EDTA, to avoid clotting.

Abnormal peritoneal fluid in cattle is a highly sensitive indicator of peritoneal disease, but not a good indicator of the *nature* of the disease. The most pronounced abnormalities occur in acute diseases of the peritoneum; chronic peritonitis may be accompanied by peritoneal fluid that is almost normal.

Examination of the fluid should take into account the following characteristics:

- Large amounts (10–20 mL) of serosanguineous fluid suggest infarction or necrosis of the gut wall.
- Heavily bloodstained fluid, whole blood, or fluid with streaks of blood through it are more likely to result from puncture of a blood vessel or from bleeding into the cavity, as in dicoumarol poisoning or with a neoplasm of the vascular system.

- The same sort of bloodstained fluid as previously discussed may accompany a ruptured uterus or bladder or severe congestive heart failure.
- Large quantities of yellowish-colored turbid fluid suggest acute diffuse peritonitis. The degree of turbidity depends on the number of cells and the amount of fibrin present.
- Particulate food material in the sample indicates perforation or rupture of the gut, except that penetration of the gut with the instrument during collection may be misleading. Such samples are usually heavily fecal in appearance and contain no mesothelial cells.
- Laboratory examination is necessary to derive full benefit from the sample. This will include assessment of the number and type of **leukocytes** present (the number is increased in peritonitis), neutrophils predominating in acute peritonitis, and monocytes in chronic forms; the number of **erythrocytes** present; whether **bacteria** are present inside or outside the neutrophils; and **total protein** content.

The significant values for these items are included in [Table 7-2](#).

Reference values for peritoneal fluid constituents of normal adult cattle may be inappropriate for interpretation of peritoneal fluid analysis in calves of up to 8 weeks of age. The peritoneal fluid nucleated cell count and mononuclear cell counts are higher in calves, and the eosinophil counts are lower than in adult cows.

## INTESTINAL AND LIVER BIOPSY

An intestinal biopsy may be obtained from an exploratory laparotomy but is costly and time-consuming. Rectal biopsy is easily done and of low cost. It is a valuable diagnostic aid for evaluating certain intestinal diseases of the horse. Biopsy specimens are taken using minimal restraint and unaided by proctoscopic visualization in the standing horse. A rectal biopsy forceps is used to obtain the biopsy from the floor of the rectum approximately 30 cm proximal to the anal sphincter. The technique for liver biopsy is presented in [Chapter 9](#).

## Principles of Treatment in Alimentary Tract Disease

Removal of the primary cause of the disease is essential, but a major part of the treatment of diseases of the alimentary tract is supportive and symptomatic. This is aimed at relieving pain and distension, replacement of fluids and electrolytes, correcting abnormal motility, and relieving tenesmus and reconstitution of the digestive flora if necessary. Specific treatment for individual diseases is

presented with each disease throughout this book. General principles are outlined here.

## RELIEF OF ABDOMINAL PAIN

The relief of abdominal pain is of prime importance from a humane aspect, to prevent the animal from self-injury associated with falling and throwing itself against a wall or other solid objects, and to allay the concerns of the owner. No single analgesic is completely satisfactory for every situation. Non-narcotic and narcotic analgesics that are in general use and the analgesics used in the important subject of equine colic are presented later.

## RELIEF OF DISTENSION

The relief of distension of the gastrointestinal viscera is a critical principle to minimize shock and to prevent rupture of the viscus. **Relief of distension of the stomach of the horse with colic is accomplished by nasogastric intubation.** Distension caused by bloat in cattle can be relieved by stomach tube or trocarization of the rumen. Relief of distension of the large colon by percutaneous or per rectal trocarization is used in horses. Either technique can be useful in relieving distension and signs of abdominal pain, but potential complications include peritonitis, infection, and abscessation at the site of trocarization.<sup>34,35</sup>

Relief of distension may be possible by medical means alone with the use of laxatives and purgatives when there is accumulation of ingesta without a physical obstruction. Surgical intervention is often necessary when the distension is associated with a physical obstruction. In functional distension (paralytic ileus), relief of the atony or spasm can be effected by the use of drugs such as metoclopramide. Distension caused by intestinal or gastric accidents requires surgical correction.

## REPLACEMENT OF FLUIDS AND ELECTROLYTES

Replacement of fluid and electrolytes lost in gastrointestinal disease is one of the most important principles of treatment. In gastric or intestinal obstruction, or when diarrhea is severe, it is necessary to replace lost fluids and electrolytes by the parenteral administration of large quantities of isotonic glucose-saline or other physiologically normal electrolyte solutions. The amount of fluid lost may be very large and fluids must be given in quantities to replace losses and to support continuing losses and maintenance requirements. In acute, severe dehydration in horses, such as occurs in acute intestinal obstruction, the amount of fluid required before and during surgery ranges from 50 to 100 mL/kg BW per 24 hours. It is critical that administration of fluid is commenced at the earliest

possible time because of the need to maintain homeostasis. Details of fluid therapy are given in [Chapter 5](#).

In young animals the need is much greater still and amounts of 100 mL/kg BW, given slowly intravenously, are commonly necessary and not excessive. The treatment of shock is also presented in [Chapters 2 and 9](#) and includes the administration of fluids, plasma or blood, and nonsteroidal anti-inflammatory drugs (NSAIDs). The use of intravenous administration of hypertonic saline followed by the ingestion of large quantities of water by the animal is another aspect of fluid therapy in gastrointestinal disease (see [Chapter 5](#)).

## CORRECTION OF ABNORMAL MOTILITY

### INCREASED MOTILITY

When motility is increased, the administration of atropine or other spasmolytics such as dipyron or proquamezine is usually followed by the disappearance of the abdominal pain and a diminution of fluid loss. Meperidine, butorphanol, and pentazocine inhibit regular cyclic myoelectric activity in the jejunum. There is a need for some scientific clinical investigation into the desirability of treating intestinal hypermotility, if it does exist in enteritis, for example, and the efficacy of anticholinergics. Loperamide has an antidiarrheal effect in experimentally induced diarrhea in calves, but the mechanism of action does not involve changes in intestinal motility.

### DECREASED MOTILITY

When gastrointestinal motility is decreased, the usual practice is to administer parasympathomimetic drugs or purgatives, usually combined with an analgesic. Prokinetic drugs such as metoclopramide hydrochloride and cisapride monohydrate increase the movement of ingesta through the gastrointestinal tract. They are useful because they induce coordinated motility patterns.

### Metoclopramide

**Metoclopramide**, acting in the upper gastrointestinal tract, increases acetylcholine release from neurons and increases cholinergic receptor sensitivity to acetylcholine. It is a dopamine antagonist and stimulates and coordinates esophageal, gastric, pyloric, and duodenal motor activity. It increases lower esophageal sphincter tone and stimulates gastric contractions, while relaxing the pylorus and duodenum. This results in accelerated gastric emptying and reduced esophageal reflux. The transit time of ingested material from the duodenum to the ileocecal valve is reduced because of increased jejunal peristalsis. It has little or no effect on colonic motility. The pharmacokinetics of metoclopramide in cattle has been studied.

Metoclopramide crosses the blood-brain barrier, where its dopamine antagonist activity at the chemoreceptor trigger zone can result in an antiemetic effect. It can also result in involuntary activity including tremors, restlessness, and aggressive behavior characterized by charging and jumping walls. This can be reversed by the use of an anticholinergic such as diphenhydramine hydrochloride intravenously at 0.5 to 2.0 mg/kg BW.

Indications for metoclopramide include reflux esophagitis and gastritis, chronic gastritis associated with delayed emptying, abomasal emptying defects in ruminants, gastric stasis following gastric dilatation and volvulus surgery, and **postoperative ileus**. It is contraindicated in animals with physical obstruction of the gastrointestinal tract.

In horses, the dose is 0.125 to 0.25 mg/kg BW diluted in multiple electrolyte solution and given intravenously over 60 minutes. It is used for stimulating equine gastric and small-intestinal activity at dose rates of 0.25 mg/kg BW per hour when there is intestinal hypomotility. Given as continuous intravenous infusion of 0.04 (mg/kg)/h it can decrease the incidence and severity of persistent postoperative ileus following resection and anastomosis of the small intestine in horses without serious side effects.

In cattle and sheep metoclopramide is used at 0.3 mg/kg BW subcutaneously every 6 to 8 hours. Metoclopramide did not alter cecocolic myoelectrical activity in cattle.

### Cisapride

**Cisapride** promotes gastrointestinal motility by enhancing the release of acetylcholine from postganglionic nerve endings of the myenteric plexus. It is more potent and has broader prokinetic activity than metoclopramide by increasing the motility of the colon as well as the esophagus, stomach, and small intestine. It does not have dopaminergic effects and does not have either the antiemetic or the extrapyramidal effects of metoclopramide. Cisapride is useful for the treatment of gastric stasis, gastroesophageal reflux, and postoperative ileus. In horses, it increases left dorsal colon motility and improves ileocecal junction coordination. The suggested dose is 0.1 mg/kg BW orally every 8 hours. Cisapride may have some value in the clinical management of cecal dilatation in cattle.

### Xylazine and Naloxone

Although **xylazine** is used for alleviation of visceral pain in horses and cattle, it is not indicated in cecal dilatation in cattle because it reduces the myoelectric activity of the cecum and proximal loop of the ascending colon. **Naloxone**, a widely used opiate antagonist with a high affinity for  $\mu$ -receptors, is also not indicated for medical treatment of cecal dilatation when hypomotility must be reversed.



### Bethanechol and Neostigmine

**Bethanechol** is a methyl derivative of carbachol and classified as a direct-acting cholinomimetic drug. Its action is more specific on the gastrointestinal tract and urinary bladder. **Neostigmine**, a cholinesterase inhibitor, is an indirect-acting cholinergic drug with motor-stimulating activities but only on the gastrointestinal tract. Bethanechol at 0.07 mg/kg BW intramuscularly may be useful for medical treatment of cecal dilatation in cattle in which hypomotility of the cecum and proximal loop of the ascending colon must be reversed. Neostigmine at 0.02 mg/kg BW intramuscularly increased the number of propagated spike sequences, but they were uncoordinated.

### RELIEF OF TENESMUS

Tenesmus can be difficult to treat effectively. Long-acting epidural anesthesia and sedation are in common use. Combinations of xylazine and lidocaine may be used. Irrigation of the rectum with water and the application of topical anesthetic in a jelly-like base are also used.

### RECONSTITUTION OF RUMEN FLORA AND CORRECTION OF ACIDITY OR ALKALINITY

When prolonged anorexia or acute indigestion occurs in ruminants, the rumen flora may be seriously reduced. In convalescence, the reconstitution of the flora can be hastened by the oral administration of a suspension of ruminal contents from a normal cow, or of dried ruminal contents, which contain viable bacteria and yeasts and the substances necessary for growth of the organisms.

The pH of the rumen affects the growth of rumen organisms, and hyperacidity (such as occurs on overeating of grain), or hyperalkalinity (such as occurs on overeating of protein-rich feeds), should be corrected by the administration of alkalinizing or acidifying drugs as needed.

### FURTHER READING

Hudson NPH, Pirie RS. Equine post-operative ileus: a review of current thinking on pathophysiology and management. *Equine Vet Educ*. 2015;1:39-47.

Wong DM, et al. Motility of the equine gastrointestinal tract: physiology and pharmacotherapy. *Equine Vet Educ*. 2011;23:88-100.

### REFERENCES

1. Fintl C, et al. *Equine Vet J*. 2011;43:145.
2. Freeman DE. *Equine Vet J*. 2008;40:297.
3. Holcombe SJ, et al. *Vet Surg*. 2009;38:368.
4. Torfó S, et al. *J Vet Intern Med*. 2009;23:606.
5. Hudson NPH, et al. *Equine Vet Educ*. 2015;27:39.
6. Cook VL, et al. *JAVMA*. 2008;232:1144.
7. Wittek T, et al. *JAVMA*. 2008;232:418.
8. Wittek T, et al. *Vet Surg*. 2008;37:537.
9. Okamura K, et al. *J Vet Sci*. 2009;10:157.
10. Okamura K, et al. *Res Vet Sci*. 2009;86:302.
11. Wong DM, et al. *Equine Vet Educ*. 2011;23:88.
12. Lejeune B, et al. *Can Vet J*. 2008;49:386.

13. Braun U, et al. *Vet Rec*. 2010;166:79.
14. le Jeune S, et al. *Vet Clin Equine*. 2014;30:353.
15. Kendall A, et al. *Acta Vet Scand*. 2008;50:17.
16. Keppie N, et al. *Vet Radiol Ultra*. 2008;49:122.
17. Maher O, et al. *JAVMA*. 2011;239:1483.
18. Kelleher ME, et al. *JAVMA*. 2014;245:126.
19. Beccati F, et al. *Equine Vet J*. 2011;43:98.
20. Ness SL, et al. *Can Vet J*. 2012;53:378.
21. Banse HE, et al. *Comp Exerc Physiol*. 2013;9:125.
22. Beccati F, et al. *Equine Vet J*. 2011;43:98.
23. Korolainen R, et al. *Equine Vet J*. 2002;34:499.
24. Williams S, et al. *Equine Vet J*. 2011;43:93.
25. Abraham M, et al. *J Vet Intern Med*. 2014;28:1580.
26. Braun U, et al. *Vet Rec*. 2007;160:865.
27. Sykes BW, et al. *Equine Vet Educ*. 2014;26:543.
28. Bonilla AG, et al. *Equine Vet Educ*. 2014;26:141.
29. Sykes BW, et al. *Vet Rec*. 2014;175.
30. Sykes BW, et al. *Equine Vet J*. 2014;46:416.
31. Sykes BW, et al. *Equine Vet J*. 2014;46:422.
32. Fintl C, et al. *Equine Vet J*. 2011;43:149.
33. Kaikkonen R, et al. *Acta Vet Scand*. 2014;56:35.
34. Scotti GB, et al. *Equine Vet Educ*. 2013;25:184.
35. Unger L, et al. *Equine Vet Educ*. 2014;26:430.

## Diseases of the Buccal Cavity and Associated Organs

### DISEASES OF THE MUZZLE

Severe dermatitis with scab formation, development of fissures, and sloughing and gangrene of the skin of the muzzle are common lesions in cattle affected with photosensitive dermatitis, bovine malignant catarrh, bovine virus diarrhea, and rinderpest.

In sheep severe lesions of the muzzle are less common, but occur in bluetongue and ecthyma.

In pigs, only the vesicular diseases—vesicular exanthema of swine (VES), swine vesicular disease, and FMD—cause such lesions on the snout and on other sites. The lesions are vesicular initially, and confusion has arisen in recent years because of isolated incidents in Australia and New Zealand in which such outbreaks occurred but no pathogenic agent was identified.

Congenital lesions of solely the muzzle are rare; the congenital defect of harelip can be contiguous with a cleft palate.

### STOMATITIS

Stomatitis is inflammation of the oral mucosa and includes **glossitis** (inflammation of the tongue), **palatitis** (lampas; inflammation of the palate), and **gingivitis** (inflammation of the mucosa of the gums). Clinically it is characterized by partial or complete loss of appetite, smacking of the lips, and profuse salivation. It is commonly an accompaniment of systemic disease.

### ETIOLOGY

Stomatitis can be caused by physical, chemical, or infectious agents, with the last being the largest group of causes. The agents are listed next.

### Physical Agents

- Trauma while dosing orally with a balling gun or similar instruments.<sup>1</sup>
- Laceration of the tongue.
- Foreign body injury.
- Malocclusion of teeth.
- Sharp awns or spines on plants. The most common lesions are on the gums of cattle and sheep just below the corner incisors where tough grass is pulled around the corner of the incisor arcade. In spear grass country the alveoli are often stuffed full of grass seeds. Very young animals, e.g., 1- to 6-week-old lambs, are particularly susceptible to traumatic injury from abrasive feed. Among the most dramatic lesions are those in the mouths of horses. They are large (2–3 cm long and 5 mm wide) and linear in shape. They can be caused in horses or cattle by eating hairy caterpillars that infest pasture,<sup>2</sup> or by the awns in hay or chaff made from triticale (a hybrid of wheat and rye) and a yellow bristle grass (*Setaria lutescens*).<sup>3</sup> Foxtail awns can cause multiple painful nodules on the lips of horses that have eaten hay contaminated with the awns,<sup>4</sup> as can the seedheads of mouse barley (*Hordeum murinum*).<sup>5</sup>
- The strength and thickness of the awn in dwarf barley cultivars used to make silage fed to feedlot cattle in some regions is associated with mouth lesions. The incidence of tongue lesions in slaughter cattle in some areas can be about 19%, and the incidence is higher in cattle finished on silage from semidwarf rough awn (29.3%) compared with normal-stem rough awn (13.5%) and normal-stem smooth awn barley (11.8%).
- Eating frozen feed and drinking hot water are recorded, but seem highly improbable.
- Ulcers of the soft palate of horses can be caused by mechanical trauma associated with dorsal displacement of the soft palate.

### Chemical Agents

- Irritant drugs, e.g., chloral hydrate, administered in excessive concentrations.
- Counterirritants applied to skin, left unprotected, and licked by the animal, including mercury and cantharides compounds.
- Irritant substances administered by mistake, including acids, alkalis, and phenolic compounds.
- Manifestation of systemic poisoning, e.g., chronic mercury poisoning. Poisoning with bracken, *Heracleum mantegazzianum*, furazolidone, and some fungi (*Stachybotrys*, *Fusarium* spp., and mushrooms) cause a combination of focal hemorrhages and necrotic ulcers

or erosions. They are a common cause of confusion with vesicular or erosive disease.

- Lesions associated with uremia syndrome in horses.

### Infectious Agents

#### Cattle

- Oral necrobacillosis associated with *Fusobacterium necrophorum*.
- Actinobacillosis of the bovine tongue is not a stomatitis, but there can be one or two ulcers on the dorsum and sides of the tongue and on the lips. Characteristically, there is initially an acute diffuse myositis of the muscle of the tongue, followed by the development of multiple granulomas and subsequently fibrosis and shrinkage.
- Ulcerative, granulomatous lesions may occur on the gums in cases of actinomycosis.
- Stomatitis with vesicles occurs in FMD and in vesicular stomatitis (VS).
- Erosive, with some secondary ulcerative, stomatitis occurs in bovine viral diarrhea (mucosal disease), bovine malignant catarrh, rinderpest, and rarely in bluetongue. Cases of infectious bovine rhinotracheitis in young calves may have similar lesions.
- Proliferative lesions occur in papular stomatitis, proliferative stomatitis, and rare cases of rhinosporidiosis and papillomatosis where the oral mucosa is invaded.
- Oral mucosal necrosis in bovine sweating sickness.
- Nondescript lesions varying from erosions to ulcers occur late in the stages of many of the previously mentioned diseases when secondary bacteria have invaded the breaches in the mucosa. In some cases the involvement goes deeper still and a phlegmonous condition or a cellulitis may develop. Thus lesions that were initially vesicular are converted to what look like bacterial ulcers. Secondary infection with fungi, especially *Monilia* spp., may also occur.

#### Sheep

- Erosive lesions in bluetongue, rinderpest, and peste de petits ruminants.
- Vesicular lesions rarely in foot-and-mouth disease (FMD).
- Granulomatous lesions caused by ecthyma are not unusual in the mouth, especially in young lambs. Similarly, oral lesions occur in bad cases of sheep pox, ulcerative dermatosis, coital exanthema, and mycotic dermatitis.

#### Horses

- Cheilitis and gingivitis (inflammatory nodules of the lips and gums caused by plant awns)

- Vesicular lesions in VS
- Lingual abscess associated with *Actinobacillus* spp.

#### Pigs

- The vesicular diseases: FMD, VS, VES, and swine vesicular disease.

#### Bullous Stomatitis

- Bullous stomatitis has been reported in the horse and can be associated with a paraneoplastic pemphigus syndrome.

Many other causes of stomatitis have been suggested, but the relationship of these conditions to the specific diseases listed previously is unknown. It is common to find stomatitides that cannot be defined as belonging to any of these etiologic groups. An example is necrotic glossitis reported in feeder steers in the United States in which the necrotic lesions are confined to the anterior part of the tongue.

#### PATHOGENESIS

The lesions of stomatitis are produced by the causative agents being applied directly to the mucosa, or gaining entrance to it by way of minor abrasions, or by localization in the mucosa from a viremia. In the first two instances, the stomatitis is designated as primary. In the third, it is usually described as secondary because of the common occurrence of similar lesions in other organs or on other parts of the body, and the presence of a systemic disease. The clinical signs of stomatitis are caused by the inflammation or erosion of the mucosa and the signs vary in severity with the degree of inflammation.

#### CLINICAL FINDINGS

There is partial or complete anorexia and slow, painful mastication. Chewing movements and smacking of the lips are accompanied by salivation, either frothy and in small amounts, or profuse and drooling if the animal does not swallow normally. The saliva may contain pus or shreds of epithelial tissue. A fetid odor is present on the breath only if bacterial invasion of the lesion has occurred. Enlargement of local lymph nodes may also occur if bacteria invade the lesions. Swelling of the face is observed only in cases where a cellulitis or phlegmon has extended to involve the soft tissues. An increased desire for water is apparent and the animal resents manipulation and examination of the mouth.

Toxemia may be present when the stomatitis is secondary to a systemic disease or where tissue necrosis occurs. This is a feature of oral necrobacillosis and many of the systemic viremias. In some of the specific diseases, lesions may be present on other parts of the body, especially at the coronets and mucocutaneous junctions.

Several different lesions of the oral cavity may be present and their characteristic appearances are as follows. The importance

of vesicular diseases such as FMD means that the recognition and differentiation of these lesions assumes major importance.

**Erosions** are shallow, usually discrete, areas of necrosis, which are not readily seen in the early stages. They tend to occur most often on the lingual mucosa and at the commissures of the mouth. The necrotic tissue may remain in situ but is usually shed, leaving a very shallow discontinuity of the mucosa with a dark red base that is more readily seen. If recovery occurs, these lesions heal very quickly.

**Vesicles** are thin-walled swellings 1 to 2 cm in diameter filled with clear serous fluid. They are very painful and rupture readily to leave sharp-edged, shallow ulcers.

**Ulcerative lesions** penetrate more deeply to the lamina propria and are painful, such as in necrotic stomatitis in calves associated with *F. necrophorum*. In lambs the tongue may be swollen and contain many microabscesses infected with *Actinomyces* (*Corynebacterium*) *pyogenes*. There is an accompanying abscessation of the pharyngeal lymph nodes.

**Proliferative lesions** are characterized by an abnormality raised above the surface of the mucous membrane such as in oral papillomatosis. **Traumatic lesions** are usually solitary and characterized by a discontinuity in the mucous membrane often with evidence of healing and the presence of granulation tissue.

**Catarrhal stomatitis** is manifested by a diffuse inflammation of the buccal mucosa and is commonly the result of direct injury by chemical or physical agents. **Mycotic stomatitis** is characterized by a heavy, white velvety deposit with little obvious inflammation or damage to the mucosa.

**Deformity of or loss of tissue at the tip of the tongue** may result in a chronic syndrome of chewing and swallowing food in such a way that food is always oozing from between the lips. In sheep this may cause permanent staining of the hair around the mouth, creating an appearance similar to that of a tobacco chewer. Loss of the tip is usually the result of predator attack on a newborn or sick lamb.

**Laceration of the tongue** can result in complete or partial severance of the organ, with the severed portion protruding from the oral cavity. In cattle, glossectomy interferes with prehension and the animal is unable to eat. Excessive loss of saliva is common because of interference with swallowing.

**Ulceration of the soft palate** of horses may occur in 16% of horses with dorsal displacement of the soft palate and is characterized clinically by reduced exercise tolerance, respiratory noise during light exercise or racing, dysphagia, and coughing after exercising. The ulcers can be viewed by upper respiratory airway videendoscopy. **Bullous stomatitis** in the horse is characterized by intact or ruptured vesicles on the peripheral

margin of the tongue, the sublingual region, and the mucosa of the oral cavity and lips.

### CLINICAL PATHOLOGY

Material collected from lesions of stomatitis should be examined for the presence of pathogenic bacteria and fungi. Transmission experiments may be undertaken with filtrates of swabs or scrapings if the disease is thought to be caused by a viral agent.

### NECROPSY FINDINGS

Oral lesions are easily observed, but complete necropsy examinations should be performed on all fatally affected animals to determine whether the oral lesions are primary or are local manifestations of a systemic disease.

### DIFFERENTIAL DIAGNOSIS

- Particularly in cattle, and to a lesser extent in sheep, the diagnosis of stomatitis is most important because of the occurrence of oral lesions in a number of highly infectious viral diseases. The diseases are listed under etiology and their differentiation is described under their specific headings elsewhere in this book.
- Careful clinical and necropsy examinations are necessary to define the type and extent of the lesions if any attempt at field diagnosis is to be made.
- In cattle, lymphoma of the ramus of the mandible may spread extensively through the submucosal tissues of the mouth causing marked swelling of the gums, spreading of the teeth, inability to close the mouth, and profuse salivation. There is no discontinuity or inflammation of the buccal mucosa, but gross enlargement of the cranial lymph nodes is usual.
- The differentiation of causes of hypersalivation must depend on a careful examination of the mouth (the causative gingivitis is often surprisingly moderate in horses) and an awareness of the volume of increased saliva output caused by toxic hyperthermia, e.g., in fescue and ergot poisonings.
- Poisoning by the mycotoxin slaframine also causes hypersalivation.

### TREATMENT

Affected animals should be isolated and fed and watered from separate utensils if an infectious agent is suspected. Specific treatments are described under the headings of the individual diseases. Nonspecific treatment includes frequent application of a mild antiseptic collutory such as a 2% solution of copper sulfate, a 2% suspension of borax, or a 1% suspension of a sulfonamide in glycerin. Indolent ulcers require more vigorous treatment and respond well to curettage or cauterization with a silver nitrate stick or tincture of iodine.

In stomatitis caused by trauma, the teeth might need attention. In all cases, soft,

appetizing food should be offered and feeding by stomach tube or intravenous alimentation may be resorted to in severe, prolonged cases. If the disease is infectious, care should be exercised to ensure that it is not transmitted by the hands or dosing implements.

### REFERENCES

1. Fuller MC, et al. *Can Vet J*. 2007;48:845.
2. Jans HWA, et al. *Tijdschr Diergeneeskd*. 2008;133:424.
3. Campbell JR, et al. *Bovine Practitioner*. 2013;47:36.
4. Johnson PJ, et al. *Equine Vet Educ*. 2012;24:182.
5. Mohammadi G, et al. *Iranian J Vet Sci Technol*. 2009;1:47.

### DISEASES OF THE TEETH

Surgical diseases of the teeth of animals are presented in textbooks of surgery. Some of the medical aspects of diseases of the teeth of farm animals are described here.

#### ETIOLOGY

The causes may be congenital or acquired.

#### Congenital Defects

- Polyodontia (excessive number of teeth) occurs in many species. It is detected in 2.3% of donkeys.<sup>1</sup>
- Malocclusion of sufficient degree to interfere with prehension and mastication
- Red-brown staining of inherited porphyrinuria of cattle
- Defective enamel formation on all teeth combined with excessive mobility of joints is an inherited defect of collagen metabolism in Holstein/Friesian cattle identified as bovine osteogenesis imperfecta. The teeth are pink and abnormal in appearance. This defect is also recorded in a foal with severe epitheliogenesis imperfecta.

#### Dental Fluorosis

The teeth are damaged before they erupt and show erosion of the enamel.

#### Enamel Erosion

The feeding of acidic by-product feed such as sweet potato cannery waste, which is acidic because of the presence of lactic acid, can cause erosion of the enamel of the incisors of cattle. Exposure of incisor teeth in vitro to a supernatant of cannery waste or lactic acid at pH 3.2 results in removal of calcium from the surface enamel of bovine teeth. Neutralizing the cannery waste to a pH of 5.5 does not cause detectable etching of the teeth. Feeding cattle with heavily compacted silage is also associated with loss of incisor enamel and severe incisor wear.

#### Premature Wear and Loss of Teeth in Sheep (Periodontal Disease)

Premature loss of incisor teeth or “broken mouth” causes concern because of the early

age at which affected sheep have to be culled. Broken mouth is a chronic inflammatory disease of the tissue supports of the tooth. Between 60% and 70% of ewes sold at slaughter in England and Scotland have loose or missing incisor teeth. Broken mouth is geographically specific and it seems that once the disease is established on a particular farm, the animals are permanently susceptible. Many sheep are culled before the end of their useful reproductive life because of broken mouth. The problem is particularly severe in New Zealand and the hill country in Scotland. The cause is uncertain, but environmental factors that result in periodontal disease are probably important. Broken mouth is associated with abnormal bacterial flora in the mouth with affected sheep having a preponderance of *Mannheimia ruminalis* and *Moraxella caprae* compared with sheep with healthy mouths.<sup>2</sup> *Porphyromonas (Bacteroides) gingivalis*, an organism that is found in plaque from sheep's teeth, has been found with increased frequency in diseased compared with unaffected animals. The depths of the gingival crevice of sheep are heritable and it is possible that deeper crevices may already be harboring greater numbers of periodontally pathogenic bacteria so that when the animals are exposed to a broken-mouth environment they may be more prone to the changes. Although nutrition and mineral deficiencies influence dental development and tooth eruption of sheep, there is no significant difference in calcium or phosphorus status between control and affected populations of sheep. Low planes of nutrition have delayed eruption of the permanent dentition and retarded mandibular growth, but these changes are not seen in broken mouth in sheep. The occurrence of this periodontal disease is higher in some soil types than on others. The ingestion of irritating materials such as sand and spiny grass seeds has been suggested as causes, but they are considered to be secondary complications in a preexisting disease.

Another dental disease of sheep is also recorded on an extensive scale in New Zealand. There is excessive wear of deciduous incisors but no change in the rate of wear of the molar teeth. The incisor wear is episodic and is not caused by any change in the supportive tissues, and there is no change in the intrinsic resistance to wear of the incisor teeth. The disease is not related to an inadequate dietary intake of copper or vitamin D and is thought to be caused by the ingestion of soil particles. The two New Zealand diseases do not occur together and have no apparent effect on body condition score.

Dentigerous cysts have been described in ewes in the South Island of New Zealand with a prevalence of 0.91%.

### PATHOGENESIS

There are some limitations to the use of number of incisors for determining age in



sheep. In mixed-age female sheep flocks, the median age when two, four, six, and eight incisors come into wear is 15, 23, 30, and 42 months of age, respectively. Errors will be made by assuming that all sheep gain a pair of permanent incisors at annual intervals between 1.5 and 4.5 years of age.

In periodontal disease or broken-mouth disease of sheep the primary lesion is an acute gingivitis around permanent incisors and premolars at the time of their eruption. This subsides leaving a chronic gingivitis and an accumulation of subgingival plaque. On some farms, for reasons not understood, this gingivitis penetrates down into the alveoli, causing a severe periodontitis and eventual shedding of the teeth. The severity of the gingivitis can vary between farms. The disease is episodic in nature, with discrete acute inflammatory incidents leading to periodontal injury that may resolve by healing. The balance between repair and the various short- and long-term acute episodes probably accounts for the large variation in incidence and age onset of tooth loss both within and between flocks. The inflammatory periodontal disease markedly affects the tooth's mobility. Collagen fibrils supporting the tooth become abnormal. The deepened periodontal pocket resulting from inflammation removes the major area of support for the tooth and abnormal loads are applied to fibers deeper within the tissue. Although the incisor teeth are usually most severely affected, the cheek teeth are also involved. In some unusual circumstances the gingivitis appears to arise from heavy deposits of dental calculus. In the Scottish disease there is local alveolar bone loss but no accompanying general skeletal deficiency.

### CLINICAL FINDINGS

The most obvious evidence of broken-mouth disease is incisor tooth loss, which usually occurs when sheep are between 3.5 and 6.6 years; normal sheep without broken mouth will retain their teeth beyond 7 years of age. Several dental health indices can assist to assess the amount of gingivitis, tooth movement, gum recession, and pocketing. Gingivitis is characterized by redness and edema of the attached gingiva. Bleeding from the gingivae is also a feature. Clinical gingivitis is evident as soon as the permanent teeth erupt. Chronic gingivitis results in a downward retreat of the gum margin; loss of its normal, scalloped shape; and fibrosis of the gingiva. Within a year before tooth loss, tissue damage around the incisors leads to deepening of the gingival sulcus and the formation of pockets, which are readily detected by the use of graduated dental measuring probes. The normal sulcus is 0.5 to 1.0 mm deep labially and up to 4 mm deep lingually; pockets may be over 1.0 cm in depth before tooth loss. Crown lengthening, protrusion, hemorrhages, loosening, and lingual periodontitis are characteristic. If sheep affected

with broken mouth periodontal disease are examined over a 12-month period, only a few animals undergo clinically significant destruction. The relationship between periodontal disease and body condition score in sheep is variable.

Secondary starvation occurs even with a plentiful feed supply. Inspection of the mouth may reveal the worn or damaged incisor teeth, but the molar teeth are not easily inspected in the living animal and tooth lesions can be missed. Because it is common to find that both incisors and molars are affected, damage to incisors should lead the clinician to suspect that molar disease is also present.

Cattle fed sweet potato cannery waste develop black, stained teeth with severe enamel erosion.

An abattoir survey of dental defects in cull cows, all over 30 months of age, found that 14.6% had one or more missing incisors, most of which were acquired losses. Rotation and overlapping of rostral teeth were common, as was attrition. Congenitally absent first lower premolars; other missing teeth; large and often multiple interdental spaces; and a few cases of macrodontia, cavitation, multiple defects, and fractures were observed in cheek tooth arcades. There were also some unusual patterns of premolar and molar attrition, often attributable to malocclusion, one result of which was the formation of a hook at the posterior extremity of the third maxillary molar.

### CLINICAL PATHOLOGY

None definitive.

### TREATMENT AND CONTROL

There is no reliable treatment and control for broken mouth in sheep. The use of dental prosthetics glued to the incisors when the ewe has three pairs of incisors in place is being investigated. The use of antimicrobials has been proposed to control the gingivitis, but there is no apparent effect on the periodontal disease. Cutting the incisor teeth of ewes to control premature tooth loss has been explored, but the practice has been banned in the UK.

### REFERENCES

- Rodriguez JB, et al. *Equine Vet Educ.* 2013;25:363.
- Riggio MP, et al. *Vet Microbiol.* 2013;166:664.

## DISEASES OF THE PAROTID SALIVARY GLANDS

Disease of the parotid gland includes parotitis, which can be septic or associated with sialolithiasis, congenital abnormalities including brachial cyst remnants, neoplasia, and trauma. Inflammation of the salivary glands (sialadenitis) can be secondary to sialolithiasis.

### ETIOLOGY

Parotitis can be parenchymatous, when the glandular tissue is diffusely inflamed, or it may be a local suppurative process. There are no specific causes in farm animals, with cases occurring only sporadically and usually caused by localization of a blood-borne infection, invasion up the salivary ducts associated with stomatitis, irritation by grass awns in the duct, or salivary calculi. Avitaminosis A often appears to be a predisposing cause in cattle.

Septic sialadenitis of horses is an uncommon disease that causes pain, inappetence, dysphagia, and localized swelling of the parotid or submandibular salivary glands.<sup>1</sup> Some cases (one third) are associated with the presence of sialoliths.<sup>1</sup> Sialoliths can form around foreign bodies, such as grass seeds or grains.<sup>2</sup>

Local suppurative lesions are caused usually by penetrating wounds or extension from a retropharyngeal cellulitis or lymph node abscess. Neoplasia of the parotid glands of cattle, horses, and sheep occurs both as a primary tumor (adenocarcinoma and peripheral nerve sheath tumor), manifestation of a systemic tumor (lymphoma), or local extension of neoplasia in an adjacent structure, such as ocular squamous cell carcinoma.<sup>3-7</sup>

Trauma can injure the gland or draining duct.<sup>8</sup>

### PATHOGENESIS

In most cases only one gland is involved. There is no loss of salivary function and the signs are restricted to those of inflammation of the gland.

### CLINICAL FINDINGS

In the early stages, there is diffuse enlargement of the gland accompanied by warmth and pain on palpation. The pain can interfere with mastication and swallowing and induce abnormal carriage of the head and resentment when attempts are made to move the head. There can be marked local edema in severe cases. Diffuse parenchymatous parotitis usually subsides with systemic and local treatment within a few days, but suppurative lesions can discharge externally and form permanent salivary fistulae.

Examination should include careful oral examination and ultrasonographic examination of the gland and associated ducts.<sup>1</sup>

Treatment for septic sialolithiasis includes correction of the underlying defect (abnormal dentition or sialolith) and administration of antimicrobials.

### CLINICAL PATHOLOGY

Bacteriologic examination of pus from discharging abscesses in horses reveals *Fusobacterium* sp. and a variety of other bacteria.<sup>1</sup>

### NECROPSY FINDINGS

Death occurs rarely and necropsy findings are restricted to local involvement of the



gland or to primary lesions elsewhere in the case of secondary parotitis.

### DIFFERENTIAL DIAGNOSIS

- Careful palpation is necessary to differentiate the condition from lymphadenitis, abscesses of the throat region, and metastases to the parotid lymph node in ocular carcinoma or mandibular lymphoma of cattle.
- Acute phlegmonous inflammation of the throat is relatively common in cattle and is accompanied by high fever, severe toxemia, and rapid death. It can be mistaken for an acute parotitis, but the swelling is more diffuse and causes pronounced obstruction to swallowing and respiration.

### TREATMENT

Systemic treatment with sulfonamides or antibiotics is required in acute cases, especially if there is a systemic reaction. Abscesses might require draining. A salivary fistula is a common sequel.

### REFERENCES

1. Kilcoyne I, et al. *Equine Vet J.* 2015;47:54.
2. Al-Sobayil FA, et al. *J Equine Vet Sci.* 2008;28:437.
3. dos Anjos BL, et al. *Acta Scientiae Veterinariae.* 2010;38:315.
4. Salgado BS, et al. *Vet Clin Pathol.* 2012;41:424.
5. McConnell EJ, et al. *Equine Vet Educ.* 2014;26:610.
6. Elce YA, et al. *Equine Vet Educ.* 2011;23:496.
7. Kegler K, et al. *J Comp Pathol.* 2014;150:382.
8. Lempe A, et al. *Vet Surg.* 2012;41:536.

## Diseases of the Pharynx and Esophagus

### PHARYNGITIS

Pharyngitis is inflammation of the pharynx and is characterized clinically by coughing, painful swallowing, and a variable appetite. Regurgitation through the nostrils and drooling of saliva may occur in severe cases.

### ETIOLOGY

Pharyngitis in farm animals is usually traumatic. Infectious pharyngitis is often part of a syndrome with other more obvious signs.

### Physical Causes

- Injury while giving oral treatment with balling or drenching gun or following endotracheal intubation. The administration of intraruminal anthelmintic coils to calves under a minimum BW have also been associated with pharyngeal and esophageal perforation
- Improper administration of a reticular magnet, resulting in a retropharyngeal abscess.
- Accidental administration or ingestion of irritant or hot or cold substances.

- Foreign bodies, including grass and cereal awns, wire, bones, and gelatin capsules lodged in the pharynx or suprathyroid diverticulum of pigs.

### Infectious Causes

#### Cattle

- Oral necrobacillosis and actinobacillosis as a granuloma rather than the more usual lymphadenitis
- Infectious bovine rhinotracheitis
- Pharyngeal phlegmon or intermandibular cellulitis is a severe, often fatal, necrosis of the wall of the pharynx and peripharyngeal tissues without actually causing pharyngitis. *F. necrophorum* is a common isolate from the lesions.

#### Horses

- As part of strangles or anthrax
- Viral infections of the upper respiratory tract, including equine herpesvirus-1, Hoppengarten cough, parainfluenza virus, adenovirus, rhinovirus, viral arteritis, and influenza-1A/E1 and 1A/E2, cause pharyngitis.
- Chronic follicular pharyngitis with hyperplasia of lymphoid tissue in pharyngeal mucosa giving it a granular, nodular appearance with whitish tips on the lymphoid follicles.<sup>1</sup>

#### Pigs

- As part of anthrax in this species and in some outbreaks of Aujeszky's disease.

### PATHOGENESIS

Inflammation of the pharynx is attended by painful swallowing and disinclination to eat. If the swelling of the mucosa and wall is severe, there may be virtual obstruction of the pharynx. This is especially so if the retropharyngeal lymph node is enlarged, as it is likely to be in equine viral infections such as rhinovirus.

In balling-gun-induced trauma of feedlot cattle treated for respiratory disease with boluses of sulfonamides, perforations of the pharynx and esophagus may occur with the development of periesophageal diverticulations with accumulations of ruminal ingesta and cellulitis. Improper administration of a magnet to a mature cow can result in a retropharyngeal abscess.

Pharyngeal lymphoid hyperplasia in horses can be graded into four grades (I–IV) of severity based on the size of the lymphoid follicles and their distribution over the pharyngeal wall.<sup>2</sup>

### CLINICAL FINDINGS

The animal may refuse to eat or drink or it may swallow reluctantly and with evident pain. Opening of the jaws to examine the mouth is resented and manual compression of the throat from the exterior causes

paroxysmal coughing. There may be a mucopurulent nasal discharge, sometimes containing blood, spontaneous cough and, in severe cases, regurgitation of fluid and food through the nostrils. Oral medication in such cases may be impossible. Affected animals often stand with the head extended, drool saliva, and make frequent tentative jaw movements. If the local swelling is severe, there may be obstruction of respiration and visible swelling of the throat. The retropharyngeal and parotid lymph nodes are commonly enlarged.

In “**pharyngeal phlegmon**” in cattle there is an acute onset with high fever (41–41.5°C [106–107°F]), rapid heart rate, profound depression, and severe swelling of the soft tissues within and posterior to the mandible to the point where dyspnea is pronounced. Death usually occurs 36 to 48 hours after the first signs of illness.

In **traumatic pharyngitis in cattle**, visual examination of the pharynx through the oral cavity reveals hyperemia, lymphoid hyperplasia, and erosions covered by diphtheritic membranes. Pharyngeal lacerations are visible, and palpation of these reveals the presence of accumulated ruminal ingesta in diverticula on either side of the glottis. External palpation of the most proximal aspect of the neck reveals firm swellings, which represent the diverticula containing rumen contents. A retropharyngeal abscess secondary to an improperly administered magnet can result in marked diffuse painful swelling of the cranial cervical region. Ultrasonographic examination of the swelling may reveal the magnet within the abscess.

**Palpation of the pharynx** may be performed in cattle with the use of a gag if a foreign body is suspected, and endoscopic examination through the nasal cavity is possible in the horse.

Most acute cases recover in several days but chronic cases may persist for many weeks, especially if there is ulceration, a persistent foreign body, or abscess formation.

Pharyngeal lymphoid hyperplasia is the most commonly recognized abnormality of the upper respiratory tract of the horse.<sup>2–4</sup> The disorder is characterized by chronic hyperplasia of lymphoid tissue in the pharynx of young horses evident as multiple, often coalescing, raised nodules in the pharynx. Up to 60% of Thoroughbred horses are affected and without apparent association with performance.<sup>2</sup> The disease is not associated with other abnormalities of the upper airway in sport horses.<sup>3</sup> If secondary bacterial infection is present a purulent exudate is seen on the pharyngeal mucosa and in the nostrils.

### CLINICAL PATHOLOGY

Nasal discharge or swabs taken from accompanying oral lesions may assist in the identification of the causative agent. *Moraxella* spp. and *Streptococcus zooepidemicus* can be isolated in large numbers from horses with

lymphoid follicular hyperplasia grades III and IV.

### NECROPSY FINDINGS

Deaths are rare in primary pharyngitis and necropsy examinations are usually undertaken only in those animals dying of specific diseases. In pharyngeal phlegmon there is edema, hemorrhage, and abscessation of the affected area, and on incision of the area a foul-smelling liquid and some gas usually escapes.

#### DIFFERENTIAL DIAGNOSIS

- Pharyngitis is manifested by an acute onset and local pain.
- In pharyngeal paralysis, the onset is usually slow.
- Acute obstruction by a foreign body can occur rapidly and cause severe distress and continuous, expulsive coughing, but there are no systemic signs.
- Endoscopic examination of the pharyngeal mucous membranes is often diagnostic.

### TREATMENT

The primary disease must be treated, usually parenterally, by the use of antimicrobials. Pharyngeal phlegmon in cattle is frequently fatal and early, intensive antimicrobial treatment is indicated.

Pharyngeal lymphoid hyperplasia is not generally susceptible to antimicrobials or medical therapy and resolves as young horses age.

### REFERENCES

1. Koblinger K, et al. *J Vet Intern Med.* 2011;25:1118.
2. Saulez MN, et al. *Vet Rec.* 2009;165:431.
3. Van Erck E. *Equine Vet J.* 2011;43:18.
4. Barnett TP, et al. *Equine Vet J.* 2013;45:593.

## PHARYNGEAL OBSTRUCTION

Obstruction of the pharynx is accompanied by stertorous respiration, coughing, and difficult swallowing.

### ETIOLOGY

Foreign bodies or tissue swellings are the usual causes.

#### Foreign Bodies

Foreign bodies include bones, corn cobs, and pieces of wire. Although horses are considered discriminating eaters in comparison to cattle, they will occasionally pick up pieces of metal while eating.

#### Tissue Swellings

##### Cattle

- Retropharyngeal lymphadenopathy or abscess caused by tuberculosis, actinobacillosis, or bovine viral leukosis

- Fibrous or mucoid polyps are usually pedunculated because of traction during swallowing and can cause intermittent obstruction of air and food intake.

##### Horses

- Retropharyngeal lymph node hyperplasia and lymphoid granulomas as part of pharyngeal lymphoid hyperplasia
- Retropharyngeal abscess and cellulitis
- Retropharyngeal lymphadenitis caused by strangles
- Pharyngeal cysts in the subepiglottic area of the pharynx, probably of thyroglossal duct origin, and fibroma; also similar cysts on the soft palate and pharyngeal dorsum, the latter probably being remnants of the craniopharyngeal ducts
- Dermoid cysts and goitrous thyroids

##### Pigs

- Diffuse lymphoid enlargement in the pharyngeal wall and soft palate
- Food and foreign-body impaction in the suprapharyngeal diverticulum

### PATHOGENESIS

Reduction in caliber of the pharyngeal lumen interferes with swallowing and respiration.

### CLINICAL FINDINGS

There is difficulty in swallowing and animals can be hungry enough to eat but, when they attempt to swallow, cannot do so and the food is coughed up through the mouth. Drinking is usually managed successfully. There is no dilatation of the esophagus and usually little or no regurgitation through the nostrils. An obvious sign is a snoring inspiration, often loud enough to be heard some yards away. The inspiration is prolonged and accompanied by marked abdominal effort. Auscultation over the pharynx reveals loud inspiratory stertor. Manual examination of the pharynx can reveal the nature of the lesion, but an examination with a fiberoptic endoscope is likely to be much more informative. When the disease runs a long course, emaciation usually follows. Rupture of abscessed lymph nodes can occur when a nasal tube is passed and can result in aspiration pneumonia.

In horses with metallic foreign bodies in the oral cavity or pharynx, the clinical findings include purulent nasal discharge, dysphagia, halitosis, changes in phonation, laceration of the tongue and stertorous breathing. In case studies, most horses were affected with clinical signs for more than 2 weeks and had been treated with antimicrobials with only temporary improvement.

### CLINICAL PATHOLOGY

A tuberculin test might be advisable in bovine cases in areas where bovine tuberculosis is endemic. Nasal swabs can contain

*S. equi* when there is streptococcal lymphadenitis in horses.

### NECROPSY FINDINGS

Death occurs rarely and in fatal cases the physical lesion is apparent.

#### DIFFERENTIAL DIAGNOSIS

- Signs of the primary disease can aid in the diagnosis in tuberculosis, actinobacillosis, and strangles.
- Pharyngitis is accompanied by severe pain, systemic signs are common, and there is usually stertor.
- It is of particular importance to differentiate between obstruction and pharyngeal paralysis when rabies occurs in the area. Esophageal obstruction is also accompanied by the rejection of ingested food, but there is no respiratory distress. Laryngeal stenosis can cause a comparable stertor, but swallowing is not impeded. Nasal obstruction is manifested by noisy breathing, but the volume of breath from one or both nostrils is reduced and the respiratory noise is more wheezing than snoring.
- Radiography is useful for the identification of metallic foreign bodies.

### TREATMENT

Removal of a foreign body can be accomplished through the mouth. Treatment of actinobacillary lymphadenitis with iodides is usually successful and some reduction in size often occurs in tuberculous enlargement of the glands, but complete recovery is unlikely to occur. Parenteral treatment of strangles abscesses with penicillin can affect a cure. Surgical treatment has been highly successful in cases caused by medial retropharyngeal abscess.

## PHARYNGEAL PARALYSIS

Pharyngeal paralysis is manifested by inability to swallow and an absence of signs of pain and respiratory obstruction.

### ETIOLOGY

Pharyngeal paralysis occurs sporadically, caused by peripheral nerve injury, and in some encephalitides with central lesions.

#### Peripheral Nerve Injury

- Guttural pouch infections in horses
- Trauma to the throat region

#### Secondary to Specific Diseases

- Rabies and other encephalitides
- Botulism
- African horse sickness
- As an idiopathic disease in neonatal foals<sup>1</sup>

## PATHOGENESIS

Inability to swallow and regurgitation are the major manifestations of the disease. There may be an associated laryngeal paralysis, accompanied by “roaring.” The condition known as “cud-dropping” in cattle might be a partial pharyngeal paralysis because there is difficulty in controlling the regurgitated bolus, which is often dropped from the mouth. In these circumstances, aspiration pneumonia is likely to develop.

## CLINICAL FINDINGS

The animal is usually hungry but, on prehension of food or water, attempts at swallowing are followed by dropping of the food from the mouth, coughing, and the expulsion of food or regurgitation through the nostrils. Salivation occurs constantly and swallowing cannot be stimulated by external compression of the pharynx. The swallowing reflex is a complex one controlled by a number of nerves and the signs can be expected to vary greatly depending on which nerves are involved and to what degree. There is rapid loss of condition and dehydration. Clinical signs of the primary disease may be evident but, in cases of primary pharyngeal paralysis, there is no systemic reaction. Pneumonia may follow aspiration of food material into the lungs and produces loud gurgling sounds on auscultation.

In cud-dropping in cattle, the animals are normal except that regurgitated boluses are dropped from the mouth, usually in the form of flattened disks of fibrous food material. Affected animals may lose weight but the condition is usually transient, lasting for only a few days. On the other hand, complete pharyngeal paralysis is usually permanent and fatal.

Pharyngeal dysfunction in neonatal foals is characterized by the inability to nurse with discharge of milk from the nares. Affected foals are often premature or have signs of neonatal maladjustment syndrome. Diagnostic testing, including imaging studies, does not reveal abnormalities beyond a flaccid pharynx, persistent frequent dorsal displacement of the soft palate, laryngeal paralysis (unilateral or bilateral), and inability to swallow.<sup>1</sup>

## CLINICAL PATHOLOGY

The use of clinicopathologic examinations is restricted to the identification of the primary specific diseases.

## NECROPSY FINDINGS

If the primary lesion is physical, it can be detected on gross examination.

### DIFFERENTIAL DIAGNOSIS

- In all species, often the first clinical impression is the presence of a foreign body in the mouth or pharynx, and this can only be determined by physical examination.

- Pharyngeal paralysis is a typical sign in rabies and botulism, but there are other clinical findings that suggest the presence of these diseases.
- Neonatal dysphagia in foals results from cleft palate or soft palate masses, esophageal disease including megaesophagus or esophageal stricture, or primary muscle or central neurological disease, including hyperkalemic periodic paralysis.<sup>1</sup>
- Absence of pain and respiratory obstruction are usually sufficient evidence to eliminate the possibility of pharyngitis or pharyngeal obstruction.
- Endoscopic examination of the guttural pouch is a useful diagnostic aid in the horse.

## TREATMENT

Treatment is supportive in most cases in addition to management of any inciting disease, such as guttural pouch infection. Feeding by nasogastric tube allows for recovery of the ability to swallow in most (>90%) affected foals in 7 to 10 days.

## REFERENCE

1. Holcombe SJ, et al. *Equine Vet J*. 2012;44:105.

## ESOPHAGITIS

Inflammation of the esophagus is accompanied initially by clinical findings of spasm and obstruction, pain on swallowing and palpation, and regurgitation of bloodstained slimy material.

## ETIOLOGY

Primary esophagitis caused by the ingestion of chemical or physical irritants is usually accompanied by stomatitis and pharyngitis. Laceration of the mucosa by a foreign body or complications of nasogastric intubation can occur. Nasogastric intubation is associated with a higher risk of pharyngeal and esophageal injury when performed in horses examined for colic. This can be related to the use of larger diameter nasogastric tubes to provide more effective gastric decompression, the longer duration of intubation in some horses, or the presence of gastric distension resulting in increased resistance to tube passage at the cardia.<sup>1</sup> In a series of six horses with esophageal trauma the lesions were detected 5 and 20 cm from the cranial esophageal opening.

Death of *Hypoderma lineatum* larvae in the submucosa of the esophagus of cattle can cause acute local inflammation and subsequent gangrene.

Inflammation of the esophagus occurs commonly in many specific diseases, particularly those that cause stomatitis, but the other clinical signs of these diseases dominate those of esophagitis.

## PATHOGENESIS

Inflammation of the esophagus combined with local edema and swelling results in a functional obstruction and difficulty in swallowing.

## CLINICAL FINDINGS

In the acute esophagitis, there is salivation and attempts to swallow, which cause severe pain, particularly in horses. In some cases, attempts at swallowing are followed by regurgitation and coughing, pain, retching activities, and vigorous contractions of the cervical and abdominal muscles. If the esophagitis is in the cervical region, palpation in the jugular furrow causes pain and edematous tissues around the esophagus can be palpable. In specific diseases such as mucosal disease and bovine malignant catarrh, there are no obvious clinical findings of esophagitis, because the lesions are mainly erosive.

Endoscopy of the esophagus will usually reveal the location and severity of the lesion.

## CLINICAL PATHOLOGY

In severe esophagitis of traumatic origin a marked neutrophilia can occur, suggesting active inflammation.

## NECROPSY FINDINGS

Pathologic findings are restricted to those pertaining to the various specific diseases in which esophagitis occur. In traumatic lesions or those caused by irritant substances, there is gross edema, inflammation and, in some cases, perforation.

### DIFFERENTIAL DIAGNOSIS

- Esophagitis must be differentiated from pharyngitis, in which attempted swallowing is not as marked and coughing is more likely to occur. Palpation can also help to localize the lesion; however, pharyngitis and esophagitis usually occur together.

## TREATMENT

Feed should be withheld for 2 to 3 days and fluid and electrolyte therapy can be necessary for several days. Parenteral antimicrobials are indicated, especially if laceration or perforation has occurred. Reintroduction to feed should be monitored carefully and all feed should be moistened to avoid the possible accumulation of dry feed in the esophagus, which might not be fully functional.

## ESOPHAGEAL RUPTURE

Rupture of the esophagus is usually traumatic and can be life-threatening.

## ETIOLOGY

Rupture of the esophagus occurs from localized ischemia and necrosis secondary to

long-standing impaction or obstruction by foreign bodies or feed material, external trauma, nasogastric intubation, and perforation of ulcers in horses and cattle and death of *Hypoderma lineatum* larvae in cattle. In a series of six horses with esophageal trauma the lesions were detected 5 and 20 cm from the cranial esophageal opening. Spontaneous rupture can occur in horses with idiopathic muscular hypertrophy of the esophagus.<sup>1</sup> The case-fatality rate is high, approaching 100% for horses treated conservatively (without surgery), and somewhat better for horses subject to surgical intervention early in the disease.<sup>2,3</sup>

The administration of sustained-release anthelmintic boluses to young calves not large enough for the size of the bolus used can cause esophageal injury and perforation. The boluses are 8.5 cm in length and 2.5 cm in diameter and the calves 100 to 150 kg. The minimum BW for these boluses is 100 kg, but in the study some calves were younger than the recommended age and were also fractious when handled, which can have contributed to the injury.

### PATHOGENESIS

Traumatic injury to the esophagus results in edema, hemorrhage, laceration of the mucosa, and possible perforation of the esophagus, resulting in periesophageal cellulitis, which spreads proximally and distally along the esophagus in fascial planes from the site of perforation. Perforation of the thoracic esophagus can result in severe and fatal pleuritis. There is extensive edema and accumulation of swallowed or regurgitated ingesta along with gas. The extensive cellulitis and the presence of ingesta results in severe toxemia, and dysphagia can cause aspiration pneumonia.

### CLINICAL FINDINGS

In the acute injury of the esophagus, there is salivation and attempts to swallow, which cause severe pain, particularly in horses. In some cases, attempts at swallowing are followed by regurgitation and coughing, pain, retching activities, and vigorous contractions of the cervical and abdominal muscles. Marked drooling of saliva, grinding of the teeth, coughing, and profuse nasal discharge are common in the horse with esophageal trauma with complications following nasogastric intubation. Regurgitation can occur and the regurgitus contains mucus and some fresh blood.

If the esophageal rupture is in the cervical region, palpation in the jugular furrow causes pain and edematous tissues around the esophagus can be palpable. When perforation has occurred, there is local pain and swelling and often crepitus and swelling can extend to involve the head. Local cervical cellulitis can cause rupture through the skin and development of an esophageal fistula, or infiltration along fascial planes with resulting

compression obstruction of the esophagus, and toxemia. Perforation of the thoracic esophagus can lead to fatal pleuritis. Animals that recover from esophageal traumatic injury are commonly affected by chronic esophageal stenosis with distension above the stenosis. Fistulae are usually persistent, but spontaneous healing can occur.

Endoscopy of the esophagus will usually reveal the location and severity of the lesion. Lateral cervical radiographs can reveal foreign bodies and extensive soft tissue swelling with pockets of gas.

### CLINICAL PATHOLOGY

There is often hematological evidence of inflammation, dehydration, metabolic alkalosis, and toxemia.<sup>2</sup>

### NECROPSY FINDINGS

Gross necropsy findings are consistent with esophageal perforation and cellulitis.

#### DIFFERENTIAL DIAGNOSIS

- Tracheal laceration and subcutaneous emphysema
- Skin wounds over the axilla with subsequent subcutaneous emphysema
- Severe guttural pouch empyema
- Clostridial myositis secondary to puncture wounds of the neck or cervical intramuscular injections
- Pharyngeal phlegmon in cattle

### TREATMENT

Treatment involves effective drainage of the site over the esophageal perforation, prevention of further contamination, control of infection and inflammation, and provision of water and food.

Surgical treatment involves fasciotomy to provide drainage and access to the perforated esophagus. The perforation in the esophagus is debrided through a ventral fasciotomy. The fasciotomy wound is dressed and managed as an open wound. A stomach tube, of similar size as that used to perform nasogastric intubation on the animal (14–20 mm), is inserted through a separate incision in the esophagus in the midcervical region. The tip is placed in the distal esophagus. The horse is provided food (a pellet-based slurry) and water through this tube, as well as being offered water to drink. The tube remains in place until the esophageal perforation has sealed (5–7 days) and then removed.<sup>2,3</sup>

Loss of saliva can cause important abnormalities in electrolyte and acid-base status, and horses should be supplemented with sodium and potassium chloride while there is significant loss of saliva from the fistula.

Broad-spectrum antimicrobials and tetanus prophylaxis should be administered. Pain and swelling can be controlled by administration of NSAIDs.

### REFERENCES

1. Cathcart MP, et al. *Equine Vet Educ.* 2013;25:282.
2. Kruger K, et al. *Equine Vet Educ.* 2013;25:247.
3. Whitfield-Cargile CM, et al. *Equine Vet Educ.* 2013;25:456.

### ESOPHAGEAL OBSTRUCTION

Esophageal obstruction can be acute or chronic and is characterized clinically by the inability to swallow, regurgitation of feed and water, continuous drooling of saliva, and bloat in ruminants. Acute cases are accompanied by signs of distress including retching and extension of the head. Horses with choke commonly regurgitate a mixture of saliva, feed, and water through the nostrils because of the anatomic characteristics of the equine soft palate.

### ETIOLOGY

Obstruction can be **intraluminal** and caused by swallowed material or **extraluminal** caused by pressure on the esophagus by surrounding organs or tissues. Esophageal paralysis can also result in obstruction, for example, in horses with grass sickness.

### Intraluminal Obstructions

Intraluminal obstructions are usually caused by ingestion of materials that are of inappropriate size and that then become lodged in the esophagus:

- Solid obstructions, especially in cattle, by turnips, onions, potatoes, peaches, apples, oranges, and similar objects.
- Fifteen-gram gelatin capsules in Shetland ponies.
- Feedstuffs are a common cause of obstruction in horses and occasionally in other species.<sup>1</sup> Most impactions are caused by routine feedstuffs.<sup>2</sup> Improperly soaked sugarbeet pulp, inadvertent access to dry sugarbeet pulp, and cubed and pelleted feed can cause the disease in horses when eaten quickly.
- Eating while sedated
- Foreign bodies in horses include pieces of wood, antimicrobial boluses, and fragments of nasogastric tubes.
- A trichobezoar can cause esophageal obstruction cattle.
- Poor dentition is often mooted as a cause<sup>2</sup> and, although sensible, there is no objective evidence of an association between dental abnormalities and esophageal obstruction.

### Extraluminal Obstructions

- Enlarged lymph nodes in the mediastinum (tuberculosis, neoplasia, *Rhodococcus equi*, *Corynebacterium* spp., strangles, and secondary to pleuritis)
- Cervical or mediastinal abscess
- Persistent right aortic arch



- Thymoma
- Megaesophagus and caudal esophageal muscle hypertrophy in Friesian horses can cause esophageal obstruction.<sup>3</sup>
- Secondary to esophageal strictures, which can occur subsequent to esophageal trauma or perforation.<sup>6</sup>

### Esophageal Paralysis

Esophageal paralysis can be caused by **congenital or acquired abnormalities of the esophagus**, and there are many examples of such abnormalities that interfere with swallowing and cause varying degrees of obstruction, even though it may be possible to pass a stomach tube through the esophagus into the stomach or rumen.

**Esophageal paralysis**, diverticulum, or megaesophagus has been recorded in horses and in cattle. Congenital hypertrophy of esophageal musculature and esophagotracheal fistula has been found in calves. Congenital esophageal ectasia is recognized in foals, caused by degeneration of musculature and reduced ganglion cells in the myenteric plexus. Congenital esophageal dysfunction has also occurred in foals with no detectable histopathological lesion but with prolonged simultaneous contractions throughout the esophagus.

### Megaesophagus

Megaesophagus is a dilatation and atony of the body of the esophagus usually associated with asynchronous function of the esophagus and the caudal esophageal sphincter. It occurs sporadically in cattle and in horses with preexisting esophageal disease. It is usually a congenital condition that causes regurgitation and aspiration pneumonia. A mild esophagitis has been observed in some cases and congenital stenosis of the esophagus in a foal has been associated with megaesophagus. Megaesophagus and caudal esophageal muscular hypertrophy occur in Friesian horses.<sup>3</sup>

### Esophageal Strictures

These arise as a result of cicatricial or granulation tissue deposition, usually as result of previous laceration or trauma of the esophagus. They can occur in the adult horse with a history of previous obstruction. Esophageal strictures resulting in obstruction occur in foals from 1 to 6 months of age without any history of ingestion of a foreign body. An esophageal stricture has also been described in a goat.

### Other Causes of Obstruction

- **Carcinoma of stomach** causing obstruction of cardia
- Squamous cell carcinoma of the esophagus of a horse
- Esophageal hiatus hernia in cattle
- Paraesophageal cyst in a horse
- Combined esophageal and tracheal duplication cyst in a young horse

- Esophageal duplication in a horse
- Tubular duplication of the cervical portion of the esophagus in a foal
- Cranial esophageal pulsion (pushing outward) diverticulum in a horse
- Esophageal phytobezoar in a horse
- Esophageal mucosal granuloma
- Traumatic rupture of the esophagus from an external injury (e.g., a kick or striking the neck during transportation in a float involved in a motor vehicle accident or similar causing sudden slowing or stopping) or during treatment using a nasogastric tube
- Esophageal paralysis can also be associated with lesions of encephalitis, especially in the brainstem

The **case-fatality rate** for simple choke treated in the field is approximately 2%, while that in presumably more severe cases treated in referral institutions is approximately 12%. Approximately 8% of horses (60 of 758) examined by one author in primary care practice were caused by esophageal obstruction.<sup>2</sup>

Arabian horses and ponies appear to be overrepresented and Thoroughbreds underrepresented among equids with choke.<sup>2,4</sup> There is no readily apparent sex predilection. Equids can be affected at any age.

### PATHOGENESIS

An **esophageal obstruction** results in a physical inability to swallow and, in cattle, inability to eructate, with resulting bloat. In acute obstruction, there is initial spasm at the site of obstruction and forceful, painful peristalsis and swallowing movements. Complications of esophageal obstruction include laceration and rupture of the esophagus, esophagitis, stricture and stenosis, and the development of a diverticulum.

**Acquired esophageal diverticula** can occur in the horse. A traction diverticulum occurs following periesophageal scarring and is of little consequence. An esophageal pulsion diverticulum is a circumscribed sac of mucosa protruding through a defect in the muscular layer of the esophagus. Causes that have been proposed to explain pulsion diverticula include excessive intraluminal pressure from impacted feed, fluctuations in esophageal pressure, and external trauma. Complications associated with esophageal diverticula include peridiverticulitis, pulmonary adhesions, abscesses, and mediastinitis. Esophageal stricture and subsequent obstruction secondary to impaction of a diverticulum can also occur.

In **megaesophagus**, the esophagus is dysfunctional, dilated, and filled with saliva, feed, and water. This results in regurgitation and can lead to aspiration pneumonia. It can be congenital or secondary to other lesions and has been associated with gastric ulceration in foals.

Using esophageal manometry, the normal values for esophageal pressure profiles in

healthy horses, cows, and sheep have been recorded. The body of the equine and bovine esophagus has two functionally different regions: the caudal portion and the remainder of the esophageal body (cranial portion).

### CLINICAL FINDINGS

#### Acute Obstruction or Choke

##### Cattle

The obstruction is usually in the cervical esophagus just above the larynx or at the thoracic inlet. Obstructions can also occur at the base of the heart or the cardia. The animal suddenly stops eating and shows anxiety and restlessness. There are forceful attempts to swallow and regurgitate, salivation, coughing, and continuous chewing movements. If obstruction is complete, bloating occurs rapidly and adds to the animal's discomfort. Ruminant movements are continuous and forceful and there can be a systolic murmur audible on auscultation of the heart. However, rarely is the bloat severe enough to seriously affect the cardiovascular system of the animal, such as occurs in primary leguminous (frothy) bloat.

The acute signs, other than bloat, usually disappear within a few hours. This is caused by relaxation of the initial esophageal spasm and can or cannot be accompanied by onward passage of the obstruction. Many obstructions pass on spontaneously, but others can persist for several days and up to a week. In these cases, there is **inability to swallow, salivation, and continued bloat**. Passage of a nasogastric tube is impossible. Persistent obstruction causes pressure necrosis of the mucosa and can result in perforation or subsequent stenosis caused by fibrous tissue construction.

##### Horse

In the horse with esophageal obstruction caused by feed, the obstruction can occur at any level of the esophagus from the upper cervical region all the way to the thoracic portion. The ingestion of large quantities of grain or pelleted feed can cause obstruction over a long portion of the esophagus.

The clinical findings vary with the location, nature, extent, and duration of the obstruction. Typically, the major clinical finding is **dysphagia** with **nasal reflux of saliva, feed, and water**. Affected horses will usually not attempt further eating but will drink and attempt to swallow water. External palpation of the **cervical esophagus** can reveal a **firm cylindrical swelling** along the course of the neck on the left side when the esophagus is obstructed with feed.<sup>2</sup> In cases of foreign-body obstruction such as a piece of wood, there can be no palpable abnormality.

Horses with acute esophageal obstruction are commonly difficult to handle because they are panicky and make forceful attempts to swallow or retch.<sup>3</sup> They often vigorously extend and flex their necks and stamp their front feet. In some horses it can be difficult to

pass a nasogastric tube because they resist the procedure. During these episodes of hyperactivity they can sweat profusely, tachycardia can be present, and they can appear to be in abdominal pain. Such clinical findings on first examination can resemble colic, but attempted passage of a nasogastric tube as part of the examination of a horse with colic reveals the obstruction.

**Passage of a nasogastric tube** is necessary to make the diagnosis and to assess the level of the obstruction. The level of obstruction can be approximated by the amount of tube that has been passed. Care must be taken not to push the tube more than gently to avoid injury to the esophagus. Occasionally, a foreign body or bolus of feed will move distally into the stomach as the tube is gently advanced.

The nature of the obstruction can be assessed more adequately with a fiberoptic endoscope, but visualization of the entire esophagus of an adult horse requires an endoscope of 2.5 m length. The endoscope allows determination of the rostral but not the distal limit of the obstruction. Endoscopic examination of the esophagus after relief of the obstruction is useful in identifying any preexisting abnormalities or injuries caused by the obstruction. If radiographic equipment is available, standing lateral radiographs of the cervical and thoracic esophagus along with contrast media may be required to determine the extent and nature of an obstruction.

Persistent obstruction can occur in the horse and death can occur in either species from subsequent aspiration pneumonia or, when the obstruction persists, from dehydration. In **foals** with esophageal obstruction the clinical findings include **nasal reflux of saliva**, feed, and milk; reluctance to eat solid feed; and dyspnea if aspiration pneumonia has occurred. Unthriftiness occurs if the obstruction has been present for a few weeks. Affected foals can have had several episodes of choke within the previous few weeks from which they appeared to recover spontaneously. Passage of a nasogastric tube can be possible in some and not in others.

### Chronic Obstruction

No acute signs of obstruction are evident and in cattle the earliest sign is chronic bloat, which is usually of moderate severity and can persist for several days without the appearance of other signs. Rumen contractions can be within the normal range. In horses and in cattle in which the obstruction is sufficiently severe to interfere with swallowing, a characteristic syndrome develops. Swallowing movements are usually normal until the bolus reaches the obstruction, when they are replaced by more forceful movements. Dilatation of the esophagus can cause a pronounced swelling at the base of the neck. The swallowed material either passes slowly through the stenotic area or accumulates and is then regurgitated. Projectile expulsion of

ingested material occurs with esophageal diverticula, but water is retained and there is no impedance to the passage of the stomach tube. In the later stages, there can be no attempt made to eat solid food, but fluids can be taken and swallowed satisfactorily.

When there is **paralysis of the esophagus**, as in megaesophagus, regurgitation does not occur, but the esophagus fills and overflows, and saliva drools from the mouth and nostrils. Aspiration into the lungs can follow. Passage of a stomach tube or probang is obstructed by stenosis but can be unimpeded by paralysis.

### Complications Following Esophageal Obstruction

The risk of complications increases proportionate to the duration of obstruction.<sup>4</sup> Complications following an esophageal obstruction are most common in the horse and include esophagitis, mucosal ulceration, esophageal perforation and esophageal stricture, and aspiration pneumonia.<sup>4</sup> Complications developed in 51% of 109 horses hospitalized, with choke and the most frequent complication was aspiration pneumonia (39 of 109 horses).<sup>4</sup> The complication rate is much lower among horses treated in the field and in which resolution of the choke occurs within 24 hours.<sup>2</sup>

Mild cases of esophagitis heal spontaneously. Circumferential full-thickness mucosal ulceration can result in a stricture, which will be clinically evident in 2 to 5 weeks and can require surgical correction or balloon dilatation.<sup>5</sup> Esophageal perforation can occur and is characterized by diffuse cellulitis of the periesophageal tissues, often with subcutaneous emphysema, and a fistula can develop.

### CLINICAL PATHOLOGY

Laboratory tests are not used in diagnosis, although radiographic examination is helpful to outline the site of stenosis, diverticulum, or dilatation, even in animals as large as the horse. Radiologic examination after a barium swallow is a practicable procedure if the obstruction is in the cervical esophagus. Viewing of the internal lumen of the esophagus with a fiberoptic endoscope has completely revolutionized the diagnosis of esophageal malfunction. Biopsy samples of lesions and tumor masses can be taken using the endoscope. Electromyography has been used to localize the area of paralysis of the esophagus in a cow with functional megaesophagus.

### TREATMENT

#### Conservative Approach

Many obstructions will resolve spontaneously and a careful conservative approach is recommended. Of 60 cases first treated in the field, 45 resolved within 12 hours, 51 within 24 hours, and 58 in 48 hours.<sup>2</sup> If there is a history of prolonged choke with considerable nasal reflux having occurred, the

animal should be examined carefully for evidence of foreign material in the upper respiratory tract and the risk of aspiration pneumonia. It can require several hours of monitoring, reexamination, and repeated sedation before the obstruction is resolved. During this time, the animal should not have access to feed and water.

### Sedation

In acute obstruction, if there is marked anxiety and distress, the animal should be sedated before proceeding with specific treatment. Administration of a sedative such as an  $\alpha$ -2 receptor agonist, with or without an opioid, can also help to relax the esophageal spasm and allow passage of the impacted material. For sedation and esophageal relaxation in the horse, one of the following is recommended:

- Acepromazine 0.05 mg/kg BW intravenously
- Xylazine 0.5 to 1.0 mg/kg BW intravenously
- Detomidine 0.01 to 0.02 mg/kg BW intravenously
- Romifidine 0.04 to 0.12 mg/kg intravenously.

### DIFFERENTIAL DIAGNOSIS

- The clinical findings of acute esophageal obstruction in cattle and horses are usually typical but can be similar to those of esophagitis, in which local pain is more apparent and there is often an accompanying stomatitis and pharyngitis.
- The excitement, sweating, and tachycardia observed in acute choke in the horse often suggests colic. Passage of a nasogastric tube reveals the obstruction. The use of a fiberoptic endoscope will usually locate the obstruction for visualization, and obstructions are easiest to see when the endoscope is being withdrawn rather than advanced.

### Chronic obstruction

- Differentiation of the causes of chronic obstruction can be difficult. A history of previous esophagitis or acute obstruction suggests cicatricial stenosis. Contrast radiography of the esophagus is valuable in the investigation of horses with dysphagia, choke, and nasogastric reflux. The use of the sedative detomidine can affect the function of the esophagus and make interpretation of barium swallowing studies difficult.
- Persistent right aortic arch is rare and confined to young animals.
- Mediastinal lymph node enlargement is usually accompanied by other signs of tuberculosis or lymphomatosis.
- Chronic ruminal tympany in cattle can be caused by ruminal atony, in which case there is an absence of normal ruminal movements.

*Continued*

- Diaphragmatic hernia can also be a cause of chronic ruminal tympany in cattle and is sometimes accompanied by obstruction of the esophagus with incompletely regurgitated ingesta. This condition and vagus indigestion, another cause of chronic tympany, are usually accompanied by a systolic cardiac murmur, but passage of a stomach tube is unimpeded. Dysphagia can also result from purely neurogenic defects. Thus early paralytic rabies “choke” is often suspected, with dire results for the examining veterinarian.
- Equine encephalomyelitis and botulism are other diseases in which there is difficulty in swallowing.
- Cleft palate is a cause of recurrent nasal regurgitation in foals.

For esophageal relaxation, analgesia and antiinflammatory effect hyoscine: dipyrone 0.5:0.22 mg/kg BW intravenously can be used and for analgesia and antiinflammatory effect flunixin meglumine 1.1 mg/kg BW intravenously or phenylbutazone 2 to 4 mg/kg intravenously are suggested. For analgesia butorphanol 0.02 to 0.1 mg/kg intravenously can be administered.

### Pass a Stomach Tube and Allow Object to Move Into Stomach

The passage of the nasogastric tube is always necessary to locate the obstruction. Gentle attempts can be made to push the obstruction caudad, but care must be taken to avoid damage to the esophageal mucosa. A fiberoptic endoscope can be used to determine the presence of an obstruction, its nature, and the extent of any injury to the esophageal mucosa.

If the previously discussed simple procedures are unsuccessful it is then necessary to proceed to more vigorous methods. In cattle, it is usual to attempt further measures immediately, partly because of the animal's distress and the risk of self-injury and partly because of bloat. However, rarely is the bloat associated with esophageal obstruction life-threatening. The important decision is whether to proceed and risk damaging the esophagus or wait and allow the esophageal spasm to relax and the obstruction to pass spontaneously. This problem is most important in the horse. Attempts to push the obstruction too vigorously can injure the mucosa, causing esophagitis and even esophageal perforation. Alternatively, leaving a large obstruction in place can restrict blood flow to the local area of mucosa and result in ischemic necrosis. Complications such as strictures and diverticula can occur but are uncommon. As a guide in the horse it is suggested that conservative measures (principally sedation, waiting, and lavaging the esophagus) be continued for several hours before attempting radical procedures such as

general anesthesia and manipulation or esophagotomy.

### Removal by Endoscope

If a specific foreign body, such as a piece of wood, is the cause of the obstruction, it can be removed by endoscopy. The foreign body must be visible endoscopically, and suitable forceps or a snare through the scope is required. In some cases, impacted feed anterior to the foreign object must be lavaged out before the object is retrieved.

### Manual Removal Through Oral Cavity in Cattle

Solid obstructions in the upper esophagus of cattle can be reached by passing the hand into the pharynx with the aid of a speculum and having an assistant press the foreign body up toward the mouth. Because of slippery saliva, it is often difficult to grasp the obstruction sufficiently strongly to be able to extricate it from the esophagus. A long piece of strong wire bent into a loop can be passed over the object and an attempt made to pull it up into the pharynx. The use of Thygesens probang with a cutting loop is a simple and effective method of relieving choke in cattle that have attempted to swallow beets and other similar-sized vegetables and fruits. If both methods fail, it is advisable to leave the object in situ and use treatments aimed at relaxing the esophagus. In such cases in cattle it can be necessary to trocarize the rumen and leave the cannula in place until the obstruction is relieved. However, this should not be undertaken unless specifically required.

### General Anesthesia in the Horse

In horses, attempts to manually remove solid obstructions from the cranial portion of the esophagus require a general anesthetic, a speculum in the mouth, and a manipulator with a small hand. The fauces are much narrower in the horse than in the cow and it is only with difficulty that the hand can be advanced through the pharynx to the beginning of the esophagus. Fragments of nasogastric tubes have been retrieved from the esophagus of horses using sedation with xylazine and butorphanol intravenously and the use of a fiberoptic endoscope.

### Esophageal Lavage in the Horse

Accumulations of feedstuffs, which are most common in the horse, can be removed by careful lavage or flushing of the obstructed esophagus. Lavage can be performed in the **standing horse** or in **lateral recumbency under general anesthesia**. Small quantities of warm water, 0.5 to 1 L each time, are pumped through a nasogastric tube passed to the point of obstruction, and then the tube is disconnected from the pump and the liquid material is allowed to siphon out through the tube by gravity flow. Return of the fluid through the oral cavity and nostrils

is minimized by ensuring that the tube is not plugged by returning material and by using only small quantities of fluid for each input of the lavage. Throughout the procedure, the tube is gently manipulated against the impaction. The use of a transparent tube assists in helping to see the amount and nature of the material coming through the tube. This is repeated many times until the fluid becomes clear. This procedure can require a few hours, but perseverance will be successful. After each lavage the tube can be advanced caudad a few centimeters and eventually all the way to the stomach. Care must be taken to avoid overflowing the esophagus and causing aspiration into the lungs. This is a constant hazard whenever irrigative removal is attempted and the animal's head must always be kept as low as possible to avoid aspiration. Following relief of obstruction the horse can be offered water to drink and a wet mash of feed for several days.

Lavage is similar in the recumbent horse under general anesthesia. A cuffed endotracheal tube is used to maintain an airway and to prevent aspiration of foreign material. Lavage under general anesthesia provides relaxation of the esophagus, which can enhance the procedure and allow a greater volume of water to be used.

### Surgical Removal of Foreign Bodies

Surgical removal by esophagostomy can be necessary if other measures fail. Gastrotomy or rumenotomy can be necessary to relieve obstructions of the caudal portion of the esophagus adjacent to the cardia. Although stricture or fistula formation is often associated with esophageal surgery, complications do not occur in every case and healing by secondary intention is common.

### Repeated Siphonage in Chronic Cases

In chronic cases, especially those caused by paralysis, repeated siphonage can be necessary to remove fluid accumulations. Successful results are reported in foals using resection and anastomosis of the esophagus and in a horse using esophagomyotomy, but the treatment of chronic obstruction is usually unsuccessful.

### Cervical Esophagostomy Alimentation

Alimentation of horses with esophageal ruptures can be attempted by various means. Maintenance of nasogastric tubes through the nostrils is difficult but possible. Tube feeding through a **cervical esophagostomy** has some disadvantages, but it is a reasonably satisfactory procedure in any situation where continued extraoral alimentation is required in the horse. However, the death rate is higher than with nasogastric tube feeding. When the obstruction is caused by circumferential esophageal ulceration, the lumen is smallest at about 50 days and begins to dilate at that



point so that it is normal again at about 60 days.

### Antimicrobial Administration

Animals with prolonged obstruction (>12–24 hours), fever, abnormal lung sounds, ultrasonographic or radiographic evidence of aspiration, or in which there is a suspicion of aspiration of regurgitus should be administered broad-spectrum antimicrobials for 5 to 7 days.

### REFERENCES

1. Anderson R, et al. *J S Afr Vet Assoc.* 2010;81:118.
2. Duncanson GR. *Equine Vet Educ.* 2006;18:262.
3. Komine M, et al. *Vet Pathol.* 2014;51:979.
4. Chiavaccini L, et al. *J Vet Intern Med.* 2010;24:1147.
5. Reichelt U, et al. *Equine Vet Educ.* 2012;24:379.
6. Waguesspack RW, et al. *Compendium - Equine.* 2007;4:194-207.

## Diseases of the Nonruminant Stomach and Intestines

Diseases that are accompanied by physical lesions, such as displacement or strangulation, or disturbances of motility, such as ileus, are presented first for the horse and pig. Bacterial and viral infectious diseases specific to the pig are then discussed, followed by bacterial infectious diseases of large animals (including horses, pigs, and neonatal and adult ruminants) such as salmonellosis and viral diseases of large animals such as VS. Bacterial, viral, and parasitic infectious diseases of the stomach and intestine are then presented for the foal; piglet; and neonatal calf, lamb, and kid. Diseases of the stomach and intestine for the horse and pig, as well as neonatal and adult ruminants, caused by toxins or those that are caused by congenital or inherited disease, are discussed last. Diseases associated with functional disturbances of secretion are not recognized in animals. Deficiencies of biliary and pancreatic secretion are dealt with in [Chapter 9](#). Those diseases of the stomach and intestines peculiar to adult ruminants are dealt with separately in [Chapter 8](#).

### GASTRITIS

Inflammation of the stomach is manifested clinically by vomiting and is commonly associated with enteritis in gastroenteritis.

### ETIOLOGY

Gastritis may be acute or chronic, but both forms of the disease may be caused by the same etiologic agents acting with varying degrees of severity and for varying periods. The inflammation may be associated with physical, chemical, bacterial, viral, or metazoan agents.

### Cattle and Sheep

Diseases of the rumen and abomasum are presented in [Chapter 8](#). For comparative purposes the causes of abomasitis are listed here. For sheep there is no information other than about parasites. They are listed with cattle for convenience sake.

### Physical Agents

Physical agents such as frosted feeds affect only the rumen. In calves, gross overeating and the ingestion of foreign materials may cause abomasitis. In adults, there is a very low incidence of foreign bodies in the abomasum, and half the cases are associated with traumatic reticulitis.

### Chemical Agents

All of the irritant and caustic poisons (including arsenic, mercury, copper, phosphorus, and lead) cause abomasitis. Fungal toxins cause abomasal irritation, especially those of *Fusarium* spp. and *Stachybotrys alternans*. Acute lactic acidosis caused by engorgement on carbohydrate-rich food causes rumenitis with some runoff into the abomasum and the development of some abomasitis/enteritis.

### Infectious Agents

Only the viruses of rinderpest, bovine virus diarrhea, and bovine malignant catarrh cause abomasal erosions. Bacterial causes are very rare and include sporadic cases of extension from oral necrobacillosis and hemorrhagic enterotoxemia caused by *Clostridium perfringens* Types A, B, C, rarely as an adjunct to colibacillosis and its enteric lesion in calves. Fungi, e.g., *Mucor* spp. and *Aspergillus* spp. complicate abomasal ulcers from other causes.

### Metazoan Agents

Metazoan agents include nematodes such as *Trichostrongylus axei*, *Ostertagia* spp., *Haemonchus* spp., and larval paramphistomes migrating to the rumen.

### Pigs

Most often lesions are associated with ulceration of the pars esophagea (PE), which is discussed under the separate topic of gastric ulceration.

### Physical Agents

Foreign bodies, bedding, frosted feeds, moldy and fermented feeds are all possible causes. In older pigs, particularly outdoor sows, the presence of stones is a common feature and in some cases may be so bad as to be heard when sows move because considerable loss of weight is associated with the gastric fill. It may be one of the causes of the thin sow syndrome.

### Chemical Agents

As listed under cattle, these are also possible causes of gastritis in pigs. It may also occur in the achlorhydria associated with diarrhea.

Pigs are extremely inquisitive and will investigate all compounds, but hopefully in this day and age there should be more care over on-farm storage. Bitterweed and blister beetle will also cause gastritis in pigs.

### Infectious Agents

Venous hyperemia and infarction of the gastric mucosa occur in erysipelas, salmonellosis, porcine dermatitis and nephropathy syndrome (PDNS), TGE, swine dysentery and acute colibacillosis in weaned pigs. Similar lesions occur in classical swine fever, African swine fever, and swine influenza. Fungal gastritis also occurs secondarily particularly to antibiotic therapy.

### Metazoan Agents

The red stomach worm, *Hyostrogylus rubidus*, and the thick stomach worms *Ascarops strongylina* and *Physocephalus sexalatus* are of low pathogenicity but cannot be disregarded as causes of gastritis in pigs. *Simondisia* spp. are found in Europe, Asia, and Australia and cause nodular gastritis. *Gnathostoma* spp. occur in Asia and produce cysts in the submucosa. On most commercial units, especially if outdoors, routine medication is practiced, but backyard pigs are seldom treated because of unawareness. These agents are also found in many wild boar and feral pigs.

### Horses

Physical and chemical agents as listed under cattle rarely may cause gastritis. Infectious causes of gastritis are rare in the horse, but emphysematous gastritis associated with *C. perfringens* has been recorded.

Metazoan agents causing gastritis in horses include massive infestation with botfly larvae (*Gasterophilus* spp.); *Habronema muscae* and *H. microstoma* infestation; *H. megastoma* causes granulomatous and ulcerative lesions and can lead to perforation and peritonitis.

### PATHOGENESIS

Gastritis does not often occur in animals without involvement of other parts of the alimentary tract. Even in parasitic infestations in which the nematodes are relatively selective in their habitat, infestation with one nematode is usually accompanied by infestation with others, and gastroenteritis is produced. It is dealt with as a specific entity here because it may occur as such, and enteritis is common without gastric involvement. The net effects of gastroenteritis can be determined by a summation of the effects of gastritis and enteritis.

The reactions of the stomach to inflammation include increased motility and increased secretion. There is an increase in the secretion of mucus, which protects the mucosa to some extent but also delays digestion and may allow putrefactive breakdown of the ingesta. This abnormal digestion



may cause further inflammation and favors spread of the inflammation to the intestines. In acute gastritis, the major effect is on motility, and in chronic gastritis it is on secretion. In acute gastritis there is an increase in motility, causing abdominal pain and more rapid emptying of the stomach, either by vomiting or via the pylorus in animals unable to vomit. In chronic gastritis, the emptying of the stomach is prolonged because of the delay in digestion caused by excessive secretion of mucus. This may result in chronic gastric dilatation. The motility is not necessarily diminished and there may be subacute abdominal pain or a depraved appetite caused by increased stomach contractions equivalent to hunger pains.

## CLINICAL FINDINGS

### Acute Gastritis

When the inflammation is severe, pigs and, rarely, horses and ruminants vomit (or ruminants regurgitate excessive quantities of rumen contents). In monogastric animals, such as pigs, the vomitus contains a great deal of mucus, sometimes blood, and is small in amount, and vomiting is repeated with forceful retching movements. The appetite is always reduced, and often absent, but thirst is usually excessive and pigs affected with gastroenteritis may stand continually lapping water or even licking cool objects. The breath has an offensive odor and there may be abdominal pain. Diarrhea is not marked unless there is accompanying enteritis, but the feces are usually pasty and soft. Additional signs are usually evident when gastritis is part of a primary disease syndrome. Dehydration and alkalosis with tetany and rapid breathing may develop if vomiting is excessive.

### Chronic Gastritis

Chronic gastritis is much less severe. The appetite is depressed or depraved and vomiting occurs only sporadically, usually after feeding. The vomitus contains much viscous mucus. Abdominal pain is minor and dehydration is unlikely to occur, but the animal becomes emaciated through lack of food intake and incomplete digestion.

Anorexia, tympanites, gastritis, pyloric stenosis, and gastric ulcers are the clinical manifestations of abomasal foreign body in cattle.

## CLINICAL PATHOLOGY

Specimens taken for laboratory examination are usually for the purpose of identifying the causative agent in specific diseases. Estimations of gastric acidity are not usually undertaken, but samples of vomitus should be collected if a chemical poison is suspected.

## NECROPSY FINDINGS

The signs of inflammation vary in severity from a diffuse catarrhal gastritis to severe hemorrhagic and ulcerative erosion of the

mucosa. In the mucosal diseases there are discrete erosive lesions. In parasitic gastritis there is usually marked thickening and edema of the wall if the process has been in existence for some time. Chemical inflammation is usually most marked on the tips of the rugae and in the pyloric region. In severe cases the stomach contents may be hemorrhagic; in chronic cases the wall is thickened and the contents contain much mucus and have a rancid odor suggestive of a prolonged sojourn and putrefaction of the food.

It is important to differentiate between gastritis and the erythematous flush of normal gastric mucosa in animals that have died suddenly. Venous infarction in the stomach wall occurs in a number of bacterial and viral septicemias of pigs and causes extensive submucosal hemorrhages, which may easily be mistaken for hemorrhagic gastritis.

## DIFFERENTIAL DIAGNOSIS

- Gastritis and gastric dilatation have many similarities, but in the latter the vomitus is more profuse and vomiting is of a more projectile nature, although this difference is not so marked in the horse, in which any form of vomiting is severe.
- Gastritis in the horse is not usually accompanied by vomiting but may occur in gastric dilatation.
- In esophageal obstruction, the vomitus is neutral in reaction and does not have the rancid odor of stomach contents.
- Intestinal obstruction may be accompanied by vomiting and, although the vomitus is alkaline and may contain bile or even fecal material, this may also be the case in gastritis when intestinal contents are regurgitated into the stomach.
- Vomiting of central origin is extremely rare in farm animals.
- Determination of the cause of gastritis may be difficult, but the presence of signs of the specific diseases and history of access to poisons or physical agents listed under etiology may provide the necessary clues.
- Analysis of vomitus or food materials may have diagnostic value if chemical poisoning is suspected.

## TREATMENT

Treatment of the primary disease is the first principle and requires a specific diagnosis. Ancillary treatment includes the withholding of feed, the use of gastric sedatives, the administration of electrolyte solutions to replace fluids and electrolytes lost by vomiting, and stimulation of normal stomach motility in the convalescent period.

In horses and pigs, gastric lavage may be attempted to remove irritant chemicals. Gastric sedatives usually contain insoluble magnesium hydroxide or carbonate, kaolin, pectin, or charcoal. Frequent dosing at intervals of 2 to 3 hours is advisable. If purgatives

are used to empty the alimentary tract, they should be bland preparations such as mineral oil to avoid further irritation to the mucosa.

If vomiting is severe, large quantities of electrolyte solution should be administered parenterally. Details of the available solutions are given under the heading of disturbances of body water. If the liquids can be given orally without vomiting occurring, this route of administration is satisfactory.

During convalescence, the animal should be offered only soft, palatable, highly nutritious foods. Bran mashes for cattle and horses and gruels for calves and pigs are most suitable and are relished by the animal.

## ENTERITIS (INCLUDING MALABSORPTION, ENTEROPATHY, AND DIARRHEA)

The term enteritis is used to describe inflammation of the intestinal mucosa resulting in diarrhea and sometimes dysentery, abdominal pain occasionally, and varying degrees of dehydration and acid-base imbalance, depending on the cause of the lesion, its severity, and location. In many cases, gastritis also occurs together with enteritis.

There are several diseases of the intestines of farm animals in which diarrhea and dehydration are major clinical findings, but classical inflammation of the mucosa may not be present. The best example of this is the diarrhea associated with enterotoxigenic *E. coli* (ETEC) which elaborates an enterotoxin that causes a large net increase of secretion of fluids into the lumen of the gut, with very minor, if any, structural changes in the intestinal mucosa. This suggests that a word other than enteritis may be necessary to describe alterations in the intestinal secretory and absorptive mechanisms that result in diarrhea but in which pathologic lesions are not present. However, with these qualifications, for convenience, the term enteritis is used to describe those diseases in which diarrhea is a major clinical finding caused by malabsorption in the intestinal tract.

## ETIOLOGY AND EPIDEMIOLOGY

There are many causes of enteritis or malabsorption in farm animals and the disease varies considerably in its severity depending on the causative agent. Enteropathogens include bacteria, viruses, fungi, protozoa, and helminths. Many chemicals and toxins can also cause enteritis (Tables 7-4 to 7-7). In addition to the primary etiologic agents of enteritis, there are many epidemiologic characteristics of the animal and the environment that are important in facilitating or suppressing the ability of the causative agent to cause enteritis. Thus newborn calves and piglets deficient in colostral immunoglobulins are much more susceptible to diarrhea, and have a higher case-fatality rate from diarrhea than animals with adequate

**Table 7-4** Epidemiological and clinical features of diseases of cattle in which diarrhea is a significant clinical finding

<b>Etiological agent or disease</b>	<b>Age and class of animal affected and important epidemiological factors</b>	<b>Major clinical findings and diagnostic criteria</b>
<b>Bacteria</b>		
Enterotoxigenic <i>Escherichia coli</i>	Newborn calves <3–5 days of age, colostral immune status determines survival; outbreaks common	Acute profuse watery diarrhea, dehydration and acidosis Culture feces for enteropathogenic type
<i>Salmonella</i> spp.	All ages; outbreaks occur; stress induced	Acute diarrhea, dysentery, fever, and high mortality possible Culture feces
<i>Clostridium perfringens</i> types B and C	Young well-nourished calves <10 days of age	Severe hemorrhagic enterotoxemia, rapid death; fecal smear
<i>Mycobacterium avium</i> subsp. <i>paratuberculosis</i>	Mature cattle, sporadic, single animal	Chronic diarrhea with loss of weight, long course No response to therapy; special tests
<i>Proteus</i> spp. and <i>Pseudomonas</i> spp.	Calves treated for diarrhea with prolonged course of antibiotics	Chronic to subacute diarrhea, poor response to treatment, progressive loss of weight; culture feces
<b>Fungi</b>		
<i>Candida</i> spp.	Young calves following prolonged use of oral antibacterials	Chronic diarrhea, no response to treatment; fecal smears
<b>Viruses</b>		
Rotavirus and coronavirus	Newborn calves, 5–21 days old, explosive outbreaks	Acute profuse watery diarrhea; demonstrate virus in feces
Winter dysentery (Coronavirus)	Mature housed cows, explosive outbreaks	Acute epizootic of transient diarrhea and dysentery lasting 24 h; definitive diagnosis not possible currently
Bovine virus diarrhea (mucosal disease)	Young cattle 8 months to 2 years; usually sporadic but epidemics occur	Erosive gastroenteritis and stomatitis; usually fatal; virus isolation
Rinderpest	Highly contagious, occurs in plague form	Erosive stomatitis and gastroenteritis; high morbidity and mortality
Bovine malignant catarrh	Usually mature cattle, sporadic but small outbreaks occur	Erosive stomatitis and gastroenteritis, enlarged lymph nodes, ocular lesions, hematuria and terminal encephalitis Transmission with whole blood
<b>Helminths</b>		
Ostertagiasis	Young cattle on pasture	Acute or chronic diarrhea, dehydration, and hypoproteinemia Fecal examination; plasma pepsinogen
<b>Protozoa</b>		
<i>Eimeria</i> spp.	Calves over 3 weeks old and cattle up to 12 months of age; outbreaks common	Dysentery, tenesmus, nervous signs; Fecal examination diagnostic
<i>Cryptosporidium</i> spp.	Calves 5–35 days of age	Diarrhea; fecal smear and special stain
<b>Chemical agents</b>		
Arsenic, fluorine, copper, sodium chloride, mercury, molybdenum, nitrates, poisonous plants, mycotoxicoeses	All ages, history of access to substance Outbreaks occur	All severities of diarrhea, dysentery, abdominal pain, in some cases nervous signs, dehydration, toxemia; fecal and tissue analyses
<b>Physical agents</b>		
Sand, soil, silage, and feed containing lactic acid (sour brewers' grains)	Usually mature cattle, history of access; outbreaks occur	Acute, subacute diarrhea, and toxemia; see sand in feces Rumen pH
<b>Nutritional deficiency</b>		
Copper deficiency, conditioned by excess molybdenum	Usually mature cattle on pasture with high levels of molybdenum	Subacute and chronic diarrhea, osteodystrophy, no systemic effects, hair color changes; liver and blood analyses
<b>Dietary</b>		
Overfeeding	Young calves overfed on milk	Mild diarrhea, feces voluminous and pale yellow; clinical diagnosis
Simple indigestion	Change of ration of mature cows (hay to silage) or grain to feedlot cattle	Subacute diarrhea; normal in 24 h; Clinical diagnosis usually sufficient
Inferior milk replacers	Heat-denatured skim milk used in manufacturing of milk replacers for calves	Subacute to chronic diarrhea, progressive emaciation, no response to conventional treatment except cow's whole milk Clotting tests on milk replacer
<b>Miscellaneous or uncertain etiology</b>		
Intestinal disaccharidase deficiency	May occur in young calves. Sporadic	Subacute diarrhea unresponsive to usual therapy except withdrawal of milk; lactose digestion tests
Congestive heart failure	Sporadic; mature cattle	Profuse watery diarrhea associated with visceral edema
Toxemia (peracute coliform mastitis)	Sporadic	Acute diarrhea caused by endotoxemia from peracute mastitis Culture milk

Table 7-5 Epidemiological and clinical features of horses with diarrhea

Etiological agent or disease	Age and class of animal affected and important epidemiological factors	Major clinical findings; diagnostic criteria
<b>Bacteria</b>		
<i>Salmonella</i> spp.	Young foals; mature horses, following stress	Acute profuse diarrhea, severe dehydration, foul-smelling feces; leukopenia and neutropenia, culture feces, hyponatremia
<i>Rhodococcus equi</i>	Foals 2–5 months of age, some with history of respiratory disease	Diarrhea associated with <i>R. equi</i> pneumonia; culture respiratory tract
<i>Clostridium perfringens</i> or <i>C. difficile</i>	Mature horses administered antibiotics; young foals	Profuse, watery diarrhea, hypovolemia, hyponatremia. Fecal culture and demonstration of toxin in feces
<i>Aeromonas</i> spp.	Adult horses, tends to be more common in summer; often isolated from horses with diarrhea Definitive etiological role not proved	Febrile, acute diarrhea; culture feces
<b>Viruses and rickettsia</b>		
<i>Neorickettsia risticii</i> (formerly <i>Ehrlichia risticii</i> )	Endemic to certain regions in North and South America and Europe; ingestion of organism spread by insects (mayflies)	Profuse watery diarrhea, fever, laminitis; IFA, PCR
<b>Parasites</b>		
Cyathostomes and large strongyles	Individual horses; poor deworming history Seasonal occurrence of larval cyathostomiasis	Acute to chronic diarrhea. <i>Patent infections evident by fecal examination for parasite eggs</i>
<b>Physical</b>		
Sand accumulation	Individual horses or farm problem; Ingestion of sand or gravel	Watery diarrhea, not malodorous, not profuse; <i>abdominal radiography or ultrasonography, examination of feces</i>
Overdosing of cathartics (DSS, MgSO <sub>4</sub> , NaSO <sub>4</sub> , castor oil)	Treated animals	Moderate to profuse diarrhea; <i>historical confirmation of administration of compounds</i>
<b>Miscellaneous or unknown</b>		
Colitis X	Single animal; adult horses; high death rate	Acute, pyrexia diarrhea, hypovolemia, leukopenia; <i>postmortem examination</i>
Granulomatous or eosinophilic colitis	Single animal; adults	Chronic diarrhea; <i>necropsy or colonic biopsy</i>
Right dorsal colitis/ phenylbutazone toxicity	Administration of NSAIDs in large doses or prolonged administration	Mild diarrhea; low-grade fever; Mild colic; hypoproteinemia, hyponatremia; <i>necropsy, surgery</i>
Antibiotic-induced diarrhea	History of antimicrobial administration; high case–fatality rate	Acute onset diarrhea with or without fever; leukopenia, hypovolemia; <i>history</i>

DSS, dioctyl sodium sulfosuccinate; IFA, indirect fluorescence antibody test; NSAIDs, nonsteroidal antiinflammatory drugs; PCR, polymerase chain reaction.

Table 7-6 Epidemiological and clinical features of diseases of the pig in which diarrhea is a significant clinical finding

Etiological agent or disease epidemiological factors	Age and class of animal affected and important	Major clinical findings and diagnostic criteria
<b>Viruses</b>		
Classical and African swine fever	Hemorrhagic diarrhea at any age	Many other signs (pyrexia); a variety of lab tests (isolation, ELISA, PCR etc.)
Transmissible gastroenteritis	Explosive outbreaks in newborn piglets; high morbidity and mortality	Acute diarrhea, vomiting, dehydration, and death; no response to treatment (lab tests include virus isolation, ELISA, EM, FATS)
Rotavirus and coronavirus (epidemic diarrhea)	Outbreaks in newborn piglets and weaned piglets May occur in well-managed herds	Acute diarrhea and dehydration; may continue to suck the sow; death in 2–4 days; virus isolation and pathology of gut, EM, FATS (PED); PAGE for rotavirus
<b>Bacteria</b>		
Enterotoxigenic <i>Escherichia coli</i>	Common disease of newborn, 3-week-old and weaned piglets; outbreaks; colostral immune status important	Acute diarrhea, dehydration; responds to early treatment Fecal culture and serotype; virulence factor determination
<i>Salmonella</i> spp.	All ages; most common in feeder pigs	Acute septicemia or chronic diarrhea; responds to early treatment; culture and serotyping

**Table 7-6** Epidemiological and clinical features of diseases of the pig in which diarrhea is a significant clinical finding—cont'd

Etiological agent or disease epidemiological factors	Age and class of animal affected and important	Major clinical findings and diagnostic criteria
<i>Clostridium perfringens</i> type C	Newborn piglets; high mortality	Acute and peracute hemorrhagic enterotoxemia; toxin demonstration and culture
<i>C. perfringens</i> type A	Slightly older pigs, first week of life, lower mortality	As previously mentioned
<i>C. difficile</i>	Diarrhea in preweaned pigs	Smears of colon wall, culture, FAT, PCR
<i>Brachyspira hyodysenteriae</i> (swine dysentery)	Usually feeder pigs; outbreaks common	Dysentery, acute to subacute, fever; responds to treatment Culture, FATs, PCR on mucosal smears
<i>Lawsonia intracellularis</i> (PIA, PHE)	Growing and mature pigs; outbreaks common	Acute dysentery and death; MZN on mucosal smears, PCR, silver-stained sections
<i>Brachyspira pilosicoli</i>	Usually weaned pigs	PCR
<b>Protozoa</b>		
<i>Isoospora</i> spp.	Newborn piglets 5–14 days of age; high morbidity, low mortality	Acute diarrhea; poor response to therapy with amprolium Fecal examination for oocysts
Other species ( <i>Eimeria</i> )	In older pigs	Histology of gut sections
<b>Parasites</b>		
<i>Ascaris suum</i> and <i>A. lumbricoides</i>	Young pigs	Mild diarrhea for few days; worm egg count
<i>Trichuris suis</i>	All ages, usually older pigs	Diarrhea, dysentery, and loss of weight; fecal examination and gross pathology
Nutritional deficiency		
Iron deficiency	Young piglets 6–8 weeks; not common in well-managed swine herds	Mild diarrhea and anemia

ELISA, enzyme-linked immunoassay; EM, electron micrograph; FAT, fluorescence antibody transfer; MZN, modified Ziehl–Neelson; PAGE, polyacrylamide gel electrophoresis; PCR, polymerase chain reaction; PED, porcine epidemic diarrhea; PHE, proliferative hemorrhagic enteropathy; PIA, porcine intestinal adenomatosis.

**Table 7-7** Epidemiological and clinical features of the diseases of sheep and goats in which diarrhea is a significant clinical finding

Etiological agent or disease	Age and class of animal affected and important epidemiological factors	Major clinical findings and diagnostic criteria
<b>Bacteria</b>		
Enterotoxigenic <i>Escherichia coli</i> (colibacillosis)	Newborn lambs in crowded lambing sheds; cold chilling weather; outbreaks; inadequate colostrum. Mismothering problems; poor udder development	Acute diarrhea (yellow feces), septicemia, and rapid death Culture feces for enterotoxigenic <i>E. coli</i>
<i>Clostridium perfringens</i> type B (lamb dysentery)	Newborn lambs up to 10 days of age; overcrowded lambing sheds	Sudden death, diarrhea, dysentery, and toxemia; fecal smear
<i>C. perfringens</i> type D (enterotoxemia)	Adult lactating does	Peracute, acute, and chronic forms occur; enterocolitis; watery diarrhea with feces containing blood and mucus, weakness, abdominal colic
<i>Salmonella</i> spp.	Newborn lambs; adult sheep in pregnancy	Acute diarrhea and dysentery in lambs; acute toxemia, diarrhea in ewes followed by abortion; fecal culture and pathology
<i>Mycobacterium paratuberculosis</i>	Mature sheep and goats; several animals may be affected	Loss of weight, chronic diarrhea, long course, no response to therapy; serological tests
<b>Viruses</b>		
Rotavirus and coronavirus	Newborn lambs; many lambs affected	Acute profuse watery diarrhea; no toxemia; usually recover spontaneously if no secondary complications; virus isolation
<b>Parasites</b>		
<i>Nematodirus</i> spp.	Lambs 4–10 weeks of age on pasture Sudden onset; outbreaks; ideal environmental conditions for parasite are necessary	Anorexia, diarrhea, thirsty, 10%–20% of lambs may die if not treated; fecal examination
<i>Ostertagia</i> spp. Ewes on grass; types I and II	Lambs 10 weeks of age and older lambs and young	Many lambs develop diarrhea, weight loss; abomasitis
<i>Trichostrongylus</i> spp.	Older lambs 4–9 months of age	Dull, anorexic, loss of weight and chronic diarrhea; fecal examination

Continued



**Table 7-7** Epidemiological and clinical features of the diseases of sheep and goats in which diarrhea is a significant clinical finding—cont'd

Etiological agent or disease	Age and class of animal affected and important epidemiological factors	Major clinical findings and diagnostic criteria
<b>Protozoa</b> <i>Eimeria</i> spp.	Overstocking on pasture and overcrowding indoors, poor sanitation, and hygiene; commonly occurs following weaning and introduction into feedlot	Acute and subacute diarrhea and dysentery; loss of weight Mortality may be high; fecal examination
<i>Cryptosporidium</i>	Lambs 7–10 days of age	Dullness, anorexia, afebrile, diarrhea, may die in 2–3 days, survivors may be unthrifty; examination of feces and intestinal mucosa; no specific treatment

levels. Enteric salmonellosis is commonly precipitated by the stressors of transportation or deprivation of feed and water. The stress of weaning in pigs is a risk factor for PWD. The prolonged use of antimicrobials orally in all species may alter the intestinal microflora and allow the development of a superinfection by organisms that would not normally cause disease.

The salient epidemiologic characteristics and clinical findings of the diseases in which diarrhea, caused by enteritis or malabsorption, is a principal clinical finding in each species are summarized by species in [Tables 7-4 to 7-7](#). There are many other diseases in which diarrhea might be present but in which it is only of minor importance.

## PATHOGENESIS

### Normal Intestinal Absorption

Under normal conditions, a large quantity of fluid enters the small intestine from the saliva, stomach, pancreas, liver, and intestinal mucosa. This fluid and its electrolytes and other nutrients must be absorbed, mainly by the small intestines, although large quantities move into the large intestine for digestion and absorption, especially in the horse. The brush border membrane of the villous epithelial cells is of paramount importance for the absorption of water, electrolytes, and nutrients.

Details of the physiology and pathophysiology of epithelial secretion in the gastrointestinal tract are becoming clear, leading to new models of the mechanisms underlying diarrhea. The enteric nervous system is a critical component of the mechanism regulating fluid secretion in the normal intestine and a key element in the pathophysiology of diarrhea. Neural reflex pathways increase epithelial fluid secretion in response to several enteric pathogens of veterinary importance such as *Salmonella* spp., *Cryptosporidium parvum*, rotavirus, and *C. difficile*. The enteric nervous system also has an important role in epithelial secretion triggered by products of activated leukocytes during inflammation.

### Mechanisms of Diarrhea

Any dysfunction of the intestines will result in failure of adequate absorption and diarrhea. Depending on the causative agent, intestinal malabsorption may be the result of at least four different mechanisms:

- Osmotic diarrhea
- Exudative diarrhea
- Secretory diarrhea
- Abnormal intestinal motility

#### Osmotic Diarrhea

There may be an osmotic effect when substances within the lumen of the intestine increase the osmotic pressure over a greater than normal length of intestine, resulting in an osmotic movement of an excessive amount of fluid into the lumen of the intestine. The fluid is not reabsorbed and accumulates in the lumen. Examples include **saline purgatives, overfeeding, indigestible feeds, and disaccharidase deficiencies**. A deficiency of a disaccharidase leads to incomplete digestion and the accumulation of large quantities of undigested material, which acts as a hypertonic solution.

Malabsorption is associated with several epitheliotropic viruses that affect the villous absorptive cells, causing a disaccharidase deficiency. Examples include the TGE virus in newborn piglets and rotavirus and coronavirus infections in newborn calves and other species. The usual pathogenetic sequence of events is selective destruction of villous absorptive cells, villous atrophy, loss of digestive and absorptive capacities (malabsorption), diarrhea, crypt hyperplasia, and recovery. Recovery depends on the severity of the lesion, the relative injury done to the villous cells and crypt epithelium, and the age of the animal. Newborn piglets affected with TGE commonly die of dehydration and starvation before there is sufficient time for regeneration of the villous cells from the crypt epithelium. In contrast, older pigs have a greater capacity for regeneration of the villous cells and the diarrhea may be only transient.

#### Exudative Diarrhea

Acute or chronic inflammation or necrosis of the intestinal mucosa results in a net increase in fluid production; inflammatory products, including loss of serum proteins; and a reduction in absorption of fluids and electrolytes. Examples include many of the diseases associated with bacteria, viruses, fungi, protozoa, chemical agents, and tumors that are summarized in [Tables 7-4 to 7-7](#). The classic example is enteric salmonellosis, in which there is severe inflammation with the production of fibrinous, hemorrhagic enteritis. Other notable examples include swine dysentery, bovine virus diarrhea, and inorganic arsenic poisoning.

#### Secretory Diarrhea

A **secretory-absorptive imbalance** results in a large net increase in fluid secretion with little if any structural change in the mucosal cells. The enterotoxin elaborated by ETEC results in intestinal hypersecretion. The villi, along with their digestive and absorptive capabilities, remain intact. The crypts also remain intact; however, their secretion is increased beyond the absorptive capacity of the intestines, resulting in diarrhea. The increased secretion is caused by an increase in cyclic adenosine monophosphate, which in turn may be stimulated by prostaglandins. The integrity of the mucosal structure is maintained and the secreted fluid is isotonic, electrolyte-rich, alkaline, and free of exudates. This is useful diagnostically in enterotoxic colibacillosis.

An important therapeutic principle can be applied in secretory diarrhea disease. Whenever possible, because of the cost of parenteral fluid therapy, fluids and electrolytes should be given orally. The mucosa remains relatively intact and retains normal absorptive capacity. Fluid replacement solutions containing water, glucose, and amino acids can be given orally and are absorbed efficiently. Glucose and amino acids enhance the absorption of sodium and water, replacing or diminishing fluid and electrolyte losses.

There is also evidence that active electrolyte secretion occurs in enterocolitis caused by salmonellosis in several species of animal. In diseases such as swine dysentery, the permeability of the colon may remain normal or even decrease, but the absorption of water and electrolytes is decreased. This suggests that the primary cause of fluid and electrolyte loss in some diseases of the colon may be failure of the affected epithelium to absorb fluids and electrolytes.

### Abnormal Intestinal Motility

Hyperecxcitability, convulsions, and the stress of unexpected sudden confinement may result in diarrhea, which may be caused by increased peristalsis, resulting in “**intestinal hurry**” and reduced intestinal absorption caused by rapid passage of intestinal fluids in an otherwise normal intestine. This can occur in animals that are being assembled for transportation and during transportation.

### Location of Lesion

The location of the lesion in the intestinal tract may also influence the severity of the enteritis or malabsorption. Lesions involving the small intestine are considered to be more acute and severe than those in the large intestine, because approximately 75% to 80% of the intestinal fluids are absorbed by the small intestine and much lesser quantities by the large intestine. Generally, when lesions of the large intestine predominate, the fluid and electrolyte losses are not as acute or as severe as when the lesions of the small intestine predominate. However, the horse is an exception. The total amount of fluid entering the large intestine from the small intestine, plus the amount entering from the mucosa of the large intestine, is equal to the animal's total extracellular fluid volume, and 95% of this is reabsorbed by the large intestine. This illustrates the major importance of the large intestine of the horse in absorbing a large quantity of fluid originating from saliva, the stomach, liver, pancreas, and small and large intestine. Any significant dysfunction of the absorptive mechanism of the large intestine of the horse results in large losses of fluids and electrolytes. This may explain the rapid dehydration and circulatory collapse that occurs in horses with colitis X. Moderate to severe ulcerative colitis of the right dorsal colon in horses treated with phenylbutazone results in marked dehydration, endotoxic shock, and death.

### Dehydration, Electrolyte, and Acid-Base Imbalance

The net effect of an increase in the total amount of fluid in the intestinal lumen and a reduction in intestinal absorption is a loss of fluids and electrolytes at the expense of body fluids and electrolytes and the normal intestinal juices. The fluid that is lost consists primarily of water; the electrolytes sodium, chloride, potassium, and bicarbonate; and

varying quantities of protein. Protein is lost (protein-losing enteropathy) in both acute and chronic inflammation, leading to hypoproteinemia in some cases. The loss of bicarbonate results in **metabolic acidosis**, which is of major importance in acute diarrhea. The loss of sodium, chloride, and potassium results in **serum electrolyte imbalances**. In the horse with enteric salmonellosis, there is severe dehydration and marked hyponatremia. In the calf with neonatal diarrhea there are varying **degrees of dehydration** and a moderate loss of all electrolytes. With acute severe diarrhea, there is severe acidosis and reduced circulating blood volume, resulting in reduced perfusion of the liver and kidney and of peripheral tissues. This results in uremia, anaerobic oxidation, and lactic acidosis, which accentuates the metabolic acidosis. Hyperventilation occurs in some animals in an attempt to compensate for the acidosis.

In acute diarrhea, large quantities of intestinal fluid are lost in the feces and large quantities are present in the intestinal lumen (**intraluminal dehydration**), which accounts for the remarkable clinical dehydration in some affected animals. The fluid moves out of the intravascular compartment first, then out of the extravascular compartment (interstitial spaces), followed last by fluid from the intracellular space. Thus in acute diarrhea of sudden onset the actual degree of dehydration present initially may be much more severe than is recognizable clinically; as the diarrhea continues, the degree of clinical dehydration becomes much more evident.

### Chronic Enteritis

In chronic enteritis, as a sequel to acute enteritis or developing insidiously, the intestinal wall becomes thickened and mucus secretion is stimulated, the absorption of intestinal fluids is also decreased but not of the same magnitude as in acute enteritis. In chronic enteritis there is a negative nutrient balance because of decreased digestion of nutrients and decreased absorption, resulting in body wasting. The animal may continue to drink and maintain almost normal hydration. In some cases of chronic enteritis, depending on the cause, there is continuous loss of protein, leading to clinical hypoproteinemia. Intestinal helminthiasis of all species, John's disease of ruminants, and chronic diarrheas of the horse are examples. Lymphocytic plasmacytic enteritis causing chronic weight loss occurs in the horse.

**Regional ileitis** is a functional obstruction of the lower ileum associated with granulation tissue proliferation in the lamina propria and submucosa, with or without ulceration of the mucosa, and a massive muscular hypertrophy of the wall of affected areas of the intestine. It has been recognized with increased frequency in recent years in pigs, horses, and lambs. The lesion undoubtedly interferes with normal digestion and

absorption, but diarrhea is not a common clinical finding.

### Replacement of Villous Epithelial Cells

The villous absorptive epithelial cells of the small intestine are involved in almost every type of enteritis or malabsorptive syndrome. These cells that line the villi and face the lumen of the intestine contain important digestive enzymes such as the disaccharidases. They are also involved in absorption of fluids, electrolytes, monosaccharides such as glucose, and amino acids, and in the transport of fat micelles. Their replacement time is up to several days in the newborn calf and piglet, and only a few days when these animals are older (at 3 weeks). This may explain the relatively greater susceptibility of the newborn to the viral enteritides, such as TGE in piglets and rotavirus infection in all newborn farm animal species. Almost any noxious influence can increase the rate of extrusion of these cells, which are then replaced by cells that are immature and not fully functional. The villi become shortened (villous atrophy) and chronic malabsorption similar to the “sprue gut” of humans may be the result. The destruction of villous epithelial cells explains the long recovery period of several days in some animals with acute enteritis and the chronic diarrhea in others with chronic villous atrophy.

The literature on the mechanisms of intestinal mucosal repair has been reviewed.

### Role of Neutrophils in Intestinal Mucosal Injury

Neutrophils are critical elements of the cascade of events that culminates in mucosal injury in many inflammatory diseases of the gastrointestinal tract, including ischemia and reperfusion injury. Neutrophils mediate their detrimental actions by several mechanisms, especially physical disruption of the epithelium. These findings have resulted in consideration of strategies to attenuate neutrophil-mediated mucosal injury by preventing neutrophil transendothelial migration into the intestinal mucosa and subsequent activation during inflammation. Newer pharmacologic drugs that inhibit  $\beta$ -2-integrin activation, and therefore  $\beta$ -2-integrin function, may be useful clinically to inhibit neutrophil-mediated injury during inflammation.

### Intestinal Motility in Enteritis

The motility of the intestinal tract in animals with enteritis has not been sufficiently examined and little information is available. It was thought for many years that intestinal hypermotility, and increased frequency and amplitude of peristalsis, was present in most enteritides as a response to the enteritis and that the hypermotility accounted for the reduced absorption. However, when the pathogenesis of the infectious enteritides is

considered, for example, the unique secretory effect of enterotoxin, it seems more likely that, if hypermotility is present, it is a response to the distension of the intestinal lumen with fluid rather than a response to irritation. With a fluid-filled intestinal lumen, very little intestinal peristalsis would be necessary to move large quantities of fluid down the intestinal tract. This may explain the fluid-rushing sounds that are audible on auscultation of the abdomen in animals with enteritis. It is possible that the intestines may be in a state of relative hypomotility rather than hypermotility, which makes the use of antimotility drugs for the treatment of enteritis questionable.

### Concurrent Gastritis

Gastritis commonly accompanies enteritis but does not cause vomiting except perhaps in the pig. Gastritis (or abomasitis) may also be the primary lesion, resulting in a profuse diarrhea without lesions of the intestines. Examples are ostertagiasis and abomasal ulceration in cattle. Presumably the excessive amount of fluid secreted into the affected abomasum cannot be reabsorbed by the intestines.

### Effects of Enteritis on Pharmacodynamics of Drugs

Enteritis may alter the pharmacodynamics of orally administered drugs. In acute diarrheal states there is delayed or impaired absorption, resulting in subtherapeutic plasma concentration. In chronic malabsorption states, decreased, increased, or delayed absorption may occur, depending on the drug. Also, gastric antacids, anticholinergic drugs, and opiates, administered orally for the treatment of diarrhea, may impair absorption of other drugs by altering solubility or delaying gastric emptying time.

### CLINICAL FINDINGS

The major clinical finding in enteritis or malabsorption is **diarrhea**. **Dehydration**, **abdominal pain**, **septicemia**, and **toxemia** with **fever** occur commonly and their degree of severity depends on the causative agent, the age, the species of the animal, and the stage of the disease.

In **acute enteritis**, the feces are soft or fluid in consistency and may have an unpleasant odor. They may contain blood (**dysentery**), fibrinous casts, and mucus or obvious foreign material such as sand. The color of the feces will vary considerably: they are usually pale yellow because of the dilution of the brown bile pigments, but almost any color other than the normal is possible and, with the exception of frank blood (**hematochezia**) or **melena** (**black tarry feces**), the color of the feces is usually not representative of a particular disease. When the feces are watery, they may escape notice on clinical examination. Some indication of the nature of the enteritis may be obtained from the

distribution of the feces on the animal's perineum. Thus in calves, the smudge pattern may suggest coccidiosis when both the staining that accompanies it and the feces are smeared horizontally across the ischial tuberosities and the adjoining tail, or helminth infestation when there is little smearing on the pinbones, but the tail and insides of the hocks are liberally coated with feces. Straining may occur, especially in calves, and be followed by rectal prolapse, particularly when the lesions are present in the colon and rectum. Intussusception may occur when the enteritis involves the small intestine.

There are a number of diseases in which **dysentery** with or without toxemia occurs and death may occur rapidly. These include lamb dysentery, hemorrhagic enterotoxemia of calves, acute swine dysentery, and hemorrhagic bowel syndrome of pigs.

**Acute intraluminal hemorrhage** caused by ulceration of unknown etiology in the small intestine has been recorded in adult cows. Duodenal ulceration may also occur in cattle in association with left-side displacement of the abomasum.

### Systemic Effects

The **systemic effects in enteritis** vary considerably. Septicemia, toxemia, and fever are common in the infectious enteritides. An increased body temperature may return to normal following the onset of diarrhea or if circulatory collapse and shock are imminent.

**Dehydration** will vary from being just barely detectable at 4% to 6% of BW up to 10% to 12% of BW, when it is clinically very evident. The degree of dehydration can be best assessed by tenting the skin of the upper eyelid or neck and determining the time taken for the skin fold to return to normal. The degree of recession of the eyeball is also a useful aid. In the early stages of acute enteritis, the degree of clinical dehydration may be underestimated because of the time required for fluid to shift from the interstitial and intracellular spaces to the intravascular space to replace fluids already lost. Dehydration is usually evident by 10 to 12 hours following the onset of acute enteritis and clinically obvious by 18 to 24 hours. Peripheral circulatory collapse (**shock**) occurs commonly in acute and peracute cases. There may be tachycardia or bradycardia and arrhythmia depending on the degree of acidosis and electrolyte imbalance. In acute enteritis, there may be severe abdominal pain, which is most severe in the horse and is often sufficient in this species to cause rolling and kicking at the abdomen. Abdominal pain in enteritis is unusual in the other species although it does occur in heavy inorganic metal poisonings, such as arsenic and lead, and in acute salmonellosis in cattle. Some severe cases of enteric colibacillosis in calves are characterized by abdominal pain evidenced by intermittent bouts of stretching and kicking at the abdomen. The passage

of intestinal gas also occurs commonly in horses with acute and chronic diarrhea.

### Intestinal Sounds in Enteritis

Auscultation of the abdomen usually reveals sounds of **increased peristalsis** and **fluid-rushing sounds** in the early stages of acute enteritis. Later there may be **paralytic ileus** and an absence of peristaltic sounds with only fluid and gas tinkling sounds. The abdomen may be distended in the early stages because of distension of intestines and gaunt in the later stages when the fluid has been passed out in the feces. Pain may be evidenced on palpation of the abdomen in young animals.

### Chronic Enteritis

In **chronic enteritis**, the feces are usually soft and homogeneous in consistency, contain considerable mucus, and usually do not have a grossly abnormal odor. Progressive weight loss and emaciation or "runting" are common and there are usually no systemic abnormalities. Animals with chronic enteritis will often drink and absorb sufficient water to maintain clinical hydration, but there may be laboratory evidence of dehydration and electrolyte loss. In parasitic enteritis and abomasitis there may be hypoproteinemia and subcutaneous edema. In terminal ileitis, there is usually chronic progressive weight loss and occasionally some mild diarrhea. The lesion is usually recognized only at necropsy. Intestinal adenomatosis of pigs, rectal strictures in pigs, granulomatous enteritis of horses, and lymphosarcoma of the intestine of horses are examples of enteric disease causing chronic anorexia and progressive weight loss, usually without clinical evidence of diarrhea. These are commonly referred to as malabsorption syndromes.

### CLINICAL PATHOLOGY

The laboratory testing of animals to obtain an etiologic diagnosis of enteritis can be a complex and expensive procedure, which requires careful consideration of the history, the clinical findings, and the number of animals affected. In outbreaks of enteric syndromes, it may be important to submit samples from both affected and normal animals. The details of the sampling techniques and the tissues required for the diagnosis of diseases of the digestive tract caused by feeding mismanagement, infections, toxins, and other agents have been outlined and this is recommended as a reference.

### Fecal Examination

Examination of the feces to determine the presence of causative **bacteria**, **helminths**, **protozoa**, **viruses**, and **chemical agents** is described under specific diseases throughout this book. It is important that fecal specimens are taken as the differentiation of the etiologic groups depends on laboratory

examinations. In outbreaks of diarrhea, fecal samples should also be taken from a representative number of normal animals in the same group as the affected animals. Comparison of the fecal examination results between affected and normal animals will improve the accuracy of interpretation.

Fecal samples can be examined for the presence of leukocytes and epithelial cells, which occur in exudative enteritis.

### Intestinal Tissue Samples

In outbreaks of diarrhea, especially in neonates, it may be useful to do necropsies on selected early untreated cases of acute diarrhea. The lesions associated with the enteropathogens are well known, and a provisional etiologic diagnosis may be possible by gross and histopathological examination of the intestinal mucosa.

### Hematology and Serum Biochemistry

With increasing sophistication in diagnostic laboratories and in large-animal practice, it is becoming common to do considerable laboratory evaluation to determine the actual changes that are present for purposes of a more rational approach to therapy. For each specific enteritis there are changes in the hemogram and serum biochemistry that aid in the diagnosis and differential diagnosis. In bacterial enteritis, such as acute enteric salmonellosis in the horse, there may be marked changes in the total and differential leukocyte count, which is a useful diagnostic aid. In most cases of acute enteritis there is hemoconcentration, metabolic acidosis, an increase in total serum solids concentration, a decrease in plasma bicarbonate, hyponatremia, hypochloremia, and hypokalemia. However, abnormalities in body fluid compartments caused by diarrhea depend on the pathogenetic mechanisms involved and the duration of the diarrhea. In horses with diarrhea of less than 6 days' duration, the most common abnormality may be a combined anion gap, metabolic acidosis, and metabolic alkalosis characterized by hyponatremia, hypochloremia, and hyperkalemia. The **acid-base imbalances** may vary considerably from case to case, and it is suggested that optimal fluid therapy should be based on laboratory evaluation of the animal's blood gas and electrolytes. **Hyperkalemia** may occur in severe acidosis. An increase in serum creatinine may be caused by inadequate renal perfusion associated with the dehydration and circulatory failure.

### Digestion/Absorption Tests

**Digestion and absorption tests** are available for the investigation of chronic malabsorptive conditions, particularly in the horse. Intestinal biopsy may be necessary for a definitive diagnosis of chronic intestinal lesions that cannot be determined by the usual diagnostic tests. Examples include

intestinal lymphosarcoma, granulomatous enteritis, and perhaps Johne's disease. Serum electrophoresis and the administration of radioactively labeled albumin may be necessary to determine the presence of a protein-losing enteropathy.

### NECROPSY FINDINGS

The pathology of enteritis or malabsorption varies considerably depending on the cause. There may be an absence of grossly visible changes of the mucosa, but the intestinal lumen will be fluid-filled or relatively empty, depending on the stage of examination in enterotoxigenic colibacillosis. When there is

gross evidence of inflammation of the mucosa there will be varying degrees of edema, hyperemia, hemorrhage, foul-smelling intestinal contents, fibrinous inflammation, ulceration, and necrosis of the mucosa. With acute necrosis there is evidence of frank blood, fibrinous casts, and epithelial shreds. The mesenteric lymph nodes show varying degrees of enlargement, edema and congestion, and secondary involvement of spleen and liver is not unusual. In chronic enteritis, the epithelium may appear relatively normal, but the wall is usually thickened and may be edematous. In some specific diseases there are lesions typical of the particular disease.

## DIFFERENTIAL DIAGNOSIS

### Approach

- The approach to the diagnosis of diarrhea requires consideration of the epidemiological history and the nature and severity of the clinical findings. With the exception of acute enteritides in newborn farm animals, most of the other common enteritides have reasonably distinct epidemiological and clinical features.
- In some cases, a necropsy on an untreated case of diarrhea in the early stages of the disease can be very useful.
- If possible, a hemogram should be obtained to assist in determining the presence or absence of infection.

### Appearance of feces

- The gross appearance of the feces may provide some clues about the cause of the diarrhea. Generally, diarrhea caused by lesions of the small intestine are profuse and the feces are liquid and sometimes as clear as water. The diarrhea associated with lesions of the large intestine are characterized by small volumes of soft feces, often containing excess quantities of mucus.
- The presence of toxemia and fever-marked changes in the total and differential leukocyte count suggest bacterial enteritis, possibly with septicemia. This is of particular importance in horses and cattle with salmonellosis.
- The presence of frank blood and/or fibrinous casts in the feces usually indicates a severe inflammatory lesion of the intestines. In sand-induced diarrhea in horses the feces may contain sand.

### Weight loss

- Chronic diarrhea with a history of chronic weight loss in a mature cow suggests Johne's disease.
- Chronic weight loss and chronic diarrhea, or even the absence of diarrhea, in the horse may indicate the presence of granulomatous enteritis, chronic eosinophilic gastroenteritis, alimentary lymphosarcoma, tuberculosis, and histoplasmosis.

### Dietary diarrhea and toxicities

- In dietary diarrhea the feces are usually voluminous, soft, and odoriferous. The animal is usually bright and alert and there are minimal systemic effects. An examination of the diet will usually reveal if the composition of the diet or irregular feeding practices are responsible for the diarrhea. Analysis of samples of new feed may be necessary to determine the presence of toxic chemical agents.
- Arsenic poisoning is characterized by dysentery, toxemia, normal temperature, and nervous signs.
- Copper deficiency conditioned by an excess of molybdenum causes a moderately profuse diarrhea with soft feces and moderate weight loss. There is usually normal hydration and possibly depigmentation of hair.

### Parasitism

- Intestinal helminthiasis such as ostertagiasis causes a profuse diarrhea and marked loss of weight; the temperature is normal and there is no toxemia.

### Miscellaneous causes

- In cattle, the oral cavity must be examined for evidence of lesions characteristic of viral diseases.
- Many diseases of the stomach, including ulceration, parasitism, gastritis, and tumors, may result in diarrhea and must be considered in the differential diagnosis of chronic diarrhea.
- The soft scant feces associated with some cases of incomplete obstruction of the digestive tract of cattle affected with the complications of traumatic reticuloperitonitis must not be confused with diarrhea.



## TREATMENT

The principles of treatment of enteritis include the following:

- Removal of the causative agent
- Alteration of the diet
- Fluids and electrolytes
- Intestinal protectants and adsorbents
- Antidiarrheal drugs

### Removal of Causative Agent

Specific treatment is usually directed at intestinal helminthiasis with anthelmintics, anti-protozoan agents against diseases such as coccidiosis, and antimicrobial agents against the bacterial enteritides. There are no specific treatments available for the viral enteritides in farm animals.

Although a considerable number of investigations have been done on the enteritides on farm animals, the emphasis has been on the immunology, pathology, microbiology, and body fluid dynamics, each with different emphasis in different species. For example, there is considerable information on the microbiology and immunology of the common enteritides in calves and piglets in addition to the extensive knowledge of the body fluid dynamics in calves. In the horse there is some information on body fluid dynamics, but the microbiology of the diarrheas is not well understood. In none of the species is there sufficient information on the effects of antibiotics on the intestinal microflora.

### Antimicrobials

The use of antimicrobials, either orally or parenterally, or by both routes simultaneously, for the treatment of bacterial enteritides is a controversial subject in both human and veterinary medicine. Those who support their use in acute bacterial enteritis claim that they are necessary to help reduce the overgrowth of pathogenic bacteria responsible for the enteritis and to prevent or treat bacteremia or septicemia that may occur secondary to an enteritis. Those who suggest that they are contraindicated or unnecessary in bacterial enteritis suggest that the drugs may eliminate a significant proportion of the intestinal flora in addition to the pathogenic flora. This may reduce the effect of competitive antagonism in the intestine, which in turn may permit the development of a superinfection (the appearance of bacteriologic and clinical evidence of a new infection during the chemotherapy of a primary one). Also, the use of antimicrobials in infectious enteric disease allows the development of **multiple drug resistance**, which is a major public health concern. The use of antimicrobials may also increase the length of time over which affected animals excrete the organisms which, for example, may occur in enteric salmonellosis.

Many different antimicrobial preparations for both oral and parenteral administration are available. The choice will depend

on previous experience, the disease suspected, and the results of culture and drug sensitivity tests. Parenteral preparations are indicated in animals with acute diarrhea, toxemia, and fever. Many antimicrobials, when given parenterally, are excreted by the liver into the lumen of the intestine and oral preparations may not be necessary. In cases of subacute diarrhea with minimal systemic effects, the use of an oral preparation may be sufficient. However, oral preparations should not be used for more than 3 days to avoid a superinfection. The preparations and doses of the antimicrobials commonly used in bacterial enteritides are described under each disease.

### Mass Medication of Feed and Water Supplies

Mass medication of the drinking water supply with antimicrobials for the treatment of outbreaks of specific infectious enteritides in animals is used commonly and with success. One of the best examples is the use of antimicrobials in the drinking water of pigs affected with swine dysentery. However, not all affected animals will drink a sufficient quantity of the medicated water and daily intake must be monitored carefully. Severely affected animals in an outbreak need individual treatment.

### Alteration of the Diet

If the cause of the diarrhea is dietary in origin the feed should be removed until the animal has fully recovered; feed should then be replaced by another source or reintroduced gradually. The question of whether or not a normally digestible diet should be removed temporarily or the total daily intake reduced in animals with acute enteritis is a difficult one. The rationale is that in acute enteritis the digestibility of nutrients is reduced considerably and undigested feed provides a substrate for fermentation and putrefaction to occur, the products of which may accentuate the malabsorptive state. However, temporary withdrawal of feed presents practical problems, especially in the young. For example, the temporary removal from the sow of newborn piglets affected with acute enteritis presents practical problems and is of doubtful value, which is similar with beef calves nursing cows on pasture. With foals it is relatively easy to muzzle them for 24 hours. With weaned piglets affected with weanling diarrhea and feeder pigs with swine dysentery, it is common practice to reduce the normal daily intake by half for a few days until recovery is apparent. Mature horses affected with diarrhea should not have access to any feed for at least 24 hours. During the period of temporary starvation, the oral intake of fluids containing glucose and electrolytes is desirable and necessary to assist in maintaining hydration. In newborn calves with diarrhea, if oral fluid intake is maintained, the total

loss of water from feces and through the kidney is not significantly greater than in normal calves, because in diarrheic calves the kidney will effectively compensate for fecal losses. When recovery is apparent, the animal's usual diet may be reintroduced gradually over a period of a few days.

### Fluids and Electrolytes

The initial goals of fluid and electrolyte therapy for the effects of enteritis are the restoration of the body fluids to normal volume, effective osmolality, and composition and acid-base balance. The quality and quantity of fluids required to achieve these goals depend on the characteristics of the dehydration and acid-base electrolyte imbalance. Under ideal conditions when a laboratory is available, the determination of PCV, total serum proteins, plasma bicarbonate, blood pH, serum electrolytes, and a hemogram would provide the clinician with a laboratory evaluation initially and throughout the course of therapy to assess the effectiveness of the treatment. However, such laboratory service is expensive and usually not readily available. The clinician must therefore assess the degree of clinical dehydration and, based on the history and clinical findings, estimate the degree of acidosis and electrolyte deficits that are likely to be present. A practical approach to fluid therapy in the horse has been described. Fluids should be given orally whenever possible to save time and expense and to avoid the complications that can arise from long-term parenteral fluid therapy. Also, fluids should be given as early as possible to minimize the degree of dehydration. With good kidney function there is a wider safe latitude in the solution used.

The three major abnormalities of **dehydration**, **acidosis**, and **electrolyte deficit** are usually corrected simultaneously with fluid therapy. When severe acidosis is suspected, this should be corrected immediately with a hypertonic (5%) solution of bicarbonate given intravenously at the rate of 5 to 7 mL/kg BW at a speed of about 100 mL/min. This is followed by the administration of electrolyte solutions in quantities necessary to correct the dehydration. With severe dehydration, equivalent to 10% of BW, large amounts of fluids are necessary (Table 7-8).

The initial hydration therapy should be given over the first 4 to 6 hours by continuous intravenous infusion, followed by maintenance therapy for the next 20 to 24 hours, or for the duration of the diarrhea if severe, at a rate of 100 to 150 mL/kg BW per 24 hours. Horses with acute enteritis have severe hyponatremia and following fluid therapy may become severely hypokalemic, as evidenced by weakness and muscular tremors. The hypertonic solution of sodium bicarbonate will assist in correcting the hyponatremia, but potassium chloride may need to be added to the large quantity of

**Table 7-8** Fluid deficits (L) in horses, foals and calves with 10% dehydration

Animal	Dehydration (%)	Fluid deficit (L)
500-kg horse	10	50
75-kg foal	10	7.5
45-kg calf	10	4.5

fluids given for dehydration; 1 g of potassium chloride added to each liter of fluid will provide an additional 14 mOsm/L (14 mmol/L) of potassium. In preruminant calves with diarrhea, the fluids and electrolytes required for maintenance may be given orally in divided doses every few hours. In the early stage of acute diarrhea and for animals that are not severely dehydrated, the oral route can also be used successfully to correct dehydration and prevent it from becoming worse. The formula of oral glucose–electrolyte solutions are given in the section Colibacillosis. Piglets and lambs affected with dehydration are most effectively treated using balanced electrolyte solutions given subcutaneously at the dose rates of 20 mL/kg BW every 4 hours and orally at 20 mL/kg BW every 2 hours. Details of the treatment of fluid and electrolyte disturbances are given in [Chapter 5](#).

### Intestinal Protectants and Adsorbents

Kaolin and pectin mixtures are used widely to coat the intestinal mucosa, inhibit secretions, and increase the bulk of the feces in animals with enteritis. In children with diarrhea, kaolin and pectin will result in formed rather than watery feces, but the water content of the feces is unchanged. It is not possible at this time to make a recommendation on their use in animals.

### Antidiarrheal Drugs

#### Antimotility Drugs

Anticholinergic drugs and opiates are available to decrease intestinal motility. The anticholinergic drugs block the action of acetylcholine on smooth muscle and glands. This results in decreased gastric secretion and emptying and a reduction on both segmental and propulsive movements of the intestines. Dosages of anticholinergics necessary to produce effectiveness may also cause side effects such as xerostomia, photophobia, tachycardia, urinary retention, and neuromuscular paralysis. The opiates function by producing an increase in segmentation while reducing propulsive movements in the intestine. The net effect is an increase in resistance to passage of intestinal contents, and more complete absorption of both water and nutrients occurs with a subsequent decrease in the frequency of defecation. There are no published reports of clinical trials using antimotility drugs for the treatment of diarrhea in farm animals; therefore at the present time

they cannot be recommended with any assurance of effectiveness.

### Antisecretory Drugs

Antisecretory drugs are also available for the treatment of diarrhea caused by the hypersecretory activity of enterotoxin produced by bacteria such as ETEC. Loperamide hydrochloride given orally to calves with experimentally induced diarrhea can delay the onset of diarrhea by its inhibition of fluid secretion. Antisecretory drugs include chlorpromazine, opiates, atropine, and prostaglandin inhibitors. These have not yet been adequately evaluated and the provision of balanced fluids and electrolytes, containing sodium chloride, sodium bicarbonate, potassium chloride, and glucose, given both parenterally and orally, are considered to be adequate and effective for treating the effects of the hypersecretion.

Because prostaglandins have an important reparative role in the intestine, NSAIDs may retard recovery of ischemic-injured intestine and are contraindicated.

### CONTROL

The control and prevention of enteritis in farm animals is a major topic and activity of large-animal practice. The control of each specific enteritis is presented under each specific disease in Part II of this book. The principles of control include the following:

- Reduce infection pressure by controlling population density
- Ensure adequate nonspecific resistance by adequate colostrum intake of neonatal farm animals and maintaining adequate nutritional status
- Vaccinate for those diseases for which there is an effective vaccine
- Minimize managerial and environmental stressors
- Monitor morbidity and mortality and ensure that a diagnosis is obtained so that control measures for newly introduced diseases into a herd can be instituted

### INTESTINAL HYPERMOTILITY

A functional increase in intestinal motility seems to be the basis of a number of diseases of animals. Clinically there is some abdominal pain and, on auscultation, an increase in alimentary tract sounds and, in some cases, diarrhea. Affected animals do not usually die and necropsy lesions cannot be defined, but it is probable that the classification as it is used here includes many of the diseases often referred to as catarrhal enteritis or indigestion.

The major occurrence of intestinal hypermotility is spasmodic colic of the horse. Other circumstances in which hypermotility and diarrhea occur without evidence of enteritis include allergic and anaphylactic states and a change of feed to lush pasture.

### DIETARY DIARRHEA

Dietary diarrhea occurs in all species and all ages but is most common in neonatal animals in which there is either absolute or relative inability to digest food or to which inappropriate food is provided. An absolute inability to digest food occurs in primary, or severe secondary, lactose intolerance in which the neonate does not have intestinal lactase activity. The result is failure to cleave lactose to its constituent monosaccharides and therefore fermentation of lactose in the small or large intestine. Bacterial fermentation of lactose causes osmotic diarrhea. Relative lactose deficiency presumably occurs in neonates that ingest large quantities of milk that then exceed the digestive capacity of the intestine. The frequency with which this occurs is unclear and withholding or restricting of feed to neonates should be approached with caution. The feeding of indigestible feedstuffs, such as inferior milk replacers, can cause diarrhea.

### ETIOLOGY

#### Milk Replacers

The use of inferior-quality milk replacers in young calves under 3 weeks of age is one of the most common causes of dietary diarrhea. The quality of the milk replacer may be affected by the use of skim-milk powder that was heat denatured during processing, resulting in a decrease in the concentration of noncasein proteins. This results in ineffective clotting in the abomasum and reduced digestibility. The use of excessive quantities of nonmilk carbohydrates and proteins in milk replacers for calves is also associated with a high incidence of diarrhea, loss of weight, emaciation, and starvation. The use of large quantities of soybean protein and fish protein concentration in milk replacers for calves will result in chronic diarrhea and poor growth rates.

Most attempts to raise calves on diets based on large amounts of certain soybean products, such as heated soybean flour, have been unsuccessful because the animals developed diarrhea, lost appetite, and had lower weight or inferior growth rate. Preruminant calves develop gastrointestinal hypersensitive responses to certain soybean products because major proteases of the digestive tract do not denature soluble antigenic constituents of the soybean protein.

Diarrhea of nutritional origin has become one of the most important problems in which large numbers of calves are raised under intensive conditions. Because of the relatively high cost of good-quality skim-milk powder, large quantities of both nonmilk proteins and carbohydrates are used in formulating milk replacers. Although some calves in these large units can satisfactorily digest the nutrients in these milk replacers, many cannot, and this leads to a high incidence of diarrhea and secondary colibacillosis and enteric salmonellosis.

Milk replacers made from bovine milk and milk by-products used to feed orphan piglets, lambs, and foals may cause nutritional diarrhea for the same reasons given earlier. In milk-replacer-fed calves, increasing the total daily fluid intake as a percentage of BW causes a greater incidence of loose feces, dehydration, and dullness than lower levels of fluid intake and higher dry matter concentration. This suggests that a greater amount of fluid intake increases the passage rate of dry matter and decreases absorption. The concentration of solids in the liquid diet should range between 10% and 13% and should be offered at 8% of BW in calves fed milk replacer once daily and allowed free access to calf starter.

### Overfeeding of Milk

The feeding of excessive amounts of cows' whole milk to hand-fed calves will result in large amounts of abnormal feces but usually not a profuse watery diarrhea with dehydration and loss of weight. This suggests that simple overfeeding of milk might not be a cause of acute neonatal diarrhea of calves. There is some limited evidence that dietary diarrhea can occur in nursing beef calves ingesting milk that does not clot properly. Only the milk from cows with diarrheic calves showed evidence of impaired clotting in an *in vitro* test.

The ingestion of excessive quantities of sows' milk by piglets at 3 weeks of age is thought to be a contributory cause of 3-week diarrhea of piglets. This could be caused by the sow reaching peak production at 3 weeks.

Beef calves suckling high-producing cows grazing on lush pasture are often affected with a mild diarrhea at about 3 weeks of age. The cause is thought to be simple overconsumption of milk. Similarly, vigorous lambs sucking high-producing ewes can develop diarrhea.

Foals commonly have diarrhea at about 9 days of age, which coincides with the foal heat of the mare. It has been thought for many years that the cause was a sudden change in the composition of the mare's milk, but this has not been supported by analyses of mares' milk at that time. Diarrhea is associated with age-related changes in the microbiota of the foals' gastrointestinal tract.<sup>1</sup>

There is considerable interest in the optimal conditions for feeding liquid diets to young calves. The temperature of the liquid when fed, feeding once or twice daily, and the amount of dry matter intake can affect the performance of calves. However, there is a range of safety in which the performance of the calves will not be significantly affected if management is good.

### Change of Diet

Dietary diarrhea also occurs in all species following a sudden change in diet, but particularly in animals at weaning time. This is

particularly important in the pig weaned at 3 weeks of age and not adjusted to the post-weaning ration. Diarrhea occurs commonly when animals are moved from a dry pasture to a lush pasture and when first introduced to liberal quantities of concentrates containing a large percentage of the common cereal grains.

### PATHOGENESIS Digestion of Milk

In calves, the ingestion of excessive quantities of cows' whole milk after several hours of no intake causes gross distension of the abomasum and possibly of the rumen. Under these conditions, the milk-clotting capacity of the abomasum may be limited, resulting in incomplete clotting. The flow of nutrients from the abomasum is more uniform in calves fed twice daily than once daily, which suggests that twice-daily feeding allows for more effective clotting and digestion.

Under normal conditions, the milk clot forms in the abomasum within minutes after feeding, and the whey moves to the duodenum 5 to 10 minutes later. The dilution of cows' whole milk will result in increased clotting time when treated with rennin (chymosin). Overfeeding could result in whole milk or excessive quantities of whey entering the duodenum, which cannot digest whole milk or satisfactorily digest and hydrolyze the substrates in whey. The presence of excessive quantities of such substrate, especially lactose, in the intestinal lumen would serve as a hydragogue and result in a large increase in intestinal fluid, failure of complete absorption, and abnormal feces. The speed of drinking is probably also important. Prolongation of drinking time results in dilution of the milk with saliva and the production of a more easily digested milk clot. Failure of the esophageal reflex in pail-fed calves may also be important. The milk enters the rumen, where it undergoes putrefaction.

### Milk Replacers and Diarrhea

The pathogenesis of diarrhea in calves fed inferior-quality milk replacers is well known. In calves fed low-heat-treated skim-milk powder milk replacer, curd formation in the abomasum, compared with no curd formation, slows down the passage of total abomasal content (retained matter from the last feeding, residual matter from the penultimate feeding, saliva, and gastric secretions), dry matter, crude protein, and fat from the abomasum to the intestine. Heat-denatured skim-milk powder is incompletely clotted in the abomasum, leading to reduced digestibility.

Nonmilk carbohydrates and nonmilk proteins are not well digested by preruminant calves under 3 weeks of age because their amylase, maltase, and sucrase activities are insignificant, and their pepsin-HCl activity is not well developed until at least 3 weeks of age. Following the ingestion of these

nutrients, there is reduced digestibility, malabsorption, and diarrhea. This results in a negative nutrient balance, loss of BW, and gradual starvation, all of which are reversible by the feeding of cows' whole milk. The digestion of fat is particularly affected, resulting in varying degrees of steatorrhea. Preruminant calves fed milk replacer containing corn oil will have diarrhea.

The mechanism for the diarrhea, which may occur in all species following a sudden change in diet, is not well understood. However, several days may be necessary for the necessary qualitative and quantitative changes to occur in the digestive enzyme capacity. Not much is known about the development of intestinal enzymes in the fetus and newborn, but this is likely to be of importance in individual animals. In calves, lactase activity is fully developed at birth and in the period between birth and weaning there are significant changes in enzyme activity, some of which are influenced by the presence or absence of dietary substances.

In dietary diarrhea, the presence of undigested substrate in the intestine can result in marked changes of the bacterial flora, which could result in excess fermentation of carbohydrates and putrefaction of protein, the products of which accentuate the malabsorption.

### CLINICAL FINDINGS

#### Nursing Beef Calves

Dietary diarrhea of beef calves at 3 weeks of age on pasture is characterized by the passage of light yellow feces that is foul smelling and soft. The perineum and tail are usually smudged with feces. The calves are bright and alert and usually recover spontaneously without treatment in a few days.

#### Hand-Fed Dairy Calves

When overfed on cow's whole milk these animals are usually dull and anorexic and their feces are voluminous, foul smelling, and contain considerable mucus. The abdomen may be distended because of distension of the abomasum and intestines. Secondary enteric colibacillosis and salmonellosis may occur, resulting in severe dehydration. Most uncomplicated cases will respond to oral fluid therapy and withdrawal from or deprivation of milk.

#### Milk-Replacer Diarrhea

In calves fed inferior-quality milk replacers, there will be a chronic diarrhea with gradual weight loss. The calves are bright and alert, they usually drink normally, appear distended after drinking, and spend considerable time in recumbency. Not uncommonly, many treatments will have been tried unsuccessfully. The diarrhea and weight loss continues and in 2 to 4 weeks emaciation is evident and death from starvation may occur. Affected calves will often have a depraved appetite and eat bedding and other



indigestible materials, which further accentuates the condition. When large numbers of calves are involved, the incidence of enteric colibacillosis and salmonellosis may become high and the case mortality very high. This is a common situation in veal-calf-rearing units.

Alopecia occurs occasionally in calves fed a milk replacer, but the cause is unknown.

### CLINICAL PATHOLOGY

Laboratory evaluation of the animals with dietary diarrhea is usually not necessary other than for elimination of other possible causes of the diarrhea. When milk replacers are being used the determination of the rennet-clotting time of the milk replacer compared with whole milk is a useful aid in assessing the quality of the skim-milk powder for calves.

### NECROPSY FINDINGS

Emaciation, an absence of body fat, dehydration, and serous atrophy are present in calves that have died from diarrhea and starvation while being fed inferior-quality milk replacers.

#### DIFFERENTIAL DIAGNOSIS

- Dietary diarrhea occurs following a change in diet, the consumption of too much feed at once, or poor quality feed. There are usually no systemic signs and recovery occurs spontaneously when the dietary abnormality is corrected or the animal adapts to a new diet.
- Dietary diarrhea must be differentiated from all other common causes of diarrhea in a particular age group within each species.
- Examination of the recent dietary history and examination of the diet and its components will usually provide the evidence for a dietary diarrhea.

### TREATMENT

#### Alter Diet of Hand-Fed Calves

In hand-fed calves affected with dietary diarrhea, milk feeding should be stopped and oral electrolyte solutions given for 24 hours. Milk is then gradually reintroduced. If milk replacers are being used their nutrient composition and quality should be examined for evidence of indigestible nutrients. The feeding practices should be examined and the necessary adjustments made.

The care and management of hand-fed calves to minimize the incidence of dietary diarrhea is an art. Much has been said about the use of slow-flowing nipple bottles and pails to reduce dietary diarrhea, but they are not a replacement for good management. Calves that are raised for herd replacements should be fed on whole milk if possible for

up to 3 weeks. When large numbers of calves are reared for veal or for feedlots the milk replacer used should be formulated using the highest quality milk and milk by-products economically possible. The more inferior the milk replacer the more impeccable the management must become.

### Monitor Beef Calves With Dietary Diarrhea

Beef calves affected with dietary diarrhea while sucking the cow and running on pasture do not usually require treatment unless complications develop. They must be observed daily for evidence of dullness, anorexia, inactivity, and profuse watery diarrhea, at which point they need some medical care.

#### REFERENCE

1. Kuhl J, et al. *Vet Microbiol.* 2011;151:321.

### ABDOMINAL FAT NECROSIS (LIPOMATOSIS)

Abdominal fat necrosis is a variant of generalized steatitis and is dealt with in more detail in Chapter 17. The **hard masses of necrotic fat** that occur relatively commonly in the peritoneal cavity of adult cattle, especially the Channel Island breeds and possibly Aberdeen Angus, are commonly mistaken for a developing fetus and can cause intestinal obstruction. The latter usually develops slowly, resulting in the appearance of attacks of moderate abdominal pain and the passage of small amounts of feces. Many cases are detected during routine rectal examination of normal animals. The lipomatous masses are located in the small and large omentum and mesentery in cattle and more diffusely to other parts of the body in sheep and goats. The composition of the fatty deposits is identical with the fat of normal cows and there is no suggestion that the disease is neoplastic. Sporadic cases are most common but there are reports of a herd prevalence as high as 67%. The cause is unknown, but there appears to be a relationship between such high prevalence and the grazing of tall fescue grass, and an inherited predisposition is suggested. The rate of occurrence increases with age with the peak occurrence at 7 years of age. It has been suggested that excessive fatness of abdominal adipose tissue may predispose cattle to fat necrosis. An unusual form of the disease with many lesions in subcutaneous sites has been recorded in Holstein Friesian cattle and is regarded as being inherited. There is no treatment and affected animals should be salvaged. A generalized steatitis has been reported in pony foals.

**Pedunculated lipomas** provide a special problem, especially in older horses. Their pedicles can be 20 to 30 cm long, and during periods of active gut motility these pedicles can become tied around a loop of intestine anywhere from the pylorus to the rectum. At

the pylorus they cause acute intestinal obstruction with gastric dilatation. At the rectum they cause subacute colic and a characteristic inability to enter the rectum with the hand. This is accompanied by a folded coning down of the mucosa, not unlike that in a torsion of the uterus. Early diagnosis and surgical intervention can produce a resolution, but delay in the acute disease is associated with a poor prognosis because the blood supply is compromised. Less acute disease causing small-colon impaction or recurrent colic occurs.<sup>1,2</sup>

#### REFERENCES

1. Riley E, et al. *Equine Vet Educ.* 2007;19:484.
2. Verwilghen D, et al. *Equine Vet Educ.* 2013;25:451.

## Diseases of the Peritoneum

### PERITONITIS

Inflammation of the peritoneum is accompanied by abdominal pain, fever, toxemia, and a reduction in the amount of feces. Signs vary in degree with the severity and extent of the peritonitis.

#### ETIOLOGY

Peritonitis can occur as a primary disease affecting the peritoneum or secondarily as part of a disease affecting primarily other organs with secondary involvement of the peritoneum.<sup>1</sup> Primary diseases of the peritoneum include malignancies of the peritoneum, *Actinobacillus equuli* infection in horses, *Haemophilus suis* in pigs, or *Pasteurella multocida* infection in calves.<sup>2,3</sup> Primary causes of peritonitis are much less frequent than causes of secondary peritonitis. Secondary peritonitis occurs most commonly from loss of integrity of the visceral peritoneum, often from injury to the alimentary tract within the abdomen, allowing gastrointestinal contents to enter the peritoneal cavity. Less common is perforation of the abdominal wall from the exterior from traumatic injury, perforation of the reproductive tract, or the introduction of pathogens or irritating substances as a result of injections into the peritoneal cavity or exploratory laparotomy. Some of the more common individual causes are as follows.

#### Cattle

- Traumatic reticuloperitonitis, which also occurs in camelids<sup>4,5</sup>
- Secondary to ruminal trocarization
- Perforation or leakage of abomasal ulcer
- Concurrent abomasal displacement and perforating ulcer
- Necrosis and rupture of abomasal wall after abomasal volvulus
- Rumenitis of cattle subsequent to acute carbohydrate indigestion



- Complication of cesarean section
- Rupture of vagina in young heifers during coitus
- Deposition of semen into the peritoneal cavity, for example, during traumatic artificial insemination
- Injection of sterile solutions, e.g., calcium preparations for milk fever or vitamin/mineral supplements (selenium)<sup>6</sup>
- Transection of small intestine when it becomes pinched between the uterus and the pelvic cavity at parturition
- Intraperitoneal injection of nonsterile solutions
- Spontaneous uterine rupture during parturition, or during manual correction of dystocia
- Sadistic rupture of vagina or rectum<sup>7</sup>
- Spontaneous rupture of rectum at calving
- As part of specific diseases such as tuberculosis, pasteurellosis,<sup>3</sup> or algal peritonitis<sup>8</sup>

### Horses

Peritonitis in horses is often secondary to gastrointestinal disease (colic) and can be a major complication after abdominal surgery. These diseases are discussed under the appropriate topic in the sections of this text dealing with equine colic. If cases attributable to gastrointestinal disease are excluded, most cases are idiopathic.<sup>9</sup> Primary causes are infrequent and include infection associated with *A. equuli*.<sup>2,10</sup> Peritonitis can be secondary to infectious, chemical, or parasitic peritoneal injuries:

- Rupture of dorsal sac of cecum or colon at foaling
- Cecal rupture in foals subjected to anesthesia and gastric endoscopy
- Cecal rupture of adult horses<sup>11</sup>
- As a sequela to cecal trocarization<sup>12</sup>
- Secondary to torsion and infarction of a liver lobe<sup>13</sup>
- Rectal rupture or tear during rectal examination, predisposed to by inflammation of mucosa and overenthusiasm by the operator; this subject is presented separately in the section **Rectal Tears**
- Extension from a retroperitoneal infection or intraabdominal abscess,<sup>14</sup> e.g., *S. equi*, as a result of metastatic stranglers, *R. equi* in foals under 1 year of age,
- Gastric erosion or rupture related to ulceration associated with larvae of *Gasterophilus* or *Habronema* spp. or gastric ulceration (a rare sequel of gastric ulceration in adult horses)<sup>15</sup>
- Colonic perforation associated with aberrant migration of *Gasterophilus intestinalis*
- Leakage from a cecal perforation apparently associated with a heavy

infestation of *Anoplocephala perfoliata* tapeworms

- Spontaneous gastric rupture
- *A. equuli* infection, in some cases secondary to immunodeficiency<sup>10,16,17</sup>
- Secondary to penetrating gastrointestinal foreign bodies<sup>18</sup>
- Rupture of the bladder or urinary tract<sup>9</sup>
- Periorchitis<sup>19</sup>
- Pancreatitis<sup>20</sup>

### Pigs

- Ileal perforation in regional ileitis
- Glasser's disease associated with *H. suis*.

### Sheep

- Spread from intestinal wall abscess following infestation with *Esophagostomum* sp. larvae
- Serositis-arthritis associated with *Mycoplasma* sp.
  - Intraperitoneal injection of selenium<sup>6</sup>

### Goats

- Serositis-arthritis associated with *Mycoplasma* sp.

### All Species

- Traumatic perforation from the exterior of the abdominal wall by horn gore or stake wound
- Faulty asepsis at laparotomy, peritoneal injection, or trocarization for tympany of rumen or cecum
- Leakage through wall of infarcted gut segment
- Spread from subperitoneal sites in spleen, liver, and umbilical vessels

### PATHOGENESIS

At least six factors account for the clinical findings and the various consequences of peritonitis: toxemia or septicemia, shock and hemorrhage, abdominal pain, paralytic ileus, accumulation of fluid exudate, and the development of adhesions.

### Toxemia and Septicemia

Toxins produced by bacteria and by the breakdown of tissue are absorbed readily through the peritoneum. The resulting toxemia is the most important factor in the production of clinical illness, and its severity is usually governed by the size of the area of peritoneum involved. In **acute diffuse peritonitis**, the toxemia is profound, but in local inflammation, it is negligible. The type of infection present is obviously important because of variations between bacteria in their virulence and toxin production.

With rupture of the alimentary tract wall and the spillage of a large quantity of gut contents into the peritoneal cavity, some acute peritonitis does develop, but death is

usually too sudden, within 2 to 3 hours in horses, for more than an early lesion to develop. These animals die of endotoxic shock caused by absorption of toxins from the gut contents. In acute diffuse peritonitis caused solely by bacterial contamination from the gut, the reaction depends on the bacteria that gain entry, the capacity of the omentum to deal with the peritonitis, and the amount of body movement that the animal has to perform. Cows that suffer penetration of the reticular wall at calving have lowered immunologic competence, a greater than normal negative pressure in the peritoneal cavity; are invaded by *F. necrophorum*, *Corynebacterium* spp., and *E. coli*; and are required to walk to the milking parlor, to the feed supply, and so on. They are likely to develop a massive diffuse purulent peritonitis and a profound toxemia and die within 24 hours. In contrast, horses that develop acute peritonitis from streptococci or *A. equuli* show little toxemia and manifest only abdominal pain caused by the inflammatory reaction of the peritoneum.

### Shock and Hemorrhage

The shock caused by sudden deposition of gut contents, or infected uterine contents, into the peritoneal cavity, plus the hemorrhage resulting from the rupture, may be significant contributors to the common fatal outcome when an infected viscus ruptures. Following rupture of the uterus in cows, the shock and hemorrhage may be minor and peritonitis may not develop if the uterine contents are not contaminated. Failure of the uterus to heal or be repaired may be followed by peritonitis several days later.

### Abdominal Pain

Abdominal pain is a variable sign in peritonitis. In acute, diffuse peritonitis, the toxemia may be sufficiently severe to depress the response of the animal to pain stimuli, but in less severe cases the animal usually adopts an arched-back posture and shows evidence of pain on palpation of the abdominal wall. Inflammation of the serous surfaces of the peritoneum causes pain, which may be severe enough to result in rigidity of the abdominal wall and the assumption of an abnormal humped-up posture.

### Paralytic Ileus

Paralytic ileus occurs as a result of reflex inhibition of alimentary tract tone and movement in acute peritonitis. It is also an important sequel to intestinal obstruction and to traumatic abdominal surgery, in which much handling of viscera is unavoidable. Rarely, it arises because of ganglionitis and a loss of neural control of peristalsis, similar to the idiopathic intestinal pseudoobstruction of humans. The net effect is **functional obstruction of the intestine**, which, if persistent, will increase the likelihood of death. The end result is a complete

absence of defecation, often with no feces present in the rectum.

### Accumulation of Fluid Exudate

Accumulation of large quantities of inflammatory exudate in the peritoneal cavity may cause visible abdominal distension and, if severe enough, interfere with respiration by obstruction of diaphragmatic movement. It is a comparatively rare occurrence but needs to be considered in the differential diagnosis of abdominal distension.

### Adhesions

Trauma to the peritoneum results in a serosanguineous exudate, which contains two closely bound proteins, fibrinogen and plasminogen. **Fibrinogen** is converted by thrombin to fibrin, forming an early fibrinous adhesion. **Plasminogen** may be converted by plasminogen activators to plasmin, a specific fibrinolytic enzyme favoring lysis of the early adhesion. Peritoneal mesothelial cells are a source of plasminogen activators and each species of domestic animal has its own baseline peritoneal plasminogen activity. Cattle have a high capacity to respond to trauma with fibrin deposition. Intraabdominal fibrin deposition and adhesion formation is the most important factor in localizing peritonitis after peritoneal trauma from penetrating foreign bodies or abomasal ulcers. However, these adhesions can cause mechanical or functional intestinal obstruction.

In **chronic peritonitis**, the formation of adhesions is more important than either of the two preceding pathogenetic mechanisms. Adhesions are an essential part of the healing process and are important to localize the inflammation to a particular segment of the peritoneum. If this healing process is developing satisfactorily and the signs of peritonitis are diminishing, it is common to find that vigorous exercise causes breakdown of the adhesions, spread of the peritonitis, and return of the clinical signs. Thus a cow treated conservatively for traumatic reticuloperitonitis by immobilization might show an excellent recovery by the third day but, if allowed to go out to pasture at this time, could suffer an acute relapse. The secondary adverse effects of adhesions may cause partial or complete **obstruction of the intestine** or stomach, or fixation to the body wall, interfering with normal gut motility. Adhesions are important in the pathogenesis of vagus indigestion in cattle.

### CLINICAL FINDINGS

Peritonitis is common in cattle, less common in horses and rarely, if ever, identified clinically in sheep, pigs, or goats. There are general signs applicable to all species and most forms of the disease in a general way. In addition, there are special findings peculiar to individual species and to various forms of the disease.

### Acute and Subacute Peritonitis

#### Inappetence and Anorexia

Inappetence occurs in less severe and chronic cases, and complete anorexia in acute diffuse peritonitis.

#### Toxemia and Fever

Toxemia, usually with a fever, is often present, but the severity varies depending on the area of peritoneum involved, the identity of the pathogens, and the amount of tissue injury. For example, in cattle with acute local peritonitis the temperature will be elevated (39.5°C [103°F]) for the first 24 to 36 hours, but then return to normal even though the animal may still be partly or completely anorexic. A high fever (up to 41.5°C [106°F]) suggests an acute diffuse peritonitis, but in the terminal stages the temperature usually falls to subnormal. It is most noteworthy that a normal temperature does not preclude the presence of peritonitis. In horses with peritonitis, the temperature will usually exceed 38.5°C, but the fever may be intermittent. There is usually a moderate increase in heart and respiratory rates, and the latter is contributed to by the relative fixation of the abdominal wall because of pain. In some cases there is spontaneous grunting at the end of each expiratory movement.

#### Feces

The amount and composition of feces is usually abnormal. The transit time of ingesta through the alimentary tract is increased and the dry matter content of the feces increases. The amount of feces is reduced, although in the early stages there may be a transient period of increased frequency of passage of small volumes of soft feces, which may give the false impression of increased fecal output. In some horses with peritonitis, periods of diarrhea can occur but the feces are usually reduced in amount. Feces may be completely absent for periods of up to 3 days, even in animals that recover, and the rectum may be so dry and tacky, because of the presence of small amounts of tenacious mucus, that it is difficult to do a rectal examination. This might suggest a complete intestinal obstruction.

In pastured cattle with peritonitis the feces are characteristically scant, dark, and like small fecal balls accompanied by thick, jelly-like mucus. The feces may alternatively have a thick, sludge-like consistency, be tenacious and difficult to remove from a rubber glove, and have a foul smell.

#### Alimentary Tract Stasis

As well as absence of feces, there are other indicators of intestinal stasis. In cows with acute peritonitis ruminal contractions are reduced or absent; in chronic peritonitis the contractions may be present but are weaker than normal. In the horse, intestinal stasis is evidenced by an absence or reduction of typical intestinal peristaltic sounds on

auscultation, although the tinkling sounds of paralytic ileus may be audible. It is very important to differentiate the two.

#### Abdominal Pain Evidenced by Posture and Movement

In cattle with acute peritonitis there is a disinclination to move, disinclination to lie down, lying down with great care, and grunting with pain. The posture includes a characteristically arched back and a shuffling and cautious gait with the back held rigid and arched. Grunting at each step and when feces or urine are passed is common, and when urine is eventually passed it is usually in a very large volume. Sudden movements are avoided and there is an absence of kicking or bellowing or licking the coat.

**In horses** these overt signs of peritonitis that characterize the condition in cattle are uncommon, which makes the diagnosis difficult. In the horse peritonitis is often manifested as an episode of abdominal pain including flank watching, kicking at the belly, and going down and rolling, which suggests colic caused by intestinal obstruction.

In a series of 51 cases of peritonitis associated with *A. equuli* in horses, most had tachycardia, increased respiratory rates, fever, and reduced intestinal borborygmi. Affected horses were depressed, lethargic, and inappetent. Mild to moderate abdominal pain was manifested as reluctance to move, pawing on the ground, lying down, or splinting of the abdominal musculature. The onset of clinical signs was acute (<24 hours) in 30 horses, 1 to 4 days in eight horses, or longer and associated with weight loss in three horses. In 10 horses, there was no record of the duration of clinical signs. The disease is usually primary although recurrent or chronic cases can be attributable to immunodeficiency, such as common variable immunodeficiency of aged horses.<sup>17</sup>

#### Abdominal Pain as Evidenced by Deep Palpation

In cattle, deep firm palpation of the abdominal wall elicits an easily recognized pain response. It may be possible to elicit pain over the entire abdominal wall if the peritonitis is widespread. If it is localized the response may be detectable over only a very small area. Increased tenseness of the abdominal wall is not usually detectable in the cow, although it is responsible for the characteristic arched-back posture and apparent gauntness of the abdomen, because the wall is already tightly stretched anyway.

**Several methods are used to elicit a grunt in cattle** with abdominal pain. In average-sized cows with acute local peritonitis (most commonly traumatic reticuloperitonitis), while listening over the trachea with a stethoscope, a controlled upward push with the closed fist of the ventral body wall caudal to the xiphoid sternum is most successful. In large bulls, especially if the peritonitis is

subsiding, it may be difficult to elicit a grunt with this method. In these cases, the best technique is to use a heavy pole held horizontally under the area immediately caudal to the xiphoid sternum to provide a sharp lift given by assistants holding the pole on either side. **Pinching of the withers** while auscultating over the trachea is also used and with some clinical experience is highly reliable.

In horses with acute or subacute peritonitis, it is usually easy to elicit a pain response manifested by the animal lifting its leg and turning its head with anger when its lower flank is firmly lifted, but not punched. The abdominal wall also feels tense if it is lifted firmly with the heel of the hand. In all cases of peritonitis in all species a pain response is always much more evident in the early stages of the disease, and severe chronic peritonitis can be present without pain being detected on palpation.

### Rectal Examination

The general absence of feces is characteristic. In cattle, it may be possible to palpate slightly distended, saggy, thick-walled loops of intestine in some cases. Also, it may be possible to feel fibrinous adhesions separating as the intestines are manipulated. Adhesions are not often palpable, and their absence should not be interpreted as precluding the presence of peritonitis. Only adhesions in the caudal part of the abdomen may be palpable. Tough, fibrous adhesions may be present in long-standing cases. In horses, there are no specific rectal findings, other than a reduced fecal output, to indicate the presence of peritonitis. Distension of segments of both the small and large intestines may provide indirect evidence of paralytic ileus. However, there is a lack of clarity as to what can be felt in chronic cases because of the presence of fibrin deposits and thickening of the peritoneum. There may also be more than usual pain when an inflamed area is palpated or a mesenteric band or adhesion is manipulated.

In rupture of the rectum associated with a difficult dystocia, the rupture is usually easily palpable rectally in the ventral aspect of the rectum deep in the abdomen. Distended loops of intestine may become entrapped in the rectal tear.

### Peracute Diffuse Peritonitis

In those cases in which profound toxemia occurs, especially in cows immediately after calving or when rupture of the alimentary tract occurs, the syndrome is quite different. There is severe weakness, depression, and circulatory failure. The animal is recumbent and often unable to rise, depressed almost to the point of coma, has a subnormal temperature of 37 to 37.5°C (99–100°F), a high heart rate (110–120 beats/min), and a weak pulse. No abdominal pain is evidenced spontaneously or on palpation of the abdominal wall.

In mares that rupture the dorsal sac of the cecum during foaling, the owner observes that the mare has been straining and getting results when suddenly she stops making violent muscular contractions, and progress toward expelling the foal ceases. Moderate abdominal pain followed by shock is a characteristic development. Death follows 4 to 15 hours after the rupture.

The outcome in cases of acute, diffuse peritonitis varies with the severity. Peracute cases accompanied by severe toxemia usually die within 24 to 48 hours. The more common, less severe cases may be fatal in 4 to 7 days, but adequate treatment may result in recovery in about the same length of time.

In a series of 31 cases of generalized peritonitis in cattle most cases occurred peripartum. The most consistent clinical findings were depression, anorexia, decreased fecal output, and varying degrees of dehydration. The duration of illness ranged from 1 to 90 days with a median of 4 days. In 19 animals, the duration of clinical disease was less than 1 week, and in 12 cases the duration of illness was more than 1 week. All animals died or were euthanized.

### Chronic Peritonitis Cattle

The development of adhesions, which interfere with normal alimentary tract movements, and the gradual spread of infection as adhesions break down combine to produce a chronic syndrome of indigestion and toxemia punctuated by short, recurrent attacks of more severe illness. The adhesions may be detectable on rectal examination, but they are usually situated in the anterior abdomen and are impalpable. If partial intestinal obstruction occurs, the bouts of pain are usually accompanied by a marked increase in alimentary tract sounds and palpable distension of intestinal loops with gas and fluid. The course in chronic peritonitis may be several weeks and the prognosis is not favorable because of the presence of physical lesions caused by scar tissue and adhesions. In some cases there is marked abdominal distension with many liters of turbid-infected fluid present. This may be restricted in its location to the omental bursa. Detection of fluid in the peritoneal cavity of a cow is not easy because of the fluid nature of the ruminal contents. Results obtained by testing for a fluid wave should be interpreted cautiously. Collection of fluid by paracentesis abdominis is the critical test.

### Horses

Horses with chronic peritonitis usually have a history of ill-thrift for a period of several weeks. Weight loss is severe and there are usually intermittent episodes of abdominal pain suggesting intestinal colic. Gut sounds are greatly diminished or absent, and subcutaneous edema of the ventral abdominal wall occurs in some cases. There may also be

a contiguous pleurisy. Identification of the cause of the colic depends on the examination of a sample of peritoneal fluid.

### Diagnostic Medical Imaging

In cattle with traumatic reticuloperitonitis, inflammatory fibrinous changes, and abscesses can be imaged (see also Chapter 8).

In cattle, standing reticular radiography is a useful aid for the diagnosis and management of traumatic reticuloperitonitis. It can accurately detect the presence of a foreign body and in most instances if the foreign body is perforating the reticular wall.

## CLINICAL PATHOLOGY

### Hematology

The total and differential leukocyte count is a useful aid in the diagnosis of peritonitis and in assessing its severity. In acute diffuse peritonitis with toxemia there is usually a leukopenia, neutropenia, and a marked increase in immature neutrophils (a degenerative left shift). There is “toxic” granulation of neutrophils. In less severe forms of acute peritonitis of a few days’ duration there may be a leukocytosis caused by a neutrophilia with the appearance of immature neutrophils. In acute local peritonitis, commonly seen in acute traumatic reticuloperitonitis in cattle, there is commonly a normal total leukocyte count, or a slight increase, with regenerative left shift. In chronic peritonitis, depending on the extent of the lesion (diffuse or local), the total and differential leukocyte count may be normal, or there may be a leukocytosis with a marked neutrophilia and occasionally an increase in the total numbers of lymphocytes and monocytes. The plasma fibrinogen levels in cattle generally tend to increase as the severity of acute peritonitis increases and may be a useful adjunct to the cell counts for assessing severity.

In horses with peritonitis associated with *A. equuli*, there is hemoconcentration, hypoproteinemia, and a neutrophilia count with a left shift.

### Abdominocentesis and Peritoneal Fluid

Examination of peritoneal fluid obtained by paracentesis is a valuable aid in the diagnosis of peritonitis and in assessing its severity. It can also provide an indication of the kind of antibacterial treatment required. The values in healthy horses and horses with various intestinal or peritoneal diseases are provided in Table 7-3. The maximum peritoneal fluid nucleated cell count in healthy foals is much lower than reported maximum values for adult horses and similarly for calves. Particular attention should be paid to the following:

- The ease of collection of the sample as a guide to the amount of fluid present
- Whether it is bloodstained, indicating damage to a wall of the viscus



- The presence of feed or fecal material, indicating intestinal ischemic necrosis or rupture
- Whether it clots and has a high protein content, indicating inflammation rather than simple transudation
- The number and kinds of leukocytes present, as an indication of the presence of inflammation, and also its duration
- Microbiological examination

When these results are available they should be interpreted in conjunction with the history, clinical signs, and other results, including hematology, serum chemistry, and possibly radiology. In particular, it must be noted that failure to obtain a sample does not preclude a possible diagnosis of peritonitis.

Interpretation of peritoneal fluid is also influenced by simple manipulation of the abdominal viscera, and the response is greater than that following opening and closing of the abdomen without manipulation of the viscera. Surgical manipulation results in a significant and rapid postoperative peritoneal inflammatory reaction.

In peritonitis in horses associated with *A. equuli*, the peritoneal fluid was turbid and had an abnormal color in 98% of cases. The protein content was elevated above normal in 50 samples (range 25–84 g/L, mean 44 g/L, normal <20 g/L). Total nucleated cell count was elevated in all samples (range 46–810 × 10 cells/L, mean 230 × 10 cells/L, normal <10 × 10 cells/L). A nucleated cell count above 100 × 10 cells/L, was present in 88% of animals. Pleomorphic gram-negative rods were seen on cytology in 53% of samples, and a positive culture of *A. equuli* was obtained in 72% of samples.

Experimentally, resection and anastomosis of the small colon in healthy horses causes a different inflammatory response than does manipulation. Absolute values in the peritoneal fluid for cell count, total protein, and differential count are inadequate to differentiate between a normal surgical reaction and a postoperative infection. Cytologic examination of peritoneal fluid is necessary to demonstrate degenerative cell changes and the presence of bacteria and ingesta. The peripheral leukon and fibrinogen concentration should always be compared with the peritoneal fluid for evidence of postsurgical infection. The nucleated cell and red blood counts of peritoneal fluid are commonly elevated for several days in horses following open castration. These elevated counts may be mistaken for peritonitis.

### Septic Peritonitis in the Horse

Diagnosis of septic peritonitis is routinely made on the basis of physical examination and hematologic findings and peritoneal fluid analysis. After abdominal surgery, differentiation between septic peritonitis and other postoperative complications can be difficult using physical and hematological

findings alone. As a result of the exploratory process itself, diagnosis of septic peritonitis is often complicated in horses after surgery because the total nucleated cell count and protein concentration in the peritoneal fluid are often high. Consequently, identification of bacteria on cytologic evaluation or isolation of bacteria from peritoneal fluid is a more definitive indicator of septic peritonitis, but sometimes there are false-negative results. Although bacterial cultures are considered the standard criterion for the diagnosis of sepsis, positive results may not always be obtained and results may be delayed by a minimum of 24 hours for aerobic organisms and up to 10 to 14 days for anaerobic organisms. Thus ancillary tests such as pH, glucose concentrations, and lactate dehydrogenase (LDH) activity in equine pleural and synovial fluid have been used to detect sepsis with the potential advantages of speed, ease of measurement, and lower cost relative to bacterial cultures.

Horses with septic peritonitis have significantly lower peritoneal fluid pH and glucose concentrations than horses with nonseptic peritonitis and healthy horses. Compared with other tests, serum-to-peritoneal fluid glucose concentration differences of more than 50 mg/dL had the highest diagnostic use for detection of septic peritonitis. A peritoneal fluid pH below 7.3, a glucose concentration below 30 mg/dL, and a fibrinogen concentration above 200 mg/dL were also highly indicative of septic peritonitis.

### Peritonitis in Cattle

Tests for total protein, albumin, glucose, cholesterol, fibrinogen, L-lactate, D-dimer, LDH, alkaline phosphatase, creatine phosphokinase, white blood cells, and red blood cells are sometimes used to detect peritonitis in cattle. Peritoneal fluid D-dimer is most accurate in diagnosing peritonitis in cows (sensitivity and specificity >95.0% for concentrations <0.60 mg/L), LDH and LDH ratio in serum and peritoneal fluid, and the serum-ascites albumin concentration gradient have sensitivities between 49.0% and 67.1% and specificities between 88.4% and 95.5%.<sup>21</sup> A low-peritoneal fluid glucose concentration is highly indicative of septic peritonitis, as it is in horses.<sup>21</sup>

### NECROPSY FINDINGS

In acute diffuse peritonitis, the entire peritoneum is involved, but the most severe lesions are usually in the ventral abdomen. Gross hemorrhage into the subserosa, exudation, and fibrin deposits in the peritoneal cavity and fresh adhesions that are easily broken down are present. In less acute cases, the exudate is purulent and may be less fluid, often forming a thick, cheesy covering over most of the viscera. In cattle, *F. necrophorum* and *Actinomyces (Corynebacterium) pyogenes* are often present in large numbers and produce a typical, nauseating odor. Acute

local peritonitis and chronic peritonitis are not usually fatal, and the lesions are discovered only if the animal dies of intercurrent disease such as traumatic pericarditis or intestinal obstruction.

### DIAGNOSIS

The diagnosis of peritonitis can be difficult because the predominant clinical findings are often common in other diseases. The clinical features that are the most reliable as indicators of peritonitis include the following:

- Abnormal feces, in amount and composition
- Alimentary tract stasis based on auscultation and evaluation of the passage of feces
- Abdominal pain evinced as a groan with each respiration or on light or deep percussion of the abdomen
- Abnormality of intestines on rectal palpation
- Fibrinous or fibrous adhesions on rectal palpation
- Abnormal peritoneal fluid with an increased leukocyte count collected by paracentesis
- A normal or low blood leukocyte count with a degenerative left shift
- The peritonitis may be chemical, and although microbiological examination usually yields positive results, these are not essential to a diagnosis of peritonitis

### PROGNOSIS

#### Case-Fatality Rate in Horses

Peritonitis in the horse is a potentially life-threatening disease that must be treated promptly and aggressively.<sup>1,22</sup> Therapy must be aimed at reducing systemic shock and hypovolemia, correction of the primary cause, antibiotic therapy, and abdominal drainage and lavage. The case-fatality rates for peritonitis of any cause in horses range from 30% to 67%, although this includes cases with peritonitis secondary to colic, which have a worse prognosis than idiopathic cases or those caused by *A. equuli*. The case-fatality rate in horses with peritonitis not related to colic or rupture of the gastrointestinal tract is approximately 14%.<sup>9</sup> In a series of 67 cases of peritonitis in horses, of those that developed peritonitis after abdominal surgery, the case fatality was 56%. Peritonitis not associated with intestinal rupture or abdominal surgery had a lower case-fatality rate of 43%. Horses that died had higher heart rates, red blood cell count, serum creatinine concentration, PCV, and anion gap; lower venous blood pH; and a greater number of bacterial species cultured from the peritoneal fluid compared with survivors. Those that died were more likely to have clinical evidence of abdominal pain, shock, and bacteria in the peritoneal fluid.



## DIFFERENTIAL DIAGNOSIS

The diseases that could be considered in the differential diagnosis of peritonitis are as follows.

### Cattle

- **Acute local peritonitis:** Traumatic reticuloperitonitis, acute intestinal obstruction, splenic or hepatic abscess, simple indigestion, abomasal displacement (right and left), postpartum metritis, ketosis
- **Acute diffuse peritonitis:** Parturient paresis, coliform mastitis (peracute form), acute carbohydrate indigestion, perforation of or rupture at abomasal ulcer, acute intestinal obstruction, uterine rupture, postpartum metritis
- **Chronic peritonitis:** Vagus indigestion, lipomatosis or extensive fat necrosis of the mesentery and omentum, persistent minor leakage from an intestinal lesion, large accumulations of fluid as in ascites, rupture of the bladder, chronic pneumonia and chronic toxemias from a great variety of causes
- **Ascites:** Associated most often with primary or secondary cardiac disease, cor pulmonale with chronic pneumonia, endocarditis, thrombosis of the caudal vena cava, and diffuse abdominal epithelioid mesothelioma

### Horses

- **Acute and subacute peritonitis:** Acute intestinal obstruction and thromboembolic colic
- **Chronic peritonitis:** Internal abdominal abscess (retroperitoneal or mesenteric abscess) may be classified as chronic peritonitis but is dealt with separately under the heading Retroperitoneal Abscess; horses with both intraabdominal neoplasms and abscesses will have clinical findings including anorexia, weight loss, fever, colic, and depression; both groups may also have peritoneal fluid that can be classified as an exudate

### Pigs, sheep, and goats

Peritonitis is not usually diagnosed antemortem in these species.

## TREATMENT

The specific cause must be treated in each case, and the treatments used are described under the specific diseases listed earlier. An exploratory laparotomy may be indicated to determine the cause of the peritonitis and to effect repair. The literature on the treatment of peritonitis in horses has been reviewed.

### Antimicrobials

**Broad-spectrum antimicrobials** given intravenously or intramuscularly are indicated for the infection and toxemia. However, there are no published reports of clinical trials to evaluate the effectiveness of various antimicrobials for the treatment of peritonitis in cattle or horses. Thus the recommendations are empirical. Generally, **peritonitis in cattle** is commonly treated with any of the broad-spectrum antimicrobials, with the choice

dependent on ease of administration and drug withdrawal times necessary in lactating dairy cattle. Treatment for traumatic reticuloperitonitis has commonly been restricted to the use of antimicrobials; supportive therapy has not been indicated with the exception of diffuse peritonitis.

**Peritonitis in horses** associated with abdominal surgery or rupture of the gastrointestinal tract is likely to be accompanied by a mixed flora of bacteria, and broad-spectrum antimicrobials are necessary. They must be given at doses high enough to achieve high blood and tissue levels and maintained daily until recovery has occurred. In a series of cases of peritonitis in horses, the most commonly used antimicrobials were gentamicin at 2.2 to 3.3 mg/kg BW intravenously every 8 to 12 hours or 6.6 mg/kg BW intravenously every 24 hours, and penicillin at 22000 IU/kg BW intravenously or intramuscularly every 6 to 12 hours. Metronidazole given orally at 15 to 25 mg/kg BW has also been used in horses with peritonitis.

Horses with peritonitis associated with *A. equuli* respond quickly to treatment with penicillin at 22,000 units/kg BW intramuscularly twice daily for 5 days to 2 weeks. Most isolates of the organism are sensitive to penicillin, but some are resistant and gentamicin sulfate at 6.6 mg/kg BW intravenously once daily for 5 days to 2 weeks in combination with the penicillin has also been used successfully. In a series of 51 cases in horses, the recovery rate following treatment with penicillin and gentamicin and supportive therapy was 100%. Most horses responded favorably within 48 hours following commencement of treatment.

**Administration of antimicrobials into the peritoneal cavity** has been attempted on the basis that higher levels of the drug may be achieved at the site of the inflammation. However, there is no scientific evidence that it is superior to daily parenteral administration, and there is some danger of causing adhesions and subsequent intestinal obstruction.

### Fluid and Electrolytes

Intensive intravenous fluid and electrolyte therapy are a vital part of treatment of peritonitis when accompanied by severe toxemia and shock, especially during the first 24 to 72 hours following abdominal surgery in the horse. It is continued until recovery is apparent and the animal is drinking water voluntarily; water can then be supplemented with electrolytes (see [Chapter 5](#)).

### Nonsteroidal Antiinflammatory Drugs

Flunixin meglumine is recommended at 0.25 to 1.1 mg/kg BW intravenously every 8 to 12 hours when the peritonitis is accompanied by shock. However, no information is available on efficacy.

### Lavage

**Peritoneal lavage** with large volumes of fluid containing antimicrobials is rational

and has been attempted when large quantities of exudate are present. However, it is not easy to maintain the patency of drains, especially in cattle. Also, the peritoneum is highly susceptible to inflammation, and chemical peritonitis is common following the introduction of certain materials into the peritoneal cavity. Peritoneal lavage of ponies with saline and antimicrobials induces a mild, transient inflammatory response with minimal change visible at necropsy. Solutions containing povidone iodine-induced chemical peritonitis, which was severe when 10% povidone iodine solution was used. A 3% solution also causes peritonitis, and the use of these solutions is not recommended. Extreme caution is required when foreign materials are introduced into the cavity to avoid exacerbating the existing inflammation. The peritoneum is also a very vascular organ and toxic material is rapidly absorbed from it.

An **active intraabdominal drain** has been used successfully to treat abdominal contamination in horses. Closed-suction abdominal drains were placed, mostly under general anesthesia. Abdominal lavage was done every 4 to 12 hours, and about 83% of the peritoneal lavage solution was retrieved.

### Prevention of Adhesions

Attempts can be made to prevent the development of adhesions but the efficacy has not been demonstrated.

## REFERENCES

1. Dart AJ, et al. *Equine Vet Educ.* 2011;23:294.
2. Watts AE, et al. *Aust Vet J.* 2011;89:143.
3. McFadden AMJ, et al. *N Z Vet J.* 2011;59:40.
4. Ziegler J, et al. *J Zoo Wildl Med.* 2013;44:163.
5. Tharwat M, et al. *Small Rumin Res.* 2013;113:307.
6. Dennis MM, et al. *Aust Vet J.* 2011;89:209.
7. Hvozdkik A, et al. *Vet J.* 2006;172:374.
8. Hafner S, et al. *Vet Pathol.* 2013;50:256.
9. Henderson ISF, et al. *Vet Rec.* 2008;163:293.
10. Layman QD, et al. *J Vet Diagn Invest.* 2014;26:365.
11. Gray SN, et al. *Equine Vet Educ.* 2014;26:422.
12. Unger L, et al. *Equine Vet Educ.* 2014;26:430.
13. Tennent-Brown BS, et al. *JAVMA.* 2012;241:615.
14. Arnold CE, et al. *JAVMA.* 2012;241:1659.
15. Teschner D, et al. *Pferdeheilkunde.* 2012;28:447.
16. Witonsky S. *Equine Vet Educ.* 2010;22:400.
17. Tennent-Brown BS, et al. *Equine Vet Educ.* 2010;22:393.
18. Lohmann KL, et al. *Can Vet J.* 2010;51:1400.
19. Kinsley MA, et al. *Equine Vet Educ.* 2010;22:489.
20. Yamout SZ, et al. *Equine Vet J.* 2012;44:45.
21. Wittek T, et al. *J Vet Intern Med.* 2010;24:1211.
22. Southwood L, et al. *J Vet Emerg Crit Care.* 2007;17:382.

## Abdominal Diseases of the Horse Including Colic and Diarrhea

### GENERAL PRINCIPLES

Abdominal pain in horses, evident as a constellation of clinical and behavioral signs

**Table 7-9** Origin and examples of visceral pain in the horse

Origin	Example: acute	Example: chronic
<b>Thorax</b>		
Lung	Pleuropneumonia	Pleural abscessation
Pleura	Choke	Neoplasia
Esophagus	Trauma	Pericarditis
Heart	Pericarditis	
<b>Abdomen</b>		
Stomach	Most causes of acute colic	Inflammatory bowel diseases
Small intestine	Pancreatitis	Enterolithiasis
Large intestine	Nephrolithiasis	Chronic diarrhea
Cecum	Uterine artery hematoma, rupture	Nephrolithiasis
Large colon	Metritis	Neoplasia
Small colon	Cholelithiasis	Cholelithiasis
Spleen	Uterine torsion	
Liver		
Pancreas		
Kidneys		
Ureters		
Ovaries		
Uterus		
<b>Pelvis</b>		
Bladder	Cystitis	Cystitis
Testicles	Urolithiasis	Urolithiasis
Rectum	Rectal tear	Neoplasia
Anus	Foaling trauma	
Vagina	Necrotic vaginitis	

Reproduced with permission.<sup>2</sup>

described next, is commonly referred to as colic. Colic is most often caused by gastrointestinal disease, although it can manifest as a result of disease in any intraabdominal organ (Table 7-9). The discussion in this section deals with colic caused by gastrointestinal disease, which is a frequent and important cause of death and is considered the most important disease of horses encountered by practicing veterinarians. It is estimated to cost the horse industry in the United States approximately \$115,000,000 annually.<sup>1</sup>

## ETIOLOGY

Several classification systems of equine colic have been described including a disease-based system (Table 7-10) classifying the cause of colic as

- **Obstructive, nonstrangulating:** Aboral movement of ingesta and secretions is prevented or hindered by luminal or extraluminal obstructions without a physiologically important reduction in blood flow to the gastrointestinal tract during the early stages of the disease (e.g., impaction of the large colon). Distension of the stomach or intestines can reduce blood flow in later stages of the disease.

- **Obstructive and strangulating:** Obstruction of aboral movement of ingesta and secretions with impairment of blood flow caused by mechanical compression of the vessels (arterial, venous, or both). Both the obstruction and impairment of blood flow occur at the same time (e.g., small-intestinal volvulus).
- **Nonstrangulating infarctive:** Reduction in nutritive blood supply (infarction) that is not attributable to mechanical compression of the vessels (e.g., thromboembolic colic).
- **Inflammatory** (peritonitis, enteritis): Inflammation of the stomach, intestines, or parietal and visceral peritoneum (e.g., colitis, peritonitis).

Colic cases can also be classified on the basis of the duration of the disease: **acute** (<24–36 hours), **chronic** (>24–36 hours), and **recurrent** (multiple episodes separated by periods of >2 days of normality). Another classification system is anatomically based and is listed in Table 7-11.

Regardless of the classification system used, some estimates are that fewer than >25% of colic cases seen in the field do not have a definitive diagnosis.<sup>3</sup> Horses with acute transient colic relieved by analgesics

are often referred to as having “spasmodic colic,” and this is the most common diagnosis at the primary presentation of horses with colic (24%–35%).<sup>3</sup> Large-colon impaction (20%) and undiagnosed (13%–25%) are the other largest diagnostic categories.<sup>1,3</sup>

## SYNOPSIS

**Etiology** See Tables 7-9 to 7-11 and 7-13.

**Epidemiology** Incidence of 2 to 30 cases per 100 horse-years, mortality of 0.5 to 0.7 cases per 100 horse-years, and case-fatality rate of 7% to 13%. Any age predisposition is weak, although certain diseases (e.g., meconium impaction, strangulation by pedunculated lipoma) have specific age distributions. Consumption of a diet high in concentrate increases the risk of colic, as does a poor parasite control program.

**Clinical signs** Signs of abdominal pain include agitation, flank watching, flank biting, pawing, frequent lying down, kicking at the abdomen, frequent attempts to urinate or defecate, and rolling. Tachycardia is common. Normal gut sounds are absent and replaced by tympanic sounds. Abdominal distension may develop. Reflux through a nasogastric tube may occur. Rectal examination may reveal abnormalities.

**Clinical pathology** Few changes have diagnostic significance but many are used to monitor the severity of the disease. Hemoconcentration, azotemia, and metabolic acidosis are frequent findings. Peritoneal fluid may have increased protein and leukocyte concentration.

**Lesions** Consistent with the particular disease.

**Diagnostic confirmation** Physical examination, exploratory laparotomy, necropsy.

**Treatment** Analgesia (Table 7-15), correction of fluid, acid-base and electrolyte abnormalities (Chapter 5), gastric decompression via nasogastric intubation, administration of fecal softeners or lubricants (Table 7-16), surgical correction of the lesion.

**Control** Parasite control. Ensure adequate roughage in the diet.

## EPIDEMIOLOGY

Most studies of the epidemiology of colic do not provide details of specific diseases; instead they consider colic as one disease. This inclusion of many diseases into one category, while maximizing the statistical power of the studies, is unfortunate because it can obscure important details regarding the occurrence and risk factors of individual diseases. Furthermore, much of the information related to incidence, treatments, and outcome of horses with colic is derived from studies of horses examined at referral centers. Horses examined at these centers are in all

Table 7-10 Etiological classification of equine colic

Type of colic	Etiology	Lesion	Typical clinical signs	Diagnosis
Simple obstruction (not infarctive)	Luminal obstruction	Impaction of stomach, ileum or large intestine with dry ingesta Concretion-type body, e.g., fecalith, meconium, phytobezoar, enterolith, foreign body, sand colic, congenital atresia	Mild to moderate pain, heart rate mildly increased initially, moderate dehydration Mild to moderate pain, moderate dehydration	Usually subacute course Diagnosis on rectal exam or imaging; exploratory celiotomy Subacute to acute course Diagnosis on rectal exam or imaging; exploratory celiotomy
	Mural blockage	Hematoma, neoplasm, idiopathic muscular hypertrophy	Pain, moderate dehydration	Rectal exam, reflux through nasogastric tube; exploratory celiotomy
	Extramural blockage	Large colon displacement	Mild to moderate pain, mild dehydration, abdominal distension	Rectal exam; exploratory celiotomy
	Functional	Spasm (spasmodic colic) Paralytic ileus Gastric reflux (acute gastric dilatation, gastric ulcer, anterior enteritis)	Moderate to severe pain, moderate to severe signs of hypovolemia	Rectal exam, gut sounds, nasogastric intubation, ultrasonographic examination
Inflammation (irritation of peritoneal pain receptors)	Infectious (e.g., <i>Salmonella</i> spp., <i>Actinobacillus equuli</i> ), chemical irritation (urine, ingesta)	Peritonitis Enteritis	Mild pain, fever, toxemia, tachycardia, hypovolemia	Leukocytosis, abdominal paracentesis, diarrhea
Simple infarction (no obstruction)	Infarction; ischemia	Thromboembolic colic (verminous arteritis), arterial occlusion (pedunculated lipoma around mesentery), detachment of mesentery (traumatic or congenital)	Mild to severe pain, toxemia Possibly blood loss	Abdominal paracentesis, total white cell count; exploratory celiotomy
Obstruction plus infarction	Intestinal accidents	Intussusception Torsion Strangulation (epiploic foramen, diaphragmatic, inguinal hernias, mesenteric tear or congenital defect, pedunculated lipoma)	Intractable pain followed by profound depression, toxemia, severe tachycardia, hypovolemia	Rectal exam; abdominal paracentesis, packed cell volume, total white cell count, nasogastric intubation, ultrasonographic examination

Table 7-11 Disorders of the equine gastrointestinal tract causing colic, by anatomical site

SITE	DISORDER
Stomach	Gastric dilatation Primary Secondary to outflow obstruction, pyloric stenosis, ileus, or anterior enteritis
	Gastric impaction
	Gastroduodenal ulceration
Small intestine	Volvulus
	Intussusception Ileocecal Jejunojunal
	Infarction or ischemia Thromboembolic disease Disruption of blood supply by mesenteric tear
	Strangulation, including entrapment through the epiploic foramen, mesenteric rents (including cecocolic fold, splenic ligament, uterine ligaments, spermatic cord), Meckel's diverticulum and hernias (diaphragmatic, inguinal/scrotal, umbilical)
	Strangulation by pedunculated lipoma
	Luminal obstruction Foreign bodies Ascarids
	Luminal compression Lipomas Intramural masses such as <i>Pythium</i> spp. and neoplasms (adenocarcinoma, lymphoma, eosinophilic enteritis)
	Adhesions
	Enteritis

**Table 7-11** Disorders of the equine gastrointestinal tract causing colic, by anatomical site—cont'd

SITE	DISORDER
Cecum	Impaction
	Rupture and perforation
	Intussusception
	Cecocolic
	Cecocecal
	Cecal torsion
	Infarction (thromboembolic disease, necrotizing enterocolitis)
	Typhlitis
	Tympany
	Ascending (large) colon
Intestinal tympany	
Volvulus	
Displacement, including left dorsal (renosplenic or nephrosplenic), right dorsal, cranial displacement of pelvic flexure	
Infarction (verminous mesenteric arteritis, necrotizing enterocolitis)	
Luminal obstruction	
Sand accumulation	
Enterolith	
Right dorsal ulcerative colitis	
Colitis	
Descending (small) colon	Necrotizing enterocolitis
	Impaction
	Luminal obstruction
	Fecalith
	Enterolith
	Luminal compression
	Pedunculated lipoma
	Intramural hematoma
	Perirectal abscess
	Perirectal tumor (melanoma)
Avulsion of mesocolon and rectal prolapse in mares at parturition	
Strangulation	

likelihood not representative of horses with colic that are not referred for examination by specialists. Details of the epidemiology of specific etiologic entities are included under those headings. Only general principles are included here.

### Occurrence

Equine colic occurs worldwide, although there are regional differences in the types of colic (for example, enterolithiasis), and is a common and important disease of horses. For cases of equine colic recognized in the field, as distinct from those referred for specialized treatment, the **incidence** rate ranges between 3.5 and 10.6 cases per 100 horse years, although individual farms can have rates as high as 30 or more cases per 100 horse years. Owners of horses in the UK report annual prevalence of colic, as a proportion of all health concerns, of 2.1% to 5.6%.<sup>4</sup> These estimates are self-reported by owners and are not based on systematic reporting or collection of data. Estimates using a population of insured horses in Japan

identified an annual incidence rate for colic of 18.6% (of ~45,000 horses).<sup>5</sup> **Mortality** from colic is estimated to be between 0.5 and 0.7 deaths per 100 horse years in the United States and 0.7% in Japan, representing 28% of overall horse deaths (2.5 deaths per 100 horse years) in both populations.<sup>1,5</sup> The **case-fatality rate** is 6% to 13% of field cases, although a lower rate of 3.6% is reported for insured horses in Japan.<sup>5</sup> Approximately 1% to 2% of colic events in the United States and the British Isles result in surgery. It should be borne in mind that these estimates of incidence and mortality are highly influenced by the population of horses studied and can be biased or unduly influenced by inclusion of farms or groups of horses with an extremely high, or low, incidence of colic.

### Risk Factors

Risk factors for colic can be categorized as (1) intrinsic horse characteristics, (2) those associated with feeding practices, (3) management, (4) medical history, (5) parasite control, and (6) season.<sup>6</sup>

### Horse Characteristics

#### Age

There are conflicting results of studies that examine the association of colic and age. The conflicting results might be the result of varying study populations, study design, presence of varying confounding factors, and interpretation of data. Confounding factors are those that alter with the age of the horse, such as use, feeding, and management of horses, and mask an effect of age or give the impression of an effect of age when in fact such an effect is not present. Horses 2 to 10 years of age are 2.8 times more likely to develop colic than horses less than 2 years. One large-scale study reported that foals less than 6 months of age had an incidence of 0.2 cases of colic per 100 horses per year, whereas horses more than 6 months of age had an incidence of approximately 4 to 6 colic-affected horses per 100 horse years, with the incidence varying to a limited extent among older age groups. The mortality rate varies widely among insured horses in Japan, with a much higher incidence of death from colic



in older horses: 9% in horses >21 years of age compared with 1.5% in foals and yearlings.<sup>5</sup> Other studies have not found a similar effect of age. However, each age group has a particular set of diseases unique or common to it. Newborn foals can have congenital colon or anal atresia or meconium impaction (see the section **Colic in Foals**), diseases that do not affect older horses, whereas strangulating or obstructive lesions caused by pedunculated lipomas are found only in older horses.

### Sex

There is no overall effect of gender on risk of colic, but certain diseases are restricted by gender. For instance, inguinal hernias occur only in males, whereas entrapment of intestine in the mesometrium is restricted to mares. Mares that have had a foal are at increased risk of developing volvulus of the large colon (adjusted OR of 12.9, 95% confidence interval [CI] 3.2–52).<sup>7</sup>

### Breed

There is a generally consistent, although not universal, finding that Arabian horses are at increased risk of colic, but the reason for this apparently greater risk has not been determined. Thoroughbreds are reported to be at increased risk of colic, independent of their use.

### Diet and Feeding Practices

Horses on pasture are at a lower risk of developing colic than are **stabled horses** fed concentrate feeds. The risk of colic increases with the amount of concentrate fed,<sup>8</sup> such that a horse fed 5 kg of concentrated feed per day has six times as great a risk of developing colic as a horse not fed concentrate.<sup>1</sup> However, another report did not detect an effect of diet composition on risk of colic. Changes to the horse's diet through changes in quantity and quality of feed, feeding frequency, or time of feeding increase the risk of colic by two to five times.

### Management

#### Watering

Horses without constant **access to water** are at increased risk of developing colic,<sup>8</sup> whereas horses with access to ponds or dams have a reduced risk of colic compared with horses provided with water from buckets or troughs. This might represent a confounding effect of pasturing, in that horses with access to dams are probably on pasture and benefit from the lower risk of colic associated with that management practice. Alternatively, horses provided with water from buckets could be at greater risk of having periods when water is not available.

#### Housing

Increased duration of stabling per day is associated with an increased risk of colic.

Horses cared for by their owner and horses in stables with large numbers of horses are less likely to develop colic. Horses with more than three carers are at greater risk of developing large-colon volvulus.<sup>7</sup>

### Exercise

Overall, there appears to be an increased risk of colic among horses undertaking physical activity or that have a recent change in the amount of physical activity. However, the finding of this association should be considered in the context of other differences that exist between active and inactive horses, such as in feeding practices, housing (stabling versus pasture), and transportation. Increased stabling is associated with an increased risk of large-colon volvulus (5.5, 95% CI 1.03–29).<sup>7</sup>

Colic during the hours after endurance racing occurs in approximately 1.6% (47 of 2832) of horses with small-intestinal volvulus common (13 of 15 horses) among those horses requiring surgery.<sup>9</sup> Most horses with colic associated with endurance racing do not require surgical exploration of the abdomen or correction of abnormalities.<sup>10</sup> The etiology is unclear but could be associated with an exercise-induced reduction in intestinal blood flow.

Colic associated with swimming is an important cause of colic in Thoroughbred horses in training with a 3-year incidence rate of 0.08%.<sup>11</sup> Over a 3-year period, 38% (136) of 361 colic cases were associated with swimming, of which 131 resolved spontaneously or with medical care.<sup>11</sup>

### Season and Weather

There appears to be a seasonal distribution or pattern to some types of colic both in the field and in those examined at a referral hospital, with epiploic foramen entrapment, large-colon impaction and/or torsion, and medical colic having an apparent seasonal distribution.<sup>5,12</sup> There were increases in incidence of colic in early spring and autumn in the UK and increases in cases of acute abdomen during the summer in horses in Japan.<sup>5,12</sup> The seasonal pattern might represent changes in management and use of horses rather than a direct effect of weather. Despite the widespread belief that colic is associated with changes in weather, particularly thunderstorms, there is no conclusive evidence of such an association.

### Medical History

Horses with a history of colic are more likely to have another episode, and horses that have had colic surgery are approximately five times more likely to have another episode of colic than are horses that have not had colic. There is no association between dental care and incidence of colic, although horses that “quid” (drop partially masticated food when eating) are at increased (7.8, 95% CI 1.8–33) risk of large-colon volvulus,<sup>7</sup> or

recent vaccination and colic. Horses with a history of **crib biting or wind sucking** are at markedly increased risk of developing colic (~2-fold risk) and more specifically epiploic entrapment of the small intestine (adjusted OR 72, 95% CI 14–359).<sup>6,13</sup> A history of colic in the past 12 months (5.1, 95% CI 1.4–18.9), increased stabling in the past 4 weeks (3.7, 95% CI 1.4–9.7), and increased height (1.07, 95% CI 1.01–1.12 per cm) are also being significantly associated with increased risk of colic caused by epiploic entrapment.<sup>6</sup> Similarly, horses that have had colic in the previous 12 months are at increased risk of a large-colon volvulus (adjusted OR of 8.7, 95% CI 1.8–43).<sup>7</sup>

Hospitalized horses are at increased risk of developing colic (see the section **Cecal Impaction**) and among horses hospitalized for treatment of ocular disease 21% developed signs of colic with 14% of those horses having a cecal impaction.<sup>14</sup> Duration of hospitalization (>8 days) was a strong risk factor for colic.<sup>14</sup>

### Parasite Control

Inadequate parasite control programs have been estimated to put horses at two to nine times greater risk of developing colic, although other studies have not demonstrated a relationship between anthelmintic administration and colic. The presence of tapeworms (assessed by examination of feces) is associated with a three times greater risk of ileal impaction and 16 times increased risk of colic<sup>15</sup> likely because *A. perfoliata* infestation causes lesions at the ileocecal junction of horses.<sup>16</sup> The detection of exposure to *A. perfoliata* by detecting specific antibodies in the blood is either not associated, or weakly associated, with the risk of colic.<sup>15,17</sup>

Infestation by roundworms (*Parascaris equorum*) is associated with severe colic in young horses as a result of impaction or obstruction of the small intestine.<sup>18</sup> Approximately 75% of the affected horses had been administered anthelmintics in the previous 24 hours, suggesting that death or paralysis of a large burden of ascarids resulted in obstruction of the lumen of the small intestine by the dead or dying parasites.

There is an increased incidence of colic in horses on farms on which rotation of anthelmintics is practiced. This apparently paradoxical finding may be because farms with a higher incidence of colic are more likely to alter rotation of anthelmintics as a result of having more horses with colic. The apparently conflicting results of some of the epidemiologic studies should not deter veterinarians from recommending effective parasite control programs for horses, given the clear association at an individual level of the presence of tapeworms, cyathostomes, and/or large strongyles and ileocecal disease, diarrhea and ill-thrift, and verminous arteritis, respectively.

## Importance

Losses caused by colic in horses are due almost entirely to death of the patient. However, the cost of treatment and the emotional trauma to the owners of their horse being afflicted with a potentially fatal disease are important considerations. A 1989 survey of veterinarians in the United States rated colic the most serious medical disease in horses, ahead of viral respiratory disease, and recent studies estimated the cost of colic to the horse industry in the United States at \$115,000,000 annually.

## PATHOGENESIS

The pathogenesis of equine colic is variable depending on the cause and severity of the inciting disease. A horse with a strangulating lesion involving 50% of its small intestine has a much more rapidly evolving disease, with severe abnormalities, than does a horse affected with mild spasmodic colic or impaction of the pelvic flexure of the large colon. Although equine colic often involves changes in many body systems, notably the gastrointestinal, cardiovascular, metabolic, and endocrine systems, there are several features and mechanisms that are common to most causes of colic that depend only on the severity of the disease for the magnitude of their change. The features common to severe colic, and often present to a lesser degree in milder colic, are pain, gastrointestinal dysfunction, intestinal ischemia, endotoxemia or toxemia, compromised cardiovascular function (shock), and metabolic abnormalities.

## Pain

Pain is the **hallmark of gastrointestinal disease** in horses and is attributable to distension of the gastrointestinal tract and stimulation of stretch receptors in the bowel wall and mesentery; stretching of mesentery by displaced or entrapped bowel; and inflammation and irritation of the bowel, peritoneum, or mesentery. Methods for objectively assessing and scoring pain in horses have been developed but as yet have not been rigorously tested and validated in large numbers of horses in varying situations.<sup>19-21</sup> Scoring systems that provide a composite score, and for which there is good interrater and intrarater agreement, have usefulness in developing prognostic criteria, for monitoring response to treatment, and for determining the need and efficacy of analgesia/hypalgesia.

The **intensity of the pain** is often, but not always, related to the severity of the inciting disease. Horses with mild impaction of the large colon of short duration (<24 hours) often have very mild pain, whereas a horse with a strangulating lesion of the small intestine will have very severe pain. Horses that recovered from gastrointestinal tract surgery (colic surgery) had lower pain scores after surgery than did horses that did not survive.<sup>19</sup>

Gastrointestinal pain has an inhibitory effect on normal gastrointestinal function,

causing a feedback loop in which the pain inhibits normal gut motility and function, allowing accumulation of ingesta and fluid, resulting in distension and further pain. Horses can respond very violently to abdominal pain and may injure themselves when rolling or thrashing.

## Gastrointestinal Dysfunction

Colic is almost invariably associated with impaired gastrointestinal function, usually alterations to **motility** or **absorptive** function. Gastrointestinal motility may be increased, as is presumed to be the case in spasmodic colic, altered in its character or coordination, as in some cases of impaction colic, or absent, such as in ileus secondary to inflammation or ischemia of the bowel or to the presence of endotoxemia. Increased or uncoordinated gastrointestinal motility probably causes pain through excessive contraction of individual segments of bowel or distension of bowel because of the loss of normal propulsive activity. **Ileus** is associated with fluid distension of the small intestine and stomach and fluid and gas distension of the large colon, both of which cause severe pain and can lead to gastric or colonic rupture. The absorptive function of the intestine may be decreased by inflammation or ischemia, which results in distension of the small intestine or large colon, pain, and potentially rupture of the stomach or colon.

Impairment of the **barrier function** of the gastrointestinal mucosa by inflammation or ischemia can result in leakage of endotoxin and other toxic compounds into peritoneal fluid with subsequent endotoxemia, toxemia, and systemic inflammatory response syndrome (see the section **Endotoxemia**).

## Ischemia of the Intestinal Wall

Ultimately, most forms of lethal colic involve some degree of ischemia of the intestine, with subsequent loss of barrier function, evident in its most extreme form as rupture of the viscus, endotoxemia, bacteremia, cardiovascular collapse, and death. Ischemia may be the result of impaired blood flow to or from the intestine because of torsion or volvulus of the intestine, entrapment of the intestine and associated mesentery in rents or hernias, strangulation such as by a pedunculated lipoma, or thromboembolic disease. Ischemia may also result from severe gastrointestinal distension, such as occurs in the terminal stage of severe colon impaction. Mild ischemia probably impairs normal intestinal motility and function. The role of reperfusion injury in pathogenesis of ischemic disease is uncertain at this time.

## Endotoxemia

Death in fatal cases of colic in which the affected viscus ruptures secondary to distension, or when ischemia and/or infarction damages a segment of bowel wall, is caused by the absorption of endotoxins and other

compounds from the gut lumen into the systemic circulation (see the section **Endotoxemia**). Endotoxin absorption causes increased concentrations of tumor necrosis factor and interleukin (IL)-6 in peritoneal fluid and blood concentrations.

Rupture of the stomach or intestine is also a characteristic termination of distension of the intestine in the horse. The resulting deposition of large quantities of highly toxic ingesta or fecal contents into the peritoneal cavity causes profound shock and death within a few hours.

## Shock

The usual cause of death in severe colic is cardiovascular collapse secondary to endotoxemia/toxemia and hypovolemia. In less severe colic, hypovolemia and cardiovascular dysfunction may contribute to the development of the disease, and rapid correction of hypovolemia is central to the effective treatment of colic.

**Hypovolemia** is caused by the loss of fluid and electrolytes into the lumen of the gastrointestinal tract or loss of protein from the vascular space with subsequent reduction in the circulating blood volume. Hypovolemia impairs venous return to the heart and therefore cardiac output, arterial blood pressure, and oxygen delivery to tissues. Not surprisingly, measures of circulatory status are good predictors of the outcome of colic (see the section **Prognosis**).

Cardiorespiratory function is impaired if there is severe distension of gut, such as in large-colon torsion, because of restricted respiration by pressure on the diaphragm and reduced venous return to the heart because of pressure on the caudal vena cava. Cardiac function is impaired in some horses with colic, as indicated by the high incidence of arrhythmias, elevated serum concentrations of troponin, and abnormal contractile function detected by echocardiographic examination.<sup>22-25</sup> The reduction in myocardial function is most evident as an increase in the ratio of preejection time to ejection time for the left ventricle.<sup>24</sup>

## Coagulation and Fibrinolysis

Severe colic, especially that involving ischemia or necrosis of intestine, is associated with abnormalities in coagulation and fibrinolysis characterized by hypercoagulation or hypocoagulation of blood and abnormal fibrinolysis.<sup>26-28</sup> The particular abnormalities present at a point in time depend on the severity of disease and its duration. Initial increases in coagulability or fibrinolysis can progress to hypocoagulable and hypofibrinolytic states as the severity of the disease increases.<sup>28</sup>

Disseminated intravascular coagulation is common among horses with ischemia or necrosis of the gut and is a good prognostic indicator of survival.<sup>26,27</sup> Changes in coagulation and fibrinolysis include decreases in

antithrombin activity and fibrinogen concentration and increases in prothrombin time, activated partial thromboplastin time, and concentration of thrombin-antithrombin complexes in plasma.<sup>27,29</sup> Dynamic measures of clotting function or fibrinolysis also reveal that hypocoagulation, indicated by abnormalities in one or more measures by thromboelastography, is indicative of a poor prognosis.<sup>27</sup> However, changes in these variables do not always correlate well with more dynamic measures of clotting function, such as thromboelastography.<sup>27,29</sup>

## Overview of the Pathogenesis of Common Colics

### Simple Obstructive

Simple obstructive colics are those in which there is obstruction to the aboral passage of ingesta but no ischemia or strangulation of bowel. In the terminal stages there is often ischemia caused by distension of the intestine.

**Small-intestinal obstructive** lesions include ileal hypertrophy, ileocecal intussusception, and foreign-body obstruction of the lumen. The course of the disease is often 24 to 72 hours, and sometimes longer depending on the extent of the obstruction, and partial obstructions have much less severe signs and disease of longer duration. The principal abnormality is reduced aboral flow of ingesta, with subsequent distension of intestine cranial to the obstruction, causing pain and, if the distension is severe, gastric rupture.

**Large-intestinal obstructive** lesions include impaction and simple (nonstrangulating) displacements of the large colon. The course of disease is prolonged, often more than 72 hours. Signs of abdominal pain are caused by distension of the bowel. There is progressive distension with fluid and gas and ultimately ischemia of the bowel and rupture.

### Obstructive and Strangulating

Diseases that cause both obstruction and strangulation as an initial event, such as torsion of the small intestine or volvulus of the large colon, result in severe and unrelenting pain that is difficult to relieve with analgesics. Obstruction causes distension and strangulation causes ischemia, loss of barrier function, and endotoxemia. These diseases have a short course, usually less than 24 hours and sometimes as short as 6 hours, and profound clinical signs. Endotoxemia/toxemia, systemic inflammation, and cardiovascular collapse are characteristic of these diseases.

### Infarctive

Infarctive diseases, such as thromboembolic colic, are characterized by ischemia of the intestinal wall with subsequent alterations in motility and absorptive and barrier functions. Ileus causes distension of the intestines

**Table 7-12** Criteria for evaluation of pain in horses<sup>30</sup>

Behavior	Score
Depression	1
Flank watching	2
Weight shifting	
Restlessness	3
Kicking abdomen	
Pawing	4
Stretching	
Sternal recumbency	
Attempting to lie down	4
Lateral recumbency	
Rolling	5
Collapse	

and stomach and altered barrier function causes endotoxemia. The course of the disease is usually less than 48 hours and is terminated by cardiovascular collapse and death.

### Inflammatory

Inflammation of the intestine or peritoneum alters gastrointestinal motility and absorptive function leading to accumulation of fluid and ingesta, distension, and abdominal pain.

## CLINICAL FINDINGS

The bulk of the following description is generally applicable to severe acute colic. Clinical findings characteristic of each etiologic type of colic are dealt with under their individual headings. The purposes of the clinical examination are **diagnostic**—to determine whether the pain is caused gastrointestinal tract disease and, if so, to determine the nature of the lesion—and **prognostic**—to provide some estimate of the likely outcome of the disease. Veterinary clinicians are able to accurately predict the site of lesions (small intestine versus large intestine), type of lesion (simple obstructive versus strangulating or infarctive), and outcome. The ability to predict these events increases with training and experience.

**Accurate diagnosis** of the cause of the colic has some prognostic usefulness, but assessment of the horse's physiologic state by measurement of heart and respiratory rates, mucous membrane color and refill time, arterial blood pressure, hematocrit and serum total protein concentration, as well as other measures, allows more accurate prognostication. Furthermore, the cause of colic is determined in only approximately 20% of field cases.

## Visual Examination

### Behavior

Pain is manifested by **pawing, stamping, or kicking** at the belly or by restlessness evident as pacing in small circles and repeatedly getting up and lying down, often with exaggerated care. Methodology for identifying and rating pain has been validated for horses and has high intraobserver ( $\kappa = 0.9$ ) and interobserver (intraclass correlation coefficient 0.8) values indicating the repeatability of the assessments either by the same observer or by different observers. The pain scale also has good sensitivity and specificity for outcome (lived versus died, 70% and 71%) and treatment (medical, surgical, euthanasia, 70% and 57%)<sup>30</sup> (Table 7-12).

Other signs are looking or nipping at the flank, **rolling**, and lying on the back. Often the penis is protruded without urinating or with frequent urination of small volumes. Continuous playing with water without actually drinking (sham drinking) is common.

**Pain** may be continuous or, more commonly, intermittent with bouts of pain lasting as long as 10 minutes interspersed with similar periods of relaxation. Generally, the intensity of the pain is of about the same severity for the duration of the illness; sudden exacerbations may indicate a change in the disease status or the development of another abnormality, such as a horse with impaction of the large colon developing a displacement of the colon or horses with diarrhea developing necrotizing enteritis. Horses in the terminal phase of the disease may have a marked diminution of pain associated with relief of pressure after rupture of distended bowel and depression caused by toxemia and shock. Pain responses in colic can be so severe, and uncontrolled movements so violent, that the horse might do

itself serious injury. Other causes of pain, such as pleuritis or rhabdomyositis, can be confused with colic, although a horse that goes down and rolls almost certainly has alimentary tract colic.

### Posture

The posture is often abnormal, with the horse standing stretched out with the forefeet more cranial and the hindfeet more caudal than normal or the so-called “saw-horse” stance. Some horses lie down on their backs with their legs in the air, suggesting a need to relieve tension on the mesentery.

### Abdomen Size

**Distension** of the abdomen is an uncommon but important diagnostic sign. **Symmetric, severe distension** is usually caused by distension of the colon, sometimes including the cecum, secondary to colon torsion, or impaction of the large or small colon and subsequent fluid and gas accumulation. If only the cecum is distended the abdomen can show an **asymmetric enlargement** in the right sublumbar fossa. Maximum distension of stomach or small intestines does not cause appreciable distension of the abdomen.

### Vomiting

Projectile vomiting or regurgitation of intestinal contents through the nose is very unusual in horses and is a serious sign suggesting severe gastric distension and impending rupture.

### Defecation and Feces

Defecation patterns can be misleading. It is often mistakenly assumed that there is no complete obstruction because feces are still being passed, but in the very early stages of acute intestinal obstruction there can be normal feces in the rectum, and the animal might defecate several times before the more usual sign of an empty rectum with a sticky mucosa is observed.

## Physical Examination

### Heart and Respiratory Rates

The **heart rate** is a useful indicator of the severity of the disease and its progression but has little diagnostic usefulness. Horses with heart rates less than 40 beats/min usually have mild disease, whereas horses with heart rates above 120 beats/min are usually in the terminal stages of severe disease. Horses with obstructive, nonstrangulating disease often have heart rates between 40 and 60 beats/min, whereas horses with strangulating disease or necrotic bowel will usually have heart rates over 80 beats/min. However, heart rate is not an infallible indicator of disease severity, as horses with torsion of the colon can have heart rates of 40 to 50 beats/min.

The **respiratory rate** is variable and can be as high as 80 beats/min during periods of severe pain.

### Mucous Membranes and Extremities

**Mucous membranes** of normal horses and of horses without significantly impaired cardiovascular function are pink, moist, and regain their normal color within 2 seconds after firm digital pressure is removed. Dehydrated horses have dry mucous membranes, although the capillary refill time and color are normal. Horses with impaired cardiovascular function have pale, dry mucous membranes with delayed capillary refill (>2 seconds). Endotoxemic horses will often have bright red mucous membranes with normal or delayed capillary refill. As the disease becomes more severe the mucous membranes develop a bluish tint and capillary refill is longer than 3 seconds. **Terminal** stages of disease are associated with cold, purple, dry mucous membranes with a capillary refill time of more than 3 seconds; necrosis of the mucosa of the gingival margins of the gums, the so-called “toxic line,” is often seen.

**Cool extremities** can be indicative of compromised cardiovascular function but should be interpreted with caution and only in the context of the rest of the clinical examination. **Sweating** is common in horses with severe abdominal pain and, when present in a horse with cool extremities and signs of cardiovascular collapse, is indicative of a poor prognosis.

### Auscultation and Percussion

**Auscultation** of the abdomen can provide useful diagnostic and prognostic information and should be performed thoroughly and without haste. All four quadrants (dorsal and ventral, left and right sides) of the abdomen should be examined for at least 1 minute at each site. Attention should be paid to the intensity, frequency, and characteristics of the spontaneous gut sounds (borborygmi). Repeated observations are often necessary to detect intermittent or rapid changes in the character of the borborygmi.

**Continuous, loud borborygmi** distributed in all or most quadrants are indicative of intestinal hypermotility and consistent with spasmodic colic, impending diarrhea, or the very early stages of a small-intestinal obstructive/strangulating lesion. The **absence of sounds**, or the presence of occasional high-pitched, brief sounds, sometimes with a splashing character, is consistent with ileus. These sounds should not be mistaken for the rolling, prolonged sounds of normal peristalsis.

**Combined percussion and auscultation** is a valuable procedure for defining the presence of extensive gas caps; a flick or abrupt tap with a finger while auscultating with a stethoscope will elicit a **pinging** sound similar to that made by flicking an inflated balloon. The detection of such sounds indicates the presence of tightly gas-distended bowel near the body wall. Such bowel is almost always large colon or cecum and is consistent with

gas distension secondary to ileus, small or large-colon impaction, gas colic, or colon displacement, including torsion.

### Rectal Examination

A careful rectal examination is probably the most important part of the clinical examination in colic and should not be neglected. The examiner must know the anatomy of the posterior abdomen to make reasonably accurate decisions about the location of various organs. Recognition that an important abnormality exists is a critical factor in the decision to refer the horse for specialized evaluation and care.

### Normal Anatomy

The horse should be restrained so that the examination can be performed with minimal risk to both the examiner and patient. Fractious or horses in pain should be tranquilized. A twitch should be applied to all but the most cooperative horses to minimize straining and the chance of kicking. Rectal examination in small or unruly horses should be approached with caution.

Only approximately 40% of the abdomen can be examined in a mature horse, because the cranial and ventral structures are outside the reach of the examiner. In the normal 425-kg (1000-lb) horse there should not be any distended intestine and the small intestine should not be palpable. The **cecum** is readily palpable in the right caudal abdomen, with its ventral band running from the dorsal right quadrant ventrally and slightly to the left. The base of the cecum may be palpable as a soft, compressible structure containing fluid and gas. The caudal border of the **spleen** is readily palpable as it lies on the left side of the abdomen against the body wall. There should be no bowel between the spleen and the body wall, although occasionally the small colon can be detected dorsal to the spleen. Dorsal and medial to the spleen, the **left kidney** should be readily palpable, as should the **nephrosplenic ligament** and **space**. There should be no bowel in the nephrosplenic space, although some horses have portions of small colon in the region of the nephrosplenic space. Portions of **large colon**, especially the pelvic flexure, can be palpated in the caudal ventral abdomen if they contain ingesta. The inguinal rings may be palpated in males. The ovaries and uterus can be palpated in mares. The bladder can be palpated if it contains urine.

### Abnormal Findings

Abnormalities associated with specific diseases are discussed under those headings (Table 7-13). One should be able to recognize gas and fluid distension of the cecum and colon, fluid distension of the small intestine, impaction of the large and small colon, and displacement of the large colon.

**Small-intestinal distension** is evident as loops of tubular structures of up to 10 to



Table 7-13 Rectal findings and associated causes of equine colic

Rectal abnormality	Disease	Clinical characteristics	Treatment
Distended small intestine	Proximal jejunitis/duodenitis, anterior enteritis	Small intestine mildly to moderately distended; voluminous gastric reflux; marked pain relief on gastric decompression Normal peritoneal fluid in most cases	Supportive; repetitive decompression of stomach
	Strangulating intestinal lesion; small intestinal volvulus or entrapment	Severe, tight distension of small intestine; gastric reflux Severe pain not relieved by gastric decompression; abnormal peritoneal fluid	Surgery
	Ileal impaction	Mild and progressive pain; gastric reflux only late in disease Impaction occasionally palpable per rectum	Medical initially, then surgery if no resolution
	Ileal hypertrophy	Mild to moderate chronic pain occurring after feeding Hypertrophy may be palpable	Surgical resection
	Ileocecal intussusception	Moderate to severe pain; gastric reflux later in disease Usually young horse	Surgical correction
Large colon distension	Colon torsion	Tenia dorsal in some cases; cecum displaced medially Severe pain; abdominal distension; no gastric reflux Short disease course	Surgical correction
	Left dorsal colon displacement (renosplenic entrapment)	Mild to moderate pain; bands on rectal examination leading to renosplenic space; ultrasonographic confirmation	Replacement by rolling horse Surgery
	Right dorsal displacement of colon	Moderate to severe pain; bands leading ventral to right dorsal quadrant; colon lateral to base of cecum	Surgical correction
	Impaction of large colon	Impaction palpable per rectum	Fecal softeners and lubricants, oral and intravenous fluids Surgery in refractory cases
	Enterolith	Obstruction usually of right dorsal or transverse colon Not palpable rectally; refractory pain; radiography	Surgical removal
	Gas colic	Gas distension of large colon; pain readily relieved with analgesics; short course with rapid recovery; major differential is colon torsion	Analgesics, mineral oil
	Sand colic	Mild to moderate pain; Sand auscultable in ventral abdomen; sand in feces; occasional watery feces	Analgesics, psyllium orally
Cecal distension	Cecal impaction	Mild to moderate pain, course of several days with sudden deterioration when cecum ruptures	Analgesics, lubricants, fecal softeners; surgical correction
	Cecal torsion	Acute, severe pain; rare	Surgical removal or correction
Displaced spleen	Renosplenic entrapment of large colon	See previously	
	Large colon displacement	Mild to moderate pain; ultrasonographic diagnosis	Analgesics; surgery
Intraabdominal masses	Mesenteric abscess	Fever, mild chronic or intermittent abdominal pain Increased leukocyte numbers in blood and peritoneal fluid	Long-term antibiotics
	Neoplasia	Neoplastic cells in peritoneal fluid; exploratory laparotomy	None

15 cm in diameter that may extend as far caudally as the pelvic canal. The structure is often compressible, akin to squeezing a fluid-filled tubular balloon, and slightly moveable. The presence of distended small intestine is an important sign suggestive of a small-intestinal obstructive lesion or anterior enteritis.

**Colonic distension, impaction and displacement can be evident on rectal palpation.** Gas and fluid distension of the **large colon** is evident as large (>20 cm) taut structures often extending into the pelvic canal. Tenial bands are often not palpable because of the distension. The distended bowel may extend into the pelvic canal, preventing

examination of the caudal abdomen. **Impaction** is evident as columns of firm ingesta in the large or small colon. The most common site is the pelvic flexure in the caudoventral abdomen and the inlet to the pelvic canal. The impacted material remains indented when pressed with the finger tips.

**Distension of the small colon** is detectable as loops of tubular structures in the caudal abdomen. The loops of intestine have a prominent antimesenteric band, a feature not present on small intestine.

**Displacement** of the large colon is evident rectally as tight bands extending from the ventral abdomen cranially, dorsally, and to the left or cranially, dorsally, and to

the right in left and right displacements of the colon, respectively. Displacement of the colon, if it obstructs aboral flow of ingesta and gas, may cause distension.

#### Nasogastric Intubation

Passage of a nasogastric tube is an essential part of the examination of a horse with colic because of the diagnostic information it provides and because relief of gastric distension can be life-saving.

The nasogastric tube **must** be passed into the stomach. This is usually evident by the release of a small amount of sweet-smelling gas as the stomach is entered. The tube should then be advanced further into the stomach

and, if reflux of material does not occur spontaneously, a siphon should be established by filling the tube with approximately 500 mL of water and rapidly dropping the end of the tube below the level of the horse's stomach. This procedure should be repeated at least three or four times if reflux is not obtained. If **reflux** is obtained, its volume and character should be noted. The volume should be measured, and anything more than 2 L of net reflux is likely important. If reflux is obtained, the nasogastric tube should be left in place or replaced frequently (1-hour intervals) until the colic resolves. If there is no reflux but the horse remains colicky, then repeated attempts should be made to obtain reflux. **Oral medications** should not be given to horses with nasogastric reflux.

### Ancillary Diagnostic Techniques Ultrasonography

Ultrasonographic examination of the abdomen of adult horses is useful in identifying a number of abnormalities, including small-intestinal distension, ileocecal intussusception, gastric distension, gastric squamous cell

carcinoma, diaphragmatic hernia, peritoneal effusion, and other conditions.<sup>31-35</sup> Ultrasonographic examination is useful for detecting small-intestinal distension (such as occurs with anterior enteritis or small-intestinal accidents), reduced motility (anterior enteritis, enteritis, and obstruction), thickening of intestinal wall (>4 mm, enteritis, right dorsal colitis), volume and characteristics of peritoneal fluid (peritonitis and hemoperitoneum<sup>36</sup>), abnormalities in intestinal contents (such as presence of sand or excessively fluid ingesta), the presence of sacculations of the ventral colon (absence indicates distension), abnormalities in intestinal architecture (intussusceptions), and the presence of abnormal structures (neoplasia<sup>37</sup> and abscess<sup>38</sup>). Detection of colonic mesenteric vessels in an abnormal location (lateral or ventral to the colon) is strongly associated with a diagnosis of colon displacement or volvulus.<sup>32,39</sup> Ultrasonographic detection of small-intestinal distension is more sensitive than is rectal examination. (Fig. 7-1, A–D<sup>33</sup>).

Abdominal ultrasonography can be used for the accurate definitive diagnosis of

some small-intestinal and large-intestinal diseases. Distended and nonmotile small-intestinal loops are associated with strangulated obstruction. Failure to visualize the left kidney is associated with renosplenic entrapment, and thickened large colon is associated with strangulating volvulus.<sup>40</sup>

Ultrasonographic examination reveals colon with a mural thickness of 9 mm or greater in horses with colon torsion. The test has a sensitivity of approximately 67% (i.e., correctly predicts the presence of colon torsion in two-thirds of horses that have the disease) and specificity of 100% (correctly rules out the diagnosis in 100% of horses that do not have the disease). Similarly, ultrasonography has a sensitivity of 80% and a specificity of 98% for detection of dilated small intestine.<sup>33</sup>

The abdomen should be examined in a systematic fashion with a 2.0 to 3.5-MHz transducer, and a procedure allowing rapid examination of the abdomen of horses has been proposed (Table 7-14).<sup>33</sup> The value of this protocol is that it ensures a systematic and thorough examination of the abdomen and thorax for signs of the cause of colic. The normal ultrasonographic anatomy of equids is described.<sup>34</sup>

### Radiology

The large size of the adult horse precludes detailed radiographic examination of intra-abdominal structures. Enteroliths can be detected by computed radiography with a sensitivity of 85% and a specificity of 93%. Sensitivity is lower for small-colon enteroliths than for large-colon enteroliths (50% and 94.5%, respectively) and is significantly affected by gas distension.<sup>41</sup> Computed (digital) radiography provides some improvement in sensitivity over analog radiography, but both are useful techniques in diagnosis of enterolithiasis. Sand accumulation can be detected by radiographic examination of the abdomen.<sup>42,43</sup> Diaphragmatic hernias can be detected by radiographic (or ultrasonographic) examination of the thorax.

### Arterial Blood Pressure

Arterial blood pressure is a very good indicator of the degree of shock in colic, and the availability of a simple technique makes it a practical aid in assessing prognosis in a clinical case. If normal systolic pressure is about 100 mm Hg (13.3 kPa), a pressure below 80 mm Hg (10.6 kPa) indicates a critical situation (it can be as low as 50 mm Hg [6.6 kPa]). In horses with very severe pain but not shock, the systolic pressure is likely to be very high, up to 250 mm Hg (33.3 kPa).

### Course of the Disease

The course of the disease depends on its cause and the severity of the associated lesions. Spasmodic and gas colic usually resolves within hours of onset. Horses with

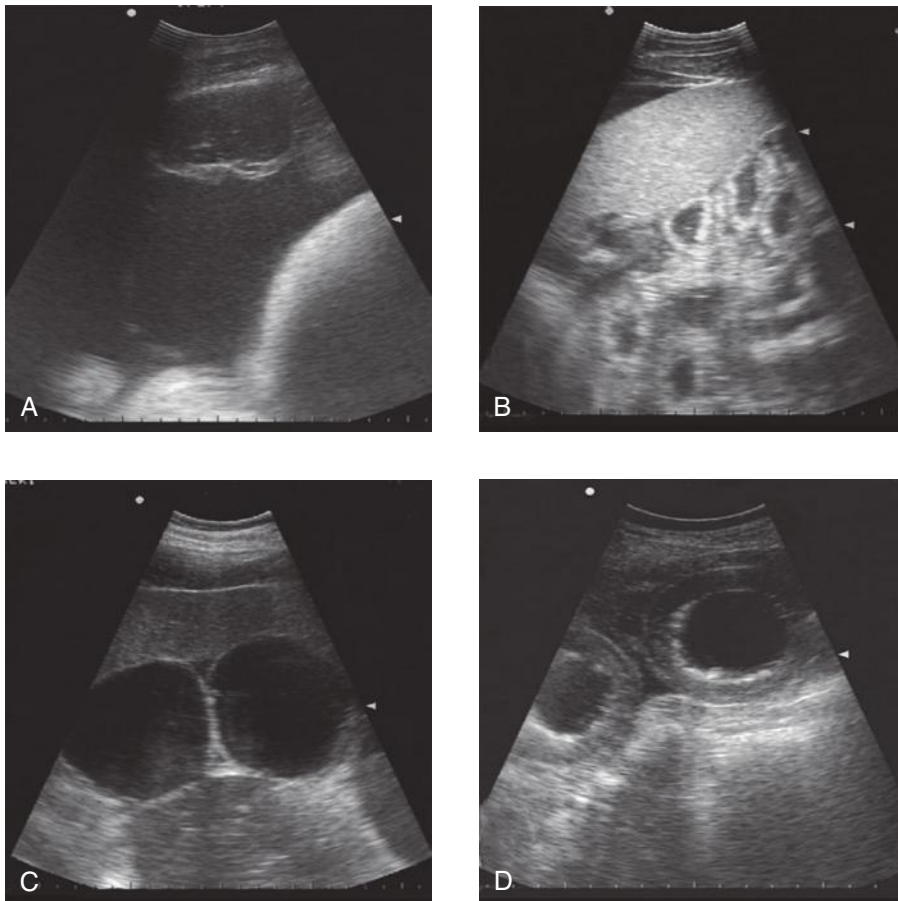

**Fig. 7-1** A, Ultrasonographic image obtained at site 1: an abnormal amount of anechoic fluid is visible. B, Ultrasonographic image showing nonturgid fluid-filled small-intestinal loops. C, Ultrasonographic image showing turgid small-intestinal loops without wall thickening in a horse with small-intestinal obstruction. D, Ultrasonographic image showing turgid small-intestinal loops with marked wall thickening in a horse with strangulated small-intestinal obstruction.

**Table 7-14** Method for brief examination of the abdomen of a horse with colic

Side	Site	Scanning procedure
Left	Ventral abdomen	Place the probe just caudal to the sternum and move caudally to assess the most gravity-dependent area of the abdomen.
	Gastric window	Visualize the stomach at the level of the 10th left ICS in the middle third (dorsoventrally) of the abdomen and then move the probe in the 2–3 ICSs cranial and caudal to the 10th one.
	Splenorenal window	Place the probe between dorsal and middle third of the abdomen at the level of the 17th ICS.
	Left middle third of the abdomen	Freely move the probe around in the middle third of the abdomen.
Right	Duodenal window	Place the probe in the 14–15th right ICS in the dorsal part of the middle third (dorsoventrally) of the abdomen.
	Right middle third of the abdomen	Freely move the probe around in the middle third of the abdomen.
	Cranial ventral thorax	Place the probe on the cranial ventral thorax just caudal to the triceps muscle.

Reproduced with permission from XX<sup>23</sup>  
ICS, intercostal space.

strangulating lesions have severe clinical signs and usually die within 24 hours of the onset of signs. Horses with nonstrangulating obstructive lesions have longer courses, often 48 hours to 1 week, and die when distension causes bowel to become devitalized and rupture.

When intestinal rupture does occur, there is a sudden onset of shock and toxemia, the acute pain that preceded it disappears, and the horse becomes quiet and immobile. The terminal stages after rupture of the intestine or stomach, or from profound endotoxemia, are very distressing. The horse might be recumbent but most continue to stand until the last few minutes, when they can literally drop dead. The respiration is sobbing and there is gross muscle tremor and profuse sweating, and there is often a delirious, staggering wandering. Euthanasia should be performed before this stage is reached.

### CLINICAL PATHOLOGY

Examination of various clinical pathology variables is useful in assessing the severity of the changes occurring as a consequence of the disease rather than in providing a definitive diagnosis. Therefore some of these variables have prognostic significance (see “Prognosis”) and should be monitored repeatedly in severe cases.

### Hematology and Serum Biochemistry

Measurement of **hematocrit** and **plasma total protein** concentration is useful in assessing hydration status (see Chapter 5). Hematocrit increases as a consequence of splenic contraction or dehydration, making the use of this variable as a sole indicator of hydration status unreliable. However, increases in both hematocrit and total protein concentration indicate dehydration,

and these variables can be used as crude estimates of response to fluid therapy. Plasma total protein concentrations may decline if there is significant loss of protein into the gut lumen or peritoneal space.

Measurement of the **blood leukocyte** count has little diagnostic significance, with the exception that the combination of leukopenia and a left shift are consistent with the endotoxemia that accompanies devitalized bowel, enteritis, or peritonitis. Serum concentrations of amyloid A, an acute phase protein, are higher in horses with colic than in healthy horses.<sup>44</sup>

Horses with severe colic often have abnormalities in coagulation, with nonsurviving horses and horses with strangulating lesions having the most severe changes, characterized by low antithrombin activity and prolonged prothrombin and activated partial thromboplastin times.<sup>26,27,29</sup> Disseminated intravascular coagulation is common among horses with ischemia or necrosis of the gut and is a good prognostic indicator of survival.<sup>26,27</sup> Changes in coagulation and fibrinolysis include decreases in antithrombin activity and fibrinogen concentration and increases in prothrombin time, activated partial thromboplastin time, and concentrations of D-dimer and thrombin–antithrombin complexes in plasma.<sup>26,27,29,45</sup> Dynamic measures of clotting function or fibrinolysis also reveal that hypocoagulation, indicated by abnormalities in one or more measures by thromboelastography, is indicative of a poor prognosis.<sup>27</sup> However, changes in these variables do not always correlate well with more dynamic measures of clotting function, such as thromboelastography.<sup>27,29</sup>

There is evidence of abnormal cardiac function or cardiac injury in up to one-half of horses with severe colic.<sup>25,46</sup> Plasma concentrations of cardiac troponin I (cTnI)

exceed the reference range for healthy horses in horses with strangulating or nonstrangulating obstructive lesions of the small or large intestine or inflammatory (noninfarctive) lesions of the intestines or peritoneum.<sup>25,46</sup> The cTnI concentration exceeded the upper reference range (>0.03 ng/mL) in 36% (9/25) horses with strangulating lesions and 47% (9/19) with nonstrangulating inflammatory (9/19 [47%]) disease.<sup>25</sup> The proportion of horses with high cTnI concentration was significantly greater among nonsurvivors (12/24 [50%]) than among survivors (10/45 [22%]).<sup>25</sup> Concentrations are higher in horses that do not survive and are negatively correlated with hematocrit and blood lactate concentration and negatively with left ventricular ejection time (a measure of cardiac function in which a shorter ejection time indicates compromised function).<sup>25</sup>

Measures of **serum electrolyte concentration** are important in providing an assessment of the horse's electrolyte status and in tailoring fluid therapy (see Chapter 5). The nature of the abnormalities depends to some extent on the cause of the disease, but is more markedly affected by the severity of the disease. Mild hyponatremia is not uncommon but is clinically unimportant in the vast majority of cases.<sup>47</sup> **Hyperkalemia** is common in horses with severe acidosis and large sections of devitalized intestine.

**Hypokalemia** is common in horses with more long-standing colic, for instance impaction of the large colon, that have not eaten for several days. **Hypocalcemia** and **hypomagnesemia** are common in horses with colic, especially horses with severe colic.<sup>47,48</sup> Measurement of total concentrations (ionized plus nonionized) can be misleading in that reductions in concentration of the physiologically important ionized component can be present in horses with normal concentrations of the total ion. Hospitalized horses with colic or diarrhea are more likely to have hypomagnesemia than are horses with other diagnoses.

Serum enzyme activities are rarely useful in aiding diagnosis or treatment of horses with colic, with the exception that **serum  $\gamma$ -glutamyl transferase (GGT)** activity is elevated in approximately 50% of horses with right dorsal displacement of the colon, whereas such elevations are rare in horses with left dorsal displacement. The elevated GGT, and less commonly serum bilirubin concentration, in horses with right dorsal displacement is attributable to compression of the common bile duct in the hepatoduodenal ligament by the displaced colon. Serum and peritoneal **alkaline phosphatase** activities are higher in horses with ischemic or inflammatory bowel disease than in horses with other forms of colic, although the differences are not sufficiently large as to be useful diagnostically. Serum creatine kinase activity above the normal range (385 U/L) is

associated with a fourfold increase in the likelihood that a horse with colic has small-intestinal ischemia.

Serum **urea nitrogen** and **creatinine** concentrations are useful indicators of hydration status and renal function. Prerenal azotemia is common in horses with colic, and can progress to acute renal failure in severe cases of colic of sufficient duration. High plasma concentrations of intestinal fatty acid binding protein (>100 pg/mL) are associated with increased need for surgery in horses with colic.

Hyperglycemia is common in horses with colic examined in referral institutions with 45% of cases having blood glucose concentrations about the reference range.<sup>49</sup> Blood glucose concentrations are indicative of the severity of disease with more severely ill horses having higher concentrations of glucose in blood.<sup>49,50</sup>

Horses that die of colic have higher circulating concentrations of epinephrine, cortisol, and lactate than do horses that survive, indicating a greater degree of sympathetic and adrenal cortical activation.<sup>51</sup>

### Acid-Base Status

Most horses with severe colic have **metabolic acidosis**, although respiratory acidosis and metabolic alkalosis also occur. Horses with less severe disease, such as simple obstructive disease or spasmodic colic, might not have abnormalities in acid-base status.

Metabolic acidosis, when severe, is usually but not always attributable to L-lactic acidosis. Lactate is present as the L-isomer, which is produced by mammalian metabolism, and the D-isomer, which is produced only by bacterial metabolism. L-Lactate accumulates as a result of increased production or decreased clearance of L-lactate by the animal. D-Lactate accumulates because of the production of this isomer in the blood or peritoneal fluid as a result of the presence of bacterial infection of these anatomic spaces or because of leakage of D-lactate produced by bacteria in the gastrointestinal tract into the circulation through compromised mucosa or as a result of a ruptured viscus.<sup>52</sup> Increases in blood and peritoneal fluid D-lactate concentrations are signs of a poor prognosis.<sup>52</sup>

L-Lactate concentrations can be estimated by calculating the anion gap:

$$\text{Anion gap} = (\text{sodium} + \text{potassium}) - (\text{bicarbonate} + \text{chloride}).$$

(If bicarbonate concentrations are not available, total serum carbon dioxide can be substituted.) However, the increasing availability of laboratory-based or stall side (point-of-care) L-lactate analyzers means that direct measurement of plasma or blood L-lactate concentrations is feasible in a variety of clinical situations.<sup>53-56</sup> Samples should be analyzed within minutes of collection unless collected into evacuated tubes containing

sodium fluoride/potassium oxalate in which case lactate concentration in plasma is stable in refrigerated samples for up to 6 hours (and perhaps longer).<sup>55</sup> Measurement of plasma lactate concentration is useful in assessing disease severity and likelihood of survival with one study documenting a 29% increase in odds of death (OR 1.20, 95% CI 1.2-1.4) for every 1 mmol/L increase in plasma lactate concentration.<sup>54</sup> Others report similar evidence in horses with surgical lesions of the small or large intestine.<sup>46</sup> Similarly, increases in plasma lactate concentration over time are indicative of a worsening prognosis.<sup>46,54</sup>

Anion gap of less than 20 mEq/L (mmol/L) is associated with 81% survival, 20 to 24.9 mEq/L (mmol/L) with 47% survival, and 25 mEq/L (mmol/L) or more with 0% survival.<sup>1</sup>

### Abdominocentesis

Analysis of peritoneal fluid is an important component of the complete examination of a horse with colic. Details of the technique and interpretation of the results were discussed previously but, briefly, if there is an increase in the total protein concentration, a change in the color to red or blood-tinged, and an increase in the leukocyte count in peritoneal fluid, it is likely that there is some insult to intraabdominal structures. The color of peritoneal fluid is also indicative of its L-lactate concentration, with yellow fluid an indicator of a low lactate concentration and red fluid having the highest concentrations.<sup>50</sup> **Total protein concentration** increases when there is an insult to the gastrointestinal tract that compromises the serosal surface of the bowel, for instance strangulating lesions of the small intestine or in the terminal stages of an impaction colic in which the bowel wall is devitalized.

Increased concentrations of **D-lactate** or **L-lactate** are associated with more severe disease and decreased chances of survival.<sup>50,52</sup> Peritoneal lactate concentrations increase with increasing disease such that 55% to 60% of horses with peritoneal lactate concentrations <2.0 mmol/L die, whereas 100% of horses with peritoneal lactate concentrations >10 mmol/L die.<sup>50</sup>

Concentrations of D-dimers in peritoneal fluid are increased in horses with increased fibrinolytic activity as a result of inflammation of the peritoneum or impaired intestinal blood flow.<sup>45,57</sup> D-dimer concentrations in peritoneal fluid are highest in horses with endotoxin in the peritoneal fluid.<sup>45</sup> Prognosis for survival declines with increasing D-dimer concentration.

The presence of intracellular bacteria, plant material, and degenerate neutrophils is indicative of gastrointestinal rupture provided that one is *certain* that the sample came from the peritoneal space and not from the bowel lumen (by inadvertent enterocentesis).

## PROTOCOL FOR EVALUATING A COLIC PATIENT

When evaluating a horse with colic the aims are to

- Determine the nature and cause of the lesion
- Establish a prognosis
- Determine the most appropriate therapy, including consideration of euthanasia
- Determine the need for referral for specialized care, including surgery

The suggested protocol for evaluating a horse with colic is discussed in the following sections. The time intervals between repeated examinations depend on a number of factors, including severity of the disease and the accessibility of the horse. For a horse with a possible intestinal obstruction this should be every hour, for a horse with probable colonic impaction examinations every 4 hours are adequate, and for a chronic colic with ileal hypertrophy an examination every day is usual. The following observations should be made.

### Behavior

The following should be assessed: severity of pain, frequency and duration of attacks, whether food is taken, amount and character of feces, and frequency of urination.

### Clinical and Clinicopathologic Observations

- **Elevated pulse rate** with a fall in **pulse amplitude** are among the most reliable indicators of the state of dehydration or shock. They can be temporarily misleading in a horse that is excited because it is in strange surroundings, or separated from its dam, foal, or close companion. They may also be marginally influenced by a bout of pain. A rate of more than 60 beats/min and a steady climb in heart rate of about 20 beats/min at each hour in a series of monitoring examinations signal a deterioration in prognosis. A high rate that continues to worsen during a period of analgesia as a result of medication also indicates a bad outcome. A small-amplitude, “thready” pulse characterizes severe shock.
- **Mucous membrane color** and **capillary refill time** are assessed. Deep congestion (dark red) or cyanosis (purple) and capillary refill times much longer than 2 seconds are indicators of peripheral circulatory failure.
- **Temperature** is infrequently taken unless there is some positive indication, such as suspicion of peritonitis, to do so.
- **Respiratory rate**, also of minor importance except as an indicator of severity of pain, or in terminal stages of endotoxic shock or dehydration, when it becomes gasping.
- **Intestinal sounds**. The disappearance of intestinal sounds indicates ileus.



Hypermotility is usually a sign of less serious disease, except in the very early stages of a small-intestinal accident. The development of a ping on auscultation–percussion indicates accumulation of gas under some pressure.

- **Rectal findings.** The development of palpable abnormalities is an ominous finding. A decision to intervene surgically is often made at this point. The inherent inadequacy of the rectal examination is that only the caudal half of the abdominal cavity can be reached. Therefore large bowel and terminal ileal problems are more easily detected. With anterior abdomen small-intestinal lesions, distended loops do not usually come into reach until 6 hours after colic commences. They may reach back as far as the pelvis by 18 hours.
- Amount and nature of **feces** is important. Failure to defecate within 12 hours of treatment is a bad sign. The empty rectum with a dry, tacky feel, or with a smear of mucus and degenerated blood some hours after the last defecation, presages a completely blocked intestine. The passage of oil but no feces suggests a partial blockage of large bowel that will permit the passage of oil but not fecal balls.
- **Reflux** through a nasogastric tube. Acute gastric dilatation or small-intestinal regurgitation of fluid sufficient to cause reflux of fluid via the stomach tube is a grim development. Large-bowel distension is also associated with fluid accumulations in the stomach. A negative test in a case suggestive of small-intestinal obstruction should be followed by repeated tests; reflux from a lesion well down in the small intestine may take some hours to reach the stomach. In ileocecal valve impaction gastric reflux may not develop until 24 hours after the commencement of the colic.
- **Abdominal paracentesis.** Repeated examinations are without serious risk and can herald the development of infarction and necrosis of gut wall, leakage and the development of peritonitis, or rupture and death caused by endotoxic shock.
- Visible **distension** of the abdomen.
- **PCV and plasma protein.** A rise in PCV of 5% (i.e., from 55%–60%) in an hour is a serious sign. A rise in PCV with a stable or declining serum protein concentration is often indicative of loss of capillary integrity and leakage of vascular proteins into extravascular spaces, such as the intestinal lumen. This is a sign of a poor prognosis.
- **Skin tenting** on its own can be a very misleading indicator of the state of a horse's dehydration, but significant changes from one examination to

another are likely to confirm deductions made on the basis of heart rate and mucosal color.

- **Arterial blood pressure** is one of the most reliable prognostic indicators in cases of colic.
- Response to **analgesics.** Diminution in the relief of pain after administration of detomidine, xylazine, butorphanol, or flunixin meglumine can be interpreted as a serious decline in the status of the affected intestine.

### When to Refer the Patient

The decision to refer a horse for specialist care and evaluation is often difficult. Most referrals occur because of the need for specialized medical or surgical treatment and therefore involve considerable expense and inconvenience to the owner. However, early referral is critical because of the improved chances of survival associated with early medical and surgical therapy of horses with severe colic.<sup>58</sup>

The criteria for referral include:

- Severe persistent pain without identifiable cause for more than 24 hours. Referral should be sooner if there is evidence of compromised cardiovascular function, or any of the signs described next.
- Recurrent attacks of colic over a period as long as several months.
- Failure of an efficient analgesic to provide analgesia or relief for at least 20 minutes.
- A rectally palpable lesion including distended small intestine, large colon, or small colon, or impaction of the large colon that does not resolve in 24 hours.
- Reflux of more than 4 L of fluid through a nasogastric tube.
- Abdominal distension.
- Blood-tinged, high-protein peritoneal fluid with a high white cell count.
- A rapid worsening of the pain and vital signs during a period of 2 to 4 hours

Not all of these criteria need to be fulfilled to warrant a decision to refer, and in most cases the presence of one of these findings is sufficient to justify a recommendation to the owner to refer the horse for further evaluation and specialized care.

Important in the decision to refer, or to perform a laparotomy, is the client's understanding of the **costs** involved and the **likely outcomes**. Because decisions to refer are often complicated by the emotional pressures on the owner and the need to make a decision quickly, it is important to take the time to fully inform the owner of the likely costs and outcomes before a final commitment is made to refer. **If there is doubt—refer it!**

### Surgery

The **decision to perform surgery** is best made by trained specialists and is usually based on a variety of clinical and clinicopathologic findings with most weight given

to the presence of severe unrelenting or intermittent pain, severe abdominal distension, large quantities of reflux through a nasogastric tube, intestinal distension palpable per rectum, serosanguinous peritoneal fluid, evidence of cardiovascular compromise including a high (>60 beats/min) and increasing heart rate, poor capillary refill, discolored mucous membranes, and the absence of borborygmi. The presence of abnormal abdominal fluid (turbid or serosanguinous) and peritoneal fluid with an elevated total protein concentration has good sensitivity (92%) and moderate specificity (74%) for the need for surgery. Formal modeling of the need for surgery in horses with colic at referral institutions provides a numerical estimate of the need for surgery, but is seldom used in most referral practices.

### Prognosis

Given the enormous emotional and financial costs of having a severely ill horse with colic, there is an obvious need for accurate prognostication. The prognosis is heavily dependent on the underlying disease, and efforts to determine the diagnosis are useful in improving the accuracy of the estimate of prognosis. For instance, strangulating infarctive lesions carry a poorer prognosis than does an uncomplicated impaction of the large colon, and a much worse prognosis than spasmodic colic. The case–fatality rates for the various causes of colic are provided in the sections addressing those diseases.

Aside from the importance to prognostication of determining an accurate diagnosis, much effort has been devoted to determining the prognostic value of various clinical and clinicopathologic factors.<sup>59</sup> Overall best predictors of survival are those clinical and clinicopathologic factors that assess cardiovascular and metabolic status. The important factors include arterial blood pressure or its clinical correlates, pulse pressure and/or capillary refill time, pulse rate, mucous membrane color, indicators of hydration status (hematocrit and serum urea nitrogen concentration), blood lactate concentration, and anion gap.

**Arterial systolic blood pressure** is one of the best predictors of survival, with horses with systolic pressures of 90 mm Hg (12 kPa) having a 50% chance of survival, whereas fewer than 20% of horses with a pressure below 80 mm Hg (10.6 kPa) survive.

**Capillary refill time**, the clinical manifestation of arterial blood pressure, is also a good predictor of the probability of survival. Capillary refill times of 3 seconds or more are associated with a survival rate of 30%. Similarly, increasing **heart rate** is associated with diminishing chances of survival—a horse with a heart rate of 80 beats/min has a 50% chance of survival, whereas one with a heart rate of 50 beats/min has a 90% chance of survival. Increasing blood lactate

concentration and anion gap (see the section [Clinical Pathology](#)) are associated with increased chance of death. Measures of hydration status are also good indicators of prognosis. A **hematocrit** of 50% (0.50 L/L) is associated with a 50% chance of survival, whereas the chance of surviving drops to 15% when the hematocrit is 60% (0.60 L/L). Horses with high circulating epinephrine, cortisol, or lactate concentrations are at greater risk of death.

Although individual variables can be good prognostic indicators, their predictive utility improves when they are combined, although this introduces the need for either remembering models or keeping the model close at hand, something often not easily accomplished in the field. Furthermore, these models have been developed from cases at specific referral institutions and are likely not be applicable to field cases or even cases at other referral sites. However, the general principles probably apply in all circumstances even if the precise weighting appropriate for each variable does not.

### NECROPSY FINDINGS

The nature of the necropsy findings depends on the underlying disease.

### DIFFERENTIAL DIAGNOSIS

Differential diagnostic features of common causes of equine colic are provided in [Table 7-15](#). The following diseases may be mistaken for colic:

- Laminitis
- Pleuritis
- Enterocolitis
- Rhabdomyolysis
- Obstructive urolithiasis
- Uroperitoneum
- Foaling and dystocia
- Uterine torsion
- Peritonitis
- Cholelithiasis
- Ovulation and ovarian pain
- Esophageal obstruction
- Duodenitis-proximal jejunitis
- Gastric ulceration
- Anthrax
- Testicular torsion
- Lactation tetany
- Tetanus
- Rabies
- Botulism
- Grass sickness
- Purpura hemorrhagica
- Clostridial myonecrosis (gas gangrene)
- Psychogenic colic

### TREATMENT

#### Medical Treatment

The specific treatment of each case of colic varies and depends on the nature of the lesion and the severity of the disease. However, several principles are common to the treatment of most colic:

- Provision of analgesia
- Correction of fluid, electrolyte, acid-base and hemostatic abnormalities
- Gastrointestinal lubrication or administration of fecal softeners
- Treatment of underlying disease

#### Analgesia<sup>2</sup>

Analgesia is important in that it relieves the horse's discomfort; minimizes the physiologic consequences of pain, including the pain-induced reduction in gastrointestinal motility; permits a thorough clinical examination; and reduces the likelihood of the horse injuring itself while rolling or thrashing. Analgesics can be broadly divided into NSAIDs, sedating analgesics, opiates, and spasmolytics. The doses of these drugs are provided in [Table 7-15](#).

The analgesic and its dose rate should be chosen such that the horse's pain is relieved, but signs of progressive cardiovascular compromise indicative of the need for more

**Table 7-15** Analgesics and spasmolytics for use in equine colic

Drug class	Drug	Dose	Comments
NSAIDs	Flunixin meglumine	0.25–1.0 mg/kg, IV or IM every 8–24 h	Potent analgesic for up to 12 h May mask signs of surgical disease
	Ketoprofen	2.2 mg/kg, IV every 12 h	Potent analgesic for up to 12 h
	Phenylbutazone	2.2–4.4 mg/kg, IV or PO every 12 h	Weak analgesic for gastrointestinal pain Minimal effect on motility
	Dipyrone	10 mg/kg, IV or IM every 4–6 h	Weak analgesic; often combined with hyoscine in commercial preparations (Buscopan compositum)
Opiates	Butorphanol	0.025–0.1 mg/kg, IV or IM as required	Potent analgesia for 30–90 min; safe. Often combined with an $\alpha$ -2 agonist May cause ataxia
	Meperidine (pethidine)	0.2–2.0 mg/kg, slowly IV or IM as required	Moderate analgesia for 0.5–4 h; can cause excitement and/or ataxia
	Pentazocine	0.5–1.0 mg/kg, IV or IM as required	Moderate analgesia; may cause ataxia
	Morphine sulfate	0.05–0.1 mg/kg slowly IV or IM as required	Potent analgesia; can cause excitement
$\alpha$ -2 Agonists	Xylazine	0.1–1.0 mg/kg, IV or IM, as needed	Potent analgesia and sedation for up to 30 min; decreases intestinal motility Often combined with butorphanol
	Detomidine	10–40 $\mu$ g/kg, IV or IM as needed	Potent analgesia and sedation for up to 120 min
	Romifidine	0.04 to 0.12 mg/kg, IV or IM	Potent analgesia and sedation
	Medetomidine	0.01–0.02 mg/kg, IV or IM	Potent analgesia for up to 120 min Sedation
Spasmolytics	Atropine	0.01–0.04 mg/kg IV or IM	Do not use because of induction of ileus
	Hyoscine butylbromide	0.1–0.4 mg/kg, IV or IM every 6–12 h	Reduces gastrointestinal motility; mild analgesic; often combined with dipyrone
Other	Acetylpromazine	0.02–0.04 mg/kg, IV or IM every 6–24 h	No analgesia but marked sedation; potent hypotensive agent; do not use
	Lidocaine	1.5 mg/kg IV loading dose followed by 0.05 (mg/kg)/min IV infusion	substance P inhibitor; analgesic, antiinflammatory, promotility agent

IM, intramuscularly; IV, intravenously; NSAIDs, nonsteroidal antiinflammatory drugs; PO, orally.

aggressive therapy or surgery are not masked. **Acupuncture** does not provide effective analgesia in horses with colic and should not be used in these animals.

#### Nonsteroidal Antiinflammatory Drugs

**Flunixin meglumine** is a potent, long-acting analgesic with the ability to mask signs of surgical disease, with the consequence that surgery might be delayed and the chance of recovery diminished. Flunixin meglumine should only be used to control pain when the diagnosis is clear or when surgical intervention is not an option. It should not be used routinely in horses being monitored for progression of disease unless such monitoring is frequent and thorough, which might not be the situation in field colics. A horse that remains painful 30 minutes after the administration of flunixin meglumine is likely to have severe gastrointestinal disease and should be further evaluated.

Comments similar to flunixin meglumine apply to **ketoprofen** but not to **phenylbutazone**, which has relatively weak analgesic effects in colic patients (as opposed to its potent analgesic effects in musculoskeletal disease). **Dipyrrone** is a weak analgesic that is useful in treatment of mild cases of colic.

Flunixin meglumine and etodolac retard recovery of equine jejunum and barrier function and flunixin inhibits electrical activity in the ventral colon. However, these effects detected in vitro have not been demonstrated to have practical relevance to treatment of horses with colic with NSAIDs. Horses in pain should not, based on current information, be deprived of these drugs.

#### $\alpha$ -2 Agonists

The  **$\alpha$ -2 agonists** (xylazine, detomidine, and romifidine) provide potent analgesia, especially when combined with the opiate **butorphanol**. Duration is relatively short (up to 90 minutes for detomidine), which means that signs of progressive disease are readily detectable. The effect of  $\beta$ -2 agonists in reducing gastrointestinal motility is not clinically important in most colic cases and should not discourage use of these very useful drugs.

#### Opiates

**Opiates**, including butorphanol, meperidine (pethidine), morphine, and pentazocine, are potent analgesics useful in the management of abdominal pain in the horse. These drugs are often combined with an  $\alpha$ -2 agonist. Morphine and meperidine can cause excitement or urticaria in some horses. All are drugs with the potential for human abuse and the consequent limitation on their availability limits their use in horses.

#### Other Agents

**Acetylpromazine** has almost no analgesic properties, although it is a potent sedative,

and should not be used in the routine treatment of colic. It is a potent hypotensive agent and should not be administered to any horse that is dehydrated or has compromised cardiovascular function.

**Hyoscine butylbromide**, a parasympatholytic drug, is widely used in certain parts of the world as the drug of choice in the initial treatment of field cases of colic. It is often combined with dipyrrone and is effective in the field treatment of mild, uncomplicated colic.

**Atropine** causes gastrointestinal stasis in horses and should not be used in the routine treatment of colic.

**Lidocaine** is a potent analgesic when administered systemically, but must be given by constant intravenous infusion. Overdosing results in central nervous system (CNS) excitement.

#### Prophylaxis and Treatment of Endotoxemia

Treatment of endotoxemia is provided elsewhere (see Chapter 4). Administration of plasma from horses **hyperimmunized** with *Salmonella typhimurium* or *E. coli* reduces the severity of clinical signs and shortens the duration of disease in horses with endotoxemia secondary to enterocolitis or colic. **Polymyxin** (5000 IU/kg intravenously every 8–12 hours) attenuates the effect of endotoxin in experimental disease and is used for the prevention and treatment of endotoxemia in hospitalized horses. Its efficacy in clinical settings has not been determined. **Aspirin** (10 mg/kg orally every 48 hours) is administered to diminish platelet aggregation around intravenous catheters. **Flunixin meglumine** (1 mg/kg intravenously every 8–12 hours) or **phenylbutazone** (2.2 mg/kg intravenously every 12 hours) is given for analgesia and to prevent endotoxin-induced increases in plasma prostaglandins. **Pentoxifylline** (8 mg/kg orally every 8 hours) is administered for its putative effective in attenuating the effects of endotoxemia. The efficacy of these treatments in a clinical setting and their effect on measures of outcome of disease, such as duration of illness, case-fatality rate, or incidence of complications, has not been determined, with the exception of hyperimmune plasma or serum.

**Antibiotics** are often administered to horses with severe colic and evidence of toxemia because of presumed bacteremia. The antibiotics of choice should have a broad spectrum including gram-negative, gram-positive, and anaerobic bacteria. A suitable regimen includes an aminoglycoside and a penicillin, possibly combined with metronidazole. NSAIDs are administered to prevent the increased production of prostaglandins induced by endotoxin and the associated clinical abnormalities including fever, malaise, and tachycardia. However, the effect of NSAIDs in improving survival or shortening

the duration of treatment has not been demonstrated.

#### Fluid and Electrolyte Therapy

Horses with evidence of dehydration, compromised cardiovascular function, or electrolyte imbalances should be administered fluids intravenously, preferably a balanced, isotonic, polyionic fluid such as lactated Ringer's solution. Horses with severe colic and signs of cardiovascular collapse require urgent resuscitation by intravenous administration of large quantities of fluids or administration of hypertonic saline followed by administration of isotonic fluids. Horses with hypoproteinemia could benefit from administration of plasma or colloidal fluids such as hetastarch (see Chapter 4 for details on fluid therapy and the section on **Shock** for a discussion of the treatment of this syndrome.)

#### Intestinal Lubricants and Fecal Softeners

The intestinal lubricant of choice is **mineral oil** (Table 7-16). It should be given only through a nasogastric tube because its aspiration is associated with severe and usually fatal pneumonia. Mineral oil is useful in cases of mild impaction colic and is often administered when the cause of the colic is not known, provided that there is no reflux of gastric contents through the nasogastric tube.

**Diocetyl sodium sulfosuccinate** is a fecal softener with the potential to be toxic at therapeutic doses, and its use is now not generally recommended. **Magnesium sulfate** is an effective fecal softener useful in the treatment of impaction colic. However, it can cause hypermagnesemia and toxicosis characterized by depression and signs of CNS dysfunction. **Sodium sulfate** is a safe and effective fecal softener, although it can induce mild hypernatremia and hypokalemia.

#### Other Treatments

**Promotility agents** (see Table 7-16) may be used in cases of ileus or large-colon impaction. Postoperative ileus is a common complication of surgical colic and should be treated by maintenance of hydration and electrolyte status and the administration of promotility agents.<sup>60</sup> **Cisapride** is apparently effective in reducing the incidence of postoperative ileus and may be useful in the treatment of ileus from other causes. The clinical efficacy of other putative promotility agents has not been demonstrated.

**Heparin** and low molecular weight heparins have been recommended for the treatment and prevention of coagulopathies associated with severe colic. The use of heparin or low molecular weight heparin is associated with increased risk of hemorrhage and heparin use causes a decrease in hematocrit. The efficacy of this treatment

**Table 7-16** Promotility agents, lubricants, and fecal softeners for use in horses with colic

Drug group	Drug	Dose	Comments
Lubricants	Mineral oil	10–15 mL/kg, via nasogastric tube, every 12–24 h	Safe; lubricant only, does not soften feces; usually passed in 12–36 h*
Fecal softeners	Diocetyl sodium sulfosuccinate	12–25 mg/kg, via nasogastric tube, every 24 h	No more than two doses; toxic at higher doses*
	Magnesium sulfate	0.5–1.0 g/kg, via nasogastric tube, in water	Osmotic cathartic; toxic (CNS signs caused by hypermagnesemia) with repeated dosing*
	Sodium sulfate	1.0 g/kg, via nasogastric tube, in water, every 12 h	Osmotic cathartic; mild hypernatremia; safe*
	Psyllium	1 g/kg, orally, every 24 h	Bulk laxative; used for treatment of sand accumulation; efficacy uncertain but widely used*
Promotility agents	Lidocaine	1.5 mg/kg slow IV, then 0.05 mg/kg/min infusion	Analgesic, antiinflammatory, promotility; used to treat ileus; toxicity evident as CNS signs
	Metoclopramide	0.25 mg/kg IV slowly over 30 min every 12 h	Toxic; minimally effective
	Erythromycin	1 (mg/kg)/h IV	Questionable efficacy; may induce colitis
	Cisapride	0.1 mg/kg, IV every 8 h	Effective in prevention and treatment of postoperative ileus; may prolong cardiac Q-T interval (importance unknown)
	Neostigmine	0.02 mg/kg, IM or SC, every 8–12 h	Increases large-colon motility, decreases small-intestine motility; may cause colon rupture around hard impaction

CNS, central nervous system; IM, intramuscularly; IV, intravenously; SC, subcutaneously.

\*None of these agents should be given if there is reflux through the nasogastric tube.

in improving survival has not been demonstrated.

### Trocarization

Occasionally in severe cases of flatulent (gas) colic or in cases of colon torsion in which the abdominal distension is impairing respiration, it may be necessary to relieve the gas distension of the colon or cecum by trocarization. Trocarization is usually performed through the **right paralumbar fossa** immediately caudal to the last rib. The exact place for trocarization can be located by simultaneously flicking the body wall with a finger and listening with a stethoscope. The area of loudest ping will indicate the point of insertion of the trocar. A suitable trocar is a 12.5- to 15-cm 14- to 16-gauge needle. The needle is inserted through the skin and advanced into the abdomen until there is an audible expulsion of gas through the trocar. The trocar should be kept in position as long as gas is escaping. It may need to be replaced as the bowel is decompressed and moves away from the trocar. The procedure is reasonably safe but will cause inflammatory changes in the peritoneal fluid. The major danger is laceration of the colon or cecum and leakage of ingesta. It is advisable to administer systemic antibiotics to horses that have been trocarized.

A device for facilitating transrectal decompression of intestinal tympany is described with encouraging results.<sup>61</sup> However, this technique cannot be recommended until there are further studies of its efficacy and safety.

### Management of Field Colic

Initial treatment of field cases of colic that do not have signs indicative of the need for referral or surgery usually includes administration of an analgesic and an intestinal lubricant. Analgesics suitable for the initial treatment of colic in the field are an  $\alpha$ -2 agonist, such as xylazine, hyoscine butylbromide, dipyrone, butorphanol, or phenylbutazone. If there is no reflux through the nasogastric tube, then mineral oil should be administered. Fluids should be administered intravenously if there are signs of dehydration, cardiovascular compromise, or electrolyte imbalance. The response to this therapy should be monitored as described under the section “**Protocol for Evaluating a Colic Patient**” in this chapter. Further doses of analgesic can be given as required, and the horse should be monitored for any evidence of deterioration. If referral is contemplated, the referral institution should be contacted for advice on analgesia during transportation. Horses should be transported with a nasogastric tube in place.

### Surgery

The only definitive treatment for many causes of equine colic is surgical correction or removal of the lesion. The availability of surgical facilities staffed by appropriately trained personnel has increased over the past two decades and there is often the opportunity to refer horses for examination by personnel with specialist training. Gastrointestinal surgery should not be attempted by those untrained or inexperienced in the

necessary techniques or without the facilities to provide postoperative care.

The decision to perform an exploratory laparotomy on a horse with colic is based on a number of factors, including the provisional diagnosis, findings on physical and laboratory examination, and degree of pain. Horses with severe pain refractory to treatment with analgesics should have an exploratory laparotomy even if no other significant abnormalities can be detected. Algorithms for the decision to perform surgery have been developed, but are not perfect and do not replace the opinion of an appropriately trained and experienced examiner. Examination of peritoneal fluid contributes to the decision to perform surgery. The survival rate for horses undergoing surgical correction of lesions depends on the nature and location of the underlying disease and its duration. However, survival rates range from 50% to 75%, with approximately two-thirds of horses returning to their intended use.<sup>62</sup> The survival rate of horses with small-intestinal lesions is less than that of horses with large-intestinal disease, and the survival rate for horses with strangulating disease is much less than that of horses with nonstrangulating disease.<sup>59</sup> Thoroughbred racehorses that return to racing after colic surgery do so successfully.<sup>63</sup>

### Prevention

Minimization of colic episodes depends on management factors, including ensuring adequate parasite control, feeding large quantities of forage and minimizing the



amount of concentrate fed, and providing dental care. However, most cases of colic not attributable to parasites or dietary factors cannot be prevented.

### FURTHER READING

- Archer DC, Proudman CJ. Epidemiological clues to preventing colic. *Vet J*. 2006;172:29.
- Dukti S, White NA. Prognosticating equine colic. *Vet Clin North Am Equine Pract*. 2009;25:217.
- Robertson S, Sanchez LC. Treatment of visceral pain in horses. *Vet Clin North Am Equine Pract*. 2010;26:603.

### REFERENCES

- Radostits O, et al. Equine Colic. *Veterinary Medicine: A Textbook of the Diseases of Cattle, Horses, Sheep, Goats and Pigs*. 10th ed. London: WB Saunders; 2007:215.
- Robertson S, et al. *Vet Clin North Am Equine Pract*. 2010;26:603.
- Issaoui L. *Vet Rec*. 2013;172.
- Slater J. *Vet Rec*. 2014;175:271.
- Higuchi T. *J Equine Sci*. 2006;17:17.
- Archer DC, et al. *Vet J*. 2006;172:29.
- Suthers JM, et al. *Equine Vet J*. 2013;45:558.
- Kaya G, et al. *J Anim Physiol Anim Nutr (Berl)*. 2009;93:339.
- Alexander GR, et al. *Equine Vet Educ*. 2012;24:193.
- Fielding CL, et al. *Equine Vet J*. 2012;44:472.
- Walmsley E, et al. *Aust Vet J*. 2011;89:180.
- Archer DC, et al. *BMC Vet Res*. 2006;2:27.
- Escalona EE, et al. *BMC Vet Res*. 2014;10.
- Patipala LA, et al. *JAVMA*. 2012;240:1488.
- Back H, et al. *Vet Parasitol*. 2013;197:580.
- Pavone S, et al. *Vet Res Commun*. 2010;34(suppl 1):S53.
- Trotz Williams L, et al. *Vet Parasitol*. 2008;153:73.
- Cribb NC, et al. *N Z Vet J*. 2006;54:338.
- van Loon JPAM, et al. *Vet J*. 2014;200:109.
- Dugdale AHA. *Vet J*. 2014;200:210.
- Graubner C, et al. *Vet J*. 2011;188:178.
- Hesselkilde EZ, et al. *Acta Vet Scand*. 2014;56.
- Diaz OMS, et al. *JAVMA*. 2014;245:118.
- Borde L, et al. *J Vet Emerg Crit Care*. 2014;24:302.
- Nath LC, et al. *JAVMA*. 2012;241:1202.
- Cesarini C, et al. *J Vet Intern Med*. 2010;24:1490.
- Epstein KL, et al. *J Vet Intern Med*. 2011;25:307.
- Cesarini C, et al. *J Vet Emerg Crit Care*. 2014;24:672.
- Dunkel B, et al. *J Vet Intern Med*. 2010;24:1467.
- Sutton GA, et al. *Vet J*. 2013;197:646.
- Sheats MK, et al. *Equine Vet J*. 2010;42:47.
- Abutarbush SM. *JAVMA*. 2006;228:409.
- Busoni V, et al. *Vet J*. 2011;188:77.
- Epstein K, et al. *Vet Radiol Ultra*. 2008;49:282.
- le Jeune S, et al. *Vet Clin Equine*. 2014;30:353.
- Conwell RC, et al. *Vet Rec*. 2010;167:514.
- Taylor SD, et al. *J Vet Intern Med*. 2006;20:1429.
- Arnold CE, et al. *JAVMA*. 2012;241:1659.
- Ness SL, et al. *Can Vet J*. 2012;53:378.
- Beccati F, et al. *Equine Vet J*. 2011;43:98.
- Maher O, et al. *JAVMA*. 2011;239:1483.
- Kendall A, et al. *Acta Vet Scand*. 2008;50:17.
- Keppie N, et al. *Vet Radiol Ultra*. 2008;49:122.
- Pihl T, et al. *Vet Clin Pathol*. 2013;42:177.
- Delgado MA, et al. *J Vet Intern Med*. 2009;23:882.
- Radcliffe RM, et al. *J Vet Emerg Crit Care*. 2012;22:313.
- Borer KE, et al. *Equine Vet Educ*. 2006;18:320.
- Borer KE, et al. *Equine Vet Educ*. 2006;18:266.
- Hassel DM, et al. *J Vet Intern Med*. 2009;23:1261.
- van den Boom R, et al. *Equine Vet Educ*. 2010;22:420.
- Mair TS, et al. *Vet J*. 2014;201:370.
- Yamout SZ, et al. *Vet Surg*. 2011;40:817.
- van Oldruitenborgh-Oosterbaan MMS, et al. *J Vet Diagn Invest*. 2008;20:83.
- Tennent-Brown BS, et al. *J Vet Intern Med*. 2010;24:198.
- Tennent-Brown BS, et al. *J Vet Intern Med*. 2007;21:1090.
- Tennent-Brown BS. *Comp Contin Educ Vet*. 2011;33:E5.
- Delgado MA, et al. *J Vet Intern Med*. 2009;23:1232.
- Cook VL, et al. *Vet Clin Equine*. 2014;30:383.
- Dukti S, et al. *Vet Clin North Am Equine Pract*. 2009;25:217.
- Koenig J, et al. *Can Vet J*. 2006;47:551.
- Scotti GB, et al. *Equine Vet Educ*. 2013;25:184.
- Davis W, et al. *Equine Vet J*. 2013;45:224.
- Hart SK, et al. *JAVMA*. 2014;244:205.

## COLIC IN THE PREGNANT AND POSTPARTURIENT MARE

Diagnosis and management of colic in pregnant and immediately postparturient mares is challenging because of the variety of conditions that can cause the disease, the difficulty in examination of intraabdominal organs in late-term mares, and concern about the viability of the fetus. There are also substantial technical challenges in surgical correction of abnormalities of either the gastrointestinal tract or reproductive tract in the presence of a gravid uterus. Colic in late-term mares can be caused by any of the causes of colic in adult horses (see the section Equine Colic), but some disorders are more common in late-term mares and, in addition to abnormalities of the reproductive tract, can cause signs of colic.<sup>1</sup> Causes of colic in the late-term mare include:

- Idiopathic, chronic, or recurrent, low-grade colic
- Large colon torsion
- Large colon impaction
- Incarceration of small intestine through a mesenteric rent
- Rupture of the cecum or colon
- Uterine torsion
- Uterine rupture
- Middle uterine or uteroovarian artery rupture
- Abdominal wall hernia
- Diaphragmatic hernia
- Dystocia
- Hydrops
- Imminent foaling

A common presentation of colic in late-term mares is chronic or recurrent, low-grade abdominal pain that is not associated with any signs of compromised cardiovascular or gastrointestinal function. It is assumed that the large gravid uterus interferes with normal motility or positioning of bowel, with subsequent pain. Severe colic in late-term mares is rarely associated with the uterus, with the exception of uterine torsion.

Colic in immediately postparturient mares (<24 hours after foaling) include:

- Cramping associated with uterine contractions and involution, often

coincident with nursing or administration of oxytocin

- Rupture of the cecum or colon
- Primary idiopathic ileus and gastric rupture<sup>2</sup>
- Incarceration of the small intestine through a mesenteric rent
- Rupture of the mesocolon with segmental ischemia of the small colon
- Rectal prolapse
- Uterine tear, with or without prolapse of intestine
- Uterine prolapse
- Inversion of uterine horn
- Bladder prolapse through urethra
- Hemorrhage from uterine or uteroovarian artery
- Retained fetal membranes
- Uroperitoneum, usually secondary to rupture of the bladder

Colic in postparturient mares that is anything more than transient and associated with passage of placenta or nursing of the foal should be considered important and the mare should be examined closely and, if the colic does not resolve, repeatedly.

Idiopathic primary ileus and gastric rupture refers to a specific syndrome in postparturient mares that present with moderate to severe colic secondary to gastric and small-intestinal distension and ileus. There can be rupture of the stomach and death. The disease is most common in mares with 1 week of foaling, but can occur up to 2 months after parturition. The colic is acute and moderate to severe. Nasogastric intubation returns excess gas and fluid, and rectal or ultrasonographic examination reveals distended loops of atonic small intestine. Treatment is by relief of gastric distension by nasogastric intubation and supportive therapy (fluids and pain relief). Approximately 50% of mares require surgical exploration of the abdomen to confirm the diagnosis and allow decompression of the small intestine and stomach. Survival rate is approximately 90% with appropriate treatment.<sup>2</sup>

**Survival rates** for colic associated with anatomic abnormalities in late-term or postparturient mares are 50% and 30%, respectively.

**Clinical examination** of late-term or postparturient mares with colic uses the same principles as applied to examination of nonpregnant adult horses with colic. Monitoring of vital signs, passage of a nasogastric tube, rectal examination, and collection of peritoneal fluid should all be performed as indicated. However, the presence of a gravid uterus in late-term mares impairs rectal examination of the abdomen and often makes collection of peritoneal fluid impossible. Manual and visual (through a speculum) examination of the vagina and cervix should be performed.

**Rectal examination** should be performed and careful attention should be paid to examination of the uterus, including

position and viability of the fetus and broad ligaments. Uterine torsion can be detected by examination of the broad ligaments, which in mares with uterine torsion will be taut and spiral in the direction of the torsion. Hemorrhage into the broad ligament, which can extend into the uterus and perivaginal regions, is detectable as swelling in these structures. Additionally, affected mares will have signs of hemorrhagic shock, including tachycardia, sweating, and pallor of mucous membranes. Palpation of gastrointestinal structures per rectum is limited in the late-term mare, although the cecum and small colon should be palpable. The spleen and left kidney can be palpated in almost all normal late-term mares.

The reduced uterine size in postparturient mares permits more thorough per rectum examination of the caudal abdomen. Again, careful attention should be given to palpation of the uterus and associated structures for evidence of hemorrhage, prolapse, or rupture. **Rectal prolapse** and eversion of the small colon in a postparturient mare is an ominous finding because it is usually associated with rupture of the mesocolon and ischemic necrosis of the small colon, a condition that is almost always fatal. Prolapse of small amounts of anal or perirectal tissue is not a serious concern.

The **abdominal silhouette** should be examined for evidence of abdominal distension, such as can occur with colon torsion or uterine hydrops, and abnormalities in contour caused by rupture of the prepubic tendon and herniation of abdominal contents.

**Vaginal and cervical examination** can reveal discharge associated with impending abortion or parturition. Vaginal examination for uterine torsion is of limited value because the torsion almost always occurs cranial to the cervix so that, unlike the cow, the torsion is not apparent as deformation of the cervix. Manual examination of the vagina, cervix, and uterus of postparturient mares with colic is important to detect uterine, cervical and vaginal trauma, uterine inversion, and retained fetal membranes.

**Ultrasonographic examination** of the abdomen in the late-term mare, both per rectum and percutaneously, allows examination of structures not palpable per rectum. The presence and any abnormalities in structure, location, and motility of bowel should be noted. For example, small-intestinal distension caused by entrapment through a mesenteric rent may not be palpable per rectum but can be imaged. Peritoneal fluid should be examined for quantity and echogenicity. Intraabdominal hemorrhage caused by uterine artery rupture is evident as large quantities of echogenic fluid that has a characteristic swirling pattern similar to turbulent blood flow imaged ultrasonographically in the cardiac ventricles of some

horses. The position, number, and viability of the fetus or fetuses should be ascertained. The nature of allantoic fluid should be noted.

Collection of **peritoneal fluid** from late-term mares can be difficult because of contact between the gravid uterus and the ventral abdominal wall. Ultrasonographic examination can be useful in locating pockets of fluid for collection. Collection of peritoneal fluid is more readily accomplished in the postpartum mare. Peritoneal fluid from late-term and postpartum mares, even those with assisted vaginal delivery, should have protein and cell concentrations within the reference range of normal horses. Abnormalities in peritoneal fluid in late-term or postparturient mares should be considered to be indicative of intraabdominal disease.

The **differential diagnosis** of colic is similar to that of nonpregnant horses except as indicated previously.

**Treatment** of colic depends on its cause. Horses with low-grade to moderate, recurrent colic respond to administration of low doses of NSAIDs, mineral oil, or fecal softeners. Clenbuterol is sometimes administered for its tocolytic effect,<sup>3</sup> but the efficacy of this practice is unclear. Progestins are sometimes administered in an attempt to prevent abortion of mares after resolution of colic, but there is evidence of their lack of efficacy in this respect.<sup>4</sup>

The **risk of abortion** in mares with colic is partially dependent on the severity of the colic and it cause, necessity for surgical intervention, the duration of colic, and the stage of gestation.<sup>3-6</sup> Abortion rates in pregnant mares treated for colic at referral institutions vary from ~20% to 50% depending on the particular disease.<sup>3-6</sup> Severely ill mares with signs of toxemia have abortion rates of almost 70%, whereas mares with less severe disease have abortion rates of 8% to 18%, which is not markedly different from the rate in mares without colic.<sup>3</sup> Mares treated surgically have a greater relative risk of abortion (3.5, 95% CI 1.7–7.3) than mares treated medically. For mares treated surgically, hypotension during surgery and prolonged anesthesia are significant risk factors for abortion.<sup>4</sup> The need for surgical intervention, hypotension during surgery, and prolonged anesthesia are likely indicative of more severe disease, which could account for the higher abortion rate in these mares.<sup>4</sup>

#### FURTHER READING

Steel CM, Gibson KT. Colic in the pregnant and periparturient mare. *Equine Vet Educ*. 2001;13:94.

#### REFERENCES

1. Crabtree J. *In Pract*. 2012;34:400.
2. Hillyer MH, et al. *Equine Vet J*. 2008;40:368.
3. Bartmann CP, et al. *Pferdeheilkunde*. 2012;28:406.
4. Chenier TS, et al. *Can Vet J*. 2009;50:481.
5. Drumm NJ, et al. *Equine Vet J*. 2013;45:346.

6. Radostits O, et al. Colic in the Pregnant and Postparturient Mare. *Veterinary Medicine: A Textbook of the Diseases of Cattle, Horses, Sheep, Goats and Pigs*. 10th ed. London: WB Saunders; 2007:229.

## COLIC IN FOALS

### SYNOPSIS

**Etiology** See Table 7-17.

**Epidemiology** Sporadic. Some causes are congenital, others heritable. Inguinal and scrotal hernias occur only in males.

**Clinical signs** Abdominal pain evidenced by kicking at the abdomen, flank watching, repeated tail movements as if chasing flies, repeated aborted attempts to suck, frequent lying down and standing within a short period, and rolling and lying in dorsal recumbency. Abdominal distension in some diseases and straining to defecate with meconium impaction. Radiography and ultrasonography are useful in identifying affected bowel.

**Clinical pathology** Nonspecific.

**Lesions** Are of the causative disease

**Diagnostic confirmation** Physical examination, radiography, ultrasonography, laparotomy, and necropsy

**Treatment** Pain control, fluid therapy, supportive care including consideration of the foal's nutritional requirements, and treatment of causative disease

### ETIOLOGY

Diseases that cause colic in horses less than 1 year of age include both congenital and acquired conditions and are listed in Table 7-17. Fifty percent of neonatal Thoroughbred foals subjected to exploratory laparotomy had nonstrangulating lesions and 30% had enteritis. Among foals 2 weeks to 6 months of age, 30% of foals subjected to exploratory laparotomy had gastric ulcer disease, 27% strangulating lesions, 21% nonstrangulating lesions, and 17% enteritis.<sup>1</sup> The most common causes of colic in foals less than 30 days of age examined at a referral institution were enterocolitis (27%), meconium-associated colic (20%), transient colic of undetermined cause (19%), and necrotizing enterocolitis (16%).<sup>2</sup> Eight percent of foals examined had small-intestinal infarctive/obstructive lesions and 7% had other lesions, with 1.5% having overo lethal white syndrome.<sup>2</sup>

**Diaphragmatic hernia** is an uncommon cause of colic in newborn foals and can be congenital or acquired.<sup>3-5</sup> Intestinal accidents including displacements of the large colon and extraluminal obstruction of the small colon by ovarian pedicle are uncommon.<sup>6,7</sup> Herniation of the large colon through umbilical hernia is reported.<sup>16</sup> Pancreatitis in foals can cause signs of colic.<sup>8</sup> Intestinal hyperammonemia can cause colic, diarrhea, and signs of neurologic disease in foals.<sup>9</sup>

Table 7-17 Diseases causing colic in foals

Congenital anomalies	Anal atresia	
	Colonic atresia	
	Rectal atresia	
	Ileocolonic agangliosis	
	Myenteric hypogangliosis	
	Inguinal hernia	
	Diaphragmatic hernia	
	Umbilical hernia	
	Scrotal hernia	
	Gastrointestinal obstruction with or without infarction	Meconium impaction
		Ileus, secondary to extraintestinal disease including neonatal hypoxia
		Small-intestinal volvulus
		Large-intestinal volvulus
		Intussusception
		Jejunojejunal
Ileocecal		
Small colon obstruction		
Fecalith		
Impaction		
Meconium		
Entrapment in hernia, mesenteric rents		
Large colon obstruction		
Impaction		
Intussusception		
Torsion		
Other	Necrotizing enterocolitis	
	Adhesions	
	Colonic stricture	
	Ileal impaction: foreign body	
	Ascarid impaction: small intestine	
	Phytobezoar	
	Gastric ulcer	
	Duodenal ulcer	
	Abdominal abscess	
	Umbilical abscess	
	Peritonitis	
	Tyzer's disease ( <i>Clostridium piliforme</i> ) <sup>1</sup>	
	Uroperitoneum	
	Enteritis	
	Ovarian torsion <sup>2</sup>	

## EPIDEMIOLOGY

Risk factors vary with the cause of colic, although congenital conditions such as **ileocolonic aganglioneurosis** in white progeny of overo spotted horses are clearly heritable, whereas others, such as “short colon” are not.<sup>10</sup> Most conditions occur sporadically, although **meconium impaction** is more common in colt foals and occurs only in the newborn foal, **intussusceptions** are most common in foals of 3 to 5 weeks of age and particularly those with diarrhea or

extraintestinal illness, and impaction of the small colon by **fecaliths** is common in miniature horse foals.<sup>1</sup> Impaction by roundworms (*P. equorum*) is a common cause of small-intestinal obstruction in foals.<sup>11</sup> **Inguinal and scrotal hernias** occur only in male foals.

**Case-fatality rate** varies with the underlying disease, but 75% of foals treated at a referral institution survived to discharge from hospital, with similar survival rates for medically and surgically treated foals.<sup>2</sup>

Foals with clinical or clinicopathologic signs of more severe disease (greater pain, absent borborygmi, abdominal distension, and evidence of hypoperfusion) had a lower survival rate.<sup>2</sup> The long-term survival rate and suitability for use is excellent for most foals that have recovered from colic (93%).<sup>2</sup> The **mortality rate** attributable to colic in foals in Japan was 1.5% (74/4843).<sup>12</sup>

## PATHOPHYSIOLOGY

The pathophysiology of colic in foals does not differ qualitatively from that of adult horses (see the section Equine Colic). The importance of pain, gastrointestinal distension, motility, and absorptive disturbances and loss of barrier function are all similar in foals and adults. Additionally, in young foals gastrointestinal disease may prevent nursing and ingestion of colostrum, causing failure of transfer of passive immunity (FTPI) to the foal. Failure to nurse also results in hypoglycemia and dehydration, which may exacerbate the abnormalities induced directly by the disease causing colic.

## CLINICAL FINDINGS

Pain is the cardinal feature of gastrointestinal disease of foals. Foals with mild **abdominal pain** are apprehensive and walk continuously with frequent but brief (<1 min) periods of sternal or lateral recumbency. Affected foals make frequent attempts to nurse but do not continue to suckle and may butt the mare's udder even though there is a letdown of milk. The foal vigorously moves its tail as if chasing flies, looks at the abdomen, and may nip at its flanks. There are often frequent attempts to urinate or defecate but without passage of significant quantities of urine or feces. Severely affected foals will roll, often violently, and may spend considerable periods of time in dorsal recumbency, often propped up against walls or fences.

Severely affected foals are **tachycardic** (>100 beats/min) and **tachypneic** (<40 beats/min; recall that young foals have higher heart and respiratory rates and rectal temperature than do older foals and adults). **Mucous membrane color** and **capillary refill time** are similar to that of adult horses, and changes can be interpreted in the same manner as for adults.

The **external abdomen** should be examined closely for the presence of inguinal, scrotal, or umbilical hernias. Abdominal distension in foals can be the result of large-colon or small-intestinal distension (or uroperitoneum), although the abdominal distension is greater with large-colon distension. Abdominal circumference should be monitored frequently by direct measurement to detect changes in the degree of abdominal distension.



**Auscultation** of the abdomen may reveal increased or decreased borborygmi and, if there is gas distension of the large colon or cecum, pinging sounds on simultaneous flicking and auscultation of the abdomen.

**Rectal examination** in foals is limited to exploration of the rectum with one or two fingers. The presence or absence of feces should be noted. Lack of fecal staining of the rectum suggests a complete obstruction such as intestinal agensis.

**Nasogastric intubation** should be performed. The presence of more than 300 mL of reflux in a foal is significant and suggestive of gastric dilatation secondary to an outflow obstruction or regurgitation of small-intestinal fluid into the stomach because of a small-intestinal obstruction.

Meconium is usually passed within the first 10 to 12 hours (usually 3 hours) after birth. **Retention of meconium** is evident as signs of colic and the presence of firm meconium in the rectum. Palpation of the caudal abdomen may reveal firm material in the small colon. Enemas (see the section **Treatment**) usually provide rapid relief and confirmation of the diagnosis.

### Ancillary Diagnostic Tests

#### Diagnostic Imaging

**Radiography** is useful in the evaluation of foals with colic, although it seldom provides a definitive diagnosis, with the possible exception of meconium impaction and contrast studies of foals with lesions of the small or large colon, or gastric outflow obstructions. **Retrograde contrast radiography** of the lower gastrointestinal tract of foals less than 30 days old is a sensitive technique for detection of anatomic anomalies such as **atresia coli** and obstruction of the **small colon**. The technique is performed by the intrarectal infusion of up to 20 mL/kg of barium sulfate (30% w/v) in sedated, laterally recumbent foals. **Meconium impaction** can be evident as a mass of radiopaque material in the caudal abdomen with accumulation of fluid and gas oral to the obstruction. Upper gastrointestinal contrast radiography is useful to detect abnormalities of the stomach and small intestine, in particular gastric outflow obstructions.

**Ultrasonographic examination** of the foal abdomen can demonstrate intussusceptions, the presence of excessive peritoneal fluid (such as urine or blood), edematous intestine, hernias, and colonic impaction. The presence of atonic, distended small intestine suggests the presence of ileus, possibly secondary to a small-intestinal strangulating lesion. However, early ultrasonographic differentiation of ileus secondary to enteritis from that accompanying a strangulating lesion is difficult. Detection of gas within the wall of the small or large intestine (pneumatosis intestinalis) is indicative of a

poor prognosis and the presence of necrotizing enterocolitis.<sup>13</sup> There is a high prevalence of asymptomatic intussusceptions (~50%) detected in healthy neonatal foals by ultrasonographic examination.<sup>14</sup> Detection of an intussusception in this way should be considered in light of the foal's other clinical signs and in a healthy foal should not necessarily provoke more extensive examination.

#### Endoscopy

**Endoscopic examination** of the stomach is indicated in any foal with recurrent or continuous mild to moderate colic, bruxism, or ptyalism suggestive of gastric or duodenal ulceration. Gastroscopy reveals the presence of any ulcers and their extent and severity.

### CLINICAL PATHOLOGY

There are few changes detected by routine hematological or serum biochemical examination of foals with colic that provide a definitive diagnosis. However, changes in the hemogram and serum biochemical profile are useful in evaluating the physiologic state of the foal and the severity of the disease. Principles used in the evaluation of these variables in adult horses apply to foals. It should be appreciated that the normal range of values for many clinical pathology variables in foals is age dependent and markedly different from that of adult horses.

Profound leukopenia is more likely to be indicative of enteritis and colic secondary to ileus than of small-intestinal strangulating obstructions. Similarly, hyponatremia is uncommon with strangulating obstructions but is a common finding in foals with enteritis.

Newborn foals with colic should have the adequacy of transfer of passive immunity examined by measurement of serum IgG concentration, or an equivalent test.

Examination of abdominal fluid is useful in the assessment of colic in foals, as it is in adults. The normal values for abdominal fluid in foals differs from that of adult horses and white cell counts greater than 1500 cells/ $\mu$ L ( $1.5 \times 10$  cells/L) should be considered abnormal.

### NECROPSY FINDINGS

The findings on necropsy examination depend on the nature of the disease.

### TREATMENT

The principles of treatment of foals with colic are the same as those for adult horses: relief of pain, correction of fluid and electrolyte abnormalities, and treatment of the underlying disease. In addition, foals with **FTPI** should receive plasma.

Foals with gastrointestinal disease that cannot eat may require **parenteral nutrition** to ensure adequate caloric intake.

### DIFFERENTIAL DIAGNOSIS

Diagnostic features of common causes of colic in foals are listed in **Table 7-18**. The principal differential diagnoses for gastrointestinal disease of foals with abdominal pain are

- Enteritis caused by rotavirus infection, salmonellosis intestinal clostridiosis (*Clostridium perfringens* or *C. difficile* or other causes).
- Uroperitoneum
- Peritonitis
- Gastroduodenal ulcer disease

**Meconium impaction** can be treated by administration of an enema of soap and warm water, commercial enema preparations, or acetylcysteine. Soap and water enemas can be administered at a rate of 5 mL/kg through a soft Foley catheter inserted into the rectum. **Acetylcysteine** (8 g in 200 mL of water with 20 g sodium bicarbonate) has the advantage of actually dissolving part of the meconium, enhancing passage of the meconium. Affected foals may require analgesics to control pain, intravenous fluids to correct or prevent dehydration, oral laxatives such as mineral oil (300 mL via nasogastric tube), and plasma to correct FTPI. Surgical correction of the impaction is rarely required.

### Surgical Treatment

The proportion of foals surviving varies with the disease and age of the foal.<sup>15</sup> Younger foals (<6 months of age) appear to have a worse prognosis after surgical correction of intestinal lesions than do older foals. Fewer foals having surgery for colic live to race than do their normal cohorts, although affected foals that do race have similar racing careers.<sup>1</sup> Others have reported no adverse effect of surgical treatment for colic on surviving foals.<sup>2</sup> Foals with nonstrangulating lesions and enteritis are more likely to survive than foals with gastric ulcer disease or strangulating lesions. Suckling foals are at greatest risk of development of postoperative adhesions and need for repeated celiotomy.<sup>1</sup>

### PREVENTION

Although not proven, the suspected association between diarrhea and small-intestinal surgical lesions in foals suggests that measures to reduce the incidence of enteritis in foals could reduce the incidence of colic. Adequate deworming programs that reduce or eliminate infestation with parasites should be implemented. Care should be taken when deworming foals with heavy infestations of *P. equorum*, as rapid killing or paralysis of the ascarids can lead to impaction and obstruction of the small intestine.<sup>11</sup>



Table 7-18 Differential diagnosis of common foal colics

Disease	History	Clinical findings	Clinical pathology	Treatment
Intestinal atresia or hypoganglionosis	White progeny of overo horses; Otherwise sporadic Newborn foals <4 days old	Failure to pass feces Abdominal distension pain	None specific	None
Small-intestinal volvulus	Any age but more common at 3–6 months; abrupt-onset abdominal pain; diarrhea	Severe pain; nasogastric reflux; abdominal distension Ultrasonography: distended, atonic intestine Radiography: gas and fluid distension of small bowel	Increased protein and leukocytes in abdominal fluid	Surgical; low survival rate
Small-intestinal intussusception	Any age, but usually 3–6 weeks; diarrhea	Severe pain, abrupt onset Nasogastric reflux Ultrasonography: intussusception Radiography: gas and fluid distension of small bowel	Increased protein and leukocytes in abdominal fluid	Surgery; 40% survival rate
Ascarid impaction	More than 3 months of age Recent history (<3 days) of anthelmintic administration	Severe pain; nasogastric reflux Ultrasonography: distended, atonic bowel, ascarids	Nonspecific	Medical therapy; lubricants and analgesics; surgery
Meconium impaction	Newborn; no passage of meconium; more common in males	Mild pain initially, becoming more severe; Abdominal distension Ultrasonography: distended large colon, may see impaction Radiography: contrast may outline impaction	Nonspecific	Warm soapy enemas Acetylcysteine; mineral oil orally; surgery for refractory cases
Large-colon torsion	Sporadic	Severe pain and abdominal distension Ultrasonography: gas-distended colon Radiography: gas-distended colon	Nonspecific	Surgery; 20% recovery rate
Large-colon impaction	Sporadic; poor diet, eating sand-polluted feed	Mild to moderate pain initially Progressive abdominal distension Ultrasonography: distended colon with impacted material	Nonspecific	Medical treatment of lubricants, fecal softeners and analgesics; surgery
Small-colon impaction	Common in Miniature horses	Moderate to marked pain Lack of feces; abdominal distension Ultrasonography: gas-distended colon Radiography: impaction of small colon	Nonspecific	Medical as previously; surgery
Gastroduodenal ulcer	Common in foals with other disease or stress	Usually clinically inapparent Colic, inappetence, teeth grinding, excessive salivation, diarrhea; gastroscopy diagnostic	None diagnostic	Antacids and antiulcer compounds (Table 7-20) Rarely surgery to correct gastric outflow obstruction

## FURTHER READING

- Neal HN. Foal colic: practical imaging of the abdomen. *Equine Vet Educ.* 2003;15:26-270.  
Bernard W. Colic in the foal. *Equine Vet Educ.* 2004;16:319-323.

## REFERENCES

- Radostits O, et al. Colic in Foals. *Veterinary Medicine: A Textbook of the Diseases of Cattle, Horses, Sheep, Goats and Pigs*. 10th ed. London: W.B. Saunders; 2007:230.
- MacKinnon MC, et al. *JAVMA*. 2013;243:1586.
- Palmer JE. *Equine Vet Educ.* 2012;24:340.
- Hart S, et al. *J Vet Emerg Crit Care.* 2009;19:357.
- Tapio H, et al. *Equine Vet Educ.* 2012;24:334.
- Hennessy SE, et al. *N Z Vet J.* 2012;60:360.
- Pilati N, et al. *Equine Vet Educ.* 2013;25:290.
- Ollivett TL, et al. *Equine Vet J.* 2012;44:96.
- Dunkel B, et al. *Equine Vet J.* 2011;43:133.
- Koenig JB, et al. *Can Vet J.* 2007;48:420.
- Tatz AJ, et al. *Equine Vet J.* 2012;44:111.
- Higuchi T. *J Equine Sci.* 2006;17:17.
- de Solis CN, et al. *Equine Vet J.* 2012;44:64.
- Abraham M, et al. *J Vet Intern Med.* 2014;28:1580.
- Southwood LL. *Equine Vet Educ.* 2009;21:513.
- Bodaan CJ, et al. *Equine Vet Educ.* 2014;26:341.

## GASTRIC DILATION IN THE HORSE

### SYNOPSIS

**Etiology** Gastric outflow obstruction. Idiopathic. Ingestion of excess fluid or feedstuffs

**Epidemiology** Sporadic. No age, breed, or sex predilection

**Clinical signs** Colic. Reflux from nasogastric tube. Gastric rupture, acute severe peritonitis, and death

**Clinical pathology** Nondiagnostic. Inflammatory cells and ingesta in peritoneal fluid of horses with gastric rupture

**Diagnostic confirmation** Nasogastric reflux without other identifiable cause

**Lesions** Gastric dilatation. Gastric rupture with hemorrhage at margins of rupture

**Treatment** Gastric decompression. Treat underlying disease.

**Control** Prevent overeating. Control inciting diseases.

### ETIOLOGY

Chronic gastric dilatation can be caused by the following:

- Outflow obstruction, such as cicatricial constriction of the pylorus secondary to gastroduodenal ulceration or pressure by a tumor
- Gastric atony in older horses or wind-sucking (aerophagic) horses

Acute gastric dilatation is associated with:

- Reflux of intestinal contents secondary to acute intestinal obstruction, e.g., anterior enteritis, small-intestinal strangulation, or ileus
- Ingestion of excess fluid or feedstuffs such as whey or grain
- Acute idiopathic dilatation after racing

## EPIDEMIOLOGY

The incidence of gastric rupture, the most severe sequela to gastric dilatation, in horses with colic is approximately 5%, although in horses subjected to exploratory laparotomy the rate may be as high as 11%.<sup>1</sup> There is no detectable effect of age, breed, or season on the risk of gastric rupture. Risk factors for gastric dilatation include consumption of excess grain, although horses routinely fed grain are at lower risk, and ingestion of palatable fluids such as whey has been implicated.

**Acute idiopathic dilatation** of the stomach occurs sporadically and is a common cause of gastric rupture, representing between 16% and 60% of cases of gastric rupture. **Chronic dilatation** secondary to pyloric obstruction caused by a tumor is a sporadic occurrence in older horses, whereas cicatricial obstruction secondary to gastroduodenal ulceration is more common in younger horses and those at risk of developing gastroduodenal ulcers.

Acute dilatation occurs secondarily to acute obstruction of the small intestine.

## PATHOGENESIS

Acute obstruction of outflow from the stomach or aboral passage of ingesta and secretions through the small intestine results in gastric dilatation. This causes severe pain and signs of shock, including elevated heart rate, sweating, and delayed mucosal capillary refill time. Gastric rupture can occur within hours and death shortly thereafter. Chronic dilatation results from partial obstruction and delayed gastric emptying. The disease is more prolonged and clinical signs can be related to the primary disease.

The obstruction can be as aboral as the ileocecal valve. Gastric distension with fluid also occurs late in the course of impaction of the large or small colon. Horses with large-intestinal volvulus have accumulation of fluid in the proximal small intestine and stomach because of tension on the duodenocolic fold causing extramural compression of the duodenum.

Gastric distension causes severe pain and there is often dehydration and hypochloremia as a result of sequestration of gastric secretions. Experimental distension of the stomach of healthy horses with water increases the intraabdominal pressure from  $-2.7$  cmH<sub>2</sub>O (i.e., subatmospheric) to  $+3.1$  cmH<sub>2</sub>O after instillation of 20 L of water. Whether similar increases occur during gastric distension associated with

gastrointestinal disease and its contribution to intraabdominal hypertension awaits clinical studies.<sup>2</sup>

Engorgement of a readily fermentable carbohydrate, such as wheat, glucose, or calf feeds, results in a syndrome characterized by shock, ileus, and laminitis. Gastric dilatation can occur secondary to grain engorgement, but the clinical signs of gastric dilatation are often masked by more severe signs secondary to endotoxemia.

## CLINICAL FINDINGS

The clinical findings in gastric distension depend in large part on the underlying disease. However, horses with primary gastric distension have abdominal pain, often of 12 to 36 hours' duration, that progressively worsens. The heart and respiratory rates increase progressively as the distension worsens, and the horse may sweat and exhibit signs of increasingly severe abdominal pain. Paradoxically, some horses with gastric distension, especially the type that develops over several days or in horses recovering from intestinal surgery and being treated with analgesics, may not exhibit any but the most subtle signs until rupture of the stomach occurs.

**Vomition** in horses is very rare, is always associated with gastric distension, and is usually a terminal event.

In **grain engorgement dilatation** abdominal pain is usually severe. Dehydration and shock develop rapidly, often within 6 to 8 hours of ingestion of the grain, and can be severe. Death from gastric rupture can occur within 18 hours.

**Passage of a nasogastric tube** usually results in the evacuation of large quantities of foul-smelling fluid, except in cases of grain engorgement, in which the fluid is absorbed by the grain. However, significant and life-threatening gastric dilatation can be present even though there is no reflux through a nasogastric tube. If gastric dilatation is suspected then repeated, persistent efforts should be made to obtain reflux. The nasogastric tube should be left in situ until the disease has resolved.

**Acute postrace dilatation** occurring immediately after racing is accompanied by more serious and acute signs. There is abdominal distension, coughing, and dyspnea. Tympany is also detectable on percussion of the anterior abdomen and large amounts of foul-smelling gas, and usually fluid, are passed via the stomach tube. This immediately relieves the animal's distress.

In **chronic dilatation** there is anorexia; mild pain, which is either continuous or recurrent; scanty feces; and gradual loss of BW persisting for a period of months. Vomiting and bouts of pain may occur after feeding, but they are not usually severe. Dehydration may be present but is usually only of moderate degree.

The distended stomach cannot be palpated on **rectal examination**, but the presence of distended loops of small intestine should alert the clinician to the probability of gastric distension. Rupture of the stomach, or other viscus, is characterized during rectal examination by a negative pressure in the abdomen and the presence of particulate matter on the serosal surface of intestine.

**Ultrasonographic** examination will reveal a distended stomach containing large quantities of fluid or ingesta and can reveal evidence of the predisposing lesion, such as the presence of distended small intestine. **Radiographic examination**, with or without a barium meal, can be of diagnostic value in young animals with chronic outflow obstruction. **Gastroscopy** performed after the stomach has been emptied can reveal lesions consistent with obstructed outflow, such as gastric squamous cell carcinoma or pyloric abnormalities secondary to gastric ulcer disease in foals.

## CLINICAL PATHOLOGY

Horses with severe gastric dilatation often, but not always, have slightly **low serum chloride concentrations**. Metabolic alkalosis, metabolic acidosis, or mixed disturbances can be present. Other abnormalities depend on the underlying disease.

**Abdominal fluid** of horses with gastric dilatation is normal, whereas that of horses with gastric rupture is characterized by an elevated total protein concentration ( $>2.5$  g/dL, 25 g/L) and leukocyte count ( $>10,000$  cells/ $\mu$ L,  $10 \times 10^6$  cells/L) which is predominantly composed of degenerate neutrophils. Microscopic examination of the fluid reveals intracellular and extracellular bacteria and plant material.

## NECROPSY FINDINGS

After grain engorgement in horses, the stomach is distended with a doughy, malodorous mass of ingesta. In acute gastric dilatation caused by other causes, the stomach is grossly distended with fluid and the wall shows patchy hemorrhages. Rupture, when it occurs, is usually along the greater curvature and results in gross contamination of the abdominal cavity with ingesta.

## DIFFERENTIAL DIAGNOSIS

See Table 7-19.

## TREATMENT

**Relief of the gastric distension** should be considered an **emergency** because gastric rupture invariably causes death. Passage of a nasogastric tube, important in diagnosing the accumulation of fluid within the stomach, also provides a means for relieving the distension. Repetition and persistence may be needed to relieve the gastric distension.

Table 7-19 Differential diagnosis of common equine colics

	Epidemiology and history	Clinical findings	Clinical pathology	Response to treatment
Acute gastric dilatation	Feeding on grain or whey; Outflow obstruction Lipoma at pylorus Reflux with proximal enteritis	Acute severe pain, gut sounds negative, rectal negative; voluminous reflux through nasogastric tube and relief of pain; regurgitation	Depends on underlying disease; no diagnostic changes	Good to relief of gastric distension; prognosis guarded and depends on underlying disease
Acute obstruction and infarction of small intestine	Sporadic	Acute, severe intractable pain, no gut sounds, rectal exam reveals distended loops of small intestine, tight bands of mesentery at 12 h; no feces after 12 h; nasogastric reflux	Hypovolemia; toxemia late in disease Packed cell volume (PCV) more than 50% after 12 h Blood-tinged peritoneal fluid	Pain intractable; surgical correction
Acute obstruction of large intestine	As previously	As previously except abdomen visibly distended; rectal exam impeded by large loops of distended large colon	As previously	As previously
Ileocecal valve impaction	Feed includes finely chopped oat straw, or sorghum, Sudan grass, coastal Bermuda grass; infestation with <i>Anoplocephala perfoliata</i>	Subacute pain for 24 h as small intestine descends; then as for small intestinal obstruction; impaction palpable rectally	PCV normal first 24 h No characteristic changes	Medical therapy initially, then surgery for refractory cases
Spasmodic/tympanic colic	Sporadic; increased incidence with poor worm control	Acute moderate pain but heart rate up to 80 Loud and gassy gut sounds; rectal exam and feces normal, recovers spontaneously, lasts only 1–2 h	Normal	Xylazine, detomidine, butorphanol, hyoscine all effective; mineral oil orally
Impaction of large intestine	Old horse, debilitated, poor teeth, indigestible feed; inadequate access to water; excessive consumption of low-energy grass	Moderate pain, depressed or absent gut sounds, rectally long columns of dry hard fecal material, distinct from individual balls	Normal	Responds well to standard analgesics, mineral oil, fecal softeners, and fluid therapy
Verminous mesenteric arteritis (thromboembolic colic)	Poor worm control; rare	Subacute pain continues for 3–4 days; no gut sounds; rectally slightly distended loops; paralytic ileus	Slight leukocytosis and shift to left Paracentesis yields bloody fluid	Irreversible even if surgery performed Prevention includes adequate parasite control
Enteroliths, colonic foreign bodies, phytobezoars	Endemic in some areas	Subacute or recurrent colic of moderate severity only; masses palpable in small colon	No changes	Surgery only
Subacute obstruction of small intestine (adhesions, neoplasm, idiopathic muscular hypertrophy of ileum, etc.*	History of recurrent moderate or persistent mild colic	Moderate pain; distended loops of small intestine on rectal exam; point of obstruction may be palpable; gut sounds normal to loud	No changes	Excellent to surgery
Sand colic	Access to polluted feed; grazing on sandy country when feed sparse; salt deficiency or boredom leading to soil eating or licking	May be severe pain with acute impaction or chronic mild pain, often with intermittent bouts of diarrhea; may palpate impacted loops containing sand; auscultate sand in ventral abdomen; radiography; ultrasonography	Normal; mixture of feces and water allowed to stand shows heavy sand sediment	Analgesia and psyllium orally; prevent ingestion of sand
Flatulent colic	Mostly on succulent green feed Some secondary to physical obstruction of large intestine	Severe acute pain; visibly distended abdomen Loud gut sounds present early; rectal exam difficult because of size of loops	Not recorded	Trocarization through right flank or exploratory laparotomy if time and analgesia not successful

Table 7-19 Differential diagnosis of common equine colics—cont'd

	Epidemiology and history	Clinical findings	Clinical pathology	Response to treatment
Dorsal displacement left colon (nephrosplenic ligament entrapment)	Sporadic	Intractable moderate pain continues for days Pelvic flexure of colon missing, spleen displaced medially	No changes No changes	Rolling of anesthetized patient to replace colon very successful; jogging with or without administration of phenylephrine
Small intestine or colon strangulation by lipoma	Only horses older than 10 years Sudden onset	Sudden onset moderate pain without toxemia May be palpable per rectum	No changes	Surgery

The clinical picture varies with time: descriptions relate to clinical signs at 12–24 h of illness.

\*Chronic intussusception, terminal ileal hypertrophy, constructive adhesions, Meckel's diverticulum, and fibroma at the root of the mesentery.

Passage of the nasogastric tube through the cardia can be difficult in horses with gastric distension. Blowing into the tube to dilate the esophagus or instillation of lidocaine (20 mL of 2% solution) can facilitate passage of the tube. If there is no spontaneous reflux of material, a siphon should be formed by filling the tube with 500 mL of water and rapidly lowering the end of the tube below the level of the horse's stomach. The nasogastric tube should be left in place until there are no longer clinically significant quantities of reflux (1–2 L every 3 hours for an adult 425-kg horse).

Gastric dilatation caused by overeating of grain, bread, or similar material may be impossible to resolve through a nasogastric tube because of the consistency of the material. Gastric lavage using water or isotonic saline administered through a large-bore nasogastric tube may aid in removal of inspissated ingesta. Surgical decompression may be attempted in refractory cases, but is technically demanding because of the position of the stomach in the adult horse.

The underlying disease should be treated to restore normal gastric emptying or stop reflux from the small intestine. Supportive therapy, including restoration of hydration and normal electrolyte and acid-base status, should be provided (see Chapter 5). Horses at risk of inhalation pneumonia should be treated with broad-spectrum antibiotics for at least 3 days.

## REFERENCES

1. Radostits O, et al. Gastric Dilation in Horses. *Veterinary Medicine: A Textbook of the Diseases of Cattle, Horses, Sheep, Goats and Pigs*. 10th ed. London: W.B. Saunders; 2007: 233.
2. Barrett EJ, et al. *J Vet Emerg Crit Care*. 2013;23: 423.

## GASTRIC IMPACTION IN HORSES

Primary gastric impaction is a usual primary cause of colic in adult horses, comprising

approximately 1.4% of 857 colic cases in one report and 20 of 653 (3.0%) horses with colic and 20/6097 admissions (0.3%) in another.<sup>1,2</sup> The case–fatality rate is 10% to 50%.<sup>1,2</sup> There does not appear to be a breed or gender predisposition, and the disease occurs in mature horses.<sup>2</sup>

The etiology of gastric impaction is unclear in most cases, with poor dentition, rapid food intake, inadequate intake of water, and abnormal gastric motility being mooted as causes of the disease.<sup>1</sup> Gastric impaction occurs secondary to hepatic fibrosis and insufficiency associated with poisoning with *Senecio jacobaea*.<sup>3</sup> Ingestion of persimmon (*Diospyros virginiana*) causes gastric impaction, ulceration, and rupture in horses because of the formation of phytobezoars.<sup>4</sup> Ingestion of thorn apple (*Datura stramonium* and other species of *Datura*) cause colic and acute gastric rupture in horses.<sup>5</sup> For cases of undetermined cause, there is usually a history of a diet of mature grass, alfalfa hay, corn, sorghum fodder, or ensilage. Other causes include insufficient access to water, poor teeth causing poor digestion, or the atony of old age. Some affected horses have histologic abnormalities of the stomach or intestine, but the clinical importance of these lesions in development of the disease is unclear.<sup>1,2</sup>

Horses can present with acute, chronic, or recurrent colic. Horses with acute disease usually have clinical signs of <3 days' duration, and half have had previous episodes of colic.<sup>2</sup> The most common clinical sign is inappetence with or without colic.<sup>1,2</sup> Heart rate and respiratory rate are usually not markedly elevated and rectal examination does not reveal diagnostic abnormalities. If the stomach has ruptured, there will be signs of septic peritonitis with toxemia and cardiovascular compromise including sweating, tachycardia, delayed mucous membrane capillary refill time, and discolored mucous membranes. Signs of long-term (chronic) disease include weight loss; intermittent colic; anorexia; dullness; and passage of small amounts of hard, dry feces.

Gastroscopy confirms the diagnosis by visualization of large amounts of ingesta in the stomach or phytobezoars, although visualization of the stomach is impaired by the presence of large quantities of ingesta causing the impaction. At exploratory laparotomy the stomach is enlarged with dry, fibrous feed material but is not grossly or acutely distended, and the intestines are relatively empty.

Clinicopathologic examination commonly reveals leucopenia and hyperfibrinogenemia,<sup>1,2</sup> although these findings are not consistent and present in every case.

Treatment includes restoration of normal hydration, which can aid in passage of the impaction. Judicious administration of lubricants (mineral oil) or osmotic cathartics (magnesium sulfate and sodium sulfate) or water might aid in softening the impaction. Phytobezoars associated with ingestion of persimmon can be treated medically by the administration of fluids (intravenous or, if tolerated, oral), intragastric administration of cola or diet cola beverages, and feeding of pelleted food.<sup>4</sup> Analgesia should be provided as needed preferably by use of drugs that do not inhibit gastrointestinal motility. Exploratory laparotomy with gastrotomy and removal of the impacted material might be required in a small proportion of cases.<sup>1,2,6</sup> Rupture of the stomach can occur and is invariably fatal.<sup>1</sup>

## FURTHER READING

- Freeman DE. Gastric impaction. *Equine Vet Educ*. 2011;23:174–176.

## REFERENCES

1. Bird AR, et al. *Equine Vet J*. 2012;44(suppl 43): 105.
2. Vainio K, et al. *Equine Vet Educ*. 2011;23:186.
3. Radostits O, et al. Gastric Impaction in Horses. *Veterinary Medicine: A Textbook of the Diseases of Cattle, Horses, Sheep, Goats and Pigs*. 10th ed. London: W.B. Saunders; 2007:234.
4. Banse HE, et al. *JAVMA*. 2011;239:1110.
5. Soler-Rodriguez F, et al. *Vet Rec*. 2006;158:132.
6. Parker RA, et al. *Equine Vet Educ*. 2011;23:169.



## GASTRIC (GASTRODUODENAL) ULCER IN FOALS

### SYNOPSIS

**Etiology** Unknown in most cases

**Epidemiology** Foals from 1 day of age; 50% of normal foals have gastric mucosal ulceration. Clinical disease in 0.5% of foals. More severe ulceration in stressed foals or foals with other diseases

**Clinical signs** None in most foals. Teeth grinding, excessive salivation, colic, diarrhea, inappetence, and weight loss. Ulcers in glandular mucosa are considered most clinically important. Sudden death with perforation. Ulcers present on gastroduodenoscopy

**Clinical pathology** Nondiagnostic

**Lesions** Gastric mucosal ulceration, duodenal ulceration and stenosis, and esophagitis. Peracute septic peritonitis

**Diagnostic confirmation** Gastroscopic demonstration of ulcers in foals with appropriate clinical signs

**Treatment** Treatment should be reserved for foals with clinically important disease. Ranitidine 6.6 mg/kg, orally every 8 to 12 h, or cimetidine 6.6 to 20 mg/kg orally or intravenously every 6 h, or omeprazole 1 to 4 mg/kg orally or intravenously every 24 h

**Control** Minimize occurrence of inciting or exacerbating diseases. Do not administer antiulcer medications as prophylaxis.

Gastroduodenal ulcer disease in young equids has a variety of manifestations. Disease in neonates is characterized by ulceration of the glandular mucosa and occurs in foals that have other disease or are exposed to physiologically important stressors. Disease in suckling foals occurs in either or both of the squamous and glandular mucosa of the stomach and/or the duodenal mucosa. The disease in this age group can progress to scarring of the gastric outflow tract with subsequent gastritis, dysphagia, and esophageal ulceration leading to inappetence, ptyalism, and death. Disease in weanlings usually affects the gastric squamous mucosa. There is no evidence that the widespread occurrence of lesions of the gastric squamous mucosa is clinically important in weanlings.<sup>1</sup>

### ETIOLOGY

There is no established etiology, although there is an association with stress (see later). There is no evidence of an infectious etiology, for instance, *Helicobacter* sp., in the development of ulcers in neonates or suckling or weanling foals. Nonsteroidal medications administered above recommended doses can induce gastroduodenal ulceration.

There is no evidence that at recommended therapeutic doses they are a common cause of gastric ulcers.<sup>2</sup>

### EPIDEMIOLOGY

#### Occurrence

Gastric ulcers are reported in foals in North America, Europe, and Australia and probably occur worldwide. The prevalence of erosion and ulcers of the gastric glandular and nonglandular mucosa, detected by gastroscopic examination, averages 50% in foals less than 2 months of age that do not have signs of gastric ulcer disease.<sup>3</sup> Lesions of the squamous mucosa are present in 45% of foals, whereas lesions in the glandular mucosa occur in fewer than 10% of foals less than 4 months of age. Fifty percent of asymptomatic weanling foals (5–7.5 months of age) have gastric mucosal lesions evident on gastroscopy.<sup>1</sup>

Ulceration of the gastric and/or duodenal mucosa is evident in 22% (155 of 691) of foals at necropsy examination.<sup>4</sup> The study was performed at a referral institution, and the foals were examined as a result of their death or euthanasia at that institution. The relevance of these results to asymptomatic foals or foals that recovered from their illness is unknown. Foals examined were all less than 6 months of age and lesions were most common in the nonglandular gastric mucosa (70 of 155 foals). Twenty-five of 155 foals had lesions only in the glandular mucosa, 25 had lesions in both glandular and nonglandular mucosa, and 20 had lesions in both squamous and duodenal mucosa. There was no association of age with lesion distribution or prevalence.<sup>4</sup> Gastric ulcers were significantly associated with the presence of other gastrointestinal disease, but not with the presence of any other disease category.

Disease attributable to gastric or duodenal ulcers occurs in approximately 0.5% of foals, although the prevalence is greater in foals with comorbid diseases such as pneumonia and septicemia.

Estimates of case–fatality rate are not available for any of the forms of gastroduodenal ulcer disease in foals.

### Risk Factors

#### Age and Sex

Age is an important risk factor for ulceration of the squamous epithelium, with 88% of foals less than 9 days of age affected compared with 30% of foals more than 70 days of age. These estimates should be considered with caution, because findings considered as lesions in earlier studies (desquamation [shedding] of the squamous mucosa) are not now considered to be abnormal or indicative of disease.<sup>4</sup> Gastric lesions occur in fewer than 10% of foals over 90 days of age. There does not appear to be an effect of age on the prevalence of ulceration of the gastric glandular mucosa, which is considered a much more clinically significant lesion.

There is no effect of gender on the prevalence of ulcers.

### Stress and Disease

Stress and disease are important risk factors for development of ulcers of the glandular mucosa. Lesions of the gastric glandular mucosa occur in 27% of foals with another disease but in 3% of otherwise healthy foals.

### PATHOGENESIS

The pathogenesis of gastric ulceration in foals has not been definitively determined and much is extrapolated from the disease in humans and other animals. It is assumed that ulcers occur because of an imbalance between the erosive capability of the low gastric pH and the protective mechanisms of the gastric mucosa. Low gastric pH was considered essential for the development of a gastric ulcer, but there is less certainty about this now that it is recognized that critically ill foals, and especially those that are premature or recumbent, often have high (less acid to alkaline) and highly variable gastric pH.<sup>5</sup> Additionally, administration of omeprazole to weanlings is effective in reducing the prevalence of lesions of the gastric squamous mucosa but might worsen lesions of the glandular mucosa.<sup>1</sup>

The conventional wisdom is that preservation of adequate mucosal blood flow and the presence of an intact, bicarbonate-rich layer of mucus over the epithelium are essential to maintaining the resistance of the epithelium to digestion by gastric acid and pepsin. Mucosal blood flow and bicarbonate secretion into the protective mucous layer are dependent in part on normal prostaglandin E concentrations in the mucosa. Factors that inhibit prostaglandin E production, such as NSAIDs and ischemia, could contribute to the development of ulcers. Trauma to the gastric epithelium can disrupt the protective layer and allow an ulcer to develop, as can the presence of compounds in duodenal fluid, such as bile salts that intermittently reflux into the stomach of normal foals.

Normal foals develop the capacity for secretion of gastric acid and the ability to achieve gastric pH less than 4 within 1 to 2 days of birth. Ingestion of milk increases gastric pH, and it is a generally held belief that frequent ingestion of milk provides a protective effect against the adverse effects of low pH on gastric mucosa. However, the development of gastric lesions in foals is not solely a result of prolonged exposure to low pH, although this might be a necessary factor, because ill neonatal foals that are at high risk of gastric erosion or ulceration have gastric pH that is often greater than 5 to 6.<sup>3</sup> The elevated pH, which can be alkaline in severely ill foals at greatest risk of death, is not consistent with development of gastric lesions.

Most ulcers do not produce clinical signs. **Severe ulceration** is associated with delayed gastric emptying, gastric distension, gastroesophageal reflux, and subsequent reflux esophagitis and pain. Ulcers can perforate the stomach wall and cause a peracute, septic peritonitis or erode into a large blood vessel with subsequent hemorrhage and occasional exsanguination. Ulcers and the attendant inflammation and pain might cause gastroproptosis and delay gastric emptying, and chronic lesions can result in both functional and physical obstructions to gastric emptying with subsequent gastric dilatation and reflux esophagitis.

### CLINICAL FINDINGS

There are six syndromes associated with gastroduodenal ulcers in foals<sup>3</sup>:

1. Ulceration or epithelial desquamation of the squamous mucosa of the greater curvature and area adjacent to the margo plicatus. These lesions are very common in foals less than 60 days of age and usually do not cause clinical signs. The lesions heal without treatment and are now considered variations of normal.<sup>4</sup>
2. Ulceration of the squamous epithelium of the lesser curvature and fundus. This is more common in older foals (>60 days) and is sometimes associated with clinical signs including diarrhea, inappetence, and colic.
3. Ulceration of the glandular mucosa, sometimes extending into the pylorus. This lesion occurs in foals of any age and is most common in foals with a comorbid disease. Clinical signs caused by the ulcer can be severe and include teeth grinding, excessive salivation, inappetence, colic, and diarrhea. There is often reflux esophagitis.
4. Gastric outflow obstruction caused by pyloric or duodenal stricture secondary to pyloric or duodenal ulceration. This occurs in 2- to 5-month-old foals and is evident as colic, inappetence, weight loss, gastric dilatation, gastroesophageal reflux, excessive salivation, and teeth grinding.
5. Peracute peritonitis secondary to gastric perforation. This usually occurs in foals that do not have a history of signs of gastric ulceration. Clinical signs include unexpected death, shock, dehydration, sweating, and an increased respiratory rate.
6. Hemorrhagic shock secondary to blood loss into the gastrointestinal tract from a bleeding gastric ulcer. This is an unusual presentation.
7. The typical signs of gastric ulcers in foals include depression, teeth grinding, excessive salivation, and abdominal pain that can range in intensity from very mild to acute and severe, similar to that of a foal with an acute intestinal accident. Diarrhea, with or without mild

to moderate abdominal pain, is often associated with gastric ulcer disease in foals. Treatment with antiulcer drugs is sometimes associated with resolution of diarrhea and signs of gastric ulcer disease. There might be pain evinced by deep palpation of the cranial abdomen, but this is not a reliable diagnostic sign.

Definitive diagnosis is provided by **gastroscopic examination**. The endoscope should be 2 m in length, although a 1-m endoscope might allow partial examination of the stomach of young or small foals. Diameter of the endoscope should be less than 1 cm. Foals can usually be examined without sedation, although sedation might facilitate examination in larger or fractious foals. Ideally, older foals should have food withheld for 12 hours before the examination but this might not be necessary or advisable in sick foals. Young foals (those relying on milk intake for their caloric needs) should have food withheld for 1 to 2 hours. Adequate examination of the nonglandular stomach can usually be achieved without fasting, especially in younger foals, but thorough examination of the glandular mucosa and pylorus requires fasting.

**Nasogastric intubation** might cause pain and cause affected foals to gag. Foals with gastric outflow obstruction, caused either by pyloric or duodenal stricture or by gastroparesis, will have reflux of material through a nasogastric tube.

Contrast **radiographic** examination is useful in defining gastric outflow obstruction and can demonstrate filling defects in the gastric wall that are consistent with ulcers. The principal use of radiography is to establish delays in gastric emptying. Normal foals have complete emptying of barium sulfate (10–20 mL/kg BW administered through a nasoesophageal or nasogastric tube) from the stomach within 2 hours of administration. Gastric ulcers are occasionally apparent as filling defects, but contrast radiography is not sufficiently sensitive to justify its routine use for diagnosis of gastric ulceration.

### CLINICAL PATHOLOGY

There are no diagnostic changes in the hemogram or serum biochemical profile. Serum pepsinogen values are of no use in diagnosing gastric ulcers in foals. Testing for fecal occult blood is not sensitive to or specific for gastric ulceration in foals. Foals with perforation of the stomach have changes consistent with septic peritonitis. Measurement of an isoform of  $\alpha$ 1-antitrypsin in serum is reported to be sensitive and specific for detection of gastric ulcers in foals, but these results have not been validated and the test is not widely available.<sup>6</sup>

### NECROPSY FINDINGS

Gastric ulcers and erosions are common findings in foals dying of unrelated disease

and their presence should not be overinterpreted.<sup>4</sup> The gross characteristics of the gastric lesions were described earlier. Foals dying of gastric ulcer disease do so from peracute diffuse peritonitis, exsanguination, or starvation secondary to the gastric outflow obstruction.

### DIAGNOSTIC CONFIRMATION

The combination of compatible clinical signs, endoscopic demonstration of gastric ulcers, a favorable response to antacid therapy, and the elimination of other diseases permits a diagnosis of gastric ulcer disease.

### DIFFERENTIAL DIAGNOSIS

The combination of teeth grinding, excessive salivation, depression, inappetence, and colic in foals is virtually diagnostic of gastric ulcer disease. Other causes of colic in foals are listed in [Table 7-17](#).

### TREATMENT

Treatment of clinically important gastric ulcer disease must be differentiated from prophylaxis of animals considered to be at high risk of disease or those in which lesions have been detected incidentally. The principles of treatment of clinically important gastroduodenal ulcer disease in foals include the following:

- Promotion of healing by reducing gastric acidity and enhancing mucosal protection
- Enhancement of gastric emptying
- Provision of nutritional and metabolic support
- Treatment of comorbid disease

**Reduction of gastric acidity** is achieved by the administration of one of several drugs that reduce secretion of gastric acid and increase gastric pH ([Table 7-20](#)). These drugs are either histamine type 2 ( $H_2$ ) receptor antagonists or inhibitors of the proton pump in the gastric parietal cells. Administration of ranitidine (6.6 mg/kg orally every 8 hour) effectively increases gastric pH in normal neonatal foals but does not affect gastric pH in hospitalized neonates.<sup>3</sup> Omeprazole (4 mg/kg orally every 24 hours), a proton pump inhibitor, increases gastric pH within 2 hours of administration and for 24 hours in clinically normal neonatal foals and in clinically ill neonatal foals.<sup>7</sup> Omeprazole enhances healing of spontaneous ulcers in foals older than 28 days and is usually considered to not have important or frequent adverse effects. However, recent evidence suggests that administration of omeprazole to clinically normal weanlings is associated with increased severity of lesions in the glandular mucosa.<sup>1</sup>

Sucralfate is used to provide protection of denuded gastric epithelium, although its

**Table 7-20** Drugs used in the treatment of *clinically important* gastroduodenal ulcer disease of foals and adult horses and recommendations for treatment (not prophylaxis)

Drug class	Drug	Dose, route, and frequency	Comments
H <sub>2</sub> -antagonists	Cimetidine	6.6–20 mg/kg PO every 6 h	Potent acid suppression; short elimination half-life necessitates frequent administration Preferably use at the higher dose rate
	Cimetidine	6.6 mg/kg IV every 6 h	Rapid and potent acid suppression; use when oral administration is not feasible or rapid effect is required
	Ranitidine	0.9–2.0 mg/kg IV or 6.6–8.8 mg/kg PO every 8–12 h	Potent acid suppression and rapid resolution of clinical signs
Proton pump inhibitor	Omeprazole	4 mg/kg PO as paste every 24 h	Potent, rapid onset and long-lasting acid suppression
	Pantoprazole	1.5 mg/kg IV every 12–24 h	Potent acid suppression in foals
Protectants	Sucralfate	40 mg/kg PO every 6 h	Can be given at the same time as inhibitors of acid secretion
Prostaglandin analogs	Misoprostol	5 µg/kg PO every 12 h	Causes diarrhea and mild colic Effective as a prophylactic for NSAID-induced ulcers in humans but minimal efficacy in enhancing healing of existing ulcers
Antacids	Aluminum hydroxide	1–2 g PO every 4–6 h	Ineffective; do not use
	Magnesium hydroxide	1–2 g PO every 4–6 h	Ineffective; do not use
	Calcium carbonate	1–2 g PO every 4–6 h	Ineffective; do not use
Promotility agents	Bethanechol	0.025 mg/kg SC every 6 h	Enhances gastric motility with minimally increased gastric acid secretion; used to treat gastroparesis; contraindicated if physical outflow obstruction exists

H<sub>2</sub>, histamine type 2 receptor; IV, intravenously; NSAID, nonsteroidal antiinflammatory drug; PO, orally; SC, subcutaneously.

efficacy in preventing lesions or enhancing healing of existing lesions in foals with spontaneous disease is doubted.

A common **treatment protocol** involves administration of an H<sub>2</sub> antagonist or omeprazole. Treatment should begin as soon as the presence of a clinically relevant ulcer is suspected and should continue for at least 1 week after the resolution of clinical signs or until there is endoscopic confirmation of healing. Foals are often treated for 2 to 6 weeks.

Foals with gastroparesis secondary to severe gastroduodenal ulceration or gastritis can benefit from the administration of bethanechol (see [Table 7-20](#)) to increase gastric motility and enhance gastric emptying. Surgical bypass of pyloric or duodenal strictures can be necessary in foals with physical obstructions to gastric emptying, and when performed by experienced surgeons have a reasonable (>50%) prognosis for recovery and survival to discharge from hospital.<sup>8</sup>

**Nonsteroidal antiinflammatory drugs** such as phenylbutazone or flunixin meglumine are ulcerogenic at high doses and should be used sparingly and at recommended doses in sick foals. There is no evidence that these compounds predispose or cause gastric ulcers when used at the recommended dose rate.<sup>2</sup> It would be prudent to minimize their use in foals with gastric or duodenal ulcers.

Nutritional and metabolic support should be provided as necessary to foals that are unable to eat or drink or that have abnormalities of fluid and electrolyte status.

## CONTROL

Control of diseases that predispose foals to gastroduodenal ulcer might reduce the incidence or severity of ulcer disease. Prophylactic treatment of sick or stressed foals with H<sub>2</sub> antagonists, sucralfate, or omeprazole is widely practiced but has been questioned because the efficacy of pharmacologic prophylaxis in prevention of disease or death caused by gastric ulceration has not been demonstrated.<sup>9</sup> Indeed, suppression of gastric acidity (increasing gastric pH) in either sick or normal foals might be unwise because of the protective effect of low gastric pH on gastric colonization of bacteria. Foals in an intensive care unit administered acid suppressive medication were 2.0 (95% CI 1.4–2.9) times as likely to develop diarrhea as those not administered these drugs.<sup>9</sup> Furthermore, the presence of detected ulcers was not different between foals administered antiulcer medication (15%) and those not administered these medications (21%).<sup>9</sup>

Administration of omeprazole to clinically normal weanlings is not recommended at this time.<sup>1</sup> Body condition score and BW of weanlings was not improved by administration of omeprazole, despite a reduction in prevalence of lesions in the squamous mucosa, and was associated with an increase in severity of lesions in the glandular mucosa.<sup>1</sup>

## REFERENCES

- Dahlkamp M, et al. *Pferdeheilkunde*. 2012;28:561.
- Fennell LC, et al. *Equine Vet Educ*. 2009;21:660.
- Radostits O, et al. Gastric (Gastroduodenal) Ulcer in Foals. *Veterinary Medicine: A Textbook of the Diseases of Cattle, Horses, Sheep, Goats and*

*Pigs*. 10th ed. London: W.B. Saunders; 2007:234.

- Elfenbein JR, et al. *Equine Vet J Suppl*. 2012;41:76.
- Javscas LH, et al. *Equine Vet J*. 2008;40:41.
- Taharaguchi S, et al. *Vet Rec*. 2007;161:338.
- Sanchez LC, et al. *J Vet Intern Med*. 2008;22:406.
- Coleman MC, et al. *Equine Vet J*. 2009;41:653.
- Furr M, et al. *Equine Vet J*. 2012;44:80.

## GASTRIC ULCER IN ADULT HORSES

Ulceration of the esophageal, gastric squamous, gastric glandular, or duodenal mucosa, either alone or in various combinations, occurs in adult horses. This constellation of lesions has been labeled the equine gastric ulcer syndrome (EGUS).<sup>1</sup> However, this label does not provide sufficient granularity to descriptions of the syndrome, which is composed of a variety of diseases each with its own etiology and pathogenesis, to permit focused discussion of the risk factors, etiology, prognosis, and treatment of each disease.<sup>1,2</sup> For instance, ulceration and gastritis of the gastric squamous mucosa associated with intense training programs has a different presentation and etiology from ulceration of the gastric glandular mucosa caused by injudicious use of NSAIDs. The etiopathogenesis of lesions of the gastric squamous mucosa might well differ from that of lesions of the glandular mucosa; therefore the presence and severity of lesions in each site should be specified.<sup>2,3</sup> Furthermore, it is likely that optimal treatment of lesions of the squamous mucosa differs from that of lesions of the glandular mucosa.



There is not sufficient information to warrant a separate description of each disease (with the exception of NSAID toxicosis). For this reason, the syndrome is described rather than having separate discussions of each disease or circumstances in which the disease occurs. However, there are differences among the various diseases and the discussion should be interpreted in that light.

## ETIOLOGY

The etiology of the most common occurrence of gastric ulcers in the horse is unknown but several risk factors have been identified, which are described in the section [Epidemiology](#).

### SYNOPSIS

**Etiology** Unknown in most cases.

Nonsteroidal antiinflammatory drug intoxication. Not associated with *Helicobacter* sp. infection

**Epidemiology** Common in horses in intense training programs and used in competitive endeavors such as Thoroughbred, Standardbred, and Quarter horses in racing or training and horses used for endurance racing. Common in horses with colic, but clinical importance in most cases is unclear. Associated with periods of feed deprivation or intermittent feeding, such as can occur with stabling or housing on dirt lots

**Clinical signs** None in most horses. Poor appetite, failure to bloom, and mild colic in some horses. Ulcers or erosions present on gastroduodenoscopy

**Clinical pathology** Nondiagnostic. Sucrose absorption test has potential utility.

**Necropsy lesions** Gastritis and/or gastric ulceration, which is rarely a cause of death

**Diagnostic confirmation** Gastroscopic demonstration of ulcers

**Treatment** Omeprazole 1 to 4 mg/kg orally once daily. Ranitidine and cimetidine are used but are less efficacious and convenient.

**Control** Minimize risk factors, including confinement and intermittent feeding. Prolonged administration of omeprazole to at-risk horses

Individual cases of gastric ulcers are associated with parasitic gastritis, such as in horses infested with *Gasterophilus* spp. and *H. megastoma* larvae. Tumors of the stomach, such as gastric squamous cell carcinoma or lymphosarcoma, cause ulceration of the gastric mucosa. Gastric phytobezoars and persimmon seeds (*D. virginiana*) have been associated with gastric impaction, ulceration, and perforation of the glandular portion of the stomach of a horse.<sup>4</sup> Administration of NSAIDs at recommended dosages is not associated with increased risk of gastric ulcers.<sup>5</sup>

There is only weak evidence that infection by *Helicobacter* spp. or similar organisms are associated with gastric ulcer disease in horses.<sup>5,7</sup> A convenience sample of 20 racehorses euthanized because of fractures of the limb during racing revealed that 18 (90%) had lesions of either or both of ulceration of the gastric mucosa or gastritis.<sup>7</sup> Spiral-shaped bacteria were detected in lesions in two of the seven horses with ulcers, four of seven animals with gastritis, and five of six horses with both lesions. *Helicobacter* DNA was detected by PCR in a similar proportion of lesions and in one of the two horses that did not have lesions. Importantly, this study demonstrated the presence of the bacterium but not its causal role in the disease; it might be that similar proportions of horses that do not have gastric lesions are infected. A study of 63 horses slaughtered for human consumption revealed gastric mucosal lesions in 36 but no evidence of infection by *Helicobacter* spp. demonstrated by urease or fluorescence in situ hybridization testing.<sup>5</sup> There is at present no convincing evidence for a role of *Helicobacter* spp. infection in the etiopathogenesis of gastric ulcer disease in horses. However, further studies that clearly define the disease being studied are needed.

## EPIDEMIOLOGY

### Occurrence

The occurrence of gastric ulceration is detected by either postmortem examination or gastroscopic examination. The frequency with which gastric ulcers are detected depends on the method of examination, the group of horses examined, and the reasons for examining them. It is not uncommon for studies of large numbers of horses (>100) to report prevalence of gastric ulcers equal to or greater than 80%, although this is not universal.<sup>8,9</sup> Studies reporting on incidence of gastric ulceration in horses with clinical abnormalities or at necropsy revealed a high frequency of gastric lesions in horses with colic (49%).<sup>10</sup> More recent studies have examined large numbers of horses without clinical signs of gastric ulcer disease but from populations at risk and have demonstrated a high prevalence in horses undertaking strenuous exercise on a regular basis.<sup>9,11-13</sup>

Gastric ulcer disease in horses is a recently recognized disease, with most reports originating after 1990 and coinciding with the widespread availability of endoscopes of sufficient length to permit examination of the stomach of adult horses. However, a longitudinal study of horses submitted for postmortem examination in Sweden demonstrated that horses have been affected with gastric ulcers since 1924.<sup>14</sup>

The condition is common in racehorses and other breeds of horse used for athletic events, and this population represents the most important occurrence of the disease. That said, less active horses and horses on

pasture can be affected and with relatively high prevalence.<sup>3,11,15,16</sup> Broodmares on pasture can have a high prevalence of gastric ulcers (71%, 44 of 62 horses examined) with 42 of the 44 affected horses having ulcers only in the squamous mucosa.<sup>16</sup> There was no difference in prevalence of ulcers between pregnant and nonpregnant mares or between pregnant and recently foaled mares.<sup>16</sup> The presence of ulcers was not correlated with the weight of foals or placenta, raising the issue of the clinical importance of the presence of the ulcers. Over 60% of a nonrandom selection of horses kept on pasture in Denmark had gastric ulcer lesions  $\geq 2$ .<sup>3</sup>

**Thoroughbred and Standardbred** horses in training or racing have a high prevalence of gastric lesions.<sup>8,9,11,12</sup> Gastroscopic studies of convenience samples of clinically normal Thoroughbred racehorses in training reveal a prevalence of lesions of the gastric mucosa of 82% to 93%. Gastric lesions are detected in 52% to 87% of Standardbred horses in training and actively racing.<sup>9</sup> Postmortem examination of Thoroughbred racehorses in Hong Kong, where many horses that retire from racing are examined postmortem, reveals a prevalence of gastric lesions of 66%, with the prevalence increasing to 80% when only horses that had raced recently were considered. Among racehorses selected for gastroscopic examination because of clinical abnormalities, including inappetence, failure to race to expectation, poor hair coat, or poor body condition, lesions of the gastric mucosa were detected in 86% to 90%.<sup>14</sup>

Lesions of the gastric mucosa occur in approximately 80% of **endurance horses** between racing seasons and in over 90% during racing.<sup>15</sup> Gastric lesions were present in 58% of **show horses** that had competed in the 30 days before gastroscopic examination.<sup>14</sup>

## Lesions of the Squamous Versus Glandular Mucosa

The frequency of ulcers of the squamous mucosa is usually, but not invariably,<sup>17</sup> greater than that of ulcers of the glandular mucosa with many horses having lesions at both sites. For example, of 201 horses of various breeds and uses examined in Denmark, 43% had lesions of both glandular and nonglandular gastric mucosa, 15% had lesions of only the glandular mucosa, and 26% had lesions of only the nonglandular mucosa.<sup>3</sup> The majority (86%) of severe lesions (greater than or equal to grade 2, using a simplified grading system) were in the squamous mucosa. Most lesions are located adjacent to the margo plicatus. Lesions of the glandular mucosa are *considered* to be of greater clinical importance than are lesions of the squamous mucosa, although severe lesions (EGUS > 2) of the squamous mucosa are *considered* clinically important. However, clear evidence of the importance of ulcers at either site, or of the relative



importance of ulcers of varying severity, is lacking.

### Risk Factors

Risk factors for gastric lesions in horses include being in training for an athletic event, exercise and the amount of time exercising, and colic. Suspected risk factors include the disposition of the horse (nervous horses are at greater risk),<sup>17</sup> diet, feeding practices, housing (pasture versus stall), stress (although the definition of stress is often not clear), and administration of NSAIDs such as phenylbutazone. Although each of these risk factors can be considered separately, it is likely that many are related and act in concert to increase the risk of development of lesions of the gastric mucosa. For instance, being in training often coincides with confined housing, intermittent feeding, daily bouts of strenuous exercise, and administration of NSAIDs. The combination of these factors, even without NSAID administration, reliably induces ulcers in Thoroughbred racehorses. Young horses (2 years old) that had arrived at the track within the month before first gastroscopic examination had a marked increase in severity of lesions at the time of a second gastroscopic examination 1 month later.

### Animal Risk Factors

Among adult horses, age and gender are the only weak risk factors, if at all, for presence of gastric lesions.<sup>17</sup> Gastric lesions tend to be more severe in older horses. Among Standardbred racehorses, trotters are twice as likely as pacers to have gastric lesions. Horses with gastric lesions are more likely to have a nervous disposition, exacerbated stress hormone response to novel stimuli, and to paw more frequently.<sup>17</sup> Nonsteroidal anti-inflammatory drugs are ulcerogenic at high doses and often administered to horses in training. The impact of NSAIDs on gastric permeability varies among drugs,<sup>19</sup> although the risk of any NSAIDs causing gastric ulcers at doses effective for treatment of musculoskeletal pain appears to be minimal.<sup>5</sup> Furthermore, among Thoroughbred racehorses there is no clear association between administration of these drugs and the risk of having gastric lesions.<sup>14,17</sup>

**Colic** is associated with presence of gastric lesions, although a cause and effect relationship is often not clear in individual cases. In a series of 111 horses with clinical evidence of abdominal discomfort of varying duration and severity, 91 had endoscopic evidence of gastric ulceration. Other abnormalities of the gastrointestinal tract or abdominal viscera were not found in 57 of the 91 horses with gastric ulcers. Thus gastric ulceration was the primary cause of colic, based on lack of concurrent abnormalities, clinical response to treatment with H<sub>2</sub> antagonists, and confirmation of improvement or resolution of gastric ulceration by endoscopy. However,

34 of the 91 horses with gastric ulceration had concurrent abnormalities of the gastrointestinal tract, demonstrating that gastric lesions can develop in horses with colic. Thus colic can cause gastric lesions and gastric ulcers can cause colic.

### Management and Environmental Risk Factors

Racehorses in **training** have a higher prevalence of ulcers than do racehorses that are spelling (not in active training), and horses that are racing regularly have a higher prevalence than resting horses or horses in training but not racing. Standardbred racehorses in training are 2.2 times more likely to have gastric lesions, and those racing regularly are 9.3 times more likely to have gastric lesions, than are horses not training or racing. Increasing time in training is associated with greater severity of gastric lesions in Thoroughbred racehorses.<sup>20</sup> Although, as discussed previously, many factors can contribute to the likelihood of a horse having gastric lesions, such as exercise. This is probably because of the increase in intragastric pressure and decrease in pH in the proximal (nonglandular) stomach that occurs during exercise.

**Feed withholding** causes gastric ulcers in horses, probably because of the lack of buffering of acid produced during periods when the stomach is empty. It is likely that the intermittent access to feed that occurs in many stables results in periods of time during each day when horses do not have feed within the stomach. The loss of buffering is caused by lack of feed material in the stomach and by decreased production of saliva, which normally buffers gastric acid. Intragastric pH declines during periods of feed withholding in horses, which provides an explanation for the mechanism of increased acid exposure as a consequence of management practices.<sup>21</sup> Horses grazing on pasture eat frequently and have food in the stomach almost all the time.

**Diet** is suggested to be a risk factor for development of gastric ulcers, but definitive studies are lacking. Horses in training for racing are usually fed diets high in concentrated rations, and this is suspected to predispose these horses to gastric ulcers. Feeding of alfalfa hay and grain was associated with fewer gastric lesions in six research horses than was feeding brome grass hay.

**Confinement** to stalls is associated with an increased prevalence of gastric lesions, although lesions do occur frequently in some groups of horses kept on pasture. Although horses with gastric lesions during confinement have healing of these lesions when they are pastured, this change is not explained by a higher pH in horses on pasture.<sup>15</sup> Horses on pasture do not have a higher pH of the proximal or ventral stomach than when the same horses are fed ad libitum in stalls,<sup>15</sup> suggesting that it is not the environment that is

affecting intragastric pH. Again, there is considerable confounding among the various risk factors, because housing on pasture is associated with constant access to feed; thus there are no periods of feed withholding, changes in diet from that rich in concentrates to that predominated by grasses, and, often, cessation of forced exercise.

### PATHOGENESIS

The equine stomach is comparatively small relative to the size of the gastrointestinal tract. The stomach mucosa is divided into two parts. The proventricular part is glistening white in color, is composed of thick **stratified squamous epithelium**, and contains no glands. It covers approximately one-third of the mucosal area and ends abruptly at the margo plicatus, a slightly raised irregular serrated border with the glandular mucosa. Most gastric lesions in horses occur in squamous mucosa.

The **glandular mucosa** has a velvet-like structure and is usually covered by a thick layer of viscous mucus. The mucosa contains three main gland types: mucous-secreting cardiac glands; fundic glands, which contain mucous-secreting cells, hydrochloric-acid-producing chief cells; and pyloric glands, which consist largely of mucous-secreting cells. The stratified squamous epithelial mucosa has minimal resistance to gastric acid. The glandular epithelium has elaborate mechanisms, including the mucus–bicarbonate barrier, prostaglandins, mucosal blood flow, and cellular restitution, to protect itself from peptic injury. Hydrochloric acid and pepsinogens, which are converted to the proteolytic enzyme pepsin in an acidic environment, are secreted in the glandular mucosa by parietal cells and chief cells, respectively. The horse is a continuous, variable hydrochloric acid secretor, and the pH of equine gastric contents in the pylorus and antrum is often less than 2.0. Gastric pH is lowest, and acidity highest, when horses have been deprived of feed or have voluntarily stopped eating, often for as little as 2 hours. Thus there are periods during the day when gastric acidity is high (notably during the nighttime hours from midnight to 9 am).<sup>15,21</sup> Periods of prolonged high gastric acidity (pH <2.0) can be induced in horses by intermittent deprivation of feed, which often results in severe ulceration in the gastric squamous epithelial mucosa. Concurrent administration of the H<sub>2</sub> antagonist ranitidine during feed deprivation substantially reduces the area of lesion in the gastric squamous epithelial mucosa.

The pathogenesis of gastric ulcer is uncertain. It is proposed that the stratified squamous epithelium reacts to excessive acidic exposure by thickening and becoming para/hyperkeratotic.<sup>22</sup> Sloughing of superficial layers then predisposes to secondary infection when opportunistic bacteria and

inflammatory cells migrate to the area. The lesion deepens and progresses from an erosion to ulceration, exposing unprotected tissue to acid contents.<sup>22</sup> Subsequent healing might occur depending on factors influencing acidity and healing capabilities of the individual animal.<sup>22</sup> Exposure of squamous mucosa to acid is probably involved in the development of ulcers in most horses and there is *in vitro* evidence that volatile fatty acids, in combination with hydrochloric acid, are important in the development of ulcers in the nonglandular mucosa.<sup>23</sup>

A particular circumstance appears to favor the development of gastritis and ulceration in horses that undertake intense exercise. During exercise intragastric pressure increases from approximately 14 mm Hg at rest to as high as 50 mm Hg, stomach volume decreases, and the acidity of fluid within the proximal part of the stomach declines from pH 5 to 7 to pH 2 to 4. The combination of reduced blood flow and exposure to low pH increases the likelihood of mucosal damage, loss of protective mechanisms, and development of gastric mucosal lesions.<sup>14</sup>

Other factors, including physical injury to gastric mucosa, reflux of bile acids from the duodenum, and the presence of volatile fatty acids in the stomach all can contribute to the development of gastric lesions, but the definitive roles, if any, of each of these factors have not been determined.

## CLINICAL FINDINGS

The vast majority of horses with lesions of the gastric mucosa, including ulceration, do not have clinical signs. Among racehorses, signs of poor performance,<sup>24</sup> feed refusal, fussy eating (not consuming all of the meal at a constant rate), and poor body condition have been associated with the presence of gastric ulcers. Of these signs only poor hair coat and poor body condition have been demonstrated to be associated with gastric ulcers, although the association of lower body condition scores with the presence of gastric lesions is not consistent across studies.<sup>9,17</sup> The high prevalence of some of the clinical signs, for instance, failure to perform to expectation, and gastric ulcers means that there is a high likelihood that horses with a given clinical sign will have an ulcer by chance. However, clinical experience indicates that horses with more extensive or severe lesions will have more severe clinical signs, including colic and failure to perform.

**Colic** is associated with the presence of lesions of the gastric mucosa, including ulceration. Ulceration can result from lesions elsewhere in the gastrointestinal tract, probably because of feed withholding or feed refusal by horses with colic. Alternatively, gastric ulceration can cause colic. The four criteria to determine whether gastric ulceration is the primary cause of colic in horses include the following:

1. Endoscopic confirmation of gastric ulceration
2. Absence of another alimentary tract abnormality
3. Clinical response to treatment that effectively suppresses or neutralizes gastric acidity
4. Confirmation of improvement or complete healing of gastric lesions

Most gastric ulcers in horses are not associated with hemorrhage and so signs of anemia or melena are unusual in horses. Horses with severe gastric ulceration and reflux esophagitis often have bruxism and retching. Rupture of gastric ulcers, perforation and subsequent peritonitis, and exsanguination from a bleeding ulcer are rare in adult horses.

Involvement of the spleen in the horse with a perforating gastric ulcer, a rare event, results in fever, anorexia, toxemia, pain on deep palpation over the left flank, and leukocytosis with a left shift.

**Gastroscopic** examination is the only means of demonstrating gastric lesions and assessing their extent and severity. Gastroscopic examination of the adult horse requires an endoscope of at least 2.5 m in length, although 3 m is preferable. The presence of feed material within the stomach prevents complete examination of the gastric mucosa, and in particular of the pylorus and antrum. The horse should be prepared by having feed withheld for at least 12 hours and water withheld for 4 hours before examination. If the horse is stabled on edible material, such as straw or shavings, it should be muzzled to prevent it eating this material. The horse may need to be sedated before examination (xylazine hydrochloride 0.1–0.3 mg/kg intravenously) and a twitch applied. The gastric mucosa is examined in a systematic fashion. As the end of the endoscope passes through the cardia the greater curvature and margo plicatus are examined. The endoscope is then advanced and rotated so that the lesser curvature and cardia are examined. The stomach should be inflated with air during the procedure. Excess fluid in the pylorus and antrum can be aspirated to allow better visualization of these regions. Careful attention should be paid to the margo plicatus because this is the most common site for lesions. The gastric glandular mucosa should be examined carefully for lesions because they are easily missed in this region. Material adherent to the mucosa should be washed away by flushing water through the endoscope. The endoscope can be passed into the duodenum to permit complete examination of the antrum. Endoscopic examination usually underestimates the number of gastric ulcers, compared with necropsy examination, and does not accurately predict the severity or depth of ulcers.

Small-intestinal segmental volvulus occurs infrequently (0.3%–3.2% of examinations) in horses after gastroscopic examination.<sup>25</sup> Signs of colic develop 10 min to 3

hours after gastroscopy and are caused by nonstrangulating segmental volvulus of gas-distended small intestine. The cause is speculated to be gas distension of the small intestine, although this is not confirmed. Movement of air from the stomach into the small intestine after instillation of air into the stomach is a common occurrence.<sup>26</sup> It is prudent to evacuate as much air as possible at completion of the gastroscopy.

A number of grading systems for description of gastric lesions in horses have been developed and proposed. Few have been validated and tested for diagnostic utility. The Gastric Ulcer Number/Severity score has been validated and compared with an unvalidated system proposed by a group of experts.<sup>27</sup> Notably, neither grading system makes explicit the anatomic location of the lesions. As this information is likely to be of diagnostic or prognostic importance, it should be recorded.<sup>3</sup> Specifically, esophageal lesions, gastric squamous lesions, gastric glandular mucosal lesions, and duodenal lesions should each be scored for location and severity regardless of the scoring system used.

The simplified scoring system, when used by three experienced observers, has greater agreement among observers (intraclass correlation coefficient [ICC] of 0.97) than does the number/severity system (ICC = 0.94 for number of lesions and 0.93 for severity).<sup>27</sup> The  $\kappa$  values for agreement among observers were significantly lower when using the number/severity system.<sup>27</sup> The simplified system was reported by the observers to be quick and easy to use.<sup>27</sup> The simplified system appears to offer a useful method of classifying the severity of gastric lesions in horses, with the caveat that the site of the lesions should be recorded.<sup>2</sup>

Gastric ulcer number/severity score		
Score	Number of lesions	Gastric ulcer severity
0	No lesions	No lesions
1	1–2 localized lesions	Appears superficial
2	3–5 localized lesions	Deeper structures involved (deeper than 1)
3	6–10 lesions	Multiple lesions and variable severity
4	>10 lesions	Same as 2 and in addition the presence of hyperemia or darkened lesion crater
5	>10 lesions	Same as 4 but hemorrhage or blood clot adherent to ulcer

*Continued*

Score	Description
0	Intact mucosal epithelium
1	Intact mucosal epithelium with reddening or hyperkeratosis
2	Small single or small multifocal lesions
3	Large single or large multifocal lesions or extensive superficial lesions
4	Extensive often coalescing lesions with areas of apparent deep ulceration

Most lesions in racehorses are in the gastric squamous mucosa with less than 20% of lesions in the glandular mucosa. The situation is different in hospitalized adult horses, in which lesions in the squamous and glandular mucosa occur with about the same frequency (58%). Most lesions in the glandular mucosa of hospitalized horses occur in the antrum or pylorus, as opposed to the glandular mucosa of the body of the stomach.

Idiopathic gastroesophageal reflux disease occurs sporadically and rarely in adult horses. Affected horses have bruxism and ptyalism that can be severe. Endoscopic examination reveals ulceration and erosion of the esophagus that is more severe in the distal esophagus. Often there is no evidence of impaired gastric outflow, as is common in foals with this disease.

### CLINICAL PATHOLOGY

Horses with gastric ulcers are reported to have higher concentrations of creatinine and activity of alkaline phosphatase in serum than do unaffected horses, but these differences are not sufficient to be clinically useful.<sup>14</sup> Horses with gastric ulcer disease are typically not anemic.

Permeability of the gastric mucosa can be assessed by measurement of concentrations of sucrose in blood (serum) or urine. Sucrose, a disaccharide, is degraded by sucrase in the small intestine to its component monosaccharides glucose and fructose, which are then absorbed. Sucrose is not absorbed intact in healthy animals. Abnormal gastric permeability allows passage of sucrose from the stomach into the blood with subsequent excretion in the urine. In horses with gastric lesions, sucrose concentrations in blood (serum) after nasogastric administration of 250 g of sucrose (table sugar) as a 10% solution in tap water increase after 30 minutes, with peak values at 45 minutes. The magnitude of the increase correlates with the severity of the lesions.<sup>28</sup> This test is quite sensitive for detection of abnormalities in permeability of gastric mucosa as evidenced by abnormal concentrations of sucrose in serum in the absence of lesions detectable by endoscopic examination in horses after administration of high doses of phenylbutazone

(4.4 mg/kg PO q12h day 1, 2.2 mg/kg PO q12h for 4 days, 2.2 mg/kg PO q24h for 9 days).<sup>19</sup> A test using concentrations of sucrose greater than 0.7 mg/dL in urine after intragastric administration of a 10% sucrose solution (1 g/kg orally after feeding) has a sensitivity and specificity of 83% and 90%, respectively, for detection of gastric ulceration.<sup>14</sup>

### NECROPSY FINDINGS

Ulcers may be singular or multiple and are most commonly located in the squamous epithelial mucosa adjacent to the margo plicatus along the lesser curvature of the stomach. They can be linear or irregular in shape; with the exception of those in the glandular mucosa, they are rarely circular in appearance. Ulcers in the squamous mucosa often have slightly raised brown-stained keratinized borders and contain small amounts of necrotic material at their base; frank blood is uncommon. Ulcers in the glandular zone are usually circular or oval depressions surrounded by an intense zone of inflammation. Classification of lesions within the squamous region included hyperkeratosis, punctate scars, diffuse erosions/ulcerations, and margo injuria, and within the glandular region included hyperemia, focal erosions, ulcerations, and glandular metaplasia.<sup>22</sup>

When perforation has occurred, there is an area of local peritonitis, the stomach wall is adherent to the tip of the spleen, and an extensive suppurative splenitis may be present. In some cases, especially when the stomach is full at the time of perforation, a long tear develops in the wall and large quantities of ingesta spill into the peritoneal cavity. Tumor masses can be present and accompanied by several glandular ulcers.

### DIFFERENTIAL DIAGNOSIS

Gastric ulceration of adult horses must be differentiated from the common causes of recurrent colic.

### TREATMENT

The goals of treatment of horses with gastric ulcer disease are healing of the ulcer, suppression of pain, and prevention of ulcer recurrence. The principle underlying treatment of gastric ulcers in horses is suppression of gastric acidity (increase intragastric pH). This can be achieved by inhibiting acid production or increasing buffering of acid. Mucosal protectants are administered with the aim of preventing exposure of damaged mucosa to acid. Management changes may reduce the risk of horses developing disease.

### Acid Suppression

The agents available to suppress acid production are compounds including omeprazole

and lansoprazole, which block the proton pump on the luminal surface of gastric parietal cells, and H<sub>2</sub> receptor antagonists including cimetidine, ranitidine, and famotidine.

### Omeprazole

Omeprazole is currently the favored treatment for gastric ulcer disease in horses. The pharmacokinetics, pharmacodynamics, safety, and efficacy of the drug have been extensively investigated in horses under a variety of conditions and management systems. Omeprazole (4 mg/kg BW orally every 24 hours) is effective in promoting healing of ulcers of the squamous mucosa in horses that continue to train or race, a situation in which ulcers will not heal spontaneously. Omeprazole is safe and no adverse effects from its administration have been reported. Omeprazole at a dosage of 4.0 mg/kg once daily is more effective at healing ulcers of both the squamous and glandular portions of the stomach than is a dosage of 0.8 mg/kg.<sup>29</sup> However, omeprazole is less efficacious at healing ulcers of the glandular mucosa than the squamous mucosa.<sup>29</sup> A frequently used treatment regimen is omeprazole 4 mg/kg once daily for 14 days followed by maintenance therapy of 1 to 2 mg/kg once daily for as long as the horse is at risk of developing gastric ulcers. Administration of omeprazole (4 mg/kg once daily either before or after exercise) resulted in healing of 80% of squamous ulcers versus 21% of glandular ulcers ( $P = 0.0002$ ), and improvement in 96% of squamous ulcers versus 53% of glandular ulcers ( $P = 0.001$ ).<sup>30</sup> Omeprazole paste administered at 1 mg/kg orally once daily is effective in both preventing development of ulcers in horses entering race training and preventing recurrence of ulcers in horses in which ulcers have healed during treatment with a higher dose of omeprazole.<sup>31,32</sup> Omeprazole (0.5 mg/kg once daily) is as efficacious as 1 mg/kg once daily in treating Thoroughbred racehorses with ulcers in training. However, there was no untreated control group, or group administered a higher dose of omeprazole, and results might have reflected healing that could be expected without medication.<sup>33</sup> Administration of omeprazole (1 mg/kg) as an enteric-coated formulation is as effective as administration of omeprazole (4 mg/kg) as a paste in a nonplacebo controlled crossover trial. Administration of the enteric-coated formulation resulted in lower plasma omeprazole concentrations than those achieved with the higher dose of the paste formulation.<sup>34</sup>

Rectal administration of omeprazole does not reliably decrease gastric pH.<sup>35</sup> Intravenous administration of omeprazole (0.5 mg/kg) significantly increases intragastric pH within 1 hour and appears to enhance healing of nonglandular ulcers.<sup>36</sup>

The addition of trimethoprim-sulfonamide to treatment with omeprazole does



not enhance healing of ulcers of the glandular mucosa.<sup>37</sup>

The composition of the excipients and form of omeprazole is important in determining efficacy. Forms of omeprazole other than that in the commercial preparation are associated with reduced or nil efficacy. Omeprazole is more effective than cimetidine (20 mg/kg orally every 8 hours) for treatment of gastric ulcers in racehorses.

Esomeprazole (0.5 mg/kg intravenously every 24 hours) is effective in raising intragastric pH in adult horses.<sup>38</sup> Its efficacy in treatment or prevention of gastric lesions has not been determined.

### Cimetidine

Cimetidine is the prototypical H<sub>2</sub> receptor antagonist. It acts by blocking action of histamine on the basilar membrane of the gastric parietal cells. It is used for treatment of gastric ulcer disease in horses, for which it must be administered frequently and in high doses (20–25 mg/kg orally every 6–8 hours). The drug has variable absorption after oral administration to horses. It is usually cheaper than omeprazole, but is less effective. Cimetidine can be administered intravenously (7 mg/kg every 6 hours) if rapid action is needed or the animal cannot take medication orally (e.g., a horse with colic).

### Ranitidine and Famotidine

Ranitidine (6.6 mg/kg orally every 8 hours) effectively suppresses gastric acidity and prevents development of ulcers in horses deprived of feed. Ranitidine does not affect rates of gastric emptying.<sup>39</sup> Commercial preparations for its use in horses are marketed in some countries.

Famotidine is an H<sub>2</sub> receptor antagonist marketed for use in humans. It is effective in suppressing gastric acidity in horses (3 mg/kg orally every 12 hours or 0.3 mg/kg intravenously every 12 hours) but is expensive.

### Gastric Antacids

Gastric antacids given orally neutralize stomach acid to form water and a neutral salt. They are not absorbed and decrease pepsin activity, binding to bile salts in the stomach, and stimulate local prostaglandin. One oral dose of 30 g of aluminum hydroxide and 15 g of magnesium hydroxide can result in a significant increase in gastric pH for up to 4 hours. The short duration of action, minimal and transient effect on gastric pH, and need for administration of large volumes orally render these products less than optimal. Moreover, there is evidence that antacids are not effective in treatment of gastric ulcers in racehorses.

### Protectants and Other Treatments

**Sucralfate** is an antiulcer drug with a cytoprotective effect on the gastric mucosa. Sucralfate dissociates in gastric acid to

sucrose octasulfate and aluminum hydroxide. The aluminum hydroxide acts as an antacid and the sucrose octasulfate polymerizes to a viscous, sticky substance that creates a protective effect by binding to ulcerated mucosa. This prevents back diffusion of hydrogen ions, inactivates pepsin, and absorbs bile acid. Sucralfate is administered to horses (22 mg/kg orally every 8 hours) but is not effective in promoting healing in induced disease or associated with a lower risk of gastric ulcers in racehorses administered the compound.

Pectin–lecithin complexes are not effective in treatment of gastric ulcer disease in horses. A combination of pectin, lecithin, and bicarbonate in unspecified amounts fed as a supplement demonstrated limited efficacy in reducing gastric ulcer scores induced by feed deprivation.<sup>40</sup>

Administration of concentrates or extracts of sea buckthorn berries (*Hippophae rhamnoides*) does not reduce the incidence of nonglandular gastric lesions in horses with experimentally induced (intermittent feed deprivation) gastric ulcerative disease.<sup>41</sup>

Misoprostol, a prostaglandin E analog, is administered for treatment of gastric and other enteric lesions,<sup>42</sup> and especially those attributable to NSAID toxicosis. However, its efficacy in treating or preventing gastric ulceration in horses has not been determined. It does appear to be safe to administer to pregnant mares.<sup>43</sup>

### Management Changes

Horses with gastric ulcers experience spontaneous healing when removed from training and kept on pasture. These management changes are not appropriate in most instances, and emphasis should be placed on feeding diets that have a low ulcerogenic potential (such as alfalfa hay) and using feeding practices that minimize or eliminate periods when the horse does not have access to feed. Hay should be constantly available to horses, if at all possible.

### Overview of Treatment

The usual approach to treatment is to promote healing of the ulcer by administration of effective agents (omeprazole or possibly ranitidine) at high dose until the ulcer has healed, as demonstrated by gastroscopy. The horse is then administered omeprazole at a lower dose (1–2 mg/kg orally every 24 hours) for the duration of time that it is at risk of developing gastric ulcers. Changes in management, including feeding practices and diet, should be instituted at the start of treatment. While not statistically associated with risk of gastric ulceration, use of phenylbutazone or other NSAIDs should be minimized in horses at high risk of disease.

### CONTROL

Prevention of gastric ulcer disease in athletic horses centers on minimizing the effect of

factors that promote ulcer development. This might involve the chronic administration of omeprazole (1 mg/kg orally once daily),<sup>32</sup> but should include attention to dietary and feeding practices (discussed previously) that minimize the time that horses have no feed in their stomach. Ideally, horses at risk would be kept on pasture, but this is not feasible under many management or husbandry systems and it does not reliably prevent the development of ulcers.<sup>16</sup> All horses in athletic training and confined to stalls should be considered at high risk of development of gastric ulcers and should be managed accordingly. Detailed recommendations about feeding practices are available.<sup>44</sup>

### FURTHER READING

- Sykes BW, Jokisalo JM. Rethinking equine gastric ulcer syndrome: Part 1—Terminology, clinical signs and diagnosis. *Equine Vet Educ.* 2014;26:543–547.
- Reese R, Andrews F. Nutrition and dietary management of equine gastric ulcer syndrome. *Vet Clin North Am Equine Pract.* 2009;25:79–92.

### REFERENCES

- Merritt AM. *Equine Vet J.* 2009;41:616.
- Sykes B, et al. *Equine Vet Educ.* 2014;26:543.
- Luthersson N, et al. *Equine Vet J.* 2009;41:619.
- Banse HE, et al. *JAVMA.* 2011;239:1110.
- Fennell LC, et al. *Equine Vet Educ.* 2009;21:660.
- Husted L, et al. *BMC Microbiol.* 2010;10:84.
- Contreras M, et al. *Lett Appl Microbiol.* 2007;45:553.
- de Bruijn CM, et al. *Vet Rec.* 2009;164:814.
- Cate RE, et al. *Comp Exerc Physiol.* 2012;8:47.
- Dukti SA, et al. *Equine Vet J.* 2006;38:347.
- Bell RJW, et al. *N Z Vet J.* 2007;55:13.
- Jonsson H, et al. *Equine Vet J.* 2006;38:209.
- Tamzali Y, et al. *Equine Vet J.* 2011;43:141.
- Radostits O, et al. *Gastric Ulcer in Adult Horses. Veterinary Medicine: A Textbook of the Diseases of Cattle, Horses, Sheep, Goats and Pigs.* 10th ed. London: W.B. Saunders; 2007:237.
- Husted L, et al. *Equine Vet J.* 2008;40:337.
- le Jeune SS, et al. *Vet J.* 2009;181:251.
- Malmkvist J, et al. *Appl Anim Behav Sci.* 2012;142:160.
- Marques FJ, et al. *Equine Vet Educ.* 2011;23:249.
- D'Arcy-Moskwa E, et al. *J Vet Intern Med.* 2012;26:1494.
- Orsini J, et al. *J Equine Vet Sci.* 2009;29:167.
- Husted L, et al. *Equine Vet J.* 2009;41:658.
- Martineau H, et al. *Equine Vet J.* 2009;41:638.
- Andrews F, et al. *Am J Vet Res.* 2006;67:1873.
- Franklin SH, et al. *Equine Vet Educ.* 2008;20:119.
- Bonilla AG, et al. *Equine Vet Educ.* 2014;26:141.
- Kihurani DO, et al. *Vet Radiol Ultrasound.* 2009;50:429.
- Bell RJW, et al. *N Z Vet J.* 2007;55:19.
- Hewetson M, et al. *J Vet Intern Med.* 2006;20:388.
- Sykes BW, et al. *Equine Vet J.* 2014;46:416.
- Sykes BW, et al. *Equine Vet J.* 2014;46:422.
- Endo Y, et al. *J Vet Med Sci.* 2012;74:1079.
- White G, et al. *JAVMA.* 2007;230:1680.
- Sykes BW, et al. *Vet Rec.* 2014;175:10.
- Birkmann K, et al. *J Vet Intern Med.* 2014;28:925.
- Rand C, et al. *Vet Rec.* 2011;169:126.
- Andrews F, et al. *J Vet Intern Med.* 2006;20:1202.
- Sykes BW, et al. *BMC Vet Res.* 2014;10:180.
- Videla R, et al. *J Vet Intern Med.* 2011;25:558.
- Maher O, et al. *Am J Vet Res.* 2008;69:1153.
- Woodward MC, et al. *BMC Vet Res.* 2014;10 (suppl 1):S4.



41. Huff NK, et al. *J Vet Intern Med.* 2012;26:1186.
42. Blikslager AT. *Equine Vet J.* 2013;45:8.
43. Jacobson CC, et al. *Equine Vet J.* 2013;45:91.
44. Reese R, et al. *Vet Clin North Am Equine Pract.* 2009;25:79.

## INTESTINAL OBSTRUCTION IN HORSES

Intestinal obstruction is an important cause of colic in horses, and can involve the small intestine, cecum, large (ascending) colon, or small (descending) colon. Because the clinical characteristics of obstruction of the various bowel segments are quite different, intestinal obstruction is discussed based on the site affected (small intestine, cecum, and large or small colon).

## SMALL-INTESTINAL OBSTRUCTION IN HORSES

### SYNOPSIS

**Etiology** Volvulus; intussusception; incarceration and strangulation in epiploic foramen, Meckel's diverticulum, mesenteric rents, or umbilical, inguinal, or diaphragmatic hernia, or by pedunculated lipoma; obstruction caused by foreign bodies or ascarids, intramural tumors including hematomas, eosinophilic infiltrates, neoplasms, and abscesses; ileal hypertrophy; ileal impaction

**Epidemiology** Mostly sporadic diseases, although the age affected can vary with the disease

**Clinical signs** Strangulating lesions cause acute, severe disease with intense pain, tachycardia, dehydration and hemoconcentration, and usually distended loops of small intestine palpable rectally or detectable by ultrasonographic examination; death occurs in untreated horses within 48 h; obstructive, nonstrangulating lesions cause less severe pain and clinical abnormalities and have a longer course until death

**Clinical pathology** Nondiagnostic; hemoconcentration and azotemia are indicative of dehydration; increases in blood (plasma) and/or peritoneal fluid lactate concentrations are useful for prognostication; leukopenia and left shift are consistent with endotoxemia and peritonitis; peritoneal fluid can be serosanguinous with infarcted intestine

**Lesions** Consistent with the disease

**Diagnostic confirmation** Surgical exploration or necropsy

**Treatment** Surgical correction of lesion; analgesia; correction of fluid, electrolyte, and acid-base abnormalities

## ETIOLOGY

A working classification is outlined next.<sup>1</sup>

### Obstruction With Infarction

- Volvulus or torsion of the mesentery
- Incarceration in or strangulation by
  - Mesenteric rents
  - Epiploic foramen
  - Meckel's diverticulum
  - Pedunculated lipoma
  - Neoplastic lesions (teratoma)<sup>2</sup>
  - Adhesions
  - Inguinal hernia
  - Umbilical hernia
  - Diaphragmatic hernia
  - Rents in mesentery or intraabdominal ligaments (e.g., gastrosplenic) or spleen
  - Spermatic cord in geldings
  - Developmental defects in mesentery

### Obstruction Without Infarction

- Intussusception:
  - Jejunojejunal, ileoileal, and other small intestinal intussusceptions
  - Acute and chronic ileocecal
- Foreign body:
  - Wood chip or fencing material impaction of duodenum or jejunum
  - Phytobezoars<sup>3</sup>
  - Linear foreign bodies such as string or baling twine
  - Impaction of the duodenum or jejunum by molasses-containing feedblocks
- Impaction by *P. equorum*<sup>4,5</sup>
- Impaction of the terminal ileum
- Muscular hypertrophy of the terminal ileum
- Intramural masses such as neoplasms (intestinal adenocarcinoma, focal lymphosarcoma, and leiomyoma), hematomas, abscesses and fungal infections (intestinal pythiosis), focal eosinophilic enteritis,<sup>6</sup> and *Lawsonia intracellularis* (LI) proliferative enteropathy
- Compression of intestine by intraabdominal masses including abscesses and neoplastic tumors

### Functional Obstruction

- Anterior enteritis
- Postoperative ileus
- Myenteric ganglioneuritis
- Intestinal ischemia of any cause (thromboembolic colic, mesenteric accidents, and postexertional ileus)

The classification used above should be used only as a guide, because the actual clinical presentations vary. For instance, intussusceptions usually result in infarction of the intussuscepted segment but, because this segment is effectively isolated from the body, the clinical signs are often not characteristic of a horse with an infarctive lesion. Similarly, horses with small intestine entrapped in the epiploic foramen often have less severe clinical signs than anticipated for the severity of the lesion.

## EPIDEMIOLOGY

The epidemiology of colic is covered in a previous section. There are no recognized risk factors for small-intestinal volvulus and for many small-intestinal accidents. Epidemiologic information is available for some small-intestinal obstructive diseases and is presented later. Obstructive diseases of the small intestine compromise approximately 20% of colic cases referred for further evaluation and treatment. For small-intestinal diseases requiring surgical correction, the case-fatality rate is 100% if surgery is not performed. Short-term survival of horses undergoing surgical correction of small-intestinal obstruction is 34% to 74%. The fatality rate is greatest in the perioperative period. Survival rates vary depending on the nature and severity of the lesion, with long-term survival rates lower for horses that require resection of the intestine, especially for resections of more than 2 m or more than one surgery. Prognosis might be improved by accurate identification of compromised, but viable, intestine and its preservation rather than resection.<sup>7</sup>

### Intestinal Herniation Through the Epiploic Foramen

This occurs in approximately 5% of horses with small-intestinal disease requiring surgery. Geldings are four times more likely than mares to be affected. Thoroughbreds were overrepresented in two studies, suggesting a breed predisposition, and there was no effect of age on incidence. There appears to be an increased incidence of the disease between October and March in Britain. Horses in the UK with a history of crib biting or wind sucking (adjusted OR 72, 95% CI 14–359), with a history of colic in the past 12 months (5.1, 95% CI 1.4–18.9), increased stabling in the past 4 weeks (3.7, 95% CI 1.4–9.7), and increased height (1.07, 95% CI 1.01–1.12 per centimeter) are at markedly increased risk of developing epiploic entrapment of the small intestine.<sup>8</sup> Similar risk factors are identified in horses from the United States, Ireland, and UK.<sup>9</sup> Horses with colic that crib (a behavioral abnormality in which horses grasp a fixed object such as a fence rail or post with the incisors, flex the neck, and draw air into the esophagus) are more likely to have herniation of the small intestine through the epiploic foramen than are horses that do not crib.<sup>1,8,9</sup> The reason for this association is not known but might be related to factors that predispose horses to both cribbing and intestinal herniation through the epiploic foramen, such as diet, exercise, or housing. Alternatively, cribbing might cause changes in intraabdominal pressure that favor herniation. There is no age predisposition to development of this disorder.

The case-fatality rate for horses subjected to surgery is between 30% and 50%, although older reports of the disease had a much higher case-fatality rate.<sup>10</sup>

### Pedunculated Lipomas

The prevalence of colic caused by pedunculated lipoma is 1% to 2.6% of horses with colic and 1% to 17% of all horses that have a celiotomy because of small-intestinal disease. The prevalence varies depending on the population of horses studied. The proportion of horses with colic caused by pedunculated lipomas increases with age, and the median age of affected horses is 19 years. Pedunculated lipomas cause small-intestinal obstruction in older horses (>8 years) with geldings (2×) and ponies (4×) being at increased risk. Pedunculated lipomas occasionally (5 of 75 cases) cause strangulating obstructive lesions of the small colon. The case-fatality rate for horses subjected to surgery is over 60%.

### Inguinal Hernias

**Inguinal hernias** occur only in males. **Congenital inguinal hernias** are usually self-limiting, do not require medical or surgical therapy, and resolve by the time foals are 3 to 6 months of age. Congenital inguinal hernias rarely cause a strangulating lesion of the small intestine (see the section **Colic in Foals**). **Acquired inguinal hernias** occur almost exclusively in stallions, and the disease is rare in geldings. There is no apparent breed or age predilection. The case-fatality rate for horses subjected to surgery is 25%.

### Intussusception

**Small-intestinal intussusception** is more common in young horses and foals but also occurs in adult horses. Approximately 50% of intussusceptions in adult horses are associated with a luminal or mural mass, whereas this is not the case in younger horses and foals. The case-fatality rate of horses subjected to surgery is 25% to 60%.

Both acute and chronic **ileocecal intussusceptions** occur more commonly in young (6–30 months) horses, although they are rare in foals. There is no breed or gender predilection. The disease is acute in approximately 70% of cases and chronic in the remainder. Ileocecal intussusceptions constitute approximately 75% of all intussusceptions involving the small intestine and 60% of all intussusceptions. The **case-fatality rate** for horses with acute ileocecal intussusception when surgery is available is approximately 70%, whereas that for chronic intussusception is less than 10%. There is strong evidence of an association between tapeworm (*A. perfoliata*) infestation and ileocecal disease causing colic in horses.<sup>11,12</sup>

### Foreign Body

**Foreign-body obstructions** occur most frequently in foals and yearlings, possibly because of their tendency to explore and eat unusual items. Impaction by *P. equorum* occurs in foals between 3 and 18 months of age and is often associated with the administration of anthelmintics to previously

untreated foals.<sup>4,5</sup> Small-intestinal obstructions by feedblocks containing molasses is associated with ingestion of large quantities of the material.

### Impaction

**Ileal impaction** is more common in mares and only in animals over 1 year of age. The disease represented 7% of surgical colic cases in one series. The case-fatality rate is as low as 8% in animals treated at a referral institution,<sup>13</sup> although older reports are of much lower survival rates.<sup>1</sup> The disease is attributed to the feeding of finely ground, high-fiber feed such as Coastal Bermuda hay, but this is not the only cause. Horses with colic that have been fed coastal Bermuda hay are approximately three times more likely to have ileal impaction than are horses with colic that have not been fed this feedstuff. Similarly, lack of administration of a compound effective against tapeworms is associated with a three times greater risk of ileal impaction among horses with colic, and tapeworm infestation is associated with an increased incidence of spasmodic colic and ileocecal impaction in Thoroughbred racehorses.

### Mesenteric Rents

Incarceration of small intestine through mesenteric rents is a cause of colic in approximately 2% of colic patients undergoing exploratory celiotomy. The long-term survival rate is approximately 40%. There are no identified age, breed, or gender predilections.

### PATHOGENESIS

The effects of intestinal obstruction and the particular influence of the related endotoxemia in horses were detailed earlier. The type of lesion is important, depending on whether the blood supply to a large section of intestine is occluded or whether effective circulation is maintained. Obstructions that do not cause widespread intestinal ischemia, such as those caused by focal external pressure or with some form of disease caused by pedunculated lipomas or caused by internal foreign bodies such as phytobezoars, are less acutely lethal and do not cause as severe signs as volvulus and forms of intussusception that result in ischemia of large sections of intestine. In the latter case, endotoxins from the gut lumen pass through the devitalized tissues of the gut wall into the circulation, resulting in signs of toxemia and cardiovascular collapse. There does not appear to be an important role for translocation of intestinal bacteria into the bloodstream in horses with small-intestinal lesions.<sup>14</sup>

### CLINICAL FINDINGS

#### Acute Disease: Infarctive Lesions

In acute, complete obstructions of the small intestine, with intestinal ischemia caused by volvulus, intussusception, or strangulation, there is usually an almost immediate onset of

severe abdominal pain. The pain can be minimally or only transiently responsive to administration of analgesics. During this early stage intestinal sounds are still present and feces still passed. The pulse rate increases to 60 to 80 beats/min, the respiratory rate can be as high as 80 beats/min, and sweating begins in many horses. It might be 8 to 12 hours before distended loops of intestine are palpable on rectal examination, and it is about the same time that clinical and laboratory evidence of hypovolemia is first apparent. Depending on the site of the obstruction there can be reflux of fluid on passage of a nasogastric tube. More proximal lesions result in distension of the stomach earlier in the course of the disease. Small-intestinal distension is readily detected by percutaneous or rectal ultrasonographic examination. The sensitivity and specificity of ultrasonographic examination for detecting small-intestinal distension (98% and 84%, respectively) is greater than that of rectal examination (50% and 98%, respectively).<sup>1,15</sup>

In the period 12 to 24 hours after obstruction commences, the pulse rate rises to 80 to 100 beats/min, loops of distended intestine can be palpated per rectum, gut sounds and defecation cease, and the rectum is empty and sticky to the touch. Abdominal paracentesis yields bloodstained fluid. From 24 hours onward, signs of hypovolemia and toxic shock become marked, but the pain may not worsen. The horse will often appear depressed and poorly responsive to external stimuli. Sweating may persist. The heart rate increases to 100 to 120 beats/min, intestinal loops are easily palpable, and reflux filling of the stomach occurs, with a great deal of fluid evacuated via the stomach tube; the horse may vomit. Death from endotoxemia or rupture of the intestine usually occurs within 48 hours. The terminal stage is one of severe endotoxic shock, with or without intestinal rupture and peracute diffuse peritonitis.

#### Subacute Cases: Noninfarctive Lesions

If there is no vascular involvement in the small-intestinal obstruction, such as occurs with ileal impaction, the pain is less severe than for horses with infarctive lesions, it is usually responsive to analgesics, and the heart rate is only mildly elevated (50–60 beats/min). The pain can be low-level continuous or intermittent with moderate attacks of pain alternating with periods of uneasiness without signs of overt pain. Pain is usually responsive to the administration of analgesics. The duration of colic in these cases can be several days to several weeks. Palpable intestinal distension and clinical and laboratory evidence of hypovolemia can be evident; for example, ileal impaction is detectable by rectal examination in approximately 25% of affected horses.<sup>13</sup> Surgical intervention becomes an option because of the failure of the horse to improve.

### Intussusception of the Small Intestine

This can cause a syndrome of acute, subacute, or chronic colic, depending on the degree of involvement of the blood supply. Horses with **acute ileocecal intussusception** have an abrupt onset of moderate to severe abdominal pain, tachycardia, reflux through a nasogastric tube, complete absence of borborygmi, and tightly distended small intestine evident on rectal palpation. The course of the disease is usually less than 24 hours. Horses with **chronic ileocecal intussusception** have a history of chronic, intermittent colic occurring after feeding, weight loss, and reduced fecal volume. The abdominal pain is mild and intermittent and the horses are not dehydrated or tachycardic. Rectal examination may reveal the presence of mildly distended small intestine, especially after a meal, and in approximately 25% of cases the intussusception can be palpated per rectum. Mild abdominal pain can be present for weeks without an abdominal crisis occurring. Ultrasonographic examination may reveal the intussusception in the right flank.

### Volvulus of the Small Intestine

This presents a typical syndrome of acute intestinal obstruction and infarction. The onset of signs is abrupt and there is severe pain, tachycardia, sweating, and a rapid deterioration in the horse's clinical condition.

### Strangulated Inguinal Hernia

This entity is often missed in the early stages because the distension of the scrotum is easily overlooked unless a specific examination of that area is performed. Severe pain in an intact male, even when distended loops of small intestine are not palpable, should prompt a thorough examination of the scrotum and, per rectum, the internal inguinal rings.

### Strangulated Diaphragmatic Hernia

When acquired after birth, this lesion has no distinguishing characteristics and will be identified only on thoracic radiography or exploratory laparotomy.<sup>16</sup> There is often a history of trauma, such as dystocia or, in adults, a fall or being hit by a car. The clinical course is characteristic of any acute, strangulating intestinal lesion. Small intestine or large colon can herniate into the thoracic cavity and be evident on radiographic or ultrasonographic examination of the thorax.

### Epiploic Foramen Entrapment

Entrapment of small intestine in the epiploic foramen is associated with an array of clinical signs, some of which are subtle. Strangulation of small intestine through the epiploic foramen typically causes signs of acute abdominal pain with reflux of material through a nasogastric tube. However, approximately 40% of affected horses do not have signs of abdominal pain when examined at a referral

center and 52% do not have nasogastric reflux. Horses with less severe clinical signs presumably have shorter lengths of incarcerated small intestine or incomplete obstructions to passage of luminal material or blood flow. Herniation of the parietal (antimesenteric) margin of the small intestine is sometimes associated with incomplete obstruction of the small intestine and signs of mild disease. Because of the anterior location of the lesion, distended small intestine cannot usually be palpated per rectum and is not identifiable without ultrasonographic examination or surgical intervention. A fatal complication of epiploic foramen herniation is rupture of the portal vein, leading to sudden death from internal hemorrhage. Tension by the incarcerated section of gut on the portal vein causes tearing of the wall and subsequent hemorrhage. Hemoperitoneum in a horse with colic should prompt consideration of entrapment of small intestine in the epiploic foramen as a cause of the disease. The outcome of this combination of diseases is almost always fatal.

### Functional Obstruction

Functional obstructions caused by anterior enteritis, intestinal ischemia, or postoperative ileus can be difficult to discriminate from obstructive lesions of the small intestine that require surgical correction. Postoperative ileus is characterized by continued pain and reflux through a nasogastric tube after surgical correction of an intestinal lesion. The ileus is probably a result of the diffuse peritonitis and inflammation of the intestine that results from surgical exploration of the abdomen. If sufficient doubt exists over the cause of a horse's signs of intestinal obstruction, then laparotomy or repeat laparotomy should be performed.

### Foreign Body

Foreign-body impaction of the duodenum by agglomerations of chewed wood or cracked corn kernels cause signs of acute obstruction but without the endotoxemia caused by infarction.

### Ileocecal Valve Impaction

Impaction of the ileocecal valve is manifest as an initial period of 8 to 12 hours of subacute abdominal pain with mild increases in heart rate. Intestinal sounds are increased in frequency and intensity. Rectal examination may reveal the enlarged, impacted ileum in the upper right flank at the base of the cecum in approximately 10% of cases. It is easily confused with an impaction of the small colon. Reflux on nasogastric intubation occurs in approximately 50% of cases. After 24 to 36 hours the pain increases in severity. There is severe depression, patchy sweating, and coldness of the extremities, and the animal stands with its head hung down, sits on its haunches, and rolls and struggles violently. The abdominal pain

becomes severe and continuous, the pulse rate rises to between 80 and 120 beats/min, and the pulse is weak. The abdominal sounds are absent and there is reflux of sanguineous fluid through a nasogastric tube. On rectal examination the small intestine is tightly distended with gas and fluid. Death usually occurs within 36 to 48 hours after the onset of illness without surgical or effective medical intervention.

### Idiopathic Muscular Hypertrophy (Terminal Ileal Hypertrophy)

This causes a long-term chronic or mild intermittent colic, with reduced appetite and weight loss, which persists over a period of weeks, sometimes months, in horses more than 5 years and up to 18 years old. Colic pain is associated with feeding. On rectal examination the greatly thickened ileum can be palpated at the base of the cecum, and there may also be distended loops of thick-walled ileum.

Difficulty can be experienced in differentiating ileal hypertrophy from chronic intussusception, especially of the terminal ileum into the cecum. Fluid ingesta can pass the much constricted lumen of an intussusception so that mural hypertrophy occurs orally. A similar clinical picture results from stenosis of the small intestine by adhesions, usually resulting from verminous migration. In all three diseases there is increased motility of the small intestine and there is no interference with the blood supply.

### Caudal Abdominal Obstructions

Obstructive lesions of the small intestine in the caudal abdomen, and therefore more likely to be palpable, include strangulation through tears in the mesentery, through a defect in the gastrosplenic ligament, entrapment behind the ventral ligament of the bladder, or through a tear in the broad ligament of the uterus.

**Radiography** is not useful in diagnosing the cause of small-intestinal obstruction in adult horses, but **ultrasonographic** examination of the abdomen is rewarding and has greater sensitivity for detection of distended loops of small intestine than does rectal examination. If available, ultrasonographic examination is indicated in the initial or second examination of all horses with colic. Ultrasonographic examination can detect, in addition to distended small intestine, reductions in or absence of motility associated with ileus, thickening of the intestinal wall, intussusceptions, increased volume of peritoneal fluid, and abnormalities in the echogenicity of peritoneal fluid.

### CLINICAL PATHOLOGY

Although laboratory examinations of animals with intestinal obstruction may not be used in the diagnosis of the obstruction, they are useful in assessing its severity and providing an indication of survival. Generally, the



laboratory findings in acute intestinal obstruction include the following:

- Hemoconcentration (the PCV usually exceeds 50%)
- Increase in serum creatinine concentration (depending on severity of the decrease in circulating blood volume)
- Decreases in plasma bicarbonate and pH, with increases in lactate concentration and anion gap
- Leukopenia and neutropenia caused by devitalization of infarcted intestine and the development of endotoxemia and, in some cases, peritonitis
- An increase in the total number of leukocytes, erythrocytes, and the protein concentration in the **peritoneal fluid** obtained by paracentesis. In acute intestinal obstruction with infarction, the peritoneal fluid will be bloodstained. As necrosis and gangrene develop there is an increase in the total number of leukocytes with an increase in the number of immature neutrophils. As devitalization proceeds, but before perforation of the gut wall, intracellular and extracellular bacteria may be seen in the fluid. Peritoneal fluid from horses with intestinal infarctive lesions has a higher alkaline phosphatase activity than fluid from horses with nonstrangulating obstructions. Peritoneal fluid lactate concentrations can be measured and are associated with probability of survival. Lactate concentrations in peritoneal fluid of horses with colic of 1, 6, 12, and 16 mM were associated with death rates of 11, 29, 63, and 82% in horses without strangulating lesions and 25, 52, 82, and 92% in horses with strangulating lesions.<sup>17</sup>
- Serum alcohol dehydrogenase activity increases in horses with colic, with concentrations increasing from (median range) of 10.5 (8.7–11 u/L) in healthy horses, 16.5 (13.8–18 u/L) in horses with colon impaction, 40 (20–74.9 u/L) in horses with small-intestinal strangulation, and 63.2 (40–78 u/L) in horses with colon torsion.<sup>18</sup>

## NECROPSY FINDINGS

The physical lesions are characteristic of the disease.

### DIFFERENTIAL DIAGNOSIS

Other diseases that may mimic pain caused by gastrointestinal disease are listed under differential diagnosis in the Equine Colic section. Gastrointestinal causes of colic that must be differentiated from small intestinal obstructive disease include:

- Enteritis and acute diarrhea
- Equine neorickettsiosis (Potomac horse fever)

- Anterior enteritis
  - Gastric ulcer in foals and adults
  - Disorders of the large or small colon
  - Intestinal tympany (gas colic)
  - Thromboembolic colic
- See also [Table 7-10](#).

## TREATMENT

The principles of treatment of horses with small-intestinal obstructive lesions are similar to those of any colic (see the section [Equine Colic](#)).

Every attempt should be made to relieve the horse's pain using appropriate doses of effective analgesics (see [Table 7-15](#)). Care should be taken when using flunixin meglumine that signs of a lesion requiring surgical correction are not masked until the severity of the disease makes successful treatment unlikely.

**Almost all obstructive lesions of the small intestine require surgical correction.** Surgical techniques including the need to resect small intestine vary with the physical lesion and viability of the intestine.<sup>19,20</sup> In addition to surgery, attention should be paid to maintaining the horse's fluid and acid-base and electrolyte status (see the section [Equine Colic](#)). Treatment of postoperative ileus should be aggressive and include correction of acid-base, fluid, and electrolyte abnormalities; continued gastric decompression through a nasogastric tube; and administration of promotility drugs such as cisapride, lidocaine, erythromycin, and metoclopramide (see [Table 7-16](#)).

Ileal impactions can be treated medically by the administration of intravenous fluids, gastric decompression, and administration of mineral oil. Horses treated medically should be closely monitored as prompt surgical intervention may be necessary if the horse's condition deteriorates.

## REFERENCES

1. Radostits O, et al. Small Intestinal Obstruction in Horses. *Veterinary Medicine: A Textbook of the Diseases of Cattle, Horses, Sheep, Goats and Pigs*. 10th ed. London: WB Saunders; 2007:241.
2. Arensburg L, et al. *Equine Vet Educ*. 2012;24:433.
3. Banse HE, et al. *AAEP Proc*. 2009;476.
4. Cribb NC, et al. *N Z Vet J*. 2006;54:338.
5. Tatz AJ, et al. *Equine Vet J Suppl*. 2012;43:111.
6. Olmos JFP, et al. *Equine Vet J*. 2006;38:354.
7. Freeman DE, et al. *Equine Vet J*. 2014;46:711.
8. Archer DC, et al. *Equine Vet J*. 2008;40:405.
9. Archer DC, et al. *Equine Vet J*. 2008;40:224.
10. Southwood LL, et al. *Equine Vet J*. 2009;41:459.
11. Back H, et al. *Vet Parasitol*. 2013;197:580.
12. Pavone S, et al. *Vet Res Commun*. 2010;34(suppl 1): S53.
13. Fleming K, et al. *Can Vet J*. 2011;52:759.
14. Hurcombe SD, et al. *J Vet Emerg Crit Care*. 2012;22:653.
15. Beccati F, et al. *Equine Vet J*. 2011;43:98.
16. Romero AE, et al. *Can Vet J*. 2010;51:1247.
17. Delesalle C, et al. *J Vet Intern Med*. 2007;21:293.
18. Gomaa NAM, et al. *J Vet Emerg Crit Care*. 2011;21:242.

19. Stewart S, et al. *Equine Vet J*. 2014;46:333.

20. Freeman DE, et al. *Equine Vet J*. 2014;46:711.

## DUODENITIS-PROXIMAL JEJUNITIS (ANTERIOR ENTERITIS, PROXIMAL ENTERITIS)

Duodenitis-proximal jejunitis is a syndrome of small-intestinal ileus characterized clinically by acute onset of abdominal pain and production of copious amounts of nasogastric reflux. It is idiopathic and associated with lesions in the duodenum and/or proximal jejunum.

### SYNOPSIS

**Etiology** Unknown—suspect strains of *Clostridium difficile*

**Epidemiology** Sporadic disease. Case–fatality rate highly variable (6%–75%)

**Clinical signs** Colic, voluminous reflux on nasogastric intubation, mild fever, resolution of pain on gastric decompression

**Clinical pathology** Nondiagnostic

**Lesions** Duodenitis, proximal jejunitis, gastric and small intestinal distension

**Diagnostic confirmation** None antemortem, resolution of disease

**Treatment** Gastric decompression, correction of fluid and electrolyte abnormalities

## ETIOLOGY

The etiology of duodenitis-proximal jejunitis is unknown with both infectious (*Salmonella* spp. and *C. difficile*) and toxigenic (aflatoxicosis, fusariotoxigenic) as putative causes. *Salmonella* spp. are isolated from some horses with duodenitis-proximal jejunitis, but this is not a consistent finding. *C. difficile* might be involved as evidenced by detection of toxigenic strains of *C. difficile* from nasogastric reflux fluid of all 10 horses with duodenitis-proximal enteritis sampled but from only one of 16 horses with other diseases causing nasogastric reflux.<sup>1</sup> This observation is based on a small number of cases and demonstrates an association rather than causation and should be interpreted in that light. Experimental intoxication with culture media of *F. moniliforme* produces histologic, but not clinical, signs consistent with the disease.

## EPIDEMIOLOGY

The disease is reported from the United States and Europe,<sup>2</sup> and there are anecdotal reports of it occurring in Australia and other countries. There is no apparent effect of age, with the exception that the disease is not reported in horses less than 1 year of age and is uncommon in horses less than 2 years of age. There is no demonstrated breed or gender predilection for the disease.<sup>3</sup>



Feeding of large amounts of concentrated feeds to horses is a risk factor for the disease, as is grazing.<sup>3</sup> Duodenitis-proximal jejunitis occurs more commonly in the warmer months.

There are anecdotal reports of farms with a high incidence of the disease, especially among , suggesting an unidentified cause or risk factor. There are no reports of the incidence, or morbidity/mortality rates of duodenitis-proximal jejunitis. The **case-fatality rate** varies from 6% to 75% but in referral institutions is likely about 10%.<sup>4</sup>

### PATHOGENESIS

The primary lesion is inflammation and edema of the duodenum and jejunum with sloughing of villous epithelium and villous atrophy. These lesions are probably associated with ileus and failure of small-intestinal absorptive function. Fluid accumulation in the atonic small intestine causes distension and pain and reflux of alkaline small-intestinal contents into the stomach. Sequestration of fluid, electrolytes, and bicarbonate in the stomach and small intestine causes a reduction in blood volume, shock, and metabolic acidosis. Gastric and small-intestinal distension and hypovolemia cause tachycardia. Disruption of the small-intestinal mucosal barrier allows absorption of toxins, including endotoxins, which further compromise cardiovascular and metabolic function. Death in untreated cases results from acute, diffuse peritonitis secondary to gastric rupture, or shock and metabolic disturbances secondary to hypovolemia and endotoxemia. Laminitis and persistent nasogastric reflux are causes of death (including euthanasia) in hospitalized horses.<sup>5</sup>

### CLINICAL FINDINGS

The onset of clinical signs is usually abrupt and characterized by mild to severe colic. Affected horses are **depressed, dehydrated**, and have prolonged capillary refill time and heart rates between 50 and 80 beats/min. The respiratory rate is variable. The horse might sweat profusely and there are muscle fasciculations in severely affected cases. Approximately two-thirds of cases are pyrexia.<sup>5</sup> **Borborygmi are absent**, although there can be tinkling sounds of gas bubbling in fluid-filled atonic intestine. **Rectal examination** usually reveals the presence of multiple loops of moderately to severely distended small intestine. **Reflux of fluid** through a nasogastric tube is a consistent finding, and usually results in marked relief of pain and resolution of tachycardia. The fluid is often sanguineous, malodorous, alkaline, and of large (10–12 L) volume.

Gastric decompression and intravenous administration of fluids results in marked improvement of clinical signs, although affected horses can continue to have nasogastric reflux for 24 hours to 10 days. Most cases resolve within 5 days. If untreated,

horses develop severe gastric distension with subsequent rupture and death from peracute, diffuse peritonitis, or die as a result of hypovolemia and toxemia. A common sequela is the development of laminitis (approximately 8%). Approximately 10% of horses with duodenitis-proximal jejunitis have cardiac arrhythmias, including ventricular depolarizations and atrioventricular conduction disturbances. Arrhythmia resolves with resolution of the duodenitis-proximal jejunitis or correction of hypokalemia and acid-base disturbances.

### CLINICAL PATHOLOGY

There is hemoconcentration with hematocrits as high as 0.70 L/L (70%) and total serum protein as high as 96 g/L (9.6 g/dL) in severely affected horses. The leukogram is variable and not diagnostic, and leukocytosis and left shift are common. Serum potassium concentration can be mildly low and blood bicarbonate concentration and pH are low in most cases. Horses with duodenitis-proximal jejunitis have serum bilirubin concentrations and serum GGT, aspartate aminotransferase, and alkaline phosphatase activities higher than horses with small-intestinal infarctive lesions. However, the differences are not sufficiently large for these variables to be useful in the differentiation of horses with duodenitis-proximal jejunitis from horses with small-intestinal infarctive lesions.

Peritoneal fluid has a normal nucleated cell count in 65% of cases; in the remaining cases it is increased. Peritoneal fluid protein concentration is often normal in cases sampled early in the disease but can be increased in more severe or prolonged disease and is a useful prognostic indicator.

### NECROPSY FINDINGS

Gross lesions are restricted to the stomach, duodenum, and jejunum in most cases. The affected stomach and small intestine are distended, and the serosal surface has numerous petechial and ecchymotic hemorrhages. The mucosa is deep red and contains petechial hemorrhages and occasional foci of necrosis and ulceration. Histologic changes include neutrophilic inflammation, edema, hyperemia, epithelial sloughing, and villous atrophy. There is necrosis of mucosa, fibrin-rich edema and heavy neutrophil infiltration of the submucosa, and extensive hemorrhage in the tunica muscularis and serosa. A proportion of horses with duodenitis-proximal jejunitis have biochemical and histologic evidence of liver disease, including hepatocellular vacuolization and neutrophilic inflammation. Some horses with duodenitis-proximal jejunitis have myocarditis.

### DIFFERENTIAL DIAGNOSIS

The most important differential diagnosis is a small intestinal obstructive lesion.

### DIAGNOSTIC CONFIRMATION

Horses with small-intestinal obstructive lesions require urgent surgical correction, whereas most horses with duodenitis-proximal jejunitis respond well to medical therapy. The differentiation of duodenitis-proximal jejunitis and a small-intestinal obstructive lesion on clinical grounds is difficult, and there is no one variable that allows the distinction to be made reliably. Horses with duodenitis-proximal jejunitis have a lower heart rate, higher rectal temperature (fever), lower volume of gastric reflux, and less turgid small intestine on rectal examination than do horses with obstructive lesions, although others report that horses with duodenitis-proximal jejunitis have a higher volume of reflux at first examination and during the first 24 hours of disease. However, these differences are not sufficiently great to be conclusive. Horses with duodenitis-proximal jejunitis more often have normal peritoneal fluid than do horses with small-intestinal obstructive lesions. The response to gastric decompression and intravenous administration of fluids is useful in discriminating between diseases because horses with duodenitis-proximal jejunitis have marked resolution of abdominal pain and tachycardia within minutes of gastric decompression, whereas horses with small-intestinal obstruction have minimal or no resolution of these signs. Generally, horses with a heart rate below 60 beats/min after gastric decompression, mildly to moderately distended loops of small intestine, resolution of abdominal pain after gastric decompression, and normal peritoneal fluid probably have duodenitis-proximal jejunitis. However, horses should be examined frequently for changes in clinical condition. Worsening pain and cardiovascular status in the face of adequate fluid therapy warrant reconsideration of a diagnosis of duodenitis-proximal jejunitis.

### TREATMENT

The principles of treatment of duodenitis-proximal jejunitis are gastric decompression; correction of fluid, acid-base, and electrolyte abnormalities and provision of maintenance fluid and electrolytes; relief of pain; and prophylaxis of laminitis. The decision on whether to elect surgical treatment for affected horses is dependent on the availability of surgical expertise and experience of clinicians in managing such cases medically or with surgical intervention. Horses for which surgical intervention is more likely are those with more severe signs of pain and absence of fever (each of which increases the likelihood of a small-intestinal obstructive lesion that requires surgical intervention for correction).<sup>5</sup> The duration of hospitalization is not different for horses treated medically (10 ± 4 days) or surgically (10 ± 6 days), although the survival rate for surgically treated horses is lower (75% versus 91%).<sup>5</sup> This could be a result of treatment modality,

**Table 7-21** Agents used to treat ileus in horses with duodenitis and proximal jejunitis

Medication	Dosing	Comments	Recommendation
Lidocaine	1.3 mg/kg slow IV, then 0.05 mg/kg infusion	Analgesic, antiinflammatory, promotility; used to treat ileus; toxicity evident as central nervous system signs	R2
Metoclopramide	0.25 mg/kg IV slowly over 30 min every 12 h	Toxic; minimally effective	R3
Erythromycin	1 (mg/kg)/h IV	Questionable efficacy; might induce colitis	R3
Cisapride	0.1 mg/kg, IV every 8 h	Effective in prevention and treatment of postoperative ileus; can prolong cardiac Q-T interval (importance unknown); availability very limited	R3

IV, intravenously.

but it could also be related to the selection of horses for surgical treatment. Surgically treated horses are more likely to develop diarrhea (12% versus 28%).<sup>5</sup>

**Gastric decompression** is an urgent need in affected horses and can be accomplished by nasogastric intubation. The nasogastric tube should be left in place, or replaced frequently, for as long as there is reflux of clinically significant quantities of fluid (more than 2–4 L/4 h in a 425-kg horse). Discontinuation of gastric siphonage should be approached cautiously and the horse monitored for any increase in heart rate, development of abdominal pain, or ultrasonographic evidence of gastric or small-intestinal distension that could indicate recurrence of gastric distension. After the nasogastric tube is removed, the horse should be reintroduced cautiously to oral fluids and food. Small amounts (1–2 L) of water should be offered frequently (every 1–2 hours) during the first 12 to 24 hours. Horses should not be given immediate access to ad libitum water because some horses in the early convalescent period from duodenitis-proximal jejunitis will consume a large quantity of water and develop gastric dilatation and colic. Feed should be reintroduced gradually over 24 to 48 hours.

Complications of prolonged or repeated gastric siphonage through a nasogastric tube are pharyngitis, esophagitis, esophageal stricture, and esophageal perforation with subsequent cellulitis.

**Fluid, electrolyte, and acid-base abnormalities** should be corrected by the intravenous administration of isotonic, polyionic fluids such as lactated Ringer's solution. Affected horses lose considerable chloride and potassium in reflux fluid necessitating supplementation of fluids with potassium (up to 20 mEq/L of administered fluids).

**Analgesia** can be provided by administration of any of a number of drugs, including flunixin meglumine or ketoprofen. If the

diagnosis of duodenitis-proximal jejunitis is uncertain, potent analgesics such as flunixin meglumine should be used judiciously until there is no possibility that a lesion requiring surgical correction exists.

**Promotility agents** such as lidocaine and cisapride (Table 7-21) and antacids such as cimetidine are sometimes administered. The efficacy of cimetidine has not been determined. There is evidence that lidocaine (lignocaine) is efficacious in reducing the duration of reflux, the amount of reflux, and the duration of hospitalization in horses with ileus of undermined cause (some of which presumably had duodenitis-proximal jejunitis) or after surgical correction of colic.<sup>5</sup>

**Antibiotics**, such as penicillin and an aminoglycoside, are often administered to affected horses because of the presumed bacteremia associated with the disease.

**Surgical treatment** of the disease is described and the outcomes were discussed previously.<sup>5</sup>

## REFERENCES

- Arroyo LG, et al. *J Med Microbiol.* 2006;55:605.
- Radostits O, et al. Anterior Enteritis. *Veterinary Medicine: A Textbook of the Diseases of Cattle, Horses, Sheep, Pigs, and Goats.* 10th ed. London: WB Saunders; 2007:245.
- Cohen ND, et al. *Equine Vet J.* 2006;38:526.
- Southwood LL, et al. *Equine Vet J.* 2009;41:459.
- Underwood C, et al. *Equine Vet J.* 2008;40:373.
- Malone E, et al. *Vet Surg.* 2006;35:60.

## DISEASES OF THE CECUM

### ETIOLOGY

- Cecal impaction
- Cecal rupture
- Cecocolic and cecocolic intussusceptions
- Cecal torsion
- Cecal tympany

- Cecal infarction
  - Congenital abnormalities (cecal duplication)<sup>1</sup>
  - Ileocecal intussusception is discussed as an obstructive disease of the small intestine (see section on [Small Intestinal Obstruction in Horses](#))

There is strong support for a role of *A. perfoliata* infestation in cecal disease of horses. Infestation with *A. perfoliata* results in edema, hyperemia, and hemorrhagic foci in the ileocecal valve mucosa with light parasitism through regional necrotizing enteritis, with extension of lesions to the muscularis mucosa and eosinophilic inflammation around arterioles and submucosal neural plexus with heavy parasitism.<sup>2,3</sup> The lesions are associated with local and systemic production of specific IgE and IgG(T) antibodies.<sup>2</sup>

### SYNOPSIS

**Etiology** Cecal impaction, perforation, cecocolic and cecocolic intussusceptions, cecal torsion, and cecal tympany.

**Epidemiology** Sporadic diseases with exception of association with *Anoplocephala perfoliata* infestation. Cecal impaction and cecal perforation are reported in horses and foals hospitalized for unrelated conditions. Cecal rupture occurs in mares during parturition.

**Clinical signs** Cecal impaction is evident as mild, intermittent colic that might not be noticed by a casual observer. Cecal perforation or rupture is evident as acute shock, sweating, and tachycardia secondary to diffuse peritonitis. Cecocolic intussusception causes acute severe colic and cecocolic intussusception causes mild, intermittent colic. Rectal examination and/or rectal or percutaneous ultrasonographic examination can be diagnostic.

**Clinical pathology** Nondiagnostic.

**Lesions** Gross lesions consistent with the disease.

**Diagnostic confirmation** Physical examination, exploratory laparotomy, or necropsy examination.

**Treatment** Cecal impaction treated medically with overhydration, fecal softeners, and analgesics. No treatment for cecal rupture or perforation. Surgical correction of some cecal impactions and all cecocolic and cecocolic intussusceptions

Larval cyathostomiasis is also associated with cecocolic and cecocolic intussusception in young horses. Other causes include intramural and extramural masses, including cecal abscesses and accumulations of fatty tissue (lipomatosis)<sup>4</sup> or neoplasia<sup>5</sup> that alter cecal motility and passage of ingesta as well as other alterations in cecal and colonic motility.

**Cecal rupture occurs in foals** with a reported age range of 1 to 6 months that have an association with previous anesthesia and administration of antiinflammatory drugs.<sup>6</sup> Rupture is not exclusively associated with impaction of the cecum in affected foals.<sup>6</sup>

Disturbed cecal motility or dehydration of cecal contents secondary to dietary changes are thought to be the cause of most cases of cecal impaction and rupture. Horses with recurrent cecal impaction have lower neuron densities in muscle layers of the base of the cecum and cecal body than do normal horses, supporting the hypothesis that disturbed motility secondary to neuronal abnormalities is a cause of the disease. Administration of drugs that interfere with cecal motility or secretory function has the potential to increase the risk of cecal disease.

## EPIDEMIOLOGY

Cecal disease accounts for approximately 4% to 10% of colic in horses examined for abdominal pain at referral centers.

## Cecal Impaction

**Cecal impaction** is the cause of colic in approximately 2% to 5% of horses treated for colic in referral institutions.<sup>7</sup> This estimate probably reflects a selection bias, with horses with less severe disease not being referred for further examination. Cecal impaction is therefore probably much less common as a cause of colic in field cases. Cecal impaction is the most common cause of cecal disease (40%–50% of cases) and 5% of horses with intestinal impaction.<sup>3,7</sup>

There is no gender predisposition to the disease, although there are reports of a high proportion (22%) of affected mares having foaled within the previous 90 days or being pregnant (20%).<sup>7</sup> Older horses are disproportionately affected with 50% of affected horses being between 10 and 17 years of age.<sup>7</sup> Horses over 15 years are at increased risk compared with horses less than 7 years of age.<sup>3</sup> The disease occurs sporadically but is reported in horses and foals hospitalized or treated for an unrelated disease, and it is speculated that anesthesia, surgery, and/or administration of NSAIDs are risk factors for the disease.<sup>3,6-8</sup> Hospitalization and treatment for ocular disease are risk factors for impaction colic, with 10 of 72 (14%) of such horses in one study developing impaction of the cecum.<sup>9</sup> Fasting, poor dentition, poor-quality feed, and restricted water intake might also be risk factors for the disease. The **case–fatality rate** is approximately 30% to 50%.<sup>7</sup>

A particular form of cecal impaction is that involving only the cecal base (cecal cupula) without accumulation of impacted material in the cecal apex or body of the cecum.<sup>10</sup> There are no identified risk factors, and the outcome of surgical treatment is good (100% survival of 7 horses treated).<sup>10</sup> The disease had a frequency of 0.45% of horses undergoing exploratory laparotomy.<sup>10</sup>

## Cecal Perforation or Rupture

**Cecal rupture** at parturition occurs in 0.1% of mares. It represents approximately 27% of cecal disease in horses, and that associated with concurrent but apparently unrelated disease is the most common (13%). Cecal rupture or perforation is otherwise a sporadic disease that is often, but not always, a sequela to cecal impaction. The case–fatality rate is 100%. Cecal rupture, often without recognized preexisting disease, is a complication of anesthesia and NSAID (usually phenylbutazone) administration. As with other cecal diseases, infestation with *A. perfoliata* has been implicated as a cause of cecal rupture, although not all horses with cecal rupture have tapeworms.

## Cecocolic or Cecocolic Intussusceptions

Cecocolic and cecocolic intussusceptions are the cause of 1% of colic cases treated surgically and approximately 3% to 7% of cecal disease. The case–fatality rate is approximately 50% to 70%.<sup>3,11</sup> There are no recognized epidemiologic patterns to the occurrence of **cecal or cecocolic intussusceptions**, with the exception that younger horses (<3 years) and Standardbreds are disproportionately affected. Cecocolic and cecocolic intussusceptions appear to disproportionately affect younger horses (range 6 months to 12 years of age) in New Zealand.<sup>11</sup> This could represent a biologic effect or selection of cases presented to the referral institution. Infestation with tapeworm (*A. perfoliata*) is suspected to increase the risk of cecal intussusceptions, although this suspicion is not universal.

## Cecal Torsion

**Cecal torsion** occurs rarely and is associated with hypoplasia of the cecocolic fold in some but not all cases.

Primary **cecal tympany** is rare. Cecal infarction is caused by thromboembolic disease secondary to *Strongylus vulgaris* arteritis or necrotizing enterocolitis.

## PATHOGENESIS

Cecal impaction is probably a result of impaired or altered cecal motility, with resultant reduced cecal emptying into the right ventral colon. Accumulation of feed material causes cecal distension and excessive tension in the wall of the cecum with ischemia, necrosis, and rupture. Infestation by tapeworms, including *A. perfoliata*, causes disruption of the cecal mucosa and submucosa, necrosis, and inflammation—changes that could contribute to cecal dysfunction. Death results from peracute diffuse peritonitis.

Cecal rupture at parturition is probably the result of high intraabdominal pressures associated with expulsion of the fetus. The pathogenesis of cecal rupture without cecal impaction is unknown.

## CLINICAL FINDINGS

### Cecal Distension and Impaction

There are a variety of classification schemes for cecal distension and impaction, including the time frame for development of the disease (acute or chronic), the presence of identifiable risk factors (hospitalization, anti-inflammatory drug administration, and the presence of *A. perfoliata*), and the nature of the material distending the cecum (impacted ingesta and fluid).<sup>10</sup> Each provides the opportunity to emphasize a particular aspect of the disease(s) and is useful in that respect. The simplified classification used previously with continue to be used.<sup>3</sup>

**Cecal distension** occurs as two clinical syndromes: one caused by impaction of the cecum with inspissated feed material and the other caused by acute distension of the cecum by a mixture of fluid and ingesta.

Cases in which the cecum is **impacted** and distended with inspissated feed material usually have signs of mild to moderate abdominal pain that is often intermittent over a 1- to 4-day period. The signs of pain can be mild enough to be missed by a casual observer. Affected horses are usually mildly depressed and have a diminished appetite. The heart rate is 40 to 60 beats/min, borborygmi are reduced, and there can be mild dehydration. Nasogastric intubation yields reflux fluid only late in the course of the disease. Rectal examination reveals a doughy mass in the right caudal abdomen permitting diagnosis in approximately 85% of cases.<sup>7</sup> The ventral, and occasionally the medial, tenia of the cecum are palpable, as is firm feed material in the base and body of the cecum. The mass extends cranially, ventrally, and across the midline of the abdomen. If not treated, the cecum ruptures, causing an acute onset of tachycardia, sweating, delayed capillary refill, and shock, with death occurring in hours. It is not unusual for the initial signs of the disease to be missed and the problem to be recognized only after the cecum ruptures.

The outcome of horses with cecal impaction depends on the disease and its stage at presentation. The prognosis for horses treated medically is good with 81% surviving to discharge from hospital. This likely reflects that horses treated medically are metabolically stable (and therefore do not have a ruptured cecum) and have less severe impaction. Exploratory laparotomy results in diagnosis of cecal rupture in approximately one-quarter of horses,<sup>7</sup> all of which die, and a survival rate of approximately 65% to 90% in those horses allowed to recover from anesthesia.<sup>7,8</sup>

Horses with chronic, **recurrent cecal impaction** have a mild disease characterized by recurrent subtle to moderate signs of colic, reduced food intake, weight loss, and loose feces.

Impaction of the **base of the cecum** (the cecal cupula) by ingesta causes a mild colic



of several days' duration. Affected horses are metabolically stable and there are no diagnostic findings on rectal examination. Diagnosis is achieved during exploratory laparotomy.

**Cecal distension** also occurs as a syndrome in which **fluid** accumulates in the cecum. This disease has a much more acute course and is characterized by severe abdominal pain, tachycardia, and signs consistent with toxemia. Rectal examination demonstrates a cecum tightly distended with fluid ingesta. Without surgical intervention the outcome is cecal rupture and death.

### Perforation and Rupture

**Cecal perforation** occurs secondary to cecal distension or as a primary entity. There are usually only very mild premonitory signs in either adults or foals, and the disease becomes apparent when the cecum ruptures and acute diffuse peritonitis develops.<sup>6</sup> Twenty-five percent of horses with cecal impaction develop cecal perforation or rupture.<sup>7</sup> Detection of serosa with a gritty feel and free gas in the abdomen on rectal examination is diagnostic of a ruptured viscus and diffuse peritonitis. Subserosal and retroperitoneal emphysema in the region of the base of the cecum can be indicative of cecal perforation or rupture.<sup>12</sup>

### Intussusception

**Cecocolic intussusception** is the invagination of the cecal apex into the body of the cecum and usually presents as a mild intermittent colic, depending on the degree of involvement of the apex of the cecum. Small intussusceptions that cause little obstruction and no infarction of the invaginated section cause only mild pain.

**Signs of cecocolic intussusception**, in which the inverted cecum (the intussusceptum) progresses through the cecocolic orifice into the right ventral colon, occur over 1 to 7 days, and vary from mild and recurrent to acute and persisting. Rectal examination can reveal a mass in the right dorsal quadrant, lack of a cecum, and pain on palpation of the right dorsal quadrant. Ultrasonographic examination of the right flank reveals the presence of the cecum in the colon, which is apparent in cross section as a "target-like" pattern or taurus.<sup>11</sup>

### CLINICAL PATHOLOGY

Cecal impaction with feed material is usually associated with mild hemoconcentration. Cecal perforation results in severe leukopenia and left shift, hemoconcentration (hematocrit > 50%, 0.50 L/L), and azotemia.

**Peritoneal fluid** from horses with cecal impaction is usually normal. However, if the cecum becomes ischemic, then the fluid is sanguineous with an elevated white blood cell count (>8000 cells/ $\mu$ L,  $8 \times 10$  cells/L) and protein concentration (>2.5 g/dL, 25 g/L). Cecal perforation is evident as a

high proportion of degenerate neutrophils, intracellular and extracellular bacteria, and plant material. Peritoneal fluid is abnormal in 81% of horses with cecocolic intussusception and 67% of cases with cecocolic intussusception.<sup>11</sup>

### NECROPSY FINDINGS

The distended cecum and diffuse peritonitis are readily apparent. Cases of cecal perforation without distension will have diffuse peritonitis, but the cause is only apparent on close examination of the intestinal tract.

### DIFFERENTIAL DIAGNOSIS

See Table 7-10 for causes of colic.

### TREATMENT

Medical treatment of cecal impaction involves control of pain, restoration of normal fluid, acid-base and electrolyte status (see Chapter 5), and administration of fecal softeners such as sodium sulfate. Mineral oil, although frequently used, is not sufficient alone to facilitate passage of the impaction because it does not cause fecal softening.

**Intravenous administration of fluid** at two to three times maintenance needs is often used in an attempt to hasten fecal softening by increasing secretion of water into the impaction. **Oral administration** of large quantities of water (4 L every 2 hours for 24 hours) may soften the impaction.

Horses with cecal impaction should be **closely monitored** for signs of deterioration, and especially for cecal ischemia, by frequent physical examinations and repeated abdominocentesis. Lack of resolution within 24 hours or signs of deterioration should prompt surgical exploration with typhlotomy and evacuation of the cecum and possible partial cecal bypass. The results of surgical treatment of horses with cecal impaction are good with survival rates of 65% to 90% reported for horses that are recovered from surgery.

**Cecocolic and cecocolic intussusceptions** must be corrected surgically. The survival rate for horses with cecocolic or cecocolic intussusceptions is approximately 50%, although estimates are variable because of the small number of animals reported.<sup>11</sup>

Horses with **cecal perforation** always die and should be euthanized without delay.

### FURTHER READING

Mair TS, Sherlock CE. Cecal perforation. *Equine Vet Educ.* 2014;26:426-429.

### REFERENCES

- Taylor EA, et al. *Equine Vet Educ.* 2014;26:477.
- Pittaway CE, et al. *Vet Parasitol.* 2014;199:32.
- Radostits O, et al. Diseases of the Cecum. *Veterinary Medicine: A Textbook of the Disease of Cattle, Horses, Sheep, Pigs, and Goats.* 10th ed. London: WB Saunders; 2007:246.

- de Bont MP, et al. *Equine Vet Educ.* 2013;25:241.
- Stephan S, et al. *Case Rep Vet Med.* 2012;2012:301498.
- Tabar J, et al. *Can Vet J.* 2009;50:65.
- Plummer A, et al. *JAVMA.* 2007;231:1378.
- Smith LCR, et al. *Equine Vet J.* 2010;42:388.
- Patipa LA, et al. *JAVMA.* 2012;240:1488.
- Sherlock CE, et al. *JAVMA.* 2013;243:1596.
- Bell RJW, et al. *Aust Vet J.* 2010;88:272.
- Gray SN, et al. *Equine Vet Educ.* 2014;26:422.

### DISPLACEMENT AND/OR VOLVULUS OF THE LARGE (ASCENDING) COLON

Displacement and volvulus of the large (ascending) colon are evident as nephrosplenic entrapment, renosplenic entrapment, left dorsal displacement of the large colon, or right dorsal displacement of the large colon.

### ETIOLOGY

- Left dorsal displacement of the large colon (renosplenic or nephrosplenic entrapment and entrapment of the large colon lateral to the spleen)
- Right dorsal displacement of the large colon
- Volvulus (both strangulating and nonstrangulating)

### SYNOPSIS

**Etiology** Unknown, probably involves disturbance of colonic motility

**Epidemiology** Volvulus is more common in mares during late gestation or after parturition. Left dorsal displacement (renosplenic entrapment) may be more common in large male horses.

**Clinical signs** Left displacement of the large colon causes signs of mild to moderate colic. Rectal examination reveals large colon in the renosplenic space, and ultrasonographic examination confirms the diagnosis. Right dorsal colon displacement causes mild to moderate colic. Rectal examination reveals colon lateral to the base of the cecum. Volvulus of the large colon causes mild to extremely severe abdominal pain, tachycardia, shock, and abdominal distension. Rectal examination reveals the distended, displaced colon.

**Clinical pathology** Nondiagnostic.

**Lesions** Displaced large colon.

**Diagnostic confirmation** Physical examination, laparotomy, and necropsy examination.

**Treatment** Volvulus and right dorsal displacement should be treated by surgical correction. Left dorsal displacement can be corrected by rolling the anesthetized horse or jogging the horse after administration of phenylephrine.



The etiology of these conditions is unknown but presumably involves some disturbance to normal colonic motility. Other causes of obstruction of the large colon include congenital abnormalities of the right ventral colon, cystic duplication of the ascending colon, defects in the mesocolon, and incarceration in epiploic foramen or gastrosplenic ligament. Intussusception of the large colon causes infarction and severe colic.

The term **volvulus** refers to rotation of the segment of bowel about the long axis of its mesentery, and **torsion** refers to rotation about the long axis of the bowel. Because of the anatomic arrangement of the mesocolon, either term may be correctly used to describe displacements of the large intestine.

### EPIDEMIOLOGY

**Left dorsal displacement of the large colon** (Figs. 7-2 and 7-3) is the cause of 2% to 10% of colic cases referred for specialist treatment. There is no breed, age, or gender predisposition, although some authors suggest that males and large horses are more likely to be affected. The case-fatality rate is approximately 5% for horses treated correctly.

**Right dorsal displacement** of the large colon (Fig. 7-4) occurs sporadically and without recognized risk factors. The case-fatality rate is reported to be as high as 43%.

Risk factors for noninfarctive displacement of the large colon include cribbing or wind sucking (OR = 90), number of hours stabled per day (OR for 24-hour stabling = 35), lack of regular exercise (OR 3.3), change in exercise program (OR 9), lack of anthelmintic administration (OR 13), and history of transport in the previous 24 hours (OR 17).

**Volvulus of the large colon** is the cause of colic in 11% to 17% of colic cases in which abdominal surgery is performed. The disease occurs commonly in mares, especially those late in gestation or having recently foaled. Risk factors for volvulus of the large colon include being a broodmare (OR 2.5 versus male horse), greater height, colic in the past 12 months (OR 2.17), having a greater number of carers, larger number of horses on the premises, and a number of variables related to feed quality or quantity.<sup>1</sup> The disease has a recurrence rate of up to 15% in broodmares. The disease occurs in horses from 2 days of age and there does not appear to be an effect of breed on occurrence of the disease. The **case-fatality rate** varies depending on the extent of the volvulus, with lesser degrees of volvulus (<270°) having a 30% fatality rate and volvulus of 360 degrees or more having a 65% fatality rate. The case-fatality rate for horses with strangulating large-colon volvulus treated surgically is approximately 30% (survival to hospital discharge), 52% at 1 year, and 67% at 2 years.<sup>2</sup>

### PATHOGENESIS

Proximate factors leading to volvulus or displacement are unknown, although risk

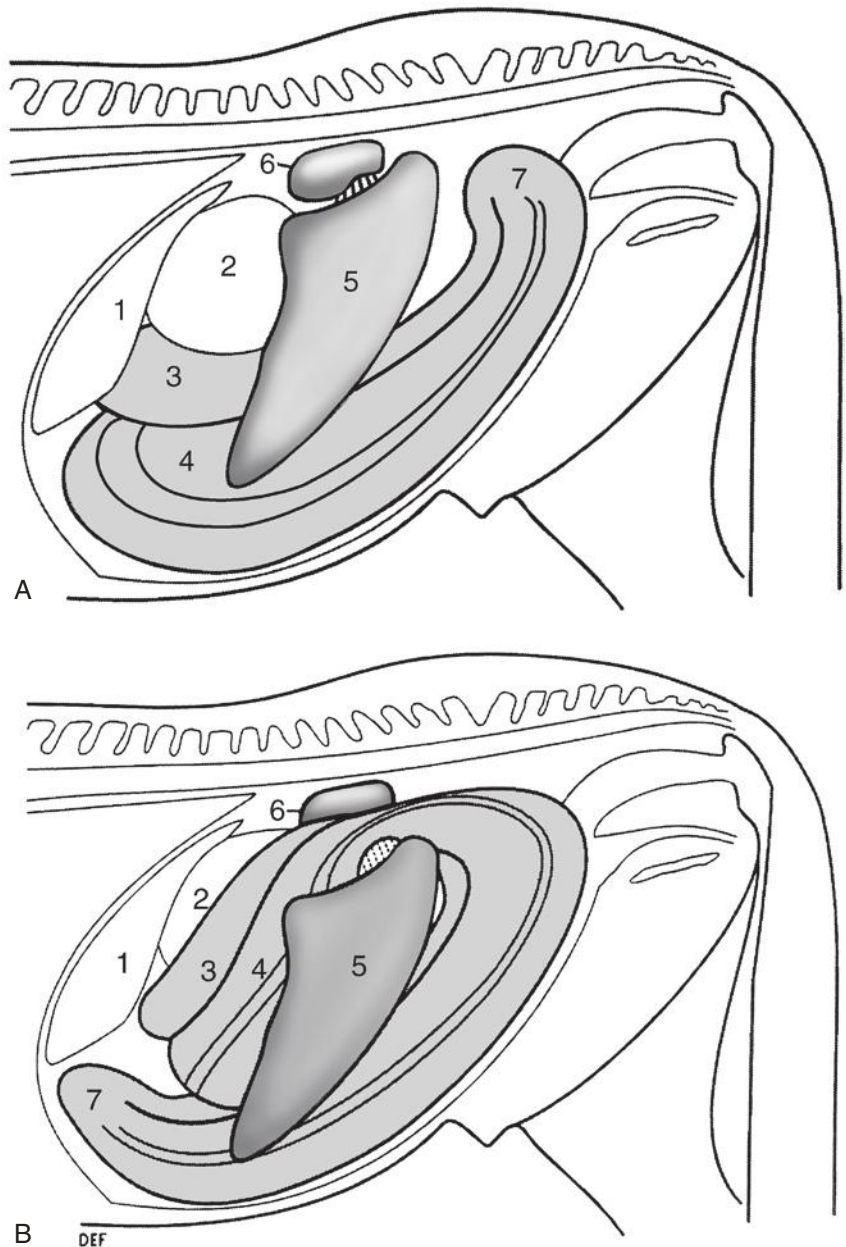
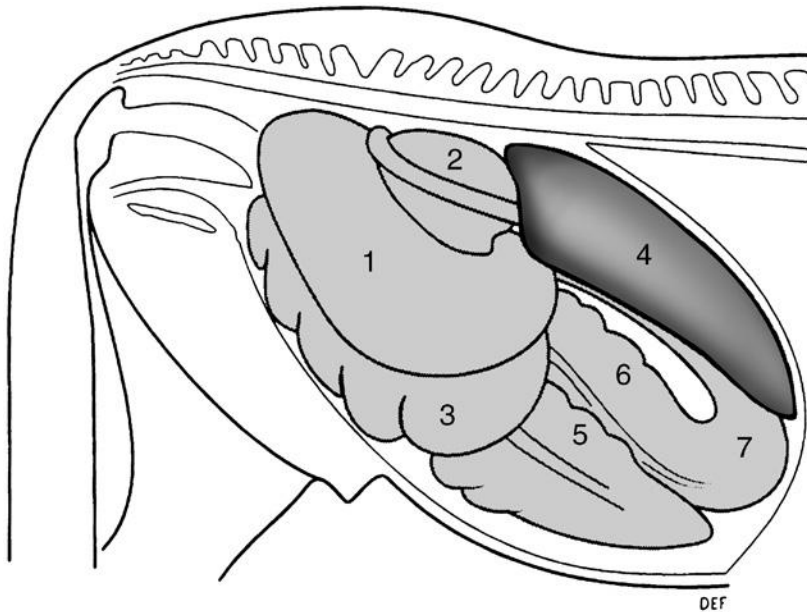

**Fig. 7-2** A, Left lateral view of abdomen of a normal horse. B, Left dorsal displacement of the left colon, left lateral view. The left ventral and dorsal colon is displaced lateral and dorsal to the spleen and occupies the resenosplenic space. 1, liver; 2, stomach; 3, left dorsal colon; 4, left ventral colon; 5, spleen; 6, left kidney and resenosplenic ligament; 7, pelvic flexure. (With permission from Johnston JK, Freeman DE. *Vet Clin North Am Equine Pract* 1997;13:317.)

factors have been identified (see earlier discussion). A plausible scenario is that altered colonic motility and subsequent distension with gas or ingesta predisposes the colon to displacement, either spontaneously or as a result of the horse rolling or lying down in response to abdominal pain.

**Left dorsal and right dorsal** displacements of the colon rarely compromise colon blood flow and represent nonstrangulating obstructive lesions (see section Pathogenesis in Equine Colic). The displacement of the large colon (see Figs. 7-2 and 7-3) impedes

aboral movement of ingesta and gas and may result in colonic distension. Should the distension become sufficiently severe, colon blood flow will be impaired and cause ischemia and necrosis of the colon. The obstruction to blood flow is predominantly in venous drainage, resulting in hemorrhagic strangulating obstruction with progressive development of intramural edema, extravasation of red blood cells, microvascular thrombosis, mesothelial cell loss from the serosal surface, and mucosal necrosis with loss of colonic epithelium.



**Fig. 7-3** Right dorsal displacement of the colon, right lateral view. The colon has passed lateral to the cecum, the pelvic flexure is displaced cranially, and the sternal and diaphragmatic flexures are displaced caudally. 1, right dorsal colon; 2, base of cecum; 3, right ventral colon; 4, liver; 5, cecum; 6, left ventral colon; 7, pelvic flexure. (With permission from Johnston JK, Freeman DE. *Vet Clin North Am Equine Pract* 1997;13:317.)

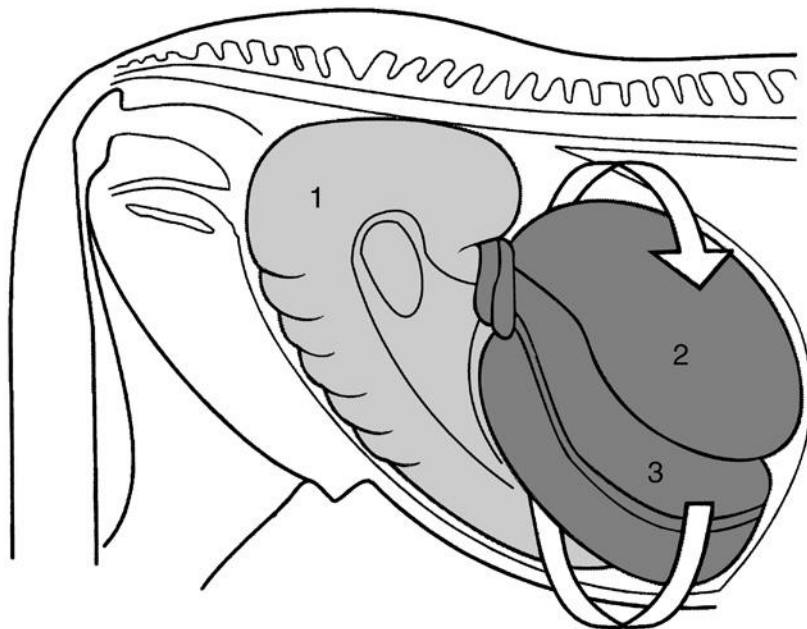

**Fig. 7-4** A 360° clockwise volvulus of the colon viewed from the right side. The volvulus has occurred in the direction of the arrow. 1, cecum; 2, right dorsal colon; 3, right ventral colon. (With permission from Johnston JK, Freeman DE. *Vet Clin North Am Equine Pract* 1997;13:317.)

**Volvulus** of the large colon of less than 270 degrees does not compromise blood supply but does impede aboral movement of ingesta and gas. Volvulus of 360 degrees or more causes ischemia through occlusion of both arterial and venous circulation of the involved large colon with rapid loss of

colonic mucosal integrity and colon viability. There is reduced microvascular perfusion in horses with large-colon volvulus.<sup>3</sup> Irreversible mucosal damage occurs after 3 to 4 hours of ischemia. Loss of mucosal integrity impairs normal barrier function and permits toxins and substances normally confined to

the colonic lumen to enter the systemic circulation. Additionally, loss of barrier function allows leakage of vascular proteins and in severe cases red blood cells into the colonic lumen. Subsequent signs are typical of strangulating obstruction (see section Equine Colic) with development of toxemia, cardiovascular collapse, and death within 12 to 18 hours.

The most common displacement is medial and dorsal movement of the ventral colon to complete a 360-degree volvulus of the large intestine (see Fig. 7-4). Lateral and dorsal displacement of the ventral colon is much less common. The volvulus is usually at the level of the cecocolic fold, although volvulus involving the cecum or at the diaphragmatic and sternal flexures does occur.

## CLINICAL FINDINGS

### Left Dorsal Displacement (Renosplenic Entrapment)

Left dorsal displacement usually has an acute onset and a duration of up to 4 days, although it can be a cause of chronic, recurrent colic. Abdominal pain in the initial stages is mild to moderate and becomes progressively more severe as distension of the large colon develops. The heart rate is usually between 50 and 70 beats/min, but may be as low as 30 beats/min. Rectal temperature is within normal limits. Mucous membrane color and refill time are usually normal provided there is no ischemia of the colon. **Abdominal distension** is appreciable in some affected horses. There is more than 2 L of reflux from a **naso-gastric tube** in approximately 28% of cases, although rarely is there profuse reflux. **Rectal examination** reveals the presence of bowel in the renosplenic space in approximately 70% of cases with the typical finding of tenia of the ventral colon being traced into that space. Distension of the large colon may impair detection of bowel in the nephrosplenic space. The spleen is usually displaced caudally, medially, and ventrally from its normal position against the left body wall (see Fig. 7-2).

**Ultrasonographic** demonstration of colon in the renosplenic space confirms the diagnosis with an accuracy of 88%. Gas in the displaced colon obscures the left kidney and dorsal border of the spleen normally visible on ultrasonographic examination of the left paralumbar region.

Approximately 8% of horses with nephrosplenic entrapment have an additional lesion. Entrapment in which the sternal and diaphragmatic flexures are displaced cranial to the stomach and liver occurs in less than 3% of cases.

### Right Dorsal Displacement

Severity of colic varies from mild to severe in horses with right dorsal displacement of the colon. Tachycardia (50–80 beats/min) and mild abdominal distension are characteristic provided that the entrapped bowel

is not ischemic. There is usually no reflux from a nasogastric tube, although as the disease progresses gastric distension may occur. **Rectal examination** reveals the presence of large colon lateral to the base of the cecum, although colonic distension may make detection of the displaced bowel difficult. Right dorsal displacement is a common sequela to impaction of the pelvic flexure.

### Volvulus

The onset of pain is abrupt and the duration of the disease ranges from hours, in horses with strangulating lesions, to days in horses with torsion of less than 270 degrees. The pain ranges from mild to severe and intractable, with the horse violently throwing itself to the ground. Pain in horses with a volvulus of 360 degrees or greater is often unresponsive to any analgesics. Heart rate is variable and may be less than 40 beats/min in horses with severe disease, although usually it is more than 60 beats/min and increases with severity of the disease. Rectal temperature is within normal range. The mucous membranes are dark red to blue and capillary refill time is more than 3 seconds in severely affected horses. Abdominal distension is marked, usually severe, and may impair respiration in horses with a 360-degree or greater volvulus. **Auscultation** of the abdomen reveals a lack of borborygmi and the presence of high-pitched, tympanitic pings on simultaneous percussion and auscultation. The pings are caused by the presence of gas in a tightly distended large colon or cecum. There is usually no reflux through a nasogastric tube. **Rectal examination** may be limited by the distended, gas-filled colon occupying the caudal abdomen. In untreated cases death occurs within 12 to 24 hours from cardiovascular collapse. **Ultrasonographic** examination reveals colon with a mural thickness of 9 mm or greater in horses with colon torsion. The test has a sensitivity of approximately 67% (i.e., correctly predicts the presence of colon torsion in two-thirds of horses that have the disease) and specificity of 100% (correctly rules out the diagnosis in 100% of horses that do not have the disease).

### CLINICAL PATHOLOGY

Changes in the hemogram, serum biochemical profile, and peritoneal fluid are nonexistent to mild in horses with uncomplicated left dorsal displacement, right dorsal displacement, and volvulus of less than 270 degrees. Horses with ischemic colon as a result of strangulation usually have a leukopenia with left shift, hemoconcentration, and increased anion gap.

**Serum GGT** activity is elevated in approximately 50% of horses with right dorsal displacement of the colon, whereas such elevations are rare in horses with left dorsal displacement. The elevated GGT, and

less commonly serum bilirubin concentration, in horses with right dorsal displacement is attributable to compression of the common bile duct in the hepatoduodenal ligament by the displaced colon.

Horses with large-colon volvulus have a high prevalence of abnormalities in hemostatic variables, including thrombin-antithrombin concentration, D-dimer concentration, antithrombin activity, prothrombin time, and platelet count. Nonsurviving horses have lower platelet counts, increased prothrombin time, and reduced antithrombin activity.

Peritoneal fluid often has an increased total protein concentration (>25 g/L, 2.5 g/dL) and white blood cell count (>8000 cells/ $\mu$ L,  $8 \times 10$  cells/L) in horses with compromised bowel. Examination of peritoneal fluid is often not necessary to achieve a diagnosis in horses with colon torsion, although it does have prognostic value in that horses with blood-tinged peritoneal fluid have a poor prognosis. The risk of inadvertent enterocentesis is increased in horses with severe distension of the colon, and abdominocentesis should be attempted with caution in such cases. Use of a bovine teat cannula or similar blunt instrument is preferred to the use of a needle.

### NECROPSY FINDINGS

The colon is displaced as described earlier for each of the diseases. Death usually results from ischemic necrosis of the colon and the associated peritonitis, endotoxemia, and shock. Histologic lesions in horses dying of colon volvulus are more severe than of those that survive and are characterized by hemorrhage into the lamina propria, edema, and loss of the mucosal cells and crypt architecture.

### DIFFERENTIAL DIAGNOSIS

See Table 7-19.

Less common conditions of the large colon include:

- Entrapment of the pelvic flexure in the epiploic foramen
- Colocolic intussusceptions
- Colonic adenocarcinoma

### TREATMENT

Treatment should consist of pain control; correction of fluid, acid-base, and electrolyte abnormalities; support of cardiovascular function; and correction of the underlying disease (see the section Equine Colic). Decompression by trocarization of gas-distended colon or cecum may be beneficial. Correction of colon volvulus or right dorsal displacement of the colon requires surgical exploration of the abdomen and manual correction of the displacement.

### Left Displacement

Correction of left dorsal displacement can be achieved by either nonsurgical or surgical means. **Nonsurgical correction** is achieved by either rolling the anesthetized horse in a particular sequence that causes the displaced colon to return to its normal position in the abdomen or exercise after intravenous administration of phenylephrine.<sup>4</sup> Nonsurgical correction is successful in approximately 80% of cases, although complications are reported, and is recommended as the initial definitive treatment for horses with uncomplicated left dorsal displacement.

Rolling of anesthetized horses after intravenous administration of phenylephrine has a somewhat higher success rate (42/50, 84%) than exercise (trotting) after administration of phenylephrine (24/38, 63%).<sup>4</sup> The sequence of events following diagnosis of the condition is depicted in Fig. 7-5. **Phenylephrine** (0.02–0.04 mg/kg, intravenously as a 10-minute infusion) causes splenic contraction and is thought to increase the chances of the colon returning to its normal position. The horse is anesthetized within 10 minutes of phenylephrine administration and placed in right lateral recumbency. The horse is then slowly rolled into dorsal recumbency, and the abdomen is vigorously massaged in an attempt to cause the colon to move ventrally and medially. If a hoist is available the horse can be lifted into dorsal recumbency. The sequence ends with the horse being rolled into left lateral recumbency and a rectal or ultrasound examination being performed to determine the position of the colon. Fatal hemoperitoneum can occur after phenylephrine administration.

An alternative means of nonsurgical correction involves administration of phenylephrine (0.01 mg/kg, intravenously, slowly) and then jogging the horse. This technique was successful in correcting the displacement in 11 of 12 horses. It might be advantageous to relieve large-colon distension by percutaneous or per rectum trocarization before jogging.<sup>5</sup>

Cases that are refractory to nonsurgical treatment require laparotomy (ventral midline or left flank) and manual correction of the displacement. Recurrence of the displacement occurs in 3% to 7% of cases. Horses with recurrent disease can benefit from surgical ablation of the nephrosplenic space.

### Right Dorsal Displacement and Colon Volvulus

Right dorsal displacement and colon volvulus require surgical correction of the anatomic abnormality.

### REFERENCES

1. Suthers JM, et al. *Equine Vet J*. 2013;45:558.
2. Suthers JM, et al. *Equine Vet J*. 2013;45:219.
3. Hurcombe SD, et al. *Equine Vet J*. 2014;46:674.
4. Fultz LE, et al. *JAVMA*. 2013;242:1146.
5. Scotti GB, et al. *Equine Vet Educ*. 2013;25:184.



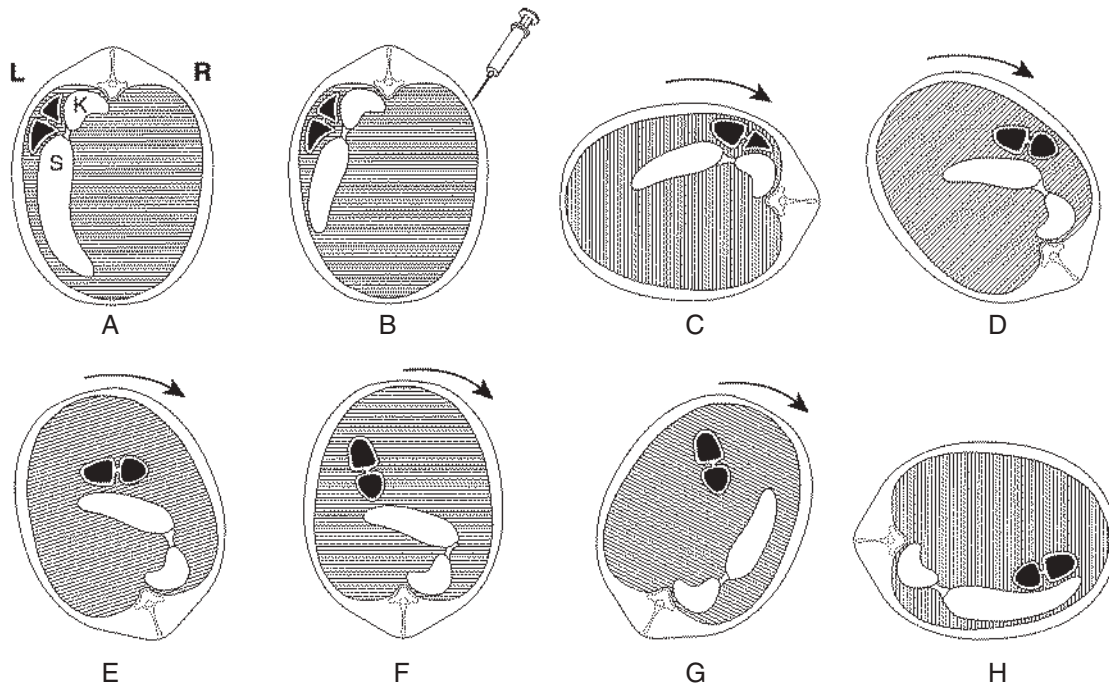

**Fig. 7-5** Steps in correction of left dorsal displacement of the colon (renosplenic entrapment). **A**, Caudal view of abdomen of horse with left dorsal displacement of the colon. Entrapped colon is shown in black. **K**, left kidney; **S**, spleen. **B**, Injection of phenylephrine and contraction of spleen. **C**, Horse anesthetized and placed in right lateral recumbency. **D–H**, Horse rolled through dorsal recumbency to left lateral recumbency. Entrapped colon moves ventrally and then medially to the contracted spleen. (Modified with permission from Kalsbeek HC. *Equine Vet J* 1989;21:442.)

## IMPACTION OF THE LARGE (ASCENDING) COLON OF HORSES

### SYNOPSIS

**Etiology** Idiopathic, often associated with restricted exercise, poor-quality diet, or restricted access to water

**Epidemiology** Sporadic. Accounts for approximately 10% to 15% of colic cases at referral institutions and in primary practice. Case-fatality rate of 10%

**Clinical signs** Mild to moderate colic often of several days duration. Rectal examination reveals impacted, distended large colon.

**Clinical pathology** No diagnostic changes

**Lesions** Impaction of large colon, usually pelvic flexure or right dorsal colon

**Diagnostic confirmation** Physical examination

**Treatment** Pain control. Administration of fecal softeners (sodium sulfate). Oral administration of water or isotonic polyionic fluids or intravenous administration of isotonic fluids at 100 ml/kg/day

Impaction of the large (ascending) colon is a common disease of horses sometimes referred to as simple colonic obstruction and distension (SCOD). This does not include causes of colon obstruction caused by strangulation, volvulus, or displacement of the colon.

### ETIOLOGY

The cause of most impactions of the large colon is unknown. Known or speculated causes include the following:

- Poor dentition, such as occurs in older horses
- Poor feeding regimens, such as infrequent feeding of stalled horses
- Horses not fed, in preparation for surgery or racing, and then given unrestricted access to feed or allowed to eat bedding materials
- Horses fed diets too high in fiber, e.g., mature sorghum or maize plants, or even mature Bermuda grass (*Cynodon* spp.) meadow hay, especially if their water intake is limited; ingestion of large volumes of indigestible seeds, e.g., *Crataegus crusgalli* (cockspur hawthorn), may cause outbreaks of impaction of the right dorsal colon
- Horses that come into loose boxes and are offered hard feed after being on soft grass on pasture are also likely to develop impaction colic.
- American Miniature horses develop impaction of the colon
- General debility
- Enteroliths and fiber balls may also cause obstruction of the large intestine and usually result in recurrent attacks of colic.
- Amitraz, a formamidine acaricide for cattle, causes impaction colic in horses.

- Retention of the meconium in foals (see section [Colic in Foals](#))
- Administration of NSAIDs, which alter colonic motility and might predispose to impaction, although epidemiologic support of this etiology is not available
- Restricted water intake, such as during winter when watering points freeze or water is unpalatable

### EPIDEMIOLOGY

Simple colon obstruction and distension occurs in horses of any age. It might be slightly less common in females,<sup>1</sup> although this is not a consistent finding in across studies of the disease. There does not appear to be a breed predisposition. The disease is more common in winter in the UK (41% of cases). The disease represented 13% of colic cases treated at a referral facility and approximately 10% of colic cases seen in private practice in the UK.<sup>1</sup> An important risk factor is a change in management, especially one that involves a reduction in exercise and change in diet.<sup>1</sup> Risk factors for SCOD include cribbing or wind sucking, stabling with the risk increasing with the number of hours stabled per day, change in regular exercise program, travel within the previous 24 hours, and lack of anthelmintic administration. A recent or current musculoskeletal injury is common in horses with SCOD.<sup>1</sup>

Among 118 cases of SCOD examined in primary care practice in the UK, 53% resolved with minimal or no treatment, 37% required multiple visits or hospitalization,



and 9% required surgical intervention or died.<sup>1</sup> The **case-fatality rate** is approximately 10%.<sup>1</sup>

The disease is common in donkeys occurring at a frequency of 3.2 per 100 donkeys per year and is the most common cause of colic in donkeys.<sup>2,3</sup> Important risk factors were increasing age (OR 1.1 per year), lower BW (0.98 per kg), previous colic (6.80), and presence of dental disease (29).<sup>2</sup> The case-fatality rate was 58%.

### PATHOGENESIS

Development of impaction of the large colon is frequently attributed to abnormal colonic motility. Other factors, including mild dehydration as a result of limited water intake or ingestion of poorly digestible material, can cause impaction. Stabling is associated with decreases in large-intestinal motility, fecal water content, and volume of feces compared with horses on pasture and could predispose to development of impaction colic.<sup>4,5</sup> The end result of abnormal motility, intestinal contents, or both is accumulation of a large mass of inspissated feed material in the large colon. Material usually accumulates first at the pelvic flexure or right dorsal colon, presumably because of the reduction in lumen diameter at those points. **Accumulation of inspissated material** causes distension of the colon and prevents aboral passage of ingesta. **Distension** causes pain and changes in colonic motility that exacerbate or perpetuate the impaction. Changes in motility can lead to displacement of the colon, such as right dorsal displacement. If the distension is sufficiently severe or prolonged the colon can become ischemic and necrotic with subsequent rupture, peracute diffuse peritonitis, and death.

### CLINICAL FINDINGS

Moderate abdominal pain is the typical sign in horses with SCOD; pulse rate and respiration are relatively normal, and gastro-intestinal sounds are reduced.<sup>1</sup> There is no reflux on nasogastric intubation. This often continues for 3 to 4 days and sometimes for as long as 2 weeks. The horse is not violent, the principal manifestation of pain is stretching out and lying down, and the bouts of pain are of moderate severity occurring at intervals of up to a half-hour. There is anorexia and the feces are passed in small amounts and are hard and covered with thick, sticky mucus. More severe clinical signs including elevated heart rate, signs of severe or unremitting abdominal pain, discolored mucous membranes, and absences of normal gut sounds are associated with vascular compromise of the colon, impending rupture, or displacement of the colon.

On **rectal examination** impaction of the pelvic flexure of the large colon is the most common site, and the distended, solid loop of the intestine often extends to the pelvic brim or even to the right of the midline. Lying

on the floor of the abdomen, it is easily palpated; the fecal mass can be indented with the fingers, and the curvature and groove between the dorsal and ventral loops of the left colon can be easily discerned. Careful attention should be paid to identifying caudal abdominal structures because impaction of the large colon can lead to displacement of the colon, such as right dorsal displacement, which necessitates surgical correction of the displacement. Impaction of the right dorsal colon cannot usually be palpated per rectum, and the only abnormality can be distension of the colon with soft ingesta that has accumulated behind the obstruction.

### CLINICAL PATHOLOGY

Hemogram, blood chemistry, and peritoneal fluid are normal until the colon becomes ischemic, at which time there is a leukopenia with a left shift and an increase in the white blood cell count and protein concentration in peritoneal fluid.

### NECROPSY FINDINGS

Necropsy findings include large intestine is packed full of firm, dry fecal material, and rupture may have occurred.

### DIFFERENTIAL DIAGNOSIS

See Table 7-19.

- Impaction of the pelvic flexure is readily diagnosed on rectal examination.
- A clinical similar syndrome is produced by strictures of the large colon.

### TREATMENT

The principles of treatment are pain control, correction of fluid and electrolyte abnormalities, and softening of ingesta to facilitate its passage. Pain control is discussed in Table 7-15. Fluid therapy is discussed in Chapter 5.

**Softening of ingesta** is achieved by rehydrating the inspissated material and providing lubrication to hasten its passage. **Fecal softeners** (see Table 7-16) such as magnesium sulfate or sodium sulfate can be given to increase the fecal water content and soften the impacted, inspissated ingesta. Magnesium sulfate is associated with a small risk of hypermagnesemia and neurologic signs, whereas sodium sulfate causes a mild hypernatremia and hypokalemia. Oral administration of a balanced, polyionic electrolyte solution is associated with the greatest increase in colonic water content and no change in serum electrolyte concentrations. Enteral administration of 10 L/h (to a 500-kg horse) of a balanced, isotonic, polyionic electrolyte solution is more effective than intravenous administration of the same quantity of water in combination with oral administration of MgO<sub>4</sub> in hydrating colonic contents in normal horses. Oral administration of plain water (100 mL/kg/day) is effective at increasing fecal water content in healthy

horses dehydrated by withholding of water. Oral administration of water resulted in equivalent increases in fecal water content as did intravenous administration of polyionic isotonic fluids, but with less urine output and less sodium loss.<sup>6</sup>

Mineral oil (see Table 7-17) is a lubricant that might not penetrate the impacted ingesta sufficiently to soften the material, although it is frequently given to horses with colon impaction.

Softening of colonic contents is ideally achieved by enteral administration of water or polyionic, isotonic fluids. Water can be given by nasogastric tube at a rate of 4 to 10 L for a 450-kg horse every 1 to 2 hours until the impaction softens. Use of this regimen results in resolution of the impaction in 20 hours (standard deviation 5 hours) in almost all horses with colon displacement and in ~80% of horses with nonstrangulating displacement.<sup>7</sup> However, some horses develop decreased small-intestinal motility or ileus with the disease and have delayed gastric emptying and reflux of fluid through the nasogastric tube. Such horses should not be administered any medication or water through the nasogastric tube until reflux has resolved. Alternatively, isotonic fluids can be given intravenously at 100 mL/kg/day until the impaction is passed.

**Promotility agents** such as neostigmine are usually contraindicated because of the risk of rupture of the distended colon when vigorous contractions are induced pharmacologically.

Horses may need to be treated for 1 to 6 days until the impaction resolves and should **not be fed** during this time. When feed is again provided it should be easily digestible and initially be of limited volume. Horses recovered from impaction of the large intestine have a higher than expected rate of recurrence of colic (30%).

**Surgical treatment** may be needed for refractory cases (about 15%) but is associated with a poor prognosis because of the risk of iatrogenic rupture of the colon during attempts to exteriorize it from the abdomen during surgery. Impaction of the right dorsal colon is more likely to require surgical treatment.

### REFERENCES

1. Jennings KM, et al. *BMC Vet Res.* 2014;10.
2. Cox R, et al. *BMC Vet Res.* 2007;3:1.
3. Cox R, et al. *Prev Vet Med.* 2009;92:179.
4. Williams S, et al. *Equine Vet J.* 2011;43:93.
5. Williams S, et al. *Equine Vet J.* 2015;47:96.
6. Lester GD, et al. *J Vet Intern Med.* 2013;27:554.
7. Monreal L, et al. *Vet Rec.* 2010;166:259.

## ENTEROLITHS AND FECALITHS

### ETIOLOGY

**Enteroliths** are rock-like concretions, which are either spherical or tetrahedral, that form in the large colon of horses, usually around

a foreign body and which can cause disease evident as **obstructive enterolithiasis**. Most enteroliths in the colon of horses are of two major types: magnesium phosphates/struvite and magnesium vivianite. There is wide variability in macrotecture and ionic concentrations between and within enteroliths of ammonium magnesium phosphate (struvite). Affected horses often have more than one enterolith and the enteroliths can weigh up to 12 kg.

Fecaliths are aggregations of indigestible material such as fencing, plastic, or rope that often have an irregular shape.

## EPIDEMIOLOGY

**Enteroliths** occur sporadically in horses in most regions of the world, but the disease is endemic with greater than expected incidence in certain areas, such as California. Equids with enterolithiasis represented 15.1% of horses admitted for treatment colic, and 27.5% of patients undergoing celiotomy for treatment of colic in a study from California, but less than 2% of horses with colic examined at a referral center in Texas. Of 1105 horses subjected to exploratory laparotomy because of colic over a 16-year period, 21% had obstructive enterolithiasis of which 41% had an enterolith in the descending colon and 59% in the ascending (large) colon.<sup>1</sup> Of 97 horses with obstructive enterolithiasis of the descending colon, 49 also had enteroliths in the large colon. Of the 139 horses with obstructive enterolithiasis of the large colon, 32 had multiple enteroliths detected.<sup>1</sup>

Arabians and Arabian crosses, Morgans, American Saddlebreds, and donkeys are overrepresented, and Thoroughbreds, Standardbreds, warmbloods, and stallions are underrepresented in some studies, suggesting a predilection of these breeds for the disease.<sup>1</sup> The disease is reported in American Miniature horses.

Female horses are overrepresented among surgical cases of obstructive enterolithiasis, and horses with disease of the small colon are younger on average than those with disease of the large colon (13.2 versus 15.4 years).<sup>1</sup> Enteroliths rarely occur in horses less than 4 years of age and are more common in older horses (>11 years). Fecaliths associated with ingestion of foreign bodies occur more commonly in young or adolescent horses.

Feeding >50% of the diet as alfalfa hay, <50% as oat hay, and lack of daily access to pasture (stabling) are associated with increased risk of enterolithiasis in horses in California (OR of 4.7, 0.2, 0.2, and 2.8, respectively).<sup>2</sup> The mean pH of colonic contents from horses with enterolithiasis is significantly higher than for control horses, and horses with enterolithiasis have a significantly lower percentage of dry matter in colonic fecal samples and higher mean mineral concentrations than controls.

About 15% of cases examined at referral institutions that see large numbers of cases

develop a ruptured viscus caused by the enterolith and die. The long-term survival rate of horses treated surgically is approximately 80% to 90% and does not differ for disease of the small or large colon.<sup>1</sup>

**Fecaliths** occur sporadically and appear to be more common in younger horses, perhaps because of their propensity to dietary exploration and ingestion of foreign materials.

## PATHOGENESIS

The mechanism underlying enterolith formation is not known. Enteroliths are formed in the large colon and, rarely, the cecum. They are clinically inapparent, even if quite large, until they cause obstruction of aboral passage of ingesta, usually by occluding the right dorsal or transverse colon. Occasional enteroliths pass into the small colon. Obstruction of the colon causes mild to moderate, often intermittent, colic, presumably when the enterolith or fecalith obstructs the colon, with the pain resolving when the enterolith moves and the obstruction clears. Complete obstruction results in obstruction of aboral movement of ingesta, accumulation of gas and ingesta proximal to the obstruction, and distension of the large colon. There is no loss of integrity of the colon early in the disease but with time and distension there is ischemia and necrosis of the colon, with subsequent perforation, development of acute peritonitis, and death.

## CLINICAL FINDINGS

Clinical signs of horses with obstructive enterolithiasis of the small (descending) colon differs somewhat from that of horses with disease of the large colon. Horses with disease of the small colon have shorter duration of clinical signs and more severe disease than do horses with obstructive enterolithiasis of the large colon. The most common historic manifestation of enterolithiasis of the large colon in horses is recurrent, intermittent colic (about one-third of cases), often with passage of enteroliths in feces (about 10% of cases).

A higher proportion of horses undergoing surgery for obstructive disease of the small colon were tachycardic (56% versus 12%) and/or had a low white cell count (16% versus 5%) than did horses treated for disease of the large colon. Horses with enterolithiasis of the small colon had a shorter duration of clinical signs (median 5 hours, range 5–72 hours) than did horses with enterolithiasis of the large colon (median 2 days, range 12 hours to 3 months).<sup>1</sup>

Horses with acute obstruction have signs typical of obstructive, nonstrangulating disease of the large colon, including mild to moderate colic with failure to pass feces. The heart rate is 50 to 70 beats/min, borborygmi are decreased but not absent, and there is mild abdominal distension. **Rectal examination** can reveal a mildly distended large

colon but the offending enterolith is never palpable, except on the rare occasion that the enterolith or fecalith is lodged in the distal small colon. In horses with complete obstruction of the small colon the severity of pain increases over the next 24 hours and there is readily apparent distension of the large colon. There is usually no reflux through a nasogastric tube. The terminal phase, which can take 72 hours to occur and is caused by rupture of a viscus, is marked by moderate to severe pain, abdominal distension, tachycardia (>80 beats/min), decreased capillary refill time, discolored mucous membranes, sweating, muscle fasciculations, and death. Rupture of a viscus and acute peritonitis occurs in approximately 15% of cases.

**Radiography** of the abdomen is useful in identifying enteroliths in horses with colic (Fig. 7-6) and is more accurate for detection of enteroliths in the large colon than the small colon.<sup>1,3,4</sup> The accuracy of the diagnosis is approximately 80% for enteroliths in the large colon and 40% for those in the small colon, with sensitivity and specificity of 84% and 96% respectively.<sup>4</sup> Sensitivity is lower for enteroliths in the small colon (62%) because visualization is impeded by gas distension of the gastrointestinal tract.<sup>4</sup> Observation of an enterolith on radiographic examination of an equid with compatible clinical signs is very highly suggestive of the diagnosis of obstructive enterolithiasis. Failure to detect an enterolith does not rule out this disease, particularly for small-colon enterolithiasis (sensitivity of 62%). The most common reason for not detecting an enterolith is poor imaging of the abdomen because of inadequate penetration by the x-ray beam, emphasizing the need for appropriate radiographic equipment.

## CLINICAL PATHOLOGY

There are no diagnostic changes in the hemogram, serum biochemical profile, or examination of peritoneal fluid. Horses with enteroliths have higher serum bilirubin concentrations on examination at referral centers, but this change is not sufficiently large to be useful as a diagnostic aid. Similarly, horses with enteroliths have higher protein and white cell counts in peritoneal fluid than do horses with other forms of colic, but again these differences are too small to be of diagnostic significance. Changes in hematological and biochemical variables during the terminal phases of the disease are characteristic of acute, diffuse peritonitis and include leukopenia with left shift, hemoconcentration, and azotemia.

## NECROPSY FINDINGS

Enteroliths are frequent incidental findings at necropsy examination of mature horses, and their presence should not be overinterpreted. Obstructive disease caused by an enterolith is characterized by colon distension, presence of an enterolith in the right

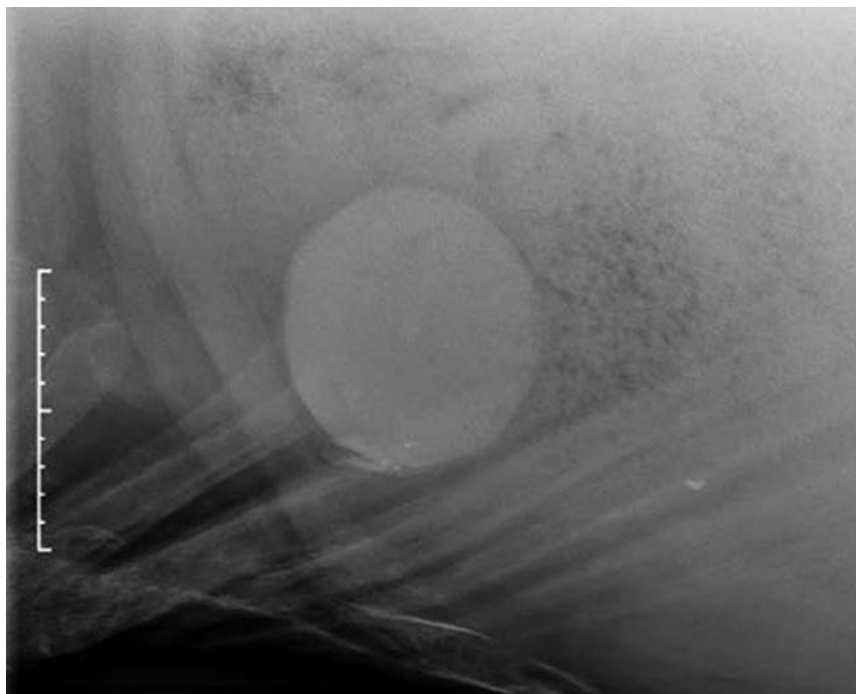

**Fig. 7-6** Enterolith in the large colon of a horse with colic. The scale marker is 10 cm. (Reproduced with permission from Kelleher ME, et al. *JAVMA*. 2014;245:126.<sup>4</sup>)

dorsal, transverse, or small colon and, in cases dying of the disease, acute diffuse peritonitis resulting from colon rupture or perforation at the site of the enterolith. Tetrahedral enteroliths with sharp points are believed to be more dangerous than are spherical enteroliths.

#### DIFFERENTIAL DIAGNOSIS

See [Table 7-19](#).

The main differential diagnosis is colon impaction, which can be difficult to differentiate from enterolith obstruction in the absence of radiographic examination of the abdomen.

#### TREATMENT

The definitive treatment is surgical removal of the enterolith. Supportive care including analgesia and fluid therapy should be provided (see section Equine Colic).

#### CONTROL

Prevention of ingestion of foreign bodies, such as small pieces of metal, can decrease the incidence of the disease. Strategies that decrease fecal pH and mineral content of feces might also decrease the incidence of the disease.

#### REFERENCES

- Pierce R, et al. *Vet Surg*. 2010;39:609.
- Hassel DM, et al. *Res Vet Sci*. 2008;85:476.
- Maher O, et al. *JAVMA*. 2011;239:1483.
- Kelleher ME, et al. *JAVMA*. 2014;245:126.

### SAND COLIC

Ingestion of sand with its accumulation in the large colon causes mild to severe colic, which can be recurrent, and cause acute or chronic diarrhea and weight loss in equids.<sup>1</sup> Sand colic is a disease of horses grazing sandy fields with short pasture, fed on sandy ground, or provided with feed contaminated with sand. It is often associated with under-feeding. Horses of all ages are affected, including foals that acquire the sand while eating dirt. The **case-fatality rate** for horses treated by surgical removal of sand is 20% to 40%, whereas the survival rate for horses treated medically is approximately 90%.<sup>1</sup> The disease is attributable to sand accumulation in the right dorsal or transverse colon or pelvic flexure causing mucosal irritation, luminal obstruction, and abnormal motility. Sand in the ventral colon does not cause obstruction but is associated with colon volvulus or displacement. Sand does not accumulate in the small intestine.

**Clinical signs** are of mild to severe colic that is often recurrent and can be associated with diarrhea (20%), abdominal distension (80%), and anorexia (10%).<sup>1,2</sup> The colic is often mild unless there is colon torsion or volvulus, in which case the signs are typical of that disease. Equids with signs of severe or persistent colic have an increased likelihood of having additional abnormalities such as colon volvulus or displacement.<sup>1</sup> The diarrhea is watery but not profuse or malodorous. Affected equids are frequently tachycardic and are sometimes mildly

pyrexia.<sup>1,2</sup> **Auscultation** over the cranial ventral abdomen just caudal to the xiphoid reveals sounds similar to those made when a paper bag is partially filled with sand and rotated. This sound is diagnostic of sand accumulation in the ventral colon.

**Rectal palpation** can reveal sand impaction in the ventral colon in approximately one-quarter of cases, but more frequently (50%) the colon, cecum, or both are distended with gas.<sup>2</sup> Rectal palpation will not detect sand accumulation in the right dorsal or transverse colon because they are beyond reach. Feces collected during rectal examination can be examined for sand by mixing it with water in a rectal sleeve, agitating the mixture of water and feces to suspend the sand, and allowing the mixture to sediment. Sand is evident in the dependent part of the glove and is detected in this way in approximately 50% to 80% of affected equids.<sup>1,2</sup>

**Radiography** will demonstrate sand in the ventral and dorsal colons ([Fig. 7-7](#)) and can be used to monitor the efficacy of treatment. The severity of sand accumulation can be assessed radiographically and assigned a grade:<sup>3</sup>

- |  |
|--|
| 0 = No sand  |
| 1 = A small amount of sand (largest accumulation <5 × 5 cm), not ventrally   |
| 2 = A small or moderate amount (largest accumulation ~15 × 5 cm, or ~5 × 15 cm) of sand, relatively ventrally or only a small part of the sand close to the ventral abdominal wall |
| 3 = A moderate amount of sand ventrally (largest accumulation ~15 × 5 cm, or ~5 × 15 cm)   |
| 4 = A large (>10 × >10 cm) sand accumulation ventrally   |

Horses with sand impaction colic have sand accumulations of grade 2 to 4, with most having grade 4, and unaffected horses having grades 0 to 2.<sup>4,5</sup> Clinically normal equids can have small amounts of radiographically detectable sand in the colon. Additional information obtained radiographically and associated with a diagnosis of sand colic is, in addition to the presence of sand, the number of sand accumulations, opacity of the accumulation, location, and standardized height of the accumulation.<sup>5</sup>

**Ultrasonography** has good sensitivity (88%) and specificity (88%) compared with a gold standard of radiography for detection of sand in the ventral colon. Ultrasonography is not as effective at detecting sand in the right dorsal or transverse colon. Ultrasonography can enable detection of associated abnormalities including evidence of colonic displacement or mural thickening and small-intestinal distension.

Abnormalities in the hemogram and serum biochemistry profile are consistent with inflammation and dehydration and



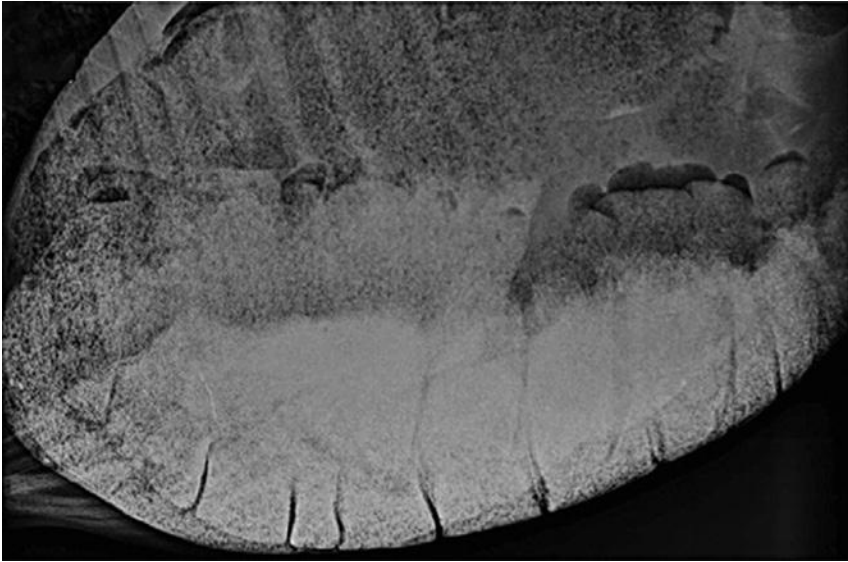

**Fig. 7-7** Lateral abdominal radiograph of a Miniature horse with severe sand accumulation. (Reproduced with permission from Hart KA, et al. *Equine Vet J.* 2013;45:465.)

include a left shift in the leukogram, neutrophilia, hyperfibrinogenemia, and mild azotemia.<sup>1,2</sup> Peritoneal fluid can be normal in mildly affected horses or indicative of inflammation and compromised intestine in severely ill equids.<sup>1</sup>

**Treatment** consists of pain relief, correction of fluid and electrolyte abnormalities, prevention of continued ingestion of sand, and removal of the sand. In horses with severe colic consistent acute obstruction of the right dorsal or transverse colon by sand, volvulus, or displacement, surgical removal is indicated. Equids that require surgical correction of sand colic and associated gastrointestinal abnormalities have a worse prognosis than do equids requiring solely medical treatment.<sup>1</sup>

**Medical treatment** to effect sand removal is indicated in less acute cases. A widely used medical treatment is administration of **psyllium mucilloid** (0.5–1 g/kg orally every 12 hours for 4–8 weeks) administered via a nasogastric tube or as a dressing on feed. However, in an experimental model of the disease this treatment was no more effective than no specific treatment in removal of sand from the cecum and colons. In contrast, administration of a combination of psyllium (0.5 kg orally twice daily) and mineral oil (2 L orally once daily) effectively removed 51% of the administered sand load, whereas treatment with mineral oil resulted in the passage of 26% of the sand. The largest amount of sand was excreted after 24 hours of treatment with psyllium and oil and after 5 days of treatment with oil only.<sup>5</sup> Mineral oil (1 mL/kg) or MgSO<sub>4</sub> (1 g/kg) orally may hasten sand removal. Administration of a combination of psyllium (1 g/kg BW) and MgSO<sub>4</sub> (1 g/kg BW) resulted in elimination of sand in 9/12 horses with naturally occurring sand accumulation, whereas MgSO<sub>4</sub>

alone resulted in elimination in 2/12 and psyllium alone in 3/12.<sup>7</sup> Pasturing of horses with sand accumulation that are otherwise housed in stables aids removal of the sand.

Control of the disease is done by preventing ingestion of sand by feeding horses hay and grain from clean feeding bins, providing adequate roughage in the diet, pasturing horses in fields with adequate grass cover, and perhaps, in areas where sand ingestion is unavoidable, daily administration of psyllium mucilloid. The recommendation for daily administration of psyllium is based on studies in healthy horses, anecdote, and extrapolation from treatment of affected horses.<sup>8</sup>

#### FURTHER READING

Walesby HA, et al. Equine sand colic. *Compend Contin Educ Pract Vet.* 2004;26:712.

#### REFERENCES

- Hart KA, et al. *Equine Vet J.* 2013;45:465.
- Granot N, et al. *Aust Vet J.* 2008;86:404.
- Korolainen R, et al. *Equine Vet J.* 2002;34:499.
- Kendall A, et al. *Acta Vet Scand.* 2008;50:17.
- Keppie N, et al. *Vet Radiol Ultra.* 2008;49:122.
- Hotwagner K, et al. *J Anim Physiol Anim Nutr (Berl).* 2008;92:86.
- Niinisto K, et al. *Vet J.* 2014;202:608.
- Landes AD, et al. *J Equine Vet Sci.* 2008;28:79.

#### RIGHT DORSAL COLITIS

This is a chronic disease caused by ulcerative colitis of the right dorsal colon. The disease is associated with prolonged administration of NSAIDs in most, but not all, cases. Ulcerative colitis occurs after administration of phenylbutazone.<sup>1,2</sup> The case–fatality rate is greater than 50%, although descriptions of large numbers of affected horses are not available.

The **pathogenesis** involves inhibition of mucosal prostaglandin synthesis and consequent decreases in water, chloride, and bicarbonate secretion by mucosa of the right dorsal colon and apoptosis (programmed cell death) of mucosal cells. Loss of secretion of bicarbonate might be associated with failure of alkalization of right dorsal colon contents and subsequent development of mucosal lesions. The right dorsal colon is the only section of the colon with net water secretion, and this unique activity may predispose this section of colon to disease.<sup>3</sup> Exposure of mucosal cells to phenylbutazone can occur both from the lumen and from blood. Luminal exposure may be related to release of phenylbutazone from ingesta in the right dorsal colon. Ulceration of the colonic mucosa allows leakage of plasma constituents into the colonic lumen, resulting in hypoalbuminemia and loss of electrolytes,<sup>2,4</sup> and entry of colonic substances such as endotoxin into the systemic circulation, with consequent signs of endotoxemia and systemic inflammatory response (leukopenia, hyperfibrinogenemia, and fever). Chronic and extensive mucosal ulceration causes growth of granulation tissue and fibrosis of the right dorsal colon with subsequent loss of secretory function, stricture, and partial obstruction.

**Clinical signs** include depression, anorexia, mild fever (38.6–39.5°C [101.5–103°F]), mild intermittent colic, ventral edema, weight loss, and occasionally mild diarrhea. There is almost always a history of administration of an NSAID. The disease can persist for weeks and often prompts inappropriate administration of NSAIDs. Rectal examination is unremarkable. **Ultrasonography** is useful in the diagnosis of right dorsal colitis by detecting the presence of a hypoechoic submucosal layer and permitting measurement of the wall thickness of the right dorsal colon. The hypoechoic layer in the wall of the right dorsal colon corresponds with edema and cellular infiltrates observed histologically. The right dorsal colon in adult horses has a maximal thickness of 6 mm, whereas that in horses with right dorsal colitis is greater than 8 mm and can be as great as 16 mm. Additionally, the ratio of right dorsal colon to right ventral colon wall thickness is up to 1.6 in normal horses and greater than 2.0 in affected horses. **Scintigraphic** detection of right dorsal colitis is achieved by the administration of 99m technetium hexamethylpropyleneamine oxime-labeled white blood cells. Images obtained 20 hours after administration of labeled white cells demonstrated uptake of cells into the right dorsal colon (right cranioventral abdomen).

There is often mild **peritonitis** (neutrophilia in peritoneal fluid). Leukopenia with a left shift and hypoproteinemia are characteristic.<sup>4</sup> **Serum biochemical abnormalities** include hypoalbuminemia, hyponatremia



(<135 mEq/L), hypochloremia (<90 mEq/L), and azotemia (serum creatinine >2 mg/dL, 170 μmol/L).

Necropsy examination reveals ulcerative colitis of the right dorsal colon. In chronic cases there may be stricture of the right colon with subsequent impaction of ingesta and colon rupture.

**Treatment** is often unrewarding, although successful treatment by feeding of a low residue diet, such as a complete pelleted ration fed 4 to 6 times daily, is reported. Psyllium (120 g once daily) for 3 to 6 weeks might enhance healing of the colon. Administration of misoprostol (see Table 7-20) has been suggested but has no demonstrated efficacy. Surgical excision of the lesion is difficult because of its location in the abdomen, but bypass of the right dorsal colon can be beneficial.<sup>5</sup> **Control** involves minimizing the amount of NSAIDs administered to horses.

### FURTHER READING

Bueno AC, et al. Diagnosis and treatment of right dorsal colitis in horses. *Compend Contin Educ Pract Vet.* 2000;22:173.

### REFERENCES

- Noble G, et al. *J Vet Intern Med.* 2012;26:1192.
- McConnico R, et al. *Am J Vet Res.* 2008;69:1496.
- Marshall JF, et al. *Equine Vet J.* 2011;43:140.
- Reed SK, et al. *Am J Vet Res.* 2006;67:398.
- Lane JK, et al. *Vet Surg.* 2010;39:879.

## SMALL COLON OBSTRUCTION

- Small colon impaction<sup>1</sup>
- Obstruction by enterolith or fecalith (see section [Enteroliths and Fecaliths](#))
- Meconium retention (see section [Foal Colic](#))
- Atresia coli (see section [Foal Colic](#))
- Strangulation by pedunculated lipoma, volvulus, intussusception, and herniation through mesenteric rents including the mesocolon or gastrosplenic ligament, ovarian pedicle,<sup>2</sup> or enlarged ovary
- Neoplasia (intramural), including lymphoma<sup>3</sup>
- Hematoma
- Rectal prolapse
- Rupture of mesocolon
- Colonic lipomatosis
- Perirectal abscess

The likelihood of any particular cause of the obstruction is related to a number of factors including age, diet, and use. A review of 84 cases of small-colon obstruction that underwent laparotomy revealed that the most common causes were impaction (37%), strangulation by a pedunculated lipoma (27%), focal eosinophilic colitis (6%), and adhesions of the small colon (6%).<sup>4</sup>

### EPIDEMIOLOGY

Small colon disease is present in approximately 2.5% to 5% of horses treated for colic

at referral institutions, and small-colon impaction represents approximately 2% of horses with colic. Aged female horses are most commonly affected, although the conditions can occur in horses of any age. Arabians, ponies, and Miniature horses are reported to be at increased risk of small-colon disease, although others have not detected this apparent predilection. Rupture of the mesocolon occurs during parturition. Small colon impaction can occur as limited outbreaks in a number of horses on a single farm over a period of days to weeks, without obvious predisposing causes or inciting events. The **case-fatality rate** depends on the condition and is 10% to 40% for impaction of the small colon.<sup>1</sup> The survival rates at discharge from hospital and 1 year and 2 years after surgical correction of small-colon disease in horses that survived the surgery were 91, 81, and 74%. Approximately 80% of horses survived surgery in the short term.<sup>4</sup>

### PATHOGENESIS

Obstruction of the small colon causes accumulation of ingesta and gas in the small colon aboral to the obstruction and in the large colon, with subsequent distension, pain, and reduced motility. Distension of the small colon may impair blood flow with subsequent ischemia, necrosis, and rupture or perforation of the small colon. Incarceration of the small colon results in ischemia of the entrapped segment and restriction of flow of ingesta. Subsequent signs are characteristic of toxemia and intestinal obstruction. The high proportion of affected horses from which *Salmonella* spp. are isolated suggests a role for colitis in the pathogenesis of small-colon impaction.

### CLINICAL FINDINGS

#### Nonstrangulating Lesions

**Nonstrangulating lesions** manifest as mild to moderate colic that may persist without a change in severity for up to 36 hours. The heart rate depends on the severity of the colic but averages 60 beats/min with a range of 30 to 110 beats/min. There is mild dehydration. **Abdominal distension** is usually mild initially but increases as the disease progresses. Borborygmi are reduced and tympanitic sounds may develop as the large colon and cecum become distended. **Rectal examination** reveals the presence of distended large colon but no evidence of colon displacement.

**Small colon impaction** is palpable as a tubular column of material in the small colon, although it might not be detected if the impaction is in the cranial section of the small colon. Approximately 40% of cases have diarrhea and 13% strain to defecate.<sup>1</sup> Fever is present in about one-third of cases.<sup>1</sup> Rectal examination reveals impaction of the small colon, evident as a tubular mass in the caudal abdomen, in approximately 40% of cases, although complete examination per

rectum can be difficult because of large-colon distension and accumulation of feces in the distal small colon. There is reflux through the nasogastric tube in approximately 30% of cases.

### Strangulating Lesions

**Strangulating lesions** that interfere with small-colon blood supply usually present as an acute colic of moderate to severe intensity. There is tachycardia and evidence of toxemia. Abdominal distension is usually marked and there is an absence of borborygmi. Rectal examination reveals distension of the large colon and occasionally soft, compressible distension of the small colon.

Avulsion of the mesocolon occurs during parturition and is often evident as a **rectal prolapse** in the mare. Avulsion results in ischemia of the distal colon. Initially the mare does not display signs of pain but, as the section of the colon from which the mesocolon has avulsed becomes necrotic, signs of toxemia develop.

### CLINICAL PATHOLOGY

There are no characteristic changes in the hemogram or serum biochemical profile. Peritoneal fluid is normal until the viability of the small colon is compromised, at which time the protein concentration and white blood cell count increase. *Salmonella* spp. are isolated from approximately 20% of cases of small-colon impaction, suggesting a role for colitis in the pathogenesis of the disease.

### NECROPSY FINDINGS

Small colon impaction is evident as a tubular column of firm ingesta in the small colon with large-colon distension. Small colon accidents, such as rupture of the mesocolon at parturition and intussusception, are readily apparent.

### DIFFERENTIAL DIAGNOSIS

See Table 7-19.

### TREATMENT

#### Small-Colon Impaction

The principles of treatment of small-colon impaction are relief of pain and of the impaction. Horses with signs of mild to moderate colic easily controlled with analgesics should be treated medically. Horses with intractable pain or progressively worsening pain, abdominal distension, or abnormal peritoneal fluid should be treated surgically. Horses treated surgically have a worse prognosis than do horses treated medically, probably because the former group has more severe disease.

**Medical treatment** of small-colon impaction involves administration of analgesics (see Table 7-15); correction of fluid, electrolyte, and acid-base abnormalities; and

administration of fecal softeners (see Table 7-16). Treatments to hasten softening and passage of the impaction include overhydration, administration of sodium or magnesium sulfate and a lubricant such as mineral oil, and occasionally administration of an enema to the standing horse. Overhydration should be achieved by either intravenous or oral administration of polyionic fluids at three to five times maintenance (10 mL/kg/h). Administration of enemas to standing horses is controversial and should be done with care so as not to rupture the small colon. Trocarization of the large colon or cecum might be necessary in horses with severe abdominal distension. Trocarization can be associated with adverse outcomes including peritonitis and hemorrhage.<sup>5,6</sup>

**Small-colon accidents** including strangulation and intussusception require surgical correction including in some instance a parainguinal approach.<sup>7-10</sup> Surgical correction of rupture of the mesocolon is not available because of limited surgical access to the site of the lesion.

#### FURTHER READING

- Prange T. Small colon obstructions in foals. *Equine Vet Educ.* 2013;25:293-296.  
Schumacher J, Mair TS. Small colon obstructions in the mature horse. *Equine Vet Educ.* 2002;14:19.

#### REFERENCES

- Frederico LM, et al. *JAVMA.* 2006;229:1612.
- Pilati N, et al. *Equine Vet Educ.* 2013;25:290.
- Smith KM, et al. *Equine Vet Educ.* 2013;25:74.
- de Bont MP, et al. *Equine Vet J.* 2013;45:460.
- Scotti GB, et al. *Equine Vet Educ.* 2013;25:184.
- Unger L, et al. *Equine Vet Educ.* 2014;26:430.
- Espinosa Buschiazio CA, et al. *Equine Vet Educ.* 2010;22:223.
- Prange T, et al. *Vet Surg.* 2010;39:748.
- Barrett EJ, et al. *Equine Vet Educ.* 2013;25:442.
- Klohnen A. *Equine Vet Educ.* 2013;25:447.

## SPASMODIC COLIC

### ETIOLOGY

Spasmodic colic occurs sporadically and causative factors are not usually identified. Suggested causes include excitement, such as occurs during thunderstorms, preparations for showing or racing, and drinks of cold water when hot and sweating after work, although epidemiologic evidence of these associations is lacking. Presence of a heavy burden of tapeworms is associated with a high incidence of spasmodic (undiagnosed) colic. Mucosal penetration and submucosal migration of *Strongylus vulgaris* larvae are known to cause changes in ileal myoelectrical activity that could lead to the development of colic in horses. Psychogenic colic occurs rarely in horses.

### EPIDEMIOLOGY

The condition is sporadic. It affects horses of all ages but is not recognized in young foals. No apparent breed or gender predisposition is noted.

## PATHOGENESIS

The hypermotility of spasmodic colic in horses is thought to arise by an increase in parasympathetic tone under the influence of the causative factors mentioned earlier.

### CLINICAL FINDINGS

Spasmodic colic of horses is characterized by **brief attacks of abdominal pain**. The pain is intermittent, with the horse rolling, pawing, and kicking for a few minutes, then shaking and standing normally for a few minutes until the next bout of pain occurs. Intestinal sounds are often audible some distance from the horse and loud, rumbling borborygmi are heard on auscultation. The pulse is elevated moderately to about 60 beats/min, and there may be some patchy sweating, but rectal findings are negative and there is no diarrhea. Rectal examination is usually unremarkable. The signs usually disappear spontaneously within a few hours.

### CLINICAL PATHOLOGY AND NECROPSY FINDINGS

Laboratory examinations are not used in diagnosis and the disease is not fatal.

#### DIFFERENTIAL DIAGNOSIS

See Table 7-19.

### TREATMENT

Acute hypermotility as manifested by spasmodic colic is usually transient, and the use of specific spasmolytics is not necessary. Detomidine, xylazine, or butorphanol are effective analgesics. Administration of hyoscine is effective. Affected horses are often administered mineral oil (1 mL/kg) by nasogastric intubation.

## INTESTINAL TYMPANY IN HORSES

Intestinal tympany is one of the most common causes of colic, as illustrated by it reported as occurring in approximately 64% of horses with acute abdominal disease in Japan.<sup>1</sup>

### ETIOLOGY

The cause of most cases of idiopathic intestinal tympany is unknown, although the ingestion of highly fermentable green feed is considered to be a risk factor. Feeding of rations rich in grains is associated with changes in colonic contents that might predispose to tympany. Intestinal tympany occurs secondary to obstructive diseases that prevent aboral passage of ingesta and gas.

### PATHOGENESIS

The excessive production of gas or its retention in a segment of bowel causes distension

and acute abdominal pain. Intestinal distension reduces intestinal motility and may contribute to the course of the disease. Severe tympany can interfere with normal respiration and cardiovascular function (see section Pathogenesis of Equine Colic).

### CLINICAL FINDINGS

Abdominal distension is evident and pain is acute and severe. Peristaltic sounds are reduced, but fluid may be heard moving in gas-filled intestinal loops, producing a tinkling, metallic sound. Pinging sounds consistent with tightly distended viscus may be heard on simultaneous flicking and auscultation of the abdomen. On rectal examination, gas-filled loops of intestine fill the abdominal cavity and make proper examination of its contents impossible. In primary tympany much flatus is passed. It is important to differentiate primary tympany from that occurring secondary to obstructive diseases such as enterolithiasis and displacement of the colon.

### CLINICAL PATHOLOGY

Laboratory examinations are of no value in diagnosis.

### NECROPSY FINDINGS

In cases of secondary tympany, the causative obstruction is evident. In primary cases, the intestines are filled with gas and the feces are usually pasty and loose.

#### DIFFERENTIAL DIAGNOSIS

See Table 7-19.

### TREATMENT

The principles of treatment are the relief of pain and distension, maintenance of hydration, and reduction of gas production. In secondary tympany the primary disease should be identified and treated.

Pain should be relieved by administration of xylazine, detomidine, or butorphanol, or similar agents (see Table 7-21). Distension of the bowel should be relieved by trocarization, which should only be performed if there is no or minimal response to analgesic medication and no return of normal peristaltic activity because of the risk of peritonitis, hemorrhage, or infection.<sup>2</sup> Trocarization can be performed percutaneously or per rectum.<sup>3</sup> Normal hydration should be restored by intravenous administration of polyionic fluids. Intestinal gas production should be minimized by the administration of mineral oil or a similar laxative (see Table 7-16).

### REFERENCES

- Higuchi T. *J Equine Sci.* 2006;17:17.
- Unger L, et al. *Equine Vet Educ.* 2014;26:430.
- Scotti GB, et al. *Equine Vet Educ.* 2013;25:184.

## VERMINOUS MESENTERIC ARTERITIS (VERMINOUS ANEURYSM AND THROMBOEMBOLIC COLIC)

### ETIOLOGY

The etiology is unknown, although it is presumed to result from thromboemboli originating at sites of verminous arteritis in the cranial mesenteric artery.

### EPIDEMIOLOGY

The disease is assumed to be more prevalent among horses on poor parasite control programs; however, except in extreme cases that die and have a necropsy examination or exploratory laparotomy, the diagnosis is not confirmed. Therefore accurate measures of its incidence are not available. Cases can occur in foals as young as 3 to 6 months. The incidence of the disease has decreased remarkably with the advent of effective broad-spectrum anthelmintics and almost complete prevention of *Strongylus* spp. infection in horses in developed countries. Post-mortem examination of 46 horses in Sardinia that were recorded as having been treated with broad-spectrum anthelmintics identified gross lesions of the cranial mesenteric artery in all horses and *S. vulgaris* larvae in 39% of the horses.<sup>1</sup>

### PATHOGENESIS

Migration of the larvae of *Strongylus vulgaris* into the wall of the **cranial mesenteric artery** and its branches occurs in horses. The presence of larvae causes chronic-active inflammatory lesions and thickening of the tunica intima and adventitial tunic of the ileocecal and colic arteries.<sup>1</sup> These lesions can cause thromboemboli that restrict blood supply to the intestines, with subsequent ischemia and dysfunction. The recurrent colic of verminous arteritis is possibly caused by impairment of the vascular and nerve supply to the intestine. The disease is basically an infarction of bowel wall without displacement of the bowel. The small intestine, colon, and cecum can be affected. The disease has also been associated with larval cyathostomiasis.

### CLINICAL FINDINGS

Signs vary depending on the severity of the disease. It is assumed that **mild, intermittent colics** that respond to analgesics in the short term and anthelmintics in the long term are caused by verminous arteritis. Affected horses are often depressed and spend long periods recumbent. Weight loss and inappetence are features of the disease in some horses. The disease can have a course of weeks to months.

**Acute, severe cases** of the disease are caused by infarction of parts or all of the small intestine, cecum, or colon. Affected horses have an acute onset of severe abdominal pain, tachycardia (>100 beats/min), and sweating. Auscultation reveals decreased borborygmi.

There is mild distension of small intestine or large colon, depending on the segment of bowel affected, on rectal examination. There are rarely signs of intestinal obstruction. Palpation of the cranial mesenteric artery can reveal thickening and pain but is not a useful diagnostic sign for the acute disease. **Death** is caused by peritonitis secondary to devitalization of the intestine,<sup>2</sup> usually within 24 hours of the onset of signs.

### CLINICAL PATHOLOGY

There are no diagnostic changes in the hemogram or serum biochemical profile. Horses with mesenteric artery lesions have higher mean corpuscular volume, mean corpuscular hemoglobin, concentrations of  $\alpha$ -2 globulins,  $\beta$ -globulins, and  $\gamma$ -globulins than in healthy horses.<sup>1</sup> Peritoneal fluid in mild cases can have mild elevations in protein concentration and white blood cell count. In severe cases, peritoneal fluid protein concentration is increased (>25 g/L, 2.5 g/dL) as is white blood cell count (9000–100,000 cells/ $\mu$ L,  $9$ – $100 \times 10^3$  cells/L).

### NECROPSY FINDINGS

Infarction of the colon and cecum is most common and evident as either gangrene of large sections of the organ or multifocal mottled lesions that are red and edematous. Histologic examination rarely reveals the presence of thrombi. There is often verminous arteritis of the cranial mesenteric artery, evident as thickening of the intima and narrowing of the lumen.<sup>1,3</sup>

### DIFFERENTIAL DIAGNOSIS

See Table 7-19.

### TREATMENT

Mild, recurrent cases are treated with analgesics such as flunixin meglumine (see Table 7-15), laxatives such as mineral oil (see Table 7-16), and anthelmintics (ivermectin 200  $\mu$ g/kg orally once; or fenbendazole 50 mg/kg orally every 24 hours for 3 days).

Severe cases are treated with analgesics (see Table 7-15), intravenous administration of fluids (see Chapter 5), and supportive care. Usually the severity of the colic prompts surgical exploration of the abdomen with resection of small lesions. Most severe cases do not survive.

### FURTHER READING

White NA. Thromboembolic colic in horses. *Compend Contin Educ.* 1985;7:S156-S161.

### REFERENCES

1. Pilo C, et al. *Vet Parasitology.* 2012;184:161.
2. Fjordbakk CT, Gunnes G. *J Equine Vet Sci.* 2012;32:638.
3. Marinkovic D, et al. *Acta Veterinaria-Beograd.* 2009;59:231.

## RETROPERITONEAL ABSCESS (INTERNAL ABDOMINAL ABSCESS, CHRONIC PERITONITIS, AND OMENTAL BURSTITIS)

A recognized form of recurrent or intermittent colic is associated with an abscess in the abdominal cavity. The abscesses are usually **retroperitoneal**, sometimes involving the omental bursa, and chronic leakage from them into the peritoneal cavity causes chronic or recurrent peritonitis. Complete recovery is difficult to effect, and there is a high failure rate in treatment. These abscesses result from any of the following:

- Infection of a **verminous aneurysm**, especially in young horses
- **Metastatic *S. equi* infection** (metastatic strangles)
- **Minor perforations of intestinal wall** allowing minimal leakage of intestinal contents so that omental containment of the leak occurs
- Erosion through a **gastric granuloma** associated with *Habronema* sp. or a squamous cell carcinoma of stomach wall
- In **mares**, development of an abscess in the pelvic fascia results after **tearing of the rectal wall during pregnancy diagnosis**.
  - Abscesses caused by *R. equi* in foals

**Clinical findings** suggestive of the disease include persistent or intermittent chronic colic and weight loss. A **fever** is common and **varying degrees of anorexia** are typical. In cases with a concurrent chronic peritonitis or an omental bursitis, the amount of inflammatory exudate may be large enough to cause abdominal distension. When the abscess is perirectal and in the pelvic fascia there may be straining and constipation caused by voluntary retention of feces.

On **rectal examination** it can be possible to feel an abscess or adhesions to one. They are often multiple and quite large and adherent to one another, so that tight bands of mesentery can be felt that will lead the hand to the site of the abscess. Pain is usually elicited by rectal palpation of the infected sites and by firm palpation of the external abdominal wall. Ultrasonography through the abdominal wall has been used to locate large retroperitoneal abscesses in a foal.

The **hemogram**, especially in acute cases, is characterized by a neutrophilia, which may be as high as 30,000/ $\mu$ L with a left shift. **Chronic anemia** caused by bone marrow depression may occur as well as increased **plasma fibrinogen** and **hypoalbuminemia**. Abdominocentesis may yield turbid fluid with a protein content greater than 2.5 g/dL and an increase in leukocytes. If culture is possible the causative bacteria are usually *S. equi*, *S. zooepidemicus*, *Corynebacterium*



*equi*, *C. pseudotuberculosis*, or mixed infections if there has been intestinal leakage. It is common, even when there is an active infection in a retroperitoneal abscess, to fail to grow bacteria from a peritoneal effusion.

**Intraabdominal abscesses** must be differentiated from **abdominal neoplasms** in the horse. Anorexia, weight loss, fever, colic, and depression are common to both syndromes. The laboratory findings in both groups are similar, but cytologic examination of the peritoneal fluid may yield an accurate diagnosis in the case of neoplasms.

Compromised or perforated stomach wall can result in adhesions to the spleen and development of splenic abscesses in horses.<sup>1</sup> In these animals a sharp pain response can be elicited on firm palpation of the abdomen in the left flank just behind the last rib. Abscesses in liver are not so easily located. Abscesses in pelvic fascia are usually not very discrete but are instantly noticeable on inserting the hand into the rectum.

## TREATMENT

**Treatment** with broad-spectrum antimicrobials is indicated and the initial response is good but often transitory if the usual course of treatment is only 3 to 5 days' duration. The prognosis is usually tentative because of the difficulty of completely eliminating the infection. Treatment must be continued for at least 2 weeks and in some cases for a period of 2 to even 4 to 5 months. Surgical treatment might be possible, but is usually ineffectual because of the deformity of the area by adhesions, and the usual outcome of tearing the intestine and spillage into the peritoneal cavity while attempting to exteriorize the lesion.

## REFERENCE

1. Lohmann KL, et al. *Can Vet J*. 2010;51:1400.

## RECTAL TEARS

Iatrogenic tears of the equine rectum are a serious problem in equine practice. They are a leading cause of malpractice suits for the veterinarian, comprising approximately 7% of insurance claims against veterinarians in equine practice in the United States and can be a large economic loss for the owner. The occurrence of rectal tears is often an emotionally charged event because they are unexpected and they usually occur in otherwise healthy horses being subjected to routine rectal examination. Prompt diagnosis and vigorous treatment, along with frank disclosure of the event to the horse's owner or handler, is essential in increasing the likelihood of a good outcome both for the horse and for the veterinarian–client relationship.

Rectal tears also occur in **cattle and sheep** during reproductive procedures including manual pregnancy diagnosis in

cattle and during insertion of ultrasound probes per rectum in sheep. The frequencies and risk factors are not recorded.

## ETIOLOGY

The etiology of rectal tears is usually readily apparent, with the vast majority of rectal tears in horses being iatrogenic. Iatrogenic rupture occurs during rectal examination by veterinarians or laypersons for reproductive management (broodmare), or examination of other intraabdominal structures, for example, during evaluation of a horse with colic.<sup>1</sup> Spontaneous or noniatrogenic rupture can occur associated with infarctive lesions of the distal small colon or rectum, injuries during parturition or coitus, and malicious trauma caused by insertion of foreign objects by attendants.<sup>2</sup> It is important that rectal tears should not be assumed to be iatrogenic until a thorough evaluation of the animal and the history has been performed.

## EPIDEMIOLOGY

**Risk factors** for rectal tears in horses have not been quantified. Reports of the *frequency* of occurrence do not provide information about the *relative risk* of occurrence in an individual animal. For example, rectal tears occur more frequently in mares, but the risk of a rectal tear occurring in a mare expressed as either the risk per examination or the risk per year might be less than that of a stallion. The less frequent occurrence in stallions (i.e., number of cases) might be because stallions are much less seldom subject to rectal examination. Given this caveat, identified associations with rectal tears include:

- **Age:** Contrary to earlier speculation, increasing age is likely a risk factor for rectal tears in horses and it is more frequent in animals >9 years of age.<sup>1</sup>
- **Gender:** The condition is more common in mares,<sup>1</sup> likely because they are more frequently subject to rectal examination as part of routine reproductive management. The relative risk of mares versus stallions and geldings is unknown.
- **Breed:** Arabian and American Miniature horses appear to be at increased risk of iatrogenic rectal tears.<sup>1</sup>
- **Size:** Smaller animals can be at increased risk.
- **Inadequate restraint:** Horses must be adequately restrained for rectal examination (see section [Prevention](#)).
- **Inadequate preparation of the rectum:** The rectum and distal small colon should be emptied of feces before an examination of the reproductive organs or gastrointestinal tract is performed.
- **The experience of the examiner is not a factor in the risk of rectal tears in horses.**
- **The use of ultrasonographic probes per rectum does not appear to increase the risk of rectal tears.**

## PATHOGENESIS

Rectal tears occur in horses because the rectum of the horse is relatively sensitive and fragile and powerful contractions occur during rectal palpation. In contrast, the bovine rectum is relatively durable and, while often traumatized, is rarely ruptured. Tears occur because of excessive tension on the rectal wall. This usually occurs in horses by peristalsis and contraction of the rectum over the examiner's hand, with splitting of the rectum often occurring over the back (knuckles) of the hand.

Complete rupture of the peritoneal portion of the rectum results in fecal contamination of the abdomen and rapid onset of septic peritonitis and death. Tears in the nonperitoneal portion of the rectum (that is, caudal to the peritoneal reflection) cause perirectal cellulitis and abscessation.

## CLINICAL SIGNS

The prominent clinical sign of the occurrence of a rectal tear is the presence of blood on the rectal sleeve of the examiner. Slight bloodstaining of mucus or lubricant is usually not associated with rectal tears (although this should be verified by repeat examination), whereas the presence of frank hemorrhage on the sleeve is usually indicative of a rectal tear. The rectum in an adult, 450-kg horse, is approximately 30 cm long and is partially within the abdomen, where it is covered by peritoneum, and partially in the pelvic canal, where it is not surrounded by peritoneum but is supported by thick connective tissue and muscle. The peritoneal portion of the rectum is supported dorsally by the mesorectum (mesocolon). Most iatrogenic rectal tears in horses occur within 25 to 30 cm of the anus, but can occur up to 60 cm from the anus, in the peritoneal portion of the rectum. The tears are almost always in the dorsal or dorsolateral wall and are longitudinal (parallel to the long axis of the rectum). It is speculated that the dorsal wall of the rectum is weaker than other segments because it is not covered by serosa, and blood vessels perforate the muscularis layers, weakening it.

Rectal tears in the horse have been classified according to the layers of the rectal wall disrupted. The classification is also a useful guide to the clinical signs to be expected and the treatment that is indicated (see the following section [Treatment](#) for management of each grade of tear):

- **Grade I:** Disruption of the mucosa only, or the mucosa and submucosa. There are usually no clinical signs other than some blood on the examiner's sleeve. Most of these injuries occur to the mucosa of the ventral aspect of the rectum.
- **Grade II:** Disruption of the muscular layer of the rectal wall with the mucosal and serosal surfaces intact. This is a



rarely recognized form of tear. There are minimal clinical signs.

- **Grade IIIa:** Tear includes mucosa, submucosa, and muscularis, but the serosal surface is intact. This degree of tear usually causes septic peritonitis. If the tear is caudal to the peritoneal reflection the pelvic fascia becomes infected, but the infection may remain contained within it for 7 to 10 days, forming a local cellulitis or abscess. During this period, the horse is likely to be affected by mild chronic peritonitis, with mild abdominal pain, fever, and mild toxemia. At the end of this time, the infection can erode through the peritoneum and cause an acute, severe, diffuse peritonitis or rupture through the perianal tissue causing a fistula.
- **Grade IIIb:** Tear is on the dorsal wall and includes the mucosa, submucosa, and muscularis. Because there is no serosa at this position, the tear extends into the mesocolon. There is usually septic peritonitis.
- **Grade IV:** Complete rupture with leakage of fecal material into the peritoneal space. Clinical signs of septic peritonitis are severe and death is almost inevitable.

Horses with a rectal tear will not display any immediate signs of discomfort. However, if there is a grade III or grade IV tear, the horse will have signs of septic peritonitis, including elevated heart and respiratory rates, sweating, colic, increased capillary refill time, and discolored mucous membranes within 1 to 2 hours.

### CLINICAL PATHOLOGY

Hematological and serum biochemical changes in horses with grade III and grade IV tears are consistent with acute septic peritonitis. These changes include leukopenia and neutropenia, increased band cell count, elevated hematocrit, and total protein concentration initially, after which serum total protein concentration can decline as protein leaks into the abdomen. Peritoneal fluid has a high white blood cell count and protein concentration. Cytologic examination reveals the presence of degenerate neutrophils, intracellular and extracellular bacteria, and plant material. Lipid material can be detected in the peritoneal fluid if there has been leakage of mineral oil through the tear.<sup>3</sup>

### PROGNOSIS

The **case-fatality rate** varies depending on the type of tear (see later section Clinical Signs). Horses with grade I or II tears almost all survive, whereas the survival rate for horses with grade III tears treated appropriately is 60% to 70%. Almost all horses with grade IV rectal tears die. Survival rates for grades I, II, III, and IV rectal tears are 100, 100, 38, and 2% for horses treated at a referral center.<sup>1</sup>

### TREATMENT

If the person doing the rectal examination feels the mucosa tear, if there is blood on the rectal sleeve, or if a horse that has had a rectal examination up to 2 hours previously starts to sweat and manifest abdominal pain, a rectal tear should be suspected. A thorough examination should be conducted immediately but great care is necessary to avoid damaging the rectum further. The principles of care are to verify the presence of a tear, determine its severity, prevent leakage of fecal material into the peritoneum or tissues surrounding the tear, treat for septic peritonitis, prevent extension of the tear, and provide pain relief.

#### Immediate Care

If a rectal tear is suspected the horse should be appropriately restrained and examined immediately. There should be no delay in conducting this examination. The client should be informed of the concern about a rectal tear. First-aid measures taken at the time of a grade III or IV tear can have a marked influence on the outcome. Horses with grade III or IV rectal tears should receive first-aid treatment and then be referred for further evaluation and treatment.<sup>4</sup>

The existence of a tear should be determined and its severity assessed. This is best achieved by sedating the horse, providing local analgesia of the rectal mucosa and anus, and careful manual and visual examination of the rectal mucosa. Sedation can be achieved by administration of adrenergic agonists (xylazine, romifidine, and detomidine) with or without a narcotic drug (butorphanol, meperidine, pethidine, and morphine). Analgesia of the rectum and anus can be induced by epidural anesthesia (lidocaine or xylazine) or local application of lidocaine gel or lidocaine enema (10–15 mL of 2% lidocaine in 50–60 mL of water infused into the rectum). Peristalsis can be reduced by administration of hyoscine (*N*-butylscopolammonium bromide, 0.3 mg/kg intravenously).

Manual or visual examination of the rectum can then be performed. Manual examination is performed after generous lubrication of the anus and examiner's hand and arm. Some authorities prefer to use bare hands, rather than gloves or a rectal sleeve, for this examination because of the decreased sensitivity when wearing gloves. However, one should be aware of the health risks to the examiner of not using barrier protection (gloves) during a rectal examination. The rectum should be evacuated of feces and a careful and thorough digital examination should be performed. If a tear is detected, the position, distance from the anus, and length and depth of the tear should be determined. Gentle digital examination should be used to determine the number of layers involved and if there is rupture of the rectum and communication with the peritoneal space.

Alternatively, the rectum can be examined visually through a mare vaginal

speculum, or using an endoscope. Both of these approaches are likely to minimize the risk of further damage to the rectum. These examinations can be impaired by the presence of fecal material.

If a grade III or IV rectal tear is detected, then the horse should be administered broad-spectrum antibiotics (penicillin, aminoglycoside, and possibly metronidazole) and NSAIDs, and referred for further evaluation. Some, but not all, authorities recommend placement of a rectal pack to prevent further contamination of the rectal tear. This is formed from a 7.5-cm (3-inch) stockinette into which is inserted a roll of cotton (approximately 250 g). The roll is moistened with povidone iodine solution, lubricated, and inserted into the rectum in the region of the tear. Epidural anesthesia will prevent expulsion of the roll in the short term.

Prompt referral and care is essential for maximizing the likelihood of a good outcome in horses with grade III and IV tears.

#### Grade I and II Tears

Treatment of these tears is medical. Horses should be administered broad-spectrum antibiotics and feces should be softened by the administration of mineral oil. These wounds heal in 7 to 10 days.

#### Grade III Tears

Both medical and surgical treatments are effective in approximately 60% to 70% of cases of grade III tears. The choice of treatment depends on the expertise and experience of the attending clinician and financial constraints imposed by the horse's owner. Surgical treatment includes direct repair of the tear (for those lesions that can be readily exposed via the anus), placement of a rectal sheath by ventral laparotomy, and placement of a loop colostomy. Various techniques are described.<sup>5,6</sup> Surgical repair is in addition to aggressive treatment of peritonitis.

Medical treatment includes administration of broad-spectrum antibiotics (such as penicillin, aminoglycoside, and metronidazole), antiendotoxin drugs (such as hyperimmune serum or polymyxin sulfate), NSAIDs, crystalloid fluids, colloidal fluids (hetastarch and plasma), and heparin, as well as other care. Peritoneal lavage might be indicated. Manual evacuation of the rectum at frequent intervals (every 1–2 hours for 72 hours and then 4–6 times daily for a further 7 days) was suggested to improve the prognosis, although others caution against manual evacuation of the rectum because of the risk of worsening the tear.

#### Grade IV Tears

Tears of this severity require immediate surgical intervention to minimize fecal contamination of the peritoneum. However, the grave prognosis and high cost of treatment, and poor success of surgical intervention in these cases, means that most horses are

euthanized. If surgical care is attempted, there should also be aggressive medical treatment of the peritonitis.

## PREVENTION

As noted earlier, rectal tears can occur during examination by even the most experienced operators. Ideally, the owner should be informed of the risks of rectal palpation and explicit consent to perform the examination should be obtained. This is especially important for animals that are at increased risk of rectal tears.

The examination should be performed only when there is a clear clinical reason for performing a rectal examination, when the animal is a suitable candidate for rectal examination, and when the animal can be adequately restrained to permit a thorough examination to be performed in relative safety for both the examiner and the animal.

The examiner should proceed cautiously with the examination. The gloved hand and arm of the examiner should be well lubricated with a water-based lubricant. The anus should be gently dilated by using fingers shaped into a cone. Feces should be evacuated from the rectum such that the rectum is empty to the most cranial extent of the region to be examined. If the horse is anxious and straining, or if there is excessive peristalsis, then the animal should be sedated and antiperistaltic drugs (such as hyoscine) should be administered. The examination should be halted if the horse begins to struggle or resist the examination excessively. Application of a nose twitch often facilitates the examination.

During the examination care should be exercised not to resist peristaltic waves; the hand should be withdrawn in front of these advancing waves and reinserted as peristalsis passes. The fingers should not be opened widely during the examination and care should be taken not to put excessive pressure on a small region of rectum, such as might occur when trying to grasp an ovary or loop of distended intestine.

A rectal tear in a horse is a common cause of a malpractice suit and the veterinarian involved with the case is advised to recommend to the owner that a second opinion be solicited from another veterinarian to minimize any misunderstanding.

## REFERENCES

1. Claes A, et al. *JAVMA*. 2008;233:1605.
2. Hvozdk A, et al. *Vet J*. 2006;172:374.
3. Brown JS, et al. *Vet Clin Pathol*. 2011;40:265.
4. Kannegieter N, et al. *Aust Equine Vet*. 2011;30:45.
5. Kay AT, et al. *Vet Surg*. 2008;37:345.
6. Stewart SG, et al. *JAVMA*. 2014;245:816.

## ACUTE DIARRHEA OF SUCKLING FOALS

### ETIOLOGY

The causes of diarrhea in suckling foals are listed in Table 7-22. In a large proportion of

foals the cause of diarrhea is not determined, in part because the disease is usually sporadic, mild, and transient. The more common identified infectious causes of diarrhea in foals on breeding farms in Britain include rotavirus, *C. perfringens*, *Salmonella*, *Cryptosporidium* sp., and *Strongyloides westeri*, although the relative importance of various pathogens varies from year to year, from farm to farm, and from region to region.<sup>1</sup> Potential pathogens can be isolated from both foals with diarrhea and healthy foals,<sup>2</sup> making etiologic diagnosis of the cause of diarrhea challenging. Of over 1000 foals examined at studs in the UK the most common disease was diarrhea with systemic disease (fever, tachycardia, depression, dehydration, or combinations thereof) affecting 5.9% of foals <30 days of age. Approximately one-half of these foals tested positive for rotavirus.<sup>1</sup>

Etiologic infectious organisms were isolated from 55% of 223 foals hospitalized in the United States for treatment of diarrhea, with 78% of the 122 positive foals having only one organism isolated.<sup>3</sup> Foals were tested for the presence of rotavirus, *Salmonella* spp., *C. perfringens*, *C. difficile*, coronavirus, helminthes, and cryptosporidium. Rotavirus was the most commonly detected organism and was identified in 20% of the foals.

*C. perfringens* causes diarrhea in young foals. There are five major types of *C. perfringens* and, while the organism is clearly associated with disease, a definitive role for each of these types in causing disease has not been established, partly because toxin production for strains isolated from foals with diarrhea has not been routinely documented. However, there is clear evidence that *C. perfringens* type C causes diarrhea in foals. *C. perfringens* types A, B, D, and E might be associated with disease in foals, but definitive proof is lacking.  $\beta$ -2 toxigenic *C. perfringens* type A has been described as a cause of colitis in a foal.<sup>4</sup> *C. difficile*, alone or in coinfection with *C. perfringens*, is a cause of diarrhea in foals.<sup>5,6</sup>

*E coli*, an important cause of disease in neonates of other livestock species, does not appear to be an important cause of diarrhea in foals, although some strains are pathogenic. Similarly, although there are reports of coronavirus causing severe disease in foals, this does not appear to be a common cause of diarrhea in foals. *Candida* spp. can cause diarrhea in critically ill foals and those administered antibiotics, but yeasts are apparently not causally associated with diarrhea in foals.<sup>7</sup> *Yersinia* spp. have been associated with diarrhea in foals but do not appear to be a common cause of disease. *Bacteroides fragilis* is an uncommon cause of diarrheal disease in foals. *C. parvum* or a specific horse-related cryptosporidium causes diarrheal disease in foals and can be isolated from broodmares.<sup>8-10</sup> The role of *Campylobacter* spp. in foal diarrhea, if there is any, is unclear, although it has been isolated from foals with enteritis.<sup>11</sup>

*Strongyloides westeri* infection, although usually regarded as causing only mild disease, if any, can cause severe disease in a foals and an outbreak of diarrhea.<sup>12</sup>

Group A rotaviruses are an important cause of diarrhea in foals and are discussed separately.<sup>13,14</sup>

Most foals develop transient, clinically unimportant mild diarrhea in the first 2 weeks of life. Colloquially referred to as **foal heat** diarrhea because of its temporal association with postpartum estrus in the dam, the occurrence of diarrhea is not associated with estrus in the dam but rather changes in intestinal flora as the foal ages.<sup>15</sup>

Noninfectious causes of diarrhea in foals include foal heat diarrhea, overfeeding of orphan foals or feeding of incorrect milk replacers, primary or secondary lactose intolerance, and pica (allotriophagia), including eating of sand or dirt. Primary lactose intolerance, the congenital absence of lactase in foals, is reportedly rare.<sup>16</sup> Secondary lactase deficiency occurs in foals recovering from enteritis and responds to feeding of lactose-free milk or administration of exogenous lactase. Acute pancreatitis causes diarrhea in foals, along with signs of abdominal pain and increases in lipase activity in blood and peritoneal fluid.<sup>17</sup>

Diarrhea is common in foals with systemic sepsis (septicemia) in which it can be attributable to the agent causing septicemia also causing colitis/enteritis (for example *Salmonella* spp.) or as a result of systemic organ dysfunction.<sup>18</sup> Approximately 50% of foals with diarrhea treated at a referral institution were bacteremic, although bacteremia was not associated with risk of death.<sup>18</sup>

## EPIDEMIOLOGY

Diarrhea is common in suckling foals worldwide although studies of its incidence, risk factors, and outcome are exiguous. Diarrhea affects 21% of foals annually in Texas, being second only to respiratory disease (22%) as a cause of disease. The frequency of disease varies with age: 25% of foals 0 to 7 days of age have diarrhea, compared with 40% and 8% of foals aged 8 to 31 days and 32 to 180 days, respectively. Although a common disease syndrome, diarrhea is not associated with a high death rate (2.6%). Results of the Texas study might not be applicable to foals in other regions as indicated by the finding of 5.9% of foals affected by diarrhea with systemic signs and an additional 2.9% with undiagnosed diarrhea without systemic signs on horse studs in the UK.<sup>1</sup>

Among the common causes of diarrhea the highest death rates are associated with diarrhea associated with *C. perfringens*, *Salmonella* sp., and *Cryptosporidium* sp.<sup>2</sup>

**Risk factors** for development of the diarrhea vary depending on its etiology, but generally the disease is less common in foals born on pasture and at low stocking density.<sup>11</sup>

Table 7-22 Epidemiological and clinical features of suckling foals with diarrhea

Etiological agent or disease	Important epidemiological factors	Major clinical findings; <i>diagnostic criteria</i>
<b>Idiopathic</b>		
Foal heat diarrhea	Foals <2 weeks of age	No systemic signs of disease; diarrhea is mild and pasty No specific diagnostic criteria
<b>Bacterial causes</b>		
Septicemia (coliforms, <i>Actinobacillus</i> sp., <i>Salmonella</i> sp., <i>Klebsiella</i> sp., and others)	Newborn foal to <2 weeks of age; failure of transfer of passive immunity	Signs of systemic sepsis in addition to diarrhea; fever, depression, recumbency, failure to nurse, swollen joints, pneumonia, omphalitis, or omphalophlebitis; <i>blood culture</i>
<i>Salmonella</i> sp.	Outbreaks in newborn foals, even those with adequate passive immunity; mare is the likely carrier Hygiene at parturition may prevent disease	Acute onset diarrhea, depression, fever, and toxemia; <i>culture of blood and feces</i>
<i>Escherichia coli</i>	Not a well-documented disease in foals (cf. calves and piglets)	Nonfetid diarrhea; <i>culture of feces yields heavy growth of mucoid E. coli (circumstantial evidence only)</i>
<i>Enterococcus</i> ( <i>Streptococcus</i> )	Young foals; disease is rarely reported	Diarrhea; <i>demonstration of S. durans in feces</i>
<i>Rhodococcus equi</i>	Foals 2–5 months of age, some with history of respiratory disease	Diarrhea associated with <i>R. equi</i> pneumonia; <i>culture respiratory tract</i>
<i>Clostridium difficile</i>	<2 weeks of age	Colic, fever, ileus, hematochezia, toxemia, and depression; <i>fecal culture and demonstration of toxin in feces</i>
<i>C. perfringens</i> type C	Neonatal foals; sporadic disease to annual outbreaks on breeding farms; most foals excrete <i>C. perfringens</i> type A, which rarely causes diseases in foals	Colic, fever, ileus, hematochezia, toxemia, depression <i>Culture of C. perfringens</i> type C in feces, demonstration of toxin in feces
<i>Lawsonia intracellularis</i>	Older suckling foals and weanlings; sporadic or outbreaks on farms	Weight loss, mild to moderate diarrhea, ventral edema, depression, hypoproteinemia; serology and polymerase chain reaction on feces
<i>Yersinia pseudotuberculosis</i>	Suckling foals; outbreaks on breeding farms	Watery diarrhea and suppurative pneumonia; <i>culture of feces and lesions</i>
<i>Aeromonas hydrophila</i>	Reports of disease are uncommon; uncertain importance	Diarrhea; <i>culture of feces</i>
<b>Viral causes</b>		
Rotavirus	<3 months of age; occurs as outbreaks or endemic disease on farm; highly contagious	Profuse watery diarrhea with variable hypovolemia and depression; detection of virus in feces by EM, IFA, ELISA
Adenovirus	Immunodeficient foals (Arabians with severe combined immunodeficiency)	Diarrhea, depression; may be associated with other diseases including pneumonia; detection of virus in feces by EM
Coronavirus	Young foals (age range not well defined) Apparently rare cause of diarrhea in foals	Diarrhea; detection of virus in feces by EM
<b>Parasites</b>		
<i>Cryptosporidium</i> sp.	Foals of any age; may be spread from other species, including calves and crias	Inapparent infection to fulminant disease with diarrhea, hypovolemia, and collapse; chronic diarrhea <i>Detection of oocysts in feces, IFA</i>
<i>Strongyloides westeri</i>	Individual foals; uncertain importance as a cause of diarrhea	Acute to chronic diarrhea; patent infections evident by fecal examination for parasite eggs
<b>Other</b>		
Nutritional	Sporadic; orphan foals fed inappropriate or poor-quality milk replacers; nursing foals fed inappropriate supplements	Mild to moderate chronic diarrhea; failure to thrive; <i>feed diet intended for foals (not plant-, protein-, or bovine-milk-based)</i>
Lactose intolerance	Nursing foals	Moderate to profuse diarrhea; <i>historical confirmation of administration of compounds</i>
Overdosing of cathartics (DSS, MgSO <sub>4</sub> , NaSO <sub>4</sub> , castor oil)	Sporadic; secondary to viral diarrhea; occurs only in milk-fed foals	Moderate to severe watery, acidic diarrhea; <i>oral lactose tolerance test or trial administration of lactase with milk feedings</i>
Enema	History of administration; diarrhea short lived	Bright alert and responsive foal with mild to moderate diarrhea; no specific diagnostic tests
Antibiotic induced	Administration of antibiotics	Mild to moderate diarrhea; may be associated with <i>Candida</i> sp. or <i>C. difficile</i> ; <i>culture of feces, examination for C. difficile toxin</i>

DSS, dioctyl sodium sulfosuccinate; ELISA, enzyme-linked immunosorbent assay; EM, electron microscopy; IFA, indirect fluorescent antibody.

Rotavirus diarrhea is often endemic on farms, and the disease occurs as outbreaks on successive years. Affected foals range in age from less than 7 days to more than 3 months.

Diarrhea caused by *R. equi* occurs in foals with *R. equi* pneumonia, and the disease is endemic on some farms. Not all foals with *R. equi* pneumonia develop diarrhea. The disease occurs in foals 2 to 5 months of age.

Salmonellosis also occurs as outbreaks of disease among foals less than 8 days of age on breeding farms and is associated with a carrier status in mares.<sup>12</sup>

Diarrhea associated with *C. perfringens* type C occurs in foals less than 10 days of age with most foals being less than 6 days old,<sup>4</sup> and can occur as a farm problem with multiple foals affected on each of several successive years.<sup>13</sup> Farm risk factors include presence of other livestock, stock-horse-type foals, foals born on dirt, and stall or drylot confinement for the first few days of life.<sup>14</sup> *C. perfringens* type A is excreted in feces of most normal foals, whereas *C. perfringens* type C is rarely isolated from feces of normal foals.<sup>15</sup> *C. difficile* causes diarrhea in foals not administered antibiotics,<sup>16</sup> in contrast to the situation in adult horses, and usually affects foals less than 14 days of age, although foals up to 120 days of age can be affected.<sup>17</sup> FTPI is not a risk factor for *C. perfringens* or *C. difficile* enteritis in foals.

*L. intracellularis* causes mild to moderate diarrhea in older suckling or weaned foals. The disease occurs as outbreaks on breeding farms. There are no recognized foal or farm risk factors.

## PATHOGENESIS

The pathogenesis of diarrhea varies somewhat depending on the inciting cause (see appropriate sections of this text for discussion of pathogenesis), although if sufficiently severe all cause excessive loss of fluid and electrolytes in feces and subsequent hypovolemia, electrolyte abnormalities, metabolic acidosis, and weakness. Although not demonstrated in foals, diarrhea in calves causes metabolic acidosis through loss of sodium and other cations in feces, which results in a decrease in the strong ion difference in blood, causing acidosis. Bicarbonate loss, per se, is not a cause of the metabolic acidosis, at least in calves. Infectious agents generally cause enteritis, although rotavirus infection is associated with loss of villous cells and subsequent loss of enzyme activity derived from the mature epithelial cell. The loss of enzyme activity, including that of disaccharidases, causes malabsorption of nutrients in milk and other feed. Failure to absorb nutrients in the small intestine causes them to be delivered to the cecum and large intestine where they are fermented. Subsequent reductions in colonic pH and increases in osmotic activity of the colon contents result in excretion of large quantities of fluid and electrolytes. *C. difficile* and *C. perfringens* produce

enterotoxins that cause damage to intestinal cells and accumulation of hemorrhagic fluid in the intestine.<sup>16</sup> *L. intracellularis* causes an infiltrative and proliferative enteropathy with subsequent protein loss and malabsorption of nutrients.<sup>19</sup>

## CLINICAL SIGNS

Clinical signs vary from mild, pasty diarrhea that adheres to the perineum and causes no detectable systemic signs of disease to profuse watery diarrhea with rapid development of loss of suckling, depressed mentation, tachycardia, increased skin tent, ileus, and recumbency.

Signs of systemic disease include failure to nurse, increased frequency or prolonged duration of recumbency, foals on pasture failing to follow the mare, fatigue, less frequent urination or production of concentrated urine (urine from normal foals is normally dilute), and weakness. Affected foals often have depressed mentation, tachycardia, fever (depending on the cause of the diarrhea), decreased capillary refill time, dry mucous membranes, increased skin tent, and eyes that are retracted into the orbit (consistent with dehydration). Depending on the cause of the diarrhea, foals can have signs of colic, which can range from mild with intermittent flank watching or biting and restlessness, through profound agitation, rolling, and dorsal recumbency. Severely affected foals can have seizures as a result of profound hyponatremia.<sup>18</sup>

Chronic diarrhea and that caused by nutritional imbalance or lactose intolerance causes rapid weight loss, failure to thrive, poor hair coat, and lethargy. Chronic fecal contamination of the perineum and escutcheon causes excoriation and loss of hair.

Diarrhea associated with foal heat is usually mild and transient and not associated with systemic signs of disease. However, diarrhea caused by infectious agents is often severe and accompanied by systemic signs of disease.

Diseases associated with *Clostridium* sp. are often severe with rapid onset of signs of toxemia, colic, hypovolemia, and death. Diarrhea is usually present and is often bloody, although it can be watery and profuse. Severely affected foals usually have signs of colic, toxemia, and ileus and may not develop diarrhea before dying. Salmonellosis can present as septicemia, with subsequent development of diarrhea, although in older foals diarrhea is a common presenting sign.

## CLINICAL PATHOLOGY

Diarrhea with systemic signs of disease in foals can cause hyponatremia, hyperkalemia, hypochloremia, metabolic acidosis, hypoproteinemia, and azotemia. The magnitude of abnormalities varies with the cause of disease and its severity. Hyponatremia can be profound (<100 mEq/L). Hypoproteinemia can be a result of loss of protein from the

inflamed intestine, a reflection of FTPI, or a combination of both. All young foals with diarrhea should have serum or plasma immunoglobulin concentrations measured or some other test for transfer of passive immunity performed.

Viral causes of diarrhea can be diagnosed by examination of feces by electron microscopy (EM). However, more rapid and sufficiently sensitive and specific tests exist for diagnosis of rotaviral disease (enzyme-linked immunosorbent assay [ELISA] and indirect fluorescent antibody [IFA]). Culture of feces will demonstrate *Salmonella* spp. in most cases if they are the cause of disease. Fecal culture yielding *C. perfringens* or *C. difficile* is insufficient for diagnosis of clostridial enterocolitis because these organisms can be recovered from normal foals. Confirmation of the diagnosis is achieved by demonstration of clostridial toxins in feces, which can be problematic given that the toxins are very labile.<sup>4,6,20</sup>

## DIAGNOSTIC CONFIRMATION

For diagnostic criteria for specific diseases, see the appropriate sections in this text.

## LESIONS

Lesions associated with diarrhea in foals depend on the inciting cause. Characteristically in severe cases there is enteritis and colitis with ulceration of intestinal mucosa. Foals with rotavirus diarrhea, most of which survive, have flattening of small-intestinal epithelium.

## TREATMENT

The principles of treatment are

- Correction and maintenance of hydration, acid-base, and electrolyte status
- Ensuring adequate transfer of passive immunity
- Ensuring adequate nutrition
- Preventing complications of disease, including bacteremia

Correction of hypovolemia and electrolyte abnormalities should follow the general guidelines presented elsewhere in this text. Mildly affected foals, such as those with no systemic signs of disease, might not require administration of fluids orally or parenterally and care involves watchful waiting and intervention as indicated by deterioration in the foal's clinical status. More severely affected foals might require oral supplementation with balanced, isotonic electrolyte rehydration solutions, such as those marketed for use in calves. The amount and frequency will depend on the size of the foal, severity of disease, and response to treatment. Foals that have clear signs of hypovolemia should be administered fluids intravenously. These fluids should ideally be selected based on the foal's serum electrolyte concentrations, but in most instances a balanced, polyionic isotonic fluid such as lactated Ringer's solution is



appropriate. Correction of hyponatremia in some but not all foals requires administration of hypertonic (7%) sodium chloride intravenously. However, rapid correction of hyponatremia, especially if it is long-standing (more than 24 hours) might be associated with an increased risk of cerebral demyelination.<sup>21,22</sup> Correction of hyponatremia will resolve seizure activity.

Correction of acid-base usually occurs with correction of fluid and electrolyte abnormalities. Provision of fluids that are sodium rich and have a high strong ion gap, for instance, lactated Ringer's solution, will usually correct the metabolic acidosis common in foals with diarrhea. However, in some foals the rate of fecal loss of cations including sodium and potassium prevents resolution of metabolic acidosis without administration of sodium bicarbonate. Sodium bicarbonate can be administered intravenously or orally. Oral administration has the advantages that it is convenient and does not require administration of large amounts of fluid or of hypertonic solutions. The dose of sodium bicarbonate can be calculated from the foal's BW and base deficit. As a guideline, a 40-kg foal that is not hypovolemic but has continued profuse watery diarrhea and metabolic acidosis should receive 30 g of sodium bicarbonate orally every 6 hours. Serum sodium and bicarbonate concentrations should be measured at least daily and doses of sodium bicarbonate should be adjusted on the basis of these values. Overdosing, or continued dosing when diarrhea has resolved, results in hypernatremia and metabolic alkalosis.

Foals with diarrhea should have serum immunoglobulin concentrations measured. Hypogammaglobulinemic foals should be administered plasma intravenously (20–40 mL/kg BW).

Ensuring that foals affected by diarrhea continue to ingest sufficient calories is critical to the foal's survival. Foals require up to 150 (kcal/kg)/day for growth but can maintain weight on as little as 50 (kcal/kg)/day, especially if the nutrients are provided intravenously. Foals with mild to moderate diarrhea should be permitted to nurse at will. If there is concern that the foal is not nursing sufficiently, a feeding tube can be placed and the foal's diet supplemented with mare's milk substitute lactose-free milk. Lactase is sometimes added to the milk on the assumption that enteritis causes lactase deficiency (see section Tests of **Absorptive Function** for details of lactose tolerance testing in foals).

Foals with severe diarrhea can benefit from parenteral administration of nutrition and gastrointestinal rest. Feed withholding results in a marked reduction in fecal volume and the extent of electrolyte and acid-base abnormalities. However, it is critical for foal recovery that complete feed withholding is accompanied by partial parenteral nutrition.

Antibiotics are usually administered to foals with severe diarrhea because approximately 50% of such foals have bacteremia.<sup>18</sup> Although there is no evidence that parenteral administration of antibiotics reduces morbidity or case-fatality rate, the precaution has merit, as it does in calves. Oral administration of antimicrobials to foals with diarrhea is common but is not recommended because of the risk of exacerbating the disease, and unknown efficacy. Foals with suspected clostridial enterocolitis should be administered metronidazole (15–20 mg/kg, intravenously or orally, every 6–12 hours).

Drugs that affect gastrointestinal motility, such as loperamide, parasympatholytics, and narcotics, have no demonstrated efficacy in reducing morbidity or case-fatality rate and their use is not recommended.

### CONTROL

Control of foal diarrhea is problematic because it is very common, many cases are mild and transient, a definitive diagnosis is frequently not available in a timely fashion, and it can be associated with a wide variety of infectious and noninfectious agents. Basic principles include ensuring adequate transfer of passive immunity, reducing exposure to pathogens, and minimizing the effect of other risk factors.<sup>23</sup>

Of the important causes of disease, in terms of morbidity and case-fatality rate, control of diarrhea associated with rotavirus and clostridial species is most important. Control of rotaviral diarrhea is discussed elsewhere. Control of clostridial diarrhea on farms with an endemic problems includes vaccinating of mares, administration of metronidazole to at-risk foals, and supplementation of passive immunity with antitoxins to clostridial toxins. Vaccination of mares with toxoids (*C. perfringens* type C and D toxoid) prepared for use in other species has been practiced, but there are no reports of safety or efficacy. Administration of antitoxin raised against *C. perfringens* C, D, and E might provide protection against the  $\alpha$ -,  $\beta$ -, and  $\epsilon$ -toxins that have the potential to affect foals. The antiserum, which is intended for use in ruminants, is administered orally (50–100 mL per foal) soon after birth. The efficacy of this practice has not been determined. Foals at risk may also be administered metronidazole (10 mg/kg every 12 hours) for the first 4 to 5 days of life. Again, the efficacy of this practice has not been determined. Vaccination of mares with recombinant protein of *C. difficile* toxin resulted in production of specific antibodies, although the efficacy of the vaccine in protecting foals was not tested.<sup>24</sup>

Administration of a probiotic containing *Lactobacillus pentosus* WE7 did not confer any protection against development of diarrhea in foals, and was associated with an increased risk of clinical disease, including diarrhea.

### FURTHER READING

Mallicote M, House AM, Sanchez LC. A review of foal diarrhea from birth to weaning. *Equine Vet Educ*. 2012;24:206–214.

### REFERENCES

1. Wohlfeiler FD, et al. *Equine Vet J*. 2009;41:179.
2. Harris R, et al. *Vet Med Intern*. 2012;2012:724959.
3. Frederick J, et al. *J Vet Intern Med*. 2009;23:1254.
4. Hazlett M, et al. *J Vet Diagn Invest*. 2011;23:373.
5. Uzal FA, et al. *Vet Microbiol*. 2012;156:395.
6. Silva ROS, et al. *Equine Vet J*. 2013;45:671.
7. Sgorbini M, et al. *J Equine Vet Sci*. 2008;28:145.
8. Grinberg A, et al. *N Z Vet J*. 2009;57:284.
9. Perrucci S, et al. *Vet Parasitol*. 2011;182:333.
10. Caffara M, et al. *Vet J*. 2013;198:531.
11. Blunden AS, et al. *Equine Vet Educ*. 2006;18:8.
12. Lucena RB, et al. *Pesquisa Veterinaria Brasileira*. 2012;32:401.
13. Bailey KE, et al. *Vet Microbiol*. 2013;167:135.
14. Ghosh S, et al. *Vet Microbiol*. 2013;166:474.
15. Kuhl J, et al. *Vet Microbiol*. 2011;151:321.
16. Roberts VLH, et al. *Equine Vet Educ*. 2008;20:249.
17. Ollivett TL, et al. *Equine Vet J*. 2012;44:96.
18. Hollis AR, et al. *J Vet Intern Med*. 2008;22:1203.
19. Wong DM, et al. *J Vet Intern Med*. 2009;23:940.
20. Silveira Silva RO, et al. *J Equine Vet Sci*. 2014;34:1032.
21. Hardefeldt LY. *Aust Vet J*. 2014;92:488.
22. Wong DM, et al. *J Vet Emerg Crit Care*. 2007;17:275.
23. Wohlfeiler FD, et al. *Equine Vet J*. 2009;41:186.
24. Artushin S, et al. *Equine Vet J*. 2013;45:476.

## ACUTE DIARRHEA OF ADULT (NONSUCKLING) HORSES

### SYNOPSIS

**Etiology** *Salmonella* spp., *Strongylus* spp., cyathostomes, *Neorickettsia risticii*, *Clostridium difficile*, antibiotic administration, coronavirus, idiopathic

**Epidemiology** Usually a sporadic disease of young horses, often temporally associated with mild respiratory disease or a stressful event such as transport. Helminthiasis has a seasonal distribution and can occur as a herd problem. *N. risticii* has a defined geographical distribution.

**Clinical signs** Vary from acute and transient diarrhea with minimal changes in vital signs to acute onset of profuse watery diarrhea with rapid development of severe clinical disease. Depression, fever, dehydration, and anorexia are common. Laminitis occurs as a sequela.

**Clinical pathology** Leukopenia, hemoconcentration, hyponatremia, hypokalemia, or hyperkalemia, and metabolic acidosis. IFA or PCR for *N. risticii*, fecal culture or PCR of *Salmonella* spp. Fecal culture for *Clostridium* spp. and ELISA to demonstrate toxin in feces

**Lesions** Colitis with or without enteritis

**Diagnostic confirmation** Cause is frequently not confirmed.

**Treatment** Maintenance of hydration and correction of acid-base and electrolyte abnormalities. Severe cases require more intensive care. Oxytetracycline for equine neorickettsiosis (monocytic ehrlichiosis). Metronidazole for *C. difficile*-associated diarrhea. Administration of anthelmintics

**Control** None

IFA, indirect fluorescent antibody; PCR, polymerase chain reaction.

## ETIOLOGY

Causes are as follows:

- **Salmonellosis:** Various *Salmonella* spp.
- **Helminthiasis:** *Strongylus* sp., cyathostomes
- **Equine neorickettsiosis** (Potomac horse fever): *Neorickettsia risticii*
- **Antibiotic administration:** macrolides (lincomycin, tylosin, and erythromycin), tetracyclines, ciprofloxacin, trimethoprim-sulfonamide combination, penicillin, aminoglycosides, ceftiofur, and others<sup>1-3</sup>
- **Intestinal clostridiosis:** *C. perfringens* (types A and C<sup>4</sup>), toxigenic strains of *C. difficile*,<sup>5-8</sup> and possibly *C. cadaveris*
- **Aeromonas spp.:** Sometimes isolated from horses with diarrhea but definitive role as a causative agent has not been demonstrated<sup>9</sup>
- **Coronavirus**<sup>10,11</sup>
- **Idiopathic**
  - Intestinal hyperammonemia<sup>12,13</sup>
  - Excessive concentration of sulfate in drinking water<sup>14</sup>
  - Administration of imidocarb for treatment of equine piroplasmiasis<sup>15</sup>
  - Intoxication with inorganic arsenic, cantharidin, or purgatives such as castor oil

Unlike other species, *E. coli* does not appear to be an important cause of diarrhea in adult horses.

In most cases (65%) of acute diarrhea in horses the cause is not determined, or if the cause is determined it is frequently at necropsy examination or as a result of serologic or microbiological testing after the horse has recovered.

## EPIDEMIOLOGY

### Occurrence

The syndrome of acute diarrhea occurs **worldwide** in adult horses of all breeds and both genders. The pattern of occurrence of the syndrome is dependent on the causative factors, with equine neorickettsiosis, associated with *N. risticii*, having a geographic distribution and **acute cyathostomiasis** having a seasonal distribution. Salmonellosis can occur sporadically or as outbreaks in stables, barns, and veterinary hospitals. *C. difficile* enterocolitis is often associated with

hospitalization, antibiotic administration, or both to adult horses.

**Colitis X** refers to an idiopathic peracute to acute enterocolitis with a high case–fatality rate. It is usually a sporadic disease, but multiple cases can occur in a barn or racing stable over a period of weeks and cause considerable economic hardship.

Estimates of incidence, morbidity and mortality, and case–fatality rate are not available for all diseases and are discussed in greater detail in those sections of this text dealing with those diseases.

The **case–fatality rate** for the spontaneous disease can be 25% to 50% even in intensively treated horses, although these estimates are based on horses treated at referral practices. The recovery rate for acute but transient diarrhea in adult horses examined in primary practice is much higher. The case–fatality rate is higher for horses with *C. difficile*-induced diarrhea than for horses with acute diarrhea of other causes and for horses with antibiotic-induced diarrhea. The prognosis is worse in horses with tachycardia, severe dehydration (PCV > 45% [0.45 L/L]), azotemia, metabolic acidosis, low serum albumin concentration, or higher immature neutrophil (band cell) count in peripheral blood.

### Risk Factors

The risk factors for salmonellosis, equine neorickettsiosis, and strongylosis/cyathostomiasis are addressed under those topics.

### Stress

Stressful episodes, such as shipping or racing, hospitalization, surgery, administration of antibiotics, or mild respiratory disease, frequently precede the onset of diarrhea.

### Celiotomy

Celiotomy for colic is associated with an incidence of severe diarrhea of up to 27% in surviving horses. The risk of diarrhea is greatest in horses with large-colon disease or with enterotomy, but is not influenced by the type of antibiotic administered after surgery.

### Antibiotic Administration

Antibiotic administration is associated with acute diarrhea in horses, and almost all antimicrobials can cause the disease although some are apparently associated with greater risk or more severe disease. For example, administration of macrolide antibiotics including lincomycin, clindamycin, and erythromycin are consistently associated with higher risk of diarrhea in adult horses. Diarrhea occurs in horses administered antimicrobials, but such horses frequently have other risk factors for development of diarrhea, and the link to antimicrobial administration is unclear.<sup>1</sup> The prevalence of antimicrobial-induced diarrhea in 5300 adult horses in three referral hospitals over 1 year was 0.6% and had an 18% case–fatality

rate.<sup>3</sup> However, 6.3% of horses administered antimicrobials developed diarrhea within 7 days of arthroscopic surgery compared with none of 44 horses after arthroscopic surgery and not administered antimicrobials.<sup>16</sup>

The macrolide antibiotic **lincomycin** causes acute, often fatal, disease of horses even when administered at relatively low doses, such as that resulting from horses ingesting medicated pig feed. Erythromycin is associated with diarrhea in adult horses and in mares of foals administered the combination of erythromycin and rifampin. **Tetracyclines** have been associated with the development of acute diarrhea but, when given intravenously at therapeutic doses (6.6 mg/kg every 12–24 hours) are probably no more likely to cause diarrhea than other broad-spectrum antibiotics. Tetracycline contamination of feed causes outbreaks of diarrhea on horse farms. Enrofloxacin can be a cause of diarrhea in horses.<sup>3</sup> The combination of **trimethoprim and sulfadiazine** given orally caused diarrhea in 7% of hospitalized horses, whereas pivampicillin, a prodrug of ampicillin, caused diarrhea in 3%, although this difference was not statistically significant. The risk of diarrhea was greatest in hospitalized horses administered enrofloxacin or combinations of drugs including gentamicin. However, the number of horses with diarrhea was small and important associations might have not been detected.<sup>3</sup>

## PATHOGENESIS

Diarrhea is the result of abnormalities in colonic water and electrolyte metabolism. Approximately 90 L of isotonic fluid enters the colon of an adult (450-kg) horse every 24 hours, and any disruption to the normal absorption of this fluid results in increased fecal water and electrolyte excretion. Horses with colitis have markedly different fecal microbiota compared with healthy horses, with loss of predominance of clostridia normally present in healthy horses and reduced diversity of microorganisms.<sup>17</sup> There appears to be a general dysbiosis of fecal microbiota in horses with colitis.

The pathogenesis of **antimicrobial-associated diarrhea** is unclear but could involve one or more of altered gastrointestinal motility (e.g., erythromycin), disturbed enteric flora allowing overgrowth of pathogens and subsequent enteritis or colitis, or altered microbial digestion of ingesta with abnormalities in water and electrolyte balance.<sup>1</sup> Antimicrobial administration markedly alters the flora of healthy horses.<sup>18</sup> Oral administration of trimethoprim-sulfadiazine or intramuscular administration of ceftiofur to healthy horses for 1 week caused a >99% decrease in the number of viable cellulolytic bacteria in feces for at least 1 week after cessation of administration.<sup>18</sup> Ceftiofur resulted in a marked reduction in the number of viable lactobacilli in feces. Antibiotic-treated horses shed more *Salmonella* in feces and

horses only had *C. difficile* during and after administration of antimicrobials.<sup>18</sup> Potential, or identified, pathogens identified in horses with suspect antimicrobial diarrhea include *C. difficile*, *C. perfringens*, *Salmonella* sp., and coliforms. Almost all adult horses with diarrhea from which *C. difficile* or its toxin can be isolated were administered antibiotics before onset of diarrhea.

Colitis results from physical, chemical, or infectious causes that induce inflammation in the colon. The proximate causes vary with the etiology of the disease. For example, colitis caused by infection from toxigenic strains of *C. perfringens* type C is attributable to binding of  $\beta$ -2 toxin to colonic mucosa, whereas colitis caused by salmonellosis is associated with invasion of the organism and loss of colonic mucosa. Colitis is associated with increased production of inflammatory cytokines, including tumor necrosis factor, in the colon, and with impaired mucosal absorptive function. Additionally, bacterial toxins and inflammation result in an increase in mucosal permeability with loss of plasma proteins into the colonic lumen and systemic absorption of toxins, including endotoxin. Loss of plasma proteins causes a reduction in plasma colloidal oncotic pressure with subsequent extravasation of water and electrolytes and development of edema and decreased effective intravascular volume (hypovolemia). The effect of the decrease in oncotic pressure becomes most apparent in horses that are treated aggressively with fluids. These horses, which often inadvertently receive excessive amounts of sodium as part of their treatment, rapidly develop edema of the ventral body wall and colon, among other tissues. Loss of other plasma proteins, including antithrombin III, and absorption from the gut of activators of coagulation, fibrinolysis, or inflammation, can contribute to the disseminated intravascular coagulation often observed in horses with enterocolitis.

The large volume of diarrhea in horses causes a reduction in body water and electrolyte content. Hypovolemia, hyponatremia, hypochloremia, and hypoproteinemia develop. Derangements in acid-base and electrolyte status impair gastrointestinal motility. Hypovolemia impairs perfusion of peripheral tissues, which, combined with absorption of endotoxin through the damaged colonic mucosa, results in toxemia, lactic acidosis, and death.

### CLINICAL SIGNS

The onset of clinical signs is usually abrupt, although in some horses diarrhea can be presaged for up to several days by inappetence, mild depression, and a mild fever. The disease varies in severity from short-lived with mild to moderate diarrhea and minimal systemic signs of disease to a fulminant disease with death in hours. The description here is of the more severe forms of the disease. Once diarrhea occurs there is often **rapid progression**, with some horses

dying within 12 hours of initial clinical signs, although most survive at least 24 hours. In a peracute form of the disease horses die, often within 6 hours, before developing diarrhea.

Typically horses are often severely depressed and stand with their heads down. They may play in water, but rarely eat or drink. Horses are usually mildly pyrexia (101.5–103°F [38.6–39.5°C]) but markedly tachycardic (80–100 beats/min), tachypneic (30–40 beats/min), and dehydrated (8%–12%). There is slow capillary refill of mucous membranes, which are usually bright red initially and then become bluish-purple as toxemia and dehydration become severe. The development of a purple line at the gingival margins is a sign of a poor prognosis. Most horses are oliguric.

The diarrhea is profuse and watery. **Abdominal pain** is usually present but mild; the onset of severe abdominal pain is often associated with necrosis of the large colon or cecum and impending death. **Rectal examination** reveals large amounts of fluid feces with minimal distension of the large colon.

**Complications** of acute, severe enterocolitis include laminitis, thrombophlebitis of the jugular veins, **thrombosis** of vessels including arteries in the limbs, renal failure, pulmonary aspergillosis, and necrotizing enterocolitis. Laminitis develops within 1 to 3 days of onset of diarrhea in approximately 10% of cases and can occur in any horse with enterocolitis, but is most common in horses with Potomac horse fever (equine neorickettsiosis). Thrombophlebitis, which may or may not be septic, usually affects veins, usually the jugular, that have or have had catheters placed or are the site of frequent intravenous injections. Thrombosis of the vein can occur several days to a week after removal of the catheter, although most occur while the catheter is in place. Renal failure occurs as a result of the combined insults of hypovolemia, endotoxemia, and administration of nephrotoxic drugs, including aminoglycosides and NSAIDs. Pulmonary aspergillosis is usually clinically inapparent. Clinically affected horses have rapidly progressive toxemia; respiratory distress; hypoxemia; and blood-tinged, frothy nasal exudates. Fatal necrotizing enterocolitis of horses is characterized by a brief course, with most horses dying within 48 hours of onset of diarrhea, profound dehydration, electrolyte derangements, severe metabolic acidosis and, terminally, severe abdominal pain.

Most horses that survive have resolution of diarrhea in about 7 days, although a small but clinically important proportion develop chronic diarrhea.

### CLINICAL PATHOLOGY

**Hematological** examination reveals an increased hematocrit (45%–60%), variable changes in plasma protein concentration, and neutropenia with a marked left shift. As the disease progresses and horses are

treated by intravenous administration of fluids, plasma protein concentrations and plasma oncotic pressure decline. Plasma or serum albumin concentration may be as low as 1.2 g/dL (12 g/L). Changes in **coagulation and fibrinolysis** are evident as increases in one or more of the following occur: one-stage prothrombin time, activated partial thromboplastin time, and concentration of fibrin degradation products, variable changes in plasma fibrinogen concentration, and a reduction in blood platelet concentration. Approximately one-third of horses hospitalized for treatment of severe diarrhea have subclinical evidence of disseminated intravascular coagulation, which carries a reduced likelihood of recovery.

**Serum biochemical analysis** usually reveals hyponatremia, hypochloremia, variable changes in serum potassium concentration, hypocalcemia (both concentrations of ionized and total calcium), azotemia (increased serum urea nitrogen and creatinine concentrations), hyperphosphatemia, and increased activities of enzymes indicative of muscle (creatine kinase) or intestinal damage (aspartate aminotransferase and alkaline phosphatase).

**Blood gas analysis** often reveals a severe metabolic acidosis, and the more negative the base excess the worse the prognosis. Interpretation of acid-base status in horses with severe enterocolitis is difficult because of the opposing effects of hypoproteinemia and combination of lactic acidosis and electrolyte loss on blood pH. Hypoproteinemia causes a metabolic alkalosis, whereas increases in plasma lactate concentration and hyponatremia cause metabolic acidosis. The presence of hypoproteinemia therefore tends to diminish the effect of lactic acidosis on blood pH, which underestimates the severity of the acidosis. Acid-base status in horses with severe abnormalities in plasma protein concentration should be ascertained by examination of base excess, strong ion gap, or strong ion difference.

Plasma endothelin concentrations are higher in horses with enterocolitis than in normal horses, although the clinical significance of this finding is unclear.

**Abdominal fluid** is usually normal initially but becomes bloody and has an increased white blood cell count and protein concentration if intestinal necrosis occurs.

### DIAGNOSTIC CONFIRMATION

This depends on the results of fecal culture for *Salmonella* sp., fecal examination for helminth eggs or larvae, and IFA or PCR tests for *N. risticii*. Demonstration of large numbers of salmonellas in feces on multiple fecal samples, or in lymph nodes of horses dying of the disease, is persuasive evidence that the horse had **salmonellosis**. However, demonstration of low numbers of salmonellas in a single fecal culture is not definitive evidence that *Salmonella* sp. infection was the cause of the horse's diarrhea.



**Fecal examinations** for helminth eggs may be negative in cases of **acute cyathostomiasis**, although large numbers of fourth-stage larvae may be present in the feces. Diagnosis of *N. risticii* infection is based on a positive IFA test. Isolation of *Clostridium* sp. and demonstration of **clostridial enterotoxin** in feces of horses with acute diarrhea supports a diagnosis of intestinal clostridiosis, although demonstration of toxin alone is usually considered sufficient evidence for diagnosis. **Latex agglutination tests** are available for the detection of *C. perfringens* type A and *C. difficile* toxins.

## NECROPSY

There are extensive lesions at necropsy examination, the most dramatic being in the large intestine, especially the cecum and ventral colon. These include hyperemia, extensive petechiation, and edema of the gut wall in the early stages, and later an intense, greenish-black, hemorrhagic necrosis. The contents are fluid, often foamy and foul smelling, and may be bloodstained.

Histologic examination demonstrates mucosal necrosis with a fibrinohemorrhagic exudate and extensive inflammation of the mucosa and submucosa.

## DIFFERENTIAL DIAGNOSIS

Differential diagnosis list:

- Salmonellosis
- Equine neorickettsiasis (Potomac horse fever)
- Cyathostomiasis
- Antibiotic-induced diarrhea
- *Clostridium* sp. infection (*C. difficile*)
- Colitis X
- Intoxication with inorganic arsenic, cantharidin, or purgatives such as castor oil
- The incipient disease in horses before onset of diarrhea can resemble colon torsion or ischemia of the large colon secondary to verminous arteritis.

## TREATMENT

Horses with mild disease, those that do not manifest systemic signs of disease, usually recover with symptomatic treatment. However, horses with severe disease require more specific treatment and supportive care, which is often intensive and expensive.

The **principles of treatment** for horses with acute diarrhea are

- Restoration and maintenance of normal hydration
- Correction of electrolyte and acid-base abnormalities
- Provision of analgesia
- Prophylaxis and treatment of the effects of endotoxemia/toxemia including management of systemic inflammatory response syndrome
- Prevention of absorption of toxins
- Correction and prevention of disseminated intravascular coagulation

## Restoration of Hydration

Restoration of hydration should be considered an **emergency procedure** in severely affected horses. Fluids should be administered intravenously until hydration is restored, after which hydration can be maintained by either oral (via nasogastric tube) or intravenous administration of fluids. Suitable fluids for restoration of hydration are sodium-rich, isotonic, preferably polyionic, electrolyte solutions such as **lactated Ringer's** or Ringer's solution. **Isotonic sodium chloride** is also suitable. Isotonic dextrose solutions are not suitable because they do not contain any electrolytes. After correction of dehydration, attention should be paid to sodium balance because the administration of excessive quantities of sodium, especially to horses with plasma oncotic pressure that is lower than normal, may cause expansion of the extracellular fluid volume and edema.

Fluid therapy is discussed elsewhere. **Maintenance of hydration** in severely affected horses can be challenging and is best accomplished by intravenous administration of fluids. **Oral administration** of fluids to horses with diarrhea, although not providing ideal rehydration or maintenance of hydration, can be effective and less costly than intravenous administration.

Horses that become **hypoproteinemic** can require transfusions of plasma or administration of synthetic colloids such as hetastarch or pentastarch. Clinical signs indicating the need for transfusion include a persistently elevated heart rate and poor peripheral perfusion in spite of the administration of large quantities of fluids. Ventral edema and edema of the head and legs can develop in hypoproteinemic horses. Sufficient plasma should be administered to restore the plasma protein concentration to at least 40 g/L. Hetastarch or pentastarch provide none of the complex proteins present in plasma and essential for maintenance of normal clot formation and fibrinolysis and do not increase plasma protein concentration. Additionally, synthetic colloids can impair platelet function. Efficacy of administration of synthetic colloids should be assessed by examination of clinical signs or by measurement of plasma oncotic pressure.

## Electrolyte and Acid-Base Status

**Hypонатremia** and **hypochloremia** will usually be corrected by administration of isotonic, sodium-rich electrolyte solutions such as lactated Ringer's solution. If this does not occur, then sodium chloride or sodium bicarbonate can be added to the intravenous fluids, or given orally. **Hypocalcemia** can be corrected by the addition of calcium gluconate (20 mL of 23% calcium gluconate per liter of fluids) to the fluids, provided that the fluids do not contain sodium bicarbonate. The mixture of sodium bicarbonate and calcium gluconate causes calcium to precipitate out of solution. Affected horses have **total body potassium depletion**, even though serum

potassium concentrations may be normal or elevated, and maintenance fluids should contain potassium at up to 25 mEq/L. Fluids with high potassium concentration should be administered slowly. Alternatively, potassium chloride can be given orally (50–100 g per 450 kg every 12 hours).

The **metabolic acidosis** in horses with acute diarrhea often resolves either partially or completely when hydration is restored. However, severe acidosis can be treated with intravenous **sodium bicarbonate**. Oral administration of sodium bicarbonate (100 g per 450 kg every 8–12 hours) is often adequate in restoring and maintaining normal acid-base status. The serum sodium concentration should be monitored if large quantities of sodium bicarbonate are administered.

## Antimicrobial Therapy

Approximately one-third of adult horses with acute diarrhea requiring hospitalization have positive blood cultures within the first day.<sup>19</sup> Bacteria detected include *Corynebacterium* spp., *Streptococcus* spp., *Pantoea agglomerans*, gram-negative rod, *Bacillus* spp., and yeast. Horses with positive blood cultures were sicker and 13 times more likely to die,<sup>19</sup> which could be a reflection of the lethality of bacteremia or that horses that were sicker and more likely to die were at greater risk of developing bacteremia. Administration of antimicrobials was not associated with outcome (lived versus died, risk of complications).

Administration of tetracycline to horses with acute diarrhea associated with *N. risticii* is clearly indicated and is often curative. However, the administration of antimicrobial drugs to horses with acute diarrhea other than that associated with *N. risticii* is controversial.

There is no evidence that administration of antimicrobials improves the prognosis of horses with acute diarrhea. The concern with antimicrobial administration is that antimicrobials can exacerbate the diarrhea in some cases. Conversely, withholding antimicrobials from severely ill horses with damaged colonic mucosa, and therefore presumably increased risk of bacteremia, is problematic. Regardless, many clinicians choose to treat horses with acute diarrhea with broad-spectrum antibiotics such as the combination of potassium penicillin (20,000 IU/kg, intravenously every 6 hours) and gentamicin (7 mg/kg intravenously or intramuscularly every 24 hours) or trimethoprim and sulfadiazine (30 mg/kg intravenously or orally every 12 hours). Metronidazole (15–20 mg/kg orally every 6–12 hours) or vancomycin has been recommended for horses with intestinal clostridiosis, although the wisdom of veterinary use of vancomycin, a drug used for the treatment of methicillin-resistant staphylococci in humans, could be questioned. In areas in which equine neorickettsiasis is endemic, all suspected cases should be treated with tetracycline (6.6 mg/kg intravenously every 12



hours for 3 days), or another effective antibiotic, pending confirmation of the disease. Isolates of toxigenic *C. difficile* from horses with diarrhea are almost always susceptible to metronidazole (15–29 mg/kg orally every 6–12 hours).

### Prophylaxis and Treatment of Endotoxemia/Toxemia and Systemic Inflammatory Response

Treatment of endotoxemia is covered elsewhere in this text. Administration of plasma from horses hyperimmunized with *S. typhimurium* or *E. coli* reduces the severity of clinical signs and shortens the duration of disease in horses with endotoxemia secondary to enterocolitis or colic. **Poly-myxin** (5000 IU/kg intravenously every 12 hours) attenuates the effect of endotoxin in experimental disease and is used for the prevention and treatment of endotoxemia in hospitalized horses. Its efficacy in clinical settings has not been determined in appropriate clinical trials. **Aspirin** (10 mg/kg orally every 48 hours) is administered to diminish platelet aggregation around intravenous catheters. **Flunixin meglumine** (1 mg/kg intravenously every 8–12 hours) or **phenylbutazone** (2.2 mg/kg intravenously every 12 hours) is given for analgesia and to prevent endotoxin-induced increases in plasma prostaglandins. **Pentoxifylline** (8 mg/kg orally every 8 hours) is administered for its putative effective in attenuating the effects of endotoxemia. The efficacy of these treatments in a clinical setting and their effect on measures of outcome of disease, such as duration of illness, case–fatality rate, and incidence of complications, has not been determined, with the exception of hyperimmune plasma or serum.

### Binding of Toxins

Smectite or activated charcoal is sometimes administered to horses with acute enterocolitis in an attempt to adsorb toxins, such as those produced by *Clostridium* spp., and prevent systemic absorption. There is in vitro evidence that smectite can bind clostridial toxins and endotoxin, but evidence of efficacy in vivo is lacking.

### Disseminated Intravascular Coagulation

Prevention and treatment of disseminated intravascular coagulation includes monitoring for changes in variables indicative of coagulation and fibrinolysis including D-dimer concentration; antithrombin III activity; one-stage prothrombin; and activated partial thromboplastin times, platelet count, and fibrinogen concentration. Plasma can be administered to increase blood antithrombin III activity, often in conjunction with heparin or low molecular weight heparin (dalteparin or enoxaparin). Doses of 50 U of dalteparin or 0.5 mg/kg of enoxaparin per kilogram subcutaneously every 24 hours seem to be adequate for prophylactic anticoagulation treatment of

horses. For treatment of coagulation disorders or for ill horses that are considered to be at high risk of developing thrombotic disease, dosages may need to be increased to 100 U of dalteparin or 1 mg/kg of enoxaparin per kilogram subcutaneously every 24 hours.

### CONTROL

Specific control measures for *Salmonella* spp. infection, equine neorickettsiasis, and cyathostomiosis (strongylosis) are discussed under their respective headings. The incidence of antibiotic-induced colitis can be reduced by minimizing the frequency with which antibiotics are administered to horses. Administration of smectite to horses undergoing colic surgery reduced the proportion of horses with postoperative diarrhea from 41% to 11%.<sup>20</sup> There is no evidence that probiotics reduce the severity of disease or shorten its duration, although most are regarded as safe and easy to administer.<sup>21</sup>

### FURTHER READING

- McGorum BC, Pirie RS. Antimicrobial associated diarrhea in the horse. Part 1: overview, pathogenesis and risk factors. *Equine Vet Educ.* 2009;21:610–616.
- McGorum BC, Pirie RS. Antimicrobial associated diarrhea in the horse. Part 2: which antimicrobials are associated with AAD in the horse. *Equine Vet Educ.* 2009;22:43–50.
- Naylor RJ, Dunkel B. The treatment of diarrhea in the adult horse. *Equine Vet Educ.* 2009;21:494–504.

### REFERENCES

- McGorum BC, et al. *Equine Vet Educ.* 2009;21:610.
- McGorum BC, et al. *Equine Vet Educ.* 2010;22:43.
- Barr BS, et al. *Equine Vet J.* 2013;45:154.
- Diab SS, et al. *Vet Pathol.* 2012;49:255.
- Diab SS, et al. *Vet Pathol.* 2013;50:1028.
- Ruby R, et al. *J Am Vet Med Assoc.* 2009;234:777.
- Songer JG, et al. *J Vet Diagn Invest.* 2009;21:377.
- Diab SS, et al. *Vet Microbiol.* 2013;167:42.
- Waldrige BM, et al. *J Equine Vet Sci.* 2011;31:700.
- Oue Y, et al. *Vet Microbiol.* 2011;150:41.
- Oue Y, et al. *J Vet Med Sci.* 2013;75:1261.
- Stickle JE, et al. *Vet Clin Pathol.* 2006;35:250.
- Dunkel B, et al. *Equine Vet J.* 2011;43:133.
- Burgess BA, et al. *Can Vet J.* 2010;51:277.
- Donnellan CMB, et al. *Equine Vet J.* 2013;45:625.
- Verwilghen D, et al. *Equine Vet Educ.* 2014;26:176.
- Costa MC, et al. *PLoS ONE.* 2012;7.
- Harlow BE, et al. *Vet Microbiol.* 2013;166:225.
- Johns I, et al. *Equine Vet J.* 2009;41:160.
- Hassel DM, et al. *Vet J.* 2009;182:210.
- Schoster A, et al. *J Vet Intern Med.* 2014;28:1640.

## CHRONIC UNDIFFERENTIATED DIARRHEA OF HORSES

### SYNOPSIS

**Etiology** Common sign of many enteric and nonenteric diseases

**Epidemiology** Sporadic disease of adult horses, except for cyathostomiosis and salmonellosis, which are discussed under those headings

**Clinical signs** Passage of unformed or liquid feces, either in increased or normal

quantities. Weight loss, increased appetite. Otherwise normal physical examination. Rectal examination is usually normal.

**Lesions** Colitis in most cases

**Diagnostic confirmation** Examination of feces for cyathostome larvae, rectal biopsy demonstrating lymphoma or granulomatous enteritis, and *Salmonella* spp. in rectal mucosal biopsy or feces. Sand in feces or evident on abdominal radiography

**Treatment** Supportive: anthelmintics, corticosteroids, antidiarrheal preparations

**Control** As for cyathostomiosis and salmonellosis

### ETIOLOGY

Chronic diarrhea is the **final common sign** of a number of causes of colonic dysfunction in horses. Diseases that cause chronic (more than 2 weeks' duration) diarrhea in horses include: cyathostomiosis, chronic idiopathic colitis, salmonellosis, alimentary lymphosarcoma,<sup>1,2</sup> granulomatous colitis, eosinophilic colitis, ingestion of sand, chronic liver disease, peritonitis, lymphangiectasia, and as a sequela to acute diarrhea. Immune deficiency, including variable adult-onset B-cell deficiency, can predispose a horse to the disease. *Brachyspira* sp. have been implicated as a cause of chronic diarrhea in horses.<sup>3,4</sup> *Campylobacter fetus* subsp. *fetus* has been isolated from feces and rectal biopsy of a 2-year-old Quarter Horse with chronic diarrhea and weight loss. Administration of enrofloxacin was temporally associated with passage of formed feces, although this change did not persist.<sup>5</sup>

There are many causes and their relative importance varies between locations. Even with concerted effort, a definitive antemortem diagnosis is achieved in fewer than 30% of cases.

### EPIDEMIOLOGY

The occurrence is sporadic, with only single cases occurring in a group. Other horses in contact are not affected. The case–fatality rate is 35% to 65%. There appears to be no age-related, gender-related, or breed-related variation in incidence. Older horses do not appear to be at increased risk of having chronic diarrhea. The epidemiology of cyathostomiosis (strongyloidosis) and salmonellosis are discussed under their respective headings.

### PATHOGENESIS

Diarrhea is attributable to colonic dysfunction, which can result in excessive loss of electrolytes in feces and diminished absorption of nutrients from the large colon. Disease of exclusively the small intestine does not cause diarrhea in horses. Protein-losing enteropathy might be present in addition to the diarrhea. Colonic dysfunction

can be associated with inflammatory or infiltrative lesions of the colon but in many cases an anatomic lesion is not detected. However, the colonic contents of affected horses have a greater fermentative capacity than those of normal horses, suggesting that in some horses the disease is essentially one of abnormal colonic digestion and absorption.

### CLINICAL FINDINGS

The characteristic finding is chronic diarrhea. The feces vary in consistency from thick porridge (oatmeal), through undigested fibers in liquid, to liquid without fiber. The consistency of the feces in an individual horse can vary widely from one day to the next. The duration of the diarrhea is variable but might be lifelong. Death or euthanasia usually results from progressive weight loss. The onset of diarrhea is usually abrupt and can be associated with signs of toxemia and dehydration, as described earlier. However, often there is no toxemia or other systemic sign apart from weight loss, and affected horses are bright and alert and have a normal or increased appetite.

Rectal examination usually fails to reveal any abnormalities, although horses with granulomatous enteritis or alimentary lymphosarcoma can have enlarged mesenteric lymph nodes.

Abdominal radiography will reveal the presence of excessive amounts of sand in the large colon in horses with that disease.

### CLINICAL PATHOLOGY

- Hematological examination can reveal a mild **neutrophilia** and **anemia**, but these changes are of little use in determining the etiology of the diarrhea.
- Serum biochemical examination typically demonstrates a mild **hypoalbuminemia**, **hypoglobulinemia**, **hyponatremia**, and **hypokalemia**, but again these changes are not specific for any particular disease.
- Hypoalbuminemia is consistent with the presence of protein-losing enteropathies such as chronic colitis, alimentary lymphosarcoma, cyathostomiosis, or granulomatous colitis.
- **Hyperbilirubinemia** and elevated serum concentrations of **serum bile acids** are suggestive of liver disease.
- Increases in **serum alkaline phosphatase** activity, while common, are of no diagnostic utility.
- Horses with cyathostomiosis usually have increased concentrations of  $\beta$ -globulins, although the sensitivity of this test is low.

**Peritoneal fluid** has a neutrophilic leukocytosis and increased (>25 g/L) protein concentration in horses with peritonitis but is normal in most horses with chronic diarrhea, including those with alimentary lymphosarcoma or granulomatous colitis.

**Fecal examination** of horses with cyathostomiosis can reveal strongyle-type ova or fourth-stage cyathostome larvae. The presence of **sand** in feces, demonstrated by allowing feces to settle in a transparent rectal glove or similar container, suggests sand accumulation in the colon as a cause of the diarrhea. The presence of **protozoa** in feces has no diagnostic significance. *Giardia* spp. are commonly found in feces of normal horses of all ages and, despite earlier reports of their presence in feces of horses with diarrhea, they are not associated with disease. **Coccidiosis** is very uncommon in horses, and *Eimeria leuckarti* is probably not pathogenic.

Demonstration of *Salmonella* spp. in feces or rectal mucosal biopsy, either by culture or PCR, is suggestive but not diagnostic of salmonellosis, given the high proportion of normal horses that shed *Salmonella* spp. in feces. Isolation of *R. equi* from feces of young horses with diarrhea is suggestive of enteric disease associated with that organism.

An abnormal **D-xylose, glucose, or starch absorption test** indicates small-intestinal disease and is suggestive of granulomatous enteritis, although most horses with this disease do not have diarrhea.

Exploratory laparotomy, either ventral midline under general anesthesia or through the left flank under local anesthesia, and **intestinal biopsy** can demonstrate alimentary lymphosarcoma, granulomatous enteritis, eosinophilic enteritis, chronic colitis, and other abdominal disease. **Rectal biopsy** is less expensive and invasive but has a relatively poor sensitivity, although good specificity for granulomatous enteritis, eosinophilic enteritis, and alimentary lymphosarcoma.

### NECROPSY FINDINGS

Necropsy findings are consistent with the underlying disease, although in many cases gross lesions are not evident. The histologic changes in some cases are restricted to a mild inflammatory response and can be difficult to correlate with the severity of clinical disease. In some of these cases the diarrhea probably reflects an imbalance in the microflora of the large bowel, and demonstration of a specific etiologic agent is an unrealistic goal. Conversely, isolation of *Salmonella* spp. from the gastrointestinal tract or mesenteric lymph nodes should be interpreted with caution in the absence of histologic evidence of salmonellosis.

Because of the wide variety of potential causes of chronic diarrhea of horses it is not possible to list all the samples required to a "confirm" a diagnosis. In most instances, formalin-fixed samples from the liver, mesenteric lymph nodes, and numerous levels of the gastrointestinal tract comprise the minimum diagnostic material required. Regardless of what other testing is performed, it is prudent to hold back frozen segments of both large and small bowel (with content) in case other tests are deemed necessary.

### DIFFERENTIAL DIAGNOSIS

Differential diagnosis list:

- Chronic idiopathic colitis
- Salmonellosis
- Cyathostomiosis
- Granulomatous colitis
- Sand ingestion
- Lymphosarcoma
- Peritonitis
- Intestinal lymphangiectasia
- Hyperlipemia
- Liver disease
- Basophilic enteritis
- Eosinophilic gastroenteritis

### TREATMENT

The **principles of treatment** are to deal with the underlying disease, correct fluid and electrolyte disturbances, give symptomatic treatment of diarrhea, and provide supportive care. Except in cases of cyathostomiosis or sand accumulation, treatment of horses with chronic diarrhea is frequently unrewarding.

#### Specific Treatments

**Cyathostomiosis** should be treated with larvicidal doses of anthelmintics such as fenbendazole (50 mg/kg once, or 7.5 mg/kg daily for 3 days), moxidectin (400  $\mu$ g/kg), or ivermectin (200  $\mu$ g/kg). Treatment can be unrewarding if there is severe damage to the large colon.

Diarrhea secondary to **sand accumulation** in the gastrointestinal tract should be treated by preventing the horse from ingesting sand and, although the efficacy is debatable, with psyllium mucilloid (1–2 g/kg orally once daily for 4–5 weeks; see section **Sand Colic**).

**Chronic idiopathic colitis** can be treated with corticosteroids (dexamethasone 0.2–0.4 mg/kg once daily) or prednisolone (0.5–1.0 mg/kg once daily) for 3 to 4 weeks and the dose reduced as clinical signs permit.

**Chronic salmonellosis** has been treated with enrofloxacin (2.5–5 mg/kg orally every 12 hours for 3–4 weeks), sometimes in combination with metronidazole (15–20 mg/kg orally every 6–12 hours), but one should be aware of the risk of articular cartilage damage in horses treated with enrofloxacin.

Many diseases commonly associated with chronic diarrhea are not treatable.

#### Symptomatic and Supportive Treatments

Symptomatic treatments include **metronidazole** (7.5–20 mg/kg orally every 6–12 hours) or **iodochlorhydroxyquin** (10–20 mg/kg orally once daily). Although some horses have resolution of diarrhea while being treated with these compounds, there is no clear demonstration of their efficacy. **Antibiotic** administration, other than as described previously, does not usually alter the course of the disease. **Antidiarrheal** preparations

such as codeine phosphate, **loperamide**, and **bismuth subsalicylate** often provide temporary improvement in fecal consistency. Some horses with chronic diarrhea respond to **transfaunation**, in which 5 to 10 L of colonic fluid collected immediately after death from a horse without enteric disease is administered via nasogastric intubation.

Supportive treatment includes provision of supplemental electrolytes, principally sodium, potassium, and bicarbonate, as a feed additive. Suitable supplements include some commercial products designed for fluid replacement in diarrhetic calves, or a mixture of potassium chloride (300 g), sodium chloride (400 g), and sodium bicarbonate (300 g). This mixture is isotonic when dissolved at the rate of 90 g/12 L, or can be given orally at the rate of 30 to 90 g per 400-kg horse every 24 hours. Unsupplemented water should be supplied without restriction and serum electrolyte concentrations should be monitored. **Severely affected** horses can require intravenous administration of polyionic isotonic electrolyte solutions or plasma.

Nutritional support should include provision of a diet of high-quality roughage and grain. Some trials can be needed to determine the diet that is best for individual horses, but care should be taken that the diet contains adequate energy and is nutritionally balanced. Horses should be fed to attain, and then maintain, an ideal BW.

**Spontaneous recovery** does occur, particularly in young horses, and this, and the often lengthy duration (6–12 months) of the illness, make it difficult to decide accurately the value of the treatment.

## CONTROL

Control of cyathostomiasis and salmonellosis is discussed under their respective headings. Diarrhea caused by sand accumulation in the colon should be prevented by not feeding horses on the ground and by avoiding grazing of short pastures on sandy soil.

## REFERENCES

1. Sheats MK, et al. *Equine Vet Educ.* 2008;20:459.
2. Sanz MG, et al. *Can Vet J.* 2010;51:522.
3. Bazargani TT, et al. *Int J Vet Res.* 2010;4:81.
4. Hampson DJ, et al. *Vet Rec.* 2006;158:661.
5. Hurcombe SDA, et al. *J Vet Diagn Invest.* 2009;21:266.

## IDIOPATHIC CHRONIC INFLAMMATORY BOWEL DISEASES OF HORSES

A syndrome of combinations of weight loss, ill-thrift, diarrhea, recurrent low-grade colic, intestinal malabsorption, and hypoproteinemia attributable to chronic inflammatory disease of the small and/or large intestine of horses is described.

The causes of idiopathic inflammatory bowel disease in horses are not well described, and the syndrome has been subdivided into

granulomatous enteritis, eosinophilic enteritis, lymphocytic-plasmacytic enterocolitis, basophilic enterocolitis, and multisystemic eosinophilic epitheliotropic disease. Other causes of chronic inflammatory bowel disease in horses include parasitism, alimentary lymphosarcoma and other gastrointestinal neoplasms,<sup>1</sup> tuberculosis, pythiosis, and histoplasmosis.<sup>2</sup> Intolerance to gluten, a protein found in wheat and similar grains, is a well-recognized cause of inflammatory bowel disease in humans. Although most horses with inflammatory bowel disease do not have evidence of gluten hypersensitivity, a horse with high concentrations of antibodies to gluten and which responded to a gluten-free diet is reported.<sup>3</sup>

Empirical treatment of 20 horses with a presumptive diagnosis of inflammatory bowel disease, based on a combination of hypoproteinemia, hypoalbuminemia, malabsorption, increased intestinal wall thickness on ultrasonographic examination or characteristic changes in rectal mucosal biopsy with a larvicidal anthelmintic, and >3 weeks' administration of corticosteroids resulted in a good response to treatment in 15 of the horses with 13 surviving for at least 3 years.<sup>4</sup> Peak xylose absorption was higher (1.36 ± 0.44 mmol/L) in survivors than in nonsurvivors (0.94 ± 0.36).<sup>4</sup>

## REFERENCES

1. Taylor SD, et al. *J Vet Intern Med.* 2006;20:1429.
2. Mair TS, et al. *Equine Vet Educ.* 2006;18:299.
3. van der Kolk JH, et al. *Vet Q.* 2012;32:3.
4. Kaikkonen R, et al. *Acta Vet Scand.* 2014;56:35.

## GRANULOMATOUS ENTERITIS OF HORSES

Granulomatous enteritis is one of several inflammatory bowel diseases of horses. It is characterized by gradual onset of weight loss and ill-thrift.

The etiology of granulomatous enteritis is unknown. Infection with *Mycobacterium* spp. is suggested as a cause but demonstration of acid-fast bacteria in tissue sections or by culture of gut or mesenteric lymph nodes of affected horses is rare and inconsistent.

The disease occurs with greatest incidence in **Standardbred horses** between 1 and 6 years of age, although it does affect other breeds of horses. The disease is usually sporadic, although it has been recorded in siblings raised on the same farm. Estimates of incidence are not available. The disease has a case-fatality rate of almost 100%, although recovery is documented for a small number of horses.

Accumulation of lymphocytes and multinucleated giant cells in the lamina propria is associated with villous blunting in the small intestine. There is malabsorption of carbohydrates and fats and excessive loss of protein in feces with subsequent hypoalbuminemia, edema, and weight loss.

**Weight loss and anorexia** are the most common presenting signs. Fever is uncommon. Approximately one-third of horses have diarrhea or a history of abdominal pain. Affected horses can have a diffuse, scaling alopecia and excoriations, especially of the coronary band. Rectal examination can reveal enlarged, soft mesenteric lymph nodes. Colic is an unusual manifestation.

**Hematological and serum** biochemical examination reveals a mild, macrocytic **anemia** (hemoglobin < 100 g/L, hematocrit < 30%) with a normal leukogram. Hypoalbuminemia is a consistent finding (<25 g/L, <2.5 g/dL) whereas the globulin concentration can be normal, low or, more commonly, high (>50 g/L, >5.0 g/dL). Plasma fibrinogen concentration is usually increased (>4 g/L, 400 mg/dL), and there are no characteristic changes on serum biochemical analysis. Peritoneal fluid is normal.

**Absorption tests** using D(+)-xylose, glucose, or starch indicate diminished absorption of carbohydrate by the small intestine in many affected horses. The D(+)-xylose absorption test is performed by administering D(+)-xylose at a dose of 0.5 or 1 g/kg as a 10% solution by nasogastric intubation after an overnight fast. The concentration of D(+)-xylose in blood samples collected at 0, 1, 2, 3, 4, and 5 hours after dosing is determined. An abnormal test is one in which there is not an obvious peak in the D(+)-xylose curve and in which the peak concentration is lower than expected for a normal horse on a similar diet. In horses with a normal small intestine, administration of a 10% glucose solution orally at a dose of 1 g/kg BW results in an increase in the plasma glucose concentration of >85% of the baseline values. An increase of <15% over baseline is found in horses with small-intestinal disease that impairs glucose absorption. Intermediate values are found in both normal and diseased horses.

**Differential diagnoses** include other causes of malabsorption syndrome in horses such as parasitism, chronic inflammatory disease (abdominal abscess), neoplasia,<sup>1</sup> multisystem eosinophilic epitheliotropic disease, and malnutrition.<sup>2</sup> **Diagnostic confirmation** is achieved by histologic examination of a biopsy of the rectum or small intestine. Rectal biopsy has a low sensitivity (less than 50%) but high specificity for diagnosis of granulomatous enteritis. Biopsy of small intestine and mesenteric lymph nodes has a much higher sensitivity than rectal biopsy and is the recommended test. Endoscopic duodenal biopsy might be useful in providing a diagnosis.<sup>3</sup>

**Necropsy examination** reveals that the intestinal wall is thickened uniformly, especially in the jejunum and ileum. Mesenteric lymph nodes may be enlarged. There is villous atrophy with a diffuse and patchy granulomatous infiltration of the lamina propria of the small intestine. Crypt abscesses are common. Granulomas are also present



in the liver, spleen, kidney, and bone marrow of many cases. The predominant cell types are macrophages and epithelioid cells with occasional giant cells. The disease may be difficult to distinguish from alimentary lymphosarcoma.

Attempts at **treatment** with a variety of antiinflammatory and antimicrobial drugs, including prednisone and sulfasalazine, have been almost universally unsuccessful. Resolution of the disease occurred for up to 7 months, whereas a horse was treated with a decreasing dose of dexamethasone, beginning at 40 mg (0.1 mg/kg) intramuscularly every 4 days for 4 weeks, and then slowly decreasing. Surgical resection of defined, solitary lesions is reported, but this is an unusual manifestation of the disease.

There are no effective control measures.

### FURTHER READING

Schumaker J, Edwards JF, Cohen ND. Chronic idiopathic inflammatory bowel disease of the horse. *J Vet Intern Med.* 2000;14: 258-265.

### REFERENCES

1. Taylor SD, et al. *J Vet Intern Med.* 2006;20: 1429.
2. Mair TS, et al. *Equine Vet Educ.* 2006;18:299.
3. Divers TJ, et al. *Equine Vet Educ.* 2006;18: 284.

## LYMPHOCYTIC-PLASMACYTIC ENTEROCOLITIS

This is an uncommon disease of horses, in contrast to dogs, which affects horses of any age and without discernible breed or gender predilection. The etiology is unknown. Presenting signs include weight loss, diarrhea, and lethargy. Clinicopathologic abnormalities include hypoproteinemia and hypoalbuminemia in approximately one-half and three-quarters of cases, respectively. Results of an oral glucose tolerance test are abnormal in approximately 75% of cases. Histologic examination of a rectal mucosal biopsy reveals abnormal tissue suggestive of the disease in about one-half of cases. The diagnosis is confirmed by biopsy of ileum or necropsy examination. Differential diagnoses are similar to those for granulomatous enteritis. There is marked infiltration of the lamina propria with lymphocytes and plasma cells in the absence of granulomatous changes. Administration of dexamethasone improves clinical signs of disease in a small proportion of horses. Control measures are not available.

### FURTHER READING

Schumaker J, Edwards JF, Cohen ND. Chronic idiopathic inflammatory bowel disease of the horse. *J Vet Intern Med.* 2000;14:258-265.

## IDIOPATHIC FOCAL EOSINOPHILIC ENTERITIS

**Focal, idiopathic eosinophilic enteritis** is an uncommon disease of horses

characterized by intestinal obstruction secondary to constrictions of primarily the small intestine caused by an eosinophil-dominated chronic inflammatory reaction.<sup>1,2</sup> The cause of the disease is unknown, although hypersensitivity or immune-mediated mechanisms are likely important in the pathogenesis of the disease. The disease is recognized with increasing frequency in the UK.<sup>5</sup>

Idiopathic focal eosinophilic enteritis occurs without any apparent gender or breed predisposition. Younger horses (<5 years) are at increased risk.<sup>3</sup> The disease is more common during the July to November period in the Northern Hemisphere.<sup>3</sup> The disease is reported in the northern United States, UK, Ireland, and the Netherlands.<sup>4-6</sup>

**Clinical signs** are usually caused by an acute intestinal obstruction and manifest as colic.<sup>4,5</sup> Affected horses rarely have weight loss or diarrhea. The common form of the disease is one in which the infiltration is segmental and associated with acute colic caused by obstruction of the small intestine or large colon by mural lesions.<sup>4,5</sup> The disease must be differentiated from other causes of colic.

Histologically, the disease is characterized by the presence of eosinophilic infiltrates in a chronic active inflammatory reaction affecting the small or large intestines. The infiltrates are restricted to the intestinal tract. There are activated endothelial cells, eosinophils and neutrophils, and components indicating a duration of inflammation of greater than 3 days.<sup>2</sup> Macrophages and eosinophils are the predominant cell type in the lesions.<sup>2</sup>

Antemortem diagnostic confirmation is achieved by small-intestinal biopsy. *Pythium insidiosum* infection can induce a similar focal enteritis.

The **prognosis** for affected horses is good. The lesion is usually amenable to surgical resection, but this does not appear to be necessary for recovery unless there is acute luminal obstruction of the intestine.<sup>1,4,5</sup> Control measures are not reported.

### REFERENCES

1. Proudman CJ, et al. *Equine Vet J.* 2006;38: 290.
2. Makinen PE, et al. *Equine Vet J.* 2008;40:386.
3. Archer DC, et al. *PLoS ONE.* 2014;9.
4. Archer D, et al. *Vet J.* 2006;171:504.
5. Olmos JFP, et al. *Equine Vet J.* 2006;38:354.
6. Winhard F, et al. *Praktische Tierarzt.* 2010;91:578.

## EQUINE GRASS SICKNESS (EQUINE DYSAUTONOMIA, GRASS DISEASE, AND MAL SECCO)

### SYNOPSIS

**Etiology** Unknown

**Epidemiology** Horses of all breeds and both sexes in the UK, Europe, and southern

South America. Greatest incidence in spring/early summer

### Clinical signs

**Acute grass sickness** Colic, nasogastric reflux, absent gut sounds, depression, dysphagia, and small intestinal distension of <2 days' duration at time of death

**Subacute grass sickness** Tachycardia with or without signs of colic, reduced intestinal sounds, impaction of the colon, and clinical course of 2-7 days

**Chronic grass sickness** Insidious onset weight loss, intermittent colic, decreased appetite, rhinitis sicca, patchy sweating, and mild dysphagia

**Clinical pathology** None is specific or diagnostic.

**Lesions** Both forms of the disease have degeneration of neurons of the autonomic nervous system, especially of the myenteric and submucosal plexuses.

**Diagnostic confirmation** Examination of ileal biopsy. Rectal biopsy is not reliable.

### Treatment

**Acute grass sickness/subacute grass sickness** Supportive. None effective

**Chronic grass sickness** Nursing care

**Control** Nonspecific. Vaccination is not currently available.

Equine grass sickness is a noncontagious acute, subacute, or chronic disease with a high case-fatality rate affecting equids in predominantly the UK and northwestern Europe.

### ETIOLOGY

There is increasing confidence that equine grass sickness is a toxicoinfectious form of botulism caused by exposure of susceptible equids to *C. botulinum* type C toxin (BoNT/C and/or C2 binary toxin).<sup>1,2</sup> However, the hypothesis of a role for toxicoinfectious botulism in grass sickness of horses does not completely explain the geographic distribution of the disease. The presence of IgG antibodies to BoNT/C in serum of 30.8% (61 of 198) of horses in Israel, where the disease is not recognized, suggests that factors other than simply exposure to BoNT/C are required for induction of the disease.<sup>3</sup> It is speculated that dietary factors (hence "grass sickness") alter gastrointestinal biota of horses and allow proliferation of *C. botulinum* type C or D, or promote increased production or absorption of neurotoxin, and initiate development of the disease.<sup>4</sup> Interestingly, horses with grass sickness have a higher prevalence of *C. perfringens* in feces (7/9 detected by culture and 15/37 by ELISA) and ileal contents than do horses with colic (1/16) of other cause or grazing healthy horses (0/60 by culture and 1/74 by ELISA).<sup>5</sup> This is interpreted as indicative of altered gastrointestinal biota rather than as



indicating a causative role for *C. perfringens* in equine grass sickness.<sup>5</sup>

Evidence supporting a role for *C. botulinum* toxins in the etiology of the disease included the isolation of toxin (BoNT/c) producing strains of *C. botulinum* type C from the ileum of 45% of horses with grass sickness and 4% of clinically normal control horses, the presence of higher concentrations of IgA antibodies to BoNT/C and BoNT/D in the ileum of horses with acute grass sickness than of unaffected controls,<sup>6</sup> and higher risk of the disease in horses with low serum concentrations of anti-BoNT/C IgG antibodies. Vaccination of horses with a botulinum toxoid markedly reduced the mortality rate among vaccinated, compared with unvaccinated, horses providing evidence of a role for immunity to *C. botulinum* toxins in resistance to the disease.<sup>1</sup> Remarkably, this study was conducted in 1922 and 1923. There are plans to conduct further vaccine trials.<sup>7</sup>

## EPIDEMIOLOGY

### Occurrence

Grass sickness is locally common in its restricted distribution to all parts of Great Britain (including possibly Ireland), the Czech Republic, Sweden, Switzerland, Hungary, Cyprus, and the northern and western coasts of Europe.<sup>2,8-10</sup> A clinically and histologically indistinguishable disease, mal secco, occurs in the Patagonia region of Argentina, southern Chile, and in the Falkland (Malvinas) Islands. Dysautonomia, with clinical signs and histologic changes consistent with equine grass sickness, is reported in a mule from Kansas in the United States.<sup>11</sup>

**Horses, ponies, donkeys, zebras, Przewalski's horses,** rabbits, and hares are affected. The **incidence** on farms with a history of the disease ranges between 0.4% and 16% per year or 2.1 grass sickness cases per 100 horses per year. Approximately 47% of cases are acute, 20% subacute, and 33% have the chronic form of the disease.<sup>12</sup>

The **case-fatality rate** for acute grass sickness is 100%, whereas that for the chronic form of the disease in horses overall is 49%,<sup>12</sup> and 60% to 70% for those treated at a referral hospital. Horses diagnosed in June are 2.7 times (95% CI 1.4–5.4) more likely to survive than those diagnosed in May.<sup>12</sup>

Horses that survive the initial phases of the chronic form of the disease are often destroyed because of weakness and emaciation, although they can make complete recoveries.

### Risk Factors

#### Animal Risk Factors

The risk and prevalence of disease is greatest in 4- to 5-year-old horses (adjusted OR of 1.9 compared with 0–3 year olds) and then declines such that the risk of disease is lowest in horses >12 years old (OR 0.02 compared with that of 0–3 year olds).<sup>12</sup> Similarly, horses 11 to 20 years of age are at

reduced risk compared with horses 2 to 10 years of age (OR 0.32) when only horses in Scotland are considered.<sup>13</sup> The median age at diagnosis is 6 years (mode 5 years) and cases are recorded in horses 2 months to >30 years of age.<sup>12</sup> Foals born of affected mares are clinically normal. There is no apparent breed predilection beyond that attributable to higher numbers of particular breeds of horses in at risk areas,<sup>12</sup> although native Scottish breeds are at increased risk compared with other breeds (OR 3.56) when only horses in Scotland are considered.<sup>13</sup> There is no clear association with gender of the horse when age distribution of genders is considered.<sup>13</sup>

Horses on pasture are at increased risk (hence the colloquial name of the disease), and the disease rarely, if ever, occurs in horses that are denied access to pasture and grazing. A recent (<14 day) change of pasture carries an increased risk (OR 24) of development of the disease. Horses that have been on the farm for less than 2 months are at increased risk of developing the disease. Horses on farms with previous cases of the disease are at increased risk (OR 2.2–45) of the disease, although horses that have been in contact with animals with the disease are at reduced risk (OR 0.1). Horses with lower serum concentrations of antibodies to BoNT/C are at increased risk for the disease.

#### Environmental Risk Factors

The risk of disease in horses in Scotland increases with increasing latitude (northing) at a rate of OR 1.08 per 10 km.<sup>13</sup> The disease occurs year round with a marked seasonal distribution peaking with 61% of cases occurring in April, May, and June in the UK.<sup>12</sup> Outbreaks of the disease are associated with the occurrence of cooler and drier weather than normal during the 2 weeks preceding the outbreak. There is increased risk associated with more sun hours (OR 1.44–2.48 per additional hour per month, after correction for latitude, as previously mentioned) and more frost days (OR 1.13–1.18 per day per month) and decreased risk with higher average temperature (0.82–0.76/°C).<sup>13</sup>

#### Pasture and Soil Risk Factors

Access to grazing is an acknowledged risk factor. Examination of pasture and soil reveals that sites that have had horses with grass sickness have significantly higher concentrations of soil nitrogen and herbage iron, lead arsenic, and chromium.<sup>14</sup> *Ranunculus* sp. (buttercup) was common at sites with affected horses.<sup>14</sup> The role, if any, for *Ranunculus* sp. or the heavy metals in pathogenesis of the disease is unclear.

Horses with grass sickness have plasma amino acid profiles expected of those with subacute or chronic cyanide intoxication. This has led to investigation of the cyanide concentration of common pasture plants

in areas with affected horses. The concentration of cyanogenic glycosides in white clover (*Trifolium repens*) is higher in pasture associated with cases of equine grass sickness (497 mg cyanide/kg dry matter) than in white clover from control pasture (<300 mg/kg).<sup>4</sup> Although white clover is a common pasture plant in many parts of the world, including areas with cases of equine grass sickness, a role for it in the pathogenesis of grass sickness is speculative. The amount of cyanide ingested by horses on pasture with a high cyanide concentration is predicted to be insufficient to induce toxicosis, but there might be other roles for the plant in predisposing the development of the disease.<sup>4</sup> Alternatively, the changes in pasture cyanogen content could be simply coincidental.

#### Farm or Premise Risk Factors

Farms with a history of horses with the disease are at increased risk of having further cases.<sup>12</sup> For premises with previous cases of grass sickness there is an increased risk of the disease developing as the number of horses on the farm increases, with the presence of young horses, on stud farms and livery/riding schools, on farms having sandy or loamy soil, and those rearing domestic birds and using mechanical fecal removal. The risk of recurrence of disease on a farm decreased with the presence of chalk soil, cograzing ruminants, grass cutting of pastures, and manual removal of feces. There is no association between the disease and the type of pasture or with provision of supplementary feeds. Feeding hay or haylage is associated with a decreased risk of the disease. Any disturbance of the soil, such as when plowing, increases the risk of disease.

#### Transmission

The disease is not contagious. Injection of normal horses with serum of affected horses causes lesions, but not clinical signs, consistent with the disease.

## PATHOGENESIS

The clinical signs are attributable to widespread damage to the autonomic nervous system, including the sympathetic neurons in prevertebral and paravertebral ganglia,<sup>15</sup> resulting in sympathetic and parasympathetic dysautonomia that is most clinically evident in the gastrointestinal tract. Coincident with damage to the autonomic nervous system are increases in plasma concentrations of dihydroxyphenylalanine, epinephrine, norepinephrine, and dopamine, possibly because of increased secretion of these compounds from affected sympathetic ganglia and neurons. Lesions in the cranial nerves and brainstem are probably responsible for dysphagia and drooling evident in most cases. Rhinitis is associated with diminished noradrenergic, noncholinergic innervation, greatest in neurons positive for substance P

or calcitonin gene-related peptide, of the nasal mucosa in subacute and chronic cases.

Electrocardiographic examination of affected horses reveals evidence of loss of parasympathetic innervation of the heart, which is consistent with lesions in the terminal cardiac ganglia. Splanchnic lesions are most severe in the myenteric and submucosal plexuses of the ileum, with less severe changes in the large colon and celiacomesenteric ganglion. There is also a reduction in interstitial cells of Cajal (cells involved in pacemaker activity and autonomic transmission within the gut). These neuronal changes are associated with a marked impairment of cholinergic activity in ileal tissue of affected horses. Because of the altered autonomic activity, peristalsis decreases (in chronic cases) or ceases (in acute cases) with subsequent accumulation of ingesta in the small intestine, stomach, and large colon. Death is caused by emaciation in chronic cases or rupture of the stomach or intestine in acute cases.

### CLINICAL FINDINGS

The clinical signs of grass sickness are varied, and accurate antemortem diagnosis on clinical signs alone is difficult. The diagnosis is usually made based on clinical signs, elimination of disease with similar presentation, and consideration of the horse's provenance.<sup>16</sup> The incubation period of the disease is approximately 10 to 14 days.

**Acute, subacute, and chronic** forms of the disease are recognized, although some authorities use a designation of acute and chronic. In all cases, there is some dysphagia, resulting in drooling of saliva and trickling of ingesta from the nose. Dried food is impacted between the cheeks and the teeth and the animal plays at drinking. These signs are attributable to lesions in the cranial nerves. Most animals are depressed.

### Acute Cases

The onset is sudden and the course of the disease is 1 to 4 days. Abdominal pain may be severe but also may be absent even in the presence of severe tachycardia. There is tachycardia (80–90 beats/min may be >100), decreased to absent gut sounds, lack of defecation, and abdominal distension. On rectal examination, the small intestine is distended with fluid and readily palpable in the caudal abdomen. Nasogastric intubation yields a large (20 L) quantity of fluid. Urination is frequent and may be accompanied by tenesmus. Affected horses may wander about in a restless manner and a fine muscle tremor occurs constantly, especially in the upper forelimb. Periodic attacks of patchy sweating are common. There is noticeable salivation. Esophageal endoscopy reveals linear ulcerations resulting from reflux esophagitis.

### Subacute Cases

These cases have signs of mild colic, or may not have any signs of colic, in the presence of

tachycardia, depression, reduced gastrointestinal sounds, and impaction of the large colon with characteristic corrugated appearance. The clinical course is 2 to 7 days and death is inevitable. Esophageal endoscopy reveals the presence of linear erosions in many affected horses.

### Chronic Cases

The course is usually >7 days and is characterized by weight loss, patchy sweating, and intermittent colic. Horses stand with all four feet close together under them ("elephant on a tub stance") and have a tucked up abdomen. Dysphagia is evident and the gut is empty except for the colon and rectum, which contain dry, hard feces. In the late stages the horse snores, the penis droops, and attempts are made to eat abnormal materials. Most cases of the chronic form have rhinitis, characterized by crusting of mucopurulent material on the turbinates and this is considered, in the presence of appropriate history and other clinical signs, almost pathognomonic for grass sickness. There can be esophageal obstruction with secondary inhalation pneumonia.

Application of phenylephrine (0.5 mL of a 0.5% solution) into one eye causes a dorsal deviation of the eyelashes of the upper eyelid in horses with grass sickness, but not in normal horses.

There is a radiologic discernible defect in esophageal motility in horses with grass sickness.

Horses with acute, subacute, or chronic grass sickness usually (12 of 14 examined) have abnormalities on electromyography including excessive spontaneous activity; fibrillation potentials; doublets, triplets, or quadruplets; neuromyotonic discharges; and complex repetitive discharges.<sup>17</sup>

Recurrence of the disease in a horse is exceedingly rare.

Antemortem diagnostic confirmation can only be achieved by examination of biopsy specimens of the ileum, although biopsy of nasal mucosa has been suggested as an alternative. Examination of rectal biopsy is specific (estimated 100% based on detection of at least three chromatolytic neurons), but not sufficiently sensitive (70%), for diagnosis of the disease based on a study of 14 cases and 10 controls.<sup>18</sup> Antemortem rectal biopsy is not reliable for diagnosis of the disease compared with ileal biopsy, which has a high sensitivity.<sup>19,20</sup> Ileal biopsies can be collected via conventional laparotomy or by laparoscopy.<sup>20</sup> The use of formalin-fixed ileum has both sensitivity and specificity of 100%.<sup>21</sup> Immunohistochemical staining for synaptophysin does not aid in the differentiation between autolytic tissue and tissue from horses with grass sickness.<sup>22</sup>

### CLINICAL PATHOLOGY

Serum biochemical profiles and hematological examinations do not demonstrate

pathognomonic changes. Serum amyloid A and plasma fibrinogen concentrations are significantly higher in horses with grass sickness than in healthy horses or horses with colic not caused by inflammatory disease, but similar to those in horses with enteritis, colitis, or peritonitis.<sup>23</sup> Signs of dehydration, electrolyte imbalances, hyperbilirubinemia, and elevations of serum activity of liver-derived enzymes are all secondary to the disease. Urine from horses with grass sickness has higher specific gravity, protein and creatinine concentrations, and lower pH than that from unaffected horses, consistent with dehydration and electrolyte imbalances that occur with the disease. Peritoneal fluid is often abnormal, with an increased protein concentration and leukocyte count but, because of the considerable overlap with values in horses with lesions of the gastrointestinal tract requiring surgery, is of limited diagnostic value.

### NECROPSY FINDINGS

In cases of short duration, the stomach and small intestines are distended with an excess of fluid and gas, and the colon is often impacted with corrugated ingesta coated with black material. In chronic cases, the alimentary tract is empty.

Histologically there is extensive degeneration of neurons of the autonomic nervous system without evidence of inflammation. These neurons include those of the ganglia (cranial cervical, stellate, celiacomesenteric, etc.) and those of the myenteric and submucosal plexuses of the intestines. Degenerative neuronal changes may also be observed in the CNS, including the oculomotor, facial, lateral vestibular, hypoglossal, and vagal nuclei; the ventral horns of the spinal cord; and the dorsal root ganglia. This neuropathy is difficult to confirm unless fresh, well-fixed samples are submitted for histologic examination. Immunohistochemical staining for synaptophysin does not aid in the differentiation between autolytic tissue and tissue from horses with grass sickness.<sup>22</sup>

### Samples for Postmortem Confirmation of Diagnosis

Samples for light microscopic examination include formalin-fixed sympathetic ganglia, brainstem, spinal cord with dorsal root ganglia, gastric fundus, duodenum, jejunum, distal ileum, ventral colon, and dorsal colon.

### DIFFERENTIAL DIAGNOSIS

Differential diagnosis list:

#### Acute grass sickness

- Small intestinal strangulation or volvulus
  - Esophageal obstruction
- Large colon displacement or torsion
- Anterior enteritis
- Peritonitis

*Continued*

- Terminal ileal impaction
- Ileocecal intussusception
  - Hemoperitoneum
  - Hypocalcemia (lactation tetany and exhaustion)

#### Subacute or chronic grass sickness

- Impaction of the large or small colon
- Helminthiasis
- Mesenteric abscessation or other chronic inflammatory disease
- Gastric squamous cell carcinoma
- Botulism
- Equine motor neuron disease
- Alimentary lymphosarcoma or other neoplasia
- Inadequate diet
- Poor dentition
- Equine motor neuron disease

## TREATMENT

Acute cases respond transiently to gastric decompression and intravenous fluid administration, but death is inevitable. Selected chronic cases benefit from careful nursing care with provision of high energy, high-protein diet, and access to grazing. Administration of the promotility, indirect acting cholinergic agent, cisapride (0.5–0.8 mg/kg orally every 8 hours for 7 days) has been recommended but is not rewarding.<sup>16</sup> Administration of brotizolam (a putative appetite stimulant), acetylcysteine (antioxidant and neuroprotectant), and aloe vera gel (antioxidant, antiinflammatory, and laxative) was without beneficial effect in 29 cases.

## CONTROL

Successful measures have not been satisfactorily established and no definitive recommendation can be made. However, consideration should be given to the factors identified as increasing the risk of disease, such as pasturing and movement to new properties, especially those on which previous cases of this disease have occurred, and the disturbance of soil. Feeding of hay and haylage is associated with a reduced risk of developing the disease. Although administration of ivermectin is associated with an increased risk of the disease, appropriate parasite control should not be ignored in horses in areas in which grass sickness is endemic.

There is no commercially available vaccine, although trials are planned.<sup>7</sup>

## FURTHER READING

- Pirie RS, Jago RC, Hudson NPH. Equine grass sickness. *Equine Vet J*. 2014;46:545-553.
- Wylie CE, Proudman CJ. Equine grass sickness: epidemiology, diagnosis, and global distribution. *Vet Clin Equine*. 2009;25:381-399.

## REFERENCES

1. Newton JR, et al. *Equine Vet J*. 2010;42:477.
2. Schwarz B. *Vet Rec*. 2013;172:393.
3. Steinman A, et al. *Equine Vet J*. 2007;39:232.
4. McGorum BC, et al. *Grass Forage Sci*. 2012;67:274.
5. Waggett BE, et al. *Equine Vet J*. 2010;42:494.

6. Nunn FG, et al. *Equine Vet J*. 2007;39:457.
7. Equine Grass Sickness Surveillance Scheme. At: <[www.equinegrasssickness.co.uk](http://www.equinegrasssickness.co.uk)>; Accessed 8.10.13.
8. Protopapas KF, et al. *Turk J Vet Anim Sci*. 2012;36:85.
9. Schwarz B, et al. *Vet Rec*. 2012;170:75.
10. Melkova P, et al. *Vet Med (Praha)*. 2014;59:137.
11. Wright A, et al. *Equine Vet J*. 2010;42:170.
12. Wylie CE, et al. *Equine Vet J*. 2011;43:571.
13. Wylie CE, et al. *Equine Vet J*. 2014;46:64.
14. Edwards SE, et al. *Front Pharmacol*. 2010;1:122.
15. Shotton HR, et al. *J Comp Pathol*. 2011;145:35.
16. Lyle C, et al. *In Pract*. 2009;31:26.
17. Wijnberg ID, et al. *Equine Vet J*. 2006;38:230.
18. Wales AD, et al. *Vet Rec*. 2006;158:372.
19. Mair TS, et al. *Vet Rec*. 2011;168:266.
20. Ireland JL, et al. *Vet Rec*. 2011;168:261.
21. Milne E, et al. *J Vet Diagn Invest*. 2010;22:248.
22. Waggett BE, et al. *J Comp Pathol*. 2010;142:284.
23. Copas VEN, et al. *Vet Rec*. 2013;172:395.

## INTESTINAL HYPERAMMONEMIA

Intestinal hyperammonemia is a syndrome recently recognized in horses and characterized by abnormally high concentrations of ammonium ion ( $\text{NH}_4^+$ ) in blood combined with signs of neurologic and gastrointestinal disease but in the absence of clinical or clinicopathologic evidence of liver disease.<sup>1-6</sup> The syndrome is associated with gastrointestinal dysfunction that results in increased production of ammonium ( $\text{NH}_4^+$ ), possibly as a result of altered gut microbiota, or increased absorption of ammonia ( $\text{NH}_3$ ) caused by altered mucosal permeability. The disease is not a hepatic encephalopathy in which increased blood ammonium concentrations are secondary to liver disease and reduced clearance of ammonium.

Ammonium is produced in the hind gut by urease-positive bacteria and in the small intestine by a glutaminase located in the enterocytes. Under normal circumstances ammonia is absorbed and transported as ammonium in the blood to the liver, where it is converted to urea or incorporated into amino acids. A decrease in liver function or absorption from the gut of excessive amounts of ammonium can result in hyperammonemia. Increases in blood ammonium concentration adversely affect neuron and astrocyte function leading to depolarization, activation of *N*-methyl-D-aspartate receptors and cell swelling. There is only a poor correlation between blood ammonium concentrations and signs of neurologic disease, although systemic inflammation combined with hyperammonemia results in more severe signs than hyperammonemia alone.<sup>1</sup>

The epidemiology of the syndrome is not well described. The disease is reported in the UK and the eastern and southeastern United States. Equids of any age can be affected including foals less than 1 day of age.<sup>4</sup> Risk factors include gastrointestinal disease (colitis, enterocolitis, colic, and meconium impaction).<sup>4</sup> Case-fatality rate in equids treated at a referral hospital was 60% (22 of

36 cases). Ingestion of black locust roots (*Robinia pseudoacacia*) caused the disease in two ponies.<sup>7</sup> Infection with *C. sordellii* is a suspected cause in adult horses.<sup>8</sup>

The clinical signs include those of colitis, enterocolitis, or colic and can include diarrhea and depressed mentation. Horses are usually tachycardic and tachypneic but not usually pyrexia. Signs of neurologic dysfunction can be present at the initial examination, with signs of gastrointestinal disease, or can develop over the next 24 to 72 hours. Signs of neurologic disease include profound depression, head pressing, ataxia, central blindness, recumbency, personality changes, aggression, abnormal mentation, compulsive walking, circling, lip smacking, and seizures (petite mal or grand mal).<sup>4</sup>

Hyperammonemia (normal is less than ~55  $\mu\text{mol/L}$ ) is present and an essential component of the diagnosis. Blood ammonium concentrations are usually over 100  $\mu\text{mol/L}$  and can exceed 1000  $\mu\text{mol/L}$ , although horses with severe systemic inflammation can have signs of neurologic disease with blood ammonium concentrations as low as 60  $\mu\text{mol/L}$ .<sup>4</sup> Affected horses have hematological signs consistent with inflammation (leukocytosis), hypovolemia (increased hematocrit, and serum total protein concentration), and some have mild increases in serum activity of liver-derived enzymes (GGT).<sup>4</sup>

Treatment is largely supportive, including correction of hypovolemia, protection from self-harm, control of seizures, efforts to reduce blood ammonium concentration, and reduction of systemic inflammation. The underlying disease should be treated as appropriate. Reduction of blood ammonium concentration can involve the administration of oral neomycin, lactulose, or both. The efficacy of these treatments has not been determined. Lactulose (~300 mg/kg orally every 8 hours) is used, but the decrement in blood ammonium concentration in affected horses is undetermined and in healthy horses is modest (3  $\mu\text{mol/L}$ ).<sup>4</sup> Lactulose is proposed to act by acidifying the colon contents, favoring conversion of the freely absorbable ammonia ( $\text{NH}_3$ ) to ammonium. Activated charcoal or mineral oil can be given to reduce absorption and increase excretion of ingested toxic materials.<sup>7</sup> Sedatives might need to be administered to control abnormal ambulation or behavior.

## FURTHER READING

- Dunkel B. Intestinal hyperammonemia in horses. *Equine Vet Educ*. 2010;22:340-345.

## REFERENCES

1. Dunkel B. *Equine Vet Educ*. 2010;22:340.
2. Sharkey LC, et al. *Vet Clin Pathol*. 2006;35:254.
3. Stickle JE, et al. *Vet Clin Pathol*. 2006;35:250.
4. Dunkel B, et al. *Equine Vet J*. 2011;43:133.
5. Gilliam LL, et al. *Vet Clin Pathol*. 2007;36:196.
6. Unt VE, et al. *Equine Vet Educ*. 2012;24:387.
7. Vanshandevijl K, et al. *Equine Vet Educ*. 2010;22:336.
8. Desrochers AM, et al. *J Vet Intern Med*. 2003;17:238.



## Abdominal Diseases of the Pig Including Diarrhea

### ACUTE GASTRIC DILATATION IN PIGS

This occurs in pigs as a result of excessive intake of finely ground meal (grain) and water resulting in excessive fermentation and gaseous distension. In the pig, simple gastric distension is usually readily relieved by vomiting.

### ACUTE GASTRIC VOLVULUS IN SOWS

This is a much more serious problem. It is most common with once-a-day feeding and is caused by the rapid intake of a large quantity of food followed by physical activity. Volvulus is thought to occur because the sow eats a large, sloppy meal very quickly. The occurrence is specifically related to intense excitement and activity at feeding time. Death occurs 6 to 24 hours after the pig's last meal. At necropsy the stomach is enormous (50–60-cm diameter), with engorgement of vessels and hemorrhagic effusion into the stomach, which contains a large amount of gas, fluid, and usually a great deal of food. Rotation varies in degree from 90° to 360° around the mesenteric axis and can occur in both directions but is usually clockwise. The spleen is markedly displaced, the liver is bloodless, and the diaphragm encroaches deeply into the chest. It is easily prevented by twice daily feeding, especially if automatic feeding is implemented.

### GASTRIC ULCERS AND HYPERKERATOSIS OF SWINE

Ulcers can occur in the fundic part of the stomach or in the PE (nonglandular part) of the stomach. The former are uncommon and occur usually as part of other diseases such as salmonellosis, *H. rubidus* infestation in sows, or transmissible gastroenteritis, and their significance in pig medicine is as yet not completely understood. The latter are far more important as a cause of economic loss and clinical importance. They are single or multiple bleeding ulcers often associated with varying degrees of hyperkeratosis. Experimental lesions in the stomach are usually produced in the glandular part of the stomach as a model for the condition in humans.

#### SYNOPSIS

**Etiology** Fine particles and pelleted feed. Certain bacterial species and other factors contribute.

**Epidemiology** Highly variable incidence but is increased with greater intensification of swine industry, emphasis on improving

digestibility and feed efficiency and use of fine particle and pelleted feed. Growing and finishing pigs, adult sows, and boars

**Signs** Sudden death from peracute gastric hemorrhage. Subacute form causes anemia, pallor, unthriftiness, and black tarry feces.

**Clinical pathology** Hemorrhagic anemia

**Lesions** Hyperkeratosis, erosions, ulcers of pars esophagea, gastric hemorrhage, and anemia

**Diagnostic confirmation** Lesions at necropsy

#### Differential diagnosis list

- Proliferative enteritis of swine
- Enteric salmonellosis
- Swine dysentery

**Treatment** None that is effective

**Control** Use of diets prepared through hammer mill screen of at least 6 mm. Incorporate S-methylmethionine-sulfonium chloride in diet and reduce stress.

### ETIOLOGY

The etiology of ulceration of the PE is multifactorial. Finely ground and pelleted feed are the important causes of ulceration of the PE. Certain environmental stressors may also be contributing factors.

### EPIDEMIOLOGY

#### Occurrence

There may be a genetic susceptibility which may be related to fastness of growth. Ulceration is not mediated by glucocorticoids.

The disease can occur in all ages but it is most common in pigs of 45 to 90 kg BW but may occur in pigs after weaning and in adults. All breeds are susceptible. Prevalence in groups of pigs may vary anywhere in the world from 1% to 90% depending on husbandry practices and feeding regimes.

Examination of the stomachs of pigs at abattoirs in various countries has revealed a high proportion of pigs with varying degrees of hyperkeratosis, erosions, and ulcers of the PE. Extensive erosions of the PE may be present in up to 63% of sows and 36% of finishing pigs. In pigs at slaughter, a range from 4% to 57% has been seen. The ulcers were mild in 9.5% and severe in 13.4% of cases. The incidence is variable between countries, which may reflect differences in feeding or husbandry methods. The disease has assumed increased economic importance with increased intensification of the swine industry.

The feed manufacturing industry is faced with the dilemma of finely ground pelleted feed providing high digestibility and feed efficiency in growing and finishing pigs but with a high incidence of lesions of the PE, which may affect performance. Pelleting swine feed is also advantageous because it flows more easily and effectively in automated distribution systems in swine farms compared with finely ground meal, which

may bridge and clog in distribution systems, decrease dustiness and segregation of ingredients, and increase bulk density. Meal is less damaging than pellets.

The incidence of clinical disease is low, but the case-fatality rate is high when severe hemorrhage occurs. The effects of the lesions on performance may vary considerably. In one study, pigs with extensive lesions gained 50 to 75 g/day less than pigs with no lesions but another showed no effects.

The disease has increased in significance with the occurrence of postweaning multi-systemic wasting syndrome and PDNS associated with porcine circovirus type 2 (PCV2). There is also an increased occurrence where there is a problem with porcine respiratory disease complex (PRDC) particularly during summer months.

### Risk Factors

Many of the risk factors affect the speed of the passage of the ingesta through the stomach whether or not the stomach contains food. Generally, anything that increases the consistency of the stomach contents reduces ulceration and vice versa. For example, finely ground feed decreases the consistency.<sup>1</sup>

Anything that causes an empty stomach will potentially increase the acidity in the PE region of the stomach is a risk factor. Back in the 1960s all that was needed to produce an esophageal ulcer in a pig was to keep the pig restricted in a feeding or farrowing crate and deprive it of water and food for 24 hours. This would therefore include intermittent feeding and watering, respiratory disease, and hot weather.

### Dietary Risk Factors

Generally, ulceration is influenced by grain component, milling procedures, and processing. A hammer mill increases the ulceration risk and in this type of milling wheat shatters more than when it is subjected to a rolling mill. The rolling mill squashes rather than shatters the grains; therefore is not so ulcerogenic. A rolling mill producing a diet based on barley or oats is the least ulcerogenic.

The disease occurs primarily in penned pigs receiving a grain diet and growing rapidly. It has also occurred in pigs fed large quantities of cheese whey or skimmed milk. Too much copper and not enough zinc may also be a factor. The incidence is highest in pigs receiving diets containing a higher proportion of corn (maize) than other grains. The incidence is even greater if the corn is finely ground or is gelatinized or expanded.

### Finely Ground Feed

This is the most important risk factor. One of the explanations of this may be the rapid emptying of the stomach when fine particles are used as the food in the stomach becomes more fluid and empties more quickly. There is normally a gradation of ascending pH from the cardia to the esophagus, but with



rapid emptying there is the possibility of the low pH reaching the esophageal region.

Feeding a diet based on finely ground barley to pigs beginning at 10 to 11 weeks results in lesions as early as 1 month later, and the incidence and severity of lesions increased progressively over the next 2 months. Diets high in wheat or corn starch may be worse than diets based on barley or oats.

The particle size and the physical form of the feed are important risk factors. The size of particles in feed is significant whatever feed is used. Finely ground diets (particularly wheat and maize) have detrimental effects on the gastric mucosa of finishing pigs. Grinding through a 4.68-mm screen approximates the screen size used most frequently for grinding barley for pigs in practice and is associated with a low incidence of ulcers. Reducing particle size and pelleting improves growth performance of finishing pigs. For every 100  $\mu\text{m}$  of decrease in size of the article size there is an approximately 1.3% increase in gain efficiency but each time the level of ulcers increases. Fine diets have the effect of increasing pepsin levels as do pelleted diets.

A pelleted diet uses grain that is finely ground before it is compressed into a pellet, but on reaching the stomach it reverts back to the fine particles that were compressed into the pellet. A diet finely ground through a 3-mm screen in a hammer mill and then pelleted will be associated with a 75% incidence of pigs with hyperkeratosis of the PE, and 11% of the pigs may have severe erosions and ulceration of the PE. The incidence of lesions decreases when the diet is ground through a 6-mm screen. Even straw (coarsely ground barley straw at 5%–10% of the ration) gives almost complete protection. In growing pigs, dietary fiber rich in structural polysaccharides has been shown to be important in preventing the development of parakeratotic lesions in the PE. An increase in the crude fiber content of a diet that is finely ground does not affect the occurrence of severe erosions and/or ulcers of the PE.

The processes have additive effects on digestibilities of dry matter, nitrogen, and energy, with maximum nutrient digestibility in pelleted diets with corn milled to a particle diameter size of 400  $\mu\text{m}$ . Reducing the particle size to below 400  $\mu\text{m}$  causes practical problems with milling and an increased incidence of gastric lesions, and it is suggested that a particle size of 600  $\mu\text{m}$ , or slightly less, is optimal for corn in either meal or pelleted diets for finishing pigs.

Using endoscopic examination of the stomachs of pigs fed a fine-particle diet (geometric mean size of 578  $\mu\text{m}$ ) it was found that as ulcer severity increases, the growth performance of individually fed pig decreases. Feeding a coarse particle diet (geometric mean size of 937  $\mu\text{m}$ ) for 3 weeks resulted in a decrease in the severity of the ulcers.

High levels of unsaturated dietary fat are not helpful, especially if they are

accompanied by low levels of vitamin E. Similarly, pigs fed waste food had more severe gastric lesions.

### Environmental and Management Risk Factors

It has been suggested that confinement, crowding, transportation, changes in environment, and exposure to other pigs are important in the etiopathogenesis of gastric ulcers of pigs. Method of feeding may also be important. Interruption of feeding may also increase dietary stress. All of these are stresses and many others including anxiety, fear, pain, fatigue, fasting, etc., will be associated with an increase of ulcers. There is an even greater occurrence in summer when water demands are higher. Males are always more affected in prevalence and severity, but they may be more easily stressed. One of the most important factors is time in the lairage. Premortem handling is extremely important. Pigs kept overnight in the lairage have more ulcers than pigs killed on the day of arrival.

Larger herds always show more of the problem, and it is probably a reflection of the different diets that they use (based on wheat and pelleted). The larger farms also have more infection pressure, more selection pressure, and more feed-related factors.

Pigs that receive porcine somatotropin may have an increased level of ulcers possibly caused by the elevated circulating gastrin.

There are a variety of foreign bodies reported from the pigs' stomach including stones, which outside sows chew all the time, and also sand. The majority of the stones are probably passed in the feces, but may accumulate in and stretch the stomach. The stomach capacity is normally about 3 to 6 L. This may lead to reduced appetite and gastritis but is not believed to be a contributor to ulceration. Similarly, hairballs are a common finding, reaching 10 to 15 cm in size in the stomach. The occurrence of rubbish indicates pica or a depraved appetite, which is often an indicator of inadequate feeding. One of the other substances found in outdoor pigs stomachs is the flakes of bitumen that remain from clay pigeon shooting, which are toxic.

### Pathogen Risk Factors

#### Gastric Bacteria

Ulcers in the fundic part of the stomach are often associated with gastritis. *Helicobacter heilmannii* and *Gastropillium suis* (now called *H. suis*,<sup>2</sup> have been found in gastric ulcers, but not ulcers of the PE of pigs and are unlikely to be the primary cause of the lesion. *Helicobacters* and *Arcobacters* are uncommon before weaning and increase with age; thus over 80% of market hogs may be infected<sup>3</sup> and 90% of adults have them in their stomachs. They are capable of causing ulcers in experimental challenges.<sup>4</sup> They have been found in some studies but not in others. They are normally found in the antrum of the stomach in close proximity to the acid-producing cells in the fundus, and

the gastritis they produce may be related to parietal cell stimulation which leads to further hyperacidity and then the damage will extend to the PE. They may extend into the PE if there is gastritis. Experimental inoculation of these *Helicobacter* agents in a carbohydrate-enriched liquid diet has failed to produce ulcers of the PE, but inoculation of *Lactobacilli* spp. and *Bacillus* spp. did produce ulcers when they were given in the same substrate. This may all be related to the degree of fermentation produced, the production of short chain fatty acids, and then the acidity generated.

The spiral-shaped *H. suis* has been found in 84% of the stomach of pigs with frank gastric ulcers of the PE. The organisms were mainly in the mucous layer and in gastric foveolae of the antral and oxyntic mucosa and only occasionally in the cardiac-PE region. The presence of the organism is now thought to be associated with lesions of the pyloric mucosa and gastritis in pigs.<sup>2</sup>

*H. heilmannii* type 1 has been found more frequently in the stomachs of pigs with ulcers (100%) and in those with preulcer lesions (90%) than in stomachs with macroscopically normal PE (35%).

### PATHOGENESIS

In pigs, nearly all naturally occurring gastroduodenal ulcers are localized in the PE of the stomach. Excessive gastric acid production, depletion of the gastric buffering system resulting in prolonged activation of pepsinogens, and changes in mucous composition are suggested as important factors related to gastric ulceration in swine. The physical texture of the feed can influence pepsin and acid secretion, and the fluidity of the stomach contents induced by ulcerogenic diets may alter the normal pH gradient within the stomach. This allows greater pepsin and acid contact to the esophagogastric area.

The concentrations of short chain fatty acids are high in the proximal gastric contents of pigs and associated with intakes high in readily fermentable carbohydrates, like ground corn. These products of bacterial metabolism, principally acetate and lactate, reach high concentrations within 4 hours after feeding because of high pH in the proximal gastric contents, which may allow some types of bacteria to proliferate. These weak acids are lipid soluble in their undissociated form and could penetrate and acidify underlying tissue more readily than free hydrogen ions. In this way, rapid production of short chain fatty acids, followed by their absorption and tissue acidification, may be similar to ruminal acidosis and rumenitis in ruminants following the ingestion of large quantities of readily fermentable carbohydrates.

The rumen epithelium, also a stratified squamous mucosa, is easily injured by short chain fatty acids at pH  $\leq 5.0$ . The breaking of the barrier by short chain fatty acids could result in underlying inflammation and widespread tissue destruction.

Experimentally, exposing undissociated short chain fatty acids to swine gastric mucosa results in rapid penetration of the outer barrier and acidification of the underlying viable tissue. This results in cell swelling and vesicle formation, followed by sloughing of the outer barrier, erosion into deeper zones, and finally, ulceration.

Weak organic acids, at pH  $\leq 2.5$ , induce a greater degree of functional and histologic injury in three stomach zones (squamous, cardiac, and oxyntic) than does hydrochloric acid. The predilection for the squamous mucosa in naturally occurring ulcers may be attributed to the lack of defense or repair mechanisms that are present in the cardiac and oxyntic mucosa, which are capable of  $\text{HCO}_3^-$  and mucous secretion, which may raise the pH adjacent to these epithelial layers. Thus the increased digestibility associated with decreased particle size of the diet may promote rapid fermentation following eating resulting in the production of increased concentrations of short chain fatty acids. Any increase in fluid content will also contribute to the changes in pH gradient that exist in the stomach. Excessive gastrin is then stimulated and more acid secretion follows.

Normally, the PE is white, smooth, and glistening and may be bile stained. The first stage in ulceration is hyperkeratosis. This is followed by erosions, ulcerations, and hemorrhage. The erosions may heal, resulting in a fibrous contraction. Chronic ulceration may occur with the development of several ulcers in combination with fibrous tissue involving all of the squamous mucosa. Advanced hyperkeratosis may cause partial stenosis of the terminal esophagus.

The erosion of a blood vessel within the ulcer will result in acute to subacute gastric hemorrhage. These cases are usually sporadic, causing deaths of individuals within a group, with cases occurring over a period of several weeks. Clinical signs are often not observed, and affected pigs are found dead from acute hemorrhage into the stomach.

The regurgitation of bile into the stomach and the intensity of bile staining of esophagogastric tissue have been linked to the pathogenesis of esophagogastric ulcers in pigs. Almost all stomachs of pigs contain bile and bile staining of the PE; there is no evidence for the hypothesis that the regurgitation of bile into the stomach is associated with esophagogastric lesions in finishing pigs. There is no evidence of an association between gastritis and ulcer.

### CLINICAL FINDINGS

The clinical signs reflect the rate of blood loss, but an animal can go from perfectly healthy to ulceration within 24 hours. It is therefore possible to have sudden death (hyperacute) acute, subacute, and chronic stages of the condition. Usually there is no fever. Mortality may be in the range of 1% to

2%, but in some cases where there is a group outbreak it may be higher.

Most cases are subclinical but sows will die of blood loss. Pigs frequently die of ulcers during concurrent disease such as respiratory disease and in this case anorexia may disturb the gastric contents and allow material of high acidity to reach the cardia. Similarly, where there is a reduced consumption of water the integrity of the mucus may be broken into plaques or flakes by desiccation of the mucosal surfaces.

Gastric ulceration is most common in pigs over 6 weeks of age and occurs in adult sows and boars; the clinical findings are dependent on the severity of the ulcers. The effects of ulceration on production may be highly variable. Most pigs with esophagogastric ulcers are clinically normal, and growth rate and feed intake appear unaffected. Some observations suggest that there is no effect of ulceration on growth rate, whereas others indicate that the presence of esophagogastric ulcers results in a marked decrease in growth rate and an increase in the length of time required for the pig to reach market weight. Some affected pigs also eat slowly and regurgitate frequently. Endoscopic monitoring of the stomachs of pigs fed ulcerogenic diets found that as the severity of the ulcer increased growth performance was decreased. The greatest economic losses were associated with sudden deaths caused by hemorrhage and marked decreases in performance associated with fine particle size.

The erosion of a blood vessel within the ulcer will result in acute to subacute gastric hemorrhage. These cases are usually sporadic, causing deaths of individuals within a group, with cases occurring over a period of several weeks. Clinical signs are often not observed, and affected pigs are found dead from acute hemorrhage into the stomach. When pigs are found dead from peracute hemorrhage, inspection of the in-contact pigs may reveal other animals with pallor and black tarry feces (melena), which represent those with subacute hemorrhage.

Cases with subacute gastric hemorrhage may survive for a few days and there is evidence of marked pallor, weakness, anorexia, and black pasty feces changing to mucous-covered pellets in small amounts. The weakness may be sufficient to cause recumbency. Vomiting frothy bile-stained fluid and grinding of the teeth may occur. Abdominal pain may be elicited by deep palpation over the xiphisternum and there may be a reluctance to walk along with a rigid back indicative of pain. Animals that survive are often unthrifty, which is usually caused by anemia from chronic blood loss, and a few cases are affected by chronic peritonitis. When the disease is occurring careful observation may detect early cases. Suggestive signs are a darkening of the feces and the development of pallor. Sows at parturition are also at risk. In cull sow surveys 60% may have stomach

lesions and 10% to 15% may have ulcers. It is a common cause of sow mortality or the most common cause. Many sows have scars that indicate previous healed ulcers.

### CLINICAL PATHOLOGY

Laboratory testing is not indicated. Animals with gastric ulceration generally have lower than normal hematocrit values, hemoglobin concentrations, and erythrocyte counts. The black tarry feces can be examined for the presence of blood.

### NECROPSY FINDINGS

At postmortem animals are usually in very good condition. Ascarids have been found in the stomach, but these are not a factor in the field. If bleeding has been extensive then the carcass may be very pale.

At necropsy, the ulcers are confined to the esophageal region of the stomach, although hyperkeratosis may block the exit from the esophagus and cause increase in the muscular layers of that organ to force through the cardia. In this case pigs often vomit and then start eating again immediately as they have voided the food. Affected stomachs consistently have more fluid contents than unaffected ones. If severe blood loss from the ulcer has been the cause of death, then the carcass is pale and fresh blood is usually present in the stomach (there may be large blood clots) and intestines. The colonic contents may also appear melanic. Early lesions in clinically unaffected animals include hyperkeratinization of the mucosa (usually pale raised areas without bile staining initially), which progresses to epithelial erosion without actual ulceration. Ulcers usually initially occur along the junction of the PE with the glandular stomach but may enlarge to efface the entire squamous portion of the stomach. These more diffuse ulcers are easily missed on cursory examination because of their uniform appearance. Chronic gastric ulcers develop thickened, raised edges caused by ongoing fibrosis, occasionally resulting in a gastroesophageal stricture. The histologic appearance varies with the stage of lesion development, but in fatalities there is typically complete loss of the epithelial layer, with exudation of neutrophils from a bed of mature granulation tissue. In one survey of apparently normal stomachs it was found that 32% had histologic parakeratosis, 38% had mild erosions, and 23% had severe ulcerations. Recent studies have demonstrated *Helicobacter*-like bacteria in porcine stomachs, but further research is required to determine whether this infection plays a significant role in ulcer formation. Small clusters of *H. heilmannii* have been seen in the gastric crypts, but they are not associated with histologic changes. A recent survey suggested no correlation between infection in the cardiac mucosa and the severity of the lesions shown by the esophagogastric region. The macroscopic findings are usually sufficient for the confirmation of a diagnosis

of esophagogastric ulceration. The initial lesion of hyperkeratosis (often stained green by bile) leads to parakeratosis with fissures and the lamina propria is then exposed. The epithelium sloughs off and then ulcers of the epithelium develop with hemorrhage from the vessels. Chronic lesions may be seen as craters floored by smooth muscle. Histologically, the lesions are thickened, with parakeratosis, and there are nucleated cells on the mucosal surface, the papillae are elongated, and there are infiltrations of neutrophils and eosinophils. Usually only the mucosa is ulcerated, but occasionally the submucosa is affected and then the muscularis and very rarely the serosa.

Severity and extent of esophagogastric lesions can be graded according to the following scheme

- 0 Intact epithelium
- 1 Small degree of hyperkeratosis (<50% of total surface)
- 2 Distinct hyperkeratosis (=50% of the total surface)
- 3 Hyperkeratosis and less than five erosions smaller than 2.5 cm in size
- 4 Hyperkeratosis and more than five erosions or erosions larger than 2.5 cm in size
- 5 Hyperkeratosis and more than 10 erosions or erosions larger than 5 cm in size, and/or an ulcer (with or without bleeding) or stenosis of the esophagus toward the stomach

No difference in lesion score was found between Duroc, Landrace, and Iberian pigs.

#### DIFFERENTIAL DIAGNOSIS

The occurrence of sudden death with a carcass that shows extreme pallor and marble white skin suggests the possibility of peracute hemorrhage from an esophagogastric ulcer. The disease must be differentiated at necropsy from proliferative hemorrhagic enteropathy, swine dysentery, and salmonellosis. Black tarry feces in growing and finishing pigs are characteristically caused by subacute hemorrhage associated with esophagogastric ulceration. There may be anemia and raised plasma pepsinogen levels.

It is possible to detect stomachs with helicobacters by covering the stomach with urea gel containing an indicator sensitive to pH change. If there are large numbers of these urease-positive bacteria then the pH changes.

Severe infestation with whipworms is a differential. The clinical diagnosis can be confirmed by endoscopy, which requires an empty stomach (may cause ulceration in itself) and anesthesia.

#### TREATMENT

In extremely valuable animals blood transfusions and intravenous fluid injections have been used. Ranitidine syrup at 300 mg per sow per day has been tried. Vitamin K and hematinics have been tried with little success. Bovine serum concentrate given as a 1% solution is supposed to have reduced the extent and severity of signs associated with ulcers in growing pigs, but generally medication does not help. If a diagnosis is made euthanasia is advised.

#### CONTROL

Attention to social factors such as overcrowding, proper ventilation, slowing growth rate, and reducing stress is important. Administration of melatonin at 5 ppm (5 mg/kg feed) has been used. Methionine has been used but is not really proven as a treatment.

Control of esophagogastric lesions of growing and finishing pigs is dependent on using diets with a particle size and physical form that will provide the most economical performance in terms of digestibility and feed efficiency and minimize the incidence of lesions. A diet based on barley and oats may be more beneficial than one based on wheat or maize. Meal may be better than pellets. Increasing fiber levels is important (oats and sugarbeet pulp). The use of a diet ground through a 6-mm screen instead of 3-mm screen using a roller rather than a hammer mill is recommended. However, screen size is not the only factor affecting particle size. Other factors include the condition of the screen and hammer, the type and variety of grain and its moisture content, the speed of the mill, the 3-week pelleting process, and the flow rate in the distribution of the feed to the pigs. A particle size of 600  $\mu\text{m}$ , or slightly less, is suggested as optimal for corn in either meal or pelleted diets for finishing pigs. Increasing the particle size to 750  $\mu\text{m}$ , using meal instead of pellets for 3 weeks, and using straw as bedding have been shown to produce improvements when an outbreak occurs.

The incorporation of *S*-methylmethionine sulfonium chloride often sold as vitamin U, a nutritional component of many vegetables such as cabbage and carrots, has antigastric ulcer properties. Addition to the diet of this substance, ground through a 3-mm screen, and fed to grower pigs from 45 kg to 107 kg live weight, at 400 parts per million (ppm) decreased the incidence of severe erosions or ulcers by about 50%. The addition of lucerne meal to increase the crude fiber content of one of the experimental diets did not have an effect on the incidence or severity of the lesions. Others have reported the beneficial effects of alfalfa (high in the antioxidants vitamins E and K), but not when somatotropin was used and it produced ulcers. Sunflower hulls in the diet have also been used to reduce the speed of feed transition from the stomach.

Incorporation of zinc in the diet may help. The diet should contain adequate amounts of vitamin E and selenium. The reduction of environmental and management stressors with attention to stocking rates may be of value.

#### REFERENCES

1. Millet S, et al. *Anim Feed Sci Tech.* 2012;175:175.
2. Baele M, et al. *Int J Syst Evol Microbiol.* 2008;58:1350.
3. Hellemans A, et al. *Vet Rec.* 2007;161:189.
4. Haesebrouck F, et al. *Clin Microbiol Rev.* 2009;22:202.

## Noninfectious Intestinal Disease of Swine

### INTESTINAL REFLUX

Acute dilatation also occurs in pigs secondary to acute obstruction of the small intestine. The obstruction may be as far down as the ileocecal valve. The oral segment of intestine dilates and fills with fluid, and refluxes into the stomach, filling it. In the pig, vomiting follows. The outcome depends on whether sufficient gastric motility returns to evacuate the stomach.

### DIAGNOSIS

The vomiting in gastric dilatation is more profuse and projectile than that of gastritis or enteritis, but may be simulated by that of obstruction of the upper part of the small intestine.

## INTESTINAL OBSTRUCTION IN PIGS

### ETIOLOGY

Some causes of intestinal obstruction include the following:

- Torsion of the coiled colon about its mesentery occurs in adult pigs.
- Obstruction of the terminal small colon in young piglets causes very hard fecal balls, or barley chaff used as bedding may be implicated in obstruction. The use of wood shavings or peat as a bedding may cause piglets to become impacted as a result of large consumption of the material.
- Heavy feeding on lactose causes a dilatation and atony of the intestine in the same way as grain feeding does in ruminants.

Sometimes the presence of ascarid worms will block the intestine. Genetic and environmental factors may contribute to the incarceration of the intestine in a patent umbilicus.

### CLINICAL FINDINGS

In pigs, distension of the abdomen, absence of feces, and complete anorexia are evident. The distension may be extreme in young pigs when the terminal colon is obstructed. Death usually occurs in 3 to 6 days.



## IMPACTION OF THE LARGE INTESTINE OF PIGS

### ETIOLOGY

- In pigs, impaction of the colon and rectum occurs sporadically, usually in adult sows that get little exercise and are fed wholly on grain. The disease also occurs in pigs that are overcrowded in sandy or gravelly outdoor yards.
- In young weaned pigs there may be obstruction of the spiral colon.
- A presumed inherited megacolon of fattening pigs is reported as a cause of abdominal distension, constipation, and wasting. There is no anal stricture.

Torsion of the long axis of the mesentery is a common condition in pigs and leads to impaction and rapid death. It can involve the small intestine or the large intestine, or both.

### CLINICAL FINDINGS

In impaction of the large intestine the effects appear to be caused largely by autointoxication, although the commonly occurring posterior paresis seems more likely to be caused by pressure from inspissated fecal material.

Retention of the meconium has no specific signs. There is anorexia and dullness and the pig is recumbent much of the time. Feces passed are scanty, very hard, and covered with mucus. Weakness to the point of inability to rise occurs in some cases. Hard balls of feces in the rectum are usually detected when a thermometer is inserted.

In paralysis of the rectum there is inability to defecate and usually some straining. The anus and rectum are ballooned and manual removal of the feces does not result in contraction of the rectum. Spontaneous recovery usually occurs 3 to 4 days after parturition.

## INTESTINAL TYMPANY IN PIGS

This is usually an incidental finding at slaughter.

### ETIOLOGY

- Primary tympany occurs with ingestion of excess whey. It has been recorded in adult dry sows. Distension of the proximal colon causes rupture with death from endotoxic shock.
- Secondary large bowel tympany is usually secondary to acute intestinal obstruction.

## OSSEUS METAPLASIA

The finding of metastatic plates of bone in the mesentery or wall of the small intestine is not an uncommon occurrence and probably results from an attempt to repair local damage by calcification. It does not seem to cause problems and is found at slaughter.

## INTESTINAL HEMORRHAGE SYNDROME

This is a sporadic occurrence but occasionally may involve all the finishing pigs in one batch, causing a significant economic loss through sudden death or enforced casualty slaughter. It has had a variety of other names including hemorrhagic bowel syndrome, porcine intestinal distension syndrome, “bloody gut,” or “whey bloat.” It is similar to intestinal distension. Large pigs are affected usually from 35 kg to adults. They become pale, have a distended abdomen, and die suddenly.

### ETIOLOGY

The cause is raised intraabdominal pressure from +3.5 mm Hg to >30 mm Hg.<sup>1</sup> The most pronounced cause is whey bloat, in which there is excess fermentation of carbohydrate in the large intestine. This causes an anticlockwise torsion of the whole of the intestines so that the cecum is directed cranially. A twist of the mesentery does not usually involve the large intestine. Other possible etiologic factors include allergy because there are large numbers of eosinophils in the gut wall, skim milk not whey and dry meal, and Lawsonia infections.

### EPIDEMIOLOGY

On whey-fed units the deaths occur more frequently because the level of whey feeding increases.

### CLINICAL SIGNS

The pigs are usually found dead or have abdominal colic. They occasionally appear pallid. There may be a distended abdomen.

### PATHOLOGY

The small intestine is almost always autolytic, but there is an underlying loss of epithelium, villous loss, and inflammatory cell infiltration with large numbers of clostridia in the gut. The small intestine is filled with blood-stained fluid and there may be volvulus with gross distension of the colon and blood-stained fluid in the abdomen.

### TREATMENT

Usually there is no time for treatment.

### CONTROL

The only possible control is to change the diet, particularly to reduce the whey concentrations, but be aware that this may reduce the growth rate and the diet needs to be adjusted to compensate.

### REFERENCE

1. Thomson JR, et al. *Pig J.* 2007;59:152.

## DIVERTICULITIS AND ILEITIS OF PIGS

In this disease there is thickening of the wall of the ileum, particularly in the terminal

portion, so that the intestine becomes thick and rigid. There is a close clinical similarity to Crohn's disease in humans, and the etiology of both conditions is obscure. Familial predisposition is probable in humans and has been suggested in pigs.

The signs are those of acute peritonitis caused by ulceration and, sometimes, perforation of the affected ileum. Illness occurs suddenly with loss of appetite, excessive thirst, dullness, and disinclination to rise. The temperature is subnormal, the respiration is distressed, and there is a bluish discoloration of the skin. Death occurs in 24 to 36 hours. Acute cases occur in young pigs up to 3 months of age, and chronic cases, caused by ulceration and chronic peritonitis, occur in the 7- to 8-month age group.

At necropsy there may be diffuse peritonitis caused by leakage of alimentary tract contents through perforating ileal ulcers. Gross thickening of the ileal wall with nodular proliferation of the ileal mucosa and enlargement of the mesenteric lymph nodes are common accompaniments. Although the macroscopic findings are similar to those of Crohn's disease in man, the histopathological findings differ markedly. There is an obvious and significant protein loss through the intestinal lesion and a marked hypoproteinemia.

## RECTAL PROLAPSE

Prolapse of the rectum is an occasional occurrence in cattle and is rarely seen in other species. Common causes include enteritis with profuse diarrhea, violent straining such as occurs in coccidiosis in young cattle, in rabies sometimes, in spinal cord abscess, and also when the pelvic organs are engorged.

## RECTAL PROLAPSE IN PIGS

Rectal prolapse is quite a common condition in pigs. It is a welfare issue often requiring casualty slaughter.

### ETIOLOGY

It seems likely that any event producing an increase in intraabdominal pressure to an average of 29 mm Hg may cause prolapse. Such a happening occurs when sows are tethered and strain against the tethers while sitting.

### EPIDEMIOLOGY

In a prospective study of rectal prolapse in a commercial swine herd, 1% of the pigs prolapsed between 12 and 28 weeks of age, with a peak incidence occurring at 14 to 16 weeks of age. Prolapse rates were highest during the winter and autumn months.

Other risk factors included:

- Male: Relative risk 2.3
- Birth weight less than 1000 g: Relative risk 3.4
- A particular Yorkshire boar: Relative risk 2.8



• Dams of litter number: 1, relative risk 14.9; 2, relative risk 8.2; 3, relative risk 9.8  
There was no evidence to support the hypothesis that diarrhea and coughing are factors associated with a risk of prolapse.

It has been suggested that low birth weight pigs may be particularly susceptible in that they have poor pelvic muscle development, which leaves a weakness at the point in the pelvis where perineal hernia is possible, and there is no firm ligamentous attachment of the rectum to the pelvic wall. In the same context excessive anal nuzzling in very young pigs has been suggested as weakening these intrapelvic structures.

Feeding rations with lysine concentrations in excess of the requirements is considered a risk factor for rectal prolapse in swine. Other practitioners have suggested that it occurs when pigs are transported at high stocking densities. It may follow impaction of phosphate crystals in the urethra. Administration of tylosin and lincomycin has also been suggested as a cause, but these effects disappear after 72 hours of treatment.

The use of estrogens as a growth stimulant and access to estrogenic fungal toxins (zearalenone) predispose to rectal prolapse. It has been suggested that mycotoxins in swine rations are a cause of rectal prolapse, but there is insufficient evidence to prove such a claim.

### CLINICAL FINDINGS

There is severe abdominal distension, which may be accompanied by coughing and the production of soft feces. Straining may or may not be present. The prolapse may reduce naturally. It may become strangulated, necrotic, drop off, or be bitten off by other pigs.

### PATHOLOGY

There may be severe loss of blood and peritonitis.

### TREATMENT

Mild cases should be hospitalized individually and severe cases euthanized immediately. Treatment is surgical by reduction under anesthesia.

### CONTROL

One possible control is to place weaners in a straw yard for 3 weeks between rearing in a cage system and transferring to slatted floors.

## RECTAL STRICTURE

The most common occurrence is as an acquired condition in pigs simply called rectal stricture. Rectal stricture occurs in feeder pigs of 2 to 3 months of age. Rectovaginal constriction occurs as an inherited defect in Jersey cattle.

### ETIOLOGY

The cause of rectal stricture is unknown, but there a number of associations. A strong

genetic component suggests it may be a developmental weakness in the structure of the rectum, which facilitates nonhealing at that particular point just proximal to the anal ring. This may be the inherited component. This point has a poor collateral blood supply as it is the point where the rectum is supplied from the caudal hemorrhoidal artery rostrally (caudal mesenteric originally) and caudally from the perineal arteries from the internal pudendal artery originally from within the pelvis.

### EPIDEMIOLOGY

- It may be a sequel to enteric salmonellosis, particularly *S. enterica* Typhimurium or possibly other infections such as *Candida*, *Selenomonas*, *Chlamydia*, or *Lawsonia*, but these may move in after the problem and not be an etiologic factor.
- It may develop from a prolapse.
- It may follow the use of tylosin.
- Quite often it follows 10 days after dietary change.

### PATHOGENESIS

The presumed pathogenesis is that a prolonged enterocolitis with ulcerative proctitis results in an annular cicatrization of the rectal wall 2 to 5 cm anterior to the anorectal junction. This results in colonic dilatation and compression atrophy of the abdominal and thoracic viscera. The disease can be reproduced experimentally with *S. Typhimurium* or the surgical manipulation of the rectal arterial blood supply, resulting in ischemic ulcerative proctitis.

### CLINICAL SIGNS

In a particular group it may affect up to 10% of the feeder pigs. The pigs are dull, depressed, and fail to grow. There is progressive abdominal distension, inappetence, emaciation, dehydration, and watery to pasty feces. The stricture of the rectum can be palpated on digital examination of the rectum. Some pigs with incomplete strictures are unaffected clinically.

### PATHOLOGY

At necropsy there is a low-grade peritonitis and gross dilatation of the colon, and sometimes the terminal ileum also. A stricture is present 2 to 5 cm from the anus, and may be so severe that it exists as a scirrhous cord with or without a narrow luminal remnant in the center. There may be abscessation at the site. Histologically, there is necrotic debris and granulation tissue at the site of the stricture.

### TREATMENT

Most affected pigs die or are destroyed on humane grounds. Surgical treatment of the condition is described but it is rarely cost-effective.

## Bacterial and Viral Diseases of the Alimentary Tract

### SALMONELLOSIS IN SWINE (PARATYPHOID)

*Salmonella* infections of pigs are important as a cause of salmonellosis in pigs and many serotypes in the pig may act as a potential source of infection for humans.

#### SYNOPSIS

**Etiology** *Salmonella* Typhimurium, *Salmonella* Choleraesuis, *S. Derby*, and rarely others.

**Epidemiology** Worldwide. Important zoonosis and food-borne illness. Prevalence of infection in healthy animals varies according to species and country. Incidence of clinical disease much lower than prevalence; outbreaks occur precipitated by stressors. Spread by direct or indirect means; infected animal is source and this contaminates feed and water supplies.

Disease may become endemic on farm.

Carrier animals shed the organism and may introduce infection into herd. Deprivation of feed and water, transportation, drought, intensive grazing and housing, and mixing animals from different sources contribute to the onset of disease. Antimicrobial resistance is a major public health problem with subclinical infection in pigs a potential zoonosis.

**Signs** Septicemia in pigs up to 4 months of age with high case-fatality rate. Acute diarrhea and dysentery, fibrinous fecal casts, fever, marked dehydration, and toxemia; chronic enteritis; abortion; dry gangrene of extremities; and arthritis and foci of osteomyelitis

**Clinical pathology** Culture organism from feces. Detect organism with special tests; use hematology for changes in leukocyte picture and clinical chemistry for electrolyte changes.

**Lesions** Septicemic hemorrhages  
Mucoenteritis to marked fibrinohemorrhagic necrotic enteritis and enlarged mesenteric lymph nodes. Kidney petechiation, foci of necrosis and thickened intestinal wall in chronic enteritis. Culture organism from blood, spleen, liver, and lymph nodes.

#### Differential diagnosis list

- Septicemia of neonates
- Coliform septicemia in piglets
- Septicemia in growing pigs
- Hog cholera
- Erysipelas
- Pasteurellosis
- Swine dysentery

**Treatment** Antimicrobials

**Control** Prevent introduction of infection into herd. Limit spread of infection within herd by identification of carrier animals,

prophylactic antimicrobials, restricting movement of animals, clean water supply, hygiene, and disinfection of buildings. Dispose of infective materials. Vaccines for immunization are available but not effective.

## ETIOLOGY

Serovars of *S. enterica* subsp. I are associated mainly with warm-blooded vertebrates and are responsible for most *Salmonella* infections in humans and domesticated animals. *Salmonella* serovars differ in the range of hosts they can infect and in the nature of disease that may result: this difference is referred to as **serovar-host specificity**. Some *Salmonella* serovars, for example, Typhimurium (STM) and Enteritidis, can infect a wide range of hosts and are termed ubiquitous. They are usually associated with a relatively mild enteric disease, although in some hosts, such as mice, the disease can be systemic and severe.

Other serovars are very restricted in their host range, causing severe systemic disease in only one host, for example, *S. Choleraesuis* (SCS).

A third group of serovars is associated predominantly with disease in one species but may also infect a limited number of other hosts for example, *S. Dublin* (SD). The nature of disease associated with this third group of serovars is variable and usually systemic.

The molecular methods are now available for epidemiologic investigation of *S. enterica* subsp. *enterica* infections. Of recent concern is the emergence of multiple-resistance isolates of SCS and also STM.<sup>1</sup> STM is the most common isolate from pigs in North America<sup>2</sup> and most other parts of the world. Occasionally, other species are found in pigs such as *S. Heidelberg*, which may be associated with PWD, and SD has also been found in pigs.

Localized epidemics of *S. Typhisuis* also occur, and recently it has been shown that it can exist on antibiotics alone.<sup>3</sup> Other serotypes are usually transient and may be associated with special factors. *Salmonellas* have been recovered from wild boar in Portugal, Spain, and Northern Italy, and STM is one of the serovars recovered.

## EPIDEMIOLOGY

*Salmonellas* are marvelous at surviving because they have the ability to persist in reservoir hosts, have the ability to be shed from carriers, persist within the environment, and use transmission vectors effectively.

Salmonellosis outbreaks are usually in intensively reared weaned pigs, but infection can also be in neonates (protected by colostrum antibodies) and adults.

In a survey of *Salmonella* in slurry tanks, in fresh pooled feces from finishers, sows, and weaners it was found that *Salmonellas* were not so easy to recover in winter and more likely to be recovered from slurry tanks

than fresh pooled samples. The four most common types were STM var Copenhagen (31%), SD (12.4%), STM (10.6%), and *S. Agona* (10.6%).<sup>4</sup>

In an interesting study of environmental samples, it was found that certain areas in the indirect environment (compartment aisles, driving boards, central aisle of the barn—areas which are often forgotten) had residual *Salmonella*.<sup>5</sup>

In a study in Germany, it was found that the main risk factors for the spread of salmonellosis were the moving of animals during the finishing period, not having a separate transporter for different age groups of pigs, and pigs having contact with other animals.<sup>6</sup>

In the United States, a study was made of *Salmonella* isolates in 2003 and 2008 from the Iowa State University diagnostic Laboratory.<sup>7</sup> Group C, SCS var. Kunzendorf decreased but Group B strains increased, *S. Typhimurium* var 5 (formerly, Copenhagen), *S. Agona*, *S. Derby*, *S. Heidelberg*, and STM all increased.

## Prevalence and Occurrence of Infection

The majority of *Salmonella* infections are subclinical, associated with a large number of serotypes. Factors influencing the prevalence of *Salmonella* spp. in swine farms using a meta-analysis approach have been described in an attempt to explain the variation between various estimates.<sup>8</sup> STM has a worldwide distribution and causes enterocolitis in young pigs.

The incidence has been increasing in some geographic areas. It is usually manifested as a septicemia. On the other hand, there is difficulty in isolating this organism at all in the UK. SCS is frequently isolated from clinically ill pigs but rarely from pig feeds or nonporcine hosts. The major sources are shedding pigs and contaminated environments. Both vertical and horizontal transmissions occur. The presence of other Enterobacteriaceae and the composition of these were not found to be useful indicators of subclinical *Salmonella* infections.<sup>9</sup>

### Belgium

In a study in Belgium<sup>10</sup> 7.8% of the pigs were seropositive (12 farms). Open farms (buying in) had twice as many seropositive pigs as closed farms. The results were also twice as high at slaughter age than halfway through finishing. STM was found in 65% of the cases, and 65% of these had a tetra-resistant antimicrobial resistance (AMR) profile.

### Canada

In Canada a study of *Salmonella* serovars found that sows had 43% of the isolates, 29% were in the nursery pigs, and 28% were in grow-finish units. There were 19 different serovars and SD (28.5%) and STM var Copenhagen (19.15) were the most common.<sup>11</sup> In a study of approximately 90 Alberta finishing farms it was found that the

sample prevalence was 13.2% (most farms were below 20% seroprevalence) and the on-farm prevalence was 83.3%.<sup>12</sup> In addition, the status changed frequently over the visits. Meal feeding and antibiotics given in water were associated with lower seroprevalence.

### Czechoslovakia

In Czechoslovakia, STM dominates in pigs but *S. Enteritidis* (SE) is also quite frequent because it is in several countries in Central Europe.<sup>13</sup> SE colonizes the intestinal tract in higher quantities but was shed in the feces in lower quantities.

### Denmark

In Danish pig herds, *Salmonella* infections are usually subclinical. A survey from 1993 to 1994 found that 22% of 1368 larger herds were infected with *Salmonella*. The most prevalent serotypes were STM (62% of infected herds), *S. Infantis* (10%), *Salmonella* 4.12:b (8%), and *S. Panama* (5%). Phage typing of isolates of STM from pigs and humans reveals that pigs are probably a major source of the infection in humans in Denmark. A more recent survey in Denmark showed that STM (mostly DT12 and DT120) was most common in finishers (7.4% + ve in lymph nodes and 3.2% + ve in carcasses) and SD in breeding herds (40.9% were + ve in at least one sample). An AMR to one or more antibiotics was found in 35.2% and to four or more in 19.3%.<sup>14</sup> The prevalence of *Salmonella* in Danish pork decreased from 3.5% in 1993 to 0.7% in 2000 following the introduction of a national program to reduce the prevalence of salmonellas in pork.

In Danish pig abattoirs it was found that by keeping the number of seropositive pigs below 50 it was possible to keep carcass prevalence below 1%, and that improved hygiene practice would reduce the carcass contamination further.<sup>15</sup>

### Italy

A similar distribution was found in Italy.<sup>16</sup>

### Japan

SCS is also an important pathogen of pigs in Japan.<sup>17</sup>

### The Netherlands

In the Netherlands, the infection rate is 25% in healthy pigs at abattoirs, but similar investigations elsewhere record a 10% (New Zealand) and 6% (UK) infection rate.

The serotype and phage-type distribution of *Salmonella* strains isolated from pigs, in the Netherlands from 1984 to 2001, showed that in pig serovars Typhimurium and Dublin were the most common. Monitoring of the population and herd for *Salmonella* seroprevalence in finishing pigs and sows provided a baseline for the success of future intervention and control strategies for *Salmonella* in pork. The seroprevalence of *Salmonella* in sows and finishing pigs in the Netherlands

was determined using indirect ELISAs on blood samples collected at the abattoirs. The population prevalence for finishing pigs in 1996 and 1999 was 23.7% and 24.5%, respectively, and for sows 40.5% and 60.4%, respectively. The prevalence in free-ranging finishing pigs was higher, at 44.6%, than in intensively housed finishing pigs. In 46 multiplying sow herds, the average herd prevalences were 54, 44, and 19%, respectively.

### Spain

In Spain, it was found that swine farms are a reservoir of *Salmonella* serovars, particularly STM and also Rissen and Derby.<sup>18</sup> A study in Spain of free-range pigs<sup>19</sup> showed that 33% of the herds had *Salmonella*, and the prevalence was 3.3% and *S. Anatum* and STM were the most commonly isolated.

### Sweden

In Sweden the prevalence of salmonellosis in food-producing animals is low because of the *Salmonella* control programs.

### Switzerland

In Switzerland, there is a low rate of positivity for *Salmonella* in meat juice ELISA from diaphragm samples (4%).<sup>20</sup>

### Thailand

In a study in Thailand<sup>21</sup> it was found that there was fecal prevalence of 63% and a seroprevalence of 72%, and the results were not significantly different. *S. Rissen* was found in 49% and STM in 19% of farms.

### United Kingdom

In the UK advisory visits were made to farms with *Salmonella*; 15,790 samples were collected from 296 farms and *Salmonella* was isolated from 28% of the samples. STM accounted for 64% of the samples (phage types U288 and DT193) and SD for 16%.<sup>22</sup>

*Salmonella* infections (seropositive pigs) on farrow to finish farms decreased from 21 to 65 days and then increased from 65 to 165 days of age.<sup>23</sup> A study in the UK<sup>24</sup> has shown that between 1994 and 2010 the number of *Salmonella* cases has greatly decreased (360–172) and STM has been the most common over the period, although the relative proportions have decreased. Today most cases are DT193 or U288. The numbers of DT104 are much reduced and now are less than 5%. The percentage of monophasic STM has increased over the period and now reaches 25%. The percentage showing AMR to six or more antibiotics has increased from 27.3% in 1994 to 58.3% in 2010. Only 3.3% were fully sensitive to all antibiotics in 2010.

### United States

American figures indicate a 10% to 13% infection rate. *Salmonellas* were isolated from the mesenteric lymph nodes and cecal contents of 84% of slaughtered sows in a Minnesota abattoir. These data are based on abattoir material and should be

viewed with caution because of the very rapid increase in infection rate that occurs when animals are held over in yards for several days.

The cecal carriage rate was 23.0%, although carcasses were only moderately contaminated at 5.3%. The meat juice ELISA results indicated that 15.2% of tissue fluid samples were positive at the 40% cutoff level and 35.7% at the 10% experimental cutoff level. This indicates that pigs are exposed to a relatively high level of *Salmonella* during the weeks before slaughter. A national U.S. survey for fecal *Salmonella* shedding by pigs most frequently found *S. enterica* serotypes Derby, Agona, Typhimurium, Brandenburg, Mbendaka, and Heidelberg. STM is most commonly isolated from clinically ill pigs in the United States.<sup>25</sup> In the Midwestern United States, salmonellosis associated with the host-adapted facultative intracellular SCS is an important cause of economic loss in pig herds because of death and reduced productivity. It is the most frequent serotype recovered from pigs and is isolated from more than 95% of porcine salmonellosis outbreaks in Iowa. In a study from the United States, it was found that *Salmonella* increased from the first to the second pull by 9.2% in bacteriologic prevalence and 31.3% in serologic prevalence.<sup>26</sup>

### Morbidity and Case–Fatality Rate

The morbidity rate in outbreaks of salmonellosis in pigs is usually high, often reaching 50% or more. The case–fatality rate in septicemia cases can be 100%.

### Methods of Transmission and Sources of Infection

*Salmonellas* are spread by direct or indirect means. Infected animals are the source of the organisms; they excrete them and infect other animals, directly or indirectly, by contamination of the environment, primarily feed, and water supplies. The farm animal may be infected in different ways: by animal-to-animal transmission, especially of host-adapted serovars; by contaminated animal feed; and by a contaminated environment (soil, birds, rodents, insects, and water supplies). In most cases transmission is over short distances, i.e., within the same pen or room, with some transmission between rooms and buildings on the same site but with limited transmission between sites.<sup>27</sup> Usually infection spreads from pen to pen, but it may be over some distances caused by fomites or vectors. Transmission of *Salmonella* between swine farms by the housefly

has been shown.<sup>28</sup> Liquid wastes from infected animals may contaminate the environment directly. Bacteria may also be disseminated during the transport of infected animals and during the holding of animals in a lairage before slaughter. In both situations, the excretion of salmonellas is exacerbated by the stress imposed.

When all animals become ill at the same time it is likely that a common source is involved such as water, feed, bedding, or contamination from one source. It is always higher in continuous flow systems in which there is no all-in/all-out systems with cleaning and disinfection. Slatted floors are much better than simple drainage gutters.

*Salmonellas* can be isolated from piggery wastewater, and the recirculation of contaminated water through the piggery serves as a constant source of the organism. Housing of finishing-age pigs in barns with open-flush gutters may contribute to increased shedding of *Salmonella* compared with pigs housed on partially slotted floors. Methanogenic fermentation in waste ponds does not eliminate *Salmonella* from piggery waste; acidogenic fermentation with the production of free acid can destroy salmonellas and other potential pathogens.

During slaughter, fecal contamination of the carcass commonly occurs and can be carried through all slaughter procedures up to the processing of the raw products. Airborne transmission can be a primary mode of infection of STM. Studies have shown that the organism can survive in air long enough to present a significant hazard of airborne spread.

In a study in Germany of 50 finishing herds with *Campylobacter* spp., *Yersinia enterocolitica* (YE), and *S. enterica*,<sup>29</sup> the sampling of feces, the direct environment, indirect environment, and flies and pests revealed the information shown in Table 7-23.

Respectively, for the three groups, 22 herds (80%), 12 herds (48%), and 7 herds (12%) were positive for both *Campylobacter* and YE, for both *Campylobacter* and *S. enterica*, and for both *Y. enterocolitica* and *S. enterica*, respectively. *Campylobacter* and YE were found more often in the low S risk group.

This study provided evidence that the pigs' environment should be studied when implementing control studies.

### Shedding and the Carrier State

In experimental infections with SD it was found that all pigs shed bacteria constantly for 2 weeks and then intermittently for several weeks.<sup>30</sup> Pigs given a high dose of

**Table 7-23** Proportion of samples testing positive for one of the listed organisms

	Fecal	Direct environment	Indirect environment	Flies/pests
<i>Campylobacter</i>	38.1%	32.7	5.3	4.6
<i>Yersinia enterocolitica</i>	17.1	8.1	1.2	3.1
<i>Salmonella enterica</i>	11.2	7.1	4.1	1.5



bacteria also seroconverted, whereas those given a low dose did not. Shedding was reduced when pigs were given oral sodium chlorate, topical disinfection, and weaned younger.<sup>31</sup> Sows are more likely to be shedding virus than nursery or grow-finishers.<sup>11</sup> The shedding can be increased by a long list of stressors including mixing of groups, transport, concurrent disease, antibiotic therapy, and food deprivation.

A longitudinal study of *Salmonella* shedding in naturally infected finishing pigs has been studied, and it was discovered that most pigs shed intermittently and there are differences in pigs and within the cohorts.<sup>32</sup> Feeding egg yolk containing anti-*Salmonella* immunoglobulin Y may not be effective in controlling shedding of *Salmonella* in pigs.<sup>33</sup> In many ways shedding is more of a problem for contamination of the food chain for humans than a source of infection for other pigs. Pigs carry low numbers of *Salmonella*, but excretion will occur when there is overcrowding, and isolation for 24 hours will cause excretion. Feed withdrawal increases cortisone production and encourages shedding.

Because salmonellas are facultative intracellular organisms that survive in the phagolysosome of macrophages, they can evade the bactericidal effects of antibody and complement. Thus persistence of infection in animals and in the environment is an important epidemiologic feature of salmonellosis.

For STM the donor can be any domestic animal species, including humans, or any wild animal or bird. Although all infected adults become carriers, it is rarely for any length of time.

The carrier pig is a source of infection in the lairage at the abattoir, especially in the absence of cleaning and disinfection. STM was the most common serotype. At the start of the week following cleaning and disinfection 6% of the swabs were positive, but by the end of the week 44% were positive.<sup>34</sup>

Experimental infection of pigs at 7 to 8 weeks of age with a single oral dose of STM can persist continually, at least until market age. Regardless of the route of infection, SCS can persist in the tonsil and ileocolic lymph nodes, ileocolic junction and colon, and can be excreted in the feces of experimentally infected pigs for at least 12 weeks. The amount of shedding and persistence of infection is dose dependent. Low doses of SCS can be easily cleared, moderate doses can persist for at least 2 months, and high doses result in long-term carrier states. After intranasal inoculation of STM the organism rapidly appears in the intestines, suggesting that the tonsils and lungs may be important sites for invasion and dissemination of *Salmonella* species. Experimental infection with a zoonotic strain of *S. Newport* can also be established in pigs at 7 weeks of age to persist until market age (28 weeks). Long-term persistence of infection is limited generally to the palatine tonsils, the intestinal tract caudal

to the midjejunum, and their lymph nodes. The prevalence of the organism in pigs creates a reservoir of infection for animals and humans. The transmission of salmonellosis in pigs can occur in a few days. Exposure to relatively low levels of SCS may result in high morbidity and initiate a severe outbreak in naive pigs within several days of being exposed to infected pigs. Only a small fraction of carrier pigs are responsible for the maintenance of the pathogen in a pig population. SCS may persist for at least 3 months in wet feces and 6 months in dried feces.

### Risk Factors Predisposing to Clinical Disease

The clinical characteristics of salmonellosis in large animals vary depending on the various management systems used, the intensity of stocking, whether or not the animals are housed, and the epidemiologic characteristics of the different *Salmonella* species.

### Animal Risk Factors

The response to infection varies depending on the challenge dose and the immunologic status of the animal, itself dependent on colostrum intake in neonates, previous exposure to infection, and exposure to stressors, particularly in older animals. It is generally accepted that the intervention of some precipitating factor such as transport, intercurrent disease, dosing with antimicrobials, acute deprivation of food, or other stress is usually necessary to cause the disease Salmonellosis, which is distinct from infection with *Salmonella* spp.

Infection is almost always via the mouth; thus the severity of the disease in an individual, or of an outbreak in a group, depends on the degree of contamination and the environmental conditions of temperature and dryness that determine the survival time of the salmonellas. Just as important is the influence of the host on the outcome of the infection. Many animals become infected naturally and are passive carriers; they shed *Salmonella* in their feces without clinical disease but only for the duration of their cohabitation with other infected animals. It is also possible to reproduce salmonellosis experimentally in most animals using a sufficiently large dose of a virulent strain of the organism. There still remains the common occurrence of the animal that is a subclinical carrier of the infection but develops clinical salmonellosis when exposed to stressors such as long transportation, hospitalization, severe feed deprivation, or parturition. Oropharyngeal secretions may contain salmonellas because the tonsils are rapidly colonized.

### Genetic Resistance to Salmonellosis in Domestic Animals

There is evidence of a strong genetic association with resistance to salmonellosis. However, as yet, selective breeding for resistance traits is not used in control of diseases or the carriage of *Salmonella*. The control

of *Salmonella* colonization of the gastrointestinal tract of food animals, particularly where intensive rearing occurs such as in pig units, would appear to be a particularly useful objective with enormous potential public health benefits. There may be a role for several inherited immunologic traits, including polymorphonuclear leukocyte function and lectin-induced mitogenic proliferation.

### *Salmonella Choleraesuis*

The epidemiology of SCS infection in pigs is well documented and has changed remarkably since the mid-1960s, when explosive outbreaks occurred that could easily be mistaken for classical swine fever. The morbidity and mortality rates were high and the disease spread rapidly through commercial pig-fishing units. These outbreaks are now rare and small in scope, largely because of the restriction of garbage feeding, much less movement and mixing of pigs through public auction marts, and disease-prevention strategies such as the use of specific pathogen-free (SPF) pigs, an all-in/all-out policy in commercial finishing units, and the vertical integration of pig-producing enterprises. This ensures a constant supply of disease-free growing hogs to finishing units and the assumption of a pyramid-type responsibility at all levels of the enterprise. The marked decline in the prevalence of swine salmonellosis coincided with the decline in and eradication of classical swine fever. However, modern methods of raising pigs in multisite production systems, using all-in/all-out management of finishing pigs, appear to have no benefit in reducing the prevalence of *Salmonella* compared with conventional farrow-finish systems.

### Subclinical Infections

*S. enterica* does not normally cause clinical disease in pigs, but subclinical infections constitute an important food safety problem throughout the world. Comprehensive longitudinal studies of two multisite pig production systems in the United States revealed considerable temporal variability in *Salmonella* prevalence between cohorts of pigs. Cohorts of sows and individually identified growing pigs from their litters were serially sampled to determine the prevalence and serotypes of salmonellas in each stage of production based on fecal culture and feed and environmental samples. A total of 15 different serotypes were isolated from the two systems. Pig prevalence estimates ranged from 0 to 48.1%. Environmental contamination was frequently encountered despite cleaning and disinfection. Feed was only rarely contaminated. The prevalence of infection within and among cohorts of pigs was highly variable, which indicates that point estimates of *Salmonella* prevalence and serotypes are not reliable indicators of the *Salmonella* status on farms, and that uncontrolled studies of interventions to control *Salmonella* on pig farms may yield misleading results.



In the United States, new regulations regarding the safety of meat products have been implemented in response to public concerns about food-borne disease outbreaks. The salient features of the regulations are requirements for approved systems of microbiological monitoring of *S. enterica*, *E. coli* O157:H7, and generic *E. coli* as an indicator of contamination by gastrointestinal contents. From the perspectives of public health, regulatory compliance, and international competitiveness, *S. enterica* is the most important food-borne pathogen for the U.S. pig industry. This has resulted in longitudinal epidemiologic studies of fecal shedding of *S. enterica* in both breeding and growing pig populations.

The relationship between subclinical infections at the levels of the herd, the individual pig, and at slaughter is complex. The onset and duration of *Salmonella* shedding and the patterns of transmission between individual pigs and between different age groups during the growing period all have influence. Bacteriology and serology can be used to assess this relationship, but repeated sampling in different cohorts of animals is required to correctly assess the infection dynamics.

Longitudinal studies of STM infection in farrow-finish pig herds in Denmark reveal that the *Salmonella* occurrence varies between and within age groups within herds, even in herds with an apparent moderate-to-high infection level. *Salmonella* was predominant in weaners, growers, and finishers, and was only occasionally detected in sows and gilts. This is contrary to the results of studies in the United States, in which *Salmonella* was found to be common in sows. In the Danish study, there was a rapid increase in *Salmonella* prevalence in the nursery, which may be associated with the stressors of weaning such as change in feed, commingling of litters, and piglets being deprived of the antibodies in sow's milk before activation of their own immune response. The observation that no piglets were shedding *Salmonella* just before weaning, but 3 to 4 weeks later in the nursery between 5% and 50% of the piglets were shedding, suggests that horizontal transmission occurred in the nursery. During the finishing period *Salmonella* shedding decreased, but with considerable variation. Some pigs cleared themselves of the infection, whereas others continued shedding. Average shedding time was estimated to be 18 to 26 days. Seroprevalence peaked approximately 60 days after peak prevalence in culture. At slaughter there is a marked increase in the prevalence of *Salmonella* infection. This increase may be caused by rapid cross-contamination during transport and lairage. Rapid infection during transport, and particularly during holding, is a major reason for increased *Salmonella* prevalence in pigs. A high degree of carcass contamination occurs at slaughter from the

delivery of *Salmonella*-positive pigs and cross-contamination from the slaughterhouse environment. Contaminated feed trucks also may serve as a potential source of *Salmonella* contamination. The withdrawal of feed from pigs before slaughter does not increase the prevalence of *Salmonella* colonization or the risk of carcass contamination. Over time in a swine production unit it was found that a particular genotype of *Salmonella*, if introduced into a breeding-gestation unit of a farm, would evolve only slowly over short time intervals; its spatial distribution would be limited primarily to adjacent or nearby pens.<sup>35</sup>

Risk factors associated with serologic *Salmonella* prevalence in finishing pig herds in the Netherlands have been examined. Feeding a complete liquid feed containing fermented by-products and the omission of disinfection after pressure washing a compartment as part of an all-in/all-out procedure were both associated with a lower *Salmonella* seroprevalence. A small to moderate herd size (<800 finishing pigs), a previous diagnosis of clinical *Salmonella* infection in the herd, the use of tylosin as an antimicrobial growth promoter in finishing feed, and herds that have more than 16% of their pigs' livers condemned at slaughter because of white spots were associated with a higher *Salmonella* seroprevalence. There was no effect on experimental *Salmonella* infection of the use of tylosin as an antimicrobial growth promoter.

In those herds in which the disease does occur, introduction is usually associated with the importation of infected carrier pigs. However, it is possible for the infection to be spread by flies and the movement of inanimate objects such as cleaning equipment and utensils. Feedstuffs do not provide a favorable environment for SCS, so food-borne infection is not common. Survival in soil and water is approximately 6 months and in slurry up to 5 weeks. Persistence in streams fouled by piggery effluent is unlikely. Susceptibility to salmonellosis in pigs is thought to be increased by intercurrent disease, especially hog cholera, nutritional deficiency of nicotinic acid, and other nutritional stress such as a sudden change in diet.

#### Immune Mechanisms

Early immune responses have been described,<sup>36</sup> and there is a higher expression of proinflammatory cytokines and T-helper type 1 cells.

In an experimental STM study, along the intestinal tract (jejunum, ileum, and colon) it was shown that there were different changes in gene expression along the tract.<sup>37</sup> All chemoattractant cytokines were upregulated in the ileum and jejunum and IL-8 was overexpressed in the colon.

Most information on the mechanisms of immunity to *Salmonella*, including the safety and immunogenicity of most *Salmonella* vaccines, has been done experimentally in

mice. In primary infections in mice, early bacterial growth in the reticuloendothelial system is controlled by the contribution of both macrophages and polymorphonuclear cells and is affected by the virulence of the strain. In lethal infections, the early growth of the bacterium in the tissues results in high bacterial numbers that lead to death of the animal. Following natural infection with *Salmonella* antibody, responses to lipopolysaccharides (LPS) and protein determinants can be detected. Anti-*Salmonella* IgM appears in serum early after infection followed by IgG. T-cells have a critical role in the later stages of primary infection. The presence of STM in mesenteric lymph nodes was examined, and it was found that there was an immune response marked by a substantial infiltration of phagocytes and an upregulation of proinflammatory genes. This resulted in a reduction of STM but not the total elimination. It might be that STM interferes with dendritic cell-T-cell interactions.<sup>38,39</sup>

#### Environmental and Management Risk Factors

##### Farming Practice in General

There are a wide variety of contributing factors to *Salmonella* infections. These include other livestock on the farm, herd size, previous clinical cases, bowl-type drinkers, dry feeding, pelleted feed, *Salmonella*-positive breeding herds, solid or partially slatted floors, reduced floor space allowance, persistent floor contamination, reduced floor space allowance, coinfections, porcine reproductive and respiratory syndrome (PRRS) infections, lack of hygiene and biosecurity practices, contact between pigs in adjacent pens, continuous flow systems, multiple pig suppliers, environmental temperature fluctuations, and *Salmonella*-contaminated feed. In a study of split marketing it was found that a significant increase in *Salmonella* prevalence occurs between the first and last groups to leave the finishing lots with the close-out groups posing a higher risk for *Salmonella* contaminations.

Longitudinal Dutch studies have shown that 25% of herds are never infected, 24% are constantly infected, and 50% are infected most of the time. There appear to be infection cycles when infection reaches a peak over the 2 to 4 weeks following the arrival of an infection, and between 5% and 30% may still be excreting by the end of the finishing period.

Intensification of husbandry in all species is recognized as a factor contributing significantly to an increase in the new infection rate. A typical example is the carrier rate of 54% observed in intensive piggeries in New Guinea compared with the 9% in village pigs. Any significant change in management of the herd or a group of animals can precipitate the onset of clinical salmonellosis if the infection preexists in those animals. Pelleted feed is associated with increased *Salmonella* prevalence.<sup>40</sup>

The association between biosecurity and *Salmonella* species prevalence on English pig farms was suggested.<sup>41</sup> Farms practicing biosecurity had a lower muscle tissue ELISA score than those that did not. Effective implementation of biosecurity in large herds may be the reason they have a shorter high serology period compared with smaller herds.<sup>15</sup>

Temperature and wetness are most important, because salmonellas are susceptible to drying and sunlight. STM can remain viable on pasture and in soil, still water, and feces for up to 7 months. Survival times of the bacteria in soil are influenced by too many variables to make any overall statement meaningful.

The survival time of *Salmonella* spp. in cold liquid manure depends on several factors, including pH of the slurry and the serotype of the organism, and can be as long as 28 weeks. Drinking water can remain infected for long periods (up to 9 months). Thus infection can be introduced by infected domestic animal carriers.

#### Housed Animals

In housed animals the premixing of food into a liquid form for pumping to feeding stations in piggeries is an effective way of spreading salmonellosis if infection is present in the feedstuffs and the mix is allowed to stand before feeding. Nose-to-nose contact through pens is also associated with a raised prevalence.<sup>40</sup>

In a longitudinal study of nucleus breeder and multiplier units in England there was an association between the *Salmonella* serovar and the immediate environment of the pens.<sup>42</sup> Pens holding breeding stock designed for production units were frequently positive, and herds under common ownership frequently had the same serovar combinations. Serovars from the wildlife were similar to those found on the associated premises.

#### Contaminated Feedstuffs

Housed animals are generally more susceptible to infection from purchased feeds. Organic feedstuffs, including bonemeal, are being increasingly incriminated in the spread of salmonellosis and although the usual figure, for example, in the UK, is 23% of consignments being infected, the figure may be as high as 70%. Most of the contamination of meat and bonemeal occurs after heat sterilization, especially if the material is left in digester tanks. Fishmeal is one of the most frequently and badly contaminated feedstuffs. For example, most of a recent increase in reported isolations of salmonellas in the United States was from *S. Agona* introduced in Peruvian fishmeal. These feed meals need to be heated at 82°C (180°F) for an hour to be sterilized. The infection of these materials may derive from antemortem infections in the animals used to make the by-product, but soiling of the material at the preparation

plant or abattoir or during storage may also occur. Stored feed not of animal origin, especially grain, is also commonly contaminated by the droppings of rodents or birds that infest it, and this can lead to sharp outbreaks of salmonellosis caused by STM. All feed stores should be protected from birds and rodents. Dried milk products appear to be relatively safe. Vegetable material can also be a source of infection.

Some serotypes such as STM have been isolated from 2.8% of pig feed and feed ingredient samples and from 46% of farm feed samples tested. SCS was not isolated from pig feed.

The risk of culturing *Salmonella* with or without AMR was higher if pelleted feed was used compared with mash or liquid feed. Fecal samples from farrow to finish farms had a lower chance of testing positive than grow-finisher farms.<sup>43</sup>

Commercial feed is potentially a vehicle for *Salmonella* transmission.<sup>44</sup> In a study in the UK it was found that cereals could become contaminated, particularly with STM, and the most likely reason was the storage of grains on cattle farms with access for birds and wildlife.<sup>45</sup> The effect of carbohydrate composition in barley and oat cultivars was studied in vitro, and it was shown that the population of salmonellas decreased with hull-less barley cultivars and increased with oat cell cultivars.<sup>46</sup>

#### Introduction of the Infection to a Farm

Contaminated feedstuffs, carrier animals, and infected clothing of visitors and casual workers are the most common methods of introducing infection. Less common methods include free-flying birds, such as the herring gull, and nematode larvae that are already infected with salmonellas. Salmonellas have been isolated from a wide variety of wild animals, which could act as reservoirs for infection of domestic animals under certain conditions.

#### Pathogen Risk Factors

**Salmonellas are facultative intracellular organisms** that survive in the phagolysosome of macrophages and can therefore evade the bactericidal effect of an antibody. Compared with other organisms of the same family, salmonellas are relatively resistant to various environmental factors. They multiply at temperatures between 8°C and 45°C, at water activities above 0.94, and in a pH range of 4 to 8. They are also able to multiply in an environment with a low level of or no oxygen. The bacterium is sensitive to heat and will not survive temperatures above 70°C. It is sensitive to pasteurization. Salmonellas have been shown to be resistant to drying, even for years, especially in dried feces, dust, and other dry materials such as feeds and certain foods. Prolonged survival in water and soil has also been described. They are quite

sensitive to beta and gamma irradiation. The O-antigen LPS of salmonellas is toxic and an important virulence factor, and immunity directed against the LPS is thought to be of major importance in the host defense against salmonellosis.

Fimbrial antigens of some *Salmonella* species have been described and characterized. The fimbriae mediate a variety of virulence factors important for the maintenance and survival of the organisms in the host and environment, including initiation and stabilization of the organism to epithelial cells, colonization of the organism to receptor sites, maintenance of persistent infection in the host by mediating selective bacterial trapping by phagocytic cells, and evasion of the host's specific immunologic defense mechanisms. The fimbriae are also useful in diagnostic tests.

Naturally occurring strains with varying virulence factors and antimicrobial susceptibility patterns can be identified in herds with endemic infection.

#### Antimicrobial Resistance of Salmonella

Strains of *Salmonella* spp. with resistance to antimicrobials are now widespread. Since 1990 there have been dramatic increases in the occurrence of multiresistant strains of *Salmonella* spp. in many developed countries. Of particular note has been the epidemic spread of STM DT104, which now has a worldwide distribution. AMR in zoonotically transmitted salmonellas is an undesirable but almost inevitable consequence of the use of antimicrobials in food animals. Generally, such use is legitimate. Recommendations have been made that new antimicrobials with cross-resistance to those used in human medicine should not be used for prophylaxis in food-animal production. For example, it is argued that the use of antimicrobials in food animals has been a major factor in the development of decreased susceptibility to antibiotics such as ciprofloxacin in zoonotically transmitted salmonellas. Multidrug resistant strains that also carry specific virulence factors are more likely to be of clinical significance.<sup>47</sup>

AMR of *Salmonella* has been a major controversial concern in veterinary medicine and human public health. Antimicrobials are used in food-producing animals for the treatment of infectious diseases and for growth-promoting effects. Their continued use has long been incriminated as a major cause of selective pressure that leads to the appearance and persistence of resistant strains. The resistance is usually to multiple antimicrobials and its existence is considered as a potential risk factor. The significance of AMR is most obvious in its impact on the treatment of human infections. If the frequency of drug resistance increases, the choice of antimicrobials for the treatment of systemic salmonellosis in humans becomes more limited. There

is also an association between drug-resistant salmonellas and the routine clinical use of antimicrobials for infections other than salmonellosis. The AMR *Salmonella* infections can complicate antimicrobial therapy of other infections; prior antimicrobial therapy allows fewer numbers of AMR *Salmonella* to cause symptomatic infections, and an increase in the proportion of *Salmonella* species that are AMR will increase the overall frequency of salmonellosis.

Infections in humans associated with AMR *Salmonella* are increasing and have become a cause for public health concern. Prospective studies in the United States claim to show that human infections with AMR *Salmonella* are increasing, and that these resistant strains can be traced to foods of animal origin. There are wide variations from country to country in the percentage of *Salmonella* isolates that are AMR. Generally, AMR among *Salmonella* is much higher in the United States than in other countries. In the UK, over a period of about 20 years, little change has occurred in the AMR patterns of salmonellas isolated from animals. Most of the resistance in STM is associated with phage-type DT204C. Serotypes other than SD and STM show low levels of resistance to most antimicrobials, with the exception of sulfonamides and tetracyclines, to which resistance is increasing.

AMR in *Salmonella* in the UK has been monitored since 1970 using disk diffusion tests. A total of 76% of all *Salmonella* isolates are still sensitive to all 16 antimicrobials used for testing.

In the Netherlands, from 1984 to 2001, monitored resistance was most common in STM. Among the strains from humans, pigs, and chickens, the level of resistance to tetracycline, ampicillin, chloramphenicol, and trimethoprim-sulfamethoxazole increased over the 17 years.

Since their introduction into veterinary medicine in Europe in the late 1980s and early 1990s, the susceptibility of several bacterial species to fluoroquinolones has increasingly been reported to be decreasing and their resistance to quinolones has been reported to be increasing. The incidence of quinolone resistance in strains of *Salmonella*-isolated pigs in Germany between 1998 and 2001 has increased.

In Canada, resistance in STM isolated from animals, animal food products, and the environment of animals to each of seven antibiotics (ampicillin, chloramphenicol, kanamycin, neomycin, streptomycin, sulfisoxazole, and tetracycline) increased persistently during each of the years from 1994 to 1997, and none of the isolates showed decreased sensitivity to ciprofloxacin.

The prevalence of STM and SCS isolates from pigs and humans that are fluoroquinolone and multidrug resistant has increased in Taiwan, and the isolates have become widespread across the country. The SCS isolates

from humans and pigs were closely related genotypically, suggesting the nationwide dissemination of the organism from pigs to humans.

In Japan, Taiwan, and Thailand there is SCS resistance to many antibiotics and many are multiresistant, including fluoroquinolone and cephalosporins.<sup>17</sup>

AMR to an antibiotic was more common in fecal samples (98%) than environmental samples (65%),<sup>48</sup> and multidrug resistance followed a similar pattern (35.7% from the barns versus 56.4% in the feces).

In the UK AMR was seen in 92% of isolates tested.<sup>22</sup> The highest frequencies were seen with tetracyclines (T), sulfonamide compounds (SU), ampicillin (AM), sulfamethoxazole/trimethoprim (SXT), streptomycin (S), and chloramphenicol (C). Fifty-nine AMR patterns were observed with the one listed previously in 33% of cases.

In a study in the United States between 2003 and 2008, it was shown that SD had increased resistance to spectinomycin and sulfadimethoxine, as did *S. Heidelberg* (and also with florfenicol). Other species had increased resistance to spectinomycin,<sup>7</sup> but only two or three isolates were resistant to enrofloxacin.

In Korea, there was also a catalog of increased resistance in STM. All the isolates were resistant to 4+ antibiotics, particularly streptomycin (94.1%), tetracycline 90.1%, and ampicillin (64.7%).<sup>49</sup>

In a study in Belgium,<sup>10</sup> 7.8% of the pigs were seropositive (12 farms). STM was found in 65% and of these 65% had a tetra-resistant AMR profile.

A study in Spain of free-range pigs<sup>19</sup> showed that multidrug resistance (four or more) was found in 36% of the pigs. Streptomycin (46%) and tetracyclines (30%) were commonly resistant.

In a study of AMR in the United States, comparing the years 2000 and 2006, it was found that 6.2% and 7.2% of the samples (2000) and 34.2% and 52.6% (2006) of the farms were positive. STM, SD, and *S. Agona* were the most common serotypes. The most common AMR pattern was streptomycin, sulfisoxazole, and streptomycin. The proportion susceptible to all antibiotics was 38.1% in 2000 and 20.4% in 2006. The proportion resistant to three or more antibiotics was similar in both years (52.8% and 52.7%).<sup>50</sup> A later study at Purdue University in the United States showed similar results in AMR but they also noted that STM and others possessed multiple AMR to amoxicillin/clavulanic acid, ampicillin, ceftiofur, and cephalothin.<sup>51</sup>

In a study of AMR in Korea,<sup>52</sup> it was found that STM, *S. Rissen*, and *S. Schwarzengrund* were most commonly isolated in normal pigs, but STM was the most commonly isolated in diarrheic pigs (89.7%). The most common were PT194 and PT203. Only 3% were DT104. The most common resistance in *Salmonella* was to streptomycin,

sulfamethoxazole, and tetracycline. Nearly all STMs were resistant to more than four antibiotics.

The genetic diversity and AMR profiles of *S. Derby* in pigs in France have been described.<sup>53</sup> The patterns were very similar among pigs, pork, and humans. Only 15.5% *S. Derby* had no AMR. The majority (over 70%) had AMR to more than three antimicrobials. Only a few isolates had resistance to  $\beta$ -lactams. The pig reservoir is the second largest contributor to human salmonellosis in the EU.

A longitudinal study of salmonellas in a unit that did not use antibiotics and a conventional production unit showed a 4% AMR in the conventional unit pigs and 11.7% in their environment and 0.2% in the pigs in the antibiotic-free unit and 0.6% in their environment. There were 42 serotypes (particularly Anatum, SD, STM, and Infantis) and they were resistant to tetracycline, streptomycin, and sulfisoxazole. Multidrug resistance was found in 27% of the pigs on the conventional unit.<sup>54</sup>

### Zoonotic Implications From Pigs

The disease has assumed increasing importance in recent years because of the much more frequent occurrence of human salmonellosis, with animal salmonellosis as the principal reservoir.<sup>2,25</sup> *Salmonella* is the second most important zoonosis to *Campylobacter*.

Human infection is usually through food and four are commonly isolated from swine (*Typhimurium*, *Heidelberg*, *Agona*, and *Infantis*), but there is also the possibility of direct contact as a source of human salmonellosis.<sup>55</sup> The important pathway today is pigs and poultry, and in Denmark this was an important source of human salmonellosis until control measures were instituted. In most instances the increase in human infections is with *exotic* serotypes other than STM that come by animal feedstuffs to pigs and chickens and then to humans through pork and chicken products. The most serious risk is that the transmitted bacteria will have acquired resistance to specific antibiotics because the animals from which they originate have been treated with the particular antibiotics repeatedly or over a long period. It is usually enteritis in humans with the exception of SCS, which often produces a septicemia.

Infected pigs leaving the farm are the major source of infection for the abattoir in which the spreading of salmonellas occurs. The longer the length of time in the lairage the greater is the chance of spread of infection.

The *Salmonella* status in lairages in Ireland in relation to the slaughter process has been assessed and it was found that the lairage, evisceration operatives, conveyor belts, and equipment in the boning hall were significant sources of contamination.<sup>56</sup> Cross-contamination within the plant



accounted for up to 69% of the *Salmonella* carcass contamination.

A study of the small abattoirs in Wisconsin suggested that contamination could be reduced by chilling carcasses 2 days before fabrication and by improving carcass-handling hygiene.<sup>57</sup>

### *Salmonella* Serovar Typhimurium DT104

The increasingly common isolation of STM DT104 (definitive phage type) is of major concern for public health officials. STM DT104 was first reported in the UK in 1984 and emerged in the 1990s as an increasing cause of *Salmonella* infections in humans and animals in the UK and other European countries such as Germany, France, Austria, and Denmark, as well as Canada. A wide range of potential reservoirs is associated with this infectious strain, from humans to the traditional food animals such as poultry, cattle, sheep, and pigs. Over a 1-year period in Scotland it was the predominant *Salmonella* isolated from nine species of animal (cattle, pigs, sheep, chickens, pigeons, horses, cats, dogs, and rabbits). All isolates were resistant to at least one antimicrobial and 98% were resistant to multiple antimicrobials.

The organism has been found in a variety of human foods, including salami and sausages. Human infections may result from contact with farm animals and from consumption of contaminated foods such as pork, sausages, and meat pastes.

Clinical signs in humans infected with DT104 include diarrhea, fever, headache, nausea, and vomiting. Septicemia may develop in a small percentage of cases with potential complications of meningitis and foci of infection in bones and joints.

The AMR factor of DT104 is a major concern. Resistance to ampicillin, chloramphenicol, streptomycin, tetracyclines, and sulfisoxazole is characteristic of the organism. There is now evidence that DT104 is developing resistance to trimethoprim and fluoroquinolones such as ciprofloxacin, the drug of choice for treating human adult *Salmonella* infections.

Control and prevention of infection with DT104 will depend on increasing surveillance activities, investigating outbreaks, and identifying vehicles and risks of infections.

Various clinical forms of salmonellosis (gastroenteritis, bacteremia, and other systemic abnormalities) can occur in veterinarians working with *Salmonella*-infected animals.

### Economic Importance

Salmonellosis is a significant cause of economic loss in farm animals because of the costs of clinical disease, which include deaths, diagnosis and treatment of clinical cases, diagnostic laboratory costs, the costs of cleaning and disinfection, and the costs of control and prevention. In addition, when

the disease is diagnosed in a herd it can create considerable apprehension in the producer because of the difficulty in identifying infected animals. The veterinarian is also often in a difficult position because the diagnosis, treatment, and control of the disease are less than reliable and it is difficult to provide advice with confidence. The losses incurred by livestock producers include reduced feed efficiency and reduced weight gains or deaths because of salmonellosis.

### PATHOGENESIS

Infection is much more common than clinical disease. The development of disease is very variable. Severity is influenced by serotype, virulence, host resistance, route, and quantity of the infective dose. Over 200 virulence factors have been identified. The establishment of experimental infections requires large numbers of organisms ( $10^8$ – $10^{11}$ ). The initial infective dose in the field is probably much less than that required experimentally.

The ability to invade is a requirement for pathogenesis and is encoded by a serotype-specific plasmid. STM resides as an extracellular pathogen in the tonsils independently of biofilm mechanisms.<sup>58</sup>

There are many virulence factors but two of the most important are genes encoding for two different type III secretion systems (T3SS) localized on the two major pathogenic islands 1 and 2.<sup>59</sup> Island 1 gets into the cell and it encourages the cell to take up *Salmonella*. It is found in the tonsil (SPI-1) and SPI-2 is important for intracellular survival. The T3SS of SCS is important for the invasion of the intestine and causes enteropathy,<sup>60</sup> and one of its effector proteins, SipB, induces caspase-1-dependent apoptosis in macrophages and plays an essential role in *Salmonella* pathogenesis. STM SPI-1 genes promote intestinal but not tonsillar colonization in pigs<sup>61</sup> and start the initial influx of neutrophils.

The replication of SCS and STM is associated with their differential virulence.<sup>62</sup> Enteric virulence of STM is associated with rapid replication in the intestinal wall and with rapid induction of proinflammatory cytokines (tumor necrosis factor [TNF]- $\alpha$ , IL-8, and IL-18), whereas the systemic virulence of SCS is associated with enhanced persistence in mesenteric lymph nodes which may help it to evade host innate immunity. The induction of seroconversion and persistence of STM in pigs is strain dependent.<sup>63</sup>

The suppression of cytokine signaling in the palatine tonsils may facilitate the initial colonization of the palatine tonsils.<sup>13</sup> Septicemic isolates may have a particular pattern of invasion.<sup>64</sup>

The pathogenesis of salmonellosis is a complex and multifactorial phenomenon. The nature of the disease that occurs following infection is dependent on the specific combination of serovar and host known as serovar–host specificity. A range of

infections is included in the term *salmonellosis*. The most common type of infection is known as “the carrier state,” in which carriage of the organism is not accompanied by clinical abnormalities or clinical disease. In production animals, these carriers are of importance because they may serve as reservoirs for further spread of infection through shedding and may be present as contaminated food products.

The infected oral secretions may lead to the possibility of aerosolized secretions, feces, or contaminated dust particles.

The evolution of host-specific *Salmonella* serovars is considered to be associated with an increase in pathogenicity for the specific host. The hypothesis is based on the fact that broad-range serovars (Typhimurium and Enteritidis) are generally associated with severe disease only in young animals, whereas host-restricted serovars cause high mortality in both young and adult hosts.

The mycotoxin deoxynivalenol promotes uptake of STM in porcine macrophages coinciding with cytoskeleton reorganization.<sup>65</sup>

### Infection

*Salmonella* infects animals and humans by the oral route. Following ingestion, a proportion of the organisms resists the low pH of the stomach, reach the distal ileum and the cecum, invade the mucosa, and replicate in the submucosa and Peyer's patches.

In young animals, and in adults whose resistance has been lowered, spread beyond the mesenteric lymph nodes occurs and the infection is established in the reticuloendothelial cells of the liver; from there it invades the bloodstream. These steps in the infection process can occur very rapidly. Once systemic infection has been established, salmonellosis as a disease can develop. Its principal manifestations are as septicemia, enteritis, abortion, and a group of localizations in various tissues as a result of bacteremia. It is likely that stress increases the effects of the salmonellas, as the catecholamines released will result in decreased gastric acid production and increased intestinal motility, aiding the passage of the salmonellas through the stomach and into the intestine and colon.

During the invasion process there is induction of synthesis of new proteins that enhance intracellular survival. Many epithelial types may be infected, but the Peyer's patches may be a major site of invasion.

SCS localizes in the colon on the luminal surface of the ileal M-cells of Peyer's patches. Attachment of epithelial receptors triggers microfilament-controlled uptake, vacuole formation, vacuole transport through the cell, and entry into the lamina propria via exostosis through the basement membrane. They cause mild and transient enterocyte damage. Salmonellas can synthesize over 30 proteins, which in practice can make the bacteria virtually intracellular parasites. Spread



to local lymph nodes can take place rapidly because of transport by CD18+ phagocytes to the spleen and the liver and then the macrophages and dendritic cells. At the same time there is an acute macrophagic inflammatory reaction and microvascular damage. Neither STM or SCS in a refeeding experiment produced changes in systemic TNF- $\alpha$  or IL-1 $\beta$ , although SCS reduced the growth rate by 25%.<sup>66</sup> Part of the first line of defense against invading pathogens is the innate immune system, and part of this is the release of antimicrobial peptides into the lumen of the intestinal tract, and a group of these are the defensins. Thus far in the pig 12 peptides have been identified, and the expressions of pBD-1 and pBD-2 have been described in the small intestine of the pig.<sup>67,68</sup> The porcine ileal cell line expressed increased levels of both when exposed to viable STM but not to SCS.<sup>69</sup>

STM does not spread effectively beyond the intestinal tract and draining lymph nodes in weaned pigs.<sup>70</sup> The lower cytokine signaling but higher toxicity of STM for macrophages correlates with the higher virulence for pigs of this serotype compared with SD or *S. Infantis*.<sup>71</sup>

### Septicemia, Bacteremia, and the Carrier State

After invasion of the bloodstream a febrile reaction follows in 24 to 48 hours, and the acute phase of the disease, similar to that seen in natural cases, is present 3 to 9 days later. The early septicemia may rapidly be fatal. If the systemic invasion is sufficient to cause only a bacteremia, acute enteritis may develop, and abortion is a common final sequel in sheep and cattle. Many animals survive this stage of the disease, but localization of the salmonellas occurs in mesenteric lymph nodes, liver, spleen, and particularly the gallbladder. In experimental STM infection in pigs, the organism can persist from 6 to 8 weeks of age until market age with long-term persistence in the palatine tonsils, gastrointestinal tract, and adjacent lymph nodes. In healthy adults there may be no clinical illness when infection first occurs, but there may be localization in abdominal viscera. In either instance the animals become chronic carriers and discharge salmonellas intermittently from the gallbladder and foci of infection in the intestinal wall into the feces and occasionally into the milk. For this reason they are important sources of infection for other animals and for humans. Carrier animals may also develop an acute septicemia or enteritis if their resistance is lowered by environmental stresses or intercurrent infection. Salmonellas can reside intracellularly where they are able to escape antibody-mediated killing, and the numbers of organisms are controlled by cellular defense mechanisms involving the macrophages in which they reside.

Septicemia in pigs associated with SCS can cause pneumonia in pigs similar to the

pneumonia in pasteurellosis and infection with *Actinobacillus pleuropneumoniae*, hepatitis, enterocolitis, and encephalitis.

### Enteritis

Enteritis may develop at the time of first infection or at some other time in carrier animals. The best information available on the pathogenesis of enteritis is derived from the experimentally produced disease. In most instances the disease is produced by the administration of massive doses of bacteria, and this may result in the production of a different syndrome from that which occurs naturally. The pathogenesis of enteric salmonellosis is much more complex than cholera, involving an increase in mucosal cell cyclic AMP content and prostaglandin concentration, as well as an inflammatory response to the invading bacteria. Intestinal invasion is a characteristic feature of *Salmonella* pathogenesis. The organism must invade the intestinal mucosal epithelium to cause disease. Neutrophil recruitment and transmigration across the epithelium is important in the enteritis. Host-derived caspase-1 can act as a proinflammatory agent by cleaving IL-1 $\beta$  and IL-18 into active molecules. SipA is a protein that *Salmonella* injects into the host cells, which has also been shown to contribute to the inflammatory response by activation of phosphokinase C. This activates the transepithelial migration of neutrophils into the intestinal lumen. Diarrhea is a result of decreased sodium absorption and increased chloride secretion caused by cholera-like and Shiga-like enterotoxins. Certain *Salmonella* outer membrane proteins also mediate cell damage. Survival within the phagocyte (O side chains, smooth LPS, and an LPS core are important) is also an important attribute of virulent salmonellas.

STM requires a functional type III secretion system encoded by SPI-1 to cause diarrhea. The SPI-1 secretion system mediates the translocation of secreted effector proteins into target epithelial cells. These effector proteins are key virulence factors required for *Salmonella* intestinal invasion and the induction of fluid secretion and inflammatory responses.

Although there is sufficient obvious enteritis to account for the diarrhea that characterizes the disease, there appear to be other factors involved. For example, it has been shown experimentally that in *Salmonella* enteritis there is stimulation of active chloride secretion combined with inhibition of sodium absorption, but invasion of the mucosa is not essential for these changes to occur. These observations are of interest in light of the known hyponatremia that characterizes the disease. In pigs, ulcerative lesions may develop in the intestinal mucosa and may be of sufficient size to cause chronic intermittent diarrhea. In pigs it has also been observed that villous atrophy is a sequel to infection with SCS.

In pigs, most clinical cases of salmonellosis are associated with SCS or STM. SCS is host-adapted to pigs, causing a systemic, typhoid-like disease. STM is not host-adapted to pigs, and infection results in a localized enterocolitis.

In the pig the development of enteritis associated with SCS begins 36 hours after infection with the appearance of erosions and edema of the cecal mucosa. At 64 hours the wall is thickened and there is diffuse caseation overlying the erosions. Microvascular thrombosis and endothelial necrosis in the submucosa and lamina propria, probably caused by endotoxins, are important early lesions in porcine salmonellosis. This then facilitates the ischemia that results in the mucosa mediated via IL-1. They have direct effects on the tissues or have effects on a variety of cytokine mediators. The necrotic membrane sloughs at 96 hours, and at 128 hours all function is lost, and the entire intestinal wall is involved in the inflammatory process with the muscular coat obliterated by 176 hours. The colon is usually the major organ affected in STM infections in pigs, causing either focal or diffuse necrotizing colitis. The organisms proliferate in the intestine, invade the intestinal epithelium, stimulate fluid secretion, and disseminate from the intestine to mesenteric lymph nodes and other organs. SCS invades enterocytes by penetration of the brush border, resulting in focal loss of microvilli, and the bacteria are endocytosed into membrane-bound vacuoles. Experimental infection of ileal-gut loops of pigs with *S. enterica* results in preferential bacterial adherence to M-cells within 5 minutes, and by 10 minutes, bacterial invasion of the apical membrane occurs in M-cells, goblet cells, and enterocytes. Experimental perfusion of porcine livers with polysaccharide or live SCS results in the release of mediators that mediate biological activities that have an important role in reducing the severity of bacterial infections.

### CLINICAL FINDINGS

The disease is most satisfactorily described as three syndromes, classified arbitrarily according to severity as **septicemia, acute enteritis, and chronic enteritis**. These are described first, but the differences between the animal species are sufficiently significant to justify describing the disease separately in each of them. There are no significant differences between infections associated with the different *Salmonella* species.

### Porcine Salmonellosis

In pigs, the disease varies widely and, although all forms occur in this species, there is often a tendency for one form to be more common in any particular outbreak. In the septicemic form in pigs affected by SCS a dark red to purple discoloration of the skin is evident, especially on the abdomen and ears, and subcutaneous petechial hemorrhages may also be visible. Nervous

signs, including tremor, weakness, paralysis, and convulsions, may be prominent and occur in a large proportion of affected pigs. The case-fatality rate in this form is usually 100%.

A semispecific entity occurring in pigs up to 4 weeks old is manifested by meningitis and clinical signs of prostration and clonic convulsions.

In the acute form there is also a tendency for pulmonary involvement to occur, but the main feature of the disease is enteritis, with pneumonia and occasionally encephalitis present as only secondary signs. In some situations, pigs dying of septicemia more commonly yield SCS, whereas those with acute enteritis are usually infected with STM. Acute pneumonia is a common accompaniment of this form of the disease in pigs, and nervous signs and cutaneous discoloration as described in the septicemic form may also be present. Meningitis caused by STM DT104 in 1-week-old piglets has been reported. Incoordination, paralysis, opisthotonus, paddling, and polyarthritis resulting in runts and deaths were common. Bronchopneumonia resembling pasteurellosis, and pleuropneumonia resembling *A. pleuropneumoniae* infection can be associated with SCS.

A syndrome of rectal stricture occurs in feeder pigs as a sequel to enteric salmonellosis associated with STM and is described under that heading.

### Septicemia

This is the characteristic form of the disease in young pigs up to 4 months old. Commonly, there is profound depression, dullness, prostration, high fever (40.5–42°C; 105–107°F), and death within 24 to 48 hours. There is often a soft, moist cough with dyspnea. There may be cyanosis of the extremities. Diarrhea is not a feature until 3 to 4 days. Rarely nervous signs may be seen. Pregnant sows may abort. Morbidity is usually low (<10%), but case mortality rates may be high.

### Acute Enteritis

This is the common form in adult animals of all species. It is most commonly associated with STM. There is a high fever (40–41°C; 104–106°F) with severe, fluid diarrhea; sometimes dysentery; and occasionally tenesmus. The fever often subsides precipitously with the onset of diarrhea. The feces are often a watery yellow without mucus or blood initially; have a putrid smell and contain mucus, and sometimes blood; have fibrinous casts, which may appear as complete tubular casts of intestine; and have intestinal mucosa in sheets or casts. There is complete anorexia and in some cases increased thirst. The heart rate is rapid, the respirations are rapid and shallow, and the mucosae are congested. Pregnant animals commonly abort. The case-fatality rate without early treatment may reach 75%. In all species, severe dehydration and toxemia occur and the animal loses

weight, becomes weak and recumbent, and dies in 2 to 5 days. Newborn animals that survive the septicemic state usually develop severe enteritis, with diarrhea becoming evident at 12 to 24 hours after the illness commences. If they survive this stage of the illness, residual polyarthritis or pneumonia may complicate the recovery phase.

### Chronic Enteritis

This is a common form in pigs following a severe outbreak. Although chronic enteritis may occur initially, it usually succeeds an acute episode. Episodes may occur at regular intervals. Affected pigs may have pyrexia, decreased feed intake, and are dehydrated.

### CLINICAL PATHOLOGY

There is heterogeneity in diagnostic accuracy revealed by using a review/metaregression approach.<sup>72</sup>

A definitive etiologic diagnosis of salmonellosis depends on culture of the organism from feces, blood, and other body fluids or tissues. Feed and water samples may also be cultured to determine the source of the organism. Numerous serologic tests are available but lack sensitivity and specificity.

Clinicopathologic support helps:

- Diagnosis in the individual animal, when its treatment and prognosis depend on a definitive diagnosis
- Diagnosis of a herd problem to ensure that expensive herdwide control measures are not implemented unnecessarily

The diagnostic techniques available are as discussed in the following sections.

### Bacterial Culture and Detection

This is the only way of making a definitive etiologic diagnosis of salmonellosis and of exactly determining the serotype. However, culturing the organism may be unreliable for various reasons, including the method used to collect samples, the amount of sample submitted, variation in the shedding of the organism, and the bacteriologic method used. A major complicating factor is the occurrence of apparently healthy carriers, which shed the organism intermittently in the feces, and silent carriers, which do not shed but harbor the organism in mesenteric lymph nodes or in the mucosa of the cecum and colon. The difficulty varies according to genotype. The conventional drag swab method probably gives a better recovery than the Swiffer wipe method.<sup>48</sup>

A discussion of enrichment media suggests that the modified semisolid Rappaport-Vassiliadis medium (MRSV) is beneficial in isolating *Salmonella*.<sup>73</sup> In a study in Japan it was shown that this method of culture was as good as flow-through immunocapture PCR.<sup>74</sup>

### Fecal Culture

The culturing of salmonellas from feces is common but can be unreliable. This difficulty is noticeable with SCS infections in

pigs. The difficulties relate to dilution by diarrhea and the heavily contaminated nature of the sample; a sample of fluid feces collected in a container is superior to a fecal swab. Clinical laboratories generally require at least 48 hours for presumptive diagnosis of *Salmonella* spp. in feces. Biochemical and serologic confirmation of the genotype and the antibiogram may require an additional 24 to 48 hours. The use of extended enrichment of fecal samples with tetrathionate broth is superior to primary enrichment for detection of salmonellas from cattle.

### Multiple Fecal Cultures

An antigen-capture ELISA with enrichment culture for detection of salmonellas from fecal samples is more rapid than routine culture techniques, with a test sensitivity of 69% and specificity of 97%.

### DNA Probes

The use of the DNA probe encoding a well-conserved VG of the *Salmonella* virulence plasmid is a sensitive method for screening large numbers of samples to detect potentially virulent *Salmonella* spp.

A reverse transcriptase-polymerase chain reaction (RT-PCR) may be a useful alternative to culture for screening large numbers of samples particularly when *Salmonella* prevalence is low.<sup>75</sup>

### Serology

In a study of pulsed-field gel electrophoresis (PFGE) subtypes there was a correlation of serotype to PFGE subtype. PFGE using XbaI restriction provided a possible method for screening and identifying swine *Salmonella* serotypes.<sup>76</sup>

### Serum Enzyme-Linked Immunosorbent Assay

The Danish mix-ELISA (DME) is a combination of LPS extractions of SCS (O antigens 6 and 7) and STM (O antigens 1, 4, 5, and 12), used to assay serum samples collected from live animals on the farm or from meat juice (collected when a meat sample from the carcass is frozen and thawed). The DME was designed for surveillance and is recommended for monitoring herds and detecting high levels of *Salmonella* infection. The test has been the basis for national *Salmonella* control programs in Denmark (SALIN-PORK), Germany, and the UK and is being considered in the Netherlands and Belgium. In a series of studies using pigs experimentally infected with either STM or *S. infantis*, the sensitivity of the DME was more than 95% and the specificity 100% compared with culture used to determine the positive or negative status of the pigs. There is a strong association between herd serology and the prevalence of *Salmonella* measured at three sampling sites: cecal content, pharynx, and carcass surface. A comparison of three commercial ELISAs showed that the results from the three different tests were very different.<sup>77</sup>

The meat juice ELISA results are always lower than the serum ELISA results.<sup>78</sup>

### Indirect Tests

These include a total and differential white cell count. A leukopenia, neutropenia, and severe degenerative left shift are highly suggestive. There is also a marked hyponatremia and a mild hypokalemia.

A positive diagnosis depends on culture of the organism, usually from feces but possibly from blood in the septicemic stage. If serologic diagnosis is available a serum sample should also be submitted. Indirect tests are very valuable and, if laboratory availability is good, a total white cell count and estimation of serum sodium levels should be undertaken urgently. A presumptive diagnosis is often all that can be stated, and this may be supported by a herd diagnosis—a diagnosis that the disease or infection is present in the herd and that it is presumed that the subject case is one of the group.

### Herd Diagnosis

A serologic examination of a sample of animals is a first step. A completely negative serologic test would indicate that the infection is not present. Positive results indicate a need for further examination, and periodic fecal cultures at 15-day intervals using enriching media should be undertaken. When STM is the causative bacteria, the feces of other species of animals on the farm should be examined, because ducks, dogs, horses, pigs, sheep, and cattle may be sources of infection for each other. It is always advisable to examine the drinking water and feed for evidence of infection.

### Detection of Clinically Normal Carrier Animals

The most difficult diagnostic problem in salmonellosis is the detection of the clinically normal carrier animal.

The reliability of diagnosis based solely on culture of fecal swabs is not high and represents the major difficulty in detecting carriers. A combination of fecal culture and serologic tests offers some improvement in accuracy, but even with the agglutination or complement fixation (CF) tests, accuracy is insufficient.

### Determination of Prevalence of Infection in Population of Animals

It is particularly important to determine the prevalence of *Salmonella* infection in a population of pigs. Pork and pork products are important sources of nontyphoidal *Salmonella* for humans consuming these products if they are not handled with care. Pigs entering the abattoir that are carriers of *Salmonella* are the most important source of carcass and product contamination. To be able to estimate the number of infected animals entering the abattoir and estimate the size of the *Salmonella* problem in pig

herds, the population and herd level prevalence of *Salmonella* have to be investigated. An estimation of the prevalence of *S. enterica* infection in finishing pigs in Iowa was done using on-farm fecal cultures, culture of on-farm necropsy and abattoir-collected samples, and serum ELISA using serum exudate (meat juice). Fecal samples collected on the farm detected only 13.3% of all positive pigs necropsied on the farm. Abattoir and on-farm results combined, the fecal sample detected 57.4% of positive pigs. Abattoir-collected samples provided prevalence estimates much higher than on-farm collected samples (39.9% versus 5.3%). Thus fecal samples have a low sensitivity for detecting infected pigs, and abattoir-collected samples overestimate the on-farm *S. enterica* prevalence. A study of subiliac lymph nodes at slaughter showed that they had a low rate of detection compared with the on-farm incidence.<sup>79</sup> Pigs can become infected during routine testing or holding periods during marketing when exposed to relatively low numbers of *Salmonella* in the preslaughter environment. Intervention at this step on the production process may have a major impact on the safety of pork products.

The probability of detecting *Salmonella* in seropositive pig herds with a correlation between serologic and fecal culture results was examined in pig herds as part of an international research program sponsored by the European Commission, *Salmonella* on Pork. Samples were examined from herds in Denmark, the Netherlands, Greece, and Germany. The serologic herd status was determined by blood sampling 50 finishing pigs. There was an increased probability of recovering *Salmonella* with increasing within-herd seroprevalence, but the correlation was only moderate.

### NECROPSY FINDINGS

#### Septicemia

There may be no gross lesions in animals that have died peracutely, but extensive submucosal and subserosal petechial hemorrhages are usually evident. The petechiae are very prominent and may give the kidney the “turkey-egg” appearance usually associated with hog cholera. A rhomboidal area of gastric mucosal infarction is usually present in pigs sometimes with frank hemorrhage. Congestion and hepatization of lung tissue may also be present with bronchopneumonia. Skin discoloration is marked and, depending on the severity of the case, this varies from extreme erythema with hemorrhage, to plaques and circumscribed scabby lesions similar to those of swine pox. There may be infarction of the tips of the ears, which may slough completely. The lymph nodes are often enlarged, moist, congested, and hemorrhagic. The liver may have focal areas of necrosis and the wall of the gallbladder may be thickened and edematous. In some cases

the necropsy findings may include splenomegaly and pinpoint white foci in the liver (paratyphoid nodules). The histologic lesions are extensive, but none specific with the exception of the somewhat granulomatous character of the older paratyphoid nodules. There are areas of coagulative necrosis, with neutrophils and histiocytes. There may be fibrinoid thrombi in the venules of the gastric mucosa, in cyanotic skin, glomerular capillaries, and pulmonary vessels. The spleen and lymph nodes show reticular cell hypoplasia and histiocytosis.

#### Acute Enteritis

The most common lesion is an enterocolitis usually involving the ileum, cecum, and spiral colon. In the past, in the UK, infection with SCS has been associated with significant “button ulcers” in the affected segments, particularly near the ileocecal junction. The mesenteric lymph nodes are consistently markedly enlarged and moist. The stomach contents are usually scant and bile-stained. Often cecal or colonic contents are black or are sand-like and gritty.

Some of the changes associated with the septicemic form are often present, but the most consistent damage is found in the large and small intestines. The character of the inflammation here varies from a mucositis with submucosal petechiation to diffuse hemorrhagic enteritis. Congestion and infarction of the gastric mucosa is often seen. Infections with STM are characterized by severe necrotic enteritis in the ileum and large intestine. The intestinal contents are watery, have a putrid odor, and may contain mucus or whole blood. In cases that have survived for longer periods, superficial necrosis and fibrin exudation may proceed to the development of an extensive diphtheritic pseudomembrane and fibrin casts. The mesenteric lymph nodes are enlarged, edematous, and hemorrhagic. The wall of the gallbladder may be thickened and inflamed.

Histologic lesions are most common in the cecum and spiral colon but may be found elsewhere. The *lamina propria* and the submucosa are typically infiltrated by neutrophils and then macrophages and a few lymphocytes. Fibrin thrombi are frequently observed in the capillaries. There may be a fibrinonecrotic crust on the surface of the mucosa often containing other bacteria and *Balantidium coli*.

Survivors of the septicemic and acute enteric forms of salmonellosis may develop rectal strictures. Lesions in pigs with *S. Heidelberg* are mild or nonexistent.

#### Chronic Enteritis

In pigs the lesions in chronic enteritis are diffuse. Less commonly the lesions are discrete in the form of button ulcers, occurring most frequently in the cecum around the ileocecal valve. The mesenteric lymph nodes and the spleen are swollen. In all species,



chronic pneumonia and a variety of other localized inflammatory processes such as polyarthritis and osteomyelitis may be found.

## DIAGNOSIS

Clinical signs and lesions may lead to a presumptive diagnosis of salmonellosis, but all porcine septicemias are superficially similar.

Salmonellas are present in the heart, blood, spleen, liver, bile, mesenteric lymph nodes, and intestinal contents in both septicemic and acute enteric forms. In the chronic form, the bacteria may be isolated from the intestinal lesions and less commonly from other viscera. Culture is more successful if enrichment media such as tetrathionate broth are used. In pigs experimentally infected with STM and SCS the organisms can be detected with peroxidase–antiperoxidase immunoenzymetric labeling and Immunogold techniques. Surveys that set out to determine the percentage of carriers in animal populations by examining abattoir material show that by far the largest number of isolations are made from the lymph nodes draining the cecum and lower small intestine.

## Samples for Confirmation of Diagnosis

- **Bacteriology:** Ileocecal lymph node, ileum, colon, spleen, lung, liver, culture swab from gallbladder (CULT). It requires brilliant green bismuth sulfite, blood agar, or MacConkey agar. Enrichment is not required unless there is fecal contamination or mishandling. In these cases, tetrathionate broth at 42°C to 43°C is the enrichment medium of choice. Selenite broth is inhibitory for SCS. Ileum is not good for septicemia confirmation.
- **Histology:** Formalin-fixed samples from these tissues plus kidney, stomach, brain. Other tests are not used routinely. PCR has a high cost and lacks sensitivity without preenrichment.

Serology (ELISAs) is used for herd diagnosis. Mixed ELISA meat juice is most important for assessing infection at slaughter.

Note the zoonotic potential of these organisms when handling carcasses and submitting specimens.

## DIFFERENTIAL DIAGNOSIS

The clinical diagnosis of salmonellosis is difficult because of the number of diseases that resemble each form of the disease. Salmonellosis is characterized by septicemia in young animals and acute and chronic enteritis in adults, although acute enteritis can occur in neonates. Thus the septicemic form of the disease must be differentiated from all other causes of septicemia and the enteric forms from all other causes of diarrhea in both young and adult animals. At necropsy the isolation of salmonellas from tissues and

intestinal contents, although suggestive of the presence of salmonellosis, does not of itself confirm the diagnosis, and care must be taken to ascertain whether other disease is present.

### Pigs

Septicemic salmonellosis occurs in pigs 1–4 months of age and is characterized by fever, depression, skin color changes, diarrhea, and rapid death.

- **Hog cholera, African swine fever, coliform gastroenteritis of recently weaned pigs, and pasteurellosis** may resemble septicemic salmonellosis very closely and laboratory examination is usually necessary for identification.
- **Acute erysipelas** is characterized by typical skin lesions, fever, swollen joints, and typical lesions at necropsy.
- **Swine dysentery** is characterized by mucoid feces with dysentery and typical lesions of the large intestine.

### Acute enteritis

The differential diagnosis of diarrhea includes:

- Swine dysentery
- Proliferative enteropathy
- Coronaviruses
- Circovirus
- Colibacillosis
- Coccidiosis
- Trichuriasis

## TREATMENT

### Primary Treatment: Antimicrobial Therapy

The choice of antibiotic should depend on the use of an antibiogram and the practitioner's previous knowledge and experience. In most salmonellas AMR is plasmid mediated.

The DT104 is especially worrying because it has a chromosomally integrated multiple AMR.

The use of antimicrobials for the treatment of clinical salmonellosis is controversial and different approaches to the problem exist among veterinarians. The controversy centers on two parts of the response to treatment and which view is taken depends to a large extent on the experience one has with respect to them.

The first issue is that of the success of treatment in saving the lives of clinically affected animals. It is the author's experience that early treatment with broad-spectrum antimicrobials is highly effective in reducing mortality and returning animals to normal function. It is generally agreed that treatment must be early, because delay means loss of the integrity of intestinal mucosa. A common pattern of response to treatment in a herd is that the first one or two cases are regarded lightly by the owner and they are treated 24 to 48 hours after diarrhea begins. When these cases die, a more prompt regimen is instituted in which the farmer has the approved

drug on hand and begins treatment as soon as diarrhea with fever is observed. The cure rate is then likely to be around 100%.

The second issue in the controversy about antimicrobial therapy for salmonellosis is the risk of inducing "carrier" animals. In humans and in animals there is some evidence that antimicrobials can prolong the duration of the period after clinical recovery during which the causative bacteria can be isolated from the intestine. It is accepted that this can occur and that the use of antimicrobials can theoretically contribute to the spread of disease. However, because of the way in which animals are kept, and because they constantly ingest contaminated pasture or other feed, there is an almost universal carrier segment in animal populations, and to regard another survivor from salmonellosis as a significant contributor to the carrier frequency seems an exaggeration. In many situations this appears to be the correct view, but in other situations an animal can become infected, for example, in a veterinary hospital or at an exhibition or show, recover clinically with treatment and, after returning to its parent herd, initiate an outbreak of fatal and debilitating salmonellosis. Both epidemiologic patterns occur, and they seem to occur in different places, so that the most appropriate attitude to take seems to be the one that fits local circumstances. In an area in which only sporadic cases of the disease occur in herds, it would be professionally negligent not to treat infected animals with appropriate antimicrobials. In endemic areas, recovered animals should not be sent into herds until they are known not to be carriers.

Other related issues are the creation of drug-resistant strains of the bacteria and the effect on the normal intestinal flora that results from oral medication. The problem with resistant strains would not have become significant if only individual animals had been treated, but mass medication of in-contact animals and prophylactic treatments have generally resulted in a large population of resistant strains.

Oral treatment in pigs is recognized as a satisfactory treatment. In summary, antimicrobials are recommended for all clinically affected animals (see later). The choice of antimicrobials depends on a test of drug sensitivity in each case or outbreak, but failing this the following generalizations can be applied.

For pigs with septicemic salmonellosis, trimethoprim-sulfadoxine is recommended, along with a combination of mass medication of the water supply with chlortetracycline and sulfamethazine (75 mg of each per liter of water). Where large numbers of pigs are affected, mass medication via the feed or drinking water is usually practiced. Because sick pigs do not eat, water treatment is necessary, and if drugs are unpalatable individual treatment is the last recourse. Drugs that dissolve readily and are palatable are therefore



in demand. Experimental disease of pigs with *S. typhisuis* can be controlled by the inclusion of low concentrations of chlortetracycline, penicillin, and sulfamethazine in the feed.

### CONTROL

It has become clear that successful interventions must be based on a range of preventive approaches.<sup>80</sup> Although in theory increased hygiene and establishing all-in/all-out production should reduce the level of *Salmonella* in practice, it is not easy to do so.<sup>81</sup>

Control of *Salmonella* in pigs can be divided into three main areas. Herd interventions are not sufficient to reduce *Salmonella* to <1% the desired target of the Danish schemes.<sup>82</sup> The cost-effectiveness of abattoir interventions varies with the size of the plant, and the most likely to succeed are steam vacuum and steam ultrasound. As yet these have not been tested for effectiveness.

### Preventing Infection From Entering the Herd (Biosecurity)

In a simulation study in France, it was found that if the movement of animals was based on the level of prevalence, and movement was not allowed from herds with high herd prevalence to those of low herd prevalence, then *Salmonella* could be significantly reduced.<sup>83</sup>

Avoidance of infection is the major objective but is not easily achieved. The principal sources of infection are carrier animals and contaminated feeds containing foodstuffs of animal origin.

Breeding stock should only be bought from herds that are certified free if the receiving herd is free from salmonellas. Buying in gilts or sows is a much greater risk than buying in boars.

For the pig finishers the following rules apply:

- Introduce the animals directly from the farm of origin. Avoid auction marts, saleyards, and public transport, all of which are likely to be sources of infection. Ensure that the farm of origin is free of salmonellosis. Finishers receiving growers that were positive had a much higher level of seroprevalence in the finishers than those that did not.
- If possible, purchase animals when they are older to provide an opportunity for specific and nonspecific immunity to develop. Animals from vaccinated herds are desirable but not always available.
- The premises of dealers, saleyards, and transport vehicles must be under close surveillance, and the need for frequent vigorous disinfection must be stressed. With decreasing levels of infection it is important that the infections in transport systems and the lairage are managed.<sup>84</sup> Introduce only those animals likely not to be carriers. Unfortunately the detection of carriers is inaccurate and expensive. To have any

confidence in the results, fecal samples for culture must be submitted on at least three occasions. Even then, occasional carriers with lesions in the gallbladder or tonsils will escape the net and be capable of reviving the disease on the farm or transferring it to another one.

Rodent and bird control is essential. Control of access to potential human fomites is also important, and they should be provided with clean protective clothing and boots before entering the herd. The significance of various environmental sources is often neglected and should be studied more intensely, such as lairages and truck-washing facilities.<sup>85</sup>

### Increased Hygiene to Prevent Intraherd Spread

Possibly the most effective method for the control of *Salmonella* infection in weaners appears to be segregated early weaning (no extra benefit before 3 weeks) into clean accommodations.<sup>86</sup>

When an outbreak occurs, procedures for limiting spread, as set out next, need to be strictly enforced, and medication of affected groups, and of susceptible groups at high risk, must be performed. The drugs to be used are those listed under treatment as well as the choice of the individual drug depending on its efficiency and cost.

- **Identify carrier animals and either cull them or isolate and treat them vigorously.** Treated animals should be resampled subsequently to determine whether a “clean” status has been achieved.
- **The prophylactic use of antimicrobials** such as oxytetracycline in the feed at the rate of 10 g/tonne, or chlortetracycline in the drinking water at the rate of 55 mg/L, is used but not recommended, because results are poor and there is a risk of developing resistant strains.
- **Restrict the movement of animals around the farm** and limit the infection to the smallest group. Pasture and permanent buildings are both important, although the major source of infection in most cases is the drinking water.
- **The water supply should be provided in troughs that are not susceptible to fecal contamination.** Static drinking water or pasture may remain infected for as long as 7 months.
- **Rigorous disinfection of buildings is important.** An all-in/all-out policy should be adopted and steam cleaning and chemical sterilization performed after each batch of animals. Piglets can be reared free of *Salmonella* infections up to 6 weeks of age by removing the piglets from infected herds to isolation facilities when they are weaned at 10 to 21 days of age. The movement of pigs either at weaning, from the nursery, or from the grower unit to newly built or rigorously cleaned and disinfected

finishing units with a known history of *Salmonella* infection is highly successful. If economics permit, individual pens for calves are beneficial. Where calves are reared indoors these pens are common and economical. Pig houses need especially careful treatment. Dirt yards present a problem, especially those used for sheep and calves, but, provided they can be kept dry and empty, two sprayings, 1 month apart, with 5% formalin are recommended. Disinfection greatly reduces the numbers but does not eliminate the organism,<sup>48</sup> irrespective of which disinfectant is used.

- **Suitable construction of housing is important.** Impervious walls to stop spread from pen to pen, pen design to permit feeding without entering the pen, avoidance of any communal activity, and slatted floors to provide escape routes for manure all assist in limiting the spread of enteric diseases. Deep litter systems are satisfactory provided they are kept dry and plenty of bedding is available. With pigs the opportunity for oral–fecal cycling of the organism and buildup and spread of infection within and between groups must be kept to a minimum. Pen design and the environment should encourage proper eliminative behavior and good pen hygiene. Drinkers should be sited at one end of the pen, preferably on a narrow end with oblong pens, to encourage defecation in this area. Wet or damp areas of the floor in other parts of the pen will encourage defecation and urination there and should be eliminated. Drinkers of the nipple type rather than bowls are preferable for hygienic reasons. Communal dunging alleys increase the possibility of spread, especially during the cleaning procedure, and the trend is toward slatted or meshed areas over a channel. A totally slatted or mesh floor for pigs from weaning until 10 to 12 weeks of age will markedly reduce the opportunity of oral–fecal cycling of organisms in this age group, which is especially susceptible to enteric disease. Feeders should allow the ingress of the pig’s head and should be constructed to avoid fecal and other contamination of feed. Pigs need to be grouped according to size, and overcrowding, which may result in improper pen hygiene, must be avoided. Space requirements vary according to pen and housing design but generally fall in the region of 0.3 m<sup>2</sup> for recently weaned piglets to 0.6 to 1 m<sup>2</sup> for market-size pigs. In conventionally floored or partially slatted floored pens, approximately ⅓ of the area should be available for the dunging area. The construction of the pen should allow for easy and efficient cleaning. In problem herds an especial vigilance for the

occurrence of enteric disease is needed following the breakdown of pen hygiene on very hot days.

- **Disposal of infective material should be done with care.** Carcasses should be burned or, better still, sent to an institution for diagnosis, rather than to a rendering plant to be converted into still more contaminated bonemeal. Slurry decreasing the storage time and manure for disposal should be placed on crops rather than on pasture. Slurry does not constitute a danger via hay, and salmonellas do not survive silage making. When slurry is used on pasture it should be stored for at least a month beforehand and even longer if silo effluent is included. Slurried pasture should not be grazed for 1 month, and for young animals a 6-month delay is recommended. Pig slurry is most dangerous and should always be avoided. Urea and to a lesser extent ammonia may be used to disinfect *Salmonella*-contaminated slurry, decreasing the storage time required while increasing its fertilizer value.<sup>87</sup>
- **All persons working on infected premises should be warned of the hazards to their own health.** Other peripatetic species, especially dogs, should be kept under close restraint. Restrictions on staff movements within the unit may also prevent cross-infection.
- No moving back of animals from pen to pen is essential.

#### Reducing Exposure to Pathogens

- Promoting appropriate personal hygiene
- Using effective methods for cleaning and disinfection
- Controlling the flow of human and animal traffic
- Implementing protocols for prompt identification of patients with signs of contagious disease
- Controlling birds, rodents, and flies

#### Avoiding Increasing Susceptibility to Pathogens

- Controlling ambient temperature
- Using antimicrobials appropriately
- Aiding in establishing normal intestinal or rumen flora
- Controlling endotoxemia

#### Monitoring Effectiveness of the Infectious Disease Control Program

- Bacterial culture of fecal samples of animals admitted to the hospital
- Regular culture of environmental samples

#### Feed Interventions to Aid the Pigs' Defenses

##### Physical Form of the Feed

Herds that use pelleted feed have on average three times the seroprevalence of herds that

mix their own feed. This is surprising because most pelleted feed follows stringent rules for production and home-mixed diets use nonheat-treated soya. Home-mixed feed and coarse ground feed protect pigs against *Salmonella*, although there is a loss of productivity.

The addition of 25% of nonheat-treated, nonpelleted wheat or barley does have a beneficial effect in those herds with a high seroprevalence. Meal feeding increased the viscosity of the stomach contents compared with pelleted feed and a higher content of organic acid producing lactobacilli were found in the stomach. Increasing the amount of barley also has a protective effect.

The use of organic acids in dry pelleted feed could reduce the seroprevalence in finishers, and 0.8% of formic acid or lactic acid could also reduce *Salmonella* prevalence.<sup>88</sup> The same can be achieved by placing organic acids in drinking water. They seem to be more beneficial in weaner diets than in finisher diets. These effects are probably much reduced in sows. In a study of direct-fed microbials or organic acids, there was no effect on the treatments except for the in-feed antibiotic.<sup>89</sup>

The effect of organic acids on *Salmonella* colonization and shedding in weaner pigs in a seeder model has shown that the organic acids could reduce fecal shedding and numbers of coliforms and salmonellas in cecal digesta. Colonization of tonsils and ileocecal clymph lymph nodes by salmonellas was not affected.<sup>90</sup>

**Liquid feed for finishers** seems to reduce the level of seroprevalence by two-thirds compared with herds using dry feed. The key seems to be to keep the pH of the feed below 5.5 so that the piped feed is also acidic by encouraging fermentation or by the addition of formic acid.

Oxygenated drinking water enhances the immune activity and response of pigs exposed to STM.<sup>91</sup>

##### Organic Acids

In a study of the effects of a mixture of formic acid and lactic acid (both 0.4% w/v) or 1.0% lactulose influenced the numbers of *Salmonella* in the ileum and cecum of experimentally challenged pigs.<sup>92</sup>

The administration of organic acids to drinking water during the last 2 weeks before slaughter on *Salmonella* shedding by slaughter pigs and the contamination of carcasses was shown to be ineffective in reducing the levels of bacteria.<sup>93</sup> The effect of the addition of organic acids in drinking water or feed during part of the finishing period on the prevalence of *Salmonella* in finishing pigs has been described.<sup>94</sup> Pigs received a mixture of acids (lactic, formic, and propionic) or potassium diformate. At the end of the trial the proportion of seropositive pigs was less with either treatment than in the controls. The frequency of fecal shedding was also lower.

**Heat treatment of feed** is an effective procedure for pigs. Heating during pelleting greatly reduces the bacterial content of feed, and the special treatment is worthwhile because of the very high proportion of animal-derived feeds that are infected. The availability of such feeds guaranteed to be *Salmonella*-free would be an advantage.

##### Feed Withdrawal

As feed withdrawal times increased before slaughter, so the numbers of salmonellas increased as the numbers of lactobacilli decreased.<sup>95</sup>

##### Other Options

In the future there is the potential use of bacteriophages to reduce the populations of salmonellas,<sup>96</sup> but this study showed that they were at very low levels in the commercial swine population. Experimental phage cocktail therapy of slaughter pigs significantly reduced the cecal STM concentrations and reduced numerically the ileal *Salmonella*.<sup>97</sup>

It may be possible to use 2-nitro-1-propanol and 2-nitroethanol with added chlorine as feed additives to control *Salmonella*.<sup>98</sup>

##### Immunization

##### *Salmonella* Vaccinology

A successful vaccine should prevent colonization of the host, shedding of the organism to the environment, the development of the carrier state, and the development of the clinical state.<sup>80</sup> At present no vaccine fulfills all these criteria, but vaccines can reduce the on-farm pressure.<sup>99-103</sup> An attenuated vaccine reduced STM numbers in a model simulating preslaughter stress.<sup>104</sup>

A live attenuated STM expressing swine interferon (IFN)- $\alpha$  has antiviral activity and alleviates clinical signs of TGE. The result indicates the value of attenuated *Salmonella* vaccines as delivery systems of cytokines.<sup>105</sup>

An inactivated STM bacterin was shown to reduce the shedding and horizontal transmission of STM as well as the proportion of shedders or carriers at slaughter.<sup>94</sup>

Immunization of pregnant sows with a novel virulence gene (VG) deleted live *Salmonella* vaccine, and protection of their suckling piglets against salmonellosis has been successful. The systemic and mucosal immune responses were highly induced by the vaccine candidate, especially when this was administered by both routes of intramuscular prime and oral booster and oral prime and booster.<sup>106</sup>

The literature on *Salmonella* vaccines has been reviewed. Host resistance to *Salmonella* relies initially on the production of inflammatory cytokines leading to the infiltration of activated inflammatory cells in the tissues. Thereafter, T-cell- and B-cell-dependent specific immunity develops, allowing the clearance of *Salmonella* from the tissues and

the establishment of long-lasting acquired immunity to reinfection. The increased resistance that develops after primary infection or vaccination requires T-cell cytokines such as IFN- $\gamma$ , TNF- $\alpha$ , and IL-2, in addition to opsonizing antibody. Seroconversion and/or the presence of detectable T-cell memory do not always correlate with the development of acquired resistance to infection.

Immunization with live salmonellas induces early resistance rechallenge with virulent organisms that appear 1 day after infection or vaccination with live but not killed organisms. Early protection is nonspecific and effective against different *Salmonella* serotypes. Long-term immunity using live attenuated vaccines is serotype specific and involves the recall of immunologic immunity. Killed vaccines induce strong antibody responses but trigger insufficient T-helper-1 (Th1)-cell responses.

Vaccines have been developed and tested in pigs. If vaccination is combined with the hygienic precautions described, the vaccines are an aid to management. Killed bacterins and live attenuated vaccines are available. Either can be used as a prenatal vaccine to provide passive immunization of the newborn. It is now generally accepted that live *Salmonella* vaccines are more effective immunogens in calves than are killed vaccines. Experimentally, a live STM vaccine delivering recombinant *E. coli*, K88ab, K88c, Fed A, and Fed F has been shown to be highly immunogenic.<sup>106</sup>

A commercial vaccine containing living, attenuated SCS has also been shown to protect neonatal pigs after vaccination of sows and weaned pigs. Because of the early age at which pigs need to be immune, it is recommended that sows be vaccinated three times at 7- to 14-day intervals. The young pigs are vaccinated at 3 weeks of age. A live avirulent SCS vaccine has been developed and evaluated for protection against experimental challenge. Vaccinated pigs were able to maintain normal BW gains during a 4-week observation period following challenge inoculation with a high dose of a virulent strain. It has consistently been safe and efficacious in pigs as young as 3 weeks and provides protection for at least 20 weeks. An STM live negative-marker (OmpD) vaccine has been constructed and given to pigs that will not interfere with meat juice ELISA diagnosis<sup>107</sup> and this holds hope for the future. A sophisticated plasmid-cured and CRP gene-deleted SCS live vaccine has been described, and the mutant may form the basis for a new vaccine.<sup>108</sup>

Most cases of salmonellosis in pigs are subclinical and caused by *S. Typhimurium*. The ideal vaccine against STM would prevent colonization, shedding of the organism in the environment, development of carriers and clinical salmonellosis, and promote elimination of the organism from infected animals. Live vaccine strains are considered

to provide superior protection compared with inactivated vaccines.

### Monitoring

Statistical methods to categorize pig herds based on serologic data have been described<sup>109,110</sup> as well as descriptive spatial epidemiology.<sup>111</sup>

Herds can be classified quite differently according to the test used<sup>112</sup> when three ELISAs were compared and their results examined.

### Nationwide Surveillance and Control Programs

In 1993, the Ministry of Food, Agriculture, and Fisheries of Denmark and the Danish Bacon and Meat Council initiated an ambitious program to eliminate pork as an important source of human salmonellosis. In the early 1990s pork had become recognized as an increasingly important source of human salmonellosis in Denmark. In Denmark, the proportion of human salmonellosis attributable to pork was estimated to be 10% to 15% in 1997 and 1998. In the Netherlands, it was estimated that approximately 15% of human cases of salmonellosis were associated with the consumption of contaminated pork.

The Danish Salmonella Surveillance and Control Program for pigs operates at all stages of the production chain and has been applied nationally since 1995. As a result of the program the level of *Salmonella* in Danish pork declined from 3.5% in 1993 to 0.7% in 2000. Simultaneously, the number of human cases of salmonellosis caused by pork declined from approximately 1444 in 1993 to 166 in 2000. Quality control has been described.<sup>113</sup>

The control program is integrated from "feed to food." It is based on routine testing and classification of slaughter pig herds and the subsequent slaughter of pigs according to the inherent risk, as measured by the continual test program. In a study of culture and ELISA testing, it was found that results cannot be compared easily, because some seronegative pigs were + ve on culture and some culture - ve pigs were + ve on serology, so the test has to be selected to answer a specific question.<sup>114</sup> Methodological problems related to the optical density data obtained from meat juice ELISAs have been shown to require recalculation; otherwise there would be an underestimation of actual seroprevalence.<sup>115</sup>

The Danish Control system and a description of an extended preharvest surveillance and control program has been described.<sup>116</sup> Only hot-water decontamination was socioeconomically profitable in a comparison with the control plan as it operated in 2006.<sup>117</sup>

Basically, the level of *Salmonella* is controlled at various stages. The UK plan has been described.<sup>118</sup> The barriers to the adoption of measures to control *Salmonella* in pigs in the UK has been reviewed<sup>119</sup> and one

of the most important measures was the failure of farmers to recognize the importance of *Salmonella* control. Other factors are the low awareness of pork as a risk for *Salmonella*, the low incidence of *Salmonella* associated with pork, and the food chain members do not want to raise the problems. It is important to recognize that pooled sampling is highly efficient compared with individual sampling and that clustering at pen level influences the results; thus it is important to take this into account in the estimation of appropriate sample sizes and the estimation of prevalence from pooled sample data.<sup>120</sup> These data can be used to study spatial disease epidemiology.<sup>121</sup>

### Feedstuffs

Compounded feeds are heat treated at 81°C to eliminate *Salmonella*. The national program requires mandatory *Salmonella* testing in all plants producing animal feeds. In 2000 the level of *Salmonella* spp. in final products was only 0.3%.

Low-level nitrate or nitroethane preconditioning enhances the bactericidal effect of chlorate treatments, and this may offer opportunities to control *Salmonella* in the future.<sup>122</sup> The supplementation of meal diets with potassium dichromate significantly reduced the duration of survival and increased the rates of decline in *Salmonella*.<sup>123</sup>

The direct feeding of microencapsulated bacteriophages has been shown experimentally to reduce colonization and shedding.<sup>124</sup>

A probiotic strain of *E. faecium* fed to pigs resulted in an enhanced infection but also an increased level of specific antibodies to STM DT104.<sup>125</sup> High-dosage dietary zinc oxide had no protective effects on weaned pigs with DT104.<sup>126</sup> Caprylate in the form of encapsulated beads or as an oil might be a *Salmonella*-reducing additive in pig feed.<sup>127</sup>

### Breeder and Multiplier Herds

Each month all herds are blood sampled and examined for *Salmonella* antibodies. Based on the level of antibodies, a *Salmonella* index is calculated. If the index exceeds 5, pen fecal samples must be taken and examined for the presence of *Salmonella* spp. When the index exceeds 15, a sales ban on breeding pigs is imposed until the index has declined below 15 again.

### Weaner Producers

If a sow herd sells weaners to a *Salmonella* level 2 or 3 finishing herd, pen fecal samples must be taken and examined for *Salmonella*.

### Slaughter Pigs

In a study of slaughter pigs, ileal contents were 18.7% + ve, the lymph nodes 17.8%, 7.2% in the rectal contents, and 3.6% in the carcass swabs.<sup>93</sup>

Slaughter herd pigs are monitored continuously by serologic testing of meat juice.



Meat samples are frozen, and meat juice (harvested after thawing) is examined for specific antibodies against *S. enterica* using an ELISA. The ELISA combines several *S. enterica* O antigens and allows detection of antibody response after a variety of serovar infections. The meat samples for testing are collected at the slaughter line, and the number of samples and frequency of sampling are determined by the size of the herd. Herds sending fewer than 200 pigs to slaughter per year are not examined, which amounts to about 1.6% of slaughter pigs. The herds are categorized in four levels based on the proportion of seropositive meat juice samples during the previous 3 months. Based on the optical density percent of the ELISA test, the herds are classified into the following levels:

**Level 0:** Herds having only seronegative over 3 months or more

**Level 1:** Herds with acceptable low *Salmonella* prevalence

**Level 2:** Herds with moderate *Salmonella* prevalence

**Level 3:** Herds with unacceptable high *Salmonella* prevalence

The herd information as to status can be used to direct the risk-based approaches to surveillance.<sup>128-130</sup>

A herd categorized as level 2 or 3 must receive an advisory visit by a practicing veterinarian and a local extension specialist, and certain management precautions must be adopted. In a level 3 herd, the finishing pigs must be slaughtered under special hygiene conditions. In a study in the UK, an increased risk of carriage at slaughter was associated with >12 hours in the lairage, pigs transported from northeast UK, and not feeding when there was no bedding available.<sup>131</sup>

The proportion of serologically positive meat juice samples collected during 1995 ranged from a mean of 2.9% in small herds to 6.1% in large herds.

Segregated transport to the abattoir has additional costs but may reduce contamination.<sup>132</sup> Costs were governed by the percentage of changed shipments and the additional distance of a changed shipment.

In a study of hog carcasses in Canada it was shown that the cleanliness of the hogs and the status of the scald water were the two most important factors involved in the *Salmonella* carriage at the end of the slaughter process.<sup>133</sup> Decontamination of pork carcasses can be achieved using hot water and acidified sodium chlorite.<sup>134</sup>

The use of lactic acid sprays as a decontamination measure when used with good manufacturing processes during processing will significantly reduce *Salmonella* contamination of pork variety meats (liver, heart, intestines, and stomachs).<sup>135</sup>

Cleaning and disinfection in the slaughterhouse, particularly the lairage area, is an area that can influence the presence of *Salmonella* on the carcass.<sup>34</sup>

Enumeration of *Salmonella* in feces of naturally infected pigs has been described.<sup>136</sup>

Most exposures to *Salmonella* of swine are at doses below the infectious dose. Doses >10<sup>3</sup> CFU increase the probability of infection in swine.<sup>137</sup> Only a few high concentrations of *Salmonella* in feces were clustered within the pig and the pen. Identification and removal of high shedders may be very effective to reduce carcass condemnation. The robustness and rapidity of the direct q-PCR assay can be a very useful screening tool for removal of the high shedder at the lairage. In an experimental evaluation of on-farm interventions, five activities were ranked feeding meal > inclusion of acids in ration > feeder pen disinfection or > *Salmonella* spp. vaccination > in-feed tetracyclines.<sup>138</sup>

### Slurry

The addition of urea to pig slurry will add additional antimicrobial ammonia and carbonate anions. It could greatly reduce the time needed to eliminate *Salmonella* in slurry and reduces the pathogen recycling risks associated with using porcine waste as a fertilizer.<sup>139</sup>

### At Abattoir

Lesion profiling at processing can be used to predict *Salmonella* contamination of swine carcasses.<sup>140</sup>

The roles of slaughtering in *Salmonella* spreading and control in pork production has been reviewed,<sup>141</sup> and they have indicated that there is a continuous source of infection from the farm. At the slaughterhouse there are some dressing activities that can reduce the carcass contamination but others may jeopardize carcass hygiene.

### REFERENCES

- Xiong N, et al. *Am J Vet Res.* 2010;71:1170.
- Foley SI, et al. *J Anim Sci.* 2008;86:e173.
- Barnhill AF, et al. *Appl Environ Microbiol.* 2010;76:2678.
- Farzan A, et al. *Zoonoses Public Health.* 2009;57:388.
- Gotter V, et al. *Epidemiol Infect.* 2012;140:150.
- Gotter V, et al. *Prev Vet Med.* 2012;106:301.
- Clothier KA, et al. *J Vet Diagn Invest.* 2010;22:578.
- Sanchez J, et al. *Prev Vet Med.* 2007;81:148.
- Guenther S, et al. *Vet Microbiol.* 2010;142:352.
- Rasschaert G, et al. *J Food Prot.* 2012;75:859.
- Wilkins W, et al. *Can J Vet Res.* 2010;74:81.
- Rajic A, et al. *Foodborne Pathog Dis.* 2007;4:169.
- Volf J, et al. *Vet Microbiol.* 2012;156:127.
- Arguello H, et al. *Res Vet Sci.* 2013;95:334.
- Baptista FM, et al. *Prev Vet Med.* 2009;92:301.
- Lomonaco S, et al. *Zoonoses Public Health.* 2008;56:137.
- Asai T, et al. *Comp Immunol Microbiol Inf Dis.* 2010;33:109.
- Garcia-Feliz C, et al. *Zoonoses Public Health.* 2007;54:294.
- Gomez-Laguna J, et al. *Vet J.* 2011;190:176.
- Wachek S, et al. *J Food Prot.* 2012;75:1483.
- Dorn-in S, et al. *Prev Vet Med.* 2009;88:15.
- Miller AJ, et al. *Zoonoses Public Health.* 2011;58:549.
- Vigo GB, et al. *Foodborne Pathog Dis.* 2009;6:965.
- Mueller-Dobles D, et al. *Prev Vet Med.* 2013;110:447.
- Foley SI, et al. *J Anim Sci.* 2008;86:e149.
- Rostagno MH, et al. *Foodborne Pathog Dis.* 2009;6:865.
- Weigel RM, et al. *Prev Vet Med.* 2007;81:274.
- Wang YC, et al. *J Food Prot.* 2011;74:1012.
- Nathues C, et al. *J Food Prot.* 2013;76:1704.
- Osterberg J, et al. *Vet Rec.* 2009;165:404.
- Patchanee P, et al. *J Food Prot.* 2007;70:1798.
- Pires AFA, et al. *Epidemiol Infect.* 2013;141:1928.
- Mathew AG, et al. *J Food Prot.* 2009;72:267.
- Boughton C, et al. *Foodborne Pathog Dis.* 2007;4:26.
- Rao S, et al. *Prev Vet Med.* 2010;97:90.
- Meurens F, et al. *Vet Res.* 2009;40:05.
- Collardo-Romero M, et al. *Vet Res.* 2010;41:23.
- Martins RP, et al. *J Proteomics.* 2012;73:4457.
- Martins RP, et al. *Comp Immunol Microbiol Infect Dis.* 2013;36:149.
- Wilkins W, et al. *Zoonoses Public Health.* 2010;57:115.
- Twomey F, et al. *Vet Rec.* 2010;166:722.
- Wales AD, et al. *Vet Rec.* 2009;165:648.
- Farzan A, et al. *Zoonoses Public Health.* 2010;57(suppl 1):85.
- Molla B, et al. *Appl Environ Microbiol.* 2010;76:7188.
- Davies RH, et al. *Vet Microbiol.* 2013;166:543.
- Pieper R, et al. *Appl Environ Microbiol.* 2009;75:7006.
- Gebreyes WA, et al. *J Clin Microbiol.* 2009;47:777.
- Zweide BM, et al. *J Food Prot.* 2009;72:142.
- Rayamajhi N, et al. *J Vet Med Sci.* 2008;70:1133.
- Haley CA, et al. *J Food Prot.* 2012;75:428.
- Huang T-M, et al. *Lett Appl Microbiol.* 2009;48:331.
- Lim S-K, et al. *Foodborne Pathog Dis.* 2009;6:981.
- Kerounton A, et al. *Foodborne Pathog Dis.* 2013;10:977.
- Keelara S, et al. *Appl Environ Microbiol.* 2013;79:5167.
- Hoelzer K, et al. *Vet Res.* 2011;42:34.
- Duggan SJ, et al. *J Food Prot.* 2010;12:2148.
- Algino RJ, et al. *J Food Prot.* 2009;72:714.
- Van Parys A, et al. *Vet Microbiol.* 2010;144:93.
- Pavlova B, et al. *Vet Res.* 2011;42:16.
- Schlumberger MC, et al. *Curr Opin Microbiol.* 2006;9:46.
- Boyen F, et al. *Microbes Infect.* 2006;8:2899.
- Paulin SM, et al. *Infect Immun.* 2007;75:3950.
- Van Parys A, et al. *Comp Immunol Microbiol Infect Dis.* 2013;36:465.
- Bergeron N, et al. *J Clin Microbiol.* 2009;47:3413.
- Vandenbroucke V, et al. *Vet Res.* 2009;40:64.
- Fraser JN, et al. *J Anim Sci.* 2007;85:1161.
- Sang Y, et al. *Mamm Genome.* 2006;17:332.
- Veldhuizen EJA, et al. *Mol Immunol.* 2007;44:276.
- Veldhuizen EJA, et al. *Vet Microbiol.* 2009;136:69.
- Boyen F, et al. *Vet Microbiol.* 2008;128:364.
- Volf J, et al. *Vet Microbiol.* 2010;146:105.
- Wilkins W, et al. *Zoonoses Public Health.* 2010;57(suppl 1):121.
- De Busser E, et al. *Foodborne Pathog Dis.* 2013;10:1820.
- Katsuda K, et al. *J Food Prot.* 2010;73:957.
- Wilkins W, et al. *Zoonoses Public Health.* 2010;57:115.
- Gaul SB, et al. *J Clin Microbiol.* 2007;45:472.
- Vico JP, et al. *Zoonoses Public Health.* 2010;57(suppl 1):107.
- Vico JP, et al. *J Vet Diagn Invest.* 2011;23:528.
- Wang B, et al. *Foodborne Pathog Dis.* 2010;7:795.
- Rostagno MH. *Vet Rec.* 2011;169:551.
- Dahl J. *Pig J.* 2008;61:6.
- Baptista FM, et al. *Epidemiol Infect.* 2011;139:754.



83. Lurette A, et al. *Prev Vet Med.* 2011;102:30.
84. Hotes S, et al. *Transbound Emerg Dis.* 2011;58:11.
85. Dorr PM, et al. *Appl Environ Microbiol.* 2009;75:1478.
86. Wales AD, et al. *Vet Rec.* 2011;168:267.
87. Bolton DJ, et al. *J Appl Microbiol.* 2012;114:134.
88. Creus E, et al. *Zoonoses Public Health.* 2007;54:314.
89. Walsh MC, et al. *J Anim Sci.* 2012;90:261.
90. Michiels J, et al. *J Food Prot.* 2012;75:1974.
91. Jung B-G, et al. *J Vet Med Sci.* 2012;74:1651.
92. Martin-Pelaez S, et al. *Vet Microbiol.* 2010;142:337.
93. De Busser EV, et al. *Zoonoses Public Health.* 2009;56:129.
94. Arguello H, et al. *Comp Immunol Microbiol Infect Dis.* 2013;36:489.
95. Martin-Pelaez S, et al. *Vet J.* 2009;182:469.
96. Callaway TR, et al. *Foodborne Pathog Dis.* 2010;7:851.
97. Wall SK, et al. *Appl Environ Microbiol.* 2010;76:48.
98. Anderson RC, et al. *J Food Prot.* 2007;70:308.
99. Roesler U, et al. *J Vet Med B Infect Dis Vet Public Health.* 2006;53:224.
100. Selke M, et al. *Infect Immun.* 2007;75:2476.
101. Farzan A, et al. *Can J Vet Res.* 2010;74:253.
102. Hur J, et al. *Vet Immunol Immunopathol.* 2011;139:250.
103. Schwartz P, et al. *Vet Rec.* 2011;169:553.
104. Leyman B, et al. *Vet J.* 2012;194:250.
105. Kim SJ, et al. *Vaccine.* 2010;28:5031.
106. Hur J, et al. *Can J Vet Res.* 2012;76:186.
107. Selke M, et al. *Infect Immun.* 2007;75:2476.
108. Chu C-Y, et al. *Vaccine.* 2007;25:7031.
109. Abrahantes JC, et al. *Prev Vet Med.* 2009;89:59.
110. de Vos CJ, et al. *Prev Vet Med.* 2007;82.
111. Benschop J, et al. *Vet Res.* 2008;39:02.
112. Poulin M-C, et al. *Vet Rec.* 2010;166:500.
113. Bak H, et al. *Prev Vet Med.* 2007;78:130.
114. Farzan A, et al. *Epidemiol Infect.* 2007;135:238.
115. Wilhelm E, et al. *J Food Prot.* 2007;70:1246.
116. Alban L, et al. *Zoonoses Public Health.* 2010;57(suppl 1):6.
117. Goldbach S, et al. *Prev Vet Med.* 2006;77:1.
118. Twomey F, et al. *Gov Vet J.* 2007;17:28.
119. Van Dam YK, et al. *Pig J.* 2010;63:50.
120. Arnold ME, et al. *AJC Epidemiol Infect.* 2009;137:1734.
121. Clough HE, et al. *Prev Vet Med.* 2009;89:67.
122. Anderson RC, et al. *Food Pathog Dis.* 2006;3:461.
123. Rajtak U, et al. *Appl Environ Microbiol.* 2012;78:110.
124. Saez AC, et al. *Food Pathog Dis.* 2011;8:1269.
125. Szabo I, et al. *Appl Environ Microbiol.* 2009;75:2621.
126. Janczyk P, et al. *Appl Environ Microbiol.* 2013;79:2914.
127. Messens W, et al. *Vet Microbiol.* 2010;141:73.
128. Baptista FM, et al. *Zoonoses Public Health.* 2010;57(suppl 1):49.
129. Smith RP, et al. *Zoonoses Public Health.* 2010;57(suppl 1):39.
130. Hotes S, et al. *Zoonoses Public Health.* 2010;57(suppl 1):30.
131. Milnes AS, et al. *Epidemiol Infect.* 2009;137:1135.
132. Hotes S, et al. *Prev Vet Med.* 2012;104:174.
133. Letellier A, et al. *J Food Prot.* 2009;72:2326.
134. Hamilton D, et al. *Zoonoses Public Health.* 2010;57(suppl 1):16.
135. King AM, et al. *J Food Prot.* 2012;75:1589.
136. Pires AFA, et al. *Foodborne Pathog Dis.* 2013;10:933.
137. Osterberg J, et al. *Vet Rec.* 2008;162:580.
138. Wilhelm B, et al. *Prev Vet Med.* 2012;107:11.
139. Bolton DJ, et al. *J Appl Microbiol.* 2012;114:134.
140. Hurd HS, et al. *Am J Vet Res.* 2012;73:91.
141. Arguello H, et al. *J Food Prot.* 2013;76:899.

## INTESTINAL CLOSTRIDIOSIS IN THE PIG

There are three Clostridia involved in intestinal clostridiosis in the pig.

- *C. perfringens* type C (CPC) affects pigs of 1 to 14 days, usually less than 7 (rarely older) and produces hemorrhagic, watery diarrhea and sudden death.
- *C. perfringens* type A (CPA) affects pigs of 2 to 10 days (rarely older) and produces creamy, watery mild diarrhea and decreased growth rate.
- *C. difficile* (CD) affects pigs of 1 to 5 days of age (rarely older) and produces creamy diarrhea, dehydration, and death.

CD is an important cause of diarrhea in humans associated with antibiotic usage. It may also present as a colitis, or fulminant colitis followed by ileus, toxic megacolon, and bowel perforation. It may also cause diarrhea in antibiotic treated foals, hamsters, and guinea pigs. Some authors highlight the high level of relatedness of CD ribotypes found in human and porcine isolates.<sup>1,2</sup> It was originally associated with hospital infections but now approximately 40% may be community-associated CD infections.<sup>3,4</sup> The ribotype O78 is an emerging strain in humans and pigs.<sup>5</sup> There is still confusion as to whether this is a potential zoonotic or food-borne disease.<sup>6</sup> It is likely that there is little food-borne risk because the level of infection in slaughter pigs is greatly reduced.<sup>7</sup> It has been suggested that humans and pigs may be exposed to the same environmental sources of CD. The comparative pathology of CD-associated disease has been described.<sup>8</sup> It may be the most important uncontrolled cause of neonatal diarrhea in the pig.<sup>9</sup>

### ETIOLOGY

CPC is a primary pathogen but can colonize other lesions. It is a large, gram-positive rod that only occasionally forms spores and produces the  $\alpha$ - and  $\beta$ -toxins (CPA and CPB toxins). The  $\beta$ -toxin is more important and is sensitive to protease/trypsin. A second toxin, the  $\beta$ -2 toxin, has been found in necrotic enteritis, and the function of this is not yet clear. Variable amounts of  $\alpha$ -,  $\beta$ - and  $\delta$ -toxin are produced. *C. perfringens* type B is found occasionally.

CPA is a normal inhabitant of the intestinal microflora of the newborn piglet but can also cause severe disease via the  $\alpha$ -toxin, which it produces. Immediately after birth, there are large numbers in the stomach of piglets and later large numbers in the colon. Quite often, there are greater numbers in the healthy piglets than diarrheic piglets. The *cpb2* gene and its expressed protein a 27.6-kD toxin (CPB2) was first described in an isolate from necrotic enteritis. It was subsequently demonstrated by PCR in a variety of animals with diarrhea and necrotic enteritis.<sup>10</sup> The

CPB2 toxin is encoded by either a “consensus gene” or by an “atypical gene” with 80.4% similarity between the two proteins.<sup>11</sup> In a study of *cpb2* encoding CPA and diarrhea it was shown that the consensus *cpb2* was present in 93% of the isolates in healthy and diarrheic piglets and the atypical gene was shown in only 56% healthy and 32% diarrheic piglets.<sup>12</sup> The presence of CPB2 toxin in the intestinal contents of normal and diarrheic piglets did not differ significantly. There is a role for  $\beta$ -2 toxin, and nearly all of the strains of type A also produce this toxin. There are also some strains that produce enterotoxin.

CD can be asymptomatic or can cause diarrhea in piglets. Spores germinate in the ileum, cecum, and colon. It has emerged as a cause of enteritis in pigs. It is classified by ribotype (O) and toxin types, e.g., O76 toxin type V. It produces two major toxins, A (lyses epithelial cells) and B (damages underlying tissues), both of which are involved in the pathogenicity, as well as a third binary toxin. Ribotype O78 was found in 83% of pig isolates from North America.<sup>13</sup>

### EPIDEMIOLOGY

The prevalence and diversity of toxigenic CPC and CD among the swine herds of the Midwest United States was studied.<sup>14</sup> CPC was isolated from 89.8% of the pigs and CD from 57.7% of the pigs. Most of the CD isolates were toxinotype V, but there was considerable diversity in the CD isolates.

In a study from Poland, CPC was found in 92% of feces samples and all the isolates belonged to type A and 48.7% of them contained the *cpb2* gene. Type A subtype  $\beta$ -2 isolates showed expression of *cpa* genes in 100% of strains and *cpb2* gene in 71% of the analyzed strains. The isolate from 1-day-old piglets demonstrated both *cpa* and *cpb2*.<sup>15</sup>

CPC occurs in most pig-producing countries; necrotic enteritis has even been seen in isolated communities in Switzerland.<sup>16</sup> In Switzerland it occurs on breeding farms that do not vaccinate for CPC.<sup>17,18</sup>

It may be transmitted from piglet to piglet but the source is usually sows' feces. It often follows the introduction of new stock to a farm and then may occur for a few months. If regular imports are made it may last for 15 months. They are usually present in small numbers in the feces of sows but are capable of outgrowing the other flora in the neonatal pig gut and eventually multiply in huge numbers.

The organism persists in the environment as spores that are resistant to heat, disinfectants, and ultraviolet light.

The epidemiology of CPA has been studied on Ontario farms with special reference to *cpb2*-positive isolates.<sup>19</sup> The conclusion was that if type A strains were involved in neonatal enteritis then there might be strains that were not identified by the existing genotyping system. In this study the

cpb2-positive and expressing CPB2 population was clonal, and this lineage appeared to be adapted to the young piglet. This was the first time this was established at the farm level.

CPA infections usually occur in the first week of life and sows are the source of infection. It is ubiquitous in the gut and the soil, and there are some strains that cause disease and others that do not, but at the moment it is not possible to tell them apart unless CBP2 positivity is shown on PCR. There are likely to be spores formed and the organism can be found in feed.

CD has appeared worldwide but particularly in Canada, the United States, France, and recently the Netherlands. Nearly two-thirds of piglets in major swine-producing areas in the United States have CD with some herds having 100% infection. It may reflect the routine use of antibiotics and also bad husbandry and hygiene. In a study in Spain,<sup>20</sup> the bacteria were recovered from newborn piglets (25.9%) and were not recovered from 1- to 2-month-old pigs. Genes for the production of both toxins were found in most of the isolates, and only a few had neither of the toxin genes. In this study there was no clear link between bacterial isolation and neonatal porcine diarrhea. A longitudinal study comparing CD in conventional and antimicrobial-free pigs at farm and slaughter<sup>21</sup> showed that CD was at its highest in both systems in the farrowing house and decreased with age. At slaughter it was very low in both carcasses and equipment. Toxinotype V was the most common type isolated at about 90% and the others were type XIII. The authors found antibiotic resistance regardless of antibiotic use on the farm.

In a study of acquisition of CD by piglets in the Netherlands a group of six sows, their crates, and their litters were studied.<sup>22</sup> Within 48 hours of birth all 71 piglets were positive for CD. One was positive within 1 hour. All six sows were positive within 113 hours, and the crates were intermittently positive. CD was found in the air and on the sow's teats. All were O78 and as in most of the Netherlands the same clonal spread except one isolate. This study showed that O78 spreads easily through the sows, piglets, and the environment. Vertical transmission was not found and is not likely to be a factor.

Piglets may be infected within 1 hour of birth, but there is no vertical transmission. The high prevalence of CD ribotype O78 in Iberian wild pigs has been demonstrated<sup>23</sup> as well as its occurrence in feral pigs.<sup>24</sup>

In a study in Switzerland,<sup>25</sup> no CD was found in pigs or ground meat.

In a study of slaughter pigs in the Netherlands, a higher incidence of CD was found than was expected.<sup>26</sup> The prevalence was 8.6%, and 16 different ribotypes were identified with O78 the most common. No specific farm factors were identified associated with the prevalence of CD.

A similar study in 2011 showed a high prevalence of CD ribotypes in pigs arriving at the slaughterhouse.<sup>27</sup> The results showed that pigs had CD ribotypes after they were stunned and bled in a slaughterhouse. Pigs from 9/10 different farms were positive with seven different PCR ribotypes, and O15 was the predominant ribotype.

In a recent study in the United States,<sup>28</sup> 88% of the pigs had a single strain of CD (196/223 pigs) but 12% carried multiple strains. This was the first report of multiple strains in one pig. Overall this study showed that a significant percentage of strains were toxigenic and often are associated with AMR genes, although they are not resistant to drugs that are used to treat CD infections.

*C. difficile* genotypes in piglet populations in Germany have been described.<sup>29</sup> The organism was isolated from 73% of rectal swabs from piglets. The rate of isolation was at 68% postpartum, 94% in animals from 2 to 14 days of age, and declined to 0% after 49 days of age. There was no link between isolation and antibiotic treatment. This study demonstrated that the human pathogenic PCR ribotypes 078 and 126 are dominant in piglets in Germany. The presence of CD in pigs is correlated with animal age but not with antibiotic treatment or clinical disease.

### PATHOGENESIS

The type C organisms colonize the neonatal bowel within 24 hours of birth. They can multiply very rapidly in the absence of colostral immunity and attach to the jejunal epithelial cells at the tips of the villi. These then slough off and the organisms proliferate along the basement membrane. Necrosis is extensive and hemorrhage follows. The necrosis may extend through the gut wall to the muscular layers. Then there may be perforation and peritonitis. The lethal and necrotizing  $\beta$ -toxin is the key factor.<sup>30</sup> The  $\beta$ -toxin binds to the endothelial lining of vessels showing early signs of thrombosis. Initially, it binds to small-intestinal mucosal endothelial cells in the early stages of experimentally induced CPC.<sup>31</sup> It disrupts the actin cytoskeleton of the cell and causes cell border retraction and cell shrinkage followed by cell death.<sup>32</sup>

Trypsin secretion deficiencies and colostrum protease inhibitors probably account for the susceptibility of piglets less than 4 days old.

The toxin has been found in the intestinal contents and the peritoneal fluid. This suggests that death may be caused by the effects of intestinal damage and toxemia.

Type A pathogenesis is not understood but it is likely to be similar to type C without the attachment of organisms to the epithelium. Attachment and invasion do not occur in experimental infections, but epithelial necrosis does occur in these, although less obviously than in natural cases. There is a minimum of lesions, which suggests this is a secretory diarrhea. CPB2 is likely to be a

marker of virulence because it occurs in >90% of natural enteritis cases but is rarely found in normal pigs. The role of the toxins is still uncertain, and the association of neonatal diarrhea requires the isolation of large numbers of cpb2-positive bacteria and the exclusion of other causes. In swine the CPB2 is nearly always the consensus type and is almost invariably expressed. The CPA nearly always belongs to a clonal type. Diarrhea disease isolates nearly all carry the CPB2 compared with a smaller proportion of CPB2-positive isolates from healthy pigs.

CD is likely to possess pili, capsule, and degradative enzymes but toxins are essential to produce the clinical picture. The two toxins produced by CD are the largest known bacterial toxins. A type of enterotoxemia is associated with the presence of monomeric CD toxin A (TcdA; 308 kDa). It causes fluid production in the intestine. Toxin B ((TcdB; 270kDa) does not appear to bind to any tissue nor does it produce lesions in explants,<sup>34</sup> but it appears to be a cytotoxin that is extremely toxic to cultured cells. Both toxins are internalized by target cells and disrupt the cytoskeleton. There is cessation of enzyme production and cell division. Degranulation of mucosal mast cells and release of inflammatory mediators follows with resultant tissue damage. The key event appears to be the receptor-mediated endocytosis in intestinal epithelial cells.<sup>35</sup>

A pore-forming toxin has been identified in necrotic enteritis strains of *C. perfringens*.<sup>36</sup>

A large survey of AMR and toxin genes in commercial swine was undertaken.<sup>37</sup> In young pigs, sampled at farrowing time, 73% had CD, and it was isolated from 47% of sows. Only one pig was positive in the nursery and no finishing pigs were positive. Resistance to ciprofloxacin was found in 91.3% in young pigs and in 94% of sows. The profile ciprofloxacin-erythromycin-tetracycline was detected in 21.4% of the piglets and 11.75 of the sows. Most had TcdA (65%), TcdB was found in 84%, and the binary toxin CdtB was found in 77%. The presence of CD spores in the feces of food-producing animals represents a risk for contamination of meat products.<sup>38</sup> In colon explants, toxin A produces cell swelling, swelling of mitochondria and other organelles, distension of cytoplasmic vesicles, expansion of paracellular spaces, apoptosis, and necrosis.<sup>35</sup>

*C. perfringens* type E rarely causes damage in the pig gut but it can in weaned pigs and does so when maternal antibodies have disappeared.

### CLINICAL SIGNS

In all three forms of intestinal clostridiosis it is likely that the picture varies with immune status and age of the pig.

In CPC the pigs are normal at birth, and in peracute cases there is often sudden death

without other clinical signs. There may also be hemorrhagic diarrhea with perineal staining. Affected pigs are weak, reluctant to move, and become rapidly moribund. They may then be crushed or starve to death. Many pigs are found dead within 12 to 36 hours.

In acute cases, the piglets may survive 1 to 2 days after the onset of clinical signs. The feces may be reddish brown (bloodstained) with tissue debris and perineal staining, and they rapidly become dehydrated, weak, and die.

In subacute cases there is yellow diarrhea without blood, but they become progressively emaciated, may pass tissue flakes, and become very thin, dehydrated, and then die usually at about 5 to 7 days of age.

Chronic cases may have intermittent diarrhea for more than 1 week. The feces are yellowish gray and mucoid, and the tail and perineum may be fecal stained. Lesions are not visible through the serosa.

In CPA cases the condition may occur over 10 to 21 days, but there is often a creamy diarrhea within 2 days of birth, the piglets have a rough hair coat, and there is perineal fecal staining. Diarrhea may last up to 5 days and may become mucoid and pink. Most piglets recover but some may be growth retarded.

In CD cases the piglets are affected between 1 and 7 days of age and quite often they are born to gilts. The prevalence decreases with age and is uncommon after 60 days of age. They present with a history of early onset scours, and occasionally with respiratory distress. The piglets develop dyspnea, emaciation, abdominal distension, and scrotal edema. Diarrhea occurs and animals rapidly dehydrate with sunken eyes and perineal staining. It can cause preweaning losses up to 90% but 50% is the norm. There is a suggestion that piglets born to sows that have been treated with fluoroquinolones are more susceptible to CD.

## **PATHOLOGY**

The pathology of hyperacute CPC is characterized by severely hemorrhagic small intestines full of bloodstained pasty feces and bloodstained fluid in the peritoneal cavity. Lesions are usually in the jejunum (may be only a part) and ileum but can almost reach forward to the pylorus. Mesenteric lymph nodes may be congested.

Histologically, there may be necrotic villi with a surface pack of gram-positive organisms on the epithelial surface. The crypts may be necrotic and there may be significant hemorrhage.

The pathology of acute CPC is less severe. The lesions are usually localized and there may be emphysema. Often these lesions are segmental. There may be a fibrinous peritonitis, and the intestinal wall may be thickened with blood and necrotic debris. In the subacute cases, there may be a thickened intestinal wall. The chronic cases may have a

diphtheritic membrane over the jejunum, and the contents are more watery.

Histologically, there is severe villous necrosis with an overlying carpet of necrotic debris, blood, and fibrin with large numbers of gram-positive bacteria.

The pathology of CPA is much less severe. The intestine is usually thin-walled, gas-filled with watery contents, and without blood. The small intestine is often congested. The necrotic areas may be seen on the intestinal surface. The inflammation is mild occasionally with adherent debris. The large intestine does not usually have lesions but may be full of pasty contents. Usually there is nothing to see outside of these gut lesions.

Microscopically, there may be villous tip necrosis. There may be large numbers of organisms on the surface or in the lumen. There is no hemorrhage. The stomach usually has no lesions.

Enterotoxigenic strains may produce superficial mucosal necrosis and villous atrophy. Experimentally, these cases have creamy diarrhea and emaciation with low mortality to profuse bloodstained diarrhea, enteritis, and death.

In CD infections, there is sometimes mesocolonic edema, and the intestines are filled with pasty to watery yellow feces. Many piglets are toxin positive in an infected barn and piglets without signs may be toxin positive.<sup>39-41</sup> Focal suppuration in the colonic lamina propria is the key lesion, and colonic and serosal edema is common. There is frequently an inflammatory infiltrate. There is frequently segmental erosion of colonic mucosal epithelium, and exudation of neutrophils and fibrin into the lumen also occurs. The association of CD toxins and gross and microscopic lesions was evaluated.<sup>42</sup> There was no significant correlation between CD toxins and mesocolonic edema. There was a significant correlation between toxins and colitis and typhlitis. The toxins were isolated in a significant proportion of the healthy pigs, which may represent a significant subclinical reservoir in swine.

## **DIFFERENTIAL DIAGNOSIS**

A presumed diagnosis of type C is formed when the clinical signs, pattern of mortality, and gross and microscopic lesions are evaluated.

A more chronic form may require detection of type C organisms in the lesions. Although it may be confused with coccidiosis, rotavirus, TGE, porcine epidemic diarrhea (PED), it is most likely to be confused with CPA, especially in the less severe forms. This requires bacteriologic culture, toxin detection, or genotyping.

Diagnosis of type A is more difficult because the clinical signs and epidemiology are more equivocal. You can find large numbers of gram-positive organisms particularly in the stomach but also the small

intestine and from feces. Genotyping reveals type A organisms with CBP2 toxin ( $\beta$ -toxin). In a summary of a recent study,<sup>12</sup> it was said that it was impossible to separate healthy and diarrheic piglets on the basis of bacterial numbers in the intestine, the presence of consensus CPB2 in CPA isolates, the expression of CPB in the intestine of pigs, and between diarrheic piglets with known or unknown causes of diarrhea. There was also no association between histologic findings and the presence of CPB2. The exclusion of other agents is not an adequate diagnostic criterion,<sup>12</sup> and the large numbers of cpb2-positive type A CP should be regarded as normal.

A very interesting document was sent to swine practitioners and veterinary pathologists to see how they diagnosed CPA infections.<sup>43</sup> Most practitioners diagnosed it based on the age of the pig affected (1–7 days), and 41% of pathologists were not certain of the diagnosis even based on the isolation of the organism, genotyping, or detection of the toxins and ruling out other pathogens through histopathology.

Diagnosis of CD is by finding the lesions in the colon and by finding TcdA and TcdB in the feces or colonic contents using commercially available enzyme immunoassays.

## **LABORATORY DIAGNOSIS**

### **Bacteriology**

It is possible to smear the intestinal contents and the mucosal lesions. Large gram-positive rods are visible. In culture the organisms are 3 to 5 mm in diameter, gray, and circular after 24 hours on horse or bovine blood agar. The CPC produces an inner zone of hemolysis associated with theta toxin (perfringolysin O) and an outer less complete area caused by the  $\beta$ -toxin. A large gram-positive rod that grows anaerobically and has a double layer of hemolysis is *C. perfringens*.

Toxin testing is then essential. The  $\beta$ -toxin is demonstrated in the intestinal contents or peritoneal fluid. Clonal relationships can be detected by multilocus sequence typing (MLST).<sup>33</sup>

Enzyme immunoassays are now in use to detect the genes for the toxins. An RT-PCR can be used for the detection of CP toxin genes in animal isolates.<sup>43</sup>

The presence of enterotoxin in fecal infiltrates can be confirmed using commercial reversed passive latex agglutination tests, counter electrophoresis, ELISA, and Vero cells. An antigen-capture ELISA for CP  $\beta$ -2-toxin has been developed.<sup>45</sup> PCRs for the genes are also in use. The detection of toxigenic CD in pig feces has been described.<sup>46</sup> The authors developed three different sequences: the triose phosphate isomerase gene *tpi*, specific for CD, and the *TcdA* and *TcdB* genes, which code for the A and B toxins of CD, respectively.

Four different diagnostic tests were used to detect CD in piglets.<sup>47</sup> It was concluded



that all four tests had a low performance as a test for CD in pigs. The RT-PCR was the most appropriate test to screen for negativity in a herd as a first step, followed by toxigenic culture as the second part of the two-step algorithm.

## HISTOLOGY

Large gram-positive rods can be seen in sections. The hemorrhagic lesions can be almost diagnostic.

In many instances the clostridia are found in association with other agents causing diarrhea in the neonate (e.g., rotavirus, TGE, PED, coccidia, cryptosporidiosis).

## TREATMENT

Treatment is of little use in type C cases and prophylaxis is the most important. Protection against type C can be achieved by the use of equine antitoxin in nonimmune sows, or given to the piglets parenterally immediately after birth, when it will usually protect for about 3 weeks.

Treatment is of more use in type A infections and antimicrobials will work.

Treatment of CD may be successful using tylosin. A North American study showed 99% resistance to ciprofloxacin, while 1% showed resistance to tetracycline and 6% to erythromycin.<sup>21</sup>

## CONTROL

For type C infections oral antibiotics such as ampicillin or amoxicillin should be given immediately after birth and continued daily for 3 days. There may be resistance and tetracycline-resistant plasmids have been identified.

Sows should be vaccinated with type C toxoid at breeding or midgestation and 2 to 3 weeks before farrowing. The disease is usually eradicated after one farrowing cycle. Booster injections should be given 3 weeks before the next farrowing. Even after repeated vaccinations and the absence of clinical necrotic enteritis on the farm, CPC can still be detected.<sup>18</sup>

To prevent type A infections autogenous vaccines can be made and toxoids for  $\alpha$ -toxin and  $\beta$ -2-toxin have been used in sows for protecting piglets or some other products used off license. In addition, avoparcin and salinomycin have been used in feed.

For CD there is a limited approach with Bacitracin methylene disalicylate, which can be used in the sows to protect the piglets. It is given at 250 g/tonne for 2 weeks in the feed prefarrowing and in the lactation ration at the same level for 3 weeks.

In a recent study the use of recombinant *C. perfringens* toxoids  $\alpha$  and  $\beta$  produced in *E. coli* elevated antepartum and passive humoral immunity and could possibly be used for the development of a commercial vaccine.<sup>48</sup>

There has also been a suggestion that competitive exclusion with nontoxigenic

organisms can also inhibit CD toxigenic strains.<sup>49</sup> Spores were given to the dams or sprayed on the teats or given orally to the piglets.

## REFERENCES

1. Debast SB, et al. *Environ Microbiol.* 2009;11:505.
2. Bakker D, et al. *J Clin Microbiol.* 2010;48:3744.
3. Khanna S, et al. *Am J Gastroenterol.* 2012;107:89.
4. Kuntz J, et al. *BMC Infect Dis.* 2011;11:194.
5. Goorhuis A, et al. *J Clin Microbiol.* 2008;46:1157.
6. Rupnik M. *Clin Microbiol Infect.* 2007;13:457.
7. Norman KN, et al. *Appl Environ Microbiol.* 2011;77:5755.
8. Keel MK, et al. *Vet Pathol.* 2007;44:814.
9. Songer JG, et al. *Anaerobe.* 2006;12:1.
10. Van Asten AJ, et al. *Vet J.* 2010;183:135.
11. LeBrun M, et al. *Vet Microbiol.* 2006;116:158.
12. Farzan A, et al. *Can J Vet Res.* 2013;77:45.
13. Keel K, et al. *J Clin Microbiol.* 2007;45:1963.
14. Baker AA, et al. *Appl Environ Microbiol.* 2010;76:2961.
15. Kukier E, et al. *Bull Vet Inst Pulawy.* 2012;56:495.
16. Jaggi U, et al. *Schweiz Arch Tierheilk.* 2009;151:369.
17. Wollschlaeger N, et al. *Schweizer Arch Tierheilk.* 2009;151:377.
18. Schafer K, et al. *Vet Rec.* 2012;doi:10.1136/vr.101052.
19. Chan G, et al. *BMC Vet Res.* 2012;8:156.
20. Alvarez-Perez S, et al. *Vet Microbiol.* 2009;137:302.
21. Susick EK, et al. *Vet Microbiol.* 2012;157:172.
22. Hopman NEM, et al. *Vet Microbiol.* 2011;149:186.
23. Alvarez-Perez S, et al. *Res Vet Sci.* 2013;95:358.
24. Thakur S, et al. *J Wildl Dis.* 2011;47:774.
25. Hofer E, et al. *J Food Prot.* 2010;73:973.
26. Keessen EC, et al. *Vet Microbiol.* 2011;154:130.
27. Hopman NEM, et al. *Vet Q.* 2011;31:179.
28. Fry PR, et al. *J Clin Microbiol.* 2012;50:2366.
29. Schneeberg A, et al. *J Clin Microbiol.* 2013;51:3796.
30. Uzal FA, et al. *Infect Immun.* 2009;77:5291.
31. Schumacher VL, et al. *Vet Pathol.* 2013;50:626.
32. Gartner C, et al. *Infect Immun.* 2010;78:2966.
33. Jost HB, et al. *Vet Microbiol.* 2006;116:158.
34. Keel MK, et al. *Vet Pathol.* 2006;43:225.
35. Keel MK, et al. *Vet Pathol.* 2011;48:369.
36. Keyburn AL, et al. *Toxins (Basel).* 2010;2:1913.
37. Thakur S, et al. *Am J Vet Res.* 2010;71:1189.
38. Rodriguez-Palacios A, et al. *Emerg Infect Dis.* 2007;13:485.
39. Bakker D, et al. *J Clin Microbiol.* 2010;48:3744.
40. Hunter PA, et al. *J Antimicrob Chemother.* 2010;65(suppl 1):13.
41. Weese JS, et al. *Anaerobe.* 2010;16:501.
42. Yaeger MJ, et al. *J Vet Diagn Invest.* 2007;19:52.
43. Chan G, et al. *Can Vet J.* 2013;54:504.
44. Albini S, et al. *Vet Microbiol.* 2008;127:179.
45. Kircanski J, et al. *J Vet Diagn Invest.* 2012;24:895.
46. Alvarez-Perez S, et al. *Vet Med.* 2009;54:360.
47. Keessen EC, et al. *J Clin Microbiol.* 2011;49:1816.
48. Salvarani FM, et al. *Vaccine.* 2013;31:4152.
49. Songer JG, et al. *Vet Microbiol.* 2007;124:358.

## ESCHERICHIA COLI INFECTIONS IN WEANED PIGS

Diarrhea is most frequent when pigs are exposed to pathogenic *E. coli* strains. The effect of weaning is to produce a marked decrease in the diversity of coliforms in the individual piglet. Different strains of *E. coli* were predominant in different animals, which may in turn facilitate the spread of pathogenic strains.

Many strains are nonpathogenic. Nonpathogenic *E. coli* supports the physiologic intestinal balance of the host. Pathogenic *E. coli* with VG profiles can cause outbreaks of diarrhea. It was concluded that VG carrying *E. coli* are a normal part of the intestinal bacterial population.<sup>1</sup> Pathogenic *E. coli* can be divided into a variety of pathotypes, but there are three major types. These are ETEC, verotoxin-producing *E. coli* (VPEC), and attaching and effacing *E. coli* (AEEC).

There are two major complicating factors in pigs: one of these is that the intestine has different distributions of receptors with changing age. The other is that nearly all isolates (94.8%) that carry the enterotoxin genes also carry genes for one of the fimbrial adhesins. The two most prominent genotypes are K88, LT1, STb and F18, STa, STb, and SLT.

## Enterotoxigenic Escherichia coli

ETEC have two major virulence factors: (1) adhesins or fimbriae and (2) enterotoxins. The adhesins promote or control the adherence to small-intestinal epithelial cells and include K88, K99, F41, 987P, and F18. Only F18 and K88 are frequently associated with disease in weaned pigs. Only young pigs are susceptible to K99 or 987P. Age-related susceptibility is related to the presence or absence of the appropriate receptors in the small intestine. The enterotoxins belong to two groups; heat-labile enterotoxin (LT) and the heat-stable enterotoxins STa or STb. Only weaned pigs are susceptible to F18, and resistance develops by 8 weeks of age, because the binding appears to be blocked. The receptor for F18 has not yet been identified, but it is a glycoconjugate in which the attached carbohydrate acts as a target for the fimbriae. The F18 adhesin occurs in two forms: ab found in VTEC and ac found in ETEC.

There is also an F4 fimbrial antigen that is on a different chromosome from F18. F4 ETEC cause problems in the first week after weaning, but F18 VTEC cause problems 1 to 2 weeks after weaning.

## Verotoxin-Producing Escherichia coli

These strains produce Shiga toxin or Shiga-like toxins (verocytotoxins) and cause edema disease (ED). Swine VTEC colonize the intestine via the F18 pilus, as do some swine ETEC. It is not uncommon to find F18-positive strains that produce enterotoxins and verotoxins and can cause both diarrhea and ED.

## Attaching and Effacing Escherichia coli

These bacteria possess the *eae* gene, which encodes for intimin. This is an adhesin factor that facilitates the attachment of bacteria to intestinal epithelial cells. It is on a plasmid that is distinct from the K88-encoding plasmid in ETEC and ETEC strains that produce attaching and effacing lesions.



The following strains are found:

- K88 ab, ac, and ad
- F18ab (more associated with ED) and F18ac
- F41, usually associated with K99 fimbriae
- Strains containing LT, STa, STb, Shiga-like toxin 2e (Stx2e), and possibly enteroaggregative *E. coli*

Twenty years ago most of the pig strains were 987 or K99 positive. The genes for Stx2e and F18 were rare then, but are much more common now.

### O157 in Pigs

In a recent survey in Sweden only two O157:H7-positive and four O157:H7-negative strains were found. Pathogenicity is indicated by genes encoding for one or more of the Shiga toxins, but several other factors may also be necessary. Most strains do not possess Shiga toxins but do carry the F4 or F18 fimbrial adhesins. A third of the strains examined produced STa or STb, but less than a third produced STx and half the *eae* gene.

**Postweaning diarrhea (PWD) and ED** are two common *E. coli* infections of weaned pigs. In PWD, there is diarrhea, dehydration, and often death. In ED or enterotoxemia there is subcutaneous edema of the forehead and eyelids, and neurologic clinical signs such as ataxia, convulsions, recumbency, and death. ETEC strains isolated from cases of PWD mainly belong to O Groups O8, O141, O147, O149, and O157. Strains associated with ED predominantly have O Groups O138, O139, or O141. PWD is a significant cause of mortality between weaning and slaughter in some herds. Although the clinical signs in these two diseases are different, they occur in similar age groups, and the same type of management change may precede their occurrence. Weaning and weaning age are both associated with significant effects on the microbial populations. In PWD the bacteria disappear more quickly, usually by about 7 days postinfection (DPI), but in ED they may still be there 9 DPI but with a slower buildup to a peak within 3 to 5 DPI. A typical scenario would be 4 to 5 days PWD followed by clinical ED with mortality reaching as high as 50%. Both are associated with the proliferation of predominantly hemolytic serotypes of *E. coli* within the small intestine. However, it is rare to encounter both diseases concurrently on the same farm. In PWD the serotypes are ETEC and the major manifestation is diarrhea resulting from enterotoxin activity at the time of proliferation. In ED nonenterotoxigenic strains produce a verotoxin that, after a period of time, indirectly produces the neurologic syndrome characteristic of this disease.

One of the features of virulence in *E. coli* is the presence of mobile genetic elements such as plasmids, bacteriophages, and pathogenicity islands. A pathogenicity island coding for F18-positive fimbriae has been found. Cytolethal distending toxins have also

been described. In many countries the prevalence of ED has decreased, whereas coliform gastroenteritis has increased. It is possible that this change reflects the trend toward earlier weaning of pigs, although the emergence and spread of new ETEC strains may also be a factor. More recently a third disease, cerebrospinal angiopathy, has been attributed to the effects of infection with *E. coli*. Although there are some similarities in the etiology and epidemiology of these diseases, they are sufficiently different to warrant a separate description.

One of the major features in common is the process of weaning, which is probably the most serious disturbance a young piglet may face. This change of diet from liquid to solid is also accompanied by a multitude of other changes such as moving, mixing, environmental, and managerial. It also alters immune functions and produces stress and profoundly alters the intestinal microflora, particularly the coliform flora. Some strains may increase but others may decrease.

It is also important to realize that some *E. coli* may also cause fatal shock. They are usually F4 (K88-positive) ETEC (O149, O157, or O8) or ED causing *E. coli* (Stxe). Death occurs before either the diarrhea or the edema is produced. It is probably caused by the rapid release of large amounts of LPS by colonizing ETEC, which then produce a cytokine storm (TNF- $\alpha$ , IL-1, and IL-6). There are usually no clinical signs and minimal lesions including congestion and blood-tinged enteritis.

Systemic *E. coli* infections also occur in pigs of any age but often in the very young when there is little colostral protection. Usually, the infections are ETEC. The clinical signs are quite variable and develop within 12 hours, with as little as distended abdomens on or piglets are found dead within 48 hours on the other.

### EDEMA DISEASE (GUT EDEMA, *ESCHERICHIA COLI* ENTEROTOXEMIA)

ED occurs in weaner and grower pigs and is characterized by subcutaneous and subserosal edema, progressive ataxia, recumbency, and death. Although isolated strains from pigs are unlikely to be associated with severe human disease, healthy pigs cannot be excluded as a potential source of human infection with Stx2e-producing STEC (Shiga toxin producers).<sup>2</sup>

#### SYNOPSIS

**Etiology** *Escherichia coli* strains producing verocytotoxin and Shiga-like toxin

**Epidemiology** In rapidly growing weaner pigs between 4 and 12 weeks of age following change in diet or feeding practices and waning of maternal antibody

**Sign** Sudden death. Incoordination, falling, edema of eyelids and face; piglets die in 6–36 h.

**Clinical pathology** Culture *E. coli* from feces.

**Lesions** Facial edema, full stomach, and mesenteric edema

**Diagnostic confirmation** Culture specific organism

#### Differential diagnosis list

- Pseudorabies
- Viral encephalomyelitis of pigs
- Encephalomyocarditis
- Streptococcal meningitis
- Salt poisoning
- Organic arsenic poisoning
- Mulberry heart disease

**Treatment** None

**Control** Avoid drastic changes in diet.

### ETIOLOGY

ED is associated with *E. coli* strains producing a Stx,Stx2e toxin, which enters the bloodstream and damages vessel walls. Three serogroups cause ED: O138, O139, and O141 and sometimes O147. They are called EDEC and are nearly all  $\alpha$ -hemolytic. The strains have adhesins that enable the bacteria to colonize the intestine and elaborate protein exotoxins. The biochemical phenotypes were studied in Sweden and O138, O139, and O141 are dominated by one phenotypic type, even though others do occur within the serotype. The entire pathogenicity island known as ETT2 is necessary for the ED virulence factors in O138, O139, or O141. Isolates of *E. coli* have been found in which the toxin or F18 fimbrial types were not related to selected electrophoretic types. This suggests that toxin and F18 genes in the isolates from pigs with PWD or ED occur in a variety of chromosomal backgrounds. The bacteria colonize the small intestine without causing significant changes by means of the adherence factor F18 (F107), usually F18ab or occasionally F18ac, as the fimbrial adhesin. The *E. coli* strains with the highest mucin-binding capacity belonged to potential ST toxin producers, whereas strains without genes encoding for toxin production displayed a much weaker binding to mucin capacity. In a recent outbreak in Denmark, in which ED had not previously been observed, most isolates were O139, but a few were untypeable. All the isolates from the Danish pigs with ED were in one cluster in contrast to isolates from other countries, which did not form any clusters. In the Denmark study, 563 isolates were serotyped and O149 was found in 49.9% of the isolates, O138 in 14.9%, O139 in 6.9%, O141 in 4.1%, and O8 in 3.7%. The VGs were examined and they fell into six pathotypes that covered 65.7% of all isolates. The F107 fimbriae are a major colonization factor in *E. coli* that causes ED.

### Inheritance of Susceptibility to ED

Inheritance of resistance to intestinal colonization with *E. coli* causing ED is thought to be under the control of one locus consisting of two alleles with susceptibility (S)-dominating resistance(s). Genetic susceptibility to ED is caused by the ability of F107-expressing *E. coli* to adhere to and colonize intestinal brush border cells and not toxin susceptibility. There is a high correlation between intestinal F18 receptor genotype and susceptibility to disease, but pigs with resistant F18 receptor genotypes were not entirely protected against colonization by *E. coli*.

### EPIDEMIOLOGY

Possibly the most significant factor in the development of ED is the loss of milk antibodies at weaning. The environment of the weaner unit is the most likely source of the *E. coli*, either from other weaned pigs or from a dirty environment. Not all infected pigs develop the disease.

The specific serotypes of *E. coli* that may cause disease are introduced into a piggery and become part of the normal intestinal flora. They may not cause disease until a particular set of environmental conditions arises, such as when they proliferate excessively within the intestine to produce toxin. The disease occurs predominantly in pigs between 4 and 12 weeks of age. It may occur sporadically but more commonly occurs as an outbreak affecting up to 50% of the pigs within the group. Characteristically, the larger and faster growing pigs within the group are affected. The disease is not common in runt or poorly thriving pigs. Age at weaning, diet, overcrowding, chilling, transportation, and other factors influence the susceptibility of pigs to *E. coli*-producing SLTIIe, and could determine whether subclinical or clinical ED occurs following infection. Piglets fed high-protein diets are more susceptible to experimental clinical ED than piglets fed low-protein diets. The disease frequently occurs within 1 week following a change in diet or ad libitum feeding but may also follow such factors as weaning, vaccination, pen change, and regrouping. A study even found VPEC O139 in water storage tanks and drinking water.

F18 fimbriae have increased greatly since 1997 from 10% to 70%, and this may be tied into the genetic selection of the stress gene.

The outbreak is sudden in onset but short-lived, averaging 8 days and seldom exceeding 15 days. The epidemiology of the disease in affected herds is not characteristic of a highly contagious disease, and it does not usually spread to involve other pens of pigs on the same farm.

The disease follows proliferation of the relevant serotypes within the intestine. Serotypes of *E. coli* associated with gut edema may be isolated from the feces of healthy

pigs. The factors initiating proliferation are unknown, but changes in the composition or amount of diet commonly precipitate the onset. Management factors that potentiate oral-fecal cycling of these organisms are likely to be important to spread within the group.

### PATHOGENESIS

A number of F18ab or F18ac strains produce both enterotoxins and Stx2e, and in these cases PWD is usually more common than ED. There may also be mixed infections of both ETEC and EDEC strains in which diarrhea usually predominates.

The F18 receptors important in ED are not fully expressed in pigs under 20 days of age. The F18-positive strains cause ED about 5 to 14 days after weaning. The fimbrial receptors can be moderated by lectins in the diet, and this may be the reason that the F18 colonization is reduced after weaning. Toxemia resulting in severe edema in specific sites that have absorbed Stx2. Colonization by EDEC develops on the tips and sides of the villi in the distal jejunum and ileum. The Stxe is absorbed into the circulation and causes vascular damage to the target organs. It is not normally absorbed, but is under the influence of unknown factors that may include bile. Absorption causes a degenerative angiopathy of small arteries and arterioles. In the brain the changes may be exacerbated by the anoxia that results from the slow blood flow.

It is a simple progression. The intestine of a susceptible pig, which is usually fast-growing and without maternal antibody, has receptors for F18 pili. This appears to be the major factor, and then colonization by *E. coli* occurs with toxin production, absorption of toxin, and damage to vascular epithelium. The endothelium appears to have a specific toxin receptor for Stx2e, and finally edema develops in target tissues. Epithelial receptors for pathogenic ED are not found in all pigs. The receptors for both F14 are on one chromosome (13) and for F18 on another.<sup>3,4</sup> The numbers of *E. coli* rapidly proliferate when infected to levels of 10<sup>9</sup>/g feces.

Nutritional factors and gastrointestinal stasis result in proliferation of the *E. coli* strains in the small intestine and toxin production. There is generally a delay between the initial period of maximal intestinal proliferation and the onset of clinical signs. In the experimental disease, clinical signs occur 5 to 7 days following initial oral challenge with bacteria and up to 36 hours following intravenous inoculation with toxin. The delay appears to be related to the development of vascular lesions, with increased vascular permeability leading to edema formation and encephalomalacia. The experimental oral inoculation of the ED-producing *E. coli* results in colonization of the small intestine, and lesions of the vessels of the

intestinal mucosa are detectable as early as 2 days after infection. An experimental model for subclinical ED in weaned pigs has been described. Microscopic vascular lesions were found in pigs 14 days after oral inoculation with a SLT2-positive strain of *E. coli*. Once PWD occurs there is an increased intestinal permeability that predisposes to ED, and once developed the influx of SLT toxin into the bloodstream is facilitated further, precipitating the disease. ED is associated with metabolic acidosis, which might be explained by endogenous acid production and small-intestinal acidosis. Intestinal acidosis is known to cause mucosal hyperexcitability.

### CLINICAL FINDINGS

PWD and ED can occur simultaneously. The case mortality rate varies from 50% to 90%. It may appear suddenly and disappear suddenly. Recurrence on premises is not unusual. It usually occurs after weaning but can occur at any time.

The diseases occur sporadically and unexpectedly in a group, often affecting a number of pigs within a few hours, and show no tendency to spread from group to group. The thriest pigs are most likely to be affected and, once the diagnosis is made, all pigs in the pen should be examined in an attempt to detect other animals in the early stages of the disease. The incidence in a litter will vary up to 50% or more.

Quite often pigs may become inappetent, with swelling of the eyelids and forehead. The earliest and most obvious sign is incoordination of the hindlimbs, although this may be preceded by an attack of diarrhea. The pig has difficulty in standing and sways and sags in the hindquarters. There is difficulty in getting up and in getting the legs past each other when walking because of a stiff, stringhalt-like action affecting either the forelegs or hindlegs. In some cases there are obvious signs of nervous irritation manifested by muscle tremor, aimless wandering, and clonic convulsions. Complete flaccid paralysis follows. A peculiar squeal may also be heard. There is usually no diarrhea or fever. There may be pruritus. In the terminal stages there may be a watery diarrhea.

Subclinical disease may occur when pigs are clinically normal and may then develop vascular lesions and have a slow growth rate.

On close examination, edema of the eyelids and conjunctiva may be visible. This may also involve the front of the face and ears but cannot usually be seen until necropsy. The voice is often hoarse and may become almost inaudible. Blindness may be apparent. The feces are usually firm, and rectal temperatures are almost always below normal. The course of the disease may be very short, with some pigs being found dead without signs having been observed. In most cases, illness is observed for 6 to 36 hours, with a few cases being more prolonged. Recovery does sometimes occur,

but some degree of incoordination may persist.

### CLINICAL PATHOLOGY

As an aid to diagnosis, while affected animals are still alive, fecal samples should be cultured to determine the presence of hemolytic *E. coli*. Knowledge of the drug sensitivity of the organism may be important in prescribing control measures. The ED principle is cytotoxic to Vero cells and may be useful in an assay system for diagnosis. The toxin Stx2e has been detected in the peripheral blood of pigs with clinical disease, which not only shows that toxin is transported but may eventually lead to a technique for the detection of early cases.

### NECROPSY FINDINGS

The pig is well grown for its age, the stomach is full of feed, and the feces are usually normal. Edema is variable. Edema of the eyelids, forehead, belly, elbow and hock joints, throat, and ears is accompanied by edema of the stomach wall and mesocolon in classical cases. The gelatinous edema may be very thick around the stomach and mesentery. The mesocolon is also edematous and edema of the gallbladder is sometimes observed. The lymph nodes may be swollen and edematous. Quite often the stomach is full of dry food. Colonic contents may be reduced. There may be pulmonary edema and petechial hemorrhages in the epicardium and pericardium. Excess pleural, peritoneal, and pericardial fluid is also characteristic, and the skeletal muscles are pale. The edema may often be slight and quite localized, so examination of suspected areas should be performed carefully, using multiple incisions, especially along the greater curvature of the stomach near the cardia. Hemolytic *E. coli* can be recovered in almost pure culture from the intestine, particularly the colon and the rectum, and in some cases from the mesenteric lymph nodes. Polyclonal antisera directed against serotypes of *E. coli* associated with ED are used to confirm the diagnosis via an agglutination test.

In some cases, an atypical hemorrhagic gastroenteritis has been described with marked edema, but the mucosae of the small and large intestine show extensive hemorrhage and there is a watery diarrhea, followed by death.

There may be multifocal encephalomalacia in the brainstem together with typical lesions in small arteries and arterioles.

Histologically, the important lesions are mural edema, hyaline degeneration, and fibrinoid necrosis in arteries and arterioles. Sometimes the lesions are minimal and difficult to recognize. In subacute to chronic cases this angiopathy may result in focal brain hemorrhages and encephalomalacia. Patchy layers of bacteria are adherent to distal jejunal and ileal mucosa but have often disappeared by the time the pig dies.

### Samples for Confirmation of Diagnosis

- **Bacteriology:** Ileum and colon (CULT); culture of the types of *E. coli* and confirmation of serotype and virulence factors is essential. In ED a large number of the *E. coli* may have disappeared. The presence of hemolytic *E. coli* is not diagnostic for ED because there are some strains of EPEC that can cause ED but are nonhemolytic. There are more cases of mixed infections with *E. coli* now than before. The differentiation of pathogenic and nonpathogenic *E. coli* can be achieved through PCR. A multiplex PCR has been developed for STa, STb, K99, 987P, and F41.<sup>5</sup> A multiplex PCR assay for nine different virulence factors associated with *E. coli* that cause ED in swine is available.<sup>6</sup> The tests tell you that the gene is present but not whether it is actually encoding for the proteins.
- **Histology:** Formalin-fixed colon, ileum, jejunum, gastric fundus, brain, and mesenteric lymph node (LM).

### DIFFERENTIAL DIAGNOSIS

The appearance 2 weeks postweaning is suggestive, as are visible edema and nervous signs. Although there are a number of diseases of pigs in the susceptible age group in which nervous signs predominate, gut edema is usually easy to diagnose because of the rapidity with which the disease strikes, the number of pigs affected at one time, the short duration of the outbreak, and the obvious edema of tissues. Affected pigs are usually in prime condition. The ataxia and recumbency must be differentiated from diseases of the nervous system of pigs that cause ataxia and recumbency. These include pseudorabies, viral encephalomyelitis (Teschen disease), encephalomyocarditis, streptococcal meningitis, salt poisoning, and organic arsenic poisoning. Mulberry heart disease and encephalomyocarditis can produce similar signs, and differentiation on necropsy findings and histopathology is necessary. In poisoning by *Amaranthus* spp. and *Chenopodium album* the signs may be roughly similar, but the edema is limited to the perirenal tissues.

### TREATMENT

Sick pigs should be treated initially with antimicrobials and electrolytes parenterally because they do not eat or drink. Administration in water may then follow. Treatment is ineffective. Elimination of the toxin-producing bacteria may be attempted by use of antimicrobials in the feed or water supplies. The choice of antimicrobial will vary depending on area variations of the drug sensitivities of *E. coli*. The drug should be highly active in the lumen of the gut (possibly fluoroquinolones, cephalosporins, apramycin, ceftiofur, neomycin, or trimethoprim),

depending on the prescribing rules in each country. The feed consumption of the unaffected pigs in the group should be reduced immediately and then gradually returned to previous levels over a period of a few days. Recovered pigs have protective antibodies to Stx2e.

### CONTROL

Nurseries should be managed as all-in/all-out facilities and properly cleaned, disinfected and dried, and rested before the next arrivals. Correct temperatures for weaning and the avoidance of cooling drafts are especially significant.

The strains of PWD and ED of all the *E. coli* are the ones that are likely to show the most antibiotic resistance.

Pigs should be kept on the same creep feed for at least 2 weeks after weaning, and the change in feed should be made gradually over a 3- to 5-day period. Feed restriction through the critical period is frequently practiced and may reduce the occurrence of ED. Similarly, an increase in crude fiber and decrease in nutrient quality of the diet through this period may reduce the incidence. However, it is evident that a severe restriction and marked decrease in nutrient quality is required to fully achieve this effect, and this is not compatible with the purpose of growing pigs. It is essential that pigs on restricted intakes be provided with adequate trough space to allow an even intake of food among the group. For similar reasons, litters of pigs that are batched at or after weaning should be divided into groups of approximately equal BW.

The strategic incorporation of an antimicrobial into the feed during the risk period may be necessary on some farms. A reduction in the potential for oral-fecal cycling of organisms in the group may reduce the incidence of ED. A reduction in the age of weaning may also reduce the incidence. Both organic acids and medication with 50 ppm of enrofloxacin are useful in controlling and/or preventing PWD or ED.

Treatment with anti-VT2E serum can provide protective immunity against ED in pigs.

Spray dried porcine plasma has helped because it contains specific anti-ETEC antibodies. The use of eggs from previously vaccinated hens has also been used.

No successful vaccine is available to produce the increased levels of IgA required to neutralize the attached *E. coli*. A new recombinant vaccine has been developed for a Stx22e subunit vaccine.<sup>7</sup> Only vaccines with the preformed fimbriae induce protection, and this is limited to the homologous variant but, experimentally, vaccination of piglets with a genetically modified Shiga-like toxin 2e prevents ED following challenge with the Shiga-like toxin after weaning. The concentration of protein in the diet also influenced susceptibility to ED. Pigs fed a



low-protein diet and not vaccinated developed subclinical ED. Pigs fed a high-protein diet and not vaccinated developed clinical ED. Pigs fed a high-protein diet and vaccinated had a reduction in the incidence of subclinical edema and did not develop clinical ED.

## REFERENCES

- Schierack P, et al. *Appl Environ Microbiol.* 2006;72:6680.
- Zweifel C, et al. *Vet Microbiol.* 2006;117:328.
- Bao WB, et al. *Mol Biol Rep.* 2012;39:3131.
- Barth S, et al. *J Vet Diagn Invest.* 2011;23:454.
- Han W, et al. *Appl Environ Microbiol.* 2007;73:4082.
- Casey TA, et al. *J Vet Diagn Invest.* 2009;21:25.
- Florian V, et al. *Proc Int Pig Vet Sci.* 2012;22:77.

## POSTWEANING DIARRHEA OF PIGS (COLIFORM GASTROENTERITIS)

PWD is common within several days after weaning and is characterized by a reduced growth rate associated with alterations in the mucosa of the small intestine and, in some pigs, by acute coliform gastroenteritis characterized by sudden death, or severe diarrhea, dehydration, and toxemia. It is a major cause of economic loss from both mortality and inferior growth rates for several days to 2 weeks following weaning. The etiology, epidemiology, and pathogenesis are multifactorial and complex because of the several weaning-associated factors that may interact. In some instances the PWD may be followed by ED.

### SYNOPSIS

**Etiology** Specific serotype of enterotoxigenic *Escherichia coli*

**Epidemiology** Three to 10 days postweaning; high morbidity and case-fatality rates. Stressors of weaning are risk factors (change of feed, loss of maternal contact and maternal antibody, mixing litters, and environmental changes)

**Sign** Some pigs found dead. Outbreaks of severe diarrhea a few days postweaning. Fever, dehydration, anorexia, loss of weight, and death in a few days

**Clinical pathology** Culture organism from feces and intestinal contents.

**Lesions** Dehydration, serofibrinous peritonitis, fluid-filled intestines, and mesenteric edema

**Diagnostic confirmation** Isolate specific serotypes of *E. coli*.

#### Differential diagnosis list

- Gut edema
- Swine dysentery
- Salmonellosis
- Erysipelas
- Pasteurellosis

**Treatment** Antimicrobials in water supply

**Control** Minimize stress at weaning. Antimicrobials in feed and water postweaning. Intestinal acidification. Zinc oxide in diet postweaning

## ETIOLOGY

Some strains of *E. coli* can cause both ED and PWD. The key feature is the disappearance after weaning of antibodies to *E. coli* previously provided by milk. The disease is associated with ETEC that produce adhesion factors that allow colonization of the intestine and mediated by enterotoxins that induce the intact intestinal mucosa to secrete fluid. It can also be caused by EPEC that do not possess any of the virulence factors of PWD or ED. A summary would be that PWD is associated with fimbrial types F4 (K88) and F18 variants (F18ac or F18ab as fimbrial adhesins)<sup>1,2</sup> and carrying the genes for the Shiga-like toxin 2 (SLT-2E), LT, and/or Shiga toxin A and B (STa or STb). Toxin and F18 fimbrial genes in *E. coli* isolated from pigs with PWD or ED occur in a variety of chromosomal backgrounds. The three F4 receptors (F4ab, F4ac, and F4ad) are encoded on distinct loci.<sup>3</sup> Nearly all are  $\alpha$ -hemolytic and belong to a limited number of serotypes.

The presence of the F4 receptor was associated strongly with pigs being high shedders of *E. coli*.<sup>4</sup> Most commonly, F4 is serotype O149, and F18 is serotype O 139, O138, O141, O149, and O157, which are associated with the disease. Most serotypes appear to be O149:STaSTbLT:F4 (K88). The strains of O149 isolated in recent years from weaned pigs with diarrhea possess the gene for an additional enterotoxin STa, which older strains lack. Of the new strains that correspond to O149 H10, 92% code for this gene. This enteroaggregative *E. coli* heat-stable enterotoxin 1 (*EAST 1*) gene is found in isolates from weaned pigs that have diarrhea or ED. The F107 fimbriae can be found in association with PWD isolates, and other adhesive fimbriae such as Av24 and 2134P have been described. Many ETEC isolates colonize the small intestine of weaned pigs but lack known colonization factors. The serogroups of *E. coli* isolated from pigs with PWD in piggeries in Spain include strains that produce the ETEC and VTEC *E. coli* and cytotoxic necrotizing factor toxins. The disease can be reproduced consistently in weaned pigs, provided the pig's epithelial cell brush borders are susceptible to the adhesin of strains of *E. coli* with fimbrial antigen F4 (K88). The DNA sequences coding for the F18 fimbrial antigens and AIDA adhesin are on the same plasmid in *E. coli* isolated from the cecum. Usually they were LTSTb or STb (13%) and 12% were hemolytic and F18-positive. The remainder were nonhemolytic, belonging to the K48 serogroup.

Although there is an etiologic similarity between PWD and neonatal enteric colibacillosis in suckling piglets, the relationship is not exact. Strains associated with neonatal enteric colibacillosis may not have the ability to produce PWD, and many strains isolated from coliform gastroenteritis lack K88<sup>+</sup> antigen.

Cytotoxic necrotizing factor strains of *E. coli* have been isolated from weaner pigs with necrotic enteritis in South Africa.

Some nonenterotoxigenic O45 isolates of *E. coli* associated with PWD produce AEEC, and their proliferation may be associated with diet. Dual infection with AEEC may also be associated with PWD.

Infection with rotavirus may be an etiologic factor. The rotavirus may infect and destroy villous epithelial cells of the small intestine, which may allow colonization of the *E. coli*. Experimentally, a high nutrient intake fed three times daily to piglets weaned at 3 weeks of age produced the most prolonged diarrhea, colonization of the intestine by hemolytic ETEC, and persistent shedding of rotavirus. However, other observations cast doubt on the importance of rotaviruses as a cause of the diarrhea, because rotaviruses may be found in the feces of pigs without diarrhea a few days after weaning. The acute disease can be reproduced using K88 *E. coli* strains without concomitant infection with rotavirus.

A number of F18ab-positive or F18ac-positive strains produce enterotoxins and Stxe, and in these strains it is more likely that PWD will occur rather than ED.

## EPIDEMIOLOGY

It is found worldwide and in a single geographic area a serotype may predominate.<sup>46</sup> Occasionally different serogroups may be involved in an outbreak.

PWD occurs predominantly in pigs 3 to 10 days after they are weaned. There is considerable variation in the morbidity and mortality between groups, rooms of pigs, and buildings. The age group clinically affected varies with pig age and diet. F4 receptors are expressed in pigs of all ages, but F18 is not fully expressed until pigs are 2 to 3 weeks of age. The diet may push back the time of PWD to as far as 6 to 8 weeks after weaning if substances such as zinc or acidifying agents are added to the diet.

Most outbreaks are in early weaned pigs. Infections are usually picked up from the environment. Most commonly, pigs are first observed sick or dead on the fourth or fifth day. The spread within affected groups is rapid and a morbidity rate of 80% to 90% of the group within 2 to 3 days is not uncommon. Frequently, other pens of susceptible pigs within the same area will also develop the disease within a short period of the initial outbreak. The problem may persist within a herd, affecting successive groups of weaned pigs over a period of weeks or months. The



onset of the problem may be associated with the introduction of a different batch or formulation of the creep feed. The case-fatality rate may be as high as 30%, and survivors may subsequently show a reduced growth rate. The weaning of piglets at 3 weeks of age is commonly followed in a few days by a postweaning reduction in growth rate, variations in total dietary intake, and the development of diarrhea. Piglets weaned at 3 to 4 weeks of age into an uncomfortable dirty environment appear especially susceptible.

The proliferation of *E. coli* in the intestine following weaning appears secondary to some underlying gastrointestinal disturbance. After weaning there is a progressive increase in viscosity of the intestinal contents, which alters the intestinal structure and growth and stimulates the proliferation of ETEC in newly weaned pigs. In all groups of pigs examined the number of serotypes or diversity of intestinal flora was reduced in the first week after weaning. The disease is associated with an earlier, more prolonged and greater proliferation of ETEC in the small intestines than occurs in healthy pigs after weaning. Some studies have shown that susceptibility to adhesion with K88<sup>+</sup> ETEC is a requirement for the production of the disease. Experimentally, pigs that did not have the adhesin receptor did not develop diarrhea when challenged with K88<sup>+</sup> *E. coli* and when in the same environment as the adhesin-positive pigs.

It is believed that several factors commonly associated with weaning predispose pigs to PWD associated with ETEC. Some of these risk factors include:

- Stress from loss of maternal contact
- Introduction to strange pens and penmates
- Inadequate ventilation in the weaning pens
- Reduction in ambient temperature
- Change in diet
- Cessation of lactation immunoglobulins
- Decreased gastric bactericidal activity attributable to a temporary increase in gastric pH
- Preweaning exposure (creep feeding) to the dietary antigens fed after weaning

Hand-washing and donning clean outerwear did not prevent the transmission of *E. coli*, but showering and donning clean outerwear did.

Experimentally, there is some evidence that the stress of cold ambient temperature (15°C) can result in a greater incidence of diarrhea in weaned pigs than in those housed at 30°C.

The nature and the amount of the diet that the piglet consumes before and after weaning may be a predisposing factor. One hypothesis suggests that a transient hypersensitivity of the intestine may occur if piglets are primed by small amounts of dietary antigen before weaning (creep feeding), followed by ingestion of greater quantities of the diet after weaning. Pigs that develop diarrhea tend to

be those that consume more food after weaning than their contemporaries.

Generally, weaning at 3 weeks of age is associated with alterations in the villous epithelium of the small intestine that result in varying degrees of malabsorption and a reduction in daily growth rate that may last for 2 weeks. There are large rapid reductions in intestinal lactase activity that coincide with reductions in growth rate and a reduced ability to absorb xylose. There is a reduction in villous height and an increase in crypt depth in the small intestine, but these alterations are not necessarily associated with the consumption of creep feed before weaning, which does not support the hypothesis that hypersensitivity to a dietary antigen caused by priming before weaning is a factor. There is now considerable doubt about the validity of the intestinal hypersensitivity hypothesis. Recent experimental work indicates that creep feeding is not required for the production of the diarrhea and does not induce morphologic changes characteristic of an allergic reaction in the small intestine. The presence of nondigested food in the gut lumen favors proliferation of ETEC. Proteins of animal origin may provide some protection.

Dietary manipulation can modify several changes that normally occur in the small intestine of the piglet after weaning. Feeding a sow milk replacer or a diet based on hydrolyzed casein reduces the increases in crypt depth and the reductions in brush border enzymes. The use of an antibiotic to suppress the microbial activity does not alter the changes in the mucosa after weaning.

The ecology of *E. coli* and rotavirus in the stomach and intestines of healthy unweaned pigs and pigs after weaning has been examined. Gastric pH is higher in weaned pigs and may not reach a level sufficient to prevent significant numbers gaining access to the small intestine. This factor can be of importance in pigs weaned in pens where oral-fecal cycling of *E. coli* may provide a massive challenge. After weaning, the hemolytic ETEC serotype O149:K91, K88ac (Abbotstown strain), commonly colonizes the rostral small intestine from lower down the intestinal tract. This serotype has never been found in the gastric contents of weaned pigs. When this serotype is present it tends to dominate the *E. coli* flora at all levels of the intestine. Although rotaviruses are common in the intestinal contents of weaned pigs, the presence of the virus is not necessary for production of PWD.

The loss of lactogenic immunity at weaning may be a risk factor. Milk from sows whose progeny develop PWD contain antibodies capable of neutralizing the enterotoxigenic effect of the homologous *E. coli*. This suggests that the presence of antibody-mediated activity against ETEC may be important in preventing the disease during the nursing period. At weaning this protection is removed and the piglet is unable to

produce its own antibodies rapidly enough to prevent the disease. The stress of weaning does not appear to affect the immune mechanisms of the pig.

The weaning of piglets at birth or at 1 day old is associated with a high mortality rate caused by diarrhea and septicemia. The high mortality rate is associated with a lack of colostral antibodies and the strict hygienic conditions required for the artificial rearing of pigs weaned at birth.

## PATHOGENESIS

Different parts of the porcine intestinal tract may harbor different strains of *E. coli*, and it may be that these strains have different characteristics.<sup>5</sup>

The colonization and proliferation of *E. coli* in the small intestine originates from organisms in the lower part of the intestinal tract. There is a rapid increase in numbers of the organisms in the small intestine epithelium or the mucus covering from the midjejunum to the ileum serotypes of *E. coli* associated with PWD, which may be found in the feces of healthy pigs. The virulence factors for PWD are associated with the F4 and F18 fimbrial antigens that carry the genes for the production of toxins (STa, STb, LT, SLT2a, and SLX2e). The receptor for the F4 adhesin is not found in all pigs. There are five phenotypes based on the susceptibility of brush borders of different pigs to adherence of isolates producing variants F14ab (K88ab), F4ac (K88ac), and F4ad (K88ad). Pigs with at least one copy of the dominant allele for the receptor are susceptible to epithelial cell adherence and therefore colonization. The F18ab variant is expressed by the *E. coli* O139 strain producing Shiga-like toxin and causing ED. The F18ac fimbrial *E. coli* strains often relating to O141 or O157 cause diarrhea by expressing enterotoxins (STa or STb) either together or with or without Shiga-like toxins. STb binds to a particular receptor.<sup>6</sup> The PWD strains also produce LT, which lead to hypersecretion of electrolytes and water.<sup>7,8</sup> Following weaning, their numbers in feces normally increase markedly, even in pigs that remain healthy. The *E. coli* proliferate in the small intestine and produce an enterotoxin that appears to attach to the receptors. This triggers the uptake of calcium into the cell, which results in the excretion of water and electrolytes into the lumen. This causes a net loss of fluid and electrolytes to the lumen and subsequent diarrhea. After weaning, the net absorption of fluid and electrolytes in the small intestine of pigs is temporarily decreased.

In porcine EPEC the intimin binds to its receptor on the apical surface of the cells of the small and large intestine<sup>9,10</sup> with most in the colon and the duodenum. How they produce diarrhea is not really understood.

Heat-labile enterotoxins type IIa and type IIb are involved in the pathogenesis of ETEC for neonatal pigs.<sup>48</sup>

The number of hemolytic *E. coli* present in the proximal portion of the jejunum may be  $10^3$  to  $10^5$  times higher in affected pigs than healthy weaned pigs of the same age. The susceptibility of the small intestine to the enterotoxin varies according to area; the upper small intestine is highly susceptible, and susceptibility decreases down through the more distal portions. Unlike many other species, the weanling pig depends largely on its large intestine for absorption of fluid and electrolytes with only small changes in net fluid movement occurring along the jejunal and ileal segments. In fatal cases, death results from the combined effects of dehydration and acidosis resulting from fluid and electrolyte losses. In the peracute and acute forms of the disease, there is a shock-like syndrome with marked gastric and enteric congestion, hemorrhagic enteritis, and death.

The experimental model of the disease is characterized by the three syndromes:

- Peracute fatal diarrhea
- Moderate diarrhea of 3 to 4 days' duration, accompanied by fecal shedding of the inoculated organism and reduced BW gain
- Fecal shedding of the organism with reduced weight gain but without diarrhea

The role of the rotavirus in the pathogenesis of PWD is uncertain. It can be found in the feces of healthy unweaned and weaned pigs. The virus is capable of infecting and destroying villous epithelial cells that could contribute to the partial villous atrophy, loss of digestive enzyme activity, malabsorption, and reduced growth rate. Experimental inoculation of an ETEC and the rotavirus causes a more severe disease than either agent does alone.

Changes in the mucosa of the small intestine of recently weaned pigs have been observed and are the subject of much controversy. There is a reduction in the length of the villi, a marked reduction in intestinal disaccharidase activity, and an increase in the depth and activity of the intestinal crypts. These changes are maximal at 3 to 7 days following weaning, persisting until the second week and coinciding with the reduced growth rate.

### CLINICAL FINDINGS

PWD and ED can occur simultaneously. Usually in PWD mortality is 1.5% to 2.0% but in prolonged outbreaks may reach 25%. The mortality is similar to the neonatal disease but is less severe, and there is a lower mortality. Morbidity may reach 100%. The postweaning reduction in growth rate may affect 50% to 100% of the pigs within a few days after weaning and persist for up to 2 weeks. In some situations diarrhea may not develop in any of the pigs in the group or may be delayed for 6 to 8 weeks. A reduction in feed intake, gaunt abdomens, and lusterless hair coats are characteristic findings of

piglets with postweaning "check." They may appear unthrifty for 10 days to 2 weeks, by which time they will improve remarkably.

It is common for one or two pigs, in good nutritional condition, to be found dead with little seen in the way of premonitory signs. At this time the others within the group may appear normal, but closer examination will reveal several pigs showing mild depression and moderate pyrexia. A postmortem examination of dead pigs should be conducted early in the examination. A proportion of the group will develop diarrhea within 6 to 24 hours, and by 3 days after the initial onset the morbidity may approach 100%. Feed consumption falls precipitously at the early stages of the outbreak, but affected pigs will still drink. Affected pigs may show a pink discoloration of the skin of the ears, ventral neck, and belly in the terminal stages. Diarrhea is the cardinal sign—the feces are very watery and yellow in color but may be passed without staining of the buttocks and tail. Pyrexia is not a feature in individual pigs once diarrhea is evident. Affected pigs show a dramatic loss of condition and luster and become progressively dehydrated. Voice changes and staggering, incoordinated movements may be observed in the terminal stage in some pigs. The course of an outbreak within a group is generally 7 to 10 days, and the majority of pigs that die do so within the initial 5 days. Surviving pigs show poor growth rate for a further 2 to 3 weeks, and some individuals show permanent retardation in growth. In outbreaks in early weaned pigs diarrhea is usually evident before death occurs. There is some evidence to show that PWD may be activated by PRRS.

### CLINICAL PATHOLOGY

Culture of the feces and intestinal contents for ETEC strains of *E. coli* is indicated.

### NECROPSY FINDINGS

Pigs dying early in the course of the outbreak are in good nutritional condition, but those dying later show weight loss and dehydration and occasionally cyanosis. Mild skin discoloration of the ears and ventral areas of the head, neck, and abdomen is usually present. In acute cases there is a moderate increase in peritoneal fluid, and barely perceptible fibrinous tags between loops of the small intestine may be present. The vessels of the mesentery are congested and occasionally petechial hemorrhages and edema are present. The stomach may be distended with dry food, and the small intestine may be dilated with slight edema and hyperemia. The gastric mucosa is congested, and an infarct (ulceration) may be present along the greater curvature. The small intestines are dilated and contain yellow mucoid liquid or occasionally bloodstained material. The mucosa of the small intestine is congested and sometimes there are hemorrhagic areas. The content of the large intestine is fluid to

porridge like in consistency, and the mucosa may be congested. Pigs dying later may be emaciated and smell of ammonia. In some cases mild mesocolonic edema is visible. Hemolytic *E. coli* can be isolated in large numbers from the small intestine and mesenteric lymph nodes. Polyclonal antisera directed against known pathogenic serotypes are usually used to test the isolate, but a negative result does not preclude the strain from being an enteropathogenic organism.

Microscopically, there may be no lesions, but there is usually bacterial adherence to intestinal villi. This is at its worst in the duodenum and the colon. There may be bacteria in the cells in enterocytes, and sometimes these cells disintegrate and lead to sloughing. Other changes are those commonly associated with endotoxemia, especially microvascular thrombosis in a variety of organs.

### Samples for Confirmation of Diagnosis

- **Bacteriology:** Mesenteric lymph node, segment of ileum, colon (CULT); in PWD cases the culture usually yields of hemolytic (ETEC) and nonhemolytic (EPEC) *E. coli*. An RT-PCR assay for the detection of *E. coli* F14 in pig fecal samples by targeting part of the *rfb* sequence specific for this group has been used.<sup>11</sup> A multiplex PCR for nine different virulence factors associated with *E. coli* that cause diarrhea and ED in swine has been described.<sup>12</sup> An RT-PCR for the differentiation of F4 (K88) variants (F4ab, F4ac, and F4ad) of ETEC from diarrheic piglets has been described.<sup>47</sup>
- **Histology:** Formalin-fixed stomach, several segments of small intestine, colon, liver, lung, spleen (LM); colonization of the epithelium can be seen by light microscopy, and confirmed using immunohistochemistry (IHC) or in situ hybridization (ISH).

### DIFFERENTIAL DIAGNOSIS

Postweaning diarrhea is the prime consideration in pigs that are scouring or dying within a 3- to 10-day period after a feed or management change with marked dehydration and low to moderate mortality. The gross lesions and the associated smell are helpful.

Swine dysentery and salmonellosis are manifested by diarrhea and death but they are not necessarily related to weaning or feed change, and both are more common in older growing pigs. Salmonellosis poses the greatest difficulty in initial diagnosis from coliform gastroenteritis. In salmonellosis, the feces are generally more fetid with more mucus, mucosal shreds, and occasionally blood, and the skin discoloration is more dramatic. On necropsy examination enlarged hemorrhagic

*Continued*

peripheral and abdominal lymph nodes and an enlarged pulpy spleen are more suggestive of salmonellosis; however, cultural differentiation is frequently required. If there is doubt, the pigs should be treated to cover both conditions until a final decision is obtained. The onset of swine dysentery is comparatively more insidious than that of postweaning diarrhea; the characteristic feces, clinical and epidemiological pattern, and postmortem lesions differentiate these two conditions.

Swine fever should always be a consideration in outbreaks in pigs manifested by diarrhea and death. However, the epidemiological and postmortem features are different.

Other common causes of acute death in growing pigs such as erysipelas, pasteurellosis, and *Actinobacillus pleuropneumoniae* infection are easily differentiated on necropsy examination.

Edema disease occurs under similar circumstances to coliform gastroenteritis, but the clinical manifestation and postmortem findings are entirely different.

## TREATMENT

### Antimicrobial Resistance and *E. Coli*

In a study in Spain,<sup>13</sup> it was shown that *E. coli* in the pig fecal microbiome were highly dynamic and show a high level of diversity. The finishing pigs showed the lowest levels of AMR. On-farm AMR did not select for the VGs in *E. coli* carried by a population of healthy pigs.<sup>14</sup>

In a study of pigs fed antibiotics it was shown that bacterial biotypes shifted after 14 days of treatment, with the medicated pigs showing an increase in Proteobacteria (1%–11%) compared with the nonmedicated pigs. Antibiotic resistance genes increased in diarrhea and diversity. Some of the new genes conferred resistance to antibiotics that had not been given.<sup>15</sup>

The *E. coli* stored in a storage tank was more diverse than that in fresh feces. The detection of resistance to specific antibiotics was not significantly different.<sup>16</sup>

There may be a horizontal exchange of AMR genes. Almost half (47%) of *E. coli* and *Salmonella* isolated from the same fecal samples showed the AMR genes at the same level.<sup>17,18</sup>

Significant space-time clusters of resistant *E. coli* were found in parts of Denmark.<sup>19</sup> In a study of *E. coli* isolated from pigs in China it was found that most isolates were genetically unrelated. AMR was found in 89% of *E. coli* strains. Most prevalent VG was *East 1*, followed by *Stx2e* and *eaec*. The authors stressed that there was a great need to monitor changes as a result of the high incidence of VG and AMR.<sup>20</sup> The pharmacodynamics of antimicrobials at different levels of the intestinal tract of pigs and their relationship to *E. coli* resistance patterns in the pig have been described.<sup>21</sup> A study of AMR and

virulence profile genes in multidrug-resistant ETEC isolated from pigs with PWD in Australia<sup>22</sup> has shown that nine serogroups were identified, particularly O149. None showed resistance to ceftiofur or enrofloxacin, and 9.4% were resistant to florfenicol. O141 had a higher AMR index than other serogroups. There were few associations between AMR and VGs. The multidrug-resistant ETEC ARG/VG profiles suggested that there was a considerable strain and plasmid diversity reflecting various selection pressures at the individual farm level rather than emergence and lateral spread of multidrug-resistant clones.

A Swedish study showed that, except for resistance to tetracyclines, sulfamethoxazole, and streptomycin, antibiotic resistance is not equally spread across *E. coli* isolates. Tetracyclines should not be the first choice of treatment because of the rapid acquisition of resistance. Nearly all isolates are highly susceptible to enrofloxacin, gentamicin, and neomycin.

It is imperative that treatment of all pigs within the group is instigated at the initial signs of the onset of PWD, even though at that time the majority of pigs may appear clinically normal. Delay will result in high mortality rates. Any pig within the group that shows fever, depression, or diarrhea should be initially hospitalized, treated individually, both parenterally and orally, and the whole group should then be placed on oral antibacterial medication. Water medication is preferable to medication, although the feed is easier to institute, but affected pigs will generally drink (less than usual if sick) even if they do not eat. Neomycin, tetracyclines, sulfonamides, or trimethoprim-potentiated sulfonamides and ampicillin are the usual drugs of choice. Danofloxacin is safe and highly effective. Experimental infection with K88-positive *E. coli* was controlled by ceftiofur sodium given intramuscularly daily for three consecutive days. When pulse dosing is used there appears to be less resistance. In herds with PWD problems, prior sensitivity testing will guide the choice of the antibacterial to be used. Antibiotic medication should be continued for a further 2 days after diarrhea is no longer evident and is generally required for a period of 5 to 7 days.

Consideration should be given to the medication of at-risk equivalent groups of pigs within the same environment. Intra-peritoneal fluid and electrolyte replacement for severely dehydrated pigs and electrolytes in the drinking water should also be considered.

## CONTROL

Recommendations for effective and economical control of postweaning reduced growth rate and PWD in pigs weaned at 3 weeks of age are difficult because the etiology and pathogenesis of this complex disease are not well understood. Epidemiologically, the

disease is associated with weaning and the effects of the diet consumed before and after weaning. In all cases the piglet should be 4.5 kg (10 lb) and preferably 5.5 kg (12 lb) at weaning. Protective antibodies are produced in recovered animals.

A whole variety of techniques, including intestinal acidification; antimicrobial medication in water or feed; environmental modifications; competitive exclusion; feeding probiotics; binding agents such as eggs, milk, or bacterial by-products (most of these studies show they do not work); zinc oxide; or vaccination of sows and piglets with toxoids have been tried. The use of dietary egg yolk antibodies may or may not be effective.

Spray dried plasma powder obtained from pigs immunized with a vaccine containing ETEC fimbrial subunit F4 and LT can reduce diarrhea because of spontaneous antibodies against ETEC.<sup>23</sup> This study showed that the combination of anti-LT and anti-F4 antibodies is most effective.

Intestinal acidification reduces the binding of the *E. coli* to the epithelial surface, and a pH of 3.5 to 4.0 at the trough or nipple drinker is best. Citric acid, formic acid, propionic acid, or a citric acid/copper sulfate mixture can be used.

Zinc oxide in particular stabilizes the intestinal flora. It impacts both host cell and pathogen metabolism and may provide insight into the mechanisms for diarrhea reduction.<sup>24</sup> Piglets given lactose and fiber were least affected, and the next least affected were animals that received zinc oxide. Pigs fed dietary antibiotic growth promoters and zinc oxide had lower counts of anaerobic bacteria in their feces than control piglets. The removal of these ingredients from the diet will increase days to slaughter. In a study of the effect of feeding kaolin on ETEC infections in weaned pigs,<sup>25</sup> it was found that there was a protective effect on the course of ETEC. Colonization and shedding of ETEC by piglets fed the kaolin were milder and of shorter duration.

It has been traditionally accepted, without reliable evidence, that the sudden transition in diet at weaning is the major predisposing factor, but the experimental observations are conflicting. One set of observations indicates that, if pigs eat a small quantity of creep feed before weaning, they are then “primed” and develop an intestinal hypersensitivity that, following the ingestion of the same diet after weaning, results in PWD. On the other hand, it has been suggested that piglets should consume at least 600 g of creep feed before weaning to develop a mature digestive system. Another set of observations indicates that those pigs that consumed an excessive quantity of feed after weaning developed the disease.

The complete withholding of creep feed followed by abrupt weaning at 3 weeks of age seemed to have a protective effect, possibly



associated with a low dietary intake. Farms with lower rates of PWD used their first piglet ration (phase 1 feeding) for much longer and also changed over to the second ration over a much longer period. Competitive exclusion has been shown to be beneficial.

The recommendations set out here are based on the hypothesis that the consumption of adequate quantities of creep feed before weaning is the most effective and economical practice. Every effort should be made to minimize the stress associated with weaning. Stressors influence the fecal shedding of ETEC by young piglets by a mechanism that may not involve modulation of the immune response. To avoid a sudden transition in diet at weaning, creep feed should be introduced to the suckling piglets by at least 10 days of age. It is important that the creep feed and feeder area be kept fresh to maintain palatability. The same feed should be fed for at least 2 weeks following weaning, and all subsequent feed changes should be made gradually over a 3- to 5-day period. Feed restriction in the immediate 2-week period following weaning may reduce the incidence but generally is not successful. It is a common field observation that the incidence of diarrhea varies with different sources of feed, but experimental studies to confirm this relationship are not available.

The addition of fiber to the diet may be beneficial but leads to a reduced growth rate. In a study<sup>26</sup> of the role of fiber in the control of PWD it was found that there were two major means of reducing enteric disorders: (1) by minimizing the use of nonstarch polysaccharides (NSPs) such as pearl barley and guar gum, which lead to increased digesta viscosity and (2) by including moderate levels of NSPs that do not increase digesta viscosity, such as oats and inulin, especially where there are levels of high crude protein. NSP fractions affect the taxonomic composition and metabolic features of the fecal microbiota.<sup>27</sup>

The use of low-protein diets may reduce the toxic products and reduce PWD. A diet with decreased protein content reduces protein fermentation and the incidence of PWD challenged with ETEC.<sup>28</sup> The development of greater digestibility or stimulation of higher feed intake may also be responsible for reduction of PWD.<sup>29</sup> Zinc oxide in the diets at 300 to 4000 ppm may stop PWD by preventing colonization of the epithelial lining of the intestine. A variety of feedstuffs reduced the adhesion of ETEC to a porcine intestinal cell line and reduced the inflammatory response.<sup>30</sup>

A symbiotic preparation of starch and anti-ETEC K88 probiotic in the presence of raw potato starch is an effective method for reducing the negative effects of ETEC in the piglet model.<sup>31</sup>

Organic acid administration in drinking water to reduce the pH to 4.0 has shown that there was a reduction in the excretion of

fecal *E. coli*, but there was also a significantly decreased water intake.<sup>32</sup>

β-Glucans also reduce susceptibility to ETEC,<sup>33</sup> and in this study there was a reduced excretion of F4 + *E. coli* and a reduced F4-specific serum antibody response.

Colicin also reduced PWD<sup>34</sup>, as did probiotics.<sup>35</sup> One study of a probiotic has shown promise.<sup>36</sup>

A tryptophan-enriched diet improved feed intake and growth performance of ETEC-challenged (K88 +) pigs<sup>37</sup> and *E. coli* F4.<sup>38</sup>

Where possible, at weaning, the sow should be removed and the pigs should be kept as single litters in the same pen for the immediate postweaning period. If grouping of litters is practiced at this time, or later, the pigs should be grouped in equivalent sizes. Multiple suckling in the preweaning period may reduce stress associated with groupings of part-weaned pigs. With all pigs, but especially those weaned earlier than 6 weeks, the pen construction should encourage proper eliminative patterns by the pigs and good pen hygiene to minimize oral-fecal cycling of hemolytic *E. coli*. The environment also appears especially important in this group, and draft-free pen construction should encourage proper ventilation. It is preferable to wean pigs on weight rather than age, and in many piggeries a weaning weight of less than 6 kg is associated with a high incidence of PWD.

There is a development of bacterial resistance against a wide range of antibiotics. This means that the susceptibility of microorganisms should be tested before their use.

The inclusion of an antimicrobial in the feed or water to cover the critical period of susceptibility (generally for 7–10 days after weaning) can be used as a preventive measure. Apramycin at the rate of 150 g/tonne of feed for 2 weeks after weaning may be associated with improved growth rates and a reduction in mortality. The high incidence of drug resistance in isolates of *E. coli* makes prior sensitivity testing mandatory, and the antibiotic may need to be changed if new strains gain access to the herd. The routine use of prophylactic antibiotics for this purpose needs to be considered in relation to the problem of genetically transmitted drug resistance; however, it is currently often necessary for short-term control of a problem.

Vaccination may offer an alternative method of control. Injectable vaccines for sows are designed to produce an improved colostrum provision of antibodies but do not increase suitable IgA antibodies in the weaned pig intestine.

However, currently there are no vaccines available for the control of colibacillosis in weaned pigs. Oral inoculation with  $5 \times 10^8$  to  $10^9$  of nontoxigenic strains can be followed with K88 at day 1 of move, K88/F18ab at day 7, and F18 at days 13 to 15. Only the oral

vaccines with the preformed fimbriae appear to produce any protection from the homologous fimbrial variant. The results vary, and some authors think that the prolonged transit time in the stomach after weaning may deactivate the F4 fimbriae when this has been used as a fimbrial vaccine. Microencapsulated ETEC and detached fimbriae have been used for peroral vaccination in pigs. Parenteral vaccination for the control of coliform gastroenteritis has proved of variable value, probably because parenterally administered antigens do not usually stimulate the production of IgA antibodies and intestinal immunity. Oral immunization by the incorporation of *E. coli* antigens into creep feed has been shown to reduce the incidence and severity of PWD. A live avirulent experimental *E. coli* vaccine with K88<sup>+</sup>, LT<sup>+</sup> ETEC in weaned pigs provided protection. Rearing early-weaned piglets artificially for the purpose of increasing the efficiency of the sow is an attractive management concept. However, high death losses from diarrhea have slowed progress in this new development. The incorporation of antibodies in the diet of such piglets as a prophylactic measure should be possible and is being explored.

Bacteriophages can be used to prevent and treat diarrhea caused by experimental ETEC O149 infection.<sup>39</sup>

A vaccine candidate expressing ETEC adhesins (*K88ab*, *K88ac*, *K99*, *FasA*, and *F41fimbrial* genes) inserted into a plasmid and transferred to *Salmonella* produced a significantly increased antibody response.<sup>40</sup> The study showed that the candidate vaccine can effectively protect their young pigs against colibacillosis.

A commercial vaccine of F4 fimbrial origin has shown to be useful in preventing a virulent F4 ETEC challenge.<sup>41,42</sup> An F18 fimbrial vaccine did not induce protective immunity.<sup>43</sup>

Chitosan-alginate microcapsules for oral delivery of egg yolk immunoglobulin (IgY) has been evaluated in a pig model of enteric colibacillosis,<sup>44</sup> and it has been shown that it is useful and may be a future method for preventing *E. coli* disease.

The ultimate control of PWD is to remove the receptor gene in the population. Although this has been done experimentally, these animals are not yet available in large numbers commercially. The MUC13 gene may provide potential markers for the selection of ETEC F14ab/ac (K88ab/ac)-resistant animals.<sup>45</sup>

Oral antimicrobials increase AMR in porcine *E. coli*.<sup>46</sup>

## FURTHER READING

- Burrow E, et al. Oral antimicrobials increase antimicrobial resistance in porcine *E. coli*—A systematic review. *Prev Vet Med.* 2014;113:364.
- Friendship RM, Amezcua MR. Post-weaning *E. coli* diarrhea. *Pig J.* 2007;59:144-151.
- Gyles CI, Fairbrother JM. *Escherichia Coli. Pathogenesis of Bacterial Infections in Animals.* 4th ed. Ames, IA: Wiley-Blackwell; 2010:267-308.



Hodgson KR, Barton MD. Treatment and control of ETEC infections in pigs. *CAB Rev Persp Agric Vet Sci Nutr Nat Rev*. 2009;4:044.

Isaacson R, Kim HB. The intestinal microbiome of the pig. *Anim Health Res Rev*. 2012;13:100-109.

Schroyen M, et al. The search for gene mutations underlying enterotoxigenic *E. coli* F4ab/ac susceptibility in pigs: a review. *BMC Vet Res*. 2012;43:70.

## REFERENCES

1. DeRoy C, et al. *J Vet Diagn Invest*. 2009;21:359.
2. Duan Q, et al. *Microbial Pathog*. 2013;55:32.
3. Yan X, et al. *J Med Microbiol*. 2009;58:1112.
4. Geenen PL, et al. *Epidemiol Infect Dis*. 2007;135:1001.
5. Abraham S, et al. *Appl Environ Microbiol*. 2012;78:6799.
6. Goncalves C, et al. *FEMS Microbiol Lett*. 2008;281:30.
7. Dorsey FC, et al. *Cell Microbiol*. 2006;8:1516.
8. Johnson AM, et al. *J Bacteriol*. 2009;191:178.
9. Dean P, et al. *Curr Opin Microbiol*. 2009;12:101.
10. Gyles CI, et al. *Escherichia Coli. Pathogenesis of Bacterial Infections in Animals*. 4th ed. Ames, IA: Wiley-Blackwell; 2010:267-308.
11. Goswami P, et al. *Vet Microbiol*. 2010;141:120.
12. Casey TA, et al. *J Vet Diagn Invest*. 2009;21:25.
13. Marchant M, et al. *Appl Environ Microbiol*. 2013;79:853.
14. Rosengren LB, et al. *Appl Environ Microbiol*. 2009;75:1373.
15. Looft T, et al. *PNAS*. 2012;109:1691.
16. Duriez P, et al. *Appl Environ Microbiol*. 2007;73:5486.
17. Frye G, et al. *Foodborne Pathog Dis*. 2011;8:663.
18. Wang X-M, et al. *Foodborne Pathog Dis*. 2011;8:687.
19. Abatih EN, et al. *Prev Vet Med*. 2009;89:90.
20. Wang X-M, et al. *FEMS Microbiol Lett*. 2010;306:15.
21. Burch DGS. *Pig J*. 2007;59:91.
22. Smith MG, et al. *Vet Microbiol*. 2010;145:299.
23. Niewold TA, et al. *Vet Microbiol*. 2007;124:362.
24. Sargeant HR, et al. *Livestock Sci*. 2010;133:45.
25. Trickova M, et al. *Vet Med*. 2009;54:47.
26. Wellock IJ, et al. *Pig J*. 2007;59:113.
27. Metzler-Zebeli B, et al. *Appl Environ Microbiol*. 2010;76:3692.
28. Heo JM, et al. *J Anim Sci*. 2009;87:2833.
29. Lalles JP, et al. *Proc Nutr Soc*. 2007;66:267.
30. Hermes RC, et al. *Comp Immunol Microbiol Infect Dis*. 2011;34:479.
31. Krause DO, et al. *Appl Environ Microbiol*. 2010;76:8192.
32. De Busser EV, et al. *Vet J*. 2011;188:184.
33. Stuyven E, et al. *Vet Immunol Immunopathol*. 2009;128:60.
34. Cutler SA, et al. *Antimicrob Agents Chemother*. 2007;51:3830.
35. Tsukahara T, et al. *J Vet Med Sci*. 2007;69:103.
36. Konstantinov SR, et al. *FEMS Microbiol Ecol*. 2008;66:599.
37. Trevisi P, et al. *J Anim Sci*. 2009;87:148.
38. Messori S, et al. *Vet Microbiol*. 2013;162:173.
39. Jamalludeen N, et al. *Vet Microbiol*. 2009;136:135.
40. Hur J, et al. *Vaccine*. 2012;30:3829.
41. Nadeau E, et al. *Proc Int Cong Pig Vet Sci*. 2010;463.
42. Hodgson KR, et al. *Rev Persp Agric Vet Sci Nutr Nat Res*. 2009;44:1.
43. Verdonck F, et al. *Vet Immunol Immunopathol*. 2007;120:69.
44. Li X-Y, et al. *Vet Immunol Immunopathol*. 2009;129:132.
45. Zhang B, et al. *Anim Genet*. 2008;39:25.
46. Burrow E, et al. *Prev Vet Med*. 2014;113:364.
47. Byun J-W, et al. *Vet J*. 2012;193:593.
48. Casey TA, et al. *Vet Microbiol*. 2012;159:83.

## CAMPYLOBACTERIOSIS IN PIGS

Several species of the genus *Campylobacter* are known to cause disease in farm animals; some are potentially zoonotic and the role of some is uncertain. The organisms are a cause of diarrhea, often with mucus, in 3-day-old to 3-week-old pigs and in nonimmune pigs in older age groups. They are often not diagnosed because they are not suspected.

### ETIOLOGY

There are two main species in the pig, *C. coli* (CC) and *C. jejuni* (CJ). Both are gram-negative, microaerophilic rods that are catalase positive and cause disease naturally and in experimental infections.<sup>1</sup> Other species have been given experimentally to pigs and have caused disease (*C. hyointestinalis*, *C. sputorum*) and some have been found naturally, often in high numbers, in the pig and have been sometimes associated with disease (*C. hyointestinalis* subsp. *hyointestinalis*, *C. hyointestinalis* subsp. *lawsonii*, *C. mucosalis*, *C. hyoilei*, *C. lari*, and *C. lanienae*). They also have been found in wild boar and feral pigs. Virulence factors include motility, secreted toxins,<sup>2</sup> flagella, virulence proteins,<sup>3</sup> inflammation, and invasion.<sup>4,5</sup> Six species of *Campylobacter* were isolated from feral swine in California.<sup>6</sup>

### EPIDEMIOLOGY

#### Prevalence of Infection

The prevalence of *Campylobacter* infections in both diarrheic and nondiarrheic piglets may average around 50%, but there is no correlation between the occurrence of the organism in the feces and the presence of diarrhea. However, the presence of these organisms constitutes a potential zoonosis among animal handlers.

CJ, CC, and *C. lari* can be isolated from pigs in commercial swine herds. The organisms are present worldwide. CC is isolated from the intestinal contents of 99% of pigs at slaughter. Approximately 60% of the specimens of healthy slaughter pigs may yield *C. jejuni* (CJ).

The prevalence of CC may be 100% in young pigs and others such CJ may be under 10% in young pigs. Both can be isolated from the intestines of healthy pigs. Carriage of the organism is in the gallbladder, ileal mucosa, and large-intestinal mucosa.

#### Risk Factors

Possible risk factors for CJ were application of manure with broadcast spreaders, feeding of whole cottonseed or hulls, and accessibility of feed to birds.

#### Transmission

The organisms are spread by the fecal/oral route from the dam, infected feces, or water. Piglets have the same genotypes of CC as their dams<sup>7</sup> at the start of their lives, but

these are then partially replaced by strains from elsewhere so that by 66 days of age 33% of piglet isolates were from other sources. Infected animals may secrete organisms at a high level ( $10^3$ – $10^9$ /g feces) for months. It will survive at 4°C for 24 hours and at 22°C for 6 days. Parturition enhances fecal shedding by the sow and accounts for the piglet infection.<sup>8</sup> Piglets are infected when young and the infection then spreads. Management factors are correlated with herd size with the smaller farms having a higher prevalence of campylobacters.<sup>9</sup>

#### Pathogen Risk Factors

Wild birds probably constitute the main natural reservoir of infection but possibly also other farm livestock and rodents.

The distribution and diversity of *Campylobacter* in a large-scale farming environment in the UK was determined by systematic sampling of feces, soil, and water. Warmer months, large farms, and individual housing were identified as risk factors for shedding by sows.<sup>10</sup> The annual increase in *Campylobacter* infections in England and Wales begins in early May and reaches a peak in early June, and this seasonal incidence may be associated with transmission of the organism by flies.

There is an unprecedented level of heterogeneity in the CC in the United States.<sup>11</sup>

CJ is adapted to the intestinal tract of warm-blooded animals and does not normally replicate outside this environmental niche. The single polar flagellum and cork-screw shape facilitates motility in the viscous intestinal mucus. The bacterium gradually dies outside the host's intestinal tract. CJ strains could not be isolated from water after 3 weeks but may survive for up to 60 days in unstirred water.<sup>12</sup>

CC was widespread, with low levels of antibiotic resistance, high genetic diversity, and a strain of CCi, which may have become adapted to survival or persistence in water. The pig farm may become a reservoir for CC for transmission to poultry.

#### Antimicrobial Resistance

Increasing AMR in *Campylobacter* is being recognized worldwide, and resistance to the quinolones is most common in isolates of both CJ and CC from food-producing animals, especially poultry. In Switzerland, there were many novel sequence types in pigs with macrolide resistance,<sup>13</sup> and the use of tylosin selects for resistance.<sup>14</sup> In Canada, a study showed a high level of resistance to macrolides, lincomycin, and tetracyclines but not to fluoroquinolones.<sup>15</sup> In a study in eight states in the Midwest United States where there was no antibiotic usage on a pig farm there were fewer resistant organisms.<sup>16</sup> A high prevalence of CC in the stomach of pigs at slaughter in France was recorded, and a high proportion of the strains were resistant to tetracyclines and erythromycin.

In Japan, AMR was associated with the resistance in CC both within and between classes of antimicrobials.<sup>17</sup> Tetracyclines are most often used to treat pig diseases, followed by  $\beta$ -lactams and macrolides.<sup>18</sup> Most CC were resistant to one or more antibiotics in some form.<sup>19</sup> In Australia, pigs are more resistant to oxytetracycline than poultry. A dose-response relationship between macrolide use and macrolide resistance has been shown.<sup>20</sup> The use of fluoroquinolones was the most important factor associated with the emergence of fluoroquinolone-resistant CC.<sup>21</sup> The resistant strains are persisting environmental isolates that have been acquired by the different livestock species.

### Zoonotic Implications

*Campylobacter* is the leading bacterial cause of diarrhea in humans in many industrialized countries. The most important cause of indigenous food-borne disease is contaminated chicken. Red meats (beef, lamb, and pork) also contribute to illness despite the lower risk.

There is a strong association of *Campylobacter* infection in humans living on farms, and contact with diarrheic animals is a major risk for *Campylobacter* enteritis in humans. Fecal contamination is the main cause in retail raw meats (chicken, turkey, pork, and beef) sampled in supermarket chain stores at levels of 1% to 10%.<sup>22</sup> Both of the main organisms have been identified in pig meat<sup>23</sup> and in livers at abattoirs,<sup>24</sup> but the pig is not a significant contributor to human disease,<sup>25</sup> although it can pose a threat to human health through the food chain.<sup>26,27</sup> In addition, antibiotic treatment of farm animals may have increased resistance in CC isolated from food.<sup>28</sup>

There is good evidence that isolates of CJ from human disease and farm animals are very similar. The use of MLST is being used to compare the genotypes of CJ from farm animals and the environment with those from retail food and human disease. The risk of a meat product being contaminated is associated with pigs that shed higher concentrations of *Campylobacter* before slaughter.<sup>29</sup>

### PATHOGENESIS

The role of CJ as primary pathogens in farm animals is uncertain. The organism is not normally pathogenic in farm animals. In humans, the infectious dose is considered to be <1000 *Campylobacter* organisms.

The flagellated motile organisms are more invasive than the nonflagellated nonmotile ones. They can survive for long periods of time inside both phagocytes and epithelial cells. The attachment, invasion, and translocation of CJ in pig small-intestinal cells have been described.<sup>30</sup>

Following infection the organism rapidly multiplies, particularly in the ileum in close contact with the mucosa, but it does not appear to invade the mucosa in large numbers. They may then spread to the

gut-associated lymphoid tissues, tonsils, spleen, and gallbladder.<sup>1</sup> It may, however, produce a cytotoxin. The organism then spreads to the large intestine.

It has been shown recently that the secretion of IL-4 damages the paracellular junctions and allows the increased invasion of CJ into cells.<sup>31</sup>

### CLINICAL FINDINGS

The disease may be so mild as to be unapparent, without fever, and may be manifested only by mild depression and soft feces with occasional strands of mucus. The incubation period may be 1 to 3 days.

Maternal immunity usually protects against clinical disease but not infection, and most piglets have antibody by 5 to 7 weeks of age.

The clinical signs include a mild fever for 2 to 3 days and a watery or creamy diarrhea with mucus and occasional flecks of blood for a few days. In older pigs with CC there may be a chronic mucoid diarrhea with weight loss.

### CLINICAL PATHOLOGY

The information on the various methods used for the detection and identification of *Campylobacter* in laboratory samples has been reviewed. Because of the unique growth characteristics of *Campylobacter*, isolation of these organisms from field samples requires the use of special media and culture conditions and is generally laborious and time-consuming. However, isolation of *Campylobacter* from feces is possible with high success rates. Recovery of *Campylobacter* from environmental samples can be difficult because the organism does not propagate in the environment. The use of molecular detection methods has greatly facilitated the specific and rapid detection and identification of *Campylobacter*, but has not replaced the gold standard of traditional culture methods. Detection and quantification of CJ in the feces of naturally infected cattle is possible using real-time quantitative PCR.

### NECROPSY FINDINGS

At necropsy, lesions are restricted to the small intestine; there may be diffuse catarrhal to severe hemorrhagic enteritis of the jejunum and particularly the terminal ileum. The lymph nodes may be enlarged, and the terminal ileum may be thickened. There may be ileal villi loss, and the mucosa may be slightly inflamed. Histologically, the most important finding is proliferation of the lymphoid tissue in the terminal ileum. Large numbers of *Campylobacters* may be seen on smears from the mucosa and isolated in culture.

### DIAGNOSIS

If there is a mucoid diarrhea with some mucus and perhaps a little blood in young piglets with no great morbidity and no

mortality, then campylobacteriosis should be suspected.

Culture is sufficient but can be supplemented by DNA probes and PCR and improved by using RT-PCR.<sup>32</sup> Discrimination of the major capsular types of CJ is possible using multiplex PCR.<sup>33</sup> It is possible in some laboratories to use ELISA for serum antibody, but this has limited commercial availability.

### TREATMENT

Treatment is rarely performed, which is good as a high proportion of CC are resistant to erythromycin (5%–62%) and streptomycin (70% in Canada).<sup>34</sup> Potential macrolide resistance is associated with farms that use tylosin for the treatment of diarrhea in young pigs.<sup>26</sup> A high resistance was also reported for pig CC for ciprofloxacin.<sup>25</sup>

### CONTROL

Control depends on sanitation and hygiene in livestock barns to reduce the bacterial populations in the environment of the animals. A high dosage of zinc oxide dietary supplement has an inhibitory effect on CC excretion in weaned piglets.<sup>35</sup>

### FURTHER READING

Jacobs-Reitsma WI. *Campylobacter in the food chain*. In: Nachamkin I, et al., eds. *Campylobacter*. 3rd ed. Washington, DC: American Society of Microbiology; 2008:627–644.

### REFERENCES

- Bratz K, et al. *Vet Microbiol*. 2013;162:136.
- Zheng J, et al. *Infect Immun*. 2008;76:4498.
- Guerry P. *Trends Microbiol*. 2007;10:456.
- Mansfield IS, et al. *Microbiol Pathog*. 2008;4:241.
- Malik-Kale P, et al. *J Bacteriol*. 2008;190:2286.
- Jay-Russell MT, et al. *Zoonoses Public Health*. 2012;59:314.
- Soultos N, et al. *J Appl Microbiol*. 2006;102:916.
- Laroche M, et al. *Zoonoses Public Health*. 2007;54(suppl 1):27.
- Wehnebrink T, et al. *Proc 7th Int Symp Ep Fd Borne Path Pork Verona*. 2007;173.
- Denis M, et al. *Vet Microbiol*. 2011;154:163.
- Thakur S, et al. *Zoonoses Public Health*. 2010;57(suppl 1):100.
- Xuan TB, et al. *Front Microbiol*. 2011;article 282.
- Egger R, et al. *Vet Microbiol*. 2012;155:272.
- Jutunen P, et al. *Vet Microbiol*. 2010;146:90.
- Varela NP, et al. *Can J Vet Res*. 2007;71:189.
- Rollo SN, et al. *J Am Vet Med Assoc*. 2010;236:201.
- Ozawa M, et al. *Prev Vet Med*. 2012;106:295.
- Koike R, et al. *Ann Rep Natl Vet Assay Lab*. 2012;45:30.
- Qin SS, et al. *Int J Food Microbiol*. 2011;146:94.
- Rosengren LB, et al. *Can J Food Prot*. 2009;72:482.
- Taylor NM, et al. *Epidemiol Infect*. 2009;137:1121.
- Jacobs-Reitsma W. *Campylobacter in the Food Supply*. In: Nachamkin I, et al., eds. *Campylobacter*. 3rd ed. Washington, DC: American Society for Microbiology; 2008:627–644.
- Little CL, et al. *Food Microbiol*. 2008;25:538.
- von Altröck A, et al. *Prev Vet Med*. 2013;109:152.
- de Jong A, et al. *J Antimicrob Chemother*. 2009;63:733.
- Mataragas M, et al. *Int J Food Microbiol*. 2007;126:1.
- Oporto B, et al. *J Appl Microbiol*. 2007;103:977.

28. Alfredson DA, et al. *FEMS Microbiol Lett.* 2007;2277:123.
29. Abley MJ, et al. *J Food Prot.* 2012;75:139.
30. Rubesia-Mihaljevic R, et al. *Microbiol Pathog.* 2007;43:120.
31. Parthasarathy G, et al. *Microb Pathog.* 2009;47:38.
32. LeBlanc-Maridor M, et al. *J Microbiol Methods.* 2011;85:53.
33. Poly F, et al. *J Clin Microbiol.* 2011;49:1750.
34. Varela NP, et al. *Can Vet J.* 2007;48:515.
35. Bratz K, et al. *J Appl Microbiol.* 2013;115:1194.

## PORCINE PROLIFERATIVE ENTEROPATHY

### SYNOPSIS

**Etiology** *Lawsonia intracellularis* (ileal symbiont intracellularis)

**Epidemiology** Four to 8 weeks after weaning; feeder pigs, and young gilts, sows, and boars. Risk factors not known

**Signs** Diarrhea, weight loss, inappetence, and may recover. Outbreaks of bloody diarrhea and rapid death may occur in feeder pigs, young gilts, and boars.

**Clinical pathology** Demonstrate organism.

**Lesions** Proliferative ileitis. Proliferative hemorrhagic enteropathy, fibrinous casts, and blood clots

**Diagnostic confirmation** Demonstrate organism in tissues.

#### Differential diagnosis list

- Esophagogastric ulceration
- Intestinal hemorrhage syndrome
- *Clostridium perfringens* type C hemorrhagic enteritis

**Treatment** Antimicrobials in feed

**Control** No reliable strategies. Medication of feed

Porcine proliferative enteropathy (PPE) has been called a variety of names in the past, including **ileitis regional ileitis, porcine proliferative enteritis complex, porcine intestinal adenomatosis (PIA), PPE, necrotic enteritis, regional enteritis, and proliferative hemorrhagic enteropathy (PHE) of pigs**. All of these terms are a reflection of the lesions caused by LI.

PPE causes considerable economic loss. There is a close relationship to the *Desulfovibrio* species, and it is closely related to *Bilophila wadsworthii*, which is a known inhabitant of the human colon and associated with appendicitis. It is widely found in pigs in Australia. There are no known associations with human disease.<sup>1</sup> It does cause disease in young horses and can be isolated from laboratory animals.<sup>2</sup> There may be two biovars, one for pigs and one for the other species.<sup>3</sup> The pig LI are >99% similar worldwide in 16S rDNA and outer membrane proteins. Most work has been performed using a mucosal homogenate challenge model.<sup>4</sup>

### ETIOLOGY

The causative agent, first described in Iowa in the 1930s, is LI, which was isolated and Koch's postulates fulfilled in 1993. It is a gram-negative, curved rod (vibrioid shaped) obligate intracellular bacterium in the cytoplasm of intestinal epithelial cells. Molecular typing of the organism and sequencing of the genome and the three small plasmids have been described. The isolates worldwide are similar.

Both pure cultures and mucosal homogenates of LI will produce clinical signs, lesions, and shedding. It is best cultivated in cell-free media and also in a rat enterocyte cell line.<sup>5</sup>

The disease is complex, often just called ileitis, and occurs in two forms. There is an acute form called porcine hemorrhagic enteropathy or regional ileitis that occurs from 4 to 12 weeks and a chronic form usually referred to as PIA or necrotic enteritis, which occurs from 6 to 20 weeks.

### EPIDEMIOLOGY Occurrence

There is a worldwide occurrence. The PPE complex affects pigs from weaning age to feeder pigs and also young gilts, sows, and boars. It is characterized clinically by diarrhea, loss of BW and inappetence in recently weaned pigs, and sudden death in feeder pigs, young gilts, and boars. The essential lesions are proliferative, and there seems to be an etiologic and pathologic relationship between PIA, necrotic enteritis, regional enteritis, and hemorrhagic enteropathy. Nonhemorrhagic proliferative enteritis occurred most often in pigs 6 to 24 weeks of age.

PHE usually affects pigs over 16 weeks of age but occurs in pigs as young as 6 weeks and as old as 4 years of age. PHE is one form and appears to occur in most countries. It probably has a worldwide distribution with 30% to 60% of herds affected depending on the country. In Germany, 82.7% of finishing herds had seroconversion. It is especially common in hysterectomy-derived or SPF herds and has a higher prevalence in the hot summer period. In some countries its prevalence is increasing, and it is emerging as a major syndrome in SPF herds.

The disease in all ages is frequently associated with the concurrent occurrence of PIA, but it is unknown whether the hemorrhagic syndrome results from some insult to the intestine that also predisposes to a proliferative enteropathy or whether it is simply an acute manifestation of this disease. The related syndromes of necrotic enteritis and regional ileitis can be found in apparently healthy pigs examined at slaughter. Because the disease is common in pigs, suboptimal growth of pigs in nutritional studies may be caused by the disease complex.

It has been suggested that it can live extracellularly within the environment for 2 weeks at 5 to 15°C. It appears highly resistant

to a lot of cleaning agents such as povidone iodine or potassium permanganate, but may be susceptible to 3% cetrimide. In one study transmission occurred despite cleaning, use of footbaths, dedicated boots, etc.

It has been suggested that it normally lives in organic matter in weaner units awaiting the arrival of batches of susceptible pigs, with the resultant sudden increase in shedding 4 to 12 weeks after weaning. The recent finding of LI in the tonsil may be a coincidental finding, as they may have just been trapped in the crypts after licking infected material, because they were only found in this site in 2/32 pigs. Mixed infections are found in 10% of growers, and there is a strong association between diarrhea and prevalence of *Brachyspira hyodysenteriae* and *B. pilosicoli*.

### Prevalence of Infection

A study in Belgium suggested that 24% of slaughtered pigs had a thickened ileum with a range in farm batches from 10% to 49%. In Denmark 94% of herds were infected with a mean within herd prevalence of 30%. In Canada, there is a widespread distribution between 50% and 100% of herds in the provinces with 5% to 89% of pigs affected. In the United States it was found using the immunoperoxidase monolayer (IPMA) test to study antibodies that 75% of growing herds had antibodies, and within the herd prevalence was 11% to 91%. Of the breeding herds 78% had antibodies with two peaks at the time of infection and 9 to 18 weeks later and with an overall prevalence of 5% to 61%.

In Canada, studying 96 cases of PPE, it was found that 15% were in weaners (8–10 weeks), 36% in growers from 10 to 18 weeks, and 14% among finishers of 18 to 26 weeks. A further 16% were in mature pigs of >26 weeks.

Estimation of the incidence of disease is complicated by the difficulties in making an accurate clinical and pathologic diagnosis. Surveys of pig farms in Australia indicated that 56% had either observed the disease or the veterinarian had made the diagnosis.

Surveys of fecal samples from swine herds in Taiwan revealed an overall prevalence of infection of LI in 30% of herds and 5.5% of pigs.

### Morbidity and Case Fatality

The disease can occur in all ages of post-weaned pigs, but it has a high incidence in young replacement gilts and boars at 6 to 9 months of age and in pigs approximately 4 to 8 weeks after weaning. The high incidence in replacement gilts may be caused by suppression of the disease by low-level feeding of antibacterial agents during the growing period, but frequently the syndrome appears first in gilts and some time later in the growing pigs. In gilts, outbreaks may be explosive, but generally are short lived with



morbidity rates of up to 50% of the group occurring within a 2- to 3-week period. The case-fatality rate does not usually exceed 10%. In large herds with continual addition to the replacement gilt herd and in herds where the disease occurs in grower pigs, outbreaks may be more prolonged. The disease in growers generally has equivalent morbidity and case-fatality rates. It is more severe in that runting of surviving and contemporary pigs may occur, necessitating further economic loss through culling.

When given experimentally at a high level of  $10^9$  to  $10^{10}$  LI per pig, mortality in the untreated groups varied from 10% to 50%, which is considered much higher than in the natural outbreak.

### Risk Factors

There may be two patterns of infection. One is an early infection and the second is a delayed infection, which is seen in farms that separate pigs at weaning and have all-in/all-out methods of production.

Very little is known about the risk factors of PPE. A gene has been discovered that encodes for a surface antigen (LsaA) that is believed to be associated with attachment to and entry into cells and that is synthesized during infections. A study of recorded outbreaks of PHE indicated the disease often occurred within 12 months after repopulation of the herd and following withdrawal of antimicrobials from the feed. It has been proposed that the introduction of breeding stock from herds in which the disease is endemic may be a risk factor, but this is not documented. In a study in the UK showed there seemed to be a higher risk when there were more than 500 sows. An older parity structure in the sow population seemed to reduce infection. There seemed to be a higher risk if buying in boars. Fully slatted or fully meshed floors also carried a higher risk of infection compared with solid floors or straw. A higher risk was seen in those herds in which large numbers of pigs entered the finishing units simultaneously. Pigs on concrete slats may also be predisposed. Intensive systems were more severely affected than outdoor systems. There was a reduced risk if there was thorough cleaning and disinfection (all-in/all-out) before the next group of pigs arrived. Seroconversion usually occurred as the pigs entered the finishing site suggesting that the exposure takes place in the nursery. There may be five major types of risk factor: comingling, temperature fluctuations (overheating/ chilling), transportation, depopulation, and new buildings. Sows may have low levels of antibody and are capable of passing on colostral protection to the piglets. Maternal antibodies have usually declined by 3 to 5 weeks of age but may be extended to 42 days by repeated sow vaccination, by which time exposure may have occurred and there may be both active and passive antibodies.

### Methods of Transmission

The organism is found in hamsters, ferrets, foxes, hares, deer, emus, ostriches, and primates. Colonization of rodents and wild rodents has been described.<sup>6</sup> The significance of these alternative hosts has not yet been ascertained. The role of vectors is not clear, but the main source of infection is the incoming pig (both growing pigs and adults). Gilts can be shedders and carriers, and the organism can probably survive in the extracellular world for 1 to 2 weeks at 5°C to 15°C. It may be transmitted on boots, other fomites, and by insects and flies.<sup>7</sup> The method of transmission between pigs is assumed to be the fecal-oral route.<sup>8</sup>

### PATHOGENESIS

Contact-dependent excretion systems, such as the type III secretion system (T3SS), play an important role in the pathogenicity of many gram-negative organisms.<sup>9,10</sup> This system transfers bacterial proteins (effectors) into the cell where they disrupt the various cellular processes<sup>11</sup> and promote bacterial pathogenicity. They have shown that the system is operative in LI.<sup>9</sup>

The infection is by oral means and enters the epithelial cells of the crypts of the small intestine. The process appears to go ileum first then colon, to cecum, and finally rectum.<sup>4</sup> The infection process appears to take about 3 weeks to peak with the organisms appearing in the feces about 1 week after experimental infection. The histologic lesions may have cleared from the ileum by day 29 following inoculation. Considerable progress has been made using porcine ileal models.<sup>12</sup>

Proliferative enteropathy is characterized by the hyperplasia of the epithelial cells of the intestinal crypts, particularly in the ileum and colon. The presence of non-membrane bound, curved bacteria free in the cytoplasm of the affected enterocytes is a consistent feature of the disease. The bacteria associate with the enterocyte and enter through an entry vacuole, which then breaks down and the LI live freely in the cell. The organisms infect the immature cells of the mucosal glands and stop them from maturing.<sup>13</sup> The goblet cells decrease and then disappear. The cells lose protein and fail to absorb nutrients, which then contributes to the weight loss that occurs.<sup>14</sup> This causes them to multiply without leaving the gland, and the cells then degenerate probably by apoptosis and the glands continue to proliferate.<sup>15</sup>

Gross and microscopic lesions typical of acute proliferative enteritis can be reproduced by inoculation of cell-cultured LI into pigs 3 or 7 weeks of age. The incubation period is about 7 to 14 days with the early lesions appearing in the terminal ileum. Fecal shedding usually occurs about 7 days postchallenge and the animals seroconvert about 14 days postchallenge. The disease

peak is about 21 days postinfection. The clinical signs decrease, and the lesions begin to resolve after 28 days. The disease process results in a 2-week delay in marketing. Inoculation of gnotobiotic pigs does not cause the disease. It now seems certain that LI is the causative agent of the disease complex. Infection of intestinal epithelial cells is causally linked to marked hyperplastic proliferation of affected tissue.

The organism internalizes and multiplies within the cells, and it is proposed that the organism is capable of affecting, directly or indirectly, the cell cycle within the intestinal epithelium. This may or may not be concerned with the role of cyclin kinase p27, which regulates differentiation of immature crypt cells into the differentiated form. The changes in the experimental disease are similar to those in the natural disease. Following experimental infection there is almost complete replacement of normal ileal mucosa by adenomatous mucosa. Affected crypts are enlarged and branched, with loss of goblet cells and marked proliferation of crypt epithelial cells. Hyperplastic lesions may develop 2 to 3 weeks after challenge and persist for several weeks. In older animals, the lesions may be complicated by acute mucosal hemorrhage or necrosis. In the progressive stage of the disease, 3 weeks after infection, numerous organisms are consistently present within affected intestinal epithelial cells but not elsewhere. In the developed and recovering stage of the disease, 7 to 9 weeks after infection, ultrastructural features in affected intestinal tissues consist of pale, swollen, protruding epithelial cells and shrunken epithelial cells. This is followed by the appearance of apoptotic bodies in both epithelial cells and macrophages, the reappearance of normal goblet cells, and reduced numbers of organisms within the lesions. Bacteria are released from cells via cytoplasmic and cellular protrusions into the intestinal lumen and can be found in fecal samples.

In the experimental disease in pigs, seroconversion to the organism does not occur, confirming the weak response characteristic of the natural disease.

The proliferative lesion may result in suboptimal performance in otherwise normal pigs or unthriftiness, or be manifested as acute intestinal hemorrhage during the recovery stages of intestinal adenomatosis. The hemorrhagic lesions are more difficult to explain, but there may be direct or indirect toxic damage to the endothelium of the blood vessels.

It has been suggested that there is a close association between the presence of LI and reduced T-cell and B-cell numbers. This provides evidence of an immunosuppressive effect operating in this disease. It seems also that macrophages have an important function with activated macrophages accumulating in the infected hyperplastic glands. At day 14 postinfection there were a few



pinpoint lesions, and the percentage of infected crypts was minimal. At the same time the number of CD3+ cells was reduced and the number of intraepithelial CD3+ cells was also reduced, while the CD8 and CD4 cells showed no changes. Apparently there is an induction of an immunosuppressive phenotype with downregulation of an adaptive immune response through the reduction in the CD8+ T- and B-cells.

### CLINICAL FINDINGS

The disease can occur in pigs from a few weeks of age to adults and lasts about 6 weeks on average. It is most common in the newly weaned. Morbidity may reach 12% and the mortality rarely exceeds 6%, even when the hemorrhagic form is very severe.

This disease is one of the common causes of failure to grow, weight variation in batches of pigs, and delay to market. In many cases, the clinical signs are not obvious as they are growth effects. Pigs may appear gaunt and may pass watery stools.

Between 6 and 20 weeks the endemic form is called porcine intestinal adenomatous with wasting and ill-thrift. In vaccination studies the improvement has been of the order of 5% for average daily gain or feed conversion ratio.<sup>16</sup> A 56 g/day reduction in average daily gain for each log 10 unit increase in LI excretion has been found. In a German study, LI PCR positivity had a significant negative effect on average daily gain.<sup>17</sup>

**Regional ileitis** is the most common differential diagnosis of the granulomatous enteritis that is seen in PCV2-associated enteric disease. In many cases both PCV2 and LI have been seen in the same case as both target the ileum.

PPE or ileitis occurs in pigs 6 to 16 weeks of age. In the chronic form, a reduction in growth rate and failure to thrive are common. Affected pigs are afebrile and diarrhea occurs but is unremarkable. Most cases recover spontaneously within 6 weeks of the onset of signs. When inflammation and necrosis have resulted in necrotic enteritis and regional ileitis, diarrhea and severe weight loss occur followed by death, often by ileal perforation in the case of regional ileitis.

PHE occurs in older pigs, such as young gilts and boars, and is manifested primarily by bloody diarrhea and sudden death. Others within the group may show skin pallor and hemorrhagic feces with fibrin casts but otherwise appear clinically normal. In some pigs there is continual blood loss, and death occurs within 48 hours of the onset of hemorrhage, but in the majority of pigs the hemorrhage is transient. In outbreaks, up to 70% of pigs affected with dysentery may die within 24 hours after the onset of signs. Fever is not a feature and the majority of pigs suffer only a minor setback for a 2-week period. A small percentage will develop chronic ill-thrift.

In grower pigs the disease is economically more severe. As in gilts, acute death with marked skin pallor and without premonitory signs can occur, but survivors show ill-thrift, and as the outbreak progresses contemporary pigs may show a chronic syndrome of ill-thrift with the periodic passage of bloody feces.

When sows are affected in early pregnancy they may abort. Usually about 6 days after the onset of clinical signs and in late pregnancy they can infect their newborn litter.<sup>18</sup>

Pigs that have been experimentally infected are resistant to later reinfection.<sup>19</sup>

### CLINICAL PATHOLOGY

Many affected pigs are pale and anemic and the packed cell blood volume may be only 20% of normal. In these instances there may be black feces (melena) from the digested blood.

The organism can be detected in the feces of healthy 10- to 25-week-old growing/finishing pigs, which is probably the age group of pigs serving as the main source of infection for younger nursery pigs.

A PCR assay is highly reliable for the detection of the organism in feces and intestinal tissues. It may detect as few as  $2 \times 10^2$  bacterial cells per gram of feces, but it is more likely that the PCR detects shedding of  $10^3$  or greater per gram of feces.

Positive results with the PCR are only present in animals with active lesions of proliferative enteropathy. Shedding as detected by PCR may start as early as 6 to 8 weeks and continue to 28 weeks. From seroconversion to first shedding was 2 to 8 weeks.

A fluorescent ISH technique targeting 16S ribosomal RNA using an oligonucleotide probe successfully identified LI. The indirect IF test works as soon as 2 weeks postshedding of LI.

Seroconversion may commence between 12 and 27 weeks. The range for positivity from first detection was 7 to 23 weeks. Maternal antibody appears not to prevent infection of piglets. ELISAs detect antibodies 21 to 28 days postinfection.

### NECROPSY FINDINGS

The immediate impact of PPE is a thickened ileum and cecum and less frequently a spiral colon. Not all cases have lesions. Some may be so mild they are overlooked. Obvious gross lesions occur in severe cases, but in the less severe cases histology is needed. The pathology is related to the dose. As long as you remember these facts you can monitor LI in the abattoir.

A complex gross, histologic, and immunohistochemical study of LI has been made in which the pigs showed complete recovery and were IHC -ve by 35 days postinfection. The antigen was detected in the intestine, lymph node (macrophages), and tonsils (free

living in the crypts). They were found in the rectum and in several portions of the large intestine. The first site of colonization was the jejunum and ileum and then the lower intestinal segments. On day 29 there was nothing in the small intestine, but the LI were still observed in the cecum, proximal colon, and rectum. Mucosal IgA was first detected on day 15 and was still detectable on day 29, but in all cases the titers varied from only 1:4 to 1:16.

The macroscopic lesions of proliferative enteropathy were first detected at 11 days postinfection, which is the same time as histologic identification with enterocyte hyperplasia and reduced goblet cells. Immunohistochemical identification can be seen at 5 days postinfection and continues until day 29.

In PIA, the prominent lesions are in the terminal ileum and proximal portion of the large intestine. There is gross thickening of the mucosa and submucosa of the terminal ileum, and the colonic mucosa may also appear congested and slightly thickened.

In both forms of the disease the mucosal surface may be eroded and may look granular with abundant adherent material in the form of fibrinonecrotic debris. There may also be a fibrinonecrotic core filling the lumen. In PHE the only difference may be that the surface of the mucosa may be covered by large undigested blood clots.

Histologically, the mucosal change consists of marked proliferation of immature epithelial cells and a suppurative cryptitis. In many cases the affected crypts are 5 to 10 or more cells thick with numerous mitotic figures.

In **necrotic enteritis** the lining of the intestine may be covered in yellow or gray masses of necrotic material.

In **regional ileitis (called hosepipe gut)** the distal ileum is rigid from thickening of the intestinal wall caused by muscular hypertrophy and granulation tissue formation. The initiating mucosal damage is often somewhat masked because of colonization of the ulcerated mucosa by secondary bacterial invaders.

In **PHE**, the carcass is usually very pale, and massive amounts of blood are often present within the intestinal tract. The mucosa and submucosa of the ileum are thickened and may be coated in fibrin. Fibrin casts are also sometimes present. Although the intestinal wall is dark red and hemorrhagic, there may be no obvious points of hemorrhage. Histologically, there is evidence of vascular congestion, fibrin thrombi, increased permeability of blood vessels, and necrosis of the intestinal mucosa. The character of the vascular lesion resembles an acute bacterial infection and type I hypersensitivity reaction. Again, the key microscopic feature is the presence of proliferating immature epithelial cells with basophilic nuclei,

which line the greatly elongated crypts. There are no goblet cells in this site. In an analysis of histologic lesions crypt abscesses were seen in 20% of pigs, decreased goblet cells in 90%, hypertrophy and hyperplasia in 3%, hypertrophy of both muscle coats in 78%, increased eosinophils in 34%, and lymphoid hyperplasia in 90%.

In chronic cases the lesions described previously are nearly all replaced by fibrous connective tissue, and the diagnosis may rely on seeing just isolated pieces of mucosa.

*Lawsonia* are also a common cause of colitis. In 70% of cases of colitis LI are also found in the colonic mucosa. In three cases, LI were found only in the colon, and in these infected large bowels there was an excess of mucus on the surface.

Staining of smears of ileal mucosa with modified acid-fast stains may reveal typical curved bacterial rods in the apical cytoplasm of the infected proliferating enterocytes, permitting a presumptive diagnosis. It is not always specific for *Lawsonia*. They are not always present in necrotic debris or autolyzed tissue. IHC or silver stains (Warthin-Starry) of formalin-fixed gut are usually sufficient to detect the intracellular organisms in all forms of proliferative enteritis. LI can also be identified using a PCR assay. It is possible to find bacterial antigen in the lamina propria and draining lymph nodes of the ileum. This is a result of the natural process of infection clearance.

There has been a considerable interest in the relationship between PCV2 and LI and the difficulties in separating the two.<sup>20,21</sup>

### Samples for Confirmation of Diagnosis

- **Bacteriology:** Distal ileum, proximal colon (direct smear and PCR); the organism needs to grow on tissue cell lines at oxygen and CO<sub>2</sub> concentrations that mimic the small intestine. It is not really an option because these techniques are difficult and the organism is an obligate intracellular organism. A simple staining with Ziehl-Neelsen or a modified Gimenez stain will show up the organisms.

There has been a considerable development in PCR techniques for feces as an antemortem technique. This is a variable sensitivity that is affected by sample quality and the presence of inhibitory factors in feces, but the specificity is around 97%. It appears to be very useful in the clinically ill but not so reliable in the subclinically affected. The PCR is more specific when applied to the ileal mucosa rather than to feces. It has been reported that fecal samples are more likely to be PCR-positive in herds with PHE rather than in PIA herds. It is more sensitive than either WS staining or immunofluorescence antibody test (IFAT). Shedding commences around 7 weeks and is observed most between

13 and 16 weeks. A one tube-nested PCR has been developed that is very sensitive and less prone to false positives compared with a standard nested PCR. A 5' nuclease assay has been developed with a detection limit of one LI cell per PCR tube. A real-time PCR has been designed as a high-throughput test for use on feces. It is as specific as a conventional PCR but is more sensitive. It can be quantified and performed with pure cultures, tissue homogenate, or bacteria shed in feces.

A multiplex PCR has also been described for *B. hyodysenteriae*, *B. pilosicoli*, and LI.<sup>22</sup> It has a 100% specificity for the three species and does not generate false positives. The PCR can detect 10<sup>2</sup> to 10<sup>5</sup> LI per gram feces. A TaqMan quantitative PCR for use on feces and tissue samples<sup>23</sup> was shown to be more sensitive and more specific than conventional PCR on tissues.

There is also an indirect fluorescent technique, but this requires expertise and a reliable *Lawsonia*-specific antibody, and again is not 100% for subclinically affected animals. The percentage of agreement between IFAT and IPMA was 98.6%. It has been suggested that IFAT is more sensitive than PCR in antemortem testing.

- **Histology:** Distal ileum, proximal colon (LM, IHC); IHC was described.<sup>24</sup>
- **Serology:** Serum antibody response in pigs to LI is specific and involves both IgM and IgG.

Methods utilize LI grown in enterocytes or LI prepared on slides as the antigen. These assays are specific because cell cultures or slides are examined microscopically, and specifically stained bacteria can be distinguished from any background. Staining of bacteria is either by fluorescent (IFA), which detects antibodies 28 days after infection, or peroxidase-labeled IPMA. The IPMA test is highly specific (100%) and fairly sensitive (90%) in experimentally infected animals. It is an appropriate diagnostic test for herd screening but not for diagnosing PPE on an individual animal basis. The IgG antibodies may be only short lived and found only between 18 to 24 weeks. These have proved useful for routine PPE diagnosis, although the humoral response is often weak and short lived. Titers of 1:30 to LI appear about 2 weeks after infection, and 90% become positive by about 3 weeks after challenge with 5% having titers of 1:480 or above. They are, however, already decaying by about 4 weeks after challenge. Antibody was not detected until 16 weeks of age and often not until 19 to 22 weeks. Today there are ELISAs for herd diagnosis.

A **cell-mediated response** can be detected in the research laboratory using an enzyme-linked immunospot assay (Elispot-T-cell assay) that measures the LI-specific secretion of IFN- $\gamma$  by lymphocytes. It appears to follow the same pattern as the humoral response, and it also starts to decay from about 3 weeks although more slowly.

Both humoral and cell-mediated responses can still be detected 13 weeks after challenge or vaccination.

### DIAGNOSIS

In a comparative review of diagnostic methods in 2009, it was suggested in that gross and histopathological examinations including the use of Warthin-Starry staining (34% sensitive but 100% specific) of tissue sections were of limited value.<sup>24</sup> The authors suggested that PCR examination of feces was the most useful in terms of sensitivity but less specific (95%) than either IHC (99%) or ISH (100%).

### DIFFERENTIAL DIAGNOSIS

#### Porcine intestinal adenomatosis

Characteristic clinical findings are inappetence, loss of weight, and mild diarrhea in recently weaned pigs. Must be differentiated from postweaning coliform gastroenteritis, which is clinically much more severe, and death rapidly occurs. The postweaning drop in average daily gain (postweaning check) occurs within several days after weaning, and recovery occurs within several days following consumption of a normal daily intake of feed.

#### Proliferative hemorrhagic enteropathy

Occurs in feeder pigs, young gilts, and boars and is characterized by sudden death and extreme pallor of the skin. Must be differentiated from fatal hemorrhagic esophagogastric ulceration, acute swine dysentery, and intestinal hemorrhage syndrome

#### Esophagogastric ulceration

Occurs in all ages of pigs but especially in growers. The necropsy finding of ulceration in the nonglandular portion of the stomach at the esophageal entrance along with hemorrhage into the stomach with passage into the intestines provides easy differentiation. Acute death with intestinal hemorrhage occurs occasionally in swine dysentery. More common in adults affected with the disease and at the onset of an outbreak. Skin pallor is not as marked, and hemorrhage is restricted to the large intestine and associated with the characteristic lesions of swine dysentery in this area. Contemporary pigs show clinical and necropsy findings typical for this disease, and the diagnosis can be confirmed with laboratory studies.

#### Intestinal hemorrhage syndrome

More difficult to differentiate from the proliferative hemorrhagic enteropathy. Occurs most commonly in 3- to 6-month-old pigs that are well nourished, and many but not all outbreaks have been associated with whey feeding. Typically associated with abdominal distension and evidence of abdominal pain preceding death and the presence of marked intestinal tympany on postmortem examination. In many cases, hemorrhage in

*Continued*

the intestine appears to result from torsion, which occludes the mesenteric veins. It occurs in all areas of the intestine except the proximal duodenum and stomach, which have separate drainage. Because of intestinal distension the torsion may be easily missed, but it is best determined by the abnormal cranial direction of the blind end of the cecum and palpation of the mesentery. This distribution of hemorrhage may occur without the occurrence of torsion, and the etiology in these cases is unknown.

#### Other diseases

**Infectious necrotic enteritis associated with *Clostridium perfringens* type C** may cause hemorrhage into the intestine but it is easily differentiated on clinical, epidemiologic, and laboratory findings. **Mild *brachyspiral* enteritis, salmonellosis, porcine circovirus type 2, and nutritional diarrheas are alternative diagnoses.**

## TREATMENT AND CONTROL

Treatment is via antimicrobials, and control relies on biosecurity, antimicrobial therapy, and biosecurity and resolute hygiene, particularly between buildings, is also important. Strict rodent control and fly control is advisable.

Biosecurity to prevent the entry of infection is the key to control. Quarternary ammonium compounds are very effective disinfectants,<sup>25</sup> and iodine and Virkon S also are effective. Beware of carrier pigs; isolate for 30 to 60 days, use preventive antibiotics as outlined later, use laboratory diagnostics, and vaccinate using the new water vaccine.

A program for the monitoring of LI in breeding herd gilts has been described<sup>18</sup> in which gilts were tested at regular intervals before sale in an infected herd and on arrival at the recipient herd. In addition, the growing pigs in the recipient herd were also tested. It was found that it was possible to establish herd profiles and to prevent transmission from herd to herd.

Eradication using early weaning is not a possibility, but using medication and vaccination is a possibility. It has been said that pigs between 30 to 50 kg shed fewer LI in the feces when they are fed nonpelleted and nonheated (home-mixed) feed. An eradication scheme for LI used in Denmark following the use of antimicrobials (tiamulin, lincomycin, and tylosin) failed. A control program was tried in the UK using PCR to identify affected animals and medication with chlortetracycline and tiamulin for control. The number of PCR-positive animals declined from 50% to 70% to 0%. In pigs over 14 weeks there were some PCR positives derived from treated groups. Another farm used tylosin phosphate and these remained clean.

### Antimicrobials

It is likely that administration of antibiotics is necessary in the early stages in water or in feed. This is usually around 8 to 11 weeks of

age. A preferred treatment would be tiamulin 120 ppm or tylosin 100 ppm for 14 days.

In acute disease, water medication and particularly individual medications are more effective than treatment through in-feed medication.

Continuous medication for LI can prevent infection but is frowned upon because it can prevent the development of immunity and extend susceptibility to infection. In fact, the timing of any medication can affect the immune response, subsequent fecal shedding, and the development of lesions.

There is no published information available on the treatment of individually affected pigs. The disease is usually treated on a herd basis by medication of the feed.

There appears to have been no changes in the in vitro minimum inhibitory concentrations (MICs) since the 1980s and 1990s. There are probably four reasons why medication does not work: (1) underdosing; (2) concurrent infections; (3) some other disease or nutrition problem, i.e., misdiagnosis; and (4) antibiotics given too late to be effective.

If antimicrobials are going to be used, it is a good idea to start at least 3 weeks before the anticipated acquisition of the infection.

In a study of 10 North American and European LI isolates it was found that for extracellular activity valnemulin was the most active with intermediate activity from chlortetracycline, tylosin, and tiamulin, but lincomycin showed the least activity.<sup>26</sup> For intracellular activity carbadox, tiamulin, and valnemulin were the most effective. Tylosin and chlortetracycline showed intermediate activity, and lincomycin was the least effective.

The antimicrobial susceptibility of the organism isolated from pigs with proliferative enteropathy was determined in a tissue culture system. Penicillin, erythromycin, difloxacin, virginiamycin, and chlortetracycline were the most active compounds tested. Tiamulin and tilimicosin were the next most active, and the aminoglycosides had the highest minimum inhibitory concentrations. Both lincomycin and tylosin were relatively inactive against the strains of the organism tested.

In the field Bacitracin, virginiamycin, and salinomycin are useless as are penicillins and fluoroquinolones.

Oral chlortetracycline, one of the oldest drugs, is still used; at 300 ppm or 600 ppm it can prevent challenged pigs from developing clinical disease. Chlortetracycline at 300 ppm and tylosin at 600 ppm have prevented the clinical signs of PPE.

Tylosin is ideal for treatment by injection, in feed, or through water and was successfully used for treating PPE at 100 ppm. For effectiveness, the antimicrobial would have to accumulate in the cytoplasm of the intestinal cell and block bacterial protein synthesis. The macrolides, tetracyclines, and virginiamycin act by selectively blocking protein synthesis

in ribosomes. The oral administration of tylosin phosphate at a dose of 100 ppm or 40 ppm in the feed to pigs for 4 days before experimental challenge and continued for 16 days when the dose was reduced to 40 and 20 ppm was effective in preventing the clinical signs and lesions of proliferative enteropathy. It does not appear to block the pattern of seroconversion to LI. Tylosin at 110 ppm significantly reduced fecal shedding of LI and histologic lesions consistent with PPE. Injection of tylosin produced an improved diarrhea score and clinical impression score, which improved weight gain. Tylosin tartrate in drinking water for the treatment of ileitis was effective in reducing clinical signs, lesions, and reduction in growth rate.

Lincomycin is ideal for injection, water treatment, and in-feed treatment. Lincomycin at 80 ppm used consecutively was shown to be useful for treatment of PPE. Lincomycin at 44 and 110 ppm for 21 consecutive days was effective in controlling the clinical signs of PPE and at 110 ppm also reduced the mortality associated with PPE. Lincomycin water-soluble powder at 250 mL/gal is also effective.

Aivlosin was found to be useful at concentrations 25% less than those used for tylosin.<sup>27</sup> Valnemulin was also shown to be effective at 75 ppm in the feed. Tiamulin is useful for in-feed medication and water administration. Tiamulin given 50 ppm, 2 days before experimental challenge and kept for 3 weeks prevented clinical disease. In addition, pigs given 150-ppm tiamulin 7 days after challenge remained clinically normal and had no specific lesions of proliferative enteropathy at necropsy. Tiamulin in water is very useful, but a study showed that in water it interfered with seroconversion, whereas administration in feed did not.

The use of Bacitracin Zinc in the feed of growing/finishing pigs at 300 ppm or 200 ppm from weaning up to 100 days of age, or 200 ppm or 100 ppm from 100 to 125 days of age, and 100 ppm or 50 ppm from 125 to 156 days of age was effective in controlling the effects of proliferative enteropathy in pigs on a farm with a previous history of the disease.<sup>7</sup>

Carbadox and zinc oxide might have some effect against LI. It has been shown to be useful if fed in the final 2 weeks in the nursery. It reduces fecal shedding, clinical signs, and no IHC + ve or PCR + ve animals were found in one study.

Hyperimmune chicken eggs fed to the swine have been suggested for controlling LI infection in growing swine.

### Vaccines

The main difference between respiratory and alimentary diseases in the last few years has been the development of vaccines for the former but not the latter. The recent development of an ileitis vaccine is the first of these for the enteric diseases.<sup>28,29</sup> This vaccination<sup>30</sup> may increase daily gain by as much as 46 g/day,



increase the carcass weight, and shorten the finishing period. It is given orally from 3 weeks of age or in clean drinking water. Be careful with the use of antimicrobials before vaccination because this may reduce the response to the vaccine. In a recent study in Denmark,<sup>29</sup> the use of oxytetracycline for treatment of LI was reduced by 79% with a significantly lower number of pigs being treated.

Vaccinating pigs through the administration of drinking water using the water proportioner is a safe, labor-saving, efficient, and easy method of vaccination. In the presence of feed medication, vaccinated pigs performed better than the nonvaccinated pigs when exposed to an LI challenge. The percentage morbidity was reduced, the feed conversion better, and the average daily gain increased by about 6%. There was also a 23% reduction in culls. It is best given in a 7-day antibiotic-free period. The present vaccine is given in water to 70- to 90-lb (30–40 kg) gilts. It can be dispensed with antimicrobials and produce protective immunity. There is a reduction in gross and microscopic lesions in the complete absence of antimicrobials when the gilts are vaccinated as finishers and the animals receive a booster vaccination every 6 months.

## REFERENCES

- Michalski CW, et al. *BMC Microbiol.* 2006;6:81.
- Pusterla N, et al. *Vet Microbiol.* 2009;136:173.
- Murakata K, et al. *J Comp Pathol.* 2008;139:8.
- Boutrop TS, et al. *J Comp Pathol.* 2010;143:101.
- Schmitz-Esser S, et al. *J Bacteriol.* 2008;190:5746.
- Collins AM, et al. *Vet Microbiol.* 2011;150:384.
- McOrist S, et al. *J Swine Health Prod.* 2011;19:277.
- Friedman M, et al. *Lett Appl Microbiol.* 2008;47:117.
- Alberdi MP, et al. *Vet Microbiol.* 2009;139:298.
- Peters J, et al. *Trends Microbiol.* 2007;15:241.
- McOrist CR. *Nat Rev Microbiol.* 2006;4:811.
- McOrist S, et al. *Can J Vet Res.* 2006;70:155.
- Oh Y-S, et al. *Vet J.* 2009;184:340.
- Vanucci FA, et al. *BMC Microbiol.* 2010;10:1016.
- Riber U, et al. *Vet Microbiol.* 2011;149:506.
- Scholz AM, et al. *Pig J.* 2008;61:25.
- Nathues H, et al. *Dtsch Tierarztl Wochenschr.* 2008;115:404.
- Jacobson M, et al. *Vet Microbiol.* 2010;142:317.
- Collins AM, et al. *Vet Microbiol.* 2007;120:381.
- Opriessnig T, et al. *J Comp Pathol.* 2011;145:261.
- Jensen TK, et al. *J Comp Pathol.* 2006;135:176.
- Stahl M, et al. *Vet Microbiol.* 2011;151:307.
- Richter B, et al. *J Vet Diag Invest.* 2010;22:70.
- Lading A, et al. *J Comp Pathol.* 2009;140:140.
- Wattanaphasak S, et al. *J Swine Health Prod.* 2010;18:11.
- Wattanaphasak S, et al. *Vet Microbiol.* 2009;134:305.
- Guedes RMC, et al. *Vet Rec.* 2009;165:342.
- McOrist S, et al. *J Vet Rec.* 2007;184:340.
- Bak H, et al. *Acta Vet Scand.* 2009;51:1.

## BRACHYSPERAL COLITIS (SWINE DYSENTERY, PORCINE SPIROCHETAL COLITIS) AND NONSPECIFIC COLITIS

The postweaned pig is susceptible to several severe enteric bacterial diseases causing considerable economic loss. *Brachyspira*

*hyodysenteriae* (BH) (swine dysentery), *Lawsoniana* and *Campylobacter* infections, postweaning *E. coli* infections including bowel edema and *B. pilosicoli* (BP; porcine spirochetal colitis [PCS]) are the main contenders. In addition ulcers, torsion, rectal stricture, and rectal prolapse add to the gamut of gut disorders of the older pig.

## SWINE DYSENTERY

Swine dysentery is a highly fatal disease characterized by mucohemorrhagic diarrhea and death if untreated for a few days. It causes economic loss (circa \$10–\$15 per pig) from mortality, morbidity, slow growth and poor feed utilization, and high costs of medication and biosecurity. It is of no public health significance. Human intestinal spirochetes are distinct.

### SYNOPSIS

**Etiology** *Brachyspira hyodysenteriae*

**Epidemiology** Probably the most economically important enteric disease in growing pigs, 8–16 weeks of age. Transmitted by fecal–oral route. Crowding and high stocking density are risk factors. High morbidity and moderate mortality if not treated

**Signs** Mucohemorrhagic diarrhea, and weight loss that are commonly persistent if not treated

**Lesions** Colitis and typhlitis

**Diagnostic confirmation** Detection of organism, in intestine. Serological diagnosis in herd

**Treatment** Tiamulin, valnemulin, tylosin, and lincomycin by injection and in water and in feed. Organic arsenicals in feed and water supplies and carbadox and monensin in feed and water in some countries

**Control** Eliminate infection with treatment in the feed and water supplies. Prevent reinfection and avoidance of introduction of carrier animals into herd. Eradicate by depopulation and repopulation, medication, and biosecurity measures.

## ETIOLOGY

The genus *Brachyspira* contains seven species including others not yet officially named. They are gram-negative, filamentous, snake-like organisms. The seven species that are known to occur in swine are listed in Table 7-24. The species characterization has recently been described.<sup>1</sup>

These species can be distinguished by their zones of  $\beta$ -hemolysis, ability to produce indole, and enzymic profiles. They all have subtypes with unusual phenotypes and genotypes. All are distinct from *B. hyodysenteriae* on ultrastructure, gene sequences, biochemical tests, and antigenic grounds. *B. hyodysenteriae* has two specific antigens, the 36-kDa protein and the 46-kDa periplasmic

**Table 7-24** Biochemical characteristics of species of *Brachyspira* isolated from pigs

Species	Main features
<i>Brachyspira hyodysenteriae</i> (swine dysentery)	Strongly hemolytic, indole +ve, some –ve
<i>B. pilosicoli</i> (porcine spirochetal colitis)	Weakly hemolytic, some +ve
<i>B. suanatina</i> (pigs and mallard) <sup>2</sup>	Strongly hemolytic, indole weakly +ve
<i>B. murdochii</i> (rarely, mild colitis in pigs)	Weakly hemolytic, indole –ve
<i>B. intermedia</i> (rarely diarrhea and colitis) <sup>3,4</sup>	Weakly hemolytic, indole –ve
<i>B. innocens</i> (rarely diarrhea, commensal?)	Weakly hemolytic, indole –ve
<i>B. hamptonii</i> (new species, colitis)	Strongly $\beta$ -hemolytic

flagellar protein. There is much antigenic heterogeneity among isolates of *B. hyodysenteriae*. There are 11 serogroups with subdivisions into serovars. Serotyping of isolates of the organism is important in terms of diagnosis and epidemiologic evaluation. The range of serologically distinct strains of the organism is much wider than previously realized. *B. hyodysenteriae* has heterogeneous antigens in the LPS portion of the outer membrane, and several serotypes of *B. hyodysenteriae* have been described on the basis of agar gel double immunodiffusion precipitation. Some serotypes predominate in certain geographic areas.

*B. hyodysenteriae* (formerly *Serpulina* and before that *Treponema*), a large strongly  $\beta$ -hemolytic spirochete, is the principal causative agent. It is supposedly indole positive, but in a study in Belgium half were indole negative. It will cause typhlocolitis in captive rhesus. Rats and mice may act as reservoirs. They are all anaerobic organisms, but they are oxygen tolerant and will grow in the presence of 1% oxygen. The genomes have been studied.<sup>5-8</sup> The diversity of isolates has been shown by MLST<sup>2,9</sup> and multilocus variable number tandem-report analysis.<sup>10</sup> *B. hyodysenteriae* can be confirmed using random amplified polymorphic DNA analysis.<sup>11</sup> It seems that they have the ability to acquire genes from each other and other enteric bacteria. They can be differentiated by pulsed field electrophoresis and multilocus electrophoresis, and the former is particularly good at differentiating strains that are genetically 53% to 100% similar. Strains of *B. hyodysenteriae* possess several antigens, some of which are shared by both *B. hyodysenteriae* and BP species. Organisms have been described that are phenotypically characteristic of *B. hyodysenteriae*, but their 23s RNA genetic



signature and sequence are consistent with *B. innocens*. Within the genus of *B. hyodysenteriae* there are some strains that are apparently nonvirulent or of reduced virulence potential. In some cases there may be clonal groups of *B. hyodysenteriae*.<sup>12</sup> The comparative virulence of *Brachyspira* isolates has recently been compared<sup>13</sup> and it was suggested that the phenotypic cultural characteristics results may be a more sensitive indicator of potential to induce dysentery-like disease than molecular identification alone based on current PCR assays. The virulence factors of *B. hyodysenteriae* have also been examined,<sup>14</sup> and although several factors were isolated only the *nox* gene was found in all the isolates and *tlyA* and *hlyA/ACP* were restricted to some *B. hyodysenteriae* isolates only. In this study a high degree of heterogeneity was seen.

## EPIDEMIOLOGY

### Occurrence

A Swedish study showed that brachyspirae species were isolated from 58.5% of all samples. Of these 25.4% were *B. hyodysenteriae*, 16.4% were BP, and 58.2% were *B. intermedia*, *B. innocens*, or *B. murdochii*.

Swine dysentery occurs worldwide and is an important disease of pigs in South America, South East Asia, and Europe. The disease had until recently declined in North America, probably because of strict biosecurity and the use of carbadox. It is most common in the 7- to 16-week-old age group but may affect older pigs to 6 months. Adult pigs and suckling pigs are seldom affected. The overall occurrence is probably around 10% with control through drugs, particularly growth-promoting antibiotics. Once a farm is affected the organism will remain, evolve, or acquire new antibiotic resistance unless there is depopulation, disinfection, and restocking or whole herd medication.

### Risk Factors

In a recent study of an outbreak in East Anglia, UK, that began on one farm following the movement of 400 pigs to an outdoor unit in mid-2006, it was found that by early 2009 it had spread to 29 units by a variety of methods (Table 7-25).

**Table 7-25** Importance of fomites and animals in spread of *Brachyspira* sp. on one farm

Method of spread	Out of 29 (%)
Pig movement	13 (44.8)
Local spread	3 (10.4)
Management	4 (13.9)
Contractor	1 (3.4)
Pig transport	3 (10.4)
Birds	2 (6.9)
Feed truck	1 (3.4)
Unknown	1 (3.4)

### Animal Risk Factors

Pigs from 8 to 16 weeks of age are most susceptible to swine dysentery. Most outbreaks occur after purchasing infected animals from herds known to have the disease or where the disease is not acknowledged (sold as weaners) and trading continues. Infection is spread within and between swine herds by carrier pigs. It has been found in feral pigs and wild boar and occasionally affects birds, mice, rats, and dogs on infected farms. Mice are capable of carrying the organism for up to 180 days after inoculation.

### Pathogen Factors

There are many latent infections without clinical signs. There is some evidence that the organism destabilizes the microbial community in the large intestine. Experimentally, the oral inoculation of gnotobiotic pigs with a combination of *B. hyodysenteriae* and *B. vulgatus* or *F. necrophorum* will result in the development of the characteristic clinical signs and lesions of swine dysentery. The disease has been reproduced with pure cultures of *B. hyodysenteriae* in conventional and SPF pigs. Challenge of gnotobiotic pigs with pure cultures results in colonization, but disease does not occur until other intestinal organisms are given, which suggests that the disease is the result of a mixed synergistic infection of the spirochete and other intestinal anaerobic organisms. These results and others are consistent with the concept that *B. hyodysenteriae* is the primary causative agent of swine dysentery and that the presence of one or more other anaerobes is a prerequisite for expression of pathogenicity of *B. hyodysenteriae*. This prerequisite can be met by a variety of anaerobes. There is considerable variation in virulence among strains of different serotypes of *B. hyodysenteriae* when given orally to SPF piglets or mice. A virulent *B. hyodysenteriae* has been isolated from a herd free of clinical swine dysentery, which indicates that the organism can still be present in herds considered to be free of the disease.

The major polypeptides of *B. hyodysenteriae* are strong immunogens and present in the various serotypes, but there is considerable diversity in the antigenicity of LPS between those same serotypes. A PCR-based DNA fingerprinting technique can analyze genetic profiles of isolates of the organism from cases of swine dysentery in different herds, which could be important epidemiologically.

Potentially pathogenic weakly  $\beta$ -hemolytic intestinal spirochetes may be present in swine herds with a high incidence of diarrhea and can be distinguished from nonpathogenic strains by the hippurate hydrolysis test. The prevalence of these strains is reduced in herds medicated with olaquinox.

### Environmental and Management Risk Factors

The usual source of infection is through the import of pigs. It is, however, difficult to

control these because of asymptomatic carriers. Investigation has shown that it may be the dirty truck that is important. In other words, biosecurity has failed.

Overcrowding and the buildup of fecal wastes in pens contribute to an increased incidence of swine dysentery. The failure to clean solid floor pens on a regular basis results in an accumulation of fecal wastes, which increases the infection pressure. The contamination of pens with fecal effluent from adjacent pens or by open flush gutter systems allows pigs access to the flush water and can provide sources of infection and reinfection. The continuous introduction of young pigs into pens that have not been previously cleaned out and washed provides sources of infection. The mixing of weaner pigs from different sources is often a source of infection for susceptible pigs.

Several factors affect the survival of the organism from the feces of infected pigs. It can survive 10 days in soil at 10°C and up to 78 days if there is 10% pig feces in the soil. The organism can survive for up to 48 days in dysenteric feces at 0 to 10°C (32–50°F); survival is reduced to 7 days at 25°C (77°F) and to less than 24 hours at 37°C (98.6°F). Dilution of dysenteric feces with tap water (1:10) enhances survival to 61 days at 5°C (41°F). It has been found in feces after 112 days. Drying and disinfection rapidly eliminates the organism from the environment. Phenolic and sodium hypochlorite disinfectants are most effective. The organism can survive in lagoons for up to 60 days. In swine herd facilities with an open gutter-flush system that has housed dysentery-infected swine, the lagoon water is used to expel feces from the building, allowing the pigs to drink the effluent as it flows through the gutter. Under these conditions the organism may survive for 5 to 6 days after the removal of infected shedders. The organism has been isolated from the lagoon of a waste-handling system of a swine farm, which could be partially responsible for maintenance of swine dysentery within a herd.

The effects of dietary constituents on the commensal bacterial flora of the large intestine are not well understood. It was thought that nonstarch polysaccharide was drawn into the distal parts of the colon and was then available for fermentation. The inclusion of wheat and soybean and/or the addition of exogenous enzymes to pig diets might influence the large intestine microflora, but did not prevent swine dysentery. The colonization of the gut by spirochetes was highly related to soluble nonstarch polysaccharide, and the development of swine dysentery was influenced by the resistant starch content of the diet. Feed containing large amounts of soya bean meal and group housing of pigs were considered to be the major contributing factors in the experimental production of swine dysentery. Feed containing high levels of soluble nonstarch polysaccharides results in an increase in viscosity of gut contents, an

increased amount of gut fluid, a low pH, and an increased number of coliforms in the intestines. A recent experiment with feeding and swine dysentery showed no effect of feeding rice in the diet. The feeding of rice was not able to prevent swine dysentery, and the increase of nonstarch polysaccharide or resistant starch was not able to reduce the incidence or prevalence of swine dysentery; in fact the clinical signs were worse.

### Methods of Transmission

*B. hyodysenteriae* is present in the feces of affected pigs. Infection is by ingestion, and transmission is enhanced by conditions leading to fecal–oral cycling. Spread of infection within a group is slow, taking up to 7 to 14 days, and it may spread to other pens of pigs over a 2- to 3-week period. Pigs that have recovered from clinical disease with or without treatment may become carriers and still have the ability to shed the organism and infect in-contact animals for 50 to 90 days. Clinical disease may initially be precipitated by stress, but infection subsequently spreads by direct contact. The frequency of shedding varies with time, and only a small proportion of a convalescent population may be expected to be carriers. Every method of fecal transmission is a likely source (trucks, people, clothing, boots, etc.).

### PATHOGENESIS

*B. hyodysenteriae* survives gastric acid and reaches the large intestine. In viscous environments *B. hyodysenteriae* has an improved movement. The agent possesses several outer membrane proteins including a 29.7-kDa lipoprotein (*B. hyodysenteriae*lp29.7) and a 39-kDa variable surface protein.<sup>15</sup> It also has an LPS in the outer envelope that may help it to disrupt the colonic epithelial barrier. In addition, NADH oxidase activity protects it from oxygen toxicity. Hemolytic activity is an essential virulence factor possibly controlled by four genes, *tly* A, B, and C and *Lly*A.

A hemolysin with cytotoxic activity extracted from a virulent strain of the organism causes severe epithelial damage when injected into ligated loops of the ileum and colon of germ-free pigs and is a virulence factor in swine dysentery. The organism can adhere to a culture of intestinal cells in vitro, which may be one of its virulence factors. The organism is also highly motile, which provides it with the ability to move through mucus and facilitates penetration into the mucosa. This may be a very important virulence factor. A wide variety of other virulence factors may be important. The organism probably does not attach to the epithelial surface of cells; instead it colonizes the overlying mucous layer. Chemotactic attraction of the organism to sites containing mucus is also a potentially important factor. It penetrates the mucus and moves down into the crypts and disrupts the colonic epithelium, causing mucohemorrhagic colitis while resisting oxygen toxicity. The organism

colonizes the intestinal mucosa by association with intestinal mucus in both the mucous gel covering the epithelium and the mucous-filled crypts (on the other hand, the weakly  $\beta$ -hemolytic *B. pilosicoli* [BP] attaches by one cell end to the luminal surface of the colonic epithelium to form a dense carpet of adherent spirochetes).

It is still not known if invasion is a necessary feature of infection for swine dysentery. Where it lives normally is unknown, but in the intestine it can obviously breed more quickly than it is evacuated. The pattern of colonization appears to be random. The hemolysin lyses the intestinal mucosal cells, which then supply the brachyspirae with the vital sterols from the membranes. Several genes may be involved in virulence including *tly*A and *Lly*A. For infection to become established, it seems that a gene for the production of NADH oxidase is required because it protects against the effects of oxygen toxicity. Similarly, there may be a *Brachyspira* iron transport system, and the presence of this may correlate with the pathogenicity of *B. hyodysenteriae*. Another gene of interest is the *mgfB* gene, which may eventually be shown to be of great importance. Lipooligosaccharide production may also be a virulence factor.

Chemotactic- or motility-regulated mucous association appears to be the predominant mechanism of mucosal association. There is progressive erosion of superficial epithelium, excess mucous production, edema, and hemorrhage of the lamina propria and pseudomembrane production. When the numbers of organisms reach  $10^6$ /cm<sup>2</sup> of mucosa then lesions begin to appear. The spirochetes appear in the feces about 1 to 4 days before the diarrhea starts. The erosive colitis is the cause of the diarrhea, dysentery, and excessive quantities of mucus in the feces. Some CD8+ cells may be associated with susceptibility to experimentally induced swine dysentery, whereas monocytes and CD4+CD8+ T-cells appear to be the major responding leukocytes during the disease. Death results from chronic dehydration and bacterial toxemia. In some animals, an acute shock syndrome results in rapid and sudden death. Early in the disease it activates IL-1 and IL-6 and stimulates macrophages. In the later stages T-cells play an important part in defense.

The diet has a major effect on the outcome of *B. hyodysenteriae* infections. Colonization can be controlled by feeding diets high in digestibility, which alter the colonic microbiota and encourage species that inhibit spirochetes to flourish.<sup>16,17</sup> Diets rich in inulin will do the same.<sup>18,19</sup>

### CLINICAL FINDINGS

The disease usually affects growers and finishers a few weeks after moving from the nursery, and rarely weaners. Occasionally it affects sows at farrowing or in midlactation. It usually affects 6- to 12-week-old pigs, but

can be of any age. The incubation period in the field may be 7 to 60 days but experimentally is usually 4 to 14 days.

Morbidity within a group of pigs can range from 10% to 75%, mortality from 5% to 25%, and if untreated the case–fatality rate can be as high as 50%. Most often, initially, only a few pigs are affected within a group, but spread occurs over a period of a few days to 2 weeks to involve the majority. Affected pigs are slightly depressed, have a reduced appetite, and a moderate fever (40.0–40.5°C). The feces are only partially formed, usually of a porridge-like consistency, and are passed without apparent conscious effort and splatter on contact with the pen floor. Affected pigs commonly defecate almost anywhere and on anything in the pen. The feces are light gray to black and on close inspection a great deal of mucus is present and flecks of blood and epithelial casts may be seen. In some pigs, the presence of larger amounts of blood will discolor the feces accordingly. The occurrence of blood in the feces generally occurs 2 to 3 days after the initial onset of diarrhea. Affected pigs become progressively dehydrated and their abdomens appear gaunt and sunken. Death usually occurs some days to weeks after the initial onset of signs and results primarily from dehydration and toxemia. Pigs with a severe hemorrhagic diarrhea die more quickly. Skin discoloration is not a feature except in the terminal stages.

In untreated pigs the disease may persist for 3 to 4 weeks before clinical recovery. Less commonly an outbreak may start with the sudden death of one or two pigs with no evidence of premonitory signs or a terminal hemorrhagic diarrhea. This occurs more often in market-age pigs and adults in herds in which swine dysentery has been introduced for the first time. It also is a rare cause of sporadic death of gilts and sows in conventional herds.

The disease responds well to treatment, but following withdrawal of treatment the disease may recur within the same group of pigs. It can also recycle on farms at 3- to 4-week intervals and reappear after the cessation of antibiotic therapy. A chronic form of the disease with persistent diarrhea and failure to grow occurs in some pigs with irreversible lesions of the colonic mucosa.

### Immunity

Maternal antibody must be present to protect the young pigs. Clinical disease is associated with development of specific IgG, IgA, and IgM antibodies in serum and local production of IgA in gut mucosal tissues. The IgG levels correlate with detection of clinical signs. IgA in the large intestine indicates recent infection. Treated and untreated convalescent pigs develop elevated titers that are maintained as long as 150 days after infection. The relationship between the magnitude of the agglutinin titers and protective immunity is not clear. Carrier pigs shed *B.*

hyodysenteriae while elevated agglutination titers against the organism are present.

Untreated pigs that recover from swine dysentery are resistant to experimental challenge for up to 16 to 17 weeks postinfection, and these are partially species specific. In herds affected with swine dysentery, the disease may reappear at 3- to 4-week intervals following treatment, and the more efficacious drugs may inhibit the development of immunity.

### CLINICAL PATHOLOGY

Hematology may well show an elevation of the leukocytes with a shift to the left. The acute phase proteins may increase. There is an early increase in the erythrocyte sedimentation rate and fibrinogen levels. Total plasma proteins may be elevated. The blood levels of sodium, chloride, and bicarbonate decrease. A marked metabolic acidosis and terminal hyperkalemia may follow. In experimental swine dysentery, neither blood glucose nor lactate showed any changes, but the serum concentrations of glucogenic nonessential amino acids such as serine, alanine, glutamine, and tyrosine decreased.<sup>20</sup> Lysine increased during the swine dysentery and leucine increased during the recovery.

### Detection and Culture of Organism

The organism may be detected in the feces of affected pigs by dark-field microscopy as highly motile organisms with a characteristic serpentine motility or in dried smears with Giemsa or Victoria blue 4R staining. The best diagnosis is achieved by taking samples from the upper colon. Fecal samples submitted for laboratory examination should be diluted (1:10) in phosphate-buffered saline or rectal swabs placed in Amies medium to avoid death of the organisms, which will occur when the samples are stored at room temperature or sent in the mail. Microagglutination tests (MATs), slide agglutination tests, and indirect and direct FATs are also used to detect the organisms.

The organism can be cultured on Trypticase soy agar containing 5% defibrinated bovine blood under specific atmospheric conditions.

**Florescent antibody staining** aids considerably in its demonstration, but may not distinguish nonpathogenic strains and false-positive and false-negative results are common. The presumptive diagnosis from the fluorescent antibody test (FAT) can be supplemented with a variety of laboratory tests that serve to identify the spirochetes as pathogenic. The **slide agglutination test** is a useful and specific means of identifying an organism but requires an appreciable amount of growth of spirochetes on the surface of the agar to perform the test. The **microscopic agglutination test** is a rapid test for the definitive laboratory identification of *B. hyodysenteriae*, but it cannot distinguish the avirulent strains of the organism.

A major diagnostic problem has been the identification of carrier pigs that are infected with the organism and are a potential source of infection to other pigs. Indirect and direct FATs used to examine feces and colonic material from pigs for *B. hyodysenteriae* have not been sensitive or specific enough to identify individual infected pigs.

Any diagnostic test must be able to distinguish between the different *Brachyspira* spp. Some are harmless commensals, whereas others are potentially pathogenic. *B. innocens*, a nonpathogenic inhabitant of the porcine large intestine, is very similar to *B. hyodysenteriae* in both morphology and growth characteristics and shares many of the same surface antigens. Numerous serologic tests with sera from pigs that have recovered from *B. hyodysenteriae* infection have demonstrated the presence of cross-reactive antibodies between *B. hyodysenteriae* and *B. innocens*, which makes differentiation difficult.

**Antigen detection methods** based on the use of DNA probes or PCR have recently been developed and show considerable promise. They use portions of the 16sRNA and 23sRNA gene or the *nox* gene or *tylA* gene. The PCR is usually performed on the primary isolation plate (3–5 days), which can also be used for antimicrobial sensitivity.

A PCR was developed that could detect  $10^3$  to  $10^6$  organisms, and this was more rapid and detected more positive samples than did fecal culture and isolation.

The duplex PCR developed was also more sensitive than the culture and biochemical tests, which were shown to detect  $10^2$  bacteria per gram of tissue and would be used to differentiate *B. hyodysenteriae* from BP.

A multiplex PCR has been developed that will differentiate *B. hyodysenteriae*, BP, and *L. intracellularis*.<sup>21,22</sup> RT-PCR enables detection of the numbers of the bacteria. ISH will also work for *B. hyodysenteriae*.

The most definitive method for differentiating *B. hyodysenteriae*, *B. innocens*, and BP is the DNA–DNA relative reassociation method.

### Serologic Tests

Monoclonal antibodies against the serotype-specific LPS antigens of *B. hyodysenteriae* can be used in ELISA,<sup>23</sup> indirect immunofluorescence, and immunoblot assays to differentiate between *B. hyodysenteriae* and *B. innocens*.

Serologic tests such as microtiter agglutination tests and ELISAs can be used on a herd basis to identify infected herds. It is 100% sensitive and specific but cannot confirm individual infected animals. The ELISAs will detect  $10^2$  organisms per milliliter of feces.

A variety of serologic tests have been used, and typically these tests have used whole cultures or LPS as the antigen.<sup>9</sup> The former tends to increase false positives, and the latter increases false negatives but gives fewer false

positives. Generally, these techniques are useful for detecting infected herds but are unable to detect individual infected pigs that may be acting as carrier animals. Recently a 30-kDa outer membrane lipoprotein (BMPB), which is specific to *B. hyodysenteriae* and is recognized in both experimentally and naturally infected pigs, was identified, the gene cloned and sequenced, and specific epitopes on BMPB are being identified.

Serologic tests can assist in the identification of carrier pigs. An evaluation of several serologic tests for detection of antibodies against *B. hyodysenteriae* concluded that only the MAT detected antibodies to the organism. The ELISA has been used to detect antibodies in individual pigs, but cross-reactions between *B. hyodysenteriae* and *B. innocens* are common. An ELISA using serotype 2 *B. hyodysenteriae* as antigen could not differentiate between stages of infection but could indicate if the pig had been infected.

### NECROPSY FINDINGS

Lesions are restricted to the cecum and colon and occasionally the rectum,<sup>24</sup> and these can be found in healthy pigs. Sometimes the lesions extend over the whole large intestine or are localized. There may be hyperemia and edema of the large-intestinal walls and mesentery. The mesenteric lymph nodes may be swollen with edema fluid. The mucosal lesions vary from catarrhal to fibrinonecrotic to hemorrhagic typhlocolitis. They are often covered by mucus and fibrin and flecks of blood. Colonic contents are soft to watery. With progression the edema and mucosal lesions become more severe with increased fibrin exudation and the formation of a thick mucinous pseudomembrane containing blood. Goblet cell hyperplasia is very prevalent. The cells at the base of the crypts may be elongated and hyperchromic. There may be spirochetes in the goblet cells and in disrupted epithelial cells. Some spirochetes may be found around blood vessels.

The carcasses of pigs that have died from swine dysentery usually show weight loss, dehydration, and a microscopically visible typhlitis and colitis. The colitis is initially present in the apex of the spiral colon but subsequently spreads to involve the whole colon and the cecum. In the early stages, there is inflammation and necrosis with varying degrees of hemorrhage into the lumen. The submucosal glands are enlarged and frequently visible through the serosa of the colon as opaque spots. In advanced cases a fibrinonecrotic exudate is adherent to a reddened and granular mucosal surface. Intestinal contents may also adhere to the mucosa. The crypts are often thickened with edema. The draining lymph nodes are enlarged and congested. The small intestine is spared except for involvement of the terminal ileum in advanced cases. Spirochetes may be demonstrated in large numbers using Warthin/Starry stains in smears from the mucosal



surface of these lesions, especially in early cases, but there is no systemic invasion.

Electron microscopic examination of the colon of pigs with swine dysentery reveals changes indicative of stasis in the microcirculatory vessels of the lamina propria. The earliest colonic lesion consists of superficial vascular congestion and dilatation, edema of the lamina propria, and intercellular separation of the epithelial cells at the crypt shoulders. This lesion progresses to epithelial cell necrosis and extrusion with extravasation of red blood cells into the lumen. Degeneration, necrosis, and extrusion of superficial colonic enterocytes follows progressively. Large spirochetes are present in the crypts, in the cytoplasm of damaged epithelial cells, and in cavities around vessels of the lamina propria. The characteristic lesion of swine dysentery is necrosis of the superficial colonic epithelium. This feature may be difficult to appreciate in partially autolyzed tissues, or if the animals sampled are recovering from the infection or being treated with antibiotics. In subacute lesions the crypt hyperplasia and goblet cell hyperplasia is more pronounced, and the extensive mucous production distends all the crypts.

*B. hyodysenteriae* is difficult to culture, requiring anaerobic conditions and selective media. This has promoted the development of alternative diagnostic techniques such as PCR and immunohistochemical stains. Wet mount preparations from the colonic mucosa are often used to make a presumptive diagnosis and an FAT is available to confirm.

A consecutive study was made of the pathology of lesions by repeated endoscopy and biopsy samplings was made.<sup>24</sup> On the third day, endoscopy showed a hyperemic reactive mucosa and excessive amounts of mucus. Histologically, there was crypt hyperplasia, depletion of goblet cell mucus, and epithelial erosions. At the same time there were elevations of acute phase proteins, circulating monocytes, and decreased numbers of CD3+ cells. After 5 days the pigs returned to normal.

## DIAGNOSIS

The history and clinical signs indicate either *B. hyodysenteriae* or *B. hamptonii* and are more severe than those of BP. Confirmation can be started by smears of feces or mucosal smears and finding typical spirochetes. The rest of the confirmation requires laboratory testing using the methods described earlier, particularly culture on selective media. Spirochetes can be confirmed by growth inhibition tests and by specific antisera, and enzyme analysis using the API ZYM system is useful because *B. hyodysenteriae* lacks  $\alpha$ -galactosidase.

## Samples for Confirmation of Diagnosis

- **Bacteriology:** Colon culture (culture has special requirements such as an agar

gel plate with added spectinomycin, colistin, and vancomycin media or BJ medium). Direct smear (modified acid-fast stains), FAT, PCR

- **Histology:** Formalin-fixed colon, several sites (LM, IHC). ISH and an IFA can be used on fixed tissue.

## DIFFERENTIAL DIAGNOSIS

Swine dysentery must be differentiated from other diseases in which there is diarrhea in growing pigs. Pigs with swine dysentery are usually emaciated, dehydrated, have a rough hair coat and fecal staining of the perineum, and have mucohemorrhagic colitis.

Identification of the new species *Brachyspira hamptonii* also requires laboratory identification.

**Porcine colonic spirochetosis:** This is the most difficult differential diagnosis of swine dysentery and is associated with a mild diarrhea in weanlings and growing pigs. It requires laboratory confirmation.

**Coliform gastroenteritis, salmonellosis, and hog cholera:** Characterized by more rapid onset and spread within a group than with swine dysentery and death occurs earlier. In coliform gastroenteritis and salmonellosis, the initial sign may be sudden death or severely depressed and weak pigs with fever, skin discoloration, anorexia, and a profuse watery diarrhea. Coliform gastroenteritis occurs within a few days after weaning, whereas hog cholera occurs in all ages of pig with a high mortality. Swine dysentery is more insidious at onset, the appetite is rarely completely lost, and the feces are soft and mucohemorrhagic. At necropsy the lesions of swine dysentery are confined to the large intestine, whereas in coliform gastroenteritis, salmonellosis, and hog cholera lesions are also present in the small intestine. Salmonellosis has deep hemorrhagic, necrotic lesions with coagulative necrosis. Other diseases may result in the passage of bloody feces.

*Trichuris suis* is usually grossly visible in large numbers.

**Intestinal hemorrhage syndrome:** Generally persists as a severe hemorrhagic diarrhea with rapid death rather than as a chronic syndrome, but pathological differentiation may be necessary. It is usually associated with whey feeding. Swine dysentery does not affect the small intestine. Chronic hemorrhage caused by **esophagogastric ulcer** results in melena; the epidemiological findings are different, and the necropsy findings are characteristic in the intestine and other organs.

## TREATMENT

Affected pigs may need supportive therapy.

## Antimicrobial Therapy

Some authorities have suggested that the recurrence of *B. hyodysenteriae* in the United

States may be caused by increasing antibiotic resistance as has happened in Europe and Asia. In a recent study, the MICs against lincomycin and gentamicin were high, as were the patterns shown by *B. murdochii* and *Brachyspira* species rather than *B. hyodysenteriae*. The other antibiotics had MICs at the low end of the range.

Antimicrobials are usually administered by mass medication to all pigs within the affected group. Treatment by water medication rather than feed medication is preferable, because it is generally easier and quicker to put into place, and affected pigs usually continue to drink (but perhaps not in the same quantities as when unaffected) while they are anorexic. Pigs with severe hemorrhagic diarrhea and toxemia may not drink sufficient medicated water and must be treated initially by parenteral injection.

Medication of feed is most suitable for subsequent prophylaxis. When outbreaks occur, all severely affected pigs should be treated individually, and the drinking water medicated for several days at therapeutic levels, followed by possible medication of the feed for up to 3 weeks or longer at prophylactic levels.

## Choice of Antimicrobials

Several antimicrobials are suitable for the treatment and control of swine dysentery, and the choice is largely dependent on availability, cost, efficacy, and the regional withdrawal regulations. The antimicrobials and their dosages given here are used in treatment and control.

Currently, tiamulin, lincomycin, and the nitroimidazoles (dimetridazole, ronidazole, and ipronidazole) are the most effective antimicrobials for treatment by water medication. In some countries, certain antimicrobials may not be approved for use in pigs. The most efficacious antimicrobials for use in the feed are carbadox, the nitroimidazoles, tiamulin, and lincomycin.

A macrobroth dilution in vitro technique determined the antimicrobial sensitivity of a group of isolates of *B. hyodysenteriae* from Australia, the United States, and Canada. Dimetridazole and tiamulin were effective against most of the isolates. Lincomycin inhibited the growth of some isolates, and tylosin failed to inhibit most of the isolates tested. A group of isolates of *B. hyodysenteriae* from the UK were all sensitive to tiamulin, and there was no evidence that the organism was developing resistance to the drug. A large number of strains of *B. hyodysenteriae* isolated in Hungary between 1978 and 1992 were tested against seven chemotherapeutic agents commonly used for the treatment of swine dysentery, and the changes in patterns of resistance were also monitored. All strains remained sensitive to carbadox. The sensitivity to dimetridazole gradually decreased with about 50% of strains still sensitive. Most strains were



resistant to tylosin. Resistance to lincomycin gradually increased but about 50% remained sensitive. Tiamulin was most effective but some resistant strains have emerged. Monensin was effective for prevention but resistance may evolve quickly. Sedecamycin, a macrolide antimicrobial, was effective but the MICs were much higher than expected. Isolates of *B. hyodysenteriae* in Denmark were sensitive *in vitro* to virginiamycin, but medication of the feed at 20 ppm was ineffective for control. A combination of tiamulin and salinomycin, and salinomycin alone in the feed for 105 days in diminishing doses is effective in controlling naturally occurring disease and in the first 30 days (60 ppm salinomycin and 30 ppm tiamulin), in the next 60 days (30 ppm each), and the next 15 days (30 ppm salinomycin). For salinomycin alone the diminishing dose is the first 30 days (60 ppm), the next 60 days (30 ppm), and the next 15 days (30 ppm; Table 7-26).

Organic arsenicals are the least expensive and are recommended as the first drug of choice when available in the country. When given in either the feed or water, there is a risk of toxicity. The general recommendation is to administer the medication for a 7-day period and then withdraw it for a 7-day period before reintroduction. However, this is frequently impractical, and continuous medication at 250 ppm in the feed is often used as follow-up therapy. Toxicity does not usually occur below levels of 500 ppm, but it has occurred at levels as low as 200 ppm where continuous medication is practiced, and constant surveillance for signs of toxicity is necessary. Although resistance to organic arsenicals has been suspected, it has not been documented. There has been a marked decline in the use of arsenicals for the clinical management of swine dysentery.

It is essential to use agar or broth dilution methods to reach MICs for the various antibacterials, because there is a need to standardize at this time of decreasing sensitivity<sup>26</sup> and increasing transfer of resistance genes.<sup>27</sup>

### Failure to Respond to Therapy

**For elimination of *B. hyodysenteriae* the selection of an effective drug is necessary.** The major problems with the treatment of swine dysentery are the failure of some outbreaks of the disease to respond favorably to treatment, and relapses or new cases that may occur following withdrawal of medication of the feed or water. Several drug-related problems have been postulated to explain these problems.

**Drug-delayed** swine dysentery occurs several days after withdrawal of medicated feed. It may be caused by either an ineffective drug or inadequate dosage of an effective drug and failure to eliminate the causative organism from the colon. However, reinfection from other swine must also be considered. The nitroimidazoles at high levels will apparently prevent the delay or recurrence of dysentery.

**Table 7-26** Antibiotic therapy in use for swine dysentery

Antibiotic	Dosages
Tiamulin	10 mg/kg BW IM for 3 days 8 mg/kg for 5–7 days in water (60 mg/L for 5 days in water) 106–120 ppm (30–40 g/tonne) for 7 days in feed Followed by 30–40 mg/tonne for 2–4 weeks Recovery often occurs in 24 h
Valnemulin	3–4 mg/kg BW/day for 3–4 weeks in feed For prevention 25 ppm (1.0–1.5 mg/kg) for 7–28 days Both valnemulin and tiamulin cross-react with ionophores (salinomycin, narasin, and monensin) and they should not be given together.
Carbadox	50 mg/kg of feed for 30 days to 35 kg only or combined with sulfamethazine at 100 mg/kg of feed
Lincomycin	11 mg/kg BW IM daily for 3 days, <10 days In water at 44 ppm (8 mg/kg BW) in water for <10 days In feed at 100 g/tonne for 3 weeks or until signs disappear Followed by 40 g/tonne Not suitable for animals over 110 kg Resistance occurs at an MIC of 30 mg/L.
Lincomycin/spectinomycin	66 ppm of both in the feed for 8 days Followed by 44 ppm for 20 days
Tylosin	10 mg/kg BW IM twice daily for 3–5 days 5–10 mg/kg BW in water for 5–7 days Then next 100 g/tonne for 3 weeks in feed Followed by 40 g/tonne in feed Widespread resistance, but where sensitive it works
Aivlosin	Can be used when there is tylosin resistance <sup>25</sup>
<b>Imidazoles</b>	
Nitroimidazole	(Not in the United States or Europe) 260 ppm in water for 7–14 days
Dimetridazole	200 g/tonne in feed
Ronidazole	60 ppm in water for 3–5 days, 120 ppm (60 mg/tonne) in feed. Resistant strains will develop.
Monensin	100 ppm in feed for 56 days Followed by 50 ppm from 56–84 days, and 25 ppm until 112 days Toxicity if used with pleuromutitins
<b>Arsenicals (formerly in common use)</b>	
Sodium arsenilate	In water at 175 ppm for 6 days
Arsanilic acid	500 g/tonne for 21 days in feed (monitor for signs of toxicity)

*BW*, body weight; *IM*, intramuscularly; *MIC*, minimum inhibitory concentration; *ppm*, parts per million.

In experimentally induced swine dysentery using colon from affected pigs, oral inoculums such as tiamulin in the drinking water at 45 mg/L or 60 mg/L for 5 days were also effective in treating clinical disease. However, diarrhea commonly recurred 2 to 10 days after withdrawal of the drug and repeated medication of the water with tiamulin was necessary to reduce the severity of diarrhea and prevent deaths. After one to three retreatments, the pigs were immune to experimental exposure and there was a significant increase in their serum anti-*B. hyodysenteriae* antibodies. This supports the observation that when certain antimicrobial agents such as dimetridazole, which are

highly effective in preventing the development of diarrhea, are withdrawn, the affected pigs do not become immune.

**Drug-diminished** swine dysentery occurs when suboptimal levels of the drug are used. The severity of the diarrhea is reduced and deaths do not occur, but the disease is not eliminated. However, severe disease may follow withdrawal of medication.

The feeding of ronidazole at 60 ppm for 10 weeks, or carbadox at 55 ppm or lincomycin at 110 ppm for 6 weeks eliminated an experimental infection, and swine dysentery did not recur during a 9-week period after withdrawal of the medication. The feeding of sodium arsenilate at a level of 220 ppm for 3

weeks to pigs, which had been fed ronidazole for only 6 weeks, did cause the development of swine dysentery.

In both drug-delayed and drug-diminished swine dysentery, there are chronic lesions in the colon. In drug-resistant swine dysentery, medication of the feed is not effective and diarrhea and deaths occur. Certain outbreaks of the disease may be resistant to both tylosin and sodium arsanilate. The sensitivity of *B. hyodysenteriae* to dimetridazole has not decreased significantly following use of the drug over several years.

**Drug-augmented** swine dysentery is a more severe form of the drug-resistant disease in which affected pigs are more severely affected than nonmedicated controls. The cause is unknown. The disease occurs in a severe form several days or weeks following withdrawal of successful medication for a previous outbreak of the disease. This form appears to occur most commonly in pigs that did not have clinical disease during an earlier outbreak but received medication. The concentration of the drug administered was sufficient to prevent diarrhea, but not sufficient to eliminate the spirochetes from the colon. During the delay of the initial diarrhea by the drug, there may have been intraglandular recolonization of spirochetes throughout the colon. After withdrawal of medication, rapid intraglandular multiplication of the large spirochetes may occur and result in clinical disease. Drug-delayed augmented dysentery usually occurs only in those pigs that have been infected but did not develop clinical disease, which usually results in immunity. The occurrence of diarrhea is necessary for its development, which occurs 4 to 13 weeks after infection. Treatment of swine dysentery with the more efficacious drugs has been shown to inhibit the development of this immunity and serum antibody to *B. hyodysenteriae*. However, the clinical significance of this is undermined, and at present it is suggested that outbreaks of swine dysentery be treated vigorously.

It should be possible to minimize these drug-related problems of swine dysentery by the use of therapeutic levels of effective drugs in the drinking water for short periods followed by prophylactic levels in the feed for 3 weeks or more. This must be combined with proper management techniques and waste disposal systems that minimize or prevent reexposure.

Regardless of the drug used, many pigs are reinfected following withdrawal of medication because of the continual presence of the organism in the environment. The sources of the organism include in-contact carrier pigs shedding the organism and survival of the organism in waste materials (see the section [Epidemiology](#)).

### Cleaning and Disinfection

After the institution of treatment, thorough cleansing of the contaminated pens is necessary to prevent reinfection or the

transmission of infection to new groups of pigs. This is usually done after 3 to 6 days, when all diarrhea has ceased. The decision to continue with prophylactic medication depends on the hygiene and a knowledge of past patterns of the disease on the farm. It is generally recommended to continue prophylaxis for at least 2 weeks. Swine housing units with open gutter-flush systems in which swine dysentery-infected pigs have been maintained should remain idle for a longer period than 5 or 6 days to eliminate *B. hyodysenteriae*.

### CONTROL

Experimentally, a highly digestible diet can protect pigs from swine dysentery. Diet cannot influence the colonization of *B. hyodysenteriae*.<sup>28</sup> Diets containing inulin but not lupins helped to prevent swine dysentery in experimentally challenged pigs.<sup>18</sup>

Effective control of swine dysentery is dependent on the control of infection in the herd and the limitation of reinfection, eradication by depopulation, and repopulation or mass medication without depopulation.

### Control of Infection/Limitation of Reinfection

Control of the clinical disease can be achieved by early treatment with adequate levels of antimicrobials for a sufficient length of time. This must be combined with adequate removal of fecal wastes to prevent reinfection. Pigs destined for market should be moved out as a group and their pens cleaned, disinfected, and allowed to dry for a few days before pigs are restocked. Where possible the purchase of feeder pigs should be restricted to private sales from herds with no history of the disease. Communal trucks should not be used for transport. Where this is not possible pigs should be placed in isolation pens for 3 weeks and provided with medicated feed or water to eliminate the carrier state in infected pigs. Every effort should be made to avoid potential fecal–oral cycles and contamination by feces between pens. Preventing the buildup of fecal wastes is also of paramount importance. Pigs from different source farms should not be grouped in the same pen. It is also necessary to reduce the stress of transportation and overcrowding on the pigs.

In farrowing-to-market enterprises where the disease is always a threat, routine prophylactic medication may also be necessary. This is commonly performed following weaning and during the early growing phase. In countries where withdrawal periods are in force, the use of certain antibiotics is precluded for this purpose.

The feeding of tiamulin at a dose of 20 mg/kg BW to pregnant sows, beginning 10 days before farrowing and continuing until 5 days after farrowing when the piglets are weaned and transferred to an isolation unit, has been successful in the prevention of infection of newborn piglets. This is known

as the “barrier method,” which can be an efficient method of eradicating endemic infections. To reduce the risk of postnatal infection of the progeny, the piglets should stay with the latently infected sows for the shortest time possible. Furthermore, early weaning is necessary, and strict isolation is an important condition to success. The disease is spread primarily by carrier pigs, and contact between infected and uninfected pigs must be avoided.

The administration of tiamulin at 10 mg/kg BW IM daily for 5 days to all animals in a large herd, combined with cleaning, disinfection, and rodent control, was effective in controlling the disease, and no further clinical signs occurred in the subsequent 2.5 years.

### Mass Medication and Sanitation Program Without Depopulation

With the strategic use of antimicrobials, effective sanitation, serial depopulation of possible carrier animals, and the introduction of infected animals, it is possible to virtually eradicate the infection from a herd.

Elimination of infection from closed swine herds is possible using antimicrobials (see the section [Treatment](#)), and there are various options.

### Dietary Modification

Experimentally, modification of the diet can assist in the control of swine dysentery. Feeding a highly digestible diet reduces fermentation in the large intestine and is associated with a failure of colonization by *B. hyodysenteriae* when challenged orally. Pigs fed on a diet based on steam-flaked maize and steam-flaked sorghum had a decreased incidence of disease. Pigs fed on a diet based on cooked white rice were fully protected from experimental infection with *B. hyodysenteriae*.

### Depopulation and Repopulation

The infection can be eradicated by depopulation of the entire herd and repopulation with breeding stock free of infection. However, this can be uneconomical unless it is part of the long-term plans for the herd and the producer.

The disease can be eradicated through the use of minimal disease or high-health-status herds that are free of several infectious diseases and maintain disease-free status. In such herds, diseases such as swine dysentery occur only rarely and almost never over a period of several years.

### Biosecurity

Strict biosecurity measures are necessary to prevent introduction of infected carrier pigs. This requires knowledge of the infection status of the herd of origin. It also requires a highly reliable test to detect the infected pig. Particular attention should be paid to the state of vehicles visiting the farm. The farm staff and the truck drivers should not cross over the gate at the loading point. The

loading gate should be at the perimeter of the unit.

Monitoring of the herd for continuous freedom is essential. This includes clinical observations, examination of colons at abattoir, culture of feces, ELISA monitoring,<sup>23</sup> and PCR examination of feces.

### Vaccines

Pigs that have recovered from clinical swine dysentery may be protected against subsequent challenge, but attempts to immunize pigs with *B. hyodysenteriae* have been proven to provide incomplete protection and involve complex procedures that may have limited practical value. The development of effective vaccines will require attention to serospecificity of the organisms used to formulate the vaccines.

Effective vaccines are not widely available as yet. A commercial vaccine using a protein-digested bacterin has shown efficacy in the reduction of disease caused by *B. hyodysenteriae*. It produced both a systemic and mucosal immunity. Both IFN- $\gamma$  and lymphocyte blastogenesis responses were stimulated. A recombinant outer membrane lipoprotein has also been shown to be a hopeful vaccine.

An inactivated, adjuvant, whole-cell vaccine against *B. hyodysenteriae* has been tested experimentally. The vaccine provided significant protection in two small trials, but some of the vaccinated and unvaccinated pigs developed late-onset swine dysentery, which is unexplainable. Field trials to test the vaccine are required. An experimentally inactivated *B. hyodysenteriae* vaccine with mineral oil adjuvant resulted in exacerbation of the clinical disease following challenge; a majority of the vaccinated pigs developed the disease earlier and to a more severe degree than the unvaccinated pigs.

### REFERENCES

- Clothier KA, et al. *J Vet Diag Invest.* 2011;23:1140.
- Rasback T, et al. *Microbiol.* 2007;153:4074.
- Burrough ER, et al. *BMC Genomics.* 2011;12:395.
- Phillips ND, et al. *Vet Microbiol.* 2010;143:246.
- Bellgard MI, et al. *PLoS ONE.* 2009;4(3):e4641.
- Pati A, et al. *Stand Genomic Sci.* 2010;2:260.
- Wanchanthueck P, et al. *PLoS ONE.* 2010;5(7):e11455.
- Motro Y, et al. *Vet Microbiol.* 2009;134:340.
- La T, et al. *Vet Microbiol.* 2009; *Vet Microbiol* 138:330.
- Hidalgo A, et al. *J Clin Microbiol.* 2010;48:2859.
- Hidalgo A, et al. *Epidemiol Infect.* 2010;138:76.
- Osorio J, et al. *PLoS ONE.* 2012;7:6.
- Burrough ER, et al. *J Vet Diag Invest.* 2012;20:1.
- Barth S, et al. *Vet Microbiol.* 2012;155:438.
- Witchell TD, et al. *Infect Immun.* 2006;74:3271.
- Molbak L, et al. *J Appl Microbiol.* 2007;103:1853.
- Klose V, et al. *J Appl Microbiol.* 2010;108:1271.
- Hansen CF, et al. *J Anim Sci.* 2010;88:3327.
- Thomsen LE, et al. *Vet Microbiol.* 2007;119:152.
- Song Y, Hampson DJ. *Vet Microbiol.* 2009;137:129.
- Jonasson R, et al. *Res Vet Sci.* 2007;82:323.
- Willems H, Reiner G. *Berl Munch Tierarztl Wochenschr.* 2010;123:205.
- Song Y, et al. *Vet Res.* 2012;8:6.
- Jacobson M, et al. *Res Vet Sci.* 2007;82:287.

- Vyt P, et al. *Vlaams Diergeneeskd.* 2012;81:205.
- Duijnhof TF, et al. *Tijdschr Diergeneeskd.* 2008;133:604.
- Stanton TB, et al. *Appl Environ Microbiol.* 2008;65:5028.
- Pluske JR, et al. *Br J Nutr.* 2007;97:298.

### BRACHYSPIRA HAMPSONII

In every respect *B. hampsonii* produces the same clinical and pathologic syndrome as *B. hyodysenteriae*. It is possible that several unrecognized *Brachyspira* species play an important role in clinically relevant swine intestinal disease. Recently a novel strongly hemolytic *Brachyspira* species was encountered in North America in cases similar to those caused by *B. hyodysenteriae*<sup>1</sup> and subsequently found in Spain. In other words, swine dysentery was caused by an entirely different agent. The isolates were found to be different from all known *Brachyspira* spp. on the basis of the *nox* gene, 16S ribosomal RNA sequencing, and biochemical testing. The organism is called *B. hampsonii* after David Hampson, who contributed so much to the study of *Brachyspira*. To identify the organism, the duplex PCR was first used to differentiate or eliminate *B. hyodysenteriae* and BP, and then PCR was used to identify the *nox* gene. The PCR products were then sequenced and then multilocus typing was used.<sup>2,3</sup> The results of this typing grouped the isolates into two clades (I and II), which formed a cluster independent of each other. Most of clade I was positive for  $\beta$ -glucosidase and clade II negative for this enzyme. This organism is strongly  $\beta$ -hemolytic but is indole negative, which distinguishes it from *B. hyodysenteriae* and *B. suanatina*, which are the other  $\beta$ -hemolytic *Brachyspira*.

The disease has been almost absent from the United States until quite recently, but a number of recent outbreaks of severe bloody diarrhea have been seen in the United States and Canada.<sup>4</sup> Since 2008, more than 50% of isolates from query swine dysentery cases have been nontypeable at the Minnesota laboratory,<sup>1</sup> and only 36% at the Iowa laboratory<sup>4</sup> in the first 9 months of 2010 were typeable to the species level. The others may turn out to all be *B. hampsonii*. All the isolates were associated with severe bloody diarrhea in the field.

In October 2009, two herds in Saskatchewan in Canada had a disease indistinguishable from swine dysentery. All pigs had characteristic lesions in the large bowel, and abundant spirochetes were seen in smears from the colonic mucosa of affected pigs but not from the nonaffected pigs. They were unable to identify *B. hyodysenteriae*. A quantitative (q)RT-PCR was developed, and it showed that  $10^5$  to  $10^6$  organisms per gram of tissue or cecal contents were found.<sup>5</sup> In 2011 a similar condition was reported in Iowa and Minnesota.<sup>6</sup> Recently the organism was found in Spain and isolated from geese

and ducks, which suggests that wildfowl may transmit the organism around the world to pigs.

### REFERENCES

- Chander Y, et al. *J Vet Diag Invest.* 2012;24:903.
- La T, et al. *Vet Microbiol.* 2009;138:330.
- Rasback T, et al. *Environ Microbiol.* 2007;9:83.
- Clothier KA, et al. *J Vet Diag Invest.* 2011;23:1140.
- Harding J, et al. *Allen D Leman Swine Conf St Paul MN.* 2010;65.
- Harding J, et al. *Proc Int Pig Vet Soc Vancouver Canada.* 2010;740.

### NONSPECIFIC COLITIS IN PIGS

This condition is found worldwide and as yet has no known definitive causes. It can be found in all ages from weaning to slaughter but particularly from weaning to 40 kg. Non-specific colitis was first seen in the UK in intensive management systems.

### ETIOLOGY

At the moment the role of the various possible players is not clear. It might involve feed ingredients, feeding practices, predisposing viral enteritis, poor management, poor hygiene, or even sudden changes in husbandry.

The condition is ill defined but nutrition and infection are thought to be important. Undigested food ingredients reach the colon as a result of poor digestion of feed. This undigested feed allows fermentation in the colon, and all these factors may not allow the colon to absorb water. Sometimes the condition is found on feeding pellets but not on meal. The pelleting has the capacity to caramelize carbohydrates, alter particle size, and destroy micronutrients.

It may be associated with variations in a wide variety of factors including feed ingredients, feed formulations, feed availability, absence of fiber, or high salt in the water.<sup>1</sup>

### EPIDEMIOLOGY

The epidemiology may be individual farms, breeding stock suppliers, unhygienic conditions, and different suppliers of feed involved in the spread of the condition.

### PATHOGENESIS

Many infections may contribute to disorders of the colon, particularly brachyspirae and *Lawsoniana* and those organisms that contribute to villous atrophy in the small intestine.

Any abnormalities of the small intestine will further increase the amount of undigested and harmful food entering the large intestine. It has now been shown that some diets induce a colonic acidosis and enhance colonization by spirochetes. Many of these cases have no involvement of any of the brachyspirae, and the possibility exists that there may be a syndrome of colonic dysfunction without direct spirochetal involvement.



It is possible that any event that leads to the disturbance of colonic microflora may lead to colonic lactic acidosis and damage to the colonic mucosa and then a reduction in colonic fluid absorption, resulting in diarrhea.

### CLINICAL SIGNS

The clinical signs of nonspecific colitis are mild and characterized by mild persistent diarrhea in pigs 5 to 14 weeks of age. Growth retardation and partial anorexia are common. Morbidity and mortality data are not available.

Pigs showed a sporadic diarrhea with soft, wet feces, which may bubble on passing, occasional mucus in the stools, growth depression, and hollow flanks in 18- to 35-kg pigs and with a morbidity of 20% to 30%. Pigs may be ill for up to 3 weeks. Most pigs continued to thrive but some grew poorly.

### PATHOLOGY

Pigs had enlarged colons with frothy contents and most had a reddened mucosa. In a study of nonspecific colitis there was increased crypt depth in the colon of weaned pigs with diarrhea.<sup>2</sup> There was no association with any of the common infectious causes of colitis, but there was an association with a diet high in protein and wheat. The total level and digestibility of protein is believed to affect the intestinal microbiota. The further fermentation of the undigested protein in the colon may then result in the production of toxic by-products, and this may be the explanation for protein-associated diarrhea. The increased crypt depth in the colon may result from the protein degradation in the colon as well as the more usual diet rich in dietary fiber and coarsely ground cereals. In this study<sup>2</sup> it is possible that the increased crypt depth may be associated with the feed particle size. Microscopically, they have a mild erosive colitis. A grossly distended large intestine is sometimes seen. The contents are fluid, contain bubbles, and sometimes seem oily. An increased crypt depth was discovered in these colitis cases.<sup>1</sup> Sometimes there may be colonic lesions.

### DIAGNOSIS

Clinical signs may indicate nonspecific colitis, and the absence of any positive diagnostics on laboratory testing may further suggest this.

### TREATMENT

Identify any specific causes and treat these, and provide general antibiotic treatment such as oxytetracycline.

### CONTROL

Control coincident infections such as PCV2 and porcine reproductive and respiratory syndrome virus (PRRSV) through vaccination.

Introduce a general cleanup of the hygiene and in particular use all-in/all-out by age and then thorough cleaning, disinfection, and drying. Examine the nutrition and in general change from pelleted feed to meal. Also eliminate or reduce the anti-tryptic factors in the food (reducing trypticase in soya meal) and reduce indigestible carbohydrates. Some varieties of wheat and peas should be avoided, and wheat can be replaced by barley. Enzymes can also be used to reduce nonstarch polysaccharides entering the colon.

### REFERENCES

1. Chase-Topping EM, et al. *Vet J.* 2007;173:353.
2. Pedersen KS, et al. *Vet Q.* 2012;32:45.

## PORCINE INTESTINAL SPIROCHETOSIS (SPIROCHETAL COLITIS, PORCINE COLITIS, AND PORCINE COLONIC SPIROCHETOSIS) AND NONSPECIFIC COLITIS

### INTRODUCTION

Porcine intestinal spirochetosis is a nonfatal, colonic disease of recently weaned, grower and finisher pigs. The causative organism, BP, was first recognized in 1980 and is a gram-negative, anaerobic, but oxygen-tolerant spirochete found in the colon.

It is found in a wide variety of hosts including immunocompromised humans, primates, dogs, opossums, commercial chicken production, and various species of birds. There appears to be no risk to pig workers. The human strains can cause colitis in pigs, and the wide species occurrence may cause concern for zoonotic risk but this has not yet been confirmed. A cause of special concern is that in some parts of the world the level of infection in humans is quite high, and this may be an indicator that spread is possible from some of the other species to humans.

Porcine colonic spirochetosis (PCS) and nonspecific colitis may be two different syndromes, or the former may contribute to the latter with other organisms and nutritional contributions. Even now the effect of various intestinal combinations of flora and fauna to the pathogenicity of various organisms is unknown. As yet, there is no way to introduce a known intestinal microbiota that encourages well-being. The interrelationship between what goes on in the small intestine and the results in the large intestine in pigs is still largely unknown.

A nonspecific colitis can be part of *Brachyspira*, *Salmonella*, *Lawsoniana*, *Trichuris*, or *Balantidium* infections. PCS is certainly associated with BP, formerly known as *Serpulina pilosicoli*. *B. hyodysenteriae* and BP are the only two confirmed pathogens of the brachyspirae group together with the newly described *B. hamptonii*, *B. innocens*, *B. intermedia*,<sup>1</sup> *B. suanatina*,<sup>2</sup> and *B. murdochii*,<sup>3,4</sup>

which are still considered nonpathogenic for the most part.

Large, anaerobic weakly  $\beta$ -hemolytic non-*B. hyodysenteriae* spirochetes have been associated with porcine colitis and are capable of inducing disease in gnotobiotic pigs, but their role as primary or opportunistic pathogens in colitis in conventional pigs is uncertain.

### ETIOLOGY

BP is the cause of PCS. It is a weakly  $\beta$ -hemolytic spirochete usually typed by PFGE. It has 4 to 7 flagella and no plasmids.<sup>5</sup> The outer membrane has LPS, which are serologically heterogeneous. There are a number of outer membrane proteins. The organism is more tolerant of oxidative stress than *B. hyodysenteriae*.

Swedish workers grouped the intestinal spirochetes isolated from pigs into four groups based on phylogenetic studies, although they are closely related. Groups I and II were isolated only from pigs with dysentery or diarrhea. Group II was differentiated from Group I only by weak  $\beta$ -hemolysis. In Sweden, members of Group II are often isolated from young weaned pigs up to 25 kg in herds where a nonspecific diarrhea, which is clinically distinct from swine dysentery, occurs frequently. These strains seem to be absent or rare in herds without such diarrheic pigs. Group III included the type strain for *B. innocens*. Group IV (detected by PCR) included the pathogenic, weakly  $\beta$ -hemolytic strain P43 (BP) shown to cause spirochetal diarrhea in pigs. Most farms have distinct BP genotypes, and common genotypes between and among herds are rare.

A complex investigation of 20- to 40-kg pigs (8–16 weeks of age) on 85 pig units in Scotland from 1992 to 1996 showing diarrhea and slow growth provided much needed information on the occurrence of mixed infections. BP was found on 25% of the units; atypical brachyspirae on 7%; *B. hyodysenteriae* on 6%; with *S. typhimurium* on 4%, *Y. pseudotuberculosis* (YP) on 4%, and LI on a mere 3%. Mixed infections of BP with *Yersinia*, *Salmonella*, other combinations, and *B. hyodysenteriae* were found on 27%. On 6 of the 85 units no pathogens were detected.

### Occurrence

PCS probably has a worldwide occurrence. Herds using carbadox had a lower prevalence of *Brachyspira* species than the ones using olaquinox. It has been seen in minimal disease herds in which no antibiotics are used, and it is also seen in herds where no growth promoters are used. There may be multiple strains on a farm or a farm with just one strain.

### Risk Factors

#### Transmission

PCS is usually introduced into herds by other pigs. The shedding may be continuous over



several weeks or intermittent. It is likely that the common route of transmission is fecal-oral but there may be a role for mice and birds. It has been recorded in a wide range of species that may be naturally infected (pigs, dogs, and birds), but rodents are probably not a long-term host.<sup>6</sup> It is possible that feral water birds may be a reservoir.

### Managemental and Environmental Factors

The organism has a greater environmental survival than *B. hyodysenteriae*, particularly in slurry lagoons and manure heaps and the soil itself. It will survive in lake water at 40°C for 66 days and remains viable at 10°C for 119 days in soil and 210 days in soil with 10% pig feces added. It is susceptible to most disinfectants, but not when there is organic matter present.

There may be a close association between this agent and other nonspecific factors in the gut. Changes in colonic microenvironment may predispose to colonization and damage associated with BP. There is a lower incidence if antibiotics are fed compared with no antibiotics.

### Feed

Consumption of a rice-based diet significantly reduced the onset of excretion of BP after experimental challenge. In a recent set of experiments five diets were used in conjunction with BP. They included pelleted feed, nonpelleted standard food, standard diet plus lactic acid, formulated liquid diet, and a diet based on cooked rice. The group of pigs that were fed rice did indeed excrete BP for less time in their feces and in fewer numbers than the other groups. The pigs on the pelleted diet were worst. Nonpelleted and home-mixed diets were better.

### PATHOGENESIS

The initial colonization of the colon appears to be mediated by the motility-regulated mucin association in which there is a positive chemotaxis toward mucin. Galactosamine and glucosamine are important constituents of intestinal mucin, and BP uses both of these substrates when it is grown *in vitro*. The organisms penetrate the mucus. This is followed by the multiplication of the spirochetes in close proximity to the mucosal surface and inside the lumen of the crypts. Intimate attachment of BP to the apical membrane of the colonic enterocytes occurs and causes destruction of the enterocyte microvilli. The cell junctions are the target. No receptors have been found as yet. These lesions are only seen in the first three weeks postinoculation in the experiments that have been performed. There may be a specific spirochete ligand and host cell membrane receptor interaction. BP can invade between the enterocytes and reach the lamina propria, where it may remain extracellularly or be seen in macrophages. BP can virtually eat its

way through from the lumen to the lamina propria. They spread extracellularly in the underlying lamina propria and are phagocytosed by the macrophages and also enter the capillary blood vessels. They are taken up by a novel mechanism called coiling phagocytosis in which the BP are localized and replicate in the endoplasmic reticulum (ER) of the infected cells, which suggests intracellular trafficking.

Penetration of the epithelium may involve disassociation of the intercellular junctional areas by the action of a subtilisin-like serine protease present in the outer membrane of the spirochete. The proliferation of the organism raises the levels of IL-1 $\beta$  and IL-8.

### CLINICAL FINDINGS

Porcine colonic spirochetosis is characterized by mild persistent diarrhea in pigs and loss in weight and increased days to slaughter. It affects mostly young weaned animals of 20 to 40 kg but can occur in finishers and sows. There is believed to be an incubation period of 5 to 20 days. It occurs often after a change in diet. There may be a slight fever (40°C), and growth retardation and partial anorexia occur commonly.

The clinical signs of porcine intestinal spirochetosis (PIS) are difficult to distinguish from nonspecific colitis (NSC) and are similar to those seen in other forms of colitis, including early swine dysentery. In one study, prevalence was found to be 5% to 15% and the mortality <1% in affected batches.

Typically, PIS occurs 7 to 14 days after weaning or after they have been mixed. Morbidity is in the region of 5% to 30%, and the signs last for 2 to 6 weeks. It is distinct clinically and pathologically from swine dysentery. Clinical findings include a mucoid nonbloody diarrhea, which is greenish or gray, often soft and wet to start, forming puddles like “wet cement,” and then becoming watery. It is usually self-limiting and lasts 2 to 14 days. There may be a stained perineum. During recovery and in chronic cases there may be large amounts of mucus. Affected pigs are usually alert and active but may become depressed, gaunt, and found with starry, rough coats. Affected pigs rarely die and eventually recover. Chronic infection and relapses are sometimes recorded. Mixed infections took longer to recover and had a more profound effect on growth rates and often persisted unless there was medication.

### PATHOLOGY

Gross lesions are usually subtle or not recognized. They are restricted to the cecum and colon in all species. The spiral colon is flaccid and full of watery contents with a variable amount of mucus. The large bowel is usually full of content. Mucosal lesions are most obvious in the midregion of the spiral colon followed by the proximal spiral colon. The cecal mucosa is usually not involved or only mildly. The mucosa is reddened or thickened

by edema, and it may even form ridges. There are a variable number of erosions. If there are a few erosions, then there appears to be nothing visible, but if there are many erosions then the surface appears granular, and it may be necessary to gently wash the mucosa with water to see these erosions. Fibrin may be mixed with mucus or blood, and there may be variable amounts of either loose in the lumen of the colon. In mixed infections with BP the lesions were more extensive and sometimes affected the cecum as well as the colon.

Microscopically, with time the surface epithelium becomes eroded and attenuated, but these changes are not specific to BP. There is a mild to moderately severe erosive colitis that can be multifocal or diffuse. The extent and severity of this is probably a function of the colonic microflora. The lesions may extend to the muscularis. There are often adherent fibrinonecrotic exudates and feed particles. Goblet cell hyperplasia with distended mucous-filled crypts, mucosal edema, and lymphoplasmacytic infiltrates are also found. Crypt abscesses are not uncommon.

The characteristic histologic feature is a dense mat or false brush border of spirochetes that are closely packed parallel to one another and are attached by one end to the colonic epithelium resembling a brush border. This may be a feature only in the first 2 to 3 weeks of infection. With time the spirochetes persist in the lumen of the colonic glands, which are dilated and filled with mucus. In chronic infections there may be a large increase in chronic inflammatory cells. On EM spirochetes can be seen in the epithelial cells.

### IMMUNOLOGY

Immunity to BP is not understood. There is a low level of IgG produced after 2 to 3 weeks. BP may be able to evade the immune system. Recovered pigs may have serum immunoglobulins, but in experimental infections there seems to be a lack of a systemic response.

### LABORATORY DIAGNOSIS

The laboratory diagnosis of PCS is similar to that for swine dysentery. The identification of spirochetes in fresh wet smears of feces viewed by phase contrast microscopy may provide evidence of spirochetal infection, but this method alone is not reliable and cannot differentiate between the various groups of pathogenic and nonpathogenic spirochetes. It can be improved with fluorescent-labeled antibodies.

Primary isolation is the technique of choice for confirmation of the disease, and it is then necessary to show BP in the mucosa or feces by culture or PCR. The weakly  $\beta$ -hemolytic BP organisms can then be demonstrated and provisional identification is done by hippurate hydrolysis, although there are organisms that are hippurate negative, but have been confirmed as BP by

16S ribosomal DNA analysis. Most have the hippurate cleaving capacity. It is safer to remember that biochemical analysis is not definite as they can be both hippurate negative or positive. For this reason, it is worth checking on their reaction with  $\beta$ -glucuronidase because they should be negative if they are true BP.

Microscopic lesions are not diagnostic because they may be confused with salmonellosis or swine dysentery but the organisms in the hematoxylin and eosin sections can be seen, and they may be confirmed in Warthin–Starry silver-stained sections. Specific identification requires IHC staining with BP-specific mouse monoclonal antibodies. Fluorescent ribosomal RNA can also be detected in ISH. Scanning EM shows degenerating epithelial cells and spirochetal colonization of the epithelium with BP but nothing with *B. intermedia*. The presence of *B. intermedia* can then be detected by PCR using 23S rDNA genes. Specific PCRs targeting 16S RNA or 23S RNA or *nox* genes<sup>7</sup> are available. The duplex and multiple PCRs have been designed to differentiate BP from *B. hyodysenteriae* and *Lawsoniana*. RT-PCR is available, and restriction fragment length polymorphism analysis can be used to identify the BP isolates. There are no antibody detection systems as yet.

## TREATMENT

Treatment and control uses the same principles as those used for swine dysentery. In an old study in the United States, all isolates were susceptible to tiamulin and carbadox; over 50% were resistant to gentamicin; and 42% were susceptible to lincomycin, 15.8% resistant, and 42% had an intermediate susceptibility. Few strains are susceptible to tylosin. In all time-related studies of resistance there seems to be an increasing resistance. In those countries where olaquinoxol can be used 100 ppm is useful.

In experimental infections when given after challenge valnemulin significantly reduced diarrhea and colonization by spirochetes. More recently in-feed valnemulin has also been shown to be useful at 25 ppm for 14 to 27 days giving lower lesion scores and less widespread colitis.

## CONTROL

An effective rodent control policy and prevention of bird entry is probably essential for the control of PSC. Treatment and control of PIS and PSC are achieved using the same principles as those used for swine dysentery. Control can produce significant savings where there is all-in/all-out management and multiple site production. Improving hygiene and reducing contact with feces are the essential ingredients for successful control. If there is a lot of contamination then it is always better to allow exposure for about a week before giving antibiotics because this allows at least some immunity

to be produced. Because other species may be a source of infection it is necessary to control mice and birds. Rational use of antibiotics may be useful. Rotation of antibiotic usage may make the occurrence of resistance less likely. The three most likely successful treatments are valnemulin, carbadox, and tiamulin, although carbadox cannot be used in many countries.

- Rations shown to contain 33 and 110 ppm of lincomycin provided an effective control.
- In Finland the use of tiamulin at 200 ppm for 18 to 30 days combined with thorough cleaning removed PCS from a 60 farrow-to-finish operation.
- Valnemulin at 25 ppm (1.25 mg/kg) was shown to be effective in controlling spontaneous PCS.

## Vaccination

Vaccination seems to induce a primary and secondary serologic response to BP, but an experimental whole-cell bacterin was not protective when administered parenterally. There is no vaccine in widespread use.

## REFERENCES

1. Phillips ND, et al. *Vet Microbiol.* 2010;143:246.
2. Rasback T, et al. *Environ Microbiol.* 2007;9:983.
3. Komarek V, et al. *Vet Microbiol.* 2009;131:311.
4. Jensen TK, et al. *Vet Pathol.* 2010;47:334.
5. Wanchanthueck P, et al. *PLoS ONE.* 2010;5(7):e11455.
6. Backhams A, et al. *Vet Microbiol.* 2011;153:156.
7. Ronde J, Habighorst-Blome K. *Vet Microbiol.* 2012;158:211.

## YERSINIOSIS IN PIGS

The principal disease of pigs is caused by *Y. enterocolitica* (YE) as well as YP. It causes enteritis and typhlocolitis in pigs and similar conditions occur in man. Contamination of carcasses during the slaughtering process may lead to carcass contamination and problems in the food chain (biotypes 4, 2:O9, and 1:O3), and may pose a threat to abattoir workers. *Yersinia* also has significance in that cross-reactions of O9 with *Brucella* are a frequent cause of problems in *Brucella* testing.

## ETIOLOGY

The organisms are gram-negative coccobacilli. There are biotypes and serotypes and some of the human food-poisoning types have virulence factors.

## EPIDEMIOLOGY

Both species are widespread in pigs<sup>1</sup> and carriage may persist for a long time in both tonsils and feces. Shedding is low in weaners (30%), increases in growers, reaches a peak in finishers (70%), declines in gilts (20%), and is usually absent in sows and boars. Antibody has a similar trend, and is low in neonates and weaners and increases so that usually 100% of sows have antibodies. It can survive in the environment and infects

other species including rats, mice, flies, and humans.

## PATHOGENESIS

Infection is carried in the tonsils where it sometimes may lodge, and multiplication occurs in the ileum and large intestine. Shedding occurs between 5 and 21 days post infection (DPI) and may continue for up to 10 weeks. Antibodies appear after about 18 days and may also last about 10 weeks. Septicemia may occur with YP, and in these cases there may be abscesses in the liver, spleen, lymph nodes, and guts, as well as the enteritis.

## CLINICAL SIGNS

There may be mild fever, watery diarrhea (3–5 days), dark-colored feces, and blood-stained mucosa and soft feces in YE cases. Rectal stricture may also be seen. In YP cases there may be dullness, inappetence, edema, and bloodstained diarrhea, and it has also been isolated from rectal stricture cases.

## PATHOLOGY

In former clinical cases at necropsy there may be a catarrhal enteritis. In YP cases the lesions are perhaps more severe with button ulcers in the colon, gut, mesenteric lymph nodes, and liver.

## DIAGNOSIS

Clinical signs do not make a provisional diagnosis of yersiniosis likely, but the organism is usually found at postmortem or on bacteriologic testing. They can be isolated on culture from enrichment media or broths. DNA probes or PCR will also detect both organisms, and YE can also be detected in feces by PCR in feces at 5 CFU/mL feces. Diagnosis usually depends on the pathology associated with demonstration of the organism by culture or PCR. Serology (ELISAs) can be useful for detecting herd infection from 2 weeks after infection to a peak at around 30 to 35 days and disappearance at around 70 days.

## TREATMENT

If there is a problem it will usually respond to antimicrobial treatment in water or feed, particularly tetracyclines, synthetic penicillins, fluoroquinolones, and furazolidone (not in the EU).

## CONTROL

Hygiene and biosecurity are the best controls, aided by rodent and fly control.

## REFERENCE

1. von Altmock A, et al. *Foodborne Pathog Dis.* 2011;8:1249.

## VIRAL DIARRHEA IN NEONATAL PIGS

Neonatal diarrhea in the pig involves principally viruses such as PED, rotaviruses, and the TGE virus, probably in that order of

importance, since 2013. In addition, there are several other viruses of lesser or unknown importance.

Additional major groups in neonatal pigs include the bacterial diseases and principally clostridial infections (*C. perfringens* type A and C and *C. difficile*). In addition, there are the protozoal conditions of coccidiosis and cryptosporidiosis to further complicate the situation. Multiple infections are probably more common than realized because there is a temptation to not look for a further diagnosis once the initial culprit is found.

## OVERVIEW OF VIRAL DIARRHEA

Emerging and reemerging swine viruses have been reviewed.<sup>1</sup> The etiologic agents of diarrhea are varied but the predominant group are the viruses. These include TGE and PED, which are the most severe infections causing considerable mortality. The latter is a cause of much recent disease in Asia (China, Thailand, Vietnam, and Korea) in which 50% of the cases may be caused by this agent<sup>2-5</sup> and the mortality approached 100% and now, since May 2013, a large epizootic has occurred in North America.

The most common agent is porcine rotavirus. In addition there are several newly emerging agents including porcine kobuvirus and porcine bocavirus.<sup>6-9</sup>

A systematic study was made in China of these viruses.<sup>10</sup> In finishing pigs, 5% to 10% had diarrhea and usually recovered within 1 week. Sows had diarrhea in 15% to 20% of cases when pregnant and were usually well within 1 to 3 days. Piglets were ill within 1 week of farrowing. These outbreaks spread rapidly within 3 to 5 days. Clinical signs included yellow, watery diarrhea, vomiting, depression, anorexia, and death from dehydration from within 2 to 3 days. The stomach contained a mass of curdled and undigested milk. The small intestine was thin walled and almost transparent. Mortality often reached 80% to 100% but supportive therapy might reduce this to 20% to 30%. If piglets were infected at >14 days then mortality was low. The pathologic changes were mostly in the jejunum and the ileum with little change in the duodenum. There was often villous atrophy.

The pathogens causing diarrhea are diverse with over 96% of the cases having at least one cause in Korea,<sup>4</sup> in Italy,<sup>8</sup> and in Thailand.<sup>11</sup>

In this Chinese study from 2013,<sup>10</sup> not surprisingly 82% had PED. Kobuvirus was frequently detected in single infections but more importantly in mixed infections. Bocavirus and rotavirus were also often detected in mixed infections and only occasionally in single infections. Over 75% in this study were mixed infections. Dual infections were 43.9%, triple 26.1%, and quadruple 2.3% of cases.

Various viruses may coexist with PED. Different infection patterns are observed in

different age groups. The viral load of PED tended to be higher in the infected pigs than in the healthy. TGE and rotavirus were not detected in healthy pigs. The viability of enteric viruses after waste treatments has been examined.<sup>12</sup>

## REFERENCES

1. Meng XJ. *Transbound Emerg Dis.* 2012;(suppl 1): 85.
2. Chen J, et al. *Arch Virol.* 2010;155:1471.
3. Duy DT, et al. *Thai J Vet Med.* 2011;41:55.
4. Park SJ, et al. *Arch Virol.* 2011;156:577.
5. Puranaveja S, et al. *Emerg Infect Dis.* 2009;15: 1112.
6. Cheng WX, et al. *PLoS ONE.* 2010;5:e13583.
7. Manteufel J, Truyen U. *Intervirology.* 2008;51:328.
8. Martelli P, et al. *Vet Rec.* 2008;162:307.
9. Reuter G, et al. *Arch Virol.* 2009;154:101.
10. Zhang Q, et al. *Arch Virol.* 2013;158:1631.
11. Khamrin P, et al. *Emerg Infect Dis.* 2009;15:2075.
12. Costantini VP, et al. *Appl Environ Microbiol.* 2007;73:5284.

## PORCINE ROTAVIRUSES

This virus is a major cause of diarrhea in the pig. The zoonotic potential is unknown, although pig and human strains do reassort.<sup>1</sup> In a recent case in an infant in China it was shown that the rotavirus responsible was a pig-cattle reassortant.<sup>2</sup>

## ETIOLOGY

The virus has 11 segments of double-stranded RNA (dsRNA), and each segment encodes for a viral structural protein (VSP) or a non-structural protein except segment 11, which encodes for both.<sup>3</sup> The virus is a triple-layered particle, and if the outer proteins are removed (VP4 and VP7) by a disinfectant then there is a double-layered particle remaining; in an EM picture both particles can be seen. Only the triple-layered are infectious.<sup>4</sup> There are seven groups that are morphologically similar but antigenically different based on the VP6. Of these Group A is the most important in the pig,<sup>4</sup> but Group C has become more of a problem recently<sup>5-7</sup> and Group E was detected in the UK many years ago. The classification of rotaviruses has been the subject of much discussion.<sup>8,9</sup> In the United States, there has been a substantial diversity.<sup>10</sup>

The Group A rotaviruses are a common cause of diarrhea in nursing pigs from 1 to 5 weeks of age with peak occurrence from 1 to 3 weeks of age, and weanling pigs at 3 to 5 weeks of age and within 3 to 5 days of weaning. Groups A, B, and C occur in diagnostic surveys with about 90% belonging to Group A. Substantial diversity of Group B viruses has recently been described in the United States.<sup>10</sup> Group C rotavirus has also been found to be the cause of enzootic neonatal diarrhea in a minimal disease herd. They are divided into two serotypes, G (15+) and P (25), and different types predominate in different outbreaks.

Multiple rotavirus G serotypes and P types have been detected in swine. In a recent survey in Europe 14% of the pig samples were positive for rotavirus and the number of G-P combinations was high and confirms the high diversity of genetic diversity.<sup>11</sup> New combinations are being discovered all the time, for example, the discovery of a G2-like virus with a novel VP4 type P32 in Ireland<sup>12</sup> and the G9 P<sup>13</sup> in Ohio in nursing piglets. There is little or no cross-protection between porcine rotaviruses with distinct G and P types, but viruses that share common G and P types induce at least partial cross-protection in experimental studies. This is why it is sometimes essential to know which types are present on the farm. The most common are G3, G4, G5, and G11.

In some countries a certain genotype may be more common, e.g., P23 in Thailand.<sup>14</sup> Variant serotypes of porcine rotavirus such as G3 may cause severe outbreaks of diarrhea in piglets. Subclinical infections are common, and age resistance to rotavirus infection may not occur.

## EPIDEMIOLOGY

The serotypes are present worldwide, and up to 100% of adult pigs may be serologically positive for Groups A, B, C, and E, and multiple serogroups and serotypes have been found in the pig.<sup>15-18</sup>

Fecal-oral transmission is common and possibly by aerosol, although this is not confirmed. In the past most infections were Group A, but recently in the United States<sup>6</sup> and Brazil<sup>19</sup> Group C has flared up. The infection dynamics on farms have been described.<sup>20</sup> Reassortants have occurred between pigs on one hand and cattle, horses, and humans on the other.<sup>9,21-23</sup>

In an infected herd, piglets become infected between 7 and 35 days of age, and the virus cannot be detected usually in piglets under 10 days of age, presumably as a result of protection by lactogenic antibody. Virus shedding can occur from 1 to 14 days for the Group A viruses and rather less for the Group B viruses. It is suggested that in an intensive piggery, with a constant shedding of viruses in feces of sows before and after farrowing leads to a continuing cycle of rotavirus infection, with a buildup of host immunity against a circulating strain in the pig population. A virus such as CRW-8 probably could undergo changes through mutations over a period of time, leading to antigenic drift.

In piglets, rotaviral diarrhea is most common in pigs weaned under intensive management conditions, and the incidence increases rapidly from birth to 3 weeks of age. There is no age-dependent resistance up to 12 weeks of age. The disease resembles milk scours, or 3-week scours of piglets. Mortality caused by rotavirus varies from 7% to 20% in nursing pigs and 3% to 50% in weaned pigs, depending on the level of



sanitation. In the United States the peak incidence occurs in February and a moderate rise occurs in from August to September.

A case-control epidemiologic study examined the relationship between Group A rotavirus and management practices in Ontario over a 5-year period. In rotavirus-positive herds, herd size was larger and weaning age was younger compared with rotavirus-negative herds. Pigs raised in all-in/all-out nurseries were three to four times more likely to have a positive Group A rotavirus diagnosis than pigs in a continuous flow system. Pigs in the all-in/all-out system were weaned at an earlier age.

The sow is the source of infection. Sero-positive sows can shed rotavirus from 5 days before to 2 weeks after farrowing, when piglets are most susceptible to infection. There are increased secretory IgA and IgG antibodies to rotavirus in the milk of sows after natural rotavirus infection or following parenteral inoculation of pregnant or lactating sows with live attenuated rotaviruses. The early weaning of piglets at a few days of age or at 3 weeks of age results in the removal of the antibody supplied by the sow's milk and predisposes to infection.

Continuous transmission of the virus from one group to another is an important factor in maintaining the cycle of rotaviral infection in a piggery. The virus can be found in dust and dried feces in farrowing houses that have been cleaned and disinfected. This suggests that the environment is also an important source of infection. The porcine rotavirus can survive in original feces from infected pigs for 32 months at 10°C. Gilts and sows shed virus antigen before farrowing and during lactation, which makes it next to impossible to eliminate the infection from a herd. As sows increase in age they develop increasing levels of lactogenic IgA rotavirus antibodies but do not transfer increasing levels of protection to their piglets.

Different electrophore types of Group A rotavirus and different groups of rotaviruses may occur at the same time in a single piggery, which must be considered when developing vaccines. The subgroups of Group A porcine rotaviruses have been classified, and there are differences in virulence of isolates. Most isolates from outbreaks of diarrhea belong to Group A, whereas a small percentage are atypical rotaviruses. Some porcine rotaviruses are related antigenically to human rotavirus serotypes 1 and 2. Porcine rotaviruses displaying the typical bovine P[1], P[5], P[11], G[6], and G8 genotypes have been detected in pigs, which indicates the high frequency of rotavirus transmission between cattle and pigs. The various G and P types of the virus have been examined and compared in Poland and the United States.

Atypical rotaviruses and other enteroviruses are often present in preweaning and PWD in swine herds and should be considered as potential pathogens. Some atypical

rotaviruses are associated with villous epithelial cell syncytia in piglets with enteritis. Single and mixed infections of neonatal piglets with rotaviruses and enteroviruses have been described. Combined rotavirus and K99 + *E. coli* infection causes an additive effect when induced experimentally in gnotobiotic pigs. The inoculation of calici-like viruses into gnotobiotic piglets can result in diarrhea and villous atrophy. Diarrhea in unweaned piglets 1 to 3 weeks of age has been associated with a combined infection of rotavirus and *Isospora suis*. There can be an important synergistic effect with other viruses such as PED.<sup>24</sup> The combined effect of a dietary change at weaning and rotavirus infection in gnotobiotic piglets is a temporary villous atrophy, and there is no evidence of persistent atrophy of the small intestine.

### PATHOGENESIS

They replicate in enterocytes of the small intestinal villi and the cecal and colonic epithelial cells. Jejunum and ileum are the most affected. Within 12 to 48 hours of an experimental inoculation, the affected cells lyse and disruption of villous architecture follows. To some extent this is age dependent and strain and serogroup dependent. Groups A and C produce the most serious effects. Malabsorption results as a result of impaired glucose-regulated sodium transport, impaired disaccharidase production, and increased thymidine kinase activity.

### CLINICAL SIGNS

The incubation period may be 18 to 96 hours. Rotaviral diarrhea may occur in nursing piglets from 1 to 4 weeks of age and in pigs 1 to 7 days following weaning. If the condition is uncomplicated by other agents then the disease is often mild. Lactogenic immunity is very protective. Direct experimental infections are always more severe than the natural infections. In older piglets it is less severe, and in pigs of 4 to 5 weeks it produces only a very slight diarrhea. The disease in nursing piglets resembles milk scours or 3-week scours. Most of the pigs in the litter are affected with a profuse liquid to soft diarrhea with varying degrees of dehydration. Recovery usually occurs in a few days unless complicated by ETEC or unsatisfactory sanitation, overcrowding, and poor management. The disease is often most severe in herds in which there is continuous farrowing with no period of vacancy for cleaning and disinfection in the farrowing barn. The disease may also occur in pigs a few days after weaning and may be a major factor in PWD of piglets weaned at 3 weeks of age, or earlier in the case of weaning pigs at 1 to 2 days of age.

### PATHOLOGY

Gross lesions are most severe in 1- to 14-day-old pigs when the stomach is empty and the intestine is thin walled, flaccid, and full of watery flocculent fluid. The lacteals in the

mesentery are empty and the lymph nodes are small. In pigs older than 21 days there are no gross lesions in the uncomplicated cases.

Histologically, there is loss of the villi tips within 16 to 18 hours postinoculation. Significant villous atrophy occurs within 24 hours and reaches its height at 24 to 72 hours. Then there is a flattened squamous epithelium and crypt hyperplasia.

### DIAGNOSIS

Porcine rotaviruses grow in cell cultures with a characteristic rounding of the cells, and the virus can be detected in these cultures by immunofluorescence or IHC. The latter is also used directly on tissue sections from the small intestine.

A whole variety of methods are used to detect rotavirus, but many rely on the commercial ELISA kits for rotavirus A, and monoclonal antibody capture ELISAs have been developed for Groups B and C. Nucleic acid hybridization and viral RNA have been detected by RT-PCR. The latter is often used for the detection of serogroups and genotyping.<sup>1,6,15-17,25</sup>

Because the infection is so widespread there is little point in measuring antibodies, but a whole variety of techniques can be used to detect high levels of IgA and IgM, which will indicate recent infection.

### IMMUNITY

The immune response appears to be specific for either the P or G type. There appears to be little cross-protection between the groups. The presence of a neutralizing IgA antibody in the small intestine appears to be the most important feature in the immune response. This is the reason the pig is most prone to infection when the level of maternal antibody has decreased.

### DIFFERENTIAL DIAGNOSIS

Transmissible gastroenteritis is most common in piglets under 1 week of age and explosive outbreaks are common. There is acute profuse diarrhea and vomiting. Affected piglets may continue to nurse for several hours after the onset of the diarrhea. The case-fatality rate is high in piglets under 7 days of age; older pigs usually survive.

Porcine epidemic diarrhea type I affects piglets under 4–5 weeks of age and is characterized by profuse watery diarrhea, high morbidity, and low mortality.

Porcine epidemic diarrhea type II causes a profuse fluid diarrhea in pigs of all ages, including nursing piglets. Explosive outbreaks may occur and the morbidity may reach 100%. Mortality is usually restricted to piglets under 3 weeks of age.

Enteric colibacillosis usually occurs in piglets under 3 days of age. There is acute diarrhea, dehydration, and rapid death. Pigs with coliform septicemia may die without

*Continued*



obvious diarrhea and usually appear cyanotic. Entire litters may be affected and the case–fatality rate may be 100%. Early treatment with antibiotics and subcutaneous fluids will result in recovery. Coccidiosis occurs in piglets from 5 to 10 days of age and is characterized by an acute diarrhea in which the feces are foul smelling and vary in consistency from cottage cheese–like to liquid, and gray or yellow and frothy. The diarrhea is persistent for several days and nonresponsive to antibiotics. Some pigs recover spontaneously, whereas others die in 2 to 4 days. Coccidial oocysts can be detected in the feces. The morbidity rate varies from 50% to 75% and the case–fatality rate from 10% to 20%.

Hemorrhagic enterotoxaemia caused by *Clostridium perfringens* type C affects entire litters of pigs under 1 week of age; is characterized clinically by severe toxemia, dysentery, and rapid death; and at necropsy there is a hemorrhagic enteritis.

Coccidiosis

*C. perfringens* type A

*C. difficile*

Other pig diarrhea viruses (calicivirus, sapovirus, norovirus, adenovirus, etc.)

## TREATMENT

Diarrhea causes dehydration and electrolyte imbalance, so rehydration and energy provision is essential using oral electrolytes. The younger the pig is, the worse the effect, because in these animals reserves of energy and cold tolerance are largely reduced. It is therefore essential to maintain a warm environment and to provide the correct creep feeds for young piglets to encourage food consumption. Regular cleaning and disinfection will reduce the level of virus challenge.

## CONTROL

A variety of disinfectants including phenols, formalin, and chlorine have been used to deal with a virus that is resistant to a variety of environments. It can survive for 9 months at the temperatures normally found in a farrowing house. As yet there is no good porcine rotavirus vaccine.<sup>26</sup>

## REFERENCES

- Martella V, et al. *Vet Microbiol.* 2010;140:246.
- Wang YH, et al. *J Med Virol.* 2010;82:1094.
- Estes MK, Kapikian AZ. *Fields Virology*. 5th ed. Lippincott; 2007:1917-1974.
- Jeong Y-J, et al. *Vet Microbiol.* 2009;138:217.
- Rossov K, et al. Rotavirus; National Hog Farmer. com Nov 1. 2010.
- Chun Y-H, et al. *J Vet Diag Invest.* 2010;22:74.
- Mattihijnsens J, et al. *Arch Virol.* 2008;153:1621.
- Mattihijnsens J, et al. *Arch Virol.* 2010;156:1397.
- Marthaler D, et al. *Virology.* 2012;433:85.
- Midgley S, et al. *Vet Microbiol.* 2012;156:238.
- Collins PJ, et al. *Vet Res.* 2010;41:73.
- Amimo JO, et al. *J Clin Microbiol.* 2013;51:1142.
- Okitsu S, et al. *J Clin Microbiol.* 2011;49:442.
- Halaihel N, et al. *Epidem Infect.* 2010;138:542.
- Katsuda K, et al. *J Vet Diag Invest.* 2010;18:350.

- Kim H-J, et al. *Vet Microbiol.* 2010;144:274.
- Lamhoujeb S, et al. *Arch Virol.* 2010;155:1127.
- Medici MC, et al. *J Swine Health Prod.* 2010;19:146.
- Miyazaki A, et al. *J Clin Microbiol.* 2012;50:2009.
- Cao D, et al. *J Virol.* 2008;82:6073.
- Ghosh S, et al. *Virus Genes.* 2010;40:382.
- Parra GI, et al. *Vet Microbiol.* 2009;126:243.
- Jung K, et al. *Res Vet Sci.* 2008;84:502.
- Ben Salem AN, et al. *J Virol Methods.* 2010;165:283.
- El-Attar L, et al. *Vaccine.* 2009;27:3201.
- Costantini VP, et al. *Appl Environ Microbiol.* 2007;73:5284.

## PORCINE HEMAGGLUTINATING ENCEPHALOMYELITIS VIRUS

Porcine hemagglutinating encephalomyelitis virus (HEV) is also known as vomiting and wasting disease. It is also a disease of neonatal pigs. It can be seen as different manifestations, and there is no public health significance.

## ETIOLOGY

The cause is a Betacoronavirus of the *Coronaviridae*, and the natural host of the virus is the pig. It was originally described in the UK and Canada, and there is only one serotype. There are mostly inapparent infections with occasional outbreaks in nonimmune herds,<sup>1,2</sup> and it has a tropism for neural tissues.

## EPIDEMIOLOGY

The condition occurs worldwide. The condition affects neonates and is maintained by the infection of piglets from sows. Because most sows are protected there are few outbreaks. A new herd of 6000 sows with 55% gilts and first or second litter sows was severely affected.<sup>2</sup> The piglet is affected before 3 to 4 weeks of age if born to nonimmune sows. It is transmitted in nasal secretions probably resulting in nose-to-nose transmission and possibly aerosols. Excretion of the virus following infection probably lasts 8 to 10 days. The presence of maternal antibody, which lasts up to 15 weeks, protects the piglet against neural damage. Pigs over 3 to 4 weeks do not get nervous signs.

The virus will also spread rapidly among newly weaned finishing pigs, and immunity develops within 8 to 16 weeks. The virus is rapidly destroyed by ultraviolet light.

## PATHOGENESIS

After oronasal infection signs begin within 3 to 5 days. These signs are affected by age at infection and possibly also by any strain differences in the virus. Replication is widespread in the respiratory tract, particularly lungs, tonsils, and small intestine. It may spread to the CNS via the peripheral nervous system, particularly the trigeminal, vagus, and intestinal plexuses to the spinal cord. On reaching the brain it particularly affects the vomiting and appetite centers to produce wasting. Virus replication in the gastric nerve plexi

causes damage and disturbs gastric emptying and starvation. Viremia is of no importance.

## CLINICAL SIGNS

Piglets between 5 days and 3 weeks are affected. They will often try to suckle, then stop and vomit. The first signs are vomiting and huddling together, which indicates a raised temperature that may last 1 to 2 days. Anorexia, dehydration, and constipation follow, and the vomiting increases in frequency and is usually followed by death or wasting. Nervous signs may follow in some pigs with hindleg weakness, difficulty in swallowing, and persistent retching and vomiting. Older pigs nearer 3 weeks may just lose their appetite and become emaciated, and may require euthanasia. Morbidity may be 100% if totally susceptible, and mortality may also be high under similar circumstances. Pigs in outbreaks of the so-called motor encephalomyelitic form may huddle, sneeze, cough, and vomit as early as 7 days after birth. They may then huddle, show tremors, hyperesthesia, jerky gait, walk backward, or adopt a dog-sitting posture. Blindness, opisthotonus, nystagmus, and paddling on the side in lateral recumbency, followed by coma and death, are also seen.

## PATHOLOGY

There are usually no gross lesions. The abdomen may be swollen. The intestinal tract and particularly the stomach are usually empty. There may be intestinal dilatation.

Histologically, there may be nonsuppurative inflammation in the tonsils or lungs. In the V and W form there may be degeneration of the ganglia in the stomach and perivascular cuffing in the stomach. If there is an encephalitic form, a nonsuppurative encephalitis is found that is most pronounced in the pons, medulla, and the dorsal horns of the spinal cord with perivascular cuffing, gliosis, and neuronal degeneration.

## DIAGNOSIS

The clinical signs in young pigs less than 3 weeks of age are highly suggestive. Virus isolation in the first 2 to 3 days of an acute infection is possible using PK cells and then using hemadsorption, immunofluorescence, neutralization or hemagglutination, or the presence of syncytia to confirm. IHC on tonsils, brainstem, and lungs will also confirm the diagnosis.

RT-PCR on tonsils, brainstem, and lungs will also demonstrate the agent. An antibody that arises 7 to 10 DPI can be detected by plaque reduction, virus-neutralization (VN), or hemagglutination inhibition tests. Antibody concentrations increase rapidly after infection but their presence does not indicate active disease.

## DIFFERENTIAL DIAGNOSIS

The most likely differential diagnoses are pseudorabies or Teschen–Talfan.

## TREATMENT AND CONTROL

There is no treatment or control. If you know the herd is free, keep it so by biosecurity, purchase new stock from a known-free source and quarantine on arrival, and then adapt to the unit to encourage immunity to the strains present on the farm; otherwise maintain a high herd immunity by mixing ages of sows to encourage circulation of the virus, increasing colostral immunity.

## REFERENCES

1. Alsop JGE. *J Swine Health Prod.* 2006;14:97.
2. Quiroga MA, et al. *Emerg Infect Dis.* 2008;14:484.

## PORCINE ADENOVIRUSES

Porcine adenoviruses cause mild diarrhea and pneumonia in pigs.

## ETIOLOGY

Porcine adenoviruses are DNA viruses and can be cultured in cells to show cytopathic effects and intranuclear inclusions. They are resistant to the environment and may live up to 1 year at 4°C but are susceptible to most disinfectants. Seven types have been found in pigs and types 1 and 4 are the most common.

## EPIDEMIOLOGY

Porcine adenoviruses are found worldwide; for example, antibodies have been found in 80% of slaughter pigs in the UK and similarly in Japan. Antibody positivity increases with age. Virus has been isolated from nasal discharges, abortions, and from stillborn piglets following transplacental infection, and from normal animals. In one herd 24% of piglets to 8 weeks were positive as well as 60% of finishers and 90%+ of the sows.

## PATHOGENESIS

Intestinal strains colonize the tonsils and the intestines and infect the intestinal cells of the villi of the lower jejunum and the ileum. Intranuclear inclusions can be seen in the cells that have nuclear swelling and lose microvilli, and then villous shortening follows. The affected cells migrate to the tips of the villi.

Type 4 also has a predilection for the respiratory tract, where it causes interstitial pneumonia and occasionally encephalitis.

## CLINICAL SIGNS

Pigs less than 3 weeks of age are affected in the main, but there can be infection from 5 days to 24 weeks. The incubation period is 3 to 5 days, and the diarrhea lasts for 3 to 6 days. It is yellow, intermittent, and of variable consistency. Dehydration does occur but death is rare.

## PATHOLOGY

There is thinning of the intestinal wall in the jejunum and ileum. Histologically, there are intranuclear inclusions in the enterocytes,

particularly over the Peyer's patches, and these are of the Cowdry type (eosinophilic or amphophilic surrounded by a clear halo).

## DIAGNOSIS

Diagnosis is based on the detection of virus particles in the gut contents by EM, demonstration of inclusions in histologic sections, and the detection of the virus by PCR and qPCR.

## PORCINE CALCIVIRUSES

Porcine enteric calciviruses<sup>1,2</sup> have been found in Europe,<sup>3</sup> Korea,<sup>4</sup> and Japan.<sup>5,6</sup> They are common and of unknown pathogenicity. It is not known if they are zoonotic, but they are of no public health concern at the moment.<sup>7,8</sup> They are RNA-containing viruses. Infection of gnotobiotic piglets causes diarrhea lasting 3 to 7 days. The viruses are found in the usual place on the sides and base of the villi and caused significant villous atrophy.

The family Calciviridae is divided into four genera: *Norovirus*, *Sapovirus*, *Lagovirus*, and *Vesivirus*. An unassigned fifth genera<sup>9</sup> and both the sapoviruses and noroviruses are of uncertain pathogenicity in the pig.<sup>8</sup> The pig viruses are called porcine sapoviruses (PoSaVs) and the porcine noroviruses (PoNoVs). The prevalence and molecular characteristics of these viruses has been studied in the United States.<sup>9</sup>

No clear relationship between diarrhea and infection has been demonstrated,<sup>10</sup> and they are often recovered from normal pigs.<sup>11,12,13</sup>

## REFERENCES

1. Halaihel N, et al. *Epidem Infect.* 2009;138:542.
2. Wang QH, et al. *Vaccine.* 2007;25:5453.
3. Martella V, et al. *J Clin Microbiol.* 2008;46:1907.
4. Kim HJ, et al. *J Vet Med B.* 2006;53:155.
5. Song YJ, et al. *Virus Genes.* 2011;42:394.
6. Yin Y, et al. *Arch Virol.* 2006;151:1749.
7. Mattison K, et al. *Emerg Infect Dis.* 2007;13:1184.
8. Reuter G, et al. *J Clin Microbiol.* 2010;48:363.
9. Scipioni A, et al. *Vet J.* 2008;178:32.
10. Scheuer KA, et al. *J Clin Microbiol.* 2013;51:2344.
11. Sisay Z, et al. *Arch Virol.* 2013;158:1583.
12. Wang Q, et al. *J Clin Microbiol.* 2006;44:2057.
13. Collins PJ, et al. *Vet Microbiol.* 2009;139:176.

## PORCINE SAPOVIRUSES

The first of the PoSaVs was isolated in 1980 in a diarrhetic piglet using EM. The prototype was known as the Cowden virus, and most of the ones studied since are similar to this virus. It was originally known as the porcine enteric calcivirus. Experimental infections with this virus produced severe diarrhea, anorexia, and intestinal lesions.

They are found in all age groups of pigs including those with diarrhea and those without clinical signs. It is suggested that sapoviruses play a part in enteritis in piglets.<sup>1</sup> A Korean-like sapovirus was recently identi-

fied in the United States.<sup>2</sup> Sapovirus characterization has been described.<sup>3</sup>

A survey of pigs with diarrhea showed that 32.5% had sapoviruses, but there was no proof that these were the cause of the problem.<sup>4</sup> They have evolved by recombination.<sup>5</sup>

Both sapoviruses and noroviruses are resistant to environmental conditions. At least six sapovirus genotypes have been identified and they are widespread on European farms.<sup>3</sup> They also have been identified in Japan.<sup>6</sup> They are highly diverse, but PoSaVs belong to genotypes GIII, GVI, GVII, GVIII, and GIX, and GX and GIII are the most common in pigs. Double infections with two or more sapoviruses are common.

In experimental infections sapoviruses do produce diarrhea. The virus produces lesions in the small intestine and replicates in the enterocytes. When given orally to piglets the virus is shed for up to 9 days.

In histologic examination it produces shortening, blunting, and fusion or destruction of the villi in the duodenum and the jejunum. There is crypt cell hyperplasia and reduction of the villus:crypt ratio (villous atrophy).

The incubation period with the original Cowden virus was 2 to 4 days after oral inoculation, and diarrhea and anorexia persisted for 3 to 7 days.

In another study, the viruses were homogeneously distributed among the different age groups of pigs and were not associated with disease.<sup>4</sup>

In a serologic survey in Spain,<sup>6</sup> 85 samples from pigs of 8 to 34 weeks were examined and 62% were positive.

A high maternal antibody is probably developed in the first few weeks of life, which then falls, and by 3 months has risen again (active immunity).

No human sapoviruses were detected in pigs by the authors who analyzed sapoviruses across Europe.<sup>3</sup> They detected the virus in 80/1050 samples (7.6%) collected from 39 farms in 6 countries. The highest prevalence was in 2- to 8-week-old pigs, and there was no difference in prevalence between healthy and diseased piglets. Six old genotypes and two new types were discovered.

Diagnostic tests are available in research laboratories (e.g., EM PCR, RT-PCR).<sup>7,8</sup>

Little is known about immunity, although it is assumed that sows produce colostral antibodies.

## REFERENCES

1. Alcalá AC, et al. *Vet Immunol Immunopathol.* 2010;137:269.
2. Sisay Z, et al. *Arch Virol.* 2013;158:1583.
3. L'Homme Y, et al. *Arch Virol.* 2010;155:839.
4. Martella V, et al. *Virus Genes.* 2008;36:365.
5. Dos Anjos K, et al. *Arch Virol.* 2011;156:1953.
6. Nakamura K, et al. *J Clin Microbiol.* 2010;48:1215.
7. Reuter G, et al. *J Clin Microbiol.* 2010;48:363.
8. Wang QH, et al. *J Clin Microbiol.* 2006;44:2057.

## PORCINE NOROVIRUS

It is not certain whether the pig and human noroviruses are antigenically distinct or related. These viruses have not been detected in nursery or postweaning pigs but have been found in healthy finishing pigs.<sup>1,2</sup>

A PoNoV was found in asymptomatic finishers and adult pigs.<sup>1</sup> It has positive sense single-stranded (ss)RNA viruses with three ORFs. Genetically diverse, they have five genotypes<sup>3</sup> and G11 is the one found in pigs and humans. There are three separate genotypes (11, 18, and 19) in pigs, and they have a worldwide distribution.<sup>4-11</sup> Epidemiologically, it will survive waste treatments. Little is known about their pathogenicity.

In an experiment with human norovirus in gnotobiotic pigs, a mild diarrhea was produced with lesions in the proximal small intestine.<sup>12</sup> It replicated in some pigs and produced antibody in some pigs. No diagnostic tests are available commercially, but a variety have been used in research laboratories (e.g., EM, RT-PCR, and PCR).<sup>9</sup>

### REFERENCES

- Martella V, et al. *Virus Genes*. 2008;36:365.
- Wang OH, et al. *J Clin Microbiol*. 2006;44:2057.
- Zheng DP, et al. *Virology*. 2006;346:312.
- Cunha JB, et al. *Res Vet Sci*. 2010;89:126.
- Keum HO, et al. *Arch Virol*. 2009;154:1765.
- L'Homme Y, et al. *Arch Virol*. 2009;154:581.
- Mauroy A, et al. *Arch Virol*. 2008;153:1927.
- Mijovskij JZ, et al. *Infect Genet Evol*. 2010;10:413.
- Reuter G, et al. *Arch Virol*. 2007;152:611.
- Shen Q, et al. *Arch Virol*. 2009;154:1625.
- L'Homme Y, et al. *Virus Genes*. 2009;39:66.
- Cheetham S, et al. *J Virol*. 2006;80:10372.

## PORCINE ASTROVIRUSES

Porcine astroviruses, although isolated from pigs, are of unknown importance. They are not zoonotic, and they were first isolated from pigs in the 1980s.

### ETIOLOGY

The viruses from the different species are probably antigenically different, and five types have been recognized.<sup>1-5</sup> All five types have been found in the United States,<sup>6</sup> and in some cases more than one type was found in a pig. The porcine strains are different from the human strains.<sup>7</sup> They are members of the family Astroviridae and of the genera *Mamastrovirus*; are positive sense, ssRNA viruses; and are highly diverse. They have partially clustered genomes<sup>4,8</sup> and are of two different lineages (PAST-1 and PAST-2).

### EPIDEMIOLOGY

Porcine astroviruses have a worldwide distribution. A recent survey<sup>9</sup> suggested that perhaps 62% of pigs had astrovirus (260 pigs with diarrhea were studied). The transmission is presumed to be the usual fecal-oral route such as for most enteric pathogens.

## PATHOGENESIS

The viruses are only known to cause disease in association with other agents. In an experimental infection given with PAST-1, only mild diarrhea was produced, which occurred within 1 day and continued for 5 to 6 days.

### CLINICAL SIGNS

The association between these viruses and clinical disease is obscure because they are found in pigs with diarrhea and in healthy pigs. The clinical signs are more likely to be found in association with simultaneous infection with rotavirus, coronavirus, or calicivirus.<sup>9</sup>

### DIAGNOSIS

EM, cell culture, and RT-PCR have been used to detect the antigen. VN and IFA techniques have been used to detect antibodies.<sup>10</sup>

### TREATMENT AND CONTROL

Treatment and control are probably not possible, and if affected then supportive therapy may be instituted.

### REFERENCES

- Laurin MA, et al. *Arch Virol*. 2011;156:2095.
- Luo Z, et al. *Vet Microbiol*. 2011;149:316.
- Lan D, et al. *Arch Virol*. 2011;156:1869.
- Reuter GY, et al. *Arch Virol*. 2011;156:125.
- Reuter G, et al. *Arch Virol*. 2012;157:1143.
- Xiao C-T, et al. *J Gen Virol*. 2013;94:570.
- Kapoor A, et al. *J Gen Virol*. 2009;90:2965.
- Indik S, et al. *Vet Microbiol*. 2006;117:276.
- De Benedictis P, et al. *Infect Genet Evol*. 2011;11:1529.
- Mor SY, et al. *J Vet Diag Invest*. 2012;24:1064.

## PORCINE TOROVIRUS

The link between these viruses and clinical disease is obscure. They are probably found worldwide and most recently have been found in Spain.<sup>1,2</sup> These kidney-shaped viruses are members of one of the four species within the *Torovirus* genus of the Toroviridae subfamily of the Coronaviridae.<sup>3</sup> and have been identified in a variety of pigs with diarrhea including the following:

- A 3-week-old pig with diarrhea
- Four-week-old pigs from Italy had greenish-yellow diarrhea and 30% morbidity and 8% to 10% mortality.
- Korean torovirus strains cause sporadic infections.
- In South Africa, 6- to 8-week-old pigs showed a sudden increase in mortality with piglets showing a reduction in appetite, weakness, tremors, recumbency, and death.

Generally, they are probably endemic in most pig herds and probably occur in closely related clusters in an area. Most pigs are affected postweaning. There is a high prevalence in subclinically infected weaned pigs.<sup>4,5</sup> There is probably endemic subclinical infection in neonates and young pigs and possibly there is a low incidence in adults.<sup>4</sup> In Korea, they are genetically diverse.<sup>5</sup>

Toroviruses can be demonstrated by PCR, RT-PCR, and qRT-PCR for antigen, and ELISA and VN for antibodies.

Antibodies can be demonstrated using ELISAs using recombinant viral proteins.

### REFERENCES

- Pignatelli J, et al. *Virus Res*. 2009;143:33.
- Pignatelli J, et al. *J Virol Methods*. 2010;163:398.
- Carstens EB, et al. *Arch Virol*. 2010;155:133.
- Pignatelli J, et al. *Vet Microbiol*. 2010;144:260.
- Shin DJ, et al. *Arch Virol*. 2010;155:417.

## PORCINE ORBIVIRUSES

Porcine orbiviruses have been found in porcine feces and seem to have no clinical significance.

## PORCINE PICOBIRNAVIRUSES

Porcine picobirnaviruses have been found in the UK, Argentina, Venezuela, and Hungary. Their clinical significance is unknown, but on one farm 11% of the samples from 15- to 35-day-old pigs were positive. Excretion has been followed from birth to slaughter.<sup>1</sup>

### REFERENCE

- Martinez LC, et al. *Infect Genet Evol*. 2010;10:984.

## PORCINE KOBUVIRUSES

The virus was first identified in Hungary in 2008.<sup>1</sup> These viruses are also Picornaviridae and belong to the genus *Kobuvirus*, and the virus is found in pigs with diarrhea and in healthy pigs.<sup>1,2</sup> No significance has as yet been attributed to them. They have been found worldwide by RT-PCR, and infection rates seem to vary from 45% to 99%. It has been reported that as many as 84.5% of pigs have the virus.<sup>3</sup> These infections are most commonly observed in nursery pigs and also as single infections. The viral load in healthy and infected pigs is also similar. They have been found in Brazil and the Netherlands,<sup>4</sup> Thailand,<sup>5</sup> Japan,<sup>6</sup> Korea,<sup>3</sup> and China.<sup>7,8</sup> They have also been found in the Czech Republic<sup>9</sup> and in 2013 found in the United States.<sup>10</sup>

### REFERENCES

- Reuter G, et al. *Arch Virol*. 2009;154:101.
- Reuter G, et al. *Rev Med Virol*. 2011;21:32.
- Park SJ, et al. *Arch Virol*. 2010;155:1803.
- Barry AF, et al. *Infect Genet Evol*. 2011;11:1811.
- Khamrin P, et al. *Emerg Infect Dis*. 2009;15:2075.
- Khamrin P, et al. *Infect Genet Evol*. 2010;10:950.
- Yu JM, et al. *Emerg Infect Dis*. 2009;15:823.
- Wang C, et al. *Virus Genes*. 2011;43:350.
- Dufkova L, et al. *Arch Virol*. 2012;158:549.
- Sisay Z, et al. *Arch Virol*. 2013;158:1583.

## PORCINE NEW VIRUS

A new circular ssDNA virus was isolated from porcine feces,<sup>1</sup> and these viruses can affect a wide range of species including pigs.<sup>2</sup>



## REFERENCES

1. Skorski A, et al. *Arch Virol*. 2013;158:283.
2. Shan T, et al. *J Virol*. 2011;85:11697.

## PORCINE BOCAVIRUS

Studies have indicated that Bocavirus,<sup>1</sup> which has a close relationship with enteric disease in domestic animals, had a high prevalence in stool samples of pigs.<sup>2,3</sup> It is commonly found in grower pigs,<sup>4</sup> and the level of virus load is not different between healthy and infected pigs. It can be detected using Taq-Man-based RT-PCR.<sup>5</sup> A bocavirus causing respiratory tract signs has been found in China.<sup>6</sup> It has been found in pigs in Sweden,<sup>7,8</sup> China,<sup>9,10</sup> and in Northern Ireland.<sup>11</sup>

## REFERENCES

1. Manteufel J, Truyen U. *Intervirology*. 2008;51:328.
2. Cheng WX, et al. *PLoS ONE*. 2010;5:e13583.
3. Zhang HB, et al. *Epidemiol Infect*. 2011;139:1581.
4. Zhang Q, et al. *Arch Virol*. 2013;158:1631.
5. Li B, et al. *Virology*. 2011;8:357.
6. Zhai S, et al. *Arch Virol*. 2010;155:1313.
7. Blomstrom A, et al. *Virus Res*. 2009;146:125.
8. Blomstrom A, et al. *Virus Res*. 2010;152:59.
9. Shao Lun Z, et al. *Arch Virol*. 2010;155:1313.
10. Cheung AK, et al. *Arch Virol*. 2010;155:801.
11. McKillen J, et al. *Vet Microbiol*. 2011;15:39.

## A NEW NEONATAL DIARRHEA SYNDROME

A French study<sup>1</sup> has suggested that there is a new neonatal diarrhea syndrome (NNDS) in France and Denmark characterized by a mortality rate of up to 40% in suckling pigs, of unknown cause, with 15% to 20% of French herds supposedly having experienced this outbreak and with over 80% of submissions to Danish laboratories having been associated with this outbreak. It has been suggested that the herds are mainly the high-yielding well-managed herds. There is considerable variability between the litters; particularly the gilts and second litter sows may be affected. The length of parturition in the affected litters was longer than in the unaffected herds. The proportion of piglets born late was higher. Levels of antibodies in colostrum varied, but there was no evidence of differences in quality of colostrum. No consistent pattern emerged in the herds, and no consistent pattern of microbiological observations has been found. Piglet serum IgG is a reflection of the rate of absorption from the gut, which depends on the level of IgG in the colostrum and in turn depends on the level of maternal antibody in the sow. There were normal amounts of milk in the stomach of affected pigs; there were no obvious gross lesions; they were not dehydrated; the small intestines were contracted, or atonic, and dilated; hyperemia was rare, and intestinal contents were yellowish and aqueous. The intestinal mucosa was not

inflamed and the lymph nodes were reactive. The colon had no changes, and the contents were creamy or watery. In the Danish laboratories 55% of the cases had nonhemolytic *E. coli* and 7% hemolytic *E. coli* that was mostly O7, 16% had ETEC, *C. perfringens* type A was found in 80%, *C. difficile* was found in 12%, and rotavirus was also found in 12%. Only 1/220 samples had *C. perfringens* type C.

Four Danish pig herds with NNDS were investigated.<sup>2</sup> This has occurred since 2008 and is characterized by a nonresponse to treatment or to management therapies. No pathogens have been detected in the past, and in this investigation no pathogens were detected either. Macroscopically, these pigs had filled stomachs and flaccid intestines without mucosal changes. The predominant histologic changes were villous atrophy in the jejunum and ileum. Epithelial lesions were seen in the colon in one-third of the cases. In the Danish cases it was found that (1) microbiological testing was not sufficient to explain the problem, (2) histopathology was generally inconclusive, (3) *E. coli* and *C. perfringens* type A are found in normal pigs and are therefore not considered to be important, and (4) the role of *C. difficile* under Danish conditions has not been elucidated.

A suggested case definition was nonhemorrhagic diarrhea during the first week of life without detection of known infectious pathogens characterized by milk-filled stomachs and flaccid intestines at necropsy.

## REFERENCES

1. Sialelli J-N, et al. *J Rech Porc*. 2009;41:167.
2. Kongsted H, et al. *Vet Res*. 2013;9:206.

## TRANSMISSIBLE GASTROENTERITIS IN PIGS

### SYNOPSIS

**Etiology** Transmissible gastroenteritis virus, member of the Family Coronaviridae

**Epidemiology** Highly contagious disease of newborn piglets but may affect pigs of all ages in susceptible herds. High morbidity and high case-fatality rate in piglets under 10 days of age. Over 5 weeks of age, mortality is low. Large economic losses. Epidemics of disease occur in susceptible herds. Transmission by oral and aerosol routes. Recrudescence of infection and endemic disease commonly follows epidemics. Infection of pregnant sows results in protection of piglets by secretory IgA in milk. Porcine respiratory coronavirus mutant of transmissible gastroenteritis (TGE) virus has reduced the incidence of TGE.

**Signs** *Epidemic disease:* Acute diarrhea, vomiting, dehydration, and death in piglets under 10 days of age. Less severe diarrhea in older pigs of all ages.

*Endemic disease:* Diarrhea in young pigs 6 days of age and older, including weaned pigs.

**Clinical pathology** Detection of virus in tissues. Serology.

**Lesions** Fluid-filled intestines. Villous atrophy.

**Diagnostic confirmation** Detection of virus in mucosal scrapings of intestine.

Differential diagnosis list

- Enteric colibacillosis
- Coccidiosis
- *Clostridium perfringens* types A and C; *Clostridium difficile*
- Rotavirus enteritis
- Porcine epidemic diarrhea, especially new strains
- Vomiting and wasting disease
- Diarrhea of adult sows, gilts, and boars

**Treatment** Supportive therapy. Fluids and electrolytes. No specific treatment.

**Control** Isolation of sows due to farrow.

Planned exposure to virus. Biosecurity and acquisition of virus-free replacement stock. All-in, all-out management system. Vaccination.

## ETIOLOGY

Gastroenteritis is associated with the transmissible gastroenteritis (TGE) virus, an alphacoronavirus 1 and member of the Family Coronaviridae<sup>1</sup> belonging to the Order Nidovirales. The nucleotide sequences from 20 TGE virus isolates obtained from eight countries between 1946 and 1996 have been compared. The virion is an enveloped, large, single-stranded RNA genome with positive polarity. It has three major structural polypeptides: 200-Kda spike protein (S protein), 30-Kda membrane protein (M), and a minor 10-Kda protein (E). These are produced by open reading frames (ORFs) 2, 5 and 6. The function of ORF products from 3a and 3b are not known, but they have been postulated as an important determinant of virulence.

In Europe, TGE-like strains of coronavirus have recently emerged.<sup>2</sup> These might be novel recombinants and are associated with the winter season, possibly occur in nonporcine hosts (cats, dogs, and foxes), and can be spread by starlings and houseflies.<sup>3</sup>

## EPIDEMIOLOGY

### Occurrence and Prevalence of Infection

The disease occurs in pig-producing areas of North America, Europe, and many parts of Asia, principally in the northern hemisphere. During the past three decades, TGE has changed from a sporadic disease that historically occurred in the midwestern United States to an endemic disease in most countries of the northern hemisphere. It can cause severe disease even in seronegative herds, especially if the protection of porcine respiratory coronavirus (PRCV) is missing. In Asia, TGE and porcine epidemic diarrhea



(PED) often cocirculate. In densely swine-populated areas, such as the midwestern United States, the disease is one of the major causes of morbidity and mortality in young pigs. The disease has not been diagnosed in Australia and New Zealand. In 1990, the prevalence of infection in the United Kingdom was low, with 0.6% of sows sampled being seropositive compared with 3% in 1984. No major epidemics have occurred since 1981. In 1984, a seroconversion to the TGE virus occurred in a closed herd in the absence of any clinical disease. The TGE virus was not isolated, and it is possible that the seroconversion resulted from the emergence of PRCV throughout Europe and the United Kingdom beginning in 1986. PRCV is a deletion mutant of the TGE virus, and its high rate of prevalence has markedly reduced the number of TGE outbreaks in European swine herds. The TGE virus probably coexists in these herds together with PRCV. In 1999, a single case was diagnosed in East Yorkshire as a one-off. Other isolated outbreaks in herds that were seropositive for PRCV were also reported. An outbreak of TGE occurred in the United Kingdom in 1996 in which the virus was a variant with an intact spike gene but with a large deletion in ORF 3a, which therefore may not be necessary for enteric virulence.

The **prevalence of infection** with the TGE virus based on serological surveys of swine herds varies with the size of the herd, the distance between herds, and the purchase of breeding stock from nonspecific pathogen-free herds. Depending on the geographical location, up to 50% of herds may be seronegative, and in 45% of herds, the prevalence of infection in sows will vary from 10% to 80%. In the United States in 1990, a national survey of swine herds found that 36% of herds were positive for the TGE virus, and 24% of the producers' herds were vaccinated for the virus. By 1997, up to 100% of surveyed herds and 91% of the sampled sera were positive for both the TGE virus and PRCV, which indicates a marked increase, probably as a result of subclinical infections.

The disease is highly contagious and affects piglets primarily under 10 days to 2 weeks of age. Pigs over 5 weeks of age often have milder clinical signs. **Epidemic TGE** occurs when the virus is first introduced into a susceptible herd and is usually of short duration and no longer clinically evident after herd immunity develops. Epidemics of the disease occur most commonly during the winter months. **Endemic TGE** occurs when the virus persists in a partially immune herd into which susceptible swine are introduced or if the epidemic form is not well managed. Endemic TGE is a common sequela to a primary epidemic in herds of more than 300 sows in which diarrhea occurs in piglets from 6 days of age to approximately 2 to 3 weeks after weaning. Recurrence of clinical

TGE often occurs in endemically infected herds approximately 9 months after the first outbreak as the piglets of susceptible sows are exposed to the virus. Recurrence has been associated with the following factors:

- Breeding herd sizes of over 100 sows
- Presence of finishing pigs in large herds
- Introduction of purchased gilts

### Morbidity and Case Fatality

Typically, an epidemic in a herd is explosive and dramatic. Rapid spread and high morbidity occur in pigs of all ages within 2 to 3 days, but major clinical disease is restricted to pigs prior to weaning and lactating sows. Case-fatality rates can approach 100% in pigs under 10 to 14 days of age but are much lower with increasing age, and mortality is low in postweaned and adult pigs. The epidemic commonly terminates in 3 to 5 weeks with the loss of young, susceptible pigs and the development of herd immunity, and, generally, the disease does not recur again for a 3- to 6-year period.

### Risk Factors

#### Animal Risk Factors

**Level of Herd Immunity.** Epidemics of clinical disease occur following the introduction of the virus into a **susceptible herd with no previous exposure** to the virus. All age groups will become infected, and most pigs will be affected clinically to variable degrees. Nursing piglets under 2 to 3 weeks of age are most susceptible to clinical disease and experience the highest case-fatality rate. Clinical disease disappears when the herd becomes immune. Endemic TGE develops when the virus and clinical disease persist within partially immune herds, as a result of continual or periodic introduction of susceptible pigs. In endemic situations, diarrhea is generally observed in pigs from the age of approximately 6 days until approximately 14 days after weaning. Overall pig mortality is lower and generally occurs in recrudescence episodes. After weaning, piglets no longer have the protection provided by TGE-specific secretory IgA antibody in milk and are susceptible to infection and clinical disease if the infection rate in the weanlings is high. Thus, weaning pigs serve as a major reservoir of infection.

**Sow parity** may be a risk factor. Parity-1 sows with no previous exposure to the virus may be a risk factor on some farms. On other farms, parity-3 sows were at increased risk for unknown reasons. A single boar may be a high-risk animal on some farms.

**Herd Size.** There is a higher likelihood that sows will be seropositive if the herd size exceeds 500 sows and if more than 25 replacement breeding animals are purchased from nonspecific pathogen-free herds. A mathematical model of the detection and dynamics of the disease in Australia

indicates that the disease is likely to be established in breeding and finishing swine herds of average size. The threshold number of susceptible pigs for establishment of the infection is 90 to 160. Swine herds most at risk are those with large numbers of susceptible pigs, continuous breeding of susceptible pigs, high numbers of purchased pigs, and close contact between feral pigs and susceptible domestic pigs. The risk is highest in herds that do not receive a rapid diagnosis, such as when there is little or no veterinary involvement in health and disease management. In small farms (containing 15-40 sows), outbreaks of TGE are characterized by rapid spread of infection to most animals of all ages but a duration of only 3 to 5 weeks.

### Environmental and Management Risk Factors

Climatic factors appear to be important in the occurrence and establishment of the disease. Climate does not yet have significance in the tropics or southern hemisphere, and there is evidence that spread of the disease is limited in hot climates. In areas where the disease is endemic, it has a distinct seasonal occurrence, with the majority of outbreaks occurring from midwinter to spring, and cyclic occurrence has been recorded. The virus is labile above 21° C and is very sensitive to sunlight. It is also killed by most disinfectants. The disease tends to occur in area outbreaks in which herds in close proximity are affected within several weeks. Within swine barns, the location of the farrowing crates may be a risk factor if the cold-air inlets are directly above the crates.

The use of a continuous-flow system of production in a herd is a major risk factor. The constant overlap of farrowing sows in farrowing rooms, overlap of weaned pigs in nursery rooms, and a continuous flow of finishing pigs without adequate cleaning and disinfection between each group of pigs are major risk factors and perpetuate persistent infection and the endemic form of the disease. An all-in, all-out system for each group of pigs reduces the risk of infection between pigs.

**Lack of adequate biosecurity is a major management risk factor.** Infection can be introduced into herds by the importation of infected breeding stock, by contaminated trucks and other vehicles, or on workers' clothing and boots.

### Pathogen Risk Factors

The virus has a long survival in slurry, water, and sewage. It is readily destroyed by standard solutions of phenol and formalin, by boiling, and by drying but not by freezing. The virus is highly photosensitive, which may account for the more frequent occurrence of the disease during the winter and spring months. The virus survives freezing, and infected pork scraps or offal may provide

a source of infection either directly through feeding of uncooked garbage or possibly indirectly via dogs. Purposeful infection by the feeding of frozen infected piglet intestine to sows to induce immunity can also be a significant source of continued infection of a herd or area.

The genome and the genetic basis for the pathogenesis of the virus have been described. Antigenic differences between TGE viruses have been examined, and the nucleotide sequences of isolates from various countries have been compared.

The TGE virus is not antigenically related to the two other porcine coronaviruses, hemagglutinating encephalomyelitis virus and porcine epidemic diarrhea virus, but it is related to PRCV.

### Porcine Respiratory Coronaviruses

PRCV is a deletion mutant of the TGE virus with altered tissue tropism to the respiratory tract, first recognized in Belgium in 1984. It has a partially deleted receptor binding protein. The virus closely resembles the TGE virus antigenically, and pigs infected with PRCV develop a serological response that cannot be distinguished by virus-neutralization tests from the response of pigs infected with the TGE virus. In other words, it provides cross-protection. Infection with PRCV produces high levels of interferon and nitric oxide in the lungs.<sup>4,5</sup> Despite the antigenic relation of PRCV and the TGE virus, they can be differentiated with monoclonal antibodies. All PRCV strains have around 600 to 700 nucleotide (nt) deletions within the amino-terminal S gene, resulting in the loss of hemagglutination activity and two antigenic sites. European PRCVs have an identical deletion of 672 nt at the same position, whereas U.S. strains have 621 to 681 nt deletions located at different positions, which suggests that they arose separately. Natural infection of the sow with PRCV induces natural antibodies that neutralize classic TGE. The virus has spread throughout Europe and has been identified in the United States and Canada. Spread of the virus has been explained in part by airborne transmission, and infection shows a seasonal pattern, affecting farms during winter and spring. Seroprevalence studies in Belgium indicate that 95% of sows are PRCV positive. Nearly all piglets are infected by 10 to 15 days of age. The infection is widespread in swine herds in Spain. The risk factors associated with seropositivity in Danish swine herds include (a) increasing herd size, (b) certain geographical locations, (c) presence of a slurry system with slatted floors, and (d) purchase of pigs. The serological status of neighboring herds is also a risk factor; closeness of a seropositive herd has been associated with an increased risk of a herd becoming serologically positive.

PRCV replicates in the respiratory tract of pigs and to a very limited extent in the intestines.<sup>6,7</sup> Its pathogenicity is

controversial. Some studies indicate that the virus causes only subclinical respiratory infections, whereas others have linked the virus with field outbreaks of respiratory disease. Experimentally, inoculation of the virus intratracheally into 8-week-old piglets resulted in clinical respiratory disease and bronchointerstitial pneumonia, and the virus was recovered from the respiratory tract. Some isolates of the virus produce interstitial pneumonia in neonatal piglets with no recognizable clinical respiratory disease. The administration of dexamethasone will produce severe lung lesions,<sup>8</sup> as will concurrent infection with porcine reproductive and respiratory syndrome virus (PRRS). In a recent study in Japan, it was shown that most pigs are seropositive for PRCV, but TGE is present on some of the farms.<sup>9</sup>

### Methods of Transmission

The exact mode of transmission of the TGE virus is uncertain. Virus shedding in the feces of infected pigs usually ends at or within a few weeks of recovery, although recovered pigs may harbor the virus in pulmonary or intestinal tissue for periods of more than 100 days. The shedding period is thought to be 14 days. After weaning, the pig is no longer protected by specific secretory IgA antibody of the sow's milk and is highly susceptible to infection if the rate of infection is high in the weanling population. The weanling pig is a major reservoir of infection for continuous infection in the herd. Feeder pigs with no clinical signs can be an important reservoir of the virus. The virus has also been isolated from pharyngeal swabs taken from farm-raised sows sent to slaughter.

**Epidemics commonly follow the introduction of pigs into a herd, and the carrier pig is a major source of infection.** Frequently, the disease first appears in older pigs in the herd and then subsequently spreads to newborn pigs and sows in the farrowing area. **Spread is much more rapid in a continuous-flow system of production compared with an all-in, all-out system, whereby groups of pigs of the same age or production stage are handled as groups and their housing facilities are cleaned and disinfected before and after being occupied.** Visitors and their boots, transport vehicles, equipment, and starlings have also been incriminated in the transfer of infection to new locations. Starlings may act as vectors in spreading the disease to adjacent farms. The virus can also multiply in houseflies (*Musca domestica*), and they may be a vector. Feral pigs are not a significant reservoir for the TGE virus in the southern United States but are capable of becoming infected and developing virus-neutralizing antibodies against the virus. Subpopulations of infected pigs may exist within the herd, and although shedding normally lasts for 14 days, it is possible for animals to be infected for 100 days.

Once the infection has gained access to a herd, transmission occurs by both oral and respiratory routes. The speed of spread without direct contact indicates that the virus can be spread by aerosol. Respiratory transmission appears significant in adults, and replication in the respiratory tract is followed by excretion in nasal secretions and milk within 1 day of infection and also in feces. Excretion in milk results in rapid transmission to suckling piglets, which in turn may excrete large quantities of the virus within 2 days of infection.

### Immune Mechanisms

Immunity to clinical disease in newborn piglets is dependent on the level of TGE-specific secretory IgA antibody in the colostrum of the sow and is known as **lactogenic immunity**. When pregnant sows are infected orally with the virulent TGE virus, specific IgA precursor cells are sensitized in the intestine. These sensitized cells migrate to the mammary glands and differentiate into plasma cells that secrete IgA-class TGE virus antibody in colostrum and milk. This immune mechanism to induce protective antibody for suckling pigs is termed the *gut-mammary gland link* or the *gut-associated lymphoid tissue* (GALT) system. Following natural infection with TGE during pregnancy, the recovered sow or gilt is capable of protecting her litter against the disease. After farrowing, the colostrum contains antibodies of the IgG, IgM, and IgA isotypes derived from serum. After the third day, milk is produced, and the only antibody it contains is the IgA antibody, which is synthesized in the mammary gland. The IgA antibodies of immune sows are the most critical in the protection of mucosal surfaces such as the gastrointestinal tract, and this immunoglobulin is the most abundant isotype in porcine milk. These IgA antibodies are not induced after the parenteral administration of viral antigens, which explains the relative ineffectiveness of parenteral vaccines. Serum antibody induced by vaccination of the pregnant sow does not provide protection of piglets through colostrum or milk.

Secretory IgA is the predominant antibody class in milk and is responsible for lactogenic protection of pigs and active protection of the intestine. It is stimulated by oral inoculation with nonattenuated TGE virus, but it is not associated with attenuated TGE virus. Although high concentrations of IgA and IgG originating from the serum are present in colostrum, IgG does not persist in the milk, whereas IgA does persist because of local mammary secretion. After the first week of lactation, secretory IgA constitutes 50% to 60% of the total immunoglobulin concentration in swine milk, and IgG makes up 20% to 30%.

Suckling pigs are protected from infection by continued ingestion of antibody of the IgA class secreted in milk. The level of

serum IgA antibody as an indicator of immunity to transmissible gastroenteritis can be measured using the indirect immunoperoxidase antibody test. Young pigs of 6 weeks of age that are exposed to experimental infection with the virus develop both a humoral and cellular immunity, which reach peaks at 21 and 28 days, respectively.

In recent years, less typical forms of the disease have been observed. With continuous farrowing and the continual introduction of susceptible pigs into an infective environment, outbreaks may be considerably prolonged, and prolongation or recrudescence is more likely than when pregnant sows are kept in relative isolation on pasture or elsewhere. Atypical endemic forms of the disease with a low morbidity and mortality and frequently with the onset of clinical disease delayed until piglets are 2 to 4 weeks of age have been observed and may go unrecognized because of the atypical clinical findings. They are more likely to occur in large continuous-farrowing units and may be associated with partial herd immunity and low-virulence strains. Some sows do not develop a significant immunity following a single infection, and in large herds, there may be a sufficient number of these to allow the disease to perpetuate in a low-incidence, endemic form.

A recrudescence of the disease may occur after a period of several months and is thought to result from inadequate exposure and immunity of some pigs, particularly dry stock during the initial outbreak followed by reinfection from a carrier pig. Recrudescence of clinical disease is usually of much shorter duration than the primary outbreak and commonly lasts only 6 to 10 days. The periods of recrudescence are commonly precipitated by the simultaneous farrowing of several susceptible gilts in the same farrowing room. Of greater long-term concern is that approximately 50% of some large herds continue to experience clinical recrudescences for almost 2 years or more. The endemic form of the disease appears to be correlated with herds of more than 100 sows and herds in which finishing pigs were kept. In large herds, the virus may spread more slowly, and replacement gilts entering the herd may take several months to become infected and to seroconvert. In large herds, the rapid turnover of breeding stock, continuous farrowing, and early weaning also contribute to the perpetuation of an endemic infection, and thus TGE can maintain itself through the slow and incomplete spread of the virus among adult pigs, particularly herd replacements. Joint infection with PRRS and TGE does not appear to affect the clinical effects, shedding, or persistence of either virus.

### Economic Losses

A herd epidemic of TGE causes economic losses through the following routes:

- Death of pigs
- Increased downtime of the swine enterprise

- Increased labor
- Disturbance of the breeding program
- Subsequent reduced growth of young pigs destined for slaughter
- Curtailed performance of older pigs

The economic losses can be very large. Simulation of the economic losses resulting from an outbreak of disease in Australia, where the disease is exotic, estimated a reduction in net revenue of 70% in the 6 months after a moderate outbreak (50% mortality of piglets under 1 week of age) and 100% for a severe outbreak (95% mortality of piglets under 1 week of age). An analysis of the economic losses resulting from the disease in swine farms in some areas in the United States over a 2-year period estimated the average loss to be between 13% and 18% of the average return earned above total production costs. It has been assumed that the growth of surviving pigs was depressed by 10% and their feed conversion by 18%, but pigs surviving or born shortly after an epidemic of TGE are profitable to raise.

### PATHOGENESIS

The S protein of the viral membrane of the TGE virus (TGEv) has four major antigenic sites and is the major inducer of neutralizing antibodies. The protein mediates the binding of the virus to the cell surface and the subsequent fusion of the viral and cellular membranes.<sup>3</sup> High titers of serum IgG and virus-neutralizing antibody to TGEv probably reflect the amount of S protein the pig has received. Two different ligands have been shown to interact with the S protein, and binding to the porcine aminopeptidase N, the cellular receptor for TGEv, is essential for infection of the cells. TGEv is also able to recognize sialic acid residues and attach to sialylated macromolecules. A second binding site on the N-terminal division of the S protein allows TGEv to interact with terminal sialic acid residues on glycoproteins or glycolipids and to agglutinate red blood cells (RBCs). TGEv also recognizes a porcine intestinal brush-border protein called mucin-type glycoprotein (MEP), and TGEv binds to this mucin produced by goblet cells. A mutant virus that has lost its sialic acid binding capability is not pathogenic because it is unable to attach to goblet cells. Sialic acid binding activity is a pathogenicity factor for TGEv, and it is important to note that the sialic acid binding sites for TGEv and *Escherichia coli* are different.

The virus infects the upper respiratory tract and the intestines, but the major clinical effects result from intestinal infection. Following oral challenge of susceptible piglets, the incubation period may be as short as 24 hours. After 12 to 24 hours, there is massive necrosis, and no enzyme activity in the epithelium remains. The virus infects mature differentiated columnar epithelial cells of the intestinal villi but not the undifferentiated cells of the crypts. Replication occurs within 4 to 5 hours, with sloughing of the infected

cells and release of the virus, and after several replication cycles, there is a marked reduction in villous size with villous atrophy. The loss of epithelial cells results in increased migration of undifferentiated cells from the crypts to line the shortened villi. With virulent virus, epithelial cells at all levels of the small intestine are infected, with major lesions occurring at the proximal jejunum and, to a lesser extent, at the ileum. In most cases, the duodenum is not affected. The lesser virulence of attenuated strains of the virus may be associated with their inability to infect and produce lesions in the villi of the more cranial portions of the jejunum. Gnotobiotic pigs inoculated orally with a TGE vaccine will develop lesions similar to those in the naturally occurring disease.

Diarrhea results from a combination of malabsorption, the osmotic effects subsequent to the loss of intestinal surface area and disaccharidase activity, and impaired lumen-to-extracellular fluid flux of sodium caused by the occurrence of undifferentiated cells lining the stunted villi. The virus invades the villus, but not the crypt epithelium of the small intestine, within hours after experimental administration. The infected villus cells are quickly shed and replaced by relatively undifferentiated enterocytes. As infected cells are shed, the epithelium proliferates, and migration of cells from the crypts accelerates. There are marked abnormalities in ion transport function in the jejunum and ileum at the peak of the diarrhea. There is a failure of the intestine to actively transport sodium and chloride, and there is a defect of glucose-mediated sodium ion transport. Macromolecular hyperpermeability of the small intestine also occurs, but its significance is uncertain. Experimentally induced infection of 3-week-old pigs results in villous atrophy, crypt hyperplasia, and a marked decrease in the secretory response of the villous epithelium to *E. coli* enterotoxins. The disease is more severe in gnotobiotic pigs that are infected with *E. coli* in addition to the TGE virus, suggesting that bacterial factors also influence the severity of the diarrhea.

In the experimental disease in 2-day-old pigs, vomiting and diarrhea occur 12 to 24 hours after oral inoculation of the virus, and affected piglets are moribund 1 or 2 days later. Before becoming moribund, most piglets become lethargic and comatose. In addition to dehydration and metabolic acidosis, there is a severe hypoglycemia resulting from a combination of inadequate glucose metabolism inherent to neonatal piglets and the acute maldigestion and malabsorption from the diffuse and severe villous atrophy. The high death rate is attributable to a combination of dehydration, acidosis, and severe hypoglycemia.

The age-dependent resistance to TGE can be explained in part by a decreased susceptibility of the epithelial cells of older pigs to infection and by an increased proliferative capacity of crypt cells with much more rapid



regeneration of atrophic villi in pigs over 2 weeks of age. It may be that the virus has developed strategies to evade apoptosis in intestinal enterocytes by producing huge amounts of the virus.

A recent experiment comparing a Korean strain with two U.S. strains showed that the progression of the Korean virus was much slower (i.e., much less virulent), possibly because there was only replication in the ileum and jejunum, whereas the U.S. strains also replicated in the duodenum. The more virulent strains attack a wider area of enterocytes. Most only attack the villous rather than the crypt enterocytes. An outbreak of reduced-virulence TGEv was associated with the presence on the farm of three strains of PRCV that had variable-sequence changes in ORF 3, 3a, and 3b.

## CLINICAL FINDINGS

In a primary or epidemic outbreak, the clinical findings of typical acute TGE are characteristic. The appearance of the disease is not significantly altered by a concurrent infection with PRRS. Sows may become ill when lactating and may develop anorexia and agalactia, further contributing to piglet mortality.

### Piglets

After an incubation period of 18 to 72 hours, there is a sudden onset of vomiting and diarrhea. The diarrhea is profuse and frequent; the feces are watery and usually yellow-green in color. The feces may contain clots of white undigested milk and have an offensive odor. The vomitus is yellow, foamy, and slimy. There may be a transitory fever, but in most cases the temperature is normal. Depression and dehydration are pronounced, the hair coat is ruffled, and weakness and emaciation progress to death on days 2 to 5. Some piglets may continue to suck to within a few hours of death; those that survive are severely emaciated and gain weight slowly. The illness may commence as soon as 24 hours after birth. It is not uncommon on an individual farm for the disease to become less severe (endemic), and in these cases, it resembles rotavirus infection and spreads more slowly with the passage of time.

### Older Pigs

In older pigs, there may be signs similar to those that occur in piglets, but many animals become infected without clinical abnormalities. Diarrhea may occur first in the dry sows. In older pigs, recovery is much more likely to occur, with the illness lasting for up to 10 days. Lactating sows may or may not be affected clinically. Fever and inappetence occur, with or without diarrhea, and agalactia is a common complication in sows. In endemically affected herds with continuous farrowing and partial sow immunity, the disease is milder, with diarrhea affecting piglets approximately 6 days of age or older and diarrhea in weaned pigs. Brief periods of

clinical disease occur in some parts of the herd, mortality is low, and affected pigs subsequently grow poorly.

## CLINICAL PATHOLOGY

### Serum Biochemistry

Severe dehydration with metabolic acidosis and marked hypoglycemia is common.

### Detection of the Virus

TGE virus can be grown in pig kidney (PK) cells and PRCV in PK cells and swine testicle cells.

The virus can be detected in the mucosal scrapings and feces using an enzyme-linked immunosorbent assay (ELISA), immune electron microscopy, fluorescent antibody staining, or the immunoperoxidase test. A capture-enzyme immunoassay has also been developed. A reversed passive hemagglutination test for detection of the virus in feces is also available. A solid-phase immune electron microscopic technique for detection of the virus in feces is also useful for diagnosis in living animals. PRCV can be isolated by tissue culture.

### DNA Probe

DNA probes can differentiate PRCV from TGEv. Polymerase chain reactions (PCRs) were described quite early on for identifying TGE. The real-time PCR (RT-PCR), a rapid RT-TaqMan, has been shown to be a very good sensitive test for TGEv in pig fecal samples.<sup>10</sup> Tests are now available to differentiate PRCV from TGEv.

In situ hybridization (ISH) has been described, and a nested RT-PCR has been developed that is very sensitive. A multiplex RT-PCR for differentiating the PED virus (PEDv) from TGEv in clinical samples has been described. It has also proved possible to use formalin-fixed tissue for multiplex PCR, nested-PCR, and ISH with 100% conformity.

A multiplex RT-PCR has been developed for the simultaneous detection of both TGEv and PEDv.<sup>11</sup> A multiplex microassay can be used for the rapid differential diagnosis of eight viruses, including TGEv.<sup>12</sup>

### Serology

Several serological tests can detect and measure antibody to the virus in live animals. The serum neutralization test is sensitive and reliable, but it is time-consuming and requires facilities for cell culture techniques. Neutralizing antibodies appear in the serum 7 to 8 days after infection and persist for at least 18 months. An ELISA is more sensitive than the virus neutralization test, and a competitive ELISA differentiates between TGEv and PRCV. A blocking ELISA to differentiate TGEv and PRCV has also been described.<sup>13,14</sup>

## NECROPSY FINDINGS

The lesions are confined to the intestine and stomach, although he changes may be minor in many field outbreaks and in the experimental disease. The intestinal wall is thin and

translucent, and the intestine is distended with fluid ingesta. Despite the presence of milk in the intestine, there is little evidence of fat absorption in the draining lymphatics. The important histopathological change is atrophy of villi with failure of epithelial cell differentiation in the small intestine. The atrophy is evident 24 hours after infection, and regeneration occurs 5 to 7 days later. The marked reduction in the size of intestinal villi may even be detected at low magnification with a stereomicroscope. In the stomach, there may be engorgement of vessels and necrosis of the epithelium deep in mucosal crypts. No inclusion bodies are detectable. When secondary pathogens contribute to the disease, there may be inflammatory lesions in the intestines. In chronic cases, a thickening of the intestinal wall identical to that seen in terminal (regional) ileitis has been described.

In Europe, the disease is characterized by more severe mucosal lesions, often including fibrin exudation. There is also degeneration of the heart muscle and, in some cases, of the skeletal muscle.

A simple test for the presence of intestinal lactase in intestinal washings may assist in the laboratory diagnosis. Examination of frozen sections of jejunum from acutely ill piglets by the fluorescent antibody technique is a rapid and effective method for the detection of virus in tissues. The intestine may be segmentally affected, so multiple areas must be sampled. Viral antigen is detectable for only 24 to 36 hours when utilizing most fluorescent antibody (FA) conjugates. This makes the selection of acute cases critical. Electron microscopy is often utilized to identify the presence of coronavirus, but this method is not specific for TGEv. PCR methods for TGEv detection are being developed, and immunohistochemical techniques are available for use in formalin-fixed tissues.

The use of apoptotic markers shows that most of the cells are undergoing apoptosis but are not infected with TGEv; they are termed *bystander cells*. It has been previously suggested that apoptosis does not occur in the enterocytes of piglets infected with TGEv. An accumulation of interferon-alpha-producing cells occurs in the GALT of TGEv-infected piglets. It has been suggested that these are the mucosal counterparts of the dendritic cells recently shown to produce interferon (IFN) alpha after in vitro viral induction. The TGEv challenge of pigs produces an increase in CD4+/CD8+ cells, an increase in natural killer cells and cytotoxic T cells, an increase in the expression of IL-2 receptors, and a decrease in null cell phenotypes.

## Samples for Confirmation of Diagnosis

- **Histology**—several segments of jejunum and ileum, stomach (LM, IHC)
- **Virology**—several segments of jejunum and ileum (FAT), feces (EM)



## DIFFERENTIAL DIAGNOSIS

The epidemiological and clinical characteristics of transmissible gastroenteritis (TGE) should make possible a presumptive diagnosis, but confirmation must depend on the finding of compatible histological lesions, the detection of antigen, transmission experiments, and evidence of seroconversion. It is unusual to encounter outbreaks of diarrhea in piglets that appear to be typical of TGE where there is porcine respiratory coronavirus (PRCV) on the same farm. Either the virus can be demonstrated in the tissues by fluorescent antibody test (FAT), but serum antibodies cannot be detected in the breeding animals; or serum antibodies can be detected in the adults, but the virus cannot be demonstrated in the tissues by either immunofluorescence or tissue culture.

Villous atrophy is not pathognomonic for the disease because it occurs in 3-week-old piglets affected with diarrhea and steatorrhea, in rotavirus infections of piglets, in coccidiosis, and in some herds for undetermined causes immediately following weaning. In some instances, diagnosis in suckling or recently weaned pigs is difficult.

In piglets, TGE must be differentiated from the following:

- **Enteric colibacillosis** A common disease of piglets under 10 days of age with profuse diarrhea, no vomiting, dehydration, and a good response to therapy if treated early.
- ***Clostridium perfringens* type C** Enterotoxemia occurs in piglets under a few days of age and causes marked depression, diarrhea, dysentery, reddening of the anus, and rapid death. Lesions at necropsy are characteristic.
- ***Clostridium perfringens* type A**
- ***Clostridium difficile***
- **Coccidiosis** Affects newborn piglets 5 to 15 days of age, causing profuse diarrhea, depression, dehydration, and unthriftiness. Affected piglets may continue to suck. There is high morbidity, low mortality, and oocysts in the feces.
- **Rotavirus enteritis** Rotavirus causes diarrhea in suckling and weaned piglets, with a high morbidity and low mortality. Most affected piglets recover in a few days, and epidemics are commonly associated with continuous farrowing.
- **Porcine epidemic diarrhea** A coronavirus-like virus causes diarrhea in pigs similar to that in TGE, except much less severe and with reduced mortality. **Porcine epidemic diarrhea type I** causes diarrhea only in pigs up to 4 to 5 weeks; whereas porcine epidemic diarrhea type II causes diarrhea in pigs of all ages. The morbidity may reach 100%, but mortality is low. The disease may start in the finishing pigs and spread rapidly to pregnant sows and their nursing piglets. The diarrhea may persist in the 6- to 10-week-old pigs, and seronegative gilts introduced into the herd may become infected and develop profuse diarrhea

lasting a few days. The recent strains appearing in Korea, Vietnam, China, and now the United States are much more similar to TGE.

- **Vomiting and wasting disease** Affects piglets under 10 days of age in epidemics similar to TGE. However, vomiting is characteristic, diarrhea is not a feature, and laboratory differentiation is necessary.

**In adults (gilts, sows, and boars),** TGE must be differentiated from diarrhea resulting from the following diseases:

- Swine dysentery
- Salmonellosis
- Porcine proliferative enteritis

## TREATMENT

There is no specific treatment, but good husbandry in the form of warm, dry, draught-free conditions with ad lib water and nutrient provision helps. Treatment aims at alleviating starvation, dehydration, and metabolic acidosis, which result in hypoglycemia. Treatment with fluids and electrolytes containing glucose is indicated. Because there is loss of intestinal villi and the enzyme lactase, the ideal treatment would be to reduce the intake of milk for up to 5 days and administer a glucose–glycine–electrolyte solution orally every few hours to maintain hydration. However, removal of affected piglets from the sow is impractical and not recommended. Oral fluid therapy should improve the survival rate, with affected piglets recovering in a few days following treatment. In experimentally induced TGE, removal of the milk diet and the use of an oral glucose–glycine–electrolyte solution plus a 5% dextrose solution given intraperitoneally at the rate of 25 mL/kg body weight (BW) once daily decreased the severity of the diarrhea, dehydration, and metabolic acidosis but did not prevent or significantly improve the renal failure and severe hypoglycemia. A newborn piglet weighing 1.25 kg has an energy expenditure of approximately 170 kcal/d (711 kJ) if maintained at 30°C (86°F); 30 mL of a 5% dextrose solution supplies 1.5 g of glucose for a total of approximately 5.6 kcal/d (the gross energy of glucose is 3.74 kcal/g). Because the volume of 5% dextrose solution injected daily into piglets should not exceed 8% of their body weight, it is unlikely that the hypoglycemia can be prevented or treated.

The use of natural human interferon given orally to piglets 1 to 12 days of age affected with the disease increased survival rates compared with placebo-treated piglets.

## CONTROL

Endemic infection will persist as long as susceptible or partially immune sows are exposed to the virus.

Control of the disease is complex because it is so highly contagious and because of the dynamics of infection between the different age groups of animals within large swine herds. Although there is considerable

information available about the biology of the virus and the nature of the disease, there is little documented reliable information about the control in a swine-breeding herd. Most of the recommendations for control are empirical and based on clinical experience without any controlled field trials to evaluate the different strategies. The following guidelines for the control of TGE are based on the characteristics of the virus and the disease:

- The disease is highly contagious and spreads rapidly between groups of pigs in a herd. Most epidemics last 6 weeks.
- Newborn piglets are highly susceptible to disease if the sow's milk does not contain specific TGE secretory IgA antibody.
- Infection of pregnant sows with the virulent virus results in protective immunity for their piglets. Recovered sows are immune, usually do not harbor or shed the virus, and need not necessarily be culled.
- Weaned pigs are a major reservoir of infection in farrow-finish herds.
- Vaccination of pregnant sows with any of the available vaccines is not as effective as natural infection in providing protection for piglets.
- The disease is controlled either by elimination of the virus from the herd or by controlled natural immunization and use of the all-in, all-out system of production.

## Control During and After an Outbreak

The highly contagious nature of the disease makes the immediate control of an outbreak in a herd virtually impossible. Epidemics usually last approximately 6 weeks, during which time many piglets die, and the herd eventually becomes immune. Successful control depends on planning and implementation of certain strategies, which must be understood and implemented by the producer and monitored by the veterinarian. Failure of the producer to fully understand or accept the diagnosis and apply the principles of control will result in failure to control the disease and the persistence of an endemic form of the disease in the herd. Several strategies are used to control the infection pressure and to enhance immunity where possible.

### Isolation of Sows Due to Farrow

To avoid further new infections of newborn piglets, sows due to farrow within 2 to 3 weeks should be isolated under strict hygienic conditions. However, this is usually impractical in most intensive swine production enterprises, where isolation facilities are usually not available. The disease is so highly contagious that isolation is ineffective. There should be no movement of pigs between the farrowing or nursery rooms. An all-in, all-out system for movement of pigs,

especially in the farrowing rooms and nurseries, with complete cleaning and disinfection between groups should be established (see later discussion of all-in, all-out practices).

### Discontinuation of Breeding Stock Sales and Purchases

Once a diagnosis of TGE has been confirmed in a breeding herd that sells breeding stock, all sales should be discontinued. Likewise, all purchases of breeding stock from other herds should be discontinued for a few months until the epidemic has subsided and the future production plans of the herd, including disease control, are reviewed.

### Partial Depopulation and Culling

If possible and feasible, all weaned pigs ready for finishing units should be moved off the farm to contract finishing units. This allows for a general cleanup of facilities, a break in the production cycle, and an intensive all-in, all-out system. All culled pigs should be destroyed to prevent a reservoir of pigs actively shedding the virus.

### Planned Exposure to Virulent Virus

To minimize the duration and severity of the outbreak, all pregnant sows due to farrow more than 3 to 4 weeks ahead should be given an inoculum of virulent TGEv obtained from virus-infected intestines, ideally from piglets in which the disease began within the last 12 to 24 hours. The piglets should be submitted for necropsy and TGE confirmed by a diagnostic laboratory. It cannot be assumed that all piglets that die in an epidemic of TGE will be infected with the virus. The intestines of the confirmed cases should be homogenized in special media and centrifuged, and supernatants should be poured into capsules and frozen for storage. The contents of the capsules are then thawed and poured onto the feed of the sows. The inoculum is given daily for 3 days. Preparation and use of the inoculum will ensure adequate uniform inoculation of sows, compared with earlier recommendations to feed feces and intestines of piglets that died of the disease to the other pigs. More inoculum can be prepared by inoculating weaned piglets in isolation and collecting their small intestines 1 to 2 hours after onset of diarrhea, which is usually 16 to 21 hours after inoculation. The boars are also fed the inoculum. An alternative to the inoculum is to mix the intestines from two affected piglets in 25 L of water and feed 50 mL of the solution daily for 3 days.

If there is sufficient time for immunity to develop, the piglets born 3 to 4 weeks later will be protected through the colostrum and milk, which will contain the TGEv-specific IgA antibodies. Piglets sucking such sows are resistant to infection while sucking, but they become fully susceptible if transferred to a nonimmune sow. Natural infection by mouth produces a high level of secretory antibody, particularly IgA, in the colostrum and milk,

whereas vaccination produces a good IgG response but a much lower IgA response. The newer recombinant vaccines have also been shown to be immunogenic but are still not able to produce lactogenic immunity.

An alternative to the feeding of infectious material to pregnant gilts and sows is vaccination using the available vaccines. The gilts, sows, replacement stock, boars, and newborn piglets are vaccinated according to the indications of the vaccines used. However, the efficacy of the vaccines is questionable. Over the last two decades, the aim has been to produce TGEv protein subunit vaccines. The most novel approach has been to feed recombinant immunoproteins (capable of neutralizing TGEv *in vitro*) to confer protective immunity.<sup>15</sup>

### Biosecurity and Acquisition of Replacement Breeding Stock

Following recovery from an epidemic in a herd, replacement breeding stock should be introduced as a group at one time and exposed to animals in the herd, monitored for clinical disease, and tested. Serological testing using paired sera at 30 and 60 days after entry will indicate seroconversion to the virus. The usual precautions to prevent transmission of infection between units of the herd and between herds are necessary, including the following:

- Washing of boots
- Sanitation of trucks
- Use of separate clothing for each unit of large herds
- Showering of personnel moving between units

Washing hands and changing into clean outerwear or showering and changing into clean outerwear after being in contact with TGEv-infected pigs was found to be sufficient to prevent mechanical transmission of TGEv to susceptible pigs.

### All-in, All-out Management System

The all-in, all-out management and production system is based on the principle of handling, feeding, and housing pigs in small subgroups as they move through the various stages of production. These subgroups either remain free of certain infectious agents, if absent, or all animals in the group become infected and immune to the infectious agents that are present in some pigs and transmitted to others in the subgroup but not to other subgroups. With this system, breeding gilts and sows are handled and bred as subgroups, kept in the gestation units as subgroups, farrowed as subgroups, and nurse their pigs as subgroups. The pigs are weaned as subgroups at the same time, the weaned pigs are placed in the nursery facilities as a subgroup at the same time, and all of the pigs are moved out of the nursery to the finishing facilities at the same time. The pigs are handled in finishing units as subgroups, and all pigs are marketed as a subgroup. At each stage of production,

the housing facilities should be cleaned and disinfected following removal of the pigs and left vacant for a few days before a new subgroup of pigs is introduced into the previously cleaned rooms. This system avoids the mixing of pigs back and forth between groups and ages, which is often done to maintain uniformity of size and age of pigs. During an epidemic, the use of a strict all-in, all-out system in the farrowing and nursery units will aid in the control of clinical disease. Approximately 2 months after the epidemic and the absence of clinical disease, sentinel seronegative pigs of 2 to 4 months of age can be introduced to each part of the herd and monitored serologically for evidence of viral activity.

### Complete Depopulation and Repopulation or Establishment of New Herd

In some situations where the disease cannot be controlled, complete depopulation of the herd is the best option. This should be followed by repopulation with breeding stock derived from specific pathogen-free herds or minimal disease-free herds that are known to be free of the virus. Serological testing can be used to test the animals before they are moved into the facilities. The establishment of new swine herds now commonly depends on the acquisition of breeding stock from disease-free herds.

### TGEv Vaccines and Vaccination

In many instances, TGEv vaccines do not provide reliable, complete protection for suckling pigs against a challenge exposure. However, priming piglets with PRCV was shown to be very beneficial in providing resistance to TGEv and also resulted in a much better maternal antibody response.

### Vaccination of Pregnant Sows

Because of the effectiveness of acquired immunity following natural infection, vaccination of the pregnant sow would appear to be the method of choice for control of the disease. However, the available vaccines have not been efficacious enough to be a reliable control strategy. Circulating virus-neutralizing (VN) antibodies, acquired actively or passively, provide insufficient protection against clinical disease, and parenteral vaccines have been relatively ineffective. Protection against the disease requires the presence of secretory IgA antibody, either actively or passively acquired, in the intestine (see "Immune Mechanisms").

### TGE Vaccines

Several live-attenuated and inactivated virus vaccines are available for use in pregnant sows and neonatal pigs. Vaccines for oral and intranasal administration were developed on the basis that vaccination by the oral or intranasal route would induce the production of secretory IgA antibody. However, these vaccines have not been efficacious.

The vaccination of pregnant sows with attenuated strains of TGEv by either the parenteral or oral route does not provide sufficient lactogenic immunity to protect their piglets against virulent strains of TGEv. Some litters sucking vaccinated sows may achieve partial protection in which the onset of diarrhea is delayed, the diarrhea is less severe, and the case-fatality rate is decreased. Villous atrophy is inhibited to varying degrees in pigs sucking immunized sows, depending in part on the antibody titer in the colostrum and milk.

The severity of the losses in a vaccinated herd after exposure to the virus will vary, depending on the following factors:

- Herd management
- Environmental conditions
- History of previous exposure
- Severity of viral exposure

After natural infection or experimental oral infection of pregnant sows with a virulent strain of TGEv, lactogenic immunity is highly protective for piglets, and neutralizing antibodies in milk are mainly associated with the IgA fraction. Vaccination of sows orally with a nonattenuated vaccine provides greater levels of lactogenic protection than does orally or parenterally administered attenuated-virus vaccine. In vaccinated sows, the levels of colostrum antibody correlate with the percentage of survivability of their piglets when challenge-exposed at 3 to 5 days, whereas the serum antibody to TGEv does not. There is also a significant relationship between milk antibody and percentage survivability when pigs are challenge-exposed at 5 days of age but not at 3 days of age. There is a need to develop an attenuated virus strain that is completely avirulent for pigs but that also replicates sufficiently in the small intestine of sows after oral administration and induces secretory IgA antibody. It appears that no strains of the virus have been identified that are sufficiently attenuated and safe for pigs while still being able to provide a sufficient immune stimulus in the intestine of the sow. The Nouzilly strain, which is a mutant type of TGEv resistant to acidity and the proteases of the digestive tracts of adult pigs, is being evaluated as a vaccine.

### Vaccine Schedule

If vaccines are used, it is generally recommended that the two vaccinations, 14 days apart, be given during the last trimester of pregnancy. Vaccines are available for vaccination of neonatal piglets, weaner pigs, and finishing pigs, but there is insufficient published information available on the efficacy of the vaccines based on randomized clinical trials using controls under field conditions.

### Subunit TGEv Vaccine

Experimentally, a recombinant TGE virus S glycoprotein subunit vaccine given subcutaneously or intramammarily to pregnant sows induced colostrum and milk IgG,

but not IgA, antibodies to the virus. Piglets born from vaccinated sows were challenged at 4 to 5 days of age with the virulent virus, and the morbidity was 100%, with mortality ranging from 20% to 80%. The same vaccine given subcutaneously to 11-day-old piglets induced VN antibodies. This is consistent with the well-known observation that secretory IgA antibody in the milk is necessary for protection in piglets. Compared to VN antibodies, antibodies of the secretory IgA class are more effective at neutralizing TGEv because they are at higher titers in milk, are more resistant to proteolytic enzymes, and bind to gastrointestinal enterocytes. Protective immunity to transmissible gastroenteritis correlates with milk whey secretory IgA antibody titer to the TGE virus when pigs are challenge-exposed with the virulent virus at 3 to 5 days of age.

### Immunity to PRCV

There is considerable cross-protection between TGEv and PRCV. There is indirect evidence that a bronchial-associated lymphoid tissue (BALT)-mammary gland link similar to the gut-associated lymphoid tissue (GALT)-mammary gland link described for TGEv may exist in pregnant, multiple-PRCV-exposed sows. In herds infected with PRCV, multiple exposures of pregnant sows are associated with higher IgA and IgG antibody titers to TGEv in milk, and these titers contribute to protection against TGEv. The immunization of pregnant gilts with PRCV induces lactogenic immunity and partial protection of piglets from challenge with TGEv. An overall survival rate of 70% was found for piglets nursing PRCV-infected gilts compared with a 16% survival rate for piglets nursing control gilts. The highest degree of protection occurs in sows primed with PRCV, then given a booster vaccination with TGEv 2 weeks later. Infection of pigs with PRCV primes the systemic and mucosal humoral immune system against TGEv, and subsequent challenge with TGEv results in a secondary antibody response and decreased duration of excretion of the virus. Protective immunity to TGEv infection can also be induced in piglets exposed to PRCV at 2 to 6 days of age.

### REFERENCES

1. Carstens EB, et al. *Arch Virol*. 2010;155:133.
2. Decaro N, et al. *Emerg Infect Dis*. 2010;16:41.
3. Sedlak K, et al. *Wildl Dis*. 2008;44:777.
4. Jung K, et al. *J Gen Virol*. 2009;90:2713.
5. Jung K, et al. *Vet Immunol Immunopathol*. 2010;136:375.
6. Atanasova K, et al. *Open Vet Sci*. 2008;2:117.
7. Jung K, et al. *J Virol*. 2007;81:13681.
8. Zhang X, et al. *J Virol*. 2008;82:4420.
9. Miyazaki A, et al. *J Vet Med Sci*. 2010;72:943.
10. Vermulapalli R, et al. *J Virol Meth*. 2009;162:231.
11. Ogawa H, et al. *J Virol Meth*. 160:210.
12. Chen Q, et al. *Intervirology*. 2010;53:95.
13. Elia G, et al. *J Virol Meth*. 2010;163:309.
14. Lopez I, et al. *J Vet Diag Invest*. 2009;21:598.
15. Bestagno M, et al. *J Gen Virol*. 2007;88:187.

## PORCINE EPIDEMIC DIARRHEA

PED was first described in Britain in 1977, although it probably first appeared in 1971, and spread globally and rarely occurred after the 1970s and 1980s. It is a highly contagious disease in pigs of all ages but particularly young pigs. It was thought to be similar but not as severe as TGE. Before 2012 in Asia and 2013 in the United States and then Canada, the disease was sporadic in Asia and Europe. It was not found in the Western Hemisphere before May 2013.

Recently in a new wave of severe infections it was mostly associated with Asia, particularly China,<sup>1,2</sup> Vietnam,<sup>3</sup> Thailand,<sup>4</sup> and Korea (originally but has recently reappeared in Europe<sup>5</sup>).

It was detected for the first time in U.S. swine in May 2013<sup>6</sup> and by November 9, 2013, 1069 PED virus (PEDV) cases had been found in over 19 states ([www.aasv.org/pedv](http://www.aasv.org/pedv)).

The 2013 outbreak in the United States of this Chinese strain is particularly severe because within 3 to 4 months of the start of the outbreak there may have been 250,000 to 300,000 deaths in Oklahoma, Indiana, and Iowa. The total number of deaths between April 2013 and June 2014 may have been 7 million.

### ETIOLOGY

There are several porcine coronaviruses: TGE was described in 1946, HEV in 1962, PEDV in 1977, PRDC in 1984, and the newly discovered Deltacoronavirus described in Hong Kong in 2012. They are the largest RNA viruses. All of the coronaviruses are very closely related. They are subject to deletions and insertions of their genetic material, and two of these may have occurred in the new PEDV in the United States.

PEDV is a positive-sense RNA virus of the family Coronaviridae and subfamily Coronavirinae and the genus *Alphacoronavirus*, which contains PEDV, TGE, and PRCV.

It is a coronavirus with three major non-structural protein antigens. The virus genome is similar to that of TGE and is composed of seven ORFs that encode four structural proteins. It can be cultured in Vero cells. Chinese and Korean isolates form clusters distinct from European isolates.<sup>7-10</sup> Recent Chinese strains<sup>2</sup> differ from Korean isolates. It has also been found in India and reemerged in Thailand,<sup>5</sup> where it is now endemic. It caused massive losses in Vietnam in 2009. Recent Korean strains differ from European and vaccine strains.

The complete genome sequence of the virus been described from a pig infected with the PEDV strain USA/Colorado/2013.<sup>11</sup> It has 96.5% to 99.5% homology with other PEDV in the gene bank and 99.5% homology with a recent Chinese strain. Thus far, the initial cases in Colorado, Oklahoma, and



Kansas have similar S gene sequences (99.8–100%).

The genetic properties of endemic Chinese strains of PEDV have been described.<sup>12</sup> The study showed that 10 post-2010 isolates shared high homology with each other and were clustered together with the virulent DR13 strains from South Korea and one earlier Chinese strain.

This virus has been observed in various parts of China since December 2010. Ten post-2010 isolates showed homology with one another.<sup>12</sup> They were all clustered close to the Korean strain and to an earlier strain from China. It is suggested that the current strains are derived by similar genetic changes from the Korean strains or earlier Chinese strains.

Viruses recently isolated in Iowa (five cases) have a different gene sequence from those investigated from April 2013 showing greater similarity to strains isolated from China between 2004 to 2012. The first isolate has been described.<sup>11</sup> They show only 93.9 to 94.6% nucleotide identities to those previously found since April 2013 but are 99.5% to 100% similar to each other.

The virus causes a distinct cytopathic effect with characteristic cell fusion, syncytia formation, and eventual cell death. The U.S. isolates are closely related to one another and are 96.3% to 99.5% related at the nucleotide level to the 23 non-U.S. PEDV strains, and are closest to the Chinese 2011 to 2012 strains.<sup>16</sup>

Recent studies suggest that there are two distinctly different groups of PEDV circulating in the United States. The first group has a 99.1% to 100% identity with the initial Chinese strains. The second group has a 99.6% to 100% identity with each other but only 93.4% to 94.4% nucleotide identity with the original U.S. strain, showing that mutation has already started to occur.

A new virus, porcine Deltacoronavirus, closely related to avian coronaviruses, was discovered in Hong Kong in 2012.<sup>19</sup> It causes severe diarrhea and vomiting in mature pigs but is not so severe in suckling pigs. Recovery seems to follow. It is not cross-protective. It was found in the United States in August 2013.<sup>20,21</sup>

## EPIDEMIOLOGY

The severity and outcome of the disease depend on age, challenge dose, immunity, and other on-farm conditions. Under experimental conditions 4-week-old pigs inoculated with PEDV did not gain much weight for 7 to 10 days after challenge.

The virus is usually introduced by carrier pigs, which is usually new stock coming onto the farm. Pig movements through sale or purchase of pigs are an important source of infection. It is easily spread in markets. Contaminated transport trucks, boots, and other fomites are also a possibility for spread. There is no semen transmission.

The recommendation to use feedback in Asia has probably contributed to it becoming endemic in Asia.

In studies in the United States, in the recent outbreak, larger herds are more likely to be affected, positive sites had more feed truck deliveries, half the frequency of the visits of company service persons were found on the positive sites, and trucks removing pigs (×2) and trucks removing trash were also associated with positivity (×5). Staff or family workers working off the site were also associated with positivity.

Recent studies of the partial S gene have shown that the Thai and Vietnamese strains originated from the original Chinese strain JS-2004-2.

Transmission is by the fecal–oral route, and shedding of the virus begins at the time of the development of the diarrhea. There is a high concentration of the virus in feces and the virus is very stable, so fomites, equipment, and people are easily contaminated. Truck transport of infected feces is a considerable risk.

The virus excretion may be 10,000 to 1,000,000 times more in PEDV compared with a TGE case, and the virus is much more infectious.

The recent epidemic in the United States began in Colorado and Ohio in April 2013 and has rapidly spread to at least 16 states by July 2013, with possibly over 400 cases. The virus is 99.4% similar to the 2012 Chinese virus when sequenced. It has been difficult to find out the origin because it seemed to occur separately in several sites.

A recent study of the original Chinese virus has already suggested that new variants are appearing.

The fecal and nasal shedding was first observed 24 hours postinfection. Some studies have suggested that the greatest virus shedding is greatest at 12 to 18 hours of the onset of diarrhea. Peak fecal shedding occurs 5 to 6 DPI and was much greater than nasal shedding. Some pigs still shed 21 and 28 DPI and even 35 DPI without clinical signs.<sup>17</sup> Pigs remain PCR positive for up to 6 weeks. Only tissues from the gastrointestinal tract appear to be positive. No aerosol transmission was detected but virus was found in the walls, pens, and food bins. The virus is highly infectious and is highly stable in the environment (>28 days in fecal slurry at –20°C, >28 days in wet feed mixture, <2 weeks in dry feed at room temperature, >14 days and <28 days in fecal slurry at room temperature, and 28 days at 40°C in fecal slurry at room temperature). There was no effect of relative humidity on virus survival.

During acute infections in a boar stud the virus has been detected in feces, blood, and semen.<sup>18</sup> There is also evidence for area spread of the virus and it may travel through the area on dust particles and not as a true aerosol. Virus has been detected by PCR in

air samples collected up to 10 miles from an infected farm.

In the United States, there has been considerable discussion of how it spreads: air, people, feeds, or fomites. At the moment it seems most likely that it reached the United States either in feeds or in processed plasma. The PCRs are not designed to find the virus in feeds, but spiked feeds have been shown to be capable of infecting pigs in experimental studies. Samples from feed bins have proved positive for live virus. Live virus has also been found in air samples and in bird feces.

Recent studies have suggested that plasma proteins, particularly those that are imported, are a possible means of infection. A statement by the Canadian Food Inspection Agency on February 18, 2014, stated that testing with a swine bioassay has determined that the plasma ingredients contain PEDV capable of causing disease in pigs. The epidemiology clearly links the live PEDV-contaminated plasma shipment to the 18 infected herds in Ontario. These infected imports originated in the United States. As of March 5, 2014, there were 25 pig sites in Ontario with PED. At this date only 6% of the 1063 trailers tested for PED had turned up positive. An assembly yard also tested positive. The Ontario authorities suggested that the virus would not be as easily transmitted in the warmer months as it is in March. The Canadian authorities said that plasma products, spray dried plasma, and feed were PCR positive.

## OCCURRENCE

In April 2013 in west central Iowa piglets were described with fetid, watery diarrhea and mortality in 90% of the pigs. It then spread rapidly to sites in northwest and northeast Iowa and then Indiana with a piglet mortality greater than 90%. There was no connection between the production systems, there were no known relationships and no common trucking or feed service. In May, confirmation occurred through EM of the presence of a coronavirus. The virus was then confirmed as being similar to the Chinese 2012 PEDV strain, and PCR and sequencing at the National Veterinary Services Laboratories in the United States confirmed this. On June 13, 2013, it had reached 12 states; by September<sup>15</sup> five more states; by December<sup>15</sup> another nine states; and by July 5, 2014, 29 states had reported infected pigs.

After occurring widely in the United States it has now spread to Canada. In March 2014 there were 25 cases in Ontario and one each in Quebec, Prince Edward Island, and Manitoba.

## PATHOGENESIS

The virus appears to need trypsin for its replication to open up the Spike protein, which is why it is particularly attached to the intestinal enterocytes, which are a source of trypsin.



The virus resembles TGE in its behavior but does not replicate in the respiratory tract.

The major structural gene of the 28-kb PEDV genome encodes the multifunctional virulence factor, Spike (S), which is responsible for viral receptor binding, induction of neutralizing antibody and host cell fusion. These S gene sequences are a distinguishing feature of the PEDV strains, which affect virulence and evolution. The new strain began life in China in 2010.

The virus localizes in the porcine intestinal epithelial cells via receptors particularly on the sides and tips of the villi. Porcine amino-peptidase N is a functional receptor for the PEDV coronavirus. The PEDV N protein then localizes in the ER of the cell and inhibits intestinal epithelial cell growth and prolongs the S-phase of the cell cycle. It then causes the expression of IL-8, which further induces ER stress. The N protein also binds to the virion RNA and provides a structural basis for the helical nucleocapsid giving stability to the virus. The level of production of the digestive enzymes is rapidly reduced and malnutrition results in starvation very quickly followed by dehydration. In partially immune pigs only a small portion of the intestine is affected.

### IMMUNITY

PEDV antibodies have been reported to persist for at least 1 year. Colostral protection may last for up to 2 weeks in the piglet (specific IgG antibodies). Lactogenic immunity is said to be poor. The length of protection depends on the titer in the dam. Colostral IgA is a better method of assessing protection than serum levels. It is more resistant to enzyme degradation in the gut and therefore better at neutralizing gut infections. It also has greater activity than IgM and IgG. One of the characteristics of the recent Chinese strains is that there is poor herd immunity, with recurrent outbreaks every 6 months.

### CLINICAL SIGNS

In the 1970s, when it first occurred in Europe, there were two types described. Epidemic virus diarrhea type 1 occurred in mature pigs and not suckling pigs and was similar to a mild form of TGE. The more severe type, which occurred in suckling pigs and was associated with a much higher mortality, was called epidemic virus diarrhea type 2.

It is exactly the same as a severe TGE outbreak because it spreads very rapidly to affect all nursery pigs. Sows may have anorexia and diarrhea but the picture is more variable in adults. Now with the new strains preweaning mortality will be 100% over a 3.5- to 5-week period. In the nursery, there will be diarrhea with a slight increase in mortality and a reduction of growth rate.

It affects pigs of all ages with an incubation period of 1 to 3 days. Most sows are ill within 12 to 36 hours with diarrhea and

sometimes with vomiting. Affected pigs are unwell, dull, and unwilling to rise, but pyrexia is rare. The piglets then produce an extremely watery diarrhea, may vomit, and are inappetent. In the old style PED the morbidity was often 100% but the mortality was low, which distinguished the condition from TGE. It also rarely occurred if there was access to water. The clinical signs may then last 2 to 3 days before death or recovery of the damaged piglets. This recovery may take 7 to 8 days. In older stock there may just be 100% inappetence without other signs. Only 20% to 80% of older stock may have vomiting or diarrhea. Sometimes the piglets under about 30 kg are not affected and this may be because of maternal antibodies, which may last 5 to 13 weeks.

In the United States, the new cases in 2013 have had severe diarrhea and vomiting. The death rate in many cases has been 100% below 7 days of age, and up to 3 weeks of age the morbidity is 90% but falls as the piglets become older.

There is severe watery diarrhea, dehydration, and milk curd in the stomach in all affected naive piglets. Death is caused by dehydration and loss of electrolytes.

In the new outbreaks in Vietnam the morbidity reached 100% and the mortality ranged from 65% to 91%, and the disease appeared milder in Vietnam than in Thailand. In Asia, there appears to be poor herd immunity with outbreaks recurring at 6-month intervals.

In the new outbreaks in the United States the clinical signs are characterized by acute vomiting, anorexia, watery diarrhea, and heavy mortality in pigs less than 10 days old. It is highly contagious and can be seen in all ages of pigs. It took nearly 6 weeks to return to baseline production after an outbreak. (Villous cells are replaced about three times more quickly in 3-week-old pigs than in 1-week-old pigs.)

There was also an effect on the sows with a 12% decrease in farrowing rate if infected in the first 30 days of pregnancy. A 2.2 piglet decrease in born-alive to gilt litters if affected at a similar time and a severe effect on subsequent reproduction in gilts more than sows.

### PATHOLOGY

The stomach is usually empty or may be full of undigested milk curd. The intestines are thin walled and pale with watery contents. There is a severe atrophic enteritis with shortened blunted villi (villous atrophy) and fused villi within 24 hours of the onset of clinical signs. The atrophy is as severe as those seen in TGE. The villous height/crypt ratio falls from 7:1-9:1 to 3:1. Under experimental conditions, in weaned pigs, there was severe villous atrophy occurring by 3 DPI and remained until 7 days but was repairing by 14 days. In neonatal pigs the

villous atrophy was visible within 12 hours postinfection and was significant at 24 hours.

The pathology is milder than TGE except in the new post-2010 Chinese type outbreaks in which the pathology was as severe as TGE. A study of the U.S. outbreak in 2013 shows that the disease is exactly the same as TGE. Degenerate tips and sides of villi with swollen epithelial cells full of eosinophilic cytoplasm were described. Some cells were loose from their surrounding cells, and sometimes there were syncytia. Initial investigations showed a coronavirus on EM, but the tissues were negative for TGE and rotavirus A on RT-PCR. Subsequent testing by sequencing showed that all the PCR products were PEDV and 99+% similar to the Chinese strains.

### DIAGNOSIS

The clinical signs suggest either TGE virus or PEDV and in the past PEDV was mild and differentiated by the lack of mortality. The new strains of PEDV are identical to TGE. TGE and PED have the same morphology under EM, so immunoelectron microscopy is necessary to differentiate the strain, using intestinal contents or feces. Fecal samples from clinically affected pigs are considered the gold standard. The virus is difficult to grow, which is why PCR technology was developed. The virus can be demonstrated by ELISAs; RT-PCR; multiplex RT-PCR,<sup>13</sup> which is rapid, cost-effective, and sensitive; and qRT-PCR.<sup>14</sup> The new multiplex PCRs with specific primers are useful for simultaneous detection of TGE, PED, and rotavirus type A in field samples. Immunoperoxidase techniques can be used to detect virus in the intestinal epithelium. The PCR targets the conserved portion of the N gene.

Most diagnostic labs in the United States now offer a PEDV/TGE differential PCR. It is very sensitive and can be performed on intestinal tissue, feces, or oral fluid samples.

Specific antibodies can be detected by immunofluorescence, and there are ELISAs for the detection of specific antibody in pig sera and milk from recovered pigs.

Very recently, Iowa State University validated an IFA test that measures exposure to the virus, and the best time to test is 3 to 4 weeks after the onset. It is labor intensive and the antibody titers fall very quickly but will rise erratically on reexposure.

There is now a differential multiplex PCR that can be used to differentiate the two groups of virus in the United States.

Oral fluids were as good as fecal samples in a study from the United States.<sup>17</sup> According to PCR results on both oral fluids and fecal swabs, viral shedding began on day one and reached its peak during 3 to 4 DPI. There were no clinical signs of virus infection present 10 DPI. In oral fluids and fecal swabs, viral nucleic acid continued to be found at the limits of detection from 10 to 35 DPI. A slight increase in viral shedding was seen in days 14

to 17 in oral fluids. It was surprising to find that viral shedding occurred for nearly 30 days after the clinical signs ceased.<sup>17</sup> Where the virus is endemic there may be no clinical disease and the PCR may be positive.

## TREATMENT

There is no real treatment. You can make sure there is adequate water provision, give milk substitute, and provide glucose:glycine electrolyte solutions for the old style PEDV infection. The new Chinese strains now in the rest of Asia, Europe, and the United States are usually too quickly fatal to necessitate early treatment. Euthanasia is often required for the very badly affected animals and for the lesser affected hospitalization is necessary.

There is no cross-immunity with TGE or PRCV. On a breeding unit the old style PEDV was self-limiting. Serum antibody titer levels become detectable 2 weeks after infection and rise to levels of 1:1000 and then decline to 1:20 to 1:640. Passive antibody levels from a previously exposed sow may protect piglets for 5 to 13 weeks, but antibody in the sow does not always mean that the piglet is protected.

Immunity from previous natural infections and the previously used Asian vaccines do not appear to give any protection to this recent strain. In China, a bivalent live vaccine has been used for protection against TGE and PED since 1977, but there is little evidence that this works for the new virulent strains of PED.

## CONTROL

Disinfectants used for TGE work effectively for PEDV. Heating at 160°F for 10 minutes for trailers will kill the virus as will exposure to 68°F for 7 days.

The key thing for producers to realize is that after the disappearance of clinical signs, the virus may be shed for up to 35 days, and therefore there has to be care when moving pigs (which are then stressed and may well reexcrete the PEDV).

The only control is very tight biosecurity and strict sanitation measures including isolation before integration for new incoming stock.

Authors in the United States have drawn attention to the risk that may be associated with pig diets and their ingredients. Some producers are choosing not to use any porcine products in pig diets and many choose to remove any porcine plasma from the diet and replace it with bovine plasma. Other suitable products would be fermented soybean meal, soy protein concentrate, whey protein concentrate, skim milk powder, and poultry meal among others. Specific use of feedback may be applied with sows when efforts to control sporadic outbreaks of PEDV fail. The material to be used in feedback occurs within 24 hours of the onset of diarrhea when the virus count is very high. Exposure of pregnant sows to

virus using feces from infected piglets will stimulate rapid lactogenic immunity and shorten the outbreak on the farm.

The old method for the control of TGE may work for pigs with PEDV. The methods used for the control of TGE are as follows:

- Addition of 4 to 6 months of replacements and then close the herd.
- Feedback (forced exposure) of the entire herd, feces, intestines, and intestinal contents from acute farrowing/nursery cases is used.
- Strict all-in/all-out and one-directional flows should be practiced until after the clinical signs have disappeared.
- Introduction of sentinels about 30 days after the clinical signs have disappeared to confirm there is no circulation of virus
- Strict control of unidirectional flow of pigs and people to allow the PEDV to be walked out of the premises

In another study Dufresne<sup>18</sup> suggested:

- That all piglets down to 10 days of age be weaned off the farm
- Expose all gilts and sows 2 to 5 weeks pre-farrow with scours wiped from the heat lamps in the farrowing areas with tissues. This can then be saturated in water and placed in the water trough daily for 3 days.
- Delay feedback until they have sufficient intestines from scouring piglets. Ideal material appears to be intestines from euthanized piglets 24 hours after the outbreak has started.
- The author repeats the feedback three times in 2 weeks using one intestine for 10 sows.

This sort of approach seems to lead to a stabilization at around 18 to 20 weeks after commencement of the protocol. The process is more difficult than for PRRSV because there is greater transmission of virus, a greater virus stability, and sow immunity is lower. On the other hand, the persistence of viral infection in the host is much shorter.

Most herds return to normal mortality 5 weeks after exposure. In the experience of one veterinarian,<sup>18</sup> about 70% of herds' prewean mortality remains normal for an extended period but the remainder has varying degrees of clinical relapse. It is believed that the relapse is not just an example of failure of exposure, but it is possible that the relapse occurs because of waning herd immunity. They have seen relapses in herds with little or no closure time, in very large sow farms (5000+), and where there is pen gestation rather than crate gestation.

Control relies only on biosecurity and making sure that all blood products are properly heat treated to 80°F followed by storage at room temperature for 6 weeks. In 2014 the disease was made reportable in the United States so that a record of its spread is possible.

## FURTHER READING

- Song D, Park B. Porcine epidemic diarrhea virus; a comprehensive review of the molecular epidemiology, diagnosis and vaccines. *Virus Genes*. 2012;44:167-175.
- Stevenson GW, et al. Emergence of porcine epidemic diarrhea virus in the United States: clinical signs, lesions and viral genomic sequences. *J Vet Diag Invest*. 2013;25:649.

## REFERENCES

1. Chen J, et al. *Arch Virol*. 2010;155:1471.
2. Sun RQ, et al. *Emerg Infect Dis*. 2012;18:161.
3. Duy DT, et al. *Thai J Vet Med*. 2011;41:55.
4. Puranaveja S, et al. *Emerg Infect Dis*. 2009;15:1112.
5. Martelli P, et al. *Vet Rec*. 2008;162:307.
6. Stevenson GW, et al. *J Vet Diag Invest*. 2013;25:649.
7. Park SJ, et al. *Virus Genes*. 2007;35:321.
8. Chen JF, et al. *Virus Genes*. 2008;36:355.
9. Pan YF, et al. *Virology J*. 2012;9:195.
10. Park SJ, et al. *Arch Virol*. 2011;156:577.
11. Marthaler D, et al. *Genome*. 2013;1:e00555-13.
12. Wang X-M, et al. *Arch Virol*. 2013;158:2487.
13. Li W, et al. *Emerg Infect Dis*. 2012;18:1350.
14. Xu X, et al. *Vet Microbiol*. 2013;164:212.
15. Xu X, et al. *Virol J*. 2013;19:26.
16. Chen Q, et al. *Proc Am Assoc Swine Vet*. 2014;59-60.
17. Bower L, et al. *Proc Am Assoc Swine Vet*. 2014;61-62.
18. Dufresne L. *Proc Am Assoc Swine Vet*. 2014;613.
19. Woo PCY. *J Virol*. 2012;86:3995.
20. Marthaler D, et al. *Emerg Inf Dis*. 2014;20:1620.
21. Li G, et al. *Genome Announc*. 2014;2:e00218-14.

## SWINE VESICULAR DISEASE

### SYNOPSIS

**Etiology** Enterovirus of family Picornaviridae

**Epidemiology** Important because it resembles foot-and-mouth disease. No outbreaks since 2011 in Europe and in Asia since 2000. Transmitted by direct contact, movement of pigs, and feeding uncooked garbage containing pork products

**Signs** Fever, lameness, vesicles on coronary bands, and recovery in 2–3 weeks

**Clinical pathology** Demonstrate antigen in tissues.

**Lesions** Vesicles

**Diagnostic confirmation** Demonstrate virus in tissues. Isolate virus. RT-PCR

**Differential diagnosis**

- Foot rot of pigs
- Differentiate from other vesicular diseases by laboratory examination and virus identification.

**Treatment** None needed

**Control** Control of garbage feeding and movement of infected pigs

The importance of swine vesicular disease is that the clinical signs of this economically unimportant disease are indistinguishable from those of FMD, which is an economic disaster if it occurs in your country. It can mask FMD as was the case in Taiwan in 1997,

although diagnosis is now easier and possible on farm.<sup>1</sup>

## ETIOLOGY

The disease is associated with an enterovirus (family Picornaviridae) related to human coxsackie B5 virus. A variant of this virus may have become adapted to swine. It was once regarded as porcine coxsackie (75%–85% homogeneity with the human virus) virus. Human isolates of coxsackie B5 virus do not cause disease in pigs, although swine vesicular disease virus once infected humans, but this is not considered likely with the current strains. The disease is restricted to pigs, although experimental challenge of sheep has produced subclinical infection.

## EPIDEMIOLOGY

### Occurrence and Prevalence of Infection

The disease was first recognized as a limited outbreak in Italy in 1966 and was eradicated by slaughter. It then appeared in a variety of countries in Asia (last was in Chinese Taipei in 2000) and in Europe but recently only in Portugal (2007)<sup>2</sup> and Italy (2011). This latter outbreak was associated with the rapid rise in pig numbers in Lombardia and the increase in animal movements combined with weak biosecurity methods.<sup>3</sup> North and South America and Australasia remain free from infection.

Eradication programs based on a slaughter policy were instituted and in most cases were effective. There has been some variation in virulence, which is determined by two amino acids in the capsid, and there may be seven antigenic strains, although there is no wide genetic variation. The epidemiologic pattern of the disease in the various outbreaks is presumably caused by different strains of the virus.

### Methods of Transmission

Infection generally occurs through minor abrasions on the feet but may occur through other routes. The incubation period is 2 to 14 days, and the virus may be excreted before the onset of clinical signs. During and for a short period following the viremic phase, the virus is excreted in oral and nasal secretions. It is excreted in feces for periods up to 3 weeks, and vesicular fluid and shed vesicular epithelium are potent sources of infection. A chronic infection with shedding of virus for periods up to 3 months has been described. Contact within a contaminated environment may lead to viremia within 1 day and clinical signs within 2 days.

Large amounts of virus are shed in the immediate vicinity of infected pigs. Transmission occurs by direct contact or contact with infected food or water or infected feces, and the disease spreads rapidly between pigs within the same group. Airborne transmission of the virus is not a feature, and the spread between groups of pigs is less rapid

than that which occurs with FMD. The resistance of the virus and its persistence within the environment allows spread by mechanical methods such as trucks and contaminated boots. Areas that have housed infected pigs may remain infective for a considerable period of time. The potential for contaminated communal livestock trucks and markets to spread infection is considerable because of the occurrence of minor foot abrasions that occur during the movement of pigs and the presence of persistently infected organic matter.

In the UK epidemic in the 1970s, the major methods of spread were movement of pigs (48%), contaminated vehicles (21%), feeding contaminated waste (15%), and contact at markets (11%). Other methods included movement of equipment or personnel, local spread, and recrudescence of previous infection. The outbreaks were fewer in the summer when less pork was consumed, and this resulted in much reduced pig movements.

The disease may be sufficiently mild to escape clinical detection. This, plus the occurrence of subclinical infection, and the reluctance of farmers to report suspicions of its occurrence, facilitates spread by the movement of infected pigs to other farms or through markets. Vertical transmission has not been demonstrated.

The disease may also be spread by the feeding of uncooked garbage, but it is believed that more of the virus is needed to infect pigs via this route. Pigs killed during the incubation period of the disease or with subclinical infection possess a considerable amount of virus in body tissues. There is little reduction in infectivity with cold storage, and the virus can persist in pork and pork products indefinitely.

## Risk Factors

### Pathogen Factors

There are minor antigenic differences and variation in virulence between some isolates of swine vesicular disease virus from different countries and two genetically and antigenically distinct variants exist in Europe. Swine vesicular disease virus can be grown in tissue culture and has characteristics distinguishing it from the viruses associated with FMD, VS, and vesicular exanthema. The virus is extremely resistant to chemical and physical influences, which has made control of the disease very difficult. It is inactivated only at extremes of pH (it can survive at pH 2–12) and temperatures. It may remain infective in the environment and in manure for periods of at least 6 months. It is resistant to the action of many disinfectants, and recommendations for disinfectants include 2% sodium hydroxide, 8% formaldehyde, and 0.04% sodium hypochlorite if organic material is not present. It is easily transmitted in infected meat. The virus survives the processing of pork and pork products, especially

salami, except when heated at greater than 68°C (154°F). It can persist in these products indefinitely (salami, 40 days).

Infected carcasses can be held in cold storage for months and then released at neutral pH and 40°C and the virus can still be found after 160 days. It is very stable and therefore difficult to decontaminate the environment, particularly where swine are housed on the soil. The virus can be found in earthworms from above the burial pits.

## Economic Importance

Although the economic effects of the primary disease are minor, the cost of the slaughter method for eradication is high. Although the morbidity rate with most strains is high, the disease generally runs its course in 2 to 3 weeks and produces a negligible mortality and only a minor setback to production. The major importance of the disease is its close clinical similarity to other vesicular diseases and the effects of a ban on export animals to other countries. The necessity for immediate differentiation of an outbreak from FMD and the problem of having such a similar clinical entity present in the pig population has made eradication of the disease desirable. In most countries this has proved extremely expensive.

## PATHOGENESIS

There is variation in the susceptibility of different sites of the body to invasion by swine vesicular disease virus, and in natural outbreaks initial infection is most likely through damaged skin, particularly damaged feet. It has been suggested that 90% of the infection may be through the tonsil. A large amount of virus is in the tissues before the clinical signs develop. Once infection is established in a pig, virus excretion is so massive it results in infection of others in the group through the tonsil and gastrointestinal tract as well as through skin abrasions. Massive amounts of the virus are excreted in the feces. Experimentally, the disease can be reproduced by intravenous, intramuscular, subcutaneous, and intradermal inoculation of virus. Virus spreads at the site of infection and enters the bloodstream through the lymphatics. It is followed by viremia, which may last 2 to 3 days. Recent research has suggested that the virus can persist for a longer length of time for up to 63 days, but at 119 DPI the virus was again found in feces when two groups of pigs were mixed. This suggests that the virus and RNA can persist for a long time and possibly suggests a carrier state, but the same authors also suggest that persistent infection is rare. Most virus is produced during the first week, but lesions are infective for a long time. The virus has a special affinity for epithelium of the coronary band, tongue, lip, and snout, and for myocardium. Lesions in the brain, especially the brainstem, are seen histologically, but nervous signs are not a common clinical finding.



## CLINICAL FINDINGS

The incubation period varies from 2 to 14 days. The disease is usually mild or even inapparent. It may be seen initially just as lame pigs. The morbidity rate varies from 25% to 65% and up to 100% of pigs within a pen may be affected. A transient fever (40–41°C; 104–105°F) and temporary mild inappetence may be seen. Lameness, arching of the back, and other signs of foot discomfort are evident but are less severe than with FMD. Very occasionally they walk on the knees or scream. The incidence of lameness and of foot lesions are influenced by management and are less severe on bedding or with soft conditions underfoot. Characteristic vesicles occur at predilection sites frequently associated with trauma. They are most common on the coronary band of the claws, especially at the heel, and of the supernumerary digits. They start as areas of blanching and swelling and progress in 1 to 2 days to thick-walled vesicles that rupture, giving the appearance of an ulcer. Sometimes pigs may have a retracted recovery. In severely affected pigs, the lesions will encircle the coronary band and the horn may be shed as in FMD. Lesions also occur on the tongue, lips, and snout and the skin of the legs and belly. They are much less frequent in these areas and frequently do not progress to typical vesicles. An examination of the feet of other apparently normal pigs within the group will often reveal the presence of minor lesions, and the extent of involvement of pigs within the group may be underestimated without careful examination. In some outbreaks, the incidence of clinical lesions has been minimal and even a single vesicle on the pig's foot should be treated as suspect. Some pigs show no clinical signs but develop significant titers of neutralizing antibody. The course of the disease within a group is generally 2 to 3 weeks, mortality is very uncommon, and there is only a minor setback to production unless complete separation of the horny foot occurs. Nervous signs with ataxia, circling, head pressing and convulsions, and paralysis have been observed rarely. Recovered pigs have immunity that protects against reinfection.

## CLINICAL PATHOLOGY

Tests for the identification of swine vesicular disease include the demonstration of antigen in tissue and the detection of antibody. Vesicular epithelium provides the best material for direct antigen demonstration, and it may be present even in the remnants of 10-day-old lesions. The virus can also be grown on tissue culture and identified. An RT-PCR has been developed, and PCR and PCR-ELISA have been described including those to differentiate between the various vesicular diseases.<sup>4,5</sup> A lateral flow device for the detection of swine vesicular disease and differentiation from FMD in clinical samples has also been developed.<sup>6</sup> It has potential for being used next to the animal in providing a

rapid support to clinical diagnosis as a rapid pen-side test.

Specific antibody is produced within 4 to 6 days and may be demonstrable before clinical disease is evident. With FA or direct CF, a result may be obtained within 8 to 12 hours. Antibody may be detected by VN or ELISA for the diagnosis and surveillance of the disease. Isotype-specific ELISAs have been described. The direct liquid-phase blocking ELISA (LP-ELISA) correlates well with the neutralization test, which is used by the European Community authorities. Monoclonal antibody trapping ELISA was used in Canada, Italy, and England to test results against other tests, and it was found that VN should be used as a definitive test. Virus isolation and RT-PCR are the first choices for detection of swine vesicular disease virus in feces or organs.

## NECROPSY FINDINGS

There are no gross or histologic findings that differentiate swine vesicular disease from FMD. Lesions in the skin consist of areas of coagulative necrosis with intraepithelial vesicle formation. Additional necrotic foci are present in the tonsils, renal pelvis, bladder, salivary glands, pancreas, and myocardium. There is also nonpurulent meningoencephalitis. Intranuclear inclusions are present in the ganglion amphicytes. An ELISA used on vesicular fluid or epithelium can give a result in 4 to 24 hours. It grows well in culture in swine kidney cells and may show effects within 6 hours. The intracerebral infection of mice causes paralysis and death.

### DIFFERENTIAL DIAGNOSIS

The occurrence of vesicles differentiates this disease from other nonvesicular diseases of pigs. So-called foot rot in pigs is associated with lesions on the sole and horn of the claw rather than the epithelial area of the coronary band. The differentiation of swine vesicular disease from other vesicular diseases relies on laboratory examination and virus identification as detailed previously.

## TREATMENT AND CONTROL

No treatment is described and none is warranted. In most countries where outbreaks have occurred, control has been attempted or achieved by slaughter eradication. Depopulation is followed by thorough cleansing and disinfection and limited repopulation effected after a period of 2 to 3 months. The disposal of infected carcasses can be important because the disposal site may remain infective.

The detection of infected herds can be a problem. The mild nature of the disease means that it can easily escape detection,

especially in darkened pig houses or where conditions underfoot obscure observation of the feet. Mild infections may produce little clinical disease and any vesicular lesions should be treated with suspicion. The reluctance of some farmers to report suspicious lesions can also be important, and it is essential to institute educational programs that emphasize the necessity for early detection and diagnosis of outbreaks. Serologic surveys to identify present or past infections have proved of value in aiding detection of the disease. Serologic single reactors cause a lot of trouble in trade. Piglets receive maternal antibodies from the sow and these may last for 30 to 50 days.

The three most important methods of spread are

1. Feeding of garbage containing infected pig meat
2. Movement of pigs from infected farms either directly from farm to farm or indirectly through markets
3. Movement of pigs in contaminated transport vehicles

Control of these methods of spread must include:

- Strict enforcement of garbage-cooking regulations
- Closing of markets, except perhaps for holding areas for pigs going directly to slaughter
- Strict control of movement and sale of pigs
- Adequate cleansing and sanitation of infected areas and transport vehicles

Transmission through feeding of infected meat in garbage appears the most difficult to control, and the latent period of this cycle means that outbreaks can recur at a time when eradication was thought to be complete. Disinfection of slurry is also difficult but can be attempted by treatment with sodium hydroxide.

In the UK, the most crucial item for control was the introduction of a 21-day movement prevention after the initial movement. Sentinels are put in after 8 weeks after the initial disinfection and are observed for about 3 weeks. If they are free after this time they are allowed to restock.

Vaccination has not been used for control in most countries, although experimental vaccines are available but not commercially.

## FURTHER READING

Kitching P. Swine vesicular disease. In: Morilla A, Yoon KJ, Zimmermann JJ, eds. *Trends in emerging viral infections of swine*. Ames, IA: Iowa State Press; 2002:205-208.

## REFERENCES

1. Ferris NP, et al. *J Virol Methods*. 2009;155:10.
2. Knowles NJ, et al. *Vet Rec*. 2007;161:71.
3. Bellini S, et al. *Rev Sci Tech*. 2010;29:639.
4. Fernandez J, et al. *J Virol Methods*. 2008;147:301.
5. Niedbalski W. *Polish J Vet Sci*. 2009;12:119.
6. Ferris NP, et al. *J Virol Methods*. 2010;163:477.

## VESICULAR EXANTHEMA OF SWINE

VES is an acute, febrile, infectious disease of swine associated with a calicivirus. At least 34 types of calicivirus have been recognized in the ocean and new outbreaks continue to occur. The relationship between these viruses and VES is a continual source of speculation. The virus isolated in 2000 from sea lions was shown to be infectious for swine. It is indistinguishable clinically from FMD in swine, VS, and swine vesicular disease. It has not been a problem for the pig industry for over 50 years.

### ETIOLOGY

The causative virus is a calicivirus, and 13 antigenic strains have been isolated with some variation in virulence between strains. Even in one herd the virus isolated may have been antigenically different from others. At least 17 antigenic types have been isolated since 1972. Only pigs are susceptible, although experimental transmission to horses can be effected with some strains. All ages and breeds of pigs are susceptible to infection. The initial outbreak in pigs was traced to the feeding of meat from sea mammals.

### EPIDEMIOLOGY

#### Occurrence

VES was first diagnosed in Southern California in 1932. In 1952 it was diagnosed outside California and by 1953 had occurred in 42 states. However, rigid control eradicated it by 1956 with particular importance being paid to garbage-feeding control.

Except for isolated outbreaks in Hawaii and Iceland, the disease has occurred only in the United States. This is important because of its direct effect and because of its resemblance to FMD. Although VES is a mild disease with a low mortality rate (usually less than 5% and there may be many deaths in unweaned pigs), affected animals may suffer a severe loss of BW and convalescence may require several weeks. Pregnant sows may abort and lactating sows may go dry with resultant heavy losses in baby pigs. The disease was eradicated from the United States in 1959, 27 years after its initial appearance.

#### Methods of Transmission

The sources of infection are infected live pigs and infective pork. Infected pigs excrete the virus in saliva and feces but not in the urine for 12 hours before vesicles develop and for 1 to 5 days afterward. Raw garbage containing infective pork scraps is the most common medium of spread from farm to farm. On infected premises the disease is spread by direct contact and, although the virus is resistant to environmental influences, spread by indirect means does not occur readily. Pigs frequently become infected, as evidenced

by the development of immunity, without evidence of clinical disease. Ingestion of infected material is sufficient to produce infection.

The isolation from marine animals of an identical virus, which is capable of producing a disease identical to vesicular exanthema when inoculated into pigs, has led to the hypothesis that the primary reservoir for vesicular exanthema is in marine animals. Epizootics in pigs may have been initiated by the feeding of marine meat or garbage containing marine animal products.

### Risk Factors

#### Pathogen Risk Factors

The virus is resistant to environmental influences and persists in frozen and chilled meats. It is readily destroyed by several different commonly used disinfectants including sodium hypochlorite, sodium hydroxide, and phenol. A good immunity develops after an attack and persists for about 20 months. There is no appreciable cross-immunity between the strains of the virus, and a series of outbreaks, each associated with a different strain of the virus, may occur in the one herd of pigs.

A similar if not identical virus, San Miguel sea lion virus, has been isolated from sea lions and fur seals off the coast of California in the United States. It is physically, chemically, and morphologically identical to the vesicular exanthema virus, although the same antigenic types have not been found. The virus produces an identical disease to vesicular exanthema when inoculated into pigs and appears to have a similar host range. The VES virus is infective for the harp seal, but the disease is inapparent and self-limiting. The intradermal inoculation of VES into otrariid (fur) seal pups will result in plaque-like lesions. Feeding swine the seal tissues from the inoculation experiments resulted in seroconversion in swine that were fed tissues from seals infected with VES virus but not in those fed tissues from seals infected with the San Miguel sea lion virus. Antibody to this virus has also been detected in California gray whales and in feral swine inhabiting coastal areas.

### PATHOGENESIS

As in other vesicular diseases there is a viremia, lasting for 72 to 84 hours and commencing 48 hours before vesication, with localization occurring in the buccal mucosa and the skin above the hooves. The intradermal inoculation of the VES virus and the San Miguel sea lion virus into swine results in fluid-filled vesicles at the sites of inoculation in the snout, coronary band, and tongue. Lesions are usually limited to the nonhaired portions of the integument and tongue. A mild viral encephalitis occurs in pigs inoculated with the swine virus, and the sea lion virus can be recovered from the brain tissue of pigs infected with the virus.

### CLINICAL FINDINGS

The incubation period varies with the virulence of the causative strain of virus but is usually 1 to 3 days. Morbidity is always high but mortality is low. There is an initial high fever (40.5–41°C; 105–106°F) followed by the development of vesicles in the mouth, on the snout, on the teats and udder, as well as on the coronary skin, the sole, the heel bulbs, and between the claws. This is accompanied by extreme lassitude and complete anorexia. The initial lesion is a blanched area that soon develops into a vesicle full of clear fluid. The vesicles rupture easily leaving raw, eroded areas. This usually occurs about 24 to 48 hours after they appear and is accompanied by a rapid fall of temperature. Secondary crops of vesicles often follow and may cause local swelling of the face and tongue. Lesions on the feet may predominate in some outbreaks, whereas in others they may be of little significance. The affected feet are very sensitive and there is severe lameness. Healing of the oral vesicles occurs rapidly, although secondary bacterial infection often exacerbates the lesions on the feet. Recovery in uncomplicated cases is usually complete in 1 to 2 weeks. It may occasionally cause encephalitis, myocarditis, and diarrhea as well as failure to thrive. When sows become infected late in pregnancy, abortion frequently occurs and lactating sows may go dry.

### CLINICAL PATHOLOGY

Fluid from the vesicles is used in transmission experiments and for tissue culture. Blood serum is used for the CF, viral neutralization in cell culture, and gel diffusion precipitin tests.

### NECROPSY FINDINGS

Postmortem examinations are not of much value in the diagnosis of vesicular exanthema, but the pathology of the disease has been defined. The lesions are limited to epithelial lesions in which there are vesicles, necrosis, sloughing, and rapid healing with mild scarring. Diagnosis involves virus isolation in cell culture, with EM as a possibility and various serologic tests including FATs for the antigen. PCR tests have also been developed.

### DIFFERENTIAL DIAGNOSIS

Because of its case-for-case similarity to foot-and-mouth disease (FMD), prompt and accurate diagnosis of the disease is essential. In most countries the **disease is notifiable**.

#### All species

- FMD and other vesicular diseases

#### Cattle

- Bovine virus diarrhoea
- Bovine malignant catarrh
- Pseudocowpox

**Horses**

- Blister beetle toxicosis
- Bullous pemphigoid
- Phenylbutazone toxicity
- Grass seed awns

**TREATMENT**

There is no effective treatment. The immunity is solid following infection, but heterologous infection is possible.

**CONTROL**

Eradication of the disease should be attempted whenever practicable. In most instances it is essential to report to the regulatory authorities. The first step is to quarantine infected premises and restrict movement of pigs in the area. Infected animals should be slaughtered, but the carcasses may be salvaged for human consumption provided the meat undergoes special treatment to ensure destruction of the virus. Normal freezing and chilling procedures are not sufficient to destroy it. All garbage fed to pigs must be boiled. Infected premises should be thoroughly cleaned and disinfected with a 2% sodium hydroxide solution before restocking. The implementation of these measures was eminently successful in eradicating the disease from the United States.

In view of the reservoir of virus in marine animals and apparent infection in feral swine in the coastal areas of California, it is possible that the disease could recur in domestic swine in the United States. Possible methods of reintroduction that need to be guarded against have been described.

Active immunization may be practicable if the disease reappears and other control measures fail. A formalin-killed virus preparation produces an immunity lasting for at least 6 months. Multivalent vaccines may be required if more than one strain of the virus is involved.

Recently the pathogenic class of VES virus-like caliciviruses (genus *Vesivirus*) endemic in certain ocean species and U.S. livestock has possibly caused vesicular disease on the hands and feet of humans.

## SALMONELLOSIS IN RUMINANTS AND HORSES

**SYNOPSIS**

**Etiology** *Salmonella* spp. Cattle: *S. Typhimurium*, *S. Dublin*, and *S. Newport*. Sheep and goats: *S. Typhimurium*, *S. Dublin*, *S. Abortusovis*, and *S. enterica* subsp. *diarizonae*. Horses: *S. Typhimurium* and *S. Enteritidis*. Differentiation between host-specific, host-restrictive, and ubiquitous serovars

**Epidemiology** Worldwide occurrence.

Important zoonosis and food-borne illness. Prevalence of infection in healthy animals varies according to species and country. Incidence of clinical disease lower than prevalence, and outbreaks occur precipitated by stressors. Spread by direct or indirect means; the infected animal is the source of organism, which contaminates feed and water supplies.

Disease may become endemic on farm.

Carrier animals shed organism and may introduce infection into herd. Deprivation of feed and water, transportation, drought, intensive grazing and housing, and mixing animals from different sources contribute to onset of disease. Antimicrobial resistance is a major public health issue and is more common in isolated sick animals than from healthy carriers.

**Signs** Septicemia in neonatal ruminants and foals with a high case-fatality rate. Acute diarrhea and dysentery, fibrinous fecal casts, fever, marked dehydration, and toxemia; chronic enteritis; abortion; dry gangrene of extremities; and arthritis and foci of osteomyelitis. Severe diarrhea and dehydration characteristic in the horse

**Clinical pathology** Culture of organism from feces, repeated culture of feces required to identify carrier animals, serology in blood or milk, use hematology for changes in leukon and clinical chemistry for electrolyte changes

**Lesions** Septicemic hemorrhages.

Mucoenteritis to marked fibrinohemorrhagic necrotic enteritis; enlarged mesenteric lymph nodes. Foci of necrosis and thickened intestinal wall in chronic enteritis

**Diagnostic confirmation** Culture of organism from feces, tissue, or body fluids; polymerase chain reaction and antigen-ELISA to detect specific DNA

**Treatment** Antimicrobials in cases of bacteremia, antiinflammatory therapy, and supportive fluid and electrolyte therapy

**Control** Prevent introduction of infection into herd. Limit spread of infection within the herd by identification of carrier animals, prophylactic antimicrobials, restricting movement of animals, clean water supply, hygiene, and disinfection of buildings. Avoid spread of infection in veterinary clinics and dispose of infective materials. Vaccines for immunization are available but not effective.

**ETIOLOGY**

*Salmonella* are gram-negative, rod-shaped bacilli belonging to the family Enterobacteriaceae. *Salmonella* spp. belong to the most important food-borne pathogens causing human infection. The bacterium is a facultative intracellular organism with worldwide occurrence in all mammal species. The genus *Salmonella* consists of only two species,

*S. enterica* and *S. bongori*. Based on molecular characteristics *S. enterica* is further divided into six subspecies that are subsp. *enterica* (formerly subgenus I), subsp. *salamae* (formerly subgenus II), subsp. *arizonae* (subgenus IIIa), subsp. *diarizonae* (subgenus IIIb), subsp. *houtenae* (subgenus IV), and subsp. *indica* (subgenus VI). Subgenus V is now assigned to *S. bongori* to avoid confusion with serovar names of *S. enterica* subsp. *enterica*.<sup>1</sup> Within each subspecies different strains are classified into serovars (or serotypes) based on their LPS antigen (O) and flagellar antigen (H) characteristics according to the Kauffmann-White scheme. Currently over 2600 serovars are recognized, of which most of the ones causing infection in people and mammals belong to *S. enterica* subsp. *enterica*.<sup>2</sup> In practice for *S. enterica* subsp. *enterica*, the subspecies name does not need to be indicated as only serovars of this subspecies bear names. Serovars of the other subspecies are designated by their antigenic formula. The name of the serovar is no longer italicized but is capitalized.<sup>1</sup>

Before this novel taxonomy and nomenclature for the genus *Salmonella* was introduced in 1986, subspecies were treated as subgenera and serovars were considered species. This change in taxonomy has caused and will be causing confusion as long as both terminologies appear in the medical literature. The way former *Salmonella* species and now serovars were designated changed with time. Initially the serovar name denoted a syndrome (e.g., *S. typhi*) or host-syndrome combinations (e.g., *S. abortus-ovis*, *S. abortus-equi*). Later serovars were designated by the geographic origin of the first identified strain of the serovar in question (e.g., *S. dublin*, *S. london*). When the new nomenclature was introduced names were retained for serovars of subspecies *enterica*, which comprises the great majority of isolated serovars, because these names were so familiar. In contrast, serovars of other subspecies are now designated by their antigenic formula.<sup>1</sup>

*Salmonella* serovars differ in the range of hosts they can infect and in the nature of disease that may result: this difference is referred to as **serovar-host specificity**. So-called **ubiquitous serovars** such as *S. Typhimurium* or *S. Enteritidis* can affect a wide range of hosts and produce acute but self-limiting illness. **Host-specific serovars**, such as *S. Typhi* in humans or *S. Gallinarum* in poultry affect only a single species, and are associated with severe illness that does not necessarily include diarrhea. **Host-restricted serovars** primarily affect one specific species, but can also cause illness in a limited number of other species. Such serovars are, for example, SD, primarily affecting cattle or SCS, primarily affecting pigs.<sup>3</sup> The serovars that most commonly cause salmonellosis in farm animal species are as follows:

- **Cattle:** *S. Typhimurium*, SD, *S. Newport*, *S. Enteritidis*



- **Sheep and goats:** *S. Typhimurium*, SD, *S. enterica* subsp. *diarizonae*, *S. Abortusovis*
- **Horses:** *S. Typhimurium*, *S. Abortusequi*, *S. Newport*, *S. Enteritidis*

## EPIDEMIOLOGY

The epidemiology of salmonellosis is complex, which often makes control of the disease difficult. The epidemiologic patterns of prevalence of infection and incidence of disease differ greatly between geographic areas depending on climate, population density, land use, farming practices, food harvesting and processing technologies, and consumer habits. In addition, the biology of the serovars differs so widely that consideration of salmonellosis, *Salmonella* infection, or *Salmonella* contamination are inevitably complex.

### Prevalence of Infection

Surveys investigating the prevalence of fecal shedding indicate considerable variation between countries and animal species. In the following section the literature of the prevalence of infection or fecal shedding in healthy animals is reviewed by species.

#### Cattle

The prevalence of positive culture results in feces from dairy cattle in the United States has been studied in three comparable studies conducted in 1996, 2002, and 2007 and including over 90 operations from at least 17 states.<sup>4</sup> In the most recent study, 39.7% of participating herds and 13.7% of tested animals were culture positive for *Salmonella* spp., which is double the herd and animal prevalence reported in the first study of 1996.<sup>4</sup> Overall larger herds with more than 500 cows were found to be more likely to have culture-positive fecal samples (61.0%) than smaller herds with less than 500 cows (41.5%). The most common serovars isolated in the 2007 study were, in descending order, *S. Cerro*, *S. Kentucky*, *S. Montevideo*, *S. Muenster*, *S. Meleagridis*, *S. Mbandaka*, and *S. Newport*.

A study conducted in one large U.S. feedlot receiving calves from the Midwest and High Plains found a prevalence of culture-positive environmental samples in cohorts at the time of feedlot entry of 64.7%.<sup>5</sup> The predominantly isolated serotypes in this study were *S. Anatum*, *S. Montevideo*, *S. Orion*, *S. Kentucky*, *S. Mbandaka*, and *S. Newport*. The geographic distribution of the serotypes differs: *S. Typhimurium* has a universal distribution and SD has a patchier habitat. In the United States, up until 1948, it was limited to California and as recently as 1971 it had not been reported in cattle east of the Rocky Mountains. In 1980 the first case of SD occurred in Indiana. The movement of infected adult cattle and calves is responsible for the introduction of infection to areas in which it had not previously been diagnosed. In a California survey of 60 dairy herds, milk

samples and serum samples tested with an ELISA for antibodies against *Salmonella* serogroups B, C1, and D1 antigens found that 75% of dairy herds surveyed had cows with serologic evidence of recent exposure to salmonellas, especially *S. Typhimurium* and SD.

Data from bacteriologic monitoring of *Salmonella* in cattle herds were reported by several member states of the European Union (EU) in 2009.<sup>6</sup> Finland and the Netherlands reported a herd prevalence of 0% and 5.5% of culture-positive fecal samples, respectively. Animal prevalence levels determined either at the farm or at the time of slaughter between 0% and 3.4% were reported from 8 European member states and Norway. The results of microbiological examinations of bovine meat conducted in Denmark, Germany, Ireland, Italy, and the Netherlands indicate that the most prevalent serovars, in descending order, were *S. Typhimurium*, SD, *S. Infantis*, *S. Derby*, and *S. Enteritidis*.<sup>6</sup>

An Australian study investigating the prevalence of culture-positive fecal samples in slaughter age cattle reported an estimated animal level prevalence of 1.7% for dairy, 0.8% for feedlot beef, and 0.5% for pasture beef cattle.<sup>7</sup> The determined herd level prevalence for non-Dublin *Salmonella* spp. positive fecal samples in this study was 17% for dairy, 13% for feedlot beef, and 5.5% for pasture beef herds.<sup>7</sup> The most prevalent serovars in cattle were SD, *S. Typhimurium*, and *S. Anatum*.

The prevalence of culture-positive fecal samples from cattle and calves hospitalized in a veterinary teaching hospital in the United States that were cultured as part of a *Salmonella* surveillance program but were not clinical *Salmonella* suspects was 3.2% for calves and 2.3% for adult cattle.<sup>8</sup> The most prevalent serotypes in these non-*Salmonella*-suspect patients were, in the order of occurrence, *S. Newport*, *S. Typhimurium*, and *S. Agona*.<sup>8</sup>

#### Sheep

The literature on infection prevalence in sheep is scant. The recent U.S. Department of Agriculture-Animal and Plant Health Inspection Service (USDA-APHIS) "Sheep 2011" study included 247 sheep operations from 22 states to investigate the prevalence of enteric pathogens and commensal organisms in the U.S. sheep population.<sup>9</sup> In this study a herd prevalence of culture-positive fecal samples of 66.4% was determined. The proportion of positive composite fecal samples stratified by sheep type was 38.2% for ewes nursing lambs; 30.9% for the group of nursing lambs, market lambs, and replacement ewes; and 29.1% for pregnant ewes and others.<sup>9</sup> By far the most prevalent serovar was *S. enterica* subsp. *diarizonae* IIIb:61 -:1,5,7 accounting for 94.6% of all isolates. *S. Enteritidis* and *S. Newport* combined accounted for only 4% of all isolates, whereas *S. Typhimurium* was not isolated.<sup>9</sup>

Abattoir studies conducted in different countries reported prevalences of culture-positive samples of sheep between 0.1% in the UK and 40% in Australia.<sup>10</sup> In a recent Australian abattoir study, *Salmonella* spp. were isolated from 20% of fecal samples and 13% of fleeces in slaughtered sheep.<sup>11</sup> Another Australian study used a multiplex qPCR to determine the prevalence of *S. enterica* in fecal samples collected from lambs at weaning, postweaning, and pre-slaughter from eight farms across four states. The overall prevalence of *Salmonella*-positive fecal samples was 5.0%, but wide variations among states were found. Highest prevalence rates were determined in New South Wales in lambs at weaning (18.1%) and postweaning (23.8%).<sup>10</sup>

*S. Abortusovis* is an ovine-restricted serovar that represents a common cause of abortion and mortality in newborn lambs in Western Asia.<sup>12</sup> Infections have been reported from France, Spain, Germany, Cyprus, Italy, Switzerland, Russia, and Bulgaria, but few infection prevalence studies are available. A recent Swiss study determined the seroprevalence of *S. Abortusovis* infection in sheep flocks in 2007 after a series of abortion storms that had occurred between 2003 and 2007 throughout the country. Before 2003 abortion caused by *S. Abortusovis* had not been reported for several decades in this country. Overall an animal seroprevalence of 1.7% and a flock prevalence of 16.3% were found.<sup>13</sup>

#### Horses

Few infection prevalence studies conducted in nonclinical horses have been conducted. The National Animal Health Monitoring System Equine 1998 study that included over 8000 horses on nearly 1000 operations across the country reported prevalence of culture-positive fecal samples of 0.8%. At least one horse on 1.8% of operations was estimated to shed salmonellas in feces.<sup>14</sup> A total of 14 different serotypes were isolated with the most common serotype being *S. Muenchen*.

Four percent of specimens of equine origin submitted to a diagnostic laboratory in the United Arab Emirates were found to be *Salmonella* positive. The two predominant *Salmonella* serovars were *S. Typhimurium* and *S. Kentucky*, followed by *S. Anatum* and *S. Agona*.<sup>15</sup>

### Occurrence

Salmonellosis occurs universally in all species.

#### Cattle

The disease has assumed major importance, particularly for the dairy industry. Apart from having implications for health and productivity on an individual animal and on a herd level, infections and outbreaks in dairy cattle present an important risk of zoonotic transmission. Remarkably the prevalences of

the different *Salmonella* serovars isolated in samples in clinically healthy animals differ considerably from the prevalence rates of serovars isolated in fecal samples from sick animals.

A recent U.S. field study conducted in 831 dairy herds from New York, Pennsylvania, Vermont, Massachusetts, and Connecticut that agreed to submit fecal samples of *Salmonella*-suspect clinical animals to a diagnostic laboratory reported culture-positive results in 22.5% of over 2500 cultured samples.<sup>16</sup> The herd level incidence rate was 8.6 positive herds per 100 herd years, and the animal-level incidence rates for preweaned heifers, postweaned heifers, and adult cows was 8.1, 0.04, and 1.8 cases per 1000 animal years, respectively.<sup>16</sup> In this study *S. Newport* was the most prevalent serovar with 41%, followed by *S. Typhimurium* (including var. Copenhagen) with 19.1%, *S. Infantis* (8.2%), 4,5,12:i:- (6.1%), *S. Agona* (5.2%), and *S. Muenster* (4.2%).<sup>16</sup>

Among 768 *Salmonella* suspect clinical cases of a veterinary teaching hospital in New York State 6.5% were identified as fecal shedders based on culture results.<sup>8</sup> The prevalence of culture-positive fecal samples of clinical cases was 9.1% in calves and 3.6% in adult cows with highest proportions of positive samples in the fall and lowest during spring.<sup>8</sup> The most common serovars were *S. Typhimurium*, *S. Typhimurium* var. Copenhagen, and *S. Newport* with similar numbers of isolates.<sup>8</sup>

In the UK, with a cattle population of 8.26 million in 2013, a total of 52,922 samples from clinical cases have been submitted for diagnostic purposes; salmonellas were isolated from 604 samples. The most prevalent serovars isolated in cattle were SD (72.5%), *S. Mbandaka* (7.5%), *S. Typhimurium* (5.0%), and *S. Montevideo* (3.3%).<sup>17</sup> SD was the most common serovar isolated from cattle with clinical disease for the past 15 years in the UK. The prevalence of *S. Typhimurium*, which was the most prevalent serovar with over 60% at the end of the 1990s in the UK and other countries, has continuously declined over the past years, and in particular *S. Typhimurium* definitive type (DT)104 that was associated with outbreaks of salmonellosis in dairy cattle and humans in the UK and the United States subsided.

In Germany the number of outbreaks of bovine salmonellosis has decreased over the past years from 258 outbreaks in 2002 to 81 outbreaks in 2009. From 2009 to 2011 this number had increased again to 109 outbreaks of bovine salmonellosis in 2011.<sup>18</sup> *S. Typhimurium* (including var. Copenhagen) was the most common serovar associated with approximately 40% of all outbreaks between 2009 and 2011, followed by SD (22%), *S. Enteritidis* (6.4%), and *S. Abony* (5.5%).<sup>18</sup>

A recent study investigated the prevalence of different serovars of culture-positive

fecal samples from diarrheic calves in Australia including a total of 597 samples from 84 herds.<sup>19</sup> The most common serovars in these diarrheic calves were SD (27.4%), *S. Typhimurium* (14.5%), *S. Zanzibar* (11.3%), and *S. Bovismorbificans* (9.7%).

*S. Montevideo* has been the cause of large economic losses from abortion and cow mortality in an outwintered beef herd in Scotland. Up to 25% of the cows aborted and the overall herd mortality was 7%. The organism had been the cause of abortion in a neighboring sheep flock.

### Sheep

Salmonellosis is commonly encountered when sheep are assembled at high stocking rates. In the UK, with a sheep population of 30.95 million, approximately 9500 ovine samples from *Salmonella*-suspect clinical cases have been processed by official diagnostic laboratories in 2013.<sup>20</sup> The most common serovars were *Salmonella enterica* subsp. *diarizonae* 61:k:1,5,(7) and variants (36.6%), followed by *S. Montevideo* (32.1%), SD (11.6%), and *S. Agama* (8.9%).<sup>20</sup> There were no *S. Typhimurium* or *S. Abortusovis* cases in sheep in the UK in 2013.

Serovar Dublin can cause both enteritis and abortion in adult sheep, and the disease is often associated with metritis, anorexia, and loss of wool. Newborn lambs may develop diarrhea with a high mortality rate. Serovar *Typhimurium* is associated with acute disease, enteritis but not usually abortion. *S. Brandenburg* has affected livestock and humans in the South Island of New Zealand. The strain has caused abortions in sheep and cattle as well as gastroenteritis in calves and adult cattle. The same strain also caused disease in horses, goats, deer, pigs, and humans. Spread of the disease on farms was strongly associated with aborting ewes, which resulted in considerable environmental contamination. During the abortion season, black-backed gulls appeared to spread the disease to other farms. Other potential sources of infection were carrier sheep, contaminated water sources, and contaminated sheep dust.

Outbreaks of *S. Abortusovis* infections causing abortion storms in sheep have occurred in different European and West Asian countries. Most recently such outbreaks occurred in Switzerland during the lambing seasons of 2003/2004 to 2007/2008 with up to 70% fetal losses in affected flocks.<sup>13</sup>

### Horses

The incidence of salmonellosis has been increasing in the horse population, particularly where horses are assembled at large clinical centers and breeding farms. Nosocomial salmonellosis is an important problem for horses in veterinary hospitals.<sup>21</sup> It is also possible that many of the unidentified enteritides of horses may have been associated with *Salmonella* spp.

**In the UK 44 isolations of *Salmonella* spp. from clinical cases were reported in 2013.** Unlike previous years *Salmonella* 4,5,12:i:-, and not *S. Typhimurium* was the most commonly isolated serovar (25%).<sup>22</sup>

### Morbidity and Case Fatality

The morbidity rate in outbreaks of salmonellosis in calves and sheep is usually high, often reaching 50% or more. Morbidity and mortality are usually highest in calves under 12 weeks of age. In all species the case-fatality rate often reaches 100% if treatment is not provided. In outbreaks in outwintered suckler cattle herds, the morbidity varied from 14% to 60% and mortality in adult cattle from 0% to 14%. In a review of 40 cases of clinical salmonellosis in horses that were diagnosed in one clinic, the case-fatality rate was 60%. Epidemics of salmonellosis affecting up to 40% of foals under 8 days of age on one Thoroughbred horse farm have been reported.

### Methods of Transmission

Salmonellas are spread by direct or indirect means. Infected animals are the source of the organisms; they excrete bacteria and infect other animals, directly or indirectly, by contamination of the environment, primarily feed and water supplies. The farm animal may be infected in different ways: by animal-to-animal transmission, especially of host-adapted serovars; by contaminated animal feed; and by a contaminated environment (soil, birds, rodents, insects, and water supplies). Liquid wastes from infected animals may contaminate the environment directly, including streams, rivers, and pastures. Bacteria may also be disseminated during the transport of infected animals and during the holding of animals in a lairage before slaughter. In these situations, the excretion of salmonellas is exacerbated by the stress imposed.

The mixing of young susceptible calves and their subsequent transportation is an efficient mechanism for the rapid dissemination of *Salmonella*. Saleyards and dealers' premises can serve as reservoirs of infection despite cleaning and disinfection. Many vehicles and markets are contaminated with *Salmonella*. The introduction of infected carrier animals into a herd is a common cause of outbreaks of clinical salmonellosis in dairy herds that are expanding in size.

The organism can persist for an average of 14 months in the environment where calves are reared. *Salmonella* spp. do not survive for more than 5 days in bovine urine not mixed with feces but will survive in dried bovine feces for up to 6 years. After a clinical outbreak of salmonellosis, for example, in a dairy herd raising its own replacements, the premises cannot be declared to be *Salmonella* free solely on the basis of freedom from clinical cases over the next few years or on the basis of comparatively high herd

performance. In large dairy herds with modern free stalls that recycle water in their manure flush systems, it may be possible to isolate *Salmonella* serovars for several years following an outbreak of clinical salmonellosis. The organisms may be found in recycled water samples, bulk tank milk filters, and the feces of calves and adult cows.

During slaughter, fecal contamination of the carcass commonly occurs and can be carried through all slaughter procedures up to the processing of the raw products. Milk can be contaminated directly by cows that excrete the organism in the udder, especially those cattle infected with SD and *S. Muenster*, both of which have adapted to colonize the bovine mammary gland. Although *S. Typhimurium* is not usually excreted in milk, except during the febrile stage of clinical disease, it has been reported to have been persistently isolated from the milk of a healthy cow. *S. Enteritidis* has been isolated from milking filters, milk from a bulk tank, and milk from one-quarter of a 5-year-old dairy cow that persistently shed the organism in the milk for several months. Milk is most likely to become contaminated by feces, either from an animal with clinical salmonellosis or from a healthy carrier animal, during the milking process. Additional sources of contamination during milking are use of polluted water or contaminated equipment. Workers who lack personal hygiene skills and have clinical salmonellosis or are chronic shedders of the organism may also contaminate milk supplies.

Airborne transmission can be a primary mode of infection of *S. Typhimurium*. Studies have shown that the organism can survive in air sufficiently long to present a significant hazard of airborne spread.

### Carrier State

Because salmonellas are facultative intracellular organisms that survive in the phagolysosome of macrophages and other cells, they can evade the bactericidal effects of antibody and complement. Thus persistence of infection in animals and in the environment is an important epidemiologic feature of salmonellosis. A cow infected with SD may become a clinical case or an **active carrier**, shedding organisms constantly or intermittently in the feces. It may alternatively become a **latent carrier** with infection persisting in lymph nodes or tonsils but no salmonellas in the feces, or even a **passive carrier**, which is constantly acquiring infection from pasture or the calf-pen floor. In passive carriers invasion of tissues does not occur, and when the animal is removed from the environment the infection disappears. However, passive carriers probably multiply the salmonellas, contributing to the epidemiology of the pathogen. Latent carriers can become active carriers or even clinical cases under stress, especially at calving time or during illness. A major problem with the

control of SD infection is that latent carriers of the organism, unlike persistent excretors, cannot be readily identified by fecal culture or serologic methods. In a 3-year study of one dairy herd, the organism was isolated occasionally from the feces of adult cattle, from some cattle after parturition, and from some calves within 24 hours after birth. In some dairy herds, the organism may persist for many years with a low incidence rate of clinical disease.

For *S. Typhimurium*, which is one of the most common serovars associated with human disease, the donor can be any domestic animal species, including humans, or any wild animal or bird. Although all infected adults become carriers, it is rarely for any length of time, and calves rarely become carriers. In sheep and cattle the carrier state may persist for as long as 10 weeks, and in horses up to 14 months.

### Risk Factors Predisposing to Clinical Disease

The clinical characteristics of salmonellosis in large animals vary depending on the various management systems used, the intensity of stocking, whether or not the animals are housed, and the epidemiologic characteristics of the different *Salmonella* species. Thus salmonellosis in cattle is a very serious and persistent disease in areas where it is caused principally by the host-adapted serovar SD. In contrast bovine salmonellosis associated with *S. Typhimurium* is sporadic and, even though it is fatal to individual animals, it is not a serious disease. Although there are probably similar differences with the other species, they are not particularly well defined. The difference between the diseases associated with SD and *S. Typhimurium* is the marked tendency for SD to persist in adult cattle and create a significant reservoir of carrier animals. *S. Typhimurium* does not do so as much, so that the disease is likely to subside after an initial exposure and to recur only when the source of infection, from rodents or feedstuffs, or sewage or slurry, reappears. This does not preclude the disease from persisting in a flock or herd for long periods. *S. Typhimurium* infection persisted in a large dairy herd for 3.5 years. Although the incidence rate of clinical disease declined over the study period, the organism could still be cultured from the bulk tank milk filters, which may have been associated with one cow identified as a milk excretor. Several incidents of human illness associated with *S. Typhimurium* infection following the consumption of raw milk are documented.

In hospitalized horses several studies determined an increase of developing a nosocomial *Salmonella* infection following treatment with antimicrobial drugs or nasogastric intubation as well as in horses presenting with colic at the time of admission.<sup>21</sup> Other studies reported an increasing risk of

developing salmonellosis with prolonged duration of parenteral treatment with penicillin G potassium.<sup>21</sup>

### Animal Risk Factors

Except in the newborn, especially foals, infection with a *Salmonella* sp. is usually not sufficient to cause clinical salmonellosis. The response to infection with a *Salmonella* sp. varies depending on the size of the challenge dose and the immunologic status of the animal, itself dependent on colostrum intake in neonates, as well as previous exposure to infection and exposure to stressors, particularly in older animals. It is generally accepted that the intervention of some precipitating factor such as transport, intercurrent disease, anesthesia and surgery, dosing with antimicrobials or anthelmintics, acute deprivation of food, or parturition is usually necessary to cause clinical disease distinct from infection with *Salmonella* spp.

The portal of infection in salmonellosis is almost always the mouth, so that the severity of the disease in an individual, or of an outbreak in a group, depends on the degree of contamination and the environmental conditions of temperature and dryness that determine the survival time of salmonellas. Just as important is the influence of the host on the outcome of the infection. Many animals become infected naturally and are passive carriers; they shed salmonellas in their feces without clinical disease but only for the duration of their cohabitation with other infected animals. It is possible to reproduce salmonellosis experimentally in most animals using a sufficiently large dose of a virulent strain of the organism. There still remains the common occurrence of the animal that is a subclinical carrier of the infection but develops clinical salmonellosis when exposed to stressors such as long transportation, hospitalization, severe feed deprivation, or parturition.

### Genetic Resistance to Salmonellosis in Domestic Animals

There is evidence of a strong genetic association with resistance to salmonellosis in several economically important domestic animal species. However, selective breeding for resistance traits is not used in control of diseases or the carriage of *Salmonella* in any of these species. The value of a particular resistance trait in reduction of disease must be balanced against other factors, such as productivity of meat and milk. The control of *Salmonella* colonization of the gastrointestinal tract of food animals would appear to be a particularly useful objective with enormous potential public health benefits. There may be a role for several inherited immunologic traits, including polymorphonuclear leukocyte function and lecithin-induced mitogenic proliferation.

The interrelationships between the risk factors of the host, the environment, and the



pathogen are described here according to species differences.

### Dairy Cattle

In calves, the disease is usually endemic on a particular farm, although outbreaks can occur.

*S. Typhimurium* is commonly associated with enteritis or septicemia in calves younger than 2 months, whereas serovar Dublin is identified with similar frequency in young (>2 months) and adult cattle.<sup>23</sup> Spread between calves of a group is by the fecal–oral route. Infection of the newborn calf may be from the dam because many cows that are latent shedders become active shedders at parturition. The calves are not infected at birth but become infected from the environment.

In adult cattle, SD is the common infection and occurs sporadically, but as outbreaks when stressors occur. Spread is usually by the oral route and in cattle at pasture is greatly enhanced by persistently wet conditions. Wild mice are potential reservoirs of SD in dairy herds.

### Beef Cattle Herds and Feedlots

Although salmonellosis can cause significant economic losses in beef herds and feedlots, it is not as important as in dairy cattle. Low numbers of beef cattle are found to shed *Salmonella* at the time of slaughter, and beef cattle do not appear to be a major risk of carcass contamination.

### Sheep

Salmonellosis in sheep may occur with a range of different syndromes of variable severity, depending mainly on the particular serovar involved. *Salmonella enterica* subsp. *diarizonae* are most commonly found in sheep. Serovars of *Salmonella enterica* subsp. *enterica* commonly found in sheep include *S. Montevideo*, SD, *S. Typhimurium*, and *S. Agama*.

### Horses

Horses are frequently passive carriers, hosting *Salmonella* in internal organs such as lymph nodes but not or only intermittently shedding them in feces. Accordingly the search for a carrier can be laborious and even fruitless. At least five negative cultural examinations of feces should be made before acquitting a suspected donor.<sup>21</sup>

As in other species age is an important risk factor for developing clinical diseases, with foals at increased risk of developing severe clinical disease and septicemia. Risk factors in foals include a history of dystocia, immaturity or prematurity, FTPI, an unsanitary environment, infection with a concomitant pathogen, or other debilitating disease and poor health of the dam.

The occurrence of salmonellosis in horses hospitalized for another disease has become a major problem and can at least in part be

attributed to increased stress and immune suppression caused by illness and debilitating procedures such as anesthesia or surgery.

### Immune Mechanisms

Most information on the mechanisms of immunity to *Salmonella*, including the safety and immunogenicity of most *Salmonella* vaccines, has been found experimentally in mice. In primary infections in mice, early bacterial growth in the reticuloendothelial system is controlled by the contribution of both macrophages and polymorphonuclear cells and is affected by the virulence of the strain. In lethal infections, the early growth of the bacteria in the tissues results in high bacterial numbers that lead to death of the animal. Following natural infection with *Salmonella* antibody, responses to LPS and protein determinants can be detected. Anti-*Salmonella* IgM appear in serum early after infection followed by IgG. T-cells have a critical role in the later stages of primary infection.

### Environmental and Management Risk Factors

#### Cattle

Intensification of husbandry in all species is recognized as a factor contributing significantly to an increase in the new infection rate. Any significant change in management of the herd or a group of animals can precipitate the onset of clinical salmonellosis if the infection preexists in those animals. The risk factors for fecal shedding of *Salmonella* and clinical salmonellosis in dairy herds were herd size, rodent activity in housing and feed areas, use of flush water systems, and feeding brewers' products to lactating cows. Large herd size and intensive management are likely to provide an environment conducive to *Salmonella* shedding and chronic dairy herd infection.

Nutritional stress caused by transition diets and heat stress was associated with outbreaks in some herds. Feed withdrawal, transport stress, and the commingling of animals before slaughter can affect the number of cattle that are contaminated with bacterial pathogens such as *Salmonella*. However, none of the risk factors evaluated before or throughout the transport process had an impact on fecal shedding and hide or carcass contamination. The pH of rumen contents has been shown to affect the number of salmonellas surviving passage through the rumen. A high volatile fatty acid content and a low pH, such as prevails when a ruminant is on full feed, is unfavorable to salmonellas passing through the forestomachs. Feed intake depression as a result of transportation or around calving may further contribute to the risk of clinical or subclinical infection. In some herds there are sporadic cases in periparturient cows, usually within 1 week of calving.

Pastures contaminated by the feces of infected animals present an important source

of infection for grazing animals. In grazing cattle there is a distinct seasonal incidence in late summer, fall, and early winter, probably because of greater exposure to infection at pasture. Temperature and wetness are most important, as salmonellas are susceptible to drying and sunlight. *S. Typhimurium* can remain viable on pasture and in soil, still water, and feces for up to 7 months. The use of "slurry" as a means of disposal of animal manure from cow housing is a highly efficient means of spreading *Salmonella* infections. The chance of cows becoming infected increases considerably if they are grazed soon after the slurry is applied, and is less likely during dry, sunny periods and when there is sufficient pasture growth to avoid it being eaten right down to the ground surface. The survival time of *Salmonella* spp. in cold liquid manure depends on several factors, including pH of the slurry and the serotype of the organism. It can be as long as 28 weeks.

*Salmonella* contamination of water supplies of calves and cows was identified as a potential source of exposure. Water offered to weaned dairy calves in a continuous water-tank-filling method was a risk factor compared with a valve on demand and a water pH of more than 8. Drinking water can remain infected for long periods, as long as 9 months, and in cattle at extensive pasture infected drinking water in stagnant ponds is a significant source of infection. Feedlot playas (temporary shallow lakes) are frequently contaminated with many *Salmonella* serotypes. Using playas as a source of water for feedlots can be a source of *Salmonella*, and they should not be used to cool cattle in the summer months, or for dust abatement, or for irrigation of crops. Wildlife, birds, and migratory waterfowl have access to these bodies of water and, because of their size and number, there is little that can be done to prevent them from becoming contaminated.

Infection can be introduced by infected domestic animal carriers. For example, in large-scale calf-rearing units many of the calves are infected when they are picked up from their home farms and, if they are penned in groups, all calves in the group are soon infected. The infection can spread among calves penned individually, which suggests that aerosol spread may occur. *S. Typhimurium* can survive for several months in calf-rearing premises despite depopulation, cleansing, and disinfection. However, because of the failure of most calves to continue as carriers, they are usually free of infection within 6 weeks of arrival.

Contaminated feedstuffs, carrier animals, and infected clothing of visitors and casual workers are the most common methods of introducing infection. Less common methods include free-flying birds and nematode larvae that are already infected with salmonellas. Salmonellas have been isolated from a wide variety of wild animals that

could act as reservoirs for infection of domestic animals under certain conditions.

Previous antimicrobial treatment of cattle or calves with laboratory-confirmed *Salmonella* infections increases the probability of isolating salmonellas. Vaccination with a modified-live vaccine producing a systemic reaction, treatment with irritant compounds such as carbon tetrachloride for fluke, and fluke infestation can also precipitate clinical disease.

### Sheep

In range sheep, the most common occurrence of the disease is during a drought when sheep are concentrated in small areas of surviving grass heavily contaminated by feces. Sheep held in holding yards or transport vehicles previously occupied by sheep for long periods are also susceptible to clinical disease. This is most likely to occur when they drink from puddles of water, especially in heavily contaminated yards, or when they are exposed to recycled dip wash. In sheep, the disease is commonly associated with deprivation of feed when animals are assembled for vaccination, anthelmintic administration, or shipment over long distances. Lambs in feedlots are susceptible to salmonellosis within a few weeks after arrival in the lot.

The modern development of pen lambing, in which ewes about to lamb are brought into small pens, is also a means of potentiating spread from a chronic shedder. In all these situations feed stress by deprivation is likely to contribute to susceptibility. Field outbreaks in range sheep have been recorded. In some instances they have been caused by the use of unsterilized bonemeal as a phosphorus supplement. Outbreaks occurring in sheep on a number of farms in the same area at the same time have been ascribed to contamination of drinking water by birds eating carrion. Heavy dosing with zinc oxide as a prophylaxis against facial eczema is also credited with precipitating outbreaks of salmonellosis in young sheep.

### Horses

In adult horses, most clinical salmonellosis occurs after the stress of transport and mostly in horses that are overfed before shipment, receive little or no food or water for the duration of a protracted journey, and are fed excessively on arrival. Cases can appear 1 to 4 days later. Groups of horses that have been exposed to a contaminated environment, such as saleyards or railroad yards, may experience outbreaks in which up to 50% are affected. Multiple serotypes of *S. Enteritidis* have been isolated from the mesenteric lymph nodes of 71% of healthy horses examined at an abattoir, which indicates that extraintestinal infection occurs in the horse as it does in other species. In the light of the high carrier rate in this species, it is surprising that there are not more outbreaks.

The occurrence of salmonellosis in horses hospitalized for another disease has become a major problem for veterinary teaching hospitals and private equine practices that provide surgical veterinary care. In these circumstances there is a constant reintroduction of carriers of the disease, a persisting contamination of the environment, and a large population of horses, all of which are under stress because of anesthesia, surgical invasion, or intercurrent disease and many of which are exposed to oral and parenteral treatment with antimicrobials, which appears to greatly increase their chances of acquiring salmonellosis. Horses in which nasogastric tubes were passed were at 2.9 times greater risk of having salmonellas isolated than horses that did not undergo this procedure. Horses treated with antibiotics parenterally were at 6.4 times greater risk, and those treated with antimicrobials orally and parenterally were at 40 times greater risk of developing salmonellosis, compared with horses not receiving such treatment. In hospitalized horses, the factors found to be associated with fecal shedding of salmonellas included diarrhea at the time of admission as well as fever and a change of diet while hospitalized.

Outbreaks of nosocomial salmonellosis among horses in a veterinary teaching hospital have been described. Case-fatality rates may be high, necessitating closure of the hospital for complete disinfection and systematic sampling of the environment to detect the presence of persistent *Salmonella*. Strict isolation of hospitalized horses that have been shedding *Salmonella* and the planning and implementation of infectious disease control (IDC) throughout the hospital are necessary. Bleach is an effective disinfectant on the largest number of surfaces. The factors potentially associated with *Salmonella* shedding among horses hospitalized for colic at a veterinary teaching hospital were examined. *Salmonella* spp. were detected in the feces of 9% of patients at least once during hospitalization. They were more likely to shed *Salmonella* if diarrhea was evident 6 hours or less after hospitalization and the duration of hospitalization exceeded 8 days (OR 20.3), laminitis developed during hospitalization (OR 12.0), results of nasogastric intubation were abnormal (OR 4.9), leukopenia was evident 6 hours or less after hospitalization (OR 4.6), or travel time to the teaching hospital exceeded 1 hour (OR 3.5). Horses treated with a probiotic did not differ from control horses in likelihood of fecal shedding of *Salmonella* (OR 1.5) or prevalence of clinical signs.

Salmonellosis is also one of the common causes of neonatal septicemias of foals, and the disease may occur as endemic on particular studs, or there may be outbreaks with many foals being affected at one time. The common management strategy on "visiting stud-farms" of bringing mares and newborn foals to communal studs and then bringing

them daily to a central point for observation and teasing is also likely to facilitate spread of an infection through a group of foals.

### Contaminated Feedstuffs

Housed animals are generally more susceptible to infection from purchased feeds containing animal by-products than are pastured animals, which are again more susceptible to animal-product-based fertilizers. Organic feedstuffs, including bonemeal, are being increasingly incriminated in the spread of salmonellosis. Most of the contamination of meat and bonemeal occurs after heat sterilization, especially if the material is left in digester tanks. Fishmeal is one of the most frequently and badly contaminated feedstuffs. These feed meals need to be heated at 82°C (180°F) for an hour to be sterilized. The contamination of these materials may derive from antemortem infections in the animals used to make the by-product, but soiling of the material at the preparation plant or abattoir or during storage may also occur. Stored feed not of animal origin, especially grain, is also commonly contaminated by the droppings of rodents that infest it and this can lead to sharp outbreaks of salmonellosis caused by *S. Typhimurium*. Of special importance is colostrum stored without refrigeration. If the colostrum is contaminated initially, multiplication of salmonellas may occur and transmission of the infection is likely. Dried milk products appear to be relatively safe.

### Pathogen Risk Factors

Salmonellas are facultative intracellular organisms that survive in the phagolysosome of macrophages and other cells and can therefore evade the bactericidal effect of antibodies. Compared with other organisms of the same family, salmonellas are relatively resistant to various environmental factors. They multiply at temperatures between 8°C and 45°C, at water activities above 0.94, and in a pH range of 4 to 8. They are also able to multiply in an environment with a low level of or no oxygen. The bacterium is sensitive to heat and will not survive temperatures above 70°C. It is sensitive to pasteurization. Salmonellas have been shown to be resistant to drying, even for years, especially in dried feces, dust, and other dry materials such as feeds and certain foods. Prolonged survival in water and soil has also been described. They are quite sensitive to beta- and gamma-irradiation.

*Salmonella* spp. have 13 predicted fimbrial loci, of which most are deployed in vivo. **Fimbriae** are required for the attachment onto host cells, colonization, and biofilm formation, but not specifically for intracellular survival.<sup>24</sup>

**Flagella** have been implicated as virulence factors because they may enhance motility and the invasiveness of the bacterium. This view, however, remains controversial because flagella that consist of flagellin

monomers are potent inducers of innate immunity. In the intestinal epithelium flagellin induces inflammation while inhibiting apoptosis.<sup>24</sup>

Like in other gram-negative bacteria, the cell membrane of salmonellas contain LPS (endotoxins), which on release, can induce shock in the host organism, contributing to its virulence. The O-antigen LPS of salmonellas is toxic and an important virulence factor, and immunity directed against the LPS is thought to be of major importance in the host defense against salmonellosis.

Salmonellas possess a **type three secretion system (TTSS)** that is required for invasion of epithelial cells of the intestine. The TTSS functions like a needle allowing the bacterium to inject its outer proteins, the so-called effector proteins, into the host cell to which it is attached. Effector proteins signal the host cell to take up the bacterium, which consequently is engulfed into the host cell encased in a vesicle called the *Salmonella*-containing vacuole.<sup>25</sup>

Salmonellas have acquired at least five **SPIs** through horizontal gene transfer. SPI-1 and SP-2 in particular are important determinants of the pathogen's virulence.

The capacity to produce **superoxide dismutase** is another virulence factor that protects salmonellas from reactive oxygen species produced by the host cells to kill intracellular pathogens.<sup>24</sup>

In states of iron deprivation salmonellas have the capacity to produce two potent siderophores, **enterobactin** and salmochelin, allowing them to overcome this limitation.<sup>24</sup>

### Antimicrobial Resistance of *Salmonella*

Strains of *Salmonella* spp. with resistance to antimicrobials are now widespread in both developed and developing countries. Since 1990 there have been considerable increases in the occurrence of multiply-resistant strains of *Salmonella* spp. in many developed countries.

AMR of salmonellas has been and is a major point of concern and controversy in veterinary medicine and human public health. The continued use of antimicrobials in veterinary medicine, and in food animals in particular, is believed to be a major cause of selective pressure that leads to the appearance and persistence of resistant strains. The resistance is usually to multiple antimicrobials and its existence is considered as a potential risk factor. The significance of AMR is most obvious in its impact on the treatment of human infections. AMR of *Salmonella* spp. causing clinical disease leads to increased morbidity, mortality, and treatment costs and limits the choice of antimicrobials for the treatment of systemic salmonellosis in humans.<sup>26</sup> Antimicrobial-resistant *Salmonella* infections can further complicate antimicrobial therapy of other infections; prior antimicrobial therapy allows fewer numbers

of antimicrobial-resistant salmonellas to cause symptomatic infections, and an increase in the proportion of salmonellas that are antimicrobial resistant will increase the overall frequency of salmonellosis. Infections in humans associated with antimicrobial-resistant salmonellas are increasing and have become a cause for public health concern. Resistance to third- and fourth-generation cephalosporins and fluoroquinolones is considered of greatest public health importance, because these are the antimicrobials of particular relevance for the treatment of human salmonellosis.<sup>27</sup>

The prevalence of *Salmonella* isolates that are antimicrobial-resistant varies widely between countries, animal species, and serovars. National and species-specific differences have been attributed to differences in the practice of antimicrobial use between animal species, production systems, and countries. Generally, AMR among salmonellas is higher in the United States than in other countries, is more common in isolates from swine than from other species, and is more common in serovar Typhimurium than in other *Salmonella* serovars. The comparison of AMR levels in different studies consistently showed that AMR is much less common in isolates from healthy individuals than in isolates from diseased animals.

During the 1990s AMR of *Salmonella* became an important issue because of a global epidemic of the *S. Typhimurium* DT104 in animals and humans that was frequently resistant to a wide range of commonly used antimicrobials for the treatment of salmonellosis in humans. Multidrug-resistant *S. Newport* has been spreading on an epidemic scale in both animals and humans throughout the United States. In addition to the resistance to five drugs found in *S. Typhimurium* DT104, *S. Newport*, called *Newport* MDR-AmpC, is also resistant to amoxicillin-clavulanic acid, cephalothin, ceftiofur, and ceftiofur and exhibits decreased susceptibility to ceftriaxone. The emergence of *Newport* MDR-AmpC strains in humans has coincided with the emergence of *Newport* MDR-AmpC infections in cattle. Although the role of farm animals as a primary source of *Salmonella* infection in humans is not undisputed, it should be noted that transfer of AMR between species does not necessarily require pathogen transfer.<sup>28</sup> Resistance genes can be carried on plasmids or integrons, which are potentially independently mobile DNA elements encoding a site-specific integration system responsible for the acquisition of multiple small mobile elements called gene cassettes which, in turn, encode antibiotic resistance genes. Integrons have also been described on plasmid DNA in *S. Enteritidis*. Plasmids and integrons can be transferred between animal-associated *Salmonella* and *E. coli*, and identical *CMY-2* genes carried by similar plasmids have been identified in humans, suggesting that the *CMY-2* plasmid

has undergone transfer between different bacterial species and may have been transmitted between food animals and humans.

A survey including 380 *Salmonella*-positive samples from diseased animals submitted to different diagnostic labs in the United States revealed that 82% of the samples were resistant to at least one antimicrobial and 70% to at least three antimicrobials.<sup>29</sup> When stratified by animal species the highest prevalence rates of resistance to at least one antimicrobial were found for swine (92%), followed by cattle (77%), chickens (68%), and horses (29%).<sup>29</sup> Approximately 35% of cattle isolates and 10% of equine isolates were resistant to over 9 antimicrobials. The serovars showing resistance to 5 to 8 antimicrobials were *S. Typhimurium* (71%), SD (69%), and SCS (40%). In this study resistance was most often observed to tetracyclines (78%), streptomycin (73%), sulfamethoxazole (68%), and ampicillin (54%).<sup>29</sup> Worryingly, 36% of cattle isolates exhibited resistance to ceftiofur, a third-generation cephalosporin extensively used in cattle practice in the United States. Resistance to nalidixic acid, a compound used to detect emerging resistance to fluoroquinolones, was observed in isolates from chicken (9%), cattle (8%), and turkeys (6%).

The annual UK survey of 2013, including a total 2886 isolates from submissions of clinical cases to diagnostic laboratories, reported resistance to at least one antimicrobial in 35.8% but 87.1% of swine isolates.<sup>27</sup> When stratified by serovar 69.7% of *S. Typhimurium* but only 5.1% of SD isolates were resistant to at least one antimicrobial. Of the serovars other than *S. Typhimurium* and SD 38.8% were resistant to at least one antimicrobial substance.<sup>27</sup> AMR was most often observed to tetracyclines (26.1%), sulfonamide compounds (24.8%), streptomycin (18.8%), and ampicillin (13.2%). Resistance to nalidixic acid was observed in 5% of all isolates and was most common in turkeys (20.2%), other avian species (14.6%), chickens (8.0%), and dogs (6.0%). Isolates from cattle were resistant to this compound in 1.4%. Resistance to ceftazidime occurred in 0.03% of all samples.<sup>27</sup>

A smaller study from Australia including 76 *Salmonella*-positive fecal samples from diarrheic calves reported resistance to at least one antimicrobial in 27.6% of all isolates. Resistance to over four antimicrobials occurred in 14.3%.<sup>19</sup> Most common resistance was to streptomycin (25.5%), a combination of sulfonamides (21.1%), and ampicillin (18.4%). Resistance to nalidixic acid was not observed in this study.

### Zoonotic Implications

Salmonellosis, a common human intestinal disorder primarily associated with *Salmonella*-contaminated meats and poultry, causes over 90 million human cases every year. Annual costs of human salmonellosis



have been estimated to be approximately €3 billion in the EU and \$2.7 billion in the United States.<sup>30</sup> The Centers for Disease Control estimate approximately 1 million illnesses per year, 19,000 hospitalizations, and 380 annual deaths.<sup>31</sup> In the EU approximately 109,000 confirmed cases of human salmonellosis have been reported in 2009, corresponding to 23.7 cases per 100,000 population.<sup>30</sup>

The disease has assumed increasing importance in recent years because of the much more frequent occurrence of human salmonellosis, with animal salmonellosis as the principal reservoir. *S. Enteritidis* and *S. Typhimurium* are the serovars most commonly associated with human illness. Human *S. Enteritidis* cases are most commonly associated with the consumption of contaminated eggs and poultry meat, whereas infection with *S. Typhimurium* is typically associated with the consumption of pig, poultry, or bovine meat.<sup>30</sup> The most serious risk is that the transmitted bacteria will have acquired resistance to specific antibiotics because the animals from which they originate have been treated with the particular antibiotics repeatedly or over a long period.

Various clinical forms of salmonellosis can occur in veterinarians working with *Salmonella*-infected animals. Gastroenteritis, bacteremia, and other systemic abnormalities can occur. Cutaneous salmonellosis has been reported in veterinarians attending to infected cattle at the time of parturition. The disease was characterized by pustular dermatitis from which *S. Virchow* and SD were isolated. Veterinarians may develop skin lesions after obstetric deliveries, even after hygienic precautions and the use of abundant amounts of disinfectant creams and careful washing of the arms and hands.

### *Salmonella* Typhimurium DT104

Throughout the 1990s there was a global epidemic of multidrug-resistant *S. Typhimurium* DT104 (DT stands for definitive phage type) in animals and humans. It was important because of its widespread prevalence, its presumed zoonotic nature, and the high frequency of multiple AMR. *S. Typhimurium* DT104 was first reported in the UK in 1984 and emerged in the 1990s as an increasing cause of *Salmonella* infections in humans and animals in England, Wales, and Scotland, as well as other European countries such as Germany, France, Austria, and Denmark and Canada. A wide range of potential reservoirs is associated with this infectious strain, from humans to the traditional food animals such as poultry, cattle, sheep, and pigs. Over a 1-year period in Scotland it was the predominant *Salmonella* isolated from nine species of animal (cattle, pigs, sheep, chickens, pigeons, horses, cats, dogs, and rabbits). A large outbreak of salmonellosis caused by multiply-resistant (mr) DT104 occurred in people in England who had consumed milk from a

dairy that received raw milk supplied by two farms. The DT104 was isolated from the milk filter, and failure of on-farm pasteurization was thought to be the cause. Strains of the organism from humans, the dairy cattle, and the milk filter showed decreased susceptibility to ciprofloxacin.

All isolates were resistant to at least one antimicrobial and 98% were resistant to multiple antimicrobials, with R-type ACTSp being the predominant resistance pattern. In the UK, a clonal strain of mrDT104 resistant to at least five antimicrobials (ampicillin, chloramphenicol, streptomycin, sulfonamides, and tetracycline; R-type ACSSu T) was detected in humans in 1984 and cattle in 1988. The organism has emerged as an important cause of diarrhea in horses in Ontario.

The organism has been found in a variety of human foods, including salami, sausages, chicken, burgers, oysters, and vegetables. Human infections have been associated with contact with farm animals and from consumption of contaminated foods such as chicken, pork, sausages, meat pastes, and beef. The organism's ecology, its precise reservoirs, and its distribution in the human food chain are unclear. Clinical signs in humans infected with DT104 include diarrhea, fever, headache, nausea, and vomiting. Septicemia may develop in a small percentage of cases with potential complications of meningitis and foci of infection in bones and joints.

### Economic Importance

Salmonellosis is a significant cause of economic loss in farm animals because of the costs of clinical disease, which include deaths, diagnosis, and treatment of clinical cases, diagnostic laboratory costs, the costs of cleaning and disinfection, and the costs of control and prevention. In addition, when the disease is diagnosed in a herd it can create considerable apprehension in the producer because of the difficulty in identifying infected animals. The veterinarian is also often in a difficult position because the diagnosis, treatment, and control of the disease are less than reliable, and it is difficult to provide advice with confidence. An estimation of the economic impact of an outbreak of SD infection in a calf-rearing unit indicated that the cost of disease represented a substantial proportion of the gross margin of rearing calves. The losses incurred by livestock producers include reduced feed efficiency and reduced weight gains or deaths because of salmonellosis.

### PATHOGENESIS

The pathogenesis of salmonellosis is a complex and multifactorial phenomenon. The nature of the disease that occurs following infection is dependent on the specific combination of serovar and host known as serovar–host specificity. A range of infections is included in the term *salmonellosis*.

The most common type of infection is known as “the carrier state,” in which carriage of the organism is not accompanied by clinical abnormalities or clinical disease. In production animals, these carriers are of importance because they may serve as reservoirs for further spread of infection through shedding and may be present as contaminated food products.

The evolution of host-specific *Salmonella* serovars is considered to be associated with an increase in pathogenicity for the specific host. The hypothesis is based on the fact that broad-range serovars (*Typhimurium* and *Enteritidis*) are generally associated with severe disease only in young animals, whereas host-restricted serovars cause high mortality in both young and adult hosts.

The pathogenesis of different *Salmonella* serovars possessing different degrees of host restriction have been studied in young lambs to evaluate the basis of the serovar–host specificity in sheep. Infection with *S. Abortusovis* resulted in clinical signs of salmonellosis, including a fever and bacterial dissemination to systemic tissues. This confirms the virulence of the strain with sheep. *S. Gallinarum* caused relatively mild disease but is virulent in chickens. SD was virulent in sheep, confirming its association with ovine salmonellosis. The apparent specificity of a serovar for a particular host or range of hosts as defined by epidemiologic data is influenced not only by bacterial virulence but also by the ability of the serovar to circulate within the population of the host.

### Infection

*Salmonella* infects animals and humans by the oral route. Following ingestion, a proportion of the organisms resists the low pH of the stomach, reach the distal ileum and the cecum, invade the mucosa, and replicate in the submucosa and Peyer's patches.

In young animals, and in adults whose resistance has been lowered, spread beyond the mesenteric lymph nodes occurs, and the infection is established in the reticuloendothelial cells of the liver, and from there it invades the bloodstream. These steps in the infection process can occur very rapidly. For example, in newborn calves, SD when taken by mouth can be found in the bloodstream 15 minutes later. In older calves bacteria can be isolated from the intestinal lymph nodes 18 hours after their oral administration. Provided a sufficient number of a sufficiently pathogenic serotype is used, the disease is reproducible with pure cultures, for example, of *S. Typhimurium* in lambs, SCS in pigs, SD, *S. Typhimurium*, and *S. Enteritidis* in calves, and *S. Typhimurium* in horses. Once systemic infection has been established, salmonellosis as a disease can develop. Its principal manifestations are septicemia, enteritis, abortion, and a group of localizations in various tissues as a result of bacteremia.

### Septicemia, Bacteremia, and the Carrier State

After invasion of the bloodstream occurs, a febrile reaction follows in 24 to 48 hours, and the acute phase of the disease, similar to that seen in natural cases, is present 3 to 9 days later. The early septicemia may be rapidly fatal. If the systemic invasion is sufficient to cause only a bacteremia, acute enteritis may develop, and abortion is a common final sequel in sheep and cattle. Many animals survive this stage of the disease, but localization of the salmonellas occurs in mesenteric lymph nodes, liver, spleen, and particularly the gallbladder. In healthy adults there may be no clinical illness when infection first occurs, but there may be localization in abdominal viscera. In either instance the animals become chronic carriers and discharge salmonellas intermittently from the gallbladder and foci of infection in the intestinal wall into the feces and occasionally into the milk. For this reason, they are important sources of infection for other animals and for humans. Carrier animals may also develop an acute septicemia or enteritis if their resistance is lowered by environmental stresses or intercurrent infection. Salmonellas can reside intracellularly where they are able to escape antibody-mediated killing, and the numbers of organisms are controlled by cellular defense mechanisms involving the macrophages in which they reside.

### Enteritis

Enteritis may develop at the time of first infection or at some other time in carrier animals. The best information available on the pathogenesis of enteritis is derived from the experimentally produced disease. In most instances the disease is produced by the administration of massive doses of bacteria, and this may result in the production of a different syndrome from that which occurs naturally. The pathogenesis of enteric salmonellosis is much more complex than cholera, involving an increase in mucosal cell cyclic AMP content and prostaglandin concentration as well as an inflammatory response to the invading bacteria. Intestinal invasion is a characteristic feature of *Salmonella* pathogenesis. Within minutes of injecting ileal loops in calves, *Salmonella* can be seen to invade both M-cells and enterocytes that overlie domed villi associated with lymphoid follicles and absorptive villi. The organism must invade the intestinal mucosal epithelium to cause disease.

After oral infection with SD, invasion occurs through the intestinal wall in the terminal ileum and cecum and progresses only as far as the mesenteric lymph nodes. Progress beyond this point, and the development of salmonellosis, is determined by factors such as immune status and age of the animal, whether or not it is exposed to stress, and the virulence of the strains. A number of characteristics of the bacteria influence their

virulence, including the presence of adhesin pili and flagella, cytotoxin, enterotoxin, LPS, and the inflammatory response that they initiate in the intestinal wall. The effects of some of these factors are not limited to the intestinal tract and also contribute to the systemic complications of salmonellosis. The SD virulence plasmid mediates systemic infection in cattle by causing macrophage dysfunction.

SD infections in calves have been used to create the disease experimentally. In calves 6 to 7 weeks of age, an oral dose of the organisms is fatal within 24 hours, with the animals dying of septicemia and an acute necrotizing panenteritis. Calves 12 to 14 weeks of age developed a progressive fatal diarrhea within 1 week following infection. Experimental infection of ligated ileal loops from calves with *S. Typhimurium* results in an acute neutrophilic inflammatory response associated with invasion of Peyer's patches.

In calves, infection is initiated by bacterial invasion of the mucosal epithelium of the distal ileum or proximal colon causing extensive local tissue damage that leads to shortening of the villi and degeneration of the enterocyte layer. *Salmonella* invasion induces potent inflammatory response characterized by a massive infiltrate of polymorphonuclear cells into the lamina propria and submucosa and secretion of fluid into the intestinal lumen. Damage to the enterocyte layer and the secretion of fluid into the intestinal lumen results in diarrhea, and the fever is caused by circulating inflammatory cytokines.

Experimentally induced *Salmonella* infection in calves results in an increase in serum haptoglobin levels within 3 days of challenge. By day 3 after experimental infection the serum haptoglobin levels increased to a median level of 212 µg/mL, whereas placebo controls had median levels of 0 µg/mL. The increased levels closely reflected the clinical findings of infection and are considered useful markers of infection severity in salmonellosis in calves.

In **sheep**, the experimental disease produced by oral dosing with *S. Typhimurium* includes an early acute enteritis of the small intestine at 24 hours. At 5 to 8 days there is hemorrhagic and necrotic typhlitis and the infection is established in mesenteric lymph nodes and the liver. Experimental SD infection of the mammary gland of dairy cattle results in a persistent infection associated with a chronic active mastitis similar to carriers with naturally acquired SD infection.

In ponies with experimental infection with *S. Typhimurium* orally, there is much variation in the time after infection that the various signs appear. Pyrexia, neutropenia, and high fecal *Salmonella* counts coincided on the second and fourth days, but diarrhea occurred in only some ponies and then on the third to eleventh days after inoculation. Positive agglutination tests were recorded from day 1 but were mostly during the period 6 to 12 days postinoculation. The

neutropenia of the early stages of the disease is transient, and neutrophilia occurs when diarrhea commences.

The characteristic **fever** and **leukopenia** of **equine salmonellosis** have been attributed to the release of endotoxin from the bacteria during invasion of, and replication within, the intestinal epithelium. The equine colonic mucosa can respond to cholera toxin, which causes an increased secretion of chloride, sodium, and water into the intestinal lumen. The enterotoxin activity of *S. Typhimurium* of equine origin has been compared with cholera enterotoxin.

Although there is sufficient obvious enteritis to account for the diarrhea that characterizes the disease, there appear to be other factors involved. For example, it has been shown experimentally that in *Salmonella* enteritis there is stimulation of active chloride secretion combined with inhibition of sodium absorption, but invasion of the mucosa is not essential for these changes to occur. These observations are of interest in light of the known hyponatremia that characterizes the disease. Studies of calves with salmonellosis have shown that the fluid loss associated with the diarrhea of this disease is much greater than in other calf diarrheas. This, together with a large solid matter output, contributes to the significant weight loss occurring in salmonellosis.

### Abomasitis

*S. Typhimurium* DT104 has been associated with some independent outbreaks of abomasitis in veal calves. Abomasitis was reproduced experimentally by oral infection of calves.

### Abortion

Abortion is a common manifestation of salmonellosis in cattle between days 124 and 270 of gestation. When infection is associated with SD, the organism multiplies in the placenta, having been seeded there from a primary lesion in other maternal tissues. Fetal death has already occurred in many cases, because of its invasion by bacteria, but live calves also occur, suggesting that the placental lesion is the critical one. *S. Montevideo*, *S. enterica* subsp. *diarizonae*, and *S. Abortusovis* all are frequently associated with a significant number of outbreaks of abortion in ewes.<sup>13,20</sup> Abortion caused by *S. Abortusovis* infection typically occurs during the second half or last third of pregnancy. In horses *S. Abortusequi* is typically associated with late abortion (7–8 months of gestation).

### Terminal Dry Gangrene, Osteitis, and Polyarthrits

Terminal dry gangrene caused by endarteritis of the extremities of the limbs, ears, and tail may occur in calves with SD infection. Epiphyseal osteomyelitis affecting the metaphyses, and polysynovitis and arthritis are also possible sequelae.

## CLINICAL FINDINGS

The most common clinical manifestation of salmonellosis is enteritis, but a variety of other conditions including acute septicemia, abortion, arthritis, and respiratory disease are frequently observed.

The disease is most satisfactorily described as three syndromes classified arbitrarily according to severity as **septicemia**, **acute enteritis**, and **chronic enteritis**. These are described first, but the differences between the animal species are sufficiently significant to justify describing the disease separately in each of them.

### Septicemia

This is the characteristic form of the disease in newborn foals, calves, and lambs. Commonly, there is profound depression, dullness, prostration, high fever (40.5–42°C, 105–107°F), and death within 24 to 48 hours.

### Acute Enteritis

This is the common form in adult animals of all species. There is a high fever (40–41°C, 104–106°F) with severe, fluid diarrhea, sometimes dysentery, and occasionally tenesmus. The fever often subsides precipitously with the onset of diarrhea. The feces have a putrid smell and contain mucus, sometimes blood, and fibrinous casts, which may appear as complete tubular casts of intestine, and intestinal mucosa in sheets or casts. There is complete anorexia but in some cases increased thirst. The heart rate is rapid, the respirations are rapid and shallow, and the mucosae are congested. Pregnant animals commonly abort. The case-fatality rate without early treatment may reach 75%. In all species, severe dehydration and toxemia occur and the animal loses weight, becomes weak and recumbent, and dies in 2 to 5 days. Newborn animals that survive the septicemic state usually develop severe enteritis, with diarrhea becoming evident at 12 to 24 hours after the illness commences. If they survive this stage of the illness, residual polyarthritis or pneumonia may complicate the recovery phase.

### Chronic Enteritis

This is a common form in pigs following a severe outbreak, and occurs occasionally in cattle and adult horses. In calves there is intermittent or persistent diarrhea, with the occasional passage of spots of blood, mucus, and firm fibrinous casts; intermittent moderate fever (39°C, 102°F); and loss of weight leading to emaciation. Although chronic enteritis may occur initially, it usually succeeds an acute episode.

### Bovine Salmonellosis

The disease associated with SD is usually endemic on a particular farm, with sporadic cases occurring when individual animals are exposed to stress. Severe outbreaks are rare but do occur when there is severe stress,

usually acute nutritional deprivation, applied to the entire herd.

When *S. Typhimurium* is the cause, it is usual to have a single animal or a small number of animals affected at one time. When the disease is in the calf population it is usual for it to be much more severe, with many affected, either as a point outbreak or, when there is a succession of calves, a continuing occurrence of the disease. The emphasis therefore is generally on the occurrence of individual, sporadic cases in newborn calves and recently calved cows. Depending on the geographic region other less commonly occurring serovars that have been associated with clinical disease in cattle and calves include *S. Newport*, *S. Agona*, *S. Infantis*, *S. Enteritidis*, *S. Mbandaka*, *S. Muenster*, and *S. Bovismorbificans*.<sup>16–19</sup> *S. Muenster* in a dairy herd has been associated with abortions, diarrhea in adults and calves, and shedding of the organism in the milk of about 8% of the cows.

**Septicemia** is the common form of the disease in newborn calves under a few weeks of age. There is depression, toxemia, fever, dyspnea, and weakness, and nervous signs, including incoordination and nystagmus, may occur. Diarrhea and dysentery may occur but are not common.

Calves older than a week and adults are usually affected by **acute enteritis**, followed in survivors by abortion in pregnant cows and polyarthritis in calves. In severe cases of enteritis, there is often dysentery, with whole blood passed in large clots, and complete agalactia in lactating cows. Abdominal pain, with kicking at the abdomen; rolling; crouching; groaning; and looking at the flanks, may occur in adult cattle. Rectal examination at this stage usually causes severe distress.

**Chronic enteritis** with inappetence, reduced weight gain, and unthriftiness may follow an attack of acute enteritis or be the only manifestation of the disease. Abortion is a common sequel in pregnant cows that survive an attack of acute enteritis. However, infection with SD is also a significant cause of abortion in cattle without there having been any clinical signs other than retained placenta. A sequel to some cases of apparent enteric salmonellosis is the development of terminal dry gangrene caused by endarteritis of the extremities, including ear tips, tail tips, and the limbs from the fetlock down.

**Terminal dry gangrene of the extremities** of calves is characterized by lameness, swelling of the hindlimbs below the fetlocks, and separation of the skin above the fetlock. The distal portion of the limb is cool, not painful, and the skin is dry or moist. There is a clear line of demarcation of the skin at the level of the fetlock joints between the normal proximal skin and the distal necrotic tissue. The phalanges may be separated from the metatarsus. The tips of the ears may be indurated and deviated medially, and the distal aspect of the tail may be dry and shriveled.

**Abortion** caused by SD may occur spontaneously without any previous clinical evidence of salmonellosis in the herd and occurs from days 124 to 270 of gestation. Cows that abort may be ill with a fever, anorexia, and hypogalactia, and some will retain fetal membranes. In a number of cases, calves may be born shortly before term and die in the perinatal period. *S. Muenster* has also been implicated in abortions in a dairy herd.

The experimental disease produced by infecting adult cattle with SD by mouth varies from no clinical illness to fatal dysentery. Abortion occurs in some pregnant females. Many suffer pyrexia, anorexia, and mild diarrhea. Experimental infection of calves with *S. Typhimurium* has the same general effect, with more severe syndromes occurring in younger calves. Chronic cases may develop bone lesions, including osteoperiostitis and osteomyelitis, sometimes with epiphyseal separation. Experimental infection with *S. Enteritidis* causes profuse yellow diarrhea, fever, dehydration, frequent cough, and a mucopurulent nasal discharge.

### Ovine and Caprine Salmonellosis

Depending on the geographic region the serovars most commonly associated with clinical disease in sheep include *S. Typhimurium*, *S. enterica* subsp. *diarizonae*, *S. Montevideo*, SD, *S. Abortusovis*, and *S. Enteritidis*.<sup>13,20,32</sup> Salmonellosis in sheep may occur as acute enteritis or abortion on a flock scale. However, in the early stages of the outbreak and young lambs the infection may present as septicemic form. After experimental infection of sheep with SD, fever and diarrhea are followed in pregnant ewes by abortion. Abortion is also common in the naturally occurring disease associated with all serovars causing clinical disease, not just *S. Abortusovis*. Some ewes die after abortion, and many of the lambs born alive die subsequently. Fever and diarrhea, followed by abortion, have also been produced experimentally in sheep by the administration of SD.

In goats, naturally occurring cases are not often reported. SD is the usual pathogen in those countries where it is a resident, but *S. Typhimurium* is also recorded as a cause. Peracute septicemia, in newborn animals, and acute enteritis occur with signs and lesions similar to those in cattle.

### Equine Salmonellosis

Salmonellosis is one of the common causes of infectious diarrhea in horses, and *S. Typhimurium* and *S. Agona* are the most commonly isolated serovars from clinical cases. The disease in horses usually occurs in a single animal and is sporadic. However, outbreaks do occur in newborn foals, in groups of horses recently transported, and in horses hospitalized in veterinary clinics. Analysis of spatial and temporal clustering of horses with salmonellosis in an intensive



care unit of a veterinary teaching hospital suggested that affected horses were grouped in time. Experimental infection of horses by oral administration of *S. Typhimurium* produces a disease similar to the natural disease. The incubation period may be as short as 24 hours. The following four syndromes occur:

- **Asymptomatic shedding of *S. Typhimurium*** in feces intermittently or continuously for short periods of 4 to 6 days
- **A subacute enteric form in adult horses** on farms in which the disease is endemic, with fever, depression, and anorexia but without severe diarrhea, although the feces may have the consistency of soft bovine feces. There is no other obvious intestinal abnormality. There may be a neutropenia with a left shift.
- **Severe, acute fulminating enteritis with diarrhea, fever, dehydration, and neutropenia occurs.** There is abdominal pain, which may be sufficiently severe to stimulate violent actions. This is the common form of the disease, occurring commonly in adults that are exposed to stress in one form or another. Newborn and young foals up to 8 days of age also often have this form of the disease, characterized by depression, anorexia, and diarrhea.
- **In foals up to about 2 days of age there is a highly fatal septicemia.** Localization in survivors includes lesions in the brain, causing meningoencephalitis and polyarthritis. Fatal meningoencephalomyelitis caused by *S. Agona* has been described in a 7-day-old foal. Clinical findings included head tilt, seizures, and diarrhea.

*S. Abortusequi* has become a rare, only occurring in few countries worldwide. Infection with this serovar is associated with abortion in the last third of gestation, followed by retained placenta and metritis. Foals born alive may develop acute septicemia in the first week of life or polyarthritis in the second week of life. In stallions orchitis, pneumonia, arthritis, and more rarely tendovaginitis have been described.

### CLINICAL PATHOLOGY

A definitive etiologic diagnosis of salmonellosis depends on the isolation of the organism from tissue aseptically collected at necropsy and from feces, blood, milk, and other body fluids. In the case of abortion suitable material for culture include placenta, vaginal swabs, and fetal stomach contents.<sup>33</sup> Feed, water, and environmental samples may be cultured to confirm the presence of the pathogen in a herd or flock or to determine the source of the organism. The type of sample required and frequency of sampling will largely depend on the objective of the

testing strategy, the clinical presentation (if any), and the degree of precision of prevalence estimates that is required. Samples from individual animals should be obtained as aseptically as possible to prevent cross-contamination. Clinical cases are best sampled during the acute phase of the disease and before initiating antimicrobial therapy. In the case of herd/flocks testing environmental samples, such as pooled feces or swabs from floor swabs or boots, may be most cost effective.<sup>33</sup> Identifying subclinical infection may require repeated sampling and a larger sample size because so-called carrier animals may shed the bacterium only intermittently and in low numbers.

The diagnostic techniques available are as follows.

### Bacterial Culture

Bacterial culture is the only way to make a definitive etiologic diagnosis of salmonellosis and to exactly determine the serotype. However, culturing the organism, particularly from feces, is unreliable for various factors including the method used to collect samples, the amount of material submitted, variation in the fecal shedding of the organism, and the bacteriologic method used. A major complicating factor is the occurrence of apparently healthy carriers, which shed the organism intermittently and in low numbers, and silent carriers, which do not shed *Salmonella* in feces but harbor the organism in mesenteric lymph nodes or in the mucosa of the cecum and colon. The difficulty varies according to genotype. Host-adapted serovars (e.g., SD in cattle or *S. Abortusovis* in sheep) are more difficult to isolate from feces than serovars with a broader host range such as *S. Typhimurium*. In cattle with SD infection, the bacteria are present in the blood and milk for a very brief period during the bacteremic phase and before diarrhea commences. Cows near calving are most likely to be shedding *Salmonella* in the feces. Multiple cultures at 24-hour intervals were found to be superior to single fecal cultures for the diagnosis of clinical salmonellosis in horses; currently at least five consecutive fecal samples are recommended to rule out the carrier state in an individual animal with over 95% confidence.<sup>21</sup>

The organism can be cultured from tissue, body fluids, fecal samples, bulk tank milk, milk filters, water, feed, and environmental sites. When sampling dairy farms weekly for 7 to 8 weeks, the prevalence of fecal shedding from different groups of cattle may vary widely among herds, indicating that herds with infected cattle may be classified incorrectly if only one group is tested.

Clinical laboratories generally require at least 48 hours for presumptive diagnosis of *Salmonella* spp. in feces because of required preenrichment and enrichment steps. Biochemical and serologic confirmation of the genotype and the following susceptibility

testing may require an additional 24 to 48 hours.

There are numerous methods to culture *Salmonella*, and the choice of the appropriate method depends on the suspected serovars, the source and type of the sample, and the affected animal species.

### Preenrichment Media

The use of preenrichment media, such as buffered peptone water or preenrichment broth, can increase the sensitivity of the fecal culture by resuscitating severely damaged salmonellas that may otherwise not grow on selective culture media. The use of preenrichment media may, however, not be ideal to isolate host-specific serovars that are less vigorous and may suffer from overgrowth of competing bacteria during this nonselective enrichment process.<sup>33</sup>

### Enrichment Media

Enrichment media contain additives that selectively stimulate growth of *Salmonella* while inhibiting the growth of competing organisms. Examples of selective growth media include sodium tetrathionate, selenite cysteine, or brilliant green broth. Some of these specific enrichment media are, however, toxic to the certain *Salmonella* serovars; for example, brilliant green is toxic to many SD strains.<sup>33</sup>

### Selective Plating Media

Selective media are solid agars inhibiting growth of bacteria other than *Salmonella* spp. while giving information on some of the principal biochemical characteristics, such as nonlactose fermentation and hydrogen sulfide production of *Salmonella* spp.<sup>33</sup> Selective agars are usually incubated for 24 to 48 hours at 37°C and *Salmonella* are present as characteristic colonies on these agars that can be differentiated from colonies of other bacteria. There are, however, certain organisms such as *Proteus*, *Pseudomonas*, or *Citrobacter*, which may be difficult to differentiate from *Salmonella* on selective agars. In positive samples additional biochemical tests are required to identify specific serovar variants.

### DNA Recognition and Immunologic Methods

A variety of rapid *Salmonella* detection methods such as electrical conductance/impedance immunomagnetic separation, ELISA, and DNA probe PCR methods are available. Many of these methods have been developed for the use in human foodstuffs but have not been fully validated for environmental or fecal samples. Samples containing fecal material present a problem for PCR-based methods because of the presence of inhibitors of the PCR reaction in the test sample matrix.<sup>33</sup> In most cases selective or nonselective enrichment stages and DNA extraction techniques are required when using DNA-based methods, resulting in

more steps and operator time for the isolation procedure.

### Serology

#### Serum Enzyme-Linked Immunosorbent Assay

Serologic testing using ELISA tests on serum or milk can be used in herds to identify *S. Typhimurium* or *S. Enteritidis* infections in farm animals and has also been used as a diagnostic aid to identify SD carriers. The test is based on immunoglobulins to the O antigens of the LPS of the organism and is usually designed to detect a limited range of *Salmonella* serovars or serogroups.<sup>33</sup>

*Salmonella* antibody ELISAs are now in routine use and are widely available commercially. The tests can be run on individual blood or milk samples to identify potentially infected individuals or to determine a vaccine response; it can also be used to identify infected herds or flocks by determining the presence or absence of antibody in bulk milk samples.<sup>33</sup> Bulk tank milk testing for antibodies to SD is used as a national screening diagnostic aid in some countries. Using a variety of ELISA tests, muscle fluid samples from cattle taken at slaughter can be used as an alternative to serum to detect antibodies to *Salmonella* polysaccharide.

Serologic results of individual animals should be interpreted cautiously because serologically positive animals may no longer be infected with *Salmonella*. On the other hand, infected and shedding individuals may not have seroconverted. Particularly in regions with low prevalence of *Salmonella* infection the specificity issue means that most positive results will be false.<sup>33</sup> Repeated positive serology in individual animals may, however, be used as a diagnostic aid to selective culling of chronic carrier animals.

#### Laboratory Diagnosis in a Suspected Sick Animal

A positive diagnosis depends on culture of the organism, usually from feces but possibly from blood in the septicemic stage. In case of abortion fetal material and placenta should be submitted for culture. If serologic diagnosis is available a serum sample should also be submitted. Indirect tests are very valuable and, if laboratory availability is good, a total white cell count and estimation of serum sodium levels should be undertaken. A presumptive diagnosis is often all that can be stated, and this may be supported by a herd diagnosis.

#### Herd Diagnosis

A serologic examination of a sample of animals is a first step. A completely negative serologic test would indicate that the infection is not present. Positive results indicate a need for further examination, and periodic fecal cultures at 15-day intervals should be undertaken. When *S. Typhimurium* is the causative bacteria, the feces of other species

of animals on the farm should be examined, because ducks, dogs, horses, pigs, sheep, and cattle may be sources of infection for each other. It is always advisable to examine the drinking water and feed for evidence of infection.

#### Detection of Clinically Normal Carrier Animals

The most difficult diagnostic problem in salmonellosis is the detection of the clinically normal carrier animal. The recommended procedure is to do fecal cultures on all cows at 14-day intervals for three examinations and repeat the examination on the day of calving. At that time, swabs are taken from feces and the vagina of the cow and the feces of the calf. The sampling should preferably be done when the cows are tied in stanchions and not grazing pasture, because of the large number of passive carriers of the infection in the latter circumstance. In horses at least five samples should be submitted for fecal culture as a diagnostic procedure to identify carrier horses to have over 95% confidence that the tested animal is negative for *Salmonella* spp.<sup>21</sup>

The reliability of diagnosis based solely on culture of fecal swabs is not high and represents the major difficulty in detecting carriers. A combination of fecal culture and serologic tests offers some improvement in accuracy, but even with the agglutination or CF tests accuracy is insufficient.

#### Determination of Prevalence of Infection in Population of Animals

In food-producing animals it is particularly important to determine the prevalence of *Salmonella* infection in a population of cattle.

#### NECROPSY FINDINGS Septicemia

There may be no gross lesions in animals that have died peracutely but extensive submucosal and subserosal petechial hemorrhages are usually evident. In some cases the necropsy findings may include splenomegaly and pinpoint white foci in the liver (paratyphoid nodules). The histologic lesions are nonspecific, with the exception of the somewhat granulomatous character of the older paratyphoid nodules. The placentas of cattle and sheep aborting because of *Salmonella* spp. often contain very large numbers of intravascular bacteria.

#### Acute Enteritis

Some of the changes associated with the septicemic form are often present, but the most consistent damage is found in the large and small intestines. The character of the inflammation here varies from a mucoenteritis with submucosal petechiation to diffuse hemorrhagic enteritis. Similar lesions may be present in the abomasum, and in SD infections in calves multiple mucosal erosions and petechiation of the abomasal wall are common. Infections with *S. Typhimurium*

are characterized by severe necrotic enteritis in the ileum and large intestine. The intestinal contents are watery, have a putrid odor, and may contain mucus or whole blood. In cases that have survived for longer periods, superficial necrosis and fibrin exudation may proceed to the development of an extensive diphtheritic pseudomembrane and fibrin casts. The mesenteric lymph nodes are enlarged, edematous, and hemorrhagic. The wall of the gallbladder may be thickened and inflamed.

#### Chronic Enteritis

In cattle, the chronic form is usually manifested by discrete areas of necrosis of the wall of the cecum and colon. The wall is thickened and covered with a yellow-gray necrotic material overlying a red, granular mucosal surface. Less commonly the lesions are discrete in the form of button ulcers, occurring most frequently in the cecum around the ileocecal valve. The mesenteric lymph nodes and the spleen are swollen. In all species, chronic pneumonia and a variety of other localized inflammatory processes such as polyarthritis and osteomyelitis may be found.

*Salmonellas* are present in the heart, blood, spleen, liver, bile, mesenteric lymph nodes, and intestinal contents in both septicemic and acute enteric forms. In the chronic form, the bacteria may be isolated from the intestinal lesions and less commonly from other viscera. Culture is more successful if enrichment media such as tetrathionate broth are used. Surveys that set out to determine the percentage of carriers in animal populations by examining abattoir material show that by far the largest number of isolations are made from the lymph nodes draining the cecum and lower small intestine.

#### Samples for Confirmation of Diagnosis

- Bacteriology: Ileocecal lymph node, ileum, colon, spleen, lung, liver, and culture swab from gall bladder (CULT)
- Histology: Formalin-fixed samples from these tissues plus kidney, stomach, and brain (LM)

Note the zoonotic potential of these organisms when handling carcasses and submitting specimens.

#### DIFFERENTIAL DIAGNOSIS

The clinical diagnosis of salmonellosis is difficult because of the number of other diseases that resemble each form of the disease. Salmonellosis is characterized by septicemia in young animals and acute and chronic enteritis in adults, although acute enteritis can occur in neonates. Thus the septicemic form of the disease must be differentiated from all other causes of septicemia, and the enteric forms

differentiated from all other causes of diarrhea in both young and adult animals. At necropsy the isolation of salmonellas from tissues and intestinal contents, although suggestive of the presence of salmonellosis, does not of itself confirm the diagnosis, and care must be taken to ascertain whether other disease is present.

### Cattle

#### Septicemia

The septicemic form of salmonellosis in calves resembles coliform septicemia, and differentiation is possible only by bacteriological examination of blood, feces, and tissues. Salmonellosis occurs most often during the second and third weeks of life in contrast to coliform septicemia, which occurs most often in the first few days of life. Both are characterized by weakness, depression, polypnea, tachycardia, fever or hypothermia, scleral injection and hemorrhages, diarrhea, and rapid death.

#### Acute enteritis

Acute enteric salmonellosis in adult cattle or calves is characterized by fever, anorexia, toxemia, abdominal pain, diarrhea and dysentery, excessive mucus and fibrinous casts and strands in the feces, and dehydration.

- **Coccidiosis** is most common in young cattle 2–8 months of age and is characterized by diarrhea with frank blood in the feces, tenesmus, only occasionally systemic signs of dehydration and anemia, and spontaneous recovery in a few days; rarely there are nervous signs and death.
- **Acute intestinal obstruction** is characterized by abdominal pain, scant or absent feces, bloodstained feces, tenesmus, anorexia, and palpable abnormalities on rectal examination.
- **Hemorrhagic bowel syndrome** is characterized by acute onset and pronounced abdominal pain associated with signs of systemic disease but no fever. Feces contain large amounts of dark red, partially or entirely clotted blood resembling blackberry jam. The condition typically affects individual adult midlactating cows.
- **Winter dysentery** occurs in explosive outbreaks in housed adult cattle; the feces are gray with flecks of blood, there is no toxemia, no dehydration, and the disease is self-limiting in 24–48 h.
- **Mucosal disease** is characterized by typical oral erosions, anorexia, fever, persistent diarrhea, dehydration, lesions in the interdigital clefts, and a high case–fatality rate.
- **Bracken fern poisoning** is characterized by dysentery, scleral hemorrhages, and a history of access to the bracken plant.
- **Other poisonings**, especially arsenic and to a lesser extent lead and a number of miscellaneous weeds, may cause a similar acute enteritis.

#### Chronic enteritis

Chronic enteric salmonellosis may resemble **paratuberculosis (Johne's disease)** or **chronic molybdenum poisoning**, but

dysentery and epithelial casts do not occur in these diseases. Massive **stomach fluke infestations** may also cause diarrhea and dysentery.

#### Abortion

Abortion caused by salmonellosis requires laboratory examination of the fetus, fetal fluids, vaginal mucus, feces, and milk of the aborting animals.

#### Sheep

Diarrhea associated with infections with coccidia or *Campylobacter* spp. or by parasitic infestation may resemble enteric salmonellosis in sheep, but the latter is usually more acute with a higher fatality rate. *Salmonella*-related abortion requires laboratory examination of the fetus, fetal fluids, vaginal mucus, feces, of the aborting animals.

### Horses

#### Septicemia

Septicemic salmonellosis in foals may resemble the septicemias associated with *Escherichia coli* and *Actinobacillus equuli*.

#### Acute enteritis

Acute enteric salmonellosis in adult horses causes profuse diarrhea, dehydration, severe depression, and weakness. A history of recent transportation often helps in suggesting the diagnosis of salmonellosis in adult horses, in which colitis X is the important differential diagnosis.

**Idiopathic equine colitis X** is a severe enterocolitis of adult horses characterized by profuse diarrhea, marked dehydration, and a high case–fatality rate in spite of intensive fluid therapy. Many cases are considered to be enteric salmonellosis, but the definitive etiological diagnosis is often not obtained.

Other diagnoses that must be considered include:

- **Clostridiosis** caused by *C. perfringens* type A and *C. difficile* may result in peracute hemorrhagic diarrhea, marked dehydration, and rapid death.

#### Chronic enteritis

Chronic diarrhea caused by salmonellosis may resemble **parasitism, granulomatous enteritis, or lymphosarcoma**.

## TREATMENT

### Primary Treatment: Antimicrobial Therapy

The use of antimicrobials for the treatment of clinical salmonellosis is controversial. Concerns with this treatment approach include the risk of creating so-called carrier animals and the selection for AMR particularly when using antimicrobials not only on clinically affected individuals but metaphylactically on a group of exposed animals. Issues are in part derived from experience in human medicine where invasive infection with *Salmonella* is uncommon and antimicrobial therapy is discouraged.<sup>23</sup> However, bacteremia is frequently encountered in cattle with acute enteritis, and septicemia is

a feature of clinical salmonellosis in foals, calves, and lambs. In acute cases of clinical salmonellosis with suspected or confirmed bacteremia it would be professionally negligent not to treat affected animals with appropriate antimicrobials. There is indeed evidence that antimicrobials can prolong the duration of the period after clinical recovery from acute and in particular from chronic enteritis in humans and animals during which the causative bacteria can be isolated from the intestine. It is accepted that this can occur and that the use of antimicrobials may contribute to the spread of disease.

Another related issue is the creation of drug-resistant strains. The problem with resistant strains would not have become a significant one if only individual animals had been treated, but mass medication of in-contact animals and prophylactic treatments have generally resulted in a large population of resistant strains.

Oral treatment in cattle and pigs is recognized as a satisfactory treatment, but it is not recommended in horses in which an immediate worsening of the diarrhea, or its prolongation as a persisting chronic diarrhea, may be encountered. It is thought that both sequelae result from an alteration of the normal population of intestinal microflora resulting from the 8 to 10 times greater concentration of drug that occurs in the intestine after oral treatment, compared with the concentration resulting from parenteral injection.

If antimicrobial therapy is considered, the choice of antimicrobials should be based on antimicrobial susceptibility testing whenever this is possible. Because salmonellas are facultative intracellular pathogens, it is critical to choose an antimicrobial with good tissue penetration that attains adequate intracellular concentrations.

### Ruminants

Currently many countries lack antimicrobials labeled for treatment of bovine salmonellosis. In cases of acute and severe disease in which antimicrobial therapy is most appropriate and treatment cannot be delayed, broad-spectrum antibiotics are often used because of the considerable turnaround time of bacterial culture and susceptibility testing in the case of *Salmonella*. As a result, treatment of salmonellosis in cattle is largely empirical, and extralabel use of certain antimicrobials is common in veterinary practice.

*Salmonella* spp. are gram-negative bacteria that are generally resistant to penicillin, erythromycin, and tylosin. Resistance to other antimicrobials such as ampicillin, amoxicillin, ceftiofur, florfenicol, sulfonamides, ceftiofur, trimethoprim-sulfas, and tetracyclines is variable.<sup>16,23</sup> Multidrug resistance is encountered more often in strains isolated from calves than from adult cows.<sup>16</sup>

Historically ampicillin, chloramphenicol, and trimethoprim-sulfas have been widely



used for the treatment of salmonellosis in cattle, but with resistance to these compounds becoming increasingly common and food safety concerns with the use of chloramphenicol in food-producing animals the use of ceftiofur has become more common, particularly in the United States. Chloramphenicol is now banned for use in food-producing animals in many countries. Nitrofurazone given orally to calves and adult cattle was commonly used for the treatment of salmonellosis but is now similarly banned. In countries where it is permitted fluoroquinolones are widely used for the treatment of clinical cases. The use of third- and fourth-generation cephalosporins and fluoroquinolones that are considered critically important antimicrobial agents in human and veterinary medicine for veterinary use is, however, discouraged by the World Organization of Animal Health (OIE); the use of these compounds should be limited to cases in which resistance to other antimicrobials is confirmed or at least must be assumed.

### Horses

As in other species antimicrobial therapy in horses infected with *Salmonella* is controversial. Although antimicrobials are indicated in cases of bacteremia or septicemia as it occurs in foals, their efficacy for the treatment of enterocolitis or healthy shedders is questionable. In any case the choice of an antibiotic should be based on drug sensitivity of the organisms isolated whenever possible. Based on some studies of isolates from horses, gentamicin at 3 mg/kg BW combined with ampicillin at 20 mg/kg BW given intravenously at 8- to 12-hour intervals has been recommended. An alternative is trimethoprim-sulfonamide given twice daily intravenously at a combined dose of 30 mg/kg BW or ceftiofur at 2 to 4 mg/kg BW, twice daily. Sulfadiazine, sulfadoxine, and sulfamethoxazole are the best sulfonamides to combine with trimethoprim for salmonellosis in the horse. Care needs to be exercised when treating adult horses for salmonellosis because of the tendency for antimicrobials, especially tetracyclines, to precipitate attacks of diarrhea.

Foals with septicemic salmonellosis are usually treated both systemically and orally with antimicrobials, sometimes a different one by each route. Treatment must be given at least at 6-hour intervals and accompanied by a supportive fluid therapy. Antimicrobials recommended include gentamicin, ampicillin, sulfonamide combinations, and chloramphenicol.

### Supportive Therapy

Supportive therapy includes the use of oral electrolyte solutions and polyionic ion fluids administered intravenously to replace fluid and correct electrolyte and acid-base imbalances (see Chapter 5).

NSAIDs have been recommended to alleviate endotoxin-related symptoms, control

pain, and possibly prevent the risk of laminitis in horses. Maintaining adequate hydration is particularly important when using NSAIDs that decrease renal perfusion and may become nephrotoxic in dehydrated individuals. Prolonged use of NSAIDs has been associated with gastric/abomasal ulceration in different species and colonic ulceration in horses. Their use should therefore be limited in time and at the lowest possible dose.

### TREATMENT

#### Antimicrobial therapy in cases of suspected/confirmed bacteremia

The use of antimicrobials for the treatment of chronic enteritis or healthy shedders is highly controversial.

#### Cattle/calves

Trimethoprim-sulfonamide (20 mg combined/kg IV/IM every 12–24 h) (R2)

Amoxicillin (10 mg/kg IM every 12 h) (R2)

Amoxicillin-clavulanate (12 mg combined/kg IM every 12 h) (R2)

Ampicillin (10 mg/kg PO/IM every 12 h) (R2)

Enrofloxacin\* (2.5–5.0 mg/kg SC/IM every 24 h) (R2)

Ceftiofur\* (1.1–2.2 mg/kg BW every 24 h SC/IM for 3 days) (R2)

#### Horses/foals

Trimethoprim-sulfonamide (30 mg combined/kg IV/IM/PO every 12 h) (R2)

Ampicillin (20 mg/kg IV/IM every 8–12 h) (R2)

Amoxicillin trihydrate (20 mg/kg IM every 12 h) (R2)

Ceftiofur\* (2–4 mg/kg every 24 h SC) (R2)

Fluoroquinolones\* (R3)

#### Foals

Gentamicin 6.6 mg/kg IV every 24 h or 4.4 mg/kg IV every 12 h, ensure adequate hydration (R2)

Chloramphenicol (50 mg/kg IV every 6–8 h) (R2)

#### Antiinflammatory therapy

Flunixin meglumine (2.2 mg/kg IV as a single dose) (R2)

Meloxicam (0.5 mg/kg SC/IV as a single dose) (R2)

#### Fluid therapy

Oral and parenteral fluid therapy to substitute water and correct acid-base and electrolyte imbalances<sup>†</sup>

IM, intramuscularly; IV, intravenously; PO, orally; SC, subcutaneously.

\*Are classified as critically important antimicrobials in human and veterinary medicine. Use as first line treatment is discouraged.

### CONTROL

#### Prevention of Introduction of Infection (Biosecurity)

Avoidance of infection is the major objective but is not easily achieved. The principal sources of infection are carrier animals and

contaminated feeds containing foodstuffs of animal origin. There is a critical need to develop methods to control the spread of *Salmonella* infections on dairy farms by instituting biosecurity and biocontainment practices in addition to enhanced farm management. This would result in a reduction in the use of excessive antibiotic treatment of individual animals or herds.

A closed herd minimizes the risk of infection but is not a practicable procedure for the types of animal producer (the calf-rearer and the commercial pig fatterer) for which salmonellosis is a major problem. For such producers the following rules apply:

- Introduce the animals directly from the farm of origin. Avoid auction marts, saleyards, and public transport, all of which are likely to be sources of infection. Ensure that the farm of origin is free of salmonellosis.
- If possible, purchase animals when they are older, such as 6 weeks of age for calves, to provide an opportunity for specific and nonspecific immunity to develop. Animals from vaccinated herds are desirable.
- The premises of dealers, saleyards, and transport vehicles must be under close surveillance and the need for frequent vigorous disinfection must be stressed. The infection rate in calves delivered to calf-dealers' yards in the UK was less than 1%, but the infection rate increased to 36% if the calves were kept on the premises over the weekend.
- Introduce only those animals likely not to be carriers. Unfortunately the detection of carriers is inaccurate and expensive. To have any confidence in the results, fecal samples for culture must be submitted on at least three occasions. Even then, occasional carriers with lesions in the gallbladder or tonsils will escape the net and be capable of reviving the disease on the farm or transferring it to another one.

Management practices to reduce the risk of *S. Brandenburg* on a sheep farm include reducing stocking density; avoiding strip grazing; maintaining adequate nutrition; minimizing yarding of ewes and the time spent in yards; dampening down yards before yarding; providing stock with a fresh clean source of drinking water; avoiding the purchase and/or grazing of stock from known affected farms, as they may contain carrier animals; preventing dogs from scavenging; and preventing scavenging by black-backed gulls by removing and burying aborted fetuses frequently during the lambing season.

#### Limitation of Spread Within a Herd

When an outbreak occurs, procedures for limiting spread, as set out next, need to be strictly enforced, and medication of affected groups, and of susceptible groups at high risk, must be performed.

- **Identify carrier animals and either cull them or isolate and treat them vigorously.** Treated animals should be resampled subsequently to determine whether a “clean” status has been achieved.
- **The prophylactic use of antimicrobials is used but not recommended** because results are poor and there is a risk of developing resistant strains. Probiotics intended for the prevention of shedding of *Salmonella* in the postoperative period in horses with colic have been evaluated and found to be ineffective.
- **Restrict the movement of animals around the farm** and limit the infection to the smallest group. Pasture and permanent buildings are both important, although the major source of infection in most cases is the drinking water.
- **The water supply should be provided in troughs that are not susceptible to fecal contamination.** Static drinking water or pasture may remain infected for as long as 7 months.
- **Rigorous disinfection of buildings is important.** An all-in/all-out policy should be adopted and steam cleaning and disinfection performed after each batch of animals. If economics permit, individual pens for calves are beneficial. Where calves are reared indoors they are common and economical. Dirt yards present a problem, especially those used for sheep and calves, but, provided they can be kept dry and empty, two sprayings, 1 month apart, with 5% formalin is recommended.
- **The control of salmonellosis in veterinary clinics and veterinary teaching hospitals** requires special attention to the possible sources of infection and containing and preventing the spread of infection. Following the diagnosis of the disease in a clinic, an environmental survey should be performed using bacteriologic culturing of stalls, wall padding, stomach pumps, nasogastric tubes, alleyways, water drains, and other equipment used routinely. This is followed by a thorough cleaning and disinfection of the entire animal-holding premises. The surfaces are then recultured to determine the presence of residual contamination. Medical and surgical equipment are cleaned and sterilized. Traffic flow patterns in the clinic are reviewed and modified accordingly. Use of disposable gloves and thorough washing of hands after handling suspect animals are recommended. Stalls in which horses with salmonellosis were housed should only be used to accommodate newly hospitalized horses after samples (collected after two cycles of cleaning and disinfection) from stall drains, cracks, and corners yield negative results

on bacteriologic culture. Using PCR assay for *Salmonella* DNA, samples from floor drains and drainpipes yield the greatest proportion of positive results. The PCR results should be confirmed by bacteriologic culture, because a positive PCR in itself is not considered to pose a risk of salmonellosis to hospitalized horses. When a hospitalized horse leaves its stall permanently, it should be cleaned of organic matter using a cold water hose and scrubbed with a steel wool mop. This is followed by an application of generic bleach solution. This is then followed 24 hours later by another cleaning and disinfection with a peroxygen solution (Virkon) and allowed to dry. Virkon is a balanced stabilized blend of peroxygen compounds, surfactants, organic acids, and inorganic buffer system. Active ingredients are potassium peroxymonosulfate, sodium chloride, and other ingredients. It is effective against a wide range of bacteria, virus, and fungi, including: *S. pyogenes*, *C. pyloridis*, *Klebsiella pneumoniae*, *E. coli*, and *S. Typhimurium*.

- **Suitable construction of housing is important.** Impervious walls to stop spread from pen to pen, pen design to permit feeding without entering the pen, avoidance of any communal activity, and slatted floors to provide escape routes for manure all assist in limiting the spread of enteric diseases. Pen design and the environment should be such as to encourage proper eliminative behavior and good pen hygiene. Drinkers should be sited at one end of the pen, preferably on a narrow end with oblong pens, to encourage defecation in this area. Wet or damp areas of the floor in other parts of the pen will encourage defecation and urination there and should be eliminated. Drinkers of the nipple type rather than bowls are preferable for hygienic reasons. Communal dunging alleys increase the possibility of spread, especially during the cleaning procedure, and the trend is toward slatted or meshed areas over a channel.
- **Disposal of infective material should be done with care.** Carcasses should be burned or, better still, sent to an institution for diagnosis, rather than to a rendering plant to be converted into still more contaminated bonemeal. Slurry and manure for disposal should be placed on crops rather than on pasture. Slurry does not constitute a danger via hay, and salmonellas do not survive silage making. When slurry is used on pasture it should be stored for at least a month beforehand and even longer if silo effluent is included. Slurried pasture should not be grazed for 1 month, and

for young animals a 6-month delay is recommended. Pig slurry is most dangerous and should always be avoided.

- **All persons working on infected premises should be warned of the hazards to their own health.** Other peripartetic species, especially dogs, should be kept under close restraint.

### Principles of Infectious Disease Control for Prevention of Nosocomial Gastrointestinal and Respiratory Diseases in Large-Animal Hospitals

The principles of an IDC program for the prevention of gastrointestinal and respiratory diseases in a large-animal hospital have been described and are applicable to the control of salmonellosis. The three basic strategies are reducing exposure to pathogens, avoiding increasing susceptibility to pathogens, and monitoring effectiveness of the IDC program. The major procedures are summarized here.

#### Reducing Exposure to Pathogens

- Promoting appropriate personal hygiene
- Using effective methods for cleaning and disinfection
- Controlling the flow of human and animal traffic
- Implementing protocols for prompt identification of patients with signs of contagious disease
- Controlling birds, rodents, and flies

#### Avoiding Increasing Susceptibility to Pathogens

- Controlling ambient temperature
- Using antimicrobials appropriately
- Aiding in establishing normal intestinal or rumen flora
- Controlling endotoxemia

#### Monitoring Effectiveness of the Infectious Disease Control Program

- Bacterial culture of fecal samples of animals admitted to the hospital
- Regular culture of environmental samples.

### Recommended Steps in Developing an Effective Infectious Disease Control Program for a Large-Animal Hospital

An effective IDC program is necessary for all large-animal veterinary teaching hospitals and private veterinary clinics. The recommended steps are outlined here.

- Have all clinicians work together to develop and approve the IDC program, because grassroots buy-in is vital.
- Develop a specific, written IDC program and disseminate it widely among staff members.
- Identify a veterinarian who is active in the large-animal hospital to serve as the IDC officer; this individual will oversee

the IDC program and should report to the hospital director and practice partners.

- Provide the resources, both human and monetary, needed for the IDC officer to effectively perform the approved IDC program; prevention costs less than the alternatives.
- Make students, residents, and staff aware of the key points of the IDC program and the importance that clinicians place on compliance.
- Teach the barn crew, particularly those actually responsible for cleaning, disinfecting, and feeding, about the goals of the IDC program and the methods to be used.
- Monitor the effectiveness of cleaning and sanitation by means of bacterial culture of environmental samples and give regular feedback to the barn crew, staff, students, and clinicians.
- Hold a seminar at least yearly to distribute written information about the IDC program and results of monitoring.

### Animals Being Transported

Animals being transported are a special case. They should be unloaded or exercised at least once every 24 hours and given water and feed, with the feed provided first and at least 2 hours before watering. Hay or chopped hay is preferred to succulent feeds. All railroad cars and feeding and watering troughs should be properly cleaned and disinfected between shipments. Horses that are to be transported should be yarded and hand-fed on hard feed for 4 to 5 days beforehand. If the disease is likely to occur, prophylactic feeding with sulfonamides or antimicrobials has been shown to decrease the incidence in all species. Apart from the risk that this practice will produce resistant bacteria, there has been a suggestion that it may so change the normal bacterial flora of the gut as to encourage the proliferation of salmonellas and lead to the development of the clinical disease.

### Immunization

#### *Salmonella* Vaccinology

Host resistance to *Salmonella* relies initially on the production of inflammatory cytokines leading to the infiltration of activated inflammatory cells in the tissues. Thereafter, T- and B-cell-dependent specific immunity develops, allowing the clearance of *Salmonella* from the tissues and the establishment of long-lasting acquired immunity to reinfection. The increased resistance that develops after primary infection or vaccination requires T-cells, cytokines such as IFN- $\gamma$ , TNF, and IL-2, in addition to opsonizing antibody. Seroconversion and/or the presence of detectable T-cell memory do not always correlate with the development of acquired resistance to infection.

Long-term immunity using live attenuated vaccines is serotype specific and involves the recall of immunologic immunity. Killed vaccines induce strong antibody responses but trigger insufficient Th1-cell responses.

Vaccination can decrease the number of bacteria shed in feces and the number of blood-culture-positive calves, thus decreasing the number of carriers and reducing environmental contamination. Many types of vaccines have been developed and tested in cattle and pigs. If vaccination is combined with the hygienic precautions described, the vaccines are an aid to management. Killed bacterins and live attenuated vaccines are available. Either can be used as a prenatal vaccine to provide passive immunization of the newborn. It is now generally accepted that live *Salmonella* vaccines are more effective immunogens in calves than are killed vaccines.

#### Cattle

In cattle, SD is the infection likely to be endemic in a herd and a commercial vaccine, to be effective, must have a strong SD component. Live organisms are better able to stimulate anti-LPS antibodies and to stimulate cell-mediated immunity. Calves vaccinated at 1 to 3 weeks of age with a modified-live aromatic-dependent SD bacterin have detectable anti-LPS immunoglobulins after immunization. Safe live oral vaccines against *S. Typhimurium* and SD have been constructed and shown to confer protection against experimental infection with virulent wild-type strains of the organism. Vaccination of calves orally with a genetically altered stable nonreverting aro-SD as a modified-live vaccine provided a measurable systemic immune response, but the vaccine volume makes it unlikely to be practical for field use. Vaccinated calves responded with increases in humoral-mediated and cell-mediated immunity, as measured by ELISA and skin testing. It is claimed that the combination of humoral immunity and cell-mediated immunity stimulated by live-organism vaccines provides superior protection. Other genetically altered vaccines consisting of hybrid strains derived from SD and *S. Typhimurium* are being evaluated. An avirulent live SCS vaccine is efficacious experimentally against salmonellosis caused by SD infection in calves.

The vaccine strain 51, produced in the UK from a rough variant strain of this organism, has been found to be efficient and safe and provides good protection against *S. Typhimurium* as well as SD. It has the disadvantages of a living vaccine, but calves can be vaccinated successfully at 2 to 4 weeks of age. In limited experiments other living, attenuated, and killed, adjuvanted vaccines have given calves protection, and a comprehensive program of vaccination, hygiene, and adoption of a closed herd policy has been successful in controlling the disease. Reports on

killed *S. Typhimurium* vaccines used in calves indicated good results provided the antigenic mass in the vaccine is kept high, but commercial killed vaccines are of doubtful value.

Attenuated *S. Typhimurium* (strain SL1479) given orally or intramuscularly has shown good efficiency, and attenuated SD (strain SL1438) has been similarly effective. The *S. Typhimurium* vaccine also gives some protection against SD.

The autogenous bacterin, which must be precipitated on aluminum hydroxide to have any significant effect, is given as two injections 2 weeks apart. Good immunity is produced but calves and pigs less than 6 weeks of age are refractory, and anaphylactic reactions may cause the loss of a significant number of animals. To protect young calves the best program is to vaccinate the cows during late pregnancy. This will give passive protection to the calves for 6 weeks, provided they take sufficient colostrum, and the calves can be vaccinated at that time if danger still exists. Vaccination of pregnant cattle with a formalin-killed *S. Typhimurium* vaccine approximately 7 weeks and then 2 weeks before parturition protected their calves against experimental infection. Reports of results have not been enthusiastic, but if proper attention is given to the detail of the program it has been sufficient, in the author's hands, to provide almost complete protection. A similar observation has been made with respect to vaccination of calves against *S. Typhimurium*.

#### Horses

In horses, a similar regimen with a booster dose for all mares in late pregnancy appears to be effective. In foals, an autogenous *S. Typhimurium* bacterin has been used in several bad field situations and has been credited with preventing further clinical cases and with reducing environmental contamination, in spite of continued poor hygiene and management practices.

#### Sheep

Results in sheep have been unconvincing. Some live *S. Typhimurium* vaccines are being evaluated for their efficacy against salmonellosis in sheep.

### FURTHER READING

- Akkina JE, Hogue AT, Angulo FJ, et al. Epidemiologic aspects, control, and importance of multiple-drug resistant *Salmonella typhimurium* DT 104 in the United States. *J Am Vet Med Assoc.* 1999;214:790-798.
- Wallis TS, Galyov EE. Molecular basis of *Salmonella*-induced enteritis. *Mol Microbiol.* 2000;36:997-1005.
- Liebana E. Molecular tools for epidemiological investigations of *S. enterica* subspecies *enterica* infections. *Res Vet Sci.* 2002;72:169-175.
- Smith BP, House JK, Magdesian KG, et al. Principles of an infectious disease control program for preventing nosocomial gastrointestinal and respiratory tract diseases in large animal veterinary hospitals. *J Am Vet Med Assoc.* 2004;225:1186-1195.



## REFERENCES

- Grimont PAD, Weill FX. At: <<http://www.pasteur.fr/ip/portal/action/WebdriveActionEvent/oid/01s-000036-089>>; 2007 Accessed 01.12.15.
- OIE. At: <[http://www.oie.int/fileadmin/Home/eng/Health\\_standards/tahm/2.09.09\\_SALMONELLOSIS.pdf](http://www.oie.int/fileadmin/Home/eng/Health_standards/tahm/2.09.09_SALMONELLOSIS.pdf)>; 2010 Accessed 01.12.15.
- Stevens MP, et al. *Phil Trans R Soc B*. 2009;364:2709-2723.
- USDA-APHIS. At: <[http://www.aphis.usda.gov/animal\\_health/nahms/dairy/downloads/dairy07/Dairy07\\_is\\_SalCampy.pdf](http://www.aphis.usda.gov/animal_health/nahms/dairy/downloads/dairy07/Dairy07_is_SalCampy.pdf)>; 2009 Accessed 01.12.15.
- Dodd CC, et al. *Foodborne Pathog Dis*. 2011;8:781.
- EFSA. *EFSA Journal*. 2011;9(3):2090.
- Vanselow BA, et al. *Aust Vet J*. 2007;85:498-502.
- Cummings KJ, et al. *J Am Vet Med Assoc*. 2009;234:1578.
- USDA-APHIS. At: <[http://www.aphis.usda.gov/animal\\_health/nahms/sheep/downloads/sheep11/Sheep11\\_is\\_Salmonella.pdf](http://www.aphis.usda.gov/animal_health/nahms/sheep/downloads/sheep11/Sheep11_is_Salmonella.pdf)>; 2011 Accessed 01.12.15.
- Yang R, et al. *Vet J*. 2012;202:250.
- Duffy U, et al. *Aust Vet J*. 2010;88:399.
- Cagiola M, et al. *Vet Microbiol*. 2007;121:330.
- Wirz-Dittus S, et al. *Prev Vet Med*. 2010;97:126.
- Traub-Dargatz JL, et al. *J Am Vet Med Assoc*. 2000;217:226.
- Münch S, et al. *Trop Anim Health Prod*. 2012;44:1725.
- Cummings KJ, et al. *J Dairy Sci*. 2009;92:3766.
- AHVL. At: <[https://www.gov.uk/government/uploads/system/uploads/attachment\\_data/file/348959/pub-salm13-chp2.pdf](https://www.gov.uk/government/uploads/system/uploads/attachment_data/file/348959/pub-salm13-chp2.pdf)>; 2014 Accessed 01.12.15.
- FLI. At: <[http://www.fli.bund.de/fileadmin/dam\\_uploads/jahresberichte/TG-JB/TGJB\\_2012.pdf](http://www.fli.bund.de/fileadmin/dam_uploads/jahresberichte/TG-JB/TGJB_2012.pdf)>; 2013 Accessed 01.12.15.
- Izzo MM, et al. *Aust Vet J*. 2011;89:402.
- AHVL. At: <[https://www.gov.uk/government/uploads/system/uploads/attachment\\_data/file/348960/pub-salm13-chp3.pdf](https://www.gov.uk/government/uploads/system/uploads/attachment_data/file/348960/pub-salm13-chp3.pdf)>; 2013 Accessed 01.12.15.
- Ekiri AB, et al. *J Am Vet Med Assoc*. 2009;234:109.
- AHVL. At: <[https://www.gov.uk/government/uploads/system/uploads/attachment\\_data/file/348962/pub-salm13-chp5.pdf](https://www.gov.uk/government/uploads/system/uploads/attachment_data/file/348962/pub-salm13-chp5.pdf)>; 2013 Accessed 01.12.15.
- Mohler VL, et al. *Vet Clin Food Anim*. 2009;25:37.
- Ibarra JA, Steele-Mortimer O. *Cell Microbiol*. 2009;11:1579.
- Stevens MP, et al. *Philos Trans R Soc Lond B Biol Sci*. 2009;364:2709.
- CMO. At: <[https://www.gov.uk/government/uploads/system/uploads/attachment\\_data/file/138331/CMO\\_Annual\\_Report\\_Volume\\_2\\_2011.pdf](https://www.gov.uk/government/uploads/system/uploads/attachment_data/file/138331/CMO_Annual_Report_Volume_2_2011.pdf)>; 2011 Accessed 01.12.15.
- AHVL. At: <[https://www.gov.uk/government/uploads/system/uploads/attachment\\_data/file/348969/pub-salm13-chp12.pdf](https://www.gov.uk/government/uploads/system/uploads/attachment_data/file/348969/pub-salm13-chp12.pdf)>; 2013 Accessed 15.12.15.
- Mather AE, et al. *Science*. 2013;431:1514.
- Zhao S, et al. *Vet Microbiol*. 2007;123:122.
- EFSA. USDA 2013. At: <<http://www.ers.usda.gov/topics/food-safety/foodborne-illness/readings.aspx>>; 2011 Accessed 15.12.15.
- CDC. At: <<http://www.cdc.gov/foodborneburden/PDFs/pathogens-complete-list-01-12.pdf>>; 2013 Accessed 01.12.15.
- Government of Australia. At: <[http://archive.agric.wa.gov.au/objtwr/imported\\_assets/content/pw/ah/dis/salmonellosis%20of%20sheep%20factsheet.pdf](http://archive.agric.wa.gov.au/objtwr/imported_assets/content/pw/ah/dis/salmonellosis%20of%20sheep%20factsheet.pdf)>; 2013 Accessed 01.12.15.
- OIE. At: <[http://www.oie.int/fileadmin/Home/eng/Health\\_standards/tahm/2.09.09\\_SALMONELLOSIS.pdf](http://www.oie.int/fileadmin/Home/eng/Health_standards/tahm/2.09.09_SALMONELLOSIS.pdf)>; 2010 Accessed 01.12.15.

## ACUTE UNDIFFERENTIATED DIARRHEA OF NEWBORN FARM ANIMALS (PARTICULARLY CALVES AND PIGLETS)

Diarrhea in newborn farm animals, particularly calves under 30 days of age and piglets in the first week of life, is one of the most common disease complexes that the large-animal clinician encounters in practice. It is a significant cause of economic loss in cattle and pig herds and continues to assume major importance as livestock production becomes more intensified. Considerable progress has been made in the treatment of the effects of diarrhea, such as dehydration and acidemia, but less so in the control of these disease complexes.

The causes of calf and piglet diarrhea are complex and usually involve an interaction between enteropathogenic bacteria, viruses, protozoa, the colostral immunity of the animal, and the effects of the environment (Table 7-27). Thus the term **acute undifferentiated diarrhea of newborn calves** is used to describe the type of acute diarrhea that occurs in newborn calves under 30 days of age, characterized clinically by acute profuse watery diarrhea, progressive dehydration, acidemia, and death within days, or earlier if not treated. Based on clinical findings alone, it is not usually possible to differentiate between the common known causes of diarrhea in newborn calves, which include ETEC, enteropathogenic (attaching and effacing) *E. coli* (EPEC), necrotogenic *E. coli*, rotavirus, coronavirus, bovine torovirus (Breda virus), norovirus, *Cryptosporidium* spp., *Giardia* spp., and *Salmonella* spp. The

common necropsy findings are dehydration, emaciation, and a fluid-filled intestinal tract, with no other obvious gross lesions. The exceptions are enteritis associated with *Salmonella* spp., *C. perfringens* types B and C, *Eimeria* spp., and EPEC, in which there are usually typical gross lesions at necropsy.

Thus the disease is considered to be a complex syndrome because one or any combination of more than one of the specific etiologic agents is isolated in clinical cases. **Animal and environmental risk factors** play an important predisposing role in the development of clinical disease, and disease may not occur or may occur with lower incidence and/or severity in absence of such predisposing factors.

### RISK FACTORS

Many interrelated risk factors have been associated with increased incidence of calf diarrhea and have added to the difficulty of understanding the complexity of the disease and controlling it. The identification and modification or removal of these risk factors can be very effective in the clinical management and control of epidemics of the disease.

### Animal Risk Factors

The host risk factors, some of which are interrelated, include the following:

- Primiparous dam (higher risk of dystocia, lower quality of colostrum ...)
- Immaturity/low birth weight of the neonate
- Difficult birth (mechanical trauma, asphyxia, acidemia, and impaired vigor)
- FTPI

**Table 7-27** Differential diarrhea: Most likely causes of acute neonatal diarrhea in farm animals

Calves	Piglets	Lambs and kids	Foals
<b>Acute neonatal diarrhea</b>			
Enteropathogenic and enterotoxigenic <i>Escherichia coli</i>	Enteropathogenic <i>E. coli</i>	<i>C. perfringens</i> type C	Foal-heat diarrhea
Rotavirus	<i>Salmonella</i> spp.	<i>C. perfringens</i> type B	Rotavirus
Coronavirus	Transmissible gastroenteritis virus	(lamb dysentery)	<i>C. perfringens</i> type B
Bovine torovirus (Breda virus)		Rotavirus	
Bovine calicivirus	<i>C. perfringens</i> type C (rarely A)	Caprine herpesvirus	
Bovine norovirus			
<i>Cryptosporidium</i> spp.	<i>C. difficile</i>		
<i>Giardia</i> spp.	Rotavirus		
<i>Salmonella</i> spp.	PRRSV		
<i>Eimeria</i> spp. (calves at least 3 weeks old)	<i>Isospora</i> spp.		
<i>Clostridium perfringens</i> type C			
PRRSV, porcine reproductive and respiratory syndrome virus.			

- Nutrition of the pregnant dam (reduced quantity and altered nutrient content of colostrum)
- Litter size (increased morbidity and mortality with increasing litter size in piglets)
- Disease of the dam around or after parturition (e.g., mastitis–metritis complex in sows)

### Colostrum

The role of colostrum in protecting the newborn calf from infectious disease in early life cannot be overemphasized. The failure of the neonate to ingest an adequate quantity of colostrum containing a high level of colostral immunoglobulin within a few hours after birth is a major risk factor contributing to development of diarrhea and other infectious diseases. Complete or partial FTPI occurs with an incidence of between 5% and over 20% in different farm animal species, with highest incidence rates in dairy calves (see also Failure of transfer of colostral immunoglobulins (transfer of passive immunity) in Chapter 19).

Causes for FTPI can be various and include impaired vigor of the calf with low drive to suck (e.g., immaturity, acidemia, asphyxia, birth-related trauma), inadequate immunoglobulin content of colostrum (e.g., colostrum leaking before calving, colostrum collected later than 6 hours after calving), inadequate volume of colostrum available to the calf (e.g., agalactia, mastitis, poor mothering skills of the dam), or delayed ingestion of colostrum.

Cases of diarrhea caused by specific **nutritional deficiencies** are reported rarely and not well documented. However, field observations indicate that outbreaks of diarrhea in suckling beef calves may have been associated with specific nutrient deficiencies such as copper or selenium. These are not documented but should be considered in certain situations in which these deficiencies are known to be present in the herd. An epidemic of intractable diarrhea in 2-month-old beef calves was associated with deficient tissue and plasma levels of vitamin E in the affected calves, which also had lesions of skeletal and myocardial muscular dystrophy with adequate levels of selenium. An inadequate supply of vitamin E and  $\beta$ -carotene to the neonate though colostrum from dams that were vitamin E and  $\beta$ -carotene deficient during late gestation has been incriminated as a predisposing factor for neonatal diarrhea in dairy calves.<sup>1</sup> A combination of low vitamin E status and low immunoglobulin status may contribute to neonatal diarrhea by impairing the immune cell function of calves, but this is not well documented.

### Environmental and Management Risk Factors

A number of environmental and management risk factors have been identified as predisposing diarrhea in different farm animal species and different production systems.

**Table 7-28** Calf diarrhea risk factors: Risk factors and their role in acute undifferentiated diarrhea of newborn calves

Risk factor	Role of risk factor
Colostral immunity of calf	Low levels of serum immunoglobulins render calves highly susceptible to death from diarrhea.
Dystocia	Calves born at a difficult calving were at increased risk of developing and dying of diarrhea.
Parity of dam	Calves born from heifers may not acquire sufficient levels of colostral immunoglobulins.
Residence time in maternity pen (dairy)	Dairy calves remaining in the maternity pen with their dam for longer than 24 h were found to be at increased risk of developing diarrhea, presumably caused by longer exposure to pathogens and/or lower amounts of ingested colostrum.
Group housing (versus hutches)	Calves housed in groups were at higher risk of developing diarrhea, presumably because of facilitated fecal–oral transmission of pathogen.
Overcrowding	Increased population density increases infection rate and high morbidity and mortality.
Preventive antimicrobial use	Calves with adequate colostrum supply were at higher risk of developing diarrhea when treated preventively with medicated milk replacer. <sup>12</sup>
Meteorological	Changes in weather; wet, windy, and cold weather commonly precedes outbreaks of diarrhea in beef calves; higher mortality in dairy calves exposed to hot environmental temperatures; high environmental temperatures precipitate outbreaks
Quality of diet	Heat denatured skim milk used in milk replacers is less digestible than whole milk and precipitates diarrhea.
Calf rearer	The concern and care provided by the calf rearer will have a direct effect on morbidity and mortality associated with diarrhea.
Herd size	Conflicting reports over the effect of herd size on the incidence rate of calf diarrhea and calf mortality have been published.

### Calves

A wide range of management practices from housing and feeding of the pregnant dam, to over calving management, to calf housing and feeding have been associated with an increased risk of enteric disease in dairy calves (Table 7-28).

#### *Nutrition of the Dam in the Preparturient Period*

Nutrient deficiencies in cows during the late trimester of pregnancy have been associated with decreased birth weights and impaired efficiency of intestinal IgG absorption of the calves born to cows fed a protein deficient diet.<sup>2,3</sup> Although little effect of the dam's nutrition on the colostral immunoglobulin content has been reported,  $\beta$ -carotene and tocopherol deficiency of the dam during late gestation was associated with deficiency of these substances in their calves. Because deficiencies in  $\beta$ -carotene and tocopherol were more common in herds with high incidence rates of neonatal diarrhea, this has been incriminated as a potential predisposing factor.<sup>1,4</sup>

#### *Calving Management: Dairy*

The calving management has a great impact on the calf's health and development during the neonatal period and beyond. Calves born in a separate maternity facility are at decreased risk of developing neonatal

diarrhea compared with calves born in regular stalls (either stanchion or free stalls),<sup>5</sup> and calves born in individual maternity pens had a lower risk of diarrhea than animals born in a group maternity pen.<sup>6</sup> Prolonged residence time of the neonate in the maternity pen (over 24 hours) was associated with increased risk of diarrhea and calf mortality. These effects have been attributed to differences in exposure to pathogens and differences in colostrum intake associated with the different management systems.

The degree of calving supervision and quality of obstetric care also affects the disease incidence in neonatal calves. Lack of calving supervision can lead to prolonged calvings resulting in more severe acidemia and asphyxia, which will impair the calf's vigor in early life. Good obstetric technique will reduce stress and reduce the risk of birth-related trauma in dams and calves.<sup>5</sup>

#### *Calving Management: Beef*

Crowding of maternity or wintering lots and calving cows and heifers on the same grounds is considered an important risk factor for calf diarrhea in cow–calf operations. A decrease in the surface of the effective calving yard per cow is generally associated with poor drainage and wetness and results in increased pathogen exposure. Similarly, the odds of diarrhea occurring in calves born toward the end of the calving season are twice that of

calves born in the first part of the calving season. This also may be because of increased pathogen exposure as the calving season progresses.

#### *Colostrum Management: Dairy*

Although in most farm-animal species adequate colostrum intake can be anticipated in the large majority of spontaneously delivered healthy neonates, this is not the case in dairy calves. Numerous studies have demonstrated that a considerable number of calves allowed to voluntarily nurse from their dam after birth suffer from FTPI, which is the major risk factor for diarrhea and other neonatal infectious diseases (see also Failure of transfer of passive immunity).<sup>4,6</sup> Assuring adequate colostrum intake in a timely manner by separating the calf from its dam and hand-feeding colostrum is associated with significantly lower rates of FTPI and a significantly lower risk of neonatal diarrhea.

Other colostrum management practices that can affect the occurrence of disease are avoiding fecal contamination during collection, pasteurization of colostrum, and proper storage.

#### *Calf Housing and Feeding: Dairy*

Group housing of calves during their first month of life is associated with higher diarrhea incidence than housing calves in individual hutches, and the overall morbidity rate of neonatal calves is higher when calves are housed in groups of 6 to 30 calves compared with small groups of up to 6 calves.<sup>7</sup> Similarly indoor housing was associated with higher morbidity and mortality rates in neonatal dairy calves than housing calves in outdoor hutches.

Overall disease occurrence and mortality of neonatal calves has been shown to be influenced by feeding practices. Adequate energy and nutrient supply are critically important for proper immune function. In the dairy industry it is customary to limit the daily feed supply of unweaned calves to 10% to 15% BW, a procedure also known as “restricted feeding.” The objective of restricted feeding is to facilitate early weaning and to decrease the risk of diarrhea. Notwithstanding the voluntary intake of calves fed whole milk ad libitum can easily exceed double this amount, and it was shown that calves can safely ingest milk equivalent to 20% of their BW and achieve markedly higher daily weight gains than calves on restricted feeding.<sup>8</sup> The effect of feeding larger amounts of milk on the incidence of diarrhea was studied with inconsistent results; some studies have reported higher diarrhea incidence when feeding larger volumes while others did not.<sup>8</sup>

Feeding milk replacer instead of whole milk also presents a form of undernutrition, particularly during the cold season of the year, when the energetic requirements of the calf are increased. The energy density and the digestibility of proteins contained in

commercial milk replacers are generally speaking lower than in whole milk, which has been proposed to predispose to impaired immune function and thus to disease. A study comparing calves fed the same amount of whole milk or milk replacer in a commercial dairy farm found that mortality rates in both groups were similar during summer but differed dramatically during winter between calves fed whole milk (2.8%) and milk replacer (21.0%).<sup>9</sup>

Some studies have shown that the major contributing factor to dairy calf mortality is the care provided by the calf attendant.

#### *Calf Housing and Feeding: Beef*

In beef herds veterinarians have commonly observed a relationship between adverse climatic conditions and epidemics of diarrhea in calves. During inclement weather, such as a snowstorm, a common practice in beef herds is to confine the calving cows in a small area where they can be fed and watered and observed more easily. The overcrowding may be followed by an outbreak of calf diarrhea.

#### *Disease Control and Management: Dairy*

Antibiotics are widely used for the control and treatment of diarrhea and other diseases, particularly in dairy and veal calves. A common practice is feeding medicated milk or milk replacer during the first weeks of life, which is a practice that has been associated with reduced calf morbidity and mortality and increased daily weight gains particularly in herds with a high prevalence of FTPI and high infectious pressure.<sup>10</sup> In contrast, this effect was much less pronounced over even the opposite in a well-managed herd with low FTPI prevalences. In well-managed herds calves fed a medicated milk replacer had over 30% more days with diarrhea than herd mates receiving nonmedicated milk replacer.<sup>10</sup>

Although antimicrobial therapy is clearly indicated in diarrheic calves with signs of systemic disease, antibiotics may be counterproductive in scouring calves without systemic illness.<sup>11</sup> Scouring calves without systemic illness that were treated with antibiotics in addition to oral rehydration had 70% more days with diarrhea than calves without systemic disease that received oral rehydration without antibiotics.<sup>12</sup>

#### *Other Environmental and Management Factors*

Cold, wet, and windy weather during the winter months in temperate climates and hot humid weather during the summer months may be associated with an increased incidence of dairy calf mortality caused by diarrhea. Changes in weather and wet, windy, and cold weather are commonly associated with subsequent outbreaks of the disease in beef calves raised outdoors. Increases in

population density in calf barns, and on calving grounds, resulting in highly contaminated calving grounds, are important risk factors.

Increasing the percentage of heifers calving in the herd is associated with an increased risk of diarrhea because calves born to heifers may be about four times greater than in calves born to cows.

Large herd size was found to be associated with increased diarrhea incidence and overall calf morbidity and mortality in some studies but not in others.<sup>7</sup>

#### **Piglets**

Epidemics of diarrhea in piglets are commonly associated with inadequate sanitation and hygiene in the farrowing facility, which may be under continuous use without sufficient time for cleaning and disinfection between farrowings. Producers that managed their farrowing barns as all-in/all-out facilities had lower diarrhea-related morbidity and mortality rates.<sup>13</sup> Herd size was found to have a positive association with piglet morbidity but not mortality related to diarrhea.<sup>13</sup>

Piglets in litters receiving milk replacer as feed supplement were at increased risk of developing diarrhea (OR 1.9) compared with piglets that did not. Although the explanation for this observation is not evident, it was suggested that feed supplementation might either be associated with increased occurrence of hypogalactia or agalactia in sows, or the provision of milk replacers reduces the voluntary intake of sow's milk.<sup>13</sup>

Other management practices that were associated with reduced diarrhea incidence in piglets were the parenteral administration of iron to piglets and vaccination of the sow herd against *E.coli*.<sup>13</sup> Increasing the percentage of gilts among the sow population was associated with increasing diarrhea incidence in the herd.<sup>14</sup>

Seasonal effects have also been reported with highest diarrhea incidence rates in piglets occurring during the cold season of the year.<sup>15</sup>

#### **Lambs**

Management factors associated with diarrhea in neonatal lambs were animal density in pens, cleaning frequency of lambing pens, and the use of anthelmintic drugs.<sup>16,17</sup>

Conflicting results regarding the effect of the flock size on diarrhea incidence in lambs have been published. Although some authors reported an increased risk of diarrhea with increasing flock size, this was not confirmed by others.<sup>17</sup>

#### **Pathogen Risk Factors Calves**

The distribution and occurrence of enteropathogens in the feces of diarrheic and normal healthy calves vary depending on the geographic location, the farm, the age and type of calves being examined, and the extent



to which the diagnostic laboratory is capable of isolating or demonstrating the pathogens. Rotavirus, *Cryptosporidium* spp., coronavirus, and ETEC, collectively, are responsible for 75% to 95% of infections in neonatal calves worldwide. The relative frequencies of each of the four differ between locations and between seasons and years. Any one of the common pathogens may predominate or be absent in a certain group of animals. Mixed infections are common. Rotavirus will be most common in some groups, especially housed calves. Coronavirus may predominate in beef calves in some countries, and *Cryptosporidium* spp. may occur in 30% to 50% of diarrheic calves on a worldwide basis. *Cryptosporidium* spp., rotavirus, and coronavirus are the most commonly identified enteropathogens in intensively reared veal calves. In dairy calves, the prevalence of giardiasis and cryptosporidiosis may be high and both parasites may be associated with diarrhea. *C. parvum* is an important pathogen in calves under 1 month of age, but *Giardia duodenalis* may be more important in older calves. Calves may clear *C. parvum* infections within 2 weeks, whereas *G. duodenalis* infection may become chronic in the same calves. The combination of *Cryptosporidium* spp. and rotavirus may predominate in some situations. *Cryptosporidium* spp. were the second most commonly detected pathogens next to rotavirus, and case-control studies indicated a highly significant association with diarrhea. Enteropathogens may not be detectable in up to 30% of diarrheic calves. *Eimeria* spp. can cause coccidiosis in calves any time after about 21 days after birth, but the disease is more common in calves several months old.

In some countries, enterotoxigenic F5 (K99<sup>+</sup>) *E. coli* may occur in 30% to 40% of diarrheic calves, whereas in others the incidence may be as low as 3% to 6%. AEEC that causes hemorrhagic colitis and blood in the feces of diarrheic calves about 2 weeks of age is being recognized with increasing frequency. It may occur concurrently with other enteropathogens (cryptosporidia, rotavirus, coronavirus, ETEC, bovine viral diarrhea virus [BVDV], and coccidia).

The age occurrence of the common enteropathogens associated with diarrhea in calves is shown in Table 7-29. Case-control studies of diarrheic and healthy calves from the same groups indicate that the enteropathogens commonly found in diarrheic calves can also be found in healthy calves but at a lower frequency, with the exception of rotavirus, which may be excreted by up to 50% of healthy calves. It appears that healthy calves may be infected more often with ETEC, *Cryptosporidium* spp., coronavirus, and rotavirus in herds in which some calves have or recently have had enteric disease than in herds free from major enteric disease.

*Campylobacter* spp. and *Yersinia* spp. are well adapted to the bovine host and can be

**Table 7-29** Calf enteropathogens: Age occurrence of the common enteropathogens in calves

Enteropathogen	Age (days)
Enterotoxigenic <i>Escherichia coli</i>	<3
Attaching and effacing <i>E. coli</i>	20–30
Rotavirus	5–15
Coronavirus	5–21
Other viruses (Breda virus, parvovirus, bovine virus, diarrhea virus)	14–30 (and older, up to several weeks)

found in the feces of diarrheic and healthy calves at a similar prevalence. Their significance as pathogens in newborn calves is uncertain. They are probably part of the normal enteric flora of ruminants. However, as they represent a source of gastrointestinal infections in humans, management factors limiting intestinal colonization of these bacteria should be considered in beef cow/calf herds.

Rotavirus and coronavirus occur with almost equal frequency in the intestinal tracts of normal and diarrheic calves of some studies. Intestinal lesions compatible with the viral infection are found in about 70% of diarrheic calves. Thus these viruses are widespread in the bovine population and only under some predisposing circumstances will the infection be severe enough to cause clinical disease. Other viruses, such as parvovirus, astrovirus, Breda virus, and norovirus, have been isolated from the feces of diarrheic calves, but their role in the etiology is yet to be defined.

A necrotizing enteritis of suckled beef calves 7 to 10 weeks of age on pasture in Scotland has been reported. Fever, acute diarrhea and dysentery, and a case-fatality rate of 25% are characteristic. No etiologic agent has been identified.

#### Lambs and Goat Kids

The *E. coli* strains isolated from diarrheic lambs and goat kids on Spanish farms are not generally toxigenic and belong to a large number of O serogroups.

#### Piglets

In outbreaks of diarrhea in neonatal piglets during the first 5 days of life, the enteropathogens that are commonly present in the feces include the TGE virus, ETEC, *Isospora* spp., rotavirus, *C. perfringens*, and adenovirus. *C. difficile* has emerged as an important pathogen causing enteritis in suckling piglets. The TGE virus causes diarrhea in piglets under 15 days of age, *Isospora* sp. between 5 and 15 days of age, and rotavirus in piglets over 10 days of age. ETEC was found to

be preferentially shed by weaned diarrheic piglets. Suckling diarrheic piglets had a low prevalence of ETEC shedding that decreased from the first to third week of life.<sup>18</sup> During the second and third weeks of life, *I. suis* is the most common pathogen in outbreaks of diarrhea in litters of piglets. Although individual piglets may be infected by a single pathogen, it is common for more than one pathogen to be present in the litter.

A seasonal occurrence of the common enteropathogens has also been observed. The prevalence of the TGE virus may be highest during the fall, winter, and spring months, and coccidia and *E. coli* are more common during the summer, fall, and early winter, with the lowest prevalence in the spring.

#### Foals

Diarrhea in foals is common but most cases are mild, transient, and not associated with infectious agents. Diarrhea is the most commonly reported disease in foals under 7 days of age. The most common occurrence is associated with “foal heat” in the mare. Diarrhea is a common clinical finding in septic foals and is presumably the result of mucosal hypoperfusion and sepsis-related inflammatory mediators rather than bacterial or viral enteritis.

Rotavirus group A (RVA) is the most common cause of epidemics of diarrhea in foals and most commonly occurs in foals under 30 days of age.<sup>19</sup> Clostridial infection associated with diarrhea is most commonly caused by *C. perfringens* type C or *C. difficile*.<sup>19</sup> *Salmonella* spp. have been associated with diarrhea in foals but can cause diarrhea in horses of any age. A variety of other pathogens have occasionally been isolated from diarrheic foals, such as *E. coli*, *B. fragilis*, *Enterococcus* spp., and *Aeromonas* spp.

#### CLINICAL MANAGEMENT OF EPIDEMICS

When faced with an outbreak of acute diarrhea in neonatal calves (less than 30 days old) in which there is profuse watery diarrhea, progressive dehydration, and death within a few days or earlier, the following steps are suggested:

1. Visit the herd and do an epidemiologic investigation to identify the risk factors that may be responsible for the outbreak. Most outbreaks are multifactorial and an interaction among the environment, management, feeding, and the pathogens is probable. The investigation of the underlying causes of the outbreak should involve an examination of the following:
  - Dry cow management (including vaccination protocols)
  - Calving management
  - Colostrum management
  - Calf management (housing, prophylactic treatments, vaccinations ...)

- Calf feeding (whole milk or milk replacer, type of milk replacer, amount fed, feeding frequency, feeding hygiene ...)
  - History of the present outbreak
  - Farm history of previous disease outbreaks (not only affecting neonatal calves)
  - The affected calves (which calves are affected?, age, vigor, housing type ...)
  - Results of necropsy, clinical pathology, and microbiology if available
  - Treatments used in the current outbreak and their efficacy
  - Recent changes in management and environment or changes of the herd that may be associated with the outbreak
2. Each of the commonly recognized risk factors must be examined for its possible role in the particular outbreak:
    - Overcrowding of calving yards in beef herds
    - Recent changes in incidence rate of dystocia and perinatal mortality in calves and periparturient disease in cows
    - Recent changes in climate and recent stress of any kind on the herd
    - In dairy herds feeding milk replacer, the feeding plan should be investigated.
    - Any recent introductions of replacement calves into the herd should be considered as possible sources of pathogens.
    - Prevalence of FTPI can be crudely assessed by checking 10 to 12 healthy calves between 24 hours and 7 days of age for the serum protein or preferably the serum IgG concentration (see Failure of transfer of passive immunity); the prevalence of FTPI should certainly not exceed 20%.
  3. Affected calves should be examined clinically, dead ones by necropsy, and a case definition should be determined to ensure that diarrhea is the major problem.
  4. All affected calves should be identified, isolated, and treated immediately with oral and parenteral fluid therapy as indicated. The use of oral fluid and electrolyte therapy for the treatment of dehydration and acidemia as soon as the calves are seen to be diarrheic must be emphasized.
  5. Antimicrobial therapy should be considered for diarrheic calves with systemic illness but not for alert calves with diarrhea as the only clinical sign.
  6. Fecal samples (30–50 g) should be collected from diarrheic calves at the first sign of diarrhea and from normal calves and submitted to a laboratory for the attempted isolation and

characterization of ETEC as well as rotavirus and coronaviruses, *Salmonella* spp., and *Cryptosporidium* spp. A rapid ELISA test is available for the simultaneous detection of *E. coli* F5 (K99<sup>+</sup>) antigen, bovine coronavirus (BCoV), and rotavirus in the feces of diarrheic calves during the acute phase of the infection. Commercial test kits that can be used calf-side for the detection of BCoV, RVA, F5 (K99<sup>+</sup>) *E. coli*, and *Cryptosporidium* spp. antigen have become available in recent years.

7. Pregnant cows that are due to calve shortly should be moved to a new calving area. In a dairy herd this means a different, clean calving stall, preferably in another barn not previously occupied by cattle; in beef herds it may mean moving a large number of cows to a new, uncontaminated calving pasture.
8. The control of the disease in future calf crops will depend on application of the principles of control, which are described under Acute undifferentiated diarrhea of newborn farm animals and Viral diarrhea of calves, lambs, kids, piglets and foals. If a significant number of cows are due to calve in more than 3 to 6 weeks, vaccination with the calf diarrhea vaccines can be considered.
9. A report should be submitted to the owner that records the observations made at the farm visit and outlines specific recommendations for clinical management of affected calves and for control of the disease in the future.

### CONTROL

The principles of control are presented in detail in the sections on colibacillosis of newborn calves, piglets, lambs, kids, and foals, and viral diarrhea in calves, lambs, kids, piglets, and foals, using the following principles:

- Reduction of the degree of exposure of the newborn to the infectious agents
- Provision of maximum nonspecific resistance with adequate colostrum and optimum animal management
- Increasing the specific resistance of the newborn by vaccination of the dam or the newborn

### FURTHER READING

- Andrews AH. Calf enteritis—diarrhea in the preweaned calf—strategic investigation of outbreaks. *Cattle Pract.* 2004;12:109-114.
- McGuirk S. Disease management of dairy calves and heifers. *Vet Clin Food Anim Pract.* 2004;24:139-153.

### REFERENCES

1. Torstein M, et al. *Prev Vet Med.* 2011;99:136.
2. Cartsens GE, et al. *J Anim Sci.* 1987;65:745.
3. Blecha F, et al. *J Anim Sci.* 1981;53:1174.
4. Godden S. *Vet Clin Food Anim Pract.* 2008;24:19.
5. Lorenz I, et al. *Irish Vet J.* 2011;64:10.
6. Mee JF. *Vet Clin Food Anim Pract.* 2008;24:1.
7. Svenson C, et al. *J Dairy Sci.* 2006;89:4769.
8. Khan MA, et al. *J Dairy Sci.* 2011;94:1071.

9. Godden SM, et al. *J Am Vet Med Assoc.* 2005;226:1547.
10. Berge ACB, et al. *J Dairy Sci.* 2005;88:2166.
11. Constable PD. *Vet Clin Food Anim Pract.* 2009;25:101.
12. Berge ACB, et al. *J Dairy Sci.* 2009;92:4707.
13. Dewey CE, et al. *Swine Health Prod.* 1995;3:105.
14. Svensmark B, et al. *Acta Vet Scand.* 1989;30:43.
15. Chang G, et al. *Can J Vet Res.* 2013;77:254.
16. Sweeney JPA, et al. *Vet J.* 2012;192:503.
17. Andrés S, et al. *Small Ruminant Res.* 2007;70:272.
18. Wieler LH, et al. *J Vet Med B.* 2001;48:151.
19. Mallicote M, et al. *Equine Vet Edu.* 2012;24:206.

## ENTEROCOLITIS ASSOCIATED WITH *CLOSTRIDIUM DIFFICILE*

### SYNOPSIS

**Etiology** Toxigenic strains of *Clostridium difficile*. Common bacterial etiology in antibiotic-associated diarrhea. Fecal–oral spread

**Epidemiology** Horses: occurs in foals and adults. Commonly precipitated by therapy with antimicrobial agents and/or hospitalization. Pigs: diarrhea and death in piglets in first week of life

**Clinical findings** Profuse watery diarrhea, tachypnea, dehydration, and metabolic acidosis. High case fatality, especially in very young foals

**Necropsy findings** Fibrinous to necrotic enterocolitis. Edema of mesocolon in pigs

**Diagnostic confirmation** Demonstration of organism and toxins

**Treatment** Fluids and electrolytes. Horses: metronidazole, if sensitive, or vancomycin (noting public health concern)

**Control** Isolation and barrier protection and prophylactic metronidazole

### ETIOLOGY

*C. difficile* is a gram-positive, spore-forming, anaerobic bacterium. It is a recognized cause of antibiotic-associated diarrhea and pseudomembranous colitis in humans suffering perturbation of the bowel flora from antibiotic therapy or other causes. *C. difficile* causes enterocolitis in horses of any age and is associated with diarrhea in neonatal pigs.

Strains of *C. difficile* pathogenic to horses produce two toxins, A and B, and the degree of pathogenicity is related to the capacity for toxin production.<sup>1</sup> There are numerous strains of *C. difficile* (>50 ribotypes by one estimate), although a much smaller number (~4) constitutes the predominant isolates in animals.<sup>2</sup> Ribotype 078 is the most commonly reported in animals, especially in pigs and cattle,<sup>3</sup> although common human ribotypes (014/020 and 002) also occur in animals. *C. difficile* is isolated commonly from cattle. All *C. difficile* isolates from pigs, cattle, and poultry in the Netherlands were toxinogenic.<sup>3</sup>

## EPIDEMIOLOGY

### Occurrence

#### Horses

The disease can occur as outbreaks or, more commonly, is sporadic and associated with the risk factors of antimicrobial administration, hospitalization, or both.<sup>1</sup> It appears to occur worldwide. In young foals within the first 2 weeks of life it may occur without apparent predisposing causes but in adult horses it commonly follows the use of antimicrobial agents.<sup>4</sup> Case-fatality rates are highest in very young foals, in which the disease can be complicated by other existing neonatal diseases.

The microbiota of horses is complex and clostridial species are common in the feces of healthy horses, although *C. difficile* (mostly nontoxigenic) is isolated from <10% of horses on single sampling.<sup>5-7</sup> However, monthly sampling of 25 healthy horses for 1 year detected toxigenic *C. difficile* in 40% of horses at least once,<sup>8</sup> and toxigenic *C. difficile* was detected in 7 of 55 healthy race horses examined once during summer in Ohio, suggesting that asymptomatic carriage of toxigenic strains by some populations of healthy horses is relatively common.<sup>9</sup> Detection of toxigenic *C. difficile* is often, but not always, associated with disease in horses of any age, as demonstrated by the disproportionate representation of this organism in feces of horses with diarrhea.<sup>6,8,10-14</sup> Seven of 14 foals with diarrhea had *C. difficile* toxin (A/B) identified in feces, whereas none of 139 healthy foals were positive.<sup>15</sup> *C. difficile* was detected only in foals with gastrointestinal disease, and not in healthy foals (OR 5.4), in central Kentucky.<sup>14</sup> *C. difficile* toxin(s) is detected in approximately 5% of hospitalized foals with diarrhea,<sup>10</sup> and *C. difficile* was isolated from 10 of 73 hospitalized horses, 7 of which were positive for toxin A and/or B.<sup>16</sup> There was no association of *C. difficile* with a particular disease in this study.<sup>16</sup> One or both animals in mare-foal pairs can be subclinically infected with *C. difficile* and are potentially a source of infection for the other.<sup>11</sup> This is exemplified by the development of acute *C. difficile* enterocolitis in mares of foals treated with erythromycin and rifampin. Both *C. perfringens* (type A) and *C. difficile* can simultaneously infect foals with severe enterocolitis not associated with administration of antimicrobials, suggesting the potential for an interaction resulting in more severe disease.<sup>4</sup>

There is a strong anecdotal association of *C. difficile*-associated enterocolitis in horses with the administration of antimicrobials. Although most clinicians would agree that this association exists, there is no evidence that quantifies the increase in risk of a horse developing *C. difficile*-associated disease with the administration of antimicrobials or particular antimicrobials. Antimicrobial administration was not significantly more likely in horses with *C. difficile*-associated

diarrhea than in horses with diarrhea from which *C. difficile* was not identified, and only 26% of hospitalized horses with *C. difficile*-associated diarrhea had been administered antimicrobials.<sup>17</sup> Thirty-two of 33 (97%) horses and all adult horses with *C. difficile*-associated diarrhea had been administered antimicrobials before onset of diarrhea compared with 48% to 79% of horses with diarrhea of other causes.<sup>18</sup>

Horses with longer duration of hospitalization before onset of diarrhea are more likely to develop *C. difficile*-associated diarrhea.<sup>18</sup>

#### Pigs

*C. difficile* has increasing reportage, or recognition, and occurs predominantly in young piglets but also is recorded as a major cause of disease and mortality in sows.<sup>19</sup> The disease occurs worldwide and is an important cause of loss of young piglets.<sup>20,21</sup> The disease in piglets occurs predominantly in the first week of life, when the majority of the litter can be affected, and the case fatality can approach 50% but is usually lower. Stunting is a common sequel. Outbreaks occur with or without a history of processing with antibiotics.

The disease has not been effectively reproduced with simple challenge of conventional animals, suggesting that *C. difficile* in itself is not a sufficient cause. Challenge of adult horses with *C. difficile* with and without pretreatment with penicillin did not result in clinical disease in any of the horses, but *C. difficile* was subsequently isolated at greater frequency from the feces of the horses pretreated with penicillin. Challenge of newborn foals with *C. difficile* has resulted in enteric disease and diarrhea, but only in foals not receiving adequate transfer of colostral antibodies. *C. difficile* has been reproduced in gnotobiotic but not conventional pigs.

Routine prophylactic antimicrobial treatment of periparturient sows for diseases such as mastitis-metritis-agalactia has resulted in outbreaks of enterocolitis.

### Pathogen Risk Factors

Pathogenic strains of *C. difficile* produce an enterotoxin (toxin A) and a cytotoxin (toxin B). There are degrees of virulence between strains, but nontoxigenic strains are considered nonpathogenic. Other virulence factors, including an actin-specific adenosine diphosphate-ribosylating toxin and an outer cell surface coat S layer, have been proposed as additional virulence factors.

The organism can be isolated from a number of environmental samples, including soil and the environment of veterinary hospitals. Although it appears that the organism is not commonly present in the feces of normal horses, it can be isolated from those of other animal species and has high prevalence in the feces of dogs and cats. The organism can survive in feces for at least 4

years. Spores are resistant to common disinfectants, but a 5% bleach solution is stated to be effective for disinfection.

### Zoonotic Implications

*C. difficile* is a cause of diarrhea in humans and most commonly occurs following the administration of antibiotics, although sporadic cases without these risk factors also occur. The disease in humans may be mild and self-limiting or develop to severe pseudomembranous colitis with risk of intestinal perforation. In one study using molecular typing, 25% of isolates from humans were indistinguishable from isolates from animals. The risk for zoonotic infection should be considered, but barrier protection and attention to personal hygiene when handling animal cases should limit the risk for infection. Veterinarians and animal handlers undergoing antimicrobial therapy are particularly at risk.

### PATHOGENESIS

The disease is associated with severe watery diarrhea and a hemorrhagic necrotizing enterocolitis. The enterotoxin A damages villous tip and brush border membranes and causes necrosis and increased intestinal permeability. The cytotoxin B is lethal to cells once the gut wall has been damaged. Complete erosion of the mucosa may result. Both toxins induce the production of TFN and proinflammatory interleukins, with a resultant inflammatory response and pseudomembrane formation. Lactose intolerance may develop secondary to infection.

### CLINICAL FINDINGS

#### Horses

*C. difficile* occurs in horses of any age. In foals, it is part of the complex of diseases causing diarrhea and with a variety of clinical severity characteristic of these diseases.<sup>10,14</sup> In adults, infection causes hemorrhagic or necrotizing enterocolitis with classical signs of that syndrome.<sup>22</sup>

The disease in foals ranges from mild, self-limiting diarrhea to acute, rapidly fatal enterocolitis. Disease occurring with onset in the first 2 weeks of life is initially manifested with a decreased interest in suckling, often with signs of colic with increasingly prolonged and severe episodes of rolling and kicking at the abdomen and the occurrence of profuse watery and occasionally hemorrhagic diarrhea. Rectal temperatures are within the normal range but there is severe dehydration, an elevation of heart rate and respiratory rate, acidemia attributable to metabolic acidosis, and the development of septic shock. There is progressive enlargement of the abdomen, and transcutaneous ultrasound shows thickened, fluid-filled loops of intestine and fluid in the ventral abdomen.

In adult horses the disease is manifested with acute and often fatal colitis with profuse



diarrhea, toxemia, hypovolemia, and metabolic acidosis and is reported in individuals and as outbreaks in horses hospitalized and treated for various diseases.<sup>13,17,18</sup> The clinical signs of horses with *C. difficile*-associated disease are not distinguishable from those with non-*C. difficile*-associated disease,<sup>17</sup> although horses with *C. difficile*-associated diarrhea have higher rectal temperatures, band neutrophil counts, hematocrit, and hemoglobin concentration than do horses with diarrhea not associated with toxinogenic *C. difficile*. Horses with *C. difficile*-associated diarrhea have longer duration of hospitalization after onset of diarrhea than do horses with diarrhea of other causes.<sup>18</sup> The case-fatality rate for adult horses is approximately 25%.<sup>18</sup>

### Pigs

Affected piglets are depressed and have a yellow, mucoid diarrhea with occasional piglets passing feces with specks of blood. As the condition progresses, affected pigs show abdominal distension and tachypnea, and some have scrotal edema. There is progressive dehydration and hypoglycemia.

### CLINICAL PATHOLOGY

There is a leukopenia, a toxic left shift, a high hematocrit, and hyperfibrinogenemia. Plasma protein may be normal to low and there are high bilirubin and elevated liver enzyme values. Metabolic acidosis, as evidenced by an increase in anion gap and decrease in total CO<sub>2</sub> concentration, hyponatremia, and azotemia are present.<sup>17,18</sup> Blood IgG concentrations of affected foals are commonly within the normal range.

Classic methods of diagnosis are by examination of feces by culture of the organism and demonstration of toxins A and B by cytotoxin assays and enzyme immunoassays, some of which have been validated for use in horses with acute diarrhea and in foals.<sup>12,23</sup> Cycloserine-cefoxitin-fructose agar is commonly used to isolate *C. difficile* from feces, and detection is improved by use of PCR technology.<sup>24</sup> The isolation of *C. difficile*, in itself, is generally not considered to be diagnostic and should be accompanied by demonstration of toxin A in the feces by ELISA, or by tissue culture cytotoxin assays, to allow a putative diagnosis. Fecal toxin testing in live animals is an effective method of diagnostic conformation and correlates highly with toxin tests on intestinal contents at postmortem.

The organism, but not the toxins, is labile when kept aerobically at 4°C, with a significant decrease in recovery after 24 hours. Consequently, samples for culture should be taken in anaerobic transport media and shipped on ice.

PCR can provide a more reliable method of detection of genes encoding toxin A and toxin B.<sup>11,13,15</sup> Feces, or isolates, can be tested for genes encoding toxins A and B by PCR,

and PCR can also be used retrospectively following postmortem for diagnosis in formalin-fixed tissues.

Human assays are not all suitable for diagnosis of the disease in piglets, with performance of molecular tests designed for humans being inadequate for diagnosis of disease in pigs.<sup>25</sup>

### NECROPSY FINDINGS

#### Horses

Gross findings are of necrotizing or hemorrhagic enterocolitis with histologic findings that vary from a superficial fibrinous colitis with hemorrhage and edema to a severe hemorrhagic multifocal necrosuppurative and ulcerative enterocolitis.<sup>22</sup>

#### Pigs

The contents of the small intestine are scant and those of the large intestine yellow to dark yellow in color. Edema of the mesocolon is a common finding, along with increased fluid in the peritoneal and pleural cavities. Histologic findings vary from necrosis and exfoliation of the intestinal mucosa to segmental transmural necrosis in the large intestine.<sup>11,15</sup>

### DIFFERENTIAL DIAGNOSIS

- Horses: See Table 7-5.
- Swine: See Table 7-6.

### TREATMENT

Horses should be aggressively treated with fluids, plasma, and pressors to correct the fluid and electrolyte imbalance, correct the metabolic acidosis, and control pain. Antimicrobial therapy should be based on sensitivity testing if possible, but most isolates of *C. difficile* are susceptible to commonly used antimicrobials.<sup>26</sup> Isolates are usually resistant to trimethoprim-sulfamethoxazole and bacitracin, variably resistant to rifampicin, and susceptible to vancomycin. Metronidazole, 10 mg/kg intravenously four times daily or 15 mg/kg orally four times daily, has been commonly used for therapy, but there is geographic variation in sensitivity and there are reports of clinically important resistant strains.<sup>27</sup> Metronidazole and vancomycin are not approved for use in food animal species in most countries, and use of vancomycin is not prudent on public health grounds. Pharmacokinetics of metronidazole in foals are highly age dependent, and dosing should be adjusted in foals by increasing the period between administration of the drug from every 6 hours to every 12 hours until foals are 2 to 3 weeks of age.<sup>28</sup>

In vitro studies have shown that di-tri-octahedral (DTO) smectite can bind *C. difficile* toxins A and B, and that this can occur without inhibiting the antibacterial action of metronidazole. Clinical trials of efficacy have not been conducted but pharmacologic

considerations indicate that an initial dose of 1.4 kg of DTO smectite, administered by stomach tube, followed by 454 g every 6 to 8 hours, could be of therapeutic value. Experimental studies in hamsters indicate promise for the use of immune sera and vaccines, but these are not currently available in agricultural animals.

### CONTROL

There is no definitive control procedure. The organism is commonly present in veterinary environments and equine environments where there are foals. Foaling areas should be clean and disinfected with a sporicidal disinfectant. Metronidazole, 500 mg administered orally twice a day for 2 weeks, may be indicated for at-risk horses. Clinical cases should be isolated and, in a veterinary environment, strict barrier protection established between them and other animals under antimicrobial therapy. Orally administered probiotics and lactic-acid-producing bacteria are in use as an aid to prevention, but there are data indicating lack of efficacy.<sup>29</sup>

### FURTHER READING

Diab SS, et al. Clostridium difficile infection in horses: a review. *Vet Microbiol*. 2013;167:42-49.

### REFERENCES

1. Diab SS, et al. *Vet Microbiol*. 2013;167:42.
2. Janezic S, et al. *BMC Microbiol*. 2014;14:173.
3. Koene MGJ, et al. *Clin Microbiol Infect*. 2012;18:778.
4. Uzal FA, et al. *Vet Microbiol*. 2012;156:395.
5. Costa MC, et al. *PLoS ONE*. 2012;7(4):e35858.
6. Medina-Torres CE, et al. *Vet Microbiol*. 2011;152:212.
7. Schoster A, et al. *BMC Vet Res*. 2012;8:94.
8. Schoster A, et al. *Vet Microbiol*. 2012;159:364.
9. Rodriguez-Palacios A, et al. *Can Vet J*. 2014;55:786.
10. Frederick J, et al. *J Vet Int Med*. 2009;23:1254.
11. Magdesian KG, et al. *Vet J*. 2011;190:119.
12. Medina-Torres CE, et al. *J Vet Int Med*. 2010;24:628.
13. Niwa H, et al. *Vet Rec*. 2013;173:607.
14. Slovis NM, et al. *Equine Vet J*. 2014;46:311.
15. Silva ROS, et al. *Equine Vet J*. 2013;45:671.
16. Rodriguez C, et al. *Vet Microbiol*. 2014;172:309.
17. Weese JS, et al. *Equine Vet J*. 2006;38:185.
18. Ruby R, et al. *JAVMA*. 2009;234:777.
19. Yaeger MJ, et al. *J Vet Diagn Invest*. 2007;19:52.
20. Chan G, et al. *Can J Vet Res*. 2013;77:254.
21. Knight DR, et al. *Appl Environ Microbiol*. 2015;81:119.
22. Diab SS, et al. *Vet Pathol*. 2013;50:1028.
23. Silveira Silva RO, et al. *J Equine Vet Sci*. 2014;34:1032.
24. Avbersek J, et al. *Vet Microbiol*. 2013;164:93.
25. Knight DR, et al. *J Clin Microbiol*. 2014;52:3856.
26. Lawhon SD, et al. *J Clin Microbiol*. 2013;51:3804.
27. Magdesian KG, et al. *JAVMA*. 2006;228:751.
28. Swain EA, et al. *J Vet Pharmacol Ther*. 2015;38:227.
29. Schoster A, et al. *J Vet Int Med*. 2015;29:925.

### PROLIFERATIVE ENTEROPATHY IN HORSES

#### ETIOLOGY

Proliferative enteropathy is associated with LI, an obligate intracellular gram-negative

bacterium associated with proliferative enteropathy in pigs, horses, hamsters, dogs, deer, rabbits, rats, camels,<sup>1</sup> and ratites. The disease in foals can be reproduced by experimental oral infection of foals with a virulent organism.<sup>2</sup> The organism can be isolated from feces of a large number of mammalian species including striped skunks, Virginia opossums, jackrabbits, and coyotes.<sup>3</sup> There is close similarity in DNA among isolates from a variety of species, although strains of the organism isolated from one species vary in their capacity to produce disease in other species. Infection of foals with an organism derived from clinically affected foals, foals with an organism derived from pigs, pigs with an organism derived from foals, and pigs infected with an organism derived from pigs demonstrated more severe disease in species-specific isolates. Such isolates resulted in the development of clinical signs, longer fecal shedding of the organism, and high serologic response than non-species-specific isolates.<sup>4</sup> There is also evidence of varying infectivity and pathogenicity in laboratory animals (hamsters and New Zealand rabbits) of equine or porcine isolates from clinically affected foals or piglets.<sup>5</sup>

### EPIDEMIOLOGY

The disease was initially reported from North America and has subsequently been detected in most, if not all, areas of the world with commercial horse studs, including Japan, Europe, South America, Australia, and Israel.<sup>6-11</sup> Prevalence of serum antibodies against the organism increases with increasing age, for instance, 15% of foals before weaning, 23% in weanlings, 89% in yearlings, and 99% in horses >2 years of age.<sup>8</sup> Serum antibodies are detected, by ELISA, in 14% to 100% of horses on individual farms in Kentucky, with seroprevalence positively related to occurrence of the disease. Farms without evidence of endemic clinical disease had lower mean titers and lower maximal titers in individual horses than did farms on which the disease was endemic. Whether this finding is a reflection of prevalence of the disease (i.e., a consequence of high disease prevalence on some farms) or reflects greater exposure of horses that subsequently develop disease is unclear.<sup>12</sup> Approximately 50% of mares on farms with endemic disease are seropositive and ~50% of foals acquire passive immunity (become seropositive after nursing) from mares, and these maternally derived antibodies persist for 1 to 3 months.<sup>13</sup> Thirty percent of foals have evidence of infection, but not disease.<sup>13</sup>

The organism was not detected in foals with signs of gastrointestinal disease in Kentucky in one study,<sup>9</sup> although the disease is endemic in the area.<sup>14</sup> The disease occurs almost exclusively during late summer and early winter in Kentucky.<sup>14</sup>

Affected foals are usually 3 to 13 months of age and disease in adults is rare.<sup>15</sup> There is insufficient information to determine whether there is a breed predisposition to the disease. The disease is presumably transmitted by the fecal-oral route, with mares a potential, but unproven, source of infection.<sup>16</sup>

Proliferative enteropathy in foals occurs as isolated cases and as outbreaks on breeding farms. There is evidence that outbreaks begin after introduction of foals or weanlings to farms with no history of the disease, although whether this is coincidence or represents the mechanism of introduction of infection to the farm is unknown. Morbidity among foals and weanlings on affected farms is 20% to 25%, although this is based on disease outbreaks on only two farms. Case-fatality rate is as low as 7% in treated foals.<sup>14</sup>

### PATHOGENESIS

The pathogenesis of the disease in foals has not been determined, but it is probably similar to that of the disease in pigs. Infection results in development of an enteropathy characterized by proliferation of intestinal crypt epithelial cells and infiltration of the lamina propria with mononuclear inflammatory cells. Subsequent malabsorption of small-intestinal contents and protein loss from diseased intestine cause weight loss and hypoproteinemia characteristic of the disease in foals. There is decreased or absent absorption of glucose in foals that can persist, with decreasing severity, for >2 months.<sup>17</sup> Colic and diarrhea result from intestinal dysfunction and malabsorption. Hypoproteinemia and the subsequent decrease in plasma oncotic pressure result in edema and signs of hypovolemia. Death is associated with severe hypoproteinemia, inanition, and colic.

### CLINICAL SIGNS

The disease may present as one with a short course characterized by rapid weight loss, colic, and death within 2 to 3 days of onset of clinical signs or as a more chronic disease characterized by gradual development of weight loss and depression. Weight loss and poor body condition are consistent findings among foals affected by the chronic disease. Most affected foals have diarrhea that ranges in severity from acute profuse watery diarrhea to, more commonly, excessively soft feces. Foals are often depressed although they continue to nurse. Edema of the ventral abdomen and intermandibular space is common.<sup>14</sup> Fever is not a consistent feature of the disease.

An acute form of the disease results from ulcerative and necrotizing hemorrhagic enteritis.<sup>18,19</sup> Affected foals might be found dead or die after a brief illness (usually <8 hours) characterized by mild fever and rapid development of mild to severe colic and signs of sepsis.

**Ultrasonographic** examination of the abdomen reveals multiple loops of mildly distended small intestine with thickened walls. Loops of intestine can have walls of 5 to 8 mm thick (normal <3 mm; Fig. 7-8).

Many affected foals, and especially those that die of the disease, have concurrent diseases including parasitism and pneumonia.

The incubation period in pigs is 2 to 3 weeks but that in horses is unknown. Foals that recover from the disease may take several weeks to regain normal BW. Recovered foals that recover sell for approximately 70% of the sale price of unaffected siblings and peers.<sup>14</sup>

### CLINICAL PATHOLOGY

**Hypoproteinemia** with moderate to severe hypoalbuminemia is present in most affected foals. Serum albumin concentrations can be as low as 0.6 g/dL (6 g/L). Hyperfibrinogenemia and mild anemia are common but not consistent findings. White cell count is elevated (>14 × 10 cells/L) in most foals. Serum sodium and chloride concentrations are lower than normal and serum creatinine concentrations higher than normal in about 50% of affected foals.

Detection of exposure can be by detection of antibodies in serum (IPMA or ELISA) or detection of LI DNA in feces or rectal swabs.<sup>12-14,20,21</sup> PCR examination of feces for LI is specific for detection of the organism in affected foals. Examination of feces detects LI in approximately 80% of samples, of rectal swabs approximately 75%, and of both combined approximately 90% of samples from affected foals.<sup>21</sup> An indirect immunofluorescent assay detects serum IgG antibody to LI in foals, although the specificity of this finding for detection of the disease in foals is unknown. Foals with proliferative enteropathy have titers of 1:30 or greater.

### NECROPSY

Gross lesions are mainly thickening and irregular corrugation of the small intestine. There is proliferation of intestinal crypt epithelium with projection of crypt cells into the intestinal lumen. The lamina propria is infiltrated by mononuclear inflammatory cells. Silver staining of intestinal sections reveals numerous short, curved bacteria in apical cytoplasm of crypt epithelial cells.

### Samples for Confirmation of Diagnosis

- **Histopathology** of small intestine
- **Silver staining** of small intestine to demonstrate intracellular bacteria associated with hyperplastic cryptic cell
- **Bacteriology** is culture (which can be difficult as it requires cell cultures) and PCR examination of small-intestinal tissue

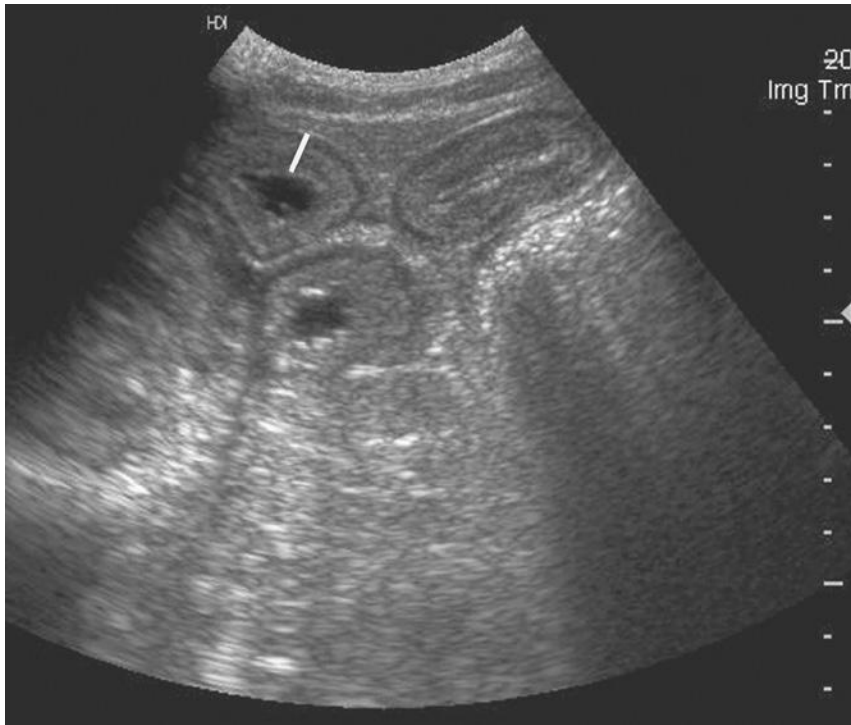

**Fig. 7-8** Percutaneous ultrasonographic image of an 8-month-old filly with enteritis caused by *Lawsonia intracellularis* and demonstrating markedly thickened small-intestinal wall (9 mm; normal <3 mm). (Reproduced with permission. Arroyo LG, et al. *Can Vet J.* 2013;54:853.<sup>18</sup>)

## DIFFERENTIAL DIAGNOSIS

Antemortem diagnosis of proliferative enteropathy in foals should be based on the presence of characteristic clinical, hematologic, and biochemical signs; positive serology; and detection of *Lawsonia intracellularis* DNA in feces by polymerase chain reaction.

The primary differential diagnosis is **parasitism** by *Parascaris equorum*, cyathostomes, and large strongyles (in older foals). Examination of feces for helminth ova is diagnostic in cases with patent infections, but parasite infestations are often not patent in young foals. A history of an adequate parasite control program makes parasitism less likely but does not rule it out. **Malnutrition** caused by inappropriate or inadequate feeding practices oragalactia should be ruled out as a cause of failure to thrive.

Protein-losing enteropathy secondary to **enteritis and colitis** may be associated with *Salmonella* sp., *Rhodococcus equi*, or *Cryptosporidium* sp. Other intestinal diseases that cause enteritis but less often cause protein loss include the intestinal clostridiosis, equine granulocytic anaplasmosis, and *Bacteroides* sp. infection. Intraabdominal abscesses associated with *R. equi* or *Streptococcus* sp. can cause chronic weight loss and hematological signs similar to proliferative enteropathy.

Hypoproteinemia can occur secondary to gastrointestinal ulceration. Neoplasia is rare in foals of this age, but intestinal lymphosarcoma can cause hypoproteinemia and weight loss.

Intoxication by **nonsteroidal antiinflammatory** drugs can cause a protein-losing enteropathy.

Diarrhea and ill-thrift caused by colitis and typhilitis associated with *Brachyspira* sp. (a spirochete) are reported from Japan.

## TREATMENT AND CONTROL

Principles of treatment are eradication of infection and correction of hypoproteinemia. Administration of **antibiotics** is curative in many foals, and response to treatment does not appear to vary markedly with administration of oxytetracycline, chloramphenicol, or clarithromycin.<sup>14</sup> Isolates of the organism from pigs are sensitive in vitro to a wide range of antimicrobials including penicillin, erythromycin, difloxacin, virginiamycin, and chlortetracycline. Antibiotics used to treat LI infection in foals include oxytetracycline (6.6 mg/kg every 12 hours intravenously), doxycycline (10 mg/kg every 12 hours orally), chloramphenicol (50 mg/kg, every 6 hours orally), clarithromycin (7.5 mg/kg orally), or erythromycin estolate or similar product (15–25 mg/kg every 6–8 hours orally), sometimes in combination with rifampin (5–10 mg/kg every 12 hours orally). Erythromycin or oxytetracycline/doxycycline appear to be effective in the treatment of affected foals. Chloramphenicol is used in place of erythromycin in foals that develop intractable or severe diarrhea when treated with erythromycin, but its use is

illegal in some countries and is not recommended because of the risk of aplastic anemia in people exposed to the drug. Enrofloxacin might be effective, based on MIC values, but should be reserved as a drug of last resort because of the arthropathy associated with its use in foals.

Mildly or moderately affected foals require only administration of antimicrobials and nursing care. More severely affected foals can require intensive supportive care including intravenous administration of plasma and/or hetastarch to restore plasma oncotic pressure and minimize edema formation, fluid and electrolyte supplementation because of hypovolemia and abnormalities in serum electrolyte concentration, calorie-enhanced diets or parenteral nutrition, and antiulcer medications if signs of gastric ulceration are present.

Specific **control measures** to prevent spread of the disease among horses have not been developed. Given the putative fecal-oral cycle of infection and association of outbreaks of the disease in pigs after introduction of new stock or mingling of groups, hygiene measures that minimize fecal contamination of the environment by potentially infected foals are sensible. The organism from pigs can survive in feces for up to 2 weeks. Foals with the disease should be isolated from healthy foals, although the duration of this isolation is not known, and should not be transported to other farms until clinical and hematological signs of the disease have resolved. The role for wildlife hosts, if any, in the disease of foals is unknown.

Administration of an avirulent, modified live vaccine intrarectally appears to protect foals from disease after experimental exposure or on farms with endemic disease.<sup>22-24</sup>

## REFERENCES

1. Badouei MA, et al. *J Camel Pract.* 2014;21:219.
2. Pusterla N, et al. *J Vet Int Med.* 2010;24:622.
3. Pusterla N, et al. *J Wildl Dis.* 2008;44:992.
4. Vannucci FA, et al. *Vet Res.* 2012;43:53.
5. Sampieri F, et al. *Can J Vet Res.* 2013;77:261.
6. Endo Y, et al. *J Jpn Vet Med Assoc.* 2015;68:239.
7. Gabardo MP, et al. *Pesquisa Veterinaria Brasileira.* 2015;35:443.
8. Kranenburg LC, et al. *Tijdschrift Diergeneesk.* 2011;136:237.
9. Slovis NM, et al. *Equine Vet J.* 2014;46:311.
10. Steinman A, et al. *J Equine Vet Sci.* 2014;34:641.
11. van den Wollenberg L, et al. *Tijdschrift Diergeneesk.* 2011;136:565.
12. Page AE, et al. *Equine Vet J.* 2011;43:25.
13. Pusterla N, et al. *Vet Microbiol.* 2009;136:173.
14. Frazer ML. *J Vet Int Med.* 2008;22:1243.
15. Mayer JR, et al. *Equine Vet Educ.* 2014;26:619.
16. Page AE, et al. *J Equine Vet Sci.* 2015;35:116.
17. Wong DM, et al. *J Vet Int Med.* 2009;23:940.
18. Arroyo LG, et al. *Can Vet J.* 2013;54:853.
19. Page AE, et al. *J Vet Int Med.* 2012;26:1476.
20. Page AE, et al. *JAVMA.* 2011;238:1482.
21. Pusterla N, et al. *J Vet Diagn Invest.* 2010;22:741.
22. Nogradi N, et al. *Vet J.* 2012;192:511.
23. Pusterla N, et al. *Vet J.* 2010;186:110.
24. Pusterla N, et al. *Am J Vet Res.* 2012;73:741.



## EQUINE NEORICKETTSIOSIS (EQUINE MONOCYTC EHRLICHIOSIS, EQUINE EHRLICHIAL COLITIS, AND POTOMAC HORSE FEVER)

### SYNOPSIS

**Etiology** *Neorickettsia risticii*, which is a rickettsia. Infection occurs by ingestion of infected immature trematodes (the aquatic cercariae), trematode-infected snails, or aquatic insects (including adults capable of flight, e.g., mayflies).

**Epidemiology** An infectious, but not contagious, sporadic disease of horses in North and South America and parts of Europe. Localized epidemics occur. Disease is most common near large rivers, but can occur elsewhere.

**Clinical signs** Fever and diarrhea with colic and laminitis in severe cases. Abortion is a sequela of clinical disease in some mares.

**Lesions** No gross lesions, except for laminitis. Histologic evidence of typhlitis and colitis

**Diagnostic confirmation** Demonstration of *N. risticii* by polymerase chain reaction or cultivation, in blood or feces of sick horses. More commonly the presence of a high antibody titer in horses with appropriate clinical signs is considered diagnostic.

**Treatment** Oxytetracycline (6.6 mg/kg, intravenously every 12–24 h), fluids, and supportive care. Prophylaxis for laminitis

**Control** Vaccination, which is of questionable efficacy and not recommended

### ETIOLOGY

The causative agent is *N. risticii*, a small gram-negative coccus that is closely related to the agents of human ehrlichiosis (*Ehrlichia senetsu*) and salmon poisoning of dogs (*N. helminthoeca*).<sup>1</sup>

### EPIDEMIOLOGY

This disease is infectious, but not contagious, and usually has a sporadic occurrence. Localized epidemics occur.

### Occurrence

Equine neorickettsiosis is recorded in the United States, Canada, Europe, Uruguay, and southern Brazil. Although it might have wider occurrence, evidence of infection based on the commonly used indirect FAT should be interpreted with caution because of the high rate of false-positive results. The highest prevalence of disease is near large rivers, apparently related to the infection of horses by ingestion of infected aquatic insects, although the disease can occur elsewhere, for instance, when strong winds carry infected insects (mayflies, *Hexagenia* spp.) from water sources.<sup>2</sup>

Clinical disease is sporadic and seasonal, with the predominance of cases occurring during the summer and the autumn periods in areas with cool to cold winters. In warmer areas, such as Florida and Texas, cases occur year round. The prevalence of horses in the Midwest and East Coast of the United States with antibodies to *N. risticii* varies with geographic region, but can be as high as 86% of horses tested, although the overall rate appears to be closer to 25%. The prevalence of horses with serologic evidence of exposure is much less in California. There is a marked seasonal variation in the prevalence of seropositive horses, with the highest prevalence in the summer months (July and August) and the lowest prevalence in the winter.

### Animal Risk Factors

Clinical disease is believed to be uncommon in horses under 1 year of age (14% in one case series),<sup>3</sup> although peracute disease can occur in foals, and there is no age difference in prevalence of disease in adult horses. Similarly, there is no evidence that breed and sex influence susceptibility to disease. The risk for disease is greater in horses housed on premises with a history of previous infection or those that have other livestock.

The clinical attack rate varies considerably, but estimates range between 0.44 and 19 cases per year per 1000 horses at risk. During epidemics, the clinical attack rate may be as high as 20% to 50% of horses on affected farms. **Case-fatality** rates range from 7% to 30%.<sup>3</sup>

The risk of horses being seropositive in some areas is related to breed (Thoroughbreds are three times more likely to be seropositive than are non-Thoroughbreds and non-Standardbreds), sex (females are 2.7 times more likely to be exposed than are stallions and geldings), and age (increasing risk up to 12 years of age). Horses that have had clinical signs compatible with neorickettsiosis are more likely to be seropositive than are horses with no such history.

### Transmission

The disease is infectious but not contagious. Horses develop infection and disease after ingestion of aquatic insects including caddisflies (*Dicosmoecus gilvipes*) or mayflies (*Hexagenia* spp.).<sup>1,2</sup> The disease can be transmitted experimentally to horses by parenteral administration of *N. risticii* or blood from infected horses. Studies of a tick (*Dermacentor variabilis*), black flies (*Simulium* spp.), fleas, flies (*Tabanus* spp., *Hybomitra* spp., *Stomoxys* spp., *Haematobia* spp.), and mosquitoes have failed to demonstrate transmission of infection.

*N. risticii* infects trematode stages (cercariae and xiphidiocercariae) found in freshwater snails (*Juga yrekaensis* and *Planorbella subcrenata* in California and northwestern United States and *Elimia* sp. including *E. livescens* and *E. virginica* in the eastern United

States).<sup>4</sup> *N. risticii* infects metacercariae found in adults and juveniles of aquatic insects including caddisflies (Trichoptera), mayflies (Ephemeroptera), damselflies (Odonata, Zygoptera), dragonflies (Odonata, Anisoptera), and stoneflies (Plecoptera). *N. risticii* DNA has been detected in trematodes (Lecithodendriidae) infecting bats and swallows. *N. risticii* DNA is present in eggs of the trematode (*Acanthatrium oregonense*) found in bats demonstrating vertical (adult to egg) transmission of infection in trematodes. Furthermore, *N. risticii* DNA was detected in the blood, liver, or spleen of bats infected with the trematode, suggesting that *N. risticii* can also be transmitted horizontally from trematode to bat. These results indicate that the trematode *A. oregonense* is a natural reservoir and probably a vector of *N. risticii*. This information suggests that insectivorous bats and birds are the definitive hosts of trematodes that maintain the natural reservoir of *N. risticii*. Briefly, it appears that horses are accidentally infected by *N. risticii* that normally cycles between trematode life stages in bats, freshwater snails, and aquatic insects. Infection by horses occurs when they ingest *N. risticii*-infected immature trematodes (the aquatic cercariae) directly while drinking from waterways or trematode-infected snails or aquatic insects while drinking or feeding.

Infected horses develop a sterile immunity and so are unlikely to be a source of subsequent infection.

### PATHOGENESIS

Infection is followed by monocyte-associated bacteremia and the organism is present in monocytes, macrophages, and the glandular epithelial cells of the intestinal tract. The number of *N. risticii* in blood is greatest before the development of clinical signs, which in experimentally infected horses and ponies occurs approximately 19 days after infection by ingestion of infected aquatic insects. The prominent clinical sign of diarrhea is caused by colitis and typhlitis and is associated with a neorickettsia-induced disruption of sodium and chloride absorption by the large colon. Fluid and electrolyte losses associated with diarrhea cause dehydration, hyponatremia, and acidosis.

Transplacental infection with *N. risticii* occurs and causes abortion, which can be weeks to months after resolution of clinical disease in the dam.<sup>5</sup>

### CLINICAL FINDINGS

The classic manifestation of *N. risticii* infection in horses is fever, depression, anorexia, diarrhea, colic, and laminitis. A retrospective review identified diarrhea (66% of 44 horses), fever (50%), anorexia (45%), depression (39%), colic (39%), and lameness (18%) as the most common clinical signs of the disease in horses at each of two referral clinics.<sup>3</sup> However, infection can result in a variety of clinical abnormalities ranging

from inapparent infection, through transient fever and depression, to the severe signs described earlier. Equine neorickettsiosis should be considered in any horse living in an endemic area that demonstrates fever and depression.

In naturally occurring cases of severe clinical disease there is typically an acute onset with depression, anorexia, tachycardia, congested mucous membranes, and fever. There are decreased intestinal sounds on abdominal auscultation in the early stages of the syndrome and subsequently tinkling sounds before the onset of diarrhea, which usually occurs 24 to 72 hours later. The severity of the diarrhea varies, but it is usually profuse and projectile. It persists for up to 10 days and there can be sufficient fluid loss resulting in severe and rapid dehydration and hypovolemic shock. Colic is a presenting sign in some horses and may be mild or present as an acute abdomen. There can also be subcutaneous edema in the ventral abdomen and limbs. Less severe clinical manifestations of infection include the occurrence of fever and anorexia without other signs or the occurrence of mild colic or subcutaneous edema.

Laminitis occurs in up to 40% of horses and is usually apparent within 3 days of initial signs of disease.<sup>3</sup> One retrospective review of 44 cases identified laminitis present on admission (12 hours to 5 days after first developing clinical signs of equine neorickettsiosis) in 18% of cases with a further 18% developing laminitis during hospitalization (0–4 days after admission, median of 24 hours).<sup>3</sup> Laminitis is often severe, involving all four feet in most horses (88% of those with laminitis) and with rotation of the distal phalanx in 60% of cases that had radiographic examination of the feet (likely the most severely affected horses).<sup>3</sup>

Abortion occurs as a result of *N. risticii* infection and, in experimental and natural infections, occurs 65–111 days after infection of the dam.<sup>3</sup> The dams that aborted all became clinically ill after infection, but clinical signs of disease had resolved at the time they aborted. Abortion was presaged by ventral edema and enlargement of the udder in experimental disease, and placenta was retained in some cases including that with natural infection.

## CLINICAL PATHOLOGY

**Hematological examination** usually reveals leukopenia (<5000 leukocytes per microliter) with neutropenia (74% of cases) and a marked left shift, mild thrombocytopenia, and hemoconcentration (hematocrit 50%–60%, 0.5–0.6 L/L) in 38% of cases.<sup>3</sup> **Serum biochemical analysis** often reveals hypocalcemia (76% of 32 horses), hyponatremia (64%), hyperglycemia (59%), hypochloremia (53%), azotemia (50%), hyperbilirubinemia (50%), and hypoalbuminemia (34%).<sup>3</sup> Hyperlactatemia and metabolic acidosis are common. **Peritoneal fluid** is usually normal.

Horses with hemoconcentration are less likely to survive.<sup>3</sup>

**Diagnostic confirmation** is achieved by demonstration of *N. risticii* in blood or feces, or serologic evidence of infection, in horses with clinical signs compatible with the disease. Routine diagnosis is based on demonstration of a high serum antibody titer on the IFA test. Most horses with disease caused by *N. risticii* have titers  $\geq 1:80$  at the onset of clinical signs, whereas horses with titers  $\leq 1:40$  probably do not have the disease. The presence of a high titer at the time of onset of clinical signs is a result of the 8- to 12-day incubation period during which there is a high level of neorickettsemia and the production of a strong IgM antibody response. The IgM antibody response wanes rapidly and can be undetectable by 60 days after infection, although a prominent IgG response occurs. Therefore by the time clinical signs are apparent the horse has a high titer that might decline, making the use of acute and convalescent (2 weeks after clinical signs resolve) serum titers potentially misleading. A rising titer in samples collected several days apart soon after the onset of disease is indicative of the disease, but a declining titer does not rule it out. The IFA test performed in some laboratories has a high rate of false-positive reactions and should be interpreted with caution. The preferred diagnostic test is a demonstration of antigen or DNA of *N. risticii*.

Detection of the organism in white blood cells by microscopic examination of stained blood smears is usually not possible because of the low level of infection of blood monocytes. The organism can be cultivated, but this is time-consuming and expensive. However, nest PCR detects the presence of *N. risticii* nucleic acid with a sensitivity similar to that of blood culture in experimental infection. PCR testing depends on the presence of the organism in the blood and could lack sensitivity because of variable levels of the organism in blood.<sup>3</sup> The specificity of the test, in the presence of compatible clinical signs, is assumed to be high.

Similarly, *N. risticii* can be detected by a PCR test in feces of horses. The sensitivity is not reported, but specificity is assumed to be high in the presence of compatible clinical signs.

## NECROPSY FINDINGS

The gross changes in horses dying of equine neorickettsiosis usually include subcutaneous edema of the ventral body wall and a very fluid consistency to the contents of the large bowel. Congestion, hemorrhage, and mucosal erosions can occur throughout the alimentary tract but are concentrated in the cecum and colon. The mesenteric lymph nodes are often swollen and edematous. There may be lesions of laminitis. Histologic examination confirms the alimentary mucosal erosion and ulceration, which is

accompanied by an infiltrate of a mixed population of leukocytes within the lamina propria and submucosa. The causative organisms can be demonstrated in tissue sections using Steiner's silver stain. Detection using EM or PCR techniques are other options.

Fetuses that are aborted as a result of *N. risticii* infection of the dam have gross lesions consisting of enlarged liver, spleen, and mesenteric lymph nodes and histologic evidence of enterocolitis, hepatitis, myocarditis, and lymphoid hyperplasia with necrosis of mesenteric lymph nodes.<sup>5</sup>

## Samples for Postmortem Confirmation of Diagnosis

The parasite can be demonstrated in cecum, colon, and mesenteric lymph node by a polymerase reaction test or EM. Formalin-fixed tissue for light microscopy should include cecum, colon, liver, and mesenteric lymph node.

### DIFFERENTIAL DIAGNOSIS

The main differentials are as follows (Table 7-5):

- Diarrhea caused by salmonellosis, *Clostridium difficile* colitis, massive emergence of hypobiotic cyathostomes, colitis X, and antibiotic-induced colitis
- Abortion caused by equine herpesvirus-1, leptospirosis, congenital anomalies, and *Salmonella abortusequi*

## TREATMENT

### TREATMENT AND PROPHYLAXIS

#### Treatment of equine neorickettsiosis

- Oxytetracycline 6.6 mg/kg intravenously every 12–24 h for 5 days (R1)

#### Prophylaxis

- Vaccination (R3)

The specific treatment of equine neorickettsiosis is oxytetracycline (6.6 mg/kg BW intravenously every 12–24 hours for 5 days), and horses treated early in the disease respond well. Administration of oxytetracycline increases the likelihood of survival by nine times (OR 95% CI 1.2–70), with 6/14 horses not treated with oxytetracycline (usually treated with another antibiotic) surviving compared with 26/30 oxytetracycline-treated horses.<sup>3</sup> Administration of metronidazole with oxytetracycline offers no clear survival advantage.<sup>3</sup>

Given the effectiveness of oxytetracycline in the treatment of the disease and the lack of clear evidence that oxytetracycline at the recommended dose induces or exacerbates diarrhea, this drug should be administered to all horses that live in an endemic area and that develop signs consistent with equine neorickettsiosis. Treatment does not

interfere with the development of immunity. Other antibiotics that have been used include combinations of a sulfonamide and trimethoprim or rifampin and erythromycin. Doxycycline has been used, but intravenous administration is associated with cardiovascular abnormalities and sudden death.

Treatment of horses with acute diarrhea is discussed in Chapter 7. Prophylaxis for laminitis is indicated in Chapter 15.

## CONTROL

Control centers on vaccination, although this is inadequate in controlling disease in field situations.<sup>6</sup> The apparent lack of efficacy of vaccination in the United States might be caused by the inclusion of only one strain of *N. risticii* in the vaccine, and this strain is immunologically distinct (based on the P51 surface protein) from most strains from the eastern or midwestern United States and from most strains isolated after 2000.<sup>6</sup> There are a number of strains of the organism, with associated variation in surface-expressed proteins and in particular P51, and the vaccine might not confer immunity to all these strains.<sup>1,6</sup> P51 is strongly recognized by sera from horses with IFA titers of 1:80 and above, and it could be useful for inclusion in vaccines or diagnostic tests.<sup>6</sup>

Infection is followed by the development of a neutralizing antibody response that is associated with clearance of *N. risticii* and the presence of a sterile immunity to the homologous strain, which persists for at least 20 months. An inactivated whole-cell adjuvanted vaccine is available, and vaccinated animals have resistance to experimental challenge. However, protection from vaccination is not complete and wanes within 6 months. Survival rate of horses with clinical equine neorickettsiosis is not different among horses that were vaccinated (7 of 9, 78%) before development of the disease from that of all horses studied ( $n = 44$ , 79% survival rate).<sup>3</sup> In an area with a low attack rate of the disease (0.44–1.7 horses/1000 per year) the risk of neorickettsiosis in horses vaccinated once per year is almost identical (OR 0.93) to that of unvaccinated horses, and there is no difference in the severity of the disease in vaccinated and unvaccinated horses. Furthermore, it is more economical *not* to vaccinate horses in areas with a low attack rate. In areas with a high attack rate it may be appropriate to provide an initial vaccination of two doses 3 weeks apart, with revaccination at 4-month intervals during the disease season.

Current recommendations from the American Association of Equine Practitioners included details on vaccination of horses against equine neorickettsiosis.<sup>7</sup> Because of evidence demonstrating the limited, or lack of, efficacy of vaccination with the currently available product, routine vaccination of horses is not recommended at this time.

## REFERENCES

1. Radostits O, et al. Equine Neorickettsiosis (Potomac Horse Fever). *Veterinary Medicine: A Textbook of the Diseases of Cattle, Horse, Sheep, Goats and Pigs*. 10th ed. London: W.B. Saunders; 2007:1466.
2. Wilson JH, et al. *AAEP Proc*. 2006;324.
3. Bertin FR, et al. *J Vet Intern Med*. 2013;27:1528.
4. Pusterla N, et al. *Vet J*. 2013;197:489.
5. Coffman EA, et al. *J Vet Diagn Invest*. 2008;20:827.
6. Gibson K, et al. *Vet Res*. 2011;42:71.
7. Potomac Horse Fever. American Association of Equine Practitioners. At: <[www.aaep.org/potomac\\_fever.htm](http://www.aaep.org/potomac_fever.htm)>; 2013 Accessed 08.11.13.

## EQUINE CORONAVIRUS INFECTION

Coronavirus infection is associated with diarrhea in foals, although rarely,<sup>1</sup> and is also incriminated as a cause of acute lethargy, fever, and signs of gastrointestinal dysfunction in adult horses. The putative causative agent is equine coronavirus (ECoV), and the strains identified in Japan, France, and the United States are virtually identical to the strain initially isolated from foals in North Carolina.<sup>1-4</sup> There is some variation in the virus, principally within p4.7 and the noncoding region following the p4.7 gene.<sup>5</sup> ECoV is of the genus *Betacoronavirus* and the species *Betacoronavirus-1*, which includes BCoV, porcine HEV, and canine respiratory coronavirus.<sup>6</sup> Experimental inoculation of adult horses reproduces the disease.<sup>7</sup>

The association between coronavirus infection and clinical disease in adult horses is reported in Japan, North America, and Europe.<sup>1-5,8</sup> Animal risk factors have not been identified, and the disease occurs in horses from 1 to 29 years of age.<sup>2,5,8</sup> The disease in adult horses is most commonly reported as an outbreak in stables affecting 15% to 60% of horses.<sup>2,4,5</sup> The case-fatality rate is approximately 0% to 7% with deaths caused by acute, profuse diarrhea; septicemia; or signs of neurologic disease.<sup>2,5,8</sup> A case-fatality rate of 27% is reported in two outbreaks of disease in Miniature horses and Miniature donkeys.<sup>8</sup>

Transmission is assumed to be fecal-oral, but the importance of fomites is spread within a stable, and longevity of the virus in the environment is not reported. The virus can be detected in feces for at least 12 to 14 days after oral inoculation of horses,<sup>7</sup> although the median shedding time from onset of clinical signs in horses with spontaneous disease is 4 days.<sup>8</sup>

The incubation period for horses experimentally infected with ECoV is 2 to 4 days before development of fever or anorexia.<sup>7</sup> The main clinical signs are anorexia, lethargy, and fever (43). Approximately 10% of affected horses have diarrhea and colic in approximately 2% of horses.<sup>2,5</sup> Horses that die do so with rapid progression of the disease including profuse diarrhea, septicemia, or neurologic disease. Depression, ataxia, and recumbency with abnormally

high blood ammonia concentrations are suggestive of intestinal hyperammonemia.<sup>8</sup> Clinical signs generally resolved within 1 to 4 days with supportive care. Outbreaks last approximately 3 weeks.<sup>2,5</sup>

Affected horses are leukopenic (neutropenic).<sup>2,5</sup> Serum amyloid A concentrations increase in experimentally infected horses 2 to 4 days after inoculation with the virus.<sup>7</sup> Serology is useful for demonstrating seroconversion to ECoV or high titers in recovered horses.<sup>3-5</sup> The virus can be detected in feces and blood, but not nasal discharges, in nonexperimental cases using PCR technology.<sup>2,3</sup> Reverse transcription and loop-mediated isothermal amplification (LAMP) assay are less sensitive but cheaper than RT-PCR technology for detection of the virus.<sup>9</sup> The virus is more frequently recovered from feces of clinically affected horses during outbreaks, and viral load in feces is associated with severity of disease.<sup>2,3,8</sup>

Treatment is supportive. There is no vaccine. Control is facilitated by implementation of measures to reduce viral spread, such as strict limitations on movement of horses within the facility, use of sanitary procedures including disinfectants, and cessation of racing or competition until the outbreak has abated. Most commonly used disinfectants are efficacious in reducing infectivity of coronavirus on surfaces, including benzalkonium and glutaraldehyde as well as alcohol-based hand disinfectants.

## REFERENCES

1. Miszczak F, et al. *Vet Microbiol*. 2014;171:206.
2. Pusterla N, et al. *Vet Microbiol*. 2013;162:228.
3. Oue Y, et al. *Vet Microbiol*. 2011;150:41.
4. Narita M, et al. *J Jpn Vet Med Assoc*. 2011;64:535.
5. Oue Y, et al. *J Vet Med Sci*. 2013;75:1261.
6. Zhang J, et al. *Virology*. 2007;369:92.
7. Nemoto M, et al. *Arch Virol*. 2014;159:3329.
8. Fielding CL, et al. *J Vet Int Med*. 2015;29:307.
9. Nemoto M, et al. *J Virol Methods*. 2015;215:13.

## VIRAL DIARRHEA IN CALVES, LAMBS, KIDS, PIGLETS, AND FOALS

### SYNOPSIS

**Etiology** Rotaviruses, coronaviruses, toroviruses, and parvoviruses

**Epidemiology** Common cause of diarrhea in newborn farm animals, usually in calves but also in lambs, kids, piglets, and foals. Rotaviruses ubiquitous in environment and 50%–100% of adults seropositive. Spread by feces. Protection dependent on specific antibody in colostrum in intestinal lumen. Bovine coronavirus is also pneumotropic and causes respiratory disease.

### Signs

**Calves** Outbreaks of diarrhea at 5–14 days of age and older up to 3–4 weeks. Recovery occurs in a few days.



**Piglets** Outbreaks of diarrhea at 1–4 weeks of age and following weaning. Porcine epidemic diarrhea type I at 4 to 5 weeks of age; type II at all ages. Recovery occurs in a few days.

**Foals** Profuse diarrhea, slight fever, and dehydration. Recovery occurs in a few days.

**Lesions** Fluid-filled intestine and dehydration. Villous and crypt atrophy. Diagnostic confirmation. Many diagnostic tests to identify viruses in fecal samples

**Treatment** Oral and parenteral fluid and electrolyte therapy; correction of acid-base disturbances

**Control** Reduce infection pressure, ensure adequate transfer of passive immunity, and vaccination of dam to provide specific colostral antibody.

## ETIOLOGY

Several families of viruses cause diarrhea in neonatal farm animals, and occasionally in adults. These include Reoviridae, Coronaviridae, Toroviridae, Parvoviridae.

### Rotaviruses

Rotaviruses are nonenveloped, dsRNA viruses pertaining to the family Reoviridae and are a primary cause of diarrhea in humans, calves, lambs, kids, piglets, and foals. All members of the group of viruses share a common morphology and were previously designated as reovirus-like viruses. Rotaviruses of human infants, calves, pigs, and foals are morphologically indistinguishable from each other and from the virus of infant mice; the lamb rotavirus is similar to both calf and pig viruses.

Rotaviruses are assigned to serogroups with group members sharing distinctive common antigens. Currently, seven serogroups (A through G) are recognized, which are antigenically and electrophoretically distinct. Rotaviruses belonging to groups A–C are associated with clinical disease in humans and animals, whereas groups D–G have only been isolated from diarrheic animals. **RVA is by far the most prevalent group in humans and animals.**

Rotavirus serogroups are further classified into serotypes based on specificity of the outer capsid proteins VP7 (G type, for glycoprotein) and VP4 (P type, for protease sensitive protein). At least 27 G serotypes and 35 P serotypes of Group A rotavirus are recognized.<sup>1</sup>

### Coronaviruses

Coronaviruses are ssRNA viruses pertaining to the family Coronaviridae. They are associated with acute enteritis in neonatal calves and piglets and possibly also in foals. In ruminants coronavirus infection can be associated with calf diarrhea, calf respiratory disease, diarrhea in adult cattle (winter dysentery), and respiratory disease in adult cattle.<sup>2</sup>

The coronavirus-like virus of pigs is similar to, but distinct from, the virus of TGE and is the cause of PED type II.

### Toroviruses

The family Toroviridae includes the Berne virus of horses and the Breda virus, which has been isolated from cattle.

### Parvovirus

Parvoviruses have been associated with diarrhea in calves but are not significant pathogens in cattle.

### Other Viruses and Mixed Infections

Although the rotavirus and coronavirus are the most common causes of viral diarrhea in newborn farm animals (other than TGE of piglets), the adenovirus and small viruses resembling astroviruses and caliciviruses have been isolated from diarrheic calves and foals, but their etiologic significance is uncertain.<sup>3</sup>

Multiple mixed viral infections are being recognized more frequently as diagnostic techniques are improved. Both rotavirus and coronavirus may occur in the same diarrheic calf with or without the presence of ETEC.

## EPIDEMIOLOGY

The general aspects of the epidemiology of viral diarrheas of newborn farm animals are described here, followed by the specific epidemiologic features in calves, lambs and kids, piglets, and foals. The rotavirus is used as a model.

### Occurrence

The rotavirus is ubiquitous in the environment of domestic animals, and serologic surveys indicate that 50% to 100% of adult cattle, sheep, horses, and pigs have antiviral antibody. Although different animal species commonly host different coronavirus genotypes there is evidence for interspecies transmission not only between animal species but also between animals and humans. Two routes for interspecies transmission have been proposed, direct interspecies transmission and transmission coupled with reassortment.<sup>4</sup> However, the significance of interspecies infection under field conditions has not been evaluated. Cross-infection between species is not a property shared by all rotaviruses.

### Methods of Transmission

The intestinal tract is the site of multiplication of the rotavirus and the virus is excreted only in the feces. Infected feces may contain as many as  $10^{10}$  virus particles per gram. **Rotaviruses are considered to be highly contagious;** studies in pigs showed infection can be achieved with as little as 90 virus particles. **Because rotaviruses are stable in feces and relatively resistant to commonly used disinfectants, it is extremely difficult to prevent gross contamination of animal housing once infection has been**

**introduced.** The adult animal is the primary source of infection for the neonate. The survival of the bovine rotavirus in air and on surfaces is directly influenced by the level of relative humidity. The rotaviruses generally survive well in an aerosol state, and medium-range of relative humidity and air may be one of the vehicles for dissemination of the virus.

### Immune Mechanisms

An important epidemiologic characteristic of rotavirus and coronavirus infections in newborn farm animals is that protection against disease is dependent on the presence of specific colostral antibody in the lumen of the intestine of the newborn. Colostral antibody in serum does not directly protect but contributes to mucosal immunity through re-secretion into the gut lumen. Protection against clinical disease depends on the amount of immunoglobulin in the lumen of the intestine. The daily oral administration of colostrum containing specific antibody or hyperimmune serum to neonates beyond the time of “gut closure” (intestinal absorption of colostral antibody) will improve resistance to clinical rotavirus enteritis.

The protection is against clinical disease but not necessarily against infection, which means that calves, lambs, and piglets can shed virus in feces while being protected from clinical disease. The protection lasts only as long as colostral antibody is present within the lumen of the intestine, which explains why rotaviral diarrhea occurs commonly after 5 to 7 days of age. Survival from rotavirus diarrhea in calves may be dependent on a high level of serum colostral immunoglobulin.

### Calves: Bovine Rotavirus

Many of the epidemiologic characteristics of neonatal calf diarrhea associated with the rotavirus and coronavirus must be considered in the context of “acute undifferentiated diarrhea of newborn calves,” because mixed infections are more common than single infections.

### Occurrence and Prevalence of Infection

Worldwide prevalence rates for bovine rotavirus infection range from 7% to 94% depending on the geographic region, although most studies report prevalences in the range of 30% to 40%.<sup>5</sup> RVA is by far the most prevalent group and is the group most commonly associated with clinical disease, although serogroups B and C have also been isolated from diarrheic calves. Diarrhea caused by RVA occurs in calves from 1 to 2 weeks of age.

In cattle RVA strains belonging to at least 12 G types (G1–G3, G5, G6, G8, G10, G11, G15, G17, G21 and G24) and 11 P types (P[1], P[3], P[5–7], P[11], P[14], P[17], P[21], P[29], and P[33]) have been identified. Most common strains belong to G6, G8, and G10 in association with P[1], P[5], and P[11].<sup>1</sup> Serotypes G6 and G10 are the most

prevalent RVA serotypes in dairy and beef calves with diarrhea in the United States. Rotavirus strains belonging to G10 P[11] constitute the largest proportion of bovine rotaviruses in cattle throughout India. This has major zoonotic implications because this strain is related to those found in newborn children in India.

The prevalence of subclinical infection may be greater than that indicated by isolation of the virus from feces. Rotavirus-immunoglobulin and coronavirus-immunoglobulin complexes may be present in the feces of 44% and 70% of adult cattle, respectively, whereas the free rotavirus and coronavirus may be absent or present in only 6% of fecal samples, respectively. Clinically normal cows can shed the virus for several weeks in the presence of fecal and serum antibody. Repeated bovine rotavirus infection and reexcretion can occur in calves several months of age, even in the presence of serum antibodies. Clinically normal calves may also shed the virus and there may be histologic evidence of lesions of the small intestine caused by rotavirus infection.

### Concurrent Infections

Rotavirus was detected in the feces of 43% of neonatal diarrheic dairy calves in Spain. A concurrent infection was detected in 58% of the rotavirus-infected calves, and the most common mixed infection was rotavirus-*Cryptosporidium*. The detection rates of the other enteropathogens with rotavirus infection were 20% for coronavirus, 85% for *Cryptosporidium* spp., 17% for F5 (K99) *E. coli*, and 2% for *Salmonella* spp. As the age of the calf increased, the detection rates of other enteropathogens decreased. Similar results were recently reported from dairy calves in the Netherlands.<sup>6</sup>

### Risk Factors

#### Animal Risk Factors

The factors that influence rotavirus infection and its clinical severity include the following:

- Age of the animal
- Immune status of the dam and absorption of colostrum antibody
- Ambient temperature
- Degree of viral exposure
- Occurrence of weaning
- Presence of other enteropathogens

Calves are most susceptible to rotavirus diarrhea between 1 to 3 weeks of age. This age occurrence is related in part to the rapid decline in specific colostrum antibody to rotavirus.

The mortality is highest in the youngest animals that have received insufficient colostrum and are subjected to severe weather conditions.

#### Environmental Risk Factors

Although the rotavirus has been most commonly associated with outbreaks of diarrhea

in beef calves raised in groups outdoors, it has also been recovered from dairy calves raised together in large groups in large dairy herds. The morbidity rate in beef herds varies from herd to herd and from one year to another.

The survival of the bovine rotavirus in air and on surfaces is directly influenced by the level of relative humidity. Rotaviruses generally survive well in an aerosol state and medium range of relative humidity, and air may be one of the vehicles for dissemination of the virus.

### Pathogen Risk Factors

There are differences in virulence among the bovine rotaviruses, which may explain the variability in the severity of disease in natural outbreaks and must be considered when developing vaccines.

Rotaviruses possess two outer capsid proteins, VP4 and VP7. The neutralization specificity related to VP7 is the G (for glycoprotein) serotype and that associated with VP4 is referred to as the P (for protease sensitive protein) serotype. Specific G and P types have been associated with specific animal species. As more rotaviruses have been characterized from diverse locations worldwide, the host species specificity of P and G types has become less distinct. G types 6, 8, and 10, once thought to be specific to cattle, have been found in humans.

In contrast to natural recovery from infection, which results in high titers of P-specific neutralizing antibodies, parenteral administration elicits primarily G-specific neutralizing antibodies. Thus failure in passive protection with a monovalent vaccine for prevention of rotavirus-associated diarrhea in neonatal calves may be less than optimal because of the diversity of P and G types occurring in nature.

Natural subclinical infections are common in calves in the second week of life, which raises doubts about rotavirus pathogenicity. Experimentally, the clinical outcome of infection is dependent on both age and rotavirus isolate. Age-dependent resistance to infection was not found. Bovine rotaviruses differ in virulence for calves in the second week of life, and older calves are susceptible to rotavirus infection and disease.

The calf rotavirus can be experimentally transmitted to piglets and has been isolated from natural outbreaks of diarrhea in piglets. The isolation of a rotavirus from neonatal deer affected with diarrhea in a zoo in Australia raises some interesting epidemiologic possibilities.

### Morbidity and Case Fatality

In some herds the disease starts at a low rate of 5% to 10% in the first year, increases to 20% to 50% in the second, and to 50% to 80% in the third year. In other herds, explosive outbreaks affecting 80% of the calves have occurred in the first year. The case-fatality

rate has also been variable (in some herds as low as 5%), whereas in other herds it has been as high as 60%. The mortality rate probably depends on the level of colostrum immunity in the calves, the incidence of enteric colibacillosis, and the level of animal husbandry and clinical management provided in the herd.

### Method of Transmission

The virus is excreted by both calves and adult cattle in large numbers (up to  $10^{10}$ /g of feces) and excretion may last for several weeks. Transmission is by the fecal-oral route via contaminated feces or fomites. The minimal infectious dose in cattle does not appear to have been determined, but as few as 90 virus particles were found to be sufficient to induce infection in piglets, making this a highly infectious pathogen.

Even under open-range conditions, there is a rapid spread of the virus throughout calves that come into frequent contact with each other, particularly during the calving season. Calves are infected after birth from the dam's feces or from other infected diarrheic calves. Pregnant cows excrete the rotavirus intermittently throughout pregnancy, from one calving to the next, and provide a direct source of infection for the newborn calf. Both subclinically infected and diarrheic calves infected by rotavirus can be a source of infection for other in-contact calves.

### Immune Mechanisms

Newborn calves are protected from the rotavirus only during the first few days after birth, when colostrum contains a specific rotavirus antibody that is active in the lumen of the intestine. This correlates well with the peak incidence of rotavirus diarrhea, which is at 5 to 7 days of age, and coincides with a marked drop in colostrum immunoglobulin by the third day after parturition and an incubation period of 18 to 24 hours for the disease to occur. The serum colostrum immunoglobulin of the calf may also be re-secreted from the serum into the intestine and complement the role of colostrum and milk antibodies in the lumen of the intestine.

### Bovine Coronavirus (Calf Diarrhea)

BCoV is associated with diarrhea in adults (winter dysentery) and calves (calf diarrhea). Diarrhea in both dairy and beef calves associated with BCoV has a worldwide prevalence and occurs from 1 day to 3 months of age but mostly between 1 and 2 weeks of age. Disease is more common during the winter months, which may reflect enhanced survival of the virus in a cool, moist environment. The virus is ubiquitous in cattle populations, and the majority of adult cattle are seropositive. The coronavirus may be present in both diarrheic and healthy calves; the incidence rates range from 8% to 69% and 0% to 24% for diarrheic calves and healthy calves, respectively.

The virus can be shed by up to 70% of adult cows despite the presence of specific antibodies in their serum and feces. The peaks of shedding are during the winter months and at parturition. Calves born to carrier cows are at a higher risk of diarrhea. Subclinical persistence and recurrent infections are also common in both neonatal and older calves, and virus excretion from these animals may maintain a reservoir of infection.

Vaccination of the cows with a modified-live rotavirus–coronavirus–*E. coli* combination vaccine does not influence seasonal shedding, but in vaccinated cows the incidence of shedding does not increase at parturition as it does in nonvaccinated cows. The BCoV isolates all belong to a single serotype as polyclonal sera have detected only minor antigenic variations.

The BCoV is also a pneumotropic virus that can replicate in epithelium of the upper respiratory tract. In dairy calves, initial infections occur when the calves are 1 to 3 weeks of age, but there are multiple episodes of shedding of viral antigens or seroconversion when the calves are several weeks of age. Clinical signs of respiratory disease occur between 2 and 16 weeks of age but are mild. A more severe lower respiratory tract infection causing minor lung lesions has been reported but is also not severe enough to warrant treatment. Such infections are probably common in closed herds with recurrent subclinical infections occurring in older calves. Persistence of infection or reinfection of the upper respiratory tract with the virus is also common. The amount and specificity of BCoV maternal antibodies in calves at the time of infection with the virus may interfere with the development of an active antibody response in serum and mucosal secretions. The fecal–oral route is the presumed method of transmission, but aerosol transmission may also occur.

The BCoV has been isolated from wild ruminants with diarrhea. Feces from diarrheic sambar deer, one waterbuck, and one white-tailed deer in wild animal habitats contained coronavirus particles identified as BCoV. Gnotobiotic and colostrum-deprived calves inoculated with the isolates developed diarrhea and shed coronavirus in their feces and nasal discharge. Thus wild ruminants may harbor coronavirus strains transmissible to cattle.

The BCoV of winter dysentery in adult cattle is closely related to the BCoV causing diarrhea in young calves.<sup>2</sup> There is no evidence for serologic or in vivo antigenic differences between these two BCOVs.

### Parvovirus

The parvovirus has been associated with outbreaks of PWD in beef calves, but its pathogenicity is uncertain. Seroprevalence studies found 49% to 83% of adult cattle seropositive to the virus over a 2-year period.

### Bovine Torovirus (Breda Virus)

Breda virus, a member of the genus *Torovirus*, has been isolated from the feces of neonatal calves with diarrhea in Iowa, Ohio, several areas in Europe, and in Canada. In Ohio, the virus was detected in 9.7% of fecal samples from cattle with diarrhea; it occurred in 26% of the total calf samples. It is a common virus in the feces of calves with diarrhea on farms in Ontario. In veal calf operations in Ohio, 24% of calves shed the virus during the first 35 days after arrival, which was associated with diarrhea. Calves shedding additional pathogens were more likely to have diarrhea than those shedding less than one pathogen. Calves that were seronegative or had low antibody titer to the Breda virus on arrival were more likely to shed the virus than those calves that were seropositive on arrival.

More than 88% of adult cattle are seropositive for the Breda virus. More than 90% of newborn calves have high maternal antibodies to the virus that wane at a few months of age, followed by active seroconversion between 7 and 24 months of age.

### Bovine Norovirus

Noroviruses, formerly known as Norwalk-like viruses, are ssRNA viruses belonging to the family Caliciviridae and have been recognized as the most common pathogens involved in outbreaks of acute nonbacterial gastroenteritis in humans. Noroviruses can be genetically classified into five genogroups, GI–GV. Genogroups I, II, and IV are considered as human pathogens, whereas genogroup III is isolated from bovines. The prototype strains identified in cattle are the Newbury-2 strain (formerly Newbury agent 2) and the Jena virus. The seroepidemiologic prevalence of the Jena virus, a bovine enteric calicivirus, is 99% in some selected cattle populations in Germany. In the Netherlands Norovirus is endemic in veal calf operations and in a selected dairy herd. The highest number of norovirus-positive veal calf farms was found in the regions with the highest number of veal calf farms. The virus is endemic in cattle populations and genetically distinct from human norovirus.<sup>7</sup> Norovirus genotype III strains were isolated from healthy and diarrheic calves in Hungary, Italy, and recently in France.<sup>7–9</sup> Although the clinical significance of the presence of norovirus in diarrheic calves remains unclear, a significant quantitative difference in the amount of virus particles shed in feces between healthy and diarrheic calves has been demonstrated in a recent case–control study.<sup>10</sup>

### Lambs and Kids Rotavirus

Rotavirus has been associated with diarrhea in lambs 7 to 30 days of age.<sup>11</sup> Rotavirus infection associated with diarrhea in lambs has been reported from several countries

including the UK, United States, Australia, Japan, Spain, Egypt, Morocco, and India. Rotavirus groups A and B have been isolated from diarrheic lambs, but there appear to be geographic differences in the occurrence between groups A and B. Although group B has predominantly been isolated in the United States and the UK, RVA is most common in India.<sup>12</sup>

The prevalence of rotavirus infection in diarrheic lambs was recently assessed in India by screening 500 fecal samples from diarrheic lambs collected over a period of 3 years. RVA was isolated from 13.2% of all samples.<sup>13</sup> A similar study from Egypt reported a prevalence of rotavirus infection among diarrheic lambs of 12.3%.<sup>14</sup>

Atypical rotaviruses, possibly group B, have been isolated from the feces of diarrheic goat kids. Affected kids were 2 to 3 days of age, and the disease was severe with marked dehydration, anorexia, and prostration.

The prevalence of rotavirus infection in lambs appears to be influenced by the season of the year, because an increase in the number of outbreaks with high morbidity and mortality has been reported in the early spring months.<sup>11</sup>

The experimental disease in lambs is mild and characterized by mild diarrhea, abdominal discomfort, and recovery in a few days. The mortality in lambs is much higher when both the rotavirus and EPEC are used.

### Piglets

#### Porcine Rotavirus

Rotavirus is recognized as an important etiologic agent of diarrhea in weaned and unweaned piglets. At least four of the rotavirus groups (A–E) have been associated with diarrhea in piglets, but RVA is by far the most prevalent. Within the RVA the genotypes G3–G5, G9, and G11 in combination with P[6], P[7], P[13], and P[19] are most prevalent in pigs and there are differences in virulence of isolates.<sup>4</sup> Different genotypes of RVA and even different groups of rotaviruses may occur at the same time in a single piggery. Some porcine rotaviruses are related antigenically to human rotavirus serotypes. Porcine rotaviruses that display the typical bovine P[1], P[5], P[11], G6, and G8 genotypes have been detected in pigs, which indicates the high frequency of rotavirus transmission between cattle and pigs.

There is little or no cross-protection between porcine rotaviruses with distinct G and P types, but viruses that share common G and P types induce at least partial cross-protection in experimental studies. Variant serotypes of porcine rotavirus such as G3 may cause severe outbreaks of diarrhea in piglets. Subclinical infections are common, and age resistance to rotavirus infection may not occur.

Rotaviruses have a worldwide occurrence and are highly prevalent in the swine population. Infected gilts and sows shed the virus



before farrowing and during lactation, which makes it next to impossible to eliminate the infection from a herd. Continuous transmission of the virus from one group to another is an important factor in maintaining the cycle of rotaviral infection in a piggery. The virus can be found in dust and dried feces in farrowing houses that have been cleaned and disinfected. This suggests that the environment is also an important source of infection. The porcine rotavirus can survive in original feces from infected pigs for 32 months at 10°C (50°F).

In an infected herd, piglets become infected between 19 and 35 days of age, and the virus cannot be detected in piglets under 10 days of age, presumably as a result of protection by lactogenic antibody. There are increased secretory IgA and IgG antibodies to rotavirus in the milk of sows after natural rotavirus infection or following parenteral inoculation of pregnant or lactating sows with live attenuated rotaviruses. Early weaning of piglets at 3 weeks of age results in the removal of the antibody supplied by the sow's milk.

In piglets, rotaviral diarrhea is most common in pigs weaned under intensive management conditions, and the incidence increases rapidly from birth to 3 weeks of age. There is no age-dependent resistance up to 12 weeks of age. The disease resembles milk scours or the 3-week scours of piglets. Mortality caused by rotavirus varies from 7% to 20% in nursing pigs and 3% to 50% in weaned pigs depending on the level of sanitation. In the United States the peak incidence occurs in February, and a moderate rise occurs from August to September.

A case-control epidemiologic study examined the relationship between RVA and management practices in Ontario over a 5-year period. In rotavirus-positive herds, herd size was larger and weaning age was younger compared with rotavirus-negative herds. Pigs raised in all-in/all-out nurseries were 3.4 times more likely to have a positive RVA diagnosis than in pigs in a continuous flow system. Pigs in the all-in/all-out system were weaned at an earlier age.

Concurrent infection of rotavirus with other enteric pathogens such as ETEC, *Salmonella* spp., or TGE virus is common and causes an additive effect resulting in more severe clinical disease and higher mortality rates.

### Porcine Coronavirus

The PEDV is a corona-like virus that causes diarrhea in pigs. This is similar to TGE except much less severe and with less mortality. Two clinical forms of the disease have been described: PED types I and II. **PED type I** causes diarrhea only in pigs up to 4 to 5 weeks of age. **PED type II** causes diarrhea in pigs of all ages. The morbidity may reach 100% but mortality is low. The disease may start in the finishing pigs and spread rapidly to pregnant sows and their nursing piglets.

The diarrhea may persist in the 6- to 10-week-old pigs, and seronegative gilts introduced into the herd may become infected and develop a profuse diarrhea that lasts a few days.

A PRCV with close antigenic relationship to the TGE virus has been identified as enzootic in the UK and in some European countries. A Canadian isolate of the virus inoculated into 8-week-old piglets caused polypnea and dyspnea and diffuse bronchioalveolar lesions. Seroprevalence studies in Spain revealed that 100% of large herds and 91% of small herds had animals with antibodies. Only mild or inapparent respiratory signs occur and the growth of finishing pigs may be temporarily affected.

### Foals

#### Equine Rotavirus

Rotavirus is the most common viral cause of diarrhea and is endemic in most if not all horse populations, as has been concluded from high seroprevalence rates in unvaccinated adult horses.<sup>15,16</sup> RVA is the group most commonly associated with diarrhea in foals up to 3 months of age. Most equine rotaviruses are distinct from those of other species with a distinctive electropherotype and subgroup reaction. Six G types and six P types have been described among equine rotaviruses thus far; however, the majority of circulating equine rotaviruses are G3 P[12] and G14 P[12].<sup>17</sup>

The virus can be isolated from the feces of healthy foals and from diarrheic foals in outbreaks of diarrhea. Outbreaks of the disease occur on horse farms with a large number of young foals in which the population density is high. A case-control study of foal diarrhea in the UK over a 3-year period revealed rotavirus was a significant pathogen associated with diarrhea in foals. The other common pathogens were *C. perfringens*, *S. westeri*, and *Cryptosporidium* spp. A survey of the enteric pathogens in diarrheic Thoroughbred foals in the UK and Ireland revealed a prevalence of 37% rotaviruses and 8% in normal foals.

Dual infection with different rotavirus strains as well as coinfection with other enteropathogens including *Salmonella* spp., *Cryptosporidium* spp., and ECoV have been reported, but their clinical significance remains to be determined.<sup>15</sup>

### PATHOGENESIS

#### Rotavirus

The rotavirus infects mature brush border villous epithelial cells in the small intestine and to a lesser extent in the large intestine. The infected cells are sloughed, leading to partial villous atrophy, and the atrophic villi are rapidly recovered with relatively undifferentiated crypt cells that mature over a few days and result in the healing of the lesion. The activity of the mucosal  $\beta$ -galactosidase (lactase) in the brush border of the villous epithelium is less than that found in normal

animals, which results in decreased utilization of lactose. This reduction in enzymes is associated with immature enterocytes on the villi during rotavirus infection. In vitro studies have suggested that lactase may be the receptor and uncoating enzyme for rotavirus, which may explain the high degree of susceptibility of the newborn with high levels of lactase. The net effect of the morphologic and functional changes in the intestine is malabsorption resulting in diarrhea, dehydration, loss of electrolytes, and acidemia.

The pathogenesis is similar in calves, lambs, pigs, and foals. Lesions occur within 24 hours after infection, villous epithelial cells of the small intestine are infected and become detached, and regeneration occurs within 4 to 6 days after the onset of the diarrhea. The intestinal villi usually return to near normal within about 7 days after recovery from the diarrhea. However, calves and pigs may require 10 to 21 days to fully recover to a normal growth rate following rotavirus infection. Experimental rotaviral infection in 3-week-old piglets results in diarrhea, anorexia, and vomiting. Villous atrophy of the small intestine is the most severe lesion but returns to normal in 6 days. Infection and clinical disease developed in the presence of serum-neutralizing antibody obtained from seropositive sows.

Although it has been generally accepted that lactose malabsorption is an important factor in the pathogenesis of diarrhea, the experimental infection of gnotobiotic lambs with rotavirus did not result in lactose intolerance, as assessed by the measurement of reducing substances in the feces or by the clinical effects and blood glucose levels after a lactose load. Lactose intolerance could be demonstrated by using extremely high doses of lactose, three to four times the normal dietary intake. Thus lactose-containing feeds such as milk are not necessarily contraindicated in rotavirus diarrhea.

A combined infection with rotavirus ETEC may result in a more severe disease than produced by rotavirus infection alone, particularly in calves several days of age when the rotavirus normally produces a mild disease and when calves are resistant to enterotoxigenic colibacillosis. The intestinal lesions of villous atrophy are also more severe and extend into the colon in dual infections. Naturally occurring cases of the dual infection in calves are considered to be more severe than single infections. Under field conditions more than one enteropathogen is likely to be involved in the pathogenesis of the diarrhea.<sup>6,12,15</sup>

Experimentally, in gnotobiotic 1-day-old calves, concurrent infection with BVDV and bovine rotavirus results in a more severe enteric disease than that associated with either virus alone. The BVDV potentiated the effect of the rotavirus. Severe lymphoid depletion was associated with BVDV infection regardless of the concurrent rotavirus infection. The clinical findings of induced

combined BVDV and rotavirus infections in neonatal calves at 8 to 9 days of age are much more severe and the duration of diarrhea much longer than in rotavirus infection alone.

### Coronavirus

The pathogenesis of coronaviral enteritis in calves is similar to the rotavirus infection. The villous epithelial cells of the small and large intestines are commonly affected. The crypt epithelium is also affected, which makes regeneration of villous epithelial cells much longer, which in turn results in persistent diarrhea for several days and death from dehydration and malnutrition. Experimental infection of calves with virulent BCoV results in depletion of lymphocytes in the mesenteric lymph nodes and Peyer's patches, low levels of immunoglobulin, and generalized immune suppression. Experimental infection with the attenuated virus results in lower levels of intestinal immunoglobulin titers than with the virulent virus. Experimentally, newborn calves are capable of mounting an intestinal immune response to BCoV and vaccine failures may be the result of overattenuation of the virus. The pathophysiological changes caused by coronavirus-induced diarrhea in the calf have been described and are similar to the changes that occur in acute diarrheal disease in the calf associated with other enteropathogens.

### Porcine Coronavirus

This virus replicates in the villous epithelial cells of both the small and large intestine and clinically resembles TGE of piglets. There is no evidence that rotavirus infection in piglets is accompanied by increased permeability of the intestine to macromolecules.

### Calicivirus-Like (Norovirus) Agent

Norovirus causes degeneration of the villous epithelial cells of the proximal part of the small intestine leading to villous atrophy, a reduction in disaccharidase activity, and xylose malabsorption. In gnotobiotic calves experimentally infected with the Breda virus, the villous epithelial cells of the ileum and colon are affected, including the dome epithelial cells.

### Parvovirus

Experimental infection of calves with the parvovirus results in lymphopenia and viremia and damage to the small-intestinal crypt epithelium and the associated mitotically active lymphoid tissues. Villous atrophy occurs because of failure of replacement of villous epithelial cells. By 5 days after inoculation there was evidence of repair of the intestinal lesions. Following experimental challenge, the tonsillar tissues, intestinal mucosa, and mesenteric lymph nodes all become infected. Subsequent spread also results in greater involvement in the large intestine and the upper jejunum, Peyer's patches, and mesenteric lymph nodes.

## CLINICAL FINDINGS

### Calves

The naturally occurring disease usually occurs in calves over 4 days of age and is characterized by a sudden onset of a profuse liquid diarrhea. The feces are pale yellow, mucoid, and may contain flecks of blood. Recovery usually occurs in a few days. Explosive outbreaks occur, and up to 50% of calves from 5 to 14 days of age in the affected population may develop the disease. If ETEC are present, the disease may be acute; dehydration is severe and deaths may occur. Multiple mixed infection with *E. coli*, coronavirus, and *Cryptosporidium* spp. are common in calves over 4 days of age; thus it may be impossible to describe a typical case of uncomplicated naturally occurring rotavirus or coronavirus-like diarrhea. There is a tendency for viral diarrhea in newborn calves to occur in explosive outbreaks; the calves are usually not toxemic, but the character of the diarrhea cannot be differentiated clinically from that associated with the other common enteric pathogens of newborn calves.

A coronaviral enteritis affecting calves from 1 to 7 days of age has been described, but there are no distinguishing clinical characteristics. The diarrhea may be persistent for several days, followed by death in spite of fluid therapy and careful realimentation with milk. The feces are voluminous, mucoid and slimy, and may be dark-green or light-brown in color.

### Lambs

Experimentally, newborn gnotobiotic lambs develop diarrhea 15 to 20 hours following oral inoculation and show dullness and mild abdominal discomfort. There are only a few documented descriptions of naturally occurring rotaviral diarrhea in newborn lambs. Affected lambs under 3 weeks of age develop a profuse diarrhea, and the case-fatality rate is high. It is not clear if outbreaks of uncomplicated rotaviral diarrhea occur in newborn lambs.

### Piglets

Rotaviral diarrhea may occur in nursing piglets from 1 to 4 weeks of age and in pigs following weaning. The disease in nursing piglets resembles milk scours or 3-week scours. Most of the pigs in the litter are affected with a profuse liquid to soft diarrhea with varying degrees of dehydration. Recovery usually occurs in a few days unless complicated by ETEC or unsatisfactory sanitation, overcrowding, and poor management. The disease is often most severe in herds in which there is continuous farrowing with no period of vacancy for cleaning and disinfection in the farrowing barn. The disease may also occur in pigs a few days after weaning and may be a major factor in PWD of piglets weaned at 3 weeks of age or earlier in the case of weaning pigs at 1 to 2 days of age.

**PED type I** affects piglets only up to 4 to 5 weeks of age and is characterized by profuse

watery diarrhea, high morbidity, and low mortality.

**PED type II** causes a profuse fluid diarrhea in pigs of all ages, including nursing piglets. Explosive outbreaks may occur and the morbidity may reach 100%. Mortality is usually restricted to piglets under 3 weeks of age.

### Foals

Affected foals—usually from 3 days to 5 months of age—appear depressed, fail to suck, and become recumbent. The temperature ranges from 39.5 to 41.0°C (103–106°F) and respirations may be rapid and shallow. There is a profuse, watery, nonfetid diarrhea that results in severe dehydration and electrolyte imbalances. Recovery following treatment usually occurs within 2 to 4 days. Death may occur within 24 hours after the onset of diarrhea.

## CLINICAL PATHOLOGY

### Detection of Virus

Fecal samples (20–30 g) should be collected from affected animals as soon possible after the onset of diarrhea and submitted to the laboratory in a chilled state. Samples of intestinal mucosa from several sections of the small and large intestine should be submitted chilled for virus detection and possible isolation.

Because multiple mixed viral and bacterial infections are common, the request for a laboratory diagnosis must include consideration of all of the common pathogens. The viruses are much more difficult to detect than bacterial enteropathogens. In herd outbreaks, fecal samples from several affected animals and some normal animals should be submitted. The rotavirus will usually be present in both normal and diarrheic animals, which presents problems in interpretation and requires evaluation of the clinical and epidemiologic findings.

Several laboratory tests are available for detection of rotaviruses and coronaviruses in the feces and intestinal contents and tissues. The particular test used will depend on the facilities and equipment available.

### Electron Microscopy

Demonstration of the virus in feces using EM has been a standard diagnostic technique. It is easier to see the virus if it has been concentrated by ultracentrifugation or clumped by immunoelectron microscopy using specific antiserum. With EM, the virus can be detected for up to 6 to 10 days after the onset of diarrhea. Protein A-gold immunoelectron microscopy is a valuable test to detect BCoV in the feces and nasal secretions of infected calves. However, because the equipment and expertise necessary for EM are not available in many laboratories, alternative diagnostic techniques have been developed.

### Immunofluorescence

Several tests are based on immunofluorescence. These include immunofluorescent

staining of fecal smears and cell culture immunofluorescence of fecal preparations. Immunofluorescent staining of a fecal smear is a more convenient test for diagnostic laboratories because a diagnosis can be made in a few hours, and an EM is not necessary. However, the immunofluorescence tests may not be as reliable as some other tests. The FA technique will only detect the virus within epithelial cells which are present in the feces for 4 to 6h after the onset of diarrhea. In some studies the FA technique detects the virus in only 20% of samples, whereas EM detected the virus in about 60% of the samples.

### Immunodiffusion and Electron Microscopy

Immunodiffusion and EM are superior to the FA technique. Treatment of the feces with chymotrypsin improves the detection rate. Monoclonal antibodies to porcine Group C rotavirus can be used in an immunofluorescent test and may have wider applications in the study of Group C rotavirus diarrheas in swine, cattle, and potentially, other species.

**Testing immunofluorescent sections of spiral colon** is the diagnostic method of choice for the detection of coronavirus in calves; fecal samples are unreliable. Isolation of coronavirus in tracheal organ culture is the most sensitive in vitro culture technique. A hemadsorption–elution–hemagglutination assay test for the detection of coronavirus in the feces of calves is a simple and rapid procedure. A counterimmunoelectrophoresis test is available for the detection of coronavirus in calves. An immunohistochemical technique can be used to detect the virus of PED in the small intestine.

**ELISAs** are more sensitive and simple than immunoelectroosmophoresis, CF, immunofluorescence on inoculated cell cultures, or EM for the detection of rotavirus in calf feces. The ELISA is effective in detecting the presence of porcine rotavirus in feces and was confirmed in two-thirds of the samples tested using EM, immunofluorescence, and polyacrylamide gel electrophoresis (PAGE). A blocking-ELISA using monoclonal antibodies can detect the PEDV in feces and serum antibodies in both naturally and experimentally infected piglets and earlier than an indirect immunofluorescence test.

A competitive blocking-ELISA is considered most suitable for routine detection of porcine epidemic virus in the feces of pigs.

The ELISA and EM of feces are equally reliable in detecting the rotavirus and coronavirus in the feces of experimentally infected calves. The agreement between the two tests was 95% for coronavirus and 84% for rotavirus. There will always be borderline samples containing antigen in quantities near the detection limit for each test. Some samples will be positive for one test and

negative for the other and vice versa. This problem can be minimized if several individual samples from a disease outbreak are examined. The morphologic identification of rotavirus is usually straightforward, but the pleomorphism of BCoV can present problems. The ELISA may also fail to detect viral antigen in feces that also contain antibody. The test can provide diagnostic results within 24 hours after collection of the fecal samples.

### Reverse Passive Hemagglutination, ELISA, and Polyacrylamide Gel Electrophoresis

The three techniques for the detection of rotavirus in fecal samples from diarrheic calves have been compared. The reverse passive hemagglutination (RPHA) was at least as sensitive as the ELISA, and both were compared with the PAGE. The overall agreement between RPHA and PAGE was 96%; the ELISA was not as sensitive. The commercial ELISA has a slightly higher sensitivity than agglutination, PAGE, and concentrated PAGE, but the specificity of ELISA is lower. The latex agglutination test has a lower sensitivity than ELISA, but its specificity is higher. The latex agglutination test is easy to perform, more sensitive than EM, and more specific for detection of rotavirus. A dot hybridization assay can detect and differentiate two serotypes of porcine rotavirus.

The fast and inexpensive ELISA combined with the highly specific and sensitive RT-PCR is a practical approach in epidemiologic studies of bovine rotavirus.

PCR assays are now available for the detection of BCoV in feces. Nonradioactive PCR-derived cDNA probe assays can be used to detect rotavirus serotypes.

A rapid ELISA using monoclonal antibodies can be used for the simultaneous detection of BCoV, rotavirus serogroup A, and *E. coli* K99 antigen in the feces of calves. The specificity of all of the components was more than 90% specific and the sensitivity for BCoV, F5 (K99) *E. coli*, and rotavirus, 77, 93, and 100%, respectively.

Immunochromatography is used for the detection of RVA in the feces of calves, piglets, and foals, and has a sensitivity of 89% and specificity of 99% compared with ELISA, and its reproducibility is 100%. It is a one-step procedure, simple to use, very rapid, and can be performed on the farm.

A field enzyme immunoassay test (Rotazyme test) is highly accurate and reliable for the detection of rotavirus in the feces of horses with and without diarrhea. The test is a simple, rapid, and specific procedure that can take the place of a more expensive and slower procedure such as EM.

ImmunoCardSTAT Rotavirus is a human group A assay that can be used as an on-site diagnostic test for bovine rotavirus with a sensitivity and specificity of 87.0% and 93.6%, respectively. The assay is a 10-minute

one-step test with all the necessary reagents included in the kit and with no need for any laboratory equipment.

### Serology

Several serologic tests are available for the measurement of rotaviral antibody in serum and lacteal secretions. An ELISA is used to detect PED coronavirus antibodies in swine sera. The radioimmunoassay is the most sensitive test compared with the agar gel immunodiffusion, CF, hemagglutination, and hemagglutination inhibition tests.

### NECROPSY FINDINGS

The pathology of experimentally induced rotavirus and coronavirus diarrhea in colostrum-deprived and gnotobiotic calves, lambs, and piglets has been described. Grossly, the changes are unremarkable and consist of dehydration, fluid-filled intestinal tract, and distension of the abomasum. The microscopic changes consist of shortening of the length of the villi and replacement of the tall columnar villous epithelial cells by cuboidal and squamous cells. Segments of the small intestine may reveal villous fusion, rounded absorptive cells, villous atrophy, and exposure of lamina propria. Crypt hyperplasia occurs in response to the loss of columnar epithelial cells from the villi. Histologic lesions caused by previous rotavirus infection may be present in the upper small intestine of clinically normal calves. The rate at which enterocytes are affected in older disease-resistant calves is caused by the slowing of the virus from entering the cells.

In coronavirus enteritis in calves, there is commonly villous atrophy of both the small and large intestines and destruction of the crypt epithelium; destruction does not occur in rotavirus enteritis. The changes are more severe in field cases of acute diarrhea in calves in which both viruses and ETEC can be isolated. Concurrent infection with BVDV has also been demonstrated to be synergistic in bovine rotaviral diarrhea.

The histologic appearance of the intestinal lesions of experimental infection of calves with Breda virus, calicivirus-like agent, and parvovirus have been described. Generally, the lesions are similar to those associated with rotavirus and coronavirus infection.

The wide array of diagnostic tests available to confirm the presence of enteric viruses has already been discussed. Because of the frequency of subclinical infection with these agents, it is important to histologically confirm concurrent atrophy of villi.

### Samples for Confirmation of Diagnosis

- **Histology:** Duodenum, jejunum, ileum, colon (LM, IHC)
- **Virology:** Colonic content (EM, ELISA, latex agglutination); colon, ileum, jejunum (FAT, culture)



## DIFFERENTIAL DIAGNOSIS

The cause of acute diarrhea in newborn farm animals cannot be determined clinically. All of the common bacterial and viral enteropathogens can cause an acute profuse fluid diarrhea, with progressive dehydration and death in a few days.

When outbreaks of diarrhea are encountered, a detailed examination of the possible risk factors should be made, and the appropriate fecal samples and tissues from affected animals should be submitted to the laboratory. The most reliable specimens include fecal samples obtained from animals within a few hours after the onset of diarrhea, and untreated affected animals are submitted for necropsy and microbiological examination within a few hours after the onset of diarrhea.

The clinical and epidemiological characteristics of the common acute diarrheas of neonatal farm animals are as follows:

### Calves

**Enterotoxigenic colibacillosis** occurs primarily in calves under 5 days of age and is characterized clinically by an acute, profuse diarrhea. Recovery following treatment usually occurs in 2 days. Outbreaks occur in beef and dairy calves. Rotavirus and coronavirus diarrhea usually occur in calves over 5–10 days of age and up to 3 weeks of age. Explosive outbreaks occur, characterized by an acute profuse liquid diarrhea with recovery in 2–4 days.

Recovery is assisted by oral fluid therapy.

**Cryptosporidiosis** occurs in calves from 5 to 15 days of age and is characterized by a persistent diarrhea that may last for several days. The cryptosporidia may be detected by Giemsa stain of fecal smears or by fecal flotation.

### Bovine viral diarrhea virus (BVDV)

Whether or not BVDV causes clinically significant diarrhea with lesions of the small intestine of calves 3–6 weeks of age is unknown. Diagnostic laboratories report the presence of intestinal lesions such as villous atrophy and crypt cell destruction in calves 3–6 weeks of age that have been affected with intractable diarrhea and from which the BVDV was isolated from the feces. However, there is no evidence of a cause-and-effect relationship.

### Piglets

**Transmissible gastroenteritis** is most common in piglets under 1 week of age, and explosive outbreaks are common. There is acute profuse diarrhea and vomiting. Affected piglets may continue to nurse for several hours after the onset of the diarrhea. The case–fatality rate is high in piglets under 7 days of age; older pigs usually survive.

**Porcine epidemic diarrhea type I** affects piglets under 4–5 weeks of age and is characterized by profuse watery diarrhea, high morbidity, and low mortality.

**Porcine epidemic diarrhea type II** causes a profuse fluid diarrhea in pigs of all ages, including nursing piglets. Explosive outbreaks may occur and the morbidity may reach 100%. Mortality is usually restricted to piglets under 3 weeks of age.

**Enterotoxigenic colibacillosis** usually occurs in weaned and unweaned piglets. There is acute diarrhea, dehydration, and rapid death. Pigs with endotoxemia (Shiga-toxin producing *Escherichia coli*) may die without obvious diarrhea and usually appear cyanotic. Entire litters may be affected and the case–fatality rate may be 100%. Early treatment with antibiotics and subcutaneous fluids will result in recovery.

**Coccidiosis** occurs in piglets from 5 to 10 days of age and is characterized by an acute diarrhea in which the feces are foul smelling and vary in consistency from cottage cheese–like to liquid and gray or yellow and frothy. The diarrhea is persistent for several days and nonresponsive to antibiotics. Some pigs recover spontaneously; others die in 2–4 days. Coccidial oocysts can be detected in the feces. The morbidity rate varies from 50% to 75% and the case–fatality rate from 10% to 20%.

**Hemorrhagic enterotoxemia** caused by *Clostridium perfringens* type C affects entire litters of pigs under 1 week of age; is characterized clinically by severe toxemia, dysentery, and rapid death; and at necropsy there is a hemorrhagic enteritis.

### Lambs

**Enterotoxigenic colibacillosis** occurs in lambs most often under 1 week of age and is characterized by dullness, failure to suck, and acute diarrhea, which responds to antibiotic and fluid therapy.

**Coliform septicemia** affects lambs under a few days of age and usually causes sudden death. Lamb dysentery occurs most often in lambs under 10 days of age, and there may be sudden death or acute toxemia, tucked-up abdomen, and a severe diarrhea and dysentery. At necropsy the characteristic finding is hemorrhagic enteritis.

### Foals

**Rotaviral diarrhea** occurs in foals from 5 to 35 days of age, but is most common in foals under 2 weeks of age. There is acute profuse watery diarrhea, failure to suck, recumbency, and dehydration. Recovery is common within 1 week. A mild fever is common.

**Foal heat diarrhea** occurs in foals 6–10 days of age whose dams are in estrus 7–10 days after foaling.

**Salmonellosis, *C. perfringens* type B, and dietary diarrhea from excessive consumption of milk** are less common causes of diarrhea in newborn foals.

## TREATMENT

The treatment of viral diarrheas in newborn farm animals is essentially the same as described for acute undifferentiated diarrhea of newborn calves. There is no specific therapy for viral diarrhea, but antimicrobial agents may be used both orally and parentally for the possible occurrence of secondary enteric and systemic bacterial infections. In the absence of complications, recovery from viral enteritis usually occurs without specific treatment in 2 to 5 days, which parallels the replacement of the villous epithelial cells whose complete replacement and maturation requires several days after the cessation of diarrhea.

**Oral and parenteral fluid therapy** as indicated is essential (Chapter 5). Affected foals may require fluid and electrolyte therapy for up to 72 hours. A glucose–glycine electrolyte formulation is an effective fluid therapy for pigs affected with experimental rotaviral diarrhea. The formula is glucose 67.53%, sodium chloride 14.34%, glycine 10.3%, citric acid 0.8%, potassium citrate 0.2%, and potassium dihydrogen phosphate 6.8%. A weight of 64 g of this formula is dissolved in 2 L of water to produce an isotonic solution.

When possible, affected animals, particularly calves and foals, should be separated from other neonates. When outbreaks of the disease occur in any species, the principles of good sanitation and hygiene should be emphasized to minimize the spread of infection.

## CONTROL

The principles of control of viral diarrhea are similar to those described for acute undifferentiated diarrhea of newborn calves:

- Reduce infection pressure
- Ensure adequate transfer of passive immunity
- Vaccinate the dam to induce specific immunity in the colostrum (passive immunization of the neonate)

## Management and Colostral Intake

Colostrum management strategies are discussed in detail (see the section Failure of transfer of Passive Immunity).

## Vaccination

Vaccination of the dam before parturition is a common strategy to control rotavirus infection in calves, piglets, and foals.

Two major approaches are used to provide specific immunity for the control of rotavirus and coronavirus diarrhea in calves:

1. Stimulation of active immunity by vaccinating the newborn calf with an oral vaccine containing MLVs
2. Enhancement of lactogenic immunity by vaccinating the dam during pregnancy (passive immunization)

### Oral Vaccines to Newborn Calves

An MLV rotavirus vaccine for oral administration to calves immediately after birth has been available commercially for many years. Initially, good results were claimed but vaccine field trials did not include contemporary controls, and the efficacy of the vaccine was uncertain. The incidence of diarrhea in herds not vaccinated in the previous year was compared with the incidence during the year of vaccination, which is inadequate to assess the efficacy of the vaccine.

Field trials using the oral vaccine indicate a failure of protection of calves against rotavirus infection and rotavirus–coronavirus infection. Effective oral vaccination of calves may be hindered by the presence of specific antibodies in the colostrum (the colostrum barrier) and may explain the failure of the vaccine under field conditions. The intestinal antibody response of young calves to an enteric viral infection is associated with the production of IgM and IgA antibodies locally in the intestine. This response is absent or diminished in calves that have ingested adequate amounts of colostrum with specific antibodies to the viruses. Most of the efficacy trials with the vaccine were performed on colostrum-deprived gnotobiotic calves that were vaccinated orally at birth and experimentally challenged a few days after birth. It is probably futile to vaccinate calves orally immediately after birth, particularly in herds in which the disease is endemic, because the colostrum will contain high levels of specific antibodies.

Fecal shedding of oral vaccine rotavirus seldom occurs after oral inoculation of gnotobiotic calves with a commercial modified-live bovine rotavirus-BCoV vaccine. Because of low shedding of virus in gnotobiotic calves that do not have the interfering effects of colostral antibodies, it seems unlikely that vaccine rotavirus will be shed in quantities from orally vaccinated conventional calves that have ingested colostrum containing antibody. Thus detection of the virus by negative stain EM in feces from orally vaccinated calves is most likely to be virulent field virus rather than vaccine virus.

### Vaccination of Pregnant Dam (for Passive Immunization of the Neonate Through Colostral Immunoglobulin)

Vaccination of the pregnant dam to enhance specific colostral immunity can provide passive protection against enteric viral infection of newborn farm animals. The success of this method depends on the continuous presence of a sufficient amount of specific antibody to the rotavirus and coronavirus in the intestinal lumen. Normally, the colostral levels of antibody are high in the first few milkings after parturition. However, there is a rapid decline in colostral antibodies to below protective levels within 24 to 48 hours following parturition. Most cases of

rotavirus and coronavirus diarrhea occur from 5 to 14 days after birth when the antibody levels in the postcolostral milk are too low to be protective.

The parenteral vaccination of the pregnant dam before parturition with a rotavirus and coronavirus vaccine will usually increase the level and duration of specific antibody in the colostrum. The use of a modified-live rotavirus–coronavirus vaccine stimulated a small but insignificant increase in colostral and milk antibodies. However, by 3 days after parturition, the rotavirus and coronavirus antibody titers in the milk of vaccinated heifers had declined to low or undetectable levels.

Inactivated rotavirus vaccines given to pregnant cows in the last trimester will significantly increase rotavirus antibody in colostrum and milk from vaccinated dams compared with controls, but the severity of diarrhea may be the same in calves from both groups. The increased milk antibody delays the establishment of infection but does not reduce the severity of clinical disease that was experimentally induced.

### Experimental Studies of Maternal Bovine Rotavirus Vaccines

The use of an adjuvanted rotavirus vaccine given simultaneously intramuscularly and by the intramammary route significantly enhanced serum, colostrum, and milk rotavirus antibody titers, whereas intramuscular vaccination with a commercial modified-live rotavirus–coronavirus vaccine did not. Colostrum supplements, from the cows vaccinated by the intramammary and intramuscular routes, fed to rotavirus-challenged calves at a rate of 1% of the total daily intake of milk, provided protection against both diarrhea and shedding. The 30-day milk antibody titers from these experimental cows were also considered to be protective for calves by which time the calves should have developed a high degree of age-specific resistance to rotavirus infection. The use of an inactivated rotavirus vaccine in an oil adjuvant given to pregnant cows 60 to 90 days before calving and repeated on the day of calving resulted in a significant increase and prolongation of colostral antibodies up to 28 days after calving. Diarrhea in calves from vaccinated cows was less common and less serious. Similar results were obtained with a combined inactivated adjuvanted rotavirus and *E. coli* vaccine. Similar results have been achieved by vaccination of pregnant ewes. Vaccination of ewes can result in an elevation of specific colostral antibody and prolong the period over which the antibody is present in the lumen of the intestines of the lambs. The vaccination of cows with a monovalent vaccine results in a heterotypic response to all serotypes of rotavirus to which the animals have been previously exposed, which suggests that single serotype vaccination may be sufficient.

The lactogenic antibody responses in pregnant cows vaccinated with recombinant bovine rotavirus-like particles (VLPs) of two serotypes or inactivated bovine rotavirus vaccines have been evaluated. Bovine rotavirus antibody titers in serum, colostrum, and milk were significantly enhanced by the use of triple-layered VLPs, and inactivated vaccines but higher antibody responses occurred in VLP-vaccinated cows.

### Bovine Coronavirus Vaccine

An oil-adjuvanted vaccine containing BCoV antigen to enhance lactogenic immunity in the calf by vaccinating pregnant cows and heifers between 2 and 12 weeks before calving increased serum antibody in the dams, which was reflected in a similar increase in the titer and duration of specific antibody in colostrum and milk for up to 28 days after calving. The overall response was dependent on an adequate antigen payload being incorporated within the single dose vaccine.

### Commercial Bovine Rotavirus–Coronavirus and *E. Coli* F5 (K99) Vaccines

The original rotavirus and coronavirus vaccines for use in pregnant cows to provide passive immunization were not sufficiently efficacious because of the rapid decline in specific colostral antibodies, which renders the calves susceptible to the viral diarrhea several days after birth. The relative success of the enterotoxigenic F5 *E. coli* bacterium has resulted in a shift of the epidemic curve for acute diarrhea in calves under 30 days of age from a few days of age to 2 to 3 weeks of age.

More recently developed vaccines are efficacious. An inactivated combined vaccine against rotavirus, coronavirus, and *E. coli* F5 administered 31 days before the first expected calving date has been evaluated and compared with controls. There was a significant increase in serum antibody against all three antigens in vaccinated animals, which was accompanied by increased levels of protective antibodies to rotavirus, coronavirus, and *E. coli* in their colostrum and milk for at least 28 days. The levels of specific rotavirus and coronavirus antibodies in the milk of vaccinated cows were greater than the fourfold increase seen in the control cows for at least 28 days after calving.

The primary vaccination of pregnant cows with a trivalent commercial vaccine containing live attenuated bovine rotavirus and coronavirus and *E. coli* F5 followed by an annual booster at 6 weeks and 3 weeks before calving, or using the same protocol with an inactivated trivalent vaccine resulted in significant increase in the serum antibody of all vaccinated animals compared with controls. The antibody titers were higher in cows receiving the live vaccine compared with those receiving the inactivated vaccine.

The colostral antibodies against all three antigens increased in all live vaccinated groups, whereas inactivated vaccinated animals had only significant increases in F5 titers. The colostrum of live vaccinated cows contained much higher specific antibody titers. Thus the MLV vaccine can significantly enhance the specific response to rotavirus and coronavirus and *E. coli* F5 after a primary vaccination followed by a booster annually.

### Stored Colostrum

The high levels of viral antibody in the colostrum of the first two milkings of cows can be used to advantage in hand-fed calves. The daily feeding of stored colostrum from the first milkings of cows from the affected herd will reduce the incidence of clinical disease in the calves. The colostrum must be fed daily—beyond the time of gut closure (i.e., intestinal absorption of colostral immunoglobulin)—because rotavirus antibody is not retained in the intestinal lumen for more than 2 to 3 days. In affected herds the specific antiviral antibody in the stored colostrum may be sufficient to prevent the disease if colostrum is fed daily for up to 20 to 30 days. If a large number of cows are calving over a short period of time, the colostrum from immunized cows can be pooled and fed to the calves daily. Even small amounts of colostrum from immunized cows are efficacious if mixed with cows' whole milk or milk replacer. This supplemental feeding of colostrum may be required for only 3 to 4 weeks, because older calves generally possess a high degree of age-specific resistance to rotavirus infections.

### Systemic Colostral Antibody

For many years it was uncertain if circulating colostral antibody in calves was transferred back into the intestinal tract. Evidence shows that passive immunity to calf rotavirus diarrhea can be achieved by adequate calf serum colostral antibody titers. Calves fed colostrum on the first day of life had significant rotavirus-neutralizing antibody titers in their small-intestinal lumina for 5 and 10 days later. The intestinal antibody titers correlated with the serum antibody titers derived from colostrum and were predominantly of the IgG<sub>1</sub> isotype. Intestinal antibody titers were approximately equivalent in 5- and 10-day-old calves, suggesting that **antibody transfer to the intestinal tract is a continuing process for up to 10 days after birth**. Additional evidence that transfer of passive immunity occurs is that calves can be protected from rotavirus challenge by the administration of colostral immunoglobulin by parenteral injection. This protection was not caused by lactogenic antibody, because the calves received no source of dietary antibody. The transfer of circulating antibody into the intestinal tract may be the mechanism that results in the decreased morbidity and case fatality caused by diarrhea in calves

with high concentrations of passive serum immunoglobulin.

### Porcine Rotavirus Vaccines

Although oral porcine rotaviral vaccines have been unsuccessful, the use of either modified-live or inactivated rotavirus vaccines for parenteral immunization of the sow before farrowing is common practice. In pigs, as in ruminants, IgG antibodies to rotavirus are predominant in colostrum and decline 8- to 32-fold in the transition to milk. However, secretory IgA is the primary isotype of rotavirus antibody in the milk of pigs. Increased levels of IgA and IgG antibodies to rotavirus occur in the milk of sows after natural rotavirus infection of nursing piglets or following parenteral inoculation of pregnant or lactating sows with live attenuated rotaviruses. But titers decline by the end of lactation, suggesting that repeated natural rotavirus infection of sows or parenteral re vaccination may be necessary to maintain high IgA antibody to rotavirus in milk. This observation may account for the higher prevalence of rotavirus infection during the first week of life in pigs born to gilts (38%) than in those born to sows (3%).

### Equine Rotavirus Vaccine

Several inactivated equine rotavirus vaccines are available. These vaccines were shown to significantly increase serum antibody concentration in vaccinated mares and their foals. Notwithstanding it was shown that foals can acquire rotavirus infection despite having a high rotavirus antibody titer. The incidence of rotaviral diarrhea was lower in foals born to vaccinated mares, compared with foals born to control mares but the difference was not significant. Because most clinical trials found that foals of vaccinated mares can still contract a rotavirus infection and develop clinical disease, these vaccines can at most be considered to be partially protective.<sup>15</sup> Parenteral vaccination of mares with inactivated rotaviral vaccine stimulates production of high levels of specific IgG, and not IgA, in colostrum and milk.

### Subunit Vaccines

Subunit rotaviral vaccines consisting of VLPs given parenterally can enhance bovine rotavirus antibody titers in serum, colostrum, and milk. These vaccines offer advantages over conventional modified-live or inactivated vaccines including:

- Exclusion of adventitious agents associated with live vaccines
- Consistent production of outer capsid proteins
- Genetic engineering to allow updating of efficacious vaccines for boosting lactogenic immunity

### FURTHER READING

Boileau MJ, Kapil S. Bovine coronavirus. *Vet Clin Food Anim Pract.* 2010;26:126-146.

Parwani AV, Tsunemitsu H, Saif LJ. Current research in bovine group A and group C rotaviruses. *Curr Top Vet Res.* 1994;1:115-132.

Saif LJ, Rosen BI, Parwani AV. Animal rotaviruses. In: Kapikian AZ, ed. *Viral Infections of the Gastrointestinal Tract.* New York: Marcel Dekker; 1994:289-314.

### REFERENCES

1. Papp H, et al. *Vet Microbiol.* 2013;165:190.
2. Boileau MJ, Kapil S. *Vet Clin Food Anim Pract.* 2010;26:126.
3. Mallicote M, et al. *Equine Vet Edu.* 2012;24:206.
4. Midgley SE, et al. *Vet Microbiol.* 2012;156:238.
5. Swiatek DL, et al. *Vet Microbiol.* 2010;140:56.
6. Bartels CJM, et al. *Prev Vet Med.* 2010;93:162.
7. Koplan J, et al. *Emerg Infect Dis.* 2011;17:1120.
8. Di Bartolo I, et al. *Vet Rec.* 2011;169:73.
9. Reuter G, et al. *Vet Rec.* 2009;165:537.
10. Cho YI, et al. *Vet Microbiol.* 2013;166:375.
11. Wani SA, et al. *Small Ruminant Res.* 2004;52:145.
12. Gaza S, et al. *Open Vet J.* 2011;1:50.
13. Gazzal S, et al. *Vet J.* 2012;193:299.
14. Khafagi MH, et al. *Global Veterinaria.* 2010;4:539.
15. Bailey KE, et al. *Vet Microbiol.* 2013;167:135.
16. Mallicote M, et al. *Equine Vet Educ.* 2012;24:206.
17. Papp H, et al. *Vaccine.* 2013;31:5627.

## VESICULAR STOMATITIS (SORE MOUTH, INDIANA FEVER)

### SYNOPSIS

- Etiology** Vesicular stomatitis virus, genus *Vesiculovirus* in the family Rhabdoviridae
- Epidemiology** Disease of cattle, horses, and pigs occurring only in the Americas. Affects predominantly adult animals. Seasonal disease occurrence with clustered outbreaks in summer and autumn. Vector-borne, direct, and mediate transmission. World Organization of Animal Health List A disease (reportable in most countries). Prime importance as differential diagnosis for foot-and-mouth disease
- Clinical findings** Vesicular lesions or healing ulcers on oral mucosa, coronary bands, teats, and prepuce
- Diagnostic confirmation** Virus isolation, indirect sandwich ELISA, complement fixation, and polymerase chain reaction. Serology (paired samples) via liquid-phase blocking ELISA, virus neutralization, or complement fixation
- Treatment** None specifically, just supportive
- Control** Notifiable disease. Quarantine and movement control

ELISA, enzyme-linked immunosorbent assay.

### ETIOLOGY

The causative agent of VS is the *vesicular stomatitis virus* (VSV), genus *Vesiculovirus*, pertaining to the family Rhabdoviridae. Two distinct immunologic classes of the virus have been recognized: VSV New Jersey (VSV-NJ) and VSV Indiana (VSV-IND). There are three subtypes of VSV-IND based on serologic relationships, including IND-1



(classical IND), IND-2 (cocal virus), and IND-3 (alagoas virus). The serotype NJ is the most virulent and most common.

The virus is much less resistant to environmental influences than the virus of FMD. It is readily destroyed by sunlight, boiling, and the use of common disinfectants but can survive in the environment for prolonged periods in a dark and cool environment.

VS is listed on “List A” of the OIE and as such is a reportable disease to the OIE for member states. Accordingly it is a **reportable disease** in most countries of the world. The disease is of major importance because it is clinically indistinguishable from FMD in ruminants and swine. It is considered as a minor zoonosis because it can cause disease in humans.

## EPIDEMIOLOGY

### Occurrence

#### Geographic Occurrence

The disease is limited to the Americas, although historically it has been reported from South Africa (1896–1897) and France (1915 and 1917). VS is **endemic** in Mexico, Central America, northern South America, and eastern Brazil as well as in limited areas of the southeastern United States in which area outbreaks occur annually.<sup>2</sup> Periodic **incursions** to the north and south of the endemic area into the United States, Brazil, and Argentina produce epizootic disease. It is also enzootic in Ossabaw Island, off the shore of Georgia in the United States. Ossabaw Island is the only recognized enzootic focus of VSV-NJ. The VSV-NJ antibodies have been detected only from feral swine, cattle, horses and donkeys, deer, and raccoons. However, despite high transmission rates, clinical disease is rarely detected.

Strains of VSV-NJ are endemic in southern Mexico, Central America, Venezuela, Colombia, Ecuador, and Peru and account for more than 80% of clinical cases. Sporadic activity of these strains has been observed in northern Mexico and the western United States. Cases of the disease reported from Brazil and Argentina were related to VSV-IN2 and VSV-IN3.<sup>1</sup> VSV-IN2 has only been isolated in these two countries and only from horses. Cattle in close proximity to affected horses neither developed clinical disease nor antibodies against VSV.<sup>1</sup>

In endemic areas, outbreaks are seasonal, often associated with the transitions between rainy and dry seasons. In these regions the disease occurs seasonally every year, emerging from tropical areas to cause sporadic outbreaks in cooler climates during the summer months.

In the **United States** outbreaks occur periodically in the late summer and autumn; a major outbreak occurred in 14 western states from 1982 to 1983, one in 1995 involving six states, and another one in 2005 involving nine states, with sporadic disease in the intervening and following years. The outbreaks occur

in the **southwestern and western states**, start in the south and progress northerly, and **cluster** in areas of high livestock density in irrigated and green zone areas.<sup>3</sup>

In the 1995 outbreak the disease occurred in Arizona, Colorado, New Mexico, and Utah. The epidemic curve suggested a propagating epidemic; the number of positive premises peaked during week 39 and then rapidly declined. As in previous outbreaks in the southwestern United States, there was a northerly progression of the disease over time. Nationwide, horses accounted for 88% of examinations done for the disease, and 97% of the premises on which species of infected animals were identified recorded horses to be positive. Cattle accounted for 10% of examinations performed, and 3% positive premises on which species were identified were cattle positive.

The first major occurrence of the disease or “sore tongue” in horses, cattle, and swine in the United States was in 1801. The disease disabled 4000 horses needed to fight the Civil War in 1862. Major epidemics in U.S. cattle and horses occurred in the southwestern states from 1889 to 2005. A major outbreak occurred in military horses in the United States during the 1914 to 1918 war but in recent years, in addition to clinical disease in horses, it has come to assume greater importance in cattle and pig herds.

### Host Occurrence

VS primarily affects equids including horses, donkeys, and mules, as well as cattle and swine. Camelids and possibly sheep and goats as well as humans occasionally develop clinical signs. Domestic animals appear to be dead-end hosts in which the virus does not persist and does not return to its natural cycle. Outbreaks of the disease are **most common in horses followed by cattle** and to a lesser extent in pigs. Calves are much more resistant to infection than adult cattle. Serologic surveys have found that in endemic areas of Mexico and Central and South America in addition to domestic livestock, many species of wild animals such as deer, pronghorn antelope, bighorn sheep, bats, raccoons, opossums, bears, coyotes, foxes, dogs, monkeys, rabbits, rodents, turkeys, ducks, and humans are exposed to the infection and develop neutralizing antibodies.<sup>2</sup> Experimental infection is possible in guinea pigs, mice, ferrets, hamsters, and chicken. The reservoir and amplifying host of VSV has thus far not been identified.

Humans are susceptible with the infection causing an influenza-like disease, and the development of high antibody titers in humans often accompanies outbreaks in cattle.

In the 1995 outbreak in the United States, the overall seroprevalence in livestock in Colorado was lower than the seroprevalence in epidemic areas, and seroprevalence rates in epidemic areas were greater for horses

than cattle. The seroprevalence results suggest that some animals had subclinical VS infection during epidemics, and that animals may be exposed to the virus between epidemics. Sentinel premises in Colorado visited quarterly during a 3-year period, when there was no clinical disease, found evidence of seroconversion to both serotypes of virus.

### Morbidity and Mortality

The morbidity rate varies considerably; 5% to 10% is usual but it may be as high as 80%. There is usually no mortality in horses and dairy herds, but overall case-fatality rates ranging from 0% to 15% are recorded for beef herds. Higher mortality rates than in other species have been reported in pigs infected with VSV-NJ. Most cases occur in adult animals, whereas animals under 1 year of age are rarely affected. Outbreaks in an area are usually not extensive, but the disease closely resembles FMD and has achieved considerable importance for this reason.

### Method of Transmission

The mechanisms of VSV transmission are still not entirely understood. **Vector-borne transmission** is considered the epidemiologically most relevant route, although transmission through direct skin-to-skin contact is likely to contribute to the spread of the disease within a herd.<sup>4</sup> There is strong epidemiologic evidence corroborating the assumption of vector-borne transmission. Apart from an obviously seasonal pattern of disease occurrence, the disease incidence was determined to be increased with an increasing population of potential insect vectors, with proximity of affected animals to running water as well as with a lack of use of shelters.<sup>4</sup> Biological transmission by blood-feeding insects, which have been demonstrated repeatedly to be abundant on case-positive premises, also indicates that the insect-vector hypothesis is plausible. **Biological transmission** of VSV has been verified in **blackflies** (*Simulium vittatum*), **phlebotomine sandflies** (*Lutzomyia* spp.), and **biting midges** (*Culicoides* spp.).<sup>4</sup> Mechanical transmission through flies (*Musca domestica*, and *M. autumnalis*) and eye gnats (*Hippelates* spp.) on which the virus has been isolated may also occur. Experimentally, VSV-NJ-infected blackflies readily transmitted the virus to domestic swine. Transmission was confirmed by seroconversion or by the presence of clinical VS.

Vector-borne virus transmission has been debated because viremia, which is considered to be essential for disease transmission by blood-sucking insects, is not commonly observed in animals infected with VSV. As in other domestic animal species in which viremia has not been detected naturally or experimentally, viremia did not occur in the pigs experimentally infected by infected blackflies. Furthermore, the natural vertebrate host required to maintain the

virus between outbreaks has not been identified. Antibody to VSV has been demonstrated in a large number of **wildlife species** in Central America, but their significance as wildlife reservoirs remains to be determined. Feral pigs are believed to be the reservoir and amplifying host on Ossabaw Island.

Another proposed hypothesis is that VSV is actually a plant virus that would be ingested with forages and then undergo an adaptation process to infect its host.<sup>1</sup>

**Mediate or immediate contagion** occurs by contact or ingestion of contaminated materials, especially in large intensive dairies where there is a great deal of communal use of water and feed troughs. It also occurs by the ingestion of contaminated pasture. Spread within dairy herds also appears to be aided by milking procedures. The importation of embryos from infected areas is considered a minimal risk for introduction of infection.

**Convalescent cattle** have been suspect as perpetuating disease and spreading it with movement to other herds. VSV has been isolated from convalescent cattle 38 days after the disappearance of clinical signs, and disease can recur in convalescent cattle. Viral RNA can be detected in the tongue and draining lymph nodes of cattle 5 months after experimental inoculation, but there is no evidence for the long-term persistence of replication-competent virus in cattle.

## Risk Factors

### Host Risk Factors

Differences in susceptibility of different species are well established with horses followed by cattle and then swine, which are considered most susceptible to clinical disease.<sup>1</sup> Age is another well-documented risk factor predisposing to clinical disease, with foals and calves less than 1 year old being less likely to develop clinical disease, although infection and seroconversion still occur.<sup>1</sup> In Costa Rica, which is an endemic area for VS in dairy cattle, parity was associated with clinical disease (animals of parity 4 or 5 were 5.3 times more likely to exhibit clinical signs of VS than animals of parity 3 or lower). Animals of parity 6 and higher had an OR of 4.6 times greater than animals of parity 3 and lower. Factors associated with seropositivity at birth were also found to be breed associated (Jersey calves had an OR of 14.7 times greater than Holstein calves).<sup>5</sup>

### Environmental Risk Factors

There is a marked **seasonal incidence** of the disease, with cases decreasing sharply with the onset of cold weather. The disease is enzootic in low-lying coastal countries with tropical climates, heavy rainfall, and high insect populations. There is also a greater incidence in geographically protected areas with heavy rainfall, such as valleys in the mountains and foothills. Areas of low incidence are protected by natural barriers to

insect migration. These observations promote the importance of biting insects in the spread of the disease both locally and from infected to clean areas. In enzootic areas there is a much higher risk for dairies in forest land, the presence of sandflies, and a higher risk for clinical disease in older cows and cows in lactation.

The management factors affecting the risk for VS in horses, cattle, and sheep during the 1997 outbreak in Colorado, New Mexico, Utah, and Arizona were examined. Animals with access to a shelter or barn had a reduced risk of developing the disease with an OR of 0.6. This was more pronounced for horses at an OR of 0.5. When horses had access to pasture, the risk of developing disease was increased with an OR of 2.01. On all premises where owners reported insect populations were greater than normal, the OR was 2.5. Premises with animals housed <0.5 miles from running water were more than twice as likely to have clinical signs of VS (OR 2.6). This suggests that rivers are a pathway or a risk factor for VS, which is consistent with outbreaks of the disease following major waterways northward during the summer.

### Pathogen Risk Factors

The two major VSV serotypes, VSV-IN and VSV-NJ, are distinct viruses with only 50% similarity in the glycoprotein gene sequence. VSV-NJ is more predominant than VSV-IN in North America.

In the last 70 years, each sporadic outbreak in the southwestern United States has been associated with viral lineages distant from those causing previous outbreaks in the United States but closely related to viruses maintained in endemic areas in Mexico. This pattern of viral occurrence contrasts with that observed in endemic areas in Central and South America where viral genetic lineages are maintained in specific ecological areas over long periods of time. Thus the phylogenetic data and the geographic and temporal distribution of outbreaks indicate that VS does not have a stable endemic cycle in the western United States.

### Experimental Reproduction

Livestock can be infected with VSV by injection or aerosol exposure but not by rubbing virus on intact skin. Intradermal injection causes obvious skin lesions at the inoculation site. Experimental inoculation with the virus kills neonatal mice and chick embryos, and most guinea pigs, hamsters, ferrets, and mice, and chicks.

Experimentally, VS-NJ virus-infected blackflies when exposed to the abdomen or snout of young pigs results in lesions developing postinfection day 1. The entire surface of the snout ventral to the nostrils becomes reddened and swollen with pinpoint pale raised areas. This proceeds to vesiculation on day 2, and subsequent rupture, erosion, and crusting by day 3. Erosion persists for several

days, and by day 7, the vesiculated area is almost healed. Secondary vesicles develop on the upper lips and the tip of the tongue by day 3. Virus can be recovered from tissues surrounding the snout lesions but cannot be isolated from whole blood or plasma.

Viremia has not been detected in any domestic animal species naturally or experimentally infected with the New Jersey serotype of the virus.

### Economic Importance

Most cases of VS recover within days. The economic losses on large dairy farms are largely caused by decreased milk production and mastitis occurring secondary to VSV infection. There is also a great deal of inconvenience and the temporary inability to feed.

There are also losses associated with quarantine such as loss of market opportunities and pasture damage from overgrazing of pastures used for quarantine. Other economic effects result from the cancellation of animal events such as fairs and the cost of loss of international markets.

In the 1995 epidemic of VSV-NJ in the western United States, the direct costs for increased labor and veterinary expenses incurred in caring for horses with the disease were estimated at \$382.00 per case. In a dairy herd, losses were estimated at \$787.00 per animal from increased culling, and in beef ranches the costs were \$15,565.00 per ranch. State regulations restricting the movement of animals within a zone of 10 miles around premises with confirmed cases for 30 days after the last lesion healed, and declaring a quarantine, all added to economic losses.

VS is classified by the OIE as a so-called List A disease, making it a **reportable disease** in all member countries of the OIE.<sup>6</sup> In the United States, all livestock with clinical signs of vesicular disease must be inspected by personnel from USDA-APHIS. Premises confirmed to have VS-positive animals remain quarantined until 30 days after all clinical signs of the disease have disappeared from livestock on the premises. Thus local and national activities involving horses and cattle may be disrupted, and international exports may be prohibited because of meat and livestock embargoes.

### Zoonotic Implications

Occasional human infections give the disease some public health significance, but the disease is mild, resembling influenza, and is considered as minor zoonosis.<sup>1</sup>

### PATHOGENESIS

Local infection of the mucous membrane of the mouth and the skin around the mouth and coronets is followed by the development of vesicles on the lips, muzzle, tongue, as well as on the teats and interdigital clefts. The frequent **absence of classical vesicles** on the oral mucosa of affected animals in field outbreaks has led to careful examination of the

pathogenesis of the mucosal lesions. Even in experimentally produced cases, only 30% of lesions develop as vesicles; the remainder dehydrate by seepage during development and terminate by eroding as a dry necrotic lesion.

### Immune Mechanisms

Following infection, serum-neutralizing antibodies develop within a few days and may persist for 8 to 10 years. Reinfection can occur in the presence of a high antibody titer. In cattle, horses, and swine, high titers of virus are found at the margins of lesions and in vesicular fluids for a short period after infection. However, viremia is undetectable and there is no known carrier state in cattle, horses, or swine.

### CLINICAL FINDINGS

#### Cattle

In cattle after an incubation period of 3 to 15 days, there is a sudden appearance of mild fever and the development of vesicles on the dorsum of the tongue, dental pad, lips, and buccal mucosa. The vesicles rupture quickly and the resultant irritation causes profuse, ropy salivation and anorexia. Confusion often arises in field outbreaks of the disease because of failure to find vesicles. In some outbreaks with thousands of cattle affected, vesicles have been almost completely absent. They are most likely to be found on the cheeks and tongue where soft tissues are abraded by the teeth. At other sites there is an erosive, necrotic lesion. In milking cows there is a marked decrease in milk yield. Lesions on the feet and udder occur only rarely except in milking cows where teat lesions may be extensive and lead to the development of mastitis. Lesions are very painful and cause a decline in feed intake and resistance to be milked in dairy cattle. Recovery is rapid, affected animals are clinically normal in 3 to 10 days, and secondary complications are relatively rare.

#### Horses

In horses, the signs are broadly similar. There is fever, depression, inappetence, drooling of saliva, and affected horses may rub their lips on troughs and jaw champ. Vesicles coalesce and rupture with detachment of the epithelium and the formation of shallow ulcers. The period of fever and vesicles is short lived. Not infrequently the lesions seen are limited to the dorsum of the tongue or the lips and are in the coalescing ulcer stage. Other less common sites include the udder of the mare and the prepuce of males. Lesions may occur at the coronary band and lead to lameness and deformity of the hoof wall.

#### Pigs

In pigs, vesicles develop on or behind the snout, the lips, or on the feet, and lameness is more frequent than in other animals.

### CLINICAL PATHOLOGY

Vesicle fluid, epithelium covering unruptured vesicles, epithelial flaps of freshly ruptured vesicles, or swabs of vesicles are ideal diagnostic specimens for virus isolation. If unavailable, oropharyngeal fluid from cattle or throat swabs from pigs may be submitted. Samples should be placed in containers with Tris-buffered tryptose broth with phenol red at pH 7.6. Glycerophosphate buffer, pH 7.2–7.6, can be used for specimens intended for CF.<sup>1</sup> Samples need to be kept refrigerated for shipping for up to 48 hours or otherwise frozen.

The **indirect sandwich ELISA** (IS-ELISA) is currently the diagnostic method of choice for identification of viral serotypes of VSV and other causative agents of vesicular diseases. Virus isolation can also be performed by inoculation into Vero cell cultures and subsequent staining with anti-VSV FA conjugate. CF is less sensitive than the IS-ELISA and is affected by procomplementary or anticomplementary factors.<sup>1</sup> Nucleic acid recognition by PCR has been used to detect presence of viral DNA.

**Serologic tests** include VN, CF, and a LP-ELISA, all of which are prescribed tests for international trade. LP-ELISA is currently considered the method of choice for the detection and quantification of antibodies against different VSV serogroups. The ELISA has advantages in speed and expense and has comparable specificity and gives fewer false-negative results than VN.<sup>1</sup>

### NECROPSY FINDINGS

Necropsy examinations are not usually undertaken for diagnostic purposes.

### DIFFERENTIAL DIAGNOSIS

Because of its case-for-case similarity to foot-and-mouth disease (FMD), prompt and accurate diagnosis of the disease is essential. In most countries the **disease is notifiable**.

#### Cattle

- FMD
- Pseudocowpox
- Bovine papular stomatitis
- Bovine viral diarrhea/mucosal disease
- Infectious bovine rhinotracheitis
- Bovine malignant catarrh fever
- Bluetongue
- Epizootic hemorrhagic disease
- Rinderpest
- Chemical or thermal burns

#### Horses

- Blister beetle toxicosis
- Bullous pemphigoid
- Equine infectious arteritis
- Equine herpes virus infection
- Calicivirus infection
- Jamestown Canyon virus infection
- Phenylbutazone toxicity
- Equine exfoliative eosinophilic dermatitis and stomatitis

- Squamous cell carcinoma
- Melanoma
- Grass seed awns

#### Swine

- FMD
- Swine vesicular disease
- Vesicular exanthema of swine
- Foot rot
- Thermal or chemical burns

### TREATMENT

Treatment is seldom undertaken, but nonsteroidal antiinflammatories may contribute to the comfort of the animal and the rapidity of recovery.

### CONTROL

**Hygienic and quarantine precautions** to contain the infection within a herd are sufficient control, and the disease usually dies out of its own accord. Animal movement off the farm should be prohibited until 30 days after all lesions have healed. There are usually restrictions of movement of animals from infected areas to different jurisdictional areas that are free of clinical disease, and VS is an **OIE List A disease**.

Immunity after an attack appears to be of very short duration, probably not more than 6 months, but serologic titers persist much longer. An **autogenous killed vaccine** was approved for use in dairy cattle in infected or at-risk areas during the 1995 outbreak in the United States, but vaccine efficacy could not be determined.

A DNA vaccine expressing the glycoprotein gene from VS-NJ virus elicits neutralizing antibody titers in mice, cattle, and horses. The level of protection of antibody required for protection is unknown.

A recombinant VSV-IND expressing NJ and IND glycoproteins has been generated and examined as vaccine candidate. When inoculated into pigs it induced neutralizing antibodies and the pigs were protected against homologous high-dose challenge.

### FURTHER READING

- Letchworth GJ, Rodriguez LL, Barrera JDC. Vesicular stomatitis. *Vet J*. 1999;157:239-260.
- Schmitt B. Vesicular stomatitis. *Vet Clin North Am Food Anim Pract*. 2002;18:453-459.
- OIE Terrestrial Manual 2010; Chapter 2.1.19. Vesicular stomatitis. At: <[http://www.oie.int/fileadmin/Home/eng/Health\\_standards/tahm/2.01.19\\_vesicular\\_stomatitis.pdf](http://www.oie.int/fileadmin/Home/eng/Health_standards/tahm/2.01.19_vesicular_stomatitis.pdf)>; Accessed 10.01.14.

### REFERENCES

1. OIE Terrestrial Handbook. At: <[http://www.oie.int/fileadmin/Home/eng/Health\\_standards/tahm/2.01.19\\_vesicular\\_stomatitis.pdf](http://www.oie.int/fileadmin/Home/eng/Health_standards/tahm/2.01.19_vesicular_stomatitis.pdf)>; 2010 Accessed 10.01.14.
2. The Center for Food and Public Health. At: <[http://www.cfsph.iastate.edu/Factsheets/pdfs/vesicular\\_stomatitis.pdf](http://www.cfsph.iastate.edu/Factsheets/pdfs/vesicular_stomatitis.pdf)>; 2008 Accessed 10.01.14.
3. USDA. At: <<http://www.aphis.usda.gov/vs/nahss/equine/vsv/>>; 2012 Accessed 10.01.14.



4. Durante PC, et al. *J Am Vet Med Assoc.* 2008;232: 249.
5. Remmers L, et al. *Ann NY Acad Sci.* 2000;96:417.
6. OIE. At: <<http://www.oie.int/en/animal-health-in-the-world/the-world-animal-health-information-system/old-classification-of-diseases-notifiable-to-the-oie-list-a/>>; 2013 Accessed 10.01.14.

## Parasitic Diseases of the Alimentary Tract

### CRYPTOSPORIDIOSIS

#### SYNOPSIS

**Etiology** Usually *Cryptosporidium parvum*, *C. andersoni*, and/or *C. bovis*

**Epidemiology** Infection common in ruminant neonates. May cause diarrhea, particularly if there is intercurrent infection with other enteropathogens and nutritional or environmental stress

**Clinical findings** Malabsorption-type diarrhea

**Clinical pathology** Oocysts in feces demonstrated by immunofluorescent or oocyst DNA detected by polymerase chain reaction

**Lesions** Villous atrophy

**Diagnostic confirmation** Demonstration of lesions and the organism

**Treatment** Supportive. Halofuginone in cattle, if approved

**Control** Hygiene and management to ensure passive transfer of colostral antibodies and minimization of infection pressure

#### ETIOLOGY

*Cryptosporidium* spp. are apicomplexan (coccidial) protozoans.<sup>1-14</sup> They have direct life cycles, and infections are transmitted via the fecal-oral route. Currently, based primarily on molecular data, more than 16 *Cryptosporidium* species and more than 44 genotypes have been reported to parasitize the epithelial cells (usually in the gastric or intestinal tract) of hosts representing all classes of vertebrates.<sup>2-4</sup> *C. parvum* is a **common infection** in young animals, including ruminants, and is found in many species of mammals, including humans. *C. parvum* is considered a significant cause of varying degrees of naturally occurring diarrhea in neonatal farm animals. This agent can act in concert with other enteropathogens to produce intestinal damage and diarrhea.

#### EPIDEMIOLOGY

##### Occurrence and Prevalence

Cryptosporidiosis has been recognized worldwide in numerous host animals, including cattle, lambs, goat kids, foals, and piglets.<sup>4</sup> Many studies report prevalence of

infection, but this does not imply clinical disease.

#### Calves

Many studies have found limited association between infection and diarrhea, but there are many reports that associate infection in calves with diarrhea occurring between 5 and 15 days of age. A study of preweaned (5–60 days of age) and postweaned (3–11 months of age) calves has shown strong evidence of an age-related association between host and cryptosporidiosis. The prevalence of *Cryptosporidium* in preweaned calves has been shown to be ~50% (of 503) and can decrease to ~20% (of 468) calves following weaning. Interestingly, although most of the infections in preweaned calves relate to *C. parvum*, only a small percentage (e.g., <1%) of weaned calves have been found to be infected with this species; the dominant species in weaned calves, based on DNA studies, are *C. andersoni* and *C. bovis*. This information suggests that young calves represent a more significant zoonotic risk than older cattle. Infection of calves is often followed by the development of resistance to reinfection, and oocyst excretion is less common and intermittent in older and adult cattle, although high excretion rates can be found in adult cattle in some herds (which likely relate to species other than *C. parvum*).

Because calves are likely to be infected by *C. parvum* shortly after birth, and clinical signs of disease are typically limited to a period of intense, self-limiting diarrhea, and the high cost and limited effectiveness of chemotherapeutic and supportive treatment, there appears to have been little incentive for developing husbandry practices to limit bovine cryptosporidiosis. However, intensive farms (e.g., dairy and feedlots) can represent a significant source of human-infective oocyst contamination in the environment, which is presumably exacerbated by the presence of newborn calves.

#### Sheep and Goats

*C. parvum* is also a **common** enteric infection in **young lambs** and **goats**, and diarrhea can result from a monoinfection, but more commonly it is associated with mixed infections. The features of infection(s) and pattern of excretion of the cryptosporidial oocysts is similar to that in calves.<sup>1</sup> Infection can sometimes be associated with outbreaks of diarrhea, with high case fatality in lambs from 4 to 10 days of age and goat kids from 5 to 21 days of age.<sup>1</sup>

#### Pigs

Cryptosporidial infection in pigs occurs over a **wider age range** than in ruminants and has been observed in pigs from 1 week of age through to market age. Infection seems to be common between 6 and 12 weeks of age. Many cryptosporidial infections appear to be

**asymptomatic**, although cryptosporidiosis might contribute to malabsorptive diarrhea after weaning.

#### Foals

Cryptosporidial infection in foals appears to be less prevalent. Diarrhea has been recorded in foals from 5 days to 6 weeks of age. Disease might occur in Arabian foals with inherited combined immunodeficiency.

#### Farmed Deer

Cryptosporidiosis is also recorded in young deer and can be a cause of diarrhea. Infection has also been recorded in red deer calves dying at 24 to 72 hours of age, following a syndrome of severe weakness and depression accompanied by a terminal uremia.<sup>1</sup>

#### Source of Infection and Transmission

Experiments have shown that a small number of oocysts are required for infection. The replicative cycle in the intestine amplifies a minor infective dose, and studies in gnotobiotic animals indicate a minimum **infectious dose** as low as one oocyst. The source of infection is **feces** that contain oocysts that are already sporulated and infective when excreted. Large numbers of oocysts are excreted during patency in calves, resulting in heavy environmental contamination. Transmission may occur directly from calf to calf, indirectly via fomite or human transmission, and from contamination in the environment or fecal contamination of the feed or water supplies. Infection in newborn animals and an increase in contamination of their immediate environment might occur as the result of a **periparturient rise** in fecal output oocysts by the dam.

#### Risk Factors

The factors that make animals susceptible to infection and that predispose infected animals to develop clinical disease are still not well understood.<sup>4</sup> Cryptosporidiosis in young agricultural animals is often associated with infection with *C. parvum*. Other enteric infections can occur concurrently with *Cryptosporidium*/cryptosporidiosis. The site of infection with *Cryptosporidium* is predominantly on the enterocyte where it results in cell damage, loss of brush border enzymes, and a reduction of villous surface area.

#### Pathogen Risk Factors

Oocysts are resistant to most **disinfectants** and can reportedly remain viable for ≥18 months in a cool, damp, or wet environment and can survive for several months in soil and slurry, but are susceptible to desiccation, temperatures of more than 60°C, and ultraviolet light. The infectivity of the oocysts can be destroyed by ammonia, formalin, freeze-drying, and exposure to temperatures below 0°C (32°F) and >65°C (149°F). Ammonium hydroxide, hydrogen peroxide, chlorine dioxide, 10% formol saline, and 5%

ammonia are effective in destroying the infectivity of the oocysts. The infectivity of oocysts in calf feces is reduced after 1 to 4 days of drying.

### Concurrent Infections

Infections with other enteropathogens, particularly rotavirus and coronavirus, are common, and epidemiologic studies suggest that diarrhea is more severe with mixed infections with other pathogens. The rates of single and mixed infections vary among studies. Generally, mixed pathogen infections are most common, but cryptosporidial infection can be very significant in its own right. **Immunologically compromised** animals are more susceptible to cryptosporidiosis than immunocompetent animals, but the relationship between disease and failure of passive transfer of colostral immunoglobulins is not entirely clear. Disease can be reproduced in both colostrum-deprived and colostrum-fed calves and, in the field, clinical disease can occur, for example, in calves with adequate passive transfer of colostral immunoglobulins. However, the shedding of oocysts has been observed to be higher in calves with low absorptive efficiency of IgG from colostrum and low serum IgG concentrations.

Case-fatality rates in cryptosporidiosis are usually low and the disease self-limiting, unless there are other complicating factors. In addition to concurrent infections, these include deficits linked to an inadequate intake of colostrum and milk and chilling from adverse weather conditions. Age-related resistance, unrelated to prior exposure, has been observed in lambs but not calves. Infection may result in a serum antibody response, but both cell-mediated and humoral responses are important in immunity against cryptosporidia.

### Zoonotic Implications

Infections in domestic animals may be a reservoir for infection to susceptible humans.<sup>4-9</sup> In humans, *Cryptosporidium* is recognized as a relatively common nonviral cause of self-limiting diarrhea in immunocompetent persons, particularly children. In symptomatic, immunocompetent patients, cryptosporidiosis most commonly presents with diarrhea that can lead to rapid weight loss and dehydration and require parenteral fluid therapy. The disease is usually self-limiting, with symptoms normally lasting between 3 and 12 days. In **immunologically compromised** persons, clinical disease may be severe. This is particularly serious in human patients with acquired immune deficiency syndrome or who are immunocompromised or immunosuppressed. The infection can be transmitted from person to person, but direct infection from animals and indirect water-borne infection from surface water and drinking water contaminated by

domestic or wild animal feces can also be significant. Animal manures and slurry may contain *Cryptosporidium* oocysts, and there is potential for contamination of the food chain as a result of runoff into adjacent surface waters or from direct application of the untreated wastes to crops.

Direct animal contact can result in human infection where there is hand-to-mouth transmission and infection. Cryptosporidiosis has been recorded in veterinary students and is a concern for children at fairs, petting zoos, and sometimes during educational visits to farm settings. Cryptosporidiosis is one of a number of zoonotic infections that have recently emerged in these settings. The apparent increase in prevalence of these infections might be caused by the general movement of populations from rural to urban communities and the consequent removal from early exposure to farm animal-derived zoonotic agents. Similarly, it could result from better detection and reporting by public health authorities. Regardless, the risk of transmission of zoonotic agents associated with petting zoos, farm animal exhibits, fairs, etc., is real and veterinarians are increasingly asked for advice on this issue. This can be in association with an official capacity as a fair veterinarian or in consultation with farm owners, who desire to bridge the increasing estrangement of urban populations to farm activities. Animal handlers on cattle farms can be at high risk of diarrhea caused by cryptosporidiosis transmitted from calves infected with *Cryptosporidium*, and immunocompromised people might be restricted from access to young animals and possibly from access to farms.

### PATHOGENESIS

*Cryptosporidium* is usually transmitted via the fecal-oral route and exhibits a monoxenous (single-host) life cycle.<sup>4</sup> Briefly, a sporulated oocyst (containing four infective sporozoites) is ingested by the host and excysts usually in either the intestine or the stomach (abomasum) (depending on the species of *Cryptosporidium*). Each motile sporozoite migrates, by gliding motility, along the exterior surface of the epithelial cells of the gut (e.g., microvilli in the small intestine) and penetrates the cell, eliciting an invagination in the cell membrane (of enterocytes in the small intestine) and forming a bilayered membranous vacuole (outer layer is host derived; inner layer is parasite derived, parasitophorous vacuolar membrane [PVM]). The host-derived outer layer of the vacuole disintegrates, and the inner PVM thickens and acts as the interface between the developing parasite and the host cytoplasm, which results in the parasite being located intracellularly but external to the cell cytoplasm (i.e., extracytoplasmic). Intracytoplasmic invasions are possible in rare instances, but appear to be limited to the

invasion of macrophages within the Peyer's patches.

Within the cell, the sporozoite develops into a trophozoite, which subsequently undergoes asexual reproduction (schizogony or merogony; longitudinal binary fission) to produce type 1 meronts (schizonts). Each of these type 1 meronts contains 16 merozoites, which are released from the enterocyte. Each merozoite infects a new enterocyte, then replicates and develops into new type 1 meronts to repeat the cycle, or enters into the reproductive phase to replicate and develop into a type 2 meront, each of which contains four merozoites. After entering a host cell, each type 2 merozoite initiates the sexual cycle (gametogony) and eventually develops either into a microgamont (containing 12-16 microgametes) or a macrogamont (maturing into a macrogamete). Microgametes (male) are released and fertilize macrogametes (female) to form zygotes. The zygote then develops, within the PVM into an oocyst. In another asexual reproductive phase (sporogony), the oocyst sporulates to produce, internally, four naked sporozoites. Two types of oocyst are produced and slough off the epithelial layer. The thin-walled oocysts (~20% of the overall population of oocysts) remain in the alimentary tract and have the ability to sustain an autoinfection, whereas the thick-walled oocysts (~80%) are passed in the feces. The thin-walled oocysts are of particular relevance in immunocompromised, immunodeficient, or immunosuppressed individuals, as the likely cause of chronic cryptosporidiosis. In cattle, cryptosporidia are most numerous in the small intestine or abomasum (*C. andersoni*). The prepatent periods can range from 2 to 7 days in calves, and from 2 to 5 days in lambs. Oocysts are usually passed in the feces of calves for 3 to 12 days, but there is considerable variation in both prepatency and patency.

*Cryptosporidium* infection usually most directly and severely impacts the intestinal tract. Cryptosporidial infection in the intestine is best characterized and is initiated when zoites infect vicinal enterocytes and endogenous forms spread to the enterocytes of both the villi and crypts. Severe diarrhea occurs mainly as a result of proximal infection of the small intestine, whereas infections confined to the distal ileum and/or the large bowel tend to be associated with intermittent diarrhea or can be asymptomatic. Endogenous forms of *Cryptosporidium* disrupt the microvillous border, which leads to the loss of mature enterocytes, a shortening and fusion of villi, and a lengthening of crypts caused by increased cell division and edema. This leads to the loss of membrane-bound digestive enzymes; diminishes the absorptive capacity of the intestine; and reduces the uptake of fluids, electrolytes, and nutrients from the intestinal lumen.

## CLINICAL FINDINGS

There are no clinical findings that are pathognomonic for cryptosporidiosis in calves.<sup>4</sup> Affected calves are usually 5 to 15 days old and have a mild to moderate diarrhea, which persists for several days, regardless of treatment. The duration of diarrhea tends to be a few days longer than that associated with rotavirus, coronavirus, or ETEC. Feces are yellow or pale and watery and can contain mucus. Persistent diarrhea can result in a marked loss of BW and emaciation. In most cases, the diarrhea is self-limiting after several days. Varying degrees of apathy, reduced feed intake, and dehydration are common. Only rarely does severe dehydration, weakness, and collapse occur, which is in contrast to other causes of acute diarrhea in neonatal calves. Case–fatality rates can be high in herds with cryptosporidiosis when the calf feeder withholds milk and feeds only electrolyte solutions during the episode of diarrhea. The persistent nature of the diarrhea leads to a marked energy deficit in these circumstances, and the calves can die of inanition at 3 to 4 weeks of life. This syndrome may be particularly common in the winter months when cold stress can affect energy requirements.

In the experimentally induced cryptosporidiosis in calves, depression and anorexia are the earliest and most consistent clinical findings. Feed intake is reduced and, combined with the persistent diarrhea over several days, may cause emaciation. Recovery can occur between 6 and 10 days after the onset of diarrhea. In the experimentally induced cryptosporidiosis in lambs and kids, depression, diarrhea, and reduced feed intake are common, and recovery can occur within a few days. Severe clinical manifestations have been observed in the field in lambs subject to environmental cold stress and those that are energy deficient because of an inadequate intake of colostrum.

## CLINICAL PATHOLOGY

Traditionally, diagnosis of cryptosporidiosis has been based on the detection of *Cryptosporidium* oocysts or DNA in host feces. Oocysts can be detected in the feces by examination of fecal smears with particular stains, by fecal flotation, and by immunologically or DNA-based methods.<sup>4</sup> Diagnostic techniques include the immunofluorescent assay detection of fecal oocysts. It has been suggested that, if the diarrhea is associated with cryptosporidia, the feces might contain 10<sup>5</sup> to 10<sup>7</sup> oocysts per milliliter. The oocysts are small (5–6 μm in diameter), relatively nonrefractile, and difficult to detect by light microscopy. They can be detected by phase-contrast microscopy. Oocysts can be concentrated from fecal samples by centrifugal flotation in high specific gravity salt or sugar solutions. The modified Ziehl–Neelsen

is a simple and rapid staining procedure suited for large-scale routine diagnosis.<sup>4</sup> Immunofluorescence and other immunologic techniques are relatively widely used, as are a range of PCR-coupled DNA methods for the specific detection and genetic characterization of *Cryptosporidium* stages present in fecal samples.<sup>4</sup>

## NECROPSY FINDINGS

Varying degrees of dehydration, emaciation, and serous atrophy are present in calves that suffer from persistent diarrhea over many days. There is atrophy of villi in the small intestine. Histologically, large numbers of different stages of the parasite, including meronts or schizonts, are at the tips of the enterocysts (microvilli). In low-grade infections, only small numbers of parasite stages are detected, with no apparent or limited histopathological changes in the intestine. The villi are shorter than normal, and crypt hyperplasia and infiltration with a mixture of inflammatory cells are common.

## Samples for Confirmation of Diagnosis

- **Parasitology:** Feces (microscopic examination, ELISA, IFAT)
- **Histology:** Formalin-fixed intestine (several sites) or abomasum (e.g., *C. andersoni*)

## DIFFERENTIAL DIAGNOSIS

The disease must be differentiated from other common infectious diarrheas in calves, which are covered in the section Acute undifferentiated diarrhea of newborn farm animals.

## PREVENTION AND CONTROL

In animals, the key **components for prevention and control** of cryptosporidiosis include the maintenance of a clean environment and the introduction of effective management strategies to minimize the potential for rapid spread from animal to animal, farm to farm, and from animal to human.<sup>4</sup> The prevention of *Cryptosporidium* infection is challenging in intensively farmed animals, because the infective dose can be very low; thus exclusion or elimination of the parasite from the farm environment is almost impossible. Although the maintenance of “closed” herds or flocks can control the introduction of cryptosporidiosis from animals purchased from external sources (e.g., saleyards), additional external factors, such as parasite transport via “mechanical” means and parasite introduction through contaminated water or feed, can introduce infection on to a farm and are difficult, if not impossible, to control. In addition, oocysts shed by wildlife

and/or introduced into water supplies from wildlife may represent another potential source of infection for herds of domestic animals. The role of wildlife as a reservoir and its involvement in transmission to and disease in livestock and humans are not yet well understood, requiring further investigation using advanced molecular methods.

Because the prevention of infection in livestock herds is not always practical, control is a critical feature of a sound management strategy. However, limiting infection of neonatal animals and minimizing the risk of spread from infected to uninfected animals is a significant challenge. Numerous scientists have studied the factors linked to the prevalence of *Cryptosporidium* and the associated impact of cryptosporidiosis. Although useful for highlighting potentially important factors either contributing to or protecting against infection and disease, such studies are usually limited to showing a statistical association between any “factor” and increased or decreased “risk” caused by unavoidable limits of the experimental designs of such surveys. Specifically, because these surveys are conducted in herds, multiple factors (e.g., housing, frequency of pen cleaning, proximity to other livestock herds, food and water sources) can vary among herds, all of which can contribute to disease prevalence. None of these factors can be specifically isolated, making the determination of the actual impact of any single factor difficult. Acknowledging this, herd management practices, which appear to be associated with protection against infection by *Cryptosporidium* and/or affliction with cryptosporidiosis, include calving in winter rather than summer, removing neonates from the dam within 1 hour of birth, ensuring the neonate receives an adequate initial dosage of colostrum (either from the dam, from another animal, or via bottle feeding from a frozen supply), and ensuring optimal housing for calves.

Environmental factors considered important in decreasing the risk of cryptosporidiosis in neonates include low population density for calves; use of concrete flooring over straw, gravel, or sand; and the routine cleaning of pens (i.e., hygiene) and feeding utensils. The regular cleaning of pens and feeding apparatus is considered to be essential to a rigorous management strategy of cryptosporidiosis; however, because of the robust nature of *Cryptosporidium* oocysts, care must be taken to ensure that such cleaning regimens are effective. Oocysts remain viable for long periods of time and are resistant to various disinfectants suitable for use in agricultural settings (e.g., bleach-based disinfectants). Ammonia-based disinfectants can kill *Cryptosporidium* oocysts, but they release irritating fumes and can only be used after destocking. Disinfectants containing hydrogen peroxide plus either



peracetic acid or silver nitrate have also been shown to have a deleterious effect on the survival of *C. parvum* oocysts and are commercially available for application in a farm setting. Steam cleaning is another supportive measure, has been shown to be effective for killing *Cryptosporidium* oocysts on instrumentation in hospitals, and may be suitable for decontaminating instrumentation used in farming for feeding or milking.

Mechanical removal of oocysts daily from concrete surfaces using a high-pressure hose appears to be an effective means of reducing the spread of *Cryptosporidium* and is preferable to sweeping, which imposes an increased risk of cross-contamination among pens via the mechanical transfer of oocysts. Importantly, the desiccation of oocysts appears to be a highly effective means of parasite control and further highlights the benefit of using concrete floors in pens instead of porous or absorptive materials to facilitate drying.

### Treatment Options

Compared with the previous management strategies, immunotherapeutic or chemotherapeutic options are limited.<sup>4,10,11</sup> The demonstrated host age stratification of *Cryptosporidium* in many animal species suggests that passive immunity is possible and likely results from prior exposure to disease, but the effective eliciting of passive immunity via colostrum is still unclear. Passive immunotherapy using colostrum from dams immunized with native or recombinant antigens of *Cryptosporidium* has been explored and shown to be a protective infection of young calves in some studies but not in others.<sup>4</sup>

“Risk-factor” surveys indicate that neonate calves have a reduced probability of infection by *Cryptosporidium* following the ingestion of colostrum; however, the prevalence of infection in neonates, even after colostrum ingestion, is high before weaning, indicating that the passive transfer of immunity is limited. Overall, evidence indicates that the passive transfer of immunity via colostrum is unlikely to be effective as a single means of defense against cryptosporidiosis in young calves.

Although various avenues have been explored for the development of a vaccine against cryptosporidiosis, none are yet commercially available. Recently the use of a whole oocyst-based vaccine from an attenuated line of *C. parvum* (gamma irradiated) has been revisited and shown to show a protective response in calves. Other efforts have focused on assessing immune responses against antigens derived from oocysts or the cell surface of sporozoites.<sup>10</sup> The proteins CP15 and P23, involved in zoite motility and/or host cell invasion, have been expressed using recombinant methods and appear to be promising immunogens. Although overall success has been limited, the availability of the complete nuclear genome sequences

for some *Cryptosporidium* spp. and developments in molecular and computer technologies might provide opportunities for identifying novel proteins as vaccine targets.

In the absence of a vaccine, supportive and chemotherapeutic treatment options have been an area of significant research. The simplest, but at present one of the more effective, means of treating cryptosporidiosis in livestock is oral or intravenous rehydration of clinically affected, dehydrated animals. Chemotherapy has been explored with only limited success. Numerous organic-based antimicrobial compounds, including various quinones, aminoglycosides (e.g., paromomycin and streptomycin) and folate antagonists (e.g., sulfanitran and trimethoprim), have been evaluated with mixed success. **Halofuginone lactate** (HFL) has been used as a supportive measure to treatment of clinical cryptosporidiosis in calves. Studies have indicated that administering HFL to infected calves at a dosage of 60 to 125 µg/kg BW (e.g., for 7 days from 1 day of age) decreased the severity of clinical disease as well as oocyst numbers in feces shortly after treatment. Other studies have provided further support of these findings, indicating that HFL is an effective chemotherapy in calves for the purpose of reducing the severity of bovine cryptosporidiosis, and suggesting that HFL decreases the spread of *Cryptosporidium* from animal to animal because of decreased fecal oocyst output. However, although HFL may be useful in diminishing the severity of disease symptoms, this drug delays rather than eliminates the excretion of oocysts in feces. In spite of the use of HFL as a supportive measure, its recommended dosage must be strictly adhered to (given its limited safety index), and severely dehydrated calves should not be treated to prevent toxic effects. **Paromomycin sulfate** given orally at a dose of 100 mg/kg BW daily for 11 consecutive days from the second day of age seems to prevent disease in goat kids and to reduce, but not completely prevent, diarrhea in infected lambs.<sup>1</sup>

### Supportive Treatment

Affected calves should be supported with **fluids and electrolytes**, both orally and parenterally, as necessary until spontaneous recovery occurs.<sup>4,12</sup> Cows' **whole milk** should be given in small quantities several times daily to optimize digestion and to minimize loss of BW. It is important to **continue to feed** milk to the full level of requirement despite the presence of diarrhea, because a reduction in intake may lead to death from inanition. Several days of intensive care and feeding may be required before recovery is apparent. **Parenteral nutrition** could be considered for valuable calves.

### Management Strategies

In addition to treatment and control regimens to limit the impact of *Cryptosporidium*

infection on herds, **management** strategies are critical to limit the spread of infective *Cryptosporidium* oocysts to other farms, and, for *C. parvum*, to the human population.<sup>4</sup> Cryptosporidiosis is difficult to control. The rational approach to prevention is to **minimize transmission** between the source of the organism and neonatal farm animals and between the animals. Reducing the number of oocysts ingested may reduce the severity of infection and allow immunity to develop. Calves should be born in a clean environment, and adequate amounts of colostrum should be fed at an early age. Calves should be kept separate without calf-to-calf contact for at least the first 2 weeks of life, with strict hygiene at feeding. Disinfectants detailed earlier should be used in hygiene.

Diarrheic calves should always be **isolated** from healthy calves during the course of the diarrhea and for several days after recovery. Sick calves are commonly treated by the same person who feeds the healthy calves, and great care must be taken to avoid mechanical transmission of infection. Calf-rearing houses should be vacated and cleaned out on a regular basis; an all-in/all-out management system, with thorough cleaning and several weeks of drying between batches of calves, should be used.

Manure from animals is a major contributor of *Cryptosporidium* oocysts in the environment on farms, and measures also need to be implemented to reduce the risks of pollution to drinking water.<sup>4,13,14</sup> Adequately controlled storage and handling of manures and slurry (e.g., from cattle yards or dairies) or leachate from bedding will assist to reduce the risk of contamination in waterways. Runoff into water catchments presents a significant risk, particularly during and after heavy rainfall; although the risk posed by oocysts in water runoff varies depending on the soil type and the density of vegetation in the surrounding area. Generally, grazing animals should be excluded from access to water catchments and water sources through the introduction of buffer zones.

### FURTHER READING

- Budu-Amoako E, Greenwood SJ, Dixon BR, Barkema HW, McClure JT. Foodborne illness associated with *Cryptosporidium* and *Giardia* from livestock. *J Food Prot.* 2011;74:1944-1955.
- Fletcher SM, Stark D, Harkness J, Ellis J. Enteric protozoa in the developed world: a public health perspective. *Clin Microbiol Rev.* 2012;25:420-449.
- Jex AR, Smith HV, Monis PT, Campbell BE, Gasser RB. *Cryptosporidium*—biotechnological advances in the detection, diagnosis and analysis of genetic variation. *Biotechnol Adv.* 2008;26:304-317.
- Jex AR, Smith HV, Nolan MJ, et al. Cryptic parasite revealed improved prospects for treatment and control of human cryptosporidiosis through advanced technologies. *Adv Parasitol.* 2008;77:141-173.
- McDonald V. Cryptosporidiosis: host immune responses and the prospects for effective immunotherapies. *Expert Rev Anti Infect Ther.* 2011;9:1077-1086.

- Marcos LA, Gotuzzo E. Intestinal protozoan infections in the immunocompromised host. *Curr Opin Infect Dis.* 2013;26:295-301.
- McDonald V, Korbel DS, Barakat FM, Choudhry N, Petry F. Innate immune responses against *Cryptosporidium parvum* infection. *Parasite Immunol.* 2013;35:55-64.
- Ryan U, Power M. *Cryptosporidium* species in Australian wildlife and domestic animals. *Parasitology.* 2012;139:1673-1788.
- Santin M. Clinical and subclinical infections with *Cryptosporidium* in animals. *N Z Vet J.* 2013;61:1-10.
- Xiao L, Fayer R, Ryan U, Upton SJ. *Cryptosporidium* taxonomy: recent advances and implications for public health. *Clin Microbiol Rev.* 2004;17:72-97.
- Xiao L, Feng Y. Zoonotic cryptosporidiosis. *FEMS Immunol Med Microbiol.* 2008;52:309-323.

## REFERENCES

- Radostits O, et al. Diseases Associated with Protozoa. *Veterinary Medicine: A Textbook of the Disease of Cattle, Horses, Sheep, Goats and Pigs.* 10th ed. London: W.B. Saunders; 2007:1512.
- Fayer R. *Exp Parasitol.* 2010;124:90.
- Xiao L, Fayer R. *Int J Parasitol.* 2008;38:1239.
- Jex AR, et al. Oxford textbook of zoonoses (2 ed.): Biology, clinical practice, and public health control. In: Palmer SR, Soulsby L, Torgerson P, Brown DWG, eds. *Cryptosporidiosis.* Oxford, UK: Oxford University Press; 2011.
- Xiao L. *Exp Parasitol.* 2010;124:80.
- Caccio SM, Pozio E. *Expert Rev Anti Infect Ther.* 2006;4:429.
- Tzipori S, Widmer G. *Trends Parasitol.* 2008;24:184.
- Bouزيد M, et al. *Clin Microbiol Rev.* 2013;26:115.
- Robertson LJ. *Epidemiol Infect.* 2009;137:913.
- Boulter-Bitzer JI, et al. *Biotechnol Adv.* 2007;25:13.
- Armson A, et al. *Expert Rev Anti Infect Ther.* 2003;1:297.
- Constable PD. *Vet Clin North Am Food Anim Pract.* 2009;25:101.
- Smith A, et al. *Epidemiol Infect.* 2006;134:1141.
- Baldursson S, Karanis P. *Water Res.* 2011;45:6603.

## COCCIDIOSIS

### SYNOPSIS

**Etiology** Many different *Eimeria* spp., *Isoospora* spp.

**Epidemiology** Mainly young calves, lambs, piglets, and kids. Infection rate can be high, clinical disease relatively common; high morbidity with low case-fatality rate. Occurs most often in crowded conditions both in barns and on pasture, particularly in calves and lambs moved from pasture to feedlot. Transmitted by fecal-oral route; oocysts shed from infected animals. Immunity develops after infection; clinical disease occurs rarely in adult cattle.

**Signs** Diarrhea, dysentery, tenesmus, appetite normal or inappetence, mild abdominal pain in lambs, nervous signs in calves with coccidiosis in cold climates, loss of body weight, and anemia in some cases but it is uncommon. Epidemics occur in calves and lambs, particularly in feedlot animals.

Diarrhea without blood in feces of piglets

**Clinical pathology** Diagnostic number of oocysts in feces

**Lesions** Ileitis, cecitis, and colitis

**Diagnostic confirmation** Oocysts in feces; asexual stages (schizonts or merozoites) in intestinal tissues

**Differential diagnosis**

**Calves:** Rotavirus and coronavirus diarrhea; *Clostridium perfringens* type C enterotoxemia; colibacillosis caused by attaching and effacing *Escherichia coli*

**Lambs:** Salmonellosis; helminthiasis; *C. perfringens* type C enterotoxemia

**Piglets:** Transmissible gastroenteritis; colibacillosis; *Strongyloides ransomi*; *C. perfringens* type C enterotoxemia

**Treatment** Supportive therapy. Coccidiostats

**Control** Control population density to minimize number of oocysts ingested while immunity develops. Use of coccidiostats in feed and water supplies. Sanitize the environment if possible.

## ETIOLOGY

Coccidial species are as follows:

- Cattle:** *Eimeria zuernii*, *E. bovis*, and *E. ellipsoidalis*; *E. alabamensis*, *E. auburnensis*, and *E. wyomingensis* may also cause disease in calves
- Sheep:** *E. arloingi* A (ovina), *E. weybridgei* (*E. arloingi* B), *E. crandallis*, *E. ahsata*, and *E. ovinoidalis* (previously known as *E. ninakohlyakimovae*), and *E. gilruthi*
- Goats:** *E. arloingi*, *E. faurei*, and *E. gilruthi*, *E. caprovina*, *E. ninakohlyakimovae*,<sup>1</sup> and *E. christenseni*
- Pigs:** *I. suis*; numerous species of *Eimeria* (no clinical importance), including *E. deblickei*, *E. neodeblickei*, *E. polita*, *E. perminuta*, *E. scabra*, and *E. suis*
- Horses and donkeys:** *E. leuckarti* (ubiquitous, but of no clinical significance)

## EPIDEMIOLOGY

### Occurrence and Prevalence of Infection

Coccidiosis is most frequently seen in livestock animals housed or confined in small areas contaminated with oocysts.<sup>2,3</sup> Coccidia are usually host specific, and there is no cross-immunity between species of coccidia. Clinical disease is common in cattle and sheep. Coccidiosis causing diarrhea in newborn piglets is a major problem in some swine herds.

Coccidiosis is most common in young animals, with a seasonal incidence that may be associated with the time of year young calves and lambs are brought together for weaning or moved into feedlots or fed

in small areas for the winter months. The prevalence of infection and the incidence of clinical disease are also age related. In housed dairy cattle, the prevalence of infection in calves and in yearlings can be high (40%–50%).

## Calves

In North America, the disease is most common in beef calves after weaning in the fall and when confined and fed in small, overcrowded areas during the winter months. Infection occurs most often when weaned calves are fed on the ground, resulting in continuous fecal contamination of the feed. The prevalence of infection in calves in the northwestern and midwestern part of the United States is highest in summer, fall, and spring compared with midwinter (January) and early summer (June). In Canada, for example, winter coccidiosis occurs in beef calves 6 to 10 months of age, most commonly following a prolonged cold period or a sudden change from a moderate winter to severely cold temperature. Cold weather may act as a stressor to precipitate clinical disease in animals previously infected. Acute coccidiosis and a marked increase in the numbers of oocysts discharged will occur following the treatment of infected calves with a corticosteroid on the 20th day after infection, when clinical signs are apparent, or from the 12th to 15th day after infection.

Occasional outbreaks occur in nursing beef calves on pasture when they mingle near water supplies. Postweaning coccidiosis occurs in beef calves grazing on pastures in the subcoastal, dry tropics (e.g., northern Queensland, Australia). It may be more severe in dry years, suggesting that oocyst challenge is less important than immunosuppressive effect of weaning and dietary stress in precipitating clinical disease. Calves are usually weaned and yarded for 3 weeks and then turned out to graze. Severe *E. zuernii* coccidiosis causing diarrhea, dysentery, weight loss, and death occurs with up to 10% of calves clinically affected. The disease is most severe in hot, dry, and sunny conditions when, despite heavy fecal contamination, the yard conditions remain dry and dusty, and oocysts are difficult to find. Coccidiosis caused by *E. alabamensis* along with other species is a common cause of diarrhea and unthriftiness in calves 2 to 4 months of age within the first few weeks after being placed on permanent pasture in the spring.

In **dairy calves**, the disease occurs under overcrowded and dirty, wet conditions, and when feed is contaminated with feces. Some surveys of dairy farms reveal that coccidiosis is one of the most common health-related problems, particularly in crowded situations. Dairy farmers quite frequently elect to treat animals, or feeding a coccidiostat, for the control of coccidiosis.

### Adult Cattle

Coccidiosis is uncommon in adult cattle, but occasional cases and even epidemics can occur, sometimes in dairy cows that have calved 6 to 8 weeks earlier. Older animals can serve as a source of infection for younger calves in the herd.

### Sheep and Goats

Coccidiosis can be a major problem in housed lambs. In some countries, such as Germany, the cumulative incidences of *E. ovinoidalis* and *E. weybridgei*/*E. crandallii* have been found to increase rapidly, resulting in an incidence of almost 100% in 8-week-old lambs. Acute coccidiosis in intensively grazed lambs occurs at about 6 to 8 weeks of age when the oocyst output is very high in healthy and in clinically affected lambs. There is no periparturient rise in oocyst output in ewes. The fecal oocyst excretion rates in grazing lambs are very high compared with those of ewes. Disease can occur commonly in lambs following introduction into a feedlot situation with problems of overcrowding and other stressors. Lambs with no previous exposure to coccidia are highly susceptible to infection.

Coccidiosis is one of the most important diseases of goats kept in large numbers under intensive management conditions. The prevalence of infection may be as high as 100% in some goat farms. Kids are the major source of pasture contamination, and newly weaned kids can have high oocyst counts. More than 13 different species of *Eimeria* have been described in different parts of the world.

### Pigs

Observations suggesting neonatal porcine coccidiosis include repeated episodes of diarrhea in piglets 5 to 15 days of age, no response to therapy with antimicrobials, and a failure of vaccination of the pregnant sow with *E. coli* bacterins to control neonatal piglet diarrhea. Peak incidence occurs between 7 and 10 days of age, most commonly during the warm summer months when high temperatures favor the sporulation of the oocysts. *I. suis* is a common parasite on pig farms;<sup>1,3</sup> it can be found in 90% of herds and 25% to 50% of litters. The prevalence may be higher when piglets and their sows are kept on solid concrete floors compared with self-cleaning floors. The morbidity rates are variable, and case-fatality rates can be up to 20%. Rotavirus infection may occur concurrently with *I. suis* infection in piglets of 1 to 3 weeks of age, which may be important causes of steatorrhea or unspecified diarrhea, known as milk scour, white scour, or 3-week diarrhea. *I. suis* infection commonly occurs in large pig-producing farming systems; the highest rate of infection occurs in litters at 3 to 4 weeks of age.

### Morbidity and Case Fatality

Generally, for **most species** of farm animals, the infection rate is high, and rate of clinical disease is usually low (5–10%), although epidemics affecting up to 80% can occur. The case-fatality rate is usually low, with the exception of the high case-fatality rate in calves with winter coccidiosis accompanied by nervous signs.<sup>1</sup> The case-fatality rate may be high in calves or lambs with no previous exposure to coccidia. In calves, BW gains and feed consumption are commonly reduced for many weeks after acute clinical coccidiosis, and affected calves do not regain losses in BW compared with uninfected controls.

In **lambs on pasture**, subclinical infections are common but there is no documented evidence that growth rate is affected, even with high levels of infection. Although medication with a coccidiostat may lower the infection rate, there is no apparent difference in performance between medicated and nonmedicated sheep. In lambs raised under crowded conditions indoors, the acquisition of infections with multiple species of *Eimeria* does not appear to affect growth rates, but artificial infection with *E. ninakohlyakimovae* has been shown to cause severe clinical disease and a case-fatality rate of up to 50%.

**Piglets** infected with *I. suis* have significantly reduced BW at 7, 14, and 21 days of age. The reduction in weight at 3 weeks is economically important, because this weight is factored into the “sow productivity index,” which is used as a management aid to help producers assess the potential value of gilts as replacement animals.

### Methods of Transmission

The **source of infection** is the feces of clinically affected or carrier animals, and infection is acquired by ingestion of feed and water contaminated with sporulated coccidial oocysts or by licking the hair coat contaminated with such oocysts. Unsporulated oocysts are passed in the feces and require suitable environmental conditions to sporulate. **Moist, temperate, or cool conditions favor sporulation, whereas high temperatures and dryness impede it.** Depending on the species of coccidium, oocysts sporulate at a range of 12°C to 32°C (53.5°F–89.5°F) and require oxygen. They can resist freezing down to approximately –7°C to –8°C (19.5°F–17.5°F) for 2 months, but –30°C (–22°F) is usually lethal.<sup>1</sup> It has been suggested that oocysts might sporulate in the winter months on the hair coats of animals contaminated with feces. This may explain the continual production of several different species of coccidia during the cold winter months, when sporulation on the ground is not possible.<sup>1</sup> Dry conditions and high temperatures also destroy sporulated oocysts within a few weeks, but the oocysts may survive for up to

2 years under favorable conditions. Temperatures of >35°C, humidity of <25%, and sunlight for at least 4 hours are fatal for *E. zuernii*.

Ingestion of the sporulated oocysts results in infection. **Large numbers of oocysts usually arise by continual reinfection and a buildup of the degree of environmental contamination.** This is most common when calves or lambs are crowded into small pens or confined in feedlots. Lambs can become infected within a few weeks after birth from lambing grounds heavily contaminated by the ewes. Overcrowding of animals on irrigated pastures, or around surface water holes in drought conditions, may also lead to heavy infections and disease. Feeder lambs and calves brought into feedlots from sparse grazing may carry a few oocysts, which build up into heavy infections in the lots, particularly if conditions are moist. In such situations, clinical signs of the disease usually appear several weeks to a month after the animals are confined. Young calves and lambs on pasture may shed large numbers of oocysts for long periods, which results in a buildup of coccidial populations. In cow-calf herds, the prevalence and intensity of oocyst excretion can vary with time, resulting in peak values around the time of parturition (periparturient rise).

**Sows** do not play a significant role in the transmission of *I. suis* infection from one generation of piglets to the next through contamination of the farrowing pen. Oocysts of *I. suis* cannot usually be found in the feces of sows on swine farms where neonatal coccidiosis occurs.

### Risk Factors

#### Animal Risk Factors

Acute coccidiosis occurs primarily in **young animals**, but may occur at any age when resistance is affected by intercurrent disease or inclement weather. The prevalence of infection is usually higher in calves than yearlings or adults in the same herd, but there is also evidence of variation in resistance against *Eimeria* species. A concurrent experimental infection of calves with the viruses and *E. bovis* can result in clinical disease and lesions that are more severe than those caused by either infection alone.

**Nutritional status of the animal** as a risk factor for clinical coccidiosis is well known. Early weaning of lambs at 21 days of age, followed by experimental infection, results in a failure of growth. In addition, field observations have shown that lambs that are weaned early are more susceptible to coccidiosis than those weaned at a later date. This observation might be a reflection of a lack of immunity in the younger lambs, but dietary stress in early weaned lambs can contribute to disease. Lambs kept on a low plane of nutrition have been reported to be less affected by clinical coccidiosis than those



kept on a high plane of nutrition. The planes of nutrition can also be associated with differences in the prevalence of *Eimeria* spp. Considerable numbers of oocysts can be excreted into the environment, even by well-fed sheep 14 to 16 months of age.

In many countries in Europe, for example, coccidiosis is common in **housed lambs weaned at 6 to 8 weeks of age** and reared on straw with a high stocking density, which provides an ideal environment for oocyst survival and sporulation. Often the use of coccidiostats does not affect the oocyst excretion rate, which suggests either inconsistencies in the effect of in-feed medication, or the infection may be controllable in nonmedicated flocks without the use of coccidiostats.

### Environmental and Management Risk Factors

Coccidiosis occurs in livestock when environmental and managerial conditions result in **oral exposure** of large numbers of sporulated oocysts to nonimmune animals. Overcrowding, overstocking, feeding animals on the ground, or situations in which the feed and water supplies are contaminated with feces and oocysts increase coccidial infection pressure and promote transmission. The disease is common in small beef cattle herds that raise their own replacements and finish their own feedlot cattle in small pens that are overcrowded; in these situations, feed and the environment become heavily contaminated with fecal matter. Grazing calves for the first time on permanent pastures can be associated with clinical coccidiosis caused by the ingestion of oocysts that have survived over the winter.

In parts of Europe, the rare occurrence of clinical coccidiosis in housed dairy cattle appears to be associated with management practices, in which calves are individually housed during the first few weeks and subsequently housed in small groups in relatively large pens. Hygiene standards are high, and manure is frequently removed. These measures reduce the intake of high numbers of oocysts and are favorable; the intensity of coccidial infections is usually associated with the number of oocysts in the environment and ingested by animals.

The production system can influence the development of subclinical and clinical coccidiosis. Two production systems are commonly used for the fattening of lambs. In the **extensive system**, lambs are not weaned until slaughter, with little or no concentrate feeding. In the **intensive system**, the lambs receive a high level of concentrates. Even if no clinical signs of coccidiosis are observed, lambs are likely to be subclinically affected in both systems. Straw and high stocking density predispose lambs to a heavy contamination of the environment, which supports oocyst survival and rapid sporulation.

### Multiinfections

Natural infections commonly involve multiple species of coccidian. A single species of coccidia might be a major pathogen, but others likely contribute to disease. In some cases, clinical coccidiosis in cattle happens only when *E. bovis* and *E. zuernii* occur together. Although *E. bovis* and *E. zuernii* are the species most commonly associated with bovine coccidiosis,<sup>2</sup> many more species have been described. In sheep and goats, the prevalence of multiple species can be high (>80%). *I. suis* is a major cause of neonatal or weanling diarrhea in pigs,<sup>3</sup> whereas *E. deblickei* is not pathogenic. Coccidia often have a widespread distribution in livestock animals.

### Immune Mechanisms

Immunity against intestinal coccidia consists of both cellular and humoral components.<sup>1</sup> Cellular immunity appears to be more important in "resistance" against reinfection than humoral immunity. Field observations suggest that coccidiosis in cattle is immunosuppressive, which can increase their susceptibility to other common infections. In experimental coccidiosis, neutrophil function may be inhibited, and the feeding of decoquinate may prevent this inhibition.

The administration of dexamethasone to calves suppresses the immunologic response of the animal, and allows the life cycle of the coccidia to proceed uninterrupted. Estradiol and progesterone can enhance cell-mediated immunity and can provide some protection against the often severe wasting and debilitation in calves associated with *E. bovis* infection.

Coccidiosis is an important disease in young lambs on pasture after having been raised indoors, as is also the case in European countries, for example. In this situation, lambs spend the first few weeks of their life indoors and have little exposure to infective oocysts, and little or no immunity is acquired. When the lambs are turned out on to pastures grazed by sheep in the previous grazing season, they rapidly become infected with overwintered oocysts. Coccidiosis develops in such nonimmune lambs 2 to 3 weeks later. The immunity induced by the first infection seems to protect most lambs from reinfections later in the grazing season. If lambs are treated with sulfadimidine at 200 mg/kg BW on days 12, 13, and 14 after turnout, then a marked reduction in the severity of the coccidial infections is seen.

Specific immunity to each coccidial species develops after infection, so that young animals exposed for the first time are often more susceptible to a severe infection and clinical disease than other animals. A single initial infection with as few as 50 oocysts can induce strong immunity to reinfection with the same species, and oocyst production can cease after about 10 days. Under field

conditions, animals (e.g., sheep) are probably continually ingesting oocysts from pastures that become increasingly contaminated as the season progresses. Thus immunity to a range of species of coccidia is boosted by frequent reinfection or reexposure.

Very young lambs are relatively resistant to infection with a mixture of pathogenic species of coccidia, but susceptibility increases progressively up to at least 4 weeks of age.<sup>1</sup> Lambs inoculated at 4 to 6 weeks of age develop severe diarrhea, whereas the same inoculum given at 1 day of age causes no clinical disease. Early subclinical infection improves the resistance of lambs to later challenge. When lambs receive a relatively large inoculum of oocysts during their first week of life, they are relatively resistant to the pathogenic effects of some coccidia, are able to respond immunologically, and seem to be protected from subsequent challenges. This information suggests that early exposure or infection of lambs with coccidia, before they are susceptible to the parasites' pathogenic effects, may assist in reducing the incidence, prevalence, and severity of subsequent coccidiosis. In calves, resistance to *E. zuernii* infection can occur after chemotherapy, or experimental infection, with monensin or amprolium. Both drugs suppress the development of disease, during which time immunity can develop. An effective immunity develops in piglets following natural or experimental infection with *I. suis*, which appears to be the most immunogenic coccidial parasite of pigs. Susceptible piglets are infected by this species from infected older pigs. Piglets develop a disease that is more severe when infected with *I. suis* at 1 to 3 days of age than when infected at 2 weeks of age.<sup>3</sup>

### PATHOGENESIS

The coccidia of livestock pass through most stages of their life cycle in the gastrointestinal tract. Individual species of coccidia have their particular predilection sites. For instance, *E. zuernii* and *E. bovis* occur primarily in the cecum, colon, and the distal ileum, whereas *E. ellipsoidalis* and *E. arloingi* affect the small intestines. *E. gilruthi* localizes in the abomasum and occasionally the duodenum.

### Life Cycle

The life cycles of *Eimeria* spp. are direct. Unsporulated oocysts are passed in the feces from an infected host and develop into the infective stage (sporulated oocysts) in the environment. The original single cell of *Eimeria* divides, forming four sporoblasts, each of which develops into one sporocyst, and within each sporocyst two sporozoites develop (1:4:2 configuration of the oocyst for *Eimeria*). When ingested, the wall of the oocyst breaks down, and sporocysts and sporozoites are released. The sporozoites then enter epithelial cells. Once within the cells,

the sporozoites transform to merozoites, which then undergo asexual replication (schizogony or merogony) and produce **first-generation schizonts**, which contain many merozoites. After the schizont matures, the merozoites are released by rupture of the epithelial cell. New epithelial cells are again invaded, and **second-generation and third-generation schizogony** occur. The second-generation and/or third-generation schizonts (depending on *Eimeria* species) are deeper in the mucosa than first-generation schizonts and usually lead to the sloughing of the epithelium, associated hemorrhage, and tissue destruction; therefore these schizonts cause pathogenic effects and lead to enteritis (bloody in severe infections) and clinical disease, but also induce immunity. Following schizogony, the final merozoites that are released invade epithelial cells and “switch” to produce sexual stages, **called the macrogametocyte (female) and the microgametocyte (male) during the phase of gametogony**. The microgametocyte eventually produces microgametes, which fertilize macrogametes (from microgametocyte; within the mucosa) to produce zygotes. These zygotes become oocysts, which slough from the epithelium and are excreted in the feces. The sloughing of the epithelial layer during gametogony can also lead to bleeding. The prepatent period varies depending on the species of coccidian.

In cattle, *E. zuernii* and *E. bovis* are pathogenic, and their life cycles are similar. In infected calves, first-generation schizogony occurs in the lower ileum, and second-generation schizogony and gametogony occur in the cecum and proximal colon. Both phases cause pathogenic effects for these two parasites and cause rupture of the cells they invade, with consequent exfoliation of the epithelial lining of the intestine. It is notable that the oocyst count is often low when the disease is at its peak, because the oocysts have not yet formed. Exfoliation of the mucosa causes diarrhea, and in severe cases, hemorrhage into the intestinal lumen, and the resultant hemorrhagic anemia may be fatal. If the animal survives this stage, the life cycle of the coccidia terminates without further damage, and the intestinal mucosa will regenerate and return to normal. The patent periods of *E. zuernii* and *E. bovis* are 15 to 17 and 18 to 21 days, respectively. Treatment of calves with a corticosteroid can convert subclinical infection in calves to acute disease, which suggests that environmental, nutritional, and management factors can also act as stressors in inducing disease.

Severely affected calves surviving the acute phase of the disease do not regain losses in BW unless they are fed for an additional 3 to 4 weeks, suggesting that bovine coccidia can have a marked effect on performance. A subclinical coccidial infection superimposed on an established, low-grade, subclinical nematode infection in the small

intestine may have a marked effect on the mineralization of the skeletal matrix in young adult ruminants, predisposing them to osteodystrophy.

That infections with multiple species of *Eimeria* are so common in livestock may explain the variations in oocyst discharge from infected animals, but, more importantly, in groups of animals. New cases may develop every few days for some weeks, because of the variation in length of the prepatent periods among species of coccidia.

The **pathogenesis of the neurologic signs associated with coccidiosis** in calves is unknown. Examination of a series of cases excluded possible explanations such as alterations in serum electrolytes, vitamin A and thiamin deficiencies, lead poisoning, uremia, *H. somnus* meningoencephalitis, severity of disease, and gross alteration in intestinal bacterial flora and hepatopathy.

The **pathogenesis of bovine winter coccidiosis**, which occurs during or following very cold weather in Canada and the northern United States, is not understood. In January, February, and March, the outside temperatures may reach  $-40^{\circ}\text{C}$  ( $-40^{\circ}\text{F}$ ) with daily mean temperatures of  $-10^{\circ}\text{C}$  to  $-15^{\circ}\text{C}$  ( $14^{\circ}\text{F}$ – $5^{\circ}\text{F}$ ) for several consecutive days. Such temperatures should be too cold for sporulation of oocysts in feces on the ground. There is speculation that sporulation could occur on the moist hair coats of cattle, or the endogenous stages of *E. zuernii* may be in a latent phase and reactivated by the stress of cold weather.

In **lambs**, most natural infections are composed of multiple different species of coccidia, and there is a wide range of values in the production of oocysts from individual lambs, either in the feces from the same lamb over a period of time or in the feces from a number of lambs on any one occasion. Under field conditions, constant reinfection occurs and waves of pathogenic stages succeed each other. The occurrence of villous atrophy in the intestinal mucosa of lambs affected by coccidiosis is probably related to recurrent diarrhea. However, in lambs, there is some doubt about the effects of coccidial infection on growth rate, feed consumption, and clinical signs. There may be no obvious relationship between infective dose, the fecal oocyst production, and disease. This information suggests that, in lambs, the mere presence of large numbers of fecal oocysts does not constitute a diagnosis of coccidiosis and that a range of factors may lead to disease. In many cases, it is possible that a large number of oocysts in sheep feces, in the absence of disease, may relate to nonpathogenic species of *Eimeria*.

*I. suis* has at least three asexual and one sexual intrainestinal replication cycles.<sup>3</sup> All stages are most prominent in the distal half of the small intestine, but also occur in the proximal small intestine, cecum, and colon. The prepatent period is 5 to 7 days; patency

is usually 4 to 16 days. Disease relates to diarrhea, villous atrophy, and necrosis of intestinal epithelium, and is characterized by high morbidity and low mortality. In the temperature range of  $32^{\circ}\text{C}$  to  $35^{\circ}\text{C}$  ( $89.5^{\circ}\text{F}$ – $95^{\circ}\text{F}$ ), the oocysts of *I. suis* can sporulate and become infective within 12 to 16 hours. Pathogenic changes are most pronounced in the small intestine and consist of villous atrophy and focal ulceration from the destruction of villous epithelial cells, principally during the peak of asexual reproduction. A fibrinonecrotic pseudomembrane may develop in severe cases. Extraintestinal stages of *I. suis* have been detected in lymph nodes, liver, and spleen, and their significance is unclear. Piglets develop more severe clinical signs of coccidiosis when inoculated with *I. suis* at 3 days of age than at 19 days of age, and affected piglets that survive develop immunity to reinfection. Rotavirus and other infections can complicate disease.

### CLINICAL FINDINGS

The prepatent period depends on the causative agent(s) and the host animal. It usually ranges from 1 to 3 weeks in cattle, from 2 to 3 weeks in sheep, and can be as short as 5 days in piglets. The clinical syndromes associated with the various coccidia are similar in all animals.

### Cattle and Sheep

A mild fever may occur in the early stages, but in most clinical cases body temperature is normal or subnormal. The first sign of clinical coccidiosis is the sudden onset of diarrhea with foul-smelling, fluid feces containing mucus and/or blood. Blood may appear as a dark, tarry staining of the feces or as streaks or clots, or the evacuation may consist entirely of large clots of fresh, red blood. The perineum and tail are commonly smudged with bloodstained feces. Severe straining is characteristic, often accompanied by the passage of feces, and rectal prolapse may occur. The degree of hemorrhagic anemia is variable, depending on the amount of blood lost, and in most naturally acquired cases in calves anemia is not a feature. Nonetheless, in exceptional cases, anemia can occur with pale mucosa, weakness, staggering, and dyspnea. Dehydration is common, but is not usually severe if affected animals continue to drink water.

Inappetence is common and, in exceptional cases, there may be anorexia. The course of the disease is usually 5 to 6 days, but some animals undergo a long convalescent period in which feed consumption and BW gains are reduced. Severely affected calves do not rapidly regain BW losses that occurred during the clinical phase of the disease. In mild cases of coccidiosis, diarrhea and reduced growth rate may occur. Subclinical cases may show inferior growth rates and chronic anemia only.

Clinical coccidiosis occurs only rarely in adult cattle. Young dairy cows may be affected, commonly 6 to 8 weeks after calving. Diarrhea, dysentery, tenesmus, pale mucous membrane, thickening and corrugation of the rectal wall, and rapid recovery often without treatment are common signs.

### Coccidiosis With Nervous Signs

Nervous signs consisting of muscular tremors, hyperesthesia, clonic-tonic convulsions with ventroflexion of the head and neck and nystagmus, and high mortality rate (80%–90%) can occur in calves with acute clinical coccidiosis. Outbreaks of this “nervous form” have occurred, in which 30% to 50% of all susceptible calves are affected. It is most common during, or following, severely cold weather in midwinter in the northern United States and in Canada. Affected calves may die within 24 hours of the onset of dysentery and the nervous signs, or they may live for several days, commonly in a laterally recumbent position with a mild degree of opisthotonus. In spite of intensive supportive therapy, mortality is high. Nervous signs have not been described in experimentally induced coccidiosis in calves, which suggests that the nervous signs may be unrelated to the dysentery or, indeed, even to coccidiosis.

### Lambs

Coccidiosis in lambs is similar to that in calves, but with much less dysentery. In groups of lambs raised and fed under intensive conditions, inferior growth rate, diarrhea (with or without blood), low-grade abdominal pain, gradual onset of weakness, inappetence, fleece damage, mild fever, recumbency, emaciation, or death with a course of 1 to 3 weeks have been described. The diarrhea may escape cursory examination, but clinical examination of affected lambs reveals a perineum smudged with feces, and soft feces in the rectum. Lambs moved directly from range pasture to a feedlot and with little or no previous exposure to coccidia often develop acute disease with a high morbidity and case-fatality rate.

### Piglets

In piglets, severe outbreaks of coccidiosis occur between 5 and 15 days of age, irrespective of time of the year. Anorexia and depression are common. There is profuse diarrhea; the feces are yellow, watery, and sometimes appear foamy. The diarrhea may persist for several days when dehydration and unthriftiness are obvious. Although affected piglets continue to suck, they become dehydrated and lose weight. Vomition may occur. Entire litters may be affected, and the case-fatality rate may reach 20%. The disease may persist in a herd for several weeks or months, particularly where a continuous farrowing program is used.

## CLINICAL PATHOLOGY

### Fecal Oocyst Counts

Animals with acute coccidiosis will be excreting oocysts in the feces only if the infection is patent (i.e., multiple generations of schizogony have occurred and gametogony has led to the production of oocysts). In ruminants with a patent infection and/or disease, a count of more than 5000 oocysts per gram of feces is considered “significant.” Although counts of <5000 oocytes per gram of feces do not usually suggest clinical disease, they indicate a source of infection and spread, depending on management and environmental conditions. Oocyst counts of  $>10^5$ /g are common in severe coccidiosis outbreaks, although similar counts may also be encountered in asymptomatic animals (e.g., sheep). The output of oocysts following an acute infection or disease can fall sharply after a peak. If oocysts are not found and the disease is suspected, fecal smears can be examined for merozoites; these zoites can also be detected upon fecal flotation. Depending on the host animal, some species of coccidia can be identified and differentiated based on the size and characteristics of the oocysts (particularly following sporulation), although there can be some size overlap among species.

### Calves

Affected animals exposed to oocysts may develop severe dysentery a few days before oocysts appear in the feces. However, when the feces from several affected animals are examined, and usually within 2 to 4 days after the onset of dysentery, oocysts can be detected in the feces. The period during which oocysts are discharged in significant numbers (patent period) varies among species of coccidia, the age of the animal, and the degree of immunity; therefore it is useful to examine a number of animals in a group or herd (preferably multiple times) rather than to rely only on the results from a single animal.

### Lambs

In lambs at pasture, oocysts first appear in the feces at about 2 weeks of age. The oocyst count continues to rise in lambs until about 8 to 12 weeks when the counts can reach  $10^5$  to  $10^6$ /g of feces. Thereafter, the counts will decline to approximately 500/g when lambs are 6 to 12 months of age. There is also considerable variation, both among individual lambs and from day to day, in the numbers and species of oocysts present in the feces. Hence, it is useful to examine several samples over a period of several days to assess oocyst output.

### Piglets

In piglets, the prepatent period varies from 5 to 7 days, and oocysts are shed in the feces for 5 to 8 days after the onset of clinical signs. Piglets may develop coccidiosis at 5 days of

age, and oocysts may not be present in the feces until 3 days later. The use of a saturated sodium chloride with glucose as a flotation solution is recommended when examining piglet feces for *I. suis* oocysts.

Necropsy examination of selected, untreated clinical cases is often useful to make a diagnosis. The disease should be suspected when piglets 5 to 8 days of age develop diarrhea that responds poorly to treatment. Outbreaks of diarrhea in piglets under 5 days of age are usually associated with *E. coli* or TGE. However, mixed infections are common, and extensive laboratory investigations are often necessary to isolate the causative agents. The diagnosis often requires a combination of consideration of the history of diarrhea in piglets of 5 to 15 days of age, gross and microscopic lesions, the presence of coccidial stages in mucosal scrapings and/or histologic sections, and the identification of oocysts in intestinal contents and feces. In heavy infections, piglets may die before the sexual stages of the parasite have developed, and the diagnosis is dependent on finding lesions and, in particular, schizonts and merozoites of *I. suis* in the jejunum and ileum. These developmental stages can also be detected on fecal smears or mucosal scrapings. A rapid field diagnostic procedure consists of staining glass slide impression smears of the mucosa of the ileum and jejunum. Autofluorescence microscopy and PCR-based methods can be used as complementary tools for the detection of *I. suis* and other coccidia.

## NECROPSY FINDINGS

Carcasses often have generalized tissue pallor, and there is usually fecal staining of the hindquarters. **In cattle**, congestion, hemorrhage, and thickening of the mucosa of the cecum, colon, rectum, and ileum are the characteristic gross changes seen at necropsy. The thickening may be severe enough to produce ridges in the mucosa. Small, white cyst-like bodies, formed by large schizonts, may be visible on the tips of the villi of the terminal ileum. Ulceration or sloughing of the mucosa might occur in severe cases. Infections in the small and large intestines can be characterized by a fibrinous typhlitis and colitis. Clotted blood or bloodstained feces might be present in the lumen of the large intestine. Histologically, there is a denudation of the epithelium, and merozoites might be detected in some cells. Smears of the mucosa or intestinal contents should be examined for the various developmental stages.

The necropsy findings **in sheep** are marked by more severe involvement of the small intestine than in cattle. Characteristic intestinal changes seen in sheep are hemorrhagic typhlitis and colitis (*E. ovinoidalis*), focal epithelial desquamation (*E. crandallii*), focal mucosal lesions with the formation of



polyps (*E. bakuensis*), and catarrhal enteritis (*E. ahsata* and *E. faurei*), associated with the presence of one or more stages of the parasites (schizonts = meronts and/or gamonts). In sheep affected with *E. gilruthi*, the abomasum contains numerous nodules of 1 to 2 mm in diameter, similar (superficially) in gross appearance to nodules caused by *Ostertagia*. These nodules contain the large schizonts of *E. gilruthi*.

In piglets, the small intestines are usually flaccid, but occasionally a fibrinonecrotic enteritis may be observed. Clinical signs precede the production of oocysts, such that mucosal scrapings should be examined for the presence of earlier stages of the life cycle.

### Samples for Confirmation of Diagnosis

- **Parasitology:** Feces (fecal flotation); segments of jejunum, ileum, and colon (direct smear)
- **Histology:** Formalin-fixed duodenum, jejunum, ileum, cecum, and colon (LM)

### DIFFERENTIAL DIAGNOSIS

**Calves** Clinical coccidiosis is characterized by dysentery, tenesmus, mild systemic involvement, and dehydration. The presence of large numbers of oocysts supports the diagnosis, and necropsy findings are usually characteristic. When nervous signs occur in calves appearing to have coccidiosis, differentiation from other diseases causing brain dysfunction must be made.

**Sheep** The diagnosis is dependent on the clinical findings of diarrhea and/or dysentery, the presence of large numbers of oocysts in the feces, and the intestinal lesions at necropsy. Large numbers ( $10^5/g$ ) of oocysts may occur in the feces of asymptomatic lambs; thus the observation of large numbers of oocysts in the feces of lambs affected with diarrhea and/or dysentery may not, in itself, constitute a diagnosis of coccidiosis. In lambs that have had previous exposure to coccidia, and that may be relatively immune, other causes of diarrhea, such as helminthiasis, salmonellosis, *Clostridium perfringens* type C enterotoxemia and helminthiasis, should be considered. See Table 7.7 for epidemiological and clinical features of the diseases causing diarrhea in small ruminants.

**Piglets** Diarrhea caused by coccidiosis must be differentiated from enteric colibacillosis, transmissible gastroenteritis, rotavirus infection, *Strongyloides ransomi*, and

*C. perfringens* type C. See Table 7.6 for epidemiological and clinical features of the diseases causing diarrhea in pigs.

### TREATMENT

Coccidiosis is usually a self-limiting disease, and spontaneous recovery without specific treatment is common when the schizogony (merogony) stages have passed. Many treatments have been recommended without taking this into account, and it is unlikely that any of the chemotherapeutic agents in common use for clinical coccidiosis has any effect on the late (gametogony) stages of the coccidia. Most of the coccidiostats have a depressant effect on the early, first-stage schizonts and are used for prevention or control.

In an outbreak, the clinically affected animals should be isolated and given supportive oral and parenteral fluid therapy, as necessary. The population density of animals in pens should be reduced. All feed and water supplies should be elevated from the ground to avoid fecal contamination. Mass medication of the feed and water supplies may be indicated, in an attempt to prevent new cases and to minimize the effects of an outbreak. Cattle with coccidiosis and nervous signs should be brought indoors, kept warm and on bedding, and given fluid therapy orally and parenterally. However, the case fatality of bovine coccidiosis can be high, in spite of intensive supportive therapy. Sulfonamide therapy parenterally may be indicated to control the development of secondary bacterial enteritis or pneumonia, which may occur in calves with coccidiosis during very cold weather. Corticosteroids are contraindicated.

### Calves and Lambs

The chemotherapeutic agents recommended for treatment and control of coccidiosis in calves and lambs are summarized in Table 7-30. There is insufficient information available to make reliable recommendations for the specific treatment of acute clinical coccidiosis. Most of these chemotherapeutic agents have not been adequately tested in clinical trials. Sulfadimidine is used widely empirically for the treatment of acute coccidiosis in calves. **Amprolium** is also used for treatment, and there may be a beneficial effect in terms of increased BW gains and feed consumption compared with untreated controls recovering spontaneously.

### Piglets

Symmetric triazinetriones are effective against the asexual and sexual stages of experimental *I. suis* infection in piglets and are most effective before the onset of clinical signs.<sup>1</sup>

**Table 7-30** Chemotherapeutics recommended for treatment and control of coccidiosis in calves and lambs

#### Chemotherapeutic agent treatment prevention

Sulfadimidine (sulfamethazine) *Calves and lambs:* 140mg/kg BW orally daily for 3 days  
*individually Calves:* in feed 35mg/kg BW for 15 days

*Lambs:* daily dose 25mg/kg BW for 1 week

Amprolium *Calves:* individual dose at 10mg/kg BW daily for 5 days or 65mg/kg BW one dose  
*Calves:* in feed at 5mg/kg BW for 21 days

*Lambs:* in feed, 50mg/kg BW for 21 days

Monensin *Lambs:* 2mg/kg BW daily for 20 days beginning on 13th day following experimental inoculation  
*Lambs:* 20mg/kg feed fed continuously

*Calves:* 16.5 or 33g/tonne for 31 days

Lasalocid *Lambs:* 25–100mg/kg feed from weaning until market. Also, in ewe's diet from 2 weeks before and until 60 days after lambing.

### CONTROL

The control of coccidiosis assumes greatest importance in calves, lambs, and pigs, and can sometimes be challenging to achieve.

### Management of Environment

Successful control will depend on avoiding the overcrowding of animals while they develop a specific anticoccidial immunity. Only small numbers (50 per day) of oocysts are required for the development of solid immunity in lambs. Lambing and calving grounds should be well drained and kept as dry as possible. Lambing pens should be kept dry, cleaned out frequently, and bedding disposed of, such that oocysts do not have time to sporulate and become infective.<sup>1</sup> All measures that minimize the amount of fecal contamination of hair coats and fleece should be practiced. Feed and water troughs should be elevated to avoid fecal contamination. Feeding cattle on the ground should be avoided if possible, particularly when overcrowding is a problem.

### Lambs at Pasture

In groups of lambs at pasture, the frequent rotation of pastures for parasite control will also assist in the control of coccidial infections. However, when lambs are exposed to infection early in life as a result of infections from ewes and a contaminated lambing ground, a solid immunity can usually develop; only when stocking density is extremely high will a problem arise.

### Feedlot Cattle and Lambs

Control of coccidiosis in feeder calves and lambs brought into a crowded feedlot depends on the management of population density, or the preventative use of chemotherapeutics to suppress infections in animals while effective immunity develops. Management procedures include establishing a suitable stocking density, which can be assessed by visual inspection. When animals are overcrowded, they usually become dirty, there is excessive competition for feed supplies, and their growth rate can be affected.

### Piglets

The control of coccidiosis in newborn piglets infected with *I. suis* has been unreliable. The use of coccidiostats in the feed of sows for several days or a few weeks before and following farrowing has been recommended and used in the field, but the results are variable. Amprolium and monensin have been evaluated for the prevention of experimental coccidiosis in piglets and are ineffective. An effective control program consisting of proper cleaning, disinfection, and steam cleaning of the farrowing housing to decrease oocysts in the environment has been recommended. Amprolium (25% feed grade) at the rate of 10 kg/tonne of sows' feed, beginning 1 week before farrowing and continuing until piglets are 3 weeks of age, has been recommended, but results are reported to be unsatisfactory. A single oral dose of 1.0 mL of toltrazuril, given to piglets of 3 to 6 days of age, reduces considerably the occurrence of coccidiosis and the patency period by approximately half.<sup>1</sup> A single treatment of toltrazuril at 20 mg/kg BW (oral) is highly effective against *I. suis* at an early stage of infection (e.g., 2 days) in suckling pigs.<sup>1</sup>

### Coccidiostats

Coccidiostats are used for the control of naturally occurring coccidiosis, mainly in calves and lambs. The ideal coccidiostat suppresses the full development of the life cycle of the coccidia, allows immunity to develop, and does not interfere with production performance. Drugs that have been used for treatment are summarized in Table 7-30.

To be effective, coccidiostats must be given beginning early in infection. In any group of animals, there will be several different species of coccidia at different stages of the life cycle, some at the drug-susceptible stage (before 13–15 days in calves) and some beyond the drug-susceptible stage (after 16–17 days), which explains why coccidiostats appear to be effective in some epidemics and ineffective in others. In an epidemic in calves, new cases may develop for up to 12 to 15 days after the commencement of feeding of an effective coccidiostat to in-contact calves. However, precise commencement of infection is unknown and the prepatent period cannot be established; the most that can be

done is to medicate the feed and water supplies with a coccidiostat of choice, treat new cases that develop, and avoid the stressors of overcrowding and nutritional disorders.

Some comments about some of the coccidiostats are made here. Routine prophylactic medication of the feed and water supplies of feeder calves and lambs with an effective coccidiostat will usually control the disease and allow the development of effective immunity, but drug resistance can develop.

### Antimicrobials

**Sulfonamides** in the feed at a level of 25 to 35 mg/kg BW for at least 15 days are effective for the treatment of coccidiosis in calves and lambs. Sulfadimidine at 55 g/tonne is also effective in goats. A combination of chlortetracycline and a sulfonamide has provided protection in calves and lambs.

### Ionophores

**Monensin** is an effective coccidiostat and growth promotant in cattle, sheep, and goats. The recommended doses are 16 to 33 g/tonne feed for calves and 20 g/tonne of feed for lambs. Levels of 11 g/tonne feed are not as reliable as the higher dose for calves. The recommended level for goats is 16 g/tonne of feed. A concentrated ration containing monensin at 15 g/tonne can be fed to ewes from 4 weeks before lambing until weaning, and to lambs from 4 to 20 weeks of age. Monensin can markedly reduce the oocyst output from ewes and lambs when fed before and after lambing. Withdrawal of monensin may be followed by the development of fatal coccidiosis in some animals, presumably because the drug suppressed infection and the development of immunity. Coccidiosis in beef calves after weaning has been treated with monensin from intraruminal continuous release devices. The toxic level of monensin for lambs is 4 mg/kg BW.

**Lasalocid** is related to monensin and is also an effective coccidiostat for use in ruminants. For maximum benefit, lasalocid should be used daily in the feed of coccidia-susceptible lambs for as long as possible. An effective method of control is to medicate the feed of the ewes beginning approximately 2 weeks before lambing and continuing the medication until the lambs are weaned. The lambs begin to receive lasalocid in their creep ration and subsequently in their rations from weaning until market. For the treatment of coccidiosis and improved feedlot performance, lasalocid should be given before and during the time that coccidia-naive lambs are first exposed to the natural occurrence of oocysts. A dose as low as 25 mg/kg of feed will control coccidiosis and improve performance when fed to lambs early in life. Improvements in feedlot performance do not usually occur in heavier lambs already passing oocysts and being fed lasalocid at 25 mg/kg feed.

Lasalocid fed at a dose rate of 40 mg/kg of starter to dairy calves beginning at 3 days of age, and up to 12 weeks of age, is effective in reducing fecal oocyst excretion rates and increasing mean daily BW gain, dry-matter intake, and improved feed efficiency. Mixing lasalocid in the milk replacer of calves beginning at 2 to 4 days of age is an effective method of preventing or controlling coccidiosis. It is also effective as a coccidiostat when fed free choice in salt at a level of 0.75% of the total salt mixture. Lasalocid at levels from 0.75 to 3 mg/kg BW are effective in preventing experimental coccidiosis in calves. The level of 1 mg/kg BW is the most effective and rapid and is recommended when outbreaks of coccidiosis are predicted or imminent in cattle. Lasalocid and decoquinatate are effective in suppressing coccidial infections in young calves under conditions of apparent low exposure and good management. However, evidence shows that neither lasalocid nor decoquinatate, or both, added to the feed of 16-week-old dairy calves naturally infected with subclinical coccidiosis for 56 days, have any significant effect on weight performance.<sup>1</sup>

Monensin, lasalocid, and decoquinatate at the manufacturer's recommended levels are equally effective. A combination of monensin and lasalocid at 22 mg/kg and 100 mg/kg of diet, respectively, is an effective prophylactic against naturally occurring coccidiosis in lambs weaned early under feedlot conditions. Ionophores have been used in the feed continuously from weaning to market, and control coccidiosis and improve feedlot performance. The continuous feeding of lasalocid, decoquinatate, or monensin will effectively control coccidiosis; cessation of medication might result in the appearance of oocysts in the feces and of diarrhea.

**Decoquinatate** in the feed at a dose of 0.5 to 1.0 mg/kg BW can suppress oocyst production in experimentally induced coccidiosis of calves.<sup>1</sup> It is effective in preventing coccidial infections when fed continuously in dry feed at 0.5 mg/kg BW.<sup>1</sup> When fed to dairy calves from 9 weeks to 24 weeks of age, there appears to be an improvement in growth rate. A level of 0.5 mg/kg BW is also effective in goats.

**Toltrazuril** is an efficacious compound.<sup>4,5</sup> Used at 20 mg/kg BW as a single oral dose, 10 days after being turned out to pasture, will prevent coccidiosis in cattle and sheep. In addition, medication of naturally infected lambs with toltrazuril on day 10 after turnout markedly reduces the excretion of oocysts for a prolonged period, and lessens the contamination of pasture with oocysts. A single treatment of toltrazuril can reduce the oocyst output in naturally infected lambs for a period of approximately 3 weeks after administration. Weekly oral treatment of suckling lambs with 20 mg/kg BW of toltrazuril can reduce oocyst output and increase weight gain over a 10-week period.<sup>1</sup>

## Vaccines

Although subunit vaccines might offer theoretical advantages, limited detailed understanding of the immunobiology of coccidiosis in livestock and the relatively large number of species remain obstacles to developing effective anticoccidial vaccines.

## FURTHER READING

- Dauguschies A, Najdrowski M. Eimeriosis in cattle: current understanding. *J Vet Med B Infect Dis Vet Public Health*. 2005;52:417-427.
- Hermisilla C, Ruiz A, Taubert A. *Eimeria bovis*: an update on parasite-host cell interactions. *Int J Med Microbiol*. 2012;302:210-215.
- Innes A, Vermeulen AN. Vaccination as a control strategy against the coccidial parasites *Eimeria*, *Toxoplasma* and *Neospora*. *Parasitology*. 2006;133(suppl S):145-168.
- Step DL, Streeter RN, Kirkpatrick JG. Bovine coccidiosis: a review. *Bov Pract*. 2002;36:126-135.

## REFERENCES

- Radostits O, et al. Diseases Associated with Protozoa. *Veterinary Medicine: A Textbook of the Disease of Cattle, Horses, Sheep, Goats and Pigs*. 10th ed. London: W.B. Saunders; 2007:1498.
- Bangoura B, et al. *Parasitol Res*. 2012;110:875.
- Worliczek H, et al. *Wien Klin Wochenschr*. 2007;119:33.
- Jonsson NN, et al. *Parasitol Res*. 2011;109(suppl 1): S113.
- Veronesi F, et al. *Vet J*. 2011;190:296.

## GIARDIASIS

### SYNOPSIS

**Etiology** *Giardia duodenalis*. Zoonotic and livestock-specific assemblages

**Epidemiology** High prevalence of infection in young farm animals. Fecal-oral cycle of infection from excreting young animals, the dam, and fomite contamination in environment. Cross-species and water transmission possible

**Clinical findings** May result in intermittent pasty feces and growth suppression. Some infections are asymptomatic.

**Clinical pathology** Demonstration of cysts in feces by phase microscopy or fluorescent antibody

**Necropsy findings** Villous atrophy

**Treatment and control** Benzimidazoles, metronidazole, and hygiene

## ETIOLOGY

*Giardia duodenalis* (synonym *G. lamblia*, *G. intestinalis*) is a flagellate (binucleated) protozoan that infects a variety of vertebrates, particularly mammals.<sup>1-8</sup> It is a major cause of diarrhea in humans and has been recognized to causing diarrhea in agricultural animals. Currently, there are numerous genetic variants within *G. duodenalis*, and the genotypic assignment of members of *G. duodenalis* is evolving. Genetic variants (genotypes) are called assemblages. Cattle

are susceptible to infection with the zoonotic assemblage A, which infects several different animal species, and assemblage E, which appears to be restricted to hoofed animals.

The organism develops in the small intestine, where it multiplies by longitudinal binary fission on the surface of the intestinal mucosa at the trophozoite stage, and is excreted in feces as a cyst.<sup>2,3</sup>

## EPIDEMIOLOGY

### Occurrence

*Giardia* infection, as opposed to disease, has been reported from most continents and has been identified in **all of the common agricultural animals**.<sup>4</sup> There is a wide variation in reported prevalence among regions, which probably reflects sampling strategies and methods of detection. The excretion of *Giardia* cysts may be continual but is also usually intermittent in young animals. Most prevalence studies have been in calves, and reported point prevalence infection rates of 1% to 100% in different countries, with the majority of studies showing prevalences of between 20% and 80% in calves.<sup>1</sup> A similar range is evident for more limited studies in lambs, kids, foals, and piglets.<sup>1</sup> Longitudinal studies of excretion patterns in grazing beef cattle, feedlot cattle, dairy cattle, calves, and foals sometimes show high infection rates.<sup>1</sup>

### Source of Infection

**Young animals** are the primary source of infection, and infection is transmitted through the fecal-oral route. High cyst excretion rates in young animals result in the contamination of the **environment** and infection via fomites.

The **dam** is also a source of infection for young animals. Linked to a decrease in immunity in terminal pregnancy, a **periparturient rise** in *Giardia* cyst shedding has been shown in ewes, where cyst excretion increased 2 weeks prepartum, peaked at 0 to 4 weeks postpartum, and declined to low levels at 6 to 8 weeks postpartum.<sup>1</sup> A periparturient rise is suspected to occur also in mares. Cross-infection from other animal species and infection from contaminated water and feed are other possible sources of infection.

### Pathogen Risk Factors

The infectious dose of *Giardia* is thought to be very small. *Giardia* cysts are relatively resistant to environmental influences, can survive at 4°C for 11 weeks in water, 7 weeks in soil, and 1 week in cattle feces, but do not survive freezing. They are resistant to chlorination, and extensive disinfection of the environment does not prevent reinfection.

### Animal and Management Risk Factors

Age is a determinant of infection; cyst excretion rates in feces are much higher in the

young livestock than in adults. Cyst excretion rates in groups of calves are usually highest between 3 and 10 weeks of age, with the number of cysts in feces being highest at 1 to 6 weeks of age. Cyst excretion falls after weaning, but may persist intermittently into adulthood. Similar patterns are seen in lambs. The influence of age on infection in pigs may be confounded by prophylactic medicants routinely used in pig operations. No effect of housing, feeding water management, or season has been observed in cattle, but hygiene in management practices can influence exposure and infection dynamics. The high and early infection rates in calves and lambs compared with other livestock species are probably a reflection of this. Pigs reared on wire floors are infected later in life than pigs reared on porous concrete floors. The prevalence of infection is higher in calves left with their dams to nurse colostrum for 3 days than in calves removed from the dam at birth to individual housing and fed colostrum by a nipple bottle.

### Experimental Studies

Based on experiments in calves, *Giardia* has a prepatent period of 7 to 8 days and a patency of 60 to 112 days without evidence of giardiasis.<sup>1</sup> Infection of 6-week-old SPF lambs with *Giardia* trophozoites resulted in the occurrence of episodes of diarrhea and soft feces that were temporally associated with the detection of *Giardia* cysts in feces.<sup>1</sup> Compared with controls, infected lambs had a reduced rate of weight gain without reduction in food intake and took longer to reach market weight.

### Economic Importance

Evidence for a significant economic importance for the majority of *Giardia* infections in agricultural animals is not convincing.

### Zoonotic Implications

The majority of giardial infections in cattle are with the livestock-associated assemblage E, with a small proportion of infections with the zoonotic assemblage A.<sup>2-6</sup> Contact with farm livestock is a risk factor for disease in humans. There is considerable concern in public health circles that infection of humans could also occur via water bodies receiving agricultural effluent and pasture runoff, leading to drinking water contamination. There is also concern for fecal dispersion of *Giardia* in back-country watersheds from pack animals.

### PATHOGENESIS

Ingested cysts excyst and release trophozoites, which multiply and colonize the surface of small intestine. Trophozoites adhere to the villi of the small intestine by means of a sucking disk on their ventral surface. The parasite induces an inflammatory response, villous atrophy, a reduced **villus to crypt**



ratio, and a reduction in brush border disaccharidase enzymes.<sup>1</sup> Disease is believed to result from increased motility in the gut (as a consequence of inflammation) and consequent diarrhea and nutrient maldigestion and malabsorption.

### CLINICAL FINDINGS

There are several reports that detail the demonstration of giardial infection in individual animals with a chronic, malabsorptive type of diarrhea, and most imply an association with diarrheal disease. Most of these reports relate to young animals at an age when both undifferentiated diarrhea and *Giardia* cyst excretion are common, but the evidence for a causal association is not always entirely convincing, because other possible causes of diarrhea are not excluded. There are also various studies in animals that describe that infection is sometimes not accompanied by evidence of clinical disease.<sup>3-5</sup> In calves and lambs, giardial infection has been associated with a semifluid, pasty, intermittent diarrhea containing mucus, lasting 2 to 3 days but up to 6 weeks in some animals, and growth depression despite a normal appetite. Controlled experimentation demonstrating loose feces and reduced weight gain in experimentally infected lambs has indicated that *Giardia* can be pathogenic in sheep.

### CLINICAL PATHOLOGY

*Giardia* cysts can be demonstrated in feces by phase contrast microscopy or immunofluorescent microscopy following flotation. Saturated salt or sugar solutions may disfigure the cyst, and the demonstration of infection is best conducted by sucrose gradient or zinc sulfate solution flotation. Immunofluorescence might be more sensitive than microscopy for the detection of cysts, and PCR-coupled methods are commonly used for the detection and genetic characterization of *G. duodenalis*.<sup>7</sup>

### NECROPSY FINDINGS

Findings are in the upper small intestine. Although there is often no macroscopic change, microscopically there may be an increase in intraepithelial lymphocytes in the jejunum, with moderate to severe diffuse inflammation, villous atrophy, crypt distortion, and a reduction in the villus to crypt ratio. Trophozoites can be detected histologically on the mucosa and in stained mucosal scrapings taken from the small intestine.

### TREATMENT AND CONTROL

Giardial infections in agricultural animals have been successfully treated with dimetridazole at an oral dose of 50 mg/kg BW daily for 5 days<sup>1</sup> and are also susceptible to furazolidone, but both drugs are illegal for use in food animals in many countries.

Oral administration of the **benzimidazoles** albendazole (20 mg/kg BW daily for 3 days) and fenbendazole (10 mg/kg BW daily

for 3 days) are effective for the treatment of *Giardia* infection or giardiasis in calves.<sup>8</sup> The 3-day course is required for effective treatment; some calves become reinfected following treatment. The principles for the control of giardiasis are similar to those used for cryptosporidiosis, but have not really been developed specifically for livestock. Recommended procedures described to achieve a reduction of exposure (in the section Acute undifferentiated diarrhea of newborn farm animals) are appropriate.

### FURTHER READING

- Baldursson S, Karanis P. Waterborne transmission of protozoan parasites: review of worldwide outbreaks—an update 2004-2010. *Water Res.* 2011;45:6603-6614.
- Cacciò SM, Ryan U. Molecular epidemiology of giardiasis. *Mol Biochem Parasitol.* 2008;160:75-80.
- Fletcher SM, Stark D, Harkness J, Ellis J. Enteric protozoa in the developed world: a public health perspective. *Clin Microbiol Rev.* 2012;25:420-449.
- Lane S, Lloyd D. Current trends in research into the waterborne parasite *Giardia*. *Crit Rev Microbiol.* 2002;28:123-147.
- Olsen ME, et al. Update on *Cryptosporidium* and *Giardia* infections in cattle. *Trends Parasitol.* 2004;20:185-191.

### REFERENCES

1. Radostits O, et al. Diseases Associated with Protozoa. *Veterinary Medicine: A Textbook of the Disease of Cattle, Horses, Sheep, Goats and Pigs*. 10th ed. London: W.B. Saunders; 2007:1515.
2. Thompson RC, Monis PT. *Adv Parasitol.* 2012; 78:57.
3. Monis PT, et al. *Trends Parasitol.* 2009;25:93.
4. Thompson RC, et al. *Vet J.* 2008;177:18.
5. O'Handley RM, Olson ME. *Vet Clin North Am Food Anim Pract.* 2006;22:623.
6. Robertson LJ. *Epidemiol Infect.* 2009;137:913.
7. Koehler AV, et al. *Biotechnol Adv.* 2014;32:280.
8. Budu-Amoako E, et al. *J Food Prot.* 2011;74: 1944.

## ASCARIASIS IN PIGS, HORSES, AND CATTLE

### SYNOPSIS

**Etiology** Nematode worms from the ascarid family: *Ascaris suum* in pigs, *Parascaris equorum* in horses, and *Toxocara vitulorum* in buffalo and cattle

**Epidemiology** Transmission is by ingestion of highly resistant and long-lived larvated eggs; *T. vitulorum* is also transferred via colostrum.

**Signs** Heavy infestation leads to poor growth and afebrile diarrhea, sometimes with obstructive jaundice, intestinal obstruction, and respiratory signs.

**Clinical pathology** Characteristic eggs in feces and a marked eosinophilia

**Lesions** Petechial hemorrhages in lungs and fibrotic spots on the liver

**Diagnostic confirmation** Demonstration of characteristic eggs in feces

### Treatment

**Pigs:** Ivermectin, abamectin, doramectin, flubendazole, febantel, oxbendazole, thiophanate, pyrantel tartrate, and levamisole

**Horses:** Febantel, fenbendazole, mebendazole, and oxbendazole

### Control

**Pigs and horses:** Keep young stock away from sites in which eggs may accumulate.

**Cattle/buffalo:** Prophylactic anthelmintic treatment of 10- to 16-day-old calves

### ETIOLOGY

Each species has its own ascarid: *Ascaris suum* in pigs and *Parascaris equorum* in horses are cosmopolitan, whereas *Toxocara vitulorum* is an important cause of mortality in buffalo calves in India and Southeast Asia.<sup>1</sup> Genetic studies show that although *A. suum* of the pig is very similar to *A. lumbricoides* of man, host-specific differences do exist,<sup>2</sup> and cross-infections occur only infrequently.<sup>3</sup> There is no ascarid specific for sheep, but they may rarely become infected with *A. suum*.

### LIFE CYCLE

*A. suum* and *P. equorum* have similar life cycles. The adult worms are long (females are 20–40 cm and males are 15–25 cm in length), cylindrical, and pointed at both ends and have a thick, glistening, yellow-white cuticle. They live in the small intestine and lay very large numbers (0.5–2 million eggs per day) of thick-shelled eggs.<sup>4</sup> These are not infective until a larva has developed inside. This process needs suitable warmth and humidity and takes place over a period of several weeks. When swallowed, infective eggs hatch quickly in the intestine of the host and the larvae migrate through the intestinal wall, reach the portal vein, and are transported to the liver. They cross to the hepatic venous system and travel to the lungs, are passed up the bronchi and trachea to the pharynx, and are swallowed and come to rest in the intestine where they mature. The prepatent period (time from infestation to the appearance of eggs in the feces) is 6 to 8 weeks for *A. suum* and 11 to 15 weeks for *P. equorum*.

*T. vitulorum* has a more complex life cycle. When eggs are ingested by cattle or buffalo more than 4 to 5 months of age, the larvae settle in somatic tissues without developing or growing instead of traveling to the intestine. Subsequently they become activated around calving and migrate to the udder. They transfer to the calf in the colostrum and grow to the adult stage in the intestine over a period of 3 to 4 weeks and produce large numbers of eggs for about 4 weeks.<sup>1</sup> After 8 weeks of infection, the worm counts in the infected calf decline because of strengthened host immunity.<sup>1</sup>

## EPIDEMIOLOGY

In pigs and horses the only route of infection is by ingestion of larvated eggs. Because the eggs have very thick walls the infective stage is protected from deleterious environmental influences. Few disinfectants will harm them, and they are very resistant to cold but survive most readily in cool, moist surroundings. Periods of survival of up to 5 years have been recorded. In the UK, *A. suum* eggs shed from September to May, become infective more or less synchronously in July, and the number of eggs becoming infective then falls away rapidly. This coincides with the prevalence of damaged livers recorded at bacon factories. Transmission is therefore seasonal but as ascarid eggs are very resistant and can overwinter, pigs and horses may in the absence of good hygiene become infected at all periods of the year. Clinical ascariasis is usually associated with conditions that allow infective eggs to accumulate. This may happen where, for example, the stocking rate is high and the same paddocks are used year after year, or when indoor pens are inadequately cleaned. Although the eggs in the environment are resistant to drying and freezing, exposure to sunlight will kill them within a few weeks.<sup>4</sup>

**Protective immunity** develops and consequently only the young are seriously affected. Ascarid worms are very immunogenic and induce strong Th2 immune responses characterized by eosinophilia and high levels of antiinflammatory cytokines, resulting in worm expulsion.<sup>5</sup> However, this strong Th2 induction may inhibit Th1 responses against bacterial and viral infections, reducing the efficacy of vaccinations.<sup>6,7</sup> Under field conditions, eggs are passed by foals from 12 to 13 weeks of age and spontaneous expulsion of worms occurs 6 to 9 weeks later. Eggs are seen occasionally in the feces of very young foals, but this is thought to be from the ingestion of uninfected eggs during coprophagia. In older animals no clinical signs are observed but infested animals, particularly adult sows and yearling horses, continue to contaminate their surroundings and are an important link in the chain of infection.

*T. vitulorum* larvae are present in greatest numbers in the colostrum 2 to 5 days after calving, and few are present after day 9. Mature worms are present in the intestine of the calf by 10 days of age, and eggs are passed by 3 weeks. Worms are expelled by 5 months of age; thus toxocarosis is a calfhood disease.

## PATHOGENESIS

Migration of larvae through the liver results in hemorrhage and fibrosis, the latter appearing as white spots under the capsule. In heavy infection diffuse fibrosis may occur. The most serious damage occurs in the lungs where the larvae provoke alveolar injury with edema and consolidation. This damage

can exacerbate preexisting lung infections or provide a portal of entry into the body for pyogenic organisms. Immunity to migrating larvae is acquired and can be transferred through colostrum or immune serum.

**In animals other than pigs**, *A. suum* larvae migrate and develop, but the worms do not normally reach the small intestine. During this process severe clinical signs of pulmonary involvement may appear. The disease has been produced experimentally in lambs and calves and has also been observed as a field occurrence in yearling cattle.

**Foals with *P. equorum*** have reduced gut motility, an increase in the ratio of body water to body solids, and a lowering of the body pool of albumin.

## CLINICAL FINDINGS

In pigs up to 4 to 5 months old, clinical signs associated with heavy infestation are poor growth, an afebrile diarrhea, and lowered resistance to other disease. There is some evidence that exposure to parasites during the growing phase without anthelmintic treatment causes permanent damage to growth potential. Adult worms may be vomited up and occasional cases of obstructive jaundice and intestinal obstruction or rupture occur. There may be coughing while larvae are passing through the lungs, but this is not marked, and there is seldom sufficient damage to cause a noticeable increase in respiratory rate or depth. In rare cases the infestation may be so severe that pigs manifest severe dyspnea or die of acute hepatic insufficiency. Enzootic pneumonia of pigs and swine influenza are reported to be much more serious diseases when accompanied by heavy *A. suum* infections, and breaks in hog cholera vaccination with live virus have been attributed to this cause. *A. suum* in other host species produces fever, dyspnea, and anorexia about the 8th day after infestation.

Effects in foals and calves caused by heavy infestation with *P. equorum* and *T. vitulorum* are similar to those observed in young pigs and include poor coat, diarrhea, and occasionally colic. In addition, in foals, convulsions, intestinal obstruction, and perforation may occur. Lung damage may give rise to fever, coughing, and a mucopurulent nasal discharge.<sup>8</sup> In calves, anemia and steatorrhea are additional signs.

## CLINICAL PATHOLOGY

Characteristic eggs are usually present in large numbers in the feces of clinically affected animals. A marked eosinophilia and systemic elevated expression of IL-4<sup>7</sup> often accompany the early stages of infestation in pigs and in other species, with the eosinophilia shown to persist in calves for at least 1 year.

## NECROPSY FINDINGS

In the early stages of a massive infestation, there are subpleural hemorrhages and edema and congestion of the lungs. The pleural

cavity may contain bloodstained fluid. The liver is enlarged and congested, and there may be hemorrhages under the capsule. Microscopically, necrotic tracts and sections of larvae are observed. In species other than the pig, infestation with *A. suum* is accompanied by emphysema, alveolar wall thickening with fibrin, eosinophils and hemorrhage in the lungs, and necrotic tracts in the liver.

In chronic cases the capsule of the liver is marked with small-diameter white spots which may, in severe cases, be confluent and constitute a network of connective tissue. Histologically, the necrotic tracts have been replaced by fibrous tissue. The carcass is usually in poor condition and may be jaundiced. Large numbers of mature worms may almost fill the lumen of the small intestine.

## DIAGNOSTIC CONFIRMATION

Ascarid eggs are brown and have thick walls with a pitted surface. Fecal egg counts in excess of 1000 epg (eggs per gram) are considered to be indicative of significant infection. Migrating larvae are too small to be observed by the naked eye at postmortem examination. They can be recovered from macerated lung tissue by the Baermann technique or seen microscopically in scrapings of bronchial mucus. Experimentally, for *T. vitulorum*, species-specific and highly sensitive molecular diagnostic PCR and LAMP DNA-based tests have been developed for accurate identification and diagnosis of *Toxocara* spp., overcoming the inherent limitations of the traditional approaches.<sup>8,9</sup>

## DIFFERENTIAL DIAGNOSIS

### Early stages of massive infection:

- Enzootic pneumonia in pigs
- Chronic form of *Rhodococcus equi* pneumonia in young foals
- Other forms of pneumonia in calves

### Chronic infection:

- Other causes of unthriftiness including malnutrition and chronic enteritis caused by infections with *Salmonella* and *Brachyspina* spp.

## TREATMENT

### TREATMENT AND PROPHYLAXIS

#### Treatment

##### Pigs

Ivermectin or doramectin (0.3 mg/kg by IM) (R1)<sup>10,11</sup>

Abamectin (0.1 mg/kg/day for 7 days in feed) (R1)<sup>10</sup>

Flubendazole (5 mg/kg as a single dose or 30 g/tonne finished feed given for 5–10 days) (R2)

Fenbendazole (5 mg/kg in feed as a single dose or divided over 7–14 days) (R3)

Febantel (5 mg/kg, orally) (R3)  
Oxibendazole (15 mg/kg or 1.6 mg/kg/days orally for 10 days) (R3)

#### Horses

Febantel (6 mg/kg, orally) (R1)  
Fenbendazole (7.5 mg/kg, orally) (R1)  
Mebendazole (5–10 mg/kg, orally) (R1)  
Oxibendazole (10 mg/kg, orally) (R1)

#### Buffalo

Pyrantel (12.5 mg/kg, orally) (R2)<sup>17</sup>

## Pigs

In pigs, ivermectin, abamectin, or doramectin and flubendazole are effective against adult and fourth-stage (intestinal) larvae of *A. suum*, whereas fenbendazole, febantel, oxibendazole, thiophanate, pyrantel tartrate, and levamisole are effective against the adult worm. Ivermectin, fenbendazole, flubendazole, thiophanate, and pyrantel may be given in feed as divided doses over several days. Ivermectin may have some activity against migrating larvae.

## Horses

In horses, febantel, fenbendazole, mebendazole, and oxibendazole are all effective against adult *P. equorum*. Fenbendazole is also active against immature forms in the intestine. *P. equorum* has been shown to be resistant to ivermectin and pyrantel.<sup>11–15</sup>

## Buffalo Calves

In buffalo calves, the limited data available suggest that pyrantel has good efficacy against both immature and adult worms.<sup>16</sup> Other compounds such as levamisole, febantel, oxfendazole, and even piperazine can be used for treatment but may not expel all worms.

## CONTROL

Important life cycle features that must be taken into account when devising a control program for ascarid infections include the following:

- Worms are prolific egg layers
- Infective eggs are very resistant and long lived
- Young animals are most susceptible

Emphasis must be placed on preventing the environment from becoming contaminated. This is achieved by periodic treatment of the animals likely to be shedding eggs, which are asymptomatic adult carriers and the more vulnerable young stock. Exposure of young pigs and foals to contaminated soil or bedding should be avoided.

Unnecessary treatments can be avoided by regular monitoring with fecal egg counts. In intensive pig-raising systems on concrete floors, the risk of ascarid infestation can be greatly reduced, but rarely eliminated, with good standards of hygiene. In the case of

straw yards, epidemiologic studies in the UK suggest that all bedding should be removed at the end of June (to remove eggs shed in preceding months before they become infective) and again at the end of August (to remove eggs deposited in the summer). If pigs are allowed access to small earthen yards, these must be kept well drained and the manure removed frequently. Control is difficult in free-range systems because the eggs become infective in 4 to 6 weeks in summer and many persist over the winter. Deep plowing of contaminated soil after use will reduce risk of *A. suum* and *Trichuris suis* eggs infecting future batches of pigs.

If farrowing pens are regularly cleaned with high-pressure water and sows are treated immediately before entry, it may be possible to control infection in piglets without anthelmintic treatment. Breakdowns may occur as ascarid eggs are adhesive and not all will be washed away by hosing. For the same reason, eggs are easily introduced from outside on boots, etc. It may therefore be necessary to treat piglets at weaning. Ascarids may be controlled in growing pigs by periodic anthelmintic treatments, but this has to be combined with rigorous hygiene to eliminate liver damage caused by migrating larvae.

Young foals present more of a problem because they often run on permanent pasture used by foals in previous years. Such pastures may become heavily contaminated with eggs. Recommendations for control include:

- Thorough cleaning and disinfection of the maternity stall after each foaling
- Use of small exercise paddocks that should preferably have been rested from occupation by horses for a year
- Weekly removal of manure from the pasture. The foals should be routinely treated at about 10 to 12 weeks of age when the worms are first becoming mature and again at bimonthly intervals.

In this way heavy egg contamination of the pasture can be avoided.

Anthelmintic resistance in *P. equorum* in recent years been widely reported.<sup>11–14</sup>

In buffalo calves, a single anthelmintic treatment at 10 to 16 days of age using a compound with high activity against larval stages gives good control of *T. vitulorum*.<sup>18</sup>

## FURTHER READING

- Matthews JB. Anthelmintic resistance in equine nematodes. *Int J Parasitol Drugs Drug Resist.* 2014;4:310.
- Roepstorff A, Mejer H, Nejsun P, Thamsborg SM. Helminth parasites in pigs: new challenges in pig production and current research highlights. *Vet Parasitol.* 2011;180:72.

## REFERENCES

1. Dorny P, et al. *Korean J Parasitol.* 2015;53:197.
2. Leles D, et al. *Parasit Vectors.* 2012;5:42.
3. Izumikawa K, et al. *Jpn J Infect.* 2011;64:428.

4. Lee A. *Internal Parasites of Pigs.* Australia: Department of Primary Industries, State of New South Wales; 2012 Primefact 1149 first edition, Pub12/20.
5. Steenhard NR, et al. *Parasite Immunol.* 2007;29:535.
6. Urban JF, et al. *Vet Parasitol.* 2007;148:14.
7. Steenhard NR, et al. *Vaccine.* 2009;27:5161.
8. Macuhova K, et al. *J Parasitol.* 2010;96:1224.
9. Tomita N, et al. *Nat Protoc.* 2008;3:877.
10. Cribb NC, et al. *N Z Vet J.* 2006;54:338.
11. Lopes Wdz, et al. *Res Vet Sci.* 2014;97:546.
12. Mkupasi EM, et al. *Acta Trop.* 2013;128:48.
13. Carig TM, et al. *J Equine Vet Sci.* 2007;27:67.
14. Stoneham S, Coles GC. *Vet Rec.* 2006;158:552.
15. Schougaard H, Nielsen MK. *Vet Rec.* 2007;160:439.
16. Von Samson-Himmelsjerna G, et al. *Vet Parasitol.* 2007;144:74.
17. Reinemeyer CR. *Vet Parasitol.* 2012;185:9.
18. Rast L, et al. *Prev Vet Med.* 2014;113:211.

## STRONGYLOSIS (CYATHOSTOMINOSIS) IN HORSES

### SYNOPSIS

**Etiology** Two nematode subfamilies: the Strongylinae (large strongyles) and Cyathostominae (known variously as small strongyles, small redworms, trichonemes, cyathostomes, or cyathostomins)

**Epidemiology** Eggs are shed by horses of all ages, the life cycle is direct, infective larvae develop seasonally on pasture, and hypobiotic cyathostomin larvae can cause severe disease when they resume development in late winter.

### Signs

**General strongylosis:** Ill-thrift, weight loss, poor hair coat, and impaired performance

**Verminous arteritis (associated with *Strongylus vulgaris*):** Variable, including colic and diarrhea

**Larval cyathostominosis:** Rapid weight loss, often with sudden onset diarrhea

**Clinical pathology** Strongylid eggs in feces (except disease caused by larvae); reduced hemoglobin, erythrocyte counts, and packed cell volumes; leukocytosis; eosinophilia (with migrating larvae); hyperglobulinemia, particularly IgG(T); hypoalbuminemia

### Lesions

**General strongylosis:** Large numbers of adult worms in cecum and colon; hemorrhagic inflammation of mucosa with multiple small ulcers, and large and small nodules

**Larval cyathostominosis:** Mucosa grossly inflamed with large numbers of larvae appearing as brown specks

**Verminous arteritis:** Wall of cranial mesenteric artery greatly thickened, organizing thrombi and larvae on internal surface; and ischemia or

Continued



necrosis of parts of the intestinal wall caused by emboli

**Migratory larvae:** Seen in various subserosal sites; some cause nodules in the liver

**Diagnostic confirmation** Few pathognomonic indicators; judgment made on overall appraisal of clinical history, presenting signs, and laboratory findings; arteritis of cranial mesenteric artery sometimes palpable per rectum; immature worms are sometimes in feces in larval cyathostominosis

#### Treatment

**General strongylosis:** Ivermectin, moxidectin; benzimidazoles, e.g., febantel, mebendazole, oxbendazole

**Migrating strongyles:** Ivermectin, moxidectin

**Larval cyathostominosis:** Ivermectin, moxidectin

**Control** Twice-weekly removal of feces from pastures, mixed or alternate grazing, and routine dosing to prevent contamination of pasture with eggs

## ETIOLOGY

The redworms (strongyles) are nematodes commonly found in the large intestine of horses and other Equidae. They belong to two subfamilies: the Strongylidae (large strongyles) and Cyathostominae (known variously as small strongyles, small redworms, trichonemes, cyathostomes, or cyathostomins).<sup>1</sup> The large strongyles include *S. vulgaris*, *S. edentatus*, and *S. equinus*, which migrate extensively through the body, and *Triodontophorus* spp. and *Oesophagodontus robustus*, which do not. The cyathostomins consist of a complex of 50 species from 14 genera including *Cylicostephanus*, *Cyathostomum*, *Cylicocyclus*, *Cylicodontophorus*, *Poteriostomum*, *Gyalocephalus*, and *Cylindropharynx*.<sup>1</sup> Of these, about 10 species are common.

## LIFE CYCLE

Eggs are passed in the feces, and under suitable climatic conditions produce infective third-stage larvae from 7 days onward. As in many other parasitic conditions, the survival of eggs and larvae is favored by shade, moisture, and moderate temperature. Desiccation, ultraviolet light, and repeated freezing and thawing are particularly detrimental to their development and survival.<sup>2</sup> Some eggs and larvae may withstand freezing temperatures, but development ceases below 7.5°C (46°F) to be resumed when temperatures increase. Optimum chances for infection of the host occur in the early morning or evening, when dew produces a moisture film on plants, or after rain, both of which give conditions that encourage larvae to migrate onto pasture.<sup>3</sup> The pasture's soil moisture content influenced by rainfall in the days before fecal deposition on pasture influences larval development and migration onto herbage.<sup>4</sup> The life cycle of all

species is direct; horses become infected by ingestion of the infective larvae.

After ingestion, the larvae of nonmigratory strongyles, such as the cyathostomins, exsheath and enter the walls of the cecum and colon, where they remain in small subserosal nodules for 7 to 18 weeks before breaking out into the lumen of the intestine. The time spent in the mucosa depends on the following:

- Species
- Season of the year
- Age and degree of immunity of the host

They can become arrested in their mucosal development, and their synchronous emergence some weeks later may provoke severe clinical signs. This may occur spontaneously, particularly in late winter, or may be induced by anthelmintic treatment. Expulsion of the adult worm population seems to remove an inhibitory feedback mechanism and may provoke clinical signs. Hypobiotic early third-stage larvae are present in the mucosa at all seasons of the year.

**Larvae of *S. edentatus*** penetrate the intestine and travel via the portal vessels to the liver, where larvae remain and produce hemorrhagic tracts for a month or so. They then migrate via the hepatorenal ligament to the connective tissue under the peritoneum and form hemorrhagic nodules. After about 3 months, they return via the root of the mesentery to the large bowel wall and again form hemorrhagic nodules, which finally rupture and release the worms into the lumen. Adult egg-laying females are present from 40 weeks. Larvae may be found in other organs, e.g., the testes, but these larvae do not return to the intestine. *S. equinus* migrates via the liver to the pancreas and peritoneal cavity but how they return to the intestine is uncertain.

**Larvae of *S. vulgaris*** penetrate the intestinal wall, molt to the fourth larval stage in the submucosa, and then pass into and up small arteries. By day 14, they have reached the cranial mesenteric artery, where they develop to late fourth-stage larvae. In 3 to 4 months they molt and the young adults then return to the intestine via the lumina of the arteries. Nodules are formed in the intestine wall and later rupture, releasing adults into the lumen of the intestine. The prepatent period is 6 months.

## EPIDEMIOLOGY

Strongylosis is a common disease of horses throughout the world and causes death when control measures are neglected. In areas with cold winters and mild summers, egg deposition peaks in spring and remains high over summer. At this time, temperatures are suitable for larval development, and massive contamination of infective larvae may occur in late summer and early autumn, when young susceptible horses are present. *S. vulgaris* larvae can overwinter in considerable numbers in Europe. If the summers are hot

and dry, only a small proportion of strongyle eggs develop to larvae and these may be short lived, but continual reinfestation keeps pasture contamination high.

In subtropical regions, eggs can hatch throughout the year, and larval availability is influenced more by rainfall than temperature. For example, in Florida fecal egg counts remain high throughout the year, and there is an autumn rise in infective larvae. Such associations between disease risk and local climate have important implications in the timing of treatments.

The onset of disease following ingestion of large numbers of larvae depends on the maturation period of the parasite in the host and whether it is the immature or adult stages that are pathogenic. Outbreaks of disease caused by the emergence of small strongyles after hypobiosis are commonly seen in Europe in late winter and early spring (winter or larval cyathostominosis), whereas arterial lesions caused by larval *S. vulgaris* are first seen in late summer and reach a maximum by midwinter.

Mares are the main source of infection for younger horses because many adults carry appreciable burdens of adult stages of strongyle worms and pass large numbers of eggs.<sup>5</sup> Nevertheless, horses do gain some acquired immunity to infection, so young stock are the most susceptible. Possibilities for vaccination are being investigated, but a commercial product seems an unlikely prospect in the short term.

The extensive use of anthelmintics with high efficacy at regular intervals has resulted in a marked decline in the prevalence of *S. vulgaris* in many regions. The cyathostomins, on the other hand, are becoming increasingly important. This may be caused by any of the following factors:

- Insusceptibility of mucosal cyathostomins to many drugs
- Selection for benzimidazole-resistant worms
- Selection for shorter egg reappearance periods

## PATHOGENESIS

The disease processes associated with the strongyles can be divided into those produced by migrating larvae, those provoked by the mass emergence of mucosal larvae, and those associated with adult worms. Heavy intestinal infection can alter intestinal motility, permeability, and absorption.

**The larvae of *S. vulgaris*** are the most pathogenic, causing arteritis, thrombosis, and thickening of the wall of the cranial mesenteric artery. Emboli may break away and lodge in smaller blood vessels, leading to partial or complete ischemia in part of the intestine, thus producing colic. The result of this depends on the length of the segment of intestine affected and the ability of the collateral blood supply to become established

before necrosis and gangrene occur. It is not clear whether the ischemia is directly caused by the mechanical effects of embolism or by consequent pathophysiological events. Whatever the cause, greatly enhanced mobility proximal to the lesion follows and can cause volvulus or torsion. Intussusception is seen occasionally. Colic may also be caused by pressure of the thickened cranial mesenteric artery on the mesenteric plexus.

**Other arterial lesions** associated with migrating *S. vulgaris* larvae include aneurysm of the cranial mesenteric artery, but this is a relatively rare occurrence. More often, larvae aberrantly migrating beyond the cranial mesenteric artery cause migratory tracts and thrombi in other blood vessels. Multiple lesions may be seen in the cecal and colic arteries, which may completely occlude the lumen and cause gangrene in parts of the bowel. Smaller lesions are occasionally seen in iliac, renal, splenic, hepatic, and coronary arteries. Aortic and iliac thrombosis may result in hindlimb lameness. Field and experimental cases of cerebrospinal nematodosis caused by *S. vulgaris* invasion of the CNS have been reported.

**Strongylus sp. larvae** returning to the intestine cause large nodules in the wall of the cecum and colon. Considerable hemorrhage may follow when these rupture to release the worm into the lumen of the intestine. In very heavy burdens, bleeding sufficient enough to cause death can occur.

**Developing cyathostomin larvae** provoke the formation of small nodules, which may be superficial or submucosal, depending on species. In heavy infections, the emergence of large numbers of larvae over a short period causes inflammation of the cecum or ventral colon, with small ulcers where larvae have emerged; hemorrhages of varying sizes; and excess mucous production. Typically, this leads to weight loss, diarrhea, and sometimes a variety of other clinical manifestations including colic and cecocolic intussusception. Affected animals may sometimes secrete *Salmonella*.

**Adult strongyles** can be divided into those that cause blood losses and those that are superficial tissue feeders. *Strongylus* spp. have large buccal cavities, which they use to draw in and digest plugs of mucosa, while secreting anticoagulants to aid the ingestion of blood. Hemorrhage continues from feeding points after worms detach to find new attachment sites. *Triodontophorus* spp. and *O. robustus* feed similarly but are less harmful because they have smaller buccal capsules. An exception is *T. tenuicollis*, because this species attaches in groups in the right dorsal colon and can cause large ulcers. The small strongyles (cyathostomins) have even smaller buccal cavities and produce only superficial damage, so that even relatively large numbers (tens or hundreds of

thousands) of adults often cause little apparent harm.

### CLINICAL FINDINGS

In natural infestations it is often impossible to quantify the effects of individual strongyle species because the clinical picture usually represents the combined effects of a mixed infestation. Ill-thrift, poor hair coat, impaired performance, weight loss, and anemia are signs associated with a “wormy” horse. The greatest losses are probably caused by the failure of young horses to grow optimally and the less efficient performance of moderately parasitized working horses and donkeys.

**Clinical syndromes caused by arteritis** in the cranial mesenteric artery, aorta, and iliac artery are described in other chapters. Experimentally, the migratory phase of *S. vulgaris* infection is associated with pyrexia, inappetence, depression, leukocytosis, and intermittent or continuous colic. In more chronic cases there is a

- Persistent low-grade fever
- Poor appetite
- Intermittent colic
- Poor weight gain

Diarrhea may be present. Adult mares exposed to heavy *S. vulgaris* in late pregnancy may become very weak to the point of recumbency. On clinical examination the mucosae are pale, the heart rapid and loud, and respiration moderately increased. Intestinal sounds are increased although the feces are normal. Abortion may occur and the mare usually dies.

The simultaneous maturation of large numbers of hypobiotic larvae induces the condition known as winter or larval cyathostominosis, which is potentially life-threatening and associated with development of large numbers of immature worm stages in the wall of the large intestines, typically in horses 1 to 3 years old. This is usually characterized by severe loss of weight, weakness, acute or chronic diarrhea, subcutaneous edema, pyrexia, and colic.<sup>6</sup> Numerous cyathostomin larvae may be passed with the feces or may be seen adhering to the glove after rectal examination. Larval cyathostominosis can occur in horses of all ages but are most common in adults under 5 years old. Unless treated early, prognosis is guarded.

### CLINICAL PATHOLOGY

Examination of feces for strongylid eggs confirms the presence of adult strongyles but does not differentiate species. To do this it is necessary to hatch the eggs and examine the infective larvae. This has to be done by an expert parasitologist and delays results by at least 10 days. Experimentally, specific amplification of ribosomal DNA in feces can be used for the detection and identification of strongyle infections and may lead to diagnostic tests.

Hematological values, particularly reduced hemoglobin levels, erythrocyte counts, and PCVs are often taken as a non-specific indication of the degree of infestation with strongyles. Leukocytosis is a feature of heavy infection, whereas eosinophilia may reflect the presence of migrating larvae. Serum analysis reveals a marked increase in  $\beta$ -globulins, particularly IgG(T), and a decrease in albumin.

### NECROPSY FINDINGS

Adult strongyle worms may be seen attached or close to the mucosal surface. The three *Strongylus* spp. are red in color and 2 to 5 cm long. *Triodontophorus* and *Oesophagodontus* are smaller, up to 2 cm. Less easy to see are the small strongyles (cyathostomins), which are more slender and generally under 2 cm long with smaller buccal capsules. Because most cases of strongylosis are caused by mixed infestations with all genera, necropsy findings usually include most of the lesions characteristic of each worm.

**In cases of general strongylosis**, very large numbers of adult worms will be found in the cecum and colon. There may be so many that they appear to form a living cover to the contents of these organs. Catarrhal, hemorrhagic, or fibrinous inflammation of the cecum and ventral colon with multiple small ulcers is associated with the emergence of cyathostomin larvae. There may be edema with excessive mucous production or numerous punctate hemorrhages. Fewer adult worms may be present in winter cyathostominosis but large numbers of larvae (several per square centimeter) can be seen as brown specks in the mucosa, especially if this is illuminated from behind. Adult *T. tenuicollis* are often found in large numbers in the right dorsal colon in association with small circular hemorrhages, and they are sometimes attached in groups at the base of deep mucosal ulcers.

**Strongylus larvae** occur in many subserous sites, especially in nodules in the intestinal wall, and the body cavities may contain an excess of bloodstained fluid. Verminous arteritis lesions of varying size associated with *S. vulgaris* are common at the root of the cranial mesenteric artery and occasionally in the iliac artery. The affected arterial wall is greatly thickened and contains loculi on its internal surface, many of which contain living larvae. Lamellated thrombi are also common at this site and these are sometimes infected. The thickening of the arterial wall often extends along the cecal and colic arteries and complete occlusion of these may be followed by gangrene of a segment of intestine. Similar lesions of arteritis may be present at the base of the aorta. Spontaneous rupture of the vessel occasionally occurs. A significant correlation has been reported between lesions in the proximal aorta and the presence of focal ischemic lesions in the myocardium. These are thought

to be caused by microembolization causing arteriosclerotic lesions in the myocardial arterioles.

**Larvae of *S. edentatus*** cause hemorrhagic tracts and nodules in the liver and adhesions and disruptions of omental architecture. Hemorrhagic nodules 1 to 3 cm in diameter are produced in the subperitoneal region, and these are reported to cause colic and anemia.

### DIAGNOSTIC CONFIRMATION

A specific diagnosis is difficult to achieve in every case. Few clinical observations or laboratory results are pathognomonic for the disease syndromes associated with strongyle infection. Often a judgment has to be made on an overall appraisal of clinical history, presenting signs, and laboratory findings. For example, only 7 of 14 cases of larval cyathostomiasis were diagnosed antemortem in a series of adult horses with chronic diarrhea investigated at university referral clinics.

A diagnosis of general strongylosis should be considered when poor growth, inappetence, diarrhea, and some degree of anemia are the presenting signs. It is generally accepted that strongylosis is an important cause of anemia in horses. Fecal egg counts are generally high (over 800 epg) but are difficult to interpret. They have little direct correlation with worm burden because they are influenced by immunity and species composition. Also, they do not differentiate between different strongyle genera or between these and *Trichostrongylus axei* infection of the stomach. In foals, eggs observed during the first few weeks of life are obtained by coprophagia and are not indicative of a patent infection.

The diagnosis of verminous arteritis also presents difficulty. The thickening of the cranial mesenteric artery may be palpable *per rectum*; the artery is situated below the aorta at the level of the posterior pole of the kidneys. Low serum albumin and increased  $\beta$ -globulins, particularly IgG(T), are the most useful laboratory tests, and arteriography may demonstrate lesions in a number of arteries. Transrectal ultrasonography may also be useful.

In larval cyathostomiasis marked weight loss, diarrhea, leukocytosis, microcytosis, hyperglobulinemia, elevated serum fibrinogen, and hypoalbuminemia are usually seen.<sup>6</sup> Peripheral edema is present in a proportion of cases. Fecal egg counts may be low or zero because it is the immature stages that cause this disease, and owners have often wormed the animal before advice is sought. Consequently, species-specific serologic diagnostic tests using larval antigens are being investigated.<sup>7,8</sup> Additionally, experimental PCR assays targeting the intergenic spacer region of ribosomal DNA have been developed for the identification of cyathostomin larvae at species level.<sup>9-11</sup>

### DIFFERENTIAL DIAGNOSIS

#### General strongylosis:

- Other causes of anemia in the horse, including:
  - Babesiosis
  - Equine infectious anemia
  - Dietary deficiency in stabled stock and the effect of racing for long periods
- Other causes of ill-thrift in horses, including:
  - Ascariasis in the foal
  - Gross nutritional deficiency or agalactia in the mare

#### Larval cyathostomiasis:

- Other causes of chronic diarrhea including:
  - Other parasitic infections, particularly migratory strongyles
  - Granulomatous enteritis
  - Alimentary neoplasia
  - Salmonellosis
  - Chronic liver disease
  - Peritonitis
  - Sand enteropathy
  - Hyperlipidemia

### TREATMENT

#### TREATMENT AND PROPHYLAXIS

##### Treatment and prophylaxis

- Ivermectin (0.2 mg/kg, orally) (R1)
- Moxidectin (0.4 mg/kg, orally) (R1)
- Febantel (6 mg/kg, orally) (R3)
- Mebendazole (10 mg/kg, orally) (R3)
- Oxibendazole (10 mg/kg, orally) (R3)

##### Prophylaxis

- Ivermectin (0.2 mg/kg orally every 8–10 weeks) (R3)
- Moxidectin (0.4 mg/kg orally every 13–16 weeks) (R3)
- Oxibendazole (10 mg/kg orally every 4–6 weeks) (R3)
- Febantel (6 mg/kg orally every 4–6 weeks) (R-3)
- Mebendazole (5–10 mg/kg orally every 4–6 weeks) (R3)

Treatment may be targeted against immature and adult large and small strongyle worms in the lumen of the intestine, against migrating *Strongylus* larvae, particularly *S. vulgaris*, or against cyathostomin larvae in the intestinal mucosa. The latter may be developing third- or fourth-stage, or hypobiotic early third-stage larvae. Anthelmintics vary in their efficacy against these larval stages. This influences the egg reappearance period (i.e., the time from treatment to the reappearance of eggs in the feces as new adult worm populations establish). This in turn determines the treatment interval in control programs.

For elimination of adult worms there is a wide choice of compounds and formulations for use in feed, as pastes, or by tubing.

Most of these, however, belong to just three chemical groups that are administered orally:

1. *Avermectin/milbemycins*, also known as macrocyclic lactones (ivermectin 0.2 mg/kg, moxidectin 0.4 mg/kg)
2. *Benzimidazoles* (febantel 6 mg/kg, mebendazole 5–10 mg/kg, oxibendazole 10 mg/kg)
3. *Tetrahydropyrimidines* (pyrantel 19 mg pyrantel embonate [pamoate]/kg or 6.6 mg pyrantel base/kg)

In both Europe and North America, a high prevalence of cyathostomin populations resistant to the benzimidazoles and pyrantel has been reported.<sup>12</sup> Cyathostomin resistance to fenbendazole is ubiquitous in many regions, and this anthelmintic is now not recommended for use to control cyathostomins.<sup>13-17</sup> There are also reports of emerging resistance to macrocyclic lactones (both ivermectin and moxidectin).<sup>18,19</sup> Where resistance to any of the three groups is a problem, the choice of effective anthelmintics can be extended by use of products containing piperazine, which may be synergized with phenothiazine. An alternative is the cautious use of selected organophosphorus compounds such as dichlorvos or haloxon (which should not be given to foals).

**Mucosal cyathostomin larvae** are more problematic. Publications on this topic are difficult to interpret because results may be influenced by experimental design and methodology. Moxidectin 0.4 mg/kg orally has activity against hypobiotic and developing third-stage larvae as well as the fourth stage. Consequently, this compound has a prolonged egg reappearance period allowing a treatment interval of 13 weeks for prevention of egg output onto pasture. Ivermectin seems at best to be variable in its activity against mucosal stages, and a treatment interval of 8 to 10 weeks is generally recommended. Other anthelmintics at adulticidal doses have little or no effect on mucosal cyathostomin larvae, and treatment intervals of 4 to 6 weeks are necessary during periods of heavy pasture challenge.

**Migrating *S. vulgaris* and *S. edentatus*** can be controlled with ivermectin 0.2 mg/kg orally or fenbendazole at 60 mg/kg orally (single dose) or, more reliably, 7.5 mg/kg orally daily for 5 days. In cases of verminous arteritis, it may take some months after removal of the parasites for the lesion to resolve.

### CONTROL

Eradication of all horse strongyles is not feasible, because infections are ubiquitous and no drug currently available can completely eliminate the mucosal larvae. Adult horses can pass substantial numbers of eggs throughout their lives; stocking densities are often high and foals usually graze with their dam. Infective larvae on grass can be long lived and there are usually few opportunities for the long-term resting or reseeded of



pastures on horse farms. Consequently, the primary objective of control programs is to minimize the numbers of infective larvae accumulating on pasture. There is no pasture treatment that is economically or environmentally acceptable. The possibility of using nematophagous fungi that will destroy larvae in the feces is an exciting prospect. Options for control by grazing management are limited. Alternate or mixed grazing with ruminants can reduce pasture infectivity, as horse strongyles will not establish in these hosts. The stomach worm *T. axei*, however, is a shared parasite. Removal of all horse feces from fields twice weekly is highly effective provided heavy rainfall does not disperse the material. This approach can be cost-effective where valuable animals are at risk or labor is relatively inexpensive. Tractor-mounted mechanical devices are available for this purpose. A further benefit of fecal removal is that the area within the field grazed by the horses is enlarged, i.e., the ratio of lawn to rough increases. Harrowing is effective in hot, dry conditions when eggs and larvae are quickly desiccated, but at other times is likely to have a deleterious effect by spreading infective larvae.

**Prophylactic chemotherapy** is used to a greater or lesser extent at most stables because land and labor constraints often limit the effectiveness of nonchemical approaches. The latter should, nevertheless, be used wherever possible to minimize the number of treatments needed during the year, which in turn reduces the risk of development of anthelmintic resistance. The purpose of prophylactic chemotherapy in the control of strongylosis is to prevent the output of strongylid eggs onto the pasture. Under conditions of heavy pasture challenge, regular dosing at 4 to 6 weeks with benzimidazoles (other than fenbendazole), 8 to 10 weeks with ivermectin, or 13 to 16 weeks with moxidectin is necessary throughout the period of risk. Once pasture larval counts have been reduced to insignificant levels, the time between doses can be extended. Routine fecal egg counts are an important component of any control strategy because they are a direct measure of the rate at which pasture contamination is taking place. They also confirm the continuing efficacy of the drugs used and can be used to determine optimum treatment intervals.

**Parasitism is a herd problem** and all horses on a property should be treated simultaneously, even if they have different owners. If routine fecal examinations are performed, dosing can be restricted to those horses with significant egg counts. Untreated animals then provide parasite refugia for conserving anthelmintic efficacy. As horses and ruminants generally harbor different worm parasites, disease risk can be reduced by grazing these species together or by alternating the use of paddocks between each species. As most eggs are deposited on the

pasture in spring and summer in temperate regions, concentration of treatments at this time should reduce contamination and give much lower pasture larvae counts in the following autumn and winter. Intensive treatment programs are often adopted on stud farms, where maximum reduction of contamination is required. Less frequent dosing may be necessary on properties with lower stocking intensities or where horses are run with other stock. As the mare is the main source of contamination for the foal, she should be treated about 2 months before foaling, again at foaling, and regularly thereafter. Treatment of foals should commence at 10 weeks of age to remove small strongyles before they start to lay eggs and should be repeated at intervals, depending on the choice of drug.

**Delaying the onset of resistance** is an important consideration in the design of any control program. The major equine anthelmintics belong to just three chemical groups and worm populations resistant to one compound are usually unsusceptible to, or more tolerant of, the effects of others in that chemical group. The level of resistance in a herd can be estimated by means of the **fecal egg count reduction technique**. At least six horses with high egg counts are weighed (e.g., with a weigh band) and treated with an accurately measured dose of anthelmintic. A reduction in mean egg count after 7 to 14 days of less than 90% is suggestive of resistance. More stringent tests are required for confirmation. Recommendations for extending the useful life of existing products similar to those listed earlier for ruminants have been published for horse anthelmintics.

#### FURTHER READING

- Nielsen MK, Kaplan RM, Thamsborg SM, Monrad J, Olsen SN. Climatic influences on development and survival of free-living stages of equine strongyles: implications for worm control strategies and managing anthelmintic resistance. *Vet J*. 2007;174:23-32.
- Nielsen MK. Universal challenges for parasite control: a perspective from equine parasitology. *Trends Parasitol*. 2015;31:282-284.
- Peregrine AS, Molento MB, Kaplan RM, Nielsen MK. Anthelmintic resistance in important parasites of horses: does it really matter? *Vet Parasitol*. 2014;201:1-8.

#### REFERENCES

- Lichtenfels JR, et al. *Vet Parasitol*. 2008;156:4.
- Van Dijk J, et al. *Int J Parasitol*. 2009;39:1151.
- Qinelato S, et al. *Vet Parasitol*. 2008;152:100.
- Khadijah S, et al. *Vet Parasitol*. 2013;197:204.
- Gras LM, et al. *Vet Parasitol*. 2011;179:167.
- Peregrine AS, et al. *Can Vet J*. 2006;47:80.
- McWilliam HE, et al. *Int J Parasitol*. 2010;40:265.
- Paz-Silva A, et al. *Clin Vaccine Immunol*. 2011;18:1462.
- Van Doorn DC, et al. *Vet Parasitol*. 2010;168:84.
- Cwiklinski C, et al. *Parasitology*. 2012;139:1063.
- Traversa D, et al. *J Clin Microbiol*. 2007;45:2937.
- Traversa D, et al. *Parasit Vectors*. 2009;2:52.
- Traversa D, et al. *Vet Parasitol*. 2012;188:294.

- Osterman Lind E, et al. *Vet Res Commun*. 2007;31:53.
- Lester HE, et al. *Vet Parasitol*. 2013;197:189.
- Relf VE, et al. *Int J Parasitol*. 2014;44:507.
- Startford CH, et al. *Equine Vet J*. 2014;46:17.
- Lyons ET, et al. *Parasitol Res*. 2009;104:569.
- Lyons ET, Tolliver SC. *Parasitol Res*. 2013;112:889.

### OXYURIS EQUI (PINWORM)

*Oxyuris equi* is a nematode that provokes irritation of the perianal region of horses, causing them to rub and bite their tails. This can result in hair loss and sometimes physical damage to the tissues of the area. The parasite is ubiquitous but of greater prevalence in areas of high rainfall.

The life cycle is direct. The mature worms are gray in color and inhabit the cecum and colon. The male is 1 to 2 cm long, but the female is much longer, up to 15 cm, and has a long tapering tail. When full of eggs, the female migrates down the gut and crawls onto the perianal area, where she exudes her eggs onto the skin in yellow clusters and then shrivels up and dies. An embryo develops in about 3 days within the egg, which is then infective. Eggs may be licked off the skin and swallowed or they may eventually fall to the ground. They resist desiccation, may become airborne in dust, and remain viable in stables for long periods. Transmission then occurs via contaminated feedstuffs.

Diagnosis is by detection of operculated eggs, slightly flattened on one side, on transparent adhesive tape that has been pressed against the perianal skin and then placed on a microscope slide for examination or by the chance observation of an adult worm in the feces.

#### TREATMENT AND PROPHYLAXIS

##### Treatment

- Ivermectin (0.2 mg/kg, orally) (R1)
- Moxidectin (0.4 mg/kg, orally) (R1)
- Pyrantel (13.2 mg/kg, orally) (R1)
- Febantel (6 mg/kg, orally) (R1)
- Mebendazole (10 mg/kg, orally) (R1)
- Oxibendazole (10 mg/kg, orally) (R1)

Treatment comprises the application of a mild disinfectant ointment to the perianal region and the administration of ivermectin, moxidectin, pyrantel, and any of the newer broad-spectrum benzimidazoles at the standard dose rate for horses.<sup>1</sup> Piperazine salts are also effective. However, recent studies in Europe and the United States have found that *O. equi* resistance to ivermectin and moxidectin is emerging.<sup>2,3</sup>

#### FURTHER READING

- Reinemeyer CR. Anthelmintic resistance in non-strongylid parasites of horses. *Vet Parasitol*. 2012;185:9-15.

## REFERENCES

1. Reinemeyer CR, et al. *Vet Parasitol.* 2010;171:106.
2. Durham A, Coles G. *Vet Rec.* 2010;167:913.
3. Wolf D, et al. *Vet Parasitol.* 2014;201:163.

## STRONGYLOIDES (THREADWORM)

Farm animals in many countries are exposed to infection with the nematode genus *Strongyloides*. Disease outbreaks occur in young pigs, foals, calves, and lambs, but the overall economic importance of this parasite does not appear to be very great. Different species occur in each host: *S. ransomi* in pigs, *S. westeri* in horses, and *S. papillosus* in sheep and cattle. All are parasites of the small intestine. They are threadlike and less than 1 cm in length.

**Only female worms** are present in the intestine, so eggs are produced by parthenogenesis. The eggs are thin shelled and contain an embryo. The larvae that hatch out may develop into infective or nonparasitic forms. The latter become free-living males and females that live in decaying organic material and produce fertilized eggs that give rise to infective larvae. Transmission occurs when infective larvae enter the host either by ingestion or by skin penetration. In older animals they accumulate in subcutaneous tissues and migrate to the mammary gland when lactation starts. Thus neonates are infected via milk, and egg-laying females may be present in the intestine from about 1 week after birth. Infective larvae penetrating the skin of young animals travel via the blood to the lungs, where they break into alveoli, ascend the air passages to the pharynx, and are then swallowed.

**Diarrhea in young animals** is the most common clinical sign, but the passage of massive numbers of larvae through the skin may also provoke dermatitis. Experimental infections in calves cause pallor and coughing, but cases of sudden death without previous symptoms have been ascribed to heavy burdens with many migratory larvae. In bulls, balanoposthitis may be seen. In lambs, dermatitis, pulmonary hemorrhage, and enteritis occur. Sheep may also develop lameness or be more susceptible to foot rot when subject to heavy infestations. Experimental infection of young goats produced transient diarrhea, dehydration, cachexia, gnashing of teeth, foaming at mouth, anemia, and nervous signs. Pigs may show anorexia, listlessness, and anemia but diarrhea is the principal clinical sign. Infestation in pigs has been shown to reduce intestinal enzyme activity, to increase intestinal plasma and blood loss, and to reduce protein synthesis in the liver. In foals, high egg counts may be recorded in apparently healthy animals but may coincide with the onset of diarrhea (independent of the first heat of the mare) in other individuals. Episodes of frenzy in foals

lasting approximately 30 minutes have been attributed to percutaneous larval invasion. Within 2 days skin lesions developed on the lower limbs that persisted for 2 to 3 weeks. Experimental PCR assays targeting the 18S ribosomal DNA sequence have been developed for species-specific identification of *Strongyloides* species.<sup>1</sup>

### TREATMENT AND PROPHYLAXIS

#### Treatment

##### Pigs

Ivermectin (0.1 mg/kg, orally) (R1)<sup>2</sup>

Abamectin (0.1 mg/kg, orally) (R1)<sup>2</sup>

Moxidectin (0.4 mg/kg, orally) (R1)

##### Foals

Ivermectin (0.2 mg/kg, orally) (R1)

Moxidectin (0.4 mg/kg, orally) (R1)

Oxibendazole (15 mg/kg, orally) (R3)

##### Sheep

Combination of derquantel (2 mg/kg, orally) and abamectin (0.2 mg/kg, orally) (R1)<sup>3</sup>

Most broad-spectrum anthelmintics are effective in eliminating this parasite. In foals, ivermectin is used at the standard equine dose, but elevated doses of oxibendazole (15 mg/kg) are needed. The treatment of mares with ivermectin on the day of parturition did not prevent transmammary transmission but markedly reduced egg counts in the foals. Treatment of infected sows was effective in removing arrested larvae from the subventral fat. In sheep derquantel, which belongs to a new class of anthelmintics called spiroindoles, when used in combination with abamectin, has been shown to have consistently high efficacy against *Strongyloides* infections.<sup>3</sup>

Control depends on the elimination of warm, moist areas such as damp litter or bedding, which is suitable for parasite multiplication.

## REFERENCES

1. Hasegawa H, et al. *Parasitol Res.* 2009;104:869.
2. Lopes WDZ, et al. *Res Vet Sci.* 2014;97:546.
3. Little PR, et al. *Vet Parasitol.* 2011;181:180.

## TRICHURIS (WHIPWORM)

Three species of whipworms are found in ruminants: *Trichuris ovis*, *T. discolor*, and *T. globulosa*, whereas *T. suis* occurs in pigs. Whipworms in farm livestock are usually considered to be relatively innocuous. Indeed, induced *T. suis* infections are being evaluated in human medicine for amelioration of chronic inflammatory bowel disease, because whipworm-induced Th2 immune responses dampen harmful Th1 activity in some patients.<sup>1</sup> Heavy infestations can, nevertheless, produce serious disease with

diarrhea and dysentery, and the mortality rate can be high in recently weaned pigs. Severely affected animals are anorexic and rapidly lose weight. The feces may contain bloodstained mucus and strips of necrotic mucosa. The nematodes lie with their thin anterior end superficially embedded in the wall of the cecum, and in heavy infections the colon may also be involved. The activities of the worms produce little tissue reaction per se but enable microorganisms in the gut microflora to become invasive. This is the main cause of the severe inflammation and clinical signs associated with whipworm infestation. A synergy has also been demonstrated between *T. suis* and *C. jejuni*.

**The life cycle** of the whipworm is direct. The eggs are very resistant to external environmental conditions and can survive for up to 6 years in old pigsties, and for at least 2 years on pasture in the south of England. An infective larva develops inside the egg, but a relatively high temperature is required for rapid growth. In temperate climates, embryonation of *T. suis* eggs may take more than 1 year. When swallowed by a suitable host, the eggs hatch and develop to mature adults in about 12 to 20 weeks after infection in lambs and goats and 6 to 7 weeks in pigs.<sup>2</sup> The disease in sheep is most common after hot, dry weather, which effectively cleanses the pasture of other nematode larvae, but the resistant *Trichuris* spp. eggs survive and are ingested when the sheep eat close to the ground to obtain grain given as drought feed.

**Diagnosis** depends on detection in the feces of the yellow oval eggs, which have a transparent plug at each end. The eggs are heavier than many others and do not always float well in saturated salt (NaCl) solution. An alternative flotation fluid such as zinc sulfate or sugar is more reliable. At necropsy, the adult worms, which are 2 to 5 cm long, are easily recognized by their whiplike appearance—the anterior third is much thinner than the handle-like posterior end.

### TREATMENT AND PROPHYLAXIS

#### Treatment

Ivermectin (0.1 mg/kg orally every 24 hours for 7 days) (R2)<sup>3</sup>

Abamectin (0.1 mg/kg orally every 24 hours for 7 days) (R2)<sup>3</sup>

Oxfendazole (30 mg/g orally) (R2)<sup>4</sup>

## Chemotherapy

Low uptake of benzimidazoles by *Trichuris* worms is responsible for low pharmacologic efficacy of this class of anthelmintics against *Trichuris* infestations.<sup>5</sup> Therefore dosages that are five times higher than recommended are used to treat *Trichuris* infestations.<sup>6</sup> Similarly, high efficacy of ivermectin and

abamectin is achieved when they are administered repeatedly for seven consecutive days.<sup>3</sup>

## REFERENCES

1. Broadhurst MJ, et al. *Sci Trans Med*. 2010;2:60.
2. Nejsum P, et al. *Heredity*. 2009;102:357.
3. Lopes WDZ, et al. *Res Vet Sci*. 2014;97:546.
4. Alvarez CS, et al. *Vet Parasitol*. 2013;194:70.
5. Hansen TVA, et al. *PLoS Negl Trop Dis*. 2014;8:e2752.
6. Danish Health and Medicine Authority 2013; Collection 87.

## PARASITIC GASTRITIS IN PIGS

### SYNOPSIS

**Etiology** The nematodes *Hyostrongylus rubidus*, *Ascarops*, and *Physocephalus*

**Epidemiology** Infections occur in outdoor husbandry systems; *H. rubidus* has a direct life cycle, but *Ascarops* and *Physocephalus* use dung beetles as intermediate hosts.

**Signs** Generally asymptomatic but heavy infections can produce gastritis; sows with *H. rubidus* may become thin during lactation.

**Clinical pathology** Eggs of *Ascarops* and *Physocephalus* in feces are characteristic; those of *H. rubidus* are similar to *Oesophagostomum*.

**Lesions** Excess mucus; gastritis; often ulceration of glandular part of stomach; nodular hyperplasia in hyostrongylosis

**Diagnostic confirmation** Demonstration of eggs of *Ascarops* or *Physocephalus*; examination of larvae from fecal culture for *H. rubidus*

### Treatment

***H. rubidus*:** Doramectin, abamectin, ivermectin, fenbendazole, thiabendazole, febantel, oxi-bendazole, thiophanate, levamisole, and dichlorvos

***Ascarops*:** Ivermectin

**Control** Good husbandry practices, such as rotating pastures, normally suffice.

## ETIOLOGY

Three categories of nematode inhabit the stomach of the pig. The first is a trichostrongylid, *Hyostrongylus rubidus*. This is closely related to the *Ostertagia* spp. of ruminants and occurs in most countries where pigs are kept. The next group comprises members of several related genera including *Ascarops strongylina*, *A. dentata*, and *Physocephalus sexalatus*, which occur in the United States, Southeast Asia, and Australia, and *Simondsia paradoxa*, found in parts of Europe and India. Finally, *Ollulanus tricuspis* is a very small nematode (0.7–1.0 mm) that causes gastritis on rare occasions in pigs, cats, foxes, and dogs.

## LIFE CYCLES

*H. rubidus* is a small (0.5–1.25 cm) thin, red worm with a life cycle very similar to that of *O. ostertagi*. Eggs develop at temperatures between 10°C and 27°C (50°F and 80°F). In the UK, eggs deposited outdoors from May to October develop into infective larvae. These larvae survive on pasture for up to 10 months but are rapidly killed by desiccation and by freezing. Transmission occurs by ingestion of the infective larvae, which spend the next 13 to 14 days in the gastric glands. They then return to the lumen, and the first eggs are passed 20 to 25 days after infection. In some circumstances larvae become hypobiotic and remain in the gastric mucosa for several months.

*Ascarops* and *Physocephalus* are thick, white worms 1 to 2.5 cm long. They have indirect life cycles; eggs passed in the feces of the pig are eaten by dung beetles, in which hatching and development to infective larvae occur. Infestation of the final host occurs when pigs eat infested beetles. Little is known of the biology of *Simondsia paradoxa*.

## EPIDEMIOLOGY

The stomach worms of pigs are almost exclusively confined to outdoor management systems. The reason for this is different in each group. With *Ascarops* and *Physocephalus*, it is a consequence of the essential role of the dung beetle in the life cycle. With *H. rubidus*, it is because the daily output of eggs by each female is so sparse that the life cycle is unlikely to persist in pig houses practicing a reasonable standard of hygiene. Young pigs are the most susceptible to hyostrongylosis but adult sows, especially when lactating, may also be affected. Hypobiosis is seasonal, but disease outbreaks analogous to type II ostertagiosis have not been reported.

## PATHOGENESIS

Developing *H. rubidus* provokes hyperplastic nodular lesions in the glandular part of the stomach. These and consequent biochemical and physiologic sequelae are similar to those described for *O. ostertagi*. *Ascarops* and *Physocephalus* lie close to the gastric mucosa where they stimulate excessive mucous production. Heavy infections cause a catarrhal gastritis.

## CLINICAL FINDINGS

The effect of *H. rubidus* on young pigs is not usually clinically apparent. Heavy infestations may be associated with anemia, unthriftiness, poor growth, and diarrhea. Signs in adult sows are usually seen during lactation. Affected animals lose more weight than normal and are slow to regain condition after weaning. In severe cases, sows may become emaciated. There may be pallor caused by anemia and often a deprived appetite, but no diarrhea. Adult sows often carry heavy infestations without clinical illness, but sudden death caused by hemorrhage

from gastric ulcers or to peritonitis by ulcerative perforation has been observed on rare occasions.<sup>1</sup> Although *Ascarops* and *Physocephalus* are common in many areas, most infections are low grade and without clinical effect. Heavy infections can lead to inappetence and other signs of gastritis.

## CLINICAL PATHOLOGY

Fecal examination is not very useful for the diagnosis of hyostrongylosis, because the eggs of *H. rubidus* are indistinguishable from those of the less pathogenic but more prolific *Oesophagostomum* spp. *Physocephalus* and *Ascarops* spp. eggs are small, thick shelled, and contain a larva when laid.

## NECROPSY FINDINGS

The presence of *H. rubidus* is easily missed as the worms are slender and often lie beneath a thick layer of mucus. Adult worms are <10 mm in length and are bright red when first removed from the host. The gastric mucosa is hyperemic and nodular lesions are present. There may be one or more deep ulcers in the glandular region of the stomach. These may contain clusters of adult *H. rubidus*. In severe cases the mucosa is thickened and edematous and covered with a diphtheritic pseudomembrane.<sup>1</sup> In *Physocephalus* and *Ascarops* infections, adult worms are readily visible lying in mucus on the gastric mucosa. There is an obvious gastritis in heavy infections and ulceration may occur.

## DIAGNOSTIC CONFIRMATION

Confirmation of infection with *H. rubidus* is made by examination of larvae from fecal cultures. Those of *H. rubidus* are longer and more vigorously motile than those of *Oesophagostomum* spp. As *H. rubidus* produces so few eggs, even small numbers of larvae may indicate a pathogenic worm burden. Elevated serum pepsinogen concentrations may also be indicative of infection.

## DIFFERENTIAL DIAGNOSIS

*Hyostrongylus rubidus* must be differentiated from other causes of unthriftiness or emaciation such as:

- Swine dysentery
- Necrotic enteritis
- Coccidiosis
- Infestation with *Oesophagostomum* spp.
- Thin sow syndrome
- Malnutrition

## TREATMENT

### TREATMENT AND PROPHYLAXIS

#### Treatment

Doramectin (0.3 mg/kg, IM) (R1)

Abamectin (0.1 mg/kg of feed/day for 7 days) (R1)<sup>2</sup>

Continued



Ivermectin (0.3 mg/kg BW by SC or IM injection or 0.1 mg/kg of feed/day for 7 days) (R2)<sup>3</sup>  
 Fenbendazole (5 mg/kg BW in feed as a single dose or divided over 7–14 days) (R3)  
 Flubendazole (5 mg/kg BW as a single dose or 30 g/tonne finished feed given for 5–10 days) (R3)  
 Febantel (5 mg/kg BW) (R4)  
 Oxibendazole (15 mg/kg BW or 1.6 mg/kg BW/day for 10 days) (R4)

Doramectin, abamectin, ivermectin, fenbendazole, and flubendazole are active against fourth-stage and adult *H. rubidus*. Febantel, oxibendazole, and thiophanate have label claims only for the adult worms. Levamisole and dichlorvos have also been widely used in the treatment of pig nematodes. In-feed ivermectin is also effective against *A. strongylina*.

## CONTROL

Standard hygienic precautions including frequent removal of manure, the provision of drainage in outside pens, and rotation of pastures will reduce environmental contamination. Control of the dung beetle intermediate hosts of *Physocephalus* and *Ascarops* is impracticable.

Hyostrongylosis is most likely to affect sows during lactation, so animals at risk should be dosed before farrowing. The behavior of *H. rubidus* larvae on pasture is similar to that described for *Oesophagostomum*, and control schemes should be effective for both parasites.

## REFERENCES

1. Lee A. Internal parasites of Pigs. Department of Primary Industries, State of New South Wales, Australia. Primefact 1149 first edition, Pub12/20. 2012.
2. Lopes WDJ, et al. *Res Vet Sci*. 2014;97:546.
3. Mkupasi EM, et al. *Acta Trop*. 2013;128:48.

## GASTEROPHILUS SPP. INFESTATION (BOTFLY)

Infestations with larvae of *Gasterophilus* spp. have a widespread distribution. They cause a chronic gastritis and a loss of condition in infested horses, donkeys, and mules. Reduced performance is often attributed to this infestation. On rare occasions they cause perforation of the stomach and death.

### SYNOPSIS

**Etiology** Six species of *Gasterophilus* spp. that inhabit the gastrointestinal tract of horses

**Epidemiology** Eggs are laid on the hair of the body or around the lips; eggs hatch spontaneously or are stimulated to hatch by oral grooming, larvae penetrate oral mucosa or external epithelium of cheek and migrate to inner regions of mouth,

and congregate at epithelial surface around teeth for 6–10 weeks before migration to the stomach and intestine. Larvae attach in stomach or intestine and remain there for a number of months before being passed in the feces. One species attaches near the rectum. Larvae pupate and adults emerge after 3–5 weeks. Adults only live a few days and are mainly active in the summer, and the larvae overwinter in the stomach.

**Clinical signs** Adult flies frighten horses and larvae cause nonspecific signs of unthriftiness.

**Clinical pathology** Eggs can be seen on hairs on legs or around the lips by direct inspection.

**Lesions** Area of larval attachment is pitted and the gastric wall may be thickened.

**Diagnostic confirmation** Eggs present on hairs, and there are characteristic lesions at autopsy.

**Differential diagnosis** Unthriftiness usually caused by helminth infection

**Treatment** Ivermectin, moxidectin

**Control** Treatment given when fly activity has ceased and when larvae are in stomach, usually two treatments in mid and late winter. Fringes and tassels protect against worry associated with one species of fly

## ETIOLOGY

Six species of flies have larvae that are known to parasitize domestic equids: *Gasterophilus nasalis*, *G. intestinalis*, *G. haemorrhoidalis*, *G. pecorum*, *G. nigricornis*, and *G. inermis*. Their larvae are the “stomach bots” of horses, donkeys, and mules. Three species, *G. intestinalis*, *G. nasalis*, and *G. haemorrhoidalis*, are the most important and have a worldwide distribution, although *G. pecorum* is noted as becoming more important, particularly in parts of Asia and in the UK.<sup>1,2</sup> The later larval stages inhabit the stomach and duodenum. These creamy pink larvae are thick, segmented, and about 5 to 15 mm long. The adult flies are golden brown, hairy, and about the size of a bee, with two wings and vestigial mouth parts.

## LIFE CYCLE AND EPIDEMIOLOGY

Flies do not feed and only live a few days. They are active during the summer months and there may be overlap among the species in their periods of activity. In areas with mild winters the flies may be active throughout the year. In colder regions fly activity ceases with the first frost, and there is usually only a single generation per year. In these regions the second and third instars remain in the stomach over the winter.

Eggs are attached to hairs while the fly hovers close to the horse. Fecundity is roughly correlated to the size of the fly. *G. haemorrhoidalis* matures about 50 to 200 eggs, *G. nasalis* 300 to 500 eggs, and *G. intestinalis* up to 1000. Eggs of the various species are laid in specific locations and are attached

in a specific manner, allowing identification of eggs to species. The eggs are laid on the horse's coat except for *G. pecorum*, which lays up to 2000 eggs in batches of 100 to 200 on pasture plants. The eggs of *G. pecorum* and *G. haemorrhoidalis* are dark brown; the eggs of the others are yellow and are readily visible glued to the hairs, usually one to a hair. The eggs of *G. intestinalis*, the most common fly, are laid on the front legs, particularly the lower parts; those of *G. nasalis* in the intermandibular area; and the others species' eggs are laid on the cheeks and lips.

The eggs are ready to hatch in about 2 to 10 days, and the first instars enter the mouth either by host biting or licking or by subcutaneous migration from the cheeks into the oral cavity. The eggs of *G. intestinalis* and *G. pecorum* require a stimulus, provided by licking (moisture) or rubbing (friction), before they will hatch. The larvae penetrate oral mucosa, migrate to inner surfaces, and emerge in the interdental spaces. The larvae of *G. intestinalis* penetrate the anterior end of the tongue and burrow in the buccal mucosa for about 3 to 4 weeks before invading pockets between the teeth or between the gum and molars. *G. nasalis* may also accumulate in pockets alongside the molar teeth and cause mouth irritation. *G. haemorrhoidalis* can penetrate the skin of the cheek and after wandering in the tissues of the mouth may attach in the pharynx. The second instar of *G. intestinalis* may also attach for a few days to the pharynx and the sides of the epiglottis before passing to the stomach. The first instars of *G. pecorum* burrow into the mucous membranes of the hard palate, cheek, and tongue where they develop into second instars. They then move to the pharynx where they develop into the third instar. Occasional larvae migrate to abnormal sites including the brain, the cranial sinuses, the heart, and lungs.

Third instars of *G. intestinalis* larvae are found attached to the mucosa, usually in bunches, at the junction of the glandular and nonglandular portion of the stomach, where they become attached to the mucosa. *G. nasalis* larvae are found in the pyloric region of the stomach and the duodenum. *G. pecorum* larvae may be found in the pharynx and upper part of the esophagus and in the fundus of the stomach. *G. haemorrhoidalis* larvae are found in the tongue, the pharynx, and the gastric fundus.

In the host, two molts are made and the larvae pass out in the droppings 10 to 12 months after infestation, usually in the spring and early summer. Some larvae may attach temporarily to the rectal mucosa on their way through. The larvae migrate into the ground, pupate, and adult flies emerge after 3 to 5 weeks to recommence the late summer attacks on horses.

## PATHOGENESIS

The adult fly causes considerable annoyance when ovipositing. The droning noise and the sudden attacks to lay eggs cause head tossing

and running in the host. *G. nasalis* is particularly troublesome because it darts at the lips and throat.

There is some doubt as to the importance of the lesions caused by the larvae. At the sites where they adhere there is an area of thickening and inflammation, and in rare cases gastric perforation occurs. It is probable that there is some chronic gastritis and interference with digestion in most infestations. *G. intestinalis*, the most common species, attaches to the squamous epithelium, and this has a relatively slight impact on the digestion in the horse. However, the ulceration, edema, and abscessation caused by this species cannot be overlooked, and one must expect some effect from such lesions, although it is difficult in practice to separate these findings from those caused by a concurrent worm burden. Occasional perforation of the gut has been documented. The larvae do not remove sufficient blood to cause anemia, feeding mostly on tissue exudate. In rare cases pleurisy may occur following perforation of the esophagus close to the cardia. In very heavy infestations with *G. pecorum* the presence of large numbers of larvae (100–500) on the soft palate and base of the tongue can cause stomatitis and some deaths. Migration of first instars in the tongue and interdental gingiva and the aggregation of larvae in periodontal pockets may produce irritation or pain and may prevent foals from eating.

A recent proteomic analysis using two-dimensional (2D) gels and other techniques has described the influence of larvae on the development of immune responses.<sup>3</sup> Novel antigens that were identified could be developed as a vaccination for a control option.

### CLINICAL FINDINGS

A nonspecific syndrome of unthriftiness, poor coat, occasional mild colic and lack of appetite, plus bad temper and unwillingness to work is usually ascribed to bot infestations. Adult flies frighten horses by their hovering, darting flight, especially around the head of the horse, and may be a cause of shying and balking.

### CLINICAL PATHOLOGY

The eggs on the hairs can be seen by direct inspection, but the presence of larvae in the stomach and intestines can only be detected after treatment with a suitable insecticide.

### NECROPSY FINDINGS

A few larvae are present in the stomach of most horses at necropsy, but clinical illness is usually associated with very large numbers. The areas of larval attachment are pitted and the gastric wall thickened. There may be an adhesive peritonitis and attachment and abscessation of the spleen over such areas.

### DIAGNOSIS

The syndrome produced is not sufficiently characteristic to make antemortem diagnosis

possible, and bot infestations are commonly associated with helminth infestations, which produce most of the signs observed. A tentative diagnosis of infestation of the gums can be made by signs of pain on mastication and the presence of botfly eggs on the horse at that time. A variety of serologic tests, including an ELISA, have been evaluated and found to be generally specific and sensitive. There has been no further development of a practical test. Endoscopy using a video gastroscope has been applied to the diagnosis of gasterophilosis, although its use has been confined to use in drug efficacy studies.

### TREATMENT

Macrocyclic lactone-based compounds administered as a paste are the most effective products for treatment.

### CONTROL

Treatment should be administered after fly activity has ceased and the larvae have reached the stomach but before gastric damage has occurred. Single treatments are usually all that is required for control. Recent combination therapies containing a macrocyclic lactone plus praziquantel are used for control of gastrointestinal worms, tapeworms, and bots in a single dose. In foals showing pain on mastication, treatment with ivermectin paste should be given as needed throughout the fly season.

### Treatment Recommendations

Treatment with a macrocyclic lactone-based product is strongly advised to increase productivity and to maintain overall health of the animals.

### FURTHER READING

Colwell DD, Hall MJ, Scholl PJ, eds. *The Oestrid Flies: Biology, Host-Parasite Relationships, Impact and Management*. CABI; 2006:1-376.

### REFERENCES

1. Liu S, et al. *Vet Parasitol*. 2015;217:36.
2. Smith MA, et al. *Vet Rec*. 2005;156:283.
3. Roelfstra L, et al. *Parasit Vectors*. 2009;2:6.

## THORNY-HEADED WORM IN PIGS (*MACRACANTHORHYNCHUS HIRUDINACEUS*)

*Macracanthorhynchus hirudinaceus* is included with other nematodes for convenience, but it is not a nematode. It belongs to a different phylum, the acanthocephalans. These resemble roundworms in appearance but in some ways are more similar to tapeworms because they lack, for example, a digestive tract. The name “thorny-headed worm” denotes the hook-covered proboscis they all possess.

*M. hirudinaceus* infestations in pigs are not usually heavy and cause relatively little loss. The worms have thick bodies (0.5–1.25 cm), are long (up to 38 cm), and are transversely wrinkled. They inhabit the small

intestine and pass eggs that are very resistant to environmental stress and survive for up to 2 years. The life cycle is indirect with a variety of beetles acting as intermediate hosts. Transmission occurs when a pig eats an infested grub or adult beetle, and eggs are passed about 2 to 3 months later. The female worm is a prolific egg layer and lives in the host for about 1 year.

Heavy infestations cause slow growth or loss of BW. The head of the worm pushes deeply into the intestinal mucosa and causes nodules that are clearly visible from the serous surface. Occasional deaths may occur because of intestinal perforation. Sedimentation techniques are better than flotation methods for detecting eggs in feces. Treatment is rarely given because the condition is usually only diagnosed at necropsy.

### TREATMENT AND PROPHYLAXIS

#### Treatment

Ivermectin (0.1 mg/kg orally every 24 hours for 5 days) (R3)

A single dose of doramectin is only partly effective. Control, if necessary, involves suitable disposal of pig manure and avoidance of contact with the intermediate hosts (beetles).

## TAPEWORM INFESTATIONS

### LARVAL TAPEWORM INFESTATION

Livestock may act as the intermediate hosts for the tapeworms of humans and other animals. The larval tapeworms (metacestodes) develop as fluid-filled cysts, each at a typical site in the body. They act as space-occupying lesions and cause condemnation at meat inspection. Cattle around the world may harbor the metacestode of *Taenia saginata* (the beef tapeworm of humans), also known as *Cysticercus bovis*, in their striated musculature. *T. solium* (the pork tapeworm of humans) occurs similarly in pigs (known as *C. cellulosae*), mainly in poorer regions.<sup>1</sup> The recently discovered *T. asiatica*, found only in East Asia, is closely related to *T. saginata* but uses pigs as its intermediate host. Cysts in the musculature of sheep (known as *C. ovis*) are the intermediate form of a dog cestode (*T. ovis*). Hydatid cysts (*Echinococcus granulosus*), which develop in the lungs and/or liver of sheep, cattle, and horses, are also acquired from tapeworm eggs excreted by infected dogs and wild canids. These metacestodes rarely cause clinical disease in veterinary species (although some are serious zoonoses), so the reader is referred to parasitology textbooks for detailed information.

Clinical disease is, however, associated with two other metacestodes. *T. (Multiceps) multiceps* metacestodes cause coenurosis (“gid”) in sheep,<sup>1</sup> which is described later. *T. hydatigena* metacestodes are normally asymptomatic, but if a sheep or goat swallows a whole tapeworm segment, which may

contain 100,000 eggs, sudden death may occur as massive numbers of developing metacestodes (known as cysticerci) migrate through the liver parenchyma. This condition (hepatitis cysticercosis) resembles acute hepatic fasciolosis but is an individual rather than a flock problem.

### FURTHER READING

Cardona GA, Carmena D. *Vet Parasitol.* 2013;192:10.

### REFERENCE

1. Avcioglu H, et al. *Rev Med Vet (Toulouse).* 2012;163:295.

## ADULT TAPEWORM INFESTATION

### SYNOPSIS

**Etiology** Cestodes belonging to the anoplocephalid family, including *Moniezia* spp. in ruminants and *Anoplocephala* spp. in horses

**Epidemiology** Transmission by ingestion of infected free-living pasture (oribatid) mites

**Signs** Little pathogenicity but heavy infestation may cause failure to thrive and, in horses, increased risk of ileocecal colic.

**Clinical pathology** Demonstration of tapeworm eggs in feces

#### Lesions

**Horse:** Mild inflammation of intestinal mucosa with small ulcers

**Diagnostic confirmation** Tapeworm segments around tail base or on feces; eggs in feces

#### Treatment

**Ruminants:** Albendazole, febantel, fenbendazole, mebendazole, netobimin, oxfendazole, and praziquantel

**Horses:** Pyrantel, praziquantel

**Control** If necessary, periodic dosing is the only feasible option.

### ETIOLOGY

The common anoplocephalid tapeworms of ruminants, *Moniezia expansa*, *M. benedeni*, and *Thysaniezia* (syn. *Helictometra giardi* also known as *T. ovilla*) are cosmopolitan, whereas *Avitellina* spp. occur mainly in Mediterranean countries and India, *Stilesia hepatica* in Africa, and *Thysanosoma actinioides* in North America.

In horses, *Anoplocephala magna*, *A. perfoliata*, and *Anoplocephaloides* (syn. *Paranoplocephala mamillana*) are cosmopolitan in their distribution.

### LIFE CYCLE

The life cycles of all the anoplocephalid tapeworms are very similar. Eggs, which are immediately infective, pass in the feces of the host, either singly or protected within a tapeworm segment. These are ingested by free-living pasture (oribatid) mites and the

intermediate stage (the metacestode) forms. Mature tapeworms develop when the primary host accidentally swallows infected mites while grazing. Most species establish in the small intestine, but *T. actinioides* also invades biliary and pancreatic ducts, whereas *A. perfoliata* is found around the ileocecal junction and *S. hepatica* lives in the bile ducts. Lengths vary with species: *A. perfoliata* grows to 4 to 8 cm and *Moniezia* may be over 2 m.

### EPIDEMIOLOGY

Oribatid mites are ubiquitous but most numerous on permanent pastures in the summer months. All grazing animals are therefore potentially at risk.

### PATHOGENESIS

In ruminants, anoplocephalid tapeworms have little apparent effect on health. In heavy infestations, it has been postulated that they may compete for nutrients, excrete toxic materials or, because of their length, interfere with the motility of the gut. Very heavy burdens of *M. expansa* in lambs have been associated with outbreaks of enterotoxemia. Pancreatic and biliary duct species cause little harm, but liver damage may cause rejection at meat inspection.

In horses, *A. perfoliata* causes a mild local inflammatory response around its site of attachment. Where 20 or more tapeworms are clustered, ulceration and other degenerative changes may occur. This may be accompanied by diphtheresis, granulomatosis, and occasionally polyp formation. The ileocecal valve may be thickened. Heavy infestations may interfere with gut motility and increase the risk of ileocecal colic. A recent matched case-control study indicated that 22% of a series of spasmodic colic cases were likely to have been tapeworm associated. Evidence is accumulating to implicate *A. perfoliata* as a significant risk factor in ileal impaction cases.

### CLINICAL FINDINGS

In ruminants, there is disagreement over the importance of anoplocephalid tapeworms in causing disease; farmers usually overemphasize their importance and veterinarians underestimate it. Most infestations are asymptomatic but, on occasion, heavy burdens may result in unthriftiness; poor coat; vague digestive disturbances including constipation, mild diarrhea, and dysentery; and sometimes anemia. These signs are restricted chiefly to animals less than 6 months of age on an inadequate diet. With *T. actinioides*, signs may be delayed until the animal reaches a later age. Infested animals may be more susceptible to the effects of other internal parasites and to other diseases or adverse environmental conditions.

Infections in horses are usually asymptomatic<sup>1</sup> but, occasionally, heavy infestations may be associated with a range of abdominal conditions including colic<sup>2</sup>; perforation of the cecum; ileocecal, cecocolic, and ileoileal

intussusception; colonic and cecal torsion; and ileal thickening and obstruction.

### CLINICAL PATHOLOGY

Shed tapeworm segments may be visible macroscopically on the skin and hair around the tail base or in the feces. Eggs may be present in feces.

### NECROPSY FINDINGS

The site of attachment on the intestinal mucosa may be indicated by the presence of a small ulcer and a mild inflammatory response. In the case of infestations with *T. actinioides* and *S. hepatica*, the presence of worms in the biliary and pancreatic ducts is accompanied by fibrosis and thickening of duct walls. In horses, *A. perfoliata* can cause inflammation of the lamina propria and mucosal damage at the region of the ileocecal junction, and there is an association between the number of worms present and the severity of the histologic changes.<sup>3,4</sup> Significant gross thickening and fibrosis of the ileocecal junction and several changes in neuronal cells in horses have been observed where more than 20 tapeworms were present.<sup>4</sup>

### DIAGNOSTIC CONFIRMATION

Shed segments are much wider than they are long. They can be seen to be full of characteristic eggs if broken in a drop of water on a slide and examined microscopically. Anoplocephalid eggs are roughly D shaped, thick shelled, and contain an embryo within a chitinous ring. They are not easy to find in feces. Centrifugation/flotation using a saturated sugar solution is recommended for diagnosis in horses. At best the sensitivity of such techniques is only 60% for light infections rising to 90% for heavy burdens, so repeat samples may be needed to demonstrate the presence of the parasite. Methods have been devised for detection of specific antibodies in serum or antigen in feces<sup>5</sup> but are not as yet generally available. Experimentally, a species-specific and highly sensitive molecular diagnostic PCR has been developed for accurate identification and diagnosis of *Moniezia* species targeting the parasites' 18S regions of the ribosomal DNA.<sup>6-8</sup> In equines an experimental multiplex PCR assay for simultaneous detection of various *Anoplocephala* spp. targeting the hypervariable SSUrRNA gene regions has been developed.<sup>9</sup>

### DIFFERENTIAL DIAGNOSIS

- Other causes of unthriftiness
- In horses, other causes of colic

### TREATMENT

#### TREATMENT AND PROPHYLAXIS

##### Treatment

**Cattle**  
Praziquantel (5 mg/kg BW, orally) (R2)



**Horses**

Pyrantel (38 mg/kg) (R2)

Praziquantel (2.5 mg/kg BW, orally) (R2)

For ruminants, praziquantel 3.75 mg/kg is highly effective against *Moniezia*, but higher doses are required for *Thysaniezia* spp. (5 mg/kg), *Avitellina* (7.5 mg/kg), and *S. hepatica* (15 mg/kg). Some benzimidazole and probenzimidazole drugs have cestocidal activity in ruminants, including albendazole, febantel, fenbendazole, mebendazole, netobimin, and oxfendazole. The efficacy of some of these compounds against *Moniezia* may be variable. Albendazole at 7.5 mg/kg orally is effective against cestodes in the bile ducts.

For horses, pyrantel embonate at 38 mg/kg orally (i.e., double the standard dose for roundworm control) is an established treatment for *A. perfoliata* but is ineffective against *A. mammillana*. Although toxic effects have not been fully evaluated at this high dose rate, pyrantel is generally regarded as having low toxicity in herbivores when administered orally. More recently praziquantel has been shown to provide high efficacy against *A. perfoliata* at doses of 1 to 2.5 mg/kg BW orally and *A. mammillana*. Such treatment may half the estimated risk of tapeworm-associated colic.

## Control

Control of the mites that act as intermediate hosts is impractical. If a potential problem is perceived in, for example, valuable horses, consideration could be given to reducing the numbers of oribatid mites by plowing permanent pasture and reseeded. Otherwise stabling or tactical dosing, in early summer and autumn, are the only options.

## FURTHER READING

Nielsen MK. Sustainable equine parasite control: perspectives and research needs. *Vet Parasitol.* 2012;185:32-44.

## REFERENCES

- Veronesi F, et al. *Vet Res Commun.* 2009;1:161.
- Back H, et al. *Vet Parasitol.* 2013;197:580.
- Kjaer LN, et al. *Equine Vet J.* 2007;39:529.
- Pavone S, et al. *Vet Parasitol.* 2011;176:43.
- Skotarek DD, et al. *Vet Parasitol.* 2010;172:249.
- Ohtori M, et al. *J Vet Med Sci.* 2015;77:105.
- Yan H, et al. *Acta Vet Hung.* 2013;61:463.
- Nguyen TD, et al. *J Helminthol.* 2012;86:426.
- Bohorquez GA, et al. *Vet Parasitol.* 2015;207:56.

## Toxins Affecting the Alimentary Tract

### PHOSPHORUS TOXICOSIS

Poisoning from phosphorous-containing products rarely occurs anymore.

Rodenticides, once a common source of phosphorus intoxication for animals, are no longer used, and current exposure occurs primarily from ingestion of old products found in abandoned sheds and buildings. Animals may also be exposed either by grazing on pastures or drinking water contaminated with white phosphorous used for military ammunitions training.<sup>1,2</sup> Occasionally, animal feeds inadvertently contain an excess concentration of dietary phosphates disrupting the Ca:P balance and causing clinical signs. In ruminants, this may result in urinary or bladder calculi, and in horses, secondary hyperparathyroidism.<sup>3</sup>

Phosphorus has a local caustic action, and ingestion is associated with severe irritation of the gastrointestinal mucosa with signs of gastroenteritis appearing within an hour or two. Some phosphorus may be absorbed and is associated with acute hepatic necrosis, but signs do not appear for several days. Toxic effects are increased when the phosphorus is finely divided and mixed with oils or fats that facilitate absorption.

### CLINICAL FINDINGS

Common signs include salivation, acute abdominal pain, intense thirst, and diarrhea. Pigs vomit violently and the vomitus is luminous with a garlic odor. The animal often dies of acute shock during this stage. Survivors show jaundice, weakness, anorexia, oliguria, and hematuria. Death may occur suddenly or be accompanied by convulsions. Phosphorus can be detected in the vomitus and feces of affected animals.

### NECROPSY FINDINGS

Macroscopically there is congestion and hemorrhage of the gastrointestinal mucosa. The carcass is often jaundiced and the liver is swollen and pale. Histologically there is fatty degeneration of both the liver and kidney, sometimes accompanied by hepatic necrosis. The acute stages of phosphorus poisoning may appear similar to acute stages of inorganic arsenic, mercury, or selenium poisoning.

### DIAGNOSTIC CONFIRMATION

Diagnostic confirmation requires evidence of access to the poison and the detection of large amounts of it in the gastrointestinal tract.

### Samples for Analysis

- Toxicology: Use 50 g of liver, kidney, and a portion of gastrointestinal tract with content
- Histology: Formalin-fixed liver, kidney (LM)

### TREATMENT

The use of emetics to remove the contents from the stomach is generally not recommended because phosphorous is caustic and can cause significant damage to the

esophageal lining during emesis and because vomiting normally occurs. Gastric lavage followed by activated charcoal with a cathartic may be beneficial in solitary animals when used early after ingestion. Further treatment is supportive and includes analgesics and intravenous fluids for dehydration. Hypotension and shock as well as coagulopathy may occur and should be treated supportively as needed.

### REFERENCES

- Steinheim G, et al. *Acta Agr Scand Sect A-Anim.* 2011;61:60.
- Oyvind AV, et al. *Sci Total Environ.* 2010;408:1833.
- Stewart J, et al. *Aust Equine Vet.* 2010;29:55.

## ARSENIC TOXICOSIS

### SYNOPSIS

**Etiology** Insecticidal dips or sprays; herbicides; wood preservatives, pharmaceuticals, and feed additives. Inorganic compounds are the most toxic, and organic arsenicals are the least toxic.

**Epidemiology** Outbreaks caused by accidental access; use of excessive amounts in feed, spray, or dip. Most cases result from ingestion, but percutaneous absorption is also possible.

**Clinical signs** Enteric form a highly fatal gastroenteritis with diarrhea; dehydration. Neurological form with incoordination and blindness or a syndrome of incoordination, restlessness, squealing, and convulsions

**Clinical pathology** High levels of arsenic in feces, urine, and milk for 5 days (organic arsenicals) and 10 days (inorganic arsenic). Chronic cases best assayed in hair or skin

**Necropsy lesions** Gastroenteritis in enteric form, and no lesions in neurological form

**Diagnostic confirmation** Higher than normal levels of arsenic in body fluids or tissues

**Treatment** Decontamination, antidotes, and supportive care

**Control** Remove from environment and do not exceed label directions.

### ETIOLOGY

#### Background Information

- Inorganic arsenicals most often have a valence of +3 (trivalent; arsenite) or +5 (pentavalent; arsenate) and arsenite is more toxic than arsenate.
- Organic arsenicals most often have valences of +3 (trivalent) or +5 (pentavalent) and by definition contain at least one carbon atom.

The toxicologic profile of arsenic is complicated. The absorption and toxicity of arsenic depend on many factors other than the valence and chemical form. Absorption is dependent on particle size, solubility, and species, with other factors such as animal

health playing a role. Large, less soluble particles of an inherently toxic arsenical compound may not be well absorbed, whereas a less toxic but more soluble substance may have greater absorption.<sup>1,2</sup> Animals in poor health with compromised gastrointestinal systems may have far greater absorption than those in good health. Species plays an important role with humans and dogs the most susceptible to arsenic toxicity and the development of clinical signs.

Arsenic compounds likely to be encountered by large animals are numerous and varied but include the following:

Inorganic compounds used as insecticidal dips or as herbicides

- Oxide, e.g., arsenic trioxide (+3)
- Trivalent, e.g., sodium arsenite (+3), copper acetoarsenite (Paris green)
- Pentavalent, e.g., sodium arsenate (+5)

Inorganic compounds used as wood preservatives

- Chromated copper arsenate (+5)

Inorganic compounds used as medicinals

- Inorganic lead arsenate (+5)
- Potassium arsenite (+3), e.g., Fowler's solution and others

Organic compounds used as herbicides

- Monosodium and disodium methanearsonates (+5), e.g., MSMA and DSMA

Organic compounds used as medicinals

- Trivalent phenylorganic arsenicals (+3), e.g., thiacetarsamide and melarsoprol
- Pentavalent phenylorganic arsenicals (5), e.g., arsanilic acid, roxarsone (4-hydroxy-3-nitrophenylarsonic acid), and nitarosone (4-nitrophenylarsonic acid)

### Relative Toxicities

The organic pharmaceuticals are least toxic, the insoluble oxides are of medium toxicity, and the trivalent inorganic compounds are associated with the most severe syndrome.<sup>1,2,4</sup> Toxic oral doses may range from 1 to 25 mg/kg for the arsenites, 30 to 100 mg/kg for the arsenates, 25 mg/kg daily for 8 to 10 days for cacodylic acid, and 10 to 25 mg/kg for 5 to 6 days for the methanearsonates.

Aromatic organic arsenicals are toxic when the cumulative dose is exceeded by two to four times the recommended dose, delivered by either exceeding the recommended percentage in the feed, or feeding it for too long. Seven to 10 days' feeding of arsanilic acid at 500 mg/kg diet or 3-nitro, 4-hydroxyphenylarsonic acid at 250 mg/kg diet will be associated with toxicosis in swine; approximately twice these concentrations will result in poisoning of poultry.

### EPIDEMIOLOGY

#### Occurrence

Arsenic toxicosis usually occurs after ingestion of the toxic substance, but dermal

absorption can occur especially if the skin is abraded or hyperemic. Today, arsenic is less commonly associated with generalized livestock poisoning, but poisoning still occurs in some areas of the world because of its presence in groundwater.<sup>3</sup> In addition, arsenic can still be found in the following products.

#### Dips and Sprays

Fluids used for dipping and spraying of animals to control ectoparasites are a very common source of poisoning. Animals may swallow the solution while in the dip or in the draining yards after dipping. Animals that are not allowed to drain completely as well as faulty disposal of drainage from yards and dips may contaminate the pasture. Opened containers of dipping solutions or powders may accidentally contaminate feed or be mistakenly applied as a skin dressing. Appreciable amounts of arsenic are absorbed through the skin after dipping in sodium arsenite. The absorption is increased if the animals are dipped when hot, if the fleece is long, if they are crowded too tightly in draining yards, or driven too soon after dipping. However, in most outbreaks of poisoning some ingestion appears to occur and supplements the cutaneous absorption. There is some danger in dipping rams at mating time when erythema of the skin of the thighs and scrotum is present. Dipping immediately after shearing and jetting at too high pressure or with excessively strong solutions may also be associated with increased absorption.

#### Herbicides

These include sodium or potassium arsenite, arsenic pentoxide, and monosodium or disodium acid methanearsonate sprays used to kill weeds. Grass clippings taken from lawn areas treated 6 months earlier with arsenical herbicides may carry 15,000 mg/kg arsenic.

#### Insecticidal Sprays

These are often used in orchards and pasture applied to kill Colorado beetle grubs and other pests. In most instances poisoning occurs when animals accidentally gain access to recently sprayed areas, although drifting of windblown spray may result in accidental contamination of pasture.

#### Leaded Gasoline

The major effects are usually ascribed to the effects of the lead, but this does not always appear to be so.

#### Insect Baits

Paris green (copper acetoarsenite) has historically been mixed with bran and applied to large areas of land in an attempt to control grasshopper plagues.

#### Wood Preservatives

Wood products such as fence boards, posts, calf hutches, and old buildings treated with a chromated copper arsenate preservative

remain a source of arsenic exposure. The compound has a salty taste and arsenic concentrates in the ashes when the wood is burned.

#### Metal-Bearing Ore Deposits

Several natural deposits, including iron arsenic pyrites in volcanic soils as well as gold and copper ores, contain large quantities of arsenic that may be licked in situ or carried off in the fumes from smelters and contaminate surrounding pastures and drinking water supplies.

#### Pharmaceuticals and Growth Stimulants

These include arsanilic acid and sodium arsanilate, as well as phenylarsonic acid preparations such as roxarsone and nitarosone, which are used as feed additives, growth promotants, antidotes for selenium toxicosis, and in the control and treatment of animal dysentery. Overdosing can occur by continuing the administration for too long or when there is an error in mixing a batch of feed. The toxicity of feed containing arsanilic acid depends to a certain extent on the intake of drinking water, but moderate water restriction does not make normal dose rates dangerous.

#### Animal Risk Factors

Soluble salts are highly poisonous; arsenic trioxide and sodium arsenate are much less soluble and thus less toxic than sodium arsenite. The LD<sub>50</sub> of sodium arsenite varies between species with pigs, horses, cattle, and sheep requiring increasing doses to be affected. Organic chemicals used as herbicides are as poisonous as the arsenite, but organic arsenicals used as growth stimulants are less toxic, although they are absorbed rapidly.

In cases in which gastroenteritis is the predominant lesion, the case-fatality rate approximates 100%.<sup>4</sup> In cases characterized by nervous system involvement the illness is incidental and losses minimal if access to the poison denied, but residues become a problem.

#### Human Risk Factors

Meat and milk residues reduce the safety of the products for human consumption.<sup>1,5</sup> Arsenic is excreted rapidly after absorption, chiefly in the urine, and after the ingestion of nontoxic amounts by the cow there is no detectable secretion into the milk.<sup>6</sup> When much larger doses are consumed arsenic may be excreted in the milk, as well as in urine and feces, but the concentration is still low. The biological half-life of arsenic taken orally in the form of arsanilate is 4.2 days in liver, 5.7 days in kidney, and 15 days in muscle. In pigs receiving arsanilic acid at 200 mg/kg in the feed the level of arsenic in muscle is still more than the admissible level of 0.1 mg/kg 18 days after withdrawal. The usual recommendation is to withdraw arsanilic acid 5 to

7 days before slaughter. This is adequate at normal dose levels.

### Environmental Risk Factors

The presence of arsenic in groundwater is well documented in various parts of the world, especially in some parts of Asia.<sup>7,8</sup> This is associated with suboptimal milk production in cows as well as the potential for further soil and water contamination from arsenic excreted in the urine.<sup>8</sup>

## PATHOGENESIS

### Mechanism of Action

Inorganic trivalent salts and trivalent organic compounds exert their toxic effects by combining with sulfhydryl groups on proteins and inhibiting tissue enzymes such as  $\alpha$ -keto oxidase, pyruvic acid oxidase, and  $\alpha$ -oxoglutaric acid oxidase.<sup>2,4,9</sup> Trivalent arsenicals are most toxic because of their greater affinity for these sulfhydryl groups. The efficiency of sulfur-containing compounds such as dimercaptopropanol (British antilewisite or BAL) as antidotes depends on the ability of these compounds to compete with sulfur-containing compounds of enzyme systems for the available arsenic.<sup>2,4</sup> Pentavalent inorganic arsenates work by uncoupling oxidative phosphorylation, perhaps by substituting phosphate into the reaction. The mechanism of action for pentavalent organic compounds is unknown, but interference with the actions of pyridoxine and thiamine may be involved.<sup>2</sup> In ruminants, pentavalent arsenicals can be converted to trivalent arsenicals.

### Tissue Susceptibility

Once absorbed into the bloodstream, arsenic is well distributed to all body organs, accumulating in the liver before distribution. Others organs such as the kidneys, lungs, and spleen also accumulate arsenic.<sup>2,4,9</sup> The body areas affected are primarily those with tissues rich in oxidative enzyme systems. Thus the alimentary tract wall, liver, kidney, spleen, and lung are most susceptible to the general depression of metabolic activity and development of clinical signs. Gastrointestinal tract lesions produce the most obvious clinical signs because of the extensive damage to capillaries causing increased permeability and exudation of serum into tissue spaces. The mucosa lifts from the underlying muscle coat and is shed with a resultant loss of large quantities of body fluids. Arsenic does not precipitate protein, and there is no direct local effect on alimentary tract mucosa; this is indicated by the fact that the parenteral injection of arsenic produces lesions in the gut wall, which are identical with those associated with ingestion.

### Time Lag

Because arsenic does not precipitate protein it does not limit its own absorption, and there is a considerable time lag after ingestion before clinical signs appear; corrosive substances produce lesions and signs immediately.

### Percutaneous Absorption

Arsenic absorbed from the skin may be associated with local necrosis without systemic signs if the peripheral circulation is poor or the concentration of arsenic is excessively high, but if the cutaneous circulation is good, the arsenic is quickly carried away and is associated with a systemic disease without skin necrosis.

### Chronic Poisoning

The chronic toxicity of arsenic at low levels of intake is caused by its accumulation in particular organs, especially the skin, bone, hooves, and hair.<sup>1,4,10</sup>

### Nervous Tissue Lesions

Pentavalent organic arsenicals cause degenerative changes in peripheral nerves. These appear as demyelination and axonal degeneration in prolonged cases.<sup>2</sup> Animals recumbent longer than 7 days are unlikely to recover and will remain paralyzed until death from other associated conditions. In poisoning with arsenilic acid compounds the lesions occur primarily in the optic nerves, causing blindness. In poisoning with the phenylarsonic acid group the nerves to the limbs appear to be most affected.

## CLINICAL FINDINGS

The occurrence of clinical signs depends on the specific form of arsenic to which animals are exposed. As a general rule, all inorganic arsenicals and trivalent organic arsenicals affect the capillaries and gastrointestinal tract, and pentavalent organic arsenicals affect the neurologic system.

## GASTROINTESTINAL SYNDROME

### Peracute Cases

These animals show little except depression and prostration and generally die before signs of enteritis develop.<sup>4,11</sup> Death occurs minutes to a few hours after exposure and may be preceded by clonic convulsions and diarrhea.

### Acute and Subacute Cases

In ruminants, the onset of signs of illness is often delayed 20 to 50 hours from ingestion of the poison, with the length of time depending on the fullness of the forestomachs.<sup>4,11</sup> Distress develops suddenly, beginning with severe abdominal pain, restlessness, groaning, an increased respiratory rate, salivation, grinding of the teeth, complete rumen stasis, and vomiting (even in cattle), followed by a fluid and fetid diarrhea that may be hemorrhagic. Tachycardia, rapid and weak pulse, dehydration, and oliguria are marked.

Horses show similar signs with a marked congestion of the mucous membranes and a very sudden onset of severe colic. Severe diarrhea ( $\pm$  blood) may be followed by a period of complete stasis of the alimentary tract with diarrhea recurring just before death.

Subacute cases give the same signs as acute cases, but the course may extend over 2 to 7 days. Nervous signs of muscle tremor, incoordination, and clonic convulsions are followed by terminal coma.

### Chronic Cases

Commonly observed signs include low BW; a dry, rough coat that is easily shed; fatigue; bouts of indigestion; conjunctival and mucosal erythema; eyelid edema; and conjunctivitis. Buccal mucosal ulceration may extend to the muzzle. Milk yield is seriously reduced and abortions and stillbirths may occur. Local skin lesions include initial hyperemia followed by necrosis and sloughing, leaving indolent lesions that are extremely slow to heal.

## NEUROLOGICAL SYNDROME

Chronic poisoning resulting from arsenilic acid overdose occurs primarily in pigs and lambs. It is manifested by incoordination 3 to 7 days after ingestion; blindness may or may not occur. Consciousness, body temperature, and appetite are unaffected. If feeding is continued the signs gradually worsen; if feed is changed the signs disappear within a few days. Some pigs remain permanently blind or paralyzed. In chronic poisoning with roxarsone and nitarsone the emphasis is on restlessness, frequent urination and defecation, incoordination caused by loss of balance, frequent shrill "screaming," tremor, and convulsions, all of which are stimulated by rousing the pig. If left alone in a recumbent position it may appear normal. Almost all animals have some form of gastrointestinal irritation.

## CLINICAL PATHOLOGY

Arsenic can be detected in the urine, feces, and milk for periods of up to about 10 days, beginning shortly after the toxic material is ingested. The rate of excretion is faster with organic compounds than with inorganic arsenic, and urine levels may be back to normal in 5 days. The most satisfactory material for laboratory examination from a living animal is a large volume (about 1 L) of urine in which arsenic levels may be as high as 16 mg/kg. Levels in milk are low.<sup>6</sup> Normal levels of up to 0.25 mg/kg in cows' milk may be elevated to 0.34 to 0.47 mg/kg in cases of acute poisoning and to 0.8 to 1.5 mg/kg in the milk of normal cows that graze arsenic-contaminated pasture for long periods. Deposition in the hair occurs and arsenic persists there until the hair is shed, making possible the detection of prior arsenic ingestion in the absence of arsenic from the blood and feces. The hair of animals not exposed to arsenic should contain less than 0.5 mg/kg, and that of exposed animals may contain as much as 5 to 10 mg/kg.

## NECROPSY FINDINGS

In acute and subacute cases of **inorganic arsenic poisoning** there are pronounced



hyperemic and patchy submucosal hemorrhages in the stomach, duodenum, and cecum. Hemorrhage and multifocal ulceration of the cecum and large colon have been observed in horses. In ruminants, the mucosa of the forestomachs is unaffected, but typical lesions are present in the abomasum and intestines. Renal tubular necrosis, suppurative pyelonephritis, and petechiation of bladder mucosa are found in cattle.<sup>4</sup> The gut contents are very fluid and contain mucus and shreds of mucosa. Profuse subendocardial hemorrhages are common, and ulceration of the gallbladder mucosa is often observed in sheep. Macroscopic lesions may be minimal in cases that die after a very short course. Histologically, most of the hemorrhages can be attributed to the necrosis of capillaries, although damage to the walls of larger vessels may sometimes be found. Severe intravascular hemolysis has been observed in sheep. Degenerative changes are common in the liver and kidney of animals suffering from arsenic toxicosis, and these changes become more pronounced if the disease course is prolonged. In some cases of chronic poisoning, loss of myelin may be observed in the peripheral nerves, with secondary neural degeneration in the CNS.

The liver is the best organ for assay of acute arsenic poisoning, whereas the kidney may contain high levels in subacute or chronic poisoning. Levels of over 10 to 15 mg/kg wet matter of arsenic trioxide in the kidney or liver are considered to be diagnostic of arsenic poisoning. However, it is probable that many animals die of arsenic poisoning when their hepatic levels are much lower than this. Maximum concentrations of arsenic in tissues occur about 8 hours after ingestion, and animals that survive for 2 to 3 days may have levels as low as 3 mg/kg. Diagnostic levels in the urine and feces are between 10 and 20 mg/kg. Conversely, normal animals that are dipped routinely in arsenical dips may have hepatic levels of the element as high as 8 mg/kg. Levels of 1 to 3 mg/kg are obtained in cattle dying from arsenic poisoning after percutaneous exposure, and levels of over 10 mg/kg are found in cattle that ingest arsenical dip. Assay of the arsenic level in hair may be useful in chronically poisoned animals.

Animals poisoned with **organic arsenicals** show no significant gross pathologic changes. Histologically, degeneration and demyelination of the optic nerves, optic tracts, and peripheral nerves are apparent. The animals maintain tissue levels of arsenic for as long as exposure continues, although the levels fall rapidly during the first 7 days after feeding of the arsenic ceases, and normal levels are not reached for another 7 days. The liver and kidney obtained from pigs dying of roxarsone toxicosis contained an average arsenic content of 2.9 and 1.8 mg/kg (wet weight), respectively.

### Samples for Confirmation of Diagnosis

#### TOXICOLOGY:

- Liver and kidney, segment of stomach/intestine including content, sample of suspected poison, and hair (chronic)

#### HISTOLOGY:

- Inorganic arsenic: Formalin-fixed stomach, intestine, cecum, large colon, liver, kidney, and peripheral nerve
- Organic arsenic: Formalin-fixed optic nerve and tract and peripheral nerve

#### DIFFERENTIAL DIAGNOSIS

Diagnostic confirmation in all arsenic poisoning is by detection of toxic levels of arsenic in animal tissues and fluids.

Differential diagnosis list:

- **Acute inorganic arsenic toxicosis**  
Bovine malignant catarrhal fever (peracute, gastrointestinal form)  
Lead toxicosis  
Mushroom toxicosis (amatoxins)  
Poisonous plants (bracken, mustards, etc.)  
Salmonellosis
- **Chronic inorganic arsenic toxicosis**  
Parasitism (ostertagiasis, trichostrongylosis, and oesophagostomiasis)  
Starvation
- **Organic arsenical toxicosis**  
Encephalitis  
Mercury (organic) toxicosis  
Salt toxicosis  
Selenium toxicosis  
Tri-ortho-cresyl phosphate or other industrial chemical toxicosis

#### TREATMENT

##### TREATMENT AND PROPHYLAXIS

###### Treatment and prophylaxis<sup>2,4</sup>

Sodium thiosulfate (20–40 mg/kg intravenously every 8 h; 80 mg/kg orally every 24 h or 30–60 mg/kg orally every 6 h for 3–4 days) (R2)

2,3-Dimercaptopropanol (1.5–5 mg/kg intramuscularly every 4–6 h for 10 days) (R2)

Thioctic acid (50 mg/kg intravenously every 8 h) (R2)

In acute cases, treatment is of little value because of the large amount ingested and the delay between ingestion and the onset of clinical signs. Affected animals are unsuitable for human consumption, so treatment is not usually undertaken. Although BAL has a general beneficial effect and is recommended as a treatment, the drug is quite toxic itself and in the doses required may be associated

with death in sheep. It also is associated with a reaction at the injection site that is sometimes serious enough to warrant the animal's destruction.

The most commonly used antidotes are sodium thiosulfate, dimercaptopropanol (BAL), and thioctic acid.<sup>2,4</sup> There is a wide variation in results as well as recommended dose and dosage. A comparison of these antidotes used in experimentally poisoned cattle showed little benefit from sodium thiosulfate administration, and most benefit with a combination of BAL and thioctic acid. Dimercaptosuccinate, a water-soluble analog of dimercaprol, is less toxic than BAL, may be available in the United States, and should be more effective than BAL. The antioxidants zinc, methionine, and cysteine, used with chelation therapy, have been reported to enhance excretion of arsenic in experimental poisoning. Their use may be helpful as adjuncts to recommended chelation therapy.

Further therapy is supportive. Attempts should be made to adsorb the residual arsenic in the gut by administering charcoal (1–4 g/kg orally), and moved through the gastrointestinal tract with the administration of an oil demulcent or osmotic agent like magnesium sulfate. Drastic purgatives should be avoided. Severe dehydration occurs, and outcome improves when supportive treatment includes the provision of ample fluids, preferably by parenteral injection.<sup>4</sup> An adequate supply of drinking water containing electrolytes should be provided, and the animals should be disturbed as little as possible and provided shelter from the sun and elements. Recovering animals should receive a bland diet and high-quality protein.

#### CONTROL

Arsenical preparations must be handled and stored with care and contamination of feed and pasture avoided. Old products should not be left in abandoned sheds or buildings. Wood treated with chromated copper arsenate should not be used for fences, posts, or buildings inhabited by animals. When treated wood is destroyed, animals should not be allowed access to the ashes, and the ashes should not be spread on the pasture or drylots. Therapeutic preparations containing arsenic should be labeled "Poison" and strict instructions given on dosage, particularly the length of time for which administration should continue. Animals to be dipped in arsenical solutions should be allowed to cool off before dipping, drain properly afterward, and dry before being driven. They should be watered before dipping to prevent them from drinking the dip. Much mortality has occurred when instructions for mixing dip solutions were not closely followed. Dipping solutions containing more arsenic than is safe usually occur when tanks, which have lost water by evaporation, are reconstituted by guesswork. The maximum safe concentration of arsenic trioxide in a dip for cattle is 0.20%.

## FURTHER READING

- Bahri LE. Arsenic poisoning in livestock. *Vet Human Toxicol.* 1991;33:259-264.
- Neiger R, Nelson N, Miskimins D, et al. Bovine arsenic toxicosis. *J Vet Diag Invest.* 2004;14:436-438.
- Pace LW, Turnquist SE, Casteel SW, et al. Acute arsenic toxicosis in five horses. *Vet Pathol.* 1997;34:160-164.
- Selby LA, Case AA, Osweiler GD, et al. Epidemiology and toxicology of arsenic poisoning in domestic animals. *Environ Health Persp.* 1977;19:183-189.

## REFERENCES

- Bampidis VA, et al. *Anim Sci Biotech.* 2013;46:17.
- Garland T. Arsenic. In: Gupta RC, ed. *Veterinary Toxicology.* New York: Academic Press; 2007:418.
- Bera AK, et al. *Toxicol Ind Health.* 2010;10:709.
- Bertin FR, et al. *J Vet Intern Med.* 2013;27:977.
- Silbergeld EK, et al. *Ann NY Acad Sci.* 2008;1140:346.
- Sigrist M, et al. *Food Chem.* 2010;121:487.
- Rana T, et al. *Environ Toxicol Pharmacol.* 2012;33:372.
- Rana T, et al. *Ecotox Environ Saf.* 2010;73:1327.
- Roy D, et al. *Vet World.* 2013;6:53.
- Kempson IM, et al. *Angew Chem Int Ed Engl.* 2010;49:4237.
- Valentine BA, et al. *J Vet Diagn Invest.* 2007;19:212.

## MOLYBDENUM TOXICOSIS (MOLYBDENOSIS)

### SYNOPSIS

<b>Etiology</b>	Ingestion of toxic amounts of molybdenum
<b>Clinical pathology</b>	High serum levels of molybdenum, low serum levels of copper
<b>Necropsy lesions</b>	No significant lesions
<b>Diagnostic confirmation</b>	High levels of molybdenum in feed and blood
<b>Treatment</b>	
<b>Primary:</b>	Copper salts orally
<b>Supportive:</b>	None necessary
<b>Control</b>	Dietary supplementation with copper

## ETIOLOGY

Molybdenum is an essential element needed by humans and animals for activity of the biological enzymes xanthine oxidase, aldehyde oxidase, and sulfite oxidase.<sup>1</sup> It is involved in a variety of metabolic processes including protein and sulfur metabolism and iron transport. Signs of molybdenum toxicosis may be associated with inhibition of these processes and other enzymes, such as glutaminase and cytochrome oxidase, but many are linked to specific deficiencies in copper-containing enzymes.<sup>1,2</sup> Species variation occurs, with cattle the most susceptible to poisoning, followed by sheep and goats, pigs, and finally horses.<sup>3</sup> The toxic dose varies widely with the intake of sulfate, copper, and other factors.<sup>2,3</sup>

## EPIDEMIOLOGY

### Occurrence

The major occurrence of molybdenum poisoning is associated with ruminants grazing on pasture growing on molybdenum-rich soils, usually derived from particular geological formations, e.g., the “teart” pastures of Somerset (UK), the United States, and Canada; marine black shales in the UK; pastures containing excess molybdenum intake with or without a marginal deficiency of copper in New Zealand, Canada, Ireland, and Australia.<sup>4</sup> Soil in areas of mining operations, metallurgical industries, paint manufacturers, and refineries may be heavily contaminated with molybdenum, and animals grazing there or ingesting water or plants grown there may develop molybdenum toxicosis.<sup>4,6</sup>

Acute poisoning has occurred in cattle ingesting 7400 mg molybdenum/kg of diet ingested or approximately 30 mg molybdenum/kg BW per day.<sup>2,7</sup> Acute toxicosis occurred in sheep receiving 132 to 137 mg molybdenum/kg for 2 to 3 days.

Chronic toxicosis occurs in cattle receiving only 3 mg molybdenum/kg BW per day.<sup>7</sup> Diets providing less than 3 mg/kg BW are usually considered to be safe, but signs of toxicosis may occur when the diet contains as little as 1 mg/kg BW if the sulfate intake is high and the copper status low; the level of molybdenum at which the interference with the metabolism of copper may occur is 2.4 mg/kg dry matter in the diet.

Forage containing 10 mg/kg must be considered dangerous at all times and, on pasture, affected by aerial contamination levels of 10 to 200 mg/kg may be encountered. Such intakes can be provided by the following:

- The use of molybdenum in fertilizer mixtures to increase nitrogen fixation by legumes may lead to excessive amounts of molybdenum in soils.
- Contamination of pasture by motor oil containing molybdenum as an additive
- Industrial fallouts of 5 to 40 ng/m<sup>3</sup> of air or 2 mg/m<sup>2</sup> per month on pasture

Aerial contamination by fumes from aluminum and steel alloy factories and oil refineries using molybdenum is associated with secondary copper deficiency.

Drinking water may not be as toxic as the same amount in fresh forages. For calves, the minimum toxic concentration in drinking water is between 10 and 50 mg/kg when dietary copper and sulfur intake in the diet is normal.

### Risk Factors

#### Animal Risk Factors

Cattle, sheep, and goats are clinically affected in field outbreaks of the disease and signs are most marked in young growing animals. Cattle are much more susceptible than sheep.<sup>3</sup> Horses and pigs are susceptible to

a lesser extent, presumably because of a decreased absorption and lack of a rumen.<sup>3</sup>

### Environmental Risk Factors

The concentration of molybdenum in forage varies with the season; it is highest in the spring and autumn and with the plant species, legumes, and particularly alsike clover taking up molybdenum in much greater quantities than grasses. Soil and plants in pastures and other grazing areas near mining industries or using molybdenum may be contaminated.<sup>4,6</sup>

### Transmission

Animals are primarily poisoned by ingesting plants or soil high in molybdenum, but the amount of dietary sulfur/sulfates and copper in the diet plays an integral role.

### PATHOGENESIS

Molybdenum, sulfur, and copper are all intimately involved in the development of poisoning. The mechanism of action differs for ruminants and monogastrics. Sulfur or sulfate in the rumen is converted to sulfide, which combines with molybdenum to form four thiomolybdates (mono-, di-, tri-, and tetra-).<sup>2,3,8</sup> In the digestive tract, these thiomolybdates bind to copper forming a cupric-thiomolybdate complex that prevents copper absorption; once systemic, they bind to copper preventing further copper utilization and increasing copper excretion.<sup>2,3,9</sup> In addition, some free molybdenum is absorbed throughout the intestinal tract.<sup>2</sup> Monogastric animals, who lack a rumen, do not form thiomolybdates; instead molybdenum is absorbed beginning with the stomach and continuing throughout the intestinal tract.<sup>9</sup>

Once absorbed molybdenum is rapidly distributed to many body tissues, with the highest concentrations in the liver, kidney, spleen, and bone.<sup>3,10</sup> Excretion is rapid and occurs primarily in the urine and bile (ruminants), with milk a concentration-dependent route in lactating animals.<sup>9,11</sup>

Most signs of molybdenum poisoning result from some form of copper deficiency, either real or functional. The situation is exacerbated by a high intake of sulfur or a low intake of copper. The syndrome of molybdenum intoxication resembles that of copper deficiency, and treatment and prevention by the administration of copper is effective.

Not all signs of molybdenum poisoning, particularly diarrhea, are characteristic of copper deficiency and may represent a specific toxic effect of molybdenum. An identified toxic effect specific to molybdenum occurred in sheep experimentally fed molybdenum. Exostoses and hemorrhages about the long bones developed, as well as separation of the great trochanters of the femur. The lesions appear to be caused by defects in connective tissue at muscle insertion points and by defects in the epiphyseal growth plates.

## CLINICAL FINDINGS

### Acute Intoxication

Cattle and sheep show anorexia and inappetence, profuse salivation, weakness and progressive ataxia beginning with the hindlimbs, recumbency, and death.<sup>9</sup>

### Chronic Intoxication

Cattle, sheep, and goats show the following signs<sup>1,8,9,11</sup>:

- Persistent diarrhea within 8 to 10 days of the animals having access to affected pasture
- Emaciation and a dry coat
- Profound decrease in milk production
- Depigmentation of black hair with the appearance of a red or gray tinge to hair. This may be particularly noticeable around the eyes, giving a bespectacled appearance.
- Intense craving for copper supplement has been noted.
- Young cattle (3 months to 2.5 years) show abnormalities of locomotion, including marked stiffness of the legs and back, difficulty in rising, and great reluctance to move. The gait is suggestive of laminitis but the feet appear normal. The lameness may be caused by the periosteal lesions described earlier. The appetite remains good.

Horses, although rarely affected, show diarrhea and impaction colic. The mortality rate is high.

### CLINICAL PATHOLOGY

Blood copper levels are reduced from the normal of 1.0 µg/mL to 0.25 µg/mL. Seasonal variations occur depending on the intake of molybdenum.

Blood molybdenum levels in normal animals are of the order of 0.05 mg/kg and rise to about 0.10 mg/kg when excess molybdenum is ingested. Levels as high as 0.70 and 1.4 mg/kg have been recorded in cattle and horses grazing on pasture contaminated by smelter fumes. On very large intakes of molybdenum cattle, which are clinically normal, may have molybdenum levels of 1000 mg/kg in feces, 45 mg/kg in urine, 10 mg/kg in blood, and 1 mg/kg in milk.

Goats treated with ammonium molybdate orally at 20 mg/kg BW per day for 30 days developed significant declines in the mean values of hemoglobin, PCV, total leukocyte count, total erythrocyte count, and mean corpuscular hemoglobin concentration, with significant increases in neutrophil count and mean corpuscular volume.<sup>1</sup> These did not occur in a similar group treated with molybdenum and copper sulfate (II) pentahydrate.

### NECROPSY FINDINGS

There are no gross or histologic findings that characterize the disease, and enteritis is conspicuously absent. The carcass is emaciated

and dehydrated and there may be anemia if there is an accompanying copper deficiency. Tissue copper levels will be below normal.

### DIFFERENTIAL DIAGNOSIS

Diagnostic diagnosis list:

- Copper toxicosis
- Internal parasitism, e.g., trichostrongylosis, ostertagiasis
- Paratuberculosis
- Acute enteritides including salmonellosis, winter dysentery, and virus diarrhea

### TREATMENT

Effective treatment depends on removing the source of molybdenum and providing copper to the affected animals. The most effective method is to treat affected animals orally with copper sulfate (2 g daily or 5 g weekly for adult cattle and 1.5 g for adult sheep). The diarrhea should stop in 2 to 3 days, and improvement in the other signs is rapid. Care should be used in sheep not to overdose and cause copper toxicoses. In monogastric animals, sulfate may enhance elimination.<sup>9</sup>

### TREATMENT AND PROPHYLAXIS

#### Treatment

Copper sulfate (2 g/day orally for adult cattle; 1.5 g orally for adult sheep × 2–3 days) (R1)

#### Prophylaxis

Keep Cu:Mo ratio at 4:1 and S:Mo ratio < 100:1. (R2)

### CONTROL

If animals cannot be removed from the source (i.e., grazing on contaminated lands), then copper sulfate should be added to their diet.<sup>6</sup> For long-term control, the recommended ratio of Cu:Mo is 4:1 to 10:1, and a S:Mo ratio of <100:1 is considered safe as opposed to copper accumulation.

### REFERENCES

1. Kusum RR, et al. *Toxicol Int.* 2010;17:82.
2. Gould L, et al. *Nutr Res Rev.* 2011;24:176.
3. Reis LS, et al. *J Med Sci.* 2010;1:560.
4. Alloway BJ. *Environ Pollut.* 2013;22:527.
5. Steinke DR, et al. *J Agric Food Chem.* 2008;56:5437.
6. Steinke DR, et al. *J Mini Reclam Environ.* 2010;24:255.
7. National Research Council (NRC). *Molybdenum. Mineral Tolerance of Animals.* 2nd ed. National Academies Press; 2006:262.
8. Kessler KL, et al. *J Anim Sci.* 2012;90:5005.
9. Hall JO. Molybdenum. In: Gupta RC, ed. *Veterinary Toxicology.* 2nd ed. New York: Academic Press; 2012:544.
10. Yang Z, et al. *Chin J Vet Sci.* 2011;6:895-898.

11. Herdt TH, et al. *Vet Clin North Am Food Anim Pract.* 2011;27:268.

## AMITRAZ TOXICOSIS

### ETIOLOGY

Amitraz is a topical acaricide and insecticide widely used in most large-animal species including cattle, sheep, goats, and ostriches.<sup>1</sup> It is not labeled for use in horses because they are easily poisoned when amitraz is applied to their skin or accidentally ingested.<sup>1</sup> Most commercial products on the market contain 12.5 to 50% amitraz in a solvent such as xylene and must be diluted before use.<sup>1,2</sup>

### PATHOGENESIS

Amitraz is a centrally acting  $\alpha$ -2 adrenergic agonist that also inhibits monoamine oxidase and prostaglandin synthesis. It is highly soluble and rapidly absorbed through skin and mucous membranes.<sup>3</sup> Concentration of the dipping fluid, solvent carrier, environmental temperature, and the condition of the skin may influence absorption of the compound, clinical signs, and susceptibility of the animal.

### CLINICAL FINDINGS

Clinical signs occur in horses within 12 to 48 hours and include anorexia, depression, sedation, ataxia, incoordination, and large intestine impaction. Resolution of signs may take 7 to 8 days.<sup>1</sup> Equine susceptibility to amitraz is likely caused by prolonged persistence in the body. Salivation, depression, anorexia, ataxia, tremors, and coma are signs attributed to amitraz in other species.

### TREATMENT

Decontamination with activated charcoal and a cathartic may be used in an ingestion if clinical signs have not yet occurred. Residual topical amitraz should be removed from affected animals by bathing with soap and tepid water. Further therapy is supportive and includes oral or intravenous fluids, analgesics, and treatment of the impaction colic. The use of  $\alpha$ -2 adrenergic antagonists such as yohimbine and atipamezole has been suggested.<sup>1</sup>

### FURTHER READING

- Jones RD. Xylene/amitraz: a pharmacological review and profile. *Vet Hum Toxicol.* 1990;32:446-448.
- Pass MA, Mogg TD. Pharmacokinetics and metabolism of amitraz in ponies and sheep. *J Vet Pharmacol Ther.* 1995;18:210-215.

### REFERENCES

1. Product Details–Taktic® Cattle Spray. At: <[http://www.msds-animal-health.co.za/products/taktic\\_cattle\\_spray/020\\_product\\_details.aspx](http://www.msds-animal-health.co.za/products/taktic_cattle_spray/020_product_details.aspx)>; Accessed 20.10.13.
2. Yang JH, et al. *Korean J Vet Res.* 2010;50:253.
3. Chakraborty J, et al. *Australas Med J.* 2011;4:439.



## PROPYLENE GLYCOL TOXICOSIS

Propylene glycol is an unlikely poison, but it is used extensively as an oral treatment for acetoneemia in cattle and can be associated with poisoning if it is accidentally administered to horses, when mistaken for mineral oil. Dose rates of 3 L to horses of 500 kg BW by stomach tube is associated with an immediate but short duration episode of abdominal pain, sweating, salivation, severe ataxia and depression, and a fetid odor of the feces. Much larger doses (8 L) can be fatal. Moderate-to-severe inflammation of the lining of the gut and edema of the brain are noticeable at necropsy examination.

### FURTHER READING

Dorman DC, Hascheck WM. Fatal propylene glycol toxicosis in a horse. *J Am Vet Med Assoc.* 1991;198:1643.

## PLANT MATERIALS CAUSING PHYSICAL DAMAGE

### COLIC IN HORSES FROM INGESTION OF INDIGESTIBLE FIBER IS ASSOCIATED WITH

- Gastric impaction (*Senecio jacobaea*)
- Impaction of the ileocecal valve (*Sorghum* spp.)

### RUMINAL IMPACTION IN CATTLE IS ASSOCIATED WITH INGESTION OF CUTTINGS FROM

- *Fraxinus excelsior* (ash tree)
- *Chrysocoma tenuifolia* (bitter weed)
- *Eriocephalus* spp.
- *Pinus taeda* (loblolly pine)
- *Prosopis juliflora* (mesquite)
- *Eremocarpus setigerus* (turkey mullein)

Gastric impaction in pigs is associated with ingestion of *Nicotiana* spp. stalks.

The tough fiber in *Romulea rosea* (onion grass, rosy sandcrocus) is associated with an enzootic problem of bovine intestinal and abomasal impaction by phytobezoar in parts of Australia.<sup>1</sup> Phytobezoars can be a problem wherever indigestible fiber is available to ruminants. Cocoon silk of *Gonometa* spp. (Molopo moth) can be associated with ruminal impaction in cattle that eat foliage of *Acacia erioloba* or *A. mellifera* trees, the preferred habitat for the moth larvae.

Other physical injuries associated with plant material include persistent corneal ulcers from the bristles of *Arctium lappa* (burdock seeds) and ulcers in the mouth from the spines of *Setaria lutescens* (yellow bristle grass) and the awns of *S. geniculata* (prairie foxtail) and *Triticosecale* (triticale varieties).<sup>2</sup> *S. lutescens* carries heavy bristles

that are associated with mechanical stomatitis in cattle and horses. *S. geniculata* awns are associated with ulcerative stomatitis and glossitis and gingivitis in horses.<sup>2</sup> Triticale is a hybrid between wheat and rice used mainly for grain production. If it is harvested green as a crop and made into hay the dried awns are irritating to the pharynx and mouth of cattle and horses. Affected horses are slow eaters, refuse hay, and show excess salivation. Clinical signs result in about a week and include cough, mucoid nasal discharge, foul breath, hypersalivation, quidding, and loss of BW. Some horses develop submandibular edema and there are severe ulcerations at the gum-tooth margins, with many awns embedded in the ulcers. The ulcers are very painful and up to 5 cm in diameter at the labial-lingual junction, the lingual frenulum, the base of the lingual dorsum, soft palate, and the sides of the tongue. After careful cleaning, the lesions heal slowly over about 3 weeks.

Grass seed abscesses are frequent when there is a large population of *Stipa* and *Stipagrostis* spp. (spear grass), *Tagetes* spp., *Aristida arenaria* (silver or kerosene grasses), *Opuntia* spp. (prickly pear), and *Hordeum jubatum* (barley grass) in the pasture. The hairs on the plant *Dittrichia graveolens* (stinkwort) are thought to be associated with the fatal enteritis that occurs in sheep eating the plant.

### FURTHER READING

Philbey AW, Morton AG. Pyogranulomatous enteritis in sheep due to penetrating seed heads of *Dittrichia graveolens*. *Aust Vet J.* 2000;78:858.

### REFERENCES

1. AG1389. At: <<http://www.dpi.vic.gov.au/agriculture/dairy/pastures-management/ag1389-onion-grass-romulea-rosea>>; 2009 Accessed 24.10.13.
2. Johnson PJ, et al. *Equine Vet Educ.* 2012;24:182.

## PLANT TOXINS AFFECTING THE ALIMENTARY TRACT

### ANDROMEDOTOXIN

Andromedotoxin (syn. acetylandromedol, grayanotoxin, rhodotoxin) is a resinoid substance, a member of the diterpenoid group of substances, and found in plants of the Ericaceae family including:

*Agarista* spp.  
*Agauria salifolia*  
*Clethra arborea*  
*Kalmia* spp. (laurels, lambkill)  
*Ledum* spp. (labrador tea)  
*Leucothoe* spp. (sierra laurel, hanahiri)  
*Lyonia ligustrina* (staggerbush)  
*Menziesia ferruginea* (mock azalea)  
*Pieris* (Andromeda) spp.  
*Rhododendron* spp. (rhododendrons and azaleas)

Andromedotoxins, or more commonly grayanotoxins, are found in the flowers, leaves, twigs, and stems of plants in the Ericaceae

family.<sup>1-4</sup> More than 25 different grayanotoxin isoforms (e.g., grayanotoxin I, grayanotoxin II, etc.) exist depending on the species of plant.<sup>1</sup> Plants in this family are very poisonous to animals and humans. Cattle, horses, sheep, and goats have all become symptomatic or died shortly after exposure.<sup>1,2</sup> Death occurs most often when livestock or horses have access to clippings thrown into their pastures or drylots. Different grayanotoxin isoforms do not degrade in a similar manner during composting but are not expected to be a risk to animals coming into contact with the waste.<sup>5</sup> Humans are exposed by ingesting honey produced by bees obtaining nectar from rhododendrons (mad honey disease), herbal teas, and other natural products.<sup>1</sup>

The toxins interfere with the function of voltage-gated sodium channels resulting in a continuous state of cell membrane depolarization.<sup>1,2</sup> Clinical signs are related to the gastrointestinal, cardiovascular, nervous, and respiratory systems. Signs generally begin within 3 to 14 hours after the plant or clippings are eaten and include dullness, salivation, projectile vomiting, bloat, repeated swallowing or belching, tenesmus, abdominal pain, a staggering gait, recumbency, convulsions with opisthotonus, tremor, dyspnea, and groaning and bleating. Tachycardia, hypotension, and cardiac arrhythmias occur in some cases. Aspiration pneumonia is a common sequel and is the only common gross necropsy finding. Histopathological changes are limited to minor lesions in the gray matter of the spinal cord.

### ANTHRAQUINONE

Anthraquinones are extracted commercially from plants for use as irritant cathartics. Plants growing wild that contain these compounds include:

*Cassia occidentalis* (syn *Senna occidentalis*) (coffee senna)  
*Senna obtusifolia* (sicklepod)  
*C. roemierana*  
*C. italica*  
*Frangula alnus* (alder buckthorn)  
*Rhamnus* spp. (buckthorn)

Horses, pigs, and cattle may be poisoned by *S. occidentalis* seeds that contaminate prepared rations.<sup>6</sup> All of these plants are associated with severe gastroenteritis manifested by diarrhea, often with transitory signs of abdominal pain if the dose is large. Liver damage is a common lesion in experimental and field cases and may dominate the necropsy findings.<sup>6,7</sup> Smaller doses of *Senna* spp. over a period of a week are associated with necrosis of striated muscle fibers characterized by limb weakness, incoordination, dragging the hind toe tips, and eventually paralysis in sternal or lateral recumbency. Necropsy lesions are cardiac and skeletal muscle necrosis, but these have not been shown to be direct effects of anthraquinones.

## COLCHICINE

The alkaloid colchicine, found in *Colchicum autumnale* (autumn crocus, meadow saffron) and *Gloriosa superba* (flame or glory lily), is associated with acute fetid diarrhea  $\pm$  blood, abdominal pain, tenesmus, vomiting, and salivation in sheep, cattle, and pigs.<sup>2,8</sup> Colchicine interferes with mitotic spindle formation, and the rapidly dividing, sensitive cells of the gastrointestinal tract are most frequently affected.<sup>8</sup> Consumption of 8 to 10 g of fresh leaves/kg BW has been associated with severe diarrhea. Mortalities are likely when cattle graze dense patches of *C. autumnale* in pasture or are fed hay containing the plant. Excretion is primarily through the bile with extensive enterohepatic recirculation; a small percentage (10%–30% in humans) is excreted unchanged in the urine. The toxin is excreted in the milk for an unspecified time period.<sup>8</sup> Confirmation of colchicine in the serum, urine, or milk can be made with several laboratory methods; liquid chromatography/mass spectrometry is the most current.<sup>2,8</sup> Treatment is limited as sudden death is the normal result, but would include multiple doses of activated charcoal and intravenous fluid and electrolyte therapy. In human cases, colchicine-specific antibodies (colchicine-specific Fab fragments) have been used successfully.<sup>8</sup> At necropsy, subserosal hemorrhages and gastroenteritis are evident.

## IRRITANT DITERPENOIDS

The two important irritant diterpenoids are 12-deoxyphorbol found in *Euphorbia* spp. (spurges) and simplexin, an irritant diterpenoid daphnane ester found in *Pimelia simplex*, *P. trichostachya*, and others.

Poisoning by 12-deoxyphorbol is associated with a syndrome of stomatitis and enteritis presumably related to the irritant nature of the latex sap.<sup>9</sup> Cattle generally avoid leafy spurge (*E. esula*), apparently because they develop a conditioned aversion to it, but sheep and goats will graze it.

**Simplexin** is primarily associated with a syndrome of congestive heart failure with diarrhea and anemia in cattle in eastern Australia called St. George disease or Marree disease.<sup>10,11</sup> The syndrome is only rarely reported in horses.<sup>12</sup> St. George or Marree disease is associated with ingestion of *P. trichostachya*, *P. simplex*, *P. contunua*, and *P. elongata* (desert rice flower, flaxweed, wild flax, mustard weed, broom bush) and is characterized clinically by massive edema under the jaw and down the brisket, distended jugular veins, persistent diarrhea, anemia, loss of condition, and death. Ingested simplexin is associated with constriction of pulmonary venules, pulmonary venous hypertension, and right heart failure.<sup>12</sup> Diarrhea is caused by direct irritation of the intestinal lining. Inhalation of the powdered plant is associated with the pulmonary–cardiac lesion only. A severe anemia caused by

a significant hemodilution of unknown pathogenesis occurs. The usual field picture is that of cattle looking for feed between old, dry flaxweed plants and inhaling it, so the pulmonary–cardiac form is most common in summer. Experimentally, it has been possible to produce two forms of the disease: the subacute with diarrhea, weakness, and anemia as the predominant signs, and the chronic form characterized by circulatory failure as evidenced by anasarca, hydrothorax, and cardiac dilatation.

Severe diarrhea and colic without other cardiac effects have occurred in cattle, sheep, and horses consuming *Pimelea* plant material.<sup>11,12</sup> The difference between the signs present in St. George disease and acute diarrhea/colic, among other things, is likely related to lower concentrations of simplexin in various species of *Pimelea*.<sup>10,11</sup>

## IRRITANT OILS

Irritant oils in plants are associated with gastroenteritis, salivation, oral mucosal lesions, abdominal pain, diarrhea, and sometimes dysentery. Plants known to contain these oils include:

*Actaea spicata* (baneberry)  
*Artemisia filifolia*  
*Barbarea vulgaris* (yellow rocket)  
*Bryonia dioica* (white bryony)  
*Croton* spp. (croton)  
*Cryptocarya pleurosperma* (poison walnut; contains cryptopleurine and pleurospermine)  
*D. graveolens* (stinkwort)  
*Inula conyza* (ploughman's spikenard)  
*Sambucus* spp. (elders, elderberry)

Bryonin is an irritant oil found in the roots and seeds of *B. dioica* (white bryony or British mandrake) and is associated with a syndrome of depression, dyspnea, diarrhea, polyuria, stumbling gait, tremor, recumbency, and convulsions. Sweating, agalactia, and sudden death are also recorded.

## LYCORINE

Lycorine, an alkaloid found in the bulbs or roots of many garden plants, e.g., *Amaryllis*, *Clivia*, *Daffodil*, *Lycoris*, *Narcissus*, and *Nerine* spp., is associated with salivation, vomiting, and diarrhea when eaten by animals.

## PODOPHYLLIN POISONING

Podophyllin, a resin found in *Podophyllum peltatum*, is associated with enteritis with excessive salivation and severe, acute diarrhea.

## PROTOANEMONIN POISONING

Protoanemonin exists in the plant as a glucoside ranunculin, which releases protoanemonin when the leaves are macerated. Plants containing ranunculin include:

*Anemone* spp.  
*Callitha palustris*

*Clematis* spp.  
*Pulsatilla* spp.  
*Ranunculus* spp. (buttercups)  
*Thalictrum* spp.  
*Trollius* spp.

Ingestion of these plants may be associated with salivation, stomatitis, abdominal pain, diarrhea, dysentery, hematuria, blindness, ataxia, and convulsions.

## TOXALBUMINS (LECTINS)

Plants known to be associated with toxalbumin poisoning are:

*Abrus precatorius* (abrin is toxin; jequirity, rosary pea, Crab's eye)<sup>15</sup>  
*Adenia* spp.  
*Jatropha curcas* (purging nut, Barbados nut)  
*Phaseolus vulgaris* containing phytohemagglutinin (*Phaseolus* hemolytic agent)  
*Robinia pseudoacacia* (robinin is toxin; black locust, false acacia)<sup>2,16</sup>  
*Ricinus communis* (ricin is toxin; castor bean, wonder tree)<sup>2,13,14</sup>  
*Wisteria sinensis* (wisteria, Chinese wisteria)

Lectins are important glycoproteins in human nutrition because of their common occurrence in foods. Many of the toxalbumins, however, are poisonous to animals. Horses appear to be the most susceptible to toxicosis followed by sheep, cattle, and pigs.<sup>2,13,14</sup> Toxalbumins are associated with inhibition of protein synthesis and damage to the gut epithelium, leading to defective digestion and absorption and increased permeability of the intestinal mucosa.<sup>13,15</sup> The toxins are present in foliage and seeds but are concentrated in the latter.<sup>14</sup> The clinical syndrome includes inappetence, vomiting, severe diarrhea, dehydration, dyspnea, rapid weight loss, recumbency, and death in most cases. Neurologic signs including depression, weakness, and encephalopathy may occur.<sup>2,15,16</sup> PCV, serum liver enzymes, and blood urea nitrogen (BUN) and creatinine levels are elevated.<sup>14</sup> Necropsy lesions include abomasal and intestinal hemorrhage and erosions, hepatocyte and renal tubular injury, pulmonary hemorrhage, edema, and emphysema.

## FURTHER READING

Poppenga R. Poisonous Plants. In: Luch A, ed. *Molecular, Clinical and Environmental Toxicology, Volume 2*. Basel: Birkhauser; 2010:123-175.

## REFERENCES

- Jansen SA, et al. *Cardiovasc Toxicol*. 2012;12:208.
- Cortinovis C, et al. *Vet J*. 2013;197:163.
- Gundaz A, et al. *Clin Toxicol*. 2008;46:437.
- Popescu R, et al. *J Ethnopharmacol*. 2013;147:42.
- Hough RL, et al. *Sci Total Environ*. 2010;408:4128.
- Oliveria-Filho JP, et al. *Equine Vet J*. 2013;45:240.
- Vashishtha VM, et al. *Indian J Med Res*. 2009; 130:23.
- Kupper J, et al. *J Vet Diagn Invest*. 2010;22:119.
- Kheyrodin H, et al. *J Rec Adv Agric*. 2012;1:77.
- Chow S, et al. *J Agric Food Chem*. 2010;58:7482.

11. Fletcher MT, et al. LC/MS/MS Analysis of the Daphnane Orthoester Simplex in Poisonous *Pimelea* Species of Australian Rangelands. In: Riet-Corre J, Pfister J, Schild AL, Wierenga TL, eds. *Poisoning by Plants, Mycotoxins, and Related Toxins*. Wallingford, UK: CAB International; 2011:550.
12. Wilson SJ, et al. *Aust Vet J*. 2007;85:201.
13. Worbs S, et al. *Toxins (Basel)*. 2011;3:1332.
14. Aslani MR, et al. *Toxicol*. 2007;40:400.
15. Sahni V, et al. *Clin Toxicol*. 2007;45:77.
16. Vanschandevijl K, et al. *Equine Vet Educ*. 2010;22:336.

## PLANTS (UNIDENTIFIED TOXINS) AFFECTING THE GASTROINTESTINAL TRACT

The following plants affect the gastrointestinal tract in some manner. Toxins are believed to be involved but have not yet been identified.

### DIARRHEA: WITHOUT GASTROENTERITIS AS A LESION

*Anredera cordifolia* (lamb's tail)  
*Blechnum* spp. (bungwall fern)  
*Bulbine bulbosa* (native leek)  
*Cadaba rotundifolia*  
*Centaurium* spp.  
*Chaerophyllum sylvestre*  
*Cichorium intybus* (chicory)  
*Chlorozophora* spp.  
*Datisca glomerata* (Durango root)  
*Dichrocephalia chrysanthemifolia*  
*Juncus inflexus* (blue rush)  
*Linum catharticum* (purging flax)  
*Mentha australis* (native mint)  
*Pipturus argenteus*  
*Philydrum languinosum* (woolly water lily)  
*Polygala klotzchii*  
*Salvia coccinea* (red salvia)  
*Synadenium arborescens* (African milk bush)

### DIARRHEA: WITH GASTROENTERITIS AS A LESION, OFTEN WITH ABDOMINAL PAIN AND INCOORDINATION, SOMETIMES WITH DYSENTERY AND VOMITING

*Azadirachta indica* (neem)  
*Brunfelsia australis* (*B. bonodora*; yesterday, today, and tomorrow)  
*Buxus sempervirens* (common box bush)  
*Centaurium beyrichii* (rock centaury)  
*Chrysocoma tenuifolia* (bitter bush)  
*Cissus quadrangularis*  
*Cuscuta* spp. (dodder)  
*Datisca glomerata* (Durango root)  
*Dichrocephalia chrysanthemifolia*  
*Dipcaadi glaucum* (poison onion)  
*Diplocyclos palmatus*  
*Diplophium africanum*  
*Drymaria* spp.  
*Ephedra viridis*  
*Fagus sylvatica* (European beech tree)  
*Galanthus nivalis* (snowdrop)  
*Gymnocladus dioica* (Kentucky coffee tree)  
*Ligustrum vulgare* (privet hedge)  
*Ludwigia peploides* (water primrose)

*Ornithogalum longibracteatum* (chinchinchee)  
*Robinia pseudoacacia* (black locust, locust tree)  
*Rudbeckia* spp.  
*Sapium sebiferum* (Chinese tallow wood)  
*Scrophularia aquatica* (water betony)  
*Sisyrinchium* spp. (scour weed)  
*Sium angustifolium*  
*Tulipa* spp. (tulips)  
*Turraea robusta*

### DYSPHAGIA

*Buxus sempervirens* (box tree)  
*Descurainia pinnata* (tansy mustard); difficulty in swallowing caused by paralysis of the tongue and the masseter and pharyngeal muscles is accompanied by spasmodic contractions of neck muscles, causing head bobbing in sheep, and may occur after sheep ingest *D. pinnata*; there is doubt about the relationship.<sup>3</sup>  
*Prosopis juliflora*

### ESOPHAGEAL ULCERATION

*Crotalaria aridicola* (horses only)  
*C. medicaginea* (horses only)

### SALIVATION WITH OR WITHOUT STOMATITIS

*Arenaris serpyllifolia* (thyme-leaved sandwort)  
*Puccinia graminis*  
*Scabiosa succisa* (devil's bit)

### VOMITING

*Cephaelis ipecacuanha*  
*Tamus communis* (black bryony; plus colic, paralysis, and death)

## SLAFRAMINE TOXICOSIS (SLOBBERS, BLACK PATCH DISEASE)

### SYNOPSIS

**Etiology** Contamination of leguminous pasture plants with slaframine, a mycotoxin produced by the fungus *Rhizoctonia leguminicola*

**Epidemiology** Ingestion of slaframine from contaminated hay or pasture is associated with a syndrome identified as "slobbers"; the term *black patch disease* refers to the discoloration of pasture or stored hay.

**Clinical pathology** Nothing in particular

**Lesions** The primary clinical sign in horses and ruminants is profuse salivation occurring within 4–6 h of ingestion.

**Diagnostic confirmation** The diagnosis is made based on the clinical sign of profuse salivation after ingestion of contaminated hay or pasture. The toxin can be identified

in legumes by gas chromatography/mass spectrometry.

**Treatment** Treatment is generally not needed. Signs resolve 24–48 h after removal from contaminated pasture or hay.

**Control** Remove animals from contaminated food source, dispose of hay, and plant chemically treated seeds.

### ETIOLOGY

Slaframine is an indolizidine alkaloid produced by the fungus *Rhizoctonia leguminicola* that contaminates leguminous pasture plants, in particular red clover (*Trifolium pretense*) and *Medicago sativa* (alfalfa or lucerne). Swainsonine, the phytotoxin found in *Swainsona* and *Astragalus* spp., is very similar to slaframine and has also been isolated from this fungus. Infested plants carry bronze to black spots or rings, and the hay is usually discolored by black patches on the stems and leaves.

### EPIDEMIOLOGY

#### Occurrence

Ingestion of slaframine is associated with a syndrome, identified colloquially as "slobbers." Horses and cattle are primarily affected, although sheep, goats, llamas, and swine have also developed signs of toxicosis after ingestion.<sup>1–3</sup> Slaframine poisoning has been reported most often in the United States, but domestic animals in South America (Uruguay, Argentina, and Brazil), Japan, France, and the Netherlands have been affected.<sup>2,4</sup> The fungus *R. leguminicola* grows well in hot, humid weather and remains active in stored hay for at least 10 months and perhaps as long as 2 years.<sup>2,4</sup>

### Risk Factors

#### Animal Risk Factors

There are no animal risk factors.

#### Environmental Risk Factors

The fungus grows well in hot, humid weather and survives growth cycles once the pasture or field is contaminated.<sup>2</sup>

#### Farm or Premise Risk Factors

Intoxication is primarily associated with ingestion of contaminated red clover or alfalfa, either in the field or stored hay, but other legumes such as white clover, alsike clover, soy beans, kudzu, cowpea, blue lupine, and black medic can become infected under the right weather conditions.<sup>4</sup> The fungus appears as black patches or rings in the pasture or black to brownish discolored areas on the plant stems or leaves.<sup>1,5</sup>

### Transmission

Animals are intoxicated by grazing on pastures or eating hay infected with *R. leguminicola*. The fungus is seedborne and contaminates hay and pasture in this manner.<sup>1</sup>



## PATHOGENESIS

Slaframine, a mycotoxin, undergoes metabolism in the liver into 6-ketoimine.<sup>2,5</sup> Structurally, ketoimine is very similar to acetylcholine, a parasympathetic neurotransmitter. Pharmacologically, ketoimine is a cholinergic agonist with action at the muscarinic receptors. Stimulation of muscarinic receptors by slaframine results in stimulation of exocrine glands, in particular the salivary glands and pancreas.<sup>1,2</sup> Swainsonine, another alkaloid produced by *R. leguminicola*, may also be involved with the production of some of the clinical signs.<sup>1,5</sup>

## CLINICAL FINDINGS

### Horses

Hypersalivation (and thus the term *slobbers*) is most frequent and often the only sign observed.<sup>1,2,4</sup> Other signs such as anorexia, diarrhea, polyuria, epiphora, and abortion have been reported but are uncommon.<sup>2,4</sup> Salivation occurs 4 to 6 hours after ingestion and lasts for 24 to 48 hours after the horses have been removed from contaminated pastures or hay.<sup>1</sup>

### Ruminants

Hypersalivation occurs in ruminants as well but is often accompanied by decreased milk production, epiphora, and piloerection.<sup>1,2</sup> Other less common signs are polyuria, bloat, dyspnea, and stiffness. Occurrence and regressions of signs is similar to horses.

### Swine

Vomiting, dyspnea, and stiffness have been reported.

## NECROPSY FINDINGS

No necropsy lesions are recorded.

### DIFFERENTIAL DIAGNOSIS

The diagnosis is generally made based on the clinical sign of hypersalivation and consumption of contaminated hay or pasture. The toxin can be identified in hay by gas chromatography/mass spectrometry.<sup>4</sup>

Differential diagnosis list:

#### Horses

Cholinesterase toxicosis (e.g., carbamates [imidocarb], organophosphorus insecticides)  
Dental abnormalities  
Esophageal choke  
Foreign body (oral cavity, plant awns in hay)  
Glossitis  
Other infectious diseases (rabies, botulism, etc.)  
Trauma  
Vesicular stomatitis virus

#### Ruminants

Bluetongue virus  
Caterpillar hairs (*Thaumetopoea processionea*, oak processionary caterpillar)

Cholinesterase toxicosis (e.g., carbamates [imidocarb], organophosphorus insecticides)  
Food-and-mouth disease  
Foreign body (oral cavity, plant awns in hay)  
Vesicular stomatitis

## TREATMENT

No treatment other than removing animals from the contaminated source is generally needed.<sup>2,4</sup> Atropine may be used to reverse hypersalivation but must be used with caution in horses and ruminants.<sup>2</sup>

## CONTROL

The presence of the fungus *R. leguminicola* cannot be controlled once the pastures and/or hay are contaminated. Grazing animals should be removed from contaminated pasture, contaminated hay disposed, and seeds chemically treated before planting.<sup>4</sup>

## FURTHER READING

Crump MH. Slaframine (Slobber factor) toxicosis. *J Am Vet Med Assoc.* 1973;163:100.

## REFERENCES

- Riet-Correa F, et al. *J Vet Diagn Invest.* 2013;25:692.
- Winjberg IS, et al. *Vet Rec.* 2009;64:595.
- Smith TK, et al. The effects of feed borne mycotoxins on equine performance and metabolism. In: Oswald IP, Taranu I, eds. *Mycotoxins in Farm Animals*. India: Transworld Research; 2008:47.
- Borges AS, et al. *Equine Vet Educ.* 2012;24:279.
- Fink-Gremmels J. *Vet J.* 2008;176:84.

## CANTHARIDIN TOXICOSIS (BLISTER BEETLE POISONING, CANTHARIASIS)

### SYNOPSIS

**Etiology** Blister beetle (*Epicauta occidentalis*, *E. temexa*, etc.)

**Epidemiology** Cantharidin, the toxin present in blister beetles, is incorporated into alfalfa hay and ingested by animals

**Clinical pathology** Hemoconcentration, azotemia, profound hypomagnesaemia and hypocalcaemia, hematuria, hyposthenuria

**Lesions** Oral and gastrointestinal ulcers and erosions

**Diagnostic confirmation** History, presence of beetles in hay, GCMS or LCMS using urine, blood, gastrointestinal contents, and feed

**Treatment** Activated charcoal, intravenous fluids, electrolyte replacement as needed, analgesics, gastrointestinal protectants

**Control** Know beetles in area, examine hay, do not harvest infested fields.

GCMS, gas chromatography-mass spectrometry; LCMS, liquid chromatography-mass spectrometry.

## ETIOLOGY

Cantharidin toxicosis has been reported in horses as well as a number of other species including emu, sheep, goats, and cattle.<sup>1,2</sup> Horses are more susceptible and generally poisoned by the consumption of blister beetles (*Epicauta* spp.) present in hay. Cantharidin, a potent vesicant, is found in the hemolymph and leg joints of blister beetles.<sup>3</sup> There are over 200 named species of the beetle, and the most common association with toxicosis in horses are the three striped blister beetles *E. occidentalis* and *E. temexa*.

## EPIDEMIOLOGY

### Occurrence

Blister beetles feed on flowering foliage, primarily alfalfa, and are incorporated into hay when it is harvested. Cantharidin is stable in the environment and persists for extended time periods. Toxicosis was originally confined to the Southern states, but outbreaks now occur elsewhere because of the widespread shipment of alfalfa hay, and occasionally weedy meadow hay, infested with the beetles.

### Risk Factors

The greatest risk factor for horses is the ingestion of blister beetle-contaminated hay. The beetles contain cantharidin, and administration of 1 g of ground beetles by nasogastric tube is fatal to a pony. The ingested lethal amount in adult horses is 0.5 to 1 mg/kg or about 4 to 6 g of dried beetles.<sup>2,3</sup> The cantharidin content of the beetles varies widely (0.77%–3.31% dry weight) between species, and male beetles contain more toxin than females.

### Transmission

Whole or crushed blister beetles can be incorporated into hay and fed to horses and other livestock. It is possible that cantharidin released from crushed beetles may contaminate hay without any evidence of their presence.

## PATHOGENESIS

The mechanism of action of cantharidin is not well established but may include inhibition of phosphatase 2A and protein mitochondrial damage from inhibition of enzymes responsible for active transport.<sup>1,3</sup>

Cantharidin is rapidly absorbed across all mucous membranes and to some extent the skin. It produces a strong irritant effect on the esophagus, stomach, and intestines. Once absorbed it is transferred to several body organs in which it produces systemic effects. It is not metabolized but is excreted unchanged in the urine where the irritant effect continues in the bladder, ureters, and urethra.<sup>3</sup>

## CLINICAL FINDINGS

Clinical signs are dose dependent. Horses ingesting large amounts may die within 4

hours of ingestion. The ingestion of smaller doses may result in gastroenteritis (anorexia, diarrhea  $\pm$  blood and/or mucus, severe colic), myocarditis (tachycardia, decreased capillary refill), nephritis (polyuria, oliguria), cystitis, or urethritis.<sup>1,3,4</sup> Generalized systemic signs include hyperthermia, depression, dehydration, sweating, synchronous diaphragmatic flutter, dyspnea, and rales. Death occurs in approximately 50% of cases. Prognosis is good for those horses surviving 7 days or more.<sup>3</sup>

### CLINICAL PATHOLOGY

Serum protein and PCV will be elevated, indicating hemoconcentration, dehydration, and shock. Other laboratory abnormalities include an elevation in BUN, profound hypocalcemia and hypomagnesemia, hypostenuria, and hematuria.<sup>1,3</sup>

### NECROPSY FINDINGS

Vesiculating gastropathy of the gastric squamous mucosa is highly diagnostic, but no necropsy findings occur in many cases. Mass spectrometric and gas or liquid chromatographic methods facilitate detection of cantharidin in field specimens of blood, urine, stomach and intestinal contents, and feed. Cantharidin is rapidly excreted and may not be present in samples taken more than 4 to 5 days after ingestion.<sup>3</sup>

### DIFFERENTIAL DIAGNOSIS

Differential diagnosis list:

- Arsenic toxicosis
- Cyanobacteria toxicosis
- Ionophore (monensin) toxicosis
- Colic (impaction and tympanic)
- Gastrointestinal enteritis (colitis, proximal enteritis, peritonitis)

### TREATMENT

There is no antidote and treatment is symptomatic. In early cases, activated charcoal or smectite may be used to decrease absorption of cantharidin.<sup>1,5</sup> The use of mineral oil is not recommended because it may actually increase cantharidin absorption and worsen morbidity.<sup>1,2</sup> Intravenous fluid therapy should be used to correct fluid and electrolyte deficits, with specific attention to calcium and magnesium supplementation.<sup>1,5</sup> Analgesics and gastrointestinal protectants should be used as needed. Broad-spectrum antibiotics may be used in animals with gastrointestinal erosions; the use of nephrotoxic antibiotics is contraindicated.

### TREATMENT AND PROPHYLAXIS

- Activated charcoal (1–3 g/kg per nasogastric  $\times$  1) (R2)
- Mineral oil (4–6 L per nasogastric tube  $\times$  1) (R4)

Furosemide (1 mg/kg intramuscularly or intravenously every 6 h) (R3)

Sucralfate (20 mg/kg orally every 6–8 h) (R1)

### CONTROL

Veterinarians should be aware of the presence of blister beetles in their area, and infested fields should not be harvested. Hay purchased from unknown sources should be inspected for the beetles, although cantharidin may still be present in the absence of beetles.

### FURTHER READING

- Helman RG, Edwards WC. Clinical features of blister beetle poisoning in equids; 70 cases (1983–1996). *J Am Vet Med Assoc.* 1997;211:1018.
- Schmitz DG. Cantharidin toxicosis in horses. *J Vet Intern Med.* 1989;3:208–215.

### REFERENCES

1. Qualls HJ, et al. *J Vet Intern Med.* 2013;27:1179.
2. Bush MR. Blister beetles: pest or beneficial predator. At: <<https://research.libraries.wsu.edu/xmlui/bitstream/handle/2376/4620/FS113E.pdf?sequence=2>>; October 18, 2013.
3. Krinsky WL. Beetles (*Coleoptera*). In: Mullen GR, Durden LA, eds. *Medical and Veterinary Entomology*. Amsterdam: Elsevier; 2009:101.
4. Holbrook TC, et al. *ACVIM Proc.* 2008;210.
5. Weese JS, et al. Cantharidin toxicosis (blister beetle toxicosis). In: Munroe GA, Weese JS, eds. *Equine Clinical Medicine, Surgery, and Reproduction*. London: Manson Publishing; 2011:523.

## Neoplasms of the Alimentary Tract

### MOUTH

Oral neoplasms in ruminants, other than viral papillomas, may be associated with heavy bracken intake. The tumors are usually squamous cell carcinomas arising from the gums and cause interference with mastication. They are most common in aged animals and probably arise from alveolar epithelium after periodontitis has caused chronic hyperplasia. Sporadic occurrences of other tumors, e.g., adenocarcinoma, cause obvious local swelling and dysphagia.

### PHARYNX AND ESOPHAGUS

Papillomas sometimes involve the pharynx, esophagus, esophageal groove, and reticulum and cause chronic ruminal tympany in cattle. A high incidence of malignant neoplasia affecting the pharynx, esophagus, and rumen has been recorded in one area in South Africa. The tumors were multicentric in origin and showed evidence of malignancy on histologic examination. The clinical disease was chronic and confined to adult animals, with persistent, moderate tympany of the rumen and progressive emaciation as typical signs. A similar occurrence has been recorded in cattle in western Scotland and

related to the long-term consumption of bracken. The tumors were squamous cell carcinoma in the pharynx and dorsal esophagus. The principal clinical abnormality was difficulty in eating and swallowing. Many of the carcinomas arise in preexisting papillomas, which are associated with a virus infection. The carcinomas occur only in cattle more than 6 years of age.

### STOMACH AND RUMEN

Squamous cell carcinomas occasionally develop in the mouth and stomach of horses and the rumen of cattle. In the stomach of the horse, they occur in the cardiac portion and may cause obscure indigestion syndromes, lack of appetite, weight loss, anemia, obstruction of the lower esophagus, dysphagia, colic, and occasionally chronic diarrhea. Also, a tumor may ulcerate to terminate with perforation of the stomach wall and the development of peritonitis. Metastases may spread to abdominal and thoracic cavities with an accumulation of fluid. Subcutaneous edema is a common accompanying sign. There may also be pleural effusion caused by metastases in the pleura. Metastases in the female genital tract have also been noted. Most affected animals are euthanized because of anorexia and chronic weight loss. Large masses of metastatic tumor tissue may be palpable on rectal examination. In such cases an examination of paracentesis fluid sample cells should be valuable.

Lymphoma in horses is classified into multicentric, alimentary, mediastinal, cutaneous, and solitary tumors of extranodal sites. The alimentary form accounts for approximately 19% of the equine lymphoma cases and is often manifested by chronic diarrhea caused by massive infiltration of the intestinal wall.<sup>1</sup> There is severe weight loss, even in the absence of diarrhea in some cases, usually a large appetite and often severe ascites, and anasarca and sometimes colic. The same signs are recorded in a case of mesothelioma in a horse. The oral glucose absorption test is abnormal with a poor absorption response. Rectal examination may reveal large masses of hard nodular tissue, and hematological examination may be of assistance in diagnosis. Pseudodiverticula or intestinal obstruction may develop in the small intestine associated with tumor tissue.<sup>2,3</sup> Paracentesis and examination of cells in the fluid for the presence of mitotic figures is an essential part of an examination in suspected cases of neoplasia in the abdominal cavity. Nasal fibrogastroscopy is an obvious technique for visualizing proximally located tumors but is limited because standard instruments are usually not long enough. The course of this disease in horses is quite variable, with the period of illness lasting from 3 weeks to 3 months.

In a large case series from Brazil, the alimentary tract was the most common

location for tumor development (comprising 24% of 586 tumors), with squamous cell carcinoma of the upper gastrointestinal tract predominating.<sup>4</sup> Lesion locations were preferentially located at the base of the tongue, in the esophagus, and adjacent to the cardia in the ruminal wall. Lesion location was typically associated with clinical signs, including dysphagia and coughing for proximal tumors and bloating for tumors in the distal esophagus or ruminal wall.<sup>5</sup> Almost all affected cattle had access to bracken fern (*Pteridium aquilinum*), and it was speculated that chronic bracken fern ingestion was the cause for the tumors. Small numbers of lingual fibroma, abomasal adenoma, small-intestinal adenocarcinoma, ruminal fibrosarcoma, peritoneal mesothelioma, peritoneal fibroma, and anal squamous cell carcinoma were also reported. Ruminal tumors in cattle include papilloma/fibropapilloma, and bovine papillomavirus-1, -2, and -5 were associated with some of these lesions.<sup>6</sup> Squamous cell carcinoma of the reticulum with metastasis to the liver has been reported in a Simmental cow.<sup>7</sup> Although most ruminal tumors are small, if large enough they may obstruct the cardia and cause chronic tympany.

Small omasal and abomasal papillomas have been reported in 1-week-old calves and were associated with papillomavirus infection.<sup>8</sup> In lymphomatosis of cattle, there is frequently gross involvement in the abomasal wall causing persistent diarrhea. Ulceration, hemorrhage, and pyloric obstruction may also occur.

## INTESTINES

A higher than normal rate of occurrence of carcinoma of the small intestine has been recorded in sheep in Iceland, Norway, and New Zealand and in cows only in New Zealand. A series of intestinal carcinomas is also recorded in Europe and another series in Australia. The tumors in the Australian series were located at abattoirs and were causing intestinal stenosis. Metastasis to regional lymph nodes occurred readily. In New Zealand there appeared to be a much higher prevalence in British-breed ewes (0.9%–0.15%) compared with Merino and Corriedale ewes (0.2%–0.4%), and a report of intestinal adenocarcinomas in three generations of sheep is suggestive of a genetic predisposition.<sup>9</sup> Significantly higher tumor rates were observed in sheep that had been pastured on foodstuffs sprayed recently with phenoxy or picolinic acid herbicides. The use of the herbicides 2,4-D, 2,4,5-T, MCPA, piclorum, and clopyralid has been associated with an increased incidence of these tumors. A higher prevalence in sheep kept at higher stocking rates was also suggested.

Occasional tumors of the intestine are recorded in abattoir findings, but they can cause clinical signs such as chronic bloat and intermittent diarrhea in cattle, persistent

colic caused by partial intestinal obstruction in horses, and anorexia and a distended abdomen in sheep. A series of cases of lymphoma in horses was characterized by malabsorption without diarrhea but with some cases of anemia.

Occasional tumors recorded as causing colic in horses include an intramural ganglioglioma occluding the jejunum, a jejunal myxoma that resulted in jejunoileocecal intussusception,<sup>10</sup> a stromal tumor in the cecum<sup>11</sup> or colon,<sup>12</sup> an intraluminal leiomyoma causing an intussusception of the small colon, a granulosa cell tumor of an ovary causing external pressure and occlusion of a small colon, and a ganglioglioma of a small colon.<sup>13</sup> A juvenile granulosa cell tumor in a weanling filly caused a fatal volvulus and severe continuous colic. Anorexia, weight loss, abdominal distension, and constant chewing and swallowing movements are the prominent signs in gastric leiomyoma and squamous cell carcinoma. Leiomyoma may also be confined totally to the omentum and cause colic because of its size or excessive tension on the omentum.<sup>14</sup> Metastases in the peritoneal cavity are palpable in some cases. Leiomyosarcomas have caused chronic intermittent colic caused by constriction of the duodenum and partial intestinal obstruction. A colonic adenocarcinoma has caused weight loss, intermittent colic, poor appetite and scant feces, and a mass palpable in the abdomen.

Carcinoma of the stomach, small intestine, and colon are occasionally encountered in pot-bellied pigs.<sup>15,16</sup>

Tumors of the anus are rare; a mucoepidermoid carcinoma is recorded in a goat, but most tumors of the perineal area are anogenital papillomata. A rectal carcinoma has been reported in an aged Holstein cow.<sup>17</sup>

## REFERENCES

1. Taintor J, Schleis S. *Equine Vet Educ.* 2011;23:205.
2. Mair TS, et al. *Equine Vet J.* 2011;43(suppl 39):128.
3. Smith KM, et al. *Equine Vet Educ.* 2013;25:74.
4. Lucena RB, et al. *J Comp Pathol.* 2011;145:20.
5. Masuda EK, et al. *J Comp Pathol.* 2011;144:48.
6. Kumar P, et al. *Transbound Emerg Dis.* 2015;62:264.
7. Braun U, et al. *Schweiz Arch Tierheilkd.* 2012;154:331.
8. Morris WE, et al. *Can Vet J.* 2010;51:877.
9. Loken T, et al. *Vet Rec.* 2012;170:54a.
10. Zauscher JM, et al. *Equine Vet Educ.* 2015;27:e1-e4.
11. Stephan S, et al. *Case Rep Vet Med.* 2012;301498.
12. Muravnick KB, et al. *J Vet Diagn Invest.* 2009;21:387.
13. Porter BF, et al. *Vet Pathol.* 2007;44:207.
14. Schaudien D, et al. *Vet Pathol.* 2007;44:722.
15. Newman SJ, Rohrbach B. *J Vet Diagn Invest.* 2012;24:1008.
16. McCoy AM, et al. *J Am Vet Med Assoc.* 2009;235:1336-1341.
17. Michishita M, et al. *Vet Pathol.* 2007;44:414.

## TUMORS OF THE PERITONEUM

Primary tumors of the peritoneum are rare. Most tumors of the peritoneum occur by

metastasis from adjacent organs, such as with gastric squamous cell carcinoma, or disseminated disease such as lymphosarcoma. Primary tumors include leiomyomatosis and mesothelioma.

Disseminated peritoneal leiomyomatosis has been reported to occur in a mature Quarter Horse. Clinical findings included inappetence, weight loss, intermittent fever, chronic abdominal pain, and enlargement of the abdomen. Rectal examination revealed a prominent, firm, smooth-walled mass in the ventral aspect of the abdomen. Transabdominal ultrasonography was used to detect the mass, which was a friable, polycystic structure occupying a large portion of the abdominal cavity and weighing 34 kg. The mass was removed and recovery was complete.

Mesothelioma has been reported in cattle and goats,<sup>1</sup> predominantly in the peritoneal cavity, but mesothelioma can also occur in the pleural cavity and the vagina of adult cattle. The cause of mesothelioma in cattle is unknown, but pleural mesothelioma in humans is associated with asbestos exposure. One report suggested that the frequency of diagnosis in cattle is increasing. All ages of cattle can be affected with peritoneal mesothelioma, but affected animals are typically young, with fetal and neonatal cases also being reported. Calves and adult cattle most frequently present with moderate abdominal distension. Other presenting signs include scrotal edema in intact males and ventral pitting edema. Occasionally, small 2- to 20-mm, well-demarcated “bumps” can be felt on all serosal surfaces during palpation per rectum in adult cattle. Peritoneal fluid is easily obtained by ventral abdominal paracentesis and has the characteristics of a modified transudate with a moderate to marked increase in phagocytically active mesothelial cells. Definitive diagnosis is made during a right-sided exploratory laparotomy, in which numerous raised, white, and well-demarcated masses are palpated on all serosal surfaces, with copious abdominal fluid present. Biopsy of these masses and microscopic examination confirms the presumptive diagnosis of mesothelioma. Extensive peritoneal mesothelioma is fatal and there is no known treatment. All cases reported have been sporadic, and there is no apparent association with asbestos or other toxic agent in cattle.

## REFERENCE

1. Braun U, et al. *Schweiz Arch Tierheilkd.* 2009;151:397.

## Congenital Defects of the Alimentary Tract

### HARELIP AND CLEFT PALATE

Harelip may be unilateral or bilateral and may involve only the lip or extend to the



nostril. It may be associated with cleft palate and cause dysphagia and nasal regurgitation of milk and food, and a risk of inhalation pneumonia. It may be inherited or a result from poisoning of lambs with *Veratrum californicum*. Cleft palate is difficult to correct surgically, especially in foals, in which it is a common congenital defect. Cleft palate (palatoschisis) is a common inherited defect in calves and is described later.

### ATRESIA OF THE SALIVARY DUCTS

Congenital atresia of salivary ducts usually results in distension of the gland followed by atrophy. Rarely the gland may continue secreting, resulting in a gross distension of the duct.

### AGNATHIA, MICROGNATHIA, AND BRACHYGNATHIA

These are variations of a developmental deficiency of the mandible, which is relatively common in sheep. The mandible and its associated structures are partially or completely absent. Single cases of a similar defect, combined with cleft palate, are recorded in calves.

**Brachygnathia** is an abnormal shortening of the mandible, resulting in malocclusion of the maxillary and mandibular dental arcades and creating the appearance of a maxillary overbite. It is considered to be a congenital abnormality but may be acquired within the first few months of life. The incisive malocclusion is of little consequence to the nursing foal but can affect the ability to prehend and masticate as the animal matures. It is not known to spontaneously regress, and surgical intervention is necessary to correct the malocclusion.

The cause may be genetic or environmental. Some reports indicate a genetic influence but the mode of inheritance is controversial. One report suggests that brachygnathia in Angus calves was transmitted by a single autosomal recessive gene, but such mode of inheritance has not been supported in other studies. In a series of 20 horses with brachygnathia the amount of disparity between the mandible and premaxilla varied between 0.75 and 3.0 cm. Surgical correction of the abnormality resulted in improved incisive occlusion. Complete correction of the malocclusion was more likely to occur if foals were treated before 6 months of age.

### PERSISTENCE OF THE RIGHT AORTIC ARCH

Persistence of the right aortic arch as a fibrous band may occlude the esophagus and cause signs of obstruction, particularly chronic bloat in young calves.

### CHOANAL ATRESIA

Failure of the bucconasal membrane to rupture during fetal life prevents the animal breathing through the nostrils. The membrane separates the alimentary tract and the nasal cavities in the pharynx. It is incompatible with life in foals, lambs, and llama and alpaca crias, the species in which it is identified. The defect is usually bilateral; a unilateral lesion is tolerable. Surgical correction is likely to be only partially effective.

### CONGENITAL ATRESIA OF THE INTESTINE AND ANUS

**Congenital intestinal atresia** is characterized by the complete closure of some segment of the intestinal tract. Intestinal atresia has been reported in calves, lambs, foals, and piglets, and the affected newborn usually dies of autointoxication within a few days of birth. The incidence of intestinal atresia in 31 Irish dairy herds monitored over 1 year was 0.3% of all calves born.

### INTESTINAL ATRESIAS

Congenital atresia of the intestine can be differentiated from retention of meconium in foals, and rarely calves, by the passage of some fecal color in the latter. Animals with intestinal atresia die at about 7 to 19 days of age unless the defect is corrected surgically. The intestine is grossly distended by then, and the abdomen is obviously swollen as a result. There is marked absence of feces.

**Intestinal atresias** have been classified into type I (membrane atresia caused by a diaphragm or membrane), type II (cord atresia caused by blind ends joined by a small cord of fibrous or muscular tissue or both, with or without mesentery), and type III (blind-end atresia, caused by absence of a segment of the intestine, with disconnected blind ends and a gap in the mesentery, and often a short small intestine).

Atresia of the ileum and colon is probably conditioned by inheritance in Swedish Highland cattle.

### ATRESIA OF THE TERMINAL COLON

Atresia of the terminal colon occurs in foals, especially those of the Overo breed; the ileum and colon are affected in calves and the small intestine in lambs. Atresia coli has been reported in Holstein, Ayrshire, Short-horn, Simmental, Hereford, Angus, and Maine Anjou breeds and in crossbred cattle. In one dairy herd over a 10-year period the overall incidence of atresia coli in calves was 0.76%. All the affected calves were related to one another, some were inbred, and the frequency was higher in males than females. Some affected calves were aborted or born dead at term. More calves were born with atresia coli from dams in which pregnancy was diagnosed before 41 days of gestation

than from dams diagnosed as pregnant at a later date.

It is suggested that atresia coli in calves has an inherited basis and that affected calves are homozygous recessives for the defective allele for atresia coli. This is supported by planned matings between putative carrier sires and putative carrier dams. The estimated minimum gene frequency of atresia coli in cattle is 0.026, and it is thought that the defective allele for atresia coli is at high frequency in Holstein cattle in the United States. It is also plausible that early pregnancy diagnosis by palpating the amniotic sac before 40 days of gestation may be a contributing factor, but it is not essential for all cases. Intestinal atresia can be produced experimentally by terminating the mesenteric blood supply to some parts of the intestine during development.

In atresia coli, the abdomen may be grossly distended before birth when the defect is in the small intestine, and the distension may interfere with normal parturition. In defects of the large intestine, distension usually occurs after birth. In these the anus is normal, and the part of the intestine caudal to the obstructed section may be normal or absent. The principal clinical findings are depression, anorexia, and abdominal distension. Frequently the owner has not seen the calf pass meconium or feces. Thick mucus may be passed through the anus if it is patent or through the vagina in heifers with concomitant rectovaginal fistula. In many cases the animal has not sucked since the first day, and 5- to 6-day-old animals are very weak and recumbent. The intestine may rupture and acute diffuse peritonitis develop. Intestinal segmental atresia has been produced experimentally by occluding the blood supply to the intestine in fetal lambs. In one large series of congenital defects in calves the most common site of atresia was the midportion of the spiral loop of colon. The passage of a rectal tube or the infusion of barium and radiography may assist in the detection of atresia of the intestine, but care must be exercised during this procedure or the rectum and descending colon may be perforated. There are usually large quantities of thick tenacious mucus in the rectum with no evidence of meconium or feces. In the latter case only exploratory laparotomy can reveal the extent and nature of the defect. The differential diagnosis of atresia coli in calves includes acute intestinal obstructions such as volvulus and intussusception, diffuse peritonitis, and septicemia. **The presence of feces in the rectum rules out the presence of atresia coli.**

Surgical repair appears to be a satisfactory outcome in 30% to 50% of cases, and may be better with placement of a colostomy or cecostomy rather than a colocolic anastomosis.<sup>1-3</sup> In a series of intestinal atresia in calves admitted to a veterinary teaching hospital over a period of 10 years, the

survival rate was influenced by the atretic segments affected. In a series of 58 cases of intestinal atresia in calves, 7 of 18 cases corrected surgically made a satisfactory recovery; the remaining 40 calves were euthanized for different reasons.

The incidence of **atresia coli in foals** has been reported at 0.44% of foals under 2 weeks of age admitted to veterinary teaching hospitals over a period of 27 years. Clinical findings included progressive abdominal distension, colic, lack of feces, and lack of response to enemas. A neutropenia may reflect the presence of toxemia. The large transverse or small colon is commonly involved. Agenesis of the mesocolon in a 1-month-old foal with colic has been described. The prognosis for most cases is grave and surgical correction is usually unsuccessful. Atresia coli has also been reported in an alpaca cria.<sup>4</sup>

The common causes of colic in newborn foals include ileus with or without gas distension, intussusception, diaphragmatic hernia, gastroduodenal ulcers, necrotizing enterocolitis, small and large-intestinal strangulation, large intestine displacement, intraluminal obstruction other than meconium, ruptured bladder, and congenital abnormalities of the gastrointestinal tract.

### ATRESIA OF THE ANUS

This is recorded as a congenital defect in pigs, sheep, and calves. Its occurrence is usually sporadic and no genetic or management factors can be indicated as causes. When the rectal lumen is quite close to the perineum, surgical intervention is easy and the results, in terms of salvaging the animals for meat production, are good. These animals can usually be identified by the way in which the rectal distension bulges in the perineum where the anus should be; pressure on the abdomen provokes a tensing or further distension of this bulge.<sup>1</sup>

### MULTIPLE ORGAN DEFECTS

In many animals the congenital defects of the intestine are accompanied by defects in other organs, especially the lower urinary tract, so that reparative surgery is not possible. For example, multiple gut and urogenital defects are recorded in one calf and gut defects plus defects of the pancreas and gallbladder in another.

Congenital constriction of the anus and vagina is an inherited defect of Jersey cattle and discussed later. The defect may be combined with rectovaginal fistula manifested by the passage of feces via the vulva or penile urethra.

### FURTHER READING

Syed M, Shanks RD. *Cornell Vet.* 1993;83:261.

### REFERENCES

1. Azizi S, et al. *Vet Surg.* 2010;39:115.
2. Cecen G, et al. *Vet Surg.* 2010;39:722.

3. Abdelrhman MA, et al. *Pak Vet J.* 2013;33:309.

4. Poulsen KP, et al. *Vet Rec.* 2006;158:598.

## Inherited Defects of the Alimentary Tract

### INHERITED DEFECTS OF THE MOUTH AND JAW

Harelip in cattle often has a distinct familial tendency but little work appears to have been done on the mode of inheritance. An apparently inherited harelip combined with poor growth and accompanying cryptorchidism is recorded in Holstein-Friesian cattle. Bilateral cleavage of the lip, which also involves the maxilla, is recorded in Texel sheep as being conditioned by a single recessive autosomal gene.

#### Cleft Palate

Cleft palate is inherited as a simple recessive character in Hereford and Charolais cattle, concurrent with arthrogyriposis in the latter, and is commonly thought to be inherited in sheep and pigs. The progeny of a commercial swine herd (Landrace × Duroc) and Large White Boar contained a number of piglets with cleft palates. Chromosomal analysis of affected piglets found all had identical unbalanced karyotype with partial monosomy of chromosomes 16 and partial trisomy of chromosome 3, compared with normal piglets in the litters with balanced karyotypes.

#### Jaw Deformity

Shortness of the maxilla is thought to be inherited in Jersey cattle and Large White pigs, sometimes in association with chondrodysplasia. Shortness of the mandible is also inherited in cattle, and in Angus in combination with cerebellar hypoplasia and osteopetrosis.

#### Smooth Tongue (Epitheliogenesis Imperfecta Linguae Bovis)

Smooth tongue is a defect of Holstein-Friesian and Brown Swiss cattle, and it is inherited as an autosomal recessive factor. The filiform papillae on the tongue are small, there is hypersalivation and poor hair coat, and the calves do not fare well. The heterozygote is normal.

#### Tongue Aplasia

Congenital absence of the median part of the tip of the tongue occurs rarely in piglets, often in association with cleft palate and/or harelip.

#### Rectal Prolapse

Rectal prolapse may be inherited in piglets as a result of agenesis of the anal sphincter (see Inherited atresia of alimentary tract segments).

### INHERITED RECTOVAGINAL CONSTRICTION

The rectovaginal constriction defect is inherited in Jersey cattle and is manifested as stenosis of the rectum in either sex and stenosis of the vaginal vestibule in females. The tone of both rectal and vaginal sphincters is increased, but attempts to detect heterozygotes by electromyographic measurement of these tones have been unsuccessful. The defect is regulated by an autosomal recessive gene. Affected cows are difficult to inseminate and have difficulty in calving. Their udders are small and hard and productivity is low. The condition is caused by the presence of bands of nonelastic fibrous tissue. Edema of the udder is also a common complication. Some assistance in the identification of affected animals is available by the detection of collagen type II in muscle biopsies. Fifty percent of heterozygotes also test positively as well as a small percentage of normals.

### INHERITED ATRESIA OF ALIMENTARY TRACT SEGMENTS

**Anal sphincter atresia** occurs rarely in piglets and causes rectal prolapse. **Atresia ani** is quite common in pigs, sheep, and, to a less extent, cattle. Affected animals may survive for up to 10 days, and are identified by their depression, anorexia, colic, marked abdominal distension and lack of feces, and feces being replaced by thick white mucus. Abdominal distension in utero occasionally causes dystocia. Surgical repair is possible in some cases, but in others a large segment of rectum is missing, and creation of a colonic fistula in the inguinal region is necessary. The condition is thought to be inherited in pigs and calves, but supporting evidence is slim, and the evidence is less clear still in sheep. A suggestion that the defect may be also associated with the manipulation of the fetus during pregnancy examination has not been supported. A calf with atresia ani and diphalus and separate scrota has been described.

Inherited **atresia coli**, with complete closure of the ascending colon at the pelvic flexure, has been recorded in Percheron horses. A clinically similar defect in overo horses, described in the section on pseudo-albinism, is in fact an aganglionosis. Death occurs during the first few days of life. The defect appears to be inherited as a simple recessive character.

Inherited **atresia ilei** has been recorded in Swedish Highland cattle. Affected calves manifest marked abdominal distension causing fetal dystocia. The distension is caused by accumulation of intestinal contents. Inheritance of a single recessive gene conditions the occurrence of the defect in some species and breeds, but the prevalence may be higher than would be expected with

that form of inheritance, especially in Jersey cattle with atresia coli.

### LETHAL WHITE SYNDROME IN FOALS AND LAMBS (INTESTINAL AGANGLIONOSIS)

White foals and white lambs of certain breeds or matings are affected by this syndrome, which is attributable to a mutation in the endothelin type B receptor gene (EDNRB).<sup>1,2</sup> Lethal white foal syndrome (OMIA #000629-9796) is an autosomal-recessively inherited condition of newborn foals born to American Paint Horse parents of the overo coat-pattern lineage.<sup>3</sup> In addition to foals of American Paint Horses, Quarter Horses and, rarely, Thoroughbreds are affected.<sup>1</sup> The overo coat-color pattern is characterized by pigment spreading down both sides from the dorsal midline, giving way to lack of pigment (i.e., white) primarily on the ventral surfaces.<sup>3</sup>

A mutation in the EDNRB of two nucleotides (TC > AG) in the coding EDNRB sequence results in the substitution of a

single amino acid (Ile118Lys) and interference with migration of neural crest cells to the intestine causing intestinal aganglionosis, leading to a functional obstruction (megacolon) and death. Both melanocytes and myenteric ganglia cells are of neural crest origin, and their failure to migrate from the neural crest results in the absence of melanocytes in the skin and aganglionosis of the intestine.<sup>1</sup>

Over 94% of frame overo, highly white calico overo, and frame blend overo horse are heterozygotes, whereas fewer than 20% of tobiano, sabino, minimally blend overo, and breeding-stock solid are carriers.<sup>1</sup> Many solid (nonwhite coat-color pattern) horses with Paint horse bloodlines are heterozygous; therefore the genotype cannot necessarily be inferred from coat-color patterns.<sup>1</sup> White coat color can result from other genetic conformations and is not invariably associated with lethal white syndrome. Some affected foals may have flecks of black hair in the mane and tail or a small black body spot.<sup>1</sup>

Affected foals and lambs die within hours to several days of birth. Affected foals are all

white or nearly all white and die of colic shortly after birth because of functional intestinal obstruction. Rectal examination reveals a lack of meconium. Radiographic examination of the abdomen reveals a distended large colon. Diagnosis is based on characteristic coat color and confirmation of megacolon. Diagnostic testing for the causative mutation is available commercially. Control is by testing and detection of heterozygotes and implementation of appropriate breeding programs.

A similar hypopigmentation syndrome occurs in Cameroon sheep and is associated with a homozygous 110-kb interstitial deletion on chromosome 10, including the entire EDNRB gene. The disease is inherited as an autosomal recessive trait.

### REFERENCES

1. Finno CJ, et al. *Vet J*. 2009;179:336.
2. Luehken G, et al. *PLoS ONE*. 2012;7.
3. Online Mendelian Inheritance in Animals (OMIA). *Megacolon in Equus Caballus*. Faculty of Veterinary Science. University of Sydney; 2012. At: <<http://omia.angis.org.au/OMIA000629/9796/>>; Accessed 08.11.15.



**DISEASES OF THE FORESTOMACH OF RUMINANTS 436**

Anatomy and Physiology 436  
Ruminant Gastrointestinal Dysfunction 441

**SPECIAL EXAMINATION OF THE ALIMENTARY TRACT AND ABDOMEN OF CATTLE 445**

History 445  
Systemic State, Habitus, and Appetite 445  
Oral Cavity and Esophagus 445  
Inspection of the Abdomen 445  
Examination of Rumen Fluid 448  
Palpation per rectum of the Abdomen 449  
Gross Examination of Feces 449  
Detection of Abdominal Pain 451  
Ultrasonography 452  
Radiography 452  
Endoscopy of the Rumen 453  
Computed Tomography 453  
Rumination Monitors 453  
Interpretation of Clinical Findings 453  
Exploratory Laparotomy 453  
Laparoscopy 454  
Clinical Examination of the Digestive Tract and Abdomen of the Calf 455

**DISEASES OF THE RUMEN, RETICULUM AND OMASUM 457**

Simple Indigestion 457  
Rumen Impaction Due to Indigestible Foreign Bodies 459  
Indigestion in Calves Fed Milk Replacers (Ruminal Drinkers) 460  
Acute Carbohydrate Engorgement of Ruminants (Ruminal Lactic Acidosis, Rumen Overload) and Subacute Ruminal Acidosis 461  
Ruminal Parakeratosis 472  
Ruminal Tympany (Bloat) 473  
Traumatic Reticuloperitonitis 482  
Vagus Indigestion 490  
Diaphragmatic Hernia 496  
Traumatic Reticulopericarditis 497

Traumatic Reticulosplenitis and Reticulohepatitis 499  
Impaction of the Omasum 499

**DISEASES OF THE ABOMASUM 500**

Clinical Examination of the Abomasum 500  
Applied Anatomy and Pathophysiology of the Abomasum 501  
Abomasal Reflux 501  
Left-Side Displacement of the Abomasum 502  
Right-Side Displacement of the Abomasum and Abomasal Volvulus 510  
Abomasal Impaction in Cattle 515  
Abomasal Impaction in Sheep and Goats (Abomasal Emptying Defect) 517  
Abomasal Phytobezoars and Trichobezoars 518  
Abomasal Ulcers of Cattle 518  
Omental Bursitis 522  
Abomasal Bloat (Tympany) in Calves and Lambs 522

**DISEASES OF THE INTESTINES OF RUMINANTS 523**

Small and Large Intestinal Obstruction in Cattle 523  
Intestinal Obstruction in Sheep 528  
Terminal Ileitis of Lambs 528  
Cecal Dilatation and Cecocolic Volvulus in Cattle 528

**BACTERIAL DISEASES OF THE RUMINANT ALIMENTARY TRACT 531**

Actinomycosis (Lumpy Jaw) 531  
Actinobacillosis (Wooden Tongue) 532  
Oral and Laryngeal Necrobacillosis 534  
Enterohemorrhagic *Escherichia coli* in Farm Animals and Zoonotic Implications 536  
Braxy (Bradsot) 544  
Enteric Disease Associated With *Clostridium perfringens* 545  
Enterotoxemia Associated With *Clostridium perfringens* Type A 545

Enterotoxemia Associated With *Clostridium perfringens* Types B, C, and E 546

Jejunal Hemorrhage Syndrome (Hemorrhagic Bowel Syndrome, Hemorrhagic Jejunitis, or Jejunal Hematoma) in Cattle 549

Paratuberculosis (Johne's Disease): Cattle 552

Paratuberculosis (Johne's Disease): Sheep, Goats, Cervids, and Camelids 565

**VIRAL DISEASES OF THE RUMINANT ALIMENTARY TRACT 572**

Rinderpest (Cattle Plague) 572  
Peste Des Petits Ruminants (Goat Plague, or Kata) 573  
Bovine Viral Diarrhea, Mucosal Disease, and Bovine Pestivirus Disease Complex 577  
Winter Dysentery of Cattle 599  
Bovine Papular Stomatitis 601

**PARASITIC DISEASES OF THE RUMINANT ALIMENTARY TRACT 603**

Parasitic Gastroenteritis in Ruminants 603  
Hemonchosis in Ruminants 610  
Bunostomosis (Hookworm Disease) in Ruminants 613  
Oesophagostomosis (Nodule Worm Disease) in Ruminants and Pigs 615  
Chabertiosis 617  
Stomach Fluke Disease (Intestinal Amphistomosis) 617

**TOXIC DISEASES OF THE RUMINANT ALIMENTARY TRACT 618**

Nonprotein Nitrogen Toxicosis (Urea Toxicosis) 618  
Chemically Treated Natural Feeds 620

**DISEASES OF THE RUMINANT ALIMENTARY TRACT OF UNKNOWN CAUSE 621**

Chronic Inflammatory Bowel Disease of Sheep 621  
Salivary Abomasum Disease 621

**Diseases of the Forestomach of Ruminants**

Forestomach motility of ruminants, especially cattle, is of major concern to the veterinarian. Evaluation of forestomach motility is an integral part of the clinical examination

and differentiation of forestomach abnormalities into primary and secondary causes and is essential for diagnosis and accurate therapy. Application of the knowledge of the physiology of normal reticulorumen motility can improve the diagnosis, prognosis, and therapy for diseases of the forestomach. A brief review

of the clinical aspects of the motility of the reticulorumen is presented here.

**ANATOMY AND PHYSIOLOGY**

The ruminant forestomach compartments, consisting of the reticulum, rumen, and

omasum, are like a fermentation vat. The animal exerts some control over the fermentation process by selecting the feed, adding a buffer-like saliva, and providing continual agitation and mixing with specialized contractions of the forestomach. Reticulorumen motility ensures a consistent flow of partially digested material into the abomasum for further digestion.

The forestomach can be divided into primary structures such as the **reticulorumen and the omasum**, and they are functionally separated by a sphincter called the **reticuloomasal orifice**. The reticulorumen of an adult cow occupies almost the entire left half of the abdominal cavity and has a capacity of up to 90 kg of digesta. Because of its large size and ease of clinical examination, rumen motility is considered to represent digestive functions in the ruminant.

Both parasympathetic and sympathetic nerves supply the reticulorumen, but only the former nerves stimulate motility. Parasympathetic innervation occurs through the vagus nerve, which is predominantly sensory from the forestomach. Sympathetic innervation to the forestomach consists of numerous fibers from the thoracolumbar segment; these fibers join at the celiac plexus to form the splanchnic nerve. The splanchnic nerve can inhibit motility, but normally there is little or no tonic sympathetic drive to the forestomach.

### RETICULORUMEN MOTILITY

Four different specialized contraction patterns can be identified in the forestomach:

1. Primary or mixing cycle
2. Secondary or eructation cycle
3. Rumination (associated with cud chewing and associated with the primary cycle)
4. Esophageal groove closure (associated with sucking of milk)

It is important for the clinician to understand the motility pattern of each cycle. Specific diseases of the forestomach have characteristic alterations in motility, which aid in the diagnosis and prognosis.

#### Primary Contraction Cycle

The primary cyclic activity results in the mixing and circulation of digesta in an organized manner. The primary contraction in cattle begins with a **biphasic contraction of the reticulum**. The first reticular contraction forces ingesta dorsal and caudad into the rumen, as does the much stronger second reticular contraction. The dorsal ruminal sac then begins to contract as the ventral sac relaxes, causing digesta to move from the dorsal to the ventral sac. Sequential contractions of the caudoventral, caudodorsal, and ventral ruminal sacs force digesta back into the reticulum and cranial sac. After a brief pause the contraction sequence is repeated. During each reticular contraction fluid and food particles, particularly heavy grain, pass

into the reticuloomasal orifice and into the omasum and abomasum.

Reticulorumen motility results in stratification of ruminal contents, with firmer fibrous material floating on top of a more fluid layer. Solid matter remains in the rumen until the particle size is sufficiently small (1–2 mm in sheep, 2–4 mm in cattle) to pass through the reticuloomasal orifice. The size of digested plant fragments in ruminant feces can therefore be considered an indirect measurement of forestomach function.

Identification of ruminal contractions requires both auscultation and observation of the left paralumbar fossa. Sound is produced when fibrous material rubs against the rumen during contraction. Only slight sound is produced when the rumen contains small quantities of fibrous material.

External palpation of the rumen is valuable in determining the nature of ruminal contents. The normal rumen feels doughy in the dorsal sac and more fluid ventrally; the difference in consistency is attributable to stratification of ruminal contents. Very liquid ruminal contents that splash and fluctuate on ballottement (fluid-splashing sounds) are suggestive of lactic acidosis, vagal indigestion, ileus, or prolonged anorexia.

Rumen hypomotility or hypermotility is usually associated with a change in the type of sounds heard during auscultation, with gurgling, bubbling or distant rustling sounds replacing the normal crescendo–decrescendo crackling sounds. The rumen can be examined and evaluated using a combination of auscultation and simultaneous ballottement or percussion, by palpation through the left flank, and by rectal examination. Inspection and laboratory analysis of rumen contents is also possible.

#### Control of Primary Contractions

The primary contraction cycle of the reticulorumen is a complex and organized contraction that is initiated, monitored, and controlled by the gastric center in the medulla oblongata. These cycles are mediated by the vagus nerve. The reticulorumen is under extrinsic nervous control compared with the remainder of the gastrointestinal tract. It is also affected by hormones and smooth muscle tone.

The gastric center is bilaterally paired and located in the dorsal vagal nucleus in the medulla. It has no spontaneous rhythm of its own but acts as a processor and integrator of afferent information. Various excitatory and inhibitory inputs are brought together to determine both the rate and strength of contraction.

#### Ruminal Atony

**Ruminal atony**, seen in lactic acidosis and endotoxemia, can be attributed to one or more of the following factors:

- Direct depression of the gastric center, usually associated with generalized

depression and severe illness (toxemia)

- Absence of excitatory inputs to the gastric center
- Increase in excitatory inhibitory inputs to the gastric center
- Failure of vagal motor pathway (Table 8-1).

#### Hypomotility

**Hypomotility** is a reduction in the frequency or strength of extrinsic contractions, or both, and usually is caused by either a reduction in the excitatory drive to the gastric center or an increase in inhibitory inputs.

#### Properties of Contractions

The **frequency** of primary contractions is determined from information accumulated during the quiescent phase of motility. Frequency provides a rough estimate of the overall health of a ruminant. In cows, the frequency of primary contractions averages 60 cycles per hour but decreases to 50 cycles per hour during rumination and even lower when the cow is recumbent. Feeding increases the rate to up to 105 cycles per hour. Because of this variability, the clinician should auscultate the rumen for at least 2 minutes when determining the frequency of contractions.

The **strength and duration** of each contraction are determined by information obtained just before and during the contraction and are therefore more dependent on the nature of the forestomach contents than is frequency of contraction. The strength of contraction is subjectively determined by observing the movement of the left paralumbar fossa and assessing the loudness of any sounds associated with ruminal contraction.

The distinction between frequency and strength is important clinically, particularly in reference to therapy of reticulorumen hypomotility. When feed is withheld from sheep for 4 days, the rate of forestomach contractions remains unchanged, but the strength of contractions progressively decreases because of changes in ruminal contents.

#### Extrinsic Control of Primary Contractions

##### Excitatory Inputs to the Gastric Center

Tension and chewing movements are two major excitatory inputs to the gastric center. Low-threshold tension receptors deep in the circular smooth muscle layer detect reticulorumen distension. The greatest density of receptors is found in the medial wall of the reticulum and dorsal ruminal sac. These low-threshold tension receptors send afferent impulses along the dorsal or ventral vagus nerve to the gastric center in which they excite extrinsic reticulorumen contractions. Prolonged anorexia, leading to a smaller reticulorumen volume, decreases this excitatory input. Feeding increases reticulorumen

**Table 8-1** Effects of some common clinical excitatory and inhibitory influences on primary cycle movements of the reticulorumen

Clinical afferent input	Clinical findings and responses to treatment
<b>Excitatory inputs: low threshold reticular tension receptors</b>	
Increased reticular tension After feeding Mild ruminal tympany	Increases frequency, duration, and amplitude of primary cycle contractions and mixing promotes fermentation
Decreased reticular tension Starvation Anorexia	Decreases frequency, duration, and amplitude of primary cycle contractions and decreases fermentation
Lesions of medial wall of reticulum Chronic induration and fibrosis caused by traumatic reticuloperitonitis	Cause hypomotility of rumen contractions and may be an explanation for atony in some cases of vagus indigestion; some cases are characterized by erratic hypermotility
Acid receptors in abomasum Increases in abomasal acidity following emptying of organ	Increase primary cycle movements, which increases flow of ruminal contents into abomasum to maintain optimum volume and to decrease acidity
Buccal cavity receptors Following eating Inhibitory inputs	Increased reticulorumen activity
<b>High-threshold reticular tension receptors</b>	
Peak of reticular contraction Severe ruminal tympany Ruminal impaction with forage, hay, straw (not necessarily grain overload)	Depression of primary cycle movements, ruminal hypomotility, depression of fermentation because of failure of mixing
<b>Abomasal tension receptors</b>	
Impaction, distension or displacement of abomasum	Abomasal impaction, dilatation and volvulus may result in complete ruminal stasis; left-side displacement of abomasum usually does not cause clinically significant hypomotility
<b>Pain</b>	
Visceral pain caused by distension of abomasum or intestines; severe pain from anywhere in body	Moderate to total inhibition of reticulorumen movements possible with visceral pain. The degree of inhibition from pain elsewhere will vary
<b>Depressant drugs</b>	
Anesthetics, central nervous system depressants Prostaglandin E	Inhibition of primary and secondary cycle movements and of eructation, resulting in ruminal tympany
<b>Changes in rumen content</b>	
Marked decrease (<5) or increase (>8) in pH of ruminal fluid; engorgement with carbohydrates or protein-rich feeds	Inhibition of primary and secondary cycle movement and lack of fermentation; transfer ruminal fluid from a healthy animal promotes return to normal activity
Absence of protozoa in ruminal acidosis and in lead and other chemical poisoning	
<b>Changes in body water, electrolytes and acid-base balance</b>	
Hypocalcemia Dehydration and electrolyte losses, acidosis, and alkalosis	Inhibition of primary and secondary cycle movements and of eructation, resulting in ruminal tympany which responds to treatment with calcium
<b>Peritonitis</b>	
Traumatic reticuloperitonitis	Inhibition of primary and secondary cycle movements and of eructation, resulting in ruminal tympany; return of primary movements is good prognostic sign; lesions must heal without involvement of nerve receptors or adhesions that will interfere with normal motility
<b>Toxemia/fever</b>	
Peracute coliform mastitis Acute bacterial pneumonia	Inhibition of primary and secondary cycle movements, which return to normal with treatment of endotoxemia
<b>Ruminal distension</b>	
Early ruminal tympany	Increased frequency of secondary cycle movements and of eructation
<b>Covering of cardia (fluid or form)</b>	
Ruminal tympany Recumbent animal	Cardia does not open; failure of eructation, resulting in ruminal tympany; clearance of cardia results in eructation

*Most of the sensory inputs are transmitted to gastric centers in the dorsal vagal nerve nuclei from which the efferent outputs originate and pass down the vagal motor nerve fibers.*

*Source: modified from Leek BF. Vet Rec 1969; 84:238.*



volume, leading to a prolonged increase in forestomach motility.

Buccal receptors, which are stimulated during feeding, are also excitatory to the gastric center. These are mechanoreceptors, and their effect is mediated by the trigeminal nerve. This reflex increases the rate of primary contractions only but is short-lived and wanes with time. The stimulatory response of feeding also has a higher brain center component: the sight of feed can increase the frequency of primary contractions by 50% during a period of 4 to 5 minutes. Rumination, in comparison with feeding, is accompanied by a lower than normal primary contraction rate.

Other relatively minor excitatory inputs to the gastric center include milking, environmental cold, and a decrease in abomasal pH. Milking or udder massage of dairy goats markedly increases the frequency and strength of primary contractions. In a cold environment, the ruminant increases the frequency of forestomach contractions, maximizing the fermentation rate and helping to maintain body temperature.

### Inhibitory Inputs to the Gastric Center

The four most important inhibitory inputs to the gastric center are fever, pain, moderate to severe rumen distension, and increased ruminal volatile fatty acid concentrations.

#### Fever

Fever has been associated with decreased rumen motility. Endogenous pyrogens may cause prolonged forestomach hypomotility or atony often seen in cattle with endotoxemia caused by bacterial infections. Pyrogens directly affect the gastric center in the hypothalamus, and opioid receptors mediate their action.

#### Endotoxemia

Endotoxemia is common in cattle and often associated with fever, anorexia, and rumen atony. Inhibition of forestomach motility during endotoxemia is thought to be a combination of two different pathways: a prostaglandin-associated mechanism and a temperature-independent mechanism. The former can be attenuated by administration of nonsteroidal antiinflammatory drugs (NSAIDs). Therapy for endotoxin-induced hypomotility or atony includes the use of antimicrobials for the underlying cause of the inflammation and NSAIDs for the effects of the endotoxemia.

#### Pain

Pain may be associated with rumen hypomotility or atony. Painful stimuli act directly on the gastric center, although modification of reticulorumen motility in response to painful stretching of viscera can be partially attributed to catecholamine release. The sympathetic nervous system response to

pain can also stimulate splanchnic motor nerves, directly inhibiting reticulorumen motility.

Because of their stoic nature, the only clinical evidence of pain in ruminants may be anorexia and depressed forestomach motility. Prostaglandins have been implicated in increasing the sensitivity to pain both locally and centrally, and NSAIDs are indicated for alleviation of pain associated with inflammation. Other analgesics are of limited usefulness in the treatment of pain-induced forestomach hypomotility. Xylazine, an excellent sedative-analgesic for ruminants, causes a dose-dependent inhibition of reticulum contractions.

#### Distension of Forestomach

Moderate to severe forestomach distension exerts an inhibitory influence on reticulorumen motility. Epithelial receptors located in the ruminal pillars and papillae of the reticulum and cranial rumen sac respond to mechanical stimulation (stretch) as well as changes in ruminal volatile fatty acid concentration. These receptors, also known as high-threshold tension receptors, are stimulated continuously during severe rumen distension. The opposing actions of low- and high-threshold tension receptors help to control the fermentation process and maintain an optimum reticuloruminal volume. A good example of their activities is the motility changes evident with some forms of vagus indigestion.

#### Ruminal Volatile Fatty Acids

The ruminal volatile fatty acid concentration also influences forestomach motility. Epithelial receptors detect the concentration of nondissolved volatile fatty acids in ruminal fluid, which is normally high enough to produce a tonic inhibitor input to the gastric center. Volatile fatty acids in the reticulorumen exist in both the dissociated and nondissociated forms, with the degree of ionization governed by the rumen pH and the logarithm to the base 10 of the equilibrium acid dissociation constant (pKa) of each particular acid. Ruminal atony in animals with lactic acidosis results from elevated levels of nondissociated volatile fatty acids in ruminal fluid, with the decrease in rumen pH changing more of the volatile fatty acids into a nondissociated form. Systemic acidosis does not appear to contribute to ruminal atony, although increased volatile fatty acid concentrations in the abomasum may reduce forestomach motility.

#### Abomasal Disease

Diseases of the abomasum influence forestomach motility. Abomasal distension may contribute to the decreased forestomach motility often observed with abomasal volvulus (AV), impaction, or right-side dilatation. Abomasal tension receptors detect overfilling and reflexively decrease

reticuloruminal movements, reducing the rate of flow of ingesta into the abomasum. Ruminal hypomotility is not always observed in left-side displacement of the abomasum even though appetite may be decreased.

#### Effect of Depressant Drugs

General anesthetics and other depressant drugs acting on the central nervous system also inhibit reticulorumen motility by a direct effect on the gastric center.

#### Acid-Base Imbalance and Blood Glucose

Reticulorumen activity can be inhibited by alterations in blood pH, electrolyte imbalances, deprivation of water, and hyperglycemia.

#### Hormonal Control of Primary Contractions

Forestomach motility can be influenced by the action of hormones. Both cholecystokinin and gastrin can reduce feed intake and forestomach motility observed in sheep with certain intestinal nematodes.

### Intrinsic Control of Primary Contractions

The contribution of intrinsic smooth muscle tone to forestomach motility is not well understood. Intrinsic contractions are involved in maintaining normal reticulorumen tone, directly influencing the discharge of low-threshold tension receptors to the gastric center. Calcium is required for smooth muscle contraction, and hypocalcemia will usually cause ruminal atony. The administration of calcium borogluconate to cattle, sheep, and goats with hypocalcemia will restore rumen motility, and eructation commonly occurs after the intravenous administration of the calcium.

### Treatment of Forestomach Hypomotility

Anorexia and forestomach hypomotility usually exist together. Reduced feed intake reduces the two primary drives for reticulorumen activity: moderate forestomach distension and chewing activity. A wide variety of drugs have been used for many years to induce forestomach motility with the aim of stimulating anorexic cattle with forestomach hypomotility to begin eating. Most if not all of these drugs have been unsuccessful. Ruminatorics such as nux vomica, gentian, and tartar given orally have not been effective, but ginger shows potential promise as a prokinetic in cattle (see section on simple indigestion elsewhere in this chapter). Parasympathomimetics, such as neostigmine or carbamylcholine, should not be used to treat forestomach atony. Neostigmine requires vagal activity to be effective and therefore cannot incite normal primary contractions in atonic animals. Neostigmine may increase the strength

of a primary contraction without altering rhythm or coordination. Carbamylcholine causes hypermotility in sheep, but the contractions are uncoordinated, spastic, and functionless.

Any effective drug must be able to induce forestomach motility in a coordinated sequence so that the ingesta move through the reticuloomasal orifice, into the omasum, out of the omasum, and into the abomasum, and out of the abomasum into the small intestine. This means that there must be a coordinated sequence of contractions and relaxations of sphincters.

### Secondary Cycle Contraction and Eructation

Secondary cycles are contractions that involve only the rumen and are associated with the **eructation of gas**. They occur independently of the primary cycle contractions and usually less frequently (about once every 2 minutes). The contraction rate depends on the gas or fluid pressure in the dorsal sac of the rumen. Secondary cycles can be inhibited by severe distension of the rumen.

Normally, the dorsal sac of the rumen contains a pocket of gas composed of CO<sub>2</sub>, N<sub>2</sub>, and CH<sub>4</sub>. Gas is produced at a maximum rate of 1 L/min in cattle, with the rate depending on the speed of microbial degradation of ingesta. Eructation occurs during both primary and secondary contraction cycles, but most gas is removed during the latter. Eructation is capable of removing much larger quantities of gas than is produced at the maximum rates of fermentation; therefore free gas bloat does not occur because of excessive gas production but rather from insufficient gas elimination.

Ruminal contractions are essential for eructation. Tension receptors in the medial wall of the dorsal ruminal sac initiate the reflex by means of the dorsal vagus nerve. Contractions begin in the dorsal and caudodorsal ruminal sacs and spread forward to move the gas cap ventrally to the cardia region. Contraction of the reticulorumenal fold is necessary to stop fluid from moving forward to the reticulum and covering the cardia. Receptors in the cardia region detect the presence of gas; the cardia remains firmly closed if fluid or foam (as in frothy bloat) contacts it. Injury to the dorsal vagal nerve decreases the efficiency of eructation but either the ventral or dorsal vagus nerve alone can initiate enough eructation activity to prevent bloat.

Despite the presence of normal secondary contractions, eructation may not occur in recumbent animals when the cardia is covered with fluid. Bloat is often observed in ruminants in lateral recumbency. Eructation occurs after the animal stands or attains sternal recumbency as fluid moves away from the cardia. Bloat can also result from peritonitis, abscesses or masses that distort

the normal forestomach anatomy, and preventing active removal of fluid from the cardia region. Esophageal obstructions associated with intraluminal, intramural, or extraluminal masses are a common cause of free gas bloat. Passage of a stomach tube usually identifies these abnormalities, and forestomach motility is unimpaired unless the vagal nerve is damaged.

Bloat is often observed in cattle with tetanus. Distension of the rumen is usually not severe and can be accompanied by strong and regular ruminal contractions. Because the ruminant esophagus is composed of striated muscle throughout its length, tetanus-associated bloat may be caused by spasm of the esophageal musculature.

Persistent mild bloat is often observed in ruminants that have rumen atony or hypomotility secondary to systemic disease. Although the fermentation rate is lower than normal in these cases, ruminal contractions are not strong enough to remove all the gas produced. The bloat usually requires no treatment and resolves with return of normal forestomach motility.

Secondary contractions cannot be distinguished from primary contractions by auscultation of the left paralumbar fossa only, unless a synchronous belch of gas is heard. However, primary contractions can be identified by simultaneous palpation of the left paralumbar fossa and auscultation with the stethoscope over the left costochondral junction between the seventh and eighth ribs. Reticular contractions indicating the beginning of a primary contraction can be heard followed by contraction of the dorsal sac and lifting of the paralumbar fossa.

Secondary contractions are relatively autonomous and are not subject to the same central excitatory and/or inhibitory influences as are primary contractions. Agents that inhibit reticulorumen motility by a central action have a lesser effect on eructation than on primary contraction cycles. However, high doses of xylazine can inhibit secondary contractions, and the duration of inhibition is dose dependent.

No drugs are yet available to improve secondary contractions as a means of treating bloat. Severe bloat usually arises from mechanical or diet-related causes, and therapy should be directed specifically to those causes.

### Rumination

Rumination is a complex process and consists of the following:

- **Regurgitation**
- **Remastication**
- **Insalivation**
- **Deglutition**

Rumination is initiated by the rumination center close to the gastric center in the medulla oblongata. Rumination allows further physical breakdown of feed with the addition of large quantities of saliva and is an

integral part of ruminal activity. The time devoted to rumination is determined by the coarseness of ruminal contents and the nature of the diet. Rumination usually commences 30 to 90 minutes after feeding and proceeds for 10 to 60 minutes at a time, resulting in up to 7 hours per day spent on this activity.

The epithelial receptors located in the reticulum, esophageal groove area, reticulo-rumen fold, and ruminal pillars detect coarse ingesta and initiate rumination. The receptors can be activated by increases in volatile fatty acid concentration, stretching, and mechanical rubbing.

An intact dorsal or ventral vagus nerve is necessary for regurgitation to proceed. Regurgitation is associated with an extra contraction of the reticulum immediately preceding the normal reticular biphasic contraction of the primary cycle. The glottis is closed, and an inspiratory movement lowers the intrathoracic pressure. The cardia then relaxes, and the distal esophagus fills with ingesta. Reverse peristalsis moves the bolus up to the mouth in which it undergoes further mastication. Abnormal rumination can occasionally result in “dropped cuds,” during which the regurgitated bolus is dropped on the ground (Fig. 8-1).

The usual causes for a reduction or absence of rumination are the following:

- Reticulorumen hypomotility or atony
- Central nervous system depression
- Excitement, pain, or both
- Liquid ruminal contents such as a high-concentrate diet with no coarse fiber
- Mechanical injury to the reticulum (peritonitis)

Other less common causes include chronic emphysema (difficulty in creating a negative thoracic pressure) and extensive damage to the epithelial receptors that incite the reflex, as occurs in rumenitis.

Reticulorumen motility is required for rumination to proceed. The extra reticular contraction is not essential for regurgitation because fixation or removal of the reticulum does not prevent rumination from occurring. Rumination can be easily inhibited by higher brain centers, as disturbance of a ruminating cow often stops the process and is absent when animals are stressed or in pain. Milking commonly elicits rumination in cows and goats.

Pharmacologic stimulation of regurgitation is not attempted.

### Esophageal Groove Closure

The esophageal groove reflex allows milk in the sucking preruminant to bypass the forestomach and directs milk from the esophagus along the reticular groove and omasal canal into the abomasum. Milk initiates the reflex by chemical stimulation of receptors in the oral cavity, pharynx, and cranial esophagus. Once the reflex is established in neonatal





**Fig. 8-1 A and B,** Two-year-old Holstein Friesian heifer demonstrating dropped cuds while being retained in a head-gate. The heifer had a tooth root abscess.

ruminants, sensory stimuli (visual, auditory, and olfactory) can cause esophageal groove closure without milk contacting the chemoreceptors. This occurs in calves teased with milk or given water in an identical manner to which the calf previously received milk. The esophageal groove reflex continues to operate during and after the development of a functional rumen, provided the animal continues to receive milk.

Liquid administered to calves with an esophageal feeder (tube) does not cause groove closure. In calves younger than 3 weeks of age, overflow of liquid from the rumen into the abomasum begins when 400 mL of liquid are given. Thus if the goal of oral feeding is to ensure that fluid administration by esophageal tube rapidly enters the abomasum, more than 400 mL of liquid must be given.

Closure of the esophageal groove in cattle younger than 2 years of age can be induced by solutions of sodium chloride, sodium bicarbonate, or sugar. From 100 to 250 mL of 10% solution of sodium bicarbonate induces esophageal groove closure in 93% of cattle immediately and it lasts for 1 to 2 minutes. Any other oral solution administered during this time is directed into the abomasum to avoid dilution in the rumen. Closure of the groove may be used to treat abomasal ulcers if magnesium hydroxide or kaolin-pectin solutions are given orally immediately after a sodium bicarbonate solution.

## RUMINANT GASTROINTESTINAL DYSFUNCTION

Clinical findings that suggest primary ruminant gastrointestinal dysfunction include the following:

- Inappetence to anorexia, failure to ruminate.
- Dropping regurgitated cuds (see Fig. 8-1) occurs occasionally and is associated with teeth abnormalities including tooth root abscess, straw impaction of the rumen, vagus indigestion, esophageal dilatation, and rumenitis.
- Visible distension of the abdomen, which may be asymmetric or symmetric, dorsal or ventral, or both. Distension of the left dorsal abdomen because of ruminal tympany is most common.
- The abdomen may appear gaunt or empty.
- The rumen may feel abnormal on palpation through the left paralumbar fossa. It may feel more doughy than normal, distended with gas, fluid filled, or it may not be palpable.
- Ruminal atony or hypermotility observed visually and detectable on auscultation and palpation.
- Abdominal pain is usually subacute and characterized by humping of the back, reluctance to move, or acute colicky signs of kicking at the abdomen and stretching. Pain may also be detectable on deep palpation of the abdomen if there is peritonitis, either local or diffuse.
- Abnormal feces: they may be absent, reduced in amount or voluminous, and the composition may be abnormal. In carbohydrate engorgement the feces are usually increased in amount and are sweet-sour smelling. In most other diseases of the ruminant stomachs the feces are reduced in amount (scant), are pasty and foul-smelling, and appear overdigested because of the increased transit time in the alimentary tract. A complete absence of feces for 24 to



48 hours is not uncommon with diseases of the ruminant stomach and may be confused with an intestinal obstruction or the earliest stages of hypocalcemia in a recently calved mature cow,

- The temperature, heart rate, and respirations are variable and may be within normal ranges. With an inflammatory lesion such as acute peritonitis, a fever is usually present. In acute diffuse peritonitis with toxemia, the temperature may be normal or subnormal; in subacute and chronic peritonitis the temperature is

usually normal. In most other diseases of the ruminant stomachs except carbohydrate engorgement and abomasal volvulus, in which dehydration, acidosis and gastric infarction occur, vital signs may be within the normal range.

The differential diagnosis of the diseases associated with gastrointestinal dysfunction in cattle is summarized in [Table 8-2](#).

In contrast with most other parts of the ruminant alimentary tract, and with the stomach of nonruminants, specific lesions of the mucosa of the forestomachs are uncommon. Penetration of the reticular wall by

metallic foreign bodies is a common disease and is dealt with under the heading of traumatic reticuloperitonitis, but it is peritonitis that causes interference with ruminal motility. Rarely, there are actinomycotic or neoplastic lesions at the fundus of the reticulum that interfere with the proper functioning of the esophageal groove and lead to a syndrome of vagus indigestion described later. Rumenitis is common but only as a secondary change in acute carbohydrate engorgement and it is this that has such damaging effects on gut motility and fluid and electrolyte status and eventually kills most cows. The rumenitis may have a long-term effect

**Table 8-2** Differential diagnosis of causes of gastrointestinal dysfunction of cattle

Disease	Epidemiology and history	Clinical findings	Clinical pathology	Response to treatment
Simple indigestion	Dietary indiscretion, too much of a palatable, or indigestible, or change of, or damaged, or frozen food; can be outbreak. Consumption of excessive quantities of finely chopped straw	Simple gastrointestinal atony Voluminous feces during recovery Gross distension of the rumen and abdomen in straw impaction	All values normal Slight changes in ruminal acidity, should be self-buffered	Simple indigestion Excellent just with time Usually a mild purgative Rumenotomy necessary in case of straw impaction
Carbohydrate engorgement	Access to a large amount of readily fermentable carbohydrate when not accustomed; enzootic in high-grain rations in feedlots	Severe gastrointestinal atony with complete cessation of ruminal activity Fluid splashing sounds in rumen Severe dehydration, circulatory failure Apparent blindness, then recumbency and too weak to rise Soft odoriferous feces	Hemoconcentration with severe acidosis, pH of rumen juice <5, serum phosphorus concentration up to 3–5 mmol/L, serum calcium levels depressed No living protozoa in rumen	Intensive intravenous fluid and electrolyte therapy necessary for survival Rumenotomy or rumen lavage may be necessary Alkalinizing agents
Ruminal tympany	Frothy bloat on lush legume pasture or low-roughage feedlot ration, especially lucerne hay Free gas bloat secondary, occasionally primary on preserved feed	Gross distension of abdomen, especially high up on left. Sudden onset Severe pain and respiratory distress. Rumen hypermotility initially Liquid feces Resonance on percussion over rumen	None	Excellent if in time; stomach tube for free gas Froth-dispersing agent in frothy bloat Severe cases may require trocarization or emergency rumenotomy
Acute traumatic reticuloperitonitis	Exposure to pieces of metal. Sporadic; usually adult cattle	Sudden-onset reticulorumen atony, mild fever Pain on movement and deep palpation of ventral abdomen caudal to xiphoid Reduced amount of feces Lasts 3 days, then improvement begins	Neutrophilia and shift to left If no recovery after 3 days consider rumenotomy	Good response to antimicrobials for 3 days, magnet, immobilize in stall
Chronic traumatic reticuloperitonitis	Previous history of acute local peritonitis	Inappetence to anorexia; loss of weight; temperature, heart rate and respirations normal; rumen small and atonic, chronic moderate bloat common, feces scant, grunt may be detectable on deep palpation over xiphoid, reticular adhesions on laparotomy	Hemogram depends on stage and extent of inflammation	Antimicrobials for several days Consider rumenotomy Small percentage will respond
Vagus indigestion	May or may not have history of acute local peritonitis. Inappetence and progressive distension of abdomen during late pregnancy and no response to treatment with laxatives	Progressive distension of abdomen, scant soft sticky feces containing undigested feed, anorexia, rumen distended with well-macerated and frothy contents, persistent moderate bloat, hypermotile initially and atonic later, temperature normal, heart rate variable, large L-shaped rumen rectally, abomasal impaction in some, marked loss of weight, eventual recumbency, dehydration and weakness	Varying degree of dehydration, alkalosis, hypochloremia, and hypokalemia; increase in rumen chloride	Inadequate response to treatment medically or surgically Mild cases near term may respond spontaneously following parturition

Table 8-2 Differential diagnosis of causes of gastrointestinal dysfunction of cattle—cont'd

Disease	Epidemiology and history	Clinical findings	Clinical pathology	Response to treatment
Jejunal hemorrhage syndrome	Sporadic cases, sometimes several in one herd over a few months. History of sudden death or decreased milk production, anorexia, dark tarry feces, abdominal distension High-producing lactating dairy cattle, and beef cows. <i>Clostridium</i> sp. may be factor	Anorexia, abdominal discomfort, depression, abdominal distension, ping or fluid splashing sounds on ballottement over right abdomen, melena and distended loops of intestines on rectal examination. Black tarry feces	Dehydration, hypochloremia, hypokalemia fluid and electrolyte therapy, and surgery to remove damaged jejunum and obstructive luminal blood clot	Surgical treatment is occasionally successful if very early in disease course, but generally prognosis of affected cows is very poor
Rumen collapse syndrome	Diseases causing complete anorexia, fever, and toxemia for several days	Rectangular-shaped "pong" (low-pitched tympanic sound) in left paralumbar fossa; rumen pack not easily palpable through abdominal wall; on rectal examination can feel collapsed dorsal sac of rumen	None	Treat primary disease causing anorexia and ruminal stasis Rumen transfaunation often beneficial if primary cause identified and treated
Early hypocalcemia	Usually within 48 h following parturition in mature dairy cow	Anorexia, rumen hypotonic or atonic, scant or absence of feces for 12–24 h, temperature normal, heart rate increased and possibly arrhythmia, still milking and may appear normal in all other aspects	Total serum calcium <1.5 mmol/L	Good response to calcium administered intravenously or subcutaneously May require several hours to return to normal
Abomasal impaction (dietary)	Excessive intake of poor-quality roughage during cold weather outbreaks; cattle eating crops contaminated with sand or small stones	Anorexia, moderate abdominal distension, weight loss, scant feces, weak, recumbent Abomasum palpable through abdominal wall or rectally	Alkalosis, hypochloremia, hypokalemia, and dehydration	Excellent response to surgical treatment if impaction confined to pyloric antrum High case–fatality rate in advanced cases Fluids, laxatives Slaughter for salvage may be indicated
Left displaced abomasum	High-level grain diets, immediately postpartum, dairy cows, inactivity	Acetonemia in cow within days after parturition, inappetence, feces soft and amount variable (usually reduced) Ketonuria Rumen sounds present but faint Ping on percussion and auscultation of left upper abdomen between the 9th and 12th ribs and paralumbar fossa	Ketonuria	Excellent response following surgical correction unless concurrent hepatic lipidosis
Right displaced abomasum	Usually 2–4 weeks postpartum	Anorexia, scant feces, reduced milk production, moderate dehydration, rumen sluggish, fluid-filled viscus under right costal arch, ping over large area; tense viscus palpable per rectum in right lower quadrant, progressive and commonly results in volvulus	Alkalosis, hypochloremia, hypokalemia Calcium borogluconate intravenously and hay diet Surgery is immediately indicated. Prognosis good if treated early. Fluid therapy	Some recover spontaneously with medical therapy, but cannot definitively differentiate from abomasal volvulus without abdominal surgery.
Abomasal volvulus	Sequel to RDA	History of right displaced abomasum followed by sudden onset of acute abdominal pain, distension of right abdomen, loud ping Distended tense abomasum palpable per rectum in right lower quadrant, marked circulatory failure, weakness, bloodstained feces, death in 48–60 h if not treated surgically	Dehydration alkalosis, hypochloremia	Laparotomy and omentopexy, abomasotomy and drainage only if abomasum cannot be safely returned to its normal anatomic location Survival rate at least 75% if treated early Fluid therapy required
Primary acetonemia (wasting form)	Insufficient intake of energy in early lactation	Dullness, anorexia, reduced feces, lose body condition, milk yield down Rumen activity depressed	Ketonuria and hypoglycemia	Dextrose intravenously and propylene glycol orally, or intramuscular corticosteroids Usually excellent response

Continued

Table 8-2 Differential diagnosis of causes of gastrointestinal dysfunction of cattle—cont'd

Disease	Epidemiology and history	Clinical findings	Clinical pathology	Response to treatment
Acute intestinal obstruction	Often no particular history	Sudden onset, short period acute abdominal pain Kicking at belly, rolling Complete anorexia, failure to drink, and alimentary tract stasis. Progressive dehydration Distended loops of intestine may be palpable Gray to red foul-smelling rectal contents	Progressive dehydration and hemoconcentration over 3–4 days	Surgery is necessary
Idiopathic paralytic ileus	Few days postpartum, may be change in diet	Anorexia, complete absence of feces for 24–48 h; may detect ping over right flank	None	Usually recover spontaneously
Obstruction of small intestine by phytobezoars	Single animal usually Area prevalence may be high some years Depends on frequency of fibrous plants, e.g., <i>Romulea</i> spp.	Sudden onset acute abdominal pain Attack brief, often missed; then anorexia, ruminal stasis, heart rate increases to 120 beats/min over 3–4 days Abdomen distends moderately, splashing sounds and tympany right flank Rectal examination shows distended loops of intestine if obstruction in distal small intestine, may feel 5- to 6-cm diameter fiber ball; feces pasty, gray-yellow, foul-smelling, small amount only Untreated and fatal cases have course of 4–8 days	Hypochloremia, hypokalemia, severity depends on location	Depends on nature of phytobezoar: dense fiber balls require surgery, crumbly masses may pass after mineral oil for several days
Abomasal ulcer	Soon after (2 weeks) parturition High producers on heavy grain feed In intensive feeding systems disease is becoming enzootic in some areas	Gastrointestinal atony with melena and pallor May be sufficient blood loss to cause death; prompt recovery after 4 days more likely Perforation and rupture of ulcer leads to death in a few hours	Melena or occult blood in feces On perforation with local peritonitis may be leukocytosis and left shift Anemia caused by hemorrhage	Alkalinizing agents orally Surgery if medical treatment unsuccessful
Pregnancy toxemia of beef cattle	Fat beef cattle deprived of feed in last month of pregnancy Commonly have twin pregnancy	Complete anorexia, rumen stasis, scant feces, ketonuria, weak and commonly recumbent	Ketonia, increase in nonesterified fatty acids, ketonuria, increase in liver enzymes	Poor response to therapy Fluids, anabolic steroids, insulin
Fatty liver (fat cow) syndrome	Fat dairy cow, a few days following parturition or may have had LDA for several days	Complete anorexia, rumen stasis, almost no milk yield, ketonuria initially but may have more later	Ketonemia, increase in liver enzymes	Poor response to therapy in cattle that are not eating Oral propylene glycol, intravenous glucose, intramuscular corticosteroids
Cecal dilatation or cecocolic volvulus	Single case Dairy cow, early lactation, inappetence, feces may be scant Severe cases have history of mild abdominal pain	Systemically normal Rumen only slightly hypotonic, high-pitched ping on percussion over right upper flank, which may be distended Rectally enlarged cylindrical movable cecum with blind end can be felt	Nothing diagnostic, but has hemoconcentration, compensated hypochloremia, hypokalemia, and alkalosis	Good response to surgical correction Unfavorable prognosis with severe volvulus and gangrene of apex
Acute diffuse peritonitis	Following acute traumatic reticuloperitonitis, uterine rupture at parturition, rupture of rectum, postsurgical	Acute toxemia, fever followed by hypothermia, weakness, tachycardia, recumbency, groaning, moderate distension, scant feces; palpate fibrinous adhesions rectally	Leukopenia, neutropenia, degenerative left shift Hemoconcentration Paracentesis positive	Usually die
Chronic ruminal tympany in feeder calves	Beef calves 6–8 months of age following weaning; feeder cattle after arrival in feedlot	Chronic free-gas bloat, relapses after treatment, no other clinical findings	None	Good response to surgical ruminal fistula or insertion of corkscrew-type trocar and cannula left in place for a few weeks
Omasal impaction	Uncommon Single cases in pregnant cows with vagus indigestion Feedlot cattle with abomasal impaction dietary in origin	Inappetence to anorexia Scant feces, abdominal distension Rectally, large distended round hard viscus below kidney can be felt	None	Effectively impossible to confirm diagnosis without exploratory laparotomy Slaughter for salvage Treat for abomasal impaction



on ruminal motility, but its main significance is as a portal for infection leading to the development of hepatic abscesses. Ingested animal hairs, plant spicules, and fibers are also credited with causing rumenitis, but no clinical signs have been associated with the lesions. Because of the high prevalence of rumenitis lesions in cattle on heavy concentrated feed, especially when the feed is awned barley, the awns have been incriminated as traumatic agents. In acute arsenic poisoning there is an early postmortem dehiscence of the ruminal mucosa but no apparent lesions during life.

Other lesions of the forestomachs are parakeratosis, discussed later in this chapter, and villous atrophy, sometimes encountered in weanling ruminants on special diets low in fiber, even succulent young pasture, but these are not known to influence stomach function or motility. The factors that principally affect ruminal motility are those chemical and physical characteristics of its contents that are dealt with in simple indigestion and acute carbohydrate engorgement. Lesions in, and malfunctioning of, the abomasum are much more akin to abnormalities of the stomach in monogastric animals.

Some of the physiologic factors that affect reticulorumen function and the clinical factors, which cause reticulorumen dysfunction, are summarized in Table 8-1. When reticulorumen hypomotility is present, the problem is to decide if the cause is directly associated with the forestomach and abomasum, or both, or other parts of the alimentary tract, or if the cause is from an abnormality of another system. Differentiation requires a careful clinical examination, including simple laboratory evaluation of the rumen contents.

The factors that affect the motility of the rumen are presented in the section on simple indigestion, as are the principles of treatment in cases of ruminal atony.

### FURTHER READING

Constable PD, Hoffsis GF, Rings DM. The reticulorumen: normal and abnormal motor function. Part I. Primary contraction cycle. *Compend Contin Educ Pract Vet.* 1990;12:1008-1014.

Constable PD, Hoffsis GF, Rings DM. The reticulorumen: normal and abnormal motor function. Part II. Secondary contraction cycles, rumination, and esophageal groove closure. *Compend Contin Educ Pract Vet.* 1990;12:1169-1174.

## Special Examination of the Alimentary Tract and Abdomen of Cattle

When gastrointestinal dysfunction is suspected, a complete special clinical and laboratory examination may be necessary to determine the location and nature of the

lesion. A systematic method of examination is presented here.

### HISTORY

A complete history with as much detail as is available should be obtained. The stage of the pregnancy-lactation cycle, days since parturition, the nature of the diet, the speed of onset, and the duration of illness may suggest diagnostic possibilities. An accurate description of the appetite will suggest if the disease is acute or chronic. The previous treatments used and the response obtained as well as any evidence of abdominal pain and its characteristics should be determined. The nature and volume of the feces may suggest enteritis or alimentary tract stasis.

### SYSTEMIC STATE, HABITUS, AND APPETITE

The vital signs indicate the severity of the disease and suggest whether it is acute, subacute, or chronic. In acute intestinal obstruction, AV, acute diffuse peritonitis, and acute carbohydrate engorgement, the heart rate may be 100 to 120 beats/min and dehydration is usually obvious. **Pallor of the mucous membranes** is an indicator of alimentary tract hemorrhage, especially if there is concurrent **melen**a. If cattle with any of these diseases are recumbent and unable to stand, the prognosis is usually unfavorable. A marked increase in the rate and depth of respirations associated with alimentary tract disease usually indicates the presence of fluid or electrolyte disturbances and possible subacute pain. **Grunting or moaning** suggests abdominal pain associated with distension of a viscus or acute diffuse peritonitis.

The **appetite** and the **presence or absence of rumination** is very reliable indicators of the state of the alimentary tract, including the liver. Complete anorexia persisting for more than 3 to 5 days is unfavorable. The return of appetite and rumination with chewing of the cud following medical or surgical treatment for alimentary tract disease is a favorable prognostic sign. Persistent inappetence suggests a chronic lesion, which usually has an unfavorable prognosis.

### ORAL CAVITY AND ESOPHAGUS

The oral cavity is easily examined by inspection and manual palpation with the aid of a suitable mouth speculum. The patency of the esophagus is determined by passage of a stomach tube into the rumen through the oral cavity, with the aid of a cylindrical metal speculum, or through the nasal cavity. The cylindrical metal speculum should always have a rope or chain handle on one end so that the veterinarian can maintain hold of the speculum while passing a stomach tube

into the rumen. Adult cattle can swallow a 45-cm (18-inch) long metal speculum, and then a rumenotomy is required to remove the speculum from the thoracic portion of the esophagus.

### INSPECTION OF THE ABDOMEN

The **contour** or **silhouette of the abdomen** should be examined from the rear and each lateral region viewed from an oblique angle. Examination of the contour can assist in determining the cause of abdominal distension, which may be **unilateral**, **bilaterally symmetric**, or **asymmetric** or more prominent in the dorsal or ventral half. Recognition of the anatomic region of maximum distension suggests diagnostic possibilities, which are shown in Fig. 8-2. The differential diagnosis of abdominal distension of cattle is summarized in Table 8-3.

### DISTENSION OF THE ABDOMEN

The cause of distension of the abdomen of cattle is determined by a combination of the following examinations:

- Inspection of the contour or silhouette of the abdomen to determine the region of maximum distension.
- If necessary, relief of rumen contents with a stomach tube to determine whether the distension is caused by an enlarged rumen. The ruminal contents can also be examined grossly at the same time.
- Percussion or ballottement and simultaneous auscultation to detect fluid-splashing sounds indicating the presence and location of gas-filled and fluid-filled viscera.
- Palpation per rectum to feel any obvious enlargements or abnormalities.
- Abdominocentesis to determine the nature and amount of peritoneal fluid, which may indicate the presence of ischemic necrosis of intestines or peritonitis.
- Trocarization of severely gas-filled distended regions that are impeding respiration, such as an AV in a calf.

### LAVAGE OF DISTENDED RUMEN

In adult cattle presented with severe abdominal distension caused by gross distension of the rumen it is difficult, if not impossible, to assess the status of the abdomen. To determine whether the rumen is distended and/or to relieve the pressure, a large-bore stomach tube should be passed into the rumen. In vagus indigestion, the rumen may be grossly distended with fluid contents that will gush out through a large-bore tube. In some cases 100 to 150 L of rumen contents may be released. If no contents are released, the contents may be frothy or mushy and the rumen end of the tube will plug almost instantly. Rumen lavage may then be attempted using a water hose to deliver 20 to 40 L of water at

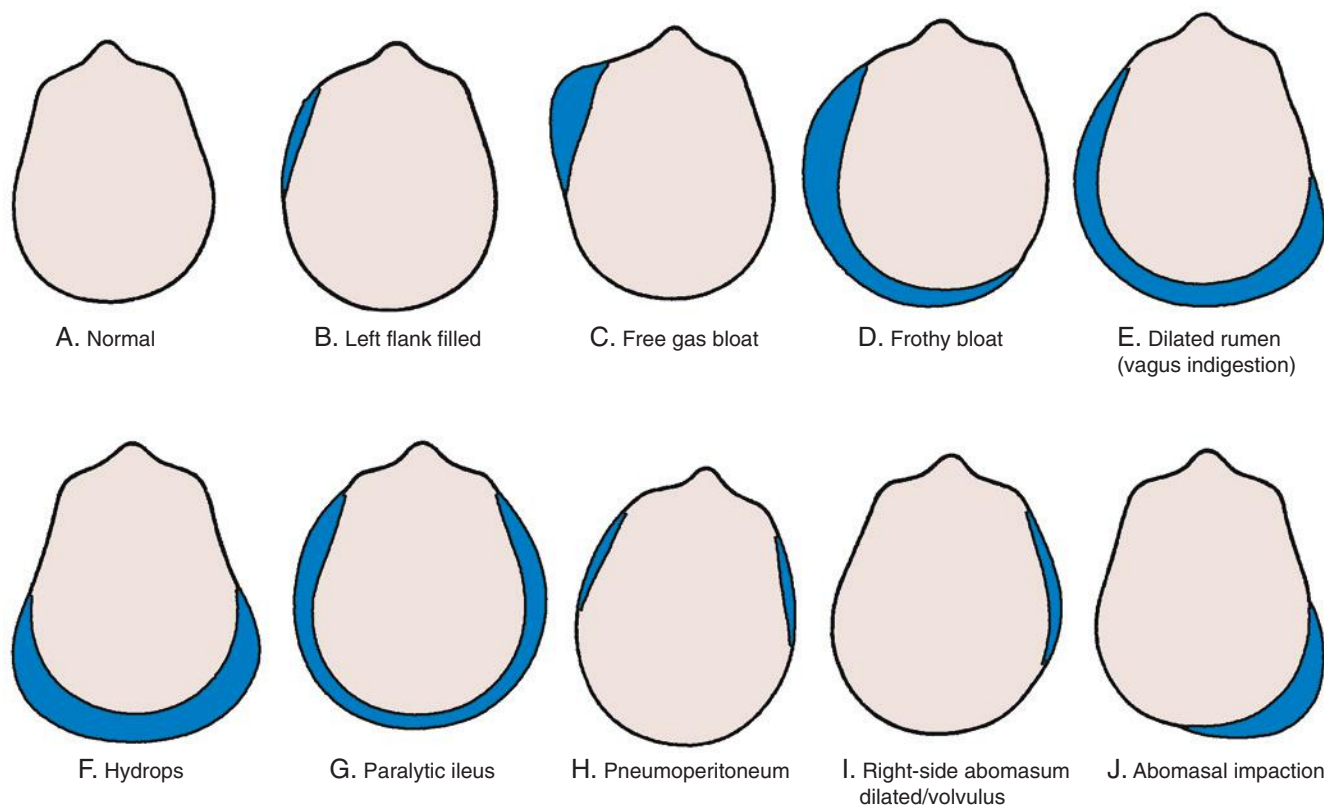

**Fig. 8-2** Silhouettes of the contour of the abdomen of cattle, viewed from the rear, with different diseases of the abdominal viscera. *a*, normal; *b*, left flank filled; *c*, free-gas bloat; *d*, frothy bloat; *e*, dilated rumen (vagus indigestion); *f*, hydrops; *g*, paralytic ileus; *h*, pneumoperitoneum; *i*, right-side abomasal dilation/volvulus; *j*, abomasal impaction. (From Stober M, Dirksen G. *Bovine Pract* 1977; 12:35-38.)

a time, followed by back drainage by gravity flow. After the rumen is partially emptied, it is usually possible to more accurately assess the rumen and the abdomen.

## LEFT SIDE OF ABDOMEN AND RUMEN

### Inspection and Palpation

The **primary and secondary cycle contractions** of the reticulorumen are identified by simultaneous auscultation, palpation, and observation of the left paralumbar fossa and the left lateral abdominal region. During contractions of the rumen there is an alternate rising and sinking of the left paralumbar fossa in conjunction with **abdominal surface ripples**. The ripples reflect reticulorumen contractions and occur during both the **primary** (or mixing) cycle contraction and the **secondary** (or eructation) cycle contractions. As the left paralumbar fossa rises during the first part of the primary cycle contraction, there are two horizontal ripples that move from the lower left abdominal region up to the paralumbar fossa. When the paralumbar fossa sinks, during the second part of the primary cycle, the ripple moves ventrally and fades out at the lower part of the left abdominal region. Similar ripples follow up and down after the rising and sinking of the

paralumbar fossa associated with the secondary cycle movements.

In early **vagus indigestion**, there may be three to five vigorous incomplete contractions of the reticulorumen per minute. These contractions may not be audible because the rumen contents are porridge-like and do not cause the normal crackling and rustling sounds of a rumen containing coarse fibrous ingesta. **However, the contractions are visible and palpable as waves of undulations of the left flank. If reticulorumen motility is assessed only on the basis of inspection and palpation, the results will be misleading.**

### Nature of Rumen Contents

The nature of the rumen contents can be assessed by palpation of the rumen through the left paralumbar fossa. In the roughage-fed animal, the rumen contents are doughy and pit on pressure. In cattle that have consumed large quantities of unchopped cereal grain straw, the rumen is large and the contents feel very firm but not hard, and they always pit on pressure. In the dehydrated animal the contents may feel almost firm. In the grain-fed animal the contents may be soft and porridge-like. When the rumen contains excessive quantities of fluid, the left flank

fluctuates on deep palpation. In the atonic rumen distended with excess gas, the left flank will be tense, resilient, and tympanitic on percussion.

In mature cattle that have been anorexic for several days, the rumen may be smaller than normal and the dorsal sac will be collapsed (**rumen collapse**). There will be a “pong” (low-pitched ping) in the left upper abdomen extending dorsally to the transverse processes of the lumbar vertebrae, lack of abdominal distension, absence of fluid on succession of the area of the ping, and on rectal palpation the dorsal sac of the rumen will feel collapsed.

### Auscultation of the Rumen and Left Flank

In the normal animal on a roughage diet there are two independent contraction sequences of the reticulorumen. The **primary cycle** recurs approximately every minute and consists of a **diphasic contraction of the reticulum** followed by a **monophasic contraction of the dorsal ruminal sac** and then by a **monophasic contraction of the ventral ruminal sac**. These movements are concerned primarily with “mixing” the rumen contents and with assisting the passage of rumen contents into the omasum.

**Table 8-3** Differential diagnosis of abdominal distension in cattle

Cause	Major clinical findings and methods of diagnosis
<b>Distension of rumen</b>	
Acute ruminal tympany	Marked distension of left abdomen, less of right; very tense distended left paralumbar fossa, dull resonance on percussion; pass stomach tube and attempt to relieve gas or froth
Vagal indigestion	Marked distension of left abdomen, less of right “papple-shaped” abdomen; fluctuating rumen on palpation; excessive rumen activity or complete atony; large L-shaped rumen on rectal examination; pass large-bore stomach tube to remove contents to aid in diagnosis
Acute ruminal acidosis	Moderate distension of left flank, less of right; rumen contents are doughy or fluctuate; fluid-splashing sounds may be audible on ballottement; rumen static and systemic acidosis; rumen pH below 5
Simple indigestion	Moderate distension of left flank; rumen pack easily palpable and doughy; contractions may be present or absent depending on severity; systemically normal
<b>Distension of abomasum</b>	
Right displaced abomasum and abomasal volvulus	Right flank and paralumbar fossa normal to severely distended; ping; rectal palpation of fluctuating or tense viscus in right lower quadrant
Abomasal impaction	Right lower flank normal to moderately distended; doughy viscus palpable caudal to costal arch; rectal palpation feel doughy viscus in right lower quadrant
Left displaced abomasum	Abdomen usually gaunt; occasionally distended left paralumbar fossa because of displaced abomasum; ping on percussion over upper aspects of ribs 9–12
Abomasal trichobezoars	Older calves (2–4 months); right lower flank distended; fluid-splashing sounds; painful grunt on deep palpation Confirm by laparotomy and abomasotomy
<b>Distension of intestines</b>	
Enteritis	Slight to moderate distension of right abdomen; fluid-rushing and splashing sounds on auscultation and ballottement Diarrhea and dehydration
Intestinal obstruction	Slight to moderate distension of right abdomen; fluid tinkling, percolating, and splashing sounds on auscultation and ballottement; may palpate distended loops of intestine or intussusception rectally; scant dark feces; paracentesis abdominis
Paralytic ileus	Slight to moderate distension of right abdomen; tinkling sounds on auscultation; tympanitic ping on percussion Loops of distended intestine palpable per rectum; scant feces but recover if no physical obstruction
Cecal dilatation and cecocolic volvulus	Right flank may be normal or moderately distended; ping present in right paralumbar fossa; palpate movable blind end cecum on rectal examination (cecal dilatation) or multiple loops of distended large intestine (ceocolic volvulus); confirm by laparotomy
<b>Enlargement of uterus</b>	
<b>Physiologic</b>	Gross distension of both flanks, especially right; normal pregnancy with more than one fetus; may palpate rectally
<b>Pathologic</b>	
Hydrops amnion	Gradual enlargement of lower half of abdomen in late gestation; flaccid uterus; fetus and placentomes are easily palpable per rectum
Hydrops allantosis	Gradual distension of lower half of abdomen in late gestation; palpable uterus rectally, cannot palpate placentomes or fetus
<b>Fetal emphysema</b>	History of dystocia or recent birth of one calf, twin in uterus and emphysematous; diagnosis obvious on vaginal and rectal examination
<b>Fluid accumulation in peritoneal cavity</b>	
<b>Ascites</b>	
Congestive heart failure, ruptured bladder	Bilateral distension of lower abdomen; positive fluid waves; paracentesis abdominis; may feel enlarged liver behind right costal arch
<b>Pneumoperitoneum</b>	
Perforated abomasal ulcer, postsurgical laparotomy	Not common; bilateral distension of dorsal half of abdomen; ping both sides

The **secondary cycle** movements occur at intervals of about 2 minutes and are confined to the rumen and consist of a **contraction of the dorsal sac** followed by a **contraction of the ventral sac**. The former causes the fluid contents of the dorsal sac to be forced ventrally and the gas layer to be forced cranially to the region of the cardia in which eructation takes place. Contractions of the dorsal and ventral sacs cause undulations of the left paralumbar fossa and lower flanks that are readily visible and palpable.

The clinical recognition of the presence or absence of either the primary cycle or secondary cycle contractions or both may aid in determining the cause and severity of the disease and the prognosis. These are outlined in [Table 8-1](#).

#### Auscultation of Rumen

To auscultate the rumen, the stethoscope is placed in the middle of the left paralumbar fossa. After two complete contractions have occurred, the stethoscope is moved cranially

in the fossa and cranial to the fossa over the dorsal third of the 10th to 13th ribs to determine whether rumen contractions are audible in the region, which commonly becomes occupied with a left-side displacement of the abomasum. In the normal animal, ruminal contractions *are* audible in this region.

The **type, strength, and frequency of rumen movements should be noted**. The rumen sounds of the normal animal consuming roughage are rasping, rustling, exploding, and booming-crackling sounds.



When the rumen contains less coarse roughage or primarily grain, the sounds may be much less distinct but still possess a crackling characteristic.

#### *Fluid-Tinkling or Fluid-Splashing Sounds*

The presence of fluid-tinkling or fluid-splashing sounds over the left paralumbar fossa, usually along with an atonic rumen, suggests the presence of an excessive quantity of liquid contents in the rumen and that the coarse ingesta is not floating on the fluid layer of the rumen contents as in the normal animal. Fluid-splashing sounds suggest diseases such as grain overload or an atonic rumen associated with prolonged anorexia (chronic diffuse peritonitis and abomasal or omasal impaction). Fluid-splashing and fluid-tinkling sounds can also be elicited by ballottement and simultaneous auscultation of the left lower flank in left-side displacement of the abomasum, because of its liquid contents. To assist in the differential diagnosis, the outline of the rumen can be auscultated and percussed to observe a much wider area of metallic sound than is normally expected in left-side displacement of the abomasum.

In early **vagus indigestion** with an enlarged hypermotile rumen, the contractions of the rumen occur more frequently than normal, at 3 to 6 contractions per minute, and are easily visible as prominent abdominal ripples over the left flank. Characteristically, the **ruminal sounds are usually not audible** or barely so because the rumen contents are homogeneous and porridge-like as a result of prolonged maceration in the rumen. The absence of coarse fiber in the ingesta and the lack of coordinated reticulorumen primary and secondary contractions minimize the intensity of the ruminal sounds. The lack of effective secondary cycle contractions and eructation results in frothy bloat. Complete atony and gross distension of the rumen is characteristic of advanced vagus indigestion.

**Percussion and simultaneous auscultation** of the left paralumbar fossa over an area extending from the midpoint of the 9th rib to the 13th rib is used to detect the presence of a “**ping**” or high-pitched metallic tympanic sound associated with left-side displacement of the abomasum. Percussion is performed with a flick of the flexed finger or most reliably with a percussion hammer. The **causes of pings on percussion of the left abdomen in mature cattle** include **left-side displacement of the abomasum, atonic rumen** and, rarely, **pneumoperitoneum**. The tympanic sound associated with an atonic rumen is lower-pitched than that associated with a left-side displacement of the abomasum and may be called a **pong**.

For special investigations of reticulorumen motility radiotelemetry capsules that measure motility, ruminal pH, and temperature can be placed in the rumen.

## RIGHT SIDE OF ABDOMEN

The contour of the right side of the abdomen should be examined by **inspection** for evidence of distension, which may be caused by a **viscus filled with fluid, gas, or ingesta; ascites**; or a **gravid uterus**. In severe distension of the rumen, the ventral sac may also distend the lower half of the right flank.

A combination of deep palpation, ballottement and simultaneous percussion and auscultation, and succussion (slightly rocking the animal from side to side) is used to detect the presence of viscera that are distended with gas and/or fluid, or ingesta.

The causes of **pings** audible on auscultation and percussion over the right abdomen include the following:

- Right-side dilatation and volvulus of the abomasum
- Cecal dilatation and cecocolic volvulus
- Obstruction of the spiral colon
- Gas-filled descending colon and rectum in a cow with persistent tenesmus
- Intestinal tympany of unknown etiology
- Volvulus of the root of the mesentery in young calves
- Intussusception causing intestinal tympany
- Pneumoperitoneum
- Postpartum intestinal tympany, which occurs in the postparturient cow (for the first few days following parturition)

The causes of fluid-splashing sounds on ballottement and auscultation of the right flank include the following:

- **Fluid-filled intestines in acute intestinal obstruction and enteritis**
- **Fluid-filled abomasum in right-side dilatation, but more prominently in AV.**

**Palpation of a firm viscus in the right flank** caudal or ventral to the right costal arch may be caused by the following:

- **Enlarged ventral sac of the rumen, which extends over to the right abdominal wall**
- **Abomasal impaction**
- **Omasal impaction**
- **Enlargement of the liver; the liver must be grossly enlarged before it is palpable caudal to the right costal arch**

A **rectal examination** is necessary to identify the distended viscus associated with these abnormal sounds, and often a laparotomy is required.

## EXAMINATION OF RUMEN FLUID

Examination of the rumen fluid is often essential to establish an accurate diagnosis of diseases of the forestomach. Rumen fluid can be obtained with a stomach tube passed into the rumen, with the fluid being withdrawn with the vacuum of a stomach pump. The major difficulty is avoiding contamination of the sample with saliva, which can be avoided if a free flow of fluid is obtained. Specialized stomach tubes are available that are weighted

and can be directed into the ventral sac to collect up to 500 mL of fluid. Rumen fluid samples can also be obtained by **rumenocentesis**, which is percutaneous aspiration of the ventral sac of the rumen on the lower left ventrolateral abdominal quadrant, horizontal with the patella, and 20 cm caudal to the last rib. The site is prepared, xylazine sedation given, and a 12- to 15-cm 14- or 16-gauge needle is thrust firmly and quickly perpendicular to the skin into the rumen. Rumen fluid is quickly withdrawn with a syringe and pH is measured immediately with a portable pH meter or wide-range pH paper (pH values of 2–12).

## ANALYSIS OF RUMEN FLUID

The **color**, depending on the feed to a limited extent, will be a green, olive green, or brown green. At pasture, the color is very green, with root crops the color tends to be gray, and with silage or straw the color is mostly yellow-brown. The color of the rumen contents is milky-gray in grain overload and greenish-black in cases in which rumen stasis is of long duration and in which putrefaction is occurring within the rumen.

The **consistency** of the rumen fluid is normally slightly viscid, and watery rumen contents are indicative of inactive bacteria and protozoa. **Excess froth** is associated with frothy bloat as in primary ruminal tympany or vagus indigestion. The odor is normally aromatic and, although somewhat pungent, not objectionable to the nose. A  **moldy, rotting odor** usually indicates protein putrefaction, and an intensely sour odor indicates an excess of lactic acid formation, which is caused by grain or carbohydrate engorgement.

The **pH of the rumen fluid** varies according to the type of feed and the time interval between the last feeding and taking a sample for pH examination. The **normal range, however, is between 6.2 and 7.2**. **High pH values (>8.0)** will be observed when putrefaction of protein is occurring in the rumen or if the sample is mixed with saliva. **Low pH values (4–5)** are found after the feeding of carbohydrates. Generally, a value below 5 indicates carbohydrate engorgement, and this pH level will be maintained for 6 to 24 hours after the animal has actually consumed the carbohydrate diet.

For experimental purposes, continuous monitoring of the pH of the rumen contents is possible with a pH probe containing a commercial microelectrode and a reference-electrode with a pressure-equalizing system placed in the reticulum. By feeding diets with changing composition it is possible to provoke marked changes in rumen pH. The probes are programmed to sample pH and temperature every 30 seconds.

**Microscopic examination** of a few drops of rumen fluid on a glass slide with a low-power field will reveal the level of protozoan activity. Normally five to seven protozoans are active per low-power field. In lactic

acidosis the protozoa are usually absent, or a few dead ones are visible. The rumen fluid can be stained with Gram stain to determine the predominant bacterial flora, which are normally gram-negative but in grain overload become gram-positive.

**Chloride** concentration can be determined by centrifuging the fluid and analyzing the supernatant for chloride levels. These are normally 10 to 25 mEq/L in cattle and <15 mEq/L in sheep. Elevated rumen chloride concentrations result from abomasal reflux, ileus, or high salt intake. Current laboratory analyzers that use ion-selective potentiometry to measure chloride concentration are not accurate when measuring rumen chloride concentration. This is because the electrode is also sensitive to acetate and bicarbonate concentration; typical concentrations of these anions in rumen fluid often result in erroneously high rumen chloride values when measured using ion-selective potentiometry.

### **PALPATION PER RECTUM OF THE ABDOMEN**

Some of the specific abnormalities of the digestive tract, which are commonly detected on palpation per rectum, include the following, which relates to Fig. 8-3, *a-l*, illustrating the abnormalities through a transverse section of the abdomen.

- (a) Normal.
- (b) L-shaped rumen: occurs commonly in vagus indigestion and other diseases of the rumen characterized by gradual distension of the rumen.
- (c) Cecocolic volvulus: commonly palpable as long distended organ, usually movable, may feel the blind end.
- (d) Abomasal volvulus: commonly palpable as tense viscus in lower right half of abdomen.
- (e) Abomasal impaction: not usually palpable per rectum except in extreme cases in which it needs to be differentiated from an enlarged ventral sac of the rumen. This is most easily accomplished by monitoring the location of the viscus over a 2-minute period; typically during this time interval the ventral ruminal sac will contract at least once and move away from the hand.
- (f) Left-side displacement of the abomasum: usually cannot palpate the displaced abomasum but can often feel rumen, which is usually smaller than normal and may be displaced a little to the right side of the midline.
- (g) Intussusception: only palpable per rectum in approximately 25% of cases; the ability to detect is dependent on the location of intussusception and the size of the animal.
- (h) Mesenteric volvulus: usually tight bands of mesentery are palpable, along

with distended loops of small intestine.

- (i) Intestinal incarceration: rarely palpable.
- (j) Peritonitis: only palpable if peritoneum of posterior aspect of abdomen is affected.
- (k) Lipomatosis: commonly palpable as “bricks” in the abdomen and pelvic cavity.
- (l) Omental bursitis: not common and usually not palpable per rectum.

In Fig. 8-3, *m-p* is included for the differential diagnosis of the diseases each represents.

As part of the differential diagnosis of digestive tract disease in the postparturient cow, the uterus should be examined carefully for evidence of retained placenta and metritis. Both vaginal and rectal examinations should be performed. The toxemia caused by retained fetal membranes and postpartum metritis may cause anorexia, rumen stasis, paralytic ileus, scant feces, and sometimes an **idiopathic postpartum ping in the right flank**, all of which may be misinterpreted as a primary digestive tract disease.

### **GROSS EXAMINATION OF FECES**

The gross appearance of the feces of cattle is not only an indicator of disease of the digestive tract but can provide valuable clues for the differential diagnosis of disease elsewhere.

#### **AMOUNT**

In adult cattle, the passage of ingesta through the digestive tract takes 1.5 to 4 days. Mature cattle generally pass some feces every 1.5 to 2 hours, amounting to a total of 30 to 50 kg/day in 10 to 24 portions.

A **reduction in the bulk of feces** can be caused by a decrease in feed or water intake or a retardation of the passage through the alimentary tract. In diarrhea, the feces are passed more frequently and in greater amounts than normal and contain a higher water content (>90%) than normal.

#### **ABSENCE OF OR SCANT FECES**

Failure to pass any feces for 24 hours or more is abnormal, and the continued absence of feces may be caused by a physical intestinal obstruction. However, in many cases the intestine is not physically obstructed; instead, there is a functional obstruction. Diseases causing disturbances of motility of the rumen and abomasum often result in a relative absence of feces. Paralytic ileus of the intestines caused by peritonitis or idiopathic intestinal tympany also results in a marked reduction in feces, sometimes a complete absence, for up to 3 days. The marked reduction of feces that occurs in functional obstruction is a major source of diagnostic confusion because it resembles physical obstructions of the intestines. The causes of physical and functional obstruction of the

alimentary tract of cattle are summarized in Fig. 8-4.

#### **COLOR**

The color of the feces is influenced by the nature of the feed, the concentration of bile in the feces, and the passage rate through the digestive tract. Calves reared on cows' milk normally produce gold-yellow feces, which become pale brown when hay or straw is eaten. The feeding of milk substitutes adds a gray component to a varying degree.

The feces of adult cattle on green forage are dark olive-green, on a hay ration more brown-olive, and the ingestion of large amounts of grain produces gray-olive feces. A retardation of the ingesta causes the color to darken. The feces become ball-shaped and dark brown with a shining surface caused by a mucous coating. Diarrheic feces tend to be paler than normal because of their higher water content and lower concentration of bile.

The presence of large amounts of bile produces a dark olive-green to black-green color such as in cattle with hemolytic anemia. In cattle with obstruction of the common bile duct, the feces are pale olive-green because of the absence of bile pigments.

**Blood** in the feces may originate from the following locations:

- Hemorrhage into the abomasum: acute hemorrhage usually appears as black, tarry feces (**melena**); chronic hemorrhage as occult blood.
- Hemorrhagic enteritis of small intestines: the feces are uniformly dark red.
- Hemorrhagic enteritis of the large intestines: in the cecum or colon, blood appears evenly distributed throughout the feces (**dysentery**); in the rectum, blood appears as streaks or chunks of frank blood unevenly distributed throughout the feces (**hematochezia**).
- “**Occult blood**” is not visible grossly; the color of the feces may be normal or dark. A variety of commercially available fecal occult blood tests have been developed for humans and adapted for use in ruminants. The most widely used occult blood tests in ruminants have been the **o-tolidine (orthotolidine) tablet test** (such as Hematest) and the **guaiac paper test**, which are performed following the manufacturers' instructions. A positive o-tolidine test is a blue color change that develops on the paper at the periphery of the test tablet within 2 minutes. This test is based on hemoglobin's peroxidase-like ability to catalyze the oxidation of a chromogen, tetramethylbenzidine, and the test is reported to detect 6 mg of hemoglobin per gram of feces. A positive guaiac test is the development of a blue color on

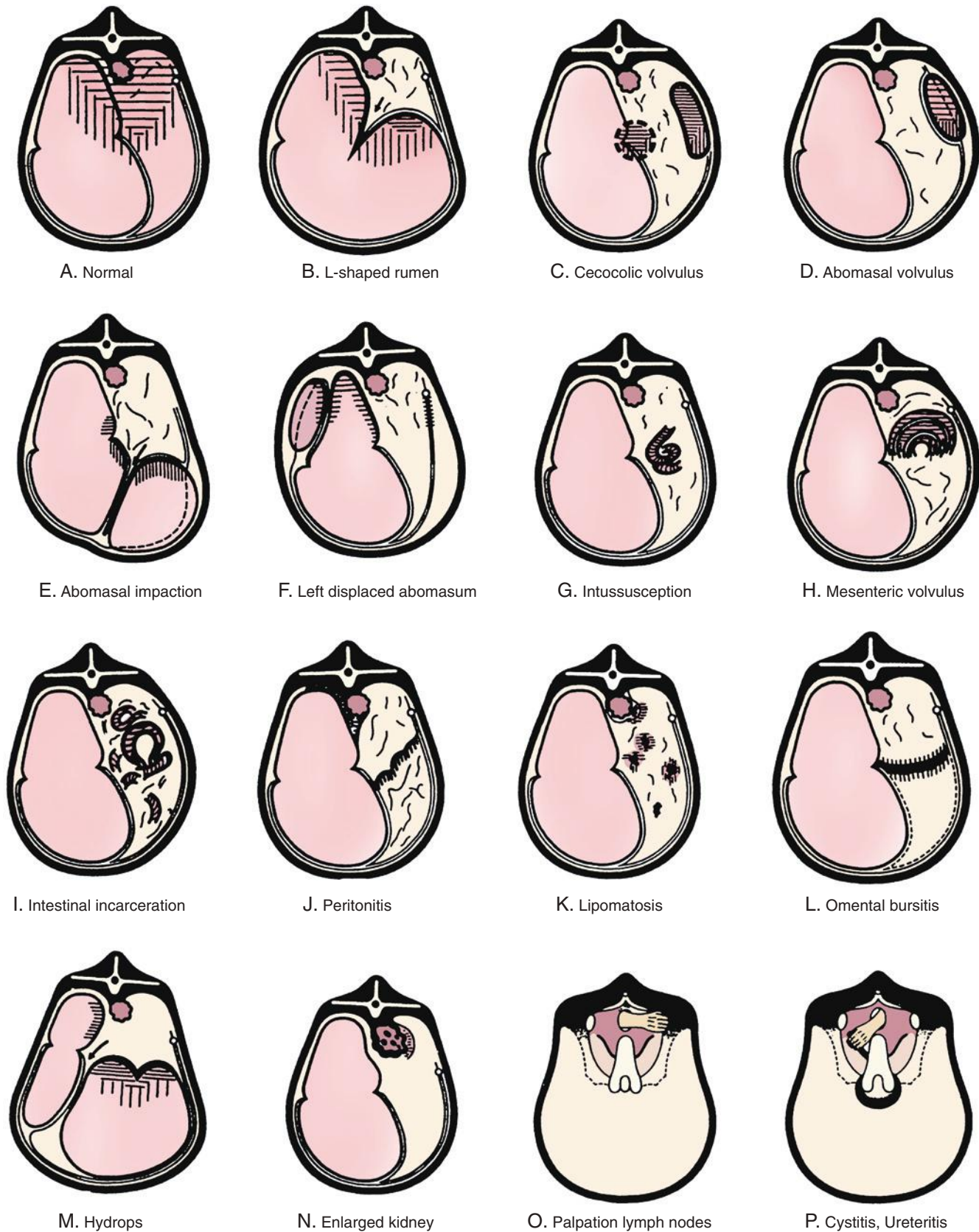

**Fig. 8-3** Schematic illustration of the rectal findings in cattle affected with different diseases of the abdominal viscera. *a*, normal; *b*, L-shaped rumen; *c*, cecocolic volvulus; *d*, abomasal volvulus; *e*, abomasal impaction; *f*, left displaced abomasum (LDA); *g*, intussusception; *h*, mesenteric volvulus; *i*, intestinal incarceration; *j*, peritonitis; *k*, lipomatosis; *l*, omental bursitis; *m*, hydrops; *n*, enlarged kidney; *o*, palpation lymph nodes; *p*, cystitis, ureteritis. (From Stober M, Dirksen G. *Bovine Pract* 1977; 12:35-38).



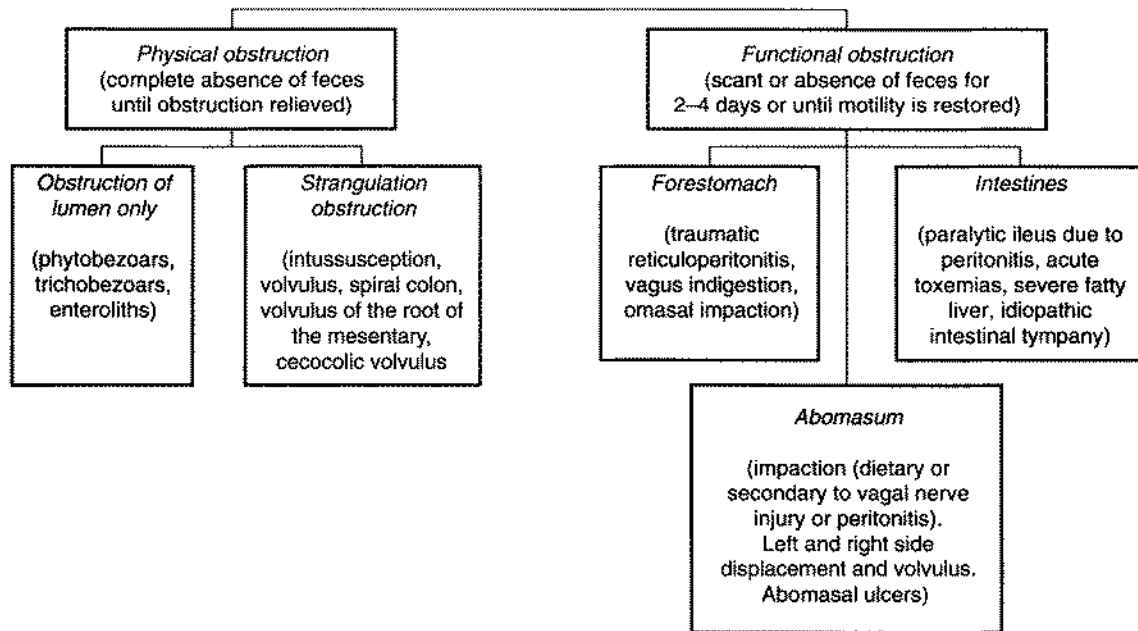

Fig. 8-4 Some common causes of physical and functional obstruction of the alimentary tract of cattle.

the test paper following the addition of hydrogen peroxide. This test is also based on hemoglobin's peroxidase-like ability to oxidize a phenolic compound in guaiac ( $\alpha$ -guaiaconic acid) to a quinone, and the test is reported to detect 10 mg of hemoglobin per gram of feces. One report in cattle indicated that a dilute alcoholic solution of guaiac was the most sensitive and reproducible method, but this test is no longer commercially available. Occult blood occurs most commonly when there are only small quantities of blood in the alimentary tract, as with minimal hemorrhage insufficient to result in melena. It also may be caused by swallowing blood coughed up from a pulmonary hemorrhage such as in caudal vena cava thrombosis. The minimum transit time of blood from abomasum to rectum was 7 to 19 hours in adult cattle.

### ODOR

Fresh bovine feces are not normally malodorous. Objectionable odors are usually caused by putrefaction or fermentation of ingesta, usually associated with inflammation. For example, the feces in cattle with salmonellosis may be fetid, whereas in advanced pericarditis with visceral edema caused by passive congestion the feces are profuse but not odoriferous.

### CONSISTENCY

The consistency of the feces is dependent on the water content, the type of feed, and the length of time the ingesta has remained in

the digestive tract. Normally, milk-fed calves excrete feces of a medium to firm porridge-like consistency. After transition to a plant diet, the first solid particles begin to appear. Normal bovine feces are of a medium porridge-like consistency. A moderate thickening leads to the passage of fecal disks of a more solid consistency, and severe dehydration causes the formation of firm balls of feces arranged in facets inside the rectum, the surfaces of which are dark and coated with mucus. The feces of cows with left-side displacement of the abomasum are commonly pasty in appearance. Sticky and tenacious feces are commonly seen in obstruction of the forestomachs (vagus indigestion and chronic peritonitis).

### DEGREE OF DIGESTION

The proportion of poorly digested plant particles in the feces is dependent on the duration and adequacy of rumination and the rate of passage of ingesta through the forestomach and abomasum. The length of time the ingesta is in the postruminal digestive tract seems to have no appreciable influence on its digestion. Inadequate digestion indicates failure in rumination or accelerated passage of ingesta through the forestomach. Thus in some cattle with acute traumatic reticuloperitonitis, the feces may contain small walnut-sized chunks of undigested plant fibers that have escaped the cellulose digestive processes of the forestomachs. The presence of large numbers of kernels of grain in the feces is associated with the ingestion of large quantities of unprocessed grain such as whole wheat or barley.

### OTHER SUBSTANCES IN THE FECES

#### Mucus

The presence of excessive mucus on the surface of feces suggests increased transit time of the ingesta in the large intestine. The presence of a plug of mucus in the rectum is suggestive of a functional obstruction (paralytic ileus). In enteritis, large quantities of clear, watery mucus may be passed, which sometimes clot to form gelatinous masses.

#### Fibrin

In fibrinous enteritis, fibrin may be excreted in the form of long strands, which may mold into a print of the intestinal lumen (**intestinal fibrinous casts**).

### DETECTION OF ABDOMINAL PAIN

Cattle with acute local or diffuse peritonitis may grunt spontaneously with almost every expiration; this is usually exaggerated in the recumbent position. However, **grunting** may also be caused by **severe pneumonia, pleurisy, and severe pulmonary emphysema**. Careful auscultation and percussion of the lungs is therefore necessary to exclude the presence of pulmonary disease.

Not all grunts occur spontaneously. **Deep palpation of the cranial part of the abdomen using the closed hand or knee is often necessary to elicit a grunt in cattle.** Auscultation over the trachea is often necessary to hear the grunt, which is best elicited if pressure is applied to the abdomen at the end of inspiration and the beginning of

expiration. The inspiratory and expiratory sounds are noted for six to eight respirations by auscultation over the trachea and then, without warning to the animal, firm palpation is applied to the abdomen. A grunt indicates the presence of a peritoneal lesion (stretching or inflammation of the peritoneum regardless of cause). The absence of a grunt does not preclude the presence of a peritoneal lesion. In acute traumatic reticuloperitonitis the grunt may be present for only 3 to 5 days after the initial penetration of the reticulum.

A rigid bar or wooden pole may be necessary to apply pressure in large cattle (large cows and bulls). The bar is held by two people in a horizontal position just behind the xiphoid sternum while a third person auscultates over the trachea when the bar is lifted firmly up into the abdomen. Simultaneous auscultation over the trachea ensures that the grunt is heard. Several attempts should be made to elicit a grunt before concluding the absence of one. The ventral aspect and both sides of the abdomen should be examined beginning at the level of the xiphoid sternum and moving caudally to approximately the umbilicus. This will ensure that the cranial and caudal aspects of the abdomen are examined for the presence of **points of abdominal pain**.

**Pinching of the withers is also used to elicit a grunt.** In the average-sized cow, pinching of the withers causes the animal to depress its back. In an animal with a painful lesion of the peritoneum, depression of its back will commonly result in a grunt, which is clearly audible by auscultation over the trachea and is often audible without the use of the stethoscope.

The term **anterior abdominal pain** is used to characterize the pain associated with several diseases of the anterior abdomen of cattle, which would include **traumatic reticuloperitonitis, hepatic abscesses, abomasal ulcers, and intestinal obstruction**. The differential diagnosis of the anterior abdominal pain would include diseases that cause thoracic pain such as pleuritis, pericarditis, and severe pulmonary disease.

## ULTRASONOGRAPHY

Ultrasonography has become a routine diagnostic method in ruminants suspected of having gastrointestinal tract disease. This is because of the widespread availability of reasonably priced portable battery powered units and the many advantages of “on-farm” diagnostic tests.

Ultrasonography provides an excellent method for investigating the presence and nature of reticular contractions in healthy ruminants and for the diagnosis of traumatic reticuloperitonitis in cattle.<sup>1,2</sup> In contrast to radiography, ultrasonography provides more precise information about the contour of the reticulum and the frequency of reticular

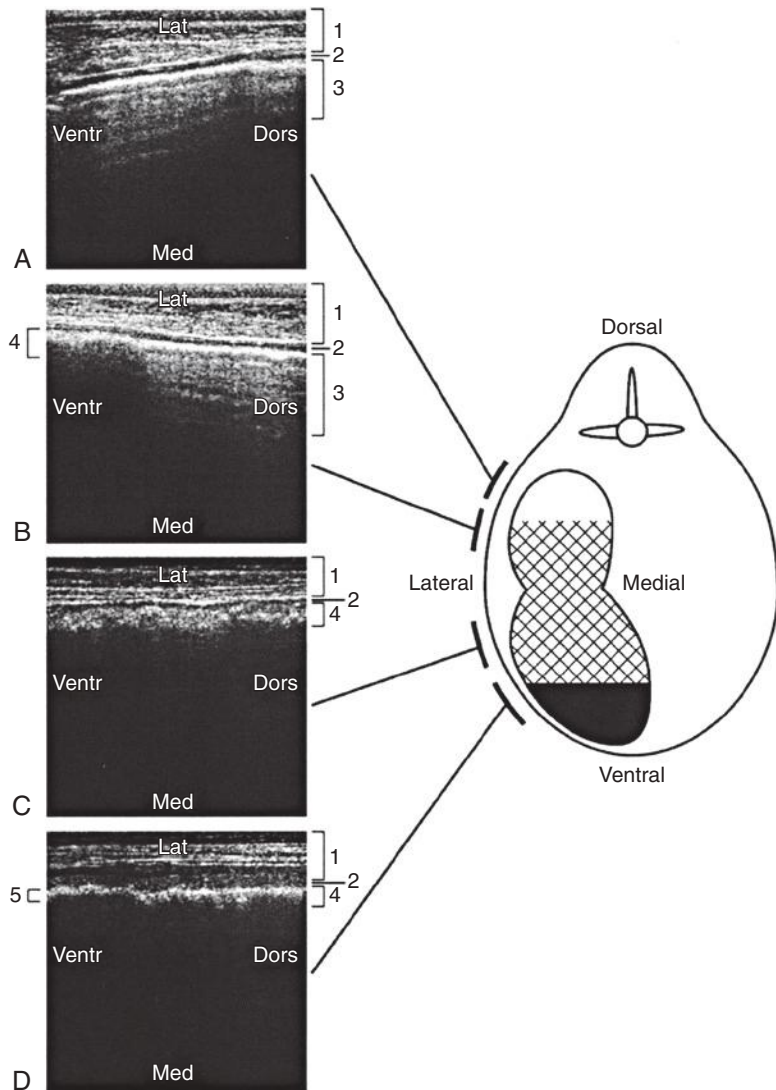

**Fig. 8-5** Ultrasonographic findings and interpretation with respect to stratification of the rumen contents of pasture-fed domestic cattle. *a*, 1, abdominal wall; 2, rumen wall; 3, reverberation lines indicative of a gas-filled space (gas dome); *b*, abrupt transition from gas dome (3) to fiber mat (4); *c*, ingesta with gaseous inclusions; fiber mat; (4) at the rumen wall; *d*, transition from fiber mat (4) to a comparatively sharp demarcating ruminal wall with no signs of gaseous ingesta (fluid layer, 5). (Reproduced, with permission from Tschuor A, Claus M. *Eur J Wildl Res* 2008; 54:627-633.)

contractions. Ultrasonography also provides information on the stratification of rumen contents (dorsal gas dome, fiber mat, and ventral fluid layer; Fig. 8-5).<sup>3-5</sup> The gas dome in the cow rumen can be identified ultrasonographically by reverberation lines that run parallel to the line identifying the rumen mucosa. The fiber mat presents a pattern indicating gaseous inclusions, whereas the fluid layer appears darker without reverberation lines.

Ultrasonography provides an ideal diagnostic aid for the examination of the omasum,<sup>6,7</sup> and abomasum of adult cattle,<sup>8,9</sup> the reticulum, rumen, omasum and abomasum of calves up to 3 months of age,<sup>10,11</sup> the reticulum, rumen, omasum, abomasum, liver, spleen, and greater omentum of adult

goats,<sup>12-15</sup> and the diaphragm and abdominal wall of adult cattle,<sup>16,17</sup> as well as left and right displacement of the abomasum, abnormal motility of the small and large intestines, and cecal dilatation.

Ultrasonography is performed on the standing nonsedated animal using a 3.5-MHz linear transducer. The techniques used are presented under the specific headings for each disease.

## RADIOGRAPHY

Radiography of the cranial abdomen and reticulum of mature cattle with the animal in a standing position can only be performed at referral centers because of the need for high-powered radiographic units. Radiologic

examination of the reticulum with the animal in dorsal recumbency (dorsal reticulography) should not be performed in cattle with suspected traumatic reticuloperitonitis because of the potential for the breaking down of adhesions and dissemination of infection throughout the abdomen. Specific techniques for radiography of standing animals suspected to have traumatic reticuloperitonitis are presented under that heading.

### ENDOSCOPY OF THE RUMEN

Endoscopic examination in ruminants has been most commonly used to examine the upper respiratory tract, pharyngeal area, and esophagus. Nasoruminal endoscopy is very challenging in calves, sheep, and goats because endoscopes that are sufficiently small to pass through the nasal passages are usually not long enough to reach the rumen. Ororuminal endoscopy using a mouth gag has been infrequently performed because of the risk of damage to the instrument as well as poor visualization of the rumen and reticulum. Visualization through a rumen fistula in 1- to 2-month-old calves was superior to visualization through the oral cavity;<sup>18</sup> however, removal of rumen contents using a siphon and lavage method improved visualization ability.

### COMPUTED TOMOGRAPHY

Increased insight into normal anatomy has been obtained in calves, sheep, goats, alpacas, and llamas using computed tomography (CT) with the animal placed in sternal recumbency. In contrast to cattle, CT has demonstrated that the rumen in goats extends to the right of the midline, and metal objects causing traumatic reticulitis are very visible on CT.<sup>19,20</sup>

### RUMINATION MONITORS

The time spent ruminating provides an excellent indicator of health in cattle, sheep, and goats. Moreover, the return of rumination is a positive clinical sign in a ruminant that has been inappetent, leading to the adage “never give up on a ruminating animal.” At least two technologies have been developed to monitor the time spent chewing each day. These use a microphone placed in the cranial cervical region in a neck band, with rumination having a different acoustic signal than eating,<sup>21</sup> or a noseband pressure sensor that is incorporated in a halter.<sup>22</sup> The microphone system appears to work better for dairy cattle than beef cattle. Typical values for confinement-fed dairy cattle are 16 daily eating phases, each with a mean duration of 28 minutes, and 13 rumination phases, each with a mean duration of 30 minutes. The total time spent ruminating per day was 6 to 7 hours, with 410 cuds per day and 60 chewing cycles per cud.<sup>22</sup> It is likely

that as confinement operations adopt more precision agriculture methods that rumination monitors become a routine monitoring tool for periparturient dairy cattle or dairy cattle in the sick pen.

### SERUM BIOMARKERS OF GASTROINTESTINAL FUNCTION

**Pepsinogen**, a proenzyme that is the inactive form of pepsin, is the most important proteolytic enzyme in abomasal fluid. A small amount of pepsinogen is present in the serum of healthy ruminants. Abomasal injury, particularly caused by abomasal parasitism, causes a marked increase in serum pepsinogen concentration,<sup>23,24</sup> providing a useful clinical test for gastrointestinal parasitism and the magnitude of the injury that can guide treatment. Serum pepsinogen concentration is increased in ruminants with abomasal ulcers and cattle with ostertagiasis.

**Gastrin** is a hormone secreted from G (gastrin) cells of the pyloric region of the abomasum into the blood from where it reaches the parietal cells and subsequently stimulates acid and pepsinogen secretion.<sup>23</sup> Serum gastrin concentration is increased in ruminants with abomasal ulcers, cattle with left displaced abomasum (LDA) or right displaced abomasum (RDA),<sup>25</sup> and sheep with hemonchosis.

Serum **motilin** and **ghrelin** concentrations are increased in cattle with LDA and RDA.<sup>25</sup> Motilin is increased by cells in the proximal gastrointestinal tract and promotes abomasal emptying rate. Ghrelin is also a gastrointestinal regulating hormone.

### INTERPRETATION OF CLINICAL FINDINGS

A guide to the interpretation of the clinical findings associated with diseases of the digestive tract and abdomen of cattle is summarized in [Table 8-4](#). In conjunction with the history and the laboratory findings, a differential diagnosis list can be generated.

### EXPLORATORY LAPAROTOMY

An exploratory laparotomy can usually assist in the diagnosis of diseases of the digestive tract or abdomen. Identification and evaluation of the abnormality allows for a more accurate diagnosis, prognosis, and rational treatment. However, because a properly done laparotomy is time-consuming and expensive, the veterinarian would like to minimize the number of laparotomies in which no significant lesions are present. Therefore the challenge is to improve the accuracy of diagnosis and to evaluate the prognosis as much as possible before doing a laparotomy unnecessarily.

There are some well-recognized diseases in which, if a clinical diagnosis can be made, a laparotomy is indicated ([Table 8-5](#)). (In

some cases slaughter for salvage may be more economical.)

Other than the rumenotomy for the treatment of grain overload and the cesarean section, the most common indication for a laparotomy in cattle is for the surgical correction of displacement or obstruction of parts of the digestive tract (i.e., abomasal displacement, abomasal dilatation and volvulus, intussusception and volvulus, volvulus of the root of the mesentery, luminal obstruction of the spiral colon, cecal dilatation and cecocolic volvulus). If any of these diagnoses can be made, a laparotomy is indicated.

In other cases, the diagnosis may be suspected, but is not obvious and the indications for a laparotomy, slaughter, euthanasia, or conservative medical treatment are not clear. The major question is under what conditions is a laparotomy indicated if the history and clinical and laboratory findings *suggest* an obstruction (strangulation obstruction or functional) but the obstruction cannot be located on clinical examination?

Some examples of diseases that may elude diagnosis before laparotomy and that are or may be amenable to surgical correction are included in the following sections.

### INTUSSUSCEPTION AND OTHER STRANGULATION OBSTRUCTIONS OF THE SMALL INTESTINES

An intussusception may be located in the anterior part of the abdomen and not palpable per rectum. A clinical history of acute onset of colic, absence of feces, and serosanguineous exudate on peritoneal tap are indications for a laparotomy. However, phytobezoars and trichobezoars can cause acute intestinal obstruction that may not be palpable rectally and which becomes progressively more severe with time, and only minimal, if any, changes may occur in the peritoneal fluid. A progressively worsening systemic state warrants a laparotomy.

### “ATYPICAL” LEFT-SIDE DISPLACEMENT OF THE ABOMASUM

A small percentage of cases are difficult to detect on auscultation and percussion. When the typical left-side displacement of the abomasum ping cannot be detected after several examinations over a period of a few days, a presumptive diagnosis may be made on the basis of ketosis in a recently calved cow (within the last week); the presence of rumen contractions, but reduced intensity; normal vital signs (unless fatty liver is present); and spontaneous fluid-gurgling sounds audible over the left flank or fluid-splashing sounds on ballottement and auscultation of the lower left flank. Ultrasonographic examination of the left ventral abdomen using a 3-MHz transducer will identify the abomasal position within the abdomen (see section on left displaced abomasum in this chapter).



**Table 8-4** Pathogenesis and interpretation of clinical findings associated with diseases of the digestive tract and abdomen of cattle

Clinical findings	Pathogenesis, interpretation
Anorexia, inappetence	Toxemia, distension of intestines and stomachs, enteritis, peritonitis
Scant feces, includes small-volume diarrhea	Reduced feed intake, functional obstruction of forestomachs and abomasum, paralytic ileus, strangulation obstruction or obstruction of lumen of intestine with phytobezoar or trichobezoar
Large-volume diarrhea	Profuse, watery diarrhea usually associated with enteritis, simple indigestion or carbohydrate engorgement
Dehydration	Failure to drink adequate amounts of water (caused by toxemia or lesions of oral cavity), malabsorption caused by enteritis, diseases of the forestomachs interfering with absorption of water, e.g., vagus indigestion
Tachycardia	Toxemia, acid-base imbalance, abdominal pain, distension of intestines
Polypnea	Acid-base imbalance (abomasal volvulus, severe enteritis, and vagus indigestion), distension of the abdomen caused by gas-filled or fluid-filled intestines
Weakness and recumbency	Toxemia, severe dehydration, severe distension of abdomen, peritonitis
Colic (abdominal pain)	Sudden onset of distension of forestomachs, abomasum, or intestines Stretching of mesenteric bands, strangulation of intestine in mesenteric tear or scrotal hernia
Grunting with every respiration	Diffuse peritonitis (also pleuritis, pulmonary emphysema, and advanced pneumonia), distension of stomachs or intestines
Presence of grunt on deep palpation of ventral abdominal wall	Presence of peritoneal lesion (stretching of the peritoneum, inflammation, edema, and recent adhesions)
Abdominal distension	Most commonly caused by gas-filled or fluid-filled intestines and/or forestomachs and abomasum; rarely caused by pneumoperitoneum Also caused by ascites and hydrops allantois/amnion
Rumen distension	May be distended with gas, fluid, or ingesta; primary dietary ruminal tympany and grain overload; secondary ruminal tympany caused by peritonitis, vagus indigestion
Rumen stasis	Toxemia, metabolic (hypocalcemia), fever, ruminal acidosis, distension of omasum or abomasum, peritonitis, vagal nerve injury
Hypermotile rumen	Early stages of primary dietary ruminal tympany; vagal nerve injury
Acidic rumen pH	Ruminal acidosis associated with carbohydrate engorgement; almost no other cause known
Alkaline rumen pH	Ruminal alkalosis associated with accidental consumption of high-protein diet, urea poisoning
Reduced or absent rumen protozoan activity	Ruminal acidosis (lactic acid inactivates protozoa); primary starvation lasting more than 2–3 days; ingestion of lead, arsenic, and other poisonous substances
Abnormal foul-smelling	Putrefaction of rumen contents in static and defaunated rumen contents
Presence of ping or pong over left flank	Left displacement of abomasum (ping), atonic rumen with a gas cap (pong), pneumoperitoneum (rarely)
Ping over right flank	Right-side dilatation displacement and volvulus of the abomasum, cecal dilatation and cecocolic volvulus, obstruction of the spiral colon, gas in distended colon and rectum
Presence of low-pitched pings not clearly distinct over right flank	Tympany of right paralumbar fossa in recently calved cows (2–3 days); gas in distended colon and rectum; fluid- and gas-filled intestines with enteritis
Distended upper right flank	Dilatation and volvulus of abomasum; cecal dilatation and cecocolic volvulus; obstruction to the spiral colon
Distended lower right flank	Impaction of the abomasum; enlarged L-shaped rumen and distension of ventral sac to the right flank; advanced pregnancy
Fluid-splashing sounds on ballottement of abdomen or succussion	Fluid-filled intestines or forestomachs or abomasum; usually associated with enteritis, paralytic ileus, or obstruction; fluid-splashing sounds are <i>rarely</i> caused by fluid in the peritoneal cavity; percolating fluid sounds audible over right flank are common in cattle with acute intestinal obstruction
Dropping cuds	Cattle rarely regurgitate uncontrollably (dropping cuds); it is usually associated with chronic inflammatory lesions of the reticulum and cardia resulting in lack of control of regurgitation and a larger than normal bolus of rumen contents being regurgitated that cannot be controlled by the animal; also occurs in certain heavy-metal poisonings such as arsenic poisoning; cattle affected with straw impaction of the rumen will also drop large, dry, fibrous cuds

### TRAUMATIC RETICULOPERITONITIS

In traumatic reticuloperitonitis with a persistently penetrating foreign body, conservative medical treatment of immobilization in a stanchion, antimicrobials, and a magnet may be unsuccessful even after several days of antimicrobial therapy. Diagnosis depends on continued anorexia, mild fever, grunt, rumen stasis, a hemogram indicating infection, and peritoneal fluid containing predominant

neutrophils (typically >90% in traumatic reticuloperitonitis). Recent reports of reference ranges for peritoneal fluid constituents in healthy cattle are available,<sup>26</sup> as well as changes in peritoneal fluid constituents in cattle with peritonitis.<sup>27</sup> More information on peritonitis is available in [Chapter 7](#).

The guidelines for the indications of an exploratory laparotomy when a tentative diagnosis is not made are listed in [Table 8-6](#).

### LAPAROSCOPY

Endoscopy of the abdomen through the right paralumbar fossa, left paralumbar fossa, and cranioventral midline provides a safe alternative to exploratory celiotomy in cattle. Feed and water are withheld for 24 hours, and the animals are sedated with acepromazine for both right and left paralumbar fossa laparoscopies and xylazine for the

**Table 8-5** Diseases of the digestive tract and abdomen of cattle in which a laparotomy is indicated if the diagnosis can be made

Disease	Major clinical findings
Left displaced abomasum	Ping over ribs 9–12 and other well-recognized findings
Right displaced abomasum and volvulus of the abomasum	Distension of upper right flank, ping on percussion over ribs 9–12, viscus palpable per rectum
Cecal dilatation and cecocolic volvulus	Distension of upper right flank, ping in right paralumbar fossa, long cylindrical mass palpable per rectum
Obstruction of the spiral colon	Distension of upper right flank, ping, distended loops of intestine easily palpable
Intussusception	Abdominal pain, absence of feces, distended loops of intestine, palpable intussusception
Phytobezoars or trichobezoars	Scant feces, subacute abdominal pain, distended loops of intestine and hard lumps palpable rectally
Severe life-threatening ruminal tympany	Severe distension of rumen, skin over rumen cannot be picked up, animal grunting, is lying down, mouth breathing, cannot relieve with stomach tube or trocar
Unidentifiable lumps palpable on rectal examination, i.e., fat necrosis	Chronic gastrointestinal atony, scant feces, large hard lumps palpable per rectum
Peracute grain overload	Weakness, recumbency, dehydration, tachycardia, rumen pH 5 (see Table 8-8 for guidelines in the treatment of grain overload)

**Table 8-6** Clinical and laboratory indications for an exploratory laparotomy in cattle when the diagnosis is not obvious

Parameter/criterion	Significance and interpretation of criteria
History	Does the history suggest an acute surgically correctable condition?
Abdominal distension	Laparotomy indicated if distension of abdomen caused by distension of abomasum, cecum, or intestines with fluid and gas
Volume and nature of feces	Scant or absence of feces for more than 36–48 h indicates a <i>physical</i> or <i>functional</i> obstruction. In <i>functional obstruction</i> (i.e., peritonitis) some dark feces are usually present; in <i>physical obstruction</i> (intussusception) feces are very scant and dark red because of leakage of blood into intussusceptum Laparotomy indicated unless can determine that cause of absence of feces is not surgically correctable (diffuse peritonitis or impaction of abomasum or omasum)
Rectal findings	Distended viscera other than rumen (abomasum, cecum, and small and large intestines) warrant laparotomy Palpable “bread and butter” fibrinous inflammation in caudal part of abdomen suggests acute diffuse peritonitis and laparotomy would not be rewarding
Peritoneal fluid and hemogram	Bloodstained peritoneal exudate and a degenerative left shift in the leukocyte count suggest leakage of the intestinal wall and warrants laparotomy if history and clinical findings suggest a strangulation obstruction
Abdominal pain (colic) and grunting	Behavioral and postural signs of acute abdominal pain (colic), such as kicking at the belly and stretching the body, suggest acute distension of the stomachs or intestines with fluid and gas Spontaneous grunting with each respiration, which usually becomes pronounced in sternal recumbency, or the presence of a grunt on deep palpation of the abdomen suggests inflammation or stretching of the peritoneum

cranioventral approach. For laparoscopy through the fossae, the sites are prepared aseptically and a 2-cm incision is made through the skin and abdominal musculature after infiltration with 2% lidocaine. Each incision is made 8 cm ventral to the tip of the transverse process of the third lumbar vertebra and 5 cm caudal to the caudal aspect of the last rib. The laparoscope is introduced by standard technique and carbon dioxide gas is used to insufflate the abdominal cavity, after introduction of the trocar and cannula and before introduction of the laparoscope. The abdominal cavity is insufflated to a pressure of 20 to 24 mm Hg. Each examination is completed by directing the laparoscope cranially then moving counterclockwise to examine the caudal portion of the abdomen. After the laparoscopy, the abdomen is passively deflated through the cannula and the skin is closed with sutures.

Cranioventral laparoscopy is performed with the animal positioned in dorsal

recumbency. The incision for entry is made on the midline, through the linea alba, 10 cm caudal to the xiphoid process. Examination of the cranioventral portion of the abdomen is begun at the central aspect of the diaphragm then circularly moving the laparoscope counterclockwise.

Right paralumbar fossa laparoscopy provides excellent viewing of the caudal and right cranial portions of the abdomen for evaluation of diseases involving the right kidney, liver, diaphragm, small intestine, cecum, colon, reproductive tract, and cranial part of the pelvic canal. Inadvertent penetration of the greater omentum or mesoduodenum may be avoided by careful placement of the trocar and periodic examination with the laparoscope to assess proper positioning of the cannula. Left paralumbar fossa laparoscopy provides excellent viewing of the left cranial portion of the abdomen and is appropriate for evaluation of diseases involving the left kidney, rumen, spleen, and diaphragm.

The cranioventral midline laparoscopy provides excellent visibility of the cranioventral portion of the abdomen. It allows evaluation of diseases involving the abomasum, liver, reticulum, spleen, and diaphragm.

### CLINICAL EXAMINATION OF THE DIGESTIVE TRACT AND ABDOMEN OF THE CALF

Clinical examination of the digestive tract and abdomen of the calf may be more difficult than in the adult animal. The rumen in the preruminant calf is not yet functional and thus cannot be used as an indicator of the state of the alimentary tract as in adult cattle. Also, rectal examination is not usually possible until the animal is about 10 to 12 months of age, depending on the breed. A digital examination of the rectum of young calves is useful for determining the nature and amount of feces. This may provide an indication of the presence of impending diarrhea.

A complete absence of feces suggests the presence of an acute intestinal obstruction, acute diffuse peritonitis, or atresia coli.

The oral cavity of the calf is easily examined and should be part of the clinical examination of every sick calf.

### ABDOMINAL DISTENSION IN CALVES

Abdominal distension is common in calves under 2 months of age. If the distension is symmetric, it may be difficult to determine whether it originates in the rumen, abomasum, intestines, or peritoneal cavity.

Examination of the abdomen of the young calf includes inspection of the contour of the abdomen to determine the maximum area of any distension, deep palpation and

ballotment of each flank to determine the presence of fluid-splashing sounds that indicate a fluid-filled viscus, and percussion and auscultation to determine the presence of a gas-filled viscus. Placing the calf's hindquarters on the ground and allowing the viscera to move to the caudal part of the abdomen may allow visual inspection and palpation of a distended abomasum below the xiphoid sternum. With the calf in lateral recumbency, careful palpation and simultaneous auscultation may reveal the location of the distended viscus. However, it is often necessary to do an exploratory laparotomy to determine the cause. A stomach tube should always be passed into the rumen to relieve any pressure caused by the accumulation of gas or fluid. In the case of severe distension of the

abdomen accompanied by severe abdominal pain (kicking, bellowing, rolling, and getting up and lying down) it may be necessary to relieve intraabdominal pressure with a large-gauge needle (12- to 14-gauge, 75–100 mm; 3–4 inches). The most common cause of severe abdominal distension in a young calf that can be relieved by trocarization is AV.

Abdominocentesis is easily done in the calf and at least three punctures should be attempted before concluding the absence of fluid. To avoid puncture of the abomasum, sites that are caudal to the umbilicus are used (see Chapter 7).

The differential diagnosis of the common causes of abdominal distension in the calf is summarized in Table 8-7.

**Table 8-7** Differential diagnosis of diseases of the digestive tract and abdomen of young calves presented with distension of the abdomen

Disease	History, clinical and laboratory findings, treatment
Abomasal volvulus	Always acute to peracute, 1 week to 6 months of age, acute abdominal pain, bellowing, up and down, severe tight distension of abdomen, loud ping and fluid-splashing right side, emergency surgery necessary; recovery about 50% if recognized and corrected early
Abomasal dilatation (fluid, milk, hairballs, and often abomasal ulcers)	Chronic or acute onset, calves 1–6 months of age, history of abnormal feces, may be unthrifty, mild to moderate abdominal distension and pain, fluid-splashing sounds over right flank, dehydration, negative peritoneal fluid, laparotomy and abomasotomy required
Perforated abomasal ulcers	Acute onset, sudden collapse, calves 2 weeks to 3 months, hand-fed or nursing calves, weakness, recumbency, tachycardia, mild to moderate abdominal distension, mild or no abdominal pain, abdominal splinting occasionally, <i>positive paracentesis</i> , feces variable Laparotomy required; survival about 25%
Volvulus of root of mesentery	Sudden onset, found in state of collapse, abdominal pain common, moderate abdominal distension, distended loops of intestine visible and palpable over right flank, bloodstained peritoneal tap, fluid-splashing sounds on palpation and auscultation, scant feces, emergency surgery
Acute diffuse peritonitis (not caused by perforated abomasal ulcer)	Usually in calves under 3 weeks of age, toxemia, temperature variable, weak, may be grunting, splinting of abdominal wall, mild abdominal distension, scant feces, fluid-splashing sounds over right flank (caused by paralytic ileus), <i>abnormal peritoneal fluid</i> , commonly associated with enteric colibacillosis, polyarthritis and umbilical and urachal abscess Exploratory laparotomy, prognosis poor
Atresia coli	Calf usually under 10 days of age, progressive distension of abdomen, bright and alert for first few days then becomes depressed, no feces only thick mucus from rectum, surgery indicated but only a minority have a successful lactation as a first-calf heifer, potential genetic component in Holstein Friesian cattle
Intussusception	May have history of diarrhea, now scant bloodstained feces, depressed, will not suck or drink, dehydrated, contour of abdomen may appear normal or slightly distended, fluid-splashing sounds and small ping may be audible, bloodstained peritoneal fluid, presurgical diagnosis often difficult, surgery necessary Recovery rate moderate if diagnosis early
Peracute to acute enteritis	Usually in calves under 3 weeks of age, acute onset of abdominal pain (kicking and stretching), will not suck or drink, may not yet appear dehydrated, temperature variable, mild to moderate abdominal distension, fluid-splashing sounds on auscultation and succussion of abdomen, continuous loud peristaltic sounds on auscultation, diarrhetic feces may not be present on first examination, digital examination of rectum may stimulate defecation of foul-smelling, soft, watery feces, peritoneal tap negative
Omphalitis, omphalophlebitis, umbilical abscess	Single calf, usually 2–6 weeks of age. May be unthrifty, chronic toxemia. Large, painful swelling of umbilicus that may be obvious externally or deep palpation dorsal to umbilicus reveals firm swellings directed toward liver or bladder. Surgical excision required, usually with excellent outcome
Gastrointestinal tympany of dietary origin	Calves under 10 days of age, nursing calves sucking good cows. May be caused by ingestion of excessive quantities of milk and excessive gas formation in abomasum and large intestine Abdominal pain (kicking at abdomen), and pain on palpation of abdomen Marked to severe abdominal distension At laparotomy there is gaseous distension of the abomasum and cecum Recovery is usually good
Intestinal hairball	Calves 3–8 weeks of age, sudden onset of failure to suck, normal vital signs, total absence of feces, slight to moderate distension of the abdomen, fluid-splashing sounds over right abdomen, and normal peritoneal fluid; will remain anorexic, and fail to pass any feces for up to several days; hemogram normal; metabolic alkalosis with hypokalemia, and hypochloremia may occur Laparotomy and surgical removal of hairball required



## FURTHER READING

- Braun U, ed. *Atlas und Lehrbuch der Ultraschall-diagnostik beim Rind*. Berlin: Parey Buchverlag; 1997:1-279.
- Braun U. Ultrasonography of the gastrointestinal tract in cattle. *Vet Clin North Am Food Anim Pract*. 2009;25:567-590.
- Lean IJ, Golder HM, Hall MB. Feeding, evaluating, and controlling rumen function. *Vet Clin North Am Food Anim Pract*. 2014;30:539-575.
- Radostits OM. Clinical examination of the alimentary system: Ruminants. In: Radostits OM, Mayhew IGJ, Houston DM, eds. *Veterinary Clinical Examination and Diagnosis*. London: WB Saunders; 2000:409-468.

## REFERENCES

- Braun U, Rauch S. *Vet Rec*. 2008;163:571.
- Braun U, Jacquat D. *Acta Vet Scand*. 2011;53:19.
- Tschoor A, Clauss M. *Eur J Wildl Res*. 2008;54:627.
- Braun U, et al. *Schweiz Arch Tierheilkd*. 2011;153:393.
- Braun U, et al. *BMC Vet Res*. 2013;9:44.
- Mohindroo J, et al. *Vet Radiol Ultrasound*. 2008;49:295.
- Braun U, Jacquat D. *BMC Vet Res*. 2011;7:11.
- Buczinski S, et al. *J Am Vet Med Assoc*. 2011;238:1044.
- Braun U, et al. *BMC Vet Res*. 2011;7:20.
- Braun U, et al. *Res Vet Sci*. 2013;95:326.
- Braun U, Krüger S. *Acta Vet Scand*. 2013;55:68.
- Braun U, et al. *Schweiz Arch Tierheilkd*. 2013;155:173.
- Braun U, Jacquat D. *Res Vet Sci*. 2012;92:295.
- Braun U, et al. *Schweiz Arch Tierheilkd*. 2013;155:185.
- Braun U, et al. *Am J Vet Res*. 2011;72:219.
- Athar H, et al. *Vet Med Int*. 2010;93:9870.
- Braun U, et al. *Schweiz Arch Tierheilkd*. 2011;153:71.
- Franz S, et al. *Vet J*. 2006;172:308.
- Braun U, et al. *Schweiz Arch Tierheilkd*. 2011;153:307.
- Stieger-Vanegas SM, Cebra CK. *J Am Vet Med Assoc*. 2013;242:254.
- Elischer MF, et al. *J Dairy Sci*. 2013;96:6412.
- Braun U, et al. *BMC Vet Res*. 2013;9:164.
- Kataria N, et al. *Slov Vet Res*. 2008;45:121.
- Banga-Mboko H, et al. *J Anim Vet Adv*. 2007;6:776.
- Ozturk AS, et al. *Vet Rec*. 2013;172:636.
- Wittek T, et al. *Vet Rec*. 2010;166:15.
- Wittek T, et al. *J Vet Intern Med*. 2010;24:1211.

## Diseases of the Rumen, Reticulum and Omasum

### SIMPLE INDIGESTION

#### ETIOLOGY

Indigestion is common in dairy cattle and stall-fed beef cattle because of the variability in quality and the large amounts of feed consumed. It is not common in pastured beef cattle or sheep because they are less heavily fed. The common causes are minor dietary abnormalities including indigestible roughage, particularly when the protein intake is

#### SYNOPSIS

**Etiology** Excessive feed intake (grain and silage); indigestible roughage; sudden change in diet.

**Epidemiology** Usually in hand-fed dairy cattle and stall-fed beef cattle.

**Signs** Inappetence, drop in milk production, lack of rumination, rumen usually full and reticulorumen contractions decreased or absent, vital signs are normal. Spontaneous recovery in 12–24 h.

**Clinical pathology** None needed except to rule out differential diagnoses. Lesions not fatal.

**Diagnostic confirmation** A diagnosis of exclusion associated with spontaneous recovery.

**Differential diagnosis list** Early parturient hypocalcemia, acetonemia, traumatic reticuloperitonitis, carbohydrate engorgement, left-side displacement of the abomasum, right-side dilatation of abomasum, abomasal volvulus, vagus indigestion, phytobezoars, and secondary ruminal atony in toxemia.

**Treatment** None required except consider need for rumen transfaunation.

**Control** Feeding management and provision of digestible feeds.

low, moldy, overheated, and frosted feeds, and moderate excesses of grain and concentrate intake.

Cases occur under excellent feeding regimens and are usually attributed to overfeeding with grain or a sudden change in feed. Although the difference between simple indigestion and carbohydrate engorgement (grain overload) is one of degree, their separation can be justified by the marked clinical difference between the two syndromes. Gross overfeeding usually occurs when cattle or sheep gain accidental access to large quantities of grain or are suddenly introduced to high-grain diets in feedlots. Indigestion is more common when heavily fed cows are fed a little more concentrate than they can digest adequately. A sudden change to a new source of grain, especially from oats to wheat or barley, may have the same effect.

**Indigestible roughage** may include straw, bedding, or scrub fed during drought periods. It is probable that limitation of the available drinking water may contribute to the occurrence of the disease during dry seasons. Depraved appetite may also contribute to the ingestion of coarse indigestible material. Although good-quality ensilage cannot be considered an indigestible roughage, cases of indigestion can occur in cattle that are allowed unlimited access to good-quality ensilage. This is most likely to happen in heavy-producing cows

running outside in cold weather whose hay and grain rations are limited. It is not uncommon for large Holstein cows to eat 45 to 50 kg of ensilage daily in such circumstances, and the high intake of acetate and acetic acid may be sufficient to depress their appetite. Prolonged or heavy oral dosing with antimicrobials may cause indigestion from inhibition of the normal ruminal flora. An unusual circumstance is the feeding of a special diet to produce milk, and dairy products, with a high content of polyunsaturated fats for special diets in humans. Fats in the diet are protected against hydrogenation in the rumen by a coating of formalin. The efficiency and safety of the diet depends on a thorough mixing of the formalin with the concentrates. If this is not done, the free formalin causes severe rumenitis.

#### PATHOGENESIS

Primary atony caused by dietary abnormality is difficult to explain. Changes in the pH of its contents markedly affect the motility of the rumen, and in cases caused by overeating on grain an increase in acidity is probably of importance. High-protein diets, including the feeding of excessively large quantities of legumes or urea, also depress motility because of the sharp increase in alkalinity that results. Atony that occurs after feeding on damaged feeds may have the same basis or be caused by other unidentified agents in the food. The simple accumulation of indigestible food may physically impede ruminal activity. Putrefaction of protein may also play a part in the production of atony. The toxic amides and amines produced may include histamine, which is known to cause ruminal atony when given intravenously and to be reversed by the administration of antihistamine drugs. Histamine may contribute to the ruminal atony that occurs in allergy, or after heavy grain feeding, but the absorption of histamine from the forestomachs in any circumstances is probably very limited.

A marked fall in milk yield occurs, caused probably by the sharp decrease in volatile fatty acid production in a hypotonic reticulorumen. Rumen contractions appear to play the same role as hunger contractions in simple stomachs and the decreased food intake is probably caused by the ruminal hypomotility or atony.

#### CLINICAL FINDINGS

A reduction in appetite is the first clinical finding, followed closely in milking cows by a slight drop in milk production. Both occur suddenly; the anorexia may be partial or complete but the fall in milk yield is relatively slight. The animal's posture is unaffected but there is mild depression and dullness. Rumination ceases and the ruminal movements are depressed in frequency and amplitude and sometimes are almost absent. The rumen may be larger than normal if the cause is

sudden access to an unlimited supply of palatable feed. There may be moderate tympany, especially with frozen or damaged feeds or in allergy, but the usual finding is a firm, doughy rumen without obvious distension. The feces are usually reduced in quantity and are drier than normal on the first day. However, 24 to 48 hours later the animal is commonly diarrhetic; the feces are softer than normal, voluminous, and commonly malodorous.

There is no systemic reaction and the heart rate, temperature, and respirations are usually within normal ranges. Pain cannot be elicited by deep palpation of the ventral abdominal wall, although cows that have consumed an excessive quantity of a highly palatable feed such as silage, after not having had any for a long period of time, will have a grossly distended rumen, and mild abdominal discomfort may be present for several hours. The discomfort usually resolves when the rumen movements return to normal and the rumen returns to its normal size. Most cases recover spontaneously or with simple treatments in about 48 hours.

### CLINICAL PATHOLOGY

Examination of the urine for ketone bodies is usually necessary to differentiate indigestion from acetonemia. Two simple laboratory tests have been introduced to assess the activity of the ruminal microflora. The sediment activity test is performed on aspirated ruminal fluid strained to remove coarse particles. The strained fluid is allowed to stand in a glass vessel at body temperature, and the time required for flotation of the particulate material is recorded. The time in normal animals varies between 3 minutes, if the animal has just been fed, and 9 minutes, if the last feeding has occurred sometime previously. Settling of the particulate material indicates gross inactivity, and less severe degrees are manifested by prolongation of the time required for flotation. The cellulose digestion test is also performed on aspirated rumen fluid and depends on the time required to digest a thread of cotton. A bead is tied to the end of the thread to indicate when separation occurs. Digestion times in excess of 30 hours indicate abnormality; the time required to obtain the test results has meant that the test is rarely performed.

The rumen fluid can be examined for pH using wide-range indicator paper. Values between 6.5 and 7.0 are considered normal. In cattle on grain diets, the pH may range from 5.5 to 6.0 normally but in cattle that have been on roughage diets such low values should arouse suspicion of lactic acidosis and careful monitoring is necessary.

### NECROPSY FINDINGS

Simple indigestion is not fatal.

### DIFFERENTIAL DIAGNOSIS

Simple indigestion is a **diagnosis of exclusion** and as such must be differentiated from all the diseases of the forestomachs and abomasum in which ruminal atony is a common clinical finding, and from diseases of other body systems that cause secondary ruminal atony:

- **Acetonemia:** the appetite and milk production decrease over a few days, there is ketonuria and the rumen contractions are present but weaker than normal.
- **Traumatic reticuloperitonitis:** there is a sudden onset of anorexia and agalactia, a mild fever, a painful grunt on deep palpation of the xiphoid sternum, and the rumen is static with an increase in the size of the gas cap.
- **Carbohydrate engorgement:** characterized by depression, dehydration, tachycardia, staggering, recumbency, diarrhea, and ruminal stasis with the presence of fluid-splashing sounds, and the pH of the ruminal fluid is usually below 6 and commonly down to 5.
- **Left displaced abomasum (LDA):** usually occurs within a few days after parturition and the rumen is usually smaller than normal, the contractions are usually reduced in amplitude, there is a ping on percussion over the lower left flank, and ketonuria.
- **Right displaced abomasum:** is most common in dairy cows 2–4 weeks postpartum, there is inappetence, reduced feces, ruminal atony, reduced milk production and a ping over the right flank, and a distended viscus is palpable per rectum in the lower right quadrant.
- **Abomasal volvulus:** anorexia, depression, reduced feces, dehydration, tachycardia, a ping over the right flank, and a distended viscus in the lower right quadrant are common.
- **Vagal indigestion:** characterized by gradual distension of the abdomen caused by distension of the rumen over a period of several days, progressive dehydration, and scant feces. Initially there is hypermotility of the rumen and the development of secondary frothy bloat. This is commonly followed by ruminal atony.
- **Phytobezoars:** cause inappetence to anorexia and scant feces, and on rectal examination distended loops of intestine and the firm masses may be palpable.
- **Secondary ruminal atony:** occurs in many diseases in which septicemia or toxemia (coliform mastitis) are present, but there are usually additional clinical findings to indicate their presence.
- Ruminal atony with mild bloat is common in the early stages of hypocalcemia, which may last for 6–18 hours, and is usually accompanied by anorexia and a decreased amount of feces. The ruminal motility and appetite return to normal following treatment with calcium borogluconate.

- The rumen is also atonic in allergic and anaphylactic states and returns to normal following treatment.

### TREATMENT

#### Spontaneous Recovery

Most cases of simple indigestion recover spontaneously. Small quantities of fresh, good-quality, palatable hay should be provided several times daily to encourage eating and to stimulate reticulorumen motility. Because anorexia and forestomach hypomotility usually exist together, the objective is to stimulate both appetite and motility. Reduced feed intake reduces the two primary drives for reticulorumen activity: moderate forestomach distension and chewing activity.

#### Rumenatorics

A wide variety of oral preparations containing rumenatorics were available for many years and it was conventional to administer these to “stimulate” reticulorumen motility and to stimulate appetite. These preparations contained nux vomica, ginger, and tartar emetic in powder form to be added to water and pumped into the rumen. However, there is no evidence that nux vomica and tartar emetic are effective and they are not recommended. Ginger may be an effective prokinetic agent in ruminants, based on the results of a preliminary study demonstrating that the daily oral administration of ginger extract (40 mg/kg body weight [BW]) increased the frequency of reticular and ruminal contractions in healthy sheep within 24 hours.<sup>1</sup>

#### Parasympathomimetics

These agents have also been used to stimulate reticulorumen activity but have the disadvantage of inducing undesirable side effects and being uncoordinated and transitory in effect. Large doses depress reticulorumen activity, and there is no data indicating they increase ruminal activity in normal animals. The normal flow of rumen contents from the reticulorumen to the abomasum is the result of a complex of synchronized contractions and relaxations of various parts of the forestomachs, orifices, and abomasum occurring simultaneously. One of the major limitations of injectable parasympathomimetics used as rumenatorics is that they do not provide these synchronized movements; therefore minimal effective movement of ingesta can occur. Carbamylcholine chloride, physostigmine, and neostigmine have been most commonly administered to ruminants. Carbamylcholine acts on the musculature only and causes uncoordinated and functionless movements. Neostigmine at 0.02 to 0.04mg/kg subcutaneously has no effect on the rate and strength of reticular contractions in healthy cattle.<sup>2</sup> These drugs are not without danger, especially in very sick animals or those with peritonitis, and are specifically

contraindicated during late pregnancy. Their use is no longer recommended.

Experimentally, metoclopramide increases the rate of ruminal contractions and therefore might be beneficial in rumen hypomotility or motility disturbances associated with vagal nerve damage. However, a positive prokinetic effect of metoclopramide was transient and only seen when administered at 0.3mg/kg intramuscularly, at which dose rate mild neurologic signs were evident and manifested as restlessness followed by depression.<sup>2</sup> Similarly, Epsom salts (0.5–1.0 kg per adult cow) and other magnesium salts have not been demonstrated to be effective and are not recommended.

### Alkalinizing and Acidifying Agents

If an excessive quantity of grain is the cause of the simple indigestion, the use of alkalinizers, such as magnesium hydroxide, at the rate of 400 g per adult cow (450 kg BW), is recommended when the rumen contents are excessively acid. Magnesium hydroxide should be used only if ruminal acidosis is present. A sample of rumen fluid can be readily obtained and the pH determined. If the rumen contents are dry, 15 to 30 L of water should be administered by stomach tube. The oral administration of boluses of magnesium hydroxide (162 g) or a powdered form (450 g) dissolved in 3.5 L of water daily for 3 days resulted in a significant increase in rumen pH after 48 and 24 hours, respectively. Both the boluses and the powder forms of magnesium hydroxide decreased rumen protozoal numbers and increased methylene blue reduction times compared with baseline values. There was no change in blood pH, bicarbonate, or base excess values.

Acetic acid or vinegar, 5 to 10 L, is used when the rumen contents are alkaline as a result of the ingestion of high-protein concentrates. This is a very uncommon occurrence.

### Reconstitution of Ruminal Microflora (Rumen Transfaunation)

In cases of indigestion that have run a course of more than a few days, and in animals that have been anorexic for prolonged periods, there will be significant loss of ruminal microflora, especially if there have been marked changes in pH. Reconstitution of the flora by the use of rumen fluid transfers from healthy cows is highly effective. An abattoir is the best source of rumen contents (especially rumen fluid). Sufficient quantities of rumen fluid cannot be obtained from live animals by reaching into their mouth during rumination when the bolus is regurgitated, and “stealing the cud.” Rumen fluid may also be removed from healthy animals by siphoning from the rumen with a stomach tube or by vacuum withdrawal with a special pump. The best results are obtained if 20 to 30 L of water is pumped into the rumen and then allowed to siphon by gravity flow (rumen

lavage). The rumen fluid to be transferred should be strained and administered as an oral drench or preferably by stomach tube. At least 5 L of rumen fluid should be transferred to be effective, although a dose-response study verifying this volume has not been completed.<sup>3</sup> Repeated daily dosing is advisable, and rumen fluid will keep for several days at room temperature. Commercial products comprising dried rumen solids are available and provide some bacteria and substrate for their activity when reconstituted with warm water at 37°C.

When affected animals resume eating, they are best tempted by good, stinky meadow or cereal hay. Good-quality alfalfa (lucerne) or clover hay, green feed, and concentrate may be added to the diet as the appetite improves.

### TREATMENT AND CONTROL

#### Treatment

Feed palatable grass hay and discontinue grain feeding (R-2)

Rumen transfaunation, 5 L daily for at least 3 days (R7-2)

Metoclopramide IM, neostigmine SC, carbamylcholine (R-3)

Oral magnesium hydroxide without determining rumen pH (R-3)

#### Control

Change rations gradually over 7–14 days (R-1)

IM, intramuscularly; SC, subcutaneously.

### FURTHER READING

Constable PD, Hoffsis GF, Rings DM. The reticulorumen: normal and abnormal motor function. Part I. Primary contraction cycle. *Compend Contin Educ Pract Vet.* 1990;12:1008-1014.

Constable PD, Hoffsis GF, Rings DM. The reticulorumen: normal and abnormal motor function. Part II. Secondary contraction cycles, rumination, and esophageal groove closure. *Compend Contin Educ Pract Vet.* 1990;12:1169-1174.

### REFERENCES

1. Mamaghani A, et al. *Vet Res Forum.* 2013;4:91.
2. El-Khodery SA, Sato M. *Vet Res Commun.* 2008;32:473.
3. DePeters EJ, George LW. *Immunol Lett.* 2014;162:69.

### RUMEN IMPACTION DUE TO INDIGESTIBLE FOREIGN BODIES

Foreign body ingestion is common in ruminants because of a general lack of alimentary finesse, particularly in cattle. Ingestion of metallic foreign bodies can lead directly to penetration of the reticular or ruminal wall, and this common disease is covered elsewhere in this chapter in the section on traumatic reticuloperitonitis. Ingestion of nonmetallic foreign bodies is addressed in

this section, and if extensive or located in the reticulum, such ingestion can result in decreased feed intake, weight loss, and electrolyte and acid-base abnormalities. Nonmetallic foreign bodies are most frequently found in the rumen.

Foreign bodies were detected in 42% of 400 cattle, 21% of 320 sheep, and 12% of 320 goats at slaughter in northern Ethiopia.<sup>1</sup> In a related study, foreign bodies were detected in 43% of 332 cattle, 57% of 193 sheep, and 59% of 169 goats at slaughter in eastern Ethiopia.<sup>2</sup> The foreign bodies were predominantly located in the rumen and consisted of plastic bags, cloth, rope, and leather (Fig. 8-6); consequently, increased use of paper bags is recommended wherever possible. Foreign bodies were detected in 17% of 1261 cattle at slaughter in Rwanda.<sup>3</sup> The foreign bodies were primarily plastic bags, despite a ban on the use of plastic bags in supermarkets. Cattle with foreign bodies present in the rumen were much thinner than cattle without foreign bodies. In a study in Jordan, cattle with nonmetallic foreign bodies in the rumen were more likely to exhibit signs of ruminal tympany than unaffected cattle.<sup>4</sup> Cattle with foreign body ruminal impaction have serum biochemical changes consistent with low BW and decreased feed intake.<sup>5</sup>

Rumen impaction in sheep with indigestible foreign bodies has been described in a semiarid region of Nigeria. The sheep had visited refuse dumps around a town. Only certain breeds of sheep, the Yankasa, Uda, and their crossbreeds, were found feeding on refuse dumps. Rumen-indigestible foreign bodies were present in 19% of the sheep slaughtered in the local abattoir. The foreign bodies were plastic materials, ropes, dry seeds, caked sand, metallic objects, paper, fiber, and hairballs. The plastic materials were present in 82% of the sheep. Clinically, the rumen impaction was characterized by emaciation, abdominal distension and symmetry, lack of feces in the rectum, foamy salivation, recumbency, and inappetence. At necropsy, the foreign bodies were usually loosely matted together and impacted with rumen ingesta. Hyperglycemia, metabolic alkalosis, hyponatremia, hypochloremia, hypocalcemia, hypoproteinemia, and hypoalbuminemia occurred in some cases. The impaction was related to the sheep scavenging on refuse dumps and the blood biochemical changes, along with the clinical signs, might be of some diagnostic significance.

Ultrasound of the rumen using a 3.5-MHz transducer at the left 11th–12th intercostal space after intraruminal placement of 1.5 to 2.0 L of water was helpful in identifying the presence of intraruminal foreign bodies in goats.<sup>6</sup> Foreign bodies appeared as a hyperechoic band with acoustic shadowing. Esophageal and ruminal endoscopy was helpful in resolving esophageal obstruction and removing foreign bodies in calves, with a low rate of complication.<sup>7</sup> The use of





**Fig. 8-6** Rope rumen foreign body removed during a rumenotomy on a dairy cow with chronic weight loss, weakness, and clinical signs of vagal indigestion.

duck-billed loop snares or Dormi baskets facilitated capture of foreign objects located in the esophagus.

Foreign bodies are more common in sheep and goats that graze at the outskirts of urban areas. The lower prevalence of foreign bodies in goats in some studies is consistent with decreased exposure because they feed mainly on bushes and shrubs.

## REFERENCES

1. Sheferaw D, et al. *Trop Anim Health Prod.* 2014;46:247.
2. Negash S, et al. *Onderstepoort J Vet Res.* 2015;82:881.
3. Mushonga B, et al. *J S Afr Vet Assoc.* 2015;86:1233.
4. Ismail ZB, et al. *Am J Anim Vet Sci.* 2007;2:66.
5. Akinrinmade JF, Akinrinde AS. *Int J Anim Vet Adv.* 2012;4:344.
6. Abdelaal AM, El-Maghawry S. *Vet World.* 2014;7:522-527.
7. Gomez DE, et al. *Can Vet J.* 2014;55:965.

## INDIGESTION IN CALVES FED MILK REPLACERS (RUMINAL DRINKERS)

A form of indigestion known as ruminal drinking occurs in veal calves and is characterized clinically by recurrent ruminal tympany, inappetence, unthriftiness, and the production of clay-like feces. The disease is most common in calves 5 to 6 weeks after being placed on a milk diet and being fed with a bucket.

The cause is insufficient closure of the reticular groove while drinking milk. The ingested milk enters the rumen in large quantities instead of flowing directly into the abomasum. The experimental intraruminal administration of milk to calves at 6 weeks of age induces changes in the rumen similar

to those seen in spontaneous cases of the disease. The pH of the rumen decreases and L-lactate and D-lactate concentrations increase rapidly. The daily oral administration of untreated whole milk via stomach tube into calves 5 to 23 days of age results in a D-lactic metabolic acidosis within a few days. The onset of ruminal acidosis occurred quickly, and mean ruminal pH values fell from 6.7 to 4.9 after the first feeding. In the following days the rumen pH values varied between 4 and 5, and rumen fluid usually has a milky appearance and a sour smell. During ruminal acidosis, both L-lactic acid and D-lactic acid are produced abundantly by bacterial fermentative activity. Both isomers of lactic acid are absorbed from the rumen, or from the intestines, in which they exert an acidemic effect by inducing a strong ion (metabolic) acidosis.<sup>1</sup> The L-lactate can be metabolized quickly by the body and does accumulate despite the continuous influx into the blood. However, D-lactate cannot be metabolized at the same rate because of a lack of specific metabolic pathway, and it accumulates with the consequence of the risk of hyper-D-lactatemia. This will result in acidemia caused by strong ion acidosis, depression, and reluctance to move, with impaired palpebral reflex being the best clinical indicator of hyper-D-lactatemia in calves with ruminal drinking or diarrhea.<sup>2</sup>

There is marked ruminal hyperkeratosis. Villous atrophy occurs in the proximal jejunum accompanied by a reduction in brush border enzyme activities. Clinical recovery occurs within several days after returning to normal feeding practices, with restoration of villous length and brush border enzyme activities in 3 to 4 weeks.

On clinical examination the temperature, heart rate, and respiratory rates are within normal range. The abdominal contour is increased in size, especially over the ventral half of the abdomen. Distension is more obvious on the left side. Ballottement of the left abdominal wall commonly reveals fluid-splashing sounds. Auscultation of the left paralumbar fossa while the calf is drinking reveals loud fluid-splashing sounds. Large volumes of foul-smelling or acid-smelling, grayish-white fluid can be siphoned off from the rumen. Examination of the rumen contents after calves have consumed milk reveals the presence of a casein clot. Radiologic examination reveals that ingested milk enters the rumen and reticulum and is only slowly moved on to the abomasum. An acetaminophen absorption test can be performed in equivocal cases, in which acetaminophen (paracetamol) is added to a 2-L test solution of milk or milk replacer at 20 to 50 mg/kg and the calf allowed to ingest the test solution.<sup>3,4</sup> Calves that are ruminal drinkers have a very flat acetaminophen absorption curve and delayed time to maximal plasma acetaminophen concentration, indicating failure of the esophageal groove closure and ruminal drinking syndrome. Alternatively, the dimensions of the abomasum can be measured on the ventral midline before and after the calf suckles a 2-L volume of milk or milk replacer. From the abomasal dimensions and assuming the abomasum can be modeled as an ellipse, abomasal volume can be calculated as length × width × depth ×  $\pi/6$ ;<sup>5,6</sup> in healthy calves the calculated abomasal volume should have increased by 2 L. Alternatively, an ultrasound can be performed on the ventral abdomen and the reticulum examined for the presence of milk. Immediately after suckling, the reticulum is displaced dorsally by the enlarged abomasum, which lies on the ventral abdominal floor. In calves with ruminal drinking syndrome, the reticular content could be visualized and consisted of a heterogeneous echoic liquid content.<sup>7</sup> Milk can also be visualized in the ventral aspects of the rumen after milk ingestion by calves with ruminal drinking syndrome.<sup>7</sup>

Affected calves remain unthrifty while they continue to drink milk. Esophageal groove reflex dysfunction may be a complication in some milk-fed calves affected with diarrhea. Treatment should initially start with draining of the rumen contents by passing an ororuminal tube. Drainage may require the addition of 1 to 2 L of warm tap water to create a siphon and facilitate emptying of the rumen. Calves should not be bucket fed, but should be fed milk with a small nipple hole to ensure slower ingestion. This is done because the disease is rarely diagnosed in calves that are left suckling their dam. Retraining the calf to suckle on a nipple by allowing the calf to suck on a finger before offering the nipple can be important.

In older calves that can be weaned, weaning on to hay and concentrates returns the calf to normal very quickly. Rumen movements, via eructation reflex, and ruminations become normal within 1 to 2 weeks.

The administration of colostrum and other fluids to calves using an esophageal feeder does not induce the esophageal groove reflex. However, colostrum and other fluids administered directly into the rumen with a feeder does move from the forestomach into the abomasum within minutes. Feeding colostrum to newborn calves by means of an esophageal feeder is a labor-saving and effective method of obtaining optimum levels of serum immunoglobulins. This is particularly useful in large dairy herds because colostrum can be given to calves immediately after birth.

At necropsy the rumen of calves with ruminal drinking syndrome is enlarged and there are varying degrees of hyperkeratosis and parakeratosis. Villous atrophy is prominent in the small intestine, which is partially restored to normal when the reticular groove reflex is restored.

Affected calves can be treated by inducing them to suck on the herdsman's fingers while they are being fed a small quantity of cows' whole milk or milk replacer. Ideally, calves recovering from ruminal drinking syndrome should be fed multiple small meals of milk or milk replacer frequently.

## REFERENCES

1. Trefz FM, et al. *J Vet Intern Med.* 2015;29:678.
2. Trefz FM, et al. *BMC Vet Res.* 2012;8:238.
3. Marshall TS, et al. *Am J Vet Res.* 2005;66:364.
4. Schaer S, et al. *J Vet Med A Physiol Pathol Clin Med.* 2005;52:325.
5. Wittek T, et al. *Am J Vet Res.* 2005;66:537.
6. Labussiere E, et al. *Animal.* 2014;8:1643.
7. Braun U, Gautschi A. *Acta Vet Scand.* 2012;55:1.

## ACUTE CARBOHYDRATE ENGORGEMENT OF RUMINANTS (RUMINAL LACTIC ACIDOSIS, RUMEN OVERLOAD) AND SUBACUTE RUMINAL ACIDOSIS

### ETIOLOGY

**Acute ruminal acidosis** is most commonly caused by the sudden ingestion of toxic doses of carbohydrate-rich feed, such as grain. Less common causes include engorgement with apples, grapes, bread, baker's dough, sugar beet, mangels, sour wet brewers' grain that was incompletely fermented in the brewery, and concentrated sucrose solutions used in apiculture. **Subacute ruminal acidosis (SARA)** in dairy cattle is a disorder of ruminal fermentation in dairy cattle caused by the ingestion of large amounts of concentrates and inadequate amounts of fiber administered to increase milk production in early lactation.

### SYNOPSIS

**Etiology** Sudden ingestion of large amounts of highly fermentable carbohydrates.

**Epidemiology** Accidental consumption by ruminating cattle of excessive quantities of highly digestible feeds such as cereal grains, corn, baker's bread, grapes, apples, and the like. In beef and lamb feedlots the rapid introduction of high-level grain diets is a major risk factor. Outbreaks occur when animals gain access to a large quantity of grain. High mortality rate when large quantity of grain ingested. Subacute ruminal acidosis is considered an important problem in dairy herds.

**Signs** Anorexia, depression, dehydration, ruminal stasis, profuse diarrhea with sweet-sour odor of feces that may contain undigested kernels, weakness, and ataxia leading to recumbency. Rumen may or may not feel full, but atonic and fluid-splashing sounds are audible on ballottement. Laminitis and mycotic rumenitis are complications.

**Clinical pathology** Ruminal fluid pH below 5, rumen protozoa absent or inactive in rumen fluid; hemoconcentration, blood L-late and D-lactate concentration increased, hypocalcemia.

**Lesions** Acute congested and inflamed rumenitis, sloughing ruminal mucosa; mycotic inflammation and necrosis of forestomach and fungal hepatitis if disease lasts several days.

**Diagnostic confirmation** Ruminal fluid pH below 5.

**Differential diagnosis list** Simple indigestion, parturient hypocalcemia, peracute coliform mastitis, acute diffuse peritonitis.

**Treatment** Triage to determine which animals need medical treatment, rumen lavage, or rumenotomy. Correct ruminal and systemic acidosis with alkalinizing agents parenterally or orally depending on severity. Fluid and electrolyte therapy as necessary. Restore forestomach and intestinal motility by providing palatable hay.

**Control** Prevent accidental access to grain. Gradual introduction to high-level grain diets in feedlots. Total mixed rations containing chopped roughage and grain to ensure controlled intake of carbohydrates. Careful feeding management of dairy cattle during late pregnancy and early lactation. Use of ionophores in feed alter rumen metabolism and potentially can control ruminal acidosis.

### EPIDEMIOLOGY

#### Occurrence

All types of **ruminant** cattle and sheep are susceptible to acute ruminal acidosis, but the disease is most common in feedlot cattle. It also occurs in lamb feedlots and has been recorded in goats, wild deer, and farmed

ungulates. SARA is most common in dairy cattle fed high-level grain diets.

### Previous Diet and Change of Ration

Because the type and level of ration consumed by a ruminant affects the numbers and species of bacteria and protozoa in the rumen, a change from one ration to another requires a period of microbial adaptation, which is a variable interval of time before stabilization occurs. Animals being fed a low-energy ration are most susceptible to a rapid change to a high-energy ration because satisfactory adaptation cannot occur quickly enough. This results in the rapid onset of abnormal fermentation.

### Accidental Consumption of Excess Carbohydrates

The disease occurs is common following accidental consumption of toxic amounts of grain by cattle gaining sudden access to large quantities of grain. A single animal or a group of hungry cows may break into a grain storage bin or find a large supply of unprotected grain, which is not uncommon on a mixed cattle-grain farm. Another common occurrence is when cattle are left under the care of an assistant who, being unaware of the feeding schedule, gives the cattle an unaccustomed quantity of grain. Outbreaks have occurred in dairy herds following malfunction of automatic feeders, which delivered many times more than the usual amount of grain. In a similar outbreak, recently calved cows consumed an excessive amount of feed delivered by an automatic feeder but not eaten by other cows because of hot weather.

Outbreaks have occurred when cattle have been turned into unripe, green corn standing in the field, when cattle or sheep have been placed on stubble fields in which considerable grain lost by the harvester was available on the ground, and following the irregular feeding of large quantities of other less common animal feeds and by-products, such as bread, baker's dough, and wet brewers' grain. Problems usually arise with these feeds when a larger than usual amount is fed to cattle either for the first time or because the usual supplementary feed is in short supply.

### Feedlot Cattle

The occurrence of grain overload in feedlot cattle, however, has gained the most attention, presumably because of its economic impact. Digestive disorders account for approximately 25% to 35% of deaths in feedlot cattle and may contribute to decreased performance and efficiency of production. The economics of feedlot beef production dictate that cattle should gain weight at their maximum potential rate, and this usually involves getting them on to a full feed of a high concentration of grain quickly. Economics also favor the processing of grain by

one of several methods available that will increase the availability of starch, increase the rate of degradation in the rumen. All these factors set the stage for a high incidence of grain overload in feedlot cattle.

There are some critical periods during which grain overload occurs in feedlot cattle. When starting cattle on feed, animals with previous experience of eating grain will commonly consume a toxic dose if offered a ration with a high percentage of grain. The disease is common in feedlot cattle in which the total daily feed intake has been brought up to what is considered the same feed on an *ad libitum* basis, and they gorge themselves. When increasing the concentration of grain in the ration from one level to another, if the increment is too high the total amount of grain consumed by some cattle will be excessive. Rapid changes in barometric pressures may affect the voluntary intake of cattle. A rapid change to cold weather may result in a moderate increase in feed intake in animals that are fed *ad libitum* and outbreaks of grain overload may occur. When rain is involved and feed becomes wet and possibly even moldy, feed intake will drop, but when fresh dry feed is offered again there may be a marked increase in feed intake that results in grain overload.

The disease also occurs when cattle that have been on a high-level grain ration (full feed) have become hungry because they have been out of feed for 12 to 24 hours as a result of a breakdown in the feed mill or handling facilities. Offering an unlimited supply of feed to these cattle will often result in severe cases of grain overload. In large feedlots, in which communications can be a problem, the accidental feeding of a high-level grain ration to cattle that are on a high-level roughage ration is a common cause of the disease.

The ruminal lesions of rumenitis and ruminal parakeratosis, which are common in feedlot cattle at slaughter, are thought to be associated with the continuous feeding of grain. These lesions are often remarkable at slaughter in well-nourished cattle, and their effect on live weight gain and feed conversion is not known.

### Beef Breeding Herds

Cows in beef cow-calf herds may develop acute ruminal acidosis if offered a high-energy grain ration during the winter feeding period without a period of adjustment.

### Lamb Feedlots and Liquid-Fed Calves

Outbreaks of the disease occur in lamb feedlots in which lambs are started on a high-level grain ration without a period of adjustment. The disease is not as common in lambs as in cattle, perhaps because lambs are usually fed on oats.

Rumenitis and metabolic acidosis have also been reported when newborn calves were force-fed liquid feeds or nutrient-

electrolyte solutions containing easily digestible carbohydrates.

### Dairy Cattle Herds

SARA occurs in dairy cattle herds fed high-grain, low-fiber rations in early lactation. It is considered of major economic importance because of the possible association with laminitis in dairy herds.

The transition from the pregnant, nonlactating state to the nonpregnant, lactating state is the period during which the majority of metabolic diseases occur in the dairy cow. During this period, which ranges from 3 weeks before until 3 weeks after calving, the cow is changed from a high-fiber, low-concentrate diet to a diet that is higher in concentrate feeds and lower in fiber. Cows that have not adapted to these high-grain diets are particularly susceptible to ruminal acidosis. SARA is characterized by repeated bouts of depressed rumen pH between 5.2 and 5.6. The abnormality often results from a large intake of rapidly fermentable carbohydrates that leads to the accumulation of organic acids in the rumen. Up to 20% of cows on commercial dairy farms in early to midlactation have a rumen pH of less than 5.5, indicative of SARA. The economic losses associated with SARA have been estimated at \$1.12 per cow per day.

Field observations suggest that periparturient cows are at risk of SARA because of the time required for the rumen microflora and papillae to adapt to increased intakes of concentrates immediately before parturition and during early lactation when feed intake increases rapidly to meet the energy needs of high-producing dairy cows. The adaptation of the ruminal microflora and papillae from a system appropriate for forage to a system capable of using high-energy lactation rations requires a gradual change during a period of 3 to 5 weeks.

The need for individual cows to adapt to high-energy rations and the common practice of feeding dairy cows as groups results in periparturient cows being at risk of developing SARA. For practical reasons, as total mixed rations have become more common, many dairy herds limit the number of rations to a single dry-cow ration and a single lactating-cow ration, because of the time and labor required to mix each ration. This system has made it difficult to introduce concentrates to individual cows in the first few weeks after calving. If the dry-cow ration has not resulted in adaptation of the ruminal microflora required for high-energy rations, acidosis may occur when the cow is fed the lactating-group ration. The net energy of a ration can be safely increased in 10% increments. For example, a change from an energy density of 0.70 Mcal/lb NE<sub>1</sub> (net energy, lactation) to 0.77 Mcal/lb NE<sub>1</sub> would be considered safe. The National Research Council recommends that dry-cow total mixed rations have 0.57 Mcal/lb NE<sub>1</sub> and that a

high-production lactation cow ration have 0.78 Mcal/lb NE<sub>1</sub>. Using the 10% guideline for gradual energy change would require at least two intermediate rations.

Dairy producers attempt to minimize the **negative energy balance** of lactating cows in early lactation by maximizing concentrate intake early in the period after parturition. The early lactation period is a high-risk period for lactating dairy cows if they are fed rations as separate components, for three reasons:

1. Concentrates are consumed by the cow in preference to forage.
2. Forage consumption is not usually measured on an individual cow basis and is commonly assumed to approximate the herd average.
3. Dry matter intake of periparturient cows is lower than commonly thought and is very dynamic through this period.

Thus high-producing lactating dairy cows consuming large quantities of high-energy grains are susceptible to SARA during early lactation.

Field recommendations for feeding component-fed concentrates during the first 3 weeks of lactation are usually excessive. Feeding excessive quantities of concentrate and insufficient forage results in a fiber-deficient ration likely to cause subacute acidosis. The same situation may occur during the last few days before parturition if the ration is fed in separate components; as dry matter intake drops before calving, dry cows will preferentially consume too much concentrate and insufficient fiber, and develop acidosis.

SARA may also be caused by formulation of rations that contain excessive amounts of rapidly fermentable carbohydrates, a deficiency of fiber, or errors in delivery of the rations. Recommendations for the fiber content of dairy rations are available in the National Research Council (Nutrient Requirements of Dairy Cattle). Dry matter content errors in total mixed rations are commonly related to a failure to adjust for changes in moisture content of forages.

### Morbidity and Case-Fatality Rates

Outbreaks of the disease occur in cattle herds kept on grain farms and in feedlots. Depending on the species of grain, the total amount eaten and the previous experience of the animals, the morbidity will vary from 10% to 50%. The case-fatality rate may be up to 90% in untreated cases, whereas in treated cases it still may be up to 30% to 40%.

### Types and Toxic Amounts of Feeds

Wheat, barley, and corn grains are the most toxic when ingested in large quantities. Oats and grain sorghum are least toxic. All grains are more toxic when ground finely or even crushed or just cracked, which are processes



that expose the starch component of the grain to the ruminal microflora. The experimental feeding of unprocessed barley to cattle did not result in rumenitis, whereas feeding rolled barley was associated with ruminal lesions. An unrestricted supply of stale bread can cause outbreaks.

The amount of a feed required to cause acute illness depends on the species of grain, previous experience of the animal with the grain, its nutritional status and body condition score, and the nature of the ruminal microflora. Dairy cattle accustomed to high-level grain diets may consume 15 to 20 kg of grain and develop only moderate illness, whereas beef cows or feedlot cattle may become acutely ill and die after eating 10 kg of grain to which they are unaccustomed. Amounts of feed that are lethal range from 50 to 60 g of crushed wheat per kilogram BW in undernourished sheep to 75 to 80 g/kg BW in well-nourished sheep, and in cattle doses ranging from 25 to 62 g/kg BW of ground cereal grain or corn produced severe acidosis.

### PATHOGENESIS

A summary of the events that occur in the rumen and the systemic effects on the animal with acute ruminal acidosis is presented here. The disease provides an excellent example of strong ion (metabolic) acidosis in ruminants.

### Changes in Rumen Microflora

The ingestion of excessive quantities of highly fermentable feeds by a ruminant is followed within 2 to 6 hours by a marked change in the microbial population in the rumen. There is an increase in the number of *Streptococcus bovis*, which use the carbohydrate to produce large quantities of lactic acid. In the presence of a sufficient amount of carbohydrate (a toxic or a lethal amount) the organism will continue to produce lactic acid, which decreases the rumen pH to 5 or less, which results in the destruction of the cellulolytic bacteria and protozoa. When large amounts of starch are added to the diet, growth of *S. bovis* is no longer restricted by energy source and it multiplies faster than any other species of bacteria.

### Volatile Fatty Acids and Lactic Acid in the Rumen

The concentration of volatile fatty acids increases initially, contributing to the fall in ruminal pH. The low pH allows lactobacilli to use the large quantities of carbohydrate in the rumen to produce excessive quantities of lactic acid, resulting in **ruminal lactic acidosis**. Both D and L forms of the acid are produced, which markedly increases ruminal osmolality, and water is drawn in from the systemic circulation, causing hemoconcentration and dehydration. Ruminal osmolality increases from a normal of 280 mOsm/kg to almost 400 mOsm/kg, and this increase in

rumen osmolality plays an important role in decreasing appetite and increasing dehydration, because extracellular fluid volume is translocated into the rumen.

Some of the lactic acid is buffered by ruminal buffers, but large amounts are absorbed by the rumen and some moves into and is absorbed further down the intestinal tract. Lactate is a 10 times stronger acid than the volatile fatty acids, and accumulation of lactate eventually exceeds the buffering capacity of rumen fluid. As the ruminal pH declines, the amplitude and frequency of the rumen contractions are decreased, and at about a pH of 5 there is ruminal atony. The increased concentration of undissociated volatile fatty acids in the rumen is thought to be more important than increased lactic acid concentration or decreasing ruminal pH in causing ruminal atony. Experimentally, ruminal atony occurs in sheep within 8 to 12 hours after grain engorgement, but the precise pathophysiological mechanism for loss of forestomach motility is uncertain. The diarrhea is thought to be osmotic because of the large increase in rumen osmolality and, consequently, small and large intestinal osmolality, which is similar to the cathartic effects of orally administered magnesium sulfate.

In experimental lactic acidosis using sucrose in sheep, feed intake does not resume until rumen pH has returned to 6.0 or higher and lactic acid is no longer detectable in the rumen. Renal blood flow and glomerular filtration rate are also decreased, resulting in anuria. Eventually there is shock and death. All these events can occur within 24 hours after engorgement of a lethal dose of carbohydrate; with toxic doses the course of events may take 24 to 48 hours.

### Systemic Lactic Acidosis

The absorbed lactic acid acts as a strong anion, and when absorbed in sufficiently large enough amounts results in a decreased strong ion difference (the net difference in charge between strong cations and strong anions) and a strong ion acidosis and acidemia. The L-lactate is rapidly metabolized to bicarbonate, increasing the plasma strong ion difference and increasing blood pH toward the normal range. D-lactate is very slowly metabolized and plasma concentrations decrease primarily by renal excretion, which is low in advanced cases of ruminal acidosis because of marked dehydration. In animals with mild or moderate dehydration that survive the acute form of the disease, the rapid clearance of L-lactate and D-lactate and other compensatory mechanisms may overcompensate, resulting in alkalosis. In severe cases of lactic acidosis the reserves of plasma bicarbonate are reduced, the blood pH declines steadily, and the blood pressure and renal blood flow decline, causing a decrease in perfusion pressure and oxygen supply to peripheral tissues. This results in a further

increase in lactic acid from cellular respiration and decreased elimination of D-lactate in the urine.

**Both D- and L-lactic acids** are produced.

The L-lactic acid is used much more rapidly than the D-isomer, which accumulates and causes a severe D-lactic acidosis. If the rate of entry of lactic acid into body fluids is not too rapid, compensatory mechanisms are able to maintain the blood pH at a compatible level until the crisis is over, and recovery is usually rapid. This may explain the common observation that feedlot cattle may be ill for a few days after being introduced to a grain ration but quickly recover, whereas in other cases when the rate of entry is rapid the compensatory mechanisms are overcome and urgent treatment is necessary.

### Chemical and Mycotic Rumenitis

The high concentration of lactic acid in the rumen causes chemical rumenitis, which is the precursor for mycotic rumenitis in those that survive; this occurs about 4 to 6 days later. The low pH of the rumen favors the growth of *Mucor*, *Rhizopus*, and *Absidia* spp., which invade the ruminal vessels, causing thrombosis and infarction. Inoculation of *A. corymbifera* orally into sheep with experimental ruminal acidosis produced with barley causes desquamation of the superficial layers of the mucosae and focal necrosis from lamina propria to muscular layers. Severe bacterial rumenitis also occurs. Widespread necrosis and gangrene may affect the entire ventral half of the ruminal walls and lead to the development of an acute peritonitis. The damage to the viscus causes complete atony and this, together with the toxemia resulting from the gangrene, is usually sufficient to cause death. Mycotic omasitis and rumenitis may also occur without a history of grain engorgement in cattle. Anorexia and forestomach atonicity associated with a primary illness in other body systems may predispose the mucosae to fungal infection because of abomasal reflux of acid and the prolonged use of antimicrobials.

Chronic rumenitis and ruminal parakeratosis are common in cattle fed for long periods on grain rations, and the lesions are attributed to the chronic acidosis, but it is possible that barley awns and ingested hair may contribute to the severity of the lesions.

### Hepatic Abscesses

In uncomplicated chemical rumenitis, the ruminal mucosa sloughs and heals with scar tissue and some mucosal regeneration. Hepatic abscesses commonly occur as a complication as a result of a combination of rumenitis caused by lactic acidosis and allowing *Fusobacterium necrophorum* and *Trueperella* (formerly *Arcanobacterium* or *Corynebacterium*) *pyogenes* to enter directly into ruminal vessels and spread to the liver, which may have also undergone injury from the lactic acidosis. Severe diffuse coagulation

necrosis and hyperplasia of the bile duct epithelium and degeneration of renal tubules may also be present histologically. A small proportion of cattle with hepatic abscesses proceed to develop **caudal vena caval syndrome**, which is addressed in [Chapter 12](#).

In cattle being placed on a grain ration, even with control of the daily intake, hepatic cell damage and liver dysfunction occur even though dietary adaptation may have occurred in 2 to 3 weeks. The biochemical profile indicates that complete metabolic adaptation requires at least 40 days following the start of grain feeding.

### Laminitis

Laminitis occurs in acute, subclinical, and chronic forms associated with varying degrees of severity of ruminal acidosis. The association between acidosis and laminitis appears to be associated with altered hemodynamics of the peripheral microvasculature. Vasoactive substances are released during the decline of rumen pH and the bacteriolysis and tissue degradation. These substances cause vasoconstriction and dilatation, which injure the microvasculature of the corium. Ischemia results, which causes a reduction in oxygen and nutrients reaching the extremities of the corium and cell swelling. Ischemia causes physical degradation of junctures between tissues that are structurally critical for locomotion, and cell swelling within an enclosed noncompliant structure such as the hoof can result in further decrease in blood flow within the digit. The insidious rotation of the distal phalanx (pedal bone) can result in permanent anatomic change. Manifestations of subclinical laminitis are sole hemorrhages and yellowish discoloration. Other clinical manifestations include double soles, heel erosion, dorsal wall cavity, and ridging of the dorsal wall.

### Other Toxic Substances Produced

Several toxic substances other than lactic acid have been suggested as contributory to the disease. Increased concentrations of histamine have been found in the rumen of experimentally engorged cattle, but its possible role in the disease remains unknown. Histamine is not absorbed from the rumen except at abnormally high pH values, but is absorbed from the small intestine. Laminitis occurs in some cases of rumen overload, but the pathogenesis is unknown.

Other substances that have been recovered from the rumen in grain overload include a suspected endotoxin, ethanol, and methanol. In experimental lactic acidosis induced in cattle with 70 g of barley per kilogram BW, endotoxin and arachidonic acid metabolites are produced and may be important. However, the role of the endotoxin is uncertain but appears to be minor because of effective hepatic clearance. Endotoxin administered into the intestine of lactic acidotic sheep is not absorbed. *Clostridium*

*perfringens* and coliform bacteria have also been found in increased numbers, but their significance is uncertain. The electrolyte changes that occur include a mild hypocalcemia caused by temporary malabsorption, loss of serum chloride caused by sequestration in the abomasum as a result of gastrointestinal hypomotility, and an increase in serum phosphate concentration caused by renal failure.

### Experimental Lactic Acidosis

The disease can be reproduced in cattle and sheep with a variety of grains, fruits, sugars, and pure solutions of lactic acid. The oral administration of sucrose at 18 g/kg BW to goats can cause lactic acidosis. In cattle the sucrose is used to induce rumen lactic acidosis experimentally. The severity of the experimental disease and the magnitude of the pathophysiological changes vary depending on the substance used, but changes similar to the natural disease occur.

Lesions in the brain have been recorded in the experimental disease in sheep and naturally occurring cases in cattle, but their pathogenesis and significance are uncertain. There are detectable changes in the cellular and biochemical composition of the cerebrospinal fluid, which suggests that the blood-brain barrier may be affected. Experimentally, sublethal doses of volatile fatty acids, lactate, and succinate have an effect on liver function. Toxic and lethal doses of butyrate can cause sudden flaccid paralysis and death from asphyxia.

### Subacute Ruminal Acidosis (Dairy Cattle)

There continues to be disagreement as to the consensus definition of SARA, although there is agreement that the definition should focus on rumen pH. Part of the disagreement is caused by differences in mean rumen pH measured by stomach tube or rumenocentesis in which it appears that stomach tube pH values are approximately 0.3 units higher than those obtained by rumenocentesis. This difference may reflect handling differences in the sample, because the pH of free-catch urine samples are often 0.2 to 0.3 pH units higher than those obtained with an anaerobically collected sample from a bladder catheter; loss of carbon dioxide is thought to account for the difference in pH values. Part of the disagreement is caused by **SARA being the result of repetitive transient and moderate decreases in rumen pH**, compared with acute ruminal acidosis, which is the result of a **sustained and marked decreased in rumen pH**. There is a growing consensus that a **definition of SARA is a rumen pH (measured by rumenocentesis)  $\leq 5.5$** ;<sup>1,2</sup> preferably this low pH should be sustained for at least 3 hours of each day.<sup>3,4</sup> However, it should be noted that in vitro fiber digestibility is decreased when pH is below 6.2.<sup>5</sup>

The pathogenesis of SARA in lactating dairy cows is not as well understood as acute ruminal acidosis associated with the sudden ingestion of large amounts of readily fermentable carbohydrates, for example, it is most common in beef cattle that gain accidental access to large quantities of grain. In early-lactating dairy cows, SARA is usually caused by the consumption of diets with high levels of rapidly fermentable carbohydrates or marginal, often deficient, levels of physically active fiber. SARA has been documented most frequently in confinement herds fed a total mixed ration or component feeds; however, it can also occur in pasture-fed cattle in Ireland and New Zealand in which there are lush pastures with high concentrations of rapidly fermentable carbohydrates and low levels of effective fiber.<sup>5,6</sup>

The biochemical changes that occur in lactating dairy cows in early lactation that are affected with SARA have not been examined in detail. In SARA, fermentation of non-structural carbohydrates leads to the production of large quantities of volatile fatty acids and lactate, which accumulate in the rumen and subsequently decrease rumen pH. It has been difficult to reproduce SARA in early-lactation dairy cows even with diets such as high-moisture corn, cracked dried corn grain, and rolled barley. These feeds did not induce SARA, either because of an inability of the feeds to depress the rumen pH rapidly enough or because of the cow's refusal to consume them.

Wheat/barley pellets were readily consumed by lactating dairy cows and did result in a sustained reduction in rumen pH. When cows with experimental SARA are given a choice between alfalfa hay and alfalfa pellets, cows will choose the alfalfa hay more often, which implies that dairy cows would increase their dietary preference for a feed of longer particle size when given the appropriate choice during a bout of SARA. As intake of long hay will result in more saliva production and rumen buffering than intake of pelleted alfalfa, this indicates that cows select feeds with high rumen-buffering capacity in an attempt to prevent SARA. When cows with SARA were offered sodium bicarbonate ad libitum, they did not select the compound to attenuate the ruminal acidosis. When cows with SARA were offered a choice between two test pellets, one containing 4% sodium bicarbonate and the other 4.5% sodium chloride, the intake of the sodium bicarbonate pellets increased over time, but the intake of sodium chloride pellets remained unaltered.

There is some evidence that lactic acid is not the causal reason for the prolonged reduction in pH of the ruminal contents. Studies have shown only low lactate levels between 0.45 and 0.74 mmol/L in cows with suspected SARA. Excessive volatile fatty acid production may be a more important contributor to SARA in lactating dairy cows.

The induction of SARA by excess feeding of wheat/barley pellets reduces the rumen digestion of neutral detergent fiber from grass hay, legume hay, and corn silage. It is thought that SARA affects the productivity of dairy cows by reducing the fiber digestion, because low pH negatively affects cellulolytic bacteria. The induction of SARA in lactating dairy cows by replacing 25% of the total mixed ration intake with pellets consisting of 50% wheat and 50% barley reduced the in situ dry matter and neutral detergent fiber digestion of mixed hay. Disappearance of neutral detergent fiber was reduced from 39.5% to 30.9%.

Rumen pH drops considerably in dairy cows after calving when the diet is changed. Monitoring rumen pH throughout the transition period of dairy cows in which the concentrate to forage ration was changed from 70:30 to 55:45 at calving found that 1 week before calving the average daily pH was 6.83, the average daily time with rumen pH below 6 was 26 minutes, and the average daily time with rumen pH below 5.6 was 6 minutes. During the first week after calving, the average daily pH was 6.51, and the average daily time with rumen pH below 6 and 5.6 were 312 and 60 minutes, respectively. The drop in rumen pH is associated with an increase in the rate of production of volatile fatty acids, which temporarily increases the concentration of volatile fatty acids in the rumen, until the absorptive capacity of the rumen mucosa for volatile fatty acids has been increased.

The pathogenesis of rumenitis, hepatic abnormalities, and laminitis associated with SARA is considered to be similar to those described earlier for acute ruminal acidosis.

## CLINICAL FINDINGS

### Speed of Onset and Severity

The speed of onset of the illness varies with the nature of the feed; it is more rapid with ground feed than with whole grain. The severity increases with the amount of feed eaten. If cattle are examined clinically within a few hours after engorgement, the only abnormalities that may be detectable are a **distended rumen** and **abdomen**, and occasionally some abdominal discomfort, evidenced by kicking at the belly. In the **mild form**, affected cattle are anorexic and still fairly bright and alert, and the feces may be softer than normal. Rumen movements are reduced but not entirely absent. Affected cattle do not ruminate for a few days but usually begin to eat on the third or fourth day without any specific treatment.

In **outbreaks of the severe form**, within 24 to 48 hours some animals will be recumbent, some staggering, and others standing quietly alone. Most affected cattle are anorexic, apathetic, and depressed. Teeth grinding may occur in about 25% of affected sheep and goats. Once they are ill they usually do not drink water, but cattle may engorge themselves on water if it is readily available immediately after consuming large

quantities of dry grain. In an outbreak, inspection of the feces on the ground will usually reveal many spots of soft to watery feces.

### Individual Animals

**Depression, dehydration, inactivity, weakness, abdominal distension, diarrhea, and anorexia** are typical. The temperature is usually below normal, 36.5°C to 38.5°C (98°F–101°F), but animals exposed to the sun may have temperatures up to 41°C (106°F). In sheep and goats, the rectal temperatures may be slightly higher than normal. The heart rate in cattle is usually increased and continues to increase with the severity of the acidosis and circulatory failure. Generally, the prognosis is better in those with heart rates below 100 beats/min than those with rates up to 120 to 140 beats/min. In sheep and goats, the heart rate may be higher than 100 beats/min. The respirations are usually shallow and increased up to 60 to 90 beats/min. A mucopurulent discharge is common because animals fail to lick their nares.

**Diarrhea is almost always present** and usually profuse, and the feces are light-colored with an obvious sweet-sour odor. The feces commonly contain an excessive quantity of kernels of grain in grain overload and have pips and skins when grapes or apples have been eaten. An absence of feces is considered by some veterinarians as a grave prognostic sign, but diarrhea is much more common. The **dehydration is severe and progressive**. In mild cases, the dehydration is about 4% to 6% BW with severe involvement up to 10% to 12% BW. Anuria is a common finding in acute cases, and diuresis following fluid therapy is a good prognostic sign.

**Careful examination of the rumen is important.** The rumen contents palpated through the left paralumbar fossa may feel firm and doughy in cattle that were previously on a roughage diet and have consumed a large amount of grain. In cattle that have become ill on smaller amounts of grain, the rumen will not necessarily feel full but rather resilient because the excessive fluid contents are being palpated. Therefore the findings on palpation of the rumen may be deceptive and a source of error. The primary contractions of the reticulorumen are usually totally absent, although **low-pitched tinkling and gurgling sounds** associated with the excessive quantity of fluid in the rumen are commonly audible on auscultation of the rumen. The ruminal fluid is a milky green to olive brown color and has a pungent acid smell. Collection of a sample of ruminal fluid in a glass beaker will reveal an absence of foam. The **pH of the rumen fluid is usually below 5.**

**Severely affected animals have a staggers, drunken gait and their eyesight is impaired.** They bump into objects and their palpebral eye preservation reflex is sluggish or absent. Recent investigations in calves

with diarrhea have associated high plasma D-lactate concentrations with depressed palpebral reflex,<sup>7</sup> and presumably the same is true in adult ruminants. The pupillary light reflex is usually present but slower than normal. Acute laminitis may be present and is most common in cases that are not severely affected and appear to be good treatment risks. Affected animals are lame in all four feet, shuffle while they walk slowly, and may be reluctant to stand. The lameness commonly resolves if the animal recovers from the acute acidosis. Evidence of chronic laminitis may develop several weeks later.

**Recumbency usually follows after about 48 hours** but may occur earlier. Affected animals lie quietly, often with their heads turned into the flank, and their response to any stimulus is much decreased so that they resemble **parturient paresis**. A rapid onset of recumbency suggests an unfavorable prognosis and the necessity for urgent treatment, because death may occur in 24 to 72 hours after the ingestion of the feed. Evidence of improvement during this time includes a fall in heart rate, rise in temperature, return of ruminal movement, and passage of large amounts of soft feces.

The clinical findings described previously are the most common, but when a group of animals has been exposed to overfeeding there are all degrees of severity from simple indigestion, cases of which recover spontaneously, to the severe cases that need intensive therapy. The prognosis varies with the severity, and the clinical variables that are useful when deciding on a course of treatment or action are summarized in [Table 8-8](#).

### Ultrasonography

Transabdominal ultrasonography of the rumen mucosa has the potential to be a useful noninvasive diagnostic tool for identifying SARA in cattle.<sup>8</sup> The thickness of the rumen mucosa is inversely associated with rumen pH caused by pH-induced epithelial changes, particularly in the upper portion of the ventral rumen sac. The optimal site for ultrasonographic imaging can be obtained by identifying the intersection of a horizontal line going through the costochondral junction and a vertical line centered on the third lumbar vertebrae. In a preliminary study using an 8-MHz linear transducer, a ruminal mucosal thickness >7.3 mm at this location was associated with a ruminal fluid pH <5.5 approximately 4 hours postfeeding.<sup>8</sup>

### Mycotic Rumenitis

Some animals appear to recover following treatment but become severely ill again on the third or fourth day. Mycotic rumenitis is common in these animals and is characterized by a fluid-filled atonic rumen, dehydration in spite of fluid therapy, diarrhea, anorexia, weakness leading to recumbency, and death in 2 to 3 days caused by acute diffuse peritonitis.



**Table 8-8** Guidelines for the use of clinical findings in assessing the severity of grain overload in cattle for the selection of the treatment of choice

CLINICAL PARAMETERS							
Degree of illness	Mental state and muscular strength	Degree of dehydration (% of BW)	Abdominal distension	Heart rate (min)	Body temp. (°C)	State of rumen; fullness, consistency of contents, movements and pH	Treatment
Peracute	Severely depressed, weak, in lateral recumbency, unable to stand, apparent blindness, pupils dilated and slow response	8–12	Prominent	110–130	35.5–38.0	Distended with fluid and soft rumen contents, complete stasis, sweet–sour smelling fluid contents Rumen juice pH below 5 and usually about 4 No protozoa	Rumenotomy Sodium bicarbonate 5 L (5% IV in 30 min (for 450 kg BW) followed by isotonic balanced fluids and electrolytes at 150 mL/kg BW for 6–12 h
Acute	Depressed, still able to walk but ataxic, complete anorexia, may want to drink water, pupils slightly dilated and slow response	8–10	Moderate	90–100	38.5–39.5	Distended with fluid, complete stasis, sweet–sour smelling fluid contents Rumen pH between 5 and 6 No protozoa	Consider immediate slaughter Rumen lavage or rumenotomy Sodium bicarbonate and fluids IV as in peracute case Feed hay
Subacute	Fairly bright and alert, able to walk, no ataxia, may eat, usually wants to drink, pupils normal	4–6 (Just barely detectable clinically)	Mild or none	72–84	38.5–39.0	Moderate distension with fluid, some doughy ruminal ingesta palpable, some weak ruminal contractions, rumen pH between 5.5 and 6.5 Some protozoa alive	Magnesium hydroxide 500 g/450 kg BW into rumen Fluids if indicated Feed hay Should begin eating in 24–36 h
Mild	Bright and alert, able to walk, no ataxia, eats and drinks normally	Not detectable clinically	Not significant	Normal	Normal 38.5–39.0	No detectable distension, ruminal contents palpable, ruminal contractions still present but not as strong as normal, rumen pH 6.5–7 Almost normal protozoal activity	Feed hay and observe for 48 h Watch for anorexia

BW, body weight; IV, intravenously.

## Complications

**Chronic laminitis** may occur several weeks or months later. This is particularly important in dairy cattle herds affected with SARA. The mechanism remains undetermined and does not appear to be related to systemic endotoxemia, because endotoxin is rarely detected in cattle with acute ruminal acidosis. However, it is hypothesized that endotoxin absorbed into the portal circulation creates a proinflammatory response, but that the endotoxin is subsequently cleared by resident macrophages (Kupffer cells) in the liver.

**Abortions** may occur 10 days to 2 weeks later in pregnant cattle that survive the severe form of the disease.

## Subacute Ruminal Acidosis in Dairy Cattle

SARA is being recognized with increased frequency in dairy herds. However, the case definition is not yet well described. Clinical findings include laminitis, intermittent

diarrhea, suboptimal appetite or cyclic feed intake, a high herd culling rate, loss of body condition in spite of adequate energy intake, liver abscesses, and hemoptysis and epistaxis associated with venal caval thrombosis and pulmonary hemorrhage. Milk-fat depression and suboptimal milk production in the second-lactation and subsequent-lactation cows compared with the first-lactation cows may occur.

A decrease in dry matter intake is commonly reported in herds with SARA. The causes of a lowered dry matter intake are uncertain but may be related to weaker rumen motility during low pH phases, bacterial endotoxins, and changes in the osmolality of the rumen contents.

The laminitis is characterized by ridges in the dorsal hoof wall, sole ulceration, white line lesions, sole hemorrhages, and misshapen hooves. It is suggested that when the incidence of laminitis exceeds 10% of the herd, it should be considered a herd problem related to the feeding program.

## CLINICAL PATHOLOGY

The severity of the disease can usually be determined by clinical examination, but field and laboratory tests are of some additional value, particularly in diagnosing SARA in lactating dairy cattle.

### Ruminal Fluid pH

The pH of the ruminal fluid obtained by specially designed stomach tubes or by rumenocentesis through the left ventral abdominal region can be measured in the field using wide-range pH (2–12) indicator paper. The ruminal fluid must be examined immediately because the pH will increase on exposure to air. Cattle that have been fed a roughage diet will have a ruminal pH of 6 to 7; for those on a grain diet it will be 5.5 to 6. A ruminal pH of 5 to 6 in roughage-fed cattle suggests a moderate degree of abnormality, but a pH of less than 5 suggests severe grain overload and the need for aggressive treatment. Feedlot cattle that have been on grain for several days or weeks and are

affected with grain overload usually have a pH below 5.

Rumen fluid pH measurement has not been widely adopted because of producer concern regarding the safety of the rumenocentesis procedure and the time taken and facilities required to obtain a suitable rumen fluid sample using a stomach tube.<sup>8</sup> Whether rumen fluid obtained by a specially designed stomach tube provides an accurate reflection of rumen pH remains controversial. Challenges with sampling rumen fluid using a tube are to ensure that the tube opening is ventral to the rumen mat and in the fluid layer, and that the sample is not contaminated with saliva. Use of specialized designed tubes and rapid collection of a large rumen fluid volume increase the likelihood that the sample accurately reflects intraruminal pH.<sup>9</sup> There is no doubt that the agreement between rumen pH values collected by rumenocentesis and a standard stomach tube is poor in some studies, most likely because of excessive saliva contamination and sustained exposure of a large surface area of the sample to air. What remains in dispute is the level of agreement between pH values for rumen fluid collected by rumenocentesis or by specially designed stomach tubes.<sup>9</sup> The consensus is that rumenocentesis of the ventral ruminal sac provides the most accurate method for measuring ruminal pH.

**Rumenocentesis** has become a commonly used diagnostic test for SARA but few studies have been published documenting its safety, and anecdotal reports of decreased milk production for 24 to 48 hours following the procedure exist. One German report revealed complications in 6% of 164 sampled cows, with hematoma and abscess formation as the most common side effects. It needs to be recognized that rumenocentesis is a transient planned hardware except the wire transverses the rumen wall from outside-in, compared with the typical hardware case in which the wire transverses the reticular wall from inside-out and stays in that location for some time. Rumenocentesis does not appear to be any more painful or stressful than restraint or injection of local anesthetic agent in the same location<sup>10</sup>; consequently there does not appear to be a need to infiltrate the abdominal musculature and skin with local anesthetic at the proposed site for rumenocentesis.

A hypodermic needle of 2.1 (outer diameter) × 80 mm (length) is inserted into the ventral rumen and rumen contents aspirated with a syringe. Landmarks for the puncture site are the left side, on a horizontal line level with the top of the patella about 15 to 20 cm posterior to the last rib. The hair of the site is clipped and prepared using a standard scrub. The cow is restrained in a stanchion or head-gate and one assistant elevates the tail of the cow while another assistant inserts a “nose leader” and pulls the cow’s head to the right side. The needle will usually become

obstructed by ingesta, which is cleared by forcing a small amount of air or fluid back through the needle. When the needle becomes obstructed, it is important to avoid creating a negative pressure within the syringe because carbon dioxide will leave the fluid and increase the pH. Typically, 3 to 5 mL of rumen fluid can be collected with minimal difficulty.

The pH is measured immediately using a pH meter with a digital readout. Samples should be collected when the pH is likely to be near the lowest point of the day. If the ration is fed as separate components, rumenocentesis should be performed 2 to 4 hours after the cows are fed the primary concentrate of the day. If the ration is fed as a total mixed ration, the samples should be collected 4 to 8 hours after the start of feeding. A pH of 5.5 is recommended as the cut-point between normal and abnormal, but this cut point has not been validated against any performance metric. At least 12 or more cows should be sampled from any group in which acidosis is suspected. If 30% of 10 or more sampled cows are below 5.5, the group is classified as in a state of ruminal acidosis. A subsample of 12 cows from a herd or diet group and a critical number of three cows with a ruminal pH ≤ 5.5 may effectively differentiate between herds with 15% or less or greater than 30% prevalence of cows with a low ruminal pH.

### Ruminal Protozoa

Microscopic examination of a few drops of ruminal fluid on a glass slide (with a coverslip) at low power will reveal the absence of ruminal protozoa, particularly medium- and large-sized protozoa, which is a reliable indicator of an abnormal state of the rumen that is usually acidosis. The predominantly gram-negative bacterial flora of the rumen is replaced by a gram-positive one.

### Serum Biochemistry

The degree of hemoconcentration, as indicated by hematocrit, increases with the amount of fluid withdrawn from the extracellular fluid space into the rumen and probably provides the best single indicator of clinical severity in ruminal acidosis.<sup>11</sup> The hematocrit rises from a value of approximately 34% to 50% to 60% in the terminal stages and is accompanied by a fall in blood pressure. The acute phase reactants serum amyloid A (SAA) and haptoglobin are markedly increased within 6 to 12 hours and 18 to 36 hours, respectively, of experimental induction of acute ruminal acidosis, whereas a much smaller increase in serum fibrinogen concentration was present after 24 hours.<sup>12,13</sup> The acute phase response is consistent with the presence of damaged ruminal epithelium and systemic effects of proinflammatory cytokines. Surprisingly, there is at the most only a mild increase in the white blood cell count,<sup>12,13</sup> and endotoxin (core

lipopolysaccharide [LPS] from gram-negative bacteria) is rarely identified in the plasma of cattle with acute ruminal acidosis<sup>11</sup> or SARA.<sup>3,4</sup> This result is attributed to effective clearance by macrophages in the liver.

Increased permeability of the forestomach and possibly abomasum is present in cattle with acute ruminal acidosis, based on histologic examination of affected tissues and marked increases in plasma concentration of lactulose after its oral administration. This indicates disruption to the epithelial tight junctions and impaired epithelial barrier integrity of the forestomach.<sup>12</sup> Mild disruption to rumen epithelial integrity is present in cattle and sheep with SARA, and the disruption is pH dependent and more severe at a rumen pH of 5.2 than 5.5.<sup>14,15</sup>

Blood pH, bicarbonate, and base excess fall markedly whereas plasma L-lactate and inorganic phosphate concentrations rise. In almost all cases there is a mild hypocalcemia, which is presumably caused by a temporary decrease in feed intake and gastrointestinal motility. Serum concentrations may drop to between 6 and 8 mg/dL (1.5–2.0 mmol/L).

### Fecal pH

It would appear logical that fecal pH should be directly and positively correlated with rumen pH. However, because of fermentation and buffering of ingesta in the large intestine, there is generally a poor correlation between fecal pH and ruminal pH, unless large amounts of starch escape the rumen undegraded and are fermented in the large intestine.

### Urine pH

The urine pH falls to 4.5 to 5.0 in advanced cases of acute ruminal acidosis and becomes progressively more concentrated as the animal becomes more dehydrated; terminally there is anuria. An experimental study involving 40 steers with experimentally induced acute ruminal acidosis identified a good linear relationship between blood pH and urine pH ( $r = 0.75$ ) in which blood pH =  $0.062 \times$  urine pH + 6.90. A similar linear relationship ( $r = 0.80$ ) existed between Base excess in mEq/L and urine pH, in which Base excess =  $4.44 \times$  urine pH – 32.7.<sup>16</sup>

### Low Milk-Fat Percentage

Ruminal pH is positively correlated with milk-fat concentration for cows more than 30 days in milk, and a number of studies have indicated a **milk fat percentage to milk protein percentage of <1.15:1** is indicative of the presence of SARA in lactating dairy cattle. This index is readily available with monthly herd tests and is underutilized as a monitoring tool, mainly because it is only available on a monthly basis. The proposed mechanism is SARA, which is associated with increased intraruminal propionate production; once absorbed, propionate is energy sparing resulting in increased lipogenesis in

fat tissues and lowered milk fat content. This mechanism is particularly active in cattle past peak milk that are not in a state of negative energy balance. The increased production of transoctadecenoic acids in the rumen of cattle with lower rumen pH may also play a role in SARA-induced milk-fat depression.

An argument can be made that rumen pH measurements obtained by rumenocentesis provide no more additional information to that provided by the milk fat to protein ratio on the same day. A good rule of thumb is that additional investigation is indicated if more than 10% of cows have a lower milk-fat percentage than milk-protein percentage.

### NECROPSY FINDINGS

In acute cases in which the animal dies in 24 to 48 hours, the contents of the rumen and reticulum are thin and porridge-like and have a typical odor suggestive of fermentation. The cornified epithelium may be mushy and easily wiped off, leaving a dark, hemorrhagic surface beneath. This change may be patchy, caused probably by the production of excess lactic acid in pockets in which the grain collects, but is generally restricted to the ventral half of the sacs. Abomasitis and enteritis are also evident in many cases. The abomasum may contain large quantities of grain. There is a pronounced thickening and darkening of the blood, and the visceral veins stand out prominently.

In cases that have persisted for 3 to 4 days the wall of the reticulum and rumen may be gangrenous. This change is again patchy but may be widespread. In affected areas the wall may be three or four times the normal thickness, show a soft black mucosal surface raised above surrounding normal areas, and have a dark red appearance visible through the serous surface. The thickened area is very friable and on cutting has a gelatinous appearance. Histologic preparations show infiltration of the area by fungal mycelia and a severe hemorrhagic necrosis. A fungal hepatitis is common in those with fungal rumenitis. In the nervous system, in cases of 72 hours' or more duration, demyelination has been reported. A terminal ischemic nephrosis is present in varying degrees in most fatal cases of more than several days' duration.

If the examination takes place less than an hour after death, estimation of ruminal pH may be of value in confirming the diagnosis, but after 1 hour the pH of the rumen contents begins to increase and its measurement may not be reliable. A secondary enteritis is common in animals that have been ill for several days.

### DIFFERENTIAL DIAGNOSIS

When outbreaks of the disease with an appropriate history are encountered, the diagnosis is usually readily obvious and

confirmed by the clinical findings and examination of the ruminal fluid for pH and rumen protozoa.

When the disease occurs in a single animal without a history of engorgement, the diagnosis may not be readily obvious. The anorexia, depression, ruminal stasis with gurgling fluid sounds from the rumen, diarrhea, and a staggy gait with a normal temperature are characteristics of rumen overload.

Acute and subacute carbohydrate engorgement must be differentiated from the following:

- **Simple indigestion.** The consumption of large quantities of palatable feed, such as ensiled green feed offered to cattle for the first time, may cause simple indigestion, which may resemble grain overload. The rumen is full, the movements are reduced in frequency and amplitude, and there may be mild abdominal pain from the distension, but the ruminal pH and protozoan numbers and activity are normal.
- **Parturient paresis.** Severe cases that are recumbent may resemble parturient paresis, but in the latter the feces are usually firm and dry, marked dehydration does not occur, the absolute intensity of the heart sounds is reduced, and the response to calcium injection is favorable.
- **Toxemias.** Common toxemias of cattle that may resemble ruminal overload include peracute coliform mastitis and acute diffuse peritonitis, but clinical examination will usually reveal the cause of the toxemia.
- **Subacute ruminal acidosis** must be differentiated from diseases of dairy cows in early lactation in which there is reduced appetite and milk production. These include simple indigestion, left-side displacement of the abomasum, and ketosis, as well as other causes of suboptimal milk production in dairy cows in early lactation. Feeding management problems such as poor-quality forage or poor feeding bunk management are common causes of suboptimal performance in lactating dairy cows that are not affected with SARA.

### TREATMENT

The following are principles of treatment:

- Correct the ruminal and systemic acidosis and prevent further production of lactic acid.
- Restore fluid and electrolyte losses and maintain circulating blood volumes.
- Restore forestomach and intestinal motility to normal.

There are at least two common clinical situations encountered. One is when cattle have been found accidentally eating large quantities of grain, are not yet ill, and all appear similar clinically except for varying degrees of distension depending on the amount each animal has consumed. In the other situation, the engorgement occurred 24 to 48 hours previously and the animals have clinical evidence of lactic acidosis.

**When cattle are found engorging themselves, the following procedures are recommended:**

- Prevent further access to feed.
- Monitor water intake and prevent the rapid intake of excessive quantities of water.
- Offer a supply of good-quality palatable hay equal to one-half of the daily allowance per head.
- Exercise all animals every hour for 12 to 24 hours to encourage movement of the ingesta through the digestive tract.

Those cattle that have consumed a toxic amount of grain will show signs of anorexia, inactivity, and depression in approximately 6 to 8 hours and should be identified and removed from the group for individual treatment. Those cattle that did not consume a toxic amount are usually bright and alert and will usually begin eating hay if it is offered. Not all cattle found engorging themselves with grain will have consumed a toxic dose, and careful monitoring over a 24- to 48-hour period will usually distinguish between those that need treatment and those that do not.

After 18 to 24 hours, those cattle that have continued to eat hay may be allowed free access to water. Those with clinical evidence of grain overload must be identified and treated accordingly. They will engorge themselves with water if allowed free access to it. The rumen becomes grossly distended with fluid and affected cattle may die 18 to 24 hours later from electrolyte disturbances and acid-base imbalance.

In certain situations, if feasible and warranted by economics, such as when finished beef cattle have accidentally engorged on grain, **emergency slaughter** may be the most economical course of action.

### Triage

The recommendations for treatment given in Table 8-8 are guidelines. In an outbreak, some animals will not require any treatment, whereas severely affected cases will obviously need a rumenotomy. For those that are not severely affected, it is often difficult to decide whether to treat them only medically with alkalinizing agents orally and systemically or to do a rumenotomy. Each case must be examined clinically and the most appropriate treatment selected. The degree of mental depression, muscular strength, degree of dehydration, heart rate, body temperature, and rumen pH are clinical parameters that can be used to assess severity and to determine the treatment likely to be most successful.

### Rumenotomy

In severe cases, in which there is recumbency, severe depression, hypothermia, prominent ruminal distension with fluid, a heart rate of 110 to 130 beats/min and a rumen pH of 5 or below, a rumenotomy





**Fig. 8-7** Rumenotomy of a beef bull with grain overload. Forty kilograms of barley was removed and 10 L of fresh rumen fluid and some chopped grass hay was placed back into the rumen.

is the best course of action (Fig. 8-7). Descriptions of the surgical procedures are available.<sup>17,18</sup>

The rumen is emptied, washed out with a siphon and examined for evidence of and the extent of chemical rumenitis, and rumen transfaunation (10–20 L of rumen juice) placed in the rumen along with a few handfuls of hay for “scratch factor.” The rumenotomy will usually correct the ruminal acidosis and prevent subsequent production of L-lactate and D-lactate and an alkalinizing agent in the rumen is not necessary. A large

quantity of the lactic acid and its substrate can be removed. The oral or intraruminal administration of compounds such as magnesium oxide or magnesium hydroxide to cattle following complete evacuation of the rumen may cause metabolic alkalosis for up to 24 to 36 hours (see section on simple indigestion in this chapter). Not all of the feed consumed will be removed because considerable quantities may have moved into the omasum and abomasum in which fermentation may also occur. The major disadvantages of a rumenotomy are time, cost, and

access to appropriate facilities, particularly when many animals are involved.

### Intravenous Sodium Bicarbonate and Fluid Therapy

The systemic acidosis and the dehydration are treated with intravenous solutions of 5% sodium bicarbonate at the rate of 5 L for a 450-kg animal given initially over a period of about 30 minutes. This will usually correct the systemic acidosis. This is followed by isotonic sodium bicarbonate (1.3%) at 150 mL/kg BW intravenously over the next 6 to 12 hours. Cattle that respond favorably to the rumenotomy and fluid therapy will show improved muscular strength, begin to urinate within 1 hour, and attempt to stand within 6 to 12 hours.

### Rumen Lavage

In less severe cases, in which affected cattle are still standing but are depressed, their heart rate is 90 to 100 beats/min, there is moderate ruminal distension, and the rumen pH is between 5 and 6, an alternative to a rumenotomy is rumen lavage if the necessary facilities are available. A large 25- to 28-mm inside-diameter rubber tube is passed into the rumen and warm water is pumped in until there is an obvious distension of the left paralumbar fossa; the rumen is then allowed to empty by gravity flow after creating a siphon. The rumen can be almost completely emptied by 10 to 15 irrigations, but there is the risk of aspiration pneumonia and cattle may become recumbent during the procedure. Challenges with completing this on many animals is access to warm water, a knowledgeable assistant, and physical fatigue. With successful gastric lavage, alkalinizing agents are not placed in the rumen, but the systemic acidosis is treated as described earlier.

### Intraruminal Alkalinizing Agents

In moderately affected cases, the use of 500 g of magnesium hydroxide per 450 kg BW or magnesium oxide in 10 L of warm water pumped into the rumen, followed by kneading of the rumen to promote mixing, will usually suffice.

Magnesium hydroxide is a potent alkalinizing agent for use in ruminants as an antacid and mild laxative. It can significantly decrease rumen microbial activity and should be used only in cattle with confirmed ruminal acidosis and not for symptomatic therapy of idiopathic rumen disorders or hypomagnesemia. The oral administration of boluses of magnesium hydroxide (162 g) or a powdered form (450 g) dissolved in 3.5 L of water daily for 3 days resulted in a significant increase in rumen pH after 48 and 24 hours, respectively. Both the boluses and the powder forms of magnesium hydroxide decreased rumen protozoal numbers and increased methylene blue reduction times compared with baseline values. There was no change in

blood pH, bicarbonate, or base excess values. Serum magnesium values were significantly increased in cows receiving the powder.

### Ruminal Transfaunation

It is widely thought that animals with acute ruminal acidosis benefit from rumen transfaunation, but randomized clinical trials are lacking. General recommendations are to transfer at least 5 L of fresh rumen fluid from a healthy animal<sup>19</sup> to adult cattle with acute ruminal acidosis, but only after rumen lavage or rumenotomy has been performed, excessive amounts of grain have been removed, and ruminal pH is within the normal range of 6.0 to 7.0.

Large volumes of rumen fluid can be obtained by use of specially constructed rumen fluid collection tubes (such as the Dirksen or Geishauer tubes).<sup>20</sup> Alternatively, large dairies may maintain one animal with a large-diameter rumen cannula that is readily available to provide up to 20 L of rumen fluid at a time. In some regions, producers join together to maintain a rumen-fistulated cow for joint use. Descriptions for the surgical procedure for rumen cannula placement in cattle and sheep are available.<sup>21,22</sup>

### Ancillary Therapy

Ancillary treatment has included antihistamines for laminitis, NSAIDs for their antiinflammatory and analgesic effects, thiamin or brewer's yeast to promote the metabolism of lactic acid, and parasymphathomimetics to stimulate gut motility. Their efficacy has been difficult to evaluate, and it is unlikely that any of them would be of much value. Calcium borogluconate is used widely because there is a mild hypocalcemia and a beneficial but temporary response does occur, but it is of doubtful value.

Orally administered antimicrobials, including penicillin and the tetracyclines, have been used to control growth of the bacteria that produce lactic acid, but they appear to be of limited value.

### Monitor Response to Therapy

Regardless of the treatment used, all cases must be monitored several times daily until recovery is obvious for evidence of unexpected deterioration. Following treatment, cattle should begin eating hay by the third day, some ruminal movements should be present, large quantities of soft feces should be passed, and they should maintain hydration. In those that become worse, the heart rate increases, depression is marked, the rumen fills with fluid, and weakness and recumbency occur. During treatment, the water supply should be restricted because some cattle, either immediately after they have engorged themselves or once they become ill, appear to have an intense thirst and will drink excessive quantities of water and die precipitously within a few hours.

The fungal rumenitis that may occur about 3 to 5 days after engorgement is best prevented by early effective treatment of the ruminal acidosis. There are no randomized clinical trials supporting the administration of antifungal agents to affected animals.

### CONTROL AND PREVENTION

Cattle can be started, grown, and finished on high-level grain rations successfully, provided that they are allowed a **gradual period of adaptation** during the critical period of introduction. The important principle of prevention is that the ruminant can adapt to an all-concentrate ration. For animals that have just arrived in the feedlot, the length of the adaptation period required will depend on the immediate nutritional history of the animals, their appetite, and the composition of the ration to be used. Dietary management should emphasize ensuring adequate fiber, a sufficiently long daily chewing time, and a “grazing” eating behavior rather than “slug” feeding.

#### Total Mixed Rations

One of the safest procedures is to feed a milled mixed ration, consisting of 50% to 60% roughage and 40% to 50% grain, as the starting ration for 7 to 10 days and monitor the response. If results are satisfactory, the level of roughage is decreased by 10% every 2 to 4 days down to a level of 10% to 15% roughage, with the remainder grain and vitamins-mineral-salt supplement. The use of roughage-grain mixtures ensures that cattle do not engorge themselves on grain, and adaptation can occur in about 21 days.

#### Small Incremental Increases in Concentrate

Another method is to begin with small amounts of concentrate 8 to 10 g/kg BW, which is increased every 2 to 4 days by increments of 10% to 12%. A source of roughage is supplied separately. The disadvantages of this system are that hungry or dominant cattle may eat much more than their calculated share and there is no assurance that sufficient roughage will be consumed. In this system, on a practical basis, the cattle are usually fed twice daily and brought up to a daily intake of concentrate that satisfies their appetite and then the concentrate ration is offered free choice from self-feeders. Unless there is sufficient feeding space in the self-feeders, competitive and dominant animals will often overeat, so careful monitoring is necessary.

#### Feedlot Starter Rations

Feedlot starter rations consisting of a mixture of roughage and grain, offered free choice along with hay and gradually replaced by a finishing ration have successfully adapted cattle in 10 days. The starter ration contains about 2500 kcal (10,460 kJ) digestible energy (DE) per kilogram of feed. The finishing

ration contains about 3100 kcal (12,970 kJ), and controlling the rate of increase of DE concentration of the ration was a major factor in getting cattle on feed.

A comparison of the effect of rapid or gradual grain adaptation on subacute acidosis and feed intake by feedlot cattle indicates a range of individual responses to grain challenge and current management strategies for preventing acidosis in pens of cattle are based on responses of the most susceptible individuals. Using this approach requires consideration of individual animal responses. The data suggest that most cattle can be rapidly adapted to high-grain diets in few incremental steps; minimizing acidosis in the most susceptible individuals requires decreasing the pace of grain adaptation for the entire group.

### Dietary Buffers

The incorporation of buffers, such as sodium bicarbonate, into the ration of feedlot cattle has been studied extensively, but the results are inconclusive and reliable recommendations cannot be made. A level of 2% dietary sodium bicarbonate, sodium bentonite, or limestone provided some protection from acidosis during the early adaptation phase of high-concentrate feeding; but they were no more effective than 10% alfalfa hay. Buffers have been most effective in reducing acidosis early in the feeding period and have little or no effect later. Buffers may also be associated with an increased incidence of urinary calculi, bloat, and vitamin deficiencies. The experimental results are conflicting. Some trials indicate that buffers maintain a gram-negative rumen flora in sheep fed grain compared with a shift to gram-positive rumen flora in animals not fed buffers. Live weight performance is also improved in some trials but not in others fed 0.75, 1.0, or 2.25% of diet as sodium bicarbonate.

The potential efficiency of products for the control of ruminal acidosis has been examined through the measurement of the increase in buffer capacity and acid-consuming capacity. Sodium bicarbonate provided the highest increment in buffering capacity and acid-consuming capacity compared with calcium carbonate. Magnesium oxide provided higher acid-consuming capacity but had no effect on buffer capacity.

Dietary supplementation of sodium bicarbonate at a level of 1.5% for 90 days in high-concentrate diets fed to lambs improved cellulose digestibility, ciliate protozoal number, ruminal pH, and total nitrogen concentration, resulting in improved growth of lambs maintained on a high-concentrate diet.

### Ionophores

The ionophores salinomycin, monensin, and lasalocid have been compared for their protective effects, and salinomycin is more effective than the other two; monensin also shows



some promise. Laidlomycin propionate does not prevent ruminal acidosis but may reduce the severity of ruminal acidosis during adaptation to a 100% concentrated diet. Monensin decreases meal size and therefore increases the frequency of eating, both of which minimize the daily range in rumen pH and should therefore be beneficial in addressing SARA.

### Subacute Ruminal Acidosis in Dairy Cattle

The basic principles of preventing SARA in dairy herds include the following:

- Limiting the intake of rapidly fermentable carbohydrates
- Providing adequate ruminal buffering
- Allowing for ruminal adaptation to high-grain diets

Prevention of SARA includes **proper adaptation of rumen papillae during the prepartum period, adequate intake of forage in early lactation, and adequate fiber nutrition throughout lactation.** Successful management of energy balance through the **periparturient transition period** depends on providing adequate energy density in the prepartum diet. Increasing energy density of the prepartum diet also promotes dry matter intake before and after calving. The energy density in the prepartum diet should be 1.54 to 1.63 Mcal/kg NE<sub>i</sub>.

Dry cows should be fed according to their needs; cows in the early and middle portion of the dry period (far-off cows) and cows in the final 3 weeks before calving (prefresh cows) have different nutritional requirements to achieve optimal milk production and maintain the health and fertility of early-lactation cows.

Prepartum diets should be offered, starting at least 3 weeks before calving. Because of the different calving dates of dry cows fed in groups, the use of a prepartum diet over a prepartum feeding period of 21 days will usually allow each cow to consume the diet for a minimum of 5 days. The nutrient requirements for the prefresh dry cow are controversial. The National Research Council does not provide recommendations for prefresh cows, and it is recommended that a dairy cattle nutritionist be consulted for formulation of such rations. Generally, a prefresh diet will provide about 0.50 to 0.75% BW per day as concentrates. Prefresh diets should be similar to early lactation diets so that the transition occurs effectively. The forages fed in the prefresh diet should be similar to those fed in early lactation.

Dairy cows are usually fed total mixed rations in which the concentrates and forages are mixed and fed as a total ration or separate component rations in which the concentrates and forage are fed independently. In herds using separate component diets, the concentrates in the prefresh diet should be gradually introduced over a period of 3 to 5 days and preferably fed individually. Forages

should also be fed individually so that intake can be evaluated. Delivering new feed twice daily facilitates dairy cattle to take more frequently but smaller meals, and moving on the continuum from slug feeding to grazing, which should minimize large changes in ruminal pH.

### Limiting the Intake of Rapidly Fermentable Carbohydrates

As a guideline, cows should not receive more than 8 to 12 lb (3–5 kg) of dry matter from grain in the first week after calving. Grain feeding should then increase by about 0.25 to 0.50 lb (110–220 g) per cow per day until peak grain feeding is reached at 6 to 8 weeks postcalving.

The physical form of the feed ingredients is as important as their chemical composition in determining how rapidly and completely they are fermented in the rumen. Grains that are finely ground, steam-flaked, extruded, and/or very wet will ferment more rapidly and completely in the rumen than unprocessed or dry grains. Starch from wheat or barley is more rapidly and completely fermented than starch from corn (maize). Corn silage that is very wet, finely chopped, or kernel processed is also a greater risk for SARA than drier, coarsely chopped, or unprocessed corn silage. Particle size analysis of grains is a useful adjunct test when assessing the risk for SARA in a dairy herd. Grain particle size length can be determined using metal sieves.

### Providing Adequate Ruminal Buffering

Ruminal buffering includes dietary and endogenous buffering. **Dietary buffering** is the inherent buffering capacity of the diet and is dependent on the dietary cation-anion difference (DCAD). Diets high in sodium and potassium relative to chloride and sulfur have higher DCAD concentrations, tend to support higher ruminal pH, and increase dry matter intake and milk yield. Optimal DCAD ((Na + K) – (Cl + S)) for early lactation diets is approximately +400 mEq/kg dry matter (40 mEq/100 g of dry matter). Midlactation cows have an optimal DCAD of +275 to +400 mEq/kg (28–40 mEq/100 g of dry matter). Formulating diets with a high DCAD requires the addition of buffers such as sodium bicarbonate. Alfalfa forages have a higher DCAD than corn (maize) silage, depending on the mineral composition of the soil. Concentrate feeds typically have a low or negative DCAD, which adds to their already high potential to cause ruminal acidosis because of their high fermentable carbohydrate content.

**Endogenous buffers** are produced by the cow and secreted into the rumen via saliva. The amount of physical fiber in the diet determines the extent of buffer production by the salivary glands. Coarse, fibrous feeds contain more effective fiber and stimulate

more saliva production during eating than do finely ground feeds or fresh pasture. Coarse, fibrous feeds also make up the mat layer of the rumen, which is the stimulus for rumination. Fiber particles must be at least 4 cm in length to contribute to mat layer formation. Rumination promotes a great deal of chewing activity and the secretion of large amounts of saliva into the rumen. Ruminal pH increases during bouts of rumination.

The ability of a diet and feeding program to promote maximal amounts of ruminal buffering must be evaluated in herds with SARA. Wet chemistry analysis of a carefully collected total mixed ration bunk sample can be used to determine the DCAD of the diet actually consumed by the cows. Diets with measured DCAD ((Na + K) – (Cl + S)) values below +275 to 400 mEq/kg of dry matter (28–40 mEq/100 g dry matter) should be supplemented with additional buffers to provide more Na or K relative to Cl and S.

Endogenous buffering can be estimated by observing the number of cows ruminating (a goal is at least 40% of cows ruminating at any given time) and by measuring the particle length of the total mixed ration actually consumed by the cows using the Pennsylvania State Forage Particle Separator. Diets with less than 7% long particles render cows at increased risk of SARA, especially if the diets are also borderline or low in chemical fiber content. Diets with excessive (over 15%) long forage particles can paradoxically increase the risk of SARA if the long particles are unpalatable and sortable. Sorting of the long particles occurs soon after delivery of the feed, resulting in the cows consuming a diet low in physically effective fiber after feeding. The diet consumed later in the feeding period is then excessively high in physically effective fiber and low in energy. Socially dominant cows are particularly susceptible to SARA in this situation because they are likely to consume more of the fine total mixed ration particles soon after delivery of the feed. Cows lower on the social order then consume a very low-energy diet. Limiting feed bunk space to less than 75 cm per cow exacerbates the effect of total mixed ration sorting in a group of cows.

### Allowing for Ruminal Adaptation to High-Grain Diets

Cows in early lactation are susceptible to SARA if they are poorly adapted for the lactation diet. Ruminal adaptation to diets high in fermentable carbohydrates depends on microbial adaptation (particularly the lactate-utilizing bacteria, which grow more slowly than the lactate-producing bacteria) and the length of the ruminal papillae (longer rumen papillae promote greater volatile fatty acid absorption and thus lower ruminal pH).

In herds with total mixed rations, the prefresh diets can be offered to prefresh cows as they approach calving, usually with success.



With total mixed rations, cows cannot eat excessive quantities of concentrate at the expense of forage. Cows that have become adapted on a well-formulated prepartum total mixed ration during the prepartum period can go directly on to the high-producing lactating total mixed ration after calving without any further adaptation.

In summary, one of the most challenging aspects of diet formulation for lactating dairy cows is balancing for carbohydrates. Adequate effective fiber must be provided to stimulate chewing and secretion of salivary buffers. However, effective fiber is more filling than other nutritional components of the diet, and the filling effect often limits the energy intake of high-producing cows. Therefore diets for high-producing cows should be balanced to provide adequate effective fiber with the least filling effect. A balance must also be attained for ruminal carbohydrate fermentation, which is desirable to provide nutrients for microbial growth and protein. However, the fermentability of the diet must be limited to prevent excessive production of acids of fermentation.

### Feeding Management in Early Lactation

This consists of ensuring that concentrates are introduced gradually, and preferably at the same rate as dry matter intake increases in the first 6 weeks of lactation. Formulation strategies for feeding concentrates in the first 6 weeks of lactation without compromising fiber nutrition have been developed. Weekly dry matter predictions were used, and the proper increase in concentrate feeding is only 0.9 to 1.6 kg/week. At the same time, it is necessary to ensure that cows receive adequate dietary energy to prevent primary acetoneemia.

Routine monitoring of the dry matter content of feed ingredients is an important strategy in preparing total mixed rations for dairy cattle. Electronic silage testers are available and recommended.

**Ionophores**, such as monensin sodium, alter rumen metabolism and have the potential to control ruminal acidosis in dairy cattle, increase milk production, modify milk composition, and improve health. Monensin alters the volatile fatty acid profile in the rumen toward increased propionate production, which induces glucogenesis. Milk production is increased but the percentage of milk fat is depressed, which is effective in reducing the incidence of ketosis. Monensin decreases the population of *S. bovis* in the rumen, resulting in a reduction in the production of lactic acid; it increases the clearance of lactate from the rumen and increases ruminal pH. This has the potential to reduce the incidence of SARA in dairy cattle and the sequelae of rumenitis, laminitis, and hepatic abscessation. Monensin also decreases ruminal methanogenesis, ruminal ammonia, and blood levels of ketone bodies.

Thus monensin has the potential to improve the health of dairy cows and prevent ruminal acidosis during the transition period of the periparturient cow as described previously. Ionophores have not yet been approved for use in lactating dairy cows in North America, but extensive studies are under way.

### Vaccination Against Lactic Acidosis

Some preliminary research has investigated the immunization of cattle against lactic-acid-producing bacteria, *S. bovis*, and *Lactobacillus*. Immunization induced high levels of persistent saliva antibody responses against *S. bovis* and *Lactobacillus*, which reduced the risk of lactic acidosis in cattle.

### TREATMENT AND CONTROL

#### Treatment

Triage to determine which animals need medical treatment, rumen lavage, or rumenotomy (R-1)

Provide palatable grass hay and access to water (R-1)

Transfaunate selected cases with at least 5 L of fresh rumen fluid (R-1)

Correct ruminal and systemic acidosis with alkalinizing agents orally (magnesium hydroxide) or parenterally (1.3% sodium bicarbonate, Ringers solution) depending on severity (R-1)

Administer parenteral procaine penicillin G or oxytetracycline to severely affected cases to treat presumed rumenitis and as a preventative against liver abscess development (R-2)

Administered vitamin B<sub>1</sub> to assist in metabolizing L-lactate (R-2)

#### Control

Prevent accidental access to grain (R-1)

Introduce dietary changes gradually over 7–14 days (R-1)

Feed two times a day if confinement housed (R-2)

Use of ionophores in feed to alter rumen metabolism (R-2)

### FURTHER READING

- Dunlop RH. Pathogenesis of ruminant lactic acidosis. In: *Advances in Veterinary Science and Comparative Medicine*. New York: Academic Press; 1972:259–302.
- Enemark JMD. The monitoring, prevention and treatment of sub-acute ruminal acidosis (SARA): a review. *Vet J*. 2008;176:32–43.
- Gonzalez LA, Manteca X, Calsamiglia S, Schwartzkopf-Genswein KS, Ferret A. Ruminal acidosis in feedlot cattle: interplay between feed ingredients, rumen function and feeding behavior (a review). *Anim Feed Sci Tech*. 2012;172:66–79.
- Kleen JL, Cannizzo C. Incidence, prevalence and impact of SARA in dairy herds. *Anim Feed Sci Tech*. 2012;172:4–8.
- Plaizier JC, Krause DO, Gozho GN, McBride BW. Subacute ruminal acidosis in dairy cows: the physiological causes, incidence and consequences. *Vet J*. 2009;176:21–31.

Reference Advisory Group on Fermentative Acidosis of Ruminants (RAGFAR). Ruminal acidosis—understandings, prevention and treatment. 2007. <[www.dairyaustralia.com.au](http://www.dairyaustralia.com.au)>; Accessed August, 2016.

### REFERENCES

- Kleen JL, et al. *Vet Rec*. 2009;164:681.
- Kleen JL, et al. *Acta Vet Scand*. 2013;55:48.
- Gozho GN, et al. *J Dairy Sci*. 2007;90:856.
- Li S, et al. *Can J Anim Sci*. 2012;92:353.
- Bramley E, et al. *J Dairy Sci*. 2008;91:308.
- O'Grady L, et al. *Vet J*. 2008;176:44.
- Trefz FM, et al. *J Vet Intern Med*. 2012;26:162.
- Mirmazhari-Anwar V, et al. *Vet Q*. 2013;33:139.
- Steiner S, et al. *Vet Rec*. 2015;176:50.
- Mialon MM, et al. *Vet J*. 2012;194:55.
- Marchesini G, et al. *BMC Vet Res*. 2013;9:98.
- Minuti A, et al. *J Anim Sci*. 2014;92:3966.
- Danscher AM, et al. *Livestock Sci*. 2011;135:62.
- Steele MA, et al. *Am J Physiol Regul Integr Comp Physiol*. 2011;300:R1515.
- Penner GB, et al. *J Dairy Sci*. 2010;93:4838.
- Maruta CA, et al. *Ciencia Rural Santa Maria*. 2008;38:717.
- Niehaus AJ. *Vet Clin Food Anim*. 2008;24:341.
- Hartnack AK, et al. *J Am Vet Med Assoc*. 2015;247:659.
- DePeters EJ, George LW. *Immunol Lett*. 2014;162:69.
- Steiner S, et al. *Vet Rec*. 2015;176:50.
- Lafin SL, Gnad DP. *Vet Clin Food Anim*. 2008;24:335.
- Saeed A, et al. *J Anim Vet Adv*. 2007;6:29.

### RUMINAL PARAKERATOSIS

Parakeratosis of the ruminal epithelium is associated with subacute lactic acidosis and ruminal tympany in calves, and its presence indicates a lack of fiber and rumen buffering. Opinions vary as to whether parakeratosis has a direct effect on weight gain and productivity. There is evidence that the development of parakeratosis increases and then reduces the absorption of volatile fatty acids from the rumen and that the addition of volatile fatty acids to a calf starter ration increases the incidence of the condition. The abnormality is most common in cattle and sheep fed high-concentrate rations of alfalfa pellets that have been subjected to heat treatment, and it does not occur in cattle fed on rations containing normal quantities of unpelleted roughage. The incidence of the disease does not appear to be related to the feeding of antibiotics or protein concentrates.

In affected rumens the rumen papillae are enlarged, leathery, dark in color, and often adhered to forming clumps (Fig. 8-8). Histologically there is an increase in thickness of the cornified portion of the ruminal epithelium and a persistence of nuclei in the cornified cells. Some of the affected cells contain vacuoles. The greatest severity of lesions is present on the dorsal surface of the rumen about the level of the fluid ruminal contents, and parakeratosis in the region of the cardia is thought to increase the likelihood of ruminal tympany because receptors in this



**Fig. 8-8** Ruminal parakeratosis in the dorsal rumen of a 3-month-old Holstein Friesian calf with recurrent free gas bloat and poor weight gain. Note the clumping of rumen papilla and excessive cornification of papilla.

region can no longer detect the presence of free gas. This supposition needs to be verified. It is thought that parakeratosis is caused by the lowered pH and the increased volatile fatty acid content in the rumen liquor. The fact that unprocessed, whole grain—on which animals gain weight as readily as on processed grain—does not lead to the development of the disease is probably related to the higher pH and higher concentration of acetic versus longer chain volatile fatty acids in the ruminal liquor. The incidence of affected animals in a group may be as high as 40%.

### RUMINAL TYMPANY (BLOAT)

Ruminal tympany is abnormal distension of the rumen and reticulum caused by excessive retention of the gases of fermentation, either in the form of a persistent foam mixed with the rumen contents or as free gas separated from the ingesta. Normally, gas bubbles produced in the rumen coalesce, separate from the rumen contents to form pockets of free gas above the level of the contents, and finally are eliminated by eructation.

#### SYNOPSIS

**Etiology** Ingestion of bloating forages or interference with eructation mechanism.

**Epidemiology** Primary ruminal tympany (frothy bloat) is a major problem in cattle pastured on bloating forages (legumes) and in feedlot cattle fed high-level grain rations with minimal roughage. Occurs within a few days after turning into bloating pasture. High morbidity and mortality possible and cost of control makes pasture bloat an economically important disease. Bloating forages most dangerous in prebloom stage and when covered with dew in the morning. Feedlot bloat common when feed contains 80% grain and is ground fine. Secondary ruminal tympany (free-gas bloat) occurs in single animals caused by interference with eructation because of physical obstruction of

esophagus or eructation mechanism, as in reticular adhesions.

**Clinical signs** Cattle may be found dead on pasture. Mild to marked distension of left abdomen, which is tympanic; when severe it distends right abdomen also. Severe distress, dyspnea, protrusion of tongue. Passage of stomach tube in frothy bloat reveals froth and failure to release a significant amount of gas; in secondary free-gas bloat, large quantities of gas released with ease. If severe, animal may die within a few hours if tympany not relieved.

**Lesions** Marked congestion and hemorrhages of tissues of cranial aspect of body (tongue, nasal sinuses, lymph nodes, and proximal part of esophagus—bloat line) compared with caudal because of ruminal tympany. Distended rumen, frothy contents if examined early; later the froth dissipates.

**Diagnostic confirmation** Excessive quantity of froth or free gas in rumen.

**Differential diagnosis** Primary bloat is easily recognizable, and there are no other diseases of the reticulorumen that result in ruminal tympany. Secondary bloat must be differentiated from causes of failure of eructation, including esophageal obstruction, chronic reticuloperitonitis, vagus indigestion, and tetanus.

**Treatment** Remove animals from bloating pasture. In severe cases, emergency rumenotomy. In less severe cases, passage of stomach tube or trocar and cannula to release rumen gas. Antifoaming agents into rumen

**Control** *Pasture bloat* Management strategies to reduce rate of rumen fermentation. Use of grass–legume mixtures. Delay grazing each day until dew is off; feed hay before grazing. Feed forage supplements before grazing. Strategic use of antifoaming agents to pastured cattle. Sustained-release antifoaming agents such as monensin. *Feedlot bloat* Use total mixed rations containing chopped roughage and grain

#### ETIOLOGY

##### Primary Ruminal Tympany (Frothy Bloat)

Primary ruminal tympany or frothy bloat is caused by the production of a stable foam that traps the normal gases of fermentation in the rumen. The essential feature is that coalescence of the small gas bubbles is inhibited and intraruminal pressure increases because eructation cannot occur.

##### Pasture and Feedlot Bloat

**Leguminous or pasture bloat** is caused by the foaming qualities of the soluble leaf proteins in bloating legumes and other bloating forages ingested by cattle on pasture. Alfalfa hay may also cause bloat.

**Feedlot bloat** is caused by feeding finely ground grain, which promotes frothiness of

rumen contents. The cause of this is not clear. Feeding large quantities of grain to cattle results in marked changes in the total numbers and proportions of certain ruminal protozoa and bacteria. Some species of encapsulated bacteria increase in numbers and produce a slime that may result in a stable foam. Feedlot bloat may also be of the free-gas type based on the observations that gas may be easily released with a stomach tube. Feedlot cattle are susceptible to esophagitis, ruminal acidosis, rumenitis, overfill, and ruminal atony, each of which can interfere with eructation and cause secondary ruminal tympany and free-gas bloat.

##### Frothy Rumen Contents

Frothiness of the ruminal contents is the vital factor in **pasture bloat**. The froth in the rumen contents is not a true foam but rather a dispersion of gas and particles in liquid. The liquid lamellae between the bubbles are wide, and fragments of chloroplast membranes are dispersed in the fluid. **The stable dispersion of small feed particles is primarily responsible for the frothiness of the rumen fluid. The concentration of chloroplast membrane particles (measured as chlorophyll) is higher in frothy rumen fluid than in non-frothy liquid.**

The soluble leaf cytoplasmic proteins were once considered to be the principal foaming agents, but their role is now questioned. It is now accepted that bloat-causing legumes are more rapidly digested by rumen microflora than nonbloat-causing forages and that rupture of leaf mesophyll cells leads to the release of chloroplast particles. These particles are readily colonized by rumen microflora and gas bubbles are trapped among the particles, which prevent coalescence of bubbles by preventing drainage of rumen fluid from the liquid lamellae between the bubbles. The higher foam production in bloat-prone cattle is attributed to slower rates of passage of the liquid phase of ruminal contents. The slower clearance enhances microbial activity and promotes gas production, which contributes to stable foam formation. Rapid clearance decreases microbial gas production, enhances protein bypass, and reduces the probability of bloat. **Generally, bloat-causing legumes are susceptible to rapid digestion by rumen microflora, whereas bloat-safe legumes are digested more slowly.**

The condition of the rumen before feeding is an important factor in the immediate susceptibility of an animal to pasture bloat. **A predisposed rumen is characterized by an excess of dispersed particulate matter with adherent microbes, which provides an active inoculum for the fermentation of incoming feedstuffs.** The soluble leaf protein may contribute to the frothiness but is not the primary foaming agent. The chloroplast particles in the rumen have a slower

rate of clearance from the rumen in bloating animals than in nonbloating ones. It is also known that bloating animals have larger rumen volumes than nonbloating animals. Because chloroplast particles are negatively charged, it is possible that the concentrations of ions such as sodium, potassium, calcium, and magnesium in the rumen fluid before feeding are associated with the onset of bloat.

The **froth in feedlot bloat** is associated with high-level grain diets. The viscosity of the ruminal fluid is markedly increased because of the production of insoluble slime by certain species of bacteria that proliferate to large numbers in cattle on a high-carbohydrate diet. The slime may entrap the gases of fermentation. The delay in occurrence of feedlot bloat suggests that a gradual change in the microbial population of the rumen may be an important factor in explaining the cause. The physical form of a grain ration appears to be related to grain bloat. As in frothy legume bloat, in which a rapid release of leaf nutrients is important in producing bloat, it seems likely that the small particle size of ground feed could have the same effect.

Fine particulate matter can markedly increase foam stability. The feeding of ground grain of fine particle size (geometric mean particle size 388  $\mu\text{m}$ ) was associated with more rumen froth than the use of a coarse particle size (715  $\mu\text{m}$ ). The pH of the rumen contents also plays an important part in the stability of the foam (maximum stability occurs at a pH of about 6), and the composition of the diet and the activity and composition of the rumen microflora are known to influence this factor.

#### Role of Saliva

The rate of flow and composition of the saliva has an effect on the tendency for bloat to occur. Saliva may have a buffering effect on the pH of the rumen contents or it may influence the contents because of variation in its content of mucoproteins. The physical effects of dilution of ruminal ingesta by saliva may also be important. There is a negative correlation between the moisture content of the feed and the incidence of bloat. Feed of a low fiber and high water content depresses the volume of saliva secreted. Also, bloat-susceptible cows secrete significantly less saliva than nonsusceptible cows, and there are differences in the composition of saliva that are genetically determined.

In summary, **primary frothy pasture bloat occurs when there is rapid digestion of leaf material by rumen microorganisms, leading to the release of chloroplast particles into the liquid phase of the rumen contents, which prevents the coalescence of the gas bubbles.** In addition, there is a slower rate of clearance of these particles from the rumen in bloating cows, which also have larger rumen volumes. In primary

frothy feedlot bloat, the fine particle size of the feed and the presence of rumen microorganisms that produce slime may be important factors.

#### Secondary Ruminal Tympany (Free-Gas Bloat)

Physical obstruction to eructation occurs in esophageal obstruction caused by a foreign body, by stenosis of the esophagus, by pressure from enlargements outside the esophagus, such as tuberculous lymphadenitis or bovine viral leukosis involvement of bronchial lymph nodes, or by obstruction of the cardia. Interference with esophageal groove function in vagus indigestion and diaphragmatic hernia may cause chronic ruminal tympany and the condition also occurs in tetanus, particularly in young animals and in poisoning with the fungus *Rhizoctonia leguminicola*, probably as a result of spasm of the esophageal musculature. Carcinoma, granulomatous lesions associated with *Actinomyces bovis* near the esophageal groove and in the reticular wall, and papillomata of the esophageal groove and reticulum are less common causes of obstructive bloat. Tetanus in cattle is usually accompanied by secondary free-gas bloat caused by spasm of the esophagus and inability to eructate normally.

Interference with the nerve pathways responsible for maintenance of the eructation reflex may also occur. The receptor organs in this reflex are situated in the dorsal aspect of the reticulum and can discriminate between gas, foam, and liquid. The afferent and efferent nerve fibers are contained in the vagus nerve, but the location of the central coordinating mechanism has not been defined. Depression of this center or lesions of the vagus nerve can interrupt the reflex, which is essential for removal of gas from the rumen.

Normal tone and motility of the musculature of the rumen and reticulum are also necessary for eructation. In anaphylaxis, bloat is common because of ruminal atony and is relieved by the administration of epinephrine or antihistamine drugs. A sudden marked change in the pH of the rumen contents caused by either acidity or alkalinity causes ruminal atony but the tympany that results is usually of a minor degree only, probably because the gas-producing activity of the microflora is greatly reduced. Hypocalcemia in milk fever of cattle is commonly associated with secondary free-gas bloat caused by ruminal atony, which is reversible following treatment with calcium salts.

Although most cases of feedlot bloat associated with outbreaks are of the frothy type (primary) and cannot be easily relieved with a stomach tube, sporadic cases are of the free-gas type, which suggests that they are secondary. Possible causes of the ruminal atony and failure of eructation include **esophagitis, acidosis, rumenitis, and failure**

**of rumination because of an all-grain diet.** Feedlot cattle on high-level grain diets for long periods will not ruminate normally, and their rumen movements are significantly reduced.

#### Chronic Ruminal Tympany

**Chronic ruminal tympany** occurs in calves up to 6 months of age. Persistence of an enlarged thymus, continued feeding on coarse indigestible roughage, and the passage of unpalatable milk replacer into the rumen in which it undergoes fermentation and gas production, instead of into the abomasum, have all been suggested as causes, but the condition usually disappears spontaneously in time and in most cases the cause is undetermined. Necropsy examination of a number of cases has failed to detect any physical abnormality, although a developmental defect appears to be likely because of the age at which it occurs. Unusual postures, particularly lateral recumbency, are commonly characterized by secondary tympany. Cattle may die of secondary tympany if they become accidentally cast in dorsal recumbency in handling facilities, crowded transportation vehicles, irrigation ditches, and other restrictive positions.

In some cases of vagus indigestion characterized by ruminal hyperactivity the secondary bloat may be of the frothy type because of ruminal hyperactivity.

#### EPIDEMIOLOGY

##### Occurrence

##### Pasture Bloat

Pasture bloat occurs in both dairy and beef cattle that graze pastures consisting of bloat-inducing forages. The incidence is highest when the pasture is lushest. Spring and autumn are the most dangerous seasons, when the pastures are lush and young and the leaves of the plants contain a high concentration of soluble proteins. Dry hot conditions and matured plants, and thus midsummer, are the forerunners of a decline in incidence. Sheep can also be affected but appear to be much less susceptible than cattle.

##### Feedlot Bloat

Feedlot bloat occurs in feedlot cattle during the 50 to 100 days when cattle are fed large quantities of grain and small quantities of roughage. In some cases the use of pelleted, finely ground feed has been associated with outbreaks of feedlot bloat. High-producing dairy cows that are fed 12 to 22 kg of grain daily may also develop grain bloat.

#### Morbidity and Case Fatality

##### Pasture Bloat

Reliable current field data on the incidence of pasture bloat in cattle are not available. Canadian observations in 1975 indicated that cattle fed fresh alfalfa typically bloat on 35% of the feeding days and 10% of the total



animal days. Frothiness of rumen contents, observed in fistulated cattle, occurs on about 50% of the feeding days and 25% of the animal days. In dairy herds in New Zealand, the average death rate from legume pasture bloat has ranged from 0.3% to 1.2%. A survey of 312 dairy farms in New Zealand over a period of 2 months revealed that 87% of all farms experienced bloat, ranging from mild to severe. The percentage of lactating cows dying of bloat in the spring of 1986 averaged 0.8%. The highest death rate of milking cows in an individual herd was 16% and in young stock 48%. The majority of variation among farms in bloat severity was not accounted for by any of the management, soil, or pasture factors measured.

### Feedlot Bloat

In a survey of Kansas feedlots (60 feedlots totaling 450,000 head of cattle) the incidence of deaths from bloat was 0.1%; 0.2% of cattle had severe bloat and 0.6% moderate bloat. In a Colorado feedlot, during one full year, bloat was the cause of 3% of all mortalities. In the same study, bloat was among the four most common causes of sudden death or of cattle found dead without having been obviously ill. Outbreaks of feedlot bloat are usually of the frothy type (primary), whereas the sporadic cases are of the free-gas type and secondary to lesions that cause dysfunction of eructation.

### Risk Factors That Influence the Occurrence of Primary Ruminal Tympany

Several risk factors have an influence on the occurrence of primary bloat and possibly contribute to its causation. Dietary, weather, and animal factors have received the most attention.

#### Dietary Risk Factors

##### Bloating Forages

**Alfalfa** (*Medicago sativa*), **red clover** (*Trifolium pratense*), and **white clover** (*T. repens*) are the principal bloat-causing legumes. Alfalfa has been recognized for its superior yield and quality in seeded pastures. Alfalfa is the most productive and most widely adapted forage species and is considered the “queen of forages.” Sweet clover and alsike clover are also bloat-causing forages.

Bloat also occurs occasionally when cattle are grazed on cereal crops; rape; cabbages; leguminous vegetable crops, including peas and beans; and young grass pasture with a high protein content. An increasing occurrence of bloat is noted when cattle are grazed on young green cereal crops such as **winter wheat**, especially if it is heavily fertilized and irrigated.

Frothy bloat may also occur in cattle fed alfalfa hay, even when mixed with cereal grains and another hay. Outbreaks are commonly associated with particular lots of hay, often containing fine particles. Alfalfa hay

produces a frothy bloat with a typical viscous consistency of the rumen contents, but it is commonly more subacute and chronic rather than acute and peracute as in pasture bloat.

##### Nonbloating Forages

Bird's foot trefoil (*Lotus corniculatus*), cicer milkvetch (*Astragalus cicer*), arrowleaf clover (*T. vesiculosum*), sainfoin (*Onobrychis viciifolia*), and crown vetch (*Coronilla varia*) are the bloat-safe forages. These contain tannins that bind with soluble proteins and inhibit microbial digestion.

##### Crop Maturity

The maturity of the forage is the major plant factor affecting the incidence of pasture bloat. Grazing very succulent pasture—immature, rapidly growing legumes in the prebloom stage—is the biggest single risk of bloat in cattle. The bloat potential of alfalfa varies significantly with the phenologic stage of the plant. The greatest risk to cattle occurs during the vegetative stage of growth, and the risk declines during the bud stage and may be absent during the bloom stage. Feeding cattle freshly chopped alfalfa herbage daily at different stages of growth resulted in animal-days of bloat of 62, 10, and 0, respectively, for the vegetative, bud, and bloom stages of the alfalfa. The leaf:stem ratio decreased from 1.2 to 0.5 and 1.5 to 0.4 in two different years as the crop matured from vegetative to bloom stage. The absence of bloat during bloom can be attributed to the much lower leaf:stem ratio at that stage. As most chloroplasts are within the leaves, the lower leaf:stem ratio at bloom would reduce the concentration of these fragments. A leaf:stem ratio of less than 0.5 (1:2) could be used as an indicator of a low potential for bloat in alfalfa.

The rapid rate of digestion of the immature bloating forages results in the production of a stable foam. In the summer months, especially under irrigated conditions when the growth rate of alfalfa is rapid, bloat occurs in cattle fed alfalfa herbage at the **vegetative to prebud stages of growth**. Alfalfa's potential for causing bloat is highest when moisture conditions are optimal for vegetative growth. Under these conditions the stems become turgid and fleshy but not fibrous; the leaves are soft and easily crushed between the fingers. In autumn, the growth rate of alfalfa is slower because of lower temperatures. A rapid rate of growth of the alfalfa is a necessary condition for bloat. Field observations of the relationship between plant factors to alfalfa bloat found that the percentages of dry matter and acid detergent fiber were lower, and the concentration of chlorophyll, total nitrogen, and soluble nitrogen were higher on days when bloat occurred.

**Ingestion of the more succulent parts of plants** and avoidance of the more mature portions can be a precipitating factor, and

tympany is less likely to occur if the crop is harvested and fed than if it is grazed. Restriction of the grazing area has a similar effect; it forces the cattle to eat the entire plants. A high incidence is recorded when pasture is wet, but this is probably caused by the rapid growth of the plants during heavy rainfall periods rather than to the physical wetness of the crop. Under experimental conditions the production of tympany is not influenced by the water content of clover or by wilting. Other plant factors that are known to be associated with an increased tendency to bloat are liberal administration of urea to the pasture; a high intake of glucose, calcium, and magnesium; and a high nitrogen intake.

A high herbage potassium to sodium ratio can increase the risk of bloat in cattle, which may be caused by digestion rate. There is some indication that sodium fertilizer can affect the digestion rate of perennial ryegrass and white clover. Sodium fertilizer increased maximum gas output from grass and rate of production, which was associated with an increase in grass digestibility; however, in clover it had the opposite effect, potentially reducing bloat in cows fed a high-legume diet.

The risk of bloat is reduced by waiting until the dew was off the alfalfa before allowing cattle to graze, leading to the practice of many cattlemen of delaying morning grazing “until the dew has dried.” Bloat was observed 2 to 17 times more often when cattle were fed between 0700 and 0800 hours than when they were fed 4 hours later in both grazing and feedlot trials. Ruminal chlorophyll was higher before the early feeding than before the late feeding, suggesting that feeding later in the morning reduced the predisposition of cattle to bloat by increasing particle clearance from the rumen. The risk of bloat was also reduced when cattle grazed alfalfa continuously than when grazing was interrupted and cattle were allowed to graze for only 6 hours daily. Pasture management systems that promote continuous and rapid ruminal clearance (more bypass and less gas production) are most likely to reduce the incidence of bloat.

#### Weather Risk Factors

The relationship of weather conditions to the occurrence and incidence of pasture bloat has been examined under conditions in Canada. Under ordinary grazing conditions, bloat occurs sporadically over large parts of the growing season. The occurrence of pasture bloat was not associated with a simple, unique weather variable. The effect of temperature on the incidence of bloat is complex. Bloat seems to occur when moderate daytime temperatures (20°C–25°C) permit optimum vegetative growth. Cool overnight temperatures in combination with moderate daytime temperatures may induce bloat in the fall. Cool temperatures delay maturation and extend the vegetative growth

phase of forage crops and optimize conditions for bloat. On a daily basis, bloat tended to be preceded immediately by nights and days that were cooler than usual. Bloat can also occur after a killing frost.

#### Feedlot Bloat

Feedlot bloat occurs in hand-fed cattle confined in feedlots and barns when insufficient roughage is fed or the feed is too finely ground. Two separate sets of circumstances conducive to feedlot bloat have been identified. In one, the cattle are being fed a **high-level grain finishing ration** in which grain comprises more than 80% of the weight of the ration. The effect of these rations on the rumen is a tendency to acidity and a shortage of rumen-stimulating roughage, which may interfere with motility and eructation. In the other situation, grain comprises 30% to 70% of the ration, with the same but less marked effect as mentioned previously, but the **roughage component is alfalfa hay** with its own bloat-inducing capacity.

#### Animal Risk Factors

Cattle vary in their susceptibility to primary ruminal tympany, especially that caused by legumes, and this individual susceptibility may be inherited. Cows can be classified according to their susceptibility to pasture bloat into **high or low susceptibility** and their progeny are similar. Total exchange of rumen contents between high-susceptibility and low-susceptibility animals produces a temporary exchange of susceptibilities that lasts about 24 hours. A number of inherited characteristics are related to bloat. They include ruminal structure and motility, composition of salivary proteins, rate of salivation, and the greater capacity of the rumen contents of high-susceptibility animals to degrade mucoproteins that would either reduce antifoaming activity or increase foam-stabilizing activity. A salivary protein, bSP30, is correlated with susceptibility to bloat in cattle herds selected for high or low bloat susceptibility. One obvious application for such a protein marker for bloat would be to screen cattle to eliminate highly susceptible herds. Blood and urinary metabolites in cattle have also differed with respect to susceptibility to bloat.

There may also be differences between animals in the rate and extent of physical breakdown of feed in the rumen and the rate of passage of solids out of the rumen. However, neither differences in gas production nor foam production nor the stability of the foam are important factors in distinguishing between high-susceptibility and low-susceptibility cows. One major physiologic difference between high and low susceptibility is the volume of rumen fluid. It is suggested that low-susceptibility cows do not bloat because they have a lower relative volume of rumen digesta than high-susceptibility cows.

Under experimental conditions the production of tympany is not influenced by the rate of intake or the total intake of dry matter. Susceptibility increases with time when a tympany-producing diet is fed for a relatively short period. However, animals accustomed over very long periods to grazing bloating pastures may be less susceptible than other animals. Accordingly, the mortality rate in young cattle is much higher than in mature animals.

There may be a common biological basis for partial preference for grass and clover in sheep and cattle. Dairy heifers select between 50% and 65% white clover when given a free choice between adjacent ryegrass and white clover monocultures. There is also a diurnal pattern to preference, with a stronger preference for clover in the morning, with the preference for grass increasing toward evening. Providing animals with antibloat treatment (slow-release monensin capsules) did not have any effect on the proportion of clover selected.

#### Economic Importance

Primary ruminal tympany causes heavy losses through death, severe loss of production, and the strict limitations placed on the use of some high-producing pastures for grazing. For example, it is estimated that bloat costs the dairy industry in New Zealand \$50 million annually. The incidence of the disease has increased markedly with the improvement of pastures by heavy applications of fertilizers and the use of high-producing leguminous pasture plants, and losses in cattle at times have reached enormous proportions.

The most obvious form of loss is sudden death. Although this is the dramatic loss, especially when a large number of cattle are unexpectedly found dead, an equivalent loss occurs as the result of reduced food intake. For example, on clover-dominant pasture (60%–80% white clover) in which bloat was common the weight gains of cattle grazing it were 20% to 30% less than normal. It has been argued that the returns achieved by good bloat prevention in pastured cattle would not compensate for the costs incurred, but the opposite view is strongly held.

#### PATHOGENESIS

Normally, gas bubbles produced in the rumen fluid coalesce, separate from the rumen contents to form pockets of free gas above the level of the contents, and are finally eliminated by eructation. Much of the gas of fermentation will be eructated. A grass-fed cow can produce 100 L during the first hour of feeding. A cow maintained on a legume diet may produce 200 L/h. In **frothy bloat**, the gas bubbles remain dispersed throughout the rumen contents, producing an abnormal increase in the volume of the ruminoreticular contents and, consequently, **inhibiting**

**eructation**. The characteristic frothiness of ruminal contents is caused by **inadequate coalescence of gas bubbles**. In **free-gas bloat** the gas bubbles coalesce and separate from the rumen fluid, but the animals cannot eructate the pockets of free gas because of abnormalities of the reticulorumen or esophagus.

Most cases of naturally occurring pasture or feedlot bloat are not accompanied by ruminal atony. In the early stages there is unusually pronounced hypermotility. Most of the gas is mixed with the solid and fluid ruminal contents to form a dense, stable froth. Some free gas is present but the amount that can be removed by a stomach tube or trocar and cannula does little to relieve the distension of the rumen. Generally, free-gas bloat characterized by the accumulation of free gas is caused by esophageal obstruction or ruminal atony. If the **eructation reflex is functional**, the experimental introduction of very large amounts of gas does not cause tympany, because eructation removes the excess. Bloat-producing forages do not produce more gas than safe feeds, and the simple production of excessive gas is known not to be a precipitating factor.

**Frothiness of the ruminal contents** interferes with **function of the cardia** and inhibits the eructation reflex. Rumen movements are initially stimulated by the distension, and the resulting hypermotility exacerbates the frothiness of the ruminal contents. Terminally there is a loss of muscle tone and ruminal motility.

The most distinctive aspect of bloated cattle is abdominal distension, particularly the left abdomen, caused by distension of the rumen. Experimentally there is a relationship between reticulorumen volume, intraruminal pressure, and the abdomen of cows fed fresh alfalfa. The volumes of gas in a bloated cow are large, 50 to 70 L, and there is an exponential increase in intraruminal pressure with increasing rumen volume, especially as the potential for further increases in the abdomen diminishes. Most severely bloated cows will attempt to urinate and defecate when intraruminal pressures exceed 25 cmH<sub>2</sub>O but some cows can tolerate pressures in excess of 50 cmH<sub>2</sub>O. As the intraruminal pressure increases, occlusion of the vena cava occurs, causing congestion of the caudal part of the body. In addition, the pressure exerted by the distended rumen on the diaphragm is very high, which results in reduced lung capacity and death from hypoxia.

#### CLINICAL FINDINGS

##### Primary Pasture or Feedlot Bloat

Bloat is a common cause of **sudden death (or found dead)** in cattle. **Pastured beef cattle** that die of bloat are usually found dead because they are not observed as regularly as dairy cattle. **Feedlot cattle** that die of bloat are commonly found dead in the morning, which may be from their relative inactivity

during the night or to the lack of observation, detection, and treatment. **Dairy cattle** that are being milked and observed regularly will commonly begin to bloat within 1 hour after being turned into a bloat-producing pasture. There is commonly a lag period of 24 to 48 hours before bloating occurs in cattle that have been placed on a bloat-producing pasture for the first time. They may bloat on the first day but more commonly they bloat on the second and third days. A similar situation has been observed in pastured beef cattle that have been on a particular pasture for several days or weeks before bloat occurs. This is always a surprise to the owner and the veterinarian, who find it difficult to explain why bloat suddenly becomes a problem on a pasture that cattle have grazed safely for some time.

In **primary pasture bloat**, obvious distension of the rumen occurs quickly, sometimes as soon as 15 minutes after going on to bloat-producing pasture, and the animal stops grazing. The distension is usually more obvious in the upper left paralumbar fossa, but the entire abdomen is enlarged. There is discomfort and the animal may stand and lie down frequently, kick at its abdomen, and even roll. Frequent defecation and urination are common. Dyspnea is marked and is accompanied by mouth breathing, protrusion of the tongue, salivation, and extension of the head. The respiratory rate is increased up to 60 breaths/min. Occasionally, projectile vomiting occurs and soft feces may be expelled in a stream.

In **mild bloat**, the left paralumbar fossa is distended, the animal is not in distress, and 5 to 7 cm of skin over the left paralumbar fossa may be easily grasped and “tented,” which provides a measure of the degree of abdominal distension and tautness of the skin. In **moderate bloat**, a more obvious distension of the abdomen is evident, the animal may appear anxious and slightly uncomfortable, and the skin over the paralumbar fossa is usually taut but some can be grasped and tented. In **severe bloat**, there is prominent distension of both sides of the abdomen and the animal may breathe through its mouth and protrude the tongue. The animal is usually uncomfortable, anxious, and may be staggering. The skin over the left flank is very tense and cannot be grasped and tented.

Ruminal contractions are usually increased in strength and frequency in the early stages and may be almost continuous, but the sounds are reduced in volume because of the frothy nature of the ingesta. Later, when the distension is extreme, contractions are decreased and may be completely absent. The low-pitched tympanic sound produced by percussion over the rumen is characteristic. Before clinical tympany occurs, there is a temporary increase in eructation, but this disappears in the acute stages. The course in ruminal tympany is short but death does not usually

occur in less than 3 to 4 hours of the onset of clinical signs. Collapse and death almost without struggle occur quickly.

If animals are treated by **trocarization or the passage of a stomach tube, only small amounts of gas are released** before froth blocks the cannula or tube. In a group of affected cattle, some will be bloated and the remainder will have mild to moderate distension of the abdomen. These animals are uncomfortable, graze for only short periods, and their milk production is decreased. The drop in production may be caused by depression of food intake or by failure of milk letdown.

### Secondary Bloat

In secondary bloat, the excess gas is present as a **free gas cap** on top of the ruminal contents, although frothy bloat may occur in vagus indigestion with increased ruminal motility (see vagus indigestion). There is usually an increase in the frequency and strength of ruminal movements in the early stages followed by atony. Passage of a stomach tube or trocarization results in the release of large quantities of gas and subsidence of the ruminal distension. If an esophageal obstruction is present, it will be detected when the stomach tube is passed.

### Dyspnea and Tachycardia in Severe Bloat

In both severe primary and secondary bloat there is dyspnea and a marked elevation of the heart rate up to 100 to 120 beats/min in the acute stages. A systolic murmur may be audible, caused probably by distortion of the base of the heart by the forward displacement of the diaphragm. This murmur has been observed in ruminal tympany associated with tetanus, diaphragmatic hernia, vagus indigestion, and esophageal obstruction and disappears immediately if the bloat is relieved.

### CLINICAL PATHOLOGY

Laboratory tests are not necessary for the diagnosis of ruminal tympany.

### NECROPSY FINDINGS

In cattle that have died from bloat within an hour previously there is protrusion and congestion of the tongue; marked congestion and hemorrhages of lymph nodes to the head and neck, epicardium, and upper respiratory tract; friable kidneys; and mucosal hyperemia in the small intestine. The lungs are compressed and there is congestion and hemorrhage of the cervical portion of the esophagus, but the thoracic portion of the esophagus is pale and blanched. Generally, congestion is marked in the front quarters and less marked or absent in the hindquarters. The rumen is distended but the contents are much less frothy than before death. A marked erythema is evident beneath the ruminal mucosa, especially in the ventral sacs. The liver is pale

because of expulsion of blood from the organ. Occasionally, the rumen or diaphragm have ruptured. In animals dead for several hours there is subcutaneous emphysema, almost complete absence of froth in the rumen, and exfoliation of the cornified epithelium of the rumen with marked congestion of submucosal tissues.

### TREATMENT

The approach to treatment depends on the circumstances in which bloat occurs, whether the bloat is frothy or due to free gas, and whether or not the bloat is life-threatening.

### First-Aid Emergency Measures Emergency Rumenotomy

It is often necessary to advise an owner to use some first-aid measures before the veterinarian arrives on the farm. All animals should be removed immediately from the source of the bloating pasture or feed. In severe cases in which there is gross distension, mouth-breathing with protrusion of the tongue, and staggering, an emergency rumenotomy is necessary to save the life of the animal. Once the animal falls down, death occurs within a few minutes, and many animals have died unnecessarily because owners are unable or reluctant to do an emergency rumenotomy. Using a sharp knife, a quick incision 10 to 20 cm in length is made over the midpoint of the left paralumbar fossa through the skin and abdominal musculature and directly into the rumen. There will be an explosive release of rumen contents and marked relief for the animal. There is remarkably little contamination of the peritoneal cavity, and irrigation and cleaning of the incision site followed by standard surgical closure usually results in uneventful recovery with only occasional minor complications.

### DIFFERENTIAL DIAGNOSIS

When presented with ruminating cattle with a distended abdomen and marked distension of the left paralumbar fossa, the most obvious diagnosis is ruminal tympany.

- **Primary bloat** is likely if the dietary conditions are present and the passage of a stomach tube reveals the presence of froth and the inability to release gas.
- **Secondary bloat** is likely if the history indicates that distension of the abdomen and left flank has been present for a few days or if the bloat has been intermittent within the last several days. Passage of a stomach tube will detect esophageal obstruction or stenosis, both of which are accompanied by difficult swallowing and, in acute cases, by violent attempts at vomiting.
- In secondary bloat associated with **vagus indigestion**, the history usually indicates that distension of the abdomen has been

*Continued*



progressive over the last several days or few weeks with loss of weight and scant feces. In addition, the rumen is grossly enlarged and the ventral sac is commonly enlarged and distends the right lower flank.

- **Tetanus** is manifested by limb and tail rigidity, free-gas bloat, prolapse of the third eyelid, and hyperesthesia.
- **Carcinoma** and **papillomata** of the esophageal groove and reticulum and actinobacillosis of the reticulum cannot usually be diagnosed antemortem without exploratory rumenotomy.
- **Animals found dead.** One of the difficult situations encountered in veterinary practice is the postmortem diagnosis of bloat, especially in animals found dead at pasture in warm weather. **Blackleg, lightning strike, anthrax,** and **snakebite** are common causes of cattle being found dead, and the necropsy findings are characteristic. A diagnosis of bloat must depend on an absence of local lesions characteristic of these diseases, the presence of marked ruminal tympany in the absence of other signs of postmortem decomposition, the relative pallor of the liver, and the other lesions described earlier.

### Trocar and Cannula

The trocar and cannula have been used for many years for the emergency release of rumen contents and gas in bloat. However, the standard-sized trocar and cannula does not have a large enough diameter to allow the very viscous stable foam in peracute frothy bloat to escape quickly enough to save an animal's life. A larger-bore instrument (2.5 cm in diameter) is necessary, and an incision with a scalpel or knife must be made through the skin before it can be inserted into the rumen. If any size of trocar and cannula fails to reduce the intraruminal pressure and the animal's life is being compromised by the pressure, an emergency rumenotomy should be performed. If the trocar is successful in reducing the pressure, the antifoaming agent of choice can be administered through the cannula, which can be left in place until the animal has returned to normal in a few hours. Owners should be advised on the proper use of the trocar and cannula, the method of insertion and the need for a small incision in the skin, and the care of cannulas left in place for several hours or days.

A corkscrew-type trocar and cannula has been recommended for long-term insertion in cases of chronic bloat that occur in feedlot cattle and in beef calves following weaning. The etiology of these is usually uncertain; insertion of a cannula for several days or use of a rumen fistula will often yield good results.

### Promote Salivation

For less severe cases, owners may be advised to tie a stick in the mouth like a bit on a horse

bridle to promote the production of excessive saliva, which is alkaline and may assist in denaturation of the stable foam. Careful drenching with sodium bicarbonate (150–200 g in 1 L of water) or any nontoxic oil as described later is also satisfactory.

### Stomach Tube

The passage of a stomach tube of the largest bore possible is recommended for cases in which the animal's life is not being threatened. The use of a Frick oral speculum and passage of the tube through the oral cavity permits the passage of tubes measuring up to 2 cm in diameter, whereas this may not be possible if passed through the nasal cavity. In free-gas bloat, there is a sudden release of gas and the intraruminal pressure may return to normal. While the tube is in place, the anti-foaming agent can be administered. In frothy bloat, the tube may become plugged immediately on entering the rumen. A few attempts should be made to clear the tube by blowing through the proximal end of the tube and moving it back and forth in an attempt to locate large pockets of rumen gas that can be released. However, in frothy bloat it may be impossible to reduce the pressure with the stomach tube, and the antifoaming agent should be administered while the tube is in place.

If the bloat cannot be relieved but an anti-foaming agent has been administered, the animal must be observed closely for the next hour to determine whether the treatment has been successful or if the bloat is becoming worse, which requires an alternative treatment.

### Feedlot Bloat

In an outbreak of feedlot bloat, the acute and peracute cases should be treated individually as necessary. There may be many “swellers,” which are moderate cases of bloat that will usually resolve if the cattle are coaxed to walk. After a few minutes of walking they usually begin to eructate. Shaking of experimentally reproduced foam results in loss of stability of foam and coalescence into large bubbles and the movement of walking has the same effect. If walking is effective in reducing the foam, the animals should be kept under close surveillance for several hours for evidence of continued bloating, which is unusual.

### Antifoaming Agents

Details of the oils and synthetic surfactants used as antifoaming agents in treatment are described in the section on control because the same compounds are used in prevention. Any nontoxic oil, especially a mineral one that persists in the rumen, that is not biodegradable, is effective and there are no other significant differences between them. Their effect is to reduce surface tension and foam. A dose of 250 mL is suggested for cattle but doses of up to 500 mL are commonly used.

An emulsified oil or one containing a detergent such as dioctyl sodium sulfosuccinate is preferred because it mixes effectively with ruminal contents. Of the **synthetic surfactants**, **poloxalene** is the one in most general use for leguminous bloat, and a dose of 25 to 50 g is recommended for treatment. Poloxalene is not as effective for feedlot or grain bloat. **Alcohol ethoxylates** are also used as bloat remedies and both poloxalene and the ethoxylates are more effective and faster than oil, which is relatively slow and better suited to prevention than treatment. All three are recommended as satisfactory for legume hay bloat, but **poloxalene is not recommended for feedlot bloat**. All of them can be given by drench, stomach tube, or through a ruminal cannula. The effect of all treatments is enhanced if they are thoroughly mixed with the ruminal contents; if rumen movements are still present mixing will occur. If the rumen is static, it should be kneaded through the left flank while the animal is encouraged to walk.

A polyoxypropylene-polyoxyethylene glycol surfactant polymer (Alfasure), which is a water-soluble pluronic detergent available in Canada, is effective for the treatment of alfalfa bloat when 30 mL is given intraruminally using a 6-cm 14-gauge hypodermic needle directly into the rumen through the abdominal wall in the middle of the paralumbar fossa. The median time of disappearance after treatment was 25 minutes; the swelling returned to normal within 52 minutes.

### Return to Pasture or Feed

Following the treatment of the individual cases of bloat. The major problem remaining is the decision about whether or not, or when, or under what conditions, to return the cattle to the bloat-producing pasture or to the concentrate ration in the case of feedlot cattle. The possible preventive measures are presented under control but, unless one of the reliable ones can be instituted, the cattle should not be returned until the hazardous period has passed. This is difficult on some farms because the bloat-producing pasture may be the sole source of feed.

### CONTROL

#### Pasture Bloat

#### Management Strategies to Reduce Rate of Rumen Fermentation

The prevention of pasture bloat is challenging. Grazing management strategies are the principal methods used for the prevention of pasture bloat, along with controlling pasture yields and quality. Several different management practices have been recommended, including the prior feeding of dry, scabrous hay, particularly Sudan grass, cereal hay and straw, or orchardgrass hay,<sup>1</sup> restricting the grazing to 20 minutes at a time or until the first cow stops eating, harvesting the crop and feeding it in troughs, and strip grazing to ensure that all available pasture is used each

day. **The principle of each of these strategies is to decrease the rate of rumen fermentation.** These methods have value when the pasture is only moderately dangerous but may be ineffective when the bloat-producing potential is high. In these circumstances the use of simple management procedures is unreliable because the occurrence of bloat is unpredictable. In other cases, the strategies such as limited grazing are impractical. Generally, the farmer does not know if the pastures are dangerous until bloat occurs and, once effective prophylactic methods are being used, it is difficult to know when they are no longer required. The bloat-producing potential of a pasture can change dramatically almost overnight, and the management strategy can be quickly nullified.

#### Stage of Growth

The probability of legume bloat decreases with advancing stages of plant maturity because of a decrease in the soluble protein content of the legume. Alfalfa at the vegetative stage of growth results in the highest incidence of bloat compared with the bud and bloom stages, with moderate and no bloat, respectively. These results indicate the potential for grazing management through selection of plant phenology (periodic phases of plant growth) as a method of bloat control. In practice, it would be essential to recognize the predominant stage of growth of the stand before turning cattle into the pasture. The leaf:stem ratio should also be considered as a factor.

#### Choice of Forages

Seeding cultivated pastures to grass–legume mixtures is the most effective and least costly method of minimizing pasture bloat, particularly for beef herds grazing over large areas under continuous grazing systems. In a grass–legume mixture, a legume content of 50% is suggested as the maximum bloat-safe level. However, this ratio may be impractical for large areas, especially on rolling terrain, in which it is impossible to maintain a uniform 50:50 stand. If cattle have a tendency to avoid the grass and select the legume, the potential for bloat increases. Bloat can occur in mixed pastures in which the proportion of legume is less than 15%, possibly because of selective grazing.

Because of the potential for causing bloat, grasses alone or nonbloating forages may be used. Sainfoin, bird's foot trefoil, cicer milkvetch, and crown vetch are useful bloat-safe legumes in regions in which they are adapted. However, their yield, vigor, regrowth, winter-hardiness, and persistence are well below the superior growth and production characteristics of alfalfa. Seeding grasses alone avoids the problem of bloat but the benefits of including a legume in the mixture include much greater production, higher protein and nutritional value, and lower fertilization costs. A decision to use

grass with or without bloat-safe legumes should be based on the economic benefits of the greater protein from alfalfa or clover compared with the possible losses from bloat. At present, a pasture comprising equal quantities of clovers and grasses comes closest to achieving this ideal, but with available pasture plants and current methods of pasture management this clover:grass ratio is not easy to maintain. Research work in this area is directed toward selecting cattle that are less susceptible to bloat. More practical are the moves being made to breed varieties of legume that are low on bloat-producing potential. The incidence of frothy bloat can be substantially reduced if alfalfa herbage contains as little as 25% orchardgrass.

#### Alternative Temperate Forages

Forages comprise a major proportion of the diet in most ruminant animal–production systems. Grazed forages are used especially during the late spring, summer, and early autumn in many countries, whereas in some regions, such as Australasia and South America, ruminant animal production is based on year-round grazing of forages, with no indoor housing. Grazing systems are generally based on swards of which the major portion consists of grasses (perennial ryegrass [*Lolium perenne*] in the case of New Zealand), with a legume (white clover [*T. repens*] in the case of New Zealand) forming a minor portion (approximately 20%), mainly to fix atmospheric nitrogen and to provide a higher quality feed. Different grasses and legumes form the grazed pastures in other countries. The grazing of alternative forages is being developed for the sustainable control of internal parasites, with reduced anthelmintic use, for increasing reproductive performance in sheep and the growth rate in young animals, and for reducing the incidence of bloat in cattle.

It has been long accepted in ruminant nutrition that the feeding value of legumes is greater than that of grasses, because of their more rapid particle breakdown, faster rumen fermentation, lower rumen mean retention time and, consequently, greater voluntary feed intake. Despite these advantages, legumes have never attained their true potential in many grazing systems because of three principal disadvantages: legumes generally grow slowly in winter, producing less feed per hectare than grasses; rumen frothy bloat in cattle is caused by rapid solubilization of protein in many legumes; and the presence in some legumes of estrogenic substances depresses reproductive performance when grazed by ewes during the breeding season. Thus the identification of legumes that could overcome these limitations would offer major advantages.

#### Grazing Management

Uniform and regular intake is the key to managing cattle on legume pastures. Waiting until

the dew is off before placing animals on pasture is a common practice and is probably useful when animals are first exposed to a legume pasture. Before animals are placed on a legume pasture they should be fed coarse hay to satiety. This prevents them from gorging themselves and overeating the fresh and lush legume forage. Thereafter, they should stay on pasture. Mild bloat may occur on first exposure, but the problem should disappear in a few days because animals usually adapt to legume pastures with continuous grazing. If the legume pasture continues to have a high bloat potential, the animals should be removed until the legume becomes more mature and less bloat provoking.

#### Grazing Patterns and Strip Grazing

Bloat is often associated with discontinuous grazing such as removal of animals from the legume pasture for a period of time, e.g., overnight. Similarly, outbreaks may occur when grazing is interrupted by adverse weather, such as storms, and by biting flies or other insect pests. These factors alter normal grazing habits, generally resulting in more intensive, shorter feeding periods that may increase the incidence of bloat.

In **strip grazing**, the field is grazed in strips that are changed every 1 to 3 days. This is done by careful placement of an electric fence so that the grazing strip is moved further and further away from the entrance. In this way the animals are forced to graze a greater proportion of the entire plant, which increases the dry matter intake and proportionately decreases the intake of soluble protein, which results in a decrease in the rate of digestion in the rumen. In some situations, the most reliable methods for the prevention of bloat in dairy cows are either strip grazing of pasture sprayed daily with oil or pluronics, or twice-daily drenching with the same preparations.

#### Swathing and Wilting

The frequency of alfalfa bloat can be decreased by grazing pastures that have been swathed and wilted. Wilting swathed alfalfa for 24 hours produces changes in the protein configuration of the sulfhydryl and disulfide content of the proteins. Compared with feeding a fresh swath, wilting a swath for 24 or 48 hours reduces the incidence of alfalfa bloat. The reduction is greatest by 48 hours and may be eliminated after 48 hours. A reduction in moisture content during wilting may be sufficient to eliminate the risk of bloat. Alfalfa silage is virtually bloat free because of protein degradation by proteolysis during ensiling.

#### Alfalfa Hay Bloat Prevention

The bloat potential of alfalfa hay is unpredictable. The best indicators are leafy, immature hay with soft stems. Hay grown under cool, moist conditions is more likely to cause bloat than hay produced in hot, dry areas.

Reports of bloat on damp, moldy hay are common but not documented and are unexplained. Because fine particles and leaves are especially dangerous, chopping hay can increase the incidence of bloat. When alternative roughages are available, a coarse grass hay, cereal grain hay, or straw can be substituted for a portion of the bloat-causing hay. In dairy herds, alfalfa hay can be fed in the morning and grass hay in the evening. Animals should be adjusted gradually to new lots of alfalfa hay; old and new lots should be mixed for the first 5 days of feeding.

Rations containing a 50:50 mixture of alfalfa hay and grain are most dangerous, but the risk of bloat is low when grain consists of less than 35% of the mixture.

### Antifoaming Agents

One satisfactory strategy for the prevention of pasture bloat is the administration of antifoaming agents.

### Oils and Fats

Oils and fats have achieved great success for the control of pasture bloat in New Zealand and Australia.

### Individual Drenching

Individual drenching is sometimes practiced but because of the time and labor involved it is most suited to short-term prophylaxis. It is popular as an effective standard practice in pastured cattle in New Zealand. The common practice is to administer the antifoaming agent (antibloat drench) at the time of milking using an automatic dose syringe that is moved up and down to reach each cow in the milking parlor. Cows become conditioned quickly and turn their heads to the operator to receive their twice-daily dose of 60 to 120 mL of the oil. The duration of the foam-preventing effect is short, lasting only a few hours, and increasing the dose does not significantly lengthen the period of protection.

The combined use of sodium chloride and antibloat drenching of lactating dairy cows in New Zealand may stimulate the closure of the reticular groove, causing the swallowed fluid to bypass the reticulorumen, rendering the drenching with the antibloat solution ineffective. The proportion of antibloat-sodium-chloride fluid bypassed was considered to be of no practical significance to the protection from bloat in most animals. However, there may be decreased protection in 10% to 15% of drenched cows. Thus cows should be drenched with these compounds at separate times, morning for one, evening for the other, or, if drenching at the same milking, drench with the antibloat solution first, followed by a separate drench with sodium chloride.

### Application of Oil to Pasture

If the oil or fat is emulsified with water it can be sprayed onto a limited pasture area that

provides part or all of the anticipated food requirements for the day. Back-grazing must be prevented, and care is required during rainy periods when the oil is likely to be washed from the pasture. The method is ideal where strip-grazing is practiced on irrigated pasture but is ineffective when grazing is uncontrolled.

### Addition to Feed and Water

The oil can be administered at the rate of 120 g per head in concentrates fed before the cattle go on to the pasture or by addition to the drinking water to make a 2% emulsion. Oil can be added to water in all available troughs, turning off the water supply and refilling the troughs when they are emptied. However, the actual intake of the oil cannot be guaranteed. Climatic conditions also cause variations in the amount of water that is taken, with consequent variation in the oil intake. Thus it is best to make provision for a daily intake of 240 to 300 g of oil per head during those periods when the risk of bloating is highest. The recommended procedure is to provide an automatic watering pump that injects antifoaming agents into all the drinking water supplies in amounts that will maintain a concentration of 1% of the antifoaming agent. Hand replenishment means that the preparation must be added twice daily. Surfactants are preferred to oils because of their faster action, the smaller dose rates (5–8 mL in 10–20 mL of water), and their longer period of effectiveness (10–18 hours).

### Application to Flanks

Antifoaming agents can be applied with a large paintbrush to the flanks of cows as they go out of the milking shed. A preparation that is palatable to cattle and encourages them to lick their flanks is preferred. This has been a popular method of controlling bloat in dairy cows in Australia, but failures are not infrequent, especially in individual cows.

### Types of Oil

Many different oils have been used and most vegetable oils, mineral oil, and emulsified tallow are effective. The choice of oil to be used depends on local availability and cost. If the oils are to be used over an extended period, some consideration must be given to the effects of the oil on the animal. Continued administration of mineral oil causes restriction of carotene absorption and reduces the carotene and tocopherol content of the butter produced. Linseed oil, soya oil, and whale oil have undesirable effects on the quality and flavor of the milk and butter. Peanut oil and tallow are the most satisfactory. In most areas the tympany-producing effect of pasture is short-lived and may last for only 2 to 3 weeks. During this time the pasture can be grazed under the protection of oil administration until the bloat-producing period is passed.

### Water-Soluble Feed Supplements

Commercially available sources of Proanthocyanidin (condensed tannins), and plant extracts of *Yucca schidigera* (yucca) are a natural source of steroidal saponins. Both compounds were ineffective in preventing bloat in cattle fed fresh alfalfa herbage when used as a water-soluble feed supplement added to the drinking water or given as a top-dressing.

### Synthetic Nonionic Surfactants

#### *Polyoxyethylene-Polyoxypropylene Block Polymer*

**Poloxalene** is a nonionic surfactant (surface active agent) that has been used successfully for the prevention of leguminous bloat for more than 30 years. It is a polyoxyethylene-polyoxypropylene block polymer that is highly effective for use in cattle grazing lush legume pasture or young cereal crops such as wheat pasture. Poloxalene moderates the ingestive behavior of cattle grazing immature alfalfa. In cattle the recommended daily level for prevention of bloat is 2 g/100 kg BW. In high-risk situations it may be advisable to administer the drug at least twice daily. Poloxalene is unpalatable and its use in drinking water was not possible until the introduction of the pluronic L64, which is suitable for mixing with drinking water and is effective. It needs to be introduced to the cattle several weeks before the bloat season commences. It is commonly used as an additive to grain mixtures, in feed pellets, and in mineral blocks. The use of pluronics administered by mixing with molasses to be licked from a roller drum was popular for a short period of time for the control of bloat in pastured beef cattle, but consumption was erratic and the control of bloat unreliable. The alternative of mixing pluronics with the drinking water is also not dependable.

#### *Polyoxypropylene-Polyoxyethylene Glycol Surfactant Polymer (Alfasure)*

Alfasure, a polyoxypropylene-polyoxyethylene glycol surfactant polymer, is very effective for the prevention of bloat when used at 0.05% in drinking water of cattle fed fresh alfalfa herbage and when added as a top-dressing. An Alfasure spray on pasture is completely effective in eliminating the occurrence of bloat in cattle grazing alfalfa at the vegetative to bud stage of growth.

### Alcohol Ethoxylate Detergents

These products are known to have equal foam-reducing qualities to poloxalene and have the advantage of better palatability so that they can be administered by a voluntary intake method such as medicated blocks. Small-scale field trials show that these blocks are palatable and attractive and should be satisfactory in reducing the severity and prevalence of bloat. Not all cattle visit them voluntarily, so some cases of bloat are likely to occur. The blocks contain 10% of the



alcohol ethoxylate, known as Teric, and a daily consumption of 17 to 19 g of it is usual. Application of Teric to the flanks of cows has not been as successful as a bloat prevention as other similar application of oils. Alcohol ethoxylate and pluronic detergents controlled the occurrence of bloat in sheep fed freshly harvested alfalfa in confinement and in grazing studies in which the products were added to the water supply. In cattle grazing early to late bud alfalfa stands, the addition of the products to the water supplies prevented the occurrence of bloat.

### Ionophores

Rumen modifiers such as the ionophore monensin have been used to control bloat using controlled-release capsules and liquid formulations.

#### *Controlled-Release Monensin Capsules*

Sustained-release capsules containing antifoaming agents are available for the control of pasture bloat. The capsule is administered into the rumen, where it opens, exposing an antifoaming agent, which diffuses slowly from a matrix. Monensin, a polyether ionophore antibiotic, is potentially an important agent for bloat relief in dairy cows grazing legume-based pasture. A monensin controlled-release intraruminal capsule is available that releases approximately 300 mg per head per day for 100 days. Experimental and field studies indicate that monensin can reduce the severity of bloat and increase milk production in dairy cows grazing legume pastures. In dairy farms in Australia, sustained-release monensin capsules were effective in reducing the incidence of clinical bloat in pasture-fed cattle. There was also a significant decrease in the use of pasture spraying, drinking water administration, and flank-spraying of antifoaming agents on the farms using the capsules, with no compensatory rise in the use of other bloat-prevention techniques.

A controlled-release monensin capsule reduced the incidence of bloat by about 50% in experimental steers fed alfalfa at the vegetative to early bud stages of growth.

#### *Liquid Formulation of Monensin*

Oral drenching with a liquid formulation of monensin is effective in reducing bloat in milking cows grazing white-clover-ryegrass or red-clover pastures. A daily dose of 300 mg per cow given as an oral drench in a volume of 100 mL daily provided protection for 24 hours.

### Feedlot Bloat

#### Roughage in Ration

Feedlot high-level grain rations should contain at least 10% to 15% roughage, which is cut or chopped and mixed into a complete feed. This ensures that cattle will consume a minimum amount of roughage.

The roughage should be a cereal grain straw or grass hay. The use of leafy alfalfa hay may be hazardous. The roughage may be fed separately in the long form as a supplement to the grain ration, but this practice is dangerous because the voluntary intake of roughage will vary considerably. The more palatable the grain ration, the less total roughage will be eaten, and outbreaks of feedlot bloat may occur.

### Consistency of Grain

The best results in feedlot bloat are achieved by the incorporation of nonbloating roughages in the grain ration at a level of at least 10% and avoiding fine grinding of the grain. Grains for feedlot rations should be only rolled or cracked, not finely ground. If the grain is very dry, the addition of water during processing will prevent pulverization to fine particles. The use of pelleted rations for feedlot cattle cannot be recommended, because a fine grind of the grain is normally necessary to process a solid pellet. When the pellet dissolves in the rumen, a fine pasty rumen content forms, which may be associated with the development of a stable foam. In addition, it is difficult to incorporate a sufficient quantity of roughage into a pellet.

### Antifoaming Agents

The use of dietary antifoaming agents for the prevention of feedlot bloat has had variable success. The addition of tallow at the level of 3% to 5% of the total ration has been successful and judged empirically, but controlled trials did not reduce bloat scores. If animal fats are effective in preventing feedlot bloat, they would be useful as a source of energy and for the control of dust in dusty feeds. Poloxalene is ineffective for the prevention of feedlot bloat.

### Dietary Salt

The addition of a 4% salt to feedlot rations has been recommended when other methods are not readily available. However, feed intake and rate of BW gain will be reduced. A high salt diet increased water intake, causes an alteration in the proportion of disrupted cells in the forage due to changes in fermentation, and increases the rate of flow of particulate material out of the rumen. Other management factors considered to be important in the prevention of feedlot bloat generally include **avoid overfeeding after a period of temporary starvation** (e.g., after bad weather, machinery failure, transportation, or feed handling failure), and **ensure that the water supply** is available at all times.

### Genetic Control of Pasture Bloat

Because of the high costs of bloat from deaths, lost production, treatment costs, and extra labor, one possible long-term solution is to breed cattle with reduced susceptibility to bloat. Bloat score on a single day is heritable, but the required testing procedures are

expensive in labor and can put the lives of otherwise valuable animals at risk. Selection on bloat score has been achieved successfully in an experimental herd, and genetic markers and candidate genes for bloat susceptibility are now being explored. The ultimate aim is to assist the dairy industry to identify bloat-susceptible animals, so that they can be culled or used less frequently as parents in the national herd. Work in New Zealand suggests that the prospects are good for providing the dairy industry with a means of removing bloat-susceptible cattle. Carrier sires could be identified, using a marker, and these sires could be withheld from the teams of widely used proven sires available for commercial use. The use of noncarrier artificial insemination sires in the dairy cattle industry could minimize the bloat problem in one generation by removing all homozygous bloat-susceptible progeny from the population. There has been no recent research on this aspect of bloat in cattle.

### General Comments

Apart from the impressive reduction in clinical and fatal cases of ruminal tympany resulting from the prophylactic use of oils, there are the added advantages of being able to use dangerous pasture with impunity and the reduction of subclinical bloat and its attendant lowering of food intake. Production may rise by as much as 25% in 24 hours after the use of oil. Nevertheless, these preventive methods should be considered as temporary measures only. The ultimate aim should be the development of a pasture of high net productivity in which the maximum productivity is consistent with a low incidence of bloat and diarrhea.

#### TREATMENT AND CONTROL

##### Treatment of pasture bloat

Immediately remove animals from bloating pasture (R-1)

In severe cases, emergency trocar/cannula (2.5-cm diameter) into left paralumbar fossa to release rumen foam (R-1)

In less severe cases, passage of stomach tube to release rumen foam and administer synthetic antifoaming agents (such as polyoxyethylene-polyoxypropylene block polymer, alcohol ethoxylate, or polyoxypropylene-polyoxyethylene glycol) into rumen (R-1)

##### Treatment of feedlot bloat

Passage of stomach tube to release rumen foam and administer antifoaming agent (mineral oil preferred) into rumen, followed by walking for 20 minutes to disperse antifoaming agent (R-1)

##### Control of pasture bloat

Strategic daily use of synthetic antifoaming agents or sustained-release antifoaming

*Continued*

agents such as monensin to pastured cattle (R-1)

Use of grass–legume mixtures (R-2)

Delay grazing each day until dew is off (R-2)

Feed hay before grazing (R-2)

#### Control of feedlot bloat

Increase ingestion of coarse roughage and minimize sorting of feed (R-2)

#### FURTHER READING

Wang Y, Majak W, McAllister TA. Frothy bloat in ruminants: cause, occurrence, and mitigation strategies. *Anim Feed Sci Tech.* 2012;172:103-114.

#### REFERENCE

1. Majak W, et al. *Can J Anim Sci.* 2008;88:29.

### TRAUMATIC RETICULOPERITONITIS

Perforation of the wall of the reticulum by a sharp foreign body initially produces an acute local peritonitis, which may spread to cause acute diffuse peritonitis or remain localized to cause subsequent damage, including vagal indigestion and, in rare cases, diaphragmatic hernia. The penetration of the foreign body may proceed beyond the peritoneum and cause involvement of other organs resulting in pericarditis; cardiac tamponade; pneumonia; pleurisy and mediastinitis; and hepatic, splenic, or diaphragmatic

abscess. These sequelae of traumatic perforation of the reticular wall are shown diagrammatically in Fig. 8-9.

This complexity of development makes diagnosis and prognosis difficult, and the possibility that a number of syndromes may occur together further complicates the picture. For convenience and to avoid repetition, all these entities except endocarditis are dealt with together here, even though many of them are diseases of other systems.

#### ETIOLOGY

Traumatic reticuloperitonitis is caused by the penetration of the reticulum by metallic foreign objects that have been ingested in prepared feed. Baling or fencing wire that has passed through a chaff cutter, feed chopper, or forage harvester is one of the most common causes. In one series of 1400 necropsies, 59% of lesions were caused by pieces of wire, 36% by nails, and 6% by miscellaneous objects. The metal objects may be in the roughage or concentrate or may originate on the farm when repairs are made to fences, yards, and in the vicinity of feed troughs.

The wire from motor vehicle radial tires may be the cause. Used tires are commonly used to hold down plastic sheeting over silage piles. The wire is gradually released from the tires, which are in a state of deterioration, and is mixed with the feed supply, or the tires may be inadvertently dropped into

a feed mixer wagon and become fragmented, mixing the pieces of wire throughout the ration.

#### SYNOPSIS

- **Etiology** Penetration of reticulum by metallic foreign objects such as nails and pieces of wire, including tire wire, which were ingested by the animal and located in the reticulum.
- **Epidemiology** Most common in adult dairy cattle fed prepared feeds.
- **Signs** Sudden anorexia and fall in milk yield, mild fever, ruminal stasis, and local pain in the abdomen. Rapid recovery may occur, or the disease may persist in a chronic form or spread widely to produce an acute, diffuse peritonitis.
- **Clinical pathology** In acute local peritonitis, neutrophilia and regenerative left shift; in chronic form, leukopenia and degenerative left shift. Peritoneal fluid contains marked increase in nucleated cells and total protein. Plasma protein concentration increased. Ultrasonography and radiography of the anteroventral abdomen.
- **Lesions** Localized reticuloperitonitis and varying degrees of locally extensive fibrinous adhesions. Abnormal peritoneal fluid. Abscesses and adhesions possible throughout the peritoneal cavity

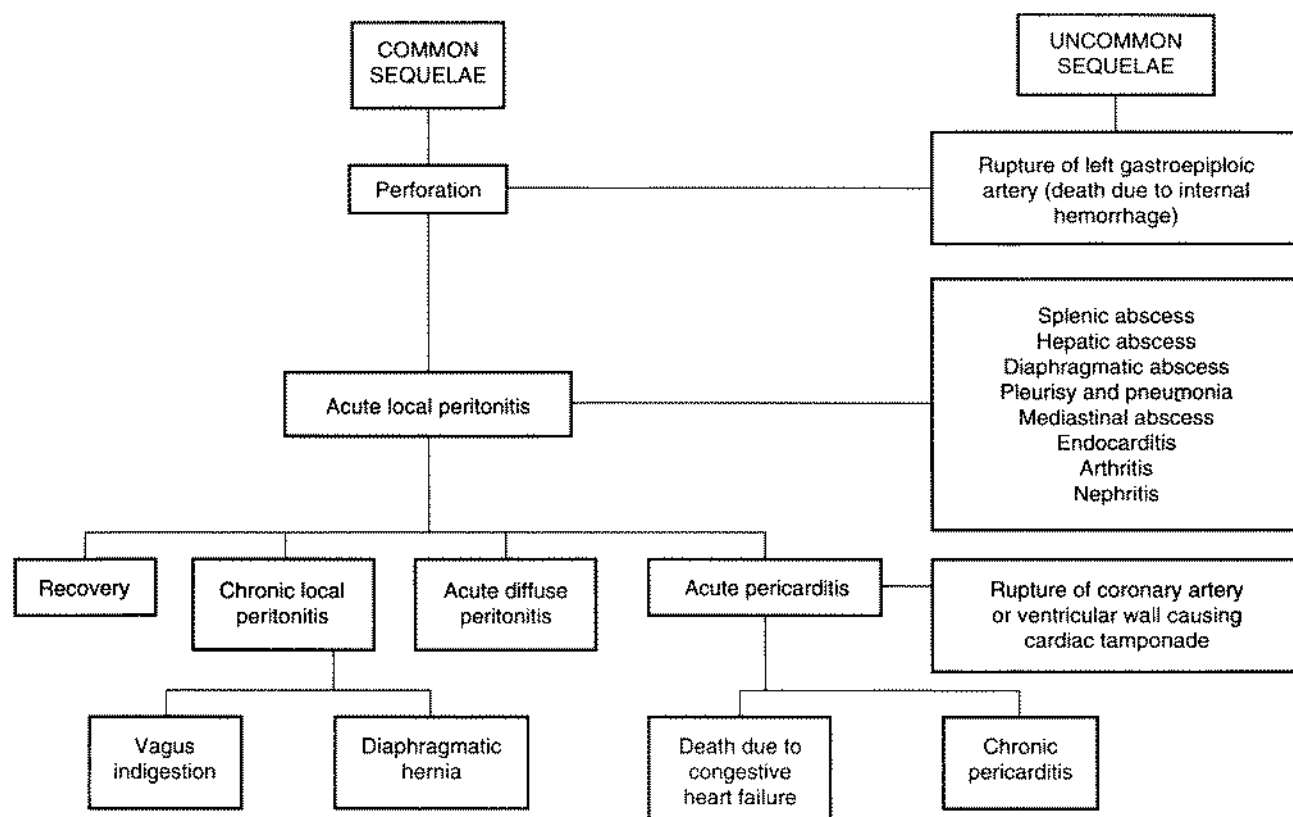

Fig. 8-9 Sequelae of traumatic perforation of the reticular wall.

- **Diagnostic confirmation**

Reticuloperitonitis and metallic foreign body.

- **Differential diagnosis list:**

- *Acute local traumatic reticuloperitonitis* must be differentiated from simple indigestion, acute carbohydrate engorgement, acute intestinal obstruction, abomasal volvulus, pericarditis, acute pleuritis, perforated abomasal ulcer, postpartum septic metritis, pyelonephritis acute hepatitis, and acetonemia.

- *Acute diffuse or generalized peritonitis* must be differentiated from those diseases causing severe toxemia or acid-base imbalance, dehydration, and shock, which include the following: carbohydrate engorgement, acute intestinal obstruction, advanced vagus indigestion, abomasal volvulus, perforated abomasal ulcer, and miscellaneous causes of generalized peritonitis.

- *Chronic traumatic reticuloperitonitis* must be differentiated from early stages of vagus indigestion, hepatic abscessation, traumatic splenitis, chronic pneumonia and pleuritis, and miscellaneous causes of chronic peritonitis such as peritoneal abscesses secondary to intraperitoneal injections.

- **Treatment** Antimicrobials daily for several days, reticular magnet, and immobilization in stall to promote adhesions. Rumenotomy to remove foreign body if medical treatment is unsuccessful or in valuable animal.

- **Control** Prevent exposure of cattle to metallic foreign objects that can be ingested. Feed-processing equipment should be equipped with magnets to remove metallic foreign bodies.

In an abattoir survey of the gastrointestinal tract of 1491 slaughter cows in Denmark, foreign bodies were found in 16% of the cows. Of 286 foreign bodies, 11% were tire wires, 14% fencing wires, 5% screws, 9% nails, 37% mixed pieces of metal, 2% copper, and 22% remnants of boluses containing antiparasitic drugs. A significant association was found between the type of foreign body and the presence of lesions, and a significant association between the cross-section of the foreign body and the presence of lesions. There was also an association between the end shape of the foreign body and the presence of lesions. Tire wire was the most common traumatizing foreign body, because 81% of all lesions were associated with tire wires.

## EPIDEMIOLOGY

### Occurrence

Adult dairy cattle are most commonly affected because of their more frequent exposure but cases occur infrequently in yearlings, beef cattle, dairy bulls, sheep, and goats. In the series of 1400 referred to earlier,

93% were in cattle over 2 years old and 87% were in dairy cattle. In the Danish abattoir survey of cows (see earlier in Etiology), foreign body lesions were present in 10% of the cows. Magnets were found in only 7% of the cows. All magnets collected iron filings and fencing wire (30%), and “other pieces of metal” (39%) were the predominant contents of the magnet. There were no lesions in 97% of the cows with magnets, and a significant association was found between the use of magnets and the absence of lesions.

Reticuloperitonitis is much more common in cattle fed on prepared feeds, especially those fed inside for part of the year. It is almost unknown in cattle fed entirely on pasture. Accordingly, it is much more common in the winter months in the Northern Hemisphere. The incidence is much lower in sheep and goats because they are rarely fed chopped forages.

The incidence is usually sporadic but outbreaks have occurred when sources of wire have become mixed into feed supplies, as in the case of perforation of the alimentary tract by pieces of tire wire. Over a period of 6 months, 30% of 170 lactating dairy cows in one herd exhibited clinical signs suggestive of hardware disease associated with the ingestion of tire wire in the feed supplies.

### Risk Factors

There are few studies of the epidemiology of traumatic reticuloperitonitis. The effects of 23 veterinary diagnoses, host characteristics, and production were examined on the risks of ruminal acidosis and traumatic reticuloperitonitis. The lactational incidence risk for the disease in Finnish Ayrshire dairy cattle was 0.6%, which is similar to observations made in Holstein Friesian cows. The risk of the disease in the former study increased with early metritis, nonparturient paresis, ketosis, acute and chronic mastitis, and foot and leg problems. It is unknown how metritis and mastitis could be risk factors for traumatic reticuloperitonitis. The median day of occurrence was on 113 days after calving, which makes it unlikely that calving was a risk factor. Similarly, dystocia was not found to be a risk factor.

When several or more cases occur in a cluster outbreak, the nature of the feed supply should be considered as a risk factor. The use of used tires to secure plastic sheeting over silage piles may be an important risk factor.

### Economic Importance

The disease is economically important because of the severe loss of production it causes and the high mortality rate. Many cases go unrecognized and many more make spontaneous recoveries. In industrialized countries, metallic foreign bodies may be present in the reticulum in up to 90% of normal cattle, and residual traumatic lesions

may be present in as many as 70% of dairy cows. Among the clinically affected animals, about 25% develop incurable complications. The other 75% can be expected to recover completely with conservative treatment or routine surgical intervention.

## PATHOGENESIS

### Ingestion of Foreign Body

Lack of oral discrimination by cattle leads to the ingestion of foreign bodies that would be rejected by other species. Swallowed foreign bodies may lodge in the upper esophagus and cause obstruction or in the esophageal groove and cause vomiting, but in most instances they pass to the reticulum. Radiologic examination of goats that have been fed foreign bodies experimentally indicate that they may first enter various sacs of the reticulorumen before reaching the reticulum. Many lie there without causing harm but the honeycomb-like structure of the reticulum provides many sites for fixation of the foreign body, and contractions of the reticulum are sufficient to push a sharp-pointed object through the wall.

### Penetration of Reticulum

Most perforations occur in the lower part of the cranial wall of the reticulum but some occur laterally in the direction of the spleen and medially toward the liver.

If the reticular wall is injured without penetration to the serous surface, no detectable illness occurs, and the foreign body may remain fixed in the site for long periods and gradually be corroded away. A piece of wire can disappear in 6 weeks, but certain nails last much longer and are unlikely to corrode away in less than 1 year. The ease with which perforation occurs has been illustrated by the artificial production of the disease. Sharp-ended foreign bodies were given to 10 cows in gelatin capsules. Of 20 pieces of wire and 10 nails, 25 were found in the reticulum. Of the 20 pieces of wire, 18 had perforated or were embedded in the wall or plicae. Only one of the nails was embedded. Complete perforations were caused by 13 foreign bodies and incomplete by 6. All cows suffered at least one perforation, showed clinical signs of acute local peritonitis, and recovered after surgical removal of the foreign bodies.

Many foreign bodies may not remain embedded but are commonly found free in the reticulum if surgery is performed about 72 hours after illness commences. This may be from necrosis around the penetrating object and the reticular contractions moving the foreign body back into the reticulum. Objects that are deeply embedded or have kinks, barbs, or large diameters tend to remain in situ and cause persistent peritonitis.

### Acute Local Peritonitis

The initial reaction to perforation is one of acute local peritonitis and, in experimentally



induced cases, clinical signs commence about 24 hours after penetration. The peritonitis causes ruminal atony and abdominal pain. If the foreign body moves back into the reticulum, spontaneous recovery may occur.

**Resolution of acute fibrinous local peritonitis** is characterized by the development of **fibrous adhesions**, which gradually become long, stringy strands over a period of weeks and months; **motility of the reticulum is restored** and the animal may recover fully. Follow-up ultrasonographic examinations of cows with traumatic reticuloperitonitis in which rumenotomies were done showed that the adhesions disappeared in most of the animals by 6 months.

Depending on the severity of the local peritonitis, the ventral aspect of the reticulum becomes adherent to varying degrees to the abdominal floor and diaphragm. This results in **decreased reticular motility**. Ultrasonography of cows with traumatic reticuloperitonitis reveals that the **biphasic contractions of the reticulum are slower than normal or indistinct and the number of contractions are reduced**. **Reticular abscesses are common complications** and may be located between the reticulum and the ventral body wall, between the reticulum and the right thoracic wall, and between the reticulum and the spleen. **Persistent local peritonitis** with or without abscesses results in reduced reticulorumen motility, inappetence to anorexia, a capricious appetite (may eat hay not concentrate), chronic ruminal tympany, persistent mild fever, abdominal pain on deep palpation, and changes in the hemogram and feces. Immobilization of the reticulum impairs the clearance function of the reticulum, which results in the passage of poorly comminuted feces characterized by an increased proportion of large particles.

### Generalized Peritonitis and Extension of Disease

Spread of the inflammation causing **generalized or diffuse peritonitis** may occur in cows that calve at the time of perforation and in cattle that are forced to exercise. Immobility is a prominent clinical finding and may be a protective mechanism so that adhesions are able to form and localize the peritonitis. Animals made to walk or transported long distances frequently suffer relapses when these adhesions are broken during body movements. Generalized peritonitis results in toxemia, alimentary tract stasis, dehydration, and shock.

During the initial penetration of the reticulum, the foreign body may penetrate beyond the peritoneal cavity and into the **pleural or pericardial sacs**. This may be more common in cows in advanced pregnancy than in nonpregnant cows, because of the gravid uterus, although this is uncertain. Complications such as pericarditis are most common in cows after the sixth month of pregnancy.

Details of the pathogenesis of the more common complications are presented under **traumatic pericarditis, vagus indigestion, diaphragmatic hernia, and traumatic abscess of the spleen and liver**. Less common sequelae include laceration or erosion of the left gastroepiploic artery causing sudden death from internal hemorrhage and the development of a diaphragmatic abscess, which infiltrates tissues to the ventral abdominal wall at the xiphoid process, rupturing to the exterior and sometimes discharging the foreign body. Hematogenous spread of infection from a diaphragmatic abscess or chronic local peritonitis is a common cause of endocarditis and its sequelae of polysynovitis and arthritis, nephritis, and pulmonary abscessation. Penetration into the pleural cavity causes **acute suppurative pleuritis and pneumonia**. In rare cases the infection is localized to the mediastinum causing abscessation, which causes pressure on the pericardial sac and congestive heart failure. Rarely, the foreign body penetrates to the abomasum, causing abomasitis, pyloric stenosis, and abomasal ulceration. Even more rarely, puncture of the reticular vein by a migrating metal wire may lead to fatal hemorrhage causing sudden death.

### CLINICAL FINDINGS

#### Acute Local Peritonitis

Characteristically, the onset is sudden with **complete anorexia** and a **marked drop in milk yield**, usually to about one-third or less of the previous milking. These changes occur within a 12-hour period and their abrupt appearance is typical. **Subacute abdominal pain** is common in most cases. The animal is reluctant to move and does so slowly. Walking, particularly downhill, is often accompanied by grunting. Most animals prefer to remain standing for long periods and lie down with great care; habitual recumbency is characteristic in others. **Arching of the back** occurs in about 50% of cases, along with the appearance of tenseness of the back and the abdominal muscles so that the animal appears gaunt or “tucked-up.” **Defecation and urination cause pain**, and the acts are performed infrequently and usually with grunting. This results in constipation, scant feces, and in some cases retention of urine. Rarely, acute abdominal pain with kicking at the belly and stretching occurs. In others there is recumbency and reluctance to stand.

A **moderate systemic reaction** is **common** in acute localized peritonitis. The temperature ranges from 39.5°C to 40°C (103°F–104°F), rarely higher, the heart rate is about 80 beats/min, and the respiratory rate about 30 per minute. Temperatures above 40°C (104°F) accompanied by heart rates greater than 90 beats/min suggest severe complications. The respirations are usually shallow and, if the pleural cavity has been

penetrated, are painful and accompanied by an audible expiratory grunt.

**Rumination is absent and reticulorumen movements** are markedly depressed and usually absent. The rumen may appear to be full because of the presence of a **free-gas bloat** with moderate distension of the left paralumbar fossa. On palpation of the fossa, the ruminal gas cap is usually larger than usual and the rumen contents more doughy than normal. Deep palpation of the gas cap in the fossa may be required to feel the rumen pack below the gas cap.

**Pain can be elicited by deep palpation of the abdominal wall** just caudal to the xiphisternum. Palpation is done using short, sharp pushes with the closed fist or knee over an imaginary band about 20 cm wide covering the ventral third of the abdomen from the left to the right side with the cranial border of the band being the point just caudal to the xiphisternum. This area should be probed with at least six deep palpations on both sides of the abdomen while listening with a stethoscope over the trachea for evidence of a grunt. Pinching the withers to cause depression of the back and eliciting a grunt is also an effective diagnostic aid, except in large adult cows and bulls; for these the sharp elevation of a solid rail held horizontally under the abdomen is a useful method for eliciting a grunt. A positive response to any of these tests is a grunt of pain, which may be audible some distance away but is best detected by auscultation of the trachea. Rarely, a grunt may also be audible by auscultation over the trachea when infrequent reticulorumen contractions occur.

The course of acute local peritonitis is short and the findings described previously are most obvious on the first day; in most cases they subside quickly and may be difficult to detect by the third day. In these cases, in addition to persistent anorexia and ruminal atony, the most constant finding is the abdominal pain, which may require deep palpation for its demonstration. In cases that recover spontaneously or respond satisfactorily to conservative treatment there may be no detectable signs of illness by the fourth day.

#### Chronic Local Peritonitis

In chronic peritonitis the appetite and milk yield do not return to normal after prolonged therapy with antimicrobials. The body condition is usually poor, the feces are reduced in quantity, and there is an increase in undigested particles. In some cases, the temperature may be within the normal range, which makes the diagnosis uncertain. A persistent slightly elevated temperature is supportive evidence of the presence of a chronic inflammatory lesion. The grunt test may be positive or negative; often it is uncertain. The gait may be slow and careful and, occasionally, grunting may occur during rumination,

defecation, and urination. Rumination activities are infrequent, the rumen is usually smaller than normal, chronic moderate bloat is common, and there is ruminal atony or some moderate reticulorumen activity.

**Reticular abscesses** in cows are characterized by poor body condition, a relatively full rumen but with reduced ruminal contractions or almost complete ruminal atony, persistent mild bloat, an arched back with a tense abdomen and a grunt indicating abdominal pain, and undigested particles in the feces. Most have a clinical history of not responding to prolonged therapy with antimicrobials. These can be diagnosed with radiography and ultrasonography.

### Rectal Examination

**Rectal examination** of cattle with acute or local traumatic reticuloperitonitis may cause a painful grunt when the animal strains during the examination. The feces are usually dry and firm and covered by a thin coating of mucus because of prolonged retention. In acute localized peritonitis the rumen may feel larger than normal and the gas cap is easily palpable. In acute and chronic generalized peritonitis, fibrinous adhesions may be palpable between the rumen and the left abdominal wall or between loops of intestine, or in the pelvic cavity.

### Acute Diffuse (Generalized) Peritonitis

Acute diffuse peritonitis is characterized by the appearance of profound toxemia within a day or two of the onset of local peritonitis. Alimentary tract motility is reduced, mental depression is marked, and the temperature is elevated or subnormal in severe cases, especially those that occur immediately after calving. The heart rate increases to 100 to 120 beats/min and a painful grunt may be elicited by deep digital palpation at almost any location over the ventral abdominal wall. This stage is usually followed by rapid collapse and peripheral circulatory failure and an absence of pain responses. Terminally, recumbency and depression are common.

### Sudden Death

There is a record of sudden death in a 20-month-old pregnant heifer in which the reticular vein was punctured by a migrating piece of metal wire, causing fatal hemorrhage into the reticulum. At necropsy, a large blood clot was present in the reticulum, the rumen contents were red-brown, and no reticular adhesions were present.

### Iatrogenic Reticulitis

There is a record of iatrogenic reticulitis that occurred as a result of the oral administration of intraruminal anthelmintic boluses, which may have lodged in the reticulum and become filled with other foreign objects ingested by the animal, resulting in a syndrome similar to acute traumatic reticuloperitonitis.

Inappetence, reduced milk production, reduced reticulorumen motility, abdominal pain, and scant feces were present. On exploratory rumenotomy the reticulum contained two cylindrical boluses filled with stones, nuts, and bolts. Removal of the boluses was followed by prompt recovery.

### CLINICAL PATHOLOGY

#### Hemogram

The total and differential leukocyte counts provide useful diagnostic and prognostic data. The differential leukocyte count is usually considerably more indicative of acute peritonitis than the total count.

In **acute local peritonitis** a neutrophilia (mature neutrophils above 4000 cells/ $\mu$ L) and a left shift (immature neutrophils above 200 cells/ $\mu$ L) are common. This is a **regenerative left shift**. Both the neutrophilia and the left shift will be increased on the first day and will last for up to 3 days, when in uncomplicated cases the count begins to return to normal. In chronic cases the levels do not return completely to normal for several days or longer periods and there is usually a moderate leukocytosis, neutrophilia, and a monocytosis.

In **acute diffuse peritonitis** a leukopenia (total count below 4000 cells/ $\mu$ L) with a greater absolute number of immature neutrophils than mature neutrophils (**degenerative left shift**) occurs, which suggests an unfavorable prognosis if severe. The degree of lymphopenia (lymphocyte count below 2500–3000 cells/ $\mu$ L) is an indication of a stress reaction to inflammation.

#### Plasma Protein, Fibrinogen, Acute Phase Reactants, and Coagulation Profile

There is a significant difference in total plasma protein (TPP) levels between cattle with traumatic reticuloperitonitis and those with other diseases of the gastrointestinal tract that might be confused with the former. The mean plasma protein concentrations, measured before surgery, were  $88 \pm 13$  g/L for traumatic reticuloperitonitis and  $77 \pm 12$  g/L for controls. In severe diffuse peritonitis the fibrinogen levels may be increased up to 10 to 20 g/L.

Cutoff points for TPP and plasma fibrinogen (PF) were determined to differentiate between traumatic reticuloperitonitis and other gastrointestinal diseases with similar clinical findings. There was moderate negative dependence between sensitivities of TPP and PF at the 8.8 g/dL and 766 mg/dL cutoff points, and mild negative dependence between their specificities at the 7.8 g/dL and 691 mg/dL cutoff points, respectively. Acceptable accuracy (98% or 86% specificity with 62% or 88% sensitivity, respectively) was obtained with serial interpretation of the tests.

Cattle with active peritonitis caused by traumatic reticuloperitonitis have an acute

phase response, manifested as an increased plasma concentration of SAA and haptoglobin, and a decreased plasma albumin concentration. Optimal cut points for the diagnosis of traumatic reticuloperitonitis were  $>68$   $\mu$ g/mL for SAA (sensitivity = 1.00; specificity = 0.86) and  $>0.74$  g/L for serum haptoglobin concentration (sensitivity = 1.00; specificity = 0.86),<sup>1</sup> with PF concentration  $> 380$  mg/dL having a lower test sensitivity and specificity.

Affected cattle have prolonged prothrombin time, thrombin time, and activated partial thromboplastin time and thrombocytopenia, indicating the presence of abnormal coagulation.<sup>2</sup> This was attributed to diffuse peritonitis and hepatocellular dysfunction. Cattle with traumatic reticuloperitonitis also have increased serum nitric oxide concentration and decreased total antioxidant capacity, which probably reflects the diverse bacterial population associated with the peritonitis.<sup>3</sup>

### Abdominocentesis and Peritoneal Fluid

Abdominocentesis and analysis of peritoneal fluid can be a valuable diagnostic aid. The best site for abdominocentesis is uncertain because the rumen occupies a large portion of the ventral abdominal wall and avoiding penetration of it is difficult. Cattle have a low volume of peritoneal fluid and failure to obtain a sample is not unusual. Empirically, the best sites are those in which, on an anatomic basis, there are recesses between the forestomachs, abomasum, diaphragm, and liver. These are usually 10 to 12 cm caudal to the xiphisternum and 10 to 15 cm lateral to the midline. A blunt-ended teat cannula is recommended, but with care and caution a 16-gauge or 18-gauge 5-cm hypodermic needle may also be used. The hair of the site is clipped, the skin is prepared aseptically, and a local anesthetic is applied. The skin is incised with a stab scalpel and the cannula is pushed carefully and slowly through the abdominal wall. The latter will twitch and a "pop" will be felt when the peritoneum is punctured. When the cannula is in the peritoneal cavity, the fluid may leak out without the aid of a vacuum. If it does not, a syringe may be used to apply a vacuum while the needle is manipulated in an attempt to locate some fluid.

If no fluid can be obtained, a trocar and cannula 80 mm long and with a 4-mm internal diameter can be used with success. The trocar and cannula are inserted into the abdomen, the trocar is removed and an 80-cm long 10-French gauge infant feeding tube is inserted into the abdomen through the cannula, leaving about 10 to 20 cm outside. The tube acts as a wick and within several minutes fluid can be collected into vials. At least three different sites should be attempted to obtain peritoneal fluid. Peritonitis in cattle is characterized by a marked fibrinous response and localization of a

lesion, and the amount of exudative fluid available at the abdominocentesis sites may be minimal. Thus the failure to obtain fluid does not preclude the presence of peritonitis.

**Laboratory evaluation of peritoneal fluid** consists of determinations of total white blood cell count, differential cell count, total protein, and culture for pathogens. The interpretation of the analysis of the peritoneal fluid can be unreliable because only a few correlations have been made between the laboratory findings and the presence or absence of peritoneal lesions. A nucleated cell count above 6000 cells/ $\mu$ L and total protein above 3 g/dL is consistent with the diagnosis of peritonitis in 80% of cases. Using a differential cell count, a relative neutrophil count more than 40% and a relative eosinophil count less than 10% was frequently associated with the diagnosis of peritonitis. A D-dimer concentration of peritoneal fluid higher than the reference range (0–0.6 mg/L) provides an excellent method for identifying the presence of peritonitis in cattle, with sensitivity = 0.96 and specificity = 0.99.<sup>4</sup>

### RADIOGRAPHY OF CRANIAL ABDOMEN AND RETICULUM

Radiologic examination of the reticulum is an accurate diagnostic method for the evaluation of cattle with suspected traumatic reticuloperitonitis and should be done with the animal standing. Although there are some reports of reticular radiography with the cow in dorsal recumbency, this method is not recommended because of the potential for breaking down adhesions and disseminating peritonitis throughout the entire abdomen, as well as decreased diagnostic accuracy. There are also technical difficulties in positioning an unsedated animal in dorsal recumbency, and sedatives are not recommended because of the risk of aspiration pneumonia. The availability of ultrasonographic equipment and lack of adequate radiographic equipment in private veterinary practices has resulted in the decreased use of radiography to diagnose traumatic reticuloperitonitis. However, the technique provides clinically useful information for valuable animals that may warrant referral to a veterinary medical center.

The **cranioventral abdomen of cattle** can be evaluated using two cranial abdominal and one caudal thoracic radiograph. An x-ray machine with a capacity of 1000 to 1250 mA and 150 kV is necessary, which is usually only available in veterinary teaching hospitals. However, such techniques may be appropriate in valuable animals in which an accurate diagnosis and prognosis for surgical treatment may be desirable. In a consecutive series of standing lateral cranial abdominal radiographs, the sensitivity and specificity for detecting traumatic reticuloperitonitis or pericarditis was 83% and 90%, respectively.

These values are higher than those achieved with the animal being placed dorsal recumbency. In standing lateral radiographs, an enlarged reticulum was associated with a final diagnosis of vagal indigestion. Alteration in reticulodiaphragmatic separation does not correlate with any specific disease process. The presence of focal perireticular gas collections and reticular foreign bodies greater than 1 cm in length unattached to a magnet were good indicators of traumatic reticuloperitonitis. Radiography is best suited for identification of radiodense foreign bodies in and outside the reticulum (these cannot be visualized ultrasonographically). A magnet should be administered before radiographs are taken in cattle with a magnet; orally administered magnets rapidly find their way to the reticulum and in this location provide a helpful anatomic landmark and indicate if wire located in the reticulum is free floating or imbedded in the reticular wall (see Fig. 8-16). There is minimal value in performing a rumenotomy if radiographs identify that a wire is fully attached to a magnet and therefore not capable of re-penetration of the reticulum.

Features found to be reliable in the diagnosis of traumatic reticuloperitonitis using lateral radiographs of the reticulum include the following:

- **Atypically positioned foreign bodies**
- **Abnormal gas shadows in the region of the reticulum**
- **Depressions in the cranioventral margin of the reticulum**

The reticulum is often markedly displaced caudally from the diaphragm or dorsally or caudodorsally from the ventral abdominal wall. Space-occupying masses of the density of soft tissue, with or without gas inclusions, gas shadows, and gas–fluid interfaces in the region of the reticulum, were highly predictive of peritonitis (specificity 97%, positive predictive value 96%).

### ULTRASONOGRAPHY OF THE RETICULUM

Ultrasonography is a suitable method for investigation of reticular contractions in healthy ruminants and in cattle for the diagnosis of traumatic reticuloperitonitis.

The reticulum and adjacent organs of cows can be examined with ultrasonography using a 3.5-MHz linear transducer applied to the ventral midline of the thorax over the sixth and seventh intercostal spaces and from the left and right sides of the midline. It may not be possible to image the reticulum in large cows in good body condition because of the high proportion of fat in the muscle layers. In older cows, calcification of the xiphisternum may interfere with imaging. The most common reason for being unable to visualize the reticulum in sick animals is the displacement of the reticulum by a markedly distended rumen or by space-occupying lesions such as abscesses and

fibrin-containing effusions. The pattern, number, amplitude, and duration of the interval between contractions can be visualized. The contour of reticulum, the reticular contractions, and the organs adjacent to the reticulum can be imaged. The biphasic reticular contractions can be visualized at the rate of four contractions during a 4-minute period. During the first incomplete contraction, the reticulum contracts by a mean of about 7.2 cm, and during the second contraction the reticulum disappears from the screen.

### Ultrasonography for Traumatic Reticuloperitonitis

In contrast to radiography, ultrasonography provides more precise information about the contour of the reticulum and reticular motility. In cattle with traumatic reticuloperitonitis, ultrasonography can be used to identify morphologic changes in the region of the cranial, ventral, or caudal reticular wall. The caudoventral reticular wall is the most frequently affected, often in association with the craniodorsal blind sac of the rumen. The changes in the contour of the reticulum depend on the severity of the inflammatory changes.

The reticulum can be visualized in more than 90% of cows in spite of interference by the ribs and sternum. In cows with disturbed reticular motility, biphasic contractions are slower than normal, or indistinct, and the number of contractions is reduced. Fibrinous material appears as echogenic deposits, sometimes accompanied by hypoechoic fluid. Reticular abscesses have an echogenic capsule with a hypoechoic center. Involvement of the spleen, omasum, liver, and abomasum may also be imaged. Neither magnets nor foreign bodies can be visualized by ultrasonography.

Reticular activity is almost always affected in cattle with traumatic reticuloperitonitis. The frequency, amplitude, or velocity of contractions, singly or combined, may be abnormal. The frequency can be reduced from 3 to 2, 1, or no contractions per 3 minutes (normal rate is approximately one contraction per minute). The reticular contraction rate is increased to 1.5 per minute at the onset of feeding. The reduction in the amplitude of contractions varies: when formation of adhesions is extensive, reticular contractions appear indistinct. Although the pattern of biphasic contraction is often maintained, the reticulum contracts only 1 to 3 cm. The velocity of reticular contractions may be normal but can be markedly reduced. In cattle with reticuloomasal obstruction caused by a foreign body, the frequency of reticular contractions may be increased.

Reticular abscesses associated with traumatic reticuloperitonitis can be visualized by ultrasonography (Fig. 8-10). The amplitude of reticular contractions is reduced to only 1 to 3 cm, the reticulum is displaced from



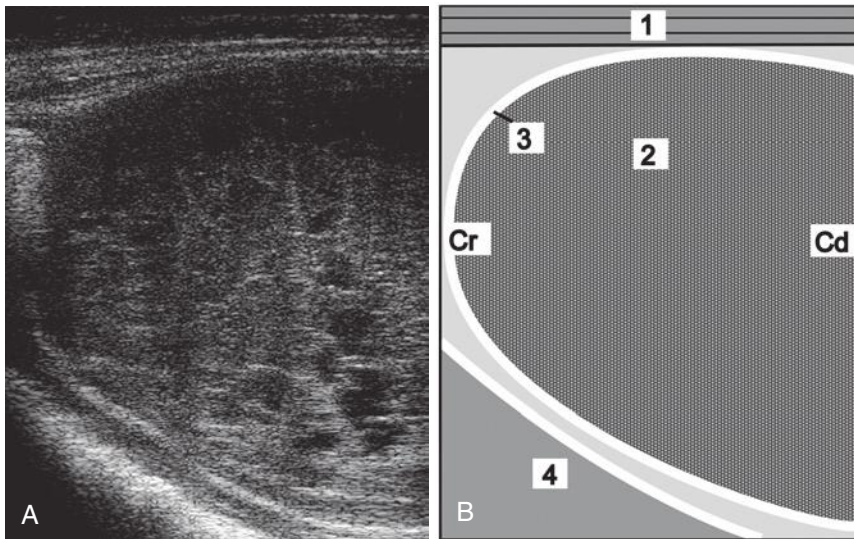

**Fig. 8-10 A, and B,** Ultrasonogram and schematic of a reticular abscess in a cow with chronic traumatic reticuloperitonitis. The abscess is between the reticulum and the ventral abdominal wall. The ultrasonogram was obtained from the sternal region with a 5.0-MHz linear transducer. 1, Ventral abdominal wall; 2, abscess; 3, capsule of the abscess; 4, reticulum; Cr, cranial; Cd, caudal. (Reproduced with permission of U. Braun.)

the ventral body wall, and the abscesses have hypoechoic centers and echogenic capsules.

Peritoneal effusion is visible as an accumulation of fluid without an echogenic margin and restricted to the reticular area. Depending on the fibrin and cell content, the fluid may be anechoic or hypoechoic. Fibrinous deposits are easily identified in the fluid, and bands of fibrin are sometimes seen within the effusion. Occasionally, the peritoneal effusion is considerable and extends to the caudal abdomen.

The spleen, particularly its distal portion, is often affected. Fibrinous changes are frequently seen as echogenic deposits of varying thickness, often surrounded by fluid, between the spleen and reticulum or rumen. The spleen may be covered by fibrinous deposits. Occasionally, one or more splenic abscesses are visible, and the vasculature may be dilated, indicating splenitis.

### Ultrasonography and Radiography of Cattle With Traumatic Reticuloperitonitis

These two techniques have been compared in cows with traumatic reticuloperitonitis. The major advantages of radiography are that metallic foreign bodies can be visualized and their position determined. It has a specificity of 82%, a positive predictive value of 88%, and a sensitivity of 71%. Abnormal gas shadows or gas–fluid interfaces observed on radiographs are highly diagnostic for the disease and have a specificity of 97% and positive predictive value of 88%. However, they are seldom seen on radiographs and their sensitivity is only 19%. The position of the reticulum is a good criterion for

the diagnosis of traumatic reticuloperitonitis, with a specificity of 80% and a positive predictive value of 82%. Thick-walled changes or abscessation should be suspected when the reticulum is displaced caudodorsally from the sternum. Changes in the contour of the reticulum such as indentations are highly suggestive of inflammation, with a specificity of 95% and positive predictive value but a low sensitivity of only 34%.

The major advantage of ultrasonography is being able to visualize and assess reticular motility. Even in the presence of severe adhesions and abscessation, the reticulum may maintain its basic contractile rhythm, but it will be quite reduced. Abscesses have an echogenic capsule of varying width and a central cavity filled with hypoechoic material. Purely fibrous deposits are echogenic, and fibrinous deposits containing an accumulation of fluid from inflammatory processes are echogenic interspersed with hypoechoic accumulations of fluid (Fig. 8-11). Radiography and ultrasonography complement each other, and the combined results can be used to decide whether an exploratory laparotomy is indicated, if the animal should be treated conservatively with antibiotics, or if it should be slaughtered for salvage.

### METAL DETECTION

**Metal detectors** were used at one time to aid in the diagnosis of traumatic reticuloperitonitis. Ferrous metallic foreign bodies can be detected with metal detectors but the instruments are of limited use because most dairy cows eating chopped forages are positive for metal over the reticular area.

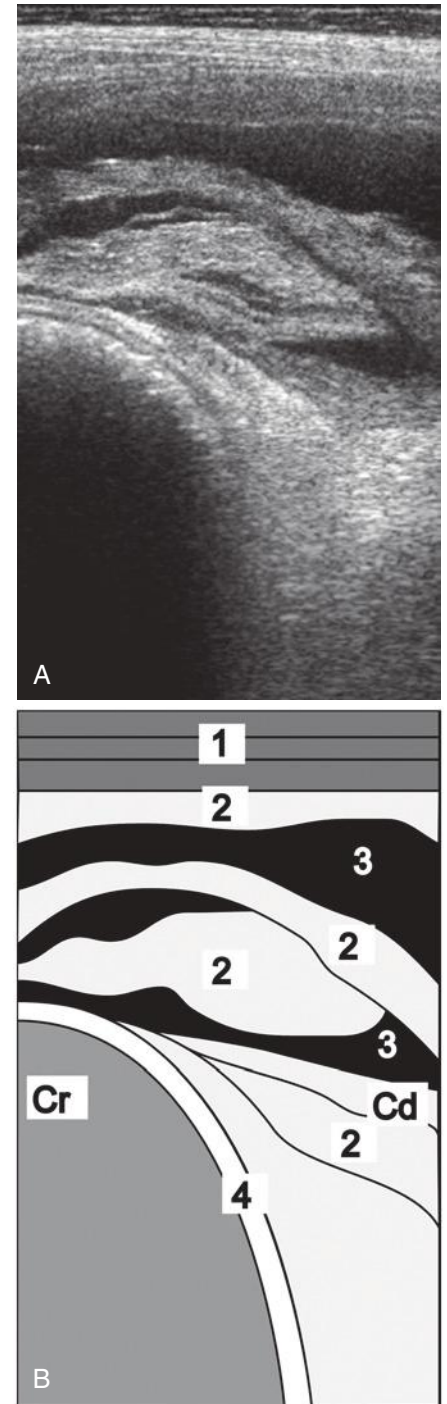

**Fig. 8-11 A, and B,** Ultrasonogram and schematic of the reticulum in a cow with chronic traumatic reticuloperitonitis. The reticulum is covered with fibrinous deposits. The ultrasonogram was obtained from the sternal region with a 5.0-MHz linear scanner. 1, Lateral abdominal wall; 2, fibrinous deposits; 3, anechoic fluid; 4, reticulum; Cr, cranial; Cd, caudal. (Reproduced with permission from U. Braun.)

## LAPAROSCOPY

Right flank laparoscopy using a flexible fiberoptic laparoscope, 14 mm in diameter and 1.1 m in working length, is a reliable diagnostic aid for the presence of traumatic reticuloperitonitis, but the diagnostic technique has been replaced by ultrasonography of the reticular region.

## NECROPSY FINDINGS

Localized traumatic reticuloperitonitis is characterized by varying degrees of locally extensive fibrinous adhesions between the cranioventral aspects of the reticulum and the ventral abdominal wall and the diaphragm. Adhesions and multiple abscesses may extend to either side of the reticulum involving the spleen, omasum, liver, abomasum, and ventral aspects of the rumen. Large quantities of turbid, foul-smelling peritoneal fluid may be present, containing fibrinous clots. Some cases of reticular abscesses are solitary and there are adhesions between the reticulum, diaphragm, and ventral body wall, which are strictly localized. The size of the abscess varies. It may be from 5 to 10 cm in diameter or a single one may be irregularly shaped and measure  $30 \times 10 \times 10$  cm, along with multiple smaller ones measuring around  $3 \times 3 \times 3$  cm. The foreign body can usually be found perforating the cranioventral aspect of the reticulum, although it may have fallen back into the reticulum, leaving only the perforation site and its surrounding inflammation as evidence of the site of penetration. A reticular magnet with many pieces of metallic foreign bodies stuck to it may be present in the reticulum, the mucosa of which is usually normal.

In **acute diffuse peritonitis** a fibrinous or suppurative inflammation may affect almost the entire peritoneal cavity with extensive fibrinous adhesions of various stages of development involving the forestomach, abomasum, small and large intestines, liver, bladder, reproductive tract, and pelvic cavity. Large quantities of turbid, foul-smelling fluid containing clots of fibrin are usually present. Loops of intestine and omenta are commonly stuck together by thick layers of fibrin.

## DIFFERENTIAL DIAGNOSIS

Typical acute traumatic reticuloperitonitis is characterized by a sudden onset of complete anorexia, marked drop in milk production, mild fever, ruminal atony, pain on deep palpation of the ventral abdomen, an elevated leukocyte count with a left shift in the hemogram, and a peritoneal fluid sample that indicates inflammation.

However, the times at which cases of traumatic reticuloperitonitis are seen varies from day 1, when the syndrome is typical, to day 3 or 4, by which time the acuteness has subsided so much clinically that confusion with other diseases is a significant possibility. The sudden onset of anorexia and marked drop in milk production will usually be noted in lactating dairy cattle but not in dry dairy cattle or beef cattle, including mature bulls whose feed intake and behaviors are not monitored daily. In these animals the clinical findings can change in a few days and be characterized by anorexia to inappetence, normal temperature, ruminal hypotonicity or atony, and no evidence of abdominal pain on deep palpation of the abdomen.

The clinician must review the history carefully, conduct a thorough clinical examination, and attempt to intensify the diagnostic efforts on those abnormalities that are present.

The differential diagnosis of gastrointestinal dysfunction of cattle is summarized in [Table 8-2](#). An algorithm for the causes of grunting in cattle is shown in [Fig. 8-12](#).

### Acute local traumatic reticuloperitonitis

Acute local traumatic reticuloperitonitis must be differentiated from those diseases in which sudden anorexia or inappetence, normal production, ruminal atony, abdominal pain, and abnormal feces are common. They include the following:

- **Simple indigestion** characterized by sudden anorexia or inappetence, normal mental state, full rumen but atonic, perhaps uncomfortable if ingested large quantities of palatable feed like fresh silage, normal vital signs, abnormal feces, and spontaneous recovery in 24 hours are typical.
- **Obstruction of reticuloomasal orifice** with a foreign body such as a roll of polyethylene twine causes intermittent inappetence, a slightly enlarged rumen with normal motility, slight reduction in the amount of feces, a decrease in milk yield for 24–48 h followed by a return to normal and then subsequent relapses. A grunt is not present; the temperature, heart, and respiratory rates are normal; and the hemogram is normal. Obstruction of the reticuloomasal orifice with foreign bodies such as rope can cause distension and hypermotility of the rumen and persistent

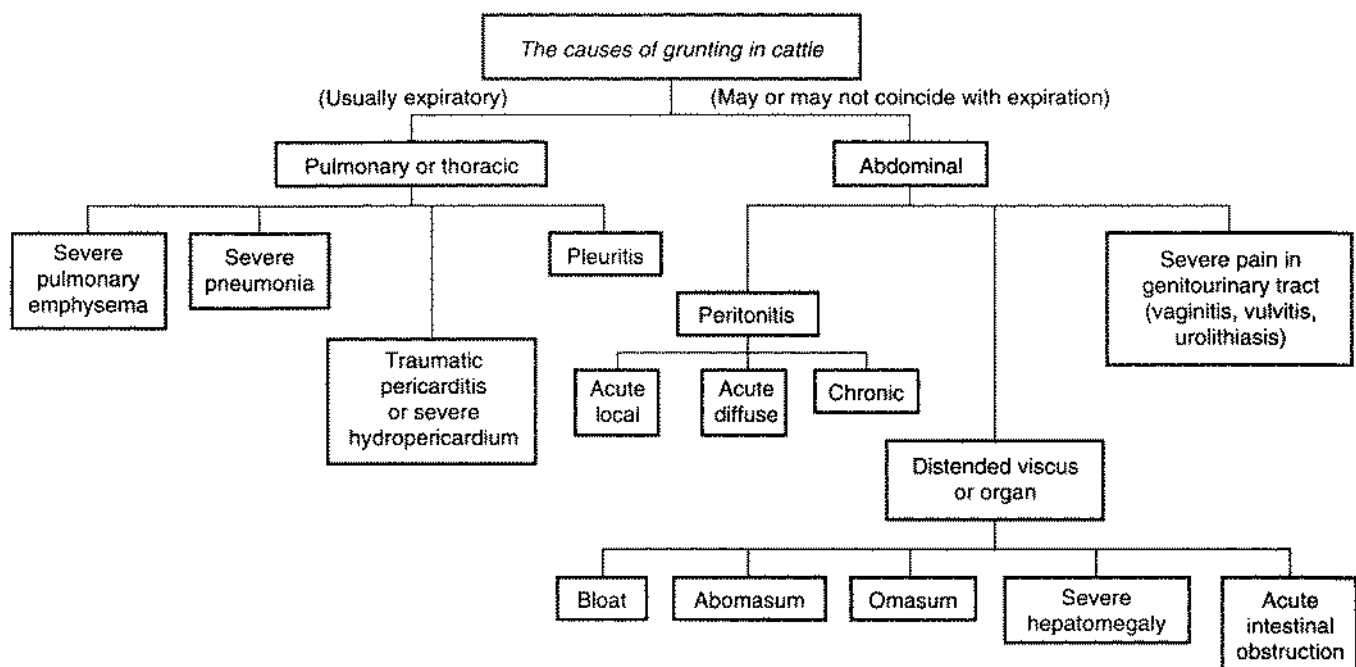

Fig. 8-12 Causes of grunting in cattle.

vomiting. A rumenotomy must be done to make the diagnosis.

- **Acute carbohydrate engorgement** characterized by sudden anorexia, diarrhea and dehydration, weakness, tachycardia, staggering, ruminal distension and atony, fluid-splashing sounds in the rumen with a rumen pH of less than 5, and a history of access to grain.
- **Acute intestinal obstruction** characterized by sudden anorexia, mild abdominal pain perhaps with kicking at the abdomen and stretching, ruminal atony, mild dehydration, scant feces or complete absence of feces, straining on rectal examination, dark bloodstained feces, and perhaps distended loops of intestine palpable on rectal examination.
- **Abomasal volvulus (following right-side dilatation)** characterized by anorexia, dehydration, tachycardia, distended right abdomen, ping audible over right flank, distended viscus palpable on rectal examination. Usually in lactating dairy cows a few weeks after parturition and following the clinical findings of right-side dilatation of the abomasum that lasts several days culminating in the volvulus but may occur spontaneously in some cows with no immediate history of previous illness.
- **Pericarditis.** Continued high fever, toxemia, anorexia, tachycardia, and muffled heart sounds suggest pericarditis, which is marked by markedly elevated total leukocyte and neutrophil counts. In pericarditis, the heart sounds are muffled and the typical to and fro fluid-splashing sounds are audible. The jugular veins are engorged and other signs of congestive heart failure such as anasarca are present. Pericardiocentesis to obtain foul-smelling, turbid fluid is diagnostic.
- **Acute pleuritis** is characterized by a fever, toxemia, anorexia, painful respirations that may be accompanied by a grunt, pain on digital palpation of intercostal spaces, ruminal atony, and abnormal and muffled lung sounds. Fluid on thoracentesis.
- **Perforated abomasal ulcer** causes acute local peritonitis characterized by marked pain on palpation over a much larger area of the abdominal wall, and in the early stages is most marked on the right-hand side. If, as is usual, the peritonitis becomes diffuse, the syndrome cannot be distinguished clinically from that caused by traumatic reticuloperitonitis. Extension from a metritis to involve the peritoneum is suggested by other signs of the primary disease.
- **Postpartum septic metritis** occurs a few days after parturition and is characterized by anorexia, fever, tachycardia, ruminal hypotonicity to atony, reduced amount of feces and foul-smelling vaginal discharge, and retained placenta may be present. Very important to examine the uterus vaginally for the presence of the placenta, which may be protruding through the cervix.

- **Acute local peritonitis** caused by penetration of the uterine wall by a catheter or of the rectal wall by a foreign body thrust sadistically into the rectum may be difficult to differentiate unless the painful area of the peritoneum can be determined. Acute local peritonitis can be differentiated from indigestion, acute ruminal impaction and acetoneemia by the presence of fever, local abdominal pain, and the abrupt fall in milk yield and appetite.
- **Pyelonephritis** is occasionally accompanied by mild abdominal pain but can be distinguished by the presence of pus and blood in the urine.
- **Acute hepatitis or severe hepatic abscess** is characterized by anorexia, fever, decreased ruminal movements, reluctance to move, a painful grunt on deep palpation over the cranial aspects of the right lower flank, icterus if obstruction of the bile ducts has occurred, and a poor response to therapy. A marked neutrophilia is typical of hepatic abscessation secondary to traumatic reticuloperitonitis.
- **Acetoneemia.** Traumatic reticuloperitonitis usually causes a secondary acetoneemia when it occurs during early lactation, and the presence of ketonuria should not be used as the sole basis for differentiation of the diseases. Differentiation may be extremely difficult if the peritonitis is of 3–4 days' duration. Response to treatment may also serve as a guide. The history is often helpful; the appetite and milk yield fall abruptly in traumatic reticuloperitonitis but slowly over a period of several days and not to the same degree in acetoneemia.

#### Acute diffuse or generalized peritonitis

**Acute diffuse peritonitis** is characterized by anorexia, fever, toxemia, tachycardia, dehydration, weakness leading to recumbency, distended abdomen, ruminal atony, spontaneous grunting or a grunt on deep palpation over the abdomen, fluid-splashing sounds and pings on auscultation and percussion or ballottement of the abdomen caused by ileus, scant feces, perhaps palpable fibrinous adhesions on rectal palpation, profuse quantities of abnormal peritoneal fluid, and marked changes in the hemogram. It must be differentiated from those diseases causing severe toxemia or acid-base imbalance, dehydration, and shock, which include carbohydrate engorgement, acute intestinal obstruction, advanced vagus indigestion, abomasal volvulus, perforated abomasal ulcer, and miscellaneous causes of generalized peritonitis.

#### Chronic reticuloperitonitis

The clinical findings of chronic traumatic reticuloperitonitis are not typical. Each chronic case may have a different combination of clinical findings, which makes the diagnosis uncertain. The clinical findings that may be present include inappetence to anorexia, mild fever, loss of body condition, lack of rumination, ruminal hypotonicity to atony, moderate bloat, scant feces containing increased amounts of undigested feed

particles, possibly a grunt on deep palpation of the abdomen, and changes in the hemogram. The presence of abnormal peritoneal fluid is highly supportive. It must be differentiated from early stages of vagus indigestion, hepatic abscessation, traumatic splenitis, chronic pneumonia and pleuritis, and miscellaneous causes of chronic peritonitis such as peritoneal abscesses secondary to intraperitoneal injections.

## TREATMENT

Two methods of treatment are in general use: conservative treatment with or without the use of a magnet and rumenotomy. Both have advantages and each case must be considered when deciding on the form of treatment to be used.

### Conservative Medical Therapy

Conservative treatment comprises immobilization of the animal, administration of antimicrobials for the inflammation, and the oral administration of a magnet to immobilize the foreign body. Despite the decreased reticuloruminal motility, 85% of magnets are in the reticulum 1 to 4 days after administration, and 32% of penetrating foreign bodies are attached to the magnet. The cow is tied, stanchioned, or confined in a box stall for several days. Immobilization of the animal facilitates the formation of adhesions.

### Antimicrobials

Penicillin or broad-spectrum antimicrobials given parenterally daily for 3 to 5 days are widely used with empirical success. Because of the high probability that a mixed gastrointestinal flora is the cause of the lesion, it is more rational to use a broad-spectrum antimicrobial such as the tetracyclines or trimethoprim-potentiated sulfonamides rather than procaine penicillin, which is commonly used because of cost and a short withdrawal period in the event that the animal does not respond favorably in a few days. For lactating dairy cattle, those antimicrobials with a short milk withdrawal period are desirable. However, there are no published clinical trials to indicate the preferential value of any particular antimicrobial. The general effect appears to be good and a high rate of recovery is recorded with antimicrobials parenterally combined with immobilization provided treatment is begun in the early stages of the disease.<sup>5</sup> Cows past their sixth month of pregnancy are unlikely to recover completely and commonly relapse.

### Rumenotomy

Surgical removal of the foreign body through a rumenotomy incision is the optimal initial treatment and is, consequently, widely used as a primary treatment.<sup>6</sup> It has the advantage of being both a diagnostic procedure in the first instance and a definitive but satisfactory treatment. The recovery rate varies, depending on when the surgery is done relative to the



time of initial penetration, but is approximately the same as that obtained with the conservative treatment described earlier. In both instances, 80% to 90% of animals recover compared with about 60% in untreated animals. Failure to improve is usually from involvement of other organs or to the development of locally extensive peritonitis and reticular abscesses associated with persistent penetration of the foreign body or, uncommonly, generalized peritonitis.

Based on follow-up ultrasonography of cows that had surgery for traumatic reticuloperitonitis, the inflammatory adhesions resolved and disappeared in the majority of animals by 6 months. As a consequence, reticular function normalizes. In animals with severe adhesions, there is a marked disturbance of digesta passage and, in these animals, extensive abscesses are present.

Persistent penetration by the foreign body necessitates removal for optimum results, but a rumenotomy is necessary to determine the extent of the lesion. Radiography and ultrasonography as described earlier may assist in determining the presence and location of the foreign body. A single preoperative dose of antimicrobial such as potassium penicillin G at 10 million IU given intravenously is recommended to avoid complications after a rumenotomy in cattle.

The recovery rate after surgery is likely to be much lower if only complicated cases are selected for rumenotomy and conservative treatment is given to the early mild cases. In one series the recovery rate in the cases treated conservatively was 84% and in those difficult cases treated surgically it was 47%.

### Drainage of Reticular Abscesses

Reticular abscesses may be drained through an ultrasound-guided transcutaneous incision.

### Choice of Treatment

The choice of treatment is largely governed by economics and the facilities and time available for surgery. A rumenotomy, satisfactorily performed, is the best treatment but is unnecessary in many cases because of the tendency of the foreign body to return to the reticulum. A commonly used practice is to treat the animal conservatively for 3 days and if marked improvement has not occurred by that time to consider a rumenotomy. A rumenotomy is highly desirable in cows in the last 3 months of pregnancy if severe sequelae are to be avoided. Movement of the cow during the early stages of the disease is undesirable because of the risk of disrupting the adhesions that localize the infection.

Cases of chronic traumatic reticuloperitonitis are best treated by rumenotomy because of the probability that the foreign body is still embedded in the wall. Acute diffuse peritonitis is highly fatal, but if detected early daily treatment with broad-spectrum antimicrobials may be effective.

### PREVENTION

All processed feed should be passed over magnets to remove metallic material before being fed to cattle. The use of synthetic string instead of wire has resulted in a major decrease in the incidence of the disease.

### Reticular Magnets

Small cylindrical or bar magnets, 7.5 cm long by 1.0 to 2.5 cm diameter with rounded ends, are used to prevent reticuloperitonitis but are also used in acute cases to minimize penetration of the foreign body. When given orally to normal healthy animals, the magnets locate in the reticulum within a few days, where they remain indefinitely and maintain their magnetic pull. The magnets attract foreign bodies, which then do not penetrate the reticular wall as easily as when they are free. The extensive prophylactic use of these magnets in a dairy herd has reduced the incidence of the disease and its complications by 90% to 98%. The magnets are given to herd replacement heifers at 18 months to 2 years of age as part of a herd health program.

The effects of magnets in traumatic reticulitis was examined in the Danish study of cows at slaughter (see under Etiology). Two magnets tested were cylindrical cage magnets with different fields of magnetic force. Magnet I had a magnetic force of attraction of 110 mT; magnet II had a force of 210 mT. Magnets were found in only 7% of the cows. There were no lesions in 97% of the cows with magnets. Magnet II was superior to magnet I in attracting all types of foreign bodies, including tire wires. Thus the prophylactic use of magnets should be promoted to reduce the occurrence of foreign body lesions.

It is unlikely that magnets will extract a firmly embedded foreign body from the wall of the reticulum, but loosely embedded ones with long free ends may be returned to the reticulum and loose foreign bodies will be immobilized. The position of the foreign body within the reticulum greatly influences the efficacy of treatment with a magnet. A foreign body at an angle to the ventral aspect of the reticulum of more than 30 degrees is less likely to become attached to a magnet than a foreign body situated horizontally on the ventral aspect of the reticulum. There have been only a few reports of physical injury to the wall of the reticulum being caused by the magnets or the foreign bodies that may be attached to them. A compass can be used to locate the presence and position of the magnet.

### TREATMENT AND CONTROL

#### Treatment

Oral administration of the strongest magnet possible to cattle without a magnet (check with compass) (R-1)

Procaine penicillin 22,000 U/kg BW IM daily for at least 5 days (R-1)

Oxytetracycline 16.5 mg/kg IV daily for at least 5 days (R-2)

Minimize movement by keeping confined in a small stall (R-2)

Rumenotomy and wire removal for cattle of higher economic value or after 3 days of medical treatment with no improvement (R-2)

#### Control

Routine oral administration of the strongest magnet possible to dairy cattle eating chopped feed (R-2)

Ensure feed chopping equipment have magnets attached to remove metal from feed (R-2)

BW, body weight; IM, intramuscularly; IV, intravenously.

### FURTHER READING

- Braun U. Ultrasound as a decision-making tool in abdominal surgery in cows. *Vet Clin North Am Food Anim Pract.* 2005;21:33-53.
- Braun U. Ultrasonography of the gastrointestinal tract in cattle. *Vet Clin North Am Food Anim Pract.* 2009;25:567-590.

### REFERENCES

- Nazifi S, et al. *Vet J.* 2009;182:315.
- Gokce HI, et al. *Vet Res Commun.* 2007;31:529.
- Atakisi E, et al. *Vet Rec.* 2010;167:908.
- Wittek T, et al. *J Vet Intern Med.* 2010;24:1211.
- Hajjigharamani S, Ghane M. *Global Veterinaria.* 2010;5:135.
- Orphin B, Harwood D. *In Pract.* 2008;30:544.

### VAGUS INDIGESTION

#### SYNOPSIS

**Etiology** Reticular adhesions from traumatic reticuloperitonitis and failure of passage of ingesta from the reticulorumen or abomasum resulting in accumulation of fluid in the forestomach and abomasum. Abomasal emptying defect in sheep (uncertain etiology).

**Epidemiology** Primarily mature dairy cattle; also in mature beef cows and bulls. Also occurs in sheep as abomasal emptying defect of uncertain etiology.

**Signs** Gradual distension of abdomen, especially left upper abdomen and bilateral aspects of ventral abdomen. Inappetence to anorexia and scant feces containing undigested long particles. Large L-shaped rumen viewed from rear. Hypermotility or hypomotility of the rumen and reticulum determined by auscultation or ultrasonography, respectively. Dehydration.

**Clinical pathology** Hemoconcentration, metabolic alkalosis with hypochloremia and hypokalemia, increased ruminal chloride levels.

**Lesions** Reticular adhesions. Enlarged rumen containing pasty and frothy material or fluid contents. Abomasum impacted with semidry ingesta.

**Differential diagnosis**

*Ruminal distension with hypermotility:*  
indigestion of late pregnancy,  
obstruction of the reticuloomasal orifice.

*Ruminal distension with atony:* chronic  
traumatic reticuloperitonitis.

*Abomasal impaction:* abomasal impaction,  
dietary in origin.

*Omasal impaction:* phytobezoars blocking  
the abomasal pylorus, abomasal  
ulceration without melena.

**Treatment** Fluid and electrolyte therapy,  
rumen lavage with large diameter tube,  
rumenotomy, drain reticular abscess,  
slaughter for salvage.

**Control** Prevent traumatic reticuloperitonitis.

## ETIOLOGY

The etiology of vagus indigestion has been controversial but has been divided into two major subcategories of complications of traumatic reticuloperitonitis: vagal nerve injury and reticular adhesions, with the latter being the most common cause. In addition, there are some other causes.

### Complications of Traumatic Reticuloperitonitis

#### Vagal Nerve Injury and Dysfunction

Historically, it was thought that vagal indigestion was caused by vagal nerve dysfunction caused by injury to the vagus nerve injury associated with complications of traumatic reticuloperitonitis. It was hypothesized that the inflammatory and scar tissue lesions affected vagal nerve fibers supplying the forestomach and abomasum. The naturally occurring syndrome was similar to the Hoflund syndrome created by experimentally sectioning the vagus nerves and thus the term “vagal indigestion” was coined.

The prevailing explanation was that dorsal vagal nerve injury resulted in **achalasia of the reticuloomasal orifice (anterior stenosis)** and inhibited the passage of ingesta from the reticulorumen into the omasum and abomasum, resulting in an enlarged rumen with abnormal rumen contents. Similarly, injury of the pyloric branch of the ventral vagus nerve resulted in achalasia of the **pylorus (posterior stenosis)** and inhibited the flow of ingesta from the abomasum resulting in abomasal impaction. Both abnormalities resulted in scant feces containing undigested long feed particles.

However, although in many cases of vagal indigestion there are extensive adhesions between the reticulum and adjacent organs, there is little evidence of vagal nerve injury. It is also known that the syndrome can occur without any gross evidence of inflammation of the serosa of the forestomach and

abomasum over which the vagus nerves are located. In the absence of gross lesions, it has been suggested that microscopic lesions of the medial reticular wall in which vagal tension receptors are located may interfere with forestomach motility and esophageal groove reflexes.

New information based on clinicopathologic examination of clinical cases has questioned the long-held view that vagal nerve injury is an important cause of this syndrome.

#### Reticular Adhesions

Mechanical impairment of reticular motility and esophageal groove dysfunction as a result of reticular adhesions is probably the **most important cause of vagal indigestion syndrome**. An examination of 42 dairy cows with complications of traumatic reticuloperitonitis found that the primary mechanism was a **disturbance in particle-separation processes in the reticulorumen attributable to mechanical inhibition of reticular motility associated with extensive inflammatory parareticular adhesions**. Based on examination of necropsy tissue grossly and histologically, there was no evidence of vagal nerve injury. Definitive evidence for this being the primary mechanism was provided by a study in sheep in which the placement of magnets in the reticulum inducing abomasal impaction and forestomach distension and long particles in the feces; removal of the magnet (and therefore removal of the reticular “fixation”) led to resolution of the abomasal impaction, return to normal feces, and reduction in ruminal volume.

#### Other Causes

Several causes unrelated to traumatic reticuloperitonitis have been recorded. Actinobacillosis of the rumen and reticulum is a less common cause. Perireticular abscesses near the reticuloomasal orifice of cattle can cause the disease. In sheep, peritonitis associated with *Sarcosporidia* and *Cysticercus tenuicollis*<sup>1</sup> may be a cause. **Fibropapillomas of the cardia** can mechanically occlude the distal esophagus and cause interference with forestomach motility, and there is one report of vagal indigestion caused by a fibromyxoma of the reticuloomasal orifice of a cow.<sup>2</sup> **Abomasal impaction in sheep** has been recorded, but the etiology and pathogenesis have not been determined.

Disturbances similar to those that occur under natural conditions have been produced by sectioning the vagus nerve. Following surgery for abomasal volvulus, some cattle develop a vagal indigestion-like syndrome characterized by anorexia, scant feces, ruminal distension, and abdominal distension. It has been suggested that distension of the abomasum and thrombosis of its vessels may have caused injury to the ventral vagus nerve, which has been documented in a small number of cases.

**Pyloric achalasia** is described as part of a secondary indigestion caused by septicemia and toxemia, but this is not well documented. There is also ruminal distension with fluid material, abomasal reflux into the reticulorumen, dehydration, hypochloremia, hypokalemic metabolic alkalosis, and uremia.

**Indigestion of late pregnancy of cows** is considered a type of vagus indigestion (type IV) in which the rumen and abomasum are grossly distended, but the cause is uncertain.<sup>3</sup> There is no direct evidence that the effects of an advanced pregnancy alone will cause a vagal indigestion-like syndrome; however, in some pregnancies the uterus is located entirely within the ommental sling, decreasing abomasal emptying rate.

**Peripheral nerve sheath tumors**, such as a **solitary schwannoma**, have been described causing a syndrome similar to vagus indigestion in a mature cow.

A **vagal indigestion-like syndrome may be a postsurgical complication of AV**. Gastric wall injury, peritonitis, and vagal nerve lesions may be causative factors. It occurs in 14% to 21% of cases, and only 12% to 20% of cases return to normal production (see under right-side displacement of the abomasum and abomasal volvulus).

## EPIDEMIOLOGY

Vagal indigestion is most common in dairy cows that have a history of traumatic reticuloperitonitis, which may have occurred several weeks or a few months previously. The disease is not restricted to dairy cows; it also occurs in beef cattle and in mature bulls.

## PATHOGENESIS

The syndrome of vagal indigestion is characterized by disturbances in the passage of ingesta through the reticuloomasal orifice (**failure of omasal transport and anterior functional stenosis**) and disturbances in the passage of ingesta through the pylorus (**pyloric stenosis and posterior functional stenosis**). *Stenosis* is a misnomer because there is no evidence of stenosis but achalasia of the sphincters may occur, which mimics a functional stenosis. The characteristic clinical findings are distension of the rumen with pasty or frothy contents because of increased time and maceration in the reticulorumen; alterations in reticulorumen motility, with consequences such as dehydration; an increase in undigested particles in the feces; scant feces; acid-base imbalance; and secondary starvation. It is an **outflow abnormality of the reticulorumen and abomasum**.

Based on careful clinicopathologic observations of 42 cows with complications of traumatic reticuloperitonitis including vagal indigestion, it is now proposed that the disturbances in the flow of ingesta are associated with particle separation in the reticulorumen caused by mechanical inhibition of reticular motility associated with

extensive adhesions of the reticulum. Experimentally impaired reticular contractions in sheep support the central role of reticular motility for the separation of particles in the forestomach, the outflow of digesta from the reticulorumen, and transpyloric digesta flow.

Normally, reticulorumen motility results in **stratification of ruminal contents into three layers of ingesta** in addition to the most dorsal gas pocket. The **top layer**, consisting of firm fibrous material of **low-density** particles (coarse hay), floats on the **middle layer** of liquid ingesta, consisting of particles of **medium density**; the **bottom layer** consists of fine particles of **high density**. The solid material remains in the rumen and is digested until the particle size is sufficiently small (1–4 mm in cattle) to pass through the reticuloomasal orifice. The size of the digested plant fragments in ruminant feces can be considered an indirect measurement of forestomach function. In cows, the presence of large plant particles (>0.5 cm) in the feces indicates inadequate rumination or abnormalities in forestomach motility.

In normal cattle, the mean retention time of particles in the reticulorumen depends on particle size and density. The density of large feed particles is low because of their air-filled interior. During biphasic reticular contractions, most of these large, light particles are pushed caudodorsally in the rumen. Thus large particles are retained in the reticulorumen, because outflow through the reticuloomasal orifice occurs mainly during the maximum portion of the second reticular contraction. Feed particles with a high density (small and well digested) are moved out of the reticulorumen preferentially, because the majority of them remain in the reticulum during the biphasic contraction.

If **reticular motility is inhibited**, the balance of particle retention time and particle outflow in the reticulorumen is disturbed. Immobilization of the reticulum experimentally causes a decrease in feed intake, an increase in ruminal volume, a decrease of mean retention time of light plastic particles, a fourfold increase in mean retention time of heavy plastic particles, a marked increase in the amount of large particles in the feces, and an increase in abomasal volume. Such changes reflect the changes occurring in naturally occurring vagus indigestion. An increase in the amount of large particles in the feces of cows with traumatic reticuloperitonitis is indicative of inhibited clearance function of the reticulum.

Liquid consistency of the abomasal contents is important to ensure physiologic transpyloric flow. In cows with uncomplicated traumatic reticuloperitonitis, the process of particle separation in the reticulorumen is disturbed, which results in an increase in the amount of large particles in the feces. In uncomplicated traumatic reticuloperitonitis, the reticulorumen is not large and the abomasum is not impacted

because the fluid outflow is probably adequate to flush even large particles out of the abomasum.

In cows with pyloric stenosis and an increase in the size of the abomasum, the rumen contents are homogeneous and pasty and not stratified. Thus consistency of rumen outflow contents changes markedly. Normally, transpyloric digesta flow depends predominantly on hydrodynamic factors, especially viscosity. Even small increases in viscosity of abomasal contents may cause a marked decrease in abomasal outflow.

Disturbances of the passage of digesta in cows with traumatic reticuloperitonitis develop in three phases.

- In the **first phase**, reticulorumen motility is decreased because of immobilization of the reticulum caused by the inflammation, pain, and fever. Immobilization of the reticulum impairs clearance function of the reticulum, resulting in poorly comminuted feces.
- The **second phase** occurs when the adhesions are extensive enough to cause additional impairment of reticular motility. Particle distribution within the reticulorumen is changed, resulting in a loss of stratification. Although feed intake decreases, the volume of the reticulorumen increases because rumen outflow is decreased. During the second phase, comparatively small amounts of rumen outflow contents can exit the abomasum, because the dry matter content of the material is similar to that of a clinically normal cow. During this phase, the rumen may become hypermotile because of excitation of low-threshold tension receptors as a consequence of moderate rumen distension.
- The **third phase** is characterized by a further change in the consistency of rumen contents, resulting in a homogeneous pasty mass of relatively high viscosity. The increase in dry matter content of the rumen outflow material inhibits transpyloric digesta flow. The abomasum enlarges, and reflux of abomasal contents may occur. It is suggested that the primary underlying process of reflux of abomasal contents in cows with posterior stenosis is a disturbance of ruminal outflow.

In summary, the current hypothesis for the pathogenesis indicates that disturbances of the passage of ingesta consist of two phases of the same syndrome. Pyloric stenosis represents the phase with the most severe clinical consequences. The prognosis is poorer for cows with anterior stenosis than for those with uncomplicated traumatic reticuloperitonitis and is poorer for cows with posterior stenosis than for those with anterior stenosis. Only a small percentage of cows with traumatic reticuloperitonitis develop disturbances of digesta passage through the

reticuloomasal orifice and not all cows with anterior stenosis develop posterior stenosis. The extent and location may determine the course of the syndrome and how rapidly it develops. In cows with acute traumatic reticuloperitonitis, the consistency of the adhesions changes from a widespread fibrous type to a stringy type after several months, and with time the reticulum may regain sufficient motility to provide its clearance function.

### Anterior Functional Stenosis (Achalasia)

This is characterized by accumulation of ingesta in the reticulorumen, known also as failure of omasal transport. If the ruminal wall is atonic, the ingesta accumulates without bloat occurring; if it has normal motility, the ruminal wall responds to the distension by increased motility and the production of frothy bloat. Ruminal motility will be almost continuous (3–6 contractions per minute) but the contractions are ineffective in propelling the ingesta into the omasum. As a result, the rumen enlarges to fill the majority of the abdomen, which accounts for the gross distension of the abdomen. The dorsal sac of the rumen enlarges to the right of the midline, and the ventral sac enlarges to fill most or all of the right lower quadrant of the abdomen; this results in the “L-shaped” rumen as viewed from the rear of the animal. The continuous rumen contractions also result in frothy rumen contents, which can be fatal if progressive and not relieved. Occasionally there is free gas bloat. Bradycardia is common and has been attributed to increased vagal tone of the injured nerve, causing parasympathetic slowing of the heart, but it is much more likely to be caused by decreased feed intake.

Obstruction of the reticuloomasal orifice by foreign bodies such as polyethylene twine ingested by the animal may cause a syndrome indistinguishable from anterior functional stenosis.

### Posterior Functional Stenosis (Achalasia)

This is characterized by failure of transpyloric outflow resulting in abomasal impaction with large particles. Abomasal fluid containing hydrochloric acid may reflux into the rumen if the fluid does not move from the abomasum into the small intestines. This is known as the **abomasal reflux syndrome**. The chloride concentrations in the rumen fluid increase and there is a hypochloremia and hypokalemia. Bile acids may also reflux from the duodenum into the rumen of animals with an ileus of the small intestine. Associated with pyloric achalasia there is, in some cases, an apparent failure of the esophageal groove to permit the passage of ingesta into the rumen, with this organ containing only fluid. The syndrome observed depends on the stage of the disease at which the animal is first examined.



### Metabolic Alkalosis and Abomasal Reflux

Depending on the location and severity of the functional obstruction and distension or impaction, there will be varying degrees of dehydration and a tendency toward a **metabolic hypochloremic, hypokalemic alkalosis**. In pyloric stenosis with abomasal impaction, there is sequestration of abomasal fluid in the abomasum and a reflux of abomasal contents into the rumen, resulting in a ruminal chloride concentration of more than 20 mmol/L. In anterior stenosis, the abomasal fluid can pass into the duodenum and neither metabolic alkalosis nor dehydration can be expected.

### Postsurgical Complication in Abomasal Volvulus

A vagal indigestion-like syndrome may occur in cattle treated for AV. Possible mechanisms include vagus nerve injury, overstretching of the abomasal wall during prolonged distension resulting in neuromuscular junction alterations and autonomic motility modification, thrombosis and abomasal wall necrosis, and peritonitis.

### Abomasal Impaction in Sheep

Abomasal emptying defects associated with dilatation and impaction of the abomasum in Suffolk sheep and other sheep breeds have been reported. The electrolyte imbalances that occur in cattle with abomasal impaction do not occur in sheep.

## CLINICAL FINDINGS

Three similar but separate clinical syndromes have been recognized, with some clinical findings characteristic of all three, including the following:

- Inappetence for several days or complete anorexia with evidence of loss of BW.
- An enlarged papple-shaped abdomen (pear-shaped on the right and apple-shaped on the left) with or without bloat (Fig. 8-13). The upper left abdomen is distended and the lower half of the abdomen is distended bilaterally.
- Dehydration and electrolyte imbalance with metabolic alkalosis.
- Enlarged rumen palpable on rectal examination.
- Scant feces with an increase in undigested particles.
- Enlarged ingesta-impacted or fluid-distended abomasum palpable through right flank or on rectal examination (except cannot be easily palpated in advanced pregnancy).
- Vital signs within the normal range.
- Inadequate response to treatment.

### Ruminal Distension With Hypermotility

The occurrence of ruminal distension with hypermotility is not particularly related to pregnancy or parturition. Moderate to severe

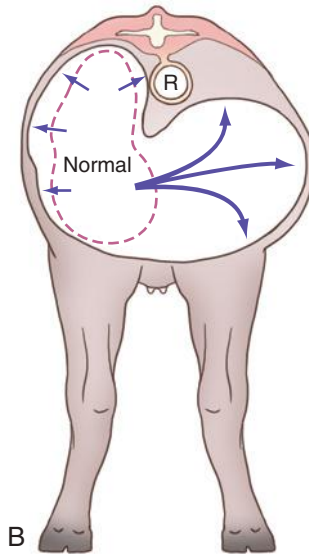

**Fig. 8-13** **A**, Classic papple shaped abdominal profile of vagal indigestion in a Holstein Friesian cow, with an apple on the left and a pear on the right. **B**, Figure depicting the rumen enlargement that causes the classic papple-shaped abdominal profile of vagal indigestion (pear on the right side, apple on the left side). *R*, rectum. (Reproduced with permission from Constable PD, Hoffsis GF, Rings DM. *Compend Contin Educ Pract Vet* 1990; 12:1169-1174.)

bloat is common. There is evidence of loss of BW. The animal has usually been inappetent or anorexic intermittently for the past few weeks. The abdomen is prominently distended and the rumen movements represented by the **abdominal ripples** are often unusually prominent and may occur at the rate of **4 to 6 per minute**. The sounds of the rumen contractions are often reduced or almost absent in spite of hyperactivity because the rumen contents are pasty and

frothy. Initially, this contradiction is misleading because the hyperactivity of the rumen tends to indicate normal reticulorumen activity. Fluid-splashing sounds may be audible on ballottement of the left and right flanks if the rumen is distended with excessive quantities of fluid. The feces are scant and pasty and contain undigested particles. The temperature is usually normal and bradycardia (44–60 beats/min) may be present because of decreased feed intake and not because of stimulation of the vagus nerve. A systolic murmur that waxes and wanes with respiration, being loudest at the peak of inspiration, may be present because of the ruminal distension and tympany causing compression of the heart and distortion of the valves. The murmur disappears when the tympany is relieved.

**Ruminal distension is obvious on rectal examination.** The dorsal sac of the rumen is grossly distended to the right of the midline and is pushed back against the brim of the pelvis; the ventral sac is also enlarged and occupies much of the right lower quadrant of the abdomen. This may be difficult to appreciate in advanced pregnancy. Viewed from the rear the enlarged rumen is **L-shaped**, giving an external silhouette with the left flank distended from top to bottom and the right flank distended only in the lower half—the papple-shaped abdomen.

An important aspect of the clinical history of vagal indigestion cases is that standard treatments for ruminal tympany and impaction usually have no effect on the course of the disease. If the acid-base imbalances can be corrected and hydration maintained and adequate nutritional status maintained until parturition occurs in these cows, the prognosis is favorable and the recovery rate is high.

The frequency of reticular contractions determined using ultrasonography ranges between 2.7 and 4.5 per 3 minutes. Of 144 cattle with vagal indigestion, 15% had <2.7 contractions per 3 minutes, and 41% had >4.5 contractions per 3 minutes; the latter finding was more commonly associated with proximal functional stenosis.<sup>4</sup>

### Ruminal Distension With Atony

Ruminal distension with atony is most common in late pregnancy and may persist after calving. The cow is clinically normal in all respects except that she is anorexic; passes only scant amounts of soft pasty feces; and has a distended abdomen and will not respond to treatment with purgatives, lubricants, or parasympathetic stimulants.<sup>3</sup> Ruminal movements are seriously reduced or absent and there may be persistent mild bloat. Fluid-splashing sounds may also be audible on ballottement of the left and right flanks if the rumen is distended with excessive quantities of fluid. The temperature and heart rate are usually normal. There is no pain on deep palpation of the ventral

abdomen. On rectal examination the primary abnormality is gross distension of the rumen, which may almost block the pelvic inlet. The animal loses weight rapidly, becoming weak and recumbent. At this stage the heart rate increases markedly. The animal dies slowly of inanition.

### Pyloric Obstruction and Abomasal Impaction

Most cases of abomasal impaction also occur late in pregnancy and are manifested by anorexia and a reduced volume of pasty feces. There may be no abdominal distension and no systemic reaction until the late stages, when the heart rate rises rapidly. The distended and impacted abomasum may be palpable in the lower right abdomen as a heavy, doughy viscus. On rectal examination the impacted abomasum may be palpable as a doughy viscus that pits on pressure in the right lower quadrant. If the animal is in advanced pregnancy, the impacted abomasum may not be palpable through the abdominal wall or by rectal palpation, but the gravid uterus may feel as if it is displaced into the pelvic cavity by the enlarged abomasum. Rumen movements are usually completely absent. As in the first type, affected animals usually become weak and recumbent and die slowly of inanition and electrolyte and acid-base imbalances. In some cases, the impacted abomasum may rupture and cause death in a few hours.

Combinations of these types may occur; in particular, distension of the rumen with atony combined with abomasal impaction is the most commonly observed syndrome.

**Indigestion of late pregnancy** in cattle characterized by distension and hypermotility of the rumen with distension of the abomasum has been described but is probably not caused by advanced pregnancy alone. In late pregnancy, the abomasum is difficult to examine clinically either through the abdominal wall or by rectal examination. The presence of fluid-splashing sounds on ballottement and auscultation over the right lower flank is indirect evidence of distension of the abomasum with fluid. The distended abomasum can be palpated and evaluated by left or right side laparotomy (celiotomy).

### CLINICAL PATHOLOGY

#### Hemogram

In most cases there are no abnormalities on hematological examination although a moderate neutrophilia, a shift to the left, and a relative monocytosis may suggest the presence of chronic traumatic reticuloperitonitis. Hemoconcentration is common, associated with the clinical dehydration. TPP concentrations may be increased and a positive glutaraldehyde test and hyperfibrino-

genemia is present, similar to traumatic reticuloperitonitis.<sup>5,6</sup>

#### Peritoneal Fluid

Peritoneal fluid be indicative of a chronic reticuloperitonitis.

#### Serum Biochemistry

In abomasal impaction there is metabolic hypochloremic, hypokalemic alkalosis.

#### Ruminal Chloride Concentrations

Ruminal chloride concentrations are normally below 30 mmol/L and stay low in cattle with proximal functional stenosis (reticuloomasal stenosis). Rumen chloride concentrations are increased in posterior stenosis to above 40 mmol/L caused by abomasal reflux.<sup>5</sup> Levels of 66 mmol/L have been recorded in cows with indigestion of late pregnancy.

### NECROPSY FINDINGS

The rumen is grossly enlarged and the contents are pasty and may be frothy and may have undergone some putrefaction. In some cases the rumen is grossly distended with liquid rumen contents containing floating large particles of ingesta. The reticulum and omasum are usually grossly enlarged and the reticuloomasal orifice is commonly dilated and filled with rumen contents. The omasum may be almost twice its normal size and is firmer than normal. Sectioning of the omasum reveals rumen contents impacted between its leaves. The abomasum may be up to twice its normal size and firm on palpation. It is impacted and grossly distended with semidry partially digested ingesta that resembles partially dried rumen contents. Erosions and ulcers may be present in the pyloric part of the abomasum. The intestines may be relatively empty and the feces in the large intestine are pasty, containing an increased amount of undigested particles.

Lesions between the reticulum and ventral abdominal floor and the diaphragm vary considerably from thick fibrinous suppurative adhesions to multiple abscesses containing a foreign body or noninflammatory fibrous bands and strings.

### DIFFERENTIAL DIAGNOSIS

The salient clinical features of vagal indigestion in cattle are inappetence for several days leading to anorexia; a gradually enlarging abdomen, especially on the left side; scant feces; failure to respond to common medical therapy; loss of body condition and varying degrees of dehydration. Obtaining an accurate history is of paramount importance. Most cases of vagal indigestion

have been affected for at least several days or a few weeks. The diagnosis can be perplexing in those cases that occur in late pregnancy because the animal has usually been housed and fed with other dry cows and daily observation of feed intake and fecal output have not been made, so it is difficult to obtain an accurate and helpful history. The clinical examination should focus on the state of the rumen and the abomasum. In valuable animals, a left-side exploratory laparotomy and rumenotomy will often be necessary to make a diagnosis. This will allow the determination of the presence of reticular adhesions, obstructions of the reticuloomasal orifice and the state of the abomasum.

The various forms of vagal indigestion must be differentiated from diseases of the forestomach and abomasum resulting in distension and hypermotility or atony of the rumen and enlargement of the abomasum.

- **Ruminal distension with hypermotility**

is typical of vagus indigestion and, if accompanied by anorexia, dehydration, scant and abnormal feces, and a large L-shaped rumen on rectal examination, it must be differentiated from:

- *Indigestion of late pregnancy:* characterized by anorexia; lethargy; dehydration; grossly distended papple-shaped abdomen; ruminal distension with hypermotility; abomasal distension with fluid; elevated ruminal chloride levels and hypochloremic, hypokalemic alkalosis.
- *Obstruction of the reticuloomasal orifice* by ingested baling twine, plastic sleeves and bags may cause distension of the rumen indistinguishable from vagus indigestion. The rumen is moderately distended but its size will vary daily and reticulorumen motility is normal. The animal is bright and alert but the feed intake, amount of feces, and milk production varies daily from normal to subnormal for no obvious reason. Rumenotomy is the only method of making the diagnosis. The ruminal foreign body will be floating in the rumen or may be partially lodged in the reticuloomasal orifice

- **Ruminal distension with atony** must be differentiated from diseases of the forestomach and abomasum in which there is failure of passage of ingesta. These include:

- **Chronic traumatic reticuloperitonitis**, which is characterized by inappetence to anorexia, a usually smaller than normal rumen with atony, but in some cases the rumen feels larger than normal with free-gas bloat, loss of body weight, persistent slight fever, perhaps the presence of a grunt, an absence of rumination, scant feces with an increased amount of undigested particles, and changes in the hemogram indicating chronic inflammation.



- **Abomasal impaction in vagal indigestion**, characterized by a papple-shaped abdomen; perhaps prominent enlargement of the right lower abdomen; ruminal distension with hypermotility or atony; the presence of a palpable heavy viscus in the right lower abdomen; scant feces with long undigested particles of ingesta; loss of body weight; dehydration; and hypochloremic, hypokalemic alkalosis. The gravid uterus is easily palpable on rectal examination, and the fetus may be displaced into the pelvic cavity because of the impacted and enlarged abomasum. Ruminal chloride levels are elevated.
- **Abomasal impaction dietary in origin** caused by ingestion of straw or sand occurs in cattle with unlimited access to chopped straw during cold weather or consuming tuber crops contaminated with sand. The rumen is grossly distended with coarse ruminal ingesta or liquid contents and is atonic. Ballottement of the rumen elicits fluid-splashing sounds. The right flank is distended and the impacted abomasum can be palpated as a heavy, firm viscus in the right lower flank (except in late pregnancy when it cannot be palpated). Hypochloremic, hypokalemic alkalosis is present.
- **Omasal impaction** occurs sporadically and is usually part of the vagus indigestion syndrome, but its cause is uncertain. Anorexia, ruminal distension and atony, scant inadequately digested feces.
- **Phytobezoars** blocking the abomasal pylorus cause loss of body weight; abomasal distension with fluid-splashing sounds on ballottement over the right lower flank; ruminal distension and hypotonicity; anorexia; and hypochloremic, hypokalemic alkalosis. Right flank laparotomy and abomasotomy is necessary to make the diagnosis.
- **Abomasal ulceration without melena** is uncommon but occurs in dairy cows with a history of chronic inappetence and decreased milk production. There is distension of the abomasum with fluid-splashing sounds on ballottement, ruminal hypotonicity, inappetence and loss of body weight, occult blood, and moderate dehydration. Diagnosis is only made surgically or at necropsy.
- **Peripheral nerve sheath tumors** of the vagus nerve may cause a syndrome similar to vagus indigestion. Clinically, there is chronic ruminal stasis and tympany, persistently distended loops of intestine palpable per rectum, and inappetence to anorexia and progressive loss of body weight. The diagnosis cannot be made clinically; lesions are present on the vagus nerve above the base of the heart.

## TREATMENT

The prognosis in most cases is unfavorable but also unpredictable. The problem is to determine the location and extent of the lesion, which may be difficult or impossible even on exploratory laparotomy or rumenotomy.

### Rumen Lavage

If the rumen is grossly distended with fluid or mushy rumen contents, it can be emptied using a large-diameter (25-mm inside diameter) stomach tube followed by flushing warm water into the rumen and lavaging it by gravity flow. The contents are usually well macerated and foul smelling. Emptying the rumen not only relieves the pressure but allows for easier examination of the abdomen (Fig. 8-14).

### Fluid and Electrolyte Therapy and Laxatives

Some cases respond beneficially following fluid and balanced electrolyte therapy for 3 days combined with the oral administration of mineral oil (5–10 L) daily for 3 days or dioctyl sodium sulfosuccinate as described under the treatment of abomasal impaction of dietary origin. Other cases do not respond, but there is no reliable method of knowing which ones will respond other than by attempting treatment for a few days. Valuable pregnant cows near parturition may be maintained on fluid and electrolyte therapy for several days or until near enough to term to induce parturition and hopefully obtain a live calf. Some cows will recover following parturition, but the syndrome may recur in the next pregnancy.

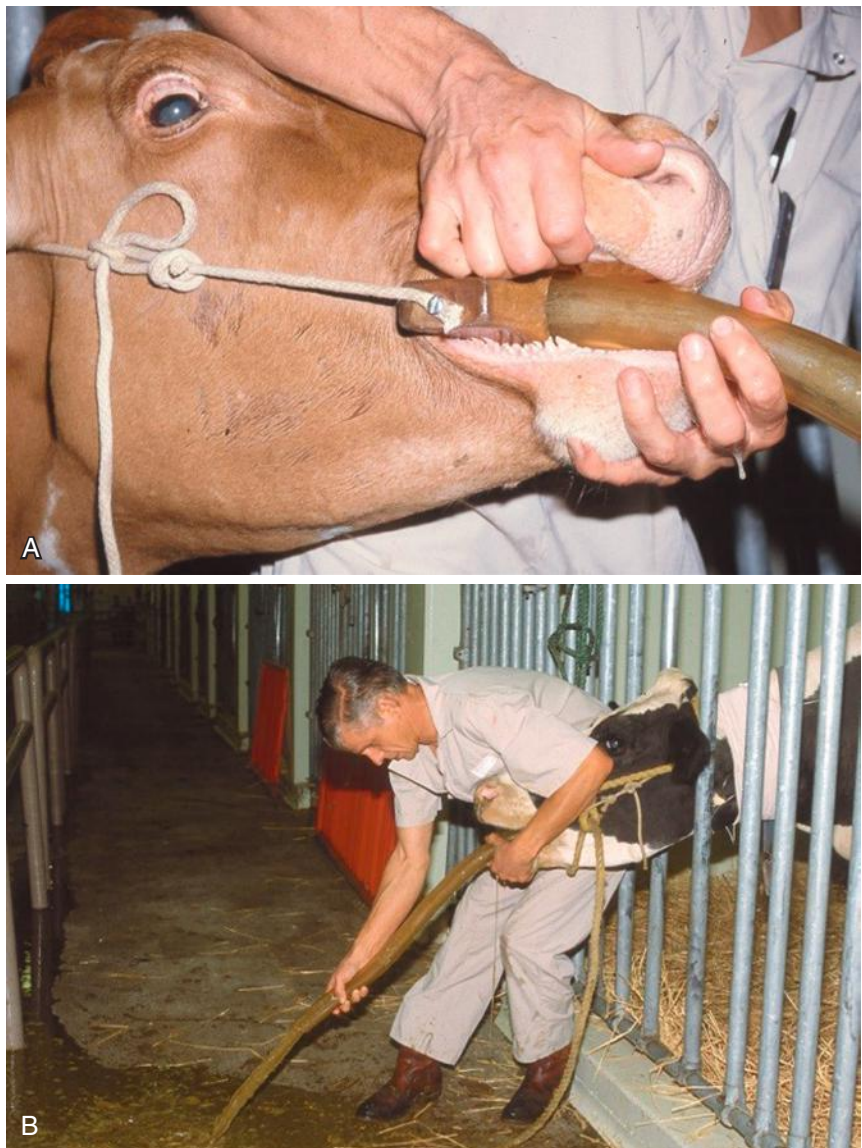

**Fig. 8-14** A, Passage of a large-diameter tube through a wooden mouth gag to decompress the rumen in a Guernsey cow with vagal indigestion. B, Rapid emptying of ruminal contents through a large-diameter tube.



## Rumenotomy

Rumenotomy and emptying of the rumen is usually followed by slow recovery over a period of 7 to 10 days when there is ruminal hypermotility. The creation of a permanent ruminal fistula to permit the escape of gas in cases in which gas retention is a problem may cause dramatic improvement. Surgical correction of abomasal distension or impaction by abomasotomy is usually unsatisfactory because the motility of the abomasum does not return. Surgical drainage of perireticular abscesses into the reticulum or omasum at the site of the lesion through a rumenotomy incision has been successful in prolonging survival of affected cattle for at least 1 year. Reticular abscesses may be drained successfully by ultrasound-guided transcuteaneous incision. For some cases of vagal indigestion, the most satisfactory procedure may be to recommend slaughter for salvage. In suspected cases of obstruction of the reticulomasal orifice by rope or twine, an exploratory rumenotomy is required to remove the foreign object. Descriptions of different approaches to rumenotomy in cattle are available.<sup>7,8</sup>

## PREVENTION

Prevention is dependent on preventing traumatic reticuloperitonitis through management of the environment and the administration of reticular magnets.

### TREATMENT AND CONTROL

#### Treatment

Rumen decompression using large-diameter tube or rumenotomy (R-1)  
 Daily administration of 4 L of mineral oil for 3 days (R-1)  
 Correction of fluid, electrolyte, and acid-base imbalances (R-1)

#### Control

Prevent ingestion of metallic and nonmetallic objects (R-1)  
 Administer rumen magnet to all animals eating chopped forage or with access to metal objects (R-2)

## FURTHER READING

Chanie M, Tesfaye D. Clinico-pathological findings in metallic and non-metallic foreign bodies in dairy cattle: a review. *Acad J Anim Dis.* 2012;1:13-20.

## REFERENCES

1. Lacasta D, et al. *Small Rumin Res.* 2013;110:62.
2. Movassaghi AR, et al. *Comp Clin Pathol.* 2013;22:535.
3. Hussain SA, et al. *Vet Med Int.* 2014;525607.
4. Braun U, et al. *Vet Rec.* 2009;164:11.
5. Gul Y, Issi M. *Veterinarski Arhiv.* 2009;79:351.
6. Ismail ZB, et al. *Am J Anim Vet Sci.* 2007;2:66.
7. Hartnack AK, et al. *J Am Vet Med Assoc.* 2015;247:659.
8. Niehaus AJ. *Vet Clin North Am Food Anim Pract.* 2008;24:341.

## DIAPHRAGMATIC HERNIA

Herniation of a portion of the reticulum through a diaphragmatic rupture causes chronic ruminal tympany, anorexia, and displacement of the heart.

## ETIOLOGY

Most cases of diaphragmatic hernia occur because of weakening of the diaphragm by lesions of traumatic reticuloperitonitis, but diaphragmatic rupture can occur independently of a foreign body and congenital defects of the diaphragm may be a cause in some animals. An unusually high incidence of herniation of the reticulum through the diaphragm, sometimes accompanied by the abomasum, has been recorded in water buffalo.

## PATHOGENESIS

The usual syndrome is similar to that of vagus indigestion in which ruminal hypermotility is present. It seems probable that there is either achalasia of the reticulomasal sphincter caused by involvement of the vagus nerve or impairment of function of the esophageal groove caused by the fixation of the reticulum to the ventral diaphragm. The disturbance of function in the forestomachs suggests that food can get into the rumen but cannot pass from there to the abomasum. The hypermotility is thought to be caused by overdistension of the rumen and to be the cause of frothy bloat.

There is usually no interference with respiration without major herniation, but displacement and compression of the heart is common.

## CLINICAL FINDINGS

There is a capricious appetite and loss of condition for several weeks before abdominal distension caused by accumulation of fluid and froth in the rumen, persistent moderate tympany of the rumen, occurs. Grinding of the teeth may occur, and the feces are pasty and reduced in volume. Rumination does not occur but occasionally animals regurgitate when a stomach tube is passed.

The temperature is normal and bradycardia may be present (40–60 beats/min). Breathing is usually normal. A systolic murmur may be present and the intensity of the heart sounds may suggest displacement of the heart, usually anteriorly or to the left. Reticular sounds are audible just posterior to the cardiac area in many normal cows, and they are not significantly increased in diaphragmatic hernia.

A more severe syndrome is recorded in cases in which viscera other than a portion of the reticulum is herniated. Peristaltic sounds may be audible in the thorax and there may be interference with respiration and signs of pain with each reticular contraction. Affected animals usually die of inanition in 3 to 4 weeks after the onset of bloat.

## CLINICAL PATHOLOGY

Laboratory examinations are of no value in diagnosis. Radiologic examination after a barium meal has facilitated diagnosis but requires a radiographic unit that is only available at referral centers.

## NECROPSY FINDINGS

The majority of cases are complications of traumatic reticuloperitonitis and a fistulous tract is often found in the vicinity of the diaphragmatic rupture, which is usually 15 to 20 cm in diameter. A portion of the reticulum protrudes into the right pleural cavity to form a spherical distension usually 20 to 30 cm in diameter, but is more extensive in some cases. The reticulum is very tightly adherent to the hernial ring, which is thickened by fibrous tissue. The omasum and abomasum are relatively empty but the rumen is overfilled with frothy, porridge-like material, which contains very little fiber. Less common cases are those in which part of the reticulum, the omasum, and part of the abomasum are herniated.

### DIFFERENTIAL DIAGNOSIS

- Other causes of chronic bloat must be considered in the differential diagnosis, especially vagus indigestion with hypermotility, which is also often accompanied by a systolic murmur. The two can only be differentiated by rumenotomy, but there is the hazard that cases of diaphragmatic hernia are not relieved by the operation and tympany returns rapidly, sometimes necessitating a permanent ruminal fistula.
- Passage of a stomach tube is usually necessary to determine whether or not a physical obstruction is present in the esophagus. Regurgitation is likely to occur in cases of diaphragmatic hernia, and this occasionally causes blockage of the esophagus with ingesta, simulating choke.
- Causes of diaphragmatic hernia other than traumatic reticuloperitonitis include violent trauma to the abdomen and straining at parturition. In both instances, there is probably a primary weakness of the diaphragm. In water buffalo, this is thought to be an anatomic characteristic of the species, with the weakness located in the right half of the diaphragm.

## TREATMENT

Most recorded attempts at surgical repair in cattle have been unsuccessful and treatment is not usually recommended. The animals could not be left as they were, so salvage by slaughter has been the usual outcome. Successful treatment of diaphragmatic hernia in water buffalo has been recorded.

The ruminal contents are frothy, and trocarization or passing a stomach tube has virtually no effect in reducing the tympany, nor

have standard antifoaming agents. The tympany is usually not sufficiently severe to require emergency rumenotomy. The signs may be partly relieved by keeping the animal confined with the forequarters elevated.

## TRAUMATIC RETICULOPERICARDITIS

Perforation of the pericardial sac by a sharp foreign body originating in the reticulum causes pericarditis with the development of toxemia and congestive heart failure. Tachycardia, fever, engorgement of the jugular veins, anasarca, hydrothorax and ascites, and abnormalities of the heart sounds are the diagnostic features of the disease.

### SYNOPSIS

**Etiology** Perforation of pericardial sac by foreign body originating from the reticulum.

**Epidemiology** Usually mature cattle; may have had history of traumatic reticuloperitonitis.

**Signs** Depression, toxemia, fever, inappetence to anorexia, engorged jugular veins, brisket edema, heart sounds muffled and accompanied by pericardial friction rubs and to-and-fro fluid movement sounds.

**Clinical pathology** Marked neutrophilia. Pericardiocentesis yields foul-smelling and turbid fluid.

**Lesions** Distension of pericardial sac, foul-smelling, grayish fluid containing fibrin. Adhesions and sinus tracts to reticulum.

**Diagnostic confirmation** Pericardiocentesis.

**Differential diagnosis** Common causes of congestive heart failure in cattle include endocarditis, myocardopathy (lymphomatosis), and congenital cardiac defect.

**Treatment** Pericardial drainage and lavage by indwelling catheter or fifth rib resection. Rumenotomy to remove metallic foreign body. Antimicrobials. Prognosis poor. Euthanasia commonly recommended.

### ETIOLOGY

Traumatic pericarditis is caused by penetration of the pericardial sac by a migrating metal foreign body from the reticulum. The incidence is greater during the last 3 months of pregnancy and at parturition than at other times. Approximately 8% of all cases of traumatic reticuloperitonitis will develop traumatic pericarditis. Most affected animals die or suffer from chronic pericarditis and do not return to completely normal health.

### PATHOGENESIS

Penetration of the pericardial sac may occur with the initial perforation of the reticular

wall. However, the animal may have had a history of traumatic reticuloperitonitis sometime previously, followed by pericarditis, usually during late pregnancy or at parturition. In this case it is probable that the foreign body remains in a sinus in the reticular wall after the initial perforation and penetrates the pericardial sac at a later date. Physical penetration of the sac by a metallic foreign body is not essential to the development of pericarditis, and infection sometimes penetrates through the pericardium from a traumatic mediastinitis.

Introduction of a mixed bacterial infection from the reticulum causes a severe local inflammation, and persistence of the foreign body in the tissues is not essential for the further progress of the disease. The first effect of the inflammation is hyperemia of the pericardial surfaces and the production of friction sounds synchronous with the heart beats. Two mechanisms then operate to produce signs: the toxemia caused by the infection and the pressure on the heart from the fluid that accumulates in the sac and produces congestive heart failure. In individual cases one of these two factors may be more important. Depression is characteristic of the first and edema of the second. Thus an affected animal may be severely ill for several weeks, with edema developing only gradually, or extreme edema may develop within 2 to 3 days. The rapid development of edema usually indicates early death.

If chronic pericarditis persists, there is restriction of the heart action caused by adhesion of the pericardium to the heart. Congestive heart failure results in most cases, but some animals may recover. An uncommon sequel a after perforation of the pericardial sac by a foreign body is laceration of a coronary artery by the wire or rarely

rupture of the ventricular wall. Death usually occurs suddenly caused by acute, congestive heart failure from compression of the heart by the hemopericardium, and often without premonitory illness.

### CLINICAL FINDINGS

Depression, anorexia, habitual recumbency, and rapid weight loss are common. Diarrhea or scant feces may be present and grinding of the teeth, salivation, and nasal discharge are occasionally observed. The animal stands with the back arched and the elbows abducted. Respiratory movements are more obvious, and are mainly abdominal and shallow with an increase in rate to 40 to 50 beats/min and often accompanied by grunting. **Bilateral distension of the jugular veins and edema of the brisket and ventral abdominal wall are common (Fig. 8-15)** and in severe cases there may even be edema of the conjunctiva with grapelike masses of edematous conjunctiva hanging over the eyelids. A prominent jugular venous pulse is usually visible and extends proximally up the neck.

**Pyrexia** (40°C–41°C, 104°F–106°F) is common in the early stages, and an increase in the heart rate to 100 beats/min and a diminution in the pulse amplitude are constant.<sup>1</sup> Rumen movements are usually present but depressed. Pinching of the withers to depress the back or deep palpation of the ventral abdominal wall behind the xiphoid sternum commonly elicits a marked painful grunt. A grunt and an increased area of cardiac dullness can also be detected by percussion over the precordial area, preferably with a pleximeter and hammer.

**Auscultation of the thorax reveals the diagnostic findings.** In the early stages before effusion commences, the heart sounds

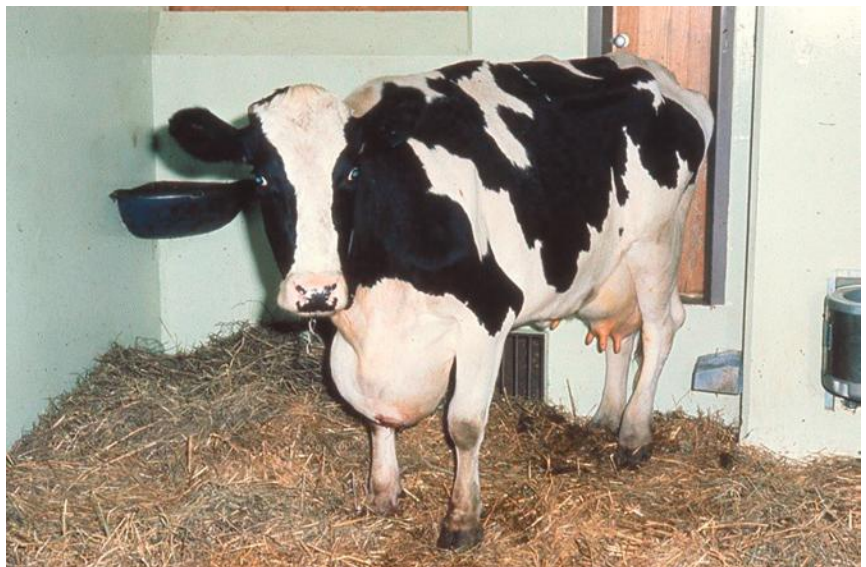

**Fig. 8-15** Holstein Friesian dairy cow with right-sided heart failure (brisket edema) caused by traumatic reticulopericarditis.

are normal but are accompanied by a **pericardial friction rub**, which may wax and wane with respiratory movements. Care must be taken to differentiate this from a pleural friction rub caused by inflammation of the mediastinum. In this case the rub is much louder and the heart rate will not be so high. Several days later when there is marked effusion, the **heart sounds are muffled** and there may be **gurgling, splashing, or tinkling sounds**. In all cases of suspected pericarditis, careful auscultation of the entire precordium on both sides of the thorax is essential as abnormal sounds may be audible only over restricted areas. This is especially so in chronic cases.

Lateral radiographs of the ventral thorax and cranial abdomen with the animal standing are very helpful in directing treatment but can only be performed at referral centers (Fig. 8-16). A diagnosis of traumatic reticulopericarditis is made when a foreign body is present that perforates the cranial reticular wall and diaphragm or is located entirely in the thoracic cavity. Dorsoventral radiographs to confirm the location of the foreign body in the pericardium are not possible because of the tissue mass. Gas formation is commonly present in the caudoventral thorax.

Ultrasonography is the preferred method for documenting the presence of pericardial effusion and facilitating pericardiocentesis. It is performed with the cow standing and front legs advanced cranially using soft ropes. A 5-MHz sector or convex transducer is applied

from the left and right intercostal spaces. Cattle with traumatic reticulopericarditis typically have a large amount of hypoechogenic fluid in the thorax and pericardial sac; the latter occasionally contains fibrin tags. Ultrasound of the ventral reticular region is performed to confirm the presence of traumatic reticuloperitonitis, including decreased reticular motility and variable echogenicity. Most affected animals die within a period of 1 to 2 weeks, although a small proportion persist with chronic pericarditis. The obvious clinical findings in the terminal stages are **gross edema, dyspnea, severe watery diarrhea, depression, recumbency, and complete anorexia. Enlargement of the liver** may be detectable by palpation behind the upper part of the right costal arch in the cranial part of the right paralumbar fossa. Death is usually caused by asphyxia and toxemia.

Animals that have recovered from an initial pericarditis are usually affected by the chronic form of the disease. Body condition is poor, the appetite is variable, there is no systemic reaction, and the demeanor is bright. Edema of the brisket is usually not prominent, but there is jugular engorgement. Auscultation reveals variable findings. The **heart sounds are muffled and fluid splashing sounds** may be heard over small discrete areas corresponding to the loculi of fluid in the sac,<sup>1</sup> or there may be a cardiac arrhythmia. The heart rate is rapid (90–100 beats/min), and the pulse is small in amplitude.

These animals remain unthrifty and are unlikely to withstand the stress of another pregnancy or lactation.

## CLINICAL PATHOLOGY

### Hemogram

A pronounced leukocytosis with a total count of 16,000 to 30,000 cells/ $\mu$ L accompanied by a neutrophilia and eosinopenia is usual although less dramatic changes are recorded in one series of cases.<sup>1</sup> Hyperfibrinogenemia and marked increases in serum total protein concentration are frequently present in longstanding advanced cases, as is a shortened time for the glutaraldehyde clotting test.<sup>1</sup>

### Pericardiocentesis

When gross effusion is present the pericardial fluid may be sampled by centesis with a 10-cm 18-gauge needle over the site of maximum audibility of the heart sound, usually in the fourth or fifth intercostal space on the left side. In midstage pericarditis, the fluid is usually easily obtained and is **foul-smelling (similar to a severe metritis in cattle caused by a retained placenta) and turbid, which is diagnostic for pericarditis**. In chronic pericarditis, only small amounts may be present and a sample may not be obtainable.

## NECROPSY FINDINGS

In acute cases there is gross distension of the pericardial sac with foul-smelling, grayish fluid containing flakes of fibrin, and the serous surface of the sac is covered by heavy deposits of newly formed fibrin. A cordlike, fibrous sinus tract usually connects the reticulum with the pericardium. Additional lesions of pleurisy and pneumonia are commonly present. In chronic cases the pericardial sac is grossly thickened and fused to the pericardium by strong fibrous adhesions surrounding loculi of varying size, which contain pus or thin straw-colored fluid.



**Fig. 8-16** Left-lateral radiograph of the caudoventral thorax and cranioventral abdomen in a cow with traumatic reticulopericarditis. The reticulum with a vague honeycomb pattern is on the right and contains a magnet with a vertically aligned wire that does not appear attached to the magnet. This is consistent with a diagnosis of traumatic reticuloperitonitis. A separate foreign body is present cranial to the reticulum and diaphragm (not visible) with a dorsal gas pocket. This is consistent with a diagnosis of traumatic reticulopericarditis, although traumatic reticulopleuritis could not be ruled out. (Reproduced with permission from Braun U. *Vet J* 2009; 182:176-186.)

## DIFFERENTIAL DIAGNOSIS

The typical clinical findings in pericarditis are chronic illness, toxemia, fever, congestive heart failure, and muffled heart sounds. The major causes of congestive heart failure in cattle are pericarditis, endocardial disease, myocardopathy, and cor pulmonale (pulmonary hypertension caused by chronic pulmonary disease). Endocarditis, lymphosarcoma with cardiac involvement caused by bovine leukosis virus infection, and congenital cardiac defects are all likely to be confused with traumatic pericarditis because of the similarity of the abnormal heart sounds.

- **Endocarditis** is usually associated with a suppurative process in another organ, particularly the uterus or udder, and although the abnormal heart sounds are typical bruits rather than pericardial friction



sounds, this may be difficult to determine when extensive pericardial effusion has occurred.

- **Lymphosarcoma** is usually accompanied by lesions in other organs or the presence of a marked leukocytosis and lymphocytosis.
- **Congenital cardiac defects** may not cause clinical abnormality until the first pregnancy but can be diagnosed by the presence of loud murmurs, a pronounced cardiac thrill, and an absence of toxemia.
- Less common causes of abnormal heart sounds include thoracic tumors and abscesses, thymic lymphosarcoma, diaphragmatic hernia, and chronic bloat, which may cause pleural effusion, constriction of the cranial vena cava, distortion of the atria, and atrioventricular orifices. They are associated with other diagnostic signs, particularly displacement of the heart.
- In severely debilitated animals or those suffering from severe anemia a hemic murmur that fluctuates with respiration may be audible.
- Occasional cases of hematogenous pericarditis are encountered, and in some cases of pasteurellosis a fibrinous pericarditis may be present, but there is usually serious involvement of other organs and the pericarditis is only secondary.

## TREATMENT

The results of treatment are usually unsatisfactory but salvage in a small percentage of cases can be achieved by placement of a pericardial catheter and daily pericardial lavage with dilute iodine solutions in 0.9% NaCl and long-term systemic treatment with antimicrobials. Rapid onset of generalized edema represents a poor prognosis. One-time drainage of the pericardial sac may temporarily relieve the edema and respiratory embarrassment, but relapse usually occurs within a few days. Selected cases of traumatic pericarditis have been treated satisfactorily by pericardiectomy using a fifth rib resection.

## PREVENTION

Prevention depends on preventing traumatic reticuloperitonitis through management of the environment and the administration of reticular magnets.

### TREATMENT AND CONTROL

#### Treatment

Prognosis poor and euthanasia commonly recommended

Chronic effective pericardial drainage and lavage via an indwelling flexible pericardial catheter (R-1)

Systemic antimicrobials such as procaine penicillin or oxytetracycline (R-1)

Rumenotomy to remove metallic foreign body if portion of wire still in reticulum (R-1)

Left fifth rib resection and pericardial marsupialization in advanced cases that are unresponsive to pericardial lavage (R-2)

#### Control

See control of traumatic reticuloperitonitis

## FURTHER READING

Braun U. Traumatic pericarditis in cattle: clinical, radiographic and ultrasonographic findings. *Vet J.* 2009;182:16-186.

## REFERENCE

1. Braun U, et al. *Vet Rec.* 2007;161:558.

## TRAUMATIC RETICULOSPLENITIS AND RETICULOHEPATITIS

Traumatic reticulospinitis and reticulohepatitis are relatively uncommon as sequelae to traumatic reticuloperitonitis and are manifested either by continuation of the illness caused by the initial perforation or by apparent recovery followed by relapse several weeks later. The prominent clinical findings include fever (39.5°C–40.5°C, 103°F–105°F), tachycardia, and gradual decrease in feed intake and milk yield, but ruminal movements may be present and may be normal. Percussion of the abdomen over the site usually used to detect the pain of traumatic reticuloperitonitis gives a negative response although deep, forceful palpation may elicit a mild grunt. The diagnostic sign is pain on palpation with the thumb in the last two intercostal spaces halfway down the abdomen on the right side when there is hepatic involvement and on the left side when the spleen is affected.

The total leukocyte count is elevated (above 12,000 cells/μL) with a marked neutrophilia and a left shift. Left-sided exploratory laparotomy and rumenotomy is not usually undertaken except for diagnostic purposes and to remove a penetrating wire if one is still present. Treatment with antibacterial drugs such as oxytetracycline or procaine penicillin is effective if commenced sufficiently early.

## IMPACTION OF THE OMASUM

The omasum is usually spherical in shape and located to the right of the midline in the central third of the abdomen. The main functions of the omasum are to absorb short chain volatile fatty acids (acetate, propionate, and butyrate), electrolytes, and water. The omasum can vary in size in cattle for unknown reasons and is typically firmer on palpation than the rumen or reticulum. The omasum of cattle on a percent BW basis is larger than in sheep or goats.

The omasum cannot be directly examined in adult cattle by auscultation, percussion,

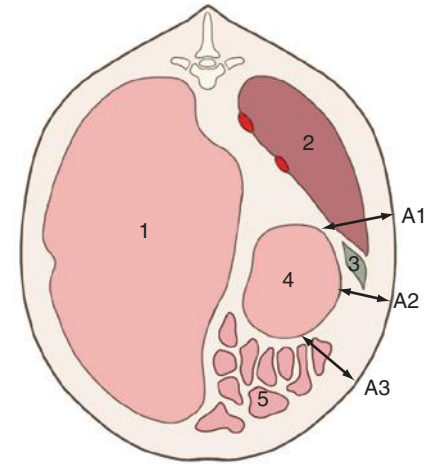

**Fig. 8-17** Schematic diagram of a cross-sectional view of the bovine abdomen at the level of the ninth intercostal space. 1, Rumen; 2, Liver; 3, gallbladder; 4, omasum; 5, small intestine. The distance between the abdominal wall and the dorsal limit of omasum (A1), the closest distance to the omasum (A2), and the ventral limit of the omasum (A3) are identified. (Reproduced with permission from Braun U, Blessing S. *Vet Rec* 2006; 159:812.)

external palpation, and palpation per rectum, or by radiography or laparoscopy. It can be palpated directly during a right flank laparotomy with the cow standing and indirectly through the medial wall of the rumen during a rumenotomy. Occasionally during an exploratory laparotomy of adult cattle, the omasum feels excessively firm and is painful when manipulated or palpated. The clinical significance of this finding has not been determined. The omasum of sheep and goats can occasionally be identified with deep palpation under the right costochondral arch.

The margins of the omasum in cattle have been identified using a 3.5-MHz linear transducer, with the right ninth intercostal space providing the best acoustic window to determine omasal dimensions (Fig. 8-17); the omasum was also closest to the right abdominal wall in this location.<sup>1</sup> Weight of the omasum was moderately correlated ( $r = +0.55$ ) with omasal dimensions in the right ninth intercostal space; this may provide the best method to monitor change in omasal size over time. Omasal motility was not observed ultrasonographically in healthy cattle but was visible in 3/6 cows with vagal indigestion caused by reticuloomasal stenosis.<sup>1,2</sup> Omasal size was smaller in cattle with vagal indigestion caused by reticuloomasal stenosis, RDA, AV, and intestinal hypomotility or ileus.<sup>2</sup>

**Omasal impaction** as a clinical entity is difficult to define and is usually diagnosed at necropsy or right flank exploratory laparotomy or during rumenotomy when the omasum is enlarged and excessively firm.<sup>3</sup> It seems unlikely that omasal impaction could cause death and is frequently observed in

animals dying of other disease. Omasal impaction is reputed to occur when feed is tough and fibrous, particularly when wheat straw is fed, but is also reported when cattle and sheep are fed alfalfa stalks and loppings from fodder trees, or under drought feeding conditions in sheep that are fed on the ground. In the latter, the impaction is caused by the accumulation of soil in the omasum. Omasal impaction appears very rare in goats. Chronic recurrent bouts of indigestion occur in cattle and are manifested by decreased rumen motility, infrequent and scanty feces, refusal to eat grain, and a negative ketone test. Pain may be elicited and the hard distended viscus palpated on deep pressure under the right costal arch or in the seventh to ninth intercostal spaces on the right side. Serum concentrations of gastrin and motilin are increased in cattle with omasal impaction,<sup>1</sup> suggesting that prokinetic agents such as erythromycin will not be effective in treating affected animals. In cattle with a large firm omasum detected during rumenotomy, a flexible tube can be passed through the reticuloomasal orifice and warm water used to flush the omasum while it was kneaded through the medial rumen wall to soften and break up the impacted mass.<sup>3</sup> Repeated dosing with mineral oil (4 L/day for at least 3 days) is recommended as treatment and appears to be effective, but randomized clinical trials have not been performed to confirm this impression.

At necropsy, the omasum is grossly distended; patches of necrosis may be present on the leaves and peritonitis may be evident. Necrosis of the ruminal lining may also be present. Clinically the disease is manifested by complete anorexia, cessation of defecation, an empty rectum, and subacute abdominal pain with disinclination to move or lie down.

The number of omasal laminae in cattle ranges from 122 to 69. There is one report of congenital hypoplasia of the omasal laminae in a Japanese Black steer with persistent bloat and poor growth rate.<sup>5</sup> It appears that the congenital omasal defect impeded omasal transport of ingesta.<sup>5</sup>

## REFERENCES

- Braun U, Blessing S. *Vet Rec.* 2006;159:812.
- Braun U, et al. *Vet Rec.* 2007;160:865.
- Hussain SA, et al. *Turk J Vet Anim Sci.* 2013;37:329.
- Ozturk AS, Askar TK. *Kafkas Univ Vet Fak Derg.* 2015;21:919.
- Takagi M, et al. *J Vet Med Sci.* 2007;69:1281.

## Diseases of the Abomasum

Diseases of the abomasum are common in adult dairy cattle, and consist of five important entities:

- Left displaced abomasum
- Right displaced abomasum

### 3. Abomasal volvulus (historically called abomasal torsion)

### 4. Abomasal impaction

### 5. Abomasal ulcers

There appears to be an increase in occurrence of LDA, RDA, and AV that is associated with management, environmental, and genetic factors. Dairy cattle are being selected for high milk production and are being fed large quantities of grain and kept more often in total confinement in which exercise is limited. All of this may contribute to abomasal hypomotility, which is the precursor of abomasal displacements. A number of general comments are summarized here that apply to most diseases of the abomasum.

## CLINICAL EXAMINATION OF THE ABOMASUM

### PHYSICAL EXAMINATION

The normal abomasum cannot usually be examined by the standard techniques of clinical examination except indirectly by simultaneous auscultation and percussion, as well as by abdominal paracentesis. In LDA, the tympanitic sounds (**pings**) audible on auscultation and percussion between the middle to upper third of the 9th and 13th ribs and over the anterior aspect of the left paralumbar fossa are characteristic. In RDA, the tympanitic sounds (**pings**) audible on auscultation and percussion between the lower third of the 9th and 13th ribs and extending into the anterior aspect of the right paralumbar fossa, and the **fluid-splashing sounds** audible on auscultation and ballottement of the right lower to middle third of the abdomen, are characteristic. An enlarged abomasum may be palpable on rectal examination deep in the right lower quadrant of the abdomen, depending on the size of the animal and the size of the distended abomasum, and provided the animal is not in advanced pregnancy.

In AV, the clinical findings are similar to right-side displacement but much more severe. On rectal palpation a fluid-filled abomasum feels tense; an impacted abomasum pits on digital pressure. In abomasal impaction, the enlarged, firm, doughy viscus can usually be palpated behind the lower aspect of the right costal arch, but the gravid uterus of later pregnancy commonly makes this difficult. Following parturition, the abomasum is more readily detectable by palpation through the abdominal wall or rectally.

## ULTRASONOGRAPHY OF THE ABOMASUM

The abomasum can be visualized by ultrasonography over the ventral midline caudal to the xiphoid process and from both left and right paramedian regions lateral to the midline site. It can be clearly differentiated from adjacent viscera because of its contents, which appear as a heterogeneous,

moderately echogenic structure with echogenic stippling. Abomasal motility cannot be observed ultrasonographically, but the relative size and anatomic location of the abomasum can be detected (Figs. 8-18 and 8-19).<sup>1</sup>

Contrary to most pictorial representations of the shape of the abomasum within a cow's abdomen, the abomasum in adult cows is always wider than it is longer and it is always located predominantly to the right of the midline.<sup>1</sup> Marked changes in abomasal dimensions and position occur in dairy cattle during the last 3 months of gestation and first 3 months of lactation. The abomasal length decreases and the width increases during the last 3 months of gestation, resulting in a more transverse orientation of the abomasum within the abdomen compared with nonpregnant cattle or cattle in early gestation. These changes appear to be a direct response to cranial expansion of the gravid uterus. Within 14 days after parturition the abomasum returns to a caudal and right sagittal position, similar to that at the beginning of the last 3 months of gestation.<sup>1</sup>

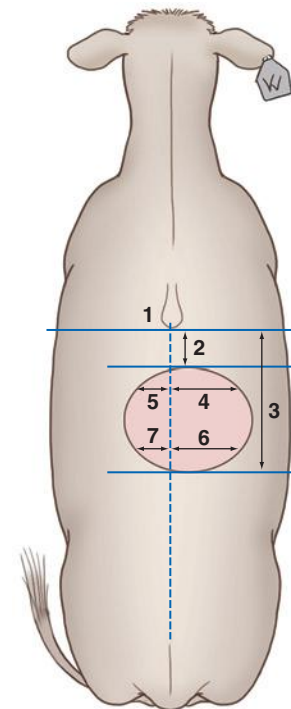

**Fig. 8-18** Illustration of transabdominal ultrasonographic measurements of abomasal margins on the ventral abdominal wall (dorsal view) in Holstein Friesian heifers and cows. The numbers indicate anatomic landmarks and measurements: 1, xiphoid process; 2, cranial abomasal margin; 3, caudal abomasal margin; 4, right lateral extension in cranial region; 5, left lateral extension in cranial region; 6, right lateral extension in caudal region; 7, left lateral extension in caudal region. (Reproduced with permission from Wittek T, Constable PD, Morin DE. *J Am Vet Med Assoc* 2005; 227:1469-1475.)

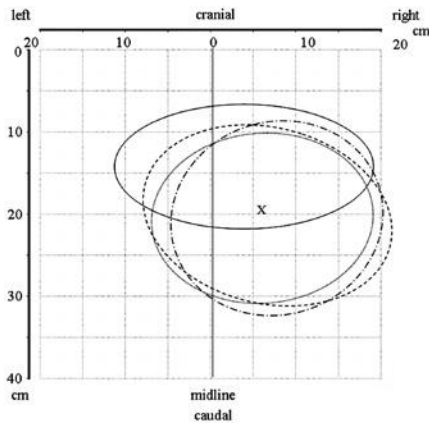

**Fig. 8-19** Dorsal view of abomasal position and shape (modeled as an ellipse in the horizontal plane) of Holstein Friesian cows at the beginning of the last 3 months of gestation (dashed line), immediately before parturition (solid line), immediately after parturition (dotted line), and during the third month of lactation (dashed and dotted line). The abomasum moves cranially and to the left in late gestation. X, Center of the abomasal body projection in nonpregnant cows. (Reproduced with permission from Wittek T, Constable PD, Morin DE. *J Am Vet Med Assoc* 2005; 227: 1469-1475.)

Ultrasonographic examination of the abomasum of neonatal lambs provides an immediate indication of whether or not the lambs have sucked and may be useful in investigations of neonatal mortality.

### ABOMASOCENTESIS

Centesis of abomasal contents is a safe procedure if done carefully. Percutaneous ultrasound-guided abomasocentesis can be done to evaluate the nature and chemical composition of abomasal contents. The procedure is done at a site in which the abomasum is large and no other viscera are located. The optimum site for abomasocentesis is 20 cm caudal to the xiphoid process and 5 to 10 cm lateral to the midline on the right, equivalent to 12 finger widths caudal to the xiphoid process and 3 to 6 finger widths to the right of the midline.<sup>1</sup> A spinal needle (0.12 × 9.0 cm) with a stylet is guided by ultrasonography through the skin and abdominal wall and into the abomasum. Abomasal fluid is assessed for color, smell and the presence of blood, and pH. Normally, the color ranges from olive green to gray, and the fluid has a sour smell. The pH varies from 1.4 to 4.5. Higher values occur with abomasal hemorrhage, the presence of bile, or chronic abomasitis caused by ostertagiasis.

### APPLIED ANATOMY AND PATHOPHYSIOLOGY OF THE ABOMASUM

In a healthy, nonpregnant cow, the abomasum is positioned below the rumen in the

ventral part of the abdomen and is predominantly located on the right side of the animal. During pregnancy, the enlarging uterus forces the abomasum into a more cranial position, with a greater leftward extension of the abomasum. This change is assumed to contribute to the development of an LDA, which generally occurs during the first 3 weeks after parturition.

The flow of rumen fluid into the abomasum can result in the production of carbon dioxide and methane gases, which when their absorption or the motility of the abomasum is decreased, are unable to escape from the blind pocket in the abomasum and may be a major factor in the pathogenesis of left-side displacement. This may explain why 90% of abomasal displacements occur toward the left side.

**Diseases of the abomasum that cause hypomotility and accumulation** of ingesta, fluid, and gas in the viscus result in varying degrees of dehydration, metabolic alkalosis, hypochloremia, and hypokalemia. The metabolic alkalosis and hypokalemia are often accompanied by muscular weakness and paradoxical aciduria. When these changes are severe, as in right-side dilatation, AV, and abomasal impaction, intensive fluid therapy is usually necessary for a favorable response.

**Abomasal luminal pressure** is increased in left-side displacement and in volvulus of the abomasum. This may be associated with the pathogenesis of ulceration in long-standing cases of LDA and with the prognosis of survival in AV. The luminal pressure is high in AV and higher in cattle that die or are sold for slaughter than in cattle that survive and are retained in the herd. Thus measurement of luminal pressure during surgery for volvulus may be of value in formulating prognosis for survival.

Abomasal hypomotility and a decreased rate of abomasal emptying are thought to be important factors in the etiology and pathogenesis of several diseases of the abomasum of adult cattle and calves. Because abomasal hypomotility has been associated with hypocalcemia, endotoxemia, acidosis and alkalosis, hyperinsulinemia, and hyperglycemia, the approach in treatment of suspected abomasal hypomotility in adult cattle and calves has been the correction of acid-base and electrolyte imbalances, control of the effects of endotoxemia, and elimination of gram-negative bacterial infections. Neostigmine, metoclopramide, or erythromycin have been used in ruminants for the treatment of abomasal hypomotility on the basis that these drugs have a prokinetic effect in other animals; however, neostigmine and metoclopramide are not effective in ruminants in improving abomasal emptying rate. Prokinetic agents have the ability to stimulate, coordinate, and restore gastric, pyloric, and small-intestinal motility.

Erythromycin is an effective prokinetic agent in healthy sucking milk-fed calves

similar to its effects in humans, dogs, and horses.<sup>1</sup> Intramuscular administration of erythromycin at 8.8 mg/kg increased the frequency of abomasal luminal pressure waves and the mean abomasal luminal pressure and decreased the half-time of abomasal emptying by 37%. Metoclopramide, neostigmine, and low-dose (0.88 mg/kg) erythromycin did not alter abomasal motility, mean luminal pressure, or emptying rate. Additional studies have demonstrated that all macrolide formulations have prokinetic activity, although none of them are as effective as erythromycin at the labeled treatment dose.<sup>2-7</sup> It should be remembered that it is not appropriate to use an antimicrobial agent such as erythromycin for a nonantimicrobial use, and alternative prokinetic agents that are potentially as effective as erythromycin are currently under investigation.

Abomasal emptying rate and volume in calves has been determined using nuclear scintigraphy and acetaminophen absorption methods. Ultrasonography has also been used to evaluate abomasal volume, location, and emptying rate in sucking calves.

### ABOMASAL REFLUX

Reflux of abomasal fluid into the omasum and reticulorumen occurs when the abomasal fluid fails to move aborally through the pylorus into the duodenum. This is most common in diseases of the abomasum, left-side displacement, AV, and vagal indigestion. Reflux may also occur in peritonitis, compression of the abomasum in advanced pregnancy, intussusception, and toxemias. The rumen chloride concentrations increase from a normal of 10 to 25 mmol/L to 80 to 100 mmol/L, and the buffering capacity of the rumen is decreased from 80 to 110 mmol/L to less than 50 mmol/L. Hypochloremic, hypokalemic metabolic alkalosis occurs. Treatment consists of removing excessive quantities of fluid from the rumen and the administration of large quantities of balanced electrolytes or simply saline intravenously.

**Duodenal-abomasal reflux** occurs normally in cattle and may increase during abomasal displacement; the influx is lower in LDA than in RDA. The concentration of bile acids in the abomasum is twice as high in LDA and RDA as in healthy cattle.

The administration of apomorphine to sheep causes expulsion of acidic abomasal contents back into the preabomasal compartments without expulsion of gastric contents through the mouth, or “internal vomiting.” In sheep, it is estimated that approximately 280 g of sodium bicarbonate given orally would be necessary to return the ruminal pH to the neutral range.

### FURTHER READING

Constable PD, Nouri M, Sen I, Baird AN, Wittek T. Evidence-based use of prokinetic drugs for abomasal disorders in cattle. In: Buczinski S,



Vandeweerd JM, eds. *Evidence-Based Medicine for the Bovine Veterinarian*. Vet Clin North Am Food Anim Pract. 2012;28:50-70.

Geishauser T. Abomasal displacement in the bovine—a review on character, occurrence, aetiology and pathogenesis. *J Vet Med A Physiol Pathol Clin Med*. 1995;42:229-251.

## REFERENCES

1. Wittek T, et al. *J Am Vet Med Assoc*. 2005;227:1469.
2. Ghoreishi SM, et al. *J Vet Intern Med*. 2015;29:714.
3. El Badawy SA, et al. *Small Rumin Res*. 2014;121:3959.
4. Rashnavadi M, et al. *Can J Vet Res*. 2014;78:61.
5. Wittek T, et al. *Vet Surg*. 2008;37:537.
6. Wittek T, et al. *J Am Vet Med Assoc*. 2008;232:418.
7. Nouri M, et al. *J Vet Intern Med*. 2008;22:196.

## LEFT-SIDE DISPLACEMENT OF THE ABOMASUM

### ETIOLOGY

The cause of LDA in cattle is multifactorial but is related primarily to feed intake before and after calving. The transition period occurring 2 weeks prepartum through 2 to 4 weeks postpartum is the major risk period in the etiology of LDA. The prepartum depression of feed intake and the slow postpartum increase in intake are risk factors causing decreased ruminal fill, reduced forage to concentrate ratio, and increased incidence of other postpartum diseases. Excessive amounts of concentrate during the prepartum period increase the risk of LDA, which may occur from the decreased ruminal fill caused by greater prepartum intake depression and reduced forage to concentrate ratio, decreased ruminal motility from lower ruminal fill and higher volatile fatty acid concentration, and decreased abomasal emptying. The feeding of high levels of concentrate to dairy cattle results in a decrease in abomasal motility and increased accumulation of abomasal gas.

### SYNOPSIS

**Etiology** Gaseous distension and hypomotility of abomasum possibly caused by feeding high levels of concentrate to dairy cattle in late pregnancy.

**Epidemiology** High-producing dairy cows within 6 weeks of calving. Insufficient crude fiber and roughage in ration. Concurrent disease such as hypocalcemia and ketosis may be risk factors, but this is uncertain.

**Signs** Inappetence, ketosis, decreased milk production, abdomen usually smaller than normal, reticulorumen movements not clearly audible or absent, rumen pack not easily palpable, ping over left paralumbar fossa and cranial to it. Hepatic lipidosis and abomasal ulceration are possible complications.

**Clinical pathology** Ketonemia, ketonuria. Normal hemogram.

**Lesions** Not usually fatal, deaths usually from concurrent disease conditions.

**Diagnostic confirmation** Laparotomy to confirm displacement.

**Differential diagnosis** Left displaced abomasum must be differentiated from those common diseases of the forestomach and abomasum that cause inappetence to anorexia, ketosis, reduced or abnormal reticulorumen motility, and abnormal sounds on percussion and auscultation of the left abdomen. They are simple indigestion, primary ketosis, traumatic reticuloperitonitis, vagus indigestion, and fat mobilization syndrome.

**Treatment** Open and closed surgical techniques to replace abomasum and secure in normal position.

**Control** Avoid negative energy balance prepartum, avoid overconditioning of cows prepartum, provide optimal feed bunk management, and maximize dry matter intake in late pregnancy.

### EPIDEMIOLOGY

#### Occurrence

LDA is most common in large, high-producing adult dairy cows immediately after parturition. Approximately 90% of cases occur within 6 weeks following parturition. Occasional cases occur a few to several weeks before parturition. The disease is common worldwide where dairy cattle are fed grain for high milk production and the animals are usually housed for part of the year or kept under confinement (zero grazing and loose housing). The disease is uncommon in Australia and New Zealand, where much less concentrate is fed to dairy cattle and the animals are usually on pasture for most of the year. However, LDA can occur in pasture-fed dairy cattle, and the incidence has increased in Australia and New Zealand associated with the increased use of North American genetic stock. The importance of exercise in the etiology of LDA has not been explored. The incidence of LDA is higher during late winter and early spring, which may be a reflection of a higher frequency of calving, relative inactivity, or nutritional effects of feeding long-stored rations.

The much higher incidence of LDA in the first month of lactation does not appear to be associated with an intrinsic decrease in the abomasal emptying rate in healthy dairy cows at this stage of the lactation cycle caused by periparturient changes in plasma hormone concentrations.<sup>1</sup>

#### Calves

LDA has been recorded in calves up to 6 months of age and, rarely, in heifer calves 4 and 8 weeks of age in which abomasal ulceration perforation and peritonitis, and perforation of the abdominal wall occurred. It was

not possible to determine whether the ulceration led to the atony with subsequent displacement of the abomasum, or if the displacement facilitated the ulceration.

#### Lactational Incidence Rate

The lactational incidence of LDA for dairy herds in North America is estimated to range from 3% to 5%. A common goal in North America is to keep the annual incidence of LDA below 3%. The mean lactation incidence in German Holstein herds is estimated at 1.6%.

#### Case Fatality

In one series of observations, the case-fatality rate was much higher (21%) in cows with LDA and diarrhea than in cows with LDA and normal feces (8%). Typical case-fatality rates at referral hospitals are approximately 5%, with most of the mortality caused by concurrent disease.

### Risk Factors

#### Dietary Risk Factors

##### Prepartum Nutrition and Management

Based on observations in dairy herds, significant associations were found between negative energy balance prepartum, as reflected by increased nonesterified fatty acid concentrations, and the occurrence of LDA. High body condition scores, suboptimal feed bunk management, prepartum diets containing more than 1.65 Mcal of NE<sub>i</sub>/kg of dry matter, winter and summer seasons, high genetic merit, and low parity were significant risk factors. Cows fed these high-energy diets during the dry period may become obese, which may result in a **decline in dry matter intake** before calving. Calving during hot summer months also decreases dry matter intake. It is suggested that hepatic lipidosis may be an important risk factor for LDA. Herds with a high mean predicted transmitting ability were associated with a high occurrence of LDA, suggesting a genetic component associated with high milk production.

Ketosis diagnosed before the occurrence of LDA has been frequently implicated as the major risk factor for developing LDA. This may reflect a mechanistic causal relationship, in that ketosis is associated with low dry matter intake, which would reduce rumen fill and volume, reducing forestomach motility and, potentially, abomasal motility. A low rumen volume also offers less resistance to LDA. Alternatively, it could be that many of these cases of ketosis actually had an LDA that was not auscultable. A study in four cows with LDA suggests this is unlikely because LDA occurs rapidly over a 12-hour period.<sup>2</sup> However, with the widespread availability of ultrasound units and information regarding the normal anatomic location of the abomasum in late gestation and early lactation,<sup>1</sup> it would appear that ketotic dairy cows in early lactation without an

auscultable left-sided ping consistent with an LDA could benefit from ultrasonographic determination of the abomasal position.

#### High-Level Grain Feeding

LDA is a disorder of throughput because of its relationship to diseases associated with high milk production and concentrate feeding. The practice of beginning to feed concentrates to high-producing dairy cattle during the last few weeks of the dry period in preparation for the transition to lactation after parturition (**lead feeding**) may be a high risk factor for LDA. Cows dried off in high body condition scores are at increased risk of LDA because of inadequate dry matter intake around the time of parturition.

High-level grain feeding increases the flow of ruminal ingesta to the abomasum, which causes an increase in the concentration of volatile fatty acids, which can inhibit the motility of the abomasum. This inhibits the flow of digesta from the abomasum to the duodenum so that ingesta accumulates in the abomasum. The large volume of methane and carbon dioxide found in the abomasum following grain feeding may become trapped there, causing its distension and displacement. However, the role of an increase in abomasal volatile fatty acid concentration as the cause of the abomasal atony is controversial.

#### Dietary Crude Fiber

A crude fiber concentration of less than 16% to 17% in the diet of dairy cows was considered a significant risk factor for LDA. Some initial epidemiologic studies indicated that cows affected with LDA were higher producers than their herdmates, and they were from higher-producing herds than herds without LDAs. The affected cows were also older and heavier than the average for cows examined in the survey.

The feeding of an experimental **completely pelleted ration** to dairy cattle resulted in an increased incidence of LDA: 17% compared with 1.6% in cows receiving loose alfalfa hay, sorghum silage, and an 18% crude protein concentrate. The pelleted ration was finely ground and the short length of the dietary fiber may have been a risk factor by increasing volatile fatty acid and gas production.

**In summary, feeding rations high in carbohydrates, inadequate levels of roughage, and crude fiber levels below 17% during the last few weeks of pregnancy are probably important dietary risk factors.**

#### Animal Risk Factors

A hospital-based case-control study of LDA and AV in cattle based on the medical records of 17 North American veterinary teaching hospitals over a period of 10 years compared risk factors for the two diseases.

#### Breed and Age of Cow

LDA occurs predominantly in Holstein Friesian, Guernsey, and Jersey cows. The breed disposition for LDA has been controversial. Some studies have found higher risk of LDA occurring in Holstein Friesian cattle and a lower risk in Brown Swiss cattle compared with the risk in Simmental Red Holstein cross cows in Switzerland. In other studies, a breed disposition for displaced abomasum was found in Ayrshire, Canadienne, Guernsey, Holstein Friesian, and Jersey cattle. In vitro studies of contractile activity of the abomasal wall of healthy cows of different breeds did not find any differences between breeds of cattle.

The ratio of LDA to AV cases was 7.4 to 1. The risk for the two diseases increased with age with **greatest risk at 4 to 7 years of age**. Dairy cattle were at higher risk of developing LDA than beef cattle, with an odds ratio of 95. Female cattle were at a higher risk of developing LDA than male cattle, with an odds ratio of 29.

#### Season of the Year

The odds of both diseases varied considerably throughout the year, with the lowest number of cases in the autumn. The **odds of AV and LDA were highest in January and March**, respectively. The **greater incidence of the disease in the spring** may also be related to the depletion of roughage supplies on farms in the Midwest region of the United States. In other regions of the world, the disease occurs throughout the year independently of the incidence of parturition.

#### Influence of Weather

The possible effects of weather on the incidence of abomasal displacement has been examined. In a study over a period of 2 years, on 26 farms with a total of 6500 Holstein Friesian lactating cows, 373 cases of abomasal displacement occurred. A change from sunny, warm, and dry days to cool, overcast, and humid days was associated with an increased incidence of displacement. There were no effect of either wind velocity or atmospheric pressure.

#### Milk Production

The relationship between high milk yield or high milk yield potential and LDA has been examined in several studies and the results are inconclusive. In some observations, a higher incidence of the disease occurred in high-yielding cows. Later studies found no difference in herd milk yield between high- and low-incidence herds. Genetic correlations between LDA and production of milk and protein are very small and should be independent for selection. In some studies, dairy herds with a high mean PTA milk index were associated with a high occurrence of LDA.

#### Late Pregnancy

Because parturition appears to be the most common precipitating factor, it has been postulated that during late pregnancy the rumen is lifted from the abdominal floor by the expanding uterus and the abomasum is pushed forward and to the left under the rumen. Following parturition, the rumen subsides, trapping the abomasum, especially if it is atonic or distended with feed, as it is likely to be if the cow is fed heavily on grain. A longitudinal ultrasound study identifying changes in abomasal position from 3 months before to 3 months after calving failed to provide support for this widely held belief.<sup>1</sup>

Proportionately fewer cases of AV than LDA occurred during the first 2 weeks after parturition (28% and 57%, respectively). Because proportionately fewer cases of AV develop in the immediate postpartum period it is suggested that the rumen volume may directly influence the direction of abomasal displacement. On the basis of these findings, it is suggested that abomasal atony is a prerequisite for AV and LDA, and that existence of a less than full abdomen because of reduced rumen volume is a major risk and facilitates development of AV and LDA. It is suggested that normal rumen volume is an effective barrier against LDA and that the high incidence of LDA in lactating dairy cattle is the result of the additive effects of decreased rumen volume, increased **abdominal void** immediately after parturition, and increased exposure to factors that induce abomasal hypomotility. Additional indirect evidence for the **rumen barrier** hypothesis is that feeding a high-roughage diet, containing at least 17% crude fiber, immediately before parturition is a commonly recommended and successful strategy for minimizing the incidence of LDA.

#### Concurrent Diseases

Cows with an LDA are more likely to have had retained placenta, ketosis, stillborn calf, metritis, twins, or parturient paresis than control cows. Concurrent diseases were present in 30% of AV cases and 54% of LDA cases. The greater incidence of concurrent disease in LDA suggests that inappetence and anorexia results in **decreased rumen volume**, which would predispose to displacement to the left. Diseases of the wall of the abomasum (secondary ulceration) and ketosis and fatty liver are common concurrent diseases in dairy cows with LDA.

#### Preexisting Subclinical Ketosis and Hepatic Lipidosis

Ketosis is one of the most common complications of LDA, but whether or not preexisting subclinical ketosis is a risk factor for LDA has been controversial. Some clinical studies have reported that subclinical ketosis is a risk factor for LDA. The serum activity of

aspartate transaminase (AST) and the serum concentration of  $\beta$ -hydroxybutyrate may be used in dairy cows during the first and second weeks after parturition as tests to predict the subsequent diagnosis of LDA. Serum AST activities between 100 and 180 U/L, and serum  $\beta$ -hydroxybutyrate concentrations between 1.0 and 1.6 mmol/L were associated with an increased odds ratio and likelihood ratio of LDA. The predictive ability of serum AST activity and serum  $\beta$ -hydroxybutyrate concentration has been confirmed in a study in Iran; serum non-esterified fatty acid, calcium, sodium, and potassium concentrations were also identified as being significant predictors of an increased risk of LDA development.<sup>3</sup> Hypokalemia may decrease abomasal contraction activity via its effect on the resting membrane potential of abomasal smooth muscle cells.<sup>4</sup> The presence of hepatic lipidosis is related to postoperative outcome; cattle with increased serum concentrations of AST are more likely to have an increased liver fat percentage.<sup>5</sup>

The evaluation of two milk ketone tests as predictors of LDA in dairy cows within 2 weeks of parturition (median of 6 days postpartum and 12 days before the diagnosis of LDA) found high specificity but low sensitivity for prediction of subsequent occurrence of LDA. Increased ketone body concentration in milk is claimed to be a significant risk factor for LDA. This correlates with an increased fat to protein ratio in the first milk dairy herd improvement test as a predictor of subsequent LDA. However, the studies that conclude that preexisting subclinical ketosis occurs before the occurrence of LDA, and is a risk factor (cause-and-effect relationship), do not provide evidence that the cause of the ketosis was not a preexisting LDA. It is possible for the LDA to develop over a period of several days to a few weeks in susceptible cows, which would affect feed intake and contribute to the pathogenesis of ketosis. In addition, the sensitivity and specificity of the clinical diagnostic techniques (auscultation and percussion) are unknown, and it is plausible that some cases of LDA are not recognized in their very early stages when the fundus of the abomasum has moved only a small distance up along the left lateral abdominal wall. The studies did not describe how the diagnosis of LDA was made. Cows with LDA are also twice as likely to have another disease as cows without LDA, and the presence of those diseases could be risk factors for ketosis.

#### *Hypocalcemia*

Hypocalcemia, which is common in mature dairy cows at the time of parturition, has been suggested as an important contributing factor in LDA. Blood calcium levels affect abomasal motility; motility is normal down to a threshold value of 1.2 mmol total

calcium/L and below that level abomasal motility is absent. In a series of 510 dairy cows, those with hypocalcemia 12 hours before parturition (serum ionized calcium concentrations <4.0 mg/dL or total serum calcium concentration <7.9 mg/dL) had a 4.8 times greater risk of developing LDA than did normocalcemic cows. Other studies concluded that hypocalcemia is not an important risk factor for LDA. In cows with LDA, the ionized calcium is not significantly different from controls.

#### *Metabolic Predictors of Left-Side Displacement of Abomasum*

There is a predictive association of prepartum nonesterified fatty acids (NEFA) and postpartum  $\beta$ -hydroxybutyrate concentrations with LDA. In cows with subsequent LDA, mean NEFA concentrations began to diverge from the means of cows without LDA 14 days before calving, whereas mean serum NEFA concentrations did not diverge until the day of calving. Prepartum, only NEFA concentration was associated with the risk of subsequent LDA. Between 0 and 6 days before calving, cows with NEFA concentration of 0.5 mEq/L or less were 3.6 times more likely to develop LDA after calving. Between 1 and 7 days postpartum, retained placenta, metritis, and increasing serum concentration of  $\beta$ -hydroxybutyrate and NEFA were associated with increased risk of subsequent LDA. Serum  $\beta$ -hydroxybutyrate was a more sensitive and specific test than NEFA concentration. The odds of LDA were eight times greater in cows with serum  $\beta$ -hydroxybutyrate levels of 1.2 mmol/L or higher. Cows with a milk  $\beta$ -hydroxybutyrate concentration of 1.2 mmol/L or higher were 3.4 times more likely to develop LDA. Serum calcium concentration was not associated with LDA. In summary, the strategic use of metabolic tests to monitor transition dairy cows should focus on NEFA in the last week prepartum and  $\beta$ -hydroxybutyrate in the first week postpartum.

Endotoxemia appears to play a role in the periparturient period via alterations in metabolism and the immune response. The results of an experimental study in periparturient dairy cows indicated that intermittently induced endotoxemia was associated with an increased incidence of LDA.<sup>6</sup>

#### *Genetic Predisposition*

The prevalence of LDA is positively associated with milk yield, milk-fat yield, and milk protein yield.<sup>7</sup> LDA is associated with specific sires and dams, and it is generally accepted that genetic predisposition is a risk factor for abomasal displacement. Most estimates for heritability ( $h^2$ ) of LDA range from 0.2 to 0.5. Relative to Holstein Friesian cattle, the German Fleckvieh has a much lower incidence of LDA despite being feed similar rations.<sup>8,9</sup> Holstein Friesian cows have a

lower content of the vasoactive intestinal polypeptide, substance P, than German Fleckvieh cows, and this might provide an explanation for their predisposition to abomasal displacement.<sup>8</sup>

Recent studies have identified single nucleotide polymorphism (SNP) and an insertion mutation associated with an increased risk of LDA via decreased expression of the motilin gene in the abomasum.<sup>9-11</sup> Motilin is a potent natural prokinetic agent (erythromycin is an agonist), and a biologically plausible hypothesis is that dairy cattle with the SNP defect have abomasal hypomotility and are therefore at increased risk of developing LDA. A gene locus at the *SLITRK5* gene has also been associated with LDA; this gene is involved in neurologic activities such as axonogenesis and synaptic transmission.<sup>12</sup> This gene also has a biologically plausible association with abomasal hypomotility.

Cattle with LDA have a deeper abdomen and greater vertical distance between the ventral abdomen and descending duodenum.<sup>13</sup> This vertical distance represents the luminal pressure that must be generated within the abomasum for emptying to occur; the greater the distance the greater is the intraluminal pressure required for emptying, therefore, the contractile ability of the abomasum must be greater. As such, abomasal hypomotility is more likely to result in abomasal displacement in cattle with deep abdomens, and skeletal structure is moderately heritable.

#### *Miscellaneous Animal Risk Factors*

Unusual activity, including jumping on other cows during estrus, is a common history in cases not associated with parturition. Occasional cases occur in calves and bulls, and the disease occurs only rarely in beef cattle. Retained fetal membranes, metritis, and mastitis are common with LDA but a cause-and-effect relationship has been difficult to establish. In one retrospective study, the disease was associated in terms of increased relative risk with periparturient factors such as stillbirth, twins, retained placenta, metritis, aciduria, ketonuria, and low milk yield in the previous lactation.

#### *Economic Importance and Effects on Production and Survivorship*

The economic losses from the disease include lost milk production during the illness and postoperatively, and the cost of the surgery. The effects of LDA on test-day milk yields from 12,572 cows from parities 1 to 6 over a 2-year period were evaluated. From calving to 60 days after diagnosis, cows with LDA yielded on average 557 kg less milk than cows without LDA and 30% of the losses occurred before diagnosis. Milk loss increased with parity and productivity and milk losses were greatest in the highest yielding cows. Cows with LDA were nearly twice



as likely to have another disease as were cows without LDA. Cows with LDA are more likely to be removed from the herd at any point in time after the diagnosis than their herdmates. Cows with LDA survived a median of 18 months, and control cows survived a median of 27 months. Low milk production is a common reason for removal of cows with an LDA and the probability of removal increased as the lactation number increased.

### PATHOGENESIS

In the nonpregnant cow, the abomasum occupies the ventral portion of the abdomen very nearly on the midline with more to the right of the midline, with the pylorus extending to the right side caudal to the omasum. As pregnancy progresses, the enlarging uterus occupies an increasing amount of the abdominal cavity. The uterus begins to slide under the caudal aspects of the rumen, reducing rumen volume by one-third at the end of gestation. This also forces the abomasum forward and slightly to the left side of the abdomen, although the pylorus continues to extend across the abdomen to the right side.<sup>14</sup> After calving, the uterus retracts caudally toward the pelvic inlet, which under normal conditions allows the abomasum to return to its normal position (see earlier section on ultrasonography of the abomasum). During LDA, the pyloric end of the abomasum slides completely under the rumen to the left side of the abdomen. The relative lack of rumen fill and abomasal hypomotility permits the abomasum to distend and move into the left side of the abdomen.

Normally, the abomasum contains fluid and is located in the ventral part of the abdomen. In postpartum cows, the abomasum may shift to the left without causing any clinical signs. **Abomasal hypomotility and gaseous distension are considered to be the primary dysfunctions in LDA.** A decline in plasma concentration of calcium around the time of parturition may contribute to the abomasal hypomotility. The existence of abomasal hypomotility precedes distension and displacement of the abomasum. The gas accumulated in the abomasum consists mainly of methane (70%) and carbon dioxide. In a normal abomasum, the gas production is equal to the clearance in an oral or aboral direction. When motility of the abomasum is inadequate, accumulation of gas occurs. The origin of the excess gas is uncertain, but there is evidence that the gas in the abomasum originates from the rumen in association with increased concentrate feeding and an increase in volatile fatty acid concentrations in the abomasum. A high-grain, low-forage diet can promote the appearance of volatile fatty acids in the abomasum by reducing the depth of the ruminal mat or raft (consisting primarily of the long fibers of forages). Physical reduction of forage particle length

by chopping forages too finely before ensiling or overzealous use of mixer wagons also can contribute to loss of rumen raft. The rumen raft captures grain particles so that they are fermented at the top of the ruminal fluid. The volatile fatty acids produced at the top of the ruminal fluid are generally absorbed from the rumen with little volatile fatty acid entering the abomasum. In cows with an inadequate rumen raft, grain particles fall to the ventral portion of the rumen and reticulum in which they are fermented or pass on to the abomasum. The volatile fatty acids produced in the ventral rumen can pass through the ruminoreticular orifice to enter the abomasum before the rumen can absorb them. A thick ruminal raft is generally present during the dry period, when cows are fed a high forage diet, but the depth of the raft is rapidly reduced in early lactation, especially if dry matter intake decreases. Also, when cows are fed a higher grain ration, there is less regurgitation of the cud and mastication, and less saliva produced, which affects buffering of the rumen. The amount of effective fiber determines the consistency and depth of the rumen raft and stimulates rumen contractions. Total mixed rations that are easily sorted by cows may affect the ratio of forage to concentrate of total feed consumed, which contributes to the development of an LDA.

The atonic gas-filled abomasum becomes displaced under the rumen and upward along the left abdominal wall, usually lateral to the spleen and the dorsal sac of the rumen. It is primarily the fundus and greater curvature of the abomasum that becomes displaced, which in turn causes displacement of the pylorus and duodenum. Based on epidemiologic observations, it is hypothesized that a reduced rumen volume in the immediate postpartum period when there is some abdominal void allows this displacement to occur. The omasum, reticulum, and liver are also displaced to varying degrees. The displacement of the abomasum invariably results in rupture of the attachment of the greater omentum to the abomasum. In some cases, the LDA resolves spontaneously; such cases are known as “floaters.”

LDA can be experimentally induced by placement of a stomach tube through the nasal passage into the rumen. A rumenotomy is then performed and the tube guided through the reticuloomasal orifice and omasal canal into the abomasum. The tube is then secured to a halter placed on the animal to prevent tube migration. The rumenotomy and abdomen are closed, and the animal cast using ropes into right lateral recumbency. While maintaining this position, the abomasum is distended with air and the animal encouraged to stand. At this time, an LDA is present and readily auscultable.<sup>15</sup> Right-side displaced abomasum can be induced using a similar method but casting the animal into left lateral recumbency.<sup>15</sup>

Insulin resistance is common in cows with an LDA, but direct comparisons with the disease in humans cannot be made because lactating cattle metabolize a large amount of glucose that enters mammary epithelial cells through noninsulin-dependent pathways. As a consequence, interpretation of plasma glucose-insulin concentrations in lactating dairy cows must consider the impact of the level of milk production on that relationship. Mild increases in plasma insulin concentrations associated with hyperglycemia but independent of ketosis are common in cows with LDA, but these animals also have decreased milk production. In vitro studies of abomasal motility indicate that the contractions of the longitudinal muscle from the pyloric myenteric plexus of cows with an LDA or RDA are significantly reduced compared with muscle from normal cows. In cows with an LDA and high concentrations of blood glucose and insulin, the myoelectrical activity of the abomasum was reduced, but it increased following surgical correction along with a decrease in the concentrations of glucose and insulin.

In cattle with LDA, there is probably some interference with the function of the esophageal groove caused by slight rotation of all the stomachs in a clockwise direction as viewed from behind the cow, and this impedes forward passage of digesta. The obstruction of the displaced segment is incomplete and, although it contains some gas and fluid, a certain amount is still able to escape and the distension rarely becomes severe. There is no interference with blood supply to the trapped portion of the LDA, so the effects of the displacement are entirely those of interference with digestion and movement of the ingesta, leading to a state of chronic inanition.

A mild metabolic alkalosis with hypochloremia and hypokalemia are common, probably because of the abomasal hypomotility, continued secretion of hydrochloric acid into the abomasum, and impairment of flow into the duodenum. Affected cattle usually develop secondary ketosis which, in fat cows, may be complicated by the development of the fat mobilization syndrome and hepatic lipidosis. Endotoxemia does not occur in LDA or RDA.

### Abomasal Luminal Gas Pressure, Volume, and Perfusion in Cows With Left Displaced Abomasum or Abomasal Volvulus

The luminal pressure in LDA is increased (median 9 mm Hg; range 4–21 mm Hg), which may contribute to the pathogenesis of abomasal ulceration. Abomasal luminal pressure and volume is higher in cattle with an AV than in cattle with an LDA. Abomasal perfusion decreases as luminal pressure increases in cattle with an AV or LDA.

### Perforating Abomasal Ulceration

Perforating abomasal ulceration and acute local peritonitis with fibrinous adhesions also occur in some cases of LDA. Abdominal pain and pneumoperitoneum are common sequelae. The ulcers may perforate acutely and cause rapid death from acute diffuse peritonitis. Duodenal ulceration has also been associated with LDA.

### CLINICAL FINDINGS

#### General Appearance and Ketosis

Usually within a few days or a week following parturition there will be inappetence, sometimes almost complete **anorexia**, a marked **drop in milk production**, and varying degrees of **ketosis**, based on ketonuria and other clinical findings of ketosis. It is not uncommon to diagnose an LDA that was treated for ketosis, improved for a few days, and then relapsed.

On inspection of the abdomen, the left lateral abdomen appears “**slab-sided**” because the rumen is smaller than normal and displaced medially by the abomasum. The temperature, heart rate, and respirations are usually within normal ranges. The feces are usually reduced in volume and softer than normal, but periods of profuse diarrhea may occur.

#### Status of Reticulorumen and Spontaneous Abomasal Sounds

Ruminal movements are common but decreased in frequency and intensity and sometimes inaudible, even though there are movements of the left paralumbar fossa indicating rumen motility. In some cases, the rumen pack is palpable in the left paralumbar fossa, and the rumen contractions and sounds can be detected in the fossa as in normal cows. However, the rumen sounds may not be audible over an area anterior to the fossa in which they are also audible in normal cows. The absence of normal ruminal sounds in the presence of abdominal ripples suggests the presence of an LDA.

Auscultation of an area below an imaginary line from the center of the left paralumbar fossa to just behind the left elbow reveals the presence of **high-pitched tinkling sounds**, which often have a progressive peristaltic character. These are **abomasal sounds** and may occur several times per minute or infrequently (as long as 5 minutes apart). They are not related in occurrence to ruminal movements, and this can be ascertained by simultaneous auscultation over an area between the upper third of the 9th and 12th ribs and palpation of the left paralumbar fossa for movements of the dorsal sac of the rumen. While auscultating over the same area and ballotting the left lower abdomen just below the fossa, high-pitched fluid-splashing sounds of the LDA are commonly audible.

### Pings of the Left Displaced Abomasum

**Percussion**, using a flick of the finger or a plexor, and **simultaneous auscultation over an area between the upper third of the 9th and 12th ribs of the abdominal wall** commonly elicits the high-pitched tympanitic sounds (**pings**) that are characteristic of LDA. These pings may not be present if the cow has just previously been transported to a clinic for surgery but they will commonly reappear in 24 to 48 hours. Occasionally, careful, repeated, time-consuming examinations using percussion and simultaneous auscultation are necessary to elicit the pings.

#### Acute Left Displaced Abomasum

In rare cases there is initially a sudden onset of anorexia accompanied by signs of moderate abdominal pain and abdominal distension. These are the acute cases, which are uncommon. An obvious bulge caused by the distended abomasum may develop in the anterior part of the upper left paralumbar fossa and this may extend up behind the costal arch almost to the top of the fossa. The swelling is tympanitic and gives a resonant note on percussion. In acute cases the temperature may rise to 39.5°C (103°F) and the heart rate to 100 beats/min, but in the more common subacute cases the temperature and pulse rate are normal. The appetite returns but is intermittent and selective, with the animal eating only certain feeds, particularly hay. There may be transitory periods of improvement in appetite and disappearance of these sounds, especially after transport or vigorous exercise.

#### Concurrent Perforating Abomasal Ulceration

Perforating abomasal ulceration occurs concurrently in some cases of LDA, resulting in localized peritonitis and pneumoperitoneum. Affected cattle have the ping over the left abdomen typical of an LDA, but a ping over both the right and left paralumbar fossae caused by pneumoperitoneum is also common. Abdominal pain caused by the local peritonitis is characterized by tensing of the abdominal wall, grunting, and arching of the back on deep palpation over the abomasal area. The peritonitis is associated with a fever. The prognosis in these cases is unfavorable.

#### Other Clinical Features

##### Ultrasound Examination

Ultrasound examination can assist in the diagnosis of abomasal displacements. In cattle with LDA, the abomasum is seen between the left abdominal wall and the rumen. The LDA contains fluid ingesta ventrally and a gas cap of varying size dorsally. Occasionally, the abomasal folds are seen in the ingesta. In cattle with AV, the liver is displaced medially from the right abdominal

wall by the abomasum, which has an ultrasonographic appearance similar to that described for left displacement. Whether the liver is displaced or not is an important component of differentiating an RDA (liver not displaced) from an AV (liver displaced).

#### Rectal Examination

On rectal examination a sense of emptiness in the upper right abdomen may be appreciated. The rumen is usually smaller than expected and displaced to the right of the midline in cattle with a large LDA. Only rarely is the distended abomasum palpable to the left of the rumen, and in these circumstances usually it is a small cow, a large LDA, and a small rumen. Occasionally, there is chronic ruminal tympany.

#### Secondary Ketosis and Hepatic Lipidosis

Cows in fat body condition at parturition commonly have severe ketosis and the fat mobilization syndrome secondary to LDA. The disease can be fatal unless aggressively treated.

#### Atrial Fibrillation

A paroxysmal atrial fibrillation is present in some cases, which is considered to be caused by a concurrent hypochloremic, hypokalemic metabolic alkalosis. Following surgical correction and normalization of acid-base and electrolyte abnormalities, the arrhythmia usually disappears within 5 days.

#### Course of Left-Side Displacement of the Abomasum

The course of an LDA is highly variable. Undiagnosed cases usually reach a certain level of inanition and may remain at an equilibrium for several weeks or even a few months. Milk production decreases to a small volume and the animal becomes thin, with the abdomen greatly reduced in size.

#### Unusual Cases of Left-Side Displacement

Occasional cases occur in cows that are clinically normal in all other respects. In one case, a cow had an LDA, which was confirmed at necropsy, for 1.5 years, during which time she calved twice and ate and produced milk normally.

#### Left-Side Displacement of the Abomasum in Calves

In calves, the clinical findings include inappetence, reduced weight gain, recurrent distension of the left paralumbar fossa and a metabolic ping, and fluid-splashing sounds on auscultation and percussion of the left flank.

### CLINICAL PATHOLOGY

#### Hemogram

There are no marked changes in the hemogram unless there is concurrent disease,

particularly metritis, mastitis, or pneumonia. There is usually a mild hemoconcentration evidenced by elevations of the packed cell volume (PCV), hemoglobin, and total serum protein.

### Serum Biochemistry

A mild metabolic alkalosis with slight hypochloremia and hypokalemia are usually present. A moderate to severe ketonuria is always present, but the plasma glucose concentration is usually within the normal range or elevated. Ketosis is the most common complication of LDA and severe cases of ketosis are commonly accompanied by fatty liver. The serum activity of AST and  $\beta$ -hydroxybutyrate can be measured in dairy cows during the first and second weeks after parturition as possible tests to predict the subsequent diagnosis of LDA. Serum AST activity between 100 and 180 U/L and serum  $\beta$ -hydroxybutyrate concentration between 1.0 and 1.6 mmol/L were associated with increased odds ratio and likelihood ratio of LDA.

In cows with fatty liver, plasma lipoprotein concentrations are decreased. Cows with LDA may have varying degrees of fatty liver. Fat degeneration is present in liver biopsy samples from 55% of cows with LDA. In some cows with LDA, liver biopsies found 31% fat infiltration and in those same animals, serum AST and  $\gamma$ -glutamyl transferase activities were increased. In addition to those of lipoprotein lipids, concentrations of **apolipoprotein B-100 (apo-100)**, the major apoprotein in very low-density lipoproteins and low-density lipoproteins, and **apolipoprotein A-1 (apoA-1)**, the predominant protein constituent of high-density lipoprotein, are reduced in cows with fatty liver. Decreased serum concentrations of apo-100 and apoA-I occur in cows with ketosis and LDA and may be used during the stages of nonlactation and early lactation to predict cows susceptible to ketosis and LDA. Dairy cows with LDA also have low plasma and liver  $\alpha$ -tocopherol content, and plasma vitamin E concentrations may decrease in cows with increased liver triglyceride content.

A mild hypocalcemia is usually present, but parturient hypocalcemia is uncommon.

The acute phase reactants Serum Amyloid A (SAA) and haptoglobin are increased in dairy cows with LDA.<sup>16,17</sup> This does not necessarily reflect the presence of an inflammatory condition, because cows with LDA have mild to moderate hepatic lipidosis, based on a liver fat percentage of 9%, and SAA and haptoglobin concentrations are most strongly associated with liver fat percentage.<sup>16</sup>

**Ghrelin, motilin, and gastrin** are gastrointestinal motility hormones that have an increased serum concentration in cattle with LDA.<sup>18</sup> The increase in ghrelin concentration may reflect decreased feed intake or the presence or a partial obstruction to abomasal

emptying. The increase in motilin concentration may also be related to a partial obstruction to abomasal emptying. Finally, hypergastrinemia is most likely from the presence of abomasal distension.

### Cowside Tests of Blood $\beta$ -Hydroxybutyrate Concentration and Urinary Ketones

For **urine ketones** the Ketostix (urine nitroprusside strip detecting acetoacetate) is used routinely to provide a cost-effective method to detect subclinical ketosis. For more details on testing for ketosis please read the ketosis section in Chapter 17. **Blood  $\beta$ -hydroxybutyrate** tests are available using a point of care device and whole blood. **Milk ketone** tests are not as clinically useful as urine or blood ketone tests and are now rarely used.

### Peritoneal Fluid Analysis

The peritoneal fluid in dairy cattle with LDA is within reference limits, although the mean fibrinogen concentration is increased relative to controls.<sup>19</sup> This change is consistent with fibrin deposition on parts of the displaced abomasum; fibrin deposition is particularly evident on the cranial aspect of the pyloric antrum within 1 to 2 cm of the pylorus.

### Abomasocentesis

Centesis of the displaced abomasum through the 10th or 11th intercostal space in the middle third of the left abdominal wall may reveal the presence of fluid with no protozoa and a pH of 2. Ruminal fluid will have protozoa and a pH of between 6 and 7. Fluid is not always present in appreciable quantity in the abomasum and a negative result on puncture cannot be interpreted as eliminating the possibility of abomasal displacement.

### NECROPSY FINDINGS

The disease is not usually fatal but carcasses of affected animals are sometimes observed at abattoirs. The displaced abomasum is trapped between the rumen and the ventral abdominal floor and contains variable amounts of fluid and gas. In occasional cases, it is fixed in position by adhesions, which usually arise from a perforated abomasal ulcer with local peritonitis. Fatty liver is common in cows that died from complications of LDA within a few days of parturition or following surgery.

### DIFFERENTIAL DIAGNOSIS

Left-side displacement of the abomasum is most common in cows within 2 weeks of parturition and is characterized by gauntness, a relatively slab-sided left abdomen, and secondary ketosis. The characteristic pings can

usually be elicited by percussion and auscultation. The presence of secondary ketosis in a cow immediately after parturition should arouse suspicion of the disease. Primary ketosis usually occurs in high-producing cows 2–6 weeks after parturition. The response to treatment of primary ketosis is usually permanent when treated early, whereas the response to treatment of the ketosis because of left-displaced abomasum is temporary and a relapse in a few days is common.

Left-side displacement of the abomasum must be differentiated from those common diseases of the forestomach and abomasum that cause inappetence to anorexia, ketosis, reduced or abnormal reticulorumen motility, and abnormal sounds on percussion and auscultation of the left abdomen.

### Common differentials

- **Simple indigestion** is characterized by normal vital signs, inappetence to anorexia, history of change of feed, reduced milk production, a relatively full rumen with reduced frequency and intensity of contractions, the absence of pings, and spontaneous recovery in 24 h.
- **Primary ketosis** is characterized by inappetence, decline in milk production, strong ketonuria, normal vital signs, full rumen with reduced frequency and intensity of contractions, dry but normal amount of feces, and response to therapy with dextrose and propylene glycol in 12–24 h.
- **Traumatic reticuloperitonitis** in its acute form is characterized by ruminal stasis, mild fever, a grunt on deep palpation over the xiphoid sternum, and a slight neutrophilia with a regenerative left shift. However, in subacute and chronic traumatic reticuloperitonitis a painful grunt may be absent, the temperature and hemogram may be normal, and on auscultation and percussion the atonic rumen may be mistaken for a left-displaced abomasum. The tympanic sounds of an atonic rumen occur over a larger area than with left-displaced abomasum and are not as high-pitched as those of left-displaced abomasum—they have been called “pungs.” An exploratory laparotomy may be necessary to distinguish between the two, although laparoscopy, ultrasonography, and abdominocentesis are alternatives.
- **Vagal indigestion** is characterized by progressive abdominal distension caused by a grossly distended rumen with or without an enlarged abomasum; it is more common before parturition. Dehydration is also common.
- **Fat cow syndrome** at parturition is characterized by excessive body condition, inappetence to anorexia, ketonuria, and reduced to absent reticulorumen motility, but there are usually no pings over the rumen.



## TREATMENT

Surgical correction is now commonly practiced and several techniques have been devised with emphasis on avoidance of recurrence of the displacement.<sup>20</sup> There is one report of a 93% cure rate at 1 week in 72 cattle with LDA by rolling the cow and then performing moxibustion (acupuncture with heating of selected acupoints).<sup>21</sup>

### Open Surgical Techniques

**The right paralumbar fossa omentopexy** is the most widely used means of correcting left displacement of the abomasum. The right paralumbar fossa omentopexy is popular because the animal is standing, an excellent exploratory laparotomy can be performed, and the surgeon can work alone without assistance. More skill is required than for the right paramedian abomasopexy. **Right paramedian abomasopexy** is technically simpler but is declining in popularity. The major disadvantages with this procedure are the cow is placed in dorsal recumbency, which increases the potential for aspiration pneumonia, and the number of people required to restrain the animal in this position. An additional disadvantage is that the ventral incision in cows with right paramedian abomasopexy appears to be painful to the cow when in sternal recumbency, leading to an increase in standing time postoperatively compared with right flank omentopexy.<sup>22</sup> A **left flank abomasopexy** can also be performed with the cow in a standing position, but this technique requires an assistant and should only be used in cattle with a prominent LDA ping.

### Laparoscopic Techniques

Two laparoscopic techniques have been developed, a two-step (Janowitz) method and a one-step method.<sup>22-24</sup> The main advantage of these methods are their minimally invasive nature. Abomasal emptying rate is faster immediately after laparoscopy-guided abomasopexy than after omentopexy via right flank laparotomy.<sup>25</sup> Rumen contraction rate and milk yield increased more quickly after laparoscopy-guided abomasopexy, compared with values obtained after omentopexy.<sup>25</sup> Moreover, there is less muscle damage with laparoscopic surgery based on postoperative increases in creatine kinase activity, relative to right flank laparotomy and omentopexy or left flank laparotomy and omentopexy.<sup>26</sup> As a consequence, some producers prefer the laparoscopic technique because cows more rapidly return to full appetite and expected milk production. The laparoscopic techniques require at least one assistant and expensive laparoscopic equipment and are most frequently performed in northern Europe.

### Closed Suture Techniques

A few closed suturing abomasopexy techniques have been advocated because they are rapid and inexpensive, but the complications

that can occur indicate that laparotomy and omentopexy are desirable. In the blind suture technique, the precise location of insertion of the sutures is unknown. Complications include peritonitis, cellulitis, abomasal displacement or evisceration, complete forestomach obstruction, and thrombophlebitis of the subcutaneous abdominal vein. The roll-and-toggle-pin suture, a modification of the closed suture technique, is also available and has the advantage that the abomasum is identified by the presence of abomasal gas (burnt almond smell). Closed suture techniques are associated with higher culling rates at 14 and 60 days (10% and 20%, respectively) than surgical correction by a flank incision with the cow in a standing position (3% and 7%, respectively).<sup>27</sup> As a consequence, closed suture techniques are not recommended for cattle that are expected to be retained in the milking herd.

### Prokinetic and Analgesic Administration

As expected, abomasal emptying is slower in dairy cows with LDA than healthy cows at the same stage of lactation. An interesting finding is that the abomasal emptying rate is further reduced immediately after surgical correction of LDA via right flank laparotomy and omentopexy.<sup>1</sup> This finding suggests that the postoperative course may be improved by the administration of a **prokinetic**, which is a therapeutic agent that stimulates, coordinates, and restores gastrointestinal motility.

The results of clinical trials and experimental studies indicate that the most effective prokinetic for abomasal hypomotility in cattle is erythromycin (8.8–10 mg/kg, intramuscularly). Cows treated with the motilin agonist erythromycin (10 mg/kg, intramuscularly) once before surgery had an increased rate of abomasal emptying immediately after surgery and greater milk production on postoperative days 1 and 2 than did control cows. This provides strong support for the routine administration of prokinetic agents in the immediate postoperative period.<sup>28</sup> The prokinetic effect of erythromycin is sufficiently strong to warrant a clinical trial of its use in the medical treatment of LDA in conjunction with rolling the cow and repositioning the abomasum to the ventral midline. Four other macrolides (spiramycin, tilmicosin, tulathromycin, and tylosin) are also effective prokinetic drugs in healthy ruminants,<sup>29</sup> but their motility-promoting effects are milder than erythromycin and have not been proven in a clinical trial of diseased cattle to be clinically significant. Parenteral administration of erythromycin and other macrolides as prokinetic agents constitutes extralabel drug use. It is clearly inappropriate to administer an antimicrobial for a nonantimicrobial effect (such as increasing abomasal emptying rate) because such use may unnecessarily promote the development of antimicrobial resistance.

The available evidence indicates that the direct acting parasympathomimetic agent bethanechol (0.07 mg/kg subcutaneously) can result in a general increase in gastrointestinal tract tone, which may not necessarily facilitate abomasal emptying. In fact, a generalized increase in intestinal smooth muscle tone may impede abomasal emptying in ruminants administered an effective prokinetic agent. Parasympathomimetics cannot be currently recommended as prokinetic agents in promoting abomasal motility because of the lack of controlled clinical trials demonstrating their effectiveness. Calcium and potassium are likely to be effective prokinetic agents in cattle with marked hypocalcemia and hypokalemia, respectively. The available evidence indicates that metoclopramide is not an effective prokinetic drug in cattle, and its use cannot be recommended.

Postoperative administration of the nonsteroidal antiinflammatory agent ketoprofen (3 mg/kg BW intramuscularly at the end of surgery and 24 hours later) did not alter heart rate and rumen motility or blood  $\beta$ -hydroxybutyrate concentrations.<sup>30</sup> The nonsteroidal antiinflammatory agent flunixin meglumine (2.2 mg/kg BW intravenously) once immediately before surgery increased the rumen contraction rate on day 1 after surgery compared with untreated animals.<sup>28</sup> The results of other clinical trials indicate that flunixin meglumine is not an effective treatment for abomasal hypomotility.

### Survivorship Following Surgery to Correct Left-Side Displacement of the Abomasum

In a series of 564 cases of displaced abomasum (466 LDA and 98 RDA), survival after surgery was evaluated after 10 days and 15 months. More LDA than RDA cows were discharged as cured (82% versus 74%). However, survival after the early postsurgical period was similar for RDA and LDA cows. In LDA cows, the factors associated with a favorable prognosis were a short duration of disease; an undisturbed general condition; good appetite; normal feces; a higher BW; lower hematocrit, hemoglobin, and erythrocyte counts; lower urea and bilirubin concentrations and AST activity; and higher serum sodium, potassium, and chloride concentrations compared with cows with an unfavorable prognosis. A thorough clinical and laboratory examination with special emphasis on general physical condition, liver function, and dehydration status are important in determining the prognosis of abdominal surgery in LDA.

Longevity in the herd at 1 year following corrective surgery is associated with higher blood  $\beta$ -hydroxybutyrate and serum magnesium concentrations at the time of surgery.<sup>31</sup>

### Treatment of Ketosis

Parenteral dextrose and oral propylene glycol are necessary for treatment of the ketosis and

to avoid fatty liver as a complication. Post-surgical convalescence of cows with LDA is clearly related to disturbances in energy metabolism and fatty liver. During convalescence, in cows with no fatty liver or moderate fatty liver, the feed intake and daily milk production increases steadily. In cows with severe fatty liver, feed intake remains low. This emphasizes the need for effective treatment of excessive lipomobilization, ketosis, and fatty liver along with surgical correction of the LDA. All cases of LDA should be corrected as soon as possible to minimize the incidence of peritoneal adhesions and abomasal ulcers, which may perforate and cause sudden death.

### Rumen Transfaunation Following Surgery for Left-Side Displacement of the Abomasum

The administration of 10 L of rumen fluid via a stomach tube immediately after surgical correction of an LDA, and on the next day, resulted in a beneficial effect characterized by a greater feed intake, less degree of ketonuria, and higher milk yield compared with control cows given water. This technique is covered in more detail in the section in this chapter on acute ruminal acidosis.

### CONTROL

The transition period occurring 2 to 3 weeks before and after calving is a major risk period in the etiology of LDA. The prepartum depression of dry matter intake and the slow postpartum increase in dry matter intake are risk factors causing lower ruminal fill, reduced forage to concentrate ratios (in non-total mixed ration feeding systems), and increased incidence of other postpartum diseases. Retained fetal membranes, metritis, and either clinical or subclinical ketosis and hypocalcemia are probable risk factors for LDA. Excessive amounts of concentrate, or too rapid an increase in concentrate feeding during the peripartum period, increases the risk of LDA, because higher volatile fatty acid concentration in the abomasal contents leads to decreased abomasal motility and emptying and excess gas in the abomasum. (See further details of importance of crude fiber in the rumen and its effect on the abomasum under Pathogenesis.)

### Prepartum Nutrition and Management

Reduction of the incidence of LDA in a dairy herd can be achieved by optimal nutrition and management during the dry period. The following principles are important:

- Avoid a negative energy balance prepartum by avoiding overconditioning and by providing optimal feed bunk management to cows in late gestation.
- Feed some concentrates before calving to ensure development of ruminal papillae.

- Maximize dry matter intake in the immediate postpartum period.
- Ensure palatable feed and water are available to periparturient cows at all times.
- Feed bunk management must ensure that cows have adequate access to fresh feed at all times to maximize dry matter intake in late pregnancy and thus improve energy balance.
- Energy density of prepartum diets should not exceed 1.65 Mcal of NE<sub>i</sub>/kg of dry matter.

Every effort should be made to minimize dietary alterations near parturition that could result in indigestion. The amount of grain and corn (maize) silage fed prepartum should be kept at a minimum, whereas other forages are fed ad libitum.

Several experiments have shown no response in production to feeding large quantities of grain or concentrates (lead feeding) before parturition when cows were in good condition at drying-off and were fed well following parturition. Consequently, there seems little reason to continue the practice of “steaming-up” cows before parturition.

### Crude Fiber Intake

Ensuring an adequate intake of a high-fiber diet to dairy cows during the “far-off” and “close-up” periods in late pregnancy and the immediate “postfreshening” period is of critical importance to the prevention of this disease. The high-fiber diet will physically expand the rumen and provide a barrier against abomasal migration. The basic principle is to maintain adequate ruminal filling before and after calving. This requires careful **analysis and implementation** of the dry cow feeding program. Readers are referred to National Research Council (2001; see Further Reading literature) for details on feeding programs for dairy cattle.

The emphasis in the dry cow feeding program must be on increasing dry matter intake, increasing particle length, and effective fiber content of the ration. Feeding a high-roughage diet is consistent with one of the most commonly recommended and successful management strategies for minimizing LDA during the postparturient period. This means ensuring adequate fiber content of at least 17%. An adequate level of fiber will also aid in the control of SARA, which may occur when dairy cows are fed grain in the latter part of the dry period in preparation for lactation.

### Monensin in Controlled-Release Capsule Prepartum

Monensin is an ionophore antibiotic that alters volatile fatty acid production in the rumen in favor of propionate, which is a major precursor for glucose in the ruminant. A monensin controlled-release capsule is available as an aid in the prevention of

subclinical ketosis in lactating dairy cattle. The device delivers 335 mg of monensin per day for 95 days. A monensin controlled-release capsule has been shown to decrease the incidence of subclinical ketosis, displaced abomasum, and multiple illnesses when administered to dairy cows 3 weeks before calving. It is likely that these effects on clinical health are mediated by improved energy balance in monensin-supplemented cows. There are improvements in energy indicators such as increased glucose and decreased  $\beta$ -hydroxybutyrate after calving.

The administration of a monensin controlled-release capsule to cows 3 weeks prepartum significantly decreased NEFA and  $\beta$ -hydroxybutyrate and significantly increased concentrations of serum cholesterol and urea in the week immediately precalving. No effect of treatment was observed for calcium, phosphorus, or glucose in the precalving period. After calving, concentrations of phosphorus were lower and  $\beta$ -hydroxybutyrate tended to be lower, and cholesterol and urea were higher in monensin-treated cows. There was no effect of treatment on NEFA, glucose, or calcium in the first week after calving. Monensin treatment administered precalving significantly improved indicators of energy balance in both the immediate precalving and postcalving periods. The prevalence of subclinical ketosis as measured by cow-side tests was lower in monensin-treated cows. These findings indicate more effective energy metabolism in monensin-treated cows as they approach calving, which is important for the prevention of retained placenta, clinical ketosis, and displaced abomasum. Generally, a 40% reduction in both LDA and clinical ketosis can be expected with precalving administration of monensin controlled-release capsules. In addition, a 25% decrease in retained placenta may occur.

### Genetic Selection

LDA is a moderately heritable trait; therefore the incidence of LDA should be lowered by genetic selection. It is likely that genetic tests will be developed for the SNPs associated with LDA, and that a test and cull approach will be used for bulls extensively used in artificial insemination programs.

#### TREATMENT AND CONTROL

##### Treatment

Perform open or closed (blind) surgical techniques to replace and secure the abomasum in a normal position (R-1)

Treat concurrent diseases such as ketosis, metritis, and mastitis (R-1)

Return acid-base, electrolyte, and hydration status to normal (R-1)

*Continued*

**Control**

- Avoid negative energy balance prepartum (R-1)
- Avoid overconditioning in prepartum (R-1)
- Provide optimal feed bunk management (R-1)
- Control milk fever and subclinical hypocalcemia (R-1)
- Minimize ketosis and subclinical ketosis in periparturient period (R-1)
- Maximize dry matter intake and ensure adequate fiber intake in late gestation (R-1)

**FURTHER READING**

- Constable PD, Nouri M, Sen I, Baird AN, Wittek T. Evidence-based use of prokinetic drugs for abomasal disorders in cattle. *Vet Clin North Am Food Anim Pract.* 2012;28:51-70.
- Doll K, Sickinger M, Seeger T. New aspects in the pathogenesis of abomasal displacement. *Vet J.* 2009;181:90-96.
- Geishauser T. Abomasal displacement in the bovine—a review on character, occurrence, etiology and pathogenesis. *J Vet Med A Physiol Pathol Clin Med.* 1995;42:229-251.
- National Research Council. *Nutrient Requirements of Dairy Cattle.* 7th ed. Washington, DC: National Academy Press; 2001.
- Sen I, Wittek T, Guzelbektes H. Metabolic indicators and risk factors of left displaced abomasum in dairy cattle. *Eurasian J Vet Sci.* 2015;32:63-69.

**REFERENCES**

1. Wittek T, et al. *J Vet Intern Med.* 2005;19:905.
2. Itoh N, et al. *J Vet Med A Physiol Pathol Clin Med.* 2006;53:375.
3. Basiri N, et al. *Comp Clin Pathol.* 2013;22:431.
4. Zurr L, Leonhard-Marek S. *J Dairy Sci.* 2012;95:5750.
5. Kalaitzakis E, et al. *J Am Vet Med Assoc.* 2006;229:1463.
6. Zebeli Q, et al. *J Dairy Sci.* 2011;94:4968.
7. Mömke S, et al. *J Dairy Sci.* 2008;91:4383.
8. Sickinger M, et al. *Am J Vet Res.* 2008;69:1247.
9. Mömke S, et al. *PLoS ONE.* 2012;7:e35562.
10. Zerin I, et al. *Vet J.* 2015;204:17.
11. Doll K. *Vet J.* 2015;205:329.
12. Biffani S, et al. *Livestock Sci.* 2014;167:104.
13. Wittek T, et al. *Vet Rec.* 2007;161:155.
14. Wittek T, et al. *J Am Vet Med Assoc.* 2005;227:1469.
15. Jahromi R, et al. *Iran J Vet Res.* 2014;15:290.
16. Guzelbektes H, et al. *J Vet Intern Med.* 2010;24:213.
17. Maden M, et al. *J Vet Intern Med.* 2012;26:1470.
18. Ozturk AS, et al. *Vet Rec.* 2013;172:636.
19. Grosche A, et al. *Vet Rec.* 2012;170:413.
20. Niehaus AJ. *Vet Clin North Am Food Anim Pract.* 2008;24:349.
21. Lee JY, et al. *Am J Chin Med.* 2007;35:63.
22. Newman KD, et al. *J Am Vet Med Assoc.* 2005;227:1142.
23. Roy JP, et al. *J Am Vet Med Assoc.* 2008;232:1700.
24. Seeger T, et al. *Am J Vet Res.* 2006;67:472.
25. Wittek T, et al. *J Am Vet Med Assoc.* 2009;234:652.
26. Wittek T, et al. *Vet Rec.* 2012;171:594.
27. Sterner KE, et al. *J Am Vet Med Assoc.* 2008;232:1521.
28. Wittek T, et al. *J Am Vet Med Assoc.* 2008;232:418.
29. Rashnavadi M, et al. *Can J Vet Res.* 2014;78:61.
30. Newby NC, et al. *J Dairy Sci.* 2013;96:1511.
31. Reynen JL, et al. *J Dairy Sci.* 2015;98:3806.

**RIGHT-SIDE DISPLACEMENT OF THE ABOMASUM AND ABOMASAL VOLVULUS****SYNOPSIS**

**Etiology** Abomasal atony associated with high-level grain feeding. Cause in calves unknown.

**Epidemiology** Mature dairy cows within a few weeks of calving. Abomasal volvulus usually preceded by right-side displacement of abomasum but not a necessary precursor. Occurs in calves spontaneously.

**Signs** Inappetence to anorexia, depression, absence of rumination, scant abnormal feces, distension of right abdomen, ping over right flank, fluid-splashing sounds on ballottement of right flank, and distended abomasum may be palpable rectally. Abomasal volvulus manifested by anorexia, abdominal pain, tachycardia, absence of feces, ping, fluid-splashing sounds, severe dehydration and shock, and distended and tense abomasum rectally that displaces the liver medially. High case-fatality rate unless surgically corrected.

**Clinical pathology** Hypokalemia, hypochloremia, metabolic alkalosis, and severe dehydration.

**Lesions** Gross distension and/or torsion of abomasum.

**Diagnostic confirmation** Laparotomy.

**Differential diagnosis**

*Dilatation and displacement of abomasum:* impaction of abomasum in vaginal indigestion, abomasal ulceration with dilatation, and cecocolic volvulus, and chronic or subacute traumatic reticuloperitonitis.

*Abomasal volvulus:* intestinal obstruction and acute diffuse peritonitis.

*Pings in right abdomen:* Right-side displacement of abomasum, abomasal volvulus, cecal dilatation, intestinal obstruction, dilatation of descending colon and rectum, and pneumoperitoneum.

**Treatment** It is difficult to differentiate right displaced abomasum from abomasal volvulus. Medical treatment if detected early. Deflation of distended abomasum. Surgical correction. Fluid and electrolyte therapy. Oral fluid and electrolyte therapy.

**Control** Nothing reliable.

**ETIOLOGY**

The etiology of RDA is not well understood, but it is probably similar to LDA. **Abomasal atony is thought to be the precursor of dilatation and displacement, and consequently AV.** The cause of the abomasal atony and gaseous distension is thought to be related to the feeding of grain and the production of excessive quantities of gas and volatile fatty acids. The dilatation is thought to be the

result of primary distension of the abomasum occurring because of either obstruction of the pylorus or primary atony of the abomasal musculature. In adult cattle with RDA, there is no obstruction of the pylorus and hypomotility of the abomasum seems to be the more likely cause, similar to LDA, with a full rumen making RDA more likely. In calves, there may be an obstruction of the pylorus resulting in dilatation.

**EPIDEMIOLOGY****Occurrence and Incidence****Lactating Dairy Cows**

Dilatation, RDA, and AV occur primarily in adult dairy cows, usually within the 3 to 6 weeks after calving. The disease is recognized with increased frequency because of improvements in diagnostic techniques and perhaps because more cows are being fed intensively for milk production. Incidence rates on individual dairy herds are not available, but based on cases of abomasal disease admitted to a veterinary teaching hospital, the ratio of AV to LDA was 1 to 7.4.

**Beef Cattle**

Abomasal displacement and volvulus has been described in beef cattle breeds from 1 month to 6 years of age with a median age of 10 months. The typical case was under 1 year of age.

**Calves**

AV occurs in young calves from a few weeks of age up to 6 months, usually without a history of previous illness, which suggests that the cause may be accidental. Abomasal bloat occurs in calves with no apparent predisposing cause.

**Mature Bulls and Pregnant Cows**

AV has also occurred in bulls and pregnant cows but to a much lesser degree.

**Risk Factors**

There is little information available on the epidemiology of RDA and AV. Most of the risk factors described for LDA are relevant to RDA and AV. The feeding of high levels of grain to high-producing dairy cows in early lactation is considered to be a major risk factor. However, there are no good reliable data to support this cause-and-effect relationship. Why the disease occurs in a small percentage of high-producing dairy cattle being fed high-level grain rations is unknown.

When this disease was originally described, the incidence appeared to be higher in Scandinavian countries. The risk factors in those situations were not identified, but it was thought that indoor winter feeding and the shift of the acid-base balance to an alkalotic state during the winter months might be important factors. In Denmark, the ingestion of large quantities of soil particles on unwashed root crops used as feed is



considered to be significant. This may be the reason for the higher incidence of the disease in the later part of the winter. However, attempts to reproduce the condition by feeding large quantities of sand have been unsuccessful. Because atony is often associated with vagal indigestion, a relationship between the two has been suspected, but there are usually no lesions affecting the reticulum or vagus nerves.

A hospital-based epidemiologic study of the risk factors for AV and FDA was performed using the medical record abstracts derived from the veterinary teaching hospitals of 17 North American veterinary schools. The risk for AV increased with increasing age, with a greater risk in dairy cows 4 to 7 years of age. Dairy cattle were at a much higher risk than beef cattle. Approximately 28% of cases of AV occurred within the first 2 weeks and 52% within 1 month following parturition. This indicates that proportionately fewer cases of AV than left displacement occur during the first 2 weeks following parturition. The hospital case-fatality rate for AV and LDA was 24% and 6%, respectively.

It is currently thought that abomasal atony is a prerequisite for the development of right-side displacement and AV, and that following parturition the abdominal void and decreased rumen volume facilitates such development. The direction of the displacement could be influenced predominantly by the volume of the forestomach. Immediately after parturition, displacement occurs to the left because of a reduction in the size of the rumen volume. Several weeks later the dilated abomasum moves caudally and dorsally in the right abdomen because the volume of the forestomach is much larger, providing an effective barrier (rumen barrier).

AV has also occurred following correction of LDA by casting and rolling.

## PATHOGENESIS

### Definition of Right Displaced Abomasum and Abomasal Volvulus

Many of the reports related to RDA and AV are confusing because they lack a clear case definition. The following definition was proposed in 1991 and should be used as the standard definition for different clinical entities or departures from this definition.

The following criteria should be used to differentiate four abomasal conditions, namely RDA, AV, omaso-abomasal volvulus (OAV), and reticulomaso-abomasal volvulus (ROAV). RDA is diagnosed when (1) a distended viscus (abomasum) is in the right cranial abdominal quadrant without displacement of the liver, such that the diaphragmatic surface of the liver still contacts the right abdominal wall; (2) the serosal surface of the abomasum visible through the incision may or may not be covered by omentum, depending on the nature of the

displacement; (3) a firm twist is not palpated at either the omasal-abomasal or reticulomasal junction; and (4) clockwise rotation of the abomasum is not observed from the right side of the animal during gas decompression, but it is observed when looking from behind the animal. AV is diagnosed if (1) a distended viscus (abomasum) is identified in the right cranial abdominal quadrant displacing the liver medially, such that the diaphragmatic surface of the liver no longer contacts the right abdominal wall; (2) the serosal surface of the abomasum visible through the incision is not covered by omentum; (3) a firm twist is palpated, primarily involving the omasal-abomasal junction; and (4) surgical correction required clockwise rotation of the abomasum when viewed from the right side of the animal. OAV was diagnosed if Conditions (1) and (2) for AV are true and (3) a firm twist is palpated and determined to be located primarily at the reticulomasal junction; (4) the omasum is ovoid or partially flattened instead of being spherical; and (5) surgical correction requires clockwise rotation of both the abomasum and omasum when viewed from the right side of the animal. ROAV is very rare and is most accurately diagnosed at necropsy; a diagnosis includes Conditions (1) and (2) for AV, as well as the presence of a firm twist located primarily at the reticulomasal junction and a flattened omasum.<sup>1</sup>

### Dilatation and Displacement Phase

In RDA, abomasal atony occurs initially, resulting in the accumulation of fluid and gas in the viscus leading to gradual distension and displacement in a caudal and dorsal direction on the right side (dilatation phase). This is best appreciated as a counterclockwise rotation of the abomasum as viewed from behind the cow and is therefore a mirror image of LDA. During the dilatation phase, which commonly extends over several days, there is continuous secretion of hydrochloric acid, sodium chloride, and potassium into the abomasum, which becomes gradually distended and does not evacuate its contents into the duodenum. This leads to dehydration and metabolic alkalosis with hypochloremia and hypokalemia. These changes are typical of a functional obstruction of the upper part of the intestinal tract and occur in experimental RDA and experimental obstruction of the duodenum in calves. An RDA is a surgical emergency because the abomasum is unstable and can quickly move into an AV.

### Volvulus Phase

Following the dilatation and displacement phase, the distended abomasum may twist in a clockwise (viewed from the right side) direction in a vertical plane around a horizontal axis passing transversely across the body in the vicinity of the omaso-abomasal

orifice. The volvulus will usually be of the order of 180° to 270° and causes a syndrome of acute obstruction with local circulatory impairment and ischemic necrosis of the abomasum. Abomasal volvulus is the correct term; use of the term abomasal torsion is discouraged because a torsion is a twist along the longitudinal axis and an AV has a twist along its longitudinal axis as well as a mesenteric axis.

The abomasal luminal pressure in naturally occurring AV is increased (median 12 mm Hg; range 4–32 mm Hg). Increased luminal pressure in AV could cause mucosal injury by local vascular occlusion and affect the prognosis. Among cattle with AV, the abomasal luminal pressure was significantly higher in those that died or were sold following surgery (median 21 mm Hg) than in cattle that recovered and were retained in the herd (median 11 mm Hg). Calculation of likelihood ratios suggests that selecting cattle with a value of 16 mm Hg for luminal pressure optimized the distribution of cattle into productive and nonproductive groups.

The abomasal luminal gas pressure and volume were higher in cattle with an AV than in cattle with an LDA. As luminal gas pressure increases, abomasal perfusion decreases, resulting in varying degrees of ischemia to the abomasal mucosa. In cows with an AV, L-lactate concentration in the gastroepiploic vein was greater than that in the jugular vein, whereas no difference in L-lactate concentrations was detected in cows with an LDA. This indicates that cattle with a large and tensely distended abomasum associated with a volvulus or LDA should have the viscus decompressed as soon as possible to minimize the potential for ischemia-induced injury to the abomasal mucosa, which may result in ulcers and perforations.

Up to 35 L of fluid may accumulate in the dilated abomasum of a mature 600-kg cow, resulting in dehydration, which will vary from 5% to 12% of BW. In uncomplicated cases, there is only slight hemoconcentration and a mild electrolyte and acid-base imbalance, with moderate distension of the abomasum. These cases are reversible with fluid therapy. In complicated cases there is severe hemoconcentration, hypovolemia, and dehydration and marked metabolic alkalosis with a severely distended abomasum. The degree of dehydration is a reliable preoperative prognostic aid. The hypovolemia, compression of the caudal vena cava, and stimulation of the sympathetic nervous system in response to distension and twisting of the abomasum results in tachycardia, which is also a reliable preoperative prognostic aid.

In cattle with severe and prolonged AV, a metabolic acidosis may develop and be superimposed on the metabolic alkalosis, leading to a low base excess concentration of extracellular fluid. In experimental disease in

sheep, the metabolic acidosis observed terminally was associated with an increase in plasma L-lactate concentration probably caused by hypovolemic shock and anaerobic metabolism. These severe cases require surgery and intensive fluid therapy. A **paradoxical aciduria** may occur in cattle affected with metabolic alkalosis associated with abomasal disease. This is most likely caused by the concurrent presence of dehydration and the need for sodium retention (hence low urine sodium concentration), hypokalemia and the need for potassium retention (hence the low urine potassium concentration), and hypochloremia, with the net result a decrease in urine strong ion difference and therefore urine pH.<sup>2</sup>

### Postsurgical Complication in Right-Side Displacement of the Abomasum or Abomasal Volvulus

The postoperative survival rate of cattle with AV was 87% and that of OAV was 55% in one case series. The postoperative survival rate of cattle with ROAV is likely to be 0%. Part of the difference in survival rate is caused by the magnitude and severity of the ischemic damage to the abomasal wall, and some cases may be caused by excessive stretching to the vagus nerve as it courses around the medial aspect of the reticulum. Affected cattle may exhibit clinical signs consistent with vagal indigestion syndrome; however, necropsy examination of these animals usually demonstrates the presence of thrombosis, abomasal wall necrosis, and peritonitis.

### CLINICAL FINDINGS

#### Right Displaced Abomasum and Abomasal Volvulus (Adult Cattle)

In right-side dilatation and displacement there is usually a history of calving within the last few weeks with inappetence and decreased milk production; the feces are reduced in amount and are abnormal. The cow may have been treated for an uncertain disorder of the digestive tract within the last several days and in many instances the clinical signs are identical to those for LDA, except that the ping detected during simultaneous percussion and auscultation is located on the right side instead of the left side. **Percussion and simultaneous auscultation over the right middle to upper third of the abdomen commonly elicits a characteristic high-pitched ping with variable fluid splash** The ping rarely extends to the eighth rib because a ping in this location indicates displacement of the liver medially by a distended viscus (the abomasum), meeting the case definition for AV.

AV usually develops several days after the onset of dilatation of the abomasum, but it is usually not possible to distinguish precisely the stages of the disease. However, in AV that consists of a continuum of clinical signs, it is helpful to identify early and advanced cases. In early cases there is usually depression,

dehydration, no interest in feed, perhaps increased thirst, and sometimes muscular weakness. Affected cows will commonly sip water continuously. The temperature is usually normal, the heart rate will vary from normal to 100 beats/min, and the respirations are usually within the normal range. The mucous membranes are usually pale and dry. The reticulorumen is atonic, and the rumen contents (the rumen pack) feel excessively doughy. The distended abomasum may be detectable as a tense viscus on palpation immediately behind and below the right costal arch. Ballotment of the middle third of the right lateral abdomen immediately behind the right costal arch along with simultaneous auscultation will reveal fluid-splashing sounds, suggesting a fluid-filled viscus. In many cases the dilatation continues and after 3 to 4 days the abdomen is visibly distended on the right side and the abomasum can be palpated on rectal examination. It may completely fill the right lower quadrant of the abdomen and feel tense and filled with fluid and gas.

The clinical findings are usually much more severe in advanced cases of AV. The abdomen is visibly distended, depression and weakness are marked, dehydration is obvious, the heart rate is 100 to 120 beats/min, and respirations are increased. Recumbency with a grossly distended abdomen and grunting may occur and represents a poor prognosis. A rectal examination is very important at this stage. In the early stage the partially distended abomasum may be palpable with the tips of the fingers in the right lower quadrant of the abdomen. It may not be palpable in large cows. In the advanced stage, the distended tense viscus is usually palpable in the right abdomen anywhere from the upper to the lower quadrant and there is prominent fluid splash on succussion.

The feces are usually scant, soft and dark in color, and become bloodstained or melanic in the ensuing 48 hours if the cow lives long enough. The soft feces must not be mistaken for diarrhea, as is commonly done by the owner of the animal. Cattle with AV that is not surgically corrected will become recumbent and death usually occurs in 48 to 96 hours from shock and dehydration. Rupture of the abomasum may occur and cause sudden death.

#### Acute Abomasal Volvulus (Calves)

In calves with acute AV, there is a sudden onset of anorexia, acute abdominal pain with kicking at the belly, depression of the back, bellowing, and straining. The heart rate is usually 120 to 160 beats/min, the abdomen is distended and tense, and auscultation and percussion over the right abdomen reveals distinct high-pitched pings. Palpation behind the right costal arch reveals a tense viscus that is painful on even moderate palpation.

### Postsurgical Complication in Abomasal Volvulus

The most frequent complication encountered following surgical correction of RDA and AV resembles vagal indigestion, which occurs in 14% to 21% of cases. The case-fatality rate of cattle exhibiting postoperative signs consistent with vagal indigestion is high, with only 12% to 20% of affected animals returning to normal production. In affected cattle, there is ruminal distension, rumen hypermotility or atony, and abnormal feces (usually scant and dry).

### CLINICAL PATHOLOGY

#### Serum Biochemistry

There are varying degrees of hemoconcentration (increased PCV and total serum proteins), metabolic alkalosis, hypochloremia, and hypokalemia.<sup>3</sup>

The severity of volvulus can be classified, and the prognosis evaluated, according to the amount of fluid in the abomasum and the increase in heart rate:

- **Group 1:** abomasum distended principally with gas, normal heart rate, excellent prognosis
- **Group 2:** abomasum distended with gas and <20 L of fluid, heart rate <100 beats/min, good prognosis
- **Group 3:** abomasum distended with gas and ≥20 L of fluid, heart rate ≥100 beats/min, moderate prognosis

The heart rates before surgery are also valuable prognostic aids. Cows having pulse rates of 100 beats/min or more have a moderate prognosis.

A cross-sectional study of the serum electrolyte and mineral concentrations in dairy cows with abomasal displacement or volvulus at the time of on-farm diagnosis found lower serum potassium, chloride, calcium, magnesium, and phosphorus concentrations and an increase in the anion gap compared with controls.

#### Urinalysis

Paradoxical aciduria may also be present.

#### Hemogram

The total and differential leukocyte count may indicate a stress reaction in the early stages, and in the later stages of volvulus there may be leukopenia with a neutropenia and degenerative left shift caused by ischemic necrosis of the abomasum and early peritonitis.

#### Ultrasonography of Right Abdomen

Ultrasound can be used but seldom provides any clinically useful examination from that provided by the physical examination.<sup>4,5</sup> In particular, ultrasonography provides similar information to that provided by simultaneous percussion and auscultation, specifically whether there is displacement of the liver medial by a distended viscus (the abomasum), consistent with a large ping that

extends to the eighth rib and indicative of the presence of AV.

### Peritoneal Fluid Analysis

Peritoneal fluid is usually readily obtained in cattle with AV but is not required to make a diagnosis. Peritoneal fluid changes generally reflect changes in plasma concentrations, and as such most peritoneal fluid components provide no additional information to that provided by plasma biochemical analysis. Cattle with AV have an increase in the percentage of peritoneal fluid neutrophils that appeared necrotic or apoptotic.<sup>6</sup> They also have increased concentrations of D-dimer and fibrinogen in peritoneal fluid, which is consistent with abdominal inflammation.

### Abomasocentesis

Centesis of the distended abomasum will yield large quantities of fluid without protozoa and a pH of 2 to 4. The fluid may be serosanguineous when volvulus is present.

### PROGNOSTIC INDICATORS

Several clinical and laboratory findings have been examined as prognostic indicators of cows affected with RDA and AV. In a prospective study of 80 cattle with AV, the heart rate, hydration status, period of inappetence, and serum alkaline phosphatase activity were the best preoperative prognostic indicators. An anion gap of 30 mEq/L was indicative of a poor prognosis and was more accurate than either serum chloride concentration or base excess values. The surgical and postoperative findings in cattle with AV are good prognostic indicators of outcome. Cattle with OAV have a worse prognosis than those without omasal involvement. Large abomasal fluid volume, venous thrombosis, and blue or black abomasal color before decompression are all indicative of a poor prognosis.

The evaluation of the degree of circulatory insufficiency, dehydration, and levels of base excess and blood L-lactate concentration are also used as preoperative prognostic indicators. A preoperative blood L-lactate concentration  $\leq 2$  mmol/L is a good indicator of a positive outcome, whereas cattle with blood L-lactate concentration  $\geq 6$  mmol/L have a poor prognosis.<sup>7</sup> Postoperative decreases in blood L-lactate concentration are also a positive sign,<sup>8</sup> whereas postoperative decreased gastrointestinal motility is an unfavorable prognostic sign.

### NECROPSY FINDINGS

In abomasal dilatation the abomasum is grossly distended with fluid and some gas. The rumen may contain an excessive amount of fluid. In some cases there may be impaction of the pylorus with particles of soil or sand and there may be an accompanying pyloric ulcer. In AV the abomasum is grossly distended with brownish, sanguineous fluid

and is twisted. In complete volvulus the wall of the abomasum is grossly hemorrhagic and gangrenous and may have ruptured.

### DIFFERENTIAL DIAGNOSIS

The diagnosis and differential diagnosis of right displaced abomasum and abomasal volvulus is dependent on consideration of the presence or absence of pings in the right abdomen, the findings on rectal examination, and the other clinical findings, including the history. Detecting a ping on percussion and auscultation of the right abdomen must be accompanied by a rectal examination to determine the presence and nature of a gas-filled viscus to account for the ping.

#### Dilatation and displacement of abomasum

The characteristic features of dilatation and right-sided displacement of the abomasum are recent calving, a vague indigestion since calving, soft scant feces, a ping over the right abdomen, and the presence of the distended tense viscus in the right lower abdomen. It must be differentiated from the following:

- **Impaction of the abomasum associated with vagal indigestion** is characterized by an enlarged abomasum that pits on digital palpation and feels like a doughy mass behind the lower aspect of the costal arch, situated on the floor of the abdomen, whereas most cases of dilatation are situated more dorsally adjacent to the right paralumbar fossa. Pings are not present in abomasal impaction. A laparotomy may be required to distinguish between them.
- **Subacute abomasal ulceration with moderate dilatation** of the abomasum in a recently calved cow may not be distinguishable clinically from RDA. The presence of melena suggests abomasal ulcers, but these may be present as secondary complications in dilatation and RDA.
- **Cecocolic volvulus** is characterized by distension of the right flank, tympanitic sounds on auscultation and percussion, and the distended large intestine can usually be palpated and identified tentatively, on rectal examination, as more than one cylindrical, tense tube (10–20 cm in diameter).
- **Fetal hydrops** is characterized by bilateral distension of the lower abdomen and an enlarged gravid uterus palpable on rectal examination.
- **Chronic or subacute traumatic reticuloperitonitis** may resemble abomasal dilatation, but in the former there may be a grunt on deep palpation, the feces are usually firm and dry, the abdomen is gaunt, and a mild fever may be present. However, a laparotomy may be necessary to make the diagnosis. Abdominocentesis may be useful.
- **Abomasal volvulus** is characterized by abdominal distension of the right side, pings on percussion and auscultation, dehydration, weakness, and shock with a

heart rate up to 120 beats/min. The distended viscus can usually be palpated in the right lower quadrant of the abdomen. It must be differentiated from the following:

- **Intestinal obstruction** is characterized by a history of sudden onset of anorexia; abdominal pain; scant feces, which may be blood-tinged; and the affected portion of the intestines or loops of distended intestine may be palpable rectally.
- **Acute diffuse peritonitis** as a sequel to local peritonitis in a cow soon after calving may be indistinguishable from acute abomasal volvulus. There is severe toxemia, tachycardia, dehydration, abdominal distension, grunting, weakness, recumbency, and rapid death. Paracentesis of the peritoneal cavity will assist in the diagnosis.

#### Pings over the right abdomen

Diseases resulting in pings over the right abdomen include dilatation and distension of the abomasum, cecum, cranial duodenum, parts of the small intestine, descending colon, and rectum and pneumoperitoneum.

The evaluation of a ping is dependent on the size of the area and location of the sound elicited by percussion and simultaneous auscultation. The common clinical characteristics of these pings are as follows:

- **Dilatation and right-side displacement of the abomasum:** the ping is usually audible between the 9th and 12th ribs extending from the costochondral junction of the ribs to their proximal third aspects. Rarely will the ping extend into the paralumbar fossa in right-side dilatation and displacement.
- **Abomasal volvulus:** the area of the ping is typically larger than that of the RDA and extends more cranially to the 8th rib and caudally, often extending into the right paralumbar fossa but not completely filling the fossa. Also, the ventral border of the ping area in an abomasal volvulus is variable, and is often horizontal because of the level of fluid within the abomasum.
- **Cecal dilatation:** the ping is usually confined to the dorsal paralumbar fossa and caudal one or two intercostal spaces. In dilatation and torsion of the cecum the ping usually fills the paralumbar fossa and extends cranially and caudally the equivalent of two rib spaces. The ascending colon is often involved in a torsion of the cecum, which will result in an enlarged ping area extending from the paralumbar fossa. In dilatation of the ascending colon the ping may be centered over the proximal aspects of the 12th and 13th ribs.
- **Intestinal obstruction:** the presence of multiple, small areas of ping that vary in pitch and intensity is characteristic of dilatation of the jejunoleum caused by intussusception or intestinal volvulus.
- **Dilatation of descending colon and rectum:** a ping in the right caudal

Continued



abdomen just ventral to the transverse processes of the vertebrae indicates dilatation of the descending colon and rectum, which is commonly heard following rectal examination.

- **Pneumoperitoneum:** pings may be audible over a wide area of the dorsal third of the abdomen bilaterally. In one study, the sensitivity and predictive values of abomasum as the source of the ping were 98% and 96%, respectively; for cecum and/or ascending colon, the sensitivity and predictive values were both 87%.

## TREATMENT

The prognosis in RDA and AV is favorable if the diagnosis is made within a few days after the onset of clinical signs and before large quantities of fluid accumulate in the abomasum. The immediate treatment for both conditions should be surgical (right flank laparotomy with the cow standing) because RDA cannot be reliably differentiated from AV without performing surgery.

### Surgical Correction

A right flank laparotomy for correction of the right displacement or volvulus is the preferred surgical method. Intensive fluid therapy is usually necessary preoperatively and for several days postoperatively to correct the dehydration and metabolic alkalosis and to restore normal abomasal motility.

### Prokinetic Administration

Electromyographic studies of the postoperative abomasal and duodenal motility in cattle with surgically corrected AV reveal loss of motility, some retrograde motility, and loss of spike activity. This is associated with a decreased rate of abomasal emptying.<sup>9</sup>

These findings suggest that the postoperative course may be improved by the administration of a **prokinetic**, which is a therapeutic agent that stimulates, coordinates, and restores gastrointestinal motility.

The results of clinical trials and experimental studies indicate that the most effective prokinetic for abomasal hypomotility in cattle is erythromycin (8.8–10 mg/kg, intramuscularly). Cows treated with the motilin agonist erythromycin (10 mg/kg, intramuscularly) once before surgical correction of AV had an increased rate of abomasal emptying immediately after surgery and greater milk production on postoperative days 1 and 2 than did control cows. This provides strong support for the routine administration of prokinetic agents in the immediate postoperative period to cattle with RDA or AV. Four other macrolides (spiramycin, tilmicosin, tulathromycin, and tylosin) are also effective prokinetic drugs in healthy ruminants, but their motility-promoting effects are milder than erythromycin and have not been proven in a clinical trial of diseased cattle

to be clinically significant.<sup>10</sup> Parenteral administration of erythromycin and other macrolides as prokinetic agents constitutes extralabel drug use. It is clearly inappropriate to administer an antimicrobial for a nonantimicrobial effect (such as increasing abomasal emptying rate) because such use may unnecessarily promote the development of antimicrobial resistance.

Cholinergic agents have been used to help restore motility but are not effective and are not recommended. Empirical treatment with 500 mL of 25% calcium borogluconate intravenously may yield good results. The rationale for the calcium administration is to improve abomasal motility.

Rumen transfaunation to restore rumen function and appetite will provide a more effective stimulus to restore gastrointestinal tract motility. Cattle are also offered good-quality hay but no grain for 3 to 5 days after surgery and monitored daily.

Postsurgical complications resembling a vagal-indigestion-like syndrome have been described (see under Clinical findings, above).

### Fluid and Electrolyte Therapy

The composition of the fluids and electrolyte solutions that are indicated in RDA and AV has been a subject of much investigation. There are varying degrees of **dehydration, metabolic alkalosis, hypochloremia, and hypokalemia**. With the aid of a laboratory it is possible to monitor the serum biochemistry during administration of the fluids and electrolytes and to correct certain electrolyte deficits by adding (“spiking”) the appropriate electrolytes to the fluids. Without a laboratory, the veterinarian has no choice but to use the solutions that are considered safe and judicious. **Balanced electrolyte solutions containing sodium, chloride, potassium, calcium, and a source of glucose will usually suffice.** A mixture of 2 L of isotonic saline (0.85%), 1 L of isotonic potassium chloride (1.1%), and 1 L of isotonic dextrose (5%) given at the rate of 4 to 6 L/h intravenously is also recommended and reliable. Experimentally induced hypochloremic, hypokalemic metabolic alkalosis in sheep has been corrected using 0.9 (300 mOsm/L), 3.6 (1200 mOsm/L), and 7.2% (2400 mOsm/L) of sodium chloride solutions given intravenously over a 2-hour period with the administered volume determined by the estimated total extracellular fluid chloride deficit. Significant difference was not found among treatments, with all solutions resulting in the return of clinicopathologic variables to preexperimental values within 12 hours. The rapid intravenous replacement of chloride with small volumes of hypertonic saline solution is safe and effective for correction of experimentally induced hypochloremic, hypokalemic metabolic alkalosis in sheep.

A randomized clinical trial investigated the efficacy of rapid intravenous infusion of hypertonic saline solution (7.2%, 2 L over 10 minutes, equivalent to 3.4 mL/kg) followed by 10 L of 0.9% NaCl for 50 minutes for resuscitating cattle with AV.<sup>11</sup> Hypertonic saline treatment was compared with conventional intravenous fluid therapy using an equivalent sodium load in a large-volume isotonic solution (26 L of 0.9% NaCl in 65 minutes, equivalent to 400 mL/min). Cattle treated with hypertonic saline were more rapidly and effectively resuscitated at lower cost. This field study strongly supports the use of hypertonic saline in the treatment of dehydration and dairy cattle.<sup>11</sup>

### Oral Therapy

**Oral electrolyte therapy** has been recommended, particularly in the postoperative period following surgical drainage of the distended abomasum. A mixture of sodium chloride (50–100 g) and potassium chloride (50–120 g) is given orally daily postoperatively along with the parenteral fluids as necessary. Treatment with potassium chloride (120 g/day) orally can be continued daily until the cow resumes her normal appetite.

### Deflation of Distended Abomasum in Calves

Gas can be removed from a grossly distended (bloated) abomasum of calves as an emergency measure before surgical correction by laparotomy. The calf is placed in dorsal recumbency and the abdomen is punctured with a 16-gauge 12-cm hypodermic needle at the highest point of the distended abdomen between the umbilicus and the xiphoid. After the distension is relieved and fluid therapy is begun, the need for a laparotomy can be assessed and performed if necessary.

### CONTROL

No reliable information is available on the control of right-side dilatation, displacement, and volvulus of the abomasum. Because its pathogenesis is similar to LDA it would seem rational to recommend feeding programs that are used for the control of LDA.

### FURTHER READING

Geishauser T. Abomasal displacement in the bovine—a review on character, occurrence, etiology and pathogenesis. *J Vet Med A Physiol Pathol Clin Med.* 1995;42:229-251.

### REFERENCES

1. Constable PD, et al. *J Am Vet Med Assoc.* 1991;199:892.
2. Sahinduran S, Albay MK. *Revue Méd Vét.* 2006;157:352.
3. Constable PD, et al. *Am J Vet Res.* 2009;70:915.
4. Braun U, et al. *Am J Vet Res.* 2008;69:777.
5. Braun U, Feller B. *Vet Rec.* 2008;162:311.
6. Grosche A, et al. *Vet Rec.* 2012;170:413.
7. Boulay G, et al. *J Dairy Sci.* 2014;97:212.
8. Buczinski S, et al. *J Vet Intern Med.* 2015;29:375.
9. Wittek T, et al. *Vet Surg.* 2008;37:537.

10. Rashnavadi M, et al. *Can J Vet Res.* 2014;78:61.  
 11. Sickinger M, et al. *Vet J.* 2014;201:338.

## ABOMASAL IMPACTION IN CATTLE

Abomasal impaction is defined as the presence of drier than normal abomasal contents and a larger than normal abomasal volume.<sup>1</sup> Abomasal impaction of cattle may be a **primary disorder** or develop secondary to another condition, such as traumatic reticuloperitonitis (see section on vagal indigestion syndrome) or ingestion of an abnormal diet (**dietary abomasal impaction**).<sup>1</sup> Primary abomasal impaction is most common in postparturient dairy cattle and appears to be under diagnosed because the specific findings can only be determined during right flank exploratory laparotomy.

Dietary abomasal impaction occurs in cattle in the prairie provinces of western Canada during the cold winter months, and elsewhere with similar circumstances, when the animals are fed poor-quality roughage. The disease is most common in pregnant beef cattle, which increase their feed intake during extremely cold weather in an attempt to meet the increased needs of a higher metabolic rate. The disease has also occurred in feedlot cattle fed a variety of mixed rations containing chopped or ground roughage (straw and hay) and cereal grains and in late pregnant dairy cows on similar feeds.

### SYNOPSIS

**Etiology** Abomasal hypomotility in periparturient dairy cattle. Ingestion of abnormal diet, including large quantities of low-quality roughage during cold weather.

**Epidemiology** Periparturient dairy cattle (primary abomasal impaction). Pregnant primiparous beef cattle during cold weather consuming low-quality roughage (dietary abomasal impaction).

**Signs** Anorexia, scant feces, distension of abdomen, and loss of body weight. Normal vital signs initially. Rumen full and atonic. Right lower flank distended and may be able to palpate abomasum through abdominal wall and rectally in advanced cases. Periparturient dairy cattle with primary abomasal impaction may look very much like a left displaced abomasum, but a ping cannot be detected on the left side. Gradually become weak and recumbent.

**Clinical pathology** hypochloremia, hypokalemia, metabolic alkalosis.

**Lesions** Gross enlargement of abomasum impacted with dry, rumen-like contents; enlargement may be confined to pyloric antrum.

**Diagnostic confirmation** Laparotomy.

**Differential diagnosis** Impaction of abomasum associated with vagal indigestion, impaction of the omasum, diffuse peritonitis, and intestinal obstruction.

**Treatment** Medical treatment with mineral oil or dioctyl sodium sulfosuccinate. External massage of impacted pyloric antral contents and injection of dioctyl sodium sulfosuccinate (100 mL) directly into abomasal lumen during right flank laparotomy. Abomasotomy in extensive cases.

**Control** Provide nutrient requirements for pregnant beef cattle during cold weather.

## ETIOLOGY AND EPIDEMIOLOGY

### Primary Abomasal Impaction

Affected animals have distension and impaction of the pyloric antrum region only, or pyloric antrum and body. This appears to have a very similar epidemiology to that of LDA, with abomasal hypomotility likely to play a central role in the condition.

### Dietary Abomasal Impaction

The consumption of excessive quantities of poor-quality roughage, which are low in both digestible protein and energy, is the primary cause. Outbreaks of impaction with sand have occurred in which up to 10% of cattle at risk were affected. Impaction of the abomasum with sand can also occur in cattle if they are fed hay on sandy soils or root crops that are sandy or dirty, or sand is accidentally mixed into silage while it is being packed; in one herd outbreak it was estimated that cattle fed this silage were ingesting 0.7 kg of sand each day.<sup>2</sup> There is one report of severe sand abomasal impaction in five periparturient dairy cows housed in free stalls bedded with sand.<sup>3</sup> The diet fed to these dairy cows during late gestation was too acidogenic based on measured DCAD and urine pH. In this case the sand ingestion was attributed to pica.

The disease is most common in young pregnant beef cows that are kept outdoors year-round, including during the cold winter months, when they are fed roughages consisting of either grass or legume hay or cereal straw, which may or may not be supplemented with some grain. In these circumstances cows commonly lose 10% to 15% of their total BW from October to May and even more during very cold winters. In one retrospective study of the necropsy reports of cattle that died with abomasal impaction, 20% of the animals had lesions of traumatic reticuloperitonitis, 60% were thought to be caused by the ingestion of too much poor-quality roughage without a supplement of concentrate, and 20% did not fit into either category.

When large quantities of long roughage without sufficient grain are fed during very cold weather, the cattle cannot eat sufficient

feed to satisfy energy needs, so the roughage is then provided in a chopped form. The chopped roughage is commonly mixed with some grain in a mix mill but usually at an insufficient level to meet the energy requirements. Cattle can and do eat more of these chopped roughage-grain mixtures than of long roughage because the smaller particles pass through the forestomach at a more rapid rate. Impaction of the abomasum, omasum, and rumen may occur because of the relative indigestibility of the roughage. Outbreaks may occur affecting up to 15% of all pregnant cattle on individual farms when the ambient temperature drops to  $-5^{\circ}\text{C}$  to  $-10^{\circ}\text{C}$  ( $14^{\circ}\text{F}$  to  $-22^{\circ}\text{F}$ ) for several days.

Omasal and abomasal impaction has occurred in a group of beef suckler cows in late gestation housed in straw yards and fed solely on pea haulm. The disease has also occurred in feedlot cattle fed similar rations (e.g., 80% roughage, 20% grain) in an attempt to reduce the high cost of grain feeding and to satisfy beef grading standards that put the emphasis on producing a smaller amount of fat cover. With these constraints and the increased emphasis on roughage feeding, it is possible that the incidence of abomasal impaction may increase in feedlot cattle. The feeding of almond shells to dairy replacement heifers has also resulted in abomasal impaction.

The ingestion of gravel (stones) by dairy cattle kept in drylot facilities can result in complete, nonstrangulating intraluminal obstruction of the abomasum and duodenum. The gravel, consisting of sand and small stones, may be inadvertently mixed with the feed when it is being scraped from bunker silos. It is also possible that some cows may ingest the gravel when attempting to eat all available feed.

## PATHOGENESIS

A description of the likely pathogenesis of primary abomasal impaction is given in the section pathogenesis of LDA, and it is thought to be similar to that for abomasal displacement. In dietary abomasal impaction, chopped roughage and finely ground feeds pass through the forestomach of ruminants more quickly than long roughage, and perhaps in this situation the combination of low digestibility and excessive intake leads to excessive accumulation in the forestomach and abomasum. When large quantities of sand are ingested, the omasum, abomasum, large intestine, and cecum can become impacted. The sand that accumulates in the abomasum causes abomasal atony and chronic dilatation.

Once impaction of the abomasum occurs in both primary and dietary causes, a state of subacute obstruction of the upper alimentary tract develops. Hydrochloric acid continues to be secreted into the abomasum in spite of the impaction and hypomotility, resulting in hypochloremia and increased

strong ion difference (strong ion or metabolic alkalosis). Varying degrees of dehydration occur because fluids are not moving beyond the abomasum into the duodenum for absorption. Potassium ions are also sequestered in the abomasum, resulting in a hypokalemia. Almost no ingesta or fluids move beyond the pylorus, and dehydration, alkalosis, electrolyte imbalance, and progressive starvation occur. The impaction of the abomasum is usually severe enough to cause extensive distension, which impedes return of normal motility.

### CLINICAL FINDINGS

Periparturient dairy cattle with primary abomasal impaction have identical clinical signs to that of cattle with LDA, except that a ping is not auscultated in the left flank.

Complete anorexia, scant feces, and moderate distension of the abdomen are the usual presenting complaints given by the owner in cattle with dietary abomasal impaction. The onset is usually slow and progressive over a period of several days. Cattle that have been affected for several days have lost considerable weight and are too weak to rise. The body temperature is usually normal but may be subnormal during cold weather, which suggests that the specific fermentative action of the rumen is not sufficient to meet the energy needs of basal metabolism. The heart rate varies from normal to 90 to 100 beats/min and may increase to 120 beats/min in advanced cases in which hypochloremia, alkalosis, and dehydration are marked. The respiratory rate is commonly increased and an expiratory grunt caused by the abdominal distension may be audible, especially in recumbent cattle. A mucoid nasal discharge usually collects on the external nares and muzzle, which is usually dry and cracking because of the failure of the animal to lick its nostrils and the effects of the dehydration.

The rumen is usually static and full of dry rumen contents, or it may contain an excessive quantity of fluid in those cattle that have been fed finely ground feed. The pH of the ruminal fluid is usually within the normal range (6.5–7.0). The rumen protozoan activity ranges from normal to a marked reduction in numbers and activity as assessed on a low-power field. The impacted abomasum is usually situated in the right lower quadrant of the abdomen on the floor of the abdominal wall. It usually extends caudally beyond the right costal arch but may or may not be easily palpable because of the gravid uterus, but an impacted omasum may also be palpable. It may be impossible, however, to distinguish between an impacted abomasum and an impacted omasum. In feedlot steers and nonpregnant heifers the impacted abomasum and omasum may be easily palpable on rectal examination. Deep palpation and strong percussion of the right flank may elicit a “grunt,” which is common in acute traumatic reticuloperitonitis, and this is

probably caused by overdistension of the abomasum and stretching of its serosa.

The course of the disease in dietary abomasal impaction depends on the extent of the impaction when the animal is first examined and the severity of the acid-base and electrolyte imbalances. Severely affected cattle will die in 3 to 6 days after the onset of signs. Rupture of the abomasum has occurred in some cases, and death from acute diffuse peritonitis and shock occurs precipitously in a few hours. In sand impaction, there is considerable weight loss, chronic diarrhea with sand in the feces, weakness, recumbency, and death within a few weeks.

Severe impaction and distension of the rumen and the abomasum can occur in cattle given access to large quantities of finely chopped straw during the cold winter months. There is gross distension of the abdomen, anorexia, and scant dry feces, and affected animals will drop large, dry, fibrous cuds. The rumen is grossly distended and usually static.

Cows fed solely on pea haulm are dull and anorexic with grossly distended abdomens and varying degrees of bloat. Cattle with obstruction of the abomasum and duodenum with gravel are anorexic, depressed, and weak. The abdomen may be distended and rumen hypomotility or atony is present. The feces are scant. The obstruction cannot usually be felt on rectal examination, and a right flank laparotomy is necessary to make the diagnosis. A marked hypochloremic, hypokalemic metabolic alkalosis is characteristic.

### CLINICAL PATHOLOGY

A metabolic alkalosis, hypochloremia, hypokalemia, hemoconcentration, and a total and differential leukocyte count within the normal range are common. Hypochloremia is more severe in cattle with primary impaction confined to the pyloric antrum compared with cattle with primary impaction of the pyloric antrum and body.<sup>1</sup>

### NECROPSY FINDINGS

Cattle with primary abomasal impaction confined to the pyloric antrum are rarely necropsied because the condition responds well to treatment during surgery.

At necropsy of cattle with primary abomasal impaction that extends to the abomasal body or dietary abomasal impaction the abomasum is commonly grossly enlarged to up to twice normal size and impacted with dry rumen-like contents. The omasum may be similarly enlarged and impacted with the same contents as in the abomasum. The rumen is usually grossly enlarged and filled with dry ruminal contents or ruminal fluid. The intestinal tract beyond the pylorus is characteristically empty and has a dry appearance. Varying degrees of dehydration and emaciation are also present. If rupture of the abomasum

occurs, lesions of acute diffuse peritonitis are present. Abomasal tears, ulcers, and necrosis of the walls of the rumen, omasum, or abomasum may occur.

### TREATMENT

The challenge in treatment is to be able to recognize the cases that will respond to treatment and those that will not and should therefore be slaughtered immediately for salvage.

Dairy cattle in early lactation with primary abomasal impaction confined to the pyloric antrum respond extremely well to treatment during right flank laparotomy and have a similar postoperative course to cattle with LDA that have been surgically corrected.<sup>1</sup>

Cattle that have a severely impacted abomasum and are weak with a marked tachycardia (100–120 beats/min) are poor treatment risks and should be euthanized if they are of low economic value. Rational treatment would appear to consist of correcting the metabolic alkalosis, hypochloremia, hypokalemia, and dehydration and attempting to move the impacted material with lubricants such as mineral oil or dioctyl sodium succinate, or surgically emptying the abomasum. Balanced electrolyte solutions are infused intravenously on a continuous basis for up to 72 hours at a rate of 100 to 150 mL/kg BW over a 24-hour period. Some cases will respond remarkably well to combined medical treatment of intravenous fluid therapy and oral mineral oil and begin ruminating and passing feces in 48 hours.

### DIFFERENTIAL DIAGNOSIS

The clinical diagnosis of impacted abomasum depends on the nutritional history, the clinical evidence of impaction of the abomasum, and the laboratory results. The disease must be differentiated from abomasal impaction as a complication of vagal indigestion, omasal impaction, diffuse peritonitis, and acute intestinal obstruction caused by intestinal accidents or enteroliths and lipomas.

- **Impaction of the abomasum as a complication of traumatic reticuloperitonitis** usually occurs in late pregnancy, and commonly only in one animal; a mild fever may or may not be present and there may be a grunt on deep palpation of the xiphoid. The rumen is usually enlarged and may be atonic or hypermotile. Depending on the lesion present a neutrophilia may be present, which is suggestive of a chronic infection. A hypochloremia is common, as in dietary impaction. In many cases it is impossible to distinguish between the two causes of impacted abomasum, and a laparotomy may be necessary to explore the abdomen for evidence of peritoneal lesions. Cattle with abomasal impaction as a complication



of traumatic reticuloperitonitis are usually a single incident and have usually been ill for several days, whereas those with dietary impaction have usually been ill for only a few days and more than one may be affected.

- **Impaction of the omasum** occurs in advanced pregnancy and is characterized by anorexia, scant feces, normal rumen movements, moderate dehydration, and an enlarged omasum that is usually only palpable during an exploratory laparotomy. The serum electrolyte concentrations may be within reference limits if the abomasum is normal.
- **Diffuse peritonitis** is characterized by anorexia, toxemia, dehydration, scant feces, and a grunt on deep palpation and percussion. However, in peracute cases the abdominal pain may be absent. Fibrinous adhesions may be palpable on rectal examination, and paracentesis may yield some diagnostic peritoneal exudate, but a negative result cannot rule out peritonitis. The presence of a marked leukopenia and neutropenia or a neutrophilia may assist in the diagnosis, but it is often necessary to perform an exploratory laparotomy to confirm the diagnosis.
- **Intestinal obstructions** caused by intestinal accidents or enteroliths result in anorexia, scant feces, dehydration, and abdominal pain, and the abnormality may be palpable on rectal examination. The rumen is usually static and filled with doughy contents. Fluid and gas accumulations in the intestines anterior to the obstruction may be detectable as fluid-splashing sounds by using simultaneous auscultation and succussion of the abdomen.

**Diocetyl sodium sulfosuccinate** is administered into the rumen by stomach tube at a dose rate of 120 to 180 mL of a 25% solution for a 450-kg animal repeated daily for 3 to 5 days. It is **mixed with 10 L of warm water and 5 L of mineral oil**. A beneficial response cannot be expected in less than 24 hours, and most cattle that do respond will show improvement by the end of the third day after treatment begins. The presence of increased fecal volume that is well mixed with mineral oil is usually a good clinical sign. Cholinergics such as neostigmine, physostigmine, and carbamylcholine have been used but do not appear to alter the outcome. Research studies indicate poor efficacy of cholinergics in healthy animals and cattle with displaced abomasum. Erythromycin is the best prokinetic agent available, but antimicrobials should not be administered for a nonantimicrobial effect (see section on LDA in this chapter for more information on prokinetic agents).

### Surgery

**Surgical correction of impaction of the pyloric antrum** consists of external massage

of impacted pyloric antral contents and injection of dioctyl sodium sulfosuccinate (100 mL) directly into abomasal lumen during right flank laparotomy.

**Surgical correction of impaction of the abomasal body** consists of an abomasotomy through a right paramedian approach and removal of the contents of the abomasum. The results are often unsuccessful, probably because of abomasal atony that exists and that appears to worsen following surgery. An alternative approach may be to do a rumenotomy, empty the rumen, and infuse dioctyl sodium sulfosuccinate directly into the abomasum through the reticuloomasal orifice in an attempt to soften and promote the evacuation of the contents of the abomasum. The placement of a nasogastric tube into the omasal groove and into the abomasum through a rumenotomy procedure is described. Mineral oil can then be pumped into the abomasum at the rate of 2 L/day for several days. Recovery should occur within 5 to 7 days. A rumenotomy and emptying of the rumen is necessary in the case of severe straw impaction of the rumen.

The induction of parturition using 20 mg of dexamethasone intramuscularly may be indicated in affected cattle that are within 2 weeks of parturition and in which the response to a few days' treatment has been unsuccessful. Parturition may assist recovery as a result of a reduction in intraabdominal volume. In sand impaction, affected cattle should be moved off the sandy soil and fed good hay and a grass mixture containing molasses and minerals. Severely affected cattle should be treated with large daily doses of mineral oil (at least 15 L/day).

**Gravel or sand obstruction of the abomasum and duodenum** can be corrected surgically by right flank laparotomy and by removing all of the gravel or sand.

### CONTROL

#### Primary Abomasal Impaction

The major control measures are those for LDA, because the conditions are thought to have abomasal hypomotility as a primary requirement.

#### Dietary Abomasal Impaction

Prevention of the disease is possible by providing the necessary nutrient requirements for wintering pregnant beef cattle with added allowances for cold windy weather when energy needs for maintenance are increased. When low-quality roughage is to be used for wintering pregnant beef cattle, it should be analyzed for crude protein and DE. Based on the analysis, grain is usually added to the ration to meet the energy and protein requirements. Pregnant beef cows fed a diet of 94% barley straw for 83 days during the cold winter months may consume only 70% of their energy requirements. Such straw-based diets must be supplemented with protein and energy. During prolonged

periods of cold weather, wintering pregnant beef cattle should be given additional amounts of feed to meet the increased feed requirement for maintenance, which has been estimated to be 30% to 40% greater during the colder months than during the warmer months. These increased requirements are due almost equally to the effects of reduced feed digestibility and the increased maintenance requirements.

The published nutrient requirements of beef cattle are guidelines for the nutrition of cattle under average conditions and higher nutrient levels than those indicated may be necessary to provide for maintenance requirements, particularly during periods of cold stress. **Adequate amounts of fresh drinking water** should be supplied at all times, and the practice of forcing wintering cows to obtain their water requirements from eating snow while on low-quality roughage is extremely hazardous. The question of whether or not low-quality roughages should be chopped or ground for wintering pregnant beef cattle is controversial. The daily voluntary intake of low-quality roughage can be increased by chopping or grinding but neither processing method increases quality or digestibility; in fact digestibility is usually decreased. If increased consumption during cold weather exceeds physical capacity and the nutrient requirements are still not satisfied, impaction of the abomasum may occur. Thus during the coldest period of the winter low-quality roughages must be supplemented with concentrated sources of energy such as cereal grains.

Omasal and abomasal impaction caused by the provision of excessive poor-quality roughage is preventable by supplementation with appropriate sources of energy and protein.

### REFERENCES

1. Wittek T, et al. *J Am Vet Med Assoc.* 2005;227:287.
2. Erickson N, Hendrick S. *Can Vet J.* 2011;52:74.
3. Melendez P, et al. *Can Vet J.* 2007;48:1067.

### ABOMASAL IMPACTION IN SHEEP AND GOATS (ABOMASAL EMPTYING DEFECT)

Abomasal dilatation and impaction in sheep as a result of an **abomasal emptying defect** has been reported predominantly in adult Suffolk sheep, but also occurs sporadically in adult Hampshire, Texel, and Dorset sheep, as well as Toggenberg goats. Affected sheep are usually large-framed rams and ewes, usually 2 to 6 years of age, and the ewes are often in late gestation or recently lambed. The disease has been reported in two goats that were 8 years old.<sup>1</sup> The duration of illness varies from several days to a few months and affected animals may become emaciated. The diets fed to affected animals consisted of grain and good-quality hay. The etiopathogenesis is unknown but may reflect

abnormalities in autonomic innervation to the abomasum or an increased vertical distance between the ventral abdomen and proximal duodenum. Current associations between the occurrence of LDA in Holstein Friesian cattle and SNPs associated with coding for the motilin receptor suggest that a genetic disorder may contribute to the occurrence of an abomasal emptying defect in sheep and goats.

Clinical signs include progressive weight loss, anorexia, variable degrees of distension of the right lower abdomen, a large palpable mass in the right lower abdomen, increased concentrations of rumen chloride, and a grossly enlarged and impacted abomasum. Some animals have abdominal distension accompanied by ruminal hypermotility, which is evident in the left paralumbar fossa. A firm enlarged viscus can be balloted on the lower right quadrant in advanced cases. Ultrasonography of the ventral abdomen is helpful in identifying the abomasal dimensions and confirming the presence of a large distended abomasum. Hypochloremia, hypokalemia, and metabolic alkalosis are common and ruminal chloride concentrations are increased up to 39 mmol/L, suggesting reflux from the abomasum. A standing right flank laparotomy is helpful in confirming the presumptive diagnosis in equivocal cases.

Surgical treatment by emptying the abomasum via a right paramedian abomaso-pexy provides relief for a few months but the disease invariably returns. Affected animals may have concurrent renal disease that may reflect chronic abomasal emptying abnormalities. Medical treatment has been ineffective using parasympathomimetic agents and metoclopramide, although there are no reports describing the response to erythromycin, which is the most effective prokinetic agent in calves and adult (see section on LDA in this chapter). At necropsy, the abomasum is grossly enlarged and commonly contains up to 30 L of rumen-like contents, which are dry and doughy. In some cases the abomasum contains an excessive quantity of fluid.

There is a report of abomasal impaction with anorexia causing high mortality in young lambs. Affected lambs developed anorexia, dullness, and reluctance to walk. Sudden death occurred in lambs less than 1 month of age, and progressive loss of body condition and dehydration occurred in older lambs. Affected animals did not suck their dams normally. It is suggested that the ewes had insufficient milk for the lambs, which consequently forced them to begin consuming solid feed at an early age. The impaction was associated with the presence of phytobezoars; trichophytobezoars; and coagulated, rubber-like milk clots in the abomasum, usually at the entrance to the pylorus.

Abdominal enlargement caused by abomasal dilatation and impaction

associated with multiple adenomas of the abomasal mucosa has been recorded in an adult ewe.

## REFERENCE

1. Edwards GT, Nevel A. *Vet Rec.* 2008;162:418.

## ABOMASAL PHYTOBEZOARS AND TRICHOBEZOARS

A velvety form of abomasal phytobezoar occurs in goats and sheep in the arid regions of southern Africa and causes significant economic loss. The composition of the bezoars resembles that of pappus hairs and stems of the Karoo bushes. They have a striking velvety appearance. Phytobezoars have been experimentally reproduced in goats and sheep by feeding the mature flowers or seeds and pappus hairs of Karoo bushes.

Trichobezoars are frequently found in calves 2 to 3 months of age when they can occasionally result in intestinal obstruction and have been associated with abomasal ulceration (addressed in the relevant sections elsewhere in the chapter). Rumenoabomasal trichobezoars have been reported in steers 20 to 24 months of age with a history of inappetence and weight loss and licking their own and other animals' hair coats. Numerous hairs (0.5- to 1.5-cm in length) were found implanted in the abomasal mucosa, especially in the region of the torus pyloricus. Areas of hair implantation were frequently accompanied by scattered and severe abomasitis, erosions, and ulcers. Thickening of the rugae and plicae of the pylorus was present. In the rumen, rumenitis and hyperkeratosis, characterized by short, reddish edematous ruminal papillae containing small numbers of trapped hairs, were present. The severity of the lesions increased with the number of hairs implanted in the mucosa.

An abomasal phytobezoar was removed surgically from a 5-year-old Holstein Friesian cow through a right flank laparotomy with the cow in a standing position.<sup>1</sup> Abomasotomy for removal of foreign bodies is usually performed using a right paramedian incision with the cow in left lateral recumbency.

## REFERENCE

1. Tschuor AC, et al. *Can Vet J.* 2010;51:761.

## ABOMASAL ULCERS OF CATTLE

Abomasal ulceration occurs in mature cattle and calves and may cause acute abomasal hemorrhage with indigestion, melena, and sometimes perforation, resulting in a painful acute local peritonitis or acute diffuse peritonitis and rapid death, or a chronic indigestion with only minimal abomasal hemorrhage. Some calves have abomasal ulceration at necropsy or slaughter that was subclinical.

## SYNOPSIS

**Etiology** Cause of primary ulceration unknown. Many ulcers occur secondary to lymphoma, left-displaced abomasum, and viral diseases.

**Epidemiology** Mature lactating dairy cattle, hand-fed calves, nursing beef calves. Risk factors not understood. Presence of hairballs not a risk factor in calves.

**Signs** Melena, pallor from anemia, abdominal pain, acute local peritonitis caused by perforation.

**Clinical pathology** Melena, occult blood in feces, anemia.

**Lesions** Ulceration of mucosa, blood in abomasum. Acute local peritonitis if perforated.

**Diagnostic confirmation** Abomasotomy.

**Differential diagnosis** Duodenal ulceration, acute and chronic traumatic reticuloperitonitis if ulcer perforated, acute diffuse peritonitis if perforated, right-side dilatation of abomasum.

**Treatment** Antacids. Blood transfusions. Surgical excision.

**Control** Nothing reliable.

## ETIOLOGY

### Primary Ulceration

Although many different causes of primary abomasal ulceration have been suggested, the cause is unknown. Possible causes that have been considered but for which there is no reliable evidence of a cause-and-effect relationship include the following:

- **Abomasal hyperacidity** in adult cattle, although there is no direct evidence to support the hypothesis except in animals subject to **fasting**
- **Mechanical abrasion** of the pyloric antrum caused by the ingestion of coarse roughage, such as straw, or possibly the presence of trichobezoars
- **Bacterial infections** such as *C. perfringens* type A or fungi such as *Aspergillus fumigatus* and *Mucor* spp.<sup>1</sup>
- **Trace mineral deficiencies** such as copper deficiency (evidence is weak)
- **Concurrent stress** as in cattle with severe inflammatory processes or in severe pain that result in hypercortisolemia

### Secondary Ulceration

Abomasal ulceration can occur secondary to other diseases. Reflux of bile into the abomasal lumen, particularly in ruminants with LDA or RDA, is strongly associated with abomasal ulceration.<sup>2</sup> Bile acids are a well-documented cause of gastric injury. Other examples include lymphoma of the abomasum and erosions of the abomasal mucosa in viral diseases such as bovine virus diarrhea (BVD) and bovine malignant catarrh. There

is one report of abomasal ulceration in a 2-month-old calf caused by a yolk sac tumor around the abomasum (a very rare germ cell tumor of cattle).<sup>3</sup>

## EPIDEMIOLOGY

### Primary Abomasal Ulcers

Primary abomasal ulcers occur in lactating dairy cows, mature bulls, hand-fed calves, veal calves, and sucking beef calves. The epidemiologic circumstances for each of these groups are presented here.

#### Lactating Dairy Cows

Some observations have found that acute hemorrhagic abomasal ulcers occur in high-producing mature dairy cows in early lactation, whereas others have found that most acute bleeding ulcers occurred in cows 3 to 6 months after parturition. The close relationship of the disease to parturition suggests that a combination of the stress of parturition with associated hypercortisolemia, the onset of lactation, and high-level grain feeding is associated with acute ulceration in dairy cows.

However, epidemiologic observations of acute hemorrhagic abomasal ulceration in cattle have found no association with the stress of calving. The incidence was highest in dairy cows during the summer months when the animals were grazing on pasture. There was also a direct association between amount of rainfall, amount of fertilizer used, and stocking rate, as well as the amount of milk produced by affected cows. This suggests that some factor in grass may be a risk factor in the acute disease in mature dairy cattle.

Mature high-producing dairy cows in **early lactation** may develop acute hemorrhagic ulceration of the abomasum following a prolonged illness such as pneumonia or after having been to a cattle show and sale. This suggests that **stress** and hypercortisolemia may be an important contributing cause.

The prevalence of abomasal ulcers in mature cattle varies depending on the population of animals surveyed. Of cattle admitted to a veterinary teaching hospital over a 4-year period, 2.2% had confirmed abomasal ulcers. In surveys at abattoirs the prevalence may reach 6%. The case-fatality rate for mature cattle with confirmed abomasal ulcers is about 50%, and for those with severe blood loss or diffuse peritonitis the case-fatality rate is usually 100%. Type I nonperforating abomasal ulcers were found in 21% of cows examined at the abattoir and there was no clinical evidence of the ulcers before slaughter, but 32% of the animals were anemic and 44% were hyperproteinemic, which could be expected in cattle with chronic blood loss.

#### Mature Bulls and Feedlot Cattle

Acute bleeding ulcers occur occasionally in mature dairy and beef bulls, particularly following long transportation, prolonged

surgical procedures, and in painful conditions such as a fractured limb or rupture of the cruciate ligaments of the stifle joint. Abomasal ulcers have also been the cause of sudden death in yearling feedlot cattle. Examination of a random sample of the abomasa of feedlot cattle revealed that erosions were present in up to 33% of the animals, depending on their origin. It is hypothesized that the feeding of high levels of grain in feedlot cattle may be a risk factor associated with abomasal erosions.

#### Hand-Fed Calves

Ulcers of the abomasum are common in hand-fed calves when they are weaned from milk or milk replacer and begin consuming roughage. The causes of the acute ulceration are unknown, but by association it appears that some calves are susceptible when they are changing from a diet of low dry matter content (milk or milk replacer) to one of a higher dry matter content (grass, hay, and grain). Most of these ulcers are subclinical and not hemorrhagic. The incidence of abomasal ulcers in milk-fed veal calves is higher when the animals have access to roughage than when roughage is not provided. The type of roughage may also be a factor: pellets produced from corn silage were associated with more lesions than pellets produced from barley straw or alfalfa hay, suggesting that loss of pH partitioning in the abomasum may play a primary role. Occasionally, milk-fed calves under 2 weeks of age are affected by acute hemorrhagic abomasal ulcers, which may perforate and cause rapid death.

Perforating abomasal ulcers have occurred in calves up to 6 months of age, with the majority between 6 and 12 weeks of age. **LDA** was present in 70% of the cases.

#### Veal Calves

Abomasal ulceration is a common finding in veal calves slaughtered at 3 to 5 months of age. The incidence and severity of lesions are greatest in loose-housed calves with access to straw and fed milk substitute ad libitum. There was no evidence that erosions and ulcers found in the majority of veal calves affected their growth rate or welfare. No relationship was found between the presence of abomasal erosions and ulcers and the behavior of crated veal calves fed milk for 22 to 24 weeks.

#### Sucking Beef Calves

Well-nourished sucking beef calves, 2 to 4 months of age, may be affected by acute hemorrhagic and perforating abomasal ulcers while they are on summer pasture. Abomasal trichobezoars are commonly present in these calves, but whether the hairballs initiated the ulcers or developed after the ulcers is uncertain.

Abomasal ulcers and abomasal tympany occurs in range beef calves from 3 to 12

weeks of age in beef herds in the north central region of the United States, along the eastern slopes of the Rocky Mountains, and in Alberta.

In a retrospective study of 46 abomasotomies in young beef calves in western Canada, in affected herds the average incidence was 1.0% with a range among herds from 0.2% to 5.7%. In 80% of surgeries of the abomasum, abomasal ulcers were found, and hairballs were present in the abomasum of 76%, but this does not necessarily mean that hairballs are a causative agent (see later). Calves housed in pens or on stubble fields were nearly three times more likely to receive surgery for abomasal disease than those kept on pasture.

On-farm investigations of western Canadian beef herds that had reported **abomasal ulcers in calves** found that the average number of suspected and confirmed cases of fatal abomasal ulcers were 2.4 and 1.9 per farm, respectively. Most producers reported that the affected calves had died without exhibiting any clinical signs and that the affected calves were average or above average in growth performance. Most (86%) of the ulcers occurred in calves under 2 months of age. Most (93%) of the fatal ulcers were perforating, and the remainder (6.7%) were hemorrhagic ulcers. The peak number of cases occurred in April and May but this seasonal incidence reflects the age structure of the calf population in Canada, in which most beef calves are born during the late winter and early spring months. There was no sex predilection and no evidence of breed predisposition. There is minimal evidence to suggest that *C. perfringens* type A, *Helicobacter pylori*, or *Campylobacter* spp. are involved in ulcer formation.<sup>4</sup>

The relationship between the **abomasal hairballs** and perforating abomasal ulcers in unweaned beef calves under 4 months of age has been examined. For many years it was thought that the presence of hairballs in the abomasum abraded the mucosa, initiating an ulcerogenic process, eventually culminating in a perforating ulcer. However, finding hairballs in the abomasum of nursing beef calves with perforating ulcers does not necessarily mean that the hairballs caused the ulcer. Hairballs are present in the abomasum of the same class of calves that die of other diseases unrelated to the abomasum. Calves under 1 month of age dying of an ulcer were almost four times more likely to have an abomasal hairball than were calves dying of all other diseases. This relationship did not exist in older calves over 30 days of age, in which about 60% of all calves, regardless of the cause of death, had an abomasal hairball. The prevalence of hairballs in the young and old ulcer calves was 58% and 57%, respectively; in the old nonulcer calves it was 63%. The prevalence of hairballs in the young nonulcer calves was 20%.



Two factors may account for the lower prevalence in young nonulcer calves. First, more than half (55%) of the nonulcer calves died in the first few weeks of life, compared with only 12.5% of the ulcer calves. Thus calves in the ulcer group had more time to develop an abomasal hairball. Second, the majority (68%) of the calves died of enteritis and sepsis, making them less likely to engage in normal nursing behavior, which involves muzzling and licking the udder, resulting in the ingestion of hair. Only 57% of calves dying of perforating ulcer had a hairball, indicating that the hairballs are not necessary for an ulcer to develop. This is supported by field observations of pathologists who report that only 25% of calves with a perforating ulcer had an abomasal hairball. Another argument against the hairball theory is that 89% of perforations occurred in the body of the abomasum, a region that has a poorly developed musculature and is incapable of producing strong peristaltic contractions. It is suggested that the weak frictional forces generated in this region could exert an abrasive action on the mucosal surfaces. In summary, it is suggested that abomasal hairballs are not necessary for abomasal ulcers to develop in nursing beef calves.

#### *Dietary Factors in Calves Fed Milk or Milk Replacer*

The cause of the high prevalence of abomasal ulceration in nursing beef calves is unknown. A low abomasal luminal pH caused by the diet has been proposed as a possible factor. Experimentally, feeding dairy calves (17 days of age) cow's whole milk resulted in lower abomasal luminal pH compared with the feeding of two different milk replacers (an all milk protein or combined milk and soy protein milk replacer). It has been hypothesized that the sucking of cow's whole milk results in a lower mean abomasal luminal pH and, because fasting or infrequent sucking of milk replacer results in a sustained period of low abomasal luminal pH, this may provide evidence for primary abomasal ulceration in nursing beef calves. This may be related to the occurrence of abomasal ulceration in nursing beef calves after a period of inclement weather, during which time the frequency of nursing may be decreased.

#### **Secondary Abomasal Ulcers**

Abomasal ulcers occur secondary to left-side and right-side abomasal displacements, abomasal impaction or volvulus, lymphomatosis and vagal indigestion, or unrelated to other diseases.

#### **PATHOGENESIS**

Any injury to the gastric mucosa allows diffusion of hydrogen ions from the lumen into the tissues of the mucosa and also permits diffusion of pepsin into the different layers of the mucosa, resulting in further damage.

There may be only one large ulcer, but more often there is evidence of numerous acute and chronic ulcers.

A classification of abomasal ulcers in cattle is as follows.

#### **Type 1: Nonperforating Ulcer**

In this classification there is incomplete penetration of the abomasal wall resulting in a minimal degree of intraluminal hemorrhage, focal abomasal thickening, or local serositis. Nonbleeding chronic ulcers commonly cause a chronic gastritis. This category has been expanded to include erosions in a modified categorization system: 1a = erosion with minimal mucosal defects; 1b = deeper erosions combined with local hemorrhage; and 1c = craters with a superficial coating of detritus, fibrin, or inflammatory products. However, erosions are discrete mucosal defects that do not penetrate the muscularis mucosa of the abomasum, whereas ulcers penetrate the entire thickness of the mucosa and extend into the submucosa.

#### **Type 2: Ulcer Causing Severe Blood Loss**

With the type 2 ulcer there is penetration of the wall of a major abomasal vessel, usually in the submucosa, resulting in severe intraluminal hemorrhage and anemia. In acute ulceration with erosion of a blood vessel there is acute gastric hemorrhage with reflex spasm of the pylorus and accumulation of fluid in the abomasum, resulting in distension, metabolic alkalosis, hypochloremia, hypokalemia, and hemorrhagic anemia. Usually within 24 hours there is release of some of the abomasal contents into the intestine, resulting in melena. The ruminal chloride concentration may increase in about 40% of cows with bleeding ulcers, which suggests abomasal reflux of acid into the rumen.

Plasma gastrin activity increases significantly in cattle with bleeding abomasal ulcers.

#### **Type 3: Perforating Ulcer With Acute, Local Peritonitis**

In this classification there is penetration of the full thickness of the abomasal wall, resulting in leakage of abomasal contents. Resulting peritonitis is localized to the region of the perforation by adhesion of the involved portion of abomasum to adjacent viscera, omentum, peritoneal surface, or diaphragm. Omental bursitis and empyema may develop, with the accumulation of a large quantity of exudate and necrotic debris in the omental cavity. In rare instances the abomasal acidity may erode through the diaphragm, causing an abomasal–pleural fistula.

#### **Type 4: Perforating Ulcer With Diffuse Peritonitis**

With a type 4 ulcer there is penetration of the full thickness of the abomasal wall, resulting in leakage of abomasal contents. Resulting

peritonitis is not localized to the region of the perforation; thus digesta is spread diffusely throughout the peritoneal cavity.

In nursing beef calves, about 90% of perforated abomasal ulcers occur in the body of the abomasum, with a propensity for the greater curvature. In some calves the ulcers are subclinical and the factors that determine how large or how deep an ulcer will become are unknown. Based on abattoir studies it is evident that abomasal ulcers will heal by scar formation.

#### **CLINICAL FINDINGS**

The clinical syndrome varies depending on whether ulceration is complicated by hemorrhage or perforation. The important clinical findings of hemorrhagic abomasal ulcers in cattle are **abdominal pain, melena, and pale mucous membranes**. At least one of these clinical findings is present in about 70% of cattle with abomasal ulcers. The case–fatality rates for cattle with types 1, 2, 3, or 4 are 25, 100, 50, and 100%, respectively. In the common clinical form of bleeding abomasal ulcers there is a **sudden onset of anorexia, mild abdominal pain, tachycardia (90–100 beats/min), severely depressed milk production, and melena**. Acute hemorrhage may be severe enough to cause death in less than 24 hours. More commonly there is subacute blood loss over a period of a few days with the development of hemorrhagic anemia. The feces are usually scant, black, and tarry. There are occasional bouts of diarrhea. Melena may be present for 4 to 6 days, after which time the cow usually begins to recover or lapses into a stage of chronic ulceration without evidence of hemorrhage.

**Melena is almost a pathognomonic sign of an acute bleeding ulcer of the abomasum.** However, the presence of normal-colored feces does not preclude the presence of chronic nonbleeding ulcers, which may be the cause of an intractable indigestion. The use of an **occult blood test on the feces** will aid in differentiating those that are equivocal. Abomasal ulceration secondary to lymphoma of the abomasum is characterized by chronic diarrhea and melena. The ulcer does not heal.

In some cases the **abomasum is grossly distended and fluid-splashing sounds** are audible on succussion similar to those in RDA. Moderate dehydration is common, and affected cows commonly sip water continuously and grind their teeth frequently. The prognosis in chronic ulceration is poor because of the presence of several ulcers and the development of chronic abomasal atony. Some cows improve temporarily but relapse several days later and fail to recover permanently. Duodenal ulceration and abdominal abscesses have also been described.

#### **Perforation of Ulcer**

Perforation of an ulcer is usually followed by **acute local peritonitis** unless the abomasum

is full and ruptures, when **acute diffuse peritonitis** and shock result in death in a few hours. With the development of local peritonitis, with or without omental adhesions, there is a chronic illness accompanied by a fluctuating fever, anorexia, and intermittent diarrhea. This is common in dairy cows in the immediate postpartum period. Pain may be detectable on deep palpation of the abdomen and the distended, fluid-filled abomasum may be palpable behind the right costal arch. Periaabomasal abscess formation from a perforated ulcer also occurs and is similar to local peritonitis.

In calves with a perforated abomasal ulcer, abdominal distension and abdominal pain are common.

### Nursing Beef Calves

Calves with abomasal ulceration may have a distended gas-filled and fluid-filled abomasum that is palpable behind the right costal arch. Deep palpation may reveal abdominal pain associated with local peritonitis caused by a perforated ulcer. Unless an abomasal ulcer has extended to the serosa, it is unlikely that it can be detected by deep palpation. Many cases of abomasal ulcers, particularly in calves, cause no apparent illness.

## CLINICAL PATHOLOGY

### Melena

The dark brown to black color of the feces is usually sufficient indication of gastric hemorrhage but tests for occult blood may be necessary. Results from experiments simulating abomasal hemorrhage indicate that the transit time for blood to move from the abomasum to the rectum ranges from 7 to 19 hours. The available fecal occult blood tests may not detect slow abomasal hemorrhage at any one sampling. This can be overcome by testing several fecal samples over a 2- to 4-day period and reading multiple smears per specimen. The sensitivity of the occult blood tests increases after the fecal samples have been stored at room temperature for 2 days. The predictive value of the occult blood test may be a more reliable diagnostic indicator of abomasal disease than abdominal pain or the presence of anemia. When perforation has occurred with acute local peritonitis, there is neutrophilia with a regenerative left shift for a few days, after which time the total leukocyte and differential count may be normal.

### Hemogram

In acute gastric hemorrhage, there is acute hemorrhagic anemia.

### Plasma Gastrin and Pepsinogen Concentration

Plasma gastrin concentration increases significantly in cattle with bleeding abomasal ulcers. The mean plasma gastrin concentration in healthy cattle was 103 pg/mL; in

cattle with bleeding abomasal ulcers the mean was 1213 pg/mL.

Serum pepsinogen concentration >5.5 U/L is indicative of the presence of abomasal ulcers in cows with an appropriate anthelmintic control program.<sup>5</sup> However, the test sensitivity (0.65) and specificity (0.81) and area under the response operating characteristic curve (0.77) are not sufficiently high enough to make this a clinically useful test, particularly when applied to cattle with unknown parasite control programs. In contrast, serum pepsinogen does not appear to indicate the presence of abomasal ulcers in sheep.<sup>6</sup>

### Microbiology

The microbiome of abomasal ulcers has been recently investigated using pyrosequencing. Abomasal ulcers contain a high diversity and species richness of abomasal bacteria, including the following genera: *Helicobacter*, *Acetobacter*, *Lactobacillus*, and novel *Mycoplasma*-like phylotypes.<sup>7</sup> Interestingly, no differences in microbiological communities attached to abomasal mucosa were detected between abomasal ulcers and normal mucosal morphology.

## NECROPSY FINDINGS

Ulceration is most common along the greater curvature of the abomasum. There is a distinct preference for most of the ulcers to occur on the most ventral part of the fundic region with a few on the border between the fundic and pyloric regions. The ulcers are usually deep and well defined but may be filled with blood clot or necrotic material and often contain fungal mycelia, which may be of etiologic significance in calves. The ulcers will measure from a few millimeters to 5 cm in diameter and are either round or oval with the longest dimension usually parallel to the long axis of the abomasum. In bleeding ulcers the affected artery is usually visible after the ulcer is cleaned out.

Most cases of perforation in cattle are walled off by omentum, with the formation of a large cavity 12 to 15 cm in diameter in the peritoneal cavity that contains degenerated blood and necrotic debris. Material from this cavity may infiltrate widely through the omental fat. Adhesions may form between the ulcer and surrounding organs or the abdominal wall (**omental bursitis** and **omental emphysema**). Multiple phytobezoars are common in the abomasum of beef calves with abomasal ulcers. The mucosal changes associated with abomasal ulceration in veal calves reveal an increase in the depth of the mucosa with a loss of mucins in the region of erosions and ulcers.

## DIFFERENTIAL DIAGNOSIS

- **Acute abomasal ulceration** in mature cattle is characterized by abdominal pain,

melena, and pallor. The melena may not be evident for 18–24 h after the onset of hemorrhage. Examination of the right abdomen may reveal a distended abomasum and a grunt on deep palpation over the abomasum, caudal to the xiphoid sternum on the right side. Tachycardia is common.

- **Duodenal ulceration** may cause melena and a syndrome indistinguishable from hemorrhagic abomasal ulceration.
- **Chronic abomasal ulceration** in mature cattle is difficult to diagnose clinically if the hemorrhage is insufficient to result in melena. The clinical findings of chronic ulceration are similar to several other diseases of the forestomach and abomasum of mature cattle. An illness of several days' duration with inappetence, ruminal hypotonicity, scant feces, and dehydration are common to many of those diseases. The presence of occult blood in the feces of hemorrhagic anemia suggests ulceration. The hemorrhage may be intermittent, and repeated fecal tests for occult blood may be necessary. A positive result for occult blood may also be caused by abomasal volvulus, intestinal obstruction, or blood-sucking helminths.
- **Abomasal ulceration with perforation and local peritonitis** is indistinguishable from acute traumatic reticuloperitonitis unless hemorrhage and melena occur. However, the abdominal pain elicited on deep palpation is most intense over the right lower abdomen and lateral aspect of right lower thoracic wall.
- **Abomasal ulceration with perforation in sucking beef calves** is characterized by sudden onset of weakness, collapse, moderate abdominal distension shock, and rapid death. It must be differentiated from other causes of diffuse peritonitis and intestinal obstruction.
- **Chronic abomasal ulceration in sucking beef calves** associated with hairballs and chronic abomasitis from eating sand and dirt cannot usually be diagnosed as a separate entity.

## TREATMENT

The conservative medical approach is usually used for the treatment of abomasal ulcers in cattle.

### Blood Transfusions

Blood transfusions and fluid therapy may be necessary for acute hemorrhagic ulceration. The most reliable indication for a blood transfusion is the clinical state of the animal. Weakness, tachycardia, and dyspnea are indications for a blood transfusion. Hematocrits do not provide an accurate indication as to the magnitude of the blood loss until at least 4 hours after the start of hemorrhage. For this reason, although it is important to determine the hematocrit to obtain a reference point in time, a firm cut point for the

need for a blood transfusion cannot be developed. In the case of severe blood loss, a dose of 20 mL/kg BW may be necessary.

### Coagulants

Parenteral coagulants are used but are of doubtful value. These are covered in detail in Chapter 4.

### Antacids

The goal of antacid treatment is to create an environment that is favorable to ulcer healing. This can be done by decreasing acid secretion (oral or parenteral administration of histamine type-2 receptor antagonists [ $H_2$  antagonists] and proton pump inhibitors) or neutralizing secreted acid (oral administration of magnesium hydroxide and aluminum hydroxide). The elevation of the pH of the abomasal contents abolishes the proteolytic activity of pepsin and reduces the damaging effect of the acidity on the mucosa.

### Histamine Type-2 Receptor Antagonists

These compounds increase gastric pH through selective and competitive antagonism of histamine at the  $H_2$ -receptor on the basolateral membrane of parietal cells, reducing acid secretion.  $H_2$ -receptor antagonists are characterized pharmacologically by their ability to inhibit gastric acid secretion and kinetically by their similarity in absorption, distribution, and elimination.

Cimetidine and ranitidine are synthetic  $H_2$  antagonists that inhibit basal as well as pentagastrin-stimulated and cholinergic-stimulated gastric acid secretion. Both have been used extensively to treat gastric ulcers in many species, including horses, dogs, and humans. Oral and parenteral administration of cimetidine and ranitidine increases abomasal pH in sheep and cattle. High doses of cimetidine (20 mg/kg BW intravenously, or 50–100 mg/kg orally) increased abomasal pH in weaned lambs for more than 2 hours. Daily oral administration of cimetidine (10 mg/kg BW for 30 days) to veal calves may facilitate healing of abomasal ulcers. Because ranitidine is three to four times more potent than cimetidine, results of studies in ruminants suggest that oral administration of cimetidine (50–100 mg/kg) and ranitidine (10–50 mg/kg) should increase abomasal pH in milk-fed calves.

Experimentally, the oral administration of cimetidine (50 mg/kg or 100 mg/kg every 8 hours) and ranitidine (10 or 50 mg/kg every 8 hours) to normal calves fed milk-replacer caused a significant dose-dependent increase in mean 24-hour abomasal luminal pH. However, the effects of these agents have not been examined in calves with known abomasal ulcers.

### Alkalinizing Agents

Compounds such as magnesium hydroxide and aluminum hydroxide are weak bases that

have a direct effect on gastric acidity by neutralizing secreted acids. Aluminum hydroxide directly absorbs pepsin, decreasing the proteolytic activity of pepsin in the stomach. Both compounds bind bile acids, protecting against ulceration induced by bile reflux.

Experimentally, the oral administration of commercially available preparations containing aluminum hydroxide and magnesium hydroxide to calves being fed milk replacer resulted in a short-term increase in abomasal luminal pH. However, as with the synthetic  $H_2$  antagonists, the efficacy of these weak bases to aid in the treatment of calves with abomasal ulcers has not been determined.

Magnesium oxide (500–800 g per 450-kg BW weight daily for 2–4 days) has been successful empirically in some cases of abomasal ulceration in mature cattle. The injection or infusion of the antacid directly into the abomasum would probably be much more effective, but injections of the abomasum through the abdominal wall are not completely reliable. An abomasal cannula placed through the abdominal wall may provide a means of ensuring the infusion of antacids directly into the abomasum.

### Kaolin and Pectin

Large doses of liquid mixtures of kaolin and pectin (2–3 L twice daily for a mature cow) to coat the ulcer and minimize further ulcerogenesis have been suggested and used with limited success. This treatment is no longer recommended.

### Surgical Excision

Surgical excision of abomasal ulcers has been attempted, with some limited success. The presence of multiple ulcers may require the radical excision of a large portion of the abomasal mucosa and hemorrhage is usually considerable. A laparotomy and exploratory abomasotomy are required to determine the presence and location of the ulcer. The diagnostic criteria for deciding to do surgery have not been described, which makes it difficult to select cases with a favorable prognosis. Valuable animals with clinical evidence of chronic ulceration or those that relapse should be considered for surgical correction. Surgical correction of perforated abomasal ulcers in calves is possible and may be successful.

### PREVENTION

Recommendations for the prevention of abomasal ulceration in cattle cannot be given because the etiology is so poorly understood.

### FURTHER READING

Marshall TS. Abomasal ulceration and tympany of calves. *Vet Clin North Am Food Anim Pract.* 2009;25:209–220.

### REFERENCES

1. Kureljušić B, et al. *Acta Veterinaria (Beograd).* 2013;63:237.

2. Mostaghni K, et al. *Comp Clin Pathol.* 2008;17:81.
3. Sasaki H, et al. *J Vet Diagn Invest.* 2012;24:804.
4. Valgaeren BR, et al. *Vet Rec.* 2013;172:269.
5. Mesarič M. *Veterinarski Arhiv.* 2005;75:111.
6. Hajimohammadi A, et al. *Vet Med (Praha).* 2010;55:311.
7. Hund A, et al. *Vet Microbiol.* 2015;177:132.

## OMENTAL BURSTITIS

Inflammation of the omental bursa occurs rarely, usually in dairy cattle. The causes include perforated abomasal ulcers of the medial wall of the abomasum, penetration of the ventral wall of the blind sac of the rumen, penetration of the reticulum by a foreign body, spread of an umbilical infection to the greater omentum, and extension of an abdominal abscess and localized peritonitis, with subsequent spread to the omental bursa secondary to postpartum parametritis. Inflammation of the bursa results in the accumulation of inflammatory exudate in the bursal cavity, which enlarges beyond its normal capacity. There may also be rupture of the leaves of the greater omentum, resulting in diffuse peritonitis, ileus, or functional obstruction of the intestines.

Clinical findings include anorexia of several days' duration, chronic toxemia, dehydration, and **abdominal distension**, particularly of the right lower flank.<sup>1</sup> Fluid-splashing sounds may be audible on auscultation and percussion of the right flank. On rectal examination in a small number of cases a large, amorphous, spongy mass may be palpable anterior to the pelvic brim in the right upper quadrant of the abdomen. The peritoneal fluid may reveal evidence of a chronic suppurative inflammation. A neutrophilia and an increase in the serum fibrinogen concentration are common. There may also be a metabolic alkalosis with hypochloremia and hypokalemia. Most cases require a right flank exploratory laparotomy to make the diagnosis.

Treatment consists of surgical drainage and long-term therapy with antimicrobials. Successful treatment is uncommon but possible. At necropsy there is diffuse fibrinous and necrotizing peritonitis and a large accumulation of purulent exudate in the omental bursa.

### REFERENCE

1. Sardari K. *Comp Clin Pathol.* 2007;16:285.

## ABOMASAL BLOAT (TYMPANY) IN CALVES AND LAMBS

Abomasal bloat or severe distension (tympany) occurs in calves and lambs fed milk-replacer diets. The incidence appears to have increased recently in North America, and this has been attributed to increased use of whey-based milk replacers, which have a high salt content and therefore high osmolality when fed. Both factors have been shown



to decrease abomasal emptying rate in calves.<sup>1,2</sup> Feeding systems that allow calves or lambs to drink large quantities of milk replacer at infrequent intervals predispose them to abomasal bloat. This situation can occur under ad libitum feeding when the supply of milk replacer is kept at about 15°C (59°F) or higher, and particularly if it is not available for several hours. Lambs fed warm milk replacer to appetite twice daily appear to be very susceptible to abomasal bloat. Ad libitum feeding of cold milk replacers containing few or no insoluble ingredients, and adequately refrigerated, results in little or no bloating.

The pathogenesis of the abomasal tympany is thought to be associated with a sudden filling of the abomasum with decreased abomasal emptying rate followed by the proliferation of gas-forming organisms such as *C. perfringens* type A, *Sarcina ventriculi*, or *Lactobacillus* spp., which release an excessive quantity of gas that cannot escape from the abomasum. Administration of high-glucose solutions or high-osmolality solutions are thought to be associated with the disease occurrence because both decrease abomasal emptying rate in milk-fed calves.<sup>1,2</sup> The disease has been reproduced by drenching milk-fed Holstein Friesian calves with a carbohydrate mixture containing milk replacer, corn starch, and glucose mixed in water.<sup>3</sup> The severe abomasal distension causes compression of the thoracic and abdominal viscera and their blood vessels. This results in asphyxia and acute circulatory failure caused by the lack of venous return. Affected calves and lambs will become grossly distended within 1 hour after feeding and die in a few minutes after the distension of the abdomen is clinically obvious. At necropsy, the abomasum is grossly distended with gas, fluid, and milk replacer, which is usually not clotted. The abomasal mucosa is hyperemic.

Abomasal bloat, hemorrhage, and ulcers occur in young lambs in Norway just before being turned onto pasture. Affected lambs are 3 to 4 weeks of age. Affected lambs, approximately 1 week before developing abomasal bloat, had significantly lower serum iron levels than unaffected lambs. The administration of iron dextran to lambs during their first week of life reduced the incidence of abomasal bloat, suggesting that iron deficiency may be a predisposing factor that results in pica. Housing these lambs on floors with built-up litter when silage is used as a roughage is a predisposing epidemiologic factor. It is postulated that affected lambs eat bedding contaminated with feces, which may result in the growth of an abnormal gas-producing microflora in the abomasum. A similar association with fecal material was observed in an outbreak of abomasal tympany in dairy calves.<sup>4</sup> Affected calves died suddenly with abomasal tympany and emphysema, and *C. Perfringens* type A was

cultured from pooled colostrum being fed to calves, the bucket being used to collect colostrum, and the walls of the refrigerator used to store the colostrum.

The major clinical findings are tympany and colic. There is severe abdominal pain, such as stretching of the hind legs, lifted tails, repeated attempts to defecate, and anorexia. Untreated calves and lambs die within a few hours, but some are found dead without having shown any clinical signs. Some lambs are anemic and have melena.

At necropsy, there is abomasal tympany, abomasal hemorrhage, and ulceration. Lambs with ulcers had a higher frequency of trichophytobezoars than the cases without ulcers or the controls. *Sarcina*-like bacteria were found in sections of and smears from the abomasum in 79% of cases.<sup>5</sup> *C. fallax* and *C. sordellii* were also cultured from some cases, but their causative significance is uncertain.

Successful treatment of calves has been reported by placing them in dorsal recumbency and inserting a large-diameter needle (such as a 14 gauge) into the abomasum to relieve the gas. Placement in dorsal recumbency is considered the key to success because attempting to percutaneously deflate the bloat with the calf standing is often ineffective and may facilitate leakage of abomasal fluid into the abdomen. Calves should be administered parenteral antibiotics with good efficacy against *Clostridium* spp. bacteria, such as Procaine penicillin (22,000 U/kg BW, intramuscularly daily).

Effective control measures would appear to include good hygiene related to feeding utensils and equipment to prevent ingestion of *Clostridium* spp., minimizing ingestion of fecal material, and providing small meals frequently instead of large meals infrequently.

#### FURTHER READING

Marshall TM. Abomasal ulceration and tympany of calves. *Vet Clin North Am Food Anim Pract.* 2009;25:209-220.

#### REFERENCES

1. Nouri M, Constable PD. *J Vet Intern Med.* 2006;20:620.
2. Sen I, et al. *Am J Vet Res.* 2006;67:1377.
3. Panciera RJ, et al. *J Vet Diagn Invest.* 2007;19:392.
4. van Kruiningen HJ, et al. *Can Vet J.* 2009;50:857.
5. Edwards GT, et al. *Vet Rec.* 2008;163:391.

## Diseases of the Intestines of Ruminants

### SMALL AND LARGE INTESTINAL OBSTRUCTION IN CATTLE

Small and large intestinal obstructions in cattle include luminal blockages, intussusception, volvulus, and strangulation. The characteristic clinical findings are anorexia, abdominal pain, absence of feces, the passage

of dark fecal blood and mucus, dehydration, and acid-base imbalance and death if physical obstructions are untreated.

#### SYNOPSIS

**Etiology** Physical obstruction of intestine caused by luminal blockages, intussusception, mesenteric volvulus, and strangulation.

**Epidemiology** Uncommon, but do occur.

**Signs** Abdominal pain (treading of hindlegs, stretching, and kicking at abdomen), scant or absence of feces, feces may be bloodstained, rumen stasis, distension of abdomen (later stages), distended loops of intestine, progressive dehydration, and toxemia leading to shock and recumbency.

**Clinical pathology** Hypochloremic, hypokalemic metabolic alkalosis, hemoconcentration.

**Lesions** Intussusception, volvulus, strangulation, and intraluminal obstruction.

**Diagnostic confirmation** Laparotomy.

#### Differential diagnosis

*Adult cattle:* diffuse peritonitis, acute local peritonitis, abomasal ulcers, right displaced abomasum, abomasal volvulus, grain overload, duodenal ileus, and urethral obstruction in male ruminants.

*Calves under 2 months of age:* abomasal dilatation: dietary in origin, abomasal volvulus, perforated abomasal ulcers, intussusception, volvulus at the root of the mesentery, acute diffuse peritonitis, and peracute to acute enteritis.

**Treatment** Surgical correction.

**Control** Nothing reliable.

#### ETIOLOGY AND EPIDEMIOLOGY

The most common causes are the intestinal accidents—volvulus, intussusception and strangulation—in which there is **physical occlusion of the intestinal lumen**. A **functional obstruction** occurs with local or general paralytic ileus; the lumen remains physically patent but there is no passage of ingesta.

There are three common groups of causes:

- Physical obstruction of the intestinal lumen along with infarction of the affected section of intestine (**intestinal accidents**)
- Physical obstruction of the intestinal lumen (**luminal blockages**)
- Functional obstructions with no passage of intestinal contents but with the lumen still patent (**paralytic ileus**).

#### Intestinal Accidents

##### Volvulus

Volvulus of the small intestine is rare and sporadic in cattle and is more common in dairy cattle than beef cattle. It is not more common in calves than in adults but there may be a decreased risk in cattle over 7 years

of age compared with calves under 2 months of age.

**Mesenteric volvulus** is most common in calves and young cattle, e.g., coiled colon on its mesentery. As in cecocolic volvulus, the colon may be dilated before volvulus develops. A case has been described in a mature cow, which recovered following surgery.

**Volvulus of the duodenal sigmoid flexure** has been recently reported in dairy cattle.<sup>1</sup> Most of the affected animals had a right flank omentopexy and pyloropexy performed 1 day to 2 years previously and it is likely that the omentopexy site altered the normal anatomic location of the cranial duodenum, predisposing this section of the duodenum to accumulation of ingesta and subsequent volvulus. Clinically the cattle resembled an RDA or AV. The common bile duct is included in the volvulus, causing obstruction to bile flow and an enlarged gallbladder that may be visible ultrasonographically.

### Intussusception

Intussusceptions are rare in cattle and most common in calves under 2 months of age. The high prevalence of diarrhea caused by enteritis in calves suggests that enteritis may be a risk factor in this age group.

Four types of intussusception are recognized in cattle:

1. **Enteric:** this involves one segment of the small intestine, usually the distal jejunum or ileum, invaginating into another. It is most common in adults, with the distal jejunum most commonly affected because of the length and mobility of its mesenteric attachments. The high incidence of **jejunojejunal intussusception** in cattle has been attributed to the length and mobility of the jejunal mesenteric attachments, especially the distal third (Fig. 8-20). The presence of a mass in the intestinal wall may facilitate formation of intussusception, and there is one report of an intussusception associated with jejunal adenocarcinoma in a dairy cow.<sup>2</sup>
2. **Ileocecolic:** with this type the ileum invaginates into the cecum or into the proximal colon at the cecocolic junction.
3. **Cecocolic:** this occurs with invagination of the cecal apex into the proximal colon.
4. **Colonic:** invagination of the proximal colon, or sometimes the spiral colon, occurs into a more distal segment. One report of spiral colon intussusception identified fibroserous granulation tissue as a likely predisposing cause.<sup>3</sup>

The latter three are not common in adult cattle, presumably because the mesenteric fat deposits and the ileocolic ligament stabilize the intestine. In calves, the incidence of intussusception is more uniformly distributed among the four types, presumably because of the thin, fragile nature of the mesentery, which may be more susceptible to



**Fig. 8-20** Jejunal intussusception in an adult Holstein Friesian cow. The cow is in sternal recumbency with the head to the right. A right flank incision was made and much of the small intestine exteriorized. The surgeon is holding the jejunal flange, which is empty, as is the cecum (top). Most of the jejunum is markedly distended with fluid, and the mesentery is tied up into a knot in the center of the picture, which is the location of a large intussusception.

tearing under tension and allowing increased movement of adjacent segments of intestine. A series is recorded in cows with intestinal polyposis: polyps in the mucosa dragged a section of intestine into an invagination in the next section. There is also intussusception of colon into spiral colon, and intussusception of the spiral colon has been described in an adult bull. One recorded intussusception has been associated with a transmural adenocarcinoma in an aged cow.

### Strangulation

Strangulation may occur through a mesenteric tear or behind a persistent vitelloumbilical band, the ventral ligament of the bladder, through the lateral ligament of a bull's bladder, or via an adhesion, especially one between the omentum and an abscess of the umbilical artery in a young animal. Rupture of the small intestinal mesentery and strangulation of the intestine has been described in adult postparturient cows. A persistent urachus can also cause intestinal strangulation in mature cattle. Herniation of distal jejunum into a partially everted urinary bladder of a mature cow has been reported. Strangulation of the duodenum by the uterus during late pregnancy in cows has been described. The entire uterus had passed through a gap between the mesoduodenum and duodenum and with increasing weight had led to strangulation of the duodenum. The mesoduodenum and both walls of the greater omentum adjacent to its caudal edge were not connected with the duodenum, probably as a result of a congenital inhibitory malformation. Torsion of the descending

sigmoid colon was identified in a 5-year-old Brown Swiss cow with no identifiable mesentery on the mesenteric border.<sup>4</sup>

**Gut tie** has been described in male cattle that have recently been castrated using the open method and traction of the spermatic cord. When the spermatic cord is pulled and broken during castration, it may recoil through the inguinal ring and become entangled around small intestine, causing a physical obstruction (Fig. 8-21). This is considered more likely if the right spermatic cord retracts into the abdomen after castration, but reports exist of bilateral abdominal adhesions.<sup>5</sup> It is also possible that traction of the spermatic cord may tear the peritoneal fold of the ductus deferens that attaches the ductus to the abdominal wall, permitting loops of intestine to pass through this hiatus and resulting in incarceration.

### Compression Stenosis

Compression stenosis may arise from a blood clot from an expressed corpus luteum site on an ovary or traumatic duodenitis caused by migration of a metallic foreign body.

### Cecal Dilatation

Cecal dilatation can be followed by cecocolic volvulus (see cecal dilatation and cecocolic volvulus in this chapter).

### Luminal Blockages

#### External Pressure

External pressure by fat necrosis of mesenteries and omenta as well as lipomas may occur.





**Fig. 8-21** Entrapment of the jejunum by a remnant of the ductus deferens (“gut tie”) in an Angus steer (remnant being held by the surgeon). The steer was standing with its head to the right and a right flank laparotomy was performed. An incision was made in the right flank under regional analgesia and much of the jejunum was distended.

### Ileal Impaction in Cows

Ileal impaction in Swiss Braunvieh cows in Switzerland has been described. The cause is uncertain but may be related to seasonal influences and winter feeding with a hay-based ration.

### Fiber Balls or Phytobezoars

Fiber balls or phytobezoars may be common in areas in which fibrous feeds, e.g., *Romulea bulbocodium* or tree loppings, form a large part of the diet. The ability of *R. bulbocodium* to survive dry autumns and dominate the pasture ensures that many fiber balls develop in the abomasum in autumn. Obstructions do not occur until the next spring when pasture is lush. The disease is common in late pregnancy or the first 2 weeks of lactation or after a period of activity such as estrus. Bezoars pass at this time from the abomasum into the first part of the duodenum, where they stick fast.

### Trichobezoars (Hairballs)

In cold climates a more common obstruction is by trichobezoars. Cattle confined outside have long shaggy hair coats and licking themselves and others probably leads to ingestion of the hair. Hairballs causing obstruction of the small intestine of young beef calves has been described.<sup>3</sup>

### “Rectal Paralysis”

In cows near parturition, an apparent rectal paralysis leading to constipation may occur. The cause is unknown but is considered to be the result of pressure by the fetus or fetuses on pelvic nerves.

### Duodenal Ileus

**Duodenal ileus** caused by obstruction or compression of the duodenum has been

described in mature cows. The lumen may be obstructed by phytobezoars, blood clots, or compression from or adhesion to a liver abscess.

### Functional Obstructions

Peritonitis and hypocalcemia are two common causes of functional obstruction in cattle.

### PATHOGENESIS

#### Physical Obstruction

**Physical obstruction of the small intestines of cattle** results in an absence of feces, distension of the intestine cranial to the obstruction with fluid and gas, and acute abdominal pain. Luminal obstruction can be caused by trichobezoars or phytobezoars, ingestion of foreign objects such as a calf feeding nipple,<sup>6</sup> obstruction by a luminal blood clot (see section on hemorrhagic jejunitis in this chapter), dry feed impaction in the ileum,<sup>7</sup> or constriction and spasm of the jejunal lumen by a jejunal diverticulum.<sup>8</sup> Hypochloremic, hypokalemic metabolic alkalosis and dehydration are commonly present, particularly with obstructions to the proximal small intestine. The alkalosis results from small-intestinal and abomasal reflux into the rumen, with sequestration of hydrochloric acid in the abomasum. Ileus of the small intestines is one of the most common consequences of obstruction, resulting in distension and hypomotility cranial to the obstruction. The myoelectric activity patterns occurring during small intestinal obstruction are disorganized in the segment oral to the obstruction, characterized by rapidly migrating, prolonged, high-amplitude spikes that sometimes occur in clusters. This probably accounts for the intermittent abdominal pain.

**Ileal impaction** in Swiss Braunvieh cows in Switzerland is characterized clinically by anorexia, sudden drop in milk production, and some evidence of colic, including shifting of weight from leg to leg and occasional kicking at the abdomen.<sup>7</sup> The ventral aspect of the abdomen was enlarged and pear shaped, and a tense abdominal wall was present in some cows. A ping could be elicited over the right abdomen in most cows. The feces in the rectum may be reduced in amount or there may be none. On rectal palpation, dilated loops of small intestine are usually palpable. On laparotomy, the impaction was situated at the ileocecal valve, and the ileum proximal to ileocecal junction was impacted with ingesta for up to 15 cm in length. The color of the serosa of the ileum and distal part of the jejunum was normal. The cause of ileal impaction is attributed to seasonal influences and winter feeding with a hay-based ration.<sup>8</sup>

### Volvulus and Intussusception

**Volvulus of the small intestine** is a rotation of the entire small intestine, with or without the cecum and spiral colon, or of only the distal third of the jejunum and the proximal portion of the ileum about its mesenteric axis (called a **flange volvulus**). The volvulus results in intestinal distension, vascular compromise, intestinal necrosis, and eventually death unless surgically corrected.

**Intussusception** is the invagination of one portion of the intestine into the lumen of an adjacent segment of intestine. Jejuno-jejunal intussusception is the most common form in cattle, although isolated cases of ileocecal, ileocolic, cecocolic, and colocolic intussusception also occur. In most cases the intussusception is single, but doubles do occur. There are reports of cattle surviving after sloughing of an intussusceptum, but these are rare and death usually occurs 5 to 8 days after the onset of clinical findings if surgical correction is not performed.

Generally, the effects of intestinal accidents in cattle are not as remarkable as in the horse. Neither the abdominal pain nor the cardiovascular collapse is as severe in adult cattle as in horses with similar lesions. The exception is in calves, in which the effects are more marked and more rapid. Distension of the abdomen occurs much more frequently in calves than in adult cattle. Involvement of large segments of intestine as in volvulus of the root of the mesentery may result in metabolic acidosis because of the rapid onset of shock. Ischemic necrosis of the intestinal wall results in various degrees of severity of peritonitis and abnormal peritoneal fluid containing erythrocytes, leukocytes, and increased serum proteins.

Hemorrhage into the intestinal tract at the level of the obstruction results in the passage of small quantities of dark blood, which may be almost black if the obstruction is high up in the small intestinal tract.



Distension of intestines with fluid and gas cranial to the obstruction may cause some mild distension of the abdomen but primarily if the large intestine is obstructed as in torsion of the coiled colon. The longer duration of the disease and the profound depression that develops suggest that endotoxemia, as in horses, may be the lethal agent, but the course is much slower than in the horse.

The effect of myoelectric activity of the cecum and proximal loop of the ascending colon on motility of this segment of intestine in experimental obstruction of the large intestine in cattle has been examined. Obstruction of the colon results in prestenotic hypermotility (colic motor complex) or prolonged propulsive peristaltic waves directed toward the obstruction site. This may represent an effort of the intestine to overcome the obstruction to reestablish the continuity of the passage of ingesta.

Patterns of myoelectric activity in the small and large intestine of cows orad and aborad to an obstruction site have been measured. Myoelectric activity in the ileum immediately orad to the occlusion was characterized by abolition of the migrating myoelectric complex and a constant pattern of strong bursts of long duration. Organized cyclic activity occurred in the large intestine despite complete disruption of the small-intestinal migrating myoelectric complexes, indicating the presence of mechanisms able to initiate and regulate coordinated myoelectric patterns in the large intestine independently of the small intestine.

#### Incarceration

The small intestine can be incarcerated in the epiploic foramen<sup>7</sup> or an acquired omental rent.<sup>8-12</sup> Incarceration may follow herniation of a gravid uterus into the omental bursa.<sup>13</sup> Definitive diagnosis is made during right flank laparotomy.

#### Duodenal Ileus

In **duodenal ileus** caused by obstruction of the lumen by phytobezoars or compression of the duodenum by a liver abscess associated with traumatic reticuloperitonitis in mature cows, there is abomasal and duodenal reflux into the rumen resulting in metabolic alkalosis with hypochloremia and increased ruminal chloride. The obstruction caused by phytobezoars and liver abscesses may occur at almost any segment of the duodenum. The ileus results in a marked reduction in gastrointestinal motility and distension of the forestomach and abomasum caused by the accumulation of excessive quantities of fluid, which results in dehydration. Abdominal pain is associated with the distension of the duodenum. The ileus results in marked decrease in movement of ingesta, and the feces are markedly reduced in quantity. Duodenal obstruction caused by malposition of the gallbladder in a heifer has been described.

#### Functional Obstruction

In **functional obstruction**, there is paralytic ileus and an increase in the transit time of ingesta and feces. The feces are scant and do not contain blood. Sequestration of fluids in the intestines may result in varying degrees of dehydration and a metabolic alkalosis with hypochloremia and hypokalemia.

#### CLINICAL FINDINGS

##### General Findings

There is an initial attack of acute abdominal pain in which the animal kicks at its abdomen, treads uneasily with the hindlegs, depresses the back, and may groan or bellow from pain. The pain occurs spasmodically and at short, regular intervals and may occasionally be accompanied by rolling. This stage of acute pain usually passes off within a few (8–12) hours and during this time there is anorexia and little or no feces are passed. In subacute abdominal pain the

animal may assume a sawhorse stance and guard the abdomen (Fig. 8-22). The temperature and respiratory rates are relatively unaffected and the heart rate may be normal or elevated, depending on whether or not blood vessels are occluded. If there is infarction of a section of intestine there will be signs of endotoxic shock, including low blood pressure, very rapid heart rate, and muscle weakness and recumbency. These signs are absent in cases in which the blood supply of the intestine is not compromised. For example, in cecocolic volvulus the heart rate may be normal. In all cases, as the disease progresses and dehydration becomes serious, the heart rate rises and may reach as high as 100 beats/min just before death.

When the acute pain has subsided, the cow remains depressed, does not eat or ruminate, and passes no feces. The circulation, temperature, and respirations are usually within normal limits and ruminal

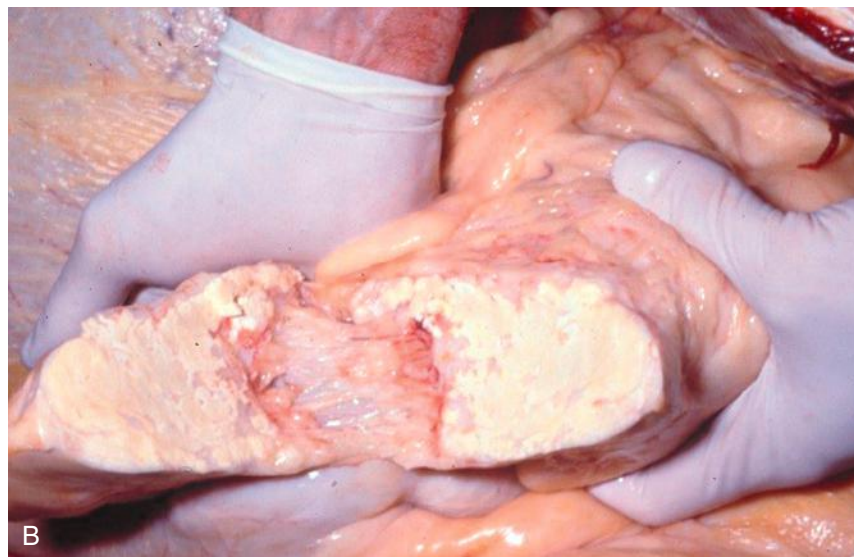

**Fig. 8-22** Simmental cow exhibiting signs of subacute abdominal pain with ears forward, and alert expression, and a slight sawhorse stance (A). The jejunal mesentery contained multiple areas of hard fat, which occluded the intestinal lumen (B).

activity varies. In most cases there is complete ruminal stasis but, in exceptional cases, movements will continue, although they are usually greatly reduced. The rumen pack feels dry and firm on palpation through the abdominal wall.

### Abdomen

The abdomen is slightly distended in all cases. Where there is distension of loops of intestine, as in ileus caused by dietary error, there may be some distension of the right abdomen. Fluid-splashing sounds can be elicited by ballottement and simultaneous auscultation over the right abdomen in most cases and in a minority of cases over the left abdomen. With obstruction of the pylorus the splashing sounds can be elicited only on the right side, just behind the costal arch and approximately halfway down its length. Regurgitation of fluid ingesta through the nose is common.

### Feces

The character of the feces is highly variable. In the early stages they will be normal but passed frequently and in small amounts. It may be necessary to perform a rectal examination because the feces may not be passed from the anus. In some cases they will be hard lumps, usually covered with mucus. Blood is often present, not as melena but as altered red blood, in the form of a thick red slurry, leaving dried flakes of it around the anus, especially in intussusception. The last fecal material is more mucoid and may consist entirely of a plug of mucus (Fig. 8-23). In some cases of obstruction caused by fiber balls the fecal material is pasty, foul-smelling, and yellow-gray in color.

### Palpation Per Rectum

When there is intussusception or volvulus of the small intestine, the affected segment is usually felt in the lower right abdomen, but the site varies with the nature of the obstruction. It is important to appreciate that not all intestinal obstructions can be palpated on rectal examination. It depends on the location of the affected segment of intestine:



**Fig. 8-23** Contents present in the rectum of a cow with acute intestinal obstruction caused by intussusception of the jejunum. There is very little fecal material evident, and the rectal contents are predominately mucus.

those in the anterior part of the abdomen are not palpable, and those in the caudal part of the abdomen may be palpable. In addition, the affected segment may or may not be palpable, and the adjacent segments cranial to the obstruction may be palpable as distended segments of intestine.

In intussusception the affected segment may be palpable in approximately 20% of cases, usually as an oblong, sausage-shaped mass of firm consistency, but if a long length of intestine is involved a spiral develops and is palpable as such. In volvulus the intestinal loop may be small, soft, and mobile. In many cases, it is possible to follow tightly stretched mesenteric bands coursing dorsoventrally in the middle part of the abdomen. Palpation of distended loops of intestine may cause distress, especially in the early stages, and distension of a number of loops may increase intraabdominal pressure to the point where entry of the hand beyond the pelvis is difficult. Within a few days, the rectum is empty except for tarry mucus and exudate and insertion of the arm usually causes pain and vigorous straining. Distension of loops of intestine is not nearly as obvious as in horses with intestinal obstruction and may not occur unless the colon or cecum is involved.

### Duodenal Ileus

**Duodenal ileus** in mature cows is characterized by anorexia, depression, dehydration, abdominal pain (treading, kicking and stretching, and frequent lying down and standing up), rumen distension and hypotonicity, moderate bloat in some cases, scant feces, and the presence of fluid-splashing sounds on auscultation and ballottement of the right abdomen. Rectal examination may reveal no abnormal findings or an enlarged L-shaped rumen and distended loops of small intestine. Ultrasonography can be used to visualize the distended duodenum in the 10th to 12th intercostal spaces. If only one loop of intestine is visible, it indicates distension of the duodenum; when several loops of intestine are visible it indicates ileus of the jejunum or ileum. Duodenal obstruction caused by malposition of the gallbladder in cattle can be diagnosed using abdominal ultrasonography and laparotomy.

### Volvulus of the Spiral Colon (Mesenteric Root Volvulus)

This can cause death in less than 24 hours. It is characterized by distension of the right abdomen, and a number of distended loops of intestine can be palpated. When there is cecal dilatation or cecocolic volvulus, there is usually one grossly distended intestinal loop extending horizontally across the abdomen just cranial to the pelvis and caudally or medially to the rumen. It may be possible to palpate the blind end of the cecum, and in cases that have been affected for several days the organ may be so distended with fluid and gas that it can be seen through the right

flank, or fluid sounds can be produced by ballottement or simultaneous percussion and auscultation. Rarely, the distended cecum may be located in the left paralumbar fossa between the rumen and the abdominal wall, in a position reminiscent of an LDA. The disease is likely to recur in the same cow in subsequent years, and a case of chronic dilatation that persisted for 10 months is recorded.

### Lipomas and Fat Necrosis

These abnormalities are usually easily palpable as firm, lobulated masses that can be moved manually. They may encircle the rectum. An obstructing phytobezoar may be palpable on rectal examination in the right anterior abdomen. It is usually 5 to 15 cm in diameter and so mobile that when touched it may immediately pass out of reach. Affected cattle may remain in this state for 6 to 8 days, but during this time there is a gradual development of a moderate, pendulous, abdominal enlargement; profound toxemia; and an increase in heart rate. The animal becomes recumbent and dies at the end of 3 to 8 days.

### CLINICAL PATHOLOGY

Clinicopathologic findings are generally nonspecific and of limited assistance in making a diagnosis or assessing prognosis preoperatively; however, the more proximal and complete the intestinal obstruction, the more severe the magnitude of hypochloremia, hypokalemia, hyponatremia, and strong ion (metabolic) alkalosis.

### Serum Biochemistry

Hypochloremia, hyponatremia, azotemia, and hyperglycemia are common.

### Hemogram

Hemoconcentration, a mild left shift, and an inverted neutrophil to lymphocyte ratio are common in cases of intussusception.

### NECROPSY FINDINGS

In small-intestinal volvulus, gross changes are consistent with vascular thrombosis and intestinal necrosis. Serosal, omental, and mesenteric hemorrhages of varying degrees of transmural necrosis are common. Intestinal contents include gas, ingesta, and various amounts of blood. In both intussusception and volvulus extensive intestinal necrosis and diffuse peritonitis are common.

### TREATMENT

#### Surgical Correction

Surgical correction of physical obstructions of the intestine is the only method of treatment for animals in which survival and recovery are desirable. Right paralumbar fossa laparotomy is the most common approach. The methods for surgical correction are presented in textbooks dealing with large-animal surgery. Survival rates for correction of volvulus of the entire small



intestine have been 44%, with 86% for volvulus of the distal jejunum and ileum. Survival rates were much higher in dairy cattle (63%) than beef cattle (22%). Survival rates for intussusception in cattle were about 50%. Survival rates following surgical correction of a luminal obstruction of the small intestine by a trichobezoar are high (72%).<sup>6</sup> In ileal impaction in cattle, the postoperative outcome following laparotomy and massage of the contents of the impacted ileum into the cecum is excellent.<sup>8</sup>

### Fluid Therapy

**Fluid and electrolyte therapy** given intravenously may be necessary preoperatively and always postoperatively (see Chapter 5). Multiple electrolyte solutions or 0.9% sodium chloride solution are effective even though metabolic alkalosis with hypochloremia and hypokalemia may be present.

### Antimicrobials

Antimicrobials preoperatively and postoperatively are recommended for the control of peritonitis, which is inevitable.

#### DIFFERENTIAL DIAGNOSIS

- **Acute intestinal obstruction in mature cattle** is characterized by sudden onset of anorexia, reticulorumen atony, usually moderate abdominal pain, scant feces, fluid-splashing sounds over the right abdomen, possibly distended loops of intestine on palpation per rectum, and a progressively worsening course. It must be differentiated from other diseases of the forestomach and abomasum that result in scant feces, reduced reticulorumen activity, abdominal pain, and distended loops of intestine on rectal examination (see Table 8-2). Those diseases include vagus indigestion with or without abomasal impaction, diffuse peritonitis, right-displaced abomasum, abomasal ulcers, and duodenal ileus (see Table 8-2).
- **Hemorrhagic jejunitis syndrome** of dairy cattle is a sporadic disease characterized by sudden anorexia and loss of milk production, moderate abdominal distension, weakness leading to recumbency, bloody to dark feces (melena), fluid-splashing sounds on ballottement over the right abdomen, tachycardia, and distended firm loops of small intestine palpable on rectal examination. The case–fatality rate is high. At necropsy there is severe necrohemorrhagic enteritis or jejunitis with intraluminal hemorrhage or blood clots. This topic is addressed in detail elsewhere in this chapter.
- **Cecal dilatation and cecocolic volvulus** are characterized by gastrointestinal atony with inappetence, possibly distension of the right abdomen, and a high-pitched ping on auscultation and percussion of the right paralumbar fossa, and the cecum is easily identifiable by palpation per rectum.

- **Renal and ureteric colic** may simulate intestinal obstruction but occur rarely. Acute involvement of individual renal papillae in pyelonephritis in cattle is also thought to cause some of these attacks of colic.
- **Urethral obstruction in male ruminants** causes abdominal pain, but there are additional signs of grunting, straining, distension of the urinary bladder, and tenderness of the urethra. Defecation is not affected.
- **Photosensitive dermatitis** in cattle is also accompanied by kicking at the belly, but the skin lesions are obvious and there are no other alimentary tract signs.
- **Acute intestinal obstruction in calves** under 2 months of age must be differentiated from abomasal dilatation—dietary in origin, abomasal volvulus, perforated abomasal ulcers, intussusception, volvulus of the root of mesentery, acute diffuse peritonitis, peracute to acute enteritis, and gastrointestinal tympany. The salient features of each of these diseases is summarized in Table 8-7.

### Nonsteroidal Antiinflammatory Drugs

NSAIDs have been routinely administered in the perioperative period for their antiinflammatory and analgesic effects. Because prostaglandins are critical for the recovery of barrier function in ischemic intestine, concern has been raised about whether the routine administration of NSAIDs may have negative effects on intestinal repair and recovery in animals with damaged intestine.<sup>14</sup> Studies that have been conducted suggest that NSAIDs vary in their effect on the recovery of ischemic-injured jejunum,<sup>14,15</sup> but current knowledge is incomplete regarding a preferred NSAID in ruminants following surgical correction of an intestinal lesion.

#### FURTHER READING

Anderson DE. Surgical diseases of the small intestine. *Vet Clin North Am Food Anim Pract.* 2008;24:383-401.

#### REFERENCES

1. Vogel SR, et al. *J Am Vet Med Assoc.* 2012;241:621.
2. Milnes EL, McLachlan A. *N Z Vet J.* 2015;63:288.
3. Okamoto M, et al. *Vet Rec.* 2007;160:376.
4. Tschuor AC, et al. *Vet Rec.* 2007;161:567-568.
5. Lores M, et al. *Can Vet J.* 2006;47:155.
6. Abutarbush SM, Naylor JM. *J Am Vet Med Assoc.* 2006;229:1627.
7. Braun U, et al. *BMC Vet Res.* 2011;7:2.
8. Nuss K, et al. *Vet J.* 2006;171:456.
9. Steiner S, Winter P. *Vet Rec.* 2007;160:627.
10. Deprez P, et al. *Vet Rec.* 2006;158:869.
11. Pardon B, et al. *Vet Rec.* 2009;165:718.
12. Ruf-Ritz J, et al. *Vet J.* 2013;197:374.
13. Muggli E, et al. *Vet Surg.* 2014;43:91.
14. Little D, et al. *Am J Vet Res.* 2007;68:614.
15. Little D, et al. *J Vet Intern Med.* 2007;21:367.

### INTESTINAL OBSTRUCTION IN SHEEP

Intestinal obstructions are not commonly observed in sheep unless a series of them causes a noticeable mortality. Some notable occurrences are the following:

- Heavy infestation with nodular worm (*Oesophagostomum columbianum*) leading to high prevalence of intussusception occlusion by adhesion.
- High incidence of intussusception in traveling sheep for no apparent reason.
- Cecocolic volvulus (red-gut) is seen in sheep grazing lush pastures of alfalfa or clover in New Zealand. Affected lambs survive only a few hours, and up to 20% of a flock are affected. The outstanding postmortem lesion is a distended, reddened cecum and/or colon that has undergone volvulus. The rumen is smaller and the large intestine larger than normal because of the high digestibility of the diet. All ages, except sucking lambs, are affected and the mortality rate may be as high as 20%. Sheep that are seen alive have a distended abdomen, show abdominal pain, and have tinkling sounds on auscultation of the right flank.

### TERMINAL ILEITIS OF LAMBS

This disease causes poor growth in lambs 4 to 6 months old. The circumstances usually suggest parasitism or coccidiosis. The terminal 50 to 75 cm of the ileum is thickened and resembles the classical lesion of John's disease. Chronic inflammation is evident and there are some shallow ulcers in the epithelium. The terminal mesenteric lymph node is enlarged. Histopathological examination of affected ileal wall shows mucosa thickened by epithelial hyperplasia, leukocytic infiltration, and connective tissue infiltration. The cause is unknown, and the course of the disease has not been identified because most affected lambs are likely to be culled for ill-thrift.

### CECAL DILATATION AND CECOCOLIC VOLVULUS IN CATTLE

Cecal dilatation occurs primarily in dairy cattle in the first few months of lactation. The cecum may be dilated with gas or distended with ingesta, and volvulus may occur. Cecocolic volvulus is characterized by the rotation of the cecum, terminal ileum, and proximal loop of the ascending colon around their mesenteric axis. Clinically, both cecal dilatation and cecocolic volvulus are characterized by inappetence; drop in milk production; decreased amount of feces; a ping over the right upper flank; and a distended, easily recognizable viscus (or more than one in the case of cecocolic volvulus) on rectal



palpation. The prognosis is excellent with cecal dilatation and usually good with cecocolic volvulus if the diagnosis is made early.

### ETIOLOGY

The etiology is uncertain. Experimentally, an increase in the concentration of volatile fatty acids in the cecum can result in cecal atony. Dietary carbohydrates not completely fermented in the rumen are fermented in the cecum, resulting in an increase in the concentration of volatile fatty acids, a drop in pH, and cecal atony. Butyric acid has the greatest depressant effect on cecal motility and acetic acid has the least. Inhibition of cecal motility may lead to accumulation of ingesta and gas in the organ and consequently dilatation, displacement, and possible volvulus.

The concentrations of absolute and undissociated acetic, propionic, butyric, i-valerianic, and n-valerianic acids, as well as total volatile fatty acids, are higher in samples collected from the cecum and proximal loop of the ascending colon of cows with cecal dilatation or dislocation compared with concentrations in control cows. However, the role of increased concentrations of volatile fatty acids in the etiology and pathogenesis of cecal dilatation or dislocation is uncertain. The results of more recent studies have highlighted the potential role that decreased spiral colon motility plays in the development of cecal dilatation and cecocolic volvulus.<sup>1</sup>

### EPIDEMIOLOGY

Dilatation of the cecum and volvulus of the cecum and ascending colon occurs in well-fed, high-producing dairy cows 3 to 5 years of age during the first 12 weeks after parturition. Brown Swiss cattle appear overrepresented in most case series. The disease occurs throughout the year but is most common during the calving season in North America and Europe. There is a record of five cases occurring in lactating dairy cows on one farm within 9 days. The cows were pastured day and night on grass dominated by white clover and received a 22% crude protein concentrate in the milk parlor twice daily in addition to silage. Cecocolic volvulus has also been described in sheep.

Atony or hypomotility of the spiral colon is thought to initiate the disease, leading to dilatation and displacement, including volvulus.<sup>1</sup>

### PATHOGENESIS

The pathogenesis of cecal dilatation, displacement, and volvulus is thought to be similar to that which occurs in dilatation and displacement of the abomasum, except that the primary defect appears to be downstream in the spiral colon. The combination of intestinal gas and decreased cecal emptying into the proximal loop of the ascending colon results in accumulation of fluid and gas in the cecum followed by dilatation and displacement of the cecum into the pelvic inlet.

This results in a mild indigestion, or the dilatation may be subclinical and may be detected incidentally when the cow is examined for other purposes.

The myoelectrical activity of the cecum is well coordinated with the ileum and the proximal loop of the ascending colon and spiral colon. The patterns of myoelectrical activity observed in cattle with cecal dilatation following surgical correction are more consistent with that of an obstructive pattern; as a consequence, the main area of hypomotility appears to be the spiral colon.<sup>1</sup> This hypothesis is consistent with alterations in mRNA expression for adrenergic,<sup>2</sup> muscarinic,<sup>3</sup> and serotonergic<sup>4</sup> receptors in cattle with cecal dilatation; the changes in expression appear to be greatest in the spiral colon.

In cecocolic volvulus, the apex of the cecum is rotated cranially and the cecal body becomes distended. The viscus and the first few segments of the proximal loop of the ascending colon twist about the mesentery, causing incarceration and eventually strangulation obstruction of the affected portions of the intestine. The term cecocolic volvulus is a more accurate description of this condition because cecal torsion indicates a twist of the cecum along its longitudinal axis, which is extremely rare. Translocation of the cecum may occur to the left or right and in each case involves the proximal loop of the ascending colon. The net effect is partial or total obstruction of the intestinal tract, accumulation of gas or ingesta in the cecum and ascending colon, varying degrees of paralytic ileus, reduced amount of feces, and necrosis of the cecum because of ischemia. **Cecal impaction** is rare and characterized by gross distension of the viscus with dry ingesta, and in a mature cow the cecum may measure 90 cm in length by 20 cm in diameter. The severity of the disease depends primarily on the degree of twisting of the cecum and its adjacent spiral colon, which results in ischemic necrosis. Rarely, a prolapse of the small intestine through a tear in the mesentery of the small intestine near its root may also pull the cecum cranially by the ileocecal fold and cause an anticlockwise volvulus, as viewed from the right side of the animal.

It has been postulated that hypomotility of the cecum and proximal loop of the ascending colon may be responsible for the delayed recovery from and recurrence of cecal dilatation and displacement that occur following surgical evacuation of the cecum. However, the myoelectric activity of the cecum and proximal loop of the ascending colon in cows after spontaneous dilatation and displacement of the cecum indicates that delayed recovery is not caused by hypomotility; instead, hypomotility of the spiral colon appears to be the primary factor.

### CLINICAL FINDINGS

In **cecal dilatation without volvulus**, there are varying degrees of anorexia, mild

abdominal discomfort, a decline of milk production over a period of a few days, and a decreased amount of feces. In some cases, there are no clinical signs and the dilated cecum is found coincidentally on rectal examination. In simple dilatation, the temperature, heart rate, and respirations are usually within normal ranges. A distinct ping is detectable on percussion and simultaneous auscultation in the right paralumbar fossa, extending forward to the 10th intercostal space; however, the ping usually changes in quality over time. Simultaneous ballottement and auscultation of the right flank may elicit fluid-splashing sounds. There may be slight distension of the upper right flank, but in some cases the contour of the flank is normal.

In **cecocolic volvulus**, anorexia, ruminal stasis, reduced amount or complete absence of feces, distension of the right flank, dehydration, and tachycardia are evident, depending on the severity of the volvulus and the degree of ischemic necrosis. There may be some evidence of mild abdominal pain characterized by treading of the pelvic limbs and kicking at the abdomen. The ping is centered over the right paralumbar fossa and may extend to the 10th and 12th intercostal spaces. Fluid-splashing sounds are usually audible on ballottement and auscultation of the right flank.

On palpation per rectum the distended cecum can usually be palpated as a long, cylindrical, movable organ measuring up to 20 cm in diameter and 90 cm in length. Palpation and identification of the blind end of the cecum directed toward the pelvic cavity is diagnostic. In **simple dilatation**, with minimal quantities of ingesta, the cecum is enlarged and easily compressible on rectal palpation. In **cecocolic volvulus**, the viscus is usually distended with ingesta and feels enlarged and tense on rectal palpation. The blind end of the cecum may be displaced cranially and laterally or medially, and the body of the cecum is then felt in the pelvic cavity. Varying degrees of distension of the colon and ileum may occur, depending on the degree of displacement or volvulus present (Fig. 8-24). Rupture of the distended cecum may occur following rectal palpation or transportation of the animal. This is followed by shock and death within a few hours.

### Ultrasonographic Examination of the Cecum

The cecum and proximal and spiral ansa of the colon can be visualized ultrasonographically using a 3.5-MHz linear transducer in mature cows. The cecum can be visualized from the middle region of the abdominal wall. It extends caudocranially, varies in diameter from 5.2 to 18.0 cm, and is situated immediately adjacent to the abdominal wall. The lateral wall of the cecum appears as a thick, echogenic, crescent-shaped line. The cecum can be visualized as far cranially as

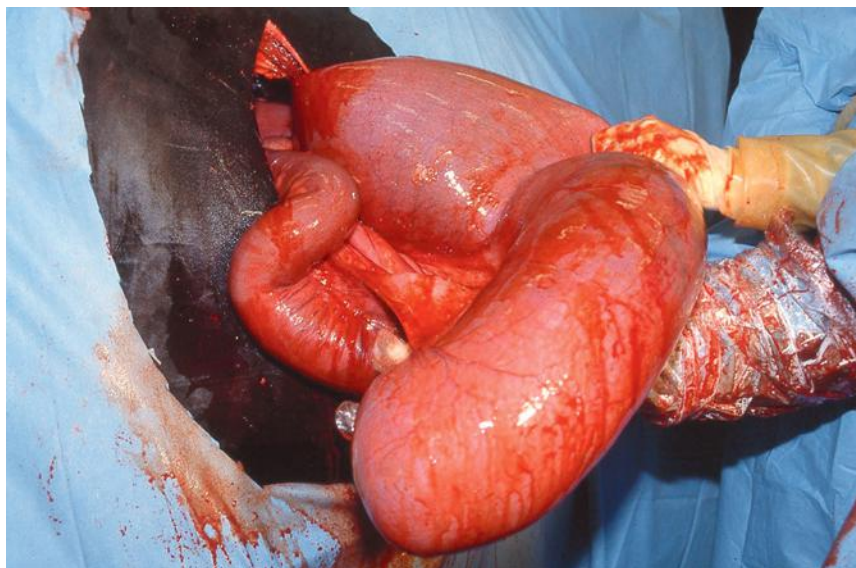

**Fig. 8-24** Cecocolic volvulus in a Holstein Friesian cow. The cow's head is to the right and a right flank laparotomy is being performed with the cow standing. The cecum is markedly distended and has a bluish color suggestive of ischemia. The ileum is also markedly distended (smaller luminal structure caudal to the cecum).

the 12th intercostal space. Although its junction cannot be identified, the proximal ansa of the colon is recognizable on the basis of its anatomic position and its diameter, which is smaller than that of the cecum. The spiral ansa of the colon and the descending colon are situated dorsal to the cecum and can be identified by moving the transducer horizontally along the abdominal wall to the last rib. The spiral ansa of the colon is situated ventral to the descending colon, and its walls appear as thick echogenic lines. In a contracted state, the spiral colon has the appearance of a garland.

The ultrasonographic findings in cows with dilatation, volvulus, and retroflexion of the cecum have been described and compared with the findings on laparotomy. The wall of the proximal ansa of the colon and of the dilated cecum closest to the abdominal wall is visible in all cows and appears as an echogenic semicircular line immediately adjacent to the peritoneum. The contents of the cecum and of the proximal and spiral ansa of the colon are not always visible because of gas. In some cows, the contents are hypoechoic to echogenic in appearance. The dilated cecum can be imaged from the right abdominal wall at the level of the tuber coxae. The cecum can be imaged from the 12th, 11<sup>th</sup>, and 10th intercostal spaces in some cows, and in other cows the cecum and proximal ansa of the colon are situated immediately adjacent to the right abdominal wall by the liver and/or gallbladder. The diameter of the cecum, measured at various sites, varies from 7.0 to 25.0 cm. Cecal dilatation can be diagnosed on the basis of the results of rectal examination in most cows but in all cows ultrasonographically. Dilatation and caudal displacement of the cecum

and dilatation and craniodorsal retroflexion of the cecum can be visualized. In some cows, the direction of the retroflexed cecum cannot be determined.

#### CLINICAL PATHOLOGY

A mild degree of dehydration may be present and a compensated hypochloremia and hypokalemia occur. Hypocalcemia is present in 85% of cases.<sup>5</sup> Hematological values are normal in most affected cattle unless there is necrosis of the cecum accompanied by peritonitis.

#### DIFFERENTIAL DIAGNOSIS

- **Cecal dilatation and cecocolic volvulus** must be differentiated from right-side dilatation and volvulus of the abomasum. The ping in cecal dilatation and volvulus is usually centered in the paralumbar fossa; in abomasal dilatation and volvulus it is usually centered over the last few ribs and lower in the middle third of the right abdomen. The distended cecum is usually easily palpable rectally in the upper part of the abdomen and is readily identified as the cecum because it is movable. In dilatation and volvulus of the abomasum, the distended viscus is usually palpable in the right lower quadrant of the abdomen much further forward than a dilated cecum and not movable. In many cases, the distended abomasum can barely be touched with the tips of the fingers, whereas the distended cecum can be palpated easily.
- **Intestinal obstruction** of the small intestines or other parts of the large intestine are characterized by subacute

abdominal pain, absence of feces, more marked systemic signs such as dehydration and tachycardia, and perhaps the presence of distended loops of intestine on rectal examination.

#### TREATMENT

The method of treatment depends on the severity of the case and whether there is uncomplicated dilatation and displacement caudally or if volvulus is present.

#### Medical Therapy

Mild cases of uncomplicated gaseous dilatation of the cecum may be treated conservatively by feeding good-quality hay, and recovery can occur in 2 to 4 days. The use of parasympathomimetic drugs such as neostigmine 0.02 mg/kg BW given subcutaneously every hour for 2 to 3 days has been recommended, but controlled trials demonstrating efficacy have not been performed. Xylazine is contraindicated for the abdominal pain associated with cecal dilatation because it reduces the myoelectrical activity of the cecum and proximal loop of the ascending colon. Cisapride at 0.08 mg/kg BW orally shows some promise. Bethanechol at 0.07 mg/kg BW subcutaneously and neostigmine at 0.02 mg/kg BW subcutaneously increased the frequency of cecocolic spike activity, the duration of cecocolic spike activity, and the number of cecocolic propagated spike sequences every 10 minutes. Bethanechol is considered superior to neostigmine because it induces more pronounced coordinated and aborally propagated spike activity.

#### Surgical Correction

For volvulus with the accumulation of ingesta and the possibility of necrosis of the cecum and ascending colon, the treatment of choice is surgical correction, and the prognosis is usually good. The recurrence rate of cecal dilatation and displacement ranges from 11% to 13% within the first week after surgery, whereas the long-term recurrence rate is about 25%. In severe cases with necrosis of the cecum, partial resection or total typhlectomy may be necessary. Extensive cecal necrosis requires total typhlectomy, which can be successful and lactating dairy cows may thrive and their milk production may be excellent in the current lactation.

#### FURTHER READING

Meylan M. Surgery of the bovine large intestine. *Vet Clin North Am Food Anim Pract.* 2008;24:479.

#### REFERENCES

1. Kunz-Kirchhofer C, et al. *Am J Vet Res.* 2010;71:304.
2. Kobel B, et al. *Am J Vet Res.* 2006;67:1367.
3. Ontsouka EC, et al. *Vet J.* 2009;180:259.
4. Engel L, et al. *Am J Vet Res.* 2006;67:95.
5. Braun U. *BMC Vet Res.* 2012;8:75.



## Bacterial Diseases of the Ruminant Alimentary Tract

### ACTINOMYCOSIS (LUMPY JAW)

#### SYNOPSIS

**Etiology** *Actinomyces bovis*, normal inhabitant of the ruminant oral cavity.

**Epidemiology** Common but sporadic disease from infection through wounds to the buccal mucosa by feed or through dental alveoli.

**Clinical findings** Initially painless, hard, immovable bony swelling on mandible or maxilla. Eventually discharge of small amounts of pus through one or more openings in skin.

**Clinical pathology** Presence of "club" colonies containing gram-positive filaments.

**Diagnostic confirmation** Isolation of organism.

**Treatment and control** Surgical debridement. Iodides and/or antimicrobial orally or parenterally.

#### ETIOLOGY

*Actinomyces bovis* is the primary cause, but other bacteria may be present in extensive lesions including non-*bovis* *Actinomyces* spp.

#### EPIDEMIOLOGY

The disease is sporadic but common in cattle. Occasional cases occur in pigs, horses, goats, dogs, and humans. Although actinomycosis occurs only sporadically, it is important because of its widespread occurrence and poor response to treatment. It is recorded in most countries of the world.

*A. bovis* is a common inhabitant of the bovine mouth and infection is presumed to occur through wounds to the **buccal mucosa** caused by sharp pieces of feed or foreign material. Infection may also occur through **dental alveoli** and may account for the more common occurrence of the disease in young cattle when the teeth are erupting. Infection of the **alimentary tract** wall is probably related to laceration by sharp foreign bodies.

#### PATHOGENESIS

An initial trauma of the oral mucosa or gingiva caused by small but sharp penetrating feed particles creates a portal of entry for the causative agent. The ensuing infection causes periostitis and osteomyelitis.<sup>1</sup> In the jawbones a rarefying **pyelogrammatous osteomyelitis** is produced.

The effects on the animal are purely physical. Involvement of the jaw causes interference with prehension and mastication, and when the alimentary tract is involved there is physical interference with ruminal movement and digestion, both resulting in partial starvation. Rarely, localization occurs in

other organs, caused apparently by hematogenous spread from these primary lesions.

#### CLINICAL FINDINGS

##### Cattle

Actinomycosis of the **jaw** commences as a painless, **bony swelling** that appears on the mandible or maxilla, usually at the level of the **central molar teeth**. The enlargement may be diffuse or discrete and in the case of the mandible may appear only as a thickening of the lower edge of the bone with most of the enlargement in the intermandibular space. Such lesions are often not detected until they are too extensive for treatment to be effective.

The more common, discrete lesions on the lateral surfaces of the bones are more readily observed. Some lesions enlarge rapidly within a few weeks, others slowly over a period of months. The swellings are very **hard, immovable** and, in the later stages, painful to the touch. They usually break through the skin and discharge through one or more openings (Fig. 8-25).

The discharge of pus is small in amount and consists of sticky, honey-like fluid containing minute, hard, yellow-white granules. There is a tendency for the sinuses to heal and for fresh ones to develop periodically. Teeth embedded in the affected bone become malaligned and painful and cause difficult mastication with consequent loss of condition. In severe cases, spread to contiguous soft tissues may be extensive and involve the muscles and fascia of the throat. Excessive swelling of the **maxilla** may cause dyspnea. Involvement of the local lymph nodes does not occur. Eventually the animal becomes so emaciated that destruction is necessary, although the time required to reach this stage varies from several months to a year or more.

The most common form of actinomycosis of soft tissues is involvement of the **esophageal groove** region, with spread to the lower esophagus and the anterior wall of the reticulum. The syndrome is one of **impaired digestion**. There is periodic diarrhea with the passage of undigested food material, chronic bloat, and allotriophagia. Less common lesions of soft tissue include **orchitis** in bulls, the **trachea** causing partial obstruction, and abscess in the brain or lungs.

##### Pigs

Rare cases of wasting occur because of visceral actinomycosis but extensive granulomatous lesions on the skin, particularly over the **udder**, are more common.

#### CLINICAL PATHOLOGY

Smears of the discharging pus stained with Gram stain provide an effective simple method of confirming the diagnosis. In non-draining lesions tissue core biopsies or fluid aspirates provide suitable material to identify



**Fig. 8-25** A, Polled Hereford cow with actinomycosis of the left mandible. B, Brown Swiss cow with actinomycosis of the left mandible with a draining tract.

the causative agent. Gram-positive filamentous rods can be identified by staining the crushed yellow granules found in pus.

#### NECROPSY FINDINGS

Rarefaction of the bone and the presence of loculi and sinuses containing thin, whey-like pus with small, gritty granules are usual. An extensive fibrous tissue reaction around the lesion is constant, and there may be contiguous spread to surrounding soft tissues. The



presence of “club” colonies containing the typical, thread-like bacteria is characteristic of the disease. These formations may be seen on microscopic examination of smears made from crushed granules in pus or on histologic examination of section.

**Granulomatous lesions** containing pockets of pus may be found in the esophageal groove, the lower esophagus, and the anterior wall of the reticulum. Spread from these lesions may cause a chronic, local peritonitis. There may be evidence of deranged digestion with the rumen contents sloppier than usual, an empty abomasum, and a mild abomasitis and enteritis. Involvement of local lymph nodes does not occur, irrespective of the site of the primary lesion.

### DIFFERENTIAL DIAGNOSIS

**Abscesses** of the cheek muscles and throat region are quite common when spiny grass awns occur in the diet. They are characterized by their movability and localization in soft tissues compared with the immovability of an actinomycotic lesion. Pus may be thin, fetid, or caseous depending on the duration of the abscess. Prompt recovery follows opening and drainage.

**Foreign bodies** or accumulations of dry feed jammed between the teeth and cheek commonly cause a clinical picture that resembles actinomycosis, and the inside of the mouth should be inspected if the enlargement has occurred suddenly.

The syndrome of indigestion caused by **visceral actinomycotic lesions** resembles that caused by chronic peritonitis.

Cutaneous and mammary lesions in sows closely resemble necrotic ulcers associated with *Borrelia suilla*.

### TREATMENT AND CONTROL

Treatment is with surgical debridement and antibacterial therapy, particularly iodides. Oral or intravenous administration of iodides is the most common treatment approach, although less effective in cases of actinobacillosis. For intravenous treatment a 10% or 20% sodium-iodide solution is administered slowly intravenously at a dose of 70 mg/kg. This treatment may be repeated after 1 to 2 weeks. Oral treatment with potassium iodide at a dose of 6 to 10 g per animal daily for at least 10 days has also been proposed; reports of treatment efficiency are anecdotal. Another treatment recorded as being effective consists of isoniazid given orally at the rate of 10 to 20 mg/kg BW daily for about 30 days. Cessation of the growth of the lesion should occur, but response in advanced cases is poor. Repeated cryotherapy with liquid nitrogen is reported to be effective. For control, isolation or disposal of animals with discharging lesions may be advisable, although the disease does not spread readily unless predisposing environmental factors cause a high incidence of oral

lacerations. In severe cases and cases unresponsive to iodide treatment, parenteral antimicrobial therapy using penicillin, ampicillin, tetracyclines, or florfenicol have been suggested.

### TREATMENT AND CONTROL

#### Treatment

Sodium-iodide (as 10% or 20% solution) (70 mg/kg IV, may be repeated after 7–10 days) (R-2)

Potassium-iodide (6–10 g per animal orally every 24 h for 10 days) (R-2)

Isoniazid (2.5–5 mg/kg orally every 24 h for 30 days) (R-2)

Procaine penicillin (44,000 IU/kg IM every 24 h for 7 days) (R-2)

Florfenicol (20 mg/kg every 48 h IM) (R-2)

Oxytetracycline (10 mg/kg IM every 24 h for at least 7 days) (R-2)

Oxytetracycline long-acting formulation (20 mg/kg IM every 72 h) (R-2)

#### Control

Isolation and disposal of cattle with discharging lesions (R-2)

IM, intramuscularly; IV, intravenously.

### REFERENCE

1. Militerno G. *Vet Rec.* 2008;163:369.

## ACTINOBACILLOSIS (WOODEN TONGUE)

### SYNOPSIS

**Etiology** *Actinobacillus lignieresii*.

**Epidemiology** Organism is normal inhabitant of alimentary tract. Infection through abrasion of oral mucosa or skin. Site difference in sheep and cattle reflects differences in risk associated with prehension of food. Sporadic disease but outbreaks in which herd/flock predisposing factors are present.

**Clinical findings** Difficulty in prehension of food. Inflammation and abscessation of tongue and draining lymph nodes in cattle and of lips in sheep; Nodular/proliferative skin lesions most common on head, neck, or lower limbs.

**Clinical pathology and diagnostic confirmation** Demonstration of organism.

**Treatment and control** Iodides, antibiotics, and hygiene. Avoidance of abrasive pastures.

Actinobacillosis refers to a sporadically occurring inflammatory process of soft tissue usually occurring in cattle, sheep, goats, and buffaloes. A similar condition has also been reported in horses and humans, where it was associated with animal bites. The condition manifests as a chronic pyogranulomatous

inflammatory condition involving the tongue (wooden tongue), skin (skin actinomycosis), lymph nodes, and more rarely parts of the upper digestive tract including esophagus, rumen, and reticulum.

### ETIOLOGY

The causative agent of actinobacillosis is *A. lignieresii*, a normal inhabitant of the upper digestive tract of ruminants that becomes an opportunistic pathogen once having penetrated into deeper soft tissue through an integumental or mucosal break. *A. lignieresii* may be recovered in pure culture from the lesions, but other pyogenic organisms may also be present. Recent investigations have shown that bacteria with phenotypic similarity to *A. lignieresii* isolated from horses are genotypically distinct from those isolated from ruminants and they have been designated as *Actinobacillus* genomospecies 1.

### EPIDEMIOLOGY

#### Occurrence

The disease in **cattle** has a worldwide distribution and is usually of sporadic occurrence on individual farms. In **sheep**, the disease is recorded in most sheep-raising countries and is common in Scotland. In most instances, only occasional cases occur but in some flocks a morbidity rate of up to 25% may be encountered. Actinobacillosis also occurs, but is rare, in horses.

#### Source of Infection and Transmission

*A. lignieresii* is a normal inhabitant of the oral cavity and rumen of ruminants. The organism is susceptible to ordinary environmental influences and does not survive for more than 5 days on hay or straw. Infection in soft tissue results from damage to the oral mucosa or skin.

In **cattle**, infection most often occurs through ulcerating or penetrating lesions to the sulcus of the tongue, penetrating lesions in the apex, and lacerations to the side of the body of the tongue caused by the teeth. Abattoir surveys suggest that subclinical infections are common and have found small actinobacillary granulomas in the draining lymph nodes of the head and approximately 3% of tongues in slaughter cattle. Recently reports of outbreaks of **skin actinomycosis** in young beef cattle that were associated with skin lesions on lower limbs have been published. The underlying cause could not be determined but was assumed to be increased occurrence of skin lesions e.g., though abrasive surfaces that would have created portals of entry for this environmental pathogen.<sup>1</sup> An incidental report of a postoperative complication of a C-section in which actinobacillosis occurred in the wound is available.<sup>2</sup>

In **sheep**, the different nature of prehension of food leads to lesions predominantly in the lips and cheeks with occasional extension to the mucous membranes of the turbinates and the soft tissue of the head and neck.

## Risk Factors

The disease is usually sporadic, but multiple cases in a herd and apparent outbreaks of the disease can occur when animals graze **abrasive pasture** species or pastures with **spiny awns** and transmission may be enhanced by infected discharges contaminating these pastures or feeds. A high prevalence is recorded in cattle grazing “burnt-over” peat pastures in New Zealand. These pastures contain a great deal of gravel and ash likely to cause oral injury. A similar high incidence has been observed in sheep fed prickly pear (*Opuntia* spp.). A severe outbreak has also been reported in heifers fed on very dry, stemmy, tough haylage and in cattle fed wheat straw from a specific thresher that produced straw with sharp edges. There is a higher prevalence of this disease in cattle in areas of copper deficiency.

Actinobacillosis granulomas may also occur at **atypical sites** in cattle, such as the external nares or the jugular furrow following infection of surgery wounds or **traumatic lesions** caused by nose grips or jugular venipuncture.<sup>2</sup> Reports of skin actinomycosis affecting several to many animals in a herd have been reported in recent years.<sup>1,3</sup> Infection of the cheeks resulting in bilateral facial enlargement is also recorded.

## Zoonotic Implications

*A. lignieresii* is rarely associated with human disease but has been isolated from bite wounds inflicted by horses and ruminants.

## PATHOGENESIS

Local infection by the organism causes an acute inflammatory reaction and the subsequent development of granulomatous lesions in which necrosis and suppuration occur, often with the discharge of pus to the exterior. Spread to regional lymph nodes with **ensuing lymphadenitis** is usual. Lingual involvement in cattle causes interference with prehension and mastication because of acute inflammation in the early stages and distortion of the tongue at a later stage. Visceral involvement is recorded and is identical with that described under actinomycosis.

## CLINICAL FINDINGS

### Cattle

The onset of **glossal actinobacillosis** is usually acute, and the affected animal is unable to eat for a period of about 48 hours. There is excessive **salivation** and **gentle chewing** of the tongue as though a foreign body were present in the mouth. On **palpation** the tongue is swollen and hard, particularly at the base, with the tip often appearing to be normal. Manipulation of the tongue causes pain and resentment. Nodules and ulcers are present on the side of the tongue, and there may be an ulcer at the anterior edge of the dorsum. In the later stages in which the acute inflammation is replaced by fibrous tissue, the tongue becomes shrunken

and immobile and there is considerable interference with prehension.

**Lymphadenitis** is common and is often independent of lesions in the tongue. There may be visible and palpable enlargement of the submaxillary and parotid nodes. Local, firm swellings develop and often rupture with the discharge of thin, nonodorous pus. Healing is slow and relapse is common. Enlargement of the retropharyngeal nodes causes loud snoring respiration and interferes with **swallowing**.

**Cutaneous actinobacillosis** is also recorded with actinobacillosis granulomas occurring on atypical but visible areas such as the external nares, cheeks, skin or eyelid, and limbs. External trauma from abrasive materials in the environment is the usual initiating cause. Lesions are several centimeters in diameter and are pliable or firm and painful on palpation, red, and can bleed easily. Caseated small foci may be evident in the mass when it is debulked.

### Sheep

In sheep the tongue is not usually affected. Lesions up to 8 cm in diameter occur on the **lower jaw, face, and nose**, or in the skin folds from the lower jaw to the sternum. They may be superficial or deep and usually extend to the cranial or cervical lymph nodes. Viscid, yellow-green pus containing granules is discharged through a number of small openings. Extensive lesions cause the formation of much fibrous tissue, which may physically impede prehension or respiration. Thickening and scabbiness of the lips may also be observed. Involvement of the nasal cavities may cause persistent bilateral nasal discharge. Affected sheep have difficulty in eating and many die of starvation. *A. lignieresii* is also an occasional cause of **mastitis** in ewes.

A similar involvement of the lips with abscessation in the area of the mandibular lymph nodes is recorded in camels. Incidental cases as well as outbreaks reported in **buffaloes** all were associated with cutaneous but not with glossal involvement.<sup>4</sup> In **horses** the disease is uncommon but intermandibular phlegmon, or infection of the tongue or of the muzzle can occur as well as infection at other body sites.

## CLINICAL PATHOLOGY

Purulent discharges commonly contain “sulfur” bodies, which are granular in nature and, on microscopic examination, consist of **club-like rosettes** with a central mass of bacteria. These are not pathognomonic for *A. lignieresii* but can also be found in purulent exudate from granulomas associated with *A. bovis*, *Pseudomonas aeruginosa*, and *S. aureus*. Definitive diagnosis depends on the recovery of the organism from the lesion; therefore examination of smears or culture of pus for the presence of *A. lignieresii* is advisable. Isolation of the pathogen has been

reported to be difficult from chronic lesions particularly when antimicrobials have been used. Full-thickness incision biopsies used for histopathological examination can be of value in diagnosis and show multiple pyelo-granulomas in the deep dermis with distinct eosinophilic club rosettes surrounding gram-negative bacterial rods.

## NECROPSY FINDINGS

Necropsy examination is not usually performed in cattle affected by the disease. In sheep, lymphangitis and abscesses containing thick, tenacious, yellow-green pus occur around the local lesion. Typical club colonies are visible on staining sections of affected tissue. Culture of material from lesions usually detects the presence of *A. lignieresii*.

## DIFFERENTIAL DIAGNOSIS

- Foreign bodies in the mouth
- Rabies
- Esophageal obstruction
- Tuberculosis
- Cutaneous lymphosarcoma

## TREATMENT

Iodides are still a standard treatment for both actinomycosis and actinobacillosis. In the former, the results are relatively inefficient, but in actinobacillosis, response is usually dramatic and permanent. Laboratory studies suggest that iodides have little bactericidal effect against *A. lignieresii*. It is probable that iodides exert their effect by reducing the severity of the fibrous tissue reaction.

Oral or intravenous dosing of iodides may be used. Potassium iodide, 6 to 10 g/day for 7 to 10 days, given orally to cattle, is effective. Treatment must be discontinued when symptoms of iodism develop. Lacrimation, anorexia, coughing, and the appearance of dandruff indicate that maximum systemic levels of iodine have been reached. Sodium iodide (70 mg/kg) can be given intravenously as a 10% or 20% solution in one dose to both cattle and sheep. One course of potassium iodide or one injection of sodium iodide is usually sufficient for soft-tissue lesions, with the acute signs in actinobacillosis disappearing in 24 to 48 hours after treatment. At least one or preferably two further treatments at 10- to 14-day intervals are required for bony lesions.

Occasionally animals show distress, including restlessness, dyspnea, tachycardia, and staggering during injections of sodium iodide. Abortion occasionally occurs following the treatment of heavily pregnant cows with sodium iodide. This has not been reproduced in an experimental study; however, although uncommon, it is wise to advise the owner of this risk. Subcutaneous injections of sodium iodide cause severe irritation and local swelling immediately. The irritation

disappears within an hour or two but the swelling persists for some days. Subcutaneous injection is the standard route of administration for sheep, with the dose rate of sodium iodide being 20 mL of a 10% solution weekly for 4 to 5 weeks.

Sulfonamides, penicillin, streptomycin, and broad-spectrum antibiotics are also used. Streptomycin, given by intramuscular injection and repeated if necessary, has given good results in actinomycosis in cattle when combined with iodides and local surgical treatment. Isoniazid has been used as a treatment for actinomycotic infections in humans, and it has been reported on favorably as an adjunct to antibiotic or iodide therapy in cattle. The daily dose rate recommended is 10 mg/kg BW orally or intramuscularly, continued for 3 to 4 weeks.

Cutaneous actinobacillosis may require an extended course of treatment with streptomycin and/or dihydrostreptomycin for 2 to 4 weeks to achieve resolution.

#### TREATMENT AND CONTROL

##### Treatment

Sodium-iodide (as 10% or 20% solution) (70 mg/kg IV, may be repeated after 7–10 days) (R-2)

Potassium-iodide (6–10 g per animal orally every 24 h for 10 days) (R-2)

Isoniazid (2.5–5 mg/kg orally every 24 h for 30 days) (R-2)

Procaine penicillin (44,000 IU/kg IM every 24 h for 7 days) (R-2)

Florfenicol (20 mg/kg every 48 h IM) (R-2)

Oxytetracycline (10 mg/kg IM every 24 h for at least 7 days) (R-2)

Oxytetracycline long-acting formulation (20 mg/kg every 72 h IM) (R-2)

Dihydrostreptomycin 10 mg/kg IM for at least 7 days) (R-2)

##### Control

Isolation or disposal of animals with discharging lesions (R-1)

IM, intramuscularly; IV, intravenously.

#### CONTROL

Restriction of the spread of disease is best implemented by quick treatment of affected animals and the prevention of contamination of pasture and feed troughs. Isolation or disposal of animals with discharging lesions is essential, although the disease does not spread readily unless predisposing environmental factors cause a high incidence of oral or skin lacerations.

#### REFERENCES

- Cahalan SD, et al. *Vet Rec.* 2012;171:375.
- DeKruif A, et al. *Vet Rec.* 1992;131:414.
- Milne MH, et al. *Vet Rec.* 2001;148:273.
- Muhammad G, et al. *Acta Vet Brno.* 2006;75:247.

## ORAL AND LARYNGEAL NECROBACILLOSIS

### SYNOPSIS

**Etiology** *Fusobacterium necrophorum*.

**Epidemiology** Oral infection of calves less than 3 months old; laryngeal involvement in older animals up to 18 months of age.

#### Clinical findings

*Necrotic stomatitis*: Fetid breath and necrotic ulceration of mucosa of cheek.

*Laryngeal necrobacillosis*: Fetid breath. Inspiratory dyspnea and stridor, necrotic lesions on arytenoid cartilages.

*Lesions*: Necrosis at site of lesion.

**Treatment** Antimicrobials. Surgical debridement of necrotic lesions and arytenoidectomy in unresponsive cases. Tracheostomy may be required to allow breathing with necrotic laryngitis.

**Control** None specific.

The term “necrobacillosis” commonly refers to infections associated with necrotizing lesions caused by *F. necrophorum*.<sup>1</sup> Although oral necrobacillosis refers to an inflammatory process affecting tissue of the oral cavity of calves, laryngeal necrobacillosis refers to an infection of the more caudal pharyngeal and laryngeal region. **Calf diphtheria** is a common synonym for necrobacillosis of the pharynx and larynx, and **necrotic stomatitis** is a synonym for the oral form. They are considered together because the essential lesion and infection are the same in both instances.

#### ETIOLOGY

*F. necrophorum* is a gram-negative, non-spore-forming, rod-shaped anaerobic but aerotolerant organism. It is a normal inhabitant of the ruminant oral cavity and upper digestive and respiratory tract and an opportunistic pathogen generally associated with abscesses and various necrotic infections.<sup>2</sup> Along with the oral/laryngeal necrobacillosis, *F. necrophorum* is also the causative agent of digital necrobacillosis (foot rot) and liver necrobacillosis (liver abscesses) in cattle.

Historically a subdivision of *F. necrophorum* divided into four different biotypes (A, B, AB, and C) was used. Biotypes A and B, which are considered to be most relevant in the etiology of *F. necrophorum*-associated diseases in cattle have been renamed as *F. necrophorum* subsp. *necrophorum* (formerly biotype A) and *F. necrophorum* subsp. *funduliforme* (formerly type B). The subspecies *necrophorum* is the more prevalent subspecies in necrobacillosis processes in animals. *F. necrophorum* subsp. *funduliforme* tends to occur more frequently in mixed infections.<sup>2</sup> Both *F. necrophorum* subsp. *necrophorum* and *F. necrophorum* subsp. *funduliforme* are associated with the disease.

*F. necrophorum* possesses a number of virulence factors such as endotoxic LPS,

leukotoxin (LT) hemolysin, and hemagglutinin as well as others that are considered to be of critical importance for the anaerobic pathogen to penetrate, colonize, and proliferate in nonsuperficial tissue.<sup>2</sup> The pathogen is considered incapable of penetrating the intact mucosa or skin. Therefore other factors causing a primary tissue trauma, and thereby a portal of entry, are probably required. In the case of laryngeal disease, the point of entry is thought to be contact ulcers in the mucosa caused by repeated closure of the larynx.

#### EPIDEMIOLOGY

##### Occurrence

The disease has no geographic limitations but is more common in countries in which animals are housed in winter or maintained in feedlots. In the United States infections involving the pharynx and larynx appear to be more prevalent in the western states than in other sections of the country. It is a common disease in feedlots in yearling cattle, often in company with papillomatosis of the larynx. Laryngeal necrobacillosis is one of the most common infectious upper airway diseases associated with severe respiratory distress in calves observed in Belgium, the Netherlands, and parts of France. The condition in this region primarily affects **double-musled Belgian Blue calves**, which are considered to be genetically predisposed to the condition.<sup>3</sup>

The disease is seen incidentally in sheep and goats. Laryngeal chondritis has been described in Texel sheep, which may be predisposed to the disease because of anatomic factors, namely the short head of the breed. This may affect the shape of the larynx or its relationship to adjacent tissues.

##### Transmission

Oral/laryngeal necrobacillosis is an infectious but noncontagious disease. The causative bacterium is a common inhabitant of the environment and upper digestive tract of cattle. It has been proposed that the infection may be spread through dirty milk pails and feeding troughs. Entry through the mucosa is probably affected through abrasions caused by rough feed and erupting teeth. The difficulty of reproducing the disease and the irregularity of its occurrence, even when *F. necrophorum* is known to be present, suggests the possibility of etiologic factors presently unknown.

##### Risk Factors

###### Host Risk Factors

Animals suffering from intercurrent disease or nutritional deficiency are most susceptible, but there is also an obvious **age predisposition** to the condition. Necrotic stomatitis is predominantly seen in weaned and unweaned calves 2 weeks to 3 months of age. Laryngeal infections commonly affect older calves up to 1 year of age and rarely occur in older animals up to 3 years of age.



An unusually high disease incidence has been observed in double-musled Belgian Blue calves, a breed that is common in Belgium, the Netherlands, and some parts of France.<sup>3</sup>

### Pathogen Risk Factors

A number of pathogen risk factors have been identified for *F. necrophorum*, of which LT and LPS are considered most important for the pathogenesis of necrobacillic infections. Several investigations have reported that subtypes and strains of the bacterium vary in the amount of LT produced, which may contribute to the virulence of a specific strain. A correlation between LT production and the ability to induce abscesses has been reported in laboratory rats.<sup>1</sup>

### Environmental Risk Factors

Necrobacillosis is highest in groups kept in confined quarters. Cases in pastured animals have been reported but are rare. Unsanitary conditions have been incriminated in facilitating the spread of the condition through contaminated nipples or pails.

### PATHOGENESIS

*F. necrophorum* is a normal inhabitant of the oral cavity and causes inflammation and necrosis once it is able to penetrate tissue, e.g., through an injury of the mucosa of the oral cavity, pharynx, and larynx. Edema and inflammation of the mucosa of the larynx results in varying degrees of closure of the rima glottidis and inspiratory dyspnea and stridor. The presence of the lesion causes discomfort, painful swallowing, and toxemia. Extension of the lesion to the arytenoid cartilages will result in laryngeal chondritis. Involvement of the cartilage will usually result in delayed healing or failure to recover completely.

### CLINICAL FINDINGS

In describing the clinical findings, a distinction must be made between calf diphtheria, which is characterized by the involvement of the larynx and necrotic stomatitis. In the former, a moist painful cough accompanied by severe inspiratory dyspnea that cause a roaring inspiratory sound (“honker calf” or “hard breather”), salivation, painful swallowing movements, complete anorexia, and severe depression are the characteristic signs. The temperature is high at 41°C (106°F), the pharyngeal region may be swollen and painful on external palpation, and there is salivation and nasal discharge. The breath has a foul rancid smell.

In cases of laryngeal necrobacillosis examination of the pharynx and larynx by visual inspection through the oral cavity with the aid of a speculum positioned over the base of the tongue will often reveal the lesions. The larynx can be viewed directly and illuminated with a strong source of light. A flexible endoscope is also useful when

available and is necessary for examination of the larynx and cranial part of the trachea. The mucosa of the larynx and glottis are usually edematous and inflamed and a necrotic lesion is usually present and visible on one or both arytenoid cartilages. The opening of the larynx is often reduced because of the edema and inflammation. Careful visual inspection of the larynx during inspiration may reveal that the lesion extends into one or both vocal cords. The examination usually causes considerable discomfort, anxiety, and the production of purulent or bloodstained saliva.

Death is likely to occur from toxemia or obstruction to the respiratory passages on days 2 to 7. Most affected calves die without treatment, but only a small proportion of calves in a group are usually affected. Spread to the lungs may cause a severe, suppurative aspiration bronchopneumonia.

In calves affected with necrotic stomatitis, there is usually a moderate increase in temperature (39.5°C–40°C; 103°F–104°F), depression, and anorexia. The breath is foul and saliva, often mixed with straw, hangs from the mouth. A characteristic swelling of the cheeks may be observed posterior to the lip commissures, which, on opening the mouth this, is found to be caused by a deep ulcer in the mucosa of the cheek. The ulcer is usually filled with a mixture of necrotic material and food particles. An ulcer may also be present on the adjacent side of the tongue and cause severe swelling and protrusion of the tongue. In severe cases the lesions may spread to the tissues of the face and throat and into the orbital cavity. Similar lesions may be present on the vulva and around the coronets, and a spread to the lungs may cause fatal pneumonia. In other cases death appears to be caused by toxemia.

### CLINICAL PATHOLOGY

Bacteriologic examination of swabs from lesions may assist in confirming the diagnosis.

### NECROPSY FINDINGS

Severe swelling, caused by edema and inflammation of the tissues surrounding the ulcer, is accompanied by the presence of large masses of caseous material. Occasionally, lesions similar to those in the mouth, pharynx, and larynx may be found in the lungs and in the abomasum. Microscopically, areas of coagulation necrosis are bordered by large numbers of neutrophils and filamentous bacteria.

### Samples for Confirmation of Diagnosis

- **Bacteriology:** anaerobic culture swab from deep within lesion (ANAEROBIC CULT)
- **Histology:** formalin-fixed sample of interface between ulcer site and normal tissue (light microscopy).

### DIFFERENTIAL DIAGNOSIS

Necrotic laryngitis is characterized by inspiratory dyspnea and stridor, toxemia, fever, edema, (inflammation), and necrotic lesions of the laryngeal mucosa.

- **Neoplasms of the larynx** Occur only rarely, usually in mature cattle, and cause chronic inspiratory dyspnea.
- **Traumatic pharyngitis** May resemble laryngitis, but the lesions are obvious on visual inspection of the pharynx. In chronic cases of traumatic pharyngitis there may be periesophageal cavities containing rumen contents
- **Foreign bodies** Pieces of wire and small wooden sticks, for example, may become lodged in the mucosa of the arytenoid cartilages and cause clinical signs similar to necrotic laryngitis.

### TREATMENT

The lesions of necrotic stomatitis will usually heal in a few days following debridement of the ulcers, application of a solution of tincture of iodine, and oral administration of sulfamethazine at a dose of 150 mg/kg BW daily for 3 to 5 days as labeled for use in food animals, or parenteral penicillin or broad-spectrum antimicrobials. Therapy should be at least for 5 days, and therapy for up to 3 weeks may be necessary.

Successful treatment of necrotic laryngitis is dependent on early recognition and prompt therapy with antimicrobials daily for several days. A broad range of antimicrobials have been proposed for the treatment of oral/laryngeal necrobacillosis. *F. necrophorum* is susceptible in vitro to  $\beta$ -lactam antibiotics, tetracyclines, macrolides, and lincomycins but is resistant to aminoglycosides and ionophore antibiotics.<sup>2</sup> The apparent sensitivity of this gram-negative pathogen to penicillins and cephalosporins is peculiar even based on its cell wall structure.<sup>2</sup> Although third- and fourth-generation cephalosporins (e.g., ceftiofur and cefquinome) are highly effective against *F. necrophorum*, these antimicrobials that have been classified as critically important for human and veterinary medicine are only indicated as second choice for cases that have poorly responded to other antimicrobials. Corticosteroids may be a beneficial adjunctive therapy, especially to reduce the edema. Tracheostomy may be necessary in some cases to relieve dyspnea. Failure to respond is usually associated with chronic suppurative chondritis, which requires subtotal arytenoidectomy.

### TREATMENT AND CONTROL

#### Treatment

Procaine penicillin (22,000 IU/kg IM every 12 h or 44,000 IU/kg IM every 24 h for at least 7 days) (R-2)

Continued

Oxytetracycline (10 mg/kg IM every 24h for at least 7 days or long-acting formulation 20 mg/kg every 72 h) (R-2)

Ampicillin trihydrate (10 mg/kg SC or IM every 24 h for at least 7 days) (R-2)

Ceftiofur hydrochloride (2.2 mg/kg SC or IM every 24 h for at least 7 days) (R-2)

Dexamethasone (0.2–0.5 mg/kg IV or IM as a single dose) (R-2)

IM, intramuscularly; IV, intravenously; SC, subcutaneously.

## CONTROL

Proper hygienic precautions in calf pens or feeding and drinking places together with avoidance of rough feed should prevent the spread of the disease. When the incidence is high, prophylactic antibiotic feeding may keep the disease in check.

## REFERENCES

1. Nagaraja TG, et al. *Anaerobe*. 2005;11:230.
2. Tadeipalli S, et al. *Anaerobe*. 2009;15:36.
3. Lekeux P, et al. *Vet Rec*. 1987;121:353.

## ENTEROHEMORRHAGIC ESCHERICHIA COLI IN FARM ANIMALS AND ZONOTIC IMPLICATIONS

Enterohemorrhagic *Escherichia coli* (EHEC), particularly *E. coli* serogroup O157:H7, have been recognized as food-borne pathogens causing potentially fatal human illness since the 1980s and have since then become a worldwide public health concern of increasing relevance. First outbreaks of human EHEC infections were recorded in 1982 in Oregon and Michigan and have been associated to the consumption of undercooked hamburger patties.<sup>1</sup> Since then, *E. coli* O157:H7, and in more recent years also a number of other serotypes, have caused major human illness outbreaks worldwide with considerable morbidity and mortality. Clinical signs can range from mild diarrhea, bloody diarrhea, and hemorrhagic colitis to the hemolytic uremic syndrome (HUS).<sup>1</sup>

Ruminants, and cattle in particular, are the main reservoir of EHEC but do not typically develop clinical disease. Human infection is acquired through consumption of contaminated food or water, direct contact with EHEC-carrying animals, or via person-to-person transmission.<sup>1</sup>

## ETIOLOGY

EHEC comprise a subgroup of so-called Shiga-toxin-producing serotypes of *E. coli* that have been implicated in severe human disease. Shiga-toxin-producing *E. coli* strains produce toxins similar to the one produced by *Shigella dysenteriae*, the so-called Shiga toxins (Stx), and are therefore also denoted as **Shiga-toxin-producing *E. coli* (STEC)**. The presence of Shiga-toxin is determined

by the Vero cell toxicity test, so STEC are also called **verotoxin** or **verocytotoxin-producing *E. coli* (VTEC)**.<sup>2</sup> The only consistent difference between pathogenic STEC serovars and apathogenic *E. coli* strains is indeed the possession of Stx genes.<sup>3</sup>

The large majority of outbreaks and sporadic cases of severe disease in humans are associated with a very limited number of EHEC serotypes.<sup>1</sup> By far the most prevalent single serotype of *E. coli* associated with human illness is *E. coli* O157:H7. However, in recent years a number of other EHEC serotypes have been linked to human illness and are on the rise worldwide; EHEC strains have therefore been classified into *E. coli* O157:H7 and non-O157:H7 *E. coli* recently. The six most prevalent non-O157 STEC serogroups associated with clinical disease in humans are in descending order: O26, O111, O103, O121, O45, and O145.<sup>4</sup>

## EPIDEMIOLOGY

The predominant carriers and shedders of EHEC are healthy domesticated ruminants, cattle in particular, and to a lesser extent sheep and possibly goats.<sup>5</sup> EHEC strains associated with clinical disease in humans constitute only a minor fraction of the STEC isolates that are routinely recovered from healthy cattle, whereas the large majority of bovine STEC isolates either do not occur at all or are greatly underrepresented in people.<sup>5</sup> Although the majority of STEC isolates carried by healthy ruminants are not transmitted to humans there is no doubt that cattle are the main source of human EHEC infection.<sup>5</sup> The highest recovery rates of STEC among non-ruminant farm animal species was reported for turkeys, whereas other species such as pigs or chicken are only incidental carriers.<sup>5</sup> Rodents, domestic animals, and flies have been identified as incidental carriers.

It is estimated that between 20% and 50% of human EHEC infections are attributable to non-O157 *E. coli* strains, but estimates vary greatly from country to country and within one country from region to region.<sup>4</sup> In North America, Japan, and the UK *E. coli* O157:H7 is the serotype most commonly associated with clinical disease in people, whereas in Europe, Australia, Argentina, or South Africa infections with non-O157 serotypes have been estimated to be at least as prevalent as infections with the O157:H7 serotype in people.<sup>4</sup> Human cases of HUS are in most cases associated with infections from the serotype O157:H7. Estimates of sporadic cases of HUS in people associated with non-O157 STEC are less than 10% in North America and between 10% and 30% in Germany, Italy, and Great Britain.<sup>4</sup>

## Occurrence and Prevalence of Infection

### Cattle

Ruminants, and cattle in particular, are the most important nonclinical natural reservoirs of STEC. Generally, cattle remain

asymptomatic because intestinal mucosal cells lack the Stx-specific globotriaosylceramide receptor.<sup>4</sup>

Estimates of the prevalence of STEC fecal carriage among populations of cattle vary considerably, and data from different surveys are difficult to compare because of inconsistent experimental approaches, differences in sampling strategies, and applied analytical methods.<sup>2</sup> In many studies the analytical approaches used specifically aim at the detection of serotype O157:H7, whereas fewer surveys used laboratory methods suitable to detect all or at least selected non-O157 STEC serogroups.<sup>2</sup> Generally, the reported prevalence rates for non-O157 STEC strains in cattle are much higher than the prevalence rates of O157:H7 in cattle. Between 2007 and 2009 the fecal prevalence of STEC in cattle determined at the level of the European Union (EU) was between 2.2% and 6.8%. Strain O157 was isolated in between 0.5% and 2.9% of these samples.<sup>2</sup> The prevalence rates reported by different member states varied between 0% and 48.5%, which is at least in part due to the different sampling strategies and laboratory methods used in the different countries. Tested specimens included feces, ear, and hide samples.<sup>2</sup> The most sensitive sampling method, at least for STEC O157:H7, was found to be the rectal swab, which has been explained by the fact that STEC tend to specifically colonize the rectoanal junction of the intestinal mucosa that is directly sampled with the swab approach.<sup>3</sup> There is a correlation between the prevalence of *E. coli* O157:H7 in the feces, hides, and carcasses of beef cattle during slaughter. Overall, the prevalence of *E. coli* O157:H7 in feces and on hides was 28% and 11%, respectively.

A recent study investigating the prevalence of STEC O157 in Belgium found that the viable O157 strain was present in 37.8% of 180 participating farms. In this study dairy farms had the highest herd prevalence rate (61.2%) followed by beef (22.7%) and veal calf operations (9.1%).<sup>6</sup> Prevalence rates of STEC in dairy cattle in the United States range between 0.17% and 8.4% in cows, 1.7% and 9.5% in heifers, and 0.2% and 40% in calves.<sup>7</sup> Prevalence estimates in North American beef cattle range from 10% to 28% with a herd prevalence approaching 100%.<sup>1</sup>

Generally, prevalence rates are higher in calves and heifers than in adult cattle, which is an effect that has been attributed to the greater susceptibility to colonization of calves and heifers than for cows.<sup>7</sup> The prevalence of fecal STEC shedding is influenced by numerous variables, including the season, the scope, frequency and timing of sampling, and the conditions of sampling and storage. The organism can be found widely distributed in samples from several types of cattle including beef calves, stocker cattle, feedlot cattle, adult beef cows, dairy calves, water sources, and wildlife.

Shedding of STEC has been proposed to vary between individuals. Although most animals may only shed the bacteria transiently following exposure, some individuals shed the pathogen for prolonged periods and at much higher rates due to colonization of the terminal rectum of the gastrointestinal tract.<sup>1</sup> Cattle shedding STEC at much higher concentrations and for prolonged periods of time are so-called **supershedders**. The percentage of STEC-shedding cattle that are considered supershedders has been estimated at 3.9% for serovar O157 and 10% for non-O157 serovars.<sup>3</sup> Although supershedders constitute a small proportion of cattle in an infected herd, they are thought to substantially impact the on-farm epidemiology. It has been estimated that serotype O157:H7 supershedders may be responsible for over 95% of the bacteria shed.<sup>1</sup>

### Prevalence of Infection in Cattle, Sheep, and Pigs at Slaughter

Abattoir surveys conducted in the UK determined prevalence rates of fecal carriage of STEC O157 between 4.7% and 15.7% in cattle and between 0.7% and 2.2% in sheep in the UK. STEC O157 was only isolated from 0.4% of slaughtered pigs.<sup>5</sup> In a Dutch abattoir study STEC O157 strains were isolated from 10.6% of slaughtered cattle and 4.0% of slaughtered sheep. An overall prevalence of *E. coli* O157:H7 fecal shedding by New York cull dairy cattle of 1.3% was found in specimens just before processing the packing plant. In a survey of downer cattle submitted to two slaughter facilities in Wisconsin, the prevalence of *E. coli* O157:H7 in the feces and/or tissues of downer dairy cattle was 4.9% compared with 1.5% in healthy cattle.

In an abattoir study the polymerase chain reaction (PCR) was used to detect virulence genes and molecular epidemiology of *E. coli* O157:H7 isolates. Samples included swabs of tools, knives, and saws; fecal samples; carcass samples; and ears removed after slaughter. From 1432 samples, 143 *E. coli* O157:H7 strains were isolated. These results indicate the increase in contamination frequencies during transportation to the abattoir and the lairage period before slaughter as a result of cross-infection caused by mixing of animals from different sources. The presence of supershedding animals at the abattoir increases the potential risk of beef contamination during the slaughtering process and stresses the need for correct hazard analysis and critical control points procedures. Carcass samples were taken at three points during processing: preevisceration, postevisceration before antimicrobial intervention, and postprocessing after carcasses entered the cooler. The prevalence of *E. coli* O157:H7 in the three postprocessing samples was 43%, 18%, and 2%, respectively. Antimicrobial intervention included steam pasteurization, hot water washes, organic acid washes, or combinations of these treatments. The reduction in carcass prevalence from

preevisceration to postprocessing suggests that sanitary procedures can be effective within processing plants. Fecal and hide prevalence were significantly correlated with carcass contamination, indicating a role for control of *E. coli* O157:H7 in live cattle.

### Sheep and Goats

Sheep and goats can be naturally infected with *E. coli* O157:H7, and sheep have been used as a model of ruminant infection. Sheep may harbor *E. coli* O157:H7 and non-O157:H7 STEC at rates similar to or higher than in cattle. Prevalence rates of 67% and 45% have been reported in Germany and Australia, respectively. Worldwide, sheep have been shown to shed several non-O157 strains in their feces. Several of these STEC serotypes have been associated with sporadic cases or major outbreaks of human illnesses. Thus lamb, mutton, and their products share a food safety risk factor similar to that of beef. Non-O157:H7 STEC have been found in sheep grazing irrigated pasture or arid rangeland forage in Nevada. In Brazil, STEC occurred in the feces of 51% of healthy sheep grazing on pasture.

### Wildlife

Based on fecal samples of deer submitted by hunters, *E. coli* O157:H7 have been found in the feces of free-ranging white-tailed deer in Nebraska at a rate of 0.25%. The prevalence of infection of *E. coli* O157:H7 in white-tailed deer sharing rangeland with cattle was 2.4%. Deer experimentally inoculated with *E. coli* O157:H7 shed the pathogen for over 26 days to naive penmates. Fermented deer sausage was identified as a vehicle for *E. coli* O157:H7 transmission in Missouri.<sup>8</sup> The low overall prevalence of *E. coli* O157:H7 and the identification of only one site with positive deer suggest that wild deer are not a major reservoir of *E. coli* O157:H7.

High prevalence of fecal carriage of STEC O157 of 3.3% was reported in wild boars in Spain, and one strain was identical to a strain associated with clinical disease in people.<sup>9</sup>

### Pigs

*E. coli* O157:H7 has been found in fecal samples of finished pigs at the time of slaughter, but the prevalence was very low at 0.08%. In experimentally infected pigs, *E. coli* O157:H7 can persist for more than 2 months. In a longitudinal study conducted in four U.S. swine farms STEC O157:H7 was isolated from 8.9% of rectal swabs; however, shedding was not associated with clinical disease, and isolated strains could have been nonvirulent.<sup>10</sup> Potentially pathogenic O157:H7 strains have, however, been isolated from 2% of slaughter pigs in one study as well as in feral swine in California.<sup>5</sup> Pigs may have the potential to be reservoirs hosts for *E. coli* O157:H7, but the magnitude of the risk needs to be determined.

## Risk Factors

### Animal Risk Factors

Cattle that are infected with *E. coli* O157:H7 remain free of disease because of the lack of specific vascular receptors for Stx and are tolerant of *E. coli* O157:H7 for their entire lives.

Although most exposed cattle shed STEC at less than 100 colony forming units (CFU)/g feces, a small subset of cows are predisposed to shed exceptionally high numbers of bacteria (>10<sup>4</sup> CFU/g feces) for prolonged periods of time. These individuals, also called **supershedders**, are estimated to be responsible for over 95% of the bacterial shedding within a herd.<sup>11</sup>

Age has been identified as an animal risk factor for STEC infection in cattle. Although preweaned calves were found to rarely carry STEC, postweaning calves and heifers have a higher fecal carriage prevalence of STEC and shed larger numbers of bacteria than older cows.<sup>7</sup> Studies conducted in colostrum-deprived calves suggest that the low prevalence of O157 carriage in unweaned calves is at least partly because of the protective effect of colostrum antibodies during the first weeks of life.<sup>5</sup>

Higher prevalence rates of fecal STEC carriage in heifers than in young bulls suggest a gender effect that may be caused by hormonal effects around pregnancy and lactation.<sup>5</sup>

### Environmental and Management Risk Factors

Although a larger number of STEC serotypes may be isolated from some farms, typically a herd only harbors a small number of isolates that tend to persist on the farm for over 2 years independently of animal carriers. This underscores the importance of environmental contamination and the circulation of the pathogen between animals and environment for the on-farm epidemiology of STEC infection.<sup>5</sup> Water tanks in feedlots, for example, were found to be frequently contaminated with STEC. *E. coli* O157:H7 was isolated from 13% of the water tanks in U.S. feedlots, with at least one water tank positive on 60% of the feedlots. Water tanks were five times more likely to be contaminated with *E. coli* O157:H7 if a pen was positive for bacteria, but the direction of the spread was not determined.<sup>5</sup> Similarly *E. coli* O157:H7 was isolated from 14.9% of the feed samples obtained from the feed bunks. Factors positively associated with *E. coli* O157:H7 in the feed were higher heat index at the time of sampling, the presence of cottonseed meal in the ration, and the feedlot location.

A seasonal effect is well established in temperate climates with peaks in the prevalence of fecal STEC carriage between late spring and early fall. For example, fecal samples and rope swabs from dairy herds collected over a period of 1 year in Alberta, Canada, revealed a 15-fold increase in



prevalence of positive samples between June and September compared with the rest of the year.<sup>12</sup> Several abattoir surveys conducted in different European countries revealed similar peaks in the fecal carriage prevalence during the summer months.<sup>5</sup> The specific factors contributing to this seasonal effect are not well understood.

#### Housing and Management Practices

Environmental dissemination of an inoculated strain of *E. coli* O157:H7 given to dairy calves spreads more quickly when calves are housed in groups compared with calves housed in individual pens from 7 to 110 days of age. The use of segregated penning systems rather than group housing of weaning calves may reduce the prevalence of these potential pathogens within the calf unit. If this results in a reduction in the general herd or farm STEC prevalence, then such changes in calf-rearing practice may offer a control point.

#### Pathogen Risk Factors

##### Virulence Attributes and Mechanisms

The primary feature of STEC isolates is their ability to produce potent cytotoxins encoded by *stx1* and *stx2* genes. They also have the ability to adhere to the intestinal mucosa in an intimate manner through the attachment and effacement protein intimin, encoded by the *eaeA* gene, and most produce a plasmid-encoded enterohemolysin, encoded by the *ehxA* gene. STEC isolates that cause disease in humans usually have one or both of these virulence-associated factors and have been referred to as complex Shiga-toxin-producing *E. coli* (cSTEC). The most often reported STEC serotype causing diseases in humans worldwide is *E. coli* O157:H7, but non-O157 serotypes such as O8:H19, O8:H21, O22:H8, O113:H21, and Orough:NM (nonmotile) are commonly found to cause diseases such as HUS.<sup>3</sup> There are over 160 STEC serotypes that have been isolated from human patients around the world.

##### Acid Resistance

*E. coli* O157:H7 is extremely acid resistant, which contributes to the low infectious dose for humans; this has been estimated to be fewer than 100 CFU and possibly even as low as 10. Certain strains of *E. coli* O157:H7 have been considered to be more acid tolerant than some commensal *E. coli*. In addition, *E. coli* O157:H7 strains may become acid habituated by exposure to weak acids in the rumen. Consequently, *E. coli* O157:H7 may survive passage through the acid barrier in the abomasum, colonizing and replicating in the ruminant colon.

The acid-resistance characteristics of *E. coli* O157:H7 led to the hypothesis that feeding grain to cattle created an ideal environment in the gastrointestinal tract to promote the growth and persistence of the organism. The research data on the effects of grain versus forage feeding to cattle and its

effects on fecal *E. coli* O157:H7 are limited and conflicting. Some early research indicated that grain feeding increased the dissemination of acid-resistant *E. coli* by cattle and that feeding hay for a brief period immediately before slaughter would decrease the shedding of *E. coli* O157:H7. The numbers, persistence, and acid resistance of generic coliforms and *E. coli* O157:H7 from various gastrointestinal tract sites of cattle fed grain or hay were compared. Grain feeding or hay feeding did not affect survival of *E. coli* O157:H7 in the rumen or its passage through the abomasum (pH 2.0) to the duodenum.

Recent studies on the effect of forage or grain diets have shown that cattle fed forage diets had ruminal persistence of fecal *E. coli* O157:H7 at quantifiable concentrations for twice as long as cattle fed grain diets. Diets high in grain generate high volatile fatty acid concentrations and low pH, creating a less conducive environment for *E. coli* O157:H7, whereas lower volatile fatty acid concentrations and higher pH in forage-fed cattle may be more conducive to the growth and survival of the organism. Monensin supplementation decreased the duration of shedding with forage diet, and the cecum and colon were culture positive for *E. coli* O157:H7 more often than the rumen of cattle.

##### Antimicrobial Resistance

Although antimicrobial therapy in cases of EHEC infection is considered to be contraindicated, numerous studies evaluating antimicrobial-resistance patterns of *E. coli* O157:H7 have been conducted. Antimicrobial resistance is common in O157:H7 and other STEC strains and include multiple drug resistance to streptomycin, tetracycline, and sulfisoxazole.<sup>1</sup> The prevalence of antimicrobial resistance among isolates of *E. coli* O157:H7 recovered from clinical cases in humans, pigs, cattle, and food over a 15-year period (1985–2000) in the United States has been described. There was a high prevalence of resistance to tetracycline, sulfamethoxazole, cephalothin, and ampicillin. The highest prevalence occurred among isolates from pigs, in which more than 50% of all isolates were resistant to sulfamethoxazole, cephalothin, or tetracycline and more than 20% were resistant to ampicillin or gentamicin.

#### Methods of Transmission

##### Sources of Organism

###### Ruminants as Reservoirs

*E. coli* O157:H7 is a transient inhabitant of the gastrointestinal tract of normal healthy ruminants. Cattle and sheep feces serve as sources for contamination of feed and water sources. Fecal shedding is transient in cattle, often lasting 1 to 3 months or less, but the organism can persist on individual farms for up to 2 years. Longitudinal surveys have

shown that maintenance of *E. coli* O157:H7 and other STEC strains in cattle herds relies on continual reinoculation of individual cattle. Repeated isolations of *E. coli* O157:H7 from healthy beef and dairy cattle demonstrate that cattle are asymptomatic carriers of the organism. Short periods of relatively high prevalence of excretion are separated by longer periods of reduced or undetectable shedding. This has contributed to the variance in prevalence data reported in the literature.

Fecal shedding is more prevalent from spring to early fall than during the cold season of the year. Fecal shedding also varies among different classes of animal. Weaned heifers between 3 months of age and breeding age are more likely to shed STEC in feces than adult cattle or younger calves.

Contaminated water troughs, particularly those that are allowed to develop sediments, provide an environment for survival, proliferation, and horizontal spread of *E. coli* O157:H7 and other STEC serotypes. The organism can also proliferate to very high levels in moist silage.

The pattern of fecal carriage of *E. coli* O157:H7 in cattle finished under modern intensive feedlot management conditions has been examined. *E. coli* O157:H7 was isolated from 13% of fecal samples, with the highest prevalence values of the organism in pens supplied with chlorinated drinking water compared with nonchlorinated water pens. Over a period of 7 months from April to September, certain specific clonal types of *E. coli* O157:H7 persisted and predominated despite massive cattle population turnover. This suggests that the farm environment, and not necessarily the incoming cattle, is an important potential source of *E. coli* O157:H7 on farms.

##### Other Species

*E. coli* O157:H7 subtypes indistinguishable from those detected in cattle have been found in turkeys, pigeons, geese, horses, dogs, opossums, and flies. *E. coli* O157:H7 also has been isolated from insects in cattle environments, but their role in dissemination is uncertain.

##### Wild Birds

*E. coli* O157:H7 has been found in the feces of wild birds, which may contribute to the spread of the organism within and between farms. The presence of wild geese was a significant risk factor in the shedding of *E. coli* O157:H7 by beef suckler cows in Scotland.

##### Flies

The increased presence of flies around cattle during the summer months represents a potential mechanism for the spread of *E. coli* O157:H7 among farm animals. *E. coli* O157:H7 has been isolated from the crop of houseflies (*Musca domestica*) immediately after feeding on a bacterial preparation.

### Environmental Sources

There are many possible sources of STEC in the farm environment, including manure piles, ponds, dams and wells, barns, calf hutches, straw and other bedding, feed and feed troughs, water and water troughs, farm equipment, ground surface and pasture, and watercourses. Once in the environment, the organism can be transferred to other sites by rainwater, wind, and removal and spreading of manure, including animals and humans.

### Water Supplies for Livestock

Drinking water offered to cattle is often of poor microbiological quality, and the daily exposure of animals to various STEC strains from this source can be substantial. The degree of *E. coli* exposure is positively associated with proximity of water troughs to the feed bunk, protection of the trough from sunlight, and warmer weather. Cattle water troughs can serve as environmental reservoirs for STEC and as a long-term source infection for cattle.

The experimental inoculation of *E. coli* O157:H7 with 1 L of water into dairy calves in a confined environment resulted in shedding of the organism by the calves within 24 hours after administration. The duration of shedding varied from 18 to more than 43 days, and the number of doses necessary to initiate shedding varied among calves.

STEC is present in as many as 10% of water troughs, and water is more likely to be positive when *E. coli* O157:H7 was detected in the sediment. Chlorination of input water in feedlots was unable to reduce the prevalence of *E. coli* O157:H7-contaminated water troughs.

Water trough sediments with feces from cattle excreting STEC may serve as a long-term reservoir of the organism on farms and a source of infection for cattle. The accumulation of large amounts of organic matter would be expected to rapidly inactivate the biocidal activity of chlorine and provide an ideal niche for the survival of the organism. *E. coli* O157:H7 can survive in farm water under field and shed conditions at temperatures less than 15°C for up to 24 days. The addition of feces to water outdoors resulted in survival for 24 days.

*E. coli* O157:H7 has been isolated from surface waters collected from a Canadian watershed. Systematic sampling of surface water within the Oldman River basin in southern Alberta reveals that it is often contaminated with *E. coli* O157:H7 and *Salmonella* spp. The prevalence of *E. coli* O157:H7 and *Salmonella* spp. in water samples was 0.9% and 6.2%, respectively. The region surveyed is noted for high cattle density as well as for one of the highest incidences of gastroenteritis in Canada, resulting from infection by *Salmonella* spp. and *E. coli* O157:H7. Although the data indicated a relationship between high livestock density and high pathogen levels in southern Alberta, analysis of the point source

data indicates that the predicted manure output from cattle, pig, and poultry feeding operations was not directly associated with the prevalence of either *Salmonella* spp. or *E. coli* O157:H7. Variations in time, amount, and frequency of manure applications onto agricultural lands may have influenced levels of surface-water contamination with these bacterial pathogens.

### Feed Supplies

The prevalence of *E. coli* O157:H7 in cattle feeds in feedlots was 14.9%, which was higher than previously reported, and may be because of more sensitive detection methods. Feed may be a vehicle for dissemination and colonization; however, the source of the STEC contamination in cattle feed is uncertain. Possible sources include saliva and fecal contamination by cattle or other species, or by wildlife, including birds, rodents, and insects. Another possible source is contaminated feed components mixed into the feed. Pulse-field gel electrophoresis (PFGE) profiles of *E. coli* O157:H7 isolated from a component feed sample closely resembled that isolated later from the same farm, suggesting that cattle feed may be an important vector for the transmission of *E. coli* O157:H7.

### Manure

Survival of STEC in manure and manure slurry has been observed under various experimental and environmental conditions. The use of manure as fertilizer could explain food-borne outbreaks of *E. coli* O157:H7 and other strains associated with unpasteurized apple cider, potatoes, and other vegetables. Because STEC can survive for extended periods of time, proper manure management is of major importance in preventing the spread of this organism to the environment. Composting is an effective method for eliminating pathogens such as *E. coli* O157:H7 from manure.

### Soil

*E. coli* O157:H7 inoculated into loam and clay soils can survive for 25 weeks and in sandy soil for 8 weeks. The organism was detectable for up to 7 days after inoculation into the uppermost 2.5 cm of the soil and for up to 7 days on grass plots inoculated with a fecal slurry from dairy cattle at an application rate of *E. coli* O157:H7 of 660 CFU/m<sup>2</sup>.

### Animal-Holding Facilities

The organism can be cultured from rope devices in a feedlot pen that cattle rub or chew, and there is a correlation with the prevalence of cattle shedding the organism in the feces from within the same pen. This pen-test strategy may be useful for identifying pens of cattle posing a higher risk to food safety.

### Immune Mechanisms

The Esp and Tir proteins secreted by some STEC strains play critical roles in the

development of the attaching and effacing lesions and are recognized serologically in human patients with HUS. Antibodies to intimin, Esp, and Tir proteins have been detected in HUS patients following infections with EHEC.

In contrast, little is known about the immune responses of cattle to STEC infection. *E. coli* O157:H7 and other STEC serotypes are shed sporadically by cattle, and it appears that natural exposure to these organisms does not confer protection on the host. Calves 13 to 30 days of age developed anti-O157 IgG responses following experimental oral inoculation with *E. coli* O157:H7. Mature cows did not develop a significant increase in their serum anti-O157 IgG levels following oral inoculation. These observations suggest that local immunity to *E. coli* O157:H7 may not develop to any degree in the intestine and that immunization to reduce fecal shedding of *E. coli* O157:H7 may not be effective.

Vaccination of cattle with antigenic bacterial proteins involved in colonization can significantly reduce fecal shedding and prevalence of *E. coli* O157:H7 in cattle. Vaccination of cattle with *E. coli* O157:H7 type III secreted proteins can reduce the numbers of *E. coli* O157:H7 shed in the feces, the duration of shedding in experimentally challenged cattle, and in feedlot cattle under field conditions. Vaccination of pregnant gilts with intimin from *E. coli* O157:H7 induced high intimin-specific immune responses in the serum and colostrum, and suckling neonatal piglets had reduced bacterial colonization and intestinal lesions following experimental challenge. These results suggest that vaccination may be a useful preharvest strategy for reducing the prevalence of *E. coli* O157:H7 infection in cattle.

### Zoonotic Implications

Enterohemorrhagic strains of *E. coli*, especially serotype *E. coli* O157:H7, have been linked in humans with hemorrhagic colitis, HUS, and thrombocytopenic purpura from eating contaminated foods such as beef and dairy products, vegetables, and apple cider, and from contaminated drinking water or from contact with infected animals or contaminated environments. As few as 100 *E. coli* O157:H7 bacteria can cause illness in humans.

In the United States the Centers for Disease Control and Prevention estimate that around 265,000 human STEC infections occur every year, of which approximately 36% are attributed to *E. coli* O157:H7 and the remainder to non-O157 serotypes.<sup>13</sup>

Between 2005 and 2009 a total of 16,263 confirmed cases of STEC infection in people have been reported from the 24 member states of the EU. For 2009 the notification rate of STEC infection within the EU was 0.75 per 100,000 population with between two and six deaths per year.<sup>14</sup> The highest

notification rate was recorded for the age group 0 to 4 years (7.2 per 100,000 population) followed by children aged 5 to 14 years (1.8 per 100,000 population).<sup>14</sup> Although outbreaks of EHEC infection in people are recorded regularly, public health surveillance data indicate that sporadic cases of infection greatly outnumber outbreak cases.<sup>15</sup>

The number of patients infected with EHEC that develop HUS, particularly children, has been estimated to be approximately 10%.<sup>15</sup> In 2009 a total of 242 cases of HUS were reported within the EU; the serogroup O157 was isolated in 47% of cases affecting children (0–4 years old) and the serogroup O26 in 15%.<sup>14</sup>

Most cases of STEC illness are attributable to food-borne infection, and in particular to the consumption of undercooked ground beef; however, acquisition of disease by direct contact with animals and manure at petting zoos and dairy farms are of increasing concern. Consumption of pink hamburgers at home or in restaurants is a risk factor for EHEC infection. Microbiological testing of ground beef patties from a large outbreak that occurred in the Pacific northwest between November 1992 and February 1993 suggested that the infectious dose for *E. coli* O157:H7 is fewer than 700 organisms. This represents a strong argument for enforcing zero tolerance for this organism in processed food and for markedly decreasing contamination of raw ground beef. In 2009 overall 9285 beef samples have been tested for the presence of EHEC in the EU; 2.3% were found positive for EHEC and 0.7% contained EHEC serogroup O157.<sup>14</sup> Argentina is the country with the highest recorded incidence of HUS in the world with around 400 cases per year. It also has the highest per capita consumption of beef of any country in the world.

A major source of the bacteria in ground beef is bovine feces, which contaminates carcasses before evisceration; the organism is thought to be spread from contaminated hides to the surfaces of carcasses at slaughter. In addition to feces and hides, STEC has been isolated from the oral cavities of cattle.

In May 2000, *E. coli* O157:H7 and *Campylobacter jejuni* contaminated the drinking water supply in Walkerton, Ontario, Canada. As a result, seven people died and over 2000 became ill. The pathogens causing the outbreak were attributed to contamination of the town's water well arising from cattle manure from a nearby cattle farm following a period of heavy spring rainfall. Failure to adequately chlorinate the water supply resulted in the contaminated water being consumed by the people in the town.

Visits to farms for recreational or educational purposes have become an important part of the tourism and leisure industries in some countries. The emergence of STEC, with its very low infectious dose and associated risks of serious human illness, has

greatly increased the potential for zoonotic disease acquired from livestock, including those on open farms. The livestock of these farms may include sheep, goats, mature cattle and calves, pigs, donkeys, ponies, rabbits, guinea pigs, chipmunks, laying hens, bantams, ducks, geese, and a variety of waterfowl. Outbreaks of *E. coli* O157:H7 infection have occurred in people visiting these farms, and the *E. coli* O157:H7 has been isolated primarily from the calves and goats.

In a large outbreak of *E. coli* O157:H7 infections among visitors to a dairy farm (predominantly children), high rates of carriage of *E. coli* O157:H7 among calves and young cattle most probably resulted in contamination of both the hides of the animals and the environment. Contact with calves and their environment was associated with an increased risk of infection, whereas hand washing was protective. Thirteen percent of the cattle were colonized with *E. coli* O157:H7, which had the same distinct pattern on PFGE found in isolates from the patients. The organism was also recovered from surfaces that were accessible to the public.

Transmission of EHEC occurs by three major routes: food items such as undercooked meat, unpasteurized milk or cheese made from raw milk, person-to-person spread, and direct or indirect contact with animals. Infections have been associated with visits to cattle farms and farms open to the public, with consumption of farm products, and with camping on a cattle-grazing site. Infections have also been described in farm family members and other farm dwellers.

### Economic Importance

The economic consequences of beef contaminated with *E. coli* O157:H7 are enormous. Since 1994 in the United States, millions of kilograms of ground beef have been recalled from retail outlets because of contamination with *E. coli* O157:H7. Such beef products must be destroyed and not used for animal or human food. Human illness associated with the most common food-borne pathogens alone cost the U.S. economy more than \$7 billion each year. Some of these human outbreaks have been linked to the consumption of meat-based products or to contact with animals and their wastes.

### PATHOGENESIS

EHEC are characterized by the presence of Stx genes, **locus for enterocyte effacement (LEE)**, and a high molecular weight plasmid that encodes for a hemolysin. These three virulence factors are present in most *E. coli* associated with bloody diarrhea and HUS in humans.

The LEE is a large cluster of genes that are collectively responsible for the intimate attachment of the bacterium to the apical membrane of the enterocyte and subsequent

destruction or effacement of the microvilli. The intimate attachment of the bacterial cell to the epithelium is attributed to the adhesin **intimin** and Tir, a bacterial protein, which is inserted into the host membrane and serves as the response for intimin. Both factors are part of the LEE in enteropathogenic *E. coli* (EPEC) and EHEC. Intimin appears to be an essential component in initiating attachment, colonization, and the subsequent pathologic changes that follow infection with EPEC and EHEC.

*E. coli* O157:H7 also possesses a high molecular weight plasmid that contains several putative virulence genes, including a pore-forming hemolysin. Virulence plasmids are common features of pathogenic *E. coli*, encoding toxins, adhesins, and other factors necessary for colonization, survival, and ability to cause disease in its animal host.

In ruminants, STEC persists and proliferates in the lower gastrointestinal tract and does not remain for long periods in the ruminant stomachs or duodenum. *E. coli* O157:H7 exhibits a tropism for the terminal rectum in cattle. In calves experimentally infected with *E. coli* O157:H7, in almost all persistently colonized animals, the majority of tissue-associated bacteria identified are in a region within 3 to 5 cm proximal to the rectoanal junction. This region contains a high density of lymphoid follicles, and microcolonies of the bacterium are readily detectable on the epithelium of this region by immunofluorescence microscopy. As a consequence of this specific distribution, *E. coli* O157:H7 are present predominantly on the surface of the fecal mass. Sampling the feces and terminal rectum or swabbing the rectal mucosa of cattle immediately after slaughter found higher numbers of *E. coli* O157:H7 at the site closer to the rectoanal junction, and low-level and high-level carriers (so-called supershedders) were identified. Carriage on the mucosal surface of the terminal rectum was associated with high-level fecal excretion.

### Experimental Reproduction

Experimentally, *E. coli* O157:H7 causes fatal ileocolitis in newborn calves under 36 hours of age. Affected calves developed diarrhea and enterocolitis with attaching and effacing lesions in both the large and small intestines by 18 hours after inoculation.

Natural and experimental infection of calves from 13 to 30 days of age and mature cows with *E. coli* O157:H7 do not result in any clinical signs of disease, and no lesions were present at necropsy. A serologic response occurred in the calves but not in the cows.

Attaching and effacing intestinal lesions can be produced by experimental inoculation of 6-day-old conventionally reared lambs with *E. coli* O157:H7. All animals remain normal clinically, but attaching and effacing lesions occur in the cecum at 12 and 36 hours postinoculation and in the terminal



colon and rectum at 84 hours. This indicates that the well-characterized mechanisms for intimate attachment encoded by the LEE of *E. coli* O157:H7 may contribute to the initial events of colonization. Similar lesions can be produced in ligated intestine loops of 6-month-old sheep using *E. coli* O157:H7.

### CLINICAL PATHOLOGY

STEC comprises over 400 different serotypes with diverse biochemical and physiologic characteristics and accordingly a large variety of detection methods are used. With the exception of the serotype O157:H7 for which an International Organization for Standardization (ISO) protocol for the detection in food and animal feedstuff is available, there are currently no internationally standardized procedures for the detection of non-O157 STEC.<sup>15</sup> For *E. coli* O157:H7, the most prevalent single STEC serotype associated with human illness, genetic detection assays, and the use of culture and enrichment media are well developed and widely used as routine diagnostic procedures. Non-O157 serotypes have been recognized as potential human pathogens with increasing occurrence worldwide; accordingly, detection methods and culture and enrichment broths to isolate the most prevalent pathogenic serotypes have been developed in recent years but have not yet been standardized.

Food, feedstuff, or feces samples may be directly plated onto selective media and/or differential agars, which are reliable in detecting STEC O157 at densities above 100 CFU/g.<sup>5</sup> Food samples, however, often contain few colony-forming units that still may suffice to cause clinical disease in people. Direct plating may fail to identify bacteria stressed or injured by manufacturing processes, transport, or storage. Furthermore, STEC cells may enter a dormancy state in which they are viable but not culturable, which can lead to an underestimation of the number of bacteria contained in the sample or even failure to isolate STEC.<sup>16</sup> Regardless of the culture protocol used, recovery of *E. coli* O157:H7 is more likely from fresh fecal samples than from frozen samples.

Enrichment before plating facilitates the recovery of injured bacteria and can decrease the detection limit to below 5 CFU/g. Tryptone soya broth and *E. coli* broth incubated at 35°C to 37°C for 18 to 24 hours are commonly used for nonselective enrichment. Selective enrichment media are supplemented with selective agents or antimicrobials to inhibit growth of competing microflora.<sup>15</sup> Several studies have reported incidental susceptibility of STEC O157 to various selective components in the enrichment medium, which may hamper the growth not only of apathogenic microflora but also of some potentially pathogenic STEC strains. The use of nonselective enrichment media such as buffered peptone water is therefore preferred over the use of selective enrichment media.<sup>15</sup>

Enrichment may be followed by immunomagnetic separation (IMS) with beads coated with O157-specific antibody before plating onto agar. Immunomagnetic separation is part of the official standard procedure for the detection of STEC O157:H7.

### CONTROL

Studying STEC during the entire cattle-production process is problematic because of the complexity of the system and the complexity of the ecology of the organism. The development of economically feasible intervention strategies that are effective in reducing food-borne pathogens is a priority for both the beef and dairy industries.

The effective control of *E. coli* O157:H7 and other STEC serotypes will require the implementation of several different infectious disease control strategies and management procedures extending from the farm environment to the meat processing plant, the retail handling and processing of meat products, and the handling and cooking of beef products in the home.

The features of the ecology of *E. coli* O157:H7 that are important to consider in a control program include the following:

- Lack of a host specificity such that indistinguishable isolates can be found in a variety of species.
- Near ubiquitous distribution on cattle farms.
- Transient residence in the gastrointestinal tract of individual animals that is not associated with disease.
- A higher prevalence in animals with gastrointestinal flora disturbances such as those associated with transit, feed changes, or antimicrobial dosing.
- A markedly higher prevalence during warm months.
- Molecular subtyping indicates that specific subtypes can persist on a farm for years.
- Commercial feeds are sometimes contaminated with STEC and it seems likely that feeds represent an important route of dissemination.
- Mixed feeds collected from feeding troughs are commonly positive for STEC, as are water troughs, and feed and water probably represent the most common means of infection.
- Environmental replication in feeds and in the sediments of water troughs occurs and may account for the higher level of fecal shedding in the summer months.
- Because *E. coli* O157:H7 has been found to persist in and remain infective for at least 6 months in water trough sediments, this may be an important environmental in which the organism survives during periods when it cannot be detected, especially during cold months.

- Traditional means of controlling infectious diseases, such as eradication or test and removal of carrier animals, do not appear to be feasible.
- It is virtually impossible to exclude *E. coli* O157:H7 from beef-processing plants and carcasses.
- Cross-contamination of whole carcasses with fecal-derived bacteria occurs as a result of airborne transmission (during removal of the hide). Contaminated equipment and cross-contamination is inevitable during boning-out and grinding (where portions of carcasses from a large number of animals are commingled or make contact with a common piece of equipment).
- The very small numbers of STEC predicted to contaminate carcasses under highly effective control could be spread to a large volume of beef product during processing and multiply if the product experienced temperature abuse. Because the dose of STEC to cause human illness is very low, this dispersion of the organism throughout a high volume of product may constitute the greatest risk to public health.

The control of STEC will depend on implementation of management procedures that extend from the farm (preharvest), slaughtering process (postharvest), and retail handling and processing, to ultimately the consumer.

Preharvest beef safety production programs consist of policies, strategies, and procedures that are performed on food-producing animal farms with the objective of producing a safe and wholesome product free of antibiotic or chemical residues and with a minimum of pathogens that could be transferred through meat to humans. Some examples follow here.

### Specific Strategies for Control of *Escherichia coli* O157:H7 at Preharvest Level

A stochastic simulation model was used to assess the benefit of measures implemented in the preslaughter period that are aimed at reducing the contamination of beef carcasses with STEC O157:H7. Control measures were based on either reducing the herd prevalence of infection; reducing the opportunity for cross-contamination in the processing plant by reordering of the slaughter procedures; reducing the concentration of *E. coli* O157:H7 in fresh feces or reducing the amount of feces, mud, and bedding ("tag") transferred from the hide to the carcass. Simulations suggested that the greatest potential is associated with vaccination and with an agent that reduces shedding of *E. coli* O157:H7 in feces. An industrywide reduction in the amount of tag attached to hides and addition of a source of cattle having a prolonged average fasting time were not predicted to have a large impact on the mean amount

of carcass contamination with *E. coli* O157:H7.

### Animal Management Strategies

#### *Water Systems and Runoff*

Interventions at the water trough level offer significant potential to reduce STEC contamination and cross-contamination. Suggested potential strategies to reduce STEC survival in the water supply include chlorination, ozonization, frequent cleaning, and screens that reduce organic solids in water troughs. However, field studies found that chlorination of water troughs did not alter the prevalence of *E. coli* O157:H7 in the troughs or in the feces of cattle in those pens.

#### *Environmental Control of STEC*

The survival of STEC for extended periods of time (weeks to months) in livestock production environments may enable transfer of the organism back to cattle through contaminated feed or water. This creates a cycle of infection allowing STEC to be maintained in cattle herds. Effective control of STEC requires suppression at as many points in the cycle of infection as possible to reduce its spread. Minimizing contamination of water troughs and feed bunks together with adequate manure management should contribute to a significant reduction in the spread of STEC in cattle, crops, and water sources.

The fecal prevalence of STEC among mature dairy cattle is associated with the choice of bedding material used on a farm. The use of sawdust for bedding material for lactating dairy cows, as opposed to sand, was associated with a significantly higher fecal prevalence of *E. coli* O157:H7. The overall average herd prevalence was 3.1% and 1.4%, respectively, for cows on sawdust and on sand. The total number of days on which herds were positive for *E. coli* O157:H7 was higher for sawdust-bedded herds than for sand-bedded herds; 22 versus 14, respectively. These results provide evidence that specific farm management practices can influence the prevalence of *E. coli* O157:H7 on the farm.

#### *Diet Changes*

Feedlot and high-producing dairy cattle are fed rations with a high percentage of grain. When the starches that escape the ruminal microbial degradation move on to the large intestine, EHEC ferment the sugars and the populations of *E. coli* increase. Cattle fed grain rations shed larger numbers of *E. coli*, especially *E. coli* O157:H7 in barley-fed cattle. When cattle are abruptly switched from a high-grain ration to a forage diet, generic *E. coli* populations decline by 1000-fold within 5 days. Cattle naturally infected with *E. coli* O157:H7 shed smaller numbers of the organism when the ration is changed to a forage-based diet compared with cattle fed continuously on a high-grain diet.

However, the magnitude of reduction is highly variable between studies and thus is not currently recommended. Fasting for 48 hours and type of diet before fasting has no effect on fecal shedding of *E. coli* O157:H7 in cattle. Thus feed withdrawal before slaughter should not increase the risk of STEC entering the food chain. However, refeeding 100% forage following a 48-hour fast results in a significant increase in the number of animals shedding *E. coli* O157:H7. This may occur when feeder cattle are moved from one farm to another through a sale barn and may be one of the reasons for the higher incidence of *E. coli* O157:H7 shedding by cattle when they first enter the feedlot.

Proposals aimed at dietary modifications must be balanced with the practical applications of commercial livestock feeding operations.

### Direct Antipathogen Strategies

Several strategies have been examined that specifically target and directly kill pathogenic bacteria. These include the use of antibiotics, antimicrobial proteins produced by bacteria, bacteriophages, compounds that specifically target the physiology of pathogenic bacteria, and vaccination.

#### *Vaccination Against Escherichia coli O157:H7*

There is evidence that virulence factors secreted by the type III system can be used as effective vaccine components for the reduction of colonization of cattle by *E. coli* O157:H7. Vaccination of cattle with proteins secreted by *E. coli* O157:H7, three times at 3-week intervals, significantly reduced the numbers of bacteria shed in feces, the numbers of animals that shed, and the duration of shedding in an experimental model. Vaccination of cattle also significantly reduced the prevalence of *E. coli* O157:H7 in a clinical trial conducted in a typical feedlot. The pretreatment prevalence of animals shedding *E. coli* O157:H7 averaged 30%. The average proportion of cattle shedding the organism in vaccine-treated pens was 8.8%, and in nonvaccinated pens 21.3%. Because the type III-secreted antigens are relatively conserved among non-O157 EHEC serotypes, the vaccine formulation might be broadly cross-protective.

Using the pig as an experimental model, pregnant dams were vaccinated with *E. coli* O157:H7 adhesin (intimin<sub>O157</sub>) at 2 and 4 weeks before farrowing. *E. coli* O157:H7 adhesin (intimin<sub>O157</sub>)-specific antibody titers in colostrum and serum of dams were increased after parenteral vaccination. Neonatal piglets were allowed to suck vaccinated dams for up to 8 hours before being inoculated with a Shiga-toxin–negative strain of *E. coli* O157:H7. Piglets that had ingested colostrum containing *E. coli* O157:H7 adhesin (intimin<sub>O157</sub>)-specific antibodies from vaccinated dams, but not those nursing

sham-vaccinated dams, were protected from *E. coli* O157:H7 colonization and intestinal lesions. This supports the hypothesis that intimin<sub>O157</sub> is a potential antigen for an *E. coli* O157:H7 antitransmission vaccine.

A vaccination field trial evaluated the efficacy of *E. coli* O157:H7 vaccine in a sample of feedlots in Alberta and Saskatchewan. Pens of cattle were vaccinated once on arrival processing and again at reimplanting. The *E. coli* O157:H7 vaccine included 50 µg of type III-secreted proteins. Fecal samples were collected from 30 fresh fecal droppings within each feedlot pen at arrival, at revaccination, and within 2 weeks of slaughter. The mean pen prevalence of *E. coli* O157:H7 in feces was 5.0%, ranging from 0% to 90%. There was no significant association between vaccination and pen prevalence of fecal *E. coli* O157:H7 following initial vaccination at reimplanting or before slaughter.

### Competitive Enhancement Strategies

The use of native or introduced microflora to reduce pathogenic bacteria in the intestine is termed a “probiotic” or competitive enhancement strategy. The principle is to promote growth of groups of beneficial bacteria that are competitive with, or antagonistic to, pathogens.

#### *Probiotics*

Probiotic bacteria are effective in reducing the duration of ruminal carriage of *E. coli* O157:H7 in cattle. Probiotics are live microbial feed supplements that beneficially affect the host animal by improving its intestinal microbial balance. The principle is that these beneficial organisms will combat the effects of stress and prevent undesirable microorganisms from becoming established in the gastrointestinal tract. Dietary supplementation of cattle with *Lactobacillus*-based and *Propionibacterium*-based direct-fed microbials reduced the prevalence of *E. coli* O157:H7 in both fecal and hide samples.

#### *Sodium Chlorate Supplementation*

Chlorate supplementation has been investigated as a preharvest strategy to reduce populations of *E. coli* O157:H7 and *Salmonella* spp. in food animals. Certain bacteria can respire anaerobically by reducing nitrate to nitrite via the intracellular enzyme nitrate reductase. This same enzyme also reduces chlorate to chlorite, a cytotoxic end product. Chlorate significantly reduced *E. coli* O157:H7 populations in ruminal fluid incubations, wild-type *E. coli*, inoculated *E. coli* O157:H7 and total coliforms in cattle, and inoculated *E. coli* O157:H7 in sheep. The administration of sodium chlorate in the feed of cattle preharvest for 24 hours reduced the population of *E. coli* O157:H7 strains approximately by two logs (10<sup>4</sup>–10<sup>2</sup>) in the rumen and three logs (10<sup>6</sup>–10<sup>3</sup>) in the feces.

### Control of *Escherichia coli* O157:H7 During Slaughtering and Postharvest Stage Meat Inspection Service and Surveillance

As a result of public concern about *E. coli* O157:H7, the meat inspection service in many countries has been reorganized to deal with control of the organism in the processing of beef. In the United States, the presence of *E. coli* O157:H7 in ground beef was declared an **adulterant**. Surveillance systems have also been established in many countries to obtain more information about the presence of the organism and to report outbreaks, and considerable research has emerged.

Elaborate *E. coli* O157:H7 detection systems are now in place in abattoirs in many countries as part of the **Hazard Analysis of Critical Points System (HACCP)** to ensure that contamination of beef carcasses with *E. coli* O157:H7 is below certain legislated levels. Although laboratory testing focuses on this serotype in many countries, screening has been extended to other pathogenic serogroups associated with illness in humans, such as O26, O103, O91, O145, and O111 in several countries.<sup>2</sup>

Major progress has been made in the last decades in the processing of beef carcasses following slaughter to reduce the microbial contamination of beef using the HACCP.

HACCP is a process control system designed to identify and prevent microbial and other hazards in food production. It includes steps designed to prevent problems before they occur and to correct deviations as soon as they are detected. Such preventive control systems with documentation and verification are widely recognized by scientific authorities and international organizations as the most effective approach available for producing safe food.

In the United States, as of 1996, the U.S. Department of Agriculture (USDA) adopted the Pathogen Reduction HACCP system, which includes four major elements:

- Every plant must adopt and carry out its own HACCP plan, which systematically addresses all significant hazards associated with its products.
- Mandatory *E. coli* testing in slaughter plants: Every plant must regularly test carcasses for *E. coli* to verify the effectiveness of the plant's procedures for preventing and reducing fecal contamination.
- Pathogen reduction performance standards for *Salmonella*: All plants and plants producing raw ground products must ensure that their *Salmonella* contamination is below the current national baseline prevalence.
- Sanitation standard operating procedures: Every plant must adopt and carry out a written plan for meeting its sanitation responsibilities. Effective

sanitation in slaughter and processing plants is essential to prevent adulteration of meat and poultry products.

HACCP is endorsed by such scientific and food safety authorities as the National Academy of Sciences and the National Advisory Committee on Microbiological Criteria for Foods, and by such international organizations as the Codex Alimentarius Commission and the International Commission on Microbiological Specifications for Foods.

#### Postharvest Decontamination Techniques

Meat carcasses may become contaminated from fecal material, the stomach contents, and the hide. Additional sources of cross-contamination exist in the slaughter process, such as processing tools and equipment, structural components of the facility, human contact, and carcass-to-carcass contact.

Decontamination techniques for carcasses are targeted at reducing or eliminating bacteria that may be human pathogens as well as those that may cause meat spoilage. The pathogenic bacteria of most concern include *E. coli* O157:H7, *Salmonella* spp., *Listeria monocytogenes*, *Campylobacter* spp., *C. botulinum*, *C. perfringens*, *Staphylococcus aureus*, *Aeromonas hydrophila*, and *Bacillus cereus*.

Meat processors strive to produce raw products that have low levels of bacteria on the surface and no pathogenic bacteria. However, the process is not done in a sterile environment and contamination is unavoidable, and occasionally pathogenic microorganisms may come into contact with the surface of the meat carcass. Routine slaughter practices have evolved over the years to reduce the likelihood of inadvertent microbial contamination. This evolution has led to the adoption of the **hurdle technology** approach to microbial carcass interventions.

The principles of hurdle technology state that, if the initial microbial load is substantially reduced as a result of carcass decontamination procedures, fewer microorganisms are present, which are then more easily inhibited in subsequent processing steps. The effectiveness of hurdle technology has been demonstrated experimentally for beef decontamination technologies under controlled conditions. The concept of hurdle technology for beef carcass decontamination has also been validated to be effective in field studies in beef-processing facilities.

The following are some of the more widely used and researched intervention strategies:

- **Hot water rinse.** There is substantial scientific evidence that hot water (>74°C) will produce a sanitizing effect on beef carcasses, and this is widely practiced in the industry.
- **Steam pasteurization.** The commercialization of the steam pasteurization system has been

successful and it is in use in many large beef slaughter facilities in North America. Hot water/steam vacuum systems are designed to remove visible spots of contamination from small areas on the carcass and are used to augment the traditional knife trimming. Steam pasteurization is a process in which beef carcasses are placed in a slightly pressurized, closed chamber at room temperature and sprayed with steam that blankets and condenses over the entire carcass. This raises the surface temperature to 90°C (195°F) or 93°C (200°F) and kills nearly all pathogens. Carcasses then are sprayed with cold water.

- **Steam vacuum.** Steam or hot water is sprayed on a beef carcass followed by vacuuming, which has the combined effect of removing and/or inactivating surface contamination. The handheld device includes a vacuum wand with a hot water spray nozzle, which delivers water at approximately 82°C to 88°C (180°F–190°F) to the carcass surface, as well as the vacuum unit. Steam vacuuming is approved for use by the USDA-Food Safety and Inspection Service (FSIS) as a substitute for knife trimming for removing fecal and ingesta contamination when such contamination is less than 2.54 cm at its greatest dimension.
- **Chemical rinses.** Organic acids are typically applied as a rinse to the entire surface of the carcass. The USDA-FSIS approved the use of organic acid solutions such as acetic, lactic, and citric acids at concentrations of 1.5% to 2.5%. Acetic and lactic acids have been most widely accepted as carcass decontamination rinses. The effectiveness of organic acids is best achieved shortly after hide removal, when the carcass is still warm.

#### Progress Made With Decontamination Processes

The multiple decontamination processes, as applied in actual plant settings, have resulted in significant improvements in the microbiological quality of beef. There is considerable evidence to support the effectiveness of in-plant application of multiple decontamination technologies (hurdle technology). Reductions were achieved from 43% of lots sampled preevisceration as positive for *E. coli* O157:H7 to 1.9% remaining positive post-processing after multiple decontamination methods on the slaughter floor.

In February 2005, the beef industry welcomed news from the USDA-FSIS showing a significant drop in *E. coli* O157:H7 prevalence in 2004, compared with 2003. The FSIS data showed that the percentage of *E. coli* O157:H7–positive ground beef samples collected in 2004 fell by 43.3% compared with



the previous year. The data showed that, between 2000 and 2004, the percentage of positive samples of *E. coli* O157:H7 had declined by more than 80%. FSIS also reported that there were six recalls related to *E. coli* O157:H7 in 2004 compared with 12 in 2003 and 21 in 2002.

### Irradiation

Irradiation of beef in the postharvest stage is a process that could be used to inactivate pathogens. At the present time, the percentage of beef being irradiated is very small. Constraints include reluctant consumer acceptance of radiation-treated food, increased price of production, and the irradiation's negative effect on odor and flavor.

### Consumer Education on Handling and Cooking Meat

To prevent infection with STEC, consumers must be encouraged to follow four simple steps: chill promptly; clean hand and kitchen surfaces; separate, do not cross-contaminate; and cook thoroughly.

### Visitors to Animal Farms

Farm animals and the farm environment present a variety of possible sources of infection with STEC. Farm visits are popular among city families for holidays and family gatherings, and schools in urban areas frequently promote educational farm visits for their students. The consumption of unpasteurized milk by visiting children and close physical contact with animals have been documented as most likely sources of infection in some outbreaks of *E. coli* O157:H7 infection. Farm animals and the farm environment present a variety of possible sources of infection. Visitors to animal farms, especially groups such as schoolchildren, must avoid petting animals whose hair coats and skin may harbor *E. coli* O157:H7. STEC of bovine origin can infect humans in the farm environment. Many dairy-farm residents regularly consume unpasteurized milk, which is a potential source of STEC.

### FURTHER READING

- Bettelheim KA. Non-O157 verotoxin-producing *Escherichia coli*: a problem, paradox, and paradigm. *Exp Biol Med*. 2003;228:333-344.
- Farrokh C, Jordan K, Auvray F, et al. Review of Shiga-toxin-producing *Escherichia coli* (STEC) and their significance in dairy production. *Int J Food Microbiol*. 2013;162:190-212.
- Ferens WA, Hovde CJ. *Escherichia coli* O157:H7: Animal reservoir and sources of human infection. *Foodborne Pathog Dis*. 2011;8:465-487.
- Karmali MA, Gannon V, Sargeant JM. Verocytotoxin-producing *Escherichia coli* (VTEC). *Vet Microbiol*. 2010;140:360-370.
- Mathusa EC, Chen Y, Enache E, et al. Non-O157 Shiga toxin-producing *Escherichia coli* in foods. *J Food Prot*. 2010;73:1721-1736.

### REFERENCES

- Karmali MA, et al. *Vet Microbiol*. 2010;140:363.
- EFSA. 2011. *EFSA Journal* 2011;9(10):2390.
- Menrath A, et al. *Gut Pathog*. 2010;2:7.
- Mathusa EC, et al. *J Food Prot*. 2010;73:1721.
- Ferens WA, Hovde CJ. *Foodborne Pathog Dis*. 2011;8:465.
- Cobbaut K, et al. *J Food Prot*. 2009;72:1848.
- Hussein HS, Sakuma T. *J Dairy Sci*. 2005;88:450.
- Ahn CK, et al. *J Pediatr*. 2009;155:587.
- Sanchez S, et al. *Vet Microbiol*. 2009;143:420.
- Doane CA, et al. *J Food Prot*. 2007;70:6.
- Cobbold RN, et al. *Appl Environ Microbiol*. 2007;73:1563.
- Stanford K, et al. *J Dairy Sci*. 2005;88:4441.
- CDC. 2014. <<http://www.cdc.gov/ecoli/general/index.html#what-are-shiga-toxin>>; Accessed on 28.12.14.
- EFSA. 2011. <<http://www.efsa.europa.eu/de/efsajournal/doc/2090.pdf>>; Accessed 29.12.14.
- Farrokh C, et al. *Int J Food Microbiol*. 2013;162:190.
- Dinu LD, Bach S. *Appl Environ Microbiol*. 2011;77:8295.

## BRAXY (BRADSOOT)

Braxy is an acute infectious disease of sheep in Britain characterized by inflammation of the abomasal wall, toxemia, and a high mortality rate. The disease was common in the early twentieth century but now is extremely rare.

### SYNOPSIS

<b>Etiology</b>	<i>Clostridium septicum</i> and ingestion of frosted feedstuffs
<b>Epidemiology</b>	Weaners and yearling sheep in winter
<b>Clinical findings</b>	Rapid death
<b>Clinical pathology</b>	Death too rapid
<b>Necropsy findings</b>	Pathognomonic lesion in abomasum
<b>Diagnostic confirmation</b>	Typical abomasal lesion and positive fluorescent antibody staining of organism in lesion
<b>Treatment</b>	None
<b>Control</b>	Annual vaccination preceding the period of risk

### ETIOLOGY

*C. septicum* is a common cause of malignant edema in animals.

### EPIDEMIOLOGY

Braxy occurs only in midwinter when there are heavy frosts and snow, and usually only in weaner and yearling sheep. It has occurred in experimental sheep receiving infusions of acetic acid into the abomasum, and these were thought to cause abomasitis. Adult animals in an enzootic area appear to have acquired immunity.

*C. septicum* is a soil-borne organism and in many areas can be considered as a normal inhabitant of the ovine intestinal tract.

The disease occurs in the UK and various parts of Europe and has been reported in the southern part of Australia but appears to be rare in North America. It is now not of major

importance because of its low prevalence, although it once was sufficiently common to be an important cause of loss in some countries. In affected sheep the case-fatality rate is usually about 50%, and in enzootic areas an annual loss of 8% has been reported.

### PATHOGENESIS

Presumably a primary abomasitis, associated with the ingestion of frozen grass or other feed, permits invasion by *C. septicum*, resulting in a fatal toxemia.

### CLINICAL FINDINGS

There is a sudden onset of illness with segregation from the group, complete anorexia, depression, and high fever 42°C (107°F) or more). The abdomen may be distended with gas, and there may be signs of abdominal pain. The sheep becomes recumbent, comatose, and dies within a few hours of first becoming ill.

### CLINICAL PATHOLOGY

Antemortem laboratory examinations are of little value in establishing a diagnosis.

### NECROPSY FINDINGS

There are localized areas of edema, congestion, necrosis, and ulceration of the abomasal wall. Congestion of the mucosa of the small intestine may also be present, and there may be a few subepicardial petechiae. *C. septicum* can be isolated by smear from the cut surface of the abomasal wall or by culture from the heart, blood, and other organs of fresh carcasses. Bacteriologic examinations of tissues must be performed within an hour of death if the diagnosis is to be confirmed.

Mortality in calves with braxy-like lesions in the abomasum is also recorded.

### Samples for Confirmation of Diagnosis

- Bacteriology: frozen abomasum, in air-tight container; four air-dried impression smears from freshly cut surface of abomasal mucosa (anaerobic culture, fluorescent antibody test)
- Histology: fixed abomasum

### DIFFERENTIAL DIAGNOSIS

Clinical diagnosis of braxy is difficult. At necropsy the lesions of abomasitis are characteristic, especially if the disease occurs under conditions of severe cold. Overeating on grain may cause local patches of rumenitis and reticulitis, but there are no lesions in the abomasum. Braxy may resemble infectious necrotic hepatitis, but there are no liver lesions in braxy. The final diagnosis depends on isolation of *C. septicum* from typical alimentary tract lesions.

### TREATMENT

No treatment has been found to be of any value.

## CONTROL

Management of the flock is important. The sheep should be yarded at night and fed hay before being let out to the frosted pasture each morning. Vaccination with a formalin-killed whole culture of *C. septicum*, preferably two injections 2 weeks apart, is also an effective preventive.

## FURTHER READING

Radostits O, et al. Braxy (Bradsot). In: *Veterinary Medicine: A Textbook of the Disease of Cattle, Horses, Sheep, Goats and Pigs*. 10th ed. London: W.B. Saunders; 2007:832.

## ENTERIC DISEASE ASSOCIATED WITH CLOSTRIDIUM PERFRINGENS

*C. perfringens* resides in the intestinal tract of domestic animals and can produce a number of toxins that result in enteric and histotoxic disease. *C. perfringens* isolates are classified into one of five types, types A–E, depending on their ability to produce the four major lethal toxins:  $\alpha$ -toxin,  $\beta$ -toxin,  $\epsilon$ -toxin, and  $\iota$ -toxin. The activities of these major lethal toxins are the basis of the pathogenesis of the classical enterotoxemias attributed to this organism and described later. More recently, it has been recognized that *C. perfringens* produces other toxins that are probably important in animal disease. These include an enterotoxin and a cytotoxic  $\beta$ -2 toxin, the latter encoded by the *cbp2* gene.<sup>1,2</sup> Regulation of the expression of the genes responsible for  $\alpha$ -,  $\beta$ -,  $\beta$ -2-, and NetB-toxin production, the latter involved in the pathogenesis of necrotic enteritis in chickens, is performed by the proteins VirR and VirS, whereas the regulation of  $\epsilon$ - and  $\iota$ -toxins is not yet fully understood.<sup>1,3</sup>

The amino acid sequence of the  $\beta$ -2 toxin has little homology with that of the major  $\beta$ -toxin, and they are only weakly related immunologically, but the biological activity of the two toxins is similar and both are cytotoxic and cause hemorrhagic necrosis of the intestinal wall. The importance of enterotoxin and the  $\beta$ -2-toxin to animal disease is still uncertain. Both appear important in the cause and pathogenesis of enteric disease in pigs. The  $\beta$ -2-toxin may be important in enterocolitis in foals and adult horses as *Cbp2*-positive *C. perfringens* type A has been isolated from diarrheic foals and adult horses; however, the significance of these isolations to the disease is still not fully determined. *C. perfringens* normally resides in the intestine, but plasmids encoding virulence genes can be transferred to resident strains from environmental ones converting these into enteropathogens.<sup>4</sup> Surplus dietary carbohydrate or protein that exceeds the capacity of intestine to absorb it are used by *C. perfringens* for growth and toxin production, so it is a risk factor for *C. perfringens*-associated disease.<sup>1</sup> A multiplex PCR has

been described for the rapid toxin typing of *C. perfringens* isolates.<sup>5</sup>

## REFERENCES

- Allaart JG, et al. *Comp Immunol Micro Infect Dis*. 2013;36:449.
- Uzal FA, et al. *Open Toxicol J*. 2013;3:24.
- Ohtani K, et al. *Anaerobe*. 2010;16:258.
- Kobayashi S, et al. *Epidemiol Infect*. 2009;137:108.
- van Asten AJAM, et al. *Vet Microbiol*. 2009;136:411.

## ENTEROTOXEMIA ASSOCIATED WITH CLOSTRIDIUM PERFRINGENS TYPE A

The role of *C. perfringens* type A in the pathogenesis of diseases of animals is uncertain because the organism forms part of the bacterial flora of the alimentary tract in many normal animals. However, there are an increasing number of reports that attribute disease and mortality to this organism. The validity of these attributions remains to be fully determined, but they are listed next.

### Enterocolitis in Horses

Enterocolitis in foals and adult horses is an etiologically poorly defined syndrome. Enterocolitis associated with *C. difficile* is one cause and is covered under that heading elsewhere in this text. In addition, enterocolitis associated with *C. perfringens* type C is covered under that heading. There remains a syndrome of enterocolitis that is manifested with enteritis, diarrhea, and colic, and a high case fatality, and one that is diagnosed most often at postmortem. It appears to occur worldwide and although occurrence is sporadic, there is the perception that there is an increasing prevalence of this disease. A study of risk factors in the western United States found that stock horse breeds were more at risk and that the presence of other livestock on the farm, and housing in a stall or drylot for the first 3 days of life, was associated with increased risk. Other studies have implicated barn hygiene as a factor that should be considered in preventive procedures.

There have been a number of clostridial species that have historically been associated with the syndrome besides *C. perfringens* type A. In some cases, this association has been by identification of type-specific toxin in the intestine of the affected horse but in others it has been made by the presence of large numbers of the incriminated organism in affected animals in comparison to occurrence and numbers in normal horses. This association has risk because the number of clostridia in the intestine can be influenced by diet, clostridia can multiply in the intestine following death, and they can exist in different forms that may be variably isolated with different cultural techniques.

### Equine Intestinal Clostridiosis

A syndrome historically named equine intestinal clostridiosis has been attributed to

intestinal infection with *C. perfringens* type A in adult horses. The syndrome was characterized by an acute profuse watery diarrhea with high mortality in adult horses and the demonstration of large numbers of *C. perfringens* type A in the intestine at postmortem. It was described as occurring in horses with hemorrhagic cecitis and colitis similar to colitis X, in horses collapsing and dying following exercise, and in other circumstances. Diarrhea and death were reproduced with massive (biologically implausible) oral challenge with broth cultures of these organisms, and colic and hemorrhagic gastroenteritis were produced by intravenous injection of ponies with *C. perfringens* type A enterotoxin. The evidence of an association of *C. perfringens* type A with disease in these early studies was equivocal, but *C. perfringens* type A can be isolated from both foals and adults with enterocolitis. However, isolation from this disease and causal association remain to be determined. *C. perfringens* is common in the environment of foals, and one study in over 128 healthy foals found that *C. perfringens* type A could be isolated from the feces of the majority of foals at 3 days of age. *C. perfringens* with the gene for  $\beta$ -2-toxin expression were found in the feces of 28 foals and with the enterotoxin gene in five foals. Consequently, the isolation of *C. perfringens* type A expressing the gene for  $\beta$ -2-toxin does not constitute a causal diagnosis. There is, however, a suggestion that *C. perfringens* type A that expresses the gene for  $\beta$ -2-toxin may be the particular subset of this isolate that is responsible for this disease.

### Enteritis in Piglets

*C. perfringens* type A is associated with diarrheic food poisoning in humans, and a similar diarrhea in pigs may be produced by infection with this organism. The disease is manifested with a watery yellow diarrhea occurring in piglets under 5 days of age, usually in the first 3 days of age, and a high morbidity but low case fatality. At postmortem, there is a mild enterocolitis and villous atrophy. It is controlled with sanitation procedures or with the type of prophylactic procedures used with enterotoxemia associated with *C. perfringens* type C. Simultaneous infection with *Isospora suis* and *C. perfringens* may cause more severe disease.<sup>1,2</sup>

### Hemorrhagic Enterotoxemia and Hemolytic Disease in Cattle, Sheep, and Goats

There are reports of a highly fatal hemolytic disease in cattle, sheep, and lambs (yellow lamb disease), of an acute hemorrhagic enteritis in calves and adult cattle, and of an acute hemolytic enterotoxemia in foals and goats, associated with the presence of large numbers of *C. perfringens* type A in the intestine. These reports have some credibility because of the activity of the primary toxin of *C. perfringens* type A,  $\alpha$ -toxin, which possesses

phospholipase C and sphingomyelinase activity and consequently hemolytic action. The presence of  $\beta$ -2-toxin in these strains may also contribute to the pathogenicity.

Some credibility is also engendered by reports, albeit occasional, of similar syndromes in different geographic areas and by different institutes.

In the hemolytic disease there is an acute onset of severe depression, collapse, mucosal pallor, jaundice, hemoglobinuria, dyspnea, and the presence of severe abdominal pain. Temperatures range from normal to 41°C (106°F). The disease is highly fatal, most affected animals dying within 12 hours of the onset of illness, although occasional animals survive for several days. Large numbers of *C. perfringens* and the presence of the specific toxin in feces is used to make a presumptive diagnosis. At necropsy the cardinal features are pallor, jaundice, and hemoglobinuria. The kidneys are swollen, dark brown in color, and may contain infarcts; the liver is pale and swollen and there may be hydropericardium and pulmonary edema. There is extensive necrosis of the small intestine. Clostridia dominate the bacterial population of the small intestine, as indicated by smears made from the contents, and  $\alpha$ -toxin is present in large quantities. The toxin is present in large quantities in the intestine, which is indicative of the existence of the disease.

The syndrome is very similar to that associated with chronic copper poisoning and leptospirosis in calves.

In the hemorrhagic enteritis of calves, foals, and adult cattle the syndrome observed is indistinguishable from that associated with *C. perfringens* types B and C. The disease in adult cattle is most common in the period shortly after calving. The experimental disease in lambs and calves produced by the intravenous injection of toxin is characterized by transitory diarrhea and hyperemia of the intestinal mucosa. Type A antiserum has been effective in prevention of the disease in calves, and a formalinized vaccine has shown some immunizing capacity in sheep.

### Abomasal Ulcer

*C. perfringens* type A has been suspected in the etiology of abomasal ulcers in suckling beef calves in western North America and is less common elsewhere.<sup>3,4</sup> A clonal population of *C. perfringens* type A was isolated from ulcers in a 3-month-old calf, but its role in the causation of this syndrome is still unclear. A study of the prevalence and bacterial colonization of fundic ulcers in veal calves, which are more associated with welfare and nutritional factors than pyloric ulcers, recovered less *C. perfringens* from affected compared with healthy abomasa.<sup>5</sup>

### Jejunal Hemorrhage Syndrome in Cattle

*C. perfringens* type A has been proposed as a cause of this disease, largely based on the

isolation of this organism from the intestine of affected animals.<sup>6</sup> This organism is present in the intestinal tract of normal animals and, although it is possible that a subset of Cbp2-positive,  $\beta$ -2-toxin-producing *C. perfringens* type A organisms are responsible for this disease, the current evidence is equivocal.<sup>7</sup> Animals are often found dead, but clinical signs include going off-feed, restlessness, incoordination and staggering, tachycardia, weak ruminal contractions, and abdominal colic.<sup>8</sup> Adult cattle are more typically affected, but cases in 9-month-old calves have been described.<sup>8</sup> Despite the pathogenesis of this disease being imperfectly understood,<sup>9</sup> a commercial toxoid and autogenous vaccines against *C. perfringens* type A are available in North America.

### FURTHER READING

Radosits O, et al. Enterotoxemia associated with *Clostridium perfringens* Type A. In: *Veterinary Medicine: A Textbook of the Diseases of Cattle, Horses, Sheep, Goats and Pigs*. 10th ed. London: W.B. Saunders; 2007:836-838.

### REFERENCES

1. Collier CT, et al. *Vet Immunol Immunopathol*. 2008;122:104.
2. Mengel H, et al. *Parasitol Res*. 2012;110:1347.
3. Van Immerseel F, et al. *J Comp Pathol*. 2010;143:289.
4. Songer JG, Miskimins DW. *Anaerobe*. 2005;11:290.
5. Valgaeren BR, et al. *Vet Rec*. 2013;172:269.
6. Elhanafy MM, French DD. *J Am Vet Med Assoc*. 2013;243.
7. Lebrun M, et al. *Vet Rec*. 2010;167:13.
8. Savic B, et al. *Can Vet J*. 2012;53:174.
9. Ewoldt J, Anderson D. *Can Vet J*. 2006;46:821.

## ENTEROTOXEMIA ASSOCIATED WITH CLOSTRIDIUM PERFRINGENS TYPES B, C, AND E

### SYNOPSIS

**Etiology**  $\beta$ -Toxin, a trypsin-sensitive toxin produced by *C. perfringens* types B and C, produces hemorrhagic enteritis and ulceration of the intestinal mucosa resulting in diarrhea and dysentery in young lambs, goats, calves, pigs, and foals.  $\beta$ -2 toxin also contributes to these diseases. A number of diseases associated with these clostridia occur in different parts of the world and are given specific names.

**Epidemiology** Young animals, with the exception of struck in sheep, often occurring as outbreaks with a high case-fatality rate in which there is buildup of infection.

**Clinical findings** Rapid course with hemorrhagic diarrhea, abdominal pain, and toxemia.

**Necropsy findings** Focal (type B) or extensive (type C) areas of necrosis in the small intestine.

**Diagnostic confirmation** Clinical signs, gross and microscopic pathology from sacrificed or freshly dead animals, and direct or cultural examination for clostridia.

**Treatment** Antibiotics, specific antitoxin, supportive therapy.

**Control** Vaccination.

### ETIOLOGY

The general etiology of these diseases is given in this section but, because of differing circumstances of occurrence, the description of the epidemiology of these diseases is given separately according to animal species.

The causative clostridia are commonly found in soil, the animals' housing environment and the alimentary tract of healthy animals, and management factors precipitate disease. The diseases produced by these organisms occur in animals in the first few days of life, with the exception of the disease struck in sheep. Their predominance in very young animals may be caused by the immaturity of their alimentary tracts, the  $\beta$ -toxin being readily inactivated by trypsin, and because of the ready colonization of the gut by *C. perfringens* in the absence of a mature intestinal flora. It is probable that many animals become subclinically challenged but do not show clinical illness, because antitoxin has been detected in clinically normal animals.

The bacteria are capable of forming spores that survive for long periods. Generally, rapidly growing, well-nourished animals are most susceptible. The toxins produced are alpha, beta, and epsilon in type B, and alpha and beta in type C.

$\beta$ -2 toxin is also produced by some of these organisms and appears important to their pathogenicity in pigs and horses. There are subtypes of these organisms with differing toxin production abilities.  $\alpha$ - and  $\iota$ -toxin are produced by type E, which is a far less common cause of enterotoxemia in calves, kids, and lambs but has been associated with an outbreak of enterotoxemia of adult cattle in Argentina.<sup>1</sup>

The diseases that are produced by these organisms in the different animal species, and the organisms' names, are as follows:

- **Lamb dysentery** associated with *C. perfringens* type B. An enterotoxemia of young lambs is also associated with *C. perfringens* type C.
- **Goat enterotoxemia** associated with *C. perfringens* type C and rarely by type B.
- **Necrotic enteritis of pigs, pig enterotoxemia** associated with *C. perfringens* types C and less commonly by type B.
- **Foal enterotoxemia** associated with *C. perfringens* types C and B.



- **Calf enterotoxemia** associated with *C. perfringens* types B and C (and rarely E).
- **Struck**, associated with *C. perfringens* type C, affects adult sheep, particularly when feed is abundant.

## EPIDEMIOLOGY

### Lamb Dysentery and Type C Enterotoxemia

#### Occurrence

**Lamb dysentery** associated with type B occurs in Great Britain, Europe, and South Africa and is an important disease in these countries. In contrast, this disease is rare or absent in Australia, New Zealand, North America, and Japan, in which type C infections are more important. The geographic variation may be caused by variation in the occurrence of the types of *C. perfringens*. Lamb dysentery does not occur in New Zealand, and *C. perfringens* type B has not been found in sheep or soil samples in that country.

Type C enterotoxemia in lambs and goats occurs particularly with shed lambing in North America and where there is close stocking of ewes and lambs at lambing. It is also recorded in Australasia.

#### Animal and Environmental Risk Factors

In lamb dysentery, the incidence of clinical disease in groups of lambs may reach as high as 20% to 30%. In an outbreak, the disease initially affects 1- to 4-day-old lambs and the clinical course is very short. A characteristic of the disease is the tendency for an increase in incidence rate as lambing progresses and for the involvement of older lambs, up to 2 to 3 weeks of age, which survive for longer periods. The case-fatality rate approaches 100%.

In Great Britain lamb dysentery occurs primarily in the hill breeds of sheep, breeds that have a small litter size but good milk production, and the appearance of the disease in a particular year appears to be related to weather conditions that allow sufficient pasture growth to produce profuse lactation in the ewes. The time of onset of the disease in a lambing season is related to the weather conditions that predispose to its occurrence.

Type C enterotoxemia in lambs and goats is prevalent in cold weather and on farms in which ewes are kept closely confined in small yards or fields for lambing and kidding. Gross contamination of the surroundings with the causative bacteria is likely to occur in these circumstances. The disease can occur as an outbreak with an attack rate of 15% to 20% and a case fatality that approaches 100%. Type C enterotoxemia is more common in single-born lambs and is largely restricted to lambs 12 hours to 4 days of age. Sporadic disease occurs in orphan lambs reared on milk replacer, which appear

particularly at risk and may develop the disease at up to 2 weeks of age.

### Necrotic Enteritis of Pigs

#### Occurrence

Necrotic enteritis is an important disease of piglets, particularly in intensive pig units. It occurs in most countries but is most common in certain areas in the United States, Europe, and the UK.

#### Animal and Environmental Risk Factors

The organisms are recoverable from the skin of sows and the feces of affected piglets, and infection probably occurs during suckling. The number of piglets affected varies between herds and between litters. The disease may occur sporadically in a piggery but commonly occurs as an outbreak affecting several litters within a given time period. Pigs up to 7 days of age are most commonly affected, and susceptibility to disease and its severity decreases with age. Peracute disease with rapid death occurs in piglets affected at 1 to 2 days of age, whereas piglets affected at 1 to 2 weeks show a more protracted clinical course. The case fatality is high, and in severe outbreaks 80% of piglets at risk may die. The disease tends to become endemic in pig units and to recur on the same premises in succeeding years.

Insufficient cleaning and disinfection of farrowing pens, the housing of pigs on concrete, and the routine use of antibiotics to which *C. perfringens* is resistant, such as the aminoglycosides, have been proposed as risk factors for buildup of infection in swine units.

### Enterotoxemia in Foals

Enterotoxemia in foals has been associated with both *C. perfringens* type B and type C. Type C predominates in reports from North America. Cases are usually sporadic, with most in single animals under 7 to 14 days of age, although *C. perfringens* type C and  $\beta$ -toxin has been demonstrated in cases of necrotic enteritis in adult horses.<sup>2</sup> The factors that predispose to disease in foals are poorly defined. Isolates of *C. perfringens* from 55 Canadian horses with clinical colitis, including 12 foals, were less cytotoxic than a  $\beta$ -toxin-producing control, and none were positive for enterotoxin, NetB, or large cytotoxin gene.<sup>3</sup>

### Enterotoxemia in Calves

Enterotoxemia caused by *C. perfringens* type B or C is uncommon in calves. The disease usually occurs as outbreaks of severe dysentery with some deaths in calves 7 to 10 days old, although calves up to 10 weeks of age may be affected.

### Struck in Sheep

Struck in adult sheep on good pasture in spring is limited in its occurrence to certain localities in Britain and is rarely reported.

## PATHOGENESIS

The organism is ingested from soil and fecal contamination on the surface of the dam's udder. It proliferates and attaches to the surface of the epithelial cells of the intestinal villus, but toxin production and mucosal damage may precede attachment. Information on the rate of carriage in normal animals is scant and the factors that allow proliferation and attachment are poorly understood.<sup>4</sup> Toxigenic strains of *C. perfringens* types B and C produce both  $\alpha$ - and  $\beta$ -toxins.

The  $\alpha$ -toxin is a lethal toxin that is produced in varying amounts by isolates of both types. It is a phospholipase, and hydrolysis of membrane phospholipids in erythrocytes, platelets, leukocytes, and endothelial cells results in cell lysis or other forms of cytotoxicity. The  $\beta$ -toxin causes increased capillary permeability and may facilitate its uptake from the intestine.  $\beta$ -Toxin is a necrotizing toxin and initially produces damage to the microvilli with degeneration of mitochondria, with eventual destruction and desquamation of the intestinal epithelial cells and the production of a hemorrhagic enteritis and ulceration of the intestinal mucosa.<sup>5</sup>

The age incidence of these diseases may be partially explained by the observation that  $\beta$ -toxin is highly sensitive to inactivation by trypsin, which is a component of normal pancreatic proteases. Colostrum contains a trypsin inhibitor, and trypsin is decreased or absent in affected pigs. Experimentally administered soybean flour used as a protease inhibitor converts experimentally induced clostridial enteritis from a nonfatal to a fatal disease.

## CLINICAL FINDINGS

Lamb dysentery can be manifested by sudden death without premonitory signs in peracute cases. In the more common acute form, there is loss of sucking drive and severe abdominal pain manifested by bleating, stretching, and looking at the abdomen. Lambs pass brown, fluid feces sometimes containing blood, and defecation is often accompanied by painful straining. Death usually occurs after a period of recumbency and coma and within 24 hours of the onset of illness. On farms in which the disease has become established, cases may occur in older lambs up to 3 weeks of age and occasional cases may survive for several days. A chronic form of the disease in older lambs is called "pine," and manifests with chronic abdominal pain and reluctance to suck but no diarrhea, and is recognized and responds to treatment with specific antiserum.

Necrotic enteritis in piglets is also manifested with rapid death in young animals and more prolonged disease in slightly older piglets. Affected pigs become dull and depressed and exhibit diarrhea, dysentery, and gross reddening of the anus. The feces of piglets affected within 2 to 3 days of life is watery and initially yellow but in a

proportion of pigs will become hemorrhagic and red-brown in color and contain necrotic debris. The clinical course in piglets affected at this age is usually less than 24 hours; they rapidly become dehydrated, hypoglycemic, hypothermic, and comatose. Piglets affected at an older age have a fluid, yellow-colored diarrhea and blood may not be evident. Frequently the majority of litters born during an outbreak will be affected, although affected litters may include some normal pigs. Occasionally weaned pigs are affected. Acute outbreaks in herds may be followed by the occurrence of chronic necrotizing enteritis.

Foals with enterotoxemia associated with *C. perfringens* type B or C show evidence of severe depression, pronounced toxemia, and marked abdominal pain. Affected foals are a few days old and have an acute attack of collapse with bloody feces, subnormal temperature, fast pulse and respiratory rate, and death within a few hours. Colic may be evident, and a major differential diagnosis is an acute intestinal accident. The clinical course is very short and diarrhea does not occur in many cases. There are limited descriptions of the clinical disease in foals because of its sporadic occurrence and rapid course.

In calves, signs include diarrhea, dysentery, and acute abdominal pain accompanied by violent bellowing and aimless running. There may be additional nervous signs, including tetany and opisthotonus. In very acute cases, death occurs in a few hours, sometimes without diarrhea being evident. In less severe cases, the illness lasts for about 4 days and recovery is slow, usually requiring 10 to 14 days.

Struck in adult sheep is manifested only by sudden death with no clinical signs observed beforehand. Occasionally death is preceded by abdominal pain and convulsions.

### CLINICAL PATHOLOGY

The disease in all species is so acute and so highly fatal that the diagnosis is usually made on necropsy material.<sup>6</sup> Antemortem laboratory examinations are not widely used in diagnosis and there is no database, but the predominance of clostridia in a fecal smear may suggest a diagnosis of hemorrhagic enterotoxemia. Specific antitoxins are detectable in the sera of recovered animals. A severe hypoglycemia has been observed in baby pigs dying of the disease, but this is not specific in this infection.

### NECROPSY FINDINGS

The major lesion in all species is hemorrhagic enteritis, with ulceration of the mucosa in some cases. With type B infections the lesions occur as localized areas of necrosis, usually most evident in the ileum. The intestinal mucosa is dark red and the ulcers are large (up to 2.5 cm in diameter) and almost transmural. Intestinal contents

are bloodstained and may contain fibrin clots, and there is often excess serosanguineous fluid in the abdominal cavity.

With type C infection the areas of necrosis are more extensive, involving entire segments of small intestine and often inducing a peritonitis.<sup>7</sup> Subendocardial and subepicardial hemorrhages are common in ruminants dying of enterotoxemia. If the necropsy of adult sheep is delayed for several hours, the fascial tissues may develop the appearance of malignant edema. Carcasses of 7- to 10-day-old pigs may lack the severe hemorrhagic enteritis typical of the disease in newborn pigs. The less acute disease course in this older age group often results in a yellow, fibrinous deposit on the intestinal mucosa, accompanied by large quantities of watery, lightly bloodstained ingesta in the lumen.

Generally, the histologic features of gut segments affected by these types of enterotoxemia include mucosal hemorrhage, necrosis, fibrin exudation, and a neutrophilic infiltrate. Large numbers of bacterial rods line the luminal surface of these lesions. Unfortunately, postmortem autolysis frequently eliminates the possibility of identifying some of the features.

Smears of intestinal contents can be stained and examined for large numbers of clostridium-like organisms, and filtrates of the contents may be tested for toxin content. Definitive typing of the clostridia has traditionally been via *in vivo* assays, but these are undesirable on humanitarian grounds and are being replaced by immunoassays, such as enzyme-linked immunosorbent assay (ELISA) and passive latex agglutination. A rapid passive latex agglutination test permits confirmation of the presence of  $\alpha$ -toxin but does not permit distinction between the various types of *C. perfringens* capable of producing the toxin. A multiplex PCR test enables characterization of *C. perfringens* isolates based on their genotypic potential for toxin production. PCR techniques detect the genes encoding the major toxins and are promoted for replacing *in vivo* tests for toxin.<sup>8</sup> The PCR test can differentiate toxigenic clostridial isolates recovered from diseased animals and nontoxigenic isolates recovered from normal animals.

### Samples for Confirmation of Diagnosis

- Bacteriology: 20 to 30 mL of intestinal content, frozen in a glass or plastic leak-proof container (latex agglutination, anaerobic CULT, bioassay, PCR); air-dried smears of mucosal surface from several levels of small intestine (cyto: Gram stain)
- Histology: fixed ileum, jejunum (several segments of each)

### TREATMENT

In individual cases the disease is often too acute for effective therapy but fluid and

supportive therapy are indicated. Hyperimmune serum is the specific therapy and the major therapy of value. Oral and parenteral administration of penicillin may prevent further proliferation of organisms and production of toxins.

### CONTROL

Vaccination, preferably with type-specific toxoid or bacterin, is the specific preventive measure. Recombinant vaccines appear to evoke a similar or better antibody response and may be more cost-effective to produce.<sup>9</sup>

### Outbreaks

In outbreaks, because of the need for rapid action, it is usually necessary to proceed with vaccination before typing of the organism can be performed. Cross-protection occurs between *C. perfringens* types B and C because the  $\beta$ -toxin is produced by both strains and is central to the disease produced by both strains. Lamb dysentery antiserum will protect against type C infections. Type C toxoid and antiserum are also available.

### DIFFERENTIAL DIAGNOSIS

The rapid course and typical necropsy findings suggest the diagnosis, but the major differential is with other causes of diarrhea in young animals.

#### All species

- Enteritis associated with *Clostridium perfringens* type A
- Salmonellosis
- Enteric colibacillosis
- Cryptosporidiosis

#### Foals

Enteritis associated with:

- *Strongyloides westeri*
- *Clostridium difficile*
- *Actinobacillus equuli*

#### Piglets

- *Isospora suis*
- Transmissible gastroenteritis

Struck in sheep is strictly regional in distribution and in affected areas can usually be diagnosed on the basis of necropsy lesions.

When an outbreak occurs all pregnant animals can be vaccinated to provide some colostral immunity to their progeny. However, vaccination of the dam requires a period of at least 2 weeks before there is sufficient protective antibody in colostrum. As a result, there will be a period of time between vaccination and protection of the newborn, and animals born during this period need to be provided with protection by the administration of specific antiserum. Antiserum will protect susceptible animals and can be administered immediately after birth. An alternate, and sometimes more

cost-effective procedure, is to administer benzathine or benethamine penicillin G or depot amoxicillin at birth and to repeat as required during the period of susceptibility.

### Long-Term Control

Long-term control is by vaccination of the dams. To initiate the program two injections of vaccine are necessary 1 month apart, the second injection being given 2 to 3 weeks before parturition. For the prevention of lamb dysentery the two vaccinations of ewes may be spaced 2 to 5 weeks apart and the second injection can be given as early as 2 months before lambing, thus avoiding handling of heavily pregnant ewes. In subsequent years, ewes require only one booster injection immediately before parturition.

For the protection of piglets the sow is vaccinated 5 and 3 weeks before farrowing, but vaccination at mating, repeated 2 to 3 weeks before farrowing, is adequate.

Attention should be given to the unitage of the antigen or antitoxin present in clostridial toxoids and antisera. These vary widely and the manufacturer's instructions should be followed closely. Anaphylaxis may occur with some antisera of equine origin, and treated animals should be kept under close observation for 24 hours and treated quickly if signs of dyspnea and muscle shivering occur.

In the face of an outbreak the lambing area should be moved, or with piglets the farrowing rooms vigorously cleaned and disinfected. The feeding of bacitracin (300 mg/kg of feed) or salinomycin (60 mg/kg feed) to the sow for 1 to 2 weeks before farrowing has been shown to reduce disease incidence, possibly by decreasing the level of excretion of *C. perfringens* by the sow.

### FURTHER READING

- Alves GG, et al. Clostridium perfringens epsilon toxin: the third most potent bacterial toxin known. *Anaerobe*. 2014;30:102-107.
- Radostits O, et al. Enterotoxemia associated with Clostridium perfringens Types B, C and E. In: *Veterinary Medicine: A Textbook of the Diseases of Cattle, Horses, Sheep, Goats and Pigs*. 10th ed. London: W.B. Saunders; 2007:838-840.
- Redondo LM, et al. Clostridium perfringens Type E virulence traits involved in gut colonization. *PLoS ONE*. 2015;10:1-18.
- Uzal FA, McClane BA. Recent progress in understanding the pathogenesis of Clostridium perfringens type C infections. *Vet Microbiol*. 2011;153:37-43.

### REFERENCES

- Redondo LM, et al. *Anaerobe*. 2013;20:1.
- Diab SS, et al. *Vet Pathol*. 2012;49:255.
- Gohari I, et al. *Can J Vet Res*. 2014;78:1.
- Uzal FA, et al. *Vet Microbiol*. 2011;153:37.
- Nagahama M, et al. *Toxins (Basel)*. 2015;7:396.
- Uzal FA, Songer JG. *J Vet Diagn Invest*. 2008;20:253.
- Garcia JP, et al. *J Vet Diagn Invest*. 2013;25:438.
- van Asten AJAM, et al. *Vet Microbiol*. 2009;136:411.
- Salvarini FM, et al. *Vaccine*. 2013;31:4152.

## JEJUNAL HEMORRHAGE SYNDROME (HEMORRHAGIC BOWEL SYNDROME, HEMORRHAGIC JEJUNITIS, OR JEJUNAL HEMATOMA) IN CATTLE

Jejunal hemorrhage syndrome, also known as hemorrhagic bowel syndrome, hemorrhagic jejunitis, or jejunal hematoma, is a recently recognized disease of cattle characterized clinically by a syndrome similar to obstruction of the small intestine causing abdominal distension, dehydration, and shock caused by necrohemorrhagic enteritis affecting primarily the small intestine. At necropsy there is segmental necrohemorrhagic enteritis of the small intestine and large intraluminal blood clots. In spite of intensive medical and surgical therapy, the prognosis is unsatisfactory and the case-fatality rate approaches 100%, unless surgical intervention is early.

The first case series reports were of five affected Holstein Friesian cows from Idaho in the United States in 1991<sup>1</sup> and two cows from Pennsylvania in 1992,<sup>2</sup> although the first report of jejunal hemorrhage syndrome appears to be in a 1990 paper from Ohio documenting the condition in a Holstein Friesian cow.<sup>3</sup>

### ETIOLOGY

The etiology is uncertain. *C. perfringens* type A has been frequently isolated from the intestines of naturally occurring cases in dairy cattle, but its significance is uncertain. This is because *C. perfringens* type A is a normal inhabitant of the intestinal tracts of healthy cattle and is able to proliferate quickly after death. *C. perfringens* type A isolates that contain the  $\beta$ -2-toxin gene (*cpb2*) were initially thought to play an important role in the disease.<sup>4</sup> A subsequent study of five cases of jejunal hemorrhage syndrome failed to identify the presence of any known or possible virulence-associated genes, and the authors concluded that a *C. perfringens* type A "virulence signature" did not exist.<sup>5</sup> Studies in beef cattle suggest that mycotoxins and STEC are part of the disease complex for jejunal hemorrhage syndrome and that *C. perfringens* type A or mycotoxigenic fungi did not play a role in the disease.<sup>6</sup> The latter findings suggest that *C. perfringens* type A plays a secondary role in the disease. It is important to note that all attempts to reproduce the disease using *C. perfringens* type A isolates have been unsuccessful.

The fungus *A. fumigatus* has also been implicated as a causative agent of jejunal hemorrhage syndrome, but there is minimal enthusiasm for this being a primary agent.

### EPIDEMIOLOGY

Although the first reports of jejunal hemorrhage syndrome were from the United States,

the disease has now been identified in many countries in Europe and the Middle east, as well as multiple cases from Canada. The disease occurs sporadically, primarily in mature lactating dairy cows at peak dry matter intake and milk production. Cases occur throughout the year with slightly more reported in winter in the United States. Among dairy breeds, Brown Swiss cattle appear overrepresented in published case series.<sup>4,7</sup> Individual cases have also occurred in beef cows. In Germany, the disease occurs in Simmental cattle. The morbidity is low but the case-fatality rate is very high, even with surgical intervention.

Investigations of herds with cases have failed to identify any reliable possible risk factors. Most cases occur in lactating dairy cows in the first 3 months of lactation. In a single dairy herd, 22 cases occurred in a period of 4 years. Affected cows ranged from 2 to 8 years of age and the time since parturition ranged from 9 to 319 days.

As part of the National Animal Health Monitoring System's Dairy 2002, information was collected about jejunal hemorrhage syndrome in dairy cattle in the United States. The disease was observed in 9% of herds within the previous 5 years and in 5% of herds during the preceding 12 months. Risk factors found to be associated with the disease during the preceding 12 months were large herd size, administration of bovine somatotropin, and routine use of milk urea nitrogen concentration to determine ration composition. Use of pasture as part of the lactating cow ration during the growing season was associated with decreased odds of the disease in herds with a rolling herd average milk production of 9000 kg (20,000 lb) or less, whereas in herds with higher milk production, use of pasture was not associated with the occurrence of the disease. For individual cows with signs consistent with the disease, the third lactation was the median of the parity distribution and the median time between parturition and the onset of clinical signs was 104 days. In summary, management practices implemented to achieve high milk production may increase the risk of developing the disease in dairy cattle. Increased consumption of a high-energy diet seems to be the most plausible common pathway of all the risk factors that have been described.

Feeding rations high in soluble carbohydrates has been suggested as a possible risk factor by providing the intestinal environment for *C. perfringens* type A to proliferate and produce enterotoxins, similar to the situation that may cause hemorrhagic enteritis, abomasitis, and abomasal ulceration in calves.

### PATHOGENESIS

The primary lesion is an acute localized necrotizing hemorrhagic enteritis of the jejunum leading to the development of an



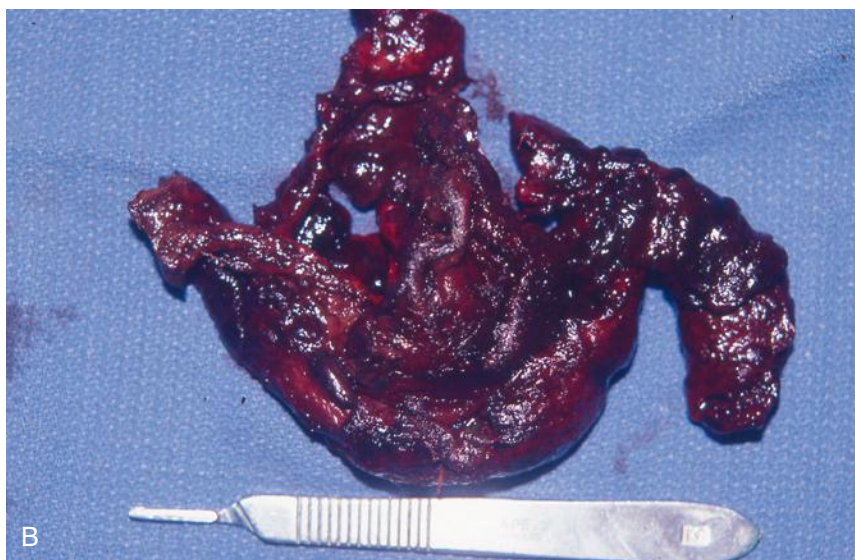

**Fig. 8-26** Holstein Friesian cow with jejunal hemorrhage syndrome. **A**, Indicates the typical lesion in the jejunum as visible through a right flank laparotomy with the cow standing. The cow's head is to the right. **B**, Organized blood clot that was removed from the intestinal lumen from an enterotomy distal to the lesion.

intraluminal blood clot, which causes a physical obstruction of the intestine and ischemia and devitalization of the wall of the affected segment of the intestine (Fig. 8-26). The lesion is similar to hemorrhagic enterotoxemia associated with *C. perfringens* in young rapidly growing calves, lambs, or piglets. Puzzling and unexplained factors of the disease are that it is a focal lesion in the

midjejunum. A satisfactory reason for both factors has yet to be developed.

Recent detailed histologic examination of 21 cases showed that 6 cases identified the presence of an **intramural hematoma** that split the muscularis mucosa at its margins and dilatation of villus lacteals.<sup>8,9</sup> These observations led to the suggestion that the initial disturbance was a decrease in blood or

lymphatic flow leading to leakage into the lamina propria followed by development of an intramural hematoma. *C. perfringens* type A then proliferates in the presence of ischemic tissue and extravascular blood, and in this scenario *C. perfringens* type A acts as a secondary and not a primary agent.

There is gastrointestinal stasis with accumulation of intestinal gas and fluids proximal to the obstructed intestine, resulting in distended loops of intestine, hypochloremia, hypokalemia, dehydration, and varying degrees of anemia. The serum biochemistry changes are those of an obstruction of the upper small intestine and sequestration of abomasal secretions, with resultant hypochloremia, hypokalemia, and strong ion (metabolic) alkalosis. The hemorrhagic enteritis is progressive, with the ischemia and necrosis extending through the intestinal wall, and within 24 to 48 hours there is marked fibrinous peritonitis, dehydration, continued electrolyte imbalance, marked toxemia, and death.

#### CLINICAL FINDINGS

Common historical findings include sudden anorexia and depression, marked reduction in milk production, abdominal distension, weakness progressing to recumbency, bloody to dark-red feces or dry scant feces, dehydration, and abdominal pain, including bruxism, vocalization, treading, and kicking at the abdomen. Sudden death without prior clinical findings has been reported.

On clinical examination there is depression, dehydration, and the body temperature may be normal to slightly elevated; the heart rate is increased to 90 to 120 beats/min; the mucous membranes are pale; and the respiratory rate is increased. The abdomen is usually distended moderately over the right side. The rumen is usually hypomotile but distended.<sup>10</sup> Fluid-splashing sounds are commonly audible by succussion over the right abdomen. In some cases, a ping can be elicited over the right abdomen.

On rectal examination, the feces are black-red, jelly-like, and sticky, and smell like digested blood. On deep palpation of the right abdomen, distended loops of intestine may be palpable, some of which are firm (those loops containing the blood clot), whereas others may be resilient, representing loops of intestine proximal to the blood clot obstruction that contain excessive fluid and gas and in which the intestine is in a state of ileus.<sup>10</sup> The disease is difficult to differentiate from jejunal intussusception from the results of the physical examination.

The course of the disease in most cases is 2 to 4 days. Even with intensive fluid and electrolyte therapy, affected animals continue to worsen progressively, become weak, recumbent, and die, or euthanasia is chosen.

**Ultrasonographic** examination of the abdomen from the right flank using a 5-MHz linear transducer was very helpful in

identifying the presence of distended loops of intestine (diameter 4.3–12.0 cm, mean 6.8 cm) and reduced or absent intestinal motility. In 19% of cases, the jejunum was observed to contain localized hyperechoic material consistent with blood clots, confirming a diagnosis of jejunal hemorrhage syndrome.<sup>11</sup> The presence of fluid between intestinal loops and fibrin was observed in some cases; this usually indicates more advanced disease and could be used to identify poor surgical candidates.

On laparotomy, the abomasum is commonly distended with fluid. Up to 60 to 100 cm of small intestine may be distended and firm to touch, with a markedly dark red to purplish hemorrhagic serosal surface covered with fibrin tags. The mesenteric band may be too tense to allow exteriorization of the affected intestine. Manipulation of the affected intestine may lead to its rupture because of its thin and fragile intestinal wall caused by ischemia and devitalization. The small intestine proximal to the affected segment is usually distended with fluid and gas and compressible; that distal to the affected segment is usually relatively empty.<sup>12</sup>

## CLINICAL PATHOLOGY

### Hematology

The hemogram is variable and not diagnostic. Leukocytosis and mature neutrophilia with increased band neutrophils and increased fibrinogen concentrations are common, but neutropenia with a left shift may also occur. The PCV and plasma protein concentrations are variable.

### Serum Biochemistry

Metabolic alkalosis with compensatory respiratory acidosis, hypokalemia, and hypochloremia are common, which is consistent with abomasal outflow obstruction due to the obstruction caused by the clotted blood or ileus.

## NECROPSY FINDINGS

The abdomen is moderately distended as a result of marked dilatation of the small intestine, which is dark red, hemorrhagic, and commonly covered by fibrinous exudate. The affected segment of intestine, especially the jejunum and ileum, may be 1 m or more in length and contains a firm blood clot, adherent to the mucosa, which is necrotic and hemorrhagic over the entire length of the affected portion.

Histologically, there is multifocal submucosal edema and neutrophil infiltration, segmental necrosis, ulceration, and mucosal and transmural hemorrhage (hematoma) of the jejunum. Frequently, the epithelium is completely sloughed and, in the area of attachment of the blood clot, the mucosa is absent. Extensive fibrin and neutrophil infiltration occur on the serosal surface and fibrinous peritonitis is common.

*C. perfringens* type A has been isolated from the intestinal contents of typical cases, but its significance is unknown.

## TREATMENT

No specific medical treatment is available, and surgical confirmation and correction is recommended. For valuable animals, intensive fluid and electrolyte therapy is indicated. Because of the possibility of clostridial infection, penicillin is indicated if treatment is attempted. Recent histologic examination of the lesion suggests that the primary hemorrhagic area is intramural and not intraluminal.<sup>8,9</sup> Based on this information, it would appear that right flank laparotomy and resection of the affected segment of the intestine and anastomosis is the preferred surgical approach; support for routine resection of the lesion is provided by the results following surgery in one case series,<sup>10</sup> whereas another case series reported good success treating less extensive (and presumably earlier) lesions by massaging the intraluminal blood clot to break up the intraluminal obstruction;<sup>7</sup> presumably in these cases the intramural damage was milder and recoverable without resection. The overall success rate is usually poor because of the advanced nature of the lesion.

## DIFFERENTIAL DIAGNOSIS

The disease must be differentiated from other causes of acute physical or functional obstruction of the small intestine causing

distended loops of intestine, fluid-splashing sounds on ballottement of the abdomen, and dehydration and electrolyte imbalances. These include intussusception, volvulus of the jejunal flange, incarceration of small intestine through an omental rent, ileal impaction, and diffuse peritonitis (causing ileus). In ileal impaction in mature cows, distended loops of intestine are palpable on rectal examination but on laparotomy the abnormalities consist of ileal impaction and distended loops of intestine, which are amenable to treatment.

Diseases causing melena and dysentery include bleeding abomasal ulcers, acute salmonellosis, and acute bovine viral diarrhea.

Transabdominal ultrasonography (Fig. 8-27) can be used to detect ileus of the small intestine and distension of loops of small intestine with homogeneous echogenic intraluminal material compatible with intraluminal hemorrhage and clot formation.

## CONTROL

Solid control or prevention strategies have not been identified because the cause of jejunal hemorrhage syndrome has not been confirmed. However, because of the association between the incidence of jejunal hemorrhage syndrome and nutritional factors, the following strategies are suggested:

- Increase fiber in the diet, prevent cattle from sorting feed at the bunk, and decrease the amount of rapidly fermentable carbohydrates in the diet.
- Keep feed pushed up, maintain constant feed intake to minimize bolus ingestion

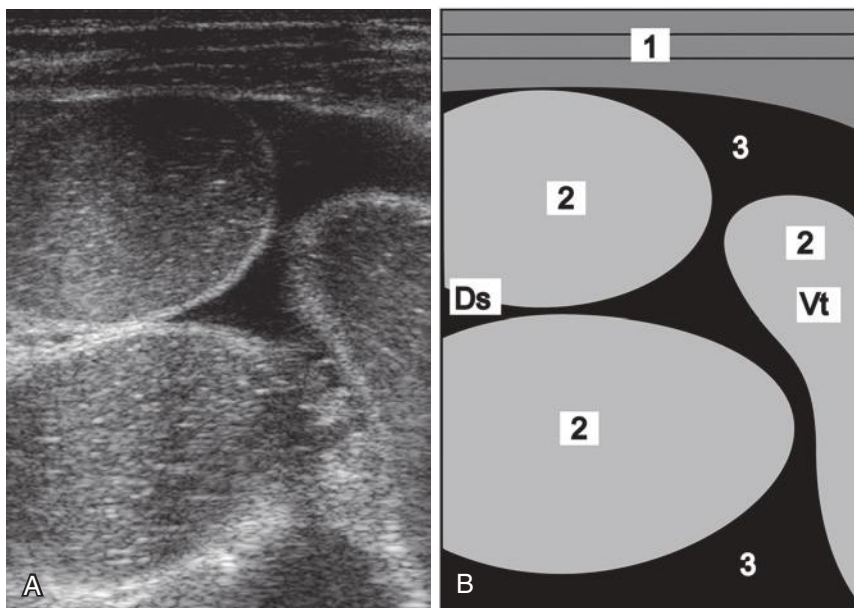

**Fig. 8-27** A and B, Ultrasonogram and schematic of the abdomen in a cow with ileus caused by obstruction of the jejunum with coagulated blood (hemorrhagic bowel syndrome). The jejunal loops are dilated and there is anechoic fluid (transudate) between the dilated loops. The ultrasonogram was obtained from the right abdominal wall caudal to the last rib using a 5.0-MHz linear scanner. 1, Lateral abdominal wall; 2, dilated jejunal loops; 3, anechoic fluid between the jejunal loops; Ds, dorsal; Vt, ventral. (Reproduced with kind permission of U. Braun.)



of rapidly fermentable carbohydrates, and avoid sudden ration changes.

- Test forage for presence of *C. perfringens* and *A. fumigatus*.

Consider administering autogenous vaccines containing *C. perfringens* type A from an affected case on the farm; commercially available vaccines targeting *C. perfringens* types C and D are very unlikely to be efficacious based on current knowledge. There is no published randomized clinical trial demonstrating vaccine efficacy, and the role of *C. perfringens* type A as a primary agent is questioned.

### FURTHER READING

Elhanafy MM, French DD, Braun U. Understanding jejunal hemorrhage syndrome. *J Am Vet Med Assoc.* 2013;243:352.

### REFERENCES

1. Anderson BC. *Vet Rec.* 1991;128:619.
2. Ruggles AJ, et al. *Cornell Vet.* 1992;82:181.
3. Constable PD, et al. *J Am Vet Med Assoc.* 1990;196:329.
4. Ceci L, et al. *J Vet Med A Physiol Pathol Clin Med.* 2006;53:518.
5. Schlegel BJ, et al. *Can J Vet Res.* 2012;76:248.
6. Baines D, et al. *BMV Vet Res.* 2011;7:24.
7. Peek SF, et al. *J Am Vet Med Assoc.* 2009;234:1308.
8. Adaska JM, et al. *J Vet Diagn Invest.* 2014;26:96.
9. Owaki S, et al. *J Vet Med Sci.* 2015;77:879.
10. Braun U, et al. *Schweiz Arch Tierheilkd.* 2010;152:515.
11. Braun U, et al. *Vet Rec.* 2010;166:79.
12. Abutarbush SM, Radostits OM. *Can Vet J.* 2005;46:711.

## PARATUBERCULOSIS (JOHNE'S DISEASE): CATTLE

### SYNOPSIS

**Etiology** *Mycobacterium avium subspecies paratuberculosis* (MAP).

**Epidemiology** Occurs in cattle, sheep, goats, and camelids. High prevalence of infection in cattle population and among herds. Ten percent to 15% of infected animals develop clinical disease. Primarily transmitted by fecal–oral route. Intrauterine infection occurs. Highest susceptibility to infection in the first months of life. Long incubation period.

**Clinical signs** Chronic or recurrent progressive intractable diarrhea with concomitant weight loss and decreased milk production in adult cattle while appetite often remains unaffected. Subcutaneous edema may develop between mandibles. Disease progresses over several weeks and months leading to progressing emaciation and eventual death.

**Clinical pathology** Culture or polymerase chain reaction on fecal material, and serologic tests (ELISA, AGID, CF). Low serum protein.

**Lesions** Chronic granulomatous enteritis, regional lymphangitis, and lymphadenitis.

**Diagnostic confirmation** Presence of intestinal lesion and identification of organism. Positive serologic test.

**Treatment** No specific treatment of significant value.

**Control** Identify and eliminate clinically and subclinically infected animals from the herd. Prevent introduction of infected animals into the herd. Prevent exposure of calves and young stock to MAP through contact with fecal material of infected animals. Improve management and hygiene to minimize spread of infection in herd with emphasis on avoiding infection of newborn calves.

### Differential diagnosis list

#### Diarrhea in adult cattle

- Intestinal parasitism (ostertagiasis)
- Salmonellosis
- Secondary copper deficiency

#### Emaciation in adult cattle

- Chronic traumatic reticuloperitonitis
- Malnutrition
- Pyelonephritis
- Lymphosarcoma
- Amyloidosis

AGID, agar gel immunodiffusion; CF, complement fixation; ELISA, enzyme-linked immunosorbent assay; MAP, *Mycobacterium avium subspecies paratuberculosis*.

### ETIOLOGY

The causative agent of paratuberculosis in ruminants is *Mycobacterium avium subspecies paratuberculosis* (MAP), a slow growing acid-fast aerobic microorganism forming part of the *M. avium complex*. Although MAP is an obligate intracellular pathogen requiring a host for replication, its tenacity allows it to survive for longer than 1 year in the environment. MAP has been subdivided into two main lineages designated as the slow growing type I (or S for sheep) and the faster growing type II (or C for cattle) according to the species from which these lineages were first isolated. Type I strains indeed appear to have a strong host preference for sheep and are more virulent for this species, whereas type II strains are more commonly isolated from cattle and a broad range of other species. Notwithstanding this association of each lineage with either cattle or sheep, it is not exclusive as strains of each lineage can cause disease in all type of ruminants.<sup>1</sup> Whereas S strains are predominantly isolated from sheep in Australia and New Zealand, in Europe C strains are more commonly isolated from sheep, cattle, and other species.

Molecular epidemiology studies of MAP have identified a high degree of genetic similarity within the bovine isolates, regardless of geographic origin, indicating that only a few closely related clones of MAP may be responsible for widespread infection in cattle, other

ruminants, and possibly wildlife. In contrast a higher degree of genetic heterogeneity among MAP isolates recovered from human and ovine sources has been reported. Extensive analyses of the IS900 restriction fragment length polymorphism (RFLP) patterns have identified that Johne's disease in cattle and other species such as goats and rabbits is associated with indistinguishable strains. Bovine strains infect cattle, goats, and deer, and rarely sheep.

### EPIDEMIOLOGY

#### Occurrence

The disease occurs worldwide most commonly in cattle and to a lesser extent in sheep and goats. Paratuberculosis is widespread in cattle in Europe and has been spread to many countries by the export of infected clinically normal purebred stock. The incidence is greatest in animals kept intensively under climatic and husbandry conditions as is common in dairy herds. Only a few countries in the world have no record of diagnosed paratuberculosis in ruminants, making this condition a globally endemic disease in livestock. During the last century MAP spread globally from Western Europe. Increasing incidences in eastern European countries over the past decades were attributed to intensifying life animal trade after the fall of the "Iron Curtain" and eastward extension of the EU.

Paratuberculosis was first confirmed in Australia in 1980 and is now considered endemic in Victoria and in the dairy population of New South Wales. Western Australia in contrast is considered free of paratuberculosis. Similarly, paratuberculosis is now endemic in dairy cattle in New Zealand. Data over the prevalence of this condition in Africa are scant, but paratuberculosis was diagnosed at least incidentally in most African countries.<sup>2</sup> Clinical and subclinical cases have also been reported from Mexico, Brazil, and Argentina.

#### Morbidity and Case Fatality

With only 10% to 15% of infected animals expected to develop clinical disease, the incidence of clinical disease in an infected herd rarely exceeds 5% of mature animals. The population mortality rate is less than 1% per year but under exceptional circumstances can reach 5% to 10%. For every clinical case of Johne's disease in a herd, it is estimated that there are 15 to 25 additional infected animals in various stages of clinical disease; 4 to 8 cases of subclinical disease and carrier adults; and 10 to 14 with silent infection in calves, young cattle, and adults.

#### Wildlife and Exotic Species

MAP has a very broad host range. Infection may also occur in many different wildlife and exotic species. Water buffalo and captive and free-living wild ruminants including deer, bighorn sheep, Rocky Mountain goats,



oudads, mouflon sheep, camels, mountains goats, reindeer, antelopes, New World camels, and yaks are all susceptible. Outbreaks of the disease have occurred in farmed red deer and the incidence is increasing in some regions.

There is evidence that wildlife in Scotland are naturally infected with MAP and that the host range is much wider than previously thought. The organism has been found in fecal cultures from foxes, stoats, crows, weasels, jackdaws, hares, badgers, rooks, rats, and wood mice. Such environmental contamination with the organism can pose a risk to grazing livestock and farms adjoining paratuberculosis-infected properties. Paratuberculosis has been found in wild rabbits (*Oryctolagus cuniculus*) in Scotland. Analysis indicates a significant relationship between a past or current problem of paratuberculosis in cattle and in the wild rabbit population on infected farms. On infected farms, rabbits potentially input millions of viable MAP organisms per hectare per day onto pasture grazed by livestock through fecal contamination. Also, grazing cattle do not avoid rabbit fecal contaminated pasture, which is the only recorded example of a herbivore species not avoiding their own feces or the feces from sympatric wildlife species. The greatest overlap between habitat use by rabbits and livestock grazing occurred in rough grazing and gorse scrub habitats, particularly in autumn. Therefore a reduction in potential transmission risk could be achieved by reducing contact between livestock and rabbits in these habitats, especially reducing access to these habitats by young livestock because they are more susceptible to infection.

In the Czech Republic, paratuberculosis has been diagnosed in all four of the most common wild ruminant species including red deer, roe deer, fallow deer, and mouflon. The highest incidence of clinical disease in wild ruminants was in farmed deer. Using RFLP, transmission from domestic infected ruminants to wild animals could be confirmed, whereas the transmission from wild animals to domestic ruminants was uncertain. Nonvertebrates, wild ruminants, or nonruminant wildlife can be vectors and potentially become a risk factor in the spread of MAP.

The epidemiologic implications of cattle and wildlife comingling on the same pasture are unknown. The rate of infection can be the same in both species and it seems that both share a common source, which might well be a common herd of deer and cattle. Pigs mixed with infected cattle may develop enlargement of the mesenteric lymph nodes suggestive of tuberculosis and from which the causative organism can be isolated. Pigs and horses infected experimentally develop granulomatous enteritis and lymphadenitis. Mice and hamsters are also susceptible and are used in experimental work.

### Prevalence of Infection

The prevalence of infection in a region is difficult to estimate because of the difficulty in diagnosing subclinical infection and the failure to report diagnosed cases unless a specific survey or control program is undertaken. Numerous studies reporting herd and animal prevalences in different regions have been published. Nonetheless, results are difficult to compare because different diagnostic approaches (e.g., fecal cultures, PCR or serology in blood or milk) with markedly different sensitivities have been used and several studies suffer from an important sample selection bias.<sup>3</sup>

In a recent meta-analysis the estimated animal prevalence of paratuberculosis in the European cattle population was estimated to be over 20% with lowest reported animal prevalences of at least 3% to 5% in some countries. The herd prevalence of paratuberculosis in European cattle herds was estimated to be above 50%.<sup>3</sup> The UK reported a herd prevalence for paratuberculosis of almost 35%. In dairy herds in the United States, the overall animal seroprevalence ranged from 5% to 17%.<sup>4</sup> The most recent survey conducted in the top 17 U.S. dairy states using environmental fecal cultures reported a herd prevalence of approximately 68% in U.S. dairy herds.<sup>5</sup> In this study over 95% of dairy operations with over 500 cows were found to be infected, whereas only 63% of smaller dairy operations with fewer than 100 cows were infected with MAP.<sup>5</sup> In dairy herds in Alberta, Canada, the herd prevalence determined by ELISA was 26.8%. The herd prevalence as determined by fecal culture ranged from 27% to 57%. In Australia the herd prevalence in dairy herds of the infected southeast part of the country is about 15%, whereas the western part of Australia is considered free of MAP.

Although much fewer reports of the prevalence of MAP infection in beef cattle are available reported herd-level and animal-level prevalences are consistently lower than in dairy cattle. In the United States the prevalence of MAP infection in beef herds of 23 states was determined based on serology and revealed a herd prevalence of 7.9% and an animal prevalence of 0.4% in the studied population.<sup>6</sup> Smaller scale studies conducted in Louisiana, Florida, and Missouri estimated the animal seroprevalence in beef cattle between 4% and 8% and herd prevalence in beef herds between 30 and 40%. Serologic surveys conducted in Canada revealed between 0.8% and 1.7% of seropositive animals in 3% to 11% of beef herds in Western Canada.<sup>7</sup>

### Methods of Transmission

The main route of transmission of paratuberculosis is widely accepted to be through oral uptake of MAP by susceptible animals via ingestion of contaminated milk, water, and other feed products or uptake from the environment. With newborn calves being the

most susceptible age group for MAP infection, contaminated colostrum and milk are considered a primary source of infection. MAP is introduced into milk and colostrum either via contaminated teats or direct shedding of the organism into the colostrum/milk. Infected cows and other species excrete MAP directly into the milk during at least the late disseminated stage of the infection. Up to 45% of clinically affected cows may excrete the organism in milk, which was isolated from 36% of colostrum samples from heavy shedders and 9% of samples from light shedders (nearly three times as often as it is found in milk).

MAP was isolated from dust and bioaerosols collected in barns housing MAP-infected cows, suggesting that inhalation or ingestion of these bioaerosols has the potential to function as an alternative route of infection.<sup>8</sup>

Vertical transmission of infection in utero is well established in cattle, and intrauterine MAP infection was identified as significant risk in dairy herds.<sup>9</sup> Data suggest that up to 9% of fetuses from subclinically infected and 39% of fetuses from clinically infected dams contract infection with MAP.<sup>9</sup> Transmission of the organism from moderate shedders via the trophoblast is unlikely before the stage of development of cotyledons. Transfer of embryos from infected to uninfected dams is thus unlikely to present a risk of disease transmission. It is hypothesized that the epitheliochorial placenta is impermeable to the organism from 42 to 49 days postinsemination but that this could change after 60 days. Isolation of MAP from the semen of bulls and rams is unusual and represented by single case reports.

Because of the normally long incubation period, infected animals may excrete organisms in the feces for 15 to 18 months before clinical signs appear. Also, animals reared in a contaminated environment may excrete MAP in feces without being infected, becoming so-called "pass-through shedders."<sup>10</sup> Spread of the organism from farm to farm is usually caused by trading of livestock, which are unknown infected carriers and shedders of the organism, but lateral spread of feces across boundary fences also occurs.

Field studies have shown that the nymphs of the Oriental cockroach (*Blatta orientalis*) may serve as a passive vector of MAP. Also, earthworms and adult Diptera may be vectors of the organism on cattle farms with paratuberculosis. Ovine trichostrongylid larvae (*Haemonchus contortus*, *Ostertagia circumcincta*, and *Trichostrongylus colubriformis*) may become contaminated with MAP and may play a role in the transmission of the organism.

The survival of MAP in amitraz-based dip fluid for at least 2 weeks suggests that dips could play some role in the transmission of Johne's disease in cattle. The main risk is to calves suckled by cows that have just been dipped and whose udders are covered in dip fluid.

## Risk Factors

### Animal Risk Factors

#### Age of Animal

A distinguishing characteristic of paratuberculosis is that resistance to infection increases with age. Experimental and field studies showed that infection becomes more difficult when calves are 4 months or older, and susceptibility to infection from 1 year of age on appears to be similar to that of adult animals.<sup>11</sup> Although the mechanism rendering young calves more susceptible to infection is not entirely understood, considerable importance is attributed to the permeability of the intestinal mucosa for large molecules in early life. Immaturity of the innate immune response in neonatal calves may contribute to higher susceptibility to MAP infection in calves. Increased resistance of adult cattle to MAP infection is thought to result primarily from effective containment or even elimination of infection rather than from impaired penetration of the intestinal mucosa.<sup>11</sup> The age-related resistance to MAP may be overwhelmed when very high doses of MAP are ingested in a heavily contaminated environment.

Because of a long incubation period of over 2 years, in most cases clinical disease does not occur until 2 to 5 years of age. Notwithstanding this age limit should not be used as a reliable diagnostic criterion; in extreme circumstances the magnitude of the ingested MAP dose will affect the course of the disease. Clinical disease incidentally was reported to occur at 12 to 18 months of age.

#### Breed Incidence and Genetic Susceptibility

Breed differences have been suggested based on the different prevalences of MAP infection between beef and dairy cattle or differences in prevalence in different geographic regions in which different cattle breeds predominate. However, these differences cannot lead to reliable conclusions concerning breed effects given the confounding effects of animal husbandry. Studies conducted in Texas reported that *Bos indicus* purebred and crosses had odds ratios 17- and 3.5-fold greater than *Bos taurus* breeds for positive serologic results. Although these results could also suggest differences in response to MAP infection (i.e., seroconversion) rather than susceptibility to MAP infection they provide evidence for a breed or subspecies effect.<sup>12</sup> Evidence for a certain degree of genetic variation in host susceptibility to MAP infection has accumulated in recent years.<sup>13,14</sup> Heritability of host susceptibility to MAP infection has been studied at sire level using the phenotype of daughters as a key parameter. Heritability estimates in dairy cattle range between 1% and 18% with the majority of estimates between 9% and 12%.<sup>10</sup> Although these heritability estimates are modest, these data suggest that genetic selection of bulls with the objective of breeding

more resistant animals may be a potentially useful tool contributing to the control of paratuberculosis in the future. Whole Genome Association Studies identified SNPs in multiple genes like TLR-2 or NOD-2, indicating that susceptibility or resistance to MAP is likely caused by multiple genes.<sup>14</sup>

#### Other Diseases and Stressors

Factors that affect susceptibility to infection include size of infective dose, level of dietary iron intake, age, stress, and immunosuppressive agents such as BVD virus. These factors may affect the probability of development of clinical disease, but they have not been well documented. Field observations indicate that stress, including parturition, transportation, and nutritional deficiencies or excesses may influence the development of clinical disease. Housed animals are subjected to a high risk of infection because of the heavy contamination by feces and the long survival of the bacteria in protected sites.

The possible cross-protection between tuberculosis and paratuberculosis suggests that eradication of tuberculosis may make the cattle population generally more susceptible to paratuberculosis, but this has not been borne out by field experience in North America.

#### Herd Characteristics

A computer simulation model of paratuberculosis in dairy cattle has been used to examine the course of the disease in a herd. Seven variables were specified at the initial stage of the model:

- Herd size
- Annual herd birth rate
- Annual herd replacement rate
- Number of infected cows at time zero
- Number of herd replacements purchased each year
- Risk of purchasing an infected heifer
- Number of effective cow-calf contacts per year

All variables affect the course of paratuberculosis spread in herds, but the model is most sensitive to the effective contact rate. This is consistent with the findings of other infectious disease models and with recommendations on Johne's disease control, namely **minimize cow-calf contact** to prevent transmission of infection.

The prevalence of infection in purchased cattle directly affects the risk of buying infected cattle and the rate at which herds become infected in the model. Purchase of a large percentage of replacement heifers from populations with modest infection rates annually will quickly result in infection of a herd. Age-specific culling rates are also important in the development of the model. Accurate prediction of the rate at which infected cattle leave a herd was a major determinant of the course of the epidemic because each year an infectious cow remained in the herd, the cow contributed in an exponential

manner to the generation of infected calves and thus the number of infected herd replacements. Over the range of realistic values for all variables in the model, the prevalence of the disease in infected herds continued to increase until a plateau was reached. True prevalence rates in the model generally plateaued at 40% to 60% of the herd. These data results suggest infection is spreading quickly in dairy cattle.

### Environmental and Management Risk Factors

Management factors that were identified as important in influencing the prevalence of infection include the following:

- Newborn calf care
- Bred heifer management
- Environmental conditions
- Handling of manure
- Care and management of growing calves

These are not cause-and-effect relationships but hypotheses based on observations in dairy herds.

#### Care of the Newborn Calf

The fecal-oral route is widely accepted as the major route of transmission for MAP. Because of the increased permeability of the intestines in the first hours after birth, the first hours and days of life are deemed to bear the highest risk of infection for a calf. Exposure of the newborn calf to MAP generally occurs by feeding colostrum contaminated with feces, by directly nursing from teats contaminated with feces, by ingesting colostrum from MAP-infected dams that are at increased risk of shedding MAP through the mammary gland, or through direct contact with feces from infected dams. Accordingly control strategies to prevent infection of neonatal calves must focus on providing excellent sanitary conditions in the maternity area, avoiding contamination of colostrum with manure by thoroughly cleaning teats before milking or the calf nursing the dam, separating calves as soon as possible from adult animals to minimize contact with manure, avoiding the presence of infected dams in the maternity area, and avoiding the use of colostrum from MAP-infected dams. Additional measures recommended to reduce to risk of transmission of MAP to neonatal calves include avoiding the use of pooled colostrum, the use of heat-treated colostrum, and feeding milk replacer or pasteurized milk.<sup>10</sup>

#### Calf Rearing

Although risk of infection is highest in the first days of life experimental studies showed that increased susceptibility to infection persists at least for the first 4 months of life.<sup>11</sup> Feeding whole milk or feed contaminated with MAP or allowing contact of calves with manure from MAP-infected cows present the highest risks of infection. Transmission of MAP may also occur horizontally from an infected calf to its herdmates. Although

model studies suggest that calf-to-calf transmission does not constitute a major route of MAP transmission, experimental studies showed that calves and young stock are capable of excreting detectable quantities of MAP in feces.<sup>15,16</sup> More recently the presence of MAP in dust and bioaerosols in barns housing MAP-infected cows was documented. Although the transmission of MAP infection through bioaerosols needs further investigation, it was suggested that growing calves housed in the same barn with infected cows are more likely to be exposed to MAP than calves housed separately from adult-infected cows.<sup>8</sup> Recommendations for calf rearing to reduce the risk of MAP infection include raising young stock well separated from adult cattle; feeding unweaned calves milk replacer or pasteurized milk; preventing contamination of feed, water, and pens of young stock with manure from adult cows; and avoiding to feed leftovers from adult cows to young stock.<sup>10</sup>

A survey of farms in Scotland found the factors that increased the likelihood of a farm having Johne's disease included large numbers of rabbits, access of wildlife to feed supplies, the application of manure to grazing pasture, the type of water supplies, and the number of cows.

#### *Soil Characteristics and Manure Handling*

An association between high prevalence of MAP infection in ruminants and soil type has been recognized. The evidence strongly implicates regional soil acidification, excesses of iron and molybdenum, and marginal deficiencies in copper and selenium in the progressive expression of Johne's disease. Survival of the organism may be enhanced by silt or sand content in loamy soils.

The organism can persist without multiplication in pasture for up to 1 year. MAP is relatively susceptible to sunlight and drying, to high calcium content, and high pH of the soil. Continuous contact with urine and feces reduces the longevity of the bacteria. The alkalinity of the soil may also influence the severity of the clinical signs. Herds raised on alkaline soils, particularly in limestone areas, may have a high incidence of infection but little clinical disease.

Environmental conditions and manure handling are correlated with prevalence and are reflected in overall cleanliness of the farm and the amount of contamination resulting from faulty design, maintenance, location of housing facilities, and frequency of cleaning by the farm operator.

The distribution of MAP in the environment surrounding dairy farms and its relationship to fecal pool prevalence in herds known to be infected and uninfected was described and compared. Environmental samples were culture positive in 78% of infected herds. Environmental samples were cultured positive in cow alleyways (77% of

herds), manure storage (68%), calving areas (21%), sick cow pen (18%), water runoff (6%), and postweaned calves areas (3%). Herds with both areas cultured negative were estimated to have 0.3% to 4% fecal pool prevalence. Herds with both areas having a heavy load of bacteria were estimated to have 53% to 73% fecal pool prevalence. These findings support the concept that targeted sampling of cow alleyways and manure storage areas may be a suitable alternative strategy for herd screening and MAP infection status assessment and for estimating herd fecal prevalence.

#### **Pathogen Risk Factors**

MAP is an obligate pathogen and parasite of animals and in theory can be eradicated by removal of all infected animals. However, the organism can survive for long periods in the environment, enabling it to persist and spread in the grassland environment and to withstand a periodic lack of suitable hosts.

#### *Survival and Dormancy of Organism in the Environment*

Bovine strains of MAP can be extremely persistent in nature, with survival for more than 1 year. Studies of the survival of the organism on Australian farms on which paratuberculosis is prevalent indicate that when the organism in feces becomes mixed with soil, there is a reduction of 90% to 99% in the apparent viable count of the organism. This is thought to be caused by binding of bacteria to soil particles, which are excluded from culture by sedimentation during sample preparation. Survival of the organism in fecal material applied to soil was greatest in a fully shaded environment and was least where fecal material and soil were fully exposed to the weather and where vegetation was also removed. Significant degrees of pasture decontamination can be achieved in a relatively short period, which will be beneficial for disease reduction in a herd because of the beneficial effects lower doses of the organism would have on the incubation period and disease outcome. Pasture management, such as selective grazing with no susceptible hosts or mechanical slashing, may be used to maintain a relatively low level of shade at the soil surface to hasten decontamination.

#### *Thermal Resistance of Organism*

MAP was found to be more heat resistant than other mycobacteria. Studies investigating the effectiveness of different pasteurization protocols detected viable MAP after standard thermal treatments such as low-temperature holding at 63°C for 30 minutes or high temperature-short time (HTST) at 72°C for 15 seconds. MAP strains were reported to be able to survive HTST pasteurization with survival rates ranging from 3% to 5% in bovine tissue.<sup>17</sup> Extending holding time from 15 to 25 seconds as implemented in the UK in 1998 for

commercial milk pasteurization in an effort to increase the effectiveness of the pasteurization process was found to be no more effective at killing MAP than conventional HTST pasteurization. These findings are corroborated by several independent retail-milk surveys reporting recovery of viable MAP from retail HTST pasteurized milk.<sup>18,19</sup> It is a general consensus that the presence of MAP in concentrations greater than 10<sup>4</sup> CFU/mL in milk may not be completely destroyed by HTST pasteurization. Pasteurization of colostrum with a temperature of 63°C for 60 minutes was recommended as suitable procedure under field conditions even when using large batches (30 L) to eliminate MAP from colostrum in most cases.<sup>20</sup> Pasteurization of colostrum resulted in a decrease in colostral IgG concentrations but not to a level that would preclude its use for transfer of passive immunity.

#### **Economic Importance**

The economic impact of MAP infection for the dairy industry is substantial and occurs across all herd sizes and regions. At the end of last century estimated costs ranged between US\$40 and 227 per cow per year. Economic losses result from decreased milk production, decreased lifetime production caused by premature culling, decreased fertility, decreased slaughter value of the carcass, potentially delayed genetic improvement caused by involuntary culling of genetically valuable animals, replacement costs, and costs associated with MAP control programs. Some studies reported higher risk for mastitis, increased somatic cell counts, and decreased milk fat and milk protein production in MAP-infected dairy cows.

Infection of MAP was found to be associated with decreased milk production in dairy cows in several studies. Depending on the degree of shedding milk production of infected cows was found to be decreased between 2.1 and 6.0 kg/day.<sup>21</sup> The magnitude and direction of the association between subclinical MAP infection and milk production depends on the parity of the animal, stage of disease, and stage in lactation. In herds with an average parity of 2 or less, subclinical infection may have little impact on milk production. In herds maintaining an average herd parity of 2, many subclinical infected animals would be culled before experiencing any decline in milk production in which case the direct economic losses attributable to reduced milk production would be negligible.

Progressively decreasing feed efficiency in clinical and subclinical paratuberculosis results in loss of body condition despite unaffected feed intake. Decreased slaughter weight at culling has been documented for clinically and subclinically infected cows. Reduction of slaughter value was estimated to range between 5% in subclinical cases and 30% of clinical cases of paratuberculosis.



Associations between MAP infection in dairy cows and incidence of mastitis, somatic cell count, and milk constituents were studied with conflicting results. Although several studies documented a higher proportion of cows culled for mastitis in a group of animals with subclinical MAP infection compared with uninfected control cows, other studies failed to find an association between MAP infection status and mastitis or even reported lower rates of mastitis in MAP-infected cows. Studies reporting an association between subclinical MAP infection and increased somatic cell counts stand against reports failing to reveal a significant difference in somatic cell counts between infected and uninfected dairy cows or even documenting lower somatic cell counts in MAP-infected cows compared with uninfected control cows.<sup>22-24</sup> The effect of MAP infection on milk constituents such as protein and fat has been studied with similarly inconsistent results. Some authors reported that milk-fat and milk-protein production or the mature equivalent for milk fat and milk protein in subclinically MAP-infected cows were significantly lower than in uninfected herd-mates, whereas other studies did not reproduce significant differences between infected and uninfected cows.<sup>25</sup>

Because the incidence of infertility was reported to be significantly higher in the cohort of MAP-infected cows than in uninfected control cows, reduced fertility is likely to contribute to the economic losses associated with MAP infection on a herd level.

A large fraction of economic losses associated with paratuberculosis are considered to result from loss of future income. Under normal conditions productivity and thus average income of a dairy cow increases with age. Culling seropositive or culture-positive animals before they reach their peak productivity therefore contributes to undetermined economic losses resulting from the lost production potential and potential breeding value.

#### Losses at National Dairy Industry Level

In 1996, averaged across all dairy herds in the United States, Johne's disease cost the dairy cattle industry, in reduced productivity, \$22 to 27 per cow or \$200 to 250 million annually. The economic impact of the disease in Australia and New Zealand and regions of the United States have been estimated, but their validity is questionable because of the accuracy of the diagnostic tests and the survey methodology. Some observers have indicated that paratuberculosis has emerged as one of the most prevalent and costly diseases of dairy cattle, but this is not well-documented. There is insufficient information available on the economic importance of paratuberculosis in the beef cattle industry.

#### Zoonotic Implications

Potentially, MAP is of great public health significance because it is speculated to be involved in **Crohn's disease** in humans. Crohn's disease is an inflammatory bowel disease of unknown etiology that can affect any portion of the gastrointestinal tract although the terminal ileum and colon are most commonly affected. It is characterized clinically by chronic weight loss, abdominal pain, diarrhea or constipation, vomiting, and generalized malaise. Surgical resection of the affected intestine is often necessary because of complications. Crohn's disease and paratuberculosis share many similarities in gross pathology, histopathology, clinical presentation, and epidemiology. Furthermore MAP has been recovered from tissue and blood samples of patients suffering from Crohn's disease, which led to concerns over the potential role of MAP in the development of Crohn's disease in humans.

A number of studies attempting to determine the prevalence of MAP in patients diagnosed with Crohn's disease have been conducted. A study using nested PCR and culture to detect the presence of MAP detected this pathogen in 26% of patients with noninflammatory bowel disease and 92% of those affected by Crohn's disease. More recently a study attempting to directly visualize mycobacteria in tissue of Crohn's disease patients found these microorganisms in just over 50% of samples of patients with Crohn's disease but rarely in control samples.<sup>26</sup> The organism has been cultured from the peripheral blood of a higher percentage of individuals with Crohn's disease than in controls, which does not prove that MAP is a cause of the disease, but suggests that a larger scale investigation is needed to ascertain the role of the organism in the illness.

Thus far there has been no definitive evidence for or against the theory assigning a causative role to MAP in the etiology of Crohn's disease in humans. There is no epidemiologic evidence at present to indicate that the incidence of Crohn's disease is associated with possible exposure to organisms such as might be expected in farmers, animal health care workers, or other individuals with direct contact with infected animals.

Although the role of MAP in the etiology of Crohn's disease is still under debate, it is rational to consider that in case MAP would be the causative agent or a contributing factor in the etiology of Crohn's disease this microorganism might be acquired through ingestion of foodstuffs. Also, the epidemiology of the disease, which includes rising incidence rates in Western societies concurrent with low rates in developing countries over the second half of the twentieth century and high rates among immigrants to Western societies, is consistent

with the possibility that a critical infection may be acquired from cattle or other farm animals via milk or meat ingestion, staples of Western diets, and cause Crohn's disease in subjects with an appropriate genetic predisposition.

In Manitoba, Canada, the reported incidence of Crohn's disease at 15 patients per 100,000 people per year is among the highest in the world. Population-based case-control studies of the seroprevalence of MAP in patients with Crohn's disease and ulcerative colitis have concluded that a high seroprevalence in Manitoba raises the possibility that the high rates of Crohn's disease in Manitoba could be related to high exposure rates for MAP. However, MAP is not serologically specifically associated with Crohn's disease in a community with a relatively high prevalence of Crohn's disease.

If MAP does have a role in Crohn's disease, then milk and possibly meat from infected animals may be a potential vehicle of transmission of the organism from animal to man. MAP has been cultured from milk from cows with subclinical and clinical paratuberculosis. Laboratory studies investigating the thermal tolerance of MAP showed that standard pasteurization procedures such as HTST either for 15 or 25 seconds destroy large numbers of MAP in milk, although they may not kill 100% of MAP cells. Accordingly, several independent surveys conducted on HTST pasteurized retail milk reported that viable MAP was occasionally present in retail milk.<sup>18</sup>

The organism can also survive in cheese made from raw milk. MAP is resilient and is able to withstand the acidic conditions in cheese. During the laboratory manufacture of soft cheese using raw milk spiked with MAP, the majority of MAP cells are concentrated into the cheese curd rather than lost with the whey. When the resulting soft cheese was stored at 4°C, MAP could still be cultured after 35 days.

Meat for human food consumption was found to be a potential source of MAP, most commonly originating from surface contamination of the carcass with fecal material during processing in the abattoir. Few studies investigated the prevalence of MAP contamination in U.S. packing plants suggesting that few MAP are present on the carcass even following decontamination.<sup>27</sup> In addition to the possibility of being present on the surface, MAP was also isolated from within muscle tissue and different organs such as liver, heart, spleen, and lymph nodes of infected animals used for human food. Ground beef represents the highest risk for containing MAP because it is in a large part produced from cull dairy cows, the subgroup of cattle having the highest animal prevalence for MAP infection. Ground beef not only consists of blended meat from different animals,

increasing the risk of containing MAP, but it also contains lymph nodes in which MAP concentrate.<sup>28</sup>

Because MAP is currently not recognized as a human pathogen by regulatory authorities in most countries, there are generally no restrictions on the slaughter of cattle identified as MAP infected and culling subclinical and even clinical cases of paratuberculosis is common practice.

Although the amount of MAP is likely to be greatly decreased by cooking meat to a well-done condition, consumption of undercooked meat could potentially harbor viable MAP.<sup>28</sup>

## PATHOGENESIS

Following oral ingestion, the organism localizes in the mucosa of the small intestine, its associated lymph nodes, and, to a lesser extent, in the tonsils and suprathypharyngeal lymph nodes. Although MAP can invade the organism through the tonsils and then spread either hematogenously or via lymph nodes, the primary portal of entry is the terminal part of the small intestine and the large intestine.

### Susceptibility to Infection

It is widely assumed that calves contract MAP infection in their first month of life and are the most susceptible to infection in the first hours and days of life. The mechanism behind the age-dependent resistance to MAP infection is not entirely understood, but several hypotheses have been proposed. The “open gut” theory suggests that increased permeability of the neonate’s intestinal mucosa facilitating immunoglobulin uptake from the intestinal lumen facilitates the penetration of MAP through the mucosal membrane. Other hypotheses suggest that immaturity of the innate and adaptive immune response in the newborn calf contributes to the higher susceptibility to MAP infection in early life.<sup>11</sup>

Susceptibility to MAP infection is likely not only driven by the age of the host but also by the degree of contamination with MAP of the environment. Higher doses of MAP may not only increase the risk of infection in early life but may also overwhelm age-dependent resistance, extending the period of susceptibility of infection.

The presence of MAP within the intestinal submucosa and mesenteric lymph nodes triggers an inflammatory response as well as the attraction of more macrophages and lymphocytes to the area. The result is a granuloma formation with multinucleated giant and immune cells infiltrating the intestinal submucosa, which results in decreased absorption, chronic diarrhea, and ensuing malabsorption. There is a reduction in protein absorption and leakage of protein into the lumen of the jejunum, termed protein losing enteropathy. The loss of

protein results in muscle wasting, hypoproteinemia, and edema.

### Immune Response and Spectrum

The differentiation of at least three different groups of animals, depending on the host–bacteria relationship that becomes established, has been proposed in the literature. In the first group, animals develop resistance quickly, control the infection, and do not become shedders (**infected resistant**). In the second group, the infection is not completely controlled; some animals will partially control the infection and will shed the organism intermittently, others will become **intermediate** cases that are incubating the disease and will be heavy shedders of the organism. In the third group, the organism persists in the intestinal mucosa, and it is from these animals that the **clinical** cases eventually develop. The different possibilities are summarized in [Table 8.9](#).

The first line of defense against invading MAP in the ruminant intestine involves M cells (special epithelial cells associated with ileal Peyer’s patches and lymphoid follicles that actively take up particulate matter from the intestinal contents; they are the portal of entry for bacteria and viruses) and phagocytic macrophages. In early stages of infection the organism is found in phagocytic macrophages in the intestine. Once inside the phagosome of an infected macrophage, the organism interferes with the normal course of phagosome maturation into phagolysosome, escaping the process of destruction. The infection of inactivated macrophages within the intestine is the first step in establishing persistent infection and in the subsequent development of disease. The host immune system begins a series of attacks against MAP-infected macrophages, including the rapid development of activated T helper 1 cells (Th1), CD4+ T cells, and cytolytic CD8+ cells. Activated Th1 cells are characterized by their production of interferon- $\gamma$  (IFN- $\gamma$ ) and IgG2. Later in the course of infection a Th2 cell response becomes predominant over the Th1-mediated response. The Th2-type cell immune response is characterized by the production of cytokines such as interleukin (IL)-4 and IL-10 and is associated with an enhanced humoral

immune response, whereas cell-mediated immunity wanes. Progression of cattle from subclinical to clinical Johne’s disease is associated with a decreased ability of mononuclear cells to produce IFN- $\gamma$ , both specifically and nonspecifically, at the site of infection and in the blood. The loss of putatively protective Th1 cell response leads to a lack of control of mycobacterial replication and, subsequently, to fecal shedding and the progressive granulomatous enteritis typical of bovine paratuberculosis. In contrast to the Th1-mediated cellular immune response, antibodies against MAP do not protect the organism from clinical disease. During the final stages of disease, lack of antigen-specific cell-mediated immune response or complete anergy may result, allowing for rapid dissemination of the infection throughout the host.

The immunologic response following infection is highly variable. Generally, infected animals initially develop a cell-mediated response, followed by a humoral response initiated by the release of bacteria from dying macrophages as the disease progresses. It has been speculated that the time to occurrence of seroconversion and fecal shedding in infected animals depends on the infective doses occurring with natural infection.<sup>29</sup>

There appears to be an immune spectrum, and no serologic or cellular immunity test will identify all animals in the spectrum. There are infected-resistant animals that control their infection but are unable to completely eliminate the organism. These animals do not react in antibody assays, only rarely or never shed organisms, and respond to the lymphocyte transformation test because their circulating lymphocytes are sensitized. In the intermediate stage, the animal fails to control the infection, antibodies appear in the serum, and organisms are shed in the feces. In the stage of clinical disease, the organisms are shed in the feces and the antibody responses and skin tests are variable.

The bacteria are carried by macrophages to other sites, particularly the uterus, the fetus, and the mammary gland, as well as the testes and semen of bulls. The postprimary dissemination of the lesions is more widespread in adult animals than in calves, and

**Table 8-9** The relationship between the stages in the pathogenesis of Johne’s disease, the presence of clinical disease and the results of diagnostic test

	Resistant animals	Intermediate (incubation period)	Advanced clinical disease
Clinical signs present	–	+	+++
Fecal shedding	+ (–)	++	+++
Antibody response	–	++	+++
Skin test	+ (–)	+ (–)	+ (–)
Lymphocyte transformation	+++	+++	+ (–)

the early lesions are more severe in the former but the organisms do not persist. Disseminated lesions consisting of microgranulomas in lymph nodes and other organs have been described in mature cattle. In calves, the organism proliferates slowly, particularly in the small intestinal site, which results in a massive cellular infiltration of the intestinal submucosa. In adult cows, infection may penetrate to the fetus and cause prenatal infection.

Important features of the natural history of the disease are the long incubation period of 2 years or more and the development of sensitization to johnin and to mammalian and avian tuberculin. This sensitivity develops in the preclinical stage but has disappeared in most cases by the time clinical signs are evident. On the other hand, complement-fixing antibodies appear late in the disease and generally increase with increasing severity of the lesions. This suggests that two independent antibodies are involved in the two reactions.

## CLINICAL FINDINGS

### Stages of Disease

Four stages of paratuberculosis in cattle have been described.

#### Stage One

**Silent Infection.** Calves, heifers, and young cattle up to 2 years of age are affected. There are no clinical signs and no effects on BW gain or body condition, but these animals may shed the organism. Clinicopathologic tests cannot detect the infection, but culture of the feces or demonstration of the organism in tissues may be possible.

#### Stage Two

**Subclinical Disease.** Carrier adults show no specific clinical signs but may be affected by other abnormalities such as mastitis or infertility. Most of these animals will be negative on fecal culture but 15% to 25% may be positive on fecal culture. These are also negative to most serologic tests.

#### Stage Three

**Clinical Disease.** Clinical disease is the tip of the iceberg in terms of the total number of infected animals in the herd. The “iceberg concept” states that for every animal with clinical signs born in the herd, another 15 to 20 animals are infected and less than half of whom will be detected by fecal culture. Clinical signs in most cases do not appear before 2 years of age and are most common in the 2- to 6-year-old age group. Cases occur only sporadically because of the slow rate of spread of the disease. A hallmark of the clinical stage is gradual loss of BW despite a normal appetite. During a period of several weeks, concurrent with the weight loss, diarrhea develops. Milk production declines but the temperature, heart rate, and respirations are within normal limits. The fall in milk

yield is often apparent in the lactation before diarrhea commences. The feces are soft and thin, homogeneous, and without offensive odor. There is marked absence of blood, epithelial debris, and mucus. Diarrhea may be continuous or intermittent with a marked tendency to improve in late pregnancy only to reappear in a severe form soon after parturition. A temporary improvement may also occur when animals are taken off pasture and placed on dry feed.

#### Stage Four

**Advanced Clinical Disease.** As the disease worsens, emaciation is the most obvious abnormality and is usually accompanied by intermandibular edema, which has a tendency to disappear as diarrhea develops. The diarrhea is characterized by a fluid “water-hose” or “pipestream” passage of feces. The course of the disease varies from weeks to months but always terminates in severe dehydration, emaciation, and weakness with an ultimately fatal outcome.

## CLINICAL PATHOLOGY

In an infected herd, animals may be divided into four categories:

- Animals with clinical disease and shedding the organism
- Subclinical infection and shedding the organism (intermediate and incubating)
- Infected, but not ill or shedding enough bacteria to be culturally detectable (infected resistant)
- Uninfected cattle

For successful eradication and control of the disease a diagnostic test is required that is able to identify the intermediate group. The primary hindrance to making a diagnosis in the live animal is the paradoxical immune response during various stages of the disease. Subclinical infection is characterized by a strong cell-mediated immune response that can be detected by such assays as lymphocyte proliferation to a T-cell-independent mitogen and delayed-type hypersensitivity reactions or skin tests. A negligible humoral response during subclinical infection reduces the usefulness of serologic diagnostic tests. In contrast, clinical disease is characterized by a strong humoral immune response and a weak cell-mediated response. During clinical disease, high numbers of MAP are shed in the feces, and one of the definitive tests is culture of the organism from feces.

### Diagnosis of MAP Infection

To diagnose paratuberculosis in an individual animal several testing methods are available. Although in clinical cases the clinical presentation can be highly suggestive of paratuberculosis, confirmation of the diagnosis will require either directly identifying MAP in feces or tissue or identifying a humoral or cell-mediated immune response of the affected animal.

Direct identification of MAP in feces or tissue can be achieved by microscopy, culture, or the use of specific DNA probes in combination with PCR. Serologic tests for paratuberculosis in cattle identifying the presence of specific antibodies include the absorbed ELISA, complement fixation (CF), and agar gel immunodiffusion (AGID). The choice of the appropriate test must be based on the intended purpose of testing.

### Culture or Detection of Organism

**Bacteriologic Culture.** Examination of the feces is a valuable diagnostic aid for detecting infection in clinically diseased animals and to some extent in apparently healthy cattle in known infected herds. **Fecal culture** is presently recognized as the **most reliable index of infection in live cattle**. Conventional MAP culture is preceded by specimen decontamination and concentration of the organisms before inoculating a growth medium. Culture of MAP can either be done on solid or liquid growth medium requiring an incubation period of 4 to 8 weeks for liquid culture media and 8 to 16 weeks for solid culture media. A technique of radio-metric culture based on the release of radioactive CO<sub>2</sub> from bacterial metabolism that reduces the incubation period is available but requires the use of radioactive reagents.

Sensitivity of the fecal culture varies with the stage of infection. In clinical cases fecal culture sensitivities of 70% and higher were reported, whereas in clinically healthy but infected cows the sensitivity of fecal cultures was reported to range between 23% and 29%.<sup>29</sup> The specificity of fecal culture is estimated to be at least 98%. False-positive results may occur in a population in which the noninfected animals are subject to contamination from infected herdmates.<sup>29</sup> Cattle kept in a heavily MAP-contaminated environment are at increased risk of oral ingestion and consequent fecal excretion of MAP without being infected, yielding potentially false-positive results through the so-called “pass through” effect. It is therefore advised to cautiously interpret fecal samples yielding a low degree of MAP shedding in herds with a high prevalence of paratuberculosis.<sup>10</sup>

Counting the number of colony forming units on solid medium or measuring the time to detection on liquid medium in fecal cultures allows one to assess the degree of shedding and thus the risk of disease transmission presented by an individual.<sup>10</sup> Cultured isolates must be subjected to appropriate testing, such as PCR, to confirm that isolates are MAP.<sup>29</sup>

Fecal cultures can be performed either on feces collected from individual animals, from pooled fecal samples, or from environmental fecal samples.

**Pooled Fecal Samples and Culture.** The culture of pooled fecal samples from several animals in a herd has been evaluated as a



means of determining a herd's infection status. Pooling samples reduces the number of fecal cultures necessary to determine infection in low-prevalence herds, reducing the cost of a large-scale Johne's disease control or eradication program. Strategically pooled culture specimens (five animals of the same age per pool) compared with individual fecal specimens can yield a sensitivity and specificity of 86% and 96%, respectively.

**Environmental fecal samples** collected from cow alleyways and manure storage areas appear to be an alternative strategy for herd screening and MAP infection status assessment and for estimating herd prevalence.

**Microscopic examination of Ziehl-Neelsen stained smears of feces** for the presence of typical clumps of acid-fast bacteria has been an attractive alternative to fecal culture because the results are available within an hour. However, the sensitivity and specificity of the microscopic examination have always been in doubt. It may be difficult to distinguish MAP from other acid-fast organisms, which are frequent in feces. Also, it may be necessary to examine smears on several occasions to obtain a positive result. Clumps of acid-fast bacteria in epithelial cells are diagnostic and are more likely to be observed during a diarrheic phase, when epithelial cells are more likely to be shed, than in a period when feces are normal. Generally, the microscopic examination of fecal smears for the presence of acid-fast clumps is an unreliable method of detecting MAP in bovine feces. A pinch biopsy collected with the fingernails, or scrapings of rectal mucosa, are of no great advantage compared with fecal smears, because it is probably only in the late clinical stages that the rectal mucosa is invaded. If rectal scrapings or rectal pinch biopsy are used, a positive finding is clumps of acid-fast bacilli in epithelial cells or macrophages.

**DNA Probes and Polymerase Chain Reaction.** Using DNA probes and PCR to determine the presence of specific MAP DNA in a specimen greatly reduces turnaround time for the diagnosis of paratuberculosis compared with culture. The majority of commercial paratuberculosis PCR tests use the IS900 sequence. This DNA sequence has the advantage of being present with several copies in the MAP genome, increasing sensitivity. Because this sequence also forms part of the genome of a few other environmental mycobacteria, the diagnostic specificity of the IS900 DNA probe is impaired. The use of unique sequences in the MAP genome such as ISMap02, ISMav2, F57, or Hsp X result in higher specificity but are less sensitive because fewer copies of these sequences are present in the MAP genome compared with IS900. Molecular methods to detect MAP include single PCR, nested PCR, and real-time PCR and are preceded by concentration

and separation steps. Real-time PCR monitors amplification of the specific DNA sequence after each replication cycle. Therefore, in contrast to other methods, it provides a quantitative result for estimating the amount of MAP DNA present in the specimen and thus the degree of fecal shedding.<sup>10</sup> Positive PCR results prove the presence of MAP DNA in the specimen but do not confirm the presence of viable MAP.

**Culture of Milk and Blood.** The organism can be cultured in the milk of subclinically infected cows, and the prevalence of infection of milk is highest in samples from cows with heavy fecal shedding and lowest with light shedding. A nested PCR test has been used to detect MAP in the blood and milk of cattle with clinical and subclinical infection. Between 8% and 22% of subclinically infected and about 35% of clinically affected cows harbor MAP in their udders.

**Tests on Tissue Samples.** Diagnosis of paratuberculosis may be attempted by surgically collecting a full-thickness biopsy of the ileum (>1 g) in combination with a biopsy of an ileum-associated lymph node (>1 g). Obtained specimens should be used for culture and histologic examination. Because acid-fast organisms are not necessarily encountered in all tissue specimens of infected animals negative results based on a single biopsy should be interpreted cautiously.

#### Serologic Tests

The serologic tests commonly used to identify humoral immune responses to MAP infection in cattle are the CF test, the ELISA, and the AGID. Cellular immune responses are commonly identified by means of the IFN- $\gamma$  assay.

**Complement Fixation Test.** Historically the most widely used serologic test for the diagnosis of bovine paratuberculosis was the CF test. Although diagnostic sensitivities of approximately 90%, and specificities of approximately 70%, for the CF test have been reported in clinical cases, early cases and nonclinical carriers fail to give positive reactions. Moreover a number of nonspecific, transient, positive reactions caused by cross-reactions do occur, impairing the specificity of the CF test. Notwithstanding some countries require that cattle have a negative CF test before importation. Negative test results in apparently normal cattle should be interpreted with caution; positive test result can be regarded as a presumptive diagnosis of infection but should be confirmed by fecal culture.

**Agar Gel Immunodiffusion.** The sensitivity of the AGID test for the diagnosis of clinical paratuberculosis is 96% with a specificity of 94%. It is considered to be the most appropriate test available for the diagnosis of

clinical disease. The test has one-third the diagnostic sensitivity of fecal culture in the diagnosis of subclinical infection. The test is inexpensive and the results are available within 48 hours. Because positive reactions are given by tuberculous animals, the test is limited to use in tuberculosis-free herds.

A fluorescent antibody test is available but is unable to distinguish between the antigens of *M. avium* and *M. paratuberculosis*. It does distinguish between *M. paratuberculosis* and *C. renale*, which are easily confused by the CF test. Combined with the CF test the fluorescent antibody test is used to detect early, subclinical cases, but the results are far from accurate. A refinement of the conventional fluorescent antibody test, which gives greater accuracy in identifying specific mycobacterial antigens, is the observation of the uptake by macrophages of fluorescein-coated insoluble spheres.

#### Enzyme-Linked Immunosorbent Assay.

ELISA is considered the test for serum antibodies against MAP with the highest sensitivity and specificity available. Although the test accuracy in clinical cases is similar to the CF test, ELISA outperforms other serologic tests to identify subclinically infected carriers. Generally, the sensitivity of the ELISA is limited by the nature of the immune response to MAP infection in which antibodies are only produced in advanced stages of infection. The sensitivity of serum ELISA is considered to be medium to high in clinical cases of paratuberculosis. In contrast the sensitivity of ELISA used to detect infected but subclinical cases reported in the literature ranges between 7% and 39%.<sup>30</sup>

The ELISA response to MAP may also vary according to the characteristics of the cow and stage of lactation. The probability of being ELISA positive may be two to three times lower for cows in parity 1 compared with cows in later parities. In early lactation the probability of being positive was highest in the milk ELISA. In the serum ELISA the odds of being positive was highest at the end of lactation.

These results demonstrate the effect of stage of infection on serodiagnosis. The subclinical, light-shedding cattle are usually seronegative, whereas heavily infected animals are usually seropositive. In most cows in the early stages of infection when fecal shedding is low, the humoral antibody response is below the limit of detection, and currently available serologic tests are inadequate to detect those animals. As the infection progresses, the humoral response increases, and heavy fecal shedders and clinically affected animals are more readily detected.

It has been recommended to use quantitative results of the serum ELISA (i.e., Optical Density or S/P ratios) rather than simple dichotomous (positive/negative) results in the decision-making processes of a

control program. These quantitative values correspond well with the degree of shedding and thus the infectious risk of an individual animal.<sup>10</sup>

Using milk samples from dairy cows to detect antibodies to the organism facilitates the testing of large numbers of animals and has already been incorporated into routine milk testing programs in some countries. The sensitivity of different milk ELISAs has been studied on a herd level and on an individual animal level and were found to be similar to serum ELISA sensitivity.<sup>23,30</sup> The odds for a cow testing seropositive with a milk ELISA were higher for animals in the first 2 weeks of lactation and again after 45 weeks of lactation. This was explained with higher amounts of immunoglobulins lost into the udder at the onset of lactation. Decreasing transfer of immunoglobulins to the mammary gland and increasing milk production supposedly result in dilution of milk antibodies after the early postparturient period. Decreasing milk production toward the end of lactation is thought to be the main reason for increased odds to test positive with a milk ELISA in later stages of lactation.<sup>23</sup> Accordingly high-yielding dairy cows were found to be less likely to test positive with milk ELISA than low-producing cows. Although this observation could be explained by higher dilution of antibodies in dairy cows with higher milk production, decreased milk production in MAP-infected cows has been documented. It is therefore not clear if higher milk production of uninfected cows or higher antibody titers in milk in infected cows are the underlying mechanisms behind this observation. These results indicate that sensitivity of milk ELISA is improved when conducted in cows in either early or late lactation.

**Immunity Tests.** The *in vivo* tests of cell-mediated immunity included the skin and intravenous johnin tests, which were the original tests used. They are no longer used because of inadequate sensitivity and specificity. The IFN- $\gamma$  assay is based on the release of this compound from sensitized lymphocytes during incubation with a specific antigen. The amount of released IFN- $\gamma$  is quantified with a sandwich ELISA. Results from this assay are frequently difficult to interpret because neither the amount of antigen used nor the interpretation criteria have been standardized. Depending on the applied interpretation criteria, sensitivity for the IFN- $\gamma$  assay in MAP-shedding cattle reported in the literature range between 13% and 85% and specificity between 67% and 94%.<sup>29</sup> Because of costs and variable performance of this diagnostic test it is currently not recommended.<sup>10</sup>

### Summary of Diagnostic Testing

Apart from postmortem examination most diagnostic tests provide adequate specificity

but only moderate to weak sensitivity to diagnose subclinical MAP infection. Fecal cultures provide the highest specificity but have a long turnaround time because of long incubation periods. Genetic probes and PCR yield results within days but suffer from inferior sensitivity compared with fecal culture specifically in low-shedding MAP carriers. ELISAs for serum or milk are the most commonly used diagnostic tests. The sensitivity of the ELISA test is highest in animals in the later stages of the disease, usually when clinical disease is developed. However, the absorbed ELISA sensitivity for stage 1 animals will be low at about 10%. Overall the absorbed ELISA detects approximately 35% of the animals found positive by concurrent fecal culture. Only repeated testing of cattle, especially young animals, from infected herds will provide the data to determine the true infection rates within infected herds.

### Diagnostic Strategies for Different Situations

Eight specific testing purposes were considered<sup>30</sup>:

- **Herd classification** (infected/noninfected). In dairy herds bacterial culture of six environmental fecal samples is considered sufficiently sensitive and most cost-effective to determine the infection status of a dairy herd. Negative culture results on all six samples suggest that the herd is either not infected with MAP or has a low herd prevalence. For beef cow-calf operations fecal cultures or serum ELISA can be conducted on the whole herd. If case serology is chosen, positive ELISA results should be confirmed by fecal culture. Alternatively, target testing of a particular group of animals (e.g., thin animals over 30 months of age or all animals over 36 months of age) by fecal culture or serology as described previously can be conducted.
- **Precise estimation of within-herd prevalence.** This testing objective is expensive and is of limited value for the control of paratuberculosis under field conditions but may be appropriate for certain experimental conditions. For the precise estimation of the within-herd prevalence a large number of animals that must be determined by the use of standard epidemiologic equations have to be tested. For herds with up to 300 animals all animals must be tested. For herds with over 1000 animals a statistically determined and randomly selected subset of animals can be chosen. Diagnostic tests used include fecal cultures, PCR assay on feces, or ELISA. To be able to reliably follow the longitudinal development of the within-herd prevalence application of the same diagnostic procedure in subsequent tests is required.
- **Disease control in herds with known high infection prevalence (>10%) and clinical disease.** The main objective of a paratuberculosis control program is to reduce the economic impact of the infection rather than eradication of the disease. Because greatest economic losses are caused by animals in advanced stages of infection, in which seroconversion occurred in many cases, testing by ELISA is recommended as part of a control program. ELISA has a low cost and the sensitivity was estimated to approximate 85% in MAP-shedding cattle.<sup>30</sup> Effective control strategies require that highly positive animals on ELISA are removed from the herd. Although testing of beef cow-calf operations by ELISA also has been recommended, the economic impact of this control strategy has not accurately been documented. Because of the generally lower within-herd incidence of MAP infection in beef cow-calf operations the motivation of beef producers to invest in control programs is rather low.
- **Surveillance (estimation of biological burden).** Objective of MAP surveillance is to monitor the infectious pressure in herds in which paratuberculosis is controlled. Corrective measures will be implemented when surveillance testing indicates an increase of infectious pressure above a specified threshold value. Whereas in dairy herds surveillance presents a low-cost strategy to monitor the disease prevalence in herds in which MAP infection is controlled, in beef cow-calf operations MAP surveillance is not considered economically effective. Periodic target testing of thin cows, cultures of environmental fecal samples and identification of clinical cases either by fecal culture or ELISA are the most commonly used approaches.
- **Eradication (elimination of MAP from the herd).** Disease eradication is the logical step following effective disease control that led to a low within-herd prevalence. Although theoretically possible there is currently no convincing data available supporting the assumption that MAP eradication under field conditions is actually possible. For commercial herds disease eradication is unlikely to be a cost-effective option. Because of the presumed low disease prevalence in operations attempting to eradicate paratuberculosis, the diagnostic test with the highest sensitivity, which is fecal culture, is the best choice. Because there is limited loss in test sensitivity, the use of pooled fecal samples (five samples per pool) for fecal cultures is a valid testing alternative. Regular whole-herd testing is required

over several years, and positive animals must imperatively be removed from the herd.

- **Confirmation of clinical diagnosis in herds with no prior history of paratuberculosis.** In herds without history of paratuberculosis appropriate confirmation of a suspected case of paratuberculosis is essential. Postmortem examination, which includes identification of pathognomonic gross lesions as well as histology and bacteriology of ileal and mesenteric lymph node tissue, presents the most sensitive and definitive diagnosis. Suitable antemortem tests include fecal culture or PCR assay on a fecal sample.
- **Confirmation of clinical diagnosis in herds with prior history of paratuberculosis.** In a herd with previously confirmed cases of MAP infection confirmation of the diagnosis is a useful tool for any control or surveillance strategy. Fecal culture or PCR assay on a fecal sample as well as serum or milk ELISA are all acceptable antemortem diagnostic tests with high sensitivity and specificity in clinically affected animals.
- **Biosecurity (prepurchase testing).** The objective of prepurchase testing is to reduce the risk of introducing infected replacements animals into the herd. Evidently the most effective approach is to avoid or at least minimize the number of purchased animals introduced into the herd. When considering the acquisition of an animal, evaluation of the infection status of the herd of origin rather than the test result of the animal in question is critical. The objective should be to only purchase animals that are test negative and originate from herds that have a within-herd prevalence that is at least 50% below the within-herd prevalence of the buyer's herd.

## NECROPSY FINDINGS

Lesions are confined to the posterior part of the alimentary tract and its associated lymph nodes. The terminal part of the small intestine, the cecum, and the first part of the colon are usually affected. In advanced cases the lesions may extend from the rectum to the duodenum. Typically, the intestinal wall is three or four times normal thickness, with a corrugated mucosa and prominent thickened serosal lymphatics. The ileocecal valve is always involved, with the lesion varying from reddening of the lips of the valve in the early stages to edema with gross thickening and corrugation later. A high incidence of arteriosclerosis has been observed in advanced cases of Johne's disease, with a distinct correlation between the vascular lesions and macroscopic changes in the intestine.

The mesenteric and ileocecal lymph nodes are enlarged and edematous, but unlike tuberculosis, foci of necrosis and mineralization are rarely visible. The characteristic microscopic findings include large numbers of epithelioid macrophages and multinucleate giant cells within the lamina propria and submucosa of affected gut segments and within the paracortical areas of draining lymph nodes. A granulomatous lymphangitis is often visible.

## DIFFERENTIAL DIAGNOSIS

The characteristic features of clinical paratuberculosis include chronic diarrhea, which does not respond to therapy; progressive weight loss; and emaciation in a single animal. The definitive etiologic diagnosis can be obtained by using a combination of serologic tests, fecal culture, polymerase chain reaction on fecal material; and histologic examination of ileal and mesenteric lymph node tissue.

The clinical disease must be differentiated from diseases that cause chronic diarrhea in adult cattle. The chronic nature of Johne's disease is usually sufficient to differentiate it from the other common enteritis of cattle. **Salmonellosis, coccidiosis, and gastrointestinal helminthiasis** are usually acute, and the latter two occur principally in younger animals and are distinguishable on fecal examination for oocysts and helminth eggs. **Secondary copper deficiency (chronic molybdenum poisoning)** is likely to be confused with Johne's disease in cattle, but is usually an area problem affecting large numbers of animals and responds well to the administration of copper. Other debilitating diseases in which diarrhea is not an important clinical finding are **malnutrition, chronic reticuloperitonitis, hepatic abscess, pyelonephritis, lymphosarcoma, and amyloidosis.**

Idiopathic eosinophilic enteritis in cattle is characterized clinically by chronic diarrhea and weight loss, and recovery may occur following treatment with dexamethasone.

## TREATMENT

Currently there are no definitive cures for paratuberculosis and no therapeutic agents registered for the treatment of MAP infection. Because of this lack of efficacy and the failure of any of the antimicrobials to provide a bacteriologic cure, treatment is not recommended. If initiated, treatment that typically must be maintained for life is aimed at reducing clinical signs and possibly the degree of fecal MAP shedding.<sup>10</sup> Treatment attempts can potentially increase environmental contamination by extending the life of the treated animal and should therefore only be considered for exceptional circumstances such as the treatment of valuable sport or zoo animals.

The antimicrobials which have been used are summarized here:

- **Isoniazid** given to cattle at between 10 and 20 mg/kg BW orally daily has been used with varying degree of success. Isoniazid kills MAP only in the replication phase and thus only has a bacteriostatic effect creating a state of remission, whereas treatment is administered without eliminating MAP. Isoniazid is metabolized by the liver and has a narrow therapeutic range. Avoiding overdosage and periodic monitoring of liver function is therefore advisable
- **Rifampin** has been used extensively for the treatment of human tuberculosis and *Rhodococcus equi* infections in foals. For the treatment of paratuberculosis in rabbits rifampin (10 mg/kg once daily orally) has successfully been used in combination with streptomycin (10 mg/kg twice daily intramuscularly). Combinations with other drugs such as levamisole have also been proposed. Based on pharmacologic studies a dosage between 10 and 20 mg/kg administered orally has been recommended.
- **Clofazimine**, a phenazine derivate, was originally used for the treatment of sulfone-resistant leprosy and later also to treat paratuberculosis in experimentally and naturally infected small ruminants. Although complete cure was not achieved, clinical improvement and decreased fecal shedding was reported in clinical cases of paratuberculosis after oral treatment with an oral daily dose of 2 mg/kg. Dosage recommendations are 600 to 1000 mg orally per animal per day for the rest of the animal's life.
- **Monensin**, a carboxylic polyether ionophore, has been widely used in beef cattle as a growth enhancer as well as to control coccidiosis. In dairy cattle monensin is registered in different countries as a feed additive to improve energy metabolism. In Canada monensin is labeled for the indication of reducing fecal shedding of MAP in adult cattle in high-risk Johne's disease herds. Several studies demonstrated a decrease in number in colony forming units in different tissues of naturally and experimentally infected cattle treated with monensin. Monensin was also evaluated as an infection-prevention drug in calves experimentally challenged with MAP. Monensin-treated calves had fewer culture-positive tissue and fecal samples and fewer colony forming units compared with a control group. Dairy cows treated with monensin as a feed additive were found less likely to test positive for MAP infection by milk ELISA. Anecdotal reports of clinical improvement in advanced clinical cases after treatment



with monensin administered at the dose approved for other indications are available.<sup>10</sup> The use of monensin at the dosage approved for other indications may therefore be a suitable component of a MAP control program provided its use is legally permitted.<sup>10</sup>

- **Dietzia subspecies (C79793-74)**, a probiotic bacterium, was reported to hamper growth of MAP *in vitro* and treatment of infected animals with Dietzia with daily doses of 2 to  $5 \times 10^{11}$  CFU per cow per day was associated with longer survival times and lower MAP antibody titers.<sup>31-33</sup> Neonatal calves fed live Dietzia but not calves fed inactivated Dietzia at a dose of 1 to  $2 \times 10^{11}$  CFU per calf per day over 60 days were reported to be resistant to MAP infection. Because all publications come from one research group with commercial interest, further independent research is needed to substantiate the effectiveness of Dietzia for the treatment and control of paratuberculosis.

#### TREATMENT AND CONTROL

##### Treatment

Isoniazid (10 and 20 mg/kg BW every 24 h orally for life) (R-3)

Rifampin (10 and 20 mg/kg BW orally for life) (R-3)

Clofazimine (600–1000 mg per animal every 24 h orally for life) (R-3)

Monensin (185–660 mg per lactating animal every 24 h orally for life or 115–410 mg per nonlactating animal every 24 h orally for life) (R-2)

*Dietzia* subspecies C79793-74 ( $2-5 \times 10^{11}$  CFU per animal every 24 h orally long term) (R-2)

##### Prevention in calves

*Dietzia* subspecies C79793-74 ( $1-2 \times 10^{11}$  CFU per calf every 24 orally for the first 60 days of life) (R-2)

BW, body weight; CFU, colony-forming units.

#### CONTROL

The control of Johne's disease in ruminants is challenging because of the ubiquitous nature of the organism, the long incubation period, most cases are subclinical, and the laboratory tests available lack sufficient sensitivity to identify subclinically infected animals.

Because of the difficulty in diagnosing subclinical cases eradication strategies are usually not practical for economic reasons. Most current paratuberculosis control programs therefore are aimed at containing the disease at a low-prevalence level rather than entirely eliminating it. Before establishing a paratuberculosis control program at a herd

level it is essential to educate the producer about risks and costs associated with the disease as well as proper hygiene and biosecurity measures.<sup>10</sup> A successful control program requires long-term commitment and strict compliance of the producer.

#### Principles of Control

Decreasing within-herd MAP prevalence involves 3 basic steps:

- Identify and eliminate MAP-infected animals from the herd
- Prevent introduction of infected animals into the herd
- Prevent exposure of susceptible animals to MAP

#### Identification and Elimination of Infected Animals

As a first step a producer might want to **determine the herd status and roughly estimate the herd prevalence** of a previously untested herd independently of an official control program. Collection of several environmental fecal samples obtained from cow congregation areas for culture or PCR is an appropriate and cost-effective approach for dairy herds for initial determination of herd infection status.<sup>10</sup> To determine the prevalence of infection within a herd, testing of individual animals over 36 months of age using either the ELISA (serum or milk) or individual fecal culture or PCR has been advised.<sup>10</sup> Ultimately the choice of the specific testing strategy will depend on factors such as herd size, costs, goals of the producer, and possible participation in official paratuberculosis control programs.

The first test to estimate the prevalence of infection will identify seropositive or MAP-shedding animals, which along with their offspring can be culled and sold only for slaughter. Calves from infected animals can be kept separate and grown and fed under feedlot conditions until ready for market. Because of the low sensitivity of standard diagnostic tests, repeated testing of the herd at 6- to 12-month intervals at least until two consecutive negative herd tests are achieved is required. This method has the advantage that many heavy fecal shedders are detected early before showing clinical signs, reducing the environmental contamination with MAP. Intermittent-MAP-shedding and low-MAP-shedding animals may escape detection.

An economic decision analysis model of paratuberculosis in a dairy herd indicates that a test-and-cull program should be profitable when the pretest prevalence of infection is greater than 5%. The model predicted that the best diagnostic test would be the one with the highest specificity and lowest cost, with test sensitivity of secondary importance. Given the costs of various types of diagnostic technology, it appears that the ELISA is the most efficient for testing and culling programs.

#### Prevention of Introduction of Infected Animals Into the Herd

For herds free of Johne's disease, all measures must be used to avoid the introduction of infected animals into the herd by maintaining a completely closed herd or by carefully screening purchased animals. The purchase of cattle is the most common way MAP is introduced into a herd. Purchasing cattle only from herds documented to be free of Johne's disease is preferable to testing specific cattle before introduction because of the low sensitivity of available tests for individual cattle. Dairy herds using typical management practices experience preventable risks of Johne's infection and disease. A dairy herd with 400 cows in milk that introduces 40 cows per year from the general population of dairy cows has an estimated 64% probability of introducing MAP to the herd. This risk could be reduced to 4% through the purchase of cows from herds at level 2 of the U.S. Voluntary Johne's Disease Herd Status Program. A simulation model to assess the risk of introduction of MAP infection into a dairy herd through purchase of female replacement cattle has been used to estimate the probabilities of a producer purchasing an infected lot during a given period of time. The probability of introducing infection is directly proportional to the prevalence of infection in the herds of origin.

All herd replacements should be tested and found negative before being purchased and introduced into the herd. Only test-negative animals from herds with no or few positive animals should be purchased. The goal should be to obtain replacement animals only from herds with a test-positive percentage that is at most half of the test-positive percentage of the buyer's herd.<sup>30</sup>

#### PREVENTION OF EXPOSURE OF SUSCEPTIBLE ANIMALS TO THE INFECTIOUS AGENT

##### Dairy Herds

##### 1. Minimize contact between young and older animals and from fecal contaminated feed and water:

- Clean and disinfect maternity and calf pens after each use
- Calve cows in clean, dry, dedicated maternity pens
- Remove calves immediately after birth to clean, dry calf pens, stalls, or hutches
- Harvest colostrum hygienically to avoid contamination with fecal material
- Feed colostrum only from test-negative cows
- After colostrum feeding, use pasteurized milk, or use milk replacer
- Raise calves separate from the adult herd for at least the first year of life
- Do not allow shared feed or water between adults and young animals;

do not offer feed refusals from adult cattle to young animals

- Avoid vehicular and human traffic from adult animal areas to young animal areas

## 2. Prevent manure contamination of feed and water sources:

- Use separate equipment for handling feed and manure
- Design and maintain feed bunks and waterers to minimize risk of contamination with manure
- Do not spread manure on grazing land

## 3. Reduce total farm exposure to the organism:

- Immediately cull all animals with clinical evidence of Johne's disease
- Cull culture-positive animals as soon as possible; for cows with low or moderate fecal culture colony counts, removal at the end of lactation may be acceptable
- Test adult cattle at least annually by serum or fecal tests; positive serum test results should be confirmed by fecal culture or PCR
- Purchase replacement animals from test-negative herds

### Hygiene

Controlling the disease at a low level of prevalence in the herd requires hygienic precautions to limit the spread of infection. Environmental conditions and manure-handling procedures correlate with prevalence of infection. Overall cleanliness of the farm and especially the amount of fecal contamination resulting from the design, maintenance, location of the housing facilities, and frequency of cleaning are important items for discussion with the producer. Opportunities for exposure of young cattle to adult cattle feces, either because of direct access to water contaminated from adult cow feces or because of the common practice of using the same loader for feeding and manure handling of young stock and adult groups of cattle, are risk factors to be removed or modified. Avoidance of fecal pollution of drinking water and feed by providing troughs in high positions, fencing of marshes and ponds, and closing contaminated pastures for up to 3 years are worthwhile measures.

Strip grazing should be avoided as fecal contamination of pasture is likely to be intense. The provision of piped water supplies to cattle on pasture rather than the use of ponds and ditches has been associated with a decline in the incidence of Johne's disease. Frequent harrowing of pasture fields to disseminate dung pats facilitates destruction of the bacteria by exposing them to sun and drying. Yard and barn manure should be spread only on cultivated fields.

In infected herds, any animal with any signs suggestive of the disease should be isolated until its status has been determined.

Adoption of these hygienic precautions has been shown to greatly reduce the prevalence of the disease.

### Dairy Calf Health Management

Attention to calf health management practices is a vital component of a control program. A simulation model of the control of the disease in a dairy herd indicates that calf-management techniques that reduce the number of effective cow-calf contacts decreases the prevalence of infection in the herd. It is still advisable to rear calves away from infected cows, and if possible in individual pens to prevent spread among the calves. Newborn dairy calves should be removed from the dam immediately after birth and reared in individual calf pens. Colostrum must be collected with care to avoid contamination with feces. Teats should be thoroughly cleaned before collecting colostrum or letting the calf nurse.

HTST (72°C for 15 seconds) and on-farm pasteurization of raw milk markedly reduces the number of MAP in raw milk from infected cows. Pasteurization of colostrum at 63°C for 30 minutes was found to destroy or at least greatly decrease the number of MAP in colostrum from infected dams.

Dairy cows due to calve should be kept separately from the milking herd and calved in clean calving box stalls. Infected cows should not be allowed in the maternity ward. Calves from cows that are clinically affected should not be reared as herd replacements but grown and fed for beef production. Sucking of dams and nurse cows should not be permitted. Milk for bucket feedings should be collected hygienically, and rearing on milk substitutes should be encouraged. Calves should not have any contact with yearling animals or mature cows that may shed the organism. Postweaning calves should not have contact with the adult herd to avoid infections. In dairy herds with a high prevalence of infection, calves should be moved to calf barns and hutches rather than to pens in the cow barn.

### Beef Herds

Control programs for beef cow-calf herds apply the same principles as for those in dairy herds but must adapt the procedures to meet calf health management needs. Some specific control measures for beef herds include the following:

- Avoid manure buildup in pastures and corrals in which late-gestation cows are kept
- Provide a clean calving area, with low cow density
- Move cow-calf pairs to clean pasture as soon as bonding occurs
- Move feed bunks, waterers, and creep-feed areas frequently to avoid exposing calves to manure buildup
- Do not place weaned calves on pasture used by cows

- Blood or fecal test the entire breeding herd annually; avoid calving-out and raising offspring from test-positive animals
- If possible, calve first-calf heifers in an area separate from older cows

### Vaccination of Cattle

Vaccination for Johne's diseases with either inactivated or live-attenuated whole-cell-based vaccines have been used since the 1920s. A number of studies collectively confirmed that vaccination reduces the occurrence of clinical symptoms and tissue colonization but does not eliminate infection. Subunit vaccines consisting of sonicated bacteria, bacterial cell fractions, or recombinant MAP antigens were reported to provide a much lower degree of protection. Efficacy of vaccination may depend on the age at the time of exposure versus age at the time of vaccination as well as on the MAP burden on the farm. Vaccination of dairy calves in the Netherlands reduced the number of clinically affected animals by almost 90%. In a cross-section study of 25 vaccinated and 29 nonvaccinated herds, the rate of shedding of MAP was not significantly different between the vaccinated (4.4%) and nonvaccinated herds (6.7%). If legally permitted, a Johne's disease vaccination program can be useful as part of a comprehensive control program but cannot replace concurrent control measures.

Major drawbacks of the use of whole-cell-based vaccines are the interference with the diagnosis of bovine tuberculosis and paratuberculosis, human health risks resulting from accidental inoculation, and the occurrence of granulomatous lesions at the injection site produced by most oil-based bacterin vaccines. Interference with diagnostic tests used in national tuberculosis eradication programs is the major hurdle affecting approval of MAP vaccines by authorities worldwide.

Vaccination is available on a limited basis in the United States and other countries. In cattle paratuberculosis vaccines are recommended for exclusive use in calves younger than 1 month with the justification that prevention of infection requires vaccination at a very young age and that single early vaccination decreases interference with diagnostic tests for tuberculosis at an older age. The positive test to tuberculin is maximum at 5 weeks after vaccination and has completely disappeared at 18 months. In general terms, vaccination can be recommended in heavily infected, tuberculosis-free herds, but only in areas in which tuberculosis eradication is neither underway nor projected. The comparative tuberculin test can be used to detect tuberculosis in Johne's vaccinated herds. Vaccination of calves from 5 to 40 days of age with an inactivated paratuberculosis vaccine resulted in positive ELISA titers for at least the first 15 months, which could interfere

with the serodiagnosis of the disease in control programs that are based on serologic tests.

### Control on a Countrywide Basis

Paratuberculosis in cattle is being recognized with increased frequency in the cattle populations of the industrialized world. The overall prevalence of infection in dairy cattle is about 10%, and no reliable data are available for beef herds. The continued spread of infection in cattle herds, the economic consequences of loss in productivity, and the biological possibility that the organism may be a food-borne disease deserves consideration by the appropriate authorities and research agencies.

Voluntary national guidelines are now available to certify herds as low-risk for paratuberculosis. Voluntary national and regional Johne's disease control programs for dairy and beef cattle herds have been introduced in the United States, Australia, New Zealand, and the Netherlands. Although the disease is notifiable in several European countries such as Austria, Germany, Greece, Ireland, Luxembourg, Norway, Switzerland, Spain, and Sweden, most countries in Western Europe do not have strategically planned control programs. Denmark, the Netherlands, and France have implemented nongovernment industry-supported programs in cattle herds. The emphasis of these programs is to control rather than to eradicate paratuberculosis.

A significant development has been the Voluntary Johne's Disease Control Program (VJDCP) in the United States, the Johne's Disease Market Assurance Program in Australia, or the paratuberculosis control program in the Netherlands.

### Johne's Disease Control in the United States

The U.S. VJDCP was developed in cooperation between state and federal animal health agencies with industry support in an effort to certify herds free of paratuberculosis. The program was intended as a model for control programs within each state, and the guidelines were considered to be minimal requirements to control the disease in dairy herds. The program consists of three basic elements:

- Education of the producer
- Risk assessment and development of a disease management plan at the herd level
- Herd testing and herd classification

### Education of the Producer

Education focuses on providing basic information over Johne's disease; explaining management strategies to prevent, control, and eliminate the disease; and outlining different state program components. The producer must understand the nature and the economic impact of the disease and must be able to recognize risk factors within his

operation. Information around Johne's disease is made available to producers at the state level as well as at a national level. The National Johne's Disease Demonstration Herd Project, the National Johne's Education Initiative, and the Johne's Disease Integrated Program are among the best known USDA-funded projects and provide a wealth of information to producers.

### Risk Assessment and Disease Management Plan

A risk assessment to identify management practices and facility issues likely to introduce or spread MAP throughout the herd is conducted. A management plan is then developed together with the herd owner with the objective to implement a practical and effective control program customized for the specific herd that the producer understands and to which he can commit. Comprehensive material including a handbook and an instructional guide has been developed to allow the attending veterinarian to conduct a thorough on-farm Johne's disease risk assessment. This risk assessment and the management plan must be reviewed and updated at least every 3 years.

### Herd Testing and Herd Classification

Initial testing is required to determine the herd status. The testing strategy can be customized to the needs of the specific herd and the objective of testing. The primary objective of the VJDCP is to identify herds with low prevalence of paratuberculosis. The classification system consists of levels 1 to 6 in which levels 1 to 3 identify herds with low test-positive prevalence and levels 4 to 6 identify herds with two or more years of test-negative results. Levels 1 to 4 require annual testing according to the guidelines of the program, whereas for herds at levels 4 to 6 retesting is required in 2-year intervals.

### Johne's Disease Control in the Netherlands

In the Netherlands an industry-driven paratuberculosis control program has been implemented that requires dairy producers to participate to be able to market milk. As part of the program, a paratuberculosis status (A, B, or C) is assigned to each participating herd, based on the results of regular herd screenings. Herd screenings consist of individual animal testing of all cattle 3 years and older either by serum ELISA or by fecal PCR, or by milk ELISA of all milking cows. If no seropositive or fecal PCR-positive animals are identified, then the herd is categorized as status A (low risk of infection). Herds with one or more seropositive animals are categorized as status B, provided positive animals are culled within 1 month of testing. If positive animals are not removed from the herd in a timely manner, then the herd is categorized as status C. Follow-up herd screenings are required in 2-year intervals

for herds with status A and in 1-year intervals for herds with status B and C when using the milk or serum ELISA. Two-year testing intervals apply to herds with status B and C when using fecal PCR as a diagnostic test. Status C is maintained as long as positive animals remain in the herd, and status B is maintained until no seropositive animals are identified in one of the regular follow-up herd screenings. Producers can request to have a seropositive result confirmed by fecal PCR. The result of the fecal PCR overrules the result of the ELISA in milk or blood. Serology results are reported as simple dichotomous (positive/negative) results rather than a quantitative OD or S/P ratio.

### FURTHER READING

- Collins MT, Gardner IA, Garry FB, Roussel AJ, Wells SJ. Consensus recommendations on diagnostic testing for detection of paratuberculosis in cattle in the United States. *J Am Vet Med Assoc*. 2006;229:1912-1919.
- Harris NB, Barletta RG. *Mycobacterium avium* subsp. *Paratuberculosis* in veterinary medicine. *Clin Microbiol Rev*. 2001;14:489-512.
- Hermon-Taylor J, Bull TJ, Sheridan JM, et al. Causation of Crohn's disease by *Mycobacterium avium* subspecies *paratuberculosis*. *Can J Gastroenterol*. 2000;14:521-539.
- Kennedy DJ, Benedictus G. Control of *Mycobacterium avium* subsp. *Paratuberculosis* infection in agricultural species. *Rev Sci Technol*. 2001;20:151-179.
- Manning EJB, Collins MT. *Mycobacterium avium* subsp. *Paratuberculosis*: pathogen, pathogenesis and diagnosis. *Rev Sci Technol*. 2001;20:133-150.
- Nielsen SS, Toft N. A review of prevalence of paratuberculosis in farmed animals in Europe. *Prev Vet Med*. 2008;88:1-14.
- Over K, Crandall PG, O'Brien CA, Ricke SC. Current perspectives on mycobacterium avium subsp. *Paratuberculosis*, Johne's disease and Crohn's disease: a review. *Crit Rev Microbiol*. 2011;37:141-156.
- Sweeney RW. Pathogenesis of paratuberculosis. *Vet Clin North Am Food Anim Pract*. 2011;27:537-546.
- Sweeney RW, Collins MT, Koets AP, McGuirk SM, Roussel AJ. Paratuberculosis (Johne's disease in cattle and other susceptible species. *J Vet Intern Med*. 2012;26:1239-1250.
- Whittington RJ, Sergeant E. Progress towards understanding the spread, detection and control of *Mycobacterium avium* subsp. *paratuberculosis* in animal populations. *Aust Vet J*. 2001;79:267-278.

### REFERENCES

1. Biet F, et al. *BMC Microbiol*. 2012;12:264.
2. Okuni JB. *J Vet Adv*. 2013;3:1.
3. Nielsen SS, Toft N. *Prev Vet Med*. 2009;88:1.
4. Lombard JE. *Vet Clin North Am Food Anim Pract*. 2011;27:525.
5. USDA-APHIS-VS, 2007.
6. Dargatz DA, et al. *J Am Vet Med Assoc*. 2001;219:1163.
7. Hendrick S <<http://www.vido.org/assets/upload/johne-disease-november-2009-5478e008a6ca0.pdf>>; Accessed August, 2016.
8. Eisenberg SWF, et al. *Vet Q*. 2012;32:31.
9. Whittington RJ, Windsor PA. *Vet J*. 2009;179:60.
10. Sweeney RW, et al. *J Vet Intern Med*. 2012;26:1239.
11. Sweeney RW. *Vet Clin North Am Food Anim Pract*. 2011;27:537.



12. Roussel AJ, et al. *J Am Vet Med Assoc.* 2005;226:773.
13. Koets A, et al. *Prev Vet Med.* 2010;93:305.
14. Kirkpatrick BW, Shook GE. *Vet Clin North Am Food Anim Pract.* 2011;27:559.
15. Marce C, et al. *Prev Vet Med.* 2011;100:116.
16. van Roermund HJW, et al. *Vet Microbiol.* 2007;122:270.
17. Chiodini RJ, Hermon-Taylor J. *J Vet Diagn Invest.* 1993;5:629.
18. Ellingson JLE, et al. *J Food Prot.* 2005;67:966.
19. Ayle WY, et al. *Appl Environ Microbiol.* 2005;71:1210.
20. Godden S, et al. *J Dairy Sci.* 2006;89:3476.
21. Smith RL, et al. *J Dairy Sci.* 2009;92:2653.
22. McNab WB, et al. *Can J Vet Res.* 1991;55:252.
23. Lombard JE, et al. *J Vet Diagn Invest.* 2006;18:448.
24. Wilson DJ, et al. *Am J Vet Res.* 1993;54:1851.
25. Lombard JE, et al. *Am J Vet Med Assoc.* 2005;227:1975.
26. Jeyanathan M, et al. *Microbes Infect.* 2007;9:1567.
27. Gill CO, et al. *J Food Prot.* 2011;74:480.
28. Collins MT. *Vet Clin North Am Food Anim Pract.* 2011;27:631.
29. Nielsen SS, Toft N. *Vet Microbiol.* 2008;129:217.
30. Collins MT, et al. *J Am Vet Med Assoc.* 2006;229:1912.
31. Collins MT, et al. *Clin Diagn Lab Immunol.* 2005;12:685.
32. Click RE. *Virulence.* 2010;2:337.
33. Click RE. *Virulence.* 2011;2:131.

## PARATUBERCULOSIS (JOHNE'S DISEASE): SHEEP, GOATS, CERVIDS, AND CAMELIDS

### SYNOPSIS

**Etiology** *Mycobacterium avium* subsp. *paratuberculosis* (MAP).

**Epidemiology** Transmitted by fecal–oral route. Prenatal infection occurs in sheep and deer but not confirmed in goats. Source of infection is infected dam or contaminated pasture. Infection more likely soon after birth but age-related resistance to infection is not as pronounced as in cattle. In sheep and goats the incubation period is shorter than for cattle, usually 2–5 years, but increased stress (nutritional and gastrointestinal parasitism) can induce cases earlier. High flock and within-flock prevalence of infection in sheep in many countries. A high prevalence in farmed deer in New Zealand and some other countries. Deer can be infected with both the bovine and ovine strains of MAP, with the former being more infective and pathogenic.

### Clinical signs

**Sheep** Chronic wasting disease of adult sheep; diarrhea not a distinct clinical finding. Common cause of emaciation in ewes, although cases can occur in 10- to 15-month-old sheep in high-prevalence flocks.

**Goats** Chronic progressive intractable diarrhea and emaciation extending over several weeks and months. Generally, a higher prevalence in milch compared with fiber breeds.

**Deer** Outbreaks of diarrhea, ill-thrift, and deaths in young deer (8–15 months) or latent infection that causes sporadic cases with weight loss and terminal diarrhea in older deer.

**Clinical pathology** Culture and direct PCR of feces. Serologic tests (ELISA, AGID, and CF) and bulked fecal culture for flock diagnosis. Low serum protein and marked hypoalbuminemia in affected animals.

**Lesions** Chronic granulomatous enteritis, regional lymphangitis, and lymphadenitis in sheep and goats; caseous lesions in deer.

**Diagnostic confirmation** Presence of gross intestinal lesions, culture and PCR of organism from tissues and histopathology, especially terminal ileum, ileocecal valve and lymph node, and mesenteric lymph nodes.

**Treatment** No treatment of significant value.

**Control** Identify and eliminate clinical cases and subclinically infected animals. Test flock or herd to identify high-prevalence age groups and make these a priority for culling. Improve management and hygiene to minimize spread of infection with emphasis on avoiding infection of newborn animals. Vaccination of sheep and goats prevents clinical disease but not infection and fecal shedding.

### Differential diagnosis list

#### Diarrhea in adults

- Gastrointestinal parasitism
- Bacterial infections: Yersiniosis and salmonellosis

#### Chronic weight loss in sheep and goats

- Internal abscesses
- Caseous lymphadenitis
- Caprine arthritis-encephalitis
- Ovine progressive pneumonia
- Dental disease

AGID, agar gel immunodiffusion; CF, complement fixation; ELISA, enzyme-linked immunosorbent assay; PCR, polymerase chain reaction.

## ETIOLOGY

The causative agent of paratuberculosis in ruminants is MAP, a slow growing acid-fast aerobic microorganism forming part of MAC. Although MAP is an obligate intracellular pathogen requiring a host for replication, it can survive for longer than 1 year in the environment. MAP has been subdivided into two main lineages designated as the slow growing type I (or S for sheep) and the faster growing type II (or C for cattle) according to the species from where these lineages were first isolated. Type I strains appear to have a strong host preference for sheep and are more virulent for this species, whereas type II strains are more commonly isolated from cattle and a range of other species. Genome sequencing has confirmed that an intermediate or type III strain is a subtype of the S strain.<sup>1</sup>

Molecular studies of MAP have identified a high degree of genetic similarity within the bovine isolates, regardless of geographic origin, indicating that only a few closely related clones may be responsible for wide-spread infection in cattle, other ruminants, and possibly wildlife. There is a higher degree of genetic heterogeneity among MAP isolates recovered from ovine sources. C strain more readily infects sheep, goats, and deer, whereas sheep strains tend to be more specific and are less commonly isolated from other species.<sup>2,3</sup> However, cograzing of sheep and beef cattle means that the S strain is being isolated more often from beef cattle, whereas dairy cattle be infected predominantly with the C strain.<sup>4</sup>

## EPIDEMIOLOGY

### Occurrence, Morbidity, and Mortality Sheep and Goats

Paratuberculosis occurs worldwide and is of major importance in sheep in temperate climates and some humid, tropical areas. The prevalence is greatest in animals kept intensively under climatic and husbandry conditions, which are conducive to the spread of infection.

The history of ovine Johne's disease (OJD) in Iceland is an example of the spread of this disease from a point source. Briefly, 20 apparently healthy Karakul stud rams were imported from Germany in 1933. After 2 months' quarantine they were distributed to 14 farms, and the first clinical case of OJD was diagnosed in 1938. Gradually, infection spread from five originally infected farms and, after 18 years, 20% to 30% of the farms in the main sheep breeding areas were infected. The annual morbidity of sheep during the epidemic averaged 8% to 9% in affected areas, and was up to 40% on individual farms.

In New Zealand, OJD was first reported in the South Island in 1952, and by 1970 more than 150 farms were confirmed as infected. It was detected in the North Island in 1972, and by 1979 284 farms were known to be infected. More recent estimates of prevalence are 76% of sheep flocks (95% confidence interval [CI] 70%–81%) and 46% of deer herds (95% CI 38%–55%).<sup>5</sup> In Australia, OJD was first confirmed in 1980 and by 1999 had spread to most states. It is presumed that infection originated from sheep imported from New Zealand in the 1970s, and it is estimated that at least 40% of flocks are now infected in some areas.<sup>6</sup> In South Africa, the disease was unknown until an infected Merino ram was imported in 1967 and it then spread among sheep farms in the Western Cape and Eastern Cape provinces in the 1990s. Infection is also confirmed in South America, North America, and Europe in which 74% of 38 dairy sheep flocks in the Marche region of Italy tested positive to a commercial ELISA for Johne's disease.<sup>7</sup>

Clinical signs are progressive emaciation, with intermittent diarrhea in some sheep.

Sheep are easily infected experimentally, with doses from  $10^4$  to  $10^7$  viable bacteria reliably inducing infections in 12- to 16-week-old Merino lambs. Infected animals can excrete large numbers of the organism, up to  $10^7$  to  $10^9$  per gram of feces, but some can spontaneously recover from infection.<sup>8</sup>

Mortalities can vary considerably between farms, but OJD can cause significant financial losses. For example, in an Australian study the disease was associated with mortality rates from 2.1% to 17.5% and a decrease in farm gross margin of from 2.2% to 15.4%.<sup>6</sup> On average, these losses were estimated to cost affected farms at least \$13,700 US\$10,500 per year. In Cyprus, where sheep are farmed semi-intensively for milk to produce cheese, ewe mortalities can be as high as 4% per year. The disease is being recognized with increased frequency in goats and can cause large losses. In Australia, John's disease occurs in dairy goat breeds with endemic foci of infection in southeastern Australian states.<sup>9</sup>

#### Deer, Camelids, and Exotic Species

MAP has a broad host range, with deer, alpacas, llamas, camels, and captive and free-living wild ruminants, including bighorn sheep, Rocky Mountain goats, aoudads, mouflon sheep, reindeer, antelope, and yaks being susceptible. A high prevalence was detected in farmed alpacas in Australia in the 1990s, but a concerted control program has virtually eliminated this disease from Australian alpaca flocks.<sup>10</sup>

Outbreaks of John's disease have occurred in farmed red deer, and the incidence is increasing in some regions. For example, John's disease was recognized in farmed deer in New Zealand in the 1980s and by 2000, the disease had been diagnosed in 299 herds, or 6% of the commercial deer herds in New Zealand. Over 90% of these farms were identified from lesions in mesenteric and ileocecal lymph nodes at meat inspection, whereas only 6% were detected through the presence of clinically affected animals. The disease is now regarded as endemic in farmed deer in New Zealand (46% of herds) and has also been detected in farmed red deer in the UK, Belgium, Holland, and the Czech Republic. Young deer infected with MAP can develop disease within 5 to 7 months, with outbreaks affecting up to 20%, or can remain latent for many years.<sup>3,11</sup> Thus many infected deer will be culled before they show any clinical signs.

The epidemiologic implications of deer, cattle, and wildlife comingling on the same pasture are not fully known, but the rate of infection can be similar in both domestic species and so each can be a source of C-strain MAP for the other.

#### Prevalence and Source of Infection

The prevalence of John's disease infection in flocks or herds within a region is difficult to

estimate because of the relative insensitivity of screening tests, uncertainty of antemortem diagnosis, and the failure to report cases unless a specific survey or eradication program is undertaken.

#### Sheep

OJD was first diagnosed in Australia in central New South Wales in 1980. The disease has a highly clustered distribution indicating spread between neighboring properties and by sheep trading. In 2000, surveys found that the 95% probability limits for flock prevalence in low-, moderate-, and high-prevalence regions in New South Wales were 0.04% to 1.5%, 8% to 15%, and 29% to 39%, respectively, whereas all other states had an upper 97.5% probability limit of 1% or less. Based on these estimates, from 6% to 10% of flocks in New South Wales and 2.4% to 4.4% of flocks Australia-wide were estimated to be infected. Over 80% of affected flocks were located in a relatively small geographic area of New South Wales, whereas Queensland and Western Australia had a flock prevalence of less than 1%. Subsequently, a review of the OJD control strategy from 2007 to 2012 found that although the transmission of infection from some low-prevalence areas had been restricted, the disease had spread widely, and many areas that were classified as having a low prevalence in 2000 now had a medium or high prevalence of infected flocks.<sup>12</sup>

#### Methods of Transmission

Spread of the organism from farm to farm is usually caused by trading of livestock, which are unknown infected carriers and shedders of the organism. This results in clusters of infected flocks. Lateral spread between flocks, through contact between infected and uninfected sheep in common areas such as yards or roads, or the movement of feces across boundary fences, can then occur.

Intrauterine infection has been confirmed in sheep and deer, but most infection with MAP occurs by the fecal–oral route. This can occur by neonates suckling from an infected dam via contaminated teats or ingestion of fecally contaminated pasture.

#### Sheep

Clinically affected sheep excrete a large number of organisms, often over  $10^9$  viable MAP per gram of feces. Thus the output of 1 to 2 kg of feces from a single clinical animal over 1 day is sufficient to infect many animals, with an infective dose of S-strain MAP being as low as  $10^4$  organisms.<sup>13</sup>

Ovine trichostrongylid larvae (*Haemonchus contortus*, *O. circumcincta*, *T. colubriformis*) may become contaminated with MAP and may play a role in the transmission of the organism, although this is likely to be far less important than direct exposure to pasture contaminated with infected feces. Fetal infection can occur, with a much higher proportion of infected fetuses identified

from clinically affected ewes (83%) compared with 1.6% from subclinically affected and none from uninfected ewes.

#### Deer

Deer can be infected with either the cattle or sheep strain of MAP, but the cattle strain appears to be of higher infectivity.<sup>3,14</sup> In New Zealand and elsewhere deer are cograzed with both sheep and cattle. However, modeling of the dynamics of John's disease in farmed deer found that if mixed strains of MAP were present, a reduction in infectivity of 30% would be sufficient for a dominant strain to outcompete a less infective one. This suggests that mixed infections with C and S strains of Map in a deer herd might not be common, because the C strain would become dominant.<sup>11,15</sup>

#### Risk Factors

##### Sheep and Management

A relative resistance to infection with increasing age is a feature of John's disease in cattle but is less pronounced with OJD. For example, experimental infection with a high dose of MAP induced lesions in both lambs and adult ewes; however, the were restricted to focal granulomas within lymphoid tissue in the ewes, whereas they progressed to more widespread lesions in the lambs.<sup>16</sup>

In Australia and New Zealand, fine wool Merino sheep have a higher mortality from OJD than other sheep breeds. Within large wool-producing flocks wethers often have a higher prevalence of infection. This is probably related to higher stocking rates for this class of animal and poorer nutrition, both quality and amount of pasture, relative to the ewe portion of the flock.<sup>17</sup> Poorly controlled infections with internal parasites and undernutrition are both associated with an increased prevalence of infection and clinical disease. For example, in a cross-sectional study of 92 Merino flocks in southeastern Australia, key risk factors associated with a higher prevalence of OJD included sheep whose dams had been in low body condition at lambing time, sheep that had experienced a longer period of growth retardation during their lifetime, and high stocking rates.<sup>17</sup> In this study vaccinating for more than 2 years was associated with a significantly lower prevalence of MAP infection.

Flocks shorn in winter and farms with a high percentage of improved pastures containing subterranean clover (the latter typically associated with higher stocking rates) were also associated with a higher prevalence of OJD in flocks in southeastern Australia. Exposure of young sheep to a high level of pasture contamination with MAP was identified as a risk factor for a higher prevalence of severe OJD lesions and mortalities in this area.<sup>18</sup>

Consistent with these observations, practices associated with intensive management, such as a high proportion of introduced

sheep, or multiple or foreign breeds, have been identified as risk factors for OJD in Spanish flocks.

### Deer

The risk factors in outbreaks of Johne's disease in deer have not been investigated in any detail. However, it is likely that they are similar to other species, namely age at exposure, size of infective dose, the innate immune response of the animal, and environmental factors.<sup>3</sup>

### Environmental Risk Factors

#### *Soil Characteristics*

An association between high prevalence of MAP infection in ruminants and soil type has been recognized, and the literature on the possible links between the clinical expression of paratuberculosis and deficiency of macronutrients and micronutrients has been reviewed.<sup>19</sup> The evidence implicates regional soil acidification (low pH), excesses of iron and molybdenum, and marginal deficiencies in copper and selenium in a higher prevalence of Johne's disease. In Australia, mortality from OJD was higher on farms with light sandy soils, consistent with studies in dairy cattle in Spain. In contrast, a later study of 92 Merino flocks in southeastern Australia found a positive association between higher organic carbon, clay, and iron content, whereas there was a lower prevalence of OJD on farms with sandy soils.<sup>20</sup> It was suggested that MAP may adhere more closely to the smaller clay particles, compared with larger sand particles, and thus be retained in greater numbers for a longer period in clay soils. The association between low soil pH and occurrence of OJD was inconclusive, although most farms had relatively acidic soil and a narrow range of soil pH compared with other studies.<sup>20</sup> MAP requires iron for survival and replication, but is relatively inefficient at chelating this element compared with many other bacteria. Thus an increased concentration of iron is hypothesized to increase the survival of MAP in soil. The solubility of iron also increases with decreased pH, hence, the frequent association of increased prevalence of Johne's disease in acidic compared with alkaline soils.

### Pathogen Risk Factors

MAP is an obligate pathogen and parasite of animals, and in theory it can be eradicated by removal of all infected animals. However, the organism can survive for long periods outside the host, enabling it to persist and spread in a grassland environment and withstand a periodic lack of suitable hosts.

#### *Survival and Dormancy of Organism in the Environment*

Both S and C strains of MAP can be extremely persistent in nature, with survival for more than 1 year. Studies of the survival of S-strain MAP in eastern Australia indicate that when

the organism in feces becomes mixed with soil, there is a reduction of 90% to 99% in the apparent viable count of the organism.<sup>21</sup> This is thought to be caused by binding of bacteria to soil particles, which are excluded from culture by sedimentation during sample preparation. Survival of the organism in sheep fecal material applied to soil was greatest in a fully shaded environment (55 weeks) and was least where fecal material and soil were fully exposed to weather and where vegetation was also removed. The organism survived for up to 24 weeks on grass that germinated through infected fecal material applied to the soil surface in completely shaded boxes and for up to 9 weeks on grass placed in 70% shade.

Dormancy of the organism appears to be a feature in the Australian environment, with the dormancy characteristics related to genetic elements of MAP that are also present in other mycobacteria. However, survival is finite and significant pasture decontamination can occur within a relatively short period. This reduces exposure to the organism and the prevalence of disease.<sup>21</sup> Pasture decontamination can be hastened by pasture management, such as selective grazing with less susceptible hosts or mechanical slashing to decrease shade.

The organism persists without multiplication in pasture for long periods, and such pastures are infective for up to 1 year. The organism is relatively susceptible to sunlight and drying, to a high calcium content, and to high pH of the soil. Continuous contact with urine and feces reduces the longevity of the bacteria, but the organism can survive for 98 to 287 days in tanks, depending on the composition and alkalinity of the slurry. The alkalinity of the soil may also influence the severity of the clinical signs.

### Zoonotic Implications

MAP is potentially of public health significance because, although there is no evidence of a causal relationship between it and Crohn's disease in humans, there is a growing literature on the possible association between MAP and Crohn's disease.<sup>22</sup> This is addressed in more detail in the section on Johne's disease of cattle, but more than 500 scientific papers made reference to this topic from 1972 to March 2014, averaging around 3.5 papers per month since 2009.<sup>23</sup>

The organism has been found in raw goat milk in Norway and conditions in cheese production have little effect on the viability of MAP, with viable bacteria found in hard and semihard cheese 12 days after production. Therefore consumption of cheese manufactured from raw goat milk sourced from herds infected with Johne's disease might lead to human exposure to MAP.

### PATHOGENESIS

Following oral ingestion, the organism localizes in the mucosa of the small intestine, its

associated lymph nodes and, to a lesser extent, in the tonsils and suprapharyngeal lymph nodes. The primary site of bacterial multiplication is the terminal part of the small intestine and the large intestine. At least three different groups of animals can occur depending on the host-bacteria relationship that becomes established. In the first group, animals develop resistance quickly, control the infection, and do not become shedders (infected resistant). In the second group, the infection is not completely controlled; some animals will partially control the infection and will shed the organism intermittently, others will become intermediate cases that are incubating the disease and will be heavy shedders of the organism. In the third group the organism persists in the intestinal mucosa, and from these animals the clinical cases develop.

The organism is phagocytized by macrophages, which in turn proliferate in large numbers and infiltrate the intestinal submucosa. This results in decreased absorption, chronic diarrhea, and resulting malabsorption. There is a reduction in protein absorption and leakage of protein into the lumen of the jejunum. In sheep, a compensatory increase in protein production in the liver masks the protein loss, so clinical signs of muscle wasting appear only when this compensatory mechanism fails. Within the macrophages, the bacteria remain viable and protected from humoral factors.

### Immune Response

The first line of defense against invading MAP in the ruminant intestine involves M cells (special epithelial cells associated with ileal Peyer's patches and lymphoid follicles that actively take up particulate matter from the intestinal contents) and phagocytic macrophages. In early stages of infection, the organism is found in phagocytic macrophages in the intestine. Once inside the phagosome of an infected macrophage, the organism interferes with the normal course of phagosome maturation into phagolysosome, escaping destruction. The infection of inactivated macrophages within the intestine is the first step in establishing persistent infection and the subsequent development of disease. The host immune system begins a series of attacks against MAP-infected macrophages, initially involving CD4+ T cells, the production of IFN- $\gamma$ , and cytolytic CD8+ cells (a Th1 response). These cells interact with the PI macrophage and each other through a complex network of cytokines and receptors. Despite this response, MAP organisms persist and the immune reaction injures the intestinal epithelial cells.

During the early subclinical stages of infection, the organism elicits a cell-mediated response by the host, characterized by strong delayed-type IV hypersensitivity reactions, lymphocyte proliferation, and production of cytokines by stimulated T lymphocytes. As



the disease progresses from subclinical to clinical, the cell-mediated immune response wanes and a strong humoral response (IgG1 isotype) becomes dominant. This process is not well understood, but competition for antigen between these Th1 and Th2 responses probably contributes to this switching.<sup>24</sup> ATh1 response is needed to keep the infection under control, and antibody against MAP does not protect the host against disease. During the final stages of disease, lack of antigen-specific cell-mediated immune response or complete anergy may result, allowing for rapid dissemination of the infection throughout the host.

There appears to be an immune spectrum, and no serologic or cellular immunity test will identify all animals in the spectrum. There are infected-resistant animals that control their infection but are unable to completely eliminate the organism. These animals do not react in antibody assays, only rarely or never shed organisms, and respond to the lymphocyte transformation test because their circulating lymphocytes are sensitized. In the intermediate stage, the animal fails to control the infection, antibodies appear in the serum, and organisms are shed in the feces. In the stage of clinical disease, the organisms are shed in the feces and the antibody responses and skin tests are variable.

### Development of Lesions

In sheep with OJD two distinct histologic types of granulomatous enteritis occur, with a significant relationship between the infiltrating cell type and the degree of intestinal mycobacterial infection. At the two ends of the spectrum of lesions are these two widely differing forms:

- **Tuberculoid extreme** with a strong cell-mediated immune response and lesions consisting of small granulomata composed of epithelioid cells surrounded by many lymphocytes and with few or no bacilli in the lesions
- **Lepromatous extreme** with a strong humoral immune response and lesions composed of accumulations of macrophages containing large numbers of mycobacteria

Between these extremes are “borderline forms,” which tend to be associated with the most severe clinical disease. Most sheep with Johne’s disease have the multibacillary lesion (lepromatous) with extensive diffuse macrophage infiltrate within the intestinal mucosa and submucosa. In the paucibacillary lesion (tuberculoid) there is a marked lymphocytic and giant cell infiltration of the intestine. In sheep, the local release of macrophage and other lymphocyte-derived cytokines may influence the type of inflammatory and immune response that develops during infection. It is proposed that the elevated production of cytokines, such as IL-10, may suppress Th1 and encourage a Th2-type response.<sup>25</sup> This, along with a failure to clear

a heavy burden of bacteria, may be one factor in the development of chronic inflammatory lesions.

In experimental infections of non-Merino sheep with S-strain MAP, clear differences were found in the cell-mediated immune response and outcome of infection according to age (1-month-old lambs compared with mature ewes) and the dose of MAP given ( $1.6 \times 10^8$  CFU compared with  $4 \times 10^3$  CFU).<sup>16</sup> Lambs given a higher dose developed progressive and widespread intestinal lesions whereas, in ewes given a higher dose, lesions were smaller and confined to lymphoid tissue. Ewes given the low dose were PCR positive after infection, but no microscopic lesions were detected and tissues were culture negative at 110 and 220 days.

As infection progresses, the bacteria are carried by macrophages to other sites, particularly the uterus, the fetus, and the mammary gland. Vaccination against Johne’s disease does not prevent infection or shedding of MAP in sheep, but it restricts the cellular response to the intestinal wall and thus prevents the onset of clinical disease.<sup>26</sup> Disease progression is associated with immune dysfunction, and although the exact mechanisms are not fully understood many differences have been described. A Th1 cell-mediated response, with secretion of IFN- $\gamma$ , is predominant soon after exposure to MAP. If infection progresses to multibacillary lesions, this alters to a Th2 response, with increased expression of IL-4 and IL-10, whereas in sheep with paucibacillary lesions the Th1 response tends to remain predominant. However, the immune response is complex and not “all or none,” with a mix of cell-mediated and antibody responses occurring. Changes described in the ileal and jejunal lymph node cells of sheep exposed to MAP, but with no or paucibacillary lesions, include increased secretion of tumor necrosis factor (TNF)- $\alpha$ , increased IL-10 (which suppresses Th1 and enhances Th2 cytokine production), decreased IL-18, and increased expression of toll-like receptor 9.<sup>25,27,28</sup> Longitudinal studies of experimental infections suggest that antigen-mediated lymphocyte apoptosis may contribute to the immune dysfunction that occurs in Johne’s disease.<sup>29</sup>

### CLINICAL FINDINGS

#### Sheep and Goats

In sheep and goats the disease is manifested principally by emaciation, with a marked difference in condition between affected animals and their nonaffected cohorts. In sheep the abrupt cessation of wool growth can cause decreased staple strength or shedding of wool. Diarrhea is not as severe or as common as in cattle, but the feces may be soft enough to lose their usual pelleted form. Affected sheep may be partially anorexic and lose weight for 6 to 12 months before they die.<sup>30</sup> Their feces usually appear normal until the terminal stages of the disease when they

may become soft and pasty. Depression and dyspnea are evident in goats but are less obvious in sheep.

### Other Species (Deer, Camelids, and Bison)

In deer, Johne’s disease is unusual in that it can present as outbreaks of acute disease in young animals, with loss of BW, diarrhea, and deaths as young as 8 months of age, or sporadic cases in adults. C-strain MAP is more pathogenic, but the S strain can also cause disease.<sup>3</sup>

Similarly, in alpaca (*Lama pacos*) and lama (*L. glama*) weight loss, emaciation and diarrhea are reported in both young (8–14 months) and older animals. Some infected animals may show no clinical signs of Johne’s disease but are positive on fecal culture or serologic testing. Many cases have grossly enlarged mesenteric lymph nodes, which can be confused with lymphosarcoma, and frequently widespread mycobacterial infection in organs other than the intestine.

In American bison (*Bison bison*) the clinical signs and lesions are similar to those in cattle, with gross lesions in the distal small intestine and enlarged mesenteric lymph nodes.

### CLINICAL PATHOLOGY

In an infected flock or herd, animals can be in one of the following four groups:

- Clinical disease and be shedding the organism, usually in large numbers
- Subclinical infection and be shedding the organism, often intermittently and in intermediate numbers
- Infected, but neither ill nor shedding enough bacteria to be positive on fecal culture (infected resistant)
- Not infected

To control the disease, diagnostic tests must identify the first (heavy shedders) and second (intermediate) groups. Diagnosis in the live animal is hindered by the paradoxical immune response during various stages of the disease. Subclinical infection is characterized by a strong cell-mediated but negligible antibody response, reducing the usefulness of serologic tests at this stage. In contrast, clinical disease is characterized by a strong humoral immune response and a weak cell-mediated response. During clinical disease, high numbers of MAP are shed in the feces, so a definitive test is culture of the organism from feces.

### Diagnostic Tests

#### Culture or Detection of Organism

**Bacteriologic Examination.** Several procedures are used to improve the sensitivity of detecting MAP by culture, including decontamination and concentration of the organism from specimens. Conventional MAP culture consists of decontaminating the specimen, concentrating the organisms, and inoculating a growth medium. A

molecular-based confirmatory test, such as PCR, to detect the MAP marker sequence IS900 is typically used to confirm positive specimens after 6 to 12 weeks incubation. The main criteria for differentiating *M. paratuberculosis* from other mycobacteria are its slow growth and dependence on mycobactin for growth.

Fecal culture using a radiometric technique is more sensitive and less expensive compared with conventional fecal culture and DNA probes, but a confirmatory test such as IS900 PCR is still required on positive specimens. The most commonly used radiometric technique was the automated BACTEC system, which was faster and had slightly higher sensitivity than conventional culture. However, the liquid modified BACTEC 12B medium is being phased out because it requires radioisotopes.

**Pooled Fecal Samples and Culture.** The culture of pooled fecal samples from 50 sheep or 25 goats of a similar age in a flock or herd is a cost-effective means of determining the infection status of a flock or herd. Pooling samples reduces the number of fecal cultures necessary to determine infection, reducing laboratory costs. It is a more highly sensitive and specific flock test for detection of OJD compared with serology using the AGID test. The estimated minimum flock specificity of pooled culture when used for surveillance and assurance testing is 99.1%. Surveillance and assurance programs in Australia are designed to provide a flock sensitivity of 95% at an assumed prevalence of 2% at a much lower cost (around 30% of that for serologic testing). Pooling of samples is possible because of the large numbers of MAP present in the feces of sheep with multibacillary disease, estimated to be  $1.1 \times 10^8$  organisms per gram of feces. As the analytical sensitivity of similar culture methods has been estimated to 100 CFU/g of feces, the pooling rate can be large.

**Microscopic examination of Ziehl-Neelsen stained smears of feces** for the presence of typical clumps of acid-fast bacteria has been an attractive alternative to fecal culture because the results are available within an hour, compared with 2 to 3 months for culture. However, the sensitivity and specificity is low except in advanced clinical cases. It may also be difficult to distinguish MAP from other acid-fast organisms that are often present in feces, and with animals that are intermittent shedders it may be necessary to examine smears on several occasions to obtain a positive result.

**Genetic Probe.** A genetic element unique to MAP is an insertion sequence designated as IS900. Genetic probes for the detection of IS900 in clinical samples such as feces are available as commercial kits using the PCR. Other mycobacterial species contain IS900-like elements in low copy numbers (*M.*

*cooki*, *M. scrofulaceum*, and *M. marinum*), although these are not reported in Johne's disease and, if necessary, can be distinguished by amplicon sequencing. The advantage of PCR is the speed of reporting (hours or days) and high specificity and ability to detect low amounts of DNA. For example, a real-time (RT)-PCR was able to detect a single copy of MAP IS900 from a range of tissues of cattle and sheep infected with MAP, including ileum, liver, and muscle.<sup>31</sup> One disadvantage is that molecular tests detect both living and dead organisms, so a positive result is possible from an animal that has ingested and is shedding MAP, but is not truly infected. Validation of molecular tests to detect MAP has also been lacking, plus fecal samples are a challenge because of the presence PCR inhibitors and a large amount of nonspecific DNA from other fecal microorganisms and the host.

Subsequently, a direct quantitative PCR (qPCR) for the detection of MAP in ovine feces was shown to have a sensitivity and specificity similar to BACTEC culture, although it was laborious and unsuited for commercial application.<sup>32</sup> This led to the development of a high-throughput direct fecal PCR, which is highly specific. This test, known as the high-throughput-Johne's (HT-J) test, has been validated in sheep and cattle and approved for use as a herd/flock test in Johne's disease control programs in Australia and New Zealand.<sup>33</sup> The HT-J test detected only MAP compared with 51 other mycobacterial isolates, including those with IS900 type sequences, and 99% of samples from unexposed cattle herds and sheep flocks were negative (458 of 460 samples from 8 unexposed cattle herds, 88 of 89 samples from 1 unexposed sheep flock). It was also reasonably sensitive compared with BACTEC culture at the recommended positive/negative cut points (0.001 pg MAP DNA), detecting 67 of 111 samples positive on culture in exposed cattle (60.4%) and 93 of 117 samples positive on culture in exposed sheep (83.8%). Almost all samples with a high level of MAP DNA were culture positive (97%), whereas only 25% of samples with a low level of DNA were culture positive. Thus scope exists to vary the cut points for the test, depending on the purpose of testing. However, the HT-J test detects a subset of infected animals that overlaps with, but is not identical to, those detected by fecal culture.<sup>33</sup>

**Biopsy.** Surgical biopsy of the terminal ileum and mesenteric lymph node of sheep for detection of MAP has been described, with histologic examination and bacteriologic culture being highly specific and sensitive.<sup>8</sup> Similarly, histopathology of liver biopsy samples had a sensitivity of 96% and 100% specificity for detection of types 3b and 3c ileal lesions in aged ewes.<sup>34</sup> Early detection of animals is one advantage with these techniques. However, the time taken and costs

are major disadvantages, so use of biopsy will be restricted to special circumstances, such as valuable pedigreed animals.

### Serologic Tests

Serologic tests are usually cheaper and more rapid than fecal culture. Those used in cattle are applicable to sheep and goats, but diagnosis, particularly in individual sheep, is more difficult. The commonly used serologic tests are the CF test, AGID test, and a number of commercial ELISAs. In cattle the CF test has published estimates for sensitivity as high as 90% for clinical cases, but much lower for subclinical infections, from 11% to 54%. This test is too unreliable for routine use in sheep, because of even poorer sensitivity and specificity, hence, an unacceptably high number of false-positive reactions. Despite this, some countries still require a Johne's CF test before the importation of sheep and cattle, often in combination with intradermal johnin testing or fecal culture.

The sensitivity and specificity of ELISA are similar to those in cattle, although cross-reactions to *C. pseudotuberculosis* occur, so absorbing sera with those heat-treated organisms does give improved results. In Australia, in a population of sheep with a high prevalence of subclinical infection, the sensitivity of an absorbed ELISA was 34% to 54% compared with 38% to 56% for the AGID test. The AGID was much better at detecting infected sheep in low body condition than the ELISA, but the latter was superior in detecting infected sheep with localized lesions or those with small numbers of MAP. These tests have also been evaluated and compared in adult sheep culled from severely affected flocks, with sensitivity and specificity evaluated using histopathologic findings as a reference. The sensitivity and specificity of the AGID was 37% and 100%, respectively, whereas the sensitivity of the ELISA was 48%, but its specificity was only 89%.

As discussed previously, in sheep a spectrum of infection is defined by two widely differing forms of the disease: a tuberculoid form, with strong cell-mediated immune response and lesions characterized by small granulomata composed of a few epithelioid cells surrounded by a large number of lymphocytes, and with no or few bacilli in the lesions; and a lepromatous form, with a strong humoral immune response accompanied by lesions with macrophages full of mycobacteria. The sensitivities of ELISA and the AGID test in sheep with lepromatous lesions were 86% and 100%, respectively, but only 10% to 50% and 30% in sheep with tuberculoid lesions. Thus there is a close correlation between serologic response to AGID and the presence of acid-fast bacilli in the intestinal tissues, and the diagnosis of tuberculoid cases remains difficult.

Nevertheless, the AGID is rapid, inexpensive, easily available, and technically easy to perform. Thus it is useful for

flock-screening programs to identify infected age groups of sheep, especially those with advanced OJD lesions and shedding the greatest number of organisms. In goats, the specificity of the AGID and absorbed ELISA tests in an Australian study was 100% and 99.8%, respectively, with the ELISA preferred because of its higher sensitivity.

#### Tests of Immunity

In vivo tests of cell-mediated immunity included the skin and intravenous johnin tests, but these are no longer used in control programs because of inadequate sensitivity and specificity. An indirect estimate of cell-mediated immunity is the assay of specific cytokines, but none are available for routine use in sheep or goats.

#### Serum Biochemistry

Sheep with clinical Johne's disease have decreased serum concentrations of calcium, total serum proteins, and serum albumin compared with controls. Serum protein concentrations range from 5 to 49 g/L, compared with controls at 68 g/L, whereas serum albumin concentrations range from 14 to 19 g/L with controls at 29 g/L. Sheep with lepromatous lesions have more severe depletion of calcium and protein than tuberculoid cases.

#### Deer

Fecal culture, qPCR, and serologic tests, including the CF test, AGID, and ELISA, have been used in deer. An IgG1 ELISA developed specifically for the serodiagnosis of Johne's disease in farmed deer had a specificity of 99.5% and a sensitivity of up to 91%.<sup>35</sup> Sensitivity was estimated using 102 infected animals from 10 deer herds, whereas specificity was determined using 508 uninfected animals from 5 herds without disease. Histologic lesions were detected in 80% of the seropositive deer. The test was less sensitive in animals that were culture positive for MAP but had no detectable pathology (75%) compared with those with JD lesions (>90%). The use of a deer-specific ELISA (Paralisa) in a deer herd, followed by fecal qPCR on positive samples, has been proposed as a cost-effective way of detecting and culling deer that are shedding MAP.<sup>36</sup>

### NECROPSY FINDINGS

#### Sheep and Goats

On necropsy emaciation and subcutaneous edema are usually present, but gross necropsy lesions are often minimal despite severe clinical signs. In sheep there may be a deep yellow pigmentation of the intestinal wall and of the cortex of the draining lymph nodes. The intestinal wall may be thickened, although corrugation of the mucosa is not always obvious. Serosal lymphatics are often very prominent ("lymphatic cording"), and caseation and mineralization of the lymph nodes or enteric tubercles may occur. The

pattern of lesions seen in cases of OJD may be classified into two major types, and detailed descriptions of these histopathologic changes are available.

Bacteremia occurs with MAP infection, so granulomatous lesions are sometimes identified in filtering organs such as the liver, lung, and spleen. No lesions occur in an infected fetus, but the organism can be isolated from its viscera and from the placenta and uterus. Traditionally, the most accurate postmortem tests for detecting MAP have been a combination of histopathologic examination and bacteriologic culture. PCR techniques may offer a higher level of sensitivity, but they do not discriminate between infection and the passive presence of MAP DNA. For most clinical cases of OJD, the demonstration of acid-fast bacilli within typical lesions is sufficient to confirm the diagnosis at necropsy. *M. paratuberculosis* can be detected in tissue sections from formalin-fixed, paraffin-embedded blocks with a PCR using IS900 sequence primers. This is more sensitive than acid-fast and immunohistochemical (IHC) staining.

In adult goats with clinical and subclinical paratuberculosis, the lesions have been divided into four categories: (1) focal lesions with small granulomata in the ileocecal Peyer's patches or related lamina propria; (2) diffuse multibacillary lesions with granulomatous enteritis at different intestinal sites (numerous macrophages containing many mycobacteria are usually present, resulting in macroscopic changes in the normal gut morphology); (3) diffuse lymphocytic lesions, in which the lymphocyte was the main inflammatory cell, with some macrophages; (4) diffuse mixed lesions, in which the infiltrate consisted of numerous lymphocytes and macrophages, with small numbers of mycobacteria. The three types of diffuse lesions are often associated with necrosis in the lymph vessels of the mucosa, mesentery, and lymph nodes, and with greater thickening of the jejunum than of the ileum.

Experimental subclinical infection of goat kids with MAP at several weeks of age and killed 2 years later results in lesions predominantly associated with intestinal segments containing persistent organized lymphoid tissue, with the distal jejunum, and proximal ileum being without lesions.

#### Samples for Confirmation of Diagnosis

- Bacteriology: distal ileum, colon, ileocecal lymph node for culture (with special growth requirements), direct smear using acid-fast stains, and PCR
- Histology: formalin-fixed samples of these tissues (histopathology and PCR)

#### Rabbits

In natural paratuberculosis in rabbits there are no gross lesions suggestive of Johne's disease, and the histologic lesions are either

severe or mild. Severe lesions consist of extensive macrophage granulomata and numerous giant cells, with many intracellular acid-fast bacteria in the small intestine.

### DIFFERENTIAL DIAGNOSIS

The characteristic features of clinical Johne's disease include progressive weight loss, and emaciation in a single animal or group of animals within a mob, and chronic diarrhea, which does not respond to therapy. A definitive diagnosis can be obtained by using a combination of serologic tests, fecal culture, and biopsy of intestine.

#### Sheep and goats

The characteristic features of clinical Johne's disease in sheep and goats are emaciation, weakness, and normal feces with intermittent bouts of mild diarrhea. The other causes of unexplained weight loss in sheep and goats include **caseous lymphadenitis, internal abscesses, gastrointestinal parasitism, caprine arthritis-encephalitis, ovine progressive pneumonia, dietary deficiencies, and dental disease.**

The major difficulty encountered in the diagnosis of Johne's disease is the accurate identification of subclinically infected animals. These are usually negative to the serologic tests but in the intermediate stage of the diseases and excreting the organism in their feces. Thus tests are usually flock-based or herd-based rather than useful for an individual animal. Pooled fecal culture or serologic tests of a cross section of the flock or herd will usually indicate if the infection is present or absent.

### TREATMENT

*M. paratuberculosis* is more resistant to chemotherapeutic agents in vitro than *M. tuberculosis* so prospects for treatment are poor. Because of this lack of efficacy, and the failure of any of the antimicrobials to provide a bacteriologic cure, treatment is not recommended.

### CONTROL

The control of Johne's disease is challenging because of the widespread nature of the organism, long incubation period, and the fact that most cases are subclinical. The available tests lack sufficient sensitivity to identify a large proportion of subclinically infected animals, which allows undetected infection to spread within and between flocks. Because of this low sensitivity, it is currently not possible to eradicate the disease other than by complete depopulation of the flock or herd and restocking with noninfected animals. Thus eradication is usually not practical, both for economic reasons and the difficulties in acquiring noninfected animals. Consequently, the preferred option is to limit economic loss by keeping the disease at a very low prevalence, such as by vaccination. However, a large proportion of flocks vaccinating for more than 5 years still had infected



sheep shedding MAP, so vaccination of young sheep or goats needs to be ongoing to reduce this risk.<sup>57</sup>

Successful control requires a long-term commitment by the flock or herd owner. In addition, because of its subclinical nature, producers often fail to practice adequate control measures because they do not recognize the importance of the disease.

The lack of integrated national control programs in countries in which the disease is endemic also allows the disease to spread continuously from herd to herd and region to region.

### Control on a Flock Basis

The control of Johne's disease is based on two major principles:

- Identification and elimination of infected animals
- Prevention of new infections

For flocks known or thought to be free of Johne's disease, measures should taken to avoid the introduction of infected animals by maintaining a closed herd or by carefully screening purchased animals. The purchase of stock is the most common way MAP is introduced into a flock or herd. Thus purchasing only from flocks or herds documented to be of low risk of Johne's disease is preferable to testing specific animals before introduction because of the low sensitivity of available tests for individual animals. This is difficult because very few countries or jurisdictions have assurance programs, and few livestock producers participate in these.

The control of Johne's disease in sheep flocks has been widely implemented in Australia. This program is based on flock testing and management procedures, such as secure boundary fencing and introducing sheep only from flocks of similar MAP status. Testing is by pooled fecal culture of 350 animals (50 animals per pool), or negative serologic testing (ELISA or AGID) of a sample of 500 animals from the adult flock, defined as animals 2 years or older. This flock-sampling program has a 95% chance of detecting a 2% or greater prevalence of infection. Its purpose is to identify mobs or age groups of sheep that may have been more heavily exposed to infection. These become a priority for culling before they develop a large proportion of clinical cases, preventing further contamination and exposure of susceptible sheep to MAP.

A disadvantage of bacterial culture techniques is the relatively long incubation period needed to obtain results, typically from 2 to 3 months. Consequently, a high-throughput direct qPCR test (the HT-J test) has been developed and validated and was accepted in 2013 as a flock test suitable for use in Johne's disease control programs in Australia and New Zealand.<sup>33</sup>

Eradication by destocking for at least two summers was attempted in Australia, but the disease was often reintroduced in newly

purchased stock. This arose due to a lack of sheep with a known reduced risk of infection and due to relatively low numbers of flocks participating in the Market Assurance Program. Persistence of the organism in the environment, up to 1 year or more, contributes to reinfection. Grazing management to reduce pasture contamination, such as selective grazing with more resistant hosts (e.g., adult cattle) or reducing shade (pasture length) are ways to more rapidly decontaminate paddocks known to be contaminated with MAP.<sup>21</sup>

### Vaccination

Vaccination is now a common method of controlling OJD.<sup>26,37</sup> The most common strategy is to vaccinate the replacement ewes. However, in self-replacing Merino flocks with a high proportion of castrate males (wethers) infection can still be propagated from the unvaccinated portion of the flock, with the prevalence of shedding of MAP organisms from unvaccinated sheep six times that from vaccinates (1.27% versus 0.21%).<sup>38</sup> Mortalities and the proportion of sheep shedding MAP are reduced by up to 90% after the flock is vaccinated, although the response is variable.<sup>26</sup> In a longitudinal study involving 37 flocks, there was a decline in the prevalence of fecal shedding, from 2.72% before vaccination to 0.72% following 5 years of vaccination.<sup>39</sup> However, more than 80% of these flocks had detectable fecal shedding.<sup>37,39</sup> Thus it is advisable for them to continue vaccination, otherwise production losses and mortalities could rapidly increase. A higher initial prevalence of fecal shedding and less stringent biosecurity, such as straying or a greater number of introduced sheep, was associated with a higher prevalence of shedding.

The widespread use of a killed OJD vaccine in a mineral oil adjuvant does have the disadvantage of being a significant occupational health and safety problem, because producers have accidentally self-injected and suffered severe and debilitating injuries, often necessitating the amputation of affected digits or extensive debridement of necrotic tissue.<sup>40</sup> However, vaccination in sheep is not impeded by interference with tuberculin testing, although it will produce positive CF test titers that can interfere with serologic testing for export and diagnostic purposes. Newer vaccines may offer a more targeted cell-mediated immune response and less reactivity, but they are yet to be released commercially.<sup>41</sup>

### Goats

A high prevalence of clinical Johne's disease in goats has been controlled by vaccination using a commercial inactivated vaccine. In small or intensively managed flocks, attempts to control and eradicate the disease have been made by undertaking pooled fecal culture and blood testing two to four times

annually and weighing all goats monthly to detect any individuals losing weight. This is a relatively costly program and has a high risk of failure. Environmental and management changes were also undertaken, including altering trough design to minimize contamination of feed and water, restricting movement of goats between pens, cleaning pens three times weekly, eliminating grazing of pasture, spreading and ploughing manure into fields, isolating young and newly goats from the herd until their test status was determined, and strict attention to disinfection of footwear before entering or exiting barns and pens.

### Control on a Countrywide Basis

There are wide variations in how Johne's disease is controlled by national, state, or provincial agencies. In some jurisdictions, the disease is reportable and in others it is not. In many areas, health certificates are required for interstate or intrastate movement of livestock, and most certificates require a statement that the animals are free of certain diseases. However, often the livestock owner or certifying officer has no knowledge of the presence of Johne's disease, or relatively insensitive serologic tests are used, so infected animals are still traded. Voluntary national and regional Johne's disease control programs for sheep and goat flocks have been introduced in Australia, and the disease is notifiable in many other countries including Greece, the Republic of Ireland, Luxembourg, Norway, Switzerland, Spain, and Sweden. Often the emphasis in the early stages of programs is to control clinical disease.

In Australia, an accreditation program for negative sheep and goat flocks, the Johne's Disease Market Assurance Program (SheepMAP, GoatMAP), was launched in 1999. It is a voluntary, audited, quality assurance program based on negative pooled fecal culture (50 sheep per pool) or serologic testing of a sample of the adult flock (animals 2 years and older). Testing is combined with prudent flock management, such as secure boundary fencing, restricting introduced sheep to flocks with a similar flock status, and abattoir monitoring, to assure owners and clients that participating flocks have a very low risk of being or becoming infected with OJD. SheepMAP is part of a national OJD control program, jointly funded by the sheep industries and Commonwealth and State Governments, and managed by Animal Health Australia. In 1999 a control and surveillance program was enacted for 1 year to limit further spread of OJD and to determine the distribution of this disease. Known infected and suspect flocks were subject to movement restrictions, and movements of sheep onto and off known infected farms were traced and investigated. Proposals for development of a market assurance program and zoning according to prevalence of OJD

within a state, as well as advisory and research programs, were developed as part of the National Ovine Johne's Disease Control and Evaluation Program. By 2000, OJD had been confirmed in every Australian sheep-producing state except Queensland. As part of the control program, some states, such as Victoria, provided an industry-funded subsidy to encourage the use of OJD vaccine in known infected flocks. Subsequently, the program was reviewed and modified, with 5-year programs enacted from 2007 to 2012 and 2013 to 2018.<sup>10</sup> At each time, modifications to zoning were made based on the estimated prevalence of the disease, with a reduction in prevalence areas from four in 2004 (high, medium, low, and very low) to three in 2008 (high, medium, and low), and to none in 2013. In addition, an assurance-based credits (ABC) scheme was introduced to facilitate sheep trading. At first, points were allocated based on the location of a flock (the prevalence area), the use of vaccination, and any whole-flock or part-flock testing undertaken, including monitoring at abattoirs. Subsequently, with the recognition that vaccinated animals can still transmit OJD, because vaccination reduces clinical disease but does not eliminate shedding of MAP, and the abolition of officially recognized prevalence areas in 2013, the ABC system is no longer used to support sheep trading.

Despite the efforts invested by the program, OJD has continued to spread in Australia. This was noted in the review of the 2007 to 2012 program and incorporated into the objectives of the national OJD Plan for 2013 to 2018, which were to (1) minimize the risk of MAP infection spreading to properties and regions that currently appear disease free, and (2) reduce the financial impact and adverse animal health and welfare effects of OJD, both for individual flocks and the sheep industry as a whole.

## FURTHER READING

- Mackintosh CG, Labes RE, Clark RG, de Lisle GW, Griffin JFT. Experimental infection of young red deer (*Cervus elaphus*) with a bovine and an ovine strain of *Mycobacterium avium* subsp. *paratuberculosis*. *N Z Vet J*. 2007;55:23-29.
- Nielsen SS, Toft N. A review of prevalence of paratuberculosis in farmed animals in Europe. *Prev Vet Med*. 2008;88:1-14.
- Over K, Crandall PG, O'Brien CA, Ricke SC. Current perspectives on mycobacterium avium subsp. *Paratuberculosis*, Johne's disease and Crohn's disease: a review. *Crit Rev Microbiol*. 2011;37:141-156.
- Radostits O, et al. Paratuberculosis (Johne's Disease). In: *Veterinary Medicine: A Textbook of the Diseases of Cattle, Horses, Sheep, Goats and Pigs*. 10th ed. London: W.B. Saunders; 2007:1017-1044.
- Stevenson K. Genetic diversity of *Mycobacterium avium* subspecies *paratuberculosis* and the influence of strain type on infection and pathogenesis: a review. *Vet Res*. 2015;46:64.
- Whittington RJ, Begg DJ, de Silva K, Plain KM. Comparative immunological and microbiological

aspects of paratuberculosis as a model of mycobacterial infection. *Vet Immunol Immunopathol*. 2012;148:29-47.

## REFERENCES

1. Stevenson K. *Vet Res*. 2015;46:64.
2. Whittington RJ, et al. *Aust Vet J*. 2000;78:34.
3. Mackintosh CG, et al. *N Z Vet J*. 2007;55:23.
4. Verdugo C, et al. *Prev Vet Med*. 2014;117:436.
5. Verdugo C, et al. *Prev Vet Med*. 2014;117:447.
6. Bush RD, et al. *Aust Vet J*. 2006;84:246.
7. Attili AR, et al. *Vet Med Int*. 2011;78:2875.
8. Dennis MM, et al. *Vet Pathol*. 2011;48:565.
9. Eamens GJ, et al. *Aust Vet J*. 2007;85:243.
10. <<https://www.animalhealthaustralia.com.au/what-we-do/endemic-disease/johnes-disease/>>. Accessed August, 2016.
11. Mackintosh CG, et al. *Vet Microbiol*. 2010;143:255.
12. <<https://www.animalhealthaustralia.com.au/what-we-do/endemic-disease/market-assurance-programs-maps/sheepmap/>>. Accessed August, 2016.
13. Redacliff LA, Whittington RJ. *Vet Microbiol*. 2003;96:247.
14. O'Brien R, et al. *Infect Immun*. 2006;74:3530.
15. Heur C, et al. *Prev Vet Med*. 2012;106:63.
16. Delgado L, et al. *Vet Immunol Immunopathol*. 2012;145:23.
17. Dhand NK, et al. *Prev Vet Med*. 2007;82:51.
18. Lugton I, et al. *Aust Vet J*. 2004;82:490.
19. McGregor H, et al. *Prev Vet Med*. 2012;107:76.
20. Dhand NK, et al. *Prev Vet Med*. 2009;89:110.
21. Whittington RJ, et al. *Appl Environ Microbiol*. 2004;70:2989.
22. Over K, et al. *Crit Rev Microbiol*. 2011;37:141.
23. Whittington RJ, et al. *Vet Immunol Immunopathol*. 2012;148:29.
24. Magombedze G, et al. *PLoS Comp Biol*. 2014;10:e1003414.
25. de Silva K, et al. *Vet Immunol Immunopathol*. 2011;139:10.
26. Windsor P. *Small Rumin Res*. 2013;110:161.
27. Smeed JA, et al. *BMC Vet Res*. 2007;3:18.
28. Nalubamba K, et al. *Microbes Infect*. 2008;10:598.
29. de Silva K, et al. *Vet Immunol Immunopathol*. 2013;156:82.
30. McGregor BA, et al. *Small Rumin Res*. 2015;125:146.
31. Nelli RK, et al. *Vet Rec*. 2008;163:422.
32. Kawaji S, et al. *Vet Microbiol*. 2007;125:36.
33. Plain KM, et al. *J Clin Microbiol*. 2014;52:745.
34. Smith SL, et al. *Vet Pathol*. 2014;51:915.
35. Griffin JFT, et al. *Clin Diagn Lab Immunol*. 2005;12:1401.
36. O'Brien R, et al. *BMC Vet Res*. 2013;9:72.
37. Windsor PA, et al. *Aust Vet J*. 2014;92:263.
38. Eppleston J, et al. *Aust Vet J*. 2011;89:38.
39. Dhand NK, et al. *Prev Vet Med*. 2013;111:81.
40. Windsor PA, et al. *Aust Vet J*. 2005;83:216.
41. Griffin JFT, et al. *Vaccine*. 2009;27:911.

## Viral Diseases of the Ruminant Alimentary Tract

### RINDERPEST (CATTLE PLAGUE)

#### Synopsis of the Disease

Rinderpest, or cattle plague, caused by the rinderpest virus (RPV), was declared globally eradicated in 2011. The disease often occurred as epizootics associated with a very high mortality rate, and its eradication is arguably the greatest veterinary achievement

of our time.<sup>1</sup> Death usually resulted from severe diarrhea/dysentery and dehydration. A detailed account of the disease can be found in the 10th edition of this book. Because RPV is related to other members of the morbillivirus group causing disease in humans (measles), small ruminants (peste des petits ruminants [PPR]), dogs (canine distemper), and some marine mammals and wildlife, some lessons can be learned from a knowledge of the processes and historical background leading to rinderpest eradication.

Several authors have reviewed the history of rinderpest since its eradication.<sup>1-5</sup> Long before its etiology was known, cattle plague was recognized as a most devastating epizootic disease that spread from Asia to Europe, the Middle East, and eventually Africa, initially as a sequel to wars and later through trade-related livestock movements and seasonal migrations for water and pasture (nomadic pastoralists). The disease affected not only cattle but also over 40 other domestic and wildlife species. It is described in ancient Chinese writing, historical Asian drawings, and in documents from the Roman Empire.<sup>4</sup> It had been credited with decimation of native African wildlife and the decline of the European bison.<sup>5</sup> The virus does not cause human disease. Nevertheless, rinderpest was indirectly responsible for countless human deaths resulting from agricultural losses that led to famine, poverty, and disease for centuries.<sup>5</sup> In the nineteenth century, an epidemic in Ethiopia caused rapid loss of virtually all of the cattle, buffaloes, elands, and wild swine, as well as many sheep, goats, and wildlife species, such as antelopes, gazelles, giraffes, hartebeest, and wildebeest and resulted in the Great Ethiopian Famine of 1887 to 1892.<sup>5</sup>

The need to combat rinderpest outbreaks was instrumental in the establishment of the world's first veterinary school in 1762 in Lyon, France, and the Office International des Epizooties (OIE) in 1924, also in France. Furthermore, it led to the development of national veterinary institutions in many parts of the world. With a simple transmission chain and the environmental fragility of the virus, rinderpest was always open to control and even eradication within a zoonosanitary approach.<sup>2</sup>

#### Steps Leading to Eradication

The geographic distribution of the disease had been shrinking steadily since the beginning of the twentieth century. Rinderpest never appeared in North America, and single outbreaks in Brazil and Australia were quickly eradicated. The disease was also eradicated from southern Africa, Europe, and China by the middle of the last century but was still endemic in other parts of Africa (as lineages 1 and 2) and in Asia (as lineage 3). African countries successfully initiated the Joint Project 15 from 1962 to 1976

followed later with a Pan-African Rinderpest Campaign to rid the whole continent of the disease. The initial step was to vaccinate all animals in each national herd annually until the immune status exceeded 90%. Thereafter, calves were vaccinated annually and revaccinated the following year until there were no more outbreaks for at least 5 years. This was followed by periodic surveillance to monitor the immune status of each national herd and to deal quickly with any new outbreaks by control of animal movement and ring vaccination of all surrounding herds. As a result, the disease was cleared from West Africa and most of East Africa, but there was a dangerous resurgence less than 10 years later. Outbreaks of lineage 3 were also occurring occasionally in parts of Asia. In 1994 the Global Rinderpest Eradication Program (GREP) was created to undertake complete eradication of the disease.<sup>4</sup> GREP was funded by the EU, the United States Agency for International Development, the International Atomic Energy Agency, the African Union-Interafrican Bureau of Animal Resources, Food and Agriculture Organization (FAO), and the OIE.<sup>2</sup>

The principal vaccine used to control rinderpest was the tissue culture rinderpest vaccine (TCRV) produced in calf kidney cells for cattle. Plowright and others developed the vaccine in Kabete, Kenya, in 1957. TCRV is easy and cheap to produce and can be freeze-dried or lyophilized; therefore has a long shelf-life before it is reconstituted and it can be refrigerated for a few hours after reconstitution. Furthermore, it is capable of varying degrees of attenuation and is thus safer in all situations. Finally, it produces a life-long immunity and does not spread from vaccinated to in-contact cattle.

One key to global eradication was to ensure that vaccination programs were performed in a synchronized manner across all regions in which the disease was endemic—an objective to which the funding agencies fully subscribed.<sup>2</sup> Innovative strategies were deployed for the last mile to overcome diagnostic and surveillance challenges, unanticipated variations in virus pathogenicity, circulation of disease in wildlife populations, and to service remote and nomadic communities in often unstable states.<sup>1</sup> An example was the situation in the Greater Horn of Africa, a region with weak governance, poor security, and little infrastructure, that presented profound challenges to conventional control methods.<sup>3</sup> However, success was achieved because of the superior vaccine and the application of participatory epidemiologic techniques that allowed veterinary personnel to interact at a grassroots level with cattle herders to more effectively target control measures.<sup>3</sup> The last recorded outbreak of lineage 3 virus was in Pakistan in 2000 and of lineages 1 and 2 in Africa in 2001.<sup>6</sup> Ten years later, and after much surveillance, testing, and certification of disease

freedom, a joint meeting of the 79th General Session of the OIE and the 37th FAO Conference adopted a resolution declaring the “Global Freedom from Rinderpest” on June 28, 2011.<sup>4</sup>

Factors leading to success can be summarized as follows<sup>4</sup>:

1. Although the virus could infect wildlife, it did not have a reservoir of asymptomatic host animals capable of carrying it for prolonged periods;
2. A stable vaccine that provided good immunity was developed.
3. Animals that recovered from infection became immune for life.
4. There was a concerted, well-funded, and unparalleled international response to eradicate rinderpest.

### Lessons From the Eradication

It must be remembered that although rinderpest has been eradicated, the virus still exists in research laboratories in the world. Adequate care should be taken in handling diagnostic specimens to avoid accidental infection and spread. A recent survey revealed that 44 laboratories in 35 countries in different continents were holding laboratory-attenuated strains, field strains, or diagnostic samples of RPV.<sup>7</sup> Rigorous standards are necessary to ensure that stocks are kept under safe conditions. Under intensive system of management, any accidental infection can be easily curtailed and eradicated, but large-scale intentional introduction (agricultural bioterrorism) can have a devastating effect in a fully susceptible livestock and wildlife population before the disease is wiped out again. Nevertheless, the risk of rinderpest reintroduction in the posteradication era is estimated to be very low.<sup>8</sup>

Experience with smallpox eradication in humans was found to be valuable in planning rinderpest eradication even though their viral agents are unrelated. RPV is closely related to the human measles virus (MeV), and there is molecular evidence to suggest that MeV could have originated from RPV around the eleventh to twelfth centuries.<sup>9</sup> Furthermore, PPR in sheep and goats may have also originated from RPV. Therefore the experience with rinderpest should guide in the control of measles in humans and PPR in small ruminants. From the veterinary perspective, the focus is currently on PPR eradication.<sup>10</sup> PPR shares similarities with rinderpest in etiology, epidemiology, pathogenesis, and pathology; there is solid immunity following immunization or recovery from natural infection; and a good vaccine is available. Therefore there is optimism that PPR can be eradicated.<sup>11</sup> The triumph of rinderpest eradication should challenge the current scientific generation to view disease eradication as the ultimate means of control and prevention, to pursue eradication when the tools become available, and to seek to develop those tools when they are not available.<sup>5</sup>

### FURTHER READING

- OIE Manual of Diagnostic Tests and Vaccines for Terrestrial Animals, 2012; Chapter 2.01.15:1.
- Plowright W. *Rinderpest Virus Virology Monographs*. New York: Springer Verlag; 1986:1.
- Radostits O, et al. Rinderpest (cattle plague). In: *Veterinary Medicine: A Textbook of the Disease of Cattle, Horses, Sheep, Goats and Pigs*. 10th ed. London: W.B. Saunders; 2007:1237.
- Rossiter PB, Wamwayi HM. Surveillance and monitoring programmes in the control of rinderpest: a review. *Trop Anim Health Prod*. 1989;21:89.
- Rossiter PB. Rinderpest. In: Coetzer JAW, Tustin RC, eds. *Infectious Diseases of Livestock*. vol 2. 2nd ed. Cape Town: Oxford University Press; 2004:629.

### REFERENCES

1. Roeder P, et al. *Philos Trans R Soc Lond B Biol Sci*. 2013;368(1623):20120139.
2. Njeumi F, et al. *Rev - Off Int Epizoot*. 2012;3:729.
3. Mariner JC, et al. *Science*. 2012;337:1309.
4. Caceres SB. *Can Vet J*. 2011;52:1140.
5. Morens DM, et al. *J Infect Dis*. 2011;204:502.
6. OIE Manual of Diagnostic Tests and Vaccines for Terrestrial Animals, 2012; Chapter 2.01.15:1.
7. Fournie G, et al. *Emerg Infect Dis*. 2013;19:151.
8. Fournie G, et al. *Prev Vet Med*. 2014;113:175.
9. Furuse Y, et al. *Virol J*. 2010;7:52.
10. Liu FX, et al. *Bing Du Xue Bao*. 2012;28:89.
11. De Swart RL, et al. *Curr Opin Virol*. 2012;2:330.

## PESTE DES PETITS RUMINANTS (GOAT PLAGUE, OR KATA)

### SYNOPSIS

**Etiology** Peste des petits ruminants virus, a morbillivirus, four lineages.

**Epidemiology** Contagious disease of goats and sheep; now endemic in western, central, eastern and northern Africa, the Middle East, and Asia. High mortality especially in naive goats.

**Signs** Fever, oculonasal purulent discharge, necrotic stomatitis, diarrhea, and respiratory distress.

**Clinical pathology** Marked leukopenia and hemoconcentration.

**Diagnostic confirmation** Virus neutralization test and immunohistochemistry, polymerase chain reaction..

### Differential diagnosis list

- Rinderpest
- Contagious ecthyma
- Bacterial pneumonias
- Coccidiosis

**Treatment** None generally effective. For valuable animals, hyperimmune serum and symptomatic treatment.

**Control** Segregation of new stock, vaccination with tissue culture or recombinant vaccines. Mass vaccination and coordinated national, regional, and international efforts required for global control and possible eradication as has been done for rinderpest.



## ETIOLOGY

PPR, kata, or goat plague is caused by peste des petits ruminants virus (PPRV), a morbillivirus (family Paramyxoviridae) closely related to the morbilliviruses of rinderpest, measles (in humans), carnivores, and marine mammals. Morbilliviruses are enveloped virions that contain a nonsegmented, negative-stranded RNA genome that encodes a single envelope-associated matrix protein (M), two glycoproteins (hemagglutinin H and fusion protein F), two RNA polymerase-associated proteins (phosphoprotein P and large protein L), and a nucleocapsid protein (N) that encapsulates the viral RNA<sup>1</sup> in addition to two nonstructural proteins C and V. The H and F external glycoproteins are responsible, respectively, for the attachment and the penetration of the virus into the cell to be infected. Both proteins also elicit protection against the disease in infected or vaccinated animals. The viral genomic RNA and N, P, and L proteins form the ribonucleoprotein, which is the minimal essential structure for viral replication in cells.<sup>2</sup>

PPRV has only one serotype but four genetically distinct lineages that are based on the sequence analysis of the F and N genes of various strains of the virus originally isolated from Africa and Asia.<sup>3</sup> Lineage I and II viruses were first isolated from West Africa, lineage III from East Africa, and lineage IV from Asia. Whereas lineages I and II viruses are still largely confined to West Africa, the lineage III virus appears to have spread from East Africa to Sudan, Yemen, and Oman; the lineage IV (Asian) virus has recently been introduced to some African countries including Cameroon, Gabon, Central African Republic, Uganda, Sudan, Egypt, Algeria, and Morocco.<sup>3-6</sup> In Asia, this lineage has been identified in the Middle East and in many South Asian countries, including Pakistan, India, Nepal, Bangladesh, and Tibet/China.

When different isolates of PPRV from outbreaks in Africa and India were investigated for virulence in West African dwarf goats, it was observed that the isolates from Ivory Coast and Guinea (corresponding to lineage I) caused a peracute disease; those from India-Calcutta (lineage IV) caused an acute disease; the Sudan-Sennar strain (lineage III) produced an acute to mild disease; and the Nigerian 75/1 wild strain (lineage II) caused a mild disease and the animals recovered.<sup>7</sup> However, there is considerable variation in virulence within isolates and strains in a given lineage.

Based on genetic differences in the lineages, there have been suggestions that the African and Asian lineages of the virus may have evolved separately. Although PPRV is closely related to rinderpest and measles viruses antigenically,<sup>8</sup> all four PPRV lineages have been shown to be genetically distinct from the RPV, raising some doubt to the notion that PPRV might have evolved from

goat-adapted rinderpest vaccines developed in the first half of the twentieth century.

## EPIDEMIOLOGY

### Occurrence

The disease occurs mostly in goats and sheep and has spread extensively across national and continental boundaries in the last few decades. Outbreaks were first described in West Africa in 1942, but the disease is now endemic in many African countries as well as in the Middle East and South Asia, and there is concern that it could spread to Europe. In Africa, outbreaks have been reported as far north as Morocco, Algeria, and Egypt and as far south as Cameroon, Gabon, Uganda, and Tanzania.<sup>5</sup> Since the 1990s, outbreaks have been reported from the Arabian Peninsula as far north as Turkey and extending through Pakistan and India to Nepal, Bangladesh, and China where the disease is now endemic.<sup>9-11</sup>

It is possible that some of the earlier reports of rinderpest in sheep and goats in Asia might have been PPR outbreaks because the two diseases in these species are not easily distinguishable on clinical examination only. Cattle and pigs develop serum-neutralizing (SN) antibodies but no disease following experimental infection. Natural disease may occur in wild sheep and goats, gazelle, deer, and other small ruminants in zoos or parks, but there are no known reservoirs in domestic animals and wildlife. Phylogenetic analysis of N and F genes so far indicate that all PPRVs isolated from wildlife ungulate outbreaks belong to lineage IV, but the role of wild ungulates in the epidemiology of PPR is still uncertain.<sup>12</sup>

Camels are occasionally infected with PPRV, and the disease can be fatal. Based on clinical signs and detection of antibodies, PPR and RPVs were suspected to be involved in a highly contagious disease of Ethiopian camels in 1995. A fatal disease of camels in Sudan was investigated in 2004 and diagnosed as PPR based on positive results with the agar gel diffusion test, reverse transcription-PCR, and virus isolation in tissue culture.<sup>13</sup>

Outbreaks in sheep and goats invariably occur when new stock is introduced into a farm. In West Africa, this usually takes place when Sahelian goats and sheep thought to have high innate resistance to the virus are moved southward and commingle with the dwarf breeds in the humid and subhumid tropics. Such mingling occurs during seasonal migrations and during religious festivals. Market goats do harbor and can transmit the virus. The first outbreaks in Saudi Arabia were associated with the importation of sheep from Africa or the return of unsold lambs from livestock markets.

In Tanzania, the disease was first introduced to some southern villages in 2009 through newly purchased goats from a

market located about 700 km away in the outskirts of Dar es Salaam city.<sup>14</sup> Factors that contributed to the spread of that outbreak included communal grazing and the cheap prices of sick animals bought by livestock keepers for slaughtering in other villages. In Pakistan, at least one outbreak was traced to the introduction of PPRV-infected sheep and goats from Sindh Province (northwest) to Punjab Province (central) during the flood relief campaign of 2011.<sup>15</sup>

### Morbidity and Case-Fatality Rate

Infection rates in enzootic areas are generally high (above 50%) and can be up to 90% of the flock during outbreaks. The percentage of sheep and goats with antibodies rises with age. The clinical prevalence of PPR in India, as measured by analyzing clinical samples from suspected cases submitted from all over the country between 2003 and 2009, was 20 confirmed outbreaks in sheep, 38 in goats, and 11 in combined sheep and goat populations.<sup>16</sup> Furthermore, PPR was diagnosed in samples from 24.5% of 592 sheep and in 38.2% of 912 goats. The disease is generally more severe in goats than in sheep and is rapidly fatal in young animals.

Case-fatality rates are also much higher in goats (55%-85%) than in sheep (less than 10%). An exception to the rule was the recent (2011) outbreak in Gabon in which the case fatality in sheep was 98.9% (91 of 92 sheep) and only 18.2% in goats (2 of 11 goats).<sup>5</sup> In the Democratic Republic of the Congo, an outbreak in 2012 was reported to have killed over 75,000 goats, and there was the risk of spread to neighboring southern African countries that have not had the disease.<sup>17</sup> In Kurdistan, over 750 wild goats died between August 2010 and February 2011 from PPR, but no disease was reported in domestic animals that had been routinely vaccinated.<sup>18</sup> On the other hand, mortality rate ranged between 0% and 50% with a mean of 7.4% in an outbreak in camels in the Sudan in 2004.<sup>13</sup>

There is no significant seasonal variation in the prevalence of the disease but because maternal antibodies are lost at about 4 months of age, the number of susceptible animals is likely to increase 3 to 4 months after peak kidding and lambing seasons. In India, there are more outbreaks during the summer and in September and October corresponding to the wet season.<sup>16</sup>

### Methods of Transmission

PPRV is transmitted mainly by aerosols when animals live in close contact. Large amounts of the virus are present in exhaled air and in all body excretions and secretions including feces, saliva, ocular and nasal discharges, and urine that can contaminate fomites. Diarrheic feces are especially infectious. Infection is mainly by inhalation but could also occur through the conjunctiva and oral mucosa. Goats experimentally

infected with PPRV can shed the virus a few days during the incubation period.<sup>19</sup> Naturally infected goats can continue to shed virus in feces up to 1 month after vaccination and for 2 months without vaccination.<sup>20</sup>

### Risk Factors and Immune Mechanisms

Kids over 4 months and under 1 year of age are most susceptible to the disease, corresponding to waning maternal antibody from immune dams. The long-legged Sahelian breeds of sheep and goats are thought to be more resistant than the West African dwarf breeds in the humid and subhumid zones. In a particular flock, the risk of an outbreak is greatly increased when a new stock is introduced or when animals are returned unsold from livestock markets. Recovered animals have lifetime immunity.

### Experimental Reproduction

The disease can be experimentally transmitted through close contact with an infected animal or through inoculation of infected tissues or blood. Alpine goats experimentally infected with a Moroccan strain were highly susceptible and the mortality rate approached 100%, as opposed to local breeds of sheep that were less susceptible.<sup>21</sup>

### Economic Importance

PPR is regarded as the most important disease of goats and sheep in all countries in which the disease occurs. In many of those countries, these animals are a major source of animal protein and are reared by nomadic or poor farmers. In view of the fact that the disease has spread to more African and Asian countries, it has been estimated that more than one billion sheep and goats worldwide are at risk of contracting PPR.<sup>6</sup> According to the FAO estimates, the morbidity, mortality, and production losses and treatment cost of PPR altogether will be nearly \$3000 million per year during 2012 to 2017 in the South Asia region.<sup>9</sup> Furthermore, PPR is an important transboundary animal disease and there are concerns it could spread to Europe from Turkey and Morocco.

### Zoonotic Implication

The virus of PPR does not affect humans.

### Biosecurity Concerns

PPR requires close contact with an infected animal for transmission to occur. Nevertheless, because live goats and sheep are traded and may be carried over long distances, the disease can be easily introduced to a new herd or even a new country unknowingly from animals incubating PPR or showing only mild clinical signs.

### PATHOGENESIS

The pathogenesis of the early events following experimental infection of goats with

a PPRV isolate has been recently investigated<sup>19,22</sup> and has been comprehensively reviewed.<sup>9,10</sup> The initial site of virus multiplication is not within epithelial cells of the respiratory mucosa, as had been previously reported for PPRV and RPV, but is within macrophages and dendritic cells and is transported to local lymph nodes for multiplication before the virus enters the circulation and causes a viremia (like the viruses of measles and canine distemper). Following viremia, the virus specifically damages epithelial cells of the alimentary and respiratory systems as well as lymphocytes in the lymphoid system. Infected cells may undergo proliferation and formation of syncytial giant cells before they undergo necrosis/apoptosis.

In goats, death may occur from severe diarrhea and dehydration, before respiratory lesions become severe, or is hastened by concurrent diseases such as pneumonic pasteurellosis, coccidiosis, or coliform enteritis. Lymphoid necrosis is not as marked as in rinderpest, and the possibility of immunosuppression has not been properly investigated. Most sheep and some adult goats recover. Although the nasal mucosa is often affected along with the oral mucosa, lower respiratory involvement is usually a late event, occurring only in the face of high viral load, and may be absent in animals that die early from dehydration or those that recover from a mild disease.

### CLINICAL FINDINGS

The disease can be peracute, acute, or subacute. The peracute and acute forms are seen mainly in goats and are similar to rinderpest in cattle except that severe respiratory distress is a common feature of caprine PPR. Signs generally appear 3 to 6 days after being in contact with an infected animal. A high fever (above 40°C) is accompanied by dullness, sneezing, and serous discharge from the eyes and nostrils. A day or two later, discrete necrotic lesions develop in the mouth and extend over the entire oral mucosa, forming diphtheritic plaques. There is profound halitosis and the animal is unable to eat because of a sore mouth and swollen lips. Nasal and ocular discharges become mucopurulent and the exudate dries up, matting the eyelids and partially occluding the external nares. Diarrhea develops 3 to 4 days after the onset of fever. It is profuse and feces may be mucoid and blood tinged. Dyspnea and coughing occur later, and the respiratory signs are aggravated when there is secondary bacterial pneumonia. Erosions have been described in the vulva and prepuce. Abortions have been reported during outbreaks in India. Death usually occurs within 1 week of the onset of illness and earlier in peracute cases.

Subacute forms are more common in sheep but they also occur in goats. The signs

and lesions are less marked and a few animals may die within 2 weeks, but most recover. Contagious ecthyma (Orf) may complicate the labial lesions or develop in surviving animals.

The clinical disease reported in camels in the Sudan was characterized by sudden death of apparently healthy animals and yellowish and later bloody diarrhea and abortion.<sup>13</sup> That outbreak coincided with seasonal movement of animals toward autumn green pasture. Death was preceded with colic and difficulty in respiration.

### CLINICAL PATHOLOGY

A leukopenia occurs but is transient and not as marked as in rinderpest. As diarrhea develops, there is a progressive hemoconcentration and low serum sodium and potassium.

Diagnostic techniques used in the past were virus neutralization test (VNT), AGID, CF, counter immunoelectrophoresis (CIEP), virus isolation in cell cultures, and animal inoculation. Some are still used on a herd basis, and VNT is the prescribed test for international trade.<sup>23</sup> More recently, competitive or blocking ELISAs (c-ELISAs) have been developed based on monoclonal antibodies specific for the N or H proteins of PPR and RPVs, which enable differential diagnosis of the two viruses. The efficacy of c-ELISA compares very well with the VNT for detection and titration of antibodies to PPRV in goats and sheep. Viral antigen can also be detected in buffy coat, body secretions, feces, lymph nodes, and tonsils by immunocapture ELISA, dot-ELISA methods, and by IHC, AGID, and CIEP methods. PPR viral antigen, unlike that of rinderpest, is still high in tissues of animals dying from the disease. A rapid chromatographic strip test has also been developed for the detection of PPRV at pen side and can be used on eye swabs.<sup>24</sup>

Molecular techniques for detecting PPRV genome are now the preferred methods for definitive diagnosis, lineage determination and typing of PPR outbreaks, and for epidemiologic studies. The techniques are based on the phylogenetic analysis of the N and/or F genes of PPRV by the PCR. Reverse transcription (RT)-PCR assays that target the N gene have been shown to detect all four genetic lineages of PPRV in tissues, ocular and nasal swabs, and in blood and tissue samples collected in the field.<sup>25</sup> Furthermore, a rapid and sensitive real-time (rt) RT-PCR has been described that can detect PPR nucleic acid as early as 3 days and up to 20 days postinfection in swab materials from experimental animals.<sup>26</sup>

### NECROPSY FINDINGS

The carcass is severely dehydrated; the hindquarters are soiled with fluid feces; and crusts of exudate are present around eyes,

nose, and lips. Discrete or extensive areas of erosion, necrosis, and ulceration are present in the oral mucosa, pharynx, and upper esophagus and may extend to the abomasum and distal small intestine. Hemorrhagic ulceration is marked in the ileocecal region, colon, and rectum in which they may produce typical “zebra stripes.” Regional lymph nodes are enlarged and wet and the spleen may be enlarged. Severe lesions are often present throughout the respiratory tract. A mucopurulent exudate extends from the nasal opening to the larynx, whereas the trachea and bronchi may be hyperemic and contain froth caused by pulmonary congestion and edema. An interstitial pneumonia is usually present. Grossly, the pneumonia is diffuse or more commonly, anteroventral or apical. With bacterial complications, there will be purulent or fibrinous bronchopneumonia and pleuritis.

In a recent outbreak of PPR among sheep and goats in India, the common postmortem findings were congestion, red hepatization, raised patches of emphysema in the lungs, hemorrhages and frothy exudates in the trachea, severe enteritis and streaks of hemorrhages in the intestine, enlargement and petechial hemorrhages in the spleen, and edema and inflammation of the mesenteric lymph nodes.<sup>27</sup> The main lesions observed during an outbreak involving camels in the Sudan were lung congestion and consolidation, paleness and fragility of the liver, enlarged lymph nodes, and congestion and hemorrhage of the small intestine and stomach.<sup>13</sup>

Microscopic lesions in the alimentary tract are often very severe. In the early stages, syncytial cells are present in the oral mucosa and intracytoplasmic eosinophilic inclusion bodies in intestinal crypt epithelium. The respiratory tract shows proliferative rhinotracheitis, bronchitis, bronchiolitis, proliferation of type II pneumocytes, and formation of huge syncytial giant cells. Intracytoplasmic and intranuclear inclusion bodies are common in these cells, and viral antigens can be detected in infected cells by immunohistochemistry. Lymphoid organs are depleted of lymphocytes but not usually as marked as in rinderpest.

For diagnostic purposes, specimens should be collected from several live animals and should include swabs of conjunctival, nasal, and buccal mucosae, as well as whole blood in anticoagulant for virus isolation and other tests. At necropsy, the following specimens should be collected for histopathology and virology, including PCR detection:

- Lungs
- Small and large intestines
- Oral mucosa
- Tonsil
- Mesenteric lymph nodes

## DIFFERENTIAL DIAGNOSIS

Other diseases that cause diarrhea or pneumonia in sheep and goats may pose a diagnostic challenge, but a history of recent introduction of new stock and the clinical and postmortem findings of stomatitis, enteritis, and syncytial giant cell pneumonia are typical for peste des petits ruminants. Laboratory tests are required to rule out rinderpest. Other diseases to be considered include the following:

- Heartwater
- Pneumonic pasteurellosis
- Contagious caprine pleuropneumonia in goats
- Contagious bovine pleuropneumonia
- Helminthosis
- Coccidiosis
- Contagious ecthyma
- Possibly Nairobi sheep disease

## TREATMENT

### TREATMENT AND CONTROL

#### Treatment

Hyperimmune serum (valuable animals) (R-2)

#### Control

PPRV vaccine (tissue culture) (R-1)

Rinderpest vaccine (tissue culture) (R-2)

PPRV vaccine (recombinant) (R-2)

*PPRV, peste des petits ruminants virus.*

Treatment of goats showing clinical signs of PPR is of little value and is generally not recommended. However, valuable sick animals in the early stages of the disease could be isolated and given hyperimmune serum, which may be obtained from cattle hyperimmunized against rinderpest. Supportive treatment includes fluid therapy for dehydration and antibiotics to prevent secondary bacterial infections. Lesions around the eyes, nostrils, and mouth should be cleaned and good nursing provided.

## CONTROL

The disease can be prevented by vaccination and by not introducing new stock from unknown sources, especially animals bought at livestock markets. In addition, animals returned unsold from markets should be segregated unless the entire herd or flock has been vaccinated. The TCRP was used for some years before a live-attenuated PPRV vaccine was developed following serial passages in Vero cells in the 1980s. This vaccine is now widely used for the control of PPR in Africa, the Middle East, and Asia. The homologous vaccine has the advantage that it avoids confusion with

rinderpest vaccine when serologic surveys are performed. However, for the purpose of disease eradication, it is difficult to differentiate naturally infected and vaccinated animals when a live-attenuated virus vaccine has been used (the so-called DIVA concept). Furthermore, the vaccine is thermolabile and requires cold chain storage facilities, thus posing a serious problem in many developing countries. In India, a lyophilized, thermo-adapted PPR vaccine has been developed that keeps for 24 to 26 days at ambient temperature (25°C).<sup>28</sup>

Kids and lambs born to immunized or exposed dams should be vaccinated at 3 to 4 months of age by which time maternal antibodies start to wane.<sup>29</sup>

To fulfill the DIVA concept, recombinant vaccines from vaccinia or capripox viruses expressing the F and H protein genes of the RPV have been used for both rinderpest and PPR control. This led to the development of similar recombinant vaccines specific for PPRV. Recently a recombinant PPRV-canine adenovirus vaccine expressing the H gene was shown to elicit a neutralizing antibody response against PPR in goats for up to 7 months.<sup>30</sup> Further studies with the F, H, and F-H fusion proteins of PPRV showed that the recombinant vaccine expressing the F-H proteins was most effective in inducing both humoral and cell-mediated immune responses in goats, and vaccinated goats maintained seroconversion for 21 weeks.<sup>31</sup> The authors suggested that such recombinant vaccines might be a valuable means to differentiate infected from vaccinated animals, which is a useful tool to shorten and reduce the cost of the final eradication of PPR.

Considering the wide distribution of PPRV and its multiple target host species that have an intense mobility, PPRV eradication from the Earth will be a long process that cannot exclusively rely on mass vaccination. Its specific epidemiologic features and socioeconomic considerations will also have to be taken into account, and sustained international, coordinated, and funded strategy based on a regional approach of PPRV control will be the guarantee toward success.<sup>6</sup>

Based on the experience with rinderpest eradication, it has been proposed that the following steps would be required to control PPR in India<sup>32</sup>:

- Focused vaccinations in high-risk populations of sheep and goats
- Mass vaccination campaigns to achieve 70% to 89% herd immunity
- An understanding of the cultural and socioeconomic circumstances of owners
- A keen watch on the endemic nature of PPR in neighboring countries
- Coordinated efforts from all stake holders
- Proper funding and execution of control programs



These steps might be applicable in other countries. PPR shares similarities with rinderpest in such characteristics as etiology, epidemiology, pathogenesis, and pathology; there is solid immunity following immunization or recovery from natural infection; and a good vaccine is available. There is optimism that PPR can eventually be eradicated.<sup>9,10,33</sup> The FAO is playing a crucial role just as it did with successful rinderpest control.

## FURTHER READING

- Balamurugan V, et al. Diagnosis and control of peste des petits ruminants: a comprehensive review. *Virusdisease*. 2014;25:39.
- Kumar N, et al. Peste des petits ruminants virus infection of small ruminants: a comprehensive review. *Viruses*. 2014;6:2287.
- OIE. Manual of Diagnostic Tests and Vaccines for Terrestrial Animals, 2013; Chapter 2.07.11:1.
- Rossiter PB. Peste des petits ruminants. In: Coetzer JAW, Tustin RC, eds. *Infectious Diseases of Livestock*. vol 2. 2nd ed. Cape Town: Oxford University Press; 2004:660.

## REFERENCES

- Sato H, et al. *Front Microbiol*. 2012;3:75.
- Bailey D, et al. *Virus Res*. 2007;126:250.
- Anees M, et al. *BMC Vet Res*. 2013;9:60.
- Kwiatk O, et al. *Emerg Infect Dis*. 2011;17:1223.
- Maganga GD, et al. *Virology*. 2013;10:82.
- Albina E, et al. *Vet Microbiol*. 2013;165:38.
- Couacy-Hymann E, et al. *Vet J*. 2007;173:178.
- Zhai JJ, et al. *Bing Du Xue Bao*. 2010;26:315.
- Kumar N, et al. *Viruses*. 2014;6:2287.
- Balamurugan V, et al. *Virusdisease*. 2014;25:39.
- Wu X, et al. *Virus genes*. 2016;52:3:422.
- Munir M. *Transbound Emerg Dis*. 2013;61:411.
- Khalafalla AI, et al. *Acta Trop*. 2010;116:161.
- Muse EA, et al. *Onderstepoort J Vet Res*. 2012; 79:E1.
- Munir M, et al. *Transbound Emerg Dis*. 2013; 62:108.
- Balamurugan V, et al. *J Vet Sci*. 2012;13:279.
- FAO. (2012) Livestock epidemic causing havoc in Democratic Republic of the Congo: FAO acts to stop spread of disease that has killed 75,000 goats and threatens neighboring countries. 22/08/12. <<http://www.fao.org/news/story/en/item/150317/icode/>>; Accessed 12.07.12.
- Hoffmann B, et al. *Transbound Emerg Dis*. 2012;59:173.
- Couacy-Hymann E, et al. *Prev Vet Med*. 2007; 78:85.
- Abubakar M, et al. *Virus Res*. 2012;167:43.
- Hannouchi M, et al. *Vet Microbiol*. 2012; 160:240.
- Pope RA, et al. *PLoS ONE*. 2013;8:e55830.
- OIE. Manual of Diagnostic Tests and Vaccines for Terrestrial Animals, 2013; Chapter 2.07.11:1.
- Bruning-Richardson A, et al. *J Virol Methods*. 2011;174:42.
- Batten CA, et al. *J Virol Methods*. 2011;171:401.
- Balamurugan V, et al. *Virology*. 2012;27:1.
- Chauhan HC, et al. *Vet Ital*. 2011;47:41.
- Riyesh T, et al. *Virology*. 2011;26:324.
- Balamurugan V, et al. *Virology*. 2012;27:228.
- Qin J, et al. *PLoS ONE*. 2012;7:e37170.
- Wang Y, et al. *Vet Immunol Immunopathol*. 2013;154:1.
- Singh RP. *Rev - Off Int Epizoot*. 2011;30:879.
- De Stewart RL, et al. *Curr Opin Virol*. 2012;2:330.

## BOVINE VIRAL DIARRHEA, MUCOSAL DISEASE, AND BOVINE PESTIVIRUS DISEASE COMPLEX

### SYNOPSIS

**Etiology** Bovine viral diarrhea virus types 1 and 2 and subtypes. Noncytopathic and cytopathic biotypes. Antigenic diversity and cross-reactivity among strains of virus.

**Epidemiology** Worldwide occurrence with major economic importance. Prevalence of infection high in cattle population. Persistently infected calves are a major source of virus. Young and unvaccinated cattle in herd are most susceptible.

**Pathogenesis** Virus causes subacute infections, peracute infections, thrombocytopenia, hemorrhagic syndrome, immunosuppression, and fetal infections, which result in persistent infection until and after birth. Persistently infected cattle are immunotolerant to the BVDV strain they are infected with and may develop mucosal disease.

**Signs** Inapparent subclinical bovine viral diarrhea, acute mucosal disease in persistently infected cattle 6–24 months of age with fever, diarrhea, oral erosions and high case–fatality rate, peracute bovine viral diarrhea in cattle of all ages including adults with severe diarrhea, fever, agalactia and rapid death within few days, thrombocytopenia and hemorrhagic disease, and reproductive failure (decreased conception rate, abortion, stillbirth, weak neonates, and congenital defects).

**Clinical pathology** Leukopenia, lymphopenia. Virus isolation from transiently and persistently infected animals, serology for serum neutralizing antibodies.

**Lesions** Erosive stomatitis and gastroenteritis, depletion of Peyer's patches. Widespread hemorrhages in peracute form. Abortions. Congenital defects of calves (cerebellar hypoplasia and ocular defects).

**Diagnostic confirmation** Virus isolation from blood and tissues. Antigen detection (antigen capture ELISAs and immunohistochemical tests). Polymerase chain reaction amplification of viral RNA. Viral neutralization serum antibody and ELISA tests.

**Differential diagnosis list** Diseases with oral erosions and diarrhea (rinderpest and bovine malignant catarrh). Diseases with oral lesions and no diarrhea (foot-and-mouth disease, vesicular stomatitis, bluetongue, bovine papular stomatitis, and necrotic stomatitis), disease with diarrhea and no oral lesions (salmonellosis, winter dysentery, Johne's disease, copper deficiency, ostertagiasis, coccidiosis, arsenic poisoning, and carbohydrate engorgement).

**Treatment** None.

**Control** Detection and elimination of PI animals from the herd. Prevention of introduction of infection into herd. Vaccination of breeding females to prevent fetal infection. Eradication by detection and elimination of persistently infected animals, no vaccination, and strict biosecurity measures to prevent introduction of PI animals into the herd.

ELISA, enzyme-linked immunosorbent assay.

## ETIOLOGY

Pestiviruses are nonsegmented, enveloped, single-stranded RNA viruses with positive polarity. Phenotypic diversity, such as antigenic variation, infectivity, and replication rates, which can affect viral virulence, can be attributed to genomic reassortments, mutations, or recombinations. The viruses are classified in the virus family Flaviviridae and are members of the genus *Pestivirus*. Although *pestivirus* species are named according to the species from which they were first isolated, most pestiviruses are not host specific.<sup>1</sup>

Currently there are four recognized species of the genus *Pestivirus*:

- Bovine viral diarrhea virus type 1 (BVDV-1)
- Bovine viral diarrhea virus type 2 (BVDV-2)
- Border disease virus of sheep (BDV)
- Classical swine fever virus (CSFV also called hog cholera virus).

Phylogenetic analysis identified 12 subgenotypes for BVDV-1 (BVDV-1a to BVDV-1l) and two subgenotypes for BVDV-2 (BVDV-2a and b).

BVDV-2 genotypes are antigenically distinct, and some isolates cause severe disease outbreaks. Not all BVDV-2 isolates cause clinically severe disease; avirulent strains do exist. Virulent BVDV-2 strains inoculated into calves produce disease characterized by fever, diarrhea, leukopenia, lymphopenia, neutropenia, thrombocytopenia, and death. Infection with avirulent BVDV-2 strains causes leukopenia and low-grade fever.

A tentative fifth pestivirus species is represented by a single virus isolate from a giraffe termed Giraffe-1.<sup>2</sup> In recent years a group of atypical pestiviruses, apparently forming a separate species, termed "HoBi"-like pestiviruses and of which cattle are the most likely host species, have been isolated.<sup>2</sup> Since the first identification of D32/00\_HoBi in 2004, more than eight other related atypical HoBi-like pestivirus strains have been isolated from FCS and from infected cattle in South America and Asia.<sup>2</sup> HoBi-like pestivirus strains might already be circulating in cattle populations outside South America or Asia after having been introduced either with contaminated vaccines produced with infected batches of FCS or imported semen

or embryos.<sup>2</sup> Infection with HoBi-like strains in cattle has been associated with clinical signs similar to BVDV infection and persistent infection, which has led to incentives to rename the HoBi-like species BVDV-3.<sup>3</sup>

Among the ruminant pestiviruses, particularly BVDV-1 and BVDV-2, there are two biotypes designated as **noncytopathic (NCP)** and **cytopathic (CP)**. These biotypes are classified by their ability or lack of ability to cause overt CP change and cell death in cell cultures. NCP biotypes produce little if any visible CP change in cell cultures, and infected cells generally appear normal. CP biotypes, in contrast, cause cellular vacuolation and cell death. The biotype does not make reference to the ability to cause disease in the animal because clinical disease in most cases is caused by the NCP virus strains. The two biotypes of BVDV are not distinguishable serologically. In most cases RNA recombination is responsible for the generation of the CP viruses. A second method is based on the introduction of a set of point mutations within the NS2 gene. The NCP virus is thus the “wild-type” virus predominant in the field, whereas the CP biotypes are rarely encountered in nature and are mainly associated with clinical cases of mucosal disease (MD).

Although virus strains of both biotypes can cross the placenta, to invade the fetus only NCP virus strains can establish persistent infection in the fetus, which is crucial for spread of the virus. It is the cause of a wide range of congenital, enteric, and reproductive diseases. In contrast, the CP biotype of the virus is usually encountered in association with clinical cases of MD in animals already PI with the NCP biotype. Both biotypes can be isolated from animals with clinical MD, and there is evidence that the CP biotype evolves by mutation from the NCP biotype within persistently infected (PI) animals. Genomic recombination can occur in NCP viruses from either genotype resulting in CP viruses. Only NCP BVDVs cause severe acute BVD.

Cross-infection between animal species has been documented for several pestivirus species. **Infections of cattle with BDV** have recently been documented under field conditions resulting not only in seroconversion but also in persistent infection of calves with BDV and incidentally also in clinical cases resembling cases of acute BVD as well as MD.<sup>4,5</sup> This recently recognized possibility of infection of cattle with BDV is likely to present a challenge for the control of BVD in regions in which BVD eradication programs are in place and cattle and sheep are kept in close proximity to each other. **Infections of small ruminants with BVDV-1 and BVDV-2** are common and may even be the primary pathogen causing border disease in sheep in some countries.<sup>2,6</sup> Experimental infection of pigs with BVDV was possible and caused reproductive disease and growth

retardation in piglets. Some strains of the BVDV inoculated into pigs caused false-positive reactions to tests for swine fever antibodies and may protect against subsequent challenge with CSFV. CSFV infections have only been detected in domestic pigs and wild boars thus far.

## EPIDEMIOLOGY

### Occurrence

Diseases associated with the BVDV have been recorded in most countries in which cattle are raised, and in some countries may be the single most important viral infection of cattle. The prevalence of infection is high, but the incidence of clinical MD is low.

The BVDV causes several different diseases including the following:

- Mild BVD, which is usually subclinical
- Fatal MD, which occurs in persistently viremic animals and those specifically immunotolerant as a result of an infection acquired in early fetal life
- Peracute, highly fatal diarrhea
- Thrombocytopenia and hemorrhagic disease
- Reproductive failure
- Congenital abnormalities in calves as a result of fetal infection in midgestation
- Immunosuppression

### Prevalence of Infection

Data of serologic surveys conducted throughout the world suggest that BVDV is endemic in the cattle population of most cattle-producing countries. The prevalence of pestivirus infection in cattle varies greatly between geographic regions and countries because of vaccination practices, population densities of cattle, and housing and management practices. Surveys conducted in North America reported animal-level seroprevalences between 40% and 90% and herd-level prevalences between 28% and 53% depending on the geographic region.<sup>7</sup> In Europe animal-level seroprevalences before implementing control programs ranged from below 1% in Finland, over 19% in Sweden, 46% in Denmark, and 95% in England and Wales. In feedlot cattle in western Canada a mean animal-level seroprevalence of 27% with a range from 0% to 63% was reported.

In dairy heifers a high rate of BVDV infection has been observed between weaning and 9 months of age. The risk of BVDV infection increased from 150 to 260 days of age, which coincided with moving animals from individual calf boxes or hutches to group housing and the waning of the protection from colostral antibodies. In feedlot cattle seroepidemiological surveys revealed that animals seroconvert during the first several weeks following the arrival in the feedlot due to the presence of PI animals.

The estimated mean prevalence of PI animals in herds is about 1% to 2%. The 2007 to 2008 census of the National Animal Health Monitoring System of Beef in the

United States reported an animal-level prevalence in beef cattle (determined on ear notches) of 0.12%. Within herds the prevalence of PI animals ranged between 0% and 16%. The herd-level prevalence of persistent infection was 8.8% of studied beef herds.<sup>8</sup>

Congenital infection with the BVDV during late pregnancy resulting in seroconversion without persistent infection of the fetus at a rate of about 10% has been reported. These calves with congenital infection without persistent infection were found to have a twofold higher risk of a severe illness, compared with calves without congenital infection.

Over a 20-year period in the northwestern United States from 1980 to 2000, there was a shift in disease profiles associated with the BVDV infection and in the age of animal at onset of disease.<sup>9</sup> In 1980 data indicated a low fetal infection rate (<5%), followed by steady increases of clinical cases and peaking at 6 months of age (30%). In contrast, by 2000 BVDV infections resulted in a biphasic occurrence of disease. The first phase was fetal infections with infection rates above 25%, followed by a second phase at 6 months of age (>35%). The changing patterns have been attributed to increased susceptibility of pregnant cattle to BVDV infection and the emergence of the new BVDV-2 species. Over a 2-year period (1998–2000) BVDV-2 isolates were most common and associated with abortion-open cows. BVDV-1a was associated least with early infection (<100 days' gestation) and most with late infections (>100 days); BVDV-1b was intermediate, followed by BVDV-2, which was associated more with early infection (45%) and less with late infections (55%) compared with BVDV 1a and 1b.

Different subtypes of bovine pestiviruses predominate in different geographic regions. Within the U.S. cattle population BVDV-1a, 1b, and 2a are the predominant subtypes. Surveys conducted on material submitted for virus isolation before 2001 reported mean percentage prevalences for BVDV-1a, 1b, and 2a in U.S. cattle herds of 21, 43, and 36%, respectively. In contrast, after 2001 the percentage prevalences of BVDV-1a and 2a decreased markedly, whereas BVDV-1b strains accounted for 75% to 100% of all samples.<sup>11</sup> It was hypothesized that this shift in prevalence of BVDV strains is attributable to the effectiveness of commercial vaccines of which most are based on BVDV-1a and 2a strains.<sup>11</sup> Genetic typing of bovine pestiviruses from both Northern Ireland and the Republic of Ireland revealed BVDV-1a as the most prevalent strain, whereas most strains in England and Wales are BVDV-1b.

### Other Ruminant Species

Pestivirus-associated infection, disease, or both have been described in a wide range of ruminant and other animal species such as cattle, sheep, goats, pigs, bison, alpacas,

llamas, and several captive and free-living ruminant species. Serologic surveys indicate that many species of free-living ruminants in North America, Europe, and Africa such as antelope, giraffe, buffalo, bison, chamois, bighorn sheep, mountain goat, Old World camelids, and various cervidae were exposed to pestivirus with prevalences rates varying by ruminant species and geographic region between below 1% and above 13%.<sup>1</sup> Antibodies against BVDV were found in 31% of free-ranging American bison but less than 1% of European bison. The role of pestiviruses as a causative agent for disease in wild ruminants is unknown, and outbreaks of disease are recorded only occasionally and usually as single fatal cases. The clinical and pathologic findings in some animals are similar to those of MD in cattle.

Although **New World camelids** historically were thought to be largely resistant to pestivirus infection, cases of clinical disease and persistent infection in association with specific bovine pestivirus strains have been documented more recently. Pestivirus infection in llamas and alpacas has been associated with early pregnancy loss, abortion, premature birth, congenital malformations, and persistent infection.<sup>10</sup> Surveys conducted in the United States revealed animal-level prevalences ranging between 0.9% and 11.5%.<sup>10</sup> A census conducted among 63 alpaca herds revealed a herd seroprevalence of 25.4% with 6.3% of all herds having PI crias.<sup>11</sup> The pestivirus strains predominantly isolated in New World Camelids were BVDV-1a and b and BVDV-2.<sup>12</sup> Pestiviruses have also been associated with outbreaks of disease among captive ruminants in zoologic collections.

Border disease in sheep and goats can be caused by three of the four currently recognized species of pestivirus: BDV, BVDV-1, and BVDV-2. The importance of exchange of pestivirus from PI cattle to sheep appears to vary by country. In Norway and Sweden border disease was found to be caused exclusively by BVDV-1, whereas BDV and BVDV-1 were isolated in cases of border disease in the UK. In the United States all three species, BDV, BVDV-1, and BVD-2, were found in sheep.<sup>6</sup>

### Morbidity and Case–Fatality Rates

MD in PI immunotolerant seronegative animals occurs in all classes of cattle mostly between 6 and 24 months of age, rarely in calves as young as 4 months of age, or cattle older than 2 years of age. The incidence of MD in a herd is usually less than 5% of the animals up to 2 years of age. Occasionally, epidemics have been observed in which up to 25% or more of the animals of the most commonly affected age group will develop MD.

Outbreaks of the more recently recognized **peracute BVD** occur in **immunocompetent non-PI animals**, which are

characterized by a high case rate among all clinically affected animals. Morbidity rates may reach 40% and population mortality rates 20%. Herd outbreaks of acute disease associated with BVDV in veal calves caused population mortality rates ranging between herds from 10% to 25%.

### Methods of Transmission

**The major source of infection is the PI viremic animal.** The virus can be isolated from nasal discharge, saliva, semen, feces, urine, tears, and milk, each of which would allow wide dissemination of the virus.

#### Direct Contact

The virus is transmitted by direct contact between animals and by transplacental transmission to the fetus. Discharges from the reproductive tract of an infected cow, either PI or systemically immune, including aborted fetuses, can be potent sources of the virus. Nose-to-nose contact is an effective method of transmitting the virus from PI to susceptible animals. Thus PI animals may introduce the infection into a herd; or when infected animals are mixed with susceptible animals at the time of breeding; or under conditions requiring emergency movement because of drought, flood, or fire. The accidental mixing of a PI bull with susceptible breeding females during the breeding season in a beef herd may result in a major herd outbreak of MD.

Transmission of the virus between healthy immunocompetent animals is probably insignificant because they produce antibodies and eliminate the virus. However, the spread of transmission from transiently viremic cattle to seronegative animals in a dairy herd is slow. Primary infected animals are not effective transmitters of the virus. Susceptible animals introduced into a herd, typically heifers, become infected by contact with persistently viremic animals, and major economic losses can occur if they are at a vulnerable stage of pregnancy. The introduction of an unknown PI cow or heifer into a susceptible herd can also cause major economic losses.

The fetus can be infected by transplacental transmission of the virus from the infected dam, whether the dam is transiently or PI. Fetal infection has been produced by inoculation of nonimmune pregnant dams. Epidemics of abortion and congenital defects of calves have occurred when transplacental virus infection of the fetuses of cows in the first trimester, in previously virus-free herds, has followed the introduction of BVDV-infected animals.

**PI females can remain clinically normal for several years**, during which time they may breed successfully and their progeny may also be apparently normal but are invariably also PI. In this way a maternal viremic family can be established that can persist for several generations and provides

one of the major mechanisms for maintenance of the virus as endemic in the herd.

#### Indirect Contact

##### *Airborne Transmission*

Indirect airborne transmission of the virus can occur in calves housed near a PI calf, without having direct contact. Infection can also occur in calves housed in a pen directly after removal of a PI calf, but without the pen being cleaned and disinfected.

##### *Flies*

The virus has been experimentally transmitted by allowing blood-feeding flies to feed on a PI animal followed by feeding on BVDV-free seronegative recipients. The virus was isolated from some of the flies and from the recipient animals, which also seroconverted.

##### *Fomites*

BVDV has been transmitted from a PI animal to susceptible heifers that were examined per rectum using the same glove. Reusing a hypodermic needle on susceptible animals shortly after the needle had been used on a PI animal or reusing a nose tong shortly after it had been used on a PI animal could also transmit the infection. The virus can be spread by hypodermic needles used on vaccine bottles contaminated by the nasal discharge of PI calves.

##### *Artificial Insemination/Embryo Transfer*

BVDV can be associated with semen, oocytes, oviductal cells, cumulus cells, follicular fluid, or serum used in media for flushing the uterus.<sup>13</sup> The virus survives cryopreservation in liquid nitrogen. BVDV was isolated from semen of transiently and PI bulls without necessarily affecting semen quality. Specifically PI bulls shed large amounts of virus in semen and seronegative cows consistently seroconvert following natural or artificial breeding with semen from a PI bull. In many cases cows conceived and clinically healthy calves were born.<sup>13</sup> Once the infection is established in such a herd there is the potential for its amplification through a secondary cycle of transmission from heifers that were infected from the semen. In transiently infected bulls the virus can persist in the semen for several months after experimental exposure. There is also a record of a postpubertal bull in an artificial insemination unit that was shedding the virus in semen over a period of 11 months while not demonstrating any evidence of viremia but with a high level of serum antibodies. The virus could not be isolated from numerous blood samples and somatic organ tissues, but at necropsy the virus was sequestered in the testes. It was hypothesized that infection occurred shortly before the blood-testes barrier became fully functional, thus allowing the virus to enter the seminiferous



tubules but excluding the ensuing high levels of antibody from the site.

Oocytes or embryos obtained from transiently or PI cows can be contaminated with BVDV virus through infected cumulus cells, follicular fluid, oviductal cells, or uterine fluid. Transfer of embryos of a transiently or PI dam thus presents a risk of infection for the recipient. Several studies showed that transfer of embryos from PI donors can produce clinically normal BVDV-free calves.<sup>13</sup>

#### *Vaccines Contaminated With Bovine Viral Diarrhea Virus*

Because of the widespread use of fetal calf serum (FCS) in the production process of animal cell lines that, among others, are required for vaccine production, contamination of fetal serum with adventitious viruses presents a serious risk. With an estimated prevalence of 1% to 2% of persistent infection in bovine fetuses, BVDV is the most common contaminant of bovine fetal serum.<sup>14</sup> FCS contaminated with BVDV presents a major risk for the production process of modified live vaccines produced for species susceptible to pestivirus infection such as ruminants and pigs.<sup>15</sup> Batches of FCS must undergo a series of tests for the presence of viral contaminants. Contaminated batches are generally not discarded but are subject to an inactivation treatment according to validated methods.<sup>15</sup> Application of a modified live infectious bovine rhinotracheitis (IBR) vaccine contaminated with NCP BVDV-2 to cattle has led to outbreaks of BVD in the past.<sup>16</sup>

### Risk Factors

#### Host Risk Factors

Host factors that influence the clinical outcome of BVDV infection include the following:

- Immune status of the host
  - Immunocompetent or immunotolerant (PI) to the virus
  - If immunocompetent passive immunity (colostral antibodies) or active immunity (previous infection or vaccination)
- Age of the animal
- Pregnancy status
- Gestational age of the fetus
- Presence of stressors
- Presence of concurrent infection

Generally, young cattle are most susceptible to BVDV infection, but adult cattle may develop severe disease if infected with a highly virulent virus strain. Persistent infection can be established only during approximately the first half of fetal life. Compared with many other pathogens, fetal survival following early intrauterine infection with NCP BVDV is common and can be as high as 70%. Unvaccinated animals, improperly vaccinated animals, or animals whose immune status has waned are most

susceptible to infection and the potential for clinical disease. Vaccinated animals may be susceptible if field isolates of the virus are distinct from those used in the vaccine. PI animals are susceptible to the development of MD following superinfection with the homologous CP virus strain. They are also susceptible to other infectious diseases such as pneumonia. Genetic diversity among isolates may account for differences in the clinical response to infection.

#### Environmental and Management Risk Factors

The major management risk factors are the introduction of PI animals into a susceptible herd and the failure of a vaccination program or an inadequate vaccination program. In the recent outbreaks of severe disease in cattle herds in Ontario and Quebec, failure to vaccinate or failure to use the vaccine properly was a common historical finding.

#### Pathogen Risk Factors

BVDV isolates vary genomically, antigenically, and biotypically. These pathogen characteristics are important in the pathogenesis of the different clinical presentation of BVDV infection, the virulence of different virus isolates and the host's immune response to different virus isolates, and the laboratory diagnosis.

The **genetic diversity** among isolates of BVDV is the result of the high frequency of mutation, which is characteristic for single-stranded RNA viruses, the propensity for recombination, and the selective pressure from immune responses stimulated by natural infection or vaccination. The consequences of diversity include diversity of clinical disease, diagnostic difficulties, and vaccination failures.

Different isolates that are antigenically related are immunologically distinct. Differences in neutralizing antibody titers against specific isolates of BVDV are detectable in polyclonal serum from convalescent cattle. Monoclonal antibodies that have neutralizing activity differentiate BVD viruses into several groups. The antigenic variability of this virus may also explain the wide range of lesions and disease complexes that have been observed. The practical consequences of antigenic diversity are that neither natural infection nor vaccination can provide complete protection against most of the naturally occurring strains. There is also considerable cross-reactivity between isolates of the virus, which explains why properly vaccinated animals have considerable immunity.

**Genotypes of pestiviruses** known to be able to infect cattle under field conditions are BVDV-1, BVDV-2, BDV, and the HoBi-like genotype. Whereas BVDV-1 is most often associated with subclinical or mild clinical disease, BVDV-2 isolates are more often isolated from severe clinical cases. Experimentally, BVDV-2 induces the highest degree of

viremia and more pronounced lesions and more extensive distribution of viral antigen compared with BVDV-1, which induced the lowest degree of viremia. In the late 1980s and early 1990s in the northeastern United States, Ontario, and Quebec, virulent BVD virus strains emerged that caused severe acute disease in both calves and adult cattle. The majority of viral isolates were NCP and were typed BVDV-2. Thrombocytopenia and hemorrhagic disease associated with NCP BVDV has been recognized in adult dairy cattle and weaned beef calves. The disease occurred in veal calves in the same geographic area. In addition, highly virulent BVDV are causing severe diarrhea and death in adult cattle with clinical findings and lesions similar to those of acute MD. There are now reports of severe illness resembling acute MD in adult cattle in Great Britain, Germany, and other parts of Central Europe attributed to infections with NCP BVDV-2. Only NCP BVDV has been isolated from these animals. All of the available evidence suggests that these animals are immunocompetent and not PI. Infection of cattle with BVDV has recently been reported resulting in persistent infection, and incidentally clinical disease has recently been recognized.<sup>4,5</sup> Infections with virus strains of the HoBi-like genotype under field conditions have been documented and were associated with the development of persistent infection.<sup>2</sup>

#### Immune Mechanisms

Transient immunosuppression occurs in acutely infected animals. The virus infects cells of the innate immune system affecting the function of neutrophils, monocytes, macrophages, and dendritic cells. Neutrophils are impaired in microbicidal, chemotactic, and antibody-dependent cell-mediated cytotoxicity.

In vitro or in vivo infection with BVDV, either CP or NCP biotype, depresses various aspects of macrophage function that can adversely affect normal defense mechanisms of the lung, facilitating bacterial colonization. In the acquired or adaptive immune response, BVDV infections have their major effect on thymic and follicular T lymphocytes. The effect on the number of circulating T lymphocytes is strain dependent and varies from a mild to severe lymphopenia with highly virulent strains. The virus also affects T-helper lymphocyte and cytotoxic T-lymphocyte responses. BVDV infections have their major effect on follicular B lymphocytes. The effect on the number of circulating B lymphocytes varies, but depletion of B cells occurs in the lymphoid follicles of the lymph nodes with highly virulent NCP BVDV and in Peyer's patches with both MD and highly virulent BVDV infections.

There are four major structural antigenic polypeptides. Glycoprotein E2 is the major glycoprotein and antigenic target for antibodies. E2 is highly antigenic and elicits the

production of neutralizing antibodies in the host after infection or vaccination with modified-live (MLV) or inactivated vaccines. The ability of BVDV antibodies to protect against BVDV infection and the development of long-term virus infection is dependent on the virus strain and the level and isotype of antibodies produced. BVDV antibodies are indicators of the presence of a particular immune response rather than an indicator of a protective immune response. High levels of neutralizing antibodies prevent disease following homologous challenge. However, animals with neutralizing antibodies may develop viremia. Shedding of the virus in nasal secretions may occur in the presence of SN antibodies.

In vitro cross-protection studies with serum from cattle vaccinated with either MLV or inactivated vaccine demonstrated wide cross-neutralization against 12 to 22 different BVDV strains, although this extensive cross-neutralization was not entirely reproducible in vivo in field studies.

The immune response in the calf is influenced by two factors: the development of active immunity and the decay of maternal or passive immunity. Young calves at 10 to 14 days of age seronegative to BVDV can develop a protective immune response following vaccination with MLV vaccine. However, the presence of maternal antibody in calves interfered with the immune response and the animals were not protected from a challenge 4.5 months later. A predictive study estimated that calves must be 142 days of age to become seronegative for BVDV-1 antibodies and 114 days for BVDV-2 antibodies.

Pregnant heifers carrying PI calves develop BVDV antibody titers 5 to 10 times higher than heifers carrying non-PI calves. The inability of NCP BVDV to induce IFN- $\alpha$  in the fetus is one of the major immune evasion mechanisms that allow BVDV to establish persistent infection. The major mechanism for persistence is tolerance of the CD4+ cells. The specificity is very high, because PI animals can respond to homologous virus changes as small as a single amino acid. This explains why some PI animals can develop an antibody response to the homologous virus from the multiple BVDV subtypes. Experimental infection of PI animals with antigenically related CP BVDV resulted in 50% developing MD. Those that did not develop MD had higher levels of circulating gamma-delta T cells before the challenge with CP BVDV.

Following natural infection of seronegative immunocompetent cattle with most of the strains of BVDV that do not cause severe disease, there is a transient viremia; SN antibodies develop within 2 to 3 weeks, peak at 8 to 10 weeks, and remain detectable for many months. The humoral immune response after natural BVDV infection in cattle is considered to be lifelong and includes

antibodies to a range of virus-encoded proteins, including the immunodominant surface glycoprotein gp53 and the highly immunogenic, nonstructural, catalytic serine protease NS2-3. Experimentally and naturally infected animals may have moderate to high levels of SN antibodies to the virus for 3 years after being infected.

The high percentage of animals that are seropositive in the cattle population or in herds that have experienced the disease is due to the presence of PI animals in the herd. Vaccination of immunocompetent cattle with the live virus vaccines induces a broad-spectrum and durable immunity. It is generally accepted that cattle respond to natural infections or vaccination with MLV vaccines with a long-lasting immunity, and it is likely that the immune response includes cell-mediated immunity. Immunization with an inactivated virus vaccine may result in an only short-lived immunity with a narrow antigenic spectrum. Existence of neutralizing antibodies is generally considered to be the most significant predictor of an effective immune response. The presence of neutralizing antibodies in breeding females will protect the fetus against BVDV infection during pregnancy. Passively acquired antibodies, usually IgG, protect against nasopharyngeal shedding of the virus and reduce viremia in challenge-inoculated calves. There is considerable antigenic variation among strains of the virus, but there is also considerable cross-protection against heterotypic strains of the virus.

Colostrum antibodies in calves are detectable at least until 4 to 6 months of age depending on the initial level achieved after the ingestion of colostrum. The half-life of the antibody is 21 days in normal calves, but in PI calves titers decline more rapidly and by 4 to 8 weeks no antibodies may be detectable. About 50% of calves become seronegative for BVDV-2 by 114 days of age. Rate of antibody decay was significantly associated with antibody titer at 1 to 3 days of age and whether calves were congenitally infected with the virus.

PI calves are infected during early fetal life and are born seronegative and immunotolerant to the specific strain of virus in their tissues. Most PI calves remain seronegative to a specific virus but will respond immunologically to other pathogens.

### Economic Importance

BVDV infections are considered one of the economically most important viral infections affecting the dairy and beef industry. Although economic losses are to a large part attributed to increased incidence of reproductive disorders, BVDV infections are known to result in significant production losses originating from impaired calf health, increased risk of infectious disease in adult cattle, decreased milk production, growth retardation in sick non-PI and PI animals,

premature voluntary culling, and mortality losses. Reproductive losses are primarily associated with abortion, congenital defects, stillbirths, increased neonatal mortality, increased occurrence of other infectious diseases, prenatal and postnatal growth retardation, and suboptimal reproductive performance caused by infertility.

Economic losses caused by BVDV infection on a herd level vary depending on the immune status of the population and the pathogenicity of the infecting virus strains. Introduction of the infection into a totally susceptible population invariably causes extensive losses until a state of equilibrium is reached. Infection with highly virulent strains causes severe clinical disease and death. The magnitude of the losses in an infected herd may be expected to fluctuate. They may be relatively large with the occurrence of disease on an epidemic scale after initial horizontal transmission to nonimmune pregnant cows, but they may be considerably lower when endemic infection is maintained in the herd through the presence of viremic families. However, a further phase of high losses may occur should management allow heifers to reach breeding age without being exposed to infection or vaccinated.

Calculation of the losses associated with BVD outbreaks in dairy herds vary widely. Estimates of losses at herd level are often based on case history of "classical" BVD outbreaks in which most infections occur without clinical signs and in which losses mainly are associated with reproductive disorders and persistent infection. These were estimated to range between €21 and 135 per cow in the herd.<sup>17</sup> Outbreaks associated to more virulent BVDV strains causing severe clinical disease have been estimated to be above €340 per animal in the herd.<sup>17</sup> Estimates on a national level from the UK, Norway, and Denmark under endemic conditions range between €8.5 and 34 per calving for the classical BVD infection and €48 per calving for BVD infections associated with highly virulent virus strains.<sup>17</sup>

### PATHOGENESIS

Pathogenesis depends on multiple interactive factors. The consequences of infection with the BVDV are divided into the following categories based on the status of the animal. There is a spectrum of clinical responses based on the host factors and the virulence of the isolates involved.

#### Immunocompetent Nonpregnant Cattle Subclinical Bovine Viral Diarrhea

This is a subacute infection in seronegative, immunocompetent cattle usually after colostrum immunity has waned; it occurs in both sexes and any class of cattle. It is usually a clinically unrecognizable infection with the development of SN antibodies

and elimination of the virus from normal immunocompetent animals. This accounts for the high percentage of normal animals that are serologically positive to the virus. A mild transient clinical disease characterized by inappetence for a few days, depression, fever, mild diarrhea, transient leukopenia, and recovery in a few days may occasionally occur.

In some cases, outbreaks of diarrhea occur in animals ranging from 6 months to 1 year of age, characterized by high morbidity and low or no mortality. The most likely source of infection is PI animals in the herd.

#### Peracute Bovine Viral Diarrhea

In the late 1980s and early 1990s, a peracute form of the enteric form of the disease and thrombocytopenia in young and adult immunocompetent animals infected with highly virulent BVDV-2 strains were recognized. Outbreaks were most common in dairy herds with inadequate vaccination programs and that recently introduced animals into the herd.

#### Thrombocytopenia and Hemorrhagic Syndrome

Thrombocytopenia and the hemorrhagic syndrome occurs in adult cattle and veal calves affected with the peracute form of BVDV infection. Platelet counts are reduced to below 25,000 cells/ $\mu$ L, and clinically there are bloody diarrhea, petechial and ecchymotic hemorrhages of the sclera of the eyes, epistaxis, and abnormal bleeding from injection sites. Hyphema may also occur. Thrombocytopenia caused by destruction of platelets has been reproduced experimentally in young calves by inoculation with NCP BVDV-2 strains, which are the strains most commonly associated with the hemorrhagic syndrome. Experimentally, altered platelet function occurs in calves infected with BVDV-2 but not with BVDV-1 isolates. The important virulence characteristics are duration of neutropenia, severity of thrombocytopenia, delayed increase in proliferating myeloid cells, and the presence of virus in bone marrow precursor cells. Infection of bone marrow megakaryocyte myeloid cells may also be involved. The hypervirulent BVDV-2 genotype induces severe thrombocytopenia, profuse diarrhea, and pneumonia in all experimentally infected calves, whereas none of the BVDV-1 isolates tested induced significant pathologic signs, even though they were isolated from cases of hemorrhagic syndrome. It is suggested that induction of sporadic hemorrhagic syndrome by BVDV-1 requires the presence of other cofactors.

Osteopetrosis, anemia, thrombocytopenia, and bone marrow necrosis can occur in beef calves naturally infected with BVDV-2 strains. Experimental infection of calves with the NCP virus causes thrombocytopenia, whereas CP virus did not.

#### Diarrhea of Neonatal Calves

The causative role of BVDV for diarrhea in neonatal calves is uncertain. Naturally occurring cases of acute neonatal diarrhea caused by infection with the virus in immunocompetent calves under 6 weeks of age have been reported only rarely. PI calves may be unthrifty and be affected with chronic diarrhea and pneumonia as young calves. However, if the virus causes diarrhea in calves the pathogenesis is not clear. Immunocompetent dams provide colostral immunity to their calves, which should have a protective effect during the first months of life. Fatal enteritis has been reproduced experimentally by infecting colostrum-fed and colostrum-deprived neonatal calves with the virus. In older colostrum-fed calves, experimental infection resulted in mild disease with rapid recovery. Experimentally, calves from 7 to 50 days of age with colostral virus neutralizing antibody titers below 1:256 or lower developed a fever and systemic spread of the virus when challenged with the virus. Calves with titers below 1:16 developed severe clinical disease characterized by fever, leukopenia, thrombocytopenia, and diarrhea. The severity and duration of clinical signs decreased as titers of passively acquired viral neutralizing antibody increased. Although antibodies against BVDV are generally widely cross-reactive, maternal antibodies may not protect the calf against all circulating BVD virus strains.

#### Meningoencephalitis

BVDV-2 strain has been isolated from the brain tissue of a 15-month-old heifer with neurologic clinical findings and pathologic evidence of multifocal meningoencephalitis. This suggests a neurovirulent strain of the virus.

#### Immunosuppression

An immunosuppressive effect of BVDV infection is widely accepted, but the underlying mechanisms, the duration, the extent of recovery, and possibly ensuing long-term effects are not entirely understood.<sup>3</sup> BVDV infections with either biotype have been associated with lymphopenia and impaired function of the cells associated with the innate and acquired immune system. A decreased number of circulating lymphocytes can be the result of increased chemotaxis, impaired leukogenesis, or increased cell death. The large number of apoptotic and necrotic lymphocytes observed in infected animals suggests that cell death is a major contributing factor to this effect.<sup>18</sup> Along with a decrease in the number of circulating lymphocytes, BVDV infection also causes depletion of lymphoid tissue such as lymph nodes and Peyer's patches which further contributes to the immunosuppressive effect of BVDV. In addition to reducing lymphoid cell numbers, infection with BVDV hampers the function of immune cells by suppressing

phagocytosis, IFN production, chemotaxis, and microbial killing.<sup>18</sup>

**In Vivo Evidence of Immunosuppression.** Primary postnatal infections cause a transient reduction in the absolute number of T lymphocytes and B lymphocytes and in the percentage of T lymphocytes. The evidence incriminating the virus as a predisposing pathogen in naturally occurring cases of bovine respiratory disease is largely circumstantial. The presence of the virus in the respiratory tract tissues of cattle affected with pneumonia is difficult to interpret. Several different viruses have been incriminated in the cause of acute bovine respiratory disease but experimental evidence to support their involvement has centered on the IBR and PI-3 viruses.

In outbreaks of respiratory disease in calves and adult cattle associated with multiple viral infections, the BVDV is often the most frequent viral agent. This could indicate that the virus is an important contributory pathogen in respiratory disease of cattle.

Experimentally BVDV can facilitate the colonization of *Mannheimia haemolytica* in the lungs, resulting in severe pulmonary lesions. Severe fibrinopurulent bronchopneumonia and pleuritis involving 40% to 75% of lung volume developed in calves experimentally inoculated sequentially with the BVDV and *M. haemolytica*. However, it is also possible that the virus may be coincidentally present in some animals and have no adverse effect. Field observations suggest that following the introduction of BVDV infection into a susceptible herd, there may be an increased incidence of viral and bacterial pneumonia in the calves, which may continue for up to 2 years.

#### Bovine Viral Diarrhea Virus in the Feedlot

There is epidemiologic evidence that BVDV may be one of the most economically important infectious pathogens of feedlot cattle. The immunosuppressive potential of the virus or its synergistic effects with other pathogens are considered to be associated with bovine respiratory disease in feedlot cattle. Individual, unknown PI animals that are purchased and introduced into the feedlot serve as reservoirs of the virus for naive cattle that are subsequently commingled in the feedlot. BVDV has been incriminated in bovine respiratory disease in feedlot cattle from which pathogens such as *M. haemolytica*, *M. bovis*, *Histophilus somni*, and IBR virus, have been isolated from lung lesions.

There is considerable seroepidemiologic evidence that the BVDV titers of feedlot cattle on arrival are associated with subsequent respiratory disease. Cattle arriving with a titer were at decreased risk of respiratory disease; those cattle that seroconverted after arrival were associated with increased



risk of disease. Seroepidemiological studies of undifferentiated fever in recently weaned beef calves arriving in the feedlot indicate that animals arriving with a higher BVDV antibody titer were associated with a decreased risk of undifferentiated fever compared with those with lower levels on arrival. The risk of initial treatment for respiratory disease was 43% greater in cattle exposed to a PI animal compared with those not exposed to PI animals. Overall, 15.9% of initial respiratory tract disease events were attributable to exposure to a PI animal.

Primary BVDV infections occur in feedlot cattle that are not PI and may be the inapparent or subclinical form or the peracute form of the disease. The thrombocytopenic form of BVDV infection has also been described in feedlot cattle.

#### Ovarian Dysfunction

Ovarian dynamics may be changed in cattle infected with BVDV. Ova exposed to the virus *in vitro* can have virus particles attached to the zona pellucida, but the intact zona pellucida protects the developing embryonic cells from infection. However, following removal of the zona pellucida, CP BVDV may have detrimental effects on survivability of blastocysts. Bovine follicular cells and oocytes are permissive to BVDV at all stages of follicular development, and there may be a transient fall in estradiol secretion following acute infection. Both of these may reduce fertility. Infection during the critical period of growth of preovulatory follicles causes varying degrees of necrosis of the granulosa cells, which can result in a spectrum of ovarian dysfunction including retarded follicular growth, delayed ovulation, and anovulation. Return to ovarian function following BVDV infection may take several months in some cases.

#### Immunocompetent Pregnant Cattle and Fetal Infections

Both biotypes of the BVDV can cause significant early reproductive loss in nonimmune pregnant cattle including fertilization failure, embryonic mortality, and abortion. In addition, infection of the fetus with an NCP BVDV strain between 42 and 125 days' gestation may result in PI fetuses, which are carried to term and the calf may be born alive and thrive normally or be unthrifty.

The experimental and clinical observations of the effects of the virus on early parts of the reproductive cycle are conflicting. The virus can be transmitted by natural service or artificial insemination with the possibility of fertilization failure or early embryonic mortality, which in turn leads to repeat breeding. The principal determinant of the outcome of *in utero* infection in cattle is the age of the conceptus and fetus when infection occurs. The BVDV can cause reproductive failure in susceptible cattle during the following stages of the reproductive cycle:

1. **Infection before insemination.** Exposure of cattle to the virus during the estrus cycle before insemination can result in a decrease in conception rate caused by failure of ovulation or delayed ovulation. BVDV has been associated with ovaritis in infertile heifers. PI cows may have morphologic changes in their ovaries, suggesting a reduction in normal ovarian activities. It is not known if similar findings occur in cows acutely infected with the virus.
2. **Insemination of cattle with semen containing bovine pestivirus.** The insemination of seronegative and virus-free heifers with semen containing viable BVDV can result in poor conception rates initially, followed by normal conception following seroconversion to the virus, and the birth of normal calves with no evidence of intrauterine infection. Experimentally, the intrauterine infusion of the virus into cattle at the time of insemination has prevented conception and has been attributed to prevention of fertilization or simply recognized as an empty uterus at 5 weeks after breeding. It seems that intrauterine infection at the time of breeding may have some effects on the very early stages of reproduction, in addition to those that could be attributed to infection by other contact routes. Infection of susceptible cows either 9 days before or soon after insemination can result in a marked reduction in conception rates and significant embryo-fetal loss.
 

The BVDV can be present in the semen of bulls because of a persistent or transient infection of the bull. The semen of a PI bull may be normal, and the pregnancy rates of heifers bred by him may be normal. In other situations the quality of the semen of PI bulls may be abnormal. Acute infection of immunocompetent BVDV seronegative bulls with the virus can result in transient shedding of the virus in semen and to a marked deterioration of semen quality. The amount of virus in the semen of acutely infected bulls is much less than that found in the semen of PI bulls. Experimental acute infection of bulls with the BVDV can result in shedding of the virus in raw, unprocessed, and diluted and extended semen during and after the end of the period of viremia. The most productive sites of virus replication are in the seminal vesicles and prostate gland.
3. **Infection during embryonic period: 0 to 45 days' gestation.** Natural BVDV infection of seronegative heifers 4 days after insemination results in viremia between 8 and 17 days and a decrease in conception rate and pregnancy rate compared with uninfected heifers.

Infected heifers that fail to conceive return to estrus approximately 20 days later. Experimentally there is no indication of impairment of *in vitro* development of bovine embryos when they are exposed to the BVDV. The zona pellucida appears to prevent the virus from gaining access to the embryonic cells.

4. **Infection during late embryonic-early fetal period: 45 to 125 days' gestation.** Following the infection of a nonimmune pregnant animal, both biotypes of the virus are capable of crossing the placental barrier and invading the fetus. In experimental infection of pregnant heifers with an NCP strain of the virus at 85 days' gestation, fetal infection can occur 14 days' postinfection without preceding or simultaneous high concentration of the virus in the uterus or placenta. This supports the proposition that the passage of virus can occur via the vasculature and not via local cell-to-cell spread and that fetal infection can occur in the absence of significant levels of virus in the placenta.

Fetal infection can result in a wide spectrum of abnormalities from death of the fetus to congenital defects, to a persistent infection of the fetus until term and birth of a calf with lifelong infection without clinical signs. The results are mainly dependent on the stage of fetal development at which infection takes place. Generally, the risk for the fetus is highest during early pregnancy. Infection of the fetus from 50 to 100 days' gestation may result in fetal death and expulsion of the fetus (**abortion**) from days to several months after fetal infection or **mummification**. However, fetal survival following infection is common and can be as high as 70%.

**Persistent Viremia. One of the most important effects of BVDV infections of the fetus is the development of PI animals.** If a fetus survives infection with an NCP isolate of the virus occurring approximately between 45 and 125 days' gestation, it will become immunotolerant to the specific virus strain and not develop virus-neutralizing antibodies. The fetus may be carried normally to term, in which case it will invariably be born with a PI. MD occurs in a proportion of these, and only in these, PI animals. From birth to the time of clinical disease, which usually occurs between 6 and 24 months of age, and rarely up to 3 years of age, these animals are persistently viremic and specifically immunotolerant to the homologous strain of the persisting virus. They may appear clinically normal or unthrifty and small for their age. Occasionally, PI cattle may survive and

remain healthy for up to 5 years during which time they shed the virus in their mucous secretions and may be seropositive to a range of BVDV strains, including their own persisting strain. PI animals are infected only with the NCP biotype of the virus, and they excrete large quantities of the virus into the environment and serve as the major source of the NCP virus in a herd. MD was first recognized in 1946 and for the following 35 years it was assumed that the disease was the result of an infection before the onset of illness. It is now clear MD occurs only in PI animals as a result of a congenital infection with an NCP strain of the virus acquired in early fetal life.

Animals that are immunotolerant to the BVDV are immunocompetent to other antigens. They will also produce SN antibody titers, following the administration of commercial MLV-BVDV vaccine and against the vaccine virus as well as other laboratory strains. Furthermore, in spite of this antibody formation, the original virus will persist.

Spontaneous insulin-dependent diabetes mellitus associated with persistent BVDV infection in young cattle has been described. Lesions were present in the pancreatic islet cells. Calves with either transient or persistent infections with BVDV have lower than normal serum concentrations of thyroid hormones which may be associated with the retarded growth.

5. **Infection during fetal period: 125 to 175 days' gestation.** Transplacental infection of the fetus approximately between 125 and 175 days' gestation can result in numerous congenital defects. This period of development corresponds to the final stages of organogenesis of the nervous system and the development of the fetal immune system, which can result in the generation of an inflammatory response to the virus. Congenital abnormalities of the central nervous system along with ocular abnormalities are most common. Other congenital defects include thymic hypoplasia, hypotrichosis, alopecia, curly hair coat, hyena disease, deranged osteogenesis, mandibular brachygnathism, and growth retardation.
6. **Infection during fetal period between 180 days' gestation and term.** Infection of the fetus with BVDV after approximately 150 days' gestation results in a fully competent immune response and elimination of the virus. At birth, the fetus has antibody to the virus but is virus free. The effects of late-gestation infections are not well documented, but abortions, stillbirths, and weak calves are reported.

### Immunotolerant Persistently Infected Cattle

During the postnatal period, **superinfection of PI animals with a CP biotype of the homologous BVDV strain** may precipitate fatal clinical MD. Following the experimental production of MD, the CP biotype of the virus can be found in lesions of the lymphoid tissue of the small and large intestines, in Peyer's patches, in intramural ganglia, and in duodenal glands. Severe tissue damage is also related to the presence of the CP virus. Both biotypes of the virus are present in animals that develop fatal MD.

It is assumed that superinfection with the CP virus strain occurs following a mutation of the NCP virus to the CP biotype within the animal rather than the introduction of a CP virus from outside. Once a homologous CP virus has arisen, it can quickly spread to other PI animals within the same group, and this may explain the rapid development of an outbreak of fatal MD. Recombination between an NCP BVDV-1 virus and a CP BVDV-1 vaccine virus causing MD 3 months after vaccination, a condition termed **post-vaccinal MD**, has been described but is probably rare.

Typical MD occurs within 2 to 3 weeks following development of the antigenically homologous CP virus in the PI animal. The affected cattle do not respond serologically to the homologous CP virus. Superinfection with an antigenically heterologous CP virus does not result in typical, but rather atypical, MD several months later, or not at all, and infected animals respond serologically to the heterologous CP virus.

The pathogenesis of the lesions of MD remains obscure. The viral antigen can be detected in many tissues including the following:

- Lymph nodes
- Peyer's patches
- Ileum and lymphoid tissue in the proximal colon
- Palatine tonsils
- Spleen
- Bronchiolar epithelial cells
- Crypts of the intestinal mucosa
- Salivary glands
- Tongue
- Esophagus
- Skin

The pathologic changes that characterize the disease involve the integument and the epithelia of the respiratory and alimentary tracts as well as lymphoid tissues.

The basic lesion is a small vesicle ulcer that affects only epithelial cells. The erosions occur throughout the following:

- Oral cavity
- Esophagus
- Forestomachs
- Abomasum
- Small intestine
- Cecum
- Colon

Vascular injury leading to vasculitis is a characteristic feature of the disease caused by the pestiviruses, which may explain the type and distribution of the lesions that occur in fatal MD. The vascular injury may be initiated by degenerative changes of the endothelial cells; this may lead to formation of a thrombus, which can detach and circulate as emboli, resulting in generalized vasculitis.

Death from acute MD usually occurs within 2 weeks of the onset of clinical signs, and both CP and NCP isolates of the virus can be recovered from the tissues of affected cattle.

### CLINICAL FINDINGS

#### Inapparent or Subclinical Infection (Bovine Virus Diarrhea)

The most frequent form of BVDV infection in cattle is nonclinical or a mild disease of high morbidity and low case fatality characterized by a mild fever, leukopenia, inappetence and mild diarrhea followed by rapid recovery in a few days and the production of virus-neutralizing antibodies. This form occurs in immunocompetent seronegative cattle that are infected in postnatal life, accounting for the high proportion of adult animals that possess SN antibodies. The literature commonly refers to this subclinical infection as bovine viral diarrhea. A similar infection, with no long-term consequences other than the development of antibody, can occur in fetuses over about 150 to 180 days' gestation.

#### Acute Mucosal Disease

The acute mucosal form of the disease is characterized by the sudden onset of clinical disease in animals in most cases from 6 to 24 months of age that are PI. Depending on the prevalence of persistent infection with BVDV in the herd, several animals in this age group may develop MD over a period of few days or sporadic cases may occur over several weeks or months. Morbidity rates of 44% and case-fatality rates of 100% have been reported in isolated herds. Well-nourished, thrifty, and previously clinically normal animals can be affected. Following outbreaks of MD in a herd, there may be a rapid decline in the number of PI animals born in the subsequent few years because of spread of the infection and development of acquired immunity in the breeding females.

Affected animals are depressed, anorexic, and drool saliva, wetting hair around the mouth. Fever 40°C to 41°C (104°F–105°F), tachycardia, and polypnea are common. Ruminant contractions are usually absent, and a profuse and watery diarrhea occurs 2 to 4 days after the onset of clinical illness. The feces are foul smelling and may contain mucus and variable quantities of blood. Occasionally, small tags of fibrinous intestinal casts are present. Straining at defecation is common, and the perineum is usually stained and smeared with feces.

Lesions of the oral cavity mucosa consist of discrete, shallow erosions, which become confluent, resulting in large areas of necrotic epithelium becoming separated from the mucosa. These erosions occur in the following locations:

- Inside the lips
- On the gums and dental pad
- On the posterior part of the hard palate
- At the commissures of the mouth
- On the tongue

The entire oral cavity may have a “cooked” appearance with the grayish colored necrotic epithelium covering the deep-pink, raw base. Similar lesions occur on the muzzle and may become confluent and covered with scabs and debris. Although the oral lesions are significant in the identification of the disease, they may be absent or difficult to see in up to 20% of affected animals.

There is usually a mucopurulent nasal discharge associated with some minor erosions on the external nares and similar lesions in the pharynx. Lacrimation and corneal edema are sometimes observed. Lameness occurs in some animals and appears to be caused by laminitis, coronitis and erosive lesions of the skin of the interdigital cleft, which commonly affect all four feet.

Dehydration and weakness are progressive and death occurs 5 to 7 days after the onset of signs. In peracute cases, which die within a few days after the onset of illness, the diarrhea may not be evident even though the intestines are distended with fluid. Presumably, there is paralytic ileus and the intestinal fluid is not moved down the intestinal tract.

### Chronic Mucosal Disease

Some acute cases of MD do not die within the expected time of several days and become chronically ill. There may be intermittent bouts of the following:

- Diarrhea
- Inappetence
- Progressive emaciation
- Rough dry hair coat
- Chronic bloat
- Hoof deformities
- Chronic erosions in the oral cavity and on the skin

Shallow erosive lesions covered with scabs can be found on the perineum, around the scrotum, preputial orifice and vulva, between the legs, and at the skin-horn junction around the dew claws, in the interdigital cleft, and at the heels, and there may be extensive scurfiness of the skin. The failure of these skin lesions to heal is an important clinical finding suggesting chronic MD. Chronic cases will sometimes survive for up to 18 months during which time they are unthrifty and ultimately die of chronic inanition.

The chronic clinical form of the disease described earlier must be distinguished from the unthrifty persistently viremic animal described next.

### Unthrifty Persistently Infected Calves

Calves that are born PI may be smaller in body size than their contemporaries and may fail to grow normally. A curly haired coat is characteristic of some PI calves. They may survive and appear unthrifty for several months or more until they develop fatal MD or some other infectious disease such as pneumonia. Although these calves are stunted and unthrifty in appearance, they do not have detectable clinical evidence of MD and they may be seronegative to the BVDV. The birth of a high percentage of PI calves may result in a high incidence of fatal respiratory disease when the calves are 7 to 9 months of age.

### Peracute Bovine Virus Diarrhea

This is a severe form of the enteric form of the disease; it is often highly fatal, occurs in immunocompetent cattle in postnatal life, and is associated with highly virulent isolates of BVDV-2. Dairy herds, beef breeding herds, and beef feedlots have been affected in the outbreaks recorded in Ontario, Quebec, and Pennsylvania (in the United States), and in the UK in the late 1980s and early 1990s. Inadequate biosecurity of animals imported into the herd and the failure to vaccinate for BVDV or an inadequate BVDV vaccination program were common risk factors in affected herds. In affected herds, all ages of cattle are affected including calves, yearlings, and adults. Mortality was highest in the young-age groups.

The most common complaint given by the owners was the presence of respiratory disease in affected animals. The outbreaks were slowly progressive and lasted for several weeks. Severe depression, respiratory distress, anorexia, profuse watery diarrhea, dysentery, conjunctivitis, fever up to 42.0°C, andagalactia in adult lactating dairy cows were common. Oral erosions were inconsistent. Abortion, usually in late gestation, was a common but inconsistent occurrence. Morbidity rates may be up to 40%, and crude mortality rates may reach 25%. Many animals may die within a few days after the onset of clinical signs, and PI calves were commonly born several months following the outbreaks.

### Thrombocytopenia and Hemorrhagic Disease

Thrombocytopenia and hemorrhagic disease have been associated with NCP BVDV-2 strains but whether or not the affected animals were previously PI is uncertain; only NCP BVDVs have been isolated. Bloody diarrhea, petechial and ecchymotic hemorrhages of the visible mucosae, hyphema, epistaxis, and prolonged bleeding from injection sites or insect bites have been observed. Cattle have platelet counts of less than 25,000 cells/ $\mu$ L and clinically there is bloody diarrhea. Fever, diarrhea, rumen stasis, and dehydration are also common.

The case-fatality rate is approximately 25%; survivors can recover and thrive normally or remain unthrifty. A similar syndrome of thrombocytopenia has been described in weaned beef calves, but the virus could not be isolated from affected calves.

### Reproductive Failure and Neonatal Disease

The introduction of BVDV infection into groups of susceptible breeding females around the time of insemination and during the embryonic early to midfetal period can result in conception failure; increased embryonic mortality; fetal mummification; abortion; premature births; stillbirths; congenital defects; the birth of stunted weak calves; and the birth of PI calves, which subsequently may develop MD. Following introduction of infection into a beef herd, losses may be insidious and characterized by reduced pregnancy rates, abortions, excessive postnatal calf losses, and the premature culling of young cows because of their failure to wean a well-grown calf. These losses, including those from MD in PI animals, may continue for 2 to 4 years. Studies in dairy herds in Switzerland indicate that infection with the virus during the first 45 days' gestation did not influence the rate of return to estrus. In contrast, there was an increase in the abortion rate in midterm gestation (days 46–210), whereas no such effect occurred in animals that seroconverted during the later stages of gestation. At least 7% of fetal deaths were attributable to infection with the virus.

A large-scale assessment of the effect associated with BVDV infection on fertility of dairy cows in France found that the virus was associated with an increase in the risk of embryonic death and fetal death.

Under field conditions, the effect of sub-clinical BVDV infection on subsequent dairy heifer fertility may be caused by a complex interrelationship among multiple BVDV infections dependent on the type of and timing of infection relative to reproductive performance. A high BVDV-2 antibody titer in dairy heifers at 10 months of age was associated with 32 more days to conceive, compared with a low titer. Conversely, infection with BVDV by 5 to 6 months of age and a high BVDV-2 titer 1 month before conception or breeding was associated with improved fertility. Heifers with evidence of congenital BVDV infection had lower fertility than noninfected heifers, which depended on BVDV-2 titers at 10 months of age.

In beef herds, although abortions caused by BVDV may occur at any time during gestation, typically several cows in a herd abort during a short period of time before the start of the calving season. At the beginning of the calving season, premature births and stillbirths occur. Some calves are born alive, take a few breaths, and then die. Weak calves are generally born during the first 2 to 4 weeks of the calving season. Affected calves are



weak and flaccid at birth and may appear small or normal. Death usually occurs within several hours despite intensive care and the feeding of colostrum. In a study of health and performance in Sweden, the risks for clinical mastitis, retained placenta, and estrus-stimulating treatments were higher, and the calving intervals were longer in those herds with an increasing or maintained high prevalence of BVDV antibody-positive cows.

### Congenital Defects in Calves

The following congenital defects have been associated with fetal BVDV infection<sup>19</sup>:

- Cerebellar hypoplasia
- Microencephalopathy
- Hydrocephalus
- Hydroanencephaly
- Porencephaly
- Hypomyelination
- Cataracts
- Microphthalmia
- Retinal degeneration
- Optic neuritis
- Thymic hypoplasia
- Hypotrichosis/alopecia
- Deranged osteogenesis
- Mandibular brachygnathism
- Growth retardation

Cerebellar hypoplasia was the first recognized teratogenic effects of the virus and has been well documented. At birth, affected calves exhibit varying degrees of severity of ataxia, wide-based stance, stumbling gait, and falling backward when attempting to walk. Mildly affected calves may survive if hand fed and managed carefully, but severely affected cases usually die or are euthanized. Defects of the eyes result in varying degrees of blindness; the cataracts are obvious when they occur. Calves may be smaller than normal and have a curly hair coat.

### CLINICAL PATHOLOGY

The clinical diagnosis of MD is usually made on the basis of the presence of characteristic clinical and pathologic findings. A severe leukopenia and lymphopenia is characteristic of acute MD. The decrease is usually to below 50% of normal and total leukocyte counts of 1000 to 3000 cells/ $\mu$ L are common and may persist for weeks.

The laboratory diagnosis of BVDV infections relies on the isolation or detection of the virus or components and/or the demonstration of a serologic response to the virus. The type of samples to be submitted depends on the clinical and herd history and whether acute or persistent infections are suspected. The vaccination history is needed to interpret laboratory results.

### Virus Isolation

Despite recent advances in BVDV diagnostic science, culture and identification of the BVDV from clinical specimens remains the gold standard diagnostic technique. Strains of virus can be characterized *in vitro* as CP or

NCP biotypes. CP strains cause characteristic *in vitro* cell changes that are evident in inoculated cell cultures within 48 hours. Most BVDV isolates obtained from field cases are NCP in cell culture. The isolated virus is recognized by identifying viral antigen in positive cell cultures by immunofluorescence or immunoenzyme staining. Virus isolation can be attempted by inoculation of nasopharyngeal and ocular swabs, semen, intestinal tissues, spleen, or most other tissues, or the buffy coat or serum of blood to cell cultures. In the live animal, the best sample for BVDV isolation is whole blood from which white blood cells (buffy coat) are extracted and used as inoculum. Along with the sample type, the timing of sample collection relative to the time of infection is important to maximize the chance for successful virus isolation specifically in transiently infected animals. Both CP and NCP viruses have been isolated from the spleen or blood of individual cattle with MD. Whole blood or serum from PI animals is used for the isolation of the virus.

For handling of large numbers of samples such as in a whole-herd screening for PI animals, a microtiter virus isolation method, the immunoperoxidase monolayer assay (IPMA), using serum as the diagnostic specimen is widely used. The assay requires approximately 5 to 7 working days, which allows for two passages to be completed. The main limitation of IPMA in PI testing is its nonapplicability on sera from animals under 3 months of age in which maternal antibodies can interfere with growth of the virus in cell cultures. Some adult PI cattle have been IPMA negative on serum but virus can still be isolated from the buffy coat cells. However, the prevalence of such animals is extremely low, and IPMA is widely accepted as a reliable test for detecting PI cattle of 3 months or older.

The **indirect immunoperoxidase staining technique** is recommended for certification of BVDV-free bovine semen for artificial insemination units when the immunofluorescent test is not available.

### Antigen Detection

**Immunofluorescence or Immunohistochemistry.** The BVDV antigen can be identified rapidly in tissue samples using IHC methods such as immunofluorescence or immunoenzyme staining. A monoclonal antibody 15C5, which reacts with the E0 protein, has been shown to react broadly with most strains of BVDV and can be used to detect BVDV antigen in formalin-fixed, paraffin-embedded tissues. This has broad diagnostic and research applications. Using these methods, the identification of BVDV antigen in fixed tissues can be used as positive laboratory confirmation of BVDV infection without positive virus isolation and is useful when investigating disease syndromes such as enteric disease, respiratory tract disease, and reproductive tract disease.

**Skin Biopsy.** IHC staining for BVDV in formalin-fixed, paraffin-embedded skin biopsies is an effective method for the diagnosis of PI cattle because BVD antigens are present in large quantities in epithelial cells of the skin in persistently but not transiently infected cattle.<sup>20</sup> The technique is an easy, accurate, and affordable antemortem diagnostic test for the detection of PI animals that is not affected by the presence of maternal antibodies. It is suitable for herd screening because samples can be taken from cattle of any age, sample collection is simple, the samples are stable for transport and handling, and the test is both sensitive and specific for BVDV PI cattle. Positive IHC staining is most pronounced in the keratinocytes and in the hair follicle epithelium, hair matrix cells of the hair bulb, and the dermal papilla. IHC on skin samples is an effective method for screening neonatal calves for persistent infection. Skin samples from cattle with acute BVDV infection or transient infection may stain positive with IHC, but the distribution of staining is confined to the epidermal keratinocytes and follicular ostia, in contrast to PI animals with antigen-positive staining cells in all layers of the epidermis. Identification of PI animals is therefore possible with one single skin biopsy sample. Uncertain cases should be retested a few weeks after the first test.

A **monoclonal antigen-capture ELISA (ACE) test** is capable of rapidly and accurately detecting pestivirus-specific antigens in peripheral blood leukocytes, blood clots, milk, and tissue samples of PI cattle. It has demonstrated good agreement with conventional virus isolation procedures and is suitable for routine diagnostic and certification testing. Antigens used in those ELISA are highly conserved among BVDV strains, ensuring that most strains are recognized. Nonetheless one viral variant escaping detection by IHC staining and ACE has been identified, and the prevalence of similar viral variants in the field is not known.<sup>3</sup> Monoclonal antibody techniques have also been used to detect the virus antigen in the central nervous system of PI cattle. Four commercially available ELISAs for the detection of BVDV antigen in the blood of PI cattle have been compared and are highly sensitive and specific and considered valuable in eradication programs when monitoring large numbers of animals. The ACE is most commonly run on serum which, through the presence of maternal polyclonal BVDV antibodies, has the potential to block antigen detection. In order to circumvent problems resulting from interference of maternal antibodies with ACE in very young calves, this test is not recommended for calves less than 3 months of age.<sup>20</sup> Skin biopsies or ear notches became popular specimens for ACE because viral antigen detection in skin is not affected by the presence of maternal antibodies. Most commercially available tests are

not designed to detect transiently infected animals; thus positive animals are frequently referred to as PI animals after a single test. Nonetheless positive results on acutely infected animals have infrequently been reported.<sup>20</sup>

### Polymerase Chain Reaction Amplification

PCR amplification of an RNA genome involves the binding of specific DNA oligonucleotides to cDNA target sequences, resulting in amplification of size-specific DNA fragments that are detectable by gel electrophoresis.

The PCR test is able to detect small amounts of viral nucleic acid from samples of blood and tissues including preserved material. Factors such as cost, technical expertise, equipment and automation, and RNA extraction methods are considerations when comparing with the standard methods of virus isolation.

The reverse transcriptase (RT)-PCR amplification has gained widespread use as a routine diagnostic method for BVDV. The high analytical sensitivity of RT-PCR allows for pooling of specimens to reduce unit cost test. Pooling is especially applicable for persistent infection testing in which a single positive specimen can still be detected in a pool of several dozen samples. A positive RT-PCR does not define the clinical status of an animal because it detects transiently and PI animals as well as animals vaccinated with a modified live BVD vaccine. Follow-up tests after 2 to 3 weeks are required to identify PI animals. The high sensitivity of this analytical method makes RT-PCR more susceptible to false-positive results from contamination.

The RT-PCR test has been used to detect the presence of the BVDV in somatic cells from bulk milk samples. Compared with existing methods, RT-PCR showed 100% specificity and sensitivity in detecting PI lactating cattle in milking herds.

The RT-nested PCR (RT-nPCR) assay is a rapid and sensitive method to detect BVDV in extended semen samples. Although the prevalence of persistent testicular infection with BVDV is very low, use of the rapid, sensitive RT-nPCR assay on extended semen samples can be used to ensure that the virus is not transmitted in cryopreserved semen.

### Serology

Serologic techniques are used to detect and measure antibodies. Following acute infection, serum antibodies are first detectable at 2 to 3 weeks, and peak antibody levels occur 8 to 10 weeks later. Following successful vaccination, SN titers will be high for many months.

PI animals are frequently seronegative but can be seropositive because of the presence of colostral antibodies, exposure to a BVD field strain that is heterologous

to the persistent strain, or vaccination with a vaccine containing heterologous virus strains. Antibodies are usually not detectable in the sera of most cattle with MD. The specific immune tolerance of the persisting virus is also not broken by the CP virus if it is antigenically similar or identical to the persisting virus and results in fatal MD.

Precolostral serum from calves infected in utero as immunocompetent fetuses may have virus-specific neutralizing antibodies, and their demonstration is meaningful for the diagnosis of past infection.

In North America the serum neutralization test is the most frequently used BVD serology test, whereas in Europe the antibody ELISA is also widely used as serologic test for BVD.

### Serum Neutralization Test

The **serum neutralization test** has been the standard test to determine the occurrence of a rising BVDV titer between acute and convalescent sera. The serum neutralization test gives endpoint values that may be more biologically relevant and it is the only test that assesses antibody status regarding BVD virus strain variation.<sup>20</sup> The test is performed in microtiter plates and takes 3 to 5 days to complete and is relatively simple to interpret. A CP virus is used to easily detect the neutralization of the virus. Because of the different virus strains and cell systems used, results can vary considerably between different laboratories.

### Antibody Enzyme-Linked Immunosorbent Assay

ELISAs are available to measure serum antibodies to BVDV and are a rapid and economical alternative to the serum neutralization test. The ELISA simply determines the presence or absence of BVDV virus antibodies, which is often considered of limited value in regions with high infection prevalence and common vaccination as seen in North America. In contrast in regions with BVD control programs in place and limited use of vaccines, the antibody ELISA presents a useful diagnostic tool. The blocking ELISA for BVDV antibodies is a simple, rapid, and reliable test for the detection of specific antibodies in serum, plasma, or bulk tank milk. Test results correlate well with VNT results and may be useful for large-scale screening and eradication programs.

Using a blocking ELISA test, the level of antibodies in bulk milk is a valuable aid to indicate the infectious status of a dairy herd and for identifying herds suspected of harboring an active infection. A herd with two consecutive bulk milk results 4 months apart of 60% (percentage inhibition) is more likely to have a very high percentage of infection. Testing of bulk tank milk for antibody using the ELISA can be used to determine the prevalence of dairy herds with antibodies; the relationships between the ELISA values

in bulk milk and the location, milk yields, and somatic cell counts of the herds; the annual incidence risk of new infections; and combined with the RT-PCR to detect viral RNA, it can be used to obtain an estimate of the herd prevalence of lactating PI animals.

### Use of Laboratory Tests in the Herd

Because of the complex nature of BVDV infections, it is often difficult to obtain a definitive etiologic diagnosis. The type of samples to be submitted to the laboratory and the interpretation of the results depend on clinical and herd history and the vaccination status of the herd. The testing strategies to be used will depend on the specific disease history of the herd, the age of animals to be tested, the cost of the test, the needs of the owner of the herd, and the reasons for doing the testing.

### Acute Infections

The diagnosis of acute infections by virus isolation must be done as early as 3 days after infection to 8 to 10 days after infection. A whole-blood sample is the best sample for virus isolation to identify acutely infected animals. Other specimens such as serum, nasal swabs, feces, semen, or different tissue may be less suitable because of a possible interference by neutralizing antibodies. In herd outbreaks, blood samples from normal animals should also be submitted. For serology, paired acute and convalescent samples collected 30 days apart are required to identify a fourfold increase in serum antibody titers. In abortions, the dam may have already seroconverted before the abortion and there may be no seroconversion between acute and convalescent sera. However, some aborted fetuses may be serologically positive, which confirms intrauterine infection in the later part of fetal life. If the dam is negative, BVDV can be ruled out as a cause of abortion. Calves born with congenital defects may have antibodies, but blood samples must be taken before the ingestion of colostrum.

### Persistently Infected Animals

The PI animals in a herd can be identified using any or a combination of the following testing procedures:

1. Collect whole blood from all animals in the herd including calves to conduct virus isolation, ACE, or RT-PCR. Virus can be isolated from mononuclear cells in the buffy coat. Virus in mononuclear cells is unaffected by colostral antibodies. An RT-PCR can be done on pools of whole blood or on individual animal samples, which is very expensive. Because of its high sensitivity PCR will also detect transiently infected animals. Follow-up testing is required to define the status of positive animals as PI.
2. Collect serum on all animals over 3 months of age. Test younger calves as they age or use an alternative test. With

serum testing colostral antibodies may interfere with the test or eliminating detectable virus from the fluid fraction of blood for some variable period of time. Tests that can be done on serum include the microplate virus isolation, antigen-capture ELISA, or RT-PCR.

Although ACEs are not developed to identify acutely infected animals, these occasionally may yield positive results. When using a single sample, there is thus a chance to label an acutely infected animal as PI. Animals tested positive with RT-PCR must be retested after 3 weeks to confirm PI status.

3. Collect skin biopsies (ear notches) from all animals in the herd including calves. The tests of choice are the IHC on formalin-fixed tissues or ACE using fresh samples. Use of fresh tissue samples eliminates the need for formalin. A single positive test is confirmative for PI status.
4. For dairy herds, collect composite milk samples from lactating cows and screen the remainder of herd using procedure 1 or 3 in this list. Somatic cells from the milk are screened for the virus by RT-PCR or virus isolation. Positive animals must be retested after 3 weeks to confirm PI status.
5. Test calves as they are born with 1 or 3 in this list. If the producer has accurate calving records, the determination that the calf is not PI automatically defines the status of the dam as not being PI. Using this protocol, ongoing surveillance is maintained with a single test defining the status of two animals. For dairy herds, bull calves must be tested as well as the heifer calves to achieve a complete herd screening program.

By testing 30 days apart, it is also possible to test for a fourfold increase in antibody titer should the first virus isolation be the result of an acute infection. In most cases, serum is adequate for virus isolation in PI animals. In young calves under 3 months of age, colostral antibody may decrease the level of free virus in the serum and may result in a false-negative test. For this reason, the use of whole blood, which allows isolation of the virus from the buffy coat, is recommended in calves under 3 months of age.

Most PI animals are seronegative after the colostral immunity has waned, but they may develop SN antibodies to heterologous strains of the virus.

#### Prenatal Diagnosis of Persistent Infection

Pregnant dams with PI fetuses (PI carriers) have exceptionally high antibody titers. Testing pregnant dams can be used to identify and exclude PI carriers from livestock markets without completely blocking the trade with pregnant seropositive cattle.

Testing is most reliable when done in late pregnancy (not before the seventh month of gestation). In dams carrying PI fetuses, the immune response was markedly higher than those in dams carrying uninfected fetuses.

The BVDV has also been detected in amniotic and/or allantoic fluid from both cattle and sheep with infected fetuses. A blind puncture technique for collection of fetal fluid in late pregnancy is used to collect fetal fluid. The site of collection is over the right ventral abdominal wall approximately 10 cm cranial of the udder and 10 cm medial of the flank. A nested PCR test is used to amplify the viral RNA.

#### Herd Screening

When a diagnosis of BVDV infection has been made in a herd, for example in the case of MD in a yearling, then further investigation for the detection of infected animals at the herd level is indicated. The most common strategy for herd screening is to submit serum samples from all animals over 3 months of age and whole-blood samples from calves under 3 months of age. All animals in the herd should be tested. The samples may be tested for SN antibodies and/or the presence of the virus. Virus isolation using the microtiter immunoperoxidase test and ACE are the most common methods used for large numbers of samples. Milking cows may be tested through a bulk tank milk sample analyzed with PCR. Calves born for the next 9 months should also be tested to detect any additional PI animals born that may have been infected in utero at the time of the herd infection. The goal is to ensure that no additional PI animals appear and that the maternal–fetal transmission cycle is broken. In herds in which cases of MD have been recognized, most of the normal animals will have high levels of SN titers.

During the 9- to 12-month period of testing, management strategies should ensure that all young stock and breeding females are not in contact with infected animals. However, in some countries in which vaccines are unavailable, breeding females are placed in direct contact with PI animals before the breeding season as a method of natural vaccination.

The serologic evaluation of unvaccinated heifers 6 to 12 months of age is an accurate method for identifying herds containing PI animals. Both BVDV-1 and BVDV-2 antibody titers should be determined to prevent misclassification. In regions in which border disease is endemic and cattle are kept together with small ruminants, testing for BDV antibody titers may also be indicated.<sup>5</sup> The sensitivity and specificity of serologic evaluation of five heifers for identifying these herds were 66% and 100%, respectively, in herds that contained PI cattle. Pooled-sample testing using PCR/probe testing can be used as a herd screening test for detection of BVDV PI cattle. Whole-herd screening by use of one of

the methods for detecting virus or viral antigens such as IHC of skin (ear notch) specimens is required for detection and elimination of PI animals with BVDV in a herd.

#### NECROPSY FINDINGS

##### Acute Mucosal Disease

The gross abnormalities are usually confined to the alimentary tract. Characteristic shallow erosions with very little inflammation around them and with a raw, red base are present on the muzzle, in the mouth, and to a lesser extent in the pharynx, larynx, and posterior nares. In the esophagus these erosions are linear in shape and lie in the direction of the folds of the esophageal mucosa. Erosive lesions may be present in the fore-stomachs, but are usually confined to the pillars of the rumen and the leaves of the omasum. Histologically, the lesions of the squamous mucosa of the alimentary tract begin with necrosis of individual cells and groups of cells. These foci enlarge and result in areas of necrosis with little or no inflammation of the lamina propria. If the necrotic foci are abraded, erosions and ulcers develop. In the abomasum, there is often a marked erythema of the mucosa accompanied by multiple submucosal hemorrhages and gross edema of the wall. Erosions and ulcers are common on the sides of the rugae of the abomasum and may be punctuate or more than 1 cm in diameter. The lesions have raised margins with a distinct pale halo. Histologically, there is epithelial necrosis of the deep parts of the glandular epithelium.

The mucosa of the small intestine often appears normal except for patchy or diffuse congestion and edema in some cases. In cases with a short clinical course it is common to find coagulated blood and fibrin overlying and outlining the mucosal aspect of Peyer's patches, which are also eroded. This is a very distinctive lesion that is paralleled only by rinderpest and sometimes bovine malignant catarrh. Severely affected Peyer's patches may be obvious through the serosa as red-black oval areas up to 10 to 12 cm long on the antimesenteric border of the intestine. In the large intestine the mucosa may be congested, often in a "tiger stripe" pattern following colonic folds. The characteristic microscopic lesion in the intestinal mucosa is destruction of the epithelial lining of the crypts of Lieberkühn. In Peyer's patches, there is lysis of the follicular lymphoid tissue, collapse of the lamina propria, and often consequent downgrowth of cryptal epithelium. A less frequently noted microscopic finding is a vasculitis with fibrinoid necrosis of the media; this change may also be observed in a variety of other organs.

Nonalimentary tract lesions that may be seen on occasion include ulceration of the muzzle, interdigital skin, and conjunctival membranes. Growth arrest lines in the long bones may be seen, and secondary bacterial bronchopneumonia can also occur.



### Peracute Bovine Viral Diarrhea

The lesions of this form of the infection are similar to acute MD and it is *usually not possible to differentiate between the two forms based on gross and histopathological findings*. There may be an absence of gross enteric lesions, especially in animals that die within 24 hours after the onset of clinical signs and in calves less than 6 months of age. In these peracute cases, pneumonia may be the most obvious lesion. Cases in which there is widespread hemorrhage attributable to **thrombocytopenia** may also be a form of peracute infection. Experimental infections with NCP BVDV-2 strains have resulted in viral infection and necrosis of marrow precursor cells, especially megakaryocytes, as well as peripheral thrombocytopenia and leukopenia.

### Chronic Mucosal Disease

The necrotic epithelium may not be eroded by alimentary movements but instead remain in situ as slightly elevated, yellow, friable plaques, especially on the tongue and in the rumen. Subacute cases with a very prolonged course may show very few gross lesions in the mouth, some in the esophagus, and no lesions in the stomachs and intestines. Peyer's patches may be difficult to locate in these animals and when examined histologically the lymphoid follicles are hypocellular.

In naturally occurring MD, NCP and CP viruses can be found in the spleen, intestines, and esophagus. Viral antigens are also detectable in mucosal cells of the nares, rumen, abomasum, gallbladder, and salivary glands. In PI animals, viral antigen can be found in myenteric ganglion cells, cells within crypts, mononuclear cells of gut-associated lymphoid tissue, and mononuclear cells of mesenteric lymph nodes. Viral antigen can also be found in adrenocortical cells, cerebral neurons, endocrine cells of the pituitary gland, thyroid follicles, and pancreatic islets.

The virus can be demonstrated in sections from formalin-fixed, paraffin-embedded tissue using various IHC techniques, including a method using a monoclonal antibody, and the detection of viral antigen in formalin-fixed sections of skin collected at postmortem remains strongly indicative persistent infection. Such IHC techniques have also enabled the demonstration of viral antigen in association with specific lesions, such as within the Purkinje fibers and conduction system of the myocardium of a 4-month-old calf, pancreatic islet cells of diabetic cattle, and various cells of the central nervous system in a heifer with meningoencephalitis. This virus is also recognized as a cause of myocarditis, which may include a mild lymphoplasmacytic myocardial arteritis with or without fibrinoid necrosis. It must be remembered that the demonstration of BVDV antigen, or the isolation of the virus from necropsy material,

does not mean that the animal suffered from MD or the peracute form of infection unless supportive lesions are observed. The virus is often found in animals dying as a consequence of other disease processes, such as pneumonia. Confirmation of the presence of the virus is nevertheless significant. In terms of the individual animal, the virus may have caused a degree of immunosuppression. For the herd, the presence of circulating virus has important implications for the animals of breeding age.

### Abortion

The pathologic criteria for the diagnosis of BVDV as a cause of abortion have not been established. Finding antibody in a fetus, as in an unsuckled neonate, indicates that intrauterine infection has occurred but its diagnostic significance regarding the abortion is not clear. The recovery of virus from the fetus, or demonstration of viral antigen within fetal tissues, is only suggestive of a diagnosis of pestiviral abortion. Recognized BVDV-associated congenital defects in calves, including cerebellar hypoplasia, cataracts, retinal degeneration and dysplasia, hypoplasia and neuritis of the optic nerves, and musculoskeletal deformities are clear-cut indicators of compromised fetal health. However, microscopic lesions associated with BVD abortion have been described in fetal eyelid, lung, and myocardium yet at the present time their diagnostic value is still controversial. Growth arrest lines are sometimes noted in the long bones of aborted fetuses infected with the BVDV and in utero the infection may also produce **osteopetrosis**. Osteoporotic lesions, as well as anemia, thrombocytopenia, and marrow necrosis have been described in 2-month-old beef calves infected with an NCP strain of BVDV. Infection of megakaryocytes with NCP strains of BVDV has been confirmed experimentally. IHC analysis of cryostat sections of brain, skin, thyroid gland, abomasum, and placenta is a rapid, sensitive method for detecting pestiviruses in bovine and ovine fetuses. However, in most bovine fetuses, IHC testing of formalin-fixed, paraffin-embedded tissues is recommended, because the detection of BVDV antigen in formalin-fixed fetal tissues appears to be superior to traditional virus isolation techniques and fluorescent antibody techniques.

### Samples for Confirmation of Diagnosis

- **Histology:** formalin-fixed oral/esophageal lesions, thymus, Peyer's patches, colon, abomasum, rumen, mesenteric lymph node, heart, ear. For *abortions* eyelid, lung, thymus, spleen, intestine, liver, kidney, heart, brain, eye (LM, IHC)
- **Virology:** thymus, thyroid, Peyer's patch, spleen, lung, mesenteric lymph node (ISO, FAT, PCR)

### DIFFERENTIAL DIAGNOSIS

The differential diagnosis of diseases associated with BVDV infection must be considered according to the many different subclinical and clinical forms of the disease affecting many body systems. Each manifestation of clinical disease must be differentiated clinically and pathologically from similar diseases. The distinguishing features of each manifestation and the diseases they resemble are summarized here.

The differentiation of the diseases causing erosive lesions of the oral cavity mucosa (such as mucosal disease) can be perplexing both clinically and at necropsy. The similarity between them is the more important because rinderpest and foot-and-mouth disease are major plague diseases. The situation is so dangerous that if there is any doubt as to the identity of the disease under examination, samples should be submitted for laboratory examination.

There are many diseases of the alimentary tract of cattle that can be grouped according to the **presence or absence of oral lesions with or without diarrhea**. These have been summarized in [Table 8-10](#). An erosive stomatitis and gastroenteritis are characteristic of **rinderpest, bovine virus diarrhea, and bovine malignant catarrh**. The stomatitis and hyperemia are remarkably severe in bovine malignant catarrh along with a corneal opacity, lymph node enlargement, hematuria, and terminal encephalitis. **Rinderpest** was eradicated in 2011.

The **vesicular diseases**, foot-and-mouth disease and vesicular stomatitis, are characterized by the presence of vesicles on the tongue and buccal mucosa, teats, and coronets and should be distinguishable from erosions.

Diseases causing diarrhea with no oral lesions include **winter dysentery, salmonellosis, Johne's disease, molybdenum poisoning (conditioned copper deficiency), parasitism (ostertagiasis), and arsenic poisoning**.

A definitive diagnosis depends on isolation of BVDV from the buffy coat or serum of blood and other tissues. Calves with congenital defects can be provisionally identified as bovine virus diarrhea by detection of specific antibodies in calves that have not suckled; this is not an easy specimen to obtain in beef cattle running at pasture.

Although bovine virus diarrhea is not a disease of the respiratory tract it is not uncommon for respiratory signs to be evident and confusion in diagnosis between it and infectious bovine rhinotracheitis, and even pneumonic pasteurellosis, does arise. It is necessary to depend on a careful clinical examination of oral and nasal mucosae to ensure that there are no mucosal lesions. It is also necessary to include bovine virus diarrhea in the list of diagnostic possibilities when considering the causes of abortion and

*Continued*

**Table 8-10** Differential diagnosis of diseases of cattle in which there are either oral lesions or diarrhea alone or together in the same animal

Etiology	Epidemiology	Clinical findings	Clinical pathology and pathology	Response to treatment
Rinderpest	Eradicated in 2011	Severe erosive stomatitis, bloodstained saliva, blepharospasm, high fever, severe diarrhea and dysentery, many cattle affected and many die	Marked leukopenia, lymphopenia, karyorrhexis (submit lymph nodes)	None
Bovine virus diarrhea mucosal disease	Young cattle (8 months to 2 years) that have been persistently infected since fetal life Low incidence (5%) of acute clinical disease but high case mortality Sporadic cases of chronic form Acute clinical disease rare in over 2 years of age	Acute: Diffuse erosive stomatitis, moderate fever for few days, profuse diarrhea and severe dehydration, skin lesions of coronets and interdigital clefts common, die in 7–10 days. Chronic: Inappetence, progressive loss of weight, scant soft feces, normal temperature, small rumen, intermittent bloat, chronic skin lesions that do not heal (especially interdigital space)	Leukopenia, neutropenia and lymphopenia Seronegative Blood for virus isolation to identify persistently infected animals Nasal and fecal swabs Erosions throughout gastrointestinal tract	Almost all die
Peracute bovine virus diarrhea	Affects young and adult immunocompetent cattle not vaccinated Type II bovine viral diarrhea virus Morbidity up to 30%; case–fatality rate up to 40%	Sudden onset of anorexia, respiratory distress, fever, anorexia, agalactia, diarrhea, dysentery, death in few days	Blood for virus isolation Acute and convalescent sera Lesions similar to mucosal disease	No treatment High case–fatality rate
Bovine malignant catarrh	Usually sporadic in animals. Affects mature and young animals In North America outbreaks are common after contact with sheep In Africa outbreaks are common after contact with wildebeest Varying forms: peracute, alimentary tract, head and eye, and mild	Severe diffuse intensely hyperemic, erosive stomatitis; persistent high fever, severe conjunctivitis, corneoscleral opacity, hematuria, enlarged lymph nodes, prominent skin lesions, horn coverings shed, terminal encephalitis, diarrhea and dysentery Peracute die in 3 days, acute in 7–10 days and chronic form may live for a few weeks	Leukopenia and neutropenia early Leukocytosis later Transmission tests Vasculitis	None
Alimentary tract form of infectious bovine rhinotracheitis	Outbreaks in newborn calves (25–50% morbidity) Recent herd introduction of carrier Case mortality high (90–100%)	Small pinpoint gray pustules on soft palate, rhinotracheitis, conjunctivitis, persistent mild fever, usually die of secondary tracheitis and pneumonia	Virus isolation from feces and nasal swabs Lesions in turbinates, rumen, and abomasums	Unlikely to respond
<b>Diseases with oral lesions and no diarrhea</b>				
Foot-and-mouth disease	High morbidity (100%), low mortality Spreads quickly Occurs in enzootic areas	High fever, severe dejection, painful stomatitis, ropey saliva, large vesicles in mouth, vesicles on teats and coronets, recovery in 3–5 days, deaths in myocardial form	Animal transmission tests Serology rapid and accurate	No specific treatment
Vesicular stomatitis	In certain geographic areas, variable morbidity and mortality, insect-borne	Mild fever, anorexia, vesicles in oral cavity, less commonly on teats and feet Recover in few days	Animal transmission tests Serology rapid and accurate	Usually not indicated
Bluetongue	Clinical disease not common in cattle, insect vector, seasonal	Fever, stiffness, laminitis, coronitis, erosive lesions in oral cavity, edema of lips, drool saliva, nasal and ocular discharge, most cattle recover	Animal transmission tests Serology rapid and accurate	No specific treatment
Bovine papular stomatitis	Worldwide, common in young cattle (2 weeks to 2 years), morbidity may reach 100%, no mortality, may occur coincidentally with ostertagiasis	Round, dark-red, raised papules on muzzle, in oral cavity Heal in 4–7 days but remnants of lesion persist for several weeks No significant effect on animal In same age group as, and often associated with, severe ostertagiasis	Clinical diagnosis obvious	Spontaneous recovery
Necrotic stomatitis	Young calves In dirty conditions or on dry rough pasture	Painful stomatitis with large, deep necrotic foul-smelling ulcers on tongue, cheek, and pharyngeal mucosa	Clinical diagnosis Necrotic esophagitis	Respond in a few days to parenteral antimicrobials

**Table 8-10** Differential diagnosis of diseases of cattle in which there are either oral lesions or diarrhea alone or together in the same animal—cont'd

Etiology	Epidemiology	Clinical findings	Clinical pathology and pathology	Response to treatment
<b>Diseases with diarrhea and no oral lesions (does not include diarrhea of calves)</b>				
Salmonellosis case mortality may be high	All ages Outbreaks occur, dysentery, feces foul-smelling Stress-induced Contaminated feed supplies Veal calves Auction mart problem	Acute: High fever, diarrhea, fecal culture, fibrinous cast, abdominal pain, die in 24–48 h <i>Subacute and chronic:</i> diarrhea occurs too	Leukopenia, neutropenia Antimicrobials early Fibrinohemorrhagic enteritis	Favorable response to stage Later many cases die or become chronically ill
Winter dysentery	Housed dairy cattle, winter, explosive outbreak, 100% morbidity, no mortality	Acute: Profuse watery diarrhea and dysentery, mild fever, inappetence and drop in milk yield for 24 h, recover spontaneously, no mortality	None	Recovery is spontaneous
Johne's disease	Single animal, 2 years and older, low morbidity, long course of several months Chronic granulomatous-like enteritis	Chronic diarrhea, feces homogeneous, progressive loss of weight, normal temperature, appetite usually normal, hydration almost normal	Serologic tests and culture feces	No response to treatment
Secondary copper deficiency (molybdenosis)	Enzootic to farm/area Young cattle particularly Marginally copper-deficient areas, especially spring	Chronic diarrhea without smell, mucus, or blood Black coats are gray-flecked; red coats are rusty yellow Very thin	Plasma copper below 0.5 µg/mL, liver copper below 20 mg/kg dry matter	Excellent response in body weight and resolution of diarrhea to copper, by injection, drench, pasture dressing
Ostertagiasis	Mostly young cattle 6 months to 2 years, can be adults Many in group affected	Persistent diarrhea, without smell, mucus, or blood Decreased appetite, bottle jaw, very thin	May be heavy egg count, not if larvae inhibited, but plasma pepsinogen level greater than 5000	Several treatments with fenbendazole Good results Lesion may be irreversible
Coccidiosis	Young cattle, when overcrowded, fed on ground, gather at water source	Subacute dysentery, mild fever, 2–3 days, appetite and hydration remain normal About 20% develop "nervous signs" and die	Feces for oocysts Hemorrhagic cecitis and colitis	Self-limiting disease Amprolium and sulfonamides
Arsenic poisoning	Access to arsenic	Sudden and rapid death Acute abdominal pain, bellowing, regurgitation, diarrhea, muscular tremors, convulsions, die 4–8 h after onset of signs	Feces and tissues and feed supplies or analysis Edema of abomasum Unfavorable response	Difficult to treat
Carbohydrate engorgement	One to several animals History of access to grain	Anorexia, depression, ataxia, recumbency, dehydration, profuse, foul-smelling diarrhea, grain-kernels in feces, rumen static with fluid-splashing sounds, no rumen protozoal activity	Rumen pH below 5, lactic acidosis, hemoconcentration	Respond favorably if ruminal and systemic acidosis; may need rumen lavage or rumenotomy
Renal amyloidosis	Single animal, mature cow	Profuse chronic diarrhea, anasarca, inappetence, decreased milk production, enlarged kidney	Proteinuria, hypoalbuminemia, grossly enlarged kidneys	None
Ragwort ( <i>Senecio jacobea</i> ) poisoning	Group problem Access to ragwort on pasture or ensiled as feed	Dull, depressed, dark diarrheic feces, severe straining and prolapse of rectum, staggering and ataxia, head pressing	Liver enzymes	
Squamous cell carcinoma of upper alimentary tract	Scotland and northeast England Adult beef cows grazing marginal land infested with bracken, <i>Pteridium aquilinum</i>	Weight loss, diarrhea, bloat, feces are fibrous and watery	Tumors in oropharynx, esophagus, and rumen	



stillbirth in cattle. Immunoglobulin determinations in aborted fetuses may be of diagnostic value.

The definitive diagnosis of **chronic mucosal disease** presents problems because often the affected animal has no specific neutralizing antibody because of immunosuppression or the inability to secrete antibody. A presumptive diagnosis can be made on the basis of the clinical characteristics of the acute disease and the absence of other lesions to account for the chronic form of the disease. Virus isolation must be attempted along with detailed pathologic examination.

- **Inapparent subclinical BVDV infection.**

Common diseases include acute undifferentiated fever and acute undifferentiated bovine respiratory disease.

- **Peracute bovine virus diarrhea.**

Malignant catarrhal fever. Acute salmonellosis, bluetongue.

- **Respiratory disease.** All common causes of bovine respiratory disease. See Table 18-5.

- **Thrombocytopenia and hemorrhagic disease.** Malignant catarrhal fever. Moldy sweet clover poisoning, bluetongue.

- **Unthrifty persistently infected calves.**

General malnutrition. Copper deficiency. Chronic pneumonia.

- **Reproductive failure.** Common causes of reproductive failure in dairy and beef cattle herds are characterized by anestrus, failure to breed, unsatisfactory semen, failure of fertilization, embryonic mortality, fetal resorption, fetal mummification, abortion, stillbirth, and perinatal mortality.

- **Neonatal calf diarrhea.** All common causes of acute undifferentiated diarrhea of calves under 30 days of age.

- **Congenital defects of calves.** All inherited defects of the nervous system of calves manifested clinically at birth, and diseases of uncertain etiology characterized by nervous system involvement

## TREATMENT

There is no specific treatment for any of the diseases associated with BVDV. The prognosis for severe cases of MD with profuse watery diarrhea and marked oral lesions is unfavorable, and slaughter for salvage or euthanasia should be considered. Animals with chronic BVD should be culled and destroyed.

## CONTROL AND PREVENTION

BVDV continues to cause significant economic losses because of failures in implementing a sound immunization program, failures in establishing herd-monitoring programs, and failures in developing effective biosecurity and biocontainment programs.

The ultimate goal of BVDV prevention and control measures is to eliminate the potential for the birth of PI calves. A

combination of biosecurity, vaccination, and biocontainment strategies are necessary to control and prevent BVDV infection and its consequences in a herd and country.

The goal of a BVDV biosecurity program is to prevent the introduction of the virus into the cattle herd and preventing transmission of the virus to susceptible animals. Biocontainment strategies target minimizing the occurrence or severity of disease associated with BVDV infection. The most important subpopulation to protect from exposure is pregnant cattle, especially those in early gestation. The herd must be protected from direct exposure to cattle from other herds that may be transiently or persistently infected with BVD. Examples of these exposures include fence line contact, movement to and from fairs and exhibitions, and new herd additions. Quarantine of new additions for 2 to 3 weeks after arrival prevents exposure of the native herd to unknown infected animals. Each addition must be tested for BVDV PI while in quarantine or before arrival to identify primary reservoirs of virus before they are commingled with the native herd. New additions that arrive pregnant should not calve in the presence of pregnant cattle from the native herd. The calves born to pregnant new additions must be isolated from the native herd until their BVDV status has been determined.

Beef feedlots and heifer rearing operations present a special biosecurity challenge because the opportunity to introduce BVDV PI animals into these systems is increased by the frequent introduction of cattle usually comingled from multiple sources. The introduction of PI cattle may affect the health and performance of penmates. Dairy and beef heifers exposed to BVDV during gestation at a heifer development facility may later give birth to PI calves in destination herds. BVDV exposure could be minimized in these facilities by testing all new arrivals and removing PI cattle during a quarantine period of 2 to 3 weeks and before entering into the primary facilities.

Elimination of BVDV PI cattle early in the production system, such as at the cow-calf herd level, benefit the cattle industry at subsequent points, such as at the feedlot and heifer development enterprises. Ideally, procurement of animals from biosecure herds and animals previously tested negative for BVDV PI would eliminate the risk for virus exposure from PI animals in these types of operations (Figs. 8-28 through 8-30).

The successful control and prevention of the BVD/MD complex depends on the following:

- Identification and elimination of PI animals from the herd
- Prevention of introduction of infection into the herd (biosecurity)

- Immunization programs and biocontainment
- Eradication of the virus from herds

## Identification and Elimination of Persistently Infected Animals From the Herd

Identification and elimination of PI cattle is an essential component of a control program in an infected herd. Elimination of such animals, also known as “**clearance of infection**,” will result in the improved health of the herd. The testing procedures to detect PI animals are described under Clinical Pathology in this section.

In beef herds, to prevent contact with pregnant cows, PI animals should be identified and removed before the start of the breeding season. All calves, all replacement heifers, all bulls, and all nonpregnant dams without calves must be tested for PI status. Any female pregnant at the time the herd is tested should be isolated from the breeding herd and kept isolated until her calf is tested and found to be negative. In most whole-herd testing situations, IHC testing of skin samples is the test of choice because it can be accurately performed on animals of any age, and a single sample is all that is usually required.

Herd monitoring for PI animals can be done with pooled whole-blood or serum samples for PCR testing. By pooling samples, the expense of screening herds with a low prevalence of PI animals is minimized. The maximum number of samples per pool should be determined at the diagnostic laboratory conducting the analysis. If the initial pool is PCR positive, then it must be split and retested to identify the viremic animal(s) within the pool. Once the viremic animals are identified, they must be classified as transiently infected or PI with either a subsequent PCR, virus isolation, or IMPA test in 3 weeks, or using the IHC testing of a skin sample. Using a two-test strategy to screen feeder calves with a PCR assay of pooled samples and IHC testing only of those animals represented in pooled samples with positive assay will reduce the cost of screening incoming feedlot cattle compared with IHC testing of all animals.

Following the successful detection and removal of PI animals, “**self-clearance**” or elimination of all evidence of the infection from the herd will occur. Transient infections that occur in nonpregnant animals are inefficient in transmitting the virus. The main route of transmission within a herd is from PI animals to susceptible animals. The virus is commonly maintained in a herd when seronegative animals in early pregnancy are exposed to PI animals. Self-clearance is also more likely in small herds compared with large herds that usually have rearing conditions that increase the risk of exposure of PI animals to susceptible seronegative animals in early pregnancy.

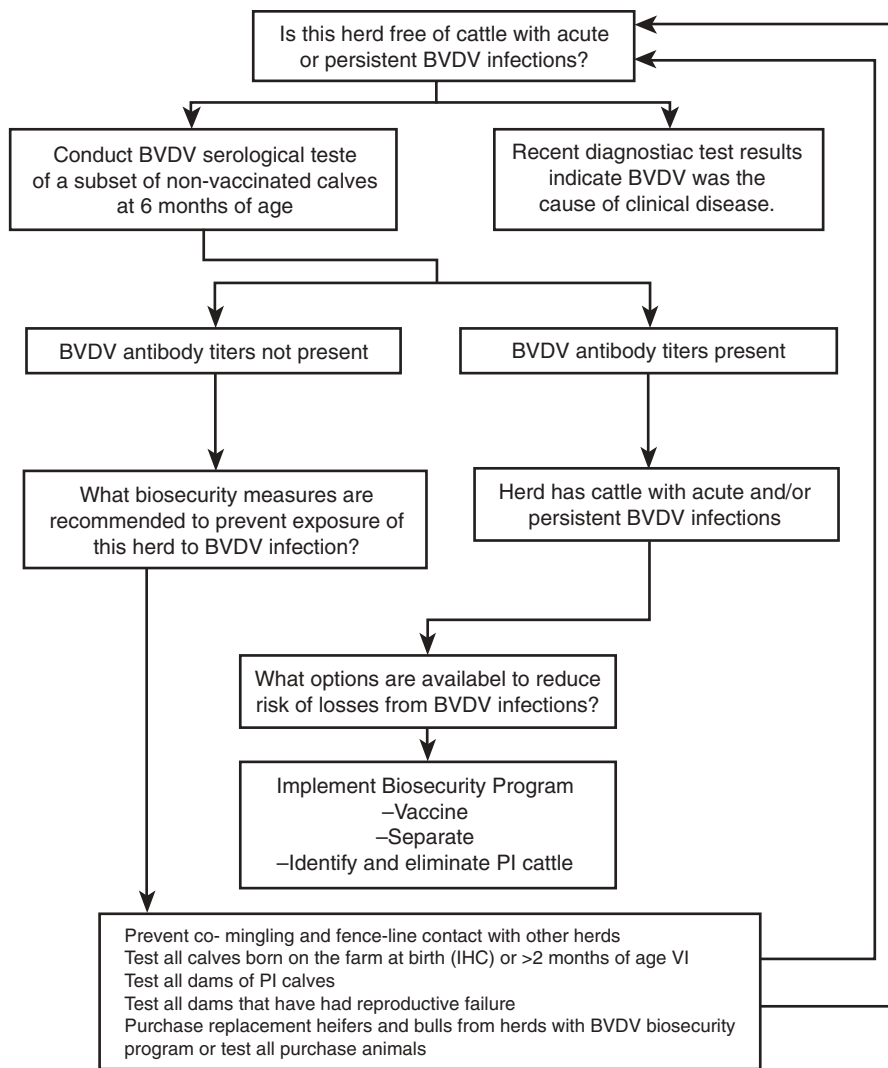

Fig. 8-28 Objectives of herd testing for bovine viral diarrhoea virus (BVDV).

### Prevention of Introduction of Infection Into Herd (Biosecurity)

After identification and elimination of the PI animals, the new virus-free status of the herd should be maintained by a program of testing all introduced animals for freedom from infection. In many cases introductions can be guaranteed, as far as is reasonably possible, to be free of infection by selecting animals that have convincing titers of serum antibody or are negative and are derived from a totally negative herd or stable subherd. According to the period over which the herd of origin has been established and has been free from introductions, its free status may be established by testing an adequate sample of animals. In other cases, antibody-negative introductions should be examined for virus or held for a period of on-property quarantine in close contact with a few serologically negative test animals that are subsequently examined for antibody.

Significant reproductive wastage caused by BVDV infection can be prevented

by testing introductions to the herd or management of the herd to maximize immunity before breeding. Cattle producers purchasing pregnant heifers to expand their herds must be aware of the possibility their fetuses may already be PI. At that stage there is no simple test to identify those heifers pregnant with a PI fetus. Calves from these purchased heifers of unknown vaccination history should be considered infected until proven otherwise.

Artificial insemination units are now adopting comprehensive testing programs to identify PI bulls and immunocompetent bulls with the transient acute BVDV infection. PI bulls are detected by virus isolation from blood and not by serologic testing. The semen of PI bulls will usually contain the virus, but the quality of the semen will not necessarily be abnormal. This emphasizes the need for virological surveillance of breeding herds and artificial insemination and embryo transfer centers. It is also important to prevent contamination by this virus

of the fluids used for recovery, in vitro manipulation, and transfer of bovine embryos.

### Immunization Programs and Biocontainment

Vaccination is effective in reducing the spread of BVDV but is unsuitable as stand-alone control strategy because vaccination cannot provide complete protection from infection or remove PI animals from the herd. Historically, widespread, nonsystematic use of BVD vaccines has been commonplace in many countries including the United States without any noticeable overall reduction in the prevalence of the disease.<sup>17</sup> Vaccination programs target one of two of the following objectives:

- Prevention of clinical disease after exposure to BVDV
- Prevention of fetal infection leading to PI calves

Considering the high prevalence of BVDV infection that causes high economic losses, vaccination of cattle herds is certainly indicated, provided efficacious and safe vaccines are available. To be effective, vaccination against BVDV infection should protect against viremia and block infection of target cells of the reproductive and lymphatic systems to avoid occurrence of fetal infection and immunosuppression, respectively. Antibodies present in the systemic circulation effectively neutralize viral infectivity, promote clearance of the virus, and prevent seeding of target organs such as the fetus. The goal of immunization is to stimulate both the B-cell and T-cell arms of the immune systems. The B-cell arm of the immune response has the major responsibility for inactivating free virus. This is achieved primarily by immunoglobulin, which neutralizes the BVDV infectivity and secondarily aggregates BVDV and enhances clearance. Cell-mediated immunity, particularly CD4+ cells, which are type-2 like, is important for the resolution of acute infection with NCP BVDV. The antibody titers required to provide protection from intra-uterine infection or clinical disease are not known. A titer of 1:16 was reported to protect from severe clinical disease, whereas a titer of 1:256 was found to prevent systemic virus shedding in experimentally challenged calves.

An important strategy for successful control is vaccination of the breeding female at least several weeks before breeding. Experimental exposure of pubertal heifers to the virus 6 weeks before breeding stimulates the production of SN antibodies, which protects against transplacental infection of the fetuses. However, immunization in terms of protecting the fetus may not be effective against strains that are different from those contained in the vaccine, and the ultimate precaution is to prevent cows or heifers from making new contacts shortly before or

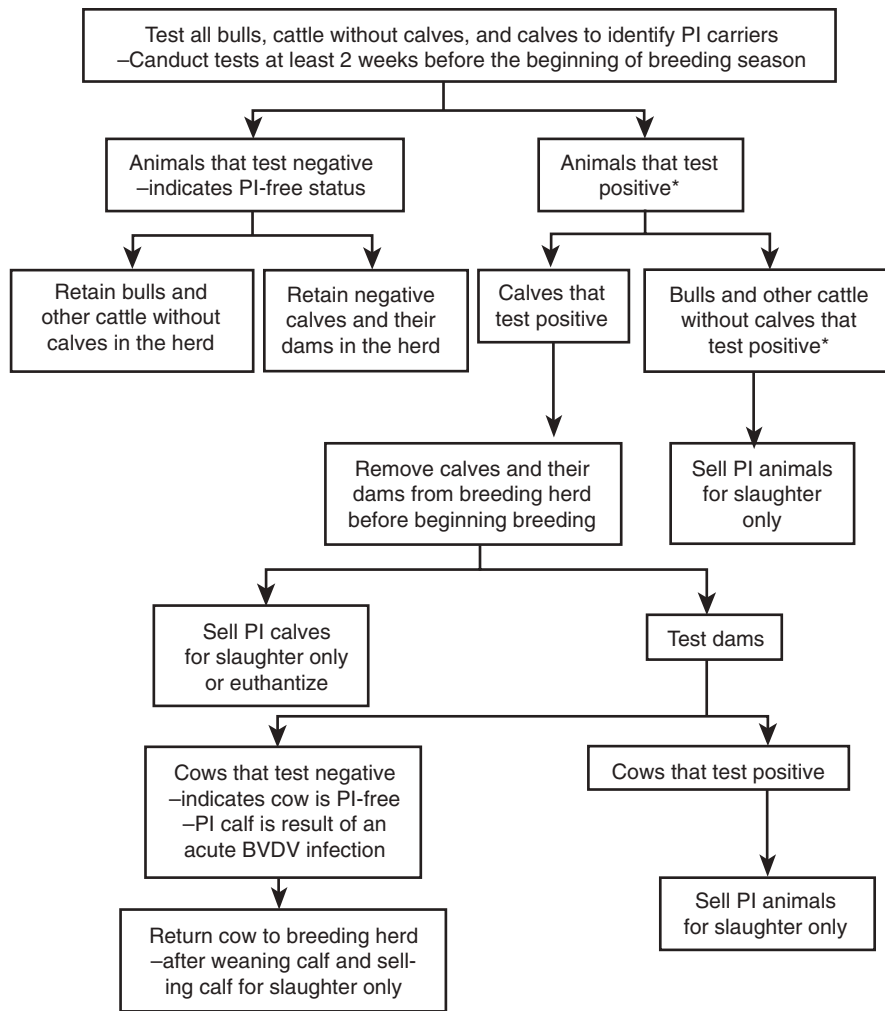

\* After 30 days, retest animals that test positive to confirm PI status. Animals that test negative in second test indicates that they were transiently infected when tested initially, and are therefore, non-PI

**Fig. 8-29** Flow chart for testing a beef herd prebreeding to detect and eliminate bovine viral diarrhea virus carrier (BVDV) cattle.

in different production systems include immune response; cross-reactivity, fetal protection, duration of immunity, immunosuppression, reversion to virulence, effect of maternal antibody on immune responses, and purity.

The MLV vaccines usually contain one or two single strains of attenuated BVDV of either biotype that pertains to the BVDV-1 and BVDV-2 genotype. The most commonly used strains are BVDV-1a, 1b, 1c, and BVDV-2a. Several inactivated BVD vaccines are also widely available.

### Modified-Live Virus-Bovine Viral Diarrhea Virus Vaccines

MLV-BVDV vaccines are attenuated so that replication of the virus is restricted, reducing both viral virulence and shedding of the vaccine virus by the vaccinee. The **advantages** of MLV-BVDV vaccines are numerous and significant. Because antigen is amplified by replication in the animal, only small numbers of viral particles are necessary; thus the vaccines are inexpensive and only a single vaccination is necessary for adequate immunization. Within 3 weeks after vaccination, antibody is detectable, which will neutralize an antigenically wide range of BVDV strains. Although antibody titers after vaccination with MLV vaccines were found to be lower than after natural infection, increase and decay of the titer follow a similar pattern.<sup>21</sup> It is suggested that protective antibody titers following vaccination persist for more than 1 year. Immunization of calves with MLV vaccine is not inhibited by colostrum antibody at titers up to 1:32. Assuming both a half-life of 21 days for colostrum antibody and an initial viral neutralizing titer of 1:2000 after ingestion of colostrum, immunization should be successful in most calves 4 to 6 months of age. Revaccination before the first breeding is recommended.

The **disadvantages** of MLV vaccines include failure of immunization if the vaccine is not stored or handled properly. MLV vaccines may cause disease if the vaccine virus regains virulence. Development of MD following vaccination with an MLV vaccine has been reported occasionally (a condition termed **postvaccinal MD**).<sup>21</sup> It is now recognized that postvaccinal MD exclusively occurs in PI animals. Although the economic loss from postvaccinal MD is negligible, from an animal welfare standpoint vaccination of PI animals should be avoided when possible. MLV vaccines are also **potentially fetopathogenic** and should not be used in pregnant cows. The possible effects of such vaccination are variable and dependent on the stage of gestation when the vaccination occurs. The vaccination of pregnant cattle, without detectable neutralizing antibodies to the virus, between 51 and 190 days' gestation with a commercial modified BVDV live vaccine can result in transplacental transmission of the vaccine virus and

during the first half of pregnancy. **Control of the infection, and of MD, depends entirely on control among the breeding stock.** Infection among nonbreeders is of no long-term consequence, except that they may be a source of infection to breeders and compromise the continuing freedom from infection of that group.

The aim of a vaccination program is to ensure that all breeding females have antibodies to the virus before they become pregnant. Independent of the vaccine used, vaccination should be done at least 3 weeks before breeding so that the breeding females become seropositive to the virus before conception.

Infectious disease models demonstrate that after BVDV is eliminated from a herd, cattle become increasingly susceptible to new infection and the possibility of an outbreak with severe clinical signs following a

new BVDV exposure increases. Thus in the absence of strict biosecurity, recurring patterns of reinfection with severe clinical signs are expected every few years once the virus is eliminated from the herd. In North America and other regions in which BVDV is endemic and reexposure is likely, it remains prudent to continue vaccination after eliminating the virus from the herd.

### Bovine Viral Diarrhea Virus Vaccines

Both MLV and **inactivated-virus** vaccines are available. Currently there are many BVDV vaccines that are federally licensed in North America alone and all meet or exceed requirements for purity, potency, and safety. These requirements ensure that vaccines elicit an immune response, are free from extraneous agents, and do not induce disease.

The important variables to consider when selecting a vaccine for use



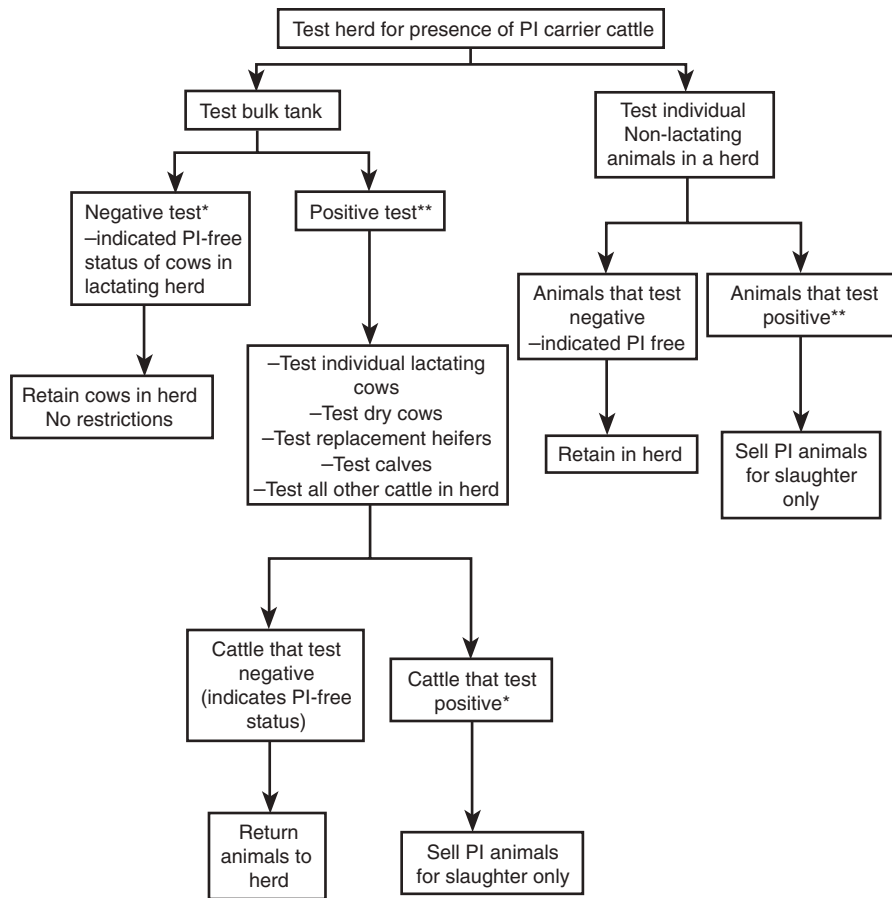

\*A bulk milk sample may yield false positive results if; 1) to shedding in milk, 2) shedding virus in milk below detectable levels, 3) viral RNA destroyed in milk, or 4) there are PCR inhibitors present.

\*\* After 30 days, retest animals that test positive to confirm PI status. Animals that test negative in second test indicates that they were transiently infected when tested initially, and are therefore, non-PI.

**Fig. 8-30** Flow chart for testing a dairy herd to detect and eliminate bovine viral diarrhoea virus persistently infected (PI) carrier cattle. *PCR*, polymerase chain reaction.

is not recommended. Abortions, congenital abnormalities of the nervous and musculoskeletal systems, perinatal deaths, growth retardation, and persistent viral infection are all possible outcomes of vaccinating pregnant cattle with an MLV before 120 days' gestation. Between 120 and 190 days', the fetus can be expected to become immunocompetent and produce serum-neutralizing antibodies that can be detected in the precolostral serum of the calf at birth. The vaccination of pregnant cattle without neutralizing antibodies to the virus between 190 and 265 days' gestation will also result in transplacental transmission of the virus and the presence of neutralizing antibodies in the precolostral serum of calves at birth. A **temperature-sensitive BVDV vaccine** will cause seroconversion and, when used experimentally in pregnant cows, does not result in fetal infection as evidenced by lack of virus isolation and absence of precolostral antibodies in the calves, which are born healthy. **Immunosuppression and genetic recombination** are other potential

risks associated with MLV vaccines. Few studies have documented impaired lymphocyte function with the use of at least one MLV vaccine, but the extent of immunosuppression is largely undefined.<sup>21</sup>

#### Inactivated Bovine Viral Diarrhoea Virus Vaccines

The disadvantages of the MLV vaccines stimulated the development of inactivated-virus vaccines.

The **advantages** of inactivated BVDV vaccines include the following:

- Lack of infectivity
- Unlikely presence of adventitious agents
- Absence of postvaccinal disease
- Safe use in pregnant animals

The **disadvantages** of inactivated BVDV vaccines include the following:

- High cost of the vaccine
- Need for two vaccinations to achieve primary vaccination
- Lower and shorter protective antibody titers

Adverse reactions at the site of vaccination may occur and are associated with the adjuvant in the vaccine. Maternal antibody may interfere with inactivated vaccines, and calves may need to be revaccinated periodically from 6 months of age to just before breeding. Vaccination of naive cattle with inactivated BVDV vaccines results in virus neutralization peak titers at about 5 weeks after the second vaccination with a return to seronegativity within 12 weeks of vaccination. This pattern of response is typical of inactivated vaccines. General consensus is that the protection afforded by inactivated BVD vaccines is narrower and of shorter duration than the protection obtained from MLV vaccines.<sup>21</sup>

#### Combination Vaccines

BVDV vaccines are often incorporated in multivalent vaccines to prevent respiratory diseases of cattle. These vaccines include combinations of the live and inactivated antigens of bovine herpesvirus-1 (BHV-1), parainfluenza-3 virus, bovine respiratory disease virus, and *M. haemolytica*, and *H. somni* for administration all at the same vaccination time.

#### Efficacy of Bovine Viral Diarrhoea Virus Vaccines

The main concern of BVDV vaccine development and protective efficacies of current vaccines results from the extensive genetic and antigenic diversity of pestiviruses. Although there is considerable antigenic similarity between the biotypes of the virus and among isolates of either biotype, there is also antigenic diversity among the isolates. Neutralizing antibodies induced by vaccination might therefore not react with certain isolates of the virus. This antigenic variance may interfere with the efficacy of a vaccine because immunity against strains that are homologous to the vaccine strains are less pronounced against heterologous field strains.<sup>17</sup> Vaccination of yearling cattle with either of two commercially available monovalent modified live BVD vaccines stimulated the production of SN antibodies to each of 10 CP and 10 NCP isolates of the virus by one or more of the animals by 14 days after vaccination. No animal produced detectable SN antibodies to all 20 viruses. The **cross-protective efficacy** of BVDV vaccines according to genotypes has been examined with contradictory results. Prior exposure of cattle to BVDV-1 (as either an MLV or inactivated vaccine) does not always provide protection against infection with BVDV-2. A commercial inactivated BVDV-1 vaccine provided significant but not complete clinical and virological protection against challenge with a heterologous BVDV-2 strain. Properly used vaccines containing BVDV-1 strains may therefore reduce the incidence and severity of disease associated with BVDV-2 but not provide complete protection.

The efficacy of BVDV vaccines for the **prevention of fetal infection** has been studied in several experimental trials. Most trials using either MLV or inactivated BVD vaccines revealed a high degree although not complete cross-protection against transplacental infection with heterologous virus strains.<sup>22</sup> The use of multivalent vaccine containing strains of BVDV-1 and BVD-2 appears to provide better cross-protection against fetal infection.

### Commercially Available Vaccines

Most of the commercially available vaccines for the BVDV are combined with other antigens such as the IBR, PI-3, and BRSV viruses. In one study, the serologic responses of beef calves 6 to 8 months of age were compared following vaccination with eight commercial vaccines containing IBR, PI-3, bovine respiratory syncytial virus (BRSV), and BVDV. Generally, the serologic responses to the viruses varied among different commercial vaccines, between and within MLV and killed-virus vaccines, and routes of administration. All vaccinated calves developed higher antibody titers to the antigens than unvaccinated controls. The serologic responses to the BVDV were low; only 20% of the calves had a fourfold seroconversion to the virus after two vaccinations. There are wide variations in onset of antibody responses and duration dependent on vaccine type and virus involved.

Field observations indicate that vaccine potency may vary considerably. Some lots of vaccines have failed to induce seroconversion in calves following carefully controlled vaccination. Unpublished observations by some clinicians found a wide variation in the amount of virus present in vaccines, and manufacturing processes may vary considerably resulting in destruction of live virus. Thus part of the vaccination program may necessarily include evaluation of the vaccine by SN testing before and after vaccination, and submitting a sample of the vaccine to a laboratory for PCR testing or viral isolation.

### Strategies for Bovine Viral Diarrhea Virus Vaccination Programs

The strategies for effective vaccination against BVDV infections are prevention of fetal infection and control and prevention of postnatal infections.

#### Prevention of Fetal Infection in Dairy and Beef Herds

With the present state of knowledge, a rational vaccination program to prevent fetal infection, for both beef-breeding herds and dairy herds, consists of vaccinating all calves at 4 to 6 months of age with an MLV vaccine. **The emphasis must be on immunization of the heifers before breeding so that the virus does not reach the fetus before 120 days' gestation.** All heifer replacements and cows

are vaccinated 3 to 6 weeks before breeding with an MLV vaccine. To ensure a level of herd immunity, all breeding females are revaccinated annually 3 to 6 weeks before breeding. All bulls are revaccinated annually.

**Colostrum immunity** is present for up to 6 months of age in calves born from immune cows. Calves with even higher titers of colostrum BVDV antibody may have an active response to vaccination, but it is questionable whether this is of any useful purpose. If vaccination of the dam before conception is the vital part of the program, the vaccination of calves born from immune cows may be unnecessary until they approach breeding age.

#### Postnatal Bovine Viral Diarrhea Virus Infections

A rational vaccination program for the control of the new BVDV infections occurring in immunocompetent animals would be similar to the earlier mentioned program in dairy and beef breeding herds. However, in herds experiencing outbreaks of BVD infection caused by the highly virulent strains of the virus, it would seem rational to vaccinate all animals in the herd with the precaution that pregnant animals will have to be vaccinated with the inactivated virus vaccine.

#### Vaccination Schedules

Strategic vaccination schedules for the various situations should emphasize induction of maximal protective responses to correspond with the stage of the production cycle when the risk and consequences of BVDV infections are greatest. This means well-timed administration of vaccines prebreeding and preweaning to protect against reproductive losses and respiratory tract disease, respectively. Recommendations for vaccination schedules for beef and dairy cattle herds are outlined here.

#### Beef Cow–Calf Herd

All beef heifer replacements should be vaccinated with an MLV-BVDV vaccine at least 3 weeks before breeding. Cows should be vaccinated annually, at least 3 weeks before breeding.

Beef calves should be vaccinated at least 3 weeks before weaning to have maximum protection during subsequent periods of high risk at and after weaning.

#### Beef Feedlot

There is no indication for vaccination of feedlot cattle for MD in PI animals. In a population of feedlot cattle originating from several sources, the risk for a PI animal to develop MD cannot be reduced by vaccinating. Postvaccinal MD may occur in some cases. If there is a risk of the postnatal forms of BVDV, such as the peracute BVD associated with the highly virulent strains of BVDV, the thrombocytopenia, and the

immunosuppressive effects of benign BVDV infection, then feedlot cattle should be vaccinated on arrival, with an MLV vaccine. A review of bovine respiratory disease vaccine efficacy concluded that there were no reliable reports of field trials evaluating the clinical effects of BVDV vaccines in North American feedlot cattle.

The use of multivalent MLV viral vaccines containing IBR, PI-3, BVDV, and BRSV have been evaluated in fall-placed, auction market-derived, feedlot calves in western Canada. Those cattle receiving the multivalent vaccine had significantly lower treatment rates than those in the univalent vaccine group. Cattle receiving the multivalent vaccine had higher carcass weights, weight gain, and average daily gain throughout the feeding period. There was a net economic advantage when the multivalent vaccine was used compared with a univalent IBR vaccine.

#### Dairy Herd

Dairy heifer calves should be vaccinated at about 4 months of age, and with a booster at 5 to 6 months of age. MLV-BVDV vaccines containing both type 1 and type 2 genotypes should be used.

Heifer replacements are vaccinated with an MLV-BVDV vaccine about 45 days before being bred for the first time. This will boost serum neutralizing titers as much as possible to prevent fetal infection in the first 140 days' gestation. Dairy bulls are vaccinated at 8 to 12 months of age.

Recently calved cows are vaccinated with MLV-BVDV vaccine at about 30 days before breeding. This will ensure high SN titers to prevent fetal infection and thus prevent some congenital infections, abortions, and stillbirths. This practice furthermore stimulates high colostrum antibody titers so that calves receive a large mass of BVDV antibody.

Inactivated BVDV vaccines can be used in pregnant cows when BVDV abortions are occurring in the herd. Two vaccinations, 2 to 3 weeks apart, beginning at the time of pregnancy diagnosis or 1 month before the estimated time of abortion. Vaccines containing both type 1 and type 2 genotypes are recommended. Inactivated vaccines have also been used at drying off and 3 to 4 weeks later to enhance colostrum antibody titers. Booster vaccination of dairy cows 35 days after calving with an MLV-BVDV vaccine greatly increased the antibody response compared with saline controls and cows vaccinated with inactivated vaccines containing BVDV, IBR, BRSV, and PI-3 viral antigens.

Vaccination of pregnant cows and heifers with a multivalent vaccine containing MLV BHV-1, BVDV, PI-3, and BRSV during all three trimesters of pregnancy is safe provided the animals have been previously vaccinated before breeding with the same MLV components.

Veal calves should be vaccinated after arrival with an MLV vaccine containing type 1 and 2 genotypes.

### Current Vaccination Practices

The most recent available survey of U.S. livestock producers indicates that the percentage of dairy operations vaccinating against BVD increased from 58% in 1991 to 74% in 2007. The same survey revealed that in 1996 over 58% of the dairy producers were using inactivated BVD vaccines, whereas over 62% were routinely using MLV vaccines in 2007.<sup>23</sup> The proportion of improperly vaccinated herds is unknown. In the 1993 outbreaks of peracute/acute forms of BVD in the United States and Canada, it was found that many affected herds had not been vaccinated or had been vaccinated improperly. Surveys in Pennsylvania indicate that many producers did not vaccinate all susceptible groups of cattle in the herd, and many producers did not administer the secondary vaccination of the inactivated vaccine. Although 82% of dairy producers indicated they routinely vaccinated their herds, only 27% of the herds were found to be adequately vaccinated. A survey of vaccination practices in Saskatchewan dairy herds indicated that only 34% of dairy herds were vaccinated against BVDV. In addition, only 25% of producers who vaccinate follow the label directions for administering inactivated virus vaccines, and more specifically, the requirement to give two doses at the recommended interval. The three most common practices were annual vaccination (50%), vaccination before breeding (19.5%), and biannual vaccination (7.3%).

Inadequate vaccination practices can be minimized by the veterinarian who can play an important role in clearly outlining in written form the vaccination program for individual herds. Constant surveillance of the health management strategies is necessary. Good and reliable records that keep track of vaccinations—when they were given, which animals were vaccinated, and which vaccines were used—are vital. Veterinarians must work with their clients to develop a specific vaccination and biosecurity protocol for each herd.

Vaccine failures may occur because of improper use and storage of the vaccine. Syringes must be not washed with water or solutions containing chemicals or ingredients because this will readily kill any live virus in the vaccine.

### Eradication of Bovine Viral Diarrhea Virus Infection Without Vaccination

The BVD disease complex has been known since the late 1940s and early 1950s. Since about 1985, veterinarians have attempted to control the disease by culling PI animals, vaccination, and using certain levels of biosecurity. The diverse and vague clinical signs of the infection have made diagnosis difficult, costly, and often elusive and

frustrating. Several diagnostic tests have been developed to aid in diagnosis of BVDV infections, and most importantly for the detection of PI animals. Many vaccines have been developed since about 1960 that have reduced losses but not adequately enough because none of the vaccines will provide complete protection given the antigenic diversity of BVDV isolates. Anything less than absolute fetal protection by vaccines will still allow some PI animals to be present in the herd. Because of these difficulties and the high economic losses associated with BVDV, total eradication of the virus from herds of cattle and from countries has now become a reality.

A control and eradication program against BVDV without vaccination has been successfully implemented in the Scandinavian and other European countries with (near) complete elimination of BVD from their cattle population. The Swedish BVD control program was among the first of the BVD eradication programs implemented on a national level and is the basis for many voluntary or national BVD control and eradication programs in other countries.

Concepts that are common to most control and eradication programs for BVDV include the following: (1) a herd is not infected until one or more persistent infections have been established; (2) the high incidence of self-clearance will reduce the prevalence of BVDV infections in cattle populations even without active disease clearance, provided virus is not reintroduced; and (3) BVDV cannot persist within a herd when contacts between PI animals and susceptible animals in early pregnancy do not occur. Thus the “**test and cull**” strategy is the major principle for effective eradication.

Before considering an eradication program in a region or country, an overall assessment of the economic importance of the BVDV disease complex should be conducted. Cost is an important factor in determining whether any measures against the infection should be initiated. Ideally, the overall cost of an organized eradication program should be administered by dairy and beef cattle associations and animal health organizations. Diagnostic laboratories must be able to assist with the planning of sampling and providing information on the epidemiology of the infection to cattle producers in general, ensuring that known risk factors are identified and minimized.

The components of an organized eradication program based on test and cull include several factors:

- **Population dynamics.** In the region of concern, basic cattle population data such as average size of herd, production type (dairy, beef or others), and population density should be available. Basic knowledge of the dynamics of the cattle industry such as movement patterns, restocking of breeding

herds, vaccination programs, livestock markets, community pastures, and cattle exhibitions and sales is necessary.

- **Prevalence monitoring.** A comprehensive knowledge of the prevalence of infection is necessary to identify herds with an ongoing infection with BVDV as well as those susceptible to infection.
- **Diagnostic tests.** Reliable diagnostic tests for test and cull programs are necessary. The tests must be as sensitive and specific as possible, and they must be easy to use, be reproducible, be suitable for large-scale testing, and be of reasonable cost.
- **Education.** All those involved in the actual program must be fully informed with the latest information about the various aspects of the BVDV disease complex, including how the virus is transmitted, diagnostic testing and interpretation of results, and the strategies to be used.
- **Biosecurity.** Biosecurity measures to prevent introduction of infection into virus-free herds must be given high priority. This includes consideration of the possibilities of direct and indirect contact with infectious animals outside of the herd, and ensuring that all replacement animals imported into a herd cleared of BVDV are kept in quarantine facilities until they are verified free of the virus. If different herds share common pastures, rules should be set out to ensure that only BVDV-free animals are allowed onto the pastures. Other means of reinfection are by biologic products, including semen, embryos, colostrum, vaccines, and other veterinary drugs, which should be verified free from BVDV before being used.
- **Logistics.** The overall plans for sampling and testing should be outlined by an advisory body with access to all available data on epidemiology and laboratory capacity. On a regional basis, organization of testing, actions after initial screening of herds, and follow-up testing could be organized advantageously by a district veterinary officer or someone with similar experience in surveillance for notifiable animal diseases.
- **Animal identification.** Individual animal identification with easily read ear tags or electronic identification is a strict requirement.
- **Legislation.** Organized efforts to control BVD on a national level requires legislation or some means of regulating free movement of potentially viremic animals. Initially, this may become a requirement of herd managers who have successfully cleared their animals of



BVDV or livestock trade or breeding companies who want to promote a specific health status of their animals. At later stages, test certificates documenting freedom from BVDV issued by district veterinary officers engaged in organization of BVD control activities may evolve as mandatory documentation to allow access to livestock auctions, exhibitions, or communal grazing land.

### Bovine Viral Diarrhea Control Programs in Different Geographic Regions and Countries

#### Scandinavian Countries

Scandinavian countries have successfully implemented BVDV control programs without the use of vaccines and have or are about to achieve complete eradication. The seroprevalences of BVDV in the cattle populations of these countries before implementing control measures ranged from very high to low. In the early 1990s, the herd-level seroprevalence of BVDV was 40% in Denmark, 25% to 40% in Norway, and 1% in Finland. No vaccines against BVDV have been licensed or used in these countries; thus the seroprevalence was from natural infection.

The basic elements of the control programs in all Scandinavian countries are similar. Three different activity levels can be distinguished. The first level included screening of all cattle herds with the principal aim of identifying BVDV-free herds and maintaining them free. Bulk milk samples collected for milk-quality monitoring or sera from a limited number of animals representing all epidemiologic groups of the herd are tested for antibodies to BVDV. Next they are scored to indicate freedom from BVDV or a more or less likely ongoing infection with BVDV. This populationwide screening is repeated annually to monitor the spread of BVDV or the effect of the control program. The second level of activity aims to identify herds with an active infection among those positive for BVDV, for example, those with one or more PI animals. By limiting the number of herds that require a full-herd screening, efforts can be focused where needed and the overall cost minimized. The aim of the third level activity is to identify all PI individuals in herds with active infection. This involves an initial sampling of all cattle on the farm, plus a follow-up phase to test calves born to BVDV antibody-positive dams that were pregnant during or shortly after the initial testing. After the herd clearing is completed, surveillance at level 2 serves to verify success and eventually to certify that cleared herds are free from BVDV, despite still strongly positive by level 1 antibody surveillance results.

#### United Kingdom

In 1999, in the UK, the cattle industry established Cattle Health Certification Standards

(Checs) as a nontrading organization to promote and regulate voluntary schemes for the control of BVDV and other pathogens. The basis of Checs is the identification and removal of PI animals from herds, combined with changes in husbandry procedures to prevent infection from being reintroduced. There are three programs, allowing the farmer to work with the veterinarian to formulate a BVDV health strategy to meet the particular needs of that farm. The accreditation program demonstrates the herd is free from BVDV and to maintain freedom from the virus and to allow the sale of animals as accredited free of the virus. In the screening and eradication program the objective is to implement a control program to reduce the detrimental effects on the herd productivity associated with the BVDV and to allow sale of animals of known status. The program applies where there is already evidence of recent BVDV infection in the herd or where positive results have been found in the course of an accreditation program. In the vaccination monitored free program the objective is to control BVDV infection through vaccination of the breeding herd and, by regular monitoring of young animals, to demonstrate that the control is effective and exposure of young animals to the virus has not occurred. The goal is to allow the sale of animals that are accredited as being from a vaccinated herd and monitored free of active BVDV infection. This program is considered appropriate for commercial herds selling animals for finishing. The status of these herds is lower than that of BVDV-accredited herds.

#### Continental Europe

Countrywide BVDV control schemes involving entire cattle populations have recently been launched in several countries on the European mainland such as Austria, Germany, and Switzerland. In **Austria**, which is currently considered free of BVD, the national BVD control program requires cattle herds to conduct a herd screening on a yearly basis. The objective of the annual screening is to identify herds with recent or ongoing BVD infection by detecting seroconversion. A herd can be tested through serologic examination of a bulk milk sample, serologic examination of a subset of young lactating cows, or a subset of animals between 6 and 24 months of age. Herds with negative serologic results are classified as free of BVD, whereas herds with positive serology are classified as suspect of BVD infection. These herds must undergo further examination, consisting among others of a compulsory virus antigen screening of all newborn calves in their first 5 weeks of life. The PI animals must be euthanized or slaughtered within 14 days. Animals leaving or entering a herd must be tested for persistent infection before they can be marketed. With the control program being based on detection of sero-

conversion, vaccination against BVD is evidently not permitted. Although sample collection and laboratory costs are the producer's expenses, compensation is granted for every PI animal that is to be destroyed.

**After several years of BVD control at a state level, Germany** implemented a nationwide BVD control program in 2011 that is based on compulsory screening for persistent infection (ear notch) of every calf in the first 6 months of life or before it leaves the herd of origin. A virus-negative result of a calf automatically grants the same status to its dam. The status of "not persistently infected with BVDV" is recorded in a national database, and only animals with this status on record are allowed to be marketed. Because the program is based on virus or virus antigen detection the use of BVD vaccines remains possible and permitted. Costs for sample analysis are covered by the authorities, and the producer is eligible for a compensation for every PI animal.

**In the United States** the Academy of Veterinary Consultants published a position statement encouraging the implementation of BVD control programs. Since then, several voluntary control programs, mainly for dairy but also for beef herds, on a state level have been developed and implemented in Colorado, Alabama, Montana, Washington, New York, and Michigan.<sup>24</sup> The main pillars of these programs include the following:

- Educating the producers about the biology of BVDV infection and the routes of transmission
- Definition and implementation of required testing strategies
- Implementation and documentation of standard biosecurity measures
- Implementation of specific vaccination strategies and schedules

Some programs provide subsidies for expenses related to testing and destruction of PI animals. Currently there are no plans to eradicate BVDV as is being done in the Scandinavian countries. However, it is very realistic and possible that the virus could be eradicated on a herd-by-herd basis using detection and elimination of PI animals, the judicious use of effective vaccines, regular diagnostic testing for PI animals, and implementation of biosecurity measures to ensure that reinfection of the herd of does not occur.

#### FURTHER READING

- Bolin SR, Grooms DL. Origination and consequences of bovine viral diarrhoea virus diversity. *Vet Clin North Am Food Anim Pract.* 2004;20:51-68.
- Chase CCL, Elmowalid G, Yousif AAA. The immune response to bovine viral diarrhoea virus: a constantly changing picture. *Vet Clin North Am Food Anim Pract.* 2004;20:95-114.
- Donis RO. Molecular biology of bovine viral diarrhoea virus and its interactions with the host. In: epidemiology of bovine virus diarrhoea. *Bovine viral diarrhoea virus. Vet Clin North Am Food Anim Pract.* 1995;113:393.

- Dubovi EJ. Laboratory diagnosis of bovine viral diarrhoea virus. *Biologicals*. 2013;41:8-13.
- Grooms DL. Reproductive consequences of infection with bovine viral diarrhoea virus. *Vet Clin North Am Food Anim Pract*. 2004;20:205-219.
- Lindberg A, et al. The control of bovine viral diarrhoea virus in Europe: today and in the future. *Rev Sci Technol*. 2006;25:961-979.
- Ridpath JF. Bovine viral diarrhoea virus: global status. *Vet Clin North Am Food Anim Pract*. 2010;26:105-121.
- Saliki JT, Dubovi EJ. Laboratory diagnosis of bovine viral diarrhoea virus infections. *Vet Clin North Am Food Anim Pract*. 2004;20:69-83.
- Sandvik T. Laboratory diagnostic investigation for bovine viral diarrhoea virus infections in cattle. *Vet Microbiol*. 1999;64:123-134.
- Walz PH, et al. Control of bovine viral diarrhoea virus in ruminants. *J Vet Intern Med*. 2010;24:476-486.

## REFERENCES

- Vilcek S, Nettleton PF. *Vet Microbiol*. 2006;116:1.
- Stahl K, et al. *Vet Res*. 2007;38:517.
- Ridpath JF, Fulton RW. *J Am Vet Med Assoc*. 2009;235:1171.
- Cranwell MP, et al. *Vet Rec*. 2007;161:211.
- Braun U, et al. *Schweiz Arch Tierheilkd*. 2013;155:123.
- Valdazo-González B, et al. *Vet Microbiol*. 2006;117:141.
- Walz PH, et al. *J Vet Intern Med*. 2010;24:476.
- APHIS. 2009; <[http://www.aphis.usda.gov/animal\\_health/nahms/beefcowcalf/downloads/beef0708/Beef0708\\_is\\_BVD\\_PI.pdf](http://www.aphis.usda.gov/animal_health/nahms/beefcowcalf/downloads/beef0708/Beef0708_is_BVD_PI.pdf)>; Accessed 19.06.13.
- Ridpath JF, et al. *J Vet Clin Invest*. 2011;23:185.
- van Amstel S, Kennedy M. *Small Rumin Res*. 2010;91:121.
- Topliff CL, et al. *J Am Vet Med Assoc*. 2009;234:519.
- Evermann JF. *Small Rumin Res*. 2006;61:201.
- Givens MD, et al. *Vet Clin North Am Food Anim Pract*. 2004;20:21.
- Makoschey B, et al. *Biologicals*. 2003;31:203.
- EMA. 2005; <[http://www.ema.europa.eu/docs/en\\_GB/document\\_library/Scientific\\_guideline/2009/10/WC500004575.pdf](http://www.ema.europa.eu/docs/en_GB/document_library/Scientific_guideline/2009/10/WC500004575.pdf)>; Accessed 19.06.13.
- Barkema HW, et al. *Tijdschr Diergeneeskd*. 2001;126:158.
- Lindberg A, et al. *Rev - Off Int Epizoot*. 2006;25:961.
- Ridpath JF. *Vet Clin North Am Food Anim Pract*. 2010;26:105.
- Grooms DL. *Vet Clin North Am Food Anim Pract*. 2004;20:5.
- Dubovi EJ. *Biologicals*. 2013;41:8.
- Ridpath JF. *Biologicals*. 2013;41:14.
- Kalaycioglu AT. *Vet Q*. 2007;29:60.
- USDA. 2008. USDA-APHIS-VS, CEAH, Fort Collins, CO.
- Van Campen H. *Vet Microbiol*. 2010;142:94.

## WINTER DYSENTERY OF CATTLE

### SYNOPSIS

**Etiology** Bovine coronavirus.

**Epidemiology** Northern climates. Adult lactating dairy cows, usually during winter months when housed. Immunity develops and lasts variable periods. High morbidity with outbreaks; low mortality. Transmitted by fecal-oral route.

**Signs** Sudden onset of diarrhoea affecting almost entire herd within several days. Mild fever, decline in milk production, inappetence. Recover in few days. Some coughing.

**Clinical pathology** None routinely.

**Lesions** Crypt atrophy on intestinal mucosa; enterocolitis.

**Diagnostic confirmation** Detection of virus in feces. Serology.

**Treatment** None required.

**Control** No specific control measures available. Hygiene. Minimize overcrowding in dairy housing.

## ETIOLOGY

Winter dysentery is associated with the bovine coronavirus (BCoV), a single-stranded RNA virus, which is a member of family Coronaviridae, order Nidovirales. BCoV has been associated with diarrhoea in calves and adult cattle (winter dysentery) as well as with respiratory disease in calves and adults. Virus strains isolated from the respiratory tract have been designated as bovine respiratory coronavirus (BRCoV), whereas those strains isolated either from adult cattle or calves with diarrhoea have been designated as bovine enteropathogenic coronavirus (BECoV). For clinical purposes strains isolated from diarrhoeic calves are often referred to as BCoV—calf diarrhoea (BCoV-CD) and those from adult diarrhoeic cattle BCoV-winter dysentery (BCoV-WD).<sup>1</sup>

There is ongoing debate over whether the strains of BCoV isolated from the respiratory and gastrointestinal tract are the same or dissimilar. It is still unclear whether the different isolates can be distinguished antigenically, but it has been proposed that enteropathogenic and respiratory strains may be the same virus at different stages of its infectious life cycle.<sup>1</sup>

Several studies have found a close serologic relationship between the coronavirus causing winter dysentery and the coronavirus causing diarrhoea in calves, but there are antigenic differences between the different isolates. The oral and intranasal inoculation of gnotobiotic and colostrum-deprived calves with BCoV-WD results in diarrhoea in the calves indistinguishable from that seen in calves inoculated with the calf diarrhoea coronavirus. The BCoV has also been isolated from the diarrhoeic feces of adult wild ruminants (sambar deer, one waterbuck, and white-tailed deer) affected with diarrhoea in both England and the United States. The BCoV has tropism for both the intestinal and respiratory tracts.

## EPIDEMIOLOGY Occurrence and Prevalence of Infection

BCoV is highly prevalent in the cattle population all over the world. The virus is

recognized as an important causative agent for diarrhoea in neonatal calves. In contrast winter dysentery is a sporadic condition associated with watery, bloody diarrhoea in adult cattle. Winter dysentery has been reported from many countries including the United States, Canada, Sweden, Germany, France, Israel, Australia, and New Zealand. It is common in dairy cattle in Sweden. A nationwide survey of antibodies to BCoV in bulk tank milk in Swedish dairy herds found that 89% of samples were positive and 52% had very high levels of antibodies.

Winter dysentery is most common in recently calved adult dairy cows. Young cattle and even calves may be affected but with only mild clinical signs. Highest incidences are observed during the colder months of the year when animals are housed with close contact to each other. In Sweden, 75% of all outbreaks occur between November and January. Winter dysentery has also occurred in adult beef cattle and in feedlot cattle 6 to 9 months of age. A typical outbreak lasts for 1 to 2 weeks and spreads in an epizootic manner throughout an infected herd.

A moderate immunity, which persists for about 6 months, develops after clinical disease, and recurrent clinical disease seldom occurs in less than 2 to 3 years. In herds regularly exposed to the infection, epidemics are mild; when the intervals between recurrences are more than 3 years, the epidemics are more severe. Serologic examination of paired serum samples from affected herds reveal that almost all cows seroconvert to BCoV and BVDV. The titers to BCoV are still high 1 year after the outbreak, and antibody is transferred to colostrum and to the calves in which it persists for up to 4 to 6 months of age.

A coronavirus indistinguishable from BCoV has been isolated from wild ruminants with diarrhoea similar to winter dysentery in cattle. The virus was isolated from the feces of sambar deer, waterbuck in a wild animal habitat, and from a white-tailed deer on a wildlife farm in Ohio. In a serologic survey of coronaviruses among wild deer, 8.7% and 6.6% of sera from mule deer in Wyoming and from white-tailed deer in Ohio, respectively, were seropositive against the wildlife isolates and selected bovine coronaviruses. Thus coronaviruses exist in wild ruminants, which may be a source of infection transmissible to cattle.

## Morbidity and Case-Fatality Rates

The morbidity rate may be as high as 30% to 50% within a few days after the first case is encountered and up to 100% after 1 week. The case-fatality rate is less than 2%. In recent years an increase in case-fatality rates as been reported in the Great Britain, for which changes in the virulence of circulating viral strains may have been the cause.<sup>2</sup> The disease is important in dairy herds because, although few animals die of the disease, it

may cause serious loss of body condition and milk production. In mild epidemics, the maximum decrease in milk production compared with a theoretical lactation curve ranges from 6% to 11%. Drops in daily milk yield in more severe cases can range from 25% to 95%.<sup>1</sup> The overall decrease in milk production may persist for 8 to 15 days.

Outbreaks of the disease exhibit space–time clustering within a 30-day time and a 5.5-km radius. Large herds with more than 60 cows and a history of an outbreak in the previous year were at increased risk of an outbreak. In Sweden, one-third of the affected herds had experienced an outbreak within the previous 4 years and 18% had a least one further outbreak during the following 2 years.

### Methods of Transmission

Feces and, to a lesser extent, secretions from the upper airways from clinical and subclinically infected animals are the main source of infection, and contamination of feed or drinking water is the method of spread. Vertical transmission has not been documented. The disease is highly contagious and can be introduced to farms by human visitors, carrier animals, and fomites. Infection of the respiratory tract with BCoV may enhance the transmission of the infection in addition to the usual fecal–oral route of transmission for enteric pathogens.

### Experimental Reproduction

Both winter dysentery and calf diarrhea can be reproduced using the same strain of BCoV. Calf diarrhea and winter dysentery strains of the virus can cause diarrhea in adult cows in conjunction with host or environmental factors. Winter dysentery can be reproduced in seronegative lactating dairy cows by direct contact with an experimentally infected calf. All experimental cattle shed the virus in the feces at the onset of profuse watery diarrhea with small amounts of blood in the feces of the most severely affected animals including both cows and calves. The cows are commonly more depressed, and their appetites are decreased, which is associated with a marked decrease in milk yield. Following infection, all cattle will produce early IFN type 1 in serum and in nasal secretions and milk. All cattle develop high IgM antibody responses and long-lasting IgA antibody responses both systemically and locally. Prolonged IgM antibody responses occur in all infected cattle. The IgA antibody response in serum may be detectable for up to 17 months after infection. Bovine-specific IgG can be detected in all cattle during the experimental period of up to 22 months.

### Risk Factors

#### Host and Environmental Risk Factors

Various host and environmental risk factors potentially contributing to the occurrence of

clinical disease have been identified in epidemiologic studies. The risk of clinical disease for an individual animal was found to be the highest for recently calved cows between 2 and 6 years old. Pregnant cattle were less likely to develop the disease compared with nonpregnant animals, and cows with high acute antibody titers to BCoV had greater odds of developing disease, compared with cows with lower titers.

On a herd level a history of previous episodes of winter dysentery and a herd size of 60 head or larger increased the risk of a winter dysentery outbreak. Housing cattle in tie-stall or stanchion barns rather than free stalls and use of equipment to handle manure and subsequently handle feed were factors that further increased the risk of winter dysentery outbreaks.

Other factors considered to contribute to the occurrence of clinical disease include environmental stress (e.g., inclement weather or shipping), human visitors that had recent contact with infected cattle, and purchase of animals potentially carrying the virus.<sup>1</sup>

### Pathogen Risk Factors

Coronaviruses are divided into at least three antigenic groups, and antigenic cross-reactivity exists within an antigenic group. BCoV, mouse hepatitis virus, murine enteric coronavirus, rat coronavirus, human coronavirus, and porcine hemagglutinating encephalomyelitis virus belong to the same group. BCoV is an important cause of neonatal calf diarrhea and winter dysentery, but BCoV also possesses tropism for the respiratory tract of young cattle.

Some BCoV strains isolated from the respiratory tract of cattle had different biological, antigenic, and genetic properties compared with enteric strains of the virus. Strains isolated from feedlot cattle and compared with those with the originally described Mebus prototype (from neonatal diarrheic calves) reveal that the respiratory strains of BCoV may differ genetically from the classical calf enteric and adult winter dysentery strains.

Cross-protection studies between respiratory and calf diarrhea and winter dysentery coronavirus strains in calves have been examined using RT-PCR and nested PCR for their detection. Calves inoculated with BRCoV, calf diarrhea coronavirus, winter dysentery coronavirus and then challenged 3 to 4 weeks later with either BRCoV, CD, or WD strains of BCoV developed diarrhea, then recovered, and were protected from BCoV-associated diarrhea after challenge exposure with either homologous or heterologous BCoV strains.

Nasal and fecal shedding of BCoV, which was detectable only by nested PCR, after challenge exposure confirmed field and experimental data documenting reinfection of the respiratory and enteric tracts of cattle. This indicates that in closed herds,

respiratory or enteric tract infections may constitute a source of BCoV transmission to cows or young calves.

### PATHOGENESIS

The pathogenesis of BCoV-WD infection is not completely understood. Because BCoV is considered to be ubiquitous in the cattle population, persisting in subclinically infected animals, it is assumed that environmental risk factors are required to trigger clinical disease. Environmental stress in the form of inclement weather, overcrowding, or shipping may result in increased virus shedding through feces and nasal secretions.

After oral infection the virus initially replicates in the enterocytes of the digestive tract and epithelial cells of different sections of the respiratory tract.<sup>2</sup> Within the intestinal tract the enteropathogenic BCoV, which has a known tropism for the small and large intestinal tract, appears to spread from the small to the large intestines.<sup>3</sup> Ultimately mucosal lesions may be found in all sections of the intestinal tract including jejunum, ileum, cecum, colon, and rectum, with the colon most severely affected.<sup>4</sup> This virus-associated tissue trauma consists of progressively worsening villous atrophy and fusion of the intestinal mucosa. The morphologic changes associated with winter dysentery have been termed **virus-induced enterocolitis**.<sup>4</sup> Within the respiratory tract, experimental infection with the enteropathogenic winter dysentery strain of BCoV was associated with epithelial damage in nasal turbinates, trachea, and lungs, as well as interstitial pneumonia.<sup>3</sup> Mucosal lesions in the intestines result in malabsorptive diarrhea and shedding of variable amounts of blood into the gut. Lesions in the respiratory tract may become clinically apparent as upper and/or lower respiratory tract disease if severe enough.

### CLINICAL FINDINGS

#### Cattle

After an incubation period of 3 to 7 days there is an explosive outbreak of diarrhea which, in the course of the next 4 to 7 days, affects the majority of adult cattle in the herd. The youngest animals of the mature group may have only mild signs. A fever (39.5°C–40.5°C; 103°F–105°F) may precede the onset of diarrhea, but when clinical signs are evident the temperature is usually normal. There is a marked fall in milk yield that lasts for up to 1 week, anorexia of short duration, and some loss of body condition. The feces are liquid, often hemorrhagic and homogeneous without much odor, and with no mucous or epithelial shreds; the color is dark green to almost black (depending on the amount of blood shedding into the gut). Feces are often passed with little warning and considerable velocity. A nasolacrimal discharge and cough may precede or accompany the epidemic. The frequency of



coughing may be higher in those herds that have not experienced a more recent outbreak. In most animals the course is short and the feces return to normal consistency in 2 to 3 days. In occasional cases the syndrome is more severe, dehydration and weakness are apparent, and dysentery—either with feces flecked with blood or the passage of whole blood—occurs. The disease in the herd usually subsides in 1 to 2 weeks but in some cases production may not return to normal for several weeks or a few months. Case fatalities associated with winter dysentery were primarily associated with severe blood loss into the gut and ensuing anemia rather than dehydration.<sup>2</sup>

In feedlot cattle, 6 to 9 months of age, the disease has been characterized by an acute onset of diarrhea with high morbidity and low mortality, dyspnea, coughing and nasal discharge, and high body temperature (40°C–41°C) in most severe cases. The diarrhea is characterized by fluid dark (brown-black) feces sometimes containing frank blood.

## CLINICAL PATHOLOGY

The laboratory diagnosis is dependent on detection of the virus in feces or upper respiratory tract secretions and serology. Fecal and blood samples should be submitted from both affected and normal cows.

## Detection of Virus

Fecal samples or oropharyngeal fluid can be examined for the presence of BCoV using ACE or electron microscopy. For routine purposes, direct electron microscopy viral identification and/or ELISA is sufficient. This can be complemented by the protein A gold **immune electron microscopy** because of its high sensitivity and specificity in the detection of viral particles. A reverse transcriptase (RT)-PCR can be used to detect BCoV in clinical samples. A LFT has been established in Europe for the BCoV antigen detection in feces.<sup>1</sup>

## Serology

Attempts at diagnosing these infections serologically are often problematic because in adult cattle high BCoV-specific IgG levels are often encountered in the acute samples, presumably due to reinfections with the virus, obscuring the detection of a possible increase in titer in paired samples. In addition, adult cattle are usually seropositive and maternal antibodies frequently obliterate the detection of infection in calves.

A capture ELISA test for BCoV-specific IgA and IgM in milk and sera has been developed and is useful for discriminating between primary infection and reinfection. In adult cattle, testing of paired serum samples using the antibody-capture ELISA may be a better indicator of recent BCoV exposure than testing of serum samples with virus neutralizing assays. Antigen-antibody binding in

feces may interfere with results of the ACE for BCoV.

## NECROPSY FINDINGS

In the rare fatalities available for necropsy, there is severe hemorrhage and hyperemia of the colonic and cecal mucosa.<sup>4</sup> Frank blood may be present in the lumen of the large intestine.<sup>2</sup> Microscopically there is widespread necrosis and degeneration of the epithelium of the large bowel. Lesions consist of pyknosis and karyorrhexis, and granular degeneration, hydropic degeneration, and hyaline droplet degeneration of crypt epithelial cells. Similar but less severe gross and microscopic changes have been observed in experimentally infected cattle.<sup>4</sup>

## Samples for Confirmation of Diagnosis

- **Histology:** formalin-fixed cecum, colon (LM, IHC)
- **Virology:** colonic content (Electron microscopy, ACE), colon (EAT).

## DIFFERENTIAL DIAGNOSIS

Winter dysentery must be differentiated from the following:

- **BVD/mucosal disease** affects primarily younger cattle in small outbreaks (BVD) or individual animals. Erosions of the oral cavity are present and the diarrhea and systemic effects are much more severe. BVD serotype II may affect cattle of all ages including adult cattle and is a severe, highly fatal disease.
- **Coccidiosis** affects cattle from 3 to 12 months of age and is characterized by frank blood in the feces, tenesmus, and diarrhea of longer duration. Fecal sample is usually diagnostic.
- **Enteric salmonellosis** is a severe toxemic enteritis with diarrhea and dysentery, fibrous casts in the feces, a high fever, severe depression, and rapid death. Culture of the feces is important.
- **Paratuberculosis** characterized by chronic intractable diarrhea in mature cattle with loss of body weight and eventual emaciation. The condition in its clinical stage generally affects single or few animals within a herd at a time.
- **Group B rotavirus.** Rare cases of diarrhea in mature lactating dairy cows associated with group B rotavirus have been described. The onset of diarrhea is sudden, milk production decreased, the feces were liquid, and recovery occurred in 3–5 days.
- **Schmallenberg virus.** Outbreaks of profuse watery, but not bloody diarrhea in dairy herds that were associated with mild systemic disease and a marked transient drop in milk production were reported in Northern Europe in the fall of 2011. Symptoms were later linked to an epidemic Schmallenberg virus infection in the region.<sup>6</sup>

- **Respiratory tract infections.** The clinical findings of dyspnea, nasal discharge, coughing, and fever associated with the bovine respiratory coronavirus must be differentiated from acute undifferentiated bovine respiratory tract disease.

*BVD, bovine diarrhoea.*

## TREATMENT

Treatment is of doubtful value because affected cattle usually respond spontaneously in 24 to 36 hours. Occasionally dehydration will become severe and is best treated with fluids and balanced electrolytes as indicated.

## CONTROL

No specific and effective methods to control or prevent outbreaks of winter dysentery are available. Control measures should focus on assuring adequate host immunity, minimizing stress, and reducing exposure to clinical cases whenever this is feasible. Every effort must be made to avoid the spread of infection on inanimate objects such as boots, feeding utensils, and bedding, but even the greatest care does not appear to prevent the spread of the disease within a herd.

## Vaccination

Some preliminary studies have tested the potency of BCoV vaccine to induce serum antibodies, but randomized controlled trials to test the efficacy of the vaccine have not been done.

## FURTHER READING

- Boileau MJ, et al. Bovine coronavirus associated syndromes. *Vet Clin North Am Food Anim Pract.* 2010;26:123-146.
- Van Kruiningen HJ, et al. Winter dysentery in dairy cattle: recent findings. *Comp Cont Educ Pract Vet.* 1985;7:S591-S599.

## REFERENCES

1. Boileau MJ, Kapil S. *Vet Clin North Am Food Anim Pract.* 2010;26:123.
2. Anonymous. *Vet Rec.* 2009;164:199.
3. Park SJ, et al. *Acta Virol.* 2007;152:1885.
4. Natsuaki S, et al. *J Vet Med Sci.* 2007;69:957.

## BOVINE PAPULAR STOMATITIS

### SYNOPSIS

**Etiology** Bovine papular stomatitis virus, member of the parapoxvirus genus.

**Epidemiology** Worldwide occurrence; cattle of all ages can be infected, clinical signs most common in young animals. Outbreaks of BPS in dairy herds have been reported. BPS is a zoonosis causing skin lesions after direct contact in animals handlers.

**Signs** Lesions on the muzzle, inside the nostrils, the oral cavity, teat and udder skin, occasionally also esophagus and

*Continued*

forestomachs. In most cases without systemic disease but transient anorexia, weight loss, ptyalism, and a slight fever may occur.

**Clinical pathology** None routinely.

**Lesions** Mildly erosive papules and vesicles, in severe cases with ulceration and secondary bacterial infection. Characteristic ballooning degeneration and the presence of cytoplasmic inclusions in affected cells.

**Diagnostic confirmation** Electron microscopy and immunohistochemistry; virus isolation from cell culture; sequencing of specific viral DNA (PCR). Serology considered of limited value.

**Treatment** Not specific treatment available.

**Control** No vaccine available, no established control measures.

*BPS, bovine papular stomatitis; PCR, polymerase chain reaction.*

## ETIOLOGY

Bovine papular stomatitis is caused by the bovine papular stomatitis virus (BPSV) that is a member of the *Parapoxvirus* (PPV) genus within the Poxviridae family. The PPV family includes four species:

- Prototype *Parapoxvirus ovis* or Orf virus (ORFV, causative agent of contagious ecthyma)
- BPSV (causing bovine papular stomatitis)
- Pseudocowpox virus (PCPV, causing “milker’s nodules”)
- PPV of read deer in New Zealand.

## EPIDEMIOLOGY

BPS is a generally mild viral disease of cattle with worldwide occurrence. It is characterized by proliferative skin lesions without systemic clinical disease. Primarily calves and young cattle present clinical signs, but outbreaks of BPS in dairy herds with skin lesions on teat and udder skin have been reported from Brazil and Japan.<sup>1,2</sup> The infection prevalence of BPS infection does not appear to have been studied in detail but is likely to be underestimated as most infections may pass unnoticed. A serologic survey conducted in Japan found a seroprevalence of PPV antibodies in cattle of over 50%, with a likelihood of seropositivity increasing with age.<sup>3</sup>

The primary importance attributed to this condition was that it presents an **important differential diagnosis for foot-and-mouth disease**. Economically BPS was considered to be of minor relevance because most infections pass unnoticed, skin lesions are minor and rarely associated with systemic disease, and healing occurs spontaneously. Notwithstanding outbreaks of BPSV infection in dairy herds in Brazil and Japan were associated with painful skin lesion on the teats of milking cows.<sup>1,2,4</sup> In these cases

BPS was associated with a decrease in milk production or even an interruption of lactation.<sup>1</sup>

BPSV infection is an often **neglected zoonosis** causing primarily mild papular skin lesions after direct contact with infected animals. Reports of confirmed BPSV infection in humans that were associated with severe skin lesions affecting 50% of the dorsal skin surface of both hands have been published recently.<sup>5</sup>

## Transmission

The transmission appears to occur fairly easily either through direct contact with skin lesions or through fomites that may play a role in the spreading of the disease during outbreaks in milking herds (milking machine).<sup>2</sup> Experimentally the infection can be transmitted by the inoculation of scrapings from lesions into the oral mucosa of susceptible calves and by submucosal inoculation of undiluted tissue culture virus.

## CLINICAL FINDINGS

The classic presentation of the disease is in young animals from 2 weeks up to 2 years of age and in a group the morbidity often approximates to 100%. Typically lesions occur in the form of papules on the muzzle, inside the nostrils, and in the oral cavity. Lesions on the muzzle may be difficult to see if the area is pigmented. In the mouth the lesions occur on all mucosal surfaces except the dorsum of the tongue and are most common inside the lips and in close proximity to the teeth. Occasional cases occur in which the only lesions are in the esophageal and forestomach mucosa.

In recent years there have been several reports of confirmed BPSV infection in adult dairy cattle that were associated with severe dermatitis on teat and udder skin, that resembled bovine herpes mammillitis, and that were clinically and histologically indistinguishable from PCPV infection.<sup>1,2,4</sup>

Lesions commence as small (0.5–1 cm) papules that become dark red in color, develop a roughening of the surface, and expand peripherally so that the lesions are always round or nearly so. Confluence of several lesions may cause the development of a large irregularly shaped area. As the lesion expands, the periphery becomes reddened and the center depressed, gray-brown in color and rough on the surface, and eventually covered with necrotic tissue or on external lesions by a scab. Individual lesions heal quickly, sometimes in as short a time as 4 to 7 days, but evidence of healed lesions in the form of circular areas of dark pink mucosa usually surrounded by a slightly paler raised zone may persist for weeks.

There may be transient anorexia, weight loss, ptyalism, and a slight fever (39.5°C; 103°F), but in most instances the disease goes unnoticed unless a careful examination of the mouth is made.

Lesions on teat and udder skin were painful reddish papules (3–10 mm in diameter) and scabby proliferative lesions that frequently appeared on several teats simultaneously. A few days after the appearance of the first lesions, papules, coalescent scabby erosions, and ulcerations were noticed. The clinical course of the condition lasted 7 to 12 days and lesions tended to regress in the third week of the disease. Affected animals resisted to being milked because of severe local pain. Secondary mastitis of undetermined etiology was reported in some cases.<sup>1,2,4</sup>

Because repeated infection with BPSV has been documented, it is suggested that no immunity occurs and the virus may only cause lesions when intercurrent disease causes lowering of the animal’s resistance.

The disease, known as “rat-tail syndrome” in young cattle in feedlots, is probably a manifestation of sarcocystosis. However, there is also a high prevalence of bovine papular stomatitis lesions and virus in these cattle and it is possible that it may contribute to the development of the disease. A concurrent infection of bovine papular stomatitis and BVD has been described in a calf.

The disease in reindeer associated with a virus closely related to the PCPV is characterized clinically by erosions, papules, pustules, and ulcers in the oral cavity. Outbreaks have occurred in Finland, particularly during the winter, and the case–fatality rate can be up to 25%.

## CLINICAL PATHOLOGY

Histologic examination of surgically excised vesicles and papules reveals a characteristic ballooning degeneration and the presence of cytoplasmic inclusions in affected cells. Diagnosis of the presence of the virus can be made by electron microscopy and immunohistochemistry of scabs. Virus isolation on cell culture can be attempted.

PCR methods have been developed and established in recent years to differentiate between different parapox virus infections in both domestic and wild animals.

The serologic tests used for detection of different PPV infections include VNT, AGID, CF test, and agglutination test. The value of serology has been questioned because of the presumed high seroprevalence of parapox antibody–positive cattle.<sup>3</sup>

## DIFFERENTIAL DIAGNOSIS

Clinical differential diagnoses for bovine papular stomatitis include the following:

- Foot-and-mouth disease
- Pseudocowpox virus infection
- Bovine viral diarrhea infection (BVD type 2 and mucosal disease)
- Bovine herpesvirus-2 (BHV-2, causing bovine mammillitis) in cases where teat skin and udder skin are affected.
- Orthopoxvirus infection.

## TREATMENT

No specific treatment is currently available.

## CONTROL

No vaccines are currently available. No established control measures for BPS have been recommended.

## FURTHER READING

Buttner M, Rziha HJ. Parapoxviruses: from the lesion to viral genome. *J Vet Med B Infect Dis Vet Public Health*. 2002;49:7-16.

## REFERENCES

1. de Sant'Ana FJF, et al. *J Vet Diagn Invest*. 2012;24:442.
2. Inoshima Y, et al. *Vet Rec*. 2009;164:311.
3. Kuorda Y, et al. *J Vet Med Sci*. 1999;61:749.
4. Leonard D, et al. *Vet Rec*. 2009;164:65.
5. Holmes PH, et al. *Vet Rec*. 2001;169:235.

# Parasitic Diseases of the Ruminant Alimentary Tract

## PARASITIC GASTROENTERITIS IN RUMINANTS

### SYNOPSIS

**Etiology** The nematode genera *Trichostrongylus*, *Ostertagia* (including *Teladorsagia*), *Cooperia*, and *Nematodirus*.

**Epidemiology** Transmission is by ingestion of infective larvae. Disease risk is determined by factors influencing the susceptibility of the host, the numbers of infective larvae accumulating on pasture, and the numbers of larvae undergoing hypobiosis within the host. Calves and lambs are most vulnerable, as are goats of all ages. Type I disease follows recent infestation; type II disease is delayed until hypobiotic larvae resume development.

**Signs** Diarrhea and weight loss, production losses.

**Clinical pathology** High fecal egg count (in young animals) (unless disease caused by immature worms), elevated plasma pepsinogen and gastrin concentrations (in abomasal infections only).

**Lesions** Raised nodules on gastric mucosa and/or inflammation and villous atrophy in anterior small intestine.

**Diagnostic confirmation** Worm counts at necropsy, otherwise largely reliant on clinical signs and history. Fecal egg counts and plasma pepsinogen concentrations confirmatory in some instances.

**Treatment** Monepantel; derquantel-abamectin; avermectins/milbemycins; eprinomectin; benzimidazoles/probenzimidazoles; levamisole and morantel. Not all compounds are suitable for controlling hypobiotic larvae.

**Control** Methods differ widely according to climatic region and management. The major aim is to maintain safe grazing by

reducing pasture contamination. Integrated management schemes that reduce dependence on drug usage are preferred because anthelmintic resistance is a serious or emerging problem in many areas, particularly in sheep and goats.

## ETIOLOGY

The nematode genera *Trichostrongylus*, *Ostertagia*, *Cooperia*, and *Nematodirus* (known locally as scour worms or hair worms) often occur together in the alimentary tract of ruminants. Their combined effects on the host, together with those of other alimentary nematodes such as *Oesophagostomum* and the hookworms, are commonly known as parasitic gastroenteritis (PGE). The main species are listed in Table 8-11 together with their hosts and anatomic preferences. The listed worms are from the same nematode family and are collectively known as the trichostrongylids. *Haemonchus* also belongs to this group but is considered separately because the disease processes it provokes are more complex. Taxonomists now think that the *Ostertagia* species of sheep should be assigned to a different genus and *Teladorsagia* and *Nematodirus* to a different family, but the clinical convenience of the older nomenclature has been retained for the purposes of this chapter. Related species from other hosts, for example, *O. leptospicularis* from deer, sometimes cause disease outbreaks in cattle.

## LIFE CYCLE

The trichostrongylids all have direct life cycles (i.e., there is no intermediate host). Eggs passed in the feces hatch under suitable environmental conditions, producing two nonparasitic larval stages and then the infective third-stage larva.<sup>1-4</sup> This is ensheathed, i.e., it retains the shed cuticle from the previous molt for protection. The eggs of *Nematodirus* spp. are different from the others. They are larger and do not hatch initially. Instead, an infective ensheathed larva develops within the egg, gaining even greater resistance to harsh environmental conditions. When infective trichostrongylid larvae are ingested by the host, they exsheath and, depending on species, enter either the gastric glands of the abomasum or the crypts of the small intestine. Here they molt, return to the lumen, and after a fourth molt mature to become adult. The time from ingestion of larvae to appearance of egg-laying females (the prepatent period) normally takes about 3 weeks, except for *Nematodirus*, which takes a week or so more. This period may become extended as third-stage or early fourth-stage larvae, depending on species, can become arrested in development (hypobiotic), delaying emergence from the mucosa for weeks or months.

**Hypobiosis** is probably an adaptation phenomenon similar to diapause in insects and happens during periods of adverse

pasture conditions. For example, strains of *O. ostertagi* from northern Europe, the northern United States, and New Zealand undergo hypobiosis in autumn with worms resuming development in spring, whereas strains in the southern United States and Australia hypobiose in spring to emerge after the dry season in autumn. Thus hypobiosis ensures that a new generation of adults is ready to lay eggs when the external environment again becomes favorable. The environmental stimuli that condition infective larvae to become hypobiotic in the host vary with species and locality, and in most cases are unknown. For *O. ostertagi* in Europe, exposure of infective larvae to low temperatures in the autumn is the trigger. The proportion of ingested larvae becoming arrested varies greatly with locality and, in some places, also from year to year.

## EPIDEMIOLOGY

Natural trichostrongylid infestations mostly comprise a mixture of species. The relative importance of each varies with locality and season. In sheep and cattle, *Ostertagia* tends to be of greatest clinical significance in winter rainfall areas, whereas *Haemonchus* is predominant in summer rainfall zones. Other genera may dominate in some areas or under some management practices. Sheep and goats share many trichostrongylid species but cross-infection between sheep and cattle occurs only to a limited extent. Patterns of disease are determined by factors influencing the susceptibility of the host, the numbers of infective larvae accumulating on the pasture, and the numbers of larvae undergoing hypobiosis in the host.

**Resistance** to trichostrongylid infections is complex and involves genetically determined physiologic and acquired immunologic components. Age resistance is seen particularly in the case of *Nematodirus*, in which 3- to 4-month-old lambs are better able to withstand larval challenge than younger animals. Differences in susceptibility occur between breeds and between individuals within a group.<sup>5,6</sup> Acquired immunity in sheep and cattle develops quickly after exposure to *Nematodirus* but takes much longer with other gastrointestinal trichostrongylids. Consequently, disease associated with *Nematodirus* is only likely to occur at first exposure, but animals remain susceptible to the other trichostrongylids for most or all of the first grazing season. In cattle, exposure to *Cooperia* leads to immunity earlier in the season than is the case with *Ostertagia*. Lambs can develop high resistance to *Trichostrongylus* by about 6 months of age when larval intake is high, but this period is extended when challenge is low. In sheep infected with *T. colubriformis*, high IgA levels in response to *T. colubriformis* L3 carbohydrate surface antigen (CarLA) can prevent larvae from establishing in the gut, resulting in rapid expulsion larvae.<sup>7</sup> Using a commercial test to measure saliva



Table 8-11 Anatomical distribution of trichostrongylid worms in ruminants

Parasite	CATTLE		SHEEP, GOATS	
	Abomasum	Small intestine	Abomasum	Small intestine
<i>Trichostrongylus</i> spp.				
<i>T. axei</i> <sup>†</sup>	*		*	
<i>T. colubriformis</i> , <i>T. longispicularis</i>		*		*
<i>T. falculatus</i> , <i>T. vitrinus</i> , <i>T. capricola</i> , <i>T. rugatus</i> , <i>T. probolurus</i>				*
<i>Ostertagia</i> spp.				
<i>O. ostertagi</i>	*			
<i>O. circumcincta</i> , <sup>‡</sup> <i>O. trifurcata</i> <sup>‡</sup>			*	
<i>Cooperia</i> spp.				
<i>C. punctata</i> , <i>C. oncophora</i>		*		*
<i>C. pectinata</i>		*		
<i>C. curticei</i>				*
<i>Nematodirus</i> spp.				
<i>N. spathiger</i> , <i>N. battus</i> ,		*		*
<i>N. filicollis</i> , <i>N. abnormalis</i> , <i>N. helvetianus</i>				*

<sup>†</sup>*Trichostrongylus axei* also occurs in the stomach of horses.

<sup>‡</sup>The genus name *Teladorsagia* is often used in place of *Ostertagia* for these species.

IgA antibody response to CarLa in animals under parasite challenge, high levels of IgA have been associated with lower fecal egg counts, and improved growth under challenge.<sup>7</sup> Immunity may be expressed as the following:

- A reduction in parasite numbers
- Stunted surviving worms
- Lowered egg output by females
- A smaller establishment of incoming larvae

The term “resilience” is used to describe the ability of an animal to withstand the damaging effects of parasitic infestation (as distinct from limiting worm numbers).<sup>8</sup> Resistance and resilience can be affected adversely by stress and nutritional deficiencies. Moderate infestations can be tolerated by animals on a good plane of nutrition when similarly infected but poorly nourished animals would succumb. In weaner lambs, the reduction of food intake at weaning increases susceptibility, whereas the poor quality of winter feed has the same effect in older stock. Massive infestations can overwhelm even well-fed animals.

A relaxation in immunity to trichostrongylid infection occurs in sheep but not cattle before or at the time of parturition and reaches a peak 6 to 8 weeks after lambing. This happens because priority is given for allocation of scarce metabolizable protein to milk production over immune functions. As

a result, ewes pass large numbers of worm eggs onto the pasture over a period of several weeks. This is known as the periparturient egg rise (PPER) and is an important source of pasture contamination.

***Nematodirus* spp. behave differently** from other trichostrongylids. This genus does not contribute to the PPER in ewes so lambs are the sole source of contamination on sheep pastures. *Nematodirus* eggs containing the infective third-stage larvae hatch only after exposure to specific stimuli, particularly warmth after a period of low temperatures.<sup>9</sup> Thus most hatch in the spring of the year following that in which they were deposited (although a proportion may hatch in the autumn of the first year). Unlike the other trichostrongylids, therefore, *Nematodirus* is transmitted from one lamb crop to the next. *N. battus* is more pathogenic than the other species because its hatching requirements are more precise. This results in many eggs hatching simultaneously to produce a sudden overwhelming wave of pasture contamination.

**The eggs and free-living larvae of *Trichostrongylus*, *Ostertagia*, *Cooperia*, and *Nematodirus*** can survive and develop at much lower temperatures than those of *Haemonchus*. The eggs and larvae of *Ostertagia* and *Nematodirus* are particularly resistant to cold temperatures. The eggs of the latter worm contain trehalose, which acts as an antifreeze. All these trichostrongylids can

survive a moderate winter but the spectrum of endemic species declines as regional winter conditions become more severe. Snow cover, however, protects infective larvae from extreme cold. Upper temperature limits for survival are also lower than for *Haemonchus* and this is why the clinical importance of *Ostertagia* spp. diminishes in warmer climates. Moisture is necessary for infective larvae to ascend the herbage and so transmission by all species is low in the absence of dew, rain, or irrigation. Desiccation will kill larvae on the pasture but those still within fecal deposits can survive to emerge when rainfall resumes. Severe outbreaks of disease may occur after the first rains following a prolonged drought. Summer storms during a dry period reduce risk as released larvae quickly die when the pasture dries out. In temperate climates, larvae leaving accumulated dung pats in the autumn after a dry summer may be conditioned for hypobiosis, increasing the risk of type II disease (see later section).

**Potential sources of contamination** on sheep pastures at the start of the grazing season are larvae that have overwintered on the herbage and, most important, larvae from eggs more recently shed by ewes during the PPER. On cattle pastures, overwintered larvae are of greatest significance as yearling and adult cattle generally deposit insignificant numbers of trichostrongylid eggs. In

both cases, overwintered larvae do not survive long in the warmer spring weather because the food stores on which they depend are soon exhausted. In the meantime, however, some will be ingested by susceptible lambs or calves. Disease does not occur at this stage unless massive numbers of larvae have survived the winter. Most often, these first infections are small and asymptomatic. They are nevertheless of great epidemiologic significance as the eggs produced are responsible for the infective larvae that appear on the pasture later in the season.

**The rate of larval development** is temperature dependent, and occurs faster in warmer weather. The life span of infective larvae is, however, shorter at higher temperatures as food stores are used more quickly. The number of larvae accumulating on pasture is therefore a balance between these two opposing factors and tends to follow a stereotyped pattern in each locality. Computer models are being developed to investigate these trends in different climatic zones and under different husbandry systems. The general pattern of pasture infectivity may, however, be temporarily disrupted by short-term weather fluctuations. For example, with *O. ostertagi* in grazing calves in temperate climates, the new wave of infective larvae (the “autoinfection peak”) will not appear before midsummer, but this event may be delayed or interrupted by periods of dry weather. As larvae of each trichostrongylid species have different optimum developmental conditions, peak numbers will occur at different times. In England, for example, the “succession of species” in sheep is *N. battus* followed by *O. circumcincta* then *H. contortus* and finally *Trichostrongylus* spp.

**Outbreaks of disease** caused by trichostrongylid infection can occur in different ways. Clinical signs are normally initiated when developing worms emerge from the mucosa of the alimentary tract. With normally developing mucosal larvae, this will happen when the daily intake of infective larvae has risen to a level sufficient to overwhelm any immunity that may have developed. This is sometimes termed “type I” disease. The onset of clinical signs will be considerably delayed, however, when damage is produced by previously hypobiotic larvae resuming their development. This often occurs during the winter housing period and is known as “type II” disease. Additionally, hypersensitivity responses to incoming larvae can occur under some circumstances when immune animals graze heavily contaminated pasture. This has been proposed as an explanation for the so-called nonparasitic scouring syndrome in southern Australia, which occurs in pregnant and lactating ewes grazing contaminated pasture.

**Trichostrongylosis in sheep** is favored by cool, wet weather and is a disease of the winter months in those areas in which rainfall occurs chiefly at this time of the year. Although the eggs and larvae of *Trichostrongylus* spp.

tolerate cold, they are not resistant to freezing temperatures. Consequently, in very cold climates disease may be more common in the late summer and autumn. In arid areas the disease is of little significance except in unusually wet years. *T. axei* can infect a range of species but is primarily a parasite of cattle and is usually only seen in other hosts when grazing cattle pastures.

**The epidemiology of bovine ostertagiosis** is complex. Type I disease is mostly seen in first-season grazing animals, particularly dairy calves heavily stocked on permanent calf paddocks. Large numbers of adult worms are present and egg counts are high. In areas with warm climates, Type I ostertagiosis may be seen in almost any season but is particularly important in winter and spring. In areas with harsher winters, as in northern Europe, larvae overwinter in sufficient numbers to infect autumn-born calves after spring turnout. The resulting small worm burdens produce eggs that give rise to a new generation of infective larvae. These autoinfection larvae are responsible for the disease outbreaks that occur from mid-July to the end of the grazing season. Type I ostertagiosis also occurs in beef cattle if placed on heavily infected pastures immediately after weaning. It is less often seen in calf suckler or extensive management systems because of the relatively low number of susceptible animals per unit area of grazing land.

**When hypobiosis occurs**, many fourth-stage larvae accumulate in the gastric glands. Few if any clinical signs will be apparent, and egg counts will be zero or low. This condition is called pre-type II ostertagiosis and occurs at a definite time each year depending on the region—autumn in northern Europe and spring in Australia. Type II disease occurs when waves of hypobiotic larvae emerge from the parasitized glands some 4 to 5 months later. This is typically when cattle are 12 to 24 months of age, although type II disease is sometimes seen in older animals. Few adult worms will be present and egg counts will be correspondingly low.

**Goats** do not build up an effective immune response against trichostrongylid worms and remain susceptible to disease throughout their lives. The risk is enhanced if they are forced to graze rather than browse. Problems are frequently encountered on hobby farms in which goats are overstocked on small paddocks.

## PATHOGENESIS

Each trichostrongylid species differs in its habit and in the damage it causes so details of the corresponding disease processes will vary correspondingly. The major mechanisms leading to diarrhea, weight loss, and production deficits can, however, be described in general terms.

**In abomasal infection** with *Ostertagia* spp., developing larvae distend the gastric glands and produce small white nodules on the mucosal surface, but these are of little

clinical significance. More important changes take place 18 to 21 days after infection when worms start to emerge from the glands. This triggers a hyperplastic reaction in neighboring glands causing larger nodular lesions which, if numerous, may coalesce. Many of the cells lining affected glands are nonfunctional. The resulting reduction in acid-secreting parietal cells leads to increased gastric pH, which may rise to 6 to 7. This produces several domino effects. First, incoming bacteria and ruminal protozoa are not killed. Second, pepsinogen is not converted to pepsin because this only happens in an acid environment, thus, no pepsin is available for protein digestion. Accumulating amounts of the precursor molecule are reflected in elevated blood pepsinogen concentrations. Third, blood gastrin rises as the body attempts to stimulate more acid secretion. The hyperplastic mucosal reaction also results in increased permeability of the epithelial sheet. This leads to protein loss into the lumen of the abomasum. In mild uncomplicated cases, this protein leak and the disrupted protein digestion are both compensated by digestive/absorptive intestinal mechanisms. In severe cases, hypoalbuminemia, tissue edema, and weight loss are apparent. Between these extremes, these processes lead to reduced muscle protein synthesis and consequent productivity losses.

**Intestinal trichostrongylid infections** are associated with inflammatory changes, a thickening of the mucosa, and a stunting or flattening of the villi. Epithelial enzyme activity is reduced. *Nematodirus* and *Cooperia* lie in close contact with the mucosa but *Trichostrongylus* spp. larvae and adults form superficial tunnels, causing additional tissue disruption. Lesions are confined to the anterior small intestine and their severity is determined by the density of worms. Surprisingly, malabsorption is not a marked feature of pathogenesis because unaffected parts of the intestine can usually compensate. Consequently, protein digestibility and absorption may be normal. There is, nevertheless, poor retention and utilization of nitrogen caused by a protein-losing enteropathy, together with excessive losses from sloughed cells and mucus production. This contributes to production losses and causes hypoalbuminemia and edema in severe cases. Wool growth is affected and the fleece becomes brittle. Mineral absorption is impaired, resulting in reduced skeletal growth, bone density, and mineralization. *T. colubriformis* infection reduces the absorption of phosphorus and increases the loss of endogenous phosphorus, thus leading to a phosphorus deficiency. As with abomasal parasitism, the precise reason for the diarrhea associated with these infections is unknown.

**Reduced productivity** in both abomasal and intestinal parasitism is mostly caused by a reduction in appetite that is a constant feature of these infections. In one field study, untreated heifers spent on average 105

minutes less per day grazing compared with a matched treated group, and their daily herbage intake was 0.78 kg dry matter per day lower. Experimental studies show that inappetence accounts for over 60% of the difference in weight gains between *Ostertagia*-infected and worm-free sheep and cattle. The associated mobilization of adipose tissue gives rise to increased nonesterified fatty acid levels. Voluntary feed intake may be significantly depressed even in parasitized animals showing no clinical signs. The elevated gastrin levels in abomasal trichostrongylid infections impair reticuloruminal motility and slow abomasal emptying, leading to a stasis of ingesta and hence a reduction in feed intake. Other, as yet unknown, mechanisms must also be involved because gastrin levels are not affected by intestinal worms, yet these also depress appetite.

### CLINICAL FINDINGS

In sheep the two most susceptible age groups are weaner lambs<sup>10</sup> and yearlings. Those over 18 months of age are less prone because of immunity gained from previous infestation. The onset of disease is generally insidious with young animals initially failing to grow satisfactorily and later becoming unthrifty and lacking in vitality and bloom. If they are observed sufficiently closely, their food intake can be seen to be reduced. This may be the full clinical picture in many flocks that are considered to have “weaner ill-thrift.” More severely affected sheep pass dark-green, almost black, soft feces that foul the wool of the breech. Lamb and yearling flocks are most seriously affected and a constant mortality begins, with a few animals dying each day.<sup>10</sup> The losses are not acute but may eventually exceed 35%. A more dramatic picture occurs when young lambs, especially those in the 6- to 12-week age group, are exposed to sudden pasture challenge with *Nematodirus* spp. There is profuse watery diarrhea and the lambs quickly become dehydrated. Mortality can be high and deaths may start within 2 days of the first observed illness.

**In cattle**, calves are most vulnerable in their first grazing season, although yearlings and, less often, adults are sometimes affected and do the following:

- Lose weight rapidly
- Pass soft feces that eventually become very thin and dark-green to yellow in color
- Develop a long, dry hair coat
- Become dehydrated with sinking of the eyes in the terminal stages

Until the last they continue to eat, although the amount of food taken is below normal. Gross anemia is not evident, but the mucosae are pale and dry. Submandibular edema is common, especially in type II disease. The temperature may be elevated (39.5°C; 103°F) and the heart rate increased (120 beats/min) in calves showing dehydration. In the terminal stages the calves become weak and

emaciated. Type I ostertagiosis in calves is characterized by high morbidity and low mortality. Although morbidity is low in type II disease, clinical signs are generally more severe and the prognosis poorer.

### CLINICAL PATHOLOGY

Fecal egg counts have to be interpreted with caution as they are only well correlated with worm burdens in young animals. Egg counts are, however, often over 1,000 eggs per gram (epg) feces in type I ostertagiosis. Zero or low epg values may be recorded if the following occurs:

- The worm burden comprises mainly immature stages (as in type II disease or some outbreaks of nematodiosis)
  - Intestinal damage persists after the worm population has been expelled by immunity or anthelmintic treatment
  - Disease is associated with hypersensitivity to incoming larvae
- Different trichostrongylid eggs, other than *Nematodirus*, cannot easily be differentiated, and cultures must be made if species determination is necessary.

**Plasma pepsinogen** estimations are performed routinely in many laboratories as an aid in the diagnosis of ostertagiosis. Elevated values also occur in hemochrosis. The test is difficult to standardize so results from different laboratories cannot be compared but, in calves, levels higher than 3,000 IU tyrosine are generally considered to indicate a pathogenic worm burden. Pepsinogen levels decline after effective anthelmintic treatment but do not return to preinfection values. Older immune cattle may show elevated values when grazing contaminated pasture, even though few incoming larvae are able to establish. Plasma gastrin concentrations reflect the size of the abomasal worm burden in both young and older animals, but currently can only be measured by radioimmunoassay, which limits their field application. Gastrin occurs in several molecular forms and, consequently, test kits have to be validated before use with bovine blood because not all are suitable for this purpose.

**Moderate anemia** often occurs with hemoglobin levels around 6 to 8 mg/dL and is more evident in *Cooperia* and *Ostertagia* spp. infestations than in trichostrongylosis in which there may be polycythemia. Serum protein concentrations may be as low as 4 to 5 mg/dL with a marked reduction in serum albumin values.

**Species-specific** ELISA tests are being developed for use with samples from bulk milk tanks but are currently only available for epidemiologic research.<sup>11</sup>

### NECROPSY FINDINGS

Adult worms are found in the abomasum or small intestine depending on the predilection site of the individual species. A total worm count is the critical measure of the degree of infestation. Counts less than 2000

in mixed species of sheep are considered to be light, whereas counts over 10,000 are heavy, but massive counts of 50,000 and more are often seen. In cattle, burdens of 40,000 and above are seen in type I ostertagiosis outbreaks (the majority are adults), whereas in type II disease worm numbers may be 100,000 to 200,000, with occasional animals harboring a million or more. In these cases about 90% are in the fourth larval stage. Trichostrongylids are small, translucent, and threadlike so even adults can easily evade detection by the naked eye at necropsy. Worm counting therefore involves washing the mucosa, sieving the washings and luminal contents, resuspending the residue, taking aliquots, and picking out and identifying the nematodes. A more rapid but effective field technique for demonstrating intestinal worms is to do the following:

- Roll a loop of duodenum inside out over a test tube or glass rod
- Immerse this first in aqueous iodine solution (iodine 30 g, potassium iodide 40 g, water 100 mL) for several minutes
- Immerse in a 5% solution of sodium thiosulfate for a few seconds

The mucosa is decolorized but the brown-stained worms retain their color and are easily seen. Mucosal larval stages have to be released by digesting the tissues with acid pepsin.

**Gross pathologic findings** are often not striking, apart from the nonspecific lesions of emaciation, dehydration, moderate anemia, and evidence of scouring. In severe cases, the mucosa of the abomasum and upper small intestine may be hyperemic and swollen, and local lymph nodes enlarged. In ostertagiosis there will be numerous raised nodules that may be discrete or confluent forming a “Morocco-leather” appearance. Abomasal folds are edematous and diphtheresis may sometimes be apparent. A putrid smell may reflect the growth of microorganisms in the ingesta, and estimation of the pH will confirm loss of acidity.

Heavy *T. axei* infection in lambs, calves, and horses causes circumscribed raised plaque-like hyperplastic lesions on the abomasal mucosa, sometimes with an eroded center. Close inspection is needed to see the villous atrophy associated with intestinal *Trichostrongylus* species. Initially this is diffuse but later appears as discrete patches (“fingerprint lesions”).

### DIAGNOSTIC CONFIRMATION

PGE should not be diagnosed on the basis of a fecal egg count alone. In sheep, a total worm count should be performed whenever possible, preferably with a peptic digest of the mucosa. The results should be considered together with the following:

- Clinical signs
- Age of the animal
- Season of the year
- Nutritional status
- Grazing history



The critical test in an outbreak of disease is the response to treatment. Because the epidemiology of the various species differ, it is important that the main contributing species are determined so that adequate control measures can be taken. In calves, clinical diagnosis can be confirmed by plasma pepsinogen estimation, but this assay is less helpful in adult cattle. Experimental real-time (RT)-PCR and multiplex PCR techniques have been developed for specific identification of *H. contortus*, *T. circumcincta*, *Trichostrongylus* spp., *C. oncophora*, *Nematodirus*, and other nematodes in fecal samples.<sup>12,13</sup>

### DIFFERENTIAL DIAGNOSIS

Parasitic gastroenteritis has to be differentiated from other common causes of emaciation and diarrhea in groups of young animals such as:

- Malnutrition
- Copper deficiency (in cattle)
- Coccidiosis (in particular, nematodiosis and coccidiosis occur in lambs of the same age)
- Johne's disease
- Chronic fascioliasis.

### TREATMENT

#### TREATMENT AND CONTROL

##### Treatment

###### Cattle

Eprinomectin (0.5 mg/kg TOPp) (R-1)  
 Ivermectin, doramectin or moxidectin (0.2 mg/kg SQ; 0.5 mg/kg TOPp) (R-2)  
 Albendazole (10 mg/kg PO) (R-2)  
 Febantel (7.5 mg/kg PO) (R-2)  
 Fenbendazole (5 mg/kg PO) (R-3)  
 Netobimin (7.5 mg/kg PO) (R-2)  
 Oxfendazole (4.5 mg/kg PO) (R-2)  
 Levamisole (7.5 mg/kg PO; 10 mg/kg TOPp)

###### Sheep

Ivermectin, doramectin or moxidectin (0.2 mg/kg SQ or PO) (R-1)  
 Monepantel (2.5 mg/kg PO) (R-1)  
 Combination of derquantel (2 mg/kg PO) and abamectin (0.2 mg/kg PO) (R-1)  
 Albendazole (7.5 mg/kg PO) (R-2)  
 Febantel (5 mg/kg PO) (R-2)  
 Fenbendazole (5 mg/kg PO) (R-3)  
 Netobimin (7.5 mg/kg PO) (R-2)  
 Oxfendazole (5 mg/kg PO) (R-2)  
 Mebendazole (15 mg/kg PO) (R-2)  
 Levamisole (7.5 mg/kg PO) (R-2)

###### Goats

Ivermectin, doramectin, or moxidectin (0.2 mg/kg SQ or PO) (R-2)  
 Albendazole (10 mg/kg PO) (R-2)  
 Fenbendazole (5 mg/kg PO) (R-3)  
 Levamisole (12 mg/kg PO) (R-2)

#### Control

Local geographic factors have a large influence on optimal control programs; consult local authorities (R-1)

PO, orally; SQ, subcutaneously; TOPp, topical pour on.

Many broad-spectrum anthelmintics are now available that combine high efficiency against larval and adult worms with low toxicity in sheep and cattle. Most, however, belong to just three major chemical groups:

1. Avermectins/milbemycins, also known as the macrocyclic lactone anthelmintics (MLs), which interfere with nerve transmission by opening chloride channels
2. Benzimidazoles (BZDs)/probenzimidazoles, which bind to tubulin and disrupt nutrient uptake
3. Imidazothiazoles/tetrahydropyrimidines, which act as cholinergic agonists

Two recent anthelmintics, namely monepantel<sup>14-16</sup> and derquantel,<sup>17</sup> are commercially available for the treatment of nematode infections in sheep. Derquantel is used in a formulated combination with abamectin. Monepantel has very high efficacy against adult and larval stages of nematodes, including multianthelmintic-resistant nematodes.<sup>18-20</sup> The derquantel-abamectin combination has been demonstrated to have lower efficacy against larval stage of multianthelmintic-resistant nematodes.<sup>18</sup>

**Dosage rates and label claims** may vary with formulation and from country to country according to local conditions and regulatory requirements. Figures given in this chapter should therefore be regarded only as a general guide.

#### Cattle

In cattle, ivermectin, doramectin, and moxidectin are given at 0.2 mg/kg by injection or 0.5 mg/kg as a pour-on formulation. Eprinomectin pour-on 0.5 mg/kg is the compound of choice for adult dairy cattle because it has a no milk withdrawal period. Albendazole 7.5 mg/kg, febantel 7.5 mg/kg, fenbendazole 7.5 mg/kg, netobimin 7.5 mg/kg, and oxfendazole 4.5 mg/kg are given orally. Levamisole can be used orally or by injection at 7.5 mg/kg or as a pour-on at 10 mg/kg.

Sustained-release intraruminal devices ("boluses") for use in cattle provide extended periods of protection. For example, fenbendazole is released for up to 140 d from one bolus, whereas a biodegradable bolus releases morantel tartrate for at least 90 days. There are also pulse-release boluses containing oxfendazole, which release five or six anthelmintic doses at 3-week intervals.

#### Sheep

In sheep, the dose rate for ivermectin, doramectin, and moxidectin (which are

given orally or parenterally) is 0.2 mg/kg. Dose rates for the BZDs (given orally) are albendazole 5 mg/kg, febantel 5 mg/kg, fenbendazole 5 mg/kg, netobimin 7.5 mg/kg, mebendazole 15 mg/kg, and oxfendazole 5 mg/kg. However, there are recent reports of resistance of *Trichostrongylus*, *Teladorsagia*, and *Nematodirus* to ML and BZD treatment of sheep in the UK.<sup>10,21,22</sup> Levamisole can be used orally and parenterally at 7.5 mg/kg. Morantel citrate monohydrate is also used as a drench in sheep. Pour-on formulations are not used in sheep because the wool grease does not allow absorption through the skin. Intraruminal devices for use in sheep have been developed that release albendazole or ivermectin over 100 days.

#### Goats

Goats metabolize some anthelmintics more rapidly than do sheep, and elevated dose rates are sometimes required to obtain a satisfactory level of control. Even then, there may be more surviving worms and, consequently, anthelmintic resistance tends to develop much more quickly in goats than sheep.<sup>23</sup> Examples of special dose rates for goats include albendazole 10 mg/kg PO and levamisole (which should be used with caution in goats) 12 mg/kg orally. Ivermectin can be given at the normal dose rate of 0.2 mg/kg SC or PO.

#### CHOICE OF ANTHELMINTIC

The choice of anthelmintic depends on a number of considerations. Anthelmintic resistance is a real or emerging problem in many sheep-rearing areas. Side resistance occurs within chemical groups and multiresistant strains have been reported. This can impose a severe constraint on product choice. Other factors include the following:

- Price
- Safety (including meat and milk residues and effect on environment)
- Ease of administration
- Spectrum of activity

Older products were most active against adult worms, but many now have activity against larval stages. Fewer, however, have consistently high efficacy against hypobiotic larvae and care is needed in selecting a suitable product to treat or prevent type II disease. Products with claims for this purpose at standard dose rates include avermectins/milbemycins, albendazole, fenbendazole, oxfendazole, and thiophanate, whereas netobimin is active at an elevated dose rate (20 mg/kg). The BZDs are ovicidal, which may be beneficial if stock are moved to a new pasture after treatment. Animals with PGE may also be harboring other parasites. The avermectins/milbemycins have a very broad spectrum of activity including some ectoparasites but are inactive against cestodes and trematodes. Some broad-spectrum BZDs are effective against cestodes and one, albendazole, is also active against mature *Fasciola hepatica*. The

ivermectins/milbemycins are excreted in the feces and may affect insects colonizing the dung pat. The environmental impact of this has probably been overstated because only a small proportion of the fecal mass on a property will contain anthelmintic, allowing adequate refugia for maintenance of insect populations. This class of compound should, however, be used with caution if there is concern that beneficial insects may be vulnerable, for example, dung beetles in some arid zones.

**Novel methods for increasing drug availability** and anthelmintic effect within the body are under investigation and should be adopted by veterinarians as they become available. There is uncertainty when, or even if, new chemical classes will become commercially available for nematode control, so it is essential that existing products are used as efficiently as possible to extend their effective life. Using measures that maximize the potency of anthelmintics can slow the onset of resistance and increase efficacy against partially resistant strains. The efficacy of the BZDs and orally administered ivermectins depends on their residence time in the rumen, and some simple measures can be taken to increase this. Using the correct drenching procedure (gun tip over tongue and drench dispensed directly into esophagus) will avoid stimulation of the esophageal groove reflex and ensure that the dose does not bypass the rumen. As there is an inverse relationship between feed intake and ruminal residency time, a reduction in feed intake (e.g., by penning) for 24 hours before prophylactic drenching retards transit time and significantly enhances the activity of BZDs and ivermectin. With BZDs, drug residency time in the rumen can be further increased and efficacy enhanced by dividing the dose and giving it at 12- or 24-hour intervals. This principle is reflected in medicated lick blocks and intraruminal boluses, which provide daily low-level BZD doses.

**Continued protection** must be given to animals after treatment for clinical PGE. Irrespective of the drug used, treated animals should be moved to a clean paddock (i.e., one not contaminated with large numbers of infected larvae) that provides an adequate plane of nutrition. The ovicidal action of the BZDs is particularly useful if animals are being placed on very clean areas such as cereal stubble. However, it is probably of lesser importance on many farms where residual pasture contamination is always present. If clean pasture is not available, protection can be provided by use of an anthelmintic with persistent activity against incoming larvae. In cattle, ivermectin provides up to 21 days' protection against *O. ostertagi* and up to 14 days' protection against *Cooperia* spp. A new injectable formulation of eprinomectin is effective in removing existing gastrointestinal nematode infections and provides effective control of nematode

infections in cattle for up to 150 days after treatment.<sup>24-26</sup> Corresponding figures for doramectin are 35 and 21 days (by injection) and 35 and 28 days (pour-on) and for moxidectin are up to 28 days against *O. ostertagi*. The persistent anthelmintic effect of ivermectins in sheep is much shorter and there is probably little useful effect against intestinal trichostrongylids.

Moxidectin given by injection has a label claim for 5 weeks' protection against *O. circumcincta* and 2 weeks against *T. colubriformis*.

## CONTROL

Control measures are aimed at reducing pasture contamination to minimize the uptake of infective larvae, preventing disease and allowing optimal productivity. The cost of any program and treatments must be in accordance with potential economic benefits. Where individual animals are valuable, labor-intensive strategies may be justified. Many husbandry systems, however, will support only low-input solutions and treatments may only be feasible when animals are handled for other management procedures. Epidemiologic patterns differ for each worm species and vary considerably from region to region, with subtle variations often occurring from locality to locality. It is therefore beyond the scope of this book to make specific recommendations for control, but it is possible to describe general principles that can be adapted to local needs.

**Knowledge of local epidemiology** is a necessary prerequisite for designing a control program. In particular, the animals providing the major source of contamination should be identified and the period of development from egg to infective larvae and the availability of infective larvae throughout the year known. It is essential to formulate clear and precise control objectives, otherwise, much time and expense can be wasted. Management may have to be adjusted to aid control. On organic farms, where anthelmintic usage is greatly restricted, worm control may be a major factor in determining stocking density and grazing management. Often, control measures are aimed primarily at protecting the most susceptible group, that is, young animals up to 18 months of age exposed to infestation for the first time.

**Anthelmintic resistance** is an important consideration influencing the choice and intensity of control measures. Even if economically justified, frequent routine treatments impose strong selection pressure on worm populations and encourage the development of resistant strains. As only three major chemical groups are currently available for the treatment of gastrointestinal and pulmonary nematodes, it is imperative that their usefulness be conserved for as long as possible. Many anecdotal field reports of resistance are erroneous, and the problem is one of reinfestation or incorrect anthelmintic

usage. Nevertheless, resistant and multiresistant strains are already prevalent in many sheep-rearing areas. In cattle, resistance of *Cooperia* spp. to MLs, BZDs, and levamisole have been observed in Australia and New Zealand.<sup>27-29</sup> Additionally, there are reports of *Ostertagia* and *Trichostrongylus* spp. resistance to BZDs, levamisole, and ivermectin.<sup>30</sup> The following recommendations have been made to slow the onset of resistance:

1. Use an effective drug in the most efficient manner:
  - Check fecal egg counts regularly to confirm that chosen products remain effective.
  - If a worm population is already partly resistant to a compound, continued use of products based on that chemical group will endanger the health of the animals and reinforce the resistance.
2. Do not underdose (this may encourage resistance):
  - Weigh each animal or the heaviest individuals in a group.
  - Comply with all label recommendations.
  - Ensure good maintenance and calibration of dosing equipment.
3. Use the minimum number of doses needed to maintain health:
  - Strike a balance between encouraging resistance by treating too intensively and allowing pasture contamination to rise to unacceptable levels.
4. Use sound epidemiologic principles:
  - Use an integrated approach to worm control, which maximizes the potential of management techniques and minimizes reliance on anthelmintics.
5. Rotate the chemical group annually (to ensure that worms are exposed to compounds with a different mode of action each year):
  - Remember there is no benefit in rotating compounds within a chemical group or in using a group already rendered ineffective by anthelmintic resistance.
6. Avoid introducing resistant worms onto a property (obvious, but often overlooked):
  - Place all new stock into quarantine and treat with an effective compound.
  - Do not graze goats on sheep pastures (as caprine worm populations often have a higher prevalence of resistance genes).
7. Make sure that the farmer is aware of the problem and the consequences of anthelmintic resistance.

**The concept of maintaining parasite refugia** is assuming greater prominence as a means of conserving anthelmintic efficacy in modern control strategies. The theoretical

background and clinical application are discussed in detail in Chaelier et al. (2014) and in Leathwick and Besier (2014) in the Further Reading section. Worms “in refugia” are those not exposed to anthelmintic when the flock is treated so they escape selection pressure for resistance. When the flock subsequently becomes reinfected, the genetic material from parasites surviving treatment will be diluted by susceptibility genes from worms in refugia at that time. This slows the rate at which resistance develops and extends the period over which the drug maintains clinical efficacy on the farm. The refugia concept is best illustrated by an example. In cooler temperate climates, infective *Ostertagia* larvae overwinter on grass in large numbers but most *Haemonchus* larvae succumb to the cold. If ewes are dosed during the winter to eliminate the periparturient egg rise, only a small proportion of the *Ostertagia* population (those in the animal) are exposed to the anthelmintic, whereas the remainder (those on the pasture) are in refugia. In contrast, a high proportion of the total *Haemonchus* population is exposed to the drug (as there are few larvae in refugia on the pasture) and, consequently, there is an enhanced risk of anthelmintic resistance developing. From this viewpoint, it could be beneficial in the longer term to withhold the winter treatment from some ewes. This would ensure that the majority of eggs subsequently dropped onto the pasture are produced by susceptible worms. Similarly, dose and move systems encourage resistance as all eggs dropped onto the new pasture are from worms that have survived treatment. It could therefore be advantageous to use a short-acting drug and to delay the move. This would ensure that the animals acquire a small burden of susceptible worms before the move. These strategies involve obvious inherent risks, and all aspects of a particular situation must be carefully considered before implementation.

**Protocols for detecting anthelmintic resistance** in a herd or flock are available. The fecal egg count reduction test can be performed easily without sophisticated equipment. The egg value should be reduced by 95% or more, but false negatives may be obtained with BZDs (if female worms are sterilized but not killed) and false positives obtained with levamisole (if large numbers of mucosal larvae present at the time of dosing survive treatment). Laboratory tests include egg-hatch assays for BZDs and larval development tests for avermectins and levamisole. Experimental genetic-based methods for detection of resistance to BZDs using pyrosequencing and PCR assays, targeting isotype-1  $\beta$ -tubulin gene SNPs, have been developed and demonstrated to be more robust, specific, and cost-effective than the fecal egg count reduction test.<sup>31-33</sup>

**The principles of control** generally fall into three categories:

1. *Preventive*
2. *Evasive*
3. *Diluting*

Preventive measures are those that place livestock on clean pasture or that use early season chemoprophylaxis to ensure clean grazing later in the season.

Evasive strategies are those in which pasture contamination is allowed to build up naturally but susceptible stock are moved onto clean grazing before pathogenic numbers of infective larvae have accumulated. An anthelmintic dose can be given at the time of the move. This “dose and move” system is effective and reduces anthelmintic dosage considerably. It may, however, encourage resistance, as discussed earlier.

Diluting systems reduce the effective stocking density of susceptible animals by grazing them alongside nonsusceptibles (older immune stock or alternative species). In cow-calf systems, for example, adults produce at least four times as much feces as their calves, but their average egg count is typically no more than 15 epg. The number of trichostrongylid eggs and the subsequent accumulation of infective larvae on the herbage will therefore be considerably smaller than if the pasture was fully utilized by calves alone.

**In cool temperate regions**, control measures can take advantage of the fact that overwintered larvae die away in early summer. Hay or silage pastures therefore provide safe grazing after the grass has been cropped. Alternatively, suppressive anthelmintic therapy over the first 90 to 100 days of the grazing season will prevent overwintered larvae from establishing in the host, stopping the subsequent accumulation of infective larvae on the herbage. This strategy is very effective on set-stocked permanent calf paddocks provided that no untreated animals are introduced. The required effect can be obtained by use of an intraruminal anthelmintic device administered around the time of spring turnout or by giving two or more doses of an anthelmintic with prolonged activity against incoming larvae. Because the goal is to prevent egg excretion, the required treatment interval is calculated by adding the length of the protective effect (which varies with the product) and the prepatent period of the worms (about 3 weeks). Ivermectin given 3, 8, and 13 weeks after turnout and doramectin given at turnout and 8 weeks later are very effective for this purpose, as are the intraruminal boluses listed earlier.

**Controlled field studies** have demonstrated significant weight-gain advantages from this approach but, as with cattle lungworm, there is concern that the level of immunity acquired during the first grazing season may be reduced. Usually this is of no clinical consequence, but results from an epidemiologic survey of 87 farms in Holland suggest a beneficial relationship between immunity to nematodes gained during the

first grazing season and the growth rate of cattle during their second grazing season. It seems that optimal protection has to balance risk of production losses in first and subsequent grazing seasons, but there is currently no objective way of doing this. One suggestion is that rumen boluses would be more effective if used to provide anthelmintic cover in the second half of the grazing season when pasture contamination is high (“metaphylaxis”). Good immunity would be ensured but the growth rate advantage may be inferior to that obtained with the early season prophylaxis described earlier. If cattle have been exposed to high pasture challenge in the autumn, they should be dosed with a product active against hypobiotic larvae at housing or during the winter to prevent type II ostertagiosis. In countries in which *Dictyocaulus viviparus* is a problem, control of PGE and lungworm must be integrated.

**Elimination of the PPER** is the most important feature of worm control in sheep. Ideally, ewes should be dosed toward the end of gestation and again 1 month after parturition with a product active against hypobiotic larvae. Lambs should be dosed at weaning and if possible moved to clean pasture. In most cases, further treatments will be necessary to maintain health until marketing but these should be kept to a minimum. The number will depend on the stocking density, initial pasture contamination, and weather. A compromise has to be struck between an acceptable level of disease control and the risk of inducing anthelmintic resistance. Fecal egg counts can be used to check the adequacy of the dosing interval and the efficacy of the treatments.

**Control of *Nematodirus*** differs from that of other forms of PGE because the ewe is not a source of contamination. The simplest form of control is to avoid putting the new lamb crop onto pasture contaminated by the previous year's lambs. Often, however, this is not feasible and prophylactic anthelmintic doses at 3-week intervals are necessary to cover the limited period of risk (May to early June, for example, in Scotland). Waiting for the first clinical signs before starting treatments is not recommended because deaths can occur very quickly. The precise timing of the egg hatch varies from year to year according to prevailing weather conditions, but forecasting systems are in operation in some countries.

**In warm temperate regions**, PGE control strategies are more difficult to design because animals graze all year round. The main transmission period is late winter and early spring. Treatment of beef cattle at weaning and once or twice at locally determined intervals thereafter is often sufficient to reduce pasture contamination. In sheep, an effective program is to dose lambs at weaning and move them onto safe pasture. Two or three subsequent treatments at 8-week intervals may be needed. In summer rainfall areas, *Haemonchus* is an additional hazard and



systems have to be designed to combat this as well as other gastrointestinal worms.

**In regions with a prolonged dry season,** larvae will be killed on the ground and, providing there are no foci of infection around water holes, etc., a single strategic anthelmintic dose at this time with a product active against hypobiotic larvae may be more effective at maintaining low pasture contamination around the year than repeated dosing throughout the wet season. This single dose may, however, apply greater selection pressure for resistance, because the whole parasite population is exposed to the drug and survivors are likely to carry resistance genes.

**Reduced reliance on anthelmintics** can be achieved in a number of ways. For example, alternate grazing with sheep and cattle can be used to good effect. In Australia, the number of anthelmintic drenches can be substantially reduced by alternation at 2- to 6-month intervals. In northern Britain annual stock rotations, sometimes with an arable crop grown in the third year, have been successfully evaluated. Host specificity, however, is not absolute and calves can become infected with *N. battus*. If this happens, they may drop sufficient numbers of eggs to cause clinical problems in lambs the following year. Lambs have also been known to succumb to *T. axei* on calf paddocks. An exciting future prospect is the use of nematophagous fungi. Orally administered fungal spores produce hyphae in the feces that trap and kill nematode larvae. Field experiments show that pasture contamination can be substantially reduced in this way. Feed supplementation to enhance host resilience and resistance to infection, vaccination, and future prospects for breeding lines of sheep with innate host resistance are described under *Haemonchus*.

Breakdowns in control programs are usually caused by the following:

- Failure to prevent worm egg output at times critical to the accumulation of infective larvae on the pasture
- Failure, after treatment, to move animals on an already contaminated pasture to a clean environment
- Use of an insufficient dose or incorrect anthelmintic
- Failure to repeat treatment or repeating treatment at overlapped intervals at times of high risk
- Failure to appreciate that not all anthelmintics kill all immature stages, particularly hypobiotic forms
- Introduction of susceptible sheep from a worm-free environment into a high risk area
- Failure to protect young animals adequately.

#### FURTHER READING

Chaelier J, et al. Practices to optimize gastrointestinal nematode control on sheep, goat and cattle farms in Europe using targeted (selective) treatments. *Vet Rec.* 2014;175:250.

Kaplan RM, Vidyashankar AN. An inconvenient truth: global worming and anthelmintic resistance. *Vet Parasitol.* 2012;186:70.

Kenyon F, Jackson F. Targeted flock/herd and individual ruminant treatment approaches. *Vet Parasitol.* 2012;186:10.

Kotze AC, et al. Recent advances in candidate-gene and whole genome approaches to the discovery of anthelmintic resistance markers and the description of drug/receptor interactions. *Int J Parasitol Drugs Drug Resist.* 2014;4:164.

Leathwick DM, Besier RB. The management of anthelmintic resistance in grazing ruminants in Australasia: strategies and experiences. *Vet Parasitol.* 2014;204:44.

Morgan ER, et al. Global change and helminth infections in grazing ruminants in Europe: impacts, trends and sustainable solutions. *Agriculture.* 2013;3:484.

Sargison N. Responsible use of anthelmintics for nematode control in sheep and cattle. *In Pract.* 2011;33:318.

Sutherland AI, Leathwick MD. Anthelmintic resistance in nematode parasites of cattle: a global issue? *Trends Parasitol.* 2011;27:176.

Sutherland I, Scott I. *Gastrointestinal Nematodes of Sheep and Cattle: Biology and Control.* Ames, IA: Wiley-Blackwell; 2010.

Taylor MA. Emerging parasitic diseases of sheep. *Vet Parasitol.* 2012;189:2.

#### REFERENCES

1. O'Connor LJ, et al. *Vet Parasitol.* 2006;142:1.
2. O'Connor LJ, et al. *Vet Parasitol.* 2007;150:128.
3. van Dijk J, et al. *Animal.* 2010;4:377.
4. Reynecke DP, et al. *N Z Vet J.* 2011;59:287.
5. McManus C, et al. *R Bras Zootec.* 2009;166:308.
6. Bishop SC, Morris CA. *Small Rumin Res.* 2007;70:48.
7. Shaw RJ, et al. *Int J Parasitol.* 2013;43:661.
8. Bishop SC. *Animal.* 2012;3:1.
9. Falzon LC, et al. *Can Vet J.* 2014;55:749.
10. APHA Disease Surveillance Report. *Vet Rec.* 2015;176:92.
11. Sekiya M, et al. *Ir Vet J.* 2013;66:14.
12. Bott NJ, et al. *Int J Parasitol.* 2009;39:1277.
13. Bisset SA, et al. *Vet Parasitol.* 2014;200:117.
14. Kaminsky R, et al. *Nature.* 2008;425:176.
15. Rufener L, et al. *PLoS Pathog.* 2009;103:931.
16. Kaminsky R, et al. *Parasitol Res.* 2008;103:931.
17. Little PR, et al. *N Z Vet J.* 2010;58:121.
18. Kaminsky R, et al. *Parasitol Res.* 2011;109:19.
19. Hosking BC, et al. *Parasitol Res.* 2010;106:529.
20. Sager H, et al. *Parasitol Res.* 2012;111:2205.
21. AHVLA Disease Surveillance Report. *Vet Rec.* 2014;174:10.
22. Morrison AA, et al. *Vet Res.* 2014;45:116.
23. Varady M, et al. *Helminthologia.* 2011;48:137.
24. Hunter IIIJS, et al. *Vet Parasitol.* 2013;192:346.
25. Rehbein S, et al. *Vet Parasitol.* 2013;192:321.
26. Soll MD, et al. *Vet Parasitol.* 2013;193:313.
27. Lyndal-Murphy M, et al. *Vet Parasitol.* 2010;168:146.
28. Cotter JL, et al. *Vet Parasitol.* 2015;207:276.
29. Waghorn TS, et al. *N Z Vet J.* 2006;54:278.
30. Rendell DK. *Aust Vet J.* 2010;88:504.
31. Barrere V, et al. *Can Parasitol Int.* 2013;62:464.
32. Barrere V, et al. *Vet Parasitol.* 2012;186:344.
33. Niciura SC, et al. *Vet Parasitol.* 2012;190:608.

### HEMONCHOSIS IN RUMINANTS

#### ETIOLOGY

Sheep, cattle, and goats are all affected by species of the nematode genus *Haemonchus*,

which is closely related to the other trichostrongylids of ruminants. *H. contortus* is the species most commonly found in sheep and goats, but *H. placei* is the usual species in cattle. Molecular studies have confirmed that these are distinct taxa. Even so, cross-infection may occur when small ruminants and cattle graze together but the infestations are usually of lesser severity. Another abomasal trichostrongylid, *Mecistocirrus digitatus*, occurs in sheep, cattle, and buffalo in Asia and in Central America, causing a disease very similar to hemonchosis.

#### SYNOPSIS

**Etiology** The nematode parasite *Haemonchus contortus* in sheep and goats and *H. placei* in cattle.

**Epidemiology** Female worms produce large numbers of eggs; infective larvae develop rapidly in warm wet conditions; dangerous levels of pasture contamination can therefore accumulate rapidly.

#### Signs

**Acute:** Sudden death, anemia.

**Chronic:** Wasting, anemia, anasarca.

**Clinical pathology** Anemia, hypoproteinemia; often high fecal egg count.

**Lesions** Anemic carcass; abomasal mucosa hyperemic with many red-colored worms.

**Diagnostic confirmation** "Barber's pole" appearance of female worms (if fresh).

**Treatment** All modern broad-spectrum anthelmintics; also, closantel, rafoxanide, nitroxylnil, disophenol, and some organophosphates; care needed in selection as resistant and multiresistant strains of *H. contortus* occur.

**Control** Strategic dosing schemes using broad-spectrum anthelmintics; closantel or disophenol can be used to reduce dependence on broad-spectrum products.

#### LIFE CYCLE

*H. contortus* inhabits the abomasum. It is easily seen because it is 1 to 2.5 cm long and a little stouter than most other trichostrongylids. Adult males are homogeneously red but the females have a spiral red and white appearance as the intestine and uterus intertwine. Adult *H. contortus* are prolific egg layers. Egg production increases until maximum output is reached 25 to 30 days after infection, after which individual females lay up to 10,000 eggs per day for several months. The egg hatches and passes through two noninfective larval stages in 4 days under optimal conditions, but in less suitable environments this period may be prolonged. For example, in Scotland the shortest time required for development from egg to third-stage larva is 2 weeks, but development takes a great deal longer over most of the year. Infective larvae migrate away from fecal pellets, some traveling 90 cm in 24 hours.

More than 90%, however, are found within 10 cm of the fecal mass, and this number decreases logarithmically as the distance increases. Motility is greatest in hot, moist conditions. Larvae are susceptible to desiccation and do not withstand cold temperatures well.<sup>1</sup> Where hostile external conditions occur regularly, such as winter in temperate regions or the dry season in some tropical climates, *H. contortus* larvae on pasture are conditioned at the appropriate time to become hypobiotic after uptake by a host.<sup>2</sup> Transmission occurs when the host ingests infective larvae while grazing. After developing through the fourth larval stage in the abomasal glands, the adult worms emerge to commence egg laying in about 18 days after infection. Hypobiotic larvae resume their development so that egg laying is coordinated with the start of spring or the wet season.

The life cycle of *H. placei* is similar except that the first eggs do not appear in the feces of cattle until the 26th day after infestation, rising to a peak at 6 to 7 weeks and declining rapidly to low levels by 11 to 14 weeks.

## EPIDEMIOLOGY

The epidemiology of hemonchosis is largely determined by the high fecundity of the female worms and the speed with which infective larvae can develop in warm, humid conditions. Thus when conditions are favorable, large numbers of infective larvae can accumulate very rapidly on pasture. Opportunities for transmission are, however, restricted by the susceptibility of the larvae to desiccation and cold.

**Hemonchosis is an important disease** of sheep, goats, and cattle in all but the coldest regions. The greatest economic impact is seen in sheep in tropical and warmer temperate countries, especially where there is good summer rainfall. It is not uncommon for serious outbreaks to occur in cooler climates during periods of high humidity in summer. The disease is uncommon in semi-arid regions unless there are opportunities for transmission to occur, for example, in irrigation schemes. In sheep, losses occur mostly in lambs, especially those recently weaned, but yearlings and mature sheep may also be affected. Goats of any age are susceptible but their browsing habit may protect them from the heaviest sources of contamination. Dairy calves are the most commonly involved group among cattle but steers and other young cattle up to 3 years of age may also be affected.

**Predisposing causes** for hemonchosis include overcrowding, lush pasture, hot and humid climatic conditions, and a low plane of nutrition. Disease can be precipitated in several ways. An important causal mechanism in sheep is when lambs, which may be in excellent condition on good grazing, are overcome by a sudden massive wave of

pasture contamination. Sheep in poor condition may be clinically affected by worm burdens too small to harm an otherwise healthy animal. Outbreaks of disease may occur in sheep overwintered indoors if large numbers of hypobiotic larvae mature simultaneously. Cattle harboring subclinical infestations while on a good plane of nutrition may show clinical signs if the pasture subsequently fails because of drought or overgrazing. In goats, *Trypanosoma congolense* infection has been shown to increase the susceptibility to *H. contortus*.

The climatological conditions that permit the development of hemonchosis in sheep have been the subject of a great deal of research. Bioclimatographs have been produced for many different geographic areas. In regions with narrow diurnal temperature fluctuations, outbreaks are likely during months with a mean maximum temperature of 18°C (64°F) and more than 5.25 cm of rain. In areas with regular summer rainfall, larval availability increases from late spring to reach maximum levels by late summer to early autumn and quickly declines in winter. A similar trend, but with fluctuating larval numbers, occurs in areas with more variable rainfall patterns.

**The self-cure phenomenon** is a sudden naturally occurring expulsion of adult *H. contortus* which may also, although not invariably, eliminate incoming larvae (reviewed in Alba-Hurtado and Munoz-Guzman 2013 in the Further Reading section). In some areas, this may be associated with changes in the pasture but more often it occurs in sheep when a large uptake of infective larvae is superimposed on an established worm burden in a sensitized animal. Self-cure may also expel existing *O. circumcincta* and *T. axei* from the abomasum and *Trichostrongylus* spp. from the small intestine. Strain or breed differences occur, and a genetic resistance operating primarily against worm establishment and probably controlled by the immune response has been reported. There is no complete self-cure with *H. placei* in calves, but after an initial infection there is a rapid decline in egg laying, adults are expelled, and subsequent larval development is retarded. Immunity is much stronger in calves than in sheep.

## PATHOGENESIS

Vigorous bloodsucking by both fourth-stage larvae and adults is the main factor differentiating the pathogenesis of *H. contortus* from that of other abomasal nematodes. The histologic changes and biochemical sequelae associated with *Ostertagia* infections also occur in hemonchosis, but additionally a hemorrhagic anemia evolves that is caused by the daily loss of around 0.05 mL of whole blood per worm. The course of the disease depends on the numbers of worms present and the ability of the animal to compensate for acute or chronic losses of plasma

proteins, hemoglobin, and other blood constituents. In continuing infections, the increased rate of red cell production is maintained at the expense of the animals' iron stores and a state of iron deficiency occurs. Death may be acute and result purely from blood loss or may be more gradual and accompanied by weight loss, anemia, and hypoproteinemia.<sup>3</sup> Poor growth in young lambs can result from a reduction in the ewes' milk production. Susceptibility to hemonchosis varies with breed. Those with superior resistance include the Scottish Blackface, Red Maasai, Florida Native, St Croix, and Barbados Blackbelly, whereas the Hampshire Down is relatively susceptible. Individuals within a flock also vary in vulnerability. This natural resistance to infection is heritable.

**The role of nutrition** in modifying the pathogenesis of hemonchosis in lambs is undergoing intense investigation. There is experimental evidence that lambs on a high-protein diet are better able to withstand *H. contortus* infestation. There are considerable breed differences; in some cases, animals with a higher protein intake mount a more effective immune response, in other cases they are better able to tolerate and compensate for the blood losses associated with the infection.

## CLINICAL FINDINGS

Hemonchosis causes heavy losses because of animal deaths and reduced production.<sup>4</sup> Lambs and young sheep are commonly affected by the acute form of the disease. Often only a few individuals will be seriously affected, but in very severe outbreaks a large proportion of the flock may suffer if not treated. Animals may be found dead without premonitory signs. The mucosae and conjunctivae of such sheep are always extremely pale. More chronic cases show lethargy and muscular weakness, pallor of the mucosae and conjunctivae, and anasarca, particularly under the lower jaw and to a lesser extent along the ventral abdomen. Affected sheep are often noticed for the first time when the flock is being driven: they lag behind, breathe faster, have a staggering gait, and often go down. Some sheep may die as a result of exercise but most can rise and walk a little further after rest. Grazing animals lie down a good deal of the time, often around the water troughs; the energy needed to walk and eat appears to be lacking. Most affected sheep show constipation rather than diarrhea. There is a loss of BW and a detrimental effect on wool growth and quality. In sheep with the chronic condition, there may be extreme weight loss during the dry season, even though larval uptake is negligible at this time. Sheep not fatally affected develop a break in the wool and the fleece may be lost at a later date.

**In calves**, the disease is characterized clinically by severe anemia and anasarca.

Heavy infestations occurring in summer may not manifest clinically until winter when the plane of nutrition declines.

### CLINICAL PATHOLOGY

As *Haemonchus* is a prolific egg layer, fecal egg counts tend to be high (10,000 egg in severe cases), but it must be remembered that low egg counts may be encountered in the early part of the evolution of the disease when the bulk of the pathogenic worms are in the larval stage. There is a significant rise of abomasal pH soon after infection accompanied by increased plasma pepsinogen and gastrin concentrations. Worm counts and hemoglobin levels are correlated.<sup>3</sup>

### NECROPSY FINDINGS

Gross necropsy findings include severe anemia, gelatinization of fat deposits, general anasarca, and the presence of large numbers of readily visible *H. contortus* or *H. placei* in the abomasum. If the cadaver is fresh, the worms may still be attached or swimming actively in the ingesta, but a careful search may be necessary if the animal has been dead for some time. The abomasal wall is hyperemic and blood clots may be present in the mucosa. Small ulcerations may be present in which adult worms have been attached. The abomasal contents usually have a distinct brownish color caused by the presence of free blood.

### DIAGNOSTIC CONFIRMATION

In mixed infections, eggs of *Haemonchus* spp. cannot be easily differentiated from those of many other gastrointestinal nematodes. Identification and quantification therefore depend on counting larvae in fecal cultures, which is a procedure not readily applicable in routine diagnosis. The number of worms required to depress hemoglobin levels varies with the weight of the sheep. In Merino sheep up to 20 kg, a hemoglobin level of 10.5 g/dL has been associated with 112 worms and 8.0 g/dL with 355 worms. However, in sheep over 50 kg, 355 and 1259 worms were required to give similar values. At necropsy, counts of 3000 *H. contortus* in lambs and 9000 in adult sheep are usually associated with heavy mortalities. Highly sensitive and species-specific experimental PCR<sup>5</sup> and loop-mediated isothermal amplification<sup>6</sup> assays for detection of *Haemonchus* in fecal samples, targeting the amplification of the internal transcribed spacer (ITS-1) region of ribosomal DNA (rDNA), have been developed.<sup>7,8</sup>

### DIFFERENTIAL DIAGNOSIS

#### Sheep

Other causes of sudden death, such as lightning strike, snakebite, anthrax, or enterotoxemia are often suggested by the farmer and can only be differentiated by

necropsy. The other common causes of anemia include the following:

- Fasciolosis.
- Eperythrozoonosis.
- Nutritional deficiencies of copper and cobalt.
- Diarrhea is a much more prominent sign in other parasitic infestations, particularly trichostrongylosis and coccidiosis.

#### Calves

Hemonchosis has to be differentiated from the following:

- Babesiosis
- Anaplasmosis
- Coccidiosis
- Hookworm infection
- Other causes of anemia including heavy infestations with sucking lice; hemolytic anemia caused by drinking large quantities of cold water; the ingestion of rape, kale, and chou moellier; bacillary hemoglobinuria; and leptospirosis

## TREATMENT

### TREATMENT AND CONTROL

#### Treatment

##### Sheep

Ivermectin, doramectin or moxidectin (0.2 mg/kg SQ or PO) (R-1)

Monepantel (2.5 mg/kg PO) (R-1)

Combination of derquantel (2 mg/kg PO) and abamectin (0.2 mg/kg PO) (R-1)

Albendazole (7.5 mg/kg PO) (R-2)

Febantel (5 mg/kg PO) (R-2)

Fenbendazole (5 mg/kg PO) (R-3)

Netobimin (7.5 mg/kg PO) (R-2)

Oxfendazole (5 mg/kg PO) (R-2)

Mebendazole (15 mg/kg PO) (R-2)

Levamisole (7.5 mg/kg PO) (R-2)

##### Goats

Ivermectin, doramectin, or moxidectin (0.2 mg/kg SQ or PO) (R-2)

Albendazole (10 mg/kg PO) (R-2)

Fenbendazole (5 mg/kg PO) (R-2)

Levamisole (12 mg/kg PO) (R-2)

##### Cattle

Ivermectin, doramectin, or moxidectin (0.2 mg/kg SQ; 0.5 mg/kg TOPp) (R-2)

Albendazole (10 mg/kg PO) (R-2)

Febantel (7.5 mg/kg PO) (R-2)

Fenbendazole (5 mg/kg PO) (R-3)

Netobimin (7.5 mg/kg PO) (R-2)

Oxfendazole (4.5 mg/kg PO) (R-2)

Levamisole (7.5 mg/kg PO; 10 mg/kg TOPp)

Netobimin (7.5 mg/kg PO) (R-2)

Oxfendazole (4.5 mg/kg PO) (R-2)

Levamisole (7.5 mg/kg PO; 10 mg/kg TOPp) (R-2)

### Control

Local geographic factors have a large influence on optimal control programs; consult local authorities (R-1)

FAMACHA scoring system used to identify heavily infected animals (R-1)

PO, orally; SQ, subcutaneously; TOPp, topical pour on.

All the broad-spectrum ruminant anthelmintics are effective against *Haemonchus* provided that resistance has not developed to that chemical group. Ivermectin given by injection provides up to 14 days' protection against reinfection with *H. placei* in cattle and up to 10 days' protection with *H. contortus* in sheep. Moxidectin, by mouth or by injection, gives up to 35 days' persistent activity against *H. contortus*. Some compounds active against *F. hepatica* that bind to plasma proteins are also active against blood-sucking nematodes, such as *Haemonchus*, and are useful where resistance to broad-spectrum products is a problem; these include closantel, rafoxanide, and nitroxylin. Closantel and disophenol, another narrow-spectrum product, exert a persistent protective effect in sheep for up to 4 weeks. With closantel, this period can be extended by reducing feed intake for 24 hours before treatment to enhance the uptake of the drug. Organophosphate anthelmintics are available in some localities for use against resistant strains. *H. contortus* strains resistant to benzimidazoles (BZDs), levamisole, morantel, naphthalophos, ivermectin, moxidectin, and closantel have been reported, and strains with multiple resistance to two or more of these chemicals are common in some areas.<sup>9-11</sup> There are recent reports of *H. placei* resistance to ivermectin and benzimidazoles in cattle.<sup>12-14</sup>

### CONTROL

In sheep flocks, a late winter treatment will remove hypobiotic larvae before they resume development and start to shed eggs onto the pasture. Where winters are severe enough to kill most of the free-living stages, this single drench will considerably reduce subsequent pasture contamination but may also expose the parasite population to a high level of selection pressure, encouraging the onset of resistance. In areas in which larvae overwinter on pasture and infest lambs in early spring, further treatments may be needed in spring and early summer to prevent an accumulation of infection in the sheep and a subsequent buildup of pasture contamination.

If no routine control is practiced and pasture contamination becomes high, stock should be dosed and moved to clean grazing areas. If this is not possible, anthelmintic cover must be provided by using a sustained acting compound such as closantel,



disophenol, or moxidectin. Sustained-release intraruminal devices for sheep containing ivermectin or albendazole are used in some countries. In cattle, protection can be given by avermectin/milbemycin treatment or an intraruminal bolus. If none of these are available or economically justified, other broad-spectrum compounds can be given at 2- to 4-week intervals throughout the risk period.

In the wet tropics, a rotational grazing system has been devised based on the observation that infective *H. contortus* larvae are relatively short-lived at high ambient temperatures. Small ruminants are grazed sequentially for up to 4 days on a series of suitably sized small plots, each of which is rested for at least 30 days before reuse. Where fencing is not feasible, a similar rotation can be based on a planned tethering system. This approach is not effective in temperate areas, however, because under these conditions infective larvae have a prolonged life span and substantial numbers will still be present when the grass needs to be regrazed.

**Frequent treatments** with broad-spectrum anthelmintics can lead to the development of anthelmintic resistance. Control programs have therefore been devised that reduce dependence on broad-spectrum products by using the sustained action of closantel against *H. contortus*. Treatment with closantel in late winter kills hypobiotic larvae and, subsequently, overwintering larvae from the pasture as they are ingested. In the case of ewes, which lamb in early spring, further treatments in late spring and late summer can provide excellent cover. Because closantel has no effect against *O. circumcincta* or *Trichostrongylus* spp., strategic treatments with a broad-spectrum compound must also be incorporated into the scheme. Lambs can be treated with closantel and a broad-spectrum compound when they are about 12 weeks of age and again 12 weeks later. This procedure has been designated the "Wormkill" program and variations on the theme, tailor-made for particular localities and management systems, have been widely accepted in parts of Australia in which BZD-resistant strains of *H. contortus* are prevalent. Use over a number of years has reduced *H. contortus* to negligible levels on many farms, but closantel resistance is starting to emerge. Disophenol has been used for a similar purpose in other areas.

**A BZD-resistant *H. contortus* population** on a farm is unlikely to revert to susceptibility even if this class of compound is withheld from use for a protracted period, which is because of the genetic mechanisms involved in the selection process. In a novel and partly successful attempt to find a solution to this problem, resistant *H. contortus* were diluted experimentally by spraying a susceptible strain onto pasture at different times in the grazing calendar. This approach, however, raises obvious ethical questions.

**The Faffa MAlan CHart (FAMACHA) system for managing hemonchosis** is a more easily applied field technique for reducing selection pressure for anthelmintic resistance.<sup>15</sup> It was developed in South Africa and has been validated in the United States. It uses the fact that a high proportion of the total parasitic *H. contortus* population is found in just a small proportion of individual sheep within a flock.<sup>16</sup> These will be the most anemic animals and will be shedding the greatest number of eggs onto the pasture. They are identified by comparing the ocular conjunctivae of each animal against a graded color chart. By confining treatment to these individuals, the general health of the flock is maintained with fewer anthelmintic doses, while pasture contamination is substantially reduced and is largely derived from untreated sheep.<sup>17</sup>

**Natural resistance to gastrointestinal nematodes** can be enhanced by breeding from rams selected for low fecal egg counts. This provides a feasible method of reducing reliance on chemical control. Heritability for this trait, which is mediated by IgA-induced retardation of worm growth, is between 0.2 and 0.4. Selection for genetic resistance may, however, reduce capacity to select for other production attributes in some circumstances (reviewed in Bishop 2012 in the Further Reading section).

**Vaccination** is an attractive future possibility and considerable progress is being made in this direction (reviewed in Bassetto and Amarante 2015 in the Further Reading section). An experimental molecular vaccine based on an *H. contortus* gut membrane antigen has been shown to reduce fecal egg counts by 90% and worm numbers by 72% to 80%.<sup>18-20</sup> Young lambs can be protected by the passive transfer of colostral antibodies from vaccinated ewes. There is no cross-immunity with other gastrointestinal nematodes so anthelmintic therapy will still be necessary if these pose a health risk.

**In poorer farming regions**, the routine use of modern anthelmintics or vaccination may be prohibitively expensive and alternative sustainable methods are being sought. This may involve identifying more resistant indigenous breeds to replace more productive but more vulnerable imported breeds (reviewed in Karlsson and Greeff, 2012 in the Further Reading section).<sup>21,22</sup> Another option is the provision of a supplementary diet containing locally available protein.<sup>23,24</sup> This enhances the ability of breeds more susceptible to *H. contortus* to withstand the pathogenic effects of infection<sup>25</sup> and may be economically feasible in some agricultural systems. Some native forages contain substances, for example, tannins, which are naturally deleterious to gastrointestinal worm populations.<sup>26-28</sup> Experimental supplementation with copper and selenium in small ruminants has been observed to reduce the establishment and worm fecundity of

*H. contortus* and to improve overall animal health.<sup>29-31</sup> Alternate or mixed grazing systems can also be used.

## FURTHER READING

- Alba-Hurtado F, Munoz-Guzman MA. Immune responses associated with resistance to haemonchosis in sheep. *Biomed Res Int*. 2013;162158.
- Bassetto CC, Amarante AF. Vaccination of sheep and cattle against haemonchosis. *J Helminthol*. 2015;89:517.
- Bishop SC. Possibilities to breed for resistance to nematode parasite infections in small ruminants in tropical production systems. *Animal*. 2012;6:741.
- Kaplan RM, Vidyashankar AN. An inconvenient truth: global worming and anthelmintic resistance. *Vet Parasitol*. 2012;186:70.
- Karlsson LJ, Greeff JC. Genetic aspects of sheep parasitic diseases. *Vet Parasitol*. 2012;189:104.
- Karrow NA, et al. Review: genetics of helminth resistance in sheep. *Can J Anim Sci*. 2014;94:1.

## REFERENCES

- Falzon LJ, et al. *Can Vet J*. 2014;55:749.
- Sargison DJ, et al. *Vet Parasitol*. 2007;147:326.
- Bordoloi G, et al. *J Parasitol Dis*. 2012;36:101. Charlier J, et al. *Trends Parasitol* 2014;30:361.
- Bott NJ, et al. *Int J Parasitol*. 2009;39:1277.
- Melville L, et al. *Vet Parasitol*. 2014;206:308.
- Demeler S, et al. *PLoS ONE*. 2013;8:e61285.
- Roeber F, et al. *Biotechnol Adv*. 2013;31:1136.
- Dos Santos JML, et al. *Vet Parasitol*. 2014;199:160.
- Geurden T, et al. *Vet Parasitol*. 2014;201:59.
- Pena-Espinoza M, et al. *Vet Parasitol*. 2014;206:208.
- Alonso-Diaz MA, et al. *Vet Parasitol*. 2015;212:439.
- Muniz-Lagunes A, et al. *Trop Anim Health Prod*. 2015;47:1049.
- Das Neves JH, et al. *Vet Parasitol*. 2014;206:216.
- Kenyon F, Jackson F. *Vet Parasitol*. 2012;186:10.
- Kenyon F, et al. *Vet Parasitol*. 2009;164:3.
- Maia D, et al. *Vet Parasitol*. 2015;209:202.
- Bassetto CC, et al. *Int J Parasitol*. 2014;44:1049.
- Le Jambre LF, et al. *Vet Parasitol*. 2008;153:302.
- Bassetto CC, et al. *Parasite Immunol*. 2011;33:377.
- Bishop SC, Morris CA. *Small Rumin Res*. 2007;70:48.
- Salle G, et al. *Vet Res*. 2014;45:68.
- Nnadi PA, et al. *Vet Parasitol*. 2009;161:232.
- Rocha RA, et al. *Vet Parasitol*. 2011;181:229.
- Bambou JC, et al. *Vet Parasitol*. 2011;178:279.
- Kommuru DS, et al. *Vet Parasitol*. 2015;207:170.
- Mechineni A, et al. *Vet Parasitol*. 2014;204:221.
- Gujja S, et al. *Vet Parasitol*. 2013;191:51.
- Soli F, et al. *Vet Parasitol*. 2010;168:93.
- Burke JM, Miller JE. *Vet Parasitol*. 2006;139:145.
- Fausto GC, et al. *Parasit Vectors*. 2014;7:355.
- Leal ML, et al. *Exp Parasitol*. 2014;144:39.

## BUNOSTOMOSIS (HOOKWORM DISEASE) IN RUMINANTS

### SYNOPSIS

**Etiology** Nematodes of the genus *Bunostomum* and related hookworms.

**Epidemiology** Transmission is generally by skin penetration and is favored by warm, humid conditions.

**Signs** Anemia, diarrhea, and anasarca.

Continued

**Clinical pathology** Eggs and occult blood in feces, anemia, hypoproteinemia; none of these signs is specific.

**Lesions** Red worms attached to mucosa of small intestine, nearby ingesta often bloodstained.

**Diagnostic confirmation** Necropsy is only certain method.

**Treatment** Most modern broad-spectrum ruminant anthelmintics are effective as well as those narrow-spectrum compounds that bind to plasma protein.

**Control** General preventive programs for parasitic gastroenteritis are also effective against hookworm.

## ETIOLOGY

All farm animals other than horses harbor hookworms. The main species are the following:

- **Cattle:** *Bunostomum phlebotomum* is the most widespread but *Agriostomum vryburgi* may occur in cattle in Asia and South America
- **Sheep:** *B. trigonocephalum* is found worldwide, whereas *Gaigeria pachyscelis* occurs in India, Indonesia, South America, and Africa.

Additionally, *Globocephalus* spp. occur in pigs but are rarely of clinical importance.

## LIFE CYCLE

Hookworms are reddish-colored nematodes, 1 to 2.5 cm long, and inhabit the small intestine of their hosts. The females are prolific egg layers and the life cycle is direct. The eggs hatch and two free-living, nonparasitic larval stages follow, which are very susceptible to desiccation. An infective larva is produced in about 1 week under favorable conditions. Transmission is by skin penetration alone in the case of *G. pachyscelis* but *Bunostomum* spp. larvae can enter the body via the skin or the mouth. After cutaneous penetration, larvae do the following:

- Enter the bloodstream
- Are carried to the heart and lungs
- Enter the alveoli in which the fourth-stage larvae develop
- Pass up the air passages to the pharynx
- Are swallowed
- Reach the small intestine

Ingested larvae penetrate the intestinal wall and return to its lumen without further migration. In *B. trigonocephalum* infestations, the fourth-stage larvae reach the intestine in about 11 days and egg-laying adults are present about 7 weeks after infestation. The prepatent period in *B. phlebotomum* infestations is about 8 weeks and in *G. pachyscelis* it is about 10 weeks.

## EPIDEMIOLOGY

The chances of infestation occurring by percutaneous entry are greatly enhanced when the surroundings are wet, and this, together

with the susceptibility of the larvae to desiccation, leads to a higher incidence of the disease in humid subtropical or warm temperate countries such as the southern United States, Mexico,<sup>1</sup> Africa, Asia,<sup>2</sup> northern Australia, and parts of Europe.<sup>3</sup> Heavy infestations of sheep or cattle are uncommon in cooler temperate countries but do occur occasionally when animals are winter housed in dirty surroundings with insufficient bedding. Immunity to *B. phlebotomum* in cattle appears to develop with age, and animals affected after 1 year appear to be completely immune the next year. Calves 4 to 12 months of age are most commonly affected, and the degree of infestation is always greatest in the winter months.

## PATHOGENESIS

Hookworms are active bloodsuckers and cause severe anemia in all animal species. Total worm numbers as low as 100 may cause clinical illness and 2000 may cause death in young cattle. There is a loss of whole blood and hypoproteinemic edema may result. Some irritation to the intestinal mucosa is inevitable and mild or intermittent diarrhea follows. Penetration of the skin by larvae may cause signs of irritation and lead to the introduction of pathogenic bacteria.

## CLINICAL FINDINGS

In mild infestations in stabled cattle, fidgeting, stamping, and licking of the feet may be observed. Constipation, accompanied by mild abdominal pain, is seen in the early stages and is followed by bouts of diarrhea. The cattle are unthrifty and anemic. In severe infestations there is obvious pallor of mucosae, weakness, anasarca under the jaw and along the belly, prostration, and death in 2 to 3 days. The signs in sheep are similar to those in cattle. The convalescent period, even after treatment, is prolonged unless the diet is supplemented to stimulate erythrocyte production.

## CLINICAL PATHOLOGY

The eggs in feces are similar in appearance to many other gastrointestinal nematodes. Hookworm egg counts of 400 to 500 epg are usually associated with fatal infestations. Because both larvae and adult worms are avid bloodsuckers, clinical signs are often evident before eggs appear in the feces. The degree of anemia and the presence of occult blood in the feces can be used as a measure of the severity of the infestation.

## NECROPSY FINDINGS

Hookworms attached to the mucosa are easily found but they may be few in number. In calves, total worm counts of 100 or more suggest a significant level of infestation; counts of over 2000 worms indicate a degree of infestation likely to be fatal. In sheep and goats, 24 adult *G. pachyscelis* have been reported to be fatal, but the usual fatal figure

is probably closer to 100. Most of the worms are found in the first few feet of the small intestine, and the intestinal contents nearby are often deeply bloodstained. *B. trigonocephalum* in sheep has been observed to be localized predominantly in jejunum and ileum.<sup>4</sup> Hookworms often form part of a mixed infection comprising several or many gastrointestinal nematodes.

## DIAGNOSTIC CONFIRMATION

Anemia, diarrhea, and anasarca are signs common to several diseases so necropsy is the only certain method of diagnosis. Experimental PCR assays, targeting the amplification of parasite internal transcribed spacers (ITS-1, 5.8S, and ITS-2) of nuclear rDNA, have been developed for identification of *Bunostomum* spp. in animal fecal samples.<sup>5</sup>

## DIFFERENTIAL DIAGNOSIS

- Hepatic fasciolosis
- Hemonchosis
- Coccidiosis
- *Mycoplasma ovis*
- Dietary deficiency of cobalt or copper and chronic molybdenosis

## TREATMENT

### TREATMENT AND CONTROL

#### Treatment

##### Cattle

Ivermectin, doramectin, or moxidectin (0.2 mg/kg SQ; 0.5 mg/kg TOPp) (R-1)

Eprinomectin (0.5 mg/kg TOPp) (R-2)

Albendazole (10 mg/kg PO) (R-2)

Febantel (7.5 mg/kg PO) (R-2)

Fenbendazole (5 mg/kg PO) (R-3)

Oxfendazole (4.5 mg/kg PO) (R-2)

Levamisole (7.5 mg/kg PO; 10 mg/kg TOPp) (R-2)

##### Sheep

Ivermectin, doramectin, or moxidectin (0.2 mg/kg SQ or PO) (R-1)

Albendazole (7.5 mg/kg PO) (R-2)

Febantel (5 mg/kg PO) (R-2)

Fenbendazole (5 mg/kg PO) (R-2)

Oxfendazole (5 mg/kg PO) (R-2)

Mebendazole (15 mg/kg PO) (R-2)

Levamisole (7.5 mg/kg PO) (R-2)

#### Control

Local geographic factors have a large influence on optimal control programs; consult local authorities (R-1)

PO, orally; SQ, subcutaneously; TOPp, topical pour on.

Most newer broad-spectrum anthelmintics including the benzimidazoles,<sup>6</sup> avermectin/milbemycins,<sup>7</sup> levamisole, and morantel are effective against adult *Bunostomum* spp. in

sheep and cattle, but not all products have label claims against larval stages. Eprinomectin extended-release formulation is effective against larvae of *B. phlebotomum* in cattle and provides protection for up to 150 days.<sup>8,9</sup> Moxidectin by injection gives 4 weeks residual protection in sheep against *Gaigeria*. Nitroxylin and rafoxanide, which bind to blood protein and are ingested by bloodsucking worms, are effective. Doramectin has a label claim for *G. pachyscelis*, and moxidectin has been shown to protect sheep from reinfection for at least 35 days.

**Supportive treatment** is essential in this disease because of severe anemia. The provision of a mineral mixture containing iron, copper, and cobalt is recommended and a general improvement in the quality of the diet, particularly in respect of protein, may shorten the convalescent period.

## CONTROL

Preventive programs to protect against *Haemonchus* or *Ostertagia* infections will usually give adequate protection against hookworms. Wet surroundings such as in pastures, in yards, and in barns should be avoided to reduce the chances of percutaneous infestation and reduce the viability of the free-living larvae. Pens should be cleaned frequently and ample bedding provided. Heavy stocking of sheep or calves in small pens should be avoided. Under conditions of heavy risk, periodic treatment should be administered. The hookworm of cattle will not infect sheep and vice versa, so alternate grazing may be advantageous although it has been suggested that some species of deer may act as a source of infection for *B. phlebotomum*.

## REFERENCES

1. Rehbein S, et al. *Parasitol Res.* 2015;114:47.
2. Wang CR, et al. *Res Vet Sci.* 2012;92:99.
3. Rehbein S, et al. *Vet Parasitol.* 2013;192:321.
4. Soll MD, et al. *Vet Parasitol.* 2013;192:313.
5. Nogareda C, et al. *J Vet Med B Infect Dis Vet Public Health.* 2006;53:439.
6. Acevedo-Ramirez PM, et al. *J Helminthol.* 2013;87:108.
7. Harfoush MA, et al. *J Egypt Soc Parasitol.* 2010;40:377.
8. Tarig KA, et al. *Vet Parasitol.* 2008;158:138.
9. Makovcova K, et al. *Parasitol Res.* 2008;104:123.

## OESOPHAGOSTOMOSIS (NODULE WORM DISEASE) IN RUMINANTS AND PIGS

### SYNOPSIS

**Etiology** Nematodes of the genus *Oesophagostomum*.

**Epidemiology** In sheep, disease is mostly confined to warmer summer rainfall regions; pigs of all ages are susceptible but

overt disease uncommon, except in undernourished sows.

**Signs** In sheep, failure to thrive, soft droppings, diarrhea and abdominal pain in severe cases; in sows, weight loss during lactation.

**Clinical pathology** No specific laboratory findings.

**Lesions** Nodules in the wall of intestine.

**Diagnostic confirmation** Necropsy is most reliable; otherwise need to incubate feces and identify infective larvae.

### Treatment

**Sheep:** All modern broad-spectrum wormers listed for parasitic gastroenteritis.

**Pigs:** All wormers listed for stomach worms; not all compounds are active against mucosal larvae.

**Control** General preventive programs for parasitic gastroenteritis are also effective against *Oesophagostomum*. In sows, ensure adequate nutrition.

## ETIOLOGY

All farm animals except horses can harbor nematodes of the genus *Oesophagostomum*, causing a condition known as “nodule worm disease” or “pimply gut.” The important species include the following:

- **Sheep and goats:** *O. columbianum*, *O. venulosum*, and *O. asperum*
- **Cattle:** *O. radiatum* and *O. venulosum*
- **Pig:** *O. dentatum* and *O. quadrispinulatum*

*Oesophagostomum* spp. are generally host specific but *O. venulosum* is found in both sheep and cattle. *O. columbianum* can develop in cattle to the point of penetrating the mucosa and producing lesions similar to those in lambs, but without any apparent effect on health.

## LIFE CYCLE

In appearance, *Oesophagostomum* species are stout, white roundworms, with the largest growing to 2.5 cm in length. The life cycle is direct. Eggs passed in the feces hatch and, after undergoing two molts, become infective third-stage larvae. Infestation is thought to occur only by ingestion, but skin penetration has been demonstrated experimentally. The larvae invade the intestinal wall at any level, provoking a nodular host reaction, and some may undergo hypobiosis. They return to the lumen as fourth-stage larvae and egg laying in most species commences in about 40 to 50 days.

## EPIDEMIOLOGY

*O. columbianum* eggs and larvae are particularly susceptible to cold and dryness, but under optimum conditions can reach the infective stage in 6 to 7 days. Prevalence is therefore highest in warmer temperate or

subtropical climates with summer rainfall. If sufficient larvae are ingested, acute disease may occur during the summer months. Lighter infestations or exposure of older animals to infection may give rise to a chronic condition that presents clinically in the following winter when animals are on a low plane of nutrition. Disease in cattle is similarly most common in warmer summer rainfall areas. Nevertheless, the more chronic form of the disease is quite common in ruminants in eastern Canada and the New England states of the United States.

In pigs, *Oesophagostomum* infections are cosmopolitan. The female worms produce large numbers of eggs and in pig houses only the highest standards of hygiene will prevent infections from persisting. Outdoors, the larvae thrive best when sheltered by thick vegetation. Numbers decline markedly during dry summers on bare soil or during the winter. Some larvae, however, can overwinter even in Scandinavia, but cold Canadian winters kill all free-living stages. A periparturient rise in fecal egg counts has been described in sows but it is not as constant a feature as the similar phenomenon in ewes. The periparturient egg rise is closely related to lactation and terminates when the piglets are weaned. When it occurs, it can be an important source of contamination in the farrowing house. *Oesophagostomum* has been associated with the thin sow syndrome, in which sows rapidly lose condition late in pregnancy and while they are lactating. Fecal egg counts may be very high but parasitism is only a contributory factor. The primary cause is inadequate nutrition. In group-fed animals, timid sows not able to secure an adequate share of the ration satisfy their hunger by eating bedding, increasing their intake of infective larvae.

## PATHOGENESIS

The size of the nodules in the intestinal wall, and hence their pathogenicity and economic importance to the meat industry, varies with the worm species and immunity of the host. In ruminants, for example, *O. columbianum* provokes a massive host response, whereas *O. venulosum* does not produce visible lesions. In pigs, *O. quadrispinulatum* nodules are larger than those of *O. dentatum*.

*O. columbianum* larvae in young sheep exposed for the first time stay in the wall of the anterior small intestine for about 5 days. Some subsequently enter the mucosa a second time in the large intestine, whereas others develop directly to adults. In second and subsequent infections, few larvae develop directly to adults and most are arrested in either the first or second mucosal phases. Persistence of larvae in the intestinal wall for long periods is thought to indicate host immunity, thus in older sheep, nodules develop in the intestinal wall at any level and may occasionally be present in nearby organs. Larvae may remain alive in these



nodules for periods of up to 1 year but many are destroyed by the host response. When the resistance of the animal is lowered, for example, because of poor nutrition, larvae leave the nodules, reenter the intestinal lumen, and pass down to the colon to become adults. This is the probable explanation for three common findings at necropsy:

1. Young sheep with many adult worms and no nodules
2. Adult sheep with many nodules and no adult worms
3. Adults with both

Oesophagostomosis is sometimes implicated as a primary cause of intussusception in young sheep.

**Young susceptible ruminants** generally suffer as a result of the emergence of larvae from the mucosa, which provokes a catarrhal colitis, and the feeding activities of the adults, which produce small ulcers and some mucosal bleeding. In older, immune animals the nodular reaction plays a more important role. *O. radiatum* and *O. columbianum* cause the following:

- Anorexia
- Severe and persistent mucoid diarrhea
- Loss of weight
- Anemia
- Hypoproteinemia
- Death

The hypoproteinemia follows edema of the cecum and colon and is caused by loss of albumin into the lumen. Anemia results from blood loss when mucosal larvae reenter the lumen. The fall in platelet factor levels and platelet numbers observed 6 to 7 days after primary infection of calves probably aggravates this loss. Nodules eventually caseate and calcify and may cause interference with intestinal motility or local peritonitis and adhesion formation, which leads to intussusception or stenosis. In sheep the nodules can cause considerable pain and result in an arched back (“humpy back”) and a stilted gait. The nodules in pigs are much smaller, although edema and thickening of the colon and cecum can develop in the case of heavy infestation. Outbreaks of necrotic enteritis may be activated in pigs carrying *Salmonella* spp. populations.

### CLINICAL FINDINGS

In heavily infested sheep, severe persistent diarrhea may occur in young animals. More commonly, older sheep in the winter months will show an intermittent passage of semisoft droppings that contain excessive amounts of mucus and occasionally blood. There is rapid loss of condition, hollowing of the back, stiffness of gait, and elevation of the tail. Nodules may be palpated on rectal examination. Anemia is not characteristic and is never marked.

Young calves may show anorexia, diarrhea, emaciation, and anemia. Initially the diarrhea may alternate with constipation, but later it is continuous and is dark and fetid.

In pigs, clinical signs are less severe. Loss of condition and diarrhea in weaners and growers have been attributed to heavy infection, but deleterious effects, if any, are normally found at a subclinical level. In the thin sow syndrome, lactating sows become thin or in severe cases emaciated, even though they have a good appetite, but there is usually no diarrhea.

### CLINICAL PATHOLOGY

There are no specific laboratory tests. The eggs in feces are similar in appearance to those of many other gastrointestinal nematodes. Also, the severity of the disease may bear no relation to the number of eggs in the feces; counts vary widely with the season and the stage of development of the disease. In the early stages of a massive infestation, signs may be evident but there may be no eggs in the droppings. After the prepatent period in young sheep, eggs are usually present in large numbers and may be accompanied by living adult worms. In chronic cases, however, very few eggs may be passed. Serum albumin concentrations are low in severe cases and anemia may be detected in cattle.

### NECROPSY FINDINGS

In early acute cases there is a mild catarrhal enteritis and larvae may be detectable in scrapings of intestinal mucosa. In the later more chronic stage, adult worms are easily visible in the colon. They are usually lying in thick mucus overlying a chronic catarrhal colitis. *O. columbianum* is very pathogenic and 200 adult females is considered a heavy infestation. Nodules, when they are present, may be found at all levels of the intestine; they measure up to 6 mm in diameter and, depending on their age, contain green, pasty or yellow-brown, crumbly, partly calcified material. There may be a great deal of thickening of the intestinal wall and local peritonitis.

### DIAGNOSTIC CONFIRMATION

A definite diagnosis of oesophagostomosis can only be made by necropsy examination or identification of larvae from a fecal culture. Experimental coproantigen-based ELISA and PCR-based assays for the detection of *Oesophagostomum* infection from animal fecal samples have been developed.<sup>1,2</sup>

### DIFFERENTIAL DIAGNOSIS

- Trichostrongylosis in sheep is also at its peak during the winter but diarrhea is more evident.
- Hyostrongylosis also causes emaciation in lactating sows but is confined to outdoor herds.
- Malnutrition, especially when sheep are housed and poorly fed.

## TREATMENT

### TREATMENT AND CONTROL

#### Treatment

##### Cattle

Ivermectin, doramectin, or moxidectin (0.2 mg/kg SQ; 0.5 mg/kg TOPp) (R-2)

Albendazole (10 mg/kg PO) (R-2)

Febantel (7.5 mg/kg PO) (R-2)

Fenbendazole (5 mg/kg PO) (R-3)

Netobimin (7.5 mg/kg PO) (R-2)

Oxfendazole (4.5 mg/kg PO) (R-2)

Levamisole (7.5 mg/kg PO; 10 mg/kg TOPp)

##### Sheep

Ivermectin, doramectin, or moxidectin (0.2 mg/kg SQ or PO) (R-1)

Monepantel (2.5 mg/kg PO) (R-1)

Combination of derquantel (2 mg/kg PO) and abamectin (0.2 mg/kg PO) (R-1)

Albendazole (7.5 mg/kg PO) (R-2)

Febantel (5 mg/kg PO) (R-2)

Fenbendazole (5 mg/kg PO) (R-3)

Netobimin (7.5 mg/kg PO) (R-2)

Oxfendazole (5 mg/kg PO) (R-2)

Mebendazole (15 mg/kg PO) (R-2)

Levamisole (7.5 mg/kg PO) (R-2)

##### Goats

Ivermectin, doramectin, or moxidectin (0.2 mg/kg SQ or PO) (R-2)

Albendazole (10 mg/kg PO) (R-2)

Levamisole (12 mg/kg PO) (R-2)

##### Pigs

Ivermectin (0.1 mg/kg) (R-1)

Moxidectin (0.4 mg/kg) (R-1)

Abamectin (0.1 mg/kg, PO) (R-1)

Fenbendazole (5.0 mg/kg, q.d. for 3 days) (R-2)

Flubendazole (4.0 mg/kg) (R-2)

Levamisole (8 mg/kg) (R-2)

PO, orally; q.d., four times a day; SQ, subcutaneously; TOPp, topical pour on.

All modern broad-spectrum compounds are effective against adult *Oesophagostomum*. Moxidectin provides up to 4 weeks' protection from reinfection with *O. columbianum* in sheep. *Oesophagostomum* spp. strains resistant to pyrantel have been detected on some pig farms in Denmark. Low efficacy (52%) of ivermectin against larval *O. dentatum* in pigs<sup>3</sup> and against *O. radiatum* in cattle<sup>4</sup> has been observed.

### CONTROL

In sheep and cattle, the principles of control described under PGE in ruminants apply also to *Oesophagostomum* infections. In pigs, the thin sow syndrome is unlikely to be cured or prevented by anthelmintic

treatments alone; due consideration must also be given to the nutritional requirements of the animals at risk. To prevent contamination of the farrowing house, sows should be treated before entry. Pigs should be treated at weaning and each time they are moved on to new accommodation. Boars should be treated at least once a year. Alternatively, it may be more convenient to treat all pigs on a premises simultaneously with a medicated feed. The dosing interval should be determined by fecal egg counts performed on a representative sample of all age groups in the herd. Overdependence on anthelmintic therapy should be avoided as resistance can develop in *Oesophagostomum* populations. The demonstration that diets containing highly degradable and rapidly fermentable carbohydrates can considerably reduce *O. dentatum* burdens and fecal egg counts indicates the possibility of an alternative approach to control.

In grazing pigs, the ability of the eggs and larvae to survive on the pasture must be considered. In the UK, eggs deposited in the winter and early spring do not reach the infective stage, but infective larvae can survive for a year in feces or on pasture. Under these conditions treatment of pigs in the autumn with a move to clean pasture will reduce pasture contamination through the following spring and early summer. An additional treatment in spring may give additional security. Experimental feedings of ruminants with nematophagous fungi, *Duddingtonia flagrans*, which prey on the infectious forms of nematodes (including *Oesophagostomum* spp.) have demonstrated that it is a viable way of naturally reducing the numbers of infective larvae in animal rearing environments.<sup>5-8</sup>

#### FURTHER READING

Roepstorff A, et al. Helminth parasites in pigs: new challenges in pig production and current research highlights. *Vet Parasitol.* 2011;180:72.

#### REFERENCES

1. Araujo JV, et al. *Parasitol Res.* 2008;102:787.
2. Sagues MF, et al. *Parasitol Res.* 2011;109:707.
3. Sagues MF, et al. *J Helminthol.* 2014;88:511.
4. Santurio JM, et al. *Exp Parasitol.* 2011;127:727.
5. Jas R, et al. *Vet Parasitol.* 2010;170:262.
6. Lin RQ, et al. *Parasitol Res.* 2008;103:993.
7. Borgsteede FH, et al. *Vet Parasitol.* 2007;146:288.
8. Felippelli G, et al. *Parasitol Int.* 2014;63:835.

#### CHABERTIOSIS

Chabertiosis of sheep, goats, and cattle is associated with *Chabertia ovina*, a worm 1 to 2 cm in length, which inhabits the colon and causes a clinical syndrome similar to that of oesophagostomosis. Disease is mainly seen in sheep in colder areas during the winter months. Infections do occur in cattle but are rarely pathogenic. The life cycle is direct and resembles that of other strongylid worms.

Infective larvae are relatively resistant to cold<sup>1</sup> and heavy infestations may occur in mild winters.<sup>2</sup> After ingestion, larvae undergo a period of development in the wall of the small intestine before passing to the cecum and then to the colon. Unlike *Oesophagostomum*, the larvae do not cause any significant damage. The infection becomes patent in about 7 weeks.

Clinical signs are first seen when immature adults start to attach to the mucosa about 26 days after infection. Soft blood-flecked feces with excess mucus are passed. A protein-losing enteropathy occurs with lowered blood albumin and weight loss. Death may occur in heavy infections. Fecal egg counts do not always correlate well with clinical signs because these may occur before the worms mature. Immunity can also reduce the fecundity of adult *Chabertia*.

Changes at necropsy are thickening, edema, and petechiation of the wall of the colon with blood sometimes present in the intestinal contents. The worms, which are easily recognized by their large buccal cavities, are usually confined to the first 25 to 30 cm of the coiled colon, except in very heavy infections. The number of worms present is often surprisingly small, and severe morphologic changes may be evident with only five to 10 worms. More than 100 worms is considered to be a heavy infestation. All the newer broad-spectrum anthelmintics are effective against *C. ovina*.

#### REFERENCES

1. Makovcova K, et al. *Parasitol Res.* 2009;104:795.
2. Stadaliene I, et al. *Acta Vet Scand.* 2015;57:16.

### STOMACH FLUKE DISEASE (INTESTINAL AMPHISTOMOSIS)

#### SYNOPSIS

**Etiology** *Paramphistomum cervi*, *P. microbothrioides*, and related flukes.

**Epidemiology** Infection by ingestion of metacercariae on herbage; geographic distribution, seasonality, and disease risk determined by occurrence of intermediate hosts (aquatic planorbid snails).

**Signs** Severe enteritis, fetid diarrhea.

**Clinical pathology** Hypoalbuminemia; immature flukes may be passed in feces.

**Lesions** Duodenal mucosa thickened, mucus blood stained with large numbers of small, flesh-colored flukes.

**Diagnostic confirmation** Demonstration of immature flukes in feces.

**Treatment** Oxytoclozanide, closantel, hexachlorophene.

**Control** Avoidance or drainage of snail habitats; anthelmintic treatments to prevent contamination of pastures with eggs.

#### ETIOLOGY

Intestinal amphistomosis is associated with paramphistome flukes in the duodenum migrating toward the forestomachs. Cattle and, to a lesser extent, sheep are at risk of infection. The paramphistomes are cosmopolitan but disease is most common in warmer regions, particularly Australasia, Africa, and India.<sup>1</sup> However, there are recent reports of increasing prevalence of paramphistomosis in Europe.<sup>2-7</sup> Commonly recorded paramphistome species include *Paramphistomum cervi*, *P. microbothrioides*, *P. liorchis*, *P. ichikawai*, *P. microbothrium*, *Calicophoron calicophorum*, *Ceylonocotyle streptocoelium*, *Calicophoron ijimai*, and *Cotylophoron cotylophoron*.

#### LIFE CYCLE

The life cycle is similar to that of *F. hepatica* except that the intermediate hosts are planorbid snails and the immature flukes migrate proximally along the duodenum and through the abomasum to reach their predilection site in the rumen and reticulum. The period required for maturation varies from 6 weeks to 4 months.

#### EPIDEMIOLOGY

Planorbid snails are aquatic. They are more adaptable and occupy more diverse habitats than lymnaeid snails. Thus zones of endemicity for intestinal amphistomosis and hepatic fasciolosis do not necessarily coincide. Most outbreaks of disease occur during the late summer, autumn, and early winter when pastures are heavily contaminated with encysted cercariae. Planorbid snails multiply very rapidly in warm, watery environments but can subsequently survive dry conditions. Metacercariae are therefore found on pastures prone to flooding as well as on herbage in and around ponds, streams, and other water sources. All ages of cattle, sheep, goats, and wild ruminants grazing near water or on land liable to flooding may be affected, but young cattle in the yearling class are the usual subjects. It is possible that some degree of immunity develops.

#### PATHOGENESIS

The immature flukes excyst in the duodenum or mid to proximal jejunum. As they migrate, they attach firmly to the mucosa and may penetrate as far as the muscularis mucosa. Damage is related to the numbers of migrating flukes and increases in intensity from localized enteritis through patches of villous atrophy to severe destruction of the mucosa.<sup>5,8,9</sup> Clinical and production effects are dependent on the extent of the lesions because some compensation for functional deficiency can take place in the undamaged lower small intestine. The presence of mature flukes in the rumen does not usually elicit any significant response but in massive infections papillae are short and red, becoming fused into aggregations

with ruminal contents adhering firmly to the surface.

### CLINICAL FINDINGS

Severe enteritis associated with enormous numbers of migrating flukes in the duodenum seems to be the only manifestation of disease.<sup>5</sup> A characteristic and persistent fetid diarrhea is accompanied by weakness, depression, dehydration, and anorexia. There may also be submaxillary edema and obvious pallor of the mucosae. Death usually occurs 15 to 20 days after the first signs appear. The mortality rate in heavily infested animals may be high. Mature flukes in the forestomachs of animals normally cause little harm, although loss of weight, anemia, a rough dry coat, and a drop in production have been ascribed to heavy infestations.<sup>2,10</sup>

### CLINICAL PATHOLOGY

A sedimentation and decanting technique may be used to find immature flukes passed in feces. The larvae are round with prominent anterior and posterior suckers. Because the disease is caused by immature forms, eggs are not usually present in the feces, although they may be detectable in older animals in the same herd. Paramphistome eggs are dense structures so sedimentation methods for detection are preferred to flotation. The eggs have a distinct operculum and resemble those of *F. hepatica*, but the shell is colorless. Blood biochemistry reveals a marked drop in TPP, due largely to a fall in plasma albumin.

### NECROPSY FINDINGS

There is muscular atrophy, subcutaneous edema, and accumulations of fluid in the body cavities, and the fat deposits are gelatinous. In the upper part of the duodenum the mucosa is thickened and covered with bloodstained mucus, and there are patches of hemorrhage under the serosa. Large numbers of small, flesh-colored flukes (3–4 mm long and 1–2 mm wide) are present in this area but decrease in number toward the ileum. There may be none in the abomasum and forestomachs. There may be a few in the peritoneal cavity and on histologic examination the young flukes are present not only on the mucosal surface but are also embedded in the mucosa and deeper layers.<sup>11</sup>

### DIAGNOSTIC CONFIRMATION

The occurrence in yearling cattle of a severe enteritis, unaccompanied by fever, in environmental conditions suitable for the propagation of flukes and where host snails can be found should arouse suspicion of intestinal amphistomosis. Confirmation depends on demonstration of immature flukes in feces or at necropsy. A coprological assay, mini-FLOTAC, has been demonstrated to be reliable in detecting the presence of adult rumen fluke infection in cattle.<sup>6</sup> Experimental PCR assays targeting the amplification of mitochondrial or rDNA have been demonstrated

to be sensitive and species specific in detecting paramphistomes.<sup>12–14</sup> Care is needed because the small parasites are easily missed.

### DIFFERENTIAL DIAGNOSIS

- Nutritional deficiency of copper
- Infestation intestinal roundworms
- Infectious enteritides, but these are usually accompanied by fever
- Johne's disease in adult animals, but this is a much more chronic disease
- Poisonings, including many weeds, inorganic arsenic and lead

### TREATMENT

#### TREATMENT AND CONTROL

##### Treatment

Oxyclozanide (18.7 mg/kg two doses 48 h apart, PO) (R-2)

Hexachlorophene (20 mg/kg, PO) (R-4)

Closantel (10 mg/kg, PO) (R-2)

Few drugs are oral highly effective. Two doses of oxyclozanide 18.7 mg/kg 2 days apart, or a single oral dose of hexachlorophene 20 mg/kg, give consistent results against immature paramphistomes in cattle, but hexachlorophene may show toxicity at this dose rate and is therefore not preferred as a treatment. In goats, oral oxyclozanide at 22.5 mg/kg orally has 95.9% efficacy against adult *C. daubneyi*.<sup>15</sup> This dosage protocol is higher than the recommended dose rate for oxyclozanide of 10–15 mg/kg once orally for cattle and 15 mg/kg once orally for sheep and goats. Niclosamide 160 mg/kg as a single oral dose or as two oral doses 3 days apart is effective but somewhat variable; however, it has good activity at 100 mg/kg against immature paramphistomes in sheep. Closantel used at orally 10 mg/kg has up to 99% efficacy against rumen flukes in cattle.<sup>4,6</sup> Bithionol has been used in Asia and Africa.

### CONTROL

Animals should, where possible, be denied access to contaminated areas. Otherwise, regular treatments will be needed. Snails quickly repopulate pastures once they become wet and stock should be removed before the intermediate hosts start to shed large numbers of cercariae (1–2 months from infection of the snail depending on temperature). Metacercariae may persist on pasture for up to 2 or 3 months after floodwater has dried out.

In areas where paramphistomes are a regular problem, knowledge of the local epidemiologic cycle will help determine optimum times for prophylactic treatments. These are aimed at killing migrating immature flukes before they cause disease and at reducing egg output by adult worms, minimizing opportunity for snails to become infected. Drainage of low-lying areas and

destruction of host snails by the use of molluscicides could be considered.

### FURTHER READING

- Brown CC, et al. Infections and parasitic diseases of the alimentary tract. In: Maxie MG, ed. *Jubb, Kennedy, and Palmer's Pathology of Domestic Animals*. vol 2. 5th ed. Edinburgh: Elsevier Saunders; 2006:135-279.
- Kilni M, et al. Lefevre PC, Blancou J, Chemette R, Uilenberg G, eds. *Gastrointestinal Helminthosis: Amphistomosis*. Paris: Lavoisier; 2010:1589-1601.

### REFERENCES

1. Dorny P, et al. *Vet Parasitol*. 2011;175:293.
2. Toledo R, et al. *Adv Parasitol*. 2006;63:285.
3. Millar M, et al. *Vet Rec*. 2012;171:509.
4. Mason C, et al. *Vet Rec*. 2012;170:343.
5. Foster AP, et al. *Vet Rec*. 2008;162:528.
6. Fuertes M, et al. *Vet Parasitol*. 2015;209:188.
7. Anuracpreeda P, et al. *Exp Parasitol*. 2008;118:203.
8. Murphy TM, et al. *Vet Rec*. 2008;162:831.
9. Arias MS, et al. *Vet Parasitol*. 2013;197:126.
10. Malrait K, et al. *Vet Parasitol*. 2015;207:134.
11. Paraud C, et al. *Vet J*. 2009;180:265.
12. Toolan DP, et al. *Vet Parasitol*. 2015;212:168.
13. Martinez-Ibeas AM, et al. *Vet Parasitol*. 2013;195:57.
14. Lotfy WM, et al. *Vet Parasitol*. 2010;174:234.
15. Sanabria R, et al. *Vet Parasitol*. 2011;177:182.

## Toxic Diseases of the Ruminant Alimentary Tract

### NONPROTEIN NITROGEN TOXICOSIS (UREA TOXICOSIS)

#### SYNOPSIS

**Etiology** Urea or other nonprotein nitrogen (NPN) sources in the diet; urea as fertilizer or incorporated into mineral block.

**Epidemiology** NPN products are used in ruminants as inexpensive protein sources. When too much is fed or accidentally ingested, excess ammonia produced from rumen metabolism of urea or NPN is absorbed resulting in hyperammonemia and resulting clinical signs.

**Clinical pathology** Hyperammonemia, lactic acidosis, metabolic acidosis, hyperkalemia, other nonspecific chemistry changes.

**Lesions** Affected animals show severe abdominal pain, frothing at the mouth and nose, hypersensitivity to sound and movement to the point of being aggressive, muscle tremors, incoordination, weakness, dyspnea, bloat, and violent struggling and bellowing.

**Diagnostic confirmations** History of exposure to NPN source; increased rumen pH; elevated ammonia concentrations in serum, plasma, ocular fluid, and rumen.

**Treatment** 5% acetic acid (vinegar) orally to decrease rumen pH and cold water to slow urea metabolism by urease.

**Control** Follow manufacturer's feeding recommendations; keep ruminants away from stored fertilizers and fertilizer spills.



## ETIOLOGY

Urea is a common, inexpensive, and readily available form of nonprotein nitrogen (NPN) used in ruminant rations and as a fertilizer.<sup>1,2</sup> Less common ammoniated sources used in rations include ammonium acetate, ammonium lactate, ammonium sulfate, biuret, diammonium phosphate, and others.<sup>2,3</sup> Most of the supplements other than urea are mixed directly into the feed. Urea is unique because it not only exists as food supplement, but can be incorporated into solid mineral blocks, added to other liquid products such as molasses, or used as a fertilizer. Accidental access to the powder or liquid form of the urea can cause heavy mortalities. Toxicosis occurs when cattle or sheep gain access to large amounts of NPN, are fed larger quantities than they are accustomed to, ingest improperly mixed feeds, or drink polluted water. Feed-grade urea contains approximately 45% nitrogen and protein is approximately 16% nitrogen, so each gram of urea is equivalent to 2.81 g of protein. Thus a ration containing 1% urea supplies the protein equivalent of 2.81% natural protein. Some care is required in bringing the animals onto urea gradually, and an adequate proportion of carbohydrate must be included in the ration.

## EPIDEMIOLOGY

### Occurrence

Urea is used in agriculture as a feed additive for ruminants to provide an inexpensive protein substitute in the diet and as a fertilizer on crops, pastures, and fields. Protein production from urea is dependent on rumen microorganisms assimilating the ammonia released from urea and converting it to protein useful to the animal. Natural occurring urease in the rumen supports the hydrolysis of urea to ammonia. The degree of toxicity of urea depends on the rapidity with which ammonia is released from the urea in the rumen. This may be increased if soybean meal is being fed; soybeans contain urease, which facilitates the breakdown of urea to ammonia.

### Animal Risk Factors

Ruminants are more able to assimilate ammonia into protein when adequate amounts of readily available carbohydrates are provided. This is usually from grain or a sugar source such as molasses. In the absence of sufficient digestible carbohydrate, such as when only roughages are fed, urea is more toxic. In the past, mixtures of molasses and urea were popular as feed supplements for cattle and were associated with outbreaks of poisoning. Signs were similar to those of urea poisoning and those associated with feeding ammoniated hay.

The toxic dose of NPN in ruminants depends on a number of factors such as current diet, acclimation to product, rumen pH, body temperature, and the presence of other diseases. Urea needs to be gradually

introduced into the diet over several days to allow the rumen bacteria time to become accustomed to the ammonia source.

- **Cattle:** In cattle starved beforehand, dose levels up to 0.33 g/kg BW are associated with increases in blood levels of ammonia, dose levels in cattle of 0.44 g/kg BW produce signs of poisoning within 10 minutes of dosing, and dose rates of 1 to 1.5 g/kg BW are associated with death. Cows unaccustomed to urea may show clinical signs of toxicosis when fed 0.4 g/kg BW, but by gradually increasing the quantity fed this amount can be tolerated. Most rations contain 3% urea in the grain mixture or 1% in the total ration but as the rumen adjusts, cattle can tolerate larger amounts. Tolerance is lost rapidly and animals receiving no urea for 3 days are again susceptible. Tolerance is also reduced by starvation, lack of readily available dietary carbohydrate, and a low protein diet.
- **Sheep:** They can eat 6% of their total ration throughout the day as urea provided it is well mixed with roughage, preferably by spraying the urea mixed with molasses onto the roughage. Much more urea is tolerated if provided to sheep in molasses (18 g) than if given as a drench (8 g). Prior feeding on lucerne further increases the tolerance; fasting for 24 hours reduces it. A dose rate of 1 g/kg BW to sheep appears to be nontoxic, but 2 g/kg BW is quickly fatal.
- **Horses:** They appear to be tolerant of relatively large doses of urea and poisoning rarely occurs. The disease has been produced experimentally in ponies by administering 450 g by stomach tube. The clinical picture is similar to that seen in cattle. There is a sharp increase in blood ammonia levels after ingestion of the urea, and it is assumed that hydrolysis of the urea occurs in the cecum.<sup>4</sup>
- **Pigs:** They are quite unaffected by very large doses of urea unless they are deprived of water or have developed a cecal flora that produces urease.

## PATHOGENESIS

Under normal circumstances, urea in the rumen is broken down by urease to ammonia, which is then used by rumen bacteria to synthesize proteins. Excess ammonia remains in the rumen as the ionized ammonium ion. The sudden introduction of large amounts of urea upsets this reaction and toxicosis occurs. Excess quantities of ammonia produced are rapidly absorbed across the rumen into the systemic circulation. Rumen pH is elevated and more ammonia remains in the nonionized form and is absorbed.<sup>1,2</sup> The onset of signs occurs in 10 to 30 minutes after feeding. The severity of signs is directly

related to blood ammonia levels and not to ammonia levels in the rumen.<sup>2,5</sup> Excess blood ammonia interferes with energy metabolism, inhibits the citric acid cycle, and results in systemic lactic acidosis.<sup>5,6</sup> Hyperkalemia, associated with systemic metabolic acidosis, may cause cardiac arrhythmias and arrest.<sup>6</sup>

## CLINICAL FINDINGS

### Cattle and Sheep

Signs of toxicosis occur as early as 10 minutes after the urea is eaten and include severe abdominal pain, frothing at the mouth and nose, bellowing, hypersensitivity to sound, movement to the point of being aggressive, muscle tremors, incoordination, weakness, dyspnea, bloat, and violent struggling. Less severe cases are drowsy and recumbent. In severe cases death occurs in a few minutes, but more commonly, animals die about 4 hours after ingestion. The case-fatality rate in affected animals is high.

## CLINICAL PATHOLOGY

### Cattle

Signs are visible when rumen ingesta levels of ammonia are 1000 mg/L, serum levels of ammonia nitrogen (NH<sub>3</sub>-N) are 10 to 13 mmol/L, and when blood ammonia nitrogen concentrations reach 0.7 to 0.8 mg/dL. The higher the serum ammonia levels (up to 1719 μmol/L), the higher the blood lactate levels (up to 26.01 μmol/L) were in a group of poisoned steers.<sup>5,6</sup> Blood pH (7.24) in this group was consistent with metabolic acidosis.<sup>5</sup>

### Sheep

Deaths occur at blood ammonia nitrogen levels of 33 μg/mL of blood, when the rumen contents are alkaline (pH elevated from 6.94–7.90), and rumen ammonia levels rise from 6 to 50 mg/dL.

## NECROPSY FINDINGS

There are no characteristic lesions at necropsy, but most animals show generalized congestion, hemorrhages, and pulmonary edema. Death is thought to result from respiratory or cardiac arrest caused by ammonia intoxication. In pigs, encephalomalacia has been produced by feeding a ration containing 15% urea. The clinical picture and histopathological findings were similar to those of salt poisoning except that no eosinophilic aggregations are present in the cerebral lesions.

## DIFFERENTIAL DIAGNOSIS

Outbreaks of this poisoning are usually closely linked to known exposure to urea or nonprotein nitrogen source and are confirmed by high serum levels of ammonia. In dead animals, fluid from the rumen, abomasum, or eye may be used. Without the historical link to a source of urea the differential list is very

*Continued*

long because of the similarity of the syndrome to other diseases.

**Differential diagnosis list:**

- Acute 4-methylimidazole poisoning from ammoniated forages (bovine bonkers syndrome)
- Acute bovine pulmonary emphysema and edema
- Acute hepatic insufficiency
- Acute salt toxicosis
- Anaphylaxis
- *Clavibacter toxicus* toxicosis
- Cyanobacteria toxicosis
- Encephalitis, encephalomalacia
- Hypomagnesemia

## TREATMENT

### TREATMENT AND CONTROL

5% acetic acid (vinegar) (0.5–1 L orally to a sheep, 4 L orally to a cow) (R-2)

Cold water (10–30 L PO for adult cattle, repeat as needed). (R-2)

No primary treatment is likely to be effective, especially in large herd situations, because the mortality rate is high and death occurs before treatment can be instituted. In single ruminants or small groups, the oral administration of a 5% acetic acid solution such as vinegar (0.5–1 L to a sheep, 4 L to a cow) is recommended to lower the rumen pH.<sup>1,2</sup> Cold water (10–30 L for adult cattle) will dilute excess urea, temporarily lower rumen pH, and slow NPN metabolism by urease enzymes.<sup>1,2</sup> This may reduce the amount of ammonia absorbed, but it must be administered as soon as the first clinical signs appear and treatment repeated because clinical signs tend to recur about 30 minutes after treatment. The only really effective treatment is prompt and efficient emptying of the rumen, either via a large-bore stomach tube or by rumenotomy, but the results are variable because serum ammonia levels may already be high.<sup>1</sup>

## CONTROL

Urea is highly toxic and care is essential when handling it in the vicinity of animals. Feed manufacturers' recommendations about maximum concentration of urea in prepared rations and acclimatization to the diet with inclusion of adequate readily available carbohydrates should be adhered to. In dairy cows, urea should be fed at 1% of the concentrate, 135 g per animal per day, and not more than 20% of the total crude protein (including other NPN sources).<sup>1</sup> Other sources of NPN cause similar clinical signs, but toxicosis is much less frequently reported with them.

Nevertheless, if they are incorporated into the diet all of the issues with control of urea should be followed.

## FURTHER READING

Bartley EE, Davidovich AD, Barr GW, et al. Ammonia toxicity in cattle. Rumen and blood changes associated with toxicity and treatment methods. *J Anim Sci.* 1976;43:835-841.

## REFERENCES

1. Kertz AF. *Prof Anim Sci.* 2010;26:257.
2. Shaikat AH, et al. *Univ J Zoo.* 2012;31:65.
3. Alvarez EG, et al. *Anim Feed Sci Tech.* 2012;171:136.
4. Santos SA, et al. *Animal.* 2012;6:1096.
5. Antonelli AC, et al. *Braz J Vet Res Anim Sci.* 2009;46:69.
6. Antonelli AC, et al. *Braz J Agric Sci.* 2013;7:680.

## CHEMICALLY TREATED NATURAL FEEDS

### Formalin-Treated Grain

This is a special diet fed to dairy cows to produce dairy products containing an increased proportion of polyunsaturated fats for special human diets. Fats in the grain are protected against hydrogenation in the rumen by coating the grains with formalin. If the formalin and the grain are not properly mixed, the free formalin left as a residue is associated with rumenitis and severe diarrhea.

### Caustic-Treated Grain

Grain treated with caustic to improve its digestibility is recorded as causing focal interstitial nephritis, rumenitis, and abomasal ulceration in feedlot steers. The lesions have been produced experimentally. They may not be detected until the animals are slaughtered.

### Ammoniated Forage

Anhydrous ammonia is added to hay to improve its digestibility and nitrogen content. Environmental risk factors enhancing the production are low dry matter content of the feed, high environmental temperature, and high concentrations of ammonia in the treatment mixture. If the forage is high quality and has a high carbohydrate content, it may undergo chemical change, possibly with the formation of a substituted imidazole, 4-methylimidazole (MeI), which is associated with hysteria (bovine bonkers) in the cattle eating it. Calves sucking cows fed ammoniated hay may also be affected by this same syndrome. Experimental feeding with MeI produces the same syndrome but it is not the sole cause; other substances are also involved.

Clinical signs include hyperexcitability, hyperesthesia, restlessness, rapid blinking, pupillary dilatation, ear flicking, frequent urination and defecation, dyspnea, frothing at the mouth, bellowing, charging, circling, and convulsions. Tremors, beginning at the head and opisthotonus are obvious early signs. Between convulsions, affected sheep walk in circles and have a stiff gait. Nursing calves may show signs even though their

dams are unaffected. No clinicopathologic abnormalities occur, blood ammonia levels are normal, and no specific necropsy lesions have been identified.

Treatment consists of sedation, but many patients do not respond to agents such as acepromazine. Dilution of toxic forage with normal feed is not recommended because the toxin may be cumulative. The maximum rate of ammoniation to avoid toxicity for poor forage is 3% and 1% for high-moisture forage.

## Newsprint

Newsprint is fed commercially to ruminants as alternative roughage. Toxicologic hazards of the material in sheep fed colored magazines for 6 months and comprising 23% of their ration included a significant deposition of lead in tissues and an increase in enzyme activity in liver, but there were no clinical signs and no histopathological lesions. Feeding for periods of several weeks has no detectable clinicopathologic effects, and there is evidence that the known toxins are not secreted in cows' milk.

## Sewage Sludge

Urban sewage sludge is incorporated into the soil when used as top-dressing for pasture and grazing lands and may be associated with the spread of infectious disease as well as goiter.<sup>1</sup> Sewage sludge may also be fed directly to animals, but may lead to dissemination of lead, cadmium, and polybrominated and polychlorinated biphenyls to animals and the food products derived from them. Potential damage caused by illness or contamination of animal-produced feed can be minimized by leaving treated pasture exposed to weather for a period of several weeks before allowing animals access to it.

## FURTHER READING

### Ammoniated feeds:

Morgan SE, Edwards W. Bovine bonkers: new terminology for an old problem a review of toxicity problems with ammoniated feeds. *Vet Hum Toxicol.* 1986;28:16-18.

Orr J, Hutchinson T, Can Vet J. Saskatchewan. Ammoniated forage poisoning of cattle ("bovine bonkers"). *Can Vet J.* 1988;29:846-849.

### Caustics:

Orskov ER, Greenhalgh JFD. Alkali treatment as a method of processing whole grain for cattle. *J Agric Sci.* 1977;89:253-255.

### Newsprint:

Dinius DA, Oltjen RR. Newsprint as a feedstuff for beef cattle. *J Anim Sci.* 1971;33:1344-1350.

### Sewage sludge:

Johnson DE, Kienholz EW, Baxter JC, et al. Heavy metal retention in tissues of cattle fed high cadmium sewage sludge. *J Anim Sci.* 1981;52:106-114.

McLachlan M, Richter W. Uptake and transfer of PCDD/Fs by cattle fed naturally contaminated feedstuffs and feed contaminated as a result of sewage sludge application. *J Agric Food Chem.* 1998;46:1166-1172.

## REFERENCE

1. Hough RL, et al. *Waste Manag.* 2012;32:117.

## Diseases of the Ruminant Alimentary Tract of Unknown Cause

### CHRONIC INFLAMMATORY BOWEL DISEASE OF SHEEP

This syndrome of unknown etiology manifests with wasting, ill-thrift and mortality, or culling for poor production, and is reported in England and Canada. It affects both housed and pastured sheep predominantly in their first year of life, but cases up to 3 years of age have been seen. Affected sheep are dull and anorectic with pale mucous membranes and have fecal staining of the perineum. The rumen fill is reduced, and the feces are soft and malodorous. Blood examination shows hypoalbuminemia, an elevated blood urea nitrogen, and leukocytosis with

neutrophilia. On postmortem there is lymphocytic enteritis with gross thickening of segments or the entire or distal part of the small intestine. There is no evidence for John's disease or parasitic gastroenteritis, and the syndrome has similarities to the proliferative enteropathies of swine and horses.

### FURTHER READING

Radostits O, et al. Chronic inflammatory bowel disease of sheep. In: *Veterinary Medicine: A Textbook of the Diseases of Cattle, Horses, Sheep, Goats and Pigs*. 10th ed. London: W.B. Saunders; 2007:1997.

### SALIVARY ABOMASUM DISEASE

This was first reported in lambs and kids aged 3 to 17 days old Greece in 2008.<sup>1</sup> Affected lambs are lethargic, weak, and not sucking with increased abdominal distension, but did not have clinical evidence of profuse salivation, septicemia, or umbilical infection.<sup>2</sup> Some lambs had mild uremia on serum biochemical analysis. At necropsy,

the abomasum was distended with gas or saliva, with multiple small mucosal and serosal hemorrhages and associated blood clots. Histologic examination of the abomasal lesions indicated the presence of a mild to moderate inflammatory cell infiltrate and acute tubular necrosis. Bacteriologic culture results were unremarkable. Salivary abomasum disease has an unknown pathogenesis but appears to have a different presentation of **watery mouth disease** from lambs reported from the UK and elsewhere and **abomasal tympany** in lambs from Norway.

Early treatment of affected lambs with oral erythromycin<sup>1</sup> or sodium bicarbonate solution has been successful in some lambs, in combination with general nursing care.<sup>2</sup> Erythromycin might be effective because it promotes abomasal emptying.<sup>3</sup>

### REFERENCES

1. Christodouloupoulos G. *Vet Rec.* 2008;162:732.
2. Christodouloupoulos G, et al. *Vet Rec.* 2012;172:100.
3. Wittek T, et al. *J Am Vet Med Assoc.* 2008;232:418.



**DISEASES OF THE LIVER:  
INTRODUCTION 622****PRINCIPLES OF HEPATIC  
DYSFUNCTION 622**

Diffuse and Focal Hepatic Disease 622  
Hepatic Dysfunction 623  
Portal Circulation 623

**MANIFESTATIONS OF LIVER AND  
BILIARY DISEASE 623**

Jaundice (Icterus) 623  
Hepatic Encephalopathy 624  
Edema and Emaciation 624  
Diarrhea and Constipation 625  
Photosensitization 625  
Hemorrhagic Diathesis 625  
Abdominal Pain 625  
Alteration in Size of the Liver 625  
Displacement of the Liver 625  
Rupture of the Liver 625  
Black Livers of Sheep 625

**SPECIAL EXAMINATION OF THE  
LIVER 625**

Palpation and Percussion 625  
Biopsy 626  
Medical Imaging of the Liver 626  
Laboratory Tests for Hepatic Disease and  
Function 626

**PRINCIPLES OF TREATMENT IN  
DISEASES OF THE LIVER 629****DIFFUSE DISEASES OF THE  
LIVER 629**

Hepatitis 629  
Liver Abscess and Necrobacillosis of the  
Liver 632  
Bacillary Hemoglobinuria (Red Water  
Disease) 635  
Infectious Necrotic Hepatitis (Black  
Disease) 637  
*Clostridium novyi* Infection 638

**DISEASES CHARACTERIZED BY  
SYSTEMIC INVOLVEMENT 639**

Acute Hepatitis (Postvaccinal Hepatitis)  
of Horses (Theiler's Disease, Serum  
Hepatitis) 639  
Hepatitis E Virus (HEV) 640

**HEPATIC DISEASES ASSOCIATED  
WITH TREMATODES 641**

Fasciolosis (Liver Fluke Disease) 641  
Diagnostic Confirmation 643  
*Fascioloides magna* 645  
*Dicrocoelium* 645

**DISEASES ASSOCIATED WITH MAJOR  
PHYTOTOXINS 645**

Pyrrrolizidine Alkaloid Toxicosis 645  
Plants Causing Hepatic Injury  
(Unidentified Toxin) 649

**POISONING BY MYCOTOXINS 649**

Poisoning by Aflatoxins  
(Aflatoxicosis) 649  
Phomopsins Toxicosis (Lupinosis) 650  
Pithomycototoxicosis (Sporidesmin Toxicity  
and Facial Eczema) 652  
Rubratoxin Toxicosis 654  
Miscellaneous Fungi Causing Hepatic  
Damage (Unidentified Toxin) 654  
Sawfly Larvae (Lophyrtomin and  
Pergidin) Toxicosis 654  
Coal Tar Pitch Poisoning in Pigs 655

**FOCAL DISEASES OF THE LIVER 655**

Tumors of the Liver 655  
Diseases of the Biliary System 655

**DISEASES OF THE PANCREAS 656**

Pancreatitis 656  
Diabetes Mellitus 656  
Pancreatic Adenoma 656  
Pancreatic Adenocarcinoma 656

**Diseases of the Liver:  
Introduction**

Liver disease in farm animals can have a variety of etiologies including toxicities, parasitism, metabolic disorders, infectious diseases, or biliary obstructive disorders. A classification of hepatic diseases into primary and secondary liver disease is sometimes used in the literature. In primary hepatic disease the clinical manifestations are caused solely by liver disease, whereas with secondary liver disease symptoms arise as part of a generalized disease process, or they are spread from another organ.

This chapter is devoted to a consideration of primary diseases of the liver and to those aspects of other diseases in which manifestations of hepatic involvement occur.

**Principles of Hepatic  
Dysfunction****DIFFUSE AND FOCAL  
HEPATIC DISEASE**

The liver has a large reserve of function and approximately three-quarters of its parenchyma must be rendered inactive before clinical signs of hepatic dysfunction appear. Diffuse diseases of the liver are usually accompanied by signs of insufficiency than are focal diseases, which produce their effects either by the toxins formed in the lesions or by pressure on other organs, including the biliary system. The origin of a toxemia is often difficult to localize to the liver because of the physical difficulty of examining the organ.

Diffuse diseases of the liver can be classified as hepatitis and hepatosis according to

the pathologic change that occurs, and the classification also corresponds roughly with the type of causative agent. **Hepatitis** is defined as inflammation of the liver occurring in response to a causative factor and characterized by a series of mesenchymal reactions such as proliferation of bile ducts and Kupffer cells or fibrotic processes. The classical symptoms of inflammation, such as increased capillary permeability and exudation, are not readily applicable to the liver, because high capillary permeability is a feature of healthy hepatic sinusoids. In contrast, **hepatosis** is defined as a metabolic disorder of liver cells in the widest sense and is characterized by degenerative, noninflammatory changes of the liver parenchyma. Clinically, the differences between these two diseases are not marked, although some assistance can be obtained from clinicopathologic examination.

## HEPATIC DYSFUNCTION

There are no specific modes of hepatic dysfunction. The liver has several important functions and any diffuse disease of the organ interferes with most or all of the functions to the same degree. Variations occur in the acuteness and severity of the damage, but the effects are the same and the clinical manifestations vary in degree only. The major hepatic functions that, when disordered, are responsible for clinical signs include:

- Maintenance of normoglycemia
- Synthesis of plasma proteins including so-called positive and negative acute phase proteins
- Formation and excretion of bile salts as well as conversion and excretion of bilirubin
- Formation of prothrombin
- Detoxification and excretion of toxic substances, including ammonia and photodynamic agents

The clinical signs produced by interference with each of these functions are dealt with under manifestations of hepatic dysfunction. A rather special aspect is the role of the liver in the genesis of primary ketosis of cattle.

## PORTAL CIRCULATION

The portal circulation and the liver are mutually interdependent, with the liver depending on the portal vein for its supply of nutrients and the portal flow depending on the patency of the hepatic sinusoids. The portal flow is unusual because blood from the gastrosplenic area and the lower part of the large intestine passes to the left half of the liver and the blood from the two intestines to the right half, without mixing of the two streams in the portal vein. The restriction of toxipathic hepatitis to one half of the liver and the localization of metastatic abscesses and neoplasms in specific lobes occurs because of the failure of portal vein blood from different gut segments to mix. The localization of toxipathic hepatitis may be because of selective distribution of the toxin or of protective metabolites. The passage of blood from the portal circuit through the liver to the caudal vena cava is dependent on the patency of the hepatic vascular bed, and obstruction results in the damming of blood in the portal system, portal hypertension, interference with digestion and absorption, and in the final stages the development of ascites.

## Manifestations of Liver and Biliary Disease

### JAUNDICE (ICTERUS)

Jaundice or icterus is characterized by the yellow discoloration of unpigmented skin, mucosal and conjunctival membranes, as



**Fig. 9-1** Severe jaundice in a Holstein Friesian cow

well as membranes over the sclera and is caused by elevated blood bilirubin concentrations (Fig. 9-1). Jaundice often arises in diseases of the liver and biliary system but is not pathognomonic for disturbed function of one of these organ systems. Approximately 10% to 15% of healthy horses are mildly icteric, and jaundice is commonly observed in fasted or anorectic horses. On the other hand, jaundice does not always occur with hepatic or biliary disease and may be conspicuously absent in acute hepatitis.

Jaundice is classified into three categories depending on its etiology: prehepatic or hemolytic, hepatic or hepatocellular, and posthepatic or cholestatic.

### PREHEPATIC OR HEMOLYTIC JAUNDICE

Hemolytic jaundice is caused by massive intravascular or extravascular hemolysis resulting in the release of red blood cell hemoglobin. The breakdown of the increased amounts of hemoglobin results in elevated concentrations of unconjugated (or indirect) bilirubin, which needs to be converted into conjugated (or direct) bilirubin by the liver before being excreted through the biliary system.

Hemolytic jaundice is common in animals and may be associated with bacterial toxins, invasion of erythrocytes by protozoa or viruses, inorganic and organic poisons, and immunologic reactions. Diseases in which bacterial toxins cause intravascular hemolysis are bacillary hemoglobinuria of cattle and leptospirosis, although the mechanism by which hemolysis is produced in the latter disease does not seem to have been accurately determined. The common protozoan and viral diseases in which hemolysis occur include babesiosis, anaplasmosis, eperythrozoonosis, and equine infectious anemia. Chronic copper poisoning, selenium poisoning in sheep, phenothiazine poisoning in horses, pasturing on rape and other cruciferous plants, and bites by snakes are other common causes. Postparturient hemoglobinuria has an uncertain etiology but has been attributed to a deficiency of phosphorus in the diet and the feeding of cruciferous plants. Isoimmunization hemolytic anemia of the newborn is caused by an

immunologic reaction between the sensitized cells of the newborn and antibodies in the colostrum of the dam. The occurrence of acute hemolytic anemia and jaundice in calves that drink large quantities of cold water (water intoxication) has been associated with a sudden drop in plasma osmolarity thought to occur after rapid ingestion of large volumes of salt-free water. Lower plasma osmolarity would result in a shift of water into red blood cells and could result in a burst of erythrocytes in severe cases.

Neonatal jaundice is relatively common in babies and is regarded as a benign condition. It is rarely, if ever, observed clinically in newborn animals but may be noticeable at necropsy. Although generally jaundice is hemolytic and results from the destruction of excess erythrocytes when postnatal life begins, it appears more probable that it is caused by retention of bile pigments because of the immaturity of the hepatic excretion mechanism. It does occur in foals and is an important differential diagnosis from isoerythrolysis.

Prehepatic or hemolytic jaundice is characterized by a moderate degree of yellowing of the mucosae. Although both intravascular and extravascular hemolysis can cause hemolytic jaundice, hemoglobinemia and hemoglobinuria are only observed with intravascular hemolysis. An extravascular destruction of erythrocytes in organs of the reticuloendothelial system as it occurs, for instance, with bovine anaplasmosis, does not result in the release of free hemoglobin into plasma or urine. Clinicopathologic findings indicate the presence of regenerative anemia, with normal blood protein concentrations. An increase in urobilinogen and the absence of bilirubin in urine, as well as a preponderance of indirect bilirubin in the serum, are characteristic findings.

In cattle most cases of jaundice are seen with hemolytic disease and are primarily associated with highly elevated levels of unconjugated bilirubin in serum.<sup>1</sup>

### HEPATIC OR HEPATOCELLULAR JAUNDICE

Hepatocellular jaundice is the result of impaired capacity of the liver to conjugate indirect to direct bilirubin, which is required for excretion of bilirubin with bile. The cause may be any of those diffuse diseases of the liver that cause degeneration of hepatic cells, which are listed under hepatitis. Swelling and edema in the liver caused by inflammation can result in a mechanical obstruction of the biliary flow within the liver. The degree of obstruction of the intrahepatic bile tree can vary and may result in varying levels of conjugated bilirubin in serum. Clinical experience shows that although both conversion and excretion of bilirubin can be disturbed with hepatic disease, it is the excretion through the biliary tract that is impaired to the greatest extent. As a result, conjugated

bilirubin is the most elevated with hepatic jaundice.

Mechanical stasis of the biliary flow can also be caused by fibrous tissue constriction and obliteration of the small biliary canaliculi after hepatitis and in many forms of fibrosis. Cholelithiasis, the formation of biliary calculi, is frequently reported as a cause of cholestasis in humans and has been reported in horses and cattle. Functional stasis is a major problem in hepatic disease in humans but has not been defined in animals. In these instances, the defect is the same as in posthepatic biliary obstruction, and the two conditions cannot be differentiated by laboratory tests.

Serum concentrations of total bilirubin are increased primarily because of retention of direct bilirubin, which also passes in the urine, causing an elevation of urine levels. The urobilinogen levels in the urine also rise.

### POSTHEPATIC JAUNDICE

Obstruction of the bile ducts or common bile duct by nematodes, flukes, or biliary calculi, as well as compression by tumor masses, is a possible cause of posthepatic jaundice. Inflammation of the bile ducts by extension from enteritis or by infestation with trematodes can also impair the bile flow and result in elevated concentrations of direct bilirubin.

A significant number of pigs die with biliary obstruction and purulent cholangitis secondary to invasion of the ducts by *Ascaris lumbricoides*. Parasitic cholangitis and cholecystitis also occur because of fascioliasis and infestation with *Dicrocoelium dentriticum*. In horses an ascending cholangitis may develop from a parasitic duodenal catarrh and cause signs of biliary obstruction.

Obstruction is usually complete and results in the disappearance of bile pigments from the feces. Serum concentrations of conjugated bilirubin rise, causing a marked elevation of total bilirubin in the serum. Excretion of the conjugated bilirubin in urine occurs on a large scale, but there is no urobilinogen because of the failure of excretion into the alimentary tract. Partial obstruction of the common bile duct or occlusion of a number of major bile ducts may cause variations in serum and urine similar to those observed in complete obstruction, except that the feces do contain bile pigments and urobilinogen appears in the urine. In this circumstance it is difficult to differentiate between partial extrahepatic biliary obstruction and jaundice caused by hepatic cell degeneration.

### CLINICAL FINDINGS

The staining of jaundice is caused by staining of tissues, especially elastic tissue, and not by accumulation in tissue fluids, which makes it best detected clinically in the sclera.

Jaundice is usually much more severe with impairment of bile flow and when bile

pigments are absent from the feces. However, obstructive jaundice can occur with only partial occlusion of hepatic flow provided at least half the bile flow is obstructed. In such cases jaundice may occur even though bile pigments are still present in the feces. With lesser obstruction the portion of the liver and biliary tract that is functioning normally excretes the extra load of bile pigments.

### CLINICAL PATHOLOGY

The levels of bilirubin in blood affect the intensity of the jaundice. The obstructive form is often associated with levels of bilirubin that are 10 times higher than those commonly seen in hemolytic anemia.

The only accurate basis for the differentiation between jaundice with impaired bile flow and jaundice without impaired flow is the examination of the urine for the presence of bilirubin and urobilinogen and the determination of the relative amounts of conjugated and unconjugated bilirubin present in the serum. Unconjugated (indirect) bilirubin that has not passed through hepatic cells is not excreted by the kidney, so that in hemolytic jaundice the indirect bilirubin content of serum is increased markedly and, although the urine contains an increased amount of urobilinogen, no bilirubin is present. When jaundice is caused by impairment of bile flow there is a marked increase in the serum level of conjugated (direct) bilirubin, and the bilirubin content of the urine is greatly increased. The amount of urobilinogen varies depending on whether any bilirubin reaches the intestine to be metabolized to urobilinogen and reabsorbed. In complete extrahepatic biliary obstruction urobilinogen is not present in the urine.

### HEPATIC ENCEPHALOPATHY

Hepatic encephalopathy is defined as the occurrence of neurologic signs caused by neurotoxic substances in the blood that are normally detoxified by the liver. Typical signs include the following:

- Dullness
- Head pressing
- Compulsive walking
- Ataxia
- Muscle tremors and weakness
- Central blindness
- Hyperexcitability
- Convulsions

These signs are common with any severe hepatocellular insufficiency or major circulatory bypass of the liver. Terminally, **hepatic coma** may occur. The biochemical and anatomic basis for these signs is not well understood. Many factors, including hypoglycemia and failure of normal hepatic detoxification mechanisms, leading to the accumulation of excess amino acids and ammonia, or of acetylcholine, and the liberation of toxic breakdown products of liver parenchyma, have all

been suggested as causes, and it is probable that more than one factor is involved.

One of the primary effects of severe, acute liver damage is a precipitate fall in blood glucose. If the hepatic damage occurs more slowly, the hypoglycemia is less marked and less precipitous. With persistent **hypoglycemia**, structural changes may occur in the brain (hypoglycemic encephalopathy), and these may be the basis for the chronically drowsy animals or dummies. However, hypoglycemia does not always occur in acute hepatitis and cannot be considered to be the only or even the most important factor in producing cerebral signs.

**High blood levels of ammonia** occur in pyrrolizidine poisoning in sheep, and are reflected in the development of spongy degeneration in the brain and the clinical signs of hepatic encephalopathy. The role of ammonia as a cerebrototoxicant can be important in hepatopathies in which the detoxicating function of the liver is lost, and also in congenital defects of hepatic vasculature in which blood is bypassed around the liver. In the latter case ammonia and similar toxic by-products of protein degradation in the large intestine avoid the detoxification filter of the liver. However, the severity of encephalopathy clinically correlates well with the degree of hepatic functional compromise but only poorly with the degree of hyperammonemia, suggesting that hyperammonemia may not be the only factor causing hepatic encephalopathy. On the other hand, **status spongiosus**, a form of spongiform encephalopathy, has been reproduced experimentally in sheep and calves by the intravenous infusion of ammonia.

Other factors, such as hypokalemia, alkalosis, short chain volatile fatty acids, and false and true neurotransmitters, may be important in the pathogenesis of hepatic coma in cattle and horses.

In horses the most common cause of hyperammonemia and encephalopathy is a depression of hepatic function caused by acute or chronic liver disease. In cattle severe hepatic lipidosis (with hepatic lipid concentration of 30% and higher) has been associated with hepatic encephalopathy and liver coma.

### EDEMA AND EMACIATION

Failure of the liver to anabolize amino acids and protein during hepatic insufficiency is manifested by tissue wasting and a fall in plasma protein.<sup>2</sup> This may be sufficiently severe to cause edema because of the lowered oncotic pressure of the plasma. Hepatic edema is not usually very marked and is manifested most often in the intermandibular space (bottle jaw). If there is obstruction to the portal circulation, as may occur in hepatic fibrosis, the edema is much more severe but is largely limited to the abdominal cavity.



## DIARRHEA AND CONSTIPATION

In hepatitis, hepatic fibrosis, and obstruction or stasis of the biliary system, the partial or complete absence of bile salts from the alimentary tract deprives it of the laxative and mildly disinfectant qualities of these salts. This, together with the reflex effects from the distended liver in acute hepatitis, produces an alimentary tract syndrome comprising anorexia, vomiting in some species, and constipation punctuated by attacks of diarrhea. The feces are pale in color and, if there is an appreciable amount of fat in the diet, there is steatorrhea.

Diarrhea can also be the result of impaired blood flow from the portal vein through inflamed liver tissue. Congestion of the portal vein is associated with increased hydrostatic pressure in the capillary system of the digestive tract. This in turn may result in edematous swelling of mucous membranes and hampered absorptive capacity of the digestive tract.

## PHOTOSENSITIZATION

Photosensitization is caused by the accumulation of photosensitizing substances in the skin, resulting in the local irritation of unprotected, unpigmented skin after exposure to sunlight. Phylloerythrin, a breakdown product of chlorophyll in the alimentary tract, is excreted in the bile. In hepatic or biliary insufficiency excretion of these substances is retarded and photosensitization occurs (see also Photosensitization in Chapter 16).

## HEMORRHAGIC DIATHESIS

In severe diffuse diseases of the liver there is a deficiency in prothrombin formation and a consequent prolongation of the clotting time of the blood. Abnormality of the prothrombin complex is not the only defect, and deficiencies of fibrinogen and thromboplastin also occur. Prothrombin and other factors in the prothrombin complex depend on the presence of vitamin K for their formation, and an absence of bile salts from the intestine retards the absorption of this fat-soluble vitamin. Parenteral administration of vitamin K is advisable before surgery is undertaken in patients with severe hepatic dysfunction.

## ABDOMINAL PAIN

Two mechanisms cause the pain in diseases of the liver: distension of the organ with increased tension of the capsule and lesions of the capsule. Acute swelling of the liver occurs as a result of engorgement with blood in congestive heart failure and in acute inflammation. Inflammatory and neoplastic lesions of the capsule or of the liver parenchyma just beneath the capsule cause local irritation to its pain end organs. The pain is

usually subacute, causing abnormal posture, particularly arching the back, and disinclination to move. Tenseness of the abdominal wall and pain on deep palpation over the liver area may also be detected in the majority of cases.

## ALTERATION IN SIZE OF THE LIVER

Great variation in the size of the liver is often seen at necropsy, but clinical detection is not easy unless the liver is grossly enlarged. This is most likely to occur in advanced congestion of the liver caused by congestive heart failure, in some plant poisonings in horses, and when multiple abscesses or neoplastic metastases occur. In acute hepatitis the swelling is not sufficiently large to be detected clinically, and in terminal fibrosis the liver is much smaller than normal.

Atrophy of the right lobe of the liver occurs in the horse and may be related to chronic distension of adjacent segments of the intestinal tract. The normal equine liver is anatomically bisected into two approximately equal halves by the umbilical interlobar fissure; additional interlobular fissures divide the liver into four distinct lobes in the foal: right, left, quadrate, and caudate. In horses with right lobe atrophy, the capsule of the right lobe is wrinkled and thick when atrophy is severe. In clinically normal horses, the right lobe constitutes half of the total liver weight, whereas the right lobe in horses with atrophy ranges from 11.0% to 38.8% of the total liver weight. This is thought to be caused by long-term, insidious compression of this portion of the liver by abnormal distension of the right dorsal colon and base of the cecum.

## DISPLACEMENT OF THE LIVER

The liver may be displaced from its normal position and protrude into the thoracic cavity through a diaphragmatic hernia, causing respiratory distress and abnormal findings on percussion of the chest. Torsion of a lobe of the liver has been recorded in aged sows in the early part of lactation. Inappetence, uneasiness, and unwillingness to suckle the young were followed by severe prolonged vomiting, acute abdominal pain, and dyspnea. The twisted lobe was greatly increased in size and in one case the capsule was ruptured, leading to severe internal hemorrhage.

## RUPTURE OF THE LIVER

Rupture of the liver is an occasional accident in animals, occurring usually as a result of trauma. In most instances rupture results in death from hemorrhage, although small breaks in the capsule may heal. Horses used for the production of serum frequently develop hepatic amyloidosis, presumably as

a reaction to repeated injection of foreign protein, and the death rate from rupture of the liver is relatively high in this group. Amyloidosis is essentially a space-occupying lesion, which results in a liver with a friable texture. The amyloid masses exert pressure on liver cell cords and sinusoids, gradually causing pressure atrophy, ischemic degeneration, and necrosis of hepatic parenchyma.

A high prevalence of liver rupture is recorded in newborn lambs of the North Country Cheviot breed. Losses resulting from this condition were 12.5% of all neonatal deaths in purebred lambs and varied from 6.4% to 24.7% on individual farms. The lambs are stillborn or are born alive but become anemic and weak and die within 12 hours of birth from internal hemorrhage. It is thought that the cause of the fatal anemia is an inherited short sternum, which exposes the liver to compression and rupture of its capsule. Vitamin E deficiency in the ewes and lambs may also be a factor.

## BLACK LIVERS OF SHEEP

Dark brown to black pigmentation of the liver and kidneys occurs often in sheep in certain parts of Australia. No illness is associated with the condition, but the livers are not used for human consumption for esthetic reasons and extensive financial loss may result. Commonly referred to as "melanosis," it has been determined that the pigmentation is the result of deposition of the pigment lipofuscin at various stages of oxidation. Areas in which the disease occurs have many mulga trees (*Acacia aneura*), the leaves of which are fed to sheep in drought times.

This condition should not be confused with the black livers found in a mutant strain of Corriedales in California. In these mutant sheep there is photosensitization following retention of phylloerythrin. The darkening of the liver is caused by melanin.

## REFERENCES

1. Russel KE, Roussel AJ. *Vet North Am Clin Food Anim Pract.* 2007;23:403.
2. Bertoni G, Trevisi E. *Vet North Am Clin Food Anim Pract.* 2013;29:413.

## Special Examination of the Liver

When disease of the liver is suspected after a general clinical examination, special techniques of palpation, biopsy, and laboratory diagnostic tests can be used to determine further the status of the liver.

## PALPATION AND PERCUSSION

In cattle, the liver is well concealed by the rib cage on the right side, and in most cases its edge cannot be palpated. A general impression of the size of the liver can be obtained

by percussion of the area of liver dullness, but accurate definition is not usually attempted. Deep percussion or palpation to detect the presence of hepatic pain can be performed over the area of liver dullness in the posterior thoracic region on the right side. Percussion over the entire area is necessary, because the pain of a discrete lesion may be quite localized. If the liver is grossly enlarged in cattle, its edge can be felt on deep palpation behind the right costal arch. In cattle, the liver may be enlarged and palpable in advanced right-sided congestive heart failure, multiple liver abscesses, hepatic lipidosis, and diffuse hepatitis. This type of palpation is relatively easy in ruminants but is unrewarding in horses and pigs because of the thickness of the abdominal wall and the shortness of the flank.

## BIOPSY

Biopsy of the liver has been used extensively as a diagnostic procedure in infectious equine anemia, hepatic lipidosis in cattle, poisoning by *Crotalaria* spp. and other species of plants, and experimental work on copper and vitamin A deficiency. The technique is straightforward but requires some anatomic knowledge.

The most satisfactory instrument is a Tru-Cut type biopsy instrument. Tru-Cut needles are either spring-loaded or manually activated cutting devices available with various diameters and lengths.<sup>1</sup> Spring-loaded biopsy guns cut more reliably because of the higher force and speed with which the cutting edge is advanced into the tissue.

Liver biopsies can be performed blind, but with the widespread availability of ultrasonography it is advisable to perform a liver biopsy under ultrasound guidance whenever possible.<sup>1</sup> In horses the anatomic location for biopsy is the right 13th or 14th intercostal space halfway between two imaginary lines, one going from the tuber coxae to the shoulder and one from the tuber coxae to the elbow.<sup>1</sup> In cattle the liver biopsy site is in the right 10th intercostal space between two imaginary lines, one going from the tuber coxae to the elbow and one horizontal line departing from the greater trochanter.<sup>2</sup>

Sedation in most cases is not required in cattle but is recommended in horses. The biopsy site must be clipped, prepared aseptically, and infiltrated with a local anesthetic. The skin must be prepierced either with a large-bore needle or incised with a scalpel. After confirming proper function of the biopsy instrument, the sharp point of the instrument is inserted into the skin incision and advanced through the intercostal muscles and the diaphragm into the liver. Penetration of the diaphragm can be felt by the movement of the needle that is synchronous with respiration. Once the sharp edge of the instrument has been advanced several centimeters into the liver, the needle is fired and

then retracted swiftly. Depending on the intended examination, the sample can be processed immediately and fixed in 10% formaldehyde or frozen. Several biopsies can be obtained through the same skin incision just by slightly changing the direction in which the needle is advanced into the liver. The stab incision can then be stapled or sutured if necessary and covered with wound spray. Details of the technique for cattle and horses are available.<sup>1,2</sup>

The principal danger of this procedure is that if the direction of the instrument is at fault it may approach the hilus and damage the large blood vessels or bile ducts. If the liver is shrunken or the approach too caudal, then there is no sample obtained. Fatal hemoperitoneum may result if a hemorrhagic tendency is present, and peritonitis may occur if the liver lesion is an abscess containing viable bacteria. Biliary peritonitis results if a large bile duct is perforated. It seems possible that the technique could precipitate a fatal attack of "black disease," but many thousands of biopsies are performed without such an incident.

Evidence indicates that liver biopsy is the antemortem test of greatest value, in the absence of noninvasive tests, in reliably distinguishing animals with significant liver disease from those without it. Examination of liver biopsies may establish the presence of liver disease, provide a specific diagnosis, guide therapeutic choice, and help determine prognosis in cases of suspected liver disease.

The major deficiency of this method lies in the small sample that is obtained, and unless the liver change is diffuse the sample may not be representative.

## MEDICAL IMAGING OF THE LIVER

### ULTRASONOGRAPHY

Ultrasonography of the liver is now an established technique that is routinely used for the diagnosis of liver disease. Ultrasonographic examination of the liver can provide detailed information about the size, position, and parenchymal pattern of the liver as well as the size and position of the gallbladder and bile ducts. Ultrasonography can be used to guide the collection of liver biopsy and bile samples; furthermore, it is the only practical method for the diagnosis of thrombosis of the caudal vena cava.<sup>3</sup> A systematic approach for the ultrasonographic examination of the liver of cattle and small ruminants has been described.<sup>3,4</sup>

Examination of the liver is performed with a 3.5- to 5.0-MHz linear or convex transducer. The hair is clipped and contact gel or alcohol applied onto the skin. In cattle the liver is imaged from caudal to the last rib to the fifth intercostal space of the standing cow. In horses the liver is examined between the 6th and 15th right intercostal space and between the 6th and 9th left intercostal space

of the standing horse. Each intercostal space is examined from dorsal to ventral, with the transducer held parallel to the ribs. The texture and the visceral and diaphragmatic surface of the liver are scanned, and the hepatic and portal veins, caudal vena cava, and biliary system are examined. Breed and age of cow does not influence the ultrasonographic appearance of the liver, particularly position, size, and vasculature of the liver and gallbladder. During pregnancy, the diameter of the caudal vena cava increases slightly and that of the portal vein decreases.

Ultrasonography can be used to detect **thrombosis of the caudal vena cava** in a cow with ascites. **Cholestasis** in cows can be diagnosed using ultrasonography to visualize dilatation of the extrahepatic and intrahepatic bile ducts and dilatation of the gallbladder (Fig. 9-2). In cattle bile samples can be collected by percutaneous ultrasound-guided **cholecystocentesis** for demonstration of *Fasciola hepatica* and *D. dendriticum* eggs and for determination of bile acids. The procedure is done on the right side in the 9th, 10th, or 11th intercostal space. In horses **cholelithiasis** would present ultrasonographically as distended bile ducts and hyperechoic structures causing acoustic shadows located within these ducts.

Ultrasonography and digital analysis can be used for the diagnosis and evaluation of the degree of **hepatic lipidosis** of cows.<sup>5</sup> **Hepatic abscesses** in horses and cattle can be visualized using ultrasonography. The abscesses may vary in size and location; because in adult horses and cattle only parts of the liver are accessible for ultrasonographic examination, those abscesses located in the left part of the liver may escape ultrasonographic visualization. Ultrasound-guided **catheterization of the portal or a mesenteric vein** in cows has been described and is currently used for research purposes.<sup>6</sup>

### RADIOGRAPHY

Lateral abdominal radiography can be used to determine the size and location of the liver in foals. Fluoroscopy and contrast media injected into the mesenteric vein have been used to detect the presence of portosystemic shunts in foals and calves.

## LABORATORY TESTS FOR HEPATIC DISEASE AND FUNCTION

Hepatic disease is difficult to diagnose based on clinical findings alone because of the unspecific symptoms caused by disturbed liver function. The diagnosis of liver disease therefore heavily relies on serum biochemical analyses. The results and interpretation of such diagnostic tests, however, are complicated by the fact that although several of the used parameters are specific for liver disease, they often do not allow differentiating between different types of liver disease.

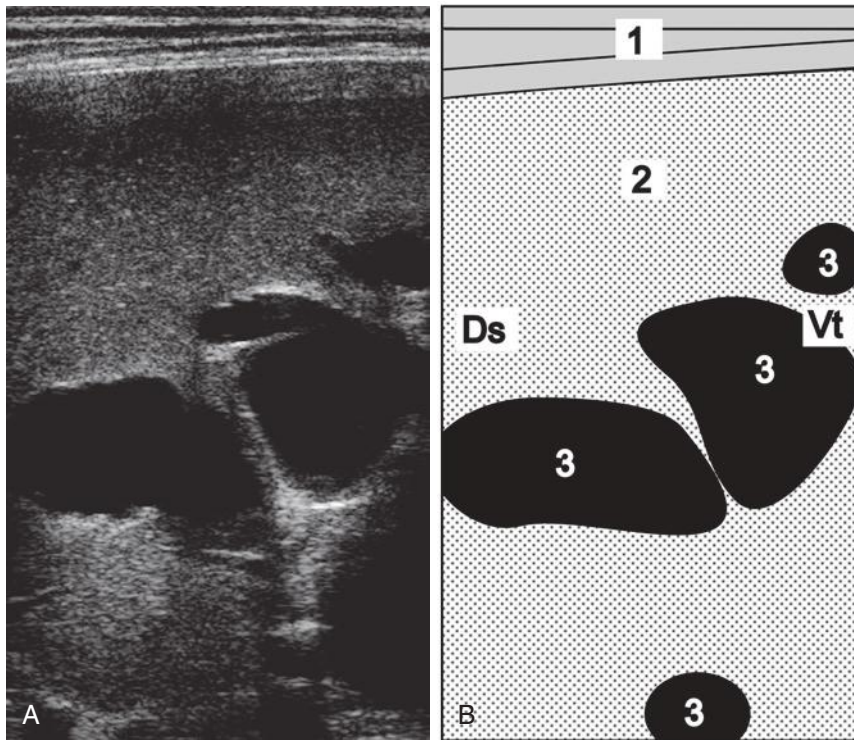

**Fig. 9-2** A, Ultrasonogram and schematic of the liver in a cow with obstructive cholestasis caused by fasciolosis. The intrahepatic bile ducts are dilated. Normally, they are not visible. B, The ultrasonogram was obtained from the 11th intercostal space on the right side using a 5.0-MHz linear transducer. 1, Lateral abdominal wall; 2, Liver; 3, Dilated intrahepatic bile ducts. Ds, dorsal; Vt, ventral. (Reproduced with kind permission of U. Braun.)

Specific tests that identify the exact nature of the lesion are not available, and a combination of tests is usually necessary to make a diagnosis.

The laboratory tests for the diagnosis of hepatic disease and to evaluate hepatic function in farm animals can be divided into those that evaluate hepatobiliary function, the hepatic function tests, and those that are indicative of hepatocellular injury, the serum hepatic enzyme tests.

### HEPATIC FUNCTION TESTS

Hepatic function tests determine the serum concentration of compounds produced, converted, or detoxified in the liver. Analytes produced by the liver include glucose, albumin, urea nitrogen, bile acids, and coagulative factors. Compounds detoxified or converted by liver cells include ammonia and unconjugated (indirect) bilirubin that is converted into conjugated (direct) bilirubin in the liver.

#### Serum Bile Acids

Bile acids are synthesized in the liver from cholesterol and are then secreted into the duodenum. The large majority of the bile acids excreted are reabsorbed from the digestive tract into the portal circulation, returned to the liver, and reexcreted into the biliary system. This recycling circuit is termed enterohepatic circulation.

The concentration of serum bile acids reflects the efficacy of this enterohepatic circulation. Elevated serum bile acid concentrations occur with impaired hepatocyte function, liver cirrhosis, and portosystemic shunts and are observed before jaundice occurs.

The rise in total serum bile acid concentration usually correlates well with the severity of liver disease. In cattle, however, there is extreme variability among all types and ages of animals, and the variation is even greater in beef cattle than in dairy cattle. There are hour-to-hour fluctuations in serum bile acid concentrations in cattle, making interpretation difficult. Feeding practices and stage of lactation can also affect the serum bile acid concentrations. Values of calves and yearlings are significantly lower than those of lactating dairy cows. Elevated serum bile acid concentrations have been reported in cattle with hepatic lipidosis, liver abscesses, fasciolosis, and biliary calculi.<sup>7</sup> However, to be specific for liver damage in cattle, the value determined for a single sample would have to be above 126  $\mu\text{mol/L}$  in beef cattle or 88  $\mu\text{mol/L}$  in lactating dairy cattle.

In cattle, the total serum bile acid concentration is considered to be a more specific and sensitive indicator of a wide variety of hepatic disease and is significantly correlated with the degree of illness compared with

other tests of hepatic function. In horses, the total serum bile acid concentration is also a sensitive indicator of several hepatic diseases and is most useful when combined with other tests of hepatic disease.

#### Serum Bilirubin

Bilirubin is a product of the degradation of hemoglobin. In blood unconjugated and thus insoluble bilirubin bound to albumin is transported to the liver to be conjugated with glucuronic acid and excreted into bile. Glucuronidation of bilirubin is required to improve water solubility and allow excretion in bile. Hyperbilirubinemia can occur as a result of increased red blood cell destruction, severe liver disease impairing either the uptake or conversion of unconjugated bilirubin by hepatocytes, or impaired bile flow out of the liver. Serum bilirubin concentration above 17  $\mu\text{mol/L}$  (1.0 mg/dL) will cause a yellow tinge of the serum, and jaundice of mucosal membranes becomes apparent with concentrations above 40  $\mu\text{mol/L}$  (2.3 mg/dL). The ratio of conjugated to unconjugated bilirubin is often used to differentiate between different etiologies of hyperbilirubinemia. Although this concept adopted from the human medical literature may appear as an attractive and straightforward diagnostic approach, more recent evidence indicates that species-specific differences in the elimination kinetics of bilirubin complicate the interpretation of this ratio to differentiate between the different forms of jaundice. In cattle and horses hyperbilirubinemia in most cases is driven by an increase of unconjugated bilirubin even with posthepatic obstruction of the bile flow.

Adult cattle with hepatic disease do not consistently have high serum bilirubin concentrations, and visible jaundice does not occur frequently in cattle with hyperbilirubinemia. The use of high bilirubin concentrations as an indicator of liver disease in calves is unreliable. This is similar to results in adult cattle in which serum bilirubin concentrations are not a specific or a sensitive test for chronic liver disease.

#### Ammonia

The microbial deamination of amino acids in the intestinal tract is the major source of ammonia, which is absorbed by the intestine into portal venous blood and converted into urea by the liver. The concentration of blood ammonia can be an indication of functional hepatic mass. Generally, plasma ammonia concentration is a sensitive and specific indicator of hepatic disease in the horse, although it may fluctuate widely even on the same day, and the concomitant low plasma urea concentration anticipated because of the liver's reduced synthetic ability is often not apparent.

In cattle with hepatic disease, plasma ammonia levels are significantly elevated compared with normal animals but not



always accompanied by a decline in plasma urea concentrations. In healthy cattle, the plasma ammonia:urea concentration ratio is 9:1 and the plasma ammonia:glucose concentration is 11:1. In hepatic disease, a plasma ammonia:glucose ratio 40:1 or plasma ammonia:urea ratio 30:1, particularly with a rising total ketone body concentration and a declining glucose concentration, represents a guarded prognosis.

Most cases of portosystemic shunts are accompanied by marked increases in blood ammonia concentrations.

Although the serum ammonia concentration is considered to be a valuable diagnostic parameter to assess liver function, it is rarely included in biochemical diagnostic profiles. Blood samples assayed for ammonia require special handling because of the volatility of this compound, which makes this parameter unsuitable for routine use under field conditions.<sup>7</sup> Samples must be placed on ice and transported to the laboratory immediately to be analyzed within 30 minutes of collection.

### Urea Nitrogen

Blood urea nitrogen (BUN) or serum urea nitrogen is the end product of the hepatic detoxification of ammonia. It is this parameter that is sometimes also used to assess liver function. Urea nitrogen concentration in blood may decrease with impaired conversion of ammonia to urea by the liver. Low serum urea concentrations are, however, not specific for liver disease. Low urea nitrogen concentration is also seen in anorectic patients consuming less protein. In ruminants that are anorectic or on a low-protein diet, rumen microbes recur to BUN as a nitrogen source for their own protein synthesis, decreasing the BUN concentration.

### Albumin

Albumin in blood is synthesized by the liver and may be decreased with severe and chronic liver disease. Low serum albumin concentrations are, however, not specific for liver disease because they may be the result of excessive loss (e.g., through the kidney) or impaired production that is unrelated to liver disease. Insufficient albumin synthesis that is not attributable to liver disease can be caused by inadequate dietary protein content or disturbed protein digestion or absorption.<sup>7</sup> Low serum albumin concentration in combination with elevated serum globulin concentration is indicative of chronic inflammatory disease and is not suggestive of a primary liver disease.

## SERUM HEPATIC ENZYME TESTS

The determination of the serum activity of hepatic enzymes is routinely used for the detection and evaluation of hepatocellular injury. Liver cell damage is, however, not necessarily correlated with disturbed liver function because of the redundancy of the

functional capacity of the liver. Liver damage, reflected in markedly elevated serum enzyme activities, is only associated with clinical disease when over half of the functional liver tissue is affected.

Serum hepatic enzymes are categorized into enzymes leaking from the cytoplasm of a damaged hepatocyte (so-called leakage enzymes) and enzymes that are increased because of increased synthesis in response to cholestasis. The serum enzyme activity in individuals with liver disease depends on the concentration of the enzyme in question in the hepatocyte, the severity and the duration of liver disease, and the half-life of the enzyme. Enzymes used for the diagnosis of hepatocellular injury ideally have a high enzyme activity within hepatocellular cytoplasm, resulting in a measurable increase of the enzyme activity in serum with liver cell injury. To be specific, the cytoplasmic activity of the enzyme in question should be higher in the liver than in any other tissue. The following enzyme activities are commonly measured in serum or plasma to diagnose liver disease in farm animals:

- L-Iditol dehydrogenase (formerly sorbitol dehydrogenase [SDH])
- This enzyme is highly selective as an indicator of acute liver injury. Liver cell damage results in a steep increase in serum enzyme activity followed by a rapid decline because of its short half-life. This parameter is thus less suited for the diagnosis of chronic liver disease. Another inconvenience is the instability of this enzyme in serum or plasma even when refrigerated or frozen. Marked drops in enzyme activity within 24 hours have been reported in chilled samples and within 72 hours in frozen samples.<sup>7</sup>
- Lactate dehydrogenase (LDH) is abundant in liver, kidney, muscle, myocardium, and red blood cells. To differentiate liver disease from muscle cell injury, the analysis of other liver or muscle-specific enzymes is required.
- Aspartate aminotransferase (AST; formerly serum glutamic oxaloacetic transaminase) like LDH is abundant in a variety of tissues including liver and muscle. Elevated serum activities of AST therefore can only be interpreted in conjunction with other more specific liver enzyme to diagnose liver disease.
- Alanine aminotransferase (formerly serum glutamic pyruvate transaminase) is commonly used for the diagnosis of hepatic disease in small animals. In ruminants, horses, and pigs, however, this enzyme is of little diagnostic value because of the low cytoplasmic enzyme activity in hepatocytes of these species.
- $\gamma$ -Glutamyl transferase (GGT) is an enzyme widely distributed in a variety of equine and bovine tissues. Specific activity of GGT is highest in the kidney,

pancreas, and liver, but GGT enzyme activity in serum or plasma almost exclusively originates from hepatocytes, making this enzyme highly specific for disease of the hepatobiliary system in cattle, horses, and sheep. In the horse, increases in serum GGT may be associated with hepatocellular damage and liver necrosis in a variety of natural and experimentally induced liver diseases. These include bile duct ligation, carbon disulfide toxicity, carbon tetrachloride toxicoses, cholestasis, iron hepatotoxicosis, *Senecio* poisoning, and hyperlipidemia in ponies. GGT is a sensitive indicator of liver damage in horses affected with pyrrolizidine alkaloids (PAs) in the early stages of the disease, but values do not correlate with the increase in the severity of the lesions observed on liver biopsy samples collected later in the chronic phase of the disease. In horses that had consumed hay contaminated with *Senecio vulgaris*, the GGT values fluctuated widely: some horses with high levels did not die, whereas others had values slightly above reference values at the initial sample collection and died. GGT is a practical routine test for the evaluation of liver amyloidosis status in serum-producing horses. In foals during the first month of life values were 1.5 to 3 times higher than the upper physiologic reference values for healthy adult horses. In neonatal foals, the serum alkaline phosphatase (ALP), GGT, and SDH activities were increased during the first 2 weeks of life.

- In neonatal calves the serum GGT activity is used as an indicator for consumption of colostrum. High serum GGT activity in newborn calves comes from the passive intestinal absorption of this enzyme from colostrum, normally containing large amounts of GGT.
- Glutamate dehydrogenase (GDH or GDH) occurs in high concentration in the serum of ruminants and horses and is considered highly specific for liver disease.
- Ornithine carbamoyl transferase (OCT) activity is also elevated, even in chronic diseases, but only when there is active liver necrosis and not when the lesions are healing. Furthermore, OCT has been proposed as a tool to assist in the diagnosis of hepatic lipidosis in cattle.<sup>8</sup>
- ALP activity is used as a test of hepatic excretory function in the horse and is of value in that species, but variations in normal cattle have such a wide range that results are difficult to interpret. Of the tests available for testing of biliary obstruction, the serum ALP test is preferred. However, there is a similar response to damage in other tissues.

## Hepatic Enzyme Profile According to Species

The serum hepatic enzymes considered to be most useful as an aid in the diagnosis of liver disease in the different species are as follows.

### Cattle

In adult cattle, GGT, ALP, SDH, AST, and GDH are most useful in identifying animals with chronic hepatic disease. The dehydrogenases (SDH and GDH) have the shortest half-lives in serum and may not increase in cattle with chronic liver disease.

In the early stages of hepatic dysfunction in cattle, SDH is the most efficient and sensitive test. The instability of this enzyme, even when the blood sample is placed on ice, requires analysis within hours of blood collection. In the later stages when tests of biliary excretion are more applicable, estimations of serum bilirubin are more indicated.

### Calves

In **neonatal calves** under 6 weeks of age, none of the common tests for the assessment of liver damage or function in adult cattle are useful for detection of hepatic disease. The serum activity of most enzymes and total bilirubin are significantly higher in newborn calves than in 2-week-old calves. In calves less than 6 weeks of age with suspected liver disease, a combination of parameters should be used to assess liver damage, including GDH activity and total serum bile acid concentration. Percutaneous liver biopsy may provide the most information.

### Horses

Total serum bile acids, GDH, GGT, and liver biopsy are helpful in studying different types of hepatic disease in the horse. In one series of primary hepatic disease all horses had high activities of serum GGT, and most had high activities of serum GDH and high concentrations of bile acids. Horses that were euthanized or died had significantly higher concentrations of GGT, GDH, and bile acids than survivors. Horses with signs of hepatic encephalopathy had plasma ammonia levels greater than 90  $\mu\text{mol/L}$ , but this was not correlated with the clinical severity of the disease. Half of the cases with hepatic encephalopathy were hyperglycemic, none was hypoglycemic, and none had abnormally low levels of plasma urea.

In a series of 82 cases in horses, 61 were confirmed to have significant liver disease and 12 were not confirmed. Only serum concentrations of GGT, globulins, and ALP were found to be significantly different between the two groups of horses.

Clinical and ultrasonographic data were found, when present, to be good indicators of the presence of liver disease.

The single positive test results of greatest diagnostic value were the presence of hepatic encephalopathy, increased GGT, hypoalbuminemia, increased ALP, increased total bile

acids, and increased total bilirubin. Increased AST and increased GDH were also of good diagnostic value but only when used in combination with the previously mentioned tests. No single combination or sequential test was able to fully discriminate between horses with and without biopsy-confirmed liver disease, and reliance on the use of noninvasive tests for the prediction of the presence or absence of significant liver disease may lead to frequent diagnostic errors. Certain positive results did reliably predict the presence of liver disease, but negative test results were invariably unsatisfactory predictors of absence of liver disease.

In the early stages of hepatic dysfunction, SDH is preferred. Plasma ammonia concentrations may be significantly elevated compared with clinically normal horses but are not always accompanied by a decline in plasma urea concentration. A fall in plasma glucose concentration represents a poor prognosis.

The most useful noninvasive prognostic test in cases of suspected liver disease in adult horses is the severity of clinical signs.

### FURTHER READING

- McGorum BC, Murphy D, Love S, Milne EM. Clinicopathological features of equine primary hepatic disease: a review of 50 cases. *Vet Rec.* 1999;145:134-139.
- Pearson EG. Liver disease in the mature horse. *Equine Vet Educ.* 1999;11:87-96.
- West HJ. The evaluation of hepatobiliary disease in horses and cattle. In: *FRCVS thesis*. London: 1994.

### REFERENCES

- Rendle D. *In Pract.* 2010;32:300.
- Herdt T 2009. (Accessed 20.03.15, at <<http://www.dcpah.msu.edu/sections/nutrition/WEB/CD.NUTR.REF.002.pdf>>.).
- Braun U. *Vet Clin North Am Food Anim Pract.* 2009;25:591.
- Braun U, Steininger K. *Am J Vet Res.* 2011;72:219.
- Starke A, et al. *J Dairy Sci.* 2010;93:2952.
- Starke A, et al. *Vet J.* 2012;192:403.
- Russel KE, Roussel A. *Vet Clin North Am Food Anim Pract.* 2007;23:403.
- Kalaizakis E, et al. *J Vet Intern Med.* 2007;21:835.

## Principles of Treatment in Diseases of the Liver

In diffuse diseases of the liver, no general treatment is satisfactory, and the main aim should be to remove the source of the damaging agent. The most that can be attempted in acute hepatitis is to help the animal over the danger period of acute hepatic insufficiency until the subsidence of the acute change and the normal regeneration of the liver restores its function. Death may occur during this stage because of hypoglycemia, and the blood glucose level must be maintained by oral or intravenous injections of glucose. Because of the danger of guanidine

intoxication, an adequate calcium intake should be ensured by oral or parenteral administration of calcium salts.

There is some doubt as to whether protein intake should be maintained at a high level, because incomplete metabolism of the protein may result in toxic effects, particularly in the kidney. However, amino acid mixtures, especially those containing methionine, are used with apparently good results. The same general recommendations apply to prevention in the treatment of acute diffuse liver disease. Diets high in carbohydrate, calcium and protein of high biological value, and a number of specific substances are known to have a protective effect against hepatotoxic agents.

In chronic, diffuse hepatic disease fibrous tissue replacement causes compression of the sinusoids and is irreversible except in the very early stages, when removal of fat from the liver by the administration of lipotropic factors including choline and maintenance on a diet low in fat and protein may reduce the compressive effects of fibrous tissue contraction. A high-protein diet at this stage causes stimulation of the metabolic activity of the liver and an increased deposit of fat, further retarding hepatic function.

Local diseases of the liver require surgical or medical treatment depending on the cause, and specific treatments are discussed under the respective diseases.

## Diffuse Diseases of the Liver

### HEPATITIS

The differentiation of hepatic diseases into hepatitis and hepatosis has not achieved general acceptance, and nonspecific terms such as hepatic injury have been suggested to avoid the connotation of inflammation associated with the word hepatitis. To facilitate ease of reading, the word hepatitis is used throughout this chapter to include all diffuse, degenerative, and inflammatory diseases that affect the liver. It is used here also to include the common pathologic classification of cirrhosis. Clinically, the syndrome caused by fibrosis of the liver is the same as that caused by hepatitis and the etiology is the same; the only difference is that the onset of the disease is slower and less acute than in hepatitis.

### ETIOLOGY AND EPIDEMIOLOGY

Although there is an extensive list of causes of hepatitis there are still a number of unknown factors. At least there are many sporadic cases of hepatic insufficiency, especially in horses, in which the cause is not determined. In most cases the clinical disease has an acute onset and a fatal outcome, but the hepatic lesion is of a much longer duration.

In a case-control study of cases of equine hepatic disease admitted to the Liphook Equine Hospital in the UK, ponies were more likely to develop hepatic disease than light riding horses. Overall the case fatality was low (25.9%); horses with unclassified hepatopathies had the lowest fatality rate, and horses with cholangiohepatitis, pyrrolizidine alkaloid toxicity, and chronic active hepatitis had significantly higher fatality rates by comparison. Age, breed, or sex had no detectable effect on outcome.

### Toxic Hepatitis

The common causes of toxic hepatitis in farm animals are

- Inorganic poisons: Copper, phosphorus, arsenic, and possibly selenium
- Organic poisons: Carbon tetrachloride, hexachloroethane, gossypol, creosols and coal tar pitch, chloroform, and copper diethylamine quinoline sulfonate

Ferrous fumarate administered in a digestive inoculate to newborn foals is also recorded as a cause.

### Poisonous Plants, Fungi, and Insects

These include the following:

- Weeds: *Senecio*, *Crotalaria*, *Heliotropium*, *Amsinckia*, and *Tribulus* spp.; *Encephalartos lanatus*; and *Trachyandra* spp.
- Pasture and cultivated plants: *Panicum effusum*, lupins, alsike clover, and water-damaged alfalfa hay
- Trees and shrubs: Lantana (*Lantana camara*), yellow wood (*Terminalia oblongata*), ngaio tree (*Myoporum laetum*), Australian boobialla (*M. tetrandrum*), and seeds of cycads (*Zamia* spp.)
- Fungi: *Pithomyces chartarum*, *Aspergillus flavus*, *Penicillium rubrum*, *Phomopsis leptostromiformis*, *Fusarium* spp., *Myrothecium* spp., and *Periconia* spp.
- Algae: The slow death factor
- Insects: Ingestion of sawfly larvae (*Lophyrotoma interrupta*)

### Miscellaneous Farm Chemicals

Miscellaneous farm chemicals include dried poultry waste, cottonseed cake, and herring meal.

### Toxemia Perfusion Hepatitis

Moderate degrees of hepatitis occur in many bacterial infections regardless of their location in the body, and the hepatitis is usually classified as toxic; whether the lesions are caused by bacterial toxins or by shock, anoxia, or vascular insufficiency is unknown. Hepatic failure may occur in dairy cattle following mastitis or metritis. It is thought that the hepatic dysfunction may have been the result of endotoxemia. This also applies to hepatitis associated with extensive tissue damage occurring after burns, injury, and infarction.

### Infectious Hepatitis

Diffuse hepatic lesions in animals are rarely associated with infectious agents. The significant ones are

- Rift Valley fever virus
- *Bacillus piliformis*, associated with Tyzzer's disease in foals
- Equine herpesvirus-1 of viral rhinopneumonitis as a cause of abortion in horses
- *Deltaproteobacterium* associated with epizootic abortion of cattle in California
- Postvaccinal hepatitis of horses, also known as **serum hepatitis, idiopathic acute hepatic disease, Theiler's disease, and acute liver atrophy**, is the most common cause of acute hepatic failure in the horse. The disease is commonly associated with the administration of biologics of equine origin, usually tetanus antitoxin.

A series of four fatal cases of serum hepatitis associated with the administration of commercial plasma in the horse has been reported. The prevalence in one veterinary teaching hospital has been recorded as 0.4%.

A large number of cases of equine hepatic encephalopathy of unknown etiology occurred in France between 1992 and 1997.

- Severe cases of equine viral arteritis manifest signs of hepatitis.
- Systemic mycoses, e.g., histoplasmosis, may be accompanied by multiple granulomatous lesions of the liver.
- There are diseases in which hepatic lesions may be common at necropsy, but in which there are no overt signs of clinical disease during life. Some of these are infectious equine anemia, salmonellosis, septicemic listeriosis, and leptospirosis in aborted foals.
- Infectious necrotic hepatitis associated with *Clostridium novyi* has been described in a 9-year-old mare.

### Parasitic Hepatitis

- Acute and chronic liver fluke infestation
- Migrating larvae of *Ascaris* spp.
- Fibrosing granulomas of liver in horses with chronic schistosomiasis
- Hepatic sarcocystosis in horses

### Nutritional Hepatitis (Trophopathic Hepatitis)

Selenium and vitamin E deficiency are factors in dietary hepatic necrosis in pigs. A multiple dietary deficiency has also been suggested as the cause of a massive hepatic necrosis observed in lambs and adult sheep on trefoil pasture in California. Hepatic lipidosis and hyperlipemia occurs most often in pregnant Shetland pony mares on a falling plane of nutrition. Hepatic lipidosis occurs in cattle during the transition period from late gestation to peak lactation. It is triggered by a negative energy balance occurring in the

periparturient period in overconditioned dry cows. Rapid mobilization of large amounts of body fat in states of energy deficiency results in accumulation of nonesterified fatty acids in the liver, where they are reesterified to triglycerides and deposited as fat droplets within the liver cells. This fatty infiltration of the liver is reversible but if severe enough presents a functional impairment of the liver metabolism.

**White liver disease** is a well-identified clinical entity occurring in young sheep in the warmer parts of New Zealand. The cause is unknown but the disease affects only cobalt-deficient sheep. The disease occurs on leafy pastures with lots of leaf litter and in spring and early summer. Affected sheep show photosensitivity, anorexia, weight loss, sometimes jaundice, and blindness. At necropsy there is a greatly enlarged, light-colored, fatty liver. Most deaths occur in a chronic phase after the acute signs have passed. A similar disease, suspected to be caused by a mycotoxin, has been observed in Norway.

### Idiopathic Hepatosis and Cirrhosis

**Hepatic cirrhosis and hemochromatosis in horses** has been recorded. There is cirrhosis with increased iron stores in the parenchymal cells of the liver. Hepatic **fatty cirrhosis (hard yellow liver)** in sheep and cattle has occurred in isolated areas of western and southern Texas during years of maximal rainfall. The cause is unknown, but the high incidence during periods of heavy rainfall suggests the possibility of either a mycotoxin or nutritional deficiency.

### Congestive Hepatopathy

Increased pressure in the sinusoids of the liver causes anoxia and compression of surrounding hepatic parenchyma. Congestive heart failure is the common cause and leads to centrilobular degeneration.

Inherited hepatic insufficiency occurs in Southdown and Corriedale sheep.

### Portosystemic Vascular Anomaly

Portosystemic shunts in large animals have been recorded occasionally in foals and calves. There is altered blood flow through the liver and hepatic insufficiency secondary to hepatic atrophy.

### PATHOGENESIS

Hepatitis may be associated with a number of agents, but the clinical effects are similar in all instances. The usual lesion in **toxipathic hepatitis** is centrilobular and varies from cloudy swelling to acute necrosis with a terminal veno-occlusive lesion in some plant poisonings. If the necrosis is severe enough or repeated a sufficient number of times, fibrosis develops. The effects of endotoxin on the liver include multifocal hepatocellular necrosis, impaired hepatic gluconeogenesis, and decreased hepatic blood flow. Endotoxin



may cause the Kupffer cells to release lysosomal enzymes, prostaglandins, and collagenase, which can damage hepatocytes. Endotoxin not detoxified by the Kupffer cells may interact directly with the hepatocytes, causing lysosomal damage and decreased mitochondrial function, leading to necrosis. In infectious hepatitis the lesions vary from necrosis of isolated cells to diffuse necrosis affecting all or most of the hepatic parenchyma.

**Serum hepatitis in the horse** is characterized by severe central lobular necrosis following the administration of biologics of equine origin such as tetanus antitoxin, commercial equine plasma, and other products.

**In parasitic hepatitis** the changes depend on the number and type of migrating parasites. In massive fluke infestations sufficient damage may occur to cause acute hepatic insufficiency, manifested particularly by submandibular edema. In more chronic cases extension from cholangitis may also cause chronic insufficiency.

**Trophopathic hepatitis** is characterized by massive or submassive necrosis. Hepatic lipidosis is characterized by fatty infiltration of hepatocytes progressing to development of fatty cysts.

**Congestive hepatitis** is characterized by dilatation of central veins and sinusoids with compression of the parenchymal cells. **Hepatic fibrosis** develops particularly if there is massive hepatic necrosis that destroys entire lobules. Degeneration is not possible, as it is when the necrosis is zonal, and fibrous tissue replacement occurs. Thus fibrosis is a terminal stage of hepatitis that may have developed acutely or chronically and is manifested by the same clinical syndrome as that of hepatitis, except that the signs develop more slowly. Fibrosis may also develop from cholangitis.

The term **cirrhosis** has been avoided because it carries connotations from human medicine that may be misleading when applied to animals. **Hepatic fatty cirrhosis** occurs in sheep and cattle and is characterized at necropsy by ascites, hydropericardium, and acquired hepatic vascular shunts. There is progressive fatty change of the liver leading to cirrhosis. Fibrosis begins in the periacinar zone associated with ruptured fatty cysts and continues until there is widespread bridging periacinar fibrosis. No lesions of hepatic encephalopathy occur.

**In portosystemic vascular anomalies** the increased levels of ammonia, short chain fatty acids, and amino acids in the peripheral circulation are the cause of the depression and neurologic abnormalities that are typical of hepatic encephalopathy. These high levels of metabolites are the result of failure of the hepatic metabolism and detoxification of substances absorbed from the intestines, which are normally delivered to the liver via the portal vein before they enter the peripheral circulation.

### Liver Disease and Liver Failure

The liver has vast reserves of function, an almost embryonic capacity to regenerate itself, and it can perform adequately despite extensive pathologic damage to its integrity. This is best exemplified in liver abscesses in cattle, in which clinical disease is rarely evident, even in the presence of large abscesses.

Liver disease is usually diagnosed by identifying clinical signs produced by failure of some of its functions. There is often liver disease before failure of function, and laboratory tests may detect disease before there is actual failure. The liver has a reserve of about 70% to 80%, and this amount of functional liver tissue must be compromised before some of its functions fail. Some functions fail before others, which explains the progression of clinical signs.

### Intravascular Hemolysis in Equine Liver Disease

Intravascular hemolysis with prominent hemoglobinuria has occurred in horses with severe and advanced liver disease. Neutrophil hypersegmentation of undetermined cause was present in one horse with liver disease and intravascular hemolysis.

### CLINICAL FINDINGS

The cardinal signs of hepatitis are anorexia, mental depression (with excitement in some cases), muscular weakness, and jaundice, as well as somnolence, recumbency, and coma with intermittent convulsion in the terminal stages. Hemoglobinuria is a variable sign in horses. The hemolytic crisis with which it is associated is always a precursor to a fatal outcome. Animals that survive the early acute stages may show photosensitization, a break in the wool or hair leading to shedding of the coat, and susceptibility to metabolic strain for up to a year.

The clinical findings of **hepatic disease in the horse** are generally nonspecific, but the most useful noninvasive prognostic test in cases of suspected liver disease in adult horses is the severity of clinical signs. Regardless of the cause, consistent clinical findings include weight loss, anorexia, dullness, and depression. Other findings include jaundice, tachycardia, intermittent fever, abdominal pain, ventral body wall edema, clotting deficiency, muscle fasciculations, and diarrhea or constipation. Jaundice is a constant feature in acute hepatic necrosis. Dysphagia, photosensitization, encephalopathy, and hemorrhages tend to occur terminally, particularly in horses with cirrhosis. In chronic liver disease, the course is several months.

The initial anorexia is often accompanied by constipation and punctuated by attacks of diarrhea. The feces are lighter in color than normal, and if the diet contains much fat then there may be steatorrhea.

In a series of 50 cases of primary hepatic disease in horses, the following occurrence

of clinical signs was observed (%): dull demeanor (68), anorexia (56), abdominal pain (50), encephalopathy (50), weight loss (50), jaundice (42), abnormal intestinal motility (42), abnormal fecal consistency (28), dehydration (18), photosensitization (16), bilateral laryngeal paralysis (14), clinical coagulopathy (10), dermatitis and pruritus (8), peripheral edema (6), oral ulceration (6), tenesmus (4), penile prolapse (2), and rectal impaction (2).

The nervous signs are often pronounced and vary from ataxia and lethargy with yawning or coma, to hyperexcitability with muscle tremor, mania including aggressive behavior, and convulsions. A characteristic syndrome is the dummy syndrome, in which affected animals push with the head, do not respond to normal stimuli, and may be blind. There may be subacute abdominal pain, usually manifested by arching of the back, and pain on palpation of the liver. The enlargement of the liver is usually not palpable.

Jaundice and edema may or may not be present and are more commonly associated with the less acute stages of the disease. Photosensitization may also occur but only when the animals are on a diet containing green feed and are exposed to sunlight. A tendency to bleed more freely than usual may be observed. In chronic hepatic fibrosis the signs are similar to those of hepatitis but develop more slowly and persist for longer periods, often months. Ascites and the dummy syndrome are more common in hepatitis.

**Serum hepatitis (Theiler's disease)** is the most common cause of acute hepatic failure in the horse. Typically, clinical findings become apparent several weeks after administration of tetanus antitoxin. Lactating mares appear to be at a higher risk than other horses, but this may be caused by the administration of the antitoxin to mares at the time of parturition. In a group of affected horses, the illness may begin with an unexplained death in a horse after a short illness. Clinical findings include sudden anorexia, marked lethargy, stiff gait, subcutaneous edema of the distal aspects of all four limbs and body wall, blindness, head pressing, circling, bruxism, abdominal pain, tachycardia, icterus, and a marked reduction in gastrointestinal sounds. Death in a few days is common.

Serum hepatitis following the transfusion of commercial plasma into horses may cause severe unresponsive colic, lethargy, and sudden death 41 to 60 days later. Severe encephalopathy has also been described.

Hepatic disease in cattle is characterized by weight loss, dullness, and depression. Signs of hepatic encephalopathy include blindness, head pressing, excitability, ataxia, and weakness. The presence of fever and jaundice represents a poor prognosis.

Hepatic fatty cirrhosis in ruminants in Texas is characterized by failure to gain

weight, progressive emaciation, loss of wool crimp, ascites, depression, head pressing, and walking with the head held high. In the terminal stages, animals become immobile and die in a state of coma. Morbidity may reach 80% to 100%, and mortality varies from 10% to 60%. Mortality increases during each succeeding month following October, climaxes in January and February, and then decreases in the months thereafter.

### Portosystemic Shunts

In young animals with portosystemic shunts the clinical findings include stunted growth, ascites, and variable neurologic abnormalities resulting from hepatic encephalopathy. Calves and foals may be a few weeks to a few months of age before they are presented for examination. Apparent cortical blindness, circling, and dementia are common. Persistent tenesmus is common in calves. Recurrent episodes of unexplained neurologic clinical findings in a young foal suggest the presence of a portosystemic shunt. A tentative diagnosis may be made using clinicopathologic results, but a definitive diagnosis requires portovenography. Blood ammonia levels are markedly increased and serum bile acids are also increased, but the serum levels of hepatic-derived enzymes may be normal.

### CLINICAL PATHOLOGY

The clinicopathologic features of primary liver disease are summarized in the section dealing with laboratory tests for hepatic disease and function.

Scoring liver biopsies of the horse with suspected liver disease is highly predictive of the severity of the lesion and of prognosis. In a series of 82 cases in horses, 61 were confirmed to have significant liver disease and 12 were not confirmed. Only serum activities of GGT and ALP and serum globulin concentration were found to be significantly different between the two groups of horses.

Clinical and ultrasonographic data were found, when present, to be good indicators of the presence of liver disease. The single positive test results of greatest diagnostic value in horses were the presence of hepatic encephalopathy, elevated serum GGT and ALP activity, hypoalbuminemia, increased total bile acids, and increased total bilirubin concentration. Increased serum AST and GDH were also good diagnostic values but only when used in combination with the previously mentioned tests. No single combination or sequential test was able to fully discriminate between horses with and without biopsy-confirmed liver disease. Reliance on the use of noninvasive tests for the prediction of the presence or absence of significant liver disease may lead to frequent diagnostic errors. Certain positive results did reliably predict the presence of liver disease, but negative test results were invariably unsatisfactory predictors of absence of liver disease.

The most useful noninvasive prognostic test in cases of suspected liver disease in adult horses is the severity of clinical signs. A significantly poorer prognosis was found in association with clinical signs suggestive of liver disease, the presence of hepatic encephalopathy, ultrasonographic abnormalities, increased globulins, increased total bile acids, increased serum ALP and GGT activity, erythrocytosis, leukocytosis, low serum albumin, and low serum urea concentrations.

### NECROPSY FINDINGS

The liver in hepatitis is usually enlarged and the edges swollen, but the appearance of the hepatic surface and cross section varies with the cause. In acute toxic and trophopathic hepatitis the lobulation is more pronounced, and the liver is paler and redder in color. The accentuation of the lobular appearance is caused by engorgement of the centrilobular vessels or centrilobular necrosis. There may be accompanying lesions of jaundice, edema, and photosensitization. In infectious hepatitis the lesions are inclined to be patchy and even focal in their distribution. Parasitic hepatitis is traumatic, with focal hemorrhages under the capsule and the necrosis and traumatic injury definable as tracks. Congestive hepatitis is marked by severe enlargement of the liver, a greatly increased content of blood, and marked accentuation of the lobular pattern caused by vascular engorgement and fatty infiltration of the parenchyma. In hepatic fibrosis the necropsy findings vary widely depending on the causative agent, on the duration of its action, and on its severity. The liver may be grossly enlarged or be greatly reduced in size with marked lobulation of the surface.

**Hepatic encephalopathy** associated with portosystemic shunt is characterized by spongiform changes and gliosis of white matter in all levels of the brain. The liver may be of normal size or small and firm, with a prominent reticular pattern visible on the capsular and cut surfaces, and the portal veins may be absent.

### TREATMENT

Protein and protein hydrolysates are probably best avoided because of the danger of ammonia intoxication. The diet should be high in carbohydrate and calcium and low in protein and fat, but affected animals are usually completely anorectic. Because of the failure of detoxification of ammonia and other nitrogenous substances by the damaged liver and their importance in the production of nervous signs, the oral administration of broad-spectrum antibiotics has been introduced in humans to control protein digestion and putrefaction. The results have been excellent with neomycin and chlortetracycline, with the disappearance of hepatic coma coinciding with depression of blood ammonia levels. Purgation and enemas have

also been used in combination with oral administration of antimicrobials, but mild purgation is recommended to avoid unnecessary fluid loss. Supplementation of the feed or periodic injections of the water-soluble vitamins are desirable. Hepatic fibrosis is considered to be a final stage in hepatitis and treatment is not usually undertaken.

### DIFFERENTIAL DIAGNOSIS

Hepatitis is easily misdiagnosed as an encephalopathy unless jaundice or photosensitization is present. The nervous signs are suggestive of the following:

- Encephalomyelitis
- Encephalomalacia
- Cerebral edema

Congestive hepatitis is usually not manifested by nervous signs and, being a secondary lesion in congestive heart failure, is usually accompanied by ascites and edema in other regions and by signs of cardiac involvement. Hepatic fibrosis may produce ascites without evidence of cardiac disease.

Acute diseases affecting the alimentary tract, particularly engorgement on grain in cattle and horses, may be manifested by signs of nervous derangement resembling those of acute hepatic dysfunction, but the history and clinical examination usually suggest a primary involvement with the alimentary tract. Anorectic hepatic insufficiency may be mirrored by an adenocarcinoma of the pancreas, which is unlikely to be diagnosed during life.

### FURTHER READING

- McGorum BC, Murphy D, Love S, Milne EM. Clinicopathological features of equine primary hepatic disease: a review of 50 cases. *Vet Rec.* 1999;145:134-139.
- Olsman AF, Sloet van Oldruitenborgh-Oosterbaan MM. Primary liver disease in the horse. *Tijdschr Diergeneesk.* 2004;129:510-522.
- Pearson EG. Liver disease in the mature horse. *Equine Vet Educ.* 1999;11:87-96.
- Ross MA. The relationship of hepatic drug metabolism to hepatotoxicity with some examples in sheep. *Vet Annual.* 1982;22:129-134.

## Liver Abscess and Necrobacillosis of the Liver

### SYNOPSIS

**Etiology** *Fusobacterium necrophorum* subsp. *necrophorum* is the most common isolate present in pure culture. *F. necrophorum* subsp. *funduliforme* is less common and isolated as a mixed infection with *Trueperella* (formerly *Arcanobacterium*) *pyogenes*.

**Epidemiology** Greatest importance in grain-fed cattle where it occurs secondary to rumenitis

**Clinical findings** May be associated with abdominal pain but most infections are subclinical. Importance is in slaughter condemnation of affected organs and negative effects on feed efficiency

**Clinical pathology** Inflammatory response

**Diagnostic confirmation** Ultrasound; slaughter examination

**Treatment** Not commonly done

**Control** Feed management to avoid ruminal acidosis; prophylactic antibiotics; vaccination

Although the terms *liver necrobacillosis* and *liver abscess* are often used synonymously, the term liver abscess refers to a morphologic diagnosis, whereas liver necrobacillosis in the strict sense of the term is an etiologic diagnosis referring to those abscesses caused by *Fusobacterium necrophorum*.<sup>1</sup> Although *F. necrophorum* is by far the most commonly isolated pathogen from liver abscesses in cattle, strictly speaking a liver abscess can be referred to as necrobacillosis of the liver only after isolation of *F. necrophorum*.

## ETIOLOGY

*F. necrophorum* is a gram-negative, non-spore-forming, rod-shaped anaerobic but aerotolerant organism. It is a normal inhabitant of the ruminant oral cavity and upper digestive and respiratory tract and an opportunistic pathogen generally associated with abscesses and various necrotic infections.<sup>2</sup> In addition to hepatic necrobacillosis, this bacterium is also the causative agent of digital necrobacillosis (foot rot) and oral/laryngeal necrobacillosis of calves.

Historically, a subdivision of *F. necrophorum* into four different biotypes (A, B, AB, and C) was used. Biotypes A and B, which are considered to be most relevant in the etiology of *F. necrophorum*-associated diseases in cattle, have been renamed *F. necrophorum* subsp. *necrophorum* (formerly biotype A) and *F. necrophorum* subsp. *funduliforme* (formerly type B). *F. necrophorum* is often found in hepatic abscesses in ruminants, and subspecies *necrophorum* is the more common type isolated and is usually present in pure culture. *F. necrophorum* subsp. *funduliforme* is less prevalent and usually isolated with other bacteria, such as *Trueperella* (formerly *Arcanobacterium*) *pyogenes*, *Bacteroides* spp., *Streptococcus* spp., and *Staphylococcus* spp.<sup>2</sup>

*T. pyogenes*, a gram-positive, rod-shaped, facultative anaerobe, is the second most common pathogen isolated from liver abscesses in cattle; it acts synergistically to promote growth of *F. necrophorum* by using oxygen to create an anaerobic environment and provide iron for growth through its hemolytic activity. In most cases *T. pyogenes* is cultured as a mixed culture with *F. necrophorum*, which has led to the widely held assumption that there is a synergism between

these pathogens. The leukotoxin (LT) of *F. necrophorum* is thought to protect *T. pyogenes* against phagocytosis, suggesting that *T. pyogenes* is an opportunistic pathogen contributing to the development of liver abscesses and not the primary invader.<sup>3</sup>

Hepatic abscesses in goats have been described. The organisms isolated included *Corynebacterium pseudotuberculosis* (58.9%), *Escherichia coli* (11.8%), *Corynebacterium* spp. (11.8%), *Mannheimia haemolytica* (5.0%), *Proteus* sp. (5.9%), and *Staphylococcus aureus* (5.9%).

*Clostridium sordellii* is associated with hepatic abscesses in neonatal lambs and bacillary hemoglobinuria by a toxin from *C. haemolyticum* with focal hepatic necroses.

A focal bacterial hepatitis in horses, identified as Tyzzer's disease and associated with *Bacillus piliformis*, and yersiniosis associated with *Yersinia pseudotuberculosis* are listed elsewhere. Occasional cases of strangles that develop bacteremic spread may also develop hepatic abscesses, as may septicemia in lambs associated with *Histophilus somni*. In most cases hepatic abscesses in horses have an unknown etiology and pathogenesis.

The fungus *Mortierella wolfii* has been isolated from a liver abscess in a cow in Australia. The liver abscess was grossly indistinguishable from other common bacterial abscesses, such as those associated with *T. pyogenes* or *F. necrophorum*.

## EPIDEMIOLOGY

### Occurrence

The disease occurs in all ages and types of cattle and sheep but achieves the greatest economic significance in **grain-fed cattle** where it occurs secondary to **rumenitis**. In feedlots in the United States the prevalence varies widely between feedlots but ranges from 12% to 32% in most; equivalent rates occur in "barley beef" cattle in the UK. In a series of recent slaughter plant surveys conducted in the United States, the incidence rate of condemnation of the liver for either minor or major abscesses was determined to be 13.7%.<sup>4</sup>

Sporadic cases or occasional outbreaks of liver abscess occur in the **neonate** from **umbilical infection** or in individuals as a complication of an episode of **acute rumen acidosis** (grain overload).

### Pathogen Risk Factors

*F. necrophorum* is a common inhabitant of the upper digestive and respiratory tract of ruminants and a common inhabitant of the environment of farm animals. It uses lactate as the major sugar substrate, and its numbers in the rumen increase with a **change from roughage** to high grain diets. *F. necrophorum* is not capable of prolonged survival outside the animal body; 1 month is the probable maximum period under favorable conditions. Infection to the liver requires a **predisposing injury** at a primary site of infection. The disease can be reproduced

experimentally by intraportal inoculation of *F. necrophorum*.

*F. necrophorum* possesses a number of virulence factors such as **endotoxin lipopolysaccharide (LPS)**, **LT hemolysin**, **hemagglutinin**, and others that are considered to be of critical importance for the anaerobic pathogen to penetrate, colonize, and proliferate in nonsuperficial tissue.<sup>2</sup> Of these factors LT and LPS have been studied in the greatest detail and are considered the primary virulence factors. The LT is cytotoxic specifically to ruminant neutrophils, macrophages, hepatocytes, and possibly also to rumen epithelial cells, possibly facilitating the penetration of the damaged rumen mucosa. The importance of LT to the virulence of *F. necrophorum* is corroborated by the correlation between toxin production and the ability to induce abscesses observed in laboratory animals.<sup>5</sup> *F. necrophorum* subsp. *necrophorum* was found to produce larger amounts of LT than *F. necrophorum* subsp. *funduliforme*, which may contribute to the obvious difference in virulence between the two subspecies. *F. necrophorum* subsp. *necrophorum* is isolated from 71% to 95% of all bovine liver abscesses (in 75% as pure culture), whereas *F. necrophorum* subsp. *funduliforme* is commonly isolated from 5% to 29% of all abscesses (in over 75% of cases as mixed culture).

### Risk Factors in Grain-Fed Cattle

Rumenitis, resulting from **rumen acidosis**, is the primary site of infection in grain-fed cattle. The risk for liver abscess is increased by factors that predispose rumenitis, such as low roughage and **high-energy diets**, and the incidence increases as roughage in the diet decreases.

### Management

Introducing hungry cattle to high-energy diets, rapidly increasing dietary energy, and poor feed bunk management with irregular periods and amounts of feeding are associated with higher rates of liver abscess.

### Diet

The type of grain and the use of processed, including gelatinized, grain can influence risk of abscess, as can the physical nature of the diet if it allows feed sorting by the animal during feeding.

### Breed

Holstein Friesian cattle are at greater risk than beef breeds, presumably because they are fed longer and have higher feed intakes. The prevalence in steers is marginally higher than in heifers, probably also related to higher feed intake.

### Risk Factors in Other Farm Animals

In lambs and calves infection usually occurs through the **navel** at birth or through **ruminal ulcers**; the infection originates from infected bedding grounds or barn



bedding. Liver abscess can be a sequela to other disease, such as traumatic reticulitis and peritonitis.

### Economic Importance

According to a recent survey conducted in several meat packing plants in the United States, liver abscesses are the single most common cause for condemnation of bovine livers by the United States Department of Agriculture Food and Safety Inspection Service, with 5.4% and 8.3% of all livers from feedlot steers condemned for major and minor abscesses, respectively.<sup>4</sup> With the liver accounting for approximately 2% of the mass of the carcass, this by itself may present a considerable financial loss. The greatest economic impact of this condition is nonetheless attributed to animal performance and carcass yield of animals with large liver abscesses. A significant negative effect on feed intake and feed efficiency has been reported in these animals.<sup>3</sup>

### PATHOGENESIS

Vascular drainage from the primary lesion into the portal vascular system, as can occur with omphalophlebitis or rumenitis, leads to embolic translocation and entrapment of bacteria in the capillary system of the liver. The pathogenesis of rumen acidosis in grain-fed cattle is described in Acute Ruminant Acidosis in [chapter 8](#). The important predisposing trauma to the rumen mucosa is caused either by short-term exposure of the mucosa to highly acidic rumen fluid (acute rumen acidosis) or chronic exposure to mild to moderate acidic rumen fluid (subacute rumen acidosis), and results in parakeratosis of the rumen mucosa and rumenitis.

Although *F. necrophorum* pertains to the normal flora of the rumen content, the pathogen is present on the rumen wall in much larger numbers when the mucosa is affected by parakeratosis and rumenitis.<sup>2</sup> Most of the ruminal wall lesions heal without penetration, especially if they are colonized only by the less virulent *F. necrophorum* subsp. *funduliforme*. The more virulent *F. necrophorum* subsp. *necrophorum* persists longer and possibly penetrates the portal system with more ease because of higher LT production. The less virulent *F. necrophorum* subsp. *funduliforme* requires helper organisms to penetrate the defense mechanisms and leads to a mixed infection. There are differences in the biological activities of *F. necrophorum* isolated from liver abscesses and those of the general population in the rumen, and many of the ruminal inhabitants are probably not capable of tissue invasion to cause disease.

The experimental inoculation of viable cultures of *F. necrophorum* into the hepatic portal veins of cattle results in the development of diffusely distributed microabscesses within 30 minutes up to 2 hours. Gross abscesses develop in 3 to 36 hours.

Neutrophils are the predominant phagocyte in lesions of 8 hours or less, and macrophages are the predominant phagocyte in lesions of 12 hours' duration or more. The LT is responsible for allowing the bacteria to withstand the phagocyte cell response and enable the infection to persist. If there is sufficient hepatic involvement, then a toxemia develops from the bacterial infection and causes a chronic or acute illness.

In most infections, the lesions are too small to produce clinical signs. **Hematogenous spread** from hepatic lesions, including rupture into the caudal vena cava, may result in multiple lesions in many organs, severe pulmonary disease with hemoptysis, and rapidly fatal termination (caudal vena cava syndrome).

### CLINICAL FINDINGS

In the majority of cases of hepatic abscessation in feeder cattle there are **no clinical signs** of illness. Abscesses that are very large may result in an acute or chronic illness.

In **acute cases** in dairy cattle there is fever, anorexia, depression, drop in milk production, and weakness. Abdominal pain is evidenced on percussion over the posterior ribs on the right side, and affected cattle show arching of the back and reluctance to move or lie down. The liver may be so enlarged that it is readily palpable behind the costal arch. The abdominal pain may be sufficiently severe to cause grunting with each breath. In **chronic cases**, there are no localizing signs but anorexia, emaciation, and intermittent diarrhea and constipation occur.

Animals infected through the navel show signs at about 7 days of age, and omphalophlebitis is usually present.

**Hepatic abscesses in horses** are characterized clinically by a history of weight loss, fever, inappetence, and depression. The prognosis is very unsatisfactory, in spite of intensive antibiotic and supportive therapy, and euthanasia is recommended.

### CLINICAL PATHOLOGY

Leukocytosis with marked neutrophilia may be present with large or multiple abscesses. Clinical chemistry and liver function tests have been found to be poor indicators and of little diagnostic value in predicting the presence of liver abscesses, but hepatic dysfunction can be detected by these means in the acute stage of hepatic injury. **Ultrasound** may aid in diagnosis.

In horses clinicopathologic abnormalities are consistent with a diagnosis of chronic bacterial infection such as leukocytosis with a mature neutrophilia, thrombocytosis, hyperglobulinemia, hypoalbuminemia, and a markedly decreased albumin-to-globulin concentrations ratio.

### NECROPSY FINDINGS

Usually, multiple hepatic abscesses are present. The hepatic lesions may be deep in

the parenchyma or under the capsule, especially on the diaphragmatic surface. Extension to the diaphragm or perirenal tissues is not unusual.

In bovine rumenitis cases, the anterior ventral sac is most commonly affected. There are local or diffuse mucosal lesions with thickening of the wall, superficial necrosis, and the subsequent development of ulcers. In lambs there may be lesions at the cardinal end of the esophagus. The histologic appearance of acute to subacute necrobacillosis lesions consists of a zone of necrosis bordered on one edge by mats of filamentous rods and on the other by a band of karyorrhectic leukocytes.

### Samples for Confirmation of Diagnosis

- **Bacteriology:** Swab of abscess or tissue sample from deep edge of lesion (anaerobic culture).

### DIFFERENTIAL DIAGNOSIS

Acute cases in cattle resemble cases of traumatic reticuloperitonitis, and differentiation can only be made on localization of the pain, ultrasonography, and by exploratory rumenotomy. The latter is essential if traumatic hepatitis is a possible diagnosis.

### TREATMENT

*F. necrophorum* is susceptible in vitro to  $\beta$ -lactam antibiotics, tetracyclines, macrolides, and lincomycins but is resistant to aminoglycosides and ionophore antibiotics.<sup>2</sup> The apparent sensitivity of this gram-negative pathogen to penicillin and cephalosporins is peculiar even based on its cell wall structure.<sup>2</sup>

Liver abscess in feedlot cattle is not clinical and not routinely treated as a clinical disease. In clinical disease associated with liver abscess, prolonged treatment with high doses of antimicrobials is required if therapeutic concentrations are to be achieved at the site of infection. **Relapse** is common because of incomplete control of the localized infection.

### TREATMENT AND CONTROL

#### Treatment

Procaine penicillin G (44,000 IU/kg IM every 24 h long term) (R-2)  
Oxytetracycline (10 mg/kg IM every 24 h or long-acting formulation 20 mg/kg every 72 h long term) (R-2)  
Ampicillin trihydrate (10 mg/kg SC or IM every 24 h long term) (R-2)

**Control**

Tylosin (90 mg/animal PO every 24 h long term) (R-1)  
 Chlortetracycline (70 mg/animal PO every 24 h long term) (R-1)  
 Oxytetracycline (75 mg/animal PO every 24 h long term) (R-1)  
 Virginiamycin (16.5–19.8 mg/kg PO every 24 h long term) (R-1)

**Vaccination**

Vaccination with *Fusobacterium necrophorum* leukotoxoid/*Trueperella pyogenes* bacterin vaccines. (R-1)

IM, intramuscularly; PO, orally; SC, subcutaneously.

**CONTROL**

Control procedures in feedlot cattle include prevention of rumenitis by feed management and the use of prophylactic antimicrobials.

**Feed Management**

Feed management aims to prevent the occurrence of rumen acidosis and rumenitis and requires controlled dietary energy step up, attention to the grain type and content of the diet, and correct feed bunk management. The control of rumen acidosis is discussed in Acute Ruminant Acidosis in [chapter 8](#).

**Prophylactic Antimicrobial Therapy**

The addition of antimicrobials to the feed can significantly reduce the incidence of liver abscesses and is a routine practice in over 70% of all feedlots in the United States.<sup>6</sup> Adding antimicrobials to feed as disease prophylaxis is not permitted in many countries, including member countries of the European Union.

In the United States bacitracin, methylene disalicylate, chlortetracycline, oxytetracycline, tylosin, and virginiamycin are approved for feed inclusion for the control of liver abscess in feedlot cattle. Tylosin is the most commonly used compound and appears highly effective. A summary of trials feeding tylosin at 11 g/tonne of feed or 90 mg per animal per day showed a 73% reduction in the occurrence of liver abscesses. Antimicrobial feed additives also increase average daily gain and feed conversion efficiency, but the inclusion level for these effects and prevention of liver abscess is not necessarily the same.

The site of action may be in rumen or the liver or possibly in both, but is probably the rumen because tylosin and virginiamycin, which are both effective in prevention, are not absorbed into the circulation. Tylosin has been shown to inhibit the increase in ruminal *F. necrophorum* numbers that occur in association with feeding high-grain diets.

**Vaccination**

Vaccination with leukotoxoid vaccines has shown some protection against intraportal

challenge and has reduced the abscess rates in a study of naturally occurring disease in a feedlot. A trial of the efficacy of a high antigenic-mass–combined *T. pyogenes*–*F. necrophorum* bacterin-toxoid in preventing naturally occurring liver abscess in feedlot cattle showed a significant effect of vaccination with a reduction of the prevalence and severity of abscesses that was equivalent to that achieved by the incorporation of tylosin in the feed. The reduction in prevalence in two trials comparing vaccinated and nonvaccinated cattle was 48.4% (31% of controls and 16% of vaccinates with liver abscess) and 37.5% (48% of controls and 30% of vaccinates with liver abscess). An additive effect when combining vaccination and preventive treatment with oral tylosin could not be observed.

**Control in Young Lambs**

In young lambs, the disease can be controlled by disinfecting the navel at birth and providing clean bedding or bedding grounds.

**FURTHER READING**

Nagaraja TG, Laudert SB, Parrott JC. Liver abscesses in feedlot cattle. Part 11. Incidence, economic importance and prevention. *Comp Cont Educ Pract Vet Suppl*. 1996;18:S264-S273.  
 Nagaraja TG, Lechtenberg KF. Liver abscesses in feedlot cattle. *Vet North Am Clin Food Anim Pract*. 2007;23:351-369.  
 Tadepalli S, Narayanan SK, Stewart GC, et al. *Fusobacterium necrophorum*: a ruminal bacterium that invades the liver to cause abscesses in cattle. *Anaerobe*. 2009;15:36-43.

**REFERENCES**

- Nagaraja TG, et al. *Anaerobe*. 2005;11:230.
- Tadepalli S, et al. *Anaerobe*. 2009;15:36.
- Nagaraja TG, Lechtenberg KF. *Vet Clin North Am Food Anim Pract*. 2007;23:351.
- McKeith RO, et al. *J Anim Sci*. 2012;90:5135.
- Nagaraja TG, Chengappa MM. *J Anim Sci*. 1998;76:287.
- USDA-APHIS Feedlot 2011; Part IV. (Accessed 10.01.14, at <[http://www.aphis.usda.gov/animal\\_health/nahms/feedlot/downloads/feedlot2011/Fee11\\_dr\\_PartIV.pdf](http://www.aphis.usda.gov/animal_health/nahms/feedlot/downloads/feedlot2011/Fee11_dr_PartIV.pdf)>).

**Bacillary Hemoglobinuria (Red Water Disease)**

**SYNOPSIS**

**Etiology** *Clostridium haemolyticum*, which is a soil-borne anaerobe, produces phospholipase C (β-toxin) with strong necrotoxic and hemolytic activity.

**Epidemiology** In cattle and sheep occurs in summer and autumn in endemic areas, which are usually irrigated or subirrigated fields

**Clinical findings** Anorexia, depression, anemia, fever, hemoglobinuria, and jaundice; high case fatality

**Clinical pathology** Hemoglobinuria, anemia, and blood culture

**Necropsy findings** Single ischemic pale infarct in the liver surrounded by a zone of hyperemia; hemoglobinuria

**Diagnostic confirmation** Typical liver lesion and positive fluorescent antibody staining of organism in lesion

**Treatment** Antibiotics, antiserum, and blood transfusion

**Control** Annual vaccination preceding the period of risk

**ETIOLOGY**

*C. haemolyticum* (*C. novyi* type D) is a soil-borne anaerobe. The longevity of the spores in soil is unknown, but the organism has been isolated from bones a year after the death of an animal from bacillary hemoglobinuria. In infected areas the organism is often found in the livers of healthy cattle. Under anaerobic conditions the organism grows and produces phospholipase C (β-toxin), a necrotoxic and hemolytic toxin responsible for the clinical disease. Damage to the liver from telangiectasis, necrobacillosis caused by *F. necrophorum*, and fasciolosis have been suggested as precipitating causes.

The disease has been produced experimentally by infecting calves orally and inducing liver damage by liver biopsy, or by implanting the organism in the liver. Cultures of the organism produce severe muscle necrosis and hemoglobinuria when injected intramuscularly into cattle and experimental animals.

**EPIDEMIOLOGY**

**Occurrence**

Bacillary hemoglobinuria has been reported principally from the western part of the United States, although the disease has also been observed in the southern United States, Canada, Mexico, Venezuela, Chile, Turkey, Australia, New Zealand, the UK, Japan, and Ireland. The disease is not common, but on infected farms death losses, which are usually less than 5%, may reach as high as 25%.

**Risk Factors**

**Animal Risk Factors**

Cattle are the usual species involved, although occasional cases occur in sheep and rare cases in pigs. As is the case in many clostridial diseases, animals in good condition are more susceptible.

**Environmental Risk Factors**

Bacillary hemoglobinuria is a disease of the summer and autumn months. A primary association occurs with pastures that also are associated with the occurrence of liver fluke although other, less determined risk factors obtain. The highest incidence of bacillary hemoglobinuria is on irrigated or poorly drained pasture, especially if the soil is

alkaline in reaction. Some outbreaks have occurred in **feedlots** where animals were fed hay cut from the infected fields.

The disease is rare on dry, open **range country** but does occur in range country where cattle have access to swales with areas naturally irrigated by springs or streams. Heavy mortalities may occur when cattle from an uninfected area are brought onto an infected farm, with cases beginning to occur 7 to 10 days later.

The disease is **spread** from infected to noninfected areas by flooding, natural drainage, contaminated hay from infected areas, or carrier animals. The carriage of bones or meat by dogs or other carnivores could also affect spread of the infection. Contamination of pasture may occur from feces or from decomposing cadavers.

### PATHOGENESIS

Although attempts to produce the disease by feeding the organism have been unsuccessful, it is probable that under natural conditions in endemic areas invasion occurs from the alimentary tract after ingestion of contaminated material. As in black disease of sheep, the bacteria are carried to the liver and lodge there until damage to the parenchyma of the liver and the resulting hypoxia create conditions suitable for their proliferation. Migrating flukes are thought to be predisposed to clinical disease by leading to liver necrosis and the establishment of anaerobic conditions in the liver that will lead to the multiplication of the causative organism. Invasion of the liver by *Cysticercus tenuicollis* and other causes of liver damage can also lead to the disease. Once *C. haemolyticum* returns to its vegetative state in an anaerobic environment and replicates, it also **produces phospholipase C ( $\beta$ -toxin)**. This  $\beta$ -toxin causes hemolysis, necrosis of hepatocytes, and damage to capillary endothelium, all of which lead to hemoglobinuria and loss of vascular fluid into tissues and serous cavities.<sup>1</sup>

The development of an organized thrombus in a subterminal branch of the portal vein produces the large anemic infarct that is characteristic of the disease. Most of the bacteria are to be found in this infarct and, under the anaerobic conditions, the necrotic and hemolytic  $\beta$ -toxin is released systemically to result in toxemia, generalized vascular damage, and intravascular hemolysis.

### CLINICAL FINDINGS

Animals brought into contact with the infection in endemic areas seldom develop disease until 7 to 10 days later. The illness is of short duration, and cattle at pasture may be **found dead** without obvious signs of the disease. More often there is a **sudden onset**, with complete cessation of rumination, feeding, lactation, and defecation. Abdominal pain is evidenced by reluctance

to move and an arched-back posture. Grunting may be evident on walking. Respiration is shallow and labored and the pulse is weak and rapid. Fever (39.5–41°C, 103–106°F) is evident in the early stages, but the temperature subsides to subnormal before death. **Edema of the brisket** is a common finding. The feces are dark brown; there may be diarrhea with a great deal of mucus and some blood.<sup>1,2</sup> The **urine** is dark red. Jaundice is present but may not be very obvious. The duration of the illness varies from 12 hours in dairy cows in advanced pregnancy to 4 days in dry stock. Pregnant cows often abort. Severe dyspnea is evident just before death. The disease in sheep presents with similar signs.

### CLINICAL PATHOLOGY

The red color of the urine is caused by the presence of hemoglobin; there are no free red cells. In the later stages there is **anemia**, characterized by a marked decline of packed cell volume and red blood cell counts. Leukocyte counts tend to be mildly to markedly elevated with the presence of toxic granulocytes. Most prominent changes in blood biochemistry analysis are elevated enzyme activity of AST and GGT, as well as mild to moderate elevation of serum bilirubin concentrations, which are reflective of liver damage.<sup>1-3</sup>

Blood cultures during the acute stages of the disease may be positive. Serum agglutinins against *C. haemolyticum* may be detectable at low levels (1:25 or 1:50) during the clinical illness and, if the animal recovers, rise to appreciable levels (1:50–1:800) a week later. Titers greater than 1:400 are usual at this time. A positive agglutination test is not conclusive evidence of the presence of the disease.

### NECROPSY FINDINGS

Rigor mortis develops quickly. The perineum is soiled with bloodstained urine and feces. Subcutaneous, gelatinous edema, which tends to become crepitant in a few hours, and extensive petechial or diffuse hemorrhages in subcutaneous tissue are characteristic. There is a variable degree of jaundice. Excessive amounts of fluid, varying from clear to bloodstained and turbid, are present in the pleural, pericardial, and peritoneal cavities. Generalized subserous hemorrhages are also present. Similar hemorrhages appear under the endocardium. Hemorrhagic abomasitis and enteritis are accompanied by the presence of bloodstained ingesta or free blood. The **characteristic lesion** of bacillary hemoglobinuria is an **ischemic infarct in the liver**. One or more may be present in any part of the organ and vary from 5 to 20 cm in diameter. The infarct is pale, surrounded by a zone of hyperemia, and has the general appearance of local necrosis. Red urine is present in the kidneys and bladder, and petechiation is evident throughout the kidney.

*C. haemolyticum* can be isolated from the liver infarct and many other organs from a fresh carcass, but postmortem invaders quickly obscure its presence. A positive fluorescent antibody test (FAT) on impression smears taken from the hyperemic zone around the liver infarct and stained with fluorescein isothiocyanate-labeled rabbit antiserum *C. novyi* antiserum will confirm the presence of *C. novyi*-type organisms but cannot differentiate type B from type D. A polymerase chain reaction (PCR) test to identify toxin-producing genotypes of *Clostridium* spp. may assist in the identification of isolates.

### Samples for Confirmation of Diagnosis

- Bacteriology: Tissue from edge of liver infarct, placed in an airtight container; four air-dried impression smears from lesion border [anaerobic culture, FAT]
- Histology: Fixed liver lesion, kidney

### DIFFERENTIAL DIAGNOSIS

The diagnosis of bacillary hemoglobinuria is largely a question of differentiation from other diseases in which hemoglobinuria, myoglobinuria, and hematuria are cardinal signs. In an animal found dead, differentiation from other clostridial diseases and anthrax may be required. Differentiating between hemoglobinuria and hematuria by spinning urine will allow the discrimination of those differentials not associated with intravascular hemolysis.

- Acute leptospirosis
- Postparturient hemoglobinuria
- Hemolytic anemia caused by cruciferous plants
- Babesiosis and anaplasmosis
- Enzootic hematuria
- Chronic copper poisoning (sheep)

### TREATMENT

**Specific treatment** includes the immediate use of penicillin or tetracyclines at high doses and antitoxic serum if available. Prompt treatment is essential. If the serum is administered in the early stages of the disease, then hemoglobinuria may disappear within 12 hours.

**Supportive treatment**, including blood transfusion, parenteral fluid, and electrolyte solutions, is of considerable importance. Care is required during treatment and examination, because undue excitement or exercise may cause sudden death. Bulls should not be used for service until at least 3 weeks after recovery because of the danger of liver rupture. Convalescence is often prolonged, and animals should be protected from nutritional and climatic stress until they are fully recovered.



## TREATMENT AND CONTROL

### Treatment

Penicillin G sodium/potassium (15,000 IU/kg IV every 6–8 h) (R-2)  
Oxytetracycline (15–20 mg/kg IV every 24 h) (R-2)  
Supportive therapy

### Control

*Clostridium haemolyticum* bacterin vaccine (R-2)

IV, intravenously.

## CONTROL

A formalin-killed whole culture adsorbed on aluminum hydroxide gives good protection for a year in cattle. Vaccination is performed 4 to 6 weeks before the expected occurrence of the disease. Annual revaccination of all animals over 6 months of age is necessary in enzootic areas. In some **locations of extreme risk** a second vaccination during the grazing season is recommended. To obviate the local reaction that occurs at the site of injection, the inoculum may be administered at several sites and distributed under the skin by massage. The injection must be subcutaneous, because intradermal and intramuscular injections are likely to produce severe reactions. Modern vaccines prepared to avoid these local reactions lack immunogenicity and need to be administered twice a year. The carcasses of animals dying of the disease should be disposed of by burning or deep burial.

## FURTHER READING

- Hatheway CL. Toxigenic clostridia. *Clin Microbiol Rev.* 1990;3:66-98.  
Songer JG. Clostridial diseases of animals. In: Rood JJ, McClane BA, Songer JG, Titball RW, eds. *The Clostridia: Molecular Biology and Pathogenesis*. London: Academic Press; 1997:153-182.  
Stogdale L, Booth AJ. Bacillary hemoglobinuria. *Compend Contin Educ Pract Vet.* 1984;6:5284-5290.

## REFERENCES

- Shinozuka Y, et al. *J Vet Med Sci.* 2011;73:255.
- Takagi M, et al. *J Vet Med Sci.* 2009;71:1105.
- Vine N, Fayers J. *Vet Rec.* 2006;159:160.

# Infectious Necrotic Hepatitis (Black Disease)

## SYNOPSIS

**Etiology** An acute toxemia of sheep, cattle, and sometimes pigs and horses caused by the toxin of *Clostridium novyi* type B produced in damaged liver tissue. Outbreaks usually associated with fasciolosis

**Epidemiology** Adult sheep in good condition; seasonal prevalence related to the migration of immature liver fluke in the liver

**Clinical findings** Sheep have a rapid clinical course and are usually found dead. Short clinical course in cattle and horses with profound depression and toxemia, abdominal pain, and peritonitis

**Clinical pathology** None described

**Necropsy findings** Rapid autolysis, engorgement of subcutaneous vessels with edema; liver has small areas of yellow-colored necrosis surrounded by a zone of hyperemia

**Diagnostic confirmation** Isolation of *C. novyi* in the typical liver lesion; fluorescent antibody staining identifies *C. novyi* but not the type

**Treatment** Parenteral penicillin may be attempted but high case fatality.

**Control** Vaccination

## ETIOLOGY

The etiologic agent of infectious necrotic hepatitis affecting sheep and cattle and rarely pigs and horses is *C. novyi*, **type B**. Spores of *C. novyi* are resident in soil and may be present in the liver of normal animals. Clinical disease is triggered by a primary necrotic process in the liver, which causes the organism to proliferate and produce lethal amounts of toxin. *C. novyi* types A and C are also resident in soil and may invade a carcass post-mortem but do not cause infectious necrotic hepatitis.

The disease has been produced experimentally in sheep by the administration of spores of *C. novyi* after prior infection with fluke metacercaria. Although field outbreaks of the disease are usually precipitated by invasion of the liver by immature liver flukes, it is possible that other causes of local hepatic injury, e.g., invasion by cysts of *Cysticercus tenuicollis*, and trauma from liver biopsy may precipitate the disease. *Thysanosoma actinoides* is thought to be a predisposing infection in South America.

Cases are reported in which no specific precipitating lesions are detected and have been advanced as an explanation of sudden deaths in feedlot cattle. *C. novyi* types A and B have been incriminated as a cause of sudden death in sows.

## EPIDEMIOLOGY Occurrence

The disease is worldwide in distribution but is of particular importance in Australia and New Zealand and to a lesser extent in the UK, the United States, and Europe. In sheep, the incidence rate in a given year is usually about 5% in affected flocks but may be as high as 10% to 30% and in rare cases up to 50%. The disease is practically always fatal in both sheep and cattle. Details of the incidence in cattle are scanty, but the disease is becoming more common in some areas where fluke is being introduced. The disease is rare in horses.

## Risk Factors

### Animal Risk Factors

Well-nourished adult sheep in the 2- to 4-year age group are particularly susceptible, and lambs and yearlings rarely are affected.

### Environmental Risk Factors

The epidemiologic association between **liver flukes** and *C. novyi* has been supported by the observation that both are more prevalent in the soil in areas where black disease occurs than in other areas, and the survival of both the bacteria and the fluke is favored by the same type of soil environment.

In temperate climates, a **seasonal occurrence** is obvious presumably because of fluctuation in the liver fluke and host snail population. Outbreaks are most common in the summer or autumn months and cease within a few weeks after frosts occur because of destruction of encysted metacercaria. Exposure to fluke infestation, as occurs when sheep graze on marshy ground during dry summers and drought, is commonly associated with outbreaks of black disease, although they can occur in winter. Sheep removed from a black disease farm may die of the disease up to 6 weeks later because of the time lag required for migration of the flukes.

Heavy irrigation of pastures creates favorable conditions for the development of flukes and may predispose disease. Outbreaks in cattle commonly occur on irrigated farms.

### Source of Infection

Infection occurs through fecal-oral transmission of *C. novyi*. Fecal contamination of the pasture by carrier animals results in ingestion of clostridial spores by herd mates; the carcasses of sheep dead of the disease may cause heavy contamination. Many normal animals in flocks in which the disease occurs carry *C. novyi* in their livers, because not all strains are pathogenic. The **spread of infection** from farm to farm occurs via these sheep and probably also by infected wild animals and birds and by the carriage of contaminated soil during flooding.

### Other Species

There is little information about the epidemiology of the disease in the horse, although prior administration of an anthelmintic may be a risk factor. *C. novyi* can be a significant cause of **sudden death of adult pigs**. In some herds the disease is more common in older sows (average parity 5.6 litters) with the highest prevalence in the spring months.

### PATHOGENESIS

Spores of *C. novyi* are ingested and carried to the liver in the lymphatic system; the organism can be isolated from the liver of normal animals. Under local anaerobic conditions, such as occur in the liver when migrating flukes cause severe tissue destruction, the organisms already present in the liver proliferate, liberating  $\alpha$ -toxin, which is

necrotic and causes local liver necrosis and more diffuse damage to the vascular system. The nervous signs observed may be caused by this general vascular disturbance or by a specific neurotoxin.

## CLINICAL FINDINGS

### Sheep

Affected sheep commonly die during the night and are found dead without having exhibited any previous signs of illness. When observation is possible, clinically affected sheep are seen to segregate from the rest of the flock, lag behind, and fall down if driven. There is fever (40–42°C, 105–107°F), which subsides to a premortal (subnormal) level, and some hyperesthesia; respiration is rapid and shallow; and the sheep remains in sternal recumbency and often dies within a few minutes while still in this position. The course from first illness to death is never more than a few hours and death usually occurs quietly, without evidence of struggling.

### Cattle

Clinical findings are the same in cattle as in sheep but the course is longer, with the illness lasting for 1 to 2 days. Outstanding clinical findings in cattle include a sudden severe depression, reluctance to move, coldness of the skin, absence of rumen sounds, a low or normal temperature, and weakness and muffling of the heart sounds. There is abdominal pain, especially on deep palpation of the liver, and the feces are semifluid. Periorbital edema may also develop.

### Horses

In the horse the syndrome presents as a peritonitis accompanied by severe and progressive toxemia and manifests with depression, reluctance to walk, pain on palpation of the abdomen, frequent straining, and recumbency. Fluid from abdominal paracentesis has a profound increase in nucleated cells and protein. Death occurs within 72 hours of onset of the disease.

## CLINICAL PATHOLOGY

Antemortem laboratory examinations are not usually possible because of the peracute nature of the disease, and there is no body of information for this disease.

## NECROPSY FINDINGS

Bloodstained froth may exude from the nostrils. The carcass undergoes rapid putrefaction. There is pronounced engorgement of the subcutaneous vessels and a variable degree of subcutaneous edema. The dark appearance of the inside of the skin, particularly noticeable on drying, has given rise to the name **black disease**. Gelatinous exudate may be present in moderate quantities in the fascial planes of the abdominal musculature. Bloodstained serous fluid is always present in abnormally large amounts in the pericardial, pleural, and peritoneal cavities. Subendocardial and subepicardial hemorrhages are frequent.

The **liver** is swollen, gray-brown, and exhibits characteristic **areas of necrosis**. These are yellow areas 1 to 2 cm in diameter and are surrounded by a **zone of bright red hyperemia**. They occur mostly under the capsule of the diaphragmatic surface of the organ but may be more deeply seated and can easily be missed unless the liver is sliced carefully. In cattle they are often linear in shape and may be difficult to find. There is usually evidence of recent invasion by liver fluke, with channels of damaged liver tissue evident on the cut surface of the liver. These may be mistaken for subcapsular hemorrhages when viewed from the surface. Mature flukes are not ordinarily observed. **Histologically**, the liver lesion consists of a central tract of eosinophilic inflammation (caused by fluke migration) surrounded by a zone of coagulation necrosis and an outer rim of infiltrating neutrophils. Gram-positive bacilli can easily be demonstrated within the lesion.

A diagnosis of infectious necrotic hepatitis requires the culture of *C. novyi* from the typical liver lesion and the demonstration of preformed toxin in the peritoneal fluid and/or the liver lesion from a fresh carcass. Autolysis rapidly clouds the postmortem findings and false-positive diagnoses are likely if toxin assays are performed on carcasses more than 24 hours old. Another problem is the relatively common occurrence of nonpathogenic strains of *C. novyi* B. These strains are detected in livers by fluorescent antibody technique, and this may lead to a false-positive identification of black disease.

Fluorescent antibody techniques are almost as accurate and much less time-consuming than traditional anaerobic culture methods. An enzyme-linked immunosorbent assay (ELISA) for  $\beta$ -toxin in intestinal contents has been described, and PCR techniques for better identification of toxin-producing strains of clostridia are available.

Unusual lesions, such as a large area of inflammation in the wall of the abomasum and congestion of the subcutaneous tissue and muscle in the shoulder and withers, have been observed in some cattle dying of the disease.

## Samples for Confirmation of Diagnosis

- Bacteriology: Liver in air-tight container; four impression smears from periphery of lesion (anaerobic culture, FAT)
- Histology: Fixed liver

## DIFFERENTIAL DIAGNOSIS

- **Acute fasciolosis** in sheep can cause heavy mortality caused by massive liver destruction at the same time and under the same conditions as does black disease.
- **Other clostridial disease** includes blackleg and malignant edema.
- **Anthrax**

## TREATMENT

No effective treatment is available. Although *C. novyi* is susceptible to penicillin, in sheep parenteral treatment with antimicrobials generally comes too late once clinical signs are apparent because of the peracute course of the disease. In cattle and horses, the longer course of the disease suggests the possibility of controlling the clostridial infection by the parenteral use of penicillin or broad-spectrum antibiotics, but reported cases have high case fatality.

## TREATMENT AND CONTROL

### Treatment

Penicillin G sodium/potassium (40,000 IU/kg IV every 6–8 h) (R-2)

### Control

*Clostridium novyi* type B  $\alpha$ -toxoid vaccine (R-2)

IV, intravenously.

## CONTROL

**Vaccination** with an alum-precipitated toxoid is highly effective and can be performed during the course of an outbreak. The mortality begins to subside within 2 weeks. On an affected farm the initial vaccination is followed by a second vaccination 4 to 6 weeks later and subsequently by annual vaccinations. To provide maximum immunity at the time when the disease is most likely to occur, vaccination as a prophylactic measure should be performed in early summer.

Control of the disease should also be attempted by **control of the liver fluke**. The host snail must be destroyed in streams and marshes by the use of a molluscicide and the flukes eliminated from the sheep by treatment with flukicides. Pasture contamination from cadavers should be minimized by burning the carcasses.

## FURTHER READING

- Hatheway CL. Toxigenic clostridia. *Clin Microbiol Rev.* 1990;3:66-98.
- Lewis C. Aspects of clostridial disease in sheep. *In Pract.* 1998;20:494-500.
- Sewell MMH. Infectious necrotic hepatitis. *Vet Annu.* 1975;15:79-82.
- Songer JG. Clostridial diseases of animals. In: Rood JI, McClane BA, Songer JG, Titball RW, eds. *The Clostridia: Molecular biology and pathogenesis*. London: Academic Press; 1997:153-182.
- Songer JG. Clostridial diseases of small ruminants. *Vet Res.* 1998;29:219-232.

## Clostridium novyi Infection

*C. novyi* type B infection in finishing pigs and sows causes unexplained sudden death.

## ETIOLOGY

The cause is *C. novyi* type B, although recently, type A has also been found in some

cases. It is a large *Clostridium* with oval, central, or subterminal spores and is a fastidious anaerobe that is difficult to cultivate and sometimes may be mistaken for *Bacillus anthracis*. The toxic factor may be the  $\alpha$ -toxin.

### PATHOGENESIS AND EPIDEMIOLOGY

Very little is known about either, but the former may be related to stress causing a reduction of liver oxygenation facilitating clostridial invasion.

### CLINICAL SIGNS

Usually you discover this condition at sudden death. An outbreak in two Iberian sows has recently been described.<sup>1</sup>

### PATHOLOGY

The characteristic pathologic finding is rapid decomposition of the carcass. The subject is usually a well-conditioned pig. They may show submandibular swelling, pulmonary edema, and tracheal froth. Fluid exudation in the pericardium, pleural sacs, and peritoneum are also a relatively common finding and the exudation may be bloodstained. A specific finding is the presence of large numbers of frothy gas-filled spaces.

### DIAGNOSIS

Accurate diagnosis depends on the recognition of sudden death in well-fed pigs, and the classic postmortem findings. Confirmation is by culture of the organism on egg yolk agar under anaerobic conditions, the use of fluorescent antibody techniques, and PCR tests.

### TREATMENT

Rarely is there time to see the condition clinically.

### PREVENTION

Prevention may involve feeding bacitracin zinc at 225 to 260 g/tonne of feed.

The use of clostridial vaccines for sheep has been helpful when the condition has become endemic, and *C. oedematiens* Type B vaccine has also proved useful.

### REFERENCE

1. Garcia A, et al. *J Swine Health Prod.* 2009;17:264.

### ETIOLOGY

The disease appears to be associated with infection by "Theiler's disease-associated virus" (TDAV), a recently recognized virus in the *Pegivirus* genus of Flaviviridae.<sup>1</sup> The virus is capable of parenteral transmission and infection can be subclinical.<sup>1</sup> Infection can be chronic, persisting for over a year in some clinically normal horses. Infection of horses with another pegivirus (equine pegivirus [EPgV]) causes persistent viremia usually, but not invariably, without apparent clinical signs.<sup>2,3</sup> Given the frequency of viremia in healthy horses, the importance of detection of EPgV RNA in horses with signs of liver disease is unclear. Approximately 50% of 326 horses sampled, some which had evidence of liver disease, had antibodies to EPgV, although the frequency with which antibodies, or RNA, were detected in healthy and ill horses did not differ.<sup>3</sup>

Horses have recently been demonstrated to be infected with viruses, named Nonprimate hepacivirus (NPHV), from the closely related hepacivirus group (which included human hepatitis C virus).<sup>4</sup> The clinical importance of infection by this virus, if any, is unclear, although it appears to be minimal despite approximately 50% of horses having serum antibodies to the virus.<sup>3</sup> Antibodies, RNA of NPHV, or EPgV were not detected in 100 donkeys sampled.<sup>3</sup> One of 113 dogs sampled had antibodies to NPHV and that dog was from a stable with a viremic horse, although any causal connection was not established.<sup>3</sup>

There is evidence of infection of horses by human hepatitis E virus (HEV) in China and Egypt, but the clinical or human public health aspects of this observation are uncertain.<sup>5,6</sup>

### EPIDEMIOLOGY

Hepatitis occurs in horses administered equine serum or tissue products. The first reports of the disease were in 1919 in horses in South Africa administered equine serum as prophylaxis for Africa horse sickness. Outbreaks of the disease have occurred in horses in Africa, Europe, and North America administered equine serum as prophylaxis for a variety of diseases including African horse sickness, encephalomyelitis, botulism, *Streptococcus equi* infection, tetanus, and influenza, and in mares given pregnant mare serum. Most sporadic cases of the disease appear to be associated with administration of tetanus antitoxin.

Administration of equine antitoxin positive for TDAV to 17 horses resulted in clinically overt disease in two horses and biochemical evidence of liver damage in eight horses.<sup>1</sup> Fifteen of the 17 horses had TDAV detected in blood by quantitative reverse transcriptase (qRT)-PCR, and the virus was detected in blood samples from the antitoxin donor horse. Horses from the same farm as the affected horses that were not administered the incriminated antitoxin did

not have evidence of liver disease, and TDAV also was not isolated from them.<sup>1</sup> Of the 17 horses administered contaminated antitoxin, 16 were sampled 1 year later. Of these, 4 were positive for TDAV, whereas the remaining 12, including the 2 horses that had clinical disease soon after administration of antitoxin, did not have detectable virus in their blood.

Experimental inoculation of four horses revealed diversity of viral dynamics among the horses, with most horses having high viral loads 4 weeks after inoculation, with persistence of detectable virus for at least 14 weeks in one horse and 10 weeks (the latest time point examined) in three horses.

The disease is reported only from adult horses (>1 year of age), and most cases are reported in the summer and autumn. There is a suspicion that pregnant mares are at increased risk.

The **morbidity rate** in outbreaks among horses administered equine serum ranges between 2% and 18%, although the rate among horses administered tetanus antitoxin as prophylaxis following injuries is clearly much lower. Acute hepatitis developed in 4 (0.4%) of 1260 horses >1 year of age administered commercial equine plasma at one institution in the United States over a 6-year period. The disease can occur after intrauterine infusion of equine serum to mares.

The **case-fatality rate** is between 50% and 90%.

The disease occurs sporadically in horses that have not been administered equine biological products. There are reports of in-contact, nontreated horses developing the disease, but such transmission, if indeed it occurs, is inefficient and uncommon.<sup>1</sup>

### PATHOGENESIS

Experimental induction of the disease by administration of serum from TDAV-positive horses reveals viremia that precedes biochemical evidence of liver damage and/or clinical disease by several weeks.<sup>1</sup> Destruction of hepatocytes results in hepatic dysfunction. Hepatoencephalopathy develops in severely affected horses.

### CLINICAL FINDINGS

The disease usually occurs after an **incubation period** of 40 to 70 days (range 27–165 days). Depression, anorexia, and icterus are evident in mildly affected cases. There can be mild to moderate colic. Body temperature and heart rate are usually normal. Acutely affected, or horses observed infrequently, can die unexpectedly. Signs of **hepatoencephalopathy** include restlessness, excitement, compulsive walking and head pressing, abnormal head position, seizures, apparent blindness, muscle tremors, and ataxia. Affected horses often injure themselves by walking into fences and troughs.

## Diseases Characterized by Systemic Involvement

### ACUTE HEPATITIS (POSTVACCINAL HEPATITIS) OF HORSES (THEILER'S DISEASE, SERUM HEPATITIS)

Acute hepatitis is an acute hepatopathy of horses associated with administration of equine biological products such as tetanus antitoxin.



## CLINICAL PATHOLOGY

Leukocytosis with neutrophilia and mild lymphocytopenia is common. The hematocrit and plasma total protein concentrations may be mildly increased. Hyperbilirubinemia and an increase in direct (conjugated) bilirubin concentration are present and serum bile acid concentration is increased, as is serum activity of liver-specific enzymes AST, GGT, and SDH. Increases in serum GGT activity is often less than expected for the increases in serum AST, SDH, and bile acid concentrations, likely reflecting the primary insult to hepatocytes.

Hypoglycemia (<2 mmol/L, 40 mg/dL) and hyperammonemia (>150 μmol/L) may be severe. Clotting time, especially the one-stage prothrombin time, can be prolonged.

A qRT-PCR test is available to identify virus genome in blood or plasma.<sup>1</sup>

## NECROPSY FINDINGS

The liver may be enlarged, normal, or shrunken and discolored slightly yellow to green. There is severe centrilobular necrosis of hepatocytes with mild infiltration of lymphocytes and plasma cells. Alzheimer type II astrocytes are present in the brains of horses with encephalopathy.

### DIFFERENTIAL DIAGNOSIS

Diagnostic confirmation antemortem is achieved by examination of a liver biopsy, although this should be performed with caution in animals with coagulation abnormalities.

Differential diagnosis list:

- Acute aflatoxicosis
- Rubratoxicosis (*Penicillin rubrum*)
- Pyrrolizidine alkaloid intoxication
- Dioxin intoxication
- Idiopathic hyperammonemia
  - Fluphenazine toxicosis<sup>7</sup>
  - Congenital abnormalities (Gilbert's syndrome)<sup>8</sup>

## TREATMENT

Treatment is essentially supportive and consists of correction of metabolic and acid-base abnormalities, reduction of plasma ammonia concentration, and preventing horses with hepatoencephalopathy from injuring themselves.

Hypoglycemia and dehydration can be corrected by intravenous administration of 5% dextrose and isotonic electrolyte solutions. Metabolic acidosis can be corrected by infusion of sodium bicarbonate. Plasma transfusions might be necessary to correct coagulation abnormalities.

Hyperammonemia can be treated by giving neomycin (20 mg/kg, orally, every 6 hours for four doses) or lactulose (0.25 mL/kg, orally every 8 hours) to decrease absorption of ammonia from the gastrointestinal tract.

**Sedation** with xylazine or similar compounds may be necessary to prevent the animal from injuring itself. The affected horse should be housed in an area where it has the least opportunity to injure itself and might need to be fitted with a padded helmet.

## CONTROL

Minimal use of biologics, including plasma, of equine origin is prudent.

## REFERENCES

1. Chandriani S, et al. *Proc Natl Acad Sci*. 2013;110:E1407.
2. Kapoor A, et al. *J Virol*. 2013;87:7185.
3. Lyons S, et al. *J Gen Virol*. 2014;95:1701.
4. Lyons S, et al. *Emerg Infect Dis*. 2012;18:1976.
5. Saad MD, et al. *Infect Genet Evol*. 2007;7:368.
6. Zhang W, et al. *Zoonoses Pub Hlth*. 2008;55:291.
7. Rodriguez-Palacios A, et al. *J Vet Intern Med*. 2007;21:336.
8. Schusser GF, et al. *Tierarztl Prax Ausgabe G N*. 2007;35:75.

## Hepatitis E Virus (HEV)

HEV is the cause of acute hepatitis in humans, causing 1% to 4% mortality in the normal population but 25% in pregnant women. It therefore can be considered a serious public health risk. It is also a serious risk in immuno-compromised patients.<sup>1-3</sup> It is possible but not yet proven that the pig may act as a reservoir for infection.<sup>4,5</sup> There is a high prevalence in pig liver. Although the consumption of pig meat by humans is quite high, the consumption of pig liver is generally much lower, which may explain the low prevalence in humans.<sup>5,8</sup> The consumption of raw pig liver sausage is considered a risk.<sup>6</sup> The consumption of certain pork products may also be a source of exposure. Those people who have a high occupational contact with swine and swine excrement, such as veterinarians, farmers, and slaughterhouse workers, have a high seroprevalence. Swine farm workers in one study in Japan had a 16.7% prevalence.<sup>7</sup> Pig farmers in Inner Mongolia are frequently infected with a markedly divergent genotype 4 virus.<sup>8</sup> It has also been found in deer.

## ETIOLOGY

The virus is a small nonenveloped single-stranded positive sense RNA virus. It is the sole member of the genus *Herpesvirus* in the family Herpesviridae. There are considered to be four genotypes; genotypes 1 and 2 are found in humans.<sup>9</sup> Human HEV 1 is particularly common in Asia and Africa<sup>10</sup> and HEV 2 in Mexico and Western Africa. Types 3 and 4 are found in both pigs and humans and thus considered potentially zoonotic. The seroprevalence has increased<sup>11</sup> recently, but this may be lower than in previous decades.<sup>12,13</sup> Isolates of human and porcine HEVs are phylogenetically closely related with nucleotide sequences, sometimes up to

100% similar.<sup>1</sup> In one study the prevalence in the pigs and humans was similar.<sup>1</sup> Recently, novel herpesvirus was identified in Japanese wild boars.<sup>14</sup>

## EPIDEMIOLOGY

HEV has been widespread in Spain since 1985.<sup>15</sup> A high prevalence of HEV and HEV-specific antibodies in pigs has been observed in a number of European countries<sup>16</sup> and in Portugal,<sup>17</sup> Denmark,<sup>18</sup> Italy,<sup>19</sup> Spain,<sup>20</sup> England,<sup>21,22</sup> France,<sup>23,24</sup> and Switzerland.<sup>25</sup> Generally, these results revealed a high farm prevalence of HEV and infected livers on the farms, although there is considerable variation among farms, suggesting the existence of specific on-farm factors.

Pigs shed the virus for 10 days on average in experimental infections of specific pathogen-free pigs but for much longer in natural infections.<sup>5,26</sup>

Although no evidence was found in Italy for porcine circovirus type 2 (PCV2)/HEV infections,<sup>27</sup> there was in Spain,<sup>28</sup> especially in pigs with hepatitis lesions.

Many human infections arise with HEV type 3, which is found in a variety of species including the wild boar and domestic pigs.<sup>29-33</sup> In Asia and Belgium, HEV 4 is found in domestic pigs and wild boars.<sup>34,35</sup>

Recent studies in Europe suggest that type 3 is the most common,<sup>2</sup> and certainly this was found to be true in a recent Danish study.<sup>3</sup> In another Danish study, 49.5% of the pigs were seropositive,<sup>18</sup> which was much higher than the Spanish studies (17.4%). This is similar to levels found in the United States and Italy.<sup>36</sup> In Germany, the seroprevalence ranged from 34.9% to 60%.<sup>37</sup>

A recent study has shown that the seroprevalence of HEV depends on the pig's age and herd origin.

The seroprevalence results also still depend on the test assay used.<sup>38</sup> In Portugal, the prevalence varies from 10% to 30%.<sup>17</sup> Studies in the Netherlands showed an increase in prevalence from 22% in 1999 to 55% in 2006.<sup>39,48</sup> In France, a high prevalence on the farm of 65% and 31% of slaughter pigs had antibodies all of genotype 3,<sup>24</sup> and the same genotype was found in Czechoslovakia.<sup>40</sup> In Italy, HEV is widespread and might be endemic on most farms (one study revealed 97% of farms were affected and 50% of the pigs).<sup>41</sup>

Genotypes 3 and 4 are found in a wide variety of countries, including the United States, Europe, Argentina, Japan, and Australasia. Genotype 4 is mainly Asian (Japan, China, India, and Indonesia).

Transmission is largely oral-fecal through infected water, and it seems it is particularly associated with heavy rain and flooding in unhygienic conditions.<sup>4</sup>

It has also been found in wild boar in Japan<sup>5</sup> and Sweden where there was found to be a close association between the prevalence in the domestic population and wild boar in

the same county.<sup>42</sup> Types 3 and 4 have also been found in swine livers in Japan.<sup>43</sup>

It has been transmitted through the consumption of uncooked or undercooked pork and viscera.<sup>67</sup> Pork liver sausage in France (Figatelli) seems particularly suspect.<sup>17</sup> It has been found in livers purchased from grocery stores in the Netherlands, the United States, and Japan,<sup>44,45</sup> and some of the livers were found to have infective virus.

The virus has also been found in the liver of aborted fetuses and in fecal and serum samples of their mothers. The results suggested that the piglets were infected by transplacental spread.<sup>46</sup>

Pork consumption and HEV positivity have been suggested,<sup>35</sup> but the source of infection often remains unknown,<sup>4</sup> and is not consistently related, but in many cases it is.

Direct contact and environmental contaminations are responsible for HEV transmission in pigs.<sup>47</sup> Domestic pigs are considered the main reservoir for human HEV. Direct transmission from infected to naive pigs is responsible for most of the transmission and for persistence of the infection within a population. The quantity of the virus in the environment was found to play an essential role in the transmission process. Direct and within-pen environmental transmissions were essential components to explain the transmission process. Environmental transmission between pens remained a rare event. HEV propagation within a pig population is therefore highly dependent on pig management and hygiene procedures.

In a study of healthy people directly exposed or unexposed to pigs, a cross-sectional study HEV infection in a rural community in Thailand was described.<sup>48</sup> The prevalence of antibodies was 23%. The presence of frequent hand washing was associated with a lower prevalence. Humans living in an area with frequent flooding or regularly eating internal pig organs more than twice a week are found to be associated with a higher seroprevalence of antibodies. There was no association with direct occupational pig contact.

In a study in Serbia<sup>49</sup> in pigs referred to a clinic 29/50 livers (58%) had mild to moderate hepatitis, 37/50 (74%) had PCR-positive titers for transfusion-transmitted viruses (TTVs), 28/50 (56%) had PCR positives for PCV2, and 13/50 (26%) had an RT-PCR for HEV. There was an association between TTVs and infectious hepatitis of pigs in concomitant infections with PCV2 and HEV.

## PATHOGENESIS

It is thought most pigs become infected early on in life between 8 and 12 weeks, have a transient viremia for 1 to 2 weeks, and shed virus for about 3 to 7 weeks. In a Spanish study of viremia it was found in 7% of the pigs at 1 week of age and decreased to 2% at 6 weeks before rising again at 9 weeks.<sup>5</sup> In a

Canadian study, HEV prevalence in fecal samples increased from 11.8% at 2 weeks to 52.9% at 8 weeks of age.<sup>50</sup> Most nursery and finishing pigs are positive. At slaughter most pigs are not shedding virus in the feces and have detectable IgG levels in the serum. However, 6% and 12% of livers may have virus in the liver at slaughter. In a study in Yorkshire in the UK, 9% of the pigs were excreting HEV in the slaughterhouse.<sup>51</sup>

Experimentally infected pigs can shed the virus for several weeks.<sup>43</sup> Pigs orally inoculated with swine HEV were able to infect by contact sentinel pigs.<sup>15</sup>

## CLINICAL SIGNS

Infection in pigs is nearly always asymptomatic, but occasionally pigs may show evidence of hepatitis. Occasionally they will also abort.

## PATHOLOGY

There are no gross lesions in the pig. Histologically, there may be mild to moderate hepatitis.<sup>52</sup> This is characterized by mild to moderate multifocal and periportal lymphoplasmacytic hepatitis with mild focal hepatic cell necrosis.

## DIAGNOSIS

Diagnosis relies entirely on laboratory tests. A nested RT-PCR was developed in Korea.<sup>53</sup> A home-produced IgG ELISA has high specificity and sensitivity and was found to be comparable with commercial kits,<sup>42</sup> and an RT-loop-mediated isothermal amplification has also been developed.<sup>54</sup>

An immunofluorescence technique for tissues has been described.<sup>53</sup> A new technique is the development of fluorescent microbead immunoassay (FMIA) for the detection of HEV IgG antibodies. It was compared with an ELISA and both were found to be 100% specific, but the FMIA had a higher sensitivity of 92.3% compared with 84.6% for the ELISA.<sup>55</sup>

A recent study of handling and storage conditions and stabilizing agents on the recovery of viral RNA from oral fluid of pigs<sup>56</sup> has shown that it is not necessary to stabilize oral fluid from swine for the detection of viral RNA provided the samples are stored at 4°C or frozen at -20°C.

## TREATMENT AND CONTROL

No treatment of pigs is necessary. Most pigs are probably protected by maternal antibody. General biosecurity measures and cleaning, disinfection, and drying will reduce the level of contaminated feces.

## REFERENCES

- Gerolami R, et al. *N Engl J Med*. 2008;358:859.
- Kamar N, et al. *N Engl J Med*. 2008;358:811.
- Bihl F, Negro FJ. *Hepatology*. 2009;50:435.
- Pavio N, et al. *Virologie*. 2006;10:341.
- De Deus N, et al. *Vet Microbiol*. 2008;132:19.
- Colson P, et al. *J Infect Dis*. 2010;202:825.
- Utsumi T, et al. *Arch Virol*. 2011;156:689.

- Jinshan Y, et al. *Arch Virol*. 2010;155:1217.
- Xiao X, et al. *Arch Virol*. 2011;156:121.
- Aggarwal R. *J Gastroenterol Hepatol*. 2011;26 (suppl 1):72.
- Faber MS, et al. *Emerg Infect Dis*. 2012;18:1654.
- Christensen PB, et al. *Clin Infect Dis*. 2008;47:1026.
- Ijaz S, et al. *J Clin Virol*. 2009;44:272.
- Takahashi M, et al. *J Gen Virol*. 2011;92:902.
- Casas M, et al. *Vet Microbiol*. 2009;138:78.
- Berto A, et al. *BMC Res Notes*. 2012;5:190.
- Berto A, et al. *Zoonoses Pub Hlth*. 2012;59:477.
- Breum SO, et al. *Vet Microbiol*. 2010;146:144.
- Di Bartoli I, et al. *Vet Microbiol*. 2011;149:330.
- Jimenez de Oya N, et al. *BMC Res Notes*. 2011;4:412.
- Meader E, et al. *Zoonoses Pub Hlth*. 2010;57:504.
- Seminati C, et al. *Vet J*. 2008;175:130.
- Kaba M, et al. *J Med Microbiol*. 2009;81:1750.
- Rose N, et al. *Comp Immunol Microbiol Infect Dis*. 2011;34:419.
- Wachek S, et al. *J Food Protect*. 2012;75:1483.
- Kanai Y, et al. *J Med Virol*. 2011;82:69.
- Martelli F, et al. *Res Vet Sci*. 2010;88:361.
- De Deus N, et al. *Vet Microbiol*. 2007;119:105.
- Adlhoeh C, et al. *Vox Sang*. 2009;97:303.
- Brost S, et al. *J Clin Virol*. 2010;47:89.
- Frickmann H, et al. *J Clin Virol*. 2011;51:93.
- Pfeifferle S, et al. *Infection*. 2012;40:451.
- Preiss JC, et al. *Infection*. 2006;34:173.
- Hakze-van der Honing RW, et al. *PLoS ONE*. 2011;6:e22673.
- Meng XJ. *Virus Res*. 2011;161:23.
- Fernandez-Barredo S, et al. *Can J Vet Res*. 2007;71:236.
- Dremsk P, et al. *J Virol Methods*. 2013;190:11.
- Krumbholz A, et al. *Vet Microbiol*. 2013;167:394.
- Rutjes SA, et al. *Emerg Infect Dis*. 2009;15:381.
- Vasickova P, et al. *Res Vet Sci*. 2009;87:143.
- Martinelli N, et al. *Infect Ecol Epidemiol*. 2011;1:e7331.
- Widen F, et al. *Epidemiol Infect*. 2011;139:361.
- Ishida S, et al. *Arch Virol*. 2012;157:2363.
- Bouwknegt M, et al. *Vet Res*. 2008;39:40.
- Feagins AR, et al. *J Gen Virol*. 2007;88:912.
- Hosmilla M, et al. *Arch Virol*. 2010;155:1157.
- Andraud M, et al. *Vet Res*. 2013;44:102.
- Hinjoy S, et al. *Zoonoses Pub Hlth*. 2013;60:555.
- Savic B, et al. *Vet Res Commun*. 2010;34:641.
- Leblanc D, et al. *Int J Food Microbiol*. 2007;117:160.
- McCreary C, et al. *Vet Rec*. 2010;163:261.
- Dos Santos DR, et al. *Vet J*. 2010;186:135.
- Lee W-J, et al. *Arch Virol*. 2009;154:1361.
- Zhang L-Q, et al. *Arch Virol*. 2012;157:2383.
- Owolodun OA, et al. *J Virol Methods*. 2013;193:278.
- Jones TH, Muehlhauser V. *J Virol Methods*. 2014;198:26.

## Hepatic Diseases Associated With Trematodes

### FASCIOLIOSIS (LIVER FLUKE DISEASE)

#### SYNOPSIS

**Etiology** *Fasciola hepatica* and, in warmer climates, *F. gigantica*

**Epidemiology** Infection by ingestion of metacercariae on herbage; geographic

Continued

distribution, seasonality, and disease risk determined by occurrence of intermediate hosts (lymnaeid mud snails)

#### Signs

**Acute syndrome (sheep):** Sudden death

**Chronic syndrome (sheep and cattle):**

Weight loss, reduced milk yield, pallor, and submandibular edema

#### Clinical pathology

**Acute syndrome:** Raised serum glutamate dehydrogenase concentrations, anemia

**Chronic syndrome:** Characteristic eggs in feces, anemia, hypoalbuminemia, raised serum, and  $\gamma$ -glutamyl transpeptidase concentrations

#### Lesions

**Acute syndrome:** Pale friable liver with parasitic tracts and hemorrhage

**Chronic syndrome:** Fibrous liver, bile ducts grossly distended and thickened

#### Diagnostic confirmation

**Acute syndrome:** Immature flukes in liver parenchyma at necropsy

**Chronic syndrome:** Characteristic eggs in feces and immunoassay of blood, milk, or feces

#### Treatment

Triclabendazole, clorsulon, closantel, netobimin, nitroxylin, oxyclozanide, and albendazole; not all are equally effective against all stages of fluke development

#### Control

Avoidance or drainage of snail habitats; strategic anthelmintic dosing programs

## ETIOLOGY

*Fasciola hepatica* is the most common and important liver fluke and has a cosmopolitan distribution in cooler climates. Lymnaeid mud snails are intermediate hosts and release the infective form, the metacercaria, onto herbage. Hepatic fasciolosis is mainly of economic importance in sheep or cattle, but other species may provide a reservoir of infection. *F. hepatica* may infest all domestic animals, including Equidae and many wild-life species, but chronically infected sheep are the most important source of pasture contamination. Human cases are usually associated with the ingestion of marsh plants such as watercress. A similar but larger fluke, *F. gigantica*, is restricted to warmer regions including parts of Africa and Asia.

## LIFE CYCLE

Adult *Fasciola* live in bile ducts producing eggs that are excreted with the feces. Hatching occurs in moist conditions only after the first larval stage, the miracidium, has formed and when ambient temperatures rise above 5°C to 6°C (41–43°F). Miracidia must find and invade the tissues of a suitable host snail within 24 to 30 hours. After several cycles of asexual multiplication, the flukes leave the snail as cercariae. These attach to herbage and

transform into metacercariae by secreting a tough protective cyst wall. After ingestion by the final host, each metacercaria releases an immature fluke that crosses the intestinal wall and migrates across the peritoneal cavity to the liver. The migration is sometimes misdirected and ectopic flukes can be found in the lungs, particularly in cattle. The young *F. hepatica* migrate through the hepatic parenchyma for about 4 to 5 weeks, growing from 0.1 to 10 mm. After entering the bile ducts, they more than double in size before egg laying starts at about 10 to 12 weeks after infestation. Adult sheep and cattle may remain carriers for many years because of the longevity of the adult flukes.

## EPIDEMIOLOGY

The risk of hepatic fasciolosis is determined by the numbers of infected lymnaeid snails in the grazing area. The disease has a predictable seasonal pattern in regions where snails are active for only part of the year. Some lymnaeid snails have a more aquatic habit than others, but all are restricted to damp or wet environments. Generally, they prefer nonacidic low-lying swampy areas with slow-moving water, but land with small streams, springs, blocked drainage, or spillages from, for example, water troughs may also be potentially hazardous for grazing stock. Land frequently irrigated is also highly suitable for infection to take place. Snails burrow into the soil to survive dry periods and release cercariae when free water is present. Snail habitats may be permanent or temporary. The latter expand and contract depending on water availability. Construction works, such as road building, may alter drainage patterns and disease risk. Improvement of peaty pastures by lime application may increase risk by reducing soil acidity and allowing snail colonization.

**Important host snails** for *F. hepatica* include *Lymnaea truncatula* in the UK and Europe and *Stagnicola bulimoides*, *Stagnicola bulimoides techella*, and others in the United States. *L. columella* has been identified as an intermediate host in Canada and more recently in Brazil. In New Zealand, *L. tomentosa* and *L. truncatula* have occurred without fasciolosis becoming a major problem, but the introduction of *L. columella* markedly increased the range and severity of the disease. *L. tomentosa* is the major host snail in Australia, although *L. columella* has been reported to be present in nonfarming areas, and *L. viridis* has also been found.

**The main factors** determining the timing and severity of hepatic fasciolosis are those that influence the number of metacercariae accumulating on herbage. In particular, temperature and rainfall affect both the spatial and temporal abundance of snail hosts and the rate of development of fluke eggs and larvae.<sup>1-3</sup> Temperatures above 10°C (50°F) are necessary before the snail hosts will breed or before *F. hepatica* can develop within the

snail. Therefore no development takes place during the winter in most countries.

**The “summer infection of the snail”** by miracidia hatching from eggs in spring and early summer results in the emergence of cercariae and the consequent contamination of herbage some 5 to 8 weeks later.<sup>4</sup> For any climatic region, cercarial shedding is a fairly regular occurrence with minor differences in timing determined by year-to-year variations in weather patterns.

**The “winter infection of the snail”** is a separate cycle occurring when snails are exposed to miracidia in the autumn. Fluke development ceases in the snail during winter but resumes as temperatures rise the following spring. The relative importance of this cycle depends on the mortality rate of the snails during the winter, which varies from region to region and from year to year.

The availability of metacercariae is generally greatest in the late summer and autumn.<sup>5</sup> Massive numbers can accumulate in wetter parts of the British Isles and Europe.<sup>4,6</sup> Metacercariae may overwinter in milder climates to infect stock in spring, but they do not survive under severe winter conditions. In hot, dry regions, metacercariae die quickly, so in Australia, for example, infections are usually caused by a recent release of cercariae. Stock are also vulnerable in dry conditions if forced to feed in swampy areas to obtain green feed. Metacercariae are normally killed during the preparation of hay or silage, but can remain infective for up to 8 months if hay is harvested in moist conditions and not properly dried.

The clinical outcome of infection depends largely on the density of metacercariae on the herbage. This will be greatest when weather conditions have been favorable for snail reproduction and survival. A high intake of metacercariae over a short time will produce acute disease; lower numbers over a longer period lead to chronic disease. The degree to which immunity influences the course of infection differs with species. Sheep and goats do not develop a strong protective immune response to *F. hepatica* and remain vulnerable throughout their lives. Cattle eventually expel most but not all of their fluke burden and gain partial but not complete protection against reinfection. *F. hepatica* has a number of survival mechanisms for evading host immune responses, including changing its surface antigen during migration, releasing a proteolytic enzyme that can cleave immunoglobulins, and modulating the host immune response.

## PATHOGENESIS

Acute hepatic fasciolosis is caused by the passage of young *F. hepatica* through the liver parenchyma. Clinical signs occur 5 to 6 weeks after the ingestion of large numbers of metacercariae. By this time, the migrating flukes are large enough to do substantial



mechanical damage to the liver. Acute hepatic insufficiency and hemorrhage result.

**Quiescent spores** of *C. novyi* may become activated by the anaerobic necrotic conditions created in the liver parenchyma by migrating *F. hepatica*, causing infectious necrotic hepatitis (“black disease”) in sheep and cattle. This migration has also been thought to stimulate the development of occasional cases of bacillary hemoglobinuria in cattle.

**Chronic hepatic fasciolosis** develops only after the adult flukes are established in the bile ducts. Here they cause cholangitis, biliary obstruction, fibrosis, and a leakage of plasma protein across the epithelium. Although this protein can be reabsorbed in the intestine, there is poor utilization and retention of nitrogen leading to hypoalbuminemia. There is also a loss of whole blood caused by the feeding activities of the flukes. This exacerbates the hypoalbuminemia and eventually gives rise to anemia. It places a continuous drain on iron reserves so that the anemia, which is initially normochromic, becomes hypochromic. These changes are more severe in sheep on a low plane of nutrition. Chronic infection may limit growth rate and feed conversion in growing heifers and growth rate in beef cattle. *F. hepatica* infection has been reported to increase the susceptibility of cattle to Salmonella Dublin and predispose to prolonged infection and fecal excretion. Infected ewes may have reduced fertility, growth rate, and wool production.<sup>7</sup> Food intake is reduced and this leads to a reduction in efficiency of utilization of metabolizable energy and a reduction in calcium and protein deposition in the carcass.

**The fibrotic response** of the liver to fluke-induced damage varies with the host and may partially account for differing species susceptibilities. The severe reaction in cattle, which includes calcification of the bile ducts, appears to hinder the establishment and feeding of challenge infections, reinforcing immune responses. Both horses and pigs are generally highly resistant to infection with *F. hepatica* but differ in their mode of resistance. Horses overcome the migrating fluke at an early stage so that few reach the liver, whereas in the pig the resistance mechanism operates in the liver parenchyma.

## CLINICAL FINDINGS

### Acute Fasciolosis

Acute fasciolosis in sheep most often occurs as sudden death without other apparent clinical abnormality. It is usually seen in the summer and autumn but may occur at any time when sheep have the opportunity to graze heavily contaminated herbage. If the disease is observed clinically in sheep it is manifested by the following:

- Dullness
- Weakness
- Lack of appetite

- Pallor and edema of mucosae and conjunctivae
- Pain when pressure is exerted over the area of the liver. Death occurs quickly and may be accompanied by the passage of bloodstained discharges from the nostrils and anus. Outbreaks are usually of relatively short duration; most deaths occur within a period of 2 to 3 weeks. Acute fasciolosis rarely occurs in cattle.

### Subacute Fasciolosis

Acute and chronic fasciolosis are opposite ends of the clinical spectrum. Intermediate forms occur, and a subacute syndrome has been described in sheep. The major clinical signs are weight loss and pallor of the mucous membranes. Submandibular edema will be seen in only a few cases, but many animals will resent palpation over the region of the liver.

### Chronic Fasciolosis

Chronic fasciolosis does not become apparent until several weeks after the danger of acute disease has receded. Affected sheep lose weight and develop submandibular edema (bottle jaw) and pallor of the mucosae over a period of weeks. Shedding of the wool may occur. The course of the disease is often as long as 2 to 3 months in those that die; many survive but may remain in poor condition for longer periods. Cattle also lose weight, especially if lactating; milk production falls; and anemia may develop.

## CLINICAL PATHOLOGY

In acute fasciolosis there is a severe normochromic anemia, eosinophilia, and a severe hypoalbuminemia. Blood concentrations of a number of serum enzymes indicating liver damage are elevated. GDH is of particular value when the young flukes are migrating through the liver parenchyma, but concentrations fall after they enter the bile ducts. Increases in AST can be measured from 4 weeks and are useful as a measure of immature infection. Eggs will not be present in the feces because the flukes are still juvenile.

In subacute and chronic disease weight loss is associated with a severe hypochromic, macrocytic anemia, hypoalbuminemia, and hyperglobulinemia. Submandibular edema and ascites occur only occasionally in the subacute condition but more frequently in the chronic disease. Serum  $\gamma$ -glutamyl transpeptidase concentrations are raised by the activities of adult *F. hepatica* in the bile ducts. Other liver function tests are not significantly affected. A diagnosis of chronic hepatic fasciolosis can be confirmed by the detection of large numbers of characteristic, operculated fluke eggs in the feces. These eggs are thin walled and stained yellow-brown by biliary pigments. They are dense and do not rise satisfactorily in all flotation solutions. Zinc sulfate solution (specific

gravity 1.36) is recommended. Sedimentation tests are more accurate. Operculated fluke eggs are also characteristic of paramphistome infections, and care is needed to differentiate the two.

## NECROPSY FINDINGS

### Acute Hepatic Fasciolosis

Acute hepatic fasciolosis is characterized by a badly damaged, swollen liver. The peritoneal cavity may contain an excess of bloodstained serum. The liver capsule has many small perforations and subcapsular hemorrhages. The parenchyma shows tracts of damaged tissue and is more friable than normal. The immature flukes are often so small that they are not readily discernible. They are most easily demonstrated by slicing a piece of liver thinly and shaking in water, permitting the flukes to settle to the bottom. The size of the flukes may allow estimation of the duration of the infection and this may help to determine which pastures are hazardous.

### Chronic Hepatic Fasciolosis

Leaf-like flukes, measuring about  $3.5 \times 1$  cm, are present in grossly enlarged and thickened bile ducts, particularly in the ventral lobe of the liver. The bile ducts may protrude above the surface of the liver, and cysts may be present because of blockage of ducts with flukes and desquamated epithelial cells. Calcification of the bile duct walls is a common finding in cattle but not in sheep. The hepatic parenchyma is extensively fibrosed, and the hepatic lymph nodes are dark brown in color. Anemia, edema, and emaciation are attendant abnormalities.

## DIAGNOSTIC CONFIRMATION

In fluke-endemic areas, fasciolosis must be considered as a possible factor in any outbreak of chronic ill health in sheep, either as the main cause or as a contributory factor along with other debilitating disease processes. To support a diagnosis, grazing history and the seasonality of fasciolosis in that locality should be taken into account. There should be fluke eggs in the feces and characteristic hepatic lesions at necropsy. As these may be ubiquitous findings in endemic areas, a judgment is necessary to determine whether the severity of the lesions is sufficient to incriminate the fluke as the sole or major contributing etiologic factor. ELISAs are available for use with blood or milk and are particularly useful for the diagnosis of infection in cattle on an individual or herd basis.<sup>8,9</sup> A rise in antibody can be detected by 2 weeks after infection and keeps rising until week 6. A commercially available coproantigen ELISA (BIOK 201, Bio-X Diagnostics, Belgium) has been developed for use in cattle<sup>7,9-12</sup> that has the ability to indicate the intensity of fluke infestations in cattle.<sup>9,10</sup> Experimentally, PCR methods for species-specific diagnosis of *Fasciola* species targeting the nuclear and/or

mitochondrial DNA of the parasite have been developed.<sup>13-19</sup>

Acute disease can only be confirmed at necropsy.

### DIFFERENTIAL DIAGNOSIS

#### Acute fasciolosis

- Hemonchosis
- Infectious necrotic hepatitis
- Eperythrozoonosis
- Anthrax
- Enterotoxemia

#### Chronic fasciolosis

- Nutritional deficiencies of copper or cobalt
- Other internal parasitisms, including parasitic gastroenteritis (particularly hemonchosis) in sheep and ostertagiosis in cattle
- Johne's disease

### TREATMENT

#### TREATMENT AND CONTROL

##### Treatment

###### Cattle

Triclabendazole (12 mg/kg, PO) (R-1)  
 Combination of clorsulon (2 mg/kg SC) and nitroxylin (10.2 mg/kg SC) (R-1)<sup>20</sup>  
 Albendazole (10 mg/kg, PO) (R-2)  
 Clorsulon (13.2 mg/kg SC) (R-2)  
 Nitroxylin (10 mg/kg SC) (R-2)  
 Oxyclozanide (10 mg/kg, PO) (R-2)

###### Sheep

Triclabendazole (10 mg/kg, PO) (R-1)  
 Albendazole (7.5 mg/kg, PO) (R-2)  
 Clorsulon (13.2 mg/kg SC) (R-2)  
 Nitroxylin (10 mg/kg SC) (R-2)  
 Oxyclozanide (10 mg/kg, PO) (R-2)  
 Closantel (10 mg/kg, PO) (R-2)

PO, orally; SC, subcutaneously.

Not all compounds are equally effective against all stages of development of *F. hepatica* in the body. Oral triclabendazole comes closest to this ideal. For treatment of acute fasciolosis, it is essential to choose a product highly effective against the juveniles that damage the liver parenchyma. For chronic disease, a compound active against the adult fluke is required. Product safety is an important consideration, as hepatic detoxicating mechanisms are already impaired. Flukicides can be used therapeutically for treating disease or prophylactically to prevent outbreaks. Some bind to plasma proteins (e.g., closantel) or erythrocytes (clorsulon), extending their period of protection. All flukicides either have milk-withholding periods or are prohibited from use in animals providing milk for human consumption, so the best time to treat dairy cattle is at the drying off stage. Many products combine a flukicide with a nematocide, but these should only be used when there is simultaneous risk from the two types of parasite.

Triclabendazole is an orally compound specifically for use against *F. hepatica* in sheep (10 mg/kg) and cattle (12 mg/kg). Higher doses are required for the control of *F. gigantica* in buffalo. It is highly effective against all stages of fluke from 2 days old in sheep and 2 weeks in cattle, and is the drug of choice in outbreaks of acute fluke disease. An 8- to 10-week dosing interval is recommended for use in control programs. Fluke populations resistant to triclabendazole have developed following intensive control regimens in Australia, UK, Europe, and South America.<sup>11,21-27</sup> Combining compounds has been shown to increase efficacy against immature stages of flukes. An example of a combination is SC clorsulon (2 mg/kg) and nitroxylin (10.2 mg/kg), which increases efficiency up to 99%.<sup>20</sup> Oral triclabendazole has been used with success in horses and donkeys (12 mg/kg) but is not licensed for this purpose.

Albendazole is a broad-spectrum compound also active against nematodes and cestodes. It is effective against adult *F. hepatica* at an oral dose rate of 7.5 mg/kg in sheep and 10 mg/kg in cattle. It is ovicidal and will kill any *F. hepatica* eggs present in bile ducts or the alimentary tract at the time of treatment. Netobimin (20 mg/kg, PO) is metabolized to albendazole in the body and has similar activity against *F. hepatica*.

Closantel will kill the majority of flukes older than 4 weeks in sheep at an oral dose rate of 10 mg/kg PO and will delay fluke egg output by animals grazing contaminated pasture for up to 12 weeks. It also has a residual effect against *Haemonchus contortus*.

Clorsulon is supplied in combination with ivermectin for combined fluke and roundworm control in cattle. At the recommended dose rate of 2 mg/kg by subcutaneous injection, clorsulon is effective against adult and 12- to 14-week-old immature flukes, but activity against 8-week-old *F. hepatica* is variable.

Nitroxylin is given subcutaneously at 10 mg/kg and has good efficiency against the adult fluke, but the dose has to be increased by up to 50% to obtain adequate control of acute disease. In sheep, spillage stains the fleece yellow. It cannot be given orally because the rumen microflora reduce the compound to an inactive metabolite.

Oxyclozanide used in cattle (10 mg/kg, PO) has a shorter milk-withholding period than most other flukicides. It has a significant effect against adult fluke but is inactive against immature forms. It may cause transient softening of feces. This compound has been combined with levamisole to provide activity against fluke and gastrointestinal nematodes.

### CONTROL

Preventive measures are required in endemic areas because fasciolosis can cause death without warning or significant production losses. An integrated strategic approach is

more cost beneficial than reliance on routine dosing and is less likely to induce anthelmintic resistance, but it requires detailed knowledge of the local epidemiologic cycle. In some countries in which risk varies from year to year, predictions of likely disease levels are issued based on analysis of meteorologic data and field observations. This enables control measures to be intensified when necessary. Computer models have been devised to assist this process.<sup>3</sup>

Segregation of stock from sources of infection is the ideal method of control but not always feasible in practice. Identification and mapping of snail habitats may enable grazing plans to be devised that avoid danger areas at times of high risk. Where habitats are restricted in size and clearly defined, it may be possible to exclude stock by fencing.

Stock on heavily contaminated land may be protected from acute fasciolosis by taking advantage of the interval between the ingestion of metacercariae and the onset of disease. Treatment during this period with a product effective against young flukes will eliminate the migrating parasites before they cause serious liver damage. A further dose may be necessary depending on the duration of metacercarial intake and residual activity of the chosen product. Some metacercariae will continue to be ingested after the main danger period has passed, so treatment with a product active against adult *F. hepatica* will be needed some weeks later to ensure against possible losses from chronic fasciolosis. Additional strategic doses may be required in regions where the winter infection of the snail is of significance. The precise timing of each of these doses depends on the local epidemiologic pattern.

Reduction of pasture contamination with metacercariae will reduce future risk. This can be done by preventing the snails from becoming infected with *F. hepatica* or by diminishing the size of the snail population. To achieve the first objective, adult flukes should be eliminated from the bile ducts of all grazing stock in spring and early summer. This prevents egg excretion and minimizes the numbers of snail-seeking miracidia at this crucial stage in the epidemiologic cycle. There may, however, be wildlife sources of *F. hepatica* eggs that cannot be controlled in this way. Snail numbers can be reduced by restricting the size of their habitat. This can be done, where feasible, by draining boggy areas and by making sure that ditches, land drains, water troughs, and so forth, are well maintained.

With stall-fed buffaloes in the tropics advantage can be taken of the fact that the metacercariae of *F. gigantica* concentrate on the lower part of forage plants, for example, rice straw. This can be cut off and used for other purposes, and the upper, uninfected, part can be fed to the farm stock.

Chemical snail control was widely practiced before reliable animal treatments became available. Lymnaeid snails have an

enormous reproductive capacity and can quickly recolonize wet land. Therefore application has to be very thorough to have a significant season-long effect, and there must be no possibility of invasion from neighboring land. Chemicals can be applied in spring for maximum impact on the snail population before breeding starts, or later in the season when snails are plentiful, but before cercariae start to emerge. Efficacy is reduced if luxuriant plant growth hinders penetration to soil level. Inorganic compounds such as copper sulfate or sodium pentachlorophenate are effective but may be potentially hazardous to humans, stock, and the environment. Safer and more selective low-volume molluscicides such as *n*-trityl morpholine have been developed but are not commercially available.

Vaccines for *F. hepatica* are under development. One of these that uses recombinant fluke cathepsin L proteinases has produced up to 79% protection against infection in cattle and sheep.<sup>28</sup> Successful vaccination strategies elicit T-helper-1 (Th1) rather than Th2 immune responses induced by natural infection.

#### FURTHER READING

Knubben-Schweizer G, Torgerson PR. Bovine fasciolosis: control strategies based on the location of *Galba truncatula* habits on farms. *Vet Parasitol.* 2015;208:77.

#### REFERENCES

1. Relf V, et al. *Vet Parasitol.* 2011;175:287.
2. McCann CM, et al. *Int J Parasitol.* 2010;35:1255.
3. Caminade C, et al. *Geospatial Health.* 2015;9:301.
4. Bennema S, et al. *Int J Parasitol.* 2011;41:225.
5. Yuan W, et al. *J Helminthol.* 2015;30:1.
6. Bloemhoff Y, et al. *Irish Vet J.* 2015;68:16.
7. Charlier J, et al. *Parasitology.* 2014;141:326.
8. Charlier J, et al. *Prev Vet Med.* 2007;78:57.
9. Charlier J, et al. *Vet Parasitol.* 2008;153:44.
10. Brockwell YM, et al. *Vet Parasitol.* 2013;196:417.
11. Brockwell YM, et al. *Int J Parasitol.* 2014;44:8.
12. Palmer DG, et al. *Aust Vet J.* 2014;92:357.
13. Ai L, et al. *Ann Trop Med Parasitol.* 2010;104:65.
14. Ai L, et al. *Parasite Vector.* 2011;4:101.
15. Alasaad S, et al. *Vet Parasitol.* 2011;179:266.
16. Alasaad S, et al. *Parasitol Res.* 2011;108:1513.
17. Caron Y, et al. *Vet Parasitol.* 2011;178:93.
18. Ichikawa M, Itagaki T. *Parasitol Res.* 2010;106:757.
19. Le TH, et al. *J Clin Microbiol.* 2012;50:1178.
20. Hutchinson GW, et al. *Vet Parasitol.* 2009;162:278.
21. Gordon DK, et al. *Vet Parasitol.* 2012;187:43.
22. Ortiz P, et al. *Vet Parasitol.* 2013;195:118.
23. Robles-Perez D, et al. *Vet Parasitol.* 2013;197:277.
24. Brennan GP, et al. *Exp Mol Pathol.* 2007;82:104.
25. Sargison ND, et al. *Vet Parasitol.* 2007;145:65.
26. Daniel R, et al. *Vet Rec.* 2012;171:1.
27. Elliott TP, et al. *Vet Parasitol.* 2015;209:117.
28. Meemon K, Sobhon P. *Parasitol Res.* 2015;114:2807.

### *Fascioloides magna*

*Fascioloides magna* is a large liver fluke found mainly in North America but also occurs in some European countries.<sup>1,2</sup> It is a parasite of moose and deer but can also infect other animals grazing the same pastures. Sheep and goats are particularly susceptible to

infection. The prevalence of infestation in cattle may be high in endemic areas, but they are seldom affected clinically.

The life cycle in normal hosts is similar to that of *F. hepatica*, except that it grows up to 10 cm long and 3 cm broad in thin-walled cysts in the liver parenchyma. Connections between the cysts and the bile ducts allow the passage of eggs with the feces. Lymnaeid snails, particularly *G. truncatula* and *Radix* (syn. *Lymnaea*) *peregra*, act as intermediate hosts,<sup>3,5</sup> and the final host is infected by ingesting metacercariae encysted on herbage.<sup>6</sup> The fluke enters the liver after spending 3 to 4 weeks in the peritoneal cavity.

In sheep and goats, the fluke continually migrates, never becoming encapsulated but forming large, black tracts. Hepatic damage and hemorrhage are so severe that one or two flukes can be fatal. In cattle, necrotic tracts are seen in the parenchyma as well as dark, thick-walled cysts 4 cm in diameter<sup>7</sup> that have no connection to the bile ducts. Clinical signs in sheep and goats are similar to acute hepatic fasciolosis, and infected animals can die without warning. Infestations in cattle are usually inapparent but may cause signs similar to chronic hepatic fasciolosis. Eggs may be found in the feces. These resemble *F. hepatica* eggs but are larger and have a small appendage at the blunter end.

Most anthelmintics effective against *F. hepatica* are also active against *F. magna*, but few confirmatory reports have been published. Albendazole 10 mg/kg removed 74% of *F. magna* in naturally infected cattle, clorsulon 15 mg/kg had good efficacy in sheep 8 weeks after infection, clorsulon gave variable results in cattle at 21 mg/kg, whereas triclabendazole 20 mg/kg was 99% effective in sheep when given 12 weeks' postinfection.

#### FURTHER READING

Malcicka M. Life history and biology of *Fascioloides magna* (trematode) and its native and exotic hosts. *Ecol Evol.* 2015;5:1381.

Sattmann H, et al. Wherefrom and whereabouts of an alien: the American liver fluke *Fascioloides magna* in Austria: An overview. *Wien Klin Wochenschr.* 2014;126:S23.

#### REFERENCES

1. Correa AC, et al. *Infect Genet Evol.* 2011;11:1978.
2. Kralova-Hromadova L, et al. *Int J Parasitol.* 2011;41:373.
3. Faltynkova A, et al. *Acta Parasitol.* 2006;51:87.
4. Rondelaud D, et al. *Parasitol Res.* 2007;100:861.
5. Vignoles P, et al. *Parasitol Res.* 2006;98:462.
6. Mehlhorn H. *Encyclopedia of Parasitology.* 3rd ed. Heidelberg: Springer Verlag; 2008:1573.
7. Wobeser BK, Schumann F. *Can Vet J.* 2014;55:1093.

### *Dicrocoelium*

*D. dendriticum* is a small trematode widespread in Europe and Asia but with restricted distribution in North America and the British Isles.<sup>1</sup> Its life cycle differs from that of *F. hepatica* in several ways. Eggs passed in the feces are eaten by land snails such as *Helicella*

spp., *Cochlicopa lubrica*, and *Theba* and *Zebrina* spp.<sup>2</sup> Cercariae are passed in slime balls used as food by ants of the genus *Formica*. Grazing animals become infected when they swallow ants containing metacercariae.<sup>1</sup> The flukes travel up the common bile duct to settle in bile ducts within the liver. In contrast to *F. hepatica*, the intermediate hosts of *D. dendriticum* are not associated with wet habitats. Transmission can therefore occur on well-drained farmland and even dry heathland pastures. Protective immunity is poor and heavy infections (tens of thousands) can accumulate.

Pathogenicity is low as *D. dendriticum* does not migrate across the liver parenchyma. Very heavy infections may cause ill-thrift. Lesions comprise fibrosis of the parenchyma and a proliferation and thickening of smaller bile ducts.<sup>1</sup> Infectious necrotic hepatitis may develop as a result of infestation.<sup>3</sup> At necropsy, *D. dendriticum* infection can be recognized as the flukes are smaller (0.5–1.5 cm) than *F. hepatica*, are lanceolate in shape, and confined to the bile ducts. Eggs in feces are small, operculate, asymmetric, and dark brown in color. They are dense structures, and flotation fluids with a high specific gravity, such as potassium iodomercurate solution (SG 1.44), are recommended. Treatment with albendazole at 15 mg/kg also is effective, as is netobimin at 20 mg/kg.

#### FURTHER READING

Rana SS, et al. Parasitic infections of the biliary tract. *Curr Gastroenterol Rep.* 2007;9:156.

#### REFERENCES

1. Colwell DD, Goater CP. *Vet Parasitol.* 2010;174:162.
2. Sargison ND, et al. *Vet Parasitol.* 2012;189:233.
3. Cabeza-Barrera I, et al. *Ann Trop Med Parasitol.* 2011;105:403.

## Diseases Associated With Major Phytotoxins

### PYRROLIZIDINE ALKALOID TOXICOSIS

#### SYNOPSIS

**Etiology** Pyrrolizidine alkaloids (PAs) are present in *Crotalaria* spp., *Echium* spp., *Heliotropium* spp., *Senecio* spp., and other plants

**Epidemiology** Sporadic outbreaks (mainly in cattle and horses) occur worldwide; many herd outbreaks are enzootic to large areas in which toxic plants dominate pasture. PA-containing seeds in feed grains or dry plants in hay also lead to poisoning. A wide range of syndromes is associated with primary cumulative toxicosis and the effect of metabolites.

**Clinical pathology** Liver function tests and blood levels of hepatic enzymes indicate hepatic insufficiency.

*Continued*



**Lesions** Hepatic encephalopathy with blindness, head pressing, bouts of frenzy, jaundice, photosensitization, and intravascular hemolysis; chronic wasting; necropsy lesion of hepatic megalocytosis, fibrosis, and biliary hyperplasia

**Diagnostic confirmation** Histopathology of liver. Assay of plants for PAs. Assay of whole blood or liver for pyrrolic metabolites

**Treatment** None

**Control** Avoidance of significant exposure to plants. Biological control of plants

## ETIOLOGY

Most hepatotoxic PAs are esters of two amino alcohols, retronecine and heliotridine, and occur in three groups—monoesters, noncyclic (open) diesters, and cyclic diesters—in ascending order of toxicity.<sup>1</sup> PAs require a 1,2 double bond in the pyrrolizidine nucleus (necine) and a branch in the ester group to be hepatotoxic.<sup>1-3</sup> Nontoxic *N*-oxides of PAs may be converted to the toxic-free base in the alimentary tract. A complete list of known PAs would be too long to be useful; for example, *Echium plantagineum* contains at least 10 of them known to be toxic to grazing animals. Most PA-containing plants are classified in the plant families Boraginaceae (*Heliotropium*, *Cynoglossum*, *Amsinckia*, *Echium*, and *Symphytum* spp.), Fabaceae (Leguminosae; *Crotalaria* spp.), and Asteraceae (Compositae; *Senecio* spp.).

The recorded plant sources of hepatotoxic PAs (common names and toxins when known) include the following:

*Amsinckia intermedia* (tarweed, fiddleneck, ironweed; contains intermedine, lycopsamine, and echiumine)  
*Arnebia hispidissima* (contains monocrotaline and echimidine)  
*Crotalaria anagyroides*  
*C. crispata* (Kimberley horse poison)  
*C. dura* (wild lucerne)<sup>4</sup>  
*C. eremaea* (bluebush pea)  
*C. globifera* (wild lucerne, jaagsiektebossie)<sup>4</sup>  
*C. gorensis* (Gambia pea; contains monocrotaline)  
*C. incana* (woolly rattlepod; contains fulvine)  
*C. juncea* (sunn hemp; contains retusine)  
*C. mauensis* (contains junceine)  
*C. mesopontica*  
*C. medicaginea* (trefoil rattlepod)<sup>5</sup>  
*C. mitchellii*  
*C. novae-hollandiae* (New Holland rattlepod)  
*C. ramosissima* (Kimberley horse poison)  
*C. retusa* (wedge-leaved rattlepod; contains monocrotaline and retusine)<sup>6</sup>  
*C. spectabilis* (showy rattlepod; contains monocrotaline and spectabiline)<sup>7</sup>  
*Cynoglossum officinale* (hound's tongue; contains heliotridine, heliosupine, and echinatine)

*Echium plantagineum* (*E. lycopsis*; Patterson's curse, Salvation Jane; contains echiumine and echimidine)  
*E. sericeum* (contains echiumine)  
*E. vulgare* (viper's bugloss; contains echimidine)  
*Heliotropium europaeum* (common heliotrope, potato weed; contains indicine, heliotrine, lasiocarpine, europine, supinine, and heleurine)  
*H. amplexicaule* (blue heliotrope; contains lasiocarpine and echinatine)  
*H. ovalifolium*  
*Ligularia amplexicaulis* (dola)  
*L. mertonii* (bong dok pu)  
*Lithospermum arvense* (*Buglossoides arvensis*; corn gromwell)  
*Senecio abyssinicus*  
*S. alpinus*  
*S. aquaticus* (marsh ragwort)  
*S. brasiliensis*  
*S. burchellii* (geelgifbossie)  
*S. cineraria* (dusty miller)  
*S. cisplatinus*  
*S. cunninghamii*  
*S. erraticus*  
*S. glabellus* (bitterweed)  
*S. harvieanus*  
*S. heterotrichus*  
*S. inaequidens* DC<sup>8</sup>  
*S. integerrimus*  
*S. isatideus* (Dan's cabbage, inkanga)  
*S. jacobaea* (tansy ragwort, stinking willy; contains seneciphylline, senecionine, jacobine, jaconine, jacoline, and jacozine)  
*S. latifolius* (Dan's cabbage, dunsiektebossie)  
*S. brigalowensis* (fireweed)  
*S. linearifolius* (fireweed)  
*S. longilobus* (woody or groundleaf groundsel, thread-leaf groundsel; contains retrorsine, riddelline, and seneciphylline)  
*S. madagascariensis* (Madagascar fireweed; contains senecionine)  
*S. magnificus* (tall yellowtop; contains seneciphylline)  
*S. moorei*  
*S. oxyphyllus*  
*S. plattensis*  
*S. pterophorus* (African daisy)  
*S. quadridentatus* (cotton fireweed)  
*S. retrorsus* (staggers bush, dunsiektebossie)  
*S. riddellii* (Riddell's groundsel)  
*S. ruwenzoriensis*  
*S. scleratus*  
*S. selloi*  
*S. spartioides* (broom groundsel)  
*S. spathulatus*  
*S. squalidus* (Oxford ragwort)  
*S. tweediei*  
*S. vernalis*  
*S. vulgaris* (common groundsel; contains senecionine, seneciphylline, and retrorsine)  
*Symphytum officinale* (comfrey; contains echimidine, lycopsamine, and symphytine)

*Trichodesma incanum* (contains trichodesmine)  
*T. ehrenbergii* (contains senkirkinine)  
*T. zeylanicum* (camel bush; contains supinine)

Not all PAs affect the liver. Some PAs have their most significant effect on the lungs. Plants containing these include *C. dura*, *C. globifera*, *C. juncea*, *C. mitchellii*, and *C. spartioides*.<sup>4</sup> Some additional effects on the lungs are produced by *C. ramosissima*/*C. crispata*. In addition to the dominant hepatotoxic effect, *C. retusa* is associated with nephrosis in affected pigs and hepatic damage in goats.<sup>6</sup>

## EPIDEMIOLOGY

### Occurrence

Diseases associated with PAs occur in most animal species in most countries, causing syndromes such as “Molteno straining disease” of cattle, “walking disease,” “Winton disease” of horses and cattle, and “Kimberley horse disease” (walkabout disease), “jaagsiekte” (panting disease), and “dunsiekte” (thin disease), or stomach staggers of horses. Poisoning of humans causing hepatic veno-occlusive disease also occurs.<sup>1</sup>

Clinical manifestations of poisoning may be delayed for up to 18 months after ingestion of a toxic dose of PAs; the reason for this is unknown.

### Risk Factors

#### Animal Risk Factors

Cows and horses are 30 to 40 times more susceptible to PA poisoning than other species, followed by goats and sheep, respectively.<sup>1,9</sup> The difference appears to be related to the animal's ability to detoxify the PAs in the liver, probably related to the diet consumed before domestication.<sup>1</sup> Small herbivores are more likely to be browsers and to develop resistance to the toxins. It is possible that detoxification of the PAs may occur in the rumen as a result of microbial activity, but there are opposing opinions about this. Poisoning from several PAs has been reported in pigs.<sup>7</sup>

#### Environmental Risk Factors

##### Plant Factors

The plants associated with PA poisoning are not very palatable and are usually eaten in sufficient quantity to be associated with poisoning only when other feed is in short supply or when they are included accidentally in conserved feed, such as hay, or when their seeds contaminate feed grains. The toxicity of plants containing PAs is not significantly reduced by conversion of the plants to hay or straw, but a significant reduction occurs when made into silage.<sup>1</sup> Hot air drying of the plants considerably reduces their toxicity. Flowers are more toxic than herbage.<sup>9</sup> Mature plants are avoided; the largest intake by animals is when the plants are sending out

new shoots. With *Senecio* spp., the foliage is the source of poisoning. With *Crotalaria*, *Heliotropium*, and *Amsinckia* spp. the seeds are a common source, either as contaminants of grain crops harvested for animal feed or in the cake made from the seeds after the extraction of oils. This is usually the way in which pigs are poisoned.<sup>7</sup>

Environmental stress, including drought and high temperatures and especially spraying with herbicide, appears to increase the plants' content of PAs.<sup>10</sup> The differences in PA concentration in different samples of the same plant species invalidates the evaluation of the toxicity of the plant on the basis of intake by the animal. Fertilization with NPK products reduces the PA concentrations in *Senecio* plants.<sup>10</sup>

### Human Risk Factors

PAs and their metabolites are excreted in cows' milk and incorporated into products such as yogurt and cheese. The human implication of this is unknown but may be important because some of the PAs are genotoxic, carcinogenic, and teratogenic.<sup>1,3,11</sup> Experimental feeding of goats' milk containing PA metabolites has produced hepatic lesions in rats. Concentrations of these substances in the meat of animals eating the plants are currently not thought to be dangerous to humans.

### Transmission

Although most field cases of poisoning occur in animals grazing pasture infested with the toxic plants, the disease may result from the feeding of contaminated, stored feeds, especially hay, or the use of the plants in bedding.<sup>1,11</sup> The effects of the intoxication are cumulative, and fatal intoxication may develop over a period of years. Mass mortalities are possible among intensively housed livestock such as pigs, poultry, and feedlot cattle.

## PATHOGENESIS

### Hepatic Injury

PAs themselves are not poisonous, but their pyrrolic metabolites produced in the liver by cytochrome P450 are serious, cumulative hepatotoxins.<sup>1,9</sup> These toxic pyrroles react with cellular proteins and cross-link DNA and RNA, ultimately causing hepatic cell dysfunction or death, mitotic abnormalities, megalocytosis, and tissue necrosis.<sup>1,9,12</sup> Most of the pyrroles remain in the liver, although small amounts may enter the systemic circulation.<sup>1</sup> The relative resistance of sheep to PA toxicity may be related to the relatively low capacity of the sheep's liver to produce pyrroles. In cattle there is damage to the centrilobular and hepatic veins leading to occlusion of the vessels as well as megalocytosis.

### Hepatic Encephalopathy

One of the consequences of liver insufficiency is the systemic accumulation of

metabolites such as ammonia, which is associated with cerebral edema. This results in the nervous signs of depression, aimless walking, and head pressing. The spongy degeneration (status spongiosus) produced in the central nervous system is characteristic of hyperammonemia. Other metabolites may also be significantly involved, but ammonia is best studied.

### Toxicemic Jaundice

Liver damage caused by ingestion of PAs, commonly *H. europaeum*, results in the accumulation of copper in the liver, but only if the copper intake in the diet is above normal. This may be associated with clinical cases of chronic copper poisoning in sheep, leading to the development of one of the forms of "toxicemic jaundice." *E. plantagineum* has the double disadvantage of containing PAs and a high copper:molybdenum ratio, so that copper accumulation occurs readily in the plant. Similar accumulations of zinc and iron also occur. There is some evidence for an impairment of storage of vitamins A and E by PAs, but there are no field occurrences of resulting wastage.

Some of the reactive metabolites of hepatotoxic pyrrolizidine escape into the general circulation and are associated with damage to other tissues, including interstitial pneumonia and nephrosis (pigs), which occur in some poisonings.<sup>4,5,7</sup> They also react with erythrocytes, and the pyrrolic esters formed there are bound to hemoglobin so that they could be used as markers of past intake of the PAs. The usefulness of the technique is limited by the short life span of erythrocytes. Along with the incidental escape of toxic metabolites into the circulation and the subsequent damage to pulmonary tissue, the PAs from some plants, e.g., some southern African *Crotalaria* spp., exert their major effect on lung tissue and produce pulmonary as well as hepatic signs.<sup>4</sup>

## SECONDARY PHOTSENSITIZATION

Photosensitization occurs secondary to liver damage. Pheophytin, the degradation product of chlorophyll, is a photoreactive agent associated with hepatogenous (secondary) photosensitization. Under normal circumstances the liver conjugates pheophytin and excretes it in the bile. When the liver is impaired pheophytin accumulates in the liver, blood, and ultimately the skin, resulting in a range of signs varying from irritation with pruritus to necrosis with serum leakage and skin sloughing.<sup>13</sup>

## CLINICAL FINDINGS

Although the hepatic lesions develop slowly in most cases, the onset of clinical signs is usually sudden. The onset of illness may occur many months after the animals have been removed from the toxic pasture.<sup>14</sup> The prominent signs are hyposensitivity to external stimuli, anorexia, ill-thrift, aberrant or

odd behavior, precipitate drop in milk yield and, in cases surviving for more than 2 days, there is often jaundice and photosensitive dermatitis.<sup>1,9,14</sup> Sheep may have serious liver damage, but the effects may be limited to loss of body weight and reduction in wool yield. Most animals poisoned with PAs develop hepatic syndrome; however, some cases will have signs of uremia or interstitial pneumonia.

### Cattle

In poisoning caused by *Senecio* spp. there is a sudden onset of depression and poor sensitivity to external stimuli. This hyposensitivity is sometimes punctuated by short outbursts of excitability and frenzy and often by aggressive behavior. During these episodes there is usually severe diarrhea and straining to defecate. This may result in a high incidence of rectal prolapse. Other signs include abdominal pain, staggering gait, dragging of the hooves, walking in circles, and partial blindness. Such cases usually die within 2 to 3 days of the onset of signs.

Some cases may linger on for several weeks. There are no excitable episodes, the animal remains hyposensitive, becomes anorexic, loses weight, and is afflicted with diarrhea and tenesmus, and usually develops jaundice, mucosal pallor, and, rarely, photosensitive dermatitis.

### Horses

Horses poisoned by *S. jacobaea* or *C. crispata/C. ramosissima/C. medicaginea* lose weight, are mildly jaundiced, and profoundly hyposensitive to external stimuli, often standing with the head down.<sup>4,5</sup> They may stop eating halfway through a mouthful of hay or grass. Muscle tremors, especially of the head and neck, frequent yawning, and difficulty in swallowing occurs. The latter may be sufficiently severe to cause aspiration of food into the lungs or regurgitation through the nasal cavity. Affected horses appear to be blind. They walk in circles or straight ahead, bumping into objects and becoming wedged in places from which they cannot back out; they also walk into streams, houses, or outbuildings. Death by misadventure is a frequent outcome. Head pressing is common and there may be attacks of frenzy and violent, uncontrollable galloping. Multiple skin abrasions of the head and chest are indicators of this deranged behavior. The disease is usually fatal, the course lasting from a week to several months. An unusual outcome to pyrrolizidine toxicosis of horses is the development of gastric impaction with the dried stalks of the plant, causing colic with nasal regurgitation and, in some cases, a fatal gastric rupture.

Paralysis of the pharynx and larynx are thought to be associated with an unusual occurrence of inspiratory dyspnea in ponies with severe pyrrolizidine toxicosis. A further effect in horses may be intravascular

hemolysis, manifested as hemoglobinuria. Pseudoneoplastic proliferation of bronchiolar epithelium is the basis of jaagsiekte of horses, manifesting as progressive severe dyspnea associated with pneumotoxic pyrrolizidine alkaloids such as dicrotaline, monocrotaline, fulvine, and crispatine in some *Crotalaria* spp., including *C. dura*, *C. globifera*, *C. juncea*, and *C. spartioides* in southern Africa, and *C. ramosissima*, *C. crispata*, *C. medicaginea*, and *C. mitchellii* in Australia.<sup>4,5</sup>

The progress of the disease in horses may be in one of two patterns. In the chronic disease there is a gradual worsening of signs until death at 6 to 22 weeks. In the chronic-delayed form the lesions progress, as measured by biopsy, but there are no clinical signs until a sudden onset of illness at 38 to 58 weeks. Similarly, the signs of the disease may not occur until several months after the last ingestion of the toxic material, with death occurring soon afterward.

### Pigs

Pigs poisoned with *Crotalaria* spp. show anasarca, pale mucosae and conjunctiva, ruffled bristles, emaciation, and apathy. The disease is chronic and progressive, and the mortality rate is high. Pigs poisoned with the seeds from *C. spectabilis* had lesions consistent with hepatic damage as well as submandibular edema, hemopericardium, and petechial hemorrhages.<sup>7</sup>

### CLINICAL PATHOLOGY

Diagnosis is based on presence of a toxic PA in the feed or animal. Methods for identifying and quantitating the presence in feed products using gas or liquid chromatography and mass spectrometry have been described for many of the toxins.<sup>15,16</sup> It is far more difficult to determine the presence of PAs in the blood, primarily because they are quickly excreted and because poisoning precedes the onset of signs by many months.<sup>9</sup> Liver function tests such as serum levels of bilirubin and bile acids and bromsulphalein (BSP) clearance are useful in determining the degree of liver damage. Contributory evidence is the presence of hyperammonemia, hyperbilirubinemia, and hypoalbuminemia. Levels of serum enzymes are transiently elevated. For the prediction of early hepatic damage in cattle grazing on *Senecio* spp., measurements of serum  $\gamma$ -glutamyl transpeptidase and glutamyl dehydrogenase are recommended. In horses, GGT and ALP estimations are favored, especially the former, which is recommended as a screening test to identify subclinical cases in horse herds. The changes in serum liver enzymes precede the changes detectable histologically in liver biopsy specimens. For assessment of the degree of damage to the liver in chronic cases, a combination of BSP clearance test and liver biopsy is regarded as most useful in cattle and horses.

### NECROPSY FINDINGS

Hepatic megalocytosis; fibrosis, which may be veno-occlusive; and biliary hyperplasia are the common histopathological findings. In cases of sufficient duration there is jaundice, general edema, and ascites. Secondary histopathological changes occur in intestinal mucosal cells and may be responsible for impaired absorption of nutrients. In some poisonings associated with PA-bearing plants, necropsy findings will be dominated by lesions of nephrosis, particularly in pigs,<sup>7</sup> or interstitial pneumonia, particularly in horses.<sup>4,5</sup>

### DIFFERENTIAL DIAGNOSIS

Diagnostic confirmation depends on positive identification of pyrrolic metabolites in blood or liver. Presumptive diagnosis is provided by hepatic histopathology detecting megalocytosis, which needs to be differentiated from that seen in aflatoxicosis. Cases in which exposure to toxic plants occurred some time ago can only be diagnosed presumptively.

#### Differential diagnosis lists

Cattle hepatopathies caused by the following:

- Phytotoxins, e.g., in *Lantana* spp. (*Myoporum*)
- Mycotoxins as in *Aspergillus* spp. (*Phomopsis*, *Diaporthe toxica*, and *Myrothecium* spp.)
- Tunicamyluracil poisoning as in *Clavibacter toxicus*
- Cyanobacteria (blue-green algae) toxicosis
- Zootoxins as in *Lophyrotoma*, *Arge* spp.

Encephalopathies such as the following:

- Rabies
  - Lead toxicosis
  - Polioencephalomalacia
  - Other causes of jaundice also need to be taken into account; special attention needs to be given to chronic copper poisoning in sheep because sheep poisoned by PAs are much more inclined to develop high levels of copper in the liver than are other sheep
- Horses:
- Equine viral encephalomyelitis
  - Nigropallidal encephalomalacia
  - Leukoencephalomalacia

### TREATMENT

Primary treatment of the hepatic lesion is unlikely to be attempted. Supportive treatment requires provision of a high nutrient diet during the convalescent period plus symptomatic treatment for photosensitization and dehydration. Horses that have recovered clinically may never regain their former physical fitness, and any exertion will lead to rapid exhaustion.

### CONTROL

Populations of these plants undergo cyclic changes, and the diseases associated with them tend to wax and wane. Artificial reduction of plant numbers using herbicides is attempted. Because of the comparative resistance of sheep to PA poisoning, they may also be used to keep infested pasture under control by having them graze it only intermittently, for example, for a 1-month period once a year, or for only one season during their lifetime.<sup>17</sup> Biological control, using insects such as the cinnabar moth (*Tyria jacobea*), which feeds only on plants that contain PAs, may be an effective control procedure for their specific host plants.<sup>17</sup> A concerted effort at biological control of *H. europaeum* and *E. plantagineum* is currently underway in Australia using several insect herbivores and fungal pathogens in combination. Attempts to control *H. europaeum* poisoning by administration of cobalt or an antimethanogen have been unsuccessful. Attempts at immunization against PAs, manipulation of ruminal flora, manipulation of hepatic metabolism, protection by thiol compounds, and selection for heritable resistance, have all failed to date. The use of sesame oil and peanut oil against monocrotaline, a PA present in several species of *Crotalaria*, have been studied in a rat model and may be effective in cattle and other animals.<sup>12</sup>

### FURTHER READING

- Cheeke PR. Toxicity and metabolism of pyrrolizidine alkaloids. *J Anim Sci*. 1988;66:2342-2350.
- Pyrrolizidine Alkaloids: Structure and Toxicity*. Bonn, Germany: Bonn University Press; 2008:19-28.
- Wiedenfeld H, Edgar J. Toxicity of pyrrolizidine alkaloids to humans and ruminants. *Phytochem Rev*. 2011;10:137-151.

### REFERENCES

1. Wiedenfeld H, et al. *Phytochem Rev*. 2011;10:137.
2. He Y-Q, et al. *Chem Res Toxicol*. 2010;23:591.
3. Chen T, et al. *J Appl Toxicol*. 2010;30:183.
4. Botha C, et al. *J Vet Diagn Invest*. 2012;24:1099.
5. Fletcher M, et al. *J Agric Food Chem*. 2011;59:11888.
6. Maia L, et al. *J Vet Diagn Invest*. 2013;25:592.
7. Boabaid FM, Alberton RL, Ubalia DG, et al. Acute poisoning by *Crotalaria spectabilis* seeds in pigs of Mato Grosso state, Brazil. In: Riet-Correa F, Pfister J, Schild AL, Wierenga TL, eds. *Poisoning by Plants, Mycotoxins, and Related Toxins*. Boston: CAB International; 2011:148.
8. Dimande AF, et al. *J S Afr Vet Assoc*. 2007;78:121.
9. Varga A, et al. *Vet Med Res Rep*. 2012;3:111.
10. Hol WHG. *Phytochem Rev*. 2011;10:119.
11. Hoogenboom LAP, et al. *Food Addit Contam*. 2011;28:359.
12. Srinivasan P, et al. *J Vet Intern Med*. 2012;26:491.
13. Marrero E, Goicochea CB, Perea LMS, et al. Toxic plants of Cuba. In: Riet-Correa F, Pfister J, Schild AL, Wierenga TL, eds. *Poisoning by Plants, Mycotoxins, and Related Toxins*. Boston: CAB International; 2011:43.
14. Payne J, et al. *Vet Rec*. 2013;173:77.
15. Crews C, et al. *Anal Bioanal Chem*. 2010;396:327.
16. Zhou Y, et al. *Anal Chim Acta*. 2010;681:33.
17. Leiss K. *Phytochem Rev*. 2011;10:153.



## Plants Causing Hepatic Injury (Unidentified Toxin)

Ingestion of some plants with unidentified or unknown toxin(s) may result in hepatic injury. Several different syndromes have been identified and are listed next.

### HEPATIC INJURY-DUMMY SYNDROME (CIRCLING, HEAD PRESSING, COMPULSIVE WALKING, AND BLINDNESS)

In many cases, an expression of hepatic encephalopathy with hepatic necrosis and status spongiosus in the brain, e.g., *Helichrysum argyrosphaerum*, which is associated with blindness, paresis, and spongy degeneration of the brain in sheep and cattle, and *H. blandowskianum* (woolly daisy) has caused death and similar brain lesions in cattle. *Oxytenia acerosa* (copperweed), *Phyllanthus* spp. (spurge), and *Riedelliella graciliflora* are associated with hepatic injury. *Trema tomentosa* (syn. *T. aspera*) is associated with acute hepatic necrosis in cattle and horses. In *Matricaria nigellifolia* poisoning, affected cattle become clumsy and docile and head push against fixed objects, hence, the common name “pushing disease.” Sheep are not affected.

### HEPATIC INJURY: JAUNDICE AND/OR PHOTOSENSITIZATION

*Acanthospermum hispidum* (star burr)  
*Athanasia trifurcata*  
*Callicarpa longifolia*  
*Capparis tomentosa*  
*Chrozophora plicata* (terba)  
*Enterolobium* spp.  
*Fallopia convolvulus* (black bindweed)  
*Ficus tsiela* (fig tree)  
*Galeopsis* spp. (hedge nettle)  
*Hertia pallens* (springbokbush)  
*Heterophyllaea pustulata* (cegadera)  
*Kochia scoparia* (summer cypress)  
*Lythrum hyssopifolia*  
*Nidorella foetida*  
*Nolina texana* (sacahuiste)  
*Persicaria lapathifolia* (syn. *Polygonum lapathifolium*; pale willow weed)  
*Pongamia glabra* (Indian beech)  
*Psathyrotus annua*  
*Pteronia pallens* (Scholtz bush)  
*Sartwellia flaveriae* (sartwell)  
*Sessea brasiliensis*  
*Stryphnodendron coriaceum*  
*Tetradymia canescens* (spineless horsebrush)  
*Trifolium hybridum* (alfalfa clover)

The *Polygonum* spp. (= *Persicaria* spp.) listed next also are associated with photosensitive dermatitis but are credited with causing a primary hepatic injury. Many of the findings about these plants are equivocal:

*P. convolvulus*  
*P. orientale* (smartweeds)  
*P. sagittatum*

## Poisoning by Mycotoxins

### POISONING BY AFLATOXINS (AFLATOXICOSIS)

#### SYNOPSIS

**Etiology** Aflatoxins are mycotoxins that contaminate food and foodstuffs.

**Epidemiology** All species are affected; toxin is excreted in milk and eggs.

**Clinical pathology** Acute elevations in serum hepatic enzymes (specially  $\gamma$ -glutamyl transpeptidase, aspartate amino transferase, and sorbitol dehydrogenase); increases in prothrombin time and serum bilirubin; changes in hematological parameters

**Lesions** Primarily hepatic: jaundice, hepatocyte necrosis, megalocytosis, and fibrosis

**Diagnostic confirmation** Positive assay of aflatoxin in tissue and fluids

**Treatment** Symptomatic only

**Control** Preventive assay of large quantities of feedstock. Detoxification of contaminated feed currently being attempted by various means

#### ETIOLOGY

Aflatoxins (AFs) are metabolites produced by fungi growing on spoiled feeds. Elevated relative humidity (95%–97%) levels and warm temperatures (25°C–37°C) are associated with fungal growth.<sup>1,2</sup> Eighteen AFs have been isolated with AFB<sub>1</sub>, AFB<sub>2</sub>, AFG<sub>1</sub>, AFG<sub>2</sub>, and the second-generation metabolites M<sub>1</sub> and M<sub>2</sub> are the most widely studied.<sup>3,4</sup> AFB<sub>1</sub> is generally recognized as one of the most potent hepatic carcinogens in the world.<sup>5</sup> It is related chemically and structurally to dicoumarin compounds.<sup>5</sup> The most important toxicosis, aflatoxicosis, is associated with the ingestion of *Aspergillus* spp. and AFs, but other important toxins produced by the fungi are ochratoxin, patulin, and sterigmatocystin. *Aspergillus flavus*, *A. nomius*, and *A. parasiticus* are the most commonly recognized species that produce AFs.<sup>6</sup> Other less common AF-producing species include *A. niger*, *A. ruber*, *A. wentii*, *Penicillium citrinum*, and *P. frequentans*.<sup>5</sup>

Levels of AFs attained in feed may be as high as 3500 ng/kg for all AFs, 2000 ng/kg for AFB<sub>1</sub>, and 1000 ng/kg for AFB<sub>2</sub>. In sheep, the oral LD<sub>50</sub> is 5 mg/kg;<sup>2</sup> a dose rate of 4 mg/kg is associated with death at 15 to 18 hours caused by acute hepatic insufficiency; at dose rates of 2 mg/kg there is increased respiratory rate, a rise in temperature of 1.5°C (34°F), and diarrhea with blood and mucus; at a dose rate of 0.2 mg/kg there is anorexia and diarrhea. Similar dose relationships have been established for calves and for pigs. A great deal of AF ingested in the feed by cattle is physically bound to ruminal contents, and

as little as 2% to 5% reaches the intestine.<sup>4</sup> Levels of AFB<sub>1</sub> in excess of 100 µg/kg of feed are considered to be poisonous for cattle. The estimated LD<sub>50</sub> for AFB<sub>1</sub> in calves is estimated to be 0.5 to 1.5 mg/kg. Information regarding toxic ingestions in horses is sparse, but ingestions of 500 to 1000 mcg/kg have resulted in liver damage, with signs related to the duration of exposure. The oral LD<sub>50</sub> of AFB<sub>1</sub> is species dependent but for most species is in the range of 0.03 to 18 mg/kg.<sup>2</sup>

#### EPIDEMIOLOGY

##### Occurrence

Aflatoxicosis has been reported in most countries and on many spoiled feeds, especially harvested peanuts, peanuts in shells, cottonseed meal, sorghum grain, corn, moldy bread, green chop sorghum, or rarely on a standing crop, e.g., ears of sweet corn.<sup>1-3</sup> The mycotoxin is not destroyed by milling of the grain.

##### Animal Risk Factors

All animal species are susceptible, but outbreaks occur mostly in pigs, sheep, and cattle; beef and dairy cattle are more susceptible than sheep or horses. Young animals of any species are more susceptible than adults, and nursing animals may be at increased risk because AFs are excreted in the milk.<sup>2,4</sup>

Therapeutic administration of *A. oryzae* to newborn foals as a digestive inoculant to promote fast development of digestion is suspected of producing mycotoxins and being associated with acute hepatic insufficiency, including encephalopathy.

##### Human Risk Factors

AF is an important consideration in the etiology of human hepatocellular carcinoma. Because the toxin is excreted in cows' milk it has public health importance. The concentration of AF in cows' milk may be as high as 0.33 µg/L and may continue to be as high for 3 to 4 days after ingestion of the feed.<sup>4,7,8</sup> In dairy goats treated with a single dose of AF, a maximum concentration of AFM<sub>1</sub> was reached at 3 to 6 hours and was no longer detectable at 72 to 84 hours.<sup>9,10</sup> AFs can also be present in the meat from animals eating contaminated feed, but the risks to humans eating the meat are thought to be small.<sup>2</sup>

#### PATHOGENESIS

AFs are rapidly absorbed from the gastrointestinal tract, entering the portal blood system in a short period of time and concentrating in the liver. In the liver AFs undergo biotransformation, producing a range of metabolites.<sup>2,5</sup> Cytochrome P450 is actively involved with the transformation of AFB<sub>1</sub> to the toxic metabolite AFB<sub>1</sub>-8-9-epoxide, which forms adducts with DNA, RNA, and proteins.<sup>2</sup> AFB<sub>1</sub>-8-9-epoxide is detoxified by conjugation with glutathione.<sup>2,5</sup> About 1% to 2% of ingested AFB<sub>1</sub> is metabolized to AFM<sub>1</sub> and secreted into the milk.<sup>11</sup> Excretion

occurs primarily through the urine, bile, and feces, but also to some extent in the milk, eggs, and semen.<sup>2,12</sup>

The toxic effects of AFs are most pronounced in the liver where the metabolism of carbohydrates, lipids, and proteins is impaired. The effects of AFB<sub>1</sub>-8-9-epoxide include inhibition of RNA and protein synthesis and resistance of DNA to repair.<sup>2,5</sup> Hepatosis and hepatic insufficiency are the principal effects, but mutagenic and teratogenic effects are recorded in laboratory animals and suspected in humans on epidemiologic grounds.

## CLINICAL FINDINGS

### Cattle

Clinical signs include blindness, walking in circles, ear twitching, teeth grinding, frothing at the mouth, photosensitive dermatitis and keratoconjunctivitis, diarrhea, severe tenesmus, abortion, and anal prolapse.<sup>2,12</sup> Recumbency is followed by terminal convulsions. The appetite is normal. Affected animals usually die within 48 hours, and calves in the 3- to 6-month group are the most susceptible. Aflatoxicosis is also reputed to interfere with clotting of the blood in cattle, leading to the development of hematomas. Amounts of toxin insufficient to cause overt disease in cows may be sufficient to reduce food intake, weight gains, and milk production, and to be associated with diarrhea.

### Pigs

In pigs, the period between when the toxin is ingested and when signs appear is thought to be quite long, at least 6 weeks, and varies with the toxicity of the batch of feed. The mortality rate is often 20%, but may be as high as 90% (including euthanasia). Feeder pigs are more susceptible than adults. The clinical syndrome includes a rough coat, depression, anorexia, weight loss, muscle tremors, staggering gait, walking in a daze, and recumbency. Some pigs have intermittent or hemorrhagic diarrhea and some have seizures just before death. The course of the disease may be as short as 6 to 12 hours. Abortion is a commonly reported sequela, but there is doubt about the relationship. At necropsy there is icterus, ascites, swelling of the liver, and mesenteric edema.

### Horses

Reports of aflatoxicosis are less common probably because horses are less likely to be fed damaged feed. Clinical signs are nonspecific but include depression, anorexia, fever, tremors, ataxia, icterus, and hemorrhage.<sup>2,13</sup> A link between inhaled *A. fumigatus* and the development of chronic obstructive pulmonary disease has been proposed.<sup>5,14</sup> Necropsy lesions include encephalomalacia, hepatocyte necrosis and hepatic fibrosis, bile duct hyperplasia, hemorrhagic enteritis, and myocardial degeneration. The experimental disease is characterized by depression,

inappetence, tremor, and prostration, with death following in 2 to 6 weeks.

## CLINICAL PATHOLOGY

Acute elevations in serum hepatic enzymes with  $\gamma$ -glutamyl transpeptidase, AST, and SDH are most often reported. Elevations in prothrombin time and serum bilirubin are common as are changes in hematological parameters.

Analysis and quantitation of AFs in feed materials, urine, blood, and tissues are standard practice. Laboratory assay methods include chromatography/mass spectrometry and immunoassays.<sup>15,16</sup>

## NECROPSY FINDINGS

Necropsy findings in all species are those of hepatosis, including megalocytosis, multiple foci of necrosis and fibrosis, portal round cell infiltration, and bile duct hyperplasia. Jaundice and serous exudates in body cavities may occur in some animals. In pigs a pronounced lower enterocolitis with diarrhea and dysentery is common, but not constant. Other reported lesions include equine cardiac fiber degeneration, focal cerebral malacia, and the presence of protein in the glomerulus and renal proximal tubules; pneumonia in calves; and photosensitization.

Diagnosis confirmation depends on the detection of AF in the feed and blood serum, and the characteristic gross and histopathological findings in the liver.

## DIFFERENTIAL DIAGNOSIS

### Differential diagnosis list:

- Alsike clover toxicosis
- Cyanobacteria (blue-green algae) toxicosis
- Fascioliasis
- Lantadene toxicosis
- Phomopsin toxicosis
- Primary hepatic disease (neoplasia, bile duct obstruction)
- Pyrrolizidine alkaloid toxicosis
- Sporidesmin toxicosis
- Steroidal saponin toxicosis
- Theiler's disease

## TREATMENT

Symptomatic treatment of hepatic insufficiency is all that can be attempted.

## CONTROL

Because of the advent of reliable and accurate methods of assaying AF in feeds there has been a notable tendency for feed to be less contaminated. Supplementation of the diet with zinc, selenium, and vitamin E is not effective in preventing aflatoxicosis, and those procedures that have shown promise in experimental trials have not been translated into practicable, cost-effective techniques.

Binding of AF in the gastrointestinal tract has been useful. Studies have included smectites such as hydrated sodium calcium

aluminosilicate (several formulations of the compound are already used as anticaking agents in the animal feed industry) and sodium bentonite in the form of clay. Agromonic methods to reduce AF contamination of peanuts have recently been successful. Ammoniation of feed has been useful in reducing contamination. Modified yeast cell wall extracts (*Saccharomyces cerevisiae*) have been successful in some species.<sup>17,18</sup>

## FURTHER READING

- Radostits O, et al. Aflatoxins (aflatoxicosis). In: *Veterinary Medicine: A Textbook of the Disease of Cattle, Horses, Sheep, Pigs, and Goats*. 10th ed. London: W.B. Saunders; 2007:1899.
- Smith TK, Girish CK. The effects of feed borne mycotoxins on equine performance and metabolism. In: Oswald IP, Taranu I, eds. *Mycotoxins in Farm Animals*. Ontario: Research Signpost; 2008:47-70.

## REFERENCES

- Bertin G, Jouany JP, Yiannikouris A. Risk assessment of mycotoxins in ruminants and ruminant products. In: Papachristou TG, Parissi ZM, Salem B, Morand-Fehr R, eds. *Nutritional and Foraging Ecology of Sheep and Goats*. Paris: CIHEAM; 2009:205.
- Dhanasekaran D, Shanmugapriya S, Thajuddin N, Panneerselvam A. Aflatoxins and aflatoxicosis in humans and animals. In: Guevara-Gonzalez RG, et al., eds. *Aflatoxins—Biochemistry and Molecular Biology*. InTech; 2011:221.
- Yermeni SA, et al. *World J Sci Tech*. 2012;2:31.
- Abidin Z, et al. *Int J Vet Sci*. 2012;1:37.
- Caloni F, et al. *Vet J*. 2011;188:270.
- Varga J, et al. *World Mycotoxin J*. 2009;2:263.
- Bianchi DM, et al. *Large Anim Rev*. 2013;19:59.
- Dutton MF, et al. *Mycotoxin Res*. 2012;28:17.
- Mazzette A, et al. *Ital J Anim Sci*. 2009;8(2s):631.
- Battacone G, et al. *J Dairy Sci*. 2012;95:2656.
- Wu Q, et al. *Drug Met Rev*. 2009;41:1.
- Fink-Gremmels J. *Vet J*. 2008;176:84.
- Caloni F, et al. *Ippologia*. 2010;21:43.
- Tyden E, et al. *Res Vet Sci*. 2008;85:85.
- Grio SJ, et al. *J Sep Sci*. 2010;33:502.
- Peiwu L, et al. *Trends Anal Chem*. 2009;28:1115.
- Firmin S, et al. *J Dairy Sci*. 2011;94:5611.
- Dogi CA, et al. *Food Addit Contam*. 2011;28:1705.

## Phomopsins Toxicosis (Lupinosis)

### SYNOPSIS

**Etiology** Family of mycotoxins produced by fungus *Diaporthe toxica* growing on *Lupinus* (lupin) plant stubble or to a lesser extent seeds

**Epidemiology** Worldwide with cases in Europe, Australia, New Zealand, South Africa, and other countries. Primarily cattle and sheep grazing lupin stubble or fed seeds in ration; horses and pigs are affected less often

**Clinical pathology** Serum levels of liver and muscle-associated enzymes elevated

**Lesions** Jaundice, swollen liver, diffuse hepatic fibrosis, biliary hyperplasia, and myopathy

**Diagnosis confirmation** Positive assay for phomopsin

**Treatment** None in particular; change feed source

**Control** Do not feed infected lupin stubble; plant phomopsin-resistant lupins; a vaccine is under development.

## ETIOLOGY

Phomopsins are a family of mycotoxins produced by the saprophytic fungus *Diaporthe toxica* (anamorph *Phomopsis* spp.).<sup>1</sup> The fungus infects lupin crops and seeds and causes lupinosis in cattle and sheep ingesting contaminated feed.<sup>1,2</sup> Phomopsins A, B, C, D, and E, all cyclic hexapeptide mycotoxins, are the specific cause. Phomopsin A is the main toxic metabolite and is two to five times as toxic as Phomopsin B.<sup>1</sup> *D. woodii* (anamorph *Phomopsis leptostromiformis*) was originally, and erroneously, considered to be the source of these toxins. *P. emecis*, a saprophyte of *Emex australis*, produces phomopsins in vitro, but is not associated with natural disease incidents.

## EPIDEMIOLOGY

### Occurrence

The disease is common in Europe, Australia, New Zealand, and South Africa. It is rarely reported in the United States. Sheep, goats, and cattle are most commonly affected, probably because of their greater exposure. Poisoning of pigs and horses rarely occurs.

### Risk Factors

#### Animal Risk Factors

Naturally occurring cases are seen far more often in sheep, followed by goats, and then cattle.<sup>1</sup> Although lupinosis rarely occurs in horses, they may be the most susceptible because sudden death is the normal finding. Most occurrences are in animals grazing lupin stubble in which there is dry foliage, seed pods, and/or seeds. Poisoning occurs rarely in sheep ingesting only seeds; it has also occurred in pigs fed ground lupin seeds.

#### Environmental Risk Factors

Factors increasing the chances of poisoning associated with fungal infection of the senescent plants include summer rain, which is conducive but not essential to fungal growth; the time lapse since rain, during which toxic lupins remain poisonous for several months; and the provision of alternative feed or the presence of other plants, including weeds, in a crop, both of which may reduce lupin intake and hence its toxicity. Some varieties of lupins are much more susceptible to

fungal infections than others. The mature stalks are the most poisonous so that a heavy stocking rate, which encourages the ingestion of all parts of the plants, increases its prevalence. Stubble from which lupin seeds have been harvested is the most common cause of lupinosis.

## PATHOGENESIS

The liver is the primary target organ for phomopsins in all species, with the kidney a secondary target.<sup>1,3</sup> Ruminants develop hepatotoxicosis, whereas horses and pigs are more susceptible to renal insult and nephrotoxicosis.<sup>1</sup> Phomopsins exert their toxicity by binding to tubulin isotypes and altering microtubular functions.<sup>1,2</sup>

Phomopsins injected intraruminally have variable effects depending on dose and duration of administration. Subcutaneous dosing results in anorexia, weight loss, lethargy, jaundice, elevation of serum levels of liver enzymes, recumbency, and death in 90% of sheep. Clinical biochemistry findings suggest that the hepatosis is accompanied by injury to muscle, kidney, and adrenal cortex.

Affected sheep have a higher hepatic concentration of copper and selenium and a lower concentration of zinc, which is caused by necrosis of liver cells. The affinity for copper may lead to the development of a complicating chronic copper poisoning in affected sheep.

## CLINICAL FINDINGS

In sheep, signs include anorexia, constipation, hepatoenkephalopathy, stumbling gait, recumbency, and a variable degree of jaundice and photosensitization. A substantial skeletal muscle myopathy has also been observed in sheep poisoned by phomopsins or infected lupin stubble. Affected animals have a stiff gait, walk reluctantly, and stand with their back humped and their feet under the body, and have difficulty getting to their feet. Experimental phomopsin poisoning at mating time is associated with reduced reproductive efficiency in ewes.

In cattle, three syndromes may be encountered. Most common is ketosis, precipitated by inappetence, and found in pregnant or freshly calved cows. Less common is hepatic cirrhosis, found in cattle several weeks after they are removed from lupin stubble. The course of the disease is 1 to 3 days, and signs include anorexia, depression, staggering gait, jaundice, and bleeding from orifices. Photosensitization occurs in cases that survive for more than a few days. Death may occur within a few days of first illness or be delayed for months, with affected animals standing immobile for long periods or wandering aimlessly, often dying from misadventure. More chronic cases exhibit ill-thrift and photosensitization. Recovery may occur if animals in the early stages of the disease are taken off the dangerous pasture, but severely affected animals usually die.

Animals that regain their appetite will completely recover.

Phomopsin ingestion in pigs results in a profound anorexia, vomiting, lethargy, jaundice, and stunted growth. Larger doses cause more gait abnormalities, including incoordination, dog sitting, and hind end paralysis.<sup>1</sup>

Lupinosis in horses is often associated with sudden, acute death. Affected horses are depressed, weak, uncoordinated, jaundiced, and pass dark reddish-brown urine.<sup>1,3</sup> The duration of clinical signs is generally only 2 days.

## CLINICAL PATHOLOGY

In the early stages of lupinosis, serum liver enzyme tests are the best aids to diagnosis. The  $\gamma$ -glutamyl transpeptidase test is preferred in the early subacute stages and aspartate transaminase when the disease is more severe. In the late stages of the disease liver function tests are preferred.

## NECROPSY LESIONS

There is jaundice and either a swollen, mottled bright yellow or pale orange, firm, friable liver in acute cases, or a small and fibrotic one in chronic cases, plus extensive hemorrhages under the skin and serous membranes. Spongy transformation of the brain has been recorded in naturally occurring cases and has also been produced experimentally. Histologically, mitotic figures are found in many hepatocytes as well as necrosis of individual hepatocytes, biliary hyperplasia, and diffuse hepatic fibrosis.

## DIFFERENTIAL DIAGNOSIS

Diagnosis confirmation depends on liver histopathology and detection of phomopsins in rumen contents and feed by immunoassay or chromatography/mass spectrometry.<sup>4</sup>

### Differential diagnosis list:

The differential diagnosis list contains many cases of illness in pregnant and recently calved cows in lupin country that are diagnosed as lupinosis but are actually cases of pregnancy toxemia or fat cow syndrome. Other fungal or plant hepatopathies will need to be differentiated.

## TREATMENT

There is no treatment other than removing the animal(s) from contaminated fields and providing supportive care.

## CONTROL

Lupin crops should be grazed after seed harvest in early summer and not in late autumn. Sheep stocking rates should be less than 30 per hectare. It is an advantage to train sheep to eat lupin seed before they are exposed to crops, thus reducing the intake of stubble because the sheep will forage for seed on the ground. The intake of lupin can be decreased during summer grazing by



establishing crop mixtures with wheat, oats, or barley.

Prevention is assisted by restricting grazing on mature, standing, dry plants during warm, humid weather that favors fungal growth, avoiding copper supplementation near danger periods, and encouraging the administration of cobalt. Hay made from lupins appears to be free of toxicity, and this may be a useful technique in the prevention of the disease. Fungistatic agents, such as benomyl, are also sprayed onto lupins to reduce fungal growth, but no specific recommendations have been made. Additional protection may be gained by the oral administration of zinc, which has been shown to reduce the severity of liver damage associated with lupins/fungal poisoning, but commercial application of this knowledge is not yet possible, partly because of the toxicity of the administered zinc. It is advisable to be wary at all times when grazing mature lupin crops. If they are used, the crops should be inspected regularly for evidence of fungal infection. If this does occur, livestock should be permitted to have access for short periods only, and alternate and supplementary feed should be available.

A satisfactory measure of prevention has been achieved by the development of a phomopsin-resistant strain of *Lupinus angustifolius*, which is capable of reducing the mortality rate from 57% to 8%. A phomopsin-conjugate vaccine has been successfully tested under field conditions but is not yet commercially available.

#### FURTHER READING

Radostits O, et al. Poisoning by phomopsins. In: *Veterinary Medicine: A Textbook of the Disease of Cattle, Horses, Sheep, Pigs, and Goats*. 10th ed. London: W.B. Saunders; 2007:1906.

#### REFERENCES

1. EFSA Panel. *Eur Food Safe Auth J*. 2012;10:2567.
2. Battilani P, et al. *World Mycotoxin J*. 2011;4:345.
3. Finnie JW, et al. *Aus Vet J*. 2011;89:247.
4. De Nijs M, et al. *Food Addit Contam*. 2013;30:1819.

## Pithomycotoxicosis (Sporidesmin Toxicity and Facial Eczema)

### SYNOPSIS

**Etiology** Toxic metabolites of fungus *Pithomyces chartarum* growing on litter from pasture plants, particularly ryegrass

**Epidemiology** Outbreaks only at pasture are most common in sheep in warm moist climates when pasture is short and grazing animals consume the dead plant litter.

**Clinical findings** Pithomycotoxicosis findings include acute hepatic injury characterized by dullness, anorexia, jaundice, and

photosensitization. High case-fatality rate, long chronic course in survivors

**Clinical pathology** Elevated serum activities of liver enzymes in early stages

**Necropsy findings** Liver swollen, discolored early, and later tough, and contracted; obliterative cholangitis

**Diagnosis confirmation** High spore count on pasture; elevated concentrations of sporidesmin in serum

**Treatment** Change to rough, mature pasture.

**Control** Monitor pasture spore counts, destroy fungus on pasture with fungicide, and restrict access to dangerous pasture; daily oral dosing with zinc preparation

### ETIOLOGY

Sporidesmins are metabolites of the fungus *Pithomyces chartarum* (*Sporidesmium bakeri*) infesting dead plant material in standing pasture. The sporidesmins A–H are pyrrolidines and are associated with **pithomycotoxicosis (facial eczema)**, a major disease of sheep and cattle in selected regions of the world. The term facial eczema is misleading, and the continued use of this name is discouraged because the major pathogenic effect is **liver dysfunction**, and the main toxin is sporidesmin A. The term *facial* describes only a small part of the clinical picture, and *eczema* is a poorly defined term describing one clinical manifestation, in which photodermatitis provides a more encompassing term. In 1973, the name pithomycotoxicosis was proposed; this word combines the *pitho* of *Pithomyces chartarum*, the causative fungus, with *mycotoxicosis*, which is a widely used term describing diseases caused by fungal toxins. The occurrence of nontoxicogenic strains of *P. chartarum* probably accounts for the wide variation in disease occurrence between countries.

### EPIDEMIOLOGY

#### Occurrence

Pithomycotoxicosis was first reported in sheep in 1887 and has been recorded most often in northern New Zealand where it is of major economic importance.<sup>1</sup> The disease occurs to a limited extent in coastal regions of Europe, Turkey, Australia, South Africa, and in irrigated perennial ryegrass fields in the United States (Oregon).<sup>2</sup> The incidence varies widely depending on climatic conditions; in some years the disease does not occur, in others the morbidity rate in affected flocks of sheep may be 70% to 80%, and 5% to 50% of these may die. Of the survivors, many are unthrifty and make less than normal weight gains. In cattle, the morbidity rate is much lower and rarely exceeds 50%. In spite of the obvious weight loss associated with the nonfatal form of the disease, there is no appreciable effect on the palatability of the carcass meat.

### Risk Factors

#### Animal Factors

Sheep, cattle, goats, New World camelids, and kangaroos are affected. Experimental production of the disease in Saanen goats requires two to four times the sheep dose, and feral goats need four to eight times the sheep dose.

#### Plant Factors

The environmental factors, which encourage the growth of the fungus and the production of sporidesmin, include the type of plants in the pasture and the climatic conditions. Pithomycotoxicosis is commonly associated with **ryegrass pastures**, but the causative fungus is capable of growing on all kinds of dead leaf material, including cereal hay, and causing facial eczema. In South Africa the ingestion of *P. chartarum* is thought to enhance the toxicity of *Tribulus terrestris*.

Pithomycotoxicosis occurs extensively only when pasture is short and contains abundant dead, recently killed plant material, and during warm (grass minimum temperature >12°C), humid weather, which favors growth of the fungus. This is most likely to be a problem in autumn when the summer has been hot and dry, the pasture well eaten back, and good rains fall when the ground is still warm. In such circumstances the grass and the fungus grow rapidly. It is predicted that the disease will increase in range in New Zealand with global warming (Fig. 9-3).

### PATHOGENESIS

Sporidesmin is associated with severe damage to biliary epithelium, leading to acute biliary obstruction and a resulting severe hepatic insufficiency manifested by loss of condition, obstructive jaundice, and secondary (hepatogenous) photosensitization. Sporidesmin administered by mouth is excreted unchanged in high concentrations in urine and bile, especially the latter where it reaches 100 times the concentration in serum. Sporidesmin undergoes autooxidation in bile resulting in free radical formation in biliary epithelium and associated biliary epithelial injury. The resulting inflammation of the bile ducts and progressive obliterative cholangiolitis slows down the rate of bile flow to negligible levels over a period of about 14 days. The photodynamic agent is **phytoporphyrin** (formerly called phylloerythrin), the first porphyrin metabolite of chlorophyll, which is produced by anaerobic microbial fermentation in the ruminant forestomach and retained in tissues because of failure of its excretion through the damaged liver and bile ducts.<sup>3</sup> In nonpigmented areas of the skin and hide, phytoporphyrin absorbs ultraviolet radiation and becomes reactive, with local cell death and inflammation manifested as photosensitization. The frequent observation that only part of the liver is involved is probably explained by the deposition of toxin in

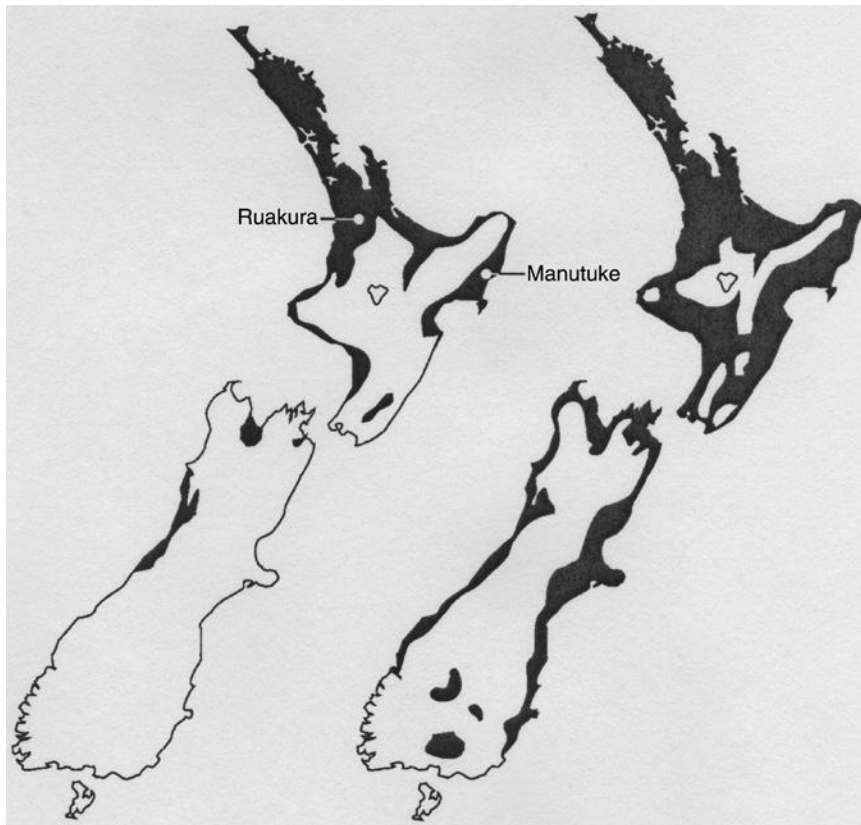

**Fig. 9-3** Current distribution of pithomycotoxicosis (facial eczema) in New Zealand (left) and predicted distribution with 3°C climate warming (right). (Reproduced with permission from Di Menna ME. *New Zeal J Agr Res* 2009;52:345-376.)

particular parts of the liver, caused by portal streaming, on its first passage through hepatic sinusoids. The toxin that reaches the general circulation is probably destroyed.

### CLINICAL FINDINGS

In cattle and sheep the disease starts suddenly with the appearance of lethargy, dullness, anorexia, jaundice, and photosensitive dermatitis (Fig. 9-4). The skin lesion and jaundice are both variable in occurrence, and sheep may die without either having been observed. Many animals die during this acute stage, but some survive and pass into a state of chronic ill-health manifested by poor bodily condition and a susceptibility to minor environmental stresses. Many others show no clinical signs but have significant changes in serum enzyme systems indicative of an acute hepatic injury and measurable reductions in reproductive efficiency and lamb weights. Occasional animals develop the syndrome of hepatic encephalopathy manifested by dullness and depression progressing to tremor and lateral recumbency. Spongy vacuolation of brain tissue is observable histologically in these cases. A moderate fall in the plane of nutrition, parasitic infestation, and pregnancy may be associated with further mortalities, and photosensitive dermatitis may recur if the animals are fed on lush green pasture.



**Fig. 9-4** Acutely affected crossbred Merino with severe secondary photosensitization caused by pithomycotoxicosis (facial eczema). Note the presence of erythema and severe ulceration with crusting around the eyes and mouth, corneal edema, drooping ears, and puffy periocular and facial skin. (Reproduced with permission from Ozmen O, Sahinduran S, Haligur M, Albay MK. *Trop Anim Health Prod* 2008;40:545-551.)

Cattle are not as commonly affected by the chronic form of the disease as are sheep, but dermatitis of the teats may lead to the development of mastitis. Beef cattle are less commonly affected than dairy cattle in New Zealand, but this most likely reflects daily pasture intake rather than a specific genetic predisposition.

### CLINICAL PATHOLOGY

Tests of hepatic function, especially the BSP clearance test, should be of value in determining the presence of liver damage. In the very early stages, serum enzyme estimations should also be of value. Serum GGT activity is regarded as the best indicator of hepatic damage in cattle and remains elevated for at least several months after an attack of pithomycotoxicosis; in cows serum GGT activities frequently range from 500 to 2000 U/L (reference range <36 U/L). Serum GDH activity and phylloerythrin concentrations are also increased in sheep with pithomycotoxicosis.<sup>1</sup>

### NECROPSY FINDINGS

In the acute stages of pithomycotoxicosis there is jaundice and a swollen, mottled liver with thickened bile duct walls. In the chronic phase there is extensive hepatic fibrosis, the liver is tough and contracted, and the left lobe is almost completely atrophic. Areas of regeneration are usually apparent macroscopically. Histologically, there is peribiliary fibrosis with obliteration of the bile ducts and pressure atrophy of hepatic cells. The changes are much more marked in the left lobe and the medium- to large-sized bile ducts.

### DIFFERENTIAL DIAGNOSIS

Diagnosis confirmation depends on a positive assay of sporidesmin in fluids and tissues of affected animals. High spore counts on pasture are circumstantial evidence. Pithomycotoxicosis must be differentiated from those other diseases in which photosensitization and hepatitis occur.

#### Differential diagnosis list:

- Pyrrolizidine alkaloid poisoning
- Aflatoxin poisoning
- Steroidal saponin poisoning
- Lantadene poisoning
- Cyanophyte (cyanobacterial) poisoning
- Fascioliasis
- Phomopsis poisoning
- A disease of cattle in the southern United States thought to be associated with the ingestion of dead forage on which a *Periconia* spp. fungus is growing

### TREATMENT

There is no **primary** treatment, except to change animals to new pasture. **Supportive** treatment for hepatitis and photosensitization, as outlined under those headings, and the administration of antibiotics and antihistamines to control secondary infection and shock, may be applicable in animals of sufficient economic value.

The provision of drinking water containing 6 g of zinc sulfate per 100 L for 28 days is claimed to hasten recovery of affected sheep and cattle.<sup>2</sup> Zinc provides protection against sporidesmin toxicity through an

unknown mechanism, but efficacy appears to be associated with an increased serum zinc concentration.

## CONTROL

Research into practical control methods for pithomycotoxicosis has focused on monitoring pasture fungal spore counts to guide grazing practice, development of pastures different to ryegrass that do not promote fungal growth, fungicide and biological control of the saprophytic fungus, and the use of zinc prophylaxis on animals.<sup>4</sup> One of the major difficulties in the control of the disease is that of predicting the occurrence of an outbreak so that the flock can be changed to nondangerous pasture. Meteorologic observation can be of value, but the counting of spores by a mobile spore catcher is now routinely used in danger areas.

In bad seasons the incidence of pithomycotoxicosis can be reduced by **alternating grazing** between native and improved pastures or by reducing the intake of the fungus in any other way. Because of the proclivity of the fungus for dead grass, two acceptable management procedures for prevention are summer irrigation and hard grazing, both of which reduce the amount of foliar substrate available for fungal growth. Avoidance of sandy soils in bad seasons is also advisable because of the greater tendency for grass death on this kind of soil. Allowing pasture to flower, the sward to grow long, the pasture to be damaged by diseases and pests, and frequent mowing encourage pithomycotoxicosis.

In a comparison of **fungicides** used to control the growth of *P. chartarum*, carbendazim was best (at 0.15 and at 0.30 kg/hectare of active ingredient), whereas benomyl and thiophanate methyl were effective only at 0.30 kg/hectare. The original methods of applying fungistatic agents to pasture included thiabendazole or benomyl (Benlate) sprayed on at the rate of 272 g/hectare in January. The growth of *P. chartarum* was controlled and the development of pithomycotoxicosis prevented.

The discovery of **nontoxic strains** of *P. chartarum* in New Zealand and South Africa, which sporulate profusely but produce no sporidesmin, and compete aggressively with sporidesmin-producing strains, raises the question of controlling pithomycotoxicosis by dominating the pastoral fungal population with the sporidesmin-negative strain.

The daily oral administration of **zinc** (15–30 mg of zinc per kilogram bodyweight per day) as zinc oxide to sheep and lactating dairy cows has been shown to reduce the toxic effects of sporidesmin. This method of disease prevention has been used since the mid-1970s.<sup>5</sup> The zinc salt can be administered by drench as a slurry of zinc oxide, by spraying zinc oxide onto pasture, adding zinc sulfate to the drinking water, or by oral administration of a continuous release

rumen device.<sup>6</sup> Zinc is thought to bind directly to sporidesmin, preventing the production of proinflammatory free radicals in biliary epithelial cells.<sup>7</sup> Zinc poisoning has been reported as a result of overzealous applications of zinc for these purposes, and zinc interferes with copper absorption from the gastrointestinal tract. As a result, additional copper has been administered to cattle ingesting excess zinc as a control measure for pithomycotoxicosis, which runs the risk of inducing copper toxicity and decreasing the absorption of zinc.<sup>5</sup> Iron salts, including ferric ammonium citrate, and ferric and ferrous sulfates, have the same protective effect as zinc, but the volume required makes their application impractical. Supplementing cows with up to 1.44 g zinc per day (equivalent to 3.6 mg of zinc per kilogram bodyweight per day) in a zinc amino acid complex was not effective in preventing pithomycotoxicosis.<sup>7</sup>

Finnish Landrace sheep are significantly more resistant to *P. chartarum* poisoning than Romneys, with crossbreeds in an intermediate position. Resistance to sporidesmin is strongly inherited (heritability estimate 0.45), but flocks containing increased numbers of resistant animals do not have superior productivity. Eight putative resistance loci have been identified on different chromosomes. A diagnostic DNA test has been developed for use in sheep with an accuracy of 0.38 for identifying pithomycotoxicosis resistance. The test accuracy is much lower than that provided by a commercially available artificial challenge test (Ramguard), in which the ram is orally dosed with sporidesmin and the serum GGT activity measured 21 days later.<sup>4</sup> Attempted **vaccination** against sporidesmin has not been successful in protecting sheep against pithomycotoxicosis.

## FURTHER READING

- Di Menna ME. A history of facial eczema (pithomycotoxicosis) research. *New Zeal J Agr Res.* 2009;52:345-376.
- Morriss CA, Phuab SA, Cullena NG, Towers NR. Review of genetic studies of susceptibility to facial eczema in sheep and dairy cattle. *New Zeal J Agr Res.* 2013;56:156-170.

## REFERENCES

- Collett MG. *Vet Pathol.* 2014;51:986.
- Ozmen O, et al. *Trop Anim Health Prod.* 2008;40:545.
- Campbell WM, et al. *New Zeal Vet J.* 2010;58:146.
- Phua SH, et al. *Anim Genet.* 2014;45:559.
- Dawson C, Laven RA. *New Zeal Vet J.* 2007;55:353.
- Bennison JJ, et al. *New Zeal Vet J.* 2010;58:196.
- DeFrain JM, et al. *Livestock Sci.* 2010;129:1.

## Rubratoin Toxicosis

*P. rubrum* and *P. purpurogenum* produce rubratoxins suspected of causing hepatic and hemorrhagic diseases.<sup>1</sup> Rubratoin administered experimentally to calves has produced mild liver damage. Naturally occurring cases

of *P. purpurogenum* poisoning in horses fed cornmeal and cottonseed cake are associated with an acute illness. Clinical signs include anorexia; depression; vomiting; profuse, foul-smelling, bloody diarrhea; recumbency on day 4 or 5; and terminal convulsions. Necropsy lesions include icterus, liver damage, and severe hemorrhagic enteritis.

## FURTHER READING

- Radostits O, et al. Poisoning by rubratoxins. In: *Veterinary Medicine: A Textbook of the Disease of Cattle, Horses, Sheep, Pigs, and Goats.* 10th ed. London: W.B. Saunders; 2007:1908.

## REFERENCE

- Atanda A, et al. *J Anim Sci Adv.* 2012;2:250.

## Miscellaneous Fungi Causing Hepatic Damage (Unidentified Toxin)

*Helminthosporium ravenelii* growing on esparto grass is credited with producing a syndrome of excitement, dyspnea, tachycardia, hypersalivation, tremor, jaundice, and some deaths in Argentinian cattle. *Drechslera campanulata* (synonym *Helminthosporium* spp.) occurs as brown-red spots on the leaves of cereal oat plants and is associated with diarrhea, milk yield reduction, and death in some cows. Similar syndromes are found in sheep and goats, except that photosensitivity is also apparent in goats. At necropsy there is ulceration of the forestomach mucosae.

A fungus, *Periconia* spp., which grows on forage in the field, is suspected of being associated with hepatic damage and photosensitization in cattle in the southern United States. There is a close resemblance in clinical signs and circumstances of occurrence to myrothecotoxicosis (*Myrothecium* genus).

## SAWFLY LARVAE (LOPHYRTOMIN AND PERGIDIN) TOXICOSIS

### ETIOLOGY

Ingestion of larvae of the sawflies *Lophyrotoma interrupta* (Australian sawfly) in Australia, *Arge pullata* (birch sawfly) in Denmark, and *Perreyia flavipes* in South America is associated with acute hepatotoxicosis.<sup>1</sup>

### EPIDEMIOLOGY

Large piles of larvae accumulate on the pasture under the infested trees and are eaten by cattle, sheep, goats, or pigs.<sup>1-4</sup> Lophyrotomin is the primary toxin in Australian and Danish larvae and pergidin in the South American larvae.<sup>1,5</sup> Sheep are more susceptible to sawfly poisoning than cattle, developing signs at 7.5 g larvae per kilogram body weight versus 40 g larvae per kilogram body weight for cattle.<sup>5</sup>



## CLINICAL SIGNS

The onset is very rapid and in many cases animals are just found dead. Most signs are associated with severe liver necrosis, and neurologic signs are attributed to hepatic encephalopathy. Clinically, animals may develop weakness, stupor, muscle tremors, depression or agitation, recumbency, convulsions, and death in 2 to 7 days.<sup>1,5</sup> Less acute cases show hyposensitivity, jaundice, photosensitization, diarrhea, and dysentery.

## NECROPSY LESIONS

These include periacinar or panacinar hepatic necrosis, some nephrosis, extensive hemorrhages in the alimentary tract, and fluid transudates in serous cavities in longer surviving cases.

## FURTHER READING

Radostits O, et al. Lophyrotomin and pergidin (sawfly larvae) poisoning. In: *Veterinary Medicine: A Textbook of the Disease of Cattle, Horses, Sheep, Pigs, and Goats*. 10th ed. London: W.B. Saunders; 2007:1920.

## REFERENCES

1. Tessele B, et al. *Pesq Vet Bras*. 2012;32:1095.
2. Soares M, et al. *Pesq Vet Bras*. 2008;28:169.
3. Raymundo D, et al. *Pesq Vet Bras*. 2008;28:19.
4. Jonck F, et al. *Pesq Vet Bras*. 2010;30:1017.
5. Raymundo D, et al. *Pesq Vet Bras*. 2012;32:735.

## Coal Tar Pitch Poisoning in Pigs

### ETIOLOGY

Pigs may be exposed to coal tar pitch and its toxic cresols when housed in pens with tarred walls or floors, which they nibble, or when they have access to pasture to fragments of "clay pigeons" used as targets by gun clubs. Bitumen and asphalt appear to be nontoxic. Young pigs 6 to 20 weeks of age are most often affected.

### CLINICAL FINDINGS

Clinical findings include an acute illness of a few days or a chronic course of some weeks. In the acute illness there are nonspecific signs of inappetence, rough coat, tucked-up abdomen, weakness, and depression. The chronic illness is characterized by anorexia, depression, weakness, anemia, and jaundice. A subclinical syndrome includes a reduction in growth rate of up to 20% to 30%, a severe reduction in hemoglobin concentration and erythrocyte count, and reduced vitamin A storage.

### NECROPSY FINDINGS

These include jaundice, ascites, and anemia, but the characteristic finding is a red and yellow mottling of the hepatic surfaces, and histologically a hepatic lesion of severe centrilobular necrosis. Cresols can be detected in the ingesta and liver of affected pigs.

## Focal Diseases of the Liver

### TUMORS OF THE LIVER

Metastatic lesions of lymphomatosis in calves are the most common neoplasms encountered in the liver of animals, although primary adenoma, adenocarcinoma, and metastases of other neoplasms in the area drained by the portal tract are not uncommon, especially in ruminants. For the most part, they produce no signs of hepatic dysfunction, but they may cause sufficient swelling to be palpable and some abdominal pain by stretching of the liver capsule. Primary tumors of the gallbladder and bile ducts also are rare and do not generally cause clinical signs. A primary hepatic fibrosarcoma in a goat has caused loss of body weight, although appetite was maintained, as well as anemia and jaundice. Hepatic biliary cystadenoma has been described in a 10-year-old horse. It is regarded as a morphologic variant of biliary cystadenoma of domestic animals.

A series of 66 primary hepatic tumors of cattle has been examined and classified using modern criteria. Fifty hepatocellular tumors (10 adenomas and 40 carcinomas), 10 cholangiocellular tumors, 2 cavernous hemangiomas, 2 hemangioendothelial sarcomas, 1 fibroma, and 1 schwannoma were diagnosed. An association with cirrhosis was not found. A bile duct hamartoma in a calf has been reported.

### DISEASES OF THE BILIARY SYSTEM

Cases of biliary tract disease with clinical manifestations are uncommon in food animals and horses. Occasional cases of cholangitis occur in cattle and horses. Associated clinical signs include jaundice, photosensitization, fever, and pain over the liver. There is usually an accompanying leukocytosis. In horses a sequela to cholangitis may be a diffuse bacterial hepatitis with signs of hepatic insufficiency.

Concretions in the biliary system of cattle are usually a sequela to fascioliasis. Mild cases show anorexia and pain over the liver. Severe cases show recurrent attacks of severe abdominal pain, alimentary tract stasis, and pain on percussion over the liver. Jaundice occurs only in the terminal stages of fatal cases and is accompanied by recumbency, depression, and coma. The frequency of pigmented gallstones is high in sheep and associated with high total bilirubin concentration in the bile. Other causes of biliary tract disease include gallbladder empyema and a bile duct carcinoma. In the latter case there was severe loss of body weight and signs referable to metastases in other organs, but there were no clinical or postmortem signs of biliary malfunction. Biliary atresia in young foals is manifested by an early period of normality for 2 to 3 weeks after birth

followed by the development of listlessness; anorexia; the passage of gray, pasty feces; and jaundice. Death occurs about one week later.

Obstructive cholelithiasis in horses that do not have a gallbladder may cause intermittent colic or continuous pain and sometimes jaundice. Clinical findings include fever, icterus, mild intermittent colic, and weight loss. Laboratory findings include leukocytosis, hyperproteinemia, and hyperbilirubinemia. Serum activity of GGT and LDH may also be elevated.

### Cholangiohepatitis in Horses

A series of nine cases was reported of cholangiohepatitis and cholelithiasis in mature horses with a median age of 13 and a range of 4 to 18 years. Clinical signs that prompted referral to a veterinary teaching hospital included anorexia, depression, weight loss, colic, intermittent fever, and icterus. In all horses, the serum activity of GGT and ALP were elevated, and there was hyperbilirubinemia. Transabdominal ultrasonography was used to evaluate the size and nature of the liver and to obtain liver biopsy for histopathology and culture. The ultrasonographic findings included increased hepatic echogenicity, hepatomegaly, enlarged distended bile ducts, and occasional calculi as the salient features. Neutrophilic cholangiohepatitis consistent with an infectious cause was a feature of biopsy material from each horse.

The etiology and pathogenesis of cholangiohepatitis and cholelithiasis in horses are uncertain. Retrograde bacterial infection from the small intestine is considered probable. Culture of liver biopsy material yielded *E. coli* and *Bacteroides vulgatus* from only a small number of affected animals. Long-term parenteral antimicrobial therapy with antibiotics with a gram-negative spectrum for a median of 51 days (range 17–124) was associated with survival in 7/9 horses. Supportive intravenous fluid therapy is recommended. Progress can be monitored by evidence of clinical improvement and declining levels of GGT.

Cholangiohepatitis in a 2-month-old calf was characterized clinically by depression, fever, and diarrhea. There was marked leukocytosis and neutrophilia. The serum activity of GGT and ALP as well as the total serum bilirubin concentration were markedly elevated. Ultrasonographic examination of the liver revealed gross abnormality, and liver biopsy results indicated neutrophilic hepatitis and multifocal hyperplasia of the biliary epithelium suggesting cholangiohepatitis. Culture of liver tissue yielded *E. coli*.

Suppurative cholangiohepatitis and cholelithiasis associated with enteritis has been described in adult horses. Clinical findings included nonresponsive colic, fever, depression, severe abdominal pain, tachycardia, dehydration, gastric fluid accumulation, and absence of abdominal sounds over all four quadrants. Distended loops of small intestine

were palpable on rectal examination, and the peritoneal fluid was serosanguinous. Azotemia, hyperbilirubinemia, and increased serum activity of ALP and GGT were determined and persisted for several days. Cases were associated with severe inflammation of the small intestine and hypovolemic shock.

Cholangiohepatitis and pancreatitis secondary to gastroduodenal ulceration in a 2-month-old foal was characterized clinically by colic unresponsive to surgical treatment. At necropsy, gastric ulceration, segmental duodenal stenosis, severe chronic cholangiohepatitis, and pancreatitis were present.

Cholelithiasis attributable to a foreign body in a horse is recorded. Clinical signs suggestive of biliary disease in adult horses may be caused by neoplasia of the pancreas. A case of congenital hepatic fibrosis in a newborn calf has been reported.

### Diseases of the Pancreas

Pancreatic disease in large animals is extremely rare and, consequently, only a few comments are offered here.

#### **PANCREATITIS**

Pancreatitis is rare in farm animals. Inflammatory and degenerative changes are detected postmortem in some cattle but are rarely diagnosed clinically because of a lack of clinical and laboratory findings. Ultrasonographic imaging of experimentally induced pancreatitis in cattle has been described.

#### **DIABETES MELLITUS**

Lesions of the pancreas resulting in diabetes mellitus, which is characterized by a lack of adequate pancreatic insulin secretion, has been described in cows, horses, and donkeys. The clinical syndrome in horses includes weight loss, polydipsia, polyuria, intense hyperlipidemia, and high plasma concentrations of cholesterol, triglycerides, and glucose. Clinical observations suggest that the disease is most likely to occur in old horses and may be caused by pancreatic injury related to migration of strongyle larvae. Diabetes mellitus resulting from pancreatic  $\beta$ -cell failure is rare in the horse but has been reported in a domesticated Spanish Mustang. In cows

there is afebrile emaciation, polydipsia, ketonuria, glucosuria, and hyperglycemia.

#### **PANCREATIC ADENOMA**

Convulsions caused by hypoglycemia have been recorded in a pony with a pancreatic adenoma. It is assumed that the hypoglycemia resulted from hyperinsulinism generated by the  $\beta$ -cell adenoma.

#### **PANCREATIC ADENOCARCINOMA**

The pancreatic duct of the horse is anatomically close to the common bile duct, and it is not unexpected that a tumor mass should cause a syndrome of biliary duct pathology, although there is a surprising absence of jaundice at some stages of the disease. There is emaciation, concomitant moderate abdominal pain, and variable fecal texture up to diarrhea. Serum GGT activity and blood ammonia levels are greatly increased.

# Diseases of the Cardiovascular System

## PRINCIPLES OF CIRCULATORY FAILURE 657

Heart Failure 657  
 Circuit Failure 658  
 Cardiac Reserve and Compensatory Mechanisms in Heart Failure 658  
 Cardiac Enlargement 659

## MANIFESTATIONS OF CIRCULATORY FAILURE 659

Chronic (Congestive) Heart Failure 659  
 Acute Heart Failure 662

## SPECIAL EXAMINATION OF THE CARDIOVASCULAR SYSTEM 663

Physical Examination 663  
 Measurement of Jugular Venous Pressure 665  
 Measurement of Central Venous Pressure 665  
 Exercise Tolerance 666  
 Electrocardiography 666  
 Biomarkers of Myocardial Injury 670  
 Measurement of Arterial Blood Pressure 671  
 Measurement of Pulmonary Artery Blood Pressure 671  
 Echocardiography 672  
 Radiographic and Angiocardiographic Examination 673  
 Phonocardiography 673

Cardiac Output 673  
 Cardiac Catheterization 673

## ARRHYTHMIAS (DYSRHYTHMIAS) 675

Sinus Tachycardia, Sinus Bradycardia, and Physiologic Dysrhythmias 675  
 Arrhythmias With Normal Heart Rates or Bradycardia 679  
 Arrhythmias With Tachycardia 680

## DISEASES OF THE HEART 685

Valvular Disease and Murmurs 685  
 Endocarditis 688  
 Myocardial Disease and Cardiomyopathy 690  
 Rupture of the Heart and Acute Cardiovascular Accidents 692  
 Cor Pulmonale 693  
 High Altitude Pulmonary Hypertension (Brisket Disease, Mountain Sickness) 693  
 Encephalomyocarditis Virus Disease in Pigs 695

## CARDIAC TOXICITIES 697

Cardiac Glycoside Toxicosis 697  
 Yew (*Taxus* spp.) Toxicosis 699  
 Monofluoroacetate Plant Toxicosis 700  
 4-Methoxy pyridone Plant Toxicosis 701

Plants Causing Heart Failure (Unidentified Toxins) 701  
 Ionophore (Carboxylic) Toxicosis 701

## CARDIAC NEOPLASIA 703

## CONGENITAL CARDIOVASCULAR DEFECTS 703

## INHERITED DEFECTS OF THE CIRCULATORY SYSTEM 706

Bovine Hereditary Dilated Cardiomyopathy 706  
 Inherited Ventricular Septal Defect 707  
 Inherited Aortic Aneurysm 707  
 Bovine Marfan Syndrome 707

## DISEASES OF THE PERICARDIUM 707

## DISEASES OF THE BLOOD VESSELS 709

Arterial Thrombosis, Embolism, and Rupture 709  
 Purpura Hemorrhagica 711  
 Venous Thrombosis 713  
 Elaeophoriosis (Filarial Dermatitis in Sheep) 714

## VASCULAR NEOPLASIA 715

Hemangioma and Hemangiosarcoma 715

## Principles of Circulatory Failure

The primary function of the cardiovascular system is to ensure an adequate circulation of blood so that nutrients are delivered, waste products are removed, and a homeostatic milieu is maintained at the organ and cellular level. An inadequate circulation interferes with nutrient delivery and waste product removal, ultimately leading to circulatory failure, the primary concept in diseases of the cardiovascular system.

The two functional units of the cardiovascular system are the heart and the blood vessels; these two units are best characterized as a **pump** (the heart) and a **circuit** (the blood vessels and blood). The pump and circuit may fail independently of each other, giving rise to two forms of circulatory failure, heart failure and circuit failure. In heart failure the primary problem is inadequate pump performance, whereas in circuit failure the deficiency is in the vascular system, which fails to return an adequate volume of blood to the heart. Circuit failure can also

result from decreased circulating blood volume or redistributed blood volume.

## HEART FAILURE

The failure of the heart as a pump can result from a filling defect of the heart, an abnormality in the generation or conduction of the electrical wave of depolarization, an abnormality in contractile function, excessive workload, anatomic abnormalities, or a combination of one or more abnormalities.

### CAUSES OF CARDIOVASCULAR DYSFUNCTION

- Cardiac arrhythmia
- Obstructed flow
- Regurgitant flow
- Contractile dysfunction (systolic failure)
- Inadequate filling (diastolic failure)
- Anatomic abnormalities

It is usual to divide heart failure into two types, **acute** and chronic (**congestive**) **heart failure**. However, a complete range of syndromes occurs and some of them do not fit

neatly into either category. Circulatory equilibrium is not maintained when cardiac output is deficient. If inadequate cardiac output develops sufficiently slowly, compensatory mechanisms, plus the failure of the heart itself as a pump, result in an increase in venous pressure and congestive heart failure. If, on the other hand, there is an acute reduction of cardiac output, as is caused by sudden cessation of the heartbeat, the effect is to deprive tissues of their oxygen supplies and the syndrome of acute heart failure develops.

Heart failure can be **left-sided**, **right-sided**, or both **left-sided and right-sided**. Left-sided heart failure causes an increase in left ventricular end-diastolic pressure, mean left atrial pressure, and pulmonary venous pressure. Depending on the magnitude and rate of the increase in pressure, left-sided heart failure results in interstitial edema in the lungs and, if severe enough, pulmonary edema, dyspnea, and death. Right-sided heart failure causes an increase in right ventricular end-diastolic pressure, mean right atrial pressure, and jugular venous pressure. Depending on the magnitude and rate of the



increase in pressure, right-sided heart failure results in symmetric venous distension (most readily detected in the jugular veins); an increase in pleural, pericardial, and abdominal fluid (ascites); and hepatomegaly.

### CIRCUIT FAILURE

In circuit failure the effective blood volume is decreased because of loss of fluid from the vascular system (hypovolemic shock) or by pooling of blood in peripheral vessels and increased capillary permeability (maldistributive shock, which is commonly seen in endotoxemia). The failure of venous return results in incomplete filling of the heart and a reduction in cardiac output, although the pump performance may be normal. The effects of circuit failure are the same as those of chronic (congestive) heart failure because the supply of nutrients to the tissues and the removal of waste products from the tissues are reduced.

### CARDIAC RESERVE AND COMPENSATORY MECHANISMS IN HEART FAILURE

The normal heart has the capacity to increase its output severalfold in response to normal physiologic demands created by exercise and to a lesser extent by pregnancy, lactation, digestion, and hot ambient temperatures. Collectively, these compensatory responses comprise the **cardiac reserve**. Similar compensatory responses are used by the failing heart in an attempt to maintain cardiac output. Cardiac reserve and its response in heart failure have not been studied extensively in large domestic animals; consequently, its description must rely heavily on studies on cardiac failure in small domestic animals and studies of the effect of exercise on cardiovascular performance in the horse. Clinical observations on cardiac insufficiency and cardiac failure in large animals suggest that the processes are very similar to those in small animals and humans.

The major mechanisms in which the blood flow to an organ can be increased are

- Increase in heart rate
- Increase in stroke volume
- Redistribution of blood flow to vital organs, or organs with particularly high metabolic requirements

All of these mechanisms act synergistically and are interrelated. Heart rate and stroke volume are the determinants of cardiac output (cardiac output is the product of heart rate and stroke volume).

### CARDIAC RESERVE AND HEART RATE

There is a great deal of cardiac reserve in the heart rate, and an elevation of heart rate alone is a significant factor in increasing cardiac output in the exercising horse. There is a limitation to heart rate reserve because with

increasing heart rates there is a decrease in diastolic filling time, and stroke volume falls at excessive heart rates. Effective heart rate reserve can be increased with exercise training, and maximum heart rate in trained exercising horses is six to seven times the resting value. This large increase in heart rate reflects the metabolic scope of trained horses. In contrast, cattle can only increase their heart rate to two to four times their resting values. An increase in heart rate is also used to maintain cardiac output by the failing heart. With cardiac insufficiency in the horse and the cow it is rare for the heart rate to exceed 120 beats/min at rest, and rates higher than this are frequently caused by tachyarrhythmias that require immediate treatment.

### CARDIAC RESERVE AND STROKE VOLUME

Stroke volume is variable and depends on the amount of shortening that the myocardial fibers can attain when working against arterial pressure. It is determined by the interplay of four factors:

- Ventricular distending or filling pressure (preload)
- Contractility of the myocardium (inotropic state)
- The tension that the ventricular myocardium must develop during contraction and early ejection (afterload)
- The sequence of atrial and ventricular depolarization

An increase in ventricular distending pressure (end-diastolic pressure or volume) will increase ventricular end-diastolic fiber length, which, by the Frank–Starling mechanism and stretch-dependent calcium sensitization, will result in increased stroke work and a larger stroke volume. Ventricular distending pressure is influenced by atrial contraction and is greatly augmented by increased venous return associated with exercise and increased sympathetic activity. Contractility is most influenced by adrenergic activity and circulating catecholamines. An increase in stroke volume is achieved primarily by an increase in the ejection fraction and a reduction in the end-systolic volume but can also be achieved by a decrease in afterload, which is primarily a function of aortic or pulmonary impedance (the resistance and reactance of the vasculature to ejection).

### CARDIAC RESERVE AND MIXED VENOUS OXYGEN TENSION

In normal animals at rest, the oxygen tension of mixed venous blood is above 40 mm Hg (5.3 kPa), which represents a considerable reserve. Increased extraction of oxygen from the blood by various tissues, with a subsequent decrease in mixed venous oxygen tension and a corresponding increase in arterial venous oxygen difference, occurs during exercise and in pump and circuit failure. In uncompensated heart failure, in which stroke volume is reduced, the mixed venous oxygen

tension falls below 40 mm Hg, reaching 15 to 25 mm Hg in severe shock states, and the arterial venous oxygen difference is large. There is also a redistribution of blood flow to vital organs. In the horse the splenic storage capacity for erythrocytes is large and the spleen may contain one-third of the total red cell volume. Maximal emptying of the spleen under adrenergic activity can significantly influence the oxygen-transporting capacity of the blood and, in the horse, the splenic reservoir contributes significantly to cardiovascular reserve.

### CARDIAC RESERVE AND AUTONOMIC NERVE ACTIVITY

It is evident that increased sympathetic nerve activity also plays a significant role in compensating for the failing ventricle, but one that is not readily determined clinically. An increase in sympathetic activity acts to augment cardiac output by increasing the heart rate, by improving the contractility of the myocardium, and by augmenting venous return to the heart. Autonomic nerve activity also regulates blood flow to more essential organs, even when faced with insufficient cardiac output.

### CARDIAC RESERVE IN CARDIAC INSUFFICIENCY

In cardiac insufficiency the principal defect is in the contractile state of the myocardium, and ventricular performance at any given end-diastolic volume or pressure is diminished. In early failure, cardiac output may still be maintained in the normal range by an increase in filling pressure and, through utilization of stretch-dependent calcium sensitization and the Frank–Starling principle, the ventricles can eject a normal stroke volume despite the depression in contractility. Thus early in the course of cardiac failure, the end-diastolic pressure may be elevated only during periods with heavy demands on the heart, such as during exercise. However, as myocardial function becomes increasingly impaired, this mechanism is increasingly used for lesser work demands until end-diastolic pressure is elevated even at rest or with normal activity.

Ventricular filling pressure is augmented by increased venous return associated with contraction of the venous capacitance vessels under increased sympathetic tone, and by an increase in blood volume as the result of salt and water retention by the kidney. Decreased renal perfusion results in the release of renin by the juxtaglomerular cells in the kidney and the activation of the **renin-angiotensin-aldosterone system**. Renin causes the conversion of angiotensinogen to angiotensin I, and angiotensin I in turn is converted to angiotensin II in the lungs. Angiotensin II is a powerful vasoconstrictor that promotes the effect of norepinephrine. Angiotensin II also stimulates the release of aldosterone from the adrenal cortex, which acts to increase

sodium retention by the kidney with consequent expansion of the interstitial fluid and blood volumes.

Although the increase in ventricular end-diastolic pressure acts to maintain cardiac output, it is associated with a marked increase in systemic or pulmonary venous pressure, producing secondary effects that result in many of the clinical abnormalities associated with congestive heart failure. Where the contractile state of the heart is markedly reduced, the increased end-diastolic pressure is unable to maintain normal stroke volume, even at normal activity, and cardiac output is reduced even at rest—the state of uncompensated heart failure, which is clinically manifested as pump failure.

### MEASUREMENT OF CARDIAC RESERVE

From a clinical standpoint it would be desirable to be able to detect incipient cardiac insufficiency at a very early stage.

A clinical estimation of cardiac reserve based on physical examination is important when a prognosis is to be made for an animal with heart disease. Some of the important criteria used in making this assessment include the heart rate, the intensity of the heart sounds, the size of the heart, the characteristics of the pulse, and the tolerance of the animal to exercise. A resting heart rate above normal indicates loss of cardiac reserve. The absolute intensity of the heart sounds suggests the strength of the ventricular contraction, soft sounds suggesting weak contractions, and sounds that are louder than normal suggesting cardiac dilatation and possibly hypertrophy, although this is a very crude and insensitive measure. The interpretation of variation in intensity must be modified by recognition of other factors, such as pleural and pericardial effusion, that interfere with audibility of the heart sounds.

Pulse characteristics are of value in determining the cardiac reserve, but they are greatly affected by factors other than cardiac activity. An increased pulse amplitude occurs when the cardiac stroke volume is increased, but a decreased pulse amplitude may result from reduced venous return as well as from reduced contractile power of cardiac muscle.

Exercise tolerance is an excellent guide to cardiac reserve and the least expensive and most practical method for quantifying cardiovascular reserve. Exercise tolerance is best assessed by measuring the maximum heart rate attained after a standard exercise test, and the time required for the heart rate to return to normal.

### CARDIAC ENLARGEMENT

The ratio of heart weight to body weight (BW) is greater in athletic animals than in nonathletic animals, and the heart:weight ratio in horses can be modestly increased during training as a result of physiologic

hypertrophy. Cardiac enlargement is also a compensatory response to persistent increased workloads that are associated with cardiovascular disease. The heart may respond by dilatation, hypertrophy, or a combination of both; with endurance training there is both cardiac hypertrophy and cardiac enlargement.<sup>1</sup>

**Cardiac hypertrophy** (concentric hypertrophy) is the usual response to an increased pressure load, and there is hypertrophy of individual fibers with an increase in the number of contractile units (sarcomeres) and an increase in total muscle mass.<sup>2</sup> However, cardiac hypertrophy is usually accompanied by decreased capillary density and increased intercapillary distance and, in states of cardiac insufficiency, coronary blood flow reserve places limitations on this compensatory mechanism.

**Cardiac dilatation** (eccentric hypertrophy) is the usual response to an increased volume load and probably results from fiber rearrangement. Contractions occurring in a dilated chamber can eject a larger volume of blood per unit of myocardial shortening. However, the limitation to this compensatory mechanism is evident in the law of Laplace, which shows that in the dilated chamber greater myocardial wall tension is required to produce an equivalent elevation of intrachamber pressure during ejection.

The significance of finding cardiac enlargement on clinical examination is that it indicates the presence of a significant volume or flow load on the heart, or the presence of myocardial disease and a reduction of cardiac reserve. The detection of cardiac enlargement on physical examination is aided by careful auscultation of the heart and palpation of the apex beat. Cardiac size can be accurately detected by thoracic percussion in the horse, and percussion is an underutilized part of the routine physical examination.<sup>3</sup> A palpable and audible increase in the apex beat and area of audibility, backward displacement of the apex beat, increased visibility of the cardiac impulse at the base of the neck and behind the elbow, and increased area for the cardiac shadow during thoracic percussion are all suggestive of cardiac enlargement. Care must be taken that the abnormalities observed are not caused by displacement of the heart by a space-occupying lesion of the thorax, such as thymic lymphosarcoma, or to collapse of the ventral part of the lung and withdrawal of lung tissue from the costal aspects of the heart. Echocardiography should be used to quantify the magnitude of the enlargement whenever the results of physical examination suspect the presence of cardiac enlargement.<sup>1</sup>

### REFERENCES

1. Buhl R, Ersboll AK. *Am J Vet Res.* 2012;240:205.
2. de Solis CN, et al. *J Am Vet Med Assoc.* 2013;243:126.
3. Bakos Z, Voros K. *Acta Vet Hung.* 2007;55:277.

## Manifestations of Circulatory Failure

The manifestations of circulatory failure depend on the rapidity of its onset, the magnitude of its severity, and the length of its duration. Chronic (congestive) heart failure and acute heart failure are discussed in the following sections.

### CHRONIC (CONGESTIVE) HEART FAILURE

#### SYNOPSIS

**Etiology** Diseases of the endocardium, myocardium, and pericardium that interfere with the flow of blood into or away from the heart, or that impair myocardial function, may result in congestive heart failure

**Clinical findings** Generalized venous distension and edema in right-sided failure; pulmonary edema and respiratory distress in left-sided failure

**Clinical pathology** Increased plasma or serum concentration of cardiac troponin I, a cardiac-specific enzyme

**Necropsy findings** Subcutaneous edema, ascites, hydrothorax, and hydropericardium; enlargement and engorgement of the liver with right-sided failure; pulmonary edema with left-sided failure

**Diagnostic confirmation** Clinical

**Treatment** Treatment of specific cause, often unsuccessful; diuretics, salt restriction, minimize activity, possibly digoxin

### ETIOLOGY

Causes of chronic (congestive) heart failure can be broadly characterized as follows.

#### Valvular Disease

- Endocarditis resulting in either valvular stenosis or valvular insufficiency
- Congenital valvular defects, most commonly valvular stenosis
- Rupture of valve or valve chordae

#### Myocardial Disease

- Myocarditis: bacterial, viral, parasitic, or toxic
- Myocardial degeneration: nutritional or toxic
- Congenital or hereditary cardiomyopathy
- Toxins affecting cardiac conduction

#### Congenital Anatomic Defects Producing Shunts

- Cardiac defects, such as ventricular or atrial septal defects, tetralogy of Fallot
- Vascular abnormalities producing shunts, such as patent ductus arteriosus

### Hypertension

- Pulmonary hypertension: high altitude disease, cor pulmonale
- Systemic hypertension: undocumented cause of congestive heart failure in large animals

### Pressure Load

Pressure loads occur with lesions that produce an obstruction to outflow, such as aortic or pulmonary valve stenosis, during which the heart is required to perform more work to eject an equivalent amount of blood. Pressure loads are not necessarily associated with lesions in the heart. For example, pulmonary hypertension, such as occurs in high altitude disease of cattle because of an increase in pulmonary vascular resistance, may result in cardiac insufficiency. Generally, the left ventricle can tolerate a pressure load to a much greater extent than the right ventricle without overt signs of cardiac insufficiency.

### Volume Load

Volume loads (flow loads) are common with both acquired and congenital heart defects. In aortic valve and mitral valve insufficiency the volume of blood delivered to the tissues does not differ significantly from normal. However, to achieve a normal cardiac output, the forward stroke volume of the ventricle is markedly increased and the heart is much more inefficient for the same amount of effective work. In a similar manner a patent ductus arteriosus or an interventricular septal defect with a large left-to-right shunt of blood can place a considerable flow load on the left ventricle. Generally, the right ventricle is more capable of sustaining a flow load than the left ventricle.

### Pumping Defects (Systolic Failure)

Cardiac insufficiency may occur without any increase in workload if there is a primary weakness in the myocardium or defect in its rhythmic and coordinated contraction. Myocarditis, cardiomyopathy, and neoplasms of the heart, especially bovine viral leukosis lesions of the right atrium, are common causes. Arrhythmias are a rare cause of congestive heart failure but a common cause of acute heart failure.

### Filling Defects (Diastolic Failure)

Pericardial diseases such as pericarditis and pericardial tamponade can result in cardiac insufficiency by interfering with diastolic filling. Filling of the ventricle is determined by the complex interaction of a number of factors, including mean circulatory filling pressure, mean right atrial pressure, stiffness of the ventricular chamber (which is determined, in part, by mean arterial blood pressure), and the pressure gradient across the ventricular wall. The latter is markedly affected by increases in pericardial fluid pressure that

are present in pericarditis and pericardial tamponade.

### PATHOGENESIS

Cardiac reserve and compensatory mechanisms in heart failure were described in the preceding section. In the early stages of cardiac disease circulatory equilibrium may be maintained. However, cardiac reserve is reduced and the animal is not able to cope with circulatory emergencies as well as a normal animal. This is the stage of waning cardiac reserve in which the animal is comparatively normal at rest but is incapable of performing exercise (the phase of poor exercise tolerance) or responding appropriately to a physiologic stressor such as late gestation or being housed in hot ambient temperatures. Congestive heart failure develops when these compensatory mechanisms reach their physiologic limit and the heart is unable to cope with the circulatory requirement at rest.

Failure may manifest as primarily being right-sided, left-sided, or both left-sided and right-sided. Many of the clinical signs that appear during the development of cardiac insufficiency, as well as those associated with decompensated heart failure, are the consequence of congestion or edema caused by increased venous hydrostatic pressure. A decreased cardiac output also contributes to the clinical signs by the production of tissue hypoxia.

### Right-Sided Congestive Heart Failure

Venous congestion is manifested in the systemic circulation. The increase in mean right atrial pressure increases the mean capillary pressure, and the net force for filtration of fluid across the capillary bed is therefore greatly increased. This results in the production of **edema** in dependent subcutaneous body areas and in body cavities. In the kidneys the increase in hydrostatic pressure is offset by the reduced flow of blood and urine output is reduced. The increased back pressure to the glomerulus causes increased permeability and escape of plasma protein into the urine. **Venous congestion** in the portal system is an inevitable sequel of hepatic congestion and is accompanied by impaired digestion and absorption and terminally by diarrhea.

### Left-Sided Congestive Heart Failure

Increased pulmonary venous pressure causes venous congestion, decreased compliance of the lung and an increase in respiratory rate, an increase in the work of breathing, and exercise intolerance. Similarly, bronchial capillary congestion and edema result in encroachment on airways and a decrease in ventilatory efficiency. When venous hydrostatic pressure is exceptionally high, the net force for filtration of fluid across the pulmonary capillary bed is greatly increased. This can result in **pulmonary edema**, with

the presence of fluid around the septal vessels and in the alveolar spaces accompanied by marked impairment of gas exchange. The development of clinically detectable pulmonary edema depends to some extent on the rapidity of the onset of cardiac failure. In chronic failure syndromes, the development of a capacious lymphatic drainage system limits the occurrence of clinical pulmonary edema and, in large animals, pulmonary edema is usually limited to acute heart failure when there is a relatively sudden onset of volume load on the left ventricle.

### CLINICAL FINDINGS

The specific findings on auscultation and other examinations were described earlier. In the very early stages when cardiac reserve is reduced but decompensation has not yet occurred, there is respiratory distress on light exertion. The time required for return to the normal respiratory and pulse rates is prolonged. In affected animals there may be evidence of cardiac enlargement and the resting heart rate is moderately increased. There may be a loss of BW. Clinical signs of heart failure are predominantly right-sided in large animals, with the exception of heart failure caused by mitral valve disease in horses and pulmonary edema in pigs caused by fumonisin mycotoxicosis.

### Right-Sided Congestive Heart Failure

In right-sided congestive heart failure the **heart rate is almost always increased** and there is venous distension and subcutaneous edema. The **superficial veins** are engorged and this is most easily detected by the presence of bilateral jugular vein distension. In ruminants there is **subcutaneous edema** occurring primarily in the brisket region (brisket edema) and less frequently under the jaw (submandibular edema) and along the ventral midline (Fig. 10-1 A and B). In advanced cases **ascites** is present and can occasionally be detected by the presence of an abdominal fluid wave on ballottement with palpation, the presence of excess abdominal fluid on palpation per rectum, and in rare cases by the presence of abdominal distension with a pear-shaped abdomen. Ascites needs to be differentiated from other causes of abdominal distension, and the detection by palpation per rectum of viscera floating in a fluid medium and the presence of a fluid wave on abdominal ballottement are highly suggestive of ascites. Care must be taken to differentiate ascites from uroabdomen and hydrops conditions of the uterus. Hydrothorax and hydropericardium may also be clinically detected in animals with ascites. Noncardiac causes for ascites, such as abdominal mesothelioma or caudal vena caval thrombosis that interfere with removal of peritoneal fluid, need to be ruled out.<sup>1</sup>

In horses, edema is initially more prominent in the pectoral region between the front





**Fig. 10-1** Brisket and preputial edema caused by right-sided congestive heart failure in a Charolais bull. Heart failure was caused by infiltration of the atrial and ventricular myocardium by lymphosarcoma (see [Chapter 11](#) for more details).

limbs, the ventral abdominal wall, the prepuce, and the limbs. Ruminants and camelids do not get edema in their legs in right-sided heart failure because their comparatively thicker skin acts as an antigravity suit (G suit), minimizing the extent of hydrostatic pooling of blood in the limbs.

The liver is enlarged and, in cattle, may be palpable, protruding beyond the right costal arch with a thickened and rounded edge. In both horses and cattle liver enlargement may be detected by ultrasound examination. The respiration is deeper than normal and the rate may be slightly increased. Urine flow is usually reduced and the urine is concentrated and contains a small amount of protein. The feces are usually normal at first, but in the late stages diarrhea may be evident. BW may increase because of edema, but the appetite is poor and condition is lost rapidly. Epistaxis may occur in the horse but is rare in other species. The attitude and behavior of the animal is one of listlessness and depression; exercise is undertaken reluctantly and the gait is shuffling and staggy through weakness.

#### Left-Sided Congestive Heart Failure

The **heart rate is increased** and there is an increase in the rate and depth of **respiration** at rest with **cough**, the presence of crackles (discontinuous sounds) at the base of the lungs, and increased dullness on percussion of the ventral borders of the lungs. Terminally there is severe dyspnea and cyanosis. A “cardiac” cough associated with pulmonary edema formation is rarely observed in large animals, with reports confined to horses with mitral valve regurgitation.

The **prognosis** in congestive heart failure varies to a certain extent with the cause, but in most cases in large animals it is poor to grave. The possibility of recovery exists with an arrhythmia, pericardial tamponade, or pericarditis, but when the epicardium, myocardium, or endocardium is involved, complete recovery rarely if ever occurs, although the animal may survive with a permanently reduced cardiac reserve. Uncomplicated defects of rhythm are common in the horse, and these defects are more compatible with life than are extensive anatomic lesions.

#### CLINICAL PATHOLOGY

Clinicopathologic examinations are usually of value only when differentiating the causes of congestive heart failure and in differentiating it from other diseases. Aspiration of fluid from accumulations in any of the cavities may be thought necessary if the origin of the fluid is in doubt.<sup>1</sup> The fluid is an edematous transudate except in pericardial tamponade (serosanguinous) or pericarditis (effusion), when it may be septic or nonseptic.<sup>2</sup> In most cases protein is present in large amounts because of leakage of plasma from damaged capillary walls. Proteinuria is often present because of pressure-induced damage to the glomerulus. The serum or plasma concentration of **cardiac troponin I (cTnI)** provides an excellent cardiac biomarker in large animals, providing a sensitive and persistent indicator of myocardial injury.

#### NECROPSY FINDINGS

On necropsy, lesions characteristic of the specific cause are present and may comprise abnormalities of the endocardium,

myocardium, pericardium, lungs, or large vessels. Space-occupying lesions of the thorax may constrict the cranial vena cava and interfere with venous return. The lesions that occur in all cases of congestive heart failure, irrespective of cause, are pulmonary congestion and edema (if the failure is left-sided) and anasarca, ascites, hydrothorax and hydropericardium, and enlargement and engorgement of the liver with a “nutmeg” pattern of congested red centers of liver lobules surrounded by paler fatty peripheral regions (if the failure is right-sided). It is important to characterize the heart failure as being left-sided, right-sided, or both left-sided and right-sided at necropsy, because this information will help prioritize the likely cause.

#### DIFFERENTIAL DIAGNOSIS

- Causes of edema
- Causes of dyspnea

#### TREATMENT

The treatment of animals with clinical signs of congestive heart failure caused by pericarditis or pericardial tamponade focuses on removing the pericardial fluid and preventing its return. In animals with pump failure, the treatment of congestive heart failure initially focuses on the reduction of the effects of increased preload by administering diuretic agents, angiotensin-converting enzyme (ACE) inhibitors, and restricting sodium intake, reducing the demands on cardiac output by restricting activity, and improving contractility by the administration of positive inotropic agents such as cardiac glycosides and dobutamine.

#### Diuretics

Diuretic treatment (furosemide, acetazolamide, or chlorothiazide) is an important component of treatment because it mobilizes and eliminates excess body fluids. **Furosemide** is most often used because it is the most potent diuretic available, is inexpensive, and pharmacokinetic parameters have been determined for large animals. Furosemide should be administered at an initial intravenous (IV) dose of 0.25 to 1 mg/kg for horses and 2.5 to 5 mg/kg for cattle for the treatment of congestive heart failure. Multiple doses of furosemide will induce a hypokalemic, hypochloremic metabolic alkalosis, so it is important to monitor serum potassium and chloride concentrations during treatment. Access to free salt should be stopped, although it is usually impractical to formulate a salt-restricted diet.

#### Angiotensin-Converting Enzyme Inhibitors

ACE inhibitors have been recommended widely for the treatment of congestive heart disease caused by valvular dysfunction in

horses, but efficacy data is lacking. Theoretically, ACE inhibitors should be beneficial in addressing the activation of the renin-angiotensin-aldosterone system that results in sodium and fluid retention and vasoconstriction. Single oral doses of benazepril (0.5 mg/kg) was a more effective ACE inhibitor in healthy adult horses than single oral doses of ramipril (0.3 mg/kg), quinapril (0.25 mg/kg), or perindopril (0.1 mg/kg).<sup>2</sup> A daily dosage protocol for benazepril has not been developed. Enalapril has low oral bioavailability and has not been formally evaluated in the horse.

### Stall Rest

Stall rest in a thermoneutral environment is also an important treatment requirement. Parturition may be electively induced in late gestation to prevent in utero fetal hypoxia and abortion as well as to decrease the additional demand placed by placental blood flow on the cardiac output.

### Positive Inotropic Agents (Dobutamine, Calcium, Cardiac Glycosides)

**Dobutamine** is a synthetic catecholamine and is the most commonly used positive inotropic agent in horses, particularly in anesthetized horses in which short-term cardiovascular support is required. At low IV doses (1 [μg/kg]/min) the major change is a small increase in mean arterial blood pressure. At intermediate IV doses (2.5–7.5 [μg/kg]/min) the major effect of dobutamine is increased cardiac contractility, and this should be the target dose range for animals needing inotropic support. Other sympathomimetics have been used in large animals (such as adrenaline, dopamine, dopexamine, and ephedrine) but none have the triple attractiveness of efficacy, minimal proarrhythmic activity, and safety that dobutamine possesses.

**Calcium gluconate**, calcium borogluconate, and calcium chloride provide a low-cost, widely available dose-dependent IV positive inotropic agent that has been used in conscious and anesthetized large animals. The major disadvantage of IV calcium as an inotropic agent is a dose-dependent increase in left ventricular end-diastolic pressure that may predispose to acute left-sided heart failure.

**Digoxin** is the most commonly used cardiac glycoside. In horses it can be administered either intravenously or orally, but in ruminants it must be given intravenously or orally after induction of esophageal groove closure because digoxin is destroyed in the rumen. Digoxin should not be given intramuscularly in any species because it causes severe muscular necrosis. This is also reflected in erratic plasma digoxin concentrations following intramuscular administration. Treatment with digoxin results in an increase in cardiac contractility and a decrease in heart rate with increased

myocardial oxygen consumption, increased cardiac output, and a decrease in cardiac size. The improvement in cardiac output promotes diuresis and the reduction and elimination of edema.

The half-life of digoxin in the **horse** is 17 to 23 hours and a plasma therapeutic range for digoxin of 0.5 to 2.0 ng/mL has been suggested. Pharmacokinetic studies suggest that therapeutic but nontoxic plasma concentrations of digoxin in the horse will be achieved by an initial IV loading dose of 0.01 to 0.015 mg/kg BW followed by a maintenance IV dose of 0.005 to 0.0075 mg/kg BW every 24 hours. In the horse the bioavailability of powdered digoxin given orally is low, being less than 20% of the administered dose. An oral loading dose of 0.07 mg/kg, followed by a daily oral maintenance dose of 0.035 mg/kg is suggested by pharmacokinetic studies.

The half-life of digoxin in **cattle** is 5.5 to 7.2 hours, requiring more frequent dosing than in horses, and an initial IV loading dose of 0.022 mg/kg BW followed by 0.0034 mg/kg BW every 4 hours has been suggested. An alternative is to give digoxin as a continual infusion at 0.86 (ug/kg BW)/hour. There is no established dose for digoxin administration in **sheep**, but the half-life is similar to that in cattle.

No dosing regimen is absolute, and the dose may need adjustment based on clinical response, evidence of toxicity, or by measuring the plasma digoxin concentration. Dose rates other than those given earlier have been used successfully. Toxicity with digoxin treatment is reported and may occur because the clearance of digoxin in some animals with congestive heart failure differs from that of normal animals on which the suggested doses have been based.

If treated animals are not eating, the daily oral administration of KCl (cattle 100 g, horses 30 g) is recommended as well as monitoring **serum potassium concentrations**, because the toxic effects of digoxin are affected by the serum potassium concentration. Because of the necessity for frequent dosing in cattle and the ineffectiveness of oral treatment, digoxin therapy has major limitations in ruminants, especially since the primary pathology that leads to congestive heart failure in cattle is usually not correctable. Unless myocardial damage is transient, administration of the digoxin in all species will probably have to be continued for life, and this is rarely practical. Calcium sensitizing agents could theoretically be beneficial in providing long-term positive inotropic support, but clinical studies are not available.

### FURTHER READING

- Buczinski S, Francoz D, Fecteau G, DiFruscia R. Heart diseases in cattle with clinical signs of heart failure: 59 cases. *Can Vet J*. 2010;51:1123-1129.
- Buczinski S, Rezakhani A, Boerboom D. Heart disease in cattle: Diagnosis, therapeutic approaches and prognosis. *Vet J*. 2010;184:258-263.

Davis JL, Gardner SY, Schwabenton B, Breuhaus B. Congestive heart failure in horses: 14 cases (1984-2001). *J Am Vet Med Assoc*. 2002;220:1512-1515.

Schauvliege S, Gasthuys F. Drugs for cardiovascular support in anesthetized horses. *Vet Clin North Am Equine Pract*. 2013;29:19-49.

### REFERENCES

- Milne MH, et al. *Vet Rec*. 2001;148:341.
- Afonso T, et al. *J Vet Intern Med*. 2013;27:1185.

## ACUTE HEART FAILURE

### ETIOLOGY

Acute heart failure can occur when there is a severe defect in filling; when there is failure of the heart as a pump, caused by severe tachycardia, bradycardia, or arrhythmia; and where there is a sudden increase in workload. The sudden occurrence of tachyarrhythmias in association with excitement that is severe enough to cause acute heart failure presumably results from the exacerbating influence of catecholamines. These are released in association with episodes of excitement and act to heighten the discharge potential of ectopic excitatory foci associated with myocardial disease.

### SYNOPSIS

**Etiology** Sudden onset of a severe arrhythmia, rupture of a heart valve or vessel, pericardial tamponade

**Clinical findings** Sudden loss of consciousness, falling with or without convulsions, severe pallor of the mucosae and either death or complete recovery from the episode

**Clinical pathology** Increased serum cardiac troponin I concentrations, but clinical course usually too short for examination

**Diagnostic confirmation** Clinical

**Necropsy findings** Pulmonary congestion and edema; findings related to specific cause

**Treatment** Treatment of specific cause, often unsuccessful

Acute heart failure can also occur in the absence of primary cardiac disease under the influence of pharmacologic agents that affect cardiac conduction. These are associated with the ingestion of certain poisonous plants.

The many causes of acute heart failure are listed in greater detail later. Some examples are as follows:

#### Disorders of filling

- Pericardial tamponade: atrial and ventricular rupture
- Aortic and pulmonary artery rupture

#### Tachyarrhythmia

- Myocarditis, e.g., encephalomyocarditis virus, foot-and-mouth disease

- Nutritional deficiency myopathy, e.g., copper or selenium deficiency
- Plant poisoning, e.g., *Phalaris* spp., white snake root
- Electrocution and lightning strike<sup>1</sup>

#### Bradycardia

- Iatrogenic, e.g., IV calcium gluconate or borogluconate administration, xylazine, tolazoline, concentrated solutions of potassium chloride
- Plant poisoning, e.g., *Taxus* spp.<sup>2</sup>

#### Increase in workload

- Rupture of aortic valve
- Acute anaphylaxis

Arrhythmias and cardiac arrest may occur during the induction of anesthesia with barbiturates in the horse and may also occur without premonitory signs in horses under halothane anesthesia.

### PATHOGENESIS

With excessive tachycardia the diastolic period is so short that filling of the ventricles is impaired and cardiac output is grossly reduced. In ventricular fibrillation no coordinated contractions occur and no blood is ejected from the heart. The cardiac output is also seriously reduced when the heart rate slows to beyond a critical point because cardiac output is the product of heart rate and stroke volume and stroke volume cannot be markedly increased. In all these circumstances there is a precipitous fall in cardiac output and a severe degree of tissue ischemia. In peracute cases the most sensitive organ, the brain, is affected first, and the clinical signs are principally neurologic. Pallor is also a prominent sign in acute heart failure because of the reduction in blood flow.

In less acute cases respiratory distress is more obvious because of pulmonary edema and, although these can be classified as acute heart failure, they are more accurately described as acute congestive heart failure.

### CLINICAL FINDINGS

The acute syndrome may occur while the animal is at rest but is most common during periods of excitement or activity. The animal usually shows **dyspnea**, staggering, and **falling**, and **death** often follows within seconds or minutes of the first appearance of signs. There is marked **pallor** of the mucosae. Although clonic convulsions may occur, they are never severe and consist mainly of sporadic **incoordinated movements** of the limbs. Death is usually preceded by deep, **asphyxial gasps**. If there is time for physical examination, weakness or absence of a palpable pulse and bradycardia, tachycardia, or absence of heart sounds are observed. The specific findings in the heart and vascular system depend on the arrhythmia and are detailed later in this chapter.

Horses with sudden onset of tachyarrhythmias caused by atrial fibrillation or multiple ventricular extrasystoles, or with rupture of the aortic or mitral valve chordae

show a syndrome in which sudden onset of **respiratory distress** is the prominent manifestation. However, examination of the heart will allow a diagnosis of the underlying cause.

Acute heart failure is the cause of death in a significant proportion of horses that die suddenly and unexpectedly during training or racing. The diagnosis is based primarily on the findings of significant pulmonary hemorrhage and edema, although myocardial pathology is absent in most cases. Severe arrhythmic disturbances secondary to preexisting myocardial injury and the concurrent presence of catecholamines, hyperkalemia, and metabolic acidosis are likely causes.

### CLINICAL PATHOLOGY

Generally, there is insufficient time available in which to conduct laboratory tests before the animal dies. The demonstration of elevated serum troponin I concentrations, a sensitive and specific marker of myocardial damage, strongly supports the presence of myocardial disease. Laboratory tests may also be used to elucidate the specific etiology.

### NECROPSY FINDINGS

In typical acute cases engorgement of visceral veins may be present if the attack has lasted for a few minutes, but there may be no gross lesions characteristic of acute heart failure. Microscopic examination may show evidence of pulmonary congestion and early pulmonary edema. In more prolonged cases, venous engorgement with pulmonary congestion and edema are evident along with hydrothorax, but these are more accurately described as acute congestive heart failure. The primary cause may be evidenced by macroscopic or microscopic lesions of the myocardium. Animals dying from electrocution have visible hemorrhages in the epicardium and endocardium that are more numerous and larger in size than those typically seen in animals that are slaughtered. Electrocuted animals also have histologic evidence of myocardial hemorrhage and fragmentation of myocardial cells.<sup>2</sup>

### DIFFERENTIAL DIAGNOSIS

Acute heart failure should always be a major consideration as a cause of sudden and unexpected death in large animals, especially when death is associated with exertion or excitement. Acute heart failure may be mistaken for primary disease of the nervous system but is characterized by excessive bradycardia or tachycardia, pallor of mucosae, weakness or absence of the pulse, and mild convulsions. Epilepsy and narcolepsy are usually transient and repetitive and have a characteristic pattern of development.

### TREATMENT

Treatment of acute heart failure is not usually possible or practical in large animals because of the short course of the disease. Deaths caused by sudden cardiac arrest or

ventricular fibrillation while under anesthesia can be avoided to a limited extent in animals by external or internal cardiac compression or electrical conversion stimulation, but these techniques are generally restricted to sophisticated institutional surgical units. Also, the electrical energy required for defibrillation of animals larger than a sheep or goat or neonatal calf is beyond the capabilities of conventional defibrillators unless the paddles are placed directly across the pericardium or transvenous electrodes are used. Intracardiac injections of very small doses of epinephrine in conjunction with external cardiac compression by jumping up and down on the thorax with the knees can be tried, with occasional success.

### REFERENCES

1. Ozmen O, Haligur M. *Vet Rec.* 2007;161:240.
2. Sula MJM, et al. *J Vet Diagn Invest.* 2013;25:522.

## Special Examination of the Cardiovascular System

The more commonly used techniques of examination of the heart and pulse are described in [Chapter 1](#). A more detailed clinical examination of the system that gives greater attention to nuances of location and intensity of heart sounds and arterial and venous pulse characteristics is conducted whenever cardiovascular disease is suspect.

Special techniques of examination are also available that may be of value in some cases. With the exception of jugular venous pressure measurement, assessment of exercise intolerance, electrocardiography, and indirect methods for measuring arterial blood pressure, many of these techniques have limited application in general practice because they require sophisticated and expensive equipment. The use of specialized diagnostic equipment is generally confined to teaching hospitals and investigative units.

### PHYSICAL EXAMINATION

In the examination of animals suspected to have heart disease, it is important to determine the rate, rhythm, and intensity of the individual heart sounds and the rate, rhythm, and amplitude of the arterial pulse, examine for the presence of venous pulsation at the jugular inlet; and identify the point of maximal intensity and timing of murmurs within the cardiac cycle.

### HEART SOUNDS

In the horse it is not uncommon to hear four heart sounds on auscultation, whereas two to three heart sounds are heard in ruminants and camelids.

#### First Heart Sound

The first heart sound (S1) signals the onset of ventricular systole, is synchronous with the apex beat, and is temporally associated



with closure of the mitral and tricuspid valves. The area for maximal audibility of the **mitral valve** in the horse is on the left fifth intercostal space, at a level midway between a horizontal line drawn through the point of the shoulder and one drawn at the sternum at the caudal edge of the triceps muscle. With cattle, sheep, goats, and swine the sound is located at a similar level but at the fourth intercostal space. The area for maximal audibility of the **tricuspid valve** is on the right side of the chest slightly ventral to the equivalent level for the mitral valve and at the fourth intercostal space in the horse, and at the level of the costochondral junction at the third intercostal space for the other species.

#### Second Heart Sound

The second heart sound (S2) is associated with aortic and pulmonic valve closure and is synchronous with the end of systole and the beginning of cardiac diastole. The **aortic component** is most audible just ventral to a horizontal line drawn through the point of the shoulder and in the left fourth intercostal space in horses and the left third in the other species. The **pulmonic component** is most audible ventral and anterior to the aortic valve area in the left third intercostal space in horses and the left second or third intercostal space close to the costochondral junction in other species. These two components of the second heart sound have the same temporal occurrence on auscultation, but tonal differences can frequently be detected at the two areas of maximal audibility. Splitting of the second sound in the horse can be detected on phonocardiographic examination but cannot be detected on auscultation, and there is no respiratory-associated splitting, as occurs with some other species.

#### Third Heart Sound

The third heart sound (S3) is associated with rapid filling of the ventricle in early diastole and is heard as a dull thudding sound occurring immediately after the second sound. It is usually most audible on the left side just posterior to the area of maximal audibility of the first heart sound. However, it is frequently heard over the base and also over the area of cardiac auscultation on the right side. Phonocardiographically there are two components to this heart sound, but these are not usually detectable on clinical auscultation.

The third heart sound is very common in horses and can be detected in the majority of fit racing animals. It is more audible at heart rates slightly above resting normal. The third heart sound is very common in slightly excited cattle (heart rates 70–90 beats/min) but becomes much more difficult to hear when the heart rate exceeds 100 beats/min.<sup>1</sup>

#### Fourth Heart Sound

The fourth heart sound (S4) is associated with atrial contraction. It is also called the “a” sound. It occurs immediately before the

first heart sound and is a soft sound most audible over the base of the heart on the left and right side. It is also common in horses but its clear separation from the first heart sound is dependent on the length of the **PR interval**, which varies between horses. At resting heart rates the S4 sound is detectable on clinical examination in at least 60% of horses. At heart rates <90 beats/min S4 is detectable in approximately 40% of cattle.<sup>1</sup> The interval between the S4 and S1 frequently varies in the same horse at rest in association with variation in the PQ interval and results in a clear separation in some beats with slurring of the two sounds together in other beats. The fourth heart sound or a split S1 is also commonly heard in young cattle, but phonocardiographic studies have not been undertaken.

#### Sequence of Heart Sounds

The sequence of heart sound occurrence is thus 4-1-2-3. The intensity of the third and fourth sounds is less than that of the first and second and the complex can be described as du LUBB DUP boo. In some horses, the third or fourth sound may be inaudible so that 1-2, 4-1-2, and 1-2-3 variations occur. The name **gallop rhythm** is frequently applied when these extra sounds occur. Gallop rhythms also occur in cattle and may be caused by the occurrence of a fourth or third sound or to true splitting of the components of the first heart sound. In sheep, goats, and pigs only two heart sounds are normally heard. The occurrence of a third or fourth heart sound in horses and cattle is not an indication of cardiovascular abnormality, as it is in other species.

#### Variation in Heart Sound Intensity

Change in the intensity of the generation of sound by the heart or change in the transmission of the sounds between the heart and the stethoscope can result in variation in the intensity of heart sounds normally heard on auscultation.

- A **decrease** in the intensity of heart sound generation occurs in disease where there is poor venous return and decreased strength of cardiac contractility, such as in terminal heart failure; in hypocalcemia in cattle; or in circulatory failure in all species.
- Conversely the intensity of the heart sounds may **increase** with anemia, cardiac hypertrophy, and metabolic diseases such as hypomagnesemia. However, the intensity of the heart sounds is most often increased by sympathetic activation as a result of exercise, fear, and excitement.

**Muffling** of the heart sounds suggests an increase in tissue and tissue interfaces between the heart and the stethoscope. This can be caused by a shift in the heart due to displacement by a mass, changes in the pericardium (increased fluid or fibrous tissue),

change in the pleural space, or increased subcutaneous fat. Heart sounds are detectable by auscultation on the left side in animals of all condition scores, but heart sounds may become inaudible on the right side in which the condition score approaches 5/5.

#### Heart Rate

The **relative temporal occurrence** and the **intensity** of the third and fourth heart sound change with the **heart rate**. At moderately elevated heart rates the third heart sound becomes more audible. At faster heart rates the third sound may merge and sum with the fourth sound, or the fourth sound may merge with the first sound if the PR interval decreases. During periods of a rapid change in heart rate, such as during the increase in rate that occurs following sudden noise or similar stimuli in excitable horses or the subsequent decrease in rate, the variation in the occurrence and the intensity of the third and fourth sound coupled with the variation in intensity of the first and second sound during this change can give the impression of a gross arrhythmia. Such impressions should be ignored if they occur only during a rapid change of rate obviously induced by external influences and if there is no arrhythmia at the resting rate or the intervening stable elevated rate. Examination of the pulse during these periods of rapid change is also of value.

Variations in the intensity of the individual heart sounds or complete absence of some of them can occur in **conduction disturbances** and **arrhythmic heart disease** and can provide valuable clinical information. In several of these disturbances there is variation in the intensity of the first and third heart sounds associated with variation in the time of the preceding diastolic period and variations in diastolic filling. The intensity of the first heart sound may also vary with variations in the PR interval or where there is complete atrioventricular (AV) dissociation. In several of the arrhythmias there is absence of one or more of the heart sounds. These findings are detailed later.

#### EXAMINATION OF THE ARTERIAL PULSE

In arrhythmic heart disease the arterial pulse should be examined in more detail than that applied during routine clinical examination.

#### Pulse Rate

The pulse rate should be examined over a period to determine whether there is any sudden change in rate such as can occur with a shift in pacemaker to an irritable myocardial focus. At some stage during the examination of animals with tachyarrhythmias the heart rate and pulse rate should be taken synchronously to determine the presence of a pulse deficit (auscultation of S1 but a weak or absent S2 accompanied by a weak or absent pulse). A convenient artery for this purpose is located on the posterior medial

aspect of the radius and carpus in the horse and cow. However, the best artery to determine the pulse rate, rhythm, and amplitude is the descending aorta; this artery should be palpated during rectal examination in horses and cattle.

### Pulse Rhythm

Pulse rhythm is carefully examined. When a “dropped pulse” or arrhythmia is detectable in the pulse, the basic underlying rhythm should be established to determine whether the heart is under regular pacemaker influence. This is best done by mentally or physically tapping out the basic rhythm of the heart and continuing this rhythm when irregularity occurs. With conditions such as second-degree heart block in which there is a basic underlying rhythm initiated by the sinoatrial (SA) node, it is possible to tap through the irregularity and reestablish synchrony with the pulse. However, in conditions such as atrial fibrillation, where there is no regular pacemaker, it is not possible to establish any basic rhythm. This examination of rhythm can alternatively be conducted by auscultation and allows an immediate categorization of the arrhythmia into one of the two basic groups: those superimposed on a regular pacemaker influence (occasionally irregular) and those in which there is no regular pacemaker (irregularly irregular).

### Amplitude

The amplitude of the pulse should also be carefully examined. Variations in pulse amplitude are associated with those arrhythmias that produce a variation in diastolic filling period within the heart. The extreme of this is a pulse deficit (decrease in intensity or absence of a pulse associated with heart sounds).

## EXAMINATION OF THE JUGULAR VEIN

In the normal adult horse and cow, the jugular vein will be distended with blood about 5 to 8 cm above the level of the base of the heart when the animal is standing with its head in a normal, nonfeeding alert position. There is a rapid but minor fall in the level of jugular distension associated with the fall of blood into the ventricle during the period of rapid filling in ventricular diastole followed by a slower rise in the level of jugular filling to its original point. Superimposed on this, and immediately preceding the fall, is a small wave or retrograde distension associated with **atrial contraction** (a wave) and a second smaller retrograde wave (“c” wave) associated with bulging of the AV valves into the atrium during ventricular systole. These pulsations can be observed in most horses and cattle by careful observation of the jugular vein at its entrance into the thorax and can be timed in conjunction with auscultation of the heart.

Observation of the presence or absence of the atrial a wave is an aid in the clinical differentiation of first- and second-degree heart block. Cannon atrial waves occur periodically in complete heart block when atrial contractions occur against a closed AV valve. An accentuated c wave occurs with tricuspid valve insufficiency.

## PERCUSSION OF THE THORAX TO IDENTIFY THE CARDIAC DULLNESS AREA

The size of the heart can be estimated by percussion of the thorax to identify the cardiac dullness area. Horses have absolute cardiac dullness on percussion, which means that the percussion sound is completely dull; this should be compared with relative dullness, which reflects a dulled sound on percussion. The technique requires a metal percussion hammer with a soft rubber tip and a pleximeter (horn). Percussion focuses on placing the pleximeter in the intercostal space, with the hammer striking the pleximeter to generate a sound. The dimensions of absolute dullness are identified and compared with those of similarly sized horses.<sup>2</sup>

Percussion was widely practiced many decades ago, but echocardiographic determination of cardiac dimensions has now replaced percussion as the preferred diagnostic method for determining relative cardiac size. This is principally because percussion can only identify the presence of a normal or enlarged heart; percussion does not provide additional information on chamber dimensions or contractile performance, which is usually provided by echocardiography.

## MEASUREMENT OF JUGULAR VENOUS PRESSURE

The jugular veins are symmetrically distended in chronic (congestive) right-sided heart failure. This distension is accompanied by an increased jugular venous pressure that can be subjectively assessed by palpation or objectively determined by measuring jugular venous pressure. This underutilized technique can be easily and rapidly performed. The equipment required is a 14- to 16-gauge needle attached to a three-way stopcock. A 20-mL syringe containing heparinized 0.9% NaCl is attached directly opposite the needle, and a flexible rigid wall fluid administration line is attached to the remaining port on the three-way stopcock. The stopcock is turned so that the needle is in the off position, the needle is threaded down the jugular vein toward the heart, the syringe is pushed to fill the first 10 cm of the flexible fluid line with heparinized 0.9% NaCl, and the stopcock is turned so that the syringe is in the off position. Blood will flow into the flexible tube and the vertical distance (in centimeters) between the top of the column of 0.9% NaCl supported by the jugular venous pressure and the point of the shoulder

(scapulothoracic joint), which approximates the position of the right atrium, is a direct measure of jugular venous pressure.

### REFERENCES

1. Rezakhani A, Zarifi M. *Acta Vet Scand.* 2007;49:12.
2. Bakos Z, Voros K. *Acta Vet Hung.* 2007;55:277.

## MEASUREMENT OF CENTRAL VENOUS PRESSURE

Central venous pressure (CVP) is the pressure in the great veins inside the thorax, but most often this is the pressure measured in the cranial vena cava. The measurement technique is identical to that described for jugular venous pressure, except that the catheter is sufficiently long to reach the thoracic cavity (70 cm in the adult horse), in which negative pressures can be measured (this should be compared with jugular venous pressure, which can never be negative). As a consequence, CVP provides a more sensitive index of cardiac function and hydration status than jugular venous pressure and has its greatest clinical utility in monitoring for fluid overload during the rapid resuscitation of hypovolemic animals that may have depressed cardiac function, such as septicemic animals, or animals with oliguric renal insufficiency. In the healthy adult horse, CVP is normally 7 to 12 cmH<sub>2</sub>O and decreases by 2.2 cmH<sub>2</sub>O for every percentage point decrease in BW caused by dehydration.<sup>1</sup> Fluid resuscitation of critically ill horses uses a CVP of 8 to 12 cmH<sub>2</sub>O as a therapeutic target (the reference range for CVP), but this target has come under criticism. In healthy adult ruminants, mean CVP is 2.3 cmH<sub>2</sub>O in cattle, 3.4 cmH<sub>2</sub>O in sheep, and 1.3 cmH<sub>2</sub>O in goats.<sup>2</sup> Mean CVP in three cattle with traumatic reticulopericarditis was 9 to 21 cmH<sub>2</sub>O, and mean CVP in two calves with diarrhea and dehydration was -3.5 to 0.7 cmH<sub>2</sub>O. Similar values for CVP were obtained when goats and sheep were standing or placed in left lateral recumbency.<sup>2</sup>

Pressure transducers can produce pressure readings that differ by up to 2 cmH<sub>2</sub>O from that provided by a column of fluid (0.9% NaCl) in a flexible fluid line.<sup>3</sup> An important technical issue when measuring CVP is that head position must be standardized (in a neutral, alert position); an elevated head decreased CVP by 2.0 cmH<sub>2</sub>O in adult horses, and a lowered head position increased CVP by 3.7 cmH<sub>2</sub>O.<sup>4</sup> The catheter should be advanced at least 40 cm in the horse, 20 to 30 cm in sheep and goats, and 60 cm in adult cattle when the site of insertion in the jugular vein is in the midcervical region.<sup>5</sup> A low-cost method for measuring CVP in the horse uses a 3.5-French, 55-cm polypropylene urinary catheter that is threaded through a 14-gauge needle placed in the jugular vein.<sup>5</sup> CVP should be measured at end-expiration when intrathoracic pressure approximates atmospheric pressure.

## REFERENCES

1. Norton JL, et al. *J Vet Intern Med.* 2011;25:570.
2. Vesal N, Karimi A. *Veterinarski Arhiv.* 2006;76:85.
3. Norton JL, et al. *J Vet Intern Med.* 2011;25:303.
4. Norton JL, et al. *J Vet Intern Med.* 2011;25:575.
5. Wilsterman S, et al. *J Vet Emerg Crit Care.* 2009;19:241.

## EXERCISE TOLERANCE

Dyspnea, fatigue, and a prolonged elevation in heart rate following exercise are signs suggestive of cardiac insufficiency. Frequently, animals with suspected cardiac disease are exercised in an attempt to elicit these signs and to get an estimate of exercise tolerance. In most practice situations, the assessment of exercise tolerance is subjective. There is obviously a considerable difference in the amount of exercise that a beef bull and a trained racehorse can tolerate under normal conditions, and the amount of exercise given to any one animal is determined by the clinician's judgment. The rate of fall in heart rate following exercise and the time required to reach resting levels depend on the severity of the exercise, even in fit horses. Heart rate falls rapidly over the first minute and then more slowly over the ensuing 10- to 15-minute period.

**More objective tests** have been developed for the horse, including evaluation by means of telemetry from horses timed over a measured distance on race tracks or the use of a treadmill to provide a defined amount of exercise. The amount and intensity of exercise can be varied by the speed and incline of the treadmill and by the duration of the exercise period. The treadmill allows the recording of a variety of cardiorespiratory measurements in the exercising horse and can be used for evaluating the significance of cardiopulmonary disease and for establishing the cause of poor racing performance.

There are many noncardiac causes of exercise intolerance and, in a report on the evaluation of 275 horses, 84% were found to have more than one problem leading to poor athletic performance.

Criteria for cardiovascular performance in endurance rides have been investigated and the rapidity of heart rate decline following completion of each section of the ride can be used for field assessment of this function.

## FURTHER READING

Reef VB, Bonagura J, Buhl R, et al. Recommendations for equine athletes with cardiovascular abnormalities. ACVIM/ECEIM consensus statement 2013. *J Vet Intern Med.* 2014;28:749-761.

## ELECTROCARDIOGRAPHY

The electrocardiogram (ECG) provides a record and measure of the time-varying potential difference that occurs over the surface of the body as the result of electrical

activity within the heart. This is associated with depolarization and repolarization of the myocardium. At any one instant during depolarization and repolarization there are generally several fronts of electrical activity within the heart. However, at the body surface the potential difference is generally the sum of this activity and at any one instant the electrical activity in the heart registers as a single dipole vector that has polarity, magnitude, and direction.

The polarity is determined by the charge on the surface of the cells while the magnitude and direction is determined by the mass of muscle being depolarized or repolarized and the sum of the instantaneous vectors. Thus a wave of depolarization or repolarization over a muscle mass such as the atria or the ventricles is presented at the body surface as a sequence of instantaneous vectors with changing magnitude and direction.

## ELECTROCARDIOGRAPH

The electrocardiograph is used to detect these characters. In simple terms it can be considered as a voltmeter consisting of two input terminals, an amplifier to allow the recording of low input signals, and a galvanometer with an attached recording device such as a heated stylus on heat-sensitive paper or an ink pen or ink squirter. When a potential difference exists across the input terminals (electrodes), current flows through the coils of the electromagnet suspended between the poles of the permanent magnet to cause a deflection of the recording pen. The electrocardiograph can therefore detect the polarity of the cardiac electrical vectors, and by calibration of the machine and appropriate placement of electrodes on the body surface it can detect their magnitude and direction.

**Calibration** of most electrocardiographs is such that an input of 1 mV produces a 1-cm deflection of the recording pen. Recording speeds are generally 25 mm/s, although 50 mm/s is occasionally used. In recording an ECG, certain standard electrode positions are used for recording.

- A **lead** is the recording or circuit between two recording points. Depending on the wiring within the electrocardiograph, the same potential difference across a lead could result in an upward or downward deflection of the recording pen
- To allow standard recording and comparison between recordings the **polarity** of the electrodes for standard leads has been established by convention, and the leads are always recorded at these polarities
- The electrodes of a lead are commonly called positive or negative.
- A **positive electrode** in a lead is one that, when electrically positive relative to the other, caused by a potential difference between them, yields an

upward or positive deflection of the recording pen.

The electrodes are usually placed using alligator clips and a 70% isopropyl alcohol or gel contact. Disposable human stick-on type electrodes can be used in horses after cleaning the skin with alcohol before application of the gel; however, specific equine self-adhesive electrodes are preferred to human stick-on electrodes because they contain more gel, which improves electrode contact with the skin and a stronger glue that helps keep the electrode in place during exercise. Clipping of the hair coat is not recommended in horses because this permits electrodes to fall off more easily during sweating. The ECG is recorded with the animal in a standing position with minimal restraint.

## DEPOLARIZATION AND REPOLARIZATION

In the normal heart, depolarization and repolarization of the myocardium occurs in a definite pattern and sequence and the electrocardiography can be used to measure and time these events. Thus discharge of the SA node results in a wave of depolarization over the atria to produce a P wave in the ECG. The delay in conduction at the AV node is registered by no electrical activity at the body surface and an isoelectric PR interval on the ECG (isoelectric means zero voltage difference between the two leads). Depolarization of the ventricles occurs with several sequential fronts to produce the QRS complex, which is followed by another isoelectric period before repolarization represented by the T wave. Important durations to measure on the ECG of large animals are the P wave duration, the duration of the PR interval (which represents the start of the P wave to the start of the QRS complex), the QRS duration, and the QT interval (which represents the start of ventricular depolarization to the end of ventricular repolarization; **Fig. 10-2**). The QT interval is markedly dependent on heart rate and is shorter in tachycardia and longer in bradycardia. Although there is no universally accepted method to correct the QT interval for heart rate, the most widely used method to calculate a corrected QT interval (QTc) is **Bazett's method**, in which  $QTc \text{ (in seconds)} = QT / (\text{preceding RR interval in seconds})^{1/3}$ . Some investigators use Fridericia correction method (QTcf), in which  $QTcf \text{ (in seconds)} = QT / (\text{preceding RR interval in seconds})^{1/4}$ . The ST segment represents the end of the QRS complex (ventricular depolarization) and the start of the T wave (ventricular repolarization). The ST segment is usually isoelectric (amplitude = 0 mV), but movement in the ST segment above or below the isoelectric line may reflect the presence of myocardial ischemia, and is most common in critically ill animals with tachycardia and systemic arterial hypotension.

The ECG can also be used as a screening test for electrolyte abnormalities, particularly



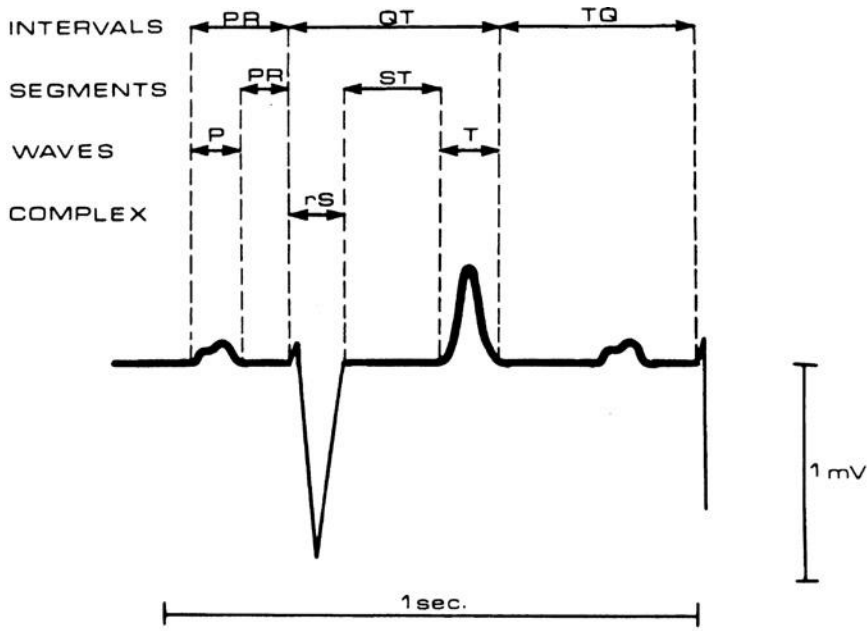

**Fig. 10-2** Typical base-apex lead electrocardiogram (ECG) from a healthy Holstein-Friesian cow. The waves, segments, and intervals are identified. The morphology is similar for the base-apex lead recording of the ECG in sheep, goats, horses, and pigs. Recorded at 25 mm/s. (Reprinted with permission from DeRoth L. *Can Vet J* 1980;21:271-277.)

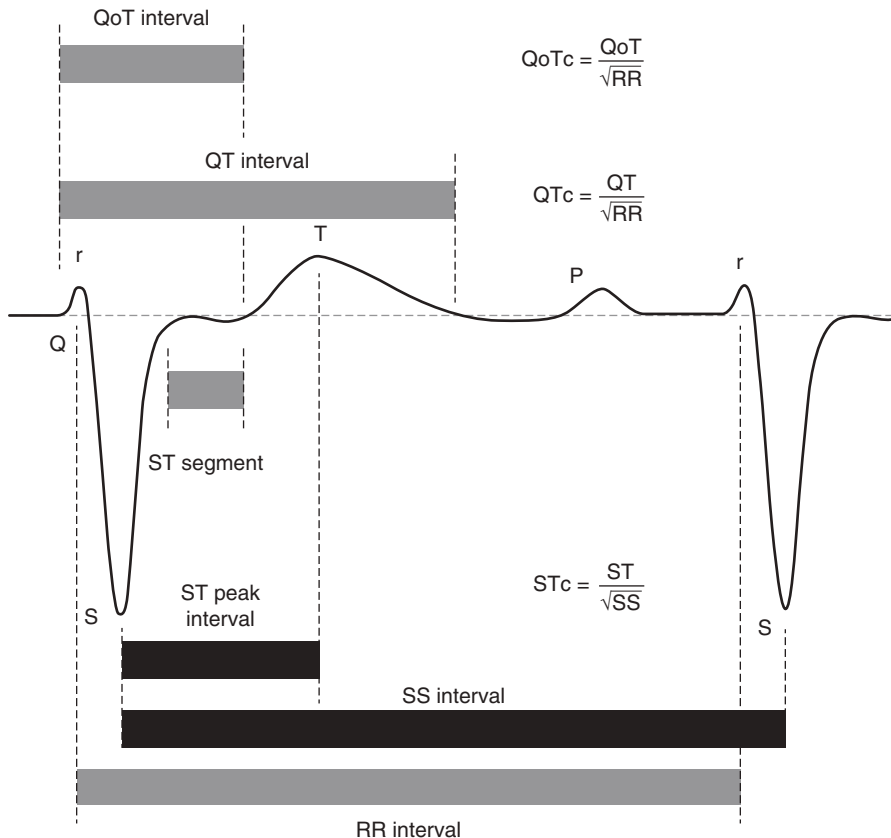

**Fig. 10-3** Typical base-apex lead electrocardiogram (ECG) from a healthy Holstein-Friesian cow. The ST peak interval is the interval between the apex of the S wave and the apex of the T wave in seconds. The SS interval is the interval between consecutive S waves in seconds. The corrected ST peak interval (STc) is calculated by dividing the ST peak interval in seconds by the square root of the SS interval in seconds. (Reprinted with permission from Itoh M, Sakurai Y, Nakajima Y, Kawamoto S. *J Vet Med Sci* 2016;77(12):1655-7.)

the presence of moderate to severe hyperkalemia or moderate to severe hypocalcemia. Progressive increases in plasma potassium concentration result in decreased P wave amplitude until the P wave is not visible, widened QRS duration, and a symmetric T wave (also called a “tenting” T wave; both terms emphasize that ventricular repolarization becomes more homogeneous). Progressive decreases in plasma calcium concentration result in prolongation in the QT interval, which in cattle is highly correlated with the ST peak interval (the time interval between the peak of the S wave and the peak of the T-wave; Fig. 10-3).<sup>1</sup> Dairy cattle with a value for STc > 0.385 are very likely to be hypocalcemic (serum calcium concentration <0.9 mmol/L or <7.5 mg/dL, respectively).<sup>1</sup>

In dogs, cats, and humans the ECG can be used to assess the cardiac rhythm and the size of the cardiac chambers. However, the **order of ventricular activation** in horses, cattle, sheep, and swine differs from that of humans and dogs in that ventricular depolarization is represented by only two fronts of activity. Depolarization of a large proportion of the myocardial mass in large animals is not recognized by the surface ECG. This is because the Purkinje fibers penetrate much more deeply in these species and depolarization occurs over multiple minor fronts that tend to cancel out rather than over a large single front as in dogs. For this reason, the detection of chamber enlargement by vector analysis of the ECG is generally not possible in large animals. Consequently, electrocardiography is confined to a simple base-apex lead system to examine for **conduction disturbances** and **arrhythmias**, which are detected by measurement of the various waveforms and intervals in the ECG that represent depolarization and repolarization in the heart, and by observation of their absence or abnormality.

A decrease in ventricular filling is associated with decreased amplitude of the QRS complex, whereas an increase in ventricular filling causes increased amplitude of the QRS complex. The effect of ventricular volume on QRS amplitude is called the **Brody effect** and results from the net effect of blood in the ventricle augmenting radial electric potentials while decreasing tangential electric potentials. The Brody effect explains why QRS amplitudes are decreased in animals experiencing hemorrhagic shock.<sup>2</sup>

### Lead Systems

The **base-apex lead system** provides the best method for electrocardiography in large animals, with the only exception being fetal electrocardiography. All other lead systems are clinically superfluous or inferior, or have only a research application.

**Traditional lead systems** are based on Einthoven's triangle as used in humans, and the standard bipolar limb leads (I, II, and III)

and the augmented unipolar limb leads (aVR, aVL, aVF) are commonly used in conjunction with an exploring unipolar chest lead. Variations in the position of the feet may produce changes in ECG waveforms with this lead system, and recordings should be taken with the animal standing square or with the left front foot set slightly in advance of the right front foot. This lead system is quite satisfactory for the detection of conduction disturbances and arrhythmic heart disease but is subject to movement artifact. There are, however, deficiencies associated with its use for the detection of change in the magnitude and direction of electrical vectors in the heart of large animals. Nevertheless, traditional lead systems have been used extensively for this purpose.

There have been several studies to determine whether it is possible to detect changes in cardiac chamber size in large animals. Many of these have examined alternative lead systems, such as **vector-based systems**, recognizing that the standard limb leads are not particularly suited for detection of vector changes associated with changes in chamber dimensions. The standard limb leads are primarily influenced by vectors in the frontal plane (longitudinal and transverse), whereas early and late forces in the myocardium are significantly directed in the vertical direction. Furthermore, the heart is not electrically equidistant from the electrodes of each lead, and distortion of recorded vector loops can result. A partial correction of these deficiencies can be made by recording a lead using an exploring electrode at the V10 position over the dorsal spinous processes in addition to the standard limb leads. However, for proper representation of the vector changes associated with electrical activity within the heart, completely different electrode placement is required. A number of systems have been proposed. The electrode placement varies and is quite complicated, but electrocardiographic studies using these methods are available for horses, cattle, pigs, and sheep. Generally, a three-lead system consisting of leads I, aVF, and V10 provides semiorthogonal axes suitable for three-dimensional (3D) reconstruction of depolarization and repolarization.

The **base-apex lead system** is the most common system used because it records the major electrical forces in the heart of large animals with consistently clear and large-amplitude waveforms. Animal movement also has minimal effect on the quality of the ECG. The most common **bipolar** lead placement in horses, ruminants, and swine consists of two electrodes, one positive and one negative, in a format called the **base-apex** lead. The positive electrode of lead I (left arm) is attached to the skin of the left thorax in the vicinity of the apex beat at the 5th–6th intercostal space immediately caudal to the olecranon, and the negative electrode (right arm) is placed on the skin over the jugular

**Table 10-1** Base-apex electrocardiographic parameters in cattle and horses (mean  $\pm$  standard deviation)

	Duration (ms) cattle	Horses	Sows
P	80 $\pm$ 10	100 $\pm$ 32	82 $\pm$ 0
PR	200 $\pm$ 20	136 $\pm$ 7	
QRS	60 $\pm$ 10	91 $\pm$ 10	75 $\pm$ 6
QT	370 $\pm$ 30	485 $\pm$ 52	276 $\pm$ 6
T	90 $\pm$ 10		

Values are obtained from 600 healthy Holstein-Friesian female cattle aged 1 or more years (Rezakhani A et al. *Vet Arch* 2004; 74:351), 17 healthy male and female horses aged 6 months to 8 years (P. Constable, personal communication), and 467 healthy sows (Takemura N et al. *Jpn Vet Med Assoc* 1988; 41:398).

furrow in the caudal third of the right neck. This is by far the most common lead placement, although a small number of investigators place the negative electrode on the left side of the neck instead of the right side. With **sheep**, where wool interferes with placement on the neck, the negative electrode can be placed on the midline of the poll. When using the base-apex lead system, the ground electrode is placed remotely from the heart, and the location of the ground is not important. Normal values for cattle, horses, and pigs are summarized in [Table 10-1](#).

Esophageal recording has been recently performed on the horse.

### TELEMETRY

Telemetry is being increasingly used to examine whether arrhythmias are present during exercise and the nature of the arrhythmia and their association with exercise intensity. Recording an ECG in an exercising horse is challenging because of the presence of artifacts caused by muscular activity. As a result, the base-apex lead should not be used and a different lead system is used with increased attention paid to the method of fixation of the electrodes to the skin. Usually, best results are obtained by placing ECG electrodes that contain an electrode liquid and adhesive in such a manner that they can be tightly fixed under a girth. For horses exercised on a treadmill or by lunging, the positive (green) electrode is usually placed on the thorax immediately caudal to the elbow joint (over the apex beat), and the negative (red) electrode is placed on the right side of the withers. A third (yellow) electrode is placed approximately 10 cm dorsal to the green electrode, and the reference electrode is placed anywhere under the girth. A different electrode system is needed for horses being ridden; in this case the electrodes should not be placed under the surcingle to minimize artifacts.

The ECG signal can be recorded and stored using a small battery-powered device and a digital card that is large enough to permit 24-hour recording (Holter monitoring, which is a continuous recording of the ECG while the animal undergoes its normal activities). Commercial systems are available with computer analysis that assists in the identification of artifacts. The software programs also automatically identify each R wave and, consequently, can be used for the evaluation of heart rate variability (HRV); however, concerns have been raised about the ability of some systems to accurately measure the interbeat interval (IBI) in moving horses.<sup>3</sup> Telemetered ECG tracings obtained during exercise contain motion artifacts and can be difficult to interpret, with levels of agreement between observers varying inversely with level of exercise intensity.<sup>4</sup>

### FETAL ELECTROCARDIOGRAPHY

The fetal ECG may be recorded, and can be of value in determining whether the fetus is alive, the presence of a **singleton or twins**, and as a monitor for **fetal distress** during difficult or prolonged parturition. A modified bipolar lead system is required, with the right atrial electrode placed on the right ventral abdomen and the left atrial electrode below placed on the ventral midline in front of the udder. The ground lead can be situated anywhere. The bipolar lead should be recorded using increased sensitivity with meticulous attention to obtaining the best electrical connection to the skin. The animal needs to be electrically isolated (standing on a rubber mat) and muscular activity must be minimized.

Fetal electrocardiography has been used in cattle to monitor fetal viability, but the fetal ECG signal is very weak and suffers from interference from the maternal ECG, the electromyogram, and motion artifacts caused by gastrointestinal movement. For these reasons, the position of the bipolar recording leads on the abdomen should be moved to provide the optimal recording site for each cow. Digital processing of the fetal ECG signal can assist in detection of the fetal heart rate at more than 157 days' gestation. Fetal heart rates for calves tend to decrease with advancing gestation, approximating 140 beats/min from 160 to 190 days of gestation and 120 beats/minute at 250 to 280 days of gestation.

The **foal** fetal heart rate can be detected as early as day 121 of gestation<sup>5</sup> and decreases logarithmically from approximately 110 beats/min at 150 days before term to 75 beats/min near to term. Continued monitoring traces may be needed to assess fetal distress, which is manifested as a decrease in HRV and bradycardia. Fetal heart rate and HRV have also been measured as an indicant of hypoxia and fetal distress during parturition in **cattle**. Cardiac arrhythmia is common at the time of birth and is thought to

result from the transient physiologic hypoxemia that occurs during the birth process. Following birth and during early growth of the foal there are age-dependent increases in the electrocardiographic intervals and changes in the orientation of the mean electrical axis.

### HEART RATE VARIABILITY

HRV has received recent interest as a research method to evaluate the relative contributions of sympathetic and parasympathetic tone to the cardiovascular system. Consequently, HRV potentially provides insight into the degree of stress experienced by the animal and therefore has great potential in investigating interventions in animal welfare studies. HRV is assessed using time domain, frequency domain, and nonlinear indices. Interesting findings of HRV analysis are that the equine heart in healthy animals is predominantly under vagal control, and low HRV in horses with colic is associated with increased mortality.<sup>6</sup> A major drawback with HRV is that measured parameters are heavily influenced by measurement errors, particularly the presence of artifacts and loss of signal.<sup>3,7</sup>

Time domain indices of HRV are the standard deviation of the normal-to-normal intervals (SDNNs) and the square root of the mean squared differences of successive normal-to-normal intervals (RMSSD); the latter is the best time domain index of vagal tone. These indices usually require that the ECG is recorded for minutes to hours. In comparison, an ECG record digitized at a sufficiently fast rate (at a minimum of 500–1000 Hz) and with accurately detected R waves for at least 512 beats can have sequential RR intervals undergo fast Fourier transform to provide frequency domain indices of HRV, such as total power, low frequency power (LF, defined between 0.01 and 0.15 Hz or 0.01 and 0.70 Hz), high frequency power (HF, defined between 0.15 and 0.40 Hz or 0.07–0.60 Hz), and the ratio of LF to HF. Of these indices, HF power corresponds to the respiratory frequency and is positively and strongly associated with parasympathetic tone, the LF/HF ratio is thought to reflect changes in sympathovagal balance, whereas SDNN and RMSSD are associated with total power and HF power.<sup>6,8,9</sup>

Accurate cut points for LF and HF power have yet to be identified for many large-animal species,<sup>10</sup> and species differences in the cut points are required based on normal respiratory rates. For instance, LF power in the pig is measured from 0.0 to 0.09 Hz and HF power from 0.09 to 2.0 Hz.<sup>11</sup> HF power in adult cattle is defined as 0.20 to 0.58 Hz (equivalent to respiratory rates of 12–35 breaths/min), whereas HF power in calves is defined as 0.5 to 0.83 Hz (equivalent to a respiratory rate of 30–50 breaths/min). Recommended frequency bands for HRV interpretation in horses are LF (0.01–0.07 Hz)

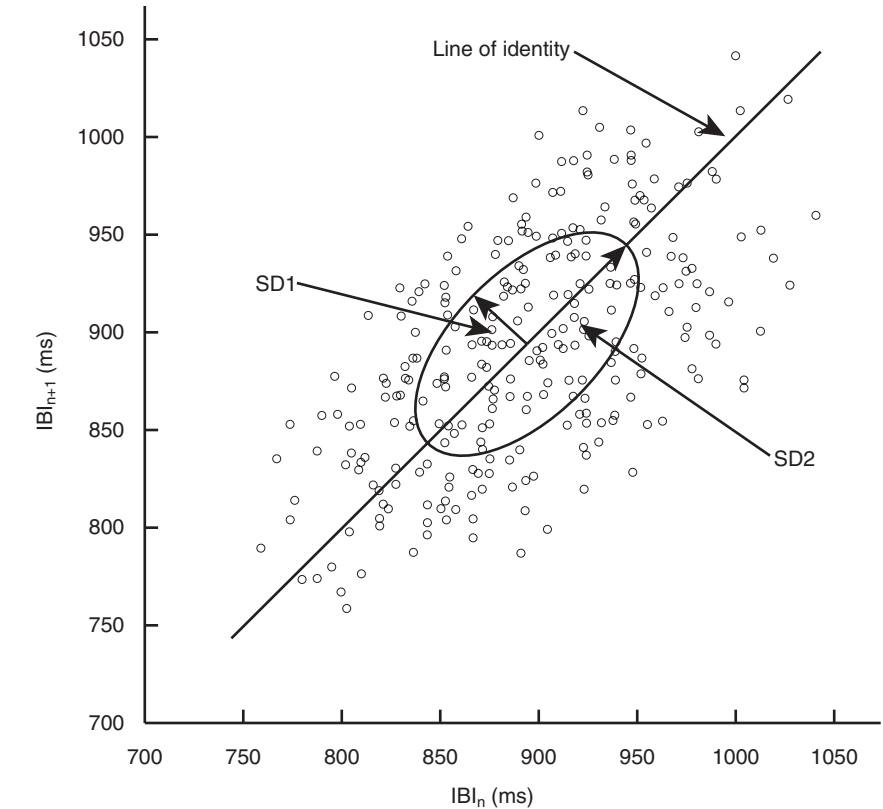

**Fig. 10-4** The Poincaré plot from an adult cow. The duration of an interbeat interval (IBI) in milliseconds is plotted against the duration of the preceding IBI in milliseconds. An ellipse is then fitted along the line of identity that summarizes the variability perpendicular to the line of identity (SD1) and along the line of identity (SD2). (Reproduced with permission from Kovacs L, Jurkovich V, Bakony M, Szenci O, Poti P, Tozser J. *Animal* 2014;8(2):316-330.)

and HF (0.07–0.6 Hz). Many HRV studies have ignored the effect of respiratory rate on the frequency cut point for HF power and, consequently, the results of these studies are difficult to interpret.

Nonlinear analysis of HRV uses a variety of approaches. A useful graphical depiction of HRV is provided by the Poincaré plot (Fig. 10-4), in which the duration of an IBI in milliseconds is plotted against the duration of the preceding IBI in milliseconds. An ellipse is then fitted along the line of identity that summarizes the variability perpendicular to the line of identity (SD1) and along the line of identity (SD2). On this basis, SD1 reflects short-term variability and is an index of parasympathetic activity, whereas SD2 reflects intermediate-term variability and is regarded as an index of sympathetic activity.

It remains to be determined whether HRV provides any useful clinical information to that provided by heart rate itself. For instance, in many studies where HRV indices indicated increased sympathetic tone, the mean heart rate was invariably increased above that in healthy individuals.<sup>12</sup>

### OTHER USES OF THE ELECTROCARDIOGRAM

- Changes in the ECG occur with some **electrolyte imbalances** in large-animal species.
- There is an approximately linear correlation between the heart-rate-corrected QT interval and plasma-ionized calcium concentration in cattle, with elongation of the interval in hypocalcemic and shortening in hypercalcemic states.
- Decreased amplitude and flattening of the P wave, widening of the QRS complex, and an increased symmetry and amplitude of the T wave are seen with hyperkalemia.
- Estimates of heart size of the horse have been made from measurements of the QRS duration on the ECG and the resultant **heart score** is used to assess potential racing performance.
- **Exercise** and **postexercise** ECGs frequently deliver information additional to that of the resting ECG and can be recorded by radiotelemetry or Holter monitoring systems.



## FURTHER READING

- Hamlin RL, Smith CR. Categorization of common domestic mammals based upon their ventricular activation process. *Ann NY Acad Sci*. 1965;12:195-203.
- Kovacs L, Jurkovich V, Bakonyi M, et al. Welfare implication of measuring heart rate and heart rate variability in dairy cattle: literature review and conclusions for future research. *Animal*. 2013;8:316-330.
- Reef VB, Bonagura J, Buhl R, et al. Recommendations for equine athletes with cardiovascular abnormalities. Joint ACVIM/ECEIM Consensus Statement. *J Vet Intern Med*. 2014;28:749-761.
- Stucke D, Ruse MG, Lebelt D. Measuring heart rate variability in horses to investigate the autonomic nervous system activity—pros and cons of different methods. *Appl Anim Behav Sci*. 2015;166:1-10.
- Verheyen T, et al. Electrocardiography in horses—part 1: How to make a good recording. *Vlaams Diergen Tijdschrift*. 2010;79:331-336.
- Verheyen T, et al. Electrocardiography in horses—part 2: how to read the equine ECG. *Vlaams Diergen Tijdschrift*. 2010;79:337-344.

## REFERENCES

- Itoh M, et al. *J Vet Med Sci*. 2015;77:1655.
- Ker J, et al. *Onderstepoort J Vet Res*. 2009;76:443.
- Parker M, et al. *Comp Exercise Physiol*. 2010;6:137.
- Trachsel DS, et al. *Equine Vet J*. 2010;42(suppl 38):208.
- Baska-Vincze B, et al. *Acta Vet Hung*. 2015;63:89.
- Sundra TM, et al. *Res Vet Sci*. 2012;93:1426.
- Hagen K, et al. *Physiol Behav*. 2005;85:195.
- Ohmura H, et al. *Am J Vet Res*. 2006;67:455.
- Matsuura A, et al. *Anim Sci J*. 2010;81:618.
- Panzon A, et al. *Lab Anim*. 2009;43:41.
- Poletto R, et al. *Physiol Behav*. 2011;103:188.
- Yoshida M, et al. *J Vet Med Sci*. 2015;77:375.

## BIOMARKERS OF MYOCARDIAL INJURY

The serum concentration of cTnI and **cardiac troponin T** (cTnT) are excellent biomarkers of myocardial injury in large animals because they provide a sensitive and specific indicator of cardiac injury. Troponins I, T, and C are myofibrillar proteins in cardiac and skeletal muscle that regulate the calcium-mediated interaction between actin and myosin, with cTnI and cTnT having different amino acid sequences at their N-terminal end compared with skeletal muscle troponin I and T. This means that an immunoassay directed at the N-terminal end of cTnI or cTnT differentiates between cardiac and skeletal muscle isoforms and therefore the site of injury. Myocardial tissue from horses, cattle, sheep, and pigs has high reactivity for cTnI and cTnT when tested using human immunoassays, and this reactivity is selective for the myocardium, because it is more than 1000-fold higher in cardiac tissue than in skeletal muscle.

The cTnT is preferred in human medicine as a biomarker for cardiac disease because high-sensitivity methodology is available and the results are consistent between laboratories because only one manufacturer makes the analytical equipment.<sup>1-3</sup> In contrast, cTnI

is preferred for detecting and quantifying myocardial injury in animals because it has greater myocardial selectivity than cTnT and because qualitative point-of-care devices using a disposable cartridge are widely available that have clinical utility for the on-farm diagnosis of myocardial disease.<sup>1,4,5</sup> However, results differ between different cTnI assays because the analytical methods often target different amino acids of the cTnI molecule.<sup>3</sup> The magnitude of the increase in serum cTnI is associated with the severity of myocardial injury, as assessed by cardiac function indices and histopathologic changes.<sup>6</sup> Damage to the myocardial cell membrane causes the rapid release of cytosolic troponin I into the interstitial fluid, increasing serum cTnI concentrations. Much larger amounts of cTnI are bound to structural proteins within myocardial cells, and release from this larger pool of troponin I is responsible for persistent elevation of serum cTnI concentration after acute myocardial injury. The half-life of serum cTnI in horses is 28 minutes,<sup>7</sup> indicating that increased serum cTnI concentrations reflect the presence of ongoing or recent myocardial injury. In other words, serum cTnI concentration provides an excellent guide to the severity of myocardial damage, and serial measurement is clinically helpful in monitoring the progression of cardiac disease.<sup>7,8</sup>

Generally, healthy horses have serum cTnI concentrations below 0.04 ng/mL when more sensitive assays are used; serum cTnI concentrations are slightly increased after exercise in some horses.<sup>9</sup> Larger increases in serum or plasma cTnI concentrations occur in horses with myocarditis, snake envenomation, cantharidin toxicosis, monensin toxicosis, babesiosis, colic, atypical myopathy, and experimentally induced endotoxemia.<sup>1-7,12</sup> Increased serum cTnI concentration is associated with the occurrence of ventricular arrhythmias in horses, and in horses with colic it is attributed to endotoxemia, inadequate oxygen delivery, myocardial damage, and a systemic inflammatory response.<sup>12</sup> Healthy neonatal foals have serum cTnI concentrations less than 0.49 ng/mL, and slight elevations in serum cTnI occur in septic foals.<sup>13</sup> The cTnI concentrations are not usually increased in foals with congenital cardiac disease unless heart failure is sufficiently severe to cause myocardial ischemia.

Healthy cattle have serum cTnI concentrations below 0.04 ng/mL when more sensitive assays are used; serum cTnI concentrations are increased in cattle with idiopathic pericarditis, traumatic reticuloperitonitis, endocarditis, theileriosis, myocarditis, monensin toxicosis, caudal vena caval thrombosis, foot-and-mouth disease, and experimentally induced endotoxemia.<sup>5,6,14-17</sup> Serum concentrations of cTnI are slightly higher in low-producing dairy cattle compared with high-producing animals.<sup>18</sup> Healthy neonatal calves have serum cTnI concentrations less than 0.04 ng/mL, and

slight elevations in serum cTnI occur in calves with experimentally induced endotoxemia.<sup>19</sup>

Healthy goats have serum cTnI concentrations below 0.04 ng/mL when more sensitive assays are used; serum cTnI concentrations are transiently increased at parturition but markedly increased in goats severely affected with pregnancy toxemia.<sup>20</sup> Sheep are reported to have serum cTnI concentrations below 0.4 ng/mL, with values increasing in experimentally induced acute ruminal acidosis<sup>21</sup> and myocardial ischemia<sup>22</sup> and increasing fourfold during experimentally induced endotoxemia.<sup>23</sup>

Serum activities of cardiac isoenzymes of creatine kinase (creatine kinase isoenzyme MB, **CK-MB**) and lactate dehydrogenase (LDH; isoenzymes 1 and 2) have been used in the past as indices of cardiac disease, but both are inferior as biomarkers to cTnI and are no longer recommended. Only 1.5% of the total CK activity in the equine heart is attributable to CK-MB (compared with 20% in the human heart); therefore CK-MB is an insensitive indicator of cardiac disease in the horse. Isoenzymes of LDH suffer from a similar lack of specificity for cardiac disease. Large animals with cardiac disease associated with inflammation, such as endocarditis in horses and cattle or traumatic reticuloperitonitis in cattle, may have increases in the serum concentration of serum amyloid A and haptoglobin that reflect an acute phase response; however, the predictive ability of acute phase biomarkers to predict the presence of cardiac disease appears to be limited.<sup>24</sup>

There is no doubt that cTnI is a clinically useful biomarker of the presence of cardiac injury in large animals. However, cardiac dysfunction may result from a variety of cardiac diseases, such as valvular incompetence, congenital heart disease, or cardiomyopathy that may not have active injury. In these animals, functional biomarkers of chamber enlargement would be clinically helpful. Plasma atrial natriuretic peptide (ANP) concentration may therefore have utility as a biomarker of cardiac disease, although it is unlikely to provide similar sensitivity and specificity as a diagnostic test as cTnI. ANP is produced and released from atrial myocardial cells in response to atrial distension; increased plasma ANP concentration results in natriuresis, inhibition of the renin-angiotensin-aldosterone system, and vasodilatation.<sup>20</sup> Large animals with distended atria caused by incompetent valves, cardiomyopathy, or volume overload would therefore be expected to have increased plasma ANP concentrations, and this has been demonstrated in calves with congenital cardiac disease<sup>25</sup> and horses with mitral regurgitation<sup>26</sup> and Human immunoassays appear to be accurate for use in large animals for ANP determination because interspecies sequence homology is high. However, plasma ANP concentrations change with age, making interpretation difficult.<sup>27</sup> In

animals with cardiac disease, plasma ANP concentration appears to be clinically valuable only in the monitoring of disease progression in adult animals with mitral valve or tricuspid valve regurgitation.

Plasma aldosterone concentration may have some utility as a biomarker of cardiac disease, although it is unlikely to provide similar sensitivity and specificity as a diagnostic test as cTnI or even ANP. Healthy warmblood horses had plasma aldosterone concentrations between 14 and 39 pg/mL, and plasma aldosterone concentrations increased in horses with enlargement of the left atrium and ventricle.<sup>28</sup>

### FURTHER READING

- Fennell L, Forbes G. Review article: Use of cardiac troponin to aid diagnosis of heart disease in horses. *Aust Equine Vet.* 2009;28:44-47.
- van der Vekens N, Decoedt A, De Clercq D, et al. The use of cardiac biomarkers in veterinary medicine: The equine perspective. *Vlaams Dierg Tijdschrift.* 2012;81:319-327.

### REFERENCES

1. Kraus MS, et al. *Equine Vet J.* 2013;45:56.
2. van der Vekens N, et al. *J Vet Intern Med.* 2015;29:348.
3. van der Vekens N, et al. *Vet J.* 2015;203:97.
4. Fraser BC, et al. *Am J Vet Res.* 2013;74:870.
5. Gunes V, et al. *Vet Rec.* 2008;162:514.
6. Varga A, et al. *J Vet Intern Med.* 2009;23:1108.
7. Nath LC, et al. *Aust Vet J.* 2012;90:351.
8. Nath LC, et al. *J Am Vet Med Assoc.* 2012;241:1202.
9. Nostell K, et al. *Vet J.* 2012;192:171.
10. Gilliam LL, et al. *J Vet Intern Med.* 2012;26:1457.
11. Verheyen T, et al. *J Vet Intern Med.* 2012;26:1019.
12. Diaz OMS, et al. *J Am Vet Med Assoc.* 2014;245:118.
13. Slack JA, et al. *J Vet Intern Med.* 2005;19:577.
14. Suzuki K, et al. *J Vet Intern Med.* 2012;26:1056.
15. Fartashvand M, et al. *J Vet Intern Med.* 2013;27:194.
16. Mellanby RJ, et al. *Vet Rec.* 2007;161:454.
17. Tunca R, et al. *J Vet Diagn Invest.* 2008;20:598.
18. Dehkordi J, et al. *Iran J Vet Med.* 2014;8:101.
19. Peek SF, et al. *Can J Vet Res.* 2008;72:356.
20. Tharwat M, et al. *Theriogenology.* 2012;78:1500.
21. Kirbas A, et al. *Veterinarski Arhiv.* 2014;84:355.
22. Leonard F, et al. *Res Vet Sci.* 2008;85:141.
23. Chalmeh A, et al. *Bulg J Vet Med.* 2013;16:123.
24. Nazifi S, et al. *Comp Clin Pathol.* 2009;18:47.
25. Hori Y, et al. *J Vet Intern Med.* 2009;23:653.
26. Trachsel DS, et al. *J Vet Cardiol.* 2013;15:105.
27. Dratwa A, et al. *Vet Med.* 2004;7:2.
28. Gehlen H, et al. *Res Vet Sci.* 2008;85:340.

### MEASUREMENT OF ARTERIAL BLOOD PRESSURE

Blood pressure may be determined directly by arterial puncture and pressure measurement, but this is impractical in clinical cases. The development of simple methods for the indirect determination of arterial blood pressure has proved difficult in large animals because of the paucity of suitably located arteries in which a pressure cuff can be applied and because there are problems in detecting pulse return by simple auscultatory or palpatory methods.

In the horse a simple and relatively inexpensive method uses oscillometric

sphygmomanometry to detect arterial pulsations and therefore simultaneously determine heart rate and systolic, diastolic, and mean arterial pressure. For adult horses, the optimal cuff width for the oscillometric method is approximately 20% to 35% of the tail circumference, when the cuff is applied snugly to the base of the tail and the ventral coccygeal artery pressure is monitored. The mean tail circumference of an adult horse is 22 cm, therefore the optimal cuff width for horses is 5 to 8 cm for oscillometric pressure measurement. Because the oscillometric units were designed for use in humans, the software programs often have difficulty in measuring arterial pressure when the heart rate is less than 40 beats/min and when arrhythmias or arterial hypotension are present, which minimizes the clinical utility of these units in trained or sick horses. The units are also susceptible to motion of the tail, therefore, it is preferable to keep the tail still during recording. For foals, the oscillometric technique can be used on the tail (coccygeal artery) or the dorsal metatarsus (dorsal metatarsal artery). Other methods of indirect pressure measurement in the horse (modified auscultatory technique, ultrasonic Doppler methodology) appear less accurate than the oscillometric sphygmomanometry. Moreover, oscillometric techniques offer the advantage of providing systolic, diastolic, and mean arterial blood pressures, whereas other indirect methods do not provide mean arterial pressure.

Systolic and diastolic blood pressures of a large series of trained Thoroughbred horses were  $112 \pm 16$  mm Hg ( $14.9 \pm 2.1$  kPa) and  $77 \pm 14$  mm Hg ( $10.2 \pm 1.9$  kPa), respectively. Equivalent values have been recorded in other breeds. These values are **coccygeal uncorrected values** and can be corrected to the correct reference level (scapulohumeral joint, which is equivalent to the right atrium) by adding 0.7 mm Hg (0.09 kPa) for every centimeter in height between the scapulohumeral joint and the tail if the coccygeal artery was the recording site for indirect pressure measurement. **Posture** of the horse is important, because lowering the head significantly lowers systolic, diastolic, and pulse pressures.

Hypertension has been found in association with epistaxis, laminitis in horses, and painful fractures of the distal bones of the limb. Systolic blood pressure is often also elevated in obstruction of the large intestine in horses. Blood pressure measurements are of value in the assessment of the degree of shock and possibly may prove of value in the differential diagnosis of conditions such as acute salmonellosis and in assessing the prognosis of colic. Mean arterial pressure is considered the true driving pressure for blood flow and organ perfusion, therefore, determination of mean arterial pressure provides one index of perfusion. However, it is important to recognize that mean arterial

pressure is poorly correlated with cardiac output.

Blood pressure readings can be obtained by equivalent techniques from the tail of cattle. However, because of anatomic differences these do not always correlate well with true blood pressure. Pressures have been observed to be 100 to 140 mm Hg (13.3–18.6 kPa) systolic and 50 to 85 mm Hg (6.7–11.3 kPa) diastolic.

### MEASUREMENT OF PULMONARY ARTERY BLOOD PRESSURE

Pulmonary artery pressure is increased in all cattle raised in high-altitude regions (>1500 m) because of chronic alveolar hypoxia. Sustained periods of time at high altitude lead to **pulmonary hypertension** caused by medial hypertrophy of pulmonary arterioles and right-sided heart failure (high mountain disease). Cattle vary in their genetic susceptibility to high mountain disease and, consequently, measurement of pulmonary artery pressure of bulls intended for breeding in herds that graze at high altitude has become commonplace in parts of the United States.

To measure pulmonary artery blood pressure, bulls are restrained in a cattle chute with moderate squeeze to minimize movement. A halter is placed and the head tied level with the shoulder to expose the jugular furrow. The skin over the jugular vein is aseptically cleaned and the jugular vein occluded at the thoracic inlet. The distended jugular vein is then punctured with a 13-gauge 8-cm needle that is advanced down the jugular vein while ensuring a free flow of blood until 1 cm is protruding from the skin to permit control of the needle. A polyethylene catheter (outside diameter, 1.7 mm; length, 120 cm) filled with sterile 0.9% NaCl and attached to a three-way stopcock and connected to a pressure transducer is advanced to the right atrium, through the tricuspid valve to the right ventricle, and then through the pulmonic valve to the pulmonary artery. The location of the catheter tip is identified by the characteristic waveforms on an invasive blood pressure monitor. The mean pulmonary artery pressure measured using the scapulohumeral joint is the reference point for 0 pressure (equivalent to the right atrium in a standing animal). After pressure measurement the polyethylene catheter is removed by first pulling the needle and catheter from the neck, and once the needle is out of the animal the catheter is grasped and removed. This process minimizes the potential for severing the polyethylene catheter.<sup>1</sup>

Mean pulmonary artery pressures at 1500 to 1800, range from 34 to 44 mm Hg; cattle with pulmonary hypertension have pressures ranging from 48 to 213 mm Hg.<sup>1</sup> When breeding stock are evaluated at more than 12

months of age at elevations >1500 m, it is preferable that pulmonary artery pressure is <41 mm Hg. When testing cattle at different altitudes, a rough rule of thumb is an additional increase in mean pulmonary artery pressure of 1 to 2 mm Hg for every 330-m increase in altitude above 1500 m.<sup>1</sup> Use of pulse oximetry and blood gas analysis has been investigated in cattle for predicting mean pulmonary artery pressure, but associations were not sufficiently strong for clinical use.<sup>2</sup>

## REFERENCES

- Holt TN, Callan RJ. *Vet Clin North Am Food Anim Pract.* 2007;23:575.
- Ahola JK, et al. *J Anim Sci.* 2006;84:1259.

## ECHOCARDIOGRAPHY

Echocardiography has provided a relatively simple and noninvasive method for the examination of the heart that can give considerable information on cardiac function and detect structural heart disease; however, it cannot reliably detect focal myocardial disease. In echocardiography, high-frequency sound waves are pulsed through tissues at known velocities. When the sound waves encounter an acoustic tissue interface, echoes are reflected back to a transducer and recorded in a number of different modalities. The modalities have become increasingly sophisticated and they have largely replaced traditional invasive evaluations of cardiac function such as cardiac catheterization. The newer technologies that accompany standard echocardiography, such as Doppler measurement of blood velocity, tissue Doppler imaging, and two-dimensional (2D) speckle tracking are becoming less and less expensive and high-quality portable units are now available.

Echocardiography allows the measurement of cardiac chamber size, wall thickness, global and regional wall movement, and valve structure and function. A complete echocardiographic study addresses the following: (1) presence of morphologic lesions, (2) motion abnormalities (global or regional), (3) cardiac chamber and great vessel size, (4) cardiac valve function, (5) blood flow disturbances, (6) global and regional ventricular systolic function, (7) hemodynamic measurements, and (8) ventricular diastolic function. Accomplishing this requires the application of complementary 2D, M-mode, and Doppler modalities.

Standard 2D and M-mode (motion mode) views are initially obtained from the right side of the thorax using an approximately 3-MHz transducer for adult horses and cattle and an approximately 5-MHz transducer for neonatal calves, foals, and adult sheep and goats. A small phased array (pencil-like probe) is preferred in ruminants because of the narrow intercostal space. It is also very helpful to tie a soft rope around

the distal right limb and have an assistant gently move the rope and right leg forward and outward to facilitate echocardiographic examination of standing adult horses and cattle, because this makes it easier to visualize the heart. A right parasternal short-axis view at the level of the chordae tendinae (papillary muscle level) is used to determine the left ventricular internal diameter at end-diastole (LVIDd) and end-systole (LVIDs) and determine wall thickness of the left ventricular free wall and ventricular septum.<sup>1</sup> Three right parasternal long-axis views are then used: the long-axis four-chambers view, the left ventricular outflow tract view, and the right ventricular outflow tract view. Different formula can be used to calculate left ventricular volumes at end-diastole and end-systole and ejection fraction from echocardiographic measurements. Left ventricular fractional shortening (FS) is calculated as  $FS = (LVIDd - LVIDs)/LVIDd$ ; FS ranges in healthy adult horses from 28% to 50%.<sup>2</sup> Volumetric measurements and Doppler measurement of right ventricular outflow tract velocity may have clinical utility for the noninvasive measurement of cardiac output in horses; however, pulsed-wave Doppler is difficult to perform because of the need to have the ultrasound beam parallel to the blood flow and the small cardiac window for echocardiography.<sup>3</sup> A new technique has been developed for ultrasonographic measurement of the right ventricle of the adult horse that offers promise in detecting the presence of right ventricular dysfunction.<sup>4</sup> An M-mode short-axis view of the aorta is obtained to calculate left ventricular ejection time from the time interval between opening and closure of the aortic valve; a value >338 ms is normal for healthy adult horses.<sup>5</sup> All these echocardiographic indices are load-dependent measures of cardiac function.

Quantitative studies are available for the horse,<sup>1</sup> sheep, pigs, and cattle. Measurements of cardiac and individual chamber dimensions, vessel diameters, and flow rates can be used to assess normality, indexes of contractility, and effects of cardiac lesions on cardiac response and function. They can also be used to predict the type of lesion likely to result in these changes.

Valvular defects and endocarditis may be diagnosed by imaging abnormal valve motion, incompetent valve orifices, or vegetative masses associated with the valves, and tumor masses in the heart can be detected. Similarly, the severity of valvular regurgitation can be quantified. Focal areas of myocardial echogenicity and asynchrony of ventricular wall motion is indicative of myocardial disease.<sup>6</sup>

Echocardiography can be of considerable value in the diagnosis of congenital cardiovascular defects and the injection of echogenic materials such as microbubble-laden saline may aid in the detection of shunts. Echocardiography can also be used to

determine the presence and extent of pleural and pericardial effusion. Combined IV administration of dobutamine (7.5 µg/kg/min) and atropine (5 µg/kg) has been used to cause a sustained increase in heart rate in horses to approximately 140 beats/min in an attempt to perform echocardiography on horses undergoing a pharmacologically induced cardiac stress test.<sup>7</sup> In the examination of the vascular system, ultrasound is capable of the early detection of iliac thrombosis in horses and is more sensitive than manual palpation per rectum.

There is a long-held belief that horses with a large heart relative to their body size have greater athletic capacity. An accurate and noninvasive method for determining heart weight therefore has potential utility as one method for predicting racing success. Echocardiography provides a useful estimate of heart weight that may compliment electrocardiographically determined **heart score** (calculated from the QRS duration) in the prediction of athletic performance. The thickness of the interventricular septum in diastole provides an accurate prediction of heart weight; the predictive accuracy was such that echocardiography using this measurement has utility as an index of subsequent athletic performance and has been used in North America, Europe, and Australia in such a manner. Significant cardiac enlargement has been observed in Standardbreds between 2.0 and 3.5 years of age, with echocardiographic changes characteristic for endurance trained athletes.<sup>8</sup>

## Fetal Echocardiography

The fetal ECG may be recorded in late gestation using transabdominal ultrasonography and can be of value in determining whether the fetus is alive and as a monitor for fetal distress during difficult or prolonged parturition. The abdomen is clipped and ultrasonic coupling gel is applied liberally to the skin. The fetal heart is detected using a 3-MHz or 5-MHz linear-array probe; however, the technique is challenging and it may take at least 10 minutes to identify the fetal heartbeat, which must be located within 12 cm of the transducer.<sup>9</sup>

## FURTHER READING

- Buczinski S. Cardiovascular ultrasonography in cattle. *Vet Clin North Am Food Anim Pract.* 2009;25:611-632.
- Buczinski S, Rezakhani A, Boerboom D. Heart disease in cattle: Diagnosis, therapeutic approaches and prognosis. *Vet J.* 2010;184:258-263.
- Reef VB, Bonagura J, Buhl R, et al. Recommendations for equine athletes with cardiovascular abnormalities. ACVIM/ECEIM consensus statement 2013. *J Vet Intern Med.* 2014;28:749-761.

## REFERENCES

- Patterson MW, et al. *Equine Vet J.* 1995;19:18.
- Lightowler C, et al. *Arch Vet Med.* 2000;32:229.
- McConachie E, et al. *J Vet Intern Med.* 2013;27:324.
- Gehlen H, Stahl AH. *J Equine Vet Sci.* 2014;34:1096.
- Lightowler C, et al. *Anim Sci J.* 2003;74:505.



6. Nath LC, et al. *Aust Vet J.* 2012;90:351.
7. Gehlen H, et al. *J Vet Intern Med.* 2006;20:562.
8. Buhl R. *J Am Vet Med Assoc.* 2005;226:1881.
9. Breukelman S, et al. *Theriogenology.* 2006;65:486.

## RADIOGRAPHIC AND ANGIOCARDIOGRAPHIC EXAMINATION

Because of the size of horses and cattle these methods of examination are largely confined to neonates of these species, except in teaching hospitals. The major limitations of radiography are the inability to obtain dorsoventral radiographs in adult horses and cattle and the frequent presence of pleural fluid and pulmonary disease that obscures the cardiac silhouette on a lateral view. Angiocardiography can be a diagnostic method of examination in congenital cardiac defects where the passage of contrast media through abnormal routes can be detected.

Lateral radiographs of neonatal foals or calves, or adult sheep and goats, can be helpful in detecting cardiac enlargement (either dilatation or hypertrophy) that may result from cardiac disease. Specifically, determination of the **vertebral heart score (VHS)** that compares the cardiac silhouette dimensions with the length of specific thoracic vertebral bodies has been used to identify the presence of cardiac enlargement in neonatal calves suspected to have congenital cardiac disease. To determine VHS, first the long axis of the heart is measured from the heart base to the apex, with the dorsal landmark defined as the ventral margin of the carina and the left mainstem bronchus. The short axis of the heart is then measured perpendicular to the long axis at the widest portion of the heart (approximately at the level of the ventral border of the caudal vena cava [CVC]) from the cranial to caudal border.<sup>1</sup> The lengths of the long axis and short axis are then added and superimposed on the long axial length of the thoracic spine, starting at the cranial margin of T4 and projecting caudally. Measurements of cardiac dimensions are then expressed in terms of vertebral units, with one vertebral unit the distance of one vertebral body and the accompanying caudal intervertebral disk space. Healthy calves <7 weeks of age had a VHS < 8.9 vertebral units, and VHS was significantly increased in calves with congenital cardiac disease such as ventricular septal defect.<sup>1</sup>

Radiographic evaluation of CVC diameter has proven useful in the diagnosis of heart disease in adult dairy cattle. Lateral thoracic radiographs are taken with cattle in a standing position and the average diameter of CVC is compared with the diameter of the aorta and the length of the thoracic vertebra at the same intercostal space (usually the 8th intercostal space). The ratio of CVC diameter to aortic diameter is  $0.61 \pm 0.10$  and the ratio of CVC diameter to vertebral length is  $0.41 \pm 0.06$  in healthy dairy cattle

of varying ages. Both ratios were markedly decreased in cattle with cardiac disease caused by endocarditis, traumatic reticulo-pericarditis, ventricular septal defect, and pericardial effusion.<sup>2</sup>

## REFERENCES

1. Suzuki K, et al. *J Vet Intern Med.* 2012;26:1056.
2. Jilintai, et al. *J Vet Med Sci.* 2006;68:995.

## PHONOCARDIOGRAPHY

Phonocardiography allows the recording and measurement of heart sounds. A special microphone is placed directly over the various areas of the thorax used for heart auscultation, and the heart sounds are recorded graphically on moving paper or on an oscilloscope. Before recording, the heart sounds are usually passed through high-pass, low-pass, or band-pass **filters** to allow better discrimination of the individual sounds and to allow a crude frequency examination.<sup>1</sup> Phonocardiograms are usually recorded in conjunction with an ECG and chamber pressure measurements, which permit timing of their occurrence in relationship to the electrical activity within the heart.

Phonocardiograms can provide considerable information on heart sounds additional to that acquired by stethoscopic examination. In the horse, up to 11 sound events can be detected in each cardiac cycle and figures of the occurrence and duration of normal heart sounds in large animals are available. In conjunction with an ECG, the phonocardiogram can be used to measure systolic time intervals, which may be altered in congenital and acquired cardiovascular abnormalities.

Phonocardiograms have been infrequently used for the characterization and timing of murmurs in animals with cardiovascular disease, especially at fast heart rates when simple stethoscopic examination may not allow this. However, phonocardiography has been rarely used as a clinical diagnostic tool, and the widespread availability of echocardiographs make the clinical application of phonocardiography less likely in the future.

## REFERENCE

1. Kharin SN, et al. *Am J Vet Res.* 2009;70:330.

## CARDIAC OUTPUT

There are several techniques available for the measurement of cardiac output, but the one almost universally applied in large animals is the indicator dilution technique using thermodilution (injection of iced 5% dextrose) or indicator dyes such as Evans blue, indocyanine green, or lithium chloride. With dye dilution, an exact amount of dye is injected into the jugular vein or pulmonary artery via a catheter and the serial collection of blood samples is performed from a suitable proximally located artery that has been

catheterized. Cardiac output is most commonly measured using thermodilution but can also be calculated from a dye dilution curve by determining the mean concentration of the dye and the time taken for one circulation through the heart. Automated cardiodensitometers are also available for this estimation. Cardiac output is expressed as liters per minute and is usually corrected to **cardiac index** on the basis of weight or body surface area.

Most domestic animals have a cardiac index of 100(mL/kg BW)/min at rest. The cardiac index for horses, sheep, and cattle at rest has been determined as  $86 \pm 13$ ,  $131 \pm 39$ , and  $113 \pm 11$ (mL/kg)/min, respectively. Stroke volume can also be calculated from the measured cardiac output and simultaneously determined heart rate, in which stroke volume = cardiac output/heart rate. Generally, the normal variation between animals in indexes of cardiac output is too great to allow it to be used as a diagnostic measure in individual animals suspected to have cardiac disease. Measures of cardiac output are used in experimental studies, where the effects of certain procedures can be followed within the same animal. Indicator dilution curves using dyes or thermodilution methodology can be used to detect the presence of intracardiac defects such as septal defects and to quantify their significance.

**Doppler echocardiography** and the direct or indirect **Fick method**<sup>1,2</sup> can be used to estimate cardiac output and gives values equivalent to those obtained by thermodilution techniques.

## REFERENCES

1. Lépez ML, et al. *Res Vet Sci.* 2008;85:307.
2. Durando MM, et al. *Am J Vet Res.* 2008;69:1054.

## CARDIAC CATHETERIZATION

The measurement of pressure within the various chambers of the heart and in the inflow and outflow vessels can provide diagnostic information in both acquired and congenital heart disease in large animals. Generally, pressure is determined by means of fluid-filled catheters introduced into these areas and connected to an external pressure transducer. These systems are generally satisfactory for the measurement of pressure and the detection of changes with abnormality. However, because of their transmission characteristics, they are less suitable for the precise timing of pressure events, and high-fidelity catheter tip manometers should be used for this purpose.

Catheterization of the right side of the heart is a comparatively simple procedure in large animals but is not without risk to the animal. Catheterization is done in the standing position, and descriptions are available for horses and cattle. Flow-directed catheters are used and can be introduced through a needle inserted into the jugular vein.

Balloon-tipped catheters aid the flow of the catheter into the pulmonary artery. Catheterization of the left side of the heart is more complicated and performed less often. Left heart catheterization is usually performed under general anesthesia and requires the use of a stiff catheter introduced into the carotid or femoral artery by surgical methods and subsequently manipulated to the left ventricle.

The systematic determination of the pressure within each area of the heart and in the inflow and outflow vessels can allow a determination of the type of abnormality that is present. Valvular stenosis or incompetence is associated with abnormal pressure differences across the affected valve during systole or diastole. Cardiac hypertrophy is generally accompanied by an increase in pressure during systole of the affected chamber. With high-fidelity equipment, pressure waveforms can also have diagnostic value.

The right atrium is usually used as the reference point for pressure comparison and is arbitrarily assigned a reference pressure of zero when recording using a fluid-filled catheter system. The scapulohumeral joint (point of the shoulder) is taken as the anatomic equivalent reference height in the standing animal. A simultaneously recorded base-apex ECG assists in interpretation of the pressure tracings. Numerous publications have reported cardiovascular values for conscious awake horses and adult cattle and calves, and representative values are presented in Table 10-2.

During catheterization blood may be withdrawn through the catheter and subjected to blood gas analysis. In right-sided catheterization, an increase in oxygen saturation in the right ventricle or pulmonary artery can be diagnostic for the presence of a left-to-right shunt caused by an atrial septal defect, a ventricular septal defect, or a patent ductus arteriosus. The normal maximum increase in venous oxygen content between the right heart chambers and pulmonary artery in humans is 0.9 mL O<sub>2</sub>/dL from the right atrium to right ventricle and 0.5 mL O<sub>2</sub>/dL blood from the right ventricle to the pulmonary artery. It is a reasonable assumption that similar changes in oxygen content (caused by streaming of blood flow and variability in sampling site within the right atrium and ventricle) exist in large animals. Not only can blood gas analysis indicate the presence of a left-to-right to shunt, but sequential blood gas analysis can be used to quantify the magnitude of the shunt by calculating the pulmonary-to-systemic flow ratio and therefore assist in prognosis.

The pulmonary blood flow and systemic blood flow are approximately equivalent in healthy individuals, with the exception of a small amount of right-to-left shunt (physiologic shunt) caused by venous blood from coronary and bronchial blood flow draining into the left ventricle, left atrium, or

**Table 10-2** Mean ( $\pm$  standard deviation) cardiopulmonary values for adult horses, cattle and calves, and pigs

Measured value	Adult horses	Adult cattle	Calves	Pigs
Body weight (kg)	560	540	40	43
Mean arterial pressure (mm Hg)	120 $\pm$ 14	150 $\pm$ 27	92 $\pm$ 15	130 $\pm$ 12
Mean pulmonary artery pressure (mm Hg)	21 $\pm$ 5	36 $\pm$ 9	18 $\pm$ 6	16 $\pm$ 2
Mean central venous pressure (mm Hg)	6.9 $\pm$ 2.7	NS	2.4 $\pm$ 1.2	4.8 $\pm$ 1.2
Heart rate (beats/min)	44 $\pm$ 8	73 $\pm$ 14	114 $\pm$ 9	134 $\pm$ 10
Cardiac index (l/mL/kg/min)	93 $\pm$ 23	64 $\pm$ 14	120 $\pm$ 48	150 $\pm$ 10
Respiratory rate (breaths/min)	18 $\pm$ 7	45 $\pm$ 12	NS	19 $\pm$ 2
Arterial pH	7.41 $\pm$ 0.02	7.42 $\pm$ 0.03	7.37 $\pm$ 0.03	7.42 $\pm$ 0.04
Arterial PCO <sub>2</sub> (mm Hg)	40 $\pm$ 3	38 $\pm$ 3	50 $\pm$ 6	43 $\pm$ 2
Arterial PO <sub>2</sub> (mm Hg)	93 $\pm$ 14	109 $\pm$ 12	92 $\pm$ 10	105 $\pm$ 4

NS, not stated.

Animals are unsedated and standing with their head in a normal, nonfeeding position. Pressures are referenced to the scapulohumeral joint.

**Table 10-3** Results of sequential blood gas analysis from a 2-year-old Holstein-Friesian heifer with a large ventricular septal defect

Measured value	Right atrium	Right ventricle	Pulmonary artery
pH	7.42	7.47	7.48
PCO <sub>2</sub> (mm Hg)	42.9	36.4	35.3
PO <sub>2</sub> (mm Hg)	33.0	48.6	48.8
O <sub>2</sub> saturation (%)	64.1	87.7	91.6
Hemoglobin concentration (g/dL)	6.5	6.4	6.2
<b>Calculated value</b>			
Blood O <sub>2</sub> content (mL O <sub>2</sub> /dL blood)	5.89	7.95	8.04

Blood was obtained from passing a fluid-filled catheter from the jugular vein through the right atrium, right ventricle, and into the pulmonary artery. The O<sub>2</sub> content of arterial and pulmonary venous blood was calculated to be 8.67 mL O<sub>2</sub>/dL blood.

pulmonary veins. The pulmonary-to-systemic flow ratio should therefore approximate 1.0. In animals with a left-to-right shunt, the pulmonary to systemic flow ratio ( $Q_p/Q_s$ ) quantifies the magnitude of the left-to-right shunt across the defect. The pulmonary-to-systemic flow ratio is calculated using the Fick method from measurements of  $S_aO_2$  (oxygen content of arterial blood),  $MVO_2$  (oxygen content of mixed venous blood, which is the pulmonary artery in animals without a shunt, the right ventricle in animals with a patent ductus arteriosus, the right atrium in animals with a ventricular septal defect, and the vena cava in animals with an atrial septal defect),  $P_{aO_2}$  (oxygen content of pulmonary venous blood), and  $P_aO_2$  (oxygen content of pulmonary artery blood), such that:  $(Q_p/Q_s) = (S_aO_2 - MVO_2) / (P_{aO_2} - P_aO_2)$ . This method assumes the animal is in steady state and that cardiac output does not change during blood sampling. Oxygen content (in mL O<sub>2</sub>/dL blood) is calculated from the measured values for blood hemoglobin concentration ([Hb], in g/dL), oxygen tension, and percentage O<sub>2</sub> saturation, such that O<sub>2</sub> content = [Hb]  $\times$  1.39  $\times$  O<sub>2</sub> saturation/100 + 0.003  $\times$  PO<sub>2</sub>. In clinical

cases at sea level, it is assumed that saturation of pulmonary venous blood and arterial blood = 97.5% and that PO<sub>2</sub> = 90 mm Hg. Application of this equation and assumptions to data from a 2-year-old Holstein-Friesian cow with a ventricular septal defect, atrial fibrillation, and pulmonary hypertension (mean pressure 67 mm Hg) indicated that  $(Q_p/Q_s) = (8.67 - 5.89) / (8.67 - 8.04) = 4.4$ , using the right atrial content as the mixed venous sample because the right ventricle contained a large volume of oxygenated blood from the left ventricle. This calculation indicated the presence of an extremely large left-to-right shunt (shunt =  $Q_p - Q_s = Q_p(1 - 1/4.4) = 0.77 \times Q_p$ ); in other words, 77% of the blood flowing through the lungs was from the left heart. Such a large shunt into the right ventricle was suspected based on the large step up in O<sub>2</sub> content from the right atrium to right ventricle (2.1 mL O<sub>2</sub>/dL; Table 10-3), which exceeded the maximal normal value of 0.9 mL O<sub>2</sub>/dL. A 2-cm diameter ventricular septal defect was confirmed at necropsy.

Shunts can also be demonstrated by dye or thermodilution techniques, but these are much more complicated to analyze than

blood gas analysis of sequential blood samples obtained from a fluid-filled catheter during a pullback from the pulmonary artery through the right ventricle into the right atrium.

Echocardiography can provide information that, although different, may be of equivalent diagnostic value to that obtained by cardiac catheterization and, because it is noninvasive and technically a much easier procedure, echocardiography has largely supplanted cardiac catheterization in the examination of cardiac disease in large animals.

## Arrhythmias (Dysrhythmias)

Variations in cardiac rate and rhythm include tachycardia (increased rate), bradycardia (decreased rate), arrhythmia or dysrhythmia (irregularity in rate and rhythm), and gallop rhythms. The rate and rhythm of the heart is influenced primarily by the integrity of the pacemaker, the conducting system, and the myocardium, and also by the influence of the autonomic nervous system. Variation in the rate and rhythm can occur in normal animals because of strong or varying **autonomic influences** and can also be a reflection of primary **myocardial disease**. Other factors such as **acid-base** and **electrolyte imbalance** can influence rate and rhythm. These factors must be taken into consideration in the assessment of apparent abnormalities detected on clinical examination of the cardiovascular system. The combination of dysautonomia and acid-base and electrolyte abnormalities (particularly hypokalemia and hypocalcemia) are the most likely reasons for the increased prevalence of arrhythmias in horses during recovery from anesthesia.<sup>1</sup> Similarly, ventricular premature complexes are more often present in horses with colic than healthy horses; the increased incidence of ventricular arrhythmias has been attributed to electrolyte abnormalities (particularly hypokalemia, hypocalcemia, and hypomagnesemia), sympathetic nervous system activation, and concurrent endotoxemia.<sup>2</sup> Cardiac arrhythmias are more common in low-producing lactating dairy cattle than high-producing dairy cattle; this is attributed to the presence of concurrent electrolyte disturbances in low-production cattle, particularly hypocalcemia, hypokalemia, and hypomagnesemia.<sup>3</sup>

The majority of arrhythmias and conduction disturbances can be detected on clinical examination. However, some may be unsuspected on clinical examination and be found only on electrocardiographic examination. The occurrence of conduction and myocardial disturbances is probably more common than generally recognized, because an ECG is usually only taken from animals in which there have been prior clinical indications of conduction abnormalities. Because of the

**Table 10-4** Common arrhythmias and conduction disturbances in the horse and cow

Horses	Cattle
Second-degree atrioventricular block	First-degree atrioventricular block
Atrial fibrillation	Atrial premature complexes
Atrial premature complexes	Ventricular premature complexes
Ventricular premature complexes	Atrial fibrillation
First-degree atrioventricular block	
Sinoatrial block	

importance of electrocardiography in the diagnosis of arrhythmias, the salient electrocardiographic findings are given in the following sections.

The common conduction disturbances and arrhythmias in large animals are listed in Table 10-4. A large-scale cross-sectional study of 952 healthy dairy cattle aged 1 or more years produced the following prevalence of arrhythmias: sinus arrhythmia, 8.5%; first-degree AV block, 1.6%; ventricular premature complexes, 0.6%; atrial premature complexes, 0.4%; sinus bradycardia, 0.2%; and ventricular escape complexes, 0.1%. Atrial fibrillation was not observed in healthy cattle in this study.

The treatment of arrhythmic heart disease generally relies on the treatment of the underlying clinical condition causing the problem. This may vary from electrolyte and acid-base disturbance and toxicities to primary myocardial disease resulting from myocarditis, myocardial ischemia, and changes resulting from heart failure or myopathies resulting from nutritional deficiency. These are detailed in later sections in this text. Racing and work horses should be rested for periods up to 3 months following evidence of myocardial disease. Frequently a course of corticosteroids, or a nonsteroidal antiinflammatory drug (NSAID) such as flunixin meglumine, is given to attempt to reduce the severity of myocarditis if this is not contraindicated by the initiating cause. Specific antiarrhythmic therapy may be applied in certain conditions and is detailed later.

A clinically useful classification system for dysrhythmias is based on the heart rate, as often an ECG is unavailable during the initial physical examination. This is the categorization system used in this text. However, when an ECG record of an arrhythmia is available, it is very helpful to categorize dysrhythmias in large animals into four categories based on their anatomic origin: SA

**nodal, atrial myocardial, AV nodal, or ventricular myocardial.** An alternative system of categorization of cardiac arrhythmias focuses on **disorders of impulse formation, disorders of impulse conduction, disorders of both impulse formation and conduction, or escape rhythms.**

It is important to be able to recognize those forms of arrhythmia that are not indicative of pathologic heart disease but are normal **physiologic variations**. These are common in the horse and most can be differentiated on physical examination. It is also important to understand the difference between a **premature beat or contraction** and a **premature complex**. A beat or contraction is a mechanical event that can be clinically detected by auscultation, palpation of an artery or visual examination of the jugular venous pulse, or recorded by pressure measurements. A complex is an electrical event that is detected by an electrocardiograph. A beat is always associated with a complex; however, a complex can be unaccompanied by a beat, particularly in electromechanical dissociation and ventricular tachycardia or ventricular fibrillation. The terms beat or contraction should therefore be used to describe an arrhythmia detected by auscultation, palpation, or recording of the arterial pulse, whereas the term complex should be used when the arrhythmia is detected electrocardiographically.

### FURTHER READING

- Reef VB, Bonagura J, Buhl R, et al. Recommendations for equine athletes with cardiovascular abnormalities. ACVIM/ECEIM Consensus Statement. *J Vet Intern Med.* 2014;28:749-761.
- Verheyen T, et al. Electrocardiography in horses—part 2: how to read the equine ECG. *Vlaams Diergen Tijdschrift.* 2010;79:337-344.

### REFERENCES

1. Morgan RA, et al. *Acta Vet Scand.* 2011;53:62.
2. Hesselkilde EZ, et al. *Acad Vet Scand.* 2014;56:58.
3. Dehkordi AJ, et al. *Iran J Vet Med.* 2014;8:101.

## SINUS TACHYCARDIA, SINUS BRADYCARDIA, AND PHYSIOLOGIC DYSRHYTHMIAS

The heart rate results from the discharge of impulses from the SA node, which has its own intrinsic rate of discharge but which is also modified by external influences, particularly the vagus nerve.

### SINUS TACHYCARDIA

The term **sinus tachycardia** or simply tachycardia is used to describe an **increase in heart rate** caused by detectable influences such as pain, excitement, exercise, hyperthermia, a fall in arterial blood pressure, or the administration of adrenergic drugs. The heart rate returns to normal when the influence is removed or relieved.

It needs to be stated that sinus tachycardia indicates an increase in heart rate that is initiated by the SA node in the right



atrium (hence the sinus modifier). This means that the term sinus tachycardia should be reserved for use when electrocardiography has been performed and the sinus node has been determined to be the dominant pacemaker. For comparison, the term tachycardia should be used when an increased heart rate is detected by auscultation or palpation of the pulse and the origin of the pacemaker has not been determined. In resting horses and cattle that are used to being handled heart rates are not usually elevated above 48 and 80 beats/min, respectively, and rates above this are usually classified as tachycardia (Fig. 10-5). Fig. 10-6 shows base-apex ECGs of horses with selected arrhythmias, which were recorded at 25 mm/s and 10 mm = 1 mV. In the cow and horse, it is rare for the causes of sinus tachycardia to elevate the heart rate above 120 beats/min in the resting animal, and at heart rates above this an intrinsic pathologic tachycardia should be sought. Sinus tachycardia (heart rate >90 beats/min), with or without sinus arrhythmia, is more common in sheep in the early postpartum period than in late gestation.<sup>1</sup>

### SINUS BRADYCARDIA

Sinus bradycardia or simple bradycardia is used to describe a decrease in heart rate caused by a decreased rate of discharge from the SA node. Sinus bradycardia is most commonly associated with highly trained, fit animals and can be differentiated from the pathologic bradycardias by its abolition by exercise or the administration of atropine. Obviously sinus bradycardia, like sinus tachycardia, requires electrocardiographic confirmation that the sinus node is the dominant pacemaker.

**Bradycardia** may also occur in association with an increase in arterial blood pressure, space-occupying lesions of the cranium and increased intracranial pressure, pituitary abscess, hyperkalemia (see Fig. 8-1), hypothermia, and hypoglycemia and following the administration of  $\alpha$ -2-adrenergic agonists such as xylazine or detomidine. Bradycardia is sometimes associated with vagus indigestion and diaphragmatic hernia in cattle and also occurs in cattle deprived of food. Bradycardia has also been reported in cattle with bovine spongiform encephalopathy, although this probably reflects inappetence rather than damage to the vagal nucleus in the brainstem; the latter would be expected to increase, rather than decrease, the heart rate. Bradycardia can be induced in young ruminants by forceful elevation of the tail. Sinus arrhythmia is usually present in animals with sinus bradycardia.

The resting heart rate seldom falls below 22 beats/min in adult horses and 44 beats/min in adult cattle. Rates below this are suggestive of pathologic bradycardias, and hypothermia, hypothyroidism, or an intrinsic cardiac problem should be suspected.

However, a general rule is that resting heart rates are inversely proportional to BW, and large, fit horses and cattle have apparently low heart rates.

### PHYSIOLOGIC DYSRHYTHMIAS

There are several dysrhythmias that can occur in the absence of heart disease and that appear to result from **excess vagal tone**.

These occur especially in the horse and include the following:

- Sinus arrhythmia
- Wandering pacemaker
- SA block
- First-degree and second-degree AV block (Mobitz type 1).

These physiologic arrhythmias occur in animals at rest and can frequently be induced

A. Normal sinus rhythm in a horse (heart rate = 33 beats/min).

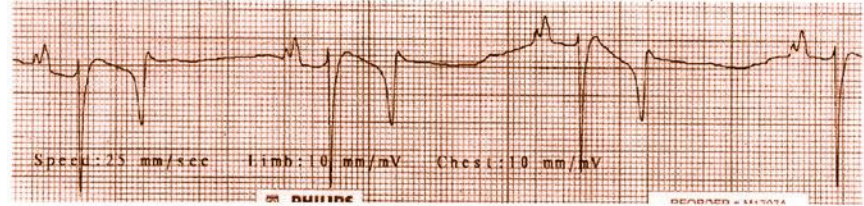

B. Normal sinus rhythm in a cow (heart rate = 68 beats/min).



C. Atrial premature complexes in a cow (4<sup>th</sup> & 5<sup>th</sup> P waves from left).

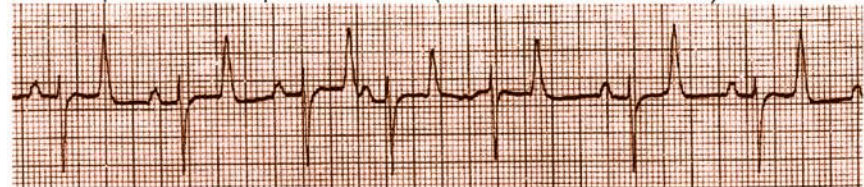

D. Paroxysmal supraventricular tachycardia in a cow.



E. Atrial fibrillation in a cow (normal ventricular rate).



F. Atrial fibrillation in a cow (increased ventricular rate).



G. Atrial fibrillation in a cow (ventricular rate = 186 beats/min) with chronic (congestive) heart failure and pleural fluid accumulation leading to decreased QRS amplitude.



**Fig. 10-5** Base-apex electrocardiograms (ECGs) of large animals with normal sinus rhythm (A and B), supraventricular arrhythmias (C-H), hyperkalemia (H and I), or ventricular arrhythmias (J-L). All ECGs were recorded at 25 mm/s and 10 mm = 1 mV. Base-apex ECGs of large animals with normal sinus rhythm (A and B), supraventricular arrhythmias (C-H), hyperkalemia (H and I), or ventricular arrhythmias (J-L). All ECGs were recorded at 25 mm/s and 10 mm = 1 mV.



H. Second degree AV block in a 3-month-old calf. The 3<sup>rd</sup> P wave is not followed by a QRS complex.



I. Bradycardia (heart rate = 58 beats/min), hyperkalemia ( $[K^+] = 8.0$  mEq/L), absence of P waves, and prolonged QRS duration in a 7-day-old calf with diarrhea and severe acidemia (jugular venous blood pH = 6.90).

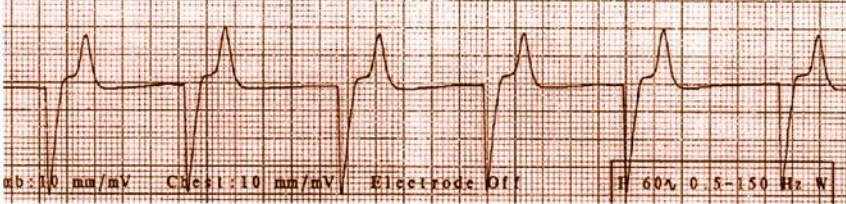

J. Sinus tachycardia in a heifer (heart rate = 148 beats/min) with a premature ventricular complex.

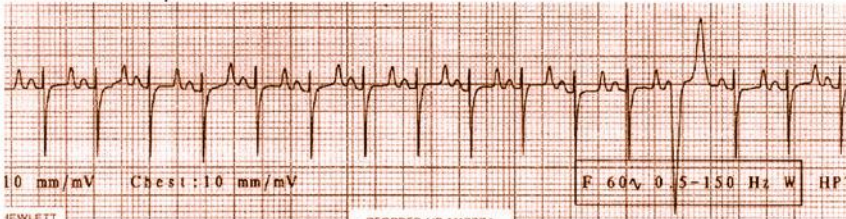

K. Ventricular premature complex in a cow. Note the markedly abnormal QRS complex that has opposite polarity to the normal complex, increased QRS duration, and a large T wave amplitude.

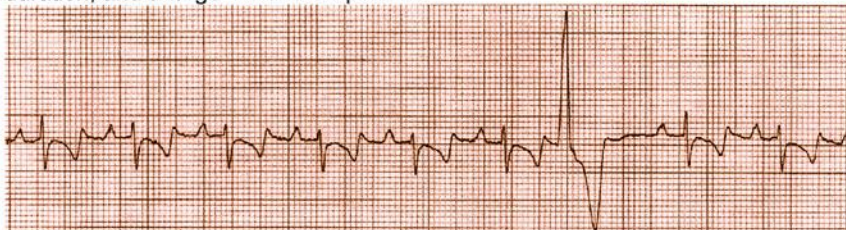

L. Ventricular arrhythmia in a cow (normal P, QRS, & T wave in 3<sup>rd</sup> complex).



Fig. 10-5, cont'd

by the application of a nose twitch in horses or by forceful elevation of the tail in young ruminants. There is some debate as to the significance of these arrhythmias in animals, but it is generally thought that if they are abolished by exercise or excitement and if there is no evidence of cardiac insufficiency they are not of pathologic significance and do not require further investigation.

Perinodal myocardial fibrosis and microvascular abnormality have been reported in horses with SA and AV block and are considered as an excitatory cause. However, because myocardial fibrosis is common in horses, and is present in 79% of horse hearts examined at random, it remains likely that these arrhythmias are physiologic in horses. All animals with evidence of arrhythmic heart disease should be examined following exercise, as should any animal in which cardiac disease is suspected.

The occurrence of **cardiac irregularities following exercise** is highly indicative of serious cardiac disease.

A high frequency of arrhythmia has been recorded in **newborn foals** immediately following birth. Forty-eight of 50 foals had some form of arrhythmia; atrial premature complexes were recorded in 30 foals, atrial fibrillation in 15 foals, and ventricular premature complexes in 10 foals. Other arrhythmias were recorded with less frequency. It was concluded that the arrhythmias resulted from transient **physiologic hypoxemia** during birth and that their occurrence should be considered as part of the normal adaptive process to extrauterine life, as normal sinus rhythm was recorded by 5 minutes following birth and the foals subsequently developed normally.

Cardiac arrhythmias also are commonly associated with **gastrointestinal disorders** in the dairy cow and less commonly in the horse and resolve without specific antiarrhythmic treatment when the primary gastrointestinal disorder is corrected. Atrial premature complexes, ventricular premature complexes, and atrial fibrillation have been

A. An ECG (base–apex configuration) of a horse with atrial fibrillation.

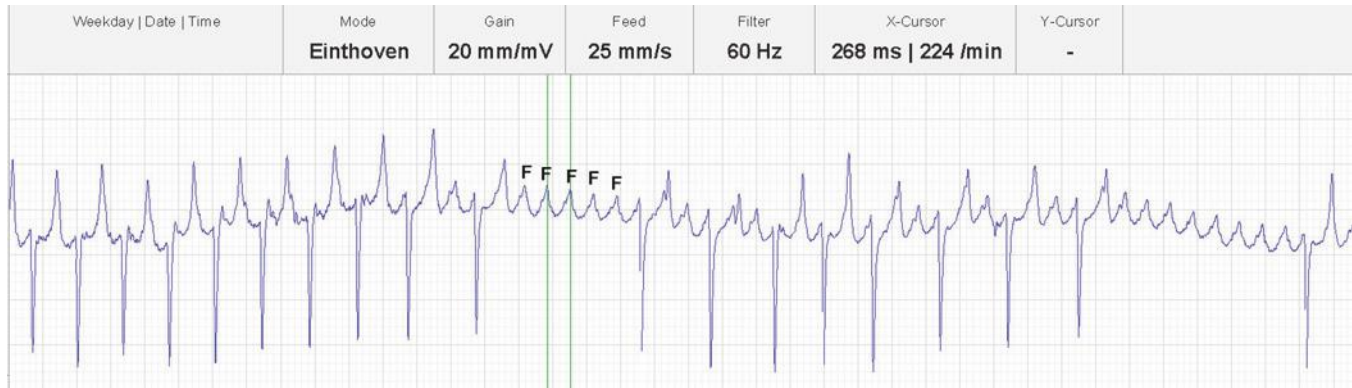

**Fig. 10-6** Base–apex electrocardiograms (ECGs) of horses with selected arrhythmias. All ECGs were recorded at 25 mm/s and 10 mm = 1 mV. **A, An ECG (base–apex configuration) of a horse with atrial fibrillation.** The typical characteristics include an irregularly irregular rhythm, absence of P waves, coarse baseline irregularity called fibrillation (“f”) waves, and “QRS” complexes of normal width and morphology. Note that for short RR intervals the T wave (arrow) has opposite polarity to the QRS complexes that follow longer diastolic intervals; the same phenomenon occurs in ECGs recorded during exercise compared with at rest. In the same horse, even in the same ECG trace, coarse and fine fibrillation waves can be present, representing the chaotic nature of the underlying electrical activation of the atria.

Continued



B. Base–apex ECG of atrial fibrillation obtained from a 5-year-old trotter with a 14-day history of reduced athletic performance. The rhythm is irregularly irregular after the 9th QRS complex.



C. During exercise and during periods of excitement 1:1, 1:2, and 1:3 atrioventricular (AV) conduction of the flutter waves occurred and the horse's heart rate rhythm sounded regular by auscultation.



D. Junctional ventricular premature depolarization (VPD) in a horse presented with poor performance.



E. Third-degree AV block in a 15-year-old Grand Prix dressage horse.



**Fig. 10-6, cont'd** B, Base–apex ECG obtained from a 5-year-old trotter with a 14-day history of reduced athletic performance. The ECG shows atrial flutter with a cycle length of 268 ms (rate 224 beats/min). C, During exercise and during periods of excitement 1:1, 1:2, and 1:3 atrioventricular (AV) conduction of the flutter waves occurred and the horse's heart rate rhythm sounded regular by auscultation. This ECG recording was obtained during and immediately after pulling up from a trot on the lunge. A 1:1 conduction of F waves as parasympathetic tone is withdrawn results in an excessively high heart rate for the work being undertaken, but the horse's cardiac rhythm is now completely regular. The horse was subsequently converted by transvenous electrical cardioversion at the first 125-J shock, after which he returned to his previous level of exercise. D, Junctional ventricular premature depolarization (VPD) in a horse presented with poor performance. The normal rhythm is broken by a ventricular premature depolarization (VPD) with a morphology that is only slightly different from the normal sinus beats (QRS). Within the QT interval of the VPD a P wave can be identified (P wave indicated by arrow) because the normal sinus rhythm is not interrupted. The P wave does not result in a QRS complex because the ventricle is still refractory. This AV dissociation is a hallmark of ventricular prematurity. Although the complex is not noticeably wider than the sinus beats, it is still ventricular in origin. Its configuration suggests that it originates from the AV junctional, or His-Purkinje system, and has been conducted using (part of) the normal conduction pathways. Note that the T wave preceding the VPD is exactly the same as the other sinus T waves, so that an ectopic P' wave could not have been hidden within it. E, Third-degree AV block in a 15-year-old Grand Prix dressage horse. There is complete AV dissociation because of third-degree AV block. PQ interval is highly variable because they have no relation; the fourth QRS complex occurs simultaneously with a P wave. Bifid "P" waves occur at a rapid rate because of associated hypotension. In this case the QRS morphologies are similar but their rate is slow and rhythm is irregular; they are junctional ventricular escape complexes. The gelding presented acutely after multiple episodes of collapse in a single day. The referring veterinarian administered antibiotics and corticosteroids and referred the horse for pacemaker implantation. At presentation, third-degree AV block was present but ventricular escape rhythm was sufficiently high to prevent collapse. Within 48 hours he reverted to normal sinus rhythm. No pacemaker was implanted. The gelding was closely monitored and returned to dressage after 6 months. He was retired 2.5 years later because of chronic tendinitis. (Reproduced with permission from Hinchcliff KW, Kaneps A, Geor R. *Equine Sports Medicine and Surgery*. 2nd edition. St. Louis, MO: Elsevier; 2013.)



detected in apparently healthy dairy cattle by serial monitoring; however, ventricular premature complexes should be assumed to indicate the presence of organic heart disease.

## REFERENCE

1. Pourjafar M, et al. *Pakistan Vet J.* 2011;31:309.

## ARRHYTHMIAS WITH NORMAL HEART RATES OR BRADYCARDIA

### SINUS ARRHYTHMIA

Sinus arrhythmia is a normal physiologic arrhythmia that occurs at slow resting heart rates and is associated with variation in the rate of discharge from the SA node associated with **variation in the intensity of vagal stimulation**. Sinus arrhythmia is most often **correlated with respiration** so that the discharge rate and heart rate increase during inspiration and decrease during expiration. In the horse, sinus arrhythmia unassociated with respiration also occurs. In the majority of large animals, sinus arrhythmia is much less overt than in the dog and generally is not detected except on very careful clinical examination or examination of the ECG. Sinus arrhythmia is more clinically obvious in tame sheep and goats and in the **young of all species** and is correlated with respiration.<sup>1</sup> Sinus arrhythmia is abolished by exercise or by the administration of atropine.

Sinus arrhythmia is detected on the ECG by variations in the PP intervals (often defined as greater than 10% of the mean heart rate but a range of 8–20% has been applied in some studies) with or without variation in the PR interval and is frequently associated with a **wandering pacemaker**. This is associated with differences in the site of discharge from the SA node with subsequent minor variations in the vector of atrial depolarization with subsequent minor variations in the configuration of the P wave. In the horse there may be an abrupt change in the contour of the P wave so that the normal biphasic positive P wave in lead II, for example, changes to one with an initial negative deflection. There may or may not be a change in PR interval. This is not pathologic and is present in as many as 30% of normal horses at rest. If sinus arrhythmia is not abolished by exercise, it is considered pathologic. Sinus arrhythmia may be induced in the early stages of hypercalcemia during treatment for milk fever in cattle.

### SINOATRIAL BLOCK

In SA block the sinus node fails to discharge or its impulse is not transmitted over the atrial myocardium. SA block is associated with the complete absence of heart sounds, of jugular atrial wave, and of an arterial pulse for one beat period. The underlying rhythm is regular unless sinus arrhythmia is present. On the ECG there is complete absence of the

P, QRS, and T complex for one beat. The distance between the preblock and postblock P waves is twice the normal PP interval or sometimes slightly shorter. This arrhythmia is not uncommon in fit racing horses at rest and can be induced in horses and cattle by procedures that increase vagal tone. Provided it does not persist during and following exercise, it is considered as a **physiologic variant** of normal rhythm.

### ATRIOVENTRICULAR BLOCK

AV block is divided into three categories (first, second, and third degree) depending on the degree of interference with conduction at the AV node.

#### First-Degree Atrioventricular Block

First-degree AV block is an **electrocardiographic diagnosis** and cannot be detected clinically, and it occurs when conduction is delayed at the AV node. The PR interval is prolonged beyond normal limits (conventionally >400 ms in the horse) and the condition may be transient because of waxing and waning vagal tone. First-degree AV block is generally considered to have little significance.

#### Second-Degree Atrioventricular Block

Also called **partial heart block**, this occurs when there is periodic interference with conduction at the AV node so that some atrial complexes are not followed by ventricular complexes (see Fig. 10-5H). This may occur at random or in a regular pattern, for example, at every third or fourth complexes. At the blocked complex there is complete absence of the first and second heart sounds and no palpable pulse. The underlying rhythm is still sinus in origin and is thus regular. In horses the presence of a **fourth heart sound** can be a valuable aid in diagnosis; with careful auscultation it can be heard during the block period in the manner of du LUBB DUPP, du ..., du LUBB DUPP. This is diagnostic for this condition. An **atrial jugular impulse** can also be detected during the block period. The intensity of the first sound in the immediate postblock beat is usually intensified.

The ECG shows the presence of a P wave but complete absence of the subsequent QRS and T waves at the blocked beat. There may be variations in the PR intervals preceding and following the block. With **Mobitz type 1** (Wenckebach) second-degree AV block there is a gradual increase in the PQ interval up to the point of the blocked conduction; however, the PR interval immediately before the blocked conduction does not have to be the longest in the series. With **Mobitz type 2** block the PQ interval remains unchanged. In most species, Mobitz type 1 is a normal physiologic response reflecting changes in vagal tone, whereas Mobitz type 2 always indicates the presence of organic heart disease such as myocarditis.

Second-degree AV block is extremely common in horses and occurs as a **normal physiologic variation** caused by variations in vagal tone. The application of a twitch to the upper lip of a horse will frequently slow the heart rate and allow the expression of second-degree heart block. Second-degree AV block is more common in Thoroughbreds and Standardbreds than in heavy horses and may be detected in approximately 20% of racehorses. Frequency is highest when they are examined in quiet surroundings at rest, at night, or early in the morning. The frequency is also increased when horses are not fed for 24 hours.<sup>2</sup> Second-degree AV block can be abolished by exercise or the administration of atropine.

Second-degree AV block can be associated with **myocarditis** in the horse and its presence has been associated with decreased racing performance by some clinicians. Second-degree AV block at fast heart rates has also been associated with the syndrome of duodenitis–proximal jejunitis in horses and was correlated with high serum bicarbonate concentrations in this condition. AV conduction disturbances can be associated with **electrolyte imbalance** in all species, overdosing with calcium salts, digoxin toxicity, cardiomyopathy, and myocarditis associated with nutritional and infectious disease.

Methods for the clinical differentiation of physiologic (Mobitz type 1) versus pathologic (Mobitz type 2) second-degree heart block in the horse have not been established. However, the persistence of the arrhythmia at heart rates above resting normal values should be considered to be abnormal. In all other species the presence of Mobitz type 2 AV block should probably be considered as an indication of myocardial disease.

It is usually not necessary to treat this arrhythmia specifically and **treatment** is generally directed at the underlying cause. In cases where the block is frequent and syncope episodes are likely, atropine may alleviate the frequency of the block; however, this is only short-term therapy. Second-degree heart block may progress to third-degree (complete) heart block.

### Third-Degree or Complete Heart Block

This occurs rarely in large animals. There is one report on third-degree block in a horse secondary to a rattlesnake bite.<sup>3</sup> In complete heart block there is no conduction at the AV node. The ventricle establishes a pacemaker in the nodal or conducting system and the atria and ventricles beat independently. The ventricular rate is regular but very slow. **Bradycardia** is the prominent feature and it is unresponsive to exercise or atropine. Atrial contractions are much faster than the ventricle. Atrial contraction sounds are rarely heard on auscultation but evidence of the rate may be detected by examination of the jugular inlet. Periodically, as the atrium

contracts during the period that the AV valves are closed, atrial cannon waves may occur up the jugular vein. There is usually variation in the intensity of the first heart sound caused by variation in ventricular filling. Affected animals may show poor exercise tolerance and may have evidence of generalized heart failure. There is usually a history of syncopal attacks.

The ECG shows a slow and independent ventricular rate characterized by QRS complexes that are completely dissociated from the faster P waves.

The prognosis in complete heart block is poor unless it is associated with a correctable electrolyte imbalance. The animal should be kept at rest in quiet surroundings while every effort is made to correct the underlying cause. Corticosteroids and dextrose are usually given intravenously in an attempt to reduce the severity of the initiating myocardial lesion. Isoproterenol (isoprenaline) may stimulate higher nodal tissue and may increase the heart rate. Isoproterenol is usually infused intravenously at a concentration of 1 mg/L of infusion fluid and the rate of infusion is adjusted to effect. This is not a practical treatment in most situations. The use of an internal pacemaker has been reported in the horse but would clearly make the animal unsuitable for athletic endeavors.

AV block and AV dissociation may develop during anesthesia and can be associated with arrhythmogenic anesthetic drugs, hypercapnia, hypoxia and electrolyte and acid-base imbalances. In these circumstances, the administration of regular doses of atropine (0.02 mg/kg) may not alleviate the arrhythmia. Dopamine HCl infusions (3–5 µg/kg per min) have been effective.

The Wolff-Parkinson-White syndrome is recorded as a rare observation in cattle.

## PREMATURE COMPLEXES

Premature complexes or extrasystoles arise by the discharge of impulses from irritable foci within the myocardium. They are classified according to the site of their origin as atrial, junctional and ventricular premature complexes. It is often not possible to distinguish between these by physical examination, particularly at fast heart rates. However, auscultation of an animal with premature beats usually reveals an **occasionally irregular rhythm**.

### Atrial Premature Complexes

These arise from the discharge of an ectopic atrial pacemaker outside the sinus node. Atrial premature contractions are difficult to detect on physical examination if they do not affect ventricular rhythm. If the stimulus from the atrial premature complex falls outside the refractory period of the ventricle, it will initiate a ventricular complex that occurs earlier than expected. Ventricular contractions initiated by atrial premature

complexes have lower intensity because of lower diastolic filling, and the associated arterial pulse amplitude is decreased.

Two main patterns occur. In some instances the sinus node becomes reset from the atrial premature complex so that a regular rhythm is established from this contraction. In this case atrial premature complexes are characterized by the occurrence of periods of regular rhythm interrupted by beats with exceptionally short interbeat periods. In other instances the sinus node is not reset following the atrial premature complexes and if its discharge occurs during the refractory period of the atrium then no atrial or subsequent ventricular contraction will occur. This will be detected electrocardiographically as an early ventricular complex followed by a pause following which normal rhythm is continued. This character is identical to that produced by many ventricular premature complexes.

At slow heart rates the presence of atrial premature complexes is suggested by periodic interruption of an underlying sinus rhythm and by the occurrence of a “dropped pulse.” The prime differentiation is from SA block and second-degree AV block, which have distinguishing electrocardiographic characteristics.

On the ECG the P wave of the premature complex occurs earlier than expected from the basic rhythm and is abnormal in configuration (see Fig. 10-5C). QRS complexes associated with atrial premature complexes are usually normal in configuration because this is a supraventricular arrhythmia and the pathway for ventricular depolarization is not altered.

### Junctional Premature Complexes

These are also AV nodal premature complexes that arise from the region of the AV node or conducting tissue. They produce a premature ventricular contraction, which is usually followed by a compensatory pause caused by the following normal discharge from the sinus node that usually falls upon the ventricle during its refractory period.

Junctional premature complexes produce QRS configurations that are similar to those of normal complexes, but they may produce a P wave that has a vector opposite to normal.

### Ventricular Premature Complexes

Ventricular premature complexes may arise from an irritable process anywhere within the ventricular myocardium. The normal rhythm is interrupted by a beat that occurs earlier than expected, but the initial rhythm is established following a **compensatory pause**. This can be established by tapping through the arrhythmia as described earlier. The heart sounds associated with the premature beat are usually markedly decreased in amplitude, whereas the first sound following the compensatory pause is usually accentuated. Occasionally, ventricular premature

complexes may be interpolated in the normal rhythm and not followed by a compensatory pause. If the diastolic filling period preceding the premature beat is short, the pulse associated with it will be markedly decreased in amplitude or even absent.

On the ECG ventricular premature complexes are characterized by bizarre QRS morphology (see Fig. 10-5K). Conduction over nonspecialized pathways results in a complex of greater duration and amplitude to normal and the complex slurs into a T wave that is also of increased duration and magnitude. The vector orientation depends on the site of the ectopic foci initiating the contraction, but it is invariably different from that of normal contractions. Electrocardiographic examination allows a differentiation of the site of origin of premature complexes and further subclassification within the categories.

Premature complexes of all site origins are indicative of **myocardial disease**; the one exception is the occurrence of atrial premature complexes accompanying cases of gastrointestinal disease in cattle. Atrial premature complexes are common in cattle with **gastrointestinal disease**, and their presence should be suspected whenever there is a variation in the intensity of the first heart sound with or without an underlying detectable cardiac irregularity. Atrial premature complexes can progress to atrial fibrillation in these cases where there is excessive vagal tone.

Horses in which premature beats are auscultated or suspected should be examined after careful exercise, which will usually increase the occurrence and severity of the arrhythmia. Premature beats are most easily auscultated during the period of slowing of heart rate after exercise.

## REFERENCES

1. Pourjafar M, et al. *Pakistan Vet J.* 2011;31:309.
2. Ohmura H, et al. *Am J Vet Res.* 2012;73:508.
3. Lawler JB, et al. *J Vet Intern Med.* 2008;22:486.

## ARRHYTHMIAS WITH TACHYCARDIA

An excitable focus within the myocardium may spontaneously discharge and cause depolarization of the remaining myocardium. If the discharge rate approaches or exceeds that of the sinus node, then the focus may transiently take over as the pacemaker of the heart.

### ATRIAL FIBRILLATION

In atrial fibrillation atrial depolarization is characterized by numerous independent fronts of excitation that course continuously and haphazardly through the atria. There is no synchronous atrial contraction and AV nodal stimulation occurs in an irregular and random fashion. The effects within the atria cannot be appreciated on auscultation and the clinical detection of this arrhythmia

occurs through its effects on ventricular function. The random stimulation of the ventricles produces a heart rate and pulse that is **irregularly irregular**. It is not possible to establish any basic rhythm by tapping out this arrhythmia, and the rate varies from period to period.

Because there is no atrial contraction, filling of the ventricles is entirely passive and very much dependent on diastolic filling time. Some contractions occur very quickly following the preceding contraction with little time for diastolic filling and this produces a marked variation in the intensity of the heart sounds and in the amplitude of the pulse. At fast heart rates there will be a pulse deficit. There is no fourth heart sound (S<sub>4</sub>) or atrial wave at the jugular inlet because there is no coordinated atrial contraction, but the third heart sound is usually grossly accentuated. The degree of cardiac insufficiency that results from this arrhythmia varies and depends on the general rate at which the ventricles beat at rest. This is determined primarily by vagal activity.

**On the ECG** there are no P waves discernible but the baseline shows multiple waveforms (f waves) that occur with a frequency of approximately 300 to 600 f waves/min (see Fig. 10-6A,B). QRST complexes are normal in configuration, but there is wide variation and no pattern in the QQ intervals. Atrial fibrillation is one of the more common arrhythmias in large-animal species. The ECG of horses in atrial fibrillation may exhibit modified P waves called F waves (**flutter waves**) that have a similar sawtooth morphology and polarity with a frequency of approximately 180 to 250 F waves/min.

### Atrial Fibrillation in the Horse

Horses with atrial fibrillation fall into two categories. In one category, sometimes called “benign fibrillators” or “**lone atrial fibrillation**,” there is no evidence of underlying heart disease, whereas in the second category, called “**secondary atrial fibrillation**,” there is evidence of heart disease.

#### Lone Atrial Fibrillation

In cases that are lone atrial fibrillation, the vagal tone may be high and conduction through the AV node is suppressed to result in heart rates in the region of approximately 26 to 48 beats/min. At this rate there is no cardiac insufficiency at rest, and hemodynamic parameters are normal. The horse can elevate its heart rate with exercise to allow moderate performance, although it will never perform satisfactorily as a racehorse. This is the most common manifestation in this species, and it is typified by a gross irregularity in rate, rhythm, and intensity of the heart sounds and by the occurrence, at rest, of occasional periods lasting for 3 to 6 seconds in which there is no ventricular activity. At very slow rates periodic syncope may occur. The ventricular rate in horses

with atrial fibrillation exhibits a high degree of periodicity that is associated with the respiratory rate. A relatively low ventricular rate in horses with atrial fibrillation reflects the dominance of the parasympathetic nervous system. In other words, horses with atrial fibrillation and ventricular response rates exceeding 60 beats/min are sympathetically activated, and concurrent disease processes or stressors should be identified.

The lone **form** of atrial fibrillation is most common in racehorses and occasionally in draft horses. A survey of 106 cases of atrial fibrillation in horses found that the disease is most common in Standardbred and Thoroughbred horses under 7 years of age, with a high proportion under 4 years of age, which may have been a reflection of the admissions to the clinic rather than real age incidence. There appears to be a genetic predisposition to atrial fibrillation in Standardbreds in Canada with a more complex pattern of inheritance than a simple autosomal recessive disorder.<sup>1</sup>

**Exercise intolerance** was the most common clinical history. All horses had an irregular heart rate and rhythm, and the pulse and intensity of the heart sounds were variable. A separate study of 67 horses showed a significantly higher prevalence in Standardbreds and Thoroughbreds than other breeds of horse and a significant difference in the mean age at diagnosis between Standardbreds (4 years) and Thoroughbreds (9 years). Horses in atrial fibrillation have higher heart rates and much higher pulmonary artery wedge pressures during a standardized treadmill exercise protocol compared with healthy trained horses.<sup>2</sup> It is likely that the marked increase in left atrial pressure in horses in atrial fibrillation will result in loss of pulmonary capillary integrity during exercise and exercise-induced pulmonary hypertension.

**Racehorses** have a history of normality at rest but poor exercise tolerance following a race in which the horse ran well for the first 200 to 300 m but subsequently faded badly and finished a long way behind the field. Paroxysmal atrial fibrillation has also been observed in the horse under these circumstances. Horses with paroxysmal atrial fibrillation show atrial fibrillation when examined immediately following the race, but convert to normal sinus rhythm shortly after and have normal cardiovascular function if the examination for poor racing performance is delayed. A large-scale study of 39,302 racehorses undergoing 404,090 race starts estimated a minimum prevalence of atrial fibrillation of 0.29%. The estimated prevalence was higher (1.39%) in horses that finished slowly or did not finish, and the prevalence increased markedly with age. Atrial fibrillation was paroxysmal in most horses, with 93% of horses with atrial fibrillation spontaneously converting to sinus rhythm within 24 hours of the race. Attempted conversion of horses with atrial fibrillation

should therefore be delayed for at least a 1 to 2 days following a race, because most will convert spontaneously without treatment. Serum potassium, magnesium, and calcium concentrations and fractional clearance of potassium should be determined in these horses to identify the presence of electrolyte deficiencies that may have facilitated induction of atrial fibrillation. There is one report of atrial fibrillation of unknown duration in a 9-year-old mare with severe hypokalemia (1.5 mEq/L) and hyponatremia (122 mEq/L) that converted to normal sinus rhythm after the electrolyte abnormalities were corrected with IV fluid administration.<sup>3</sup>

There is debate as to the cause of the lone form of atrial fibrillation and whether myocardial and vascular lesions are present in the atria of a significant proportion of animals with this arrhythmia. However, the high rate at which atrial fibrillation converts spontaneously or by treatment to be followed by successful racing performance suggests that this arrhythmia frequently occurs in young horses in the absence of significant atrial pathology. Lone atrial fibrillation in young racing horses therefore has many similarities to atrial fibrillation in lactating dairy cattle with abdominal disease because it is likely that most cases do not have underlying heart disease. The increased prevalence of atrial fibrillation in race horses with age suggests, however, that underlying heart disease does predispose to developing atrial fibrillation during a race. Increased BW is also a risk factor for atrial fibrillation<sup>4</sup>; this probably reflects an increased atrial size that facilitates sustaining atrial fibrillation, and atrial size is correlated with BW.

#### Secondary Atrial Fibrillation

Horses may develop **secondary atrial fibrillation** in response to **underlying cardiovascular disease**, such as mitral valve insufficiency, tricuspid valve insufficiency, or a combination of both, but any acquired or congenital lesion that results in atrial hypertrophy has this risk.

Where there is underlying heart disease, the ventricular rate at rest is much higher and the arrhythmia presents as a tachycardia. It has been suggested that a heart rate greater than 60 beats/min is indicative of underlying cardiac disease in cases of atrial fibrillation. In horses with atrial fibrillation, ventricular filling is impaired at heart rates above 70 beats/min, and at resting heart rates above 80 to 100 beats/min there is severe cardiac inefficiency and the animal rapidly develops signs of cardiac failure. At fast heart rates, atrial fibrillation presents with a syndrome clinically similar to ventricular tachycardia associated with multiple ventricular extrasystoles and electrocardiographic differentiation is required.

Paroxysmal atrial fibrillation has been observed in newborn foals showing signs of respiratory distress and with birth anoxia.



### Atrial Fibrillation in the Cow

There may be atrial fibrillation in the cow secondary to **myocardial disease** or endocarditis resulting in atrial enlargement, but is usually functional in occurrence and traditionally has not been associated with clinically detectable cardiac lesions. However, a histopathologic study in nine Holstein-Friesian cows with atrial fibrillation and 12 healthy controls in sinus rhythm indicated that multifocal or large areas of myocardial fibrosis were present more frequently and with greater severity in cattle with atrial fibrillation than healthy controls. Interestingly, the atrial lesions were largely confined to the dorsal regions of the cranial lateral and medial regions of the right atrium, and it is unknown whether these lesions were the result of sustained atrial fibrillation or played a causative role in the genesis of atrial fibrillation. It is likely that the presence of organic heart disease predisposes cattle to the development of atrial fibrillation because atrial myocardial inflammation is associated with an increased incidence of atrial premature complexes, which are thought to lead to atrial fibrillation when occurring during the vulnerable period for atrial myocytes. An atrial fibrillation prevalence of 2.5% was recorded in apparently healthy lactating dairy cows over an 18-month period. In a large cross-sectional study, atrial fibrillation was not observed during a 3- to 5-minute ECG recording in 952 of dairy cattle aged 1 or more years. There is only one report of atrial fibrillation in cattle less than 1 year of age, and that was a 10-day-old diarrheic calf with profound electrolyte abnormalities (Na, 95 mEq/L; K, 6.9 mEq/L; Ca, 1.7 mmol/L; Mg, 0.4 mmol/L).<sup>5</sup> The atrial fibrillation resolved within 1 day of correcting the electrolyte abnormalities.

In sick cattle, atrial fibrillation is most common in association with **gastrointestinal disease**, abnormalities causing abdominal pain, and **metabolic disease**. Abnormalities as diverse as acute enteritis, left displacement of the abomasum, and torsion of the uterus may be accompanied by this arrhythmia. Heightened excitation of the atria, in association with electrolyte and acid-base disturbances or change in vagal tone, has been postulated as a cause, and atrial premature complexes are also seen in the same types of clinical case (see Fig. 10-5). The administration of neostigmine to cattle with gastrointestinal disease may precipitate the occurrence of atrial fibrillation. The arrhythmia usually converts spontaneously to sinus rhythm with correction of the abdominal disorder.

### Atrial Fibrillation in the Sheep and Goat

This may occur as a result of incompetence of the tricuspid or mitral valves, the presence of myocarditis or, in goats, as a sequel to interstitial pneumonia along with cor

pulmonale. The presenting signs are those of respiratory distress and heart failure. Ascites is prominent and there is marked jugular distension with an irregular jugular pulse.

### Treatment of Atrial Fibrillation Horses

Horses with atrial fibrillation at sustained high heart rates are generally not treated successfully because serious cardiac pathology is usually present (secondary atrial fibrillation). Digoxin and quinidine sulfate are used. The decision to treat a horse with atrial fibrillation at low heart rates depends on the requirement for the horse to perform work, because horses with this arrhythmia can be retired and will live for several years. They may be used successfully as brood mares. Anticoagulation therapy is not administered to horses in atrial fibrillation because of the absence of reports of thromboembolic events caused by passage of blood clots from the fibrillating atria to the cerebral circulation.<sup>6</sup>

Horses with **lone atrial fibrillation** can be converted to normal sinus rhythm with subsequent return to successful racing or other performance. Conversion should be delayed for 48 hours in horses with an initial diagnosis of atrial fibrillation that was associated with poor race performance. This is because normalization of electrolyte and acid-base status after exercise results in some horses reverting to normal sinus rhythm without treatment. Conversion success is higher for horses demonstrating atrial flutter instead of atrial fibrillation, because the atrial rate is slower and depolarization is more organized in atrial flutter.

**Oral quinidine sulfate** is the initial treatment of choice for correction of atrial fibrillation, whenever quinidine sulfate can be readily obtained at a reasonable cost. The efficacy of quinidine sulfate to achieve cardioversion is 65% to 90%, which is similar to that reported for transvenous electrical cardioversion, and a prospective randomized controlled trial to compare the two methods of cardioversion has not been completed. There is a much greater success rate with conversion of atrial fibrillation in young horses and when it is attempted shortly following the onset of the arrhythmia. If the arrhythmia has been present for more than 4 months, successful conversion is much less common, presumably because of remodeling of atrial myocardial tissue, and side effects with therapy are more common. Following cardioversion, the horse should be rested for at least 2 months. Some clinicians administer corticosteroids (such as oral prednisolone) after conversion on the basis that atrial fibrillation may have been induced by myocarditis, and corticosteroids may decrease inflammatory foci within the myocardium. The efficacy of corticosteroids in preventing new episodes of atrial fibrillation is unknown. In some horses the conditions

recur after a period of racing, and repeated conversions with quinidine are possible.

Quinidine is an antiarrhythmic agent of class 1a of the Vaughan Williams classification. It slows intracardiac conduction by blocking the fast sodium channel and prolongs the action potential duration. Several dose regimens have been used, but the administration of an oral quinidine sulfate dose of 22 mg/kg every 2 hours until conversion is achieved or toxicity is manifested has proved effective. In the majority of cases, conversion will occur before the total dose exceeds 40 g. Toxicity is likely when the total dose exceeds 60 g, and the decision to continue with therapy once this dose has been reached should be considered carefully. The plasma quinidine concentration required for cardioversion ranges from 2 to 4 µg/mL and toxicosis has been reported at 5 µg/mL. Conversion by IV **quinidine gluconate** is reported in the horse using an initial dose of 1.0 to 1.5 mg/kg, given over a period of 1 minute and repeated every 5 to 10 minutes until sinus rhythm is restored or the QRS interval increases 25% over baseline, ventricular rate exceeds 90 beats/min, signs of toxicity occur, or a total dose of 11 mg/kg has been administered. Conversion by concurrent quinidine administration and atrial pacing is also recorded in the horse, but is not routinely needed.

Toxicity common with oral quinidine treatment, and separate studies report 48% and 28% of horses with some form of adverse reaction. Depression, lassitude, anorexia, urticaria, congestion of the mucous membranes, colic, and death are recorded. Prolongation of the QRS interval to 25% greater than pretreatment values has been considered a monitor for cardiovascular toxicity. The toxic effects of quinidine may be corrected by IV administration of sodium bicarbonate in an attempt to increase the percentage of quinidine bound to protein. Such treatment runs the risk of inducing hypokalemia, which may exacerbate quinidine toxicity. Some prefer to digitalize the horse intravenously before medication with quinidine in an attempt to reduce tachyarrhythmias at the point of conversion and those associated with quinidine toxicity. Nephrotoxicity with uremia and diarrhea can occur at lower doses. It is transient and repairs rapidly following withdrawal of the drug, but the serum urea concentration and urine should be monitored during therapy in addition to cardiovascular function.

Oral and IV **flecainide** has been used with mixed success to convert horses in atrial fibrillation. Flecainide is an antiarrhythmic agent of class 1c of the Vaughan Williams classification. It slows intracardiac conduction by blocking the fast sodium channel and shortens the refractory period of the Purkinje fibers. Flecainide administration in humans is currently limited to patients without evidence of structural heart disease and normal left ventricular function. IV administration

of flecainide acetate (1–2 mg/kg BW) infused at 0.2(mg/kg BW)/min was effective in converting experimentally induced atrial fibrillation in six horses and naturally occurring atrial fibrillation in two horses. These results are consistent with those of another study in horses with experimentally induced atrial fibrillation that indicated flecainide is effective in terminating atrial fibrillation of short duration.<sup>7</sup> The plasma flecainide concentration at the time of conversion was 1.3 mg/L. Oral administration of flecainide acetate (4–6 mg/kg BW every 4 hours) also produced plasma flecainide concentrations that approximated 1.3 µg/mL for a number of hours. However, in a subsequent study in 10 horses with naturally occurring atrial fibrillation, IV flecainide failed to convert nine horses with long-standing atrial fibrillation to sinus rhythm, but it did convert one horse who had been in atrial fibrillation for 12 days. Orally administered quinidine sulfate subsequently converted eight of the nine horses to normal sinus rhythm. Two horses administered flecainide developed potentially dangerous ventricular arrhythmias during treatment, and flecainide causes a temporary prolongation in ventricular repolarization, which may be a potentially dangerous proarrhythmic effect.<sup>7</sup> There is one report of sudden death in a horse with supraventricular tachycardia while being treated with flecainide.<sup>8</sup> Amiodarone has also been used in horses to convert atrial fibrillation with moderate success.<sup>6</sup> There do not appear to be persuasive reasons to use flecainide or amiodarone to convert horses in atrial fibrillation whenever quinidine is available.

**Biphasic transvenous electrical cardioversion** is an alternative treatment recommended in horses that fail to convert to oral or IV quinidine treatment, or manifest signs of quinidine toxicity during treatment, or in countries where quinidine is unavailable or prohibitively expensive. It is much safer than conventional monophasic electrical cardioversion. The goal is to deliver an electric shock to atrial myocardial tissue that electrically synchronizes the atrium and permits the return of a sinus rhythm. A custom-length 150 to 180 cm 6.5-French bipolar catheter is placed in the standing horse using ultrasonographic guidance and monitoring of pressure waveforms if the catheter has a lumen. Horses may be sedated with xylazine or detomidine for this procedure. Catheter placement is manipulated so that one electrode is placed in the pulmonary artery and the other electrode is placed in the vicinity of the right atrium. An additional bipolar pacing catheter is positioned in the apex of the right ventricle to allow ventricular pacing in the rare instance of asystole after shock delivery.<sup>9</sup> General anesthesia is then induced using agents that produce minimal cardiovascular depression (such as IV induction with guaifenesin, diazepam, and ketamine and maintenance with isoflurane or

sevoflurane).<sup>10</sup> Correct catheter positioning is confirmed after induction of general anesthesia because catheter movement does occur.<sup>6</sup> Cardioversion is accomplished at 125 to 360 J using a biphasic truncated exponential shock delivered to be synchronized with the R wave. This is a critical issue because failure to synchronize the shock with ventricular depolarization could lead to ventricular fibrillation and death. The ECG leads should be moved to maximize the QRS wave amplitude and minimize the T wave amplitude. Shocks are initially applied at 125 J and then incrementally increased at 50-J steps at a minimum of 2 minute intervals if conversion to sinus rhythm did not occur. Extensor thrust of the upper forelimb is usually evident during each shock application. The mean energy required for conversion is 165 J, but higher energies were not required for horses that had a longer duration of atrial fibrillation.<sup>11</sup> The variation in energy needed is thought to result, in part, because of suboptimal placement of electrodes on the thorax.<sup>12</sup> Concurrent use of antiarrhythmic medications or positive inotropic agents is not required but done by some clinicians, based on routine use of antiarrhythmic agents in humans undergoing electrical cardioversion.<sup>6</sup> Small and clinically insignificant increases in plasma cTnI have been reported in horses undergoing transvenous electrical cardioversion, indicating the procedure induces minimal myocardial damage.<sup>13</sup>

An alternative electrical cardioversion technique in anesthetized horses that does not use transvenous electrical cardioversion has been successfully used in one horse, but requires much higher energy for conversion. The front legs of the horse are extended and cardioversion–defibrillation pads are placed over both sides of the shaved thorax, directly over the atria (the position of which has been determined ultrasonographically). One horse converted to normal sinus rhythm after delivering 200 J by this method in conjunction with a small amount of IV quinidine.

Continuous 24-hour ECG recording is recommended after cardioversion, but the optimal time for monitoring has not been determined. Echocardiography after conversion may be of some benefit after 2 months because recovery of normal atrial contractile function can take several weeks, particularly with long-duration episodes of atrial fibrillation. The recurrence rate after successful treatment is between 15% and 40% with the duration of atrial fibrillation before conversion to normal sinus rhythm as a major risk factor for recurrence.<sup>14</sup> The presence of a relatively large atrial size (indexed to the size of the aorta) and shorter atrial fibrillation cycle length (indicating a shorter atrial effective refractory period and higher fibrillation rate) are predictive of recurrence of atrial fibrillation.<sup>14</sup> Echocardiography 24 hours after conversion to sinus rhythm does not appear to be helpful in predicting whether the horse

has an increased risk of reverting to atrial fibrillation, except for the echocardiographic index left atrial fractional area change.<sup>15</sup> This index reflects atrial contractile function, and if low (indicating poor atrial contractility) then the likelihood of recurrence is increased.

### Ruminants

Ruminants with atrial fibrillation are not usually treated with specific antiarrhythmic drugs because the heart will usually revert to sinus rhythm following the correction of the underlying abdominal disorder and sufficient time (at least 1 week after return to normal physical health). However, the IV administration of quinidine (49 mg of quinidine sulfate per kg BW, at 0.20(mg/kg)/min) was successful in converting seven of nine cows to normal sinus rhythm at a mean plasma quinidine concentration of 3.6 µg/mL. Oral quinidine administration is not effective in ruminants because of the poor oral bioavailability. Side effects of IV quinidine administration in cattle include depression, ataxia, blepharospasm, diarrhea, and increased frequency of defecation. Response to treatment in sheep and goats is poor, although one ram was successfully converted to normal sinus rhythm using electrical cardioversion using 360 J and paddles placed over the right heart base (behind the triceps muscles) and the left cardiac apex close to the sternum.

### PAROXYSMAL TACHYCARDIA

Paroxysmal tachycardia may arise from an irritant focus within the atria (paroxysmal supraventricular tachycardia) or the ventricles (paroxysmal ventricular tachycardia), but in large animals ventricular paroxysmal tachycardia is more common, particularly immediately after a race in which the increase in vagal tone during recovery appears to facilitate paroxysms of ventricular ectopic activity, some of which may be followed by torsades-like polymorphic ventricular tachycardia.<sup>16</sup> Atrial paroxysmal tachycardia (see Fig. 10-5) and atrial flutter are rare and are transient rhythm disturbances that can lead to atrial fibrillation.

In paroxysmal tachycardia, the increase in heart rate is abrupt and the fall to normal is equally sudden. This characteristic usually serves to distinguish this arrhythmia from the transient increases in heart rate that may normally follow such factors as excitement. Also, the heart rate is elevated to a rate far in excess of what would be normally expected from such stimuli.

Usually the excitable focus discharges repetitively over a long period of time to produce more continual ventricular tachycardia associated with ventricular extrasystoles. Sustained tachycardia is not normal and can lead to myonecrosis; three parturient dairy cows with sustained tachycardia (heart rate >120 beats/min) had multifocal areas of necrosis throughout the myocardium

characterized by myofibrillar lysis and disarray.

### VENTRICULAR TACHYCARDIA

Ventricular tachycardia may produce either a regular heart rate or an irregular heart rate and rhythm. When the discharge rate of the irritant focus far exceeds that of the SA pacemaker, the ectopic focus will take over completely as the pacemaker of the heart. On examination of the cardiovascular system, a rapid but regular heart rate and pulse is detected, and there is no irregularity of rhythm or of pulse amplitude or intensity of heart sounds. This is known as ventricular tachycardia with **AV dissociation**. This abnormality is easily overlooked clinically but should be suspected in any adult horse or cow in which the heart rate exceeds 90 beats/min and is frequently the cause of heart rates in excess of 120 beats/min. Ventricular tachycardia should also be suspected when the heart rate is higher than that expected from the animal's clinical condition.

The diagnosis is seen on ECG when multiple regular QRS complexes with abnormal amplitude and duration of the QRS and T complexes are seen and the T wave is oriented in a direction opposite to the QRS complex (see Fig. 10-5). P waves may be detected on the ECG, but they have no relationship to the QRST complex and are frequently lost within them.

When the discharge rate of the irritant focus within the myocardium is similar to that of the SA node, the ventricular tachycardia can be manifested by a gross irregularity in rhythm. This is a common manifestation in large animals. In this situation many of the discharges that originate in the sinus node are transmitted to the ventricle during a refractory period from a previous ectopic focus, but some reach the ventricle when it is not in a refractory state and are conducted normally. At some periods ventricular complexes may be initiated by the discharges from both sites.

The varying influence of each pacemaker on ventricular contraction produces a marked **irregularity** in cardiac rhythm, and it is frequently not possible to establish clinically a regular pattern to the heart rhythm. Variations between beats in the degree of atrial filling and in the diastolic filling period will result in a marked variation in the intensity of the heart sounds and in the amplitude of the pulse. Frequently at fast heart rates there is a pulse deficit. Cannon atrial waves can be observed in the jugular vein when atrial contraction occurs at the same time as a ventricular extrasystole. **The ECG** shows runs of extrasystoles interspersed with normally conducted complexes and usually there is the presence of fusion beats.

**Ventricular tachycardias** or the presence of multiform or polymorphic ventricular complexes on an ECG are evidence of **severe cardiac disease** and are usually accompanied

by signs of acute heart failure. They may result from primary myocarditis, nutritional cardiomyopathy, or myocardial neoplasia or be secondary to valvular disease and myocardial ischemia. Ventricular arrhythmias are common in certain plant poisonings and other toxicities and in severe electrolyte and acid-base disturbances as well as in the final stages of heart failure. If uncorrected, ventricular tachycardia may lead to ventricular fibrillation and death; frequently specific antiarrhythmic therapy is indicated during the period that the prime cause is being corrected.

### Treatment

**Lidocaine** is the drug of first choice for treating hemodynamically important ventricular arrhythmias in large animals. It is an antiarrhythmic agent of class 1b of the Vaughan Williams classification, and slows intracardiac conduction by blocking the fast sodium channel while shortening the refractory period of myocardial tissue. Typically, 2% lidocaine is given as an IV bolus at 0.5 to 1.0 mg/kg BW every 5 minutes for a total of four treatments (total dose 2–4 mg/kg BW). An alternative treatment protocol is IV administration of 2% lidocaine at 0.6 mg/kg over 15 minutes,<sup>17</sup> or an IV constant rate infusion at 0.05 (mg/kg)/min.<sup>18</sup> Lidocaine has the advantages of widespread availability, low cost, and low cardiovascular toxicity, and the major disadvantage is its very short duration of action (half-life is 40 minutes in the horse). The most common initial sign of lidocaine toxicity is muscle fasciculations, which occur at a serum lidocaine concentration of 1.9 to 4.5 mg/L. If infusion is continued, then sedation and altered visual function are apparent; the latter is manifested as rapid eye blinking, anxiety, and attempts to inspect closely located objects. Temporary recumbency, excitement, sweating, and convulsions occur with higher doses.

**Quinidine sulfate** is the drug of second choice for use in **horses**.<sup>19</sup> Quinidine is an antiarrhythmic agent of class 1a of the Vaughan Williams classification, and slows intracardiac conduction by blocking the fast sodium channel and prolongs the action potential duration. An initial dose of 20 mg/kg is given orally, followed by a dose of 10 mg/kg given every 8 hours. The drug is not effective until 1 to 2 hours following administration. IV quinidine gluconate (0.5–2.2 mg/kg BW bolus every 10 minutes to a total of 12 mg/kg BW) may be of greater value in those rare instances when oral quinidine is not indicated. Serum quinidine concentrations of 4 mg/L appear effective in treatment of **cattle** with ventricular tachycardia, but serum concentrations following an oral dose of 20 mg/kg vary widely between cows and slow IV infusion is the preferred method of therapy. There is a very narrow therapeutic index in cattle, and death can occur in some cows at doses that are

therapeutically effective in others. Quinidine treatment in cattle should be approached with caution.

**Phenytoin sodium** is a good alternative to quinidine sulfate, and has been effective in treating ventricular arrhythmias in horses. Phenytoin is an antiarrhythmic agent of class 1b of the Vaughan Williams classification (same as lidocaine), and slows intracardiac conduction by blocking the fast sodium channel while shortening the refractory period of myocardial tissue. The recommended dosage protocol for the horse requires an initial oral dose of 20 mg/kg BW every 12 hours for four doses, followed by a maintenance oral dose of 10 to 15 mg/kg BW every 12 hours, with monitoring of phenytoin plasma concentrations. Plasma concentrations of 5 to 10 mg/L appear to be effective in treatment of horses with ventricular tachycardia. High plasma phenytoin concentrations are associated with sedation, recumbency, and excitement, and the dosage protocol should be altered in horses that appear sedated. The major advantage of phenytoin over lidocaine is its long duration; conversely, its major disadvantage is the initial time required (2–6 hours) to exert an antiarrhythmic effect. An IV form of phenytoin sodium has been administered to a pony with digitalis-induced ventricular arrhythmias, but the alkaline pH of the infused solution carries a high risk of thrombophlebitis.

**Magnesium sulfate** administration at 2 to 6 (mg/kg BW)/min of MgSO<sub>4</sub> (equivalent to 1.8 to 5.4 mL of 50% MgSO<sub>4</sub>/450 kg horse/min) to effect under ECG monitoring has been recommended as part of the treatment of ventricular arrhythmias. A different dose protocol has been used in one adult horse that included 25 g of magnesium sulfate in 1 L of 0.9% NaCl administered IV over 15 minutes.<sup>17</sup>

The severity of ventricular tachycardia is augmented by factors that increase sympathetic tone, and affected animals should be kept in quiet surroundings.

### VENTRICULAR FIBRILLATION

Ventricular fibrillation is not usually observed clinically. It occurs in the terminal stages of most suddenly fatal diseases, including lightning stroke, plant poisonings such as acute *Phalaris* toxicity, overdose with anesthetics, severe toxemia, and in the terminal phases of most acquired cardiac diseases. There is complete absence of the pulse and heart sounds, the blood pressure falls precipitously, and the animal rapidly becomes unconscious and dies within a minute or two of onset. Treatment is usually impractical, although deaths during anesthesia may be prevented by immediate and aggressive external cardiac massage. Electrical defibrillation is not feasible in large animals because of the bulk of the animal and the current required. Intracardiac injections of epinephrine are often



used in acute cardiac arrest but do not correct fibrillation and are of little value.

## FURTHER READING

Reef VB, Bonagura J, Buhl R, et al. Recommendations for equine athletes with cardiovascular abnormalities. ACVIM/ECEIM Consensus Statement. *J Vet Intern Med.* 2014;28:749-761.

## REFERENCES

1. Physick-Sheard P, et al. *J Vet Cardiol.* 2014;16:173.
2. Gehlen H, et al. *Res Vet Sci.* 2006;81:134.
3. Mullen KR, et al. *J Am Vet Med Assoc.* 2014;244:657.
4. Leroux AA, et al. *J Vet Intern Med.* 2013;27:1563.
5. Chalmeh A. *J Fac Vet Med Istanbul Univ.* 2015;41:105.
6. De Clercq D, et al. *Vet J.* 2008;177:198.
7. Haugaard MM, et al. *J Vet Intern Med.* 2015;29:339.
8. Dembek KA, et al. *J Vet Emerg Crit Care.* 2014;24:759.
9. Schauvliege S, et al. *Vet Anaesth Analg.* 2009;36:341.
10. Bellei MHM, et al. *J Am Vet Med Assoc.* 2007;231:1225.
11. McGurrin MKJ, et al. *J Vet Intern Med.* 2008;22:609.
12. Preiss EE, et al. *Am J Vet Res.* 2011;72:1193.
13. Jesty SA, et al. *J Vet Intern Med.* 2009;23:1103.
14. De Clercq D, et al. *J Vet Intern Med.* 2014;28:624.
15. Decloedt A, et al. *J Vet Intern Med.* 2015;29:946.
16. Physick-Sheard PW, McGurrin MKJ. *J Vet Intern Med.* 2010;24:1158.
17. Johnson AL, et al. *J Am Vet Med Assoc.* 2007;231:706.
18. Eason BD, et al. *J Am Vet Med Assoc.* 2013;243:208.
19. Stern JA, et al. *J Vet Cardiol.* 2012;14:445.

## Diseases of the Heart

### VALVULAR DISEASE AND MURMURS

#### SYNOPSIS

**Etiology** Valvular disease is acquired or congenital. Endocarditis is the most common cause. Some murmurs are functional and not indicative of disease.

**Epidemiology** Functional murmurs are common in the horse, vary with breed and training, and their presence and severity do not appear to be associated with racing performance. Little information is available on the epidemiology of acquired valvular disease.

**Clinical findings** Murmur defined by location, timing, character, intensity, and radiation, and are possibly precordial thrill, cardiac insufficiency and, in severe cases, congestive heart failure.

**Diagnostic confirmation** Blood culture and echocardiography.

## ETIOLOGY

### Acquired

- Endocarditis, the most common cause (see the following section)
- Endocardiosis, common only in pigs
- Rupture of the chordae tendineae, either spontaneous or secondary to endocarditis

- Laceration, detachment of aortic valve leaflets, either spontaneous or secondary to endocarditis
- Dilatation of the right AV valve annulus, such as occurs in brisquet disease and secondary to some myocardial disease; may result in functional insufficiency of the valves.

### Congenital

- Pulmonic valve stenosis.
- Fenestration of the aortic and pulmonic valves in horses. The cause of the lesions is unknown, although their presence in very young animals, including newborn foals, suggests that some may be congenital defects. The importance of these lesions as causes of valvular insufficiency is doubtful, although they may cause valvular murmurs if they are present close to the attachments of the cusps.
- Blood cysts are common on the AV valves of cattle. They are lined with endothelium, can occur congenitally, and their incidence and size may increase with age. They have no clinical significance. Serous cysts occur occasionally on the mitral valve of cattle.

## EPIDEMIOLOGY

There is limited information on the epidemiology and the age-specific incidence of valvular disease or murmurs in large animals, although slaughter surveys show a high prevalence of endocardial lesions. Studies at clinical centers indicate that valvular disease is often underdiagnosed in both cattle and horses and that its presence may not be detected in more than 50% of cases.

### Horses

Auscultatory surveys show a high prevalence of murmurs with breed and horse-use differences. Functional (physiologic) murmurs are particularly common in trained, fit racehorses. In a survey of 545 clinically normal horses in England, murmurs were heard in 68%, with a higher prevalence in flat racing and National Hunt horses than in competition and pleasure horses. Murmurs with the characteristics of functional ejection murmurs were detected on auscultation over the left hemithorax in approximately 50% of horses and the right side in 8%. Murmurs with the characteristics of early diastolic functional murmurs were detected on the left side in 15% and on the right side in 13%. Murmurs with the characteristics of regurgitation at the mitral, tricuspid, and aortic valves were detected in 3.5, 9.2, and 2.2% of horses, respectively. Aortic regurgitation is more common in older horses and is usually not associated with clinical signs of heart disease.<sup>1</sup> Mitral regurgitation is the most common valvular disease associated with atrial fibrillation, ventricular arrhythmias,

and congestive heart failure. Tricuspid valve regurgitation is associated with atrial fibrillation, pulmonic valve regurgitation, and congestive heart failure.<sup>1</sup>

An extensive abattoir survey suggests that valvular lesions may be more common in the horse than is clinically appreciated. Approximately 25% of horses had lesions, and the majority was nodular or distorting lesions on the valves or chordae tendineae of the left side and, in a significant proportion, murmurs were detected before slaughter. Chronic trauma of the valve leaflets was considered an important initiating factor.

### Cattle

A slaughter survey in cattle has reported endocarditis in 5.2 hearts per 10,000 animals.

### Pigs

In a slaughter survey of pathology in the heart of pigs, mitral valve endocardiosis was observed in 63% and tricuspid endocardiosis in 18% of pigs. The prevalence and severity increases with age. These lesions can be associated with prolapse of the mitral valve and jet impact lesions. They have little significance in growing pigs, but the significance of endocardiosis to clinical cardiac disease in older sows needs examination. Bacterial endocarditis in slaughter pigs has been recorded with a prevalence of 3.1 per 10,000 animals.

## PATHOGENESIS

The important clinical indications of valvular disease are audible murmurs and palpable precordial thrills. Murmurs may occur at any phase of the cardiac cycle and are caused by the vibrations of turbulent flow of blood transmitted to the surface of the chest. Vibrations of strong intensity may also result in palpable vibrations at the surface of the chest.

### Generation of Murmurs

Blood flow is normally laminar and without turbulence. **Turbulence** in flow may be produced by a sudden change in the **diameter** of the vessel through which the blood is flowing. Its occurrence is directly related to the **velocity** of flow and inversely related to blood **viscosity**.

### Valve Lesions

With murmurs associated with valvular lesions the valve lesion produces a sufficient change in stream bed diameter to result in turbulent flow. The turbulence may occur when the valves do not close properly (regurgitation or insufficiency) and blood is forced through AV orifices during ventricular systole, or through semilunar orifices during ventricular diastole. Turbulence may also occur when the valves do not open completely (stenosis) and blood is forced through a stenotic semilunar orifice during ventricular systole or enters the ventricle through

a narrow AV orifice during ventricular diastole.

The severity of the turbulence and hence the murmur can be increased with higher flow velocities such as occur with exercise and by factors that decrease blood viscosity such as anemia or hypoproteinemia.

Acquired valvular disease usually results in insufficiency of the affected valve and less commonly both insufficiency and stenosis. Congenital lesions more often result in stenosis of the valve.

### Murmurs Without Valvular Disease

A change in vessel diameter such as occurs with dilatation of the aorta or pulmonary artery can produce turbulence and a murmur. A reduction in blood viscosity contributes to the frequency of murmurs occurring in anemic and hypoproteinemic states and **hemic murmurs** are common in anemic cattle, particularly over the pulmonic valve.

### Functional Murmurs

Turbulent flow may occur in the absence of a change in stream bed diameter if a certain critical velocity of flow is exceeded. This is thought to be the cause of functional or ejection murmurs that occur commonly in horses and lactating dairy cows during the rapid ejection phase even at rest and especially following exercise.

### Effects of Valvular Disease

Stenosis of the outflow valves results in an increased **pressure load** on the heart and compensatory hypertrophy (concentric hypertrophy). Insufficiency of the semilunar valves or of the aortic or pulmonic valve produces a **volume load** on the heart and is followed by compensatory dilatation and hypertrophy (eccentric hypertrophy). If the valves on the left side of the heart are affected, especially the aortic valve, changes in ejection of the blood from the ventricle alters the character of the **peripheral pulse**. Involvement of the tricuspid valve will produce changes in the **jugular pulse**.

### Cardiac Reserve

The presence of valvular lesions and murmurs may mean little except that some degree of **cardiac reserve** is lost. This may be small in degree, and moderate stenosis or incompetence can be compensated and supported for long periods. The importance of valvular lesions that do not result in cardiac insufficiency rests in their possible contribution to disease in other organs by the liberation of emboli, and the necessity for close examination of the heart when they are present.

The purpose for which the animal is maintained also has some bearing on the significance of a murmur. Valvular lesions are of much greater importance in racing animals than in those kept for breeding purposes. The challenge to the clinician is to determine the significance of a murmur to the health and

performance of the horse and to the safety of the rider. The presence or severity of an auscultable murmur or echocardiographically identified valvular regurgitation is not associated with athletic performance in racehorses, although a deleterious effect on a small number of horses may exist.<sup>2</sup> The likelihood of valvular regurgitation increases with training in the horse, indicating that valvular regurgitation is an expected response to training in endurance athletes.<sup>3</sup> In other words, valvular regurgitation should not be assumed to indicate the presence of serious valvular pathology in a well-performing horse.

### CLINICAL FINDINGS

Only the clinical findings referable to valvular disease are discussed here. The clinical findings in chronic (congestive) heart failure, which may coexist, are discussed elsewhere.

### Technique of Examination

Auscultation is the fundamental basis of examination and knowledge of the optimum areas of auscultation and the significance of the murmurs encountered are essential. When a murmur is detected, it should be categorized according to its timing and duration, intensity, location, and character. There is room for improvement in the correct identification of heart murmurs, and specialist clinicians can more accurately identify the likely site of heart murmurs than other clinicians.

### Timing

Timing allows a subdivision into systolic, diastolic, and continuous murmurs and immediately shortens the list of possible defects present. There is little problem in differentiating systolic from diastolic murmurs at slow heart rates because of the temporal difference between the length of the systolic and diastolic period. However, where there is a murmur present at fast heart rates this distinction is less obvious and it is possible to misclassify the period of the cycle in which the murmur is occurring.

- Murmurs should be timed with reference to the **arterial pulse**, which occurs in early to midsystole if a proximal artery is examined.
- A convenient artery is on the posteromedial aspect of the carpus and radius in cattle and horses.
- A less satisfactory alternative is timing with the occurrence of the **apex beat**.
- Timing by relation to the **heart sounds** is unreliable because these are frequently altered in character, and at fast heart rates a diastolic murmur may be mistaken for a systolic one
- **Systolic murmurs** are associated with stenosis of the outflow valves or insufficiency of the AV valves.
- **Diastolic murmurs** are associated with insufficiency of the outflow valves or stenosis of the AV valves.

- A **continuous murmur** or one that occurs during both systole and diastole may be associated with both stenosis and insufficiency of the same valve or with multiple valvular lesions but more commonly results from the turbulent flow of blood from a high-pressure to a low-pressure system with no intervening valve, such as occurs with a patent ductus arteriosus.

### Duration

Duration during systole or diastole is determined by a careful examination of the murmur with a relationship to the period between the heart sounds. **Systolic murmurs** are further classified as early, late, holosystolic, or pansystolic according to their occurrence and duration in the period between the first and the second heart sounds and **diastolic murmurs** as early (occurring between S2 and S3), holodiastolic, or presystolic (occurring between the atrial fourth heart sound and S1). Pansystolic and pandiastolic murmurs, occurring throughout the systole or diastole, have greater significance than murmurs that occur, for example, only in early systole and early diastole.

### Intensity

Intensity or loudness of a murmur provides a guide to its significance. A system of grading the intensity of murmurs that has been found to be of clinical value is as follows:

- **Grade I.** The faintest audible murmur; generally only detected after careful auscultation by an experienced clinician
- **Grade II.** A faint murmur that is clearly heard after only a few seconds auscultation
- **Grade III.** A murmur that is immediately audible as soon as auscultation begins and is heard over a reasonably large area
- **Grade IV.** An extremely loud murmur accompanied by a precordial thrill; the murmur becomes inaudible if the stethoscope is held with only light pressure on the chest
- **Grade V.** An extremely loud murmur accompanied by a precordial thrill; the murmur can still be heard when the stethoscope is held with only light pressure against the chest

Grade I murmurs are not clinically significant, whereas grades IV and V invariably are. The significance of grade II and III murmurs varies according to their cause. A system that grades on a six-grade basis is also used and differs only in a further subcategorization of moderately loud and loud murmurs.

The presence of a precordial thrill is determined by palpation over the point of maximal intensity of the murmur and palpation on the chest over other areas of the heart. A precordial thrill indicates that there is considerable energy generated by the turbulent flow and defines the intensity of the

murmur in the top two grades in both grading systems.

### Location and Radiation

Location and radiation of a murmur is related to its areas of generation and transmission. The **point of maximum intensity** is noted with reference to the areas of maximum audibility of the heart valves described earlier. Low-intensity murmurs are generally restricted to the auscultatory area overlying their area of generation. The auscultatory areas of the heart and of the individual heart sounds have been described earlier in the section on arrhythmias. The vibrations associated with very loud murmurs may be transmitted to other auscultatory areas but generally they are most intense near the area of generation, as is any associated thrill. Murmurs and thrills can be restricted to local areas, and it is essential to examine several auscultatory areas over both sides of the heart.

### Character

Character is determined by change in intensity during the duration of a murmur and is defined as crescendo, crescendo-decrescendo, decrescendo, or plateau. Murmurs may also be described according to their frequency characteristics by terms such as blowing, honking, musical, and buzzing, but these interpretations are very subjective and often not repeatable between examiners. Blowing murmurs do not have a major frequency peak of harmonics and therefore do not have an easily identifiable pitch. In contrast, musical, honking, and buzzing murmurs have a primary frequency and associated harmonics. Musical murmurs have a higher fundamental frequency (pitch) than honking or buzzing murmurs, whereas honking murmurs are shorter in duration than buzzing murmurs.

### Interpretation

Following this examination the functional defect producing the murmur and the valve involved are determined from the **characteristics** of timing and duration, location, and radiation, and also any **secondary effects** that may be present in arterial or venous pulse characteristics. The severity of the lesion is judged in part on the intensity of the murmur but also on the degree of cardiac insufficiency that is present. As a rule all pansystolic mitral and tricuspid murmurs, all holodiastolic murmurs, all right-sided murmurs, and all murmurs with a palpable precordial thrill should be considered pathologic. The cause of the lesion cannot be determined from auscultation but may be determined from the results of general clinical and special pathologic examinations and by a **knowledge and consideration of the common causes** of valvular disease that involve the particular valve affected in the animal species being examined.

### Functional (Innocent) Murmurs

Murmurs not associated with cardiac abnormality occur in all large-animal species, but particularly the horse and the lactating dairy cow. Those associated with turbulence produced during periods of high-velocity flow are often called **functional murmurs** or **flow murmurs**; those associated with turbulence resulting from decreased viscosity and increased flow are often called **physiologic murmurs**.

**Functional systolic ejection murmurs** are very common in young, fit horses and occur occasionally in cattle, sheep, and pigs. In **horses**, they are heard best over the base of the heart, usually on the left side over the aortic valve region, and in some horses on the right side, but not usually on both sides in the same horse. They are early to midsystolic murmurs of low intensity (grade 1-3), and are crescendo-decrescendo or decrescendo in character. In horses they are usually more audible at heart rates slightly elevated above the resting rate. Occasionally in horses, an ejection murmur is audible over the pulmonary valve.

In **cattle** they are most common at the base of the heart on the left side. A systolic ejection murmur is very common over the left anterior heart base in lactating dairy cattle, and this murmur is thought to be caused by turbulence at the pulmonic valves. Auscultation of this murmur requires placement of the stethoscope directly over the pulmonic valve; this murmur is usually not auscultable when the heart is auscultated at the fourth to fifth intercostal space. Holosystolic murmurs (grade 1-3) are heard in some **calves** in the first 2 to 3 weeks of life. They are possibly associated with minor deformation of the AV valves by hematocysts at the edge of the valve leaflets, which are common in young calves.

An **early diastolic murmur** occurs in horses, most commonly in young Thoroughbreds and Standardbreds, and is thought to be caused by vibrations associated with the rapid flow of blood into the heart in early diastole. It is a soft (grade 1-2), high-pitched, early diastolic murmur. When heard over the apex area, it is probably a variation of the S3 sound.

A **presystolic murmur** of grade 1 to 2 intensity and rumbling sound is occasionally heard in **horses** and is probably a component of the atrial fourth heart sound.

**Recumbent cattle** commonly have a low intensity (grade 1-3) crescendo-decrescendo systolic murmur that is auscultated over the right side. It will disappear when the animal stands. A similar murmur occurs where there is **ruminal distension** and bloat.

In **newborn** calves and foals a systolic murmur is frequently audible over the base of the heart, and it is thought to be caused by a partial temporary patency of the closing ductus arteriosus. In newborn pigs a continuous murmur may be heard, which is

often replaced by an early systolic murmur audible for the first week of life.

### Insufficiency of the Right AV Valve

Tricuspid valve insufficiency resulting from endocarditis is the **most common** acquired valvular lesion in cattle, pigs, and sheep. Insufficiency may also result from dilatation of the valve annulus in chronic anemia and with cor pulmonale in conditions such as high altitude disease in cattle. Tricuspid regurgitation can also occur with general heart failure that follows left-sided failure. Because of the association with bacterial endocarditis, tricuspid insufficiency in cattle, pigs, and sheep is usually indicative of significant cardiac disease or the presence of marked pulmonary hypertension. However, in horses, the murmur of tricuspid insufficiency may be present with little evidence of impaired performance.<sup>1</sup>

There is a harsh **holosystolic** or pansystolic plateau-type murmur most audible over the tricuspid valve area. Loud murmurs project dorsally and to the cranial part of the thoracic cavity on both right and left sides. The murmur is usually accompanied by an exaggeration of the systolic component of the jugular pulse. Congestive heart failure, if it occurs, will be manifested in the greater circulation.

### Insufficiency of the Left Atrioventricular Valve

This is the **second most common** acquired valvular disease in horses, cattle, and pigs. The insufficiency may result from endocarditis or rupture of the mitral valve chordae. There is a loud harsh **holosystolic** or pansystolic murmur that is most intense in the mitral area. The murmur transmits dorsally and in severe cases may also be heard on the right side. There is frequently marked accentuation of the occurrence of the third heart sound, which may be mistaken for the second sound. A late systolic crescendo murmur has also been associated with mitral insufficiency.

The **pulse characteristics** are unchanged until the stage of cardiac failure. Cases of mitral insufficiency may compensate at rest and may be only evidenced by decreased work tolerance. Failure, if it occurs, will be initially associated with left ventricular volume overload; however, in some cases the retrograde flow of blood through the mitral valve may lead to pulmonary hypertension and the additional occurrence of right-sided heart failure.

**Acute-onset heart failure** is usually associated with rupture of the valve chordae. In the horse, mitral insufficiency may predispose the animal to atrial fibrillation.

### Insufficiency of the Aortic Valve

Insufficiency of the aortic valve is the **most common** acquired valvular defect in horses. There is a loud **holodiastolic murmur**,



frequently accompanied by a thrill caused by the reflux of blood from the aorta into the left ventricle during diastole. The murmur is generally audible over the left cardiac area and is most intense at the aortic valve area and radiates to the apex. It may modify the second heart sound or start immediately following. The murmur may be noisy or **musical** and the relative intensity varies from horse to horse. Frequently it is decrescendo in character but other variations in its intensity occur. Valvular insufficiency of a sufficient degree to have functional significance is accompanied by an arterial pulse of very large amplitude and high systolic and low diastolic blood pressures (**water-hammer pulse**). The pulse wave may be great enough to cause a visible pulse in small vessels and even in capillaries. Rarely this lesion is accompanied by a diastolic jugular pulse caused by transmission of the impact of the reflex wave across the ventricular septum to the right side of the heart.

### Stenosis of the Aortic Valve

There is a harsh **systolic** murmur, most audible high up over the base of the heart on the left side and posteriorly. The murmur replaces or modifies the first heart sound and is often crescendo–decrescendo in character. A systolic thrill may be palpable over the base of the heart, and the cardiac impulse is increased as a result of ventricular hypertrophy. The stenosis has most functional significance when the pulse is abnormal, with a small amplitude rising slowly to a delayed peak reflecting the diminished left ventricular output. There may be signs of left-sided heart failure, and this lesion may also be associated with syncope.

### Stenosis and Insufficiency of the Pulmonary Valve

Acquired lesions of this valve are rare in large animals. The auscultatory characteristics are similar to those produced by aortic valve lesions, but there are no abnormalities of the arterial pulse. Pulmonary stenosis produces a distinct murmur at the third intercostal space on the left side of the chest, but some cases of pulmonary stenosis in the horse have no murmur. Murmurs may also be audible anterior to the aortic valve area on the left side of the chest. Heart failure, if it occurs, is right sided.

### Stenosis of the Right or Left Atrioventricular Valves

Stenosis of either AV valve is uncommon. There is a diastolic murmur caused by passage of blood through a stenosed valve during diastolic filling and audible over the base of the heart on the relevant side. The severity of the lesion will govern the duration of the murmur, but there is likely to be a presystolic accentuation caused by atrial contraction. Right AV valve stenosis may be accompanied by accentuation of the atrial component of

the jugular pulse. Some degree of mitral stenosis may occur in acquired lesions that manifested primarily as an insufficiency.

### CLINICAL PATHOLOGY

Clinicopathologic findings will reflect the changes caused by the primary disease and are significant only when there is endocarditis. Two-dimensional echocardiography, Doppler echocardiography, and color flow Doppler echocardiography are the most valuable noninvasive methods for the examination of valvular disease and allow a detection of the defect, its nature, and its severity. Echocardiography may detect regurgitant flow and flow through stenotic valves that is not detected by auscultation.

### NECROPSY FINDINGS

Care is needed when the heart is opened to ensure that the valves can be viewed properly from both upper and lower aspects. Lesions of endocarditis may be visible or there may be perforations, distortion, or thickening of the valves or breakage of the chordae tendinae. Endocardiosis in pigs is characterized by accumulation of glycosaminoglycans and hyaluronan and myofibroblast differentiation of fibroblasts. Blood and serous cysts are commonly observed on the AV valves of cattle, particularly Holstein-Friesian cattle, with one large slaughterhouse study reporting a prevalence of 49% and no age predilection. Serous cysts are larger and usually have a single occurrence, whereas blood cysts are smaller and usually have multiple occurrences. These cysts are thought not to have pathologic consequences in cattle.<sup>4</sup>

### DIFFERENTIAL DIAGNOSIS

Murmurs must be differentiated from pericardial and pleural friction sounds and from murmurs caused by congenital defects with shunts.

### TREATMENT

There is no specific treatment for valvular disease. Methods for the treatment of congestive heart failure and endocarditis are discussed under their respective sections.

### FURTHER READING

- Bexiga R, Mareus A, Philbey AW, et al. Clinicopathologic presentation of cardiac disease in cattle and its impact on decision making. *Vet Rec.* 2008;162:575-580.
- Reef VB, Bonagura J, Buhl R, et al. Recommendations for equine athletes with cardiovascular abnormalities. ACVIM/ECEIM consensus statement. *J Vet Intern Med.* 2014;28:749-761.

### REFERENCES

- Leroux AA, et al. *J Vet Intern Med.* 2013;27:1563.
- Young LE, et al. *J Vet Intern Med.* 2008;22:418.
- Buhl R, Ersboll AK. *J Am Vet Med Assoc.* 2012;240:205.
- Shekarfroush SS, et al. *Rev Med Vet.* 2006;157:477.

## ENDOCARDITIS

### SYNOPSIS

**Etiology** Bacterial, occasionally parasitic infection

**Epidemiology** History of ill-thrift, chronic illness, periodic milk drop, and shifting lameness

**Clinical findings** Type of murmur depends on valves of species predilection; embolic nephritis, arthritis, tenosynovitis, or myocarditis

**Clinical pathology** Blood culture

**Necropsy findings** Valvular lesions, often vegetative, maybe rupture of chordae tendinae; embolic lesions in other organs

**Diagnostic confirmation** Murmur or persistent tachycardia with evidence of bacteremia, positive blood culture; can be confirmed by echocardiography

**Treatment** Antimicrobial agents based on culturing causative agent; prolonged therapy required; case fatality uniformly high in cases that have heart failure

### ETIOLOGY

Most cases of endocarditis in farm animals are caused by bacterial infection but whether the infection gains entrance by direct adhesion to undamaged endothelium, or through minor discontinuities of the valvular surfaces, or by hematogenous spread through the capillaries at the base of the valve, is uncertain. A number of different organisms have been associated with this disease. The common infectious causes of endocarditis in animals are listed below.

#### Cattle<sup>1,2</sup>

- Trueperella (Arcanobacterium or Actinomyces or Corynebacterium) pyogenes*
- Helcococcus ovis*
- $\alpha$ -Hemolytic streptococci
- Micrococcus* and *Staphylococcus* spp.
- Pseudomonas* spp.
- Clostridium chauvoei* (blackleg)
- Mycoplasma mycoides*
- Bartonella bovis* (rare)
- Erysipelothrix rhusiopathiae (insidiosa)* (rare)

#### Horses

- Actinobacillus equuli*
- Streptococcus* spp., including *S. equi* and *S. zooepidemicus*
- Pasteurella/Actinobacillus* spp.
- Pseudomonas* spp.
- Migrating *Strongylus* spp. larvae

#### Pigs and Sheep

- E. rhusiopathiae (insidiosa)*
- Streptococcus* spp. including *S. equisimilis*, *S. dysgalactia*, *S. suis*

- *Escherichia coli*
- *Trueperella* (*Arcanobacterium* or *Actinomyces* or *Corynebacterium*) *pyogenes*

## EPIDEMIOLOGY

There is limited information on the epidemiology of endocarditis. The majority of cases of endocarditis are usually not diagnosed clinically, and lesions are identified at necropsy or slaughter.

Chronic bacteremia predisposes to endocarditis. There may be a history of an ongoing septic process such as mastitis, metritis, foot abscess, or traumatic reticular peritonitis, or of a procedure, such as the use of an indwelling IV catheter, that might lead to bacteremia. Often there is a history suggestive of low-grade infection. In **cattle**, ill-thrift with periodic, dramatic but temporary fall in milk production is a common history. The animals often have a lower body condition than expected for their stage of production, and there is frequently a history of intermittent lameness. **Horses** may present with similar suggestive histories, including shifting leg lameness, intermittent joint distension, coughing, seizures, jugular vein thrombosis, colic, diarrhea, poor growth, and umbilical infection. In **sows** it is common for agalactia to develop in the first 2 to 3 weeks after farrowing, followed by a loss of weight, intolerance to exercise, and dyspnea at rest.

## PATHOGENESIS

Endocarditis may arise from implantation of bacteria onto the endocardium from the bloodstream or by bacterial embolism of the valve capillaries. Endocarditis is **predisposed by trauma** to the endothelial surface exposing collagen and leading to binding of platelets, activation of the extrinsic coagulation cascade with deposition of fibrin, and the formation of sterile platelet–fibrin deposits.

**Endothelial damage** may occur along the lines of closure of valves in association with turbulent flow and also can occur for the same reason on areas of the mural endocardium. These areas are subsequently colonized by circulating bacteria, and the organisms grow in these areas enmeshed in a tight, avascular network of fibrin and platelets with further serial deposition of platelets and fibrin. This is the mechanism of endocarditis that occurs secondary to turbulent flow in congenital heart disease and of that produced by trauma such as cardiac catheterization. Myocardial disease may lead to edema of the valves, which may also predispose the animal to endothelial damage.

Endocarditis in large animals is most common as **secondary to a chronic infection** at some distant site and a **persistent bacteremia** without predisposing lesions in the heart. Certain organisms have the ability to directly adhere to endothelium, and it is probable that this is the major pathogenic factor.

**The major clinical abnormalities** associated with endocarditis result from the effect of endocarditis on **heart function** and from the effects of the embolic **showering** of microorganisms, which can lead to infarction or infection at other sites in the body. The valvular lesions may be vegetative in the early stages of the disease or, more often, there may be fibrosis and shrinking, distortion, and thickening of the valve cusps. Both interfere with valve function, leading to cardiac insufficiency and possibly cardiac failure. The functional defect produced by valvular endocarditis is usually, but not invariably, **valvular insufficiency**. Infected emboli most often produce pulmonary embolism with miliary pulmonary abscessation, or infection or abscesses in other organs, including myocardium, kidneys, and joints.

## Valve Predilection

In **cattle**, endocarditis is most common on the right AV (tricuspid) valve. The left AV (mitral) valve is the second valve of predilection, and bilateral involvement of the AV valves is not uncommon. In the **horse** the most common site of infection is the aortic valve, with the left and the right AV valves being the second and the third valve sites of predilection. Endocarditis of the pulmonary valve is uncommon but is recorded. The AV valves are the predilection sites in sheep and swine.

## CLINICAL FINDINGS

The diagnosis of endocarditis in the living animal remains a challenge. A random effects meta-analysis of 460 bovine endocarditis cases provided mean sensitivity estimates (in parentheses) for the following clinical findings: positive blood culture (87%), echocardiographic identification of a lesion (84%), presence of persistent tachycardia (80%), presence of a murmur (60%), presence of a fever (46%), presence of lameness/polyarthritis (44%), and presence of clinical signs of heart failure (37%). Specificity estimates for the same variables varied widely.<sup>3</sup>

## Cardiac Signs

The important finding is a murmur on auscultation or a thrill on palpation of the cardiac area. Details of the specific findings for individual valve abnormalities can be found in the preceding section on valvular disease. A major problem with diagnosis based on the presence of murmurs is that they are not always present or detected in cases of endocarditis, particularly with right-sided lesions. Persistent tachycardia should be regarded as the most consistent clinical sign in endocarditis.

## Embolism

Chronic bacteremia and embolic showering of microorganisms results in signs referable to infection and infarction at other sites in the body. There is a constant moderate,

fluctuating fever, and secondary involvement of other organs may cause the appearance of signs of peripheral lymphadenitis, embolic pneumonia, nephritis, arthritis, tenosynovitis, or myocarditis. There is usually much loss of condition, pallor of mucosae, and an increase in heart rate.

## Clinical Course

The clinical course in endocarditis may be as long as several weeks or months, or animals may drop dead without premonitory signs. Endocarditis is also a cause of acute heart failure and **sudden death in sows**. Because sows are confined with minimal exercise during much of the production cycle, the presence of cardiac insufficiency from chronic endocarditis can be masked, and sows with chronic endocarditis may have acute heart failure and die at times of intense exercise, such as mating or during movement to other housing.

## Rupture of the Chordae Tendineae

Rupture of the chordae tendineae of the mitral valve in horses may be predisposed by endocarditis or may occur spontaneously and occurs in both adults and foals. It is manifested by **sudden onset of acute heart failure** in horses apparently previously healthy or, when a complication of a preexisting endocarditis, as a sudden onset complication of the disease or a cause of death. There are signs of acute left failure, and there is usually a prominent third heart sound. The rupture may involve the chordae of any of the cusps of the valve. Rupture of the medial cusp of the aortic valve to produce acute left heart failure and rupture of the pulmonary valve producing right heart failure can also occur.

## Electrocardiography

**Electrocardiographic** findings suggestive of endocarditis are sinus tachycardia and decreased QRS amplitudes in a base–apex lead; ectopic foci may also be present.

**Echocardiographic** findings suggestive of endocarditis are hypoechoic and echogenic masses, irregular thickening of valves, and rupture of the chordae tendinae.<sup>4</sup> The sensitivity of valvular thickening or the presence of a vegetation on the valves for diagnosing endocarditis in cattle ranges from 75% to 100%, with the sensitivity depending on the site of the lesion.

## CLINICAL PATHOLOGY

A nonregenerative anemia, leukocytosis, neutrophilia, hyperfibrinogenemia, and hyperglobulinemia are common but **not specific** for endocarditis. In chronic cases, where the lesions are due largely to scarring of the valves, hematologic findings may be normal. Hypergammaglobulinemia is the most common and consistent finding and an indication of chronic bacterial infection. Where there is passive hepatic congestion, there may be an increase in serum alkaline

phosphatase and  $\gamma$ -glutamyl transferase activity. Repeated examination of the urine may reveal transient episodes of proteinuria and the shedding of bacteria associated with renal embolization and infarction.

**Blood cultures** should be attempted. The avoidance of skin contamination is important and the site should be adequately prepared by initial skin cleansing with 70% alcohol followed by 1% povidone iodine applied in a circular pattern around the intended venipuncture site. A contact time of at least 2 minutes should be allowed before obtaining blood for culturing. The ratio of blood to broth culture medium should be 1:10 to 1:20, and the broth should be incubated at 37°C for 24 hours before being examined for the presence of turbidity and plated onto traditional blood agar plates. Blood culture is frequently negative, and it is recommended that three samples be obtained from separate venipuncture sites during a 1-hour period. Sampling at the start of a fever is preferred but clearly impossible; however, in animals with a more constant bacteremia, repeat culturing without regard to fever is successful. Determination of the susceptibility of the organism to antimicrobial agents may aid in treatment.

### NECROPSY FINDINGS

The lesions are termed vegetative when they are large and cauliflower-like and verrucous when they are small and wartlike. The former are present on the valves in most fatal cases. In the latter stages the valves are shrunken, distorted, and often thickened along the edges. This stage of recovery is rare in farm animals but may be observed in the semilunar valves in horses. Spontaneous healing is rare, and in most cases treatment is commenced at too late a stage.

Embolic lesions may be present in any other organ. Culture of the valvular lesions should be undertaken, but in many cases no growth is obtained. Recent studies have demonstrated that culture should be extended for longer than normal (at least 3 days) because some pathogens are slow growing. Moreover, *H. ovis* may have been extensively overlooked in the past as a common cause of bovine endocarditis because its isolation requires cross-streaking a blood agar plate with *Staphylococcus aureus*.<sup>1</sup> The examination of direct smears should always be undertaken.

### DIFFERENTIAL DIAGNOSIS

- Pericarditis
- Brisket disease (cattle)
- Cardiac lymphosarcoma

### TREATMENT

Treatment is not highly successful because of the difficulty in controlling the infection. The thickness of the lesions prevents adequate penetration of antimicrobial agents and unless the susceptibility of the causative

organism is known a range of antibacterial drugs may have to be tried. For this reason there should be repeated attempts at blood culture until the causative organism is cultured to allow drug selection on the basis of susceptibility testing. The choice of antimicrobial agent should be one that allows high concentrations in serum relative to the minimal bactericidal concentration that has minimal side effects over a prolonged period of administration and has a prolonged half-life.

In the absence of a positive culture the types of organism usually isolated in cattle suggest the use of penicillin, possibly combined with gentamicin, or the use of a potentiated sulfonamide. The variety of causative organisms in horses recommends the use of broad-spectrum antibacterial treatment.

**Duration of treatment** needs to be prolonged. It is difficult to judge the duration of therapy required. A fall in temperature can be taken as an indication that infection is being brought under control, but treatment needs to be continued if therapy is to be successful. A period of continual treatment for 4 months with periodic treatment continuing for 14 months in a cow has been recorded.

**Relapse** is common. Treatment is expensive and in food animals must be extralabel; this is probably uneconomic except for particularly valuable animals. Consequently, the treatment of endocarditis should be approached with reservation. **Case fatality** is high if signs of congestive heart failure are present.

**The sequel** of embolic lesions in other organs and permanent distortion of valves resulting in valvular insufficiency also militate against a satisfactory outcome. The use of parenteral anticoagulants, as used in humans to prevent further deposition of material on vegetative lesions and to limit embolic disease, has questionable value and requires monitoring not usually available in veterinary practice.

### FURTHER READING

- Bexiga R, Mareus A, Philbey AW, et al. Clinicopathologic presentation of cardiac disease in cattle and its impact on decision making. *Vet Rec.* 2008;162:575-580.
- Buczinski S. Cardiovascular ultrasonography in cattle. *Clin North Am Food Anim Pract.* 2009;25:611-632.
- Buczinski S, Francoz D, Feceteau G, DiFrancia R. A study of heart diseases without clinical signs of heart failure in 47 cattle. *Can Vet J.* 2010;51:1239-1246.
- Buczinski S, Rezakhani A, Boerboom D. Heart disease in cattle: diagnosis, therapeutic approaches and prognosis. *Vet J.* 2010;184:258-263.
- Evans ET. Bacterial endocarditis of cattle. *Vet Rec.* 1957;69:1190.
- Jesty SA, Reef VB. Septicemia and cardiovascular infections in horses. *Vet Clin North Am Equine Pract.* 2006;22:481-495.

### REFERENCES

1. Kutzer P, et al. *J Clin Microbiol.* 2008;46:3291.
2. Erol E, et al. *J Vet Diagn Invest.* 2013;25:288.
3. Buczinski S, et al. *Vet J.* 2012;193:349.
4. Buczinski S, Belanger AM. *Can Vet J.* 2010;51:195.

## MYOCARDIAL DISEASE AND CARDIOMYOPATHY

### SYNOPSIS

**Etiology** Certain bacterial, viral, and parasitic infections, some nutritional deficiencies

**Epidemiology** Specific to causative agent

**Clinical findings** Reduction of cardiac reserve and decreased exercise tolerance, cardiac arrhythmias, congestive heart failure, or acute heart failure

**Clinical pathology** Electrocardiography, echocardiography, and serum cardiac troponin I concentrations; other examinations directed at determining the specific cause

**Necropsy findings** Myocarditis, myocardial degeneration

**Treatment** For cardiac insufficiency; specific therapy, if available, for specific cause

### ETIOLOGY

A number of diseases are accompanied by inflammation, necrosis, or degeneration of the myocardium. These include several bacterial, viral, or parasitic infections and some nutritional deficiencies and toxicities. In most cases, the involvement of the myocardium is only part of the total spectrum of these diseases, although the cardiac manifestations may be clinically preeminent. The term cardiomyopathy is generally restricted to those diseases in which myocardial damage is the prime manifestation. Causes of myocardial dysfunction are discussed in the following sections.

### Bacterial Myocarditis

- Following bacteremia, as in strangles or from navel-ill
- Tuberculosis, especially horses
- Tick pyemia in lambs
- *Clostridium chauvoei*<sup>1</sup>
- *Histophilus somni* in feedlot cattle<sup>2</sup>
- Extension from pericarditis, epicarditis, or endocarditis.

### Viral Myocarditis

- Foot-and-mouth disease, especially young animals
- African horse sickness
- Equine viral arteritis
- Equine infectious anemia
- Equine herpesvirus-1 in fetus
- Swine vesicular disease
- Parvovirus in piglets
- Encephalomyocarditis virus infection in pigs
- Porcine reproductive and respiratory syndrome virus in piglets
- Bluetongue in sheep.

### Parasitic Myocarditis

This is primarily associated with *Strongylus* spp. (migrating larvae) cysticercosis, *Sarcocystis* spp., and *Neospora caninum* (in the



neonatal calf). In a postmortem study of over 2000 equine hearts, 15% showed myocardial fibrosis in association with occlusive angiopathic change. No age association was found, but recent infarcts were more common in yearlings. It was postulated that these lesions result from thromboemboli from verminous plaques in the proximal thoracic aorta.

### Nutritional Deficiency

- Vitamin E/selenium deficiency in all large-animal species
- Some forms of chronic copper deficiency in cattle (falling disease), experimental copper deficiency in swine
- Iron deficiency in piglets and veal calves
- Copper/cobalt deficiency in lambs.

### Toxicity

- Inorganic poisons: selenium, arsenic, mercury, phosphorus, thallium
- Gossypol from cotton seed cake
- The mycotoxin fumonisin when ingested by pigs and horses
- Fluoroacetate (1080) and poisoning by *Acacia georginae*, *Gastrolobium*, and *Oxylobium* spp., *Dichapetalum cymosum*
- Plants and weeds, including members of *Ixiolena*, *Pachystigma*, *Pavette*, *Asclepias*, *Eriocarpa*, *Cryptostegia*, *Albizia*, *Cassia*, *Digitalis*, *Urechites*, *Pimelea*, *Astragalus*, *Fadogia*, *Cicuta*, *Colchicum*, *Karwinskia*, *Vicia*, *Cicuta*, *Trigonella*, *Bryophyllum*, *Palicourea*, *Lupinus*, *Lantana*, *Kalanchoe*, *Homeria*, *Hymenoxys*, and *Eupatorium* spp.
- Trees, including gidgee, yew, oleander, and avocado
- Grasses, including *Phalaris tuberosa*, corynetoxins in *Lolium rigidum* infested with nematodes, and *Corynebacterium* spp. (also tunicamycin in rain-damaged infected wheat, pigs), cantharidin in hay infested with blister beetles (horses)
- Drugs including succinylcholine, catecholamines, and xylazine (ruminants) monensin, especially in horses,<sup>3</sup> but also cattle, sheep, and pigs; lasalocid and salinomycin in horses,<sup>4</sup> pigs, cattle, and sheep; maduramicin in cattle and sheep fed poultry litter; and adriamycin (used experimentally to produce cardiomyopathy); overdosing with doxycycline in sick calves<sup>5</sup>, but cardiomyopathy could not be reproduced by overdosing in healthy calves<sup>6</sup>
- Vitamin D and myocardial and endocardial calcification following ingestion of *Cestrum diurnum*, *Solanum malacoxylon*, *Trisetum flavescens* (see enzootic calcinosis); calcification also occurs with hypomagnesemia in milk-fed calves.

### Venoms

- Rattlesnake (*Crotalus* spp.) venom in horses<sup>7</sup>
- *Vipera palaestinae*

### Embolic Infarction

- Emboli from vegetative endocarditis or other embolic disease such as bracken fern poisoning in cattle

### Tumor or Infiltration

- Enzootic bovine leukosis of cattle<sup>8</sup>
- Other cardiac neoplasia
- Cardiomyopathy in horses caused by amyloid infiltration of the myocardium

### Inherited

- Malignant hyperthermia of swine
- Hypertrophic cardiomyopathy in swine
- Arrhythmogenic right ventricular cardiomyopathy (arrhythmogenic right ventricular dysplasia) in horses<sup>9</sup>
- Congenital cardiomyopathy of Polled Hereford and Horned Hereford calves with dense curly coats in Australia,<sup>10</sup> and Japanese Black calves
- Bovine dilated cardiomyopathy in cattle of Holstein-Friesian origin, occurring in Red Holstein-Simmental crossbred cattle (Fleckvieh) in Switzerland and Austria; Red Danish dairy cattle in Denmark; Holstein-Friesian cattle in the UK, Austria, Denmark, Sweden, Japan, Canada, and Australia (inherited as an autosomal recessive gene)<sup>11</sup>
- Glycogen storage disease,  $\alpha$ -1,4-glucosidase deficiency in Shorthorn and Brahman cattle and Corriedale sheep

### Unknown or Uncertain Etiology

- Myocardial necrosis and hemorrhage secondary to acute lesions in the central nervous system
- Exertional rhabdomyolysis of horses, capture myopathy of wild ruminants, and restraint stress in swine
- Sudden death in young calves associated with acute heart failure and myocardial necrosis and precipitated by periods of intense excitement such as that experienced at feeding time
- Myocardial lipofuscinosis (brown atrophy) in aged or cachectic cattle, especially Ayrshires, but often found in healthy animals at slaughter
- Myocardial disease following mild upper respiratory disease in horses, especially when training or exercise is continued through the respiratory disease episode
- Dilated cardiomyopathy in a neonatal alpaca<sup>12</sup>
- Asymmetric hypertrophic cardiomyopathy in an adult alpaca<sup>13</sup>
- Dilated cardiomyopathy in sheep in Switzerland<sup>14</sup>

### PATHOGENESIS

The primary effect of any myocardial lesion is to reduce cardiac reserve and limit compensation in circulatory emergencies. Minor lesions may only reduce performance

efficiency, whereas more severe lesions may produce greater clinical effect.

Usually myocardial disease results in **arrhythmias** and **conduction disturbances** from primary involvement of the conduction system or establishment of excitatory foci within the myocardium. While the animal is at rest, there may be minimal evidence of cardiac disease, but catastrophic disturbances in cardiac conduction may occur under the adrenergic influences of **exercise** or excitement. The effects of pharmacologic cardiotoxic agents in poisonous plants are frequently also initially manifest when the animals are moved or otherwise excited.

Endogenous or synthetic **catecholamines**, in their own right, can produce multifocal myocardial necrosis, especially in the left ventricle. Sympathetic overactivity and local catecholamine release in the myocardium has been postulated as the cause of myocardial disease accompanying acute brain lesions in domestic animals and myocardial disease associated with some forms of stress and overexertion.

Myocardial disease may also result in **congestive heart failure** through its primary effect on the myocardium and the function of the heart as a pump.

### CLINICAL FINDINGS

In early cases, or cases with mild or moderate myocardial damage, a **decreased exercise tolerance** is the usual initial presenting sign. This is usually accompanied by an increase in heart rate and heart size, although the latter may only be detectable by echocardiography. There may be clinically recognizable **arrhythmia**, particularly tachyarrhythmias, associated with multiple ventricular ectopic foci. The characteristics of the pulse and heart sounds are also changed (see arrhythmias).

Animals with suspect myocardial disease but with no or minimal arrhythmic disturbances at rest can be judiciously exercised, which will frequently result in the expression of conduction or arrhythmic abnormality. Exercise or excitement should be avoided in animals with overt arrhythmias at rest.

In the late stages, or in cases with more severe myocardial damage, there may be **sudden death** or attacks of cardiac syncope caused by acute heart failure, or severe dyspnea or general edema caused by congestive heart failure. Details of the clinical findings associated with conduction disturbances, arrhythmias, and heart failure have been given earlier.

### CLINICAL PATHOLOGY

Electrocardiography and echocardiography are used in special examination. A mass within the right atrium of cattle is suggestive of multicentric lymphosarcoma caused by enzootic bovine leukosis, but the lesion should be differentiated from endocarditis. Hematologic examination, blood culture, and serology may be of value in determining the cause of myocardial disease, and a full

biochemical profile is advisable to determine whether multisystemic problems are present. Myocardial infarction and necrosis may be associated with the release of cell enzymes into the bloodstream during the acute phase and the determination of the serum activities of LDH, creatine kinase, and aspartate amino transaminase are of value. The cardio-specific isoenzyme troponin I provides the most sensitive and specific indication of cardiac necrosis (see chronic congestive heart failure section), whereas the predictive value of serum creatinine kinase and LDH activities is much lower. Toxicologic examination and tests for nutritional trace element deficiencies may be indicated.

### NECROPSY FINDINGS

Bacterial infections may cause discrete abscesses or areas of inflammation in the myocardium, but viral infections and degeneration caused by nutritional deficiencies and poisonings usually produce a visible pallor of the muscle, which may be uniform or present as streaks between apparently normal bundles of muscle. In acute cases, there may be petechial or linear hemorrhages in the myocardium. Calcification may occur in areas of myocardial damage and with enzootic calcinosis and vitamin D toxicity. The nature and distribution of myocardial damage within the heart can vary according to the inciting agent and this can be an aid to diagnosis. The degenerated muscle may also be present in only the inner layers of the wall, leaving the external layers with a normal appearance.

In coronary thrombosis, infarction of a large area of the wall may have occurred, but this is not visible unless the animal survives for at least 24 hours afterward. Careful examination of the coronary arteries is usually necessary to detect the causative embolus. In horses infarction occurs most commonly in the right atrium.

The terminal stage of myocardial degeneration or myocarditis is often fibrous tissue replacement of the damaged tissue. The heart is flabby and thin walled and shows patches of shrunken, tough fibrous tissue. Rupture of the atrial walls may result, with sudden death occurring as a result of the pressure of blood in the pericardial sac. The lesions of lymphomatosis are characteristic of this disease and consist of large, uneven masses of pale, firm, undifferentiated tissue with the consistency of lymphoid tissue.

Foci of osteocartilaginous material (separate to the os cordis) are occasionally palpated in the atria of sheep. Degenerative changes associated with these lesions are not evident, suggesting that these lesions are clinically insignificant.<sup>15</sup>

Focal myocardial fibrosis, possibly resulting from microembolism from strongyle-induced endarteritis, is common in healthy horses but has also been ascribed as the predisposing factor to conduction disturbances, such as atrial fibrillation and heart block.

### DIFFERENTIAL DIAGNOSIS

- Other cardiac causes of chronic (congestive) heart failure and acute heart failure
- Other causes of decreased exercise tolerance

The diagnosis and differential diagnosis of the specific etiology of myocardial disease rests with the epidemiologic and other considerations of the individual causes and may require specific bacteriologic and virologic examinations, toxicologic and nutritional analyses, or an examination of the environment.

### TREATMENT

The primary cause must be treated and details are given under the individual headings of the specific diseases listed earlier. When possible, the primary cause of the myocardial damage must be corrected or treated, and details are given elsewhere for the various etiologies listed previously. The treatment of conduction disturbances, arrhythmias, and heart failure is discussed elsewhere in this chapter.

### FURTHER READING

- Buczinski S, Francoz D, Feceteau G, DiFruscia R. A study of heart diseases without clinical signs of heart failure in 47 cattle. *Can Vet J.* 2010;51:1239-1246.
- Buczinski S, Rezakhani A, Boerboom D. Heart disease in cattle: diagnosis, therapeutic approaches and prognosis. *Vet J.* 2010;184:258-263.
- Jesty SA, Reef VB. Septicemia and cardiovascular infections in horses. *Vet Clin North Am Equine Pract.* 2006;22:481-495.

### REFERENCES

1. Snider TA, et al. *J Am Vet Med Assoc.* 2011;238:1119.
2. O'Toole D, et al. *Vet Pathol.* 2009;46:1015.
3. Hughes KJ, et al. *Equine Vet J.* 2009;41:47.
4. Declodet A, et al. *J Vet Intern Med.* 2012;26:1005.
5. Brihoum M, et al. *J Vet Intern Med.* 2010;24:1203.
6. Brihoum M, et al. *BMC Vet Res.* 2011;7:40.
7. Gilliam LL, et al. *J Vet Intern Med.* 2012;26:1457.
8. Buczinski S. *J Am Vet Med Assoc.* 2012;241:1083.
9. Freel KM, et al. *Vet Rec.* 2010;166:718.
10. Simpson MA, et al. *Anim Genet.* 2008;40:42.
11. Owczarek-Lipska M, et al. *Mamm Genome.* 2009;20:187.
12. Gentile JM, Abbott JA. *J Vet Intern Med.* 2010;24:999.
13. Van Alstine WG, Mitsui I. *J Vet Diagn Invest.* 2010;22:448.
14. Tontis A. *Tierarztl Praxis.* 2006;34:165-170.
15. Gopalakrishnan G, et al. *J Vet Diagn Invest.* 2007;19:518.

### RUPTURE OF THE HEART AND ACUTE CARDIOVASCULAR ACCIDENTS

Rupture of the heart occurs rarely in animals. It is recorded in cattle when a foreign body penetrating from the reticulum perforates the ventricular wall, and in the left atrium of horses as a consequence of chronic fibrotic myocarditis. Rupture of the base of the aorta

is not uncommon in horses and has the same effect as cardiac rupture. The pericardial sac immediately fills with blood and the animal dies of acute heart failure caused by pericardial tamponade. A similar **cardiac tamponade** occurs when reticular foreign bodies lacerate a coronary artery or when foals suffer severe laceration of the epicardium during a difficult parturition.

### RUPTURE OF THE AORTA

The aorta may rupture through its wall just above the aortic valves. The wall could have been weakened previously by verminous arteritis associated with migrating strongyles in horses or onchocerciasis in cattle or by the development of medionecrosis. Another form of rupture occurs through the aortic ring. Death occurs very suddenly; all cases reported by one author affected stallions and coincided with the time of breeding. Cardiac tamponade may occur, but the common finding is a dissecting aneurysm into the ventricular myocardium.

**Aortic rupture and aortopulmonary fistulation** occurs occasionally in Friesian horses near the ligamentum arteriosum.<sup>1</sup> Formation of a **fistula** between the aorta and the pulmonary artery produces a sudden onset of cardiac failure and respiratory distress. Affected horses usually die shortly after the onset of clinical signs because of hemorrhage from aortic rupture but can survive up to 8 days or longer if a fistula forms.<sup>1</sup> The rupture is predisposed by abnormalities in the vasa vasorum of the vessels and appears to have a familial occurrence.<sup>1</sup> Antemortem diagnosis is challenging because of the anatomic location of the rupture.

**Aortocardiac fistulas** originating at the right aortic sinus are recorded in a series of older horses with sudden onset acute distress and exercise intolerance. Five of the seven horses had a characteristic continuous murmur that was loudest at the right fourth intercostal space. Fistulas extended into the right ventricle or atrium in six horses and the left ventricle in one. Five had dissecting tracts in the septal myocardium.

Rupture of the aorta is the usual cause of death in calves with **Marfan syndrome**. Some have dissecting aneurysms of the aorta and pulmonary artery. Calves with Marfan syndrome are affected from birth. They have a loud systolic murmur over the base of the heart on the left side in association with enlargement of the aortic root. There are other phenotypic abnormalities, including long thin limbs, joint and tendon laxity, and ocular abnormalities including dorsal displacement of the lens and lens opacity. The nature of the inheritance in cattle is uncertain.

**Rupture of an abdominal artery aneurysm in Holstein-Friesian** cattle has been reported in more than 30 cattle, with the majority of reports from New York in the United States.<sup>2</sup> Affected cattle are 2½ to 6

years of age and usually present as a sudden and unexpected death with a marked hemoabdomen.<sup>2</sup> An aneurysm of the cranial mesenteric artery was diagnosed antemortem in a cow with severe abdominal pain and the presence of a large pulsatile mass at the root of the mesentery. This condition appears to be caused by an inherited defect in the wall of the abdominal aorta, left gastric artery, right ruminal artery, left ruminal artery, celiac artery, and cranial mesenteric arteries. An autosomal dominant mode of inheritance is suspected.

### RUPTURE OF HEART VALVES

Sudden death, or sudden onset of acute heart failure, can also result from rupture of the components of the heart valves. Rupture of the chordae tendineae of the mitral valve occurs in horses both without apparent predisposing lesions and as a sequel to endocarditis and occurs in adult horses as well as foals. It is manifested by sudden onset of acute heart failure in apparently previously healthy horses or, when a complication of a preexisting endocarditis, as a sudden onset complication of the disease or a cause of death. The rupture may involve the chordae of any of the cusps of the valve. Rupture of the pulmonary valve producing right heart failure can also occur.

### REFERENCES

1. Ploeg M, et al. *Equine Vet J*. 2013;45:101.
2. Lamm CG, et al. *J Vet Diagn Invest*. 2007;19:273.

### COR PULMONALE

Cor pulmonale is the syndrome of right-sided heart failure resulting from an increase in right heart workload secondary to increased pulmonary vascular resistance and pulmonary hypertension. The most documented cause of pulmonary hypertension in livestock is **alveolar hypoxia**. Acute alveolar hypoxia (lowered alveolar  $PO_2$ ) is a potent cause of pulmonary hypertension in several species, but cattle are especially reactive. This is the cause of cor pulmonale in cattle at high altitudes, or **bovine brisket disease**, which is described in more detail later.

An outbreak of cor pulmonale with pulmonary vascular lesions similar to those seen with high mountain disease but occurring in calves not at altitude is recorded; it was postulated but not proved to be the result of the ingestion of feed contaminated with the pyrrolizidine alkaloid monocrotaline.

Pulmonary hypertension can also result from partial destruction of the **pulmonary vascular bed** and a reduction in its total cross-sectional area. Pulmonary thromboembolic disease can produce right heart failure by this mechanism. Chronic interstitial pneumonia and emphysema may also induce cor pulmonale by the same mechanism.

Chronic obstructive **pneumonia**, in which there is airway constriction and

accumulation of fluid in distal airways, may induce pulmonary hypertension in cattle by a combination of chronic hypoxia and reduction of the pulmonary vascular bed. Mean pulmonary artery pressures in calves with respiratory disease was 42 mm Hg, compared with 22 mm Hg in healthy age-matched calves. Although pulmonary hypertension and right heart hypertrophy may occur in livestock with primary pulmonary disease, clinical cardiac insufficiency is usually minor, and right heart failure rare. Nevertheless, it can occur and is a cause of congestive heart failure in cattle. Despite the presence of one report of cor pulmonale in a horse,<sup>1</sup> acute pulmonary obstruction in horses with recurrent airway obstruction does not usually induce cor pulmonale; this result is attributed to the relative short term of severe respiratory disease and focal rather than generalized alveolar hypoxia in horses compared with cattle.<sup>2</sup>

In goats, cor pulmonale, with right ventricular and right atrial hypertrophy secondary to interstitial pneumonia, may lead to **atrial fibrillation**, and cor pulmonale leading to atrial fibrillation has also been recorded in horses.

In highly conditioned feedlot cattle, increased intraabdominal pressure resulting from excessive abdominal fat, forestomach engorgement, and recumbency can lead to pulmonary hypoventilation with decreased alveolar  $PO_2$  and subsequent right heart failure, which is a syndrome analogous to the Pickwickian syndrome in humans.

Chronic severe elevations in pulmonary venous pressure can lead to constriction and hypertrophy of the vascular smooth muscle of precapillary vessels with resultant pulmonary hypertension. An elevated left ventricular filling pressure is perhaps the more common cause and can set the stage for right heart failure in the left heart failure situations. The toxic principle in poisoning by *Pimelea* spp. appears to act in part by constricting the pulmonary venules producing pulmonary hypertension, which contributes to the clinical syndrome.

**Persistent pulmonary hypertension of the neonate** (PPHN) is a common problem in neonatal foals and calves, particularly in calves derived from somatic cell clone technology. Persistent pulmonary hypertension is characterized by persistent postnatal hypoxemia secondary to failure to adapt to extrauterine life. An imbalance between endogenous vasoconstrictors and vasodilators is thought to play a major role in the development and maintenance of PPHN. An increase in plasma concentration of endothelin-1 (a potent vasoconstrictor) has been observed in neonatal calves with PPHN, and the source of endothelin-1 is thought to be the placenta. Many cloned calves have abnormal placentation, characterized by a reduction in the number of established cotyledons that are enlarged and edematous. Treatment

is symptomatic, focusing on intranasal oxygen administration and maintaining the calf in sternal recumbency.

### REFERENCES

1. Sage AM, et al. *J Vet Intern Med*. 2006;20:694.
2. Johansson AM, et al. *J Vet Intern Med*. 2007;21:302.

## HIGH ALTITUDE PULMONARY HYPERTENSION (BRISKET DISEASE, MOUNTAIN SICKNESS)

### SYNOPSIS

**Etiology** Cor pulmonale secondary to pulmonary hypertension induced in susceptible cattle by exposure to high altitude (hypoxemia); heritable in autosomal dominance mode with incomplete penetrance related to gain of function mutations in the gene for hypoxia inducible factor (*EPAS1*).

**Epidemiology** Sporadic disease, at high altitudes, of cattle, particularly young or newly introduced; exacerbated by grazing locoweed

**Clinical findings** Right-sided congestive heart failure; pulmonary hypertension; the name derives from the edema that occurs in the brisket region

**Clinical pathology** No common hematologic or blood gas variables are useful in detecting or predicting the disease; measurement of pulmonary arterial pressures at higher altitudes; echocardiography

**Necropsy findings** Right-sided congestive heart failure

**Diagnostic confirmation** Clinical and epidemiologic; recovery with movement to lower altitudes

**Treatment** Move to lower altitudes

**Control** Identification of susceptible cattle by measuring pulmonary artery pressure at altitude; avoidance of grazing locoweed; possible genetic testing

### ETIOLOGY

Alveolar hypoxia in cattle at high altitudes results in pulmonary hypertension, and the resultant increase in pressure load on the right ventricle can lead to cor pulmonale and heart failure. *Bos taurus* cattle have one of the greatest pulmonary artery pressure responses to acute or chronic hypoxia of any species, and this predisposes cattle to the disease.<sup>1</sup> Any additional factor such as myocardial dystrophy, anemia, pulmonary disease, or hypoproteinemia exacerbates the primary condition. The additional effort required to obtain feed on sparse pasture at high altitudes could also be a predisposing cause.

The disease in Angus cattle appears to be associated with a **gain of function mutation** in the gene endothelial PAS domain



containing protein 1 (*EPAS1*) that results in stabilisation and therefore increased activity of hypoxia inducible factor-2  $\alpha$  (*HIF2 $\alpha$* ).<sup>2</sup> There are two variants of the mutation and cattle can have none, one, or both variants. Each variant acts to stabilize *HIF2 $\alpha$* , and the effect of each mutation is additive such that animals with both variants have an additional gain of function, as indicated by increased expression of *HIF* target genes.<sup>3</sup> Animals with this mutation are more likely to have pulmonary hypertension at altitude than are cattle that do not have the mutation, and cattle with both variants are at greatest risk (relative risk associated with mutation of 3.5 [1.6–7.8] times, odds ratio of 12.8 [2.9–66]). Cattle with this mutation at low altitude do not have abnormal pulmonary artery pressures, indicating that the disease is caused by the interaction of gene and environment, although their pulmonary artery pressure can be slightly higher than that of cattle without the mutation. The mutation is common; 41% of Angus cattle (13 of 32 samples) kept at low altitude have the mutation.<sup>2</sup>

Selection for resistance to high altitude pulmonary hypertension is associated with lower rates of weight gain at low altitude, providing an explanation for the selection of cattle with the mutation kept at low altitude.<sup>4</sup>

## EPIDEMIOLOGY

### Occurrence

Brisket disease occurs sporadically in high mountainous areas in North America and South America. The disease also occurs in the highlands of Ethiopia and India.<sup>5</sup> Cattle residing above 1500 m are predisposed and at altitudes above 2200 m an annual incidence of 0.5% to 2% is recorded.

### Risk Factors

Brisket disease can occur in all ages and breeds of **cattle** that are maintained at high altitudes for a number of months. The incidence is highest in calves, yearlings, in late pregnant cattle, and in cattle newly introduced to these altitudes. Cattle can adapt to high altitudes, and the morbidity rate in indigenous cattle seldom exceeds 1%. In affected cattle, case fatality is high unless they are moved to lower altitudes. The disease can occur in susceptible cattle at altitudes as low as 1600 m.<sup>6</sup> High rates of calf death (~4% of calves at branding) occur even in cattle herds that have selected for sires with low pulmonary arterial pressures at high altitude.<sup>7</sup>

The ingestion of **locoweed** (*Oxytropis sericea*, active ingredient swainsonine) intensifies the effect of high altitude on the development of congestive heart failure.<sup>6</sup> The mechanism is unknown, but when groups of cattle at high altitude graze locoweed the annual incidence can approach 100% with high case fatality. An unidentified plant is also thought to potentiate the disease in mountainous areas of Brazil.

The congestive heart failure that develops at altitude is peculiar to cattle, although other animal species can show an effect from altitude. **Horses** that are moved up from 300 to 2400 m above sea level show standard increases in pulse and respiratory rates and hemoglobin and erythrocyte levels. **Mules** are much less susceptible and appear to be unaffected by altitudes as high as 3200 m. **Goats, sheep, and donkeys** are also reputed to be affected in that order of reducing susceptibility. **Llamas** and **alpacas** are adapted to hypoxia at high altitudes, in particular by an oxygen dissociation curve in their hemoglobin, which increases oxygen uptake.

## PATHOGENESIS

Acute alveolar hypoxia (lowered alveolar  $P_{O_2}$ ) is a potent cause of constriction of the precapillary pulmonary vessels and pulmonary hypertension in several species, but cattle are especially reactive, and there is a genetic predisposition that determines the magnitude of the response. Prolonged hypoxia and persistent pulmonary vasoconstriction lead to medial muscular hypertrophy of the small pulmonary arteries and arterioles with a further increase in pulmonary vascular resistance and the development of cor pulmonale.

The disease can be produced experimentally in low-pressure chambers. The movement of cattle from an altitude of 1100 up to 3000 m has been shown to cause hypertrophy of the right ventricle, an increase in pulmonary arterial pressure from 27 mm Hg (3.6 kPa) to 45 mm Hg (6.0 kPa) to over 100 mm Hg (13.3 kPa) and the development of right heart failure.

## CLINICAL FINDINGS

Affected cattle have a dejected appearance; lose condition rapidly; have a rough, lusterless coat; and stand with the elbows abducted.<sup>6</sup> Jugular vein engorgement is followed by the appearance of edema of the brisket, spreading up the neck to the intermandibular space and back along the ventral aspect of the body. Abdominal enlargement caused by the development of ascites is accompanied by diarrhea.

There is hyperpnea at rest and dyspnea and weakness on slight exertion. The mucosae may be cyanotic, particularly after exercise, and the lung sounds vary from an increased vesicular murmur to moist crackles and an absence of breath sounds when pneumonia is present and to crepitant crackles in the presence of emphysema.

Auscultation of the heart reveals tachycardia, increased absolute intensity of the sounds, or a decrease when there is hydropericardium and an increase in the size of the heart. A systolic murmur is usually present, and a “**pistol shot**” sound can often be heard with auscultation over the jugular vein. The appetite is normal until the late stages, and the temperature is normal unless secondary pneumonia develops.

**Horses** at high altitude can lose weight, fatigue easily, and become weak and rough-coated, and show pain but do not develop congestive heart failure.

## CLINICAL PATHOLOGY

In sheep and cattle, a change to altitudes of 1800 to 3500 m causes a rise in hemoglobin (35% in sheep, 9% in cattle) and packed cell volumes (27% in sheep but no change in cattle) and hemoglobin concentration in red cells (8–9% increase in cattle and sheep).

Pulmonary arterial pressures increase significantly immediately after cattle are moved to high altitudes, but the high pressures subside as adaptation develops. Pressures rise from a normal of 22 to 26 mm Hg (2.9–3.5 kPa) up to 37 to 55 mm Hg (4.9–7.3 kPa) depending on whether the calf is susceptible or resistant to the effects of altitude (Table 10-5). Cattle accustomed to live at high altitudes have much less pulmonary hypertension than introduced cattle.

There are no hematologic or blood gas variables that are significantly associated with pulmonary artery pressure in cattle and could act as substitutes for measurement of pulmonary artery pressure.

In clinical cases, there can be a significant reduction in the packed cell volume and in hemoglobin levels.

## NECROPSY FINDINGS

There is enlargement of the heart, with dilatation of the right ventricle and hypertrophy of the right ventricular wall.<sup>6</sup> Slight thickening of the heart valves may be present and there may be areas of calcification in the large arteries. Accumulations of edema fluid are within the pericardial sac, peritoneal and pleural cavities, and in subcutaneous tissues. This edema may also involve the wall of the alimentary tract. Typical congestive changes are evident in the liver: enlargement, rounding of the edges, an enhanced zonal pattern on capsular and cut surfaces, dilatation of the hepatic veins, and a marked deposition of fibrous tissue around the central veins. In the lungs, there is often severe alveolar emphysema and in some cases bronchitis and pneumonia are also present. Histologically, the changes include thickening of the tunica media of vessels in the pulmonary arterial tree and hypertrophy of cardiac myofibers.<sup>6</sup> Microscopic findings in the liver are typical of chronic passive congestion.

## Samples for Diagnostic Confirmation

- **Histology:** lung, liver, right ventricular myocardium (LM).

## DIFFERENTIAL DIAGNOSIS

Other causes of congestive heart failure  
Cor pulmonale associated with chronic pneumonia

**Table 10-5** Evaluation of pulmonary arterial pressure scores in cattle examined at high altitude<sup>a</sup>

Pulmonary arterial pressure	Interpretation
30–35 mm Hg	Low risk of disease. This score is considered excellent and highly reliable.
36–39 mm Hg	Low risk of disease for any animal over the age of 12 months. If the animal is less than 12 months of age, the score is still fairly reliable, but retesting before breeding is suggested.
<41 mm Hg	Scores less than 41 mm Hg are reliable measurements in all animals more than 12 months of age. It is recommended that yearling cattle have a PAP measurement less than 41 mm Hg (depending on altitude of the test). The variation in scores 41 mm Hg and above is inconsistent and difficult to predict in some cattle as they age. Any animal measuring 41 mm Hg and greater should always be retested before use for breeding.
41–45 mm Hg	This range is acceptable for older animals (i.e., more than 16 months of age). Animals less than 16 months scoring in this range should be retested to predict the future PAP of the animal accurately.
45–48 mm Hg	This range is acceptable only for older animals that have been in high elevations for an extended period of time. Animals with this score are more susceptible to environmental stresses leading to disease and should be considered at some risk. Elevations of the test site and where the animal lives must be evaluated closely for those in this PAP score range.
>49 mm Hg	Animals that score in this range must always be considered high-risk candidates for developing brisket disease, not only for themselves but also their offspring. An option for these animals is to move them to a lower elevation. It is also recommended that offspring of these animals never return to high altitude.

PAP, pulmonary arterial pressure.

<sup>a</sup>These figures are based on cattle tested at or above 1800 m (6000 ft) and 12 months of age or greater.

## TREATMENT

The only effective treatment is to move the affected cattle to a **lower altitude**. Pending this, avoidance of excessive exercise is advisable.

Temporary improvement in severely affected animals might be achieved by treatment of the congestive heart failure, but this is not economical for commercial herds.

## CONTROL

Control measures are difficult to implement because the prime predisposing factor is the grazing of cattle at high altitudes. Avoidance of grazing of locoweed is easy to state but almost impossible to implement. Restriction of grazing of cattle showing signs by hand-feeding a high-protein diet and prompt treatment of cases of pulmonary disease are recommended as worthwhile procedures, although they are really more treatment methods. Testing of cattle for pulmonary artery pressure at altitude allows the selection of sires and dams that do not have high pulmonary artery pressure and are therefore at lower risk of the disease.<sup>8</sup> Development of genetic tests to detect cattle with the causative mutation might allow selection of cattle at lower risk of the disease,<sup>2</sup> but this could be associated with lower rates of weight gain.<sup>4</sup>

## FURTHER READING

Holt TN, et al. Pulmonary artery pressure testing for high disease (sic) in cattle. *Vet Clin North Am Food Anim Pract.* 2007;23:575-594.

## REFERENCES

- Rhodes J. *J Appl Physiol.* 2005;98:1092.
- Newman JH, et al. *Nat Commun.* 2015;6:6863.
- Newman JH, et al. *Pulm Circ.* 2011;1:462.
- Shirley KL, et al. *J Anim Sci.* 2008;86:815.
- Wuletaw Z, et al. *Livestock Sci.* 2011;138:96.
- Malherbe CR, et al. *J Vet Diagn Invest.* 2012;24:867.
- Neary JM, et al. *J Vet Diagn Invest.* 2013;25:210.
- Holt TN, et al. *Vet Clin North Am Food Anim Pract.* 2007;23:575.

## ENCEPHALOMYOCARDITIS VIRUS DISEASE IN PIGS

Encephalomyocarditis is a viral infection of rodents that is transmissible to domestic animals and humans. Although now isolated from many species (over 30), it is only a significant pathogen in pigs and elephants. It has caused a plague in primates after a rodent plague.<sup>1</sup> Recently the virus was isolated from human cases in Peru.<sup>2</sup> Mortality may reach 50% in young pigs.

## ETIOLOGY

There are two phylogenetically distinct types: type A is usually responsible for reproductive

disorders (e.g., a Belgian strain), and type B for myocarditis (a Greek strain), but some strains can cause both. They differ considerably in virulence.

The cause is a cardiovirus (family Picornaviridae), which is primarily a pathogen of rodents. There is no correlation demonstrated at the moment between genotype and clinical disease.<sup>3</sup> Isolates from different countries have the ability to produce different clinical characteristics and show differences in pathogenicity and molecular and antigenic properties. A possible pneumotropic strain was identified in Quebec, Canada, and this caused interstitial pneumonia. The Belgian isolate is classified as a reproductive strain and the Greek isolate as a myocardial strain. Both strains are able to cause reproductive failure in sows in gestation and to cause myocardial lesions in piglets, but a difference in virulence between both isolates is evident.

## EPIDEMIOLOGY

Encephalomyocarditis is found worldwide but may cluster in endemic areas, and its seriousness as a pathogen varies from probably inconsequential in the United States to important in Belgium. For example, in the UK antibodies were demonstrated in around 30% of the pigs sampled but no clinical case has ever been described. It is antigenically stable, but there is genetic variability.

It was first described as a cause of neonatal mortality in 1975. When the disease was first described, pigs from 3 to 6 weeks were affected with myocarditis and encephalitis. It is now known that the virus may cause reproductive failure in gilts and sows characterized by stillbirths and mummified fetuses. The prevalence of inapparent infection in the swine population is high.

Outbreaks of the disease or serologic evidence of the virus have been reported from the United States, Canada, Australia, Italy, Greece, and many other countries including Central America and now Venezuela. In Europe the most serious outbreaks have occurred in Belgium and Italy. Most work appears to have been performed in Belgium, where there were major outbreaks from 1995 to 1996, which were caused by a new virus.

First reported in 1991 in Belgium, between 1995 and 1996 the disease was diagnosed 154 times in Belgium either as a cause of myocardial failure with sudden death in finishing pigs and suckling piglets or as a cause of reproductive failure in sows. This experience suggests that each isolate is specific for one age category and that the spread of the virus is limited. This recent finding suggests that rodents do play a part in the transmission of the virus but that pig-to-pig transmission is equally important as a source of infection but not yet proven.

In Iowa, infection is widespread in swine herds; the true prevalence of infection in

breeding stock is estimated at 13.8% and 8.5% in finishing animals. About 90% of the herds surveyed in Iowa had one or more seropositive animals, and seroprevalence increased with age. In Italy, most herds and 70% of pigs are seropositive for the virus. Clinical disease has been observed in very young suckling pigs to grower pigs up to 4 months of age but not in adults. It may occur as a sporadic disease or as an outbreak involving several litters of pigs, or pigs within a group. In outbreaks in Greece, in one herd of 100 breeding sows, 200 pigs 8 to 16 weeks of age died from the disease within 2 months. Population mortality in a group of young pigs is variable but it may approach 50% in younger pigs. Transmission is usually thought to be oral and spread among pigs is said to be limited, although because of the presence of virus clones there may be the occasional large outbreak as well.

The role of rodents, especially the genus *Rattus*, always supposed to be the main reservoir of the virus for domestic pigs, has been suspected but not documented as the source of spread of the infection to pigs. No pig-to-pig transmission has been shown, and the pig is probably not a risk to man. Serologic surveys of free-living animal species in Iowa in the United States have failed to find evidence of infection in these species, and it is suggested that swine themselves are the main reservoir of infection. In an Australian outbreak, a plague of rats in the piggery may have been the source of the virus. The virus is relatively resistant to heat and chemical influences and a wide variety of pH but is sensitive to desiccation. Outbreaks are frequently associated with rodent plagues in the piggery or area, or with rodent infestation of feed stores. An epidemic in Australia was associated with a plague of mice that were present in all piggeries reporting the disease. It can occur sporadically within several litters at the time or as an outbreak involving a whole group of pigs. It may be related to a single farm or a group of buildings on the farm. It is thought that ingestion is the main means of infection either from infected feces or from rat carcasses. It can be transmitted experimentally from oral, nasal, or aerosol routes.

Infection from rodents to man is not documented but has been suspected in Australia when a plague of rats occurred on a farm and mice on another. It has been isolated from a variety of arthropods including mosquitoes, ticks, houseflies, and fleas. No evidence has been found for the virus in free-living populations in the United States. Feed can be contaminated by rodent feces.

The virus is relatively resistant to heat and chemicals. The virus is now considered a major cause of reproductive failure in swine herds. The virus has been recovered from fetuses, antibodies to the virus have been demonstrated in fetal fluids, and histologic

lesions supporting a diagnosis of the viral infection have been observed.

The economic losses associated with reproductive and neonatal losses associated with the virus have been estimated at \$100 per inventoried sow. Investigations of outbreaks on two Minnesota swine farms indicated that the monthly averages for the numbers of piglets born dead per litter reached 4.6 and 3.6, the preweaning mortalities 50% and 31%, and the farrowing rates 52% and 63%, respectively.

### PATHOGENESIS

Critical factors appear to include virus strain, exposure dose, passage history, and individual sensitivity but also route of infection and age of the affected pigs.

The portal of entry appears to be the tonsils and then macrophages may then disseminate the virus. Viral persistence may be most marked in the Peyer's patches and the thymus. This is followed by the viremia and spread to the lymph nodes.

The effects of different experimental doses and ages in experimental infections of pigs are described in a paper from Greece. The pathogenesis of these Greek viruses has been described, and in most cases there is a viremia with the lymphoid tissues containing the virus, which are probably the main source of the virus replication. Inoculation of a suspension of heart, spleen, and lymph node tissues from affected pigs can result in sudden deaths of experimental pigs within 3 days. The highest titers of the virus are found in the areas of damaged heart muscle.<sup>4</sup> Macrophages may play an important part in the virus replication and shedding. Cytokine production is also an important feature of infection (including IL-1 $\beta$ , TNF- $\alpha$ , and IL-6.<sup>5</sup> The virus can cause fetal death if the pregnant sow is infected in late pregnancy. The experimental inoculation of the virus into pregnant sows at 46 to 50 days of gestation results in transplacental infection and fetal deaths. On the other hand, experimental infections of 4- to 6-week-old conventional pigs with an American isolate produced no overt clinical disease. There may also be a seasonal occurrence in the autumn where there are more rats.<sup>6</sup>

### CLINICAL FINDINGS

Usually encephalomyocarditis is an inapparent infection. Subclinical infection is the normal event, particularly in older or adult animals, but even here, occasionally, death may occur.

Rarely is there clinical disease because most cases are seen as sudden death without clinical signs as a result of circulatory failure.

The clinical course in young and growing pigs is short and manifested by inappetence, depression, trembling, incoordination, and dyspnea. In the United States, it has been described as associated with respiratory disease. There may be cyanosis of the

extremities. Most frequently, pigs are found dead or die suddenly while feeding or when excited. Death appears to result from cardiac failure, and clinical signs referable to encephalitis are rare.

An outbreak in sows may last 2 to 3 months with continuing reproductive failure, characterized clinically by inappetence and fever, possibly to 41°C followed by farrowing at 109 to 111 days of gestation in affected sows. There are numbers of mid to term abortions. The numbers increase for stillborn piglets, mummified fetuses, and weak piglets, which are more susceptible to crushing and starvation and other common neonatal diseases. The course of the outbreak will usually last several weeks and possibly as long as 2 to 3 months with continuing reproductive failure with persistence of the virus. Animals with cardiac failure should be killed humanely because the heart damage does not resolve.

### CLINICAL PATHOLOGY

Neutralizing antibodies to the virus are present in sows and healthy in-contact pigs on affected farms. They are found 5 to 7 days after infection. In outbreaks of reproductive failure, specific antibody to the virus can be found in both fetal and neonatal sera collected from abnormal litters. The hemagglutination inhibition and agar gel immunodiffusion (AGID) tests are comparable for the detection of antibodies to encephalomyocarditis virus in fetal thoracic fluids.

A microtiter serum-neutralization test is a relatively specific and sensitive test for the diagnosis. Antibodies of 1:8 are suspicious, and titers  $\geq 16$  are positive. Serum-neutralizing antibodies persist for several months, and it is necessary to examine paired samples. A nucleic acid probe can detect the presence of the virus in infected cell lysates. Enzymes such as serum creatine kinase-MS and lactic dehydrogenase isoenzyme are also elevated.

### NECROPSY FINDINGS

Young weak-born piglets are more prone to crushing, starvation, and other neonatal disorders so an underlying encephalomyocarditis may be missed.

At necropsy, there is reddening of the skin and excess peritoneal, pleural, and pericardial fluid frequently seen with fibrinous strands and edema of the omentum and mesentery. Sometimes there is pulmonary edema and liver enlargement. Characteristically, the heart appears pale and soft and there is diffuse or focal myocardial pallor involving the ventricles and associated with myocardial necrosis. These may appear as distinct white foci or streaks from 2 to 15 mm in diameter and these are most common on the right ventricular epicardium. A strain was isolated in Quebec that can cause pneumonia.

Histologically, there is diffuse or focal myocarditis, with infiltration by histiocytes, lymphocytes, plasma cells, and degeneration



of cardiac muscle cells. The virus can be identified in the cytoplasm of cardiac muscle cells, and virus particles are also seen in the protrusions from the cell surface of the Purkinje fibers and endothelial cells of the capillaries and intranuclearly in the cardiac muscle fibers. In chronic cases these have healed in the only way possible—as fibrous plaques. In acute cases virus may be isolated from the heart muscle and also from the brain, spleen, and other tissues. Neutralizing antibody becomes detectable 5 to 7 days after infection.

The predominant histopathologic lesion in stillborn fetuses is myocarditis consisting of myocyte degeneration and necrosis with focal or diffuse mononuclear cell infiltration. In nursing piglets with the disease, histologically there are lesions of multifocal interstitial pneumonia, myocarditis, and mild multifocal nonsuppurative meningoencephalitis. The immunohistochemistry is usually positive in the nuclei of the cardiac muscle cells, Purkinje cells, the endothelial cells of the capillaries and in the macrophages.

### Samples for Confirmation

- Serologic samples for neutralizing antibodies, which is widely available and is specific or HI antibodies, may be helpful. Antibodies have been found in fetal fluids. Tests now include enzyme-linked immunosorbent assays (ELISAs), latex agglutination, and AGID.
- The virus can be isolated from stillborn pigs. It can also be demonstrated by polymerase chain reaction (PCR), reverse transcriptase (RT)-PCR, and one-step PCR. The RT-PCR can be followed by genetic typing using sequence analysis, and this is useful in molecular epidemiology. It has also been demonstrated by *in situ* hybridization.
- Histopathology on heart muscle is also useful with immunohistochemistry to follow to confirm. In the neonate, the brain histology may show a nonsuppurative meningoencephalitis, which can be confirmed by immunohistochemistry.

### Diagnosis

Diagnosis of encephalomyocarditis is from the history, clinical signs, gross and microscopic pathology, and from isolation of the virus or demonstration of the antigen by immunohistochemistry. In some cases it may be necessary to consider vitamin E deficiency (mulberry heart disease). The reproductive form of the infection may need to be differentiated from porcine parvovirus infection.

### DIFFERENTIAL DIAGNOSIS

The disease must be differentiated from bowel edema and mulberry heart disease in growing pigs and the peracute bacterial

diseases in suckling pigs. All potential causes of sudden death should be considered. The myocardial lesions in suckling pigs have similarities to those produced by foot-and-mouth disease virus in this age group of pigs (the so-called “tiger heart”).

### TREATMENT AND CONTROL

There is no treatment for encephalomyocarditis and control of the disease currently rests with rodent control and eradication in the piggery. There is now an inactivated vaccine available, which is an oil-adjuvanted vaccine developed to protect elephants. It has been shown to work in mice and pigs and is thought to produce high antibody titers in both domestic and wild animals.

### REFERENCES

1. Canelli E, et al. *Virology*. 2010;7:64.
2. Oberste MS, et al. *Emerg Infect Dis*. 2009;15:640.
3. Denis P, et al. *Vet Microbiol*. 2006;113:1.
4. Gelmetti D, et al. *Vet Res*. 2006;37:15.
5. Robinson P, et al. *Clin Exp Med*. 2006;2:76.
6. Maurice H, et al. *Vet Microbiol*. 2007;88:301.

## Cardiac Toxicities

### CARDIAC GLYCOSIDE TOXICOSIS

#### SYNOPSIS

**Etiology** Cardiac glycoside compounds (cardenolides and bufadienolides) found in specific plants and rarely in animals; primarily cardiotoxic but gastrointestinal and renal effects also occur

**Epidemiology** Highly toxic; found in most countries; all species affected; many toxic plants unpalatable; hay, plant prunings, seeds in contaminated grains and meals retain toxicity

**Clinical pathology** Significant electrocardiographic abnormalities; azotemia; hemoconcentration; two syndromes, acute heart failure and krimpsiekte (chronic, exercise intolerance, torticollis, and dysphagia)

**Lesions** Multifocal myocardial degeneration

**Diagnostic confirmation** Identification of plant and toxin

**Treatment** Activated charcoal and fluids; lidocaine, procainamide, atropine, and propranolol for specific cardiac abnormalities

**Control** Avoid pasture or stored feed containing toxic plants

### ETIOLOGY

Cardiac glycoside is the parent or group name for the compounds cardenolide and bufadienolide.<sup>1</sup> Chemically and structurally, they are an aglycone, which is related to the steroidal hormones, and contain one or more

sugar molecules.<sup>1,2</sup> Cardenolides are produced by plants, whereas bufadienolides are produced by both plants and animals. The most common cardenolide-containing plants toxic to large animals are *Asclepias* spp. (milkweed), *Digitalis purpurea* (foxglove), *Kalmia* spp. (laurel and lambkill), *Nerium* spp. (oleander), *Persea americana* (avocado), and *Rhododendron* spp. (azalea and rhododendron).<sup>1,3,4</sup> Bufadienolides present in some plants from southern Africa have a cumulative, neurotoxic effect (cotyledonosis or krimpsiekte disease),<sup>5</sup> whereas other bufadienolide-containing plants (genera *Moraea* and *Drimia*) produce more acute cardiotoxicity.<sup>6,7</sup> Toxins in toads (genus *Bufo*) have affinities with the aglycones of bufadienolides and poison dogs, but poisoning of farm animals seems unlikely.

The plant genera or specific plant species and toxins known to contain cardiac glycosides that can be associated with an acute syndrome or a chronic cumulative disease (cotyledonosis or krimpsiekte) are listed next.

### Acute Poisoning

*Acokanthera* (*Carissa*)  
*Adenium multiflorum* (impala lily)<sup>3</sup>  
*Adonis vernalis* (pheasant's eye)  
*Antiaris*  
*Apocynum*  
*Araujia*  
*Asclepias* spp. (milkweed)<sup>4</sup>  
*Bersama*  
*Bowiea*  
*Bryophyllum*  
*Calotropis*  
*Cascabela* (*Thevetia*)  
*Cerbera*  
*Cheiranthus cheiri* (wallflower)  
*Convallaria majalis* (lily of the valley)  
*Corchorus*  
*Cotyledon*  
*Cryptostegia gradiflora* (rubber vine)<sup>3</sup>  
*D. purpurea* (foxglove); *Digitalis* spp.; digitoxin, digitonin, digitalin  
*Drimia* spp. (slangkop)<sup>5</sup>  
*Diplarrhena*  
*Eranthis hyemalis* (winter aconite)  
*Euonymus europea* (spindle tree)  
*Gomphocarpus*  
*Gynandriris*  
*Haemanthus*  
*Helleborus* spp.  
*Homeria*  
*Hyacinthus*  
*Iris*  
*Kalanchoe*  
*Kalmia angustifolia* (lambkill); grayanotoxin (acetylandromedol)  
*Kalmia latifolia* (mountain laurel); grayanotoxin (acetylandromedol)  
*Lidneria*  
*Linaria*  
*Melampyrum*  
*Melianthus*  
*Moraea pallida* (yellow tulip); epoxyscillirosidine<sup>5,7</sup>

*Morgania*  
*Nerium oleander* (oleander); oleandrin<sup>3</sup>  
*Ornithogalum umbellatum*  
*Ornithoglossum*  
*Parsonia*  
*Persea americana* (avocado); persin  
*Rhododendron* spp. (azalea, rhododendron);  
 grayanotoxins  
*Scilla* spp. (squill)  
*Scrophularia*  
*Sisyrinchium*  
*Strophanthus* spp. (poison rope)<sup>3</sup>  
*Tacazzea*  
*Thevetia peruviana* (yellow oleander)<sup>3,8</sup>  
*Urginea*  
*Vinca*

### Chronic Poisoning: Cotyledonosis or Krimpsiekte

*Cotyledon*  
*Kalanchoe*<sup>5</sup>  
*Ornithogalum*  
*Tylecodon*<sup>5</sup>

### EPIDEMIOLOGY

#### Occurrence

Poisoning occurs wherever the plants grow, and local extension agents or plant experts should be consulted for specific plant information. Many other related plants, and some in other species, are associated with clinical illness similar to cardiac glycoside poisoning. The acute poisoning syndrome is seen in several parts of the world, principally in southern Africa, northern America, and in Australia, but chronic poisoning (cotyledonosis or krimpsiekte) is confined to southern Africa.<sup>3,5-7</sup>

### Risk Factors

#### Animal Factors

Cardiac glycoside-containing plants are highly toxic and only a very small amount needs to be ingested for toxicosis to occur. Morbidity rates vary with the intake,<sup>9,10</sup> case-fatality rates are very high. Cattle,<sup>11,12</sup> sheep,<sup>4</sup> and goats<sup>13-15</sup> are most often affected and llamas<sup>16</sup> and horses<sup>17</sup> less so. Wild animals appear to avoid the plants, and some are reputed not to be susceptible.

#### Plant Factors

Some of the plants are most readily eaten when they are in the flowering stage. Many are so unpalatable that they are unlikely to be eaten unless they are cut in with other plants and fed as hay or seed contaminates a crop of feed grain. Some of them, like *N. oleander* (oleander) and *Rhododendron* spp., are decorative plants, and animals gain access when they break into gardens, are fed prunings, or trees fall into their pastures.<sup>11</sup> *P. americana* (avocado) may be intentionally fed to pet animals as a treat, when herds have access to the plant, or there is an avocado tree in their pasture or turnout.<sup>13</sup> The plants do not lose their toxicity when dry. Insects and other plants that eat or parasitize plants con-

taining cardiac glycosides may contain the substances in significant amounts.

### Human Risk Factors

Humans ingesting grayanotoxin-containing honey produced by bees from the nectar of *Rhododendron* spp. have developed cardiac abnormalities, vomiting, sweating, dizziness, and impaired consciousness (mad honey disease).<sup>9</sup> Secondary intoxication of dogs or humans who eat meat from affected livestock dying from krimpsiekte disease occurs even after the meat is cooked.<sup>3,5</sup>

### PATHOGENESIS

Cardiac irregularity and insufficiency leads to acute or subacute heart failure. Cardiac glycosides are specific inhibitors of plasma membrane Na<sup>+</sup>-K<sup>+</sup>-ATPase, the cation pump responsible for maintaining cellular homeostasis. Inhibition results in decreased intracellular potassium and increased intracellular sodium concentrations and subsequent increases in intracellular calcium.<sup>2,10,18</sup> Elevated intracellular sodium concentrations inhibit the Na<sup>+</sup>/Ca<sup>2+</sup> channel exchange, increasing the force of cardiac contraction (positive inotrope) and raising the resting membrane potential.<sup>17,18</sup> Electrical conduction is altered and in the heart, vagal tone to the SA, and AV nodes is increased resulting in cardiac arrhythmias and cardiac arrest.

Cotyledonosis or krimpsiekte disease is most common in sheep and goats after prolonged exposure to *Cotyledon*, *Kalanchoe*, or *Tylecodon* and in bufadienolide-containing plants found in Southern Africa.<sup>3,7</sup> Chronic ingestion of these succulent plants (plakkies) generally results in the paraplegic syndrome known as krimpsiekte or “shrinking disease.” Mortality may reach 90%.<sup>3</sup> Horses and domestic chickens with chronic ingestion have also become ill.<sup>3</sup> Acute intoxication with signs of cardiac toxicosis may also occur, depending on the dose, specific plant, and other factors.<sup>3,7</sup>

### CLINICAL FINDINGS

#### Acute Poisoning

Clinical signs, although common to the cardiovascular system, also involve the kidneys, gastrointestinal tract, and nervous system.<sup>3,12,15,17</sup> Common signs are apathy, a tendency to stand with head bowed and abdomen tucked up, teeth grinding or groaning, cardiac arrhythmias (tachycardia or bradycardia and heart block), dyspnea, ruminal atony, bloat, diarrhea with mucoid or blood-stained feces, dehydration, and posterior paresis. Sudden death may occur, particularly during exertion. Poisoning by *Homeria* spp. in some parts of southern Africa only results in constipation rather than diarrhea. Additional signs include hypersalivation, tenesmus, dribbling urine, muscular tremors, dilated pupils, and seizures. Pigs are likely to vomit.

### Chronic Poisoning

Cotyledonosis or krimpsiekte in small ruminants is characterized by animals lagging behind the flock, tiring easily, walking with the head loosely dangling and then lying down, and usually with the head and neck stretched flat along the ground.<sup>3,5</sup> Many assume a characteristic posture with the feet gathered together beneath the body, the back arched, the head down, and the neck sometimes twisted toward one side. This torticollis can persist for months or years. Signs are aggravated by exertion; hyperesthesia, trembling, and tetanic spasms may also occur. Additional signs include drooping of the lower jaw, drooling of saliva, paralysis and protrusion of the tongue, and dysphagia with accumulation of half-masticated feed at the back of the mouth. Horses have pronounced torticollis and hyperesthesia and may show signs of colic or be paralyzed.

### CLINICAL PATHOLOGY

Acute poisoning of sheep by *H. pallida* produces progressive hemoconcentration; hyperkalemia; hypochloremia; progressive hyperglycemia associated with rises in catecholamines, cortisol, and lactate; and progressive increases in plasma creatinine concentration, plasma  $\alpha$ -hydroxybutyrate dehydrogenase, and LDH activities. Acute poisoning of cattle by *Bryophyllum* spp. also produces hemoconcentration, progressive hyperglycemia, glycosuria, and progressive increases in plasma urea and creatinine concentrations.

Electrocardiographs may show significant changes in the ECG of affected animals indicating the presence of ventricular fibrillation and ectopic foci in the myocardium.<sup>15</sup> Reported ECG effects include bradycardia or tachycardia, prolonged PR interval, depressed or elevated ST segment, and increased amplitude and inverted T wave. The QRS complex may widen from delayed AV conduction. Other effects include AV dissociation, varying degrees of heart block, evidence of ectopic foci, and runs of ventricular tachycardia.<sup>19</sup>

Elevations of cTnI, a biomarker for cardiac disease, have been evaluated in a limited number of horses with oleander toxicosis. Of seven horses sampled, five had cTnI serum concentrations over the normal reference range, and two were within the reference range.<sup>17</sup>

Because of the sudden death in many cases, pieces of the toxic plant can often be identified in the stomach or rumen contents by botanical characteristics. In digitalis poisoning, digitoxin may be assayed in the ruminal contents.

### NECROPSY FINDINGS

In acute poisoning, mild-to-severe multifocal myocardial degeneration and necrosis is often present if the patient survives for more than 12 hours. Subendocardial and subepicardial hemorrhages and hemorrhages into

the mucosa and lumen of the large intestine are common in acute cases. Atelectasis of lung lobules is common, and pulmonary congestion and edema secondary to cardiac failure may be seen. Fragments of the plants responsible for poisoning may be recognized in stomach contents. Nephrosis has been seen occasionally. Hemorrhages of the rumen wall and necrosis and ulceration of the omasal leaves have been seen in animals affected for several days. Evidence of hepatic insufficiency, including jaundice, is present in some poisonings, but its pathogenesis is unclear.

Toxins may be detected in the rumen or stomach contents using chromatographic/mass spectrometry techniques.

### DIFFERENTIAL DIAGNOSIS

The diagnosis depends on the detection of one of the toxic plants, either in the pasture or in conserved roughage, in the environment of animals showing characteristic clinical signs, or sudden death. Diagnosis confirmation is established by identification of the plant, cardiac glycoside, or both in ingesta in association with myocardial lesions.

#### Differential diagnosis list:

- Colic (torsion, etc.)
- Cyanide toxicosis
- Fluoroacetate toxicosis
- Gossypol toxicosis
- Heavy metal toxicosis (arsenic and lead)
- Ionophore (carboxylic) toxicosis
- Lightning/electrocution
- Myocarditis/endocarditis
- Plant poisonings: *Albizia tanganyicensis*, *A. versicolor*, *Fadogia homblei* (*F. monticola*), *Galenia africana*, *Ornithoglossum viride*, *Pachystigma* spp., *Pavetta* spp., *Taxus* spp., and *Urechites lutea*

### TREATMENT

#### Primary Treatment

Removal of animals from the suspect pasture or changing the source of conserved roughage is usually obligatory. Activated charcoal is effective in adsorbing oleander toxins; clay smectite is less effective.<sup>20</sup>

#### Supportive Treatment

IV or oral fluid replacement therapy is recommended for rehydration and correcting azotemia. Parenteral antiarrhythmic drug therapy (lidocaine and procainamide), atropine for heart block, and propranolol for tachycardia have been used with varying degrees of success.<sup>17,19</sup> Digoxin-specific antibody fragments have been used successfully in humans as an antidote for yellow oleander poisoning and anecdotally in animal species for several cardiac glycoside plant toxicoses.<sup>8</sup> Their cost may preclude the use in large animals. The recovery rate declines sharply with the lapse of time between ingestion of the plant and treatment. The presence of cardiac arrhythmias is associated with non-survival in horses poisoned with oleander.<sup>17</sup>

### CONTROL

Animals should be kept off contaminated pastures and access strictly enforced. Prunings from shrubs and trees should not be fed to animals or thrown into their pastures or drylots. Trees or branches falling in the pasture should be removed. Experimental vaccination for krimpsiekte disease has been successful in a limited number of sheep.<sup>5</sup>

### FURTHER READING

FDA poisonous plant database. At: <<http://www.accessdata.fda.gov/scripts/planttox/index>>; Accessed 10.11.13.

Poppenga RA. Poisonous Plants. In: Luch H, ed. *Molecular, Clinical and Environmental Toxicology*. Vol. 2. Zurich, Switzerland: B Verlag; 2010:123-175.

Radostits O, et al. Cardiac glycoside poisoning. *Veterinary medicine: A textbook of the disease of cattle, horses, sheep, goats and pigs*. 10th ed. London: W.B. Saunders; 2007:1862.

### REFERENCES

1. Agrawal A, et al. *New Phytol*. 2012;194:28.
2. Kumar A, et al. *Pharmacog Rev*. 2013;7:131.
3. Botha CJ, et al. *J Ethnopharmacol*. 2008;119:549.
4. Botha CJ, et al. *Onderstepoort J Vet Res*. 2007;74:307.
5. Nicholson S. *Vet Clin North Am Food Anim Pract*. 2011;27:447.
6. Kellerman TS. *Onderstepoort J Vet Res*. 2009;76:19.
7. Botha CJ. *Onderstepoort J Vet Res*. 2013;80:543.
8. <<http://ojvr.org/index.php/ojvr/article/view/543/849>>; Accessed 10.11.13.
9. Rajapakse S. *Clin Toxicol (Phila)*. 2009;47:206.
10. Jansen S, et al. *Cardiovasc Toxicol*. 2012;12:208.
11. Wink M. *Julius-Kühn-Archiv*. 2010;421:93.
12. Ozdemir O, et al. *Euras J Vet Sci*. 2011;27:73.
13. Soto-Blanco B, et al. *Trop Anim Health Prod*. 2006;38:451.
14. Poppenga RH, et al. *Proc Am Assoc Vet Lab Diagn*. 2010;35.
15. Barbosa RR, et al. *Res Vet Sci*. 2008;85:279.
16. Aslani MR, et al. *Iran J Vet Res*. 2007;8:58.
17. Kozikowski D, et al. *J Am Vet Med Assoc*. 2009;235:305.
18. Renier A, et al. *J Am Vet Med Assoc*. 2013;242:540.
19. Bandara V, et al. *Toxicol*. 2010;56:273.
20. Ozmaie S, et al. *Adv Environ Biol*. 2011;5:1401.

### YEW (*Taxus* spp.) TOXICOSIS

#### SYNOPSIS

**Etiology** Taxine alkaloids (primarily taxines A and B) found in yew plants (*Taxus* spp.)

**Epidemiology** Worldwide distribution; all species affected with horses most sensitive

**Clinical pathology** Sudden death is the normal outcome; bradycardia, arrhythmias, ataxia, dyspnea, and seizures in sublethal ingestions

**Lesions** No gross lesions; histopathology lesions associated with cardiac myocyte necrosis in some cases

**Diagnostic confirmation** History of ingestion, plant pieces in stomach or rumen, gas chromatography/mass spectrometry or liquid chromatography/mass spectrometry confirmation in body fluids and ingesta

**Treatment** No antidote; decontamination with activated charcoal and mineral oil in monogastrics; rumenotomy in ruminants

**Control** Keep plant and pieces (living and dead) away from animals; do not feed or throw clippings into pasture or drylot

### ETIOLOGY

Yews (*Taxus* spp.) are ornamental plants commonly used for landscaping in North America, Europe, and other parts of the world. The Japanese yew (*T. cuspidata*), English yew (*T. baccata*), American yew (*T. canadensis*), Hicks yew (*Taxus media*), and Pacific yew (*T. brevifolia*) are common species associated with poisoning in animals.<sup>1,2</sup> All parts of the plant except the bright red berry (aril) are poisonous; the seed within the berry is poisonous. Yews contain at least 10 taxine alkaloids with taxine A and taxine B the most widely recognized as cardiotoxins.<sup>1</sup> Taxine B is the most potent of the taxine alkaloids.<sup>2,3</sup> The Japanese yew (*T. cuspidata*) and English yew (*T. baccata*) contain the largest amounts of taxine alkaloids and the Pacific yew (*T. brevifolia*) contains the least.<sup>2</sup>

### EPIDEMIOLOGY

#### Occurrence

All species of animals as well as humans are susceptible to toxicosis from taxines present in yew plants. Most clinical cases of poisoning are accidental and occur from animals fed yew clippings or having access to them.

#### Risk Factors

##### Animal Risk Factors

Horses are the most sensitive to yew toxicosis with only 0.2 to 0.4 g yew leaves per kilogram BW required to reach a minimum toxicity (LD<sub>min</sub>).<sup>1,2</sup> They are closely followed by pigs (0.7 g yew leaves per kilogram BW), cows (2 g yew leaves per kilogram BW), sheep (2.5 g yew leaves per kilogram BW), and goats (12 g yew leaves per kilogram BW).<sup>1,2</sup> White tail deer and roe deer in the United States appear to be insensitive to the taxines present in *T. baccata*.<sup>4,5</sup> Animals with hepatic disease may be at a higher risk of toxicosis as taxines are metabolized in the liver.<sup>2</sup>

##### Environmental Risk Factors

The presence of yew plants in the animals' environment, either alive or dead, is a high-risk factor. During the holiday season, yew cuttings may be incorporated into wreaths or swags; horses have been accidentally poisoned when these were used to decorate stalls, boxes, or fence lines. The incidence of poisoning may be higher in the winter when there is no other green plant material for animals to eat.<sup>1</sup>

##### Transmission

Taxines A and B are present in clippings and dried plants and poisonous when ingested by animals.<sup>1,2</sup>



## PATHOGENESIS

Taxine alkaloids are absorbed orally, distributed to most body tissues except the central nervous system and testes, metabolized by hepatic P450 enzymes, and excreted at least to some extent in the bile.<sup>1,2</sup> Elimination in the milk has not been reported, but discarding milk is recommended.<sup>1</sup>

Taxine alkaloids are calcium channel antagonists acting on the cardiac myocytes.<sup>1,2,6</sup> There are differences in the cardiotoxicity of the alkaloids, and taxine B is much more cardiotoxic than taxine A.<sup>2</sup> Taxine B intoxication results in chronotropic effects (decreased heart rate) and changes in AV conduction (increased AV conduction time; widening of QRS interval).<sup>1,2</sup> Taxine A has minimal effects on heart rate, AV conduction time, or QRS interval.<sup>2</sup>

## CLINICAL FINDINGS

Most animals are found dead or die within hours of ingesting a lethal amount.<sup>1,2,6,7</sup> Bradycardia, dyspnea, ataxia, anxiety or depression, muscle tremors, collapse, and death have been reported in sublethal ingestions.<sup>1,2,6</sup> Vomiting, abortion, and seizures have also occurred.<sup>1</sup> Electrocardiographic changes include bradycardia, increased QRS interval, and arrhythmias, and cardiac arrest.<sup>1,2,6</sup> Ruminants surviving for 3 days postingestion have a good prognosis for recovery.<sup>1</sup>

## NECROPSY FINDINGS

Generally there are no gross lesions because sudden death is the normal outcome. Pieces of yew plant are often present in the mouth, stomach or rumen, or intestinal tract. Ecchymotic hemorrhages were noted in a horse dying of yew poisoning; microscopic multifocal myocardial necrosis of the ventricle wall and papillary muscles was present.<sup>2</sup> Histopathologic lesions in a group of calves dying from ingestion of Japanese yew leaves included multifocal cardiac myocyte eosinophilia, sarcolemma fragmentation, pyknosis, karyolysis, myocyte loss, and mild interstitial lymphocyte infiltrates with edema.<sup>6</sup> Fibrous connective tissue encompassing large areas of the myocardium were present in a calf with chronic yew toxicity.<sup>8</sup>

### DIFFERENTIAL DIAGNOSIS

The diagnosis is generally made by recognition of the plant, history of ingestion, and the presence of plant pieces in the gastrointestinal tract. Gas chromatography/mass spectrometry and liquid chromatography/mass spectrometry have been used successfully in several cases.<sup>9,10</sup> In mammals, 3,5-dimethoxyphenol has been detected in blood, urine, bile, and gastric contents and appears to be a marker for yew toxicosis.<sup>9,11</sup>

### Differential diagnosis list:

- Anthrax
- Cardiac glycoside-containing plants (oleander, rhododendron, foxglove, milkweeds, and laurel) toxicosis.
- Colic (torsion, etc.)
- Cyanide toxicosis
- Fluoroacetate toxicosis
- Heavy metal toxicosis (arsenic and lead)
- Ionophore (carboxylic) toxicosis
- Lightning strike/electrocution
- Myocarditis/endocarditis

## TREATMENT

There is no antidote and no specific treatment is generally provided as sudden death is the normal outcome. Absorption and removal should be minimized with the use of activated charcoal and a cathartic such as mineral oil or magnesium sulfate in monogastric animals and a rumenotomy and activated charcoal in ruminants.<sup>1,2</sup> Atropine and antiarrhythmic agents, including lidocaine, have been used in animals but were found to be ineffective in human cases.<sup>2</sup>

## CONTROL

Yew plants should not be planted in or around pastures, and clippings should be disposed of far away from animal enclosures. Care should be taken when plants are burned because calves have died from ingesting burned leaves.<sup>6</sup> Taxines degrade during composting, but it takes several months of extremely high temperatures for this to occur.<sup>12</sup>

## FURTHER READING

- Tiwary AK, Puschner B, Kinde H, et al. Diagnosis of *Taxus* (yew) poisoning in a horse. *J Vet Diagn Invest.* 2005;17:252-255.
- Wilson CR, Sauer JM, Hooser SB. Taxines: A review of the mechanism and toxicity of yew (*Taxus* spp.) alkaloids. *Toxicol.* 2001;39:175-185.

## REFERENCES

1. Bischoff K, et al. *Vet Clin North Am Food Anima Pract.* 2011;27:472.
2. Wilson CR, Hooser SB. Toxicity of yew (*Taxus* spp.) alkaloids. In: Gupta RC, ed. *Veterinary Toxicology. Basic and Clinical Principles.* 2nd ed. San Diego, CA: Elsevier; 2012:1121.
3. Andersen KB, et al. *Eur J Wildl Res.* 2010;56:915.
4. Angus KW. *Vet Rec.* 2010;166:216.
5. Scott WA. *Vet Rec.* 2010;166:246.
6. Sula MJM, et al. *J Vet Diagn Invest.* 2013;4:522.
7. Handeland K. *Toxicol.* 2008;52:829.
8. Burcham GN, et al. *J Vet Diagn Invest.* 2013;25:147.
9. Frolid R, et al. *J Anal Toxicol.* 2010;34:53.
10. Frommherz L, et al. *Int J Legal Med.* 2006;120:346.
11. Varlet V, et al. *Drug Test Anal.* 2012;5:474.
12. Hough RL, et al. *Sci Total Environ.* 2010;408:4128.

## MONOFLUOROACETATE PLANT TOXICOSIS

Plants containing toxic amounts of fluoroacetate include the following:

*Acacia georginae* (Georgina gidgee; Australia)<sup>1</sup>

*Amorimia* spp. (old *Mascagnia* spp.; South America)<sup>1,2</sup>

*Arrabidaea bilabiata* (South America)<sup>3</sup>

*Chaillietia toxicaria*

*Dichapetalum* spp. (Africa)<sup>1</sup>

*Gastrolobium* spp. (poison peas; Australia)<sup>1,4</sup>

*Oxylobium parviflorum* (Australia)<sup>1</sup>

*Palicourea maracgravii* (South America)<sup>3</sup>

*Spondianthus preussi* (Africa)

Monofluoroacetate or sodium fluoroacetate occurs naturally in more than 40 plants native to Australia, Brazil, and Africa. Fluoroacetate in the body is converted to fluorocitrate, which inhibits the enzymes aconitase and succinate dehydrogenase in the tricarboxylic acid cycle (Krebs cycle) leading to the accumulation of significant amounts of citrate in tissues and to irreversible cardiac damage.<sup>3</sup> Native herbivorous mammals in southwestern Australia have evolved a high level of genetic tolerance to this toxin, and this has been used as a genetic marker to trace the evolutionary history of some of the continent's indigenous marsupials.

The general syndrome appears about 12 hours after the toxic plant is ingested and includes sudden death without other signs or a syndrome of hypersensitivity, frenzy, dyspnea, cyanosis, tachycardia with rates up to 300 beats/min, cardiac arrhythmias, ataxia, recumbency, and convulsions. Minor signs include moderate bloat, appearance of signs when animals are driven, and frequent micturition. Death may follow in a few minutes to several hours. Necropsy lesions include myocardial necrosis, pulmonary congestion and edema, and generalized venous congestion.

In northern inland Australia, poisoning by *Acacia georginae* has been associated with heavy mortalities in cattle and sheep and has seriously reduced the productivity of large areas of grazing land. The fluoroacetate ion is concentrated in the young leaves and seed pods. At necropsy, there is congestion of the alimentary mucosa, flabbiness of the myocardium, and multiple subendocardial and subepicardial hemorrhages. There may be edema and congestion of the lungs. *Gastrolobium* spp. (42 species known or suspected to be toxic) are also sources of poisoning in Australia, mostly in the southwest, and *Palicourea* and *Anorimia* are responsible for many outbreaks in South America. Twelve species of *Dichapetalum*, e.g., *D. cymosum* (Gifblaar), *D. ruhlandii*, and *D. barteri*, are poisonous shrubs in Africa but are also found generally in the tropics. Their fresh green leaves contain fluoroacetate. Acetamide (2 g/kg) given experimentally soon after the ingestion of *Dichapetalum* spp. appears to have helped animals against the poison.

## REFERENCES

1. Lee ST, et al. *Toxicol.* 2012;60:791.
2. Duarte ALL, et al. *J Appl Toxicol.* 2014;34:220.
3. Camboim EKA, et al. *ScientificWorldJournal.* 2012;178254.
4. Twigg L. *Pac Con Biol.* 2011;17:299.

## 4-METHOXYPYRIDONE PLANT TOXICOSIS

4-Methoxypyridone, a pyridoxine analog found in *Albizia* spp. (*A. versicolor*, fever tree) and *Albizia tanganyicensis* [paperbark albizia]), especially in the dried pods is a cardiotoxin.<sup>1</sup> Clinical signs in cattle include hypersensitivity, hyperthermia, dyspnea, ataxia, and tetanic convulsions with rapid blinking and nystagmus. Most cases recover spontaneously.

Cardiomyopathy is the diagnostic necropsy finding. Lesions also include petechiation in many tissues, pulmonary edema, and degenerative changes in the myocardium and other organs and in some cases the brain.

Pyridoxine is a satisfactory antidote, even if signs have already appeared.

### REFERENCE

- Botha CJ, et al. *J Ethnopharmacol.* 2008;119:549.

## PLANTS CAUSING HEART FAILURE (UNIDENTIFIED TOXINS)

Several plants with unidentified toxins are associated with heart failure in large animals, and either cause congestive heart failure and cardiomyopathy and/or sudden death. These plants are listed below.

- Heart failure with sudden death or congestive failure and cardiomyopathy
  - Atalaya hemiglauca* (whitewood)
  - Galenia africana*
  - Phalaris coeruleascens* (blue canary grass)
  - Phalaris paradoxa*
  - Tanaecium exitiosum*
  - Tetrapteris* spp.
  - Urechites lutea*
- The following contribute to the African syndrome of gousiekte ("quick sickness"); the toxin may be a polyamine, purified and identified as pavetamine.<sup>1</sup>
  - Fadogia homblei*
  - Pachystigma latifolium*
  - P. pygmaeum*
  - P. thamnus*
  - Pavetta harborii*
  - P. schumanniana*

### REFERENCE

- Botha CJ, et al. *J Ethnopharmacol.* 2008;119:549.

## IONOPHORE (CARBOXYLIC) TOXICOSIS

### SYNOPSIS

**Etiology** Carboxylic ionophores used commercially as coccidiostats and growth promotants are associated with poisoning if dose rate is excessive, mixing error occurred, or animals have accidental exposure.

**Epidemiology** Worldwide, all species with access to ionophores.

**Pathogenesis** Striated muscle damage leading to acute heart failure or limb weakness and paralysis.

**Clinical pathology** Elevated serum cardiac troponin I, creatine kinase, aspartate transaminase, lactate dehydrogenase, alkaline phosphatase, and myoglobinuria.

**Lesions** Myonecrosis with hemorrhages or pale areas in heart and skeletal muscles; pulmonary edema, ascites, hydrothorax; no lesions in acute deaths.

**Diagnostic confirmation** Assay of stomach contents and representative feed samples for the ionophore; serum ionophore assays are of little benefit.

**Treatment** No primary treatment recommended.

**Control** Prevent accidental access; avoid overdosing; practice good feed manufacturing and mixing on the farm; adhere to species-specific limitations.

### ETIOLOGY

Carboxylic ionophores are used as polyether antibiotics for the control of coccidiosis in poultry and to promote growth and/or increase feed efficiency in ruminants.<sup>1,2</sup> Currently, there are seven carboxylic ionophores approved for veterinary use: monensin, lasalocid, salinomycin, narasin, maduramicin, laidlomycin, and semduramicin. Of these, monensin, lasalocid, and salinomycin are used in ruminant production; monensin is the most widely studied of the three.<sup>2,3</sup> In addition to labeled use and effects, monensin has shown to be beneficial in the treatment of acetonemia, lactic acidosis, bloat, and atypical interstitial pneumonia.<sup>4</sup> The pharmacologic effects of ionophores are similar, but they differ chemically and have differing toxicities. Used properly the compounds are effective, but the margin of safety is small and careless use has been associated with major losses.

The recommended dose of monensin varies depending on the age and size of the livestock and the purpose for which it is administered. The manufacturer's recommendations should be adhered to strictly. Approximate recommended levels, orally and usually in the feed, are cattle, 50 to 200 mg per head per day, 16.5 to 33 parts per million (ppm) and sheep 5 to 10 ppm in feed.

For monensin, dosage levels at which clinical signs of poisoning can be expected to occur are cattle 10 mg/kg BW, sheep 4 mg/kg BW, swine 7.5 mg/kg BW, and horse 1 mg/kg BW. The comparative LD<sub>50</sub>s are cattle 26.4 mg/kg BW, sheep 11.9 mg/kg BW, swine 16.7 mg/kg BW, goat 24 mg/kg BW, and horse 2 to 3 mg/kg BW.<sup>2,3</sup> It is common for cattle to be poisoned with more than 10 times the recommended dose. Toxic feed concentrations for

pigs are 200 to 220 mg/kg of feed. For lasalocid, the reported lethal dose in horses is 21.5 mg/kg BW,<sup>3</sup> in cattle it is 50 to 100 mg/kg BW, and in swine it is 58 mg/kg BW. The LD<sub>50</sub> for salinomycin for the horse is 0.6 mg/kg BW. The effects of the compounds are cumulative and may not be observed for some weeks after administration is discontinued.

### EPIDEMIOLOGY

#### Occurrence

All animal species are affected by ionophore toxicosis. Horses are the most sensitive to it, but deaths have been reported in cattle, sheep, goats, pigs, camels,<sup>5</sup> water buffalo,<sup>6</sup> and other species. Poisoning incidents are most often reported in countries where animal husbandry is intensive and high levels of stall feeding are practiced.

### Risk Factors

#### Animal Risk Factors

These compounds are specifically prohibited for use in horses at any time because of their toxicity for that species. Horses are often poisoned by ingesting premixes meant specifically for cattle. If the level of ingestion is low enough, no harm is done, but most commonly horses eat more than the no effect level and become symptomatic.

Cattle carrying reticular retention boluses of monensin to control bloat by delivering accurate daily doses of the drug may die suddenly of acute heart failure caused by cardiomyopathy, a condition associated with monensin. The compound's main use as a coccidiostat is in poultry, and deaths from congestive heart failure have occurred in cattle and sheep fed dried poultry litter from farms feeding salinomycin or maduramicin.

Along with these major involvements of monensin and lasalocid there are a number of less well-known ones. There is a risk that cattle fed on a nitrogen-rich diet will be likely to suffer an outbreak of nitrite poisoning if they are also fed monensin. Another undesirable outcome may be a fall in butterfat because of shift from acetate to propionate production in the rumen.

The concurrent administration of monensin and selenium to lambs enhances the toxicity of the selenium. Continuous feeding of monensin to male pigs (50 ppm for 52 days) reduces blood levels of testosterone and is associated with dystrophy of seminiferous tubules and reduced sperm counts.

The concurrent administration of monensin or salinomycin and tiamulin, chloramphenicol, triacetyloleandomycin, or other macrolide antibiotics at recommended doses can be associated with ionophore poisoning in pigs.<sup>2</sup> Outbreaks may occur when the product is introduced into the pigs' drug regimen to control swine dysentery when the pigs' ration already includes the ionophore as a growth promotant, or when the two drugs are combined as a coccidia prevention package.

### Swine Risk Factor (Tiamulin)

The myotoxicity of monensin for pigs is enhanced by the simultaneous administration of the two antibiotics (monensin or salinomycin and tiamulin). All three of the substances are used as coccidiostats, and it is not unusual for farmers to combine them. However, all of the agents use the same detoxification pathways in the liver with tiamulin having the priority. Tiamulin inhibits mitochondrial CYP3A enzymes that stimulate monensin metabolism, allowing accumulation of monensin.<sup>7</sup> Monensin (or salinomycin) accumulates to the point of being toxic. The clinical syndrome consists of anorexia and weight loss, and at necropsy there are lesions of myonecrosis in the tongue, diaphragm, and limbs. A similar toxicologic situation arises in pigs with simultaneous dosing with tiamulin and salinomycin in which the toxic interaction is dose related.

When tiamulin is used at therapeutic levels in feed, water, or by injection and salinomycin is used at 60 ppm, toxic reactions and deaths occur. The interaction does not occur when the two antibiotics are used concurrently and the tiamulin is used at the recommended prophylactic (30–40 ppm) or growth promotant (11 ppm) levels, and independently of whether the administration is oral or by injection, but only if a gap of 72 hours has elapsed between the last exposure to salinomycin and the first exposure to therapeutic levels of tiamulin and vice versa.

### Farm Risk Factors

The poisonous properties of these agents are well known, and poisoning is usually accidental because of failure to dilute a concentrate, poor mixing, or wrong identification of containers and feedbags. Some liquid preparations settle out and need to be constantly mixed before and during mixing with a batch of feed. Deliberate or accidental off-label use in nontarget species such as horses, camels, and water buffalo has resulted in poisoning.

### PATHOGENESIS

All of the compounds are cationic agents, causing an altered balance of cations (especially  $\text{Ca}^{2+}$ ,  $\text{Na}^+$ , and  $\text{K}^+$ ) in cells and organelles.<sup>2,3</sup> The net result is a disruption of ATP generation, cellular dysfunction, and cellular death. Monensin is rapidly absorbed, metabolized in the liver, and excreted in the bile and feces.<sup>2</sup> Other ionophores appear to follow a similar pharmacokinetic pathway. Horses have less efficient cytochrome P450 demethylating enzymes and do not appear to remove monensin from systemic circulation as rapidly as other species; this may be the reason they are more susceptible to toxicosis.

The principal target organ for monensin toxicity is striated muscle (cardiac and skeletal).<sup>2,3</sup> The exact mechanism of action is

unknown, but it appears the origin of muscle damage is related to large cellular influxes of calcium and sodium resulting in degeneration and necrosis of muscle cells. In cattle the cardiac and skeletal muscles are affected about equally, in sheep and pigs the skeletal muscle is most seriously affected, and in horses the myocardium is the focus of the damage. In the latter case, acute or congestive heart failure may result, with signs often delayed for weeks until additional stress, such as late pregnancy or parturition, precipitates cardiac insufficiency. When the damage is principally skeletal muscle, the syndrome is one of weakness, ataxia, and recumbency; myoglobinuria is a common accompaniment.

In addition to myocardial degeneration, lasalocid toxicity in horses has been associated with neurotoxicity with focal axonal degeneration and myelin sheath swelling present at postmortem.<sup>3</sup>

### CLINICAL SIGNS

The most consistent and frequently reported clinical sign in all species is anorexia.<sup>2</sup> The incidence of other signs varies among species but commonly include diarrhea, dyspnea, depression, weakness, ataxia, recumbency, and death.

#### Cattle

The onset of signs begins in 24 hours with heavy doses but may be delayed for up to 5 days when the ingestion is lower. Signs begin with anorexia followed by diarrhea, tremors, weakness, tachycardia, and ruminal atony, and animals may die at this stage from acute heart failure.<sup>2</sup> Those that survive for a day or two develop congestive heart failure manifested by brisket edema, engorgement of the jugular veins, ascites, fluid feces, dyspnea, and tachycardia.<sup>8</sup> Deaths may occur in days or months after the major outbreak<sup>4</sup> and are usually caused by the exertion of calving. When smaller doses are taken over a long period, the syndrome is one of congestive heart failure in all of the cases.

#### Sheep

The syndrome may be acute followed by hyperesthesia; tremors, especially of the head; disappearance of the pupillary light reflex; recumbency; and convulsions with death occurring during a convulsion. More commonly the disease begins with anorexia, diarrhea, rumen stasis, and depression, followed by muscle weakness, stilted gait, and recumbency.<sup>9</sup> Chronic cases show atrophy of the muscles of the hindquarters and a stiff gait.

#### Swine

Monensin poisoning is associated with dyspnea, anorexia, ataxia, paresis, myoglobinuria and cyanosis, diarrhea, tympany, and pruritus. Death follows in about 6 hours. Salinomycin is associated with the same general syndrome but also includes an

unwillingness to stand and, when forced to stand, tremors, especially in the hindlimbs; swaying; fetlock knuckling; and abrupt lying down. Exercise exacerbates the signs. Respiratory distress in the form of irregular breathing occurs. Feed intake is down 50%, and sham drinking is characteristic. Red urine is evident for up to 5 days after discontinuation of the drug.

#### Horses

Anorexia is the most consistently reported sign. Restlessness, respiratory distress, diarrhea, mucosal congestion, profuse sweating, sometimes myoglobinuria, cardiac dysrhythmias, and tachycardia (50–60 beats/min) have been reported but may depend of the specific ionophore ingested.<sup>3,10,11</sup> Some horses are just found dead. The course of the cardiac disease is short and affected horses may not show much clinical evidence of heart failure at the time of the poisoning, but survivors may develop a poor performance syndrome or congestive heart failure up to several months later.

Rarely, horses show skeletal muscle involvement with fever, red or dark urine (caused by the extensive muscle breakdown), difficulty in rising, stiff gait, knuckling of the fetlocks, and final recumbency after a period of days to as long as several months. Colic is also recorded during the acute phase but this may be the restlessness and frequent lying down and getting up of acute myositis. Euthanasia is the usual outcome of these cases because of irreparable muscle damage.

### CLINICAL PATHOLOGY

In all species, laboratory tests show increases in serum levels of creatine phosphokinase, LDH, alkaline phosphatase, and aspartate aminotransferase; myoglobinuria is frequent and often prolonged.<sup>2,4,5,9,12</sup> However, results of clinical pathology tests may vary substantially among individual affected animals. Samples of feed and stomach contents, obtained by stomach tube, are desirable specimens for analysis. Some feeds fed to horses have contained as much as 125 to 250 g/ton of feed, and their stomach contents have contained 50 to 100 ppm.

Evaluation of the cardiovascular system in animals poisoned by ionophores is important, often challenging, and necessary for long-term prognosis.<sup>13</sup> ECGs and ultrasound evaluation of cardiac function in animals are useful for evaluating early myocardial disease but may not be helpful long term.<sup>3,13</sup> Doppler imaging and two-dimensional speckle tracking may more accurately evaluate left ventricular function on a chronic basis.<sup>14</sup> The cTnI, a biomarker for myocardial injury in humans, has been used to diagnose cardiac disease in horses, cattle, and sheep<sup>15–18</sup> and may be a valuable, noninvasive tool to assess and monitor the extent of myocardial damage from ionophore intoxication.<sup>19</sup>



Human point of care cTnI analyzers have been used to measure serum and plasma cTnI concentrations in normal horses and cattle<sup>15,20</sup> and monensin-intoxicated horses.<sup>15</sup>

## NECROPSY FINDINGS

In cattle there is cardiomyopathy, pulmonary edema, enlargement of the liver and heart, hydropericardium, hydrothorax, and ascites. Gross lesions at necropsy are not always evident, and multiple samples of susceptible tissues should be collected and preserved in formalin for microscopic evaluation.

In sheep postmortem changes include necrosis in both skeletal and cardiac muscles with hydrothorax, hemopericardium, pulmonary edema, and petechial hemorrhage in heart base fat.<sup>21</sup> Other findings include pale kidneys and a swollen, yellow liver. Lambs less than 1 month old show only gastrointestinal hemorrhage.

In horses necropsy lesions in acute cases include myocardial necrosis, pulmonary congestion, hepatic swelling, and in some cases pulmonary petechiation. Skeletal muscle necrosis may be evident. Myoglobinuric nephrosis and myoglobinuria are secondary lesions. Chronic cases show marked cardiac myopathy and possibly skeletal myopathy with obvious fibrosis.

## DIFFERENTIAL DIAGNOSIS

In all species syndromes of acute or congestive heart failure caused by acute cardiac myopathy or limb paresis or recumbency caused by skeletal myopathy are sufficiently common to necessitate a positive assay for one of the ionophores in the feed or stomach contents for diagnostic confirmation. Liquid chromatography/mass spectrometry analysis is currently available for monensin, lasalocid, salinomycin, and narasin.<sup>22</sup>

### Differential diagnosis list:

#### Cattle

- Coingestion of other ionophores
- Infectious diseases, bovine rhinotracheitis, and shipping fever complex
- Nutritional deficiency of vitamin E or selenium
- Poisonous plants: cardiac glycosides (*Nerium oleander*, others), *Taxus* spp. (yew), *Karwinskia humboldtiana* (coyote plant), *Cassia occidentalis* (coffee senna), *Vicia villosa* (hairy vetch), and *Eupatorium rugosum* (white snake root)

#### Pigs

- Coingestion of other ionophores
- Gossypol poisoning
- Nutritional deficiency of vitamin E or selenium
- Poisonous plants: cardiac glycosides (*Nerium oleander*, others), *Taxus* spp. (yew), *Karwinskia humboldtiana* (coyote plant), *Cassia occidentalis* (coffee senna), *Vicia villosa* (hairy vetch), and *Eupatorium rugosum* (white snake root)
- Porcine stress syndrome

## Horses

- $\beta$ -Agonist toxicosis (clenbuterol, ractopamine, and zilpaterol)
- Exertional rhabdomyolysis
- Hyperkalemic periodic paralysis
- Poisonous plants: cardiac glycosides (*Nerium oleander*, others), *Taxus* spp. (yew), *Karwinskia humboldtiana* (coyote plant), *Cassia occidentalis* (coffee senna), *Vicia villosa* (hairy vetch), and *Eupatorium rugosum* (white snake root)
- Seasonal pasture myopathy/atypical pasture myopathy

## TREATMENT

There is no effective primary treatment and only supportive procedures are recommended. Selenium and vitamin E are ineffective after signs begin, although selenium or vitamin E given before the appearance of clinical signs may be beneficial. Activated charcoal or mineral oil are standard treatments aimed at removing the residue of the poison from the alimentary tract. They are of no value if the poison has already been absorbed; recovery is unlikely once the myocardium is affected.

## CONTROL

Horses are very susceptible to poisoning by these products and great care is needed to ensure that cattle rations containing them are not available to horses. Care should be paid that animals are not overdosed and multiple ionophores not used indiscriminately. Good feed manufacturing and mixing techniques should be followed at the mill and on the farm.

## FURTHER READING

- Miller DJ, et al. Tiamulin/salinomycin interactions in pigs. *Vet Rec.* 1986;20-415-8.
- Radostits O, et al. Ionophore poisoning. *Veterinary medicine: A Textbook of the Disease of Cattle, Horses, Sheep, Goats and Pigs.* 10th ed. London: W.B. Saunders; 2007:1844.

## REFERENCES

1. Hughes KJ, et al. *Equine Vet J.* 2009;41:47.
2. Roder JD. *Vet Clin North Am Food Anim Pract.* 2011;27:305.
3. Decloedt A, et al. *J Vet Intern Med.* 2012;26:1005.
4. Omidi A, et al. *Can Vet J.* 2010;51:1143.
5. Rozza DB, et al. *J Vet Diagn Invest.* 2006;18:494.
6. Mousa SA, et al. *J Anim Sci Adv.* 2013;3:551.
7. Islam KMS, et al. *Poultry Sci.* 2009;88:2353.
8. De La Cruz-Hernandez NI, et al. *Revue Med Vet.* 2012;163:60.
9. Hosseini R, et al. *Iran J Vet Res.* 2013;14:120.
10. Pavarini SP, et al. *Pesquisa Vet.* 2011;31:844.
11. Aleman M, et al. *J Am Vet Med Assoc.* 2007;230:1822.
12. Rajaian H, et al. *Comp Clin Pathol.* 2009;18:233.
13. Varga A, et al. *J Vet Intern Med.* 2009;23:1108.
14. Decloedt A, et al. *J Vet Intern Med.* 2012;26:1209.
15. Divers TJ, et al. *AAEP Proc.* 2010;277.
16. Nath LC, et al. *Aust Vet J.* 2012;90:351.
17. Karapinar T, et al. *Can Vet J.* 2010;51:397.
18. Karapinar T, et al. *Vet Clin Pathol.* 2012;41:375.

19. Divers TJ, et al. *J Vet Diagn Invest.* 2009;21:338.
20. Fraser B, et al. *Am J Vet Res.* 2013;74:870.
21. Khodakaram T, et al. *Comp Clin Pathol.* 2008;17:255.
22. Huang M, et al. *J Vet Diagn Invest.* 2011;23:956.

## Cardiac Neoplasia

Primary neoplasia of the heart is exceedingly rare, and cardiac disease secondary to metastatic neoplasms occurs infrequently. Aortic body adenoma, cardiac fibrosarcoma, cardiac vascular hamartoma,<sup>1</sup> and pericardial mesothelioma are reported. Primary cardiac rhabdomyosarcoma occurs rarely in cattle and sheep. A large case series of cardiac angioleiomyoma has been reported in 44 cattle in Japan; these tumors were subendocardial and involved the papillary muscles or valves and shared some features with hamartoma and fibrosarcoma,<sup>2</sup> but they were thought to differ from peripheral nerve sheath tumors.<sup>3</sup>

Lymphosarcoma is probably the most common metastatic tumor in both cattle<sup>4</sup> (see Chapter 11) and horses but cardiac involvement by melanoma, hemangiosarcoma, testicular embryonal carcinoma, squamous cell carcinoma, lipoma, and other tumors are also recorded. Angiomas and benign vasoformative tumors can occur in the heart and are recorded as obstructing blood flow and producing heart failure in a young calf.

## REFERENCES

1. Brisville AC, et al. *J Vet Cardiol.* 2012;14:377.
2. Une Y, et al. *Vet Pathol.* 2010;47:923.
3. Pavarini SP, et al. *Acta Vet Scand.* 2013;55:7.
4. Burton AJ, et al. *J Vet Intern Med.* 2010;24:960.

## Congenital Cardiovascular Defects

### SYNOPSIS

**Etiology** Abnormality in heart or vascular structure results in anomalous blood circulation. Cause of congenital defects unknown, and some may be heritable.

**Epidemiology** Sporadic occurrence; usually present with cardiac failure shortly after birth but some defects compatible with life and detected incidentally.

**Clinical and necropsy findings** Specific for individual defects.

**Clinical pathology** Echocardiography most useful diagnostic aid.

**Diagnostic confirmation** Echocardiography and postmortem examination.

**Treatment** Surgery for some.

## ETIOLOGY

An increasing number of clinical reports on congenital cardiovascular defects are

appearing in the veterinary literature; however, their general importance is low. The cause of congenital cardiac defects is unknown, but it is assumed they result from injury during development or from single recessive genes or polygenic sets that have lesion-specific effects on cardiac development. Ventricular septal defects have been observed in twin cattle. Heritable ventricular septal defect is recorded in miniature pigs and suspected in cattle and Arabian horses.<sup>1</sup>

### EPIDEMIOLOGY

Congenital cardiac anomalies occur in all species but are not common in any one of them. The prevalence is probably highest in cattle and lowest in horses.

#### Cattle

The relative frequency of individual cardiac defects in 36 calves at postmortem examination in one study was

Ventricular septal defect: 14%  
 Ectopic heart: 13%  
 Right ventricular hypoplasia: 13%  
 Left ventricular hypoplasia: 13%  
 Dextroposed aorta: 10%  
 Valvular hematomas: 9%  
 Patent ductus arteriosus: 6%  
 Patent foramen ovale: 6%  
 Endocardial fibroelastosis: 4%  
 Common aortic trunk: 4%  
 Other cardiac defects: 10%

The animals were neonatal calves and the relative frequencies are biased toward defects that are incompatible with longer life. Generally, ventricular septal defect is the most common cardiac defect in cattle.

#### Sheep

In a large series of necropsy examinations on lambs, 1.3% had cardiac anomalies, of which approximately 90% were ventricular septal defects.

#### Horses

A review of 82 publications on congenital cardiac defects in horses showed the following prevalence in the total cases:

Ventricular septal defect: 28%  
 Tetralogy of Fallot: 16%  
 Truncus arteriosus: 8.5%  
 Aortic, pulmonary, or mitral valve abnormalities: 13.2%  
 Tricuspid atresia: 14.6%  
 Abnormality of the aorta: 4.8%  
 Patent ductus arteriosus: 3.7%  
 Atrial septal defects: 1.2%.  
 Other lesions account for the remainder.

#### Pigs

The relative frequency of congenital cardiac malformations in pigs has been reported as

Dysplasia of the tricuspid valve: 34%  
 Atrial septal defect: 25%  
 Subaortic stenosis: 18%

Ventricular septal defect: 9%  
 Persistent common AV canal: 9%  
 Other defects: 10%.

### PATHOGENESIS

Congenital cardiac defects may result in a pressure load or a volume (flow) load in one or more chambers of the heart. Generally, the left ventricle can tolerate a pressure load better than the right ventricle and the right ventricle can tolerate a volume load better than the left ventricle. The heart may compensate for the increase in load with minor loss in cardiac reserve, or the defects may lead to cardiac failure.

### Shunts

The mixing of oxygenated and venous blood caused by the presence of an anatomic abnormality that allows a shunt of blood from the pulmonary circulation to the systemic circulation in the face of high pulmonary vascular resistance is an important factor in the pathogenesis of the clinical signs of some congenital cardiac defects. The resulting anoxic hypoxia causes severe dyspnea, and **cyanosis** may be marked if the right-to-left shunt is large. There is a notable absence of fever and toxemia if intercurrent disease does not develop. Cardiac enlargement is usually detectable if the animal survives past the first week of life.

### Age at Manifestation

Animals with some congenital cardiac defects can survive to maturity and be productive and perform adequately. Acute heart failure or chronic (congestive) heart failure may occur when the animals are subjected to a physical stress such as the first pregnancy or activity on the range. The primary appearance of signs of cardiac disease when an animal is 2 to 3 years of age should not eliminate congenital defects from consideration.

### CLINICAL FINDINGS

A general description of the more common defects is given next. Some of the defects described in this section are actually defects of the vascular system but are described here for convenience. Diagnosis can be confirmed by the detection of a pressure differential across valves, the detection of shunts by dye dilution and serial blood gas analysis, and by angiocardiology. Echocardiography has developed as an important aid to diagnosis.

### Ectopic Heart

An abnormal position of the heart outside the thoracic cavity is most common in cattle, with the displacement usually in the lower cervical region. The heart is easily seen and palpated and there is an accompanying divergence of the first ribs and a ventrodorsal compression of the sternum, giving the appearance of absence of the brisket. Affected animals may survive for periods of years, as they also may with an abdominal

displacement, but those with a displacement through a defective sternum or ribs rarely survive for more than a few days.<sup>2</sup>

### Patent Foramen Ovale

This defect of the atrial septum is reasonably common in cattle, usually causes no clinical signs if present as an isolated defect, and is detected incidentally at necropsy. Ostium secundum defects are also common in cattle. Large defects may allow a shunt in both directions. Relative resistance to outflow from the atria is greater in the left than the right and the shunt, if it occurs, is from left to right. This induces a moderate flow load on the right side of the heart, which is well tolerated. Large flows will generally increase pulmonary vascular resistance and result in moderate right ventricular and right atrial hypertrophy. The increase in outflow resistance from the right atrium results in a decreased flow across the shunt and control of the effects of the defect. Atrial septal defects are of much greater significance when they are present with other cardiac defects, and it is extremely rare for an atrial septal defect alone to cause clinical signs of circulatory failure. If these result in a severe right ventricular hypertrophy, the shunt may reverse from right to left and cyanosis will occur.

### Ventricular Septal Defects

These are one of the most common congenital cardiac defects in sheep, cattle, and horses. They are almost invariably subaortic defects occurring high in the septum at the pars membranacea. In the absence of other defects their presence results in the shunting of blood from the left to the right ventricle, producing a volume load on the left ventricle and left atrium.

**On auscultation** there is a loud blowing pansystolic murmur audible over both sides of the chest. It is usually audible over a large area on both sides but most intense at the left fourth intercostal and the right third intercostal space and more intense on the right than the left side. The murmur in this defect is one of the loudest and most obvious murmurs encountered. It does not modify the heart sounds, which are usually increased in intensity. A precordial thrill is frequently palpable on both left and the right sides.

**The outcome** is determined by the magnitude of the shunt and the degree of resistance to flow from the right ventricle as determined by pulmonary vascular resistance. With large defects the shunt of blood can be considerable and the animal may die at birth or show clinical signs at a few weeks to a few months of age. The major presenting signs during this period are of left-sided heart failure with lassitude, failure to grow well, and dyspnea with moderate exercise. The shunt may be less severe and allow an apparently normal existence until maturity, when left-sided or right-sided failure can occur, or

cause no apparent problem during life and be detected incidentally on necropsy or abattoir examination. Horses with this defect have raced successfully,<sup>1</sup> and a small number of dairy cows have had many productive lactations. However, it is more common for calves with ventricular septal defect to die or be culled before reaching 2 years of age.<sup>3</sup> Most horses with a ventricular septal defect greater than 3.5 cm in diameter or left-to-right shunt velocity of less than 3 m/s will develop congestive heart failure and consequently a shortened life expectancy.

### Complications

An increase in pulmonary vascular resistance occurs as the result of increased pulmonary blood flow. In cattle, this increase may be sufficient to cause reversal of the shunt, and **cyanosis** develops. This syndrome, sometimes referred to as an **Eisenmenger complex**, develops in young calves but also in mature animals between 1 and 3 years of age and should always be suspected when there is a sudden onset of cyanosis and exercise intolerance in an animal of this age.

The turbulence associated with flow across the defect may produce secondary changes in the valves located close to the defect, which may complicate the clinical picture. **Cattle** are prone to develop **endocarditis** in the region of the septal cusp of the right AV valve. In **horses**, endocarditis more commonly involves the medial cusp of the aortic valve, but there is one report of tricuspid valve endocarditis in a horse with a ventricular septal defect.<sup>4</sup>

Other complications are **prolapse** of the cusps into the septal defect caused by lack of aortic root support with the development of **aortic regurgitation**. **Rupture** of the valve may occur to produce a severe additional flow load on the left ventricle, with rapid onset of acute left heart failure and death.

Ventricular septal defects may occur in association with other congenital cardiac or vascular defects, and the clinical findings are varied.

### Prognosis

There is no practical correction for ventricular septal defects in large animals. Closure of a small ventricular septal defect has been reported in a horse, but spontaneous closure is thought to be uncommon. It should be emphasized that small defects can produce dramatic auscultatory findings and, unless signs of cardiac insufficiency are present, care should be taken in giving an unfavorable prognosis in pleasure or breeding animals. Food animals can be sent for early slaughter.

There is insufficient information on the advisability of breeding animals that have this defect. An inheritable predisposition has been suspected in Hereford cattle, and chromosomal abnormalities have been demonstrated in association with this defect in cattle. Ventricular septal defects have high

prevalence in calves and lambs with microphthalmia.

### Tetralogy of Fallot

This is almost always a lethal defect in farm animals. The tetralogy consists of **three primary abnormalities** (ventricular septal defect, pulmonary stenosis, and dextral position of the aorta so that it overrides both ventricles) and **secondary right ventricular hypertrophy**. The marked increase in resistance to outflow into the pulmonary artery causes a shunt of blood from the right to left with the major outflow of blood through the aorta. The condition presents with clinical signs very early in life, frequently results in death at or shortly following birth, and has been reported predominantly in foals and calves. Occasionally, affected animals may live for longer periods and cases are recorded in mature animals.

Affected animals show lassitude and dyspnea after minor exertion such as suckling, with the clinical signs resulting primarily from **systemic hypoxemia**. **Cyanosis** may or may not be present, depending on the degree of pulmonary stenosis, but is usually prominent, especially following exercise. On auscultation a murmur and sometimes a thrill is present and most intense in the left third or fourth intercostal space.

Other cardiac defects that result in cyanosis as a prominent sign occur when there is right-to-left shunting of blood through a patent **foramen ovale**, a patent ductus arteriosus, or ventricular or atrial septal defects as a result of tricuspid atresia or pulmonary atresia. Right-to-left shunting through these defects is rare and, if present, is usually a terminal event.

Tetralogy of Fallot should be differentiated from an even rarer condition, **double-outlet right ventricle**; the latter is characterized by having both the aorta and pulmonary artery arise from a distinct conus originating from the morphologic right ventricle and from which no fibrous continuity with the AV valves can be demonstrated. Double-outlet right ventricle has been diagnosed in three calves and a foal, with clinical signs similar to tetralogy of Fallot.

### Patent Ductus Arteriosus

This defect results from a failure of closure of the ductus arteriosus following birth and is probably the third most common defect in horses after ventricular septal defect and tetralogy of Fallot. There is some controversy over the period of time involved in normal closure in large animals. Clinically, murmurs associated with a patent ductus arteriosus are frequently heard during the first day after birth in normal foals and may persist for periods of up to 5 days. Physiologic studies in foals suggest that functional closure occurs between 48 and 72 hours after birth,<sup>1</sup> whereas anatomic closure is slightly delayed to 4 days of age. Patent ductus arteriosus is

not a common clinical cardiac defect in older animals, but can occur. The ductus arteriosus closes within minutes of birth in calves.

Patent ductus arteriosus produces a loud **continuous murmur** associated with the left-to-right shunting of blood from the aorta to the pulmonary artery. The intensity of the murmur waxes and wanes with each cycle because of the effects of normal pressure changes on blood flow, giving rise to the name of "**machinery murmur**." The systolic component of the murmur is very loud and usually audible over most of the cardiac auscultatory area, but the diastolic component is much softer and confined to the base of the heart. The pulse is large in amplitude but has a low diastolic pressure. Surgical correction is possible.

### Complete Transposition of the Great Arteries

Complete transposition of the great arteries is characterized by an aorta arising from the morphologic right ventricle and the pulmonary artery arising from the morphologic left ventricle, resulting in two circulations running in parallel with circulatory mixture via a ventricular septal defect. Calves usually present with severe arterial hypoxemia, poor growth rate, and exercise intolerance.<sup>5</sup>

### Persistent Truncus Arteriosus

This defect and other defects of the outflow vessels, including pulmonary and aortic hypoplasia and congenital absence of the aortic arch, have been recorded in animals but their prevalence is low.

### Coarctation of the Aorta

Constriction of the aorta at the site of entrance of the ductus arteriosus causes a syndrome similar to that of stenosis of the aortic semilunar valves; there is a systolic murmur and a slow-rising pulse of small amplitude.

### Double-Outlet Right Ventricle

Double-outlet right ventricle is characterized by dextropositioning of the aorta (partial transposition) that results in the aorta and pulmonary artery arising from the right ventricle. The concurrent presence of a ventricular septal defect permits blood from the left ventricle to circulate. Reports of double-outlet right ventricle are scarce in large animals but may be most common in horses.<sup>6</sup>

### Fibroelastosis

Congenital fibroelastosis has been observed in calves and pigs. The endocardium is converted into a thick fibroelastic coat and, although the wall of the left ventricle is hypertrophied, the capacity of the ventricle is reduced. The aortic valves may be thickened and irregular and obviously stenosed. The syndrome is one of congestive heart failure. The defect may cause no clinical abnormality until the animal is mature.



### Subvalvular Aortic Stenosis

Stenosis of the aorta at or just below the point of attachment of the aortic semilunar valves has been recorded as a common, possibly heritable, defect in pigs, but its differentiation from other causes of heart failure is difficult. Clinically affected animals may die suddenly with asphyxia, dyspnea, and foaming at the mouth and nostrils, or after a long period of ill-health with recurrent attacks of dyspnea. In the acute form death may occur after exercise or be unassociated with exertion.

### Parachute Left Atrioventricular Valve

This is an extremely rare congenital anomaly defined by the presence of a single papillary muscle that receives all chordae tendineae from the left AV valve. An 8-month-old colt with a loud left-sided holosystolic murmur was diagnosed with this condition using echocardiography.

### Valvular Abnormalities

A 9-week-old Standardbred colt was diagnosed with dysplasia of the mitral valve and tricuspid valve.<sup>7</sup> A quadricuspid aortic valve was identified in a stallion with a ventricular septal defect.<sup>8</sup>

### Anomalous Origin of Coronary Arteries

Either or both coronary arteries may originate from the pulmonary artery instead of the aorta. The resulting anoxia causes

myocardial weakness in the ventricle of the affected side. Congestive heart failure usually follows. Congenital deformities of the coronary arteries have been recorded in cattle and pigs.

### Persistence of the Right Aortic Arch

Persistence of the right fourth aortic arch causes constriction of the esophagus with dysphagia and regurgitation. The aorta is situated to the right of the esophagus and trachea and the ligamentum arteriosum in its connection to the pulmonary artery encloses the esophagus in a vascular ring and compresses it against the trachea. Clinical signs are usually evident soon after birth and consist primarily of **regurgitation of milk** from the mouth and nostrils after suckling,<sup>9</sup> but survival until 5 years of age has been recorded in a bull that showed **chronic bloat** and visible esophageal dilatation. Resistance to the passage of a stomach tube is encountered just behind the first rib, and the diagnosis can be confirmed by radiologic examination following a barium swallow (Fig. 10-7).<sup>9</sup> Medical treatment is concerned with the control of aspiration pneumonia, but the correction of the defect is surgical.<sup>9</sup>

### Aberrant Right Subclavian Artery

The most common vascular ring anomaly is persistence of the right fourth aortic arch. A much rarer vascular ring anomaly was

reported in an adult Friesian horse with repeated esophageal obstruction.<sup>10</sup> Necropsy revealed esophageal and tracheal stenosis secondary to an aberrant right subclavian artery. The artery constricted the esophagus, resulting in mucosal sloughing.

### FURTHER READING

- Bexiga R, Mareus A, Philbey AW, et al. Clinicopathologic presentation of cardiac disease in cattle and its impact on decision making. *Vet Rec.* 2008;162:575-580.
- Buczinski S. Cardiovascular ultrasonography in cattle. *Vet Clin North Am Food Anim Pract.* 2009;25:611-632.
- Reef VB, Bonagura J, Buhl R, et al. Recommendations for equine athletes with cardiovascular abnormalities. ACVIM/ECEIM Consensus Statement. *J Vet Intern Med.* 2014;28:749-761.

### REFERENCES

- Hall TL, et al. *J Vet Intern Med.* 2010;24:206.
- Fracowiak H, et al. *Acta Vet Brno.* 2014;83:51.
- Buczinski S, et al. *Can Vet J.* 2006;47:246.
- Froehlich W, et al. *Equine Vet Educ.* 2006;18:172.
- Grünberg W, et al. *BMC Vet Res.* 2011;7:22.
- Fennell LC, et al. *Aust Vet J.* 2009;87:204.
- Duz M, et al. *Equine Vet Educ.* 2013;25:339.
- Michlik KM, et al. *BMC Vet Res.* 2014;10:142.
- Coleman MC, et al. *J Am Vet Med Assoc.* 2014;244:1253.
- Viljoen A, et al. *Equine Vet Educ.* 2012;24:62.

## Inherited Cardiovascular Defects

### BOVINE HEREDITARY DILATED CARDIOMYOPATHY

Bovine hereditary dilated cardiomyopathy is a group of progressive degenerative diseases of the myocardium causing congestive heart failure. At least three different types have been reported: dilated cardiomyopathy in cattle of Canadian Holstein origin, cardiomyopathy in Japanese Black cattle, and cardiomyopathy in Hereford cattle.

Pedigree analysis of 75 animals in three age classes and five diagnostic classes based on clinical and pathologic findings using the Pedigree Analysis Package provided strong evidence for autosomal recessive inheritance of a single major gene responsible for the disease. Pedigree analyses of affected animals in Canada, Japan, and Switzerland revealed the Holstein bull “ABC Reflection Sovereign,” the son of Canadian Holstein sire Montwick Red Apple Sovereign, as the common ancestor. This disease in cattle is being used as a research model of human dilated cardiomyopathy. Using proteomic analysis (the examination of tissue from younger cattle that are genetically diseased but have not yet developed clinical disease), a number of proteins have been identified whose abundance is altered significantly to suggest a possible pathogenetic mechanism for the onset of the disease.



**Fig. 10-7** Persistent right aortic arch in a foal. Lateral positive contrast esophagram of the thorax of a 9-day-old pony foal that was observed to have milk coming from both nostrils when in lateral recumbency. The esophagus is distended proximally to the asterisk at the third intercostal space with barium. The trachea is narrowed at this site of esophageal narrowing. (Reproduced with permission from Coleman MC, Norman TE, Wall CR. *J Am Vet Med Assoc* 2014; 244:1253-1255.)

The disease has now been reported in Denmark in the Red Danish Dairy breed, Holsteins, and Red Holsteins. Pedigree analysis of 12 cases found both maternal and paternal relationship to the Canadian sire Montwick Red Apple Sovereign, and several sires were identified as carriers of the disease. These sires originated from breeding lines used to upgrade Danish cattle populations and pose a potential animal health problem. The introduction of the defect into the Danish cattle population is an example of how widespread a genetic disease can become in a short period of time. During their active life, two sires used for artificial insemination obtained a total of approximately 62,000 living progeny.

There can be a high incidence in certain herds, possibly associated with some unrecognized environmental precipitating factor but probably caused by autosomal recessive trait concentrated by a high coefficient of inbreeding. There are three types recorded in cattle, which will be discussed next.

#### Type 1 Calf: Acute Heart Failure

Sudden death of Poll Hereford and horned Hereford calves up to 3 months of age may be caused by inherited cardiomyopathy. The calves are often identifiable before death by their very rapid growth rate, short curly coat, and moderate bilateral exophthalmos. Death is usually precipitated by stress or exercise and is characterized by dyspnea, the passage of bloody froth from the nose, and a course of a few minutes to a few hours. Less acute cases have a syndrome of congestive heart failure for several days before death. Life expectancy is less than 6 months. At necropsy there is an obvious patchiness of the myocardium, reminiscent of a bad case of white muscle disease. The disease appears to be conditioned by a single autosomal recessive gene.

#### Type 2 Calf: Pulmonary Edema

A second form of inherited cardiomyopathy is recorded in Japanese Black cattle. Death is preceded by a brief period (a few minutes to a few hours) of agonizing dyspnea in calves aged 30 to 120 days. At necropsy there is edema, ascites, hydrothorax, and marked dilatation of the left ventricle. This is matched by acute myocardial necrosis. A new autosomal recessive gene is credited with initiating the disease.

#### Type 3: Young Adult Congestive Heart Failure

This occurs in young adult cattle and has been reported in Holstein-Friesian cattle in Japan, Canada, the UK, and Australia, and in Simmental-Red Holstein crossbred cattle and Black Spotted Friesian cattle in Switzerland.<sup>1</sup> Similar family lines in Holstein breeds have been identified in affected cattle in all three countries, and it has been suggested that there is an inherited predisposition to

cardiomyopathy in the Holstein breed. Pedigree analysis of hereditary dilated cardiomyopathy in Holstein-Friesian cattle in Japan suggests an association with hereditary myopathy of the diaphragmatic muscles. The disease is endemic in Switzerland, occurring mainly in the Simmental × Red Holstein crossbreed of cattle.

The disease occurs in cattle from 1.5 to 6 years of age, with the peak prevalence in 3- and 4-year-old cattle. The stress of pregnancy and lactation may precipitate clinical disease, and the majority of cases occur in late pregnancy or early lactation. The onset is sudden and the majority of cases have signs of congestive right heart failure. Edema of the submandibular area, brisket, ventral abdomen, and udder is prominent and there is venous engorgement, hepatomegaly, interstitial nephritis, pleural and pericardial effusion, and ascites. Muffling of the heart sounds, tachycardia, and a gallop rhythm are evident on auscultation of the heart. There is no characteristic biochemical or hematologic change.

Necropsy findings include congestive heart failure and histologic findings compatible with congestive cardiomyopathy. There is dilatation of the chambers of the heart; thickening or thinning of the ventricular wall; subcutaneous, mesenteric, and pulmonary edema; hydrothorax; hepatomegaly; and ascites. Histologically there is fibrosis, myocardial degeneration, and vacuolation of cardiomyocytes and infiltration of mononuclear cells into the myocardium. In some cases, interstitial nonsuppurative nephritis is present. Using electron microscopy, the sarcoplasm of the hypertrophic fibers is seen to be filled with fine structures of low electron-density, together with thin filamentous material, suggesting myofibrillar lysis.

The disease is inherited as an autosomal recessive gene located on bovine chromosome 18.<sup>1</sup> Following introduction of an eradication program based on culling of carriers in the sire population, the incidence in Switzerland has decreased.

#### REFERENCE

1. Owczarek-Lipska M, et al. *Archiv Tierzucht.* 2009;52:113.

#### INHERITED VENTRICULAR SEPTAL DEFECT

Ventricular septal defects are common in food animals; reports of their occurrence in lambs and Hereford cattle suggest that the condition can be inherited.

#### INHERITED AORTIC ANEURYSM

An inherited defect of the abdominal aorta, resulting in a high mortality rate from intraabdominal hemorrhage, has been

observed in an unidentified breed of cattle in Holland and is an important feature in Marfan syndrome of humans.

#### BOVINE MARFAN SYNDROME

A model of human Marfan syndrome, this disease of cattle is an autosomal dominant disorder caused by mutations in the fibrillin-1 gene.<sup>1</sup> It is manifested primarily by cardiovascular lesions and signs but lacks the skeletal abnormalities of the human disease. Necropsy lesions include aortic and pulmonary artery aneurysm, with consequent cardiac tamponade in some cases. Fragmentation of elastic laminae in the vessels is also characteristic.

#### REFERENCE

1. Singleton AC, et al. *Hum Mutat.* 2005;25:348.

## Diseases of the Pericardium

### PERICARDITIS

#### SYNOPSIS

**Etiology** Traumatic, extension from other infection, as a component of infections causing polyserositis, or idiopathic

**Epidemiology** Poorly defined other than for traumatic pericarditis in cattle

**Clinical findings** Friction sound initially, followed by muffling of the heart sounds, venous congestion, decreased pulse pressure, and congestive heart failure

**Clinical pathology** Pericardiocentesis, echocardiography, radiography

**Necropsy findings** Inflammation, fibrin and fluid, in pericardial sac; fibrous pericarditis

**Diagnostic confirmation** Triad of muffling of the heart sounds, venous congestion, decreased pulse pressure; pericardiocentesis, echocardiography

**Treatment** Antimicrobials and drainage; poor prognosis and supportive treatment

#### ETIOLOGY

Pericarditis is not common but presents in three general forms—effusive, fibrinous, and constrictive—although combinations of one or more of the three forms can occur. **Effusive pericarditis** is characterized by the accumulation of a protein-rich fluid within the pericardial sac. Subsequent fibrin deposition can lead to **fibrinous pericarditis**, and if fibrin within the pericardial sac matures to fibrous tissue and fibrosis of the pericardium or epicardium then **constrictive pericarditis** will result. **Traumatic pericarditis**, perforation of the pericardial sac by an infected foreign body, is common only in cattle.

Traumatic pericarditis is also recorded in the horse and in a lamb. Localization of a blood-borne infection occurs sporadically in many diseases. Direct extension of infection from pleurisy or myocarditis may also occur in all animals, but the clinical signs of pericarditis in such cases are usually dominated by those of the primary disease.

In most cases of pericarditis in horses no causative agent is isolated. There is usually a history of upper or lower respiratory tract disease. Most cases are fibrinous or septic and associated with **systemic inflammatory response syndrome**,<sup>1</sup> but an effusive non-septic form is also described and has been called **idiopathic effusive pericarditis**. Pericarditis in horses occurs predominantly in adults. Idiopathic effusive pericarditis has been diagnosed in two dairy cows.

### Cattle

- *Mannheimia haemolytica*
- Black disease (if patients survive more than 24 hours)
- Sporadic bovine encephalomyelitis
- *Haemophilus* spp., including *Histophilus somni*
- Tuberculosis
- *Pseudomonas aeruginosa*
- *Mycoplasma* spp.
- *Klebsiella pneumoniae*
- *Actinobacillus suis*
- Malignant peripheral nerve sheath tumor in the right atrium, epicardium, and pericardium<sup>2</sup>
- Idiopathic effusive (nonseptic) pericarditis.

### Horses

- *Streptococcus* spp., including *S. equi* subsp. *equi*, *S. equi* subsp. *zooepidemicus* and *S. faecalis*
- Tuberculosis
- *Corynebacterium pseudotuberculosis*
- *Actinobacillus equuli*
- In association with EHV-1 infection
- Effusive, fibrinous pericarditis in horses during outbreaks of mare reproductive loss syndrome associated with exposure to Eastern Tent Caterpillars or similar species.

### Sheep and Goats

- Pasteurellosis
- *Staphylococcus aureus*
- *Mycoplasma* spp.

### Pigs

- Pasteurellosis
- *Mycoplasma* spp. especially *M. hyorhinitis*
- *Haemophilus* spp. (Glasser's disease and pleuropneumonia)
- *Streptococcus* spp.
- Salmonellosis

### PATHOGENESIS

In the early stages, inflammation of the pericardium is accompanied by hyperemia

and the deposition of fibrinous exudate, which produces a friction sound when the pericardium and epicardium rub together during cardiac movement. As effusion develops the inflamed surfaces are separated, the friction sound is replaced by muffling of the heart sounds, and the accumulated fluid compresses the atria and right ventricle, preventing their complete filling. Congestive heart failure follows. A severe toxemia is usually present in suppurative pericarditis because of the toxins produced by the bacteria in the pericardial sac. Gas will occur along with fluid in the sac if gas-producing bacteria are present. If sufficient gas is present, the classical washing machine sound of fluid splashing with each heart beat will be auscultated. This is not as common in clinical cases as muffling of the heart sounds.

In the recovery stage of nonsuppurative pericarditis the fluid is reabsorbed and adhesions form between the pericardium and epicardium to cause an adhesive pericarditis, but the adhesions are usually not sufficiently strong to impair cardiac movement.

In suppurative pericarditis the adhesions that form become organized, starting on day 4 to 6, and may cause complete attachment of the pericardium to the epicardium, or this may occur only in patches to leave some loculi, which are filled with serous fluid. In either case restriction of cardiac movement will probably be followed by the appearance of congestive heart failure.

### CLINICAL FINDINGS

In the early stages there is pain, avoidance of movement, abduction of the elbows, arching of the back, and shallow abdominal respiration. Pain is evidenced on percussion or firm palpation over the cardiac area of the chest wall, and the animal lies down carefully. A pericardial friction sound is detectable on auscultation of the cardiac area. The temperature is elevated to 39.5°C to 41°C (103°F–106°F) and the pulse rate is increased. Associated signs of pleuritis, pneumonia, and peritonitis may be present.

In most cases of pericarditis caused by traumatic reticuloperitonitis, hematogenous infection, or spread from pleuritis the second stage of effusion is manifested by muffling of the heart sounds, decreased palpability of the apex beat, and an increase in the area of cardiac dullness with decreased amplitude of the peripheral pulse. If gas is present in the pericardial sac, each cardiac cycle may be accompanied by splashing sounds. Signs of congestive heart failure become evident. Fever is present, the heart rate is markedly increased, and toxemia is severe, although this varies with the types of bacteria present. This is the most dangerous period, and affected animals usually die of congestive heart failure, or of toxemia, in 1 to 3 weeks. Those that survive pass through a long period of chronic ill health during which the

toxemia subsides relatively quickly, but congestive heart failure diminishes slowly. In this stage of chronic pericarditis additional signs of myocarditis may appear. The heart sounds become less muffled and fluid sounds disappear altogether or persist in restricted areas. Complete recovery is not common.<sup>3</sup> Idiopathic hemorrhagic effusive (nonseptic) pericarditis has been reported in a small number of cattle; three of these cattle lived for months after initial diagnosis and treatment with pericardial drainage and corticosteroid treatment but subsequently died from epicardial lymphosarcoma.<sup>4</sup>

In the horse, both the idiopathic effusive/fibrinous and the septic forms of pericarditis present with marked muffling of the heart sounds, tachycardia, distension of the jugular veins, and subcutaneous edema of the ventral body wall. A nonseptic pleural effusion is also often present in cases of septic pericarditis in the horse but not in idiopathic effusive pericarditis.

### CLINICAL PATHOLOGY

A marked leukocytosis and neutrophilia, as well as hyperglobulinemia, are usually present in traumatic pericarditis because this has many of the characteristics of a large internal abscess. In the other forms of pericarditis changes in the blood depend on the other lesions present and on the causative agent. In the stage in which effusion occurs a sample of fluid may be aspirated from the pericardial sac and submitted for bacteriologic examination. This technique is not without danger, as infection may be spread to the pleural cavity.

Pericardial fluid can also be examined cytologically but usually the smell (reminiscent of retained placenta and toxic metritis in cattle) is sufficiently diagnostic in cattle with traumatic pericarditis. In septic pericarditis the fluid represents an inflammatory response, whereas in idiopathic effusive pleuritis in horses there are very few cells in the sediment. Mean right ventricular diastolic and intrapericardial fluid pressures are increased in a corresponding manner in cows with clinical signs of right-sided heart failure. Cattle with muffled heart sounds and a large pericardial fluid volume also have a decrease in cardiac output to approximately two-thirds of normal values.

Electrocardiography can aid in diagnosis. Electrocardiographic changes include sinus tachycardia and, in animals with right-sided heart failure and hydrothorax, diminished amplitude of the QRS complex. Contrary to popular belief, hydropericardium in the absence of hydrothorax leads to an increase, and not a decrease, in QRS amplitude. Moreover, removal of large volumes of pericardial fluid does not usually result in an immediate change in QRS amplitude. Also contrary to popular belief, electrical alternans is not commonly present in dogs and humans with pericardial



effusion and if present, occurs only within a narrow range of heart rates. The prevalence of electrical alternans is unknown in large animals with pericardial effusion but is suspected to be extremely low because the pericardium and heart are much more fixed in position within the thorax.

**Radiography** may be of diagnostic value, with six of seven cows having a gas–fluid interface present on standing lateral thoracic radiographs. Radiography has the additional benefit of potentially identifying the location of the penetrating wire; this information would assist surgical removal of the wire via a rumenotomy. Radiography may also aid in the clinical differentiation of pericardial effusion from pleural effusion.

**Echocardiography** is the most valuable diagnostic procedure and will show the presence of fluid in the pericardial sac and the presence or absence of fibrin deposition on the epicardium. In cattle with traumatic reticulopericarditis, hepatic ultrasonography reveals hepatic congestion, manifested as round liver margins; a round and dilated CVC; and a dilated portal vein.<sup>3,5,6</sup>

## NECROPSY FINDINGS

In the early stages there is hyperemia of the pericardial lining and a deposit of fibrin. When effusion occurs, there is an accumulation of turbid fluid, and tags of fibrin are present on the greatly thickened epicardium and pericardium. Gas may also be present and the fluid may have a putrid odor. When the pericarditis has reached a chronic stage, the pericardium is adherent to the epicardium over a greater or lesser part of the cardiac surface. Loculi containing serous fluid often remain. Embolic abscesses may be present in other organs. Lesions typical of the specific causative diseases listed earlier are described under their specific headings.

### DIFFERENTIAL DIAGNOSIS

- Pleuritis
- Cardiac valvular disease
- Mediastinal abscess
- Hydropericardium occurs in congestive heart failure, mulberry heart disease of pigs, herztod of pigs, gossypol poisoning, clostridial intoxications of sheep, and lymphomatosis

## TREATMENT

Antibacterial treatment of the specific infection should be undertaken if possible on the basis of susceptibility of organisms cultured from the pericardial fluid. When the inciting agent cannot be grown, a **broad-spectrum antibiotic** or a combination to give a broad spectrum is used. A combination of penicillin and gentamicin is common and provides cover of the likely organisms associated with this infection. Pericardiocentesis, copious lavage with warmed 0.9% NaCl solution, and drainage should be conducted as required to

relieve the fluid pressure in the pericardial sac and decrease the transmural pressure gradient across the atrial and ventricular walls and caudal and cranial vena cava, facilitating diastolic filling. Pericardiocentesis should be ideally performed under ultrasonographic guidance and with electrocardiographic monitoring.

The **prognosis** varies with the etiologic agent, but it is generally grave in cases of septic pericarditis in **horses** mainly because the stage of effusion is followed by one of fibrosis and constrictive pericarditis. Success in treatment of a series of six cases of septic pericarditis in the horse is recorded with the use of indwelling pericardial drains to allow twice-daily lavage and drainage and the instillation of antibiotics directly into the pericardial sac. This allows high concentrations of antimicrobial agents, and the twice-daily infusion of 1 to 2 L of fluid may help prevent the development of constrictive pericarditis. In **cattle** thoracotomy and pericardiectomy are used to establish drainage or to allow marsupialization of the pericardium to the body wall. Low treatment success rates are generally reported for the disease in cattle with or without surgical drainage, and it is likely that cases that responded to fifth rib resection and pericardial marsupialization would have responded to pericardial drainage and intrapericardial lavage and antimicrobial administration.

There is a more favorable prognosis for the treatment of **idiopathic effusive pericarditis** in horses and cattle with aggressive therapy and the use of pericardiocentesis, pericardial drainage and lavage, intrapericardial water-soluble antibiotics, and systemic corticosteroid or NSAIDs is an effective therapy.<sup>7</sup> In cattle with pericardial effusion caused by cardiac lymphoma, repeated pericardiocentesis was effective in maintaining a good quality of life for 4 weeks associated with increased milk production; this treatment may be considered in late gestation cows with cardiac lymphoma and no evidence of metastasis to optimize delivery of a viable fetus.<sup>8</sup>

## FURTHER READING

- Bexiga R, Mareus A, Philbey AW, et al. Clinicopathologic presentation of cardiac disease in cattle and its impact on decision making. *Vet Rec.* 2008;162:575-580.
- Buczinski S. Cardiovascular ultrasonography in cattle. *Vet Clin North Am Food Anim Pract.* 2009;25:611-632.
- Buczinski S, Rezakhani A, Boerboom D. Heart disease in cattle: Diagnosis, therapeutic approaches and prognosis. *Vet J.* 2010;184:258-263.
- Jesty SA, Reef VB. Septicemia and cardiovascular infections in horses. *Vet Clin North Am Equine Pract.* 2006;22:481-495.

## REFERENCES

1. Armstrong SK, et al. *Aust Vet J.* 2014;92:392.
2. Pavarini SP, et al. *Acta Vet Scand.* 2013;55:7.
3. Braun U, et al. *Vet Rec.* 2007;161:558.
4. Peek SF, et al. *J Vet Intern Med.* 2012;26:1069.
5. Braun U, et al. *Schweiz Arch Tierh.* 2008;150:281.

6. Kumar A, et al. *Indian J Anim Sci.* 2012;82:1489.
7. Firshman AM, et al. *J Vet Intern Med.* 2006;20:1499.
8. Buczinski S, et al. *Can Vet J.* 2011;52:663.

## Diseases of the Blood Vessels

### ARTERIAL THROMBOSIS, EMBOLISM, AND RUPTURE

#### SYNOPSIS

**Etiology** Arteritis leading to thrombus formation causes ischemia of the tissues supplied by the affected artery; rupture of abdominal arterial aneurysm in cattle; rupture of the aorta in the Friesian horse.

**Clinical findings** Reduced function or ischemic necrosis vary with the site of the obstruction. Aortoiliac thrombosis manifests with lameness, muscular weakness, and decreased pulse amplitude in affected leg. Arterial rupture associated with massive acute hemorrhage.

**Clinical pathology** Leukocytosis, hyperfibrinogenemia, and elevated serum concentrations of muscle enzymes are seen in some cases. Ultrasound is more sensitive for diagnosis than rectal palpation.

**Necropsy findings** Thrombosis and embolic lesions, muscle ischemia and necrosis, abdominal or thoracic hemorrhage in arterial rupture.

**Diagnostic confirmation** Ultrasonography for aortoiliac thrombosis.

**Treatment** Fibrinolytic enzymes; surgical removal of thrombus.

## ETIOLOGY

Injury to vascular endothelium, alteration to normal blood flow (turbulence or stasis), and alterations to the coagulability of blood can predispose thrombosis and thromboembolism. Weakness to the arterial wall can lead to aneurysmal formation and, in some animals, rupture of the artery and massive acute intraabdominal or intrathoracic hemorrhage.

## Coagulopathies

Coagulopathies and disseminated intravascular coagulation are important in the pathogenesis of thromboembolism, which occurs in many infectious diseases.

## Parasitic Arteritis

- *Strongylus vulgaris* in horses. Migrating larvae cause arteritis of the anterior mesenteric artery, iliac arteries, and base of aorta as well as occasionally cerebral, renal, or coronary arteries. This is a major cause of arteritis and associated clinical disease in horses.
- Aortoiliac thrombosis in horses. There is some controversy over the etiology of

this disease. It may result from strongyle-related thromboembolism with organization of thrombi and their incorporation into the arterial wall with centripetal development of progressive thrombosis. Alternatively, spontaneous degenerative vascular disease of unknown etiology, but particularly at the aortic quadrifurcation, may result in thrombosis in the area and subsequently thromboembolism of more distal vessels.

- Onchocerciasis and elaeophoriosis in cattle, sheep, goats, and horses.

### Viral Arteritis

- Important in pathogenesis of several viral diseases, including malignant catarrhal fever, equine viral arteritis, African swine fever, hog cholera, bluetongue, and African horse sickness.

### Bacterial Arteritis

- Including septicemic salmonellosis, erysipelas, *Histophilus somni*, *Haemophilus pleuropneumoniae*, and pasteurellosis

### Embolic Arteritis and Thromboembolism

- From vegetative endocarditis or emboli from arterial thrombus in various sites
- Hyperlipemia and hyperlipidemia in horses
- Fat emboli following surgery
- Associated with subclinical *Salmonella* Dublin infection in calves
- Rupture of abscesses into blood vessels (pulmonary embolism resulting from caudal vena caval thrombosis or jugular thrombosis)
- From indwelling catheters

### Microangiopathy

- Vitamin E/selenium deficiency
- Cerebrospinal angiopathy
- Terminal in most septicemic disease

### Calcification

- Enzootic calcinosis
- Arterial calcification in horses<sup>1</sup>
- Vitamin D toxicity
- Chronic hypomagnesemia in calves
- Lymphosarcoma in some horses

### Vasoconstrictive Agents

- Ergot poisoning
- Fescue poisoning

### EPIDEMIOLOGY

Clinical atherosclerosis occurs rarely in farm animals. It has been recorded in a horse in which sufficient vascular obstruction occurred to cause severe central nervous signs and a fatal outcome. Spontaneous atherosclerosis is a common necropsy finding in swine, cattle, goats, horses, and wild animals but is not associated with clinical disease.

Arteriosclerosis and calcification are major findings in enzootic calcinosis and occur following overdosing with vitamin D or its analogs in the prevention of milk fever in cattle and in hypomagnesemia in calves. Arterial calcification appears to be common in racehorses but its pathogenesis and clinical significance remain unknown.<sup>1</sup>

### PATHOGENESIS

In parasitic arteritis, inflammation and thickening of the arterial wall result in the formation of thrombi, which may partially or completely occlude the artery. The common site is in the anterior mesenteric artery; obstruction of this vessel causes recurrent colic or fatal ischemic necrosis of a segment of the intestine. Less common sites include the origin of the iliac artery at the abdominal aorta causing iliac thrombosis, the base of the aorta leading to rupture and hemopericardium, and the coronary arteries causing myocardial infarction.

With other causes of arteritis, the clinical syndrome is dependent on the site of arteritis or embolism. Arteritis associated with bacterial and viral infections is usually widespread and several organ systems are involved. Bacterial emboli have a predilection to lodge in the

- Vascular plexuses in the kidney to produce renal disease
  - Synovial membranes to produce arthritis and tenosynovitis
  - Endocardium to produce endocarditis
- Less common is that they may lodge in other vascular plexuses such as the rete cerebri. Large emboli that lodge in the pulmonary arteries cause anoxic anoxia. Embolism in the renal artery causes acute cortical necrosis and gross hematuria.

Vasoconstrictive alkaloids produced by *Claviceps purpurea* infestation of grass seed heads and *Acremonium coenophialium*, which infests *Festuca arundinaceae* and *Lolium perenne*, cause arteriolar constriction and result in ischemic necrosis and gangrene of distal extremities in cattle.

### CLINICAL FINDINGS

The clinical findings in mesenteric verminous arteritis of horses and renal and myocardial infarction, gangrene associated with *C. purpurea*, or endophyte infestation of grasses and other diseases listed earlier are described elsewhere under those headings. The clinical signs of aortoiliac thrombosis and pulmonary embolism are described here.

### Aortoiliac Thrombosis in the Horse

Aortoiliac thrombosis is most common in racehorses but occurs in other breeds. It is primarily a disease of horses of over 3 years of age. Either one or both hindlegs may be involved. Diagnosis rarely occurs during the early stages because clinical signs are thought to only occur when >75% of arterial flow is compromised.<sup>2</sup> The clinical manifestations

vary according to the stage of progression of the disease and are associated with ischemia of the hindlimbs.

**Early mild cases** are usually detected in racehorses or horses subjected to maximal exertion in which the disease may be a cause of poor performance. In early cases there is lameness only on exercise, and the animal returns to normal after a short rest. If the horse is forced to work when lameness develops, the signs may increase to resemble those of the acute form. The lameness takes the form of weakness, usually of one hindlimb, which tends to give way, especially when the animal turns on it. Frequent lifting of the foot or cow-kicking may also be shown. **In more severe cases**, lameness or refusal to work may be evident after minimal exercise.

The disease is chronic and progressive, but occasionally the onset may be acute. **In the acute form** there is great pain and anxiety and the pulse and respiration rates are markedly increased. Profuse sweating may be evident, but the affected limb is usually dry and may be cooler than the rest of the body. The pain is often sufficiently severe to cause the animal to go down and refuse to get up. Suspect animals should be examined following exercise.

- The affected limb is cool from the midgaskin distally, and there is usually diminished or variable sweating over this area.
- The **amplitude of the pulse** in the common digital artery is less in the affected limb than in the normal limb or the front limbs.
- **Slow filling of the saphenous vein** of the affected limb can usually be detected.
- Palpable abnormalities on **rectal examination** include enlargement and firmness of the aortic quadrifurcation, irregularity and asymmetry of the internal and external iliac arteries, and decreased amplitude or absence of an arterial pulse.

**Recovery** by the development of collateral circulation or shrinkage of the thrombus is unlikely to occur, and the disease is usually chronically progressive with a poor prognosis.

Until recently the detection and diagnosis of the occurrence of this abnormality was limited to horses showing clinical signs and horses in which abnormality could be palpated on rectal examination. **Ultrasonography** is a more sensitive method of detection than rectal palpation. The use of ultrasonography as a diagnostic technique may lead to a better definition of the occurrence of this disease and ultimately its pathogenesis. Iliac thrombosis may also be associated with impotence in stallions caused by failure to mount or accompanied by testicular atrophy. It has also been associated with a syndrome of ejaculatory failure in which the stallion has excellent libido, good coupling, and vigorous thrusting but a failure to ejaculate. The

reason for this manifestation is not known, but it is postulated that the enlarged arteries might impinge on the caudal mesenteric plexus and the hypogastric nerve.

Brachial artery thrombosis is rare in horses and may occur in neonates because of septicemia or the presence of an atrial septal defect and for unknown reasons in an adult. Affected animals may appear lame on one or both front limbs with decreased temperature and pulse amplitude of the peripheral limb.<sup>3</sup>

### Aortoiliac Thrombosis in Calves

Aortic and iliac artery thrombosis is reported as an occasional disease of unknown etiology in calves less than 6 months of age. Affected calves have a rapid onset of ataxia, paresis, or paralysis of one or both hindlimbs and in some cases the tail. Within 24 hours of onset the calves do not bear weight on the affected leg and, in calves affected in both hindlimbs, signs initially occur in a single limb. Affected legs are cold to touch, especially distal to the stifle; have poor muscle tone; and the withdrawal reflex and deep pain sensation is absent in the distal portions.<sup>4</sup> Typically, the saphenous artery pulse is markedly reduced in amplitude or absent. Subcutaneous swelling and crepitation is present in some affected animals.

Transabdominal ultrasonography of the aorta has been performed in the calf using a 3.5-MHz sectorial probe with the calf in lateral recumbency. A thrombus was easily visualized at the junction of the internal and external iliac arteries, and color flow Doppler evaluation can be used to quantify blood flow through the lesion and change in this parameter over time.<sup>5</sup> Thrombosis at the terminal part of the aorta and the iliac quadrifurcation is found at postmortem examination. The umbilical arteries arise from the iliac arteries near the iliac quadrifurcation, and it is thought that thrombus formation in the iliac arteries combined with *E. coli* septicemia predisposes to this disease.

### Pulmonary Embolism

Severe dyspnea develops suddenly and is accompanied by profuse sweating and anxiety. The temperature and pulse rate are elevated, but the lungs are normal on auscultation. In horses the signs usually pass off gradually in 12 to 24 hours, but in cattle the hypoxemia may be more severe and cause persistent blindness and imbecility. Infected emboli may lead to more severe pulmonary embolic disease with arteritis and pulmonary abscessation. There is pulmonary hypertension, and cor pulmonale is a possible sequel. Pulmonary arteritis and aneurysm may be followed by rupture and pulmonary hemorrhage and hemothysis.

### Rupture of Abdominal Artery Aneurysm in Holstein-Friesian Cattle

Abdominal artery rupture secondary to an aneurysm occurs sporadically and very

rarely, with a case series of 33 cases being reported over a 25-year period in upstate New York.<sup>6</sup> Affected cattle are 2 to 6 years of age and all were of the Holstein-Friesian breed. Cattle are found dead without any signs of illness. Histologic examination indicates a marked disruption of the tunica media and a decreased amount of elastin in the artery at the site of the rupture. The lesions were consistent with chronic damage to the arterial wall and acute rupture and massive acute hemorrhage.

### CLINICAL PATHOLOGY

Extensive thrombus formation is usually associated with a leukocytosis and a shift to the left, and there is an increase in serum fibrinogen concentration. In the majority of cases of iliac thrombosis serum aspartate aminotransferase (AST) and CK activities are within the normal range both before and after exercise, but in severe cases there may be enzymic evidence of myonecrosis with secondary hyperkalemia and uremia. Elevated serum CK and aspartate transaminase activities are present in aortic and iliac thrombosis in calves. Angiography or ultrasonography is used for diagnostic confirmation.

### NECROPSY FINDINGS

Obstruction of the affected artery is easily seen when it is opened. The thrombus or embolus is adherent to the intima and is usually laminated. Local or diffuse ischemia or infarction may be evident if the embolus has been present for some time and may have progressed to the point of abscess formation.

### DIFFERENTIAL DIAGNOSIS

#### Aortoiliac thrombosis in the horse

- Paralytic myoglobinuria
- Hyperkalemic periodic paralysis

#### Aortoiliac thrombosis in calves

- Vertebral osteomyelitis (spinal abscess)
- White muscle disease
- Vertebral fracture
- Clostridial myositis
- Pulmonary embolism
- Pneumonia

### TREATMENT

Treatment with parenteral anticoagulants or enzymes is performed rarely, and reported treatment successes are based on small numbers of cases without an untreated control for comparison. Variable doses of aspirin (12–100 mg/kg orally every 8–48 hours) have been administered to affected horses to prevent thrombus growth by inhibiting platelet aggregation; however, oral bioavailability appears variable in the horse, no doubt resulting in the large range in dosage protocols. Aspirin does not inhibit platelet aggregation in the cow, therefore, aspirin is not indicated as part of the treatment of thrombosis in cattle. Low molecular weight heparin (such as dalteparin at 50 U/kg sub-

cutaneously every 24 hours) has been administered to horses to prevent thrombus growth, but may be cost-prohibitive. Unfractionated heparin (15–80 U/kg subcutaneously every 12 hours) is much less expensive than low molecular weight heparin but has unpredictable efficacy in horses and can result in undesirable side effects such as thrombocytopenia and erythrocyte agglutination. Warfarin (0.018 mg/kg orally every 24 hours) is usually used because of its low cost, ease of administration, wide availability, and suitability for long-term administration.<sup>2</sup>

There are several records of positive results in iliac thrombosis in horses after the IV injection of sodium gluconate or fibrinolytic enzymes such as recombinant tissue plasminogen activator, and retrograde catheterization of the ventral coccygeal artery can allow the deposition of these materials at high local concentrations. Ivermectin and fenbendazole are commonly administered to horses to address *S. vulgaris* as a potential initiating agent. Many other adjunctive treatments have been administered, including butylscopolamine bromide, metamizole, acepromazine, isoxsuprine, and pentoxifylline, but case numbers are too few to comment on their efficacy. A gradually increasing exercise program may improve collateral circulation. Surgical treatment is recorded by partial or complete removal of the thrombus with a thrombectomy catheter. Treatment response can be monitored clinically, by palpation of arterial pulses during per rectal palpation, or most accurately by periodic transrectal Doppler ultrasonography of the affected artery.

Stallions with ejaculatory failure have had some success at service following treatment with phenylbutazone to reduce pain and gonadotropin-releasing hormone to maximize sexual arousal and lower the ejaculatory threshold.

### FURTHER READING

- Buczinski S. Cardiovascular ultrasonography in cattle. *Vet Clin North Am Food Anim Pract.* 2009;25:611-632.
- Jesty SA, Reef VB. Septicemia and cardiovascular infections in horses. *Vet Clin North Am Equine Pract.* 2006;22:481-495.

### REFERENCES

1. Arroyo LG, et al. *Vet Pathol.* 2008;45:617.
2. Hilton H, et al. *J Vet Intern Med.* 2008;22:679.
3. Gasthuys FMR, et al. *Vet Rec.* 2007;160:340.
4. D'Angelo A, et al. *J Vet Intern Med.* 2006;20:1261.
5. Buczinski S, et al. *J Vet Intern Med.* 2007;21:348.
6. Lamm CG, et al. *J Vet Diagn Invest.* 2007;19:273.

### PURPURA HEMORRHAGICA

#### SYNOPSIS

**Etiology** Deposition of immune complexes in the walls of capillaries with subsequent

*Continued*



vasculitis and extravasation of blood and plasma.

**Epidemiology** Sporadic disease of horses, and rarely cattle and pigs; the disease in horses is often associated with upper respiratory tract disease, especially *S. equi* infection.

**Clinical signs** Swellings of the head, limbs, and body; the swellings are usually asymmetric, not painful on palpation and pit with gentle pressure. Tachycardia and tachypnea are characteristic. Petechial hemorrhages are present in mucosal surfaces. Skin of the limbs might slough.

**Clinical pathology** Nonspecific; thrombocytopenia is not present.

**Diagnostic confirmation** Clinical signs, skin biopsy.

**Treatment** Corticosteroids (dexamethasone) and antibiotics; supportive care.

## ETIOLOGY

The disease is acute and noncontagious. The cause of the **vasculitis** that characterizes purpura hemorrhagica is likely the deposition of complexes of antigen and immunoglobulin in the walls of capillaries and small blood vessels. The disease appears to be **immune complex mediated** and caused by a **type III hypersensitivity reaction**. The common association of the disease is with ***S. equi* infection** of the upper respiratory tract. The high concentrations of antibodies to the *S. equi* M protein in affected horses and the presence of complexes of IgA and streptococcal M protein in sera are evidence that the disease is associated with an immune reaction to streptococcal protein. The immune complexes are not found in the serum of horses recovering from *S. equi* infection that do not have purpura hemorrhagica. However, in many instances there is no history of streptococcal infection. There is a suggestion that the disease might be associated with an adverse reaction to therapeutic drugs. Vaccination using modified live *S. equi*, M protein vaccines, or killed *S. equi* vaccines is suspected of inducing the disease.<sup>1,2</sup>

## EPIDEMIOLOGY

Purpura hemorrhagica is an uncommon, noncontagious, sporadic disease of horses. It has also been recorded in pigs and cattle. Estimates of the incidence of the disease are uncommon and imprecise. There was an incidence of 27 cases in 1438 horses housed over a 3-year period in a Swedish Army remount facility. All cases of purpura hemorrhagica followed upper respiratory infections, of which 11 were typical of strangles. Only a small proportion of horses are affected, but the incidence is highest when extensive outbreaks of strangles occur, possibly because of reinfection with streptococci of horses already sensitized by previous infection.

Of 53 horses with purpura hemorrhagica treated at a referral center, 17 had been exposed to or infected with *S. equi*, 5 had been vaccinated with *S. equi* M protein, 9 had been infected with *C. pseudotuberculosis*, and 5 had a history of apparently infectious respiratory disease of undiagnosed cause. Fifteen of 53 horses had no history of recent infectious disease.

Among clinicians there is a strong suspicion of an association between purpura hemorrhagica and vaccination. However, vaccination against *S. equi* infection has not been clearly demonstrated to be a risk factor for purpura hemorrhagica. Certainly, cases of purpura do occur in horses that have been vaccinated against strangles, but presumably there was a high probability that such horses were at increased risk of developing strangles. The consensus is that vaccination with vaccines containing M protein or avirulent *S. equi* is associated with increased risk of purpura. Edema of the lower limbs does occur after vaccination with streptococcal M protein and may represent a mild form of the disease. It is recommended by some authorities that horses with high serum antibody titers to streptococcal M protein not be vaccinated against strangles, although definitive data to support this recommendation are not available.

There does not appear to be breed, age, or sex predisposition to the disease. Horses as young as 6 months of age, and possibly younger, can be affected.

The case-fatality rate with appropriate treatment is approximately 10%. Purpura accounted for 2% and 8% of 2028 and 1245 deaths among horses shipped from the UK and the United States, respectively, to South Africa during the Boer War. This mortality rate was before the advent of antimicrobials or corticosteroids, which have presumably decreased the case-fatality rates.

## PATHOGENESIS

The basis of the disease process is an **aseptic vasculitis** of capillary walls accompanied by extravasation of plasma and blood into the tissues. Thrombocytopenia does not occur, and there is a defect in coagulation in most cases. Prolonged clotting times (activated clotting time, partial thrombin time, and thromboplastin time) occur in severely affected horses with infarctive purpura hemorrhagica. Skin lesions predominate but other organs, including the kidney, muscles, and gastrointestinal tract, are affected.

## CLINICAL FINDINGS

Affected horses are usually depressed and have reduced or absent appetite. The temperature is elevated in approximately 60% of cases, as is the heart rate. **Extensive subcutaneous edematous swellings** are the characteristic sign of the disease. They are most common about the face and muzzle but are often present on other parts of the

body and are not necessarily symmetric in distribution. The swellings may appear suddenly or develop gradually over several days. They are cold and painless, pit on pressure, and merge gradually into normal tissue without a definite line of demarcation. There is no discontinuity of the skin, although it may be tightly distended and even ooze redtinged serum. Swellings about the head may cause pressure on the pharynx with subsequent dyspnea and dysphagia. Lesions in the lungs are usually not clinically apparent without radiographic or ultrasonographic examination of the chest. Extensive edema of the limbs occurs in almost all cases. Rare cases of the disease in horses do not have edema.

**Submucous hemorrhages** occur in the nasal cavities and mouth, and petechiae may be present under the conjunctiva in over 80% of cases. Hemorrhage and edema of the gut wall may cause colic, but in most cases there is no diarrhea or constipation. Severely affected skin, and especially that of the legs, may slough and leave granulating wounds.

**Infarctive purpura hemorrhagica** is an uncommon manifestation of the disease characterized by infarction of multiple tissues including the gastrointestinal tract and muscle.<sup>3</sup> Affected horses have signs of colic and muscle swelling. The course is usually over 3 to 5 days and death, which is the most common outcome, and is associated with severe colic and rapidly deteriorating metabolic status. Colic is attributable to infarctions in the intestine but can be caused by intussusception of the small intestine secondary to infarctive lesions.<sup>4</sup>

The course of the disease is usually 1 to 2 weeks, and many animals die of blood loss, dyspnea caused by laryngeal or pharyngeal swelling, and secondary bacterial infections. Relapses are uncommon among appropriately treated horses.

## CLINICAL PATHOLOGY

There are no characteristic abnormalities detected on routine hematologic or biochemical examinations of affected animals. **Hematologic changes** are typically a mild anemia (usually <32% but >20%, <0.32 L/L but >0.20 L/L) with a neutrophilic leukocytosis and hyperfibrinogenemia. **The platelet count is normal.** Hypergammaglobulinemia can be present. There is an elevation in serum activity of CK and AST in affected horses, likely a result of muscle lesions, in approximately 25% to 30% of cases. Horses with infarctive purpura have marked elevations in serum activity of CK and AST, neutrophilia, and in severely affected horses, there is evidence of disseminated intravascular coagulation.

**Diagnostic confirmation** is achieved by **skin biopsy**, especially of early lesions, and reveals leukocytoclastic vasculitis. Immunofluorescence staining of sections of skin may

reveal the presence of antibodies, antigens, or complement in the walls of small blood vessels.

### NECROPSY FINDINGS

Ecchymotic and petechial hemorrhages are present generally throughout the body. The subcutaneous swellings contain plasma, which may be bloodstained, or sometimes whole blood. The lungs are edematous and congested. Histologically, the changes are also dominated by bland hemorrhage, but a leukocytoclastic vasculitis is usually observed in scattered vessels. Samples of lung, muscle, and gastrointestinal tract, in addition to skin, should be examined via light microscopy to check for the presence of vasculitis.

Horses with infarctive purpura have dark red to black, multifocal coalescing hemorrhages in skeletal muscles. Hemorrhages also occur in the lungs and gastrointestinal tract. Histologic examination reveals coagulative necrosis of muscle and other tissues. There is inflammation of the blood vessels.

### DIFFERENTIAL DIAGNOSIS

#### Horses

Causes of edematous swelling include the following:

- Equine viral arteritis and equine herpesvirus-1 or equine herpesvirus-4 infection, which do not have petechiation and are readily distinguished by their epidemiologic characteristics and by serologic testing
- Equine granulocytic anaplasmosis (ehrlichiosis), which can be differentiated by the presence of granular inclusions in the cytoplasm of neutrophils
- Congestive heart failure, which should be apparent on clinical examination
- Angioneurotic edema, which is not associated with petechiation
- Stachybotryotoxicosis

Causes of petechial hemorrhages include the following:

- Equine infectious anemia
- Thrombocytopenic purpura
- Stachybotryotoxicosis

#### Cattle

Hemorrhagic septicemia, poisoning by bracken fern and sweet clover, thrombocytopenia associated with bovine viral diarrhea, and stachybotryotoxicosis are more likely the causes of a hemorrhagic syndrome than is purpura hemorrhagica.

### TREATMENT

The **principles of treatment** are to reduce inflammation of the blood vessels, remove the inciting cause, and provide supportive care. Because of the possibility that the disease is caused by an adverse drug reaction, administration of any drugs that the horse is receiving at the time the disease develops should be discontinued.

**Reduction of inflammation of the blood vessels** involves mitigation of the immune response and removal of the source of the antigenic stimulus. The immune response, and its associated inflammatory reaction in blood vessels, should be treated with corticosteroids such as **dexamethasone** (0.05–0.2 mg/kg, IV or intramuscularly every 24 hours) or **prednisolone** (0.5–1 mg/kg, intramuscularly or IV every 24 hours). Prednisolone might not be as effective as dexamethasone. The dose of corticosteroid can be gradually reduced as the clinical signs improve, and the drug can be given orally. **NSAIDs** (phenylbutazone 2.2 mg/kg orally or IV every 12 hours, or flunixin meglumine 1.1 mg/kg orally or IV every 12 hours) may reduce inflammation and provide some analgesia.

**Removal of the source of the antigenic stimulus** of the disease is difficult, especially in cases when an antecedent infection or disease is not readily identified. On the assumption that purpura hemorrhagica is often a sequela to *S. equi* infection, and the suspicion that occult *S. equi* infection is present and the source of antigen associated with the disease, affected horses are usually treated with **penicillin G** (procaine penicillin, 20,000 IU/kg, intramuscularly every 12 hours, or potassium penicillin G, 20,000 IU/kg, IV every 6 hours) until the clinical signs resolve. Treatment with antibiotics might need to be continued for as long as 20 days.

**Supportive care** includes bandaging of swollen limbs, care of wounds, hydrotherapy, and IV fluid administration. Swelling of the head and pharynx may necessitate placement of a nasogastric feeding tube to permit enteral feeding of dysphagic horses. Respiratory distress can develop very rapidly, and emergency tracheotomy may be required to relieve respiratory distress and prevent asphyxiation.

### CONTROL

There are no specific preventive measures. However, control and prevention of upper respiratory tract infections in horses should lead to a reduction in the incidence of purpura hemorrhagica. Careful consideration should be given to the use of vaccines containing streptococcal M protein or avirulent *S. equi* in horses at low risk of developing strangles. Although the relationship between M protein-containing vaccines and purpura hemorrhagica is not definitive, circumstantial evidence and the opinion of authorities in the field support such an association. Measurement of serum antibodies to M protein might be useful in determining the need for vaccination of horses in endemic areas or at high risk. Horses with antibody titers >1:3200 should not be vaccinated.

### FURTHER READING

Rosenkrantz W. Immune-mediated dermatoses. *Vet Clin North Am Equine Pract.* 2013;29:607-617.

### REFERENCES

1. Al-Ghamdi GM. *J Anim Vet Adv.* 2012;11:3600.
2. Rosenkrantz W. *Vet Clin Equine.* 2013;29:607.
3. Whelchel DD, et al. *Equine Vet Educ.* 2009;21:135.
4. Dujardin CLL. *Tijdschr Diergeneeskd.* 2011;136:422.

### VENOUS THROMBOSIS

The development of thrombi in veins may result in local obstruction in venous drainage; in liberation of emboli that lodge in the lungs, liver, or other organs; and in the development of septicemia or of endocarditis.

### THROMBOPHLEBITIS

Thrombophlebitis is inflammation of the vein wall accompanied by the presence of thrombosis. Thrombophlebitis typically involves the classic triad of (1) blood vessel trauma, (2) stasis of blood flow (common in severely ill horses), and (3) a hypercoagulable state.<sup>1</sup> Thrombophlebitis may be caused by localization of a blood-borne infection, by extension of infection from surrounding diseased tissues, by infection of the umbilical veins in the newborn, and by irritant injections into the major veins. The jugular vein is most frequently affected in large animals because it is the vein usually used for IV injections and catheter placement.

**Thrombophlebitis** is a complication of injections or catheterization in some animals and occurs in all species. It can result from damage to the vascular endothelium by cannula or indwelling IV catheters, inflammation caused by chemical irritation, or bacterial invasion from contamination during insertion of the needle or catheter or migration along the catheter from the skin. Clipping of the skin over the jugular furrow markedly decreases bacterial counts on the skin surface of the horse, as does application of two common skin disinfectants, chlorhexidine and povidone iodine. Clipping allows easier visualization of the jugular vein, minimizing trauma during catheterization, and minimizes the potential for foreign material to be introduced under the skin during catheter placement.<sup>2</sup> The incidence of catheter- or injection-related thrombophlebitis is therefore thought to be decreased by clipping and aseptic preparation of the venipuncture site, although direct evidence of this assumption appears to be lacking in large animals. Phlebitis develops and can be detected clinically 24 to 72 hours after catheter insertion. A retrospective study of 46 cases in horses indicated that ongoing infectious disease was a risk factor for the development of catheter-associated thrombophlebitis, and thrombophlebitis is especially common in horses with severe gastrointestinal diseases that are accompanied by endotoxemia. The catheter acts as a nidus for clot formation, particularly at the site of insertion into the vein. The catheter tip, depending on its mechanical properties and blood flow velocity, may resonate in the lumen and mechanically damage the

adjacent venous endothelium. Horses are also at higher risk of thrombophlebitis following surgery. Severely ill cows are also more likely to develop jugular vein thrombophlebitis than healthy cows.

**IV injections of irritating materials**, such as tetracycline, phenylbutazone, 50% dextrose, hypertonic solutions of calcium gluconate, borogluconate and chloride, or hypertonic saline (7.2% NaCl), may cause endothelial damage followed by cicatricial contraction, with or without thrombus formation. Jugular phlebitis with thrombosis is not uncommon in feedlot cattle that have received repeated IV antibiotic medication and may lead to thromboembolic respiratory disease. Accidental injection of irritating material around the vein usually causes a marked local swelling, sometimes with necrosis and local sloughing of tissue, which may be followed by cicatricial contraction of local tissues.

Venous thrombi are relatively common in strangles in the horse, and may affect the jugular veins or the CVC. The odds of developing thrombophlebitis are markedly increased in horses with fever<sup>3</sup> or concurrent endotoxemia, salmonellosis, hypoproteinemia, or undergoing intensive care. Although IV administration of phenylbutazone is frequently associated with the development of phlebitis and jugular thrombosis at the site of injection, one study identified injection of phenylbutazone or flunixin meglumine through the catheter as protective for the development of thrombophlebitis.<sup>3</sup> Massive **pulmonary thromboembolism** probably occurs more often as a sequel of systemic illness in horses and cattle than is currently realized. In a recent case series involving six systemically ill horses, emboli that were thought to be generated somewhere in the venous circulation (particularly associated with localized thrombophlebitis) became lodged in the pulmonary circulation<sup>4</sup>; small emboli cause local infarcts with minimal to no clinical signs. In contrast, lodging of large emboli in the pulmonary circulation can rapidly lead to bronchoconstriction, tachypnea, cardiac failure, and sudden and unexpected death.

Thrombosis of the CVC caused by hepatic abscessation results in embolic pneumonia and pulmonary arterial lesions in cows and is described together with **cranial vena caval thrombosis** in Chapter 12. Caudal vena caval thrombosis can also result from inflammatory foci elsewhere; there is one report of thrombosis associated with treatment of lameness in a Holstein-Friesian cow that had deep digital sepsis that necessitated multiple regional IV perfusions.<sup>5</sup> Ultrasonography is very helpful in diagnosing caudal vena caval thrombosis in adult cattle, and excellent images of the thrombus have been obtained by placing a 7.5-MHz probe in a sterile rectal palpation sleeve during a right flank laparotomy with the cow in the standing position.<sup>6</sup>

Less common examples of venous thrombosis are those occurring in the cerebral sinuses, either by drainage of an infection from the face or those caused by the migration of parasite larvae. Purpling and later sloughing of the ears, which occur in many septicemias in pigs, are also caused by phlebitis and venous thrombosis. Thrombosis of the tarsal vein is a complication of infections in the claw of cattle and IV administration of antimicrobial agents as part of the treatment of septic arthritis or the distal interphalangeal joints.

### CLINICAL SIGNS

Clinical signs of venous thrombosis are engorgement of the vein, pain on palpation, and local edema. In unsupported tissues rupture may occur and lead to fatal internal or external hemorrhage. If the venous thrombosis is peripheral and on a limb, lameness and swelling distal to the venous thrombus may be evident.<sup>7</sup> Thrombosis of the portal vein in a neonate may result in hyperammonemic encephalopathy.<sup>8</sup> Massive pulmonary thromboembolism may be associated with acute tachypnea, fever, and collapse, or be clinically inapparent.<sup>4</sup>

Ultrasonographic examination greatly assists the diagnosis, and the detection of a cavitating area within the thrombus supports a diagnosis of septic thrombophlebitis. Ultrasonographic findings include a dilated and incompressible vein, no change in luminal volume when gentle pressure is applied at the thoracic inlet over the jugular furrow to occlude venous flow, a thickening of the wall of the vein consistent with phlebitis, and the presence of echoic or hyperechoic material in the lumen of the vein consistent with a thrombus.<sup>1</sup> Ultrasonographic changes are evident 24 hours before clinical signs of thrombophlebitis become apparent. Angiography can also assist in diagnosis but is no longer used with the widespread availability of high-resolution ultrasonographic units.

Bacteriologic culture should be attempted, preferably from the tip of the removed catheter. A variety of different organisms have been isolated from different cases. There are no typical findings on clinicopathologic examination, but there is often an abnormal leukogram and hyperfibrinogenemia. At necropsy the obstructed vessel and thrombus are usually easily located by the situation of the edema and local hemorrhage.

**Diagnosis** depends on the presence of signs of asymmetric local venous obstruction that is hot and painful to the touch in the absence of obvious external pressure by tumor, enlarged lymph nodes, hematomas, or fibrous tissue constriction. Veins with thrombophlebitis are usually firm and resist compression. Pressure of a fetus may cause symmetric edema of the perineum, udder, and ventral abdominal wall during late pregnancy, and can be easily differentiated from

thrombophlebitis by its symmetry and lack of pain. Local edema caused by infective processes such as blackleg, malignant edema, and peracute staphylococcal mastitis are accompanied by fever, severe toxemia, acute local inflammation, and necrosis.

### TREATMENT

The long-term outcome for thrombophlebitis is variable. The vein usually becomes recanalized and varying degrees of blood flow are reestablished; however, the thrombus may fibrose without recanalization, restricting venous return and causing the development of a collateral circulation.<sup>1</sup> **Parenteral treatment** with antimicrobial agents and hot fomentations to external veins to assist drainage of purulent material (particularly in cattle), or treatment with a topical anti-inflammatory agent such as 50% dimethyl sulfoxide, is usually instituted to remove the obstruction or allay the swelling. If a catheter is used, it should be immediately removed.

Treatments used for arterial thrombosis should theoretically have similar efficacy in the treatment of venous thrombosis, but usually aggressive treatment is not needed unless the venous thrombosis is extensive and enlarging. Serial ultrasonographic examinations are very helpful in monitoring recanalization of the thrombosed vein and measurements of the external jugular vein diameters are available for cattle.

### FURTHER READING

- Buczinski S. Cardiovascular ultrasonography in cattle. *Vet Clin North Am Food Anim Pract.* 2009;25:611-632.
- Schaer BLD, Epstein K. Coagulopathy of the critically ill equine patient. *J Vet Emerg Crit Care.* 2009;19:53-65.

### REFERENCES

- Moreau P, Lavoie JP. *J Am Vet Med Assoc.* 2009;235:1073.
- Geraghty TE, et al. *Vet Rec.* 2009;164:51.
- Geraghty TE, et al. *Vet Rec.* 2009;164:227.
- Norman TE, et al. *Equine Vet J.* 2008;40:514.
- Simpson KM, et al. *Can Vet J.* 2012;53:182.
- Sigrist I, et al. *J Vet Intern Med.* 2008;22:684.
- Banse H, et al. *J Vet Intern Med.* 2012;26:178.
- Ness SL, et al. *J Vet Intern Med.* 2013;27:382.

### ELAEOPHORIASIS (FILARIAL DERMATITIS IN SHEEP)

*Elaeophora* spp. are filarial nematodes that inhabit blood vessels. Relatively nonpathogenic species include *E. bohmi*, which has been reported in horses in Austria, and *E. poeli*, which occurs in cattle in Africa and Asia. Of greater clinical significance is *E. schneideri*, which is primarily a parasite of mule deer<sup>1</sup> and moose<sup>2</sup> in North America. Elk, white-tailed deer, and moose may act as reservoir hosts. This species causes chronic disease in adult sheep grazing at high altitudes during the summer months. Horse



flies such as *Hybomitra* and *Tabanus* spp. are intermediate hosts. In sheep, larvae develop in the leptomeningeal arteries for 4 to 5 weeks after which they migrate into the common carotid and internal maxillary arteries, although they may also be found in other arteries. The adults grow to 120 mm in length and mature in about 5 months.

**Elaeophorosis** usually produces no detectable effects in the natural host (the mule deer). Clinical signs in abnormal hosts attributable to migrating worms are thought to be the result of the prolonged sojourn of the larvae in smaller blood vessels. This reduces blood flow and may result in blindness, deafness, and circling. It also means that the larvae are larger when they pass through the cerebral retina to get to the common carotid and rupture of a rete artery, hemorrhage, and death may follow. Further signs are caused by the microfilariae. Sheep usually show a severe dermatitis on the poll, forehead, face, feet, and ventral abdomen. Initially the lesions are small and circumscribed but the irritation produced by them is so intense that scratching causes extensive areas of bleeding, with a granular surface containing numerous small abscesses. On the feet, the lesions extend from the coronary band to above the fetlock and cause a great deal of local swelling. Recurrent periods of quiescence occur and scabs form over the lesions, but 2 to 3 days later scratching recommences and the lesions are spread further. The course is long, often 7 months and up to 3 years, but recovery may eventually occur. Residual lesions include deformity of the hooves and bare, thickened patches of skin. Lesions also occur in the nasal and oral mucosae and on the cornea. Abnormalities of the eye include cataracts, iridocyclitis, and corneal opacity. Although sight often remains adequate in sheep, it is usually lost in elk.

#### DIFFERENTIAL DIAGNOSIS

The distribution of lesions and pruritus help to distinguish elaeophorosis from

- Contagious ecthyma
- Mycotic dermatitis
- Strawberry foot rot

Photosensitization lesions may have a very similar distribution and appearance to those caused by the elaeophorid filaria, but there is usually marked edema and swelling and a history of access to photosensitizing or hepatotoxic plants.

**Microfilariae** may be detected in skin biopsies, but skin scrapings and blood examinations are not satisfactory. The number of microfilariae in the skin of sheep is always low, and negative results may be obtained in known positive sheep.

**Treatment** with piperazine (220 mg/kg) has been suggested. Unfortunately, the death of adult parasites in heavily infected sheep may cause the death of the host, presumably by blocking branches of the carotid arteries. Information is lacking on the activity of modern drugs on this infection.

#### REFERENCES

1. Mckown RD, et al. *J Wildl Dis.* 2007;43:142.
2. LeVan IK, et al. *J Wildl Dis.* 2013;49:666.

## Vascular Neoplasia

Neoplasia of the vascular system is rare in ruminants, horses, and pigs.

### HEMANGIOMA AND HEMANGIOSARCOMA

Hemangioma and hemangiosarcoma are rare in large animals but are described and may be associated with hemorrhage related to the site of the tumor.

#### HEMANGIOMA

Hemangiomas in the skin are most common in horses aged less than 1 year and may be congenital. The most common site in horses is the skin of the distal limb. Clinically, the lesions are usually solitary, firm to fluctuant, and bluish to black in color.<sup>1</sup> The tumors grow with age; those on the skin may ulcerate and bleed and may necessitate euthanasia because of their eventual size. Similar

tumors may occur in the mouth as pedunculated pink granular masses that ulcerate and bleed. Local hemangiomas on the skin and in the mouth may respond to surgical excision, thermocautery, or radiation therapy. Widespread disseminated hemangioma is also recorded in young cattle presenting with multiple skin lesions and multiorgan involvement. Hemangioma has also been reported with moderate prevalence affecting the ovaries of sows.

#### HEMANGIOSARCOMA

Hemangiosarcoma occurs in **horses** but is not a common tumor. It is more prevalent in middle-aged and older animals. Affected horses may present with a bleeding subcutaneous mass or with signs of disseminated hemangiosarcoma. Disseminated hemangiosarcomas in horses cause anemia due to hemorrhage into the tumor or into body cavities. In addition there is weight loss, but good appetite, and weakness. Metastasis is extensive to lung, myocardium, brain, retroperitoneum, and skeletal muscle, and myocardial lesions can lead to cardiac arrhythmias. Lesions in skeletal muscle cause difficulty in movement, and tumors in the nervous system present with signs of ataxia. The thoracic cavity is a common site for metastasis and can also be a primary site of the neoplasm.

A common clinical manifestation is **pleural effusion and hemorrhage** and a clinical picture that requires differentiation from other causes of thoracic mass with effusion, which in the horse is more commonly mediastinal abscess, lymphosarcoma, squamous cell carcinoma, or pleurisy. Hemoperitoneum, detectable by paracentesis, is present with peritoneal tumors. All the tumors are cavitated and bleed profusely if incised. Early histopathologic diagnosis may permit a cure in animals with localized masses that can be surgically resected.<sup>1</sup> If masses are not interfering with quality of life and the horse is medically stable, observation may be warranted because spontaneous resolution has been reported.

#### REFERENCE

1. Taintor J. *Equine Vet Educ.* 2014;26:499.

**ABNORMALITIES OF PLASMA****PROTEIN CONCENTRATION 716**

Hypoproteinemia 716

Hyperproteinemia 718

**HEMORRHAGIC DISEASE 718**

Diseases Causing Hemorrhage 721

Disseminated Intravascular Coagulation

and Hypercoagulable States 725

Thrombosis (Hypercoagulability) 728

Diseases Characterized by Abnormalities of the Cellular Elements of the Blood 728

Bovine Neonatal Pancytopenia (BNP) 749

**LYMPHADENOPATHY****(LYMPHADENITIS) 751****DISEASES OF THE SPLEEN AND THYMUS 752**

Splenomegaly 752

Splenic Abscess 752

Splenic Hematoma, Rupture or Infarction 752

Congenital Anomalies of the Spleen 753

Thymus 753

**IMMUNE-DEFICIENCY DISORDERS****(LOWERED RESISTANCE TO INFECTION) 753**

Primary Immune Deficiencies 754

Secondary Immune Deficiencies 755

**AMYLOIDOSES 755**

Allergy and Anaphylaxis 757

Anaphylaxis and Anaphylactic Shock 758

Caseous Lymphadenitis of Sheep and Goats 761

Bovine Farcy 765

Sporadic Lymphangitis (Bigleg, Weed) 765

Tick-Borne Fever (*Anaplasma phagocytophila*) 766Anaplasmosis due to *A. marginale* and *A. ovis* 769

Equine Granulocytic Anaplasmosis

(Equine Granulocytic Ehrlichiosis, *Anaplasma phagocytophilum*) 775

Eperythrozoonosis 777

Bovine Petechial Fever (Ondiri Disease) 779

*Mycoplasma suis* Infection in Pigs 779

Epizootic Hemorrhagic Disease (Blacktongue) 781

Bovine Immunodeficiency-Like Virus 784

**ENZOOTIC BOVINE LEUKOSIS (BOVINE LYMPHOSARCOMA) 785**

Equine Infectious Anemia (Swamp Fever) 795

Ticks That Transmit Protozoan Diseases 799

Babesiosis (Texas Fever, Redwater Fever, Cattle Tick Fever) 799

Equine Piroplasmiasis 811

**NUTRITIONAL DEFICIENCIES 814**

Iron Deficiency 814

Cobalt Deficiency 817

Vitamin B<sub>12</sub> Deficiency (Hypocyanocobalaminosis) 822

Vitamin K Deficiency 822

Folic Acid Deficiency (Hypofolicosis) 823

**TOXINS AFFECTING THE HEMOLYMPHATIC SYSTEM 823**

Secondary Copper Poisoning ("Toxicemic Jaundice" Complex) 823

Anticoagulant (Dicoumarol, Sweet Clover Poisoning) Plant Toxicosis 823

Anticoagulant Rodenticide Toxicosis 825

Cyanogenic Glycoside Poisoning (Cyanide, Hydrocyanic Acid, Prussic Acid) 826

Nitrate and Nitrite Toxicosis 829

Disulfide Plant Toxicosis (*Allium* spp. [onions] and *Brassica* spp.) 832Red Maple Leaf (*Acer rubrum*) Toxicosis 834**NEOPLASIA 834**

Sporadic Bovine Leukosis (Atypical Bovine Leukosis) 834

**CONGENITAL INHERITED DISEASES 837**

Inherited Bleeding Disorders 837

Familial Polycythemia 837

Hemochromatosis 837

Inherited Anemias 838

Porphyrias 838

Inherited Congenital Porphyria 838

Inherited Erythrocytic Photoporphyria 839

**INHERITED IMMUNODEFICIENCY 839**

Bovine Leukocyte Adhesion Deficiency 839

Chediak-Higashi Syndrome 839

Inherited Deficiency of Lymphocyte

Maturation (Lethal Trait A46, Parakeratosis, Adema Disease) 840

Fell Pony and Dale Pony Foal Immunodeficiency Syndrome 840

Inherited Deficiency of Immunoglobulin Synthesis 841

Inherited Combined Immunodeficiency in Fools of Arabian Breeding 841

**DISEASES OF UNKNOWN ETIOLOGY 842**

Postparturient Hemoglobinuria in Cattle 842

Multisystemic, Eosinophilic, Epitheliotropic Disease of Horses 844

**Abnormalities of Plasma Protein Concentration**

Plasma contains hundreds of proteins, including albumin, immunoglobulins, clotting factors, acute-phase proteins, hormones, and cytokines. The proteins in plasma are produced by the liver (albumin, acute-phase proteins [fibrinogen, serum amyloid A], clotting factors) and lymphoid organs (the

gamma-globulins and many cytokines). The plasma proteins serve as sources of amino acids for tissues, serve as carrier molecules, maintain plasma oncotic pressure, regulate immune function, and function in hemostasis and fibrinolysis. Defects or deficits of individual proteins can result in specific diseases, including immune deficiency, defective hemostasis, and endocrinopathy. The individual diseases resulting from loss of activity of specific proteins are discussed

under the headings of those diseases. Provided here is an overview of hypoproteinemic and hyperproteinemic states.

**HYPOPROTEINEMIA****ETIOLOGY**

Hypoproteinemia is a plasma or serum total protein concentration that is below that expected in animals of the same age, sex, physiologic state, and species.

Hypoproteinemia can be a result of a reduction in concentration of albumin and globulin, or a reduction in either albumin or globulin concentrations. Abnormalities in plasma protein concentration include the following:

- Panhypoproteinemia with hypoalbuminemia and hypoglobulinemia
- Hypoproteinemia with hypoalbuminemia and normal globulin concentration
- Hypoproteinemia with hypoglobulinemia and normal albumin
- Normal total protein concentration with hypoalbuminemia and hyperglobulinemia; less commonly, hyperalbuminemia and hypoglobulinemia

The specific deficiency has important diagnostic significance.

### Panhypoproteinemia

Hypoproteinemia with hypoalbuminemia and hypoglobulinemia can be either relative or absolute.

**Relative hypoproteinemia** occurs when plasma protein concentrations are lower than normal, but the absolute content of protein in the vascular space is normal. This is a dilutional hypoproteinemia and is attributable to either excessive fluid therapy or excessive water intake. These causes are readily determined from a review of the history and treatment of the animal, and cases resolve within hours of discontinuation of fluid therapy or restriction of fluid intake.

**Absolute hypoproteinemia** occurs when there is a reduction in the amount of plasma proteins in the vascular space in the presence of normal or almost normal plasma volume. The reduced protein concentration can be the result of impaired production or accelerated loss. Reduced production of all plasma proteins occurs only as part of malnutrition and starvation. Liver disease can cause a reduction in the concentration in plasma of those proteins produced by the liver (see following discussion) but in large animals is an unusual cause of hypoproteinemia. Loss of protein is a more common cause of hypoproteinemia.

The loss of proteins can be either from the vascular space into the extravascular compartment (e.g., endotoxemia, vasculitis) or from the body (compensated hemorrhage, glomerulonephritis, protein-losing enteropathy). This situation is evident as a reduction in concentrations of both albumin and globulins, and in hemorrhagic disease, by a reduction in hematocrit. Loss because of vascular leakage is usually evident as hypoproteinemia with normal or elevated hematocrit. Diseases causing panhypoproteinemia include the following:

- Hemorrhage—hypoproteinemia occurs when plasma volume is restored after severe hemorrhage, or in normovolemic

anemia when there is persisting loss of blood. All causes of chronic blood loss can cause hypoproteinemia.

- Endotoxemia—protein loss is secondary to leakage of protein from the vascular space into interstitial spaces because of increased capillary permeability.
- Vasculitis—increased capillary permeability and leakage of protein result from vasculitis; it is evident in many systemic diseases, including African horse sickness, purpura hemorrhagica, swine fever, and malignant catarrhal fever.
- Protein-losing enteropathy—the initial change is in plasma albumin concentration, but panhypoproteinemia ensues as the disease progresses. Diseases causing protein-losing enteropathy include the following:
  - Intestinal parasitism
  - Abomasal ulceration in cattle
  - Lymphosarcoma in cattle and horses
  - Granulomatous/inflammatory intestinal disease in horses (granulomatous enteritis, eosinophilic enteritis) and cattle (John's disease)
  - Enteritis/colitis (salmonellosis, equine neorickettsiosis [*Neorickettsia risticii*])
  - Nonsteroidal antiinflammatory drug (NSAID) toxicosis
  - *Lawsonia intracellularis* proliferative enteropathy in young horses and pigs<sup>1</sup>
- Urinary tract disease, including cystic calculi, pyelonephritis, glomerulonephritis
- Acute, severe inflammation of the peritoneal or pleural membranes (peritonitis, pleuritis). The hypoproteinemia occurs early in the disease; if the disease becomes chronic, hypergammaglobulinemia ensues.
- Chronic heart failure

### Hypoalbuminemia

Hypoalbuminemia with normal or elevated plasma globulin concentration occurs in diseases in which there is insufficient production of albumin by the liver or excessive or selective loss of albumin compared with loss of globulin. Insufficient production of albumin occurs in diseases of the liver, although these animals might not necessarily be hypoproteinemic, and in malnutrition or starvation. Diseases of the liver that cause hypoalbuminemia are usually diffuse, severe, and chronic. The prolonged half-life of albumin in cattle and horses (approximately 18 days) renders them less liable to hypoalbuminemia than smaller animals.

Albumin has a lower molecular weight than most globulins, especially the immunoglobulins, and can be lost selectively in renal

or gastrointestinal disease. Diseases associated with hypoalbuminemia and normal to elevated globulin concentrations include the following:

- Amyloidosis—loss of albumin into urine or the gastrointestinal tract is sometimes offset, in terms of plasma protein concentration, by increases in plasma globulin concentration.<sup>2</sup>
- Chronic peritonitis or pleuritis—loss of albumin into the inflammatory exudate is offset, in terms of plasma total protein concentration, by increases in plasma globulin concentration.
- Intestinal parasitism
- Renal disease
  - Glomerulonephritis—because of changes in the size and charge on proteins of the glomerular membrane, albumin is not prevented from entering the ultrafiltrate and is lost in urine. Any diseases affecting the glomeruli can cause albumin loss.
  - Pyelonephritis

### Hypogammaglobulinemia

Hypoglobulinemia with normal plasma albumin concentration occurs in few diseases. Notably, it is a feature of failure of transfer of passive immunity in neonates (see Chapter 20). Hypoglobulinemia is an unusual isolated defect in other diseases. It can be detectable in immunodeficiencies causing decreased production of gamma-globulins, such as combined variable immunodeficiency in horses.<sup>3</sup>

### Hypofibrinogenemia

Hypofibrinogenemia usually only occurs as part of disseminated intravascular coagulation, although it could conceivably occur in chronic liver failure.

## PATHOPHYSIOLOGY

Panhypoproteinemia and hypoalbuminemia cause a reduction in the plasma concentrations of proteins essential for a variety of functions. Overall, the reduction in plasma albumin concentration results in a low plasma oncotic pressure. Low plasma oncotic pressure allows movement of fluid from the vascular space, causing a reduction in plasma volume and increases in extravascular volume. The reduction in plasma volume lowers blood flow to tissues and can result in organ dysfunction. The increased extravascular volume is sometimes evident as ventral body wall or submandibular edema.

Low plasma albumin concentration, in addition to the reduction in plasma oncotic pressure, reduces opportunities for transport of substances in the plasma, including hormones and electrolytes (calcium).

Hypogammaglobulinemia increases the risk of infectious disease, especially when it occurs as a consequence of failure of transfer of passive immunity to neonates.



## CLINICAL SIGNS

The clinical signs associated with hypoproteinemia are lethargy, ill-thrift, and edema. The edema is usually distributed symmetrically, with some species having a predilection for the site of accumulation—ventral edema in horses and submandibular edema in cattle and sheep. Affected animals are often tachycardic because of the reduced plasma volume.

Signs of the inciting disease will also be present (weight loss, diarrhea, melena, polyuria).

## CLINICAL PATHOLOGY

Detection of hypoproteinemia is readily achieved by routine hematologic or serum biochemical testing. The albumin-to-globulin (A:G) ratio can be useful in assessment of hypoproteinemia. Hypoalbuminemia with normal globulin concentration results in a low A:G ratio, whereas panhypoproteinemia results in a normal A:G ratio. Selective deficiencies can be detected by protein electrophoresis or measurement of concentrations of specific proteins, such as the immunoglobulins by enzyme-linked immunosorbent assay (ELISA), radial immunodiffusion (RID), or immunoturbidimetric analysis (see Failure of Transfer of Passive Immunity in Chapter 20).

Measurement of plasma oncotic pressure is useful in detecting low plasma oncotic pressure, which contributes to a reduction in plasma volume and increases in extravascular fluid, which can lead to formation of edema. Plasma oncotic pressure is proportional to the plasma protein concentration, with the greatest correlation being with plasma albumin concentration in animals that have not received dextran solutions. Intravenous (IV) administration of dextran or hydroxyethyl starch increases plasma oncotic pressure.

## NECROPSY

The changes observed at necropsy are those of the inciting disease, or secondary infection in animals with hypogammaglobulinemia. Edema can be present in subcutaneous and internal connective tissues.

## TREATMENT

The principles of therapy are treatment of the inciting disease and correction of hypoproteinemia or low plasma oncotic pressure. Correction of hypoproteinemia (hypoalbuminemia, hypogammaglobulinemia) is achieved by administration of plasma by transfusion. Unless anemia is also present, plasma transfusion is preferred over blood transfusion. The amount of plasma transfused to neonates is discussed in Chapter 20. Plasma transfusion to adult horses and cattle is often limited by the cost of the plasma. Ideally, plasma should be transfused to increase plasma albumin concentrations to more than 2.0 g/dL (20 g/L). This can be

calculated as follows (where 0.05 is the proportion of body weight that is plasma):

$$\text{Current plasma albumin content} = \text{body weight (kg)} \times 0.05 \times (\text{plasma albumin concentration in g/L})$$

$$\text{Desired plasma albumin content} = \text{body weight (kg)} \times 0.05 \times (\text{desired albumin concentration in g/L})$$

$$\text{Amount of albumin required (g)} = \text{Desired plasma albumin content} - \text{current albumin content}$$

$$\text{Volume of plasma required (L)} = \frac{\text{Amount of albumin required (g)}}{\text{albumin concentration in transfused plasma (g/L)}}$$

A numerical example for a 500-kg horse with a plasma albumin concentration of 1.5 g/dL (15 g/L) and a target plasma albumin concentration of 2.5 g/dL (25 g/L) is as follows:

$$\text{Current plasma albumin content} = 500 \text{ (kg)} \times 0.05 \times 15 \text{ (g/L)} = 375 \text{ g}$$

$$\text{Desired plasma albumin content} = 500 \text{ (kg)} \times 0.05 \times 25 \text{ (g/L)} = 625 \text{ g}$$

$$\text{Amount of albumin required (g)} = 625 - 375 = 250 \text{ g}$$

$$\text{Volume of plasma required (L)} = \frac{250 \text{ (g)}}{50 \text{ (g/L)}} = 5 \text{ L}$$

It is a frequent observation that transfusion of the calculated volume of plasma leads to improvement in clinical signs, but it does not result in the expected increase in the plasma albumin concentration. This is probably because transfusion of albumin results in an increase in plasma oncotic pressure and a net movement of fluid from the extravascular space into the vascular space, with subsequent expansion of the plasma volume. The expansion of plasma volume dilutes the administered albumin and attenuates the increase in plasma protein concentration.

Plasma oncotic pressure can be increased by IV administration of hydroxyethyl starch or high-molecular-weight dextrans. The dose is 8 to 10 mL/kg of 6% solution delivered intravenously over 6 to 12 hours.<sup>4</sup>

## HYPERPROTEINEMIA

### ETIOLOGY

#### Panhypoproteinemia

Panhypoproteinuria, an increase in concentration of all plasma proteins, occurs only in situations in which there is a reduction in plasma water content. This occurs in animals that are severely dehydrated through lack of access to water, inability to drink, loss of protein-poor body fluids (diarrhea, vomitus), or excessive polyuria with inadequate water intake.

#### Hyperglobulinemia

Hyperglobulinemia occurs as a consequence of chronic inflammation or abnormal

production of globulins. Chronic inflammation causes a polyclonal gammopathy, whereas plasma cell neoplasia (plasmacytoma, myeloid leukemia, see “Leukoproliferative disease”) causes a monoclonal gammopathy. Any chronic inflammatory disease, including those of infectious, toxic, or neoplastic origin, can cause hyperglobulinemia.

#### Hyperfibrinogenemia

Fibrinogen is an acute-phase protein (along with serum amyloid A, haptoglobin, C-reactive protein, and others), the concentration of which increases in plasma in response to inflammation. Any disease that causes inflammation can increase plasma fibrinogen concentration.

## PATHOPHYSIOLOGY

Chronic inflammation results in chronic stimulation of the immune system, with subsequent increased production of immune globulins and acute-phase proteins. Monoclonal gammaglobulinemia occurs as a result of unrestrained production of gammaglobulins by neoplastic plasma cells.

## CLINICAL SIGNS

The clinical signs are of the underlying inflammatory disease.

## CLINICAL PATHOLOGY

Measurement of plasma protein concentration reveals hyperglobulinemia and/or hyperfibrinogenemia. Serum protein electrophoresis demonstrates whether the abnormality is a polyclonal or monoclonal gammaglobulinopathy. Measurement of specific immunoglobulins (immunoglobulin [IgG], immunoglobulin A [IgA], etc.) can be useful. Fibrinogen concentration must be measured in plasma because it is consumed during the clotting process when blood is allowed to clot.

## NECROPSY

The findings are those of the underlying disease.

## TREATMENT

Treatment is directed toward the underlying disease.

## REFERENCES

1. Pusterla N, et al. *Vet Microbiol.* 2013;167:34.
2. Elitok OM, et al. *J Vet Int Med.* 2008;22:450.
3. Tennent-Brown BS, et al. *Equine Vet Educ.* 2010;22:393.
4. Epstein KL, et al. *J Vet Int Med.* 2014;28:223.

## Hemorrhagic Disease

Hemorrhagic disease is manifest as the presence of hemorrhage of unusual duration or severity, either externally from apparently minor wounds, or into body cavities, or as the presence of petechial and ecchymotic

hemorrhages in mucous and conjunctival membranes and the skin. Petechial and ecchymotic hemorrhage, spontaneous hemorrhage, or excessive bleeding after minor injury can result from increased capillary fragility, disorders in platelet function, or defects in the coagulation mechanism of the blood.

## DIAGNOSIS

Diagnosis of the cause of hemorrhagic disease is based on the demonstration of abnormalities in the activity, concentration, or function of components of blood coagulation and fibrinolysis. The exception is diagnosis of vasculitis, which is achieved by biopsy, usually of skin, and histologic examination and demonstration of inflammatory lesions in the walls of blood vessels. Vasculitis is not normally evident as a hemorrhagic disease.

Demonstration of prolonged **bleeding time** is achieved using devices that inflict a controlled wound on either the skin or a mucous membrane (template bleeding time). A wound is inflicted in the skin, and blood is periodically collected onto absorbent filter paper until bleeding ceases. The time from discharge of the device until bleeding stops is the bleeding time. The mean template bleeding time is less than 5 minutes in most healthy animals, but the test has poor repeatability in healthy horses, and the reference range is too wide to make the test clinically useful.<sup>1</sup>

Care must be taken when **collecting specimens of blood** for measurement of factors involved in coagulation or fibrinolysis. Blood samples collected into containers that do not contain an anticoagulant will rapidly clot, and the resulting serum sample will be minimally useful for any tests of factors involved in clotting or fibrinolysis. The ideal anticoagulant for most assays of clotting and fibrinolysis is **trisodium citrate** (1 part of 3.8% trisodium citrate to 9 parts of blood). Sodium citrate decreases the concentration of ionized calcium in blood and thereby inhibits platelet activity. Heparin, both unfractionated (conventional) and low-molecular-weight formulations, inhibits thrombin activity and activates platelets and is not a suitable anticoagulant for measurement of clotting times or platelet activity. Potassium ethylenediamine tetraacetic acid (EDTA) interferes with platelet function.

An integrated measure of the capacity of blood to clot is the **activated clotting time**. In this test, blood is collected into plastic syringes that do not contain an anticoagulant and then immediately injected into glass tubes containing diatomaceous earth. The tubes are gently agitated and then incubated for 1 minute in a water bath at 37°C (98.6°F). The tubes are then removed from the water bath and examined for clotting of blood by gently rolling the tube. The tube is then

returned to the water bath and reexamined every 30 to 60 minutes.

The rate of **clot retraction** of blood collected into a glass tube that does not contain anticoagulants is a measure of platelet activity. The time until maximum clot retraction is 1 to 2 hours in most species when the blood is held at 37°C (98.6°F).

Measurements of **prothrombin time** (an indicator of activity of the extrinsic clotting system), **activated partial thromboplastin time** (an indicator of functionality of the intrinsic clotting system), and **thrombin time** (common pathway) are routinely performed for animals. The tests are reliable when performed properly; however, values for normal animals can vary, and the recommendation is that when submitting a sample from an animal with suspected coagulopathy, a sample from a similar healthy animal should also be examined. If prothrombin or activated partial thromboplastin time are prolonged, other tests to determine the specific factor(s) involved might be warranted.

Measurement of the activity or concentration of blood clotting factors is routine in human medicine, and many of these tests have been adapted for use in animals. **Chromogenic assays** of factors VII, VIII:C, IX, and X developed for testing of human plasma are reliable when used for testing of horse plasma. An ELISA for von Willebrand factor is available that is suitable for use in a number of species, including horses, pigs, and cattle. Whereas most functional assays, including chromogenic assays, are suitable for use among species, most immunologically based assays developed for use in humans are not suitable for use in animals. It is important that assays should be validated in the species of interest before clinical use in animals.

**Fibrinogen** is an essential substrate for clot formation, and low plasma concentrations of fibrinogen, such as can be encountered in animals with disseminated intravascular coagulation, can impair blood clotting. Measurement of fibrin (fibrinogen) degradation products (FDPs) has been used to detect disseminated intravascular coagulation in horses, but the test has poor sensitivity and specificity. Measurement of **D-dimer** concentration has the potential to be more useful than FDP in assessment of fibrinolysis and detection of thromboembolic disease, although measurement of elevated D-dimer concentrations in foals is not associated with the presence of disseminated intravascular coagulation and coagulopathies.<sup>2</sup> Performance characteristics vary among assays and kit suppliers, and these should be ascertained before clinical use of kits or assays. The FDP assay was found to have low sensitivity (<40%) for diagnosis of disseminated intravascular coagulation in horses with colic, whereas the most accurate D-dimer kit had 50% sensitivity and 97% specificity. The activity of **antithrombin** (previously antithrombin III), a cofactor of

heparin, is measured in horses as a means of assessing the anticoagulant activity of plasma. Activity of antithrombin is reduced in animals with coagulopathies secondary to gastrointestinal disease. This factor is best measured in concert with thrombin-antithrombin complex concentration and protein C and plasminogen activity to detect hypercoagulable states.

**Platelet count** in blood should be evaluated in any animal with a hemorrhagic diathesis. Caution should be exercised in interpreting low platelet counts determined by automated analyzers because clumping of platelets can cause artificially low values. This **pseudothrombocytopenia** can be a result of anticoagulant-induced *ex vivo* aggregation of platelets, which can be readily detected by microscopic examination of the blood smear. Platelet counts of less than 100,000 cells/ $\mu$ L are considered abnormal, although excessive hemorrhage is usually not apparent until platelet counts are below 40,000 cells/ $\mu$ L. Determination of the proportion of platelets that stain with **thiazole orange** dye (reticulated platelets) can be useful in determining the bone-marrow regenerative response in horses, and probably other species, with thrombocytopenia. Reticulated platelets are those platelets that have been recently released from bone marrow. Healthy ponies have 1.3% to 2.8% of platelets in circulation that stain with thiazole orange, and horses have 1% to 3.4%. Thrombocytopenic, equine-infectious-anemia-positive ponies have 11% to 48% thiazole-orange-staining platelets in the circulation, and thrombocytopenic, equine-infectious-anemia-negative horses have 2% to 9%.

**Platelet function** can be evaluated using platelet function analyzers designed for use with human blood, ultrastructure, and flow cytometry. Impaired platelet aggregation can be detected as a prolongation in closure time using cartridges with collagen-adenosine diphosphate (CT-ADP) and collagen-epinephrine (CT-Epi) as platelet agonists. In normal horses calculated reference ranges are 60.5 to 115.9 seconds and 158.5 to more than 300 seconds for CT-ADP and CT-Epi, respectively. **Disorders of platelet function** can be both acquired and congenital (genetic). Genetic disorders of platelet function in large animals include Glantzmann thrombasthenia in Oldenburg, Thoroughbred, Quarter horse, and Peruvian Paso breeds of horses; thrombopathia in Simmental cattle; and Chediak-Hegashi syndrome in Japanese Black Cattle.<sup>3</sup> This is in addition to the occurrence of von Willebrand's disease (type 2) in Quarter horses and Thoroughbreds.<sup>3</sup>

**Thromboelastography** (TEG) is a viscoelastic, whole-blood-based assay that integrates information from both the cellular and soluble components of coagulation, providing a global evaluation of the hemostatic

system, unlike conventional coagulation assays.<sup>4-7</sup> Measurements of platelet count, prothrombin time (PT), activated partial thromboplastin time (aPTT), and fibrinogen concentration (FIB) individually provide information about one component of the hemostatic process, and evaluation of several assays is needed for a complete evaluation of hemostasis.<sup>4</sup>

Thromboelastography measures indicators of both the intrinsic and extrinsic clotting cascades (noting that this terminology is increasingly archaic and being replaced with a more integrated description of clotting cascades) incorporating both the cellular and noncellular components of the clotting cascade. Several variables are measured (Fig. 11-1), including the following:<sup>8</sup> coagulation time, which is the time in seconds between activation of clotting and formation of the first measurable clot; clot formation time, which is the time needed to increase the elasticity of the clot from 2 mm to 20 mm and corresponds to the initial activation of platelets; angle ( $\alpha$ ), which indicates hypo- or hypercoagulability; and maximum clot firmness, which corresponds to the maximum strength of the clot and depends on both platelet and fibrinogen activation in the presence of factor XIII. Hemolysis interferes with the reliability of testing.<sup>8</sup> There are marked effects of even short-term (<30 minutes) storage of equine blood, with significant increases in indicators of coagulation.<sup>9</sup>

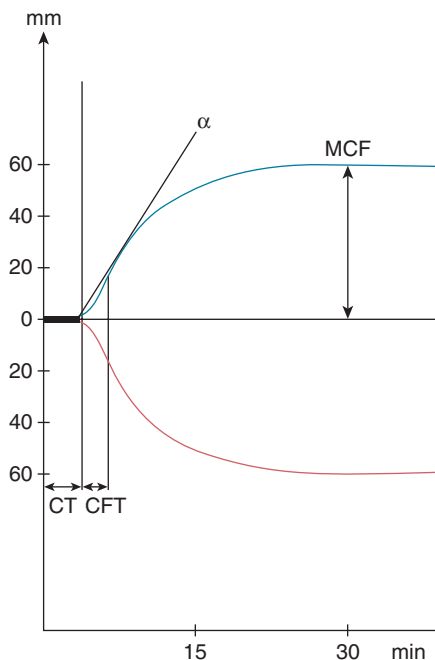

**Fig. 11-1** Schematic diagram of a representative thromboelastogram depicting coagulation time (CT), clot formation time (CFT), angle ( $\alpha$ ), and maximum clot firmness (MCF). (Reproduced with permission from Paltrinieri et al. 2008.<sup>8</sup>)

Utility of viscoelastic evaluation of blood has been reported in healthy dairy cows at various stages of lactation, in healthy and sick neonatal foals, in horses with gastrointestinal disease, and in horses with disorders of platelet function.<sup>10-14</sup> Assay validation, and careful attention to sample collection and processing, is essential for reliable results of viscoelastic testing.<sup>8,15,16</sup> The recommended anticoagulant for viscoelastic testing of blood is sodium citrate in a precise ratio of 1:9 (citrate solution to blood) using blood collected by jugular venipuncture.<sup>15</sup>

In normal animals, values of the variables just discussed have been reported inconsistently and are available in textbooks dealing with hematology. Values in foals and calves can vary with age, and this should be considered when interpreting coagulation variables in neonates and young animals.<sup>2,17,18</sup> Values for camelids are reported.<sup>19</sup>

### TREATMENT OF COAGULOPATHIES

**Plasma** is often administered to animals with hemorrhagic diatheses to replace clotting factors that are deficient because of failure of production (e.g., warfarin intoxication), increased consumption (e.g., in disseminated intravascular coagulation), or dilution (e.g., in animals with severe hemorrhage treated by administration of large quantities of fluids). The actual concentration or activity of factors involved in clotting or fibrinolysis depends on the methods used to collect and store the plasma. Fresh frozen plasma kept at  $-80^{\circ}\text{C}$  ( $-112^{\circ}\text{F}$ ) retains much of the activity of clotting factors (VII, VIII, etc.) and inhibitors of coagulation, including antithrombin, protein C, protein S, and antitrypsin, for up to 1 year, whereas plasma stored at higher temperatures might not retain as much activity.<sup>20</sup> The dosage varies from 2 to 10 mL/kg body weight (BW) intravenously, but this has not been critically evaluated. Platelet-rich plasma, which requires more sophisticated collection techniques, is useful for treatment of severe thrombocytopenic purpura.<sup>21</sup> Treatment can be delayed until there are clinically important signs of hemorrhage, such as petechiation in mucous membranes or epistaxis. Platelet-rich plasma can be prepared by centrifugation of blood at  $150 \times g$  for 20 to 30 minutes, with care taken to avoid exposure of the blood to glass, which activates plasma, or storage at less than  $15^{\circ}\text{C}$  ( $59^{\circ}\text{F}$ ), which irreversibly reduces platelet function.<sup>21</sup> Platelet-rich plasma should be administered within hours of collection or stored for no more than 5 days with constant agitation.<sup>21</sup> Plasma is preferred over whole blood for treatment of nonanemic hemorrhagic diatheses.

**Aminocaproic acid** (30 to 100 mg/kg IV) reduces plasma fibrinogen concentration and decreases partial thromboplastin time of horses for up to 5 hours after administration. At the higher dose, alpha-2-antiplasmin

activity is increased and fibrinogen concentration is decreased, consistent with an action of the drug to inhibit fibrinolysis. In vitro studies indicate that concentrations of epsilon aminocaproic acid necessary to inhibit fibrinolysis in horses are as much as 20 times lower than those for humans, suggesting that the dose rate for horses is unnecessarily high.<sup>22</sup> The utility of aminocaproic acid to inhibit bleeding in clinical situations and the appropriate dosage have not been determined. A similar situation exists for tranexamic acid.<sup>22</sup>

**Tranexamic acid** inhibits fibrin degradation and is used as adjunctive treatment in animals with hemorrhagic diathesis. Its efficacy in farm animals has not been reported. **Carbazochrome** is a compound that stabilizes capillary membranes and is used for treatment of exercise-induced pulmonary hemorrhage in horses, although with undetermined efficacy.

**Formalin** has been suggested as an effective treatment of excessive hemorrhage in horses, although it does not appreciably alter bleeding time or indices of coagulation. A common dose for an adult horse is 1 L isotonic electrolyte solution (saline or lactated Ringer's solution) with a final concentration of formalin of 0.37% to 0.74%. Adult goats administered a 5.5% solution of formalin in lactated Ringer's solution IV had a marked decrease in clotting time. However, this dose in horses is expected to be toxic.

Administration of **aspirin** to horses inhibits platelet function in a dose-dependent fashion for 48 hours after a single dose of 12 mg/kg. This is not the case in cattle, in which aspirin does not inhibit platelet aggregation even at doses of 100 mg/kg orally, even though it has a potent antiinflammatory effect.<sup>23,24</sup> Aspirin irreversibly inhibits activity of thromboxane synthetase in both cattle and horses for a prolonged period (days) despite having a short plasma elimination half-life (hours). The bleeding time in horses is not restored until the affected platelets have been replaced by unaffected platelets. Dosages of aspirin in horses range from 15 to 100 mg/kg orally every 8 to 12 hours to 10 mg/kg orally every 48 hours.

**Warfarin** reduces the concentration of vitamin-K-dependent clotting factors by inhibiting hepatic production of these compounds. Therapeutic use of warfarin was limited to treatment of navicular disease in horses, although its use for this purpose is now archaic.

**Heparin** and the newer heparin-related compounds (low-molecular-weight heparins) **dalteparin** and **enoxaparin** have been used in horses with, or at risk of developing, coagulopathies. The low-molecular-weight heparins appear to be effective in reducing the frequency of coagulopathy in horses with colic without the adverse effect of heparin on hematocrit and clotting time. Calcium heparin causes in vivo red cell aggregation in



horses, with a resultant reduction in hematocrit and hemoglobin concentration and a reduction in platelet count. The low-molecular-weight heparins are dosed on the basis of antifactor-Xa activity. At doses of these compounds that prolong factor Xa activity and thrombin time, they have a minimal effect on bleeding time or activated partial thromboplastin time in horses. Various doses of heparin calcium have been employed, ranging from 40 IU/kg BW IV or subcutaneously (SC) every 12 to 24 hours to 150 IU/kg BW initially followed by 125 IU/kg BW every 12 hours for 3 days and then 100 IU/kg BW every 12 hours. Dalteparin (50 and 100 anti-Xa U/kg) should be administered every 12 hours to maintain antifactor Xa activity within or above the suggested thromboprophylactic range in healthy horses.<sup>25</sup> The clinical utility and pharmacodynamics in septic horses or horses at increased risk of thrombosis are unknown. The doses of dalteparin required for healthy or septic foals to achieve therapeutic activities of antifactor Xa are double that of adult horses.<sup>26</sup> Enoxaparin (40 and 80 anti-Xa U/kg) can be administered once daily to horses, although its pharmacodynamics are not reported.

**Sodium pentosan polysulfate**, a compound with heparin-like activity used for treatment of arthritis in horses, at doses of 3, 6, or 10 mg/kg, causes dose-dependent increases in partial prothrombin time that persist for 24 to 48 hours. This drug is not used for treatment of coagulopathies.

**Hirudin**, an anticoagulant originally derived from leeches but now available as a recombinant compound, is a specific inhibitor of thrombin that is independent of anti-thrombin activity. The compound could be useful in treatment of hypercoagulable states in which there is diminished thrombin activity. Recombinant hirudin has been investigated in horses, in which the maximum plasma concentration occurred at approximately 130 minutes and declined with a terminal half-life of approximately 600 minutes. A doubling of activated partial thromboplastin time occurred 1.5 hours after SC administration of 0.4 mg/kg. The clinical efficacy of recombinant hirudin has not been determined.

**Tissue plasminogen activator** increases the activity of plasmin, thereby facilitating dissolution of clots. Its use in farm animals has not been reported, with the exception of its injection into the anterior segment of the eye to dissolve fibrin associated with uveitis in horses. **Recombinant tissue-type plasminogen activator (alteplase)** at a dose of 1 mg/kg IV to healthy adult horses has an elimination half-life of ~170 minutes and results in increased ex vivo thrombolytic activity, although its clinical utility is unknown.<sup>27</sup>

**Streptokinase** and **urokinase** have been used to facilitate dissolution of fibrin clots in

farm animals, but there has been no critical analysis of their effectiveness.

## DISEASES CAUSING HEMORRHAGE

### VASCULITIS

#### Septicemic and Viremic Diseases

Vasculitis is associated with endothelial damage occurring as a direct result of infection of the endothelium (e.g., equine herpesvirus-1 myeloencephalopathy, African horse sickness) or from immune-mediated events centered on the endothelium (e.g., purpura hemorrhagica). It can be complicated by defects in blood coagulation and platelet disorders, depending on the infection. In many instances coagulation defects are a manifestation of early disseminated intravascular coagulation. Clinically, petechial and ecchymotic hemorrhages associated with septicemia are most obvious in the mucous membrane of the mouth, vulva, and conjunctiva or in the sclera, but they are widely distributed throughout the body on post-mortem examination. Diseases causing vasculitis include the following:

- Systemic viral diseases: equine viral arteritis, equine infectious anemia, African horse sickness, malignant catarrhal fever, bovine ephemeral fever, bovine virus diarrhea, bluetongue, hog cholera, swine fever, equine herpesvirus-1 myeloencephalopathy
- Chlamydial and rickettsial diseases: *Anaplasma phagocytophila*
- Bacterial diseases: salmonellosis, *Histophilus somni* infection, *Actinobacillus* spp. pleuropneumonia infection, pasteurellosis, erysipelas in pigs
- Miscellaneous: aspergillosis, *Strongylus vulgaris* infection

#### Purpura Hemorrhagica

Purpura hemorrhagica is a hemorrhagic disease of horses associated with leukocytoclastic vasculitis. The majority of cases occur as sequelae to strangles (clinical disease caused by infection with *Streptococcus equi* subsp. *equi*).<sup>28</sup> Cases also occur following immunization against *S. equi* and as sequelae to infection with other streptococci. The disease appears to be an immune-complex-mediated disease with deposition of IgA-containing immune complexes on vessel walls. Hemorrhagic tendencies in the disease include petechial and ecchymotic hemorrhages but also can result in large extravasations of blood and serum into tissues. The hemorrhage and exudation of serum can cause anemia and a reduced circulating blood volume. Hemorrhage associated with purpura is usually treated with blood transfusions and corticosteroids. A fuller description of the syndrome is given elsewhere (Chapter 11).

#### Necrotizing Vasculitis

Of unknown etiology but possibly immune mediated, necrotizing vasculitis occurs in all species. It is similar to purpura and can be local or generalized, with petechial hemorrhage and serosanguineous exudation subcutaneously and into tissue spaces. Hemorrhagic tendencies associated with vasculitis can be confused with those associated with a defect in the clotting mechanisms, such as abnormal platelet number or function, as the primary cause. Differentiation depends on accurate laboratory examination.

### TREATMENT

Treatment of vasculitis centers on removal of the inciting cause and minimizing or eliminating inflammation in the vessel. Disease-specific treatments are discussed under each of those topics. Inflammation can be reduced by administration of glucocorticoids, the selection and dose of which vary with species (see Formulary in the Appendix). General supportive treatment can include the administration of blood or plasma if severe anemia or hypoproteinemia occur.

### COAGULATION DEFECTS

Coagulation defects can be either acquired or inherited. Acquired defects are usually related to exposure to compounds that interfere with production of clotting factors, or that cause depletion of these factors. Inherited defects are usually present in young animals, but defects that only marginally increase clotting time might not be detected until the animal undergoes surgery or suffers trauma. Demonstration of defects in blood clotting is based on observation of signs of excessive hemorrhage, with confirmation achieved by measurement of bleeding time, noting earlier comments about its variability and limited clinical utility, and laboratory examination of the activity or concentration of cellular and soluble blood-clotting factors.

#### Acquired Hemostatic Defects

Acquired clotting defects include those associated with intoxications that impair the production or function of clotting factors and those related to depletion of clotting factors. Disseminated intravascular coagulation is a common cause of hemorrhagic diathesis in animals and is discussed in detail under that heading. Protein-losing nephropathy is associated with loss of antithrombin in urine and increased risk of thrombosis in cattle. Similarly, horses with protein-losing enteropathy have low plasma concentrations of antithrombin, which could contribute to the thrombotic tendency noted in these animals.

**Reduction of vitamin-K<sub>1</sub>-dependent clotting factors II, VII, IX, and X** results from coumarol poisoning following ingestion of coumarol-containing plants, such as *Melilotus alba*, *Anthoxanthum odoratum*, *Apium nodiflorum*, *Ferula communis* (giant fennel), or warfarin, brodifacoum, and

related compounds. This syndrome is discussed in detail under each of those headings. A cluster of cases in racehorses of massive, fatal hemorrhage during exercise was associated with detection of traces of brodifacoum, diphacinone, or bromadiolone in the liver of the affected, but not the unaffected, horses. It is speculated that large increases in arterial blood pressure during exercise lower the threshold for toxicity of these compounds.<sup>29</sup> Vitamin K deficiency, other than that induced by intoxication with the compounds listed earlier and the disorder in postweaned pigs discussed in the following paragraph, has not been reported in farm animals, probably because forage contains high concentrations of this compound.

A **hemorrhagic syndrome in postweaned pigs** has been recorded in the United States, New Zealand, France, Japan, Germany, Brazil, and South Africa. The syndrome occurs as an outbreak with anemia, hemarthrosis, spontaneous hemorrhage under the skin of the legs and body, and hemorrhage following management procedures such as castration. There is a high case fatality, and the syndrome is particularly common in pigs a few weeks after weaning. There is prolongation of the prothrombin time and activated partial thromboplastin time. The outbreaks resolve promptly following the injection of **vitamin K** or its inclusion in the diet. An association has been made with housing on mesh floors. The disease is believed to result from a deficiency of vitamin K in the diet coupled with housing that precludes intake of vitamin K<sub>2</sub> from the feces or bedding and decreased synthesis in the gut as a result of antibiotics in the feed, especially sulfonamides.

**Snake venom** can have procoagulant or anticoagulant action. In both cases coagulation defects occur as procoagulant toxins result in the activation, consumption, and depletion of prothrombin and fibrinogen, leading to coagulopathy, prolonged clotting times, and epistaxis.

**Carcass hemorrhage**, or blood splash, in slaughter lambs has been associated with extended prothrombin times because of prior grazing of coumarin-producing plants. The method of electrical stunning at slaughter can also result in carcass hemorrhage.

**Parafilaria bovicola** produces large extravasations of blood under the skin of cattle and to some extent in tissue spaces. Bleeding from the skin can be the presenting sign of infestation.

A **number of fungal toxins** can cause hemorrhagic disease when ingested:

- Aflatoxins produced by *Aspergillus* spp. do so in association with increased prothrombin time in cattle, swine, and horses
- Trichothecene toxins produced by fungal infestations of feed by *Fusarium* spp., *Myrothecium* spp., and *Cephalosporium* spp.

- *Trichothecium* spp.
- Toxins associated with *Penicillium rubrum*
- Grass nematodes that infest *Lolium rigidum*

**Hydroxyethyl starch** solution (Hetastarch), used to increase plasma oncotic pressure in animals with hypoproteinemia, prolongs cutaneous bleeding, prothrombin. and activated partial thromboplastin times and decreases fibrinogen concentration and von Willebrand antigen and factor VIII:C activities in ponies. In vitro studies suggest that the anticoagulant effect is attributable to inhibition of platelet function and not solely to dilution of soluble clotting factors.<sup>30</sup>

**Navel (umbilical) bleeding in newborn piglets** is a syndrome of unknown etiology. Following birth and for periods up to 2 days afterward, blood drips or oozes from the umbilicus of affected pigs to produce severe anemia, with death frequently occurring from crushing. The navel cords are abnormally large and fleshy and fail to shrink after birth. The defect appears to be one of immaturity of collagen so that a proper platelet clot does not form. Ear-notching for identification is also followed by excessive bleeding. A variable number of piglets within the litter may be affected, and the syndrome may have a high incidence on certain problem farms. The addition of vitamin K and folic acid to the sows' ration may be followed by a drop in incidence, but controlled trials with menadiolone have shown no effect. Vitamin C given to pregnant sows for at least 6 days before farrowing appears to prevent the syndrome.

**Jejunal hemorrhage syndrome** in cattle is discussed in [Chapter 9](#).

Infestation of sheep by *Fasciola hepatica* shortens activated partial thromboplastin time and prolongs prothrombin and thrombin times.

### Inherited or Congenital Defects in Hemostasis

#### Hemophilia A

Factor VIII:coagulant (VIII:C) deficiency, hemophilia A, is recorded in Thoroughbreds, Standardbreds, Arabian and Quarter horse colt **foals**, **Japanese Brown cattle**,<sup>31</sup> and **sheep** and is associated with a deficiency in factor VIII. The disease in the Quarter horse colt also involved deficiency of factors IX and XI. It is inherited as a sex-linked recessive trait, with the defective gene located on the X chromosome. Clinically affected foals show signs of a hemorrhagic tendency within a few weeks of birth, with the development of hematomas, persistent nasal bleeding, bleeding from injection sites, and sudden death from massive internal hemorrhage. Affected foals are anemic. The diagnosis is made by the finding of very low plasma factor VIII:C activity (usually < 10% of values in unaffected animals). Treatment requires fresh frozen plasma or plasma concentrates but is not recommended because of

the unavailability of sufficient plasma concentrates, the recurrent nature of the problem, and the poor prognosis for long-term soundness. The disease in Japanese Brown cattle is caused by a missense mutation of the factor VIII gene and is evident as hemorrhagic tendency with prolonged activated partial thromboplastin time and markedly reduced factor VIII activity with normal von Willebrand factor activity.<sup>31,32</sup>

#### Von Willebrand Disease (Factor VIII:vWF Deficiency)

Von Willebrand factor is a large adhesive glycoprotein that mediates adhesion of platelets to exposed subendothelium and also is a carrier for coagulation factor VIII, protecting it from degradation in the circulation. There are three variations of von Willebrand's disease: types I, II, and III. Two variations of von Willebrand's disease are recorded in **pigs**, both inherited as simple autosomal-recessive traits. The disease in pigs is used as an experimental model for the disease in humans, and the pig gene for von Willebrand factor is similar in size and complexity to its human counterpart, with affected pigs having a point mutation within the vWF gene. **Type I** von Willebrand's disease occurred in an 8-day-old Quarter horse colt that was examined because of extensive purpura. The colt had a concentration of von Willebrand factor that was 9% of that of normal horses. The dam of the colt also had prolonged bleeding time and a concentration of von Willebrand factor that was 30% of that of normal animals, suggesting a familial and possibly heritable trait. **Type II** von Willebrand disease is recorded in a Quarter horse with hemorrhage associated with trauma, prolonged bleeding at an injection site lasting several hours, and spontaneous conjunctival hemorrhage, and in a Thoroughbred mare and her colt.<sup>3</sup> The hemorrhage in the Thoroughbred mare and foal was not life-threatening. **Type III** von Willebrand's disease is usually associated with low concentrations of factor VIII. Suspect factor VIII deficiency has been reported in **Hereford calves**. The prime manifestation was death shortly following castration, with bleeding from the surgical site, intra-abdominal hemorrhage, and severe anemia. The disease also occurs in **sheep** and is linked to the X chromosome.

**Diagnosis** is based on the observation of prolonged bleeding after minor trauma or surgery, prolonged activated partial thromboplastin time (although this can be minimal), normal prothrombin time, and decreased factor VIII:C activity and von Willebrand antigen concentration. The ristocetin cofactor activity of von Willebrand factor is reduced in animals with type II von Willebrand's disease. An ELISA is available that is suitable for use in a number of species, including horses, pigs, and cattle. **Chromogenic assays** of factors VII, VIII:C, IX, and

X developed for testing of human plasma are reliable when used for testing of horse plasma. Desmopressin increases the release of von Willebrand factor from vascular endothelium and is used for treatment of the disease in humans. There are no reports to date of its use in farm animals or horses. The disease can be managed by housing to minimize trauma and administration of plasma before elective surgery, although such measures were not shown to completely prevent excessive bleeding.

#### Factor XI Deficiency

Factor XI deficiency is recorded in **Holstein-Friesian** cattle in Canada and in Great Britain. It is transmitted as an autosomal-recessive gene, and occurrence in Britain has been traced to the importation of Canadian semen, with genetic links between carriers in the two countries. Heterozygous cattle have decreased levels of factor XI but are usually asymptomatic. The severity of clinical disease varies in homozygous cattle, but they usually show prolonged or repeated bleeding episodes after trauma such as dehorning and hemorrhage following venipuncture. There are occasional deaths associated with multiple hemorrhages. Heterozygote carriers have decreased factor XI coagulant activity, but measurement of factor XI activity is not a sensitive test for the carrier status, and a DNA-based test is available that accurately identifies heterozygotes.

#### Other Clotting-Factor Disorders

**Prekallikrein deficiency** is recorded in a family of **miniature horses**. The condition was not associated with clinical disease in these horses, but blood samples failed to clot. It has also been recorded in three **Belgian horses** and was detected in this group because one hemorrhaged following castration. The mode of transmission is not known, but the familial nature of the disease suggests that it is heritable.

**Heritable fibrinogen deficiency** was found in a Border Leicester lamb, manifest with inflammation and bleeding at the umbilicus and eartag wound at 7 weeks of age, and in Saanen goats.

### PLATELET DISORDERS

Disorders of platelets include alterations in the number of platelets in blood (thrombocytopenia or thrombocytosis) and their function (with reduced function referred to as thrombasthenia). The physiology of platelets varies in important ways among the farm animal species. For instance, aggregation of platelets from horses, but not cattle, is inhibited by aspirin (acetylsalicylic acid), and horse platelets adhere to immobilized autologous fibrinogen, whereas those of sheep do not. Platelets of different species respond differently to some agonists of platelet aggregation, such as ristocetin.

### Thrombocytopenia

Clinical signs associated with thrombocytopenia or thrombasthenia are petechial and ecchymotic hemorrhages, prolonged bleeding after venipuncture or from injection sites, epistaxis, hyphema, and melena. A combination of some or all of these clinical signs is referred to as purpura. Thrombocytopenia can result from decreased production of platelets in the bone marrow or by increased consumption, increased peripheral destruction, or a combination of these factors.

**Decreased platelet production** is commonly associated with disorders that impair bone-marrow function, and there is usually simultaneous suppression of granulocyte and erythrocyte production. Thrombocytopenia and neutropenia develop before anemia because of the short life span of these cells relative to erythrocytes. **Increased destruction**, that is, the abnormal consumption of platelets, is most commonly an immune-mediated response. **Increased consumption** also occurs with severe trauma and disseminated intravascular coagulation, both of which increase the rate at which platelets are incorporated into clots.

**Pseudothrombocytopenia** occurs as a result of aggregation of platelets after collection into a glass tube containing EDTA. Ex vivo aggregation can occur with other anticoagulants, including heparin. This situation can be recognized by the presence of abnormally low platelet counts in animals without evidence of excessive hemorrhage, or by the presence of clumps of platelets on microscopic examination of blood smears. Collection of blood into an anticoagulant other than EDTA or heparin, such as citrate, and measurement of a normal platelet count will confirm the diagnosis of pseudothrombocytopenia.

**Differentiation** of the causes of thrombocytopenia is by clinical examination to detect underlying disease, hematology, examination for antiplatelet antibody, and examination of bone-marrow aspirates.

#### Decreased Production

Thrombocytopenia resulting from decreased production, as opposed to increased destruction, within the marrow usually occurs with granulocytopenia because of the short intravascular half-life of both granulocytes and platelets.

This occurs with **poisonings** by *Pteridium* spp. (bracken fern) or *Cheilanthes seiberi* in cattle; the fungus *Stachybotrys* spp. (which produces a trichothecene) in cattle, pigs, sheep, and horses; chronic furazolidone poisoning in calves; poisoning caused by trichloroethylene-extracted soybean meal; **drugs** that cause bone-marrow suppression; and radiation injury. Severe myelophthisis, such as is associated with myeloid dysplasia or myelofibrosis, causes thrombocytopenia in association with anemia and leukopenia.

A familial myelofibrosis is reported in pygmy goats with anemia, granulocytopenia, and thrombocytopenia.

The syndrome is predominantly one of spontaneous hemorrhage but is complicated by bacteremia and fulminant infections facilitated by severe leukopenia. A granulocytopenic syndrome of unknown origin, occurring in all ages of cattle and manifest with a severe hemorrhagic diathesis, high morbidity, and high case fatality, has been reported on various occasions in Australia.

Familial diseases resulting in thrombocytopenia secondary to decreased production are recorded in Standardbred horses, in which there is generalized bone-marrow hypoplasia. Pancytopenia secondary to bone-marrow aplasia is reported in a Holstein heifer. Bovine neonatal pancytopenia is discussed elsewhere in this chapter.

#### Increased Destruction

**Inflammation and Infection.** The most common causes of thrombocytopenia are severe gastrointestinal disease (strangling intestinal obstruction, anterior enteritis, colitis) and infectious and inflammatory disease, where a combination of increased destruction and increased consumption is the cause.

**Infection** by a variety of viral, bacterial, or rickettsial agents causes mild to severe thrombocytopenia. African horse sickness, equine infectious anemia, *Anaplasma phagocytophila* (equine granulocytic ehrlichiosis), and infection by *Neorickettsia risticii* (Potomac horse fever) cause mild to moderate thrombocytopenia. Infection of cattle by lumpy skin disease virus causes thrombocytopenia, along with other abnormalities of the leucogram.<sup>33</sup>

Infection such as occurs in hog cholera and African swine fever can result in thrombocytopenia and contributes to the hemorrhagic tendency seen in these diseases. Outbreaks of hemorrhagic disease as a result of thrombocytopenia in veal calves have been attributed to infection with bovine virus diarrhea (BVD) virus type 2, and the disease has been reproduced experimentally with noncytopathic BVD virus. The appearance of hemorrhage was directly related to the number of circulating platelets, and bleeding was seen when platelet numbers fell below 500/mL. Calves that developed thrombocytopenia had low (+1:32) BVD neutralizing titers. The virus infects megakaryocytes. Thrombocytopenia with a bleeding tendency (bloody diarrhea, petechial and ecchymotic hemorrhage) is also recorded in approximately 10% of adult cattle with acute BVD infection.

**Bovine neonatal pancytopenia (BNP)** is a disease syndrome in newborn calves of up to 4 weeks of age, first observed in southern Germany in 2006 but subsequently reported more widely.<sup>34,35</sup> The case-fatality rate is over 80%, and death is attributable to thrombocytopenia and hemorrhagic anemia, or



infectious diseases such as pneumonia, enteritis, and septicemia.<sup>36</sup> Affected calves die within days as a result of multiple hemorrhages, thrombocytopenia, leukocytopenia, and bone-marrow depletion. The disease can be reproduced by feeding pooled colostrum of dams of affected calves.<sup>37</sup> A specific vaccine directed against BVD is associated with BNP. Immunized cows develop alloantibodies to proteins in the cell line (Madin–Darby bovine kidney) used to grow the vaccine strain of the virus.<sup>34</sup> These antibodies are transferred to newborn calves through colostrum and cause the disease by reacting with class I major histocompatibility antigens on platelets and leukocytes of the calves.<sup>35</sup> See below for a more complete description of this syndrome.

Infection by *Theileria annulata* causes thrombocytopenia and prolonged prothrombin time in cattle. Other infectious causes in cattle include bovine leukemia virus, sarcocystosis, and salmonellosis.

**Immune-Mediated (Idiopathic) Thrombocytopenia.** Most instances of thrombocytopenic purpura in the past have been described as idiopathic. However, the development of newer diagnostic tests, including flow cytometry, that can reveal the presence of antibodies on the surface of platelets has permitted the classification of many of these cases as immune-mediated. Among the immune-mediated thrombocytopenias there are autoimmune and isoimmune diseases.

**Isoimmune thrombocytopenia** can be a complication in neonatal isoerythrolysis in **foals and mules** as a result of absorption of colostrum containing antiplatelet antibodies. The disease also occurs as only thrombocytopenia in mule foals and is attributable to antiplatelet IgG antibodies in the mule foal's serum. In addition to thrombocytopenia, there is also depression of platelet aggregation in these foals, probably because of binding of IgG to collagen-binding sites on the platelet surface. Thrombocytopenia and neutropenia, assumed to be isoimmune-mediated, were found in foals with ulcerative dermatitis and mucosal ulceration. The foals had purpura and responded to supportive treatment and administration of corticosteroids.

The disease is observed in **newborn pigs** as a result of maternal isoimmunization, and it has been reproduced experimentally. Piglets are normal at birth but become thrombocytopenic after suckling colostrum containing antiplatelet antibody. Clinical signs do not develop until after the fourth day of life. There is a heavy mortality rate, with death being preceded by a generalized development of submucosal and subcutaneous hemorrhages, drowsiness, weakness, and pallor. There is no practicable treatment. The sow should be culled. Thrombocytopenic purpura has occurred in a group of **lambs** given a single cow's colostrum and was manifest with multiple hemorrhages and death by 2 days of age.

Thrombocytopenia in adult animals with normal prothrombin times and partial thromboplastin times and with no evidence of disseminated intravascular coagulation is considered most likely to develop by **autoimmune-mediated** mechanisms.<sup>38</sup> Immune-mediated thrombocytopenia can be induced by drugs or can be secondary to infectious or neoplastic disease, but most cases are idiopathic. The disease is reported most commonly in horses but does occur in cattle.

Idiopathic thrombocytopenia of adult **horses** occurs at any age. The cause is usually not identified, but the disease can be associated with administration of drugs, especially penicillin, although this might reflect the frequency of use of this antimicrobial in horses. The disease is caused by binding of IgG to platelets or to megakaryocytes, with subsequent impaired maturation, enhanced clearance, or both, resulting in low platelet counts in blood. Petechiation and hemorrhage can be confined to single systems, such as the respiratory system, with epistaxis and hematomas in the nasal sinuses, or the genital tract, producing a bloody vulval discharge, with no detectable abnormality at other mucous membranes. More generalized involvement with widespread petechiation of mucous membranes, epistaxis, and melena can also occur. Diagnosis is by measurement of blood platelet concentration and elimination of disseminated intravascular coagulation or primary diseases. Demonstration of platelet-surface-bound IgG on a significant proportion of platelets is diagnostic. Fewer than 0.15% of platelets from normal horses have IgG bound to the surface, whereas more than 4% of platelets of thrombocytopenic horses have IgG on the surface. **Treatment** includes the immediate removal from any medication and the administration of dexamethasone (0.040 mg/kg intramuscularly [IM], IV, or orally, once daily) or prednisolone (1 mg/kg orally), but not prednisone. This is usually effective in restoring platelet count and controlling hemorrhage. Resolution of hemorrhage can occur even before there are marked changes in platelet count. Treatment might need to be continued for days to weeks. Most horses do not require long-term treatment. For horses with life-threatening hemorrhage, administration of platelet-rich plasma or blood is needed. A transfusion volume of 10 mL blood per 1 kg BW can be effective. Successful treatment with azathioprine in horses that do not respond to glucocorticoids is reported (0.5 to 1.5 mg/kg orally every 24 hours).<sup>39</sup> Splenectomy has been used to treat horses with chronic idiopathic thrombocytopenia that is refractory to medical therapy. However, surgical treatment should be undertaken only in extreme cases, and with attention to the effect of thrombocytopenia on hemostasis during surgery.

Idiopathic thrombocytopenia purpura is also recorded in a 10-month-old **bull**,

and immune-mediated thrombocytopenia and anemia occurred in a cow after vaccination with a polyvalent botulism vaccine. Corticosteroid-responsive thrombocytopenia occurred in two beef-breed cows with subcutaneous hematomas and epistaxis.

### Increased Consumption

Increased consumption of platelets occurs in animals with severe trauma or disseminated intravascular coagulation.

### Other Causes

Thrombocytopenia occurs in horses with lymphosarcoma or myeloproliferative disease. Thrombocytopenia is usually associated with myelophthisic disease and is therefore a result of reduced platelet production. Heparin causes thrombocytopenia in horses, but the mechanism has not been determined.

### Thrombasthenia

Disorders of platelet function can result in purpura even in the presence of normal platelet counts. Disorders of platelet function can be congenital or acquired.

**Acquired defects** of platelet function are usually secondary to severe metabolic abnormalities such as uremia, liver failure, or septicemia, or to administration of drugs. Among the compounds commonly administered to animals, **aspirin** is most notable in that it inhibits platelet aggregation in horses but not in cattle, despite inhibition of platelet generation of thromboxane-2 in both species. Other NSAIDs have minimal, if any, effect on platelet function. Dextran inhibits platelet function when administered to horses.

A bleeding tendency is present in the **Chédiak–Higashi** syndrome in cattle.<sup>3</sup> A prolonged bleeding time is demonstrable despite the presence of normal soluble coagulation factors and platelet numbers, and it is a result of a defect in platelet aggregation. Thrombasthenia, possibly also associated with variant von Willebrand factor, is also recorded in bleeding disorders in **Simmental** and **Simmental** crossbred cattle in Canada and the United States, and manifests with epistaxis in cold weather, subcutaneous hematomas, and prolonged bleeding following minor procedures such as vaccination and ear-tagging. Platelet dysfunction and purpura were diagnosed in a 5-day-old Simmental heifer. **Umbilical bleeding** in calves has also been reported as an inherited condition in **Japanese black cattle** with low adenosine diphosphate (ADP)-induced platelet aggregation. Affected cattle die by 1 year of age from repeated umbilical cord hemorrhage.

Thrombasthenias are also reported in horses. **Glanzmann's disease** is reported in horses with a prolonged history of epistaxis not associated with exercise.<sup>12,40</sup> The horses had prolonged bleeding time, markedly delayed clot retraction, and a decrease in

concentration of fibrinogen receptors on the platelet surface. Treatment with glucocorticoids was not effective in preventing epistaxis. Another form of platelet defect was diagnosed in a Thoroughbred filly with excessive hemorrhage after pin firing. The filly had prolonged bleeding time and normal clot retraction. The filly's platelets did not bind to collagen, and the defect was deduced to be in calcium signaling within the platelets.

### Thrombocytosis

Thrombocytosis is not usually associated with purpura or a tendency to hemorrhage unless the platelets have abnormal function. Thrombocytosis is considered to be either primary or secondary. Primary thrombocytosis is a result of excessive production of megakaryocytes in the absence of any inciting disease or increased release into the circulation. Although exercise, epinephrine, and vincristine can increase platelet counts, the most important cause of primary thrombocytosis is myeloproliferative disorder resulting in an abnormal rate of platelet production. Primary thrombocytosis is rare in farm animal species.

**Secondary thrombocytosis** occurs in animals with severe systemic inflammatory or infectious diseases of more than several days in duration, and usually of several weeks in duration. Young animals appear to be more susceptible, but the condition can occur in animals of any age. Detection of thrombocytosis should prompt a thorough clinical examination for a cause of chronic inflammation in the animal. Common causes in horses include pneumonia, *Rhodococcus equi* infection, septic arthritis, and colitis. Thrombocytosis with Heinz-body anemia is reported in cattle fed cabbage.

### REFERENCES

- Segura D, et al. *J Vet Int Med.* 2008;22:238.
- Armengou L, et al. *J Vet Int Med.* 2008;22:411.
- Boudreaux MK. *J Vet Emerg Crit Care.* 2012;22:30.
- Mendez-Angulo JL, et al. *Equine Vet Educ.* 2012;24:639.
- McMichael M, et al. *J Vet Emerg Crit Care.* 2014;24:23.
- Hanel RM, et al. *J Vet Emerg Crit Care.* 2014;24:47.
- Brainard BM, et al. *J Vet Emerg Crit Care.* 2014;24:57.
- Paltrinieri S, et al. *Vet Clin Pathol.* 2008;37:277.
- Rossi TM, et al. *Am J Vet Res.* 2015;76:122.
- Epstein KL, et al. *J Vet Int Med.* 2011;25:307.
- Mendez-Angulo JL, et al. *J Vet Emerg Crit Care.* 2010;20:488.
- Macieira S, et al. *Vet Clin Pathol.* 2007;36:204.
- Mendez-Angulo JL, et al. *Aust Vet J.* 2011;89:500.
- Sommerey C-C, et al. *J Dairy Sci.* 2014;97:5474.
- Flatland B, et al. *J Vet Emerg Crit Care.* 2014;24:30.
- deLaforcade A, et al. *J Vet Emerg Crit Care.* 2014;24:37.
- Bentz AI, et al. *J Vet Int Med.* 2009;23:161.
- Armengou L, et al. *J Vet Int Med.* 2006;20:721.
- Dawson DR, et al. *Vet Clin Pathol.* 2011;40:504.
- Feige K, et al. *Pferdeheilkunde.* 2009;25:334.
- Dunkel B. *Equine Vet Educ.* 2013;25:359.
- Fletcher DJ, et al. *J Vet Int Med.* 2013;27:1589.
- Coetzee JF, et al. *J Vet Pharmacol Ther.* 2007;30:305.
- Myers MJ, et al. *J Vet Pharmacol Ther.* 2010;33:1.
- Welchell DD, et al. *Vet Surg.* 2013;42:448.
- Armengou L, et al. *J Vet Int Med.* 2010;24:1190.
- Baeumer W, et al. *BMC Vet Res.* 2013;9.
- Welchell DD, et al. *Equine Vet Educ.* 2009;21:135.
- Carvalho FR, et al. *J Vet Diagn Invest.* 2015;27:112.
- Blong AE, et al. *Am J Vet Res.* 2013;74:712.
- Moritomo Y, et al. *J Vet Med Sci.* 2008;70:293.
- Khalaj M, et al. *Anim Genet.* 2009;40:763.
- Abutarbush SM. *J Infect Dev Count.* 2015;9:283.
- Euler KN, et al. *BMC Vet Res.* 2013;9.
- Foucras G, et al. *Bulletin des GTV.* 2013;69.
- Henniger P, et al. *Berlin Munch Tierar Woch.* 2014;127:61.
- Bell CR, et al. *Vet Immunol Immunopathol.* 2013;151:303.
- Jahn P, et al. *Equine Vet Educ.* 2006;18:80.
- Hardefeldt LY, et al. *Equine Vet Educ.* 2010;22:495.
- Sanz MG, et al. *Vet Clin Pathol.* 2011;40:48.

## DISSEMINATED INTRAVASCULAR COAGULATION AND HYPERCOAGULABLE STATES

Abnormalities in blood clotting and fibrinolysis related to systemic diseases, mostly involving sepsis or extensive tissue damage, exist in both subclinical and clinical forms in many diseases of farm animals, and the presence and severity of these disorders are related to the prognosis for survival. There is a spectrum of abnormalities ranging from mild changes in concentration or activity of clotting factors on examination and indicators of fibrinolysis that are not evident on physical, through clinical and clinico-pathologic evidence of excessive coagulation or impaired fibrinolysis, to a hemorrhagic diathesis. Previously, the most extreme form of this disorder was recognized as a hemorrhagic diathesis and termed disseminated intravascular coagulation (DIC). The increasing sophistication and availability of measures of coagulation and fibrinolysis have revealed that abnormalities of hemostasis exist even in animals without clinical evidence of excessive hemorrhage. These milder changes in hemostasis and fibrinolysis are, not surprisingly, much more common than is DIC, but are still associated with an increased case-fatality rate.

### ETIOLOGY AND EPIDEMIOLOGY

DIC and hypercoagulable states are acquired disorders of hemostasis in animals that occur as a consequence of severe disease that induces systemic inflammation (systemic inflammatory syndrome). DIC is now regarded as a component and consequence of systemic inflammation, rather than being an isolated disorder of hemostasis. DIC and hypercoagulable states are therefore associated with any severe disease that initiates a systemic inflammatory response; partial listing is as follows: colitis, enteritis, infarctive lesions of the intestines, septicemia, abomasal torsion, metritis, severe trauma, immune-mediated inflammation (e.g.,

purpura hemorrhagica), hyperthermia, and neoplasia. A common, but not universal feature, of diseases that induce DIC or a hypercoagulable state is the presence of presumed or documented endotoxemia, although DIC can be induced by most infectious organisms. It is important to recognize that any severe disease that causes a systemic inflammatory response can incite changes in hemostatic function.

The presence of a hypercoagulable state or DIC is most well recognized in horses with gastrointestinal disease.<sup>1</sup> It also occurs in cattle with abomasal displacement, in endotoxemic calves, and in adult cattle with traumatic reticuloperitonitis.<sup>2</sup> Cows that die of acute *Escherichia coli* mastitis have lower antithrombin activity and prolonged prothrombin time than do cows that survive,<sup>3</sup> and cows affected with *E. coli* mastitis have significantly prolonged activated partial thromboplastin time (aPTT), increased prothrombin time (PT), and lower platelet counts.<sup>4</sup> Cows with *Staphylococcus aureus* mastitis have significantly prolonged aPTT and low platelet counts.<sup>4</sup> Low plasma antithrombin concentrations occur in cows with hepatopathy, peritonitis, or acute enteritis. The disease has been reproduced experimentally in pigs and probably occurs naturally in that species in many diseases, including African swine fever. The prevalence of DIC (clinically evident hemorrhage) is uncommon, whereas the prevalence of a hypercoagulable state detectable only by clinicopathologic testing is much more common.

The prevalence of the syndrome is not well defined, partly because of problems in achieving a confirmatory diagnosis by laboratory assessment of factors involved in coagulation or fibrinolysis because of the lack of laboratories providing the necessary assays, and partly because of lack of recognition of the disease. Additionally, criteria for diagnosis vary, as does the performance of assays used to measure the activity or concentration of factors associated with coagulation or fibrinolysis, and there is not good correlation between measures determined by thromboelastography and conventional tests of coagulation.<sup>1</sup> Of horses examined at a referral institution for colic, 3.5% had clinical signs consistent with DIC and supportive laboratory evidence. All these horses had severe inciting disease, with most requiring surgical intervention for infarctive intestinal disease. Almost 90% of 435 horses with surgical obstructive lesions or inflammatory lesions of the intestines examined prospectively had increased plasma D-dimer concentrations at some stage during hospitalization.<sup>5,6</sup> Fibrin deposits, mostly in small vessels in the lungs, are present in approximately 40% of horses with severe colic and are not present in apparently healthy horses.<sup>7</sup> It is apparent that many horses with severe gastrointestinal disease have clinical or

subclinical abnormalities in hemostasis and fibrinolysis.

Clinically relevant alternations in hemostatic and fibrinolytic indices occur in **neonatal foals** with septicemia, and fibrin deposits are present in the lungs of ~90% of septic foals.<sup>8</sup> Derangements in hemostatic or fibrinolytic indices are helpful in identification of septic foals with increased risk of coagulopathy, but they are not useful in predicting hemorrhage compared with thrombus formation. D-dimer concentration is associated with septicemia (odds ratio [OR] = 19.6, 95% confidence interval [CI], 1.9 to 203) and death (OR = 8.7, 95% CI, 1.8 to 43) in foals, but a high false-positive prediction rate (71%) means that a normal D-dimer concentration is better at eliminating the diagnosis of sepsis than an increased D-dimer concentration is at predicting sepsis.<sup>9</sup>

DIC is reported in a horse with *Streptococcus zooepidemicus* meningoencephalitis and interstitial pneumonia, illustrating that a wide range of diseases, and gram-positive organisms, can cause abnormalities in coagulation and fibrinolysis.<sup>10</sup>

## PROGNOSIS

The prognosis for animals with clinical signs of disseminated coagulation is very poor. Horses without physical signs of hemorrhage or defective fibrinolysis but with clinicopathological evidence of a hypercoagulable state have a worse prognosis than horses without evidence of a hypercoagulable state. Horses with enteritis or peritonitis have significantly higher plasma D-dimer concentrations and more severe coagulopathies on admission than do horses with other gastrointestinal diseases.<sup>6</sup> Nonsurvivors have higher plasma D-dimer concentrations at presentation than do survivors, and those horses with subclinical DIC on presentation have an OR of 8.6 (95% CI, 3.3 to 22.5,  $P < 0.001$ ) for nonsurvival. D-dimer concentrations greater than 4,000 ng/mL have a likelihood ratio for death of 5.9 and an OR of 8.8 (95% CI, 4.5 to 17.1,  $P < .001$ ) for nonsurvival.<sup>6</sup> When evaluating the prognosis of an animal with evidence of a coagulopathy as part of the systemic inflammatory syndrome, it must be kept in mind that the coagulopathy is secondary to the initiating disease; the more severe the initiating disease, the greater is the likelihood that the animal will have a coagulopathy, and the more severe the initiating disease, the poorer is the prognosis. DIC and lesser abnormalities of hemostasis can therefore be regarded as markers of disease severity and considered accordingly when determining a prognosis. This is not to minimize the importance of DIC and hemostatic defects of lesser severity in the pathogenesis of severe disease and the need to institute effective preventive measures and treatment.

## PATHOPHYSIOLOGY

DIC, or consumption coagulopathy, can develop in a number of diseases that, in themselves, are not diseases that primarily affect hemostatic mechanisms. The pathogenesis involves systemic activation of coagulation with intravascular deposition of fibrin leading to thrombosis of small and medium-sized blood vessels, with subsequent organ failure.<sup>7,8</sup> Depletion of platelets as a result of platelet activation and binding to fibrin to form clots, and of coagulation factors, results in excessive bleeding. The systemic formation of fibrin results from increased generation of thrombin and the simultaneous suppression of anticoagulation mechanisms (which are detectable in animals as reduced concentration of antithrombin) and impaired fibrinolysis. Products of fibrinogen activation, including fibrinopeptides A and B, contribute to systemic vasoconstriction and the hypoperfusion of some organs. The disorder, in its most extreme form, involves both excessive coagulation and, seemingly paradoxically, bleeding.

Systemic activation of coagulation is part of the systemic inflammatory response syndrome, which is dominated by interleukins 1 and 6 and tumor necrosis factor- $\alpha$ . There might be a contribution of complement activation to the hypercoagulability. Activation of clotting occurs through either damage to endothelium or activation and release of tissue factor. Tissue factor expression is increased by one or more of the proinflammatory cytokines (interleukin-1, interleukin-6, interleukin-8, and tumor necrosis factor), which are almost universally increased in diseases that feature systemic inflammation. Generation of tissue factor results in activation of the extrinsic clotting cascade, with resultant increases in thrombin. The increased activity of the coagulation cascade is temporally associated with impaired activity of anticoagulant mechanisms, demonstrable as decreases in plasma concentration of antithrombin and protein C. Further exacerbating the effect of increased rate of fibrin synthesis is impaired fibrinolysis, indicated by diminished activity of plasminogen and increased activity of plasminogen-activator inhibitor.

In summary, DIC is a hemorrhagic diathesis characterized by an augmentation of normal clotting mechanisms that results in depletion of coagulation factors, deposition of fibrin clots in the microvasculature, and the secondary activation of fibrinolytic mechanisms. The augmentation of clotting mechanisms can result in a depletion of platelets and factors V, VIII, IX, XI, and XIIa, and the depletion of fibrinogen in association with the formation of fibrin clots in the microvasculature. These fibrin clots decrease tissue perfusion, which can then lead to further activation and depletion of clotting factors by the release of tissue thromboplastin as a result of tissue hypoxia. The bleeding

tendency occasioned by the depletion of these clotting factors is further accentuated by the secondary activation of the thrombolytic system with the production of fibrin degradation products that have anticoagulant properties.

Impaired capacity of the **monocyte phagocytic system** contributes to the disease. Macrophages in the reticuloendothelial system remove fibrin degradation products and activated clotting factors from the circulation. Loss or diminution of the capacity to remove hemostatic and fibrinolytic compounds causes increases in the plasma concentration of these products and exacerbation of the disease. Damage to the reticuloendothelial system, notably in the liver and spleen, resulting from damage as a consequence of the underlying disease (endotoxemia) or lack of perfusion of the liver and spleen as part of DIC, decreases removal of these compounds and induces a vicious cycle of disease.

DIC can be initiated by a variety of different mechanisms, including the following:

- **Extensive tissue necrosis**, such as occurs in trauma, rapidly growing neoplasm, acute intravascular hemolysis, and infective diseases such as blackleg, can cause extensive **release of tissue thromboplastin** and initiate exuberant coagulation via the extrinsic coagulation pathway.
- **Exuberant activation of the intrinsic pathway** can occur when there is activation of the Hageman factor by extensive contact with vascular collagen, as occurs in diseases with vasculitis, or those associated with poor tissue perfusion and tissue hypoxia with resultant endothelial damage.
- Factors that initiate **platelet aggregation**, such as endotoxin; that cause reticuloendothelial blockage, such as excessive iron administration to piglets; or that cause hepatic damage to interfere with clearance of activated clotting factors can contribute to the occurrence of DIC.

## CLINICAL SIGNS

As discussed previously, defects in hemostasis and fibrinolysis range from those that are detectable by clinicopathologic examination but are not associated with clinical signs of excessive bleeding or coagulation, through fulminant hemorrhagic diathesis.

The presence of a hypercoagulable state that is not associated with signs of excessive bleeding or thrombosis nonetheless worsens the prognosis of severe diseases. This is probably a result of DIC-induced injury to organs that is not detectable against the background of damage caused by the primary disease but that has an important or pivotal effect on the animal's well-being. The next progression of the disease is enhanced thrombosis, most evident as thrombosis of large vessels after minor damage such as that associated with



intravascular catheterization or simple venipuncture. In some cases, vessels can thrombose without obvious inciting cause. An example of a common manifestation of this stage of the disease is jugular vein thrombosis in horses or cattle with severe disease and low plasma concentration of antithrombin.

An unusual, but severe, manifestation of DIC in horses is thrombosis of the distal limbs, resulting in ischemic necrosis of the limbs and death of the animal. This clinical manifestation of DIC occurs in foals and, to a lesser extent, in adults with evidence of septicemia or severe gastrointestinal disease.

The most severe acquired hemostatic defect in animals with systemic disease is DIC. This extreme of the clotting disorder is manifested by local or generalized bleeding tendencies that vary in severity from occurrence of petechial hemorrhages in mucous membranes to life-threatening hemorrhage or infarction of organs. Ischemic damage to a wide variety of organs is possible, with the gastrointestinal tract and kidneys being commonly affected.

### CLINICAL PATHOLOGY

There are a large number of hemostatic and fibrinolytic factors that can be measured in research laboratories, only a few of which are routinely available in clinical laboratories. The following measures are commonly used to detect hypercoagulable states or DIC in clinical situations:

- Platelet count—The abnormality consistent with DIC is thrombocytopenia.
- Prothrombin time—This is usually prolonged in animals with DIC but can occasionally be shortened in animals with a hypercoagulable state.
- Activated partial thromboplastin time—This measure of hemostasis is usually prolonged in animals with coagulopathies.
- Serum markers of fibrinogen activation/fibrin degradation (FDPs) have poor sensitivity and specificity for detection of DIC.
  - Plasma D-dimer concentration is more sensitive for detection of abnormalities in hemostasis/fibrinolysis, and a normal D-dimer concentration is useful in ruling out a diagnosis of sepsis in foals.<sup>9</sup>
- Fibrinogen concentration—Classical descriptions of DIC include hypofibrinogenemia as a common finding. However, this is uncommonly the case in horses and cattle, probably because fibrinogen is an acute-phase protein that increases in inflammatory diseases in these species. Declines in plasma fibrinogen concentration, with values remaining above the lower bound of the reference range, are often noted in horses with coagulopathy and impending death.

- Antithrombin activity is often reduced in animals with a hypercoagulable state or DIC.

A number of studies provide detailed descriptions of the occurrence, and time course, of abnormalities in hemostatic and fibrinolytic function in **horses with gastrointestinal disease**. The general pattern is that of prolonged clotting times (PT, aPTT) with diminished activity of antithrombin and protein C and increased plasma concentrations of fibrinogen and fibrin degradation products. D-dimer concentration increases in horses with gastrointestinal disease.<sup>5</sup> Platelet concentration is reduced in horses with colic and evidence of coagulopathy. Abnormalities in hemostatic factors are more common in the peritoneal fluid than in the blood of horses with colic. Tissue plasminogen activator, plasminogen, protein C, antithrombin, and alpha-2-antiplasmin activities and concentrations of fibrinogen and fibrin degradation products are greater in the peritoneal fluid from horses with colic than in the peritoneal fluid of healthy horses.

Compared with healthy **foals**, the PT, aPTT, and whole-blood recalcification times are significantly longer in septic foals. The concentrations of fibrinogen and fibrin degradation products, percentage plasminogen, alpha-2-antiplasmin and plasminogen activator inhibitor activities, and tumor necrosis factor and interleukin-6 activities are greater, and protein C antigen and antithrombin activity are lower, in septic foals.

**Cattle** with displaced abomasum often have abnormalities in one or more of PT, aPTT, thrombin time, platelet count, and plasma concentration of fibrin degradation products. **Pigs** with induced endotoxemia have increases in the activity of tissue factor, plasminogen activator, and plasminogen activator-inhibitor, increases in the concentrations of thrombin-antithrombin complexes and fibrin monomer; and a decline in fibrinogen and factor VII concentrations.

### NECROPSY EXAMINATION

It is important to differentiate the abnormalities at necropsy caused by DIC from those of the underlying disease. This can be challenging. The presence of DIC is suspected by the presence of hemorrhage in the carcass. Hemorrhage can vary from occasional petechiation to frank hemorrhage into body cavities. Horses dying of DIC usually have widespread lesions, including petechiation of mucosal and serosal surfaces, including the mesentery and pleura. There is often hemorrhage into the parenchymatous organs (kidneys, adrenals), lungs, and myocardium, and infarcts in the adrenals and kidney. Microthrombi are detectable in the intestine and kidney of some horses with DIC.

### DIAGNOSTIC CONFIRMATION

The presence of a hypercoagulable state is determined by clinicopathological testing.

DIC is diagnosed by the presence of clinical signs of a hemorrhagic diathesis and laboratory confirmation of abnormalities in hemostasis and fibrinolysis. A conventional definition of DIC requires the presence of clinical evidence of coagulopathy and the presence of at least three abnormal measures of coagulation or fibrinolysis. It is likely that this definition will change as our understanding of the spectrum of abnormalities and manifestations of the disorder matures.

Differential diagnoses include all of the acquired or inherited coagulopathies. However, the cardinal differentiating attribute of DIC or the lesser hypercoagulable states is the presence of severe inciting disease.

### TREATMENT

Most recommended therapies for DIC have been extrapolated from the human literature and may not be applicable to farm animals. However, generally stated, the principles of therapy are as follows:

- Treatment of the underlying disease and correction of acid-base, inflammatory, electrolyte, and perfusion abnormalities
- Restoration of normal activity or concentration of clotting factors in blood
- Halting or attenuating the increased coagulopathy
- Minimizing effect of microthrombi and thrombi on organ function

DIC is invariably secondary to an initiating primary disease. Vigorous therapy should consequently be directed toward correction of the primary initiating disease. Aggressive IV fluid administration to maintain tissue perfusion and to correct any acid-base and electrolyte imbalance is also very important. There should be aggressive treatment of endotoxemia and of diseases likely to induce endotoxemia. Treatment of endotoxemia is discussed elsewhere in this text (**Chapter 5**), and current reviews are available.

The plasma concentration of clotting factors should be restored, or supplemented, in horses with clinical or clinicopathological evidence of a coagulopathy. The practice of blood component therapy is well accepted in human medicine but because of technological limitations is not generally available in farm animals. However, stored **plasma**, preferably fresh or fresh frozen, can be administered to increase the concentration of clotting factors that are depleted during hypercoagulable states or DIC. Antithrombin is often readily measured, and horses with low plasma antithrombin activity should be administered plasma. The dose of plasma necessary to increase blood antithrombin activity to appropriate levels has not been determined. However, many clinicians use a plasma antithrombin activity 60% of that of healthy horses as a minimal acceptable activity. This choice has not been verified empirically. Dosages of plasma vary from 2 to

10 mL/kg IV. Platelet-rich plasma, or whole blood, can be used to treat thrombocytopenia.

Heparin and low-molecular-weight heparin are used to treat horses with hypercoagulable states, and their use is discussed earlier in the chapter. The aim is to prevent formation of thrombi and microthrombi. Heparin requires antithrombin as a cofactor, and it might not exert its full therapeutic activity in horses with abnormally low blood antithrombin concentrations.

Aspirin is used to inhibit platelet activity in horses with prothrombotic states. Its efficacy in reducing morbidity or case-fatality rate has not been determined.

## REFERENCES

1. Dunkel B, et al. *J Vet Int Med.* 2010;24:1467.
2. Gokce HI, et al. *Vet Res Comm.* 2007;31:529.
3. Hagiwara S, et al. *J Vet Med Sci.* 2014;76:1431.
4. Ismail ZAB, et al. *Vet Res Comm.* 2010;34:533.
5. Cesarini C, et al. *J Vet Emerg Crit Care.* 2014;24:672.
6. Cesarini C, et al. *J Vet Int Med.* 2010;24:1490.
7. Cotovio M, et al. *J Vet Int Med.* 2007;21:1083.
8. Cotovio M, et al. *J Vet Int Med.* 2008;22:1403.
9. Armengou L, et al. *J Vet Int Med.* 2008;22:411.
10. Pusterla N, et al. *J Vet Int Med.* 2007;21:344.

## THROMBOSIS (HYPERCOAGULABILITY)

Abnormal formation of thrombi is often a consequence of diminished concentrations or activity of anticoagulant factors, such as antithrombin, protein C, and antiplasmin; increased concentrations of plasminogen activator-inhibitor; or abnormalities of vessel walls. Thrombotic disease is usually a consequence of a primary disease that depletes anticoagulant factors and involves mechanisms discussed earlier under disseminated intravascular coagulopathy (DIC). Thrombosis of the jugular vein is discussed elsewhere (Chapter 11).<sup>1</sup> Other diseases involving thrombosis are thromboembolic colic and aortoiliac thrombosis in horses, although each is likely associated with inciting damage to the arterial endothelium.<sup>2</sup> Pulmonary embolism in horses is associated with sepsis or severe inflammatory disease, and thrombosis of the portal vein can result from local metastasis of gastric adenocarcinoma.<sup>3-5</sup> Aortic thrombosis occurs in calves with existing severe inflammatory or septic disease.<sup>6</sup> Thrombosis of the caudal or cranial vena cava occurs in cattle and is fully described in Chapter 13.<sup>7,8</sup> Thrombosis of the caudal vena can occur in horses.<sup>9</sup>

Idiopathic brachial artery thrombosis, which can be bilateral, occurs in adult horses without obvious preexisting clinical illness.<sup>10,11</sup>

An apparently **primary defect in protein C** activity in a Thoroughbred colt with a hypercoagulable state has been described. The colt had repeated episodes of venous thrombosis and developed renal failure. Plasma concentrations of protein C were

within the reference range for healthy horses, but the activity of protein C in plasma was 32% of that of healthy horses, suggesting a defect in the protein activity or concentration.

## REFERENCES

1. Martins Dias DP, et al. *Can Vet J.* 2013;54:65.
2. Oyamada T, et al. *J Equine Sci.* 2007;18:59.
3. Patton KM, et al. *Vet Pathol.* 2006;43:565.
4. Norman TE, et al. *Equine Vet J.* 2008;40:514.
5. Bryan J, et al. *J Vet Int Med.* 2009;23:215.
6. Wieland M, et al. *Schweiz Arch Tierheilkd.* 2014;156:441.
7. Gerspach C, et al. *Can Vet J.* 2011;52:1228.
8. Simpson KM, et al. *Can Vet J.* 2012;53:182.
9. Shoster A, et al. *Can Vet J.* 2010;51:891.
10. Gasthuys FMR, et al. *Vet Rec.* 2007;160:340.
11. Vaughan B, et al. *Vet Radiol Ultra.* 2010;51:305.

## DISEASES CHARACTERIZED BY ABNORMALITIES OF THE CELLULAR ELEMENTS OF THE BLOOD

### DISORDERS OF RED CELL NUMBER OR FUNCTION Anemia

#### SYNOPSIS

**Etiology** Deficiency of circulating erythrocytes associated with hemorrhage and increased destruction or the inefficient production of erythrocytes. There are a large number of specific etiologies.

**Epidemiology** Specific to the underlying cause of the anemia.

**Clinical findings** Pallor of mucosae, tachycardia, lethargy, exercise intolerance, arrhythmia, ileus, decreased ruminations, and colic. Petechial and ecchymotic hemorrhages, icterus, hemoglobinuria, and bleeding tendencies can be seen if the underlying cause is excessive hemorrhage.

**Clinical pathology** Examination of erythron, bone marrow, and serum total protein for nature and severity of anemia; clinical chemistry for associated organ damage. Specific tests for etiology.

**Necropsy findings** Pallor of tissues. Findings specific to specific etiology.

**Diagnostic confirmation** Decreased erythrocyte count, hemoglobin concentration, or packed cell volume.

**Treatment** Treatment of specific etiology. Transfusion of whole blood, packed red cells, or stromal-free hemoglobin if the anemia is severe. Corticosteroids for immune-mediated anemia and supportive treatment.

#### Etiology

Anemia can be classified as hemorrhagic anemia, hemolytic anemia, or anemia resulting from decreased production of erythrocytes. Another classification system is based on evidence of regeneration of anemia, with

anemia classified as either regenerative or nonregenerative. Both classifications are useful in determining the cause, treatment, and prognosis. Diseases causing anemia in horses are listed in [Table 11-1](#), and those causing hemolytic anemia in cattle are listed in [Table 11-2](#).

#### Hemorrhagic Anemia

Acute hemorrhage and hemorrhagic shock are discussed in [Chapter 5](#). The diseases discussed here are those that cause **normovolemic anemia**. Although anemia occurs after restitution of plasma volume in animals with severe hemorrhage, most diseases that cause normovolemic anemia do so because of the chronic loss of blood either from the body or into a body cavity. The most common route of loss is through the gastrointestinal tract. Diseases include the following:

- Parasitism—intestinal nematodiasis:
  - Teladorsagia circumcincta* or *Haemonchus contortus* in lambs and sheep; *Ostertagia ostertagi* in cattle; *Strongylus* spp. and cyathostomes in horses; trematodiasis, including *Fasciola hepatica*, in sheep and cattle; hematophagous lice and ticks, including *Linognathus vituli* in calves
- Gastrointestinal disease, including the following:
  - Abomasal ulceration in cattle (both spontaneous and associated with abomasal lymphoma)
  - Gastric ulceration in horses (anemia is an unusual manifestation of this disease)
  - Gastric squamous-cell carcinoma in horses in which anemia is a common finding<sup>1</sup>
  - Esophagogastric ulceration in pigs
  - Proliferative enteropathy in pigs (usually a peracute disease)
  - Bleeding from lesions in the small intestine (neoplasia, fungal infection, mural hematoma)
- Respiratory tract disease, including the following:
  - Guttural pouch mycosis in horses
  - Ethmoidal hematoma in horses
  - Caudal vena cava thrombosis and pulmonary embolism in cattle
- Genitourinary tract disease, including the following:
  - Enzootic hematuria in cattle (bladder cancer) and bladder transitional cell or squamous-cell neoplasia (horse)
  - Pyelonephritis
  - Vaginal varicose vein hemorrhage in mares
  - Ruptured corpus cavernosum and ureteral lesion causing hematuria in geldings and stallions
  - Middle uterine artery rupture of mares (usually a peracute disease)
  - Idiopathic renal hematuria in horses
- Hemorrhage into body cavities, including the following:

**Table 11-1** Differential diagnosis of anemia, with or without edema, in horses

Disease	Epidemiology	Clinical findings	Clinical pathology	Treatment
<b>Anemia</b>				
Chronic blood loss	Sporadic. Parasitism. Intestinal blood loss (e.g., gastric squamous-cell carcinoma). Guttural pouch mycosis.	Lethargy, tachycardia, pale mucous membranes. Other signs consistent with underlying disease.	Hypochromic, microcytic anemia. Low serum iron concentrations. Increased serum iron binding capacity, low serum ferritin concentration. Thrombocytopenia (+/-). Other results specific for underlying disease. Bone marrow—decreased myeloid:erythroid ratio.	Correct underlying disease. Administer ferrous sulfate 10–20 mg/kg per os once daily until serum iron concentration is normal and anemia has resolved.
Anemia of chronic disease (inflammation)	Sporadic. Associated with chronic, inflammatory disease (neoplasia, strangles abscess).	Lethargy. Signs consistent with underlying disease.	Normocytic, normochromic mild anemia. Low serum iron concentration, low to unchanged total serum iron binding capacity, increased serum ferritin concentration. Bone marrow normal.	Treat underlying disease.
Aplastic anemia	Sporadic. Can occur as an outbreak in stables in which horses are administered recombinant human erythropoietin (rEPO).	Lethargy, tachycardia, pale mucous membranes. Other signs consistent with underlying disease.	Normochromic, normocytic anemia. Normal to high serum iron concentration. Antibodies to rEPO. Bone marrow—very high myeloid:erythroid ratio as a result of lack of red cell series.	Correct underlying disease. Prognosis for rEPO-induced anemia is very poor.
Red maple ( <i>Acer rubrum</i> ) intoxication	Ingestion of green or wilted leaves of red maple trees. Sporadic or several horses in one field. Regional according to distribution of tree.	Jaundice, hemoglobinuria, depression, colic, renal failure.	High (>1.5%) concentration of methemoglobin in blood. Heinz bodies in red blood cells.	Supportive care. Blood transfusion. Vitamin C suggested.
Neonatal isoerythrolysis	Foals < 4–5 days of age. Multiparous mares. Ingestion of colostrum containing isoantibodies to foal's red blood cells.	Weakness, depression, exercise intolerance, jaundice, hemoglobinuria.	Anemia, hyperbilirubinemia, positive Coombs test. Positive jaundiced foal agglutination test. Blood typing of mare and stallion and detection of isoantibodies in dam.	Conservative. Rest. Limit exercise. Severely affected foals require transfusion of blood or packed red cells from compatible donor.
Fell and Dale pony syndrome	Fell ponies < 18 weeks of age. Suspected heritable defect.	Weakness, depression, ill-thrift, pneumonia, diarrhea and other opportunistic infections.	Normocytic, normochromic anemia. B-lymphocyte leucopenia. Decreased concentrations of immunoglobulins as foals age.	None.
Autoimmune hemolytic anemia	Secondary to other disease or drug administration. Penicillin-induced anemia.	Depression, pallor of mucous membranes. Signs of underlying disease.	Anemia. Hemoglobinemia or hemoglobinuria. Coombs positive.	Corticosteroids or immunosuppressant drugs. Withdraw inciting cause.
Clostridial myonecrosis	Sporadic. Associated with intramuscular administration of medications or vaccinations.	Acute disease—fulminant myonecrosis with fever, depression, and hemolytic anemia. Chronic disease associated with abscessation at site of injection, jaundice, hemoglobinemia, hemoglobinuria.	Anemia. Agglutination of red cells. Detection of IgM or IgG on red cell surface in chronic disease.	Treat underlying disease. Blood transfusion. Poor prognosis.
Liver failure	Sporadic. Associated with risk factors for liver disease.	Terminal phases of liver failure. Depression, weight loss, jaundice.	Consistent with liver disease (bilirubin, AST, bile acids, GGT).	None specific. Treat liver disease. Poor prognosis.
Bone-marrow hypoplasia in Standardbreds	Specific family line of Standardbred horses in North America.	Exercise intolerance, infections.	Anemia, pancytopenia	None.
Myelophthitic disorders	Sporadic. Bone-marrow neoplasia (myeloproliferative disease, lymphosarcoma).	Exercise intolerance.	Depends on underlying disease. Normochromic normocytic anemia. Profound leukocytosis in some diseases. Hypergammaglobulinemia	Treat specific disease.

Continued



**Table 11-1** Differential diagnosis of anemia, with or without edema, in horses—cont'd

Disease	Epidemiology	Clinical findings	Clinical pathology	Treatment
Iatrogenic folate deficiency	Sporadic. Horses treated with drugs that inhibit folate metabolism and are administered synthetic folate orally, such as for treatment of equine protozoal myeloencephalitis.	Signs of underlying diseases. Unusual bacterial infection. Depression, exercise intolerance, lethargy.	Mild anemia. Lymphopenia, neutropenia. Low blood folate concentrations.	Stop oral administration of folate. Administer folate parenterally.
<b>Anemia with edema</b>				
<i>Babesiosis</i> ( <i>Theileria equi</i> , <i>Babesia caballi</i> )	Regional disease related to presence of vector ticks. Adult horses. Infected carrier state. <i>T. equi</i> transmitted transplacentally in addition to by tick bite.	Incubation period of 5–30 days. Depression, reluctance to move, recumbency, fever. Dependent edema. Colic. Mild jaundice and petechiation. Young horses most severely affected. Course 8–10 days.	<i>B. equi</i> in erythrocytes. Serologic testing using IFA or CFT. PCR to detect organism.	Imidocarb.
Equine infectious anemia	Virus. Acute disease followed by lifelong infection. Insect vector (tabanid flies) or mechanical transmission (veterinary instruments).	Acute disease of fever, anemia, dependent edema, jaundice. Apparent recovery followed by intermittent relapses of usually less severe disease.	Thrombocytopenia. Anemia. AGID (Coggin's) test. cELISA.	None specific. Control includes destruction of horses with a positive AGID or c-ELISA test in many jurisdictions.
Purpura hemorrhagica	Immune-mediated (antigen-antibody complex) secondary to respiratory disease. Adult horses. Sporadic occurrence.	Nonpainful, cool, asymmetric subcutaneous swellings. Mild fever. Severe cases have multiple-organ involvement, including rhabdomyolysis.	Leucocytosis. Normal platelet count. High serum antistreptococcal M protein antibody titer.	Penicillin. Corticosteroids. Supportive care.
Congestive heart failure	Sporadic.	Murmur of valvular insufficiency. Irregular heart rhythm (atrial fibrillation). Edema that is symmetric, cool, and of dependent parts.	None specific.	None specific. Digitalis and furosemide in short term.
Strongylosis	Small strongyles (cyathostomes). Historically large strongyles.	Young horses. Mild fever, depression, diarrhea, edema.	Anemia, hypoproteinemia. In patent infestations, fecal egg count.	Anthelmintics (ivermectin, moxidectin, benzimidazoles). Resistance an increasing occurrence.

AGID, agar gel immunodiffusion; AST, aspartate aminotransferase; cELISA, competitive enzyme-linked immunosorbent assay; CFT, complement fixation test; GGT, gamma-glutamyl transpeptidase; IFA, immunofluorescence assay; PCR, polymerase chain reaction.

**Table 11-2** Differential diagnosis of diseases of cattle characterized by acute hemolytic anemia with or without hemoglobinuria

Disease	Epidemiology	Clinical findings	Laboratory findings
Leptospirosis	All ages, cattle on pasture	Acute fever, red-colored milk Hemoglobinuria abortion; may die in 24–48 hours	Leptospira titers
Postparturient hemoglobinuria	High-producing lactating cows 4–6 weeks postpartum	Acute; no changes in milk; no fever; die in 12–48 hours; marked hemoglobinuria	Hypophosphatemia
Bacillary hemoglobinuria	Usually mature cattle on summer pasture in enzootic area	Acute fever, abdominal pain; may die in 2–4 days; hemoglobinuria	Leukopenia or leukocytosis
Babesiosis	Enzootic areas, tick borne, young animals	Acute fever, jaundice, abortion, course of 2–3 weeks; marked hemoglobinuria	Blood smear, complement fixation test, transmission tests
Anaplasmosis	Yearling and mature cattle, common in summer, insect borne, common in feedlots	No hemoglobinuria, jaundice common, fever	Anaplasms on blood smear, complement fixation test
Chronic copper poisoning	Follows long-term oral administration of medicines or feeds containing copper	Severe jaundice; no fever Hemoglobinuria	Toxic levels of copper in blood, liver, and feces
Cold-water hemolytic anemia of calves	Following consumption of large quantities of cold water after period of limited intake	Sudden onset within 1 hour after ingestion; no fever; may die in a few hours; hemoglobinuria	Acute hemolytic anemia
Rape and kale poisoning	All ages of cattle on rape crop grown for fodder in fall	Peracute hemolytic anemia, may die in a few hours after onset; no fever Hemoglobinuria	Acute hemolytic anemia
Drug induced	Some drug preparations when given IV	Mild hemoglobinuria; no hemolytic anemia	Nil
Blood transfusion reaction	Using blood from same donor more than 1 week after initial transfusion	Sudden onset, dyspnea, hiccoughs, trembling, responds to adrenalin	Nil

The common causes of hematuria in cattle are pyelonephritis and cystitis caused by *Corynebacterium renale*, nonspecific cystitis, and enzootic hematuria. Myoglobinuria occurs occasionally in young cattle affected with enzootic-nutritional muscular dystrophy and may be confused with hemoglobinuria.

- Hemangiosarcoma
- Juvenile bovine angiomas
- Hemoperitoneum<sup>2</sup>
- Hemothorax
- Defects in clotting (see “[Diseases Causing Hemorrhage](#)”), including the following:
  - Thrombocytopenia
  - Deficiency of clotting factors
  - Umbilical bleeding in piglets

### Hemolytic Anemia

#### Cattle and Sheep

- Babesiosis, anaplasmosis, *Mycoplasma ovis comb. nov.* (formerly *Eperythrozoon ovis*) eperythrozoonosis, trypanosomiasis, nagana, theileriosis,<sup>3</sup> *Mycoplasma wenyonii*<sup>4</sup> alone or in various combinations
- Bacillary hemoglobinuria
- Leptospirosis (*L. interrogans serovar pomona*)
- Bovine virus diarrhea and mucosal disease
- Postparturient hemoglobinuria
- Associated with grazing *Brassica* spp., rape, kale, *chou moellier*, turnips, cabbage
- Associated with the excessive feeding of culled onions or cannery offal, especially tomatoes and onions
- Poisoning by *Mercurialis*, *Ditaxis*, *Pimelia*, and *Allium* spp.
- Poisoning by miscellaneous agents, including phenothiazine and guaifenesin
- Poisoning—chronic copper poisoning. In sheep, secondary to pyrrolizidine alkaloids, as in toxic jaundice, or primary from the feeding of diets too high in copper. Cattle are much less susceptible than sheep, although preruminant calves are very susceptible.
- Treatment with long-acting oxytetracycline
- Water intoxication and drinking cold water in calves, and in goat kids fed water from a nipple bottle
- Inadvertent IV administration of hypotonic fluids
- Part of a transfusion reaction
- Rare cases of alloimmune hemolytic anemia (isoerythrolysis) in calves from vaccination of the dam with blood-derived vaccines, such as anaplasma vaccine, or as part of the bovine neonatal pancytopenia associated with vaccination of the dam with a specific BVD vaccine<sup>5,6</sup>
- Autoimmune hemolytic anemia is recorded in calves but is rare. All reported cases have occurred in calves under 6 months of age.
- Immune-mediated anemia can occur in lambs that are fed cow colostrum as a source of immunoglobulin. This is not a common sequel to the feeding of cows' colostrum and occurs only with the colostrum from certain cows. Anemia is

evident at 7 to 20 days of age, but jaundice and hemoglobinuria are not usually present. The syndrome must be differentiated from immune-mediated thrombocytopenia, which occurs at a younger age in some lambs fed bovine colostrum<sup>7,8</sup>

- Rarely, in adults after vaccination
- Congenital anemia associated with dyserythropoiesis and accompanied by dyskeratosis and progressive alopecia is recorded in Polled Hereford calves. The anemia is present at birth, and the disease is probably inherited.
- A congenital anemia with jaundice is recorded in Murray Grey calves, and it is postulated that a defect in the red cell membrane leads to intravascular hemolysis.
- Immune-mediated anemia in cattle secondary to other systemic disease<sup>9</sup>

#### Pigs

- Eperythrozoonosis is recorded, but hemolytic anemia is rare.
- Isoerythrolysis, thrombocytopenia, and coagulation defects are discussed in the previous section.
- Generalized cytomegalovirus infection

#### Horses (Table 11-1)

- Equine infectious anemia, although the pathogenesis of the anemia is probably multifactorial, including hemolysis and decreased red cell production
- Babesiosis
  - Hemotrophic mycoplasma infection in horses has been associated with a reduced red cell count. The syndrome and its importance are currently poorly characterized.<sup>10,11</sup>
- Phenothiazine poisoning—this anthelmintic is now used rarely in horses.
- Red maple leaf (*Acer rubrum*) toxicosis<sup>12</sup>
  - Ingestion of pistache (*Pistacia* spp.) leaves<sup>13</sup>
  - Ingestion of *Pimelia trichostachya* (St. George disease)<sup>14</sup>
- Ingestion of dried garlic (>0.2 g/kg BW) results in development of Heinz bodies and hemolytic anemia.
- IV administration of hypotonic or hypertonic fluids (water, 20% dimethylsulfoxide)
- As a sequela to severe cutaneous burns—the severity of the hemolysis correlates with the amount of skin area burned. Hemolysis is a result of oxidative damage of red cell membranes that occurs within minutes of the burn. Prevention and treatment include immediate administration of polyionic fluids to prevent hemoconcentration and to prevent hemolytic uremia.
- As a sequela to clostridial abscessation—the anemia occurs more than 10 days after development of the abscess and is

associated with the presence of IgG or immunoglobulin M (IgM) on the surface of red cells<sup>15</sup>

- Alloimmune hemolytic anemia (isoerythrolysis) of foals
  - Autoimmune anemia associated with *Rhodococcus equi* infection in foals (a rare complication)<sup>16</sup>
- Autoimmune hemolytic anemia—not common, but several series have been recorded.
- Immune-mediated hemolytic anemia and thrombocytopenia (Evans syndrome)
- Penicillin-induced hemolytic anemia—this is a rare event but can occur when horses develop IgG antipenicillin antibodies. These antibodies bind to penicillin on erythrocytes, with resultant red cell destruction. Penicillin-coated erythrocytes agglutinate with patient serum. It is probable that other immune-mediated hemolytic anemias in the horse are also associated with the development of antibody to therapeutic agents.<sup>17</sup>
- Some snake envenomations cause intravascular hemolysis in dogs and cats, and hemolytic anemia can occur in snakebite in horses and calves.
- Lead intoxication in horses causes mild anemia, but signs of peripheral neuropathy are the more obvious manifestation.
- Abnormalities in red cell function can lead to increased removal of red cells from blood (extravascular hemolysis) and are discussed under “Abnormalities of Red Cell Function.”

#### Anemia Resulting From Decreased Production of Erythrocytes or Hemoglobin (Nonregenerative Anemia)

The diseases resulting from decreased production of erythrocytes or hemoglobin tend to affect all species, and thus they are presented here according to cause rather than according to animal species.

**Nutritional Deficiency.** Nutritional deficiencies impair production of hemoglobin or red cells. Specific deficiencies that result in anemia include the following:

- Starvation (chronic undernutrition) causes mild to moderate anemia.<sup>18</sup>
- Cobalt and copper—these elements are necessary for all animals, but clinically occurring anemia is observed in only ruminants. Copper deficiency induced by zinc toxicity causes anemia in pigs.
- Iron—but as a clinical occurrence this is limited to rapidly growing animals, including baby pigs, young calves designated for the white veal market, housed lambs, and foals. This predilection of young animals for iron deficiency is attributable to their rapid

growth and hence requirement for relatively large intakes of iron (which, in addition to production of hemoglobin, is used in production of myoglobin and other iron-containing compounds), the low concentration of iron in milk, and management practices that deny access of the animals to pasture or soil from which they can obtain iron.

- Anemia in piglets can be caused by iron deficiency. The disease occurs in both housed piglets and those kept on dirt, although the disease is believed to be less common in those kept at pasture or on dirt, in part because of the availability of iron ingested in dirt.
- Iron deficiency should be considered as a possible cause of failure to perform well in housed calves. Male calves up to 8 weeks of age and on a generally suitable diet can show less-than-optimum performance in erythron levels, and the calves with subclinical anemia have deficits in growth rate and resistance to diarrhea and pneumonia. Calves fed 20 mg Fe/kg milk replacer develop hypoferrremia and mild anemia, whereas those fed 50 mg Fe/kg do not.
- Iron-deficiency anemia occurs in housed lambs and is prevented by oral or parenteral supplementation with iron. Anemia and poor weight gain were not prevented in all lambs by a single administration of 330 mg of iron once orally at 1 to 5 days of age, although there was a marked increase in serum iron concentration. Treated lambs had higher hematocrit and greater weight gain than did untreated lambs.
- Microcytic anemia and hypoferrremia occur in Standardbred foals kept at pasture for 12 hours per day. These changes are not prevented by oral administration of four oral doses of 248 mg of iron, suggesting that higher levels of supplementation are needed. Conversely, hypoferrremia and anemia were reported in stabled foals but not in a pastured cohort. The stabled foals had clinical signs of anemia (lethargy) and low hematocrit, hemoglobin concentration, and serum iron concentration, which were restored to normal values by iron supplementation (0.5 g iron sulfate orally once daily, 3 g of iron sulfate top dressed on cut pasture fed to the foals and their dams, and unlimited access to a lick block containing iron). Whereas colostrum of mares is rich in iron, milk has much lower concentrations, probably explaining the low serum iron of some nursed

foals and demonstrating the need for access to iron supplements or, preferably, soil or pasture.

Supplementation of foals with iron should be undertaken cautiously because of the documented hepatotoxicity of large doses of iron given orally to newborn foals. Toxic hepatopathy develops in newborn foals administered iron fumarate at 16 mg/kg BW within 24 hours of birth, similar to the situation in piglets. Iron supplementation of foals should be done cautiously

- A great deal of attention is paid to providing adequate iron to racehorses, often by periodic injection of iron compounds regularly during the racing season or provision of hematinic supplements. Given that strongylosis is all but unknown in racehorses in the current era of intensive parasite control programs and stabling of horses, anemia is exceedingly rare in healthy racehorses. Supplementation with iron of horses on a balanced, complete ration is therefore unlikely to be necessary. Moreover, administration of excessive iron could be dangerous, although iron intoxication has not been documented in racehorses as it has in foals. Oral administration of 50 mg Fe/kg body weight to ponies for 8 weeks increased serum iron concentration, did not affect hematocrit, and did not induce signs of disease.
- Potassium deficiency is implicated in causing anemia in calves.
- Pyridoxine deficiency, produced experimentally, can contribute to the development of anemia in calves.
- Folic acid deficiency is rare in horses, has not been reported as a spontaneous disease in pigs, and is unlikely to occur in ruminants because of the constant production of folic acid by rumen bacteria. Plasma folic acid concentrations vary in pregnant mares kept at pasture and in their foals, but there is no evidence of folate deficiency in either mares or foals. Administration of antifolate drugs (trimethoprim, sulfonamides, pyrimethamine, methotrexate) could, theoretically, cause folate deficiency in horses. Folate deficiency causing anemia and leukopenia is reported in a horse treated for equine protozoal myelitis with antifolate drugs concurrent with oral supplementation with folic acid. IV administration of folic acid (0.055 to 0.11 mg/kg BW) resulted in rapid resolution of leukopenia and anemia. Paradoxically, oral administration of folic acid in monogastric animals

receiving antifolate drugs impairs absorption of folic acid in the small intestine and causes folate deficiency. Administration of folic acid, sulfonamides, and pyrimethamine orally to pregnant mares results in congenital signs of folate deficiency in foals, including anemia and leukopenia.

**Chronic Disease.** Chronic inflammatory disease causes mild to moderate anemia in all species of large animals. The anemia can be difficult to differentiate from that of mild iron-deficiency anemia. The genesis of anemia of chronic inflammation is multifactorial and includes sequestration of iron stores such that iron availability for hematopoiesis is reduced despite adequate body stores of iron, reduced erythrocyte life span, and impaired bone-marrow response to anemia.<sup>19</sup> The result is normocytic, normochromic anemia in animals with normal to increased serum ferritin concentrations. The clinicopathologic features of both iron-deficiency anemia and anemia of chronic disease are detailed in Table 11-3. Causes of anemia of chronic disease include the following:

- Chronic suppurative processes can cause severe anemia by depression of erythropoiesis.
- Radiation injury can cause anemia by reducing erythropoiesis.
- Poisoning by bracken, trichloroethylene-extracted soybean meal, arsenic, furazolidone, and phenylbutazone can cause depression of bone-marrow activity.
- Anemia can occur as a sequela to inclusion-body rhinitis infection in pigs.
- Porcine dermatitis and nephropathy syndrome can result in anemia.
- Intestinal parasitism (e.g., ostertagiasis, trichostrongylosis) in calves and sheep can have this effect.

#### Red Cell Aplasia

- Red cell hypoplasia is a fatal syndrome of anemia, immunodeficiency, and peripheral gangliopathy that develops at 4 to 8 weeks of age in some Fell pony and Dale pony foals.<sup>20-22</sup>
- Anemia in some horses follows the administration of recombinant human erythropoietin. The anemia is a result of pure red cell aplasia and is manifest as normocytic, normochromic anemia. The disease is attributable to injection of horses with recombinant human erythropoietin with subsequent development of substances in blood, presumably antibodies to rhEPO, that cross-react with and neutralize endogenous erythropoietin in affected horses. Not all horses administered rhEPO develop anemia, but the disease is reported as an outbreak in a stable of Thoroughbred racehorses that were given the compound. Severely affected



**Table 11-3** Characteristic or expected changes in hematological and serum biochemical variables in anemic animals

Variable	REGENERATIVE ANEMIA				NONREGENERATIVE ANEMIA		
	BLOOD LOSS		HEMOLYSIS		Chronic inflammation and disease	Iron deficiency (including prolonged chronic blood loss)	Hypoproliferative anemia, aplastic anemia, myelophthisis
	Acute hemorrhage	Chronic or normovolemic recovery phase of acute hemorrhage	Acute	Chronic or recovery			
Hematocrit	Normal	Low	Low	Low	Mild to moderate low	Low	Low to very low
Hemoglobin concentration in blood	Normal	Low	Normal (intravascular hemolysis) to low (extravascular hemolysis)	Low	Low	Low	Low
Plasma total protein concentration	Normal	Low	Normal	Normal	Normal to high (increased globulins and fibrinogen)	Normal	Normal
Plasma fibrinogen	Normal	Low, normal or high	Normal or high	Normal or high	High	Normal	Normal
Reticulocytosis*	No	Yes	No	Yes	Unusual	Unusual	No
Mean corpuscular volume (MCV) <sup>†</sup>	Normal	High	Normal	High	Normal to low	Low	Normal
Mean corpuscular hemoglobin	Normal	High (because of reticulocytes)	High (because of increased concentration of free hemoglobin in plasma)	High (regenerative response)	Normal to low	Low	Normal
Mean corpuscular hemoglobin concentration	Normal	Decreased (because of reticulocytes)	High (because of increased concentration of free hemoglobin in plasma)	Decreased (because of reticulocytes)	Normal to low	Low	Normal
Red cell distribution width (degree of anisocytosis)	Normal	Increased	Normal	Increased	Normal	Normal	Normal
Red cell morphology	Normocytic, normochromic	Anisocytosis, macrocytic, polychromic	Anisocytosis, spherocytosis	Anisocytosis, polychromic	Normocytic, normochromic	Microcytic, hypochromic	Normocytic, normochromic
Serum iron concentration	Normal	Normal (low if prolonged loss of red cells)	Normal to high because of release of iron from red cells	Normal to high	Low (to normal)	Low	Normal to high
Serum transferrin concentration (total iron-binding capacity)	Normal	High	Normal	Normal to high	Low to normal	Normal to increased	Low to normal
Transferrin saturation	Normal	Low to normal	NK	NK	Low to normal	Low	Normal to high
Serum ferritin concentration	Normal	Low to normal	Normal	Normal to high	Normal to high (note: ferritin is also an acute-phase protein)	Low	Normal to high
Bone-marrow iron stores	Normal	Low to normal	Normal	Normal or increased	High (or normal)	Low or absent	Normal
Bone-marrow myeloid: erythroid ratio <sup>‡</sup>	Normal (0.5–1.5)	Low (<0.5)	Normal	Low	Normal to high	Normal	High (>1.5)

Continued

**Table 11-3** Characteristic or expected changes in hematological and serum biochemical variables in anemic animals—cont'd

Variable	REGENERATIVE ANEMIA				NONREGENERATIVE ANEMIA		
	BLOOD LOSS		HEMOLYSIS		Chronic inflammation and disease	Iron deficiency (including prolonged chronic blood loss)	Hypoproliferative anemia, aplastic anemia, myelophthisis
	Acute hemorrhage	Chronic or normovolemic recovery phase of acute hemorrhage	Acute	Chronic or recovery			
Plasma erythropoietin concentration	Normal to high	High	Normal to high	High	Depends on underlying disease	High	Low—renal disease or decreased erythropoietin (EPO) production High—bone-marrow disease
Blood white cell count	Normal	Neutrophilia, thrombocytosis	Neutrophilia	Neutrophilia, thrombocytosis	Leukocytosis, thrombocytosis	Neutropenia or normal	Pancytopenia or, with pure red cell aplasia, normal

*The changes are those expected in most species but might not occur uniformly in all species. Normal are values within the range expected for healthy animals of that species, age, and physiologic status. High and low refer to values above or below this normal range.*

\*Reticulocytes are detectable in blood of horses only by use of special stains and sensitive laboratory methods.

<sup>†</sup>Increases in MCV in horses are slight and difficult to detect.

<sup>‡</sup>Values are for adult horses.

NK, not known.

horses die. Treatment of severely affected horses is futile, but mildly affected horses can recover. Whether the recovery was spontaneous or because of administered glucocorticoids is unknown. Administration of cyclophosphamide and glucocorticoids was not effective in treatment of several severely affected horses. Blood transfusion provides temporary relief.

- Pure red cell aplasia not associated with administration of rhEPO occurs, but rarely in horses. The disease can be transient.

**Myelophthisic Anemia.** Myelophthisic anemia, in which the bone marrow cavities are occupied by other, usually neoplastic, tissues is rare in farm animals. Clinical signs, other than of the anemia, which is macrocytic and normochromic, include skeletal pain, pathologic fractures, and paresis as a result of the osteolytic lesions produced by the invading neoplasm. Cavitation of the bone may be detected on radiographic examination. Causes include the following:

- Lymphosarcoma with bone marrow infiltration occurs in most species.<sup>23</sup>
- Lymphoma with immune-mediated anemia and thrombocytopenia occurs in horses.<sup>24</sup>
- Plasma-cell myelomatosis has been observed as a cause of such anemia in pigs, calves, and horses.<sup>25</sup>
- Infiltration of neoplastic cells, other than lymphoma or myeloma, such as melanoma in horses, can be a cause.

- Myelophthisic anemia as a result of myelofibrosis is reported in a pony and as a familial disease in pygmy goats.

#### Pathogenesis *Anemic Hypoxia*

The most important abnormality in anemia is the hypoxemia and subsequent tissue hypoxia that result from the reduced hemoglobin concentration and oxygen-carrying capacity of blood. The anemia becomes critical when insufficient oxygen is delivered to tissue to maintain normal function.

**Oxygen delivery** is described mathematically by the Fick equation:

$$\text{Oxygen delivery} = \text{Cardiac output} \times \text{Arteriovenous oxygen content difference}$$

Oxygen delivery is therefore the rate at which oxygen is delivered to the tissue—it is a combination of the rate at which oxygen arrives at the tissue in arterial blood and the proportion of that oxygen extracted from the capillary blood.

Cardiac output is determined by heart rate and stroke volume, whereas the arteriovenous difference in blood oxygen content is determined by the hemoglobin concentration, the hemoglobin saturation with oxygen in both arterial and venous blood, and the extraction ratio. The extraction ratio is the proportion of oxygen that is removed from the blood during its passage through tissues. In animals with a normal hematocrit and cardiac output, oxygen delivery to tissues exceeds the oxygen requirements of the tissue by a large margin, with the result that the oxygen extraction ratio is small (<40%). However, as the

oxygen-carrying capacity per unit of blood declines (usually expressed as milliliters of oxygen per 100 mL of blood), then either blood flow to the tissue or the extraction ratio must increase to maintain oxygen delivery. In reality, both of these compensatory mechanisms occur during the acute and chronic responses to anemia. Heart rate increases to increase cardiac output and therefore the delivery of oxygen to tissues, and blood flow is preferentially directed to those tissue beds that are most essential for life or are most sensitive to deprivation of oxygen (heart, brain, gut, kidney). The extraction ratio increases and is evident as a decrease in venous blood hemoglobin saturation. Hemoglobin in arterial blood is usually thoroughly saturated with oxygen, and the limitation to oxygen delivery to tissues is the low hemoglobin concentration and consequent low arterial oxygen content. Assessment of arterial blood oxygen tension and content is discussed in Chapter 13.

Reductions in hemoglobin concentration are compensated for by increases in cardiac output and the extraction ratio so that oxygen delivery to tissues is maintained in mild to moderate anemia. As the severity of anemia increases, these compensatory mechanisms are inadequate, and oxygen delivery to tissues declines. At some point the delivery of oxygen fails to meet the oxygen needs of the tissue, and organ function is impaired. It is important to realize that this is not an all-or-none phenomenon and that there is not a particular point at which decompensation occurs. In fact, with progressive anemia there are progressive increases in cardiac output and the oxygen

extraction ratio (evident as a progressive decline in venous hemoglobin saturation) until these compensatory mechanisms are maximal. **Arterial pH** and **lactate concentration** are maintained until the degree of anemia cannot be compensated for by increases in cardiac output and the extraction ratio, at which point the blood lactate concentration rises and blood pH and base excess decline. This is the degree of anemia at which oxygen use by tissues is entirely dependent on blood flow—decreases in blood flow decrease oxygen utilization, and increases in blood flow increase oxygen utilization until the point where oxygen delivery exceeds oxygen consumption.

Compensation for slowly developing anemia is more complete than for rapidly evolving anemia, such that animals with chronic anemia can tolerate a degree of anemia that would be intolerable for animals with acute anemia of a similar severity. Part of this chronic compensation includes changes in the affinity of hemoglobin for oxygen, which is in part a result of increases in 2,3-diphosphoglycerate concentration in red cells.

When anemia is sufficiently severe that it reduces oxygen delivery to tissue to rates that are less than the oxygen needs of tissue, tissue hypoxia develops and the proportion of energy generated by anaerobic metabolism increases. **Anaerobic metabolism** cannot be sustained for more than a short period of time (minutes) before tissue function is impaired. Impaired organ function is evident as decreased myocardial contractility, decreased cerebral function, decreased gastrointestinal motility, and abnormal renal function, to list just a few of many important abnormalities. The severity of these abnormalities depends on the metabolic activity of the tissues, with more metabolically active tissues (e.g., the heart) being more sensitive to hypoxia. Death usually results from acute heart failure caused by arrhythmia.

The effect of anemia is also dependent on the **metabolic state** of the animal. Exertion, even mild exertion such as grazing or following a herd or flock, can increase oxygen demands above that which can be sustained by the degree of anemia. Similarly, increases in body temperature, such as with fever, increase oxygen demand noticeably—an increase in body temperature of 1°C (1.8°F) increases oxygen need by 12%.

Anemia induces increases in plasma erythropoietin concentration, which stimulates erythropoiesis in bone marrow and, in young animals or those with extreme anemia, in extramedullary sites. The increase in plasma erythropoietin concentration is prompt, occurring within hours of the development of anemia. The compensatory erythropoietic response is slower, with new red cells being detectable in 1 to 2 days in most species and bone-marrow reticulocytosis detectable in less than 1 week.

### Autoimmune Hemolytic Anemia

Autoimmune hemolytic anemia is believed to result from an aberrant production of antibodies targeted against surface antigens of the erythrocyte as a result of an alteration in the erythrocyte membrane from systemic bacterial, viral, or neoplastic disease. An alternate hypothesis is the development of immunocompetent clones that direct antibody at the red cell membrane. Red cells are lost by intravascular hemolysis or removal by macrophages of the reticuloendothelial system, and anemia occurs when the capacity of the bone marrow to compensate for increased red cell destruction is exceeded. Autoimmune hemolytic anemia is considered to be idiopathic if it cannot be associated with an underlying disease and is considered to be secondary if associated with another condition. Often this is neoplastic disease. The antibodies are of the IgG or IgM class, may be agglutinating or nonagglutinating, and can also be temperature dependent. The antiglobulin test has been used to confirm the diagnosis in cases of nonagglutinating autoimmune hemolytic anemia, but demonstration of immunoglobulin on the surface of red cells by immunofluorescent cell staining and flow cytometry is much more sensitive and specific.

### Hemolysis

Hemolysis results from rupture of red cell membranes as a consequence of injury to the membrane or osmotic lysis when serum tonicity is lower than normal. Hemolytic disease of any cause has the potential to overwhelm the normal clearance mechanisms for hemoglobin, with the result that hemoglobin concentrations in plasma are abnormally high. This can result in hemoglobinuric nephrosis (see Chapter 14).

### Methemoglobinemia and Oxidative Damage

Methemoglobinemia results from oxidative damage of hemoglobin and occurs in disease such as red maple leaf toxicosis in horses and nitrate poisoning in ruminants. Methemoglobinemia is reversible but important as an indicator of oxidative damage and because

methemoglobin cannot transport oxygen. Oxidative damage to red cells results in denaturation of hemoglobin, with subsequent formation of Heinz bodies. Red cells damaged in this way are sensitive to osmotic lysis and fragmentation. Intravascular hemolysis and removal of damaged red cells by the reticuloendothelial system contributes to anemia.

### Clinical Findings

The clinical signs and their severity depend on the degree of anemia (Table 11-4). Mild anemia in animals that are not required to be physically active, such as veal calves or housed lambs, might be apparent only as failure to achieve optimal weight gain. More severe degrees of anemia, or mild anemia in animals required to be physically active, such as foals at pasture or racehorses, can be evident as exercise intolerance, failure to perform athletically, or lethargy. Behavioral signs of anemia include prolonged recumbency; depressed mentation; reduced nursing, foraging, or grazing; and, in extreme anemia, belligerence.

Responses to anemia varies with the severity of the anemia and its duration. Adaptive responses to anemia, which include induction of expression of hypoxia-inducible factor and subsequent pleiotropic effects that modulate and attenuate the effects of anemia,<sup>26</sup> and hypoxia, mean that animals with long-standing and slowly evolving anemia accommodate a low hematocrit with fewer clinical signs than do animals with acute anemia of the same extent that can have much more severe clinical signs.

Physical findings include pallor of the mucosae and conjunctiva, but appreciable degrees of anemia can occur without clinically visible change in mucosal, conjunctival, or skin color. The mucous membranes, conjunctiva, and skin in pale-skinned, sparsely haired animals, such as pigs, can be almost white in animals with severe anemia (Fig. 11-2). Hemolytic anemia causes jaundice in most cases.

A chart for examination of conjunctival color in sheep and goats has been validated as a means of assessing severity of anemia in

**Table 11-4** Acute hemorrhage: estimated blood loss

% Blood loss	Heart rate	Respiratory rate	Capillary refill time	Blood pressure	Other physical examination findings
<15	Normal	Normal	Normal	Normal	Possible mild anxiety
15–30	Increased	Increased	Mildly prolonged	Normal	Mild anxiety
30–40	Moderate to severely increased	Increased	Prolonged	Decreased	Anxious or depressed; cool extremities
>40	Severely increased	Increased	Very pale mucous membranes	Severe hypotension	Obtunded; cool extremities





**Fig. 11-2** Extremely pale bulbar conjunctiva in an anemic Holstein–Friesian cow. The cow had a packed cell volume of 13% secondary to massive acute hemorrhage into the lactating mammary gland.

these species. The chart (FAMACHA) was developed to aid in parasite control programs. Training programs are important in ensuring the accuracy and reproducibility of use of the chart.<sup>27</sup> Conjunctival color is assessed on a scale of 1 to 5, in which 1 = red and 5 = white. The correlation between FAMACHA score and hematocrit is very good ( $R = -0.52$  in sheep and  $-0.30$  in goats). The sensitivity and specificity for detection of a hematocrit below 15% for FAMACHA scores of 4 and 5 were 83% and 89%, respectively, for sheep and 83% and 71%, respectively, for goats.<sup>28</sup> This methodology appears to be very useful for detection of anemia in small ruminants and in increasing the adoption of appropriate anthelmintic programs by farmers trained in the technique.<sup>29</sup>

The heart rate is increased, the pulse has a large amplitude, and the absolute intensity of the heart sounds is markedly increased in anemic animals. Terminally, the moderate tachycardia of the compensatory phase is replaced by a severe tachycardia, a decrease in the intensity of the heart sounds, and a weak pulse. A hemic murmur might be heard and is likely a result of the low viscosity of blood in anemic animals combined with increased ejection velocity of blood from the heart as a consequence of increased heart rate and cardiac output. Severe anemia can cause clinically important arrhythmia, including ventricular tachycardia and ventricular premature beats.<sup>30</sup>

Dyspnea is not pronounced in anemia, with the most severe degree of respiratory distress appearing as an increase in depth of respiration without much increase in rate. Labored breathing occurs only in the terminal stages, and at those times the animals can be severely distressed.

Other signs of decompensated anemia include anxious expression, absent rumination, ileus, colic, anuria, and cardiac arrhythmia. Animals can appear quiet and comfortable unless they are forced to move or an event occurs that increases oxygen consumption and causes decompensation. An example is an animal that has compensated for its severe anemia but then develops a

fever. Fever can increase whole-body oxygen requirements by 12% for each 1°C (1.8°F) increase in temperature, and this can cause a finely balanced animal to decompensate.

There can be signs of the inciting disease, and these can include edema, jaundice, petechial and ecchymotic hemorrhages in the mucosa, and hemoglobinuria.

Adjunctive examination can include gastrointestinal, urinary, or upper respiratory endoscopy; radiography of the chest or abdomen; and ultrasonographic examination of affected regions.

### Clinical Pathology

The clinicopathological characteristics of the common forms of anemia are provided in Table 11-3.

### Hematology

Anemia is definitively diagnosed by measurement of red cell indices and demonstration of low hematocrit, red cell count, and hemoglobin concentration. Examination of various red cell indices can yield important information about the cause of anemia and evidence of regeneration. In addition to providing the diagnosis, serial monitoring of the hemogram is useful in detecting evidence of a regenerative response. At a minimum, repeated measurement of hematocrit will reveal a gradual increase when there is a regenerative response. Hematocrit of horses with induced anemia increases by approximately 1% (0.01 L/L) every 3 days.

The relationship between hematocrit (packed cell volume [PCV]) and hemoglobin concentration in cattle is:  $Hb (g/dL) = (0.3 PCV) + 3$ , where PCV is reported as a percentage (e.g., 42%).<sup>31</sup>

Red cell morphologic abnormalities include variations in size, shape, and content:

- Red cell size
  - Anisocytosis is the presence of red cells of abnormal size. Abnormal cells can be either macrocytes or microcytes. (See bullet on red cell distribution width later in list.)
  - Macrocytosis (high mean corpuscular volume [MCV]) usually indicates a regenerative response. Ruminants have a prominent macrocytic response to anemia. The increase in MCV in horses can be so slight as to be undetectable, especially in mild to moderate regenerative anemia.
  - Microcytosis (low MCV) is found in classic deficiency anemias, such as iron-deficiency anemia.
  - Red cell distribution width is a measure of the variation in red cell size in the population of red cells in blood. It is calculated by dividing the standard deviation of red cell volumes by the mean red cell volume and multiplying the product by 100. An increase in red cell distribution

width indicates the presence of anisocytosis as a result of macrocytosis in regenerative anemia.

- Red cell shape
  - Spherocytosis is found in diseases that affect the red cell membrane, such as immune-mediated anemia and red maple toxicosis.
  - Schistocytes (small, irregularly shaped cells or red cell fragments) are found in diseases that cause intravascular physical injury to red blood cells, such as DIC or vasculitis with endothelial damage.
  - Echinocytes are normal-sized red cells that have uniform membrane projections. They are of uncertain importance.
  - Eccentricocytes are cells in which hemoglobin has been damaged and accumulated eccentrically in the cell, causing variation in the color density of the cell. It is usually associated with diseases causing oxidative damage.
- Red cell content
  - Polychromasia, the presence of erythrocytes of varying staining intensity, is usually a result of the presence of reticulocytes.
  - Hypochromia can be evident as reduced staining intensity and is a result of a reduction in red cell hemoglobin concentration.
  - The amount of hemoglobin in red cells can vary. **Mean corpuscular hemoglobin (MCH)** content increases in the presence of reticulocytes. False increases in MCH occur when there is free hemoglobin in plasma, either from in vivo or ex vivo hemolysis. **Mean corpuscular hemoglobin concentration (MCHC)** is reduced in the presence of reticulocytosis, and hemolysis falsely increases MCHC.
  - Nucleated red cells appear in the peripheral blood only in ruminants among farm animals and only in response to severe anemia.
  - Howell–Jolly bodies are nuclear remnants that are common in the regenerative response in ruminants, but less so in horses.
  - Heinz bodies are round protrusions from the cell membrane or intracellular inclusions. The bodies are denatured hemoglobin and are found in diseases in which there is oxidative damage to red cells. Affected cells are fragile and susceptible to intravascular lysis or increased rate of removal by cells of the reticuloendothelial system.
  - Parasites such as *Babesia* spp., *Theileria* spp., and *Mycoplasma* spp.

(formerly *Eperythrozoon* spp.) can be detected in parasitemic animals.

- Reticulocytosis—reticulocytes are immature red cells released from the bone marrow. Reticulocytes contain remnants of nucleic acid, and this can be detected by use of appropriate stains. Until recently, reticulocytosis in response to anemia was documented in ruminants and pigs, but not in horses. This was because equine reticulocytes do not stain with Romanowsky and other stains used for routine examination of smears of peripheral blood. However, use of oxazin, a stain that combines with nucleic acid, and fluorescent detection of labeled cells have revealed the presence of reticulocytes in the peripheral blood of horses. Horses develop reticulocytosis in response to anemia, as do other species.
- Reticulocyte volume and reticulocyte hemoglobin content increase in regenerative anemia in horses, but this increase has not been evaluated in other large animals.

**Agglutination** of red cells is apparent as irregularly shaped agglomerations of red cells. The clumps of red cells do not dissociate when blood is diluted 1:4 with 0.9% saline, as happens with rouleaux. Rouleaux are normal findings in the blood of horses and are apparent as rows of erythrocytes.

**Coombs testing** or use of direct **immunofluorescent flow cytometry** can provide evidence of immune-mediated hemolytic anemia.

Other hematologic changes in severe anemia include leukocytosis and thrombocytosis.

### Bone Marrow

Examination of bone marrow is useful for demonstrating a regenerative response, especially in horses in which a regenerative response can be difficult to detect in peripheral blood, and for determining the cause of nonregenerative anemia.

**Collection of Bone Marrow.** Samples of bone marrow can be obtained by aspiration, with samples submitted for cytologic examination, or biopsy, with core samples submitted for histologic examination. Bone-marrow aspirates are useful in that they provide samples in which the relative proportions of myeloid and erythroid cell lines can be determined. However, samples obtained by aspiration do not allow examination of the overall cellularity of the marrow or its architecture.

Samples of bone marrow can be obtained from the sternbrae, proximal aspects of the ribs, or tuber coxae. The preferred site in adult animals, and in calves, is the cranial sternum. The procedure is performed on standing

adult animals or laterally recumbent calves. Animals should be adequately restrained, which could include administration of sedatives and analgesics. A site on the ventral midline over the second or third sternbrae is clipped and aseptically prepared. Local analgesia is induced by injection of lidocaine or similar local anesthetic (5 to 10 mL). The local anesthetic is injected subcutaneously and to the surface of the sternbrae. A small skin incision is made, and the aspiration needle or biopsy instrument is introduced. Bone-marrow aspirates can be collected using a 13- to 15-gauge, 5- to 7-cm needle and stylet. Bone marrow core biopsies are performed using an 8-, 11- or 13-gauge 100- to 150-mm bone-marrow biopsy needle (TrapSystem).

Bone-marrow aspirates are collected from adult horses by advancing the needle approximately 2 to 3 cm into the sternbrae. The stylet is then removed, a 5- to 10-mL syringe is attached, and bone marrow is aspirated. The samples should be placed on a clean glass slide and air-dried, or put in a Petri dish containing 0.5 to 1.0 mL of 2% EDTA.

Core samples of bone marrow are obtained by inserting the biopsy needle 2 cm into the cortex of the sternbrae. The stylet is then removed and the needle is advanced with a rotating motion. This can require considerable effort in adult animals. The needle is advanced approximately 2 to 3 cm and then rapidly withdrawn. A sample of bone marrow will be evident as pink to red bone. The sample should be rolled on a clean, dry glass slide (for cytologic examination) and then placed in 10% neutral buffered formalin for histologic examination.

**Interpretation of Bone Marrow.** Bone marrow is examined for overall architecture, cellularity, the ratio of myeloid to erythroid cells (M:E ratio), and the presence of inflammation, necrosis, or abnormal cells. A subjective assessment of iron stores can be made by staining sections of marrow with Prussian blue stain.

A regenerative response is evident as a low M:E ratio as a result of erythrocyte hyperplasia and the presence of erythroid series cells in all stages of maturity. There are increased counts of reticulocytes in bone marrow, and the number of nucleated cells relative to the hematocrit increases. The MCV and reticulocyte hemoglobin content are high in regenerative bone marrow. These responses are evident as soon as 3 days after acute anemia and peak at approximately 9 days.

Abnormal white cells, such as seen in myelophthisic disease caused by myeloma or lymphosarcoma, cause displacement of erythroid series cells and a high M:E ratio. Similarly, a high M:E ratio is obtained when there is primary red cell aplasia. A normal M:E ratio is obtained when there is aplasia of both myeloid and erythroid series of cells,

highlighting the need to evaluate the overall cellularity of the marrow. Normal marrow is approximately 50% fat and 50% combined myeloid and erythroid series cells.

### Blood-Gas Analysis, Oximetry and Lactate

**Arterial Blood-Gas Analysis.** Arterial blood oxygen *tension* (mm Hg, kPa) in animals with anemia is almost always within the reference range for healthy animals unless there is coexisting lung disease. Anemia does not interfere with diffusion of oxygen from the alveolus into capillary blood. However, the arterial oxygen *content* (mL O<sub>2</sub> per 100 mL blood) is reduced because of the reduced arterial blood hemoglobin concentration (see [Chapter 10](#)). Arterial carbon dioxide tension is often reduced in severe anemia as a result of alveolar hyperventilation that is a response to arterial hypoxemia. Arterial pH and base excess decline as the severity of anemia increases and compensatory mechanisms are no longer able to ensure delivery of sufficient oxygen to tissue, indicative of metabolic acidosis resulting from tissue anaerobiosis.

**Venous Blood-Gas Analysis.** The ideal sample is mixed venous blood collected from the pulmonary artery or right atrium. However, these sites are only infrequently available for collection, so samples should be collected from a major vein (jugular vein, cranial vena cava). Samples collected from small leg veins are less than ideal. Measurement of venous blood-gas tensions, pH, base excess, hemoglobin saturation, and oxygen content are useful in evaluating the physiologic effect of anemia. As discussed under pathophysiology, reductions in oxygen content of arterial blood cause an increase in the oxygen extraction ratio in an attempt to maintain oxygen delivery to tissues. The increased extraction ratio is evident as a reduction in venous oxygen tension, hemoglobin saturation, and oxygen content. When oxygen delivery to tissues is less than that needed to maintain aerobic metabolism, venous pH, bicarbonate concentration, and base excess decline.

**Methemoglobinemia.** Measurement of **methemoglobin** concentration is useful in documenting the severity of diseases such as red maple leaf toxicosis and nitrate poisoning. Methemoglobinemia is reversible but is a sign of oxidative damage to red cells. Oxidative damage to red cells causes Heinz-body formation and eventual lysis of the cell. Methemoglobin is measured using a cooximeter and is combined with measurement of oxygen saturation. Methemoglobin concentration in the blood of healthy animals is usually less than 3%.

**Lactate.** Concentrations of lactate can be measured in blood (whole-blood lactate) or

plasma and are almost always increased above the normal range in animals that urgently require a transfusion.<sup>32</sup> Whole-blood lactate concentrations are lower than lactate concentrations in plasma because red blood cells have lower lactate concentration than does plasma. Lactate concentrations can be measured using point-of-care analyzers, some of which have been validated for use in animals. Lactate concentration in blood or plasma increases when compensatory mechanisms are no longer effective and aerobic metabolism is impaired.

### Serum Biochemistry

Serum biochemical abnormalities are those of the inciting disease or reflect damage to organs as a result of the anemia. Severe anemia can damage many organs, resulting in increases in serum concentration or activity of urea nitrogen, creatinine, sorbitol dehydrogenase, gamma-glutamyl transpeptidase, bile acids, bilirubin, aspartate aminotransferase, creatine kinase, and troponin, among others. Hemolytic anemia causes increases in plasma hemoglobin concentration (evident grossly as pink-tinged plasma or serum) and hyperbilirubinemia (unconjugated).

**Iron metabolism** in anemic animals is defined by measurement of serum iron concentration, serum transferrin concentration (total iron-binding capacity), transferrin saturation, and serum ferritin concentration. Serum ferritin concentration correlates closely with whole-body iron stores. Values of these variables in anemia of differing cause are provided in [Table 11-3](#).

### Other Evaluations

**Feces** should be examined for the presence of parasites (ova, larvae, or adult parasites), frank blood (hematochezia or melena), and occult blood. Detection of occult blood can be difficult, and samples should be collected on multiple occasions. Samples should not be collected soon after rectal examination because false-positive results can be found as a result of trauma to the rectal mucosa.

**Urine** should be evaluated for the presence of pigmenturia, red cells, and casts. Pigmenturia should be differentiated into hemoglobinuria or myoglobinuria. Microscopic examination will reveal red cells, or ghost red cells, in animals with hematuria. Casts and isosthenuria can be present in the urine of animals with hemoglobinuric nephrosis.

**Serum erythropoietin concentration** should be evaluated in animals with nonregenerative anemia. It is not a readily available assay. Concentrations of erythropoietin in adult horses are usually less than 37 mU/mL, but values are probably dependent on the assay used.

Tests for **specific diseases** should be performed as appropriate:

- Measurement of bleeding time, PT, aPTT, and platelet count in animals with

evidence of excessive unexplained hemorrhage

- Examination for blood parasites
- Serologic testing for infectious causes of anemia
- Toxicologic testing

### Necropsy Findings

Findings indicative of anemia include pallor of tissues; thin, watery blood; and contraction of the spleen. Icterus may be evident where there has been severe hemolytic anemia and petechial and ecchymotic hemorrhages with thrombocytopenia. Necropsy findings specific to individual diseases are given under those disease headings.

### Treatment

The principles of treatment of anemia are ensuring adequate oxygen transport to tissues, prevention of the deleterious effects of anemia or hemolysis, and treatment of the inciting disease.

### Correction of Anemia

**The discussion here deals with normovolemic anemia.** Acute anemia with hypovolemia (hemorrhagic shock) is discussed in [Chapter 5](#).

**Transfusion.** The oxygen-carrying capacity of blood should be restored in the short term to at least the level at which oxygen use by tissues is not flow dependent, and to normal levels in the longer term. Short-term restoration of the oxygen-carrying capacity of blood is achieved by transfusion of whole blood or packed red cells or administration of a commercial stromal-free hemoglobin solution. Whole blood is recommended when there is anemia with hypovolemia (reduced blood volume) and is not ideal but acceptable when the facilities or time to prepare packed red blood cells is not available. Whole blood is often transfused to animals with acute hemorrhagic anemia. Packed blood cells are preferred for administration to animals with normovolemic anemia, such as occurs with chronic anemia or hemolytic anemia, and when the donor plasma contains alloantibodies to the recipient's red blood cells. Commercial stromal-free hemoglobin has the same indications for administration as packed red blood cells, but its use in farm animals is limited because of the high cost and availability of the product.

The decision to transfuse an anemic animal should not be undertaken lightly for a number of reasons. Transfusion of blood or packed red cells is not without risk to the recipient, there is usually considerable cost in identifying a suitable donor and collecting blood, and it can be a time-consuming process. An important concern in performing a blood transfusion is the risk to the recipient. Acute reactions include anaphylaxis, acute host-versus-graft reaction

(hemolysis of transfused red cells), and graft-versus-host disease (hemolysis of recipient red cells). Development of alloantibodies in the recipient with consequent problems with repeat transfusion or development of neonatal alloimmune hemolytic anemia in progeny of female recipients is a concern. The incidence of adverse events in 31 horses provided 44 transfusions of whole blood or packed red blood cells was 16% (7 of 44), and the type of adverse event varied from urticarial to anaphylactic shock.<sup>32</sup>

For transfusion of whole blood, it is important to consider the relative benefits and risks of **cross-matching** donor and recipient before completing the transfusion. Unlike humans, in which blood typing is critical before transfusion of blood because of the universal existence of alloantibodies against red blood cell antigens, transfusion of red blood cells between farm animals of the same species is unlikely to incite an acute adverse reaction for the first transfusion into a naïve animal. Furthermore, there are few, if any, laboratories that offer blood typing for ruminants,<sup>33</sup> and only a limited number that offer the service for horses.<sup>34</sup> The risk is increased with a second transfusion to a recipient, and such high-risk transfusions might warrant more careful consideration and attempts to determine suitability of the donor. When performed by a laboratory experienced in the procedure, cross-matching is highly reliable as assessed by high repeatability on multiple testing of the same freshly collected samples. Donor blood for cross-matching should be freshly collected because storage of donor samples for as little as 7 days results in an increased proportion of incompatible results compared with testing of fresh samples.<sup>35</sup>

Cross-matching is complicated by the large number of blood groups in many species: 11 blood groups with more than 70 blood group factors in cattle; 8 blood groups and more than 22 factors in sheep; more than 6 blood groups in goats; at least 6 in camelids; and 7 blood groups with 32 factors in horses.<sup>33</sup> The importance of some, or all, of these blood-group factors in inciting transfusion reactions is unknown. Donkeys should not be transfused with horse blood unless the horse donor is confirmed not to have antibodies against donkey red blood cells.<sup>34</sup> Depending on the urgency of the blood transfusion and the risk of adverse reactions, it is not imprudent to attempt an initial transfusion to a naïve recipient without prior cross-matching, although clearly cross-matching is preferred if it is available in a timely fashion.

Cross-matching should be both major (donor red cells and recipient plasma) and minor (donor plasma and recipient red cells) and should test for both hemagglutination and hemolysis.<sup>35</sup> Ideally, blood typing and examination of plasma for alloantibodies of both donor and recipient would



be performed before transfusion. Adverse events include destruction of donor red cells by alloantibodies in the recipient or destruction of recipient red blood cells by alloantigens in the donor's plasma. Risk of the latter is reduced by administration of packed, washed red blood cells.

The donor should be healthy and free from infectious diseases that could be transmitted to the recipient via the transfusion. Ideally, equine donors should be confirmed to be free of equine infectious anemia, and all donors should be free of blood-borne parasites (such as, but not limited to, *Babesia* spp., *Theileria* spp., and hemotrophic mycoplasma species). Donors should not have been vaccinated with products that might cause production of alloantibodies, such as some BVD vaccines<sup>6</sup> and vaccines for anaplasmosis in cattle. Donors should have a normal hematocrit, leucogram, and plasma protein concentration.

### Transfusion Triggers

**Indications** for transfusion (“transfusion triggers”) are not straightforward. Because of the risk to the recipient and cost, blood transfusion should be performed only when indicated. Conversely, the severe adverse effects of anemia mean that animals should not be denied a transfusion if it is needed. There is no one variable for which a single value is a transfusion trigger, and the decision to provide a transfusion should not be based on hematocrit, hemoglobin concentration, or red cell count alone. Rather, the decision to provide a transfusion should be based on a holistic evaluation of the animal, including the history, physical abnormalities, and clinicopathological data. This information should be considered in total before a decision is made to provide a transfusion. Considerations regarding transfusion include the following:<sup>32</sup>

- History—animals with acutely developing anemia are more likely to require transfusion at a given hematocrit than are animals with slowly developing anemia. Similarly, young animals with higher intrinsic metabolic rates might require transfusion at hematocrit values that would be tolerated by adults.
- Physical findings—these are some of the most important indicators of the need for transfusion and include the following:
  - Changes in demeanor and activity, including lethargy, belligerence, anxiousness, depressed mentation, anorexia, intolerance of minimal exercise (nursing, walking), prolonged or excessive recumbency
  - Tachycardia—there is no one value that is critical, but a heart rate that is 30% to 50% above the upper limit of normal is probably important. Progressive increases in heart rate

are indicative of the need for transfusion.

- Sweating, cold extremities, and other signs of sympathetic activation
- Absent rumination, ileus, gastrointestinal distension, colic
- Arrhythmias, including ventricular premature beats<sup>30</sup>
- Anuria
- Clinical pathology
  - Decline in hematocrit with exacerbation of abnormalities on physical examination—transfusion should be considered in any animal with a hematocrit below 20% (0.20 L/L). Most animals do not need a transfusion at this level, but the proportion requiring a transfusion increases at lower hematocrits. Some horses with chronic anemia and a hematocrit of 10% (0.10 L/L) do not need a transfusion, whereas others with acute anemia of 15% (0.15 L/L) need a transfusion urgently.
  - Venous blood hypoxemia and declines in hemoglobin saturation—there is no one value that is critical because there are progressive and gradual declines in these variables as the oxygen content of arterial blood declines. Venous blood oxygen tension of less than 25 mm Hg is clinically significant, and values below 20 mm Hg probably represent the need for transfusion
  - Venous pH and base excess. Development of acidosis (low base excess) and acidemia (low pH) are indications of tissue anaerobiosis and the need for transfusion. Unlike venous blood oxygen tension and saturation, these values are normal until decompensation occurs.
  - Lactate concentration (arterial or venous)—blood lactate concentrations rise rapidly when decompensation occurs. Blood lactate concentrations above 2 and below 4 mmol/L should be cause for concern and prompt closer monitoring, whereas values above 4 mmol/L probably indicate a need for prompt transfusion.
  - Evidence of organ damage, including increases in serum creatinine or bile acid concentration as indicators of kidney or hepatocellular damage, and troponin as an indicator of myocardial injury<sup>30</sup>

### Collection of Blood for Transfusion

The amount of blood to be transfused depends on the clinical status of the recipient, but rules of thumb are available. For acute hemorrhagic anemia, the volume of blood lost should be estimated (this might not be accurate), and a combination of isotonic, polyionic fluids or isotonic saline and

whole blood or packed red cells should be administered. The intent is to fully restore blood volume and ensure that the hematocrit is sufficient to meet the needs of the animal—it does not need to be restored immediately to prehemorrhage levels. For normovolemic anemia, and for hypovolemic anemia after restoration of circulating blood volume, the volume of transfusion can be calculated as shown in the accompanying box.<sup>34</sup>

Transfusion volume (mL) = Body weight of recipient (kg) × 80 mL/kg × [(desired recipient PCV – actual recipient PCV)/donor PCV]

where 80 mL/kg is the normal circulating blood volume (i.e., the dilution space of the transfused red cells).

#### Example:

500-kg horse with PCV = 15%. Desired PCV = 25%; donor PCV = 38%.

Transfusion volume required = 500 × 80 × [(25 – 15)/38] = 10,526 mL = 10.5 L

The recipient requires ~10 L of donor blood as a transfusion.

For transfusion of packed red blood cells, assume that the donor PCV is 100%.

The median volume of whole blood transfused to horses with hemorrhagic or hemolytic anemia in one study was 15 mL/kg BW with a range of 5 to 26 mL/kg.<sup>32</sup> The median volume of packed red cells transfused was 8 mL/kg. Transfusion to correct anemia in normovolemic animals should be done cautiously to minimize the risk of excessive expansion of the intravascular volume. Ideally, packed red cells can be administered to reduce the extent of blood-volume expansion. However, preparation of packed red cells can be a difficult and time-consuming process. An alternative with horses is simply to allow the collected blood to sit undisturbed for 1 to 2 hours, during which time the cells will settle to the bottom. The red cells can then be siphoned off and administered to the recipient.

Healthy, adult donors can provide up to 20% of their blood volume at one time. For example, up to 8 L of blood can be collected from a healthy 500-kg cow. Donors should be administered isotonic, polyionic fluids or isotonic saline IV in a volume equivalent to that of the blood collected after collection is complete. Blood should be collected over a 30- to 60-minute period.

Blood for immediate (<2 to 3 hours) transfusion can be collected into containers with sodium citrate (3.2% solution, 100 mL per 1 L of blood). Blood that will be stored for longer must be collected into acid citrate dextrose (ACD), citrate-phosphate-dextrose with adenine (CPDA), or similar solutions at a rate of 100 mL of solution per 1 L of blood, or according to the manufacturer's recommendation. Care must be taken to ensure that collection is aseptic and prevents microbial contamination of the collected blood.

This is especially important for blood that is to be stored.

The **response to transfusion** is almost immediate, with normalization of heart and respiratory rates, reduction of plasma or blood lactate concentration, reduction in serum creatinine concentration, increase in venous oxygen saturation, and improvement in demeanor.<sup>32</sup> PCV of donors receiving whole blood increased from 12% to 17% after transfusion of ~15 mL/kg, and from 9% to 15% for horses receiving packed red cells.<sup>32</sup> Increases in PCV are most marked in horses with normovolemic anemia (hemolytic or aplastic) treated with packed red cells and not administered concurrent isotonic fluids. Increases in PCV in horses with hemorrhagic anemia are lower, likely because of the expansion of blood volume caused by administration of whole blood and concurrent isotonic fluids,<sup>32</sup> and for this reason assessment of efficacy of transfusion to horses with hemorrhagic anemia should be based on clinical variables and not on measurement of PCV.<sup>32</sup> Fifty-four percent of the horses treated for hemorrhagic, hemolytic, or aplastic anemia were discharged from the hospital.

The survival of allogenic red blood cells in horses is 95% at 24 hours (although this can be much lower in some horses), and the half-life of transfused red cells is approximately 20 days.<sup>36</sup> Survival is reportedly longer for autologous transfusions, but this type of transfusion, with collection of the recipient's own blood days or weeks before the transfusion, is limited to elective or non-emergency situations.<sup>37</sup> An exception is where autologous blood collected during surgery or as a result of hemorrhage into the pleural or peritoneal cavities is administered to the "recipient."<sup>38,39</sup>

**Adverse reactions** to transfusion can be immune mediated (graft-versus-host disease, in which components of the donor's plasma cause hemagglutination or lysis of recipient's red cells; host-versus-graft disease, in which components of the host's plasma react with donor red cells; and anaphylactic or urticarial reactions), related to volume overload, or, with horses with hemolytic anemia and repeat transfusion, could be attributable to iron overload, as is documented in foals with alloimmune hemolytic anemia.<sup>40</sup> The presumed immune-mediated reactions can occur when cross-matching is performed before transfusion and the transfusion is considered compatible, but are probably more common when cross-matching and demonstration of compatibility have not been performed.<sup>32</sup> Adverse reactions range from mild urticaria, which does not require specific treatment, to acute anaphylaxis and death.<sup>32-34</sup> See the earlier discussion for a description of cross-matching.

An **alternative to transfusion of whole blood** or packed red cells is the administration of a commercial preparation of

**stromal-free hemoglobin**. This product is effective in increasing the oxygen-carrying capacity of blood in anemic horses and has been used for support of a foal with alloimmune hemolytic anemia until a blood transfusion was available. The compound is stable at room temperature and can therefore be stored for long periods of time and be readily available for use. However, it is expensive, and its effect is short-lived (<48 hours, and probably less). The recommended dose is 15 mL/kg BW IV, but lower doses have been used. The compound increases the oncotic pressure of plasma and causes expansion of the plasma volume.

**Hematinics.** Hematinic preparations are used in less severe cases and in animals with anemia resulting from iron deficiency or severe external blood loss (see Table of Drug Doses in the Appendix). Iron is administered to prevent iron deficiency in young animals denied access to pasture or soil. The use of recombinant human erythropoietin in horses has a risk of inducing anemia. Given that there are no known causes of low erythropoietin concentrations causing anemia in horses, with the exception of those horses with anemia subsequent to rhEPO administration, the use of this compound in horses is specifically contraindicated. Cobalt salts are administered to horses to increase erythropoiesis.<sup>26</sup> This approach has limited, if any, therapeutic value and is generally considered to be doping to achieve a competitive advantage in racehorses.<sup>26</sup> The efficacy of administration of cobalt in increasing hematocrit is unknown.

#### Supportive Care

The oxygen requirements of anemic animals should be minimized. This can be achieved by housing them individually in quiet stalls, the temperature of which is maintained in the animal's thermoneutral zone, minimizing the need for exercise (such as grazing or following the mare to nurse), and maintaining a normal body temperature. Provision of supplemental oxygen is prudent, recognizing that oxygen delivery by red blood cells is already maximal and that additional oxygen delivery will be achieved by increasing the oxygen content in plasma.

Animals with hemolytic anemia and hemoglobinuria should be administered polyionic isotonic fluids intravenously to reduce the risk of hemoglobinuric nephrosis.

#### Treatment of Autoimmune Hemolytic Anemia

Some animals with autoimmune hemolytic anemia respond well to administration of corticosteroids. Compounds used include prednisolone and dexamethasone. Horses with refractory aplastic anemia or hemolytic anemia have been administered cyclophosphamide (2 mg/kg IV every 14 to 21 days) in addition to glucocorticoids.

#### FURTHER READING

- Balcomb C, Foster D. Update on the use of blood and blood products in ruminants. *Vet Clin North Am Food A*. 2014;30:455-474.  
Mudge MC. Acute hemorrhage and blood transfusions in horses. *Vet Clin Equine*. 2014;30:427-436.

#### REFERENCES

- Taylor SD, et al. *J Vet Int Med*. 2009;23:1097.
- Gray SN, et al. *Vet Surg*. 2015;44:379.
- Lawrence K, et al. *Cattle Pract*. 2014;22:230.
- Genova SG, et al. *Can Vet J*. 2011;52:1018.
- Bell CR, et al. *Vet Immunol Immunopathol*. 2013;151:303.
- Euler KN, et al. *BMC Vet Res*. 2013;9.
- Ruby RE, et al. *NZ Vet J*. 2012;60:82.
- Winter A. *Vet Rec*. 2011;168:84.
- Nassiri SM, et al. *Vet Clin Pathol*. 2011;40:459.
- Dieckmann SM, et al. *Vet Microbiol*. 2010;145:351.
- Dieckmann SM, et al. *Vet Microbiol*. 2012;160:43.
- Agrawal K, et al. *J Vet Diagn Invest*. 2013;25:112.
- Bozorgmanesh R, et al. *J Vet Int Med*. 2015;29:410.
- Wilson SJ, et al. *Aust Vet J*. 2007;85:201.
- Cottle HJ, et al. *Equine Vet Educ*. 2010;22:13.
- Johns IC, et al. *J Vet Emerg Crit Care*. 2011;21:273.
- Kendall A, et al. *Equine Vet Educ*. 2014;26:234.
- Munoz A, et al. *J Equine Vet Sci*. 2010;30:581.
- Borges AS, et al. *J Vet Int Med*. 2007;21:489.
- Fox-Clipsham L, et al. *Vet Rec*. 2009;165:289.
- Tallmadge RL, et al. *Clin Vaccine Immunol*. 2012;19:1054.
- Fox-Clipsham LY, et al. *PLoS Genet*. 2011;7.
- Norman TE, et al. *Equine Vet Educ*. 2012;24:599.
- McGovern KE, et al. *J Vet Int Med*. 2011;25:1181.
- Forbes G, et al. *Aust Vet J*. 2011;89:269.
- Ho ENM, et al. *Drug Testing Anal*. 2015;7:21.
- Maia D, et al. *Vet Parasitol*. 2014;200:165.
- Sotomaior CS, et al. *Vet Parasitol*. 2012;190:114.
- Maia D, et al. *Vet Parasitol*. 2015;209:202.
- Navas de Solis C, et al. *J Vet Emerg Crit Care*. 2015;25:248.
- Turkson P-K, et al. *Onderstepoort J Vet Res*. 2015;82.
- Hurcombe SD, et al. *JAVMA*. 2007;231:267.
- Balcomb C, et al. *Vet Clin North Am Food A*. 2014;30:455.
- Mudge MC. *Vet Clin Equine*. 2014;30:427.
- Harris M, et al. *J Vet Int Med*. 2012;26:662.
- Mudge MC, et al. *Vet Clin Pathol*. 2012;41:56.
- Thompson KR, et al. *Equine Vet Educ*. 2015;27:295.
- Finding EJT, et al. *Equine Vet Educ*. 2011;23:339.
- Fouche N, et al. *Equine Vet Educ*. 2014;26:250.
- Polkes AC, et al. *J Vet Int Med*. 2008;22:1216.

#### Alloimmune Hemolytic Anemia of the Newborn (Neonatal Isoerythrolysis, Isoimmune Hemolytic Anemia of the Newborn)

##### SYNOPSIS

**Etiology** Maternal alloantibodies to a neonate's blood group antigens are transferred to the neonate in colostrum and cause lysis of the neonate's red blood cells.

**Epidemiology** Disease in progeny of multiparous mares or sows. The dam lacks blood-group antigens possessed by the sire and inherited by the foal, calf, or piglet. The majority of cases in foals are a result of the presence of Aa or Qa antigens and antibodies. Sows vaccinated with crystal

violet vaccine or cows with babesia or anaplasmosis vaccines can be associated with disease in their newborns. Overall survival rate in foals treated at a referral hospital was 75%.

**Clinical findings** Lethargy, recumbency, tachycardia, tachypnea, icterus, and hemoglobinuria.

**Clinical pathology** Anemia, hyperbilirubinemia.

**Diagnostic confirmation** Positive antiglobulin (Coombs test) or hemolysis test using mare's serum or colostrum and foal's red blood cells.

**Treatment** Transfusion of blood or packed red blood cells from suitable donor, or of mare's washed red blood cells. Supportive care.

**Control** Identify at-risk mares by blood typing. Examine mare's serum or colostrum for presence of incompatible antibodies before allowing foal to suckle.

## Etiology

Hemolytic anemia of **newborn horse and mule foals, calves, and piglets** occurs because of immune-mediated (**antibody-dependent cellular cytotoxicity or type II hypersensitivity**) destruction of the neonate's red blood cells by antibodies acquired from the dam. The specific antibodies are present in the colostrum, are absorbed by the neonate, and cause lysis and/or agglutination of red blood cells.

The disease is associated with the natural occurrence of **inherited blood groups** and only occurs if the dam is exposed to red blood cell antigens that she does not possess. In response to such exposure, the dam produces antibodies directed against the foreign red blood cell epitopes. If the neonate possesses a blood type against which the dam has developed antibodies and depending on the red blood cell factor involved, red blood cell destruction can occur. The newborn acquires the red blood cell types that are foreign to the dam through inheritance from the sire. Disease occurs after birth because the fetus is not exposed to the antibodies in utero because of the epitheliochorial placentation in mares and sows and the syndesmochorial placentation of cattle. Antibodies in serum are secreted into the colostrum in the peripartum period and are subsequently ingested and absorbed by the newborn. Mares that have anti-red blood cell factor antibodies in their serum almost invariably have the same antibody in their colostrum. The serum concentration of anti-Aa and Qa antibodies is highest in the last 3 months of gestation and peaks about 1 week after parturition. For neonatal isoerythrolysis to occur, the following characteristics are necessary:

- The fetus must have blood group antigens (factors) that the dam does not. These are inherited from the sire.

- The dam must be exposed to the foreign-blood-group antigens that the fetus possesses.
- The dam must produce antibodies against the blood-group antigens of the fetus. Not all blood-group antigens are highly immunogenic or are associated with disease in the neonate.
- The newborn must ingest and absorb colostrum that contains antibodies directed against antigens on the newborn's red blood cells.

The disease occurs naturally in **foals and piglets** but is usually iatrogenic in calves. Exposure of the dam to foreign red cell epitopes may occur at **parturition or during gestation** as a result of placental lesions, although most incompatible pregnancies do not result in sensitization of the mare.

Mares might also be exposed by **transfusion of incompatible blood**. Although whole-blood transfusions to mares or fillies are unusual, plasma transfusions are increasingly being used to treat failure or partial failure of transfer of passive immunity to foals. Because plasma usually contains some red blood cells, transfusion of plasma from donors possessing blood-group antigens that the foal does not could immunize the filly against these factors, with the potential for disease when the foal matures and gives birth. However, most commercial plasma products are harvested from donors that do not have the blood-group antigens identified as being problematic.

Thirty-two blood-group antigens are recognized in horses:

- A, a, b, c, d, e, f, g
- C, a
- K, a
- U, a
- D, a, b, c, d, e, f, g, h, i, k, l, m, n, o, p
- P, a, b, c, d
- Q, a, b, c

Neonatal isoerythrolysis in foals is attributable in over 90% of cases to antibodies directed against either Aa or Qa antigens, although disease resulting from antibodies against Ab, Dc, Da, Db, Ka, Qb, Qc, Qrs, Pa, and Ua is reported. The presence in the mare of antibodies against Ca decreases the probability that she will develop anti-Aa antibodies.

Fifteen blood groups have been identified in **pigs**, and the disease is recorded as occurring spontaneously in association with antibodies to the E-group antigens. Historically, the main occurrence of neonatal isoerythrolysis in pigs was manmade and related to repeated vaccination against hog cholera using the pooled blood, inactivated by addition of **crystal violet**, of affected pigs.

The disease has also occurred in **calves** whose dams had been vaccinated against babesiosis or anaplasmosis using a vaccine containing bovine blood. As a result of vaccination, the dam develops lytic antibodies against sire antigens, usually of the A and F

blood groups, and antibodies in colostrum cause acute hemolytic anemia in the calves. A variant of this disease is that causing neonatal pancytopenia in calves of dams vaccinated against BVD using a vaccine prepared in a particular cell culture line.<sup>1</sup>

## Epidemiology

### Horses and Mules

From 1% to 2% of Thoroughbred and Standardbred mares have antibodies capable of causing neonatal isoerythrolysis. The **incidence** is partially related to the proportion of the mare population at risk. An at-risk mare is one that lacks either the Aa or Qa blood group factor. The proportion of mares that lack one or both of these factors is breed dependent, with 19% of Thoroughbreds lacking either Aa or Qa antigens and 17% of Standardbred mares lacking Aa antigens. All Standardbred horses lack the Qa factor; neonatal isoerythrolysis in this breed is usually a result of antibodies against the Aa factor, with 10% of Standardbred mares having anti-Aa antibodies. Only 2% of Thoroughbred mares lack the Aa antigen, but this low proportion is important because approximately 50% of these mares will develop anti-Aa antibodies. Conversely, 16% of Thoroughbred mares lack the Qa antigen, but only 3% of these mares have the anti-Qa antibody. The risk of mares developing antibodies against certain red blood cell types is also related to the prevalence of the antigen in the horse population. For instance, Standardbred mares lack the Qa antigen, but because this antigen is not found in the breed, any Standardbred stallion the mare is mated to will not be Qa positive, neither will the foal, and there is no risk of the mare being exposed to the antigen.

The incidence of neonatal isoerythrolysis in **mule foals** (donkey sire × horse dam) can be 10% and is attributable to the universal presence of a unique blood-group antigen, "donkey factor," in jacks and mule foals. Mares do not possess this factor, and therefore all donkey sire v horse dam pregnancies are incompatible. Progeny of horse sire × donkey dam matings are not affected.

A feature of naturally occurring neonatal erythrolysis in **foals and piglets** is that it rarely, if ever, occurs in offspring of **primiparous dams** because the induced anti-red blood cell (RBC) antibody titer is not sufficiently high to induce the disease. Subsequent exposure during later pregnancies elicits an anamnestic response that results in higher anti-RBC antibodies and disease in the newborn. However, first-pregnancy offspring are often affected after vaccination of the dam with blood products.

## Pathogenesis

The interaction between the antibody and the red cells of the newborn is followed by hemolysis with resultant **anemia**,



**hemoglobinuria, and jaundice.** Following ingestion and absorption into the systemic circulation, antibodies bind to RBC membranes. Parts of the cell membrane of the antibody-coated cells are removed from the circulation, probably by the spleen and associated reticulo-endothelial tissues, and affected cells are eventually lysed and release hemoglobin into the circulation. The affected animal develops **normovolemic anemia**, and if the destruction of RBCs is sufficient, the animal develops anemic hypoxia and dies. The reaction between RBCs and antibodies occurs sufficiently quickly that the bone marrow is unable to compensate immediately for the loss of RBCs. DIC occurs and can contribute to the death.

Permeability of the intestine of the newborn foal to antibody disappears by 36 hours and in most cases much less. Hourly milking of the mare rapidly reduces the antibody content of the colostrum. The duration of the alimentary permeability in piglets has not been determined.

### Clinical Findings

#### *Horses and Mules*

Pregnancy and parturition are uneventful, and the foal is normal for some hours after birth. Signs appear only if the foal ingests and absorbs colostrum containing anti-RBC factor antibody. The severity of disease ranges from clinically inapparent to fulminant, with death ensuing soon after birth.

- **Peracute cases** develop within 8 to 36 hours of birth, and the first indication of the disease may be collapse. Severe hemoglobinuria and pallor are evident, but icterus is not apparent initially. The mortality rate is high.
- In **acute cases** signs do not develop until 2 to 4 days after birth, and jaundice is marked, with only moderate pallor and hemoglobinuria.

**Subacute cases** may not show signs until 4 to 5 days after birth. **Jaundice** is marked, but there is no hemoglobinuria and only mild pallor of mucosae. Many subacute cases recover without treatment.

The severity of the disease is related to the type and quantity of antibody ingested. Antibodies against Aa usually produce severe disease apparent within 24 hours of birth, whereas ingestion of anti-Qa antibodies causes a milder disease apparent at 3 to 4 days after birth.

General signs include lassitude, weakness, and disinclination to suck. The foal lies down in sternal recumbency for long periods and yawns frequently. There is no febrile reaction, but the heart rate is increased up to 120/min. Respiration is normal until severe anemia develops, when tachypnea (respiratory rate up to 80/min) and yawning are observed. Terminally, dyspnea and convulsions may develop.

**Bilirubin encephalopathy**, or kernicterus, is a complication of neonatal

isoerythrolysis and accounts for death in approximately 10% of cases.<sup>2,3</sup> It is apparent as altered mentation and seizures in foals with high serum bilirubin concentration.<sup>3</sup> The risk of a foal developing kernicterus are 17 times greater (95% CI, 1.8 to 165) if the serum total bilirubin is higher than 27.0 mg/dL. Survival of foals displaying signs of kernicterus is very poor.<sup>2</sup>

Liver failure results in death of approximately 10% of foals.<sup>2</sup> The risk of liver failure increases as the volume of blood products administered to the foal increases, indicating that liver failure could be related to iron overload secondary to hemolysis and transfusion. Foals administered 4 L or more of blood products have an ~20 times greater risk of developing liver failure than do foals administered a lower volume.<sup>2</sup>

**Isoimmune thrombocytopenia** of foals and mules is evident as ecchymotic hemorrhages and a tendency to bleed from relatively minor wounds. A syndrome in foals characterized by ulcerative dermatitis, neutropenia, and thrombocytopenia appears to be related to ingestion of colostrum antibodies. Affected foals have oral and lingual ulcers and crusting and erythema around the eyes, muzzle, perineum, trunk, and neck. There are ecchymotic and petechial hemorrhages in mucus membranes. Treatment with corticosteroids and antibiotics is associated with a good prognosis.

#### *Pigs*

Piglets show essentially the same syndrome, being normal at birth but developing jaundice at 24 hours and weakness at 48 hours, with most affected pigs dying by day 5. Peracute cases occur, and piglets may die within 12 hours of birth, showing acute anemia but no jaundice or hemoglobinuria. A proportion of subclinical cases also occurs in which hemolysis can be detected only by hematological examination. **Isoimmune thrombocytopenic purpura** of piglets can manifest as increased bleeding following routine management procedures such as tail docking.

#### *Cattle*

In calves, clinical signs develop within 24 to 48 hours after birth, and the calves die during the first week of life. Surviving calves are returned to normal health in 2 to 3 weeks. Peracute cases die within 24 hours, and at necropsy examination are characterized by pulmonary edema and splenomegaly.

### Clinical Pathology

**Hematological examination reveals acute anemia**; erythrocyte counts, packed cell volumes, and hemoglobin concentrations are low, and there is greatly increased erythrocyte fragility and sedimentation rate. Depending on the severity of the disease and its duration, there can be **leukocytosis**, attributable to neutrophilia and monocytosis, and

the presence of nucleated RBCs (in piglets and calves but rarely in foals). Affected mule foals, but not horse foals, are often **thrombocytopenic**. Isoimmune thrombocytopenia occurs rarely in foals and is not associated with neonatal isoerythrolysis, as it is in mule foals. In piglets, the erythrocyte count may be as low as 1 million/ $\mu$ L and the hemoglobin level below 2 g/dL, and thrombocytopenia is present. **Serum biochemical analysis reveals an increased serum concentration of unconjugated bilirubin.**

**Diagnostic confirmation** is achieved by demonstration of the presence of antibodies in the mare's serum or colostrum that cause hemagglutination or lysis of foal RBCs. Tests to demonstrate hemagglutination or lysis of foal RBCs exposed to mare serum or colostrum have been developed. Of these, the standard hemolysis test appears to have the greatest utility. However, for practical purposes a positive direct antiglobulin test (**direct Coombs' test**), confirming the presence of antibodies on the surface of RBCs in a foal with anemia, provides a diagnosis of neonatal isoerythrolysis. False-negative (foal has the disease but the Coombs' test is negative) results occur occasionally because of the hemolytic nature of the antibodies. The same principle is applicable to all species. Detection of antibodies on the surface of the neonate's RBCs is possible using direct immunofluorescence flow cytometry. The test identifies the presence of antibodies on red cells in some instances when the Coombs' test is negative.

The use of blood typing and other preparative predictive tests in the prevention of the disease are discussed under control.

### Necropsy Findings

In peracutely affected foals, there is marked pallor but only slight jaundice. The liver may be mildly swollen and friable, but the spleen is greatly enlarged and is almost black as a result of the accumulation of lysed and lysing erythrocytes. In less severe cases jaundice is marked, but pallor is only moderate in degree. The kidneys are usually pale, and the urine is dark brown. The histopathological changes may include ischemic tubular nephrosis and periacinar hepatic necrosis and degeneration. Erythrophagocytosis is prominent, and depending on the clinical course and therapeutic regime, there may be widespread hemosiderin deposition.

Hemoglobinuria is an important sign in piglets, and jaundice or port wine coloration of tissues occur constantly. The presence of blood-stained peritoneal fluid and an enlarged spleen is also typical of the disease in piglets. Necropsy includes the following:

- Samples for postmortem confirmation of diagnosis
- Formalin-fixed liver, spleen, bone marrow, kidney, and lymph node for light microscopic examination

## DIFFERENTIAL DIAGNOSIS

There are no diseases of the newborn that present the same clinical picture as that of alloimmune hemolytic anemia.

### Differential diagnosis list for unexpected death and/or lethargy of neonates:

#### Foals and calves

Septicemia

Neonatal maladjustment syndrome

Uroperitoneum

Prematurity

Birth trauma

Hypoglycemia

Equine herpesvirus-1 infection

#### Piglets

Septicemia

Birth trauma

Hypoglycemia

## Treatment

The **aims of treatment** are as follows:

- Prevent the deleterious effects of anemia.
- Prevent or treat hemoglobinuric nephrosis, kernicterus, or liver failure.
- Prevent ingestion of further colostrum.
- Prevent secondary infection in severely ill animals.
- Restore normal fluid, electrolyte, and acid–base status.
- Provide adequate nutrition.
- Minimize stress and systemic oxygen requirements.

The **treatment of choice** for neonatal isoerythrolysis depends on the severity of the disease. The choice of treatment should be based first and foremost on the severity of the clinical signs and secondarily on the hematocrit and RBC count. Foals or piglets with **mild clinical signs** (minimal lethargy, mild tachycardia, slight exercise intolerance) need only protection from environmental and nutritional stresses to prompt recovery. However, such animals should be carefully monitored to ensure that their clinical condition does not worsen.

**Severely affected** animals need a transfusion of compatible blood to alleviate the anemia and intravenous administration of polyionic, isotonic fluids to ensure adequate urine flow and minimize the risk of hemoglobin nephrosis. In general, the younger the animal at the time the disease is evident, the more severe the disease and the more likely the need for intensive treatment. See [Chapter 5](#) for a discussion of transfusion triggers.

### Foals

**Transfusion.** Transfusion of an adequate quantity of whole blood or packed RBCs results in dramatic resolution of clinical signs and anemia. The **decision to transfuse blood** should be based on the foal's clinical

condition, and not solely on the presence of a low hematocrit or RBC count (see “Blood Transfusion” in Chapter 11). In general, foals that are tachycardic, tachypneic, unable or reluctant to suck; have severe exercise intolerance; or are unable to stand should receive blood. These foals will usually have a hematocrit less than 15% (0.15 L/L). Recumbent foals usually have a hematocrit less than 10% (0.10 L/L). Foals that are mildly tachycardic and tachypneic but are able to suckle vigorously and keep up with the mare generally have hematocrits above 15% (0.15 L/L) and do not require transfusion of RBCs. The hematocrit should be monitored, and foals in which the hematocrit is declining rapidly will likely require transfusion of blood or packed red cells.

The **volume of blood transfused** depends on the clinical condition of the foal and the progression of the anemia. Foals often require transfusion of 1 to 4 L (20 to 100 mL/kg BW) of whole blood or 500 mL (approximately 10 mL/kg BW) of packed RBCs, and might require more than one transfusion. Blood should be administered slowly, 1 L/hour, and the foal's condition should be monitored closely during the infusion. Packed red cells are preferred for transfusion because of the small volume administered. Transfusion of large quantities of blood should be performed slowly because of the risk of fluid overload of the circulatory system. The half-life for mare erythrocytes transfused into foals is about 5 days.

The **optimal donor** is a horse that does not have Aa and Qa blood-group factors or anti-Aa and Qa alloantibodies. The former should not be present because the maternal antibodies against Aa or Qa in the recipient foal's plasma will destroy the transfused cells. Similarly, donor antibodies against Aa or Qa will cause further lysis of foal RBCs. Such donors must be identified in advance because of the time required for the blood type testing, and they are only likely to be available on large breeding farms or in specialized veterinary hospitals.

An **ideal source of RBCs is the dam** because the maternal alloantibodies in the foal's plasma will not react with the mare's RBCs. However, whole-blood transfusions from the dam are contraindicated because of the presence of alloantibodies in the dam's plasma. This problem can be avoided by transfusing only the mare's washed RBCs. Blood is collected from the mare (up to 25 mL/kg) into acid citrate dextrose or sodium citrate (10 mL of a 3.8% solution per 90 mL of blood). The mare's red cells are then washed by removing the plasma, resuspending the cells in isotonic (0.9%) saline, thoroughly mixing, and subsequently removing the saline. Plasma and red cells can be separated by large-volume centrifugation or sedimentation. Adequate separation of red cells and plasma occurs by sedimentation within 1 to 2 hours if the blood is undisturbed.

If an ideal blood-typed donor is not available and the mare's red cells cannot be washed in time, or are unavailable, then a donor should be chosen based on routine cross-matching. The **sire** will not be a suitable donor because the antigens against which the mare's antibodies are directed were inherited from him. A cross-match should match the foal's (or dam's) serum against the donor's RBCs and the donor's plasma against the foal's RBCs. The chance of finding a suitable donor is enhanced by selecting ponies or breeds other than Thoroughbreds, Standardbreds, and Arabians because of the higher prevalence of Aa- and Qa-negative animals in these breeds.

Emergency support of severely affected foals can be achieved by administration of a solution containing **polymerized bovine hemoglobin**.<sup>4</sup> The survival rate in seven foals administered polymerized hemoglobin to treat hemolytic anemia was low (1/7 survived), although this might reflect the severity of their illness prompting administration of this product.<sup>2,4</sup> This compound increases the hemoglobin concentration of blood, thereby increasing oxygen-carrying capacity. It is not a replacement for transfusion of blood or packed red cells, but it is a useful bridging procedure while a donor is identified and blood is collected. The recommended dose rate is 10 to 30 mL/kg administered slowly (10 mL/kg per hour IV). However, the cost of the compound might necessitate the use of lower doses (3 to 5 mL/kg).

**Nutritional Support.** The foal should not be permitted to nurse the mare until it is more than 36 hours old. Therefore **nutritional support** should provide approximately 100 kcal/kg per day in the form of mare's milk (10 L per day per 50-kg foal), goat's milk, or commercial mare's milk substitutes. If the foal is more than 36 hours old, then it is highly unlikely that either the mare's milk will still contain a significant quantity of antibodies or that the foal will be able to absorb them, and the foal should be allowed to continue to suckle the mare. In younger foals, an alternative feed should be supplied until the foal is at least 36 hours old. The mare should be milked out every 3 to 4 hours during this time to remove the colostrum.

The **fluid, electrolyte, and acid–base status** of moderately to severely ill foals should be assessed and corrected with intravenous administration of balanced polyionic fluids and sodium bicarbonate. Fluid administration should be used to ensure an adequate flow of urine to prevent hemoglobinuric nephrosis.

**Liver Failure and Kernicterus.** The liver failure affecting foals after administration of large volumes (>4 L) of blood products is suspected to be attributable to iron overload.

Administration of deferoxamine (1 g, SC Q12 h) to healthy foals administered 3 L of packed red cells increased urinary excretion of iron and reduced iron concentrations in liver.<sup>5</sup> Whether this approach would reduce the risk of liver failure in foals with hemolytic anemia administered large quantities of blood products containing RBCs is unknown.

Kernicterus in foals with alloimmune hemolytic anemia is associated with a poor prognosis. Treatment of two foals with severe hyperbilirubinemia (>365  $\mu\text{mol/L}$ , reference range for healthy foals 0 to 80  $\mu\text{mol/L}$ ), but no signs of kernicterus, by plasma exchange transfusion reduced serum bilirubin concentrations by ~50%.<sup>6</sup> Both foals survived.

**Antibiotics. Broad-spectrum antibiotics** should be administered to severely ill foals to prevent secondary infection (see “Principles of Providing Care to the Critically Ill Neonate”).

**Nursing care** should be provided to minimize stress and prevent the development of complications such as pressure sores in recumbent foals.

### Piglets

In pigs the prevention of sucking for periods of up to 24 hours does not prevent the disease. The safest procedure is to remove piglets from the sow, feed them artificially for 48 hours, and then return them to the sow. Frozen bovine colostrum collected as soon as possible after calving is a satisfactory substitute for sow colostrum but is improved by the addition of pig serum. When transfusion is necessary the intraperitoneal route is practical and safe.

### Control

The principles of control are as follows:

- Identification of incompatible matings by blood-group typing
- Identification of at-risk foals by testing of mare serum or colostrum for the presence of alloantibodies directed against blood factors possessed by the foal

**Blood-group typing** permits the identification of mares that are at risk of developing antibodies against Aa or Qa antigens. If an Aa- or Qa-negative mare is mated to a stallion that has Aa or Qa factors, then there is the potential for neonatal isoerythrolysis. If the stallion is Aa- and Qa-negative, then there is no risk of the disease caused by antibodies to these blood groups.

**Measurement of alloantibodies** in the serum or colostrum of at-risk mares is useful in identifying mares at increased risk of having affected foals. Serum from at-risk mares is collected during the last month (preferably 3 to 5 weeks before expected parturition) of pregnancy and examined for the presence of antibodies against the blood of the sire or, if a sample of the sire's blood is not available, a range of blood-group factors

including Aa and Qa. Mares that have such alloantibodies causing hemolysis at a titer greater than 1:16 are not permitted to suckle at-risk newborn foals. If the titer is between 1:2 and 1:16, it is measured again 1 to 2 weeks before anticipated parturition to determine whether the titer is rising, in which case the mare is likely carrying a foal with an incompatible blood group. Equine blood typing and detection of isoantibodies is performed by specialized laboratories in a number of countries, which can be identified by web searches.

The **jaundiced foal agglutination test (JFA)** is useful in determining the compatibility of mare's colostrum and foal's red blood cells (Table 11-5). In this test foal RBCs are added to serial dilutions (1:2 through 1:32) of colostrum, and the presence of agglutination is examined. Agglutination at dilutions of 1:16 in horses and 1:64 in mules are considered significant, and the foal should not be permitted to receive the mare's colostrum. The foal should be fed colostrum from another, compatible mare or from a colostrum bank. The mare should be milked out every 2 to 4 hours until the JFA titer is less than 1:16 or for 36 hours, after which the concentration of antibodies in the milk is negligible, and the foal can be permitted to suckle its dam. It is critical to the successful use of this test that it is performed before the foal is permitted to suckle the mare. If an incompatibility is detected the foal should be fed colostrum from a mare that does not have a positive jaundiced foal agglutination test to the current foal's red cells.

Avoidance of vaccines based on whole blood or cellular parts of blood is recommended, and if they have to be used, it should be as far away as possible from parturition and should be restricted to one injection and one booster.

### REFERENCES

1. Euler KN, et al. *BMC Vet Res.* 2013;9.
2. Polkes AC, et al. *J Vet Int Med.* 2008;22:1216.
3. Loynachan AT, et al. *J Vet Diagn Invest.* 2007;19:209.
4. Hollis AR, et al. *Equine Vet Educ.* 2011;23:562.
5. Elfenbein JR, et al. *J Vet Int Med.* 2010;24:1475.
6. Broux B, et al. *J Vet Int Med.* 2015;29:736.

### Erythrocytosis

Erythrocytosis is an increase in erythrocyte count, hemoglobin concentration, and hematocrit in blood. Polycythemia vera, a disease of humans and rarely small animals, and scarcely reported in cattle, is the result of an increase in the concentration of all blood cellular elements (erythrocytes, granulocytes, and platelets). Erythrocytosis, which is solely the result of an increase in red cell count, is either relative or absolute.

**Relative erythrocytosis** occurs when the total body red cell mass (i.e., the total amount of red cells in the body) is not elevated above normal, but the red cell count in peripheral blood is higher than expected. This is the most common form of erythrocytosis. Relative erythrocytosis occurs both as an abnormality and as a physiologic response to physical or psychological stress in animals with a capacious and capricious spleen. Abnormal relative erythrocytosis results from hemoconcentration and is evident as an increase in concentration of red cells and serum total protein. The cause is a reduction in plasma volume, which is usually associated with dehydration resulting from either lack of water intake or excessive water losses (diarrhea, vomiting). The diagnosis is usually obvious, based on the presence of hemoconcentration and other signs of the underlying disease. Physiologic relative erythrocytosis occurs most noticeably in horse as a result of either excitement or exercise. The blood in the spleen of horses has a hematocrit much

**Table 11-5 Method for performing the jaundiced foal agglutination test<sup>13</sup>**

1. Assemble eight 5–10 mL clean glass tubes. Label one as control (saline), and the others 1:2, 1:14, 1:8, 1:16, 1:32, 1:64, 1:128
2. Place 1 mL of 0.9% isotonic sterile saline in each tube
3. Add 1 mL of colostrum to the tube labeled 1:2. Mix this tube well and then transfer 1 mL of the contents of this tube to the tube labeled 1:4. Repeat this procedure until all tubes have had colostrums added. This procedure produces serial dilution of the colostrums.
4. Add one drop of well mixed, anticoagulated blood (e.g. blood collected into a tube containing EDTA) to each tube.
5. Centrifuge the tubes at 300–500 g for 2–3 minutes
6. Pour off the supernatant and observe the red cell pellet.

#### Interpretation

If no agglutination is present the red cells will flow evenly down the side of the glass tube whereas with complete agglutination (4+) the cells remain tightly packed at the bottom of the glass tube. Strong agglutination (3+) causes the cells to form large clumps that are visible to the naked eye. Agglutination of grade 3 or 4 is considered a positive test. If there is agglutination in the saline control tube, then the foal might have already ingested colostrum containing antibodies to the foal's red blood cells. Some authorities recommend running a parallel test using mare's red blood cells in place of foal's red cells. This provides a negative control (there should be no agglutination of mare red cells by her colostrum) and aids interpretation of results especially for inexperienced operators.



higher than that of blood (70% to 80%), and when relaxed the spleen contains many liters of blood. Excitement or exercise cause splenic contraction through an alpha-1-mediated event and ejection of the red-cell-rich blood into the peripheral circulation, with subsequent marked increases in hematocrit. The spleen of an adult horse can eject 5 to 10 L of blood into the circulation, which, together with a decline in plasma volume during exercise, increases hematocrit to 55% to 60% (0.55 to 0.60 L/L).

**Absolute erythrocytosis** occurs because of an increase in the number of red blood cells in the body. It is classified as primary or secondary, and within secondary erythrocytosis there is a further classification of appropriate or inappropriate. **Primary erythrocytosis** is attributable to proliferation of erythroid progenitors with maturation of the red cell series in the absence of arterial hypoxemia or increases in plasma erythropoietin concentration. It is a myeloproliferative disorder. Disorders resembling primary erythrocytosis are described in horses. These horses had marked increases in red cell count without evidence of diseases causing arterial hypoxemia or tissue hypoxia and without increases in serum erythropoietin concentration. A familial erythrocytosis is documented in cattle, but the disease resolved as the animals matured, which is not consistent with primary erythrocytosis attributable to a myeloproliferative disorder.

Secondary erythrocytosis is classified as either appropriate or inappropriate. **Appropriate secondary erythrocytosis** occurs as a consequence of diseases that cause tissue hypoxia with subsequent increases in plasma erythropoietin concentration. Tissue hypoxia is often inferred from the low arterial blood oxygen tension or content in these diseases. Tissue hypoxia can occur in the face of normal arterial blood oxygen tension when there is an abnormality in hemoglobin (such as chronic methemoglobinemia or carboxyhemoglobinemia), although this has not been reported as a cause of erythrocytosis in large animals. Diseases causing appropriate secondary erythrocytosis include chronic lung or respiratory disease and congenital cardiac anomalies in which there is right-to-left shunting (e.g., Eisenmenger's complex in cattle).<sup>1-3</sup> Physiologic appropriate secondary erythrocytosis occurs in animals living at high altitude.

**Inappropriate secondary erythrocytosis** occurs in animals that do not have arterial hypoxemia or diseases causing tissue hypoxia. Plasma erythropoietin concentrations are elevated despite there being normal arterial oxygen tension and content, hence the term "inappropriate." The disease is usually associated with hepatic or renal neoplasia.<sup>4-6</sup> The disease in horses is described in foals or young animals with hepatoblastoma<sup>5</sup> and adults with hepatic carcinoma. Erythrocytosis is recorded in a mare with a

lymphoma that expressed the gene for equine erythropoietin, suggesting that anomalous production was the cause of the secondary inappropriate erythrocytosis. Erythrocytosis also occurs in horses with liver disease. The cause is not known, but could involve increased production of erythropoietin or decreased clearance because of reduced hepatic function. Inappropriate secondary erythrocytosis in ruminants or pigs is not reported, but probably occurs.

The **clinical signs** of secondary erythrocytosis are those of the underlying disease (dyspnea, congestive heart failure, cyanosis). In addition, the erythrocytosis can be evident as dark red or slightly purplish mucous membranes, lethargy, and an increased propensity for thrombosis. These signs occur because of the increase in blood viscosity that results from marked increases in red cell concentration. **Treatment** is directed toward the inciting disease. For animals with primary erythrocytosis, repeated phlebotomy and restriction of iron intake has been used to reduce the red cell count.

A syndrome is described in Standardbred trotters in Sweden that have normal red cell count at rest but counts during maximal exercise that are higher than expected. The syndrome is referred to as **red cell hypervolemia** and is associated with poor race performance. The disorder, if it exists, is not related to a reduction in performance as part of the overtraining syndrome documented in athletic horses.<sup>7</sup> Diagnosis is based on a history of poor performance and hematocrit or red cell counts during maximal exercise or after administration of epinephrine that are higher than expected. Treatment is prolonged rest, although some horses have had phlebotomy and therapeutic bleeding.

## REFERENCES

1. Belli CB, et al. *Vet Rec.* 2011;169.
2. Iribe T, et al. *J Japan Vet Med Assoc.* 2014;67:409.
3. Trachsel D, et al. *Schweiz Arch Tierheilkd.* 2010;152:483.
4. Axiak S, et al. *Equine Vet Educ.* 2012;24:367.
5. Axon JE, et al. *Aust Vet J.* 2008;86:329.
6. Beeler-Marfisi J, et al. *J Vet Diagn Invest.* 2010;22:174.
7. Rivero JLL, et al. *Equine Vet J.* 2008;40:611.

## Abnormal Red Cell Function

The primary function of red blood cells is to transport oxygen. Abnormal red cell function that results in anemia is described under that heading. Abnormalities of red cell function can include abnormalities in red cell metabolism or the structure or function of hemoglobin. Hemoglobinopathies are not well documented in large animals, with the exception of changes caused by ingestion of oxidants (nitrate, onions, kale, red maple leaves) that cause methemoglobinemia, or the recognition that inhalation of carbon monoxide causes carboxyhemoglobinemia. Both carboxyhemoglobinemia and methemoglobinemia decrease oxygen carriage by hemoglobin.

Reported abnormalities in red cell metabolism include the following:<sup>1</sup>

- Diminished glucose-6-phosphate activity of red cells caused hemolytic anemia in an American Saddlebred colt.
- Flavine adenine dinucleotide deficiency was noted in a Spanish mustang with mild and variable anemia.
- Glutathione reductase deficiency causing hemolytic anemia was reported in a horse. Other abnormalities of glutathione metabolism, with minimal clinical expression, occur in sheep and horses.

## REFERENCES

1. Harvey JW. *Vet Clin Pathol.* 2006;35:144.

## DISORDERS OF WHITE CELLS

### Leukopenia

Leukopenia does not occur as a specific disease entity but is a common manifestation of a number of diseases. Neutropenia, often accompanied by lymphopenia, occurs with a number of acute viral diseases, such as hog cholera and equine viral arteritis. It has also been observed in leptospirosis in cattle, although bacterial infections are usually accompanied by leukocytosis. Acute local inflammation can cause a transient fall in the leukocyte count because of withdrawal of the circulating cells to the septic focus. Neutropenia occurs as part of the response to toxemia, and in particular endotoxemia, because of enhanced migration of neutrophils from blood into tissues. The emigration of neutrophils occurs at a rate faster than their entry into the peripheral blood from bone marrow. Lymphopenia occurs as part of a stress response and as a result of administration of glucocorticoids.

Leukopenia also occurs as part of a pancytopenia, in which all cellular elements of the blood are depressed. Agents that depress the activity of the bone marrow, spleen, and lymph nodes and result in pancytopenia occur in poisonings caused by trichloroethylene-extracted soybean meal, toluene, fungal toxins (e.g., fusariotoxins, notably that of *Stachybotrys alternans*), and bracken fern. Pancytopenia occurs also in radiation disease, in congenital anomalies in Fell, in foals as part of recognized hereditary diseases,<sup>1-3</sup> possibly in Japanese Black calves,<sup>4</sup> in calves as a result of furazolidone poisoning, and in calves and lambs as part of an alloimmune-mediated disease.<sup>5-9</sup> Leukopenia in pigs can occur as a result of iron deficiency.

Administration of glucocorticoids causes lymphopenia and eosinopenia in most species. Lymphopenia is present in animals with immune deficiency, such as severe combined immunodeficiency in Arabian foals and Fell and Dale pony foals with immunodeficiency.<sup>2,3</sup>

The importance of leukopenia is that it can reduce the resistance of the animal to bacterial infection. Treatment of the

condition should focus on the underlying disease, but broad-spectrum antibiotics are often administered because of the presumed greater risk of bacterial infection in leukopenic animals.

## REFERENCES

1. Fox-Clipsham L, et al. *Vet Rec.* 2009;165:289.
2. Fox-Clipsham LY, et al. *PLoS Genet.* 2011;7.
3. Tallmadge RL, et al. *Clin Vaccine Immunol.* 2012;19:1054.
4. Fukunaka M, et al. *J Vet Med Sci.* 2010;72:1655.
5. Euler KN, et al. *BMC Vet Res.* 2013;9.
6. Foucras G, et al. *Bulletin des GTV.* 2013;69.
7. Henniger P, et al. *Berlin Munch Tierarz Woch.* 2014;127:61.
8. Ruby RE, et al. *NZ Vet J.* 2012;60:82.
9. Winter A. *Vet Rec.* 2011;168:84.

## Leukocytosis

Leukocytosis, a white blood cell count in peripheral blood greater than expected in healthy animals, can be an appropriate physiologic response to an infectious or inflammatory process, a result of white cell dysfunction, or a result of leukoproliferative disease. In the latter, a particular situation is that in which there is neoplasia of the immune cells with subsequent production of growth factors or interleukins that stimulate inappropriate proliferation of other cells types that are detectable in the peripheral blood. An example is horses with intestinal lymphosarcoma that have peripheral eosinophilia. The leukoproliferative diseases are discussed under that heading.

Leukocytosis can be a result of an increase in the concentration of all white blood cells or a result of increases in count of a particular subset. The changes include lymphocytosis, neutrophilia, eosinophilia, monocytosis, and basophilia. Thrombocytosis is discussed under that heading.

**Lymphocytosis** not related to infection by bovine leukemia virus is unusual. Chronic viral or bacterial infections can result in mild increases in lymphocyte count in blood, but these changes have little diagnostic significance. The ratio of T lymphocytes to B lymphocytes changes in some disease processes, but these subsets are seldom differentiated in routine clinical practice.

**Neutrophilia** is almost always a response to an inflammatory process, with the exception of the neutrophilia associated with stress (“stress” leukogram). Subacute to chronic bacterial disease or inflammation causes marked increases in neutrophil count in peripheral blood. The neutrophilia is variable and can reduce even in the presence of continuing disease, such as *R. equi* pneumonia. A **mature neutrophilia** is evident as a high neutrophil count in the absence of immature forms (band cells). A regenerative neutrophilia is characterized by normal to elevated neutrophil counts and the presence of an excessive number of immature neutrophils (so-called “left shift”). The presence of a left shift suggests either rebound

neutrophilia subsequent to neutropenia or ongoing severe inflammation. Mature neutrophilia suggests inflammation of longer standing but is not definitive for this time frame. Mature neutrophilia can occur during the recovery stage from anemia, especially hemolytic anemia. Profound neutrophilia occurs in calves with **bovine leukocyte adhesion deficiency** and in some septicemic foals.

**Eosinophilia** is usually associated with allergy or parasitism. Examples include milk allergy in cows and intestinal parasitism in horses. Eosinophilia can occur in horses with intestinal lymphosarcoma or multisystemic eosinophilic epitheliotropic disease.<sup>1</sup>

**Monocytosis** and **basophilia** are unusual in large animals with the exception of that occurring as part of a rebound bone-marrow response to profound neutropenia.

## REFERENCE

1. Pucheu-Haston CM, et al. *Equine Vet Educ.* 2013;25:614.

## Abnormal White Cell Function

Abnormalities of white cell function can be either congenital or acquired. Congenital defects include Chédiak–Higashi syndrome and bovine leukocyte adhesion deficiency.<sup>1</sup> Acquired defects include those associated with neoplasia of cells of the innate and adaptive immune systems, and dysfunction induced by disease, intoxication, or deficiency (such as iron deficiency impairing neutrophil function). A wide variety of infectious diseases can impair function of white blood cells, including phagocytosis of microorganisms by neutrophils or macrophages. Intoxicants such as some of the mycotoxins impair leukocyte function. Malnutrition, starvation, and specific deficiencies (e.g., iron) impair leukocyte function.

## REFERENCE

1. Abdeen A, et al. *J Vet Med Sci.* 2013;75:1237.

## Leukoproliferative Disease (Leukemia, Lymphoma)

The leukoproliferative diseases are neoplastic diseases of the myeloid (hematopoietic) or lymphoid tissues. The discussion here is divided into those diseases associated with abnormal lymphoid cells (lymphoproliferative) and those associated with abnormal myeloid cells (myeloproliferative). The most common leukoproliferative diseases of large animals are lymphoma and lymphosarcoma.

## Myeloproliferative Diseases

Myeloproliferative disease is rare in large animals, but granulocytic, eosinophilic, monocytic, and myelomonocytic leukemias are reported:

- Acute (myelogenous) and chronic granulocytic leukemia are reported in horses, as is acute erythroid neoplasia.<sup>1,2</sup>

- Acute granulocytic leukemia in a goat
- Systemic mastocytosis in a goat
- Acute basophilic leukemia in a calf<sup>3</sup> and in pigs<sup>4,5</sup>
- Acute mastocytic and megakaryocytic leukemia in a calf<sup>6</sup>
- Histiocytosis in a piglet<sup>7</sup>
- Acute myeloblastic leukemia in cattle and horses
- Myelomonocytic leukemia in a calf, a horse and in an inbred line of Miniature swine<sup>8</sup>
- Malignant histiocytosis in cattle and horses
- Eosinophilic myeloproliferative disease in a horse

Cases manifest with nonspecific **clinical signs**, including weight loss, poor performance, episodic ventral and lower limb edema, petechial hemorrhage, splenomegaly, and lymph node enlargement or palpable masses in the abdomen in some. Thrombocytopenia and anemia are common because of myelophthysis. Abnormal cells are often apparent on examination of a smear of peripheral blood. Immunohistochemistry and immunostaining of cells for fluorescent cell sorting can identify the abnormal cells.

The diagnosis is often obtained at necropsy examination. Antemortem diagnosis can be facilitated by examination of peripheral blood smears and bone marrow obtained by aspiration or biopsy.

There is no effective treatment, nor are there measures to prevent the disease.

## FURTHER READING

- Taintor J. Equine leukaemia. *Equine Vet Educ.* 2012;24:604–609.

## REFERENCES

1. Forbes G, et al. *Aust Vet J.* 2011;89:269.
2. Johansson AM, et al. *J Vet Int Med.* 2007;21:1126.
3. Takahashi Y, et al. *Vet Rec.* 2006;158:702.
4. Sipos W, et al. *Vet Pathol.* 2006;43:362.
5. Twomey DF, et al. *Pig J.* 2010;63:91.
6. Ikehata T, et al. *J Vet Med Sci.* 2011;73:467.
7. Helie P, et al. *Vet Pathol.* 2014;51:812.
8. Duran-Struock R, et al. *Vet Immunol Immunopathol.* 2010;135:243.

## Lymphoproliferative Disease

Lymphoproliferative disease occurs in all large animal species but is common only in cattle, where it manifests as lymphoma or lymphosarcoma (bovine viral leukosis). In addition to lymphoma or lymphosarcoma, the other lymphoproliferative disease is plasma cell myeloma, which occurs in ruminants and horses. Lymphangiosarcoma is a rare tumor of lymphoid endothelium in horses and cattle.

## Plasmacytoma (Multiple Myeloma)

Plasmacytoma is a tumor of plasma cells that sometimes results in production of monoclonal globulins.<sup>1</sup> The disease occurs in cattle, sheep, and horses and is characterized by proliferation of lymphoid cells that

produce an immunoglobulin or immunoglobulin fragment (often referred to as M-protein). The disease characteristically, but not always, involves the bone marrow, in which case it is referred to as multiple myeloma. The tumor cells might or might not secrete abnormal protein.

**Clinical signs** are often nonspecific and include weight loss, anorexia, limb edema, and recurrent infections. There can be signs of excessive bleeding as a result of minor trauma such as needle-sticks. The tumor can infiltrate any of a number of tissues, accounting for the protean nature of the clinical signs. Involvement of cranial nerves can result in dysphagia, and infiltration of cervical vertebrae can result in pathologic fracture and acute spinal cord compression. Involvement of the mediastinal lymph nodes can cause signs of an anterior thoracic mass. The clinical signs can be sufficiently vague that the disease is easily overlooked in its early stages. Radiography reveals the presence of osteolytic bone lesions in some animals.

**Anemia** is common, and thrombocytopenia occurs in about 20% of affected horses. Plasma cells can occasionally be seen in smears of peripheral blood. Hypoalbuminemia and hyperglobulinemia are common findings. Serum protein electrophoresis is useful in demonstrating the presence of a monoclonal proteinopathy in the alpha-2, beta, or gamma regions. Bence-Jones proteinuria occurs in approximately 20% of horses with myeloma. Serum concentrations of specific immunoglobulins are often increased; there are two reports of horses with myeloma and elevated concentrations of IgA. Hypercalcemia occurs in some affected horses and can be a result of increased concentrations of parathyroid-hormone-related protein. Examination of bone marrow obtained by aspiration or biopsy can reveal the presence of an excess number of plasma cells (>10%).

There is no effective **treatment**. Most animals present with advanced disease and die within days to weeks, but animals detected earlier in the disease process can live for more than 6 months.

#### *Lymphoma and Lymphosarcoma*

Bovine leukosis virus causes lymphoma in cattle and sheep, and infection with equine herpesvirus-5 is associated with lymphoma in horses,<sup>2-5</sup> but with these exceptions the etiology of lymphoma in large animal species is unknown.

**Ruminants and Pigs.** Lymphosarcoma occurs as four distinct clinical entities in cattle:

- Juvenile multicentric lymphosarcoma occurs at birth or in early life. It is multicentric and commonly involves the bone marrow and most lymph nodes.
- Thymic lymphosarcoma develops in cattle from 3 months to 2 years of age

and involves the thymus, occasionally spreads to other lymph nodes, and rarely infiltrates other organs.

- Cutaneous lymphosarcoma occurs primarily in cattle at 1 to 3 years of age.
- Adult multicentric lymphosarcoma occurs as a result of infection by bovine viral leukosis.

Lymphosarcoma in cattle is discussed in detail under the headings "Bovine Viral Leukosis" and "Sporadic Bovine Leukosis."

- Lymphoma associated with infection by bovine leukosis virus occurs in sheep and in camelids.<sup>6</sup> The sporadic form of the disease can have a variety of presentations, including involvement of the brain, skin, and joints in addition to the expected localization in lymphoid tissue.
- Goats develop sporadic lymphoma, including a multicentric form, and exophthalmos can be a presenting sign.<sup>7</sup>
- Pigs develop lymphosarcoma sporadically, with most forms being of B cells, although disease attributable to T cells is described. There is also an inherited form of the disease.<sup>8</sup>

The clinical signs of lymphosarcoma are similar to those described for the disease associated with bovine leukosis virus in cattle. Lymphadenopathy and clinical abnormalities arising as a result of lymphadenopathy (dysphagia, bloat, respiratory distress<sup>9</sup>) are common presentations. Thymic lymphoma can be differentiated from hematoma of the ventral neck on physical and hematological examination (tachycardia, anemia in cattle with hematoma).<sup>10</sup> T-cell lymphoma can manifest as skin or nasal cavity lesions in cattle.<sup>11-13</sup> Radiography, echocardiography, and ultrasonography are useful diagnostic aids.<sup>14,15</sup> Biopsy of lymph nodes can yield a diagnosis.

Clinicopathologic abnormalities are nonspecific and can include anemia and hyperfibrinogenemia. Hypoglycemia and hyperlactatemia are reported in a cow with enzootic bovine lymphoma.<sup>16</sup>

Necropsy examination reveals lymphadenopathy and infiltration by neoplastic lymphocytes.

There is no documented effective treatment. Administration of glucocorticoids might cause transient improvement because of lympholysis. Radiotherapy is feasible in small ruminants or pigs of sufficient monetary or emotional value, but has not been reported.

#### **Horses**

**Etiology and Epidemiology.** Some equine lymphomas are associated with infection by equine herpesvirus-5 (EHV-5). Of 13 horses with lymphoma, 67% were positive on polymerase chain reaction (PCR) testing of tissue for EHV-5, whereas 14% of 21 clinically normal horses were positive. Neoplastic samples positive for EHV-5 were classified as

T-cell-rich B-cell lymphoma (three samples), T-cell lymphoma (one), and nondifferentiated (one), and two were not examined.<sup>4</sup> Although Koch's postulates have not been met and therefore a strict causal association demonstrated, there is circumstantial evidence, including response to antiviral therapy, that EHV-5 infection causes lymphoma in horses.<sup>2-5</sup> Otherwise, lymphoma and lymphosarcoma in equids is idiopathic.

Lymphoma is a neoplasm arising from lymphoid tissue, which may be in the lymph nodes, spleen, or intestine. The disease is more accurately described as neoplasia of one of many lymphoid cell lines, and with increasing sophistication of immunohistochemical staining it is possible to differentiate lymphoma by the particular cell line that is affected. At least 14 subtypes of lymphoma are recognized in horses.<sup>17</sup> Furthermore, molecular genetic techniques may soon permit use of PCR or chromosomal (genomic) analysis to better characterize the origins of tumors.<sup>18</sup> Both immunohistochemistry of fixed tissue sections and fluorescent cell sorting of cells in body fluids have been used to determine the abnormal cell type. An additional advantage of advanced testing is that tumors of uncertain origin (lymphoid, myeloid) can sometimes be characterized.

The tumors in horses are most commonly of T-cell or B-cell lines. Of 203 horses with lymphoma, multicentric lymphoma was most common (83 horses, 41%), followed by disease in the skin (38 horses, 19%), gastrointestinal tract (24 horses, 12%), mediastinum (5%), lymph nodes (5%), eye or periorbital tissues (4%), spleen (3%), nasal cavity (2%), central nervous system (2%), oral cavity (2%), bone marrow (0.5%) and heart (0.5%).<sup>17</sup> Equine T-cell-rich, large B-cell lymphoma is the most common of the equine lymphomas (87 of 203 horses, 43%) followed by peripheral T-cell lymphoma (45 horses, 22%) and diffuse large B-cell lymphoma (11%).<sup>17</sup> B-cell lymphomas that contain large numbers of T cells (which are not neoplastic) or peripheral T-cell lymphomas are characteristically tumors of the spleen and thoracic and mediastinal lymph nodes.<sup>17</sup> B-cell tumors that contain large numbers of T cells (T-cell-rich B-cell lymphoma) account for approximately one-third of equine lymphoma. These latter are typically tumors of the skin and subcutis. T-cell lymphomas account for approximately 20% of equine lymphomas and typically cause disease involving the mediastinal lymph nodes. Approximately 50% of equine lymphomas have cells that express progesterone receptors, but none express the estrogen receptor, which might explain the regression of tumors in mares during pregnancy.

The disease occurs in all **ages** of horse, being reported from animals as young as 2 months to as old as 31 years. Median age of diagnosis is 10 years.<sup>17</sup> There is no



information on age-specific incidence. One study has reported cases in horses ranging from 4 months to 22 years of age, and the mean age of cases in this, and other case reviews, suggests that there is some increase in risk with increasing age. Limited slaughter surveys show a prevalence that varies from 0.7 to 3.2 cases per 100,000 animals. Thoroughbred horses are more likely to have cutaneous lymphosarcoma than are other breeds.<sup>19</sup>

**Clinical Signs.** The **clinical manifestation** of lymphosarcoma in horses is probably best described by the statement that the disease can manifest in a **protean** manner. Lymphosarcoma can exert an influence on the function of any organ system, and this is determined by where it occurs in the body. Most cases are multicentric, although they often present with organ-specific signs, and the multicentricity might not be recognized until further, more complete, clinical or post-mortem examination.<sup>20-23</sup> External lymphadenopathy is usually a reflection of multicentric disease. Ocular lymphoma can be a solitary disease or part of a multicentric disease.<sup>22,24</sup>

**Common presenting histories** include chronic wasting and chronic diarrhea, upper respiratory distress with stertorous breathing or inspiratory dyspnea, lower respiratory abnormality, subcutaneous edema, anemia, and fever of unknown origin. **Clinical signs** include weight loss, anorexia, and depression in 30% of cases; ventral edema in 18%; pyrexia and anemia in 17%; diarrhea in 7%; and colic in 6%.<sup>17</sup>

Lymphosarcoma is the single most common cause of neoplasia in the **thorax** of the horse. A common syndrome is that of weight loss and ventral edema of the neck and thorax, sometimes accompanied by pleural or peritoneal effusion, anemia, dyspnea, cough, and abdominal masses palpable per rectum. In cases where the lesions are predominantly in the thorax, the syndrome is that produced by a space-occupying lesion, manifested by pectoral edema and jugular vein engorgement, but an absence of the jugular pulse and dyspnea. The heart may be displaced, and there may be cardiac murmurs. If there is compression of the esophagus, dysphagia is present. Thorascopic biopsy might be necessary to confirm an antemortem diagnosis.<sup>25</sup>

Another relatively common syndrome is chronic weight loss, with or without diarrhea, associated with infiltration of the **intestine**. The disease can affect multiple segments, as is the often the case in younger horses, or occur as a solitary lesion in older horses.<sup>26,27</sup> The disease can present as acute colic or as a result of intussusception around a solitary lesion, multiple diverticula, or diarrhea.<sup>26-29</sup> A case review of chronic diarrhea in horses found alimentary lymphosarcoma to be the cause in 5 of 51 cases. Oral glucose tolerance tests are adversely affected by the intestinal

infiltration of lymphosarcoma, but an abnormal test is not pathognomonic for this disease, nor is it likely to detect the presence of solitary lesions. Lymphosarcoma is also a cause of recurrent colic in horses.

**Cutaneous lymphosarcoma** is a common disease in horses and might be the most common form of lymphoma in horses. Lymphoma comprises approximately 1.7% of skin lesions in equids, and affected animals have a mean age of 15 years.<sup>19</sup> Thoroughbreds are 2.5 times more likely to be diagnosed with the disease compared with all other breeds,<sup>19</sup> and Thoroughbreds have a predilection for T-cell lymphoma compared with other breeds, with approximately 33% of cutaneous lymphomas in this breed being of this type.<sup>30</sup> Cutaneous lymphomas in Quarter horses are almost always T-cell-rich, large B-cell lymphoma.<sup>30</sup> There is no sex predilection.

The cutaneous tumors can be solitary or multiple and are usually discrete, firm, non-painful swellings. The swellings are often haired, but in the more severe disease there is loss of hair. The lesions tend to be on the head, neck, and dorsal trunk, but they can be anywhere on the body. The tumors sometimes metastasize, but horses affected with a mild or waxing and waning disease can live for years.

Cutaneous lymphoma of equids is commonly the T-cell-rich, large B-cell lymphoma (84%) variant, with cutaneous T-cell lymphoma being the next most common (11%).<sup>30</sup> Tumors that present as multiple nodules are more commonly T-cell-rich, large B-cell lymphoma.<sup>30</sup> Solitary lesions are more likely to be cutaneous T-cell lymphoma.<sup>30</sup> Diagnosis is by excisional biopsy.

Another variation is **mycosis fungoides**, a T-cell lymphoma of the skin that appears to have a more aggressive course.<sup>30,31</sup>

Lymphosarcoma is the final diagnosis in a significant proportion of horses with **fever of unknown origin**.

Lymphoma should be considered in the differential diagnosis of horses with signs of ataxia or other signs of **neurologic** disease.<sup>32-35</sup> Signs of neurologic disease are usually the result of space-occupying lesions in the spinal canal or infiltration of peripheral nerves impairing normal neurologic function.<sup>32-35</sup>

The organ systems affected by lymphosarcoma in the horse are not restricted to those mentioned previously, and individual horses can have involvement of virtually any body system or organ, such as the spleen,<sup>36</sup> mandible,<sup>37</sup> heart,<sup>38</sup> mammary gland,<sup>39</sup> pharynx,<sup>21</sup> and uterus and ovary (causing abortion).<sup>20</sup>

Ultrasound can aid in the location of tumor masses or accumulation of pleural or peritoneal fluid, and in aspiration of material from these sites. Radiography is useful for detecting mediastinal disease. Rhinolaryngoscopy permits detection and assessment of disease of the pharynx. Magnetic resonance

imaging allows more precise localization of lesions of the head and rostral neck.<sup>21</sup>

Lymphoma is sometimes accompanied by signs of **paraneoplastic syndrome**, especially if the disease is multicentric. Signs of paraneoplastic syndrome can include pseudohyperparathyroidism, alopecia, and pruritis.<sup>39,40</sup>

**Clinical Pathology.** A specific diagnosis can be obtained by cytology, and **needle aspirates** or biopsy with cytologic examination of affected lymph nodes are diagnostic. Samples can be obtained from enlarged lymph nodes or from bone marrow. Cytologic examination of fluid obtained by thoracocentesis or abdominocentesis where there is thoracic or abdominal involvement is also frequently diagnostic.

**Anemia** is a consistent finding in horses with advanced lymphosarcoma. The anemia can be a result of tumor cells occupying bone marrow or causing bone-marrow necrosis, but this is not a usual manifestation of the disease.<sup>41</sup> More commonly, anemia is probably a result of increased destruction of red cells or anemia of chronic disease.<sup>42</sup> Only a small proportion of horses with lymphadenopathy attributable to lymphosarcoma have concurrent **leukemic** blood changes. Sézary-like cells have been detected in the blood of a horse with B-cell lymphoma. **Thrombocytopenia** occurs in approximately 30% of cases.

**Immunophenotyping** cells obtained at necropsy examination, by biopsy of affected organs or lymph nodes, or from peripheral blood can aid in determining the cell type involved.

Hypergammaglobulinemia and hypoalbuminemia occur in some horses. **Hypergammaglobulinemia** in horses with lymphosarcoma is almost always caused by a polyclonal globulinopathy—in contrast to horses with plasma cell myeloma—and is probably attributable to the inflammatory response to the tumor. Plasma fibrinogen concentrations can be elevated in horses with lymphosarcoma for the same reason.

Low serum immunoglobulin concentrations have been reported in horses with lymphosarcoma, but this finding is not specific for lymphosarcoma. Detection of low **serum IgM** concentration has poor sensitivity and specificity for diagnosis of lymphosarcoma. The sensitivity and specificity of serum IgM below 60 mg/dL for diagnosis of lymphosarcoma in horses are 50% and 35%, respectively. This is not a good screening or diagnostic test for lymphosarcoma in horses.

Abnormalities in serum calcium concentration are uncommon and variable, with both hypocalcemia and hypercalcemia being reported. Hypercalcemia can be associated with elevated serum concentrations of parathyroid-hormone-related peptide.

**Treatment.** Reports of treatment of lymphoma in horses are few. Because most horses have advanced disease at the time of

**Table 11-6** Protocols for treatment of lymphoma and lymphosarcoma in adult equids

Protocol	Drug	Dosage	Route	Treatment regime
CAP	Cyclophosphamide	200 mg/m <sup>2</sup>	IV (catheter)	Every 2 weeks
	Cytosine arabinoside	1.0–1.5 g/treatment	IM or SC	alternating basis
	Prednisolone	1 mg/kg BW	Per os	Daily
COP	Cytosine arabinoside	200–300 mg/m <sup>2</sup>	SC/IM.	q 7–14 days
	Chlorambucil or cyclophosphamide	20 mg/m <sup>2</sup>	Per os IV	q 14 days
		200 mg/m <sup>2</sup>	(catheter)	q 14–21 days
	Prednisolone	1.1–2.2 g/kg BW	Per os	q 48 h
	Vincristine (can be added if no response initially)	0.5 mg/m <sup>2</sup>	IV (catheter)	q 7 days
Single-agent therapy	L-asparaginase	10,000–40,000 iu/m <sup>2</sup>	IM	q 2–3 weeks
	Cyclophosphamide or vincristine	200 mg/m <sup>2</sup>	IV (catheter)	q 2–3 weeks
		0.5 mg/m <sup>2</sup>	IV (catheter)	
Combo chemotherapeutic with autologous vaccine	Cyclophosphamide	300 mg/m <sup>2</sup>	IV (catheter)	Given days 1 and 36
	Autologous tumor vaccine	2 mL injected at 4 sites	IM	Given days 4, 21, and 39
Single drugs	Doxorubicin	30–65 mg/m <sup>2</sup>		
	Cisplatin (1 mL of 10 mg/mL cisplatin and 2 mL sesame oil)	1 mg cisplatin/cm <sup>3</sup> of tumor	Intralesional	q 2 weeks
		Spaced ~1 cm plane		

Reproduced with permission from Taintor and Schleis, 2011.<sup>40</sup>

BW, body weight; IM, intramuscularly; IV, intravenously; SC, subcutaneously.

diagnosis and because therapeutic options are limited by cost or adverse effects, treatment is rarely undertaken. Surgical removal of isolated masses in the skin is appropriate in some cases of cutaneous lymphosarcoma and can result in cure, especially of solitary T-cell-rich, large B-cell lymphoma.<sup>30</sup>

Successful treatment of a mare with EHV-5 associated T-cell-rich, large B-cell lymphoma was achieved by surgical debulking of the lesion and administration of cyclophosphamide, vincristine, and dexamethasone for 1 month, followed by 4 months of administration of acyclovir (an antiviral drug) at 20 mg/kg orally every 8 hours.

Administration of **oncolytic** agents has resulted in remission of disease in some horses.<sup>32,36,40,43</sup> Drugs used include prednisolone, vincristine, cyclophosphamide, cisplatin, and cytarabine (see [Table 11-6](#) for examples). The glucocorticoids cause lysis of abnormal lymphocytes and can result in some improvement in clinical signs. A protocol that has met with some success involves administration of cyclophosphamide (2 mg/kg IV) once weekly for 4 to 6 weeks, and then once every 2 to 3 weeks, combined with oral administration of prednisolone (0.5 to 1.5 mg/kg every 24 to 48 hours). Another protocol involves administration of vincristine (0.008 mg/kg IV) and cyclophosphamide (2 mg/kg IV) once every 2 weeks for four to six treatments, combined with daily administration of prednisolone. The aim of all of these treatments is to induce remission or to reduce clinical signs of the disease when these signs are attributable to lymphadenopathy (e.g., dysphagia, dyspnea). An example could be the treatment of a pregnant mare with retropharyngeal tumor that causes

dysphagia, with a view to prolonging the mare's life until parturition.

**Radiotherapy** of localized disease of the head and pharynx might be effective in treatment of lymphoma in horses; lymphoma in other species is radiosensitive.

#### FURTHER READING

- Durham AC, et al. Two hundred three cases of equine lymphoma classified according to the World Health Organisation (WHO) classification criteria. *Vet Pathol.* 2013;50:86-93.
- Taintor J. and Schelis S. Equine lymphoma. *Equine Vet Educ.* 2011;23:205-213.

#### REFERENCES

- Morton AJ, et al. *Equine Vet Educ.* 2007;19:564.
- Vander Werf K, et al. *J Vet Int Med.* 2013;27:387.
- Bawa B, et al. *J Equine Vet Sci.* 2014;34:694.
- Vander Werf KA, et al. *J Equine Vet Sci.* 2014;34:738.
- Werf KAV, et al. *J Vet Int Med.* 2011;25:673.
- Lee LC, et al. *Can Vet J.* 2012;53:283.
- Valentine BA, et al. *Can Vet J.* 2011;52:1350.
- Ogihara K, et al. *J Vet Med Sci.* 2012;74:149.
- Larde H, et al. *Can Vet J.* 2014;55:136.
- Braun U, et al. *Vet J.* 2007;174:344.
- Klinkon M, et al. *Vet Clin Pathol.* 2006;35:231.
- Braun U, et al. *Acta Vet Scand.* 2015;57:100.
- Otrocka-Domagala I, et al. *J Comp Pathol.* 2009;141:302.
- Buczinski S. *JAVMA.* 2012;241:1083.
- Buczinski S, et al. *JAVMA.* 2011;238:1044.
- Elfenbein J, et al. *J Vet Int Med.* 2008;22:1441.
- Durham AC, et al. *Vet Pathol.* 2013;50:86.
- Scase TJ. *Equine Vet Educ.* 2008;20:467.
- Schaffer PA, et al. *JAVMA.* 2013;242:99.
- Canisso IF, et al. *Can Vet J.* 2013;54:288.
- Jakesova V, et al. *Equine Vet Educ.* 2008;20:289.
- Rendle DI, et al. *Aust Vet J.* 2012;90:485.
- Germann SE, et al. *Vet Ophthalmol.* 2008;11:51.
- Trope GD, et al. *Vet Ophthalmol.* 2014;17:139.
- Lee WL, et al. *Equine Vet Educ.* 2013;25:79.
- Mair TS, et al. *Equine Vet J.* 2011;43:128.
- Smith KM, et al. *Equine Vet Educ.* 2013;25:74.

- Sheats MK, et al. *Equine Vet Educ.* 2008;20:459.
- Matsuda K, et al. *J Vet Med Sci.* 2013;75:1253.
- Miller CA, et al. *J Vet Diagn Invest.* 2015;27:86.
- de Bruijn CM, et al. *Res Vet Sci.* 2007;83:63.
- Finding EJT, et al. *Equine Vet Educ.* 2014;26:303.
- Lehmbecker A, et al. *J Comp Pathol.* 2014;151:181.
- Westerman TL, et al. *Can Vet J.* 2014;55:379.
- Ueno T, et al. *J Equine Vet Sci.* 2012;32:315.
- Madron MS, et al. *Equine Vet Educ.* 2011;23:606.
- Gret TRC, et al. *Vet Rec.* 2011;168:80.
- Penrose LC, et al. *Vet Rec.* 2012;171.
- Mendes LCN, et al. *Equine Vet Educ.* 2011;23:177.
- Taintor J, et al. *Equine Vet Educ.* 2011;23:205.
- Kelton DR, et al. *Vet Clin Pathol.* 2008;37:403.
- McGovern KF, et al. *J Vet Int Med.* 2011;25:1181.
- Doyle AJ, et al. *Can Vet J.* 2013;54:1137.

## BOVINE NEONATAL PANCYTOPENIA (BNP)

### SYNOPSIS

**Etiology** Currently assumed to be caused by a commercial inactivated bovine virus diarrhea (BVD) vaccine, Pregsure BVD, that triggers an alloimmune reaction against specific bovine major histocompatibility complex (MHC) class I antigens contained as impurities in the vaccine. Vaccinated dams having produced antibodies against this specific MHC-1 epitope transmit these via colostrum to their calf. Calves that share the MHC-1 epitope contained in the vaccine will suffer damage of erythropoietic and bone-marrow cells through an alloimmune reaction triggered by maternal antibodies.

**Epidemiology** Observed with increasing incidence in several European and other countries where Pregsure BVD was marketed from 2007 to 2012. Incidence,

Continued

with approximately 16 cases per 100,000 sold vaccine doses, is rather low, but mortality rate is up to 90%. Affected calves are between 2 and 4 weeks old.

**Signs** Calves 2 to 4 weeks old develop cutaneous and mucosal bleeding, petechiae on mucosal membranes, melena, and internal bleeding. Increased rectal temperature. Rapid deterioration within days, with high mortality rate.

**Clinical pathology** Pronounced thrombocytopenia, leukopenia, and nonregenerative anemia. Bone-marrow biopsies reveal reduced cell density.

**Necropsy findings** Generalized petechiae or ecchymoses on mucosal and serosal surfaces, subcutaneous hematomas. Bone-marrow hypoplasia/aplasia involving all three main hematopoietic cell series.

**Diagnostic confirmation** Pancytopenia in peripheral blood, cell depletion of bone marrow, history of vaccination of the dam with Pregsure BVD.

**Treatment** No specific treatment available.

**Control** Prevent use of colostrum from dams with a history of having caused bovine neonatal pancytopenia (BNP) in their calves or from dams vaccinated with the incriminated vaccine.

## ETIOLOGY

The etiology of bovine neonatal pancytopenia (BNP), a condition characterized by spontaneous internal and external bleeding and almost complete destruction of the red bone marrow in neonatal calves, is not yet entirely understood. The currently best established hypothesis is that BNP is caused by immunoglobulins contained in colostrum from dams of affected calves that damage calf's bone marrow via an alloimmune reaction.<sup>1</sup> The increasing incidence of BNP observed since 2007 in several European countries has been linked to the use of an inactivated bovine viral diarrhea vaccine (Pregsure BVD, Pfizer Animal Health). This vaccine contains cytopathogenic BVDV-serotype I grown on a bovine kidney cell line in combination with a novel adjuvant named Procision A and has been shown to produce a considerably stronger antibody response than other commercially available inactivated BVD vaccines and even natural BVD infection.<sup>2</sup> The vaccine was found to contain not only viral antigen but also impurities originating from bovine kidney cells used in the vaccine production process, among which the major histocompatibility antigen (MHC) class I was identified. Because similar impurities have also been identified in other commercial vaccines that have not been associated with clinical cases of BNP, it is assumed that the potent adjuvant of the vaccine not only triggers a disproportionate production of antibodies against BVDV but also against MHC class I epitopes contained

in the vaccine in cows that do not share some or all of these epitopes.

## EPIDEMIOLOGY

Bovine neonatal pancytopenia is a novel hemorrhagic disease solely affecting newborn calves and has been occurring with increasing incidence since 2006 in several European countries, including Germany, France, Belgium, the Netherlands, Luxemburg, Italy, Spain, Ireland, and the United Kingdom. More recently BNP was also reported to occur in New Zealand.<sup>3</sup> The occurrence of BNP was associated with the introduction of Pregsure BVD in 2004 in several European countries; countries where Pregsure BVD was not marketed, such as Denmark, Austria, and Switzerland, remained free of BNP. In Germany alone, the country with the highest disease incidence, over 3500 confirmed cases have been recorded since 2006.<sup>4</sup> Within affected European countries the average disease incidence is estimated to be approximately 16 clinical case per 100,000 sold doses of Pregsure BVD, underscoring the fact that BNP occurs in only a small fraction of calves from vaccinated dams.<sup>5</sup> In affected farms, generally not more than 5% to 10% of vaccinated dams actually induce BNP in calves fed with their colostrum.<sup>2</sup>

With growing epidemiologic evidence corroborating the link between Pregsure BVD and BNP, the manufacturer announced a voluntary marketing cessation for Pregsure BVD in 2010, and later that year the European Medicines Agency (EMA) recommended to suspend the marketing authorization for this vaccine.<sup>2</sup> In August 2011 Pregsure BVD was withdrawn from the market in New Zealand immediately after the first case was reported.

The lag time of nearly 3 years between the introduction of Pregsure BVD and the occurrence of the first clinical cases that were observed in European countries but also in New Zealand is not entirely understood but has been explained with the requirement of repeated vaccination with Pregsure BVD to induce a significant alloreactive immune response able to induce BNP.<sup>4</sup>

Another puzzling observation is the wide regional variation of the disease incidence that cannot solely be explained by differences in frequency of Pregsure BVD use. Within Germany the highest disease incidence was observed in Bavaria, with an estimated 99 clinical cases per 100,000 sold vaccine doses, compared with an average disease incidence of 6 cases per 100,000 sold vaccines in Lower Saxony.<sup>4</sup> A possible explanation for these regional differences was found in differences in vaccination protocols. Whereas in Bavaria repeated vaccination with Pregsure BVD following label instructions was common practice, in Lower Saxony a modified vaccination protocol consisting of an initial vaccination with Pregsure BVD followed by a booster with a modified life BVD vaccine was

implemented.<sup>4</sup> Accordingly, in Lower Saxony vaccinated animals were exposed to fewer doses of the incriminated vaccine compared with Bavaria, which may have contributed to the observed regional disease incidences.

## PATHOGENESIS

Although the basic pathophysiological mechanism behind BNP appears to have been unraveled, the detailed pathophysiology of the disease is not yet understood. According to the currently established hypothesis, vaccination with Pregsure BVD induces the production not only of BVD antibodies but potentially also of alloantibodies against the MHC class I epitopes with which the vaccine was contaminated. The MHC class I antigen contained in the vaccine originates from the bovine kidney cell line that was used in the vaccine production process and thus presents the specific MHC allotype of that cell line. Whether the vaccinated dam will mount an immune response against this allotype depends on the MHC-I allotype constellation of the individual animal. If the dam differs in its allotype repertoire it will recognize the MHC-I antigen as an antigen, against which it will mount an immune response and therefore be able to induce BNP in certain calves.<sup>3</sup> If antibodies are produced, these will be transferred via colostrum to the neonatal calf. Calves carrying MHC-I allotypes similar to the MHC-I allotype contained in the vaccine but different from the maternal allotype are thus predisposed to develop BNP.<sup>3</sup> In affected calves alloantibodies ingested with colostrum will lead to complement-dependent lysis and/or cytophagocytosis of cells expressing the MHC-I antigen.<sup>3</sup>

Alternatively, it has been proposed that the potent adjuvant contained in Pregsure BVD may not only amplify the production of alloantibodies against antigenic material contained in the vaccine but also against paternally derived fetal MHC-I antigens normally present during pregnancy.<sup>1</sup>

The severity of the clinical signs in susceptible calves is modulated by the amount of colostrum ingested, the quality of the colostrum, and the time of colostrum ingestion.<sup>6,7</sup>

It is currently not well understood why in calves with BNP only hematopoietic and bone-marrow cells appear to be affected even though the MHC-I gene is expressed and present on the cell surface of practically every nucleated cell. Although differences in the degree of MHC-I expression that would make cells expressing high levels of MHC-I, such as bone-marrow cells, more susceptible than other cells have been proposed as a possible explanation, it is probable that other yet unidentified pathophysiological mechanisms are at work.<sup>4</sup>

## CLINICAL FINDINGS

Calves with BNP in general become clinically apparent between 10 and 20 days of age.



Calves older than 1 month of age are not affected, and there is no gender predisposition. The most prominent symptoms are cutaneous and mucosal bleeding (e.g., following trauma, injection, or ear-tagging), petechiae on mucous membranes, and melena. Persistently increased rectal temperature, often above 41.0°C (105.8°F), is frequently reported. Affected calves initially appear bright but rapidly become anemic, with pale mucous membranes, and they succumb to blood loss and secondary infection. In many cases animals die within 24 to 48 hours. The mortality rate reaches up to 90%. Subclinical cases may occur but have rarely been reported.

### CLINICAL PATHOLOGY

The most prominent hematological findings are pronounced thrombocytopenia, leukopenia (neutropenia and lymphopenia), and nonregenerative anemia.<sup>1</sup> In experimental studies a decline in the number of circulating lymphocytes, neutrophils, and monocytes by over 75% has been observed as early as 4 hours following ingestion of colostrum. Thrombocyte counts in BNP calves 8 hours after ingestion of colostrum were found to be at 40% of thrombocyte counts in control calves.<sup>1</sup> Red blood cell counts were not altered in the first hours after colostrum ingestion. Reduced hematopoietic cell density in bone marrow, including erythroid cells, myeloid cells, and megakaryocytes, was observed in BNP calves 6 days but not 24 hours after ingestion of colostrum. This rapid initial depletion of leukocytes and thrombocytes combined with the protracted damage observed in the marrow suggests that pancytopenia is the result of a combination of extensive destruction of peripheral blood cells, probably resulting from complement-mediated lysis and/or enhanced phagocytosis of cells and decreased regenerative activity caused by bone-marrow depletion.<sup>1</sup>

### NECROPSY FINDINGS

At necropsy, affected calves have generalized petechiae or ecchymoses on mucosal and serosal surfaces and often hematomas in the subcutaneous tissue, especially over bony prominences.<sup>8,9</sup> The peritoneal, pleural, and synovial fluids may be serosanguinous, and the content of the colon and rectum may be bloody. Overall, the carcass is often pale from excessive bleeding.

Microscopic lesions are multiple hemorrhages without obvious vascular or tissue reaction and bone-marrow hypoplasia/aplasia involving all three main hematopoietic cell series (total or trilineage hypoplasia), with an almost complete lack of megakaryocytes.<sup>8-10</sup> In addition to hemorrhages, there will be diffuse depletion of lymphoid tissue in the spleen, lymph nodes, and thymus, in which T- and B-cell components are equally affected.<sup>8</sup>

### Samples for Postmortem Confirmation of Diagnosis

Samples for light microscopy include bone marrow smears, preferably from the sternum, femur, or humerus, and sections of bone marrow, spleen, and lymph nodes for histopathology.

#### DIFFERENTIAL DIAGNOSIS

Bovine viral diarrhea/mucosal disease (BVD/MD)
Bluetongue
Idiopathic thrombocytopenia in calves (e.g., following bacterial septicemia or immune mediated processes)
Simmental inherited thrombopathy (SHT)

### TREATMENT

There is currently no specific treatment for BNP available.

### CONTROL

Pregsure BVD has been withdrawn from the market until further notice. Assuming this vaccine is indeed associated with the occurrence of BNP, this measure should prevent future cases of BNP in calves born to dams that have not been exposed to this vaccine. Colostrum from dams with a history of having had a calf that developed BNP should not be fed to calves.

### REFERENCES

- Bell CR, et al. *Vet Immunol Immunopathol.* 2013;151:303-314.
- Bastian M, et al. *Vaccine.* 2011;29:5267-5275.
- Deutskens F, et al. *Vet Res.* 2011;42:97.
- Kasonta R, et al. *Vaccine.* 2012;30:6649-6655.
- European Medicines Agency. 2012 At: <[http://www.ema.europa.eu/docs/en\\_GB/document\\_library/Referrals\\_document/Pregsure\\_BVD\\_78/WC500095958.pdf](http://www.ema.europa.eu/docs/en_GB/document_library/Referrals_document/Pregsure_BVD_78/WC500095958.pdf)>; Accessed 20.11.2013.
- Foucras G, et al. *J Immunol.* 2011;187:6564-6570.
- Friedrich A, et al. *BMC Vet Res.* 2011;7:10.
- Pardon B, et al. *Transbound Emerg Dis.* 2010;57:135-146.
- Krappmann K, et al. *Vet J.* 2011;190:225-229.
- Lambton SL, et al. *PLoS ONE.* 2012;7:e34183.

## Lymphadenopathy (Lymphadenitis)

Lymph nodes can be enlarged because of inflammation (lymphadenitis) or infiltration with neoplastic cells. Enlargement of peripheral nodes causes visible and palpable swellings and in some cases obstruction to lymphatic drainage and subsequent local edema, as in sporadic lymphangitis of horses. Enlargement of internal nodes can cause obstruction of the esophagus or pharynx, trachea, or bronchi. Enlargement of the lymph nodes can occur as a result of infection or of neoplastic invasion. Lymphadenopathy as part of lymphoma and

lymphosarcoma is discussed under “Leukoproliferative Diseases.”

**Lymphadenitis** occurs most commonly in response to infection or inflammation in the region of the body distal to, and drained by, the lymph node. Lymphadenitis also accompanies other signs in many other diseases, including strangles, bovine malignant catarrh, sporadic bovine encephalomyelitis, porcine reproductive and respiratory syndrome, East Coast fever, Ondiri disease, and ephemeral fever.

Infection and enlargement of lymph nodes is the major presenting sign in a small number of diseases, which include the following:

- Caseous lymphadenitis of sheep and ulcerative lymphangitis in horses and cattle resulting from infection with *Corynebacterium pseudotuberculosis*
- Internal abscessation associated with *C. pseudotuberculosis* in horses
- Anthrax, especially in the pig but also in the horse, which can initially manifest as cervical lymphadenopathy with considerable inflammation and swelling in the pharyngeal region and neck
- Strangles in horses associated with *S. equi* and lymphadenitis produced by *S. zooepidemicus*. Lymphadenopathy that causes enlargement of abdominal lymph nodes is a characteristic of infection with *S. equi* in the burro.
- Anorectal lymphadenopathy in young horses, causing extraluminal rectal obstruction with colic and sometimes urinary dysfunction
- Cervical adenitis (jowl abscess) of pigs, caused principally by group E type IV *Streptococcus* spp. but also by *Actinomyces* (*Truperella*) *pyogenes* and *Pasteurella multocida*
- Granulomatous cervical adenitis, which also occurs in pigs and is a common finding at slaughter. The lesions rarely cause clinical illness but are a public health concern because they may be tuberculosis. Most commonly they are associated with *R. equi* or atypical mycobacteria, but *Mycobacterium tuberculosis*, *Mycobacterium avium*, and *Mycobacterium bovis* are also causes.
- Tularemia, infection with *Francisella tularensis*, in tick-infested sheep
- Melioidosis associated with infection with *Burkholderia pseudomallei*
- Tick pyemia associated with *S. aureus* in sheep infested with the tick *Ixodes ricinus*
- Retropharyngeal lymph node enlargement up to three or four times normal, and colored bright green, has been identified in cattle as resulting from infection with the algae *Prototheca* spp.
- Tuberculosis

- Lymphadenitis in lambs associated with *P. multocida*, and in some cases of actinobacillosis
- Morel's disease of sheep associated with infection by *S. aureus* subsp. *anaerobius*
- Bovine farcy and atypical skin tuberculosis, the latter involving the lymphatics but not associated with lymph node enlargement.
- *Trueperella pyogenes* (formerly *Arcanobacterium pyogenes*) causes lymphadenitis in cattle, sheep, goats, pigs, and horses.<sup>1</sup>

In acute lymphadenitis there is pain and heat on palpation, but the nodes are for the most part painless. Obstructions produced by enlarged lymph nodes can result in secondary signs such as respiratory difficulty with enlargement of the retropharyngeal lymph nodes and esophageal obstruction by enlarged mediastinal lymph nodes. Needle biopsy for cytology and culture can aid in the determination of the cause of lymphadenitis and can allow the differentiation between lymphadenitis and neoplastic enlargement. Ultrasound may also aid in diagnosis. The diseases listed here are discussed in more detail under their specific headings.

**Absence of lymphoid tissue** occurs as a congenital defect in Arabian foals with severe combined immunodeficiency and is recorded in an Angus calf.

## REFERENCE

1. Ribeiro MG, et al. *Vet Quart.* 2015;35:82.

## Diseases of the Spleen and Thymus

The spleen serves a number of functions—it is a storage organ for blood, a source of extramedullary erythropoiesis in some species, a major component of the reticuloendothelial system, and an important component of the immune system.<sup>1</sup> Its function is most evident in the horse, in which an intact and functioning spleen is necessary for normal work capacity. Blood in the spleen of horses has a hematocrit much higher than that of circulating blood (70% to 80% vs 35–45%), and when relaxed the spleen contains many liters of blood. Excitement or exercise causes splenic contraction through an alpha-1-mediated event and ejection of the red-cell-rich blood into the peripheral circulation, with subsequent marked increases in hematocrit. The spleen of an adult horse can eject 5 to 10 L of blood into the circulation, and together with declines in plasma volume during exercise, increase hematocrit to 55% to 60% (0.55 to 0.60 L/L).

Splenectomy is performed as part of treatment of idiopathic refractory thrombocytopenia, as a consequence of splenic infarction, and to control hemorrhage.<sup>2,3</sup> Removal of the spleen (splenectomy) impairs

the oxygen-carrying capacity of blood during exercise by preventing the normal increase in hematocrit, and it prevents the normal cardiovascular responses to exercise, including increases in right atrial pressure.<sup>4</sup>

## SPLENOMEGALY

Diffuse diseases of the spleen that result in enlargement are usually secondary to diseases in other organs. **Splenomegaly** with complete destruction of splenic function is virtually symptomless, especially if the involvement occurs gradually, and in most cases clinical signs are restricted to those caused by involvement of other organs. An enlarged spleen can be palpable on rectal examination in the horse, and careful percussion might detect enlargement of the spleen in cattle, but in most instances involvement of the organ is not diagnosed at antemortem examination unless ultrasonographic examination or laparotomy is performed.<sup>5–7</sup> Ultrasonography is useful in determining the size of the spleen and its anatomic placement (e.g., in horses with left dorsal displacement of the colon) and to detect masses or abnormalities in the composition of the spleen (infarcts, hematomata, neoplasia).<sup>5,7,8</sup>

Left dorsal displacement of the colon in the horse is a colic in which the spleen is displaced medially, and this may give the impression that the organ is enlarged. **Rupture** of a grossly enlarged spleen can cause hemoperitoneum and possibly sudden death resulting from internal hemorrhage.<sup>9</sup> This is sometimes the cause of death in bovine viral leukosis or equine amyloidosis. **Moderate degrees of splenomegaly** occur in many infectious diseases, especially salmonellosis, anthrax, babesiosis, equine infectious anemia, and diplococcus septicemias in calves, and in some noninfectious diseases, such as copper toxicity in sheep. Amyloid is deposited in the spleen of affected cows.<sup>10</sup> Animals that die suddenly because of lightning stroke, electrocution, and euthanasia can also show a moderate degree of splenomegaly, but the enlargement is minor compared with that observed in congestive heart failure, portal obstruction, or neoplastic change.

**Neoplasms** of the spleen are not common in large animals but can be lymphosarcoma, hemangiosarcoma, myelocytic leukemia, malignant melanoma, or systemic granulomatosis in horses.<sup>11–14</sup> Metastasis of hepatic carcinoma to the spleen of a dairy cow is reported. The abnormality is usually readily detected by ultrasonographic examination of the spleen or discovered incidentally during rectal examination.

## SPLENIC ABSCESS

Splenic abscess can result when a septic embolus lodges in the spleen, but is more commonly caused by extension of infection

from a neighboring organ. Perforation by a foreign body in the reticulum of cattle is the commonest cause of the disease in large animals, and gastric penetration by sharp metal or wires can cause splenitis in horses.<sup>15,16</sup> Perforation of a gastric ulcer or an erosion of the gastric wall caused by *Gasterophilus intestinalis* or extension of a granuloma caused by larvae of *Habronema* spp. in horses can lead, by extension, to development of a suppurative lesion in the spleen. In those occasional cases of strangles in horses in which systemic spread occurs, splenic abscess occasionally occurs.

Splenic abscesses associated with *C. pseudotuberculosis* infection are diagnosed in horses in those parts of the world where the infection is endemic. The most common clinical signs are concurrent external abscesses, anorexia, fever, lethargy, weight loss, and signs of respiratory tract disease or abdominal pain. Diagnosis is based on the presence of appropriate clinical signs and ultrasonographic examination of the spleen.

If the abscess is extensive and acute, there are systemic signs of fever, anorexia, and increased heart rate. Pain is evidenced on palpation over the area of the spleen, and hematological examination reveals a marked increase in the total white cell count and a distinct shift to the left in the differential count.

**Abdominocentesis** usually provides evidence of chronic peritonitis by the presence of a large amount of inflammatory exudate. Peritonitis is often coexistent and produces signs of mild abdominal pain with arching of the back and disinclination to move. Mild recurrent colic may also occur. Anemia, with marked pallor of mucosae, and terminal ventral edema are also recorded. The spleen may be sufficiently enlarged to be palpable per rectum.

**Treatment** of splenic abscess is often unrewarding because of the extensive nature of the lesion before clinical signs appear. The systemic signs can usually be brought under control by treatment with antimicrobials, but relapses are common and death is the almost certain outcome. Splenectomy is recommended if adhesions and associated peritonitis are absent.

## SPLENIC HEMATOMA, RUPTURE OR INFARCTION

Formation of a **hematoma** in the spleen or, in the more severe instance, splenic **rupture**, usually occurs as a result of trauma. The syndrome is best described in horses, occurring as a result of falling or blunt trauma to the left side of the ribcage. The clinical signs include colic, tachycardia, cold extremities, and pallor of the mucous membranes—all of which are suggestive of hemorrhagic shock.<sup>3,9</sup> If a hematoma is present, ultrasonographic examination of the abdomen will reveal an abnormally shaped spleen containing a

hypoechoic mass. Rupture of the spleen will be apparent as accumulation of a large quantity of fluid within the abdomen. The fluid will have the ultrasonographic characteristics of blood (a swirling echodensity). Laparoscopy can be used to confirm the diagnosis. Hematology can reveal leukocytosis and low hematocrit. Peritoneal fluid can be serosanguinous if the hematoma has not ruptured, or bloody if the spleen is ruptured.

**Infarction** of the spleen is reported rarely in horses, and thus predisposing factors are not identified. In other species splenomegaly predisposes to infarction. The clinical signs are mild to moderate colic, tachycardia, and signs of hemorrhagic shock. Ultrasonography and exploratory laparotomy are diagnostic. The spleen is enlarged and has numerous zones of varying echogenicity, which is in marked contrast to the usual homogenous echogenicity of the normal spleen. There can be excessive echogenic fluid in the abdomen consistent with blood. Treatment is surgical, although technically challenging because of the splenomegaly and risk of rupture of the spleen.

**Treatment** of a splenic hematoma is conservative, with enforced rest for a period of up to 3 months. Resolution of the hematoma can be monitored by periodic ultrasonographic examination. Horses with a ruptured spleen usually die within a short period of time. Emergency splenectomy might be useful, but timely diagnosis and surgery are difficult to achieve because of the short time course of the disease.

## REFERENCES

- Goff WL, et al. *Vet Immunol Immunopathol.* 2010;138:1.
- Garcia-Seeber F, et al. *Equine Vet Educ.* 2008;20:367.
- Muurlink MA, et al. *Equine Vet Educ.* 2008;20:362.
- Sherlock C. *Equine Vet Educ.* 2011;23:612.
- Alsop EJ, et al. *Equine Vet Educ.* 2007;19:5.
- Ragle CA, et al. *Equine Vet Educ.* 2007;19:11.
- Solis CND, et al. *Comp Exerc Physiol.* 2012;8:19.
- Braun U, et al. *Acta Vet Scand.* 2013;55.
- Mendoza FJ, et al. *Pferdeheilkunde.* 2012;28:306.
- Murakami T, et al. *Amyloid.* 2012;19:15.
- Madron MS, et al. *Equine Vet Educ.* 2011;23:606.
- Kutasi O, et al. *J Equine Vet Sci.* 2014;34:810.
- Ferrucci F, et al. *J Equine Vet Sci.* 2012;32:65.
- Stock ML, et al. *Can Vet J.* 2011;52:409.
- Rosso A, et al. *Equine Vet Educ.* 2012;24:286.
- Saulez MN, et al. *Vet Rec.* 2009;164:86.

## CONGENITAL ANOMALIES OF THE SPLEEN

Abdominal situs inversus likely occurs in most species and is reported in calves and foals.<sup>1-3</sup> There can be polysplenia and clinical signs of chronic bloat in calves. Situs inversus totalis with primary ciliary dyskinesia and chronic respiratory disease occurs in horses.<sup>2</sup>

## REFERENCES

- Boos A, et al. *BMC Vet Res.* 2013;9.
- Palmer K, et al. *J Vet Int Med.* 2008;22:491.
- Murakami T, et al. *J Japan Vet Med Assoc.* 2008;61:55.

## THYMUS

The thymus is the source of T cells in animals and is essential for development of normal immune responses. These functions occur during late gestation and in the neonate. Primary diseases of the thymus are rare in farm animals. The thymus is largest, relative to body size, in neonates and atrophies in adults to the extent that it can be difficult to identify. Aplasia or thymic hypoplasia occurs as part of severe combined immunodeficiency in Arabian foals. Aplasia of the thymus occurs in Holstein calves and Japanese Black cattle and results in increased susceptibility to infection.<sup>1</sup> Extrathoracic thymus tissue occurs in lambs and can be mistaken for enlargement of the thyroid glands.

Neoplasia of the thymus occurs in most species. Thymic lymphomas are reported in horses, pigs, and calves. Thymoma and thymic carcinoma are reported in horses and cattle. The clinical syndrome is that of a cranial thoracic mass. There can be compression of the cranial vena cava with obstructed blood flow and signs of congestive heart failure. The jugular veins are distended, and there can be submandibular edema. There can be accumulation of excessive pleural fluid. Esophageal obstruction evident as bloat in cattle or dysphagia in cattle and horses occurs. Radiography or ultrasonography of the chest demonstrate the mass,<sup>2</sup> and histologic diagnosis can be achieved at necropsy or in samples obtained by fine-needle biopsy.

## REFERENCES

- Takasu M, et al. *J Vet Med Sci.* 2008;70:1173.
- Kurosawa T, et al. *J Vet Med Sci.* 2011;73:1433.

## Immune-Deficiency Disorders (Lowered Resistance to Infection)

Normal immune function, both of acquired and innate immunity, is essential for functional resistance to infection. Immune function that is less than optimal can be the result of primary or secondary abnormalities in the immune system.

The history and signs that should suggest the possible presence of compromised immune function are as follows:

- Infections developing in the first 6 weeks of life
- Repeated or continuous infections that respond poorly to treatment
- Increased susceptibility to low-grade pathogens and organisms not usually pathogenic in immunocompetent animals
- Administration of attenuated vaccines leading to systemic illness
- Low leukocyte counts, either generally or as lymphopenia or neutropenia,

perhaps within an associated low platelet count

- Low concentrations of immunoglobulins
- It is not proposed to detail the mechanisms of humoral and cellular immunity here because there is a large literature based on the subject in immunology. However, it is necessary to remember that the normal immune response is a very complicated process, including many sequential steps, and there are various sites at which defective development or function can occur.

The disorders of immunity may be **primary**, in which the animal is born with a congenital defect of one of the immune processes, or **secondary**, in which the animal has a normal complement of immunologic processes at birth but suffers a dysfunction of one of them, often temporarily, during later life. Toxicologic and microbiological agents can be immunosuppressive.

Immunosuppression is a state of temporary or permanent dysfunction of the immune response resulting from damage to the immune system and leading to increased susceptibility to disease agents. In immunosuppression there is decreased immune responsiveness to all foreign antigens, whereas in immune tolerance there is a state of decreased or nonresponsiveness to one particular antigen. Immunosuppression can be associated with infectious and noninfectious agents. A review of the general aspects of immunosuppression and the various agents responsible is available. Infectious agents include bacteria, viruses, protozoa, and helminths; noninfectious causes include chemicals, hormones, some antimicrobials (e.g., chlortetracyclines), and toxins. Environmental factors such as extremes of temperature, humidity, high population density and mixing animals from different origins, and prolonged transportation have also been implicated as causes of immunosuppression, but the pathogenesis of these has not been well explained.

Various laboratory methods can be used to evaluate immunosuppression. The criteria that can be used to evaluate immune functions include the following:

- Gross and microscopic changes in the morphology of central or peripheral lymphoid tissues
- Changes in the concentration or ratios of different classes of immunoglobulin
- Changes in serum complement concentration
- Changes in the functional activity of immunoglobulins
- Changes in the functional activity of the immune response
- Interference with the results of vaccination
- Exacerbation in the course of disease associated with other agents
- Changes in the number and viability of cells from lymphoid organs



The development of monoclonal antibody reagents and analysis of all or part of the genome of animals has allowed new approaches to veterinary immunopathology, particularly the identification and analysis of leukocyte subpopulations in health and disease.

Most of the diseases associated with immunologic deficiency states are discussed in systems or other categories of disease throughout this book, and only a checklist is provided here. [Table 11-7](#) provides a summary of primary and acquired immunodeficiencies in horses.

### PRIMARY IMMUNE DEFICIENCIES

The primary immunodeficiencies can be in either innate immunity or adaptive immunity. Deficiencies of **innate immunity** include the following:

- Chédiak–Higashi syndrome, an inherited defect of many animal species, including cattle; a defect of phagocytic capacity via the neutrophils and monocytes<sup>1</sup>
- Bovine leukocyte adhesion deficiency of Holstein calves, which results

from a deficiency in CD18 and accumulation of profound numbers of neutrophils in circulation but not in tissue

Deficiencies of **adaptive immunity** include the following:

- Combined immunodeficiency (CID) of Arabian horses as a result of an inherited failure to produce and differentiate lymphoid precursor cells into B and T lymphocytes. See [Table 11-7](#) for a listing of immunodeficiencies of horses. A similar disease is reported in an Angus calf.

**Table 11-7** Defects of acquired immunity causing disease in foals and horses

Disease	Etiology	Epidemiology and clinical signs	Diagnostic confirmation	Treatment and prevention
Failure of transfer of passive immunity	Failure of mare to produce adequate quantities of colostrum with specific gravity > 1.060; prepartum loss of colostrum; failure of foal to ingest or absorb colostrum.	<i>Epidemiology:</i> Most common immunodeficiency of foals. Affects 5%–35% of foals. Rate is reduced by good management. <i>Clinical signs:</i> Bacterial infections, including bacteremia, septicemia, pneumonia, diarrhea, or septic arthritis/osteomyelitis, develop between 2 days and 4 weeks of age.	Measurement of foal blood or serum concentrations of immunoglobulin > 18 hours after birth. Concentration should be > 800 mg/dL (8 g/L).	<i>Treatment:</i> Administration of plasma (20–40 mL/kg) IV. <i>Prevention:</i> Check colostrum specific gravity at foaling. Ensure foal nurses mare within 3 hours of birth. Supplement with banked colostrum. Routinely measure foal serum IgG at 18–24 hours of age.
Severe combined immunodeficiency of Arabians	Failure of V(D)J recombination secondary to a defect of the catalytic subunit of DNA-protein kinase coded for by the DNA-PKcs gene.	<i>Epidemiology:</i> Restricted to Arabians. Autosomal inheritance. <i>Clinical signs:</i> Adenoviral pneumonia or diarrhea develop after ~4 weeks of age.	Severe lymphopenia (<1 × 10 <sup>9</sup> cells/L); no IgM in presuckle serum sample or sample collected at 4–5 weeks of age; histologic demonstration of lack of lymphoid tissue. Confirmation by demonstration of homozygosity for the abnormal DNA-PKcs gene.	<i>Treatment:</i> None. <i>Prevention:</i> Identification and removal of carrier animals from the breeding population.
IgM deficiency	Unknown.	<i>Epidemiology:</i> Arabian or Quarter horse foals 2–8 months of age. <i>Clinical signs:</i> Pneumonia, septic arthritis, or enteritis.	Low to undetectable serum IgM concentrations with normal to elevated concentrations of other immunoglobulins.	<i>Treatment:</i> None specific. Symptomatic treatment. Rare foal reported to recover. <i>Prevention:</i> None.
Fell pony syndrome	Unknown, likely heritable genetic defect.	<i>Epidemiology:</i> Fell pony foals < 4 months of age. <i>Clinical signs:</i> Depression, fever, diarrhea, anemia, and pneumonia in foals < 4 months of age.	No single confirmatory test. Presence of disease refractory to treatment in a Fell Pony foal with anemia, lymphopenia, and, after 4 weeks of age, low IgM concentration, is strongly suggestive. Histologic examination of bone marrow and lymphoid tissues.	<i>Treatment:</i> None effective. <i>Control:</i> Unknown pending elucidation of transmission.
A-gamma-globulinemia	Unknown. Suspect sex-linked heritable defect.	<i>Epidemiology:</i> Male foals. Sporadic. <i>Clinical signs:</i> Chronic infections develop at > 2 months of age (corresponds with declining colostrum immunity).	Low to absent concentrations of all immunoglobulin classes in serum. No B lymphocytes detectable in blood. Normal concentrations of T lymphocytes.	<i>Treatment:</i> None specific. Supportive and symptomatic, but all affected foals die. <i>Prevention:</i> None.
Common variable immunodeficiency	Unknown in horses.	<i>Epidemiology:</i> Adult horses. Sporadic. Either sex. <i>Clinical signs:</i> Chronic or recurrent infections unresponsive to medical treatment. Meningitis. Liver disease can occur in combination with common variable immunodeficiency.	Low to undetectable concentrations of IgG, IgG(T), IgM, and IgA in serum. No or few B lymphocytes in blood or lymph nodes. Elevations in serum markers of liver disease.	<i>Treatment:</i> None specific. Affected animals die because of the opportunistic infections. <i>Prevention:</i> Prolonged antimicrobial administration of affected horses.

- Agammaglobulinemia of Standardbred and Thoroughbred horses, probably the result of an inherited failure to produce B lymphocytes; these horses live much longer than those affected with CID.
- Selective deficiencies of one or more globulins—a deficiency of IgM in Arabian horses and Quarter horses is listed. IgM and IgA combined deficiencies with diminished but discernible levels of IgG are observed occasionally in horses. A transient hypogammaglobulinemia (absence of IgG) has been reported in one Arabian foal, which was immunodeficient until it was 3 months old and then became normal.
- Selective IgG<sub>2</sub> deficiency in Red Danish cattle
- A syndrome of immunodeficiency in Fell ponies and Dale ponies<sup>3,3</sup>
- Common variable immunodeficiency is described in adult horses.<sup>4,5</sup>
- Lethal trait A46 (inherited parakeratosis) of cattle is a primary immunodeficiency influencing T lymphocytes, with impairment of cellular immunity.
- Selective IgG<sub>2</sub> deficiency of cattle causes increased susceptibility to gangrenous mastitis and other infections. It is a primary deficiency of IgG<sub>2</sub> synthesis and is recorded in the Red Danish milk breed.
- Sheep and pigs—there are as yet no recognized primary immunodeficiencies in these species.

## SECONDARY IMMUNE DEFICIENCIES

Secondary immune deficiencies include the following:

- Failure of transfer of passive immunity (i.e., of antibodies from colostrum to the offspring) is well known as the commonest cause of deficient immunity in the newborn and is discussed in Chapter 20.
- Atrophy of lymphoid tissue and resulting lymphopenia are associated with the following:
  - Viral infections such as equine herpesvirus in newborn foals, rinderpest, bovine virus diarrhea, swine fever, porcine circovirus, and hog cholera. All of these cause lymphatic tissue suppression and a diminished immunoresponsiveness.
  - Bacterial infections such as *Mycoplasma* spp. and *Mycobacterium paratuberculosis* have approximately the same effect as the viral infections.
- Physiologic stress, such as birth, may cause immunosuppression in the fetus, making it very susceptible to infection in the period immediately after birth. There is a similar depression of

immunologic efficiency in the dam immediately after parturition, which, for example, leads to periparturient rise of worm infestation in ewes.

- Toxins such as bracken, tetrachloroethylene-extracted soybean meal, T<sub>2</sub> mycotoxin, and atomic irradiation suppress leukopoiesis. Immunosuppression is also attributed to many environmental pollutants, including polychlorinated biphenyls, 2,4,5-T contaminants, DDT, aflatoxin, and the heavy metals.
- General suppression of immune system responsiveness; examples include the following:
  - Glucocorticoids administered in large doses or over long periods reduce the activity of neutrophils and the number of circulating lymphocytes, although the reduction varies widely between species. The production of antibodies is also reduced.
  - Nutritional deficiency, especially of zinc, pantothenic acid, calcium, and vitamin E, causes general suppression. A total caloric deficiency has a similar effect. Addition of certain trace elements, such as copper, iron, zinc, and selenium, in animal feeds is necessary for an adequate immunity. Selenium, alone or in combination with vitamin E, can enhance antibody responses, whereas its deficiency results in immunosuppression. Selenium supplementation in animal feeds is important to enhance both antibody production and phagocytic activity of neutrophils. In cattle, copper deficiency induced by molybdenum or iron can cause an impairment in the ability of neutrophils to kill ingested *Candida albicans*. Nutrients that stimulate disease resistance when administered to animals deficient in these nutrients include carotenoids; vitamins A, E, and C; zinc; manganese; copper; and selenium. Neonatal calves may have low reserves of carotene and vitamins A and E and are dependent on obtaining them from colostrum, which contains highly variable quantities. Administration of drugs that impair folate metabolism can induce anemia and depletion of white blood cells, with subsequent bacterial infection.
  - Experimentally, a protein–energy malnutrition in neonatal calves results in loss of body weight and decreased lymphocyte interleukin-2 activity and lymphocyte proliferation compared with calves of similar age.

- Exposure to cold and heat stress for periods of several weeks in duration
- Events associated with parturition, in particular glucocorticoid release, that impair innate immunity
- Alloimmune disease that suppresses bone-marrow activity<sup>6</sup>

## REFERENCES

1. Takasu M, et al. *J Vet Med Sci*. 2008;70:1173.
2. Fox-Clipsham LY, et al. *PLoS Genet*. 2011;7.
3. Fox-Clipsham L, et al. *Vet Rec*. 2009;165:289.
4. Tallmadge RL, et al. *Mol Immunol*. 2012;51:169.
5. Tallmadge RL, et al. *J Clin Immunol*. 2012;32:370.
6. Euler KN, et al. *BMC Vet Res*. 2013;9.

## Amyloidoses

The amyloidoses are a group of diseases characterized by the deposition of an extracellular proteinaceous substance, amyloid, in the tissues, with subsequent disruption of normal tissue architecture that eventually leads to organ dysfunction. Amyloidosis in farm animals usually occurs in association with a chronic suppurative process elsewhere in the body and is the result of accumulation of AA amyloid. Another form of the disease involves accumulation of AL amyloid, especially as localized disease in horses.

## ETIOLOGY AND EPIDEMIOLOGY

Amyloidosis occurs rarely, and when it does occur it is most common in animals exposed systemically and repeatedly to antigenic substances. Examples include repeated injections of antigenic material for commercial production of hyperimmune serum and long-standing suppurative diseases or recurrent infection, as in Chédiak–Higashi syndrome. Severe strongylid parasitism in the horse has been reported as a cause. Holstein calves with bovine leukocyte adhesion deficiency have accumulation of amyloid in tissue, although this is not the primary disease. Many cases of amyloidosis in large animals are without apparent cause.

The incidence of visceral AA amyloidosis in slaughtered cattle in a group of 302 cattle older than 4 years of age in Japan was 5.0%; rates previously reported from Japan and other countries ranged from 0.4% to 2.7%. Systemic AA amyloidosis associated with tuberculosis has been described in a European wild boar. Systemic amyloidosis occurs in goat kids with chronic arthritis associated with seroconversion to *Erysipelothrix rhusiopathiae*. AA renal amyloidosis in cattle is often associated with traumatic reticuloperitonitis, metritis, mastitis, or pododermatitis, although 5 of 25 cows with AA amyloidosis did not have coexisting chronic inflammatory disease.<sup>1</sup>

Out of 16,000 horses referred for clinical examination to a veterinary teaching hospital over a period of 13 years, 9 horses were identified as having amyloidosis. Cutaneous

amyloidosis has been associated with malignant histiocytic lymphoma in horses.

A case of cardiac amyloidosis causing heart failure in a 16-year-old Thoroughbred gelding has been described. The disease resulted from accumulation of AL amyloid. The AL form of amyloidosis is characteristically associated with unstable monoclonal immunoglobulin light chains produced by plasma-cell dyscrasia and resulting in deposition of AL fibrils.

### PATHOGENESIS

How amyloid is formed is uncertain, but hyperglobulinemia is commonly present. This fact, together with the circumstances under which it occurs, suggests an abnormality of the antigen-antibody reaction. Amyloidoses are classified by the types of amyloid protein deposited. AA amyloid is derived from serum amyloid-A protein (SAA), which is an acute-phase reactant produced by hepatocytes. However, increased concentrations of SAA alone are not sufficient to cause amyloidosis. AA (secondary) amyloidosis is associated with recurrent acute or chronic infections, inflammatory disease, or neoplasia.

Extensive amyloid deposits may occur in the spleen, liver, or kidneys and cause major enlargement of these organs and serious depression of their functions. The commonest form that is clinically recognizable in animals is renal amyloidosis. This presents as a nephrotic syndrome with massive proteinuria and a consequent hypoproteinemia and edema. Terminally, the animal is uremic, becoming comatose and recumbent. The edema of the gut wall and its infiltration with amyloid create the conditions necessary for the development of diarrhea. In horses, cases of multiple cutaneous lesions are recorded. The amyloid is present in 5- to 25-mm diameter nodes in the skin of the head, neck, and pectoral regions.

Rare cases of involvement of the upper respiratory tract (nasal cavities, pharynx, larynx, guttural pouch and lymph nodes of the head and neck, and conjunctiva) occur in horses.<sup>2</sup> The amyloid material deposited in these tissues is usually of the AL form,<sup>2</sup> whereas systemic disease is almost always the AA form.

AL amyloidosis is also reported in an adult cow with bovine leukocyte adhesion deficiency.

### CLINICAL FINDINGS

Many cases of amyloidosis are detected incidentally at necropsy. The cutaneous form in horses is characterized by the presence of hard, nonpainful, chronic plaques in the skin. Most of the lesions, which can be widespread and severe, are on the sides of the neck, shoulders, and head. Respiratory tract involvement in the horse is usually limited to the nasal cavities,<sup>2</sup> and this may cause dyspnea. There is deposition of AA amyloid



**Fig. 11-3** Lactating Brown Swiss cow with massive persistent proteinuria and severe hypoalbuminemia (serum albumin concentration, 0.7 g/dL) as a result of advanced renal amyloidosis. Note the ventral abdominal and submandibular edema secondary to the marked hypoalbuminemia. An enlarged left kidney was detected per rectal palpation, and renal biopsy confirmed the diagnosis of renal amyloidosis.

in the ciliary body of horses with recurrent uveitis, although the clinical importance of this finding is uncertain.<sup>3</sup>

Chronic heart failure as a result of cardiac amyloidosis secondary to systemic amyloidosis in a 16-year-old gelding was characterized clinically by weight loss, dysphagia, recurrent episodes of esophageal obstruction, and anorexia of a few weeks in duration. Ventral edema, tachycardia, and irregular heart rate associated with atrial fibrillation were present. The clinical findings were consistent with biventricular heart failure from ventricular dysfunction, atrial fibrillation, and pulmonary hypertension. The amyloid was of the AL form.

A case of systemic AL amyloidosis associated with multiple myeloma in a horse was characterized clinically by rapid weight loss, muscle atrophy, soft unformed feces, and ventral edema. Amyloidosis in this situation is considered a paraneoplastic disease.<sup>4</sup>

Hemoperitoneum and acute death secondary to splenic or hepatic rupture occurs in horses with systemic amyloidosis.

Clinical cases in cattle are usually secondary to traumatic reticuloperitonitis, mastitis, metritis, or pododermatitis and are characterized by emaciation and enlargement of the spleen, liver, or kidneys; involvement of the kidney causes proteinuria and is often accompanied by profuse and chronic diarrhea, polydipsia, and anasarca.<sup>1</sup> In cattle the grossly enlarged left kidney is usually palpable per rectum. Cases can manifest within 2 weeks of calving. They are characterized by anorexia, watery diarrhea, anasarca, rapid emaciation, and death in 2 to 5 weeks.

Corpora amylacea are small, round concretions of amyloid material found in the

mammary tissue of cows. They are usually inert but may cause blockage of the teat canal.

### CLINICAL PATHOLOGY

An extreme and persistent proteinuria should suggest the presence of renal amyloidosis. Electrophoretic studies of serum may be of value in determining the presence of hyperglobulinemia. Serum alpha-globulin concentration is usually elevated and albumin concentration markedly depressed. Hypoproteinemia can be marked, with ventral edema frequently being present when the serum albumin concentration is less than 1.0 g/dL (Fig. 11-3). Horses with hepatic amyloidosis have elevated activities of gamma-glutamyltransferase and, to a lesser extent, bile acids. In cattle there is hypoproteinemia, hypoalbuminemia, hypocalcemia, hyperfibrinogenemia, hypomagnesemia, high serum urea and creatinine concentration, and low-specific-gravity urine.<sup>1</sup> Serum amyloid A and haptoglobin concentrations in the serum of cows with amyloids are higher than those in healthy cows, but not compared with cows with chronic inflammatory disease in the absence of amyloidosis.<sup>5</sup>

Biopsy of cutaneous plaques is an accurate diagnostic technique.

### NECROPSY FINDINGS

Amyloid can be detected in most organs of cows with systemic AA amyloidosis by histologic examination, including the liver, kidney, thyroid gland, adrenal gland, gastrointestinal mucosa, heart, lung, lymph nodes, ovary, hypophysis, uterus, mammary gland, and skeletal muscle.<sup>6,7</sup> Grossly affected organs are enlarged and have a pale, waxy



appearance. In the spleen, the deposits are circumscribed, whereas in the liver and kidneys they are diffuse. In a horse with systemic AL amyloidosis associated with multiple myeloma, diffuse gastrointestinal hemorrhage, thickened jejunal mucosa, and splenomegaly were present.

The pathology of AA amyloidosis in domestic sheep and goats has been described. Most sheep with amyloidosis had pneumonia and other sites of chronic inflammation. Amyloid was detected in all grossly affected kidneys using Congo Red staining. Experimental induction of amyloidosis secondary to pneumonia in sheep results in deposition of amyloid in the gastrointestinal tract from the tongue to the rectum, with the most abundant deposition in the duodenum.<sup>8</sup> Other body systems have only mild deposition of amyloid.<sup>8</sup>

Deposits of amyloid in tissues may be made visible by staining with aqueous iodine. Amyloid is detected as green birefringence of Congo Red-stained tissues viewed under polarized light. AA and AL amyloidosis can be differentiated by treatment of tissue sections with potassium permanganate. Tissue containing AA will lose its green birefringence after treatment with potassium permanganate, whereas tissue containing AL will continue to appear green after Congo Red staining and viewing under polarized light.

The Shtrasburg method is now available for the identification of AA amyloid and to distinguish it from amyloid types in a large number of domestic and wild animals.

#### DIFFERENTIAL DIAGNOSIS

Enlargement of parenchymatous organs associated with chronic suppurative processes should arouse suspicion of amyloidosis, especially if there is emaciation and marked proteinuria.

Pyelonephritis, nonspecific nephritis, and nephrosis bear a clinical similarity to amyloidosis.

#### TREATMENT

There is no effective treatment of the systemic disease. The localized disease as occurs in the upper respiratory tract of horses can be treated by surgical excision, but the results are not encouraging.

#### ZOONOTIC POTENTIAL

There is discussion of the potential for AA amyloidosis to be a transmissible disease, although there is no evidence of a risk to human health from ingestion of meat and organs from cows with clinically inapparent amyloidosis.<sup>9</sup>

#### REFERENCES

1. Elitok OM, et al. *J Vet Int Med.* 2008;22:450.
2. Ostevik L, et al. *Acta Vet Scand.* 2014;56.
3. Ostevik L, et al. *J Comp Pathol.* 2014;151:228.

4. Axiak S, et al. *Equine Vet Educ.* 2012;24:367.
5. Takahashi E, et al. *J Vet Med Sci.* 2007;69:321.
6. Yamada M, et al. *J Vet Med Sci.* 2006;68:725.
7. Murakami T, et al. *Amyloid.* 2012;19:15.
8. Biescas E, et al. *J Comp Pathol.* 2009;140:238.
9. Murakami T, et al. *Vet Pathol.* 2014;51:363.

#### ALLERGY AND ANAPHYLAXIS

Immune-mediated diseases in animals included here are those in which the fundamental abnormality is an exaggerated or misdirected immune response. Many diseases, and in particular infectious diseases, have an important component of their pathophysiology that is attributable to immune responses to the inciting agent. Although these responses can sometimes be deleterious to the animal, they are part of an expected immunologic reaction to the infectious agent. Examples of where a component of the immune response to an infection has an important role in the pathophysiology of the clinical disease include pneumonia in calves infected by *Mycoplasma bovis*, pneumonia in foals secondary to equine influenza virus infection, and enteritis and colitis secondary to salmonella infection.

Diseases manifest by allergy or anaphylaxis are characterized by exaggerated immune responses or reactions to otherwise innocuous stimuli. Examples in large animal medicine include immediate hypersensitivity reactions (anaphylaxis), milk allergy in Jersey cattle, dermatologic diseases (such as Queensland itch), neonatal isoimmune erythrolysis of foals, and purpura hemorrhagica.

There are four major mechanisms for the induction of a hypersensitivity response. They are classified as types I through IV based on the immune mechanism that elicits the disease state. Types I through III are antibody-mediated responses to antigen and include such conditions as systemic anaphylactic shock (type I), autoimmune hemolytic anemia (type II), and the local Arthus reaction (type III). Type IV hypersensitivity is caused by the induction of sensitized T lymphocytes and thus has a cell-mediated mechanism. The following description is minimalistic, including minimal mention of Th1 and Th2 responses, and readers are referred to texts dealing with veterinary immunology for more detail.

#### TYPE I

Type I disease is caused by binding of specific antigens by antibodies with local and/or systemic responses that occur within minutes. The antibody involved is almost always IgE, or its functional equivalent in species in which this role is fulfilled by a different class of antibody, that is bound to specific receptors on the surface of mast cells. Binding of the antigen to the surface-bound IgE precipitates release of inflammatory and vasoactive mediators, including histamine, various prostaglandins and leukotrienes, and

cytokines (IL-4, IL-5, IL-6, IL-13, tumor necrosis factor alpha, and others), from the cells (“degranulation”), with subsequent local reactions of hyperemia and heat and systemic reactions such as constriction of smooth muscles (importantly, bronchial smooth muscle). Degranulation of mast cells also attracts eosinophils to the site with their subsequent degranulation and release of a wide variety of compounds, including cytokines, chemokines, enzymes, oxidants, prostanooids, and cationic granule proteins. The difference in manifestation of acute, immediate-type hypersensitivity reactions between species appears to depend largely on differences in the tissue site of antibody binding and the route of entry into the body of the inciting allergen. For example, insect bite hypersensitivity (Queensland itch) is the result of an IgE-mediated response to antigens in the saliva of biting insects—the inciting allergen is deposited in the skin when the insect bites the host. The disease is only manifest in horses that do not have an appropriate tempering immunologic reaction.<sup>1</sup> The high incidence of atopic hypersensitivity with familial predisposition seen in humans and dogs does not occur as frequently in large animals, although it is notable that there are breed differences in cell-mediated and antibody-mediated hypersensitivity reactions in cattle.<sup>2,3</sup> Type I hypersensitivity is considered to be the mechanism for self-cure of gastrointestinal parasitism in sheep.

Anaphylaxis is the systemic manifestation of widespread and massive release of inflammatory mediators from mast cells. Signs are acute, occurring within minutes of exposure to the allergen, and severe, resulting in bronchoconstriction and leading to death in many cases.

Treatment involves prevention of exposure or removal of inciting allergens, administration of corticosteroids, and, in anaphylaxis, administration of drugs that counteract the severe bronchoconstriction (epinephrine). Antihistamines are minimally effective, likely because histamine is only one of numerous inflammatory activators released by mast cells and eosinophils.

#### TYPE II

Type II hypersensitivity reaction is caused by the binding of antibodies to antigenic sites on specific cell types (antibody-mediated cell cytotoxicity). The disease can occur because of the presence of antibodies against specific natural proteins on cell surfaces, such as occurs with neonatal isoerythrolysis or reactions to blood transfusions, or when foreign antigens, such as viruses or virus particles, bind to cell surfaces. Diseases include neonatal isoimmune hemolysis and thrombocytopenia.

#### TYPE III

Type III hypersensitivity reaction occurs as a result of formation of antibody-antigen

complexes, which then induce an inflammatory response in the host tissue. Examples include **Arthus-type reaction** or the **Arthus phenomenon**, which is evident as induration, erythema, edema, hemorrhage, and necrosis of the skin a few hours after intradermal injection of antigen into a previously sensitized animal; deposition of antibody-antigen complexes in the glomeruli, with resultant inflammation and tissue damage evident as glomerulonephritis; purpura hemorrhagica in equids; and in many viral diseases in which viruses are not neutralized by circulating antibodies (equine infectious anemia). The lesion results from the precipitation of antigen-antibody complexes, which causes complement activation and the release of complement fragments that are chemotactic for neutrophils; large numbers of neutrophils infiltrate the site and cause tissue destruction by release of lysosomal enzymes.

#### TYPE IV

**Cell-mediated or delayed hypersensitivity** is the basis for tuberculin and bovine paratuberculosis skin tests in cattle. The response is mediated by T cells and natural-killer (NK) cells. Allergic contact dermatitis, a cutaneous form of type IV hypersensitivity, is commonly identified in dogs and cats, but less so in large animals. Cattle can develop an allergic reaction to **calcium cyanamide**, a nitrogenous fertilizer, evident as allergic contact dermatitis.<sup>4</sup> The disease occurred in 9 of 250 dairy cattle housed on flooring to which calcium cyanamide had been added to reduce the risk of environmental mastitis. The cows developed alopecia, erythema, and crusting and pruritus of the udder, teats, ventral abdomen, and dewlap—all areas that contacted the ground surface. The disease can be severe and markedly affect the health and well-being of affected cows. Diagnosis is confirmed by skin-patch testing using cyanamide.<sup>4</sup> Cattle can also develop delayed hypersensitivity to rubber in milking machines.<sup>5</sup>

A more severe form of type IV-mediated skin disease is **toxic epidermal necrolysis** (also known as **Stevens-Johnson syndrome**). This disease in humans is often associated with administration of medications. It occurs in calves infected with *Mycoplasma bovis* and is evident as pneumonia, arthritis, and severe skin lesions manifest as marked thickening of the epidermis, detachment of the epidermis from the dermis, and blisters in the detachment sites.<sup>6</sup> Affected calves recovered, apparently in response to treatment with antimicrobials, a single administration of corticosteroid and pentoxifylline.

**Erythema multiforme** is a milder form of cutaneous expression of delayed hypersensitivity. It occurs in horses and cattle and is manifest as sudden onset of roughly symmetric erythematous wheals on the neck and dorsum with peripheral expansion and

central clearing forming donut-like lesions. Lesions can persist for days to weeks and be moderately painful. Scaling, crusting, and alopecia are unusual.<sup>7</sup> Lesions heal spontaneously. A similar disease is associated with cutaneous equine herpesvirus-5 infection, although the skin lesions were most severe on the muzzle and face.<sup>8</sup>

Delayed hypersensitivity reactions can contribute to the pathology of many diseases, such as mycoplasmal pneumonia in swine, but those are considered clinically under their initiating etiology.

#### TREATMENT

The **treatment of allergic states** is based on immediate treatment of signs of inflammation or allergy, usually by the administration of corticosteroids, antihistamines, or, in anaphylaxis, epinephrine, and prevention of continued exposure to the inciting allergen. Antihistamines have very limited usefulness, whereas corticosteroids have wide applicability and potent efficacy. The NSAIDs, including such drugs as flunixin meglumine, phenylbutazone, and meclofenamic acid, all inhibit prostaglandin synthesis and thus reduce inflammation but have only slight effect in treating allergic diseases.

### ANAPHYLAXIS AND ANAPHYLACTIC SHOCK

Anaphylaxis is an acute disease of often life-threatening severity caused by an antigen-antibody (IgE) reaction. If severe it can result in anaphylactic shock.

#### ETIOLOGY

Most commonly, severe anaphylactic reactions are seen in farm animals following the parenteral administration of a drug or biological product. Other routes of entry of the allergen, such as via the respiratory or gastrointestinal tract, can also result in anaphylactic reactions. The reaction can occur at the site of exposure or in other areas.

The disease occurs because the animal is sensitized to the inciting allergen by previous exposure. The initial exposure usually does not result in any immediate clinical abnormalities, but subsequent exposure of the animal to the antigen results in rapid degranulation of mast cells and, subsequently, eosinophils, with widespread release of vasoactive and inflammatory mediators resulting in anaphylactic shock.

Although severe anaphylactic reactions occur usually after a second exposure to a sensitizing agent, reactions of similar severity can occur with no known prior exposure. In large animal practice this is most likely to occur after the injection of sera and bacterins, particularly heterologous sera and bacterins in which heterologous serum has been used in the culture medium.

Hypersensitivity reactions are sometimes observed at a higher incidence than normal in certain families and herds of cattle.

Anaphylactic reactions can occur in the following circumstances:

- Repeated injection of biological preparations
- Repeated blood transfusions from the same incompatible donor or donors<sup>9</sup>
- Repeated injections of vaccines (e.g., those against foot-and-mouth disease and rabies)
- Injection of penicillin—although many presumed penicillin-induced anaphylactic reactions are in fact reactions to inadvertent intravenous administration of procaine or benzathine
- Similar rare occurrences after the injection of lyophilized *Brucella abortus* strain 19 vaccine and *Salmonella* vaccine
- Assumed anaphylactic reaction to ingested protein occurs in animals at pasture or in the feedlot.
- Cows, especially Channel Island cattle, can develop anaphylaxis when milking is stopped because the cows are being dried off; severe urticaria and respiratory distress occur 18 to 24 hours later.
- A systemic reaction after *Hypoderma* spp. larvae are killed in their subcutaneous sites might be anaphylactic, but is more likely to be a toxic effect from breakdown products of the larvae.
- After inadvertent intravenous administration of mare's milk to a foal<sup>10</sup>

#### PATHOGENESIS

Anaphylactic reactions occur as the result of antigen reacting with cell-bound antibody. In humans, horses, and dogs a specific class of reaginic antibody, IgE, has been identified and has particular affinity for fixed tissue mast cells. The tissue distribution of mast cells in part accounts for the involvement of certain target organs in anaphylactic reactions in these species. Homocytotropic antibody has been detected in farm animals, but the classes of antibodies involved in anaphylactic reactions have not been fully identified and might be diverse. Anaphylactic antibodies can be transferred via colostrum.

Antigen-antibody reactions occurring in contact with, or in close proximity to, fixed tissue mast cells, basophils, and neutrophil leukocytes result in the activation of these cells to release pharmacologically active substances that mediate the subsequent anaphylactic reaction. These substances include biogenic amines, such as histamine, serotonin, and catecholamines; vasoactive polypeptides, such as kinins, cationic proteins, and anaphylatoxins; vasoactive lipids, such as prostaglandins; and slow-reacting substance of anaphylaxis (SRS-A), among others. Knowledge of the type and relative

importance of pharmacologic mediators of anaphylaxis in farm animals rests with studies of severe anaphylactic reactions that have been induced experimentally, but it is likely that these mediators are also of significance in less severe reactions. From these studies it appears that histamine is of less importance as a mediator in farm animals than in other species and that prostaglandins and SRS-A are of greater importance. Bradykinin and 5-hydroxytryptamine (5-HT) are also known to act as mediators in cattle, but the reactions in all species are complex and involve a sequence of mediator effects.

In **horses**, there are four phases in the development of the anaphylactic response. The first is acute hypotension combined with pulmonary arterial hypertension 2 to 3 minutes after the injection of the triggering agent; it coincides with histamine release. In the second phase, blood plasma 5-HT levels rise, and central venous blood pressure rises sharply at about 3 minutes and onward. The third phase commences at about 8 to 12 minutes and is largely reflex and manifested by a sharp rise in blood pressure and alternating apnea and dyspnea. Finally, there is a second and more protracted systemic hypotension as a result of prostaglandin and SRS-A influence, which persists until the return to normality.

In **cattle**, there is a similar diphasic systemic hypotension with marked pulmonary venous constriction and pulmonary artery hypertension. An increase in mesenteric venous pressure and mesenteric vascular resistance causes considerable pooling of blood on the venous side of the mesenteric vessels. In both cattle and horses these reactions are accompanied by severe hemoconcentration, leukopenia, thrombocytopenia, and hyperkalemia.

**Sheep, goats, and pigs** also show a largely pulmonary reaction.<sup>11</sup>

In horses and cattle, the marked changes in vascular tone coupled with increased capillary permeability, increased secretion of mucous glands, and bronchospasm are the primary reactions leading to the development of severe pulmonary congestion, edema, and emphysema and edema of the gut wall.

Less severe reactions are also dependent on the effect of mediators on capillary permeability, vascular tone, and mucous gland secretion. The major manifestation depends on the distribution of antibody-sensitized cells and of susceptible smooth muscle in the various organs. In cattle, reactions are generally referable to the respiratory tract, but the alimentary tract and skin are also target organs. Sheep and pigs show largely a pulmonary reaction, and horses manifest changes in the lungs, skin, and feet.

Sensitization of an animal requires about 10 days after first exposure to the antigen and persists for a very long time, usually months or years.

## CLINICAL FINDINGS

### Cattle

In cattle, initially there is a sudden onset of severe dyspnea, muscle shivering, and anxiety. In some cases, there is profuse salivation, in others moderate bloat, and yet others diarrhea. After an incompatible blood transfusion, the first sign is often hiccough. Additional signs are urticaria, angioneurotic edema, and rhinitis (Fig. 11-4). Muscle tremor can be severe, and a rise in temperature to 40.5°C (105°F) is often observed. On auscultation of the chest there can be increased breath sounds, crackles if edema is present, and emphysema in the later stages if dyspnea has been severe. In most surviving cases the signs have usually subsided within 24 hours, although dyspnea may persist if emphysema has occurred.

In natural cases the time delay after injection of the reagent intravenously is about 15

to 20 minutes, but in experimentally induced cases a severe reaction may be evident within 2 minutes of the injection and death within 7 to 10 minutes. Clinical signs include collapse, dyspnea, wild paddling, nystagmus, cyanosis, cough, and the discharge of a creamy, frothy fluid from the nostrils. Recovery, if it occurs, is complete in about 2 hours.

### Sheep, Goats, and Pigs

In sheep, goats, and pigs, **acute dyspnea is common**.<sup>11</sup> Goats with disease induced by sensitization to horse serum had respiratory distress, evident as increased respiratory rate, irregular respiration, coughing, abnormal lung sounds, reluctance to move, shivering or muscle tremors, paddling, and kicking.<sup>11</sup>

### Horses

In the horse, naturally occurring anaphylactic shock is manifested by severe dyspnea,

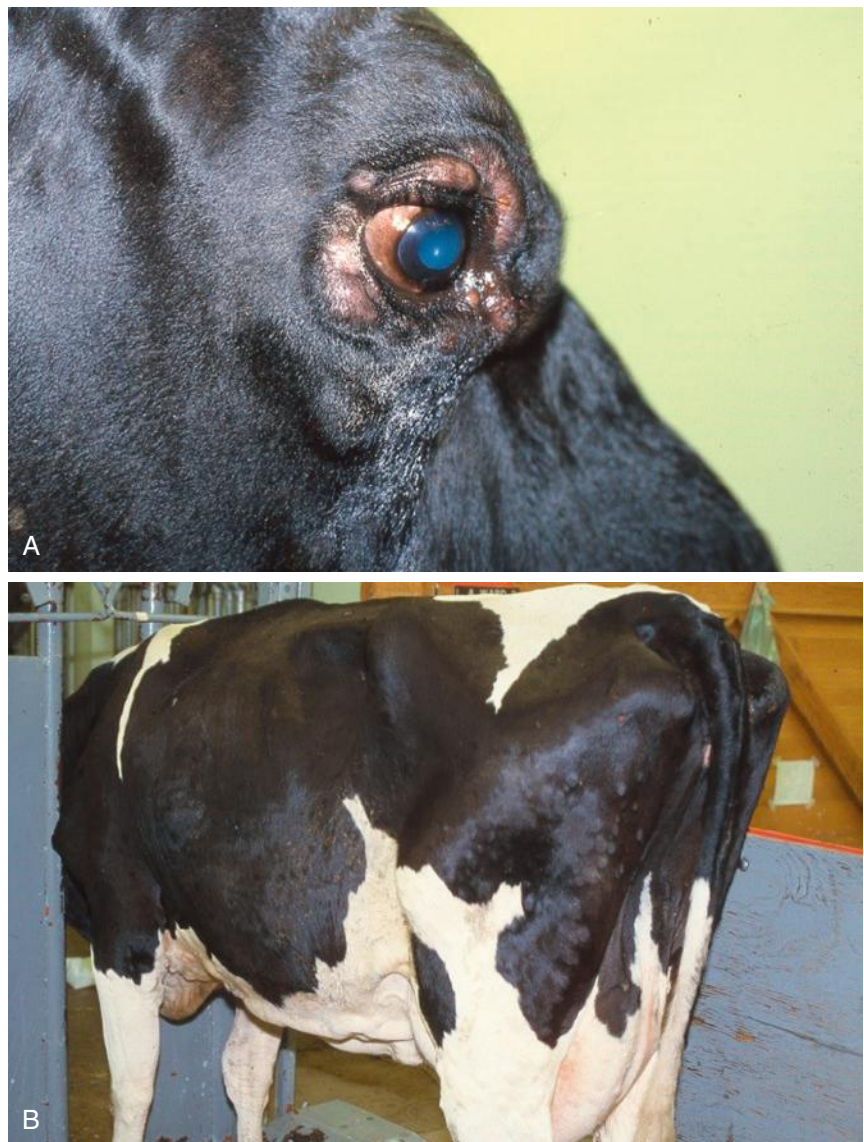

**Fig. 11-4** A and B, Urticaria in a Holstein-Friesian cow following antibiotic administration. Note the presence of multiple small raised bumps in multiple areas of the skin and the edema of the eyelid.



distress, recumbency, and convulsions. Death can occur within less than 5 minutes, but it usually requires about an hour. Laminitis and angioneurotic edema are also common signs in the horse. Experimentally induced anaphylaxis can be fatal but not in such a short time. Within 30 minutes of injecting the reagin the horse has anxiety, tachycardia, cyanosis, and dyspnea. These signs are followed by congestion of conjunctival vessels, increased peristalsis, fluid diarrhea, generalized sweating, and erection of the hair. If recovery occurs, it is about 2 hours after the incident began. Death, if it occurs, takes place about 24 hours after the injection.

### Pigs

In pigs, experimentally produced anaphylactic shock can be fatal within a few minutes, with systemic shock being severe within 2 minutes and death occurring in 5 to 10 minutes. The disease appears to occur in only one phase, in contrast to the four fairly distinct states in horses. Labored respiration, severe cyanosis, vomiting, and edema of the larynx, stomach, and gallbladder are the usual outcome.

### CLINICAL PATHOLOGY

There are no pathognomonic changes in serum biochemistry or hematological variables. There is a marked increase in packed cell volume, a high plasma potassium concentration, and neutropenia. Tests for sensitivity to determine the specific sensitizing substance are rarely carried out for diagnostic purposes, but their use as an investigation tool is warranted. Serologic tests to determine the presence of antibodies to plant proteins in the diet have been used in this way.

### NECROPSY FINDINGS

In acute anaphylaxis in young cattle and sheep the necropsy findings are confined to the lungs and are in the form of severe pulmonary edema and vascular engorgement. In adult cattle there is edema and emphysema without engorgement. In protracted anaphylaxis produced experimentally in young calves, the most prominent lesions are hyperemia and edema of the abomasum and small intestines. In pigs and sheep pulmonary emphysema is evident, and vascular engorgement of the lungs is pronounced in the latter. Pulmonary emphysema and widespread petechiation in the horse may be accompanied by massive edema and extravasations of blood in the wall of the large bowel. There may also be subcutaneous edema and lesions of laminitis.

### DIFFERENTIAL DIAGNOSIS

A diagnosis of anaphylaxis can be made with confidence if a foreign protein substance has been injected within the preceding

hour, but should be made with reservation if the substance appears to have been ingested.

Characteristic signs as described previously should arouse suspicion, and the response to treatment may be used as a test of the hypothesis.

Acute pneumonia may be confused with anaphylaxis, but there is usually more toxemia, and the lung changes are more marked in the ventral aspects; in anaphylaxis there is general involvement of the lung.

- Inadvertent intravenous administration of vasoactive compounds, such as procaine as procaine penicillin, can mimic signs of anaphylaxis in that animals collapse acutely. Such cases usually lack the characteristic abnormalities on postmortem examination.

### TREATMENT

Treatment should be administered immediately; a few minutes' delay can result in the death of the animal. Epinephrine is the most effective treatment for anaphylaxis and anaphylactic shock. Epinephrine administered intramuscularly (or one-fifth of the dose given intravenously) is often immediately effective, with the signs abating while the injection is being made. Corticosteroids potentiate the effect of epinephrine and can be given immediately following epinephrine. Antihistamines have been considered and were used commonly in the past, but they are likely ineffective, based on studies in humans, because they antagonize only one of many inflammatory mediators involved in the disease.

The identification of mediators other than histamine in anaphylactic reactions in farm animals has led to studies of the effectiveness of drugs more active against these mediators than antihistamines. Acetylsalicylic acid, sodium meclufenamate, and diethylcarbamazine have all shown ability to protect against experimentally induced anaphylaxis in cattle and horses. One of the important clinical decisions, especially in horse practice, is to decide whether an animal is sufficiently hypersensitive to be at risk when being treated. An acute anaphylactic reaction, and even death, can occur soon after intravenous injection of penicillin into a horse. In suspect cases it is customary to conduct an intradermal or a conjunctival test for hypersensitivity with a response time of about 20 minutes, but these tests have their limitations. The types of sensitivity are not necessarily related, there is no sure relationship between anaphylactic sensitivity and either skin (or conjunctival) sensitivity or circulating antibody, and the test often gives false negatives. The reason why some animals develop systemic hypersensitivity and some develop cutaneous hypersensitivity is unknown.

### OTHER HYPERSENSITIVITY REACTIONS

Other hypersensitivity reactions include anaphylaxis of a less severe degree than anaphylactic shock and cases of cell-mediated delayed hypersensitivity. The resulting clinical signs vary depending on the tissues involved, but are usually localized and mild.

### ETIOLOGY

Exposure to any of the etiologic agents described under anaphylaxis may result in this milder form of hypersensitivity. Exposure may occur by injection, by ingestion, by inhalation, or by contact with the skin.

### PATHOGENESIS

In anaphylactic reactions the clinical signs may depend on the portal of entry. Thus ingestion may lead to gastrointestinal signs of diarrhea, and inhalation may lead to conjunctivitis, rhinitis, and laryngeal and bronchial edema. Cutaneous lesions can result from introduction of the reagin via any portal. They are usually manifested by angioedema, urticaria, or a maculopapular reaction. All the lesions result from the liberation of histamine, serotonin (5-HT), and plasma kinins, as in anaphylactic shock.

### CLINICAL FINDINGS

In ruminants, inhalation of a sensitizing antigen can cause the development of allergic rhinitis. On ingestion of the sensitizing agent there may be a sharp attack of diarrhea and the appearance of urticaria or angioneurotic edema; in ruminants mild bloat can occur. Contact allergy is usually manifested by eczema. In farm animals the eczematous lesion is commonly restricted to the skin of the lower limbs, particularly behind the pastern, and at the bulbs of the heels, or to the midline of the back if the allergy is a result of insect bites. In many cases of allergic disease the signs are very transient and often disappear spontaneously within a few hours. Cases vary in severity from mild signs in a single system to a systemic illness resembling anaphylactic shock. On the other hand, cases of anaphylaxis may be accompanied by local allergic lesions.

### DIFFERENTIAL DIAGNOSIS

The transitory nature of allergic manifestations is often a good guide, as are the types of lesions and signs encountered. The response to antihistamine drugs is also a useful indicator. Skin test programs as applied to humans should be utilized when recurrent herd problems exist. The differential diagnosis of allergy is discussed under the specific diseases listed earlier.

### TREATMENT

Administration of corticosteroids is usually highly effective. Continued exposure to the allergen may result in recurrence or persistence of the signs. Hyposensitization therapy

has potential for treatment of recurrent urticaria in horses.<sup>12,13</sup>

## FURTHER READING

Tizard I. *Veterinary Immunology*. 9th ed. St. Louis: Elsevier Health Sciences; 2013.

## REFERENCES

1. Wilson AD. *Parasite Immunol*. 2014;36:558.
2. Cartwright S, et al. *Can J Anim Sci*. 2009;89:158.
3. Thompson-Crispi KA, et al. *J Dairy Sci*. 2012;95:401.
4. Onda K, et al. *Vet Rec*. 2008;163:418.
5. Holzhauser M, et al. *Vet Rec*. 2004;154:208.
6. Senturk S, et al. *Vet Rec*. 2012;170:566.
7. Oryan A, et al. *Comp Clin Path*. 2010;19:179.
8. Herder V, et al. *Vet Microbiol*. 2012;155:420.
9. Hurcombe SD, et al. *JAVMA*. 2007;231:267.
10. Alcott CJ, et al. *J Vet Emerg Crit Care*. 2010;20:616.
11. Qureshi TA, et al. *Int J Pharmacol*. 2006;2:357.
12. Rendle DI, et al. *Equine Vet Educ*. 2010;22:616.
13. Roberts HA, et al. *Vet Dermatol*. 2014;25:124.

## CASEOUS LYMPHADENITIS OF SHEEP AND GOATS

### SYNOPSIS

**Etiology** *Corynebacterium pseudotuberculosis*

**Epidemiology** Disease of sheep and goats.

Source of infection is discharge from pulmonary or skin abscesses. Infection is through intact skin or skin wounds. Transmission in sheep occurs at shearing and dipping in sheep and in goats and sheep by direct contact.

**Clinical findings** Abscesses in superficial lymph nodes. Respiratory or wasting disease associated with internal abscesses.

**Clinical pathology** Enzyme-linked immunoabsorbent assay (ELISA) tests can be used to determine flock status, but sensitivity and specificity are inadequate to provide reliable identification of infected individuals.

**Necropsy findings** Abscesses in lymph nodes and internal organs.

**Diagnostic confirmation** The clinical and necropsy features are typical. Confirmation is by bacterial culture.

**Treatment** Surgical for superficial abscesses.

**Control** Culling of abscessed sheep or based on serologic testing, hygiene at shearing, avoidance of management risk factors, vaccination.

## ETIOLOGY

*Corynebacterium pseudotuberculosis* is the specific cause of the disease. Ovine/caprine isolates are largely a clonal population, distinct from the equine/bovine biotype.<sup>1</sup> Both biotypes produce an exotoxin, phospholipidase D, which functions as a sphingomyelinase and is an immunodominant antigen. Variation in toxin production between strains may be related to differences in pathogenicity. The toxic lipid cell wall

mediates resistance to killing by phagocytes and is also a virulence factor.

*C. pseudotuberculosis* is also the cause of ulcerative lymphangitis of cattle and horses and contagious acne of horses, but these have been discussed as separate diseases because they appear to have a separate pathogenesis and do not occur in association with caseous lymphadenitis.

## EPIDEMIOLOGY

### Geographic Occurrence

Caseous lymphadenitis occurs in the major sheep-producing countries in the world, including Australia, New Zealand, South Africa, the Middle East, North and South America, the United Kingdom, and most of northern and southern Europe. The disease did not occur in the United Kingdom and the Netherlands until the importation of infected goats in the late 1980s but subsequently spread to be an important disease in both countries.

### Host Occurrence

Caseous lymphadenitis occurs in sheep and goats.

### Sheep

Caseous lymphadenitis increases in prevalence with age and reaches a peak incidence in adults. In one Australian population of unvaccinated sheep the frequency of infection at slaughter was 3.4% for lambs and 54% for adult ewes, and a similar prevalence has been recorded in North and South America. In another large study of mature sheep in Australia the overall prevalence of lesions at slaughter was 26%, with carcass lesions in 20.4% of sheep and offal lesions in 9.5%. The prevalence of infection in ewes culled for age in Western Australia fell from over 50% in the 1980s to approximately 25% in the early 2000s, which was suggested to be partly a result of cessation of compulsory dipping for lice during this period. Following introduction to British flocks in the late 1980s, outbreaks increased to a peak in 1998 but have since decreased. Examination of isolates during this period suggested that all were related to the initial introduction. A serologic survey of 745 flocks showed an overall prevalence of seropositive animals of 10%, with 18% of flocks sampled having one or more positive animals.

### Goats

Prevalence of lesions in goats tends to be lower than for sheep. In domesticated goats an overall prevalence rate of 8% is recorded in the United States, with a similar prevalence recorded in feral goats in Australia. As with sheep, prevalence increases with age and can be as high as 22% at 4 years of age. The assessment of prevalence in goats based on the presence of abscess is complicated by the fact that a significant proportion of abscesses in goats may be

produced by *Arcanobacterium (Trueperella) pyogenes*.

### Source of Infection

The primary habitat of *C. pseudotuberculosis* is in infected animals. Sources of infection are the discharges from ruptured abscessed superficial lymph nodes and the nasal and oral secretions from animals with pulmonary abscesses draining into the bronchial tree. The organism can survive in pus-infected soil for up to 8 months, in infected shearing sheds for approximately 4 months, and on straw, hay, and other fomites for up to 2 months, but it is not easily isolated from the soil of infected premises. Low temperatures and moist conditions prolong survival time, and infectivity persists in sheep dips for at least 24 hours.

### Transmission

Infection of an animal is facilitated by the presence of skin wounds, but the organism can invade through intact skin. Transmission is by direct contact with infective discharges or contaminated shearing equipment, contaminated shearing shed boards or holding pens, contaminated dipping or shower fluids, or dust from contaminated shearing sheds and yards.

### Risk Factors

#### Sheep

Most studies on risk factors have been conducted in Australia, and observed risk factors may not always apply to management systems in other countries.

#### Age and Sex

There is a higher prevalence in older sheep, which probably reflects greater exposure to risk factors such as shearing and dipping. In the United Kingdom a disproportionate number of rams are infected, and there is a significant prevalence of infection in terminal sire breeds, which are an important vector to otherwise closed flocks. The prevalence in rams may be related to the high stocking rate at which rams are kept for most of the year and fighting behavior with transmission through head wounds.

#### Breed

All breeds are susceptible, but in New Zealand, which has a mix of fine wool and meat sheep breeds, the prevalence of disease is higher in Merino and Merino-cross breeds. This may relate to greater susceptibility to skin damage at shearing because of their finer skin and the presence of neck wrinkles. In the United Kingdom, infection was initially more prevalent in terminal sire breeds but subsequently spread to hill and upland flocks.<sup>2,3</sup>

#### Shearing

Shearing is a major risk factor in sheep; in general, infection rates increase with the

number of times sheep have been shorn. When spread occurs, it occurs mostly within groups of sheep shorn together. Sheep may be infected by transfer of pus from abscesses discharging or cut at shearing, via shearing combs, but spread from sheep with discharging pulmonary abscesses to sheep with skin cuts is considered more important.

Close contact of recently shorn sheep in any circumstance may facilitate transmission through contact between infected respiratory secretions and susceptible skin. Sheep are commonly in close contact in collecting pens immediately following shearing, or before dipping, and infected nasal and oral secretions can be deposited directly onto shearing cuts. Keeping sheep under cover for more than an hour after shearing increases the odds for spread.

Poor hygiene in the shearing shed, allowing contamination of shearing boards and holding pens, may facilitate infection of sheep. Movement of infection between flocks can occur through contamination of shearing equipment, mobile shearing sheds, or dips and infection on the clothing of shearers. Contract shearing has been shown to be a risk factor in the United Kingdom.

#### Dust

Dust from contaminated yards may transmit infection to recently shorn sheep, although epidemiologic studies suggest that environmental contamination is not a major risk factor for disease in Australia.

#### Housing

Close contact associated with high stocking rates at pasture or indoor housing for much of the year may lead to high rates of infection. The difference in lesion distribution between sheep in the United Kingdom and Australia is believed to be the result of close contact at shared feed troughs under conditions of intensive husbandry in the United Kingdom.

#### Dips

The organism can persist in reused (plunge dip) or recycled (shower dip) fluids used for ectoparasite control. As few as 25 organisms/mL in the dip can produce infection. Sheep dipped in infected dipping fluid within a few days of having been shorn are especially susceptible to infection because of the ease of contact between the bacteria and the skin, but spread can also occur through dipping sheep shorn 6 months previously. In an experimental study in which infection-free sheep were shorn and exposed to artificially contaminated dips at 0, 2, 4, 8, and 24 weeks after shearing, a larger percentage of the sheep dipped immediately after shearing seroconverted and had lymph node lesions at slaughter. However, lesions also were present at slaughter in sheep dipped 2 or more weeks after shearing, and there was no significant difference in their prevalence in the groups dipped at 2 to 24 weeks after

shearing. This supports the observation that infection can occur through intact skin, possibly in the case of dip-associated infections, influenced by loss of wool grease because of wetting agents in the dip. Shower dipping of sheep immediately after shearing also significantly increases the odds of a high incidence of caseous lymphadenitis.

Although shearing and dipping are important risk factors, disease can also be transmitted from sheep with pulmonary abscesses to nonshorn sheep by aerosols.

#### Goats

Shearing is not a risk factor, other than with Angoras. The difference in abscess distribution in goats compared with sheep, with a predominance in the head, neck, and sternum in goats, suggests that contact, fomites, and trauma are important vector mechanisms. Social contact, head butting, trauma from browse, and the use of common neck collars and feed troughs are probable risk factors. Pulmonary abscesses are not as prevalent in goats as in sheep and may be of lesser importance as a source of infection.

With both sheep and goats, contamination of soil on bedding grounds, in yards, or in shelters may result in persistence of the organism in the environment for periods significant to the transmission of the disease and can result in infection of wounds created by docking and castration and infection in the region of the sternum.

#### Economic Importance

In the majority of young infected animals there is no overt clinical disease or impairment of health other than visible abscessation, but the disease is of considerable economic importance to the sheep and goat industries. In sheep, infection has been associated with a 6.6% reduction in clean fleece weight in the first year of infection and a reduction in growth rate. Infection is a significant cause of condemnation of carcass for human consumption, with condemnation rates as high as 3% to 5% for mutton carcasses and 0.02% to 0.03% for lamb carcasses. Condemnation rates and economic loss vary depending on the country, with differences in the number of abscessed lymph nodes dictating condemnation rather than carcass trimming.

In goats the hide can represent a significant proportion of the value of the carcass, and blemishes produced by infection markedly reduce hide value.

Clinical disease occurs in animals with the disseminated visceral form, which is a cause of reproductive inefficiency, a major cause of the thin ewe syndrome, and a cause of death and culling in older sheep in infected flocks.

#### Zoonotic Implications

Human infection is rare, produces a lymphadenitis with a long and recurrent course,

and is an occupational disease of shearers and abattoir workers with infection occurring through cuts. *C. pseudotuberculosis* may be present in the milk of goats from udders where the mammary lymph node is affected.

#### PATHOGENESIS

Multiple microscopic abscesses develop in the draining lymph node by 1 day after experimental infection in the skin, and between 3 and 10 days of infection these coalesce to form typical pyogranulomas. The sphingomyelin-specific phospholipidase D exotoxin produced by the organism is believed to facilitate spread of infection by promoting leakage of plasma from small blood vessels at the site of infection, with flooding of lymphatic spaces. Abscesses develop in 60% to 80% of infected sheep. The high lipid content of the bacterial cell wall gives resistance to the digestive enzymes of the phagocyte, and the organism persists as a facultative intracellular parasite.

The reduction of wool growth in the first year of infection probably results from the catabolic effects of cytokine and toxic metabolites released during the acute inflammatory and immune response to initial infection.

Hematogenous spread of the organism results in abscess formation in many organs, and these may occur in the absence of peripheral lesions. Up to 25% of affected sheep at abattoirs are recorded as having lesions only in thoracic viscera. This tendency for a high incidence of lesions in the lung appears to be general, but prevalence varies considerably between geographic areas. The abdominal visceral and somatic tissues are also commonly affected. Less commonly, hematogenous infection occurs in young lambs to produce septicemic disease.

#### CLINICAL FINDINGS

There is palpable enlargement of one or more of the superficial lymph nodes. Those most commonly affected are the submaxillary, preescapular, prefemoral, supramammary, and popliteal nodes (Fig. 11-5). The abscesses commonly rupture, and creamy to caseated pus, with no odor, is discharged. Goats have a much greater proportion of lesions in the lymph nodes draining the head, related possibly to superficial injury during browsing. Abscesses may subsequently develop in other lymph nodes. In the United Kingdom, clinical signs of infection in sheep are most commonly associated with the superficial lymph nodes of the head and neck, although in one study over 30% of sheep were found to have visceral lesions.<sup>4</sup> Both sheep and goats may also show abscess in the skin, particularly of the face, with loss of overlying hair.

In cases in which systemic involvement occurs, chronic pneumonia, pyelonephritis, ataxia, and paraplegia may be present, depending on the site of infection. The debilitating disease of adult ewes commonly





Fig. 11-5 Cheviot ewes with caseous lymphadenitis of the submaxillary lymph nodes.

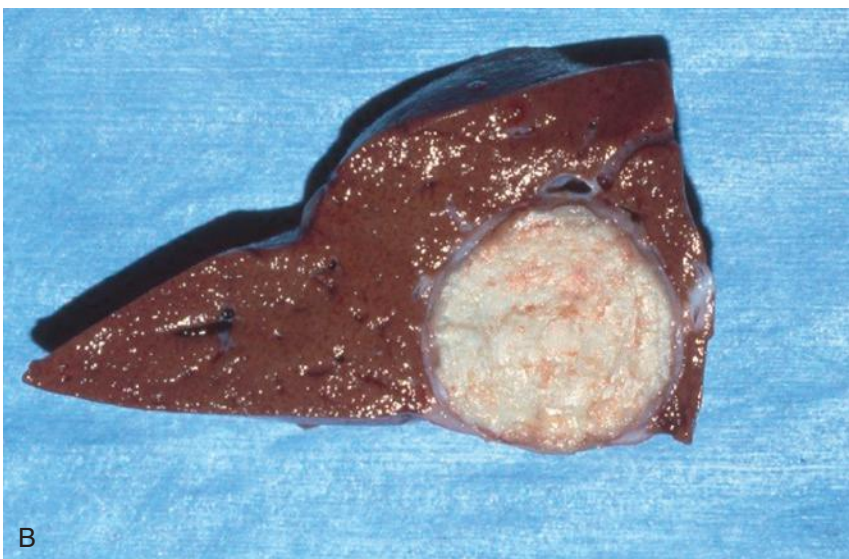
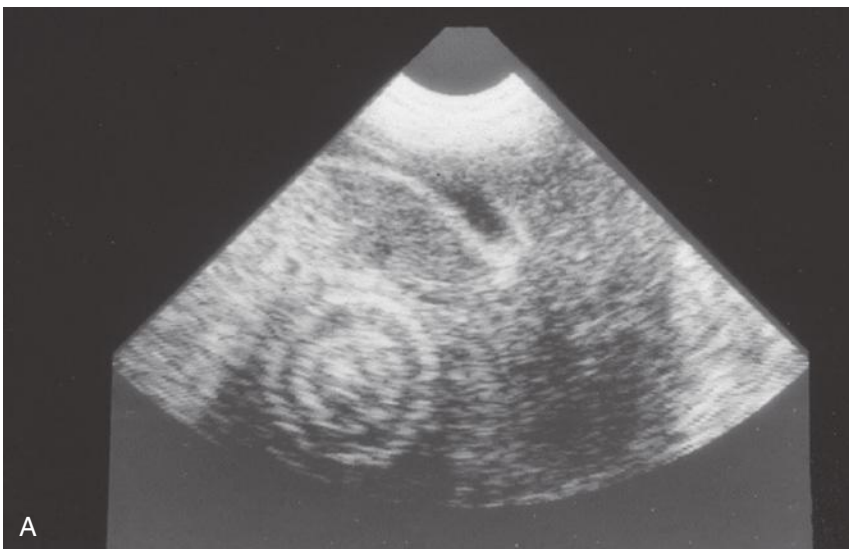

Fig. 11-6 A, Ultrasonographic image of a liver abscess identified using a 5-MHz sector transducer. The characteristic "onion peel" appearance is highly suggestive of the presence of a *Corynebacterium pseudotuberculosis* abscess (caseous lymphadenitis). B, Cross-sectional image of the liver from the same sheep obtained at necropsy. Images graciously provided by D. Michael Rings, USA.

referred to as thin ewe syndrome is often associated with the occurrence of internal abscesses (81% of ewes), many of which contain *C. pseudotuberculosis* (86%). Other bacteria, especially *Moraxella* spp., are also commonly present. In ewes, local spread from the supramammary lymph node to the mammary tissue is common. The resulting fall in milk yields leads to poor growth and even death of lambs, and this may be a serious economic feature in badly affected flocks. Intrascrotal lesions are common in rams but do not involve the testicles or semen.

### CLINICAL PATHOLOGY

There is an increase in blood lymphocytes and neutrophils.

*C. pseudotuberculosis* can be cultured from pus obtained by needle biopsy or by transtracheal wash.

Serologic tests that have been used in serodiagnosis include indirect hemagglutination, hemolysis inhibition, synergic hemolysis inhibition, immunodiffusion, and ELISA tests to detect antibody to cell-wall antigens or to the phospholipase exoenzyme. Many of these tests have good specificity but few have high **specificity and sensitivity**. Some have been used to determine flock infection and have been used in eradication schemes.<sup>2,3</sup> As yet, none is sufficiently reliable to confidently detect infection in individual sheep. The sensitivity of equivalent tests in goats is generally higher, and they are used for official control schemes in goats in some countries, such as the Netherlands.

Radiography and ultrasonography may be useful diagnostic tests in sheep and goats with chronic weight loss and no enlarged external lymph nodes. Radiographs of the thorax may reveal the presence of abscesses in the mediastinal lymph nodes. Ultrasonography of the abdomen may reveal the presence of one or more liver or kidney abscesses. Classic ultrasonographic signs of caseous lymphadenitis abscess is an "onion peel" abscess, which is particularly easy to image in liver parenchyma (Fig. 11-6).

### NECROPSY FINDINGS

Caseous abscesses filled with greenish-yellow pus occur chiefly in lymph nodes and to a lesser extent in internal organs. In the early stages the pus is soft and pasty, but in the later stages it is firm and dry and has a characteristic lamellated appearance. Locally extensive bronchopneumonia, with more fluid pus of a similar color, may also be present. Microscopically, nodal architecture is effaced by the abscess. As the lesion expands, the limiting fibrous wall keeps re-forming, creating the "onion-skin" layering noted grossly.

### Samples for Confirmation of Diagnosis

- Bacteriology—lymph node, lung, culture swab from outer portion of abscess (CULT)

- Histology—formalin-fixed lymph node (LM)

### DIFFERENTIAL DIAGNOSIS

Melioidosis  
Tularemia  
Other causes of pneumonia in small ruminants  
Lymphosarcoma (rare)

Suppurative lymphadenitis in lambs has also been found to be associated with infection with *Pasteurella multocida*, and a disease characterized by the presence of yellow-green pus in abscesses situated in close proximity to the lymph nodes of sheep is associated with a gram-positive micrococcus. The latter disease occurs in France and Kenya and is referred to as **Morel's disease**.

### TREATMENT

The organism is susceptible to antibiotics other than the aminoglycoside group, but treatment is not usually attempted because the abscess is encapsulated, the organism is intracellular, and response is poor. Subcutaneous abscesses can be treated with surgical drainage or extirpation.

### CONTROL

#### Culling

A measure of control can be achieved by culling all animals with enlarged lymph nodes. Although this is a logical procedure, it is worth noting that it is not capable of detecting early lesions or of detecting those animals with internal abscess but no external abscesses. Ideally, control would be by the identification and culling of infected animals using serologic testing. Culling on the basis of serologic tests has been used in goat herds in the Netherlands, small pedigree flocks in the United Kingdom, and a larger flock of 1000 sheep in Scotland.<sup>2,3</sup> The increased sensitivity and specificity of current ELISA tests (87% to 93.5% and 98%, respectively) makes this a feasible strategy, although large numbers of seropositive sheep may be detected and require culling (e.g., 159 following 9 tests in a flock that originally had 108 sheep).<sup>2,4</sup> Thus, the cost-effectiveness of test and cull, as opposed to control using vaccination, will be marginal unless the test-and-cull strategy is supported by other funding.<sup>2,3</sup>

#### Control of Spread

The Mules operation is being gradually phased out in Australian flocks, but all docking implements, ear-taggers, and shears used for this procedure should be dipped in strong disinfectant before each use. Similar attention should be given to the combs and cutters at shearing time. There should be good hygiene and disinfection in the shearing shed, especially of the shearing board and holding pens. Mobile shearing trailers

should be cleaned and disinfected between farms. The importance of personal hygiene should be impressed on shearers, and farm-specific overclothing should be provided if possible. Younger age groups should be shorn first, rams second to last, and any sheep with palpable lesions last. Pus spilled on the shearing floor should be cleaned up and the area disinfected. All shearing cuts should be disinfected. There can still be a high abscess rate in flocks that practice these control procedures.

Close contact of sheep following shearing should be avoided. All efforts must also be directed to avoid contaminating dipping fluid; one discharging abscess is capable of contaminating an entire tank of fluid. Dipping after shearing may be undesirable in badly affected flocks. The addition of an efficient bactericidal agent to the dipping fluid is worthy of consideration.

Goat housing should be free of wire or other causes of skin trauma, and communal use of equipment such as neck collars should be avoided. External parasites must be controlled. Goat herds that are free of the disease should avoid the purchase of animals from herds with a history of abscessation.

### Vaccination

Vaccines formulated from concentrated, formalin-inactivated *C. pseudotuberculosis* culture supernatants containing phospholipase D have considerable efficacy and are available in many countries. Attenuated mutant vaccines also show promise. Vaccination does not provide complete protection against the development of abscesses, but controlled field trials show a significant reduction in the number of sheep that develop abscesses and a reduction in the number of abscesses in infected sheep. Vaccinated sheep have fewer lung abscesses than unvaccinated sheep, in one study 96% fewer, and are less likely to spread infection from this source. Compliance with the recommended full course of the vaccine has an important influence on the efficacy of vaccination. An Australian study showed that flocks that followed the recommended protocol of two priming doses to lambs with yearly boosters to adult sheep throughout their life had an average slaughter prevalence of infection in sheep of 3%, whereas the average prevalence of lesioned sheep at slaughter from flocks that only partially followed this protocol, by administering a single dose to lambs or not giving yearly boosters to adult sheep, varied from 22% to 33%.

Immunity to caseous lymphadenitis is believed to be associated with antitoxin activity and primarily cell mediated, but colostral immunity will protect against experimental challenge at 6 weeks of life. Colostral immunity will also affect the development of immunity from vaccination, and lambs in flocks with a high prevalence of

caseous lymphadenitis should not be vaccinated at less than 10 weeks of age.

Vaccination appears less successful in goats, and although it protects against experimental challenge and spread of the organism from the site of infection, there has been little protection from natural infection in field trials.

### PREVENTION

All potential introductions to a flock should be examined clinically for evidence of disease. Although this is not a particularly sensitive method of detection of infection, obvious clinical cases will be detected. Determining the infection status of the source flock is a safer procedure, and if high-level control or eradication is an aim, purchases should be direct and not through markets. The ultimate method of prevention would include serologic testing of individual animal introductions when tests with very a high sensitivity become available.

### ERADICATION

Eradication is reported in endemically infected flocks by initial culling of all sheep with clinical signs and subsequent serologic testing and culling of reactors. In one case, seropositive ewes were allowed to lamb before culling but lambs were removed at birth, isolated from the infected dams, and fed cow's colostrum and milk replacer. These procedures were coupled with rigorous disinfection of facilities, removal of bedding and topsoil from barns and pens, isolation of seronegative sheep for 6 months from previously used pastures and tracks, and hygiene at skin-damaging management procedures. Serologically positive sheep were not detected after the second screening.<sup>5</sup> Attempted eradication in an extensively managed hill flock in Scotland eliminated clinical disease for 2 years following eight tests during a test-and-cull program using an improved ELISA that lasted 2 years, although two seropositive sheep were detected at the last test.<sup>3</sup>

Total herd or flock eradication and replacement with infection-free animals is also possible, but there is a risk of reintroduction of the disease given that the sensitivity of the current ELISA tests used for screening is only around 90%. The sensitivity and specificity of a bulk milk ELISA were 41.4% and 81.7%, respectively, and thus the screening of bulk milk may be a cost-effective way of initially detecting caseous lymphadenitis infection in dairy goats.<sup>6</sup>

### FURTHER READING

- Bird GJ, Fontaine MC. *Corynebacterium pseudotuberculosis* and its role in ovine caseous lymphadenitis. *J Comp Pathol.* 2007;137:179-210.
- Radostits O, et al. Caseous lymphadenitis of sheep and goats. In: *Veterinary Medicine: A Textbook of the Diseases of Cattle, Horses, Sheep, Goats and Pigs.* 10th ed. London: W.B. Saunders; 2007:795-798.
- Windsor P. Caseous lymphadenitis in small ruminants. *Vet Clin North Am Food A.* 2011;27:193-202.



## REFERENCES

1. Connor KM, et al. *Vet Res.* 2007;38:613.
2. Baird GJ, Malone FE. *Vet Rec.* 2010;166:358.
3. Voigt K, et al. *Small Ruminant Res.* 2012;106:21.
4. Bastos BL, et al. *Vet Clin Pathol.* 2011;40:496.
5. Schreuder BE, et al. *Vet Rec.* 1994;135:174.
6. Nagel-Alne GE, et al. *Vet Rec.* 2015;176:173.

## BOVINE FARCY

Bovine farcy, a chronic infectious disease affecting the lymph nodes of Zebu cattle; it is endemic in sub-Saharan Africa but has been reported in 19 countries in Africa, Asia, Latin America, and the Caribbean.<sup>1-2</sup> In Africa, the disease is caused by *Mycobacterium farcinogenes* in the eastern and central regions and *M. senegalense* in the western region. Both species are rapidly growing, gram-positive, branching, and acid-fast mycobacteria. It is not yet certain whether *Nocardia farcinica* in other parts of the world causes cutaneous nocardiosis (farcy) in animals that mimics bovine farcy.<sup>1-2</sup>

Epidemiologic data indicate that bovine farcy occurs in adult cattle of the transhumance pastoralist tribes of the Sahel and Sudanian savannah zones. In some areas, 25% to 30% of cattle used to be affected, but the disease has disappeared from many countries where it was once a problem.<sup>1</sup> Other domestic and nondomestic animals are not affected. It is not known whether the bacteria are zoonotic, even though an earlier study indicated that the human pathogen *Mycobacterium peregrinum* type II belongs to the species *M. senegalense*.<sup>3</sup> Ixodid ticks, including *A. variegatum*, may play a role in disease transmission; breeds of cattle resistant to ticks (e.g., the N'Dama) are resistant to farcy.<sup>1</sup>

Bovine farcy causes some economic losses as a result of damaged hides and also as a public health burden because the lesions resemble those of bovine tuberculosis in carcasses, and thus the meat from affected animals is considered inappropriate for human consumption. For example, in a study involving 6680 bovine carcasses in Sudan, 400 caseous lesions were identified, only 12 of which were a result of bovine tuberculosis, whereas 59 were caused by bovine farcy.<sup>4</sup>

The clinical diagnosis of bovine farcy in the late stage of the disease is not difficult because the cordlike nodular lesions in the skin and lymphatics are almost pathognomonic. Laboratory diagnosis is by conventional smears stained with acid-fast stain and by culture. Molecular and serologic tests developed still need to be evaluated for sensitivity and specificity, but the ELISA can be used to support early clinical diagnosis, in epidemiologic surveys, and for screening before animals are exported to farcy-free regions.<sup>5</sup>

The disease is slowly progressive, and lesions occur in superficial lymph nodes,

mostly in the prescapular and precrural lymph nodes. Affected lymph nodes suppurate, and there is induration of the lymphatic vessels. There can be infection in the mesenteric lymph nodes, with some cases having lesions in the udder or the lung. Lesions are common in areas of the body where *A. variegatum* ticks attach. Histologic examination shows a severe granulomatous reaction characterized by lymphocyte, macrophage, epithelioid, and giant-cell infiltration, along with marked fibrous proliferation. The agent can be detected in tissue sections by acid-fast staining and by PCR techniques.<sup>4</sup>

Treatment is not recommended and there is no vaccine. Most cases are detected at slaughter.

## FURTHER READING

- Hamid ME. Epidemiology, pathology, immunology and diagnosis of bovine farcy: a review. *Prev Vet Med.* 2012;105:1.
- Hamid ME. Current perspectives on *Mycobacterium farcinogenes* and *Mycobacterium senegalense*, the causal agents of bovine farcy. *Vet Med Int.* 2014;247906. doi:10.1155/2014/247906; [Epub 2014 April 30].

## REFERENCES

1. Hamid ME. *Prev Vet Med.* 2012;105:1.
2. Hamid ME. *Vet Med Int.* 2014;247906. doi:10.1155/2014/247906; [Epub 2014 April 30].
3. Wallace RJ Jr, et al. *J Clin Microbiol.* 2005;43:5925.
4. Asil el TA, et al. *Trop Anim Health Prod.* 2013;45:469.
5. El Hassan HA, Hamid ME. *Epud.* 2008.

## SPORADIC LYMPHANGITIS (BIGLEG, WEED)

Sporadic lymphangitis is also called Monday morning disease. It is an uncommon occurrence. It can affect any breed of horse but particularly heavy draught horses. It usually affects single horses, but occasionally outbreaks do occur. There are a few predisposing factors. The most frequent one is rest from work and exercise for 1 to 3 days. Another suspected factor is a change from a low-quality diet to a diet high in protein, such as peas or beans. Both of these may lead to a slowing down of lymphatic flow in the limbs, facilitating ingress of any bacteria trapped on the legs in small wounds or cracks. Dirty stables may also predispose, although the condition is seen in very hygienic stables at times. Continual wet weather may also be a predisposing factor.

This is a noncontagious disease of horses characterized by acute fever, lymphangitis, and severe swelling of one or both hindlegs—forelimbs are rarely, if ever, affected. The disease commences abruptly with fever (40.5° to 41°C; 105° to 106°F), shivering, and a rapid pulse rate and respiration. Horses are usually very thirsty. The mouth may be hot and the mucous membranes injected. Lameness rapidly results. Pain in the acute disease can be severe. There is severe pain on palpation of the affected leg, and lameness

may be so severe that the horse may refuse to put its foot to the ground. The limb is swollen and hot; the swelling extends from the top of the leg and down to the coronet. There is cording of the lymphatics on the medial aspect of the leg and palpable enlargement of the lymph nodes in some horses. There may be exudate on the skin. Affected legs may pit under pressure. The horses may show perspiration. The acute disease may last only 1 to 3 days, and recovery or conversion into a chronic phase with persistent and variable swelling of the leg, intermittent fever, and variable lameness follows. Occasionally abscesses develop in the lymph nodes and vessels, but usually there is no localization of the infection. There is a tendency for the disease to recur and cause chronic fibrotic thickening of the lower part of the limb extending to the level of the stifle in many horses. Swelling of the leg is often exacerbated by late pregnancy.

Horses that have had one attack appear to be prone to further attacks. Recurrences produce a “thick leg,” which is not a result of fluid but of connective tissue.

Sporadic lymphangitis can be associated with superficial wounds and ulcers on the lower parts of the limbs, but often there are no wounds detected. The disease is thought to develop as a lymphangitis and, potentially, lymphadenitis of the deep inguinal nodes as a result of these wounds. The affected lymph nodes and swelling of the limb obstruct lymphatic and venous drainage, causing lymphatic obstruction, edema, and, in some cases, cellulitis. Ultrasonographic examination reveals distended lymph vessels that contain fluid that is not echogenic. Ultrasound guided aspiration of this fluid yields fluid with a low total protein concentration and mild neutrophilia (high proportion of the cells present in the fluid are neutrophils, although the absolute count is usually less than  $1.0 \times 10^9$  cells/L).

Culture of the fluid is recommended. *Actinobacillus* spp., *Staphylococcus*, *Streptococcus*, *Pasteurella*, *Pseudomonas*, *Fusobacterium*, and *Nocardia* have been isolated at times. In many cases there are negative culture results, possibly because the causative agent is difficult to culture, but in some cases *Corynebacterium pseudotuberculosis* has been isolated, and this appears to be a seasonal occurrence in the late summer and autumn in the United States. The clinical significance of results of culture of the fluid is unknown, but results could be used to guide choice of antibiotics. Radiographic examination is usually unremarkable, apart from demonstrating soft tissue swelling. Affected horses, in both the acute and chronic stages, have mild neutrophilia and hyperfibrinogenemia.

It is a difficult disorder to treat effectively. Acutely affected horses should be treated aggressively. The principles of treatment are control of the presumed infection, reduction



of inflammation, and reduction of swelling. Penicillin or other antimicrobials should be administered parenterally to control the infection. Infection with *Corynebacterium* requires Rifampin. NSAIDs (flunixin is the first choice, but also phenylbutazone, meglumine, carprofen, or similar) should be administered to control the inflammation and provide pain relief. The limb should be hosed with cold water once to twice daily to reduce heat and provided with gentle massage therapy. Manual massage of the limb might be beneficial. Supportive, compressive bandaging of the limb can reduce the swelling. The horse should be exercised as much as is practical and humane.

Horses with chronic disease should be treated with prolonged courses of antimicrobials (penicillin, sulfonamide–trimethoprim combinations, enrofloxacin, or rifampin in combination with sulfonamide–trimethoprim), nonsteroidal drugs, and local therapy. Acute exacerbations can be managed by administration of dexamethasone (40 µg/kg orally or parenterally, once daily for 5 days, and then gradually tapering). This dose is not abortifacient in pregnant mares. Exercise and supportive bandaging are important in minimizing the swelling. The chronic disease requires prolonged and intermittent therapy, often for the rest of the horse's life.

Differential diagnoses include cellulitis (inflammation of the connective tissues) and ulcerative lymphangitis. Ulcerative lymphangitis is often accompanied by cording of the lymphatics, the formation of hard nodules, and the occurrence of abscesses with a discharge of greenish fetid fluid. Epizootic lymphangitis caused by *Histoplasma farciminosum* in Asia and the Mediterranean is a differential diagnosis. In the Middle East, Eastern Asia, Eastern Europe, and North Africa, Glanders is also a possibility. Sporotrichosis (*Sporothrix schenckii*) lymphangitis can also be a differential diagnosis.

Prevention of the disease necessitates prompt and careful treatment of all wounds of the lower limbs. Provision of daily exercise, restriction of the diet during prolonged rest periods, and dry standing in the stable also help to prevent the disease. Animals compelled to stabling should have a reduced diet, with corn being replaced by bran mash. The legs should be kept clean and disinfected if animals are stabled. Animals affected with the chronic condition should be kept constantly at reasonable work.

### TICK-BORNE FEVER (ANAPLASMA PHAGOCYTOPHILA)

#### SYNOPSIS

**Etiology** *Anaplasma phagocytophilum*

**Epidemiology** Occurs in the northern latitudes and is transmitted by *Ixodes*

*ricinus* in United Kingdom and Europe and *Ixodes scapularis* and *Ixodes pacificus* in the United States. Disease in sheep and cattle primarily reported from the United Kingdom and Europe. Seasonal occurrence associated with the feeding activity of the vector. More severe disease in naive introduced animals. Increases susceptibility to other infections, especially in sheep.

**Clinical findings** Fever, depression, lethargy, polypnea, and fall in milk production in cattle. Abortion.

**Clinical pathology** Thrombocytopenia followed by more prolonged neutropenia and lymphocytopenia. The organism is demonstrable in the neutrophils and monocytes during each febrile period.

**Diagnostic confirmation** Demonstration of the *A. phagocytophilum* in leukocytes at acute stage of the disease or by serology retrospectively.

**Treatment** Oxytetracycline.

**Control** Oxytetracycline during risk period. Tick control.

### ETIOLOGY

Tick-borne fever (also called pasture fever in cattle) is a tick-transmitted disease of sheep and cattle in the northern hemisphere and is caused by *Anaplasma phagocytophilum* (formerly *Ehrlichia phagocytophila*, *Cytoecetes phagocytophila*, and *Ehrlichia equi*). The genus *Anaplasma* (Rickettsiales: Anaplasmataceae) contains obligate intracellular gram-negative bacteria found exclusively within membrane-bound inclusions or vacuoles in the cytoplasm of both vertebrate and invertebrate (tick) host cells. The genus includes *A. marginale*, *A. centrale*, *A. bovis*, and *A. ovis* which are pathogens of ruminants; *A. phagocytophilum*, which affects a wide range of hosts, including humans, wildlife, and domestic animals; and *A. platys*, which infects dogs.<sup>1</sup> *A. phagocytophilum* replicates primarily in the cytoplasm of neutrophils and is 0.4 to 1.3 µm in size. The life cycle is biphasic, transitioning between the noninfectious reticulate cell that replicates and the smaller dense core form that is infective to mammalian and tick cells.<sup>2-3</sup>

There are strains (variants) of *A. phagocytophila* that have biological and ecological differences, including variations in host pathogenicity, vectors, and geographic distribution. Although the mechanisms for these differences remain largely elusive,<sup>4-5</sup> the type IV secretion system (T4SS) may play a role in strain virulence of *A. phagocytophilum*.<sup>6</sup> In sheep, different variants of *A. phagocytophilum* may exist simultaneously in the same sheep flock.

Tick-borne fever is also used as a name for similar, but less well-defined, diseases of ruminants that are associated with infection with related organisms such as *Anaplasma (Ehrlichia) bovis*. These are reported from

other areas of the world, such as India and Africa, and are transmitted by the ticks *Rhipicephalus appendiculatus*, *Amblyomma variegatum*, and *Hyalomma truncatum*.

Currently, *A. phagocytophilum* is viewed as a single bacterial species capable of infecting a broad range of hosts and is based on 16S rRNA gene analysis.<sup>7</sup> The description that follows is of tick-borne fever of sheep and goats and pasture fever of cattle associated with *A. phagocytophilum*.

### EPIDEMIOLOGY

#### Occurrence

Infection with *A. phagocytophilum* occurs in a wide range of mammalian hosts, including humans, dogs, sheep, cows, horses, wild deer, and rodents. The association of *A. phagocytophilum* with human granulocytic ehrlichiosis in the mid-1990s has led to much activity in defining its geographic occurrence by serologic surveys or detection in ticks by molecular methods. These studies have determined that the organism is present where the host ticks are present in Europe, North America, the Middle East, and Asia.<sup>4</sup> *A. phagocytophilum* is arguably the most widespread tick-borne infection in animals in Europe.<sup>8</sup>

However, the disease tick-borne fever, as opposed to infection, occurs primarily in certain areas of the United Kingdom, Ireland, Norway, Finland, France, Germany, Spain, and Switzerland. Because ticks favor particular optimal environmental conditions, the geographic distribution of the ticks is usually restricted to a specific area (small or large), and tick-borne fever only occurs in these areas. Within these areas infection can be intense; in the endemic coastal area of Norway, close to 100% of sheep grazing *Ixodes*-infested pastures are infected. Tick-borne fever has a **seasonal occurrence** in association with the feeding activity of the vector tick. Infection can be endemic in affected areas.

Sheep, cattle, goats, deer, and reindeer may be infected. The disease has long been known as a disease of sheep but in recent years is being recognized as a common infection in cattle in at-risk areas. The incidence rate of infection is high, but clinical disease may be mild and not easily observed in many areas where this disease occurs because these areas are commonly wild with little human habitation and little frequent observation of at-risk livestock. Infection, as determined by seropositivity, can occur in sheep that have had no clinical evidence of disease because of the existence of variants with low pathogenicity. The disease in horses, previously known as Equine Granulocytic Ehrlichiosis, is described separately in this chapter as “Equine anaplasmosis”.

#### Source of Infection and Transmission

In Europe, *A. phagocytophilum* is transmitted by the three host tick *Ixodes ricinus*,

which requires a single blood meal at each stage of development. The tick feeds for approximately 3 weeks every year and completes its life cycle in 3 years. The larval and nymphal stages will feed on any vertebrate, but the adult female will engorge and mate only on larger mammals.

*A. phagocytophilum* infects and multiplies in the epithelium of the midgut and salivary glands of ticks, from which it is transmitted to vertebrate hosts during feeding. A tick becomes infected by feeding on an infected host, and there is **transstadial** but not transovarial passage of the organism. It is estimated that the majority of ticks are infected with the organism in enzootic areas, and one former study of ticks from a field site found 44% of nymphs and 32% of adults infected but no infected larval stages. There is a close relation between tick density and the proportion of sheep and ticks infected with *A. phagocytophilum*, but it is nonlinear and complex.

In the United States, *Ixodes scapularis* has been implicated in transmission of the organism in eastern United States and *Ixodes pacificus* on the West Coast, as have *Ixodes persulcatus* and *Haemaphysalis longicornis* in Asia, but clinical disease in ruminants is not a feature in these locations.

Few cases of **congenital infection** of calves have been reported,<sup>9</sup> and the organism is also present in leukocytes in **milk** during the acute phase of the disease, but the significance of this in the epidemiology of the disease is not known.

As few as one *A. phagocytophila*-infected cell may be enough to transmit infection, and use of a single needle between sheep in a group could possibly transmit infection.

It has been suggested that the presence of ticks in migratory birds could spread infection of this agent to other geographic regions.<sup>10-11</sup>

### Experimental Reproduction

The disease can be readily reproduced experimentally. The severity of the clinical response of sheep following experimental infection is not dose dependent, and there is no dose effect on the degree of bacteremia or neutropenia.

### Host Risk Factors

Calves and lambs are much more susceptible than adults, although clinical disease may be less severe in very young lambs, possibly because of the mitigating effects of colostral antibody. Hyperimmunization of the pregnant ewe will produce high levels of colostral antibody that will protect the lamb against experimental challenge. However, in the field, colostral immunity does not protect against infection, and lambs born of ewes raised in endemic areas become infected. Natural infection is followed by a state of low-grade **premunity** as a result of the presence of the organism in the blood, which

provides partial resistance to subsequent infections, with the disease manifesting itself in a less severe form. Once infected, animals probably remain carriers for life and act as reservoirs of infection for new generations of ticks.

The case-fatality rate is very low, and most reported mortality is in association with **intercurrent disease**. A significant indirect effect of tick-borne fever is that it increases the susceptibility of lambs to **staphylococcal pyemia**, **staphylococcal pneumonia**, septicemic and pneumonic **pasteurellosis**, louping-ill, and possibly other diseases. The mortality rate is negligible in cattle but may be higher in sheep.

### Pathogen Risk Factors

The activity of the tick is seasonal, and consequently tick-borne fever has a seasonal occurrence. The tick is active at temperatures between 7° (44°F) and 18°C (64°F), and most ticks feed in the **spring**, with peak activity dependent on the latitude and elevation of the pasture but generally occurring in April and May. In some areas there is a second period of activity of a separate population of *I. ricinus* in the **autumn** during August and September. Clinical signs in cattle occur predominantly in spring, 1 to 2 weeks after they start to graze.

### Zoonotic Implications

Human granulocytic anaplasmosis (HGA) is associated with *A. phagocytophilum* and was first described in the United States in 1994 and is now regarded as an emerging disease. There are few reports from Europe, Russia, and Japan.<sup>4</sup> Clinical and laboratory findings are fever, myalgia, headache, malaise, thrombocytopenia, leukopenia, anemia, mild hepatic injury, and splenomegaly, with symptoms varying from none to mortality.<sup>12</sup> The disease presents most commonly as an undifferentiated, febrile, potentially severe illness occurring in summer or spring associated with occupational or recreational activities that allow exposure to infected ticks. There is no recognized direct zoonotic risk from exposure to infected animals, but the mammalian reservoir for *A. phagocytophilum* infection within the United States includes several rodents, foxes, and possibly other wild animals. These are infected with the human pathogenic variant (Ap-ha). Other animals, including the white-tail deer, are infected with different strains of the bacterium not infective to humans (Ap-V1).<sup>4,7</sup>

The organism is also present in leukocytes in **milk** during the acute phase of the disease, but the risk to humans consuming infected milk is probably minimal because strains of *A. phagocytophilus* differ in host infectivity.<sup>4</sup>

### PATHOGENESIS

*A. phagocytophilum* infects and replicates within the **neutrophil**, but can also infect

endothelial cells. The organism has evolved the remarkable ability to subvert or hijack the powerful innate antimicrobial defenses of host cells.<sup>4</sup> For example, *A. phagocytophilum* creates an intracellular membrane-bound compartment that allows replication and nutrition in seclusion from lysosomes and thereby suppresses respiratory burst.<sup>13</sup> Furthermore, it subverts the innate immune system of neutrophils by inhibiting apoptosis (through activation of an antiapoptosis cascade) and by inducing autophagy, both to keep the host cell alive and to create a safe haven for replication.<sup>4,14-17</sup> In addition, individual animals that survive acute infection develop persistent infection lasting for several months or even for life. The persistence of infection and recurrent bacteremia is a result of antigenic variation thought to be mediated by the bacterial major surface protein 2 (MSP2/p44).<sup>18</sup> Furthermore, endothelial cells of the microvasculature may play a crucial role in the development of persistence because they may be an excellent site for dissemination of the organism to circulating neutrophils.<sup>19</sup>

Tissue pathology is not associated with direct *A. phagocytophilum*-mediated injury but results from immunopathologic mechanisms associated with activated macrophages and elevation of levels of the proinflammatory cytokine, interferon gamma (IFN- $\gamma$ ), and chemokines.<sup>12,20,21</sup>

Fever develops in association with bacteremia and is the prominent clinical abnormality in the experimental disease. It persists for approximately 8 days, may exceed 41°C (105.8°F), and is accompanied by depression. Although this syndrome is of limited importance in the experimental setting, the occurrence of fever, dullness, and depression of the sucking drive can be a significant influence on the viability of lambs in the cold, wet, rough-grazing areas where this disease commonly occurs and may contribute to **lamb mortality**.

Tick-borne fever produces profound effects on **immunologic defense** systems. By **impairing the function** of neutrophils, the bacterium causes infected animals to become more susceptible to opportunistic infections. There is also a prolonged neutropenia lasting for 2 to 3 weeks combined with a thrombocytopenia. Up to 70% of the neutrophils are infected from the onset of the bacteremia. There is significant lymphocytopenia that develops 6 days after infection and that affects all T- and B-lymphocyte subsets. The **antibody response** of infected sheep to immunogens such as tetanus toxoid is also impaired.

Field observations and experimental challenge have shown that infected lambs are more susceptible to disease and mortality from **intercurrent infections**. The ability of an infection with *A. phagocytophilum* to predispose to secondary disease varies with the strain of the organism, which may explain

why secondary complications are not observed in all flock infections with tick-borne fever. There is a clear relationship between infection with *A. phagocytophilum* and susceptibility to infection with *S. aureus* and the resultant disease **tick pyemia**. This is established both by epidemiologic and experimental studies.

Concurrent infection of sheep with the agent of tick-borne fever potentiates the pathogenicity of **louping-ill** virus in experimental infections, resulting in more severe disease and a higher mortality rate. Both diseases are transmitted by *I. ricinus*. However, in areas where both diseases are endemic, colostral immunity will delay infection of lambs with the louping-ill virus until the second year of exposure to the vector tick while allowing infection with tick-borne fever. Simultaneous primary infection with both agents may be uncommon in nature.

Infection also facilitates invasion and systemic mycotic infection with *Rhizomucor pusillus*, resulting in diarrhea and dysentery and a high mortality rate. Concurrent experimental infection of sheep with *A. phagocytophilum* and *Chlamydia psittaci* results in **chlamydial pneumonia**, and simultaneous infection with parainfluenza-3 (PI-3) virus potentiates the pathogenic effect of PI-3 virus. The immunosuppressive effect of tick-borne fever is believed to have resulted in the exacerbation of latent *Brucella abortus* in a naturally occurring abortion outbreak in cattle. Concurrent infection of tick-borne fever and *Listeria monocytogenes* or *Pasteurella hemolytica* promotes the respective **septicemic disease** in lambs.

## CLINICAL FINDINGS

Disease is generally benign, but infection can produce abortion and can cause significant loss of weight in lambs and calves.

### Cattle

In cattle, there is an incubation period of 5 to 9 days followed by a rise in temperature to about 40.5°C (105°F), which persists for 2 to 12 days and for a longer period in late pregnant cows than in lactating cows. The temperature falls gradually and is followed by a secondary febrile period and, in some cases, yet further episodes of **pyrexia**. During each febrile period there is a marked fall in milk yield, lethargy, polypnea, and, in experimentally produced cases, a mild cough, although feed intake is not reduced. The fall in **milk production** can be severe and may be the first indication of infection.<sup>30</sup> Pregnant cattle in the last 2 months of pregnancy and placed on tick-infested pastures for the first time commonly **abort**, and occasionally animals die suddenly. The abortions occur shortly after the systemic disease. Some calves are born alive, but they are weak and soon die.

In a recent outbreak affecting four dairy cows in Germany, clinical findings included high fever, decreased milk production, lower

limb edema with stiff walking, eye and nasal discharge, and depression. These signs developed about a week after the animals had been brought to the pasture for the first time. All cows recovered after 5 to 15 days, although DNA of *A. phagocytophilum* could be detected by real-time PCR (qPCR) up to 6 weeks after onset of the disease.<sup>22</sup>

### Sheep

In sheep, the syndrome is similar to that observed in cattle, except that respiratory distress is not observed. However, there can be marked differences in clinical manifestation, neutropenia, and antibody response with different variants of *A. phagocytophilum*. An experimental infection of mature sheep in western United States generally resulted in a subclinical disease.<sup>23</sup> Conversely, sheep experimentally infected in the United Kingdom developed primary bacteremia (bacterial DNA) lasting for over 2 weeks and accompanied by fever, followed by secondary and recurrent cycles of bacteremia each lasting for 1 to 3 days without fever.<sup>24</sup> The sheep remained persistently infected for up to 358 days. The red deer may be a reservoir for sheep in Norway.<sup>25</sup>

The reaction in young lambs is quite mild and manifested only by a fever, which fluctuates between 40° (104.0°F) and 42°C (107.6°F) for up to 10 days. Ewes exposed to the disease for the first time commonly experience outbreaks of abortion, and affected rams are temporarily infertile.

Abortion is a major manifestation in northern Spain, whereas in the Scandinavian countries the main consequence of infection is immunosuppression leading to secondary infections with *S. aureus* (tick pyemia) and *P. hemolytica*.

### Goats

Tick-borne fever in goats is characterized by high fever, dullness, and tachycardia.

### Horses

See the section on equine granulocytic anaplasmosis later in this chapter for a description of the disease in horses.

## CLINICAL PATHOLOGY

At the commencement of the fever there is severe but transient **thrombocytopenia**, and this is followed by more prolonged **neutropenia and lymphocytopenia**. The anaplasmae are demonstrable in the neutrophils and monocytes during each febrile period and for a few days afterward in cattle and for several weeks in sheep; they can be detected as **intracytoplasmic inclusion bodies** or **morulas** in Giemsa-stained blood smears and confirmed by electron microscopy or PCR.<sup>26</sup>

Several PCR techniques (conventional, nested, or real-time) for the identification of *A. phagocytophilum* infection in blood and tissue samples have been established, primarily on the basis of the 16S rRNA, groEL,

and p44 genes.<sup>7</sup> In China, the rapid and simple loop-mediated isothermal amplification (LAMP) assay targeting the msp2 gene of *A. phagocytophilum* was found to have a high level of sensitivity comparable to that of nested PCR and qPCR for the detection of the organism in rural human patients.<sup>27</sup>

**Serologic diagnosis** is possible using counterimmunoelectrophoresis, which detects IgM antibody, or indirect immunofluorescence using cytoplasmic preparations of blood granulocytes, which detects IgG. Antibody is at a high level at the second week after experimental infection with both tests and is detectable for 6 to 8 weeks with counterimmunoelectrophoresis and for at least 18 weeks with the indirect fluorescent antibody test. ELISA is also available for serologic diagnosis. A commercial ELISA kit is available for rapid in-house identification of *A. phagocytophilum* antibodies in dogs, but the kit can be used for horses and possibly sheep.<sup>28–29</sup>

Transmission of the disease for diagnosis may be affected by the IV injection of blood taken at the height of the fever.

## NECROPSY FINDINGS

An enlarged spleen, up to 4 to 5 times the normal size, with subcapsular hemorrhages is indicative of tick-borne fever in sheep in endemic areas. Histologically, the only characteristic lesion is a depletion of lymphocytes from lymphoid tissues.

Multifocal leukomalacia (spongy change of white matter) and swelling of oligodendrocytes have been reported in the brain of aborted lambs, probably the result of fetal anoxia.

## DIFFERENTIAL DIAGNOSIS

The geographic restriction of the disease and its relation to tick infestation are diagnostic features, but the clinical signs are quite nonspecific. Lesions attributable to concurrent bacterial, mycotic, and viral infections may overshadow the primary disease in sheep and are more likely to be the cause of death.

The disease in cattle has some similarity to bovine petechial fever (Ondiri disease), associated with *E. ondiri*, which occurs only in Kenya.

## TREATMENT

### TREATMENT AND CONTROL

#### Treatment

Long-acting tetracycline (20 mg/kg IM at early stages) (R1)

Oxytetracycline (10 mg/kg IV daily for 5 days at early stages) (R1)

#### Control

Long-acting tetracycline (20 mg/kg IM to lambs and calves at risk) (R2)



The best results are with **tetracyclines**, although cattle may recover without therapy. In sheep, a single dose of long-acting tetracyclines (20 mg/kg IM) or a 5-day course with oxytetracycline (10 mg/kg IV daily) given during the acute phase of the disease is effective in treatment, but infection is not eliminated in a significant proportion of sheep. In goats, good results are provided by a single dose of oxytetracycline (10 mg/kg BW IV). A potentiated sulfonamide containing trimethoprim and sulfadimidine, and sulfamethylphenazole (20, 50, and 50 mg/kg, BW respectively) were used in the past; ampicillin is ineffective. The *Anaplasma* organisms persist in treated animals, which may subsequently suffer a relapse.

## CONTROL

Control of tick-borne fever depends on control of the tick population. The annual dipping of ewes with organophosphates or synthetic pyrethroid acaricides will help reduce tick numbers, and the double **dipping of lambs** during the tick season will help reduce disease in the lambs but can be difficult to achieve in the terrain and with the management practices of affected areas. Disease is reduced if the flock can be kept off the tick-infested pastures until the lambs are 6 weeks old and if the flock is dipped before introduction to the pasture. In some areas it may be possible to reduce tick numbers by pasture management systems that disturb the pasture microclimate required by the tick. In Norway, frequent pour-on applications of pyrethroids in lambs reduced tick infestation rate but did not reduce the seroprevalence of *A. phagocytophilum* on tick-infested pasture.<sup>30</sup> Furthermore, frequent use of chemical acaricides has led to growing concerns about environmental safety, human health, increasing costs, and increasing resistance of ticks to pesticides. Studies on the biological control of ticks are ongoing. Vaccines against ticks and/or against *A. phagocytophilum* are also being studied.

The disease can be more severe when adult animals are exposed to infection for the first time, and **naive late-pregnant cattle** should not be introduced to tick-infested pastures during the tick-rise periods. A single administration of 20 mg/kg of long-acting tetracycline is reported to provide protection against experimental challenge for periods up to 3 weeks. The prophylactic administration of **long-acting tetracycline** to lambs and to calves during the season of tick activity is reported to reduce mortality and improve growth rates over untreated controls.

## FURTHER READING

- De la Fuente J, et al. Functional genomics and evolution of tick-*Anaplasma* interactions and vaccine development. *Vet Parasitol*. 2010;167:175.
- Rikihisa Y. New findings on members of the family Anaplasmataceae of veterinary importance. *Ann NY Acad Sci*. 2006;1078:438.

- Rikihisa Y. Mechanisms of obligatory intracellular infection with *Anaplasma phagocytophilum*. *Clin Microbiol*. 2011;24:469.
- Rikihisa Y, Lin M, Niu H. Type IV secretion in the obligatory intracellular bacteria *Anaplasma phagocytophilum*. *Cell Microbiol*. 2010;12:1213.
- Severo MS, et al. *Anaplasma phagocytophilum*: deceptively simple or simply deceptive? *Future Microbiol*. 2012;7:719.
- Stuen S. *Anaplasma phagocytophilum*—the most widespread tick-borne infection in animals in Europe. *Vet Res Commun*. 2007;(suppl 1):79.
- Stuen S, et al. *Anaplasma phagocytophilum*—a wide multihost pathogen with highly adaptive strategies. *Front Cell Infect Microbiol*. 2013;3:31.
- Woldehiwet Z. *Anaplasma phagocytophilum* in ruminants in Europe. *Ann NY Acad Sci*. 2006;1078:446.
- Wolderhiwet Z. Immune evasion and immunosuppression by *Anaplasma phagocytophilum*, the causative agent of tick-borne fever of ruminants and human granulocytic anaplasmosis. *Vet J*. 2008;175:37.

## REFERENCES

- Estrada-Pena A, et al. *BMC Biol*. 2009;7:57.
- Troese MJ, et al. *Infect Immun*. 2011;79:4696.
- Kahlon A, et al. *Infect Immun*. 2013;81:65.
- Severo MS, et al. *Future Microbiol*. 2012;7:719.
- Rikihisa Y. *Clin Microbiol Rev*. 2011;24:469.
- Al-Khedery B, et al. *BMC Genomics*. 2012;13:678.
- Stuen S, et al. *Front Cell Infect Microbiol*. 2013;3:31.
- Stuen S. *Vet Res Commun*. 2007;(suppl 1):79.
- Henniger T, et al. *Acta Vet Scand*. 2013;55:38.
- Geller J, et al. *Vector Borne Zoonotic Dis*. 2013;13:443.
- Kang JG, et al. *Vector Borne Zoonotic Dis*. 2013;15.
- Chen G, et al. *Infect Immun*. 2012;89:3194.
- Woldehiwet Z. *Vet J*. 2008;175:37.
- Ayllon N, et al. *Infect Immun*. 2013;81:2415.
- Niu H, Rikihisa Y. *Autophagy*. 2013;9:787.
- Niu H, et al. *Proc Natl Acad Sci USA*. 2012;109:20800.
- Sarkar A, et al. *Infect Immun*. 2012;80:1615.
- Thomas RJ, et al. *Vet Microbiol*. 2013;pii: S0378.
- Wang J, et al. *Med Microbiol Immunol*. 2015;[Epub ahead of print].
- Woldehiwet Z, Yavari C. *J Comp Pathol*. 2014;150:351.
- Choi KS, Dumler JS. *Microbiol Immunol*. 2013;57:207.
- Nieldner M, et al. *Tierarztl Prax Ausg G Grosstiere Nutztiere*. 2012;40:101.
- Gorman JK, et al. *Am J Vet Res*. 2012;73:1029.
- Thomas RJ, et al. *J Comp Pathol*. 2012;147:360.
- Stuen S, et al. *Ticks Tick Borne Dis*. 2013;4:197.
- OIE manual of diagnostic tests and vaccines for terrestrial animals, World Animal Health Organisation 6th ed; 2008; Chapter 2.4.1.
- Pan L, et al. *J Clin Microbiol*. 2011;49:4117.
- Granquist EG, et al. *Vet Immunol Immunopathol*. 2010;133:17.
- Hansen MG, et al. *Acta Vet Scand*. 2010;52:3.
- Stuen S, et al. *Acta Vet Scand*. 2012;54:31.

## ANAPLASMOSIS DUE TO *A. MARGINALE* AND *A. OVIS*

### SYNOPSIS

**Etiology** *Anaplasma marginale*, a rickettsial bacterium in cattle and wild ruminants, and

*A. ovis* in sheep and goats. *A. centrale* causes mild anaplasmosis in cattle.

**Epidemiology** Common in tropical and subtropical regions; sporadic in temperate regions. Carrier animals are the source of infection. Disease transmitted by ticks, mechanically by tabanid vectors, iatrogenically, and transplacentally. Disease can be endemic in tick areas or sporadic in interface regions between endemic and free areas.

**Clinical findings** In cattle, death or severe debility, emaciation, anemia, and jaundice are the major clinical signs. The disease is usually subclinical in sheep and goats.

**Clinical pathology** Anemia, demonstration of organism in red cells by microscopy, fluorescent stains or polymerase chain reaction (PCR), serology.

**Necropsy findings** Anemia and attendant findings. Demonstration of organism.

**Diagnostic confirmation** Detection of the organism in blood smears, positive serology, PCR, and in some circumstances positive transmission tests. The sensitivity in a group of animals can be increased by using parallel blood smears, serologic tests, and PCR tests.

**Treatment** Clinical cases treated with tetracycline, imidocarb, or enrofloxacin. Blood transfusion. Carrier state not readily eliminated by treatment with tetracycline.

**Control** Tetracycline provides temporary or prolonged protection in face of an outbreak. Vaccination with killed *A. marginale* vaccine or live *A. centrale* vaccine used in endemic areas along with vector control. In nonendemic areas, serologic identification of carriers and culling or treatment of reactors. Prevention of iatrogenic transmission.

## ETIOLOGY

The genus *Anaplasma* (Rickettsiales: Anaplasmataceae) contains obligate intracellular gram-negative bacteria found exclusively within membrane-bound inclusions or vacuoles in the cytoplasm of both vertebrate and invertebrate (tick) host cells. The genus includes *A. marginale*, *A. centrale*, *A. bovis*, and *A. ovis*, which are pathogens of ruminants; *A. phagocytophilum*, which affects a wide range of hosts, including humans, wildlife, and domesticated animals; and *A. platys*, which infects dogs.<sup>1</sup> *A. marginale* is the type species of the genus; it is transmitted by ticks and other vectors and was first described by Sir Arnold Theiler in South Africa at the beginning of the twentieth century.

*A. marginale* is the causative agent of anaplasmosis in cattle, buffalo, and wild ruminants, and *A. ovis* in sheep and goats. *A. centrale* is closely related to, or a subspecies of, *A. marginale* and causes mild anaplasmosis in cattle. It was originally isolated in Africa but has been introduced as an

immunizing agent in Australia, South America, and Asia.

Molecular studies have identified and characterized several major surface proteins (MSPs) in *A. marginale* involved in interactions of the organism with both vertebrate and invertebrate hosts.<sup>1-2</sup> For example, MSP1a is involved with adhesion to bovine erythrocytes and to tick cells, and it can be used as a genetic marker for identifying strains of *A. marginale*.<sup>3-4</sup> Many geographic strains have been identified worldwide, and they vary in genotype, antigenic composition, morphology, and infectivity for ticks.<sup>1-2</sup> Another major surface protein, MSP2 is thought to be involved in antigenic variation to evade the mammalian host immune response, and it is also involved with infection and survival in the tick vector, thus contributing to maintenance of persistent infections in both hosts.<sup>1,5</sup> Yet another protein, MSP4 is a stable marker for the genetic characterization of strains and does not undergo antigenic variation when cycling between tick and mammalian hosts.<sup>6</sup>

As for *A. ovis* affecting sheep, goats, and some wild ruminants, the MSP4 is also used for genetic characterization and differentiation from *A. marginale* and other rickettsial organisms.<sup>7</sup> Mongolian reindeer are also affected.<sup>8</sup>

## EPIDEMIOLOGY

### Geographic Occurrence

Anaplasmosis in cattle is common and worldwide in distribution, being present on **all six continents**, but at varying degrees even within countries. It is transmitted through tick bites or by the mechanical transfer of fresh blood from infected to susceptible cattle from biting flies or by blood-contaminated fomites, including needles, ear-tagging, dehorning, and castration equipment.<sup>9</sup> Infection in cattle is **endemic** in tropical and subtropical areas that support large populations of these vectors, and prevalence rates as high as nearly 80% have been reported in cattle<sup>10-12</sup> and 40% in buffalo.<sup>13</sup> Infection occurs more **sporadically** in temperate-climate areas where vectors are seasonal; prevalence rates can be as low as 15% in Iowa<sup>14</sup> and 0% to 2% in Canada.<sup>15</sup>

In the United States and in other countries, the disease has occurred beyond the boundaries of tick-infested areas. Whereas anaplasmosis is enzootic throughout the southern Atlantic states, the Gulf Coast states, and many of the midwestern and western states, the disease occurs sporadically in the northern states and extends to the Canadian provinces of Saskatchewan, Manitoba, Ontario, and Quebec.<sup>15</sup>

In **Europe**, anaplasmosis is endemic in the Mediterranean countries of Italy, Spain, and Portugal and has been advancing northward in recent years, with sporadic cases in France, Switzerland, the Netherlands, Hungary, and Austria. A clinical case

of *A. centrale* infection has been reported in Italy.<sup>16</sup>

In **Australia** infection is closely related to the distribution of *Boophilus microplus*, which is restricted to the northern areas. Prevalence rates are negligible in cattle south of the tick line, but above the tick line the rates increase from south to north. Differences in enzootic and epizootic areas in South America and Africa are also largely related to tick distribution and climate.

In most countries there is wide geographic variation in prevalence rates, and this variability contributes to the development of geographically stable or unstable enzootic regions. There is concern, and some evidence, that the global warming trend will expand the boundaries and movement of host ticks.

Anaplasmosis of sheep and goats has a distribution similar to that of cattle, and in endemic areas the prevalence rate can be up to 100%.<sup>17-18</sup>

### Host Occurrence

Cattle and buffalo are susceptible to *A. marginale* and *A. centrale* and sheep to *A. ovis*. *A. marginale* will establish in sheep by experimental infection, but *A. ovis* will not infect cattle. A variety of species of **wild ruminants** can be infected and may have significance as reservoirs for *A. marginale*. In the United States the black-tail deer (*Odocoileus hemionus columbianus*) in the West Coast region is believed to be a reservoir. In Canada, six of six free-ranging mule deer (*Odocoileus hemionus*) from British Columbia tested positive for *A. marginale* by PCR,<sup>19</sup> and in Brazil, 79.3% of free-living and captive brown brocket deer (*Mazama gouazoubira*) and marsh deer (*Blastocercus dichotomus*) tested positive.<sup>20</sup> A number of species of antelope in Africa and deer in Europe play a similar role.

As for *A. ovis*, potential wildlife reservoirs include the bighorn sheep (*Ovis canadensis*) and the mule deer in western United States,<sup>7</sup> the farmed white-tail deer in Indiana,<sup>20</sup> and the roe and red deer in Europe.<sup>21-22</sup>

### Source and Methods of Transmission

The source of infection is always the blood of an infected animal. Recovery from acute infection results in **persistent infection** characterized by repetitive cycles of rickettsemia. Persistent carriers are the reservoir for herd infection. The level of parasitemia is often too low for detection by microscopy but can be detected by nucleic acid probe analysis. Transmission is biologically by ticks but can also occur transplacentally. Mechanical transmission is by biting flies or blood-contaminated fomites.

### Hematophagous Insect Transmission

Spread from animal to animal occurs chiefly by insect vectors. A variety of arthropods may act as vectors, but significant natural

vectors are ticks in the **family Ixodidae** and flies in the **family Tabanidae**. Of the ticks, the one-host *Rhipicephalus (Boophilus) spp.* are of major importance in tropical and subtropical regions, and the three-host *Dermacentor spp.* are of major importance in the western United States.

The organism undergoes a complex developmental cycle in the gut cells of ticks, and the final infective stage is present in the salivary gland. **Transstadial** transmission of the organism occurs in ticks, but there is little evidence for transovarial transmission of *A. marginale*; however, it has been reported for *A. platys*.<sup>23</sup> **Intrastadial** transmission is significant with some species, and transmission occurs as the ticks move from one host to another while they are engorging, including from cow to calf. Male *D. andersoni* can act as effective vectors in this manner for at least 120 days.

There appears to be no developmental sequence of *Anaplasma* spp. in flying insects. **Tabanids** are efficient mechanical vectors and can transmit infection for 2 hours after feeding. Sucking lice (*Haematopinus* spp. and *Linognathus* spp.) have been identified as potential vectors of anaplasmosis in cattle, goats, and buffalo.<sup>24-25</sup> The sheep keg (*Melophagus ovinus*) and deer keg (*Lipoptena cervi*) are also potential mechanical vectors of *A. ovis* in sheep and deer, respectively.<sup>22</sup> Nevertheless, tick-borne biological transmission is probably most important and is at least two orders of magnitude more efficient than mechanical transmission by flies<sup>26</sup> because the bacteria are able to undergo cyclical development and multiplication only in the tick.

Over 20 species of tick have been incriminated as vectors worldwide. In **Australia** the ticks *Boophilus microplus* and *Rhipicephalus sanguineus* are the vectors, and in **South Africa** it is *B. microplus*, *B. decoloratus*, and *Rhipicephalus simus*. In the **United States** *Boophilus annulatus*, *Dermacentor andersoni*, *D. variabilis*, *Argas persicus*, biting flies of tabanid species, and eye gnats (*Hippelates pusio*) also act as vectors. The male ticks of *Dermacentor albipictus* (the winter tick) and *D. occidentalis* (the Pacific Coast tick) parasitize both deer and cattle and have been suspected as vectors. *D. reticulatus* is widely distributed in Europe, from the British Isles to Central Asia, and the males have been shown to be competent vectors.<sup>6</sup>

### Iatrogenic Transmission

Anaplasmosis may also be spread mechanically by infected **hypodermic needles**; by castrating, spaying, tattooing, ear-tagging, and dehorning **instruments**; and by **blood transfusions** and embryo transplants. In one study, iatrogenic transmission was detected in 6 of 10 steers sham-vaccinated with a needle fitted to a multiple-dose syringe.<sup>27</sup> The ease with which the infection is spread mechanically may vary with the virulence of

the rickettsial strain, and this method of spread may be more important in some countries than others. Anaplasmosis may also be spread when cattle, used as donors of infected blood for immunization against babesiosis, are carriers of *A. marginale*, with the reaction occurring some 3 weeks later than that resulting from the babesia.

### Transplacental Transmission

Intrauterine infection also occurs in **cattle** but much less frequently in field cases than in experimental ones. In one study involving beef cattle chronically infected with *A. marginale* in southern Brazil, a transplacental infection rate of 10.5% was obtained from 30 cows with no history of acute anaplasmosis during gestation.<sup>28</sup> Abortion, neonatal infection, and fatal congenital infection have also been reported.<sup>29</sup> In **ewes** intrauterine infection appears to occur with ease in experimental cases, provided the ewe is exposed during the latter two-thirds of pregnancy.

### Animal and Environmental Risk Factors

#### Breed

*Bos indicus*, *Bos taurus*, and their crosses have **equal susceptibility** to infection and show the same age susceptibility, but under field conditions *B. indicus* are not as commonly affected, probably because of their relative resistance to heavy tick infestation. However, the effects of the disease on body weight and clinicopathological parameters are the same for the two races of cattle. Breeds with black or red **coat color** have a higher risk of infection than those with white coats in regions where biting flies are the insect vectors. Dairy breeds may be at greater risk for iatrogenic transmission.

#### Nutritional Status

Clinical disease is less severe in cattle on a low plane of nutrition. Exposure of infected, clinically normal animals to devitalizing environmental influences, particularly shortage of feed, and the presence of other diseases may result in the development of acute anaplasmosis. For example, cattle introduced into feedlots are highly susceptible, and outbreaks among them are not uncommon 2 to 3 weeks after entry.

#### Season

In temperate climates a seasonal occurrence of disease occurs in association with seasonal occurrence of the insect vectors. Winter outbreaks are likely associated with iatrogenic transmission<sup>9</sup> or possibly the winter tick, *D. albipictus*.

#### Age at Infection

All cattle are susceptible to infection, but age at infection is a **major determinant** of the severity of clinical disease. Young calves are less susceptible to infection with *A. marginale* than older cattle and, when infected, are

less susceptible to clinical disease. The reason for this is not understood, but splenectomized calves are fully susceptible to infection, which may be more severe than in the adult. Infection between 6 months and 3 years of age has increasing risk of clinical illness. Animals infected for the first time **after 3 years** of age are commonly affected by a peracute and fatal form of the disease. The **age-specific incidence** of clinical disease recorded in an outbreak in the United States showed 81% of cases in cattle aged between 2 and 4 years, with 94% of cases in cattle 3 years of age or older.

### Geographic Region

Clinical disease is rare in **enzootic areas** because the infection pressure is high and cattle are infected at an age when they are age-resistant to clinical disease. The average age at which calves in enzootic areas become infected is 11 weeks (range of 4 to 24 weeks), and the clinical and hematological changes in them are mild and brief. Animals that have become seronegative for whatever reason in an infected environment are fully susceptible to infection. Clinical disease occurs where there is **introduction** of susceptible animals into endemic areas or the **expansion** of the vector population into previously free areas or into the **interface** between endemic and nonendemic regions.

Case-fatality rates are usually high in outbreaks, but the mortality rate varies widely depending on susceptibility and may be 50% or more in cattle introduced to enzootic areas. Case-fatality rates of 29% to 49% are recorded in outbreaks in the United States; recovered animals are emaciated, and there is a prolonged convalescence.

### Pathogen Risk Factors

Phylogenetic analysis of the MSP1a of *A. marginale* worldwide supports the existence of clades, and their evolution is linked to ecological traits affecting the tick vector performance.<sup>1</sup> Consequently, some strains evolved under conditions that support pathogen biological transmission by *R. microplus*, whereas other strains may be linked to transmission by other tick species or to mechanical transmission in regions where *R. microplus* is currently eradicated.<sup>1</sup>

Australian isolates do not appear to differ significantly in antigenicity or virulence. In contrast, in other countries there can be significant differences between isolates in antigenic composition, the protection afforded against heterologous challenge, and virulence.

It has been demonstrated that the phenomenon of infection exclusion occurs with *A. marginale*. Infection of tick cells and bovine erythrocytes with one genotype of *A. marginale* excludes infection with other genotypes. In herds of cattle from endemic areas where many genotypes are detected, only one genotype is found per animal.

Furthermore, cattle inoculated with two *A. marginale* isolates become infected with only one isolate. However, concurrent strain infections (superinfections) have been reported. For example, experimental infection with a low-pathogenic strain of *A. marginale* did not prevent infection with a highly pathogenic isolate; instead, it provided clinical protection against the highly pathogenic strain.<sup>30</sup> Similarly, *A. centrale*-vaccinated cattle can be superinfected with field strains of *A. marginale* because they differ in their MSP2 genes.<sup>31</sup> Furthermore, superinfection with *A. marginale* is associated with a significant increase in variant diversity, and high levels of endemicity also drive pathogen divergence toward greater strain diversity.<sup>32</sup>

### Economic Importance

Costs are from death and abortion in clinical cases, loss of production in sick and recovered animals, and costs associated with preventive measures such as tick control. There have been no recent estimates of cost, but anaplasmosis was estimated to cost \$875 million in Latin American nations in 1977 and \$300 million per year in the United States in 2003.

In developed countries with the disease, exports of cattle to countries that do not have it are constrained. A major cost in developing countries is the constraint on efficient production and the limit to the introduction of susceptible cattle breeds with superior genetics.

### Experimental Reproduction

Anaplasmosis can be reproduced experimentally by subinoculating infected blood intravenously into intact or preferably splenectomized susceptible animals or by feeding infected ticks on them.

### PATHOGENESIS

Anaplasma are obligate intraerythrocytic bacteria. They infect **mature erythrocytes** by an endocytic process that possibly involves the twin-arginine translocation (Tat) pathway, which exports fully folded proteins out of the cytoplasm of the bacteria with the type IV secretion system (T4SS).<sup>33-34</sup> Inside the erythrocyte, bacterial reproduction occurs by binary fission to produce two to eight infective initial bodies that leave by exocytosis to infect other erythrocytes. The number of infected erythrocytes doubles every 24 to 48 hours, and the infection becomes patent 2 to 6 weeks after infection, with the time frame influenced by the initial challenge dose. Depending on the strain and the susceptibility of the host, from 10% to 90% of erythrocytes may be infected in the acute stage of the disease. At least 15% have to be infected before there is clinical disease. Infected erythrocytes are removed by phagocytosis in the reticular endothelial system, with release of acute-phase inflammatory reactants and the consequent development of fever.



Continued erythrocyte destruction occurs, resulting in the development of mild to severe anemia and icterus without hemoglobinemia or hemoglobinuria. Anaplasmosis is primarily an **anemia**, with the degree of anemia varying with the proportion of infected erythrocytes. The first appearance of the bacteria in the blood coincides with a fall in the hematocrit and erythrocyte levels, the appearance of immature erythrocytes in blood smears, and the development of fever. Acutely affected animals may die shortly after this phase is reached. The appearance of anti-erythrocyte antibodies late in the acute stage may exacerbate the anemia.

If the animal recovers from the initial acute attack, the disease goes into the subacute and chronic phase. The degree of anemia varies widely in young cattle up to 3 years of age but is always severe in adults and in splenectomized animals. Cattle that survive the disease become carriers for life and serve as reservoirs of *A. marginale* because they provide a source of infective blood for both mechanical and biological transmission by ticks. They have lifelong immunity and are resistant to clinical disease on challenge exposure.

Carrier animals have **cycles of parasitemia** associated with the development of new antigenic variants to allow new cycles of invasion, multiplication, and destruction approximately every 10 to 14 days. In the carrier animal, the concentration of infected erythrocytes varies markedly at bimonthly intervals from  $10^3$  to  $10^5$  infected cells/mL of blood, much lower than in the acute phase.<sup>9</sup>

Each cycle reflects the emergence of one or more clones that express a unique, hyper-variable region (HVR) of MSP2 and MSP3.<sup>35</sup> These “escape variants” are not recognized by antibody present at the time of emergence. As the new variants replicate, a new variant-specific antibody controls them. This cycle continues unabated, allowing lifelong persistent *A. marginale* infection.<sup>5,36</sup> It is believed that IgG-2 antibody is responsible for controlling the initial acute bacteremia and the subsequent peaks of bacteremia that arise during persistent infection, and that the antibody acts either by neutralizing extracellular bacteria in the process of invading new erythrocytes or by opsonizing bacteria that are then targeted for phagocytosis.<sup>37</sup> The process is not sufficient to clear infection, and cattle remain persistently infected for life. Another factor that may contribute to persistence is the rapid deletion of antigen-specific CD4<sup>+</sup> T lymphocytes following infection and the failure to establish a strong memory T-cell response during the course of the disease.<sup>38–39</sup>

## CLINICAL FINDINGS

### Cattle

There are few recent reports on clinical findings during **outbreaks of bovine anaplasmosis**. The **incubation period** varies with

the challenge dose but is generally several weeks with tick-borne infection and 1 to 5 weeks with the inoculation of blood. In most cases the disease is subacute, especially in young animals. **Rectal temperature** rises rather slowly and rarely to above 40.5°C (105°F). It may remain elevated or fluctuate with irregular periods of fever and normal temperature alternating for several days to 2 weeks. Anorexia is seldom complete. **Death** can occur at this stage, but many **survive in an emaciated condition**, and their fertility is impaired. The mucous membranes are jaundiced and show marked pallor, particularly after the acute stage is passed, but there is **no hemoglobinuria**.

Peracute cases, with a sudden onset of high fever, anemia, icterus, severe dyspnea, and death, often within 24 hours, are not uncommon in adult dairy cows. Affected animals are often **hyperexcitable** and tend to attack attendants just before death. Pregnant cows frequently abort. In convalescent bulls there may be depressed testicular function for several months.

In a recent outbreak in Hungary, two of five acutely affected cattle died, but the herd had concurrent infection with other pathogens.<sup>40</sup> A fatal congenital infection in a 2-day-old calf was associated with bovine viral diarrhea virus infection in South Africa.<sup>29</sup> In another case, clinical anaplasmosis was diagnosed in a 15-year-old cow, 13 years after eradication of the main vector *Rhipicephalus microplus* in Okinawa, Japan, implying that the cow was a long-time persistent carrier.<sup>41</sup>

### Sheep and Goats

In sheep and goats, infection is usually **subclinical**, but in some cases, particularly in goats, a severe anemia may occur, and a clinical picture similar to that found in cattle may be seen. Severe reactions of this type in goats are most frequent when the animals are suffering from concurrent disease. Goats may show hyperexcitability and may bite at inanimate objects. The experimental disease in lambs includes fever, constipation or diarrhea, pale and icteric conjunctivae, and severe anemia 15 to 20 days after inoculation. The anemia is not completely resolved in 3 to 4 months.

## CLINICAL PATHOLOGY

### Hematology

Anaplasmosis in cattle, sheep, and goats is characterized initially by normocytic normochromic anemia, which becomes macrocytic normochromic as the disease develops. Erythrocyte destruction may be so severe that the erythrocyte count is reduced to 1.5 million/ $\mu$ L. Immature red cells are common at this stage, and their presence is considered to be a favorable sign. The small dot-like bacteria are discernible at the periphery of up to 10% of the red cells in subacute cases, but in peracute cases more than 50% of the cells

may be infected. *A. ovis* are usually situated at the periphery of erythrocytes, but as many as 40% of infested cells may show submarginal organisms. Reticulocytosis and basophilic stippling are usually evident.<sup>42</sup> Packed cell volume and red blood cell count were found to be the most informative parameters in the routine clinical practice for *A. ovis* infection in sheep.<sup>43</sup>

Diff-Quik staining of blood smears is as accurate as Giemsa in the detection of *A. marginale* and can be completed in 15 seconds compared with nearly an hour for Giemsa. There are no diagnostic clinical chemistry findings, but as evidence of oxidative stress, levels of erythrocyte lipid peroxidation (LPO) and plasma nitrate (NO) may be elevated during the acute phase.<sup>44</sup> Concentrations of acute phase proteins (Hp, SAA, ceruloplasmin, and fibrinogen) may also be elevated.<sup>45</sup>

## SEROLOGY

Several serologic tests have been employed for epidemiologic studies of bovine anaplasmosis, but the two currently preferred for identifying infected animals are the competitive ELISA and the card agglutination test.<sup>46</sup>

The **competitive enzyme-linked immunosorbent assay (cELISA)** is the most accurate serologic test currently available for anaplasmosis; it uses a monoclonal antibody specific for MSP5.<sup>9</sup> However, it cannot differentiate between *A. marginale* and some other Anaplasma species, because they all possess the MSP5 antigen. A dot-ELISA with high sensitivity, specificity, and predictive value is also described and could be particularly applicable to field examinations. For further details, please see Aubry.<sup>9</sup>

The **card agglutination test (CAT)** examines serum or plasma for antibodies against *A. marginale*. It is cheap, quick, and sufficiently accurate to be used as a herd test. Currently, in most countries, the card agglutination and complement fixation tests are routinely available.

The **complement fixation test (CFT)** used to be the standard test for the detection of carrier animals. It is satisfactory for use in cattle, goats, and sheep, but the antibody titer is highest during the active phase of the disease and sufficiently low in carrier animals to give a proportion of false-negative results. False-positive reactions can occur because of erythrocyte contamination of the *A. marginale* antigen and the presence of antibodies to erythrocytes in some cattle sera.

A number of other tests have been developed. A **capillary tube agglutination test** of comparable efficiency is available, is more economical and faster than the CFT, and is particularly suited to testing in extensive field situations. An **indirect fluorescent antibody test (IFAT)** is also accurate and particularly suitable for testing blood that has been dried onto paper

for passage through the mail. It is also an accurate test for selecting recently affected animals.

A rapid **lateral flow assay (LFA)** has been developed that is a useful tool for screening cattle moving from an area with infection to a disease-free area.<sup>47</sup> The assay can be carried out in 10 to 15 minutes, it requires no expensive equipment, and it is comparable to laboratory tests in its performance. Vaccinated animals may react to all of the serologic tests for periods of over 1 year.

### Molecular Methods

**Molecular methods** can now be used to detect low levels of bacteremia and to differentiate *A. marginale* from other species.<sup>48</sup> The PCR assay is more sensitive than other methods in detecting anaplasmosis, especially in latent infections.<sup>49</sup> Nested PCR procedures showed bacteremia with a sensitivity of 50 infected erythrocytes per milliliter or as few as 10 copies of *A. marginale*.<sup>50-51</sup> Furthermore, a multiplex PCR assay has been developed for the simultaneous detection of *Theileria annulata*, *Babesia bovis*, and *A. marginale* in cattle,<sup>52</sup> and the assay was successfully used to detect *A. marginale*, *Babesia bigemina*, and *B. bovis* during an outbreak of tick-borne diseases in southern Brazil.<sup>53</sup> PCR assay can also be used to detect infected ticks.

**Transmission** to splenectomized animals is used to detect carriers and to assess the efficacy of treatment or vaccination. It has been the gold standard for the demonstration of *A. marginale*-free blood, but it is expensive and is now largely replaced by PCR in most countries.

### NECROPSY FINDINGS

The most obvious findings are emaciation, pallor of the tissues, and thin, watery blood. There is mild jaundice, and the liver is enlarged and orange. The kidneys are congested, and there may be myocardial hemorrhages. The spleen is enlarged, with a soft pulp. The bone-marrow cavity may be redened by increased hematopoietic tissue in acute cases, but there may be serous atrophy of marrow fat in chronic cases. Postmortem identification of *A. marginale* can be established by staining blood smears with Giemsa or with direct fluorescent stains. Peripheral blood is superior to organ smears. Brain smears are unsatisfactory. The technique is applicable to fetuses suspected of being aborted as a result of infection with *Anaplasma* spp. Nucleic acid-based tests may be used but are rarely needed for routine diagnosis at necropsy.

### Samples for Confirmation of Diagnosis

- **Clinical pathology**—blood smears from cut surface of an ear (CYTO, FAT)
- **Histology**—fixed spleen, liver, bone marrow

### DIFFERENTIAL DIAGNOSIS

Other causes of hemolytic anemia

### TREATMENT

#### TREATMENT AND CONTROL

##### Treatment

Oxytetracycline (6 to 10 mg/kg IM daily for 3 days, or 20 mg/kg IM single dose) (R-1)

Imidocarb (5 mg/kg IM twice, 7 days apart) (R-2)

Enrofloxacin (12.5 mg/kg SC twice, 48 hours apart) (R-1)

##### Control

Killed *A. marginale* vaccine (2 doses 4 weeks apart, then a booster) (R-1)

Live *A. centrale* vaccine (single dose, preferably in yearlings) (R-2)

Live *A. marginale* vaccine (single dose, yearlings only) (R-3)

Attenuated *A. marginale* vaccine (R-4)

Cell-culture live *A. marginale* vaccine (R-2)

Treatment is with **tetracyclines**, **imidocarb**, or **enrofloxacin**. Treatment of **clinical disease** can be with oxytetracycline, 6 to 10 mg/kg BW daily for 3 days, or a single injection of long-acting oxytetracycline at a dose of 20 mg/kg intramuscularly (IM). The convalescent period is long, and animals remain persistently infected. Concurrent administration of **estradiol** cypionate (14.3 mg/kg BW IM) appears to improve the rate of recovery by reducing rickettsemia during treatment. **Blood transfusions** are indicated in animals with a PCV less than 15%. Rough handling must be avoided.

**Imidocarb** (5 mg/kg BW IM twice, 7 days apart) is also an effective treatment for clinical cases but does not eliminate persistence.<sup>54</sup> The drug is not approved for use in the United States and Europe because it is a suspected carcinogen.

**Enrofloxacin** (12.5 mg/kg BW SC twice, 48 hours apart) is effective, but it also results in persistent infection. At 7.5 mg/kg BW it provided faster reduction of rickettsemia and PCV recuperation compared with long-acting oxytetracycline at 20 mg/kg BW.<sup>55</sup>

The risk for infection in the rest of the herd should be assessed and, if necessary, temporary or prolonged protection should be provided. Protection can be provided by tetracyclines or by vaccination.

**Temporary protection** in the face of an exposure risk can be achieved with a single intramuscular injection at 20 mg/kg BW of long-acting tetracycline. The results generally are good except when the cattle are exposed to infection during the 14 days before the treatment. **Prolonged protection** can be achieved by intramuscular injection at 20 mg/kg BW of long-acting tetracycline

every 28 days or by chlortetracycline in the feed at 1.1 mg/kg BW daily.

**Elimination of infection** is difficult but not impossible. A trial testing the ability of chlortetracycline therapy to eliminate the carrier state examined three doses (4.4 mg/kg per day, 11 mg/kg per day, and 22 mg/kg per day) of oral chlortetracycline fed for 80 days.<sup>56</sup> A negative reverse-transcription PCR assay result was confirmed in all treated groups within 49 days and by cELISA some additional 49 to 88 days later. Subinoculation of splenectomized steers confirmed chemosterilization with oral chlortetracycline.<sup>56</sup>

### CONTROL

Methods for the control of anaplasmosis have not changed greatly over the past several decades. Basically, the control and prevention measures include (1) maintenance of *Anaplasma*-free herds through import and movement control, testing, and elimination of carrier cattle; (2) vector control; (3) prevention of iatrogenic transmission; (4) administration of antibiotics; and (5) preimmunization with live vaccines and immunization with killed vaccines.<sup>9</sup> The eradication of anaplasmosis is not a practicable procedure in most countries at the present time because of the wide range of insects capable of carrying the disease, the long period of infectivity of carrier animals, and, in some areas, the presence of carriers in the wild animal population.

In enzootic areas some benefit is derived from the control of ticks and other vectors, and weekly dipping in an **acaricide** has been used in tropical areas to control this and other tick-borne diseases. However, acaricide use has limited efficacy in reducing tick infestations and is often accompanied by serious drawbacks, including the selection of acaricide-resistant ticks, environmental contamination, and contamination of milk and meat products with drug residues. Consequently, the possibility of **vector vaccines** that target tick proteins is now being investigated.<sup>57</sup> Such vaccines can reduce tick feeding and reproduction, and they also reduce the infection and transmission of pathogens from the tick to the vertebrate host. A recombinant vaccine against the tick-protective antigen subolesin has the potential not only to control tick infestation of cattle, but also infection with multiple pathogens such as *A. marginale* and *Babesia bigemina*.<sup>58-59</sup>

### General Measures

Prior serologic testing should prevent the introduction of the disease into herds by carrier animals. Attention should also be given to preventing **iatrogenic transmission** with instruments used for injections or surgical operations by disinfection after use on each animal. This is particularly important in feedlots where introduced groups are often subjected to multiple vaccinations and implantation at a time when their resistance

is lowered by transport and change of feed. On such occasions, iatrogenic transmission can be greatly reduced by single-use needles or needle-free administration systems for parenteral administration of vaccines or antimicrobials.<sup>27</sup>

### Movement of Animals

Naive animals that are to be introduced into an enzootic area should be vaccinated. Some advantage can be gained when introducing animals into an enzootic area by limiting the introductions to animals of less than 2 years of age and by bringing them in when the insect population is least numerous.

### Elimination of Carriers

Elimination of carriers is feasible in regions that are subject to only periodic incursions of infection and that do not have endemic tick vectors. It can be achieved by serologic testing and **culling of reactors** or by treating them with oral oxytetracycline over a prolonged period of time as outlined earlier.<sup>36</sup>

### Outbreaks

If an outbreak does occur, affected animals should be treated vigorously as described previously and in-contact animals vaccinated and/or placed on a regimen of prolonged tetracycline protection. Subsequently, all exposed animals should be tested serologically and the reactors treated or preferably salvaged. Prolonged treatment regimens can be used to provide protection to cattle in seasonal risk periods of transmission.

### Chemotherapy

Chemotherapy for control is more commonly used in the United States than in other areas of the world. It can be of value in feedlot cattle but is not applicable to range cattle. It is expensive and carries the risk of causing selection of resistant strains.

### Vaccination

Vaccines for the control of anaplasmosis are either live or killed vaccines. Both types use *A. marginale* or *A. centrale* from infected bovine erythrocytes, and although both types induce protective immunity that reduces or prevents clinical disease, neither type prevents cattle from becoming persistently infected with *A. marginale*. Cattle that have recovered from acute infection or have been immunized with killed vaccines are solidly protected against challenge with the homologous strain but are only partially protected against challenge with heterologous strains.

Most control programs in enzootic areas are based on increasing the resistance of the population by immunization. In any vaccination program, particular attention should be paid to the **animals at high risk**, particularly animals brought in from nonenzootic areas, those in surrounding similar areas to which infection may be spread by expansion

of the vector population under the influence of suitable climatic conditions, and animals within the area that are likely to be exposed to climatic or nutritional stress.

### Killed Vaccines

Killed *A. marginale* are usually in an adjuvant vehicle. The vaccine requires two doses, 4 weeks apart, with the last dose given at least 2 weeks before the vector season. Subsequently, **booster** doses should be given 2 weeks before the next vector season. The vaccine does not prevent infection but does significantly **reduce the severity** of the disease. It does have the advantage over the other vaccines of having a relatively short postvaccination period when animals remain positive to serologic tests. The duration of the immunity is at least 5 months.

There is a risk for **neonatal isoerythrolysis**. The risk can be reduced by vaccinating only empty cows and avoiding unnecessary booster injections. When this vaccine is used in the face of an outbreak, tetracyclines can also be given to provide temporary protection during the period of development of immunity; tetracyclines do not interfere with the development of this immunity.

Preliminary reports of the efficacy of DNA vaccines are not encouraging.

### Live Vaccines

A **living *A. centrale*** vaccine is used extensively in Australia, Africa, Israel, and Latin America, but not in the United States, and there is some reluctance to introduce it into areas where *A. centrale* does not already occur.

Living *A. centrale* vaccine is prepared from the blood of infected splenectomized donor calves and is stored chilled or frozen. The vaccine causes a mild, inapparent disease, but it can cause severe reactions in occasional animals. It is generally safe in young cattle. A **single vaccination** is used in endemic areas, and the immunity is reinforced by continuous challenge and considered to persist for life in tick areas. *A. centrale* and *A. marginale* share immunodominant epitopes and have similar antigenic variation in major surface proteins, both of which play a role in the cross-immunity that occurs.<sup>60</sup> The immunity induced by the live *A. centrale* vaccine in cattle does not prevent subsequent infection with *A. marginale* by the infection exclusion phenomenon because both differ in their MSP2 genes.<sup>31</sup>

The efficacy of this vaccine varies geographically. Vaccination with *A. centrale* reduces the severity of the reaction when infection with *A. marginale* occurs but does not give absolute protection. Protection against challenge in Australia is adequate in most cases, and certainly sufficiently effective enough to justify its use. In contrast, the use of the same vaccine in countries other than Australia, where there are more antigenically diverse and highly virulent strains,

is often inadequate, and better vaccines are required.

Tetracyclines will prevent establishment of infection and immunity by the vaccine and should not be administered for 3 weeks before vaccination.

**Living *A. marginale*** has been used as a vaccine but its administration is limited to the relatively resistant age group below 1 year of age, to the winter months when vectors are sufficiently rare to avoid the chance of spread to other age groups, and to circumstances where animals that react severely can be restrained and treated adequately. The method has the serious disadvantage of creating a large population of carrier animals that may subsequently spread the disease.

*Attenuated vaccines* have been attempted by irradiating strains, by passage of the organism through sheep or deer, and by the use of naturally low-virulence isolates. Although most have been received with initial enthusiasm, some have proved ineffective, and others have been associated with adverse reactions. Some are effective against strains in some geographic regions but give unsatisfactory protection against clinical disease in other regions.

### Problems With Live Vaccines

All vaccines currently must be produced in live animals, which is expensive. With noninactivated vaccines, there is a risk of transmitting blood-borne viruses. In Australia, a single calf infected with bovine leukosis virus was unsuspectingly used in the production of *A. centrale* vaccine. The contaminated vaccine was given to 22,627 cattle in 111 herds and resulted in a high rate of infection with bovine leukosis virus in the vaccinated cattle.

A cell-culture system has been developed for propagation of *A. marginale* in a continuous tick cell line derived from embryonic *Ixodes scapularis*. Recently, protective immunity was induced by immunization with a live, cultured *A. marginale* strain.<sup>61</sup> Vaccinated calves had a stable PCV and low bacteremia following challenge with a virulent strain, whereas *A. centrale* only afforded partial clinical protection. Important features of this cell-culture candidate vaccine are that it carries no risk of biological transmission, it can be easily distinguished from field strains, and only one dose is required.

Studies are ongoing for the development of safe and effective **subunit vaccine** containing epitopes critical to effective immunity. Whereas blood-derived whole-outer-membrane (OM) preparations and cross-linked surface proteins provide the best protection from high-level bacteremia and anemia,<sup>62</sup> they may not be practical for large-scale production. Recombinant proteins, DNA vaccines, and killed preparations of *A. marginale*, including inactivated cell-culture-derived organisms, have failed to



recapitulate the protection seen with OM-based vaccines.<sup>61</sup>

The ideal vaccine for anaplasmosis in cattle (as well as in sheep and goats) would be one that prevents infection, induces protective immunity, and possibly blocks biological transmission from the tick to the vertebrate host.<sup>9</sup> However, further research is needed to achieve this goal.

## FURTHER READING

- Aubry P, Geale DW. A review of bovine anaplasmosis. *Transbound Emerg Dis.* 2011;58:1.
- Brown WC. Adaptive immunity to *Anaplasma* pathogens and immune dysregulation: implications for bacterial persistence. *Comp Immunol Microbiol Infect Dis.* 2012;35:241.
- Howden KJ, et al. An update on bovine anaplasmosis (*Anaplasma marginale*) in Canada. *Can Vet J.* 2010;51:837.
- Kocan KM, et al. Advances toward understanding the molecular biology of the *Anaplasma*-tick interface. *Front Biosci.* 2008;13:7032.
- Kocan KM, et al. Antigens and alternatives for control of *Anaplasma marginale* infection in cattle. *Clin Microbiol Rev.* 2003;16:698.
- Kocan KM, et al. The natural history of *Anaplasma marginale*. *Vet Parasitol.* 2010;167:95.
- Merino O, et al. Tick vaccines and the control of tick-borne pathogens. *Front Cell Infect Microbiol.* 2013;3:30.
- OIE manual of diagnostic tests and vaccines for terrestrial animals; World Organisation for Animal Health 2012; chapter 2.4.1:589.
- Passos LM. In vitro cultivation of *Anaplasma marginale* and *A. phagocytophilum* in tick cell lines: a review. *Rev Bras Parasitol Vet.* 2012;21:8.

## REFERENCES

- Estrada-Pena A, et al. *BMC Biol.* 2009;7:57.
- Kocan KM, et al. *Vet Parasitol.* 2010;167:95.
- Cabezas-Cruz A, et al. *PLoS ONE.* 2013;8:e65243.
- de la Fuente J, et al. *Vet Microbiol.* 2007;119:382.
- Chavez AS, et al. *PLoS ONE.* 2012;7:e36012.
- Zivkovic Z, et al. *BMC Vet Res.* 2007;3:32.
- de la Fuente J, et al. *Vet Microbiol.* 2007;119:375.
- Haigh JC, et al. *J Wildl Dis.* 2008;44:569.
- Aubry P, Geale DW. *Transbound Emerg Dis.* 2011;58:1.
- Silveira JA, et al. *Transbound Emerg Dis.* 2012;59:353.
- Rahman WA, et al. *Trop Biomed.* 2012;29:66.
- Tembue AA, et al. *Rev Bras Parasitol Vet.* 2011;20:318.
- Ashraf QU, et al. *Ticks Tick Borne Dis.* 2013;4:395.
- Coetzee JF, et al. *Can Vet J.* 2010;51:862.
- Pare J, et al. *Can Vet J.* 2012;53:949.
- Carelli G, et al. *Ann NY Acad Sci.* 2008;1149:107.
- Kubeiova M, et al. *Parasite.* 2012;19:417.
- Hornok S, et al. *Vet Microbiol.* 2007;122:316.
- Lobanov VA, et al. *Transbound Emerg Dis.* 2012;59:233.
- Boes KM, et al. *Vet Clin Pathol.* 2012;41:77.
- de la Fuente J, et al. *Res Vet Sci.* 2008;84:382.
- Hornok S, et al. *Vector Borne Zoonotic Dis.* 2011;11:1319.
- Baldrige GD, et al. *J Med Entomol.* 2009;46:635.
- Hornok S, et al. *Vet Parasitol.* 2010;174:355.
- Da Silva AS, et al. *J Parasitol.* 2013;99:546.
- Scoles GA, et al. *J Med Entomol.* 2008;45:109.
- Reibold JB, et al. *Am J Vet Res.* 2010;71:1178.
- Grau HA, et al. *Rev Bras Parasitol Vet.* 2013;22:189.
- Pypers AR, et al. *J S Afr Vet Assoc.* 2011;82:179.
- Bastos CV, et al. *Vet J.* 2010;186:374.
- Molad T, et al. *Vet Microbiol.* 2010;143:277.
- Ueti MW, et al. *Infect Immun.* 2012;80:2354.
- Nunez PA, et al. *PLoS ONE.* 2012;7:e33605.
- Lockwood S, et al. *PLoS ONE.* 2011;6:e27724.
- Futse JE, et al. *Infect Immun.* 2009;77:3181.
- Palmer GH, et al. *NY Acad Sci.* 2006;1078:15.
- Brown WC. *Comp Immunol Microbiol Infect Dis.* 2012;35:241.
- Han S, et al. *J Immunol.* 2008;181:7759.
- Han S, et al. *Clin Vaccine Immunol.* 2010;17:1881.
- Hornok S, et al. *Res Vet Sci.* 2012;92:30.
- Ooshiro M, et al. *Vet Parasitol.* 2009;160:351.
- Yasini S, et al. *Iran J Parasitol.* 2012;7:91-98.
- Ciani E, et al. *Acta Vet Scand.* 2013;55:71.
- De United Kingdom, et al. *Trop Anim Health Prod.* 2012;44:385.
- Nazifi S, et al. *Vet Microbiol.* 2012;155:267.
- OIE manual of diagnostic tests and vaccines for terrestrial animals. 2012; chapter 2.4.1:589.
- Nielsen K, et al. *J Immunoassay Immunochem.* 2009;30:313.
- Carelli G, et al. *Vet Microbiol.* 2007;124:107.
- Ashuma, et al. *Asian Pac J Trop Med.* 2013;6:139.
- Molad T, et al. *Vet Microbiol.* 2006;113:55.
- Decaro N, et al. *J Vet Diagn Invest.* 2008;20:606.
- Bilgic HB, et al. *Exp Parasitol.* 2013;133:222.
- Canever MF, et al. *Korean J Parasitol.* 2014;52:507.
- Coetzee JF, et al. *Vet Ther.* 2006;7:347.
- Facury-Filho EJ, et al. *Rev Bras Parasitol Vet.* 2012;21:32.
- Reibold JB, et al. *Vet Microbiol.* 2010;145:69.
- Merino O, et al. *Front Cell Infect Microbiol.* 2013;3:30.
- Almazan C, et al. *Vaccine.* 2012;30:265.
- Merino O, et al. *Vaccine.* 2011;29:8575.
- Agnes T, et al. *Infect Immun.* 2011;79:1311.
- Hammac GK, et al. *Vaccine.* 2013;31:3617.
- Noh SM, et al. *Infect Immun.* 2008;76:2219.

## EQUINE GRANULOCYTIC ANAPLASMOSIS (EQUINE GRANULOCYTIC EHRLICHIOSIS, ANAPLASMA PHAGOCYTOPHILUM)

*Anaplasma phagocytophilum* causes disease of horses, humans, dogs, cattle, cats, and other mammalian species. It is characterized in horses by fever, depression, limb edema, icterus, and ataxia.<sup>1</sup> The disease is described here with emphasis on that occurring in horses. See the next section, "Tick-Borne Fever," for a description of the disease in other species.<sup>2</sup>

## ETIOLOGY

The disease in horses is associated with infection by *A. phagocytophilum*, the same agent that causes human granulocytic ehrlichiosis (HGE). The organisms *Ehrlichia equi*, *E. phagocytophilum*, and the HGE agent are now classified as *A. phagocytophilum*.<sup>3</sup> The variety of species affected and geographic distribution of the disease suggests strains of *A. phagocytophilum* of varying pathogenicity and host specificity. *A. phagocytophilum* is a recognized cause of tick-borne fever in sheep, goats, cattle, horses, dogs, cats, roe deer, reindeer, and humans in Europe and elsewhere.<sup>4,5</sup> Infection of some domestic and wild ruminants, including deer, does not

induce clinical signs, which could be a result of host susceptibility, the strain of the organism, or combinations of both.

There are multiple strains of *A. phagocytophilum*, and each has a distinct host tropism (reservoir host and vector), with disease being associated with infection of nonhost species (dogs, horses, and humans) by pathogenic strains of the organism.<sup>6-8</sup> Strains of *A. phagocytophilum* that cause disease in dogs and horses in southern Sweden differ slightly in their genetic composition from isolates derived from North America. Similarly, nucleotide sequences of strains of *A. phagocytophilum* from the West Coast of the United States differ from those of strains originating from the East Coast. Strains of *A. phagocytophilum* in the western United States vary in their pathogenicity in horses, with strains isolated from horses with the disease (and from chipmunks and tree squirrels) producing severe disease in horses, whereas a strain derived from woodrats does not cause disease in horses.<sup>6,8</sup> There is genetic variability in strains capable of causing disease in horses demonstrated in Germany and the Czech Republic.<sup>9,10</sup> The organism can be isolated from lizards, which are believed to be the host in a reptile-tick-reptile cycle.

*A. phagocytophilum* is an obligate intracellular bacterium that replicates in cells derived from the bone marrow (granulocytes).

## EPIDEMIOLOGY

### Distribution

The disease in horses occurs in the Americas (the United States, including California, Washington, Oregon, Minnesota, Wisconsin, and the southeastern and the northeastern states; and Brazil), France, Italy, Switzerland, Sweden, Germany, Poland, the Czech Republic, the Netherlands, and the United Kingdom.<sup>9,11-14</sup>

The prevalence of horses with serum antibodies to *E. equi* (*A. phagocytophilum*) in endemic areas of California is 10%, compared with 3% in areas where the disease is uncommon. On farms where the disease occurs frequently, 50% of horses have serum antibodies to *E. equi* (*A. phagocytophilum*). Approximately 18% of horses in areas of the upper Midwest of the United States in which *Ixodes* spp. ticks are endemic have antibodies to *E. equi* (*A. phagocytophilum*), whereas 4% of horses in areas in which the tick does not occur are seropositive. In a convenience sample of 96 horses in the Czech Republic, 73% were seropositive (indirect fluorescent antibody testing).<sup>15</sup> A survey of 563 horses in Lazio region of Italy (near Rome), where the disease in horses occurs, revealed a seroprevalence of 0.3%, whereas 41 of 300 (13%) of horses from Latium, Umbria, and Marche in central Italy were seropositive by immunofluorescent antibody testing for antibodies to *A. phagocytophilum*, and 20 (6%) were PCR positive.<sup>14</sup>

There is extensive evidence of exposure of dogs to *A. phagocytophilum* and of disease consistent with granulocytic ehrlichiosis;<sup>16</sup> 47% of dogs in endemic areas in California have antibodies to *E. equi* (*A. phagocytophilum*), and some show clinical signs consistent with the disease. There is evidence of widespread infection of other species with the organism; 0.2% of 2725 serum samples from cattle in California had detectable antibodies to *A. phagocytophilum*, and 43% to 96% of deer and moose, respectively, in Norway are seropositive. Serologic evidence of infection is widespread in Europe.<sup>4</sup> However, demonstration of antibodies in serum by surveys does not provide information on the pathogenicity of the infecting strains of *A. phagocytophilum* (which can vary widely in their capacity to produce disease).

### Anaplasma and Ixodes Ecology

*A. phagocytophilum* is maintained by a cycle of infection of particular host species, including wild cervids or, in apparently separate cycles, small mammals such as the white-footed mouse and dusky-footed woodrat in the United States and hedgehogs in Europe, and specific vector species of ticks.<sup>6,7,17-19</sup> The tick-host-tick sylvatic cycles are now being identified, and there appears to be multiple such cycles, with more than one cycle (i.e., different host) being possible in a geographic area. Infection of horses, dogs, and humans, which are not part of the natural cycle of the organism, occurs through the bite of *A. phagocytophilum*-infected ticks.

The organism is transmitted by hard ticks that are members of the *Ixodes persulcatus* complex, which includes *Ixodes pacificus*, *Ixodes scapularis*, and *Ixodes ricinus*. Transstadial, but not transovarial, transmission occurs. The tick vectors of *A. phagocytophilum* pass through four stages in their life cycle: egg, larva, nymph, and adult. Maturation from larva to nymph, maturation from nymph to adult, and egg laying all require the ingestion of a blood meal. Because transovarial transmission of infection does not occur, larvae or uninfected nymphs become infected by feeding on an infected mammal. The engorged and infected immature tick then dismounts and matures to the next life stage away from a mammalian host. When the immature tick reaches the nymph or adult stage, it again seeks a mammalian host. Transmission of the infection from the tick to a mammal occurs through feeding of an infected nymph or adult on a susceptible host.

Environmental factors that affect the type of host species, its density in a particular area, and the number and activity of ticks are likely important in determining risk of infection of nonhost species (e.g., horses). Changes in local vegetation, such as that produced by clearing of forest and subsequent regrowth, can influence host and vector pop-

ulation densities and hence risk of transmission of the agent to nonhost species.<sup>20</sup>

### Animal Risk Factors

Horses that have not been exposed to *A. phagocytophilum* are susceptible to infection and disease. There is a marked seasonality of the disease in California, with most cases occurring in late autumn, winter, and spring. This seasonality likely correlates with the well-documented changes in populations of various stages of the vector ticks and host mammals.<sup>18</sup>

Horses of any age are susceptible, and there is no apparent breed or sex predisposition.

Infection in horses is followed by a solid immunity, and recovered animals are resistant to the disease for at least 20 months, although it is suggested that reinfection and disease can occur. Serum antibodies persist for at least 300 days after infection in some horses but decrease to low levels in most horses by 200 days after infection.

### Transmission

As discussed previously, transmission is through the bite of an infected tick. Transmission through use of blood-contaminated veterinary equipment or by blood transfusion is possible, with the latter being used to induce disease in experimental challenges. Perinatal transmission of *A. phagocytophilum* is reported in humans.

### Morbidity and Mortality

The case-fatality rate is low, approximately 4%, and deaths of horses with uncomplicated disease are rare.

### Zoonotic Potential

There is no evidence that infection spreads directly from infected horses or dogs to humans. However, dogs have been suggested to be sentinel animals, in that humans in areas in which dogs have a high prevalence of antibodies in serum to *A. phagocytophilum* might be at increased risk of infection from bites of infected ticks.

### PATHOGENESIS

Following experimental infection, horses have organism detectable by PCR beginning 5 days after infection, with development of fever and depression 7 to 8 days after infection. Inclusions in granulocytes are detectable beginning 9 days after infection, at which time there is edema of the limbs. The organism incites a proinflammatory cascade after infection; administration of dexamethasone, which inhibits this inflammatory cascade, diminishes the severity of the disease in experimentally infected horses.<sup>21</sup>

The disease in horses is associated with rapid changeover of expressed p44 genes such that there is marked antigenic variation in the major surface protein, p44, during infection in an animal. The rapid changeover

of expression of p44 is attributed to development of specific antibody to the hyper-variable region of p44. Infection in sheep results in immune suppression secondary to granulocytic and lymphocytic leukopenia, impaired antibody production, reduced lymphocyte response to mitogens, and a decreased oxidative burst activity of neutrophils. The prominent clinical sign of edema is likely related to the vasculitis that is characteristic of the disease.

### CLINICAL SIGNS

The incubation period for the spontaneous disease is less than 2 weeks. Subclinical infections are believed to be common, based on the number of horses with serologic evidence of infection but no history of disease.

Clinically there is high fever of 40° to 42° C (104° to 107° F) followed by mucosal pallor, jaundice, anorexia, depression, increased respiratory movement, incoordination and reluctance to move, and, after 3 to 4 days, edema and heat of the extremities. There can be petechial hemorrhages on mucosal membranes and pleural or peritoneal effusion. Edema persists for 7 to 10 days, and clinical signs resolve in 14 days. Clinical disease is more severe in horses over 3 years of age and is minor in young horses. Severely affected horses can have signs consistent with neurologic disease, including ataxia, defects in conscious proprioception, and recumbency.<sup>22</sup>

Arrhythmias can occur during the acute phase of the disease. Chronic infection and disease is not recognized.

Death of an experimentally infected horse within 2 days of development of clinical signs was associated with disseminated intravascular coagulation.<sup>23</sup>

### CLINICAL PATHOLOGY

There is commonly mild anemia and leukopenia. **Thrombocytopenia** is common in the acute stage of the disease. There are no consistent serum biochemical abnormalities.

**Positive identification** of the disease is made on the presence of inclusion bodies (morulae) in the cytoplasm of neutrophils and eosinophils. Careful and protracted microscopic examination of a blood smear, stained with Giemsa, may be necessary to identify the inclusions (morulae). The inclusions are apparent as pleomorphic bodies of a blue-gray color, often in a spoke-wheel formation, in the cytoplasm of granulocytes. The number of infected cells can be quite small, and examination of a buffy-coat preparation may increase the sensitivity of the test.

**Diagnosis** is achieved through use of a PCR test to identify *A. phagocytophilum* DNA in blood samples of infected horses and by demonstration of an increase in antibody titer detected by indirect fluorescent antibody staining. However, antibody titers are low to undetectable in approximately 44% of horses at the onset of clinical signs, and they

reach a maximum within 1 month of infection.

An ELISA that detects antibodies against the p44 surface antigen of *A. phagocytophilum* is suitable for use in dogs and horses. Evaluation of one commercial version of this test did not support its clinical use.<sup>24</sup>

## NECROPSY EXAMINATION

At **necropsy** there are petechiae and edema of the legs, and at histologic examination there is vasculitis. There are often inflammatory lesions in the brain, heart, and kidneys.

### DIFFERENTIAL DIAGNOSIS

**Differential diagnoses** include the following:

- Equine infectious anemia, which has a much more protracted course and does not respond to treatment
- Purpura hemorrhagica, which is often associated with infectious upper respiratory tract disease
- Liver disease
- Viral encephalitis
- Equine herpesvirus-1 myeloencephalopathy,
- **Rabies**
- Botulism
- Equine viral arteritis

## TREATMENT

### TREATMENT

Treatment of equine granulocytic anaplasmosis:

- Oxytetracycline 7 mg/kg q 12 to 24 hours for 5 to 7 days (R1)

The specific treatment is oxytetracycline (7 mg/kg BW IV, every 24 hours) for approximately 5 to 7 days. Penicillin, streptomycin, and chloramphenicol are not effective. The response to treatment with oxytetracycline is rapid; the fever is reduced or eliminated in 12 to 24 hours, and signs of the disease resolve within 5 to 7 days in most horses. Inclusion bodies are difficult to find 24 hours after beginning treatment. Without treatment the disease is usually self-limiting to 2 to 3 weeks.

## CONTROL

There is no **vaccine**, and specific control measures cannot be recommended at this time, although minimizing access of ticks to horses would appear prudent. There is no need to isolate infected horses.

## FURTHER READING

- Dziegiel B, Adaszek L, Kalinowski M, Winiarczyk S. Equine granulocytic anaplasmosis. *Res Vet Sci.* 2013;95:316-320.
- Pusterla N, Madigan JE. Equine granulocytic anaplasmosis. *J Equine Vet Sci.* 2013;33:493.

## REFERENCES

1. Dziegiel B, et al. *Res Vet Sci.* 2013;95:316.
2. Radostits O, et al. Equine granulocytic anaplasmosis. In: *Veterinary Medicine: A Textbook of the Diseases of Cattle, Horses, Sheep, Goats and Pigs.* 10th ed. London: W.B. Saunders; 2007:1464.
3. Pusterla N, et al. *J Equine Vet Sci.* 2013;33:493.
4. Stuen S. *Vet Res Comm.* 2007;31:79.
5. Dziegiel B, et al. *J Med Micro.* 2013;62:1891.
6. Foley JE, et al. *Emerg Infect Dis.* 2009;15:842.
7. Rejmanek D, et al. *J Med Micro.* 2012;61:204.
8. Foley J, et al. In: Sparagano OAE, et al., eds. *Animal Biodiversity and Emerging Diseases: Prediction and Prevention.* 2008:94.
9. Jahn P, et al. *Vet Rec.* 2010;166:646.
10. Silaghi C, et al. *Parasite Vector.* 2011;4.
11. Adaszek L, et al. *Zoonoses Pub Hlth.* 2011;58:514.
12. Burgess H, et al. *Can Vet J.* 2012;53:886.
13. Butler CM, et al. *Vet Rec.* 2008;162:216.
14. Laus F, et al. *J Vet Med Sci.* 2013;75:715.
15. Praskova I, et al. *Ticks Tick Borne Dis.* 2011;2:111.
16. Carrade DD, et al. *J Vet Int Med.* 2009;23:1129.
17. Morissette E, et al. *Emerg Infect Dis.* 2009;15:928.
18. Rejmanek D, et al. *Ticks Tick Borne Dis.* 2011;2:81.
19. Silaghi C, et al. *Ticks Tick Borne Dis.* 2012;3:49.
20. Foley JE, et al. *Am J Trop Med Hyg.* 2009;81:1132.
21. Davies RS, et al. *Clin Vaccine Immunol.* 2011;18:1962.
22. Gussmann K, et al. *Schweiz Arch Tierheilkd.* 2014;156:345.
23. Franzen P, et al. *Vet Rec.* 2007;160:122.
24. Veronesi F, et al. *Vector Borne Zoonotic Dis.* 2014;14:317.

## EPERYTHROZONOSIS

### SYNOPSIS

**Etiology** Hemotropic mycoplasmas (previously *Eperythrozoon* species)

**Epidemiology** Subclinical infection common; clinical disease precipitated by stress. Horizontal transmission by blood. Vertical transmission important in swine.

**Clinical findings** Acute icteroanemia or chronic ill-thrift in sheep and swine. Reproductive inefficiency and neonatal anemia in swine. Syndromes in cattle less defined.

**Clinical pathology** Anemia and bilirubinemia. Blood smear for parasite in early disease. Serology useful as flock/herd test. Polymerase chain reaction (PCR).

**Treatment** Tetracyclines, organic arsenicals.

**Control** Nonspecific. Prophylactic administration of tetracyclines.

## ETIOLOGY

The disease is associated with hemotropic mycoplasmas, formerly thought to be rickettsial parasites and classified as *Eperythrozoon*. They infect a range of mammalian species and cannot be grown in culture. Species in farm livestock that have been associated with disease are *Mycoplasma (Eperythrozoon) ovis* in sheep, *M. suis* in swine, and *M. wenyonii* in cattle. Additional forms have been identified in sheep and cattle, designated Candidatus *Mycoplasma haemobovis* and Candidatus *Mycoplasma haemovis*, respectively, and the taxonomy of

the hemotropic mycoplasmas is a work in progress.

## EPIDEMIOLOGY

### Occurrence

Eperythrozoonosis occurs in sheep, swine, cattle, and llamas, with the greatest clinical occurrence and importance in swine and sheep. Latent eperythrozoonosis also occurs in several species of deer, elk, and goats. The organisms appear species specific, although *M. ovis* has been transmitted from sheep to goats, identified in a number of species of farmed and free-ranging deer,<sup>1,2</sup> and detected by PCR of the blood of a Texas veterinarian.<sup>3</sup> Three distinct species of hemotropic mycoplasmas, including two novel species, have been identified by PCR in white-tailed deer in the United States.<sup>4,5</sup> The distribution is as follows:

- **Sheep.** Eperythrozoonosis of lambs associated with *M. ovis* is recorded in Africa, Iran, the United States, Canada, Great Britain, France, Norway, Germany, Poland, Eastern Europe, Australia, and New Zealand
- **Pigs.** Also known as infectious anemia of pigs, the disease is recorded mainly in the United States, Canada, Great Britain, and continental Europe.
- **Cattle.** Eperythrozoonosis in cattle is widely distributed, with reports from North and South America, Africa, Australasia, the British Isles, continental Europe, and the Middle East.
- **Llamas.** Infection with *Eperythrozoon* spp. is reportedly widespread in llamas in the United States. Infection has been detected in animals that also had other disease problems or as the result of specific survey studies, and it is likely that the organism acts primarily as a secondary opportunistic pathogen in llamas.

## Source and Transmission

The reservoir of infection is the persistently infected animal, and the disease can be transmitted by any mechanism that transfers infected blood. In sheep it is thought that the minimal infective dose is one parasitized erythrocyte. Horizontal and vertical transmission are possible.

## Sheep

The method of natural spread of the infection in sheep is probably via biting insects. Serologic studies in Australian sheep show that the prevalence of farms with infection is high and that spatial differences are probably a result of differences in vector occurrence. In an infected flock or herd, the disease can also be spread by management practices that transfer infected blood. In sheep, these include vaccination, ear-tagging, shearing, and mulesing, although these risk factors have not been associated with infection in any epidemiologic studies.



## Pigs

Skin parasites and blood-contaminated needles and instruments have been shown to transmit disease in swine. Transplacental transmission is also important in swine.

### Host and Pathogen Risk Factors

Seasonal differences in disease prevalence occur, being more common in the summer and autumn. This corresponds to increased vector populations but also to weaning of lambs and management procedures that may encourage spread, such as the multiple use of needles for vaccination. Regional differences in the clinical severity of the disease has led to postulations of differences in virulence between strains of the organism. There may also be genetic difference in host susceptibility, and field observations are that the Merino is more susceptible to infection and disease. The increased scrutiny of isolates using PCR has identified novel strains of hemotropic *Mycoplasma* in many animal species, some of which are yet to be confirmed as new species.

Many studies suggest that subclinical infection is common and that the development of clinical disease requires the presence of some other debilitating factor or stress for disease to occur. In Merino sheep this may be the stress of weaning, suboptimal nutrition, and intercurrent gastrointestinal nematode infections. Viral infections with porcine reproductive and respiratory syndrome (PRRS) and swine influenza appear to predispose its occurrence in swine.

Intercurrent infections of hemotropic *Mycoplasma* with other blood parasites, such as *Anaplasma*, are recorded in association with severe disease in sheep and cattle.<sup>6,7</sup> However, a phenomenon known as *interference*, in which infection with one blood parasite protects against another, has been noted with *Theileria* and hemotropic *Mycoplasma* in cattle.<sup>8</sup>

### PATHOGENESIS

Following experimental infection there is a variable prepatent period, usually 1 to 3 weeks, which is followed by a period of intense parasitemia. Ring-form, coccoid, and rod-shaped organisms are evident in stained blood smears. The organism is epicellular, infecting the surface and periphery of erythrocytes, and is also found free in the plasma in blood examinations.<sup>9</sup> There is a profound hypoglycemia during the parasitemic phase, which is believed to be a result of direct consumption of glucose by the parasite. The period of intense parasitemia lasts for a period of 5 to 10 days, following which visible organisms in the blood become much less frequent and anemia develops. Parasitized erythrocytes are removed from the circulation by the spleen. It is believed that the parasite alters the erythrocyte membrane, exposing new antigenic determinants and stimulating the development of

antierythrocyte antibodies.<sup>9</sup> The severity and duration of the anemia vary between individuals, but the disease commonly lasts from 1 to 2 months. Upon recovery there may be further cycles of parasitemia and anemia, which are less severe. Sheep that develop a high antibody titer tend to rapidly clear the Parasitemia, whereas sheep that have a poorer antibody response tend to show persistent parasitemia and recurrent episodes of anemia. Once an animal is infected, it is probably infected for life.

### CLINICAL FINDINGS

#### Sheep

Sudden death and deaths associated with exercise, accompanied by hemoglobinuria and icterus, may be a feature in some sheep and some outbreaks, but, more commonly, the disease is manifest with fever and depression followed by the development of anemia, exercise intolerance, and ill-thrift. In some cases, it may be the principal cause of ill-thrift in lambs. There is reduced wool growth, and in the experimental disease in lambs at pasture, a retardation of growth of up to 2 kg has been recorded 5 weeks after infection. Lambs suckled by infected ewes are passively immunized via the colostrum until weaning.

#### Pigs

Acute icteroaemia is the classical syndrome and occurs in feeder pigs. It is characterized by weakness of the hind legs, mild fever (40°C; 104°F), increased pulse rate, pallor of the mucosae, and emaciation. Jaundice is a frequent but inconsistent feature of the disease. Case fatality is high, and death occurs 1 to 5 days after the onset of clinical signs. Although once quite common, the prevalence of this form has decreased, possibly as a result of the use of feed additives containing arsenicals and effective ectoparasite control.

Another manifestation includes anemia and weakness in neonatal pigs accompanied by low piglet viability, affecting several litters. Affected pigs are pale and lethargic, and there is marked variation in birth weight within affected litters. Low-birth-weight piglets die shortly after birth. The anemia increases in severity between birth and weaning age, the pigs have skin pallor and exercise intolerance, and there is considerable variability in weaning weights. The syndrome may or may not be accompanied by reproductive inefficiency characterized by delayed estrus cycles and embryonic death. Anemia, jaundice, and poor growth rate can also present primarily in weaner pigs.

Subclinical infections associated with subclinical anemia are reported to result in reproductive failure, anestrus and delayed estrus, reduced sow body condition, increased susceptibility to enteric and respiratory disease, and failure of feeder pigs to gain weight at the expected rate.

## Cattle

Clinical disease has been considered uncommon and has largely been a problem in cattle that have been splenectomized for experimental use, with disease occurring 1 to 4 weeks after the splenectomy. However, clinical disease is recorded in adult commercial dairy cattle manifest with lassitude, stiffness, pyrexia, diarrhea, hindlimb and udder edema, and a fall in milk production, with one reported case clustered 5 days on either side of vaccination against bluetongue virus.<sup>10</sup>

Eperythrozoonosis has also been associated with a syndrome occurring in heifers in early to midlactation, during late summer and early autumn, in which there was fever, swelling of the teats and the hindlimbs, lymph node enlargement, and a fall in milk production. Signs of infection resolved in 7 to 10 days, regardless of treatment. A similar transient disease occurring in the spring and summer months, and manifest with scrotal and hindlimb edema and infertility, has been associated with eperythrozoonosis in young bulls.

### CLINICAL PATHOLOGY

#### Blood Smears and Hematology

The presence of the organism can be established by examination of a blood smear taken during a clinical episode and when the animal has fever. In countries where there is no serologic test available this may be the only method of diagnosis. Parasitemia is most intense before the development of clinical anemia and appears as 0.5- to 1.0-mm, coccoid, rod- or ring-shaped basophilic particles on red cells or free in plasma. Parasitemia is difficult to detect once clinical signs of disease are evident and very difficult in chronic disease. It is recommended that blood samples from a number of animals in the group be examined if eperythrozoonosis is suspected.

Lowered values for hemoglobin and packed cell volume (PCV) are evident on hematological examination of clinically affected animals, and there is marked red cell anisocytosis and polychromasia with basophilic stippling and the presence of many Howell-Jolly bodies in sheep. A profound hypoglycemia may be demonstrated, and there are elevated concentrations of unconjugated and total bilirubin.

#### Polymerase Chain Reaction

The development of conventional and real-time PCR assays now offers a more precise, sensitive, and efficient diagnostic method, with many animals negative on blood smears being positive on the PCR test.<sup>10</sup>

#### Serology

##### Sheep

The complement fixation test and indirect fluorescent antibody test (IFA) have been used. With the complement fixation test, sera

from affected animals give positive reactions on the third day of clinical illness, remain positive for 2 to 3 weeks, and then gradually revert to negative. Chronic carriers of the disease are usually negative reactors. The IFA or ELISA tests are more suitable for serologic studies because infected animals remain seropositive for significantly longer periods.

### Pigs

The indirect hemagglutination test and ELISA test can be used in swine and are of value in herd diagnosis but may not detect infection in an individual pig, especially those under 3 months of age. Experimental challenge of splenectomized piglets may be used to determine the presence of infection. PCR may resolve laboratory diagnostic problems.

### TREATMENT

A single intramuscular injection of tetracycline or oxytetracycline (3 mg/kg BW or more) is an effective treatment in sheep, with clinical improvement occurring in 24 hours in the early stages of the disease. Chronic infections are less responsive. Treatment of affected lambs with neosarsphenamine (30 mg/kg BW) or Antimosan (6 mg/kg BW antimony) is effective in relieving clinical illness but does not completely eliminate the parasite. Imidocarb dipropionate also is effective in treatment, but recrudescence at 2 to 4 weeks is common.

### CONTROL

Control of disease in sows and neonates has been reported with the inclusion of chlortetracycline in the sow feed at 300 g/ton or by intramuscular administration of oxytetracycline to sows at 14 and 7 days before the expected farrowing date. Tetracyclines can also be used in feed or by in-line water medication in feeder pigs. With large flocks of sheep in enzootic areas, reinfection or recrudescence occurs so quickly that control by treatment may be an unwarranted expenditure.

In confined swine operations, the detection of carrier pigs by PCR, and their subsequent removal, has been proposed as a possible control procedure.

### FURTHER READING

- Hoezle LE. Haemotrophic mycoplasmas: recent advances in *Mycoplasma suis*. *Vet Microbiol*. 2008;130:215-226.
- Hoezle LE, et al. Pathobiology of *Mycoplasma suis*. *Vet J*. 2014;202:20-25.
- Radostits O, et al. Eperythrozoonosis. In: *Veterinary Medicine: A Textbook of the Diseases of Cattle, Horses, Sheep, Goats and Pigs*. 10th ed. London: W.B. Saunders; 2007:1154-1156.
- Strugnell B, McAuliffe L. *Mycoplasma wenyonii* infection in cattle. *In Pract*. 2012;34:146-154.

### REFERENCES

- Grazziotin AL, et al. *J Wild Dis*. 2011;47:1005.
- Grazziotin AL, et al. *Vet Microbiol*. 2011;152:415.
- Sykes JE, et al. *J Clin Microbiol*. 2010;48:3782.
- Boes KM, et al. *Vet Clin Path*. 2012;41:77.
- Maggi RG, et al. *Comp Immunol Microbiol Infect Dis*. 2013;36:607.
- Hornok S, et al. *Vet Microbiol*. 2009;136:372.
- Hornok S, et al. *Res Vet Sci*. 2012;92:30.
- Tagawa M, et al. *Vet Parasitol*. 2013;195:165.
- Hoezle LE, et al. *Vet J*. 2014;202:20-25.
- Strugnell BW, et al. *Cattle Practice*. 2011;19:75.

## BOVINE PETECHIAL FEVER (ONDIRI DISEASE)

Bovine petechial fever is a rickettsiosis of cattle caused by *Ehrlichia (Cytoecetes) ondiri*. The disease occurs in the highlands of **Kenya** and **Tanzania** at altitudes of 1500 to 3000 m, although it is considered likely to occur in neighboring countries with similar topography. Characteristically, bovine petechial fever occurs in cattle that break out from fenced pastures and graze adjacent forest or bushland areas, or when they are grazed on these areas at the end of the dry season. It also occurs in cattle that have been **recently introduced** to these areas, and indigenous cattle appear to acquire resistance. Epidemics occur in cattle imported to infected areas and last 1 to 2 months, involving 60% to 80% of the group and resulting in significant losses. However, no outbreak has been reported for over a decade.

Infection can be **experimentally transmitted** to cattle, sheep, goats, wildebeest, impala, duiker, bushbuck, and other wild ruminants, but natural disease is seen only in cattle. *E. ondiri* infection is believed to be endemic in wild ruminants, especially bushbuck and duiker, and the disease sporadically spills into cattle grazing forest edges or scrubs. The vector is not known, although epidemiologic findings suggest a tick vector of restricted distribution.

The **disease in cattle** is characterized by high fever and widespread petechial hemorrhages in mucous membranes for periods up to 10 days; epistaxis, melena, and unilateral conjunctivitis occur in more severely affected animals. The eyeball is tense, protruding through swollen, everted conjunctival sacs as the so-called "poached-egg eye." Pregnant animals may abort, and there is a fall in milk production for several weeks in lactating animals. Anemia may be severe enough to result in death 3 to 4 weeks after infection. There is a profound lymphocytopenia by the second day of infection, followed by leukopenia and thrombocytopenia. The organism can be demonstrated in granulocytes and monocytes in Giemsa-stained blood smears during the febrile period, but it cannot yet be cultured. Serology (indirect fluorescent antibody test) can be carried out to detect antibodies against *E. ondiri*.

Grossly, the main lesions of ondiri disease are widespread petechial hemorrhages and enlarged, congested lymph nodes. In severe cases, death is often a result of severe hemorrhages into the lungs and airways. Abomasal

mucosa is edematous, and the contents of the ileum and colon are tarry. Differential diagnosis includes other hemorrhagic diseases of cattle, such as acute trypanosomiasis, acute theileriosis, hemorrhagic septicemia, bracken fern poisoning, Rift valley fever, and heartwater.

Tetracyclines are effective in treating early experimental cases but are ineffective in advanced cases. Recovered animals may be latently infected and are immune to reinfection for at least 2 years. Control is by avoiding grazing cattle in forest edges and in paddocks with patches of thick scrub.

### FURTHER READING

- Blowey RW, Weaver AD. *Color Atlas of Diseases and Disorders of Cattle*. 3rd ed. New York: Mosby/Elsevier; 2011:237.
- Sumption KJ, Scott GR. Bovine petechial fever (Ondiri disease). In: Coetzer JAW, Tutsin RC, eds. *Infectious Diseases of Livestock*. Vol. 1. 2nd ed. Cape Town: Oxford University Press; 2004:536.
- Valli VEO. Bovine petechial fever. In: Maxie GM, ed. *Pathology of Domestic Animals*. Vol. 3. 5th ed. Philadelphia: Saunders/Elsevier; 2007:310.

## MYCOPLASMA SUIS INFECTION IN PIGS

*Mycoplasma suis* causes anemia, fever, and icterus in pigs and was formerly called *Eperythrozoon sui*; it is a member of the *Mollicutes* family. The classical disease is now called infectious anemia of pigs. The original descriptions of the condition had two possible causes, *E. suis* and *E. parvum*. Currently, on the basis of 16S rRNA, *E. suis* is classified as *M. suis* within the *Mycoplasma* genus. Pigs infected with *E. parvum* have only mild disease. In a recent study<sup>1</sup> in Brazil, a novel species was discovered, and by PCR this showed 98% to 99% matched identity to Candidatus *M. haemominutum* and is likely to be *E. parvum*.

This disease is probably greatly underdiagnosed because of the difficulties in diagnosis. A recent study in China showed a heavy infection rate in swine workers (32/65),<sup>2</sup> and it is now being isolated from diseased humans. Outbreaks of hemotropic mycoplasma infection have been recorded in Mongolia.<sup>3</sup> It can cause acute and chronic infections.

### ETIOLOGY

*M. suis* is a rod-shaped, coccoid, or ring-like bacterium, about 0.2 to 2.0  $\mu\text{m}$  in diameter. It is seen attached to the surface of red blood cells (RBCs), but recent studies have shown that it can also invade RBCs and live in vacuoles or free in the cytoplasm.<sup>4</sup> It has not yet been cultured, but the genome has been sequenced.<sup>5</sup> It exists in two clusters, a North American/European form and a Chinese form,<sup>6</sup> and these were also found in wild boar in Germany.<sup>7</sup>

## EPIDEMIOLOGY

The disease can be found in all ages of pigs. Maternally derived antibody may play a part in preventing or delaying infection.

It is probably found worldwide in pigs, but few surveys have been carried out. It has been found in Brazil<sup>8</sup> and has also been found in deer.<sup>9</sup> In affected herds, it is usually widespread and may cycle in waves through the herd. It was found in 13.9% of feeder pigs, and 40.3% of pig farms were positive in Germany.<sup>10</sup> The morbidity can be 10% to 60%, and the mortality can reach 90% in an acute outbreak in very young pigs.

Transmission is via blood and blood components by licking, biting, cannibalism, urine discharges, and other biological components containing blood. It is probably transmitted by biting flies, mosquitoes, and hypodermic needles. Transplacental infection has been suggested but not proven. The carrier state probably also exists.

Predisposing factors may include immune-modulating viruses such as porcine reproductive and respiratory syndrome (PRRS) virus, porcine circovirus type II (PCV-2), and possibly simian immunodeficiency virus (SIV). Other factors may include increased arthropod activity and periods of stress, such as farrowing and weaning.

## PATHOGENESIS

Initially, there is a heavy bacteremia, with colonization of the surface of the RBCs aided by a surface protein of the *M. suis*. The RBCs are then recognized as abnormal by the spleen and removed from circulation, adding to the anemia. The degree of anemia is closely related to the load of *M. suis* on the RBCs. The bacteria are also capable of penetrating the cell by an unknown method,<sup>4</sup> and this may be the means of their persistence as an infection because they can then evade host defense mechanisms, increase virulence, and reduce antimicrobial efficacy.

It is thought that the *M. suis* uses the erythrocyte glucose for its own metabolism and by damaging the cell membrane induces production of auto-agglutinins favoring removal of these cells by the phagocyte system, thereby increasing extravascular hemolysis.

Any immune response may occur not only as a result of the *M. suis* but also in response to the infected RBCs, thereby increasing the hemolysis and anemia and subsequent jaundice. The infection itself may affect T cells and cause immunosuppression. In many instances the immunosuppression caused by concurrent infections with PRRS, PCV-2, and SIV will also complicate the pathogenesis and clinical signs. The rate of destruction of RBCs may be so great that the demand for glucose by the *M. suis* outstrips the gluconeogenesis, and hypoglycaemia may result, especially in pigs of 0 to 7 days of age, which are already low in glycogen.<sup>11</sup> Endothelial cell activation, widespread

endothelial damage, and adherence of RBCs to the endothelium is evident in *M. suis* infections.<sup>12</sup> The suggestion is that *M. suis* has a tropism for endothelial cells, and this interferes with the protective function of the endothelium, resulting in hemorrhagic diatheses.

## CLINICAL PATHOLOGY

In acute cases there is a peak bacteremia 7 to 14 days following infection, with bacteria in blood smears and variable types of anemia.

Decreases in packed cell volume, total red cell count, and hemoglobin concentration occur because of massive red cell parasitism. Anemia and bilirubinemia results from the RBC destruction, with hypoglycaemia and acidosis sometimes occurring.

## CLINICAL SIGNS

In natural acute cases, which are most common in postweaned pigs, there is lethargy, pyrexia, anorexia, variable icterus, cyanosis of the extremities, petechial bleeding and ecchymoses, and often death within several days.

In chronic cases there is pyrexia; anorexia; reproductive failure; mastitis, metritis, and agalactia (MMA); reduced birth weights; weakness and anemia of neonates; poor growth rates; and ill-thrift, with a predisposition to secondary infections.

In experimental splenectomized pigs the incubation period is 3 to 10 days. It is particularly acute in the pig under 7 days of age, in which the signs include pallor, fever, occasionally icterus, and cyanosis of the extremities, particularly the ears.<sup>2</sup> More commonly there is a mild anemia and a reduced growth rate. There may be increased bleeding and in some cases navel bleeding in young pigs. The bleeding was shown to resolve with the use of tetracyclines, suggesting that *M. suis* may be associated with navel bleeding. Recovered pigs may show a reduced growth rate and unevenness in the litter. Skin hypersensitivity, pallor, and unthriftiness may be seen in the chronic infection. In sows, there may be fever, anorexia, lethargy, and agalactia, particularly around farrowing. A severe outbreak of dysgalactia was described in the United States starting 1 day after parturition and lasting 4 to 6 days.<sup>13</sup>

## PATHOLOGY

In acute cases there is anemia, jaundice, splenomegaly, and serous effusions in the body cavities. In the chronic cases, secondary infections often mask any primary lesions from the *M. suis*.

## DIAGNOSIS

The diagnosis is complicated because there is no culture available for the organism. It is therefore dependent on the clinical signs, the direct demonstration of the organism in blood smears (stained by Romanowska-type stains, Giemsa, or acridine orange) taken at

the time of collection of the blood sample and the hematology results of anemia and bilirubinemia.

The position has been improved by the development of PCR techniques. The first qPCR for *M. suis* was developed in Germany<sup>7</sup> and was shown to be much more sensitive than the blood smear test.<sup>11</sup> The blood test is entirely dependent on the number of organisms present. The test used on 120 samples from clinically normal, healthy pigs on 11 farms found *M. suis* on 6 farms and *M. parvum* on 18 farms, with 3 positive for both, using qPCR.<sup>8</sup>

Antibodies can be detected by ELISA tests. These tests have been developed using recombinant antigens,<sup>14</sup> and initially these were of high sensitivity but low specificity. Because the antibodies may only last 2 to 3 months, false negatives were common. The blocking ELISA described is more efficient.<sup>15</sup> A new ELISA was shown to be 98.5% specific and 96.9% sensitive and much more efficient than an IHA test.<sup>16</sup>

## TREATMENT

Usually a course of oxytetracycline at 20 to 30 mg/kg given daily parenterally will prevent the clinical signs. Pigs affected will not usually feed or drink properly, so administration in the feed is only effective as a prophylaxis. If given in the feed, it needs to be fed for a minimum of 14 days. Often it prevents anemia, but it does not prevent outbreaks.

## CONTROL

Usually on an infected farm an equilibrium is reached between the organism and the host, but it can be overcome by concurrent infections, bad management, and a poor environment, and thus these should be rectified. The complicating factors should be removed, such as secondary infections by vaccination (PRRS, SIV, PCV-2). Excessive use of vaccines should be avoided because they involve the use of needles. There is no specific vaccine.

## FURTHER READING

Hoelze LE. Haemotrophic mycoplasmas—recent advances in *Mycoplasma suis*. *Vet Microbiol*. 2008;130:215-226.

## REFERENCES

- Biondo AW, et al. *Rev Bras Parasitol Vet*. 2009;18:1.
- Yuan CL, et al. *Am J Vet Res*. 2009;70:890.
- Hu Z, et al. *Emerg Infect Dis*. 2009;15:1139.
- Groebel K, et al. *Infect Immun*. 2009;77:576.
- Guimaraes AMS, et al. *PLoS ONE*. 2011;6:e19574.
- Watanabe Y, et al. *J Vet Sci*. 2012;74:1315.
- Hoelze K, et al. *Vet Microbiol*. 2010;143:405.
- Guimaraes AMS, et al. *Vet Rec*. 2007;160:50.
- Watanabe Y, et al. *J Vet Med Sci*. 2010;72:1527.
- Ritzmann M, et al. *Vet Microbiol*. 2009;133:84.
- Hoelze K, et al. *J Microbiol Meth*. 2007;70:346.
- Sokoli A, et al. *Vet Res*. 2013;44:6.
- Congli Y, et al. *Vet Microbiol*. 2010;142:303.
- Hoelze K, et al. *Clin Vaccine Immunol*. 2007;14:1616.



15. Zhang CY, et al. *Vet J.* 2012;193:535.  
 16. Liu J, et al. *Res Vet Sci.* 2012;93:48.

## EPIZOOTIC HEMORRHAGIC DISEASE (BLACKTONGUE)

### SYNOPSIS

**Etiology** Epizootic hemorrhagic disease virus (EHDV), an arthropod-borne, double-stranded RNA virus of the family of *Reoviridae*, genus *Orbivirus*

**Epidemiology** Infectious but noncontagious disease transmitted by biting midges. Wild ruminants, particularly white-tailed deer, develop severe clinical disease with high mortality. Historically, cattle were believed to be resistant to clinical disease, but recent outbreaks of EHD primarily affecting cattle have been reported. Small ruminants may seroconvert but do not develop clinical disease. Occurrence is dependent on the presence of competent vectors. In temperate regions the highest disease incidence is in late summer and fall; in tropical regions EHD occurs throughout the year.

**Clinical findings** In white-tailed deer, rapid edema development on the neck and head; swelling of the tongue and conjunctivae. Hemorrhagic diathesis with bloody diarrhea, hematuria, and dehydration. More chronic presentation with erosions or ulceration in the buccal cavity.

In cattle, sudden anorexia, decreased rumination, drop in milk production, weakness, short-term low fever, stiff gait. Morbidity rate dependent on infectious pressure in the herd; low mortality rate.

**Necropsy findings** In white-tailed deer, cyanosis and petechial ecchymotic hemorrhages of oral mucosa and tongue. Ulceration and necrosis of oral mucosa in more chronic cases. Pulmonary edema; serosanguinous fluid in thorax, pericardial sac, and abdomen. Rarely fatal in cattle.

**Diagnostic confirmation** Virus isolation and detection from blood or tissue (whole blood, spleen, lungs, lymph node, liver). Serologic tests (agar gel immunodiffusion test [AGID], enzyme-linked immunosorbent assay [ELISA], serum neutralization assay).

**Treatment** Supportive treatment; no specific treatment is available.

**Control** *Culicoides* vector control (insecticides, larvicides, insect repellents, management of *Culicoides* breeding areas). Commercial vaccines are not available; autogenous inactivated vaccines have been used.

### ETIOLOGY

Epizootic hemorrhagic disease (EHD) virus is an arthropod-borne virus of the family of *Reoviridae*, genus *Orbivirus*, closely related

to bluetongue virus. At least seven different serotypes (serotype 1 through 8, with serotype 3 considered to be similar to serotype 1) exist, which have been regrouped in recent years.<sup>1</sup> Some of these have antigenic relations with serotypes of bluetongue virus. The EHD virus (EHDV) can infect most domesticated and wild ruminants naturally; pigs are not susceptible to infection. Clinical disease is primarily observed in wild ruminants. White-tailed deer are most severely affected, followed by mule deer and pronghorn antelope. In recent years several disease outbreaks in cattle herds have been reported.

### EPIDEMIOLOGY Occurrence

Because EHD is a vector-borne viral disease, occurrence of infection depends on the presence of competent vectors. Clinical disease or serologic evidence for infection has been reported from North and South America, Africa, Asia, Australia, and, more recently, from the region surrounding the Mediterranean Basin, including Morocco, Algeria, Tunisia, Israel, Jordan, and Turkey.<sup>1</sup> Although the geographic occurrence of EHD was similar to that of bluetongue during the last century, the recent northward progression of bluetongue from the Mediterranean Basin far into the European continent was not observed for EHD.

Historically, two serotypes (EHDV-1, EHDV-2) were predominant among the wild ruminant population throughout the United States, except in the Northeast and the arid Southwest, and southern Canada. Between 2006 and 2009, EHDV-6 was recovered from clinical cases in Indiana, Illinois, Missouri, Kansas, Michigan, and Texas. In Australia, six serotypes (1, 2, 5, 6, 7, and 8) have been isolated, predominantly from sentinel cattle in the north. Three serotypes have been recognized in Africa: EHDV-3 (considered to be identical to EHDV-1), EHDV-4, and EHDV-6.<sup>2</sup> Two major outbreaks of EHD mainly affecting cattle that were associated with a genetically distinct strain of EHDV-2, called **Ibaraki disease**, occurred in Japan, Korea, and Taiwan in the 1960s and again 30 years later. The first epidemic of Ibaraki disease resulted in 39,000 sick cattle and 4000 deaths. In Europe and the Mediterranean Basin numerous outbreaks of EHD, primarily affecting cattle instead of wild ruminants, have been observed since the beginning of the millennium. In 2001 clinical cases associated with EHDV of unspecified serotype were reported in Israel. Between 2004 and 2007, outbreaks caused by EHDV-6 were reported in Morocco, Algeria, Tunisia, and Turkey. In 2006 an epidemic associated with EHDV-7 and affecting dairy and beef herds was reported in Israel.<sup>3</sup> In 2008 EHD was added to the list of notifiable diseases of the World Organization of Animal Health (OIE) and is now considered an emerging disease in cattle.<sup>4</sup>

### Host Occurrence

Under natural conditions infection occurs in sheep, cattle, and wild ruminants. Natural infection does not appear to occur in goats. Historically, clinical disease was primarily observed in wild ruminants, whereas cattle and to a lesser extent sheep were considered as reservoir hosts for the virus. In recent years, outbreaks of EHD affecting cattle have been reported in different parts of the world. Among wild ruminants, **white-tailed deer** and to a lesser degree mule deer and pronghorn antelope are **most susceptible to clinical disease**.

### Method of Transmission

The disease is not contagious and is almost exclusively **transmitted biologically** by specific species of *Culicoides*. Epidemiologic data suggest that *Culicoides* species transmitting EHDV are similar, although not necessarily identical, to species transmitting bluetongue virus (BTV), but the vector competence of involved *Culicoides* species may differ for both viruses. Possible differences in the environmental temperature and number of days at or above a specific environmental temperature required for effective virus replication within the vector for BTV and EHDV may have contributed to the differences in geographic progression of these two viruses observed in recent years in Europe.<sup>1</sup>

*Culicoides* breed in damp, wet areas, including streams, irrigation channels, muddy areas, and fecal runoff areas around farms. Habitats for them exist on the majority of farm environments. Only female *Culicoides* are hematophagous and feed on their main or preferred host species, requiring at least one blood meal for the completion of the ovarian cycle. They feed nocturnally on animals in open pens and fields, and the optimal temperatures for activity are between 13° (56°F) and 35°C (95°F). In temperate areas the disease is **seasonal** because *Culicoides* do not tolerate low ambient temperatures, resulting in a vector-free season during late fall and winter.

### Culicoides Species

Different *Culicoides* species have different geographic occurrence, and their distribution in a country is determined by climatic factors and the presence of a preferred host. In the United States *C. sonorensis* is the predominant vector throughout much of the country, except in the Southeast, where *C. insignis* predominates. *C. imicola* is a predominant vector; in the Middle East and Asia, *C. imicola* has been involved in the recent expansion of EHD, but *C. obsoletus* and *C. pulicaris* have been implicated as new vectors associated with recent EHD outbreaks.<sup>1</sup>

### Other Vectors

Other vectors may transmit the disease mechanically but are unlikely to be of major significance in disease epizootics.

### Other Methods of Transmission

The Ibaraki strain (EHDV-2) was isolated from the internal organs of aborted fetuses, which proves that transplacental virus transmission is possible. The incidence of congenital infection and thus the epidemiologic relevance of this route of virus transmission has not been quantified. No reports of isolation of EHDV in the semen of infected animals are available.

Although oral and fecal shedding of EHDV-1 was reported in white-tailed deer, the epidemiologic importance of oro-fecal transmission has not been ascertained.<sup>1</sup>

### Host Risk Factors

Although most ruminant species are susceptible to infection with EHDV, clinical disease primarily is observed in white-tailed deer and, in recent years, also in cattle.

### Wild Ruminants

In North America, EHD is considered one of the most important diseases of deer, particularly of white-tailed deer (*Odocoileus virginianus*) but also mule deer (*O. hemionus*) and pronghorn antelope (*Antilocapra americana*). There are areas of enzootic stability, where seroprevalance in deer is high but the clinical disease rare, and areas with low seroprevalance where clinical disease is severe.

### Cattle

Historically, cattle were believed to function as reservoir hosts for EHDV by being susceptible to infection but resistant to clinical disease. The first reports of clinical disease related to EHDV in cattle date from 1959, when an epizootic disease called **Ibaraki disease** occurred in Japan. Disease outbreaks caused by the Ibaraki strain (EHDV-2) were subsequently observed in other Asian countries. Since 2001 a number of disease outbreaks have occurred in the Mediterranean Basin and also in the United States that have been linked to EHDV serotypes 6 and 7.<sup>5</sup> EHD is now considered an emerging disease of cattle.<sup>4</sup> Morbidity rates in cattle herds can be considerable, depending on the infectious pressure, but clinical signs are much less severe than in white-tailed deer, and mortality is low.<sup>5</sup>

### Small Ruminants

Sheep are susceptible to infection with EHDV but do not develop clinical disease. Although this species has been incriminated as a potential reservoir host for EHDV, more recent experimental studies do not support the assumption that sheep may play a relevant role in the epidemiology of EHDV.<sup>6</sup> In goats, thus far only the presence of EHDV antibodies but not the presence of virus or viral DNA has been documented. It is therefore assumed that goats are resistant to infection.

### Morbidity and Case Fatality Wild Ruminants

Morbidity and case-fatality rates of EHDV in wild ruminants are difficult to determine. Among the Cervidae, white-tailed deer are the most severely affected, and case-fatality rates in this species are much higher than those in other commonly affected species, such as mule deer, black-tailed deer, and pronghorn antelopes. In the Northeast and Midwest of the United States EHD typically recurs every year in late summer and early fall, but mortality and case-fatality rates can vary greatly from year to year. Morbidity and mortality rates may be as high as 90%, although in most instances cases are mild and mortality is low. This variability is thought to be caused by a number of factors, such as the abundance of biological vectors, the ambient temperature, the serotype of EHDV that is circulating, herd immunity (based of previous exposure to a similar strain), and the genetic variation in the susceptibility of the host.<sup>7</sup>

### Cattle

Outbreaks of EHD in cattle herds have been reported in Asia, the United States, and the Mediterranean Basin. Although in rare instances considerable morbidity and case-fatality rates have been reported, as in the case of Ibaraki disease outbreaks in Japan and Korea, in most cases morbidity rates do not exceed 5%, and deaths are uncommon. During an EHDV outbreak in Israel, within-herd morbidity rates between 5% and 80% were observed in dairy herds, but the mortality rate remained below 1%.<sup>3</sup>

### Economic Importance

Until outbreaks of EHD affecting cattle occurred, EHD was considered a disease primarily affecting wild ruminants and thus of minor economic importance. Following the most recent outbreaks in North Africa, Turkey, and Israel, the economic importance of EHD had to be reconsidered. Since 2008 EHD has been listed as reportable disease by the OIE, and EHD is now considered a potentially emerging disease of cattle.<sup>4</sup> Because the increased virulence of EHDV for cattle has only been observed in recent years, not many studies investigating the economic impact of this disease are available. Losses result from decreased productivity, increased involuntary cull rates, abortion, and, in some instances, death.<sup>5</sup> In infected herds in Israel EHD was found to cause an average loss in production of 125 kg/cow per year, an effect that was highly dependent on the season of the year the outbreak occurred and the seroprevalance of the herd. The highest losses were observed when outbreaks occurred in September and in herds with the highest seroprevalences.<sup>5</sup> With losses related to increased mortality added to the production losses, the total cost for the dairy industry in Israel was estimated to range between

US\$ 1,600,000 and 3,400,000, which is equivalent to an average loss of US\$ 26.50 per cow.<sup>5</sup>

### PATHOGENESIS

The incubation period for EHD in deer is 5 to 10 days. After infection with EHDV, initial viral replication occurs in endothelial cells of the lymphatic vessels and lymph nodes draining the site of infection.<sup>1</sup> A viremic phase ensues during which the virus is disseminated to other sites of virus replication, such as the lymph nodes and spleen, causing secondary infection of the endothelial cells of arterioles, capillaries, and venules throughout the body. In blood, EHDV is associated with erythrocytes and to a lesser extent with lymphocytes. This cell association permits prolonged viremic periods and the concomitant presence of virus and antibodies in blood.

Endothelial damage results in leakage of blood vessels and ensuing disseminated intravascular coagulopathy. Fibrin thrombi occluding small blood vessels cause congestion, hemorrhage, and edema of surrounding tissue. Ischemic necrosis occurs in tissue where blood perfusion is interrupted as a result of thrombosis.

Occurrence of viremia in relation to EHDV infection was studied in cattle and deer. The virus could be detected from 2 days following infection, and all animals were viremic 4 days after infection. After experimental infection virus could be isolated up to 28 days following infection and in rare instances up to 50 days following infection.<sup>1</sup>

Neutralizing antibodies can be detected from 10 to 14 days following infection but do not prevent or interrupt viremia. The concomitant presence of virus and homologous antibodies is commonly observed in EHD during the first weeks following infection. Maternal antibodies were identified in fawns born to dams infected with EHD for up to 18 weeks. Passive immunity was not able to prevent infection or viremia in fawns exposed to EHDV but alleviated clinical signs of the disease.<sup>1</sup>

### CLINICAL FINDINGS

#### Deer

In deer, EHD may occur in a **peracute**, **acute**, or **chronic form**. Peracute disease is characterized by high fever, anorexia, respiratory distress, and severe and rapidly developing edema of the neck and head. Conjunctivae and the tongue are commonly swollen. Affected animals may be found dead or die within 2 days of the first clinical signs.<sup>7</sup> The acute form is the classical presentation of EHD in deer, in which extensive hemorrhage affecting the skin, gastrointestinal tract, and heart is the hallmark sign. There is often hyperemia of the conjunctivae and mucosal membranes of the mouth. Ulcers and erosions may develop on the tongue, dental pad, palate, rumen, and

abomasum. Excessive salivation and nasal discharge, which can be tinged with blood, have been observed. Bloody diarrhea, hematuria, and dehydration can occur. The mortality rate for both the peracute and acute forms is generally high.

Deer with the chronic form of EHD are sick for several weeks but recover gradually. Cracks in the hooves resulting from the interrupted horn growth resulting from the disease may cause lameness. Chronic lesions of the mucosa of the rumen, with erosions, ulcers, and scarification, can cause emaciation.<sup>7</sup>

### Cattle

Most infections in cattle are unapparent. Occasional disease associated with infection with EHDV is recorded in cattle in the late summer in the United States and has been reported in recent outbreaks in the region around the Mediterranean Basin. Common clinical signs are anorexia, reduced rumination, weakness, decreased milk production, stiff gait, and short episodes of pyrexia.<sup>6</sup> Reddening and swelling of the oral mucosa with necrotic ulceration of the dental pad and behind the incisor teeth, cracking and sloughing of the skin of the muzzle, and hyperemia of the skin of the teats and udder may occur in some cases.

**Ibaraki disease** is characterized by fever, hyperemia and edema of the mucosae, hemorrhages, ulcerative stomatitis with laryngeal and pharyngeal paralysis, salivation, and dysphagia. At postmortem there were hemorrhages in the pharynx and esophagus, and animals commonly died with aspiration pneumonia. Infection of pregnant cattle with Ibaraki virus can also result in abortion and stillbirths, and currently this seems a more common clinical manifestation. Fetuses infected between 70 and 120 days of gestation may develop hydrocephaly.<sup>7</sup>

### CLINICAL PATHOLOGY

Specific diagnosis is either by isolation of the virus, detection of viral antigen or nucleic acid, or detection of specific antibodies in serum. Serologic assays can detect prior exposure to EHDV but cannot establish if the animal is viremic and thus infectious. Serologic tests may be of limited value in regions where EHDV is endemic and seroconversion is common in the affected population.

Materials that can be used for virus isolation include heparin or EDTA in the blood, biopsies, or postmortem tissue samples of the spleen, lung, lymph nodes, or liver.

### Virus Isolation

Virus isolation commonly is carried out by tissue culture or culture in embryonated chicken eggs (ECEs). Cell lines used for this purpose can be of insect origin, such as the KC cell lines derived from *Culicoides sonorensis*, or mammalian cell lines, such as baby

hamster kidney cells (BHKs), calf pulmonary artery endothelium cells (CPAEs), or African green monkey kidney cells (Vero). The cytopathic effect produced by EHDV is only observed on cell lines of mammalian origin and becomes apparent between 2 and 7 days after inoculation. Virus identification from cell cultures is based on a serum neutralization or plaque inhibition test using reference antisera. Virus isolation is the most reliable confirmation of EHDV infection because there are difficulties with the interpretation of serologic test results. However, traditional isolation methods require 2 to 4 weeks.

### Detection of Antigen or Nucleic Acid

Immunohistochemical tests, including immunofluorescence, or molecular techniques such as in situ nucleic acid hybridization, reverse-transcription polymerase chain reaction (RT-PCR), or the dot blot test can be used for rapid sensitive and specific detection of antigen. Use of RT-PCR has proliferated because of its simplicity, rapidity, reliability, reproducibility, sensitivity, and specificity. However, tests that detect viral RNA prove exposure to the virus but do not necessarily indicate that infectious virus is still present. An antigen-ELISA and sandwich-ELISA have also been used for EHDV identification but are less sensitive than the PCR.

### Serologic Tests

A number of serologic tests for detection of either group-reactive antibodies or serotype-specific antibodies are available. The commonly available tests include the complement fixation test (CFT), the agar gel immunodiffusion test (AGID), a number of different ELISA tests, and serum neutralization (SN). The **AGID test** is easy to perform and inexpensive but is also relatively **insensitive** and detects cross-reacting antibodies to other orbiviruses, such as bluetongue virus. Over the last decades the CFT and AGID have been replaced in many laboratories by the more rapid, sensitive, and specific competitive ELISA.

A number of ELISA tests have been developed that use group-specific monoclonal antibodies, and these present valuable alternatives to the AGID for routine diagnosis and international trade. The **competitive ELISA (cELISA)**, which is the most sensitive and highly specific group-specific test, is the preferred test for serodiagnosis of EHD. The **serum neutralization test (SNT)** is serotype specific and thus allows for differentiation between antibodies against specific EHDV serotypes. The biological detection system (either ECEs or cell cultures) is reacted with a reference serum for specific EHDV serotypes, and the amount of virus neutralization is determined. Although the SNT is highly sensitive and specific, it is also expensive and time-consuming and is therefore not used as a routine diagnostic procedure.

## NECROPSY FINDINGS

### Deer

Lesions in white-tailed deer and related species are similar to those described for bluetongue in sheep and cattle. In acute cases, there may be cyanosis of the oral mucosa and tongue, along with widespread petechial to ecchymotic hemorrhages. In more chronic cases, there may be ulcers and necrotic debris in the oral mucosa and severe hoof lesions, including fissures and sloughing. Lesions in yaks include swollen conjunctivae, ulcerated dental pads, mucoid sanguineous nasal discharge, and petechial hemorrhages in multiple organs; others are pulmonary edema and serosanguinous fluid in the thorax, abdomen, and pericardial sac.<sup>8</sup>

### Cattle

The disease is usually subclinical and nonfatal in cattle.<sup>9</sup>

### Samples for Confirmation of Diagnosis

- **Histology**—fixed oral and mucocutaneous lesions, abomasum, pulmonary artery, skeletal muscle from a variety of sites, left ventricular papillary muscle, brain from aborted fetus (LM, IHC)
- **Virology**—chilled lung, spleen, CNS tissues, thoracic fluid from aborted fetus (ISO, PCR, in situ HYBRID, ELISA, etc.)

### DIFFERENTIAL DIAGNOSIS

Foot-and-mouth disease  
 Bluetongue (wild ruminants)  
 Bovine viral diarrhea/mucosal disease (cattle)  
 Malignant catarrhal fever (cattle)  
 Bovine ephemeral fever (cattle)

### TREATMENT

There is currently no specific treatment available for EHDV.

### CONTROL

#### Reduction of Infection Through Vector Abatement

Attempts to control EHD through a reduction of infection consist of reducing the risk of exposure to infected *Culicoides* and reduction in *Culicoides* numbers. Neither are particularly effective. Widespread spraying for *Culicoides* control is not usually practical and has only a short-term effect.

To address recent EHD outbreaks in cattle herds, several affected countries have introduced control measures such as monitoring of wildlife reservoirs, quarantine, vector control programs on farms, and awareness campaigns for veterinarians and farmers.<sup>1</sup>

#### Vaccination

There is no commercially available vaccine against EHD. Autogenous inactivated



vaccines produced from virus isolates from ill or diseased herdsmates have been used in the United States to tackle EHD outbreaks in captive wildlife deer. In Japan, both a modified live and an inactivated vaccine derived from the Ibaraki-2 strain have been developed to control Ibaraki disease. This vaccine, which is administered once during the low-vector season, was found to be safe and effective in controlling the disease.<sup>1</sup>

### FURTHER READING

Savini G, et al. Epizootic haemorrhagic disease. *Res Vet Sci.* 2011;91:1-17.

### REFERENCES

1. Savini G, et al. *Res Vet Sci.* 2011;91:1-17.
2. Allison AB, et al. *J Gen Virol.* 2010;91:430-439.
3. Yadin H, et al. *Vet Rec.* 2008;162:53-56.
4. OIE. 2009 At: <[http://www.oie.int/fileadmin/Home/eng/Animal\\_Health\\_in\\_the\\_World/docs/pdf/EPIZOOTIC\\_HEAMORRHAGIC\\_DISEASE\\_FINAL.pdf](http://www.oie.int/fileadmin/Home/eng/Animal_Health_in_the_World/docs/pdf/EPIZOOTIC_HEAMORRHAGIC_DISEASE_FINAL.pdf)>; Accessed 15.11.2013.
5. Kedmi M, et al. *J Dairy Sci.* 2010;93:2486-2495.
6. Kedmi M, et al. *Vet Microbiol.* 2011;148:408-412.
7. Center for Food Security and Public Health. 2006 At: <[http://www.cfsph.iastate.edu/Factsheets/pdfs/epizootic\\_hemorrhagic\\_disease.pdf](http://www.cfsph.iastate.edu/Factsheets/pdfs/epizootic_hemorrhagic_disease.pdf)>; Accessed 15.11.2013.
8. Van Campen H, et al. *J Vet Diagn Invest.* 2013;25:443-446.
9. Breard E, et al. *Res Vet Sci.* 2013;95:794-798.

## BOVINE IMMUNODEFICIENCY-LIKE VIRUS

### ETIOLOGY

Bovine immunodeficiency-like virus (BIV), also known as bovine lentivirus-1, is a lentivirus, within the larger family of *Retroviridae*. The virus shares structural and genomic similarities with other lentiviruses, such as equine infectious anemia virus, caprine arthritis-encephalitis virus, maedi-visna virus, and the feline, simian, and human immunodeficiency viruses. BIV was first described in cattle in the United States in 1972. These viruses replicate primarily in the cells of the host's immune system following their insertion as provirus into the genome of these target cells, thus establishing a chronic, lifelong infection. The lentiviruses are usually associated with specific diseases. However, a clear involvement of BIV in the development of a clinical syndrome is not well established.

### EPIDEMIOLOGY

#### Prevalence of Infection

Seroepidemiological evidence indicates that BIV infection has a worldwide distribution. Seropositive cattle have been identified in the United States, the Netherlands, New Zealand, Australia, Bali, Indonesia, Brazil, and Canada, with estimates ranging from 1% to 5% of cattle being infected. In Italy, the prevalence is 5.8% in dairy cattle and 2.5% in beef cattle. In individual herds the prevalence of infection may be much higher. In the United Kingdom, the seroprevalence was found to

be 5.9% in dairy cattle and 5.0% in beef cattle. The dairy and beef herd prevalence rates were 60% and 59%, respectively. Although the prevalence of BIV infection in the United Kingdom is low, it is widespread. Recent studies, using DNA derived from semen and buffy-coat samples, analyzed by nested PCR, found no evidence of BIV infection in western Canadian cattle.

A seroprevalence of greater than 50% was present in a dairy herd at a university in the southeastern United States, which is an area with a high prevalence of infection in the cattle population. There is some evidence that in some cattle herds with a high incidence of unthrifty animals, the prevalence of seropositive animals may be as high as 95%. The prevalence of BIV infection among dairy cattle in Ontario is low and may be associated with an economically important decrease in milk production. Cases of dual infection with BIV and BLV have been reported in Mississippi dairy cattle.

The virus has been found in the seminal leukocytes of 82% of randomly selected semen samples from a bovine stud semen repository, suggesting the possibility that artificial insemination of dairy cows may have a major role in the transmission of the virus. BIV may be involved in the pathogenesis of mastitis in cattle as a result of its immunosuppressive effects, but no clear evidence is available.

Retroviruses are heat labile and readily inactivated at 56°C (133°F), and pasteurization of milk for human consumption should provide an adequate safeguard. Feeding milk seeded with the virus and pasteurized before inoculation into calves is effective in inactivating the virus and preventing transmission. There is no evidence that the virus is a potential human pathogen.

### Methods of Transmission

The virus is strongly cell-associated and may be transmitted with infected blood, colostrum, and milk that contains lymphoreticular cells. There is some evidence of transplacental infection of the virus in cattle. In dairy cows naturally infected with BIV and seropositive at parturition, 40% gave birth to calves that were BIV seropositive before receiving colostrum, whereas seronegative cows did not. Calves born with anti-BIV-specific antibody do not demonstrate increased risk of clinical disease during the neonatal period, but the calves born to dams that are seropositive at parturition appear to be at increased risk of occurrence of some clinical signs. The prevalence rate of infection among bulls housed in stud farms was 9.6% using serology and 12.6% using PCR for the presence of BIV provirus in peripheral blood leukocytes.

BIV has no obvious morphologic effects on the embryonic development of cattle, and it is possible to obtain embryos at the transferable stage free of the virus from cows

infected with the virus. It is unlikely that BIV is associated with embryos with the zona pellucida intact derived by in vitro fertilization from oocysts obtained from infected animals or with oocysts fertilized with infected semen when embryos are washed as recommended by the International Embryo Transfer Society. Embryos from donors infected with the virus are not likely to transmit the virus to recipients and the resulting offspring.

### PATHOGENESIS

The pathogenetic mechanisms of BIV infection are unclear. Its pathogenicity is controversial. It is uncertain if the virus is a primary pathogen or a primary immunodeficiency virus that predisposes the animal to secondary infections. Despite extensive experimental studies, the pathogenic significance of the virus is uncertain.

Infection of cattle with BIV is associated with lymphoproliferation, lymphadenopathy, immunosuppression, neuropathy, and progressive emaciation.

The virus was initially isolated from a cow with persistent lymphocytosis, lymphadenopathy, neuropathy, and progressive emaciation. However, overt clinical disease in seropositive cattle is rare, and experimentally induced infection in calves has resulted in only mild clinical consequences.

Early studies of inoculation of calves with the virus resulted in lymphoproliferative disease, lymphocytosis, and persistence of the virus. Later studies have failed to reproduce significant clinical disease, which may in part be a result of the long incubation period. It is also possible that the lentiviruses have variable virulence because genetic variation produces viruses with both antigenic and biological heterogeneity in pathogenesis. Experimental infection of an 11-month-old calf with the virus was followed by the development of a T-cell lymphosarcoma, and the bovine leukosis virus was not present.

The virus and its DNA have been detected in the blood and semen of experimentally infected bulls. However, the virus has not been detected in the semen, blood leukocytes, or semen leukocytes of samples supplied by artificial insemination centers.

Retroviruses, including the lentiviruses, are characterized by the expression of the unique enzyme, reverse transcriptase, that facilitates the transcription of the RNA of an infectious virus to a complementary DNA copy. The viral DNA has the ability to become incorporated into the host's cell nucleus as a "provirus." Proviruses are noninfectious, can remain latent for many years, and persist in the presence of antibody. A change in the virus from its latent form to an infectious RNA virus can occur and depends on activation of the latently infected cells. The stimuli for activation can include concurrent

infection and stress, or both. Although other lentiviruses such as equine infectious anemia virus can cause severe clinical disease, the cause-and-effect relationship between BIV infection in cattle and clinical disease has not yet been documented.

### CLINICAL FINDINGS

In the United States, naturally occurring BIV infection in Holstein dairy cattle in Louisiana has been described. Progressive weight loss was common, and concurrent infections included metritis, subcutaneous abscesses, purulent arthritis, laminitis, and infectious pododermatitis, fascioliasis, and mastitis. Reduced vitality, dullness, and stupor were also common.

The course of the disease varied from 3 to 40 weeks.

### CLINICAL PATHOLOGY

**Detection of Virus.** A PCR test has been used to detect BIV in the blood and milk of BIV-seropositive cows. The virus can be detected in experimentally infected calves using PCR in peripheral blood mononuclear cells.

**Serologic Tests.** With the BIV ELISA, naturally occurring cases in dairy cattle are serologically positive. An indirect immunofluorescent antibody test has been used to detect seroconversion in experimentally infected bulls by 17 days after infection. The sensitivity and specificity of the indirect fluorescent-antibody assay (IFA) and the nested-set PCR have been compared using Bayesian techniques. The PCR is the more sensitive assay.

### NECROPSY FINDINGS

Moderate to marked enlargement of hemal lymph nodes has been described. Lymphoid depletion is common and characterized by an absence of follicular development in nodes draining regions with secondary infections. Encephalitis characterized by meningeal, perivascular, and parenchymal infiltration with lymphocytes, plasma cells, and macrophages with perivascular edema has been observed. Several secondary infections have been observed in cattle with BIV infection, but the role of BIV as a predisposing pathogen is uncertain.

### FURTHER READING

Gonda MA. Bovine immunodeficiency virus. *AIDS*. 1992;6:759-776.

## Enzootic Bovine Leukosis (Bovine Lymphosarcoma)

### SYNOPSIS

**Etiology** Bovine leukemia virus (BLV), the causative agent of enzootic bovine leukosis

(EBL), is an exogenous C-type oncovirus in the *Retroviridae* family.

**Epidemiology** Infection is widespread in all continents, although several countries have successfully implemented BLV eradication programs. Prevalence of infection varies between countries. Persistent aleukemic (AL) infection is most common, followed by infection with persistent lymphocytosis (PL) in 30% of infected animals. Less than 5% of infected animals develop lymphosarcoma, the only clinically apparent form of EBL. Clinical disease is most common in mature cattle. Infected animals are the only source of the virus, which is transmitted horizontally by transmission of infected lymphocytes from parturition, contaminated surgical instruments, rectal palpation, and blood-sucking insects. Congenital infection in 4% to 8% of calves born to infected cows. Genetic makeup of animal determines risk of developing PL or lymphosarcoma. Economic losses as a result of loss in milk production traits, premature culling, carcass condemnation, and restrictions of international commerce. EBL is currently not considered a zoonosis.

**Signs** No clinical signs during stage of AL and PL. Lymphosarcoma characterized by loss of body weight, inappetence, pallor, weakness, and loss of milk production. Enlargement of several or all lymph nodes. Abomasal ulceration. Congestive heart failure. Paresis and paralysis as a result of neural involvement. Stertor as a result of enlargement of retropharyngeal lymph nodes. Eventually weak and recumbent.

**Clinical pathology** Serology for BLV virus using enzyme-linked immunosorbent assay (ELISA) or agar gel immunodiffusion (AGID).

Detect virus by polymerase chain reaction (PCR) or sheep bioassay.

**Lesions** Multicentric lymphoid tumors affecting all body systems, especially heart, digestive tract, nervous system, reproductive tract.

**Diagnostic confirmation** Serology and detection of virus by PCR.

### Differential diagnosis list

Sporadic bovine leukosis (SBL)

Congestive heart failure as a result of traumatic pericarditis

Lymphadenitis as a result of tuberculosis and actinobacillosis

Compression of spinal cord

Fat necrosis

Tuberculosis

**Treatment** None.

**Control** Test and slaughter seropositive animals in herds and areas with low prevalence of infection. Use bulk-tank milk ELISA as screening test. Establish virus-free herds and certify by retesting. Control disease in herds and countries with high

prevalence of infection by limiting spread within herds, segregating positive animals, and preventing the introduction of infected animals.

### ETIOLOGY

The causative agent enzootic bovine leukosis is bovine leukemia virus (BLV), an exogenous C-type oncovirus in the *Retroviridae* family that is highly homologous to human T-cell lymphotropic virus 1 and 2. Infection occurs by transfer of infected lymphocytes from one individual to another and is followed by a permanent antibody response and, less frequently, development of persistent lymphocytosis (PL) or lymphosarcoma. It has leukemogenic activity, can be grown in tissue culture, and produces specific antibodies in calves and sheep.

### EPIDEMIOLOGY

#### Prevalence of Infection

Leukosis in cattle was originally described in Germany in 1871. Reports of the disease in cattle became common following World War II, and most countries that raise cattle have reported the occurrence of the disease. The main presumed routes of transmission having led to this epizootic during the first part of the last century in Europe were **close animal contact** and the **use of whole blood vaccination**, a procedure used at that time to protect cattle from developing babesiosis.<sup>1</sup> For this purpose young cattle susceptible to babesiosis were injected with 2 to 3 mL of citrated blood drawn from donor cows with a history of babesiosis before going on pasture. Live animal transports across the Atlantic Ocean brought BLV to the Americas, where it primarily spread by close contact between infected and susceptible animals. The infection is now common in cattle in Canada, the United States, and many countries in eastern Europe and South America and some Asiatic and Middle Eastern countries.

Today large parts of Europe and New Zealand are officially free of EBL after successful implementation of EBL-eradication programs.<sup>2</sup> In Australia the National Dairy Enzootic Bovine Leukosis Eradication Program (NDEBLEP) was established in 2008 and eradicated BLV from dairy cattle by 2012. The prevalence of BLV infection in adult beef cattle in Australia is assumed to be very low. In the United States a serologic survey conducted in 2007 reported a herd prevalence of 83.9% of BLV seropositivity among dairy herds.<sup>3</sup> A similar census from 1996 revealed a within-herd prevalence of 25% or higher in BLV-positive herds in the United States.<sup>4</sup> Recent epidemiologic surveys from different Canadian provinces reported herd prevalence rates reaching up to 89% and individual animal prevalence rates between 20.8% and 37.4%.<sup>5,6</sup> In Argentina a marked increase of the prevalence was reported for dairy herds in the last decades.<sup>7</sup>

The individual animal seroprevalence was estimated with 33%, and the percentage of infected herds with one or more infected animals was 84%.

The seroprevalence of BLV infection in breeding beef bulls under 2 years of age offered for sale in Kansas was 8.5%. This indicates that young bulls purchased for entry into recipient herds could be infected with the virus. The infection occurs in water buffalo in Brazil and in draught animals in Cambodia.

An outbreak of enzootic bovine leukosis in Egypt was associated with the importation of Holstein–Friesian heifers and bulls from Minnesota in 1989 to form a closed dairy herd in upper Egypt. In 1996 clinical evidence of EBL occurred, and ELISA testing revealed a BLV seroprevalence of 37.7% in cattle under 2 years of age and 72.8% in animals over 2 years of age.

### Occurrence of Clinical Disease

The occurrence of clinical lymphosarcoma in countries where the infection occurs has been estimated to be 1 per 1000 per annum; it has been estimated at 1 per 50,000 per annum in infection-free countries. Even in countries or areas where the infection and the disease are common, there are many herds that remain uninfected. Dairy cattle are much more commonly infected than beef cattle, and they have a much higher incidence of lymphosarcoma. In severely affected dairy herds, an annual mortality rate of 2% is unremarkable, and it may be as high as 5%.

All breeds of cattle are susceptible to BLV infection. It occurs rarely in animals less than 2 years of age and increases in incidence with increasing age. The prevalence of infection is higher in large herds than in smaller herds.<sup>3</sup> The higher prevalence in dairy herds compared with beef herds is probably a result of their closer confinement and the higher average age of the herds.

There are a number of forms taken by the disease, as follows:

- Aleukemic enzootic bovine leukosis (AL) infection
- Enzootic bovine leukosis with persistent lymphocytosis (PL)
- Enzootic bovine leukosis with tumors—the common form in adults

### Methods of Transmission

#### Direct Contact

Horizontal transmission is the usual method by which the virus is spread under natural conditions. It appears that close physical contact and exchange of contaminated biological materials are required for transmission. The virus is present mostly in lymphocytes and can be found in blood, milk, and tumor masses. Most susceptible cattle become infected by exposure to infected lymphocytes, and not by cell-free virus. Either 10  $\mu$ l (45,240 lymphocytes) or 1  $\mu$ l (4524 lymphocytes) of whole blood from a BLV-seropositive cow when injected into

calves resulted in infection and seroconversion. It is likely that a threshold number of approximately 100 BLV-infected cells is required to establish infection in the recipient. Therefore any means by which BLV-infected lymphocytes can be transmitted from one cow to another is a potential means of transmission. Natural transmission occurs mostly in cattle more than 1.5 years of age with an apparently increased risk of infection during the periparturient period and after entering the milking herd.<sup>7</sup> This suggests that vaginal secretions, exudates and placentas from cows, and contaminated calving instruments may serve as sources of infected blood cells.

A considerable number of newborn calves were found to contract BLV infection around parturition or during the first hours and days of life.<sup>7,8</sup> Intrauterine infection occurs in 4% to 8% of calves born from BLV-seropositive cows in naturally infected herds. These cases probably occur as a result of transplacental exposure to the virus during gestation.

The virus has been found in the nasal secretions of infected cattle for 2 to 4 years, but there is no evidence that transmission to other animals occurred. Transmission experiments suggest that the virus is not present in saliva, but it does appear intermittently in urine. It is present in nasal and tracheal washings but only in cells, not as a free virus.

#### Semen, Artificial Insemination, and Embryo Technology

Most workers have failed to find the virus in semen and artificial insemination (AI). However, the virus has been found in semen collected by massage of the donor's urethra and accessory glands per rectum, a procedure that is associated with contamination of semen with blood. Although transmission by AI has not been demonstrated, it is possible that semen containing infected lymphocytes transmission could serve as a source of the virus. Thus bulls at AI centers will be required to be serologically negative for BLV virus. Properly collected semen from BLV-seropositive bulls will not contribute to dissemination of viral infection. More recent studies found that natural service breeding of heifers, and to a lesser extent, cows, was associated with an increase in BLV prevalence.<sup>9</sup>

Fertilized embryos from donors infected with BLV have been transferred without infection of the fetus. It is possible to produce transferable-stage *in vitro* fertilized embryos that are free of the integrated BLV provirus, from oocytes that had been exposed to BLV during maturation.

#### Iatrogenic Transmission

Transmission can occur via infected blood that contaminates surgical instruments, such as dehorning gouges, ear tattooing pliers, and hypodermic needles used on infected and then susceptible animals without

disinfection. Transmission can also occur during blood transfusions and vaccines containing blood, such as those for babesiosis and anaplasmosis. Amounts of blood as small as 0.1  $\mu$ l are capable of transmitting the infection. Thus the infection can be transmitted via the tuberculin intradermal test. However, although some studies have found that use of common needles for blood sampling of infected and noninfected cows at the same time poses a great risk of transmission of the virus to noninfected cows, other studies suggest that the quantities of infective blood passed during injection with common needles is too small to induce infection. The routine practices of brucellosis vaccination, ear-tagging, and tattooing in dairy herds did not seem to be associated with the spread of the disease, but infection could be reduced from 80% to 4% in heifers between the time of weaning to calving by altering dehorning methods. Transmission via infective milk is possible by the passage of infected lymphocytes through intestinal mucosal epithelium during the first few hours of life. However, the risk of infection via this route appears to be greatly reduced because of the presence of maternal antibodies in colostrum and milk.<sup>8</sup>

#### Rectal Palpation

The virus can be transmitted by rectal inoculation of infected blood into cattle and sheep. Using blood-contaminated sleeves from palpating seropositive heifers to palpate seronegative cows resulted in transmission of infection, as evidenced by antibody formation. This poses the possibility that the virus can be transmitted by rectal examination of cattle, particularly in dairy herds, when a single rectal palpation sleeve is used repeatedly during reproductive tract examinations. Field studies examining the use of the same sleeve for more than one animal or an individual sleeve for each animal indicate that rectal transmission is a potential route of spread of BLV, but that it is related to frequency of palpation and age of cattle. Controlled studies of rectal palpation of cows in a dairy herd over a period of 22 months, using a single sleeve per animal or not changing the sleeve between an infected animal and seronegative animals, resulted in a 2.8-fold increase in the risk of BLV infection. Thus rectal examination without a change of sleeve may be a risk factor in some herds.

#### Insects

Blood-sucking insects may be involved in transmission of the virus. Evidence implicating arthropod vectors in BLV transmission is indirect, involving experiments in which virus-carrying arthropods or parts of them were transferred to uninfected cattle. In several experiments, infected tabanids, other biting flies, and ticks were placed by hand on cattle and sheep. Minced mouthparts or hematophagous insects previously fed on



BLV-infected cattle also were injected into hosts. In some countries there is empirical evidence that the incidence of seroconversion is higher after the tabanid fly season. A space–time study found a significant positive geographic correlation between the rate of incidence of BLV infection and the density of the horse-fly population. Seasonal variations in the incidence rates also occur; the highest rates are generally observed during summer and the lowest during winter, spring, and early summer. There is also a time link between the rate of seroconversion and the variations in activity of the horse-fly population. Experimentally, the virus has been transmitted by horse flies, *Tabanus fuscicostatus*, from a seropositive cow to recipient calves and goats. Horse flies take relatively large blood meals, have a painful bite, and are often interrupted in feeding and must finish feeding on other animals. This behavior, the large number of flies, and the low volume of blood and small number of lymphocytes required to transmit BLV make tabanid flies candidates for mechanical vectors of the virus. The stable fly, *Stomoxys calcitrans*, has an insufficient mouthpart volume to carry enough blood lymphocytes to transmit the virus.

### Congenital Infection

Intrauterine infection has been estimated to occur in 4% to 8% of calves born from BLV-seropositive cows in naturally infected herds and thus is considered to play a minor role in the epidemiology of EBL. Infection of the fetus probably occurs as a result of transplacental exposure to the virus during gestation. Calves born from seropositive cows acquire colostral antibodies if they ingest colostrum, which appears to have a protective effect against BLV infection during the first days of life.<sup>8</sup> Antibody levels decline during the first 6 to 7 months of life. In one study the minimum and maximum duration of colostral antibodies were 14 and 147 days, respectively, with a half-life of 36 days. The decay of colostral antibodies and the age at which a calf can be expected to become seronegative is a function of the quantity of BLV antibodies absorbed by the calf and the infection status of the calf.

### Interspecies Transmission

Cattle are the only species infected naturally, although sheep and goats can be infected experimentally. The infection does not spread from cattle to commingled sheep or between experimentally infected and noninfected sheep. However, horizontal transmission of a naturally occurring lymphosarcoma in sheep is associated with an antigenically similar virus to the BLV. It is assumed that horizontal spread of the BLV from cattle to sheep does not occur. The experimental transfer of infection from cattle to sheep is effected so readily that it has become a preferred technique for testing for the presence of a virus.

### Source of Infection

In cattle, infection with the virus is permanent, spontaneous recovery has not been documented, and the proviral DNA is maintained in infected lymphocytes. The virus is located in lymphocytes initially in a covert nonproductive state, resulting in an inability of antibodies to arrest the infection, and multiplication of the virus is not necessary for survival or transmission. The virus is also capable of periodic antigenic change and circumventing control by immune mechanisms; thus, the infected animal remains a source of infection for life, regardless of the simultaneous presence of specific antibodies. This virus–host system is the same as that of other retroviruses, especially equine infectious anemia (EIA) and maedi-visna of sheep. In most circumstances, infection occurs when animals are in close physical contact and are more than 12 months old. Infection is established readily by subcutaneous injection, intradermal injection, and intratracheal application, but it does not occur after oral administration, with the exception of neonatal calves.

Experimental transmission of the infection using tumor material, infected blood, or tissue culture virus can be achieved in cattle, sheep, and goats, and apparently also in chimpanzees, but the tumors are produced only in the three ruminant species. A sheep bioassay can be used to determine the presence of the virus in infected cattle.

### Risk Factors

#### Animal Risk Factors

The prevalence of infection based on seroprevalence is positively associated with increasing age in both dairy and beef cattle. The prevalence of infection in dairy cattle under 17 to 24 months of age is much lower than in adult cattle and increases sharply after 24 months of age when heifers join the milking herd and are in close contact with older cattle.<sup>11</sup> The rate of spread may also be associated with the prevalence of infection; in herds with a prevalence of 13% to 22% when first tested, the spread was slow; in a herd with a prevalence of 42%, the spread was much more rapid.

#### Genetic Resistance and Susceptibility

Infection with BLV is not synonymous with clinical disease. Most animals that become infected do not develop neoplastic disease. Once infection has occurred, the subsequent development of only an antibody response, or antibody plus persistent lymphocytosis (PL), or antibody plus lymphosarcoma, with or without PL, is determined by the host's genetic makeup. Lymphosarcoma, the clinically apparent form of BLV infection involving the clonal transformation of infected B cells, occurs in about 1% to 5% of BLV-infected cattle and seems to be under genetic control of the host.

Immune responsiveness and heritable resistance or susceptibility to infection are influenced by the host major histocompatibility complex (MHC).<sup>10</sup> In cattle this MHC refers to the so called bovine lymphocyte antigen (BoLA). The earliest studies linked the presence of two class I BoLA-A alleles to the resistance to PL, an association that could not, however, be confirmed at the population level.<sup>10</sup> Later studies found that resistance or susceptibility to PL was more closely associated with polymorphisms of the class II DRB3 gene. BoLA-A-DRB3 genes not only were correlated with resistance or susceptibility to PL and lymphosarcoma in Holstein–Friesian cattle, but also with the proviral load harbored by infected lymphocytes.<sup>10</sup>

A complex relationship exists among genetic merit, milk production, BoLA genotype, and susceptibility to PL. Cows with high genetic potentials for milk and fat yields are more susceptible to PL than cows with lower genetic potentials, but cows with PL do not produce yields of milk or fat according to their predicted genetic values. The major histocompatibility gene BoLA-A was found to be not only associated with resistance to persistent lymphocytosis, but also with the individual's production potential. It was therefore hypothesized that genetic selection for increased milk production may have increased the susceptibility to BLV infection of dairy cows over the past decades.<sup>11</sup> Early attempts to quantify the economic impact of subclinical infection emphasized differences in milk production between seropositive and seronegative cattle. This approach, however, is likely to be confounded by age differences and ensuing differences in the stage of the disease complex. Antibodies to BLV may be present in recently infected cows with no other abnormality, in cows over 3 years of age with PL, and in animals older than 6 years of age with tumors.

**Susceptibility to Other Diseases.** A highly significant correlation was shown between BLV infection and the persistence of *Trichophyton verrucosum* infection, which suggests that the immune system may be impaired in BLV-infected cows. Observations in Sweden indicate many significant associations between BLV infection status and measures of incidence, reproduction, and production, but most were of low magnitude. The risk for other infectious diseases seemed to be greater among BLV-infected herds, whereas the risk for noninfectious diseases did not differ.

#### Immune Mechanisms

Both humoral- and cell-mediated immunity are induced in natural BLV infection. Although BLV is primarily associated to B lymphocytes, BLV provirus has been detected in the DNA of CD2<sup>+</sup> T cells, CD3<sup>+</sup> T cells, CD4<sup>+</sup> T cells, CD8<sup>+</sup> T cells, monocytes, and granulocytes of infected but clinically healthy

animals.<sup>12</sup> BLV infection was reported to disrupt the equilibrium between B and T lymphocytes not only in PL but also in AL BLV-infected cattle.<sup>12</sup>

Studies of cytokine profiles in healthy and BLV-infected cows suggest that type I and II cytokines are altered with increases in IL-10 and IL-4 concentrations and declines in IL-2, IL-12, and interferon- $\gamma$  concentrations.<sup>13</sup>

Following infection, a persistent antibody response occurs primarily to the envelope glycoprotein gp51 and the major core protein p24 of the BLV virions. The time from infection to development of antibodies can be as long as 14 weeks. Experimental infection of calves with the virus results in seroconversion, which can be demonstrated with the ELISA in 4 to 5 weeks after infection. Lymphocytosis can occur at about the same time after infection.

### Environmental and Management Risk Factors

#### *Lack of Biosecurity*

The introduction of infected animals into a herd has a significant positive effect on the subsequent prevalence of infection and clinical disease. The appearance of new outbreaks of leukosis is almost always the consequence of the introduction of BLV-infected animals in farms or areas previously free of the infection.

#### *Calf Management*

The level of calf management in dairy herds is also a major risk factor. Any environmental factor or management practice that allows newborn calves access to infective blood will increase the level of infection in the calves, including prolonged close contact between the cow and calf immediately after parturition or the use procedures or instruments such as the following:

- Gouge dehorners and ear-tagging equipment
- Tattooing equipment
- Instruments used for castration or the removal of supernumerary teats
- Use of single needles for vaccination
- Instruments for control of excessive fly population in calf barns

Feeding colostrum of infected dams to newborn calves has been incriminated as potential route of infection in the past. More recent research indicates that administration of maternal colostrum to calves born from BLV-positive cows greatly decreased the risk of infection in early life compared with calves born to BLV-positive dams but not receiving colostrum from their mothers.<sup>8</sup> These results suggest that exposure to BLV occurs around birth and is not dependent on ingestion of colostrum but that ingestion of colostrum-containing BLV antibodies lessens the risk of contracting BLV infection.<sup>8</sup>

Some observations have found positive associations between BLV status of dairy

herds and weaning age, housing preweaned calves in hutches or separate calf housing, and contact between young stock and older animals during the winter housing period.

### Pathogen Risk Factors

BLV is highly cell associated and persists in a subpopulation of peripheral B lymphocytes and to a much lesser extent in subpopulations of T lymphocytes. Free virus is rarely or never found in the blood of infected cattle. EBL is therefore not highly contagious. Once an animal is infected, the virus DNA persists for life, incorporated into the DNA of infected lymphocytes.

### Economic Importance

Economic losses resulting from BLV infection are associated with morbidity and mortality as a result of malignant lymphosarcoma, decreased productivity and longevity in clinically and subclinically infected cattle, BLV eradication or control measures, and restrictions of international trade.

Losses associated with clinical disease can be economically significant at a herd level in high-prevalence herds but are generally not significant in herds with low BLV seroprevalence because only 0.1% to 5% of seropositive cows and 10% to 50% of cows with persistent lymphocytosis develop lymphosarcoma. Economic losses per case of lymphosarcoma in the United States were estimated to be \$412.00 in a 2003 survey. In addition, malignant lymphosarcoma was found to be the largest single reason for carcass condemnation during postmortem inspection at slaughter plants in the United States, accounting for over 21% of all condemnations.<sup>14</sup>

The nature and extent of the economic losses associated with subclinical BLV infection have been controversial because the evidence has been conflicting and because the costs incurred by subclinical infection are difficult to assess. The effects of subclinical BLV infection on milk production, reproductive performance, longevity, and culling rate are variable. In some observations, a BLV-seropositive cow had a shorter life span than both its seronegative counterpart and the entire milk cow population.<sup>11,15</sup> Among older dairy cows, BLV-seropositive cows were culled prematurely compared with uninfected cows. The culling rate was higher and milk production was lower in BLV-infected herds compared with BLV-free herds. The effect on reproduction was minor. In other observations, milk production, somatic cell count, age at disposal, and culling rate were not influenced by seropositivity.<sup>16,17</sup> In a spreadsheet analysis of dairy herds in the Maritimes in Canada, total annual costs for an average infected 50-cow herd were \$806.00 for EBL, compared with \$2472.00 for Johne's disease, \$2412.00 for BVD, and \$2304.00 for neosporosis.

The association between EBL infection and annual value of production on dairy herds in the United States, as part of the National Animal Health Monitoring System's 1996 dairy herd study, found that compared with herds with no test-positive cows, herds with test-positive cows produced 218 kg less milk per cow and year, which is equivalent to approximately 3% of milk production. The mean annual value of production decreased by \$1.28 for each 1% increase in herd seroprevalence (based on a milk price of \$0.29/kg).

When the effects of infection were examined according to genetic potential for milk and fat production in dairy cows, the results were surprising. BLV-infected cows with high genetic potential for milk and fat yields were found to be more susceptible to become affected by PL compared with cows with inferior genetic potential. At the individual cow level, infected cows had greater milk production than uninfected cows based on seropositivity to BLV and 305-day mature equivalent fat-corrected milk production. Among seropositive cows, those with PL were culled at a younger age and had reduced production in the last lactation relative to other groups.

The cost of clinical disease and subclinical infection varied substantially with the prevalence of infection, whereas the cost of control varied with herd size. A basic BLV control program is considered economical in herds in which the prevalence of infection is greater than or equal to 12.5%.

### Trade Restrictions

A major economic effect of the disease lies in import restrictions placed by countries free of EBL on infected cattle and on semen either from infected bulls or from noninfected bulls from a positive herd. It is the practice, particularly in countries that are recognized as free of EBL by the World Organization of Animal Health (OIE), to require proof of freedom from infection with the virus from animals about to be imported into the country. This is a matter of major importance when the cattle are purebred and are sold at high prices as breeding animals. Some countries are already demanding a negative blood test for all cattle and meat to be imported, and this could represent a loss of export markets for some countries.

### Zoonotic Implications

The possibility of transmission of the virus from cattle to humans is a real one; the virus is commonly present in the milk of infected cows, and the disease has been transmitted to chimpanzees in this way. Using an immunoblot test, a serologic survey of 257 humans in California found at least one antibody isotype reactive with BLV in 74% of the sera tested. However, this does not necessarily mean that humans are actually infected with BLV. The antibodies could be a response to

heat-denatured BLV antigens from consumed milk or meat. Only 9% of the subjects indicated any direct contact with cattle or their biological products.

There is an ongoing scientific debate on the possible association of leukemia in humans with exposure to BLV, either through direct contact with animals or carcasses or through consumption of dairy or meat products. A number of retrospective and prospective epidemiologic studies have explored the risk of leukemia among specific occupational groups, such as farmers and people working in food production or meat processing. Several of these studies reported a significantly increased risk of developing leukemia for workers in livestock farming or meat processing, whereas other failed to identify such an increased risk.<sup>18-21</sup> Increased risk of developing leukemia in occupational groups having contact with cattle does not create an automatic association with exposure to BLV because people in these groups would share exposure to other chemical, biological, or environmental agents possibly causing or contributing to this risk. To this date in vivo studies have not provided any evidence that BLV increases the risk of disease in humans.<sup>19</sup>

**Other Species**

Lymphosarcoma occurs sporadically in all species, but natural infection with the BLV virus has been demonstrated only in sheep and capybaras.

Although there is no evidence of a relationship between bovine viral leukosis and any disease of pigs, there is a record of enzootic leukosis in that species, which is inherited.

**PATHOGENESIS**

**Virus and Lesion**

Infection with BLV virus may occur in utero, at the time of birth, or at a later stage of life and requires exposure of a susceptible

individual to infected lymphocytes. The virus primarily establishes a persistent infection in a subpopulation of B lymphocytes by integrating proviral DNA into the host cellular DNA. Other cells that were found to carry proviral DNA, although to a much lower extent, are CD2<sup>+</sup> T cells, CD3<sup>+</sup> T cells, CD4<sup>+</sup> T cells, CD8<sup>+</sup> T cells,  $\gamma/\beta$  T cells, monocytes, and granulocytes.<sup>11</sup>

The four possible outcomes after exposure of cattle to BLV are outlined in Fig. 11-7 and are as follows:

1. Failure of the animal to become infected, probably because of genetic resistance
2. Establishment of a permanent infection and the development of detectable levels of antibodies without clinical or hematological abnormalities (aleukemic infection)
3. Establishment of a permanent infection; the animal becomes seropositive and also develops PL, a benign lymphoproliferative process. It is not a preclinical stage of lymphosarcoma.
4. Infected, seropositive animals that may or may not have been through a stage of persistent lymphocytosis and that develop neoplastic malignant tumors—lymphosarcoma

After infection, seroconversion occurs within 2 to 12 weeks, a time frame that, among other factors, is determined by the infective viral dose. Antibodies against BLV are not protective against tumor development. Whether or not the animal becomes infected or develops any of the other forms of the disease depends on the recipient's genetic constitution. The outcome may also be influenced by the animal's immune status and the size of the infective dose of virus.

A subset of animals develops a persistent increase of lymphocytes that can become apparent any time after the infection but rarely occurs before 2 years of age. Persistent

lymphocytosis in affected animals persists for several years if not for life and may or may not precede the development of malignant lymphosarcoma. **Persistent lymphocytosis** in contrast to the malignant lymphosarcoma is the result of polyclonal proliferation of B lymphocytes and therefore presents a **benign lymphoproliferative process**. The increase of lymphocytes also involves an increase of the T lymphocyte count and a concomitant increase of the BLV antibody titer.

Development of **lymphosarcoma**, a neoplasm of the lymphoreticular system, occurs in less than 5% of infected cattle and is the only clinically apparent form of EBL. This neoplasm is usually derived from a single cell clone and is **never benign**. Lymphosarcoma usually occurs in BLV-infected cattle 5 to 8 years of age. Lesions develop at varying rates in different animals so that the course may be quite short or protracted over several months. The outcome is invariably fatal.

**Lesions and Clinical Disease**

In adult cattle, almost any organ may be the site of lesions, but the abomasum, heart, and visceral and peripheral lymph nodes are most commonly affected. Depending on the organ that is most involved, several clinical syndromes occur. Involvement of the abomasal wall results in impaired digestion and persistent diarrhea. When the atrial wall is affected, congestive heart failure occurs. In nervous tissue, the primary lesion is in the roots of peripheral nerves and spreads along the nerve to involve meninges and cord. Involvement of the spinal meninges and nerves results in the gradual onset of posterior paralysis. The skin, reproductive tract, and periorbital tissues are commonly affected. In the cutaneous form, intradermal thickenings develop, which persist but do not cause discontinuity of the epithelium. They are composed of aggregations of neoplastic lymphocytes. Invasion of periorbital tissues commonly results in exophthalmos. Esophageal obstruction may result from mediastinal lymph node involvement in calves.

The tumors consist of aggregations of neoplastic lymphocytes, but in many cases they may be more accurately described as reticulosarcoma. They are highly malignant and metastasize widely. The hemogram is variable, and although there may be an accompanying lymphocytosis, the presence of large numbers of immature lymphocytes in the blood smear is a more reliable indication of the presence of the disease. Some degree of anemia is common.

**CLINICAL FINDINGS**

This disease is characterized by tumors developing rapidly in many sites with an accompanying great variation in clinical signs and syndromes. An approximate indication of the frequency with which individual signs appear is set out in Figure 11-8.

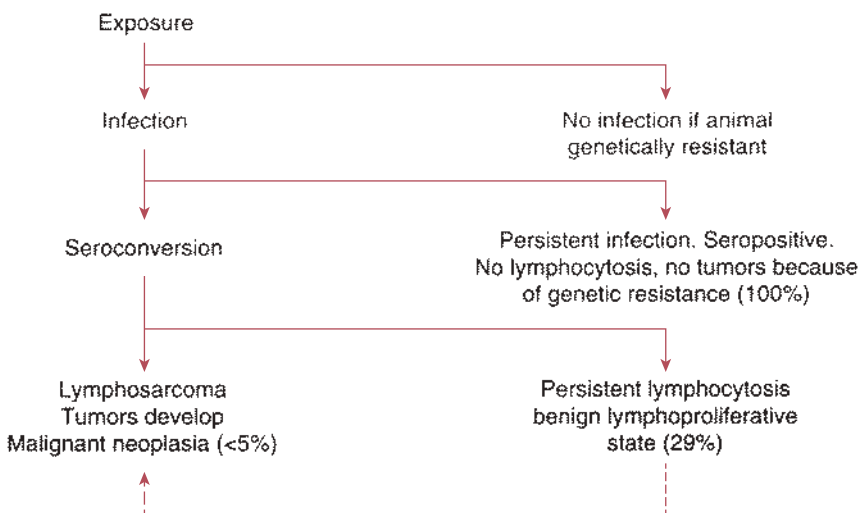

**Fig. 11-7** Possible pathways after exposure to bovine leukosis virus (percentage figures indicate proportion of seroconverted animals that develop the particular form referred to<sup>2</sup>).



## ENZOOTIC BOVINE LEUKOSIS (BOVINE LYMPHOSARCOMA)

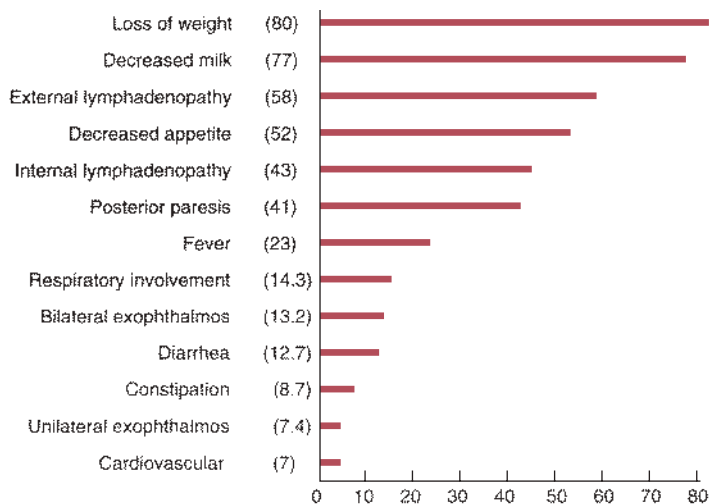

**Fig. 11-8 Clinical diagnosis frequency of predominant signs of bovine leukemia—1100 field cases.** (Courtesy of Canadian Veterinary Journal).

The usual incubation period is 4 to 5 years. This form is rarely seen in animals under 2 years of age and is most common in the 4- to 8-year-old age group. Persistent lymphocytosis without clinical signs may occur earlier but rarely before 2 years of age. Many cows remain in the preclinical stage for years, often for their complete productive lifetime, without any apparent reduction in performance, but clinical disease appears in a small subset of these cows. The clinical signs and the duration of the illness vary with the number and importance of the sites involved and the speed with which the tumor masses grow.

In 5% to 10% of clinical cases the course is peracute, and the affected animals often die suddenly or unexpectedly without any prior evidence of illness. Involvement of the adrenal glands and rupture of an abomasal ulcer or an affected spleen, followed by acute internal hemorrhage, are known causes. These animals are often in good bodily condition.

In most cases the course is subacute (up to 7 days) to chronic (several months) and initiated by an unexplainable loss of body condition and appetite, pallor, and muscular weakness. The heart rate is not increased unless the myocardium is involved, and the temperature is normal unless tumor growth is rapid and extensive, when it rises to 39.5° to 40° C (103° to 104° F). Although the following specific forms of the disease are described separately, any combination of them may occur in any one animal. In many cases, clinical illness sufficient to warrant the attention of the veterinarian is not observed until extensive involvement has occurred and the possibility of slaughter of the animal for beef purposes cannot be considered. On the other hand, many cases are examined at a time when diagnostic clinical signs are not

yet evident. Once signs of clinical illness and tumor development are detectable the course is rapid, and death occurs in 2 to 3 weeks.

#### Enlargement of the Superficial Lymph Nodes

Enlargement of the superficial lymph nodes occurs in 75% to 90% of clinical cases and is often an early clinical finding. This is usually accompanied by small (1 cm in diameter) SC lesions, often in the flanks and on the perineum. The skin lesions are probably enlarged hemolymph nodes and are of no diagnostic significance, often occurring in the absence of other signs of the disease. In many cases with advanced visceral involvement, peripheral lesions may be completely absent. Enlargement of visceral lymph nodes is common, but these are usually subclinical unless they compress other organs such as intestine or nerves. They may be palpable on rectal examination, and special attention should be given to the deep inguinal and iliac nodes. In advanced cases, extensive spread to the peritoneum and pelvic viscera occurs, and the tumor masses are easily palpable.

Although the enlargement of lymph nodes is often generalized, in many cows only a proportion of their nodes are involved. The enlargements may be confined to the pelvic nodes or to one or more SC nodes. Involvement of the nodes of the head is sometimes observed. The affected nodes are smooth and resilient and in dairy cows are easily seen, and their presence may be marked by local edema. Occasionally, the entire body surface is covered with tumor masses 5 to 11 cm in diameter in the SC tissue.

#### Digestive Tract Lesions

Digestive tract lesions are common. Involvement of the abomasal wall results in a

variable appetite, persistent diarrhea, not unlike that of John's disease, and occasionally melena as a result of bleeding of an abomasal ulcer. Tumors of the mediastinal nodes may cause chronic, moderate bloating.

#### Cardiac Lesions

Lesions in the heart usually invade the right atrial wall primarily, causing right-side congestive heart failure. There is hydropericardium with muffling of the heart sounds, hydrothorax with resulting dyspnea, engorgement of the jugular veins, and edema of the brisket and sometimes of the intermandibular space. Tachycardia as a result of insufficiency and arrhythmia as a result of heart block are common. A systolic murmur is also common, along with an abnormal jugular pulse. The liver may be enlarged and palpable caudal to right costal arch, and passive congestion of the liver and visceral edema results in persistent diarrhea.

#### Nervous System Involvement

Neural lymphomatosis is usually manifested by the gradual onset over several weeks of posterior paralysis. Knuckling of the fetlocks of the hindlegs while walking is common, and one leg may be more affected than the other. This is followed by difficulty in rising, and finally by clinical recumbency and inability to stand. At this stage, sensation is retained, but movement is limited or absent. There may be a zone of hyperesthesia at the site of the lesion, which is usually at the last lumbar or first sacral vertebra. Appetite and other functions, apart from the effects of recumbency, are usually normal. Metastases in the cranial meninges produce signs of space-occupying lesions with localizing signs referable to the site of the lesion.

#### Less Common Lesions

Less common signs include enlargement of the retropharyngeal lymph nodes, which may cause stertor and dyspnea. Sometimes clinically detectable lesions occur in the periorbital tissues, causing protrusion of the eyeball (exophthalmos), and in the limb muscles, ureter and kidney, and genitalia. Involvement of the uterus may be detectable as multiple nodular enlargements on rectal examination. Severe bilateral exophthalmos may occur, along with generalized lymphadenopathy. Periureteral lesions may lead to hydronephrosis with diffuse enlargement of the kidneys, whereas tumors in renal tissue cause nodular enlargements. In either case terminal uremia develops.

BLV particles have been detected by electron microscopy around lymphocytes in the mammary tissue of BLV-antibody-positive cows affected by subclinical mastitis. Whether the virus is a causative agent or an immunosuppressant in bovine mastitis is unknown.

## Other Species

**Outbreaks of lymphosarcoma in sheep** have been observed with clinical, epidemiologic, hematological, and necropsy findings similar to those of enzootic bovine leukosis. B-cell leukemia has been described in sheep.

Infection of other species with BLV has not been demonstrated, but epidemic occurrences of lymphosarcoma have been observed in pigs, but only sporadic cases in horses.

## CLINICAL PATHOLOGY

A definitive antemortem diagnosis depends on the clinicopathological examination of the animal. Several diagnostic techniques are available, and it is important to make the appropriate selection for the particular stage of the disease that is being considered, as follows:

- Diagnosis of the viral infection is made by serologic or virological techniques.
- Persistent lymphocytosis is identified by hematology but is not pathognomonic for BLV infection.
- Neoplastic tumors are identified by histologic examination of a biopsy specimen.

Because of the increasing economic impact of BLV infection in the cattle industry, the availability of a highly sensitive and specific assay for the identification of BLV-infected animals is of critical importance. Such an assay is needed for the selection of BLV-free cattle for commercial sale, prepurchase testing of breeding animals and import or export testing, and control and eradication programs. Ideally, the assay should be practical, inexpensive, and able to be adapted for large-scale use.

## Diagnosis of the Presence of Infection With BLV Serologic Tests

Seroconversion occurs between 3 and 16 weeks postinfection. Virtually all cattle infected with BLV will continuously have antibodies against the major internal (p24) and envelope (gp51) virion proteins in their serum, and serologic tests are commonly used for the diagnosis of BLV infection in cattle over 6 months of age. Maternally derived antibodies may be detectable until 7 months of age and are indistinguishable from antibodies resulting from infection. BLV antibodies tend to decline in the periparturient period as a result of the shift from the dam's circulation to the mammary gland, and titers may drop below the detection limit from 2 to 6 weeks before to 2 weeks after calving.<sup>22</sup>

A number of diagnostic tests are available to diagnose seroconversion in individual animals and on a herd level, as discussed in the following sections.

**Enzyme-Linked Immunosorbent Assay in Serum or Milk.** In the last decade ELISA-based testing has replaced the AGID in

eradication programs in several countries and is one of the prescribed diagnostic tests for international trade. It is more sensitive than other serologic tests and can be used on milk. The ELISA can detect antibody titers 10- to 100-fold below the detection limit of the AGID. The superior sensitivity of the ELISA allows detection of antibodies in pooled serum samples of herds with a prevalence of less than 1%, whereas the AGID test detected only 50% of the herds detected by the ELISA. Two commercially available ELISAs and the PCR were evaluated and compared with the AGID to detect antibodies to BLV or its nucleic acid. The ELISA tests detected about 10% more reactors than the AGID and the electrophoretic immunoblotting results. Some ELISA-positive animals were not detected by the PCR.

Four commercially available BLV-ELISA kits from Europe and the United States were compared with the AGID test officially approved by the Canadian Food Inspection Agency. The ELISA tests were more sensitive than the AGID test kits. A highly sensitive and specific blocking ELISA comparable to the radioimmunoprecipitation assay for the detection of BLV antibodies in serum and milk samples has been developed.

The **milk ELISA** has been adopted for testing milk from individual cows and pooled milk samples. A comparison of the ELISA and AGID tests for the detection of BLV antibodies in bovine serum and milk found a high level of agreement. The bulk-tank milk ELISA is useful for identification of herds that are negative for BLV infection and to monitor BLV-negative herds. The antibody level in milk is lower than in serum but the sensitivity of the ELISA is as effective as for sera. Testing of bulk milk is a useful and practical method for large-scale epidemiologic studies and initial eradication programs. Heifers, bulls, and dry cows and youngstock over 1 year of age that are not included when bulk milk is tested need to be sampled individually before a herd is declared free of the virus. The sensitivity and specificity of the milk ELISA is estimated to be adequate until the prevalence of BLV-infected individuals in the country is less than 1%. Herds identified as positive by the milk ELISA would require further testing at the individual or herd level to definitively establish their BLV status.

**Agar Gel Immunodiffusion Test.** The AGID is a specific but not very sensitive diagnostic test for BLV. It has, however, been proven to be highly useful and efficient as a basis for eradication or control programs because it is simple, easy to perform, and inexpensive.<sup>22</sup> It remains one of the prescribed tests for international trade. Most commercial AGIDs test for the presence of both antibodies against p24 and gp51 but are not standardized for the demonstration of antibodies against gp51.

**Radioimmunoprecipitation Assay.** The radioimmunoprecipitation (RIP) assay, which uses gp51 or p24 as antigen, is a highly sensitive and specific method for serologic diagnosis of BLV infection. The RIP assay has been used as the criterion-referenced standard to critically evaluate the performance of other diagnostic tests for BLV infection. Detailed comparisons of various BLV assays in a large number of cattle of various origins and ages found that the RIP assay is the most sensitive and specific test. However, its major disadvantage is that it requires a gamma counter and radioisotopes, which are expensive.

**Radioimmunoassay.** Radioimmunoassay (RIA) is suitable for individual cow testing because of its accuracy. There are several versions of this test, and the one using the virion gp antigen is preferred. It is one of the most sensitive tests and is useful for the detection of BLV antibodies in cattle exposed no longer than 2 weeks, in milk samples, and in serum samples from periparturient dams.

## Detection of Virus

**Polymerase Chain Reaction.** The PCR is a sensitive and specific assay for direct diagnosis of BLV infection in peripheral blood lymphocytes. The test is useful for the early detection of BLV infection even before antibodies are present. It is more sensitive than the ELISA or AGID in detecting infected cattle where the prevalence of infection is less than 5%. The test can identify proviral DNA of BLV in the lymphocytes of calves at birth in calves born to infected cows. At birth, the presence of an antibody titer can result from passive transfer of immunity or perinatal infection, and the PCR test can differentiate uninfected newborn calves with colostral antibodies from BLV-infected calves and detect the presence of the virus in the presence of antibodies. The PCR has a practical application in the identification of BLV-infected calves, regardless of colostral antibody, which allows immediate removal of the source from the herd. In a dairy herd with a high prevalence of BLV, a positive PCR assay result provided definitive evidence that a cow was infected with BLV. However, sensitivity and specificity were 0.672 and 1.00, respectively. The predictive value of a positive test was 1.00, and the predictive value of a negative test was 0.421. Thus PCR assay alone is unreliable for routine detection of BLV in herds with a high prevalence of BLV infection.

The PCR can also be used to ensure that cattle used in the production of a whole-blood vaccine for tick-borne disease are free from BLV infection. The sheep bioassay, currently in use, requires 4 months of serologic testing to ensure that donor animals are not infected. Replacement of the sheep bioassay with the PCR could result in considerable saving of time and effort. Use of the PCR

requires stringent precautions to prevent false-positive results from contamination of samples with PCR product.

A nested PCR identified 98% of BLV-seropositive cows from blood and 65% from milk, whereas real-time PCR detected 94% of BLV-seropositive cows from blood and 59% from milk. BLV was also detected in 10% of seronegative cows, most likely because of early detection before seroconversion.

**Differentiation Between Enzootic and Sporadic Bovine Leukosis.** The role of BLV in some cases of sporadic bovine lymphomas (SBL) needs to be reexamined. The findings of persistently seronegative PCR-positive and seropositive PCR-negative cattle indicates that the BLV cannot be excluded as a causative agent in some cases of SBL. Enzootic bovine leukosis cannot be distinguished from SBL on histopathological examination. The ELISA is recommended as a method of choice to differentiate between EBL and SBL because it is a rapid, reliable, and sensitive test that is inexpensive and easy to perform. In cases where no blood or other fluids are obtained, the PCR test is the most useful method for the direct detection of BLV.

### Diagnosis of Persistent Lymphocytosis

Approximately 30% of animals infected with BLV develop PL, which is defined as a benign increase in the absolute lymphocyte count of three or more standard deviations above the normal mean as determined for that respective breed and age group of animals in leukemia-free herds. The PL is an increase in peripheral B lymphocytes. It has been suggested that one additional criterion for PL should be that it persists for more than 3 months. When PL was first recognized in herds that experienced malignant lymphosarcoma, it was considered a subclinical expression of the tumor stage of the disease. Although persistent lymphocytosis is not pathognomonic for BLV infection, it became an important diagnostic criterion in control and eradication programs until BLV was identified as causative agent and serologic tests became available to more accurately identify infected animals. The majority of cells involved in PL are normal lymphocytes, but atypical and abnormal forms have been described and are considered as indicative of preleukemic condition. The total count increases from a normal of 6000 to as high as 15,000/ $\mu$ L. An increase in the percentage of lymphocytes in the total white blood cell count from the normal of 50% to 65% is considered a positive result. The presence of 25% or more of the total lymphocyte count as atypical immature cells is also considered a significant aberration. The PL may or may not subside in animals that subsequently develop lymphosarcoma.

The association between the strength of serologic recognition of BLV by the use of ELISA and lymphocyte count in BLV-infected cows has been examined. The sample-to-positive ratio, which is the ratio between the test sample and a positive control sample, was compared among lymphocytotic and nonlymphocytotic cows. The sample-to-positive ratio and lymphocyte count were related, but cows with high sample-to-positive ratio were not always lymphocytotic. Culling cows on the basis of sample-to-positive ratio will reduce culling of ELISA-positive cows; however, culling on the basis of lymphocyte count will eliminate a greater proportion of the reservoir of infection.

### Diagnosis of Lymphosarcoma

Lymphosarcoma can only be diagnosed by histopathological examination of a section of tumor material obtained by biopsy or necropsy. A needle aspirate of an enlarged peripheral lymph node may provide a rapid and inexpensive diagnosis. Enlarged lymph nodes or hemolymph nodes are the usual sources, but when the genital tract is involved an exploratory laparotomy is usually performed so that a sample can be obtained. The lymphocyte count may increase to 20,000 to 30,000/ $\mu$ L and in some cases may reach values of 50,000 to 100,000/ $\mu$ L, and even 400,000 to 500,000/ $\mu$ L. Conversely, in some cases, the lymphocyte count decreases. Chromosomal changes may be detectable in cells from lymph nodes or in leukocytes from peripheral blood of affected animals. When there is myocardial involvement there may be obvious changes in the electrocardiogram, but these are unlikely to be of value in differential diagnosis.

### NECROPSY FINDINGS

Enzootic bovine leukosis is mostly a disease of adult cattle characterized at necropsy by markedly enlarged lymph nodes and multiple firm, white tumor masses in any organ but especially the liver, spleen, heart, abomasum, and spinal cord. Affected lymph nodes may be enormously enlarged and be composed of both normal and neoplastic tissue. The latter is firmer and whiter than normal lymphoid tissue and often surrounds foci of bright yellow necrosis. Enlarged lymph nodes may appear anywhere in the body but are common in the retrobulbar, pharyngeal, and pelvic areas. An affected liver may have discrete nodular masses, or it may be diffusely enlarged and pale, and can be easily misinterpreted as fatty degeneration rather than a neoplastic process. In the heart, the tumor masses invade particularly the right atrium, although they may occur generally throughout the myocardium and extend to the pericardium. The frequency of early changes in the subepicardial tissue of the right atrium suggests that this is an area from which tissues should be selected in latent or

doubtful cases. The abomasal wall, when involved, shows a gross, uneven thickening, with tumor material in the submucosa, particularly in the pyloric region. Similar lesions occur commonly in the intestinal wall. Deep ulcerations in the affected area are not uncommon. Involvement of the nervous system usually includes thickening of the peripheral nerves coming from the last lumbar or first sacral cord segment or more rarely in a cranial cervical site. This may be associated with one or more circumscribed thickenings in the spinal meninges. Less common sites include the kidney, ureters, and uterus.

Histologically, the tumor masses are composed of densely packed, monomorphic lymphocytic cells. The cleaved variant of the diffuse large cell type with a high mitotic index is characteristic of enzootic lymphoma, and this high-grade type of B-cell tumor may be a consequence of the viral etiology of this form of the disease. It is possible to confirm viral infection in some cases by a PCR test, but such testing is rarely justified.

### Samples for Confirmation of Diagnosis

- **Histology**—formalin-fixed samples of gross lesions, plus enlarged lymph nodes, bone marrow, liver, spleen, thymus, right atrium, abomasum, uterus (LM, IHC)
- **Virology**—neoplastic tissue (PCR)

### DIFFERENTIAL DIAGNOSIS

Because of the very wide range of clinical findings, a definitive diagnosis of bovine leukemia virus (BLV) is often difficult. Enlargement of peripheral lymph nodes without fever or lymphangitis is unusual in other diseases, with the exception of tuberculosis, which can be differentiated by the tuberculin test. In the absence of these enlargements, the digestive form may easily be confused with Johne's disease. The cardiac form closely resembles traumatic pericarditis and endocarditis, but there is absence of fever and toxemia, and the characteristic neutrophilia of these two diseases is usually absent. Involvement of the spinal nerves of meninges may be confused with spinal cord abscess or with the dumb form of rabies. An examination of cerebrospinal fluid may be of value in determining the presence of an abscess, and rabies has a much shorter course and other diagnostic signs. Multiple lymph node enlargements in the abdominal cavity and nodular lesions in the uterine wall may be confused with fat necrosis, but the nature of the lesion can usually be determined by careful rectal palpation. Stertor caused by enlargement of the retropharyngeal lymph nodes is also commonly caused by tuberculosis and actinobacillosis.

Cases of sporadic bovine leukosis that are BLV-negative may resemble lymphosarcoma of enzootic bovine leukosis.



## TREATMENT

There is no treatment.

## CONTROL

The disease can be eradicated from a herd, and even a country, or controlled at a low level. The **option chosen** depends initially on the **prevalence of infection in the herd**, the **value of the animals in the herd**, and whether a **governmental indemnity** offered for seropositive cows that are culled and sent to slaughter.

### History of Compulsory Eradication Programs in Europe

Control and eradication programs have been in effect on a nationwide basis in several western European countries. **Denmark** began an eradication program in 1959 based on the occurrence of clinical lymphosarcoma and the identification of cattle with PL using the Bendixen hematological key for classifying cattle as normal, suspect, or lymphocytic. This eradication program was established more than 10 years before identification of the etiologic agent of the disease. Even though the causative agent was unknown, bovine lymphosarcoma was widely accepted to be an infectious disease because of its occurrence in clusters of diseased cows in certain herds.<sup>1</sup> Leukosis was declared a reportable disease, and all adult cattle from herds in which cases of leukosis originated were subjected to a hematological examination. Affected herds were quarantined, and indemnity was offered to induce owners to have their entire herd slaughtered. This herd-slaughter policy was continued until 1982. When the AGID test became available, the Bendixen key was discontinued, and only the AGID test was used in the official program between 1979 and 1982. Routine testing was discontinued in 1982. Surveillance involved testing random sera collected from every sixth adult cow to be slaughtered. According to the official Danish control program, the incidence of tumors in adult cattle at the start of the eradication program was at least 10 times greater than that 10 years later. The hematological test was less sensitive than subsequent serologic tests but the specificity was fairly high, and only a few herds were erroneously classified as leukosis herds. When the serologic tests were introduced, some herds that were classified as leukosis-free based on the hematological Bendixen key were found to be infected.

In **Britain** a national testing program was begun in 1992 that led to successful eradication of the disease. All blood samples collected for routine periodic testing for brucellosis have also been tested for BLV, and milk samples are collected every 3 months from dairy herds for BLV testing. The prevalence of infection has been low and the source of infection undetermined. Some of the animals had been imported from Canada, but in other cases there was no association with importation.

Enzootic bovine leukosis was eradicated from **Finland** in 1996. The disease was first recognized in 1966, and it required 30 years of use of the key principles of test and slaughter policy to achieve eradication. The infection status was monitored at meat inspection, hematologically between 1970 and 1977, and serologically between 1978 and 1989. Annual surveys including all dairy herds and samples from beef animals were conducted from 1990 to 2001. Bulk-tank samples represented the dairy herds in the surveys; beef animals were sampled individually at slaughter. The maximum positive herd-level percentage in the survey was 0.03%. The herd level prevalence of infection never exceeded 5%.

Considering the animal-health aspects and possible consumer reactions against having a widespread retrovirus infection in food-producing animals, and the requirements for exporting cattle and semen, **Sweden** introduced a national program for the eradication of BLV in 1990. An ELISA test was evaluated for detection of antibodies to BLV in individual and bulk milk and serum samples.

In the meantime, a total of 17 countries of the European Union are officially free of BLV. Similarly, since 2010 New Zealand, after having implemented a BLV eradication program, is free of evidence of EBL, and Australia expects to have eradicated the disease.

In **Canada and the United States**, it is considered cost prohibitive to cull and slaughter all seropositive cattle because of the high prevalence of infection. Many seropositive cows are valuable pedigreed animals, and there are no indemnity programs available. Thus all control and eradication programs in these countries are herd based and strictly voluntary. Livestock producers are willing to adopt control programs because of the economic losses associated with export restrictions if their cattle are infected and the losses resulting from the occasional clustering of cases of lymphosarcoma.

### Eradication Programs

Enzootic bovine leukosis can be eradicated only by the following methods:

- Test and slaughter of cattle infected with the virus—programs based on the culling of seropositive cows are effective.
- The maintenance of a closed herd, which permits the entry of only those animals free of infection

The efficiency of such a program depends on the accuracy of the test used to identify the infected animals and the repetition of the test at an appropriate interval so that animals that were in the incubation stages of the disease at the time of the first test will have had time to seroconvert. The recommended procedure is as follows:

1. Identify infected animals using the serum or milk ELISA or AGID test.
2. Cull and slaughter seropositive animals immediately.

3. Retest the herd 30 to 60 days later.
4. Use the PCR assay to test young calves and as a complementary test for clarifying doubtful test results in herds with a low prevalence of infection.

Testing is repeated until the herd has a negative test. When the herd is negative, testing is repeated every 6 months and the herd declared free when there have been no positive reactors for 2 years. Future introductions into the herd are managed most safely by artificial insemination or fertilized ovum transfer, or importations of animals that have been tested and are seronegative on two tests carried out 30 and 60 days before arrival.

In herds where the prevalence is high, a two-herd scheme can be successful. Newborn calves are removed from seropositive cows immediately after birth, fed colostrum from seronegative cows, and raised in isolation. All animals over 6 months of age are tested periodically and seropositive animals culled. The parent herd is eventually disposed of as negative replacement animals become available. Only those bulls that are seronegative may be used, and they must be tested every 3 months.

Although eradication is biologically feasible, it is unlikely that area eradication programs will be implemented on an extensive scale because losses from the disease are not sufficiently high, and there is a high risk of insect vectors reintroducing it, which poses a real threat to maintenance of a BLV-free herd. The cost-effectiveness of an eradication program on a national basis would be a major consideration. For an individual herd, it is feasible, provided some steps are taken to increase the genetic resistance of the residual stock and to reduce the chances of in-contact infection occurring.

### Limitation of Spread of Infection

In herds with a high prevalence of infection, the test and slaughter method of eradication is not economically viable if the animals have a high economic value because of superior genetic potential. Control of infection in these herds is possible using embryo transfer from infected dams to negative recipients and isolation of newborn calves, but these are not practical on a country-wide basis. An alternative method is segregation of BLV-infected and noninfected animals based on the serum/milk ELISA or AGID test. This is known as the test and segregation method, which is based on the evidence that the spread of infection between animals is relatively slow and that the virus is spread by movement of infected animals from one herd to another and within a herd. Following the initial testing of the herd, the herd is divided into two groups, BLV-positive and BLV-negative animals, and kept at least 200 m apart. A third separate location is used for quarantine of replacement animals.

Replacement animals must be found negative in two consecutive serum antibody tests, the first within 30 days before purchase and the second after 60 days of isolation, before being moved into the negative group. The serologic tests are conducted every 3 months, and the reactors removed to the positive group location until the remaining animals in the herd have attained BLV-negative status by the test. Thereafter, the tests are done every 6 months and continued until at least four consecutive negative tests are obtained for each herd. Variations of this method of test and segregation with subsequent removal of seropositive animals in the routine culling program have been successful. The colostrum and milk fed to calves in the BLV-negative group must be from seronegative cows or be pasteurized to inactivate the virus.

In Canada, cattle owners may enroll in the Canada Health Accredited Herd program to declare freedom from EBL. All reactors must be removed from the herd. If a large number of reactors are detected, two herds on two separate farms can be established: one herd comprised of the reactors and the other of cattle that are seronegative. Calves from the reactor herd can be added to the accredited herd in accordance with strict isolation and testing procedures. To qualify for accredited certification, a herd must have two consecutive negative herd tests, at least 4 and less than 12 months apart. The tests must include all cattle in the herd. The first annual renewal test must occur no more than 12 months following the second qualifying test for certification, and must include all cattle in the herd. Subsequent renewal tests must occur within the same 12-month interval. Only cattle 24 months of age and older must be tested, but a herd inventory and audit must be performed on the whole herd. In herds with reactors, the two qualifying tests do not begin until at least 4 months after the removal of the last reactor uncovered during any test. Herd additions can be made during the qualifying test period or after certification has been achieved. Each animal must be accompanied by a health certificate, and depending on the enzootic bovine leukosis status of the originating herd, certain testing and isolation procedures could apply. Owners wishing to have their animals attend exhibitions can do so providing they adhere to certain conditions. Properly processed semen and embryos can be introduced without restrictions. Owners are encouraged to follow preventive health management practices to augment the eradication of enzootic bovine leukosis from their herds. These include all areas where blood transfer could occur (needles, dehorning, castrating, extra teat removal, ear-tagging, tattooing, hoof trimming, rectal palpations, drenching) and other procedures that transfer leukocytes, in addition to routine insect control.

### Prevention of Infection in Calves and Young Stock

Several management techniques can be used to prevent infection in calves from birth until they become herd replacements. Immediate removal of newborn calves from the maternity pen and feeding of colostrum and milk from seronegative cows is widely accepted as effective in preventing infection in calves. Postnatal infection in calves can also be minimized by feeding milk replacer and/or whole milk from noninfected cows. The use of colostrum and milk from noninfected cows permits early serologic detection of infected calves. However, feeding colostrum from seropositive cows to newborn calves can provide significant protection from infection during the first 3 months of life. Field studies indicate that colostrum-derived BLV antibodies may prevent as much as 50% of the infection during the first 3 months compared with calves that did not receive colostrum with BLV antibodies. Further reduction in the risk of infection via colostrum can be achieved by pasteurization of the colostrum at 63°C (147°F) for 30 min. The colostrum-derived BLV antibodies will, however, delay early detection of infection in calves. The replacement of whole-milk feeding with high-quality milk replacer may also be considered.

Transmission to newborn calves can also be reduced by avoiding exposure to maternal blood at the time of parturition, housing calves in individual hutches with individual feeders and waterers, and management techniques to avoid iatrogenic transmission. When handling a group of calves, the youngest ones should be handled first and the older and sick calves last. Equipment that could act as a fomite in transferring blood should be disinfected with chlorhexidine when used between calves. These instruments include the following:

- Nose tongs
- Scissors
- Forceps
- Dehorning instruments
- Esophageal tubes
- Balling guns
- Tattoo equipment
- Ear taggers

Dehorning of calves with the electrocautery method before 2 months of age can reduce the prevalence of infection compared with gouge dehorning, which allows the transfer of infected blood between calves. Handling facilities that become contaminated with blood should be cleaned between calves. Fly control should be instituted as necessary. Single needles should be used for vaccination, and calves should be tested serologically for BLV infection at about 6 months of age.

A marked reduction in the prevalence of infection within the heifer age groups of a dairy herd with a high prevalence can be achieved by the following practices:

1. Use of single needles and individual sleeves for rectal examination
2. Disinfection of tattoo equipment before use
3. Dehorning by use of electrocautery

### Biosecurity

**Prevention of entry of infection into herd** can be achieved by ensuring that all imports into the herd have been tested at least 30 days before arrival and are seronegative. Control of insect vectors is highly desirable. Blood transfusions and vaccines containing blood, such as those used for babesiosis and anaplasmosis, are particularly potent means of spreading the disease, and donors must be carefully screened to ensure that they are free of the disease. In the future, the selection of cattle with inherent resistance to BLV may be a possibility. Embryo transfer from valuable pedigreed seropositive cows may aid in reducing prenatal infection. Insemination is not a method of transmission, and thus artificial breeding programs are not disrupted.

### Vaccine

The possibility of a vaccine for BLV has been explored extensively. Thus far inactivated virus vaccines, cell-derived vaccines, viral subunit vaccines, recombinant vaccinia virus vaccines, and synthetic peptides have been examined, without much success.<sup>10</sup>

### REFERENCES

1. George JW. *Vet Clin Pathol*. 2007;36:220-221.
2. Commission of the European Union. 2012 At: <<http://eur-lex.europa.eu/LexUriServ/LexUriServ.do?uri=OJ:L:2012:152:0048:0049:EN:PDF>>; Accessed 21.10.2013.
3. USDA-APHIS. 2009 At: <[http://www.aphis.usda.gov/animal\\_health/nahms/dairy/downloads/dairy07/Dairy07\\_is\\_BLV.pdf](http://www.aphis.usda.gov/animal_health/nahms/dairy/downloads/dairy07/Dairy07_is_BLV.pdf)>; Accessed 21.10.2013.
4. USDA-APHIS. 1997 At: <[http://www.aphis.usda.gov/animal\\_health/nahms/dairy/downloads/dairy96/Dairy96\\_is\\_BLV.pdf](http://www.aphis.usda.gov/animal_health/nahms/dairy/downloads/dairy96/Dairy96_is_BLV.pdf)>; Accessed 21.10.2013.
5. Scott HM, et al. *Can Vet J*. 2006;47:981-991.
6. Van Leeuwen JA, et al. *Can Vet J*. 2006;47:783-786.
7. Gutiérrez G, et al. *Vet Microbiol*. 2011;151:255-263.
8. Nagy DW, et al. *J Vet Intern Med*. 2007;21:1104-1107.
9. Erskine RJ, et al. *J Dairy Sci*. 2012;79:445-450.
10. Rodriguez SM, et al. *Viruses*. 2013;1210-1248.
11. Bartlett PC, et al. *J Dairy Sci*. 2013;96:1591-1597.
12. Panei CJ, et al. *BMV Vet Res*. 2013;9:95.
13. Erskine RJ, et al. *Am J Vet Res*. 2011;72:1059-1064.
14. USDA-FSIS. 2002 At: <<http://www.fsis.usda.gov/OPHS/adrsdata/2002/pmctfy02.htm>>; Accessed 21.10.2013.
15. Erskine RJ, et al. *J Dairy Sci*. 2012;95:727-734.
16. Tiwari A, et al. *J Dairy Sci*. 2007;90:656-659.
17. Sorge U, et al. *J Dairy Sci*. 2011;94:5062-5064.
18. Polychronakis I, et al. *J Occup Med Tox*. 2013;8:14.
19. Neasham D, et al. *Occup Environ Med*. 2011;68:77-81.
20. Cocco P, et al. *Int J Cancer*. 2012;132:2613-2618.
21. 't Mannetje A, et al. *Occup Environ Med*. 2008;65:354-363.
22. *OIE Terrestrial Manual*. 2012. Chapter 2.4.11. At: <[http://www.oie.int/fileadmin/Home/ffr/Health\\_standards/tahm/2.04.11\\_EBL.pdf](http://www.oie.int/fileadmin/Home/ffr/Health_standards/tahm/2.04.11_EBL.pdf)>; (Accessed 21.10.2013).

## EQUINE INFECTIOUS ANEMIA (SWAMP FEVER)

### SYNOPSIS

**Etiology** Equine infectious anemia virus, a retrovirus (lentivirus).

**Epidemiology** Worldwide distribution. Affects all species of Equidae. Transmission of disease is by contaminated blood of clinically affected or inapparently infected horses during interrupted feeding of blood-feeding insects or iatrogenically. Horses are infected for life.

**Clinical signs** Fever, depression, edema, petechial hemorrhages, abortion, chronic weight loss, splenomegaly.

**Clinical pathology** Anemia, thrombocytopenia, hypergammaglobulinemia, positive agar gel immunodiffusion (AGID) or competitive enzyme-linked immunoassay (cELISA) test.

**Diagnostic confirmation** AGID or cELISA test.

#### Differential diagnosis list:

##### Acute disease:

- Purpura hemorrhagica
- Babesiosis
- Equine granulocytic ehrlichiosis
- Equine viral arteritis
- Autoimmune hemolytic anemia
- Leptospirosis
- Parasitism
- Idiopathic thrombocytopenia

##### Chronic disease:

- Neoplasia
- Internal abscessation
- Liver disease

## ETIOLOGY

The equine infectious anemia virus (EIAV) is a retrovirus, a member of the subfamily *Lentivirinae* of the family *Retroviridae*. It is an RNA virus that uses a reverse transcriptase enzyme to generate proviral DNA, which is spliced into the host's genome.<sup>1</sup> The virus infects only Equidae, and there is no evidence that it infects or causes disease in humans. EIAV shares antigenic cross-reactivity with the human and feline immunodeficiency viruses but not with the viruses causing caprine arthritis-encephalitis or maedi-visna of sheep. The EIAV genome is composed of three major genes: *gag*—encoding matrix and capsid proteins; *pol*—encoding proteases, reverse transcriptase, and integrase; and *env*—encoding envelope glycoproteins.<sup>2</sup> Antibodies against gag-encoded proteins (e.g., p26) are used commonly for diagnosis of equine infectious anemia (EIA) by AGID or ELISA testing.

Analysis of the genome of the *gag* gene has revealed a strong geographic localization of clades of EIAV that are clearly related to

the evolutionary history of modern horses. Both horses and EIAV appear to have a Eurasian origin that might have differentiated as a consequence of horse movement associated with human migration. Analysis of the *gag* genome reveals that EIAV strains from the Americas form a distinct group with a potentially single common origin temporally associated with European colonization of North America.<sup>3</sup> The close geographic structuring of EIAV is a result of the insect-borne nature of the infection, which favors transmission over short distances as opposed to long distances, and the limited mobility, until very recently, of equids.<sup>3</sup> There are three distinct monophyletic groups, two of which (EIAV-1 and EIAV-2) contain only European strains and the third of which (EIAV-3) contains European, Asian, and American strains. This third group has three clades including European, Asian, and all American strains. The two Japanese strains in this group are of American origin.<sup>4</sup>

Genomic characterization of EIAV enables a more complete understanding of the geographic origin of virus strains and the epidemiology and pathogenesis of the disease. For instance, analysis of strains of the virus isolated in Belgium in 2010 confirmed that the source is Romanian,<sup>5</sup> that Japanese strains V70 and V26 are of not of Japanese origin, that there exists a distinct Japanese strain,<sup>4,6</sup> and that the virus that caused the 2006 outbreak in Ireland was of European strain origin.<sup>7</sup>

There is considerable **antigenic drift** in the surface glycoproteins (gp45, gp90), and the emergence of novel antigenic strains within an individual horse is associated with the relapsing febrile reactions characteristic of the disease. Examination of variations in the viral regulatory protein, Rev, and the transmembrane protein, gp90, demonstrates the existence of viral quasispecies such that genetically distinct viral subpopulations of differing phenotype exist within a chronically infected, often asymptomatic, animal. Mutations in gp90 are driven by the host immune response and can cause relatively large insertions or deletions in the gene.<sup>8</sup>

EIAV, like all retroviruses, integrates into the genome of the host by insertion of viral cDNA into the host DNA. This process involves nonrandom insertion of viral cDNA, as a provirus, into the host genome in the form of preintegration complexes. This integration of viral DNA into the host genome is lifelong. The sites of EIAV insertion into the genome of infected horses have been described.<sup>1</sup>

## EPIDEMIOLOGY

### Occurrence

EIA has been diagnosed on all continents except Antarctica, and there is increasingly detailed information on distribution of the virus and infection rates in many countries

and localities, including Turkey,<sup>9–12</sup> Brazil,<sup>13–16</sup> Oman,<sup>17</sup> Ethiopia,<sup>18</sup> Pakistan,<sup>19</sup> Costa Rica,<sup>20</sup> Romania,<sup>21</sup> Taiwan (where the disease is not currently present),<sup>21</sup> Greece,<sup>22</sup> India,<sup>22</sup> Italy,<sup>23</sup> and Mongolia,<sup>23</sup> among others. In Europe it is most prevalent in the northern and central regions. It has appeared in most states of the United States and the provinces of Canada, but the principal enzootic areas are the Gulf Coast region and the northern wooded sections of Canada.

Extensive **serologic surveys** using the AGID (Coggin's) test have shown rates of infection of 1.5% to 2.5% in the United States, 6% in Canada, a low level in France, 1.6% in West Germany, and 15% to 25% in Argentina. Within a geographic area, the **prevalence of infection** (positive AGID) varies depending on the density of the population, the proportion of carrier animals, and the density of the population of insect vectors. Under ideal conditions the incidence of infection can approach 100% over a period of weeks, but this rapid spread is unusual.

The **morbidity** varies considerably and depends on the strain of the virus and the inoculum delivered by the biting insect. Some horses become acutely ill and die after infection, whereas in others the infection is clinically inapparent. Outbreaks of disease associated with EIAV in horses of developed countries are rare.

## Animal Risk Factors

Horses and ponies are susceptible to infection by EIAV and characteristically develop signs of the disease within days to weeks of infection. **Mules** also become infected and develop clinical signs similar to those of horses and ponies when infected with strains of the virus pathogenic to horses, but **donkeys** do not subsequently develop signs of the disease despite persistent infection with the horse-derived virus. The resistance of donkeys to horse-derived strains of EIAV is not definitive evidence that donkeys do not develop equine infectious anemia, and there is suspicion that strains of the virus pathogenic to donkeys exist.

## Methods of Transmission

The source of all new infections with EIA is an infected horse, donkey, or mule. Horses are persistently infected, and clinically normal infected horses are a source of the virus. The virus can also be spread from clinically affected animals, which, because of the high concentration of virus in their blood, are a potent source of infection and important in the rapid spread of infection. Transmission of EIAV occurs almost exclusively through the transfer of contaminated blood or blood products. In field conditions this usually occurs through the mechanical transmission of contaminated blood from an infected horse to an uninfected horse by biting insects.



## Insect Vectors

The insect vectors responsible for the transmission of EIAV between horses are all large biting flies, including *Stomoxys calcitrans* (stable fly), *Chrysops* spp. (deer fly), and *Tabanus* spp. (horse flies). Mosquitoes are not recognized as an important vector. **Transmission is mechanical** because the virus does not replicate in insects and is related to the large quantity of blood (10 nL) that the biting insects are capable of holding in their mouths. Infection occurs only if the feeding of the insect is interrupted. If this occurs the insect may attempt to feed again on the initial host or may seek another host that is close by. If the initial host is infected, the insect can carry blood from this animal to the second host and spread the infection. Tabanid flies can travel a distance of over 6 km, but when feeding is interrupted, the flies usually attempt to complete the meal on the initial host or a nearby animal and rarely travel more than 200 m to complete the meal.

**Insect factors** that influence the likelihood of spread include the following:

- Climate and season—tabanids prefer hot and humid conditions for feeding and breeding, and their activity is much reduced or absent in winter months.
- Attractiveness of the host—foals are less likely to be bitten.
- Proximity of hosts to woodlands—tabanids prefer treed or sheltered habitat.
- Host housing—tabanids do not enter closed shelters.
- Distance between horses—as noted earlier, tabanids prefer to complete an interrupted meal on the initial host or a nearby host.

## Other Means of Transmission

**Intrauterine infection** can occur, although not invariably,<sup>24</sup> and result in abortion or the birth of infected foals that often die within 2 months. Mares can be infected by insemination with semen containing the virus.

Iatrogenic spread of infection can be important in some outbreaks. Infection can be readily achieved by the use of **contaminated surgical instruments** or needles or by the injection of minute quantities of virus, and the use of a common needle when injecting groups of horses can cause an outbreak of the disease. In enzootic areas, outbreaks have been caused by the use of untreated **biological preparations** of equine origin. This mode of spread is exemplified by the 2006 outbreak of the disease in Ireland.<sup>25,26</sup> The virus was introduced in plasma illicitly imported into the country from Italy.<sup>25</sup> The plasma was harvested from horses housed on a farm that had recently confirmed clinical cases of the disease. Foals were infected by transfusion of plasma, and mares then acquired the infection from their foals. The

route of transmission of infection from the foal to the mare is uncertain because it occurred during a period of low activity of potential insect vectors. Additional cases were related to hospitalization of horses with index cases.<sup>26</sup> The only identified risk factor was duration of hospitalization, and there was no evidence of iatrogenic spread of the infection. There is the potential for aerosol spread of the virus in the close confines of the hospital.

The virus is also capable of invasion through intact oral and nasal mucosae, wounds, and even unbroken skin, but these portals are probably of minor importance in field outbreaks. Transmission of infection from horse to horse seems possible via swabbing instruments used to collect saliva for doping tests.

## Economic Importance

The difficulty of diagnosis and the persistence of the carrier state for periods of many years have resulted in embargoes on the introduction of horses into countries with a low prevalence of the disease, causing economic losses and interference with sporting events.

## PATHOGENESIS

### Viral Multiplication

After infection, EIAV multiplies in tissues that have abundant macrophages, with the spleen being the principal site of viral infection and propagation and accounting for over 90% of cellular viral burden. Viral replication occurs only in **mature tissue macrophages**, and circulating monocytes account for only 1% of the cellular viral burden. The concentration of cell free virus in blood, which can be as high as 10 TCID<sub>50%</sub> per mL, parallels the clinical course. Fever and other clinical signs develop within **2 to 7 days of infection** as the concentration of virus in the blood increases; signs resolve as the viremia abates. There is a persistent but low-level viremia that persists for the life of the horse. The level of viremia in horses without clinical signs of the disease is very low and undetectable using conventional virus culture techniques but evident using PCR. The virus is detectable in low concentrations in most tissues of asymptomatic horses. During periods of **relapse** of the clinical disease the degree of viremia increases. On these occasions, the virus isolated from the blood has antigenic characteristics different from those of the virus that originally infected the horse. **Antigenic drift** of the gp45 and gp90 antigens, which occurs constantly even in asymptomatic horses with low levels of viremia, allows mutations of the virus, which then avoid immune surveillance, multiply, and cause clinical disease. The frequency of relapses of the clinical disease declines markedly after the first year of infection, and horses that survive become asymptomatic carriers.

## Immune Reaction

The immune response to EIAV is responsible for controlling replication of the virus and also plays an important role in the pathogenesis of the disease.<sup>8</sup> The major clinical signs and lesions of equine infection anemia are attributable to the host response to the virus and not direct viral damage to tissue. Replication of EIAV stimulates a strong immune response that is detectable in horses and ponies within 7 to 10 days of infection. The initial infection is likely controlled by **cytotoxic T-lymphocytes** before the appearance of **neutralizing antibodies**. Antibodies to the p26 core protein are detectable by AGID test in almost all horses 45 days after infection; by 60 days after infection, antibodies to gp45 and gp90 are present. The neutralizing antibodies are specific to the phenotype of the virus causing the viremia, and this phenotype can change over time, as discussed earlier. Hypergammaglobulinemia develops. The immune response includes the production of virus-neutralizing antibodies, complement-fixing antibodies, and cytotoxic T-lymphocytes. The immune responses are responsible for the termination of viremia, although this effect is not mediated by antibody-dependent cellular cytotoxicity against EIAV-infected macrophages, but rather by development of neutralizing antibody and cytotoxic T-lymphocytes. The importance of neutralizing antibodies in control of the disease within an animal is indicated by the observation that viremia is never associated with a virus with a neutralizing phenotype already recognized by the horse.

Most viruses in viremic horses consist of a complex of virus and antibody. The **virus-antibody complex** is readily phagocytosed by cells of the reticuloendothelial system, including tissue macrophages, and is involved in the development of the fever, depression, thrombocytopenia, anemia, and glomerulonephritis characteristic of the disease.

Neurologic disease in horses with EIAV infection is attributable to viral infection of neural tissue but not necessarily neurons.

## Anemia and Thrombocytopenia

The **anemia** characteristic of horses experiencing several febrile episodes of EIA is attributable to the shortened life of RBCs and decreased RBC production. Infection with EIAV shortens the life span of circulating RBCs to about 38 days, compared with the normal value of 130 days. The reduction in RBC life span is likely a result of the presence of virus-antibody complexes on the surface of RBCs with subsequent clearance of such cells by the reticuloendothelial system, as evidenced by the presence of sideroleukocytes in the peripheral blood of infected horses. EIAV also has a suppressive effect on erythroid series cells in bone marrow. Anemia occurs in Arabian foals with severe combined immunodeficiency infected with

EIAV, indicating that the anemia is not wholly a result of the adaptive immune response of the host. Anemia of chronic disease, which is in part a result of the limited availability of iron stores, likely contributes to the lack of bone-marrow response.

**Thrombocytopenia** is a consistent feature of the acute, febrile episodes of EIA and has been attributed to the deposition of virus–antibody complexes on platelets, with subsequent removal of affected platelets by tissue macrophages. However, others have identified a primary production deficit resulting from an indirect, noncytotoxic suppressive effect of EIAV on megakaryocytes. EIAV does not infect megakaryocytes, and the suppressive effect of infection is at least in part a result of tumor necrosis factors alpha and beta. Another explanation for the thrombocytopenia is increased removal of platelets because of increased *in vivo* activation and formation of platelet aggregates, a form of nonimmune-mediated platelet destruction. This was associated with increased thrombopoiesis and an increase in the proportion of young platelets in blood. The precise mechanisms underlying the thrombocytopenia associated with acute EIAV infection of horses is unclear.

Platelets of EIAV-infected horses with clinical signs of disease have diminished function *in vitro*. Platelets from infected horses had greater amounts of fibrinogen bound to their surface, ultrastructural abnormalities consistent with activation, and diminished *in vitro* aggregation responses.

### Persistence of Infection

The **cell reservoir of the virus** in persistently infected horses is unknown, as are the mechanisms underlying latency. However, the ability of retroviruses to **splice a DNA copy of their genome** into the genome of the host is probably important in the persistence of viral infection. The viral genome is detectable in clinically normal but persistently infected horses. Presence of viral DNA in host tissue is indicative of infection, whereas the presence of viral RNA in blood is suggestive of viral replication. This viral strategy allows the virus to escape immune surveillance of the host. Factors triggering a relapse of virus production from the latent genome are unknown, but relapse is associated with antigenic drift that enables the virus to evade host immune responses.<sup>8,27</sup>

### Summary of Pathogenesis

A likely scheme of pathogenetic events is as follows:

- Primary entry and infection of tissue macrophages, especially in the spleen
- Destruction of macrophages and release of virus and components
- Production of antibodies to antigenic components

- Formation of antigen–antibody complexes, which induce fever, glomerulitis, anemia, thrombocytopenia, and complement depletion
- Hemolysis or phagocytosis caused by specific complexes activating the reticuloendothelial system
- Temporary iron-deficient erythropoiesis caused by delayed release of iron from macrophages
- Subsidence of pathologic processes as virus-neutralizing antibody restrains viral multiplication in macrophages—the virus is incorporated into the host genome and becomes latent.
- Appearance of a new antigenic variant of the virus and commencement of a new cycle of viral replication in macrophages and a new clinical episode—the antigenic variation results from changes in the surface glycoprotein of EIAV.
- Less frequent recurrence of these episodes, with the horse becoming permanently asymptomatic—the animal can be said to have achieved an appropriate level of immune response sufficient to protect it against antigenic epitopes that are common to all EIAV strains.

### CLINICAL FINDINGS

An **incubation period** of 2 to 4 weeks is usual in natural outbreaks of equine infectious anemia. Outbreaks usually follow a pattern of slow spread to susceptible horses after the introduction of an infected animal. On first exposure to infection, horses manifest signs of varying degrees, classified as acute or subacute. Occasionally the initial attack is mild to inapparent and may be followed by rapid clinical recovery. As a rule, there is **initial anorexia, depression, profound weakness**, and loss of condition. Ataxia, behavioral changes, hyperesthesia, and blindness occur, and in some horses is recorded as the only clinical abnormalities. There is intermittent fever (up to 41°C; 105°F), which may rise and fall rapidly, sometimes varying as much as 1°C (1.8°F) within 1 hour. Jaundice; edema of the ventral abdomen, prepuce, and legs; and petechial hemorrhages in the mucosae, especially under the tongue and in the conjunctivae, may be observed. Pallor of the mucosae does not occur in this early stage, and they tend to be congested and edematous. There is a characteristic increase in the rate and intensity of the heart sounds, which are greatly exacerbated by moderate exercise. Respiratory signs are not marked, and there is no dyspnea until the terminal stages, but there may be a thin serosanguineous nasal discharge. There is considerable enlargement of the spleen, which may be detectable per rectum. Pregnant mares may abort. Many animals recover from this acute stage after a course of 3 days to 3 weeks. Others

become progressively weak and recumbent, and they die after a course of 10 to 14 day of illness.

Animals recovering from the acute disease may appear normal for 2 to 3 weeks and then **relapse**, with similar but usually less severe signs. Death may occur during such a relapse. Relapses continue to occur at intervals of as little as 2 weeks but usually cease after about a year. If they recur, they are usually associated with periods of stress and characterized by fever, increasing emaciation, weakness, ventral edema, and the development of pallor of the mucosae, a late sign of this disease. In this chronic stage, the appetite is usually good, although allotriophagia may be observed. Some affected animals appear to make a complete recovery, but they remain infected and can suffer relapses as many as 11 years later.<sup>28</sup> Prolonged therapy with corticosteroids can cause such a relapse. Even in the absence of clinical illness, infected animals often perform less efficiently than the uninfected. Most deaths occur within a year of infection. Survivors persist as asymptomatic carriers.

### CLINICAL PATHOLOGY

Hematological examination of horses with the acute disease reveals moderate to marked **thrombocytopenia** and **anemia**, which can be severe. Thrombocytopenia occurs during the initial episode, and can precede horses becoming serologically positive,<sup>25</sup> and during relapses of the disease, is most severe during the febrile episodes, and can be sufficiently low that it allows petechial hemorrhages to develop. The anemia can become more severe with relapse (14% to 20%, 0.14 to 0.20 L/L) and is normocytic and normochromic. During the 2006 outbreak in Ireland, anemia was an inconsistent feature of the disease (40% of cases).<sup>25</sup> The presence of **sideroleukocytes** (leukocytes containing hemosiderin) is considered highly suggestive of EIA. There are no characteristic changes in the white blood cell count, although presence of band neutrophils is common in the early stages of the clinical disease.

Hypergammaglobulinemia may be present. Serum biochemical examination might reveal an increase in bilirubin concentration, a decrease in serum iron concentration, and increased glutamate hydrogenase (GLDH) activity in serum.<sup>25</sup>

### DIAGNOSTIC CONFIRMATION

**Diagnostic confirmation** cannot be made based on hematologic or serum biochemical analysis and is achieved through detection of antibodies to the p26 core antigen of EIAV. Two tests are in general use: the AGID test (Coggin's test), which is standardized using recombinant reagents,<sup>29–31</sup> and a number of ELISAs, including a cELISA test.<sup>32–36</sup> Results of AGID testing are available in 24 hours, whereas those of ELISA testing can be

available in as little as 1 hour. Commercially available ELISA tests detect antibody to the p26 antigen, antibody to the gp45 transmembrane protein, or both.<sup>37</sup> The ELISA tests inherently have greater sensitivity (detect lower concentrations of antibody) than does the AGID, but often the characteristics of the commercial ELISA assays are modified to decrease the sensitivity (increase the lowest concentration of antibody detected by the kit) so that results obtained with these kits are concordant with those obtained by AGID.<sup>31</sup>

An advantage of an ELISA that detects antibodies to gp45 antigen is that, when combined with testing for antibodies to p26, the ability to detect infected horses with equivocal test results on a single test is increased. This is similar to the technique of using a **Western blot test** to demonstrate the presence of antibodies to more than one antigen, especially those against the gp45 and gp90 antigens, when equivocal AGID or ELISA results are obtained.

**False-negative reactions** for either test occur because the horse lacks antibodies to the p26 antigen. The AGID and cELISA tests do not detect a **recently infected** horse that has yet to develop antibodies. Some horses do not develop anti-p26 antibodies for 45 days after infection. **False-positive reactions** can occur in foals born to infected mares. Colostral transfer of anti-p26 antibodies to the foal will be detectable up to 6 months after birth.

Positive reactions to ELISA testing (to the p26 antigen) in samples that are negative by AGID testing can be the result of interspecies determinants. It is suspected that horses exposed to related lentiviruses produce antibodies to structural proteins that cross-react with the EIAV p26 antigen in ELISA, but not AGID, testing.

An algorithm for testing of equine samples for EIAV is provided in [Table 11-8](#).

Tests to detect proviral DNA or viral RNA in blood and tissue have been developed and are useful in detecting the presence of virus when viral concentrations in blood and/or tissue are low. The identification of proviral DNA in the blood of infected horses is as specific and apparently more sensitive than the AGID in detecting infected horses.

**Experimental transmission** of the disease to susceptible horses by the SC injection of 20 mL of whole blood or Seitz-filtered plasma is also used as a diagnostic test and is a valuable, although expensive and archaic, supplement to other tests. The donor blood should be collected during a febrile episode when the viremia is most pronounced, and the recipient animals should be checked for increases in body temperature twice daily.

**Molecular diagnostic tests** offer the advantage of detection of viremia, but currently are limited because available primers for PCR do not reliably detect all strains of the virus.<sup>2,38</sup>

**Table 11-8** Algorithm for testing horses for infection by equine infectious anemia virus<sup>41</sup>

Collect sample and separate serum from red cells as soon as possible.

**Tier 1**

Test sample using ELISA.  
If negative, report the results.  
If positive, continue to Tier 2.

**Tier 2**

Test with both same and at least one other ELISA format.  
If negative, report as negative.  
If positive in only one ELISA—report as negative.  
If positive in two or more ELISAs from different manufacturers, perform AGID test.  
If negative, report as negative.  
If positive, forward to Tier 3.  
If inconclusive, forward to Tier 3.

**Tier 3**

Test in all formats to confirm results.  
If confirmed, test by immunoblot.  
If gp90, gp45, and p26 positive (recognized), report as positive.  
If 2 major proteins are positive (recognized), report as positive.  
If only p26 is recognized, report as negative.

AGID, agar gel immunodiffusion; ELISA, enzyme-linked immunosorbent assay.

## NECROPSY FINDINGS

In the acute stages, there may be subcutaneous edema, jaundice, and petechial or ecchymotic subserosal hemorrhages. There is considerable enlargement of the liver, spleen, and local lymph nodes. The bone marrow is reddened as a result of increased amounts of hematopoietic tissue and may contain focal infarcts. In the chronic stages, emaciation and pallor of tissues are often the only gross findings. Histologic examination is helpful in the diagnosis, even in asymptomatic chronic carriers. Characteristic lesions include hemosiderosis, perivascular infiltrates of round cells in many organs, and an extensive proliferation of the mononuclear phagocytic cells throughout the body. Glomerulitis, probably caused by the deposition of virus-antibody complexes on the glomerular epithelium, may be present. Lesions in the brain are a lymphohistiocytic periventricular leukoencephalitis. Lesions of interstitial pneumonia are common in horses with EIA.<sup>39</sup> Culture of this virus is time-consuming, and the diagnosis is usually confirmed on the basis of a positive serologic test and typical microscopic lesions.

## Samples for Confirmation of Diagnosis

- **Histology**—formalin-fixed spleen, liver, bone marrow, kidney, lung, heart

- **Serology**—heart blood or pericardial fluid (AGID, ELISA)
- **Virology (if desired)**—chilled spleen, liver, bone marrow, and perihepatic lymph node (ISO)

## DIFFERENTIAL DIAGNOSIS

### Acute disease

Purpura hemorrhagica  
Babesiosis  
Equine granulocytic ehrlichiosis  
Equine viral arteritis  
Autoimmune hemolytic anemia  
Leptospirosis  
Parasitism  
Idiopathic thrombocytopenia.

### Chronic disease

Internal abscessation (metastatic *Streptococcus equi* infection)  
Chronic inflammatory disease, neoplasia, and chronic hepatitis

## TREATMENT

No specific treatment is available. Supportive treatment, including blood transfusions and hematinic drugs, may facilitate clinical recovery, but it is important to remember that recovered horses are persistently infected and infectious for life.

## CONTROL

Control of EIA is based on **identification and eradication or lifelong quarantine of infected animals**, quarantine and testing of new stock, compulsory testing of imported horses, and efforts to prevent spread of the virus by controlling insect access to horses and use of strict hygiene when vaccinating or collecting blood samples from horses.<sup>40</sup>

The control of equine infectious anemia is still universally based on the eradication of the disease by identifying the infected, clinically normal animals with a serologic test and then destroying them. Identification is by means of the AGID or cELISA tests. The ability of a program of test and eradication to eliminate the disease is evidenced by the eradication of EIA from Hong Kong. An effective control program is described for Kentucky in the United States that permits the maintenance of infected horses with indelible identification and prescribed restrictions on housing.

Control programs based on this test-and-slaughter policy are under fire because of the view of horse owners that many asymptomatic horses, with very low infectivity, are being destroyed unnecessarily.<sup>41</sup> A decision on the matter depends on whether the objective is eradication or containment, and if the latter, at what level. Until now the policy has been eradication, and it is obvious that another attitude is possible. Some flexibility in official attitude is desirable because of the



fallibility of the recommended control procedures and the devastating losses that can occur when the optimum environment for the spread of the disease is encountered.

Foals from infected mares can be raised free of infection. Such foals have detectable antibodies to EIAV for up to 330 days on immunoblot and 260 days on ELISA testing because of transfer of maternal immunoglobulins in colostrum during the neonatal period. However, foals that are ultimately free of infection do not have detectable viral RNA in blood and have declining concentration of antibodies to EIAV. Foals should be isolated from infected horses as soon as feasible after diagnosis of EIAV infection in the dam.

**Restriction of introduction of infected horses** into clean herds or areas is important to prevent introduction of the disease. Horses should be tested before introduction to the herd, and perhaps again in 1 to 2 months. If suspect horses are to be introduced, they should be kept under close surveillance for at least 6 months before being admitted. Horses known or suspected to be infected should be separated from all other uninfected horses, donkeys, and mules by a distance of at least 200 m. This recommendation is based on observations of the feeding behavior of tabanids, which are very unlikely to fly more than 100 m after an interrupted feeding. **Suspect positive horses** should be retested after at least 1 month and probably at regular intervals thereafter. Operators of open stud farms and rest farms can also insist on proof of a negative test before admitting each horse. One deficiency of this policy is the long period of incubation of up to 45 days between infection and seroconversion to a positive test.

In countries where the incidence is high, it is usual to control horse movement by a system of permits and certificates of freedom from the disease and to insist on skin branding or lip tattooing of all horses. Horses with a positive AGID or ELISA test should be allowed to move only under specified conditions.

Draining of marshy areas and the **control of biting insects** may aid in limiting spread of the disease. A degree of protection may be obtained by the use of **insect repellents** and by stabling in screened stables. Great care must be taken to avoid transmission of the disease on **surgical instruments** and hypodermic needles, which can only be sterilized by boiling for 15 minutes or by autoclaving at 6.6-kg pressure for a similar period. Chemical disinfection of instruments and tattoo equipment requires their immersion for 10 minutes in one of the less corrosive phenolic disinfectants. All materials to be disinfected need to be cleaned of organic matter first. For personal disinfection, sodium hypochlorite, ethanol, or iodine compounds are safe, and for materials where organic matter is not removable, agents such

as chlorhexidine or phenolic compounds combined with a detergent are satisfactory.

There are considerable problems associated with development of **vaccines** against EIA because only neutralizing antibodies are capable of causing sterile immunity and preventing infection. Neutralizing antibodies are specific for the homologous virus, but the large variation in phenotypes of the wild virus means that it will be difficult to stimulate neutralizing antibodies protective against all of the possible infecting phenotypes.<sup>42</sup> **Vaccines** are available in parts of the world but are not in general use.<sup>43</sup> Killed, whole-virus vaccines are safe, but subunit vaccines may actually enhance the occurrence of the disease. An experimental live attenuated EIAV DNA proviral vaccine affords complete protection in experimentally infected horses and has been widely used in China. The use of attenuated vaccines is associated with risk of reversion to virulence and lack of sterilizing immunity against heterologous virus challenge.<sup>38</sup>

#### FURTHER READING

Cook RF, et al. Equine infectious anemia and equine infectious anemia virus in 2013: a review. *Vet Microbiol.* 2013;167:181-204.

#### REFERENCES

- Liu Q, et al. *Viruses-Basel.* 2015;7:3241.
- Boldbaatar B, et al. *J Virol Meth.* 2013;189:41.
- Capomaccio S, et al. *Virus Res.* 2012;163:656.
- Dong J, et al. *V et Microbiol.* 2014;174:276.
- Caij AB, et al. *Transboundary Emerg Dis.* 2014;61:464.
- Dong J-B, et al. *J Gen Virol.* 2013;94:360.
- Quinlivan M, et al. *J Gen Virol.* 2013;94:612.
- Sponseller BA, et al. *Virology.* 2007;363:156.
- Albayrak H, et al. *Trop Animal Health Prod.* 2010;42:1593.
- Inci A, et al. *Ankara Univ Vet Fak Der.* 2013;60:281.
- Marenzoni ML, et al. *Turk J Vet Anim Sci.* 2013;37:76.
- Yilmaz O, et al. *J Equine Vet Sci.* 2013;33:1021.
- Borges AMCM, et al. *Res Vet Sci.* 2013;95:76.
- Cutolo AA, et al. *Semina-Ciencias Agrarias.* 2014;35:1377.
- Gaiva e Silva L, et al. *Rev Inst Med Trop Sao Paulo.* 2014;56:487.
- Guimaraes LA, et al. *Rev Bras Med Vet.* 2011;33:79.
- Body M, et al. *Pak Vet J.* 2011;31:235.
- Getachew M, et al. *J Vet Med Animal Health.* 2014;6:231.
- Hussain MH, et al. *Pak Vet J.* 2012;32:247.
- Jimenez D, et al. *Open Vet J.* 2014;4:107.
- Lo C-H, et al. *Taiwan Vet J.* 2014;40:1.
- Mangana-Vougiouka O, et al. *Rev Scien Tech OIE.* 2013;32:775.
- Pagamjav O, et al. *Microbiol Immunol.* 2011;55:289.
- Kuhar U, et al. *Equine Vet J.* 2014;46:386.
- More SJ, et al. *Equine Vet J.* 2008;40:706.
- More SJ, et al. *Equine Vet J.* 2008;40:709.
- Schwartz EJ, et al. *J Virol.* 2015;89:6945.
- Capomaccio S, et al. *Vet Microbiol.* 2012;157:320.
- Alvarez I, et al. *Clin Vaccine Immunol.* 2007;14:1646.
- Alvarez I, et al. *Vet Microbiol.* 2007;121:344.
- Reis JKP, et al. *J Virol Meth.* 2012;180:62.
- Alvarez I, et al. *Rev Arg Microbiol.* 2015;47:25.
- Craig JK, et al. *J Virol Meth.* 2012;185:221.
- Hu Y, et al. *Chin J Prev Vet Med.* 2014;36:651.
- Hu Z, et al. *Appl Microbiol Biotech.* 2014;98:9073.
- Piza AST, et al. *Prev Vet Med.* 2007;78:239.

- Issel CJ, et al. *Vet Rec.* 2013;172:210.
- Cook RF, et al. *Vet Microbiol.* 2013;167:181.
- Bolfa P, et al. *Vet Res.* 2013;44.
- Brangan P, et al. *Equine Vet J.* 2008;40:702.
- Issel CJ, et al. *Vet Clin Equine.* 2014;30:561.
- Craig JK, et al. *PLoS Pathog.* 2015;11:e1004610.
- Tagmyer TL, et al. *J Virol.* 2008;82:4052.

## TICKS THAT TRANSMIT PROTOZOAN DISEASES

Ticks are the most important vectors of many protozoan diseases, the protozoan in most instances surviving from generation to generation of ticks by infecting their eggs. Where control of these diseases is to be undertaken, it is necessary to know which ticks are vectors, how many hosts the tick parasitizes during a life cycle, and which animals can act as hosts. Much of the information on these points is fragmentary and only a summary is presented in Table 11-9. Additional information on the control of ticks is provided in Chapter 17.

## BABESIOSIS (TEXAS FEVER, REDWATER FEVER, CATTLE TICK FEVER)

*Babesia* spp. are a diverse group of tick-borne, obligate, intraerythrocytic apicomplexan parasites infecting a wide variety of organisms.<sup>1-10</sup> Infection of a vertebrate host is initiated by inoculation of sporozoites into the bloodstream while the tick takes a blood meal. Most babesial sporozoites directly invade circulating erythrocytes without a tissue stage of development. A few, notably, *Babesia equi* and *Babesia microti*, first invade lymphocytes, where they form motile merozoites, which then invade erythrocytes. Once erythrocyte invasion occurs, a seemingly perpetual cycle of asexual reproduction is established, despite a rapid development of a strong immune response.

### SYNOPSIS

**Etiology** *Babesia* spp.

**Epidemiology** Disease of tropical and subtropical countries. Occurs in cattle, sheep and goats, horses, cervids, and pigs. Transmission by blood-sucking ticks. Young calves have innate resistance. Endemic stability occurs in herds with a sufficient inoculation rate to immunize a high percentage of animals.

**Zoonotic implications** *Babesia bigemina* and *B. microti* occurs in humans where suitable ticks are found. Human donor blood may be infected.

**Clinical signs** Anemia, hemoglobinuria, jaundice, fever, high case-fatality rate.

**Clinical pathology** Parasites in stained blood smear, positive serology. Polymerase chain reaction (PCR) for detection of parasite in blood.

Continued

**Necropsy lesions** Thin, watery blood; pallor; jaundice.

**Diagnostic confirmation** Parasites in blood smear; vector present in environment.

**Differential diagnosis list** A syndrome of acute hemolytic anemia should suggest the following alternative diagnoses:

#### Cattle

Theileriosis  
Postparturient hemoglobinuria  
Bacillary hemoglobinuria  
S-methyl-L-cysteine-sulfoxide (SMCO) poisoning  
Leptospirosis

**Treatment** Diminazene aceturate and imidocarb.

**Control** Tick control, vaccination with live vaccine, chemoprophylaxis with imidocarb.

## ETIOLOGY

The nomenclature of these intraerythrocytic parasites is still subject to change; species in livestock include the following:

- **Cattle:** species include *Babesia bovis* (B. argentina), *B. bigemina*, and *B. divergens*<sup>1,2</sup>
- **Sheep and goats:** *B. motasi*, *B. ovis*
- **Pigs:** *B. trautmanni*, *B. perroncitoi*

## EPIDEMIOLOGY

### Geographic Occurrence

The distribution of the causative protozoa is governed by the geographic and seasonal distribution of the insect vectors that transmit them (Table 11-10).

### Host Occurrence

#### Bovine Babesiosis

Babesiosis caused by *B. bigemina* and *B. bovis* is an important disease mainly in tropical and subtropical regions of the world.<sup>2,3</sup> Both species are transmitted transovarially by *Boophilus* or *Rhipicephalus* ticks, but only tick larvae transmit *B. bovis*, whereas nymphs and adults transmit *B. bigemina*. Other species of *Babesia* rely on other ticks, including *Haemaphysalis* and *Hyalomma*. *B. bigemina* and *B. bovis* occur in the tropical and subtropical regions of Africa, America, Asia, Australia, and Europe (between 40°N and 32°S). *B. divergens* occurs in Europe and is the principal cause of babesiosis in the United Kingdom. Other species, such as *B. divergens* and *B. major*, occur in temperate regions.

Bovine babesiosis is widespread in South Africa, for example, and the distribution of both *B. bovis* and *B. bigemina* is determined by the distribution of their tick vectors. The seroprevalence of *B. bigemina* in nonvaccinated cattle is a result of the high vector-tick population and the endemically stable situation that can be achieved by a tick-control method that allows a reasonable

**Table 11-9** Ticks reported to transmit protozoan disease

Disease	Protozoan	Vector ticks	Country	
<b>Babesiosis</b>				
Cattle	<i>Babesia bigemina</i>	<i>Boophilus annulatus</i> , <i>B. microplus</i> , <i>B. (annulatus) calcaratus</i> , <i>B. decoloratus</i> ; <i>Rhipicephalus appendiculatus</i> , <i>R. bursa</i> , <i>R. evertsi</i> ; <i>Ixodes ricinus</i> ; <i>Haemaphysalis punctata</i>	North America, Australia, South America, Africa	
		<i>Babesia bovis</i>		Europe Former USSR Europe Iran Australia Africa
		<i>Babesia berbera</i>		Africa
Sheep and goats	<i>Babesia motasi</i>	<i>Dermacentor sylvanum</i> ; <i>Rhipicephalus bursa</i> ; <i>Haemaphysalis punctata</i> ; <i>Ixodes ricinus</i>	Europe	
		<i>Babesia ovis</i>	Former USSR India Japan	
		<i>Babesia ovata</i>	Japan	
Horses	<i>Babesia caballi</i>	<i>Hyalomma dromedarii</i> ; <i>Dermacentor (reticulata) marginatus</i> , <i>D. pictus</i> , <i>D. sylvanum</i> ;  <i>Hyalomma (excavatum) anatolicum</i> , <i>H. marginatum</i> , <i>H. volgense</i> ; <i>Rhipicephalus bursa</i> , <i>R. sanguineus</i> <i>Hyalomma dromedarii</i> ; <i>Rhipicephalus evertsi</i> , <i>R. sanguineus</i> ; <i>Dermacentor marginatus</i> , <i>D. pictus</i> ; <i>Hyalomma anatolicum</i> , <i>H. marginatum</i> , <i>H. uralense</i> ; <i>Rhipicephalus bursa</i> , <i>R. sanguineus</i>	Africa Former USSR and the Balkans, South America, Florida in the United States Africa, the Balkans, South America, Australia	
		<i>Babesia equi</i>	Africa, the Balkans, South America, Australia	
Pigs	<i>Babesia trautmanni</i>	<i>R. sanguineus (turanicus)</i>	Former USSR	
<b>Theileriosis</b>				
Cattle	<i>Theileria parva</i> <i>Theileria annulata</i>	<i>Rhipicephalus appendiculatus</i> <i>Hyalomma anaticolicum</i>	Africa Africa, Asia, former USSR, Europe, China, India	
		<i>Theileria sergenti</i> <i>Theileria mutans</i>	Japan, Asia Africa, Asia Europe, former USSR, North America Australia	
		<i>Theileria buffeli</i>	Australia	
Sheep	<i>Theileria ovis</i>	<i>Rhipicephalus bursa</i> , <i>R. evertsi</i> ; <i>Hyalomma</i> spp.;	Africa, Asia Europe	
		<i>Rhipicephalus</i> spp.	Africa, Middle East	
		<i>Theileria hirci</i> <i>Hyalomma anaticolicum</i>	Former USSR	

number of ticks on cattle rather than relying entirely on intensive tick control and vaccination.<sup>1</sup>

### Sheep and Goats

In sheep and goats, babesiosis is associated with species such as *B. ovis* and *B. motasi* and occurs in Africa, Asia, and Europe. Sheep

babesiosis is of considerable economic importance in the areas infested with *Rhipicephalus* or *Haemaphysalis*.

### Porcine Babesiosis

Associated with *B. trautmanni* and *B. perroncitoi*, porcine babesiosis occurs in Africa and Europe.

**Table 11-10** Major *Babesia* species infective to domestic animals, their tick vectors, and their geographic distribution<sup>1</sup>

<i>Babesia</i> spp.	Major ixodid vectors	Known distribution	Domestic species affected
<i>Babesia bigemina</i>	<i>Boophilus microplus</i> <i>Boophilus decoloratus</i> <i>Boophilus annulatus</i> <i>Boophilus geigy</i> <i>Rhipicephalus everti</i>	Africa, Asia, Australia, Central and South America, Southern Europe	Cattle, buffalo
<i>Babesia bovis</i>	<i>Boophilus microplus</i>	As for <i>Babesia bigemina</i> , but less widespread in Africa as a result of <i>B.</i> <i>microplus</i> competition with <i>B. decoloratus</i>	Cattle, buffalo
<i>Babesia divergens</i>	<i>Ixodes ricinus</i> <i>Ixodes persulcatus</i>	Northwestern Europe, Spain, Great Britain, Ireland	Cattle
<i>Babesia major</i>	<i>Haemaphysalis punctata</i>	Europe, northwestern Africa, Asia	Cattle
<i>Babesia ovata</i>	<i>Haemaphysalis longicornis</i>	Eastern Asia	Cattle
<i>Babesia ovis</i>	<i>Rhipicephalus bursa</i>	Southeastern Europe, northern Africa and Asia	Sheep and goat
<i>Babesia motasi</i>	<i>Rhipicephalus bursa</i>	Southeastern Europe, northern Africa and Asia	Sheep and goat
<i>Babesia caballi</i>	<i>Dermacentor</i> spp. <i>Hyalomma marginatus</i> <i>Hyalomma truncatum</i> <i>Rhipicephalus evertsi</i>	Africa, South and Central America, southern United States, Europe, Asia	Horses, donkey, mule
<i>Babesia canis</i>	<i>Rhipicephalus sanguineus</i> <i>Dermacentor</i> spp., <i>Haemaphysalis</i> spp., <i>Hyalomma</i> spp.	Southern Europe, North America, Asia, Africa, Australia	Dog
<i>Babesia gibsoni</i>	<i>Haemaphysalis</i> spp., <i>Rhipicephalus sanguineus</i>	Africa, Asia, Europe, North Dog America	
<i>Babesia trautmanni</i>	<i>Rhipicephalus</i> spp.	Southern Europe, former USSR, Africa	Pig

### Equine Piroplasmiasis

In horses, donkeys, mules, and zebras, equine piroplasmiasis is associated with *B. caballi* and “*B. equi*.”<sup>1,2</sup> The latter parasite is now recognized as *Theileria equi*<sup>2</sup> and will be retained within the context of piroplasmiasis (disease caused by *Babesia* or *Theileria*) because the diseases caused by *B. caballi* and *T. equi* are similar clinically (see the section on equine piroplasmiasis). Equine piroplasmiasis occurs in much of southern Europe, Asia, and the Americas. For example, it is widespread in China and a cause for serious concern in northeastern China. In addition, equine piroplasmiasis is also widespread in horses, mules, donkeys, and zebras in South Africa.<sup>2</sup> Fortunately, Australia is free from equine piroplasmiasis, but seropositive horses were temporarily imported into this country for the Sydney Olympic games in 2000. While in

Australia, seropositive horses were kept at particular restricted sites.

### Wildlife Babesiosis

Among *Babesia* species that infect wildlife, *B. odocoilei* infects cervids, including the white-tailed deer (*Odocoileus virginianus*), American elk, and American woodland caribou (*Rangifer tarandus caribou*).<sup>1</sup> Desert bighorn sheep (*Ovis canadensis nelsoni*) and red deer (*Cervus elaphus elaphus*) are also susceptible to infection but do not exhibit clinical signs of disease. *B. odocoilei* is transmitted by ticks of the genus *Ixodes*. Various species of *Babesia* have been recorded in reindeer, including *B. divergens* and *B. tarandirangiferis*.

### Origin of Infection and Transmission

Viable stages of *Babesia* are present in the bloodstream of animals in the active phase

of the infection. Ticks are the natural vectors of babesiosis; the causative parasites persist and pass through part of their life cycle in the invertebrate host. Both *B. bovis* and *B. bigemina* pass through part of their life cycle in the tick *Rhipicephalus australis* (previously *Boophilus microplus*). Other species of *Boophilus* and *Rhipicephalus* are major vectors of babesiosis, but other ticks of the genera *Haemaphysalis*, *Hyalomma*, *Ixodes*, and *Dermacentor* can be involved in transmission.<sup>1</sup> *Rhipicephalus australis* is the main vector of babesiosis associated with *B. bovis* and *B. bigemina* in cattle production systems in Australia and Central and South America. *Ixodes ricinus* is a common carrier of *B. divergens* in the United Kingdom.<sup>1,2</sup> *Rhipicephalus* and *Haemaphysalis* spp. are common ticks of sheep and/or goats.<sup>2</sup>

Knowledge of the life history of the tick is central to implementing effective control strategies against babesiosis or piroplasmiasis. When adult animals become infected with *Babesia*, they can act as carriers for variable periods, up to 2 years. If they are constantly reinfected, as they are in an endemic environment, they can act as carriers for life. Ticks that parasitize only one host are easier to eradicate and cause less spread of the disease than those parasitizing multiple hosts. The control of ticks capable of surviving on both domestic and wild animals presents major challenges.

### Life Cycle and Development of *Babesia*

The development of *B. bovis* and *B. bigemina* follows similar patterns. *Babesia* spp. do not parasitize any vertebrate host cell other than erythrocytes. Each sporozoite penetrates the erythrocyte membrane with the aid of a specialized structure called the apical complex. Once inside, it transforms into a trophozoite from which two merozoites develop by a process of merogony or schizogony (binary fission) (see Fig. 11-9).

The tick becomes infected when ingesting erythrocytes containing piroplasms (gametocytes). They develop into male and female gametes in the tick gut. The microgametes fuse with macrogametes to produce motile zygotes. The zygotes then multiply, and the resultant “vermicules” invade numerous organs of the tick, including the ovaries. Therefore the infection passes through the ovary and the egg to the next tick generation (called transovarial transmission). Usually the female tick becomes infected, and sporogony takes place in the salivary glands of larval, nymphal, and/or adult ticks of the next generation. When the tick attaches to a new host, sporozoites mature. In *B. bigemina*, for example, some development occurs in the feeding larvae, but infective sporozoites take about 9 days to appear, and they therefore only occur in the nymphal and adult stages of the tick. Transmission can occur throughout the rest of the nymphal stage and by adult



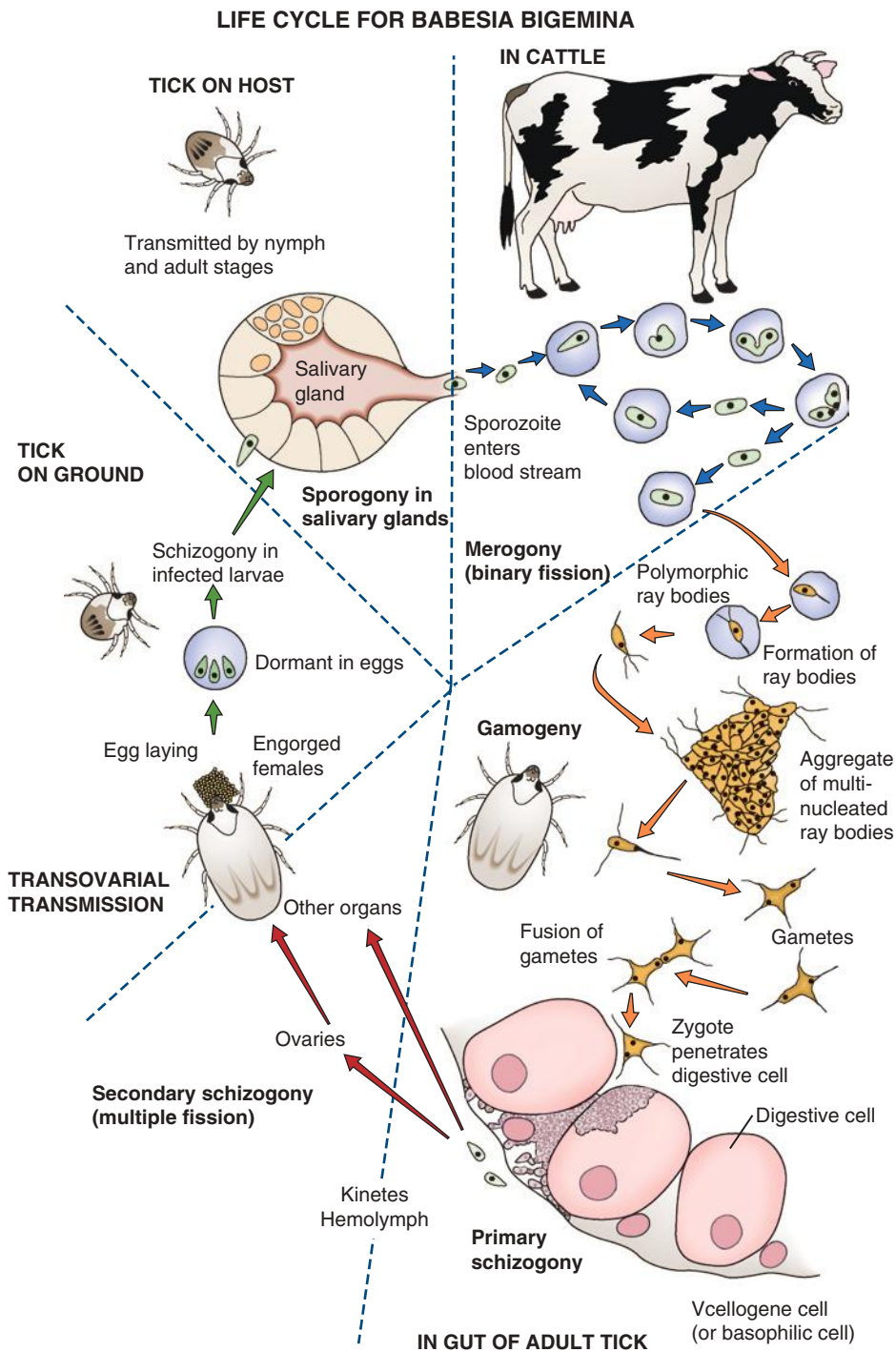

transmitted in this way depends largely on the degree of parasitemia occurring for each species. Thus the probability of physical transmission is slight with *B. bovis* and higher with *B. equi* and *B. bigemina*.

### Immunity and Susceptibility to Infection

The immune responses of cattle to infection with *B. bovis* or *B. bigemina* involve both innate and acquired mechanisms.<sup>4</sup> The response directed against infections with *Babesia* is both humoral and cellular and is T-cell dependent. In addition, an age-related immunity to initial infection with *B. bovis* in cattle is well established, characterized by strong innate immunity in young calves. Mononuclear phagocytes are engaged as the primary effector cells on innate and primary immune responses, and nitric oxide has been identified as at least one babesiacidal molecule produced by activated mononuclear phagocytes. When *B. bovis*-infected erythrocytes grown in culture are exposed to nitric oxide, death of the parasites occurs rapidly within the erythrocyte.

### Innate Immune Mechanisms

There is an age-related immunity to primary infection of cattle with *B. bovis* and *B. bigemina*. Young calves possess this strong innate immunity against *B. bovis* infection, which lasts for approximately 6 months after birth and is abrogated with the removal of the spleen.<sup>4</sup> Interleukin IL-12 and IL-10 are important immunoregulatory cytokines. The protective innate response in young calves to infection with virulent *B. bovis* involves the early appearance of IL-12 and interferon-gamma transcripts in the spleen. This is followed by a short period of inducible nitric oxide synthase expression. In contrast, IL-12 and IFN-gamma (mRNA) expression in the spleens of adult cattle that died from infection was delayed and depressed, and it occurred within the context of IL-10 expression. Also, in contrast to calves, there was no detectable antibody response before death in adults.

### Acquired Immune Mechanisms

Following *B. bovis* infection, antibodies directed against protective and nonprotective parasite antigens and host antigens are produced.<sup>4</sup> Hyperimmune serum from cattle infected with *B. bovis* many times, or a mixture of IgG1 and IgG2 prepared from hyperimmune serum from cattle, can be used to passively immunize naïve calves against *B. bovis* infection, and the protection is specific. Splenectomized calves given hyperimmune serum and challenged with *B. bovis* recover as effectively as intact calves.

Strong immunity occurs after natural infection with most *Babesia* spp. There appears to be little relationship between the degree of immunity and the level of

**Fig. 11-9** The developmental life cycle of *Babesia bigemina* in cattle and the ixodid tick vector *Boophilus microplus*. (Adapted from Mehlhorn H, Schein E. The piroplasms - life-cycle and sexual stages. *Adv Parasitol.* 1984;23:37-103; Gough JM, Jorgensen WK, Kemp DH. Development of tick gut forms of *Babesia bigemina* *in vitro*. *J Eukaryot Microbiol.* 1998;45:298-306; Mackenstedt U, Gauer M, Fuchs P. et al. DNA measurements reveal differences in the life-cycles of *Babesia bigemina* and *B. canis*, 2 typical members of the genus *Babesia*. *Parasitol Res.* 1995;81:595-604.)

females and males. For *B. bovis*, the formation of infective sporozoites usually occurs within 2 to 3 days of larval tick attachment. The host is infected with infected tick saliva. Particular species of *Babesia* can persist for several tick

generations, even in the absence of new infections.

Contaminated needles and surgical instruments can transmit the infection physically. The ease with which infection can be

antibodies in serum. If the infection recurs repeatedly, the immunity is permanent. If the illness is treated rapidly and efficiently, and the protozoa are killed before antibodies are produced, no immunity occurs. If the infection is not repeated, the protozoa survive in the host for a variable time (e.g., 6 months), and then disappear. A sterile immunity persists for approximately 6 more months, and the host is susceptible again about 1 year after infection. These periods of latent infection and resistance/protection to reinfection are usually subject to significant variation and to different responses between breeds of cattle and species of *Babesia*.

Despite the potential severity of the acute infection, individuals that survive generally develop immunity against disease, but not against infection, and could remain persistently infected. In the case of *B. bovis*, infection can persist for years, and even for the lifetime of the animal. *Babesia* infections have adapted well to survival in immune hosts. A number of phenomena are known to contribute to parasite survival: rapid antigenic variation, cytoadhesion and sequestration, binding of host proteins to the infected red blood surface, the monoallelic expression of different members of multigene families, and establishment of transient immunosuppression.<sup>4,5</sup>

The inoculation rate measures the daily probability of infection. This is based on the knowledge that animals exposed to the parasite in the first 9 months of life become infected, immune, and seropositive without showing any clinical signs of disease.<sup>1</sup> Inoculation rates of 0.0005 and 0.005 are endemically unstable because a high percentage of animals will reach the age of 9 months without having been exposed to the hemoparasite. This results in a high risk of disease (**endemic instability**) because primary infections in older animals are usually severe and can be fatal. In situations of endemic instability, the vaccination of calves against hemoparasites can be used to ensure that the herd is immune. Cattle producers can use tick control to break the transmission cycle.

**Endemic stability** is defined as the state in which the relationship between host, agent, vector, and environment is such that clinical disease occurs rarely or not at all.<sup>1</sup> Endemic stability (herd immunity) in bovine babesiosis occurs when the rate of transmission (inoculation rate) of *Babesia* spp. by the tick vector is sufficient to immunize most susceptible calves before the loss of their resistance. In tropical areas with a large vector population, natural exposure usually occurs at an early age, and cattle are thus immune to subsequent challenges as adults. If at least 75% of calves are exposed to *B. bovis* infection by 6 to 9 months of age the disease incidence will be very low, and a state of natural endemic stability will exist.

**Immunity.** Cattle develop a durable, long-lasting immunity after a single infection with *B. bovis*, *B. bigemina*, or *B. divergens*. Different species of *Babesia* do not usually induce cross-protective immunity.<sup>4</sup> Immunity to *B. bovis* and *B. bigemina* appears to last for at least 4 years. There is evidence that the presence of serum antibodies is not necessarily an indication of immunity. Conversely, the absence of detectable antibodies is not necessarily an indication of a lack of immunity.<sup>4</sup>

### Risk Factors

#### Host Factors

*B. indicus* breeds of cattle are considerably more resistant to babesiosis than *B. taurus* breeds.<sup>1</sup> This observation is thought to be a result of the evolutionary relationship among *B. indicus*, *Boophilus/Rhipicephalus* spp., and *Babesia*. Zebu and Afrikaner cattle have a higher resistance to *B. bovis* than British and European breeds; Santa Gertrudis and cross-bred cattle occupy an intermediate position. Zebu-type cattle are also relatively free from the disease because of their resistance to heavy tick infestation. In Australia, *B. bigemina* is usually of lower pathogenicity than *B. bovis* and rarely lethal even when fully susceptible adult cattle are introduced to an endemic area. Inoculation studies with *B. bigemina* in Australia have shown that *B. indicus* and *B. indicus* cross-bred cattle are more resistant than the *B. taurus* cattle.

**Age Resistance.** In cattle, there is a variation in susceptibility to infection according to age, and the severity of babesiosis increases with age. Calves and foals from naïve dams are highly susceptible to infection and clinical illness from birth to 2 months of age, at which time they develop resistance that persists to approximately 6 months of age. Calves and foals from immune dams receive antibodies via the colostrum, and this passive immunity persists for 3 to 4 months after birth. The highest infection rate is in animals between 6 to 12 months of age; infection is uncommon in animals of greater than 5 years of age. Animals of less than 1 year of age are infected predominantly with *B. bigemina* and those of greater than 2 years of age by *B. bovis*. Calves of up to 1 year of age, although fully susceptible to infection, are resistant to disease. The average age at which calves in endemic areas become infected is 11 weeks (2 to 34 weeks), but clinical signs and pathologic changes are mild and relatively short-lived at this early age. After 6 months of age the number of infected animals in enzootic areas increases.

In **housed cattle**, the level of serum antibodies in cattle are at their lowest when they come out of the barn in the spring, and this level gradually increases as they are exposed to infected ticks.

In **enzootic areas**, cattle most commonly affected by clinical disease are those that are susceptible and introduced for breeding

purposes, intended for slaughter, or are “in transit.” Cattle indigenous to endemic areas are rarely affected because of the natural resistance of very young animals, and passive immunity via colostrum from immune dams is gradually replaced by a state of active immunity. Severe clinical cases occurring in cattle in such areas are usually caused by exposure to some stress, such as parturition, starvation, or intercurrent disease. Such breakdowns in immunity are most likely to occur if there is a superimposed infection with a different parasite, such as *Anaplasma marginale*.

### Environmental Factors

There is **seasonal variation** in the prevalence of babesiosis, with the greatest incidence occurring soon after the peak of the tick population. For example, in England babesiosis mainly occurs in spring, summer, and autumn. Of the climatic factors, environmental temperature is the most important because of its effect on tick activity—higher temperatures increase activity. Humidity and rainfall have little effect, and even with temperature, the effect is limited once a threshold of 7° to 100°C (44° to 50°F) minimum temperature is exceeded. The heaviest losses occur in **marginal areas** where the tick population is highly variable in size, depending on the environmental conditions. In seasons when the tick population decreases, infection may die out, and immunity is lost. Under favorable conditions, when ticks multiply, infection can spread rapidly among susceptible individuals within a population or among/between populations. Comparable circumstances may be created artificially when an inefficient dipping or treatment program is used, which reduces the tick population to a low level and is subsequently unable to sustain control.

### Pathogen Factors

Many intraerythrocytic hemoparasites survive host immune responses through antigenic drift or shift, which has been demonstrated for *Babesia bovis*.<sup>5</sup> The molecular basis for antigenic variation in *Babesia* and its possible connection with cytoadherence and sequestration have been examined. There are different “strains” and antigenic variants of both *B. bovis* and *B. bigemina*. *Babesia* infections in cattle can relate to superinfection with antigenically distinct parasite populations. Antigenic change can provide *Babesia* with a temporary respite from attack by the host immune system and thus might prolong the infection period or cause disease relapses. Nonetheless, strain differences and antigenic variation do not appear to be of major importance in relation to the effect of a vaccine because cross-immunity between/among strains of the same *Babesia* species usually provide adequate protection against one another.

### Economic Importance

Bovine babesiosis is the most economically important of these diseases because of direct losses of production and because of the restriction of movement of cattle for trade by quarantine laws. Many animals die or undergo a long period of convalescence, resulting in major meat and milk production losses. Incidental costs of immunization and treatment add to the economic burden. With early, effective treatment, the mortality rate can be reduced to 5%.

### Zoonotic Implications

Human cases of *B. divergens* infection have been reported in France, Britain, Ireland, Spain, Sweden, Switzerland, the former Yugoslavia, and the former USSR.<sup>1,6</sup> Geographically, these cases coincide with *B. divergens*-infected cattle populations and areas in which *Ixodes ricinus* occurs, involving inhabitants of rural areas who are exposed to ticks by virtue of their occupation or their recreational activities. Most cases are reported between May and October, during the main season of tick activity.

Cases of human babesiosis have been diagnosed sporadically, mainly in North America and Europe.<sup>6</sup> Traditionally, cases of human babesiosis in Europe have been linked to *B. divergens*, whereas those in North America have been associated with *B. microti*. Autochthonous cases of *B. microti* infections have also been detected in Taiwan, Japan, and Europe. Recently, piroplasms similar to *B. duncani* and *B. divergens* have been implicated in human disease.<sup>6</sup> In addition, *B. venatorum* (a *B. divergens*-like organism), which is probably a parasite of deer, was involved in the first documented cases of human babesiosis in Austria, Germany, and Italy. This evidence indicates that various *Babesia* species known to infect wildlife and domestic animals have the potential to cause human disease. Deer-associated zoonoses have become a particular public health concern, for instance, in the United States because human contact with deer ticks has increased as a result of the proliferation of deer, abandonment of farmland that reverts to thick secondary vegetation, and increased use of coastal sites for human recreation. This explains the increasing frequency of reported human cases of babesiosis, Lyme disease, and human granulocytic ehrlichiosis.

*Babesia* spp. represent a potential threat to the blood supply for transfusion because asymptomatic infections in humans occur, and the spread of these hemoparasites via blood transfusions has been reported from various countries. Using the microaerophilous stationary-phase (MASP) culture technique, the parasites proliferate in a settled layer of blood cells. This provides the opportunity to examine the basic biology of the organism, host-microbe interactions, immune factors triggered by the parasite,

factors involved in innate resistance of young animals to infection, and antimicrobial susceptibility. Their in vitro cultivation might also be used to produce parasite antigens and attenuated strains of *Babesia* that could be used for immunization.

### PATHOGENESIS

*Babesia* spp. are a diverse group of tick-borne, obligate, intraerythrocytic apicomplexan parasites infecting a wide variety of organisms.<sup>2</sup> Infection of a vertebrate host is initiated by inoculation of sporozoite stage into the bloodstream while the tick takes a blood meal. Most *Babesia* sporozoites directly invade circulating erythrocytes. Once erythrocyte invasion occurs, a perpetual cycle of asexual reproduction is established, despite the onset of a strong immune response.<sup>4</sup>

### Acute Cases

When an animal becomes infected, multiplication of the protozoa in the visceral (*B. bovis*) or peripheral (*B. bigemina*) vessels reaches a peak with the development of clinically detectable hemolysis, the principal pathogenic effect, after an incubation period of 7 to 20 days. The hemolysis results in profound anemia, jaundice, and hemoglobinuria. A fatal outcome as a result of anemic anoxia commonly follows. In surviving animals, there are ischemic changes in skeletal and heart muscles.

In *B. bovis* infection, there is also profound vasodilation and hypotension, resulting from the stimulation of production of vasoactive substances and an associated increase in vascular permeability. Circulatory stasis and shock follow; disseminated intravascular coagulation (DIC) and subsequent fatal pulmonary thrombosis are also features. Cerebral babesiosis is possible. In contrast, *B. bigemina* is an uncomplicated hemolytic agent and does not exert these vascular and coagulation effects.

Susceptibility to infection with *Babesia* spp. decreases with age, but the severity of disease increases. For example, calves of 5 to 6 months of age infected with *B. bovis* show limited clinical signs, cattle of 1 to 2 years of age have a moderately severe disease, and aged cows suffer a severe, often fatal disease. Intrauterine infection with *B. bovis* has been reported.

Animals that survive become **carriers**, a state in which a subclinical infection is maintained by a delicate immunologic balance between protozoa and antibodies. This balance is readily disturbed by the stress of transport, deprivation of food, pregnancy, or intercurrent disease. Carrier animals are resistant to infection with *B. bovis* for up to 2 years. With **constant reinfection**, such as occurs in enzootic situations, protection is continuous.

The ability of cattle to infect ticks is much longer (1 year) with *B. bovis* than *B. bigemina*

(4–7 weeks). Similarly, the peak incidence is at a younger age for *B. bigemina*, and the reinfection rate is more rapid. Some experiments have shown that merozoites can periodically disappear from peripheral blood in infected cattle. In **pregnant cows**, there is usually no apparent infection of the calf in utero, but passive immunity is transferred via colostrum to the newborn calf.

### Immunology

Calves of less than 9 to 12 months of age are as susceptible as adult cattle to infection with *B. divergens* but are less likely to exhibit clinical disease. This phenomenon, known as inverse age resistance, is the result of an innate resistance in calves and is independent of the maternal immune status. Although offspring of resistant dams acquire specific antibodies (mainly IgG) via colostrum, these immunoglobulins are not required for protection because calves of susceptible dams without specific serum antibodies are equally resistant. Studies of *B. bovis* in vitro have shown that erythrocytes from very young calves were unfavorable for parasite development, possibly because of the inhibitory effect of fetal hemoglobin.

Cattle that recover from acute infection with *B. bigemina* or *B. bovis*, either naturally or following chemotherapy, remain persistently infected and resistant to further disease following reinfection with the same strain.<sup>1,4</sup> Immunization with dead piroplasms or extracts can induce protection against challenge with homologous or heterologous strains, indicated by low parasitemias and a diminished packed cell volume (PCV).

Immunity does not last indefinitely, and in the absence of a reinfection, the animal becomes susceptible to reinfection. Specific immune responses include both cellular and humoral components. Monocytes and lymphocytes are the main agents of cell-mediated immunity. Experimentally, the exposure of cattle to avirulent and virulent strains of *B. bovis* in a primary infection results in considerable antimicrobial activity in peripheral blood monocytes and neutrophils.<sup>1</sup> This elevated antimicrobial activity coincides with the time that parasite numbers peak in the circulation and occurs before parasite clearance. This information suggests that peripheral blood monocytes and neutrophils are active mediators in the innate immune response to a primary infection with *B. bovis*. In cattle vaccinated against *B. divergens*, protection is associated with elevated mononuclear cell proliferation.

In cattle infected with *B. divergens*, serum antibodies can be demonstrated even before infected erythrocytes appear in blood smears, suggesting that they have no inhibitory effect on merozoite replication. During secondary infection, protection seems to depend on the high specificity of some anti-*B. divergens* serum antibodies, rather than their level, because resistant animals often



have low levels of specific antibodies. The importance of the spleen in the specific immune response is indicated by the fact that the removal of the spleen following recovery may result in a clinical relapse.

Specific serum antibodies produced against the parasites are used for serologic diagnosis. The highest titers are obtained in the sera of cows that have had a series of infections, but the degree of resultant immunity is not related to the specific antibody titer. The antibodies can be passively transferred via serum or colostrum. The immunity to different strain of *B. bovis* is specific. However, when an infection with a heterologous strain of the protozoa occurs, there is an increased immune response. As with cattle, *B. ovis* infection in sheep can produce an acute attack of clinical illness, parasitemia, and the subsequent development of immunity.

## CLINICAL FINDINGS

### Cattle

**Babesia Bovis.** The acute disease generally runs a course of 3 to 7 days, and a fever of greater than 40°C (104°F) is usually present for several days before other signs emerge. This is followed by inappetence, depression, polypnea, weakness, and a reluctance to move. Hemoglobinuria is often present (known as “redwater” in some countries); urine is dark red to brown in color and produces a very stable froth. Anemia and jaundice develop, particularly in prolonged and severe cases. Diarrhea may occur. Muscle wasting, tremors, and recumbency develop in advanced cases, followed terminally by coma. Many severely affected animals die precipitately at this point, after an illness of only 24 hours. Metabolic acidosis can be present in a significant percentage of cases of bovine babesiosis. During the fever stage, pregnant cattle can abort, and bulls may become sterile for 6 to 8 weeks. Cerebral babesiosis is manifested by incoordination, followed by posterior paralysis or mania, convulsions, and coma. The mortality rate in such cases is high, in spite of chemotherapy.

In those that survive, the febrile stage usually lasts for approximately a week, and the total course about 3 weeks. Cattle that survive recover gradually from the severe emaciation and anemia, which are inevitable sequelae.

A **subacute** syndrome also occurs, particularly in young calves, in which fever is mild and hemoglobinuria is absent. The syndrome associated with *B. divergens* is similar to that of *B. bovis*, except that, in addition, there is spasm of the anal sphincter, causing the passage of feces with great force in a long, thin stream, even in the absence of diarrhea; this sign is referred to as “**pipe-stem**” feces.

**Babesia Bigemina.** Hemoglobinuria is present earlier and more consistently than in

*B. bovis* infection, and fever is less of a feature. Acutely affected animals are usually not as severely affected as those with *B. bovis* infection. There is no cerebral involvement, and recovery in nonfatal cases is usually rapid and complete. However, in some cases, disease can develop very rapidly, with sudden and severe anemia, jaundice, and death. Animals that recover from *B. bigemina* remain infective to ticks for 4 to 7 weeks and remain as carriers for only a few months.

### Sheep

Anemia, fever, icterus, and hemoglobinuria are common.

### Wildlife

Babesiosis of elk and caribou are characterized clinically by lethargy, hemoglobinuria, icterus, fever, recumbency, and sudden death.<sup>1</sup> Elk infected with *B. odocoilei* may not have any clinical signs of disease but may become ill during periods of stress, such as during the rutting season, calving, transportation, or overcrowding.

### Other Species

In all other species, the syndrome observed is clinically similar to that described for cattle.

## CLINICAL PATHOLOGY

### Hematology

Severe anemia with erythrocyte counts as low as 2 million/ $\mu$ L and hemoglobin levels down to 3g/dL occur in clinical cases in cattle, with anemia peaking 9 to 16 days following infection. Significant reduction in platelet numbers and a depression in the fibrinogen content of blood also occur.

### Demonstration of the Presence of Babesia

#### Direct Examination of Blood Smears

A diagnosis of babesiosis in clinically affected animals depends on the detection of piroplasm (merozoites) in Giemsa-stained smears of capillary blood; venous blood may give a false negative result for *B. bovis* infection. There is no exact correlation between the percentage of erythrocytes containing protozoa and the severity of the clinical signs. Also in *B. bigemina* infection, piroplasms are numerous in peripheral capillaries; *B. bovis* is less readily found. This difficulty can be largely overcome by using thick blood smears for detection. Microscopic examination can detect parasitemia of approximately  $10^3$  in thin blood films and  $10^6$  in thick blood smears. Therefore thick blood films are 10 times more sensitive and are more reliable for the detection of low-level *B. bovis* infection. Blood films should be prepared from capillary blood collected after pricking the tip of the tail or margin of the ear; blood from the general circulation may contain 20 times fewer *B. bovis* than capillary blood.

## Transmission Test

The inoculation of blood from a potentially infected bovine to susceptible splenectomized calves is a highly sensitive technique for the direct detection of *Babesia*. For this test, 50 to 100 mL of blood is injected into the recipient either SC or IV. In the latter case, the incubation period will be shorter. The recipient cattle are examined daily, and the blood is examined for protozoa at the peak of the febrile reaction.

**Carrier cattle** infected with *B. bovis* and/or *B. bigemina* are difficult to detect because of the small number of piroplasms in peripheral blood. Microscopic examination of stained blood smears is not a reliable technique for the detection of *Babesia*-carrier animals. The evaluation of the persistence of *B. bovis* and *B. bigemina* infections can be established by inoculating blood from donor cattle into splenectomized calves and measuring specific anti-*Babesia* serum antibody levels.

### Culture of Babesia

Some *Babesia* spp. can be cultured in vitro.<sup>3</sup> For instance, *B. divergens* from the blood of **carrier cattle** can be isolated using an in vitro culture technique in sheep erythrocytes. *Babesia* stages can be isolated 9 months after the acute babesiosis phase and can be successfully subcultured, cryopreserved, and resuscitated using culture medium. This culturing approach allows for detailed studies of the parasite.

**Preservation of live protozoa** can be effected by cryopreservation, by culture in a medium containing infected bovine erythrocytes, and in simple culture media in special apparatus for long periods and in large numbers.

### Methods of Detection and Identification of Babesia spp.

The accurate diagnosis of babesiosis is an important component of controlling babesiosis.<sup>7</sup> Microscopy detection methods are inexpensive and rapid, but their sensitivity and specificity are limited. Improved methods are being developed, and they offer faster, more sensitive, and more specific options compared with conventional approaches. Methods based the detection of nucleic acids (DNA) and their amplification are the most sensitive and reliable techniques available today. For instance, PCR assays have been developed for the detection and identification of common pathogenic bovine, equine, and rodent piroplasms. Following specific amplification of the parasite DNA by nested PCR, the parasite species can be identified by PCR-coupled sequencing and/or fragment-length polymorphism.<sup>7</sup>

Other combined tests include ELISA using a recombinant *B. bovis* antigen, PCR, and a DNA probe, which can specifically detect even low-level infections. The DNA probe has the added advantage of being able

to detect protozoa in necropsy specimens and in tick tissues. The PCRs are most useful because of their high sensitivity and specificity, which makes them suitable for the detection of carrier animals.

### Serology

Diagnosis of **past or present infection** can be demonstrated by any one of a wide range of serologic tests.<sup>7</sup>

### Cattle

Because of the difficulty in finding piroplasms in smears in animals during the subclinical stages of the disease, particularly in surveillance studies for the detection of the infection in herds or areas, much attention has been directed toward employing serologic tests.<sup>7</sup> Such tests are well established, but most of them have limitations in terms of specificity and sensitivity. Moreover, it is not possible, on an individual animal basis, to distinguish between current and past infections, or between exposure and infection.

**Complement Fixation Test.** CFT is a commonly used serologic test for bovine babesiosis. Other tests assessed under field conditions include passive agglutination, indirect fluorescent antibody test (IFAT), indirect hemagglutination, ELISA, microplate enzyme immunoassay (EIA), latex agglutination, capillary agglutination, slide agglutination, and card agglutination. These tests have relatively good reputations, with EIA being particularly sensitive.

**Immunofluorescence Antibody Test.** IFAT has been a popular test used to distinguish between *Babesia* spp. and to demonstrate the presence of antibodies in a population of animals. IFAT differentiates between antibodies against *B. divergens* and other bovine babesias, but not between *B. divergens* and *B. capreoli* from red deer.

**ELISA.** An ELISA test using a crude antigenic preparation of *B. bovis* was assessed for the specific detection of IgM serum antibodies and achieved a specificity of 94% and sensitivity of 100%.<sup>1</sup> Specific IgM antibodies against *B. bovis* have been reported to appear on the 11th day following inoculation in animals by *R. australis* ticks and on the 19th day after inoculation in of animals with infected blood.

A competitive ELISA (cELISA) is another high-throughput method for detecting serum antibodies against hemoparasites.<sup>1</sup> For instance, the gene encoding *B. bovis* rhoptry-associated protein 1 (RAP-1) was used to develop such an assay.<sup>1</sup> This ELISA approach was reported to differentiate animals with *B. bovis*-specific antibodies from uninfected animals, and from animals with antibodies against other tick-borne hemoparasites, with high sensitivity and specificity (both  $\geq 98.5\%$ ).

### Sheep

ELISA has been assessed for the detection of *B. ovis* in sheep.

A **latex agglutination test (LAT)** using recombinant *B. equi* merozoite antigen 1 (EMA-1) was developed for the detection of antibodies to *T. equi*.<sup>1</sup> It is a simple, rapid, relatively sensitive, specific, and inexpensive alternative to IFAT or ELISA.

### NECROPSY FINDINGS

In **acute cases** of babesiosis in all species, in which patients die after a brief illness and during an anemic crisis, the typical findings are jaundice; thin, watery blood; pale tissues; enlargement of the spleen, which has a soft, pulpy consistency; and gross enlargement and dark-brown discoloration of the liver. The gallbladder is distended, with thick, granular bile; the kidneys are enlarged and dark; and the bladder contains red-brown urine. Ecchymotic hemorrhages are present under the epicardium and endocardium, and the pericardial sac contains an increased quantity of blood-stained fluid. In cattle, a characteristic manifestation is severe intravascular clotting.

In **subacute or chronic cases** of relatively long duration, the carcass is emaciated but hemoglobinuria is absent; the other changes observed in acute cases are present but are less pronounced. The **microscopic examination** of blood smears taken from peripheral blood, from kidney and heart muscle, and, in the case of suspected *B. bovis* infection, from the brain, is mandatory for clinching the diagnosis. Smears from blood and most tissues must be made within 8 hours of death, within 28 hours for the brain, and stained with Giemsa for the detection of *B. bovis*.

Direct fluorescent antibody staining of smears permits the use of slightly "older" tissues. Organ smears are still usable 5 days after collection, provided that they are kept at 22°C (72°F). The morphology of *B. bigemina* changes quickly after the host's death, so that zoites resemble those of *B. bovis*. Blood collected after death can also be used for detection of serum antibodies in serologic tests.

### DIFFERENTIAL DIAGNOSIS

Preferably, the presence of the tick vector should be collected and verified before a definitive diagnosis of babesiosis can be made, unless an animal has left a known enzootic area within the preceding month. Clinically, a high morbidity and case-fatality rate in cases displaying jaundice with hemoglobinuria and fever are suggestive, but confirmation of the diagnosis by microscopic examination of stained blood smears, complementary immunologic or molecular tools, and/or by transmission experiments is required. A necropsied animal with

splenomegaly, jaundice, hemoglobinuria, swollen and dark kidneys and liver, and/or myocardial ecchymoses is suggestive of babesiosis/piroplasmosis, but the diagnosis needs to be confirmed by traditional or molecular laboratory testing of tissues for the presence of the parasite stages (merozoites/piroplasms).

### Differential diagnosis list

A syndrome of acute hemolytic anemia should suggest the following alternative diagnoses:

#### Cattle (see Table 11-11):

Theileriosis (caused by *Theileria*)—very similar clinically and differentiable only based on laboratory examination

Postparturient hemoglobinuria—does not require the presence of vectors, occurs only in recently calved cows in full lactation and on low-phosphorus diets, and is characterized by the absence of protozoa from blood and tissues

Bacterial hemoglobinuria—characterized by a necrotic infarct under the diaphragmatic surface of the liver in cattle grazing lush pasture

S-methyl-L-cysteine-sulfoxide (SMCO) poisoning—occurs only in cattle grazing crops of rape or other *Brassica* spp.

Leptospirosis—occurs only in this form of the disease in calves kept in unsanitary conditions that are wet underfoot. Diagnosis of this disease depends on isolation of the leptospire.

### TREATMENT

**Primary treatment** is aimed at killing the parasite(s) in the patient.<sup>7,8</sup> Effective drugs are available for use in cattle, but the initial phase of the disease is acute; if treatment is delayed for too long, the animal may succumb to the anemia, in spite of chemotherapy. If the illness is a consequence of vaccination with live vaccine, care must be taken to avoid a complete sterilization of the blood before sufficient serum antibody is produced against the parasite(s) to elicit a durable immunity. Treatment has no suppressive effect on the protozoa that are residing in the ticks parasitizing the cattle at the time.

Drugs such as diminazene aceturate, imidocarb dipropionate, amicarbalide diisethionate, and phenamidine have been used against *Babesia*. Parvaquone, buparvaquone, and alovaquone are introductions with good reputations from clinical trials. Tetracyclines have been used extensively, but their use in acutely sick animals has been discontinued. There is some use in the simultaneous administration of live *Babesia* in a chemosterilant situation; the parasite is controlled and effective immunization is achieved.

### Cattle

For many years, three babesicides, quinuonium sulfate (and generics), amicarbalide

**Table 11-11** Differential diagnosis of diseases of cattle in which red urine is a principal manifestation

Disease	Epidemiology	CLINICAL AND LABORATORY FINDINGS		
		General	Urinary	Clinical pathology
<b>Diseases with hematuria</b>				
Enzootic hematuria	Subjects older than 1 year. Endemic to specific areas with access to bracken.	Persistent intermittent hematuria; hemorrhagic anemia, acute or chronic. Rectal in acute cases nil; chronic cases have local or diffuse thickening. Long course, death by anemia.	Persistent, intermittent hematuria.	Urine has no pus, eukocytes, or bacteria.
Enzootic bovine pyelonephritis	Adults only. Sporadic cases usually. May be a series suggesting origin in one bull and relationship to mating events.	Mild fever. Frequent painful urination, toxemia. Late cases, rectal examination shows cystitis, ureters thickened and enlarged, kidneys the same. Pain on palpation. Long course, death by uremia.	Intermittent hematuria and pyuria.	Urine has pus, erythrocytes, eukocytes, <i>C. renale</i> on culture catheter sample.
<b>Diseases with hemoglobinuria</b>				
Babesiosis ( <i>B. bigemina</i> and <i>B. bovis</i> )	Outbreaks in marginal areas in heavy tick seasons in calves. Incubation 2–3 weeks. 90% morbidity and mortality.	High fever, pallor, severe jaundice terminally.	Red urine, hemoglobinuria.	Babesia in red cells in smear. Transmission test. Many serologic tests.
Tropical theileriosis ( <i>Theileria annulata</i> )	Transmitted only by ticks of <i>Hyalomma</i> spp.	Fever, anorexia, lymph node enlargement.	Hemoglobinuria.	Piroplasms in red cells; schizonts in lymphocytes from liver biopsy. Serologic tests. <i>Hyalomma</i> spp.
Postparturient hemoglobinuria	Postcalving 2–4 weeks. Adult dairy cows in 3rd–6th lactation. Sporadic but tends to endemicity on individual farms. Low-phosphorus or low-copper diet.	Acute onset, weakness, tremor, pallor, bounding pulse, loud heart sounds, tachycardia. No jaundice. Mortality 50%. Long convalescence. Die of anemia, especially if stressed.	Deep brown to black frothy.	No cells in urine but good deposit on standing. Severe hemolytic anemia. Serum inorganic P < 1.5 mg/dL and down to 0.1 mg/dL.
Bacillary hemoglobinuria	Summer on irrigated pasture. Sporadic. Very few cases. Endemic to particular farms. Mortality 100%.	Often found dead. Very acute onset, hemolytic anemia plus toxemia. Fever 41°C (105°F). Abdominal pain, pain on percussion right anterior abdomen. Diarrhea. Shallow, rapid respiration as a result of diaphragmatic pain.	Deep red brown, no cells.	Hemolytic anemia, increased serum bilirubin.
Leptospirosis ( <i>L. interrogans Pomona</i> only, not <i>L. hardjo</i> )	Calves high mortality 50%. Adults low mortality < 5%. Abortion storm more common in adults. Many subclinical infections in adults.	Hemolytic disease mostly in young calves. Sudden-onset septicemia with red urine. Severe toxemia, fever 40.5–41.5°C (104.5–106°F). Mucosal petechiae, pallor, and jaundice. Adults have thick orange milk all quarters.	Red urine, hemoglobinuria.	Initially leptospiruria 3 days. Leptospiruria by intraperitoneal injection into guinea pigs. Rising titer leptospira antibodies, with peak 4 weeks after infection.
Chronic copper poisoning	Rarely if at pasture. Copper supplement in a swine diet by mistake.	Sudden onset, weakness, pallor, jaundice, death usually in 24–48 hours.	Hemoglobinuria, some methemoglobinuria	High liver copper on biopsy 2000 ppm dry material. High plasma ceruloplasmin and copper.

isethionate, and diminazene aceturate, were available in most countries for the treatment of bovine babesiosis. In the 1970s, imidodocarb dipropionate was introduced, and it became the drug of choice in countries that licensed it, because in addition to its therapeutic utility, it also proved to be an effective prophylactic at twice the therapeutic dose. Currently, it is the only babesicide on the market in most countries of Europe. Quinuronium sulfate and amicarbilide have been withdrawn because of manufacturing safety issues; diminazene, which is widely used in

the tropics as both a babesicide and a trypanocide, also was withdrawn in Europe for marketing reasons.

Imidocarb is most toxic when given IV; IM or SC administration is recommended. Side effects of this drug include coughing, muscular tremors, salivation, colic, and local irritation at the site of injection, following the administration of high doses. Although it is regarded as being slower in action than quinuronium sulfate, it is the only babesicide that consistently clears the host of parasites. In the past, the persistence of small numbers

of parasites in the host was deemed necessary for the maintenance of resistance to reinfection. However, the concept of premunition appears no longer to be accepted. Premunition is used to describe resistance that is established after the primary infection has become chronic and is only effective if the parasite persists in the host. It was thought that only cattle actually infected with *Babesia* were resistant to clinical disease. If all organisms were removed from an animal, resistance was thought to wane immediately. However, cattle apparently cured of *Babesia*



infection by chemotherapy are resistant to challenge with the homologous strain of that organism for several years. The presence of infection does appear to be mandatory for protection against heterologous strains.

Although a certain period of antigenic exposure is necessary before treatment to facilitate the establishment of immunity, cattle treated with imidocarb dipropionate ultimately have a solid immunity. Long-term persistence of low-level parasitemia is now considered a disadvantage. Remaining parasites may give rise to recrudescence under adverse conditions, treated cattle may act as a source of infection, and parasites surviving low levels of babesicide may acquire resistance.

Imidocarb provides “protection” from clinical disease for 3 to 6 weeks, but allows a sufficient level of infection for immunity to develop. This strategy is highly effective if the host is assured to be exposed to babesiosis during the period of protection, either through a tick bite in geographic areas where babesiosis is endemic or by inoculation of live parasites. Acquired immunity then takes over from “drug protection,” and the animal passes smoothly to a resistant state without an intermediate clinical stage. However, if infection rates are sporadic or if very high doses of imidocarb are used, a complete inhibition of parasite development will hinder the mounting of an adequate immune response. The major issue associated with this approach is concern regarding drug residues in milk and meat, which has led to the withdrawal of imidocarb in several European countries.<sup>2</sup>

#### Imidocarb (Imizol)

This and the related drug, amidocarb, are effective babesicides for cattle at the dose rate of 1 mg/kg BW. At 2 mg/kg BW, it eliminates the parasites from the host and maintains some residual activity; noninfected cattle derive a month's resistance to clinical infection but can be infected subclinically. Therefore, imidocarb can be used to “protect” cattle when vaccination is undesirable (e.g., during pregnancy) or when exposure to infection is short-lived. Conversely, it can be used to temporarily protect animals before vaccination. The drug can be given SC. The hydrochloride form is inclined to be an irritant; propionate is less irritating.

#### Sheep

Diminazene aceturate is effective as a treatment in sheep (3.5 mg/kg BW on two successive days, or 12 mg/kg BW as a single dose).

#### Supportive Treatment

In all species, treatment regimens for severely affected sheep should include blood transfusions and antishock preparations. In chronic cases and convalescent patients, hematinics should be provided.

## CONTROL (BOVINE BABESIOSIS)

### Prevention and Biosecurity

**Preventing the introduction** of the disease into a nonenzootic area depends on effective quarantine to prevent the introduction of the vector tick and laboratory testing to ensure freedom of the importee from infection with the pathogen(s).<sup>1</sup>

### Control

The control of bovine babesiosis in an area depends on the control the tick vector. Eradication is usually not achievable/practical because of the high cost to local wildlife, some of which can be hosts to ticks. Other challenges encountered include the following:

- The difficulty of getting a complete muster of all cattle on every dipping day
- Multihost ticks, which can be infective but temporarily not resident on an animal on dipping day
- The spread of ticks or infested cattle as a result of environmental issues, such as floods or windstorms
- Illegal movement of cattle without a permit

Other issues include the persistence of *Babesia* through successive generations of the tick vector and the resistance of ticks to acaricides, which is also a factor relating to the infestation level of cattle.

The effect of different tick (*Rhipicephalus microplus*) control strategies (none, threshold, and strategic) on endemic stability and the likelihood of babesiosis (*Babesia bovis*) has been examined in parts of South America using a computer simulation model based on weekly tick counts. The cattle population was in a state of enzootic stability, with an inoculation rate exceeding 0.005 throughout the year. Threshold dipping strategies did not increase the risk of babesiosis. Strategic dipping resulted in an extended period of enzootic instability lasting 30 weeks, which required protection of the herd by vaccination. Therefore strategic dipping is proposed to lead to effective control or eradication of *Babesia* from tick and cattle populations, but it would not result in an eradication of the tick vector. This situation could lead to subsequent outbreaks if *Babesia* carrier animals were introduced into the herd. Strategic tick control could be accompanied by concurrent vaccination against babesiosis.

### Limitation of Prevalence

To limit prevalence at economically sustainable levels requires different solutions in different circumstances. It is largely dependent on tick control through frequent application of acaricides, chemotherapy to kill *Babesia* in the cattle host, and, to a lesser degree, by immunization of cattle.<sup>7-9</sup> These measures are only partly effective and are time-consuming and expensive. The reason for the poor performance of vaccination procedures, even after a great deal of research, is

that the mechanisms of immunity against protozoa, particularly *Babesia* spp., have not been explored in great detail. Further investigations need to elucidate how immune responses to these parasites work.

Aspects that need to be considered to limit prevalence are the following:

- Susceptible cattle moving into an enzootic area need prior **vaccination**.
- Marginal areas abutting enzootic areas in which tick populations vary with climatic change, so that resident cattle lose immunity after some dry years and are then exposed to infection when wet years foster an increased prevalence of ticks in these areas. **Vaccination** before outbreaks are predicted to commence is recommended, if forecasting is possible, and temporary **chemoprophylaxis** after outbreaks have commenced.
- In enzootic areas where losses are occurring as a result of environmental stress or, particularly, concurrent infection with another pathogen (e.g., *Anaplasma marginale*), or where the tick population has been decimated by overzealous dipping, **chemoprophylaxis** and relaxation of dipping are recommended. Exposure of cattle to ticks is important to ensure to maintain a state of infection and immunity.

### Vaccination

Vaccination with live and dead whole parasites, crude parasite extracts, and isolated parasite antigens has been used, with varying degrees of success.<sup>9</sup> Several findings support the development of vaccines against babesiosis. First, cattle that recover from a primary *Babesia* infection or that have been immunized with attenuated parasites are resistant to challenge infection. Second, the immunization of cattle with native *Babesia* antigen extracts or culture-derived supernatants containing secreted *Babesia* antigens elicit protective immunity against both homologous and heterologous challenge.

The characteristics of cattle farms on which the exposure of young cattle to tick fever organisms is sufficient to ensure that immunity is high and the risk of clinical disease is low (**endemic stability**) can be compared with those farms on which exposure is insufficient (**endemic instability**) to study and understand the relationships between the management of ticks and tick fever. In Queensland, Australia, for example, many cattle herds do not have sufficient exposure to *B. bovis*, *B. bigemina*, or *A. marginale* to confer endemic stability for tick fever.<sup>1</sup> For *B. bovis*, the major cause of outbreaks of clinical disease in Queensland, less than half of the herds had evidence of endemic stability. The decision to leave some ticks on cattle, in an effort to induce endemic stability, did increase the likelihood of endemic stability to *A. marginale*. However, it was ineffective, because only 26% of herds

had endemic stability against all three pathogens. Thus, given the low proportion of herds with endemic stability to tick fever organisms and the high likelihood of clinical disease, vaccination is recommended to protect dairy cattle from tick fever throughout tick-infested areas.

### Live Vaccines

Vaccines incorporating live, attenuated strains of *B. bovis* and *B. bigemina* have been used routinely or experimentally in Australia and a number of other countries.<sup>9</sup> The literature on designing blood-stage vaccines against *B. bovis* and *B. bigemina* has been reviewed.<sup>9</sup> The data available on the efficacy, degree, and duration of immunity elicited by live vaccines against *B. bovis* and *B. bigemina* infections in Australia have also been reviewed.<sup>9</sup> Most of the available live vaccines have been produced in government-supported production facilities in Australia, parts of South America, South Africa, and Israel. These vaccines include bovine erythrocytes infected with selected strains of the parasites. The risk of contamination of blood-derived vaccines is a concern and makes postproduction quality control essential; unfortunately, such quality control is beyond the means of some endemic countries. Techniques developed in Australia over many decades have formed the basis for the production of live *Babesia* vaccines in most countries where they are used. There is no reliable evidence to indicate that current live vaccines might spread disease from vaccinated to unvaccinated cattle.

**Origin and Purification of Strains.** Since 1990, three strains of *B. bovis* and one of *B. bigemina* (G strain) have been used to produce vaccines in Australia. After testing for virulence, immunogenicity, and purity, suitable strains are preserved as master stabilates in liquid nitrogen.

### Attenuation of Parasites

**Babesia Bovis.** The most reliable method of reducing the virulence of *B. bovis* is the rapid passage of strains through susceptible, splenectomized calves. Attenuation usually occurs after 8 to 20 calf passages.

**Babesia Bigemina.** Rapid passage in splenectomized calves is not reliable, but the virulence of *B. bigemina* decreases during prolonged residence in latently infected animals. A single *B. bigemina* isolate (G strains) has been used in the Australian and South African vaccines for many years.

### Vaccine Specifications

Live vaccines have proven very effective and reasonably safe, particularly when vaccination is restricted to cattle of less than 1 year of age, when they still are resistant to disease. Vaccines are derived from splenectomized donor calves infected with attenuated strains

of *Babesia*, or from parasites grown in vitro.<sup>9</sup> The vaccines are provided either chilled or cryopreserved. In spite of the costly and time-consuming nature of producing such live vaccines, they have usually provided greater than 95% protection for the life of the cattle vaccinated.

**Frozen Vaccine.** Frozen vaccine is superior to chilled vaccine because of its long shelf-life, which allows postproduction testing of potency and safety before dispatch.<sup>9</sup> Glycerol is used as cryoprotectant in Australia and is preferred over dimethyl sulphoxide because it allows postthaw storage life of the vaccine for at least 8 hours (at temperatures of 4° to 30°C (39° to 86°F)). Frozen vaccines are transported in suitably insulated containers with liquid N<sub>2</sub> or solid CO<sub>2</sub>, which limits the ability to supply vaccines to all destinations. To ensure infectivity, the vaccine must be used within 8 hours of thawing, and once thawed should not be refrozen. A frozen bivalent *B. bovis* and *B. bigemina* vaccine and frozen monovalent *B. bovis* and *B. bigemina* vaccines using dimethyl sulphoxide as the cryoprotectant are produced in some countries. If dimethyl-sulphoxide is used, a vaccine should be used within 30 minutes of thawing.

**Chilled Vaccine.** Most of the babesiosis vaccines produced to date have been provided in a chilled form.<sup>9</sup> In Australia, 35 million doses were supplied between 1996 and 2003. It is popular because of ease of production, ease of transportation even with limited resources, ease of use, and low cost. The chilled vaccines used in Australia contained  $1 \times 10^7$  *B. bovis*,  $2.5 \times 10^6$  *B. bigemina*, and  $1 \times 10^7$  *Anaplasma centrale* organisms per 2 mL dose. A chilled vaccine has a very short shelf-life of approximately 4 days, which requires rapid, reliable means of communication and transportation to ensure viability. Chilled vaccines can remain viable for up to a week if stored at 4°C (39°F).

To reduce the risk of neonatal hemolytic disease in calves (**alloimmune hemolytic anemia**) of vaccinated dams, the vaccine should not be used repeatedly. Most owners vaccinate only young animals, seldom more than twice. A reduction of the vaccine dose and the use of a cell-free diluent have essentially eliminated the problem in Australia.

The development of effective live vaccines against bovine babesiosis in Australia required laboratory and field research over the period from 1959 to 1996, and it is a remarkable success story of veterinary medicine.<sup>9</sup> The most significant change occurred in 1964 with the traditionally used carriers of *Babesia* being replaced as vaccine donors by acutely infected splenectomized calves. This ensured that the infectivity of the vaccine and was fortuitously associated with a reduction in the virulence of the *B. bovis*

vaccine. The vaccine reduced serious losses from babesiosis in vaccinated cattle in Australia to very low levels and gained acceptance worldwide.

The demand for a live, trivalent “tick fever” vaccine containing *B. bovis*, *B. bigemina*, and *A. centrale* produced by the Department of Primary Industries in Queensland, Australia, increased from less than 10,000 doses in 1988 to 500,000 doses in 2001.<sup>1</sup> The challenge to obtain *B. bigemina* parasitized erythrocytes on a large enough scale from infected splenectomized calves to meet the demand was achieved by reducing the dose rate of infected cells without affecting immunogenicity and still leaving a safety margin of at least 50-fold for infectivity. This change quadrupled the potential yield of doses per calf and allowed the department to meet the increased demand for the *B. bigemina* vaccine.

### Use of Live Vaccine

**Cattle Born in Tick-Infested Regions.** Any factor affecting the survival of the tick vectors will affect the risk of babesiosis. An increased number of ticks will increase the threat of disease until an endemically stable situation develops. Conversely, reduced tick numbers will increase the longer-term risk of babesiosis because of the reduced natural exposure of calves. Therefore cattle owners in endemic areas in Australia are advised to supplement natural exposure by vaccinating calves at weaning age. Vaccination is also recommended if cattle are being moved within an endemic area.

**Susceptible Cattle Imported Into Vector-Infested Country or Region.** Large numbers of cattle, predominantly *B. taurus*, are being imported into tropical developing countries to upgrade local livestock industries. This has resulted in significant economic losses from tick-borne diseases, including babesiosis. Vaccination of naïve cattle moving from tick-free to endemic areas within Australia is usually very effective. This practice has played a crucial role in making the livestock industries in these countries more sustainable and competitive in meeting market demand with regard to breed.

The K strain of *B. bovis* and G strain of *B. bigemina* from Australia have been shown experimentally to be protective in South Africa and Sri Lanka. Vaccines containing these strains have also been used with beneficial results in parts of Africa, South America, Malaysia, and the Philippines.

**Control of Outbreaks.** Use of a vaccine in the face of an outbreak is common practice in Australia. Superimposing vaccination on a natural infection will not exacerbate the disease but will preempt the development of virulent infections in a proportion of the herd not yet exposed to the pathogens. To

prevent further exposure, the group should also be treated with an acaricide capable of preventing tick attachment from the time of diagnosis to 3 weeks after vaccination. Injectable or pour-on formulations of ivermectin and moxidectin and flouzuron are highly effective acaricides but do not prevent the transmission of *Babesia*.

Clinically affected cattle should be treated as soon as possible with a suitable babesiacide. In the case of a severe outbreak, it might be advisable to treat all the cattle with a prophylactic compound, such as imidocarb or diminazene, and to vaccinate them later when the drug residue will not affect the replication of the vaccine parasite(s).

### Hazards and Precautions of Live Vaccine Use

**Severe Reactions.** The likelihood of vaccine-induced reactions has been reduced with the development of attenuated strains. However, there is always a risk of such reactions when highly susceptible adult cattle are vaccinated. Calves of 3 to 9 months of age have a high level of natural resistance and a low risk of reactions. In some countries, vaccination is only recommended for calves, whereas in Australia and South Africa, adult cattle can be vaccinated, provided proper precautions are taken. Concurrent infections may increase the likelihood of reactions. In pregnant cows, fever associated with reactions has the potential to cause abortion; in large bulls, there can be a temporary loss of fertility. In the case of valuable cows and bulls, their body temperatures should be monitored if vaccine-induced reactions occur, and those with prolonged fever should be treated with a babesiacide.

**Lack of Protection.** Since the introduction of a standardized method of production in Australia, live antibabesiosis vaccines have been highly effective. In most cases, a single vaccination provided lasting, probably life-long immunity against field infections with antigenically distinct strains. However, some failures have occurred and are thought to have been associated with a loss of immunogenicity because of frequent passaging of the vaccine strains in splenectomized calves. This was overcome by replacing the vaccine strain. To prevent future recurrences of vaccination failure, the number of passages of vaccine strains of *B. bovis* is limited by frequently reverting to a master stabilate with a low passage number. Other failures may be associated with the immune responsiveness of the host and the immunogenicity of vaccine strain subpopulations.

A single inoculation of cattle at 6 to 9 months of age with an attenuated vaccine containing *B. bovis* and *B. bigemina* usually provides good, long-lasting protection. At this age, the risk of vaccine reactions is minimal. Immunity following use of a live *B. bovis* vaccine lasts for at least 4 years,

possibly less for *B. bigemina*. It is known to persist even after elimination of *Babesia* infections, and studies on drug-cured cattle suggest that the degree of acquired immunity relates to the degree of antigenic stimulation (duration of prior infection) rather than the presence of live parasites. There is no evidence of a loss of immunity with time, and revaccination is mostly not required. Revaccination is advisable when there is uncertainty over the reliability of previous procedures, to ensure that all animals seroconvert, or if there has been a change in the strains used in the vaccine.

A cryopreserved vaccine containing in vitro culture-derived (attenuated) stains of *B. bovis* and *B. bigemina* can achieve protection in 90% of vaccinated cattle against the virulent field strains of *Babesia*.<sup>1,9</sup> Inherent disadvantages of vaccines derived from the blood of animals include the risk of reactions or contamination with pathogenic organisms, sensitization against blood groups, tick transmissibility of vaccine strains, and the need for a **cold chain transportation**.

Vaccinated cattle should be housed or kept under close observation for a month in case excessive reactions occur. A major problem in vaccination with live *Babesia* is the occasional apparent **failure to transmit the protozoa**. This may be result from the absence of the protozoa from the bloodstream of the donor at the time that the blood is drawn or from the presence of a prophylactic drug—for example, imidocarb dipropionate—or low levels of antibody in the animal's tissues. Revaccination is necessary in these circumstances, preferably with blood from a donor that is undergoing a severe reaction at the time.

The attenuated organisms used in unfrozen South Africa *B. bovis* and *B. bigemina* vaccines are susceptible for longer periods to the residual effect of the antibabesial drugs diminazene and imidocarb dipropionate compared with the virulent field strains. The waiting periods before administration of the frozen *B. bovis* and *B. bigemina* vaccines in animals that have been treated with diminazene at 3.5 mg/kg BW compare favorably with those of unfrozen vaccines at 4 and 8 weeks. The inhibitory effect of imidocarb dipropionate at 3.0 mg/kg BW on the infectivity of both frozen *B. bovis* and *B. bigemina* vaccines is longer and requires minimum waiting periods before administration of these vaccines of 12 weeks and 24 weeks, respectively.

### Vaccination With Subunit Vaccines

Subunit vaccines offer an attractive alternative to virulent or attenuated *Babesia* spp.<sup>9,10</sup> Such vaccines are based on recombinant antigens derived from cloned complementary DNA from protozoan parasites. Several protective antigens associated with merozoites or merozoite-infected erythrocytes of *B. bigemina* and *B. bovis* were identified as

possible molecules.<sup>10</sup> Rho-try-associated proteins might become targets of generic recombinant vaccines.

### Dead Vaccines

Dead vaccines would overcome many of the inherent difficulties in the production, transport, and use of live vaccines.<sup>10</sup> However, they have not been sufficiently efficacious, and more research is required.

### Vector Control

This approach was first used successfully to control and eventually eradicate the cattle tick *Boophilus annulatus* and *Babesia* from the United States.<sup>1</sup> In 1906, an eradication program began that involved livestock owners, state officials, and U.S. Department of Agriculture specialists. The program involved three tactics. First, some pastures were rendered tick-free by excluding all host animals until the ticks had starved to death. The second, more common tactic was to retain livestock on the infested pastures and to disinfect the animals at regular 2-week intervals by immersion in an arsenic solution, which killed the engorged female ticks. Third, the interstate movement of tick-infested cattle was prohibited through quarantine. The campaign to eradicate cattle ticks from the United States is the most sustained, extensive, coordinated area-wide attack ever made against an arthropod pest. The tick was removed from more than a million square kilometers over a period of 34 years. The tick is confined to the lower Rio Grande River in Texas, where reinfestation occurs via animal movement from Mexico. This necessitates continual control of fringe populations of cattle.

In Africa, babesiosis is only part of very important complexes of ticks and tick-borne disease, and intensive government-regulated tick control programs have been used for many years. In other continents, the situation is much less complex; where babesiosis is endemic, disease control (rather than eradication) is more realistic. Eradication of tick vectors is rarely considered practical, environmentally sustainable, or economically justifiable on either a national or a local basis.

### Natural Endemic Stability

Natural endemic stability can seldom be relied upon on as a disease control strategy.<sup>9</sup> First, in endemic areas, climatic effects, genetic makeup of hosts, and management strategies inevitably have a major effect on the rate of transmission and, ultimately, on the likelihood of endemic stability developing. Second, endemic stability is an economic concept that incorporates risk management and loss thresholds. The climatic, animal, and management parameters that allow endemic stability can change on a seasonal and annual basis. Third, the model for endemic stability was developed in



Australia and the Americas, where disease/vector interactions are relatively simple. The African situation is much more complex and less predictable, with four main diseases, several vectors, the presence of game reservoirs, and a larger range of susceptibility of bovine breeds.

### Control of Babesiosis in Species Other Than Cattle

The principles of the control of babesiosis in other species is similar to those used for control of this disease in cattle. Most attention is focused on controlling the vector tick, identifying infected and carrier animals by an appropriate laboratory test, and sterilizing the positive reactors using a suitable treatment strategy.

#### FURTHER READING

- Mueller J, Hemphill A. In vitro culture systems for the study of apicomplexan parasites in farm animals. *Int J Parasitol.* 2013;43:115-124.
- Suarez CE, Noh S. Emerging perspectives in the research of bovine babesiosis and anaplasmosis. *Vet Parasitol.* 2011;180:109-125.

#### REFERENCES

- Radostits O, et al. *Veterinary Medicine: A Textbook of the Disease of Cattle, Horses, Sheep, Goats and Pigs*. 10th ed. London: W.B. Saunders; 2007:1483.
- Uilenberg G. *Vet Parasitol.* 2006;138:3.
- Gohil S, et al. *Int J Parasitol.* 2013;43:125.
- Brown WC, et al. *Vet Parasitol.* 2006;138:75.
- Allred DR, Al-Khedery B. *Vet Parasitol.* 2006;138:50.
- Hunfeld KP, et al. *Int J Parasitol.* 2008;38:1219.
- Mosqueda J, et al. *Curr Med Chem.* 2012;19:1504.
- Vial HJ, Gorenflot A. *Vet Parasitol.* 2006;138:147.
- De Waal DT, Combrink MP. *Vet Parasitol.* 2006;138:88.
- Brown WC, et al. *Parasite Immunol.* 2006;28:315.

## EQUINE PIROPLASMOSIS

Piroplasmosis of equids is a tick-borne infectious disease caused by the hemoprotozoan parasites *Theileria equi* and *Babesia caballi*.<sup>1-12</sup> Piroplasmosis, also known as equine babesiosis (*B. caballi*), theileriosis (*T. equi*), or “biliary fever,” affects all equids, including horses, donkeys, mules, and zebras. Infection with either or both of these obligate intraerythrocytic organisms can cause varying degrees of hemolytic anemia and associated systemic disease. Recently *T. equi* infection has reemerged in the United States; consequently, questions have arisen as to the tick–vector–parasite–host relationship required for the development of clinical disease.

#### SYNOPSIS

**Etiology** *Babesia caballi* and *Theileria equi*.

**Epidemiology** Occurs in equids. Transmission by ticks.

**Clinical signs** Anemia, hemoglobinuria, jaundice, fever, often high case-fatality rate for *T. equi* but not for *B. caballi*.

**Clinical pathology** Parasites in stained blood smear, positive serology. Polymerase chain reaction (PCR) can be used for detection of parasite in blood or tissues.

**Necropsy lesions** Thin, watery blood; pallor; jaundice.

**Diagnostic confirmation** Parasites in blood smear; vector present in environment.

**Differential diagnosis list** A syndrome of acute hemolytic anemia should suggest the following alternative diagnoses:

- Equine infectious anemia
- Severe myoglobinuria (rhabdomyolysis associated with exercise or hypoglycemia A intoxication)
- Foals with alloimmune hemolytic anemia
- Cardiac form of African horse sickness

**Treatment** Imidocarb—drug of choice. (R1)

**Aspects of control** Tick control; chemotherapy with imidocarb; surveillance of horses and ticks using effective serologic, molecular, and complementary tools.

## ETIOLOGY

*B. caballi* and *T. equi* (previously *Babesia equi*) are known to cause infections and disease in equids, including horses, donkeys, mules, and zebras.<sup>1-4</sup> For *T. equi*, molecular studies support previous observations of pre-erythrocytic stages in lymphocytes. Nonetheless, the taxonomy of *T. equi* remains controversial.<sup>5</sup>

## EPIDEMIOLOGY

### Geographic Occurrence

The distribution of the causative protozoa is governed by the geographic and seasonal distribution of the insect vectors that transmit them (Table 11-10).

### Host Occurrence

Babesiosis and theileriosis of equids are known as **equine piroplasmosis**. In horses, donkeys, mules, and zebras the disease is associated with *B. caballi* or *T. equi*.<sup>1-4</sup> The diseases caused by *B. caballi* and *T. equi* are similar clinically, but the latter species is more virulent.<sup>3</sup> Equine piroplasmosis occurs in much of southern Europe, Asia, and the Americas.<sup>3</sup> For example, it is widespread in China and a cause for serious concern in northeastern China. In addition, equine piroplasmosis is also widespread in horses, mules, donkeys, and zebras in South Africa, and has reemerged in the United States.<sup>6-8</sup> Australia is free from equine piroplasmosis, but seropositive horses were temporarily imported into Australia for the Sydney Olympic games in 2000. While in Australia, seropositive horses were kept at particular restricted sites.

The distribution of equine piroplasmosis coincides with the distribution of tick vectors.<sup>2-4</sup> Ixodid ticks of the genera *Hyalomma*, *Dermacentor*, and *Rhipicephalus*

have been identified as vectors for the transmission of either *T. equi* or *B. caballi* to equid hosts. In tropical countries, *Hyalomma* species appear to be suitable vectors for transmission of *T. equi* to horses and donkeys.

## Impact

Mortality rates in outbreaks of equine piroplasmosis can be high, but the predominant losses in horses result from the interference with racing and equine competitions and meetings. This is a particular issue now, with the increased movement of horses between or among countries to partake in international equine competitions. Another possible form of loss is the death of foals infected in utero. Although there was early evidence that equine babesiosis might be an emerging disease threatening to be of major importance to the horse industry, this has not been the case. However, disease caused by *T. equi* appears to be a significant threat. Nonetheless, the use of diagnostic methods to screen horses before, during, and after international travel associated with international competitions or races is an important disease monitoring/prevention approach.

## Life Cycle and Transmission

The life cycles of both *T. equi* and *B. caballi* involve distinct developmental stages that occur in the host and tick.<sup>3</sup> Both parasites progress via three stages: the sporozoite (asexual transmission stage), merozoite (asexual blood stage), and gametocyte (sexual blood stage). Development within the tick varies, depending on the tick species involved. Infective sporozoites are transmitted through tick saliva to the equid host. Once within the equid host, *B. caballi* sporozoites directly invade erythrocytes, where they multiply and develop into trophozoites, and then into merozoites. After erythrocyte rupture, merozoites are released and invade other erythrocytes. In contrast, *T. equi* first enters peripheral mononuclear cells (PBMCs), which is part of the reason for its taxonomic reclassification as *Theileria*. Within PBMCs, *T. equi* zoites replicate to produce large schizonts; after ~9 days, merozoites are released and invade erythrocytes, where they multiply and develop into trophozoites, and then into merozoites. Merozoites are released and invade other erythrocytes.

For both *B. caballi* and *T. equi*, asexual replication results in a massive expansion of the population of merozoites and parasitized erythrocytes. Following multiple rounds of replication, some merozoites develop into gametocytes within peripheral blood. Upon ingestion by a competent tick, the parasites undergo sexual reproduction, with gametocytes developing into gametes, which combine to form zygotes within the midgut of the tick. After 6 to 24 days, sporozoites accumulate within the salivary gland of the tick.

Transmission can also occur iatrogenically through inappropriate mixing of the infected and uninfected blood.<sup>3</sup> This can occur during the practice of sharing needles among different horses, but use of any blood-contaminated equipment could result in transmission. Infection can also result when chronically infected horses serve as blood donors to naive horses. The illegal practice of blood doping (prerace blood transfusions) was implicated in an outbreak in Florida in 2008. Experimental infection can be induced by the IV and SC injection of infective stages and by infected ticks.

### Movement of Horses

The international movement of animals has become a very important matter to the horse industry.<sup>3</sup> These days, groups of pleasure horses are transported around the world to compete in different countries, and valuable stallions are sometimes transported to another country for a brief period to stand at stud. There is a tendency for some countries to be very restrictive in their quarantine procedures for horses; international relations might be enhanced if more was known about the relationship between a positive serologic test result and infection risk for other horses.

### PATHOGENESIS

Although some aspects of pathogenesis remain unknown, infection with *T. equi* or *B. caballi* causes the lysis of erythrocytes, resulting in varying degrees of hemolytic anemia.<sup>3,4</sup> The physical rupture of erythrocytes during the release of merozoites causes intravascular hemolytic anemia. Infected red blood cells are removed from the circulation by splenic macrophages, further contributing to hemolytic anemia. Uniformly, infection with *T. equi* results in more severe clinical disease than *B. caballi*.<sup>3</sup>

Nonparasitized erythrocytes are also removed from circulation, but the reason for this removal is unknown. It appears that the structure of erythrocyte membranes alters substantially during *T. equi* infection, suggesting that this change causes decreased deformability of the red cells, which might lead to a reduced microvascular blood flow. The level of malondialdehyde (marker of lipid peroxidation) in blood is significantly increased, suggesting that an accumulation of oxidative ions also contributes to erythrocyte lysis. *T. equi* and *B. caballi* infections also alter coagulation; *B. caballi*-infected erythrocytes cause microthrombi by clumping within small vessels, leading to venous stasis and vasculitis. Also described are thrombocytopenia and prolonged clotting times during *T. equi* and *B. caballi* infections.

Decreased platelet counts might relate to immune-mediated destruction, splenic sequestration, and/or excess consumption, as seen in disseminated intravascular coagulation (DIC). Severe piroplasmiasis often

results in hypercoagulability, systemic inflammatory response syndrome, and subsequent multiorgan system dysfunction.

Placental transmission can result in abortion (usually in late gestation), stillbirth, or neonatal infection. Variation in genotypes of host and/or parasite could influence the prevalence of placental transmission. Transmission appears not to be linked to exposure to semen from an infected stallion, but blood contamination during mating might present a transmission risk.

In most cases, horses become persistently infected and become carriers. The inapparent carrier state is life-long with *T. equi* and possibly for *B. caballi*. Persistent subclinical infection might result, in part, from the sequestration and immune-evasion strategies of the parasites. A carrier status represents a delicate balance between protozoa and immune responses; this balance is readily disturbed by the stress of transport, deprivation of food, pregnancy, or intercurrent disease.

After transmission, depending on many factors, including infectious dose and immune status of the host, clinical signs usually develop within 12 to 19 days for *T. equi* and 10 to 30 days for *B. caballi*. The fatality rate of naive horses in geographic regions endemic for equine piroplasmiasis appears to be 5% to 10%, but the severity of disease can vary significantly from one geographic region to another.

### Immunology

The responses of the equine immune system to infection with *T. equi* or *B. caballi* are not yet completely understood but are undoubtedly complex and multifaceted and involve both cellular and humoral components.<sup>3,9,10</sup> It is well accepted that infection with either parasite results in carrier status, which confers protection against disease. There is no documented cross-protection between *T. equi* and *B. caballi*, and horses can be infected with both parasites simultaneously.

### CLINICAL FINDINGS

Clinical disease can present in different forms.<sup>3</sup> For acute *T. equi* infection, clinical signs usually relate to hemolysis and resultant anemia. Although *B. caballi*-infected horses do become anemic, the rare cases of acute death from *B. caballi* appear to result from multiple-organ dysfunction linked to systemic formation of microthrombi and DIC. In these cases, clinical signs vary depending on the organ system affected.

Horses with acute infection initially develop nonspecific signs, such as high fevers, sometimes greater than 40°C (104°F), lethargy, peripheral edema, anorexia, and/or weight loss. Petechia caused by thrombocytopenia can be observed on mucous membranes, including the nictitating membrane. Signs of hemolytic anemia follow and include icteric or pale mucous membranes,

tachycardia, tachypnea, pigmenturia (linked to bilirubinuria or hemoglobinuria), and weakness.

Some horses show gastrointestinal signs, including colic or impactions, followed by diarrhea. Other less common clinical signs include a secondary development of pneumonia, pulmonary edema, cardiac arrhythmia, catarrhal enteritis, laminitis, and/or central nervous system signs, characterized by ataxia, myalgia, and/or seizures.

Permanent or temporary infertility has been seen in stallions. Acute renal failure might occur as a result of hemoglobin-induced pigment nephropathy. Systemic responses to severe inflammation (hypotension) can worsen the kidney disease. Severe infections can also culminate in liver failure or DIC.

A fulminant, abrupt onset of signs of (peracute) disease has been described. Sudden death from *T. equi* can occur, and the introduction of naive horses into an endemic region can lead to a rapid onset of a severe disease outbreak.

Neonatal foals infected in utero with *T. equi* might present with severe and acute signs. Such foals can exhibit clinical signs at birth or can become ill at 2 to 3 days of age. Clinical signs, such as decreased suckling and weakness, are often nonspecific, but progress to resemble those of an infected adult horse (icterus, fever, and anemia). Cases of fetal and neonatal *B. caballi* infection have been reported but are rare.

Chronic *T. equi* or *B. caballi* infection usually results only in nonspecific signs, including weight loss, poor performance, partial anorexia, and/or lethargy. Mild anemia might be present, and the spleen might be enlarged. Splenomegaly appears to be caused by an increased rate of extravascular hemolysis within the spleen in less severely affected horses.

Pregnancy in carrier mares can result in abortion or neonatal infection. Because inapparent carriers can serve as reservoirs for transmission (via ticks, placentally or iatrogenically), such horses represent the largest challenge in nonendemic areas.

### CLINICAL PATHOLOGY

Acute infection is characterized by severe leukocytosis, lymphopenia, and a high absolute neutrophil count. *T. equi* is detected in neutrophils and monocytes in the case of high parasitemia, indicating phagocytosis of the infected erythrocytes. Animals that die of *T. equi* infection show varying degrees of emaciation, hepato- and splenomegaly, and “flabby” kidneys. Petechial hemorrhages are also common in the liver, in the spleen, and on the cortical surface of the kidneys.

### Microscopic Examination

Light microscopic examination of Giemsa-stained blood smears can be used to identify piroplasms within erythrocytes.<sup>3</sup> *T. equi* and

*B. caballi* can be readily distinguished from one another. Within erythrocytes, *B. caballi* typically appears as two large pyriform (pear-shaped) merozoites that measure 2 to 5  $\mu\text{m}$  in length; the percentage of infected erythrocytes is typically less than 1%. *T. equi* merozoites occur within erythrocytes as small polymorphic piroplasms, occasionally in a distinct Maltese cross formation; *T. equi* merozoites usually measure 2 to 3  $\mu\text{m}$  in length. In diseased horses, the percentage of infected erythrocytes is usually 1% to 5%, but it can be greater than 20% in severe cases.

### Serologic and DNA-Based Methods

Various diagnostic techniques can be used alone or in combination.<sup>3</sup> During an outbreak in a nonendemic region, involvement of the state and national regulatory agencies is essential. Only a few laboratories in the world are authorized to carry out specific testing for equine piroplasmiasis; proper handling and dispatch of samples are crucial.

IFAT is used as an adjunct assay to compare CFT results, and it is one of the prescribed tests for equine piroplasmiasis recommended by the OIE. Western blot (or immunoblot) has also been used for the diagnosis of *T. equi* and *B. caballi* infections in a research setting, but is now increasingly used as a tool for the detection of *B. caballi* infection. Research is under way to critically validate these serologic/immunologic tests for use in routine diagnosis.

The cELISA is one of the regulatory tests prescribed by the OIE for international horse transport. This test is considered to be the most sensitive means of detection of chronic *T. equi* infection. A cELISA for *T. equi* utilizes a recombinant protein (EMA-1; immunodominant, highly conserved surface antigen specific for *T. equi*) and specific monoclonal antibodies. This test has high sensitivity and specificity compared with all other serologic tests assessed to date. For *T. equi*, both the sensitivity and specificity of cELISA are greater than 95%. A cELISA using a recombinant protein (RAP-1) was also developed for *B. caballi*. However, sequence heterogeneity in RAP-1 among parasite strains is linked to an inability of the test to detect infected horses in some regions of the world.<sup>3,10</sup> Both cELISAs are available commercially, but they are not available to practitioners. ELISA using whole *T. equi* merozoite antigen has been assessed and appears to be as an easy, economical, and reliable test.

Although PCR and cELISA show considerable promise as diagnostic tools,<sup>3,11</sup> more studies are needed to ensure adequate diagnostic specificity and sensitivity for routine application in different countries. Nonetheless, PCR assay can detect *T. equi* and *B. caballi* in the blood of horses that have recovered from acute babesiosis. Nested PCR has been used for the detection of *T. equi* and *B. caballi* in the blood samples from horses and

infections in ticks. Provided reliable genetic markers are employed, it should be possible to develop a PCR for routine diagnostic testing.

### NECROPSY FINDINGS

In **acute cases** of equine piroplasmiasis, in which patients die after a brief illness and during an anemic crisis, the typical signs include jaundice; thin, watery blood; pale tissues; enlargement of the spleen, which has a soft, pulpy consistency; and gross enlargement and dark-brown discoloration of the liver. The gallbladder is distended, with thick, granular bile; the kidneys are enlarged and dark; and the bladder contains red-brown urine. Petechial or ecchymotic hemorrhages are present under the epicardium and endocardium, and the pericardial sac contains an increased quantity of blood-stained fluid. A characteristic manifestation is severe DIC.

In **subacute or chronic cases** of relatively long duration, the carcass is emaciated but hemoglobinuria is absent; the other changes observed in acute cases are present but are less pronounced. The **microscopic examination** of blood smears taken from peripheral blood and from kidney and heart muscle, and from the brain in the case of suspected disease, is mandatory for clinching the diagnosis. Smears from blood and most tissues must be made within 8 hours of death, within 28 hours for the brain, and stained with Giemsa for the detection of piroplasms.

Direct fluorescent antibody staining of smears permits the use of slightly "older" tissues. Organ smears are still usable 5 days after collection, provided that they are kept at 22°C (72°F). The morphology of piroplasms can change quickly after the host's death. Blood collected after death can also be used for detection of serum antibodies in serologic tests or parasite DNA by PCR.

### DIFFERENTIAL DIAGNOSIS

Preferably, the presence of the tick vector should be collected and verified before a definitive diagnosis of piroplasmiasis can be made, unless an animal has left a known enzootic area within preceding months. Clinically, a high morbidity and case fatality-rate in cases displaying jaundice with hemoglobinuria and fever are suggestive, but confirmation of the diagnosis by microscopic examination of stained blood smears, complementary immunologic or molecular tools, and/or by transmission experiments is required. A necropsied animal with splenomegaly, jaundice, hemoglobinuria, swollen and dark kidneys and liver, and/or myocardial petechia/ecchymoses is suggestive of babesiosis/piroplasmiasis, but the diagnosis needs to be confirmed by traditional or molecular laboratory testing of tissues for the presence of the parasite stages (piroplasms).

### Differential diagnosis list

A syndrome of acute hemolytic anemia should suggest the following alternative diagnoses (Table 11-1):

- Equine infectious anemia—has a much longer, recurrent course; usually occurs in sporadic cases; and is not associated with protozoa in body fluids and tissues
- Myoglobinuria—red urine is a result of myoglobinuria, always associated with elevation of serum creatine phosphokinase activity
- Foals with alloimmune hemolytic anemia—detectable only upon laboratory examination for evidence of incompatibility between the serum of the dam and the foal's erythrocytes
- Other immune-mediated disorders
- Cardiac form of African horse sickness (AHS)—edematous lesions that occur are similar to those of babesiosis, but there is no evidence of hemoglobinuria or jaundice
- Equine viral arteritis virus, equine anaplasmosis, purpura hemorrhagica, and red maple leaf toxicity

### TREATMENT

#### Chemotherapy

For the alleviation of clinical signs, several drugs have been used with success, yet imidocarb, in its dipropionate salt form, is considered to be the most effective.<sup>3,12</sup> Imidocarb, a carbanilide derivative, is typically administered to horses intramuscularly. The alternate form of this drug, a dihydrochloride salt, causes more severe muscle damage at the site of injection. Reported dosages of imidocarb for the alleviation of clinical signs vary, but 2.2 to 4.4 mg/kg given IM once is effective. If necessary, lower dosages can be repeated at 24- to 72-hour intervals for two to three treatments.

In nonendemic regions, where chemotherapeutic clearance is desired, *T. equi* and *B. caballi* should be treated with 4.4 mg/kg of imidocarb IM every 72 hours (four times). Donkeys and mules are very sensitive to imidocarb; therefore, its use in these species is not recommended. Imidocarb has anticholinesterase activity, such that reactions to the drug might present as sweating, signs of agitation, colic, and/or diarrhea. Typically, these signs are transient and rarely life-threatening. Effects can be prevented with an IV dose of glycopyrrolate at 0.0025 mg/kg once, or reversed with a single IV dose of atropine at 0.2 mg/kg. Horses undergoing treatment should be monitored for complications and transient elevations of liver enzyme activities (aspartate aminotransferase [AST], alanine aminotransferase [ALT], alkaline phosphatase [ALP], and sorbitol dehydrogenase [SDH])—usually, these issues resolve following imidocarb treatment.

Diminazene aceturate and diminazene diacetate have also been used against *T. equi* and *B. caballi* at a dose of 3.5 mg/kg IM every 48 hours (two treatments).



Diminazene aceturate is more effective than diminazene diacetate; both drugs have been reported to cause damage at the injection site. Efficacy of both drugs increases with the second dosage; no chemosterilization has been reported. Signs of toxicity include respiratory distress and lethargy.

The antibiotic oxytetracycline when administered IV at a dose of 5 to 6 mg/kg, once daily for 7 days, is effective against *T. equi* but not against *B. caballi*. Other drugs reported to have efficacy in the treatment of babesiosis include amicarbilade isethionate, euflavine, artesunate and artemether (artemisinin derivatives), buparvaquone, and atovaquone, but these drugs are no longer used in practice.

### Supportive Treatment

In addition to the use of antiprotozoal drugs, acutely infected horses often require supportive treatment, including, but not limited to, intravenous fluids, NSAIDs, pain management, and blood transfusions. Adequate hydration is essential during treatment with imidocarb.<sup>3</sup>

### CONTROL

The principles of the control of piroplasmiasis are similar to those used for the control of babesiosis in cattle. Most attention is focused on controlling the vector tick, identifying infected and carrier animals by an appropriate laboratory test, and the use of a suitable treatment strategy for test-positive animals. The control of ticks in pleasure horses by periodic spraying/treatment and inspection is a practical proposition when the animals are in constant use. No vaccines have been produced for use in horses.

Chemotherapeutics that aid in the control of acute parasitemia and associated clinical signs, but do not eliminate infection, are important in endemic regions.<sup>3</sup> In nonendemic regions, the goal is to maintain an infection-free status; therefore, when infected horses are detected, a safe chemotherapeutic with high efficacy for eliminating persistent infection needs to be administered. Accurate diagnostic tools and detailed knowledge of tick populations and their ability to transmit *B. caballi* and *T. equi* are essential for prevention of outbreaks in nonendemic regions.<sup>3</sup>

Increasing globalization of the equine industry and a changing climate provide challenges for the prevention and control of *T. equi* and *B. caballi*. Disease surveillance and detailed knowledge of vector competence and habitat through the use of effective molecular tools will be essential.

### REFERENCES

1. Radostits O, et al. *Veterinary Medicine: A Textbook of the Disease of Cattle, Horses, Sheep, Goats and Pigs*. 10th ed. London: W.B. Saunders; 2007:1483.
2. Uilenberg G. *Vet Parasitol*. 2006;138:3.
3. Wise LN, et al. *J Vet Intern Med*. 2013;doi:10.1111/jvim.12168; [Epub ahead of print].
4. Kumar S, et al. *Jpn J Vet Res*. 2009;56:171.
5. Kappmeyer LS, et al. *BMC Genomics*. 2012;13:603.
6. Short MA, et al. *J Am Vet Med Assoc*. 2012;240:588.
7. Ueti MW, et al. *PLoS ONE*. 2012;7(9):e44713.
8. Scoles GA, et al. *Emerg Infect Dis*. 2011;17:1903.
9. Ramsay JD, et al. *PLoS ONE*. 2013;8(10):e76996.
10. Awinda PO, et al. *Clin Vaccine Immunol*. 2013;20:1752.
11. Baptista C, et al. *Ticks Tick Borne Dis*. 2013;4:242.
12. Grause JF, et al. *Vet J*. 2013;196:541.

## Nutritional Deficiencies

### IRON DEFICIENCY

#### SYNOPSIS

**Etiology** Dietary deficiency of iron.

**Epidemiology** Young animals on milk diet; most commonly nursing piglets that have not received supplemental iron. Housed nursing lambs. Occurs in veal calves fed milk with limited quantities of iron. Continued blood loss as a result of hemorrhage (lice, blood-sucking helminths). Subclinical iron deficiency occurs in calves and foals but is of doubtful significance. May be more susceptible to infectious diseases.

**Signs** Pale white skin of well grown nursing piglets, dyspnea, pallor of mucosae, sudden death may occur. Stillbirths if sows iron deficient. Secondary infectious diseases.

**Clinical pathology** Subnormal levels of hemoglobin and serum iron; microcytic hypochromic anemia.

**Necropsy findings** Pallor; thin, watery blood; anasarca; dilated heart; enlarged liver.

**Diagnostic confirmation** Low serum hemoglobin and serum iron with microcytic hypochromic anemia. Response to iron therapy.

**Differential diagnosis** Other causes of anemia (Table 11-3).

**Treatment** Parenteral and oral iron salts.

**Control** Ensure adequate iron intake. Parenteral iron-dextran to nursing piglets and lambs.

### ETIOLOGY

Iron deficiency is usually primary and most likely to occur in newborn animals whose sole source of iron is the milk of the dam because milk is a poor source of iron. Deposits of iron in the liver of the newborn are insufficient to maintain normal hemopoiesis for more than 2 to 3 weeks and are particularly low in piglets.

### EPIDEMIOLOGY

Iron-deficiency states are not common in farm animals except in the very young confined to a milk diet.

Iron-deficiency anemia occurs in nursing piglets for three reasons:

1. They do not have access to soil, which is a main source of iron for young farm animals.

2. They grow rapidly, and thus their absolute requirements for iron are high.
3. Milk is a poor source of iron.

The administration of iron dextran to the piglets at a few days of age is preventive and is a routine health management strategy in modern pig production. If they do not receive supplemental iron dextran, clinical disease occurs usually when the piglets are 3 to 6 weeks old. The losses that occur include those resulting from mortality, which may be high in untreated pigs, and to failure to thrive. Under modern pig production systems, piglets do not have access to sufficient dietary iron until they are weaned to a dry diet containing supplemental iron, thus the need for administration of parenteral iron dextran to all piglets at a few days of age. Even piglets raised outdoors with access to soil perform better when supplemented with iron. Iron-injected piglets raised outdoors are heavier at weaning, there is less preweaning morbidity and mortality, and they have higher blood hemoglobin concentrations compared with nonsupplemented piglets.<sup>1</sup> Larger piglets in a litter appear to be at greater risk of developing iron deficiency at weaning.<sup>2</sup>

Iron deficiency in pigs increases the severity of *Trichuris suis* and *Ascaris suum* infections.

**Iron-deficiency anemia occurs in nursing lambs** that are housed and do not have access to soil, do not consume much feed other than their dam's milk for the first 7 to 10 days of life, and grow at 0.4 kg/d. The parenteral administration of iron dextran at 24 h of age prevents the anemia. Abomasal bloat occurs in these lambs with lower serum iron concentration, and iron-dextran injections are preventive and also have a significant effect on weight gain and red blood cell and iron parameters.

**Continued blood loss by hemorrhage** in any animal may result in subclinical anemia and iron deficiency. Cattle heavily infested with sucking lice may develop serious and even fatal anemia. The chronic form is characterized by a nonregenerative anemia with subnormal levels of serum iron, and treatment with iron is necessary for an optimal response. Horses carrying heavy burdens of bloodsucking strongylid worms often have subnormal hemoglobin levels and respond to treatment with iron. Occasionally veal calves, and possibly young lambs and kids, may also suffer from an iron deficiency.

**Good-quality veal** is traditionally pale in color and is produced by feeding calves an all-liquid milk replacer diet with a low concentration of available iron. The pallor of veal is largely a result of low concentrations of myoglobin and other iron-containing compounds in muscle. Use of milk replacers containing only 10 mg iron/kg DM results in marked anemia and reduced growth performance. Feeding milk replacers with 50 mg iron/kg DM is considered, physiologically,

the optimum amount of iron for veal calves but may be too high for acceptable carcass yield in some countries. A severe iron deficiency with reduced growth rate in veal calves may be associated with a higher incidence of infectious disease because of an impaired immune system. The objective in veal calf management is to walk the narrow line between the maximum production of white meat and a degree of anemia insufficient to interfere with maximum production.

**Subclinical iron-deficiency anemia** also occurs in newborn calves and kids, but there is debate as to whether the condition has practical significance. Supplementation of dairy calves with iron, or iron and copper, increases growth rate.<sup>3</sup> In newborn calves affected with a normochromic, normocytic, and poikilocytic anemia, the levels of serum iron are not significantly different from those of normal calves. It has been proposed that severe poikilocytosis in calves is associated with abnormalities of hemoglobin composition and protein 4.2 in the erythrocyte membrane, and iron deficiency is the cause of moderate poikilocytosis in calves.

Anemia, without clinical signs, is most likely to occur when calves are born with low hemoglobin and hematocrit levels, a relatively common occurrence in twins. It is possible that suboptimal growth may occur during the period of physiologic anemia in early postnatal life. There is some evidence for this in calves in which hemoglobin levels of 11 g/dL at birth fall to about 8 g/dL between the 30th and 70th days and only begin to rise when the calves start to eat roughage. The daily intake of iron from milk is 2 to 4 mg in calves, and their daily requirement during the first 4 months of life is of the order of 50 mg, so that iron supplementation of the diet is advisable if the calves are fed entirely on milk. Even when hay and grain are fed to calves and lambs in addition to milk, there is a marked growth response to the administration of iron-dextran preparations at the rate of 5.5 mg/kg BW. The dietary iron requirement for fast-growing lambs is between 40 and 70 mg/kg BW, and growth rate is suboptimal on diets of less than 25 mg/kg BW.

**Low serum iron concentration and low serum ferritin have been observed in hospitalized young foals.** Microcytic anemia and hypoferrremia occur in Standardbred foals kept at pasture for 12 hours per day. These changes are not prevented by oral administration of four oral doses of 248 mg of iron, suggesting that higher levels of supplementation are needed. Conversely, hypoferrremia and anemia were reported in stabled foals but not in a pastured cohort. The stabled foals had clinical signs of anemia (lethargy) and low hematocrit, hemoglobin, and serum iron concentrations, which were restored to normal values by iron supplementation (0.5 g iron sulfate orally once

daily, 3 g of iron sulfate top dressed on cut pasture fed to the foals and their dams, and unlimited access to a lick block containing iron). Although the colostrum of mares is rich in iron, milk has much lower concentrations, probably explaining the low serum iron of some nursed foals and demonstrating the need for access to iron supplements or, preferably, soil or pasture. Supplementation of foals with iron should be undertaken cautiously because of the documented hepatotoxicity of large doses of iron given orally to newborn foals. Toxic hepatopathy develops in newborn foals administered iron fumarate at 16 mg/kg BW within 24 hours of birth, similar to the situation in piglets.

**Competition horses are frequently given iron supplementation** to treat anemia and to improve performance, despite the fact that neither application has any scientific basis. In contrast, iron overload and toxicity have occurred in competition horses. Some studies have shown high total plasma iron in British 3-day event team horses before transport (77  $\mu$ mol/L compared with normal levels of 24  $\mu$ mol/L). Immediately after traveling for 3 days on the road, the plasma levels had declined to 29  $\mu$ mol/L. The iron-binding antioxidant activity, an indicator of transferrin saturation, had also declined, suggesting greater saturation of available transferrin in the plasma or a decreased capacity to sequester iron. The saturation of mechanisms to sequester iron, such as may occur with excessive supplementation, may predispose the horses to iron-catalyzed oxidant injury. The total iron intake exceeded the normal recommendation of between 550 and 600 mg/d.<sup>4</sup> Anemia (or a low packed cell volume) is not synonymous with iron deficiency but is frequently associated with disease processes.<sup>5</sup> In addition, iron deficiency is unlikely to occur in healthy horses.

**Calcium carbonate** added to the diet of weaned and finishing pigs may cause a conditioned iron deficiency and a moderate anemia, but this effect is not apparent in mature pigs. Manganese may exert a similar antagonistic effect.

### **PATHOGENESIS**

More than half the iron in the animal body is found as a constituent of hemoglobin. A relatively small amount is found in myoglobin and in certain enzymes that play a part in oxygen utilization.

Piglets at birth have hemoglobin levels of about 90 to 110 g/L. A physiologic fall to 40 to 50 g/dL occurs in all pigs, with the lowest levels occurring at about the 8th to 10th day of life. Levels of iron in the liver at birth are unusually low in this species and cannot be increased appreciably by supplementary feeding of the sow during pregnancy. The IM injection of iron-dextran preparations to sows during late pregnancy does elevate the hemoglobin levels of the piglets during the first few weeks of life but not sufficiently to

prevent anemia in them. Piglets with access to iron show a gradual return to normal hemoglobin levels starting at about the 10th day of life, but in pigs denied this access, the hemoglobin levels continue to fall.

One of the important factors in the high incidence of anemia in piglets is the rapidity with which they grow in early postnatal life. Piglets normally reach 4 to 5 times their birth weight at the end of 3 weeks, and 15 times their birth weight at the end of 8 weeks. The daily requirement of iron during the first few weeks of life is of the order of 15 mg. The average intake in the milk from the sow is about 1 mg/d, and the concentration in sow's milk cannot be elevated by feeding additional iron during pregnancy or lactation. Apart from the specific effect on hemoglobin levels, iron-deficient piglets consume less creep feed, and after the first 3 weeks of life they make considerably slower weight gains than supplemented piglets. Although specific pathogen-free pigs show a less marked response to the administration of iron than pigs reared in the normal manner, it is obvious that they need supplementary iron to prevent the development of anemia. Iron-deficient piglets appear to be more susceptible to diarrhea at about 2 weeks of age than are piglets that have received iron. A marked impairment of gastric secretion of acid and chloride and atrophic gastritis occurs in iron-deprived piglets. Villous atrophy of the small intestine and changes in the gastrointestinal flora also occur in iron-deficient piglets, which may contribute to the increased susceptibility to diarrhea.

In iron-deficient piglets, lymphocyte activity is impaired, resulting in a decrease in circulating B-lymphocyte numbers and decreased immunocompetence.

Severe iron deficiency in veal calves is characterized by impaired growth and reduced feed intake and utilization. The growth rate is reduced only when hemoglobin concentrations fall below 70 g/L. The reduced growth rate may be a result of reduction in the half-life of growth hormone.

### **CLINICAL FINDINGS**

The highest incidence of iron-deficiency anemia in piglets occurs at about 3 weeks of age, but it can occur up to 10 weeks of age.

Affected pigs may be well grown and in good condition, but the growth rate of anemic pigs is significantly lower than that of normal pigs, and feed intake is reduced. A mild diarrhea may occur, but the feces are usually normal in color. Dyspnea, lethargy, and a marked increase in amplitude of the apex beat of the heart can be felt after exercise. The skin and mucosae are pale and may appear yellow in white pigs. Edema of the head and forequarters, giving the animal a fat, puffed-up appearance, may be present. A lean, white, hairy look is probably more common. Death usually occurs suddenly, or affected animals may survive in a thin,

unthrifty condition. A high incidence of infectious diseases, especially enteric infection with *E. coli*, is associated with the anemia, and streptococcal pericarditis is a well-recognized complication. Under experimental conditions, similar signs occur in calves, and there is, in addition, an apparent atrophy of the lingual papillae. A high incidence of stillbirths is recorded in the litters of sows suffering from iron-deficiency anemia.

### CLINICAL PATHOLOGY

The characteristic abnormality in iron-deficiency anemia is presence of hypochromic, microcytic red cells, although early in disease there can be macrocytic anemia as a result of chronic hemorrhage (Table 11-3). There is also reduced plasma or serum concentrations of ferritin and serum iron, increased total iron-binding capacity, and reduction in stainable iron in bone marrow. Anemia of iron deficiency must be differentiated from anemia resulting from chronic inflammatory disease (Table 11-3).<sup>5</sup>

In normal piglets there is a postnatal fall of hemoglobin levels to about 8 g/L and sometimes to as low as 4 to 5 g/L during the first 10 days of life. In iron-deficient pigs there is a secondary fall to 20 to 40 g/L during the third week. The hemoglobin level at which clinical signs appear in pigs is about 40 g/L. Erythrocyte counts also fall from a normal of  $5$  to  $8 \times 10^6$  /L down to  $3$  to  $4 \times 10^6$  /L and may be a better index of iron status than hemoglobin levels. Iron-deficiency anemia in piglets is a microcytic hypochromic anemia. In chronic blood-loss anemia in cattle infested with sucking lice, there is a nonregenerative anemia and a decrease in serum iron levels. Serum levels of iron considered to be normal in sheep and cattle are 100 to 200  $\mu\text{g/dL}$  (17.9 to 35.8  $\mu\text{mol/L}$ ). In newborn calves, the levels are 170  $\mu\text{g/dL}$  (30.4  $\mu\text{mol/L}$ ) at birth and 67  $\mu\text{g/dL}$  (12.0  $\mu\text{mol/L}$ ) at 50 days of age. Serum ferritin concentration is an index for monitoring prelatent iron deficiency of calves.

The borderline of iron-deficiency anemia of veal calves at 16 to 20 weeks of age has been defined as a hemoglobin concentration of 9 g/L and a saturation of total iron binding capacity of 10%.

### NECROPSY FINDINGS

The carcass is characterized by pallor, watery blood, and moderate anasarca. The heart is always dilated, sometimes extremely so. The cardiac dimensions in severely anemic neonatal pigs indicate that dilatation and hypertrophy occur consistently. The liver in all cases is enlarged and has a mottled tan-yellow appearance. Histologic examination of the bone marrow reveals maturation asynchrony of the erythroid line and a lack of hemosiderin stores. Other microscopic changes described include periarterial hepatocellular changes typical of hypoxia and

decreased numbers of parietal cells in the gastric mucosa.

### Samples for Confirmation of Diagnosis

- **Toxicology**—50 g liver (ASSAY [Fe]) (Note that serum ferritin from surviving littermates is a better indicator of iron status.)
- **Histology**—liver, heart, bone marrow, stomach (LM)

### DIFFERENTIAL DIAGNOSIS

Confirmation of the diagnosis will depend on hemoglobin determinations and curative and preventive trials with administered iron. The possibility that anemia in piglets may be caused by copper deficiency should not be overlooked, especially if the response to administered iron is poor. Isoimmunization hemolytic anemia can be differentiated by the presence of jaundice and hemoglobinuria, and the disease occurs in much younger pigs. Eperythrozoonosis occurs in pigs of all ages, and the protozoan parasites can be detected in the erythrocytes.

### TREATMENT

Principles of treatment are removal of the cause of iron loss (chronic bleeding, parasitism, inadequate diet) and provision of supplemental iron. The emphasis in treatment should be on removal of the inciting cause of iron deficiency.

Supplemental iron should be provided to correct the whole-body deficiency of iron and can be achieved by oral or parenteral administration. Oral administration is preferred because it is safer, is less expensive, and does not require the expertise needed for intravenous or intramuscular administration. Parenteral administration of iron preparations is associated with severe tissue reactions and, with intravenous administration, acute death.

### CONTROL

Preventive measures must be directed at the neonatal piglets because treatment of the sows before or after farrowing is generally ineffective, although some results are obtained if the iron preparations are fed at least 2 weeks before farrowing. Ferric choline citrate appears to have some special merit in this field. Allowing the nursing piglets access to pasture or dirt yards or periodically placing sods in indoor pens can offer adequate protection. Where indoor housing on impervious floors is necessary, iron should be provided at the rate of 15 mg/d until weaning, either by oral dosing with iron salts of a commercial grade or by the IM injection of organic iron preparations. These methods are satisfactory, but the results are not usually as good as when piglets are raised outdoors. However, indoor housing is practiced in many areas to avoid exposure to parasitic

infestation and some bacterial diseases, especially erysipelas. If sods are put into pens, care must be taken to ensure that these diseases are not introduced.

### Dietary Supplementation Sows

Feeding sows a diet supplemented with 2000 mg iron/kg DM of diet will satisfactorily prevent iron-deficiency anemia in the piglets. The piglets will ingest about 20 g of sow feces per day, which will contain sufficient iron and obviate the need for IM iron-dextran injections. The piglets grow and thrive as well as those receiving the iron-dextran injections.

### Veal Calves

Milk replacers for veal calves may contain up to 40 mg/kg DM of iron for the first months, but commonly contain only 10 to 15 mg/kg DM for the finishing period. The best indicator of the onset of anemia in calves on vealer diets is loss of appetite, which is a more sensitive indicator than biochemical measurement.

### Heifer Calf Herd Replacements

The National Research Council recommends that milk replacers fed to herd replacements or dairy beef contain 100 mg/kg of DM, with an upper limit of 1000 mg/kg DM. The pre-ruminant calf can tolerate between 2000 and 5000 ppm DM iron in milk replacer.

### Oral Dosing

Daily dosing with 4 mL of 1.8% solution of ferrous sulfate is adequate. Iron pyrophosphate may also be used (300 mg/d for 7 days). To overcome the necessity for daily dosing, several other methods of administering iron have been recommended. A single oral treatment with iron-dextran or iron-galactan has been recommended, provided that an excellent creep feed is available, but the method seems unnecessarily expensive. With this oral treatment it is essential that the iron be given within 12 hours of birth because absorption has to occur through the perforate neonatal intestinal mucosa; later administration is not followed by absorption. Reduced iron (British Veterinary Codex) can be administered in large doses because it does not cause irritation of the alimentary mucosa. A single dose of 0.5 to 1 g once weekly is sufficient to prevent anemia. Alternatively, the painting of a solution of ferrous sulfate on the sow's udder has been recommended (450 g ferrous sulfate, 75 g copper sulfate, 450 g sugar, 2 L water—applied daily) but has the disadvantage of being sticky and of accumulating litter. Pigs raised on steel gratings can derive enough iron from them to avoid the need for other supplementation. Excessive oral dosing with soluble iron salts may cause enteritis, diarrhea, and some deaths in pigs. High intakes of ferric hydroxide cause diarrhea, loss of



weight, and low milk production in cattle. The presence of diarrhea in a herd prevents absorption of orally administered iron, and treatment by injection is recommended in this circumstance.

### Intramuscular Injection of Iron Preparations

Suitable preparations must be used and are usually injected IM in piglets on one occasion only, between the day 3 and day 7 of life. Iron-dextran, fumarate, and glutamate are most commonly used. A dose of 200 mg of a rapidly absorbed and readily utilizable form of iron within the first few days of life will result in greater body weights at 4 weeks of age than in piglets given only 100 mg. Multiple injections give better hemoglobin levels but have not been shown to improve weight gain, and thus a second injection at 2 to 3 weeks of age may not be economical. A total dose of 200 mg is usually recommended as being required to avoid clinically manifest iron-deficiency anemia, but to avoid any chance of a subclinical deficiency the feed should contain additional iron at the level of 240 mg/kg. A new preparation (Heptomer) contains 200 mg/mL of iron, permitting a full dose in one injection. Contrasting information is that one injection of 100 mg of iron is adequate for baby pigs. Acute poisoning and rapid death can occur in piglets given iron-dextran compounds parenterally if the piglets were born from sows that were deficient in vitamin E and selenium during gestation. This is discussed in the section on iron-dextran poisoning. In normal piglets, the iron-dextran compounds are safe and are usually not toxic even on repeated injection. These preparations are ideal for treatment because of the rapid response they elicit and the absence of permanent discoloration of tissues after their use if given during the first month of life. A combination of sodium selenite and iron-dextran has been given to piglets at 3 days of age and is superior to treatment with iron alone when the piglets are deficient in selenium.

Iron supplementation should also be administered to suckling piglets raised outdoors.

**Iron-deficiency anemia in housed lambs** is preventable by the IM injection of 300 mg iron dextran at 24 hours of age. At 12 and 24 days after treatment, the hematological values in the treated group were significantly different from those of the unsupplemented group, and at weaning, the treated lambs were 1.0 kg heavier than untreated lambs. An oral iron supplement given to these housed lambs improved red cell and iron parameters but did not improve performance.

Comparable doses of parenteral iron-dextran compounds have been used for the treatment of iron-deficiency or iron-loss anemias in other species, but accurate doses have not been established, and the use of

these preparations in cattle and horses is expensive. In addition, iron-dextran preparations given IM to horses may cause death within a few minutes after administration. The most inexpensive method of supplying iron is to use ferrous sulfate orally at a dose of 2 to 4 g daily for 2 weeks to adult cattle and horses with iron-deficiency anemia.

Iron injection of beef calves in the first week after birth will result in an increase in packed cell volume (PVC), hemoglobin (Hb), mean corpuscular volume (MCV), and mean corpuscular hemoglobin (MCH), which persists for 12 weeks. However, weight gains during the first 18 weeks of life were not affected.

### REFERENCES

1. Pearson R. *Pig Journal*. 2011;64:6.
2. Bhattarai S, et al. *J Swine Health Prod*. 2015;23:10.
3. Bami MH, et al. *Vet Res Comm*. 2008;32:553.
4. Nutrition NRCSoH. Nutrient requirements of horses: National Academies. 2007.
5. Borges AS, et al. *J Vet Int Med*. 2007;21:489.

### COBALT DEFICIENCY

Cobalt deficiency is a disease of ruminants ingesting a diet deficient in cobalt, which is required for the synthesis of vitamin B<sub>12</sub> (cyanocobalamin) by rumen microflora. The disease is characterized clinically by inappetence and loss of body weight. Some effects on reproductive performance in sheep have been reported. Cobalt was first shown to be an essential nutrient for sheep and cattle following investigations in the 1930s of two naturally occurring diseases occurring on soils of Aeolian origin in Australia, coast disease of sheep and wasting disease of cattle.<sup>1</sup> Soon after it was recognized that similar wasting disorders in several countries responded to cobalt supplementation, including cobalt pine in Scotland, salt sickness in Florida, Nakururitis in Kenya, and bush sickness in New Zealand.<sup>1</sup>

#### SYNOPSIS

**Etiology** Dietary deficiency of cobalt resulting in a deficiency of vitamin B<sub>12</sub>.

**Epidemiology** Occurs worldwide, primarily in cattle and sheep, where soils are deficient in cobalt and no supplements are given. Associated with ovine white liver disease and phalaris staggers.

**Signs** Inappetence, gradual loss of body weight, pica, marked pallor of the mucous membranes, and lacrimation. Decreased wool growth, milk production, and lambing percentage.

**Clinical pathology** Liver cobalt or vitamin B<sub>12</sub> concentration, serum vitamin B<sub>12</sub> (sheep). Elevated methylmalonic acid in plasma and urine; elevated formiminoglutamic acid in urine. Normocytic normochromic anemia.

**Necropsy findings** Emaciation, hemosiderosis of spleen.

**Diagnostic confirmation** Location of farm and soil type. Vitamin B<sub>12</sub> and cobalt of liver. Response to supplementation.

#### Differential diagnosis list

Common causes of ill-thrift in ruminants:  
General nutritional deficiency (protein and energy)

Intestinal helminthiasis

Copper deficiency

Johnes disease

**Treatment** Oral dosing with cobalt or parenteral injections of vitamin B<sub>12</sub>.

**Control** Dietary supplementation with cobalt (cobalt pellets, top dressing of pastures or foliar sprays). Long-acting preparations of vitamin B<sub>12</sub>.

### ETIOLOGY

The disease is caused by a deficiency of cobalt in the diet, which results in a deficiency of vitamin B<sub>12</sub>. Vitamin B<sub>12</sub> is central to many metabolic pathways, including the conversion of propionic acid to glucose (the only direct source of glucose for ruminants) and the metabolism of methionine, which is essential for wool growth and the transport of folic acid into liver cells.

### EPIDEMIOLOGY

#### Occurrence

Cobalt deficiency occurs in Australia, New Zealand, the United Kingdom, North America, the Netherlands, and probably in many other parts of the world. Where the deficiency is extreme, large tracts of land are unsuitable for the raising of ruminants, and in certain areas, suboptimal growth and production may be limiting factors in the husbandry of sheep and cattle.

Historically, ill-thrift from cobalt deficiency was so marked that many calves and lambs died. In those that survived, growth rates were markedly depressed compared with cobalt-supplemented lambs. In most known deficient areas, signs of cobalt deficiency are now confined mainly in lambs because supplementation or cobalt fertilizer has been applied for many decades. However, cobalt-responsive ill-thrift in lambs still occurs where cobalt fertilizer applications or vitamin B<sub>12</sub> injections to lambs are haphazard, with live weight gains following vitamin B<sub>12</sub> injections of up to 180 g/d.

The soils on which cobalt deficiency occurs are usually well drained but can be of quite diverse geological origin, and the concentration of cobalt in the soil can vary widely.<sup>1</sup> Where cobalt deficiency occurs, soil cobalt is usually less than 2 mg/kg DM, and the available (extractable) cobalt is less than 0.25 mg/kg DM. The availability of cobalt to plants is reduced by high concentrations of manganese in the soil and heavy liming.

Sheep are more susceptible to cobalt deficiency than cattle, and young animals are more susceptible than adults. The disease

occurs most commonly in ruminants grazing pasture in severely deficient areas, but sporadic cases occur in marginal areas. In Australia this can occur after certain seasonal conditions, such as the intensive application of fertilizer and high spring rainfall that produces a flush of pasture growth, or in Europe after long periods of stable feeding. In the latter scenario, bulls, rams, and calves are most commonly affected.

A disease of moose called “moose sickness” occurs in eastern North America, mainly in the Tobeatic and Cape Breton Highlands of Nova Scotia in Canada. Low concentrations of cobalt and vitamin B<sub>12</sub> are found in the liver and increased concentrations of methylmalonic acid in the plasma. There are striking similarities between the North American moose sickness and a moose disease in Sweden caused by molybdenosis.

Cobalt deficiency is unlikely to occur in pigs and other omnivores or carnivores because vitamin B<sub>12</sub> is present in meat and other animal tissues. Horses appear to be unaffected.

Cobalt is also protective against the liver damage in sheep exposed to annual ryegrass and the neurologic signs induced in phalaris staggers.

### Risk Factors

#### Dietary and Environmental Factors

Pastures containing less than 0.07 and 0.04 mg/kg DM result in clinical disease in sheep and cattle, respectively. The daily requirement for sheep at pasture is 0.08 mg/kg DM of cobalt, but growing lambs have a greater requirement (11 µg/d), and reduced growth is likely at pasture levels less than 0.10 mg/kg DM.

Variations in the cobalt content of pasture occur with seasonal variations in pasture growth, and an increased incidence of deficiency in spring may be related to domination of the pasture by rapidly growing grasses, which have lower cobalt content than legumes. There is also a great deal of variation between years. Forage grown on well-drained soils has greater cobalt content than that grown on poorly drained soils of the same cobalt status. Although plant growth is not visibly affected by low soil cobalt, the addition of excessive quantities may retard growth.

Primary cobalt deficiency occurs only on soils that are deficient in cobalt. Such soils do not appear to have any geological similarity, varying from windblown shell sands to soils derived from pumice, ironstone, and granite, and Japanese soils composed largely of volcanic ash are seriously deficient. The soils in New Brunswick, Canada, are naturally acidic, and the cobalt content of the soil is decreased by leaching associated with an annual rainfall of 120 cm. Surveys in this area show average values of 0.028 and 0.088 mg/kg DM for grasses and legumes,

respectively, which justifies supplementation of ruminant diets with cobalt.

After the introduction of grazing livestock, large parts of New Zealand were found to be trace-element deficient (cobalt, selenium, and copper). Livestock grazing pastures grown on these soils may be deficient in one or more of these trace elements, and correcting these deficiencies is now a common and essential animal health management strategy. In New Zealand, soil types are categorized as severe, moderate, or marginal. Of the land considered suitable for farming, about 1 million hectares on the North Island and 918,000 hectares on the South Island are defined as cobalt deficient.

Outbreaks of cobalt deficiency have occurred in cattle grazing on pastures on the granite-derived northern tablelands of New South Wales in Australia and in sheep grazing pasture on soils derived from weathered rhyolite and ignimbrite, the former being inherently low in cobalt. Cobalt deficiency still occurs in areas where it has previously never been diagnosed, and so in seasons of lush spring and summer pasture growth it should be included as a differential diagnosis when investigating cases of unthriftiness.

In the northern Netherlands, lambs grazing cobalt-deficient pastures and not supplemented with cobalt are 6.7 times more likely to die than supplemented lambs. This occurs despite affected farms often having acetic acid-extractable soil cobalt content of pastures greater than the reference value for cobalt deficiency (≤0.30 mg Co/kg dried soil).

Although soils containing less than 0.25 mg/kg cobalt are likely to produce pastures containing insufficient cobalt, the relationship between levels of cobalt in soil and pasture is not consistent. The factors governing this relationship have not been determined, although heavy liming and high concentrations of manganese reduce the availability of cobalt in the soil.

#### Ovine White Liver Disease

A specific hepatic dysfunction of sheep has been described in New Zealand, Australia, the United Kingdom, Norway, and in grazing lambs in the Netherlands. It is called white liver disease because of the grayish color of the liver. Clinically, it is manifested by photosensitization when the disease is acute and anemia and emaciation when the disease is chronic. It seems likely that the disease is a toxic hepatopathy (fatty liver degeneration) caused by the accumulation of methylmalonic acid. This is converted into branched-chain fatty acids, causing liver failure, hepatic encephalopathy, and photosensitization. It is prevented by adequate dietary cobalt.

#### Hepatic Lipidosis in Goats

Hepatic lipidosis of goats in Oman is associated with low serum vitamin B<sub>12</sub> and low

liver cobalt and can be experimentally reproduced by a low intake of cobalt. It is one of the most frequent causes of liver condemnation and a significant economic loss because goats are the predominant domesticated animal reared for meat in Oman.

### Experimental Reproduction of Cobalt Deficiency in Sheep

Cobalt deficiency can be reproduced in sheep by feeding diets containing less than 70 µg/kg cobalt. A diet containing 4.5 µg/kg fed to lambs produced a condition similar to naturally occurring cobalt deficiency, with subnormal plasma and liver concentrations of vitamin B<sub>12</sub>, reduced growth rate, serous ocular discharge, alopecia, emaciation, and fatty degeneration of the liver, which had reduced concentrations of vitamin B<sub>12</sub> (14.5 pmol/g) at necropsy. The liver lesions included accumulation of lipid droplets and lipofuscin particles in hepatocytes, dissociation and necrosis of hepatocytes, and sparse infiltration by neutrophils, macrophages, and lymphocytes. Ultrastructural changes in hepatocytes included swelling, condensation and proliferation of mitochondria, hypertrophy of smooth endoplasmic reticulum, vesiculation and loss of arrays of rough endoplasmic reticulum, and accumulation of lipid droplets and lipofuscin granules in cytoplasm. Reduced activities of vitamin B<sub>12</sub>-dependent enzymes, methylmalonyl CoA mutase, and methionine synthesis, along with lipid peroxidation, are the likely mechanisms in the development of the liver lesions.

### PATHOGENESIS

Cobalt is a unique essential trace element in ruminant nutrition because it is stored in the body in only limited amounts and not in all tissues. In the adult ruminants the only known function of cobalt is in the rumen, where it participates in the production of vitamin B<sub>12</sub> (cyanocobalamin), and it has to be continuously ingested in the feed.

Ruminants have a much higher requirement for vitamin B<sub>12</sub> than other species. In sheep, this is around 11 µg/d, with up to 500 µg/d produced in the rumen but most being lost. Animals in the advanced stages of cobalt deficiency are cured by the oral administration of cobalt or by the parenteral administration of vitamin B<sub>12</sub>. On cobalt-deficient diets, clinical signs are accompanied by a fall of as much as 90% in the vitamin B<sub>12</sub> content of the feces. Oral dosing with cobalt resolves the clinical signs, and vitamin B<sub>12</sub> levels in the feces return to normal. Parenteral administration of cobalt has no appreciable clinical effect, although some cobalt does enter the alimentary tract in the bile and leads to the formation of a small amount of cobalamin.

The essential defect in cobalt-deficient ruminants is an inability to metabolize propionic acid. A key biochemical pathway for

propionic acid from rumen fermentation involves adenosyl cobalamin, one of several cobalt-containing coenzymes of the vitamin B<sub>12</sub> complex that is required for the conversion of methylmalonyl coenzyme A to succinyl coenzyme A, both intermediates in the utilization pathway of propionate.<sup>1</sup> The propionate-succinate pathway is the first rate-limiting pathway in vitamin B<sub>12</sub> deficiency,<sup>2</sup> and the lack of vitamin B<sub>12</sub> causes accumulation of methylmalonic acid, which can be measured in the serum. The clinical and pathologic signs of cobalt deprivation are preceded by characteristic biochemical changes in tissues and fluids of the body. As soon as depletion begins, the concentration of both cobalt and vitamin B<sub>12</sub> decreases in the rumen fluid. Serum vitamin B<sub>12</sub>, an estimate of the amount of this vitamin in transit, also shows an early decline reflecting reduced rumen synthesis. Serum vitamin B<sub>12</sub> declines before liver vitamin B<sub>12</sub>, confirming that the liver does not serve as an active storage pool. Plasma methylmalonic acid is elevated (>5 μmol/L) within 35 days of a cobalt-deficient diet being fed, before any reduction in feed intake or live weight occurs, and rumen succinate concentration is elevated after feeding a deficient diet for 6 days.<sup>3</sup>

In beef cattle, a prolonged moderate cobalt deficiency (83 μg/kg) for 43 weeks results in impaired growth and changes in lipid metabolism, including accumulation of plasma homocysteine and a marked increase of iron and nickel in the liver.

The mechanism through which cobalt prevents staggers in sheep grazing pasture dominated by phalaris (*Phalaris tuberosa*), and possibly canary grass (*Phalaris minor*) or rhompa grass, a hybrid *Phalaris* spp., is unexplained.

The pathogenesis of ovine white liver disease is unclear, as it is not known if the disease is a simple cobalt deficiency or a hepatotoxic disease in cobalt/vitamin B<sub>12</sub>-deficient lambs. A cobalt-deficient diet is essential for the development of the disease, which is characterized by hepatic dysfunction and elevated liver enzymes (alkaline phosphatase and aspartate aminotransferase).<sup>4</sup> Affected lambs have elevated serum levels of copper compared with cobalt/vitamin B<sub>12</sub>-supplemented lambs grazing the same pastures, and dosing affected lambs with copper-oxide needles can induce toxic levels of liver copper. It is suggested that the disease is a manifestation of B<sub>12</sub> deficiency exacerbated by factors triggering early hepatic fatty change, resulting in more severe liver damage and loss of intracellular homeostasis, rendering the hepatocytes more vulnerable to other elements such as copper. It is proposed that elevated concentrations of fructans in pasture could also contribute to the pathogenesis of the liver lesion by initiating hepatic lipodystrophy and hepatic insufficiency, and hence reduced growth and ovine white liver disease. The condition

responds to treatment with parenteral vitamin B<sub>12</sub>.

The pathologic changes in lambs grazing cobalt-deficient pastures are related to blood concentrations of vitamin B<sub>12</sub>, methylmalonic acid, and homocysteine, and lesions are confined mainly to the liver and brain. Acute and chronic hepatitis are characteristic, and the liver lesions are associated with polymicrocavitation of the brain. Hepatic encephalopathy associated with cobalt deficiency and white liver disease has been described in lambs. Symmetric vacuolation and status spongiosus of the neuropil in the brain is seen, with hyperammonemia secondary to the hepatic lesion considered the cause of the brain lesions.

Caprine hepatic lipidosis has been induced experimentally using low intakes of low levels of dietary cobalt. Goats provided with a diet that contains the minimum daily requirement of cobalt as specified for sheep not only developed a syndrome characterized by reduced weight gains, dry scruffy hair coat, and a decline in erythrocyte indices, but also lesions consistent with hepatic lipidosis. Goats fed diets containing levels of cobalt less than 0.1 mg/kg DM could experience even greater clinical and pathologic consequences.

In moose sickness, there are low concentrations of cobalt and vitamin B<sub>12</sub> in the liver and elevated methylmalonic acid in plasma.

## CLINICAL FINDINGS

No specific signs are characteristic of cobalt deficiency. A gradual decrease in appetite is the only obvious clinical sign, accompanied by lacrimation, loss of body weight, emaciation, and weakness, often in the presence of abundant green feed. Pica is likely to occur, especially in cattle. There is marked pallor of mucous membranes and normocytic normochromic anemia, and affected animals are easily fatigued. Growth, lactation, and wool production are severely retarded, and the wool may have reduced staple strength (be "tender" or broken). In sheep, severe lacrimation with profuse outpouring of fluid sufficient to mat the wool of the face is one of the most important signs in advanced cases. Signs usually become apparent when animals have been on affected areas for about 6 months, and death occurs in 3 to 12 months after the first appearance of illness, although severe wasting may be precipitated by the stress of parturition or abortion.

Cobalt deficiency in pregnant ewes can result in decreased lambing percentage, increased percentage of stillbirths, and increased neonatal mortality. Lambs from deficient ewes are slower to start sucking, have reduced concentrations of serum colostrum immunoglobulins, and have lower serum vitamin B<sub>12</sub> and higher methylmalonic acid concentrations than lambs from cobalt-adequate dams. Ova recovered from ewes fed a cobalt-deficient diet (0.06 mg/kg DM) are of

inferior morphologic grade compared with those from ewes that were supplemented with cobalt, and lambs born from cobalt-supplemented embryo donors had higher serum B<sub>12</sub> and were more active within 3 days of birth.<sup>5</sup>

Moose sickness in Nova Scotia is characterized by a loss of fear of humans, weakness and a staggering gait, apparent blindness, drooping of the ears, emaciation, and infestation by ticks. A decreased intake of food, increasing lethargy, and collapse, accompanied by loss of use of one or more limbs, precedes death.

## CLINICAL PATHOLOGY

### Biochemical Criteria to Determine Cobalt and Vitamin B<sub>12</sub> Status

Changes in the concurrent serum concentrations of methylmalonic acid and vitamin B<sub>12</sub> of ewes and their lambs on cobalt-deficient pastures, and their response to cobalt supplementation, can be evaluated and monitored.<sup>1,2</sup> Changes in these measures can be correlated with live-weight gains after the supplementation of lambs from suckling until after weaning.

A growth response to cobalt or vitamin B<sub>12</sub> supplementation is expected when cobalt levels in herbage fall below 0.08 to 0.1 mg/K DM.

### Serum and Liver Cobalt and Vitamin B<sub>12</sub> Concentrations

Serum cobalt concentrations of normal sheep range from 1 to 3 μg/dL (0.17 to 0.51 μmol/L), whereas in deficient animals these are reduced to 0.03 to 0.41 μmol/L.

Clinical signs of cobalt deficiency in sheep are associated with serum vitamin B<sub>12</sub> levels less than 0.20 mg/mL. This is the standard laboratory test for cobalt status in sheep, with levels of 0.2 to 0.25 μg/L indicative of deficiency, which rapidly increase to 0.5 to 1.0 μg/L following treatment. Depriving sheep of feed for 24 hours results in a marked increase in serum vitamin B<sub>12</sub>. The serum vitamin B<sub>12</sub> levels of sheep at pasture are unreliable indicators of liver vitamin B<sub>12</sub>.

In cattle, serum vitamin B<sub>12</sub> values greater than 0.2 μg/L are indicative of normal cobalt nutrition. However, there is considerable variability in this measure between laboratories because of binding within plasma.<sup>1</sup> Consequently, liver vitamin B<sub>12</sub> is preferred, although the cost of obtaining a liver biopsy restricts the utility of this test. A range of 75 to 250 nmol/kg fresh weight indicates marginal cobalt nutrition in grazing cattle, but this may be too low for cattle on predominantly grain diets.<sup>1</sup> Fatty infiltration of the liver will lead to underestimates of the liver concentration of vitamin B<sub>12</sub>.

**Concurrent Serum MMA and Vitamin B<sub>12</sub> Concentrations.** In ewes and nonsuckling lambs, the serum MMA concentration provides a more precise indication



of responsiveness to vitamin B<sub>12</sub> or cobalt supplementation than serum vitamin B<sub>12</sub>. Serum MMA concentrations greater than 13 μmol/L indicate responsiveness to supplementation, those from 7 to 13 μmol/L indicate a potential but marginal or inconsistent response, and no response is expected at concentrations less than 7 μmol/L. In a study of cobalt-deficient ewes, serum concentrations of vitamin B<sub>12</sub> decreased from 250 pmol/L during early lactation to a nadir of 100 pmol/L at peak lactation, at which time MMA concentration had increased to a range of 7 to 14 μmol/L. In this study, supplemented ewes were significantly heavier, and the vitamin B<sub>12</sub> concentration in ewe milk and the livers of their lambs was more than doubled. Supplementation of ewe with cobalt bullets appears to protect the growth performance of the lamb for 90 days and to influence the subsequent serum vitamin B<sub>12</sub> response in the lamb to vitamin B<sub>12</sub> supplementation.

On cobalt-deficient farms in New Zealand, serum vitamin B<sub>12</sub> and MMA have been compared as indices of cobalt/vitamin B<sub>12</sub> deficiency in lambs supplemented with either cobalt bullets or short- or long-acting preparations of vitamin B<sub>12</sub>. Serum MMA concentrations greater than 9 to 14 μmol/L were a more reliable indicator of cobalt deficiency, but there is considerable variation between farms. An evaluation of serum MMA and vitamin B<sub>12</sub> concentrations used to assess cobalt deficiency in New Zealand found that the reference ranges for vitamin B<sub>12</sub> responsiveness may be conservatively high. This could result in an overdiagnosis of vitamin B<sub>12</sub> deficiency as a cause of ill-thriftiness of sheep, and so response trials to assess weight gain following supplementation may be a better alternative.

**Liver Cobalt.** In lambs, normal liver cobalt ranges from 0.03 to 0.1 μg/g wet weight (WW). Concentrations less than 0.02 μg/g WW (0.07 μg DM) are associated with clinical deficiency, with 0.015 μg/g WW (0.05 μg DM) considered a critical level, and less than 0.025 μg/g WW in a sheep flock is considered marginal. In lambs with clinical signs of ovine white liver disease, mean hepatic cobalt concentrations range from 0.013 to 0.024 μg/g WW.

### Serum Methylmalonic Acid

Because of difficulties with the interpretation of serum vitamin B<sub>12</sub> results, other biochemical tests, especially MMA in plasma and urine, are now used. An elevated plasma concentration of MMA is a comparatively early indicator of functional vitamin B<sub>12</sub> deficiency, and thus this test can identify a cobalt deficiency earlier. The upper limits of MMA for grain- and pasture-fed animals are 10 and 5 μmol/L, respectively.

In cattle, serum MMA less than 2 μmol/L is considered normal, 2 to 4 μmol/L marginal,

and greater than 4 μmol/L indicative of a deficiency. Urinary MMA in cobalt-deficient animals is abnormally high, and thus this is also an appropriate test for deficiency. Cobalt-replete lambs have plasma MMA levels less than 5 μmol/L, urinary MMA less than 120 μmol/L, and urinary MMA/creatinine values less than 0.022 μmol MMA/mmol. An unequivocal result for methylmalonic acid is a concentration of greater than 30 μg/mL for 10 animals selected randomly from a flock. Samples must be acidified to avoid degradation of the methylmalonic acid if they are to be kept for more than 24 hours before testing.

### Formiminoglutamic Acid

Neither MMA nor formiminoglutamic acid is a normal constituent of urine, and so their presence in urine, without the need for a quantitative measurement, is an indication of cobalt deficiency. In lambs in the later stages of cobalt deficiency, when there is weight loss and ill-thrift, the concentration of urinary formiminoglutamic acid increases to 0.08 to 20 μmol/mL, then rapidly returns to zero following treatment. However, there is little or no increase in the urine of animals with subclinical cobalt deficiency, and thus this measure is not useful as a diagnostic test.

### Hematology

Affected animals have normocytic and normochromic anemia, but hemoglobin and erythrocyte values are often within the normal range because of hemoconcentration. There is a decrease in cellularity of the bone marrow that does not respond quickly to the administration of vitamin B<sub>12</sub> or cobalt. Affected animals are also hypoglycemic (<60 mg glucose/dL plasma) and have low serum alkaline phosphatase (<20 U/L). These measures rapidly return to normal after administration, but many other factors affect their concentration, and thus they are of little diagnostic value.

### NECROPSY FINDINGS

Emaciation is extreme, and in most cases of cobalt deficiency the spleen is dark as a result of the accumulation of hemosiderin. The livers of sheep affected with white liver disease are pale and fatty, with microscopic changes that include hepatocellular disorganization and intracytoplasmic accumulations of lipid and ceroid-lipofuscin within hepatocytes.

Biochemical assays reveal a very high concentration of iron in the liver and spleen and a low concentration of cobalt in the liver. In normal sheep, cobalt levels in the liver are usually above 0.20 mg/kg DM, but in affected sheep are usually less than 0.05 mg/kg DM. In cattle fed excessive amounts of cobalt and thought to be affected by cobalt poisoning, liver cobalt can be as high as 69 mg/kg DM.

The concentration of vitamin B<sub>12</sub> in the liver of cobalt-deficient lambs is 0.1 mg/kg compared with around 0.3 mg/kg in normal lambs. In cattle, concentrations greater than 0.3 mg/kg are necessary for optimum growth, normal levels range from 0.70 to 1.98 mg/kg, and clinical signs occur when liver vitamin B<sub>12</sub> is less than 0.1 mg/kg. After oral dosing, the concentration of cobalt in the liver rises but then returns to the pre-treatment level in 10 to 30 days. Serum B<sub>12</sub> levels reflect cobalt status, and thus it is often useful to submit sera from surviving herd-mates when attempting to confirm a diagnosis of cobalt deficiency.

### Samples for Confirmation of Diagnosis

- **Toxicology**—50 g liver (ASSAY [Co]), 2 mL serum (ASSAY [B<sub>12</sub>])
- **Histology**—formalin-fixed liver (LM)

### DIFFERENTIAL DIAGNOSIS

Cobalt deficiency must be differentiated from other causes of ill-thrift or marasmus.

#### Ill-thrift

The lack of total digestible nutrients is the most common cause of thin animals, but owners are usually aware of the shortage and do not present their animals for diagnosis. However, inexperienced stockowners may be unaware of the actual needs of animals, and so it is best to check the feed supply and whether the animals have any teeth or gum problems.

In young animals, nutritional deficiencies of copper, selenium, and vitamin D are other possible causes of ill-thrift.

In sheep, ovine Johne's disease is a cause of ill-thrift in older animals. The differential diagnosis of anemia is discussed elsewhere, but haemonchosis and eperythrozoonosis occur in younger sheep.

#### Internal parasitism

Cobalt-deficient animals are more susceptible to parasitism, and thus the presence of a heavy worm burden (high fecal egg count or total worm count) should not rule out a diagnosis of primary cobalt deficiency.

Parasitic disease and cobalt deficiency often occur together; thus, it may be necessary to initiate two control programs.

#### Dietary supplementation response

This is the most conclusive way of determining whether animal production is being affected by the deficiency of a trace mineral. The most common production measures are weight gain, milk production, wool production, and/or reproductive performance following the supplementation of animals with the element under consideration. However, if the response can be related to a tissue concentration of the element, or its metabolites, then tissue analyses may replace the need for field trials,

which require considerable resources and can take several months to collect data and analyze the results.

#### Growth response curve to supplementation

Another approach is based on constructing response curves for any specified level of serum vitamin B<sub>12</sub>, which can then be used to determine live-weight response to supplementation and the probability of obtaining a response. This relates the tissue mineral or biochemical indicator with the degree of production response to treatment. In New Zealand, no significant weight-gain responses occurred with vitamin B<sub>12</sub> or cobalt treatment in trials where serum vitamin B<sub>12</sub> was greater than 500 pmol/L or liver vitamin B<sub>12</sub> was greater than 500 nmol/kg, with the fitted response curve approaching 0 g/day at 500 pmol/L and 375 nmol/kg for serum and liver vitamin B<sub>12</sub>, respectively. The minimum vitamin B<sub>12</sub> at which an economic response to treatment is not likely (a 10-g/day gain in body weight) was 336 pmol/L for serum and 282 nmol/kg for liver. Factors that cause a variable response to cobalt or vitamin B<sub>12</sub> supplementation include age, breed, sex, energy intake, concurrent disease, and the length of pasture. Higher soil contamination on short pastures can result in increased cobalt intake and a reduced response to vitamin B<sub>12</sub> or cobalt. Serum vitamin B<sub>12</sub> levels may also increase following prolonged yarding and within 24 to 48 hours after changes in dietary cobalt.

## TREATMENT

### Cobalt and Vitamin B<sub>12</sub>

Affected animals respond to oral dosing with cobalt or the IM injection of vitamin B<sub>12</sub>. Oral dosing with vitamin B<sub>12</sub> is effective, although the commonly used dose of 0.1 mg/kg will only increase serum B<sub>12</sub> for up to 6 weeks, and thus larger or repeat doses are often required. Oral cobalt sulfate is usually given to sheep at a rate of 1 mg of cobalt per day. This can be given as a weekly dose, but intervals of 2 weeks between dosing are too long for optimum growth. However, monthly dosing of lambs with oral doses of 300 mg cobalt does greatly reduce deaths and permit some growth, albeit at a suboptimal rate. The response to treatment is rapid, with a significant increase of serum vitamin B<sub>12</sub> within 24 hours. When large doses of cobalt are given to some sheep, other undosed sheep on the same pasture may ingest sufficient additional cobalt from the feces of their flockmates to meet their needs. No exact data are available on dose rates for cattle, but 10 times the prophylactic rate should be effective.

Vitamin B<sub>12</sub> can be given in 100- to 300- $\mu$ g doses for lambs and sheep at weekly intervals, but is not likely to be used because of its high cost and the comparable effect and low cost of oral cobalt. Vitamin B<sub>12</sub> (hydroxocobalamin) may be a suitable therapeutic agent,

with an injection of 1 mg providing protection for 14 weeks and up to 40 weeks for preruminant lambs and weaners, respectively. Lambs with ovine white liver disease respond quickly to treatment with hydroxocobalamin, with retreatment recommended 10 days later.

### Cobalt Toxicity

Overdosing with cobalt compounds is unlikely, but toxic signs of loss of weight, rough hair coat, listlessness, anorexia, and muscular incoordination appear in calves at dose rates of about 40 to 45 mg of elemental cobalt per 50 kg BW/d. Sheep appear to be much more resistant to the toxic effects of cobalt than are cattle. Pigs can tolerate up to 200 mg of cobalt per 1 kg of diet, but at intakes of 400 and 600 mg/kg there is depression of growth, anorexia, stiff legs, incoordination, and muscle tremor. Supplementation of the diet with methionine, or with additional iron, manganese, and zinc, alleviates these toxic effects.

## CONTROL

### Supplementation of Diet With Cobalt

The recommended level of dietary cobalt for sheep and cattle is around 100  $\mu$ g/kg DM, but for cattle the recommended amount of dietary cobalt to achieve maximum vitamin B<sub>12</sub> is 250  $\mu$ g/kg DM. If this amount is not available, supplementation of the diet with cobalt is necessary, and calves reared on cobalt-deficient pastures need cobalt or vitamin B<sub>12</sub> supplementation before weaning.

### Top Dressing of Pastures With Cobalt

In grazing animals, cobalt deficiency can be prevented by the top dressing of pasture with cobalt salts. The amount of top dressing needed will vary with the degree of deficiency, but recommendations include 400 to 600 g/ha cobalt sulfate annually or 1.2 to 1.5 kg/ha every 3 to 4 years. The response to pasture treatment is slow (weeks), and thus clinically affected animals should be treated with oral cobalt or vitamin B<sub>12</sub> injection for a quick, interim response.

In New Zealand, the requirement for cobalt of ruminants grazing on the pumice soils of the central plateau was established in the 1930s, and top dressing to increase the cobalt intake was practiced for many years. A survey in 1978 to 1979 found that cobalt inputs could be halved because adequate reserves of cobalt had accumulated in soil. However, an economic downturn resulted in less use of cobalt, with follow-up surveys identifying a decline in soil and pasture cobalt and an increased need for top dressing. Regular cobalt applications needed to build up reserves, with an initial requirement of around 350 g cobalt sulfate/ha for 7 to 10 years on the most deficient areas. Considerable variation occurs between farms, and thus it is necessary to monitor the soil, pasture, and animal cobalt status.

To achieve a critical level of cobalt in pastures for sheep (0.08 mg/kg DM in pasture), soil cobalt concentrations of 1.7 and 2.2 mg/kg DM are required for the yellow-brown pumice soils and yellow-brown loams, respectively.

Supplementation of the diet with 0.1 mg cobalt per day for sheep and 0.3 to 1.0 mg/d for cattle is required and can be accomplished by inclusion of the cobalt in salt or a mineral mixture. Cobalt can also be supplied to cattle in their drinking water supply.

### Cobalt Pellet

The use of pellets containing 90% cobalt oxide is an effective way to maintain an adequate cobalt intake in a deficient area. These are a bolus (5 g for sheep, 20 g for cattle) that, when given orally, lodge in the reticulum and liberate cobalt in small but adequate amounts for 1 to 3 years. Pellets should not be given to lambs and calves less than 2 months old because they do not have a fully developed reticulum. Cobalt deficiency in suckling animals can be partially overcome if their dams are treated because of increased vitamin B<sub>12</sub> content in milk, although the daily intake of the lambs may still be well below their requirement. About 5% of the pellets do not lodge in the reticulum, and up to 20% are rejected within a year of administration; thus retreatment is advisable if no response occurs. Pellets can also become coated with calcareous material, particularly on limestone soils, when drinking water is highly mineralized, or with heavy pasture top dressing. This can be overcome by dosing with an abrasive metal pellet, or a second pellet, such as to correct a selenium deficiency. Pellets are more expensive than top dressing of pastures with cobalt, but they are preferred in extensive range grazing where top dressing is impracticable or animals are not handled frequently.

### Cobalt in Anthelmintics

Trace elements such as selenium and cobalt (typically 20 to 100 mg cobalt per treatment) are often added to anthelmintics. However, the response to these supplements, especially cobalt, is usually transient, and more specific supplements, such as pellets or top dressing of pastures, are recommended.

### Vitamin B<sub>12</sub> Injections

In lambs, the relationship between daily weight gains and serum and liver vitamin B<sub>12</sub> concentrations is well defined. Lambs with serum vitamin B<sub>12</sub> greater than 335 pmol/L and liver vitamin B<sub>12</sub> less than 280 nmol/kg fresh tissue are cobalt deficient and show a marked increase in growth rates when supplemented with cobalt or vitamin B<sub>12</sub>.

The subcutaneous injection of a soluble vitamin B<sub>12</sub> in lambs can maintain adequate concentrations of vitamin B<sub>12</sub> for about 24 days. Thus in cobalt-deficient areas, lambs need a 2-mg dose of vitamin B<sub>12</sub> at least

monthly to reduce the risk of vitamin B<sub>12</sub> deficiency.

A microencapsulated vitamin B<sub>12</sub> in lactide/glycolide copolymers can maintain adequate concentrations of serum vitamin B<sub>12</sub> in lambs for at least 210 days. For example, the growth of cobalt-deficient lambs, 4 to 6 weeks of age, was markedly improved by injections of 3.0, 4.5, or 6.0 mg of microencapsulated vitamin B<sub>12</sub>, and live weights were maintained for at least 260 days. An injection of 3 mg microencapsulated vitamin B<sub>12</sub> given to lambs at tailing will prevent cobalt deficiency and increase and maintain live-weight gains in a flock for up to 8 months.

Compared with untreated controls, treating ewes with three injections of long-acting vitamin B<sub>12</sub> (120 and 40 days prepartum, 40 days postpartum) increased serum and liver vitamin B<sub>12</sub> concentrations by 70% during gestation and fetal liver vitamin B<sub>12</sub> by 270%, and during lactation ewe serum and milk vitamin B<sub>12</sub> concentrations were increased by at least 200% and 44%, respectively. However, liver vitamin B<sub>12</sub> stores of the newborn lambs from the treated ewes were depleted within 58 days, and thud lambs born of ewes with a high vitamin B<sub>12</sub> status should have an adequate supply of vitamin B<sub>12</sub> for at least the first 30 days of life.

In dairy calves, an injection of 0.12 to 0.24 mg/kg BW of a long-acting microencapsulated vitamin B<sub>12</sub> increased and maintained vitamin B<sub>12</sub> for at least 110 days.

#### FURTHER READING

Radostits O, et al. Cobalt deficiency. In: *Veterinary Medicine: A Textbook of the Diseases of Cattle, Horses, Sheep, Goats and Pigs*. 10th ed. London: W.B. Saunders; 2007:1701-1707.

Suttle NF. Chapter 10: Cobalt. In: *The Mineral Nutrition of Livestock*. 4th ed. Wallingford, Oxon: CAB International; 2010:223-254.

#### REFERENCES

1. Suttle NF. *The Mineral Nutrition of Livestock*. 4th ed. Wallingford, Oxon: CAB International; 2010:223.
2. Furlong JM, et al. *NZ Vet J*. 2010;58:11.
3. Weise SC, et al. *Aust J Agric Res*. 2007;58:367.
4. Al-Habsi K, et al. *Vet J*. 2007;173:131.
5. Mitchell LM, et al. *Repro Fert Develop*. 2007;19:553.

### VITAMIN B<sub>12</sub> DEFICIENCY (HYPOCYANOCOBALAMINOSIS)

Vitamin B<sub>12</sub> deficiency is unlikely to occur under natural conditions other than because of a primary dietary deficiency of cobalt, which is an important disease in many countries of the world and discussed under that topic. Concurrent disease can influence vitamin B<sub>12</sub> absorption, such as in pigs with proliferative enteropathy, in which serum cobalamin concentrations are reduced and homocysteine concentrations are increased compared with those of healthy pigs.<sup>1</sup>

Although microbial synthesis of the vitamin occurs in the rumen in the presence

of adequate cobalt and in the intestines of other herbivores such as the horse, it is probably a dietary essential in the pig and young calf. Animal protein is a good source. A deficiency syndrome has been produced in young calves on a synthetic ration, but signs of deficiency, evident as response to supplementation, are not present in grazing dairy calves in New Zealand.<sup>2</sup> Signs of deficiency in calves include anorexia, cessation of growth, loss of condition, and muscular weakness. The daily requirement under these conditions is 20 to 40 µg of vitamin B<sub>12</sub>.

Detection of the efficacy of vitamin B<sub>12</sub> administration to grazing sheep is best accomplished by measurement of concentrations of the vitamin itself or of methylmalonic acid, as opposed to measurement of homocysteine. Supplementation of grazing lambs in New Zealand with injectable vitamin B<sub>12</sub> increased live-weight gain by 40%.<sup>3</sup>

Sows vary in their ability to absorb the vitamin, and those with poor absorption ability or on deficient diets show poor reproductive performance. For pigs, 10 to 50 mg/ton of feed is considered to be adequate.

The vitamin is used empirically in racing dogs and horses to alleviate parasitic and dietetic anemias in these animals at a dose rate of 2 µg/kg BW. Cyanocobalamin zinc tannate provides effective tissue levels of vitamin B<sub>12</sub> for 2 to 4 weeks after one injection, and normal and abnormal blood levels have been established for all species. Administration of cobalt containing supplements, such as cyanocobalamin, increases blood and urine cobalt concentrations in horses and can have implications for control of doping in racing animals.<sup>4</sup> It is also used as a feed additive for fattening pigs, usually in the form of fish or meat meal or as "animal protein factor." It is essential as a supplement if the diet contains no animal protein, and maximum results from the feeding of antibiotics to pigs are obtained only if the intake of vitamin B<sub>12</sub> is adequate. There is no beneficial effect of B<sub>12</sub> supplementation to grazing dairy cows in New Zealand.<sup>5</sup>

#### REFERENCES

1. Gruetzner N, et al. *Vet J*. 2015;203:320.
2. Grace ND, et al. *NZ Vet J*. 2014;62:274.
3. Furlong JM, et al. *NZ Vet J*. 2010;58:11.
4. Ho ENM, et al. *Drug Test Anal*. 2015;7:21.
5. Grace ND, et al. *NZ Vet J*. 2012;60:95.

### VITAMIN K DEFICIENCY

A primary deficiency of vitamin K is unlikely under natural conditions in domestic animals because of the high content of substances with vitamin K activity in most plants and the substantial synthesis of these substances by microbial activity in the alimentary canal. Neonates are relatively vitamin K deficient, and vitamin K-dependent bleeding is reported in foals.<sup>1</sup>

Vitamin K, as a fat-soluble vitamin, is dependent on the presence of bile salts for absorption in the small intestine. Sporadic cases may occur when impairment of the flow of bile reduces the digestion and absorption of this fat-soluble vitamin.

Experimentally produced vitamin K deficiency in piglets is manifested by hypersensitivity, anemia, anorexia, weakness, and a marked increase in prothrombin time. The minimum daily requirement for newborn pigs is 5 µg/kg BW, and the minimum curative injection dose is four times larger.

A hemorrhagic disease of recently weaned pigs from 6 to 15 weeks of age is considered to be associated with vitamin K deficiency. Affected pigs fail to grow, become pale, develop large subcutaneous hematomas, and exhibit lameness and epistaxis. Excessive and fatal hemorrhage following routine castration may occur in pigs from 30 to 40 days of age, but not at 15 to 20 days of age. Subcutaneous massive hemorrhage is more common in pigs at 40 to 70 days of age. Prothrombin time (PT) and activated partial thromboplastin time (aPTT) are prolonged, along with decreased levels of vitamin K-dependent factors II, VII, IX, and X. At necropsy, hemorrhages are extensive in the muscles of the hindlimbs, forelimbs, and axillary and mandibular region. Vitamin K, or vitamin K<sub>2</sub>, given at a dose of 3 mg/kg BW IM as a single dose, will restore the blood coagulation defects to normal. Vitamin K<sub>3</sub>, added to the feed at a rate of 25 mg/kg for 4 days was also shown to be effective. The cause of the vitamin K deficiency is considered to be related to the use of antibacterial drugs in the feed, but this has not been substantiated.

Vitamin K-dependent bleeding occurs rarely in foals and is evident as multiple hemorrhages or hemarthroses. Clotting profile reveals prolongation of those components of the clotting cascade that depend on vitamin K-related factors, including prothrombin time and activated partial thromboplastin time. Administration of vitamin K (2 mg/kg SC q 12 h for 2 days and then 0.5 mg/kg SC q 12 h for 17 days). Spontaneous bleeding ceased within 18 hours, and there was normalization of PT and aPTT.<sup>1</sup> Vitamin K<sub>3</sub> administered parenterally to horses causes kidney failure.

The most important therapeutic use of vitamin K in domestic animals is in sweet clover poisoning, in which toxic quantities of coumarin severely depress the prothrombin levels of the blood and interfere with its clotting mechanism. Industrial poisons used in rodent control that contain anticoagulants of the coumarin type (e.g., warfarin) cause fatal hypothermia; vitamin K is an effective antidote. For warfarin-induced anticoagulation in the horse, the administration of 300 to 500 mg of vitamin K<sub>1</sub> SC every 4 to 6 hours until the PT returns to baseline values is recommended.



Defective gamma-glutamyl carboxylase activity causes bleeding in Rambouillet sheep. Administration of vitamin K<sub>1</sub> does not restore clotting function because the enzyme is necessary for production of vitamin K-dependent clotting factors in the liver.<sup>2</sup>

## REFERENCES

1. McGorum BC, et al. *J Vet Int Med.* 2009;23:1307.
2. Johnson JS, et al. *Vet Pathol.* 2006;43:726.

## FOLIC ACID DEFICIENCY (HYPOFOLICOSIS)

Folic acid (pteroylglutamic acid) is necessary for nucleic acid metabolism, and its deficiency in humans leads to the development of pernicious anemia. A dietary source is necessary to all species, and an adequate intake is provided by pasture. Although naturally occurring deficiencies have not been diagnosed in domestic animals, folic acid has numerous and complex interrelationships with other nutrients, and the possibility of a deficiency playing a part in inferior animal performance should not be overlooked. Folic acid supplementation to dairy cows increased milk yield and milk protein concentration.<sup>1</sup> The vitamin has a particular interest for equine nutritionists. Permanently stabled horses and some horses in training may require additional folic acid, preferably on a daily basis by the oral route. Folic acid deficiency can be induced in fetal foals and adult horses by administration of folate orally coincident with administration of inhibition of folate metabolism (pyrimethamine trimethoprim, sulfonamides).

## REFERENCE

1. Graulet B, et al. *J Dairy Sci.* 2007;90:3442.

## Toxins Affecting the Hemolymphatic System

### SECONDARY COPPER POISONING ("TOXEMIC JAUNDICE" COMPLEX)

Copper poisoning is a complex problem because of the many factors that influence the intake, metabolism, and excretion of the element. Consequently, secondary copper poisoning ("toxemic jaundice") can occur even when intakes of copper are, in other dietary circumstances, nontoxic. The toxemic jaundice group includes the following syndromes:

- Phylogenous chronic copper poisoning is a condition in which relatively small amounts of copper are ingested, but excessive retention occurs because of the presence of specific plants that have no apparent association with liver damage.
- Hepatogenous chronic copper poisoning results from excessive retention of copper from the ingestion of specific

plants that are associated with liver damage.

- *Heliotropium europaeum* plant ingestion, in addition to the previously noted points, is also capable of causing uncomplicated toxic hepatitis without any abnormality of copper metabolism.

### Phylogenous Chronic Copper Poisoning

Phylogenous chronic copper poisoning occurs in sheep grazing pastures containing normal amounts of copper. The copper intake is low, but liver copper levels are high, and a hemolytic crisis typical of chronic copper poisoning occurs. The predominant association is the domination of the pasture by subterranean clover (*Trifolium subterraneum*), which may contain lower-than-normal quantities of copper (15 to 20 mg/kg). British breeds of sheep and their Merino crosses are most susceptible.

Control of this syndrome is by encouragement of grass growth in the pastures. Outbreaks can also be avoided if sheep are prevented from grazing lush, clover-dominant pastures in the autumn. Avoidance of stress, particularly malnutrition, is also important. The daily administration of molybdenum in the feed (7 mg/kg molybdenum) has been shown to greatly reduce the uptake of copper by lambs on diets of high copper content and has been used as a practical preventive measure. Molybdenized superphosphate (70 g/hectare) and molybdenized licks or mineral mixtures (86 kg salt, 63 kg finely ground gypsum, 0.45 kg sodium molybdate) are suitable alternatives. When an outbreak occurs, the administration of ammonium molybdate (50 to 100 mg/head per day) together with sodium sulfate (0.3 to 1.0 g/head per day) will stop further deaths in sheep within 3 days. Solutions of the previously noted salts may be sprayed onto hay, and administration should be continued for several weeks.

### Hepatogenous Chronic Copper Poisoning

The hepatogenous form of chronic copper poisoning occurs most commonly following the ingestion of sufficient quantities of the plants *Heliotropium europaeum*, *Echium plantagineum*, and *Senecio* spp. over a period of 2 to 5 months to produce morphologic and biochemical changes in liver cells without major impairment of liver function. After ingestion of these plants the liver cells have an increased affinity for copper, and abnormally high amounts accumulate in the liver, resulting in an increased risk of a hemolytic crisis. Sheep grazed on *H. europaeum* and then on subterranean clover are particularly prone to this form of the disease. Control depends on preventing the ingestion of hepatotoxic plants and restricting copper retention by the methods described previously.

### Poisoning by *Heliotropium europaeum*

*Heliotropium europaeum* contains hepatotoxic alkaloids, and continued ingestion of the plant is associated with liver damage. If elevated copper storage occurs, hepatogenous chronic copper poisoning may develop. Conversely, if the sheep's copper status remains normal, liver damage proceeds until the animal suffers from simple toxic hepatitis. The effects of the plant are cumulative; grazing for one season may be associated with little apparent harm, but further grazing in the subsequent year may be associated with heavy mortality. Control is aimed at eradication of the plant.

## FURTHER READING

- Radostits O, et al. Secondary copper poisoning. In: *Veterinary Medicine: A Textbook of the Disease of Cattle, Horses, Sheep, Goats and Pigs.* 10th ed. London: W.B. Saunders; 2007:1823.
- St. George-Grambauer TD, Rac R. Hepatogenous chronic copper poisoning in sheep in south Australia as a result of the consumption of *Echium plantagineum* (salvation jane). *Aust Vet J.* 1962;38:288-293.

## ANTICOAGULANT (DICOUMAROL, SWEET CLOVER POISONING) PLANT TOXICOSIS

### SYNOPSIS

**Etiology** Coumarol, melilotin, and ferulenol, which are normal constituents of some specified plants, are converted to dicoumarol in the process of infection by molds of the cut plant during the making or storage of hay or ensilage.

**Epidemiology** Outbreaks occur when toxic plants or moldy hay made from specific plants, especially *Melilotus* spp., are ingested. Insignificant trauma is associated with massive hemorrhage.

**Clinical pathology** Severe anemia, prolonged clotting times.

**Lesions** Pallor and weakness, especially in newborn calves. Hemorrhage may be internal and not visible. Massive subcutaneous, subserosal hemorrhages and hematomas.

**Diagnostic confirmation** High dicoumarol content of hay or silage.

**Treatment Primary:** Vitamin K<sub>1</sub> parenterally. **Supportive:** Blood transfusion.

**Control** Avoid feeding moldy sweet clover hay or ensilage; dilute with other feed.

## ETIOLOGY

Anticoagulant-containing plant toxicosis manifests as a bleeding diathesis. A common scenario is the presence of severe bleeding after surgery or injury or subcutaneous swelling of the head and neck in newborn animals. A short course (24 to 48 hours) and a high case-fatality rate are usual.

Coumarol (a coumarin glycoside) and melilotin, normal constituents in some plants, are converted to dicoumarol (dicoumarin or dihydroxycoumarin) by the fungi *Aspergillus* spp. and other unspecified molds, which grow in hay or ensilage made from the following plants:

- *Anthoxanthum odoratum*: sweet vernal grass
- *Lespedeza stipulacea*: lespedeza
- *Melilotus alba*: sweet or Bokhara clover is the most common plant associated with poisoning. The toxic level of dicoumarol in moldy sweet clover feed samples is approximately 20 mg/kg of feed. Hay containing 10 to 20 mg/kg dicoumarol can be fed safely for at least 100 days; 30 mg/kg is associated with illness after 4 months of feeding, and 60 to 70 mg/kg is associated with illness after only 17 days.
- *M. altissima*: tall melilot
- *M. indica*: King Island melilot, Hexham Scent
- *M. officinalis*: yellow sweet clover, ribbed melilot.

A similar syndrome is associated with the ingestion of *Ferula communis* var. *brevifolia*, which contains the substance ferulenol (4-hydroxycoumarin). Deer browsing *Wikstroemia indica* have developed a similar condition.

## EPIDEMIOLOGY

### Occurrence

Sweet clover poisoning is recorded most commonly in North America, where sweet clover is grown as a food crop. In affected herds the morbidity rate is about 12%, with a case-fatality rate of 65%. Aborted fetuses and calves less than 2 weeks of age are the common subjects in some herds. The disease occurs most often during the winter months when stored hay or ensilage is fed to cattle. Its occurrence has brought the plant into disfavor, and the disease incidence has been greatly reduced for this reason.

### Risk Factors

#### Animal Risk Factors

The disease can occur in all species but is most common in cattle, less so in sheep, and very rare in horses. Clinical signs may appear without apparent precipitating cause, but trauma, surgery (castration, dehorning), and warble fly migration are often followed by deaths from hemorrhage. Severe losses occur in newborn calves during the first few days of life when their dams have been fed poisonous hay, without the dams being clinically affected.<sup>1</sup> In most outbreaks heavy mortalities occur without warning.

#### Plant Risk Factors

Not all moldy sweet clover hay or silage contains dicoumarol, and the degree of spoilage is no indication of the toxicity of the hay sample. Varieties of sweet clover differ in

their content of coumarol and thus in their potential toxicity. For example, the Cumino variety has a low coumarol content, whereas the Arctic variety has a high coumarol content.

Grazing the crop is not dangerous, but making it into hay or ensilage without the development of mold is difficult because of the succulent nature of the plant.

Dicoumarol concentrations in sweet clover hay bales, hay stacks, or silage vary widely, being highest in small bales; round bales contain more than hay stacks, and the levels are low in silage. The levels of dicoumarol are highest in the outer parts of hay bales, presumably because they are exposed to moisture. Properly cured silage contains even less because of its anaerobic conditions; dicoumarol-producing fungi require oxygen.

## PATHOGENESIS

Dicoumarol competitively inhibits vitamin K 2,3-epoxide reductase. Reduced vitamin K is essential for final carboxylation and activation of clotting factors II (prothrombin), VII (proconvertin), IX (Christmas factor), and X (Stuart factor). Inadequate synthesis of these factors results in impaired fibrin stabilization of platelet plugs, and affected animals are subjected to internal and external hemorrhage. The degree of hypoprothrombinemia is directly related to the amount and duration of dicoumarol ingestion. Coagulation system activity is maintained until the natural decay of the clotting factors in place at the time that poisoning occurs (24 to 36 hours after the last intake of toxin).

## CLINICAL FINDINGS

Extensive hemorrhages into subcutaneous tissues, intermuscular planes, and under serous surfaces are associated with discomfort. The hemorrhages may be visible and palpable as hematomas, but they do not produce crepitus and are not painful. They may be associated with stiffness, lameness, disinclination to move, and even recumbency. One limb may be severely swollen. There are no signs of toxemia, the affected animal continues to eat well, and the temperature, respiration, and heart rate are normal until the terminal stages, but the mucosa are pale and often show petechiation or ecchymosis. Hematuria, epistaxis, and dysentery occur rarely. Accidental and surgical wounds are associated with severe bleeding, but frank hemorrhages from the mucosae seldom occur. Newborn calves may show extensive swelling of the head and neck and become weak from internal or external hemorrhages within a few hours of birth.

Large extravasations of blood into tissues may provide signs of disease because of the pressure exerted on internal organs. Large hemorrhages in the pelvic cavity and broad ligament of postpartum cows often delay uterine involution and shedding of fetal membranes.

When the loss of whole blood is severe, signs of hemorrhagic anemia appear. The animal is tachycardic and weak, the mucosae are pale, and the absolute intensity of the heart sounds is increased markedly. A short course of 24 to 48 hours and a high case-fatality rate are usual.

## CLINICAL PATHOLOGY

Severe anemia with markedly increased clotting times are characteristics of the intoxication. Laboratory values for packed cell volume (PCV), erythrocyte count, and hemoglobin are decreased; values for activated clotting time (ACT), activated partial thromboplastin time (aPTT), prothrombin time (PT), partial thromboplastin time (PTT), and PIVKA are all elevated. An increase in PT occurs before any clinical evidence of bleeding and is therefore a useful prognostic test in most species. PT time may be a more effective diagnostic test in horses.

Representative samples of suspected feed should be submitted for analysis of the dicoumarol content. Clinicopathological evidence of toxicity in sheep occurs on diets containing 10 mg/kg of dicoumarol. However, significant changes in clotting time do not occur on diets containing less than 20 to 30 mg/kg. Similar changes commence in lambs and calves when the dietary intake of dicoumarol rises to above 2 mg/kg BW.

Quantitative determinations of dicoumarol levels in blood and tissues are available and especially valuable in aborted fetuses and newborn calves in which there may have been inadequate opportunity for clinical examination. High levels of dicoumarol in the feed (20 to 30 ppm) and in the liver (1 ppm) are supportive evidence of toxicosis.

## NECROPSY FINDINGS

Subcutaneous hemorrhages and large hematomas occur in areas where normal activity produces mild contusion, such as the flanks, carpal and tarsal joints, and the side of the body where the animal exerts pressure while lying down. Hemorrhages of the serosal surface of the rumen and massive retroperitoneal hemorrhage around the kidneys are frequently observed. In contrast to hemorrhages typical of septicemia, extravasation is uncommon in the lungs, kidneys, and adrenals. The carcass is pale, and there is no intravascular hemolysis, jaundice, hemoglobinuria, or hemosiderosis. Histologic examination is unrewarding, other than as a means of eliminating other potential causes of diathesis, such as vascular diseases.

## DIFFERENTIAL DIAGNOSIS

Diagnostic confirmation is based on detection of dicoumarol, or similar compound, in the feed.

**Differential diagnosis list:**

African horse sickness  
 Anticoagulant rodenticide toxicosis  
 Epizootic hemorrhagic disease in cattle and deer  
 Equine infectious anemia  
 Hemangioma/hemangiosarcoma  
 Ptaquiloside toxicosis  
 Purpura hemorrhagica  
 Thrombocytopenia

**TREATMENT****Primary**

Feeding of the suspected hay or silage should be stopped immediately, but new cases may continue for up to about 6 days. Vitamin K<sub>1</sub> (phytonadione) is an effective antidote for sweet clover poisoning. Vitamin K<sub>1</sub> at a rate of 1 to 1.5 mg/kg BW IM or SC is effective in treating clotting issues in cattle, and phytonadione at 0.5 to 2.5 mg/kg BW IM is recommended in horses.<sup>2</sup> The duration of treatment varies depending on the amount ingested but is generally only a few days. Prothrombin time may be useful in guiding response to therapy. Vitamin K<sub>3</sub> (menadiolone) is ineffective as treatment or prevention and toxic in horses.

**Supportive Treatment**

Animals with clinical evidence of severe hemorrhage should be given a fresh plasma or whole-blood transfusion and treated for shock.

**TREATMENT AND PROPHYLAXIS****Cattle**

Vitamin K<sub>1</sub> (phytonadione) (1 to 1.5 mg/kg BW IM or SC) (R1)

**Horses**

Vitamin K<sub>1</sub> (phytonadione) (0.5 to 2.5 mg/kg BW IM) (R1)

**CONTROL**

Sweet clover forage must be carefully prepared and should not be fed if it is damaged or spoiled during curing. Moldy portions of hay or silage should be discarded, and representative samples of suspected feed should be submitted for analysis of dicoumarol content.

If the toxicosis is suspected, the feed should be discontinued immediately. After 3 weeks, the sweet clover forage may be fed alone, but preferably mixed with another type of unspoiled roughage at the rate of one part sweet clover to three parts unspoiled feed. This mixture should be alternated with unspoiled hay on a weekly basis, or for longer periods if experience shows this to be safe.

Suspected feed should not be fed for at least 3 weeks before surgery such as castration or dehorning. Pregnant cows should not

receive sweet clover during the last 3 weeks of pregnancy.

**FURTHER READING**

- Fraigui O, Lamnaouer D, Faouzi MY. Acute toxicity of ferulenol, a 4-hydroxycoumarin isolated from *Ferula coumunnis* L. *Vet Hum Tox.* 2002;44:5-7.  
 Puschner B, Galey FD, Holstege DM, et al. Sweet clover poisoning in dairy cattle in California. *J Am Vet Assoc.* 1998;212:857-859.  
 Radostits O, et al. Dicoumarin derivatives (including sweet clover) poisoning. In: *Veterinary Medicine: A Textbook of the Disease of Cattle, Horses, Sheep, Goats and Pigs.* 10th ed. London: W.B. Saunders; 2007:1864.

**REFERENCES**

1. AminiPour H, et al. *J Am Sci.* 2011;7:135.
2. Plumb DC. Phytonadione. In: *Plumb's Veterinary Drug Handbook.* 7th ed. Wiley-Blackwell; 2011:824.

**ANTICOAGULANT RODENTICIDE TOXICOSIS****SYNOPSIS**

**Etiology** Ingestion of anticoagulant-containing rodenticides.

**Epidemiology** All species worldwide are affected.

**Clinical pathology** Packed cell volume, erythrocyte count, and hemoglobin content are decreased; activated clotting time (ACT), activated partial thromboplastin time (aPTT), prothrombin time (PT), partial thromboplastin time (PTT), and PIVKA assays are prolonged.

**Lesions** Pallor of tissues and extensive, multiple hemorrhages throughout the body.

**Diagnostic confirmation** Anticoagulants or their metabolites can be detected in blood or urine in live animals and in the liver of animals that have died.

**Treatment** Vitamin K<sub>1</sub> (phytonadione); blood transfusion in critical cases.

**Control** Prevent access to rodenticides.

**ETIOLOGY**

Warfarin, available since the 1940s, is a known first-generation anticoagulant. Related compounds are coumachlor, coumafuryl, and coumatetralyl.<sup>1,2</sup> These products have largely been displaced from the commercial market because of the development of resistance by rats and mice, although some resurgence in use has occurred. Single doses are less likely to be associated with poisoning, but repeated ingestion for some days may do so.<sup>1</sup> Daily doses of warfarin of 0.2 to 0.5 mg/kg BW are fatal to pigs in 6 to 12 days. In cattle, 200 mg/kg daily for 5 days is associated with 50% mortality. At 0.25 mg/kg for 10 days, prothrombin times are depressed 20%; at 0.1 to 0.3 mg/kg, abortions occur.

Brodifacoum, bromodialone, difenacoum, difethialone, and flucoumafen, known

as second-generation hydroxycoumarin anticoagulant rodenticides, and the indandione anticoagulants chlorphacinone, diphacinone, and pindone, have largely replaced warfarin products in the commercial market.<sup>1,2</sup> The development of relay toxicity in nontarget species has resulted in a decline in their popularity and in some countries a return to the use of first-generation products. All of these toxins are far more potent than warfarin, with brodifacoum estimated to be 100 times more potent.<sup>3</sup> Poisoning most often occurs from a single dose because of their potency and prolonged elimination half-lives, but chronic, low-dose poisoning has occurred.<sup>1</sup> Brodifacoum acts over a long period and is detectable in the liver up to 128 days after intake.

**EPIDEMIOLOGY**

These products are incorporated into baits, and use is widespread because they cause no poison shyness. Although most deaths occur because of misuse by farmers, contamination of feedstuffs at the milling plant is not unknown.

**Occurrence**

Calves and poultry are not usually affected, with most outbreaks being recorded in pigs, cats, and dogs. Horses and cattle are not commonly affected unless a single large ingestion occurs or chronic, daily exposure occurs. The LD<sub>50</sub> of brodifacoum in horses is estimated to be 0.1 to 0.2 mg/kg BW.<sup>3</sup>

**Environmental Risk Factors**

Many animals are poisoned by old products inadvertently left in their environment, often in old buildings or in buckets on the back of trucks.

**PATHOGENESIS**

The oral absorption and bioavailability of these toxins is high.<sup>2</sup> The mechanism of action is similar regardless of the species. The toxins exert their effect by interfering with the enzyme Vitamin K 2,3-epoxide reductase, thus inhibiting the synthesis of normal clotting factors II, VII, IX, and X.<sup>1,4</sup> As vitamin K in the liver is depleted, hemorrhage occurs. Because it takes some time for depletion to occur, signs may be delayed for 2 to 4 days.<sup>4</sup> Sudden massive hemorrhage into body cavities or the brain may cause immediate death, or death may occur slowly with accompanying lameness as a result of hemorrhage into subcutaneous tissues.

**CLINICAL FINDINGS**

The clinical signs are often nonspecific. The clinical syndrome includes pale mucosa, weakness, anorexia, dyspnea, tachycardia, hematuria, epistaxis, melena, hematoma formation, recumbency, and death.<sup>1,3,4</sup> Coumatetralyl is associated with more specific signs in pigs, with lameness as a result of hemorrhage in and swelling of the legs. In many



cases, sudden death occurs, or the animals are found dead.

### CLINICAL PATHOLOGY

There are reduced values for packed cell volume, erythrocyte count, and hemoglobin content. Activated clotting time (ACT), activated partial thromboplastin time (APTT), prothrombin time (PT), partial thromboplastin time (PTT), and PIVKA assays are prolonged. In most animals, PT is utilized to assess clotting times; PTT may provide an earlier and more accurate picture in horses. Anticoagulants or their metabolites can be detected in blood or urine or in the liver of animals that have died of toxicosis.<sup>2,3,5</sup>

### NECROPSY FINDINGS

Pallor of tissues and extensive, multiple hemorrhages are characteristic. Ruminants may have melena in the abomasum and entire intestinal tract.

#### DIFFERENTIAL DIAGNOSIS

##### Differential diagnosis list:

African horse sickness  
Epizootic hemorrhagic disease of cattle and deer  
Equine infectious anemia  
Equine viral arteritis  
Hemangioma/hemangiosarcoma  
Moldy sweet clover (*Melilotus officinalis* and *Melilotus alba*) toxicosis  
Purpura hemorrhagica  
Thrombocytopenia (idiopathic or known)

### TREATMENT

#### Primary Treatment

Vitamin K<sub>1</sub> (phytonadione) is the documented antidote; vitamin K<sub>3</sub> should not be used, especially in horses, because it is associated with renal damage.<sup>1,4</sup> In ruminants, the recommended dose is 1 to 2 mg/kg BW IM or SQ.<sup>1</sup> Oral phytonadione is presumed to be degraded by the rumen and ineffective in those species. In horses, the recommended dose is 0.5 to 2.5 mg/kg BW IM.<sup>1,6</sup> The duration of treatment depends on the amount ingested but often is several weeks in duration. Serial PT and PTTs should be utilized to guide therapy.

#### Further Treatment

Animals with acute blood loss must be treated for shock and provided fresh frozen plasma or whole blood, which will restore clotting factors and provide immediate coagulation factors for clotting.

#### TREATMENT AND PROPHYLAXIS

Horses: Vitamin K<sub>1</sub> (phytonadione) (0.5 to 2.5 mg/kg BW IM) (R1)  
Ruminants: Vitamin K<sub>1</sub> (phytonadione) (1 to 2 mg/kg BW IM or SQ) (R1)

### CONTROL

Rodenticides should be kept sealed in containers and away from animal contact. Buckets and pails should not be left in the back of trucks or other areas where horses may find them. Old buildings should be inspected for the presence of rodenticides before allowing animal entry.

### FURTHER READING

- Boermans HJ, Johnstone I, Black WD, et al. Clinical signs, laboratory changes and toxicokinetics of brodifacoum in the horse. *Can J Vet Res.* 1991;55:21-27.  
Radostits O, et al. Rodenticides. In: *Veterinary Medicine: A Textbook of the Disease of Cattle, Horses, Sheep, Goats and Pigs*. 10th ed. London: W.B. Saunders; 2007:1839.

### REFERENCES

1. Valchev I, et al. *Turk J Vet Anim Sci.* 2008;32:237.
2. Berny PJ, et al. *Am J Vet Res.* 2006;67:363.
3. Ignacio A, et al. *Can Vet J.* 2007;48:627.
4. Del Piero F, et al. *J Vet Diagn Invest.* 2006;18:483.
5. Fourel I, et al. *J Analytical Tox.* 2010;34:95.
6. Plumb DL. Phytonadione. In: *Plumb's Veterinary Drug Handbook*. 7th ed. Wiley-Blackwell; 2011:824.

## CYANOGENIC GLYCOSIDE POISONING (CYANIDE, HYDROCYANIC ACID, PRUSSIC ACID)

#### SYNOPSIS

**Etiology** Ingestion of specific plant species containing cyanogenic glycosides.

**Epidemiology** Seasonal and other variations in glycoside content lead to periods of enhanced toxicity of pasture.

**Clinical pathology** None in particular.

**Lesions** Generally none with peracute and acute ingestion. Chronic poisoning results in a neonatal goiter or arthrogryposis, adult posterior ataxia, dysuria, frequent urination.

**Diagnostic confirmation** Assay of hydrocyanic acid in body tissues and fluids and in feed. Positive assay on rumen contents (difficult).

**Treatment** Primary treatment with sodium thiosulfate with or without sodium nitrite or other antidote.

**Control** Test feed for cyanide content.

### ETIOLOGY

Most outbreaks of hydrocyanic acid (HCN) poisoning are associated with the ingestion of plants that contain cyanogenic glycosides (also referred to as cyanogenic glucosides). The glycosides themselves are nontoxic, but HCN may be liberated from them by  $\beta$ -glycosidase and lyase present in the plant tissue.<sup>1,2</sup> Ruminants are at risk because rumen microorganisms not only produce  $\beta$ -glycosidase but also rapidly hydrolyze cyanogenic glycosides. Horses and pigs are much less susceptible to the glycosides

because the acidity of the stomach in monogastric animals inactivates  $\beta$ -glycosidase and is not great enough to be associated with acid hydrolysis of the glycosides.

Plants that contain enough cyanogenic glycosides to cause poisoning number about 120. The following list contains only the genera recognized as hazardous:

- *Acacia* (a few species only): wattle trees
- *Adenia*, for example, *A. digitata*<sup>1</sup>
- *Amelanchier alnifolia*: Saskatoon serviceberry
- *Amygdalus communis*: almond
- *Aquilegia vulgaris*: columbine
- *Bahia oppositifolia*
- *Bonafousia sananho* (see also "Nitrate-Nitrite Poisoning")<sup>3</sup>
- *Brachyachne* spp., for example, *B. convergens*: Gulf star grass, native couch<sup>1</sup>
- *Breynia oblongifolia*: coffee bush
- *Bridelia* spp., for example, *B. leichhardtii*: scrub ironbark
- *Calotis scapigera*: tufted burr daisy
- *Carex vulpina*
- *Castalis spectabilis*: Transvaal bitou
- *Cercocarpus*, for example, *C. breviflorus*: mountain mahogany
- *Chenopodium* spp., for example, *C. carinatum*: green crumbweed (see also "Nitrate-Nitrite Poisoning")
- *Cydonia oblonga*: quince tree
- *Cynodon* spp., for example, *C. aethiopicus*: couch grass, Bermuda grass, African star grass
- *Digitaria* spp., for example, *D. sanguinalis*: summer grass
- *Dimorphotheca* spp., for example, *D. cuneata*: karoo bietou
- *Drosera* spp.: Sundew
- *Dysphania* spp., for example, *D. rhadinostachya*: red crumbweed (see also "Nitrate-Nitrite Poisoning")<sup>1</sup>
- *Eleusine* spp., for example, *E. indica*: crowfoot
- *Eremophila maculate*: native fuchsia<sup>1</sup>
- *Eriobotrya japonica*: loquat
- *Eucalyptus* (a few spp. only), for example, *E. cladocalyx*: sugar gum tree<sup>1</sup>
- *Euphorbia* spp., for example, *E. drummondii*—caustic creeper
- *Flagellaria indica*
- *Florestina tripteris*
- *Glishrocaryon* spp., for example, *G. aureum*: yellow pop flower
- *Glyceria* spp., for example, *G. maxima*: reed sweet grass
- *Goodia* spp., for example, *G. lotifolia*: clover-leaf poison
- *Heterodendron*, for example, *H. oleifolium*: boonaree
- *Holcus lanatus*: Yorkshire fog grass
- *Jatropha* spp., for example, *J. multifida*: umbrella tree
- *Juncus* spp., for example, *J. effuses*: blue rush
- *Leptopus decaisnei*: andrachne
- *Linum* spp., for example, *L. usitassimum*: linseed or flax

- *Lotus* spp., for example, *L. australis*: birdsfoot trefoils
- *Macadamia* spp., for example, *M. integrifolia*: macadamia
- *Malus* spp., for example, *M. sylvestris*: common apple
- *Mascagnia concinna*<sup>3</sup>
- *Manihot esculenta*: cassava<sup>4,5</sup>
- *Mimosa* spp., for example, *M. invisa*: giant sensitive plant
- *Nandina domestica*: nandina, sacred bamboo
- *Oxalys benthamiana*
- *Osteospermum* spp., for example, *O. ecklonis*: South African daisy
- *Papaver nudicaule*: Iceland poppy
- *Passiflora* spp., for example, *P. aurantia*: red passion flower<sup>6</sup>
- *Perralderia coronopifolia*: tafes
- *Phaseolus cuneatus*: Java bean
- *Photinia* spp.: Christmas berry
- *Phyllanthus* spp., for example, *P. gasstroemii*
- *Piptadenia macrocarpa*<sup>3</sup>
- *Pomax umbellata*
- *Prunus* spp., for example, *P. laurocerasus*: cherry laurel
- *Sambucus* spp., for example, *S. nigra*: common elder
- *Sorghum* spp., for example, *S. halepense*: Johnson grass (see also “Nitrate–Nitrite Poisoning”)<sup>1</sup>
- *Stillingia treculeana*: Queen’s delight
- *Suckleya suckleyana*: poison suckleya
- *Triglochin* spp., for example, *T. maritime*: arrowgrass
- *Trifolium repens* L.: white clover<sup>7</sup>
- *Triraphis mollis*: purple plume grass
- *Vicia sativa*: vetch
- *Ximonia americana*: yellow plum
- *Xylomelum* spp., for example, *X. pyriforme*: woody pear
- *Zea mays*: maize, corn (see also “Nitrate–Nitrite Poisoning”)
- *Zieria laevigata*

### Toxic Variability

The content of cyanogenic glycosides in these plants varies widely between seasons and between different parts of the plant, with young, growing leaves usually having the greatest concentration.

### Differences Between Plant Species

Varieties of the same species often have different toxicities, for example, *Amelanchier alnifolia* var. *cusickii* has three times the toxicity of *A. alnifolia* var. *alnifolia*. Of greatest importance are the cultivated and pasture plants. Sudan grass (*Sorghum sudanense*) and sorghum (*S. bicolor*) are used extensively in some countries for forage and may be associated with heavy mortalities in particular circumstances. Sugar cane contains a cyanogenic glycoside from which HCN can be released. Release occurs through the action of an enzyme in algarrobo pods (*Prosopis glandulosa*) when the two are fed together.

### Plant Products

Linseed in the form of cake or meal may also be highly toxic if eaten in large quantities.

### Storage

Drying, hay-making, and physical factors, such as chilling and freezing, may appear to reduce the toxicity of cyanogenic material through destruction of  $\beta$ -glucosidase, but the plant material remains as potentially toxic as it was originally, requiring only the enzyme from ruminal microbes to become actively poisonous. Ensiled toxic forage loses much of its cyanide content and on exposure to air may give off large quantities of free HCN.

### Glycosides

A number of specific glycosides have been isolated and include linamarin from linseed and flax, lotaustralin from *Lotus australis*, dhurrin from sorghum, lotusin from *Lotus arabis*, and amygdalin from bitter almonds. The glycosides are byproducts of the plant’s metabolism and probably form part of its defense system against herbivores such as insects and molluscs. Their concentration in the different plant species is variable depending on weather conditions and other factors that influence plant growth.

The minimum lethal dose (MLD) of HCN is about 2 mg/kg BW for cattle and sheep when taken in the form of a glycoside. The MLD of lotaustralin for sheep is approximately 4 mg/kg BW. Cyanide potential is often used to report results of laboratory tests as cyanide is not present before testing. Plant material containing more than 20 mg of cyanide potential per 100 g (200 ppm) is likely to have toxic effects, and highly poisonous samples may contain as much as 6000 ppm. Monogastric animals, primarily horses and pigs, are poisoned by plants containing 1 to 3 mg/kg BW of preformed HCN. The toxic doses quoted must be accepted with some reservation because the toxicity of a particular specimen varies with a number of factors, including the concentration of the hydrolyzing enzyme in the plant, the preceding diet of the animals, and particularly the speed with which the material is eaten.

### EPIDEMIOLOGY

#### Occurrence

Hydrocyanic acid poisoning occurs in most countries because of the commonness of plants containing toxic quantities of cyanogenic glycosides. When poisoning occurs, most affected animals die rapidly, and although the overall economic effects are not great, the losses may be heavy on individual farms.

#### Risk Factors

##### Animal Risk Factors

The greatest danger exists in the following circumstances:

- Hungry animals are allowed access to dense plant growths.
- Traveling, recently introduced, or other animals are unaccustomed to local plants; animals accustomed to the plants and the poison can tolerate increasing doses with experience.
- Cattle or sheep may break out of dry, summer pastures into fields of young, lush, immature sorghum or Sudan grass and gorge on it.

#### Plant Risk Factors

Poisoning is most likely to occur when the cyanide content of the material is high and the plant is rapidly consumed. Plants with a cyanide potential of more than 200 mg HCN/kg plant dry matter are potentially toxic. Plants must be unwilted at time of testing or false results may be obtained.

The glycoside content is highest in the following conditions:

- When plants grow rapidly after a previous period of retardation, for example, after autumn rains on drought pasture, after a crop is eaten back by livestock or grasshoppers, or after spraying with herbicides
- When plants are wilted, frostbitten, or just young
- In drought years
- When plants are growing in soil with a high nitrogen content
- When plants growing in soil with a low phosphorus content

#### Cyanogenic Risk Factors

The rate of conversion of the glycoside to HCN in the rumen also affects the toxicity of the feed; factors affecting the conversion rate include the following:

- High pH values increase the rate and the risk of poisoning.
- The rate is less when the diet includes grain and long-stemmed hay rather than fresh pasture or cubed hay.
- The rate of conversion, and onset of signs, may be delayed if the ingested material is relatively indigestible, such as crabapples.

#### Environmental Risk Factors

Occasional cases of HCN poisoning occur when animals are exposed to any of the following:

- Chemicals used for fumigation
- Calcium cyanamide containing fertilizers
- Waste water and tailings from mines (gold ores)<sup>8</sup>

#### Farm Risk Factors

Feeding of linseed meal or cake is associated with death when excess ingestion occurs in the following situations:

- Sheep fed large quantities of linseed meal at the end of a period of starvation

- Calves fed milk replacer containing linseed that has been soaked but not boiled

## PATHOGENESIS

### Peracute or Acute Intoxication

peracute or acute intoxication is associated with tissue anoxia by its inhibition of the cytochrome  $a_3$  moiety of complex IV (the terminal cytochrome  $c$  oxidase) in the electron transport chain, thus preventing cellular aerobic respiration.<sup>2</sup> Oxygen exchange is suspended, oxygen is retained in the blood, and hypoxia occurs. If the course is prolonged for more than a few minutes, venous blood may be bright as a result of the presence of oxyhemoglobin. The central nervous system is very sensitive to hypoxia, and the major manifestation of cyanide poisoning is cerebral anoxia followed by death.

### Chronic Poisoning

Ingestion of amounts that do not produce clinical effects appears to be well tolerated. Hydrogen cyanide is volatile and exhaled or converted to thiocyanate by hepatic rhodanase and excreted in the urine. The tolerance appears to increase with experience.

Cyanides ingested in small amounts, however, are known to be goitrogenic through the effects of thiocyanate, for example, pregnant ewes grazing on star grass (*Cynodon nlemfuensis*) develop goiter partly as a result of the low iodine intake and partly as a result of the cyanide intake. Their lambs may also be goitrous and have skeletal deformities. Alpine goats fed ground cassava leaves (*Manihot esculenta*; Crantz) developed a slight increase in the number of resorption vacuoles in the thyroid follicular colloid, slight periportal hepatocyte vacuolation, and mesencephalon spongiosis.<sup>5</sup>

Sorghum cystitis–ataxia syndrome in ruminants and horses is also attributed to chronic cyanide intake. Urinary incontinence, loss of hair resulting from scalding, and incoordination of the hindlimbs occur in horses, cattle, and sheep grazing *Sorghum sudanense* (Sudan or hybrid Sudan grass).<sup>1,9</sup> In horses, the signs are most marked when the animal is backed or turned. In sheep, the syndrome includes weakness, ataxia, head shaking, fetlock knuckling, recumbency, and opisthotonos.<sup>9</sup> Mares and cows grazing sorghum may rarely produce offspring with arthrogryposis, probably the result of fetal central nervous system damage by cyanide.<sup>10</sup>

Cyanogenic glycosides in white clover (*Trifolium repens* L.) have been associated with the onset of equine grass sickness (EGS, or equine dysautonomia) for almost 100 years. White clover collected from fields where horses developed EGS was found to contain high levels of cyanogenic glycosides (mean cyanogenic potential 497 mg/kg dry matter).<sup>7</sup> Although it doesn't alone—horses have developed EGS from fields without white clover—it may be that cyanide

liberated from white clover acts as trigger or other causative factor for EGS.

## CLINICAL FINDINGS

Affected animals rarely survive for more than 1 to 2 hours. In peracute cases, animals become affected within 10 to 15 minutes of eating toxic material and die within 2 to 3 minutes after showing signs. Clinical signs include dyspnea, anxiety, restlessness, stumbling gait, tremor, moaning, recumbency, and terminal clonic convulsions with opisthotonos. The mucosae are bright red in color. In the acute cases, which are more common, the animals show depression, staggering, gross muscle tremor, and dyspnea. There may be hyperesthesia and lacrimation. The muscle tremor is evident first in the head and neck, but it soon spreads to involve the rest of the body; the animal becomes weak and goes down. The pulse is small, weak, and rapid, and it may be irregular. Other findings include dilation of the pupils and nystagmus, with congestion and cyanosis of the mucosae in the terminal stages, usually accompanied by clonic convulsions and in some cases by hypersalivation, vomiting, and aspiration of ingesta into the lungs. Vomiting is not a typical sign in cyanide poisoning, and when it does occur, it may be the result of bloating in the recumbent animal and during the final convulsions. The course in these cases may be as long as 1 to 2 hours.

## CLINICAL PATHOLOGY

There are no specific clinical pathologic abnormalities.

## NECROPSY FINDINGS

In very acute cases the venous blood may be bright red in color, but in most field cases it is dark red as a result of anoxia. The blood clots slowly, the musculature is dark, and there is congestion and hemorrhage in the trachea and lungs. Patchy congestion and petechiation may be evident in the abomasum and small intestines. Subepicardial and subendocardial hemorrhages consistently occur. A smell of “bitter almonds” in the rumen is described as typical of HCN poisoning. It may occur with some plants but is inapparent with others. There are no characteristic histologic changes. Specimens submitted for laboratory examination should include rumen contents, liver, and muscle. Much HCN may be lost from specimens during transit unless the samples are shipped in a very tightly stoppered, airtight bottle. Muscle is least likely to lose its HCN and is the preferred tissue if the delay between death and necropsy has been long. To be satisfactory, liver samples must be taken within 4 hours of death and muscle tissue within 20 hours. A level of HCN of 0.63  $\mu\text{g}/\text{mL}$  in muscle justifies a diagnosis of poisoning. Serum and rumen fluid of poisoned cattle have been assayed using gas chromatography mass spectrometry (GC-MS).

In chronic cases (arthrogryposis and cystitis–ataxia) there is focal axonal degeneration and demyelination in the spinal cord, with some cases of pyelonephritis in the cystitis–ataxia patients.

## Diagnostic Field Tests

Most tests for the presence of cyanogenic glycosides are conducted in the laboratory, but suspected plants or ruminal contents can be tested in the field by the Henrici (picric acid) test.<sup>11</sup> The material is placed in a test tube containing a little water and a few drops of chloroform and heated very gently in the presence of sodium picrate paper. A rapid change in the color of the reagent paper from yellow to red indicates the presence of free HCN. Once started, the color change occurs rapidly, although it may require 5 to 10 minutes of gentle warming before the change commences. The tube should be corked while being warmed and the paper hung from the top without touching the test material. Reagent papers are easily prepared by mixing 0.5 g picric acid and 5 g sodium carbonate in 100 mL water. Filter paper is dipped in the reagent and allowed to dry in a dark place. The reagent is stable for at least 6 months if kept in a cool place, but the papers deteriorate if kept for more than 1 week. Ruminal contents may also be tested by placing a drop of ruminal fluid on a test paper. A red discoloration is a positive reaction. The test is designed to detect free HCN and may not be positive even when cyanides are present if the gas is not liberated. Commercial test papers may give superior results.

## Samples for Confirmation of Diagnosis

- Toxicology—50 g rumen content, liver, muscle in *ai-tight container* (ASSAY [cyanide]).

## DIFFERENTIAL DIAGNOSIS

The development of an acute anoxic syndrome in ruminants grazing on plants or being fed on feeds known to be cyanogenic usually suggests the occurrence of hydrogen cyanide (HCN) poisoning. Diagnostic confirmation is dependent on a positive assay for HCN in blood or cyanogenic glycosides in rumen contents.

### Differential diagnosis list

- Peracute or acute toxicosis*
- 3-methyl indole toxicosis
  - Acute pulmonary edema and emphysema
  - Cyanobacteria (blue-green algae) toxicosis
  - Electrocutation (lightning strike)
  - Ipomeanol toxicosis
  - Nitrate/nitrite toxicosis

*Chronic (goiter, myelomalacia, and arthrogryposis):*

- Numerous and listed elsewhere



## TREATMENT

The standard primary treatment is the IV injection of a mixture of sodium nitrite and sodium thiosulfate (5 g sodium nitrite and 15 g sodium thiosulfate in 200 mL water for cattle; 1 g sodium nitrite and 3 g sodium thiosulfate in 50 mL water for sheep), and field experience with it has been very good. Ruminants have been successfully treated with a 30% to 40% solution of IV sodium thiosulfate at 25 to 50 g/100 kg BW and no sodium nitrite.<sup>12</sup> Horses can be given 10 to 20 mg/kg sodium nitrite IV in a 20% solution followed by 30 to 40 mg/kg BW sodium thiosulfate IV in a 20% solution.<sup>13</sup>

Results in cattle can be improved by using the following doses:

- Sodium thiosulfate in a much heavier dose (660 mg/kg BW in a 30% solution)<sup>13</sup>
- Sodium thiosulfate heavy dose combined with sodium nitrite (22 mg/kg BW)
- Sodium thiosulfate heavy dose with *p*-aminopropiophenone (1 to 1.5 mg/kg BW)
- Sodium thiosulfate heavy dose plus cobaltous chloride (10.6 mg/kg BW)

In all cases and in animals exposed but showing no signs, doses of 30 g of sodium thiosulfate are given orally to cattle and are repeated at hourly intervals.

## Investigational Treatments

Hydroxocobalamin, the natural form of vitamin B<sub>12</sub>, is used successfully in many countries as an antidote in human beings, dogs, mice, guinea pigs, rabbits, and baboons.<sup>14</sup> Recent work in swine demonstrated that hydroxocobalamin (150 mg/kg BW) was more effective than sodium thiosulfate (413 mg/kg BW) or a combination of hydroxocobalamin and sodium thiosulfate in treating experimentally induced cyanide poisoning.<sup>15</sup>

Sulfanegen sodium (2.5 grams IV bolus; repeated hourly), a prodrug of 3-mercaptopyruvate, in an experimental swine model was efficacious in reversing central nervous system (CNS) signs and may provide another antidote in the future.<sup>16</sup>

Treatment, whichever product is used, may have to be repeated because of further liberation of HCN. There is an upper limit of safe methemoglobinemia beyond which anemic anoxia occurs, and doses of nitrite greater than those recommended may exacerbate the tissue anoxia. The inclusion of cobalt is based on its marked antagonistic effect against cyanide, which may be enhanced by combination with thiosulfate or nitrite.

Nonspecific supportive treatments, including respiratory stimulants and artificial respiration, are unlikely to have any effect on the course of the disease.

## TREATMENT AND PROPHYLAXIS

### Ruminants (See text for other options)

- All: sodium thiosulfate 660 mg/kg BW IV in a 30% solution (R1)
- Cows: 5 g sodium nitrite, 15 g sodium thiosulfate IV in 200 mL water (R2)
- Sheep: 1 g sodium nitrite, 3 g sodium thiosulfate in 50 mL water (R2)

### Horses

- Sodium nitrite (10 to 20 mg/kg BW IV in a 20% solution) followed by sodium thiosulfate (30 to 40 mg/kg BW IV in a 20% solution) (R1)

## CONTROL

Hungry cattle and sheep should not be allowed access to toxic plants, especially cultivated *Sorghum* spp., when the plants are chronically drought-stressed, immature, wilted, frostbitten, or growing rapidly after a stage of retarded growth. For most *Sorghum* cultivars, stock should be allowed to graze them, or be fed green chop made from them, only after the plants exceed 75 cm in height. Hay should not be made from *Sorghum*, which is potentially toxic, because toxicity may persist. *Sorghum* silage is much safer than hay.

Sulfur deficiency in ruminants causing depressed feed intake and animal production may result from grazing *Sorghum* with high cyanide potential. This results from ruminal detoxification of cyanide with sulfur to form thiocyanate. Supplementation with salt licks containing 5% sulfur can counter this problem.

If there is doubt as to the toxicity of a field of these plants, a sample may be tested by the method described under clinical pathology or the field can be test-fed to a small group of animals. Linseed meal can be fed in small quantities without soaking, but gruel containing linseed should be thoroughly boiled to drive off any free HCN.

## FURTHER READING

- Nelson LS, Shih RD, Balick MJ. Individual plants. In: Nelson LS, Shih RD, eds. *Handbook of Poisonous and Injurious Plants*. 2nd ed. New York: Springer; 2007:57-306.
- Radostits O, et al. Cyanogenic glycoside poisoning (cyanide, hydrocyanic acid). In: *Veterinary Medicine: A Textbook of the Disease of Cattle, Horses, Sheep, Goats and Pigs*. 10th ed. London: W.B. Saunders; 2007.
- Rose CL, et al. The antidotal action of *p*-aminopropiophenone with or without sodium thiosulfate in cyanide poisoning. *J Pharm Exp Therap*. 1947;89:109-114.
- Vetter J. Plant cyanogenic glycosides. *Toxicon*. 2000;38:11-36.

## REFERENCES

1. Finnie JW, et al. *Aust Vet J*. 2011;89:247.
2. Zagrobelny M, et al. *Phytochemistry*. 2008;69:1457.
3. Diaz GJ, Boermans HJ. Toxic plants affecting grazing cattle in Colombia. In: Riet-Correa F, Pfister

- J, Schild AL, Wierenga TL, eds. *Poisoning by Plants, Mycotoxins, and Other Toxins*. CAB International; 2011:50.
4. Silva SMMS, Mello GW, Costa FAL, et al. Toxic plants of the state of Piauí, northeastern Brazil. In: Riet-Correa F, Pfister J, Schild AL, Wierenga TL, eds. *Poisoning by Plants, Mycotoxins, and Other Toxins*. CAB International; 2011:79.
5. Soto-Blanco S, et al. *Exp Tox Pathol*. 2010;62:361.
6. Carvalho FK, et al. *Pes Vet Bra*. 2011;31:477.
7. McGorum B, et al. *Grass Forage Sci*. 2012;67:274.
8. Donato DB, et al. *Environ Int*. 2007;33:974.
9. Odriozolo E. Poisoning by plants, mycotoxins, and algae in Argentinian livestock. In: Riet-Correa F, Pfister J, Schild AL, Wierenga TL, eds. *Poisoning by Plants, Mycotoxins, and Other Toxins*. CAB International; 2011:35.
10. Panter KE, Welch KD, Lee ST, et al. Plants teratogenic to livestock in the United States. In: Riet-Correa F, Pfister J, Schild AL, Wierenga TL, eds. *Poisoning by Plants, Mycotoxins, and Other Toxins*. CAB International; 2011:236.
11. Logue BA, et al. *Crit Rev Anal Chem*. 2010;40:122.
12. Burrows GE, Tyrl RJ. *Toxic Plants of North America*. 2nd ed. Wiley-Blackwell; 2013:1017.
13. Plumb DC. Sodium thiosulfate. In: *Plumb's Veterinary Handbook*. 7th ed. Wiley-Blackwell; 2011:926.
14. Hall AH, et al. *Ann Emerg Med*. 2007;49:806.
15. Bebartha VS, et al. *Ann Emerg Med*. 2010;55:345.
16. Belani KG, et al. *Anesth Analg*. 2012;114:956.

## NITRATE AND NITRITE TOXICOSIS

### SYNOPSIS

**Etiology** Nitrate from plants, sodium or potassium nitrate fertilizer, contaminated drinking water; nitrite preformed in nitrate-rich, moldy plant material or as nitrate converted to nitrite in the rumen.

**Epidemiology** Worldwide herd outbreaks; rare equine cases.

**Clinical pathology** Methemoglobinemia.

**Findings** Sudden onset of severe dyspnea, brown mucosa and blood, death.

**Diagnostic confirmation** Positive assay for nitrate in feed, blood, or aqueous humor.

**Treatment** Intravenous 1% to 2% methylene blue (1 to 10 mg/kg BW).

**Control** Avoidance of nitrate-rich feeds, especially in transported and hungry animals.

## ETIOLOGY

The toxic element as it occurs in growing plants is always nitrate, usually potassium nitrate, and may be ingested in sufficient quantities to be associated with gastroenteritis. Ruminant microbes reduce nitrate to nitrite,<sup>1,2</sup> which when absorbed systemically is far more toxic and responsible for most of the clinical signs. Toxic doses are hard to compute because of variation in animal susceptibility, rate of production of nitrite from nitrate, and amount of nitrate present in specific plants. Plants grown during a drought

period have higher nitrate concentrations than those in normal rainfall.<sup>2,3</sup>

The roots and stems usually contain more nitrate than leaves,<sup>4</sup> and a total plant content of 6000 to 10,000 ppm dry matter (DM) of nitrate is considered to be potentially toxic. Plants that accumulate more than 1.5% potassium nitrate in dry matter are potentially toxic. For animals at pasture probably 2% DM as nitrate is safe. Levels of potassium nitrate in plants may be as high as 20% of DM, and 3% is not uncommon in recognized forage plants such as sorghum; heavy mortality has occurred in animals that have foraged them. Dried plants retain their toxicity; ensiled plants decrease by about 30%.

### Cattle

The minimum lethal dose of nitrite is 88 to 110 mg/kg BW or about 0.6 g of potassium nitrate per 1 kg BW. Daily doses of about 0.15 g potassium nitrate have been associated with abortion after 3 to 13 doses. Cattle can eat sufficient quantities of toxic plants to be associated with death in 1 hour.

### Sheep

The lethal dose of nitrite is 40 to 50 mg/kg BW. Continued low-level dosing does not appear to affect sheep. Drinking water containing 1000 ppm of nitrate nitrogen is associated with appreciable methemoglobin formation but has no obvious clinical effect.

### Swine

Pigs are most susceptible to preformed nitrites. The lethal dose of potassium or sodium nitrite is about 20 mg/kg BW.<sup>5</sup> At dose levels of 12 to 19 mg/kg BW clinical signs occur, but the pigs recover.

### Horses

The estimated oral lethal dose of nitrate in horses is 61 to 152 g/animal.<sup>6</sup>

## EPIDEMIOLOGY

### Occurrence

Common sources of nitrate for farm animals include the following:

- Cereal crops used as pasture, for example, immature green oats, barley, wheat, and rye or hay; or green feeds, for example, Sudan grass, corn. Oat hay may contain 3% to 7% nitrate.
- Very heavy growths of rye grass (*Lolium* spp.) in pastures<sup>2</sup>
- Freshly pulled mangels—turnip tops may contain 8% nitrate, and sugar beet tops and rape have been associated with nitrite poisoning.
- Water from deep wells contaminated with fertilizer or from reservoirs created with explosives
- The following plants are recognized as important sources of hazardous nitrate concentrations:

*Alternanthera denticulata*  
*Amaranthus* spp., for example, *A. retroflexus*: redroot, pigweed,<sup>3</sup> Prince of Wales feather (see also “Oxalate Poisoning”); *Amaranthus dubius*: bledo liso; *Amaranthus hybridus*: bledo chico<sup>1</sup>  
*Aneilema accuminatum*  
*Arctotheca calendula*: capeweed  
*Atriplex muelleri*: annual saltbush  
*Avena sativa*: oats<sup>2,3,4</sup>  
*Beta vulgaris*: sugar beets, feed beets, beetroots  
*Bidens frondosa*: beggar tick  
*Bonafousia sananho*<sup>1</sup>  
*Brassica* spp., for example, *B. napus*: rape, turnips, and others; *Brassica napus*: toriya<sup>4</sup>  
*Bromus catharticus*: prairie grass  
*Carduus* spp., for example, *C. tenuifloris*: winged, slender thistle  
*Chenopodium* spp., for example, *C. ambrosioides*: mexican tea, goosefoot; *Chenopodium album*: lamb’s quarters<sup>1,3</sup>  
*Chromolaena odorata*: Siam weed  
*Cirsium arvense*: Canada thistle  
*Claoxylon australe*  
*Cleome serrulata*: Rocky Mountain bee plant  
*Dactyloctenium radulans*: button grass, but only when growing in high-nitrogen soil, such as in stockyards  
*Daucus carota*: wild carrot, Queen Anne’s lace  
*Dysphania* spp.: crumbweeds (see also “Cyanogenic Glycoside Poisoning”)  
*Echinochloa* spp., for example, *E. crus-galli*: barnyard grass, Japanese millet  
*Ehretia membranifolia*  
*Eleusine* spp., for example, *E. indica*: crowfoot (see also “Cyanogenic Glycoside Poisoning”)  
*Franseria discolor*: white ragweed  
*Galenia pubescens*  
*Glaucium corniculatum*  
*Glycine max*: soybean  
*Gnaphalium purpureum*: purple cudweed  
*Helianthus annuus*: sunflower  
*Lolium* spp., for example, *L. multiflorum*: rye grasses<sup>2,3</sup>  
*Lygodesmia juncea*: skeleton weed  
*Malva parviflora*: small-flowered mallow  
*Mascagnia concinna*: matagnado<sup>1</sup>  
*Medicago sativa*: alfalfa, lucerne  
*Mililotia greevesii*: creeping mililotia  
*Montia perfoliata*: miner’s lettuce  
*Panicum capillare*: witchgrass  
*Parsonia* spp., for example, *P. lilacina*  
*Pennisetum* spp., for example, *P. clandestinum*: kikuyu; *Pennisetum purpureum*;<sup>1</sup> *Pennisetum glaucum*: bajra<sup>4</sup>  
*Plagiobothrys* spp.: popcorn flower  
*Polygonum aviculare*: wireweed

*Portulacca* spp., for example, *P. oleracea*: pigweed (see also “Oxalate Poisoning”)  
*Rafinesquia californica*: California chicory  
*Raphanus sativus*: radish  
*Salvia reflexa*: mintweed  
*Sigesbeckia orientalis*  
*Silybum marianum*: variegated thistle  
*Sinapis* spp., for example, *S. alba*: white mustard  
*Sonchus* spp.: sow thistle  
*Sorghum* spp.,<sup>1,3,4</sup> for example, *S. bicolor*: grain sorghum  
*Spartothamnella juncea*  
*Stellaria media*: chickweed  
*Thelypodium lasiophyllum*: mustard  
*Tribulus terrestris*: caltrop  
*Triticum aestivum*: wheat  
*Urochloa* spp., for example, *U. panicoides*: liverseed grass  
*Vigna unguiculata* (catjang): cowpea  
*Zaleya galericulata*  
*Zea mays*: maize, corn<sup>3</sup>  
*Zygophyllum* spp., for example, *Z. ammodendron*: twin leaf

## Risk Factors

### Animal Risk Factors

#### Species Differences

There is considerable variation between species in their susceptibility to nitrite poisoning, with pigs being most susceptible, followed by cattle, sheep, and horses, in that order.<sup>2,5</sup> The susceptibility of cattle relative to sheep is attributable either to their ability to convert nitrate to nitrite in the rumen or to the known greater ability of sheep to convert nitrite to ammonia. Pigs are highly susceptible to nitrite poisoning but are generally affected only if they ingest it as preformed nitrite. They have a lower level of bacterial nitrite reductase in their saliva and lower levels of methemoglobin reductase.<sup>5</sup> Nitrate or nitrite toxicosis in horses is very rare.<sup>5,6</sup>

#### Dietary Differences

Cattle reduce nitrate to nitrite in the rumen,<sup>3,7,8</sup> and their capacity to do this is enhanced by continued feeding of nitrate.

Cases of nitrate poisoning that occur in sheep are associated with either the ingestion of preformed nitrite or ruminal conditions that favor reduction of nitrate. A diet rich in readily fermentable carbohydrate reduces nitrite production in the rumen of sheep. Nitrite poisoning also occurs in sheep fed an inadequate ration after dosing with nitrite at a level innocuous to sheep fed on a good ration. There is often a delay of a few days in the appearance of signs of poisoning after sheep go onto toxic forage. It seems likely that ruminal flora need to adapt to the changed nutrients. The degree of methemoglobinemia also varies with the quality of the diet.

### Differences in Susceptibility

The most important factor influencing susceptibility appears to be the rate of ingestion of the nitrate-containing plant. Poorly fed animals, especially traveling or recently transported stock, are more susceptible to poisoning than those on good diets, probably because of the greater intake in hungry animals and possibly their need to adapt their ruminal flora to the conversion of nitrite to ammonia. Prior exposure to nitrate reduces susceptibility under experimental conditions; cattle on high-nitrate hay taken off the hay for a few days and then returned to it in self-feeders where they can gorge on it may be poisoned. Monensin facilitates the conversion of nitrate to nitrite in the rumen and may result in poisoning in cattle or sheep on high-nitrate-containing feeds.

### Environmental Factors

Higher-than-normal levels of nitrate in plants are usually associated with the following:

- Application of excessive nitrogen-containing fertilizer, human sewage, or animal manure from intensive accommodation units, or with high levels of nitrogen-fixing bacteria<sup>8</sup>
- Soil nitrate being taken up but not used by plants because weather conditions are unsuitable for photosynthesis, which would provide the energy to convert the nitrogen into protein—conditions that retard photosynthesis include cloudy or cold weather, nighttime, herbicide application, disease in the plants, wilting of the plants. Periods after a prolonged drought also retard photosynthesis. High levels of nitrate accumulate in the soil during the drought and are not leached out by rain. Plants absorb large amounts when the drought ends.
- Green chop fed indoors is more hazardous than grazing material, probably because the intake is more rapid.
- Cereals and root crops are likely to contain high concentrations when heavily fertilized with nitrogenous manures, especially crude sewage, and when growth is rapid during hot, humid weather.
- Ensiled material usually contains less nitrate than the fresh crop because normal silage fermentation destroys nitrate, but juices draining from silos containing high-nitrate materials may be toxic.<sup>8</sup>
- Hay made from nitrate-rich material contains almost as much nitrate as when it was made, unless some of it is converted to nitrite by overheating and the activities of molds.
- Heavily fertilized grass made into grass cubes
- Nitrate combined with possible iodine deficiency is statistically associated with

congenital deformities and hypothyroidism in foals in western Canada where mares were fed oat hay or green oat forage during pregnancy.

- Cereal hay, especially oat hay, when grown under drought conditions and cut when sappy, may develop a high concentration of nitrite when the stacked material develops some heat. Dry oat hay that is damp for some time before it is eaten, either in the stack or loose in the field in the hot sun, is also likely to contain a high concentration of nitrite.

Nitrate-nitrite poisoning by drinking polluted water can result from the following sources:

- Industrial contamination from rubber-processing plants
- Nitrogenous fertilizer contamination
- Horse manure and urine contamination<sup>9</sup>
- Effluent from butchers' shops and meat processors where sodium nitrate is used in meat-pickling brine
- Effluent from premises where cheese is manufactured, where the whey may contain potassium nitrate
- Deep wells filled by seepage from highly fertile soils, which may contain levels as high as 1700 to 3000 ppm of nitrate
- Open surface storage tanks collecting rain runoff from roofs may contain toxic amounts of nitrite in the plant debris that collects at the bottom.
- Juices draining from silage-containing high-nitrate material may be toxic.
- Water of condensation in barns may trap ammonia and eventually contain 8000 to 10,000 ppm of nitrate.
- Composition lining board in animal barns may become highly impregnated with nitrite and is associated with poisoning if chewed.
- Water containing 2300 ppm of nitrate and less than 10 ppm of nitrite when mixed into a swill, stored in tins, and then cooked has resulted in the production of a mixture containing 1200 to 1400 ppm of nitrite. Boiling does not reduce the nitrate content of water.

Accidental poisoning with commercial nitrate compounds occurs sporadically when:

- Sodium or potassium nitrate is used by mistake instead of sodium chloride or magnesium sulfate, or when ammonium nitrate solution is used instead of whey
- Nitrates are utilized as explosives to blast out water holes used to store drinking water for cattle, which can be dangerous if the nitrate is left in the hole and the dam fills soon afterward

### PATHOGENESIS

Nitrates have a direct caustic action on alimentary mucosa, and the ingestion of sufficiently large quantities is associated with

gastroenteritis. Under normal circumstances, ingested nitrate is reduced in the rumen to nitrite and further converted to ammonia.<sup>2,3,8</sup> When this system is overwhelmed by a large or sudden ingestion of nitrates, nitrites are rapidly absorbed into the blood. Nitrates are also absorbed but are less toxic.<sup>7</sup> Ingestion of preformed nitrites often results in very rapid effects, but when conversion of nitrate to nitrite occurs in the rumen there is often a delay of some hours before clinical signs occur.

The nitrite anion oxidizes heme iron from the ferrous ( $\text{Fe}^{2+}$ ) to the ferric ( $\text{Fe}^{3+}$ ) state, resulting in methemoglobinemia and hypoxia.<sup>2,3,8</sup> Nitrites are also vasodilators, which may contribute to the development of tissue hypoxia by causing peripheral circulatory failure, but this effect appears to be of little significance compared with that of methemoglobin formation. Clinical signs of toxicosis become evident when the methemoglobin level reaches 40% to 50%.<sup>8</sup> Calves may not show signs until the level reaches 60%.<sup>10</sup> Death does not occur until a certain level of methemoglobinemia is attained. In cattle this is approximately 9 g methemoglobin per 100 mL blood; in pigs, death occurs when 76% to 88% of hemoglobin has been altered to methemoglobin. Death usually occurs within 12 to 24 hours of ingestion of the toxic material, although in acute poisoning the duration of illness may be even shorter, and clinical signs may not be observed.

### CLINICAL FINDINGS

Clinical signs of acute nitrate and nitrite toxicosis include weakness, depression, respiratory distress, cyanotic mucous membranes, ataxia, tremors, and terminal convulsions. Abortions may occur in surviving cattle 3 to 7 days after acute toxicosis.<sup>2,3,7</sup> Chronic exposure to lower levels of nitrates may result in anoxia, stillbirths and abortions, and progesterone abnormalities.<sup>3,7</sup>

### CLINICAL PATHOLOGY

There are no pathognomonic lesions in living animals. Chocolate-brown discoloration of the blood has been described but is not consistent.<sup>3</sup> Contributory information is provided by blood levels of methemoglobin, but inaccuracy creeps in because of the rapid reversion of methemoglobin to hemoglobin. Methemoglobinemia may be detected by examination of the blood in a reversion spectrometer, but it is not diagnostic of nitrite poisoning, and results are not dependable unless the blood has been collected for less than 1 or 2 hours. Methemoglobin levels of 9 g/dL of blood are lethal in cattle; levels of 1.65 to 2.97 g/dL are recorded in association with obvious clinical signs compared with normal levels of 0.12 to -0.2 g/dL.

Ocular fluid is the body fluid of choice for diagnosis; blood (serum or plasma) is also acceptable.<sup>3,8,11</sup> Samples should be collected



soon after death and refrigerated or frozen. Blood and ocular fluid levels of nitrate are stable for 24 hours at 23°C (73.4°F), 1 week at 4°C (39.2°F), and 1 month at -20°C (-4°F). Commercial nitrate test strips are available for detection of nitrate and nitrite and may be used in the field on ocular fluid. A diphenylamine test can be used in the field as well to test plants and body fluids for the presence of nitrates/nitrites. Chromatographic methods have been established to quantitate nitrate and nitrite in body fluids.<sup>3</sup>

### NECROPSY FINDINGS

The gastrointestinal mucosa is congested and hemorrhagic; the blood is dark red to coffee brown in color and clots poorly.<sup>2</sup> Petechial hemorrhages may be present in the heart muscle and trachea, and there is general vascular congestion. There are no characteristic microscopic changes.

Specimens for laboratory examination should include blood and ocular fluid, blood for methemoglobin estimation, and samples of ingesta and/or suspected plants or water. Postmortem blood specimens for methemoglobin assay must be collected within 1 to 2 hours of death to be of any value.

### Samples for Confirmation of Diagnosis

- **Toxicology**—1 cc aqueous humor (frozen); 1 cc urine (frozen); suspect forage material (dry); or other possible source of poison; 100 g ingesta (with chloroform or formalin added) (ASSAY [nitrate/nitrite]); 2 cc blood in 4 cc phosphate buffer (ASSAY [methemoglobin])

### DIFFERENTIAL DIAGNOSIS

#### Differential diagnosis list:

Acute bovine pulmonary edema and emphysema  
Carbohydrate overload  
Cyanide or hydrocyanic acid toxicosis  
Cyanobacteria (blue-green algae) toxicosis  
Hypomagnesemia (lactating cattle)  
Urea (ammonia) toxicosis

### TREATMENT

Methylene blue is the specific antidote. In large amounts it is associated with methemoglobinemia, but in small amounts it is associated with rapid reconversion of methemoglobin to hemoglobin. The standard dose rate is traditionally 1 to 2 mg/kg BW, injected IV as a 1% or 2% solution, but a variety of doses up to 10 mg/kg BW have been used.<sup>2,3,8</sup> Treatment may have to be repeated when large amounts of toxic material have been ingested. The half-life of methylene blue is about 2 hours, and if needed, treatment should be repeated at intervals of 6 to 8

hours. Tissues may become stained with methylene blue, and the urine may become dark green in color.<sup>8</sup> The withdrawal time for slaughter is 180 days.<sup>3,8</sup>

### TREATMENT AND CONTROL

Methylene blue (1 to 10 mg/kg BW as a 1% solution IV; repeat q 6 to 8 hours prn) (R1)

### CONTROL

Ruminants likely to be exposed to nitrates or nitrites should receive adequate carbohydrates in their diet, and traveling or hungry animals should not be allowed access to dangerous plants. Haylage or silage suspected of dangerous levels of nitrate should be allowed to aerate overnight before feeding. Feeding corn-based supplements may help ruminants safely reduce nitrate and nitrates.<sup>8</sup>

### Toxic Levels

Acute nitrate poisoning is likely to occur when the concentration of nitrate fed on a dry matter basis exceeds 1%, and risk of abortion occurs at 0.5%.<sup>8</sup> To be safe, the nitrate concentration in feed should not exceed 0.3% on a dry weight basis.<sup>3</sup>

### Ration Dilution

Hungry animals should be fed hay or dry pasture as a filler to reduce their rate of intake before access to potentially toxic feed. Risks of nitrate/nitrite poisoning from pasture grass is minimized if the pasture is a mixture of legumes and grass.

### FURTHER READING

Radostits O, et al. Nitrate and nitrite poisoning. In: *Veterinary Medicine: A Textbook of the Disease of Cattle, Horses, Sheep, Goats and Pigs*. 10th ed. London: W.B. Saunders; 2007:1855.

### REFERENCES

1. Diaz GJ, Boermans HJ. Toxic plants affecting grazing cattle in Colombia. In: Riet-Correa F, Pfister J, Schild AL, Wierenga TL, eds. *Poisoning by Plants, Mycotoxins, and Related Toxins*. CABI; 2011:50.
2. Jonck F, Gava A, Furlan FH, et al. Spontaneous nitrate/nitrite poisoning in cattle fed with oats (*Avena sativa*) and ryegrass (*Lolium multiflorum*) in the state of Santa Catarina, Brazil. In: Riet-Correa F, Pfister J, Schild AL, Wierenga TL, eds. *Poisoning by Plants, Mycotoxins, and Related Toxins*. CABI; 2011:469.
3. Varga A, et al. *Vet Med*. 2012;3:111.
4. Sidhu PK, et al. *Tox Int*. 2011;18:22.
5. Cockburn A, et al. *Tox Appl Pharm*. 2013;209.
6. Oruc HH, et al. *J Eq Vet Sci*. 2010;30:159.
7. Sezer K, et al. *Rev Med Vet*. 2011;162:223.
8. Nicholson SS. *Vet Clin North Am Food A*. 2011;27:477.
9. Michaelki G, et al. *Forensic Sci Int*. 2010;198:103.
10. Nagy O, et al. *Comp Clin Path*. (Accessed at doi: 10.1007/s00580-012-1665-5 on November 28, 2013.).
11. Edwards G, et al. *In Pract*. 2009;31:22.

## DISULFIDE PLANT TOXICOSIS (*ALLIUM* SPP.[ONIONS] AND *BRASSICA* SPP.)

### SYNOPSIS

**Etiology** *Allium* spp. contain *N*-propyl disulfide and *S*-methyl sulfoxide and *S*-prop(en)yl cysteine sulfoxide (SMCO); *Brassica* spp. contain SMCO.

**Epidemiology** Outbreaks when mature plants are grazed. Heavy morbidity and case-fatality rates.

**Clinical pathology** Methemoglobinemia, Heinz-body formation, hemolytic anemia, hemoglobinuria.

**Lesions** Live animals have an acute onset of pallor, hemoglobinuria, and jaundice (if the animal survives long enough). Necropsy findings include pallor, jaundice, dark-brown kidneys and urine; pieces of plant material in rumen.

**Diagnosis confirmation** High blood levels of dimethyl disulfide in SMCO poisoning. The test is not generally available.

**Treatment** No primary treatment; supportive treatment is blood transfusion.

**Control** Feed limited amounts and dilute with other feeds; limit access to plants.

### ETIOLOGY

All plants in the *Allium* species can be toxic to domestic animals, but poisoning from the onion (*Allium cepa*) is the most widely reported in large animals, with sporadic reports involving the wild onion, Canada garlic (*A. canadense*).<sup>1,2</sup> Others plants such as garlic (*A. sativum*), three-cornered garlic (*A. triquetrum*), leek (*A. prorum*), and chive (*A. schoenoprasum*) are reported as toxic to dogs and cats.<sup>3</sup> Cattle are most often poisoned by being fed culled cultivated onions, whereas sheep and horses are more often poisoned by grazing in fields where wild onions grow or gaining access to areas where cultivated onions are grown.<sup>1,4</sup> Onion toxicosis is associated with methemoglobinemia, leading to Heinz-body formation and hemolytic anemia. Plants in the genus *Allium* contain the disulfides *n*-propyl disulfate, in addition to *S*-methyl sulfoxide and *S*-prop(en)yl cysteine sulfoxide (SMCO), amino acid derivatives.<sup>1,3,4</sup> In the rumen, SMCO is hydrolyzed to thiosulfates and then metabolized to dipropyl disulfides and dipropenyl disulfides. Oxidative damage to the erythrocytes is caused by the disulfides.<sup>4</sup>

Plants of all the *Brassica* species are associated with several syndromes, including hemolytic anemia resulting from SMCO poisoning as discussed here, blindness, pulmonary emphysema,<sup>5</sup> polioencephalomalacia,<sup>6</sup> and digestive disturbances, discussed in the section on glucosinolate poisoning. These syndromes may occur separately or in

combination. SCMO occurs in some genera of plants in the family Brassicaceae (e.g., *Brassica*, *Raphanus*).<sup>7</sup> The plants known to contain SMCO are *Brassica campestris* (turnip rape, cole), *B. napobrassica* (swede, rutabaga), *B. napus* (rape = canola), *B. oleracea* (kale, kohlrabi, chou moellier, cabbage, cauliflower, broccoli, Brussels sprouts, calabrese), *Raphanus raphanistrum* (wild radish), and possibly *Thlaspi arvense* (fanweed) and *Berteroa incana* (hoary alysum). The green parts of the plants are the usual material involved in outbreaks.

The seeds and leaves of *Brassica* spp. also contain another glucosinolate, sinigrin, and its breakdown products, allyl cyanide and allyl isothiocyanate, which may depress food intake but appear to exert no hemolytic activity. The plants may also contain significant quantities of cyanogenic glycosides but rarely are associated with cyanide poisoning. Nitrate and nitrite poisoning have also been recorded on kale feeding.<sup>7</sup>

Particular note should be taken of the occurrence of SMCO in cabbages, swedes, and stubble turnips. The level may be insufficiently high to be associated with anemia but may be associated with failure to gain weight satisfactorily or clinically evident ill-thrift.

## EPIDEMIOLOGY

### Occurrence

#### Animal Risk Factors

*Allium* spp. species specificity occurs and is likely related to structural differences of hemoglobin. Cattle are most susceptible to toxicity, followed by horses, sheep, and goats.<sup>1,2,4</sup> Cattle may tolerate up to 25% culled onions on a DM basis,<sup>2</sup> whereas sheep can be maintained on a diet of up to 50% DM.<sup>3</sup> Goats may tolerate an onion diet of 30% to 60% DM.<sup>2,8</sup> Adult cattle are more susceptible to toxicosis than calves; in contrast, adult sheep are less susceptible than young sheep.<sup>2</sup>

*Brassica* spp. rape and kale poisoning are well known where these plants are grown for feed, and in some areas they are no longer used because of the danger. The overall prevalence of poisoning is probably not great, but on individual farms the number affected is usually significant, and the mortality rate is high. The toxic dose of SMCO is 15 g/100 kg BW daily to produce severe, fatal anemia. Intakes of 10 g/100 kg BW are associated with a subacute, low-grade anemia. Although there may be no etiologic relationship, it is not uncommon for hemolytic disease to occur in the presence of hypophosphorosis and therefore at the same time as postparturient hemoglobinuria.

#### Farm or Premise Risk Factors

*Brassica* spp. plants are more toxic as they mature and when secondary growth begins; the flowers and seeds are particularly poisonous. The toxicity of the plants varies from year to year, and on rape grazing most

outbreaks occur in wet years when early frosts occur and the leaves turn a purple color. The toxicity of kale also varies significantly between varieties of the plant, but the important factors in most outbreaks are the maturity of the crop and the amount eaten. The toxic element in kale is destroyed in heat-dried or ensiled material but is still present in frozen and dried material.

## PATHOGENESIS

Dimethyl disulfide and the propyl disulfides are agents responsible for oxidative damage to the erythrocytes.<sup>1,4</sup> Heme iron is oxidized to the ferric state, resulting in methemoglobinemia and decreased oxygen transport. Oxidative damage also results in Heinz-body formation from denatured hemoglobin in erythrocytes and, ultimately, hemolysis. The resulting hemolytic anemia affects all classes of ruminants, but its effects are most serious in heavily pregnant and recently parturient females. The reasons for the observed tendency for cycles of spontaneous improvement followed by recrudescence of the anemia are not explained. A previous suggestion that they were related to variations in the cellular content of reduced glutathione, which prevents the formation of Heinz bodies, has been discredited.

## CLINICAL FINDINGS

In the anemia syndrome, the onset in severe cases may be so sudden that no signs are observed before the animal collapses and dies. If clinical illness is apparent, hemoglobinuria is observed first and is soon followed by weakness and depression. Pallor of the mucosae, moderate jaundice, tachycardia, and a slight increase in respiratory rate and depth are also observed. Diarrhea occurs commonly, and although body temperatures are usually normal to low, there may be fever up to 40.5°C (105°F). Death is common unless effective treatment is provided, and surviving animals require a long period of convalescence. A normal hematological status may not be regained for up to 6 weeks. In an affected herd it is common to find a number of animals that are not seriously ill but have subclinical anemia.

## CLINICAL PATHOLOGY

The erythrocyte count, hemoglobin concentration, hematocrit, and leukocyte count are reduced, and Heinz bodies are present in up to 100% of erythrocytes. They are significantly increased in numbers before anemia appears. Methemoglobinemia and hemoglobinuria occur. The dimethyl disulfide content of the blood, which will be high at the time of occurrence of the poisoning, can be measured chromatographically.

## NECROPSY FINDINGS

There is pallor, jaundice, hemoglobinuria, thin and watery blood, dark coloration of the kidney, accentuation of the lobular

appearance of the liver and, in peracute cases, swelling of the spleen. Histologically there is moderate periarterial hepatocyte necrosis in the liver compatible with the effects of hypoxia.

## DIFFERENTIAL DIAGNOSIS

The occurrence of the disease when cattle or sheep have consumed *Allium* spp. or grazing on plants of the family Brassicaceae suggests the presumptive diagnosis. Diagnostic confirmation is by measurement of dimethyl sulfide levels in the blood.

### Differential diagnosis list:

Bacillary hemoglobinuria

Babesiosis

Chronic copper toxicosis

Leptospirosis in calves

Postparturient hemoglobinuria (recently calved cows)

Red maple (*Acer rubrum*) toxicosis (horses)

## TREATMENT

Primary treatment in the form of an antidote to SMCO toxicity is unavailable. Supportive treatment includes, in severe cases of anemia, an immediate blood transfusion. Hematinic preparations and the provision of a highly nutritious diet are also used.

## CONTROL

The disposal of superfluous onions is a major horticultural problem, best solved by feeding them to animals. This can be done without fear of causing anemia by feeding them to cows mixed into a balanced ration containing less than 25% of onions.<sup>1</sup> Sheep and goats can tolerate larger amounts without evidence of clinical anemia.<sup>1,2,8</sup>

The provision of ample hay either daily before the animals are pastured on the rape, as a stack in the rape field, or by allowing access to a field of rough grass, is recommended to reduce the consumption of rape. Rape showing purple discoloration should be regarded with suspicion and only limited grazing permitted until doubts as to its safety are satisfied. Cattle and sheep grazing on these plants should be kept under close observation so that affected animals can be treated in the early stages of the disease. An adequate phosphorus intake is particularly necessary. If feeding is stopped, the hemoglobin levels return to normal in about 3 weeks. Even if feeding is continued, there is a strong tendency for a spontaneous recovery and further similar cycles to occur. Some varieties of kale have lower concentrations of SMCO, and a genetic approach to preventing the disease might be worth examining.

## FURTHER READING

Aslani MR, Mohri M, Movasaghi AR. Heinz body anemia associated with onion (*Allium cepa*)

toxicosis in a flock of sheep. *Comp Clin Path.* 2005;14:118-120.

Prache S. Hemolytic anemia in ruminants fed forage brassicas: a review. *Vet Res.* 1994;25:497.

Radostits O, et al. S-methyl-L-cysteine sulfoxide (SMCO) and dipropyl/dipropenyl disulfide poisoning. In: *Veterinary Medicine: A Textbook of the Disease of Cattle, Horses, Sheep, Goats and Pigs.* 10th ed. London: W.B. Saunders; 2007:1881.

## REFERENCES

- Borelli V, et al. *J Vet Diag Ingest.* 2009;21:402.
- Keyvanlou M, et al. *Revue Med Vet.* 2011;162:593.
- Salgado BS, et al. *J Venom Anim Toxin Trop Dis.* 2011;17:4.
- Heidarpour M, et al. *Iran J Vet Res.* 2013;14:21.
- Muhammed G, et al. *Turk J Vet Anim Sci.* 2010;34:299.
- McKenzie RA, et al. *Aust Vet J.* 2009;87:27.
- Barry TN. *Anim Feed Sci Tech.* 2013;181:15.
- Heidarpour M, et al. *Comp Clin Path.* 2011;22:195.

## RED MAPLE LEAF (ACER RUBRUM) TOXICOSIS

Red maple trees (*Acer rubrum*) are native to eastern North America and cultivated in many parts of Europe.<sup>1</sup> Toxicosis from red maple leaves is frequently reported in horses and more rarely in alpacas and zebras (*Equus grevyi*).<sup>1,2</sup> The toxic dose is approximately 1500 mg leaves/kg BW, or approximately 1.5 to 2 pounds of dry or wilted leaves per 500-kg horse.<sup>1,3</sup> Horses are most often poisoned in the fall when leaves are falling or when tree branches have fallen into their pastures after a storm.

The toxin causes an oxidative damage to the red blood cells, resulting in Heinz-body formation, hemolysis, and methemoglobinemia.<sup>2,3</sup> Two clinical syndromes exist, characterized by hemolytic anemia, methemoglobinemia, or both. Currently, pyrogallol, a metabolite of gallic acid, is implicated as one of the toxins. The mechanism of action is still being studied, but gallotannins or gallic acid in red maple leaves may be metabolized to pyrogallol by the bacteria *Klebsiella pneumoniae* and *Enterobacter cloacae* present in the ileum.<sup>3</sup> Pyrogallol is absorbed into the blood where it forms free radicals and oxidizes Fe<sup>2+</sup> in hemoglobin to Fe<sup>3+</sup>, resulting in methemoglobinemia and ultimately tissue hypoxia. A second oxidizing toxin exists but has not yet been identified.<sup>4</sup> These toxins are found in other maple trees (silver maple [*A. saccharinum*], sugar maple [*A. saccharum*]), suggesting that ingestion of leaves of these plants could produce a similar clinical picture.<sup>1,4</sup>

Clinical signs depend on the amount of hemolysis and degree of methemoglobinemia but generally include weakness, lethargy, muddy or cyanotic mucous membranes, tachycardia, jaundice, and sudden death.<sup>1,2</sup> Less frequently reported signs include colic, pyrexia, hypothermia, tachypnea, and laminitis.<sup>2</sup> Laboratory abnormalities include anemia, methemoglobinemia, Heinz-body formation, hemolysis (intra or extravascular),

azotemia, elevated creatine kinase (CK), and hemoglobinuria.<sup>2</sup>

There is no antidote. Treatment options include IV crystalloids, mineral oil, whole-blood transfusion, hemoglobin-based oxygen carriers, ascorbic acid (30 to 50 mg/kg BW IV BID diluted in 5 to 10 L crystalloids;<sup>4</sup> 10 to 20 g PO daily<sup>5</sup>), sodium bicarbonate, and the judicious use of NSAIDs.<sup>2,4</sup> Response to therapy is often poor, and the mortality rates approach 60% to 65%.<sup>2,4</sup> Laminitis from poor perfusion, tissue hypoxia, and inflammation is a known sequela.<sup>4</sup>

## REFERENCES

- Martinson KC, Hovda LR, Murphy M. Maple. In: *Plants Poisonous or Harmful to Horses in the North Central United States.* University of Minnesota Press; 2007:20.
- Alward A, et al. *J Vet Intern Med.* 2006;20:1197.
- Agrawal K, et al. *J Vet Diagn Invest.* 2012.
- Alward A. *ACVIM 2008 Proceedings.* At: <<http://www.acvim.org>>; Accessed 15.11.2013.
- Plumb DC. Ascorbic acid. In: *Plumb's Veterinary Drug Handbook.* 7th ed. Wiley-Blackwell; 2011:80.

## Neoplasia

### SPORADIC BOVINE LEUKOSIS (ATYPICAL BOVINE LEUKOSIS)

#### SYNOPSIS

**Etiology** Unknown.

**Epidemiology** Occurs worldwide, with low prevalence.

**Signs** Three different forms of sporadic bovine leukosis (SBL) are differentiated based on age and organ primarily affected: **juvenile, thymic,** and the **cutaneous form.** Atypical forms have been reported. The juvenile form primarily affects calves up to 6 months of age with multiple enlarged lymph nodes. The thymic form affects animals up to 2 years of age with massive enlargement of the thymus. The cutaneous form affects animals between 1 and 3 years of age with dermal nodes and plaques.

**Clinical pathology** Histology on biopsy samples of enlarged lymph nodes, thymus, or skin lesions. Serologically negative for bovine leukemia virus (BLV).

**Lesions** Lymphoid tumors affecting different organs.

**Diagnostic confirmation** Histology and negative BLV serology.

#### Differential diagnosis list

- Enzootic bovine leukosis (EBL)
- Lymphadenitis as a result of tuberculosis and actinobacillosis
- Congestive heart failure as a result of traumatic pericarditis (for thymic form)
- Traumatic hematoma of jugular vein (for thymic form)
- Ring worm (for early-stage cutaneous form)

Dermatophilosis (for early-stage cutaneous form)

Skin tuberculosis (for early-stage cutaneous form)

Urticaria (for cutaneous form).

**Treatment** None

## ETIOLOGY

Sporadic bovine leukosis (SBL) is a lymphoproliferative disease of cattle of unknown etiology. Animals affected by SBL by definition must be negative for bovine leukemia virus (BLV) serology and PCR, which is why the etiology of SBL is considered to be different from enzootic bovine leukosis (EBL). Although the causative involvement of a pathogen other than BLV cannot be ruled out, SBL is currently considered to be non-infectious and noncontagious. In contrast to EBL, which is a B-cell proliferative lymphoma, lymphoid tumors in patients with SBL were found to be of either B- or T-cell lineage.

SBL primarily affects animals under 3 years of age, although atypical forms occurring in older cattle have been reported.<sup>1</sup> Three different forms of SBL are currently recognized:

- Calf or juvenile form:** Primarily occurs in calves less than 6 months old but may occasionally be seen in cattle up to 2 years of age; the condition is characterized by multiple lymph node enlargement.
- Thymic form:** Is most common in animals between 6 months and 2 years old and is characterized by a marked enlargement of the cervical and/or the intrathoracic part of the thymus. Other organs and lymph nodes are frequently involved.
- Cutaneous form:** Occurs in cattle 1 to 3 years old and is characterized by the development of nodes and plaques in the skin. Involvement of internal organs, particularly in advanced stages of the disease, is common.

In addition to these well-recognized forms of SBL, atypical cases affecting different organs or older animals have been reported in the literature. More recently the occurrence of a larger number of cases of SBL in adult cattle that were clinically and histologically indistinguishable from EBL and negative for BLV antibodies has been reported in the Netherlands.<sup>1</sup>

## EPIDEMIOLOGY

### Occurrence

The precise incidence of SBL and its different forms has not been determined, but in general all three forms are rare, and in most cases only individual animals in a herd are affected. Cases of SBL are rare compared with the occurrence of EBL in BLV-endemic regions. In countries where BLV has been eradicated, cases of SBL are encountered sporadically. In



these regions the juvenile form appears to be the prevalent form observed.

### PATHOGENESIS

Malignant proliferation of a specific B- or T-cell lineage occurs for unknown reason, resulting in tumor formation in lymphatic tissue with a strong tendency to metastasize widely. The exact nature of the tumor is unclear. The tumors consist of aggregations of neoplastic lymphocytes.

### CLINICAL FINDINGS

#### Juvenile or Calf Lymphosarcoma

Juvenile lymphosarcoma occurs in calves from 2 weeks to 6 months of age and is manifested by gradual loss of weight, the sudden enlargement of several or all lymph nodes, development of depression and weakness, and in some cases respiratory distress. Fever, tachycardia, and posterior paresis are less constant signs. Death occurs in 2 to 8 weeks after the onset of signs. Signs of pressure on internal organs, including bloat and congestive heart failure, may occur. Diffuse infiltration of major nerves of a limb may also occur. Unusually the disease may be fully developed in utero, so that the newborn calf is affected with tumors, or be delayed until 2 years of age. Lymphosarcoma of the pharyngeal region causing retropharyngeal swelling and dyspnea in a 7-month-old beef steer has been recorded. Some degree of aplastic anemia is frequently present; lymphocytosis may occur but is not characteristic. The presence of large numbers of immature lymphocytes in the blood smear is highly suggestive of the presence of the disease.

Bone and bone-marrow necrosis associated with the calf form has been recorded in calves 3 weeks to 8 months of age. Involvement of the tibiotarsal joint, ribs, and spinal canal may also occur, resulting in ataxia and paresis. Multiple bone infarcts and bone-marrow necrosis were present at necropsy. Lymphosarcoma of the mandible of a 2-year-old heifer has also been recorded.

#### Thymic Lymphosarcoma

Infiltration of the thymus is a common finding in animals 1 to 2 years of age and is characterized by massive enlargement of the cervical and/or intrathoracic part of the thymus. Concomitant involvement of the bone marrow and regional lymph nodes is common. Jugular vein engorgement and marked brisket edema extending to the submandibular region are typical clinical findings. Moderate bloat resulting from inability to eructate because of compression of the esophagus may occur (Fig. 11-10).

The thymic mass may or may not be palpable depending on what part of thymus is affected. This form is more common in beef than in dairy cattle. An atypical lymphosarcoma in a mature cow negative for BLV and similar to the thymic form has been reported. Metastatic thymic lymphosarcoma in a calf



**Fig. 11-10** A, Ventral view from the front of a basketball-sized mass in the thoracic inlet of an 18-month-old Holstein-Friesian heifer with thymic lymphosarcoma. B, Dorsal view from the front of the same heifer exhibiting chronic mild ruminal tympany.

has been recorded, including a case with metastases causing spinal cord compression. A large number of cases of thymic lymphosarcoma occurred in calves in five regions in France over a period of 5 months. Most of the calves had been sired by the same bull, which suggests that the disease had an inherited basis.

#### Cutaneous Lymphoma

Cutaneous lymphoma is the most common in cattle less than 3 years of age. It is rare and

manifested by cutaneous plaques (1 to 30 cm diameter) appearing on the neck, back, croup, and thighs (Fig. 11-11). The plaques become covered with a thick, gray-white scab, and the hair is shed; then the center becomes depressed, and the nodule commences to shrink. The surface of some plaques may become ulcerated and have a serosanguineous exudate. Some of the lesions have a cauliflower-like appearance, appear black, and are ulcerated and foul-smelling. After a period of weeks or months, hair



Fig. 11-11 Cutaneous lymphoma in a 2-year-old Holstein-Friesian heifer.

grows again, and the nodules disappear, as does the enlargement of the peripheral lymph nodes. Spontaneous regression of bovine cutaneous leukosis has been recorded. Relapse may occur in 1 to 2 years with reappearance of cutaneous lesions and signs of involvement of internal organs, as in the enzootic form of the disease. In one series of 10 heifers, all animals had lymphadenopathy. Some had leukocytosis, and some had lymphocytosis. The body condition may vary from normal to thin and underdeveloped. Some affected animals may have a fever.

Cutaneous T-cell lymphoma in two Friesian cows in the Azores has been reported. The lesions consisted of raised pink plaques, with no pruritus or signs of associated pain, which were extensively distributed over both lateral and ventral body regions. Immunocytochemistry found the tumor cells positive for CD3, confirming the T-cell origin of the cells, which involved both skin and regional lymph nodes.

### CLINICAL PATHOLOGY

A tentative diagnosis can be made based on the clinical presentation and anamnesis (age) of the patient. A definitive antemortem diagnosis requires histologic examination of a biopsy specimen as well as ruling out EBL by conducting BLV serology or PCR. A needle aspirate of an enlarged peripheral lymph node may provide a rapid and inexpensive diagnosis. Fine-needle aspirates of the enlarged thymus when accessible or a biopsy of an intracutaneous nodule present alternative diagnostic approaches. BLV serology or virus isolation is required because lymphosarcoma in SBL cannot be differentiated morphologically from EBL. An increased lymphocyte count in blood with a large number of atypical lymphocytes is suggestive of a leukemic form of SBL.

Ultrasonography of the mass in the thoracic inlet of cattle with thymic

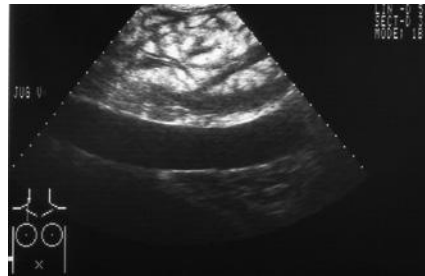

Fig. 11-12 Transcutaneous ultrasound image of thymic lymphosarcoma obtained from the ventrolateral region of the caudal neck of the heifer pictured in Figure 11-10. A 3.5-MHz sector scan transducer was used to identify a well-encapsulated tumor immediately dorsal to a distended jugular vein.

lymphosarcoma reveals a well-encapsulated mass and bilateral distention of the jugular veins resulting from extraluminal compression of the anterior vena cava by the tumor with that impedes venous return from the head (Fig. 11-12).

### NECROPSY FINDINGS

Sporadic bovine lymphomas are generally seen in younger cattle compared with cattle with EBL. The **thymic form** is characterized at necropsy by large cranial thoracic and lower cervical masses in yearlings of the beef breeds. Tumor masses may extend as far cranially as the mandible and also to the heart and lungs. Histologically, the masses are composed of sheets of lymphocytes with a diffuse architecture and minor stroma typical of thymic lymphomas. Tumor cells are of the high-grade, small uncleaved type. Immunohistochemical staining of formalin-fixed, paraffin-embedded tissue sections of tumors can be used to confirm that neoplastic lymphocytes are of thymic origin.

The **juvenile type** is seen in calves up to 6 months of age and may be present at birth. At necropsy, virtually all nodes are markedly

enlarged, and other organs such as the liver and spleen may be affected or spared. Individual tumor masses are otherwise indistinguishable grossly from those of enzootic bovine lymphoma. Microscopically, tumor cells resemble those of the thymic type, but the phenotype is yet to be undetermined.

The **skin type** occurs in cattle 1 to 3 years of age and is characterized by plaque-like, round, raised skin lesions in different parts of the body. The plaques are of varying sizes, and some will be ulcerated or alopecic. Although initially cutaneous, the lesions usually spread to internal organs in advanced cases. Such visceral lesions are grossly indistinguishable from those of enzootic bovine lymphoma. Microscopically, the skin lesions are dermatotropic and characteristically result in dense infiltrations of tumor cells in the papillary dermis and focal invasion of the epidermis (Pautrier's microabscess). The cells are postulated to be of T-cell origin.<sup>2,3</sup>

### Samples for Confirmation of Diagnosis

- **Histology**—formalin-fixed samples of gross lesions, plus thymus and skin for differentiation (LM, IHC)

### DIFFERENTIAL DIAGNOSIS

Enzootic bovine leukosis (EBL)—can only be ruled out by means of bovine leukemia virus (BLV) serology or virus/provirus polymerase chain reaction (PCR). Patients with sporadic bovine leukosis (SBL) by definition must be serologically and virologically negative for BLV.

Tuberculosis—can be differentiated by the tuberculin test.

Right-sided heart failure (for thymic lymphosarcoma)—with thymic lymphosarcoma edema is more local at the height of the thoracic inlet. In contrast to right-sided heart failure, there is neither distention of the udder vein nor liver congestion.

Hematoma from trauma of jugular vein—may be differentiated from thymic lymphosarcoma by needle aspirate.

Ringworm (for early stages of cutaneous form of SBL)

Dermatophilosis caused by *Dermatophilus congolensis* (for early stages of cutaneous form of SBL)

Skin tuberculosis (for cutaneous form of SBL)

Urticaria (for cutaneous form of SBL)

### TREATMENT

There is no treatment.

### REFERENCES

1. Grünberg W, Eisenberg SWF. *Vet Rec.* 2013;173:398.
2. Loh CC. *Can Vet J.* 2007;48:309-312.
3. Valli VEO. Hematopoietic system. In: Maxie MG, ed. *Jubb, Kennedy and Palmer Pathology of Domestic Animals.* Vol. 3. 5th ed. Edinburgh: Saunders; 2007:107.



## Congenital Inherited Diseases

### INHERITED BLEEDING DISORDERS

#### Hemophilia

**Hemophilia A** (deficiency of factor VIII, or classic hemophilia) occurs in Thoroughbred, Standardbred, Arab, and Quarter horses, causing persistent bleeding after injury or surgery, or spontaneously. This bleeding can be manifested by the sudden appearance of swellings over joints or the upper cervical region, causing dyspnea, or into joints or body cavities, causing acute hemorrhagic anemia, and blood can be aspirated from them. The platelet-dependent bleeding time is normal, but the fibrin-dependent bleeding time is markedly prolonged. The defect is genetically transmitted as a sex-linked recessive trait, appearing clinically only in males.

Hemophilia A occurs in male Japanese Brown cattle, in which it is evident as a bleeding tendency, sometimes resulting death of the animal. Cases had severely reduced factor VIII activity. Factor VIII activity is reduced in the dams of affected male cattle but does not result in excessive bleeding.<sup>1</sup> The disease is caused by a mutation in the gene for factor VIII, which is X-linked.<sup>2</sup> The nucleotide substitution is a T to A, resulting in an amino acid substitution of leucine to histidine (p.Leu2153His) in a highly conserved residue in the C1 domain of factor VIII.<sup>3</sup>

**von Willebrand's disease** has been identified in a Quarter horse that experienced bleeding episodes and a low blood level of vWF after a normal platelet count and negative coagulation screening tests. See "Inherited and congenital bleeding disorders" of this chapter.

#### Bovine Factor XI Deficiency

Factor XI (partial thromboplastin antecedent) is involved in coagulation, but animals afflicted by a deficiency of it can be clinically normal even though their whole-blood clotting time is very prolonged.<sup>4,5</sup> The disease is best described in Holstein cattle and might be limited to this breed and to Japanese Black cattle.<sup>5,6</sup> Others may have a severe bleeding tendency, but the frequency of hemorrhagic episodes with factor XI deficiency is very low. Heterozygotes experience minor episodes; homozygotes may have serious ones, especially neonates, which may die at birth and be classified as uncomplicated neonatal mortality. Affected cows also experience an increase in repeat breeder problems, apparently associated with a slower luteolysis and the development of small graafian follicles. Homozygous affected cattle are 2.7 times as likely to have fetal loss than are homozygous normal cattle.<sup>7</sup>

Homozygous cattle have reduced factor XI activity, assessed by the activated partial thromboplastin time, in plasma.<sup>8</sup> Both males

and females transmit the trait, which is inherited as an autosomal-recessive trait and is caused by a 76-bp insertion in the coding region of the FXI gene.<sup>4</sup> The abnormal gene can be detected by PCR analysis and has a low frequency in the Holstein population in China.<sup>9</sup> Control is achieved by testing for carrier animals and planned breeding to eliminate the mutated allele. See "Inherited and congenital bleeding disorders" of this chapter.

#### Prekallikrein Deficiency

Prekallikrein is necessary to activate factor XII in the coagulation process. An inherited deficiency of prekallikrein is recorded in a family of Belgian horses, as a cause of a bleeding tendency in the presence of the conventional coagulation factors. The deficiency is of the order of less than 1% of normal levels of 63% to 150%. The activated partial thromboplastin time is markedly prolonged.

#### Inherited Thrombopathia

Thrombopathia (thrombocytopenia) is a rare autosomal-recessive genetic form of hemophilia caused by a missense mutation that produces platelets with abnormal fibrinogen receptor exposure and impaired dense granule release, resulting in bleeding tendencies primarily of mucosal surfaces. It causes uncontrolled bleeding in Simmental cattle. The disease in Simmental cattle is caused by a nucleotide change (c.701 T>C) that results in the substitution of a proline for a leucine within structurally conserved region 2 (SCR2) of the catalytic domain of calcium diacylglycerol guanine nucleotide exchange factor I (CaDAG-GEFI).<sup>10</sup> This change is likely responsible for the thrombopathic phenotype observed in Simmental cattle.<sup>10</sup> Affected animals are homozygous. Collected blood undergoes good clot retraction, but platelet aggregation in response to adenosine diphosphate and collagen in a whole-blood aggregation system is badly impaired. Clinical findings include epistaxis, hematuria, the sudden development of subcutaneous swellings, hemorrhagic anemia as a result of internal bleeding, or bleeding after external lacerations or surgery.

#### Glanzmann's Thrombasthenia in Horses

In Glanzmann's thrombasthenia, a disorder of platelet function recognized in several breeds, including Peruvian Paso, Oldenburg, and Quarter horses, results in prolonged bleeding time.<sup>11-13</sup> The abnormality is in platelet fibrinogen receptor and is likely caused by a 10-base-pair deletion causing a premature stop codon or a mutation in exon 2 of the gene encoding glycoprotein IIb.<sup>13</sup>

#### Afibrinogenemia (Related Diseases Are Hypofibrinogenemia and Dysfibrinogenemia)

Afibrinogenemia is a rare cause of bleeding diathesis recorded in cattle,

sheep, and goats, especially the newborn.

### REFERENCES

- Moritomo Y, et al. *J Vet Med Sci.* 2008;70:293.
- Maryam K, et al. *Anim Sci J.* 2006;77:122.
- Khalaj M, et al. *Anim Genet.* 2009;40:763.
- Vijay K, et al. *Ag Rev.* 2011;32:228.
- Ohba Y, et al. *J Vet Med Sci.* 2008;70:297.
- Patel RK, et al. *Gen Mol Biol.* 2007;30:580.
- Ogata Y, et al. *J Japan Vet Med Assoc.* 2014;67:54.
- Windsor PA, et al. *Aust Vet J.* 2009;87:193.
- Zhang K, et al. *Ag Sci Tech—Hunan.* 2010;11:109.
- Boudreaux MK, et al. *Vet Pathol.* 2007;44:932.
- Sanz MG, et al. *Vet Clin Pathol.* 2011;40:48.
- Macieira S, et al. *Vet Clin Pathol.* 2007;36:204.
- Christopherson PW, et al. *J Vet Int Med.* 2007;21:196.

### FAMILIAL POLYCYTHEMIA

Familial polycythemia, an inherited defect, has been observed only in Jersey cattle and Japanese Black cattle.<sup>1</sup> Hematologically there is marked elevation of erythrocyte count, hemoglobin concentration, and packed cell volume. The disease in Jersey cattle appears to be a primary polycythemia inherited as a simple autosomal-recessive trait.

### REFERENCE

- Takagi M, et al. *J Vet Med Physiol Pathol Clin Med.* 2006;53:296.

### HEMOCHROMATOSIS

Hemochromatosis is rare in domestic animals. This inherited defect of iron metabolism in humans has also been observed in yearling Salers cattle in circumstances in which an inherited etiology is suggested. The pattern of inheritance is uncertain because of the small number of pedigrees available from affected cattle. Hemochromatosis occurs when inappropriately large amounts of iron are absorbed from the intestine over an extended period. The excessive accumulation of iron causes iron-induced lysosomal injury and peroxidation by free radicals, which are the two major mechanisms responsible for hepatocellular necrosis and for sequelae such as fibrosis, bile duct hyperplasia, veno-occlusive disease, and hepatic neoplasia. Unlike hemosiderosis, hemochromatosis is associated with high transferrin saturation values in serum (>60%). Clinical disease develops between 9 and 22 months of age. Animals are normal until weaning but then lose weight, develop rough hair coats, and lose incisor teeth. The skeletal changes in hemochromatosis are a result of abnormal bone development. Bone analysis reveals iron levels in affected animals may be 30 to 50 times greater than normal and a decreased percentage of ash in the outer cortex. Periosteal dysplasia and osteopenia are responsible for the pathologic fractures and tooth loss.

At necropsy, there is emaciation, firm dark-brown livers and lymph nodes, soft bones, and brown-colored small intestine.



The major histologic changes are hepatocellular siderosis and periportal bridging, along with perivenular fibrosis. Heavy deposits of iron in the liver and deposits of hemosiderin are visible in liver tissue obtained by biopsy. Hepatic iron concentrations in clinically affected cattle range from 1500 to 10500 wet weight (reference range for cattle = <3 00g/g). Ultrastructurally, the heaviest intrahepatic deposition is in the hepatocyte. Iron in bone is associated with osteopenia.

## INHERITED ANEMIAS

### Inherited Dyserythropoiesis and Dyskeratosis (Bovine Congenital Anemia, Dyskeratosis, and Progressive Alopecia)

Inherited dyserythropoiesis and dyskeratosis occurs in 1- to 16-month-old calves in some Poll Hereford families in the United States, Canada, and Australia.<sup>1</sup> It is thought to be inherited as a simple autosomal-recessive character. Clinical signs commence at about 2 months of age and include skin lesions that appear on the face and neck, especially around the muzzle and along the edges of the ears, then extend in the midline down the back, then down the sides and onto the limbs; the long hairs on the tail tip are shed. The hyperkeratotic muzzle accumulates dust. The skin lesions comprise alopecia, with surviving hairs wiry, kinked, or tightly curled; accumulations of sebum; and hyperkeratosis and marked wrinkling. The alopecia and hyperkeratotic dermatitis extend, and the calves do not thrive, becoming small in stature, intolerant of exercise, susceptible to heat stress, and eventually pining away until they die or are euthanized. Histologically the skin is affected by dyskeratosis, hyperkeratosis, and orthokeratosis, and there are morphologic abnormalities of the nucleus in erythroid precursors; anemia results from ineffective erythropoiesis. There is a persistent, nonregenerative anemia as a result of a failure of maturation of erythrocytes; the blood contains many nucleated erythrocytes, and bone-marrow aspirates contain increased numbers of erythroid precursors.<sup>1</sup>

### Inherited Glucose-6-Phosphate Dehydrogenase Enzyme Deficiency

A single case inherited glucose-6-phosphate dehydrogenase enzyme deficiency, a persistent hemolytic disease, has been recorded in a yearling American Saddlebred colt. The disease in humans is well recognized as an inherited defect. A similar clinical disease is recorded in Murray Grey calves in Australia. Signs are observed first when affected calves are 3 to 8 weeks old. Both sexes are affected. Signs include poor growth, exercise intolerance, progressive weakness, severe jaundice, and death. There is a severe regenerative anemia, hemoglobin levels of 25 to 30 g/L,

and an absolute nucleated erythrocyte count of 9 to 18 × 10<sup>6</sup>.

Necropsy lesions include jaundice; a grossly enlarged and, in some cases, misshapen and greenish liver; and brown urine. Histologic lesions are suggestive of a persistent intravascular hemolysis. A series of cases of hemolytic anemia of undetermined origin, recorded in a familial pattern in horses, was characterized by high blood levels of methemoglobin.

## REFERENCE

1. Kessell AE, et al. *Aust Vet J*. 2012;90:499.

## PORPHYRIAS

Porphyria is not common in farm animals.<sup>1</sup> The congenital disease in cattle occurs in breeds including longhorns, Holstein, Limousin, and Blonde d'Aquitane and manifests in calves as ill-thrift and pink-discolored teeth.<sup>2</sup> Affected calves often have photosensitization, but serum activity of liver-derived enzymes (such as GGT or GLDH) and serum concentrations of bilirubin are within the normal range. Postmortem findings include brown discoloration of bone, which fluoresces under ultraviolet light. Plasma porphyrin concentrations might not be increased over levels in healthy calves, whereas urine concentrations of porphyrin, expressed as a ratio to urine creatinine concentration, are increased, as are concentrations of porphyrin in feces. The cause in some cases is a genetic mutation affecting activity of the enzyme uroporphyrinogen III synthase, which mediates the fourth step in heme biosynthesis in Holstein cattle,<sup>3</sup> and in Limousin cattle the abnormality is in the mitochondrial ferrochelatase gene.<sup>4</sup>

## REFERENCES

1. Agerholm JS. *APMIS*. 2007;115:76.
2. Huxley JN, et al. *Vet Rec*. 2009;165:694.
3. Agerholm JS, et al. *Anim Genet*. 2012;43:210.
4. Black A, et al. *Surveillance (Wellington)*. 2011;38:10.

## INHERITED CONGENITAL PORPHYRIA

### SYNOPSIS

A congenital defect of porphyrin metabolism in cattle and swine characterized by excessive excretion of porphyrins in urine and feces and deposition of porphyrins in tissues, especially bones and teeth. Photosensitization occurs in affected cattle.

## ETIOLOGY

Congenital porphyria is similar to erythropoietic or Gunther's porphyria of humans. Most cases in cattle are a result of the inheritance of a single recessive factor, heterozygotes being clinically normal. A deficiency of uroporphyrinogen III cosynthetase results in

the accumulation of porphyrin type I isomers. Although there is no strict sex linkage in the mode of inheritance, the incidence is higher in females than in males. In pigs the pattern of inheritance is uncertain but may be a result of one or more dominant genes.

## EPIDEMIOLOGY

**Porphyria** is recorded only in cattle and pigs. Shorthorn, Holstein, Black and White Danish, Jamaica Red and Black cattle, and Ayrshires carry the defect.

There are no serious losses except that affected cattle suffer from incapacitating photosensitization when exposed to sunlight and must be kept indoors. In countries where sunlight hours are limited the disease may go unnoticed. Affected pigs appear to suffer little harm. Porphyria is of little economic importance because of its rarity.

## PATHOGENESIS

The porphyrins are natural pigments, but in these diseases they are present in larger-than-normal concentrations in the blood, urine, and feces. In porphyria the metabolic defect is one of abnormal synthesis of heme resulting from an enzymatic insufficiency at the stage of conversion of pyrrole groups to series 3 porphyrins. Excess series 1 porphyrins, physiologically inactive substances, are produced as a result, and there is flooding of the tissues with these coloring and photosensitizing substances. The high tissue levels of porphyrins sensitize the skin to light, and photosensitive dermatitis follows.

## CLINICAL FINDINGS

In **cattle**, the passage of amber to port-wine-colored urine, a pink to brown discoloration of the teeth and bones, and severe photosensitization are characteristic. Additional signs include pallor of the mucosae and retardation of growth.

Affected **pigs** are usually normal, and photosensitivity does not occur, but the disease can be recognized by the red-brown discoloration of the bones and teeth, which is present even in the newborn.

## CLINICAL PATHOLOGY

In porphyria the urine is amber to port wine in color when voided because of the high content of porphyrins. The urine of affected cattle may contain 500 to 1000 µg/dL of uroporphyrins and 356 to 1530 µg/dL of coproporphyrins. The urine of normal cattle contains 1.84 µg/dL of coproporphyrins and no significant quantity of uroporphyrins. The color of the urine darkens to brown on exposure to light. Spectroscopic examination is necessary to identify the pigment as porphyrin. Erythrocyte survival time is reduced considerably. Macrocytic, normochromic anemia occurs, and its severity appears to be related to the level of uroporphyrins in the erythrocytes, and there is evidence of a hemolytic anemia. Cattle with the highest

erythrocyte uroporphyrin levels are also the most sensitive to sunlight.

### NECROPSY FINDINGS

In porphyric animals the teeth and bones are stained brown or reddish purple, with the pigment occurring chiefly in the dentine in teeth and often in concentric layers in the bones. Affected bones and teeth show a red fluorescence under illumination with ultraviolet light. The histologic findings are unique to this disease.

#### DIFFERENTIAL DIAGNOSIS

Confirmation of the diagnosis depends on identification of greatly increased levels of porphyrins in the blood and urine. Presumed affected cattle and pigs can be detected at birth by the discoloration of the teeth. Breeding trials are necessary to detect heterozygous, normal carrier animals.

#### Differential diagnosis list:

Other causes of photosensitive dermatitis

### TREATMENT

Nonspecific treatment for photosensitization may be necessary. Affected cattle should be reared indoors.

### CONTROL

Elimination of affected carrier animals from the breeding program is the only measure available. Periodic examination of the urine and feces for excessive quantities of coproporphyrin is carried out on bulls used for artificial insemination in breeds in which the disease occurs.

### INHERITED ERYTHROCYTIC PHOTOPORPHYRIA

Inherited erythrocytic protoporphyria is an autosomal-recessive disease that occurs in Limousin, Holstein and Blonde d'Aquitaine cattle.<sup>1,2</sup> It is similar to the same disease in humans and to porphyria but is milder. There is deficient activity of the enzyme ferrochelatase<sup>1</sup> or uroporphyrinogen III synthase,<sup>2</sup> resulting in excessive photosensitizing protoporphyrin accumulation, with high levels appearing in the erythrocytes and feces. The total amount of the enzyme is normal, but up to 96% of it is nonfunctional.

Protoporphyria is clinically differentiated from porphyria by the absence of anemia and discoloration of the teeth and urine. The major clinical abnormality is photosensitive dermatitis affecting particularly the tips of the ears and the edges of the nostrils. There may be intense pruritus and exudative dermatitis involving the head and upper aspect of the thorax. The hematocrit values are within normal ranges, the teeth are normochromic, and there is no fluorescence of urine; however, whole blood fluoresces under ultraviolet light. Protoporphyrin binds to

proteins that are not excreted by the kidney, and thus protoporphyrin will not be detected in the urine. In a Limousin calf, the disease was characterized by ataxia and intermittent seizures. At necropsy there is hepatic portal fibrosis, bile ductule hyperplasia, and swelling of parenchyma cells. Phagocytic cells in the dermis contain large heterogeneous lysosomes. Histologically, in some cases, the earliest lesions are moderate to severe acanthosis, hyperkeratosis, and parakeratosis with dermal angiofibroplasia. There may be intercellular edema and intraepithelial vesicles and pustules. Elimination of affected carrier animals from the breeding program is the only control measure available.

#### REFERENCES

1. Black A, et al. *Surveillance (Wellington)*. 2011;38:10.
2. Agerholm JS, et al. *Anim Genet*. 2012;43:210.

## Inherited Immunodeficiency

### BOVINE LEUKOCYTE ADHESION DEFICIENCY

Bovine leukocyte adhesion deficiency (BLAD), a granulocytopenia, is inherited as an autosomal-recessive trait in Holstein-Friesian cattle. Homozygotes are not viable because of their low resistance to infection. Heterozygotes are unaffected. Signs are first observed between 2 weeks and 8 months and are characterized in most cases by bouts of infectious disease (e.g., persistent fever), diarrhea, cough, dyspnea, delayed wound healing, and stunted growth. Some cases exhibit a striking periodontal gingivitis with marked retraction of the gingiva and severe resorption of mandibular bone causing premature teeth loss. In a small proportion of cases the signs are limited to unthriftiness. Severe ulcers on oral mucosa, severe periodontitis, loss of teeth, chronic pneumonia, and recurrent or chronic diarrhea are common.

The clinical pathology is characterized by a severe and persistent neutrophilia, without a left shift, and a significantly increased cellularity of bone marrow. At necropsy there are very large numbers of intravascular neutrophils in all tissues, especially the spleen, but not in infected tissues, which may include bronchopneumonia, pseudomembranous or necrotizing enteritis, and granulomatous gingivitis. Intestinal ulcers are an essential part of the pathogenesis of the disease in chronically affected animals that receive intensive medical care. Affected animals are stunted and unlikely to live as long as 2 years.

The gene frequency is widespread in the Holstein-Friesian breed. The genetic basis for the disease is a single point mutation in the gene coding for CD18, a subunit of the beta integrins, surface glycoproteins that are important to cell adhesion processes, causing a deficiency of adhesion on the surface of

leukocytes. Neutrophils from BLAD cattle have impaired expression of  $\beta_2$  integrin (CD11a, b, c/CD 18) of the leukocyte adhesion molecule. The biochemical basis for the disease is a deficiency of interaction between receptors on the leukocytes with adhesion glycoproteins in the mediation of immunologic functions. A PCR test is available for the detection of heterozygotes, and eradication programs are in operation in Japan and the United States. Heterozygotes have poorer feed utilization and growth rates than non-carriers of the inheritance. Control of BLAD in Holstein cattle requires publishing the genotypes and avoiding the mating between BLAD carriers, which is successful. Heterozygote calves are not affected.

### CHEDIAK-HIGASHI SYNDROME

Chediak-Higashi syndrome, an inherited disease, occurs in humans, in mink, and in Hereford, Japanese Black, and Brangus cattle, and possibly other breeds of cattle. Clinically affected animals grow poorly; they are incomplete albinos with generalized oculocutaneous hypopigmentation (e.g., pale gray hair, ocular iridal and fundic hypopigmentation, photophobia and lacrimation); have anemia and enlarged, edematous lymph nodes; and have a defect in immune defense mechanisms, as a result of which they often die of septicemia. Their average life span is about 1 year. The immunologic defect has been identified as one of insufficient bactericidal activity within abnormal leukocytes. The clinical, morphologic, and biochemical characteristics of Chediak-Higashi syndrome in Japanese cattle have been described.

A mutation in the Chediak-Higashi 1/LST gene is likely responsible for the disease in Japanese Black cattle.<sup>1</sup> The LYST gene responsible for the mutation has been cloned.

The disease is readily diagnosed by the detection of anomalous enlarged cytoplasmic granules in neutrophils, lymphocytes, monocytes, and eosinophils. The granules are swollen lysosomes, and the disease is a lysosomal storage disease. There is also a defect in blood clotting, and this has been identified as a metabolic defect within structurally abnormal platelets.<sup>2,3</sup> The platelets have a storage pool deficiency of dense granules and produce much less serotonin, ATP, and ADP than normal platelets. The platelets also fail to aggregate normally in response to the presence of collagen. The disease is conditioned by a factor inherited as a single autosomal-recessive character.

A DNA diagnostic system using allele-specific PCR for detection of the nucleotide substitution has been developed as an effective DNA diagnostic aid.

#### REFERENCES

1. Abdeen A, et al. *J Vet Med Sci*. 2013;75:1237.
2. Boudreaux MK. *J Vet Emerg Crit Care*. 2012;22:30.
3. Boudreaux MK. *JAVMA*. 2008;233:1251.

## INHERITED DEFICIENCY OF LYMPHOCYTE MATURATION (LETHAL TRAIT A46, PARAKERATOSIS, ADEMA DISEASE)

Inherited deficiency of lymphocyte maturation is recorded in Black Pied Danish cattle but probably occurs in a number of European breeds of cattle, including Friesian-type cattle, and in beef Shorthorn calves in the United States. It is a defect of lymphocyte maturation and is inherited as an autosomal-recessive character.

Calves are normal at birth, and signs appear at 4 to 8 weeks of age; untreated animals die at about 4 months of age. There is exanthema and loss of hair, especially on the legs; parakeratosis in the form of scales or thick crusts around the mouth and eyes, under the jaw, and on the neck and legs; and a very poor growth rate. Lymphocyte numbers and function are reduced when the patient is in a zinc-deficient state, and antibody responses are suppressed.

At necropsy the characteristic skin lesion is acanthosis and hyperkeratosis, and there is atrophy of the thymus, spleen, lymph nodes, and gut-associated lymphoid tissue.

There is a significant response to oral treatment with zinc (0.5 g zinc oxide/day), and an apparently complete recovery can be achieved in a few weeks if treatment is continued. The disease reappears if treatment is stopped. The dose rate needs to be increased as body weight increases. It is thought that the disease is an inherited excessive requirement for zinc and that the thymic hypoplasia is a result of the dietary deficiency. Absorption studies with radioactive zinc have shown that there is impaired absorption of the element.

## FELL PONY AND DALE PONY FOAL IMMUNODEFICIENCY SYNDROME

Fell pony immunodeficiency syndrome is a familial disease of Fell ponies characterized by immunodeficiency caused by B-cell lymphopenia, anemia, opportunistic infection, and death at 2 to 3 months of age.<sup>1</sup> The same disease occurs in Dale pony foals.<sup>2</sup>

### ETIOLOGY

The disease is caused by a mutation on chromosome (ECA) 26 associated with two single-nucleotide polymorphisms (SNPs). The mutation is in the sodium/myo-inositol cotransporter gene (SLC5A3), which causes a P446L substitution in the protein.<sup>3</sup> This gene plays a crucial role in the regulatory response to osmotic stress that is essential in many tissues, including lymphoid tissues, and during early embryonic development. The amino acid substitution alters the function of SLC5A3, leading to erythropoiesis failure and compromise of the immune system.

### EPIDEMIOLOGY

The disease is restricted to Fell and Dale pony foals less than 3 months of age.<sup>1,2</sup> Population screening identified the causative mutation in colored ponies and Fell and Dale ponies, but not in other pony breeds or in horses.<sup>4</sup>

The disease is reported in this breed in the United Kingdom, the United States (which has a total population of Fell ponies of < 200), the Czech Republic, the Netherlands, and Germany.<sup>5-7</sup> The frequency of the disease is not reported. The case-fatality rate is 100%.

### PATHOGENESIS

There is immunodeficiency associated with low concentrations of immunoglobulins in serum and B lymphocytes in blood. T lymphocytes are present in normal concentration and respond appropriately to in vitro proliferation tests. Death is coincident with declines in concentrations of antibodies derived from colostrum. Immunodeficiency results in development of opportunistic infections, including glossitis, adenoviral pneumonia, and cryptosporidial diarrhea. Aplastic anemia develops and can contribute to death. Anemia is associated with aplasia of red cell series in bone marrow and is not a result of hemolysis or blood loss.

Failure of erythropoiesis and development of B-cell lymphopenia, and consequent hypogammaglobulinemia, occurs after birth; foals are not anemic and do not have depleted B cells at birth, and fetal red cell and B-cell hematopoiesis appears to be normal.<sup>1</sup>

### CLINICAL FINDINGS

Affected foals are lethargic at birth, are unable to keep up with the herd, and do not establish a strong bond with the dam. Foals develop ill-thrift, exercise intolerance, and diarrhea beginning at approximately 3 weeks of age. Clinical signs are attributable to anemia and opportunistic infections. At the time that foals develop other clinical abnormalities they are pyrexemic and tachypneic. Most foals have bilateral mucopurulent nasal discharge and abnormal lung sounds consistent with pneumonia. The tongue is covered by a pseudomembranous, hyperkeratotic membrane suggestive of *Candida* spp. infection. Foals develop diarrhea and progressive illness, with death occurring by 3 to 4 months of age even in cases treated aggressively.

### CLINICAL PATHOLOGY

The underlying hematology and serum biochemistry are influenced by the opportunistic infections that develop in all foals affected with Fell pony syndrome. Abnormalities consistently associated with the disease include anemia, B-cell lymphopenia, and variable to low concentrations of immunoglobulins in serum. It is important to note that these abnormalities are not present at

birth and develop during the first weeks to months of life.<sup>1</sup>

Normocytic, normochromic anemia (6% to 26%, 6 to -26 L/L) is present in almost all affected foals. There is no evidence of regeneration in the blood, and examination of bone marrow reveals an elevated myeloid:erythroid ratio (21:1 to 62:1, reference values 0.5:1 to 1.5:1). There is no evidence of hemolysis.

White blood cell concentration in affected foals is usually below or in the lower range of the reference range of normal, age-matched foals and is attributable to a B-cell lymphopenia. Concentrations of CD4+ and CD8+ cells in blood are normal in affected foals. The concentration of neutrophils is often elevated in affected foals.

Concentrations of immunoglobulins (IgG, IgG<sub>1</sub>, IgG<sub>2</sub>, and IgM) in serum are variable and depend on the amount of immunoglobulin ingested in colostrum and the age of the foal. Affected foals are unable to produce immunoglobulins and therefore have declining concentrations of immunoglobulins with age. Serum concentrations of IgM and IgA become undetectable before IgG does—a consequence of the shorter half-life of the former immunoglobulins in foals. Measurement of low to undetectable concentrations of IgM at greater than 4 weeks of age provides a reasonable means of diagnosing the disease.

### NECROPSY FINDINGS

Gross lesions include pale bone marrow, small thymus and lymph nodes, pneumonia, and pseudomembranous glossitis. The underlying disease is characterized by lesions in bone marrow and lymphoid tissue. Bone marrow has evidence of abnormal hemopoiesis, with an elevated myeloid:erythroid ratio. Lymph nodes have sparse to moderate numbers of lymphocytes in cortices and paracortices. The thymus has no clear demarcation of cortex and medulla, and the thymic lobules are small. Germinal centers are not present in the spleen, and the red pulp is markedly contracted and contains siderophages. Ganglionopathy reported in foals in the original report of the disease has not been found in subsequent cases.

### DIFFERENTIAL DIAGNOSIS

The differential diagnosis of immunodeficiency in foals is provided in Table 11-7.

### CONFIRMATION OF DIAGNOSIS

The disease is confirmed by presence of characteristic lesions at necropsy. Antemortem diagnosis is confounded by the presence of opportunistic infections but should be suspected in any Fell pony foal with anemia, ill-thrift, and declining serum concentrations of immunoglobulin. Affected foals have two copies of the mutated gene, whereas



unaffected carriers have one copy (are heterozygotes).<sup>4</sup>

## TREATMENT

There is no effective treatment. Supportive treatment consisting of transfusions of blood or plasma and administration of antibiotics does not affect the eventual outcome of the disease.

## CONTROL

The principles of control are as follows:<sup>4,8</sup>

- The genetic test can be used to unambiguously and quickly determine whether a foal has this immunodeficiency syndrome. Affected foals will have two copies of the mutation to the SLC5A3 gene.
- The genetic test can be used to detect carriers of the disease gene. These individuals are normal and healthy but have the potential to produce affected offspring and normal offspring. These horses will have one copy of the SLC5A3 mutation.
- The frequency of the disease gene will decrease over time without adversely affecting the extent of genetic variation in the population if carriers are not mated with carriers, allowing the eventual elimination of the disease

Use of these control measures appears to have resulted in a reduction in the incidence of the disease in Fell and Dale pony foals.<sup>9</sup>

## REFERENCES

1. Tallmadge RL, et al. *Clin Vaccine Immunol.* 2012;19:1054.
2. Fox-Clipsham L, et al. *Vet Rec.* 2009;165:289.
3. Fox-Clipsham LY, et al. *PLoS Genet.* 2011;7.
4. Fox-Clipsham LY, et al. *Vet Rec.* 2011;169:655.
5. May A, et al. *Pferdeheilkunde.* 2011;27:507.
6. Gardner RB, et al. *J Vet Int Med.* 2006;20:198.
7. Butler CM, et al. *Pferdeheilkunde.* 2006;22:478.
8. Bailey E. *Vet Rec.* 2011;169:653.
9. Carter SD, et al. *Vet Rec.* 2013;172.

## INHERITED DEFICIENCY OF IMMUNOGLOBULIN SYNTHESIS

An inherited complete deficiency of IgG<sub>2</sub> occurs in Red Danish cattle at a low level of incidence. Affected animals are unusually susceptible to severe infections, including gangrenous mastitis and pneumonia.

## INHERITED COMBINED IMMUNODEFICIENCY IN FOALS OF ARABIAN BREEDING

### SYNOPSIS

**Etiology** Inherited immunodeficiency in foals of Arabian parentage caused by a mutation in the gene coding for DNA-protein kinase catalytic subunit.

**Epidemiology** Familial pattern of occurrence with autosomal-recessive inheritance. Approximately 8% of Arabian horses are heterozygous for the mutation (carriers). Random mating results in approximately 1 in 600 foals being affected, but not all matings are random, and the incidence of the disease is less than this number.

**Clinical findings** Foals normal at birth but succumb to systemic infection soon after birth and die before 3 months of age. Death from acute septicemia or recurrent or chronic continuous infection, usually of respiratory tract. Poor response to normally effective antibiotic therapy.

**Clinical pathology** Lymphopenia, hypogammaglobulinemia. Polymerase chain reaction (PCR) test detects animals heterozygous (carriers, parents of affected foals) or homozygous (affected foals) for the mutated gene.

**Necropsy findings** Thymic, lymph node, and splenic hypoplasia and a marked reduction in the numbers of splenic and lymph node lymphocytes.

**Diagnostic confirmation.** PCR detection of mutated gene (homozygous in affected foals). Lymphopenia and agammaglobulinemia in a foal of Arabian breeding.

**Treatment** None.

**Control** Genetic testing and eventual elimination of the mutated gene by not breeding carrier animals. The disease can be prevented by not breeding a carrier animal to another carrier. Testing results in a decline in frequency of the abnormal gene in the population of horses.

## ETIOLOGY

The fundamental defect in inherited combined immunodeficiency (CID) is a 5-base-pair deletion in the specific gene that codes for DNA-dependent protein kinase. The gene is located on chromosome ECA9. This mutation causes a lack of activity of the catalytic subunit of DNA-dependent protein kinase. The deficiency of protein kinase activity, which is absolute in affected foals, results in the inability to join DNA strands that have been broken as part of the normal process of creation of V (variable) regions of T-cell and B-cell antigen receptors on lymphocytes. Without these receptors the lymphocytes are unable to respond to antigens, and thus the foal is not capable of mounting adaptive, either cellular or humoral (antibody), immune responses.

## EPIDEMIOLOGY

The immunodeficiency is inherited as an autosomal-recessive defect. The disease occurs in purebred and part-Arabian horses. It has also occurred in an Appaloosa foal that had an Arab stallion in the fifth past generation of its mother's pedigree. In one survey of Arabian foals in the United States, the

prevalence rate of affected foals was 2.3% of 257 foals of Arabian breeding, and 25.7% of the parents of affected foals were estimated to be carriers of the genetic defect. However, this likely represents an overestimation of the incidence of the disease and prevalence of the mutation in the population of Arabian horses because of selective testing. The frequency of carriers of the mutation for severe combined immunodeficiency is approximately 8%, with an estimated 0.2% (1 in 600) of foals of random matings between Arabian horses affected with the disease, based on a survey of 250 horses. Approximately 17% of Arabian horses were heterozygous for the mutation, and 0.3% of foals were homozygous, among the more than 6000 horses tested by a commercial laboratory. The frequency of occurrence of the allele (heterozygous) in Arabian horses in South Africa declined from 6.4% of those tested in 2004/2005, the first year that the test was offered, to 3.4% in 2009/2010, indicating the effectiveness of a program of education of owners and availability of testing for carriers.<sup>1</sup> The importance of the effect of even a small number of heterozygous stallions on frequency of the disease, or of the abnormal allele, is indicated by data from Morocco that identified the source of the mutant gene as three affected stallions.<sup>2</sup>

Affected foals usually appear normal at birth but are highly susceptible to infections from 2 to 65 days after birth and usually die of one or more infections by 3 months of age. The sires and dams of affected foals are clinically normal and have normal lymphocyte counts and serum immunoglobulin concentrations.

Severe combined immunodeficiency occurred in a Caspian filly. Clinicopathologic testing confirmed the nature of the disease and immunodeficiency, but genomic testing to identify the underlying genetic cause was not performed.<sup>3</sup>

A similar naturally occurring disease is reported in pigs.<sup>4</sup>

## PATHOGENESIS

Affected foals are born with a combined immunodeficiency associated with a deficiency in both B lymphocytes (which produce immunoglobulins) and T lymphocytes (which provide cellular immunity). There is a marked lymphopenia and failure of immunoglobulin (Ig) synthesis and absence of delayed hypersensitivity of skin responses. Foals that receive immunoglobulins from the dam's colostrum derive passive immunity and can survive for as long as 4 months. Foals that do not receive colostrum die much earlier. The cause of death is infectious disease.

Affected foals are susceptible to infections of all kinds, but mostly of the respiratory tract. Adenoviral pneumonia is considered to be the most common secondary complication, probably because adenovirus infection

is so widespread in the horse population. Affected foals may also die of hepatitis, enteritis, or infection of other organs without pulmonary involvement. Although adenoviral pneumonia is the most common complication, infections with bacteria and *Pneumocystis carinii* also occur. *Cryptosporidium* spp. have also been recorded in a number of foals with diarrhea, which is also a common complication.

### CLINICAL FINDINGS

Affected foals usually become ill from 10 to 35 days of age. Commonly there is a history suggesting a mild disease of the respiratory tract, especially the appearance of a bilateral nasal discharge, which often becomes sufficiently thick to interfere with sucking. The foal is unthrifty, is lethargic, and tires easily but still nurses and eats solid feed. A deep dry cough and a serous to mucopurulent ocular and nasal discharge are common when pneumonia is present. There is moderate fever (39.5°C; 103°F) and an increase in the heart and respiratory rates. The depth of respirations is increased and a double expiratory effort is common. On auscultation, loud bronchial tones and moist and dry crackles are common over the anterior ventral aspects of both lungs. Chronic diarrhea is present in some foals, and alopecia and dermatitis, commonly associated with an infection by *Dermatophilus congolensis*, also occur. An important clinical feature is that affected foals do not respond favorably to treatment with antimicrobial agents. The course of the illness will vary from a few days to a few weeks and probably depends on the degree of immunodeficiency and the nature of the infection. Most affected foals become progressively worse over a period of 2 to 4 weeks, and death by 3 months of age is the usual outcome.

### CLINICAL PATHOLOGY

Lymphopenia is a constant finding, with counts often less than 1000/mL, and there is a concurrent hypogammaglobulinemia in foals that have not received colostrum. There is no IgM in precolostral serum of the foal. Following ingestion of colostrum, all subclasses of immunoglobulin will be present, but in affected foals the level of IgM will steadily decrease weekly until at about 36 days when IgM is detectable. The lack of IgM is because of lack of synthesis and the shorter half-life of this isotype of immunoglobulin in foals—serum IgG concentrations decline more slowly. Until the development of the PCR test for detection of homozygous foals and confirmation of the disease, the measurement of serum Ig concentrations was considered essential for a definitive diagnosis. Additional tests include enumeration of B-lymphocyte and T-lymphocyte responses to phytolectin stimulation and other tests of lymphocytic immunologic function, but these tests are no longer required for diagnostic confirmation of the disease.

### NECROPSY FINDINGS

The lymph nodes are small, and splenic follicles are not visible. A viral interstitial pneumonia and a secondary bacterial bronchopneumonia are common. The thymus gland is usually hypoplastic. Histologically the lymph nodes and spleen are depleted of lymphocytes, and germinal centers are absent. In some foals there are foci of necrosis of the intestinal epithelium but with minimal infiltration of inflammatory cells. Inclusion bodies of adenovirus may be present in the cells of several different body systems. Additional histologic findings include a severe adenoviral pancreatitis and adenitis of the salivary glands.

### DIFFERENTIAL DIAGNOSIS

Diagnostic confirmation in an apparently chronic case of pneumonia in a young foal depends on the identification of the characteristic lymphopenia.

The differential diagnosis list includes the following:

- Septicemia and pneumonia of foals, caused by *Rhodococcus equi*
- Agammaglobulinemia or hypogammaglobulinemia resulting from failure of transfer of maternal immunoglobulins from colostrum—in many foal populations as many as 20% of foals are immunodeficient for this reason
- Other immunodeficiencies (Table 11-7)—foals with these deficits are very susceptible to a variety of infectious diseases and are usually chronically ill, most often with respiratory infections. However, because they have partial protection, they survive, and their life span is much longer than that of foals with CID, usually over 1 year and often 18 months. Hematologically the foal is normal unless an infection is in process, but electrophoretic examination usually reveals a marked deficiency of betaglobulins. Further tests are needed to identify the exact deficiency. A radioimmunodiffusion assay is used to quantitate serum immunoglobulins—IgA and IgM levels are usually at negligible levels, but IgG levels are discernible, although diminished. An intradermal test by injection of phytohemagglutinin determines T-lymphocyte status; a normal response is migration of mononuclear cells.
- An isoimmune neonatal leukopenia can cause immune deficiency in foals; antibodies to the sire's lymphocytes are detectable in the mare's serum.
- Neonatal septicemias

### TREATMENT

There is no satisfactory treatment for CID in foals. Hyperimmune serum, whole-blood transfusions, and broad-spectrum antibiotics are all used, but without more than a

temporary response. Affected foals may be kept alive by twice-weekly injections of hyperimmune serum and a constant antibiotic cover. Immunotherapy using a transplant of bone marrow and a fetal thymus transplant has been attempted without success. Corticosteroids are contraindicated.

### CONTROL

Horses heterozygous for the mutation can be detected using a commercial PCR assay. These horses have normal serum immunoglobulin concentrations and lymphocyte counts. Detection of heterozygous animals, which is required by some national breed organizations, is useful for several reasons. First, it should, ideally, permit elimination of the disease from the population by breeding of only homozygous normal animals. However, this approach has not met with success because of the financial and emotional value of some heterozygous animals. Second, identification of the status of an animal permits controlled breeding such that the risk of producing homozygous affected foals is eliminated. This is achieved by mating only pairs of homozygous normal animals, in which case none of the offspring will carry the mutated gene, or by mating a heterozygous animal with a homozygous normal animal. In this instance 1 in 4 of the progeny will carry the mutated gene, but none of the progeny will be homozygous for the mutated gene and therefore afflicted with the disease. This second approach, if applied consistently, should almost eliminate the disease. The effectiveness of a program of education of owners and availability of testing for carriers is demonstrated by the observation that frequency of occurrence of the allele (heterozygous) in Arabian horses in South Africa declined from 6.4% of those tested in 2004/2005, the first year that the test was offered, to 3.4% in 2009/2010.<sup>1</sup>

### REFERENCES

1. Tarr CJ, et al. *Equine Vet J*. 2014;46:512.
2. Piro M, et al. *Equine Vet J*. 2008;40:590.
3. Larson J, et al. *J Vet Int Med*. 2011;25:954.
4. Ewen CL, et al. *Vet Immunol Immunopathol*. 2014;162:174.

## Diseases of Unknown Etiology

### POSTPARTURIENT HEMOGLOBINURIA IN CATTLE

#### SYNOPSIS

**Etiology** Uncertain. Dietary phosphorus deficiency, feeding cruciferous plants or sugar beet byproducts, high dietary molybdenum content, and copper deficiency have been incriminated.

**Epidemiology** Sporadic disease predominantly observed in older

high-producing dairy cows, 2 to 4 weeks after calving.

**Signs** Hemoglobinuria, inappetence, depression, reduced milk production, pallor of mucous membranes, tachycardia, dyspnea, icterus in later stages. Death may occur. Recovery takes several weeks.

**Clinical pathology** Low packed cell volume (PCV), hemoglobinemia, hemoglobinuria, regenerative anemia; frequently associated with hypophosphatemia.

**Necropsy findings** Icterus, hepatomegaly, red urine in bladder.

**Diagnostic confirmation** Low PCV, hemoglobinuria.

**Treatment** Whole-blood transfusion. Phosphate salts intravenously and orally.

**Control** Ensure adequate intake of dietary phosphorus and copper.

## ETIOLOGY

The etiology of postparturient hemoglobinuria (PPH), a condition that is characterized by peracute and severe intravascular hemolysis occurring in older early lactating dairy cows, is still unclear. Phosphorus deficiency has been incriminated as a primary cause because hypophosphatemia is observed in many, but certainly not all, affected animals. Phosphorus deficiency in early lactation can be the result of high losses of phosphorus through the mammary gland, inadequate dietary phosphorus supply, or excessive dietary molybdenum content that hampers intestinal phosphate absorption.<sup>1,2</sup> Doubts about the role of phosphorus in the etiology of PPH have been raised because of the rare occurrence of PPH, whereas marked hypophosphatemia is common even in healthy periparturient dairy cows.<sup>2,3,4</sup> Although most studies experimentally inducing phosphorus depletion in cattle failed to reproduce clinical signs consistent with PPH, experimental induction of PPH is documented in only one single case after feeding a phosphorus deficient ration for over 30 months. Therapeutic parenteral and oral supplementation of phosphate salts yielded variable results.

The feeding of cruciferous plants and plants containing potential hemolysins such as saponins (e.g., alfalfa or sugar beet byproducts) has been associated with the disease, but many cases occur unassociated with such diets, and thus their role as a cause remains uncertain. It has been proposed that ingested hemolytic agents, some of them identified, for example, in rape, some of them not, cause erythrocyte lysis in some circumstances.

In New Zealand, one form of the disease may be related to copper- and selenium-deficient diets.

## EPIDEMIOLOGY

The occurrence of PPH is rare, and generally only individual or few animals of a herd are affected. The case-fatality rate may be as high

as 50%. Only adult cows develop the typical hemolytic syndrome, usually in the period 2 to 4 weeks after calving. High-producing dairy cows in their third to sixth lactations are most commonly affected. The disease does not commonly occur in beef cattle. Phosphorus-deficient soils, drought conditions, or rations based on sugar beet byproducts or clover are considered predisposing causes. In areas of severe phosphorus deficiency, the disease may occur at pasture, but in Europe and North America, it is more common during prolonged periods of housing.

In New Zealand, two distinct forms have been observed. In one situation, young cattle at about 2 years of age are affected with subclinical anemia of the Heinz-body type, and hypophosphatemia is not a feature. In the other, the North American type of the disease is also seen, in which older, mature, high-producing cows are affected, and hypophosphatemia is common in the affected animals and in healthy herd mates. In New Zealand, copper deficiency is considered an important etiologic factor because copper supplementation reduces the incidence of the disease in herds in marginally copper-deficient areas. The particular circumstances in which the erythrocytes of a cow become more sensitive than normal to these hemolysins include hypophosphatemia and hypocupremia, and in New Zealand possibly also selenium deficiency. However, no abnormality in copper status is present in most cases of PPH in other countries. Low levels of copper in the blood and liver of cows with the Heinz-body anemia and in the pasture grazed are also observed. The low copper status appears to be related to the application of molybdenum and lime.

The ingestion of cold water or exposure to extremely cold weather may precipitate an episode of hemoglobinuria. A similar condition accompanied by hypophosphatemia has been observed in late pregnancy in Egyptian buffalo and in the postparturient period in Indian buffalo.

## PATHOGENESIS

There is an association with hypophosphatemia and a low dietary intake of phosphorus, and it is presumed that the drain of phosphorus at the onset of lactation causes further depletion of phosphorus reserves. The dependence of mammalian red blood cells on glucose metabolism for the main source of energy for viable function and structure makes them highly vulnerable to factors inhibitory to the glycolytic pathways. Hypophosphatemia results in a decrease in red blood cell glycolysis and adenosine triphosphate (ATP) synthesis. A marked decline of the intracellular ATP concentration in red blood cells results in altered function and structure, a loss of the normal deformability of these cells, and an increase in osmotic fragility and hemolysis. The changes in the red blood cells are

irreversible, and the life span of the cells is probably diminished because they are unable to regain their previous structure and function. Copper and selenium may be important because they are commonly deficient in feedstuffs. Both copper and selenium may also provide some protection against the effects of orally acquired hemolytic agents in cruciferous plants. The clinical findings are those of acute hemolytic anemia; in fatal cases, death results from anemic anoxia.

## DIFFERENTIAL DIAGNOSIS

**Babesiosis**—can be differentiated by identifying intracellular parasites in red blood cells in a blood smear.

**Leptospirosis**—can be differentiated by determining a leptospirosis titer.

**Water intoxication** (more common in calves) and **cold water hemolytic anemia**

**Chronic copper poisoning**—can be differentiated by determining toxic levels in blood, liver, and feces

**Rape and kale poisoning**—determine access of affected animals to these plants.

**Drug induced** (e.g., large intravenous doses of oxytetracycline)

**Bacillary hemoglobinuria**—associated with *Clostridium hemolyticum* (*C. novyi* type D)

**Enzootic hematuria** (bracken fern poisoning)—can be differentiated by differentiating hemoglobinuria from hematuria and ruling out the presence of hemoglobinemia.

## CLINICAL FINDINGS

Hemoglobinuria, inappetence, and weakness develop suddenly, and there is a severe depression of the milk yield, although in some less acute cases, the cow continues to eat and milk normally for 24 hours after discoloration of the urine is evident. Dehydration develops quickly, the mucous membranes are pale, and the cardiac impulse and jugular pulse are much augmented. A moderate temperature rise (40°C; 103.5°F) often occurs. The feces are usually dry and firm. Dyspnea may be obvious, and tachycardia is common. Jaundice may be apparent in the late stages. The course of the acute disease extends from 3 to 5 days; the cow becomes weak and staggers, then finally recumbent. Death may occur within a few days. In nonfatal cases, convalescence requires about 3 weeks, and recovering animals often show pica. Ketosis commonly occurs concomitantly as a result of anorexia during the early postparturient period.

## CLINICAL PATHOLOGY

The urine is dark-reddish-brown to black in color and usually moderately turbid. No red cells are present in the urine. Blood plasma is hemolytic, and the packed cell volume,



erythrocyte counts, and hemoglobin levels are also greatly reduced. Heinz bodies may be present in erythrocytes in the New Zealand disease. Marked hypophosphatemia is a common result of the serum chemical analysis. A low copper status of the blood and liver of affected cows and the pasture grazed has been reported in some cases. In advanced stages serum hyperbilirubinemia and icterus resulting from hemoglobin breakdown are commonly seen.

### NECROPSY FINDINGS

The blood is thin, and icterus is widespread throughout the body. The liver is swollen, and fatty infiltration and degeneration are evident. Discolored urine is present in the bladder.

### TREATMENT

In severe cases of hemolytic anemia, whole-blood transfusion is indicated. A delay of 12 hours often seems to lead to an irreversible state. A minimum of 5 to 6 L of blood to an adult cow is required. This will usually suffice for up to 48 hours, by which time an additional transfusion may be necessary if the cow remains weak and the mucous membranes pale. Following successful blood transfusions, fluid therapy is recommended as both supportive therapy and to minimize the danger of hemoglobinuric nephrosis. The administration of phosphate to acutely ill animals has been proposed, but treatment outcomes are variable. Parenteral phosphate supplementation in the form of 30 g of monosodium dihydrogen phosphate ( $\text{NaH}_2\text{PO}_4$ ) dissolved in 300 mL deionized water that is administered intravenously is often recommended. Because the treatment effect of intravenous phosphate salt solutions is very short lived, the combination of this treatment with oral phosphate salt supplementation is advisable. Subcutaneous injection of the previously mentioned salt solution is discouraged because of the acidity of this solution.<sup>5</sup> Injectable solutions containing organic phosphorus compounds such as butaphosphan or toldimfos contain phosphorus in a form that is not biologically available and are therefore unsuitable for phosphorus supplementation.<sup>2,5</sup>

Oral phosphorus supplementation can effectively be achieved by drenching affected animals with 150 to 200 g  $\text{NaH}_2\text{PO}_4$  dissolved in water. Dicalcium phosphate has a much delayed effect on the plasma phosphate concentration because of its poor solubility and is therefore less suitable for rapid correction of hypophosphatemia.<sup>6</sup> Oral treatment can be repeated in 12- to 24-hour intervals. Ketosis is a common complication of the disease, and additional treatment for it may be required.

#### TREATMENT

Blood transfusion (5 to 6 L of whole blood for an adult cow) (R1)

$\text{NaH}_2\text{PO}_4$  (30 g dissolved in 300 deionized water IV for an adult cow) (R2)

Butafosfan (IM or IV) (R3)

Toldimfos (IM or IV) (R3)

$\text{NaH}_2\text{PO}_4$  (250 to 300 g PO for an adult cow q 12-24 hours for 5 days) (R2)

### CONTROL

An adequate intake of phosphorus according to the requirements for maintenance and milk production should be ensured, particularly in early lactation. A decrease in the incidence of the disease is reported after copper supplementation of cattle in a copper-deficient area.

### FURTHER READING

MacWilliams PS, et al. Postparturient hemoglobinuria: a review of the literature. *Can Vet J*. 1982;23:309-312.

### REFERENCES

1. Sing Dhillion K, et al. *Vet Rec*. 2007;160:276.
2. Grunberg W. *Proc 17. Annual Tri-State Dairy Nutrition Conference*. Ft. Wayne, IN: 2008:29-35.
3. Macrae AI, et al. *Vet Rec*. 2006;159:655-661.
4. Macrae AI, et al. *Cattle Practice*. 2012;20:120-127.
5. Gruenberg W. *Vet Clin North Am Food A*. 2013;30(2):383.
6. Gruenberg W, et al. *Br J Nutr*. 2013;110:1012-1023.

## MULTISYSTEMIC, EOSINOPHILIC, EPITHELIOTROPIC DISEASE OF HORSES

Multisystemic, eosinophilic, epitheliotropic disease of horses is characterized by eosinophilic infiltrates in a variety of tissues and organs, including the skin, lungs, liver, pancreas, biliary tree, and gastrointestinal tract.<sup>1,2</sup> Eosinophilic enterocolitis occurs either as part of the multisystemic, eosinophilic, epitheliotropic disease complex or as a lone entity.<sup>3</sup> The lone entity (focal, idiopathic eosinophilic enteritis) is discussed separately (Chapter 7).

**Multisystemic, eosinophilic, epitheliotropic disease** occurs in adult horses of any age and without apparent breed or sex predilection, although some reports suggest a predominance of younger horses that are Standardbreds or Quarter horses.<sup>1</sup> The etiology is unknown, but some cases are associated with lymphosarcoma or increased numbers of CD3-positive cells in the lesions, suggesting that the disease in these horses is a result of clonal expansion of a T-lymphocyte population that secretes interleukin-5.<sup>1,2</sup> The disease is idiopathic in most horses.

**Clinical signs** are variable and include weight loss in all cases and diarrhea and/or dermatitis in approximately two-thirds of cases. The disease is usually slowly progressive, with most affected horses having signs of the disease for more than 2 months.<sup>1</sup> Affected horses do not usually have a fever. The dermatitis occurs mainly on the face, limbs, and ventral abdomen and is exudative,

with alopecia, hyperkeratosis, and lichenification. Lesions of the coronary band and mouth are common. Urticaria occurs in some horses. Possible variations of this disease include eosinophilic pneumonia (distinct from equine multinodular pulmonary fibrosis) and eosinophilic meningoencephalitis, although these diseases do not have infiltration of eosinophils into a wide range of tissues.<sup>2,4</sup> The disease can cause pulmonary and hepatic diffuse granulomas, the former resulting in veno-occlusive remodeling and epistaxis.<sup>5</sup>

**Hyper eosinophilia** is not a consistent feature of the disease, and blood leukocyte concentrations are usually within the reference range. Most affected horses have low serum protein and albumin concentrations. There are often elevations in serum activity of gammaglutamyl transpeptidase (GGT) and alkaline phosphatase, consistent with lesions in the biliary tree. This can be useful in differentiating horses with this disease from horses with granulomatous enteritis.

**Differential diagnoses** include parasitism, both gastrointestinal (cyathostomiasis) and pulmonary (*D. arnfieldi*), other causes of protein-losing enteropathy,<sup>6</sup> eosinophilic leukemia, and pemphigus foliaceus. Diagnosis is based on demonstration of diffuse eosinophilic and lymphoplasmacytic infiltration of the skin, liver, lungs, biliary tract, and/or gastrointestinal tract. Rectal biopsy can reveal the presence of eosinophilic granulomas, but these must be differentiated from the more common eosinophilic infiltrate secondary to parasitism, and the test is likely not sufficiently specific.

**Treatment** is usually ineffective, and the prognosis for recovery is very poor. Affected horses should be administered an anthelmintic in case the disease is a result of nematodiasis. Administration of corticosteroids (dexamethasone, prednisolone) is the usual treatment but is only transiently effective in most cases. Hydroxyurea, which is used to treat a similar syndrome in people, was only transiently effective in one horse. There are no recognized control measures.

### FURTHER READING

Mair TS, Pearson GR, Divers TJ. Malabsorption syndromes in the horse. *Equine Vet Educ*. 2006;18:299-308.

Pucheu-Haston CM, Del Piero F. Equine multisystemic eosinophilic epitheliotropic disease. *Equine Vet Educ*. 2013;25:614-617.

Schumaker J, Edwards JF, Cohen ND. Chronic idiopathic inflammatory bowel disease of the horse. *J Vet Int Med*. 2000;14:258-265.

### REFERENCES

1. Bosseler L, et al. *NZ Vet J*. 2013;61:177.
2. Singh K, et al. *Vet Pathol*. 2006;43:189.
3. Proudman CJ, et al. *Equine Vet J*. 2006;38:290.
4. Loibl J, et al. *Equine Vet Educ*. 2013;25:166.
5. Horan EM, et al. *Equine Vet Educ*. 2013;25:607.
6. Mair TS, et al. *Equine Vet Educ*. 2006;18:299.

# Diseases of the Respiratory System

## PRINCIPLES OF RESPIRATORY

### INSUFFICIENCY 846

Definitions 846  
 Hypoxia 846  
 Compensatory Mechanisms 847  
 Carbon Dioxide Retention (Hypercapnia) 848  
 Respiratory Failure 848

## PRINCIPAL MANIFESTATIONS OF RESPIRATORY INSUFFICIENCY 848

Abnormalities in Rate, Depth, and Ease of Breathing 848  
 Abnormal Posture 849  
 Normal and Abnormal Breath Sounds 850  
 Respiratory Noises 852  
 Coughing 853  
 Cyanosis 853  
 Nasal Discharge 854  
 Epistaxis and Hemoptysis 854  
 Thoracic Pain 855

## SPECIAL EXAMINATION OF THE RESPIRATORY SYSTEM 855

Auscultation and Percussion 855  
 Endoscopic Examination of the Airways (Rhinolaryngoscopy, Tracheobronchoscopy) 855  
 Radiography 856  
 Magnetic Resonance Imaging 857  
 Computed Tomography 857  
 Scintigraphy (Nuclear Imaging) 858  
 Ultrasonography 858  
 Laboratory Evaluation of Respiratory Secretions 859  
 Pulmonary Function Tests 864  
 Arterial Blood Gas Analysis 865  
 Venous Blood Gas Analysis 866  
 Pulse Oximetry 866  
 Blood Lactate Concentration 867  
 Collection and Analysis of Exhaled Breath Condensate 867  
 Lung Biopsy 867  
 Respiratory Sound Spectrum Analysis 868  
 Exercise Testing 868

## PRINCIPLES OF TREATMENT AND CONTROL OF RESPIRATORY TRACT DISEASE 868

Treatment of Respiratory Disease 868  
 Control of Respiratory Disease 872

## DISEASES OF THE UPPER RESPIRATORY TRACT 874

Rhinitis 874  
 Nasal Discharge 875  
 Epistaxis and Hemoptysis 877

Pharyngitis 878  
 Laryngitis, Tracheitis, and Bronchitis 878  
 Traumatic Laryngotracheitis, Tracheal Compression, and Tracheal Collapse 879

## DISEASES OF THE LUNG PARENCHYMA 880

Pulmonary Congestion and Edema 880  
 Pulmonary Hypertension 882  
 Atelectasis 883  
 Pulmonary Hemorrhage 883  
 Pulmonary Emphysema 883  
 Pneumonia 885  
 Acute Respiratory Distress Syndrome 892  
 Aspiration Pneumonia 892  
 Drowning 893  
 Pulmonary Abscess 894

## DISEASES OF THE PLEURAL CAVITY AND DIAPHRAGM 895

Hydrothorax and Hemothorax 895  
 Pleuritis (Pleurisy) 896  
 Pneumothorax 899  
 Diaphragmatic Hernia 900

## DISEASES OF THE BOVINE RESPIRATORY TRACT 901

Enzootic Nasal Granuloma of Cattle (Bovine Atopic Rhinitis) 901  
 Tracheal Stenosis of Feedlot Cattle 902  
 Caudal Vena Caval Thrombosis (Posterior Vena Caval Thrombosis) and Embolic Pneumonia in Cattle 902  
 Cranial Vena Caval Thrombosis 903  
 Acute Undifferentiated Bovine Respiratory Disease 903  
 Pneumonic Pasteurellosis of Cattle (Shipping Fever Pneumonia) 914  
 Diseases of the Respiratory Tract Associated With *Mycoplasma* spp. 924  
 Contagious Bovine Pleuropneumonia (Lung Sickness, CBPP) 925  
*Mycoplasma bovis* Pneumonia, Polyarthritis, Mastitis, and Related Diseases of Cattle 932  
 Enzootic Pneumonia of Calves 939  
 Bovine Respiratory Syncytial Virus 946  
 Infectious Bovine Rhinotracheitis (Red Nose) and Bovine Herpesvirus-1 Infection 952

Lungworm in Cattle 961  
 Atypical Interstitial Pneumonia of Cattle (Acute Bovine Respiratory Distress Syndrome, Acute Pulmonary Emphysema and Edema) 965

## DISEASES OF THE OVINE AND CAPRINE RESPIRATORY TRACT 969

Enzootic Nasal Adenocarcinoma of Sheep and Goats (Enzootic Nasal Tumor) 969  
 Contagious Caprine Pleuropneumonia 970  
 Chronic Enzootic Pneumonia of Sheep (Chronic Nonprogressive Atypical Pneumonia, Summer Pneumonia, Proliferative Exudative Pneumonia) 972  
 Ovine Progressive Pneumonia (Maedi, Maedi-Visna) 973  
 Ovine Pulmonary Adenocarcinoma (Jaagsiekte, Pulmonary Adenomatosis) 977  
 Nasal Bots Infestation 979  
 Lungworm Infestation in Sheep and Goats 980

## DISEASES OF THE EQUINE RESPIRATORY TRACT 981

Abnormalities of the Upper Respiratory Tract of Horses 981  
 Palatal Dysfunction (Instability, Dorsal Displacement of the Soft Palate) 982  
 Diseases of the Guttural Pouches (Auditory Tube Diverticulum, Eustachian Tube Diverticulum) 984  
 Guttural Pouch Empyema 984  
 Guttural Pouch Mycosis 985  
 Guttural Pouch Tympany 987  
 Other Guttural Pouch Diseases 987  
 Diseases of the Epiglottis and Arytenoids 988  
 Recurrent Laryngeal Neuropathy (Roarers) 989  
 Equine Pleuropneumonia (Pleuritis, Pleurisy) 991  
 Acute Broncho-Interstitial Pneumonia in Foals 996  
 Chronic Interstitial Pneumonia in Foals 996  
 Interstitial Pneumonia in Adult Horses 996  
 Exercise-Induced Pulmonary Hemorrhage of Horses (Bleeders) 997

Recurrent Airway Obstruction (Heaves) 1003  
 Pasture-Associated Heaves (Pasture-Associated Recurrent Airway Obstruction of Horses) 1012  
 Synchronous Diaphragmatic Flutter in Horses (Thumps) 1013  
*Rhodococcus equi* Pneumonia of Foals 1013  
*Streptococcus zooepidemicus* Infection 1019  
 Strangles 1019  
 Glanders 1026  
 Viral Infections of the Respiratory Tract of Horses 1028  
 Equine Influenza 1029  
 Equine Rhinitis (Equine Rhinitis Virus) 1039  
 Equine Viral Rhinopneumonitis (Equine Herpesvirus-1 and -4 Infections) 1040  
 Equine Multinodular Pulmonary Fibrosis 1042

Equine Hendra Virus Infection 1043  
 Pulmonary and Systemic Aspergillosis (*Aspergillus* spp.) 1045  
 Rhinosporidiosis 1046  
 Lungworm in Horses 1047  
**DISEASES OF THE SWINE**  
**RESPIRATORY TRACT 1047**  
 Progressive Atrophic Rhinitis (Conchal Atrophy of Swine) 1047  
 Facial Necrosis (Facial Pyemia) 1054  
 Bordetella Rhinitis 1054  
 Pleuropneumonia of Pigs Associated With *Actinobacillus pleuropneumoniae* 1055  
 Mycoplasma Pneumonia (*Mycoplasma hyopneumoniae*) 1064  
 Porcine Respiratory Disease Complex and Mycoplasmal Pneumonia of Pigs 1071  
 Porcine Cytomegalic Virus (Inclusion-Body Rhinitis, Generalized Cytomegalic Inclusion-Body Disease of Swine) 1074

Swine Influenza 1075  
 Porcine Respiratory Coronavirus 1085  
 Lungworm in Pigs 1086

## RESPIRATORY SYSTEM TOXICOSES 1087

Furan (Ipomeanol and 3-Methylindole) Toxicosis 1087  
 Galegine Toxicoses 1087  
 Manure Gas Poisoning and Confinement Effects 1087  
 Plants Causing Pulmonary Disease (Unidentified Toxins) 1088

## NEOPLASTIC DISEASES OF THE RESPIRATORY TRACT 1088

Pulmonary and Pleural Neoplasms 1088

## CONGENITAL AND INHERITED DISEASES OF THE RESPIRATORY TRACT 1090

Congenital Defects 1090

## Principles of Respiratory Insufficiency

The principal function of the respiratory system is gas exchange in which oxygen is transferred from the environment to the blood and carbon dioxide is moved in the opposite direction. Other important functions include a role in thermoregulation in most species; in acid-base regulation in concert with the kidney; in functioning as an endocrine organ (e.g., angiotensin-converting enzyme); in the metabolism of metabolically active substances, including eicosanoids and nitric oxide; and in the immune response to inhaled immunogens and pathogens. Capillaries in the lungs of the farm animal species and horses also possess intravascular macrophages, which are important as a reticuloendothelial organ in the processing of antigens—an action achieved by similar cells in the liver of dogs, cats, and humans. Interference with these functions can occur in a number of ways and can have a variety of manifestations that are apparent during disease. The most readily apparent failure of the respiratory system is failure of gas exchange with resultant hypoxemia and hypercapnia. However, failure of other functions of the respiratory system can also result in clinically apparent disease.

Failure of gas exchange, and the resultant hypoxia and hypercapnia, is responsible for most of the clinical signs of respiratory disease and for respiratory failure, the terminal event of fatal cases. Death as a result of respiratory failure is attributable to hypoxia. An understanding of **hypoxia**, **hypercapnia**, and **respiratory failure** is essential to the study of clinical respiratory disease.

## DEFINITIONS

A number of terms are used to describe the function of the respiratory tract, or abnormalities that arise because of a variety of diseases. Many of these terms are described in more detail in the text that follows, but a brief definition of each is provided here:

- Hypoxia is a broad term meaning diminished availability of oxygen to tissues.
- Hypoxemia is deficient oxygenation of blood, usually assessed by measurement of blood oxygen tension, or by measurement of blood hemoglobin saturation and hemoglobin concentration, and subsequent calculation of blood oxygen content.
- Hypercapnia is an abnormally high carbon dioxide tension in blood.
- $P_{aO_2}$  is the oxygen tension (partial pressure) in arterial blood.
- $P_{AO_2}$  is the oxygen partial pressure in alveolar gas.
- $P_aCO_2$  is the carbon dioxide tension (partial pressure) in arterial blood.
- $P_ACO_2$  is the carbon dioxide partial pressure in alveolar air.
- $C_aO_2$  is the arterial oxygen content (milliliters of  $O_2$  per 100 mL of blood).
- $P_{vO_2}$  is the oxygen tension (partial pressure) in venous blood.
- $P_vCO_2$  is the carbon dioxide tension in venous blood.
- $C_vO_2$  is the venous oxygen content (milliliters of  $O_2$  per 100 mL of blood).
- Respiratory failure is the inability of an animal to maintain arterial blood

oxygenation and carbon dioxide tension within the normal range.

- Dyspnea refers to signs of respiratory distress in animals (in humans it describes the sensation of air hunger, which is a symptom and not a sign).
- Polypnea is an excessively high rate of breathing.
- Tachypnea is an excessively high rate of breathing, with the implication that the breathing is shallow.
- Hyperpnea is an increased minute ventilation.

## HYPOXIA

Failure of the tissues to receive an adequate supply of oxygen occurs in a number of ways, and the differences are clinically relevant because they are associated with failure of different organ systems and different diseases, and they have fundamentally different pathophysiologic mechanisms

### Hypoxic (or Hypoxemic) Hypoxia

Hypoxic (or hypoxemic) hypoxia occurs when there is inadequate oxygenation of blood (hypoxemia) and is usually associated with disease of the respiratory tract or other causes of hypoventilation. Situations in which there is inadequate oxygenation of blood in the lungs include hypoventilation, ventilation-perfusion mismatches, diffusion impairment, low inspired oxygen tension, and extrapulmonary right-to-left shunting.

**Hypoventilation** occurs in animals with depressed consciousness, such as occurs with general anesthesia and heavy sedation, or in newborns, in which the central respiratory drive is suppressed. **Airway obstruction**



caused by the presence of foreign bodies in the airway, luminal obstruction by masses such as retropharyngeal abscesses in horses with strangles, laryngeal spasm, or bronchoconstriction can cause inadequate alveolar ventilation and hypoxemia. Diseases that prevent adequate inflation of lungs cause alveolar hypoventilation and the consequent hypoxemia. These diseases include pneumothorax, pleural effusion, or respiratory muscle weakness, such as can occur with botulism, tick paralysis, tetanus, strychnine poisoning, or severe white muscle disease.

**Ventilation-perfusion ( $\dot{V}/\dot{Q}$ )** mismatches occur when the distribution of blood flow in the lungs does not match the distribution of alveolar ventilation, with the result that areas of lung that are well ventilated are not adequately perfused and those areas that are well perfused by blood are not well ventilated. Ventilation-perfusion mismatches are the most important cause of hypoxemia in many lung diseases, including pneumonia.

**Diffusion impairment** occurs when there is decreased transfer of oxygen from alveolar air that has a normal  $P_{A}O_2$  to red blood cells in alveolar capillaries because of increased distance of diffusion through the alveolar membranes, such as might occur with pulmonary edema; decreased surface area available for diffusion, such as occurs with positional atelectasis or pulmonary embolism; or decreased transit time of red cells through the alveolar capillaries, such as occurs in horses during heavy exercise.

**Low inspired oxygen tension** occurs naturally only in animals at high altitude. It can also occur during anesthesia if there are defects in the ventilator causing low oxygen tension in the gases delivered to the animal.

**Extrapulmonary right-to-left shunting** occurs most commonly as a vascular defect (see Ch. 10).

The actual cause of hypoxemia in an individual animal or disease is often multifactorial and not simply a result of one of the mechanisms described previously. For instance, cows placed in dorsal recumbency during general anesthesia become hypoxemic because of compression of the thorax by the abdominal viscera, thereby causing hypoventilation and compression atelectasis with diffusion impairment, ventilation-perfusion mismatching, and reduced cardiac output because of reduced venous return.

### Anemic Hypoxia

Anemic hypoxia occurs when there is a deficiency of hemoglobin per unit volume of blood (anemia). The percentage saturation of the available hemoglobin and the oxygen tension of arterial blood are normal but as a result of the low hemoglobin concentration the oxygen-carrying capacity of the blood is reduced. Anemia resulting from any cause has these characteristics. The decrease in oxygen-carrying capacity caused by a 50%

reduction in hemoglobin concentration from normal values (from 20 down to 10 g/dL) is much greater than the decrease that results from a 50% reduction in arterial oxygen tension from normal (e.g., a reduction from 100 to 50 mm Hg).

Alteration of hemoglobin to pigments, such as methemoglobin or carboxyhemoglobin, that are not capable of carrying oxygen has the same effect on oxygen content as anemia. Thus in poisoning caused by nitrite, in which hemoglobin is converted to methemoglobin, and in that caused by carbon monoxide, when the hemoglobin is converted to carboxyhemoglobin, there is hypoxia as a result of inadequate oxygenation of blood.

### Circulatory Hypoxia

Circulatory hypoxia occurs as a result of inadequate delivery of oxygen to tissue because of inadequate perfusion of tissues by blood. The blood is usually adequately oxygenated but blood flow rate to tissues is not, and therefore the rate at which it delivers oxygen to tissue is less than the amount of oxygen required to support the metabolic function of that tissue. In other words, the rate of delivery of oxygen to tissue does not match the metabolic requirements of that tissue. A common cause of this is low cardiac output, such as occurs with congestive heart failure or hypovolemic shock. It also occurs with local interruption to arterial flow, such as the thrombotic emboli of thromboembolic colic of horses or compression of vessels, such as in right displacement and torsion of the abomasum.

### Histotoxic Anoxia

Histotoxic anoxia occurs when oxygen delivery to tissue is adequate because both oxygen content of arterial blood and blood flow are appropriate, but the tissue is unable to utilize oxygen. Cyanide poisoning is the only common cause of this form of anoxia.

### Consequences of Hypoxia

Consequences of inadequate delivery of oxygen include changes in almost all body systems. The central nervous system and heart are most susceptible to the immediate and acute effects of hypoxia, whereas clinical signs related to hypoxic damage to the gastrointestinal tract and kidneys are somewhat delayed. Central nervous system hypoxia is evident as mild changes in mentation, such as depression, progressing through decreased alertness to coma and death. Cardiac changes include a reduction in the force and efficiency of contraction as a result of impaired myocardial contractility, and an increased susceptibility to arrhythmia. The kidney, gut, and liver are all metabolically active tissues and therefore susceptible to hypoxia. Renal function is reduced during hypoxia, with the renal medulla being most sensitive to decreases in oxygen delivery.

Signs of gastrointestinal dysfunction during hypoxia include ileus, abdominal pain, and abdominal distension as a result of accumulation of gas and liquid in the gastrointestinal tract. Liver dysfunction can be evident as decreases in blood glucose concentration and increases in serum activity of liver-derived enzymes (alkaline phosphatase, gamma-glutamyl transpeptidase, sorbitol (inositol) dehydrogenase), and metabolites (bile acids, bilirubin).

Some metabolically active tissues, when deprived of oxygen, use anaerobic metabolism to sustain energy supply for short periods of time (depending on the tissue, but the brain cannot survive without oxygen for more than 2-3 minutes). Use of anaerobic glycolysis for energy causes metabolic acidosis. Animals in respiratory failure therefore often have a mixed acid-base disturbance characterized by metabolic and respiratory acidosis.

## COMPENSATORY MECHANISMS

Compensation of respiratory insufficiency occurs as both short-term and long-term events. **Short-term** compensatory mechanisms for low arterial oxygen tension or oxygen delivery to tissues occur within seconds to minutes and include respiratory, cardiovascular, and behavioral responses. Stimulation of respiratory centers in the medulla oblongata by low arterial oxygen tension ( $P_{a}O_2$ ) and high arterial carbon dioxide tension ( $P_{a}CO_2$ ) causes an increase in respiratory minute volume mediated by an increase in tidal volume and respiratory frequency. Both low oxygen tension and high carbon dioxide tension in arterial blood, together or separately, are potent stimulators of these events. Inadequate tissue oxygenation also stimulates an increase in cardiac output, mainly as a result of increased heart rate and to a lesser extent by an increase in stroke volume. Splenic contraction, in those species such as the horse in which the spleen is an important reservoir of red blood cells, increases both blood volume and hemoglobin concentration, thereby increasing the oxygen-carrying capacity of blood. Hypoxemia also causes animals to attempt to decrease their oxygen requirement by decreasing physical activity, including moving and eating.

Longer-term compensatory mechanisms include an increase in erythropoietin secretion by the kidney with subsequent increases in bone marrow production of red blood cells and an increase in hemoglobin concentration in blood. This polycythemia increases the oxygen-carrying capacity of blood. Severe polycythemia, such as occurs with congenital cardiac anomalies causing chronic right-to-left shunting, increases the viscosity of blood and impairs tissue perfusion, increases the workload of the heart and the risk of thromboembolism. Longer-term

compensatory mechanisms also include changes in ventilatory pattern, such as in horses with heaves, and behavior.

### CARBON DIOXIDE RETENTION (HYPERCAPNIA)

Respiratory insufficiency results in decreased elimination of carbon dioxide and its accumulation in blood and tissues. Animals breathing room air that are hypercapnic are always hypoxemic. Increasing the oxygen tension of inspired air can alleviate the hypoxemia but, by reducing hypoxic stimulation of the respiratory center, can cause further increments in arterial  $PCO_2$ .

Acute hypercapnia causes a respiratory acidosis that reduces both blood and cerebrospinal fluid pH. The clinical signs of acute hypercapnia are initial anxiety followed by central nervous system depression and eventual coma and death. These clinical abnormalities are attributable to declines in the pH of cerebrospinal fluid (CSF), a consequence of the ease with which carbon dioxide crosses the blood–brain barrier. Decreases in CSF pH are greater for respiratory acidosis than for a similar degree of metabolic acidosis. Severe hypercapnia also causes peripheral vasodilation, which can contribute to arterial hypotension, and cardiac arrhythmia. The acid-base effects of chronic hypercapnia are compensated by renal mechanisms that return the arterial and CSF pH to almost normal and therefore do not cause more than mild clinical disease in most instances. So long as oxygen delivery to tissue is maintained, animals can tolerate quite high arterial carbon dioxide tensions for a number of days or longer; this is referred to as “permissive hypercapnia” and is sometimes an alternative to artificial or mechanical ventilation of animals with respiratory insufficiency.

### RESPIRATORY FAILURE

Respiratory movements are involuntary and are stimulated and modified by the respiratory centers in the medulla. The centers appear, at least in some species, to have spontaneous activity that is modified by afferent impulses to higher centers, including the cerebral cortex and the heat-regulating center in the hypothalamus, from the stretch receptors in the lungs via the pulmonary vagus nerves, and from the chemoreceptors in the carotid bodies. The activity of the center is also regulated directly by the pH and oxygen and carbon dioxide tensions of the cranial arterial blood supply. Stimulation of almost all afferent nerves may also cause reflex change in respiration, with stimulation of pain fibers being particularly effective.

Respiratory failure is the terminal stage of respiratory insufficiency in which the activity of the respiratory centers diminishes to the point where movements of respiratory muscles cease. Respiratory failure can be

paralytic, dyspneic or asphyxial, or tachypneic, depending on the primary disease.

The respiratory failure that occurs in animals with pneumonia, pulmonary edema, and upper respiratory tract obstruction is caused by combinations of hypoventilation, ventilation-perfusion mismatch, and diffusion impairment, which leads to hypercapnia and hypoxemia. Hypercapnia and hypoxia stimulate the respiratory center, and there is a potent respiratory drive evident as markedly increased respiratory rate and effort. As the disease progresses these changes become more marked until death occurs as a result of central nervous system or cardiac failure. Animals that die of the central nervous system effects of respiratory failure typically have dyspnea followed by periods of gasping and apnea just before death.

**Paralytic** respiratory failure is caused by depression of the respiratory centers or paralysis of the muscles of respiration. Depression of the respiratory center occurs with poisoning by respiratory center depressants, such as general anesthetics, or damage to the respiratory center, such as might occur with brainstem injury. Paralysis of respiratory muscles occurs in disease such as botulism, tetanus, strychnine poisoning, white-muscle disease, severe hypocalcemia, and tick paralysis. The signs of paralytic respiratory failure are a gradual or abrupt cessation of respiratory movements without preceding signs of increased respiratory effort or dyspnea. The animal is often unconscious, or unable to move, during the later stages of the disease.

The differentiation of these types of failure is of some importance in determining the type of treatment necessary. In the paralytic form of respiratory failure, the optimal treatment is mechanical ventilation, along with removal of the inciting cause. Administration of respiratory stimulants is seldom effective as sole therapy. The more complex pathogenesis of respiratory failure in most diseases requires a therapeutic approach that removes each of the underlying defects. In most cases this is achieved by treating the inciting disease, for example, administering antimicrobials to an animal with pneumonia or furosemide to an animal with pulmonary edema, in addition to supportive care, including, potentially, nasal or pharyngeal insufflation with oxygen or mechanical ventilation.

### Principal Manifestations of Respiratory Insufficiency

Respiratory disease is evident as one or more of a variety of signs detectable on clinical examination. The signs vary with the etiology of the disease and its anatomic location. Diseases that impair ventilation or gas

exchange have hypoxemia and hypercapnia as prominent life-threatening abnormalities. Infectious and inflammatory diseases can cause prominent clinical abnormalities as a result of a systemic inflammatory response and toxemia. The toxemia may be so severe (e.g., in calf diphtheria, aspiration pneumonia and equine pleuritis) as to cause death, even though oxygen and carbon dioxide exchange are not greatly impaired. The common signs of respiratory disease are as follows:

- Abnormalities in the rate, depth, or ease of breathing
- Lethargy or exercise intolerance
- Abnormal posture
- Abnormal lung sounds
- Abnormal respiratory noises
- Coughing
- Cyanosis
- Nasal discharge
- Epistaxis and hemoptysis.

### ABNORMALITIES IN RATE, DEPTH, AND EASE OF BREATHING

**Polypnea** is a rate of breathing that is faster than observed in clinically normal animals of the same species, breed, age, sex, and reproductive status in a similar environment.

**Tachypnea** also describes an increased rate of breathing, although with the implication that breathing is shallow (i.e., of a reduced tidal volume).

**Hyperpnea** is an abnormal increase in the rate and depth of breathing (an abnormally high minute volume), but the breathing is not labored and is not associated with signs from which one could infer represent distress on the part of the animal (i.e., the animal is not dyspneic). This assessment requires measurement of minute ventilation or arterial blood gas tensions.

**Dyspnea** is a term borrowed from human medicine, in which it refers to the *sensation* of shortness of breath or air hunger. It is used in veterinary medicine to describe labored or difficult breathing in animals that also display some signs of distress, such as anxious expression, unusual posture or stance, or unusual behavior.

Dyspnea is a physiologic occurrence after strenuous exercise and is abnormal only when it occurs at rest or with little exercise. It is usually caused by hypoxia with or without hypercapnia, arising most commonly from diseases of the respiratory tract. In pulmonary dyspnea one other factor may be of contributory importance; there may be an abnormally sensitive Hering–Breuer reflex. This is most likely to occur when there is inflammation or congestion of the lungs or pleura. Rapid, shallow breathing results.

**Expiratory dyspnea** is prolonged and forceful expiration, usually associated with

diffuse or advanced obstructive lower airway disease. The dyspnea of pulmonary emphysema is characteristically expiratory in form and is caused by anoxic anoxia and the need for forced expiration to achieve successful expulsion of the tidal air. It is commonly accompanied by an **audible expiratory grunt** in ruminants but less so in pigs and almost never in horses.

**Inspiratory dyspnea** is prolonged and forceful inspiration as a result of obstruction of the extrathoracic airways, such as with laryngeal obstruction or collapse of the cervical trachea. It may also be associated with abnormalities that restrict thoracic expansion, such as restrictive lung diseases and space-occupying lesions of the thorax. It is accompanied by a stridor or loud harsh sound on inspiration when the cause is obstruction of the extrathoracic airways, such as is typical of laryngeal or tracheal disease.

**Open-mouth breathing** is labored breathing with the mouth held open, commonly with the tongue protruded in ruminants and most commonly associated with advanced pulmonary disease or obstruction of the nasal cavities.

### DISEASES CAUSING DYSPNEA AT REST OR LACK OF EXERCISE TOLERANCE

Dyspnea, along with hypoxemia and hypercapnia, are the clinical and laboratory findings most likely to attract attention to the possible presence of disease in the respiratory system. It is most important, when attempting to differentiate diseases that cause dyspnea, to include diseases of systems other than the respiratory system that can result in dyspnea. Dyspnea at rest is usually, but not always, caused by respiratory tract disease, whereas exercise intolerance can be caused by disease in the respiratory, cardiovascular, musculoskeletal, and other body systems.

#### Respiratory Tract Disease

Respiratory tract diseases interfere with normal gas transfer, through the mechanisms discussed previously. Characteristics of respiratory disease that lead to dyspnea or lack of exercise tolerance include the following:

- **Flooding of alveoli with inflammatory cells** and/or protein-rich fluid—pneumonia and pulmonary edema
- **Atelectasis** (collapsed alveoli and small airways)—pleural effusion, hemothorax, hydrothorax, pneumothorax, chylothorax, pyothorax, prolonged recumbency of large animals, and diaphragmatic hernia
- **Airway obstruction**—nasal obstruction, pharyngeal/laryngeal obstruction, tracheal/bronchial

obstruction, bronchoconstriction, and bronchiolar obstruction.

#### Cardiovascular Disease

Cardiovascular disease causes inadequate perfusion of tissues including the lungs. There is reduced oxygen delivery to tissues, even in the presence of normal arterial oxygenation.

- **Cardiac disease.** Cardiac dyspnea results from heart failure and is multifactorial. In animals with dyspnea attributable to cardiac disease, there are other readily evident signs of heart failure.
- **Peripheral circulatory failure**—usually as a result of hypovolemic shock, although shock associated with toxemia, including endotoxemia, can cause dyspnea. There are always other prominent signs of disease.

#### Diseases of the Blood

Diseases of the blood cause inadequate delivery of oxygen to tissues because of anemia or presence of hemoglobin that is unable to carry oxygen.

- **Anemia**—an abnormally low concentration of hemoglobin
- **Altered hemoglobin**—methemoglobinemia (e.g., in nitrite poisoning of cattle, red maple toxicosis of horses), Carboxyhemoglobinemia

#### Nervous System Diseases

Diseases of the nervous system affect respiratory function by one of several mechanisms:

- **Paralysis of respiratory muscles** occurs in tick paralysis or botulism. Tetanic spasm of respiratory muscles, such as in tetanus or strychnine toxicosis, also impairs or prevents alveolar ventilation. Both flaccid and tetanic paralysis cause hypercapnia and hypoxemia and, in extreme situations, death by suffocation.
- **Paralysis of the respiratory center**, as in poisoning by nicotine sulfate, or overall central nervous system depression, causes hypoventilation because of impaired ventilatory drive.
- **Stimulation of the respiratory center**, so-called neurogenic dyspnea, occurs as a result of stimulation of the center by a small irritative lesion, such as in animals with encephalitis, or administration of drugs, such as lobeline, that increase sensitivity of the respiratory center to hypoxemia or hypercapnia.

#### Musculoskeletal Diseases

- **Muscle diseases**—diseases of the respiratory muscles can impair

ventilation. These include white-muscle disease in lambs, calves, and foals, and some congenital diseases (such as glycogen branching-enzyme deficiency in foals).

- **Fatigue**—animals with primary severe respiratory disease can develop fatigue of the respiratory muscles (intercostal, diaphragm, accessory muscles of respiration), which can further impair ventilation.
- **Trauma**—fractured ribs can impair ventilation both because of the pain of breathing and because of mechanical disruption to respiration (flail chest).

#### General Systemic States

Tachypnea can occur in a number of systemic states in which there is no lesion of the respiratory tract or nervous system. These include:

- **Pain**—such as in horses with colic
- **Hyperthermia**—as can occur with intense or strenuous exercise
- **Acidosis**—as a metabolic disturbance associated with any of a number of diseases but notably gastrointestinal disease that causes excessive loss of cationic electrolytes in feces

#### Environmental Causes

- Low inspired oxygen tension, such as in animals at high altitude
- Exposure to toxic gases.

#### Miscellaneous Poisons

A number of poisons cause dyspnea as a prominent sign, but in most cases the pathogenesis has not been identified. These poisons include the following:

- Farm chemicals, including metaldehyde and dinitrophenols (probable mechanism is stimulation of respiratory center)
- Organophosphates and carbamates (probable mechanism is alteration of pulmonary epithelium), urea (probably effective as ammonia poisoning)
- Nicotine depressing the respiratory center
- Poisonous plants, including *fast-death* factor of algae and the weeds *Albizia*, *Helenium*, *Eupatorium*, *Ipomoea*, *Taxus* spp., and *Laburnum* and ironwood (*Erythrophleum* spp.), all appear to act at least in part by central stimulation.

#### ABNORMAL POSTURE

Animals with respiratory disease, and especially those in respiratory distress, often adopt an unusual posture and are rarely recumbent except in the terminal stages of the disease. Animals in severe respiratory distress will stand with the head and neck



held low and extended. Animals, except horses, will often have open-mouthed breathing. Horses, except in extreme and unusual circumstances, are unable to breathe through the mouth because of the anatomic arrangement of the soft palate, which effectively provides an airtight barrier between the oropharynx and nasopharynx. Cattle with severe respiratory distress and open-mouthed breathing will often drool large quantities of saliva—probably a consequence of decreased frequency of swallowing as the animal labors to breathe.

The positioning of the legs is often abnormal. Severely affected animals, and those with pleuritic pain (horses or cattle with pleuritis) or severe respiratory distress, will usually stand with elbows (humeroradial joint) abducted. The animals are reluctant to move but when forced to do so can react violently. They are resistant to diagnostic or therapeutic interventions that interfere even transiently with their ability to breathe.

## NORMAL AND ABNORMAL BREATH SOUNDS

Auscultation of the lungs and air passages is the most critical of the physical examinations made of the respiratory system. The examination should be performed in as quiet an environment as possible, although it is often difficult to achieve a silent listening environment in large animal practice. The animal should be adequately restrained so that the examiner can concentrate on the lung sounds, and should not be sedated or anesthetized because of the depression in lung sounds that can occur in these instances. To be effective and diagnostically reliable, auscultation must be systematic. Both the upper and lower parts of the respiratory tract must be examined in every case. It is preferable to begin the examination by auscultating the larynx, the trachea, and the area of the tracheal bifurcation to assess the rate of airflow and the volume of air sound to be heard over the lungs.

## GENERATION OF BREATH SOUNDS

The animal must be breathing to generate lung sounds. The lung sounds are generated by movement of air in the large and mid-sized airways, including the trachea and bronchi. The greater the velocity of air in the airways, the louder the noise, explaining the loud sounds that are generated in the trachea. Air movement in the bronchioles, terminal airways, and alveoli is silent because of the large combined cross-sectional area of these airways and consequent low velocity of air movement and laminar character of the airflow. Sound is generated by turbulent airflow and the degree of turbulence is affected by the velocity of airflow and the diameter of the airway. This sound is then transmitted through the lung and chest wall

to the surface of the thorax, where it can be detected by use of a stethoscope.

Quiet breath sounds can be a result of low tidal volume with resultant low velocity of airflow or impaired transmission of sounds to the surface of the chest. Sound is transmitted most readily through dense liquids such as water. Most tissue, except fat, is approximately 70% water and transmits sounds readily. Sound is reflected at the interface of two media of markedly different densities—such as air and tissue—and less sound is transmitted. Thus in the normal lung there is marked attenuation (softening) of breath sounds because of the extensive air-tissue interfaces. This is evident by comparing the intensity of breath sounds heard over the trachea to those heard over the chest wall. However, lung sounds are more readily transmitted when areas of the lung do not contain air, such as occurs with atelectasis, pulmonary edema or infiltration of lung by inflammatory exudates. Sounds generated in the large airways are more readily transmitted through this consolidated tissue and are evident at the chest wall as louder bronchial breath sounds. The presence of bronchial breath sounds that are audible on the chest surface is dependent on the presence of a patent bronchus with airflow to generate the lung sounds and of tissue that readily transmits the sounds generated in the bronchus. Lung sounds will not be heard if they are not generated (as a result of lack of airflow in bronchi) or are muffled by extensive accumulations of fluid or fat between the lung and the chest wall. Lung sounds are reduced in animals with airflow of low velocity in large airways, such as occurs in animals with low tidal volumes, or in which there is obliteration of the bronchial lumen by fluid or tissue. Low tidal volumes occur in animals at rest or in those in which there is rapid but shallow (low tidal volume) breathing. Obliteration of the bronchial lumen occurs in many diseases, including pneumonia.

## REBREATHING (“BAGGING”) EXAMINATION

Detection of abnormal lung sounds is optimized by increasing the animal's tidal volume, and thereby the velocity of airflow in large airways. An expeditious means of temporarily increasing the animal's tidal volume is to occlude the nostrils for a brief period (30–60 seconds). When the animal is again allowed to breathe, it will take several large, deep breaths, during which lung sounds can be auscultated. However, the increase in tidal volume is transient and does not permit time for detailed auscultation of the chest. A preferred technique is to place an airtight bag over the animal's muzzle such that all the air that it inhales is contained within the bag. The volume of air in the bag should exceed the anticipated stimulated tidal volume of the animal. As a rule of thumb, the volume of the bag should be

sufficient to allow the animal a tidal volume of 10 to 15 mL of air per kilogram of body weight (BW). A 500-kg horse or cow therefore needs a bag that contains 10 L of air. Hyperventilation is stimulated by an increase in carbon dioxide content of inspired air with subsequent hypercapnia and stimulation of the respiratory center. A more refined technique has the animal inhaling gas that is 5% carbon dioxide and 95% oxygen, thereby preventing hypoxemia as a result of the examination. Rebreathing examinations (or “bagging”) are not indicated if abnormal lung sounds are detected on initial examination because the results of the rebreathing examination will not add any additional information. Animals in respiratory distress should not be subjected to a rebreathing examination because it might worsen the hypoxemia or hypercapnia already present and is inhumane. Rebreathing examinations are indicated when respiratory disease is suspected but initial auscultation of the thorax does not reveal abnormal lung sounds.

## INTERPRETATION OF BREATH SOUNDS

**Terminology** used to describe normal and abnormal lung sounds is now well established and should be used consistently so that it is a useful diagnostic aid. Associations between abnormal respiratory sounds and diseases and abnormalities of respiratory function are well established. Correct identification of lung sounds, and consistency in terms used to describe them, therefore permits greater diagnostic accuracy and provides the ability to accurately and precisely describe diseases. The identification and clinical significance of respiratory sounds are summarized in [Table 12-1](#). The clinician must carefully auscultate both the upper respiratory tract (larynx, trachea) and the entire aspects of both lung fields and interpret the sounds that are audible or not audible. The **variables that must be interpreted** include the following:

- **The nature of the sounds** (increased or decreased breath sounds, crackles or wheezes)
- **The timing of the sounds in the respiratory cycle**
- **Their anatomic location.**

The questions that should be asked are as follows:

- Are breath sounds audible?
- Are the breath sounds of normal intensity?
- Are the breath sounds normal or abnormal?
- If abnormal sounds are present, what are they (crackles, wheezes, stridor, stertor, etc.; see [Table 12-1](#))?
- Are breath sounds audible over all lung fields?

Interpretation of these variables should indicate the nature of the lesion. Examples are summarized in [Table 12-1](#). Lung sounds can

**Table 12-1** Identification and clinical significance of breath sounds

Sounds	Acoustic characteristics	Significance and examples
Normal breath sounds	Soft blowing sounds, longer and louder on inspiration than on expiration, audible over the trachea and lungs.	Normal respiratory tract
Increased audibility of breath sounds	Mild to moderate increase in loudness of breath sounds audible on inspiration and expiration over the trachea and lungs.	Any factor that increases respiratory rate or depth of respirations, including fever, excitement, exercise, high environmental temperatures, lung disease. Harsh loud breath sounds are audible over the lungs with any disease resulting in collapse or filling of alveoli and leaving bronchial lumina open; pulmonary consolidation and atelectasis.
Decreased audibility of breath sounds	Decreased audibility of breath sounds on inspiration and/or expiration over the lungs.	Obese animal, pleural effusion, space-occupying mass of lung or pleural cavity, pneumothorax, diaphragmatic hernia, occlusive (lung) airway disease as in bronchial lumen filled with exudate.
Crackles	Short duration, interrupted, nonmusical breath sounds. Coarse crackles are loud and most commonly heard over large airways in animals with pulmonary disease and may be heard during inspiration and expiration. Fine crackles are of short duration, less intense, and higher pitched.	Coarse crackles are caused by air bubbling through, and causing vibrations in, secretions in large airways. Fine crackles are caused by sudden explosive popping open of a series of airways closed during expiration. May be detected in early or late inspiration. Suggest the presence of secretions and exudate in airways and edematous bronchial mucosa as in exudative bronchopneumonia, tracheobronchitis, aspiration pneumonia, and obstructive pulmonary disease. Loud crackles may be audible in animals with interstitial pulmonary emphysema.
Wheezes	Continuous musical-type squeaking and whistling sounds audible over the lungs.	Narrowing of large airways; expiratory polyphonic wheezing common in equine reactive airway disease bronchopneumonia, any species; inspiratory monophonic wheezing occurs when upper extrathoracic airways are constricted, such as in laryngeal disease.
Pleuritic friction sounds	“Sandpaper-like” sound; grating; sound close to the surface; on inspiration and expiration; tend to be jerky and not influenced by coughing.	Pleuritis; diminish or disappear with pleural effusion.
Stridor	A harsh, high-pitched sound on inspiration audible with or without stethoscope over the larynx and trachea.	Obstruction of upper airways, especially the larynx (as a result of edema, laryngitis, paralysis of vocal cord); prime example is calf diphtheria or retropharyngeal abscessation in strangles in horses or tracheal collapse in horses.
Stertor	Snoring sound (low-pitched, coarse, and raspy) audible without a stethoscope on inspiration and expiration over the pharyngeal and laryngeal areas.	Partial obstruction of the upper respiratory tract, commonly attributable to abnormalities of soft palate and nasopharynx.
Expiratory grunting	Loud grunting on expiration, which is usually forced against a closed glottis with sudden release, audible on auscultation of the thorax, over the trachea, and often audible without the aid of a stethoscope.	Severe diffuse pulmonary emphysema; pleuropneumonia and pericarditis; extensive consolidation; in acute pleurisy and peritonitis; a groan indicating pain may occur.
Transmitted upper respiratory tract breath sounds	Abnormal tracheal breath sounds (crackles and wheezes) audible by auscultation over the extrathoracic trachea during inspiration.	Indicates presence of abnormalities of the upper respiratory tract (larynx, nasopharynx, nasal cavities, and upper trachea), resulting in accumulation of respiratory secretions causing constriction of airways. Laryngitis is an excellent example.
<b>Extraneous sounds heard on auscultation of respiratory tract</b>		
Crepitations in subcutaneous tissues	Loud superficial crackling sounds induced by movement of stethoscope over the skin.	Subcutaneous emphysema from pulmonary emphysema in cattle; trauma to any part of respiratory tract that results in penetration of airway, allowing accumulation of air subcutaneously; gas-forming bacteria in subcutaneous tissues.
Peristaltic sounds	Gurgling, grating, rumbling, squishing sounds audible over the lungs.	Gastrointestinal sounds transmitted from the abdomen: ruminal sounds in cattle; stomach and intestinal sounds in horse. Does not indicate diaphragmatic hernia unless other evidence such as an absence of breath sounds is present.

be divided into normal breath sounds and abnormal breath sounds.

**Breath sounds** are produced by air movement through the tracheobronchial tree. The terms *bronchial sounds* and *vesicular sounds* are not anatomically accurate or based on physiologic principles and should not be used. The term *breath sounds* should be used.

These are the sounds that are audible clearly over the trachea and that are attenuated over the lungs. Breath sounds are of normal, increased, or decreased intensity. Abnormally loud or soft breath sounds can be attributed to either changes in sound production in the airways by changes in flow rate or altered transmission of sound through

various normal or abnormal tissues or fluids in the thorax, as discussed previously.

### Normal Breath Sounds

Normal breath sounds vary in quality depending on where the stethoscope is placed over the respiratory tract. They are loudest over the trachea and base of the lung

and quietest over the diaphragmatic lobes of the lung. Normal breath sounds are louder on inspiration than on expiration because inspiration is active with more rapid airflow, whereas expiration is passive in normal animals and associated with lower rates of airflow. Breath sounds may be barely audible in obese animals or in the noisy surroundings common in field conditions.

**Increased loudness** of breath sounds is heard in normal animals with increased respiratory rate and depth of respiration. This can occur for physiologic reasons such as exercise, excitement or a high environmental temperature. They can also occur in abnormal states such as fever, acidosis, or pulmonary congestion in early pneumonia or myocardial disease.

**Decreased loudness** or an almost complete absence of breath sounds occurs in pleural effusion or pneumothorax because of almost complete reflection of the breath sounds at the pleural surface as a result of the mismatching of the acoustic properties of the pleural tissues and fluids. **Space-occupying masses** between the lung and the thoracic wall also cause a relative absence of breath sounds over the site as do areas of lung that are not ventilated, such as a pulmonary abscess. Thoracic auscultation is of limited value in detecting localized areas of consolidation in the lungs of calves or foals, with ultrasonographic examination having much greater sensitivity. The sensitivity of auscultation to detect lung consolidation, detected by ultrasonographic examination, in calves is only 6%.<sup>1</sup> Computer-aided lung auscultation has a reasonable sensitivity for detection of bovine respiratory disease in feedlot cattle (93%) compared with clinical examination by a veterinarian.<sup>2</sup>

**Increased loudness of breath sounds** occurs in some instances and can have diagnostic importance. The normal breath sounds heard over the trachea may sound abnormally loud over the lungs because of changes in the transmission properties of the respiratory system. This is because when sound waves pass through structures of different physical properties, the amount of sound transmitted depends on the matching of acoustic properties of the different structures. Consolidation results in less reflection of sound at the thoracic wall and consequently more transmission to the stethoscope. Thus in consolidation, the breath sounds are much louder than normal. These are harsh breath sounds that approximate those heard over the trachea. They are audible on inspiration and expiration but become louder on expiration in abnormal states such as consolidation or atelectasis. Any disease in which the bronchial lumen remains open and the surrounding lung tissue has been replaced by cells, exudate, or tissues (consolidation) that transmit sound without reflection will result in increased bronchial sounds.

### Abnormal Breath Sounds

Abnormal breath sounds include **crackles** and **wheezes**. Crackles are discontinuous sounds and wheezes are continuous sounds.

**Crackles** are abnormal lung sounds described as clicking, popping or bubbling sounds. They are caused by airways that remain closed for a portion of inspiration and then suddenly open. The crackling is caused by the sudden equalization of pressure between the proximal and distal part of the airway. Crackles may thus be caused by the presence of exudate and secretions in the airways, and edematous bronchial mucosa. Crackling lung sounds are also audible in cattle with interstitial pulmonary emphysema. Crackling sounds may move their point of maximum intensity following coughing, presumably as a result of movement of exudate.

**Wheezes** are continuous whistling, squeaking sounds caused by vibrations of airways or air passing through a narrowed airway. They can be characterized as monophonic (single tone) or polyphonic (multiple tones) and by the timing of their occurrence in the respiratory cycle. *Inspiratory* wheezing suggests obstruction of the upper airways, usually extrathoracic. *Expiratory* wheezing usually indicates intrathoracic airway obstruction, such as bronchoconstriction, with or without distal airways that are narrowed because of tenacious exudate.

**Pleuritic friction sounds** are a combination of continuous and discontinuous sounds produced by the rubbing together of inflamed parietal and visceral pleura. The sound is loud, coarse, and usually not influenced by coughing. Pleuritic friction sounds are not common, and their absence does not preclude the presence of pleuritis, particularly in the horse. Pleuritic friction rubs may also occur in cattle with severe diffuse pulmonary emphysema as the relatively dry parietal and visceral surfaces rub together during the respiratory cycle.

**Absence of lung sounds** occurs when the breath sounds are reflected at the interface between the lung and thoracic wall by the presence of a medium such as a space-occupying mass, fluid, or air. The common causes of the “silent lung” include pleural effusion; space-occupying masses of the thorax; large pulmonary abscess; complete destruction of a lobe of lung including the terminal airways, such as can occur with bronchial lumen occlusion by a foreign body or tumor; and diaphragmatic hernia.

**Extraneous sounds** are miscellaneous unexpected sounds that are occasionally audible over the thorax and include peristaltic sounds, skin and hair sounds caused by the stethoscope, crepitating sounds as a result of subcutaneous emphysema, and muscular contractions. Subcutaneous emphysema occurs in diseases in which there is leakage of air from the lungs or airways into the

subcutaneous space. This occurs with bullous lung disease in cattle, rib fractures and pneumothorax, and after percutaneous tracheal aspirate in animals that cough. Coughing in these animals causes air to be forced out of the trachea through the hole through which the tracheal aspirate was obtained. This occurs in the period of coughing when intratracheal pressures are markedly increased just before the opening of the glottis.

### RESPIRATORY NOISES

Respiration may be accompanied by audible noises that indicate certain normal or abnormal occurrences in the respiratory tract such as **sneezing, snorting, stridor, stertor or snoring, wheezing, roaring, expiratory grunting, and snuffling, bubbling, and rattling sounds**.

**Sneezing** is a sudden, involuntary, noisy expiration through the nasal cavities caused reflexively by irritation of the nasal mucosae. Sneezing occurs in rhinitis and obstruction of the nasal cavities and digital manipulation and examination of the nasal mucosae.

**Snorting** is a forceful expiration of air through the nostrils as in a sneeze, but a snort is a voluntary act used by horses and cattle as a device to intimidate potential predators.

**Stridor** is an inspiratory stenotic sound originating from a reduction in the caliber of the larynx, as occurs in laryngeal edema and abscess.

**Stertor or snoring** is a deep guttural sound on inspiration originating from vibrations of pharyngeal mucosa. Snoring is often intermittent, depending on the animal's posture. For example, a fat young bull will often snore when he is dozing half asleep, with his head hung down, but the snore will disappear when he is alert and his head is held up in a more normal position. Stertor can occur during expiration in horses with dorsal displacement of the soft palate.

**Wheezing** is a high-pitched sound made by air flowing through a narrow lumen, such as a stenotic or inflamed nasal cavity.

**Roaring** may occur during exercise and is caused by air passing through a larynx with a reduced lumen (e.g., laryngeal hemiplegia in horses).

**Expiratory grunting** is a clearly audible grunting noise synchronous with expiration. It is most common in cattle with diffuse pulmonary disease. A painful grunt may occur in painful diseases of the thorax such as fibrinous pleuritis and is unassociated with inspiration or expiration.

**Snuffling, bubbling, or rattling sounds** may be audible over the trachea or base of the lungs when there is an accumulation of secretion, or exudate, in the nasal cavities, larynx, or trachea. These are most clearly audible on inspiration.



## COUGHING

A cough is an explosive expiration of air from the lungs. It is initiated by reflex stimulation of the cough center in the medulla oblongata by irritation of sensory receptors in one of various organs, especially the respiratory tract. The stimulus may originate in the pharynx, larynx, trachea, or bronchi. Coughing may also be initiated by irritation of the esophagus, as in choking. The act of coughing consists of several stages:

- Deep inspiration followed by closure of the arytenoid cartilages (glottis)
- Compression of the air in the lungs and large increase in pressure in the thorax and airways by a forced expiratory effort against a closed glottis
- A sudden relaxation of the arytenoid adductor muscles, resulting in opening of the larynx and abrupt, vigorous, and forced expiration. Coughing in horses is associated with transient dorsal displacement of the soft palate so that material in the airways caudal to the larynx is expelled through the mouth.
- The sudden opening of the glottis allows an explosive expiration, during which the linear velocity attains a speed of several hundred kilometers per hour. The intrathoracic airways collapse after opening of the glottis during the forced expiration, whereas the extrathoracic airways are momentarily dilated.

The purpose of coughing is to remove the excess mucus, inflammatory products or foreign material from the respiratory tract distal to the larynx. An example of where impaired ability to cough reduces the capacity to clear tracheal respiratory secretions is in horses after surgical correction for recurrent laryngeal neuropathy. In this instance one side of the glottis is fixed open, thereby preventing the horse from achieving high flow rates normal associated with the explosive stage of coughing. This markedly reduces expectoration of material in the trachea.

Coughing indicates the existence of primary or secondary respiratory disease.

Coughing can be assessed according to several characteristics. Coughing is infrequent in the early stages of respiratory tract disease but can become frequent as the degree of inflammation in the larynx, trachea and bronchi becomes more severe. Assessment of the severity of coughing, at least in horses, requires prolonged observation (preferably for an hour). Coughing is a fairly specific but not very sensitive indicator of pulmonary inflammation. If coughing is detected, it is quite likely that the animal has inflammation of the airways, whereas failure to detect coughing does not reliably rule out the presence of clinically significant airway

inflammation. The severity of coughing in horses is closely linked to the severity of inflammation and accumulation of mucus in the airways. Racehorses that cough are 10 times more likely to have more than 20% neutrophils in a tracheal aspirate and more than 100 times more likely to have more than 80% neutrophils. The frequency of coughing correlates well with maximal changes in pleural pressure, extent of mucus accumulation, and proportion of neutrophils in bronchoalveolar lavage fluid of horses with heaves (recurrent airway obstruction). Coughing is therefore a specific indicator of the presence of respiratory inflammation.

The frequency of coughing is an indicator of the severity of lung disease in horses and presumably in other species. Horses that cough more than four times per hour have increased likelihood of mucus accumulation and higher pleural pressure changes during breathing than do horses that cough fewer than four times per hour. Use of **cough sound analysis** enables detection of out-breaks of respiratory disease in pigs and housed calves. Automated sound analysis systems can differentiate sounds of coughing from other sounds in the barn or piggery.<sup>3-5</sup>

A cough cannot be induced in normal adult cattle and horses by manual manipulation of the larynx or trachea. If a cough can be induced in an adult horse by manual manipulation of the larynx or trachea, then this indicates airway inflammation and is a reason for further examination of the respiratory tract.

The most common causes of coughing in farm animals are diseases of the larynx, trachea, bronchi and lungs, which are presented under the headings of diseases of those parts of the respiratory tract later in this chapter.

## CYANOSIS

Cyanosis is a bluish discoloration of the skin, conjunctivae, and visible mucosae caused by an increase in the absolute amount of reduced hemoglobin in the blood. It can occur only when the hemoglobin concentration of the blood is normal or nearly so, and when there is incomplete oxygenation of the hemoglobin. Cyanosis is apparent when the concentration of deoxygenated hemoglobin in blood is greater than 5 g/dL (50 g/L). Cyanosis does not occur in anemic animals. The bluish discoloration should disappear when pressure is exerted on the skin or mucosa. In most cases, the oral mucous membranes are examined for evidence of cyanosis, although the skin of the pinna and the urogenital mucous membranes will suffice. Examination of vaginal mucosa is preferred in horses that have severe congestion of the oral and nasal mucosa as a result of disease affecting the head, such as cellulitis or bilateral jugular thrombophlebitis. Artificial lighting and skin

pigmentation affect the ability to detect cyanosis.

**Methemoglobinemia** is accompanied by discoloration of the skin and mucosae but the color is more brown than blue and cannot be accurately described as cyanosis.

Cyanosis is classified as central or peripheral. **Central cyanosis** is present when arterial oxygen saturation is below normal with concentration of deoxygenated hemoglobin exceeding 4 to 5 g/dL. **Peripheral cyanosis** occurs when there is localized desaturation of blood despite arterial oxygen saturation being normal. This usually occurs because there is diminished blood flow to tissue, with a resulting increase in oxygen extraction by the ischemic tissues and low end-capillary and venous hemoglobin saturation.

Central cyanosis is caused by diseases include the following:

- Congenital cardiac diseases that cause right-to-left shunting
- Pulmonary diseases that cause hypoxemia—cyanosis is not usually marked in pulmonary disease unless the degree of ventilation-perfusion mismatch is severe.
- Upper airway obstruction causing hypoxemia—cyanosis is common and is a sign of life-threatening disease in severe cases of laryngeal obstruction, as occurs in severe laryngitis in calves with necrotic laryngitis or horses with bilateral laryngeal paralysis (lead poisoning, after tracheal intubation during anesthesia, idiopathic).
- Abnormalities in hemoglobin function.

Peripheral causes of cyanosis include the following:

- Arterial obstruction, such as is seen in horses with aortoiliac thrombosis (“saddle thrombus”) or thrombosis of distal limbs (such as can occur with severe septicemia)
- Venous obstruction
- Severe vasoconstriction

**Central cyanosis** is characterized by decreased arterial oxygen saturation as a result of right-to-left shunting of blood or impaired pulmonary function. Central cyanosis resulting from congenital heart disease or pulmonary disease characteristically worsens during exercise. Central cyanosis usually becomes apparent at a mean capillary concentration of 4 to 5 g/dL reduced hemoglobin (or 0.5 g/dL methemoglobin). Because it is the *absolute* quantity of reduced hemoglobin in the blood that is responsible for cyanosis, the higher the total hemoglobin content, the greater the tendency toward cyanosis. Thus cyanosis is detectable in patients with marked polycythemia at higher levels of arterial oxygen saturation than in patients with normal hematocrit values, and cyanosis may be absent in patients with anemia despite marked arterial desaturation. Patients

with congenital heart disease often have a history of cyanosis that is intensified during exertion because of the lower saturation of blood returning to the right side of the heart and the augmented right-to-left shunt. The inspiration of pure oxygen (100%  $F_{iO_2}$ ) will not resolve central cyanosis when a right-to-left shunt is present, but it can resolve when primary lung disease or polycythemia is causing the cyanosis.

**Peripheral cyanosis** is caused by obstruction of blood flow to an area. This can occur as a result of arterial or venous obstruction, although it is usually more severe when arterial blood flow is obstructed. Obstruction of arterial blood flow also causes the limb to be cold and muscle and nerve function in the ischemic area to be impaired. Cyanosis can also occur as a result of cutaneous vasoconstriction attributable to low cardiac output or exposure to cold air or water. It usually indicates stasis of blood flow in the periphery. If peripheral cyanosis is localized to an extremity, arterial or venous obstruction should be suspected. Peripheral cyanosis resulting from vasoconstriction is usually relieved by warming the affected area.

Heart failure can cause cyanosis that is restricted to the extremities, probably because of reduced blood flow to extremities during this disease and the consequent markedly lower end-capillary oxygen content. Blood in the venous end of the capillaries, and in the venous bed draining these tissues, is therefore deoxygenated and cyanosis is observed. Although this type of cyanosis has a peripheral distribution, its underlying cause is central.

## NASAL DISCHARGE

Excessive or abnormal nasal discharge is usually an indication of respiratory tract disease. Nasal discharges are common in all the farm animal species. Cattle can remove some or all of the nasal discharge by licking with their tongue, whereas horses do not remove any.

### Origin

The nasal discharge is usually obvious but the determination of its origin and significance can be difficult and elusive. The history should determine the duration of the nasal discharge and if it has been **unilateral or bilateral**.

Nasal discharges may originate from lesions in the nasal cavities, congenital defects of the hard palate such as cleft palate in the newborn, paranasal sinuses, guttural pouch in the horse, pharynx, larynx, trachea, and lungs. Diseases of the esophagus and stomach that cause dysphagia and regurgitation or vomiting can also cause a nasal discharge stained with feed material.

The origin of a nasal discharge is sometimes determined by close inspection of the external nares and the visible aspects of the

nasal cavities using a pointed source of light. Some important infectious diseases of the respiratory tract characterized by lesions of the nasal mucosae can be identified by examination of the external nares for the origin of a nasal discharge. If the source of the discharge is not apparent on this examination, then more detailed investigation is warranted.

### Examination

The characteristics of the discharge are noted carefully by inspection. It may be copious, serous, mucoid, purulent, caseous, streaked with blood, and foul smelling (ozena), or it may contain feed particles.

- A copious bilateral serous nasal discharge is characteristic of early inflammation of the nasal cavities such as in viral rhinitis.
- A bilateral mucoid discharge suggests inflammation of a few days' duration.
- A bilateral purulent discharge can indicate inflammation in the upper or lower respiratory tract.
- A copious bilateral caseous discharge suggests an allergic or bacterial rhinitis.
- Foul-smelling nasal discharges are usually associated with necrosis of tissues anywhere in the nasal cavities, the guttural pouch in the horse, or severe necrotic and gangrenous pneumonia.
- A bilateral foul-smelling discharge containing feed particles suggests dysphagia, regurgitation, or vomiting.
- In most cases, a chronic unilateral nasal discharge suggests a lesion of one nasal cavity.
- A bilateral nasal discharge suggests a lesion posterior to the nasal system.

Examination of **the paranasal sinuses** for evidence of pain and facial deformity will assist in the diagnosis of sinusitis. Percussion is useful in identifying paranasal sinuses that are filled with fluid or tissue because sinuses affected in this way do not produce a resonant sound when the skin overlying the sinus is tapped. The pharynx and larynx of cattle can be examined through the oral cavity, whereas a **flexible endoscope** is necessary for close examination of the upper and lower respiratory tract of horses or cattle of almost any age to determine the origin of a nasal discharge. The examination should include both nares, the region of the opening of the nasomaxillary sinus (this opening cannot be seen), the nasopharynx (in horses) or the pharynx (in other species), the guttural pouches in horses, the larynx, and the trachea, preferably to the level of the carina, although this might not be possible in large animals or when short endoscopes are used.

**Radiography** of the structures of the head and pharynx is also useful to locate lesions of the nasal cavities and paranasal

sinuses that might be the origin of a nasal discharge.

## Nasal Discharge and Location of Lesion

There is not necessarily a correlation between the characteristics of a nasal discharge and the nature of any pulmonary lesions. In exudative pneumonias in cattle, mucopus is produced and is moved up the trachea and into the pharynx by the mucociliary mechanism or by coughing. Some of it is then swallowed, and some may be deposited in the nasal cavities and moved forward to the external nares by ciliary action. In the horse, with its long soft palate, most purulent material from the lungs will be deposited in the nasal cavities and appear as a nasal discharge.

### Sampling of Nasal Discharge

When infectious disease is suspected, nasal swabs can be collected and submitted for microbiological examination. Nasal swabs are useful only when a specific etiologic agent is suspected and demonstration of its presence will confirm the cause of the disease. Examples of this include strangles (*Streptococcus equi*), influenza (equine or porcine), infectious bovine rhinotracheitis, and *Mycoplasma bovis*. Submission of nasal swabs for culture yields mixed flora and the results are impossible to interpret, with the exception noted previously. Organisms cultured from nasal or nasopharyngeal swabs are not representative of those cultured from lungs in individual animals but might be somewhat useful in herd outbreaks of disease. Culture of transtracheal aspirates or, in cattle but not horses, bronchoalveolar lavage fluid is representative of organisms causing pulmonary disease. Cytologic examination of the nasal discharge can reveal exfoliated cells in the case of nasal tumors or eosinophils when allergic rhinitis is present.

## EPISTAXIS AND HEMOPTYSIS

- **Epistaxis** (blood from the nostril) is in most instances a result of disease of the mucosae of the upper respiratory tract but it may originate anywhere in the upper or lower respiratory tract. Epistaxis occurring during or within several hours of intense exercise by horses is caused by exercise-induced pulmonary hemorrhage.
- **Hemoptysis** is the coughing up of blood. The blood usually originates from hemorrhage in the lower respiratory tract. The presence of hemoptysis is difficult to detect in animals. Hemoptysis occurs in horses, which is perhaps unexpected given the anatomic separation of the nasopharynx and oropharynx.

Pulmonary hemorrhage, particularly in the horse, may be manifested as epistaxis.

Pulmonary hemorrhage in cattle is commonly manifested as hemoptysis and epistaxis. These are described in more detail later in this chapter.

A small amount of serosanguineous fluid in the nostrils, as occurs in equine infectious anemia and infectious equine pneumonia, does not represent epistaxis, which must also be differentiated from the passage of blood-stained froth caused by acute pulmonary edema. In this instance the bubbles in the froth are very small in size, and passage of the froth is accompanied by severe dyspnea, coughing, and auscultatory evidence of pulmonary edema.

### THORACIC PAIN

Spontaneous pain, evidenced by grunting with each respiratory cycle, usually indicates pleural pain, such as from a fractured rib, torn intercostal muscle, or traumatic injury, including hematoma of the pleura, or pleurisy. A similar grunt may be obtained by deep palpation or gentle thumping over the affected area of the thoracic wall with a closed fist or a percussion hammer. Pain as a result of a chronic deep-seated lesion cannot be detected in this way. The use of a pole under the sternum, as described under “Traumatic Reticuloperitonitis,” provides a useful alternative.

## Special Examination of the Respiratory System

In addition to the routine clinical examination of the respiratory tract, there are a number of diagnostic techniques that can be used to aid in making a specific diagnosis, providing a reliable prognosis and formulating the most rational treatment. These techniques are being used more commonly by species specialists, particularly on valuable animals. Most equine practices have flexible endoscopes for the examination of the upper respiratory tract of horses. Medical imaging using thoracic radiography and ultrasonography of animals with suspected lung disease is now common, and the laboratory evaluation of respiratory tract secretions and exudates are commonplace. Almost all of these techniques increase the costs of making a diagnosis, and it is therefore important to consider whether the additional diagnostic testing will improve the final outcome of the case. Techniques for advanced evaluation of the respiratory system include the following:

- Auscultation and percussion of the thorax
- Endoscopy of the upper airways, guttural pouch (in Equidae), trachea, bronchi, and larger bronchioles
- Invasive endoscopic examination of the sinuses using rigid endoscopes
- Pleuroscopy using either rigid or flexible endoscopes
- Radiographic examination of the skull, pharynx, larynx, guttural pouch (in Equidae), trachea, and thorax
- Computed tomographic and magnetic resonance imaging
- Scintigraphic examination of respiratory function
- Ultrasonographic examination of the soft tissue of the pharynx and larynx, and thorax
- Collection and evaluation of the following respiratory tract secretions:
  - Nasal
  - Paranasal sinus
  - Guttural pouch
  - Pharyngeal
  - Tracheobronchial (tracheal aspirates, bronchoalveolar lavage)
  - Pleural (thoracocentesis)
- Pulmonary function testing, including measurement of tidal and minute volumes, pleural pressure, forced expiratory volume, flow-volume loops, forced oscillometry, and CO<sub>2</sub> breathing
- Arterial blood gas analysis
- Venous blood gas analysis
- Blood lactate concentration
- Pulse oximetry
- Collection and analysis of exhaled breath condensate
- Lung biopsy
- Respiratory sound spectrum analysis
- Exercise testing.

### AUSCULTATION AND PERCUSSION

The techniques of auscultation and percussion used in examination of the thorax are discussed in [Chapter 1](#), and references on percussion of the thorax are available in earlier editions of this text. Percussion of the thorax is a useful means of determining lung margins and therefore of detecting the presence of overinflation, as occurs with heaves in horses, or areas of consolidation. Consolidation is evident as a loss of resonance, and detection of this abnormality can reveal the presence of excessive pleural fluid or pulmonary consolidation. There is excellent agreement in the assessment of lung margins determined by percussion and by ultrasonographic examination. Percussion is therefore a valuable diagnostic tool, especially when ultrasonographic examination is not available.

### ENDOSCOPIC EXAMINATION OF THE AIRWAYS (RHINOLARYNGOSCOPY, TRACHEOBRONCHOSCOPY)

#### Horses

Flexible endoscopes allow examination of the upper respiratory tract of horses, including the nasal cavities, nasopharynx, auditory

tube diverticula (guttural pouches), palatal arch, epiglottis, larynx, trachea, and major bronchi. For examination to the level of the rostral trachea an endoscope of 1 m in length is suitable. However, an endoscope of 1.5 m in length is useful for examining to the level of the thoracic inlet. The endoscope is usually less than 1.5 cm in diameter. Endoscopic examinations are tolerated by most horses with the minimum of restraint (application of a nose or ear twitch). Sedation should be avoided if a purpose of the examination is to determine the functional integrity of the pharynx and larynx. Sedation depresses laryngeal function and impairs assessment of the symmetry and abductor function of the arytenoid cartilages. Sedated horses are more likely to displace the soft palate and to fail to return it to its normal position.

**Rhinolaryngoscopic** examination of horses should include a careful examination of the ventral and middle meatuses, turbinates, region of the nasomaxillary sinus opening (this cannot be visualized directly but discharge from it can be detected), ethmoidal turbinates, nasopharynx, soft palate, guttural pouches, dorsal pharyngeal recess, epiglottis, and larynx. The endoscope should be used to examine both left and right nasal cavities and ethmoid turbinates. Both guttural pouches should be examined. Passage of the endoscope into the guttural pouch is best achieved by passing the endoscope through the ipsilateral nasal cavity. The guttural pouch is then entered by first introducing a thin, stiff tube, such as an endoscopic biopsy instrument, through the biopsy port of the endoscope into the guttural pouch. The endoscope is then rotated so that the entrance to the guttural pouch is opened, and the endoscope is carefully advanced into the pouch. An alternative technique involves insertion of a stiff catheter, such as a Chambers mare uterine catheter, into the guttural pouch such that the entrance is dilated to enable passage of the endoscope.

Many disorders of the equine pharynx and larynx manifest only during strenuous exercise because of the high pressures generated in the airways by the large minute ventilation of exercising horses.<sup>6</sup> Pressures in the pharynx and larynx that are of similar magnitude to those occurring during intense exercise can be induced in resting horses by 60 seconds of **nasal occlusion**. The respiratory efforts of horses during nasal occlusion can therefore be used to simulate those during exercise, thereby permitting detection of disorders of the pharynx (displacement of the soft palate) and larynx (mild laryngeal hemiplegia) that would not otherwise be apparent in a resting horse. Rhinolaryngoscopic examination can also be performed on horses running on a treadmill (see following “**Exercise Testing**” section) or, by use of dynamic endoscopy, in horses running over ground.<sup>7</sup>

**Bronchoscopic** examination requires an endoscope that is at least 2 m in length and



less than 1.5 cm in diameter. Horses must be sedated for bronchoscopic examination (a combination of xylazine, 0.25–0.5 mg/kg intravenously [IV], and butorphanol, 1 mg per 40 kg IV, works well). Instillation of lidocaine (20 mL of 2% lidocaine diluted with 40 mL of isotonic saline or similar) minimizes coughing. The lidocaine is instilled into the trachea through the biopsy channel of the endoscope. The airways are examined in a systematic fashion and results are recorded using a system that has been described for identifying the major airways. Lobar bronchi are identified on the basis of the side of the bronchial tree on which they are found and the order in which they originate from the primary bronchus. On the right side, RB1, RB2, and RB3 refer to the right cranial lobar bronchus and subsequent right bronchi, respectively. On the left side, LB1 and LB2 refer to the left cranial lobar bronchus and the left caudal lobar bronchus, respectively. Segmental bronchi are identified by consecutive numbers in the order of origin from the lobar bronchus. The direction of the segmental bronchus is denoted by the capital letters D (dorsal), V (ventral), L (lateral), M (medial), R (rostral), and C (caudal). Subsegmental bronchi are identified in the order of origin from the segmental bronchi, using lowercase letters.

### Cattle

The nasopharynx, pharynx, and larynx of cattle can be examined by endoscopy, and this should be done without sedation if possible. Xylazine is not recommended because it commonly interferes with normal laryngeal function. Acepromazine is recommended if sedation is necessary.

The anatomy of the proximal portion of the respiratory tract of cattle differs from that of horses. The nasal septum does not completely separate the left and right aspects of the nasopharynx. In cattle, the nasal septum tapers caudodorsally, allowing both ethmoturbinates to be observed from one side. The pharyngeal septum is contiguous with the nasal septum and merges with the caudodorsal wall of the pharynx. The nasopharyngeal openings of the auditory tubes are visible. The appearance of the vocal cords is similar to that observed in the horse. Cattle do not have a laryngeal sacculle, and a laryngeal ventricle is not visible rostral to the vocal cords. During endoscopy, the arytenoid cartilages are maintained in fully abducted position. Constriction of the pharynx during swallowing is accompanied by rostroventral movement of the pharyngeal septum, completely occluding the nasopharynx, which differs from the situation in the horse.

### ENDOSCOPY OF PARANASAL SINUSES

The paranasal sinuses of the mature horse can be examined with a 4-mm arthroscope while standing and sedated or under general

anesthesia. The procedure is technically challenging and is usually performed by surgeons experienced in the use of arthroscopic equipment inserted through portals created by trephining holes in the sinus. The side to be examined is determined by physical, radiographic, and rhinoscopic examination of the animal. Endoscopic examination is indicated in animals in which diagnosis of the disease requires collection of tissue from the sinus. Therapeutic interventions that can be performed during endoscopic examination of the paranasal sinuses include lavage, removal of accretions of inflammatory material, drainage of cysts, and creation or enlargement of drainage holes.

### PLEUROSCOPY

Pleuroscopy using a rigid or flexible endoscope enables direct visual inspection of the pleural cavity for the diagnosis of pleural disease. The procedure is well tolerated in healthy horses and cattle.<sup>8,9</sup> The technique is particularly valuable in diagnosis of diseases of the thorax that extend to the pleural surface and do not exfoliate large quantities of cells, thereby making diagnosis by examination of fluid obtained by pleurocentesis unlikely. The procedure is useful in collection of tissue samples, such as from suspected thoracic neoplasia,<sup>10–12</sup> or in therapeutic procedures including relief of pleural adhesions and resection of lung sections, and in collection of large biopsies samples from the lung.<sup>13</sup>

The procedure is performed in standing, sedated horses restrained in stocks. Strict aseptic technique is used. The portal for insertion of the endoscope is at the level of the 8th to 12th intercostal space, with optimal examination of intrathoracic structures obtained via the 10th or 12th intercostal space. Either a rigid endoscope (10-mm diameter, 57-cm length) or flexible endoscope (10-mm diameter, 1-m length) can be used. The endoscope is inserted through a small incision in the intercostal space made under local anesthesia. The ipsilateral lung is partially collapsed by induced pneumothorax to permit visualization of intrathoracic structures. The mediastinum is intact in most horses. Inadequate collapse of the lung increases the likelihood of it being damaged during the procedure. The lung is reinflated by removal of air in the pleural space at the end of the procedure. Potential complications of the procedure include pneumothorax, hemothorax, damage to intrathoracic structures, and infection.

### RADIOGRAPHY

Radiography of the head, neck, and thorax is valuable in the diagnosis of diseases of the respiratory tract of animals. Examination is hindered by the large size of adult horses and cattle, the need for specialized high-capacity equipment for obtaining radiographs, and

the need for adequate restraint. Radiographic examination of adult animals in the field using portable radiographic units is very limited. However, large practices with fixed radiographic units capable of generating sufficient voltage and amperage can obtain diagnostic radiographs of the thorax of adult horses and cattle. Exposure values for radiographs of the thorax of adult horses and cattle are in the range of 110 kV and 40 mAs for caudodorsal regions to 150 kV and 70 mAs for cranioventral regions.<sup>14</sup> Diagnostic films of smaller animals, including adult sheep and goats and foals and calves, can be obtained using portable units capable of generating 80 to 100 kVp and 15 to 20 mA.

Examination of the thorax of large animals is restricted to lateral radiographs because the large amount of tissue prevents adequate exposure for ventrodorsal views. Multiple films (usually four overlapping views) are required for complete examination of the thorax, and the exposure needed for optimal-quality films varies among anatomic sites.<sup>14</sup> Localization of focal lesions can be achieved by examining sets of radiographs that include images collected with the horse or cow standing first with one side to the plate and then with the other side toward the plate. The lesion will appear larger in views obtained with the lesion closer to the source of x-rays. The radiographic anatomy of the horse has been described.<sup>14</sup>

Interpretation of thoracic radiographs of horses has classically used an approach using terms such as bronchial, alveolar, interstitial, and vascular patterns. An alternative approach that is recently suggested, and which we recommend, is depicted in [Figure 12-1](#). The process involves identification of areas of opacity, their extent and characteristics of the borders of the opacity (poorly defined vs. discrete), and the number and location of opacities. A differential diagnosis can then be established for each pattern of abnormalities ([Box 12-1](#)).<sup>14</sup>

Radiographs of **calves and foals** can be recorded with them standing or recumbent. Images obtained with the foal or calf in lateral recumbency with the forelimbs pulled forward permit optimal examination of the cranial thorax. However, calves or foals that are recumbent for prolonged periods of time (e.g., > 30 min) can develop atelectasis of the down lung that can mimic pneumonia radiographically. Ventrodorsal views assist with localizing lesions in foals and calves. Radiographic evidence of lung disease is common in ill neonatal foals (74% having such lesions in one study), and is not related to clinical evidence of respiratory disease or dyspnea. The characteristics of lung lesions detected in neonatal foals are associated with likelihood of survival. Guidelines for recognition of pulmonary patterns in foals have been proposed ([Table 12-2](#)), and these guidelines are likely to be useful aids for interpretation and

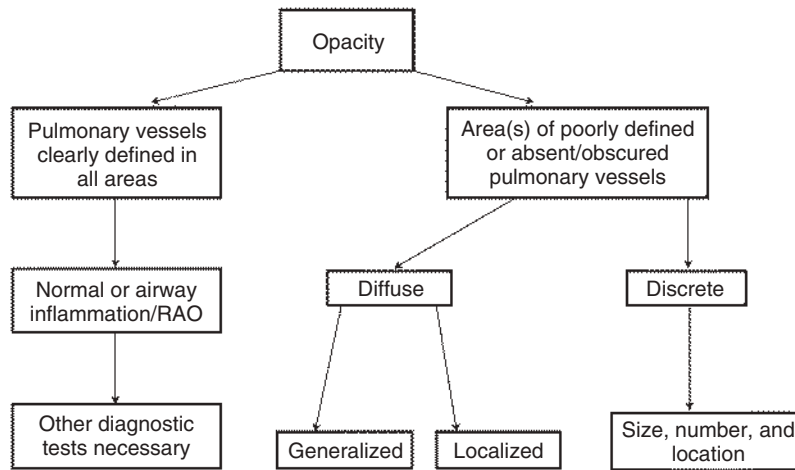

**Fig. 12-1** Decision tree for assessing thoracic radiographs of horses. RAO is recurrent airway obstruction or heaves. (Reproduced from Dunkel et al. 2013.<sup>14</sup>)

### Box 12-1 Differential diagnoses for patterns of abnormalities detected on radiographic examination of the thorax of horses

No abnormalities detected (but other clinical signs of respiratory disease are present)

- Inflammatory airway disease
- Heaves
- Summer pasture-associated recurrent airway obstruction
- Upper respiratory tract disease

Diffuse, localized opacities

- Caudodorsal lung
  - Exercise-induced pulmonary hemorrhage
  - Iatrogenic following bronchoalveolar lavage (transient)
  - Focal pneumonia
- Cranioventral
  - Infectious bronchopneumonia
  - Aspiration pneumonia
  - Pleuropneumonia

Diffuse, generalized opacities

- Interstitial pneumonia
- Pulmonary fibrosis
- Pulmonary edema
- Acute respiratory distress syndrome

One or multiple discrete opacities

- Single
  - Neoplasia
  - Pulmonary abscess

- Bacterial or fungal granuloma
- Foreign body
- Multiple
  - Pulmonary abscesses
  - Neoplasia
  - Disseminated fungal (e.g., *aspergillus* sp.), bacterial (*Rhodococcus equi*), or parasitic
  - Equine multinodular pulmonary fibrosis
  - Eosinophilic interstitial pneumonia
  - Idiopathic
- Other
  - Bronchiectasis
  - Tracheal stenosis
  - Bullae
  - Increased vascular pattern
  - Pneumothorax
  - Pneumomediastinum
  - Diaphragmatic hernia
  - Megaesophagus
  - Foreign body
  - Pleural fluid (pleuritic, hemothorax, chylothorax)

description of pulmonary patterns in neonates of other species.

Indications for thoracic radiography in horses (and likely in other large animal species) include the following.<sup>14</sup>

- Mild respiratory disease that is unresponsive to treatment
- Severe respiratory distress
- Thoracic trauma
- Signs of respiratory disease and weight loss or recurrent colic
- Suspicion of infectious or aspiration pneumonia
- Suspected thoracic or mediastinal mass

- Esophageal disease
- Suspected diaphragmatic hernia

Radiography can assist in the recognition and differentiation of atelectasis and consolidation, interstitial and exudative pneumonias, the alveolar pattern of pulmonary disease, neoplasms, pleural effusions, pneumothorax, hydropericardium, and space-occupying lesions of the thorax. Cardiomegaly, abnormalities of the cranial mediastinum, fractures of ribs, and diaphragmatic hernia can also be detected. Thoracic radiography is not as sensitive as is ultrasonography for detecting pulmonary lesions in foals with *Rhodococcus equi* pneumonia, with fewer

than 50% of affected foals detected by radiographic examination.<sup>15</sup>

Many pulmonary diseases do not have lesions that are readily detected on radiographic examination. Failure to detect abnormalities on radiographic examination of the thorax does not eliminate pulmonary disease. Furthermore, radiographically detectable signs of lung disease can persist after the animal has clinical and clinicopathologic signs of recovery or improvement.

**Bronchography** utilizing contrast agents is of value in determining the patency of the trachea and bronchi, but general anesthesia is required to overcome the coughing stimulated by the passage of the tracheal catheter. Using a fluoroscope to determine the location of the catheter tip, the contrast agent can be deposited in each dependent lobe in turn. This technique is used infrequently.

Radiographic examination of the trachea can reveal the presence of abnormalities in shape, such as occur with tracheal collapse, or the presence of foreign bodies or exudate.

Radiographic examination of the **head** can identify diseases of the paranasal sinuses, ethmoids and pharynx. Radiographic examination is useful in defining diseases of the guttural pouches and in detecting retropharyngeal abscesses or abnormalities, such as the presence of foreign bodies.

## MAGNETIC RESONANCE IMAGING

The utility of magnetic resonance imaging (MRI) in large-animal medicine is constrained by the size of the imaging bore on MRI units which limits the size of the animal, or anatomic region, that can be imaged. MRI is useful in diagnosis of diseases of the head of horses and other large animals,<sup>16</sup> and the anatomy as visualized on MRI of the head of horses and pigs has been reported.<sup>17</sup> The lack of units suitable for examination of large animals precludes routine use of this imaging modality.

## COMPUTED TOMOGRAPHY

Examination of the lung through **computed tomographic** (CT) is very sensitive and specific for lung disease in companion animals and is technically feasible in calves,<sup>18</sup> foals,<sup>19,20</sup> and small ruminants.<sup>21</sup> The technique is useful in the diagnosis of mediastinal disease in foals and correlates well with postmortem estimates of the volume of consolidated lung in experimentally induced pneumonia in calves.<sup>22</sup> CT is likely to be useful in evaluation of extent, severity and progression of lung disease in calves.

The CT anatomy of the head of horses and foals has been described including detailed anatomy of the guttural pouches and paranasal sinuses.<sup>23,24</sup> CT imaging of the nasal cavities and paranasal sinuses of horses is useful in the detection of diseases of these

**Table 12-2** Guidelines for radiographic pulmonary pattern recognition in foals

<b>Alveolar lung pattern</b> (Vessels not visualized. There is displacement of air from the distal air spaces of the lung leading to a relatively homogeneous increase in soft tissue opacity. Formation of air bronchograms is usually associated with the pattern but is not always present)	
Absent	The pulmonary vessels are easily seen
Minimal alveolar component (< 10%)	No visualization of vessels in < 10% of the lung field. Usually occurs in conjunction with a moderate or severe interstitial lung pattern
Focal (> 10% to 30%)	No visualization of vessels in 11–30% of lung fields. Air bronchograms might or might not be present within < 30% of lung fields
Localized (> 30% to 50%)	No visualization of vessels in 31–50% of lung fields. Air bronchograms might or might not be present within < 50% of lung fields
Extensive (≥ 50%)	No visualization of vessels in ≥ 50% of lung fields. Air bronchograms might or might not be present throughout the entire section of lung field
<b>Interstitial lung pattern</b> (Characterization of the non-air-containing elements of the lungs including blood vessels and bronchi)	
Normal	Clear visualization of vessels. Borders are well defined
Mild increase	The pulmonary vessels appear slightly ill defined (hazy borders with loss of visualization of the fine vascular structures). Mildly lacy appearance to lung field
Moderate increase	The vessels are ill defined, resulting in moderately lacy appearance and increased opacity of the lung field
Marked increase	Significantly increased opacity; vessel borders are barely recognizable
<b>Bronchial pattern</b> (Characterized by alterations in bronchial wall thickness and density, or in bronchial lumen diameter. Note that peribronchial cuffing is a feature of interstitial not bronchial pattern)	
Normal	Bronchial structures seen in cross section appear as small, thin-walled hollow rings between paired vessels. The bronchial walls are barely distinguishable when viewed side-on and are not clearly visualized at the periphery of the lung field
Moderate increase	A few thickened bronchial walls evident in cross section (“doughnuts”) at the periphery of the lung fields. Longitudinal sections appear as tram lines reaching two-thirds of the way to the lung periphery
Marked increase	Extensive bronchial thickening might be observed, extending far into the periphery of the visible lung field

From: Bedenice D et al. *J Vet Intern Med* 2003; 17:876.

structures and of the teeth, pharynx, larynx, and guttural pouches.<sup>25,26</sup> For example, CT of the head of horses with suspected ethmoidal hematoma provides information that influences the treatment of approximately two-thirds of cases, including identification of bilateral disease and the extent of involvement of the paranasal sinuses (and in particular the sphenopalatine sinus). CT is recommended for patients in which the lesion cannot be viewed endoscopically, when sinus involvement or multifocal disease are suspected, or when the lesion has been unresponsive to treatment.<sup>27</sup>

The technique is technically feasible in ruminants and pigs, including detection of otitis media, pulmonary and pharyngeal abscesses, and congenital pulmonary anomalies in calves.<sup>28–30</sup> CT is useful in pigs for quantitation of the extent of atrophic rhinitis and evaluation of pneumonia, in addition to assessment of body composition.<sup>31,32</sup>

### SCINTIGRAPHY (NUCLEAR IMAGING)

The basis of pulmonary scintigraphy is detection at the body surface of radiation emitted from the lungs after injection or inhalation of radioactive substances. The technique has been described in both horses and calves. The technique has limited diagnostic usefulness in large animals because of

the need for availability of appropriate isotopes and detection equipment.<sup>33</sup> Furthermore, the large size of adult cattle and horses limits the sensitivity of the technique. The technique has been used to determine the distribution of pharmaceuticals administered by aerosolization and the presence of ventilation-perfusion mismatches. Alveolar clearance can be detected using scintigraphic examination. Currently pulmonary scintigraphy is largely a research tool.

### ULTRASONOGRAPHY

Ultrasonographic examination of the thorax of farm animals and horses is a very useful diagnostic tool. Ultrasonographic examination of the thorax provides diagnostic information that is not obtained by radiographic examination and is more sensitive than radiography in detecting pulmonary abscesses in foals and is more useful than auscultation in detecting consolidation in lungs of pre-weaned calves.<sup>1,15,34</sup> The widespread availability of portable ultrasound units and the ability to image parts of the thorax using ultrasound probes intended for examination of the reproductive tract of mares and cows makes this a potentially valuable diagnostic aid for both field and hospital-based practitioners. Furthermore, the absence of radiation exposure and the “real-time” nature of images obtained by ultrasonography aid

in frequent assessment and monitoring of abnormalities and performance of diagnostic or therapeutic procedures such as thoracocentesis or aspiration of masses.

There are limitations to imaging imposed by aerated lung and the bones of the ribcage. Examination of the thorax is limited by the presence of ribs and aerated lungs because the sound waves used to create ultrasound images are reflected from these surfaces. Ultrasonography cannot reveal lesions of the lungs that are not confluent with the visceral pleura. Imaging windows are restricted to the intercostal spaces, but this impediment can be overcome by scanning through adjacent intercostal spaces and angling of the ultrasound beam.

Ultrasonographic examination of the thorax should be performed in a consistent manner that ensures thorough examination of the thorax. Preferences for the pattern of examination differ somewhat among examiners, but one common and successful technique is to scan each intercostal space from dorsal to ventral starting at the 17th intercostal space in horses and the 12th intercostal space in cattle. The ultrasound probe is slowly moved from dorsal to ventral while the examiner studies the images. When one scanning of one intercostal space is completed, the probe is moved to the most dorsal aspect of the next intercostal space, and the examination is repeated. Each side of the chest is



examined in this manner. This consistent and thorough examination ensures that no important or localized abnormalities are missed. The examination is performed in adult horses and cattle with the animal standing. The rostral thorax is scanned by pulling the ipsilateral forelimb forward. This is more readily achieved in horses than in cattle. Thorough examination of the rostral thorax might require placing the animal in lateral recumbency. Calves and foals can be examined either standing or in lateral recumbency.

Ultrasound examination of the thorax is particularly useful for detecting diseases of the pleura, pleural space, or lung surface. This is in addition to the well-documented utility of ultrasonographic examination of the heart and great vessels (see **Ch. 11**). The normal ultrasonographic anatomy of the thorax of cattle, horses, and calves has been determined. The following is a partial list of disorders or abnormalities detectable by percutaneous ultrasonographic examination of the thorax of farm animals or horses (excluding cardiac abnormalities):

- Excess pleural fluid
- Characteristics of pleural fluid (flocculent, bubbles, fibrin)
- Extent of pleural fluid accumulation
- Localized areas of pleural fluid accumulation
- Non-aerated lung (atelectatic, consolidated)
- Pulmonary abscesses (must be confluent with visceral pleura)
- Intrathoracic masses (thymic lymphoma, cranial thoracic mass, gastric squamous-cell carcinoma)
- Pleural roughening (“comet-tail” lesions)
- Pneumothorax
- Pulmonary hematoma
- Exercise-induced pulmonary hemorrhage
- Hemothorax
- Diaphragmatic hernia
- Fractured ribs (especially in neonates).

Ultrasonographic examination is more sensitive and specific than radiographic examination in detecting the presence of pleural fluid and is particularly useful in the diagnosis and management of pleuritis in horses and cattle and pneumonia in calves. The extent of pulmonary lesions detected at necropsy correlates closely with the results of ultrasonographic examination of calves with pasteurellosis. Ultrasonographic examination is useful in diagnosis of thoracic diseases of cattle. Ultrasonography can identify pulmonary lesions in horses with infectious viral pneumonia. Ultrasonography is useful in identifying the presence of pleural fluid and guiding thoracocentesis to sample and drain this fluid.

Ultrasonographic examination of the larynx and associated structures is useful in identifying recurrent laryngeal neuropathy in horses, arytenoid chondritis, and dynamic

laryngeal collapse.<sup>35-37</sup> Sensitivity and specificity for ultrasonographic examination of the larynx for detection of recurrent laryngeal neuropathy was 71% to 79% and 86% to 91%, respectively, compared with dynamic endoscopy.<sup>38</sup>

## LABORATORY EVALUATION OF RESPIRATORY SECRETIONS

### SAMPLING RESPIRATORY SECRETIONS

When an inflammatory disease process of the respiratory tract is suspected, the collection of samples of secretions and exudate for microbiological and cytologic examination can be considered. The objective is to obtain a sample uncontaminated with environmental flora, which are common in the upper respiratory tract, and to isolate the pathogen(s) or demonstrate inflammatory cells which may be associated with the lesion. This can be done by the following methods:

- Swabbing the nasal cavities or the pharynx
- Collection of fluid from the paranasal sinus
- Collection of fluid from the guttural pouch of Equidae
- Transtracheal aspirate
- Tracheal lavage
- Bronchoalveolar lavage
- Thoracocentesis

### NASAL SWAB

A swab of the nasal cavities is a reliable method for the evaluation of the secretions associated with disease of the upper respiratory tract such as infectious bovine rhinotracheitis. However, when attempting to assess the health status of the lungs the nasal swab can be unsatisfactory because microbiological examination usually yields a large population of mixed flora, consisting of pathogens and nonpathogens, which is difficult to interpret. Examination of nasal swabs is only useful when seeking to detect specific pathogens (*Strep. equi*, influenza) and when the diagnostic tests are directed toward detecting these agents.

### NASOPHARYNGEAL SWABS

For more reliable results and to lessen the contamination that occurs with nasal cavity samples, swabs of the laryngeal-pharyngeal area can be collected. A swab in a long covered sheath, of the type used for collecting cervical swabs from mares, is easily passed through the nasal cavities to the pharyngeal area. Important differences exist between the microbial isolates from nasopharyngeal swabs and those from lung tissues, which makes nasal swabs unreliable for diagnosis. For example, at the individual animal level, nasopharyngeal swabs and bronchoalveolar lavage show only moderate agreement; at the group or herd level, the isolation rates of various organisms are similar.

For isolation of viruses associated with disease of the upper respiratory tract, nasal swabs are satisfactory provided a copious amount of nasal discharge is collected, and the swabs are kept moist during transport to the laboratory. Nasal swabs sometimes contain an insufficient amount of secretion, and certain viral pathogens can become inactivated in transit.

### NASAL LAVAGE

When larger quantities of nasal discharge are required for research purposes, nasal washings are usually collected, with the simplest technique being irrigation of the nasal cavities and collection into an open dish. From these samples, it is possible to isolate bacteria and viruses and identify immunoglobulins. The development of immunofluorescent and enzyme-linked immunosorbent assay (ELISA) tests for agents of infectious disease has provided reliable systems for the diagnosis of a variety of virus diseases in the early stages of infection. A technique and apparatus are available that obtain much better samples than the conventional cotton-wool swab provides. A vacuum pump aspirates epithelial cells and secretion from the nasal passage and pharynx. Cell smears are then prepared for microscopic examination and the mucus, and cells are used for conventional microbiological isolation.

### PARANASAL SINUS FLUID

Fluid can be collected from the frontal and paranasal sinuses of most of the domestic large animals. Indications for collection of fluid include the presence or suspected presence of disease of the paranasal sinus. Medications can be administered and infected sinuses lavaged using this approach. Absolute contraindications are few but include failure to be able to adequately restrain the animal.

Demonstration of fluid in the paranasal sinuses is aided by radiographic examination of the skull. Fluid is collected by percutaneous centesis of the frontal or maxillary sinus and submitted for cytologic and bacteriologic examination (Gram stain, culture). The procedure begins with restraint of the animal, which can include the induction of moderate sedation by administration of alpha-2 agonists and narcotics, or in cattle restraint in a head gate with the head secured with a halter. Next, the area over the centesis site is prepared aseptically and the skin and subcutaneous tissues are anesthetized with local anesthetic. A stab incision (< 1cm) is made in the skin and subcutaneous tissues. A hole is then drilled into the sinus using a Jacob's chuck with a Steinmann pin (2- to 4-mm diameter). Only a short (5-mm) length of the Steinmann pin should be exposed by the chuck. The hole is drilled by applying steady pressure and making alternating clockwise and counterclockwise

movements with the chuck. Entry into the sinus cavity is evident as a sudden release of tension and easy passage of the Steinmann pin. The pin is then withdrawn, and sterile polyethylene tubing is inserted into the sinus cavity. Fluid can be aspirated at this time or, if none is forthcoming, 10 to 20 mL of sterile 0.9% saline or similar fluid can be instilled to the sinus cavity. Some of this fluid may run out the nostril if the animal's muzzle is lower than the sinus.

Complications include injury to adjacent structures, including the infraorbital nerve (trigeminal nerve), nasolacrimal duct or parotid salivary duct near its entrance to the oral cavity at the level of the upper cheek teeth. Hemorrhage is usually minor and self-limiting. Subcutaneous emphysema resolves within days. Cellulitis is a risk, especially for animals with septic processes in the paranasal sinuses. Prophylactic administration of antibiotics should be considered in these cases.

### GUTTURAL POUCH FLUID

Indications for collection of fluid from the guttural pouches of equids include bacteriologic or polymerase chain reaction (PCR) examination to determine whether the horse is infected by *S. equi* (the etiologic agent of strangles) or to investigate the suspected presence of other inflammatory or neoplastic disease. The preferred method of collection is during endoscopic examination of the guttural pouch. During this examination, fluid can be collected through a polyethylene tube inserted through the biopsy port of the endoscope. Fluid collected in this manner is potentially contaminated by organisms in the upper respiratory tract, and results of bacteriologic examination should be interpreted with caution. Usually, bacteriologic examination is for the presence of *S. equi* and demonstration of its presence is all that is required for a diagnosis of infection. Fluid can also be obtained from the guttural pouch by blind passage of a firm catheter, such as a Chambers mare catheter or 10 French dog urinary catheter, into the guttural pouch. This procedure requires some skill, and there is always the uncertainty that one might not have actually manipulated the catheter into the guttural pouch. A third technique involves percutaneous puncture of the guttural pouch just posterior to the ramus of the mandible and ventral to the ear. This technique has the potential to yield fluid that is uncontaminated by organisms from the upper respiratory tract, but it carries with it a high risk of injury to the important vascular and neural structures in and around the guttural pouch (internal and external carotid arteries, pharyngeal branch of the vagus nerve, hypoglossal nerve, and others). Percutaneous sampling of guttural pouch fluid should not be undertaken without careful consideration of the risks and benefits of the procedure.

### TRACHEOBRONCHIAL SECRETIONS

The collection and evaluation of tracheo-bronchial secretions is a useful method for assessing lower airway disease and is widely used in the determination of the etiology of infectious pneumonia (viral, mycoplasmal, fungal, and parasitic) or the severity of disease (bronchoalveolar lavage fluid cytology in horses with heaves, exercise-induced pulmonary hemorrhage in athletic horses). It is also used as a tool in evaluating the respiratory health of intensively housed animals, such as in piggeries. Cytologic examination of recovered fluid can provide valuable information about the severity, extent, and etiology of disease of the lower airway. There are two methods of sampling tracheo-bronchial secretions—aspiration of tracheal fluid or lavage of bronchioles and distal airways. Each sampling method yields fluid of differing characteristics and source, and interpretation of the results of examination of these fluids depends on their source and the method of collection.

### Comparison of Tracheal Aspirates and Bronchoalveolar Lavage Fluid

Examination of tracheal aspirates and bronchoalveolar lavage fluid yields different, but often complementary, information about the lower respiratory tract. The differences between tracheal aspirates and bronchoalveolar lavage fluid arise because cell populations, and types of cell, differ markedly among segments of airways. There is no correlation between cytologic features of tracheal aspirates and bronchoalveolar lavage fluid of horses, and this is probably the case in other species. Tracheal aspirates are representative of cell and bacterial populations of the large conducting airways (trachea and mainstem bronchi), which can originate in both the large and small conducting airways and the alveoli. Secretions of more distal airways can be modified during rostrad movement, such that fluid in a tracheal aspirate is not representative of processes deeper within the lung. Furthermore, disease localized to one region of the lung can alter tracheal fluid. Examination of tracheal aspirates is useful for detecting inflammation of the large airways and for isolation of microorganisms causing disease in these structures.<sup>39,40</sup> There is no good evidence that findings on examination of tracheal aspirates correlate with abnormalities in pulmonary function, although they can correlate with exercise performance (racing).<sup>41,42</sup> Tracheal aspirates do not accurately reflect lesions in the lungs of horses, but presence of excess mucus, detected on endoscopic examination, is associated with impaired performance, whereas presence of excess neutrophils is not.<sup>41</sup>

Bronchoalveolar lavage is useful for sampling secretions in the more distal airways. It provides a sample of secretions that have not been contaminated by upper respiratory tract organisms or secretions before collection, and the sample is therefore

assumed to be more representative of small airway and, to a lesser extent, pulmonary parenchymal and alveolar secretions or exudates. Bronchoalveolar lavage is useful in the detection of widespread lung disease but not necessarily in the detection of localized disease. Tracheal aspirates, because they in theory represent a composite sample of secretions from all regions of the lung, are likely to be more sensitive in detecting focal disease, such as a pulmonary abscess. Bronchoalveolar lavage fluid composition correlates well with pulmonary function in horses.

There is little agreement in cytologic examination of tracheal aspirates and bronchoalveolar lavage fluid of sick and healthy horses, and this difference probably exists in other species. Typically, the proportion of cells that are neutrophils is much higher in tracheal aspirates than in bronchoalveolar lavage fluid of both horses with heaves and normal horses. Mast cells are detected more frequently, and eosinophils less frequently, in bronchoalveolar lavage fluid than in tracheal fluid of normal horses.

### Tracheal Aspirates

**Indications** for collection of tracheal aspirates include the need for microbiological and cytologic assessment of tracheal fluids. The primary indication is collection of samples for microbiological diagnosis of infectious respiratory disease.<sup>39,43-45</sup> Other indications include detection and characterization of inflammation of the conducting airways. **Contraindications** include severe respiratory distress, although this is not an absolute contraindication, inability to adequately restrain the animal, and severe, spontaneous coughing. Percutaneous tracheal aspirate collection performed in animals with severe coughing can result in development of severe subcutaneous emphysema as a result of the high intratracheal pressures associated with the early phase of coughing. Most animals in which percutaneous tracheal aspirates are collected subsequently have radiographic evidence of pneumomediastinum.

Tracheal aspirates can be collected either by percutaneous puncture of the trachea or through an endoscope passed through the upper airways. The advantage of percutaneous collection of tracheal aspirates is that there is minimal risk of contamination of the sample by upper respiratory tract or oropharyngeal secretions. Microbiological examination of the samples is therefore likely to accurately reflect microbes present in tracheal fluid. Collection of tracheal aspirates through an endoscope markedly increases the risk of contamination of the sample with oropharyngeal fluids, and it compromises the diagnostic utility of culture of the sample. This disadvantage is partially alleviated by the use of guarded catheters inserted through the endoscope. The disadvantage of percutaneous collection of tracheal fluid is that it is invasive, and there is a risk of localized

cellulitis and emphysema at the site of puncture. Endoscopic collection is relatively non-invasive and readily accomplished.

### Percutaneous Transtracheal Aspiration

Percutaneous transtracheal aspiration is a practical method that has been used extensively in the horse and is adaptable to cattle, sheep and goats. For the horse, a 60-cm no. 240 to 280 polyethylene tube is passed through a 9- to 14-gauge needle inserted into the trachea between two rings. Commercially prepared kits for performing tracheal aspirates in horses are available that include all catheters and needles required. An alternative to polyethylene tubing is to use an 8 to 10 French male dog urinary catheter inserted through an appropriately sized cannula. The site for insertion of the needle or cannula is at the junction of the proximal and middle one-third of the ventral neck. The horse is usually sedated before insertion of the needle or cannula. The skin site is prepared aseptically, and a short stab incision is made after the area has been anesthetized. The cannula is removed to avoid cutting the tube, and the tube is pushed in as far as the thoracic inlet. Fluid typically pools in the trachea at the thoracic inlet in horses with lung disease (the tracheal lake or pool), and it is this fluid that is aspirated. Thirty to 50 mL of sterile saline (not bacteriostatic saline) is rapidly infused. The catheter or tubing should be rotated until tension is felt on aspiration by a syringe. Fluid is aspirated and submitted for cytologic, microbiological, or other examination.

Complications such as subcutaneous emphysema, pneumomediastinum, and cellulitis can occur, which necessitates care and asepsis during the procedure. Sudden movement of the cannula during insertion of the tubing may cause part of the tube to be cut off and to fall into the bronchi, but without exception this is immediately coughed up through the nose or mouth.

### Endoscopic Sampling of Tracheal Secretions

The flexible fiberoptic endoscope can be used to obtain tracheal lavage samples and at the same time visualize the state of the airways. The process is as for rhinolaryngoscopic examination with the addition of passage of a catheter through the biopsy port of the endoscope. Tracheal fluid is then visualized and aspirated through the catheter. The clinical advantages of the endoscopic collection include noninvasiveness, visual inspection of the airways, guidance of the catheter, and speed. The use of an endoscope with a guarded tracheal swab minimizes contamination by oropharyngeal secretions but does not eliminate it.

### Assessment of Results

Microbiological examination can yield any one or more of a variety of bacteria,

depending on the species examined, the animal's age, and its clinical condition. Tracheal aspirates of normal animals rarely yield any bacterial growth on culture. Growth of unusual organisms or known oropharyngeal commensal bacteria from samples obtained by endoscopic examination should not be given undue clinical significance as they probably result from contamination of the tracheal aspirate during collection. *Pseudomonas* spp. and anaerobes isolated from tracheal aspirates collected by endoscopy are almost always contaminants and of no clinical significance. The extent of contamination of tracheal aspirate samples by oropharyngeal bacteria can be estimated from the number of squamous epithelial cells in the sample. There is an apparent approximate linear relationship between the number of squamous cells per milliliter of fluid and the number of colony-forming bacterial units in tracheal aspirates. Samples containing over approximately 10 squamous epithelial cells per milliliter of tracheal aspirate had markedly greater bacterial contamination. Examination of Gram-stained smears of tracheal fluid is specific but not very sensitive for detection of bacteria, compared with culture. In other words, if examination of a Gram-stained smear of tracheal fluid reveals bacteria, then the sample is likely to yield bacteria on culture, whereas failure to detect bacteria predicts poorly the likelihood of growth of bacteria on culture of the sample. This indicates that examination of Gram-stained samples of tracheal fluid does not reliably predict bacterial isolation, and if an infectious etiology is suspected, the fluid should be cultured. Results of the microbiological examination of the tracheal fluid should be consistent with the animal's clinical condition and expected isolates.

Cytologic examination of tracheal fluid is an important diagnostic tool. Various stains are available to aid identification of cell types and numbers in tracheal aspirates. Neutrophils, macrophages, lymphocytes, and epithelial cells are readily identified on the basis of their classical morphology and staining using fast Romanowsky stain (Diff-Quik), but this stain is not suitable for identifying mast cells in equine tracheal fluid and probably that of other species. Leishman's stain is useful to identify mast cells. Clinically normal horses typically have fewer than 20% to 30% of cells as neutrophils with the majority of remaining cells being macrophages, lymphocytes and epithelial cells. Animals with inflammation of the airways typically have increased cell counts and proportion of neutrophils and large amounts of mucus. Horses with inflammatory airway disease such as heaves typically have more than 20% of the cells as neutrophils (see following "Heaves" section), and those with infectious pneumonia often have 50% to 90% of cells as neutrophils. Exercise markedly increases the proportion of neutrophils in tracheal

fluid collected within 1 hour of the horse completing intense exercise.<sup>46</sup> The presence of eosinophils is considered abnormal and is consistent with parasite migration (*Parascaris equorum* in foals, *Dictyocaulus viviparus* in calves). The presence of hemosiderin-laden macrophages is evidence of prior pulmonary hemorrhage.

### Bronchoalveolar Lavage

Bronchoalveolar lavage provides a sample of secretions and cells of the distal airways and alveoli, referred to as bronchoalveolar lavage fluid. It is a widely used procedure in horses and, to a lesser extent, cattle and calves, sheep, camelids,<sup>44</sup> and pigs. The procedure can be performed on foals, either sedated or anesthetized with improved fluid recovery in the latter.<sup>43</sup> Analyses performed on bronchoalveolar lavage fluid include measurement of cell number and concentrations of various acute-phase proteins, analysis of type of immune proteins and surfactant, culture (usually in pigs and cattle), and use of PCR to detect specific pathogens (e.g., the causative agent of ovine pulmonary adenocarcinoma).<sup>47,48</sup> It is a relatively noninvasive procedure that allows cytologic and biochemical evaluations of the lower airways and alveoli, which are useful diagnostic aids when evaluating animals with lung disease. Although fiberoptic bronchoscopy and tracheal aspirates permit assessment of the major bronchi and upper airways, bronchoalveolar lavage offers an extension of the diagnostic potential by sampling the terminal airways and alveolar spaces.

The primary **indication** for collection of bronchoalveolar lavage fluid is acute or chronic lung disease. This includes both infectious and noninfectious diseases, although interpretation of samples collected by passage of the collection tube through the nostrils or mouth is complicated by the inevitable contamination of the sample by oropharyngeal commensal bacteria. Despite this shortcoming, the technique has been used to detect pneumonia associated with *Mycoplasma* sp. in cattle. **Contraindications** are few, with respiratory distress being an obvious one. **Complications** of bronchoalveolar lavage are also few, and include a mild neutrophilia in lavaged sections of lungs and changes in phagocytic function of pulmonary macrophages, and microbial content, for several days after the procedure. Transient bronchial collapse can occur during the procedure in horses and is an indication of airway inflammation.<sup>49</sup>

A shortcoming of bronchoalveolar lavage is that it lavages only a small region of the lung, with the risk that focal lung disease is not detected. There is clear evidence that important differences can exist in bronchoalveolar lavage fluid from left and right lungs and that the ideal technique involves collection of fluid from both lungs.<sup>50</sup> This is best exemplified in pneumonia in horses, in



which bronchoalveolar lavage fluid from pneumonic horses can contain large numbers and a high proportion of neutrophils or can be normal, depending on the lung or area of lung lavaged. Therefore the bronchoalveolar lavage procedure is a very specific but not very sensitive test for pneumonia in horses. Abnormal lavage fluid is helpful diagnostically, whereas normal results do not exclude the presence of foci of pulmonary disease. The lavage samples may be normal in horses affected with pneumonia or pleuropneumonia, and because of these false-negative results, this is not the best diagnostic technique to evaluate a horse with pneumonia. In contrast, the tracheobronchial aspirates are more sensitive and most horses with pneumonia have cytologic abnormalities.

### Endoscopic Bronchoalveolar Lavage

Endoscopic bronchoalveolar lavage has the advantage of permitting visual examination of the airways during the procedure and selection of the region of the lung to be lavaged. This technique does require access to sophisticated endoscopic equipment. The technique described here for horses can be modified for use in other species.

Horses for bronchoalveolar lavage should be appropriately restrained. Sedation is usually essential and is achieved by administration of alpha-2-agonists. Coadministration of narcotics is recommended by some authorities to reduce the frequency and severity of coughing. Butorphanol tartrate 10 mg for a 400-kg horse is recommended, although this drug is not as effective as intratracheal lidocaine at reducing the frequency or severity of coughing when combined with detomidine for collection of bronchoalveolar lavage fluid. Effective suppression of coughing during collection of bronchoalveolar lavage fluid can be achieved by instillation of lidocaine (60 mL of a 0.7% solution—made by diluting 20 mL of 2% lidocaine solution by addition of 40 mL of isotonic saline). The lidocaine solution is administered as the endoscope enters the rostral trachea. A twitch can be applied to the nares. The endoscope must be at least 2 m in length and the external diameter should be 10 to 15 mm. Endoscopes of 10-mm diameter will pass to about the fifth-generation bronchi, whereas endoscopes of larger diameter will not pass quite as far into the lung. The endoscope is passed until it wedges, and then 300 mL of warmed (to reduced bronchospasm) isotonic saline is introduced in 5 × 60 mL aliquots. Air is infused after the last aliquot to ensure that all fluid is instilled. After the horse has taken between one and three breaths, the fluid is withdrawn and the aliquots are mixed. There is no difference in the cytologic composition of the first and subsequent aliquots.

### Blind Bronchoalveolar Lavage

Commercial bronchoalveolar lavage tubes are available for use in horses, and are

suitable for use in adult cattle and calves. The tubes are made of silicone and are therefore considerably more pliable than stomach tubes (which are not suitable for this procedure). The tubes are 2 m in length and have an external diameter of about 8 mm. The horse is restrained and sedated as for endoscopic bronchoalveolar lavage, and the tube is passed through one nostril into the trachea. The tube is then advanced until it wedges, evident as no further insertion of the tube with mild pressure. Continued vigorous attempts to pass the tube can result in the tube flexing in the pharynx and a loop of the tube entering the mouth. After the tube wedges, the cuff on the tube is inflated to prevent leakage of fluid around it, 300 mL of warm isotonic saline is instilled, the tube is flushed with air, and fluid is aspirated. The fluid should be foamy and, if cell counts are high, slightly cloudy.

Bronchoalveolar lavage can be performed in conscious **sheep** by insertion of 1.7-mm external diameter polyethylene tubing through a cannula inserted percutaneously in the trachea. The tubing is inserted until resistance is detected (about 40–45 cm in an adult sheep) and the lung is lavaged with 30 mL of sterile isotonic saline.

### Laboratory Assessment of Tracheobronchial Secretions

A problem with comparison of cell counts of bronchoalveolar lavage fluid reported by different authors is the use of inconsistent quantities of fluid to perform the lavage. The use of different volumes alters the extent of dilution of the fluid. There is a need for uniformity in technique. An approach to this problem has been to measure substances in the bronchoalveolar lavage fluid that can provide an indication of the extent of dilution of the sample. Both endogenous (urea, albumin) and exogenous (inulin, methylene blue) markers have been used. Dilution factors using urea concentration in plasma and in bronchoalveolar lavage fluid appear to be useful. The assumption is that urea concentrations in bronchial and alveolar secretions will be identical to that in plasma. The formula for correcting for dilution that occurs during collection of bronchoalveolar lavage fluid is:

$$\text{Dilution factor} = \frac{\text{Urea concentration in bronchoalveolar lavage fluid}}{\text{Urea concentration in plasma}}$$

where urea concentration in bronchoalveolar lavage fluid and in plasma is expressed in the same units. The volume of the pulmonary epithelial lining fluid can then be calculated:

$$\text{Pulmonary epithelial lining fluid volume} = \text{Dilution factor} \times \text{Volume of bronchoalveolar lavage fluid}$$

Samples for cytology are submitted for preparation involving centrifugation of the

sample to concentrate cells for preparation of slides for staining and microscopic examination. At least for samples from horses, examination of smears made directly from the sample, without centrifugation, is diagnostically useful. As for tracheal fluid, the proportion of mast cells in equine bronchoalveolar lavage fluid is underestimated if cells are stained with fast Romanowsky stain (Diff-Quik). Ideally, five fields are examined for each slide, rather than simply counting 400 cells, to ensure that the cell proportions are accurately reported, particularly for mast cells.<sup>51</sup>

### Diagnostic Value

The aspirates from normal animals contain ciliated columnar epithelial cells, mononuclear cells, and a few neutrophils with some mucus. Bronchoalveolar lavage fluid samples can be collected at 24-hour intervals without affecting the composition of the fluid, whereas collection as soon as 2 hours can result in a neutrophilic response.<sup>45</sup> The concentration of the cells depends on the volume of fluid infused and the disease status of the animal. Representative values for various species are listed in Table 12-3. The general pattern is that animals with inflammatory airway disease, either infectious or noninfectious, have a higher proportion of neutrophils than do disease-free animals. However, ranges of normal values vary considerably depending on the species, the age of the animal, and its management (primarily housing conditions). Care should be taken not to overinterpret findings on examination of tracheal aspirates or bronchoalveolar lavage fluid. Although there is good correlation between microbiological results and cell counts in bronchoalveolar lavage fluid of calves with pneumonia and Thoroughbred racehorses with inflammatory airway disease, this association might not hold for all diseases or species.

There is the potential for a seasonal effect on bronchoalveolar lavage fluid composition, with mastocytosis occurring more commonly in the antipodean spring and neutrophilia and eosinophilia more common in the summer.<sup>52</sup> Aged horses have a higher percentage of lymphocytes and lower proportion of macrophages than do younger horses.<sup>53</sup> The clinical importance of this finding is unclear.

### Thoracocentesis (Pleurocentesis)

Paracentesis of the pleural cavity is of value when the presence of pleural fluid is suspected and, in the absence of ultrasonographic examination, needs to be confirmed, and when sampling of pleural fluid for cytologic and bacteriologic examination is indicated. The primary indication for sampling pleural fluid is the presence of excess pleural fluid. Sampling of pleural fluid is usually accompanied by therapeutic drainage, in which case the cannula used for sampling is

**Table 12-3** Representative results of cytology of bronchoalveolar lavage fluid of cattle, sheep, pigs, and horses

Species	Disease status	Volume infused (mL)	Total nucleated cell count (cells × 10 <sup>9</sup> /L)	Neutrophil (%)	Macrophages (%)	Lymphocytes (%)	Eosinophils (mast cells) (%)
Weaner pigs	Normal	15–30	0.7 ± 0.2	2.0 ± 1.2	95.6 ± 2.7	1.7 ± 1.2	NR
Weaner pigs	Respiratory disease	15–30	0.9 ± 0.3	7.0 ± 4.2	87.9 ± 5.9	3.7 ± 2.0	NR
Adult sheep	Normal, pastured	30	NR	6.9 ± 5.8	81.1 ± 15.3	10.8 ± 15.8	1.2 ± 2.7
Adult sheep	Normal, housed	30	NR	21.8 ± 23.4	57.6 ± 19.6	16.1 ± 12.6	4.5 ± 9.5
Adult sheep	Respiratory disease	30	NR	26.8 ± 16.8	55.4 ± 20.9	11.6 ± 11.1	6.2 ± 8.6
Calves (2–3 months old)	Normal	240	NR	12 ± 10	86 ± 10	2 ± 1	0
Calves (2–3 months old)	Parasitic ( <i>Dictyo-caulus viviparus</i> ) pneumonia	240	NR	20 ± 20	20 ± 10	2 ± 1	70 ± 10
Cattle (6–10 months old)	Healthy	180–240	1.4 ± 0.3	< 5	80–85	10	NR
Calves (2 months old)	Healthy	180	NR	9.1 ± 11.6	90.7 ± 11.6	NR	NR
Horses (yearling)	Healthy, at pasture	300	85 ± 10.2 cells/μL	3.6 ± 0.8	39.5 ± 2.6	42.8 ± 2.4	0.8 ± 0.4 (mast cells 8.3 ± 1.7)
Horses (yearling)	Healthy, stabled	300	74.5 ± 7.8 cells/μL	13.2 ± 3.0	40.1 ± 2.7	39.1 ± 2.3	0.6 ± 0.2 (mast cells 4.1 ± 1.3)
Horses (adults)	Healthy	300	182 ± 035	8.9 ± 1.2	45 ± 2.8	43 ± 2.7	< 1
Standardbred racehorses	Healthy	300	153.2 ± 17.1	3.8 ± 0.3	64.8 ± 4.6	28.3 ± 2.9	1.2 ± 0.8 (mast cells 0.3)
Standardbred racehorses	Inflammatory airway disease	300	366 ± 16.8 cells/μL	10.4 ± 1.1	48.4 ± 1.9	36.0 ± 1.9	3.8 ± 1.5 (mast cells 1.8 ± 1.5)
Adult horses	Heaves	300	860 ± 324 cells/μL	60.3 ± 12.4	14.6 ± 4.8	22.7 ± 10.1	(mast cells 0.8 ± 0.6)
Adult horses	Remission from heaves (at pasture)	300	85 ± 15 cells/μL	17.7 ± 5.4	38.9 ± 9.1	42.4 ± 8.9	3.0 ± 0.8
Adult horses*	Mild heaves	250	253 (80–414)	17 (7–67)	28 (10–47)	43 (19–71)	0 (0–1) 1 (0–3)
Adult horses*	Moderate heaves	250	255 (117–3564)	17 (12–92)	19 (3–33)	43 (6–60)	1 (0–32) 1 (0–4)
Adult horses*	Severe heaves	250	286 (98–913)	25 (9–85)	34 (6–49)	31 (7–68)	0 (0–1) 1 (0–1)

Values are mean ± SD or median and range (\*); NR, not reported. See Radostits et al. *Veterinary Medicine* 10th edition. 2006. Page 488. Table 10-3 for references.

larger than if only collection of pleural fluid is desired. Contraindications are minimal, especially if the procedure can be performed under ultrasonographic guidance. The principal contraindication is the inability to restrain an unruly animal because this increases the risk of laceration of the lung or a coronary vessel, or cardiac puncture. Complications include hemorrhage from

lacerated intercostal or pleural vessels, pneumothorax secondary to laceration of the lung or introduction of air through the cannula, cardiac puncture and sudden death, irritation of the myocardium and ventricular arrhythmia (premature ventricular contractions), or coronary artery laceration and subsequent cardiac tamponade and death. There is a risk of cellulitis at the site of centesis,

especially if indwelling cannulas are maintained for more than a day.

The procedure is performed with the animal standing. Sedation or systemic analgesia is usually not needed, unless it is medically indicated or the animal is not easily restrained. The equipment for sampling of pleural fluid from adult horses or cattle is a blunt 10- to 15-cm cannula of approximately

3 mm in diameter (such as a bovine teat cannula) or a 7.5-cm spinal needle. The blunt-tipped cannula is preferred because use of it reduces the risk of laceration of vital structures. A three-way stopcock or similar device should be attached to the hub of the needle or cannula and closed to prevent aspiration of air when the pleural cavity is entered. The site for centesis is best identified by ultrasonographic examination of the thorax or, if that is not available, by percussion and auscultation of the chest to identify the fluid level. A commonly used site is the seventh intercostal space on the left side and the sixth intercostal space on the right side. The skin should be clipped of hair and aseptically prepared. The region can be anesthetized with approximately 10 mL of 2% lidocaine, mepiricaine, or a similar product. The cannula or needle should be introduced over the rib and then directed cranial to the rib (the intercostal vessels and nerves course along the caudal edge of the rib). If a cannula is used, then a slight “popping” sensation is felt as the cannula perforates the parietal pleura. A syringe is attached to the cannula or needle and fluid is aspirated from the pleural space.

Collected fluid should be examined visually. Normal pleural fluid, which is present in small quantities in normal animals, is clear and slightly yellow. Abnormal fluid can be bloody, thick, and yellow, suggestive of purulent material, or flocculent. The material should be smelled—a foul odor is usually present when the pleural fluid is infected by anaerobic bacteria and is a sign of a poor prognosis. Cytologic examination should be performed, including white cell count and measurement of total protein concentration. Ancillary measurements on pleural fluid include pH,  $PCO_2$ ,  $PO_2$ , bicarbonate, glucose, and lactate. Sterile pleural fluid has a pH,  $PO_2$  and  $PCO_2$  and lactate, glucose, and bicarbonate concentrations similar to those of venous blood. Infected pleural fluid is acidic, is hypercarbic, and has an increased concentration of lactate and decreased concentrations of bicarbonate and glucose compared with venous blood. Pleural fluid should be cultured for aerobic and anaerobic bacteria and mycoplasmas. Antimicrobial susceptibility should be determined for isolated organisms. Fungal cultures are rarely indicated.

Ultrasound-guided needle puncture of a suspected lung abscess to determine the species of bacteria present is sometimes practiced, but there is the risk that infection will be spread to the pleura by this technique. This technique is not recommended as a routine procedure because microbiological examination of tracheal aspirates will probably yield the offending bacteria.

### **PULMONARY FUNCTION TESTS**

Pulmonary function tests provide quantitative assessment of pulmonary ventilatory

function through measurement of expired and inspired gas volumes, intrathoracic pressures, and derivations of these variables—sometimes referred to as pulmonary mechanics. The techniques are widely used in research into pulmonary diseases, especially heaves in horses, and have been adapted for use in ruminants. A relatively simple assessment of pulmonary function is measurement of **pleural pressure changes** during respiration. This can be achieved by either insertion of a blunt cannula through the intercostal space or passage of a balloon catheter into the thoracic esophagus. The pressure changes during respiration are then recorded and the maximal pressure change between inspiration and expiration is calculated. The pressure change is closely correlated with airway resistance to airflow and is an excellent indicator of the severity of bronchoconstrictive diseases.

More complex measurements are made by application of an airtight face mask containing a flow meter to the animal. Combined with measures of airway pressure, airflow during tidal breathing yields measures of tidal volume, minute volume, respiratory rate, pulmonary resistance, and pulmonary dynamic compliance. Measurements made with the animal at rest are relatively insensitive to small changes in pulmonary function, and the sensitivity of these tests to detect heaves is low. The sensitivity of changes in maximal pleural pressure and resistance of the lower airways are 44% and 22%, respectively. The sensitivity of the test can be increased by measuring these variables during exercise. Measurement of pulmonary mechanics in horses with heaves is reproducible over both short (hours) and long (months) periods of time, indicating the usefulness of these techniques for monitoring of disease progression and response to therapy.

Measurement of **flow–volume loops** has been performed for both stationary and exercising horses. A number of variables are derived from these measures and used as indicators of pulmonary function. However, the large variability in these measures in stationary horses (16%–32%) severely limits the utility of this test to detect mild or subclinical respiratory disease. Similarly, flow–volume loops in exercising horses with obstructive lung disease of moderate severity do not differ markedly from those of the same horses when they do not have lung disease. Flow–volume loops have limited use in evaluation of lung function in animals.

Other tests of pulmonary function include the nitrogen dilution test and the single-breath diagram for  $CO_2$ . For the **nitrogen dilution test** concentrations of nitrogen in exhaled air are measured while the animal breathes 100% oxygen. A number of variables are calculated from the decay curve of nitrogen concentration in exhaled air, including the functional residual capacity. There are clinically significant differences

between animals with normal respiratory function and those with pulmonary disease. However, this test is not readily adapted for routine clinical use. Volumetric capnography is the graphic examination of expired breath  $CO_2$  concentrations versus expired volume to create a **single-breath diagram for  $CO_2$** . The results are divided into phase I, which represents the relatively carbon-dioxide-free air from the proximal or oral conducting airways, phase II, which is the transitional phase, and phase III, which is the carbon-dioxide-rich air from the alveoli. Measures of pulmonary function obtained include estimates of dead space ratio, physiologic dead space volume and alveolar efficiency. The clinical utility of this test and its ability to detect mild or subclinical disease in animals have not been demonstrated.

**Impulse oscillometry** offers the potential of being a potentially clinically useful test of respiratory function in horses, pigs, and cattle.<sup>54–57</sup> The test measures impedance of the respiratory system and provides estimates of respiratory resistance and reactance. The technique has the advantage of being more sensitive to changes in pulmonary function than measurement of pleural pressure changes, is minimally influenced by respiratory rate and tidal volume and is relatively easier to perform than more complex measures of respiratory mechanics. The test involves fitting an airtight facemask containing a pneumotachograph for measurement of respiratory volumes and tubing to a horse. The tubing is attached to a loudspeaker, which is used to generate square-wave signals containing harmonics between 0 and 10 Hz. Information from the system is analyzed using a computer program and indices of pulmonary resistance and reactance are determined. The forced oscillation technique in feedlot cattle with naturally occurring shipping fever indicates the presence of a large increase in pulmonary resistance and a decrease in dynamic compliance with obstructive lung disease located mainly at the level of large airways but also in small airways. The test is more sensitive than conventional techniques in detecting partial upper airway obstruction, heaves, and inflammatory airway disease in horses, and in pigs with lung disease.<sup>54–56</sup> Impulse oscillometry can also be used to monitor response to therapy.<sup>56</sup>

The sensitivity of these tests can be increased by provocative tests in which animals are administered agents, such as histamine or methacholine, that cause bronchoconstriction in animals with reactive airways.

Measurement of **forced expiratory flow–volume curves** and forced vital capacity in horses is a sensitive indicator of bronchoconstriction. The test involves the heavily sedated horse having a nasotracheal tube inserted. The nasotracheal tube is then attached to a large vacuum reservoir and a valve is opened abruptly. The maximum rate of forced



expiratory airflow is measured and various variables indicative of pulmonary function are calculated, including forced expiratory volume in 1 second (FEV<sub>1</sub>). The clinical utility of this test of pulmonary function is limited by the extensive instrumentation of the animal and the need for sophisticated electronics.

## ARTERIAL BLOOD GAS ANALYSIS

Measurement of  $P_{aO_2}$ ,  $P_{aCO_2}$ , and arterial oxygen content ( $C_{aO_2}$ ) provides valuable information about pulmonary function and oxygen delivery to tissues. The arterial oxygen tension and arterial oxygen content are not equivalent. The arterial oxygen tension ( $P_{aO_2}$ ) is a measure of the partial pressure of oxygen in arterial blood determined by the amount of oxygen dissolved in the blood (not the amount bound to hemoglobin) and the temperature of the blood—it is not a direct measure of arterial oxygen content. Arterial oxygen content is the amount of oxygen per unit of blood and includes both dissolved oxygen and that bound to hemoglobin. The oxygen tension can be viewed as the driving force for diffusion of oxygen from capillaries into mitochondria (in which the oxygen tension is about 2 mm Hg), whereas the oxygen content is the amount of oxygen delivered to tissue. Both are important measures of pulmonary function and oxygen delivery to tissue.

Measurement of **oxygen tension** in blood is achieved by analysis of an appropriately collected sample of arterial blood using a blood gas analyzer (oxygen electrode). Instruments designed for medical or veterinary clinical use measure pH,  $PO_2$ , and  $PCO_2$  at a temperature of 37°C (98.6 F). Depending on the software included with the instrument, various derived values are also reported, including bicarbonate concentration, base excess, and oxygen saturation. It is important to understand that **oxygen saturation** reported by blood gas instruments is a *calculated* value and might not be correct. Oxygen saturation is *measured* by a cooximeter, which is different from a blood gas machine, and the amount of oxygen carried by hemoglobin is then calculated from this value, with the assumption that each gram of hemoglobin, when fully saturated, carries approximately 1.34 to 1.39 mL of oxygen. The total **oxygen content** of blood is calculated by adding the amount carried by hemoglobin to the amount of oxygen dissolved in the aqueous phase of the blood. The formula is

$$O_2 \text{ content} = (S_aO_2 \times 1.34 \times [Hb]) + (0.003 \times P_aO_2)$$

where  $O_2$  content is in mL/100 mL,  $S_aO_2$  is the arterial oxygen saturation (%), 1.34 is the amount of oxygen carried by fully saturated hemoglobin (mL/g),  $Hb_{wsa}$  is the concentration of hemoglobin in blood

(g/100 mL), 0.003 is the amount of oxygen dissolved in the aqueous phase of 100 mL of blood for each 1-mm Hg increase in  $PO_2$ , and  $P_aO_2$  is the oxygen tension in arterial blood. The appropriate substitutions can be made to calculate the oxygen content of venous blood.

The oxygen content of arterial blood is the critical factor (with cardiac output) in determining **oxygen delivery** to tissues. However, measurement of arterial oxygen content is not as readily accomplished as measurement of arterial oxygen tension. Therefore in animals with normal hemoglobin concentration and function the arterial oxygen tension is used as a surrogate measure of arterial oxygen content. In doing so, it must be recognized that the extent of hemoglobin saturation with oxygen is dependent on both the affinity of hemoglobin for oxygen and the oxygen tension of the blood. The oxygen tension/percentage saturation relationship is sigmoidal, with 50% saturation occurring at about 30 mm Hg in most species (there are minor variations) and 80% saturation at a  $PO_2$  of 45 to 55 mm Hg. The sigmoidal shape of the oxygen-hemoglobin saturation curve has important clinical consequences. Small decrements in  $P_aO_2$  from normal values (usually 95–105 mm Hg in animals breathing ambient air at sea level) have a minimal effect on oxygen content of blood. Many modern blood gas analyzers have software that calculates oxygen content of blood, but it must be recognized that these calculations often use an assumed, not measured, hemoglobin concentration (usually 15 g/dL) and values for the human  $SO_2$ - $PO_2$  relationship. These assumed values may not be correct for animals, and one should always check the assumptions used to calculate oxygen content of blood before accepting and acting on those values. Direct measurement of blood oxygen content is restricted to research laboratories—indirect estimates gained from oxygen saturation and hemoglobin concentration are usually sufficiently accurate for clinical use.

The oxygen tension in blood is proportional to the amount of oxygen dissolved in the aqueous phase of the blood and the temperature of the blood. For a given amount of oxygen dissolved in blood, the tension varies according to the temperature of the animal. Almost all blood gas analyzers measure the  $PO_2$  at 37°C (98.6 F). If the animal's body temperature is markedly different from that, then the reported  $PO_2$  can be erroneous. For instance, the  $P_aO_2$  of a horse with a body temperature of 40°C (104.0 F) measured using an analyzer with a temperature of 37°C (98.6 F) would be 80 mm Hg (the  $PCO_2$  would be 35 mm Hg). If the  $P_aO_2$  was adjusted for the difference between the horse's body temperature and that of the analyzer, then the reported  $P_aO_2$  would be 100 mm Hg (and the  $P_aCO_2$  would be 44 mm Hg). Failure to make the appropriate temperature corrections can

result in errors of 6% to 7% per °C (3% to 4% per F). When interpreting blood gas values, attention should be paid to the temperature of the animal and consideration given to adjusting gas tension values according to the animal's body temperature. This is probably only clinically important when there are extreme deviations from normal temperature and oxygen tension. Most blood gas analyzers include software that makes the appropriate corrections.

The arterial oxygen tension is determined in the alveolus by the alveolar oxygen tension and the alveolar-arterial difference. The alveolar oxygen tension ( $P_{AO_2}$ ) can be calculated from the following equation:

$$P_{AO_2} = F_iO_2(P_B - P_{H_2O}) - (P_aCO_2/RQ)$$

where  $F_iO_2$  is the inspired oxygen fraction (21% for ambient air),  $P_B$  is the barometric pressure (760 mm Hg at sea level),  $P_{H_2O}$  is the partial pressure of water vapor in the alveolar air (47 mm Hg at 37°C, 98.6 F), and RQ is the respiratory quotient (usually assumed to be 0.8 for resting animals). The alveolar-arterial  $PO_2$  difference ( $A - a PO_2$ ) is calculated as

$$A - a PO_2 = P_{AO_2} - P_aO_2$$

The  $A - a PO_2$  difference has clinical significance in that it is an indicator of pulmonary function that is somewhat independent of inspired oxygen fraction and is therefore useful in animals being supplemented with oxygen (there is a small increase in the  $A - a$  difference with marked increases in  $F_iO_2$ ). Increases in  $A - a PO_2$  difference are indicative of ventilation-perfusion mismatches, with the  $A - a PO_2$  difference increasing with worsening ventilation-perfusion abnormalities.

## Normal Values

Values obtained from clinically normal animals breathing room air at sea level vary slightly between species, with most animals having an arterial  $P_aO_2$  of 95 to 105 mm Hg and a  $P_aCO_2$  of 35 to 45 mm Hg. Oxygen saturation in clinically normal animals breathing air at sea level is above 98% and oxygen content of arterial blood is 16 to 24 mL/dL of blood (this depends on the hemoglobin concentration in blood). The difference in oxygen content of arterial and mixed venous blood is usually 4 to 8 mL/dL of blood. Values can be influenced substantially by changes in physiologic state (exercise, hyperpnea), positioning, pulmonary disease, and altitude (Table 12-4). Positioning of the animal can be important, especially in neonatal foals, in which the compliant chest wall can impair ventilation in laterally recumbent foals—foals have lower arterial oxygen tension when in lateral recumbency than when in sternal recumbency.

## Collection of Arterial Blood Gas Samples

Arterial samples can be collected from any of the appropriate peripheral arteries, which

Table 12-4 Changes in blood gas tensions in various disease states compared with values in normal animals breathing air at sea level

Arterial oxygen tension ( $P_aO_2$ , mm Hg)	Arterial carbon dioxide tension ( $P_aCO_2$ , mm Hg)	Alveolar–arterial oxygen difference (mm Hg)	Physiologic state or disease
↑	↓	↔	Hyperventilation (excitement, panting)
↔ or ↓	↓	↔	Low inspired $O_2$ (altitude)
↓	↑	↔	Hypoventilation
↓	↔	↑	Diffusion impairment (rarely encountered)
↓	↔ or ↑	↑	Ventilation-perfusion mismatch. ↑ $P_aCO_2$ with this disorder is uncommon
↓	↑	↑	Strenuous exercise by horses

↑, above value in normal animal breathing ambient air at sea level; ↓, below value in normal animal breathing ambient air at sea level; ↔, unchanged from value in normal animal breathing ambient air at sea level.

vary depending on species. An arterial sample is representative of aortic blood in almost all instances. Samples can be collected from the carotid, transverse facial, metacarpal, and metatarsal arteries in horses and foals, and from the carotid, radial, and coccygeal arteries in cattle and calves. Minimally invasive arterial access is difficult in pigs.

Samples should be collected in glass, in which the dead space has been filled with heparin solution, and stored at 0°C until analyzed.<sup>58</sup> Typically, a 3-mL plastic syringe containing approximately 0.1 mL of sodium heparin and attached to a 22- to 25-gauge needle is used. All air should be expelled from the syringe before collection of the sample, and care should be taken to not introduce air into the syringe until blood gas tensions are measured. Air in the syringe will increase the measured oxygen tension of blood from normal animals. The sample should be measured as soon after collection as possible (within minutes). If immediate analysis is not available, the sample should be stored in iced water until analysis to prevent consumption of oxygen, production of carbon dioxide and a decrease in pH.<sup>58</sup> Storage of arterial samples in plastic syringes in iced water can increase the oxygen tension from 100 mm Hg to 109 mm Hg in as little as 30 minutes. This does not occur when samples are stored in glass syringes in iced water. The  $pH_a$  and  $P_aCO_2$  are not affected by the type of syringe.

Blood samples stored in plastic tubes (vacutainer) are not suitable for measurement of oxygen and carbon dioxide tensions, but measurements of total carbon dioxide and bicarbonate concentrations and base excess are reliable.<sup>59</sup>

### VENOUS BLOOD GAS ANALYSIS

Measurement of gas tensions in venous blood is of limited value in assessing pulmonary function because of the extensive and variable effects of passage through the capillary beds on gas tensions. However,

measurement of venous oxygen tension, saturation, or content can be useful in assessment of the adequacy of oxygen delivery to tissue. The oxygen tension, saturation and content of venous blood depends on the extent of oxygenation of arterial blood, the blood flow to the tissues, the metabolic rate of the tissues drained by the veins from which blood is sampled, and the transit time of blood through capillaries. The multiplicity of these factors means that determining the precise reasons for abnormalities in venous blood gas tensions is not possible. However, some generalizations can be made about venous oxygen tension, saturation and content.

In normal, resting animals, oxygen delivery to tissues exceeds oxygen needs (demand) of the tissue, with the result that venous blood draining these tissues is only partially desaturated. Hence, venous blood from the pulmonary artery (mixed venous blood) has oxygen tension, saturation, and content of approximately 35 to 45 mm Hg, 80% to 90%, and 12 to 18 mL/100 mL, respectively (the latter depending on hemoglobin concentration in addition to hemoglobin saturation). However, in situations in which oxygen delivery to tissue is decreased to levels that only just meet or do not meet the oxygen needs of tissue, there is extraction of a greater proportion of the oxygen in blood, and venous oxygen tension, saturation, and content decline, and the arterial–venous difference in oxygen content increases. Reasons for oxygen delivery to tissue not meeting the oxygen needs of that tissue are decreased perfusion of tissue, such as can occur with shock or circulatory failure, anemia, or decreased  $P_aO_2$ . Additionally, tissues with a high metabolic rate, such as exercising muscle, have high oxygen demands that can outstrip delivery.

Ideally, whole-body assessment of oxygen delivery by measurement of venous blood gas tensions is best achieved by examination of mixed venous blood. Mixed venous blood represents an admixture of blood draining all tissues and is collected from the pulmonary

artery (although samples collected from the right ventricle or atrium are also appropriate in most instances). Although this blood is optimal for assessment of oxygen delivery to tissue, collection of mixed venous samples is not routine because of the need for catheterization of the pulmonary artery. Samples from peripheral veins are therefore used, but care should be taken when interpreting these values as venous blood gas tensions can vary considerably among veins. For animals with normal circulatory status, blood gas tensions in jugular vein blood are likely to be reasonable estimates of mixed venous gas tensions. However, if circulatory function is not normal, then samples from peripheral veins may not be indicative of values in mixed venous blood.

Samples for venous blood gas analysis should be collected into syringes in which the dead space is filled with sodium or lithium heparin solution. The volume of heparin should not be more than 2% of the amount of blood. Samples should be processed promptly. If samples cannot be processed within an hour, they should be stored in iced water. Samples stored in iced water for 24 hours have values that are minimally different from those before storage, whereas samples stored at 25°C (77°F) change markedly in 2 to 3 hours.

### PULSE OXIMETRY

Pulse oximeters are devices for measurement of blood oxygen saturation that attach to skin or mucous membranes and sense the absorption spectrum of light by hemoglobin (the same principle is used in bench top cooximeters) in the underlying tissues. The devices are widely used for noninvasive monitoring of oxygenation in humans and have been adopted for use in animals. However, important challenges to their use exist in animals, not least of which is the presence of hair and densely pigmented skin in most farm animals. The devices have important deficiencies when used in foals and adult horses, but those applied to the ear, lip, or tongue of

foals have good sensitivity and specificity for detecting arterial  $\text{SO}_2$  of less than 90 mm Hg (12 kPa).<sup>60</sup> The devices consistently underestimate arterial  $\text{SO}_2$  at low saturations. Care should be taken when using these devices to monitor arterial hemoglobin saturation in animals.

## BLOOD LACTATE CONCENTRATION

Measurement of blood lactate concentration is useful in assessing the adequacy of oxygen delivery to tissues and is now provided by point-of-care units, some of which have been validated for use in horses and calves.<sup>61,62</sup> Hypoxia causes a shift to anaerobic metabolism and the production of lactate. Lactate production is related to the severity and duration of hypoxia, with more severe hypoxia resulting in greater accumulation of lactate in tissues and its subsequent diffusion or transport into blood. Hypoxia also reduces the rate of removal of lactate from blood. The combination of increased production and decreased removal causes lactate to accumulate in blood. Measurement of blood lactate concentrations (which are usually lower than plasma lactate concentrations) is gaining increasing clinical usefulness as point-of-care analyzers become more readily available and testing more affordable.

**Samples** for measurement of blood lactate can be collected into syringes containing heparin solution (as used for measurement of blood gas tensions) if the sample is to be analyzed within 30 minutes. Samples should be stored in iced water until analysis. Prolonged storage at room temperature results in increases in blood lactate concentration. If sample collection is anticipated to be delayed, then samples should be collected into evacuated tubes containing sodium fluoride and potassium ethylenediamine tetraacetic acid (EDTA)—the sodium fluoride inhibits glycolysis. However, plasma lactate concentrations collected in these tubes are approximately 10% lower than in samples collected into tubes containing heparin, probably because of the osmotic effect of sodium fluoride/potassium EDTA on red cells. Samples for clinical analysis should be collected into syringes containing a heparin solution and analyzed within 30 minutes of collection. Measurement of blood or plasma lactate concentrations can be made using point-of-care analyzers, although these can yield results that differ markedly from traditional analyzers, especially in animals with extreme values for hematocrit (severe anemia or polycythemia). Ideally, blood and plasma lactate concentrations should be measured only on analyzers that have been validated for the species and clinical situation being studied.

Blood lactate and plasma lactate concentrations are not equal, with blood lactate concentration being lower because of the

dilutional effect of red blood cells, which have a lower lactate concentration than plasma. However, most clinical assessments are based on blood lactate concentrations. Mixed venous or arterial blood lactate concentrations in most farm animal species are less than 2 mmol/L in normal, healthy animals. Tissue hypoxia, in addition to other conditions such as toxemia and septic shock, can increase blood lactate concentration. Blood lactate concentrations between 2 and 4 mmol/L should be interpreted with caution, whereas values above 4 mmol/L are indicative of clinically important disruption of oxygen transport and cellular metabolism. Repeated measurements over time can be useful for assessing progression of disease or efficacy of treatment. For instance, plasma lactate concentrations above 4 mmol/L in cattle with pneumonia are predictive of death within 24 hours.

## COLLECTION AND ANALYSIS OF EXHALED BREATH CONDENSATE

Collection and analysis of exhaled breath condensate have use primarily in research studies at the current time and are not likely to be sensitive or specific markers of specific disease states, although they might provide a means of assessing disease severity or pathogenesis.<sup>63</sup> Breath condensate is collected and analyzed for markers of pulmonary or systemic disease, including pH and markers of oxidative stress.<sup>64</sup> The pH of breath condensate is affected by the design of the collection device and condensation surface temperature, precluding comparison of data between studies using different methodologies.<sup>65</sup> Examples of use of analysis of breath condensate include that induction of pneumonia in calves by infection with *Pasteurella multocida* increases the concentration of leukotriene  $\text{B}_4$  in breath condensate, horses with heaves have higher concentrations of hydrogen peroxide than normal horses, probably a result of the airway neutrophilia in affected animals, and altered oxidative stress state in foals with *Rhodococcus equi* pneumonia.<sup>64</sup>

## LUNG BIOPSY

Percutaneous biopsy of the lung is useful in confirming diagnosis of lung disease by providing tissue for histologic and microbiological examination in cattle, sheep, and horses. The technique is most useful by providing a histologic diagnosis of diffuse lung diseases or, when used with ultrasonographic guidance or performed by thoracoscopy, for focal disease. Biopsy provided a diagnosis in ~80% of 65 horses with clinical evidence of diffuse lung disease.<sup>66</sup>

Biopsy is usually percutaneous but can also be performed during thoracoscopic examination.<sup>13,67</sup> Indications for the procedure include the presence of diseases of the

lungs in which a diagnosis cannot be arrived at through other forms of examination, including tracheal aspiration or bronchoalveolar lavage. It can also be used for assessing the severity of histologic changes and response to therapy. The procedure is best suited for widespread diseases of the lung, but it can be used for diseases that produce focal lesions if the biopsy is performed with ultrasonographic guidance. Contraindications include abnormalities in clotting function, pneumothorax, and severe respiratory distress. The danger in performing lung biopsy in animals in severe respiratory distress is that complications of biopsy, such as pneumothorax, hemothorax, or hemorrhage into airways, could further impair lung function and cause the death of the animal.

Complications include pneumothorax, hemothorax, hemorrhage into airways with subsequent hemoptysis or epistaxis, pulmonary hematoma, and dissemination of infection from infected lung to the pleural space. The risk of complications increases as the number of attempts at biopsy increase.<sup>66</sup> Pneumothorax, which is usually not clinically apparent, occurs in some horses in which the procedure is performed.<sup>68</sup> Coughing and epistaxis occur in about 20% and 10% of horses, respectively. Life-threatening hemorrhage occurs uncommonly ( $\approx 2\%$  of cases). Bleeding into the airways, detected by tracheobronchoscopic examination, occurred in 16 of 50 horses after use of the manually discharged biopsy needle and in 5 of 50 horses after use of the automatically discharged needle.<sup>68</sup> Two of 60 cows collapsed immediately after the procedure, but subsequently stood and recovered. The remaining cows had no clinical abnormalities detected after biopsy, although necropsy examination 24 hours later revealed small lesions in the pulmonary parenchyma at the site of biopsy. One of 10 healthy sheep had coughing and bloody nasal discharge after lung biopsy.

The procedure is performed in adult horses and cattle using a 14-gauge biopsy needle, either manually operated or one that discharges automatically. Such instruments yield tissue in over 95% of attempts in cattle. The area for examination is best determined by radiographic or ultrasonographic examination of the thorax. A common site for biopsy is at the junction of the dorsal and middle thirds of the thorax at the 9th intercostal space in cattle and sheep and the 13th intercostal space in horses. The procedure is best performed with the animal standing. The skin over the area should be clipped of hair and aseptically prepared and local anesthesia induced by injection of 2% lidocaine or a similar compound into the intercostal space. A 0.5-cm incision is made through the skin, and the biopsy instrument is advanced through the caudal intercostal space (intercostal vessels and nerves course along the



caudal aspect of the ribs) and into the lung perpendicular to the skin surface. The instrument is advanced approximately 2 cm into the lung, and tissue is collected at the end of inspiration. The procedure is repeated as necessary for collection of samples for histologic and microbiological examination. The skin incision is closed with a single suture if necessary. The animal is then monitored closely for 12 to 24 hours for signs of coughing, epistaxis, hemoptysis, fever, or respiratory distress. Hemorrhage into the airways is usually evident, often within minutes of completing the procedure, by the animal coughing. Hemorrhage into the airways is often evident as hemoptysis, even in horses. Respiratory distress can be caused by pneumothorax, hemothorax, or hemorrhage into airways. Treatment includes percutaneous aspiration of pleural air, administration of oxygen by insufflation or, in extreme instances, mechanical ventilation.

An alternative technique in cattle involves collection of lung tissue through the right cranioventral intercostal 2 space using a manual or automated 12- or 14-gauge biopsy needle.<sup>69</sup> Lung was successfully harvested from 56% of feedlot steers with chronic bovine respiratory disease and had the same pathologic diagnosis as that obtained by necropsy examination in 75% of animals. One animal of 34 had fatal complications.

### RESPIRATORY SOUND SPECTRUM ANALYSIS

Analysis of respiratory sounds has utility in the diagnosis of disorders of the upper respiratory tract of horses. Respiratory sounds can be detected by a small microphone near the horse's nostril with the recording made by a tape recorder or similar device worn on the saddle or girth strap. Studies can be performed with horses running on either a treadmill or outside over ground.<sup>70</sup> Dorsal displacement of the soft palate produces broad-frequency expiratory noises with rapid periodicity (rattling), whereas dynamic unilateral collapse of the arytenoid causes an increase in inspiratory broad band high-frequency noise. The technique correctly identifies more than 90% of horses with dynamic collapse of the left arytenoid cartilage ("roarers").

### EXERCISE TESTING

Exercise testing for assessment of respiratory tract function is essentially limited to horses, in which it is the gold standard for diagnosis of dynamic upper respiratory disease in horses.<sup>71</sup> Tests available for use on horses running on a treadmill include endoscopic examination of the upper airway, respiratory noise analysis, blood gas analysis, and measurement of respiratory mechanics. The most important of these in a clinical setting is videoendoscopy during

exercise to detect dysfunction of the upper airway of horses. With the exception of recurrent laryngeal neuropathy, there is only poor correlation between results of endoscopic examination performed in standing horses compared with results of dynamic endoscopic examination during exercise.<sup>6,71,72</sup> Endoscopy of standing horses has very limited capacity to detect disorders that occur only during exercise, and some disorders of the upper respiratory tract, such as progressive weakness of the laryngeal abductor muscles, axial deviation of the aryepiglottic fold, and epiglottic retroversion, can only be diagnosed by endoscopic examination performed during strenuous exercise.<sup>71,73</sup> Another finding is the presence of multiple upper airway abnormalities in a high proportion of horses examined during exercise.<sup>7,71,74,75</sup>

Although testing has historically been conducted on a high-speed treadmill, a recent advance has been the development of endoscopes and recording systems that allow horses to be examined while exercising in the field (overground or dynamic endoscopy).<sup>7,73-83</sup> Such overground endoscopy systems comprise an endoscope, water pump, endoscope control unit (for manipulating the tip of the endoscope), and a recording/transmitting unit carried on the horse or the rider (Fig. 12-2) weighing up to 2.5 kg.<sup>77,78</sup> The source of light are light emitting diodes in the end of the endoscope. Preferred is a recording unit that simultaneously transmits the image in real time, usually using Bluetooth or similar technology, to an observer situated a short distance (up to 220 m depending on the unit) from the horse.<sup>77</sup> The development of overground

endoscopy has enabled more widespread use of examination of the upper airway of horses during exercise and the refinement of understanding of dynamic obstructive disorders of the upper airway.

Overground endoscopy has the great advantage that it enables examination of the horse while it is performing wearing its usual tack, ridden by its usual rider, and performing its customary exercise.<sup>83</sup> Overground endoscopy performed on Standardbred racehorses does not appear to impair race time in qualifying races, and allows detection of important abnormalities associated with poor performance.<sup>81</sup> Examination using overground endoscopy allows the effect of gait and head position on upper airway function to be assessed and the relative importance of one or more abnormalities to be determined.<sup>7,77,84</sup> A disadvantage is that the intensity of exercise might not be as easily controlled by the veterinarian, or that exercise intensity that mimics that of actual competition in racehorses is not achieved, although exercise protocols to ensure the consistency of exercise are available.<sup>83</sup>

## Principles of Treatment and Control of Respiratory Tract Disease

### TREATMENT OF RESPIRATORY DISEASE

Treatment of diseases of the lower respiratory tract depends on the cause of the disease. However, the common principles are as follows:



**Fig. 12-2** Horse wearing equipment for overground endoscopy, including endoscope and water pump and control, recording, and telemetry units. (Reproduced with permission van Erck 2011.<sup>7</sup>)

- Ensure adequate oxygenation of blood and excretion of carbon dioxide.
- Relieve pulmonary inflammation.
- Effectively treat infectious causes of respiratory disease.
- Relieve bronchoconstriction.
- Provide supportive care to minimize demands for respiratory gas transport.

### Respiratory Gas Transport

Cause of acute death in animals with respiratory disease is usually failure of transport of respiratory gases with subsequent hypoxemia and hypercapnia. Treatment of failure of oxygenation of blood and excretion of carbon dioxide can be achieved through administration of supplemental oxygen or mechanical ventilation. The reasons for failure of respiratory gas transport were discussed previously, and these should be considered when therapy of an animal with respiratory disease and hypoxemia with or without hypercarbia is planned. Animals with hypercarbia and hypoxemia are probably hypoventilating, and consideration should be given to increasing the animal's minute ventilation through relief of airway obstruction (e.g., by foreign bodies or bronchoconstriction), improvement in function of the respiratory muscles (restore hydration, maintain normal blood concentrations of electrolytes, including calcium), and positional adjustments (foals have better respiratory function when in sternal recumbency). Artificial ventilation should be considered, but it is impractical for long-term treatment in animals other than those housed in referral centers. Ventilation-perfusion abnormalities cause hypoxemia with normal to only slightly elevated  $P_a\text{CO}_2$  in most affected animals. Oxygen therapy can be useful in ameliorating or attenuating the hypoxemia as a result of ventilation-perfusion abnormalities.

### OXYGEN THERAPY

The principal treatment for hypoxemia caused by diseases of the lungs is the administration of oxygen. Oxygen therapy is not often used in large animals in field situations, but the use of a portable oxygen cylinder may find a place in tiding animals over a period of critical hypoxia until inflammatory lesions of the lungs subside. It has been used most often in valuable calves and foals. Oxygen therapy must be given continuously, requires constant or frequent attendance on the animal, and can be expensive. Supplemental oxygen is usually administered through a nasal cannula with the tip placed in the nasopharynx, through a mask, or through a cannula inserted percutaneously in the trachea. The use of an oxygen tent is impractical.

Oxygen therapy is useful only when hypoxemia is attributable to failure of oxygen

transport in the respiratory system. It is of no value when the hypoxia is a result of toxins that interfere with oxygen metabolism in tissues (e.g., cyanide). Oxygen therapy will only minimally increase oxygen transport in animals with anemia, abnormal hemoglobin (methemoglobinemia), or cardiovascular shock. Cases of pneumonia, pleurisy, and edema and congestion of the lungs are most likely to benefit from provision of supplemental oxygen.

Oxygen should be delivered through a system that includes a humidifier so the insufflated gas is humidified and therefore drying of the respiratory mucosa is minimized.

Oxygen is often administered to **newborn animals**, either during resuscitation after birth or in those animals with respiratory disease. The value of supplemental oxygen in increasing  $P_a\text{O}_2$  has been examined in foals, but the recommendations probably apply to newborns of other species as well. Both a face mask and nasopharyngeal tube are effective in increasing  $P_a\text{O}_2$  when oxygen is administered at 10 L/min. The ability to elevate arterial oxygen increases with age from birth to 7 days of age because of the existence of right-to-left shunts in the newborn foal. Maximal changes in arterial oxygen tension occur within 2 minutes of the start of supplementation. In normal foals a flow rate of 4 L/min increases arterial oxygen tension, but responses in sick foals are often attenuated as a result of positional effects on gas exchange (recumbency) and other causes of hypoventilation.

**Nasal insufflation** improves arterial oxygen tensions and acid-base status in healthy foals<sup>85</sup> and in mild to moderately affected foals but might not be sufficient for oxygenation of foals with severe impairment of gas exchange. The efficacy of nasal insufflation of oxygen through intranasal catheters in foals depends on the rate of oxygen administration and whether catheters are inserted in one or both nostrils. When arterial oxygen tensions ( $P_a\text{O}_2$ ) and inspired oxygen fraction ( $F_i\text{O}_2$ ) are measured in arterial blood collected from the metatarsal artery and thoracic trachea, respectively, of healthy, standing, 5- to 7-day-old foals, insufflation results in significant increases in  $F_i\text{O}_2$  and arterial oxygen tension (Table 12-5). Unilateral administration of oxygen at flow rate of 50 mL  $\text{O}_2$  per kg body weight per minute resulted in an increase in  $F_i\text{O}_2$  from 18% to 23% and in arterial oxygen tension from 93 to 136 mm Hg. Bilateral administration and increased rates of flow up to 200 mL/kg/min resulted in further increases.<sup>85</sup> It is important to note that this study was done in healthy, standing foals and that the effect of oxygen insufflation on  $P_a\text{O}_2$  could be attenuated by recumbency and lung disease. However,  $F_i\text{O}_2$  is unlikely to be affected by these variables and this information will allow calculation of the  $P_a\text{O}_2:F_i\text{O}_2$  ratio in

foals as a way of detecting lung injury. Intranasal catheters are also difficult to maintain in active sucking foals and require the use of higher oxygen flow rates to achieve beneficial effects. Flow rates in foals with lung injury should be adjusted based on repeated measurement of arterial oxygen tension with the aim of maintaining  $P_a\text{O}_2$  at  $\geq 100$  mm Hg and  $S_a\text{O}_2$  at greater than 90%.

A **transtracheal oxygen delivery system** has been used in foals with pneumonia and rapidly progressive dyspnea and hypoxemia despite intranasal oxygen therapy. A catheter is inserted into the midcervical trachea and directly distally in the tracheal lumen for approximately 25 cm. The catheter is attached to about 6 m of oxygen tubing and suspended above the foal, allowing it to move around the stall and suck the mare for up to 6 days without dislodging the catheter. This system was more effective than nasal insufflation in increasing arterial oxygen tension, probably because the catheter tip is in the distal trachea and bypasses a significant length of dead space that would not be oxygenated were the oxygen delivered into the nasopharynx.

In foals with neonatal respiratory distress, signs of respiratory failure may be evident at birth or several hours after birth. Tachypnea, shallow and paradoxical respiration, an expiratory grunt with accentuated abdominal effort, and cyanosis are all common. Management of foals with respiratory distress includes oxygen therapy, but when the distress is severe, oxygen insufflation alone is insufficient to improve the  $P_a\text{O}_2$ , which is usually 45 to 60 mm Hg (6.0-8.0 kPa). The atelectasis and alveolar hypoventilation worsen, resulting in progressive hypoxemia and respiratory acidosis, which requires ventilatory assistance by the use of continuous positive airway pressure.

In cattle and adult horses, the nasal tube must be inserted to the nasopharynx because passage short of this causes excessive waste of oxygen. The length of tube inserted should equal the distance from the nostril to a point one-third of the way from the lateral canthus of the eye to the base of the ear. Insertion of a nebulizer in the system permits the simultaneous administration of antibiotics and moisture to prevent drying of the pharyngeal mucosa. The volume of oxygen used should be about 10 to 20 mL of oxygen per min per kg of body weight. Repeated measurement of arterial oxygen tension, if available, is useful for determining the flow rate. Arterial oxygen tension responds to changes in the rate of administration of oxygen within several minutes.

Oxygen toxicity is a risk in animals breathing pure oxygen for periods exceeding 1 to 2 days, but this rarely occurs in veterinary medicine because supplementation with oxygen does not result in the animal breathing pure oxygen (except for animals under general anesthesia). Oxygen toxicosis

**Table 12-5** Effects of unilateral or bilateral nasal insufflation of oxygen at flow rates of 50 mL O<sub>2</sub> per kg bodyweight per minute to 5- to 7-day-old healthy foals on inspired oxygen tension (measured in the thoracic trachea), arterial oxygen tension and measures of acid:base balance. (Reproduced from Wong et al.2010.<sup>85</sup>)

Variable	Oxygen delivery									
	Baseline	Unilateral (mL/kg/min)				Bilateral (mL/kg/min)				
		50	100	150	200	50	100	150	200	
F <sub>I</sub> O <sub>2</sub> (%)	18.0 ± 0.7 <sup>a</sup>	23.0 ± 1.4 <sup>b</sup>	30.9 ± 2.1 <sup>b</sup>	44.2 ± 5.8 <sup>b,c,d</sup>	52.6 ± 8.3 <sup>b,d,e</sup>	30.9 ± 2.6 <sup>b</sup>	48.7 ± 6.2 <sup>b,c</sup>	56.4 ± 3.4 <sup>b,e</sup>	74.6 ± 4.2 <sup>b</sup>	
pHa	7.435 ± 0.02 <sup>a</sup>	7.415 ± 0.02	7.417 ± 0.01	7.418 ± 0.01	7.411 ± 0.02 <sup>b</sup>	7.422 ± 0.01	7.412 ± 0.02	7.422 ± 0.02	7.426 ± 0.02	
P <sub>a</sub> O <sub>2</sub> (mm Hg)	92.5 ± 8.2 <sup>a</sup>	135.9 ± 13.2 <sup>b</sup>	175.2 ± 14.6 <sup>b</sup>	219.6 ± 31.9 <sup>b,e,f</sup>	269.7 ± 40.8 <sup>b,d,f</sup>	174.3 ± 26.8 <sup>b</sup>	261.2 ± 38.3 <sup>b,c,e</sup>	307.8 ± 41.0 <sup>b,c,d</sup>	374.2 ± 58.2 <sup>b</sup>	
P <sub>a</sub> CO <sub>2</sub> (mm Hg)	47.7 ± 2.8 <sup>a</sup>	49.7 ± 2.4	50.5 ± 2.3 <sup>b</sup>	50.1 ± 2.8	51.3 ± 3.1 <sup>b</sup>	49.8 ± 1.8	51.0 ± 2.2 <sup>b</sup>	49.8 ± 2.9	48.6 ± 3.6	
P <sub>ET</sub> CO <sub>2</sub> (mm Hg)	53.9 ± 3.3	52.6 ± 4.9	52.8 ± 7.9	53.9 ± 7.9	54.6 ± 5.6	55.6 ± 2.8	55.3 ± 6.0	55.2 ± 5.1	55.3 ± 4.8	
Bicarbonate (mmol/L)	31.4 ± 2.7	30.7 ± 1.3	31.4 ± 1.2	31.2 ± 1.3	31.4 ± 1.2	30.8 ± 1.9	31.5 ± 1.4	31.4 ± 2.0	30.8 ± 2.2	
TCO <sub>2</sub> (mmol/L)	32.3 ± 2.7	32.0 ± 1.5	32.8 ± 1.3	32.6 ± 1.3	32.8 ± 1.3	32.2 ± 2.0	32.9 ± 1.4	32.8 ± 2.1	32.2 ± 2.3	
S <sub>a</sub> O <sub>2</sub> (%)	96.7 ± 0.7 <sup>a</sup>	98.5 ± 0.3 <sup>b</sup>	99.2 ± 0.1 <sup>b</sup>	99.4 ± 0.2 <sup>b</sup>	99.6 ± 0.1 <sup>b</sup>	99.1 ± 0.3 <sup>b</sup>	99.6 ± 0.1 <sup>b</sup>	99.7 ± 0.1 <sup>b</sup>	99.8 ± 0.1 <sup>b</sup>	
P <sub>a</sub> O <sub>2</sub> ; F <sub>I</sub> O <sub>2</sub> ratio	514 ± 39	594 ± 73 <sup>g,h</sup>	569 ± 61	502 ± 75 <sup>g</sup>	517 ± 58	563 ± 55	540 ± 73	547 ± 81	501 ± 57 <sup>h</sup>	

<sup>a,b</sup>Within a row, mean baseline value and values at individual oxygen flow rates that have different superscript letters differ significantly ( $P < 0.05$ ). <sup>c-f</sup>Within a row, F<sub>I</sub>O<sub>2</sub> or P<sub>a</sub>O<sub>2</sub> at individual oxygen flow rates that have different superscript letters differ significantly ( $P \leq 0.02$  and  $\leq 0.03$  respectively). <sup>g,h</sup>Within a row, mean ratio values at individual oxygen flow rates that have different superscript letters differ significantly ( $P < 0.05$ ).

can be prevented by limiting the F<sub>I</sub>O<sub>2</sub> to less than 60%.<sup>85</sup>

## RESPIRATORY STIMULANTS

Use of respiratory stimulants, including doxapram, picrotoxin, leptazol (Metrazol), lobeline, theophylline, nikethamide (Coramine), caffeine, and amphetamine sulfate, has been advocated in animals with hypoxemia resulting from respiratory disease. In many of these animals, and especially in adults, there is already maximal stimulation of the respiratory center, and administration of drugs such as caffeine or doxapram is at best useless and at worst harmful, in that they can increase oxygen demand, in particular myocardial oxygen demand, thus exacerbating any oxygen deficit.

The situation appears to be different in neonates, in which the depression of respiration is a result of diminished central control, as is the case in foals with neonatal encephalopathy and in premature calves. Doxapram (constant rate infusion of 0.02-0.05 mg/kg/h IV) is more effective than caffeine (loading dose of 7.5-12 mg/kg followed by maintenance dose of 2.5-5 mg/kg PO q24 h) in reducing arterial carbon dioxide tension neonatal foals with respiratory acidosis (P<sub>a</sub>CO<sub>2</sub> ≥ 55 mm Hg and pH < 7.35) secondary to neonatal encephalopathy. There was no difference in survival rates although the number of animals (eight in each group) was likely too low to detect important effects on survival.<sup>86</sup> Similarly, in healthy newborn calves doxapram (40 mg IV) increased respiratory rate, peak inspiratory and expiratory flow rates, minute volume and P<sub>a</sub>O<sub>2</sub>, and

reduced P<sub>a</sub>CO<sub>2</sub> within minutes of administration, although the effect lasted less than 90 minutes.<sup>87,88</sup> Administration of doxapram (40 mg IV), atropine or caffeine to neonatal calves with naturally occurring asphyxia resulted in improvement in arterial blood gas values with all treatments with the greatest effect, and lowest death rate, among doxapram-treated calves.<sup>89</sup>

Doxapram appears to be useful in stimulating respiration in foals with pharmacologic depression of the respiratory center by general anesthetics.<sup>90</sup>

## MECHANICAL VENTILATION

**Short-term** mechanical ventilation can be achieved in neonates and small adults by use of a nasotracheal tube and a hand-operated bellows, which is usually in the form of a resilient bag equipped with a one-way valve. The animal's trachea is intubated and the bag is connected and squeezed to supply a tidal volume of approximately 5 to 10 mL/kg BW at a rate of approximately 20 breaths per minute. Commercial bags (Ambubag) are available in a variety of sizes suitable for neonates and small ruminants. There is a simple device for respiratory resuscitation of newborn calves and lambs consisting of a mouthpiece, a nonreturn valve, a flange and an oral tube. Ventilation of larger animals requires use of compressed gases and appropriate valving systems, including a Hudson demand valve. In an emergency situation, artificial ventilation of neonates and small ruminants can be achieved by mouth-to-nose ventilation by the veterinarian. This should be done only with an awareness of the

risks of disease transmission (e.g., a weak newborn calf could be infected by *Brucella* sp. or *Leptospira* sp.).

Prolonged mechanical ventilation is an activity requiring special equipment and expertise. It is indicated for the treatment of diseases of neonates, and perhaps adults, that cause hypoxemia and hypercarbia. There is usually a significant component of hypoventilation in these diseases and this is a prime indication for use of mechanical ventilation. An excellent example is the use of mechanical ventilation to treat foals with botulism. In experienced hands, this technique is effective. Because of the highly technical and demanding requirements for mechanical ventilation, the interested reader is referred to more detailed sources for descriptions of the methodology.

## ANTI-INFLAMMATORY THERAPY

Many infectious and noninfectious diseases of the lower respiratory tract have inflammation as a major component of the tissue response to the initial insult. Primarily inflammatory diseases include heave and inflammatory airway disease of horses. Inflammation is an important component of pneumonia and some of the allergic or toxic lung diseases. Suppression of the inflammatory response is indicated when the inflammatory response is exacerbating clinical signs of the disease through obliteration of alveoli (inflammatory atelectasis), blockage of airways by inflammatory exudates and infiltration of bronchial walls, and bronchoconstriction as a consequence of inflammation increasing airway reactivity.



Administration of antiinflammatory drugs is indicated as the definitive therapy in noninfectious inflammatory airway diseases (with control achieved by environmental controls; see following discussion). Care must be taken that suppression of the inflammatory response does not impair innate and adaptive immune responses to infectious agents.

Antiinflammatory drugs used in the treatment of diseases of the respiratory tract include glucocorticoids and nonsteroidal antiinflammatory drugs (NSAIDs), with other agents such as leukotriene antagonists, interferon, and cromolyn sodium used in particular situations.

**Nonsteroidal antiinflammatory drugs** are useful in the treatment of infectious respiratory disease of cattle and horses, and likely other species. The drugs act by inhibiting the inflammatory response induced by the infecting organism and tissue necrosis. Meloxicam (0.5 mg/kg subcutaneously, once), when administered with tetracycline, improves weight gain and reduces the size of lesions in lungs of cattle with bovine respiratory disease complex over those of animals treated with tetracycline alone. NSAIDs also improve the clinical signs of cattle with respiratory disease. Use of these drugs is routine in horses with pneumonia or pleuritis.

**Glucocorticoids** are administered for control of inflammation in a variety of inflammatory lung diseases but notably heaves of horses and interstitial pneumonia of foals. Treatment can be administered orally, by intravenous or intramuscular injection, or by inhalation. Oral, intramuscular, or intravenous administration results in systemic effects of the agents. Inhalation of glucocorticoids provides therapy directed to the site of the disease and minimizes, but does not always prevent the systemic effects of the drugs. Drugs for inhalation are usually human preparations of fluticasone, beclomethasone, and flunisolide that are available as metered-dose inhalers. The compounds are administered through a mask adapted so that a large proportion of the drug is inhaled. Antiinflammatory responses in the airways are pronounced and result in marked improvement in respiratory function in horses with heaves (see [Heaves](#), Recurrent airway obstruction).

## IMMUNOMODULATORS

**Interferon** is used for the treatment of inflammatory airway disease in racehorses and feedlot cattle with respiratory disease. A dose of 50 to 150 IU of interferon-alpha administered orally once daily for 5 days reduced signs of airway inflammation in young Standardbred racehorses. Immune stimulation by injection of a suspension of *Propionibacterium acnes* has been investigated for treatment of chronic inflammatory airway disease in horses. The compound enhances expression of interferon-gamma

and NK-lysin in peripheral blood mononuclear cells, increases the proportion of CD4 cells in peripheral blood and increases phagocytic activity of cells in peripheral blood. Similar changes were detected in bronchoalveolar lavage fluid. The effect on respiratory disease has yet to be definitively determined.

## ANTIMICROBIAL THERAPY

Bacterial infections of the respiratory tract of all species are treated with antimicrobial agents given parenterally or, less commonly, orally. Individual treatment is usually necessary, and the duration of treatment will depend on the causative agent and the severity when treatment was begun. In outbreaks of infectious respiratory disease, the use of mass medication of the feed and water supplies may be advisable for the treatment of subacute cases and for convalescent therapy. The response to mass medication will depend on the total amount of the drug ingested by the animal and this is a reflection of the appetite or thirst of the animal, the palatability of the drug, and its concentration in the feed or water. The choice of drug used will depend on its cost, previous experience on similar cases, and the results of drug sensitivity tests if available. The individual treatment of all in-contact animals in an affected group may be useful in controlling an outbreak of respiratory disease such as shipping fever in feedlot cattle.

**Selection of antimicrobials** is based on the principles detailed in [Chapter 6](#). Briefly, antimicrobials for treatment of bacterial respiratory disease should be active against the causative agent, should be able to achieve therapeutic concentrations in diseased lung, and should be convenient to administer. The antimicrobials should be affordable and, if used in animals intended as human food, must be approved for use in such animals.

Antimicrobials for treatment of lung disease are preferably those that achieve therapeutic concentrations in diseased lung tissue after administration of conventional doses. This has been convincingly demonstrated for the macrolide (azithromycin, erythromycin, clarithromycin), triamizide (tulathromycin), and fluoroquinolone (danofloxacin, enrofloxacin) antimicrobials, and florfenicol in a variety of species. The beta-lactam antimicrobials (penicillin, ceftiofur) are effective in treatment of pneumonia in horses, pigs, and ruminants despite having chemical properties that do not favor their accumulation in lung tissue.

Routes of administration include oral (either individually or in medicated feed or water), parenteral (subcutaneous, intramuscular, intravenous), or by inhalation. Intratracheal administration of antimicrobials to animals with respiratory disease is not an effective means of achieving therapeutic drug concentrations in diseased tissue. **Aerosolization and inhalation** of antimicrobials

has the theoretic advantage of targeting therapy to the lungs and minimizing systemic exposure to the drug. However, although administration by inhalation achieves good concentrations of drug in bronchial lining fluid,<sup>91-93</sup> it does not penetrate unventilated regions of the lungs, in which case parenteral or oral administration of antimicrobials is indicated. Gentamicin, marbofloxacin, ceftiofur, and defquinome all achieve high concentrations in pulmonary epithelial lining fluid when administered to horses.<sup>91-94</sup> Aerosol administration of gentamicin to normal horses results in gentamicin concentrations in bronchial lavage fluid 12 times that achieved after intravenous administration. Aerosolized ceftiofur sodium (1 mg/kg) is superior to intramuscular administration in treatment of calves with *Pasteurella (Mannheimia) haemolytica*.

## BRONCHODILATOR DRUGS

Bronchoconstriction is an important component of the increased airway resistance present in many animals with disease of the lower respiratory tract. Administration of bronchodilators can relieve respiratory distress and improve arterial blood oxygenation. Bronchodilator drugs are beta-2-agonists (clenbuterol, albuterol/salbutamol, terbutaline), parasympatholytic drugs (ipratropium, atropine), and methylxanthines (aminophylline, theophylline).

The **indication** for the use of bronchodilators is relief of bronchoconstriction. Bronchoconstriction is an important component of the pathophysiology of many diseases of the lungs and airways. Bronchodilators are used extensively in horses with heaves and inflammatory airway disease and less so in animals with infectious diseases. **Contraindications** are few, but caution should be exercised when using these drugs in animals that are severely hypoxemic because the beta-2-agonists can transiently worsen gas exchange by increasing perfusion of nonventilated sections of the lung, and in pregnant animals, in which the tocolytic effect of the beta-2-agonists can delay parturition. The use of beta-2-adrenergic agonist bronchodilator drugs in food animals is not permitted in most countries because of the risk of contamination of foodstuffs intended for consumption by people. This is particularly the case with clenbuterol, a drug approved in many countries for use in horses that is administered to cattle illicitly as a growth promoter. People can be poisoned by clenbuterol in tissues of treated cattle.

The **beta-2-adrenergic agonists** are potent and effective bronchodilators that can be administered orally, intravenously, or by inhalation. These drugs also enhance mucociliary clearance of material from the lungs. Most administration is oral or by inhalation. Use of these drugs is restricted to horses, and the drugs are discussed in the section on heaves.

**Parasympatholytic** (anticholinergic) drugs relieve vagally mediated bronchoconstriction. Again, their use is restricted to horses. These drugs can cause tachycardia and gastrointestinal dysfunction, including ileus.

The **methylxanthines** are used in horses and have been investigated for use in cattle with respiratory disease. Their use in horses is mainly of historical interest because the availability of the more efficacious beta-2-adrenergic agonists and parasympatholytic drugs has superseded the use of methylxanthines. The use of theophylline in feedlot cattle with respiratory disease in field conditions is associated with accumulation of toxic concentrations in blood and an excessive mortality rate.

### MUCOLYTICS, MUCOKINETIC, AND ANTITUSSIVE DRUGS

Many groups of drugs are used in the therapy of respiratory diseases with the objective of improving **mucokinesis** or **effective mucociliary clearance**. Mucokinetic agents have been divided into six groups according to their mode of action:

- Diluents, surface acting agents, and mucolytics are supposed to reduce the viscosity of the respiratory secretions.
- Bronchomucotropic agents, formerly called expectorants, are supposed to increase the production of a less viscous mucus.
- Other agents, such as beta-adrenergic agonists and methylxanthine derivatives, promote more effective clearance of mucus and act as ciliary augmentors or bronchodilators.

The aim of mucokinetic agents is to decrease the viscosity of the respiratory secretions, but in some animals with respiratory disease the excessive secretions are of low viscosity and the use of a mucolytic agent in such cases would further decrease mucokinesis. There is little or no evidence that administration of mucolytic or mucokinetic agents, with the possible exception of clenbuterol and dembrexine, relieves signs of respiratory disease or hastens recovery.

Inflammation of the lower respiratory tract results in production of mucus and immigration of inflammatory cells. This accumulation of material is cleared by rostral movement into the pharynx, where it is discharged through the nostrils or swallowed. Clearance is by the mucociliary apparatus or coughing. **Mucolytics** are agents that alter the constituents of mucoid or purulent respiratory secretions and make them less viscous. Bromhexine is a popular mucolytic with horse owners. It is said to reduce the viscosity of airway mucus and increase mucus production, although its clinical efficacy has not been determined. It may be of some value in cattle to increase mucociliary clearance.

Dembrexine alters the carbohydrate side chains of mucin and improves its flow properties and is reported to decrease coughing and hasten recovery in horses with respiratory disease.

Hyperhydration, the administration of large quantities of fluids intravenously, has been suggested as being useful in the treatment of horses with accumulation of excessive amounts of mucus or mucopus in the lower airways. However, experimental trials have demonstrated that this approach is not effective in horses with heaves.

**Bronchomucotropic agents (expectorants)** are administered with the intention of augmenting the volume of respiratory secretions by stimulating the mucus-producing cells and glands. Formerly called expectorants, they are supposed to increase the production of a less viscous mucus. These compounds include the iodides and ammonium and glycerol guaiacolate, which are commonly found in cough mixtures. These are commonly used in farm animals, especially horses, although their efficacy is unknown.

Coughing is a common sign in animals with respiratory disease, and it is an important pulmonary defense mechanism, allowing the expulsion of mucus and foreign bodies. **Antitussive (cough suppressant)** drugs are infrequently used in large-animal medicine. These drugs should only be used when definitive therapy has been implemented for the underlying disease. Control of the underlying disease will in almost all instances resolve the coughing. It is not appropriate to use antitussive agents (butorphanol, codeine, diphenhydramine) to suppress a cough when the underlying cause is unknown or untreated.

### SURFACTANT

Surfactant is critical to normal alveolar function, and a lack of this complex phospholipid results in progressive alveolar collapse. Composition of surfactant from lungs of neonatal foals differs from that of adult horses, with that from foals having a lower protein concentration and higher surface tension.<sup>95</sup> Lack of surfactant is an important cause of respiratory disease in newborn animals, with those born prematurely being at increased risk. Attempts have been made to prevent acute respiratory disease in premature newborn foals, such as those delivered by caesarian section because of maternal disease, but the results have been disappointing.

### SURGERY

Many conditions of the upper respiratory tract of horses are amenable to surgical correction. Tracheostomy is often used in the emergency or urgent relief of acute upper airway obstruction and in the removal of large amounts of tracheal debris, such as occurs in animals with smoke inhalation. Drainage of excessive or infected pleural

fluid can be therapeutic in animals with pleuritis.

### GENERAL NURSING CARE

Animals with respiratory disease should have minimal or no enforced activity, and environmental stressors should be minimized. One of the most important aspects of the treatment of respiratory tract disease in farm animals is the provision of a comfortable, well-ventilated environment during and after the disease episode. Affected animals should be placed in a draft-free area that is adequately ventilated and supplied with an abundance of bedding for comfort and warmth, particularly during convalescence. Feed and water should be readily available and dusty feeds avoided.

### CONTROL OF RESPIRATORY DISEASE

Infectious diseases of the respiratory tract of farm animals are caused by a combination of infectious agents and predisposing causes such as inclement weather, the stress of weaning or transportation, and poorly ventilated housing, each of which can weaken the defense mechanisms of the animal. Prevention and control of these diseases include the following tactics:

- Minimizing exposure to inciting agents (infectious or physical)
- Maximizing innate resistance by ensuring that the animals are in excellent general health through attention to nutrition, housing, and animal welfare
- Maximizing adaptive resistance by the administration of effective vaccines such that maximal resistance is produced to coincide with the time of greatest risk of the disease

### IMPORTANCE OF DIAGNOSIS

For some complex respiratory diseases of food animals, it is becoming increasingly more difficult to obtain a definitive etiologic diagnosis because some of the common diseases appear to be caused by multiple infections rather than a single one. Most of the infective agents that cause respiratory disease are ubiquitous in the environment and are present as normal residents in the nasal cavities of normal animals. This often creates difficulty with the interpretation of the microbiological findings in outbreaks of respiratory disease because the infectious agents can commonly be isolated from both sick and well animals. Thus there may be no well-defined cause-and-effect relationship, and the predisposing causes begin to assume major importance in any control program.

### MANAGEMENT TECHNIQUES

Most of the common respiratory diseases occur at certain times under certain

conditions, and successful control will depend on the use of management techniques before the disease is likely to occur. For example, in beef cattle, pneumonic pasteurellosis can be kept to a minimum with the use of certain management procedures that minimize stress at weaning. The incidence of pneumonia can be minimized in young bulls destined for a performance testing station if they are weaned well in advance of movement to the test center. In North America, bovine respiratory disease is most common in feedlots where young cattle from several different backgrounds have been mingled after having been transported long distances. Outbreaks of equine respiratory disease occur in young horses that are assembled at the racetrack for training or at horse shows.

### HOUSING FACILITIES

The quality of air in housing facilities is a critical determinant of the respiratory health of most species, including humans who work in these facilities.<sup>96</sup> Poor air quality, such as high particulate concentrations, persistently high humidity, bacterial and fungal growth, and excessive concentrations of ammonia, predispose to infectious and noninfectious diseases in animals housed in the barns.<sup>96-99</sup>

The incidence of pulmonary inflammation, excessive mucus in airways and coughing (heaves) in horses is much higher in those that are housed in barns that are dusty and not ventilated compared with horses kept outdoors.<sup>96,100,101</sup> Bad stabling management as a major cause of coughing in horses was described almost 200 years ago, but there is still a major emphasis on the clinical management of chronic coughing in housed horses using a wide spectrum of antibiotics, expectorants, and other drugs. Attention to barn design such that concentration of small particulates in the air is minimized will improve the respiratory health of horses housed in the barn.<sup>101,102</sup>

In pigs, enzootic pneumonia is widespread, but the effects of the pneumonia can be maintained at an insignificant level with adequate housing, ventilation, and nutrition. Too much emphasis has been placed on the attempted eradication of *Mycoplasma* spp., which is extremely difficult, and insufficient emphasis on building design and ventilation methods.

### VACCINES

Vaccines are available for the immunization of farm animals against some of the common infectious diseases of the respiratory tract. Their advantages and disadvantages are discussed under each specific disease. The general principles underlying use of vaccines for control of respiratory disease are as follows:

- The disease must be caused by a disease that is infectious.

- There must be an effective vaccine suitable for use in the species and age group of animals at most risk of the disease. Ideally, this will be known from published, appropriately designed trials testing the vaccine in a group of animals identical to those in which the vaccine will be used in practice.
- The vaccine must be administered to animals in such a manner (route, timing, frequency) to optimize the immunization (adaptive immunity).
- The timing of the vaccination program should be such that maximal resistance to the anticipated diseases is achieved at the time of greatest risk of the disease.
- Vaccination should be part of an ongoing program of disease control and should not be regarded as a panacea with which to rectify other shortcomings in management of the animals.

### ENVIRONMENTAL CONTROL

In effect, the principles of control and prevention of airborne respiratory disease are based largely on keeping the levels of pathogens in the air at a low level. This can be accomplished by a combination of the following practices:

- The use of filtered-air positive-pressure ventilation systems
- The removal of affected animals from the group
- Increasing the ventilation rate of the building unit
- Subdivision of the unit into small units, each with its own ventilation system
- A continual disinfection system where appropriate and practicable
- The provision of supplemental heat so that during cold weather the ventilation can be maintained and animals will not huddle together to keep warm and thereby increase the exposure rate of infection
- The use of vaccines for specific diseases of the respiratory tract
- Effective dust control

### FURTHER READING

- Allen KJ, et al. Exercise testing of equine athletes. *Equine Vet Educ.* 2015;doi:10.1111/eve/12410.
- Dunkel B, et al. A fresh approach to equine thoracic radiography. *In Prac.* 2013;35:589-596.
- Richard EA, et al. Laboratory findings in respiratory fluids of the poorly performing horse. *Vet J.* 2010;185:115-122.
- Scott PR. Treatment and control of respiratory disease in sheep. *Vet Clin North Am Food A.* 2011;27:175.
- Van Erck E, et al. Respiratory diseases and their effects on respiratory function and exercise capacity. *Equine Vet J.* 2013;45:376-387.

### REFERENCES

1. Buczinski S, et al. *J Vet Int Med.* 2014;28:234.
2. Mang AV, et al. *J Vet Int Med.* 2015;n/a.

3. Ferrari S, et al. *J Ag Eng.* 2009;40:7.
4. Ferrari S, et al. *Comp Elect Ag.* 2008;64:318.
5. Ferrari S, et al. *Prev Vet Med.* 2010;96:276.
6. Barakzai SZ, et al. *Equine Vet J.* 2011;43:18.
7. Van Erck E. *Equine Vet J.* 2011;43:18.
8. Scharner D, et al. *Pferdeheilkunde.* 2012;28:548.
9. Scharner D, et al. *Vet Surg.* 2014;43:85.
10. Davis EG, et al. *Equine Vet Educ.* 2013;25:96.
11. Lee WL, et al. *Equine Vet Educ.* 2013;25:79.
12. Pollock PJ, et al. *Vet Rec.* 2006;159:354.
13. Relave F, et al. *Vet Surg.* 2008;37:232.
14. Dunkel B, et al. *In Prac.* 2013;35:589.
15. Venner M, et al. *Pferdeheilkunde.* 2014;30:561.
16. Manso-Diaz G, et al. *Vet Radiol Ultra.* 2015;56:176.
17. Kyllar M, et al. *Anat Histol Embryol.* 2014;43:435.
18. Ohlerth S, et al. *Schweiz Arch Tierheilkd.* 2014;156:489.
19. Schliwert E-C, et al. *Am J Vet Res.* 2015;76:42.
20. Lascola KM, et al. *Am J Vet Res.* 2013;74:1239.
21. Ohlerth S, et al. *Res Vet Sci.* 2012;92:7.
22. Lubbers BV, et al. *Am J Vet Res.* 2007;68:1259.
23. Bahar S, et al. *J Vet Med Sci.* 2014;76:37.
24. Bahar S, et al. *J Anim Vet Adv.* 2014;13:694.
25. Barba M, et al. *Equine Vet Educ.* 2013;25:29.
26. van Galen G, et al. *J Equine Vet Sci.* 2010;30:436.
27. Textor JA, et al. *JAVMA.* 2012;240:1338.
28. Berchtold B, et al. *Acta Vet Scand.* 2013;55.
29. Finnen A, et al. *J Vet Int Med.* 2011;25:143.
30. Lee K-J, et al. *J Vet Med Sci.* 2011;73:113.
31. Magyar T, et al. *BMC Vet Res.* 2013;9.
32. Posa R, et al. *Vet Pathol.* 2013;50:971.
33. Archer DC, et al. *Vet J.* 2007;173:45.
34. Buczinski S, et al. *J Dairy Sci.* 2013;96:4523.
35. Chalmers HJ, et al. *Vet Radiol Ultra.* 2012;53:660.
36. Garrett KS, et al. *Equine Vet J.* 2013;45:598.
37. Fjordbakk CT, et al. *Equine Vet J.* 2013;45:705.
38. Karlheim B, et al. *Equine Vet Educ.* 2015;27:86.
39. Angen O, et al. *Vet Microbiol.* 2009;137:165.
40. Laus F, et al. *Vet Med.* 2009;54:444.
41. Holcombe SJ, et al. *Equine Vet J.* 2006;38:300.
42. Richard EA, et al. *Vet J.* 2010;185:115.
43. Block W, et al. *Pferdeheilkunde.* 2011;27:495.
44. Pacheco AP, et al. *Am J Vet Res.* 2012;73:146.
45. Tee SY, et al. *Aust Vet J.* 2012;90:247.
46. Malikides N, et al. *Aust Vet J.* 2007;85:414.
47. Coskun A, et al. *Rev Med Vet.* 2012;163:615.
48. Voigt K, et al. *Res Vet Sci.* 2007;83:419.
49. Koblinger K, et al. *Equine Vet J.* 2014;46:50.
50. Depecker M, et al. *Vet J.* 2014;199:150.
51. Fernandez NJ, et al. *Vet Clin Pathol.* 2013;42:92.
52. Secombe CJ, et al. *Aust Vet J.* 2015;93:152.
53. Pacheco AP, et al. *J Vet Int Med.* 2014;28:603.
54. Puellen C, et al. *Res Vet Sci.* 2015;98:106.
55. Richard EA, et al. *Equine Vet J.* 2009;41:384.
56. van Erck E, et al. *Equine Vet J.* 2006;38:52.
57. Van Erck-Westergren E, et al. *Equine Vet J.* 2013;45:376.
58. Kennedy SA, et al. *Am J Vet Res.* 2012;73:979.
59. Noel PG, et al. *Equine Vet J.* 2010;42:91.
60. Giguere S, et al. *J Vet Emerg Crit Care.* 2014;24:529.
61. Bleul U, et al. *J Vet Emerg Crit Care.* 2014;24:519.
62. Nieto JE, et al. *Vet Surg.* 2015;44:366.
63. Cathcart MP, et al. *Vet J.* 2012;191:282.
64. Crowley J, et al. *Equine Vet J.* 2013;45:20.
65. Whittaker AG, et al. *Vet J.* 2012;191:208.
66. Pusterla N, et al. *Equine Vet Educ.* 2007;19:157.
67. Relave F, et al. *Vet Surg.* 2010;39:839.
68. Venner M, et al. *J Vet Int Med.* 2006;20:968.
69. Burgess BA, et al. *Can J Vet Res.* 2011;75:254.
70. Burn JF, et al. *Equine Vet J.* 2006;38:319.
71. Barakzai SZ, et al. *Equine Vet J.* 2012;44:501.
72. Davidson EJ, et al. *Equine Vet J.* 2011;43:3.
73. Kelly PG, et al. *Equine Vet J.* 2013;45:700.
74. Strand E, et al. *Equine Vet J.* 2012;44:524.
75. Mirazo JE, et al. *J South Afr Vet Assoc.* 2015;85.



76. Allen KJ, et al. *Equine Vet J*. 2010;42:186.
77. Franklin SH, et al. *Equine Vet J*. 2008;40:712.
78. Desmaizieres LM, et al. *Equine Vet J*. 2009;41:347.
79. Gehlen H, et al. *Pferdeheilkunde*. 2010;26:344.
80. Pollock PJ, et al. *Equine Vet Educ*. 2009;21:367.
81. Priest DT, et al. *Equine Vet J*. 2012;44:529.
82. Strand E, et al. *Equine Vet J*. 2012;44:518.
83. Allen KJ, et al. *Equine Vet Educ*. 2015;n/a.
84. Go L, et al. *Equine Vet Educ*. 2014;26:41.
85. Wong DM, et al. *Am J Vet Res*. 2010;71:1081.
86. Giguere S, et al. *J Vet Int Med*. 2008;22:401.
87. Bleul U, et al. *Vet J*. 2012;194:240.
88. Bleul U, et al. *Therio*. 2010;73:612.
89. Balikci E, et al. *Rev Med Vet*. 2009;160:282.
90. Giguere S, et al. *Am J Vet Res*. 2007;68:1407.
91. Winther L, et al. *J Vet Pharmacol Ther*. 2011;34:482.
92. Fultz L, et al. *Equine Vet J*. 2015;47:473.
93. Art T, et al. *Vet Rec*. 2007;161:348.
94. Art T, et al. *Equine Vet Educ*. 2010;22:473.
95. Christmann U, et al. *J Vet Int Med*. 2006;20:1402.
96. Walinder R, et al. *Environ Health Prev Med*. 2011;16:264.
97. Ivester KM, et al. *J Vet Int Med*. 2014;28:1653.
98. Lago A, et al. *J Dairy Sci*. 2006;89:4014.
99. Robertson J. *Vet Rec*. 2012;171:121.
100. May ML, et al. *Proc Amer Assoc of Equine Pract*. 2007;53:77.
101. Riihimaki M, et al. *Can J Vet Res*. 2008;72:432.
102. Millerick-May ML, et al. *Equine Vet J*. 2013;45:85.

## Diseases of the Upper Respiratory Tract

### RHINITIS

Rhinitis (inflammation of the nasal mucosa) is characterized clinically by sneezing, wheezing, and stertor during inspiration and a nasal discharge that can be serous, mucoid, or purulent in consistency depending on the cause.

### ETIOLOGY

Rhinitis usually occurs in conjunction with inflammation of other parts of the respiratory tract. It is present as a minor lesion in most bacterial and viral pneumonias, but the diseases listed are those in which it occurs as an obvious and important part of the syndrome.

#### Cattle

- Catarrhal rhinitis in infectious bovine rhinotracheitis; adenoviruses 1, 2, and 3; and respiratory syncytial virus infections
- Ulcerative/erosive rhinitis in bovine malignant catarrh, mucosal disease, rinderpest
- *Actinobacillus lignieresii* can cause outbreaks of respiratory disease in adult cattle characterized by stertorous breathing, nasal discharge, and excessive salivation. Lesions included thickening and ulceration of the nasal planum, turbinates, and paranasal sinuses. Treatment with

oxytetracycline was associated with resolution of the disease.<sup>1</sup>

- Nasal schistosomiasis
- Nasal mycosis
- Infection by *Pseudallescheria boydii* species complex<sup>2</sup>
- Nasal actinomycosis
- Rhinosporidiosis caused by fungi and atopic rhinitis
- Familial allergic rhinitis and allergic nasal granuloma<sup>3</sup>
- Bovine nasal eosinophilic granuloma attributable to *Nocardia* sp.

#### Horses

- Glanders, strangles, and epizootic lymphangitis
- Infections with the viruses of equine viral rhinopneumonitis (herpesvirus-1), equine herpesvirus-3,<sup>4</sup> equine viral arteritis, influenza H3N8 equine rhinovirus, parainfluenza virus, reovirus, adenovirus
- Chronic rhinitis claimed to be caused by dust in dusty stables, and acute rhinitis occurring after inhalation of smoke and fumes
- Nasal granulomas as a result of chronic infections with *Pseudoallescheria boydii* and *Aspergillus*, *Conidiobolus*, and *Mucoraceous* fungi
- Equine grass sickness (dysautonomia) in the chronic form causes rhinitis sicca<sup>5</sup>

#### Sheep and Goats

- Melioidosis, bluetongue; rarely, contagious ecthyma and sheep pox
- *Oestrus ovis* and *Elaeophora schneideri* infestations
- Allergic rhinitis
- Purulent rhinitis and otitis associated with *P. aeruginosa* in sheep showered with contaminated wash
- Infection by *Conidiobolus* spp. and *Pythium* spp.<sup>6-8</sup>
- Nasal polyps in sheep<sup>9</sup>

#### Pigs

- Atrophic rhinitis, inclusion-body rhinitis, swine influenza, some outbreaks of Aujeszky's disease

### PATHOGENESIS

Rhinitis is of minor importance as a disease process except in severe cases when it causes obstruction of the passage of air through the nasal cavities. Its major importance is as an indication of the presence of some specific diseases. The type of lesion produced is important. The erosive and ulcerative lesions of rinderpest, bovine malignant catarrh, and mucosal disease; the ulcerative lesions of glanders, melioidosis, and epizootic lymphangitis; and the granular rhinitis of the

anterior nares in allergic rhinitis all have diagnostic significance.

In atrophic rhinitis of pigs, the destruction of the turbinate bones and distortion of the face appear to be a form of devitalization and atrophy of bone caused by a primary inflammatory rhinitis. Secondary bacterial invasion of facial tissue of swine appears to be the basis of necrotic rhinitis.

### CLINICAL FINDINGS

The primary clinical finding in rhinitis is a nasal discharge, which is usually serous initially but soon becomes mucoid and, in bacterial infections, purulent. Erythema, erosion, or ulceration may be visible on inspection. The inflammation may be unilateral or bilateral. Sneezing is characteristic in the early acute stages, and this is followed in the later stages by snorting and the expulsion of large amounts of mucopurulent discharge. A chronic unilateral purulent nasal discharge lasting several weeks or months in horses suggests nasal granulomas associated with mycotic infections.

#### “Summer Snuffles”

“Summer snuffles” of cattle presents a characteristic syndrome involving several animals in a herd. Cases occur in the spring and autumn when the pasture is in flower and warm, moist environmental conditions prevail. The disease may be most common in Channel Island breeds. There is a sudden onset of dyspnea with a profuse nasal discharge of thick, orange to yellow material that varies from a mucopurulent to caseous consistency. Sneezing, irritation, and obstruction are severe. The irritation may cause the animal to shake its head, rub its nose along the ground, or poke its muzzle repeatedly into hedges and bushes. Sticks and twigs may be pushed up into the nostrils as a result and cause laceration and bleeding. Stertorous, difficult respiration accompanied by mouth breathing may be evident when both nostrils are obstructed. In the most severe cases, a distinct pseudomembrane is formed that is later snorted out as a complete nasal cast. In the chronic stages, multiple proliferative nonerosive nodules 2 to 8 mm in diameter and 4 mm high with marked mucosal edema are visible in the anterior nares.

#### Familial Allergic Rhinitis

In familial allergic rhinitis in cattle, the clinical signs begin in the spring and last until late fall. Affected animals exhibit episodes of violent sneezing and extreme pruritus manifested by rubbing their nostrils on the ground, trees, and other inanimate objects and frequently scratching the nares with their hindfeet. Dyspnea and loud snoring sounds are common, and affected animals frequently clean their nostrils with their tongues. The external nares contain a thick mucoid discharge, and the nasal mucosa is

edematous and hyperemic. The clinical abnormalities resolve during the winter months. All affected animals are positive to intradermal skin testing for a wide variety of allergens.

### Mycotic Rhinitis

Mycotic rhinitis in the horse is characterized by noisy respirations, circumferential narrowing of both nasal passages, and thickening of the nasal septum. The nasal conchae and turbinates may be roughened and edematous, and the ventral meati decreased in size bilaterally. The nasal discharge may be unilateral or bilateral. Endoscopically, granulomas may be found in almost any location in the nasal cavities and extending to the soft palate and into the maxillary sinus. The disease is discussed in detail in this chapter.

### Endoscopic Examination

Endoscopic examination is useful for the visual inspection of lesions affecting the nasal mucosae of horses and cattle that are not visible externally. Radiographic or computed tomographic imaging can be used to detect atrophic rhinitis, although use of these techniques on a wide scale is clearly not practical.

### CLINICAL PATHOLOGY

Examination of nasal swabs of scrapings for bacteria, inclusion bodies, or fungi may aid in diagnosis. Discharges in allergic rhinitis usually contain many more eosinophils than normal. Nasal mucosal biopsy specimens are useful for microbiological and histopathologic examination.

### NECROPSY FINDINGS

Rhinitis is not a fatal condition, although animals may die of specific diseases in which rhinitis is a prominent lesion.

### DIFFERENTIAL DIAGNOSIS

Rhinitis is readily recognizable clinically. Differentiation of the specific diseases listed previously under "Etiology," is discussed under their respective headings.

**Allergic rhinitis in cattle** must be differentiated from maduromycosis, rhinosporidiosis, and infection with the pasture mite (*Tyrophagus palmarum*). The differential diagnosis may be difficult if allergic rhinitis occurs secondary to some of these infections.

**Rhinitis in the horse** must be differentiated from inflammation of the facial sinuses or guttural pouches in which the nasal discharge is usually purulent and persistent and often unilateral, and there is an absence of signs of nasal irritation. A malodorous nasal discharge, frontal bone distortion, draining tracts at the poll, and neurologic abnormalities are common in cattle with chronic frontal sinusitis as a complication of dehorning.

### TREATMENT

Specific treatment aimed at control of individual causative agents is described under each disease. Thick tenacious exudate that is causing nasal obstruction may be removed gently and the nasal cavities irrigated with saline. A nasal decongestant sprayed up into the nostrils may provide some relief. Newborn piglets with inclusion-body rhinitis may be affected with severe inspiratory dyspnea and mouth breathing that interferes with sucking. The removal of the exudate from each nostril followed by irrigation with a mixture of saline and antimicrobials will provide relief and minimize the development of a secondary bacterial rhinitis. Animals affected with allergic rhinitis should be taken off the pasture for about a week and treated with antihistamine preparations.

### REFERENCES

1. Wessels M, et al. *Vet Rec.* 2012;170.
2. Singh K, et al. *Vet Pathol.* 2007;44:917.
3. *Vet Rec.* 2012;171:468.
4. Barrandeguy M, et al. *Vet Rec.* 2010;166:178.
5. Pirie RS. *Clin Tech Equine Pract.* 2006;5:30.
6. Ubiali DG, et al. *J Comp Pathol.* 2013;149:137.
7. do Carmo PMS, et al. *J Comp Pathol.* 2014;150:4.
8. Santurio JM, et al. *Vet Rec.* 2008;163:276.
9. Capucchio MT, et al. *Small Rumin Res.* 2015;126:6.

### NASAL DISCHARGE

Nasal obstruction occurs commonly in cattle and sheep. The disease is usually chronic and occurs as a result of the following:

- In sheep, infestation with *Oestrus ovis*
- In cattle, most often enzootic nasal granuloma, acute obstruction or the allergic condition "summer snuffles." Cystic enlargement of the ventral nasal conchae in cattle can cause unilateral or bilateral nasal obstruction.

Minor occurrences include the following:

- Large mucus-filled polyps developing in the posterior nares of cattle and sheep and causing unilateral or bilateral obstruction
- Granulomatous lesions caused by a fungus, *Rhinosporidium* sp., and by the blood fluke, *Schistosoma nasalis*
- A chronic pyogranuloma as a result of *Coccidioides immitis* infection has occurred in the horse.
- Foreign bodies may enter the cavities when cattle rub their muzzles in bushes in an attempt to relieve the irritation of acute allergic rhinitis.
- Nasal amyloidosis occurs rarely in mature horses and is characterized clinically by stertorous breathing and raised, firm, nonpainful, nodular swellings on the rostral nasal septum and floor of the nasal cavity. Affected horses do not have any other illness,

and surgical removal of the lesions is recommended

- Infestation of the nasopharynx of horses by *Gasterophilus pecorum* causes obstruction of the upper airway.

### Neoplasms

Neoplasms of the olfactory mucosa are not common but do occur, particularly in sheep, goats, and cattle, where the incidence in individual flocks and herds may be sufficiently high to suggest an infectious cause. The lesions are usually situated just in front of the ethmoid bone, are usually unilateral but may be bilateral, and have the appearance of adenocarcinomas of moderate malignancy. In cattle, the disease is commonest in 6- to 9-year-olds and may be sufficiently extensive to cause bulging of the facial bones. The tumors are adenocarcinomas arising from the ethmoidal mucosa, and they metastasize in lungs and lymph nodes. Clinical signs include nasal discharge, often bloody; mouth breathing; and assumption of a stretched-neck posture. There is evidence to suggest that a virus may be associated. A similar syndrome is observed in cattle with other nasal tumors such as osteoma.

Neoplasia that obstructs the nasal cavity occurs in horses with squamous-cell carcinoma or adenocarcinoma of the sinus or nasal cavity or ethmoids,<sup>11</sup> angiosarcoma, and a variety of other rare tumors. Epidermal inclusions cysts of the nasal diverticulum of horses can cause obstruction of the nasal cavity, but are not neoplasms. Cysts of the paranasal sinuses can cause marked facial deformity and obstruction to air passages.

### Enzootic Nasal Adenocarcinoma

Enzootic nasal adenocarcinoma is a contagious disease that occurs in sheep and goats, in which it is associated with a virus—enzootic nasal tumor virus.<sup>1</sup> The putative etiologic agent is a beta-retrovirus, with different strains occurring in sheep and goats. The disease can be reproduced by inoculation of 14-day-old lambs with the virus.<sup>2</sup> The clinical findings include a persistent serous, mucous, or mucopurulent nasal discharge and stridor.<sup>3</sup> Affected sheep and goats progressively develop anorexia, dyspnea, and mouth breathing, and most die within 90 days after the onset of signs. The tumors originate unilaterally or occasionally bilaterally in the olfactory mucosa of the ethmoid turbinates.<sup>3</sup> They are locally invasive but not metastatic. Histologically, the tumors are classified as adenomas or, more frequently, adenocarcinomas. Budding and extracellular retrovirus-like particles have been observed ultrastructurally in enzootic nasal tumors of goats. A reverse-transcription polymerase chain reaction (RT-PCR) can detect the virus in healthy and affected sheep, although its clinical utility in allowing control of the infection has not been determined.<sup>4</sup>

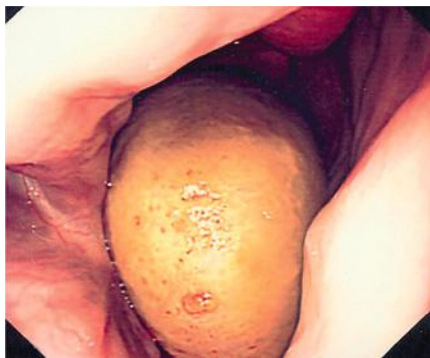

**Fig. 12-3** Endoscopic view of a progressive ethmoidal hematoma in a horse. (Reproduced with permission.<sup>12</sup>)

### Progressive Ethmoidal Hematomas in Equids

Ethmoidal hematomas are non-neoplastic tumors that are encapsulated, usually expanding, insidious, potentially distorting and obstructing lesions of the nasal cavities that occur in horses.<sup>5,6</sup> The etiology is unknown but a viral etiology (papilloma virus) should be considered. Chronic unilateral nasal discharge is common, and lesions are usually advanced at the time of diagnosis. There is stertorous breathing and upper airway obstruction in later stages of the disease. The nasal discharge is serous or mucoid and intermittently sanguineous, sanguinopurulent, and usually unrelated to exercise. The tumor arises in the ethmoids and can invade paranasal sinuses, and especially the sphenopalatine sinus, and is bilateral in approximately 50% of horses.<sup>7</sup> Diagnosis is made by endoscopy and radiography (Figs. 12-3 and 12-4). Computed tomographic examination yields information additional that obtained by radiographic examination (Fig. 12-5) and is useful in determining treatment modality and approach and prognosis. Magnetic resonance imaging (MRI) yields similar information to that obtained by computed tomography (CT) examination.<sup>8</sup>

Surgical removal is possible and successful in some cases. Surgical removal is challenging and often associated with clinically important hemorrhage and the need for intraoperative or postoperative blood transfusion.<sup>9</sup> Surgical removal of the tumor can be achieved in some horses during a standing procedure, but the long-term success has yet to be determined.<sup>10</sup>

Multiple intralesional injection of formalin (1-100 mL of 10% neutral buffered formalin injected at 10-day intervals) through an endoscope can cure the tumor, but there is the risk of serious adverse effects if the ethmoidal hematoma penetrates the cribriform plate. The procedure involves the injection of a sufficient volume of 10% neutral buffered formalin to distend the lesion. The formalin is injected via an endoscope once every 10 days until the lesion resolves by



**Fig. 12-4** Lateral radiograph of the head of a horse with progressive ethmoidal hematoma (black arrow) and related hemorrhage into the paranasal sinuses (white lines). (Reproduced with permission.<sup>12</sup>)

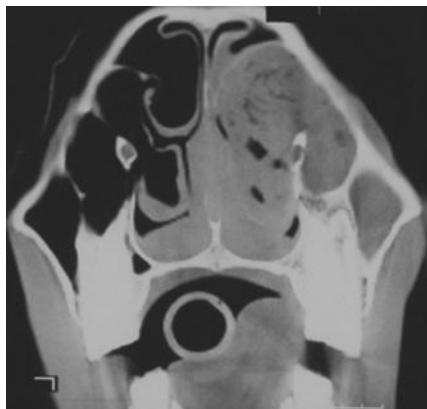

**Fig. 12-5** Computed tomographic image of the head of a horse with advanced ethmoidal hematoma revealing extension into the paranasal sinuses (white arrow). (Reproduced with permission.<sup>12</sup>)

sloughing. Between 1 and 20 injections will be required. The combination of intralesional injection of formalin and laser ablation resulted in severe neurologic complications in one horse with ethmoidal adenocarcinoma treated in this way.<sup>11</sup> Similar adverse

effects can occur with use of these treatments in horses with ethmoidal hematomas.

However, the prognosis for long-term resolution of the tumor is poor because of high rates of recurrence.

### CLINICAL FINDINGS

In cattle, sheep, and pigs there is severe inspiratory dyspnea when both cavities are blocked. The animals may show great distress and anxiety and breathe in gasps through the mouth. Obstruction is usually not complete and a loud, wheezing sound occurs with each inspiration. A nasal discharge is usually present but varies from a small amount of blood-stained serous discharge when there is a foreign body present to large quantities of purulent exudate in allergic rhinitis. Shaking of the head and snorting are also common signs. If the obstruction is unilateral, the distress is not so marked, and the difference in breath streams between the two nostrils can be detected by holding the hands in front of the nose. The magnitude of the air currents from each nostril on expiration can be assessed with the aid of a piece of cotton thread (watching the degree of deflection). The passage of a



stomach tube through each nasal cavity may reveal evidence of a space-occupying lesion. Endoscopic examination is frequently diagnostic.

## TREATMENT

Treatment must be directed at the primary cause of the obstruction. Removal of foreign bodies can usually be effected with the aid of long forceps, although strong traction is often necessary when the obstructions have been in position for a few days.

## REFERENCES

1. Walsh SR, et al. *Virus Res.* 2010;151:74.
2. Walsh SR, et al. *Vet Res.* 2013;44.
3. Yi G, et al. *Transbound Emerg Dis.* 2010;57:197.
4. Walsh SR, et al. *J Gen Virol.* 2014;95:1843.
5. Tremaine WH. *Equine Vet Educ.* 2009;21:582.
6. Tremaine WH. *Equine Vet Educ.* 2013;25:508.
7. Textor JA, et al. *JAVMA.* 2012;240:1338.
8. Tessier C, et al. *Vet Radiol Ultra.* 2013;54:54.
9. Hart SK, et al. *Equine Vet J.* 2011;43:24.
10. Smith LJ, et al. *Equine Vet Educ.* 2009;21:577.
11. Maischberger E, et al. *Equine Vet Educ.* 2014;26:563.
12. Archer D. *In Pract.* 2008;30:20.

## EPISTAXIS AND HEMOPTYSIS

Epistaxis is bleeding from the nostrils regardless of the origin of the hemorrhage, and hemoptysis is the coughing up of blood, with the hemorrhage usually originating in the lungs. Both epistaxis and hemoptysis are important clinical signs in cattle and horses. The bleeding can be in the form of a small volume of blood-stained serous discharge coming from one or both nares, or it can be a large volume of whole blood coming from both nostrils and sometimes the mouth. Pulmonary hemorrhage as a cause of epistaxis or hemoptysis is dealt with under that heading (“Pulmonary Hemorrhage” section in this chapter). The first and most important decision is to determine the anatomic location of the lesion causing bleeding.

## ETIOLOGY

Epistaxis occurs commonly in the horse and may be caused by lesions in the nasal cavity, nasopharynx, auditory tube diverticulum (guttural pouch), or lungs (see [Table 12-12](#) in the section on exercise-induced pulmonary hemorrhage in horses). Epistaxis in horses can also be a result of trauma, progressive ethmoidal hematoma, foreign bodies lodged in the respiratory tract, hemorrhagic diatheses, sinusitis, nasal amyloidosis, polyps, and bleeding from the nasolacrimal duct.<sup>1</sup> **Exercise-induced pulmonary hemorrhage** is described under that heading later in this chapter.

Hemorrhagic lesions of the nasal cavity, nasopharynx, and guttural pouch in the horse usually cause unilateral epistaxis of varying degree depending on the severity of the lesions. **Pulmonary lesions** in the horse resulting in hemorrhage into the lumen of the bronchi also result in epistaxis. Blood

originating from the lungs of the horse is discharged most commonly from the nostrils and not the mouth because of the anatomy of the horse's soft palate.

Bleeding from lesions of the upper respiratory tract of horses usually occurs spontaneously while the horse is at rest. One of the commonest causes of unilateral epistaxis in the horse is guttural pouch mycosis with erosion of the internal carotid artery.<sup>2</sup>

**Other less common causes** of nasal bleeding include hemorrhagic polyps of the mucosa of the nasal cavity or paranasal sinuses, and ethmoidal hematoma (see “Progressive ethmoidal hematoma” in the section on Nasal discharge in this chapter.). Another cause, most uncommonly, is a parasitic arteritis of the internal carotid artery as it courses around the guttural pouch. Pseudoaneurysm of the palatine artery causes unilateral epistaxis.<sup>3</sup>

Mild epistaxis is a common finding in horses and cattle with severe thrombocytopenia.<sup>4</sup>

Erosions of the nasal mucosa in glanders, granulomatous disease such as cryptococcal sinusitis,<sup>5</sup> neoplastic diseases, and trauma as a result of passage of a nasal tube or endoscope, or from physical trauma externally, are other obvious causes. Trauma to the head and skull fractures can result in epistaxis.<sup>6</sup> Rupture of the longus capitis muscle and fracture of the basisphenoid bone in horses that rear and fall backward and strike the poll causes epistaxis, among other signs.<sup>7</sup>

A case of fibrous dysplasia in the ventral meatus of a horse with epistaxis is recorded. Congestive heart failure and purpura hemorrhagica can cause mild epistaxis in horses.

Neoplasia, and notably hemangiosarcoma, of the upper or lower respiratory tract can cause epistaxis. Osteoma of the nasal bones causes nasal obstruction and epistaxis in cattle.<sup>8,9</sup>

Envenomation of horses by rattlesnakes in the western United States causes a clinical syndrome that includes swelling of the head, dyspnea, and epistaxis.

**Poisoning** by bracken fern or moldy sweet clover is a common cause of spontaneous epistaxis in cattle.<sup>10</sup> The epistaxis can be bilateral, and hemorrhages of other visible and subcutaneous mucous membranes are common. An enzootic ethmoidal tumor has been described in cattle in Brazil and was at one time a disease of some importance in Sweden. The lesion occupies the nasal cavities, causes epistaxis, and can invade paranasal sinuses.

**In hemoptysis in horses**, the blood flows along the horizontal trachea and pools in the larynx until the swallowing reflex is stimulated and swallowing occurs; or coughing is stimulated and blood is expelled through the mouth and nostrils. The origin of the hemorrhage is usually in the lungs, and in cattle the usual cause is a pulmonary arterial aneurysm and thromboembolism from a posterior

vena caval thrombosis (see “Caudal Vena Cava Syndrome”). Recurrent attacks of hemoptysis with anemia and abnormal lung sounds usually culminate in an acute intrapulmonary hemorrhage and rapid death.

**The origin** of the hemorrhage in epistaxis and hemoptysis may be obvious, as in traumatic injury to the turbinates during passage of a stomach tube intranasally or if a systemic disease with bleeding defects is present. In many other cases, however, the origin of the hemorrhage is not obvious, and special examination procedures may be required. Careful auscultation of the lungs for evidence of abnormal lung sounds associated with pulmonary diseases is necessary.

## CLINICAL EXAMINATION

The nasal cavities should be examined visually with the aid of a strong, pointed source of light through the external nares. Only the first part of the nasal cavities can be examined directly but an assessment of the integrity of the nasal mucosa can usually be made. In epistaxis resulting from systemic disease or clotting defects, the blood on the nasal mucosa will usually not be clotted. When there has been recent traumatic injury to the nasal mucosa or erosion of a blood vessel by a space-occupying lesion such as tumor or nasal polyp, the blood will usually be found in clots in the external nares.

The nasal cavities should then be examined for any evidence of obstruction as set out in the previous section. When the blood originates from a pharyngeal lesion there are frequent swallowing movements and a short explosive cough, which may be accompanied by the expulsion of blood from the mouth. Hematologic examinations are indicated to assist in the diagnosis of systemic disease or clotting defects. Radiologic examinations of the head are indicated when space-occupying lesions are suspected.

Use of the flexible fiberoptic endoscope will permit a thorough examination of the nasal cavities, nasopharynx, guttural pouch and larynx, trachea, and major bronchi.

## TREATMENT

Specific treatment of epistaxis and hemoptysis depends on the cause. Hemorrhage from traumatic injuries to the nasal mucosa does not usually require any specific treatment. Space-occupying lesions of the nasal mucosa might warrant surgical therapy. Epistaxis associated with guttural pouch mycosis usually requires surgical intervention. There is no successful treatment for the hemoptysis attributable to pulmonary aneurysm and posterior vena caval thrombosis in cattle. General supportive therapy is as for any spontaneous hemorrhage and includes rest, blood transfusions, and hematinics.

## FURTHER READING

Archer D. Differential diagnosis of epistaxis in the horse. *In Pract.* 2008;30:20-29.

## REFERENCES

1. Archer D. *In Prac.* 2008;30:20.
2. Dobesova O, et al. *Vet Rec.* 2012;171:561.
3. McClellan NR, et al. *Vet Surg.* 2014;43:487.
4. Sanz MG, et al. *Vet Clin Pathol.* 2011;40:48.
5. Stewart AJ, et al. *JAVMA.* 2009;235:723.
6. Gerding JC, et al. *Vet Ophthalmol.* 2014;17:97.
7. Beccati F, et al. *Equine Vet Educ.* 2011;23:327.
8. Yoshimoto K, et al. *J Jap Vet Med Assoc.* 2011;64:457.
9. Wuersch K, et al. *J Comp Pathol.* 2009;141:204.
10. Plessers E, et al. *Vlaams Diergeneeskundig Tijdschrift.* 2013;82:31.

## PHARYNGITIS

Pharyngitis in all species is associated with infectious diseases of the upper airway. It is most studied in horses, probably because of the frequency of examination of the upper airway in this species. Pharyngitis in horses has many similarities to tonsillitis in children. The disorder in horses involves follicular lymphoid hyperplasia of the pharynx affecting both the pharyngeal tonsil and the extensive and diffuse lymphoid tissue in the walls and dorsal aspect of the pharynx. These tissues form the mucosal associated lymphoid tissues and are an important component of the normal immunologic response of horses. The condition occurs in a high proportion of Thoroughbred racehorses and is probably as common in other breeds of horse.<sup>1</sup> The condition is first detectable in 2- to 3-month-old foals and reaches its highest prevalence and greatest severity in yearlings and 2-year-old horses in race training. It is evident on endoscopic examination as diffuse, multiple, small, white nodules in the roof and walls of the pharynx. The nodules can be confluent, and there is often excessive mucus present in severely affected horses. The clinical significance of the condition is debated.<sup>1-3</sup> Affected racehorses do not have impaired race performance. Affected horses recover spontaneously as they age or after treatment with topical antiinflammatory drugs. The condition is probably a normal aging process and necessary for development of a competent immune system in young horses.

Infestation of the nasopharynx of horses by larvae of the bot fly *Gasterophilus pecorum* causes obstruction of the upper airway and a parasitic pharyngitis. Diagnosis is by visualization of the parasite during endoscopic examination.

## REFERENCES

1. Saulez MN, et al. *Vet Rec.* 2009;165:431.
2. Van Erck-Westergren E, et al. *Equine Vet J.* 2013;45:376.
3. Van Erck E. *Equine Vet J.* 2011;43:18.

## LARYNGITIS, TRACHEITIS, BRONCHITIS

Inflammation of the air passages usually involves all levels, and no attempt is made here to differentiate between inflammations

of various parts of the tract. They are all characterized by one or more of cough, noisy inspiration, and some degree of inspiratory embarrassment.

## ETIOLOGY

All infections of the upper respiratory tract cause inflammation, either acutely or as chronic diseases. In most diseases the laryngitis, tracheitis, and bronchitis form only a part of the syndrome, and the causes listed here are those diseases in which upper respiratory infection is a prominent feature.

### Cattle

- Infectious bovine rhinotracheitis (bovine herpesvirus-1), calf diphtheria (necrotic laryngitis), *Histophilus somnus*
- Tracheal stenosis in feedlot cattle, “honker cattle,” etiology unknown
- Necrotic laryngitis in calves<sup>1</sup>
- *Syngamus laryngeus* infests the larynx of cattle in the tropics
- Trauma, including balling gun-induced injury<sup>2</sup>

### Sheep

- Chronic infection with *Actinomyces pyogenes*

### Horses

- Equine herpesvirus 1, 2 or 5 (EVR), equine viral arteritis (EVA), equine viral influenza (EVI), strangles (*S. equi*)
- Idiopathic ulceration of the mucosa covering the arytenoid cartilages
- Lymphoid hyperplasia of the pharynx of horses—the disease is more common in younger horses and might be associated with reduced athletic capacity or increased propensity to palatal instability.<sup>3,4</sup>
- Bronchitis and tracheitis of horses, most evident in athletic horses, and characterized by accumulation of mucus in the trachea and increased proportion of neutrophils in tracheal or bronchoalveolar lavage fluid—the condition is associated with impaired athletic performance.<sup>5-7</sup>

### Pigs

- Swine influenza
- Necrotic tracheitis (akin to “honker syndrome” in cattle) of uncertain etiology.<sup>8</sup>

## PATHOGENESIS

Irritation of the mucosa causes frequent coughing, and swelling causes partial obstruction of the air passages, with resulting inspiratory dyspnea. Necrotic laryngitis in calves is associated with marked changes in pulmonary function, modifies tracheal dynamics, and disturbs the growth process

by increasing the energetic cost of breathing; this can result in impaired feed intake and predisposition to secondary pulmonary infection and subsequent respiratory failure from progressive exhaustion.

## CLINICAL FINDINGS

Coughing and inspiratory dyspnea with laryngeal roaring or stridor are the common clinical signs. In the early stages of acute infections, the cough is usually dry and non-productive and is easily induced by grasping the trachea or larynx, or by exposure to cold air or dusty atmospheres. In acute laryngitis, the soft tissues around the larynx are usually enlarged and painful on palpation. In chronic infections, the cough may be less frequent and distressing and is usually dry and harsh. If the lesions cause much exudation or ulceration of the mucosa, as in bacterial tracheo-bronchitis secondary to infectious bovine rhinotracheitis in cattle, the cough is moist, and thick mucus, flecks of blood, and fibrin may be coughed up. The cough is very painful, and the animal makes attempts to suppress it. Fever and toxemia are common, and affected animals cannot eat or drink normally.

Inspiratory dyspnea varies with the degree of obstruction and is usually accompanied by a loud stridor and harsh breath sounds on each inspiration. These are best heard over the trachea, although they are quite audible over the base of the lung, being most distinct on inspiration. The respiratory movements are usually deeper than normal and the inspiratory phase more prolonged and forceful. Additional signs, indicative of the presence of a primary specific disease, may also be present.

**Examination of the larynx** is usually possible through the oral cavity using a cylindrical speculum of appropriate size and a bright, pointed source of light. This is done relatively easily in cattle, sheep, and pigs but is difficult in the horse. Lesions of the mucosae of the arytenoid cartilages and the vault of the larynx are usually visible if care and time are taken. In laryngitis, there is usually an excessive quantity of mucus, which may contain flecks of blood or pus in the pharynx. Palpation of the pharyngeal and laryngeal areas may reveal lesions not readily visible through a speculum. During opening of the larynx, lesions in the upper part of the trachea are sometimes visible. The use of a fiberoptic endoscope allows a detailed examination of the upper respiratory tract.

Inflammation or lesions of the larynx may be severe enough to cause marked inspiratory dyspnea and death from asphyxia. In calves and young cattle with diphtheria, the lesion may be large enough (or have a pedicle and act like a valve) to cause severe inspiratory dyspnea, cyanosis, anxiety, and rapid death. The excitement associated with loading for transportation to a clinic or of a clinical examination, particularly the oral examination of the larynx, can exaggerate

the dyspnea and necessitate an emergency tracheotomy.

Most cases of bacterial laryngitis will heal without obvious residual sign after several days of antimicrobial therapy. Some cases in cattle become chronic in spite of therapy as a result of the inflammation extending down into the arytenoid cartilages resulting in a chronic chondritis caused by a sequestrum similar to osteomyelitis. Abscess formation is another common cause of chronicity. Secondary bacterial infection of primary viral diseases, or extension of bacterial infections to the lungs, commonly results in pneumonia.

**Tracheal stenosis** in cattle is characterized by extensive edema and hemorrhage of the dorsal wall of the trachea, resulting in coughing (honking), dyspnea, and respiratory stertor. Complete occlusion of the trachea may occur. Affected animals may be found dead without any premonitory signs.

### CLINICAL PATHOLOGY

Laboratory examinations may be of value in determining the presence of specific diseases.

### NECROPSY FINDINGS

Upper respiratory infections are not usually fatal, but lesions vary from acute catarrhal inflammation to chronic granulomatous lesions depending on the duration and severity of the infection. When secondary bacterial invasion occurs, a diphtheritic pseudomembrane may be present and be accompanied by an accumulation of exudate and necrotic material at the tracheal bifurcation and in the dependent bronchi.

### DIFFERENTIAL DIAGNOSIS

Inflammation of the larynx usually results in coughing and inspiratory dyspnea with a stertor and loud abnormal laryngeal sounds on auscultation over the trachea and over the base of the lungs on inspiration. Lesions of the larynx are usually visible by laryngoscopic examination; those of the trachea and major bronchi are not so obvious unless special endoscopic procedures are used. Every reasonable effort should be used to inspect the larynx and trachea. Obstruction of the nasal cavities and other parts of the upper respiratory tract may also be difficult to distinguish unless other signs are present.

### TREATMENT

Most of the common viral infections of larynx, trachea, and major bronchi will resolve spontaneously if the affected animals are **rested**, not worked, and not exposed to inclement weather and dusty feeds. Secondary bacterial complications must be recognized and treated with the appropriate antimicrobial.

The bacterial infections can result in severe inflammation with necrosis and

granulomatous lesions and must be treated with **antimicrobials**. Calves with calf diphtheria should be treated with a broad-spectrum antimicrobial daily for 3 to 5 days. Several days are usually required for the animal to return to normal. A broad-spectrum antimicrobial daily or more often for up to 3 weeks or more may be necessary for treatment of the chondritis.

**NSAIDs** such as flunixin meglumide may be used in an attempt to reduce the laryngeal edema associated with some severe cases of bacterial laryngitis in cattle.

Animals with severe lesions and marked inspiratory dyspnea may require a **tracheotomy** and insertion of a tracheotomy tube for several days until the lesion heals.<sup>1,9</sup> The tube must be removed, cleaned out, and replaced at least once daily because of the accumulation of dried mucus plugs, which interferes with respiration. The techniques of tracheotomy and permanent tracheostomy in the horse have been described. Surgical excision of chronic granulomatous lesions and abscesses of the larynx may be indicated following failure of long-term antimicrobial therapy, but postoperative complications of laryngeal and pharyngeal paralysis may occur. Laryngotomy as a treatment for chronic laryngeal obstruction in cattle with long-term survival of 58% has been described.

**Tracheolaryngostomy** of calves with chronic laryngeal obstruction as a result of necrobacillosis has been used with success.<sup>1</sup> Under general anesthesia and dorsal recumbency, an incision is made over the lower third of the thyroid and cricoid cartilages and the first two tracheal rings. The larynx is easily visualized and necrotic tissue removed using a curette. The edges of the cartilages are sutured closed. A wedge-shaped piece of the first two tracheal rings is removed to create a tracheostomy, which is allowed to close after about 1 week when the postoperative swelling has subsided with the aid of daily care of the surgical site and the possible use of flunixin meglumide. No tracheotomy tube is required.

### REFERENCES

1. Heppelmann M, et al. *J Vet Med Series A*. 2007;54:390.
2. Mann S, et al. *Vet Rec*. 2013;172:685.
3. Saulez MN, et al. *Vet Rec*. 2009;165:431.
4. Van Erck E. *Equine Vet J*. 2011;43:18.
5. Robinson NE, et al. *Equine Vet J*. 2006;38:293.
6. Holcombe SJ, et al. *Equine Vet J*. 2006;38:300.
7. Widmer A, et al. *Vet J*. 2009;182:430.
8. Szeredi L, et al. *J Comp Pathol*. 2015;152:206.
9. Sasaki H, et al. *Jap J Vet Clin*. 2009;32:12.

## TRAUMATIC LARYNGOTRACHEITIS, TRACHEAL COMPRESSION, AND TRACHEAL COLLAPSE

**Traumatic laryngotracheal injury** can occur following endotracheal intubation used for general anesthesia. Nasotracheal

intubation can result in mucosal injury to the nasal meatus, the arytenoid cartilages, the trachea, the dorsal pharyngeal recess, the vocal cords, and the entrance to the guttural pouches.<sup>1</sup> The laryngeal injury is attributed to the tube pressure on the arytenoid cartilages and vocal folds, and the tracheal damage is attributable to the pressure exerted by the inflated cuff on the tracheal mucosa.

Tracheal obstruction can be intramural, a result of extramural compression, or a result of tracheal collapse. Intramural obstruction of the trachea can be caused by space-occupying lesions such as foreign bodies, neoplastic lesions (e.g., granular cell tumors in horses—see “Neoplastic Diseases of the Respiratory Tract” at the end of this chapter), infections (granulomatous tracheitis, “honking” syndrome in pigs—see following discussion), trauma, or hemorrhage. Extramural compression can be caused by intrathoracic or extrathoracic lesions, including abscesses and granulomatous lesions, cranial mediastinal masses (abscess, neoplasia), or trauma.

**Tracheal collapse** occurs in calves, in mature cattle, in goats, and in horses, including Miniature horses<sup>2</sup> and foals. Dynamic collapse is a cause of exercise intolerance in racehorses that is evident only by endoscopic examination of the trachea during strenuous exercise. Restriction of the tracheal lumen and laxity of the dorsal tracheal membrane results in varying degrees of inspiratory dyspnea with stridor, coughing, and reduced exercise tolerance. Tracheal collapse in **American Miniature horses** is not uncommon.<sup>2</sup> The clinical signs of respiratory distress, tachypnea, inspiratory honking noises, and increased respiratory effort occur in adult horses (mean age 11, range 2-15 years) and are exacerbated by exercise, pregnancy, and eating. None of the affected horses in one case series had a history of trauma. Confirmation of the diagnosis is by endoscopic tracheobronchial examination or radiography (Fig. 12-6). The severity of tracheal collapse is graded: Grade 1 = minor protrusion of the dorsal tracheal membrane into the lumen with less than 25% reduction in airway diameter; Grade 2 = mild elongation and flattening of the tracheal rings with 50% reduction in airway diameter; Grade 3 = marked flattening of the tracheal rings and lengthening of the dorsal tracheal membrane with 75% reduction in airway diameter; and Grade 4 = severe flattening of tracheal rings with dorsal elevation of the ventral tracheal surface and an airway diameter less than 10% of normal.<sup>2</sup> The case-fatality rate is high (~80%). Tracheotomy for emergency treatment of severe disease is not useful unless the collapsed trachea is dilated by an endotracheal tube. Necropsy examination of four affected horses revealed chondromalacia. The cause of the condition is not known. Tracheal prostheses have been used for the treatment of tracheal collapse in calves and Miniature horses,<sup>3-5</sup> although given the



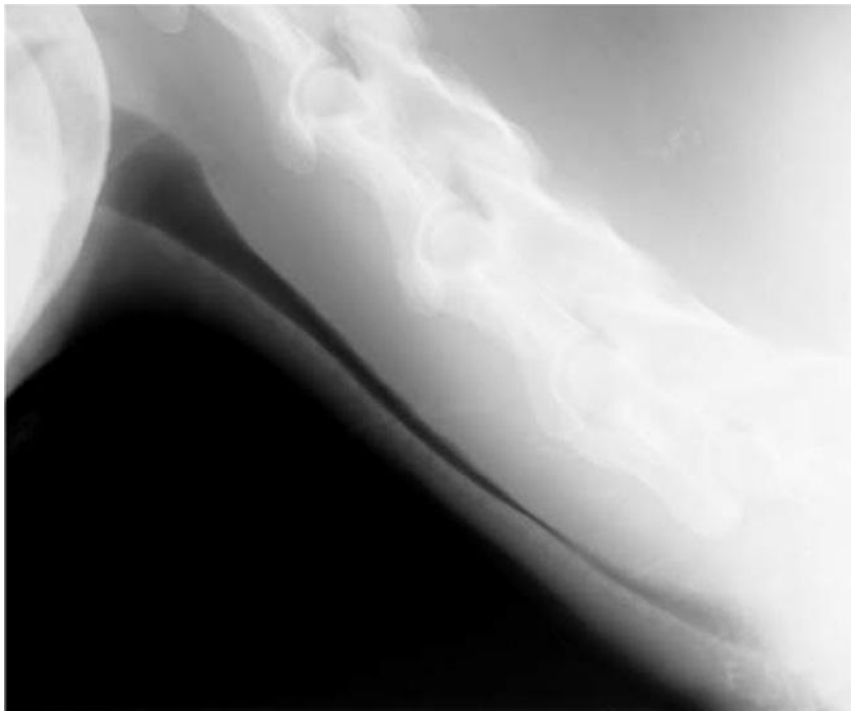

**Fig. 12-6** Lateral radiograph of the cervical region of an American Miniature horse revealing extensive tracheal collapse. (Reproduced with permission.<sup>2</sup>)

extent of collapse and high rate of complications associated with surgical repair, there is not an ideal method for alleviating the condition.<sup>6</sup>

A “honking” respiratory noise is common in affected calves when coughing spontaneously or when the trachea is palpated. Tracheal collapse in calves is associated with injuries associated with dystocia and clinical signs usually occur within a few weeks after birth. In some cases the trachea is compressed at the level of the thoracic inlet in association with callus formation of healing fractured ribs attributed to dystocia. In some cases in cattle, there is no history of dystocia or preexisting disease or previous manipulation of the trachea, and the overall lumen size may be reduced to less than 25% of normal. Auscultation of the thorax may reveal loud referred upper airway sounds. A similar syndrome is described in pigs with development of acute tracheal edema, hemorrhage, and tracheitis. Clinical signs are of sudden onset of respiratory distress, open-mouth breathing, loud inspiratory stridor, and death soon after clinical signs became apparent.<sup>7</sup> The lesion is edema, hemorrhage, and mixed cellular infiltration in the tunica adventitia, with lung lesions of mild to severe fibrinonecrotic or hemorrhagic pleuropneumonia. No infectious etiology has been identified.<sup>7</sup>

**Tracheal obstruction** and collapse can result from tracheitis associated with pneumonia in the horse, tracheal neoplasia, tracheal stricture, presence of foreign bodies in the trachea, and compression by masses

external to the trachea. It is suggested that increased respiratory effort associated with pneumonia causes collapse of the soft tissue structures of the trachea, rather than collapse of the tracheal rings. Tracheal rupture as a result of blunt trauma in the horse may result in severe subcutaneous emphysema and pneumomediastinum. Conservative therapy is usually successful. Tracheal compression secondary to enlargement of the cranial mediastinal lymph nodes can also cause inspiratory dyspnea, and conservative treatment with antimicrobials is successful.

#### REFERENCES

1. Wylie CE, et al. *Equine Vet Educ.* 2015;27:170.
2. Aleman M, et al. *JAVMA.* 2008;233:1302.
3. Graham SB, et al. *Equine Vet Educ.* 2010;22:557.
4. Busschers E, et al. *Vet Surg.* 2010;39:776.
5. Wong DM, et al. *Equine Vet Educ.* 2008;20:80.
6. Epstein K. *Equine Vet Educ.* 2008;20:91.
7. Szeredi L, et al. *J Comp Pathol.* 2015;152:206.

## Diseases of the Lung Parenchyma

### PULMONARY CONGESTION AND EDEMA

Pulmonary congestion is caused by an increase in the amount of blood in the lungs as a result of engorgement of the pulmonary vascular bed. It is sometimes accompanied by pulmonary edema, and the temporal relationship between the two can be difficult to determine. The various stages of the vascular

disturbance are characterized by respiratory compromise, the degree depending on the extent of interference with pulmonary gas exchange as a result of diffusion impairment across the alveolus, ventilation/perfusion mismatch in the lungs, and decreases in pulmonary blood flow.

#### ETIOLOGY

Pulmonary congestion and edema is a common terminal event in many diseases but is frequently overshadowed by other disturbances. Congestion that is clinically apparent can be primary when the basic lesion is in the lungs or secondary when it is in some other organ, most commonly the heart.

Pulmonary edema occurs because of imbalances in the Starling forces across the pulmonary capillary. From a clinical perspective, the common proximate causes of pulmonary edema are injury to the endothelium of the pulmonary capillary with subsequent leakage of protein-rich fluid into the interstitial spaces, elevated blood pressure in the alveolar capillaries, or, less commonly, low plasma oncotic pressure.

Damage to pulmonary vascular endothelium can occur in infectious diseases (e.g., African horse sickness) or intoxications (endotoxemia). Physical injury, including inhalation of excessively hot air or smoke, can damage the alveolar epithelium with secondary damage to capillary endothelium.<sup>1</sup> Elevated pulmonary capillary pressure occurs in left-sided heart failure (ruptured chordae tendineae of the mitral valve or congenital cardiac anomalies<sup>2</sup>) and during strenuous exercise by horses. Air embolism causes acute heart failure and pulmonary edema in horses.<sup>3</sup> Low plasma oncotic pressure occurs in diseases causing hypoproteinemia but is rarely a cause for pulmonary edema by itself, although it contributes to the pulmonary edema in hypoproteinemic animals administered large volumes of fluids intravenously.

#### Primary Pulmonary Congestion

- Early stages of most cases of pneumonia
- Inhalation of smoke and fumes
- Anaphylactic reactions
- Recumbency, especially in large animals
- Yew (*Taxus* sp.) intoxication
- Racehorses with acute severe exercise-induced pulmonary hemorrhage<sup>4</sup>

#### Secondary Pulmonary Congestion

- Congestive heart failure (cardiogenic pulmonary edema), including ruptured chordae tendineae of the mitral valve, ionophore toxicosis,<sup>5</sup> and left-sided heart failure

#### Pulmonary Edema

Pulmonary edema as a sequela to pulmonary capillary hypertension or pulmonary

microvascular damage occurs in the following situations:

- Acute anaphylaxis
- Acute pneumonia—*Pasteurella haemolytica* produces several virulence factors that induce direct or leukocyte-mediated pulmonary endothelial cell injury. Pulmonary edema is one of a number of abnormalities in cattle infected by *Theileria annulata*.<sup>6</sup>
- Gram-negative sepsis in ruminants and pigs
- Congestive heart failure and acute heart failure (e.g., the myocardial form of enzootic muscular dystrophy in inherited myocardopathy of Hereford calves); ruptured mitral valve or chordae tendonae
- Inhalation of smoke or manure gas
- Transient upper airway obstruction in the horse (negative-pressure pulmonary edema)<sup>7</sup>
- After general anesthesia in horses<sup>8</sup>
- Yew (*Taxus* sp.) intoxication
- Exercise-induced pulmonary edema in racehorses
- Fumonisin intoxication in pigs<sup>9</sup>
- Specific diseases, including: mulberry leaf disease of swine; East Coast fever in cattle; the pulmonary form of African horse sickness; Hendra virus infection of horses; poisoning with organophosphates, alpha-naphthyl thiourea (ANTU), ionophore antibiotics (monensin, salinomycin), or 1080 (sodium fluoracetate);<sup>10</sup> plant poisonings by oleander, *Hymenoxis* spp., and *Phenoscladium* spp.
- Doxycycline intoxication of calves
- *Clostridium perfringens* type D epsilon toxin in calves and sheep
- The Barker syndrome in young pigs
- Semen embolism

### PATHOGENESIS

In **pulmonary congestion**, ventilation is reduced, and oxygenation of the blood is impaired. Oxygenation is reduced by the decreased rate of blood flow through the pulmonary vascular bed. Hypoxemic anoxia develops and is the cause of most of the clinical signs that appear.

Hypoxemia occurs in **pulmonary edema** because of ventilation-perfusion abnormalities, diffusion abnormalities (although this is usually a minor contributor to the hypoxemia), and hypoventilation caused by the physical obstruction of airflow by fluid and foam in the airways. The edema is caused by damage to the capillary walls by toxins or anoxia or by transudation of fluid as a result of increased hydrostatic pressure in the capillaries. Filling of the alveoli, and in severe cases the bronchi, effectively prevents gaseous exchange.

**Smoke inhalation** in horses results in decreased oxygen content of inspired air and exposure of the respiratory tract tissues to various noxious gases. Following smoke inhalation, diffuse tracheobronchial mucosal sloughing occurs, which, if progressive, causes separation of the epithelium and development of pseudomembranous casts, which may cause partial or complete airway obstruction. Pulmonary edema is also extensive.

### CLINICAL FINDINGS

All degrees of severity of pulmonary congestion and edema occur commonly in farm animals, and only the most severe form is described here. The depth of respiration is increased to the point of extreme dyspnea with the head extended, the nostrils flared, and mouth breathing. Breathing movements are greatly exaggerated and can be best described as heaving; there is marked abdominal and thoracic movement during inspiration and expiration. A typical stance is usually adopted, with the front legs spread wide apart, the elbows abducted, and the head hung low. The respiratory rate is usually increased, especially if there is hyperthermia, which occurs in acute anaphylaxis and after violent exercise and in the early stages of pneumonia. The heart rate is usually elevated (up to 100/min), and the nasal mucosa is bright red or cyanotic in terminal cases. **Radiography** reveals diffuse pulmonary opacity in animals with pulmonary edema.

In **acute pulmonary congestion**, there are harsh breath sounds, but no crackles are present on auscultation.

When **pulmonary edema** develops, loud breath sounds and crackles are audible over the ventral aspects of the lungs. In long-standing cases, there may be emphysema with crackles and wheezes of the dorsal parts of the lungs, especially if the lesion is caused by anaphylaxis.

Coughing is usually present, but the cough is soft and moist and is not painful. A slight to moderate serous nasal discharge occurs in the early stage of congestion, but in **severe pulmonary edema** this increases to a voluminous, frothy nasal discharge, which is often pink-colored as a result of blood.

The primary importance of pulmonary congestion is as an indicator of early pathologic changes in the lung or heart. Spontaneous recovery occurs quickly unless there is damage to alveolar epithelium or myocardial asthenia develops. Severe pulmonary edema has much greater significance and usually indicates a stage of irreversibility. Death in cases of pulmonary edema is accompanied by respiratory failure.

Smoke inhalation in horses is characterized by the following:<sup>1</sup>

- Polypnea and dyspnea
- Diffuse wheezes throughout the lungs
- Coughing

- A bronchiointerstitial pattern radiographically
- The horse might expectorate large proteinaceous tracheobronchial casts.

The prognosis is good if affected animals can survive the initial stages of pulmonary damage and secondary organ involvement.

### CLINICAL PATHOLOGY

Laboratory examinations are of value only in differentiating the causes of the congestion or edema. Bacteriologic examination of nasal swabs and a complete hematologic examination, looking particularly for the presence of eosinophilia, are the standard examinations that are carried out.

### NECROPSY FINDINGS

In acute pulmonary congestion the lungs are dark red in color. Excessive quantities of venous blood exude from the cut surface. Similar but less marked changes occur in milder forms of congestion but are only seen in those animals that die of intercurrent disease. Histologically, the pulmonary capillaries are markedly engorged and some transudation and hemorrhage into alveoli is evident.

Macroscopic findings in pulmonary edema include swelling and loss of elasticity of the lungs, which pit on pressure. They are usually paler than normal. Excessive quantities of serous fluid exude from the cut surface of the lung. Histologically, there are accumulations of fluid in the alveoli and parenchyma.

### DIFFERENTIAL DIAGNOSIS

The diagnosis of pulmonary congestion and edema is always difficult unless there is a history of a precipitating cause, such as an infectious disease, strenuous exercise, ingestion of toxicants, or inhalation of smoke or fumes. Pneumonia usually presents itself as an alternative diagnosis and a decision cannot be based entirely on the presence or absence of pyrexia. The best indication is usually the presence of toxemia, but this is not entirely dependable. Bacterial pneumonia is usually accompanied by some toxemia, but cases of viral pneumonia are often free of it. Response to antibacterial treatment is one of the best indications, the only variable being the tendency for congestion and edema of allergic origin to recover spontaneously. In many instances there will be doubt, and it is then advisable to treat the animal for both conditions.

### TREATMENT

The principles of treatment of pulmonary congestion and edema are one or more of the following: reduction of pulmonary capillary pressure (by reduction either of pulmonary venous or pulmonary arterial pressure), alleviation of pulmonary microvascular damage,

and correction of low plasma oncotic pressure. The treatment of pulmonary congestion and edema must first be directed at correction of the primary cause as listed under etiology. Affected animals should be confined at rest in a clean, dry environment and exercise avoided.

**Pulmonary capillary pressure** can be reduced in animals with left-sided heart failure by reduction of cardiac preload, improvement in cardiac pump function, or a combination of these factors. These topics are dealt with in detail in Chapter 12. Briefly, preload can be reduced by administration of furosemide and pump function improved by administration of drugs that improve myocardial function (digoxin) or decrease afterload (arterial vasodilators). The usual first step is the administration of furosemide (1-2 mg/kg intravenously).

**Alleviation of pulmonary microvascular damage** is more difficult. Administration of antiinflammatory drugs, including NSAIDs or glucocorticoids, is indicated in animals in which microvascular damage is suspected. These drugs are used to treat, among other diseases, smoke inhalation of horses.

**Plasma oncotic pressure** can be increased by intravenous infusion of plasma (10-40 mL/kg) or synthetic colloids such as hetastarch. Administration of crystalloid solutions should be judicious and the amount of fluid administered must be monitored carefully to ensure that only sufficient fluids to meet the needs of the animal are given.

**Oxygen** should be administered to hypoxemic animals in conjunction with other specific treatments.

### Special Diseases

When edema is attributable to **organophosphate poisoning**, prompt administration of atropine may reduce fluid transudation. In these cases, the animal is in considerable danger, and repeated injections may be necessary. Details of the recommended treatment regimen are given in the section on treatment of poisoning by organophosphorus compounds.

**Epinephrine** is recommended in **pulmonary edema resulting from anaphylaxis**. It will have an immediate pharmacologic effect, which may be followed by the use of a corticosteroid to maintain vascular integrity and to decrease permeability of pulmonary vessels. Antihistamines are commonly used in conjunction with epinephrine for the treatment of acute pulmonary edema resulting from anaphylaxis. However, recent studies of experimental anaphylaxis in cattle and horses have shown that the antihistamines may be of limited value because histamine and serotonin are of relatively limited significance as mediating substances. On the other hand, the kinins, prostaglandins, and slow-release substances may be more important.

Studies in cattle have found that antihistamines and 5-hydroxytryptamine (5-HT) antagonists failed to protect cattle in experimental hypersensitivity. Sodium meclizemate has been more successful in antagonizing experimental anaphylaxis in cattle and horses. Acetylsalicylic acid was more effective than antihistamines or antiserotonin agents in providing symptomatic relief in experimental acute interstitial pneumonia of calves.

It is difficult, however, to extrapolate the results of these studies in which the drugs were usually given before or at the same time as the experimental disease was produced. There is a need for development of more effective antianaphylactic drugs for the treatment of acute anaphylaxis in farm animals, which invariably results in pulmonary edema and emphysema. Thus epinephrine is the drug of choice for the emergency treatment of pulmonary edema resulting from anaphylaxis.

### REFERENCES

1. Marsh PS. *Vet Clin Equine*. 2007;23:19.
2. Polledo L, et al. *J Comp Pathol*. 2013;148:99.
3. Pellegrini-Masini A, et al. *Equine Vet Educ*. 2009;21:79.
4. Morales A, et al. *Vet (Montevideo)*. 2011;47:35.
5. De La Cruz-Hernandez NI, et al. *Rev Med Vet*. 2012;163:60.
6. Oryan A, et al. *Parasitol Res*. 2013;112:123.
7. Hardcastle MR, et al. *Vet Surg*. 2012;41:649.
8. Kaartinen MJ, et al. *Vet Anaesth Analg*. 2010;37:136.
9. Domijan A-M. *Arch Indust Hyg Toxicol*. 2012;63:531.
10. Giannitti F, et al. *Vet Pathol*. 2013;50:1022.

### PULMONARY HYPERTENSION

Pulmonary hypertension is an increase in pulmonary arterial pressure above values in healthy animals. It is usually a result of structural or functional changes in the pulmonary vasculature and can result in heart failure. Primary pulmonary hypertension occurs in cattle with high-altitude disease (Brisket disease, see [Chapter 10](#)).<sup>1,2</sup> Chronic pulmonary hypertension results in right-sided congestive heart failure caused by right ventricular hypertrophy or **cor pulmonale**.<sup>3</sup>

#### Causes

Hypoxemia is a potent stimulus of pulmonary arterial pressure through increased pulmonary vascular resistance induced by pulmonary vasoconstriction. Pulmonary artery pressure can also increase in response to increases in cardiac output that are not matched by pulmonary vasodilation—the most extreme example of this being the large increase in pulmonary artery pressure of strenuously exercising horses. Alveolar hypoxia causes constriction of the precapillary pulmonary vessels, resulting in pulmonary hypertension. Conditions that can induce hypoxia include the following:

- Exposure to high altitude
- Respiratory impairment secondary to thoracic wall abnormalities
- Airway obstruction
- Pneumonia, including granulomatous pneumonia<sup>4</sup>
- Pulmonary edema
- Emphysema
- Pulmonary vascular disease
- Heaves (recurrent airway obstruction of horses)<sup>5-9</sup>

At high altitudes, the low inspired oxygen tension causes hypoxic pulmonary vasoconstriction and hypertension that are common causes of cor pulmonale (brisket disease) in cattle. Susceptible cattle can be identified by measurement of pulmonary artery pressure before clinical disease develops. This test is used to select bulls for use in high-altitude pastures. Cattle grazing pastures that contain locoweed have an increased incidence of brisket disease but the pathogenesis is unknown. Although uncommon, right-sided congestive heart failure and pulmonary hypertension can occur in cows at low altitudes with primary lung disease.

Pulmonary hypertension is a component of heaves in horses and results in abnormalities in myocardial function, which can progress to overt heart failure.<sup>6,9</sup> Progression to heart failure is uncommon, but should be considered in horses with severe or prolonged heaves. Similarly, heart function should be considered in horses with long-standing pneumonia.<sup>4,8</sup>

Pulmonary hypertension occurs in neonates and is a consequence of persistent fetal circulation. This is particularly a problem of cloned calves (see “Diseases of Cloned Offspring,” Chapter 19).

An outbreak of pulmonary hypertension in a group of dairy calves 5 to 6 months of age has been described. Some affected calves died suddenly. Clinical findings included lethargy, anorexia, pale mucous membranes, tachypnea, tachycardia, weakness, engorged jugular veins, and loss of body condition. Right-sided cardiac catheterization revealed pulmonary hypertension. Necropsy findings revealed evidence of right-sided congestive heart failure and periarteritis and fibrosis of the pulmonary and bronchial arteries. Lesions were characterized by variable stages of vasculitis; the airways were free of pathologic changes. Ingestion of monocrotaline, a pyrrolizidine alkaloid, can cause similar pulmonary vascular lesions in rats, but no evidence of such ingestion was found in affected calves.

Pulmonary hypertension occurs secondary to left-sided heart disease in horses, although the hypertension has been mistakenly identified as the primary lesion.

### REFERENCES

1. Neary JM, et al. *J Vet Diagn Invest*. 2013;25:210.
2. Newman JH, et al. *Nat Comm*. 2015;6.
3. Malherbe CR, et al. *J Vet Diagn Invest*. 2012;24:867.



4. Schwarzwald CC, et al. *Equine Vet Educ.* 2006;18:182.
5. Johansson AM, et al. *J Vet Int Med.* 2007;21:302.
6. Lightowler C, et al. *Vet Rec.* 2009;164:340.
7. Sage AM, et al. *J Vet Int Med.* 2006;20:694.
8. Slater J. *Equine Vet Educ.* 2006;18:188.
9. Stahl AH, et al. *Pferdeheilkunde.* 2010;26:335.

## ATELECTASIS

Atelectasis is collapse of the alveoli as a result of failure of the alveoli to inflate or because of compression of the alveoli. Atelectasis is therefore classified as obstruction (resorption), compression, or contraction. **Obstruction atelectasis** occurs secondary to obstruction of the airways, with subsequent resorption of alveolar gases and collapse of the alveoli. This disease is usually caused by obstruction of small bronchioles by fluid and exudate. It is common in animals with pneumonia or aspiration of a foreign body. **Compression atelectasis** occurs when intrathoracic (intrapleural) pressure exceeds alveolar pressure, thereby deflating alveoli. This occurs when there is excessive pleural fluid or the animal has a pneumothorax. It also occurs in the dependent lung or portions of lung in recumbent animals and is evident on computed tomographic or radiographic examination of the lungs of foals (Fig. 12-7).<sup>1,2</sup> Compression atelectasis is the explanation for the large shunt fraction and hypoxemia that occurs in anesthetized horses, causing marked reduction in ventilation of the dependent lung.<sup>3</sup> Compression atelectasis and secondary bronchopneumonia can occur in horses kept in flotation tanks for up to several weeks for treatment



**Fig. 12-7** Ventrrodorsal radiograph of the chest of a 7-day-old foal immediately after ~30 minutes of enforced lateral recumbency. Note the consolidation of the previously dependent lung. Repeat radiographic examination 24 hours later, and without a period of recumbency, did not reveal lesions in the lungs.

of skeletal injuries. **Contraction atelectasis** occurs when there is compression of parts of the lung by fibrotic changes in the pleura. **Patchy atelectasis** occurs in the absence of surfactant, such as can occur in newborns. Failure of the lung to inflate, or development of atelectasis of the lungs of the newborn, usually those born prematurely, occurs because of lack of pulmonary surfactant. The disorder can progress to hyaline membrane disease. Affected newborn animals are severely dyspneic, hypoxemic, cyanotic, and weak, and they commonly die in a few hours.

The clinical signs of atelectasis are not apparent until there is extensive involvement of the lungs. Animals develop respiratory distress, tachypnea, tachycardia, and cyanosis. Blood gas analysis reveals hypoxemia, with or without hypercapnia. Thoracic radiographs reveal pulmonary consolidation. Ultrasonographic examination of the thorax demonstrates consolidated lung.

Atelectasis is reversible if the primary obstruction or compression is relieved.

## REFERENCES

1. Lascola KM, et al. *Am J Vet Res.* 2013;74:1239.
2. Schliewert E-C, et al. *Am J Vet Res.* 2014;76:42.
3. Moens Y, et al. *Vet Anaesth Analg.* 2014;41:196.

## PULMONARY HEMORRHAGE

Pulmonary hemorrhage is uncommon in farm animals but does occur occasionally in cattle, and exercise-induced pulmonary hemorrhage (EIPH) occurs in 45% to 75% of racehorses (see “Exercise-induced pulmonary hemorrhage” elsewhere in this chapter). Pulmonary hemorrhage occurs with pulmonary abscesses, tumors, parasitic cysts (*Fascioloides magna*),<sup>1</sup> or foreign bodies. Tracheobronchoscopic, radiographic, and ultrasonographic examinations are useful in identifying the site and cause of the hemorrhage.

### Cattle

In cattle the most common cause of epistaxis and hemoptysis secondary to pulmonary hemorrhage is erosion of pulmonary vessels adjacent to lesions of embolic pneumonia associated with vena caval thrombosis and hepatic abscessation (Fig. 12-8).<sup>2</sup> The onset of hemorrhage can be sudden, and affected animals hemorrhage profusely and die after a short course of less than 1 hour. Marked epistaxis and hemoptysis, severe dyspnea, muscular weakness and pallor of the mucous membranes are characteristic. In other cases, episodes of epistaxis and hemoptysis can occur over a period of several days or a few weeks along with a history of dyspnea.

## REFERENCES

1. Wobeser BK, et al. *Can Vet J.* 2014;55:1093.
2. Braun U. *Vet J.* 2008;175:118.

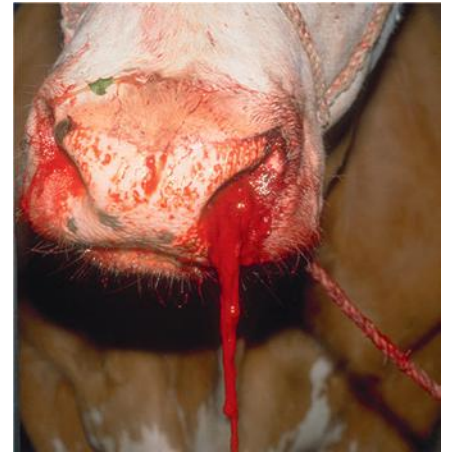

**Fig. 12-8** Epistaxis and hemoptysis in a cow with pulmonary hemorrhage and vena caval thrombosis. (Reproduced with permission from Braun 2008.<sup>2</sup>)

## PULMONARY EMPHYSEMA

Pulmonary emphysema is distension of the lung caused by overdistension of alveoli with rupture of alveolar walls with or without escape of air into the interstitial spaces. Overinflation describes the situation in which there is enlargement of airspaces without tissue destruction. Pulmonary emphysema is always secondary to some primary lesion that effectively traps an excessive amount of air in the alveoli. It is a common clinicopathologic finding in many diseases of the lungs of all species and is characterized clinically by dyspnea, hyperpnea, poor exercise tolerance, and forced expiration.

### ETIOLOGY

Pulmonary emphysema is an important lesion only in cattle, although occasional cases occur in pigs. Approximately 3.4% of cattle examined after slaughter in Tanzania had lesions of emphysema sufficiently severe to warrant condemning of the carcass.<sup>1</sup> The bovine lung is highly susceptible to the development of emphysema from many different causes, not all of them respiratory in origin. In those of respiratory origin, it is common to find pulmonary emphysema when the primary lesion in the lung causes trapping of air in alveoli or terminal bronchioles. Endotoxemia, for example, can result in diffuse alveolar damage resulting in pulmonary edema and emphysema. Some causes of emphysema are as follows.

### Cattle

- Acute interstitial pneumonia
- Parasitic pneumonia with pulmonary edema in acute anaphylaxis
- Perforation of the lung by foreign body as in traumatic reticuloperitonitis

- Poisoning by the plants *Senecio quadridentatus*, rape, *Zieria arborescens*, and *Perilla frutescens* and the fungus *Periconia* spp. are recorded as causing pulmonary emphysema in cattle.
- Pulmonary abscess

#### Horses

- Bronchiolitis as a result of viral infection of the respiratory tract in young horses

#### All Species

- Secondary to bronchopneumonia
- Poisoning by oleander, *Bryophyllum pinnatum*, and moldy sweet potatoes
- Acute chemical injury—as in inhalation of welding fumes
- Chlorine gas poisoning
- Local or perifocal emphysema is also a common necropsy finding around local pulmonary lesions, especially atelectasis, often with no respiratory dysfunction. In calves and pigs, the emphysema is sometimes sufficiently extensive to kill the animal.
- Bullous emphysema is a rarely reported disorder of premature foals.<sup>2</sup>

#### PATHOGENESIS

Emphysema occurs because of destruction of the connective tissues of the lung, including the supporting and elastic tissue of the pulmonary parenchyma. Tissue damage resulting in emphysema in humans is caused by the action of proteases in the lung. Whether this occurs in the farm animal species is unknown but is a consideration. An initial lesion probably leads to an area of weakness from which emphysema spreads during coughing or exertion. In interstitial emphysema, there is the additional factor of distension of the connective tissue with air and compression collapse of the alveoli.

The development of interstitial emphysema depends largely upon the amount of interstitial tissue that is present and is most common in cattle and pigs. Whether there is simple overdistension of alveoli or whether their walls are also ruptured is very important in prognosis and treatment. Excellent recoveries occur in simple alveolar emphysema, especially those occurring acutely at pasture. This suggests that the lesion is functional and that the alveoli are not substantially damaged.

The **pathophysiologic consequences of emphysema** depend on the inefficiency of evacuation of pulmonary airspace and failure of normal gaseous exchange in the lungs. The elastic recoil of the tissue is diminished, and when the thorax subsides during expiration, incomplete evacuation occurs. Because of the increase in residual volume, the tidal volume must be increased to maintain normal gaseous exchange. Retention of carbon dioxide stimulates an

increase in the depth of respiration, but maximum respiratory effort necessitated by exercise cannot be achieved. Anoxia develops and metabolism of all body tissues is reduced. The characteristic effect of emphysema is to produce an increase in expiratory effort necessitated by the failure of normal elastic recoil.

Interference with the pulmonary circulation results from collapse of much of the alveolar wall area and a consequent diminution of the capillary bed. The decreased negative pressure in the chest and the abnormally wide respiratory excursion also cause a general restriction of the rate of blood flow into the thorax. The combined effect of these factors may be sufficient to cause failure of the right ventricle, especially if there is a primary defect of the myocardium. Acidosis may also result because of the retention of carbon dioxide.

#### CLINICAL FINDINGS

Characteristically, diffuse pulmonary emphysema causes severe expiratory dyspnea with a grunt on expiration and loud crackling lung sounds on auscultation over the emphysematous lungs. In severe cases in cattle, the emphysema is commonly interstitial, and dissection of the mediastinum and fascial planes results in subcutaneous emphysema over the withers (Fig. 12-9). In severe cases in cattle, open-mouth breathing is common.

In cattle and pigs, the presence of pulmonary emphysema in pulmonary disease is often not detectable clinically.

#### CLINICAL PATHOLOGY

There is hypoxemia and, often, hypercapnia. Compensatory polycythemia may develop.

There are no characteristic hematologic findings, but if there is a significant secondary bronchopneumonia, a leukocytosis and left shift may be evident. In the appropriate location, an examination of feces for lungworm larvae may be desirable. In cases suspected of having an allergic origin, swabs of nasal secretion may reveal a high proportion of eosinophils, and a hematologic examination may show eosinophilia.

#### NECROPSY FINDINGS

The lungs are distended and pale in color and may bear imprints of the ribs. In interstitial emphysema, the interalveolar septae are distended with air, which may spread to beneath the pleura, to the mediastinum, and under the parietal pleura. There may be evidence of congestive heart failure. On histopathologic examination, a bronchiolitis is present in most cases. This may be diffuse and apparently primary or originate by spread from a nearby pneumonia.

#### TREATMENT

The treatment of pulmonary emphysema will depend on the species affected, the cause of the emphysema, and the stage of the disease.

There is no known specific treatment for the pulmonary emphysema associated with acute interstitial pneumonia in cattle, which is discussed under that heading. The emphysema secondary to the infectious pneumonias will usually resolve spontaneously if the primary lesion of the lung is treated effectively. In valuable animals, the administration of oxygen may be warranted if the hypoxia is severe and life-threatening. Antihistamines, atropine, and corticosteroids



**Fig. 12-9** Marked subcutaneous emphysema on the dorsal midline of a Holstein Friesian cow with acute respiratory disease. The cow's head is to the right. The skin can be depressed 5 cm with a forefinger, creating a crinkling feeling that is slightly painful to the cow. The emphysema gradually disappeared over a few days after antimicrobial treatment for bacterial pneumonia was implemented.

have been used for the treatment of pulmonary emphysema secondary to interstitial pneumonia in cattle, but their efficacy has been difficult to evaluate.

### DIFFERENTIAL DIAGNOSIS

**Acute emphysema in cattle** is often accompanied by pulmonary edema with the presence of consolidation and crackles in the ventral parts of the lungs. It may be similar to acute pulmonary congestion and edema caused by anaphylaxis, but forced expiration is not a characteristic of these latter conditions.

**Acute pneumonia** in cattle or horses is characterized by fever and localization of abnormal respiratory sounds, which are not as marked nor as widely distributed as those of emphysema.

**Chronic pneumonia** is characterized by dyspnea, chronic toxemia, crackles and wheezes, and poor response to therapy.

**Pneumothorax** is accompanied by forced inspiration and an absence of normal breath sounds.

### REFERENCES

1. Tembo W, et al. *Onderstepoort J Vet Res.* 2015;82.
2. Bezdekova B, et al. *Equine Vet Educ.* 2012;24:447.

### PNEUMONIA

Pneumonia is inflammation of the pulmonary parenchyma, usually accompanied by inflammation of the bronchioles and often by pleuritis. It is manifested clinically by an increase in the respiratory rate, changes in the depth and character of respirations, coughing, abnormal breath sounds on auscultation, and, in most bacterial pneumonias, evidence of toxemia.

### ETIOLOGY

Pneumonia may be associated with viruses, mycoplasmas, bacteria, or a combination of all three; fungi; metazoan parasites; and physical and chemical agents. Most of the pneumonias in animals are bronchogenic (inhalation) in origin, but some originate by the hematogenous route, such as pneumonia of foals and calves with septicemia. Mycoplasmal pneumonias can be devastating in cattle, goats, and pigs (Table 12-6). The pneumonias that occur in farm animals are grouped here according to species.

#### Cattle

- Pneumonic pasteurellosis (shipping fever)—*M. haemolytica*, *P. multocida* with or without parainfluenza-3 virus
- *Histophilus somnus* in feedlot cattle is not necessarily associated with the septicemic form of the disease. The role of the organism as a primary

**Table 12-6** Major pathogenic *Mycoplasma* spp. of ruminants, swine, and horses

Animal host/mycoplasma species	Disease
<b>Bovine</b>	
<i>M. mycoides</i> subsp. <i>mycoides</i> SC	Contagious bovine pleuropneumonia, CBPP
<i>Mycoplasma</i> sp. <i>bovine group 7</i>	Pneumonia and arthritis
<i>M. bovis</i>	Mastitis, pneumonia (calf), polyarthritis (calf) metritis, abortion, sterility
<i>M. dispar</i>	Pneumonia (calf)
<i>M. californicum</i>	Mastitis
<i>M. canadense</i>	Mastitis
<i>M. bovoculi</i>	Conjunctivitis
<i>Ureaplasma diversens</i>	Metritis, sterility, abortion
<i>Mycoplasma (Eperythrozoon) wenyonii</i>	Anemia
<b>Sheep and goat</b>	
<i>M. capricolum</i> subsp. <i>capripneumonia</i>	Contagious caprine pleuropneumonia
<i>M. capricolum</i> subsp. <i>capricolum</i>	Mastitis, arthritis
<i>M. mycoides</i> subsp. <i>capri</i>	Pneumonia, arthritis septicemia (goat)
<i>M. mycoides</i> subsp. <i>mycoides</i> LC	Pneumonia, mastitis, arthritis, septicemia (goat)
<i>M. agalactiae</i>	Infectious agalactia
<i>M. ovipneumoniae</i>	Pneumonia (lamb)
<i>M. conjunctivae</i>	Infectious keratoconjunctivitis (IKC) (sheep)
<b>Pig</b>	
<i>M. hyopneumoniae</i>	Enzootic pneumonia
<i>M. hyorhinis</i>	Pneumonia, arthritis
<i>M. hyosynoviae</i>	Arthritis
<i>Mycoplasma (Eperythrozoon) suis</i>	Anemia
<b>Horse</b>	
<i>M. felis</i>	Pleuritis
<i>M. equirhinis</i>	
<i>M. equipharyngis</i>	

pathogen in acute bovine respiratory disease is uncertain.

- *Bibersteinia trehalosi* appears to be a component of the bovine respiratory disease complex, as it is in sheep.<sup>1,2</sup>
- Enzootic pneumonia of calves—bovine respiratory syncytial virus; bovine herpesvirus-1 (the IBR virus); parainfluenza-3; adenovirus-1, -2, and -3; rhinovirus; reovirus; and *Chlamydia* spp., *Mycoplasma* spp., *Pasteurella* spp., *Mannheimia* spp., *Trueperella* (formerly *Actinomyces* or *Arcanobacterium* or *Corynebacterium) pyogenes*, *Streptococcus* spp., *Bedsonia* sp., and *Actinobacillus actinoides*
- Corona virus infection in adult feedlot cattle<sup>4,5</sup>
- Pneumonia, mastitis, and arthritis in cattle associated with *Mycoplasma bovis*<sup>6</sup> and in calves with *Mycoplasma californicum* or *M. bovis*<sup>7</sup>
- Viral interstitial pneumonia in recently weaned beef calves associated with bovine respiratory

syncytial virus; it may also occur in yearling and adult cattle.

- Contagious bovine pleuropneumonia—*Mycoplasma mycoides*
- Acute and chronic interstitial pneumonia associated with D,L-tryptophan, moldy hay, and other pneumotoxic agents
- Atypical interstitial pneumonia associated with ryegrass staggers in calves
- Massive infestation with pig ascarid larvae
- Lungworm pneumonia—*Dictyoaulus viviparus*
- *Klebsiella pneumoniae* infection in calves and nursing cows with mastitis associated with this organism
- Sporadically in tuberculosis associated with *M. bovis*
- *Fusobacterium necrophorus* as a complication of calf diphtheria, and sporadically in feedlot cattle
- There is a preliminary report of circovirus in adult cattle with pneumonia.



- *Trueperella pyogenes* causes pneumonia<sup>8</sup> mastitis, abscesses, and lymphadenitis in cattle, goats, sheep, pigs, and horses
- Experimental infection with *Parachlamydia acanthamoebae* in calves<sup>9</sup>
- Mycotic pneumonia associated with *Mortierella wolfii* in adult cattle

### Pigs

- Enzootic pneumonia—*Mycoplasma* sp. with *Pasteurella* sp. secondarily
- Pneumonic pasteurellosis—*P. multocida*
- Pleuropneumonia—*Actinobacillus pleuropneumoniae*
- Interstitial pneumonia—septicemic salmonellosis
- *Bordetella bronchiseptica*, *Salmonella choleraesuis*
- Influenza virus
- Porcine reproductive and respiratory syndrome virus
- *Haemophilus parasuis*
- *Actinobacillus pyogenes*
- Paramyxovirus causing respiratory and central nervous system disease in pigs
- Uncommonly, lungworm pneumonia
- Anthrax by inhalation, causing pulmonary anthrax

### Horses

- Pleuropneumonia in mature horses as a result of aerobic and anaerobic bacteria—the aerobic bacteria most commonly isolated are alpha-hemolytic *Streptococcus* spp., *Pasteurella* spp., *Escherichia coli*, and *Enterobacter* spp. The anaerobic bacteria most frequently isolated are *Bacteroides* spp., *Prevotella* spp., *Fusobacterium* spp., and *Clostridium* spp.
- Newborn foals<sup>10</sup>—*Streptococcus* spp., *E. coli*, *Actinobacillus equuli*, and other agents causing septicemia in this age group
- In immunodeficient foals, and rarely adult horses,<sup>11</sup> pneumonia associated with adenovirus or *Pneumocystis jiroveci* (formerly *P. carinii*)
- Immunosuppression following corticosteroid therapy for other diseases
- Older foals—*R. equi*, equine herpesvirus-1 or 4 (EVR)
- Bronchointerstitial pneumonia in foals 1 to 8 months of age—etiology uncertain
- Eosinophilic pneumonia secondary to parasite migration (*Parascaris equorum*) or *Dictyocaulus arnfieldi* infection, or as part of the multisystemic eosinophilic syndrome in adult horses<sup>12</sup>

- Interstitial proliferative pneumonia in foals from 6 days to 6 months of age, and the adult form in horses 2 years of age and older
- *Nicoletella semolina* in adult horses
- *Bordetella bronchiseptica* in adult horses
- Glanders and epizootic lymphangitis (*Histomonas farcinicus*) usually include pneumonic lesions.
- *Paecilomyces* spp. in foals
- Pleuropneumonia associated with pulmonary hydatidosis in a horse
- As a sequela to strangles
- Interstitial pneumonia associated with equine infectious anemia virus infection<sup>13</sup>
- Rarely, as a sequel to equine viral arteritis or equine viral rhinopneumonitis in adult animals
- Equine influenza virus causes pneumonia in foals and adult horses<sup>14,15</sup>
- Equine multinodular pulmonary fibrosis (putatively caused by EHV-5 infection)<sup>16</sup>
- Equine rhinitis A virus infection (putative cause)<sup>17</sup>
- Mycotic pneumonia associated with *Emmonsia crescens* (adiaspiromycosis) in adult horses
- Pulmonary aspergillosis in adult horses with predisposing conditions (such as colitis) and in donkey foals<sup>18</sup>
- Strenuous exercise in very cold conditions can cause damage to the airways of horses (and probably other species).

### Sheep

- Pneumonic pasteurellosis (*Mannheimia* spp.) as acute primary pneumonia in feedlot lambs, or secondary to parainfluenza-3 or *Chlamydia* sp. infection
- Newborn lambs—uncommonly *Streptococcus zooepidemicus*, *Salmonella abortusovis*
- Severe pneumonia as a result of *Mycoplasma* sp. in lambs—kageda in Iceland and Switzerland
- Clinically inapparent pneumonias without secondary infection—adenovirus, respiratory syncytial virus, reovirus, *Mycoplasma* spp. (including *M. ovipneumoniae*, *M. dispar*)
- *M. bovis* in sheep<sup>19</sup>
- *Corynebacterium pseudotuberculosis*—sporadic cases only
- Melioidosis (*Pseudomonas pseudomallei*)
- Lungworm (*Dictyocaulus filaria*)
- Ovine herpesvirus-2

- Progressive interstitial pneumonia (maedi) and pulmonary adenomatosis (jaagsiekte)
- Carbolic dip toxicosis

### Goats

- Pleuropneumonia associated with *Mycoplasma* strain F 38 or *Mycoplasma capri*, a devastating disease
- Chronic interstitial pneumonia with cor pulmonale as a common sequela associated with a number of *Mycoplasma* spp., but *M. mycoides* var. *mycoides* appears to be the most commonly recorded.
- Parainfluenza type 3
- Contagious ecthyma virus
- Retrovirus infection

### All Species

- Toxoplasmosis—rare, sporadic cases
- Systemic mycoses
- Aspiration pneumonia is dealt with as a separate entity.
- Sporadic secondary pneumonia associated with *Streptococcus* sp., *Corynebacterium* sp., *Dermatophilus* sp.
- Interstitial pneumonia, pulmonary consolidation and fibrosis by toxins in plants—*Eupatorium glandulosum* in horses, *Zieria arborescens* (stinkwood) in cattle, *Astragalus* spp. in all species

### EPIDEMIOLOGY

In addition to the infectious agents that cause the pneumonia, there are risk factors that contribute to the susceptibility of the animal. Three **risk factors** interact in the pathogenesis of specific pneumonias:

- **Animal**
- **Environmental and management**
- **Pathogen**

These are of paramount importance in any consideration of pneumonia, and the details of the epidemiology of each specific pneumonia are presented with each specific disease in this book. As examples, some of the commonly recognized risk factors include the following:

- The weaning of beef calves in northern climates
- The long transportation of beef cattle to feedlots
- The collection and mixing of animals at auction marts where they might be deprived of feed and water for prolonged periods
- The transportation of Thoroughbred horses farther than 500 miles and viral respiratory tract disease or exposure to horses with respiratory tract disease
- Housing dairy calves in poorly ventilated, overcrowded barns
- Marked changes in weather

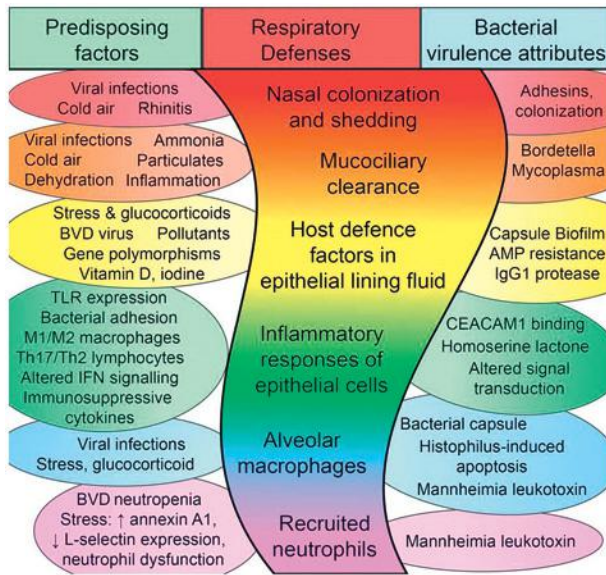

**Fig. 12-10 Mechanisms of failure of the respiratory defenses.** The center column illustrates the layered arrangement of the respiratory defenses. At left is a partial summary of causes and mechanisms whereby each of these respiratory defenses is comprised of factors that predispose to bacterial pneumonia. At right is a partial summary of how pathogens further contribute to failure of the lung defenses. BVDV, bovine viral diarrhoea virus; IFN, interferon; TLR, toll-like receptor. (Data from: Couetil, L.L. (2014) In Hinchcliff KW, Kaneps AJ, and Geor RJ (eds): Equine Sports Medicine and Surgery: Basic and clinical sciences of the equine athlete, ed. 2. Elsevier Health Sciences. p 614.)

Susceptibility to pneumonia is determined by the animal's resistance to infection by agents that cause or predispose to pneumonia. Factors that impair innate resistance or adaptive resistance (immunity) increase the animal's susceptibility to pneumonia. For instance, shipping not only increases the risk of exposure of animals to pathogens to which they have not been exposed but also can impair innate resistance through damage to the respiratory tract by airborne irritants, dehydration, food deprivation, and the effects of stress.

## PATHOGENESIS

### Pulmonary Defense Mechanisms

Under normal conditions the major airways and the lung parenchyma prevent the entry of and neutralize or remove injurious agents, so that the lung contains very few, if any, organisms beyond the large airways. Many infections of the respiratory tract originate from aerosolized particles carrying infectious agents that arise external to or within the respiratory tract. To induce an infection by the aerosol route, an etiologic agent must be aerosolized, survive in the aerosol, be deposited at a vulnerable site in the respiratory tract of a susceptible host, and then multiply. Thus the pathogenesis of these respiratory infections is related to the deposition of particles and infectious agents within the respiratory tract.

Under normal conditions a complex of biochemical, physiologic, and immunologic defense mechanisms protect the respiratory tract from inhaled particles that could be

injurious or infectious. The major defense mechanisms of the respiratory tract include (Fig. 12-10) the following:<sup>20</sup>

- Aerodynamic filtration by the nasal cavities
- Sneezing
- Local nasal antibody
- The laryngeal reflex
- The cough reflex
- Mucociliary transport mechanisms
- Alveolar macrophages
- Systemic and local antibody systems

Compromise of one or more of these defense mechanisms can result in infection, or proliferation, of infectious agents, leading to development of pneumonia. Factors that can compromise respiratory defense systems include stress, administration of glucocorticoids, viral infections, exposure to cold air by animals unaccustomed to it, or poor air quality.<sup>20</sup>

### Respiratory Mucociliary Clearance

The mucociliary escalator has important functions in the lung's physical defenses against the constant challenge of inhaled pathogens. By various physical mechanisms, mucus traps and subsequently transports inhaled particles to the pharynx, where they are normally swallowed. Mucus also protects the airways by absorbing inhaled chemicals and gases, by humidifying the inspired air and by keeping the underlying mucosa hydrated. Mucus contains antibodies, especially IgA, which together with lactoferrin and lysozyme provide immunologic defense.

**Airway secretions** consist of two layers. An underlying liquid layer, known as the periciliary fluid, in which the cilia beat, originates largely from transepithelial osmosis. An overlying gel or mucus layer is composed of intertwined mucin strands. Airway mucus is secreted in small globules, which expand several hundredfold within seconds and are later drawn into strands and transported rostrally by ciliary activity.

The secretion of respiratory mucus is a protective mechanism by which inhaled particles touching the airway mucosa stimulate local mucus production, which then traps and transports the particle from the lung. Airway mucus is produced mainly by submucosal glands and goblet cells, also known as mucus-producing cells. Airway secretions also contain alveolar fluid, surfactant and alveolar cells, including macrophages, which are drawn into the mucociliary ladder by surface tension.

Airway mucus is a complex substance consisting of 95% water and a 5% combination of glycoproteins, proteoglycans, lipids, carbohydrates, and minerals. Mucin is the main nonaqueous component. Effective mucociliary clearance or mucokinesis can occur over a range of mucus viscosity, but very-low-viscosity mucus is poorly transported and tends to gravitate toward the alveoli, whereas excessively viscous mucus, which is also poorly transported, may lodge in the airways and become inspissated.

In **respiratory disease**, mucociliary clearance is impaired through disruption of effective ciliary activity or changes in the quantity or quality of the mucus or periciliary fluid, or all three factors. In viral pulmonary disease, ciliary activity can be disrupted because of temporary deciliation or lesions of the respiratory mucosa. The defective mucociliary clearance may also last for several weeks. In chronic obstructive pulmonary disease in the horse, metaplasia of ciliated epithelium to a nonciliated epithelium may occur in the smaller airways.

**Changes in the quality of mucus** are common in respiratory tract disease, especially increases in viscosity with pulmonary disease. The destruction of leukocytes and respiratory epithelial cells and the release of DNA increases the viscosity. Large increases in the glycoprotein content of mucus also occur, which affects the mucokinetic properties. Purulent respiratory secretions have reduced elasticity and together with the increased viscosity affect the mucociliary clearance. Acute inflammation also results in the production of serum proteins from the airway exudate, which alters the viscoelasticity of mucus and further reduces mucokinesis.

**Yellow or green respiratory secretions** are attributable to the enzyme myeloperoxidase, released from leukocytes in the static secretion, or to high numbers of eosinophils.

The quantity of mucus increases in most cases of respiratory disease as a result of stimulation of goblet cells and submucosal glands by inflammatory mediators. The abnormal production can also exacerbate the original pulmonary dysfunction. Tracheal mucociliary clearance can be assessed endoscopically, *in vivo*, by dropping dye or small markers on the tracheal mucosa and measuring their rate of transit visually or using radioactive particles detected by scintigraphy.

### Large Particles in Upper Respiratory Tract

Large aerosolized particles that are inhaled are removed by the nasal cavities and only small ones are able to get into the lung. In the upper respiratory tract, essentially 100% of particles more than 10  $\mu\text{m}$  in diameter and 80% of particles of the 5  $\mu\text{m}$  size are removed by gravitational settling on mucosal surfaces. Particles deposited between the posterior two-thirds of the nasal cavity and the nasopharynx and from the larynx to the terminal bronchioles land on airways lined by mucus-covered, ciliated epithelium and are removed by means of the mucociliary transport mechanism. The nasopharyngeal and tracheobronchial portions of the ciliated airways transport mucus toward the pharynx, where it can be eliminated by swallowing. The cilia beat most effectively in mucus at a certain elasticity, viscosity, and chemical composition. Anything that interferes with the secretion and maintenance of normal mucus will interfere with the clearance of particles from the upper respiratory tract. The damaging effect of viruses on mucociliary clearance has been demonstrated in laboratory animals and in humans.

*Mycoplasma pneumoniae* infection slows tracheobronchial clearance for as long as 1 year, suggesting a possible explanation for the predisposition to bacterial pneumonia commonly observed after these infections. Viral diseases of the upper respiratory tract of farm animals are common and a similar interference in the mucociliary transport mechanism may explain the occurrence of secondary bacterial pneumonia.

### Cough Reflex

The cough reflex provides an important mechanism by which excess secretions and inflammatory exudates from the lungs and major airways can be removed and disposed of by expectoration or swallowing. In animals with relatively normal lungs, coughing represents a very effective means of expelling inhaled foreign bodies, or excessive or abnormal respiratory secretions, down to the level of the fourth- or fifth-generation bronchi. If the airways become deciliated, the cough reflex is the main and only mucus-clearance mechanism remaining. The cough reflex is valuable for transporting the increased secretions present in equine

pulmonary disease, and antitussive agents should therefore not be used in horses.

In the presence of severe tracheitis and pneumonia, coughing may result in retrograde movement of infected material to the terminal respiratory bronchioles and actually promote spread of the infection to distal parts of the lung. Any process that causes airway obstruction can predispose the lung to secondary bacterial infections. Experimental obstruction of the bronchi supplying a lobe of lung in sheep allows the development of secondary bacterial pneumonia. It has been postulated that damage to small airways following viral infections may allow the accumulation of exudate and cellular debris, which may facilitate secondary bacterial infections.

### Small Particles Into Lower Respiratory Tract

Particles of 1 to 2  $\mu\text{m}$  in size settle in the lungs through the action of gravity in the alveolar spaces, and particles below 0 to 2  $\mu\text{m}$  settle through diffusion of air. The alveolar macrophage plays a major role in clearing inhaled particles from the lung. Under normal conditions, bacteria that gain entry into the alveoli are cleared quickly and effectively in a matter of hours. Experimental parainfluenza-3 (PI-3) virus infection has the greatest adverse effect on the pulmonary clearance of *M. haemolytica* administered by intranasal aerosol on the seventh day following viral infection. The effect on pulmonary clearance is much less when the bacteria are given on the 3rd or 11th day following the initial viral infection.

The presence of preexisting antibody to *M. haemolytica* eliminates the effect of the viral infection on pulmonary clearance. Thus there is some evidence that in domestic animals, lung clearance mechanism may be affected by a concurrent viral infection. This may have major implications in the control of some of the common infectious respiratory diseases of farm animals.

### Species Susceptibility

The anatomic and physiologic features of the respiratory system of cattle may predispose them to the development of pulmonary lesions much more than other farm animal species. Cattle have a small physiologic gaseous exchange capacity and greater resultant basal ventilatory activity. The small gaseous exchange capacity may predispose cattle to low bronchiolar or alveolar oxygen levels during exposure to high altitudes and during periods of active physical or metabolic activity. During these times, low oxygen tension or hypoxia may slow mucociliary and alveolar macrophage activity and decrease pulmonary clearance rates. The basal ventilatory activity is comparatively greater than other mammals, which results in the inspired air becoming progressively more contaminated with infectious, allergic, or noxious substances.

The bovine lung also has a higher degree of compartmentalization than other species. This may predispose to airway hypoxia peripheral to airways that become occluded. This results in reduced phagocytic activity and the retention or multiplication of infectious agents. In addition, because of the low numbers of alveolar macrophages in the bovine lung, the pulmonary clearance mechanism may not be as effective as in other species. There is also a low level or atypical bioactivity of lysozyme in bovine respiratory mucus, which may make cattle more susceptible to infection of the respiratory tract than other species.

### Development of Pneumonia

The process by which pneumonia develops varies with the causative agent and its virulence and with the portal by which it is introduced into the lung.

**Bacteria are introduced** largely by way of the respiratory passages and cause a primary bronchiolitis that spreads to involve surrounding pulmonary parenchyma. The reaction of the lung tissue may be in the form of an acute fibrinous process as in pasteurellosis and contagious bovine pleuropneumonia, a necrotizing lesion as in infection with *F. necrophorum*, or as a more chronic caseous or granulomatous lesion in mycobacterial or mycotic infections. Spread of the lesion through the lung occurs by extension but also by passage of infective material along bronchioles and lymphatics. Spread along the air passages is facilitated by the normal movements of the bronchiolar epithelium and by coughing. Bronchiectasis and pulmonary abscesses are complications and common causes of failure to respond to therapy. Hematogenous infection by bacteria results in a varying number of septic foci, which may enlarge to form lung abscesses. Pneumonia occurs when these abscesses rupture into air passages and spread as a secondary bronchopneumonia.

**Viral infections** are also introduced chiefly by inhalation and cause a primary bronchiolitis, but there is an absence of the acute inflammatory reaction that occurs in bacterial pneumonia. Spread to the alveoli causes enlargement and proliferation of the alveolar epithelial cells and the development of alveolar edema. Consolidation of the affected tissue results but again there is an absence of acute inflammation and tissue necrosis so that toxemia is not a characteristic development. Histologically, the reaction is manifested by enlargement and proliferation of the alveolar epithelium, alveolar edema, thickening of the interstitial tissue, and lymphocytic aggregations around the alveoli, blood vessels, and bronchioles. This interstitial type of reaction is characteristic of viral pneumonias.

The **pathophysiology** of all pneumonias, regardless of the way in which lesions develop, is based on interference with



gaseous exchange between the alveolar air and the blood. Anoxia and hypercapnia develop, which results in polypnea, dyspnea, or tachypnea. Consolidation results in louder than normal breath sounds, especially over the anteroventral aspects of the lungs, unless a pleural effusion is present to muffle the sounds. In bacterial pneumonias, there is the added effect of toxins produced by the bacteria and necrotic tissue; the accumulation of inflammatory exudate in the bronchi is manifested by abnormal lung sounds such as crackles and wheezes on auscultation. Interstitial pneumonia results in consolidation of pulmonary parenchyma without involvement of the bronchi, and on auscultation loud breath sounds predominate in the early stages.

**Extension of the pneumonia** to the visceral surface of the pleura results in pleuritis, pleuropneumonia, pleural effusion, and thoracic pain. Fibrinous pleuritis is a common complication of pneumonic pasteurellosis in cattle. Pleuritis and pleural effusion secondary to pneumonia and pulmonary abscess are commonly recognized in adult horses with the pleuropneumonia complex associated with aerobic and anaerobic bacteria. Anaerobic bacterial pleuropneumonia in the horse is accompanied by a putrid odor of the breath, the sputum, or the pleural fluid. It is suggested that most anaerobic bacterial pulmonary infections in the horse are the result of aspiration of oropharyngeal contents, and they are most commonly located in the right lung because of the proximity of the right mainstem bronchus. Some horses with pleuropneumonia may develop acute hemorrhagic pulmonary infarction and necrotizing pneumonia.

Restriction of gaseous exchange occurs because of the obliteration of alveolar spaces and obstruction of air passages. In the stage before blood flow through the affected part ceases, the reduction in oxygenation of the blood is made more severe by failure of part of the circulating blood to come into contact with oxygen. Cyanosis is most likely to develop at this stage and to be less pronounced when hepatization is complete and blood flow through the part ceases. An additional factor in the production of anoxia is the shallow breathing that occurs. Pleuritic pain causes reduction in the respiratory excursion of the chest wall, but when no pleurisy is present the explanation of the shallow breathing probably lies in the increased sensitivity of the Hering-Breuer reflex. Retention of carbon dioxide with resulting acidosis is most likely to occur in the early stages of pneumonia because of this shallow breathing.

### CLINICAL FINDINGS

- **Rapid, shallow breathing** is the cardinal sign of early pneumonia.
- **Dyspnea** occurs in the later stages when much of the lung tissue is nonfunctional.

- **Polypnea** may be quite marked with only minor pneumonic lesions; the rapidity of the respiration is an inaccurate guide to the degree of pulmonary involvement.
- **Coughing** is another important sign, with the type of cough varying with the nature of the lesion.

Bacterial bronchopneumonia is usually accompanied by a moist and painful cough. In viral interstitial pneumonia, the coughing is frequent, dry, and hacking, often in paroxysms. Auscultation of the thorax before and after coughing may reveal coarse crackling sounds suggestive of exudate in the airways. Cyanosis is not a common sign and occurs only when large areas of the lung are affected. A nasal discharge may or may not be present, depending on the amount of exudate present in the bronchioles and whether or not there is accompanying inflammation of the upper respiratory tract. The odor of the breath may be informative: it may have an odor of decay when there is a large accumulation of inspissated pus present in the air passages; or it may be putrid, especially in horses affected with anaerobic bacterial pleuropneumonia.

In **acute bacterial bronchopneumonia**, toxemia, anorexia, depression, tachycardia, and a reluctance to lie down are common. In the advanced stages, severe dyspnea with an expiratory grunt are common.

In **viral interstitial pneumonia**, affected animals are usually not toxemic, but they may have a fever and be inappetent or anorexic. However, some cases of viral interstitial pneumonia can be diffuse and severe and cause severe respiratory distress, failure to respond to therapy, and death within a few days. A severe **bronchiointerstitial pneumonia of foals** aged 1 to 2 months of age has been described. The disease was characterized clinically by sudden onset of fever and increasingly severe dyspnea with respiratory distress and no response to treatment. In **acute interstitial pneumonia of cattle**, exemplified by the acute disease seen in mature cattle moved on to a lush pasture within the previous 10 days, some animals may be found dead. Other affected animals are severely dyspneic and anxious, commonly mouth breathe and grunt with each expiration, and, if forced to walk, may collapse and die of asphyctic respiratory failure.

**Auscultation of the lungs** is a valuable aid to diagnosis. The stage of development and the nature of the lesion can be determined, and the area of lung tissue affected can be outlined. In the early congestive stages of bronchopneumonia and interstitial pneumonia, the breath sounds are increased, especially over the anteroventral aspects of the lungs. Crackles develop in bronchopneumonia as bronchiolar exudation increases, but in uncomplicated interstitial pneumonia, clear, harsh breath sounds are audible. In viral interstitial pneumonia, wheezes may be

audible because of the presence of bronchiolitis. When complete consolidation occurs in either form, loud breath sounds are the most obvious sound audible over the affected lung, but crackles may be heard at the periphery of the affected area in bronchopneumonia. Consolidation also causes increased audibility of the heart sounds. When pleurisy is also present, a pleuritic friction rub may be audible in the early stages and muffling of the breath sounds over the ventral aspects of the lungs in the late exudative stages. If a pleural effusion is present, percussion of the thorax will reveal dullness of the ventral aspects, and a fluid line can usually be outlined. Consolidation can be detected also by percussion of the thorax.

In **chronic bronchopneumonia in cattle**, there is chronic toxemia, rough hair coat, and a gaunt appearance. The respiratory and heart rates are above normal, and there is usually a moderate persistent fever. However, the temperature may have returned to within a normal range even though the animal continues to have chronic incurable pneumonia. The depth of breathing is increased and both inspiration and expiration are prolonged. A grunt on expiration and open-mouth breathing indicate advanced pulmonary disease. A copious bilateral mucopurulent nasal discharge and a chronic moist productive cough are common. On auscultation of the lungs, loud breath sounds are usually audible over the ventral half of the lungs, and crackles and wheezes are commonly audible over the entire lung fields but are most pronounced over the ventral half.

With adequate treatment in the early stages, bacterial pneumonia usually responds favorably in 24 hours, but viral pneumonia may not respond at all or may relapse after an apparent initial beneficial response. The transient response may be attributable to control of the secondary bacterial invaders. In some bacterial pneumonias, relapses also occur that are a result of either reinfection or persistence of the infection in necrotic foci that are inaccessible to antimicrobials. The final outcome depends on the susceptibility of the causative agent to the treatments available and the severity of the lesions when treatment is undertaken. Pleurisy is a common complication of pneumonia and rarely occurs independently of it, and it is described later under that heading.

**Pneumonia and pleuritis** in horses are described separately (see following “[Equine Pleuropneumonia](#)” section).

Congestive heart failure or cor pulmonale may occur in some animals that survive a chronic pneumonia for several weeks or months.

### Medical Imaging

Thoracic radiography and ultrasonography are now commonly performed in veterinary teaching hospitals and specialty clinics and are discussed earlier in this chapter. They can

provide considerable diagnostic assistance in assessing the severity of the lesion and explaining certain clinical manifestations that may be difficult to interpret. Ultrasonography is a useful diagnostic aid in cattle and horses with anaerobic bacterial pleuropneumonia and pulmonary abscessation. Gas echoes within pleural or abscess fluid were found to be a sensitive and specific indicator of anaerobic infection, as was a putrid breath or pleural fluid.

In cattle with pleuropneumonia, ultrasonographic examination of both sides of the thorax may reveal accumulations of anechogenic and hypoechogenic fluid in the pleural space in the ventral aspect of the thorax.<sup>21</sup> In cattle, pleural effusion associated with pleuritis is usually unilateral because the pleural sacs do not communicate. Bilateral pleural effusion may indicate either bilateral pulmonary disease or a noninflammatory cause such as right-sided congestive heart failure or hypoproteinemia.

## CLINICAL PATHOLOGY

### Respiratory Secretions

The laboratory examination of the exudates and secretions of the respiratory tract is the most common diagnostic procedure performed when presented with cases of pneumonia. Nasal swabs, tracheobronchial aspirates, and bronchoalveolar lavage samples can be submitted for isolation of viruses, bacteria, and fungi; cytologic examination; and determination of **antimicrobial sensitivity**. Tracheobronchial aspirates are considered more reliable for the cytologic examination of pulmonary secretions in horses with suspected pneumonia or pleuropneumonia. Bronchoalveolar lavage samples may be normal in horses affected with pneumonia or pleuropneumonia. In suspected cases of pleuropneumonia, the collection and culture of pleural fluid is a valuable aid to diagnosis, and both anaerobic and aerobic bacteria must be considered.

### Thoracocentesis

When pleural effusion is suspected, thoracocentesis can be used to obtain pleural fluid for analysis.

### Hematology

Hematologic examination can indicate if the infection is bacterial or viral in nature and its severity. The hematocrit will be elevated in severely toxemic animals that are not drinking water. Severe bacterial bronchopneumonia and pleuritis is characterized by marked changes in the leukon. Serum fibrinogen or serum amyloid A concentrations are markedly elevated in horses with pleuropneumonia and pleuritic, or other inflammatory, lung disease.<sup>22</sup> Some limited studies indicate that the measurement of acute-phase proteins in bovine respiratory disease may be a valuable diagnostic and prognostic aid.

### Serology

When viral interstitial pneumonia is suspected, acute and convalescent sera are recommended for viral neutralization titer evaluation. For specific diseases such as porcine pleuropneumonia, serum can be taken from a percentage of the herd and submitted for serotyping to determine which serotype is most prevalent in the herd.

### Fecal Samples

When lungworm pneumonia is suspected, fecal samples can be submitted for detection of the larvae.

### Necropsy

In outbreaks of respiratory disease wherein the diagnosis is uncertain, necropsy of selected early cases will often assist in making a diagnosis.

## NECROPSY FINDINGS

Gross lesions are usually observed in the anterior and dependent parts of the lobes; even in fatal cases where much of the lung is destroyed, the dorsal parts of the lobes may be unaffected. The gross lesions vary a great deal depending on the type of pneumonia present. Bronchopneumonia is characterized by the presence of serofibrinous or purulent exudate in the bronchioles and lobular congestion or hepatization.

**In the more severe, fibrinous forms of pneumonia**, there is gelatinous exudation in the interlobular septae and an acute pleurisy, with shreds of fibrin present between the lobes.

**In interstitial pneumonia**, the bronchioles are clean, and the affected lung is sunken and dark red in color, and it has a granular appearance under the pleura and on the cut surface. There is often an apparent firm thickening of the interlobular septae. These differences are readily detected on histologic examination.

**In chronic bronchopneumonia of cattle**, there is consolidation, fibrosis, fibrinous pleuritis, interstitial and bullous emphysema, bronchi filled with exudate, bronchiectasis, and pulmonary abscessation.

Lesions typical of the specific infections listed under etiology are described under the headings of the specific diseases.

## TREATMENT

### Antimicrobial Therapy

In specific bacterial infections as listed previously, isolation of affected animals and careful surveillance of the remainder of the group to detect cases in the early stages should accompany the administration of specific antimicrobials to affected animals. The choice of antimicrobial will depend on the tentative diagnosis, the experience with the drug in previous cases and the results of drug sensitivity tests. The common bacterial pneumonias of all species will

usually recover quickly (24-72 hours) if treated with an adequate dose of the drug of choice early in the course of the disease. Animals with severe pneumonia will require daily treatment for several days until recovery occurs. Those with bacterial pneumonia and toxemia must be treated early on an individual basis. Each case should be identified and carefully monitored for failure to recover, and an assessment should be made. Clinical field trials to evaluate different antimicrobials for the treatment of acute bovine respiratory disease occurring under natural conditions are becoming more common and more meaningful, particularly under commercial feedlot conditions.

## DIFFERENTIAL DIAGNOSIS

There are two major difficulties in the clinical diagnosis of pneumonia. The first is to decide that the animal has pneumonia; the second is to determine the nature of the pneumonia and its cause. The suspected cause will influence the prognosis, the clinical management, and, more particularly in infectious pneumonias, the kind of antimicrobial therapy used.

There are two kinds of errors made in the clinical diagnosis of pneumonia. One is that the pneumonia is not detected clinically because the abnormal lung sounds are apparently not obvious. The other is to make a diagnosis of pneumonia because of the presence of dyspnea that is attributable to disease in some other body system.

- In **bacterial pneumonia** the major clinical findings are polypnea in the early stages and dyspnea later, abnormal lung sounds, and fever and toxemia.
- In **viral interstitial pneumonia** uncomplicated by secondary bacterial pneumonia, there is no toxemia. Pulmonary edema and congestion, embolism of the pulmonary artery, and emphysema are often mistaken for pneumonia but can usually be differentiated by the absence of fever and toxemia, on the basis of the history and on auscultation findings.
- **Diseases of other body systems** can cause polypnea and dyspnea. Congestive heart failure, the terminal stages of anemia, poisoning by agents such as hydrocyanic acid, hyperthermia, and acidosis are accompanied by respiratory embarrassment but not by the abnormal sounds typical of pulmonary involvement.

If pneumonia is present, the next step is to determine the nature and cause of the pneumonia. All the practical laboratory aids described earlier should be used when necessary. This is of particular importance when outbreaks of pneumonia are encountered, in which case necropsy examination of selected cases is indicated. In single routine cases of pneumonia, the cause is usually not determined. However, the age

and class of the animal, the history and epidemiologic findings, and the clinical findings can usually be correlated and a presumptive etiologic diagnosis made.

**Pleuritis** is characterized by shallow, abdominal-type respiration; by pleuritic friction sounds when effusion is minimal; a muffling of lung sounds on auscultation; and the presence of dullness and a horizontal fluid line on acoustic percussion when there is sufficient pleural fluid present. Thoracocentesis or ultrasonographic examination reveals the presence of excessive pleural fluid.

In **pneumothorax** there is inspiratory dyspnea and on the affected side and the abnormalities include the following:

- Absence of breath sounds over the lobes but still audible sounds over the base of the lung
- Increase in the absolute intensity of the heart sounds
- Increased resonance on percussion.

#### **Diseases of the upper respiratory tract**

such as laryngitis and tracheitis are accompanied by varying degrees of inspiratory dyspnea, which is often loud enough to be audible without a stethoscope. In less severe cases, auscultation of the midcervical trachea will reveal moist wheezing sounds on inspiration. These sounds are transmitted down into the lungs and are audible on auscultation of the thorax. These transmitted sounds must not be interpreted as attributable to pneumonia. In some cases of severe laryngitis and tracheitis, the inspiratory sounds audible over the trachea and lungs are markedly reduced because of almost total obliteration of these organs. In laryngitis and tracheitis, there is usually a more frequent cough than in pneumonia, and the cough can be readily stimulated by squeezing the larynx or trachea. In pneumonia the abnormal lung sounds are audible on both inspiration and expiration. Examination of the larynx through the oral cavity in cattle and with the aid of a rhinolaryngoscope in the horse will usually reveal the lesions.

Antimicrobial agents in a long-acting base may be used to provide therapy over a 4- to 6-day period instead of the daily administration of the shorter-acting preparations. However, the blood concentrations from the long-acting preparations are not as high as the shorter-acting preparations, and treatment with these compounds are not as effective in severely affected animals.

**Selection of antimicrobials** is based on the principles detailed in [Chapter 6](#). Briefly, antimicrobials for treatment of bacterial respiratory disease should be active against the causative agent, should be able to achieve therapeutic concentrations in diseased lung, and should be convenient to administer. The antimicrobials should be affordable and, if used in animals intended as human food, must be approved for use in such animals.

Antimicrobials for treatment of lung disease are preferably those that achieve therapeutic concentrations in diseased lung tissue after administration of conventional doses. This has been convincingly demonstrated for the macrolide (azithromycin, erythromycin), triamylide (tulathromycin), and fluoroquinolone (danofloxacin, enrofloxacin) antimicrobials and florfenicol in a variety of species. The beta-lactam antimicrobials (penicillin, ceftiofur) are effective in treatment of pneumonia in horses, pigs, and ruminants despite having chemical properties that do not favor their accumulation in lung tissue.

Routes of administration include oral (either individually or in medicated feed or water), parenteral (subcutaneous, intramuscular, intravenous), or inhalational. Intratracheal administration of antimicrobials to animals with respiratory disease is not an effective means of achieving therapeutic drug concentrations in diseased tissue. **Aerosolization and inhalation** of antimicrobials has the theoretic advantage of targeting therapy to the lungs and minimizing systemic exposure to the drug. However, although administration by inhalation achieves good concentrations of drug in bronchial lining fluid, the drug does not penetrate unventilated regions of the lungs, in which case parenteral or oral administration of antimicrobials is indicated. Administration of gentamicin to horses and ceftiofur sodium to calves with pneumonia has been investigated. Aerosol administration of gentamicin to normal horses results in gentamicin concentrations in bronchial lavage fluid 12 times that achieved after intravenous administration. Aerosolized ceftiofur sodium (1 mg/kg) is superior to intramuscular administration in treatment of calves with *M. haemolytica*.

Treatment of parasitic lung disease, such as that caused by migrating larvae or lungworms, is by administration of appropriate anthelmintics such as ivermectin, moxidectin, or the benzimidazoles. Refer to the sections in this book that deal with these diseases for details of the specific treatments. Treatment of *P. jiroveci* pneumonia involves the administration of a sulfonamide-trimethoprim combination or dapsone (3 mg/kg orally every 24 hours).

The antimicrobials and other drugs recommended for the treatment of each specific pneumonia listed under etiology are presented with each specific disease elsewhere in the book. The common causes for failure to respond favorably to treatment for bacterial pneumonia include the following:

- **Advanced disease when treatment was undertaken**
- **Presence of pleuritis and pulmonary abscesses**
- **Drug-resistant bacteria**
- **Inadequate dosage of drug**
- **Presence of other lesions or diseases that do not respond to antimicrobials**

There is no specific treatment for the viral pneumonias, and although many of the *Mycoplasma* spp. are sensitive to antimicrobials in vitro, the pneumonias associated with them do not respond favorably to treatment. This could be attributable to the intracellular location of the *Mycoplasma* making them inaccessible to the drugs. Because viral and mycoplasmal pneumonias are commonly complicated by secondary bacterial infections, it is common practice to treat acute viral and mycoplasmal pneumonias with antimicrobials until recovery is apparent.

**Intensive and prolonged therapy** may be required for the treatment of diseases such as equine pleuropneumonia. It may include daily care and treatment in a veterinary clinic consisting of daily lavage of the pleural cavity, including thoracostomy to drain pulmonary abscesses, and intensive antimicrobial therapy and monitoring for several weeks.

#### **Mass Medication**

In outbreaks of pneumonia where many animals are affected and new cases occur each day for several days, the use of mass medication of the feed and/or water supplies should be considered. Outbreaks of pneumonia in swine herds, lamb feedlots, veal calf enterprises, and beef feedlots are usually ideal situations for mass medication through the feed or water. Mass medication may assist in the early treatment of subclinical pneumonia and is a labor-saving method of providing convalescent therapy to animals that have been treated individually. The major limitation of mass medication is the uncertainty that those animals that need the drug will actually get it in the amounts necessary to be effective. Total daily water intake by animals is a function of total dry matter intake and well-being, and water consumption is therefore markedly reduced in toxemic animals. The provision of a reliable concentration of the drug in the water supply on a 24-hour basis is also a problem. However, with careful calculation and monitoring, mass medication can be a valuable and economical method of treating large numbers of animals. The method of calculating the amount of antimicrobials to be added to feed or water supplies is presented in [Chapter 7](#) on antimicrobial therapy.

When outbreaks of pneumonia occur and new cases are being recognized at the rate of 5% to 10% per day of the total in the group, all the remaining in-contact animals may be injected with an antimicrobial in a long-acting base. This may help to treat subclinical cases before they become clinical and thus control the outbreak.

#### **Other Drugs**

**Nonsteroidal antiinflammatory drugs** are useful in the treatment of infectious respiratory disease of cattle and horses, and likely other species. The drugs act by inhibiting



the inflammatory response induced by the infecting organism and tissue necrosis. Meloxicam (0.5 mg/kg subcutaneously, once), when administered with tetracycline, improves weight gain and reduces the size of lesions in lungs of cattle with bovine respiratory disease complex over those of animals treated with tetracycline alone. NSAIDs also improve the clinical signs of cattle with respiratory disease. Use of these drugs is routine in horses with pneumonia or pleuritis.

**Corticosteroids** have been used for their antiinflammatory effect in the treatment of acute pneumonia. However, there is no clinical evidence that they are beneficial, and they might be deleterious.

**Bronchodilators** have been investigated in the treatment of pneumonia in food animals. The **beta-2 adrenergic agonists** are potent and effective bronchodilators that can be administered orally, intravenously, or by inhalation. These drugs also enhance mucociliary clearance of material from the lungs. Most administration is orally or by inhalation. The use of beta-2 adrenergic agonist bronchodilator drugs in food animals is not permitted in most countries because of the risk of contamination of foodstuffs intended for consumption by people. This is particularly the case with clenbuterol, a drug approved in many countries for use in horses that is administered to cattle illicitly as a growth promoter. People can be poisoned by clenbuterol in tissues of treated cattle. Theophylline has been evaluated as a bronchodilator to relieve respiratory distress in cattle with pneumonia. When it was given orally at a dose of 28 mg/kg BW daily for 3 days, along with antimicrobial therapy, to calves with naturally acquired respiratory disease, the respiratory rate and rectal temperature decreased. However, some calves died, presumably from the accumulation of lethal concentrations of plasma theophylline. It is recommended that the drug should not be used unless plasma levels can be monitored.

### Supportive Therapy and Housing

Affected animals should be housed in warm, well-ventilated, draft-free accommodation and provided with ample fresh water and light, nourishing food. During convalescence premature return to work or exposure to inclement weather should be avoided. If the animal does not eat, oral or parenteral force-feeding should be instituted. If fluids are given intravenously, care should be exercised over the speed with which they are administered. Injection at too rapid a rate may cause overloading of the right ventricle and death as a result of acute heart failure.

Supportive treatment might include the provision of oxygen, if it is available, especially in the critical stages when hypoxia is severe. In foals, the oxygen can be administered through an intranasal tube passed back to the nasopharynx and delivered at the rate of about 8 L/min for several hours. Oxygen

therapy is detailed in the previous general section on treatment of respiratory disease.

### REFERENCES

- Collins RL. *Cattle Pract.* 2011;19:9.
- Hanthorn CJ, et al. *BMC Vet Res.* 2014;10.
- McFadden AMJ, et al. *NZ Vet J.* 2011;59:40.
- Fulton RW, et al. *Can J Vet Res.* 2011;75:191.
- Hick PM, et al. *Aust Vet J.* 2012;90:381.
- Aebi M, et al. *Acta Vet Scand.* 2015;57.
- Maunsell FP, et al. *J Vet Int Med.* 2011;25:772.
- Ribeiro MG, et al. *Vet Quart.* 2015;35:82.
- Lohr M, et al. *Pathogen Dis.* 2015;73.
- Reuss SM, et al. *Vet Clin Equine.* 2015;31:121.
- Ueno T, et al. *J Equine Vet Sci.* 2014;34:333.
- Horan EM, et al. *Equine Vet Educ.* 2013;25:607.
- Bolfa P, et al. *J Comp Pathol.* 2013;148:75.
- Patterson-Kane JC, et al. *Equine Vet J.* 2008;40:199.
- Begg AP, et al. *Aust Vet J.* 2011;89:19.
- Wilkins PA. *Equine Vet Educ.* 2013;25:393.
- Diaz-Mendez A, et al. *Am J Vet Res.* 2014;75:169.
- Stefanetti V, et al. *J Equine Vet Sci.* 2015;35:76.
- Kumar A, et al. *Asian J Anim Vet Adv.* 2012;7:149.
- Caswell JL. *Vet Pathol.* 2014;51:393.
- Scott PR. *Irish Vet J.* 2013;66.
- Belgrave RL, et al. *J Am Vet Med Assoc.* 2013;243:113.

### ACUTE RESPIRATORY DISTRESS SYNDROME

Acute respiratory distress syndrome is a well-recognized clinical syndrome of humans characterized by acute onset of hypoxemia and pulmonary infiltrates without increases in left atrial pressure (i.e., without evidence of cardiogenic pulmonary edema). Precipitating causes include both direct and indirect lung injury, including sepsis, multiple transfusions, trauma, near-drowning, smoke inhalation, pancreatitis, and more. The underlying lesion is diffuse alveolar capillary damage with secondary severe pulmonary edema. The disease occurs spontaneously in domestic animals, and although the spontaneous disease is not extensively documented, the disease produced experimentally as a model of the human disease is better described.

Acute respiratory distress syndrome (ARDS) in animals occurs in newborns and in adult animals. The disease in some newborn farm animals is related to lack of surfactant, but except for animals born prematurely, this is more the exception than the rule.<sup>1</sup> Most young animals and all adult animals with ARDS have some inciting acute lung injury that then progresses to ARDS. The causes can be infectious (e.g., influenza virus infection, leptospirosis,<sup>2</sup> porcine reproductive and respiratory syndrome virus infection<sup>3</sup>), physical (smoke inhalation or thoracic trauma<sup>4</sup>), toxic, or sepsis.<sup>5-7</sup>

The **pathophysiology** of the disease involves a common final pathway that results in damage to alveolar capillaries. The initial injury can be to either the endothelium of pulmonary capillaries or to alveolar epithelium. Damage to these structures leads to extravasation of protein-rich fluid and fibrin with subsequent deposition of hyaline

membranes. The capillary injury is attributed to activated leukocytes (macrophages and neutrophils) and cytokines. Accumulation of hyaline membranes and ventilation/perfusion mismatches impair respiratory gas exchange and cause hypoxemia.

The **clinical signs** are characteristic of acute, progressive pneumonia. Animals are anxious, tachycardic, tachypneic and have crackles and wheezes on thoracic auscultation. Severely affected animals can be cyanotic. Thoracic radiographs reveal diffuse pulmonary infiltrates. Hematologic changes are characteristic of the inciting disease but usually include leukopenia. There is arterial hypoxemia.

**Treatment** includes administration of antiinflammatory drugs (NSAIDs with or without glucocorticoids), colloids, antimicrobials, and oxygen. The arterial blood gas response to oxygen therapy is often minimal in severely affected animals. If it is available, mechanical ventilation can be useful, although the prognosis is grave. Inhalation of nitric oxide is beneficial in some humans with the disease, and there are anecdotal reports that it has been used to treat foals with ARDS.

### FURTHER READING

- Wilkins PA, et al. Update on interstitial pneumonia. *Vet Clin North Am Equine.* 2015;31:137+.

### REFERENCES

- Christmann U, et al. *J Vet Int Med.* 2009;23:227.
- Verma A, et al. *Vet Microbiol.* 2013;167:61.
- Han D, et al. *Vet Microbiol.* 2014;169:135.
- Gold J. *Equine Vet Educ.* 2009;21:193.
- Dunkel B, et al. *Equine Vet Educ.* 2015;27:92.
- Johnson PJ, et al. *Equine Vet Educ.* 2012;24:453.
- Simpson KM, et al. *Can Vet J.* 2011;52:784.

### ASPIRATION PNEUMONIA

Aspiration or inhalation pneumonia is a common and serious disease of farm animals caused by inhalation of ingesta, lipid, medications, meconium, or excessive dust. Cases occur after careless drenching, oral administration of medications,<sup>1</sup> or inadvertent intratracheal passage of an intended nasogastric tube during treatment for other illness, for example, administration of mineral oil to horses with colic. Even when care is taken these procedures are not without risk. Other causes include the feeding of calves and pigs on fluid feeds in inadequate troughing, with inhalation occurring in the struggle for food. Dipping of sheep and cattle when they are weak, or keeping their heads submerged for too long, also results in inhalation of fluid. Vomiting in ruminants can be followed by aspiration, especially in cattle with parturient paresis or during the passage of a stomach tube if the head is held high. Rupture of a pharyngeal abscess during palpation of the pharynx or passage of a nasal tube may cause sudden aspiration of infective material. Animals suffering from congenital defects<sup>2</sup>

and paralysis or obstruction of the larynx, pharynx, or esophagus can aspirate food or water when attempting to swallow. Esophageal obstruction is an important risk factor for aspiration pneumonia in horses (see following discussion), with 39 of 109 cases of esophageal obstruction developing aspiration pneumonia.<sup>3</sup> Bluetongue infection (BTV-12) of sheep causes myonecrosis of esophageal musculature and outbreaks of aspiration pneumonia.<sup>4</sup> Aspiration pneumonia is the consistent lesion of crude oil poisoning in cattle and probably results from vomiting or regurgitation.

## REFERENCES

1. Braun U, et al. *Schweiz Arch Tierheilkd.* 2008;149:363.
2. Barakzai SZ, et al. *Equine Vet J.* 2014;46:185.
3. Chiavaccini L, et al. *J Vet Int Med.* 2010;24:1147.
4. Antoniassi NAB, et al. *Vet Rec.* 2010;166:52.

## Lipid Pneumonia

Lipid pneumonia usually results from aspiration of mineral oil (liquid paraffin) administered for gastrointestinal disease.<sup>1</sup> Pneumonia is sometimes the result of inadvertent administration of the oil into the trachea through a misplaced stomach tube or inhalation during oral administration of oil. However, aspiration of oil can occur even when it is delivered into the stomach through a nasogastric tube, presumably because of regurgitation of oil either around the tube or after the tube has been removed. Administration of oil to sedated or severely depressed animals might increase the risk of aspiration.

Clinical signs include cough, tachypnea, tachycardia, pyrexia, respiratory distress, and abnormal lung sounds. Radiographs can reveal an alveolar and interstitial pattern. Examination of tracheal aspirates reveals a neutrophilic inflammation and the presence of lipid. Lipid can be readily identified by Sudan or oil red O staining of smears of the aspirate in acute cases. Necropsy examination reveals consolidated lungs. On cut section of these areas oil can be visible. Chronic cases have tissue necrosis and severe interstitial pneumonia. Lipid droplets can be identified in affected lung tissue after oil red O staining of sections. The presence and nature of the lipid can be demonstrated by thin-layer chromatography and gas chromatography. The prognosis for recovery is poor. Treatment is supportive and includes antiinflammatory drugs, antimicrobials, and oxygen. There is no specific treatment. Prevention includes careful insertion of nasogastric tubes, verification of their placement in the stomach, and not administering mineral oil to animals with a distended stomach or ones that are heavily sedated or severely depressed.

## Esophageal Obstruction

Esophageal obstruction is a common and important cause of pneumonia in horses. Of 109 horses with esophageal obstruction, 39

had clinical signs of aspiration pneumonia.<sup>2</sup> Obstruction of the esophagus in horses, and in other species, leads to the accumulation of saliva and feed material in the esophagus oral to the obstruction. When the esophagus is full, this material accumulates in the pharynx, with subsequent aspiration into the trachea resulting in contamination of the trachea and lower airways with feed material and oropharyngeal bacteria. Feed material is irritant and also causes obstruction of the smaller airways. Pulmonary defense mechanisms are weakened or overwhelmed by the contamination, and infection and pneumonia result. The duration of esophageal obstruction is a good indicator of the risk of aspiration pneumonia, although the extent of contamination of the trachea with feed material is not. Affected horses are pyrexia, tachycardia, and toxemic. Lung sounds can include crackles and wheezes, but the only auscultatory abnormality can be decreased breath sounds in the ventral thorax. Radiography reveals a characteristic pattern of bronchopneumonia restricted, at least initially, to the cranioventral and caudoventral lung lobes in adult horses. Ultrasonography reveals comet tail lesions in the ventral lung fields and variable consolidation. Pleuritis is a not uncommon sequela to aspiration pneumonia. Examination of tracheal aspirates demonstrates neutrophilic inflammation with presence of degenerate neutrophils, bacteria that are both intracellular and extracellular, and plant material. Culture of tracheal aspirates yields one or more of a wide variety of bacteria, including *S. zooepidemicus*, *Pasteurella* sp., *Actinobacillus* sp., *E. coli*, and anaerobes. Treatment involves prompt relief of the esophageal obstruction and administration of broad-spectrum antimicrobials, such as a combination of penicillin, aminoglycoside, and metronidazole. The prognosis for recovery from aspiration pneumonia secondary to esophageal obstruction is guarded to fair, partly because the animal has to recover from two diseases—the pneumonia and the esophageal obstruction. Prevention of aspiration pneumonia in horses with esophageal obstruction includes prompt relief of the obstruction and administration of broad-spectrum antimicrobials.

## REFERENCES

1. Metcalfe L, et al. *Irish Vet J* 2010;63:303.
2. Chiavaccini L, et al. *J Vet Int Med* 2010;24:1147.

## Meconium Aspiration Syndrome

Aspiration of meconium during parturition is associated with severe lung disease in newborns. Passage of meconium in utero, and subsequent aspiration by the fetus, is a sign of fetal distress. It is suggested that fetal distress results in expulsion of meconium into the amniotic fluid. This is followed by aspiration of contaminated amniotic fluid. The passage of meconium-contaminated amniotic fluid into the lungs may occur before birth when

the fetus gasps for air in an attempt to correct hypoxemia or when the calf takes its first breath and aspirates meconium from the oropharynx. Normally, fetal aspiration of amniotic fluid does not occur because the inspiratory forces are insufficient to allow amniotic fluid to reach the lungs, and the lung liquid, a locally produced viscous material present in the trachea and lungs, constantly flows up the major airways to the oropharynx. The result is that the fetus is doubly challenged in that it must deal with both the cause of the fetal distress and the pneumonia induced by aspiration of meconium. Although meconium is sterile, it induces a severe inflammatory response in the lungs.

The **meconium aspiration syndrome** is best described in newborn calves,<sup>1</sup> although there are numerous reports of its experimental induction in piglets and lambs as a model of the human disease. In a series of calves under 2 weeks of age submitted to a diagnostic laboratory, 42.5% had evidence of meconium, squamous cells, or keratin in the lung. Diffuse alveolitis with exudation of neutrophils, macrophages, and multinucleated cells and obstruction of small airways with atelectasis were common.

Treatment of aspiration pneumonia in farm animals is not well described. Administration of antimicrobials is prudent. Antiinflammatory drugs are indicated. Pentoxifylline is used in human neonates with meconium aspiration, but there are no reports of its use for this purpose in farm animals.

## REFERENCE

1. Poulsen KR, et al. *Vet Clin North Am Food Animal* 2009;25:121.

## Dusty Feed

Although farm animals fed on dusty feeds inhale many dust particles and bacteria, which can be readily isolated from the lung, this form of infection rarely results in the development of pneumonia. Much of the dust is filtered out in the bronchial tree and does not reach the alveoli. However, this may be of importance in the production of the primary bronchiolitis that so often precedes alveolar emphysema in horses. The inhalation of feed particles in pigs in a very poorly ventilated environment has been demonstrated to cause foreign body pneumonia. Also, a dry, dusty atmosphere can be created in a piggery by overfrequent changing of wood shavings used as bedding, and this can lead to the production of foreign body pneumonia. Liquids and droplets penetrate to the depths of the alveoli and run freely into the dependent portions, and aspiration pneumonia often results.

## DROWNING

Near drowning has been defined as survival following asphyxia and aspiration of water while submerged. Cases are rare in large

animals, but there is potential with the popularity of swimming as a method of exercising and training horses. There are cases of pneumonia after plunge dipping of sheep, which might be attributable to lung damage as a result of inhalation of dip water contaminated with bacteria.

The pulmonary responses to near drowning in sea water differ from that in fresh water.<sup>1</sup> Fresh water can inactivate pulmonary surfactant and lead to collapse of the alveolus with a loss of pulmonary compliance, and the resultant ventilation/perfusion mismatch coupled with alveolar damage can lead to severe hypoxemia. The inhalation of water may also carry bacteria and the risk of secondary bacterial aspiration pneumonia. Affected animals present with an elevated heart rate, tachypnea, and dyspnea. There is a decrease in normal airflow sounds on auscultation, which can occur in all areas of auscultation or be more pronounced in one lung, and rales or crackles may be heard in local areas. Consolidation may be detected with thoracic radiography. The mucous membranes may be congested, cyanotic, or muddy. Arterial blood gas analysis has shown a metabolic acidosis and hypoxemia. The response is typical of acute lung injury (acute respiratory distress syndrome).

Therapy has been based on experience with near drowning cases in humans; horses have been successfully treated by nasal insufflation of humidified oxygen, the correction of the base deficit with sodium bicarbonate and lactated Ringer's solutions administered intravenously, treatment with bronchodilators and nonsteroidal antiinflammatory drugs, and pulmonary infusion with a surfactant transplant from a recently euthanized horse. Antibacterials are given to cover the risk or the presence of a bacterial pneumonia, and the cover should include the possibility of infection with anaerobic organisms. Respiratory distress can be more severe when the animals are recumbent. Near drowning requires immediate and aggressive therapy, and the recovery can be prolonged.

## REFERENCE

1. Goldkarnp CE, et al. *Compendium—continuing education for veterinarians*. 2008;30:340.

## PULMONARY ABSCESS

The development of single or multiple abscesses in the lung causes a syndrome of chronic toxemia, cough, and emaciation. Abscesses can be solitary, multiple, military, or coalescing. Small solitary abscesses can be clinically silent, with clinical signs becoming more apparent at the extent of the lesions increases.

## ETIOLOGY

Pulmonary abscesses can be part of a primary disease or arise secondarily to diseases in other parts of the body.

## Primary Diseases

- *R. equi* pulmonary abscesses of foals
- *S. zooepidemicus* and *Actinobacillus* sp. in adult horses—one-third of infectious causes of abscesses in horses are polymicrobial, and anaerobic bacteria are isolated in 20% of cases
- Solitary abscess associated with strangles in horses, caseous lymphadenitis in sheep
- Tuberculosis
- Actinomycosis rarely occurs as granulomatous pulmonary lesions
- Aerogenous infections with “systemic” mycoses (e.g., coccidioidomycosis, aspergillosis, histoplasmosis, cryptococcosis, and moniliasis)
- *Helcococcus ovis* in horses and goats<sup>1</sup>
- *Mycoplasma bovis* in cattle

## Secondary Diseases

- Sequestration of an infected focus of pneumonia (e.g., bovine pleuropneumonia or pleuropneumonia in horses)
- Pulmonary abscesses secondary to ovine estrosis
- Emboli from endocarditis, caudal or cranial vena caval thrombosis, metritis, mastitis, omphalophlebitis<sup>2,3</sup>
- Rumenitis is strongly associated with development of liver abscesses, which in turn are risk factors for lung abscesses in cattle. Of cattle with liver abscesses, 14% have severe lung lesions, and 28% have mild lung lesions.<sup>4</sup>
- Aspiration pneumonia from milk fever in cows, drenching accident in sheep—in which case the abscess is a manifestation of aspiration pneumonia.
- Penetration by foreign body, such as in traumatic reticuloperitonitis, inhalation of a foreign body, or unusual causes such as diaphragmatic hernia with ileal diverticulitis causing a lung abscess<sup>5</sup>

## PATHOGENESIS

Pulmonary abscesses are present in many cases of pneumonia and are not recognizable as clinically distinct entities. In the absence of pneumonia, pulmonary abscess is usually a chronic disease, with clinical signs being produced by toxemia rather than by interference with respiration. However, when the spread is hematogenous and large numbers of small abscesses develop simultaneously, respiratory function can be compromised to the extent that it becomes clinically apparent. However, in more chronic cases the abscesses can reach a size sufficient to cause respiratory difficulty by obliteration of large areas of lung tissue. In rare cases, erosion of a pulmonary

vessel occurs, resulting in pulmonary hemorrhage and hemoptysis.

In many cases there is a period of chronic illness of varying degree when the necrotic focus is walled off by connective tissue. Exposure to environmental stress or other infection can result in a sudden extension from the abscess to produce a fatal suppurative bronchopneumonia, pleurisy, or empyema.

## CLINICAL FINDINGS

In typical cases there is dullness, anorexia, emaciation, and a fall in milk yield in cattle. The temperature is usually moderately elevated and fluctuating. Coughing is marked. The cough is short and harsh and usually not accompanied by signs of pain. Intermittent episodes of bilateral epistaxis and hemoptysis can occur and terminate in fatal pulmonary hemorrhage following erosion of an adjacent large pulmonary vessel. Respiratory signs are variable depending on the size of the lesions, and although there is usually some increase in the rate and depth, this may be so slight as to escape notice. When the abscesses are large (2-4 cm in diameter), careful auscultation and percussion will reveal the presence of a circumscribed area of dullness over which no breath sounds are audible. Crackles are often audible at the periphery of the lesion.

Multiple small abscesses may not be detectable on physical examination, but the dyspnea is usually more pronounced. There can be a purulent nasal discharge and fetid breath, but these are unusual unless bronchopneumonia has developed from extension of the abscess. Radiographic examination can be used to detect the presence of the abscess and give some information on its size and location. Ultrasonographic examination is sensitive and specific in detecting lung abscesses in foals and is useful in adult horses and other species.<sup>6</sup>

Most cases progress slowly, and many affected animals have to be euthanized because of chronic ill-health; others die of bronchopneumonia or emphysema. Persistent fever, tachycardia, and polypnea are common. A rare sequela is the development of hypertrophic pulmonary osteoarthropathy.

The clinical findings of *R. equi* pulmonary abscessation in young foals are presented under that disease.

Solitary lung abscesses are not uncommon in adult horses. Presenting signs are usually low-grade fever and depression. Most horses with lung abscesses cough. There is excessive mucopurulent material in the trachea, and examination of a tracheal aspirate reveals neutrophilic inflammation. Radiographic examination of the chest demonstrates the presence of one or more abscesses. Abscesses are in the caudal lung lobes in 60% of cases. Ultrasonography can be useful in detecting the abscess, provided



that it is confluent with the visceral pleura. The prognosis for life and for return to racing is excellent in horses that are treated appropriately.

### CLINICAL PATHOLOGY

Examination of nasal or tracheal mucus may determine the causative bacteria, but the infection is usually mixed, and interpretation of the bacteriologic findings is difficult. Culture of tracheal aspirates yields growth of pathogenic bacteria in approximately 70% of samples from horses with lung abscesses. Hematologic examination may give an indication of the severity of the inflammatory process, but the usual leukocytosis and shift to the left might not be present when the lesion is well encapsulated. In lung abscesses in foals and adult horses, hyperfibrinogenemia and neutrophilic leukocytosis are common.

### NECROPSY FINDINGS

An accumulation of necrotic material in a thick-walled fibrous capsule is usually present in the ventral border of a lung, surrounded by a zone of bronchopneumonia or pressure atelectasis. In sheep there is often an associated emphysema. In rare cases the abscess may be sufficiently large to virtually obliterate the lung. A well-encapsulated lesion may show evidence of recent rupture of the capsule and extension as an acute bronchopneumonia. Multiple small abscesses may be present when hematogenous spread has occurred.

#### DIFFERENTIAL DIAGNOSIS

The diagnosis might not be obvious when respiratory distress is minimal, and especially when multiple small abscesses are present. These cases present a syndrome of chronic toxemia, which may be mistaken for splenic or hepatic abscess. Differentiation between tuberculous lesions and nonspecific infections may require the use of the tuberculin test. Focal parasitic lesions, such as hydatid cysts, can cause a similar syndrome, but are not usually accompanied by toxemia or hematologic changes. Pulmonary neoplasms usually cause chronic respiratory disease, a progressive loss of weight, and lack of toxemia.

### TREATMENT

Pulmonary abscesses secondary to pneumonia in cattle and pigs are usually not responsive to therapy. The daily administration of large doses of antimicrobials for several days can be attempted but is usually not effective, and slaughter for salvage or euthanasia is necessary. Treatment of pulmonary abscesses in adult horses by administration of broad-spectrum antimicrobials is usually effective. Most (>80%) racehorses with single abscesses return to racing.

Diagnosis and treatment of pulmonary abscess and bronchopleural fistula can be achieved by thoracoscopy or thoracotomy and partial pneumonectomy.<sup>7</sup> As noted previously, almost all horses with solitary pulmonary abscesses recover with antimicrobial therapy.

### FURTHER READING

Roy MF, Lavoie JP. Diagnosis and management of pulmonary abscesses in the horse. *Equine Vet Educ.* 2002;14:322.

### REFERENCES

1. Garcia A, et al. *J Vet Diagn Invest.* 2012;24:235.
2. Schoster A, et al. *Can Vet J.* 2010;51:891.
3. Berger S, et al. *Pferdeheilkunde.* 2011;27:381.
4. Rezac DJ, et al. *J Anim Sci.* 2014;92:2595.
5. Ruby R, et al. *J Vet Int Med.* 2013;27:1633.
6. Venner M, et al. *Pferdeheilkunde.* 2014;30:561.
7. Bauquier SH, et al. *Equine Vet Educ.* 2010;22:231.

## Diseases of the Pleural Cavity and Diaphragm

### HYDROTHORAX AND HEMOTHORAX

The accumulation of edematous transudate or whole blood in the pleural cavities is manifested by respiratory embarrassment caused by collapse of the ventral parts of the lungs.

#### ETIOLOGY

Hydrothorax and hemothorax occur as part of a number of diseases. Hemothorax can involve rupture of vessels or leakage of blood from abnormal tissues or result from prolonged clotting times. Hydrothorax is a result of excessive accumulation of transudate secondary to altered Starling's forces or to chylothorax.

#### Hydrothorax

- As part of a general edema resulting from congestive heart failure or hypoproteinemia
- As part of African horse sickness or bovine viral leukosis
- Chylous hydrothorax, very rarely as a result of ruptured thoracic duct
- Secondary to thoracic neoplasia
- Yellow wood (*Terminalia oblongata*) poisoning of sheep
- Dilated cardiomyopathy of Holstein Friesian cattle

#### Hemothorax

- Traumatic injury to thoracic wall, a particular case of which is rib fractures in newborn foals<sup>1,2</sup>
- Hemangiosarcoma of pleura<sup>3</sup>
- Lung biopsy
- Strenuous exercise (racing) by horses.—intrathoracic, but

extrapulmonary, hemorrhage caused death in 6 of 143 Thoroughbred racehorses that died while racing.<sup>4</sup>

- Administration of phenylephrine (intravenously) to horses with left dorsal displacement (nephrosplenic entrapment) of the colon<sup>5</sup>
- Prolonged blood clotting times

### PATHOGENESIS

Accumulation of fluid in the pleural cavities causes compression atelectasis of the ventral portions of the lungs, and the degree of atelectasis governs the severity of the resulting dyspnea. Compression of the atria by fluid may cause an increase in venous pressure in the great veins, decreased cardiac return, and reduced cardiac output. Extensive hemorrhage into the pleural space can cause hemorrhagic shock.

### CLINICAL FINDINGS

Clinical signs depend on the evolution of the disease. Acute, severe hemothorax, such as occurs with penetrating injury, during racing, or associated with administration of phenylephrine, presents as sudden death or with signs of acute, severe hemorrhagic shock. Hemorrhage of lesser severity causes increased heart and respiratory rates, pale mucous membranes, and exercise intolerance.

Hydrothorax develops more slowly, and often there is an absence of systemic signs. There can be dyspnea, which usually develops gradually, and an absence of breath sounds, accompanied by dullness on percussion over the lower parts of the chest. In thin animals, the intercostal spaces might be observed to bulge. If sufficient fluid is present, it causes compression of the atria and engorgement of the jugular veins and increased amplitude of the jugular pulse. The cardiac embarrassment is not usually sufficiently severe to cause congestive heart failure, although this disease can already be present.

The accumulation of pleural fluid or blood is evident on radiographic or ultrasonographic examination of the thorax. Large quantities of blood in the pleural cavity have a characteristic swirling, turbulent appearance.

### CLINICAL PATHOLOGY

Thoracocentesis will yield a flow of clear serous fluid in hydrothorax, or blood in recent cases of hemothorax. The fluid is bacteriologically negative, and total nucleated cell counts are low ( $< 5 \times 10^6/L$ ,  $< 5000 \times 10^6/dL$ ). The pH,  $P_{CO_2}$ , and lactate and glucose concentrations of pleural fluid in animals with hydrothorax are similar to those of blood.

### NECROPSY FINDINGS

In animals that die of acute hemorrhagic shock resulting from hemothorax, the

pleural cavity is filled with blood, which usually has not clotted. Hydrothorax is not usually fatal but is a common accompaniment of other diseases, which are evidenced by their specific necropsy findings.

### DIFFERENTIAL DIAGNOSIS

Hydrothorax and hemothorax can be differentiated from pleurisy by the absence of pain, toxemia, and fever and by the sterility of an aspirated fluid sample.

### TREATMENT

Treatment of the primary condition is necessary. If the dyspnea is severe, aspiration of fluid from the pleural space causes a temporary improvement, but the fluid usually reaccumulates rapidly. Parenteral coagulants and blood transfusion are rational treatments in severe hemothorax.

### FURTHER READING

Groover ES, Wooldridge AA. Equine hemothorax. *Equine Vet Educ.* 2013;25:536-541.

### REFERENCES

- Jean D, et al. *Equine Vet J.* 2007;39:158.
- Bar R, et al. *Israel J Vet Med.* 2014;69:157.
- Taintor J. *Equine Vet Educ.* 2014;26:499.
- Lyle CH, et al. *Equine Vet J.* 2011;43:324.
- Frederick J, et al. *JAVMA.* 2010;237:830.

## PLEURITIS (PLEURISY)

Pleuritis refers to inflammation of the parietal and visceral pleura. Inflammation of the pleura almost always results in accumulation of fluid in the pleural space. Pleuritis is characterized by varying degrees of toxemia, painful shallow breathing, pleural friction sounds, and dull areas on acoustic percussion of the thorax because of pleural effusion. Treatment is often difficult because of the diffuse nature of the inflammation.

### ETIOLOGY

Pleuritis is almost always associated with diseases of the lungs. Pneumonia can progress to pleuritis, and pleuritis can cause consolidation and infection of the lungs. Primary pleuritis is usually caused by perforation of the pleural space, such as by a penetrating thoracic injury, and subsequent infection. Most commonly this occurs as a result of trauma, but it can occur in cattle with traumatic reticuloperitonitis and in any species after perforation of the thoracic esophagus.

Secondary pleuritis refers to that which develops from infectious lung disease subsequent to the following conditions. As with pneumonia, the classic triad of host-pathogen(s)-environment is present in development of pleuritic in any species. Risk factors (see following discussion) of crowding, temperature, housing, age, and weight

all contribute to increased susceptibility to the disease when the animal is exposed to one or more potential pathogens. Etiologic agents associated with pleuritis or disease syndromes involving pleuritis for specific animals are as follows.

#### Pigs

- Glasser's disease
- Pleuropneumonia associated with *Actinobacillus (Haemophilus) pleuropneumoniae* and *Haemophilus influenzae suis*<sup>1,2</sup>

#### Cattle

- Secondary to *Mannheimia haemolytica* pneumonia in cattle, especially feedlot cattle, which can be related to a high percentage of fibrotic pleural lesions found in adult cattle examined at the abattoir
- Infection of calves by *Pasteurella multocida* type B<sup>3</sup>
- Tuberculosis
- Sporadic bovine encephalomyelitis
- Contagious bovine pleuropneumonia
- *Histophilus somni* infection

#### Sheep and Goats

- Pleuropneumonia associated with *Mycoplasma* spp., including *Mycoplasma mycoides* subsp. *mycoides* and *Haemophilus* spp.
- Caprine pleuropneumonia (*Mycoplasma capricolum* subsp. *capripneumoniae*)<sup>4</sup>
- *Streptococcus dysgalactiae* in ewes
- *Helcococcus ovis* in sheep and goats<sup>5,6</sup>

#### Horses

The disease in horses is discussed separately in the next section. Rare causes of pleurisy and pleural effusion in horses include lymphosarcoma and equine infectious anemia. Mesothelioma of the pleura causing persistent dyspnea, pleural effusion, and death is also recorded in the horse. Thoracic hemangiosarcoma is recorded as a cause of chylothorax in the horse.

### Other Causes

**Sporadic and nonspecific diseases** may be accompanied by pleurisy. Examples include septicemias as a result of *Pseudomonas aeruginosa* and bacteremia with localization causing a primary septic pleural effusion. In horses, the infection is usually *S. equi*, and the original disease is strangles. In goats, it is usually spread from a mycoplasmal pneumonia.

**Perforation of the diaphragm** occurs in **traumatic reticuloperitonitis** in cattle and goats. Spread into the pleural cavity can occur without actual penetration of the diaphragm because it enters via the

lymphatics. Abomasopleural fistula secondary to abomasal ulceration can cause pleuritis in cattle.

**Chronic pleuritis** is an important cause of loss in commercial **piggeries**. The prevalence can be as low as 5.6% of pigs at slaughter in specific-pathogen-free piggeries and as high as 27% in conventional piggeries. In piggeries with a high incidence of pleuritis, 45% of lungs examined at slaughter had gross lesions of the chronic disease.<sup>1</sup> Examination of a larger number of animals (~4900) from 48 herds revealed a similar frequency of lesions of chronic pleuritic.<sup>7</sup> Risk factors for pleuritic in pigs include the following:<sup>7</sup> risk of a high pleuritic score was increased when the farrowing facilities were not disinfected (odds ratio [OR] = 2.7, 95% confidence interval [CI]:1.2-5.8,  $p = 0.01$ ), when tail docking was performed later than 1.5 days after birth (OR = 2.6, 95% CI: 1.2-5.7,  $p = 0.01$ ), when piglets were castrated at more than 14 days old (OR = 2.7, 95% CI: 1.1-6.8,  $p = 0.03$ ), a temperature range of less than 5°C (41 F) for the ventilation control rate in the farrowing room (OR = 2.7, 95% CI: 1.2-5.9,  $p = 0.01$ ), a mean temperature in the finishing room less than 23°C (OR = 3.0, 95% CI: 1.3-6.8,  $p < 0.01$ ), and large herd size (OR = 3.1, 95% CI: 1.4-6.9,  $p < 0.01$ ). The factors affecting pneumonia and pleuritis seemed to be different.<sup>7</sup>

Lesions consistent with pleuritic are common at time of slaughter in **veal calves**, with one study of calves from 174 farms in France, Belgium, and Italy reporting prevalence of 21% and another of 5825 calves reporting prevalence of 19% in 91 calves examined postmortem.<sup>8,9</sup> Risk factors for increased likelihood of lesions included lower calf weight on arrival at the farm, greater number of calves per pen, presence of slatted or rubber flooring (compared with concrete), and season.<sup>8</sup>

### PATHOGENESIS

Contact and movement between the parietal and visceral pleura causes pain as a result of stimulation of pain end organs in the pleura. Respiratory movements are restricted, and the respiration is rapid and shallow. There is production of serofibrinous inflammatory exudate, which collects in the pleural cavities and causes collapse of the ventral parts of the lungs, thus reducing vital capacity and interfering with gaseous exchange. If the accumulation is sufficiently severe, there may be pressure on the atria and a diminished return of blood to the heart. Clinical signs may be restricted to one side of the chest in all species with an imperforate mediastinum. Fluid is resorbed in animals that survive the acute disease, and adhesions develop, restricting movement of the lungs and chest wall, but interference with respiratory exchange is usually minor and disappears gradually as the adhesions stretch with continuous movement.

In all bacterial pleuritis, toxemia is common and usually severe. The toxemia may be severe when large amounts of pus accumulate.

### CLINICAL FINDINGS

The clinical findings of pleuritis vary from mild to severe depending on the species and the nature and severity of the inflammation. In peracute to acute stages of pleuropneumonia, there are **fever, toxemia, tachycardia, anorexia, depression, nasal discharge, coughing, exercise intolerance, breathing distress, and flared nostrils**. The nasal discharge depends on the presence or absence of pneumonia. It may be absent or copious, and its nature may vary from mucohemorrhagic to mucopurulent. The odor of the breath can be putrid, which is usually associated with an anaerobic lesion.

### Pleural Pain

Pleural pain (pleurodynia) is common and manifested as pawing, stiff forelimb gait, abducted elbows, and reluctance to move or lie down. In the early stages of pleuritis, breathing is rapid and shallow and, markedly abdominal, and movement of the thoracic wall is restricted. The breathing movements may appear guarded, along with a catch at end inspiration. The animal stands with its elbows abducted and is disinclined to move. The application of hand pressure on the thoracic wall and deep digital palpation of intercostal spaces usually causes pain manifested by a grunt, a spasm of the intercostal muscles, or an escape maneuver.

### Pleuritic Friction Sounds

Pleuritic friction sounds may be audible over the thoracic wall. They have a continuous to-and-fro character, are dry and abrasive, and do not abate with coughing. They may be difficult to identify if there is a coincident pneumonia accompanied by loud breath sounds and crackles. When the pleuritis involves the pleural surface of the pericardial sac, a friction rub may be heard with each cardiac cycle and be confused with the friction sound of pericarditis. However, there is usually, in addition, a friction sound synchronous with respiratory movements, and the pericardial rub waxes and wanes with expiration and inspiration. Pleural friction rubs are audible only during the initial stages of the disease; they are not audible when fluid accumulates in the pleural space.

### Subcutaneous Edema

Subcutaneous edema of the ventral body wall extending from the pectorals to the prepubic area is common in horses with severe pleuritis but is less noticeable in other species. Presumably this edema is attributable to blockage of lymphatics normally drained through the sternal lymph nodes.

### Pleural Effusion

In **cattle, an inflammatory pleural effusion** is often limited to one side because the pleural sacs do not communicate. Bilateral pleural effusion might indicate either a bilateral pulmonary disease process or a noninflammatory abnormality such as right-sided congestive heart failure or hypoproteinemia.

**Dullness on acoustic percussion** over the fluid-filled area of the thorax is characteristic of pleuritis in which there is a significant amount of pleural effusion. The dull area has a **horizontal level topline**, called a **fluid line**, which can be demarcated by acoustic percussion. As exudation causes separation of the inflamed pleural surfaces and the pleural effusion accumulates, the pain and friction sounds diminish but do not completely disappear. On auscultation there may still be pleuritic friction sounds, but they are less evident and usually localized to small areas.

In the presence of a pleural effusion, both normal and abnormal lung sounds are diminished in intensity, depending on the amount of the effusion. Dyspnea may still be evident, particularly during inspiration, and a pleuritic ridge develops at the costal arch as a result of elevation of the ribs and the abdominal-type respiration. However, the degree of dyspnea is often subtle, and careful clinical examination and counting of the breathing rate is necessary to detect the changes in breathing.

If the pleurisy is unilateral, movement of the affected side of the thorax is restricted compared with the normal side. In cattle, the pleural effusion is commonly unilateral on the right side, but both sides may be affected. Pain is still evident on percussion on deep palpation of the intercostal spaces, and the animal still stands with its elbows abducted, is disinclined to lie down or move, but is not as apprehensive as in the early stages. Toxemia is often more severe during this stage, the temperature and the heart rate are usually above normal, and the appetite is poor. A cough will be present if there is a concurrent pneumonia, and it is painful, short and shallow. Extension of the inflammation to the pericardium may occur. Death may occur at any time and is attributable to a combination of toxemia and anoxia caused by pressure atelectasis.

### Recovery

Animals with pleuritis characteristically recover slowly over a period of several days or even weeks. The toxemia usually resolves first, but abnormalities in the thorax remain for some time because of the presence of adhesions and variable amounts of pleural effusion in the loculi. Rupture of the adhesions during severe exertion may cause fatal hemothorax. Some impairment of respiratory function can be expected to persist, and racing animals do not usually regain complete efficiency. Chronic pleurisy, as occurs

in tuberculosis in cattle and in pigs, is usually subclinical, with no acute inflammation or fluid exudation occurring.

### Medical Imaging

Radiographic examination may reveal the presence of a fluid line and fluid displacement of the mediastinum and heart to the unaffected side and collapse of the lung. However, in cattle, pleural effusion cannot be located precisely by radiography because only laterolateral radiographs of the thorax can be taken. Ultrasonography is superior for the visualization of small volumes of pleural fluid that cannot be detected by auscultation and acoustic percussion of the thorax.

### Ultrasonography

Ultrasonography is more reliable for the detection of pleural fluid in horses and cattle than radiography. Pleural fluid is easily detected as hypoechoic to anechoic fluid between the parietal pleural surface, diaphragm, and lung. Transudative pleural fluid appears homogeneously anechoic to hypoechoic. Exudative fluid is commonly present in horses and cattle with pleuropneumonia and often contains echogenic material. Serosanguineous or hemorrhagic fluid is also more echogenic than transudates. Fibrin appears as filmy and filamentous strands floating in the effusion with loose attachments to the pleural surfaces. Pockets of fluid loculated by fibrin are commonly imaged in horses with fibrinous pleuropneumonia. Adhesions appear as echogenic attachments between the parietal and visceral pleural surfaces; the adhesions restrict independent motion of the surfaces. The presence of small, bright echoes (gas echoes) swirling in pleural or abscess fluid is associated with anaerobic infection of the pleural cavity. Gas echoes are usually most abundant in the dorsal aspects of the pleural cavity. Other lung and pleural abnormalities that may be visualized include compression atelectasis, consolidation, abscesses, and displacement of the lung as pleural effusion accumulates.

### Pleuroscopy

Pleuroscopy using a rigid or flexible fiberoptic endoscope allows direct inspection of the pleural cavity. The endoscope is introduced into the pleural cavity in the 10th intercostal space just above the point of the shoulder. The lung will collapse, but pneumothorax is minimized by the use of a purse-string suture placed around the stab incision and blunt dissection of the fascia and muscle layers for insertion of the endoscope. The diaphragm, costosplenic angle, aorta, mediastinal structures, and thoracic wall are clearly visible. By entering the thorax at different locations, the



ventral lung, the pericardium, and more of the diaphragm can be visualized. Lung and pleural abscesses and pleural adhesions may be visible.

### Prognosis

The prognosis depends on the severity and extent of the pleuritis and the presence of pneumonia. If the disease is in an advanced stage when first recognized and there is extensive fibrinous inflammation, the response to treatment can be protracted and extensive long-term daily care will be necessary. Also, the common failure to culture the primary causative agent, particularly in horses, makes specific therapy difficult.

## CLINICAL PATHOLOGY

### Thoracocentesis (Pleurocentesis)

Thoracocentesis to obtain a sample of the fluid for laboratory examination is necessary for a definitive diagnosis. The fluid is examined for its odor, color and viscosity, protein concentration, and presence of blood or tumor cells, and it is cultured for bacteria. It is important to determine whether the fluid is an exudate or a transudate. Pleural fluid from horses affected with anaerobic bacterial pleuropneumonia may be foul smelling. Examination of the pleural fluid usually reveals an increase in leukocytes up to 40,000 to 100,000/ $\mu\text{L}$  and protein concentrations of up to 50 g/L (5.0 g/dL). The fluid should be cultured for both aerobic and anaerobic bacteria and *Mycoplasma* spp.

### Hematology

In peracute bacterial pleuropneumonia in horses and cattle, leukopenia and neutropenia with toxic neutrophils are common. In acute pleuritis with severe toxemia, hemoconcentration, neutropenia with a left shift and toxic neutrophils are common. In subacute and chronic stages, normal to high leukocyte counts are often present. Hyperfibrinogenemia, decreased albumin–globulin ratio, and anemia are common in chronic pleuropneumonia.

### NECROPSY FINDINGS

In early acute pleurisy, there is marked edema, thickening, and hyperemia of the pleura, with engorgement of small vessels and the presence of tags and shreds of fibrin. These can most readily be seen between the lobes of the lung. In the exudative stage, the pleural cavity contains an excessive quantity of turbid fluid containing flakes and clots of fibrin. The pleura is thickened and the central parts of the lung are collapsed and dark red in color. A concurrent pneumonia is usually present, and there may be an associated pericarditis. In the later healing stages, adhesions connect the parietal and visceral pleurae. Type I fibrinous adhesions appear to be associated with pneumonia, whereas type II fibrinous proliferative adhesions are idiopathic.

## DIFFERENTIAL DIAGNOSIS

The diagnosis of pleuritis is confirmed by the following:

- The presence of inflammatory fluid in the pleural cavity
- Pleural friction sounds, common in the early stages of pleuritis and loud and abrasive; they sound very close to the surface, do not fluctuate with coughing common in the early stages, and may continue to be detectable throughout the effusion stage.
- The presence of dull areas and a horizontal fluid line on acoustic percussion of the lower aspects of the thorax, characteristic of pleuritis and the presence of pleural fluid.
- Thoracic pain, fever, and toxemia are common.

**Pneumonia** occurs commonly in conjunction with pleuritis, and differentiation is difficult and often unnecessary. The increased intensity of breath sounds associated with consolidation and the presence of crackles and wheezes are characteristic of pneumonia.

**Pulmonary emphysema** is characterized by loud crackles, expiratory dyspnea, hyperresonance of the thorax, and lack of toxemia unless associated with bacterial pneumonia.

**Hydrothorax and hemothorax** are not usually accompanied by fever or toxemia, and pain and pleuritic friction sounds are not present. Aspiration of fluid by needle puncture can be attempted if doubt exists. A pleural effusion consisting of a transudate may occur in cor pulmonale as a result of chronic interstitial pneumonia in cattle.

**Pulmonary congestion and edema** are manifested by increased vesicular murmur and ventral consolidation without hydrothorax or pleural inflammation.

## TREATMENT

The principles of treatment of pleuritis are pain control, elimination of infection, and prevention of complications.

### Antimicrobial Therapy

The primary aim of treatment is to control the infection in the pleural cavities using the systemic administration of antimicrobials, which should be selected on the basis of culture and sensitivity of pathogens from the pleural fluid. Before the antimicrobial sensitivity results are available, it is recommended that broad-spectrum antimicrobials be used. Antimicrobial therapy can be required for several weeks.

### Drainage and Lavage of Pleural Cavity

Drainage of pleural fluid removes exudate from the pleural cavity and allows the lungs to reexpand. Criteria for drainage include the following:

- An initial poor response to treatment
- Large quantities of fluid causing respiratory distress
- Putrid pleural fluid
- Bacteria in cells of the pleural fluid

Clinical experience suggests that drainage improves the outcome.

Pleural fluid can be drained using intermittent thoracocentesis or indwelling chest tubes. Intermittent drainage is satisfactory in an animal with a small amount of fluid. Small (12–20 French) chest tubes are temporarily inserted at 2- to 3-day intervals to remove the fluid. Aspiration may not be easy in some cases because the drainage tube may become blocked with fibrin, and respiratory movements may result in laceration of the lung. Drainage may be difficult or almost impossible in cases in which adhesion of visceral and parietal pleura are extensive and fluid is loculated.

Indwelling chest tubes may be required unilaterally or bilaterally depending on the patency of mediastinal fenestration and the degree of fluid loculation. A large-bore (24–32 French) chest tube is inserted and secured to prevent it from sliding out. Unidirectional drainage through the tube is facilitated by a Heimlich valve and monitored regularly. Pleural fluid is allowed to drain or drip passively because suction often results in obstruction of the tube with fibrin or peripheral lung tissue. Loculation of fluid may interfere with proper drainage and necessitate replacement of tubes. Complications include subcutaneous cellulitis or pneumothorax.

**Pleural lavage** may assist in removal of fibrin, inflammatory debris, and necrotic tissue; it can prevent loculation, dilute thick pleural fluid, and facilitate drainage (Fig. 12-11). One chest tube is placed dorsally and one ventrally using ultrasonographic guidance; 5 to 10 L of sterile, warm isotonic 0.9% NaCl solution is infused into each hemithorax by gravity flow. After infusion, the dorsal chest tube is capped, the ventral chest tube is reconnected to a unidirectional valve, and the lavage fluid is allowed to drain.

**Thoracotomy** has been used successfully for the treatment of pericarditis and pleuritis and lung abscesses in cattle. Claims are made for the use of dexamethasone at 0.1 mg/kg BW IV or IM to reduce the degree of pleural effusion. In acute cases of pleurisy in the horse, analgesics such as phenylbutazone are valuable to relieve pain and anxiety, allowing the horse to eat and drink more normally.

### Fibrinolytic Therapy

Pleural adhesions are unavoidable and may become thick and extensive with the formation of loculation, which traps pleural fluid, all of which prevent full recovery. However, some animals will stabilize at a certain level



**Fig. 12-11** Pleural lavage of the right pleural cavity of a Holstein Friesian cow with septic pleuritis secondary to a localized abomasal perforation and subsequent development of an abomasal diaphragmatic fistula. Note the dorsal ingress chest tube that is clamped and pleural fluid drainage via the ventral egress chest tube. Ten liters of warmed sterile 0.9% NaCl solution was infused dorsally, and 20 L of pleural fluid was removed via the ventral tube.

of chronicity, will survive for long periods, and may be useful for light work or as breeding animals. Fibrinolytic agents such as streptokinase have been used in human medicine to promote the thinning of pleural fluid, provide enzymatic debridement of the pleurae, lyse adhesions, and promote drainage of loculi. As reviewed under “Equine Pleuropneumonia” in this chapter, fibrinolytic therapy using recombinant tissue plasminogen activator appears promising in reducing the amount of accumulated fibrin and in hastening recovery of horses with pleuropneumonia.<sup>10-12</sup>

Prevention of the disease is achieved by prevention of exposure to etiologic agents that cause pleuritis, through specific-pathogen-free piggeries, vaccination,<sup>7</sup> and reduction of the effect of noninfectious risk factors.

## REFERENCES

1. Jirawattanapong P, et al. *Res Vet Sci.* 2010;88:11.
2. Fablet C, et al. *Res Vet Sci.* 2012;93:627.
3. McFadden AMJ, et al. *NZ Vet J.* 2011;59:40.
4. Prats-van der Ham M, et al. *J Arid Environ.* 2015;119:9.
5. Zhang Y, et al. *J Vet Diagn Invest.* 2009;21:164.
6. Garcia A, et al. *J Vet Diagn Invest.* 2012;24:235.
7. Merialdi G, et al. *Vet J.* 2012;193:234.
8. Brscic M, et al. *J Dairy Sci.* 2012;95:2753.
9. Pardon B, et al. *BMC Vet Res.* 2012;8.
10. Hilton H, et al. *Vet Rec.* 2009;164:558.
11. Rendle DI, et al. *Aust Vet J.* 2012;90:358.
12. Tomlinson JE, et al. *J Vet Int Med.* 2015;n/a.

## PNEUMOTHORAX

Pneumothorax refers to the presence of air (or other gas) in the pleural cavity. Entry of

air into the pleural cavity in sufficient quantity causes collapse of the lung and impaired respiratory gas exchange, with consequent respiratory distress.

## ETIOLOGY

Pneumothorax is defined as either spontaneous, traumatic, open, closed, or tension. Spontaneous cases occur without any identifiable inciting event. Open pneumothorax describes the situation in which gas enters the pleural space other than from a ruptured or lacerated lung, such as through an open wound in the chest wall. Closed pneumothorax refers to gas accumulation in the pleural space in the absence of an open chest wound. Tension pneumothorax occurs when a wound acts as a one-way valve, with air entering the pleural space during inspiration but being prevented from exiting during expiration by a valve-like action of the wound margins. The result is a rapid worsening of the pneumothorax. Pneumothorax can be unilateral or bilateral. The complete mediastinum of most cattle and some horses means that in many instances pneumothorax is unilateral, provided that the leakage of air into the pleural space occurs on only one side of the chest.

**Rupture of the lung** is a common cause of pneumothorax and can be either secondary to thoracic trauma, for example, a penetrating wound that injures the lung, or lung disease. Most cases of pneumothorax in cattle are associated with pulmonary disease, notably bronchopneumonia and interstitial pneumonia. Pleuropneumonia is the most common cause of pneumothorax in horses. Pneumothorax in these instances

results from “spontaneous” rupture of weakened lung or development of bronchopleural fistulae.

**Trauma to thoracic wall** can lead to pneumothorax when a wound penetrates the thoracic wall, including the parietal pleura. In cattle, the thoracic wall may be punctured accidentally by farm machinery being used around cattle, as, for example, when bales of hay are being moved among animals. Penetrating wounds of the thoracic wall are common causes in horses that impale themselves on fence posts and other solid objects. A special case of perforating lung injury occurs in newborns in which the rib is fractured during birth and the lung lacerated by the sharp edges of the fractured rib.<sup>1</sup> Bullet and arrow wounds to the chest are not uncommon causes of pneumothorax in regions in which hunting is common.

Pneumothorax also occurs during thoracotomy, thoracoscopy, lung or liver biopsy (in which there is inadvertent damage to the lung), or drainage of pleural or pericardial fluid. Pneumothorax can result from injury or surgery to the upper respiratory tract, presumably because of migration of air around the trachea into the mediastinum and subsequent leakage into the pleural space. Similarly, subcutaneous emphysema, such as commonly occurs with wounds to the axilla, leads to pneumothorax via the mediastinum.<sup>2</sup>

## PATHOGENESIS

Entry of air into the pleural cavity results in collapse of the lung. There can be partial or complete collapse of the lung. Collapse of the lung results in alveolar hypoventilation, hypoxemia, hypercapnia, cyanosis, dyspnea, anxiety, and hyperresonance on percussion of the affected thorax. Tension pneumothorax can also lead to a direct decrease in venous return to the heart by compression and collapse of the vena cava.

The degree of lung collapse varies with the amount of air that enters the cavity; small amounts are absorbed promptly, but large amounts compromise tidal volume, minute volume, and gas exchange and can result in asphyxiation.

## CLINICAL FINDINGS

There is an acute onset of inspiratory dyspnea, which may terminate fatally within a few minutes if the pneumothorax is bilateral and severe. If the collapse occurs in only one pleural sac, the ribcage on the affected side collapses and shows decreased movement. There is a compensatory increase in movement and bulging of the chest wall on the unaffected side. On auscultation of the thorax, the breath sounds are markedly decreased in intensity and commonly absent. The mediastinum may bulge toward the unaffected side and may cause moderate displacement of the heart and the apex beat,

with accentuation of the heart sounds and the apex beat. The heart sounds on the affected side have a metallic note, and the apex beat may be absent. On percussion of the thorax on the affected side, a hyperresonance is detectable over the dorsal aspects of the thorax.

Affected animals are anxious, tachypneic and in variable degrees of respiratory distress. Because many cases of pneumothorax in cattle and horses are secondary to lung disease, particularly infectious lung disease, there are usually signs of the inciting disease, including fever, toxemia, purulent nasal discharge, and cough. Pneumothorax secondary to chest wall trauma is usually readily apparent, although fractured ribs that lacerate the lung and cause pneumothorax or hemothorax can be easily missed on physical examination, especially in newborns.

Definitive diagnosis is based on demonstration of pneumothorax by radiographic or ultrasonographic examination. Radiography permits the detection of bilateral and unilateral pneumothorax and permits identification of other air leakage syndromes, including pneumomediastinum, pneumoperitoneum, and pneumopericardium. Many cattle with pneumonia and pneumothorax have radiographic evidence of emphysematous bullae. Ultrasonography is also useful in determining the extent of pneumothorax and the presence of consolidated lung and pleural fluid.

**Complications** of pneumothorax, other than respiratory distress and death, include septic pleuritis secondary to contamination of the pleural space, either secondary to trauma or from ruptured infected lung.

The **prognosis** depends on the underlying disease and its severity. Of 30 cattle with pneumothorax, mostly secondary to pneumonia, 18 survived, 8 were euthanized, and 4 died. Of 40 horses with pneumothorax, 23 survived, 12 were euthanized, and 5 died. The prognosis is better for animals with traumatic pneumothorax or that secondary to surgery than for animals with pneumothorax attributable to pneumonia.

### CLINICAL PATHOLOGY

Hematologic and serum biochemical values are indicative of the underlying or concurrent disease—pneumothorax causes no specific changes in these variables. Arterial blood gas analysis reveals hypoxemia and hypercapnia.

### NECROPSY FINDINGS

The lung in the affected sac is collapsed. In cases where spontaneous rupture occurs, there is discontinuity of the pleura, usually over an emphysematous bulla. Hemothorax might also be evident.

### DIFFERENTIAL DIAGNOSIS

The clinical findings are usually diagnostic. Diaphragmatic hernia may cause similar clinical signs but is relatively rare in farm animals. In cattle, herniation is usually associated with traumatic reticulitis and is not usually manifested by respiratory distress. Large hernias with entry of liver, stomach, and intestines cause respiratory embarrassment, a tympanitic note on percussion, and audible peristaltic sounds on auscultation.

### TREATMENT

The treatment depends on the cause of the pneumothorax and the severity of the respiratory distress and hypoxemia. Animals should receive treatment for the underlying disease. Animals with closed pneumothorax that are not in respiratory distress or hypoxemic do not require specific treatment for the pneumothorax, although the animal should be confined and prevented from exercising until the signs of pneumothorax have resolved. An open pneumothorax, as a result of a thoracic wound, should be surgically closed.

Emergency decompression of the pleural cavity using a needle into the pleural cavity, connected to a tubing and submerged into a flask of saline or water, creates a water-seal drainage. Thoracostomy tubes attached to Heimlich thoracic drainage valves are effective in preventing aspiration of air. Continuous suction, using thoracostomy (e.g., 24 French, 40-cm [16-in.] Argyle trocar thoracic catheter) and a standard three-bottle water seal drainage system or commercial equivalent is preferable if there are large continuing air leaks that may be life-threatening. Re-inflation of the lung should be gradual because rapid removal of air can result in pulmonary edema.<sup>3</sup> Inflation of the lung can be monitored by repeated ultrasonic examination. The animal should be kept as quiet as possible and permitted no exercise. Horses with wounds to the axilla should be restrained until the wound has closed because this prevents the aspiration of air into the wound.<sup>2</sup> Prophylactic antimicrobial treatment is advisable to avoid the development of septic pleuritis.

Care should be exercised in performing biopsy of the liver or lung, and the former should be done with ultrasound guidance to prevent inadvertent lung damage.<sup>4</sup>

### REFERENCES

1. Jean D, et al. *Equine Vet J*. 2007;39:158.
2. Joswig A, et al. *Equine Vet Educ*. 2013;25:139.
3. Epstein KL. *Equine Vet Educ*. 2009;21:627.
4. Sammons SC, et al. *JAVMA*. 2014;245:939.

### DIAPHRAGMATIC HERNIA

Diaphragmatic hernia is uncommon in farm animals, in which it can be acquired, usually

as a result of trauma, or congenital. Of a series of 44 horses and foals examined because of diaphragmatic hernia, 5 cases were determined to be congenital and 39 acquired.<sup>1</sup>

Congenital diaphragmatic hernias are reported in most large animal species, although details of frequency or risk factors are not available.<sup>2-10</sup> Congenital hernia results from failure of complete formation of the diaphragm during embryogenesis during a process involving the septum transversum, dorsal embryonic mesentery, pleuroperitoneal folds, and body wall mesenchyme. Congenital hernias develop as a result of defects in the diaphragmatic musculature when the septum transversum and pleuroperitoneal folds do not fuse completely or in the dorsal tendinous portion of the diaphragm.<sup>2</sup> Such hernias are characterized by a hernia sac composed of peritoneal and pleural membranes that occurs to one side or the other of midline (usually the right side in horses) in the right ventral (retrosternal hernia) or left dorsal crus.<sup>1,2</sup> The borders of congenital hernias are usually smooth, fibrous, and thickened and have a characteristic histologic appearance. In some cases, the pericardial sac is incomplete and the diaphragm is rudimentary and in the form of a small fold projecting from the chest wall. Affected animals usually survive for a few hours to several weeks, although many can survive for years with the hernia being clinically inapparent.<sup>1</sup> In pigs, a number of animals in each litter can be affected.

Acquired hernias are usually associated with trauma, such as falls, collisions with motor vehicles, foaling (for both mares and foals), or strenuous exercise.<sup>1,10,11</sup> It occurs in cattle, especially in association with traumatic reticuloperitonitis, in which case the hernia is small and causes no respiratory distress, and there may be no abnormal sounds in the thorax.

### CLINICAL FINDINGS

Clinical findings in cattle include chronic or recurrent ruminal tympany caused by herniation of reticulum preventing its normal function in eructation. Muffled heart sounds can be detectable on both sides of the thorax.

Clinical signs of diaphragmatic hernia in adult horses are usually referable to herniation with or without incarceration of sections of the gastrointestinal tract. Signs of respiratory compromise are not common. There is sometimes a history of trauma or recent parturition, but this is not invariable, and many cases in adult horses occur without such an event being noticed in the recent past. Clinical signs on examination are those typical of colic of varying severity from nonstrangulation incarceration to acute, strangulating incarceration with severe septic shock and collapse. Rectal examination does not reveal evidence specific for diaphragmatic hernia, with the rare exception of a sense that the



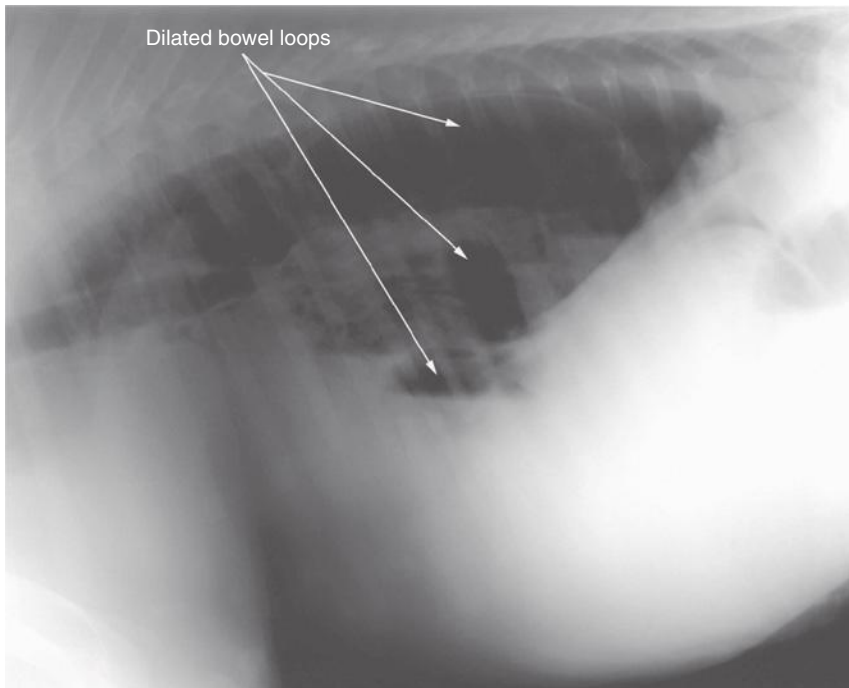

**Fig. 12-12** Lateral thoracic radiograph in a foal demonstrating presence of gas-filled intestinal loops in the caudodorsal thorax. (Reproduced with permission.<sup>4</sup>)

abdomen is not as full as one would expect. Thoracic auscultation can reveal the presence of borborygmi in the chest fields, but this should be interpreted with caution because such findings can occur in horses with an intact diaphragm. Examination of peritoneal fluid usually does not reveal abnormalities. Radiographic or ultrasonographic examination can provide a definitive diagnosis (Fig. 12-12).

The hernia is usually left dorsal (approximately 2/3 of cases) and right ventral (approximately 1/3 of cases) in horses.<sup>1,4</sup> Congenital retrosternal hernia (Morgagni hernia) is almost exclusively right ventral in horses.<sup>2</sup>

The presence of intestinal sounds in the thorax can be misleading; they are often present in the normal animal, but their presence, accompanied by dyspnea and resonance on percussion, should arouse suspicion. Radiography, ultrasonography, thoracoscopy, and exploratory laparotomy are the most useful diagnostic procedures. Radiography reveals the presence of gas- and fluid-filled intestinal contents in the thorax, apparent in cattle as oval rounded masses over the heart. Ultrasonography demonstrates presence of bowel in the thorax. There can be excessive pleural fluid.

The definitive treatment of acquired or traumatic hernia is surgical replacement of viscera in the abdomen and repair of the defect in the diaphragm. Repair of a diaphragmatic hernia through a standing thoracotomy in a cow has been described. Surgical repair has been performed in calves and foals, and in adult horses.<sup>1-4,10,12,13</sup>

The prognosis is poor to guarded, with short-term survival of affected foals and horses being 7/44 and 8/31.<sup>1,4</sup> Factors related to survival include the presence and extent of incarcerated intestine, size of the rent (smaller associated with increased chance of survival), and location of the rent. Location of the rent is likely related to survival because small, ventrally located rents are more amenable to surgical correction.<sup>4</sup>

#### REFERENCES

- Hart SK, et al. *J Vet Emerg Crit Care*. 2009;19:357.
- Pauwels FF, et al. *JAVMA*. 2007;231:427.
- Bellavance A, et al. *Can Vet J*. 2010;51:767.
- Romero AE, et al. *Can Vet J*. 2010;51:1247.
- DeVilbiss B, et al. *J Zoo Wildlife Med*. 2011;42:513.
- Foster DM, et al. *Aust Vet J*. 2011;89:51.
- Palmer JE. *Equine Vet Educ*. 2012;24:340.
- Hicks KA, et al. *Can Vet J*. 2013;54:687.
- Hifumi T, et al. *J Vet Med Sci*. 2014;76:711.
- Efraim G, et al. *Israel J Vet Med*. 2015;70:37.
- Sprayberry KA, et al. *Vet Clin Equine*. 2015;31:199.
- Roecken M, et al. *Vet Surg*. 2013;42:591.
- McMaster M, et al. *J Equine Vet Sci*. 2014;34:1333.

## Diseases of the Bovine Respiratory Tract

### ENZOOTIC NASAL GRANULOMA OF CATTLE (BOVINE ATOPIC RHINITIS)

Of the three known clinical types of chronic nasal obstruction in cattle, two have been identified etiologically and have clinical or epidemiologic features that distinguish them from enzootic nasal granuloma. One is

recorded predominantly in beef cattle and appears to be caused by a fungus, most commonly *Rhinosporidium* spp., *Drechslera* spp., *Nocardia* spp.,<sup>1</sup> or *Pseudoallescheria boydii*.<sup>2</sup> Another is caused by the parasite *Schistosoma nasalis*. The third type, **enzootic nasal granuloma (ENG)**, occurs commonly in southern Australia, less commonly in New Zealand, and is recorded as a sporadic disease in South America and an occasional disease in North America, Britain, and Europe. It is reported as a herd outbreak in Jersey cows in the United Kingdom.<sup>3</sup>

Enzootic nasal granuloma occurs sporadically in some herds but may reach an incidence of 30%. In one area, as much as 75% of herds may have the disease. Animals aged between 6 months and 4 years are most commonly affected, and the chronic disease may or may not be preceded by an attack of acute rhinitis. Most cases commence in the summer and autumn months. It is apparent that nasal granuloma develops as a continuous and progressive response to acute episodes of hypersensitivity to an allergen present in the summer months. This accords with the gradual development of the stertorous respiration and the observations, in biopsies of nasal mucosa, of the presence of mast cells in all seasons, but the regression of eosinophils in the winter months.

An extensive survey of Australian dairy-farming areas showed that 22% of cattle had lesions, and that the prevalence was greater in areas where the average annual rainfall was over 70 cm than where it was less than 70 cm; the prevalence varied between 4% and 48%; Jerseys were more commonly affected than Friesians. In New Zealand, 40% of farms and 36% of culled cattle were affected, whereas only 3.6% of young beef cattle showed lesions.

The disease has been identified as an allergic rhinitis and has been produced experimentally. Specific antigens have not been identified as the cause, but cows with nasal granuloma are much more sensitive to a number of common allergens in the environment than are unaffected cows. Additional possible causes include infestation of the nasal cavities with pasture mites (*Tyrophagus palmarum*). An allied condition has been described in the United States as maduromycosis, but there are nasal granulomas plus multiple granulomatous lesions of the skin of the ears, tail, vulva, and thigh. The granulomas contain many eosinophils and fungal elements identified provisionally as *Helminthosporium* sp.

In enzootic nasal granuloma, acute cases are characterized by a sudden onset of bilateral ocular and nasal discharge and swelling of the nasal mucosa causing difficult, noisy breathing. Affected animals shake their heads and snort and rub their noses in hedges. As a result, they commonly block their nostrils with twigs. This form of the disease is commonest in cattle of the Channel

Island breeds and their crossbreeds. The nasal discharge in these breeds is usually yellow to orange in color.

Established cases of enzootic nasal granuloma have lesions, consisting of granulomatous nodules 1 to 4 mm in diameter and height, in both nostrils. The lesions extend from just inside the nostril posteriorly for 5 to 8 cm. They may be few in number or be packed closely together. Their texture is firm, and the mucosa over them is normal. They have a characteristic histopathology of epithelial metaplasia and hyperplasia, and contain large numbers of eosinophils and mast cells.

The predominant clinical sign is respiratory stertor and dyspnea caused by obstruction to the airflow. The severity of these signs may fluctuate, but in general they progress slowly over several months and then remain static. Although the respiratory distress may be sufficiently severe to cause a loss of condition and marked reduction in milk yield, affected animals do not die. A good proportion of them have to be culled as uneconomic units.

The clinical picture in **mycotic nasal granuloma** is superficially similar with respect to noisy breathing, respiratory distress, and nasal discharge, but there is no seasonal association. Also, the visible and palpable lesions in the anterior part of the nasal cavities are polyps up to 5 cm in diameter that occur singly or in confluent masses. Their cut surfaces are yellow to green, and they are sometimes ulcerated. Histologically, the lesions are eosinophilic granulomas containing fungal spores and sometimes hyphae. Fungi (*Drechslera rostrata*) have been isolated from the lesions.

## REFERENCES

1. Shibahara T, et al. *Aust Vet J.* 2001;79:363.
2. Singh K, et al. *Vet Pathol.* 2007;44:917.
3. Anon. *Vet Rec.* 2012;171:468.

## TRACHEAL STENOSIS OF FEEDLOT CATTLE

Tracheal stenosis, also known as “honker cattle,” occurs in feedlot cattle. The etiology is unknown. It is characterized by extensive edema and hemorrhage of the dorsal wall of the trachea, resulting in coughing (honking), dyspnea, and respiratory stertor. Complete occlusion of the trachea may occur. Affected animals may be found dead without any premonitory signs.

In tracheal stenosis of feedlot cattle, there is marked submucosal hemorrhage dorsal and ventral to the trachealis muscle, resulting in ventral displacement of the mucosa and partial to complete occlusion of the tracheal lumen. Diffuse hemorrhage in the peritracheal connective tissue and surrounding muscles of the neck is common in animals dying of asphyxia. Histologically, there is hyperemia and hyperplastic tracheal mucosa

with focal erosions, squamous metaplasia, and loss of cilia. In acute cases, the mucosa is markedly thickened because of hemorrhage and edema. Culture reveals a mixed bacterial flora.

## CAUDAL VENA CAVAL THROMBOSIS (POSTERIOR VENA CAVAL THROMBOSIS) AND EMBOLIC PNEUMONIA IN CATTLE

Embolitic pneumonia as a sequel to thrombosis of the posterior vena cava is a relatively common disease of cattle in Europe and the United Kingdom. The disease is rare in cattle less than 1 year old, although it can occur at any age. Most affected animals are in feedlots on heavy-grain diets, and there are peaks of incidence at those times of the year when most cattle are on such diets. There is a relationship between the occurrence of this disease and that of hepatic abscessation arising from lactic-acid-induced rumenitis on heavy-grain diets. The disease is reported with deep digital sepsis in cattle.<sup>1</sup> A similar syndrome occurs in horses, although rarely.<sup>2</sup>

The **etiology and pathogenesis** of the disease are based on the development of a thrombus in the posterior vena cava and the subsequent shedding of emboli that lodge in the pulmonary artery, causing embolism, endarteritis, multiple pulmonary abscesses, and chronic suppurative pneumonia. Pulmonary hypertension develops in the pulmonary artery, leading to the development of aneurysms, which can rupture causing massive intrapulmonary or intrabronchial hemorrhage. In most cases the thrombi in the vena cava originate from hepatic abscesses or postdiaphragmatic abscesses. Usually there is an initial phlebitis and the subsequent thrombus extends into the thoracic part of the vessel. When the thrombus occludes the openings of the hepatic veins into the vena cava, there is congestion of the liver and hepatomegaly, ascites, and abdominal distension in some of these cases.

The **most common form** of the disease is characterized by manifestations of respiratory tract disease. Commonly there is a history of the disease for a few weeks or longer, but some animals are “found dead” without prior recorded illness. Affected animals usually have thin to moderate body condition, reduced appetite, reduced rumen motility, and a positive reticular pain response. There is usually fever and an increase in the rate and depth of respiration, coughing, epistaxis and hemoptysis, anemia with pallor, a hemic murmur, and a low packed cell volume. Respirations are painful and a mild expiratory grunt or groan may be audible with each respiration. Subcutaneous emphysema and frothing at the mouth are evident in some. Deep palpation in the intercostal spaces and over the xiphoid sternum might elicit a painful grunt. The lung sounds

can be normal in the early stages, but with the development of pulmonary arterial lesions, embolic pneumonia, and collapse of affected lung, widespread abnormal lung sounds are audible on auscultation. There can be ascites. In one series of cases, the presence of anemia, hemoptysis, epistaxis, and widespread abnormal lungs sounds were characteristic features of the disease. There are accompanying nonspecific signs of inappetence, ruminal stasis, and scant feces.

About one-third of affected cattle become progressively worse over a period of 2 to 18 days with moderate to severe dyspnea, and they die of acute or chronic anemia or are euthanized on humane grounds. Almost half of the cases die suddenly as a result of voluminous intrabronchial hemorrhage. It is probably the only common cause in cattle of acute hemorrhage from the respiratory tract that causes the animal to literally drop dead. The remainder have a brief, acute illness of about 24 hours.

Some evidence of hepatic involvement is often present, including enlargement of the liver, ascites, and melena. Chronic cor pulmonale develops in some with attendant signs of congestive heart failure.

**Radiography** of the thorax of some affected animals has found an increase in lung density and markings. These are irregular, focal or diffuse, and nonspecific. More distinct opacities are present in some and are referable to embolic infarcts and larger pulmonary hemorrhages. Radiographic abnormalities in the lungs are detected in approximately one-third of cows with caudal vena cava thrombosis. **Ultrasonography** can be a useful diagnostic aid in detecting changes in the caudal vena cava. The caudal vena cava in affected cows is round to oval rather than the triangular shape in normal cattle, and the hepatic, splenic, and portal veins can be dilated.<sup>3</sup> The presence of thrombi in the caudal vena cava can be detected (Fig. 12-13).<sup>4</sup>

There is typically anemia and leukocytosis. Neutrophilia with a regenerative left shift and hypergammaglobulinemia as a result of chronic infection are common. Serum gamma-glutamyl transpeptidase activity is high in about one-third of cases.<sup>3</sup>

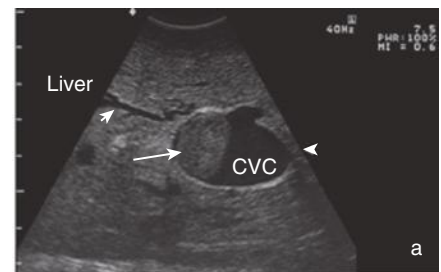

**Fig. 12-13** Ultrasonogram of intrahepatic vena cava of an adult cow demonstrating presence of a thrombus (white arrow) and dilated intrahepatic vessels (white arrowhead). (Reproduced with permission.<sup>4</sup>)



**Fig. 12-14** Cow with cranial vena cava thrombosis causing jugular vein distension and edema of the brisket. (Courtesy of Dr. Christian Gerspach, Vetsuisse Faculty University of Zurich).

The **necropsy findings** include a large, pale thrombus in the posterior vena cava between the liver and the right atrium. Occlusion of the posterior vena cava results in hepatomegaly and ascites. Hepatic abscesses of varying size and number are common and often near the wall of the thrombosed posterior vena cava. Pulmonary thromboembolism with multiple pulmonary abscesses, suppurative pneumonia, and erosion of pulmonary arterial walls with intrapulmonary hemorrhage are also common. The lungs reveal emphysema, edema, and hemorrhage. A variety of bacteria, including streptococci, *E. coli*, staphylococci, and *F. necrophorum*, are found in the abscesses in the liver.

Animals that die suddenly are found lying in a pool of blood, and necropsy reveals large quantities of clotted blood in the bronchi and trachea.<sup>3</sup>

The disease must be differentiated from verminous pneumonia, chronic aspiration pneumonia, pulmonary endarteritis as a result of endocarditis, and chronic atypical interstitial pneumonia. There is no treatment that is likely to have any effect on the disease, and the principal task is to recognize the disease early and slaughter the animal for salvage if possible.

#### REFERENCES

1. Simpson KM, et al. *Can Vet J.* 2012;53:182.
2. Schoster A, et al. *Can Vet J.* 2010;51:891.
3. Braun U. *Vet J.* 2008;175:118.
4. Sigrist I, et al. *J Vet Int Med.* 2008;22:684.

### CRANIAL VENA CAVAL THROMBOSIS

Thrombosis of the cranial vena cava occurs in cows. Cases in young animals are also

recorded, and it is suggested that they arise from navel infection. The disease has occurred with reticuloperitonitis in cattle.<sup>1</sup> Clinical signs include cough, tachypnea, muffled heart sounds, exercise intolerance, and excessive pleural fluid. As in caudal vena caval thrombosis, a number of pulmonary abscesses or bronchopneumonia can develop. Pulmonary hypertension is not a feature as it is in the caudal lesion. However, increased jugular vein pressure, dilatation of the jugular vein, and local (brisket) edema can occur (Fig. 12-14). Ultrasound examination can reveal thrombosis of the cranial vena cava extending into the right atrium.

#### REFERENCE

1. Gerspach C, et al. *Can Vet J.* 2011;52:1228.

### ACUTE UNDIFFERENTIATED BOVINE RESPIRATORY DISEASE

#### DEFINITION OF THE PROBLEM

A major problem that large-animal clinicians commonly encounter is a group of cattle that are affected with an acute respiratory disease of uncertain diagnosis.

Acute undifferentiated bovine respiratory disease (BRD) is characterized clinically by dyspnea, coughing, nasal discharge, varying degrees of depression, anorexia, pyrexia ranging from 40 to 41°C (104-105.8°F), evidence of pneumonia on auscultation of the lungs, and a variable response to treatment. Some unexpected deaths may have occurred as the initial indication of the problem. Although in most cases pneumonia is the obvious cause of the disease, determining the etiology is the major diagnostic problem. If lesions typical of any of the common diseases of the respiratory tract of cattle can be

recognized clinically, like those of infectious bovine rhinotracheitis (IBR), then on a clinical basis a specific diagnosis can be made. The affected group may be unweaned dairy heifers, weaned beef calves, or yearlings that have recently arrived in a feedlot; cattle that have been in the feedlot for varying periods of time; young growing cattle on summer pasture; mature cows that have recently been placed on a lush pasture; yearling or mature lactating dairy cattle; or a group of veal calves. The morbidity rate can range from 10% to 50% depending on the age of animals affected, the immune status of the animals, the nature of the stressors involved, and the nature of the disease.

Respiratory disease is the most common illness among cattle in feedlots, affecting on average over 16% of cattle placed.<sup>1</sup> In general, bovine respiratory disease accounts for 65% to 79% of the morbidity and 44% to 72% of mortality in feedlot cattle. Despite of intensive research in the field the incidence of respiratory disease in cattle during the first year of life could not be controlled. The proportion of mortality of weaned dairy heifers attributable to respiratory disease increased from 34.8% of all deaths in 1991 to 46.5% in 2007.<sup>2</sup>

The economic impact of respiratory disease on the U.S. beef industry is estimated to exceed \$4 billion annually, including treatment cost, disease prevention, and production loss such as decreased growth performance.<sup>3</sup> Cattle with detectable lung lesions at slaughter on average had a reduced daily weight gain of 0.08 kg/d compared with cattle without lung lesions. Protracted effects of respiratory disease in dairy calves on milk production and fertility in later life are more difficult to estimate, but repeated incidences of respiratory disease in a dairy heifer were found to almost double the risk for not completing the first lactation.<sup>4</sup>

The primary goal of the clinician must be to make the most accurate clinical diagnosis as rapidly as possible, based on the clinical and epidemiologic findings that are identifiable on the farm, preferably when examining the animals on the first visit. Giving a prognosis and the formulation of rational and economic treatment that will minimize morbidity and mortality are the next goals. In any group situation, mass medication of each in-contact animal is a major consideration that will increase costs and must be balanced against the economic losses that might occur if all animals are not treated metaphylactically. The clinical management of the outbreak, which includes treatment of the obvious cases and the prevention of new cases if possible, is dependent in part on the diagnosis. However, differentiation between the diseases based on clinical findings can be unreliable, and it is usually necessary to begin antimicrobial therapy that will be effective against the bacterial pathogens most likely to be present. Even after intensive clinical and



laboratory investigation, the specific etiology will often not be determined, and the clinician is left with a diagnosis of **acute undifferentiated respiratory disease of cattle** or **bovine respiratory disease (BRD)**.

The salient clinical and epidemiologic findings of the diseases included in the complex of BRD are summarized in [Table 12-7](#). The common diseases of the respiratory tract of cattle can be broadly divided

into those affecting the lower respiratory tract and those affecting the upper respiratory tract. Diseases of the lungs associated with either viruses or bacteria alone or in combination are difficult to distinguish from each other on the basis of clinical findings alone. The presence of toxemia, which causes depression and anorexia in bacterial pneumonias, is a useful guide in categorizing the common diseases when making a differential

diagnosis list. Cattle affected with uncomplicated viral diseases of the respiratory tract may show a high fever but are usually not depressed and anorexic because bacterial toxemia is absent.

### ETIOLOGY

The major etiologic agents that cause or may be associated with acute UBRD include the following:

**Table 12-7** Differential diagnosis of bovine respiratory disease

Disease	Epidemiology	Clinical and laboratory findings	Response to treatment
Pneumonic pasteurellosis (shipping fever)	Common disease in North America. Young cattle recently stressed by weaning or transportation, mixing from many different sources, many animals affected, some found dead, common in feedlots. Epidemics occur 7–10 days after arrival in the lot, but cattle may be sick on arrival or within a few days after arrival.	Acute toxemic bronchopneumonia, moderate dyspnea, fever, increased breath sounds over ventral aspects of lungs, moist crackles, cough, pleuritis.	Good response to treatment in early stages. Failure to respond as a result of advanced lesions, pleuritis, abscesses, inadequate dosage, and incorrect diagnosis.
Pneumonic pasteurellosis (enzootic calf pneumonia)	Common disease in unweaned, housed dairy calves, occasionally in pastured beef calves 2 and 6 months of age.	Acute, subacute, and chronic pneumonia, moderate fever, loud breath sounds ventrally, crackles and wheezes.	Respond favorably to treatment for uncomplicated secondary bacterial bronchopneumonia.
Viral interstitial pneumonia (parinfluenza-3 virus [PI-3V], bovine respiratory syncytial virus [BRSV])	Yearling and adult cattle indoors or outdoors, young cows in closed dairy herd, may occur following addition to herd, high morbidity, low mortality.	Sudden onset of acute pneumonia, moderate dyspnea and toxemia, loud breath sounds and wheezes attributable to bronchiolitis, no moist crackles unless secondary pneumonia. Leukopenia and lymphopenia.	Gradual recovery occurs in 3-5 days. Treat secondary complication with antimicrobials.
Bovine respiratory syncytial virus infection	Young cattle 6–8 months of age, adult dairy cattle, herd outbreaks are characteristic; case-fatality rate varies from 1%–30%. Maternal antibody in calves is not protective.	Inappetence, fever, coughing, dyspnea, and abnormal lung sounds suggestive of interstitial pneumonia. Death common in those with severe respiratory distress. Fourfold or greater seroconversion to BRSV. Immunofluorescence of nasopharyngeal smears and virus isolation. Acute bronchiolitis and alveolitis.	Treat secondary complications with antimicrobials for 3-5 days.
<i>Histophilus somni</i> (formerly <i>Haemophilus somnus</i> ) pneumonia, pleuritis, and myocardial abscesses	Common in feedlot calves, 6-8 months of age; mean fatal disease onset for pneumonia is 12 days after animal in the lot, and day 22 for myocarditis and pleuritis.	Toxemic suppurative pleuropneumonia, dyspnea, mouth breathing. Persistent fever for several days. Concurrent myocarditis may cause sudden death.	Inadequate response to treatment.
Infectious bovine rhinotracheitis	Common disease. All age groups but mostly young feedlot cattle, outbreaks common, occurrence unpredictable. Most common in unvaccinated herds.	Acute rhinotracheitis with discrete nasal lesions, inspiratory dyspnea, explosive loud coughing, ocular and nasal discharge, high fever for 3–5 days; 1% die of secondary bacterial pneumonia. Virus isolation from nasal swabs. Acute and convalescent serology.	Gradual recovery occurs in 3-5 days in spite of treatment. Treat secondary pneumonia.
<i>Mycoplasma bovis</i> pneumonia	Feedlot cattle with history of respiratory disease. Dairy calves with enzootic pneumonia. Mastitis in lactating dairy cows.	Acute to chronic bronchopneumonia, anorexia, fever, polyarthritis, otitis. Exudative bronchopneumonia, extensive foci of coagulative necrosis. Nasal swabs, transtracheal wash joint fluid, lung tissue, serology (consider presence of maternal antibodies in young calves).	No response to antibiotic therapy.
Atypical interstitial pneumonia (acute pulmonary emphysema and edema, fog fever)	Occurs 4–10 days after adult cattle turned into lush autumn pasture. Outbreaks usual, sudden onset, high case fatality. Incidental occurrence in feedlot cattle toward the end of the finishing period.	Sudden and rapid death, severe loud dyspnea with grunting expiration, loud breath sounds over ventral aspects, crackles, subcutaneous emphysema, severe cases die, laboratory data not helpful, confirm at necropsy.	Most severe cases die; moderate to mild cases recover; treatment difficult to evaluate. Pasture form can be prevented with monensin in the feed for a few days before and after change of pasture.

Table 12-7 Differential diagnosis of bovine respiratory disease—cont'd

Disease	Epidemiology	Clinical and laboratory findings	Response to treatment
Extrinsic allergic alveolitis (bovine farmer's lung)	Not common. Mature cattle housed during winter months and exposed to moldy or dusty feeds. Several animals over period of time.	Chronic coughing, dyspnea, weight loss, reduced milk yield, loud breath sounds, crackles, dull but not toxemic, abnormal nasal discharge.	No response to treatment.
Chronic interstitial pneumonia (diffuse fibrosing alveolitis)	Single animals only. May be chronic form of epidemic acute interstitial pneumonia.	Chronic onset of coughing, dyspnea, weight loss, reduced milk yield, decreased breath sounds, no toxemia, cor pulmonale.	No response to treatment.
Verminous pneumonia ( <i>Dictyocaulus viviparus</i> )	All ages susceptible, usually young cattle 6–12 months on pasture, wet warm seasons, outbreaks common, enzootic area.	Moderate to severe dyspnea, coughing, fever, loud breath sounds, crackles over <b>dorsal half of lung</b> , eosinophilia may occur, larvae in feces 3 weeks after infection.	No response to antimicrobials. Responds to anthelmintics.
<i>Ascaris suis</i> pneumonia	Not common. All ages. On pasture previously occupied by pigs.	Sudden onset, severe dyspnea, rapid deaths, loud breath sounds, crackles over entire lung. Will recover gradually if not too severe.	No specific treatment response.
Allergic rhinitis (summer sniffles)	Mostly late summer, autumn when pasture in flower. Sporadic cases. Mostly Channel Island breeds. Cows may have disease each year.	Sudden onset, dyspnea, inspiratory wheezing, mucopurulent then caseous yellow to orange nasal discharge. Sneeze, rub muzzle in bushes, twigs up nose, bleed.	Into housing, antihistamines, excellent response if early. In cases of long duration, wheezing persists until nasal mucosa sloughs.
Pulmonary abscess	Single animal. History of pneumonia with no response to treatment. Occasionally, several cases in feedlot.	Chronic coughing with epistaxis and hemoptysis, chronic toxemia, mild fever, crackles and wheezes distributed randomly. Neutrophilia.	None.
Calf diphtheria	Young calves, dirty conditions. or on rough dry pasture. Usually only few affected.	Acute toxemia, fever, inspiratory stridor and stertor, necrotic lesions visible in larynx and oral cavity.	Responds to antimicrobials and topical treatment.
Embolic pneumonia attributable to ruptured vena caval abscess	1–8 years of age. History of respiratory disease with hemoptysis and epistaxis and poor response to treatment.	Dullness, polypnea, hyperpnea, thoracic pain, frequent coughing with hemoptysis, epistaxis, temperature variable, anemia. Common, widespread foci of crackles and wheezes with increased breath sounds. May die rapidly from massive hemorrhage. Hepatomegaly and congestive heart failure. Neutrophilia and hypergammaglobulinemia.	No response to treatment. Slaughter for salvage.
Aspiration pneumonia	History is important. Following faulty drenching techniques or regurgitation and aspiration in weak cows (i.e., milk fever).	Acute bronchopneumonia with toxemia 24–48 hours following aspiration. Loud breath sounds ventral half, moist crackles. Marked leukopenia and neutropenia.	May respond to treatment if treated early.
Dusty feed rhinotracheitis	Few days following introduction of finely chopped dry feed. Feed contains high concentrations of "fines,"	Outbreak of coughing, rhinitis with copious serous nasal discharge, conjunctivitis, and ocular discharge. Bright and alert.	Recover in few days following removal of dusty feed.
Enzootic nasal granuloma	In enzootic area up to 30% morbidity in a herd, up to 75% of herd. Coastal regions, autumn is worst, Channel Island breeds most affected. Loss is a result of continuous loss of production. A chronic debilitating disease. All ages, mostly adults.	May be acute "summer sniffles" early. Then chronic dyspnea with stertor, eat indifferently, lose condition, have to be culled. Chronic nasal discharge. Smear nodules on nasal cavity mucosa palpable through nostril,	None.
Contagious bovine pleuropneumonia	Outbreak in susceptible cattle—morbidity up to 100%, mortality up to 50% if cattle stressed, traveling. Aerogenous spread, no mediate contagion. Outbreaks as a result of introduction of cattle often inapparent "carriers" that are detectable by CF test. Incubation period 3–6 weeks.	Acute fibrinous pneumonia, and pleurisy. Dyspnea, fever 40.5°C (104.5°F), deep cough or shallow and, fast, elbows out, grunting respiration. Pain on chest percussion. Pleuritic friction rub early; moist crackles. Course 3 days to 3 weeks,	Not to be treated. Eradication is urgent. Is treated in enzootic areas where eradication is not attempted.

### Viruses

- Bovine herpesvirus-1 (BHV-1) causing infectious bovine rhinotracheitis (IBR)
- Bovine respiratory syncytial virus (BRSV)
- Parainfluenza-3 virus (PI-3V)
- Bovine virus diarrhea virus (BVDV)
- Bovine coronavirus (BoCV)
- Bovine adenovirus (BAV)

### Bacteria

- *Mannheimia haemolytica*
- *Pasteurella multocida*
- *Histophilus somni* (formerly *Haemophilus somnus*)

### Mycoplasma spp.

- *Mycoplasma bovis*
- *Mycoplasma mycoides* causing contagious bovine pleuropneumonia (CBPP)
- *Mycoplasma bovirhinis*
- *Mycoplasma dispers*
- *Ureaplasma diversum*

### Uncertain or unknown etiology

- Atypical interstitial pneumonia

### Verminous

- *Dictyocaulus viviparus*

## Role of Etiologic Agents

The role of the etiologic agents in the cause of BRD is controversial and often uncertain because the major pathogens are ubiquitous in clinically normal animals. The disease is considered to be the result of the effects of stressors causing immunosuppression, which allow colonization of the respiratory tract by opportunistic pathogens. The spectrum of the immune status of the animals is also a major factor. Animals vaccinated well before natural infection may be resistant to clinical disease caused by specific pathogens. Animals that underwent natural infection and developed adequate humoral or cell-mediated immunity may also be immune to clinical disease.

Clearly the **viral–bacterial synergism** is a major factor in the pathophysiology of the BRD complex. It is well recognized that the effect of a virus that usually is nonfatal combined with various bacteria commonly resident in the upper respiratory tract of healthy individuals can cause fatal bacterial pneumonia. Numerous experimental models of synergism between virus and bacteria have been studied. In cattle, the viruses having received the most attention in this context are PI-3 and BHV-1, which in combination with bacteria such as *M. haemolytica* or *P. multocida* can cause clinical disease considerably more severe than experimental infection caused by either viral or bacterial infection alone. Many mechanisms have been suggested behind this viral–bacterial synergism, including impaired neutrophil function or recruitment following initial viral infection, decreased macrophage

activity, or altered number and responsiveness of lymphocytes. Most likely several mechanisms are involved in the virus induced suppression of pulmonary antibacterial defense.

Many epidemiologic studies of bovine respiratory disease have attempted to correlate the level of serum antibodies in feedlot calves on arrival at the feedlot and over the first 30 to 50 days of the feeding period with morbidity and mortality as a result of respiratory disease. A low level of antibody to a specific pathogen on arrival followed by significant seroconversion in animals that develop BRD in the first few weeks of the feeding period suggest that the pathogen was an important etiologic factor. Conversely, those animals with a high level of antibody on arrival that do not develop BRD are considered immune. However, some animals with low levels of antibody may remain normal and seroconvert during the early part of the feeding period.

Feedlot cattle commonly seroconvert to the BHV-1, PI-3V, BVDV, and BRSV, and possibly also to *Mycoplasma bovis* and other *Mycoplasma* spp., within the first month after arrival. Seroconversion to these pathogens occurs both in animals that develop respiratory disease and those that remain normal within the same group, but the relative importance of each agent and their causative nature is controversial. Seroconversion to *M. haemolytica* leukotoxin, BRSV, and BVDV were predictive of approximately 70% of all respiratory disease cases in Ontario feedlots. Calves arriving with high serum antibody levels to *Histophilus somni* had less bovine respiratory disease than calves with lower levels.

Many respiratory pathogens that can cause disease are present in diseased and clinically normal individuals alike during outbreaks of BRD. It has been suggested that UBRD in weaned beef calves is not a highly contagious disease and that although respiratory pathogens may be important etiologic factors, the presence of other contributing factors is as important for the development of clinical disease. Stress resulting from weaning, transportation, processing, crowding, or harsh weather is considered to be an important contributor to outbreaks of BRD. Studies exploring the effect of stress resulting from weaning and maternal separation showed that the viral–bacterial synergism was altered when weaning occurred at the time of a primary viral infection with BHV-1 followed by a secondary bacterial infection with *M. haemolytica* resulting in significantly increased mortality rates.<sup>5</sup> Similarly calves weaned immediately before transport to a feedlot developed significantly more UBRD compared with calves adapted to weaning for 45 days.<sup>6</sup> This suggests that identifying and avoiding environmental and management risk factors are crucial to control BRD outbreaks.

The relationships between bacterial and viral antibody titers and undifferentiated fever and mortality in recently weaned beef calves in western Canada were examined. Feedlot calves are commonly exposed to *M. haemolytica*, *H. somni*, BHV-1, BVDV, and *M. bovis* in the early feeding period. Seroconversion to *M. haemolytica* leukotoxin was associated with a decreased risk of undifferentiated fever. Higher arrival BVDV antibody titer was associated with a decreased risk of undifferentiated fever. Higher arrival *H. somni* antibody titer and increases in *H. somni* antibody titer after arrival were both associated with a decreased risk of undifferentiated fever. The odds of overall mortality (OR 5.09) and histophilosis mortality (OR 11.31) in clinical cases were higher than in the controls. In summary, protective immunity to *M. haemolytica* leukotoxin *H. somni*, BHV-1, BVDV, and *Mycoplasma* spp. may be necessary to reduce the occurrence of undifferentiated fever.

Chronic, antibiotic-resistant pneumonia, sometimes with polyarthritis, occurs in feedlot cattle. *M. bovis*, BVDV, and *H. somni* are commonly found in the tissues at necropsy. This coinfection suggests the possibility of synergism between the BVDV and *M. bovis* in the pneumonia with the arthritis syndrome.

BVDV has been identified as a contributor to respiratory disease in feedlot calves. On arrival in feedlots, 39% of animals were seropositive for BVDV, and those animals treated for UBRD had larger titer increases to the virus than nontreated animals. BVDV-1b strains have been associated with acute pneumonia in commingled calves that were not vaccinated with BVDV vaccines, and in which *M. haemolytica* and *P. multocida* were also present in the pneumonic lesions. Experimental infection of seronegative and immunocompetent calves with BVDV type resulted in primary respiratory disease.

Bovine coronavirus (BoCV) has been implicated as a cause of UBRD based largely on the isolation of the virus from the nasal cavities of cattle with respiratory disease. However, based on seroepidemiology of BoCV titers in feedlot cattle, although higher antibody titers to the virus were associated with a decreased subsequent risk of treatment for UBRD, there was no association between evidence of recent infection (titer increase) and the occurrence of UBRD. Other studies have shown that BoCV infections are not associated with an increased risk of treatment for UBRD. BoCV is widespread in the cattle and can be found in the feces and nasal swabs of recently arrived feedlot cattle and calves with and without clinical signs of BRD. Exposure to BoCV before arrival in the feedlot is common, with 90% of animals being seropositive on arrival. BoCV can be isolated from feedlot cattle in many different locations and most cattle seroconvert to the virus during the first 28



days after arrival in the feedlot. Cattle shedding the virus from the nasal cavity and developing an antibody response to the virus were 1.6 times more likely to require treatment for respiratory disease than cattle that did not shed the virus or develop an immune response. Cattle that shed the virus from the nasal cavity were 2.2 times more likely to have pulmonary lesions at slaughter than cattle that did not shed the virus. In natural outbreaks of shipping fever, more than 80% of affected cattle shed BoCV at the beginning of the epidemic when the *M. haemolytica* infection rate was low.

The role of BoCV in epidemics of shipping fever pneumonia in cattle was examined by the collection of nasal swabs and serum samples before the onset of the epidemic, during the course of the illness, and after death when necropsies were done and samples of lung tissues were examined. Respiratory BoCV was isolated from the nasal secretions before and after transport, from lung tissues of those cattle that died early in the epidemic but not later. *Pasteurella* spp. were isolated from all cattle that had severe pneumonia. All cattle were immunologically naive to both infectious agents at the onset of the epidemic, but those that died after day 7 had rising antibody titers to BoCV and *M. haemolytica*. In contrast, the 18 clinically normal and BoCV-negative cattle had high antibody titers to BoCV from the beginning, and their antibody responses to *M. haemolytica* were delayed.

## CLINICAL CASE DEFINITION AND EPIDEMIOLOGY

### Clinical Case Definition

The most important part of the clinical and epidemiologic examination is to determine the case definition, which includes the following questions.

#### What Is the Clinical Disease That Is Present in the Affected Animals?

- Which body system is affected and where in that body system is the lesion?
- Do the animals have pneumonia, rhinitis, laryngitis, tracheitis, bronchitis or combinations of these abnormalities?

The clinician should attempt to make a clinical diagnosis by closely examining several typically affected animals and determine whether the lesions are in the lower or upper respiratory tract. The presence of toxemia, depression, fever, anorexia, and agalactia in lactating dairy cattle indicates a primary or secondary bacterial infection. The presence of loud breath sounds (consolidation) and abnormal lung sounds (crackles and wheezes) indicates the presence of pneumonia. Diseases of the upper respiratory tract are characterized by inspiratory dyspnea, stridor, loud coughing, sneezing, wheezing, and lesions of the nasal mucosa.

#### Which Animals Are Affected?

Determining which animals are affected includes age of animals affected, a single animal or group of animals, and vaccination history. Recently arrived feedlot cattle mixed from many different origins are susceptible to fibrinous pneumonia associated with *M. haemolytica*.

#### Where Are the Affected Animals?

Are the infected animals in the feedlot, on pasture, or housed in a barn? If in a barn, with what quality of ventilation?

#### When Were the Animals Affected?

- How soon after arrival in the feedlot did the animals become affected?
- What stressors may have recently preceded the outbreak?
- What risk factors could have predisposed to this outbreak?
- Have the animals been recently shipped and mixed with animals from another source?

Consideration of the clinical and epidemiologic findings can then be correlated, and hypotheses formulated and tested to determine **why** the disease occurred.

### Occurrence

Bovine respiratory disease occurs under many different situations, including all age groups, feedlot animals kept outdoors, housed dairy calves, nursing and recently weaned beef calves, dairy and beef cattle heifers, and adult lactating dairy cows. Epidemics of acute respiratory disease have been described in dairy calves from birth to 6 months of age. Outbreaks of BRSV can occur in dairy cattle heifers and adult dairy cattle.

Pneumonic pasteurellosis is most common in recently arrived feedlot calves (shipping fever) and unweaned dairy calves (enzootic calf pneumonia). In calves 3 to 5 weeks after arrival in the feedlot, *H. somni* pleuropneumonia may be more likely. Atypical interstitial pneumonia (pasture-induced) is the most likely diagnosis when confronted with an outbreak of acute respiratory disease in mature cattle that have been moved from a summer pasture to a lush autumn pasture within the last 4 to 10 days.

### Risk Factors

The risk factors that have been identified in outbreaks of respiratory disease in feedlot cattle include the purchase of cattle from many different sources. An epidemiologic study of fatal fibrinous pneumonia in auction-market-derived feedlot calves in western Canada revealed that peak mortality occurred approximately 16 days after arrival at the feedlot. The risk of fatal fibrinous pneumonia was consistently greater for calves entering the feedlot in November, shortly after the auction sales had peaked,

when the feedlot was reaching capacity. Increased mixing at the auction markets was associated with increased fatal disease risk. The distance calves were transported by truck was not associated with fatal disease risk. When the incidence of fatal fibrinous pneumonia was high, the disease clustered within truckloads or pens. Risk factors positively associated with disease clustering included increased mixing of calves from different farms, month of purchase, number of calves passing through the auction markets, and weather conditions at arrival.

Transportation of feedlot calves increases serum concentration of oxidative stress biomarkers, which are related to episodes of bovine respiratory disease. Transportation stress significantly decreases serum total antioxidant capacity and increases malondialdehyde concentrations in steer calves. It is proposed that stressors such as marketing through an auction barn and transportation precipitate oxidative stress, which reduces the antioxidant defense capacity and increases total body lipid peroxidation, resulting in increased susceptibility to BRD. These biomarkers may be useful to measure the oxidative stress of transported cattle. There is some experimental evidence that acidogenic diets and ketoacidosis may affect lymphocyte function, which may affect vaccine efficacy.

The literature on how the adequacy of diets of recently arrived feedlot cattle may affect their health and immunity has been reviewed.<sup>7</sup> Diets for newly arrived stressed beef cattle must be formulated to compensate for decreased feed intake and known nutrient deficiencies.<sup>8</sup>

The literature on the risk factors for bovine respiratory disease in dairy heifers and the effect of the disease on productivity has been reviewed with relevance to commercial dairy farming in the Netherlands. Bovine respiratory disease in dairy heifers increases the risk of mortality directly after the disease episode by up to 6 times, reduces growth during the first 6 months of life by up to 10 kg, and increases the likelihood of dystocia after first calving. Both herd size and other diseases in dairy heifers are clearly associated with the risk of bovine respiratory disease. Season and colostrum feeding are important. The most important risk factors for mild and severe pneumonia in dairy calves aged birth to 3 months were inadequate air circulation and the purchase of cattle.

## DIAGNOSIS AND DIFFERENTIAL DIAGNOSIS

### Individual Animal Diagnosis

Although the clinical diagnosis of BRD can readily be made even by cursory examination in severe or advanced cases, the challenge is to identify newly affected animals in early stages of the disease, which is a critical factor for treatment efficacy. In general,

medical treatment is more effective the earlier in the process it can be initiated, and delaying treatment is considered a major factor contributing to treatment failures. A Bayesian estimation of the performance of using clinical observation for diagnosis of BRD yielded an estimated sensitivity and specificity of 0.62 and 0.63 respectively, suggesting that up to 38% of truly diseased animals may go undiagnosed and conversely that up to 37% of animals diagnosed and subsequently treated for BRD are unaffected by respiratory disease.<sup>9</sup> Another study reported that 68% of feedlot cattle with lung lesions at slaughter were never treated for bovine respiratory disease, further suggesting that current methods of diagnosing bovine respiratory disease based on visual appraisal by feedlot pen riders may not always effectively identify sick animals. The limitations of identifying clinically affected animals that need therapy was a major factor in the development of metaphylactic use of antimicrobials.

The subjective clinical findings of distant examination that have been used by animal attendants in commercial feedlots to identify sick animals that need to be closely examined include:

- *Degree of ruminal fill* (1, normal; 2, slightly gaunt; 3, moderately gaunt; 4, excessively gaunt)
- *Attitude* (1, normal; 2, slight lethargy; 3, severe lethargy; 4, nonambulatory)
- *Ocular discharge* (1, none; 2, slight; 3, moderate; 4, abundant)
- *Nasal discharge* (1, none; 2, slight; 3, moderate; 4, abundant)
- *The sounds heard on auscultation of the lungs at three sites along a line extending from the cranioventral to caudodorsal lung fields* (1, normal; 2, slightly harsh; 3, moderately harsh; 4, severely harsh)

Frequently the rectal temperature of animals that appear dull is measured; if temperature is found to be above a predetermined level, they are considered to have BRD if no other clinical findings are detectable that are referable to other organ systems. In most cases, the thorax of these animals is not auscultated for evidence of pneumonia. Although a fever when combined with other clinical signs is a valuable parameter in the process of making a diagnosis, fever of undetermined origin can as well be unassociated with respiratory disease and does not imperatively require treatment. In a feedlot pen of 112 recently arrived bull calves that were fitted with reticuloruminal temperature-sensing boluses, a total of 449 fever episodes were recorded in 110 animals during the first 40 days after arrival. Of these fever episodes, 74% were not associated with any visually apparent clinical signs or respiratory disease, and 75% lasted for less than 48 hours. A negative effect on average daily weight gain

of feverish animals with or without clinical signs was recorded with prolonged episodes of fever, with an approximate decrease of 33 g/day for each day of fever.<sup>10</sup>

Because of the difficulty in identifying cattle with early stage respiratory disease in large feedlots, several advanced monitoring techniques have been developed and studied for their suitability to help making a rapid and accurate diagnosis in the field situation. The feeding and watering behavior of healthy and sick animals in a commercial feedlot has been examined using radiofrequency technology to record individual animal behaviors. Eating and drinking behaviors are associated with clinical signs of bovine respiratory disease, but there is no obvious predictive association between signs of bovine respiratory disease in recently arrived weaned beef calves and eating and drinking behavior. Calves that were sick had greater frequency and duration of drinking 4 to 5 days after arrival than calves that were not sick. Sick calves had significantly lower frequency and duration of eating and drinking 11 to 27 days after arrival but had greater frequency of eating 28 to 57 days after arrival than calves that were not sick. Calves at slaughter that had a higher percentage of lung tissue with lesions had lower frequency and duration of eating 11 to 27 days after arrival but had greater frequency and duration of eating 28 to 57 days after arrival. Experimentally, the electronic acquisition of feeding behavior data for feedlot cattle, when analyzed using cumulative sums (CUSUM) procedures, offers the potential for predicting morbidity before conventional visual methods of appraisal. The feeding behavior during the first 30 days when cattle are in a receiving pen may be used to detect animal morbidity approximately 4 days earlier than conventional methods typically employed in commercial feedlots. Overall accuracy, positive predictive value and sensitivity of the CUSUM prediction method were 87%, 91%, and 90%, respectively.

Infrared thermography used to monitor infrared heat loss in calves has been studied as a tool for early detection of animals with BRD, with promising results.<sup>11</sup> Measuring heat loss each time calves accessed waterers allowed to combine thermography data and watering frequency, a procedure that was deemed more sensitive, specific, and cost effective than conventional approaches to monitor animals at risk of BRD.<sup>11</sup>

Temperature-sensing reticuloruminal boluses have been used to monitor calves at risk of developing BRD. This technology allows remote and continuous recording of the reticular temperature of animals fitted with a temperature-sensing bolus and permits the identification of animals with prolonged fever episodes not associated with apparent clinical signs and thereby potentially improves the sensitivity of the detection of animals with BRD in a field setting.<sup>10</sup>

Prolonged fever episodes are certainly not always attributable to respiratory disease, but even when not associated with clinical signs, prolonged fever was found to negatively affect average daily weight gain.<sup>10</sup>

### Herd-Level Diagnosis

The clinician is limited in most situations to correlating clinical, epidemiologic, and necropsy findings in making a diagnosis. Diagnostic laboratories may not be readily available, and their resources for microbiological and serologic investigations may be much less than is needed for an accurate determination of causes. In case a diagnostic laboratory is not within reach, on-site post-mortem examination of fresh carcasses of untreated animals deceased or euthanized in the early stage of the disease can provide valuable information and diagnostic material for further analysis. Coordinating the necropsy with a pathologist who may attend and guide the procedure via teleconference or assess gross findings on digital material and suggest collection of specific specimens is advisable.

A systematic method of data collection from the customized records of large feedlots has been developed and validated for use in the National Animal Health Monitoring System. The current collection of data from large feedlots provides an acceptable level of sensitivity and specificity for the program, but it is important that the veterinarian makes regular clinical observations to validate the data.

The course of the disease, especially when animals have been treated, alters the gross and microscopic appearance of tissues and the microbiological (bacteriologic, virologic) and serologic findings so that the animal's status is impossible to determine.

## CLINICAL PATHOLOGY

### Antemortem Diagnostic Procedures

A number of diagnostic procedures are available that vary in their practicality, their suitability to detect specific pathogens, the rapidity with which test results are available, their economy, the level of stress for the patient, the quality of the material obtained, and the interpretability of the results.

### Nasal/Nasopharyngeal Swabs

Nasal and nasopharyngeal swabs are frequently used for antemortem sample collection under field conditions because this procedure is technically less demanding and less invasive than a transtracheal wash or bronchoalveolar lavage. Certainly for upper respiratory tract viral infection such as BHV-1 this method has its merits. In contrast, the significance of bacterial isolates or negative test results must be interpreted cautiously.<sup>12</sup> Isolates of *M. haemolytica* from nasopharyngeal swabs were found to be highly representative for the isolates present in lung tissue in clinically affected animals.<sup>13</sup>

However, because most bacterial pathogens of the lower respiratory tract such as *M. haemolytica* can be part of the normal upper respiratory flora, isolation of one or several of these agents from a nasopharyngeal swab does not necessarily indicate that it is the cause of disease.<sup>14</sup> Although isolation of *M. bovis* from a nasal swab confirms the presence of this pathogen in the herd, the association of the presence of *M. bovis* in the upper respiratory tract with clinical disease or its presence in the lower respiratory tract reported in the literature is more variable. Some authors reported that *M. bovis* is commonly found in the upper respiratory tract in healthy calves; however, this is not confirmed by others.<sup>44-45</sup> On the other hand, cultures from nasopharyngeal swabs were found to yield a positive result in only 33% of animals infected with *M. bovis*.<sup>13</sup>

To collect a nasopharyngeal swab sample, a long, sterile culture swab guarded by an external sheath must be inserted through the nasal cavity of the properly restrained calf. The tip of the swab should be approximately at the height of the medial canthus of the eye before the tip of the swab is extruded beyond the sheath and firmly rotated against the mucosa. The tip of the swab must then be retracted into the sheath before removing the whole swab. Swabs may be submitted for bacterial/mycoplasma culture or virus isolation. Depending on the diagnostic objective, two or three swabs placed into specific transport medium for the analysis requested may be required.<sup>13</sup>

#### Transtracheal Wash/ Bronchoalveolar Lavage

Transtracheal wash (TTW) and bronchoalveolar lavage (BAL) are antemortem sample collection techniques yielding material suitable for a broader spectrum of diagnostic procedures. Besides of bacterial or fungal cultures, isolation/identification of virus or parasites samples can also be used for cytology.<sup>12</sup> These procedures are technically more demanding and more invasive than swab collection. They require proper restraint, local anesthesia, and aseptic technique. The TTW is performed in the previously clipped and aseptically prepared middle trachea region. A 10-gauge 2-inch needle is advanced through a previously placed stab incision through the anesthetized skin between two cartilage rings into trachea. Sterile polypropylene tubing is then inserted through the needle and advanced to the level approximately 10 cm beyond the thoracic inlet. Twenty to thirty mL of warm sterile saline or lactated Ringer's solution are then infused and rapidly aspirated back. This procedure typically yields between 5 and 10 mL of fluid that can either be submitted in the sealed syringe or transferred into a sterile tube.<sup>15</sup> Transtracheal wash samples can also be collected by endoscopy using the biopsy port.

To perform a BAL, commercially available kits are available that consist of a long tube with an inflatable cuff at the tip. The tube is passed intranasally into the trachea and further into the lungs, where it is lodged into a bronchus. The airway is then sealed by inflating the cuff, and warm lactated Ringer's solution is infused (approximately 30 mL for a calf and up to 180 mL for an adult cow) and immediately aspirated.<sup>12,15</sup>

#### Serology

Serum samples may be submitted for determination of the levels of specific antibody titers to suspected viral pathogens of the bovine respiratory tract and to *Mycoplasma* spp. Paired acute and convalescent serum samples from both affected and normal animals in the herd are desirable. In a group of animals in a feedlot, or dairy or beef cattle herd, serology for a specific etiologic agent may be followed over a period of time to determine seroconversion and its relationship to occurrence or absence of clinical disease. Although serology is highly sensitive because most respiratory pathogens of cattle induce a strong antibody response, the time delay with which results of paired serum samples become available presents a disadvantage.<sup>16</sup> Moreover, interpretation of serology results in animals with respiratory disease is often complicated by vaccination procedures and the timing of sample collection.<sup>12</sup> Serology is always done in serum and not in plasma.

#### Serum Biochemistry and Hematology

The suitability of serum concentrations of acute-phase proteins (APPs), such as fibrinogen, serum amyloid A (SAA), or haptoglobin (Hp), as a diagnostic tool to identify calves with BRD has been explored in numerous studies, with variable outcome.<sup>17-21</sup> Although increased concentrations of SAA and Hp in calves with BRD compared with healthy calves suggest that measuring the serum concentrations of these APPs could assist the early detection of calves with respiratory disease, the discriminative ability of Hp by itself for BRD was found to be no better than determination of the rectal temperature.<sup>18</sup> Haptoglobin concentrations vary considerably between calves even in healthy animals and were significantly affected by sex and rectal temperature.<sup>18</sup> The increase in serum Hp was found to occur within 24 hours of experimental challenge with *M. haemolytica* of BHV-1-infected calves but occurred between 4 and 8 days of infection with BRSV or BVD. For SAA, the wide variation between animals and the less pronounced increase in SAA concentration in animals suffering of respiratory disease impair the ability of this parameter to discriminate between healthy calves and animals affected by BRD.<sup>20</sup>

Leukocyte counts are of little value as predictors of respiratory disease because leukocytosis and neutrophilia occur in some

animals, but in others there may be a neutropenia or no significant change.<sup>16</sup>

#### Other Procedures

With ultrasonographic equipment having become more available in routine food animal practice, the use of this imaging technique as potentially suitable ancillary diagnostic tool to diagnose BRD was studied by several authors.<sup>22-24</sup> Thoracic ultrasonography is relatively easy to perform with standard equipment under field conditions but requires a certain degree of expertise and routine of the operator to obtain reproducible results. Results of ultrasonographic examination of pneumonic calves were found to be highly correlated with the results of radiographic and postmortem examination. In contrast, the association between ultrasonographic findings and ancillary tests assessing lung and respiratory functions are less obvious.<sup>25</sup> Although the method was found a useful ancillary diagnostic tool to determine type and degree of pleural and pulmonary lesions, ultrasonography results were not found to be associated with animal health outcomes such as subsequent treatment, chronicity, wastage, or mortality.<sup>26</sup>

More invasive diagnostic procedures such lung biopsies have been studied for their usefulness as ancillary diagnostic tool. Although easy to perform with minimal risk to the animal, this procedure was not found useful for characterizing early respiratory disease in feedlot cattle under field conditions.<sup>27</sup>

#### Postmortem Samples

Postmortem samples may be collected either during on-site necropsy or at the diagnostic laboratory. Animals selected for postmortem sample collection should have the following characteristics:

- Representative of the typical clinical case of the herd
- In the early phase of the disease
- Untreated

Contacting the diagnostic laboratory before euthanizing the animal is advisable to discuss the diagnostic workup best suited for the specific herd, and thus the required material is advisable.

#### Bacterial Culture and Antimicrobial Sensitivity

The results of antimicrobial susceptibilities of bacterial pathogens isolated from the lung tissues of cattle with pneumonia over a period of years may provide some indication of trends in antimicrobial sensitivities, but the results are of limited value for making decisions about the selection of antimicrobial in affected animals.

The literature on the principles of antimicrobial susceptibility testing of bacterial pathogens associated with bovine respiratory disease has been reviewed. Two different methods are used. The Kirby-Bauer method



is the traditional *in vitro* test of bacterial susceptibility or resistance to antimicrobials, which uses a disk containing a standardized concentration of an antimicrobial. Bacteria grow or fail to grow surrounding the disk, and results are interpreted as resistance or susceptibility of the bacteria to certain antimicrobials. The serial-dilution testing uses a broth or agar medium with selected dilutions of antimicrobials in 1:2 dilution steps. Results are expressed as susceptible, intermediate susceptibility, or resistant and also as minimum inhibitory concentrations (MICs), which are considered more reliable. The MIC is defined as “the lowest concentration of an antimicrobial that prevents visible growth of a microorganism in agar or broth dilution susceptibility test.”

It is important to adhere to standards set by the National Committee on Clinical Laboratory Standards/Veterinary Antimicrobial Susceptibility Testing Subcommittee (NCCLS/VASTS). Veterinary-specific breakpoints are determined by the NCCLS/VASTS through a consensus process based on reviewing pharmacokinetic, MIC, zone-diameter scattergram and clinical trial data relating to an antimicrobial application. The subcommittee selects MIC breakpoints and zone-interpretative criteria that best fit the definitions of susceptible, intermediate susceptibility, and resistant.

The most veterinary-specific breakpoints for pathogens in bovine respiratory disease have been determined for few antibiotics: ceftiofur crystalline free acid, ceftiofur-hydrochloride, ceftiofur-sodium, danofloxacin, enrofloxacin, florfenicol, spectinomycin-sulfate, tulathromycin, and tilmicosin-phosphate.<sup>28,29</sup> The breakpoints for oxytetracycline and chlortetracycline are adapted from human breakpoints developed for tetracycline.

### NECROPSY FINDINGS

Because this clinical syndrome has a multifactorial etiology, necropsy findings will vary with the factors involved in a particular animal or herd, but some form of pneumonia is always present. The most common finding is fibrinous bronchopneumonia with varying degrees of fibrinous pleuritis and pulmonary abscesses (usually bacterial). The pneumonia involves the cranial lung lobes and the ventral portions of the middle and caudal lobes. Affected areas are dark-red and firm (cranioventral consolidation) and may be covered with thick sheets of fibrin on the visceral and parietal pleura. A cut surface of affected lung lobe is dark-red and may be marbled, whereas the bronchi and bronchioles are filled with a purulent exudate. Tracheobronchial and mediastinal lymph nodes are usually enlarged. In subacute or chronic cases, there are areas of coagulative necrosis or encapsulated abscesses within the consolidated lungs, and the fibrin in the pleura is replaced by fibrous tissue resulting in tough

adhesions. Microscopically, alveoli are filled with an exudate composed of fibrin mixed with inflammatory cells, mostly neutrophils, macrophages, and fewer lymphocytes. The exudate extends to the lower airways.

With primarily viral infections, the common lesion is an acute, diffuse interstitial pneumonia. The lungs are diffusely red-tan, are enlarged, and do not collapse. All lobes are rubbery, wet, and heavy. Emphysema is present mainly in the diaphragmatic lobes, and there is white froth in the trachea. Microscopically, there will be interstitial pneumonia, necrotizing bronchiolitis, and, in some cases, viral inclusion bodies in epithelial cells or syncytial cells.

### Samples for Postmortem Confirmation of Diagnosis

Tissue samples (lung and tracheobronchial lymph nodes) are submitted for histopathology, bacteriology, and virology. However, the length of time usually required to do the diagnostic work and interpret the results means that the procedure is expensive and to an extent inconclusive because the results are available only when the outbreak is over, particularly in feedlot operations.

### Interpretation of Results of Clinical Pathology and Necropsy Findings

A large body of information has been generated on the microbiology and, more recently, molecular microbiology of specific pathogens associated with BRD, but only a fraction is applicable clinically. Insufficient effort has been directed toward integrating the information and applying it to the effective control of respiratory disease on the farm. Ideally, investigations of outbreaks of bovine respiratory disease should consist of in-depth examinations of a representative sample of the affected group and normal in-contact animals using a multidisciplinary approach involving clinical, epidemiologic, and laboratory investigation. These procedures, especially those requiring detailed virological and serologic examinations, are expensive, and in the light of the economic status of cattle industries, they are not likely to be lightly borne. But it will only be when such a multidisciplinary approach is brought to bear on bovine respiratory disease that we will improve our position with respect to knowing what actually occurs in outbreaks of the disease.

Of paramount importance is the identification of risk factors, which, if valid, gives the clinician a powerful clinical tool for the clinical management and control of BRD.

### TREATMENT

The principles of the clinical management of outbreaks of acute undifferentiated bovine respiratory diseases are as follows:

- The clinician must visit the farm and do the clinical and epidemiologic investigations necessary to solve the problem, to assist the owner or the

animal attendants with the clinical management of the disease, and to monitor the problem and the herd until recovery occurs. Simply dispensing antimicrobials to the owner without clinical examination of the animals is inadequate and contradicts the intention of the veterinarian-client relationship. The veterinarian is professionally obliged to provide explicit instructions about medication of affected animals and the drug withdrawal requirements and to keep adequate records of affected animals, treatments given, and the results of laboratory examinations. A final report should be prepared by the veterinarian and sent to the owner.

- Increased surveillance of the group is required to detect affected animals as soon as clinical abnormalities, such as depression, nasal discharge, and dyspnea, are noticeable.
- New cases must be treated as soon as they are detected. Each treated animal should be suitably identified and a record kept of the initial body temperature, the treatment administered and the instructions for follow-up treatment. Treatment failures and disease recurrence a few days after an initial apparent recovery are often attributable to late treatment. Delaying treatment until 48 hours after an experimental aerosol infection of *M. haemolytica* was found to prolong the course of the disease and increase mortality.
- Unless otherwise determined, when toxemia, causing pyrexia and anorexia, is present a primary or secondary bacterial pneumonia should be suspected, in which case antimicrobial therapy is of prime importance. Antimicrobials should be administered parenterally at least initially. Treatment via medicated feed or water bears the risk of underdosage in anorectic animals that are most severely affected. The regular use of a particular antimicrobial in feedlots may increase the level of resistance to *M. haemolytica*. Antimicrobials commonly used for treatment of UBRD are summarized in the treatment box of this section.
- Antiinflammatory therapy should routinely be combined with appropriate antimicrobial therapy in severe cases of BRD that are characterized by dyspnea, pyrexia, and anorexia.

A beneficial response to therapy should be apparent within 12 to 24 hours. The body temperature should decline significantly, and the appearance of the animal and its appetite

should improve. The response to treatment, or lack of it, is valuable information in making a final decision on cause. One of the emerging problems inherent in such broad policies in treatment is public health concern with the amount of antibiotic residue in meat, the spreading of resistance to antimicrobials, and the increased public awareness and concern about indiscriminate antibiotic use in food-producing animals.<sup>30</sup> Pressure is now being applied to use antimicrobials only when necessary, which necessitates a more accurate diagnosis.

A number of antimicrobials are registered for the treatment of BRD, of which some are listed in the treatment box of this section. Some of the antimicrobials with a label for treatment of BRD, such as third- and fourth-generation cephalosporins and fluoroquinolones, are also classified as critically important for human and animal health and should therefore be used restrictively. The World Organization for Animal Health (OIE) issued following recommendations for these classes of antimicrobials:<sup>31</sup>

- Not to be used as preventive treatment applied by feed or water in the absence of clinical signs
- Not to be used as first-line treatment unless justified—when used in a second-line treatment, it should ideally be based on the results of bacteriological tests.
- Extra-label/off-label use should be limited and reserved for instances where no alternatives are available. Such use should be in agreement with the national legislature in force.

A recent mixed-treatment comparison meta-analysis of antibiotic treatments for BRD attempted a ranking of commonly used antimicrobials based on data published in over 90 publications.<sup>32</sup> Based on the publically available information, the authors estimated tulathromycin followed by enrofloxacin, danofloxacin, and florfenicol as the most effective antimicrobials for the treatment of BRD. Gamithromycin was estimated to be less effective but comparable to tilmosin at label dose. Oxytetracycline, trimethoprim/sulfur, and ceftiofur injected at the base of the ear all ranked poorly in this analysis. For oxytetracycline, the retreatment risk was estimated to be between 64% and 77% and thus far above the risk calculated for other evaluated antimicrobials.<sup>32</sup>

Antiinflammatory therapy was beneficial in cases of severe BRD that is characterized by marked dyspnea, fever, and feed-intake depression. The best established effects of nonsteroidal antiinflammatory drugs (NSAIDs) in animals suffering of BRD are a more rapid decline of the rectal temperature and faster return to normal feed and water intake. Long-term effects on clinical outcome, disease recurrence, and severity of chronic lung lesions reported in the literature are more variable.<sup>33</sup> The precise

mechanism through which NSAIDs act in calves with respiratory disease is not entirely understood, but antiinflammatory properties improving respiratory gas exchange and antipyretic and analgesic properties improving the wellbeing and thereby feed and water consumption are believed to be of prime importance. Numerous studies documented a more pronounced improvement in the initial phase of the disease in calves treated with NSAIDs and antimicrobials compared with animals treated with antimicrobials alone, a finding that is significant from an animal welfare perspective. A recent survey among U.S. feedlots revealed that, on average, NSAIDs were part of the standard initial treatment for respiratory disease in 55.9% of all feedlots, whereas steroids were used in 30.9% of the surveyed U.S. feedlots.<sup>1</sup> Nevertheless, the veterinarian must be aware that the combination of antiinflammatory and antimicrobial therapy complicates the assessment of the antimicrobial effect that should take place no later than 48 hours after first treatment because clinical improvement cannot unequivocally be attributed to the susceptibility of the causative pathogen to the administered antimicrobial drug. Experimental and clinical evaluation of the role of corticosteroid therapy in acute pneumonia in cattle yielded mostly unfavorable results.<sup>34</sup> Steroids are powerful antiinflammatory agents, but their effects on the animal's defensive measures, specifically with repeated use, reduces the value of their use in syndromes of infectious origin unless they have a short duration of action.<sup>35</sup>

#### TREATMENT AND PROPHYLAXIS

##### Treatment

Antimicrobial therapy
Tulathromycin (2.5 mg/kg SC as single dose) (R1)
Florfenicol (20 mg/kg q48 IM or 40 mg/kg SC as single dose) (R1)
Tilmicosin (10 mg/kg SC as single dose) (R1)
Gamithromycin (6 mg/kg SC as single dose) (R1)
Enrofloxacin* (2.5-5.0 mg/kg q24 SC/IM for 3 days or 7.5-12.5 mg/kg SC/IM as single dose) (R1)
Danofloxacin* (6 mg/kg q48h SC or 8 mg/kg SC as single dose) (R1)
Ceftiofur* crystalline acid free (6.6 mg/kg SC posterior pinna as single treatment) (R1)
Ceftiofur hydrochloride* (1.1-2.2 mg/kg SC q24 for 3 days) (R1)
Ceftiofur sodium* (1.2-2.2 mg/kg SC/IM q24h for 3 days) (R1)
Cefquinome* (1 mg/kg IM q24 for 3-5 days) (R1)
Oxytetracycline (10 mg/kg IM q24 for 4 days) (R2)

Trimethoprim (2.66 mg/kg) + sulfadoxine (13.33 mg/kg) IM q24h for 3 days) (R2)

##### Antiinflammatory therapy

Flunixin meglumine (2.2 mg/kg IV as single dose) (R2)
Ketoprofen (3 mg/kg IM q24h for 2-3 days) (R2)
Carprofen (1.4 mg/kg IV or SC as single dose) (R2)
Meloxicam (0.5 mg/kg SC/IV as single dose) (R2)
Diclofenac (2.5 mg/kg IM as single dose) (R2)
Tolfenamic acid (2 mg/kg IM/IV q24-48h or 4 mg/kg IM/IV as single dose) (R2)
Prednisolone acetate (0.5 mg/kg IM q24h) (R3)
Dexamethasone (0.01-0.03 mg/kg IM/IV) (R3)
Flumethasone (0.03 mg/kg IM/IV) (R3)

##### Metaphylaxis

Tulathromycin (2.5 mg/kg SC as single dose) (R1)
Florfenicol (40 mg/kg SC as single dose) (R1)
Tilmicosin (10 mg/kg SC as single dose) (R1)
Gamithromycin (6 mg/kg SC as single dose) (R1)
Oxytetracycline long acting formulation (20 mg/kg IM) (R2)
Enrofloxacin* (7.5-12.5 mg/kg SC as single dose) (R3)
Danofloxacin* (8 mg/kg SC as single dose) (R3)
Ceftiofur* crystalline acid free (6.6 mg/kg SC posterior pinna as single treatment) (R3)
Cefquinome* (1 mg/kg IM q24 for 3-5 days) (R3)

##### Vaccination

Vaccination against <i>M. haemolytica</i> and <i>P. multocida</i> (R2)
Vaccination against <i>H. somni</i> (R3)
Vaccination against BRSV, PI-3V, BHV-1 (R2)
Vaccination against BVDV (R2)

\*These are classified as critically important antimicrobials in human and veterinary medicine. Use as first-line treatment is discouraged.

## CONTROL

When confronted with an outbreak, one of the major decisions to be made is whether or not to recommend metaphylactic antimicrobial mass medication of all in-contact animals in an attempt to treat cases in the preclinical stage.

### Mass Medication or Metaphylactic Antimicrobial Use

Veterinarians frequently recommend metaphylactic mass medication, and field observations claim beneficial results.<sup>8</sup> Treatment of a whole group of animals

is often preferable to selecting individuals for therapy because of the diagnostic challenge of identifying early cases of BRD.<sup>36</sup> Although the metaphylactic use of antimicrobials to control BRD is debatable from the point of view of prudent antimicrobial use, this approach was documented to considerably reduce morbidity and mortality rates in a group, thereby having a significant positive effect on animal health and welfare.<sup>37,38</sup>

The use of tilmicosin at 10 mg/kg BW subcutaneously, florfenicol at 40 mg/kg BW subcutaneously, gamithromycin at 6 mg/kg BW subcutaneously, tulathromycin at 2.5 mg/kg BW, and ceftiofur crystalline-free acid at 6.6 mg/kg BW administered subcutaneously at the base of the ear was found effective in reducing the morbidity rate when given to feedlot calves at high risk of developing respiratory diseases.<sup>39-41</sup> The results obtained with long-acting oxytetracycline at a dose of 20 mg/kg BW or higher reported in the literature are more variable.<sup>37</sup> Although an economical advantage may result from the lower price of oxytetracycline compared with newer antimicrobials, morbidity rates were found to be higher with the use of oxytetracycline compared with tilmicosin.<sup>37</sup>

The mass medication of feed supplies or water of newly arrived feedlot cattle has been investigated as a method of reducing the morbidity and mortality resulting from respiratory disease in a number of studies, but results are equivocal. Although studies suggesting that chlortetracycline and sulfamethazine in feed are effective in reducing morbidity associated with BRD have been published, issues around study design and data analysis questioned the validity of the results.<sup>37</sup> A standard recommendation is to provide 150 mg/kg BW for the first 24 hours and reduce the level to 75 mg/kg BW for the duration of the medication period, which may last 5 to 10 days.

### Management of Risk Factors

As a general outline for the control of bovine respiratory disease, the following factors are considered as contributing to disease, and their effects must be minimized with suitable management and disease prevention techniques:

- Young, growing cattle are more susceptible than mature cattle because of a lack of sufficient immunity. The mixing of young cattle of different origins requires increased surveillance to detect evidence of disease. Vaccination of calves at strategic times may be necessary.
- Cattle purchased from various sources and mingled in a feedlot are more likely to develop bovine respiratory disease than cattle that have originated from one source.

Some cattle will be highly susceptible and others relatively resistant because of differences in nasal flora and immunologic, genetic, and nutritional backgrounds. A high level of management and constant surveillance are necessary to recognize, isolate, and treat clinical cases early to minimize morbidity and case mortality.

- Rapid fluctuations in environmental temperatures and relative humidity, not only during the fall and winter months but also during warm seasons, will commonly precede outbreaks of respiratory diseases. Every practical and economical management technique must be used to provide as much comfort as possible and to avoid overcrowding.
- Inadequate ventilation is a major predisposing cause of respiratory disease of cattle raised indoors. This is of major importance in dairy herds during the winter months in temperate climates.
- Weaning calves 3 weeks or longer before sale was found to be beneficial for later development and animal health in several studies.<sup>37</sup>
- Weaning of beef calves during inclement weather may exacerbate the stress of weaning and commonly results in an outbreak of respiratory disease.
- Stress associated with the marketing of cattle is a major factor. The movement of cattle through saleyards—where they may be overcrowded; mixed with cattle of many different origins; temporarily deprived of adequate feed and water; handled roughly while being sorted, weighed, tagged, blood sampled, vaccinated, or injected with antibiotics and/or vitamins, and then loaded on to uncomfortable vehicles and transported long distances without adequate rest stops—is stressful. The practice of preconditioning cattle before they enter the feedlot must continue to be examined to determine which aspects are most profitable.

Presale vaccination programs are designed to establish an effective immune response to common respiratory tract pathogens well in advance of any natural exposure that may occur while calves travel through the auction market or after they arrive in the feedlot. These programs usually require calves to be castrated, dehorned, and vaccinated against BHV-1, PI-3V, BRSV, and BVDV. Some programs also require vaccination against *H. somni* and *M. haemolytica*. Presale conditioning programs involve these procedures but also include weaning and

nutritional components. Most such conditioning programs require calves to be weaned and adjusted to a roughage and concentrate diet for at least 30 days before sale.

### Vaccines

Although vaccines for the control of acute respiratory disease associated with BHV-1, PI-3V, and *Pasteurella* spp. are available and widely used in the field, evidence documenting their efficacy under field conditions is scant.<sup>1,37</sup> According to a large recent survey conducted in the United States, BVD vaccines are used in 96.6%, BHV-1 vaccines in 93.7%, BRSV vaccines in 89.5%, and PI-3V vaccines in 85.1% of surveyed feedlots to control respiratory disease.<sup>1</sup> The use of vaccines against *Pasteurella* spp. (63.8%) and *Histophilus somni* (69.7%) is less common. Preshipment vaccination of beef calves 3 weeks before weaning with vaccines containing BHV-1, PI-3V, *Pasteurella* spp., and *H. somni* did not reduce the incidence of UBRD compared with those unvaccinated.

Many veterinarians and feedlot owners maintain that vaccination against respiratory disease is an essential component in their disease prevention programs, both to prevent specific disease of the respiratory tract such as clinical infectious bovine rhinotracheitis (IBR) and to reduce losses resulting from respiratory disease in the first few weeks after arrival.

In North America, a large number of bacterial and viral vaccines are available for the control of bovine respiratory disease. There are single-antigen and multiple-antigen vaccines and modified live-virus or inactivated-virus vaccines containing one or more of the following antigens: *M. haemolytica*, *P. multocida*, *H. somni*, BHV-1, PI-3V, BRSV, and BVDV. There are many multiple-antigen vaccines containing combinations of the respiratory viruses, BVDV, *H. somni*, *P. multocida*, and *M. haemolytica*.

### Selection of Vaccines

The selection of which vaccine to recommend for the control of BRD in feedlot cattle is currently not possible based on the efficacy information that is available to the veterinarian. The vaccines are used widely, and many anecdotal claims for their effectiveness are made, but there is little scientific evidence that the vaccines are effective and economical in reducing the incidence or the consequences of respiratory disease such as suboptimal weight gain. In most cases the vaccines were approved for sale on the basis of tests for safety in animals, and the potency was measured by a serologic response to the vaccine or experimental challenge in animals under laboratory conditions. Nevertheless, although vaccination is consistently shown to result in antibody production, vaccine-induced titers are not always correlated with protection against disease.<sup>37</sup>



## Efficacy of Vaccines

Meaningful field trials to evaluate vaccines for the control of bovine respiratory disease are difficult to achieve. The case definition of what is a “case of respiratory disease” has been very general, such as the presence of anorexia, depression, and a fever. Therefore, when testing a vaccine for the control of pneumonic pasteurellosis, the conclusions reached may be questionable if the cause of the sick animals in either the vaccinated or control group is not known—thus the importance of case definition. In contrast to field trials, the measures used by the manufacturer in the laboratory challenge of the vaccine have been specific. In a field trial, the control group and the vaccinated groups must be comparable. Where more than one vaccine is used to control respiratory disease in vaccinates and controls, it is difficult to evaluate one of the vaccines or the components of a multiple-antigen vaccine unless large numbers of animals are used. Another problem is the difficulty of having the controls and the vaccinates experience approximately the same risk of being affected with respiratory disease.

Field trials for bovine respiratory disease vaccines are often unsatisfactory because of inadequate planning, unsatisfactory experimental design, and lack of monitoring. The following comments on the use of vaccines as an aid in the control of acute undifferentiated respiratory disease in feedlot cattle are based on the current information available.

### *Pasteurella* Vaccines

Because fibrinous pneumonia associated with *M. haemolytica* is the most common lesion associated with bovine respiratory disease in feedlot cattle, much of the emphasis has been on the development of effective vaccines for bovine pneumonic pasteurellosis. Based on the immunologic and microbiological observations of both naturally occurring and experimentally induced pneumonic pasteurellosis, it appears that effective artificial immunization of cattle is possible. High levels of naturally acquired antibody to *M. haemolytica* have been associated with protection against the disease.

Antibodies to *M. haemolytica* leukotoxin and certain bacterial surface components appear to be important for resistance to disease. The basis of a recently introduced pasteurella vaccine is that vaccination of calves with a leukotoxic culture supernatant from pathogenic *M. haemolytica* provided some protection against experimental challenge with the organism.

Vaccination of recently shipped nonpreconditioned calves with the vaccine in Ontario resulted in a slight decrease in morbidity, slight improvement in response rates, and perhaps an important reduction in relapse rates. When the vaccine was combined with an intramuscular modified live

BHV-1/PI-3V vaccine, the morbidity rate was increased, the response rate was decreased, and the mortality rate was increased in some groups. It appears that the use of modified live-virus vaccines in recently arrived calves is contraindicated; this is consistent with earlier observations in the Bruce County Project, where fall-placed calves were vaccinated on arrival with a modified live-virus vaccine.

A recent meta-analysis reviewing the evidence behind the recommendation to vaccinate to control BRD in calves identified 18 trials that studied the use of vaccines either against *M. haemolytica* or *M. haemolytica* and *P. multocida*.<sup>42</sup> From these data the authors calculated a risk ratio (RR) of 0.93 (CI 0.89-0.98), indicating a significantly although minimally lower risk of morbidity in vaccinated feedlot cattle compared with controls and thus a potential benefit of using pasteurella vaccines.

### *Histophilus somni* (Formerly *Haemophilus somnus*) Vaccine

Few studies have investigated the effectiveness of *H. somni* vaccination of feedlot cattle to control respiratory disease. The antibody response was found to be associated with protection against *H. somni*.<sup>43</sup> When used as part of a preconditioning program, the vaccine tended to have mildly positive or neutral effect on morbidity and mortality related to respiratory disease, whereas the effect appeared to be neutral or even negative when animals were vaccinated on arrival at the feedlot.<sup>43</sup> Observed effects on morbidity and mortality were below the significance level. Little scientific evidence is currently available to support the use of *H. somni* vaccination to control BRD.<sup>42</sup>

### Viral Vaccines

Because prior infection of the respiratory tract with either BHV-1, BRSV, or PI-3V may predispose to pneumonic pasteurellosis, the vaccination of beef calves 2 to 3 weeks before weaning and feedlot cattle 2 weeks before shipment to a feedlot has been recommended as part of a preconditioning program. The results are variable, but vaccination of calves at 3 to 6 months of age with an intranasal modified-live BHV-1 and PI-3V vaccine has provided protection against experimental pneumonic pasteurellosis induced by aerosol challenge with BHV-1 followed 4 days later by an aerosol of *M. haemolytica*. It is important to vaccinate the calves at least 2 weeks before they are weaned, stressed, or transported to a feedlot.

A modified-live BHV-1 vaccine given to beef calves before weaning, at weaning, or immediately after arrival in the feedlot was associated with a significant reduction in the treatment rate in one of three groups immunized before weaning and in calves immunized after arrival in the feedlot. There was no significant effect of the vaccine on treatment rate in calves immunized at weaning,

in calves immunized after arrival in a bull test station, or in yearlings immunized after arrival in the feedlot. It would appear that the vaccine did provide some protection, but the small reduction may not justify the cost of the vaccination program.

Some feedlot veterinarians recommend that feedlot cattle be vaccinated on arrival with an *M. haemolytica* vaccine, the BHV-1 and PI-3V vaccine, an *H. somni* vaccine, and the BRSV vaccine. The BVDV vaccine is the most commonly used vaccine in feedlots in the United States because BVD virus circulating in feedlots among newly received calves is considered to be an important factor predisposing to BRD.<sup>1</sup> It is expected that control will be achieved if the animals are vaccinated against all the common pathogens that contribute to lesions of bovine respiratory disease. However, there is little, if any, published evidence based on controlled field trials that such blanket recommendations are justifiable.

## FURTHER READING

- Babiuk LA, Lawman MJP, Bielefeld Ohmann H. Viral-bacterial synergistic interaction in respiratory disease. *Adv Virus Res.* 1988;35:219-249.
- Barrett DC. Cost-effective antimicrobial drug selection for the management and control of respiratory disease in European cattle. *Vet Rec.* 2000;146:545-550.
- Cusack PMV, McMeniman N, Lean IJ. The medicine and epidemiology of bovine respiratory disease in feedlots. *Aust Vet J.* 2003;81:480-487.
- O'Connor AM, Coetzee JF, daSilva N, Wang C. A mixed treatment comparison meta-analysis of antibiotic treatment for bovine respiratory disease. *Prev Vet Med.* 2013;110:77-87.
- Pancieria RJ, Confer AW. Pathogenesis and pathology of bovine pneumonia. *Vet Clin North Am Food A.* 2010;26:191-214.
- Taylor JD, Fulton RW, Lehenbauer TW, Step DL, Confer AW. The epidemiology of bovine respiratory disease: what is the evidence for preventive measures? *Can Vet J.* 2010;51:1351-1359.

## REFERENCES

- USDA Feedlot, 2011, part IV. (Accessed 15.09.15, at <[http://www.aphis.usda.gov/animal\\_health/nahms/feedlot/downloads/feedlot2011/Feed11\\_dr\\_PartIV.pdf](http://www.aphis.usda.gov/animal_health/nahms/feedlot/downloads/feedlot2011/Feed11_dr_PartIV.pdf)>).
- USDA Dairy, 2007, part I. (Accessed 15.09.15, at <[http://www.aphis.usda.gov/animal\\_health/nahms/dairy/downloads/dairy07/Dairy07\\_dr\\_PartI.pdf](http://www.aphis.usda.gov/animal_health/nahms/dairy/downloads/dairy07/Dairy07_dr_PartI.pdf)>).
- Cernicchiaro N, et al. *Am J Vet Res.* 2013;74:300-309.
- Bach A. *J Dairy Sci.* 2011;94:1052-1057.
- Hodgson PD, et al. *Vet Res.* 2012;43:21.
- Step DL, et al. *J Anim Sci.* 2008;86:3146-3158.
- Duff GC, Galylean ML. *J Anim Sci.* 2007;85:823-840.
- Edwards TA. *Vet Clin North Am Food A.* 2010;26:273-284.
- White BJ, Renter DG. *J Vet Diagn Invest.* 2009;21:446-453.
- Timsit E, et al. *J Anim Sci.* 2011;89:4272-4280.
- Schaefer AL, et al. *Res Vet Sci.* 2012;93:928-935.
- Cooper VL, Brodersen BW. *Vet Clin North Am Food A.* 2010;26:409-416.
- Godinho KS, et al. *Vet Rec.* 2007;160:22-25.
- Fulton RW, Confer AW. *Can Vet J.* 2012;53:754-761.
- Bohn AA, Callan RJ. *Vet Clin North Am Food A.* 2007;23:443-479.

16. Caswell JF, et al. *Vet Clin North Am Food A.* 2012;28:419-441.
17. Ganheim C, et al. *Vet J.* 2007;173:645-651.
18. Svenson C, et al. *Vet J.* 2007;174:288-294.
19. Eckersall PD, Bell R. *Vet J.* 2010;185:23-27.
20. Angen O, et al. *Vet Microbiol.* 2009;137:165-171.
21. Nikunen S, et al. *Comp Immunol Microbiol Infect Dis.* 2007;30:143-151.
22. Babkine M, Blond L. *Vet Clin North Am Food A.* 2009;25:633-649.
23. Scott L. *In Pract.* 2013;35:460-469.
24. Tharwat M, Okawa S. *Trop Anim Health Prod.* 2011;43:803-810.
25. Buczinski S, et al. *J Dairy Sci.* 2013;96:4523-4528.
26. Abutarbush SM, et al. *Can J Vet Res.* 2012;76:23-32.
27. Burgess BA, et al. *Can J Vet Res.* 2013;77:281-287.
28. Apley M. *Vet Clin North Am Food A.* 2006;22:399-411.
29. Watts JL, Sweeney MT. *Vet Clin North Am Food A.* 2010;6:79-88.
30. Scientific Advisory Group on Antimicrobials of the Committee for Medicinal Products for Veterinary Use. *J Vet Pharmacol Therap.* 2009;32:513-533.
31. World Organization for Animal Health. OIE list of antimicrobial agents of veterinary importance, 2013. (Accessed 15.09.15, at <[http://www.oie.int/fileadmin/Home/eng/Our\\_scientific\\_expertise/docs/pdf/OIE\\_List\\_antimicrobials.pdf](http://www.oie.int/fileadmin/Home/eng/Our_scientific_expertise/docs/pdf/OIE_List_antimicrobials.pdf)>.).
32. O'Connor AM, et al. *Prev Vet Med.* 2013;110:77-87.
33. Francoz D, et al. *Vet Clin North Am Food A.* 2012;28:23-38.
34. Peek SF. *Vet Clin North Am Food A.* 2005;21:697-710.
35. Lekeux P, et al. *Cattle Pract.* 2007;15:115-119.
36. Nickel JS, White BJ. *Vet Clin North Am Food A.* 2010;26:285-301.
37. Taylor JD, et al. *Can Vet J.* 2010;51:1351-1359.
38. Sweiger SH, et al. *Vet Clin North Am Food A.* 2010;26:261-271.
39. Torres S, et al. *Am J Vet Res.* 2013;74:839-946.
40. Catry B, et al. *J Vet Pharmacol Therap.* 2008;31:479-487.
41. Hibbard B, et al. *Vet Ther.* 2002;3:22-30.
42. Larson RL, Step DL. *Vet Clin North Am Food A.* 2012;28:97-106.
43. Griffin D. *Vet Clin North Am Food A.* 2010;26:57-71.
44. Maunsell FP, et al. *J Vet Intern Med.* 2011;25:772-783.
45. Nicholas RAJ. *Vet Rec.* 2011;168:459-462.

## PNEUMONIC PASTEURELLOSIS OF CATTLE (SHIPPING FEVER PNEUMONIA)

### SYNOPSIS

**Etiology** *Mannheimia haemolytica* serotype A1 and A6; *Pasteurella multocida* serotype A3.

**Epidemiology** Young, rapidly growing cattle, especially recently weaned beef calves placed in feedlot (shipping fever) and unweaned dairy calves (enzootic calf pneumonia). Can occur in nursing calves and mature cows. Stressors include transportation, mixing animals from many different sources, weaning, processing procedures, and ineffective ventilation of housed animals

**Signs** Acute respiratory disease, abnormal lung sounds, fever, toxemia, anorexia, sudden death; respond to treatment with antimicrobials.

**Lesions** Acute fibrohemorrhagic pneumonia, frequently with pleuritis.

**Clinical pathology** Culture organism from nasopharyngeal swabs or transtracheal wash/bronchioalveolar lavage fluid.

**Diagnostic confirmation** Culture organism from lung and histopathology of lung.

**Treatment** Antimicrobials, NSAIDs.

**Control** Preconditioning programs. Management strategies to reduce stress. Metaphylactic antimicrobial mass medication on arrival in the feedlot. Viral and bacterial vaccines.

### ETIOLOGY

Pneumonic pasteurellosis is an entity within the **bovine respiratory disease (BRD) complex**, characterized clinically by acute bronchopneumonia with toxemia and pathologically by lobar, anteroventrally distributed, exudative pneumonia in which fibrin is usually a prominent part of the exudate and fibrinous pleuritis is common.

*M. haemolytica* of the order Pasteurellales, a gram-negative coccobacillus is considered the most important bacterial pathogen in weaned calves, whereas *Pasteurella multocida* is more commonly isolated from the lower respiratory tract of younger calves with respiratory disease.<sup>1</sup> There are currently 12 recognized serotypes of *M. haemolytica* (A1, A2, A5, A6, A7, A8, A9, A12, A13, A14, A16, and A17), of which serotype A2 and to a lesser extent A4 are commonly isolated from the upper respiratory tract of healthy ruminants and thus are considered normal inhabitants of the nasopharynx and tonsils of ruminants. Serotypes A1 and, more recently, A6 are most commonly associated with respiratory disease in cattle.<sup>2,3</sup>

*Pasteurella multocida* has 5 capsular serogroups (A, B, D, E, and F) and 16 somatic serotypes (1-16). Whereas *P. multocida* serotypes B and E are associated with hemorrhagic septicemia in cattle and water buffaloes in tropical regions, serotype A3 and, to a lesser extent, D3 are the major pathogens associated with lower respiratory tract infection in cattle.<sup>4</sup> Clearly, the presence of *P. multocida* in the upper respiratory tract does not equal disease because of the ubiquitous nature of this organism, but the proportion of fatal cases of shipping fever attributable to *P. multocida* appears to be increasing, according to the recent literature.<sup>4</sup>

The *Pasteurella* spp. are opportunistic pathogens and the final cause of the pneumonia but rely on predisposing mechanisms allowing the bacteria to enter and colonize the lung and produce the lesions. Viruses or

mycoplasmas may act synergistically to allow the bacteria to be pathogenic. Numerous environmental predisposing factors, generally termed as stressors, have been discussed, such as the following:

- Transportation
- Comingling of groups of cattle from different sources
- Confinement of cattle
- Ineffective housing and ventilation
- Extreme temperature changes
- Weaning
- Processing procedures

### EPIDEMIOLOGY

#### Occurrence

Pneumonic pasteurellosis is a common disease of young growing cattle in Europe, the United Kingdom, and North America. The condition has arbitrarily been subdivided into two main categories that are **enzootic calf pneumonia (ECP)**, primarily ascribed to *Pasteurella multocida* and **shipping fever** mainly ascribed to *Mannheimia haemolytica*. Whereas ECP is considered a condition predominantly affecting unweaned dairy calves, shipping fever is discussed as disease of older weanling, stocker, or feeder cattle.<sup>1</sup> Nursing beef calves, yearlings, and mature dairy and beef cows may also be affected, but less frequently.

#### Morbidity and Mortality

Shipping fever is the most common illness among cattle in U.S. feedlots, with an average incidence of 16.2% and a mortality rate of approximately 4%.<sup>5</sup> Considerable regional differences in morbidity rates were reported, with feedlots in the central region of the United States reporting twice the percentage of cattle affected compared with other regions (17.8% vs. 8.8% respectively).<sup>5</sup> The peak incidence of disease occurs within the first 3 weeks after arrival of the calves in the feedlot.

The incidence of respiratory disease in postweaning dairy heifers in the United States was 5.9%, and respiratory disease was determined to be the most common cause of death in weaned and the second most common cause of death in unweaned heifers (after diarrhea) with 46.5% and 22.5% of death losses respectively in the United States.<sup>6</sup> The percentage of death losses attributable to respiratory disease in weaned dairy heifers rose from 34.8% of all deaths in 1991 to 46.5% in 2007.<sup>6</sup>

An observational study of the epidemiology of fatal fibrinous pneumonia in feedlot calves purchased from auction marts in western Canada and placed in a commercial feedlot between September 1 and December 31 over a 4-year period identified some valid information. Peak fibrinous pneumonia occurred approximately 16 days after arrival at the feedlot; the median number of days between arrival and the first treatment of fatal fibrinous pneumonia cases varied from

3 to 8 days. The fatal fibrinous pneumonia rates varied 11-fold (0.25%-2.73%) between years. The fatal fibrinous pneumonia proportionate mortality varied from 10% to 57%. Fully 75% of the calves that died of fibrinous pneumonia already were sick within 2 weeks after arrival. When the incidence of fatal fibrinous pneumonia was high (greater than 2%), the disease clustered, either within certain truckload groups of calves or within certain pens, or within both. Clustering could have been a result of contagious factors, noncontagious factors, or both.

### Economic Importance

Pneumonic pasteurellosis is a major cause of economic loss in the feedlot and dairy industry. It is responsible for the largest cause of mortality in feedlots in North America. In addition to the death losses, the costs of treatment (which include the personnel involved in the detection and actual treatment, the drugs used and the vaccines) are considerable. Indirect costs of the disease, which include increased risk of culling or death, losses associated with delayed entry into the milking herd and possibly decreased productivity are difficult to estimate.<sup>7</sup> The average cost of treatments for a single case of respiratory disease in feedlots determined in a recent U.S. survey was \$23.40, which was considerably higher than the costs per case of \$12.59 reported in similar study from 1999.<sup>5</sup> A study from 1990 estimated the average costs per clinical case with an average \$14.71 for unweaned and \$1.95 for weaned dairy calves.<sup>8</sup> Long-term costs were estimated at between \$15 and \$49 for a typical Dutch dairy farm with an overall disease incidence of 60%.<sup>9</sup>

### Risk Factors

#### Animal Risk Factors

The disease occurs most commonly in young growing cattle from 6 months to 2 years of age but all age groups are susceptible. Calves that are nonimmune to *M. haemolytica* are considered to be more susceptible to the disease than calves that have serum neutralizing antibodies to the organism and its leukotoxin (LKT). Calves that have recovered from the experimental disease are resistant to naturally occurring disease. Auction market calves that originate from many different farms and are mixed at the market are at high risk. Calves may develop the disease before weaning if housed in crowded, poorly ventilated barns, when exposed to rapid changes in temperature and humidity, or when subjected to stress.

The disease occurs commonly in outbreaks 7 to 10 days after cattle have arrived in the feedlot following stressful transportation. This forms a major part of the "shipping fever" complex, which is a major hazard in the practice of rearing beef cattle on range country and then transporting them long distances to other centers for growing and

finishing. However, the distance that calves were transported by truck from the auction markets to the feedlot was not associated with an increased risk of fatal fibrinous pneumonia, as determined by one study.

Herd outbreaks in dairy herds are not uncommon, especially when recent introductions have been made or cattle are returned to their home farms after summer grazing on community pastures or exhibition at fairs. Outbreaks of peracute pleuropneumonia attributable to *M. haemolytica* have been reported in adult dairy cattle. Many animals were affected of which a high proportion were in the immediate postparturient period. All affected farms had purchased cows and/or heifers within the last 12 months, but there was no history of transportation or movement of affected animals. Mature beef cows are also susceptible to pneumonic pasteurellosis if they are subjected to stressors during the summer months or in the fall of the year, usually associated with moving large groups to or from pasture during inclement weather.

#### Environmental and Management Risk Factors

A number of environmental risk factors have been discussed in the literature. In addition to prior infection with viral pathogens that are discussed under "Pathogen Risk Factors," other predisposing factors generally summarized as "stressors" include the mixing of cattle from different sources; transportation; sudden and extreme temperature changes; cold coupled with wetness, dust, or acute metabolic disturbances; and feed and/or water deprivation (e.g., during transportation).<sup>4</sup> Mixing of recently weaned beef calves from different sources at auction markets was associated with an increased risk of fatal fibrinous pneumonia in calves moved to feedlots in western Canada, especially in November, shortly after auction sales had peaked and when the feedlot was reaching capacity.

The role of stress as a risk factor in shipping fever pneumonia has been examined experimentally. Experimental transportation and handling to mimic stress, followed by an aerosol of *M. haemolytica*, did not result in significant lesions of pneumonia but did make the animals susceptible to BHV-1. Similarly, stress related to weaning and maternal separation at the time of primary BHV-1 infection increased the innate immune response that correlated significantly with mortality following a secondary bacterial infection.<sup>10</sup>

Confinement in drafty or humid and poorly ventilated barns, exposure to inclement weather, transport, fatigue, and deprivation from feed and water are commonly followed by outbreaks of the disease in cattle. In calves kept at a constant temperature of 16°C (60°F), the bacterial populations in the nasopharynx were at a minimum between

65% and 75% relative humidity and tended to rise at humidities outside that range.

An increase in virulence of the bacteria is often evident after animal passage; at the commencement of an outbreak only those animals that have been subjected to devitalizing influences are affected, but the disease may subsequently spread to other animals in the group. There is little tendency for the disease to become an area problem, with sporadic outbreaks occurring with the appearance of conditions favorable to the development of the disease.

#### Pathogen Risk Factors

*Pasteurella* are considered normal inhabitants of the upper- and opportunistic pathogens of the lower respiratory tract of cattle. Although the precise mechanism is not well understood, concurrent viral infection of the upper respiratory tract is considered a key element in the pathogenesis of pneumonic pasteurellosis. Viral infection of the upper respiratory tract causes cellular damage, resulting in microenvironmental changes that facilitate the colonization of the mucosa of the upper respiratory tract with pathogenic serotypes of *M. haemolytica* and/or *P. multocida*.<sup>1</sup> Calves inoculated intranasally with BHV-1 or PI-3V become more susceptible to colonization with *M. haemolytica* even in the presence of antibodies to the organism in the serum and nasal secretion.

The assumption that infection with several different viruses and mycoplasma may predispose to pneumonic pasteurellosis has been a subject of intense research activity and is corroborated by the observation that coinfection of the lower respiratory tract with other pathogens is significantly more common than infection with either *M. haemolytica* or *P. multocida* alone.<sup>4</sup> Seroepidemiologic surveys of cattle in feedlots reveal that BHV-1, PI-3V, BVDV, and BRSV were present, active, and associated with respiratory disease. The presence of antibody indicates current or recent exposure to the virus but does not indicate resistance. Cattle with low titers to BHV-1 or BRSV were at increased risk of subsequent treatment for bovine respiratory disease. Treated cattle also had greater increases to PI-3V and/or BVDV antibodies than control calves. Although there is evidence that BVDV can experimentally affect certain immune mechanisms, there is little direct evidence that the virus is a major predisposing factor in the causation of naturally occurring pneumonic pasteurellosis. Seroepidemiologic surveys indicate that seroconversion to BVDV is related to increased risk of respiratory disease at both individual and group levels. Serologically, there is also evidence of a high prevalence of *M. bovis* and *M. dispar* in feedlot calves. But the relative importance of these pathogens as a cause and effect relationship is controversial. Bovine coronavirus has been associated with some natural outbreaks of shipping



fever in feedlot cattle. Up to 80% of affected animals shed bovine coronavirus from their nasal cavities when the infection rate with *Pasteurella* spp. was low.

The virulence factors of *M. haemolytica* and *P. multocida* include the following:

Surface proteins and carbohydrates

- Adhesion proteins and fimbriae allowing adherence to the mucosal membranes
- Capsular polysaccharides
- Outer membrane proteins (OMPs), some of which are iron regulated and critically important for iron acquisition by the microorganism
- Lipopolysaccharides (also termed endotoxins, particularly lipid A) that are responsible for pyrexia and hypotensive shock and contribute to pulmonary lesions
- Lipoproteins (e.g., lipoprotein PlpE)

Toxins and extracellular enzymes

- Leukotoxin (LKT) of *M. haemolytica*, which induces apoptosis or cell necrosis in ruminant leukocytes
- Glycoproteases that can hydrolyze IgG
- Neuramidase

*M. haemolytica* serotypes A1 and A2 can survive for long periods of time in relatively low-nutrient *in vivo* fluids. Both strains survived for at least 244 days in ovine and 156 days in bovine tracheobronchial washings, respectively. This may provide an explanation for the long survival of the organism in the nasopharynx of ruminants.

### Immune Mechanisms

Calves that have recovered from the experimental disease are resistant to naturally occurring disease. Numerous *M. haemolytica* antigens may stimulate the immune response and resistance to disease. These antigens include many of the previously mentioned virulence factors such as capsular polysaccharides, LKT, and surface antigens, including iron-regulated proteins, a serotype-specific outer membrane protein, and several other antigens that are less well defined. High antibody responses to *M. haemolytica* surface-extract proteins are correlated with resistance to experimental pneumonic pasteurellosis. Resistance to experimental challenge with the organism correlates directly with serum LKT neutralizing titers. Aerosol exposure of calves to *M. haemolytica* results in the development of LKT neutralizing antibodies in pulmonary lavage samples and an accompanying increase in serum neutralizing antibody titer. Because aerosol exposure of calves to viable *M. haemolytica* elicits a protective immune response characterized by enhanced clearance of the organism from the lung and by protection against fibrinous pneumonia, it is possible that the presence of preexisting antibodies to LKT in the lungs provides immunity by protecting phagocytic leukocytes

from LKT and by promoting phagocytosis and intracellular killing of the organism.

Passive immunization with antibodies to whole *M. haemolytica* or LKT-containing supernatants provides protection against experimentally induced pneumonic pasteurellosis similar to the protection provided by active immunization with these antigens. In contrast, antibodies to lipopolysaccharide provided little protection against challenge.

Cattle exposed to live organisms produce antibodies to both cell surface antigens and LKT, whereas exposure to the killed vaccine results in the production of antibodies primarily to cell surface antigens.

The experimental lung challenge of calves with formalin-killed *P. multocida* does not provide subsequent protection to challenge with live *P. multocida*.

### Method of Transmission

Transmission of pasteurellas probably occurs by the inhalation of infected droplets coughed up or exhaled by infected animals, which may be clinical cases or recovered carriers in which the infection persists in the upper respiratory tract. *M. haemolytica* and *P. multocida* are highly susceptible to environmental influences and it is unlikely that mediate contagion is an important factor in the spread of the disease. When conditions are optimal, particularly when cattle are closely confined in inadequately ventilated barns, when overcrowded in trucks and trains, or held for long periods in holding pens in feedlots, the disease may spread very quickly and affect a high proportion of the herd within 48 hours. In animals at pasture, the rate of spread may be much slower.

### PATHOGENESIS

#### Colonization of Upper and Lower Respiratory Tract

Considerable research has centered on determining how the pasteurellas, which are part of the normal flora of the upper respiratory tract, colonize first the upper- and then the lower respiratory tract. Under normal conditions the bovine lung is practically sterile because of an effective lung clearance mechanism. The current hypothesis is that a combination of a viral infection of the respiratory tract and/or devitalizing influences from transportation, temporary starvation, weaning, rapid fluctuations in ambient temperature, the mixing of cattle from different origins, and the excessive handling of cattle after arrival in a feedlot can collectively promote an increase in the total number and virulence of pasteurellas in the nasopharynx. Enhanced bacterial growth in the upper respiratory tract results in inhalation of aerosol droplets into the trachea and lungs.<sup>2</sup>

In clinically normal cattle, *M. haemolytica* are present in low numbers in the tonsil and nasal passages, and those that are isolated are predominantly serotype A2, which is rarely associated with disease. Exposure of

healthy cattle to stressors such as viral infection, change in management practices, and environmental changes leads to an explosive growth and selective colonization by *M. haemolytica* A1 in the upper respiratory tract.

The experimental intranasal exposure of calves to a leukotoxin-deficient *M. haemolytica* elicits an increase in the serum antibody titers against the organism and decreased colonization of the nasopharynx by wild-type *M. haemolytica*. This could allow an immune response to develop before transportation and offer protection from nasopharyngeal colonization and pneumonia by wild-type *M. haemolytica*.

Under normal conditions, alveolar macrophages will effectively clear pasteurellas from the alveoli by phagocytic mechanisms. When the large numbers of organisms enter and colonize the lung, they interact with alveolar macrophages. Neutrophils enter the lung within the first few hours after bacterial inoculation.

Bovine alveolar macrophages release superoxide anion when exposed to *M. haemolytica*, and the response is dependent on the presence of opsonizing antibody and the quantity of organisms presented to the phagocyte. This may have a major role in the pathogenesis of the acute lung injury associated with pneumonic pasteurellosis. It is an important mechanism by which this phagocyte can initiate microbicidal activity and may provide clues to further study of the defense mechanisms of the lung.

### Virulence Factors and Cellular and Humoral Reactions

The lung injury caused by the organisms after entry into the lung is dependent on important virulence factors.

Of the previously mentioned virulence factors, the ones that are considered the most relevant for the pathophysiology of pulmonary pasteurellosis of cattle are as follows:

- Fimbriae
- Capsular polysaccharides
- Lipopolysaccharide (LPS or endotoxin)
- Leukotoxin (LKT) for *M. haemolytica*

The interactions of these virulence factors contribute to the pathogenesis of the disease. Fimbriae enhance the colonization of the upper respiratory tract. The capsular polysaccharides of the organism inhibit complement-mediated serum killing and phagocytosis and intracellular killing of the organism. The capsule also enhances neutrophil-directed migration and adhesion of the organism to the alveolar epithelium. The LPS can alter bovine leukocyte functions and is directly toxic to bovine endothelium. It also modifies cardiopulmonary hemodynamics and elevates circulatory prostanoids, serotonin, cAMP, and cGMP. The organism induces morphologic alterations in bovine pulmonary endothelial cells, the effects of

which can be partially inhibited by indomethacin. Tissue factor is involved in intra-alveolar fibrin deposition and coagulopathy associated with pneumonic pasteurellosis in cattle.

The migration and activation of neutrophils in inflamed tissue are regulated by a complex network of interactions among cytokines, leukocytes, vascular endothelium, cellular adhesion molecules, and soluble chemotactic factors. The inflammatory cytokines tumor necrosis factor alpha, interleukin (IL)-1 beta, and IL-8 play a central role in the initiation and orchestration of these interactions. IL-8 is the dominant cytokine expressed within the lungs during the acute phase of pneumonic pasteurellosis.

The **lipopolysaccharide (LPS)** of *P. multocida* or *M. haemolytica* is capable of causing direct injury to bovine pulmonary arterial endothelial cells, which may be a contributing pathogenic mechanism. LPS interacts with numerous cell types and humoral mediator systems, resulting in widespread injury to the lung. LPS can readily cross the alveolar wall either from the air or blood and interact with cells and humoral mediators. LPS can be found in the neutrophils in the alveolus, interstitial tissue, and capillary lumen; in intravascular, interstitial, and alveolar macrophages; in endothelial cells; and on alveolar epithelial cell surfaces. The interaction of endotoxin with cells leads to cell activation and death.

**Leukotoxin (LKT)** is produced by all known serotypes of *M. haemolytica* and is a heat-labile protein exotoxin, a pore-forming cytotoxin that affects macrophages, lymphocytes, neutrophils, and platelets of ruminants specifically.<sup>2</sup> The bacterium produces LKT, with maximum production occurring during the log phase of growth, peaking after 6 hours of incubation. Following the inhalation of *M. haemolytica* into the lung, there is an accumulation of neutrophils that, when destroyed by LKT, results in the release of proteolytic enzymes, oxidant products, and basic proteins, which degrade cellular membranes, increasing capillary permeability. This causes fluid accumulation in the interstitium of the alveolar wall, alveolar wall necrosis, and pulmonary edema. LKT also induces histamine release from bovine mast cells.

LKT follows a species-specific dose-dependent activation-inhibition paradox on bovine leukocytes.<sup>2</sup> Exposure to low concentrations of LKT can activate neutrophils and macrophages to stimulate respiratory burst and degranulation, proinflammatory cytokine release, and histamine release from mast cells. At high concentrations, LKT induces apoptosis in bovine leukocytes. Apoptosis is a process of programmed cell death distinguished from necrosis by the orderly shutdown of cell functions. At even higher concentrations, LKT causes transmembrane pore formation,

resulting in cell swelling and subsequent cell death.<sup>2</sup>

Supernatants of the organism can also cause rapid cytolysis of platelets. The genes that code for the synthesis and secretion of LKT have been cloned. It is a highly immunogenic protein that is produced by all 15 serotypes of *M. haemolytica*. Cattle with high LKT antibody titers have higher survival rates in natural and experimental cases of pneumonic pasteurellosis than animals with low antibody titers. LKT antigens and bacterial surface component are now used in commercial vaccines to elicit resistance against pneumonic pasteurellosis.

### Experimental Pneumonic Pasteurellosis

In an attempt to understand the pathogenesis of bovine pneumonic pasteurellosis, the experimental disease has been reproduced using several different methods; the most commonly used is the sequential aerosol infection of calves with either the PI-3 virus or the BHV-1 virus followed by an aerosol of *M. haemolytica* 3 days or more later. Exposure of calves to aerosols of PI-3V followed by *M. haemolytica* at intervals of 3 to 13 days later results in a purulent bronchopneumonia. The virus interferes with the lung clearance of *M. haemolytica* when an aerosol of the bacteria is given 7 days following the viral infection. There is little interference after only 3 days and a moderate degree at 11 days.

Pneumonic pasteurellosis similar to the naturally occurring disease can be reproduced experimentally by exposing calves sequentially to aerosols of BHV-1 and *M. haemolytica* 4 days apart. The virus infection partly destroys the clearance mechanism of the respiratory tract epithelium and exacerbates the subsequent *M. haemolytica* infection. Both antigens can be detected by immunohistochemical methods in the bronchoalveolar fluid cells.

The viral-bacterial synergism is associated with the release of cytokines, which attract more leukocytes and increase leukocyte expression of CD11a/CD18. In this experimental model, vaccination of the animal against the virus before challenge with the viral-bacterial aerosol sequence is protective. The interaction between the BHV-1 virus and *M. haemolytica* can persist for up to 30 days after infection with the virus. A sequential aerosol infection of BHV-1 and *P. multocida*, or *P. multocida* alone, can also result in pneumonia. Experimental in vitro studies indicate that BHV-1 infection does not have a direct effect on the ability of neutrophils to phagocytize *M. haemolytica*; rather, there is an indirect effect, perhaps through the release of mediators that have an effect on phagocyte function. Large amounts of interferon are produced throughout the course of BHV-1 infection, which reduces chemotaxis and elevates oxidase activity by bovine neutrophils.

The intratracheal injection of *P. multocida* serotype A3 into 8-week-old calves results in clinical and pathophysiologic findings characteristic of bovine pneumonic pasteurellosis and gross pathologic and microscopic changes similar to field cases. Concentrations of the acute-phase proteins haptoglobin, serum amyloid-A, and alpha-1 acid glycoprotein increased, suggesting a role for these proteins as markers of the onset of and progress of the disease.

The intratracheal instillation of live *M. haemolytica* into conscious calves results in acute cardiovascular changes consisting of two systemic hypodynamic and pulmonary vasoconstrictive phases.

### Synergism Between Pathogens

Experimentally, synergism may occur between *M. haemolytica* and *M. bovis* in producing pneumonia in gnotobiotic calves but not in conventional calves.

The role of BVDV in outbreaks of pneumonic pasteurellosis is uncertain. In one study the virus did not impair the pulmonary clearance of *M. haemolytica*. In a different study the endobronchial inoculation of calves with the virus and *M. haemolytica* sequentially 5 days apart resulted in a severe fibrinopurulent bronchopneumonia and pleuritis involving up to 75% of the total lung volume. Endobronchial inoculation of the organism only caused a localized noninvasive lesion in the lungs.

In summary, pneumonic pasteurellosis can be reproduced experimentally without a preceding virus infection, and it is likely that the naturally occurring disease can also occur without a preceding viral infection.<sup>4</sup>

### CLINICAL FINDINGS

The spectrum of clinical findings depends in part on whether the disease is occurring in groups of young cattle in a large commercial feedlot, in a small farm feedlot, or in individual animals such as lactating dairy cows, in which illness is more easily recognized based on milk production and feed intake. In the feedlot situation, affected animals must be identified primarily by visual observation followed by closer physical examination.

#### Feedlot

In the feedlot, the disease usually occurs within 10 to 14 days after the animals have been stressed or have arrived in the feedlot. It may occur within 1 day after arrival if the animals have been incubating the disease before arrival. Animals found dead may be the first indication of an outbreak in which many weaned beef calves are obviously affected and some are in the incubation stages of the disease.

When viewed from a distance, affected cattle are depressed, and their respirations are rapid and shallow. There may be a weak protective cough, which becomes more pronounced and frequent if they are urged to

walk. Those that have been ill for a few days will appear gaunt because of anorexia. A mucopurulent nasal discharge, a crusty nose, and an ocular discharge are common. Although affected cattle are anorexic, they may continue to drink maintenance amounts of water.

When the disease has been diagnosed in a group or pen of animals, and new cases are occurring daily, those that are in the earliest stages of the disease are not obviously ill when examined from a distance. If the entire group of animals is put through a chute and examined closely, up to 20%, or even more, of apparently normal animals may have a fever ranging from 40° to 41°C (104°-106°F) and no other obvious clinical abnormalities. Auscultation of the thorax of some of these subclinical cases will reveal rapid, shallow respirations and an increase in the loudness of the breath sounds. These animals respond remarkably well to treatment. If not treated at this stage, they may progress to clinical cases within a few days, or they may recover uneventfully.

When the presence of a fever of 40°C (104.0°F), or higher in animals that are depressed is used to decide whether or not the animal has pneumonia and requires treatment, some animals are treated unnecessarily. In a feedlot pen of 112 recently arrived bull calves that were fitted with reticuloruminal temperature-sensing boluses, a total of 449 fever episodes were recorded in 110 animals during the first 40 days after arrival. Of these fever episodes, 74% were not associated with any visually apparent clinical signs or respiratory disease, and 75% lasted for less than 48 hours. A negative effect on average daily weight gain of feverish animals with or without clinical signs was recorded with prolonged episodes of fever with an approximate decrease of 33 g/day for each day of fever.<sup>11</sup>

Outbreaks of the disease in feedlots may last for 2 to 3 weeks or longer after the first index case, depending on the health status of the cattle when first affected. Outbreaks can be prolonged in feedlots that add groups of newly arrived cattle to an existing pen of cattle every few days to fill the pen to optimum capacity. The disease then occurs in each new group of cattle and may spread to previously resident cattle, perpetuating the disease for several weeks.

The origin of the cattle also influences the severity and length of outbreaks. In well-nourished cattle originating from one ranch and maintained as a single group, the morbidity may be less than 5% and the mortality nil. The outbreak will last only a few days, and the cattle return to normal quickly. In cattle that have originated from a variety of sources and moved through saleyards and then commingled in the feedlot, the disease may persist for several weeks. In these situations, many animals are sick with the disease when they arrive at the feedlot. Some cattle

will develop complications, never fully recover, and are culled later.

### Early Identification of Affected Animals in Feedlots

Where large numbers of cattle are involved, early identification is crucial to successful therapy. Identification of individual animals with early-stage respiratory disease in a large group presents a major challenge. Methods of diagnosing bovine respiratory disease based on visual appraisal by feedlot pen riders may not always effectively identify sick animals. A bayesian estimation of the performance of using clinical observation for diagnosis of bovine respiratory disease yielded an estimated sensitivity and specificity of 0.62 and 0.63, respectively, suggesting that up to 38% of truly diseased animals may go undiagnosed and conversely that up to 37% of animals diagnosed and subsequently treated for respiratory disease are unaffected by respiratory disease.<sup>12</sup> Improvement of the accuracy of both the diagnosis and the selection of those animals that require treatment will require improvement in the accuracy of the identification of affected animals by visual observation and the use of rapid and reliable clinical examination techniques of individual animals that can identify animals with evidence of pulmonary disease. Close physical examination techniques, such as auscultation of the lungs, are not routinely used in feedlots because of the time required to examine individual animals and the perceived inaccuracy of the examination in making a clinical diagnosis.

More recently, novel approaches to monitor calves at increased risk of developing respiratory disease, such as the use of temperature-sensing reticuloruminal boluses or infrared thermography to monitor heat loss in calves, have been studied, with promising results.<sup>11,13</sup> There is certainly a need to further improve our clinical diagnostic techniques and to develop new ones that can be applied to making a rapid and accurate diagnosis beside the animal in the field situation.

### Close Physical Examination

The typical case of pneumonic pasteurellosis reveals a fever of 40 to 41°C (104-106°F), bilateral mucopurulent nasal discharge, gaunt abdomen with rumen atony, coughing, varying degrees of polypnea and dyspnea, and evidence of bronchopneumonia. In the early stages there are loud breath sounds audible over the anterior and ventral parts of the lungs. As the disease progresses, these breath sounds become louder and extend over a greater area; crackles become audible, followed by wheezes in a few days, especially in chronic cases. Pleuritic friction rubs may be audible, although their absence does not preclude the presence of extensive adherent pleuritis. In severe cases or those of several days' duration, the dyspnea is marked,

commonly with an expiratory grunt, although the respiratory rate may not be elevated.

The course of the disease is only 2 to 4 days. If treated early, affected cattle recover in 24 to 48 hours, but severe cases and those that have been ill for a few days before being treated may die or become chronic despite prolonged therapy. Some cattle recover spontaneously without treatment.

A mild diarrhea may be present in some cases but is usually of no consequence. On an affected farm, calves may be affected with pneumonia, and young calves may die of septicemia without having shown previous signs of illness.

## CLINICAL PATHOLOGY

### Bacterial Culture

Nasopharyngeal swabs taken from clinical cases before treatment often yield a pure culture of pasteurellas, but *M. haemolytica* serotype A1 is the most common isolate obtained from weaned cattle with acute pneumonic pasteurellosis. The same serotype can usually be isolated from the upper respiratory tract of apparently healthy in-contact calves. *P. multocida* is the predominant pathogen cultured from swabs or bronchioalveolar lavage fluid in unweaned calves with pulmonary pasteurellosis. In recent years the number of clinical cases of bovine pneumonic pasteurellosis in older calves attributed to *P. multocida* in the absence of other Pasteurellaceae has increased considerably.<sup>4</sup>

The antimicrobial sensitivity of the pasteurellas isolated can be determined, but interpretation of the results is often difficult because it is not known whether the isolates from nasopharyngeal swabs represent those causing the lesions. Significant differences may exist between the antimicrobial sensitivities of isolates from nasopharyngeal swabs and those from the lung tissues. Thus it is not yet possible to recommend routine culturing and antimicrobial sensitivity determination of pasteurellas from nasal cavity or nasopharyngeal mucus from cattle with acute shipping fever pneumonia. In healthy calves monitored from the farm to the feedlot, there was no relationship between the nasal flora and pulmonary lesions.

### Serum Biochemistry and Hematology

The suitability of serum concentrations of acute-phase proteins (APPs) such as fibrinogen, serum amyloid A (SAA) or haptoglobin (Hp) as a diagnostic tool to identify calves with BRD has been explored in numerous studies with variable outcome.<sup>14-19</sup> Although increased concentrations of SAA and Hp in calves with BRD compared with healthy calves suggest that measuring the serum concentrations of these APPs could assist the early detection of calves with respiratory disease, the discriminative ability of Hp by itself for BRD was found to be no better than



determination of the rectal temperature.<sup>15</sup> The concentration of Hp varies considerably between calves even in healthy animals and is significantly affected by sex and rectal temperature.<sup>15</sup> The increase in serum Hp was found to occur within 24 hours of experimental challenge with *M. haemolytica* of BHV-1 infected calves but occurred between 4 and 8 days of infection with BRSV or BVDV. For SAA the wide variation between animals and the less pronounced increase in SAA concentration in animals suffering of BRD impairs the ability of this parameter to discriminate between healthy calves and animals affected by BRD.<sup>17</sup>

Leukocyte and differential cell counts are of little value as predictors of respiratory disease because leukocytosis and neutrophilia occur in some animals, but in others there may be a neutropenia or no significant change.

### NECROPSY FINDINGS

There is marked pulmonary consolidation, usually involving at least the anteroventral third of the lungs. The stage of pneumonia varies within the affected tissue, commencing with congestion and edema and passing through various stages of airway consolidation with serofibrinous exudation in the interlobular spaces. A catarrhal bronchitis and bronchiolitis, and a fibrinous pleuritis are usually present and may be accompanied by a fibrinous pericarditis. The lung is firm and the cut surface usually reveals an irregular, variegated pattern of red, white, and gray tissue as a result of hemorrhage, necrosis, and consolidation. Coagulation necrosis of pneumonic lungs is the most characteristic lesion in pneumonic pasteurellosis. In chronic cases there are residual lesions of bronchopneumonia with overlying pleural adhesions. Occasionally, sequestra of necrotic lung tissue are found. *P. multocida* causes a fibrinopurulent bronchopneumonia without the multifocal coagulation necrosis that is characteristic of the fibrinous lobar pneumonia associated with *M. haemolytica*.

The sequential gross and microscopic lesions of experimental bovine pneumonic pasteurellosis have been described and may provide guidelines for aging the lesions in naturally occurring cases. On days 2 to 3 after infection the lesion is characterized by soft grayish-purple consolidation; on day 6 the affected areas are firm and nodular; on days 9 to 10 the nodular lesions are more prominent and fibrous tissue encapsulates the lesions and becomes obvious. The initial microscopic changes consist of flooding of the alveoli with edema, fibrin, and hemorrhage. Large numbers of neutrophils and macrophages move into the alveoli by day 2. The classical lesion is visible by day 4 and consists of necrotic tissue surrounded by a dark zone of inflammatory cells. The elongate, "oat-cell" profile of some of these leukocytes is a useful marker in culture-negative

cases. In nonfatal cases a walling-off reaction by fibrous tissue isolates the necrotic tissue. Determination of the age of the lesions by gross and/or microscopic examination may assist in correlating the occurrence of the disease with specific health management procedures in the herd. In feedlot cattle, determining the age of bacterial pneumonia can help to assess whether or not the pneumonia was present in the animal on arrival or if treatment failure resulted from late detection or from inadequate drug therapy. The degree of necrosis and fibrosis are the main lesions used to age pneumonia.

In general, *M. haemolytica* causes a fibrinous pleuropneumonia with extensive thrombosis of interstitial lymph vessels and limited evidence of bronchitis and bronchiolitis. In contrast, bronchopneumonia attributable to *P. multocida* is associated with a suppurative bronchitis, minor thrombosis of interstitial lymph vessels, and considerably less exudation of fibrin.

The organism is easily cultured from acute, untreated cases, but other species of bacteria, including anaerobes, are often found in more chronic cases. More sophisticated tests such as PCR and immunoperoxidase techniques are available for the detection of *M. haemolytica* but are seldom required in diagnostic cases.

### Samples for Confirmation of Diagnosis

- Bacteriology—lung, bronchial lymph node (CULT)
- Histology—formalin-fixed lung (LM)

### DIFFERENTIAL DIAGNOSIS

The differential clinical diagnosis of pneumonic pasteurellosis is summarized in Table 12-6.

As a general guideline the common pneumonias of cattle may be divided into bronchial, interstitial, and hematogenous.

- The **bronchial pneumonias** include pneumonic pasteurellosis and other less common bacterial pneumonias characterized by toxemia and shallow respiration and a good response to early treatment.
- The **interstitial pneumonias** include the viral and parasitic pneumonias and acute interstitial pneumonias characterized by marked respiratory distress and a slow or no response to treatment. In viral pneumonias the animals may die acutely in a few days or recover over a period of several days.
- The **hematogenous pneumonias** are associated with vena caval thrombosis and pulmonary aneurysm and are characterized by acute respiratory distress, hemoptysis, and no response to treatment.

**Pneumonic pasteurellosis of cattle** is an acute, toxemic bronchopneumonia with a high fever and a good response to treatment in the early stages. Depression and anorexia are common. The disease is most common in young beef and dairy calves that have been recently stressed following weaning or mixed in auction markets and shipped to feedlots. The disease can also occur in mature cattle as a primary or secondary pneumonia.

In **viral interstitial pneumonia** of calves, young and adult cattle there is characteristic dyspnea, a moderate fever, only a mild toxemia, and loud breath sounds over the ventral aspects of the lungs followed by crackles and wheezes in a few days, and recovery may take several days. Pneumonia attributable to BRSV may be mild with uneventful recovery or severe with dyspnea and subcutaneous emphysema and a high case-fatality rate.

**Lungworm pneumonia** occurs most commonly in young pastured cattle and is characterized by dyspnea, coughing, only mild toxemia, and a moderate or normal temperature; the course may last several days. Usually many cattle are affected. Crackles and wheezes are usually audible over the dorsal aspects of the lungs, and the response to treatment is usually favorable if treatment is initiated early when signs are first noticed.

**Less common causes of acute pneumonia in calves and young cattle** include infection with *Klebsiella pneumoniae*, *Streptococcus* spp., and *Fusobacterium necrophorum*, all of which are characterized by a bronchopneumonia indistinguishable clinically from pneumonic pasteurellosis.

**Acute/atypical interstitial pneumonia (fog fever)** usually occurs in outbreaks in pastured cattle that have been moved from dry to lush pasture (or just a different species of pasture or on to a recently harvested cereal grain field); the onset is sudden, and some cattle may be found dead, whereas others are in severe respiratory distress with an expiratory grunt.

**Infectious bovine rhinotracheitis (IBR)** is characterized by rhinitis, usually with discrete lesions in the nares, tracheitis, loud coughing, high fever, and no toxemia unless secondary bacterial pneumonia is present. Recovery usually occurs gradually over 4 to 7 days.

**Contagious bovine pleuropneumonia** resembles pneumonic pasteurellosis but occurs in plague form; there is severe, painful, toxemic pleuropneumonia, and the case-fatality rate is high.

### TREATMENT

#### Antimicrobial Therapy

The recommendations for the treatment of bovine pneumonic pasteurellosis are based on clinical experience and the results of clinical field trials. Approximately 85% to 90% of affected cattle recover within 24 hours if treated in a timely manner.

### Choice of Antimicrobial

Choice of antimicrobial will depend on the cost, availability, expected efficacy based on previous experience with the antimicrobial in a particular area, ease of administration, frequency of administration required, concentrations of the antimicrobial that can be achieved in the lung tissues of affected animals, and length of the withdrawal period required before slaughter or withholding of milk in case of lactating dairy cattle. According to a recent survey among feedlots in the United States, the most commonly used antimicrobials used for the first-line treatment of BRD were tulathromycin (66.3%), followed by fluoroquinolones (43.1%), florfenicol, or third-generation cephalosporins (both 34.8%) and tetracyclines (28.1%).<sup>5</sup> Commonly used antimicrobials registered for the treatment of BRD and their dosages are listed in the treatment table of this section.

Several novel antimicrobials, such as the macrolides tilmicosin, tulathromycin, or gamithromycin, have successfully been used for treatment and control of bovine respiratory pasteurellosis. Other commonly used antimicrobials with proven efficacy include florfenicol, an analog of thiamphenicol, and the chinolones enrofloxacin and danofloxacin. Ceftiofur preparations have been evaluated and also found to be effective for the treatment of bovine respiratory pasteurellosis. Ceftiofur crystalline-free acid sterile suspension (CCFA-SS), a long-acting ceftiofur administered subcutaneously in the middle third of the posterior aspect of the ear, is effective, safe, and practical for the treatment of experimental pneumonic pasteurellosis and the control and treatment of bovine respiratory disease in feedlot cattle.

Some of the antimicrobials with a label for treatment of BRD, such as third- and fourth-generation cephalosporins and fluoroquinolones, are also classified as critically important for human and animal health and should therefore be used restrictively. The World Organization for Animal Health (OIE) issued following recommendations for these classes of antimicrobials:<sup>20</sup>

- Not to be used as preventive treatment applied by feed or water in the absence of clinical signs
- Not to be used as first-line treatment unless justified. When used in a second-line treatment, it should ideally be based on the results of bacteriologic tests
- Extra-label/off-label use should be limited and reserved for instances where no alternatives are available. Such use should be in agreement with the national legislature in force.

### Antimicrobial Sensitivity

The antimicrobial sensitivity of *M. haemolytica* varies, depending on the geographic origin of the animals and the previous use of the drug in the herd or the feedlot. Most

isolates of *M. haemolytica* have some degree of multiple antimicrobial resistance, associated with continued use.

Surveys of antimicrobial sensitivity trends for pathogens isolated from cattle with respiratory disease from all over the world based on MIC indicate that, overall, resistance to ampicillin, tetracycline, erythromycin, and sulfamethazine is frequently encountered among isolates of *M. haemolytica* and *P. multocida*.<sup>3</sup> The widespread resistance to erythromycin may account for the wide variation in sensitivity to tilmicosin because of cross-resistance. Ampicillin- and tetracycline-resistant *Pasteurella* isolates from dairy cattle (dairy herds and calf ranches) with pneumonia were spatially clustered within certain geographic areas in California. The percentage of *M. haemolytica* isolates resistant to ampicillin was 21.3%; to *P. multocida*, 12.3%. The percentage of *M. haemolytica* isolates resistant to tetracycline was 37%; to *P. multocida*, 52.5%. This reinforces the need to establish regional estimates of percentages of bacterial isolates which are susceptible to commonly used antimicrobials.

It was noticed that *M. haemolytica* serotype A6, the prevalence of which increased significantly over the last decade, exhibited significantly higher antimicrobial resistance rates than serotypes A1 and A2.<sup>21</sup>

Tetracycline resistance (*tet*) genes have been found in isolates of *P. multocida*, *M. haemolytica*, *M. glucosida*, and *M. varigena* from cases of respiratory diseases in cattle and pigs in Germany. Tetracycline resistance in *P. multocida* and *M. haemolytica* is mediated by at least three different *tet* genes, most of which are located on the chromosomes. A new *tet* (H)-carrying plasmid has been identified, and *tet* (B) has been detected in *P. multocida* and *tet* (G) in *M. haemolytica*. More recently, a plasmid carrying chloramphenicol–florfenicol resistance gene *floR* was identified in *M. haemolytica* isolates from cattle.<sup>22</sup>

### Medication of Feed and Water Supplies

There is much interest in mass medication of the drinking water or feed supply or both. The rationale is that the medication of the feed or water would successfully abort an outbreak by treating those animals incubating the disease, provide convalescent therapy to those that have already been treated individually, and deal with mild cases before they become acutely ill and need individual treatment. However, there are problems. The amount of water that cattle drink is directly proportional to feed consumption. If they are inappetent or anorexic, water consumption will decline to only maintenance requirements, and therapeutic levels of drug will not be achieved if the concentration in the water is provided at a level for normal consumption. The other major problem is the

provision of a uniform concentration of drug in the water supply, either through automatic water proportioners in the waterline or placing the drug directly into water tanks. Both can be unreliable. The mass medication of feed supplies or water of newly arrived feedlot cattle has been investigated as a method of reducing the morbidity and mortality as a result of respiratory disease in a number of studies, but results are equivocal. Although studies suggesting that chlortetracycline and sulfamethazine in feed are effective in reducing morbidity associated with BRD in calves have been published, issues around study design and data analysis questioned the validity of the results.<sup>23</sup>

### Antiinflammatory Agents

Antiinflammatory therapy was found to be beneficial in numerous studies in cases of severe respiratory disease that is characterized by marked dyspnea, fever, and feed intake depression. The best established effects of nonsteroidal antiinflammatory drugs (NSAIDs) in animals suffering of respiratory disease are a more rapid decline of the rectal temperature and faster return to normal feed and water intake. Long-term effects on clinical outcome, disease recurrence, and severity of chronic lung lesions reported in the literature are more variable.<sup>24</sup> The precise mechanism through which NSAIDs act in calves with respiratory disease is not entirely understood, but antiinflammatory properties improving respiratory gas exchange and antipyretic and analgesic properties improving the well-being and thereby feed and water consumption are believed to be of prime importance.<sup>25</sup> Numerous studies documented a more pronounced improvement in the initial phase of the disease in calves treated with NSAIDs and antimicrobials compared with animals treated with antimicrobials alone, a finding that is significant from an animal welfare perspective. Notwithstanding the veterinarian must be aware that this combination treatment complicates the assessment of the antimicrobial effect that should take place 48 hours after first treatment, as clinical improvement cannot unequivocally be attributed to the susceptibility of the causative pathogen to the administered antimicrobial drug. Experimental and clinical evaluation of the role of corticosteroid therapy in acute pneumonia in cattle yielded mostly unfavorable results.<sup>26</sup> Steroids are powerful antiinflammatory agents, but their effects on the animal's defensive measures, specifically with repeated use, reduces the value of their use in syndromes of infectious origin unless they have a short duration of action.<sup>27</sup>

A recent survey among U.S. feedlots revealed that on average NSAIDs were part of the standard initial treatment for respiratory disease in 55.9% of all feedlots, whereas steroids were used in 30.9% of the surveyed U.S. feedlots.<sup>5</sup>

## Failure to Respond

The causes of failure to respond to therapy include the following:

- Delayed initiation of treatment resulting in complications such as pulmonary abscess, bronchiectasis, and pleuritis
- Presence of viral or interstitial pneumonia or some other pneumonia that is not responsive to antimicrobials
- Inadequate dose of antimicrobials, inadequate treatment duration
- Antimicrobial resistance of the bacteria

### TREATMENT AND CONTROL

#### Treatment

##### Antimicrobial therapy

Tulathromycin (2.5 mg/kg SC as single dose) (R-1)

Florfenicol (20 mg/kg q48h IM or 40 mg/kg SC as single dose) (R-1)

Tilmicosin (10 mg/kg SC as single dose) (R-1)

Gamithromycin (6 mg/kg SC as single dose) (R-1)

Enrofloxacin\* (2.5–5.0 mg/kg q24 SC for 3 days or 7.5–12.5 mg/kg SC as single dose) (R-1)

Danofloxacin\* (6 mg/kg q48h SC or 8 mg/kg SC as single dose) (R-1)

Ceftiofur\* crystalline acid free (6.6 mg/kg SC posterior pinna as single treatment) (R-1)

Ceftiofur hydrochloride\* (1.1–2.2 mg/kg SC q24 for 3 days) (R-1)

Ceftiofur sodium\* (1.2–2.2 mg/kg SC/IM q24h for 3 days) (R-1)

Cefquinome\* (1 mg/kg IM q24 for 3–5 days) (R-1)

Oxytetracycline (10 mg/kg IM q24 for 4 days) (R-2)

Trimethoprim (2.66 mg/kg) + sulfadoxine (13.33 mg/kg) IM q24h for 3 days (R-2)

##### Antiinflammatory therapy

Flunixin meglumine (2.2 mg/kg IV as single dose) (R-2)

Ketoprofen (3 mg/kg IM q24h for 2–3 days) (R-2)

Carprofen (1.4 mg/kg IV or SC as single dose) (R-2)

Meloxicam (0.5 mg/kg SC/IV as single dose) (R-2)

Diclofenac (2.5 mg/kg IM as single dose) (R-2)

Tolfenamic acid (2 mg/kg IM/IV q24–48h or 4 mg/kg IM/IV as single dose) (R-2)

Prednisolone acetate (0.5 mg/kg IM q24h) (R-3)

Dexamethasone (0.01–0.03 mg/kg IM/IV) (R-3)

Flumethasone (0.03 mg/kg IM/IV) (R-3)

##### Metaphylaxis

Tulathromycin (2.5 mg/kg SC as single dose) (R-1)

Florfenicol (40 mg/kg SC as single dose) (R-1)

Tilmicosin (10 mg/kg SC as single dose) (R-1)

Gamithromycin (6 mg/kg SC as single dose) (R-1)

Oxytetracycline long-acting formulation (20 mg/kg IM) (R-2)

Enrofloxacin\* (7.5–12.5 mg/kg SC as single dose) (R-3)

Danofloxacin\* (8 mg/kg SC as single dose) (R-3)

Ceftiofur\* crystalline acid free (6.6 mg/kg SC posterior pinna as single treatment) (R-3)

Cefquinome\* (1 mg/kg IM q24 for 3–5 days) (R-3)

#### Vaccination

Vaccination against *M. haemolytica* and *P. multocida* (R-2)

Vaccination against *H. somni* (R-3)

Vaccination against BRSV, PI-3V, BHV-1 (R-2)

Vaccination against BVDV (R-2)

\*These are classified as critically important antimicrobials in human and veterinary medicine. Use as first-line treatment is discouraged.<sup>20</sup>

## CONTROL

Satisfactory economical control of the disease depends on the successful integration of management and perhaps the use of vaccines and antimicrobials metaphylactically. It is unrealistic to depend on a vaccine, an antimicrobial, or a single management technique to control the disease. Successful control begins with the adoption of effective management techniques, the judicious use of efficacious vaccines, and care in handling and transportation of cattle.

### Management Strategies Preconditioning Programs

Because of the common occurrence of the disease at the time of shipment from the ranch to the feedlot, much attention has been given to reducing the incidence of disease at this time. This led to the development in North America of the concept of preconditioning. The objective of preconditioning was to prepare the weaned calf for the feedlot environment by vaccinating it for all the commonly anticipated diseases before weaning and distributing all stressful procedures such as castration, dehorning, branding, and deworming over a period of time rather than concentrating these at weaning time. Weaning at least 2 weeks before shipment is considered as one of the most desirable preconditioning practices. This was to result in a weaned calf that could be moved into a feedlot in which the feed bunks and water bowls would not be strange but familiar and the calf would adjust quickly. The most common vaccinations were for BHV-1, PI-3V, BVDV, BRSV, and clostridial disease. In some situations, calves were also

vaccinated for *H. somni* and against pneumonic pasteurellosis.

### Weaning Procedures

Beef calves should be weaned at least 2 to 3 weeks before shipping and well in advance of anticipated inclement weather. A common successful practice is to begin feeding hay and providing water to calves at least 2 weeks before weaning in the same corral or paddock into which they will subsequently be weaned. Following such a weaning program, the calves require only a minimum of adjustment; the only adjustment necessary should be to the loss of their dams. Recently weaned calves should be observed at least twice daily for evidence of respiratory disease and treated promptly if necessary. They should not be transported long distances until they appear to be healthy and are eating liberal quantities of hay and drinking water normally. During transportation liberal quantities of bedding are necessary, and cattle should not be without feed and water for more than 24 to 30 hours. For long trips, calves should be rested for 8 to 12 hours and fed water and hay at intervals of 24 hours. This will minimize the considerable loss of body weight as a result of shrinkage and the effects of temporary starvation.

### Creep Feeding

The use of creep feed for calves for several weeks before weaning has been successful but may not always be economical. A high-energy ration containing cereal grains, a protein supplement, and the necessary vitamins and minerals is provided for the calves in a creep arrangement to which the dams do not have access. At weaning time the dams are removed from the calves, and the stress on the calves is minimal. This program has been very successful for purebred herds, where it may be economical, but in commercial herds, it is only economical when the market value of the calves warrants it.

### Conditioning Programs

In the absence of preconditioning programs, conditioning programs have become the usual procedure for preparing beef calves or yearlings for the feedlot. This begins with movement of the animals from their farm source to the feedlot. The ideal situation would be to avoid public saleyards and move the cattle directly from the ranch to the feedlot. This avoids the stress of handling, overcrowding, temporary starvation, exposure to aerosol infection from other cattle, and the unnecessary delays associated with buying and selling cattle. However, large intensified feedlots are unable to buy cattle directly from the herd of origin according to their needs at a particular time and thus inevitably purchase large groups of cattle of different backgrounds. This has necessitated the development of **conditioning procedures** or processing procedures in which,



after arrival, the cattle are individually identified; injected with a mixture of vitamins A, D, and E; treated with a residual insecticide; perhaps given an anthelmintic; injected with a long-acting antimicrobial; and vaccinated for clostridial and respiratory diseases. The issue of whether the cattle should be processed immediately after arrival or after a rest period of 2 to 3 weeks remains unresolved because there are few data to support one time over the other. However, the feedlot industry feels that processing immediately after arrival is most economical.

### Feeding Newly Arrived Cattle

The feeding and nutritional status of newly arrived cattle is important, but there are few scientific data to formulate a sound economical feeding program that will promote rapid recovery from shipping stress. Good results can be achieved when stressed calves are fed a receiving ration consisting of 50% to 75% concentrate with good-quality hay in a total mixed ration for the 2 to 3 weeks until the cattle have become adapted to their new environment.

## Vaccines

### General Comments

The use of vaccines against respiratory viruses and to a lesser extent against bacterial pathogens to control shipping fever and enzootic calf pneumonia is widespread. According to a large recent survey conducted in the United States, BVD vaccines are used in 96.6%, BHV-1 vaccines in 93.7%, BRSV vaccines in 89.5%, and PI-3 vaccines in 85.1% of surveyed feedlots to control BRD.<sup>5</sup> The use of vaccines against pasteurillas (63.8%) and *Histophilus somni* (69.7%) is less common. Notwithstanding the evidence of efficacy for this practice is equivocal at best. A review of the literature in 1997 on the efficacy of the vaccines available for the control of bovine respiratory disease concluded that there were few documented data to support the use of vaccines against respiratory disease under feedlot conditions. Since that time progress has been made in understanding immunity to pneumonic pasteurellosis, and some vaccines with varying degrees of efficacy have been developed. Various commercial vaccines differ in the rapidity and intensity of serum antibody responses to *M. haemolytica* whole cells and leukotoxin. Although the vaccines have been evaluated by experimental challenge of vaccinated animals with specific pathogens in a laboratory environment, there is little scientific evidence available that the vaccines are protective against bovine respiratory pasteurellosis as it occurs in the real-world situation.<sup>23</sup> Respiratory vaccines have consistently resulted in antibody production against the specific antigen, but obtained titers did frequently not protect against respiratory disease. Failures of vaccination can certainly not exclusively be attributed to the vaccines

themselves. Factors such as timing of vaccination or animal stress hampering the immune response to vaccination are likely to contribute to the poor vaccine performance.<sup>23</sup> Optimal vaccine response can only be expected in a fully immunocompetent animal, takes 2 to 3 weeks to develop, and may require multiple doses of vaccine to elicit protective immunity.<sup>28</sup>

### *Pasteurella* Vaccines

Based on the immunologic and microbiological observations of both the naturally occurring and experimental disease, it appears that immunization of cattle is possible. Calves that recover from experimentally induced pneumonic pasteurellosis possess increased resistance to subsequent experimental challenge. Cattle that have recovered from the natural disease are resistant to the disease. The **challenge** in the development of an efficacious vaccine against pneumonic pasteurellosis has been to **determine the most effective protective antigens** of the organism. Several different *Pasteurella* vaccines have been developed based on the virulence factors, including leukotoxin, lipopolysaccharides, capsular polysaccharides, and outer membrane proteins. Each of the vaccines produced may provide some protection against experimental and naturally occurring disease, but none provides a high degree of protection.

Modified live and killed vaccines are currently available. Live streptomycin-dependent *P. multocida* vaccines have been associated with improved health and weight-gain performance compared with unvaccinated calves in some studies. Killed pasteurilla vaccines did not show significant effects on morbidity, mortality, or extent of pulmonary damage and even were reported to result in increased morbidity in some cases.<sup>29</sup>

### Leukotoxin Extract Vaccine

High leukotoxin-neutralizing antibody titers induced by natural infections have been associated with reduced susceptibility to pneumonic pasteurellosis. Vaccination of calves with a leukotoxic culture supernatant from pathogenic *M. haemolytica* provides some protection against experimental challenge with the organism.

The efficacy of the leukotoxin extract vaccine has been evaluated in clinical field trials against naturally occurring bovine respiratory disease in weaned beef calves 6 to 8 months of age entering feedlots in Ontario and Alberta. In an initial field trial in Alberta, auction-market-derived calves were given two doses of the vaccine within 1 to 5 days of arrival. Mortality from all causes was significantly lower in vaccinated calves (4.2% vs. 2.1%), and mortality as a result of fibrinous pneumonia was lower (2.2% vs. 1.1%). In a trial in Ontario feedlots, recently shipped nonpreconditioned calves were vaccinated within 24 hours after

arrival. The vaccine resulted in a slight decrease in morbidity, slight improvement in treatment response rates, and a reduction in relapse rates. When the vaccine was combined with a modified live-virus vaccine containing the BHV-1 and PI-3 viruses, the mortality rate increased. However, the number of calves in each group was insufficient to adequately evaluate the differences. In another trial in Alberta the vaccine did not result in a change in morbidity or weight gain. Total mortality rates were increased significantly, and mortality rates from respiratory disease tended to be increased in ranch calves vaccinated at the ranch. In summary, there were no major benefits from vaccination.

A single vaccination of a *M. haemolytica* bacterin-toxoid given to calves on arrival in the feedlot reduced overall crude mortality, but there were no differences between vaccinates and nonvaccinates in bovine respiratory disease-specific mortality, morbidity, and/or average daily gain.

### Passive Immunity to

#### *Mannheimia haemolytica*

Vaccination of pregnant dairy cows at 6 and 3 weeks before parturition with a leukotoxin extract vaccine induced leukotoxin-neutralizing serum antibody titers in the cows, increased titers in colostrum, and increased passive leukotoxin colostrum antibody titers in the calves. Vaccination was also associated with increased indirect agglutinating serum antibody titers in the cows. The protective effect of the antibodies against naturally occurring disease in the calves was not determined.

Vaccination of beef cows with a combined genetically attenuated leukotoxin *M. haemolytica* vaccine and an *H. somni* vaccine once at 4 weeks prepartum increases passive antibody titers to both organisms in their calves. Double vaccination of the calves with preexisting maternal antibodies at 1 and 2 months of age will increase antibody titers to both organisms until 6 months of age. Vaccination of beef calves with low levels of preexisting antibody at 3 and 4 months of age will increase antibody titers to *H. somni* until 6 months of age and to *M. haemolytica* until 5 months of age. Thus prepartum vaccination may be an effective measure for the control of pneumonia in calves under 2 months of age, and vaccination of the calves at 3 and 4 months of age may provide additional protection until the calves are 6 months of age.

### Evaluation of Efficacy of *Mannheimia haemolytica* Vaccines

Meta-analysis of the published literature on the efficacy of the various vaccines against pneumonic pasteurellosis of cattle indicates that culture supernatants and/or potassium-thiocyanate-extracted outer-membrane protein vaccines perform as well

as live vaccines. Live vaccines are considered to be the best in terms of protective immunity induced against pneumonic pasteurellosis because they replicate at the site of injection and produce the important immunogens that stimulate a protective immune response. However, live vaccines are associated with side effects such as fever, local abscessation, and lameness.

Commercial vaccines have been evaluated by measuring antibodies in 4- to 6-week-old calves vaccinated against leukotoxin, capsular polysaccharide, whole-cell antigens, and iron-regulated outer-membrane proteins. A bacterin-toxoid, a leukotoxin culture supernatant, a modified live *M. haemolytica* and *P. multocida* vaccine, and an outer-membrane extract of the organism were evaluated. All vaccines induced antibodies to the antigens, but there were wide variations between the vaccines: some vaccines demonstrated little if any antibody to leukotoxin or outer-membrane proteins. The highest leukotoxin antibody titer did not reach its peak until 14 days after the booster dose of vaccine, which suggests that a second dose of vaccine is necessary for protection.

The efficacy of three commercial vaccines was evaluated against experimental pneumonic pasteurellosis. Protective immunity was evaluated by assessment of clinical scores and lung lesions after endobronchial challenge with virulent *M. haemolytica*. There was significant correlation between lung and serum antibody levels against leukotoxin, capsular polysaccharide, and outer-membrane proteins. The vaccines did not provide optimal protection, but the bacterin-toxoid vaccine was superior to the others. The culture supernatant containing leukotoxin, lipopolysaccharide, and capsular polysaccharide provided the best protection against experimental disease compared with a sodium salicylate extract containing outer-membrane proteins, lipopolysaccharide, and capsular polysaccharide, and a combination of these two. Leukotoxin is an important virulence factor in the disease, and its use in vaccines provides significant protection. Muramyl dipeptide analogs may increase the humoral and protective response of calves to capsular polysaccharide.

#### Adverse Vaccine Reactions

Some adverse reactions are associated with live vaccines. Systemic infection attributable to *M. haemolytica* occurred 2 to 18 days following vaccination with an avirulent live culture of *M. haemolytica*. Lesions included injection site inflammation, purulent meningitis, and polyarthritis. Abscess formation at injection sites after vaccination with modified live *M. haemolytica* vaccines is also possible. The purified capsular polysaccharide of *M. haemolytica* used in combination with other antigens did not provide protection but rather caused a high incidence of anaphylaxis.

#### *Histophilus somni* Vaccines

Few studies have investigated the effectiveness of *H. somni* vaccination of feedlot cattle to control respiratory disease. The antibody response was found to be associated with protection against *H. somni*.<sup>1</sup> When used as part of a preconditioning program the vaccine tended to have mildly positive or neutral effect on morbidity and mortality related to respiratory disease, whereas the effect appeared to be neutral or even negative when animals were vaccinated on arrival at the feedlot.<sup>1</sup> Observed effects on morbidity and mortality were below the significance level. Little scientific evidence is currently available to support the use of *H. somni* vaccination to control BRD.<sup>29</sup>

#### Viral Vaccines

Because prior infection of the respiratory tract with either BHV-1, BRSV, or PI-3V may predispose to pneumonic pasteurellosis, the vaccination of beef calves 2 to 3 weeks before weaning and feedlot cattle 2 weeks before shipment to a feedlot has been recommended as part of a preconditioning program. A modified live-virus BRSV vaccine given to beef calves before weaning, at weaning, or immediately after arrival in the feedlot was associated with a significant reduction in the treatment rate in one of three groups immunized before weaning and in calves immunized after arrival in the feedlot. There was no significant effect of the vaccine on treatment rate in calves immunized at weaning, in calves immunized after arrival in a bull test station, or in yearlings immunized after arrival in the feedlot. It would appear that the vaccine did provide some protection, but the small reduction may not justify the cost of the vaccination program. Vaccination of calves at 3 to 6 months of age with an intranasal modified live BHV-1, BRSV, and PI-3V vaccine provides protection against experimental pneumonic pasteurellosis induced by aerosol challenge with BHV-1 followed 4 days later by an aerosol of *M. haemolytica*. Using this principle of control, it would be necessary to vaccinate the calves at least 2 weeks before they are weaned, stressed, or transported to a feedlot. Vaccination on arrival with modified live-virus vaccines, although commonly done, may be associated with increased mortality.

#### Antimicrobial Metaphylaxis

The early onset of pneumonic pasteurellosis in cattle within a few days after arrival in combination with the limitations of identifying clinically affected animals that need therapy was a major factor in the development of metaphylactic use of antimicrobials. Although the metaphylactic use of antimicrobials to control BRD is debatable from the point of view of prudent antimicrobial use, this approach was documented to considerably reduce morbidity and mortality rates in

a group, thereby having a significant positive effect on animal health and welfare. The administration of antimicrobials to high-risk calves immediately after arrival is particularly effective under commercial feedlot conditions. Meta-analysis of the literature on mass medication for bovine respiratory disease indicates that metaphylactic parenteral mass medication of calves with long-acting antimicrobials such as oxytetracycline, florfenicol, tilmicosin, or other novel macrolide antimicrobials on arrival at the feedlot will reduce bovine respiratory disease morbidity rates.

The use of tilmicosin at 10 mg/kg BW subcutaneously, florfenicol at 40 mg/kg BW subcutaneously, gamithromycin at 6 mg/kg BW subcutaneously, tulathromycin at 2.5 mg/kg BW and ceftiofur crystalline-free acid at 6.6 mg/kg BW administered subcutaneously at the base of the ear were found effective in reducing the morbidity rate when given to feedlot calves at high risk of developing respiratory diseases.<sup>30-32</sup> The results obtained with long acting oxytetracycline at a dose of 20 mg/kg BW or higher reported in the literature are more variable.<sup>23</sup> Although an economical advantage may result from the lower price of oxytetracycline compared with newer antimicrobials, morbidity rates were found to be higher with metaphylactic treatment with oxytetracycline compared with tilmicosin.<sup>23</sup>

#### Mass Medication of Feed and Water Supplies

The mass medication of feed supplies or water of newly arrived feedlot cattle has been investigated as a method of reducing the morbidity and mortality resulting from respiratory disease in a number of studies, but results are equivocal. Although studies suggesting that chlortetracycline and sulfamethazine in feed are effective in reducing morbidity associated with BRD in calves have been published issues around study design and data analysis questioned the validity of the results.<sup>23</sup> A standard recommendation is to provide 150 mg/kg BW for the first 24 hours and reduce the level to 75 mg/kg BW for the duration of the medication period, which may last 5 to 10 days.

#### FURTHER READING

- Ackermann MR, Brogden KA. Response of the ruminant respiratory tract to *Mannheimia* (*Pasteurella*) *haemolytica*. *Microb Infect*. 2000;2:1079-1088.
- Dabo SM, Taylor JD, Confer AW. *Pasteurella multocida* and bovine respiratory disease. *Anim Health Res Rev*. 2008;8:129-150.
- Fulton RW, Blood KS, Panciera RJ, et al. Lung pathology and infectious agents in fatal feedlot pneumonias and relationship with mortality, disease onset, and treatment. *J Vet Diagn Invest*. 2009;21:464-477.
- Jeyaseelan S, Sreevatsan S, Maheswaran SK. Role of *M. haemolytica* leukotoxin in the pathogenesis of bovine pneumonic pasteurellosis. *Anim Health Res*. 2002;3:69-82.

- Perino LJ, Hunsaker BD. A review of bovine respiratory disease vaccine field efficacy. *Bovine Pract.* 1997;31:59-66.
- Roth JA, Henderson LM. New technology for improved vaccine safety and efficacy. *Vet Clin North Am Food A.* 2001;17:585-597.
- Sing K, Ritchey JW, Confer AW. *Mannheimia haemolytica*: bacterial-host interactions in bovine pneumonia. *Vet Pathol.* 2011;48:338-348.
- Taylor JD, Fulton RW, Lehenbauer TW, et al. The epidemiology of bovine respiratory disease: what is the evidence for preventive measures? *Can Vet J.* 2010;51:1351-1359.
- Wilson BA, Ho M. *Pasteurella multocida*: from zoonosis to cellular microbiology. *Clin Microbiol Rev.* 2013;26:631-655.
- Zecchinon L, Fett T, Desmecht D. How *Mannheimia haemolytica* defeats host defence through a kiss of death mechanism. *Vet Res.* 2005;36:133-156.

## REFERENCES

- Griffin D. *Vet Clin North Am Food A.* 2010;26:57-71.
- Sing K, et al. *Vet Pathol.* 2011;48:338-348.
- Katsuda K, et al. *Vet J.* 2008;178:146-148.
- Dabo S, et al. *Anim Health Res Rev.* 2008;8:129-150.
- USDA Feedlot, 2011, part IV. (Accessed 15.09.15, at: <[http://www.aphis.usda.gov/animal\\_health/nahms/feedlot/downloads/feedlot2011/Feed11\\_dr\\_PartIV.pdf](http://www.aphis.usda.gov/animal_health/nahms/feedlot/downloads/feedlot2011/Feed11_dr_PartIV.pdf)>).
- USDA 2007 Dairy, 2007, part I. (Accessed 15.09.15, at: <[http://www.aphis.usda.gov/animal\\_health/nahms/dairy/downloads/dairy07/Dairy07\\_dr\\_PartI.pdf](http://www.aphis.usda.gov/animal_health/nahms/dairy/downloads/dairy07/Dairy07_dr_PartI.pdf)>).
- Stanton AL, et al. *J Dairy Sci.* 2010;93:574-581.
- Kaneene JB, Hurd HS. *Prev Vet Med.* 1990;8:127-140.
- van der Fels-Klerx HJ, et al. *Prev Vet Med.* 2001;51:75-94.
- Hodgson PD, et al. *Vet Res.* 2012;43:21.
- Timsit E, et al. *J Anim Sci.* 2011;89:4272-4280.
- White BJ, Renter DG. *J Vet Diagn Invest.* 2009;21:446-453.
- Schaefer AL, et al. *Res Vet Sci.* 2012;93:928-935.
- Ganheim C, et al. *Vet J.* 2007;173:645-651.
- Svenson C, et al. *Vet J.* 2007;174:288-294.
- Eckersall PD, Bell R. *Vet J.* 2010;185:23-27.
- Angen O, et al. *Vet Microbiol.* 2009;137:165-171.
- Nikunen S, et al. *Comp Immunol Microbiol Infect Dis.* 2007;30:143-151.
- Caswell JL, et al. *Vet Clin North Am Food A.* 2012;28:419-441.
- World Organization for Animal Health. OIE list of antimicrobial agents of veterinary importance, 2013. (Accessed 15.09.15, at: <[http://www.oie.int/fileadmin/Home/eng/Our\\_scientific\\_expertise/docs/pdf/OIE\\_List\\_antimicrobials.pdf](http://www.oie.int/fileadmin/Home/eng/Our_scientific_expertise/docs/pdf/OIE_List_antimicrobials.pdf)>).
- Katsuda K, et al. *Res Vet Sci.* 2013;94:205-208.
- Katsuda K, et al. *Vet Microbiol.* 2012;155:444-447.
- Taylor JD, et al. *Can Vet J.* 2010;51:1351-1359.
- Francoz D, et al. *Vet Clin North Am Food A.* 2012;28:23-38.
- Barrett DC. *Cattle Pract.* 2004;12:69-74.
- Peek SF. *Vet Clin North Am Food A.* 2005;21:697-710.
- Lekeux P, et al. *Cattle Pract.* 2007;15:115-119.
- Edwards TA. *Vet Clin North Am Food A.* 2010;26:273-284.
- Larson RL, Step DL. *Vet Clin North Am Food A.* 2012;28:97-106.
- Torres S, et al. *Am J Vet Res.* 2013;74:839-946.
- Catry B, et al. *J Vet Pharmacol Therap.* 2008;31:479-487.
- Hibbard B, et al. *Vet Ther.* 2002;3:22-30.

## DISEASES OF THE RESPIRATORY TRACT ASSOCIATED WITH MYCOPLASMA SPP.

Several mycoplasmas have been isolated from pneumonic and nonpneumonic lungs of cattle, sheep, and goats (Table 12-6), but attempts to reproduce respiratory tract disease with the isolates have resulted in inconclusive findings.

### Sheep

In sheep, *M. ovipneumoniae* is the most important species of mycoplasma affecting the respiratory tract. The pathogen is the cause of **atypical or ovine nonprogressive pneumonia**, also known as summer pneumonia in New Zealand and Australia.<sup>1</sup> *M. ovipneumoniae* is believed to cause disease by predisposing the lower respiratory tract to invasion by other organisms, such as *Parainfluenza-3 virus* or *Mannheimia haemolytica*. *M. ovipneumoniae*, although in low numbers, is frequently isolated from the upper respiratory tract of healthy sheep, which may act as source of infection to young lambs. A high prevalence of *M. ovipneumoniae* in association with *M. haemolytica* in lung tissue of lambs has been reported from Turkey and more recently from Italy.<sup>2</sup> Lambs get infected during the first days of life but usually do not show clinical signs before 5 or 10 weeks of age. Clinical disease is commonly triggered by stress, inclement weather, or a secondary bacterial infection.<sup>3</sup>

The clinical presentation can vary from mildly affected dull lambs with increased respiratory rate, coughing, increased rectal temperature, anorexia, and poor growth to severely affected animals with acute fibrinous pneumonia, lung consolidation, pleuritis, and pulmonary abscesses formation. Most commonly the disease results in chronic, persistent, and irregular cough, with mucopurulent nasal discharge.<sup>3</sup> Treatment with fluoroquinolones, tetracyclines, or macrolid antibiotics often results in a rapid improvement that is followed by a relapse once the treatment is discontinued.

The diagnosis is complicated by the common occurrence of *M. ovipneumoniae* in the field. Whereas isolation of the pathogen from the upper respiratory tract is of little diagnostic value, the presence of it in the lower respiratory tract, particularly when associated with lung lesions is highly suggestive of an etiologic role of this pathogen. Paired serum samples obtained 2 to 3 weeks apart from acutely affected animals to determine rising antibody titers give a good indication of an active infectious process and are of more diagnostic value than the simple determination of an antibody titer at one time.

In the United States, *M. ovipneumoniae* has recently been associated with several outbreaks of epizootic pneumonia, a devastating respiratory tract disease of yet

unknown etiology in sheep.<sup>4</sup> Although a number of other pathogens, such as *Mannheimia haemolytica* and *Pasteurella multocida*, have consistently been isolated from sick animals along *M. ovipneumoniae*; this latter pathogen was the only agent with a significantly higher prevalence in animals from outbreaks (95%) than unaffected control animals (0%).<sup>4</sup>

Other *Mycoplasma* spp. occasionally associated with respiratory disease in sheep include *M. arginini*, *M. agalactiae*, *M. putrefaciens*, *M. mycoides* subsp. *capri* (formerly *M. mycoides* subsp. *mycoides* LC), *M. capricolum* subsp. *capricolum*, and *M. bovis*. When found in clinically affected animals, these *Mycoplasma* spp. are frequently isolated in combination with other pathogens, obscuring their role in ovine respiratory disease. Only *M. capricolum* subsp. *capricolum* is considered an important pathogen and the major cause of pneumonia in sheep in North Africa.

### Goats

Mycoplasma infections in goats most commonly involve the *Mycoplasma mycoides* cluster organisms that include *M. mycoides* subsp. *capri*, *M. capricolum* subsp. *capricolum*, and *M. capricolum* subsp. *capripneumoniae*, the etiologic agent of the **contagious caprine pleuropneumonia** (see also “Contagious Caprine Pleuropneumonia”).<sup>5</sup> Although contagious caprine pleuropneumonia is characterized by clinical disease specifically affecting the respiratory tract, the other members of the *M. mycoides* cluster have also been associated with polyarthritis.<sup>6</sup>

**Contagious agalactia** is another economically important disease of sheep and goats caused by mycoplasma infection and occasionally associated with respiratory disease (see also “Contagious Agalactia”). *Mycoplasma* spp. incriminated as etiologic agents of contagious agalactia are *Mycoplasma agalactia*, the classical etiologic agent of the disease, *Mycoplasma putrefaciens*, and the two species of the *mycoides* cluster, *Mycoplasma mycoides* subsp. *capri* and *M. capricolum* subsp. *capricolum*.

Other *Mycoplasma* spp. associated with respiratory disease in goats include *M. arginini*, *M. bovis*, and *M. ovipneumoniae*.<sup>7</sup>

The most common syndrome in goats associated with mycoplasma is a chronic interstitial pneumonia with cough, unthriftiness proceeding to extreme emaciation, chronic nonpainful bony enlargement of joints, and chronic indurative mastitis. The pneumonia in some cases progresses to the point where cor pulmonale develops, with a subsequent appearance of the signs of congestive heart failure.

### Cattle

*M. bovis* is a major cause of calf pneumonia (see also “*Mycoplasma bovis* Pneumonia”). In



England and Wales, serologic screening between 2000 and 2009 revealed a herd seroprevalence of *M. bovis* of over 30%, and *M. bovis* was isolated on average in 40% of pneumonic lungs submitted during that time period.<sup>8</sup> In Israel, *M. bovis* was isolated from 26% to 65% of samples from pneumonic calves submitted between 2004 and 2008.<sup>9</sup> *M. bovis* was also the strain isolated from more than half of the 1000 samples from calves with bronchopneumonia that were submitted to different diagnostic laboratories in France between 2003 and 2008.<sup>8</sup> In a series of cases of chronic, antibiotic-resistant pneumonia, sometimes with concurrent polyarthritis, in feedlot cattle in western Canada, *M. bovis* was present in the lung tissues of more than 90% of cases, and bovine viral diarrhoea virus (BVDV) was present in 60% of the cases suggesting a possible synergism between *M. bovis* and the BVDV. Outbreaks of pneumonia and arthritis in beef calves associated with infection caused by *M. bovis* and *Mycoplasma californicum* have been described in a mixed dairy cattle and beef cattle herd kept under extremely poor housing and hygienic conditions. The prevalence of infection of *M. bovis* in Danish cattle appeared to increase over a period of several years.

A large increase in the detection of *M. alkalescens* since 2003 has been reported from Great Britain, where this species accounted for 26% of all isolated from bovine lungs in 2009. A similar trend has been observed in France and Israel, but the significance of this development is not clear.<sup>8</sup>

*M. arginini*, *M. dispar*, *Ureaplasma diversum*, *M. bovirhinis*, *M. canis*, *M. canadense*, and *M. bovis* have also been isolated from the lungs of pneumonic cattle, but it is uncertain if they are primary causes of disease.<sup>8</sup> During a 3-year period in Belgium, in calves with respiratory disease, the prevalence of *M. bovis* was 31.5%, *M. dispar* 45.5%, *M. canis* 10.7%, and *Ureaplasma diversum* 14.8%, and in half the cases they occurred in association with *Pasteurella* and/or *Mannheimia* species. In a survey of pneumonic bovine lungs submitted to a diagnostic laboratory in Denmark, 83% were found infected with mycoplasmas. The predominant mycoplasmas were *Ureaplasma* spp. (72%), *M. dispar*, (48%), and *M. bovis* (24%). Multiple species mycoplasma infections were predominant.

*M. dispar* is capable of producing pneumonia without clinical signs in gnotobiotic calves, and in conjunction with *Ureaplasma* spp. it has been found commonly in “cuffing” pneumonia of calves. It could, therefore, be a precursor to other infections causing enzootic pneumonia in calves or with pasteurellae producing fibrinous pneumonia of calves.

### Horses

*Mycoplasma* spp. appear to be opportunistic pathogens in equine respiratory tract

infection. *M. felis* has been associated with outbreaks of lower respiratory tract disease and pleuritis of horses. In a retrospective study reviewing the occurrence of different pathogens isolated from specific anatomic sites of horses revealed that *Mycoplasma* spp. were isolated from 6 out of nearly 200 horses with respiratory disease and in each case were part of chronic, mixed infection.<sup>10</sup>

### REFERENCES

1. Goncalves R, et al. *Vet J.* 2010;183:219-221.
2. Ettore C, et al. *Vet Ital.* 2007;43:149-155.
3. Nicholas RAJ, et al. *Small Ruminant Res.* 2008;76:92-98.
4. Besset TE, et al. *Emerg Infect Dis.* 2012;18:406-414.
5. Nicholas R, Chuchward C. *Transbound Emerg Dis.* 2012;59:189-196.
6. Giadinis ND, et al. *Vet Rec.* 2008;163:278-279.
7. Adehan RK, et al. *Small Ruminant Res.* 2006;63:44-49.
8. Nicholas RAJ. *Vet Rec.* 2011;168:459-462.
9. Gerchmann I, et al. *Vet Microbiol.* 2009;137:268-275.
10. Clark C, et al. *Can Vet J.* 2008;49:153-160.

## CONTAGIOUS BOVINE PLEUROPNEUMONIA (LUNG SICKNESS, CBPP)

### SYNOPSIS

**Etiology** *Mycoplasma mycoides* subsp. *mycoides* (small colony) (*MmmSC*).

**Epidemiology** A major plague of cattle, endemic in Africa but considered as eradicated in most other parts of the world. Reportable disease to the World Organization for Animal Health (OIE, list A). Insidious nature of disease allows it to spread undetected for months.

**Signs** Fever, agalactia, anorexia, depression, coughing, thoracic pain, back arched, dyspnea, expiratory grunting, pleuritic friction rubs, dull areas of lung, edema of throat and dewlap.

**Clinical pathology** Complement fixation test (CFT), competitive enzyme-linked immunosorbent assay (C-ELISA). Nucleic acid recognition of causative organism with polymerase chain reaction (PCR).

**Lesions** Remarkable pleuritis, marked consolidation and marbling of lung, pleural adhesions.

**Diagnostic confirmation** Isolation of organism from tissue (lung) or pleural or synovial fluid.

**Treatment** Not recommended because of usually poor treatment response and the risk of developing carrier animals.

**Control** Identification and slaughter of sick animals. Vaccination followed by test and slaughter. Antimicrobial therapy of exposed animals may reduce disease transmission but is prohibited in many countries. Establish disease-free areas. Control movement of cattle in control areas.

### ETIOLOGY

*Mycoplasma mycoides* subsp. *mycoides* small colony (SC) (*MmmSC*) is the cause of the contagious bovine pleuropneumonia (CBPP). This pleomorphic organism belongs to the *mycoides* cluster, which consists of six closely related mycoplasma species, that are subdivided into two groups, *capricoloum* and *mycoides* (Table 12-8). Only two of the six species cause disease in cattle, *MmmSC*, which is the cause of CBPP, and *Mycoplasma bovine group 7* (Bg7), which may cause arthritis and bovine mastitis. The four others, two subspecies within the *Mycoplasma mycoides* group and two subspecies within the *Mycoplasma capricoloum* group, are responsible for goat respiratory and other diseases.

Although *MmmSC* has been isolated from buffalos, sheep, and goats, which may thus function as hosts, the pathogen only causes disease in ruminants of the *Bos* genus (i.e., bovine and zebu cattle). The disease is not communicable to other species.<sup>1</sup> *MmmSC* is very similar culturally and antigenically to the causative organism of caprine contagious pleuropneumonia, but the two can be differentiated culturally and biochemically.

### EPIDEMIOLOGY

CBPP is considered one of the economically most important cattle plagues affecting Africa, and with relaxation of import controls and increase in international trade, it presents a constant risk for disease-free countries. The World Organization for Animal Health (OIE) has categorized CBPP as so-called “List A” disease. List A currently lists a total of 15 diseases notifiable to the OIE that are considered “transmissible diseases that have the potential for very serious and rapid spread, irrespective of national borders, that are of serious socioeconomic or public health consequence and that are of major importance in the international trade of animals and animal products.”<sup>2</sup> The Pan African Programme for the Control of Epizootics (PACE), which is implemented in 32 African countries, identified CBPP as the second most common transboundary disease in Africa after rinderpest.<sup>3</sup>

### Occurrence and Prevalence of Infection

Under natural conditions, CBPP occurs in cattle of the species *Bos*. Although buffaloes can be infected by artificial means, only one single case has been reported in an American buffalo and none in African buffaloes or other wild ruminants. Wild and small ruminants are currently not considered to play a relevant role in the epidemiology of CBPP.<sup>1,3</sup>

Currently CBPP affects around 30 countries in sub-Saharan Africa, of which several are endemically infected. Although the condition was eradicated from many countries during the nineteenth and twentieth centuries through stringent movement control and culling of infected cattle, it has reemerged

**Table 12-8** Contagious pleuropneumonia-1: Members of the *Mycoplasma mycoides* cluster

Name	Main disease	Main (and other) hosts
<i>M. mycoides</i> subsp. <i>mycoides</i> SC variant	Contagious bovine pleuropneumonia	Cattle (goats, sheep, buffalo)
<i>M. mycoides</i> subsp. <i>mycoides</i> LC variant	Caprine pneumonia, contagious agalactiae	Goats (sheep, cattle)
<i>Mycopoides</i> subsp. <i>capri</i>	Caprine pneumonia	Goats (sheep) but rare
<i>M. capricolum</i> subsp. <i>capricolum</i>	Caprine pneumonia, contagious agalactiae	Goats (sheep, cattle)
<i>M. capricolum</i> subsp. <i>capripneumoniae</i>	Contagious caprine pleuropneumonia	Goats (sheep)
<i>M. bovine</i> group 7 (Bg7)	Arthritis, also mastitis, calf pneumonia	Cattle

in Africa during the second half of the past century, and several outbreaks have been recorded in southern Europe until the end of last century. Reasons behind the failure to contain CBPP in Africa include the following:<sup>4,5</sup>

- **Changes of ecological/environmental factors**, such as availability of water, droughts, and floods, leading to increased movement of livestock over long distances
- **Civil strife and political and economic difficulties** complicating the strict movement control of apparently infected cattle
- **Lack or insufficient resources allocated to CBPP control**, particularly limited funding for vaccination, livestock movement control, and mass education of farmers and veterinarians
- **Limited potency and field performance of CBPP vaccines**
- **Reduced disease surveillance** (e.g., serologic screening and abattoir studies)
- **Distraction by control and prevention of other economically important diseases** (e.g., rinderpest or avian influenza)

Historically CBPP spread throughout the European continent during the eighteenth century through uncontrolled movement of livestock caused by transhumance and wars. During the nineteenth and twentieth centuries the disease was introduced into the United States, Asia, Australia, and Japan. CBPP was first introduced into **Africa** through an infected Holstein Friesian bull imported from the Netherlands to South Africa in 1854.<sup>4</sup> From there the disease spread to other South African countries, causing the death of over 100,000 cattle.<sup>6</sup> By 1939 the disease was eradicated in most South African countries but not in war-torn Angola and Namibia, where it still remains a threat for neighboring disease-free countries.<sup>6</sup>

CBPP was reported from 27 African countries between 1995 and 2002, of which 13 were in West Africa, two in Central Africa, six in East Africa and the remainder in South Africa.<sup>3</sup> In East Africa CBPP is endemic in Burundi, Rwanda, large parts of Tanzania, southern Sudan, Ethiopia, and Somalia.<sup>3,7,8</sup> Guinea, Mali, Niger, and Mauritania are endemically infected countries in West Africa and Angola and Zambia in the South African region.<sup>3</sup> Numerous epidemic outbreaks of the disease, spreading from endemic neighboring regions through livestock movement have been reported, including Burundi and Zambia in 1997, Tanzania in 1996 and 1999, and Botswana in 1995 and 1998.<sup>3,9</sup>

The infection prevalence varies considerably in endemic regions of the world. Whereas a seroprevalence of 8% of the cattle population has been reported in Sudan, prevalence rates in the range of 25% have been given for Ethiopia, Chad, Guinea, and Tanzania. For Burkina Faso and Uganda, prevalence rates below 5% have been reported.<sup>3</sup>

In **Asia**, CBPP has been reported from Assam in India, Bangladesh, and Myanmar. Sporadic outbreaks have been recognized in the Middle East, probably derived from importation of cattle from Africa. The latest Asian outbreaks reported to the OIE occurred in Mongolia, India, and Pakistan in 1973, 1990, and 1997 respectively.<sup>10</sup> In China CBPP first occurred at the beginning of the twentieth century through livestock shipments from Australia.<sup>10</sup> In the early 1950s China implemented its first control measures, including a vaccination program, after having suffered severe economic damage from the plague. The country declared itself free of CBPP in 1996 and is currently officially recognized as CBPP-free by the OIE.<sup>11</sup>

The disease was introduced into **Australia** in 1858 by dairy cattle imported from England into the colony of Victoria. It spread rapidly throughout Australia by cattle being driven to take up new pastoral lands

everywhere, aided by the bullock teams, which provided the only form of transportation of goods and supplies in those days. In 1958 a national eradication campaign was commenced. Australia was declared free from the disease 1973.

The disease was introduced into the **United States** in 1842 through cattle imports from England. CBPP became so widespread over the following 40 years that the federal government initiated the first intensive campaign to control an animal disease in 1887. By implementing strict quarantine and culling diseased animals the disease could be eradicated by 1892. CBPP was never recorded to occur in **South America**.

In **Europe**, after having been eradicated at the end of the nineteenth century, the disease reemerged in Portugal in 1951 and in Spain in 1957.<sup>4</sup> In the 1980s, after an apparent absence of 13 years, CBPP was diagnosed on the borders of France and Spain, from where the disease apparently spread to Portugal, where another outbreak was recorded in 1983. Although the disease could be rapidly controlled in France and Spain, recurrent outbreaks occurred in Portugal until the end of last century. Italy, which had been free of the disease since 1899, saw an outbreak of CBPP between 1990 and 1993 that could never be traced back to its source. Within these 3 years the disease spread over an area 59 km<sup>2</sup>, affecting nearly 100 cattle herds and requiring the slaughter of over 24,000 cattle. The disease was eradicated in 1993. The last reported outbreak in Europe occurred in northern Portugal in 1999. As of 2004, Europe is free from CBPP and the European Union rules prevent the importation of live animals from affected areas. A recent phylogenetic analysis indicated all *MmmSC* strains isolated in Europe since 1980 were derived from a common ancestor, suggesting that a single strain may have spread, largely unnoticed, in southern Europe between 1980 and 1993.<sup>12</sup>

### Source of Infection

The focus of infection is often provided by recovered “carrier” animals in which a pulmonary sequestrum preserves a potential source of organisms for periods as long as 3 years. For many years, it was thought that conditions of stress attributable to starvation, exhaustion, or intercurrent disease can cause the sequestrum to break down and convert the animal into an active case. Experimental evidence throws some doubt on this explanation, but droplet infection is usually associated with a donor lesion in the lungs. Renal lesions are not uncommon and large numbers of viable *MmmSC* are passed in the urine of infected animals, and inhalation of urine droplets may be a route of infection. The organism has been **isolated from the semen** and preputial washings of two young bulls that were the result of frozen embryos implanted into Portuguese cows and were

being considered for entry into a breeding center.

### Methods of Transmission

Transmission occurs from direct and repeated contacts between sick and healthy animals. The principal route of infection is by the inhalation of infective droplets from active or carrier cases of the disease. Mediate infection by contamination of inanimate objects is unlikely under natural conditions, but it has been effected experimentally. Infected hay remained infective for up to 144 hours. Other inanimate objects such as placenta and urine can also remain infective for long periods. It has been suggested that urine may be a mode of transmission, especially in European countries with temperate climates, where cattle are reared intensively in restricted geographic areas and many herds share the same watercourse. Spread of the pathogen may also occur by discharges from local tail lesions resulting from vaccination with virulent culture.

A separation of 6 m between animals is usually considered to be sufficient, but transmission over 200 m is suspected to occur.<sup>3</sup> Cattle may be infected for periods of up to 8 months before the disease becomes apparent, underscoring the importance of sufficiently long quarantine period before a herd can be declared to be free of the disease.

CBPP is usually transmitted through movements of live animals; trade in animal products is not thought to be a significant risk.

### Risk Factors

#### Animal Risk Factors

CBPP occurs only in cattle; a rare natural case has been observed in one buffalo but has not been detected in other wildlife. In sheep and goats, the injection of culture causes a local cellulitis without pulmonary involvement. There is no difference in the susceptibility of *Bos taurus* and *Bos indicus* cattle and both races respond equally to vaccination.

#### Immune Mechanisms

The exact nature of the immunity conferred by vaccination or by naturally occurring disease is not entirely understood, although it can be transferred by the administration of serum from an immune animal. The lack of a cell wall and endotoxins may enable mycoplasmas to colonize the animal without inducing an immune response, and the predilection for the mucosal membranes may also limit the humoral response. For these reasons it is suggested that the organism is a poor immunogen, which may account for the frequent lack of good circulating antibody responses in experimentally infected and vaccinated cattle. There is a poor relationship between antibody titer and the severity of lesions; animals with high antibody titers may have no visible lesions, and

those with severe lesions may have low or undetectable titers.

### Management Risk Factors

The occurrence and incidence of CBPP is heavily influenced by management systems, disease control policies and regulations of a country, knowledge of the disease by farmers and veterinarians, and livestock field officers. The diagnostic capability of veterinary laboratories, disease-surveillance and monitoring systems, adequacy of vaccination programs, government budgets allocated to control programs, the effectiveness of education programs, and the desire of cattle owners and traders to control the disease are critically important management factors that influence the effectiveness of control of the disease in a country.

### Pathogen Risk Factors

*M. mycoides* subsp. *mycoides* is sensitive to all environmental influences, including disinfectants, heat, and drying, and does not ordinarily survive outside the animal body for more than a few hours. A low incidence can be anticipated in arid regions because of the rapid destruction of the organism in exhaled droplets.

The organism can be grouped into two major, epidemiologically distinct, clusters. One cluster contains strains isolated from different European countries since 1980, and a second cluster contains African and Australian strains collected over the last 50 years.

The current European strains lack a substantial segment of genetic information, which may have occurred by a deletion event. The strains found in reemerging outbreaks of CBPP, which occurred after the eradication of the epidemic in Europe in the middle of the twentieth century, represent a phylogenetically newer cluster that has been derived from a strain of the older cluster of *MmmSC* that is still endemic on the African continent. The genome of *MmmSC* type strain PG1<sup>T</sup> has been sequenced to map all genes and to facilitate further studies regarding the cell function of the organism.

A variety of potential virulence factors have been identified, including genes encoding putative **variable surface proteins**, enzymes, and transport proteins responsible for the production of hydrogen peroxide and the capsule that is thought to have toxic effects on the animal. **Galactan** is also associated with pathogenicity of the organism, but its mode of action is uncertain. Galactan can cause necrosis and a connective tissue response in cattle similar to the sequestra in chronically infected animals.

The phylogeny of the *Mycoplasma mycoides* cluster according to sequencing of putative membrane protein genes has been examined. Molecular epidemiology of CBPP by multilocus sequence analysis of *MmmSC*

strains found a clear distinction between European, south-western African, and sub-Saharan strains. This indicates that the CBPP outbreaks that occurred in Europe were not a result of introduction from Africa and confirms true reemergence. Strains of *MmmSC* isolated from recent outbreaks of CBPP in Africa have been compared with vaccine strains and older isolates. A Botswana field isolate differed from all other strains of *MmmSC* tested by a variety of criteria. The new isolate may possess a set of protective antigens different from those of other strains of *MmmSC*, including vaccine strains. Such findings have implications for the control of CBPP in Africa.

The last strains isolated from an epidemic are usually of lower virulence than the first strains. Strains are most virulent when first isolated and lose their virulence after subculture.

### Economic Importance

CBPP is considered as one of the two economically most important diseases of cattle (beside rinderpest) in Africa. Direct losses are from mortality, reduced milk yield, vaccination costs, and disease surveillance. The indirect costs associated with the chronic nature of the disease are more difficult to assess and include decreased weight gain or loss of body weight, impaired working ability, reduced fertility, losses resulting from quarantine, and losses related to restrictions of trade and cattle movement.

Annual losses attributed to mortality, decreased beef and milk production, and loss in draught power occurring in 12 endemically infected sub-Saharan African countries were estimated to be €30.1 million.<sup>3</sup>

Costs associated of managing and eradicating the disease after the CBPP outbreak of 1995 in Botswana were estimated at \$98 million.<sup>13</sup> The eradication campaign after the most recent European outbreak of CBPP in Portugal at the end last century, which required the slaughter of over 85,000 cattle was estimated to cost more than €200 million.<sup>14</sup>

### PATHOGENESIS

Even after more than 100 years since CBPP was discovered, the pathogenesis is not well understood. The disease is an acute lobar pneumonia and pleurisy. The organism invades the lungs of cattle and causes a mycoplasmaemia; this results in localization in numerous other sites including the kidneys, joints and brain, resulting in high morbidity and mortality. An essential part of the pathogenesis of the disease is thrombosis in the pulmonary vessels, probably before the development of pneumonic lesions. The mechanism of development of the thrombosis is not understood, but there is no general increase in blood coagulability and no generalized tendency to spontaneous thrombosis.



The production of hydrogen peroxide and other active oxygen species is widely believed to play an important role in mycoplasma pathogenicity, and it has been demonstrated to result in lysis of erythrocytes, the peroxidation of lipids in *M. mycoides* infected fibroblasts, and inhibition of ciliary movement in tracheal organ cultures infected with *M. mycoides* and *M. ovipneumoniae*. European *MmmSC* strains appear to be distinguished from other *M. mycoides* strains by their lack of glycerol phosphate oxidase activity and ability to oxidize glycerol.

Death results from anoxia and presumably from toxemia. Under natural conditions a proportion of animals in a group do not become infected, either because of natural immunity or because they are not exposed to a sufficiently large infective dose. These animals may show a transient positive reaction to the complement fixation test (CFT). Approximately 50% of the animals that do become infected go through a mild form of the disease and are often recognized as clinical cases.

### CLINICAL FINDINGS

There is considerable variation in the severity of clinical disease from hyperacute to acute to chronic and subacute forms. With acute presentation, high disease incidence of nearly 90% and fatality rates of 50% and higher are observed. Acute disease is the common presentation in outbreaks occurring in previously unaffected regions.<sup>15</sup> Mild or even subacute forms with low mortality rates are common presentation in zones where the disease is endemic. Approximately 25% of the infected cattle have been estimated to remain as recovered carriers with or without clinical signs.

### Acute Form

After an incubation period of 3 to 6 weeks (in occasional instances up to 6 months), there is a sudden onset of high fever (40°C [105°F]), a drop in milk yield, anorexia, and cessation of rumination. There is severe depression, and the animals stand apart or lag behind a traveling group. Coughing, at first only on exercise, and thoracic pain are evident; affected animals are disinclined to move, standing with the elbows out, the back arched, and the head extended. Respirations are shallow, rapid, and accompanied by expiratory grunting. Pain is evidenced on percussion of the chest. Auscultation reveals pleuritic friction sounds in the early stages of acute inflammation, and dullness, fluid sounds, and moist gurgling crackles in the later stages of effusion. Dullness of areas of the lung may be detectable on percussion. Edematous swellings of the throat and dewlap may occur, and swelling of the large movable joints may be present. In calves, valvular endocarditis and myocarditis may occur. In fatal cases death occurs after a

variable course of disease from several days to 3 weeks. In the **peracute form**, affected cattle may die within 1 week after the onset of respiratory distress.

### Chronic and Subacute Forms

Recovered animals may be clinically normal but in some an inactive **sequestrum** forms **in the lung**, with a necrotic center of sufficient size to produce a toxemia causing unthriftiness, a chronic cough, and mild respiratory distress on exercise. These sequestra may break down when the animal is exposed to environmental stress and may cause an acute attack of the disease. During the Italian outbreak of 1990, less than 5% of cattle in an infected herd had evidence of clinical disease. This was possibly a result of the use of antimicrobials and antiinflammatory agents, which may have masked clinical signs and facilitated the formation of chronic lesions. In Africa, up to one-third of acute cases that recover become potential carriers.

### CLINICAL PATHOLOGY

#### Culture and Nucleic Acid Recognition

**Culture** of the organism is the reference method for detection of the pathogen. However, mycoplasmas are labile, making it necessary to use a special transport medium protecting this microorganism and preventing proliferation of other bacteria. Long-distance transport of samples, particularly when unrefrigerated drastically affects the viability of the bacteria rendering them unfit for culture.<sup>16</sup> Frequently, attempts to isolate *MmmSC* fail because the organism is labile, is present in too little quantities, and is so demanding in its growth requirements. Negative results should therefore always be regarded as inconclusive.<sup>1</sup>

In case of successful culture final identification of mycoplasmas is usually made by means of a biochemical test such growth inhibition, the fluorescent antibody test (FAT) or the immunofluorescence tests (IMF). Specific nucleic acid recognition using the **polymerase chain reaction (PCR)** has become common practice over the last two decades.

Although most PCR protocols rely on previous culture, preenrichment, or extraction of mycoplasma, PCR is also used without prior culture, directly using samples taken from nasal swabs, bronchioalveolar lavage or transtracheal wash fluid, pleural fluid, blood, urine, or pulmonary tissue. The PCR can identify the organism in bacterial isolates or clinical material within 2 days of extraction and is sensitive and highly specific.<sup>1</sup> An inconvenience of the PCR results from its high sensitivity, which makes it susceptible to false-positive results caused by contamination.

More recently **isothermal loop-mediated amplification (LAMP)** of DNA sequences specific for *MmmSC* has been

developed. The LAMP assay detects *MmmSC* DNA directly from crude samples of pulmonary or pleural fluid and serum or plasma within 1 hour using a simple dilution protocol.<sup>16</sup>

### Immunologic Tests

A number of immunologic test to identify the causative agent or its antigen in tissue, biological fluids, or cultures are available. Such tests include the **indirect fluorescent antibody test (IFA)** and the **fluorescent antibody test (FAT)**, which both use hyperimmune rabbit serum against *MmmSC* and labeled antbovine IgG. The **growth inhibition test (GIT)** is based on direct inhibition of growth of *MmmSC* by a specific hyperimmune serum. Although this is a simple test to perform cross-reactions within the *mycoides cluster* are common.<sup>1</sup> The **antigen immunodiffusion test (AGID)** has also been used to detect specific antigens present on the surface of *MmmSC*. The AGID is considered to lack sensitivity, and little is known about its specificity.<sup>1</sup> Because all these tests depend on the presence of a minimum number of organisms, only positive results should be considered conclusive.

### Serologic Tests

Serologic tests that identify an immune reaction of an individual animal to infection with *MmmSC* include the complement fixation test (CFT) and the competitive enzyme-linked immunosorbent assay (C-ELISA). Both are prescribed tests for international trade according to the OIE. This group of diagnostic tests has important limitations because of the nature of the pathogenesis of the disease with its long incubation period and the relatively rapid decline of the antibody titer.

The **complement fixation test (CFT)** is rapid to perform and easy to interpret. With a sensitivity in the range of 70% to 80% and specificity of 98% it is best suited to diagnose clinically affected animals with acute lesions but less suitable to identify either animals in early stage of the disease, chronically infected or carrier animals with low antibody titers.<sup>1,17</sup> The therapeutic use of antimicrobials further increases the risk of a false-negative test results. Vaccinated animals give a positive reaction for about 6 weeks, although this period may be much longer if severe vaccination reactions occur. Because of the limited sensitivity the CFT is considered unreliable on an individual animal level, but it is deemed to be highly effective in detecting infected herds when testing the entire population. The test is widely used in to determine freedom of disease on a herd level.<sup>1</sup> Because false positive results caused by serologic cross-reactions with other species of the *mycoides cluster* can occur, it is advisable to confirm a positive test result by postmortem and bacteriologic examination.

The C-ELISA has a similar or even greater specificity than the CFT.<sup>1,17</sup> The sensitivity of the C-ELISA was found to be superior to the CFT particularly to detect animals in the chronic stage of the disease, whereas the CFT appears to outperform the C-ELISA in the detection of animals in the acute phase of the disease.<sup>17,18</sup> An indirect ELISA based on a **recombinant protein, LppQ-NX (LppQ ELISA)**, has been developed and provides good sensitivity and specificity for the diagnosis of CBPP and is robust under harsh climatic conditions. The CFT, competitive ELISA, and LppQ ELISA, all used for detection of antibodies to *MmmSC*, were compared with postmortem inspection for the diagnosis of CBPP in naturally infected cattle in an endemic area in Zambia between 2007 and 2008.<sup>17</sup> The percentage of positive sample was 67.5% for post mortem examination, 59.0% for the C-ELISA, 52.6% for the CFT, and 44.4% for the LppQ ELISA. Of the three serologic tests the CFT identified the largest number of animals in the acute phase of the disease, whereas the C-ELISA was the most sensitive test to detect animals in advanced stages of the disease. The LppQ ELISA had a very poor sensitivity (10.8%) to identify animals in the early stage of the disease, whereas in the chronic stage it had a sensitivity ranging above the CFT but below the C-ELISA.

The **immunoblotting test (IB)** is based on an immunoenzymatic reaction with higher sensitivity and specificity than the CFT. The IB is recommended as a confirmatory test on positive samples previously analyzed with another test because IB is not suitable for mass screening and may be difficult to standardize.<sup>1</sup>

No single serologic test is capable of detecting all CBPP affected animals in the field. These tests are most useful for diagnosis at the herd level. In the absence of a “gold standard” test for the serologic diagnosis of CBPP, some uncertainties remain unresolved. Suspicious CBPP cases identified by positive serology must be confirmed by further investigations that demonstrate the presence of antigen in the respiratory tissues of animals.

### NECROPSY FINDINGS

Lesions are confined to the thoracic cavity and lungs, and the lesions are usually unilateral. The pleural cavity may contain large quantities of clear, yellowish-brown fluid with pieces of fibrin. This fluid is ideal for culture of the organism. Caseous fibrinous deposits are present on the parietal and visceral surfaces of the pleura. The interlobular septae are prominently distended with amber-colored fluid surrounding distended lymphatics. This fluid distinctly outlines the lobules, which vary in color, with red, gray, or yellow hepatization. Consolidation of the lungs with a typically marbled appearance is

characteristic. In chronic or advanced cases, a **sequestrum** of necrotic lung varying size from 1 to 10 cm in diameter is surrounded by a fibrous capsule. If these sequestrae rupture and are drained by a bronchus, they can be a source of aerosol infection to cattle. Such a mechanism may contribute to epidemics in closed herds. In affected calves, exudative peritonitis, arthritis, bursitis, and fibrinous arthritis of carpal and tarsal joints may be present.

Histologically, in the early stages the typical lesion consists of bronchiolar necrosis and edema, progressing to exudative serofibrinous bronchiolitis with extension to the alveoli and adjacent lymphatics. This process extends to the tracheobronchial lymph nodes and pleural lymphatics. The mediastinal, sternal, aortic, and intercostal lymph nodes are enlarged, edematous, and hemorrhagic. Lymphatics become thrombosed and fibrosed. The pulmonary lobules become consolidated with alveolar edema, fibrin, and inflammatory cells. Coagulation necrosis is common, and the organism can be demonstrated in these lobules by immunohistochemistry.

Perivascular organization foci, or “organizing centers,” in the interlobular septa are considered typical of CBPP. They consist of a center occupied by a blood vessel with proliferation of connective and inflammatory cells surrounded by a peripheral zone of necrotic cells. Type I foci contain more proliferative cells in the central zone, which is larger than the peripheral zone. In Type II foci, the proliferative cells are scarce, and the peripheral zone is relatively larger. Immunoreactive antigen is visible in the central zone inside blood vessels. Immunocytochemical tests can be used to detect the organism in tissue sections and provide valuable confirmatory diagnosis after slaughter. Stained antigen is visible in the smaller bronchioles and alveoli and within the interlobular septa of the lung. Immunofluorescent staining of impression smears of lungs may be more sensitive and rapid than culture.

Renal lesions are frequently detectable in CBPP in field and experimental cases. In the acute phase of the disease, multiple renal infarcts are common. In subacute and chronic cases, the infarcts progress to form large areas of fibrosis accompanied by tubular dystrophic calcification, tubular atrophy, and lymphocyte interstitial infiltrates. Immunohistochemically, the *MmmSC* antigen is present in several renal structures.

### Samples for Confirmation of Diagnosis

- **Histology**—formalin-fixed lung (LM, IHC)
- **Mycoplasmology**—effusion fluid in serum tube, lung, bronchial lymph node (MCULT, FAT, PCR, C-ELISA)

### DIFFERENTIAL DIAGNOSIS

A diagnosis based on a history of contact with infected animals, clinical findings, a complement fixation test, necropsy findings, and cultural examination is necessary.

Diseases that must be differentiated from CBPP include the following:

**Rinderpest** Erosive stomatitis, dysentery, and erosions throughout the alimentary tract

**Foot and mouth disease** Salivation, lameness, fever, and vesicular stomatitis

**Hemorrhagic septicemia** Acute disease with death in 6 to 72 hours. Edema of the neck and brisket, lung lesions similar to CBPP. Culture of *Pasteurella* spp.

**Theileriosis (East Coast fever)** Coughing, nasal and ocular discharge, diarrhea, enlargement of peripheral lymph nodes, ulceration of abomasum. No lung lesions.

**Ephemeral fever** Ocular discharge, drooling saliva, lameness, enlarged joints, self-limiting disease of short duration; most affected cattle recover quickly; fluctuating fever; secondary pneumonia may occur.

**Pulmonary abscesses** Large abscesses containing foul-smelling purulent material; may have total destruction of lung.

**Tuberculosis** Tubercular nodules may resemble CBPP sequestra, but they are degenerative cheese-like lesions, often calcified.

**Farcy** Abscesses of lungs containing foul-smelling material and enlarged local lymph nodes.

**Actinobacillosis** Generalized lesions of lung and other adjacent tissues.

**Echinococcal (hydatid cysts)** Pulmonary cysts with a double wall and containing clear fluid, often calcified when old.

### TREATMENT

Official conventional wisdom in the past held that treatment of clinical cases of CBPP with antimicrobials is counterproductive to contain the disease because it gives rise to persistent infection and may produce symptomless carrier animals.<sup>5</sup> Accordingly, the use of antimicrobials is legally banned in many endemically affected countries. Nevertheless, the use of antimicrobials in affected regions is widespread, mainly because, with limited availability of vaccines, it is considered the only available and effective treatment and control measure.<sup>5,19</sup> In recent years the popularity of antibiotic treatment and the perception of positive results led to some research activity suggesting that antimicrobial use may be of value primarily to control disease transmission.<sup>5</sup>

Despite the perception of veterinarians and farmers that antibiotics can alleviate the clinical course of the disease, enabling some

improvement in condition, field studies suggest that antimicrobial therapy had little to no effect on severity of signs, course of the disease, and mortality rate in clinically affected animals.<sup>20,21</sup> Treatment failures in clinically affected animals may be attributable to inadequate dosage or duration of treatment and to the chronic nature of the condition. Treatment success of antimicrobial therapy to treat mycoplasma infection greatly depends on a timely initiation of the treatment, but clinically affected animals in endemic areas frequently are in an advanced or even chronic stage of disease and thus are unlikely to show strong treatment response.<sup>21</sup> Because of the generally poor treatment response and because these animals present a source of infection for herd mates, clinically affected animals should rather be culled than treated.

In contrast the treatment of in-contact animals appeared to considerably reduce disease transmission, which resulted in a marked decrease in the disease occurrence, morbidity, and mortality rates in affected herds.<sup>21</sup> An increasing body of evidence suggests that use of antimicrobials, primarily as a part of a disease control program, should be reconsidered.<sup>5,15,19</sup>

The major classes of antimicrobials that are effective against mycoplasmas are tetracyclines, macrolides, florfenicol, and fluoroquinolones. A number of in vitro and in vivo studies have been published in recent years with results supporting the use of fluoroquinolones, several different macrolides, and tetracyclines to reduce the shedding of MmmSC.<sup>21-24</sup> Beta-lactam antibiotics and sulfonamides are inherently ineffective against the *Mycoplasmas* that do not have a cell wall and do not synthesize folic acid.

#### TREATMENT AND CONTROL

##### Treatment\*

Tulathromycin (2.5 mg/kg SC as single dose) (R-3)  
 Florfenicol (20 mg/kg q48 IM) (R-3)  
 Tilimicosin (10 mg/kg SC as single dose) (R-3)  
 Gamithromycin (6 mg/kg SC as single dose) (R-3)  
 Danofloxacin (2.5 mg/kg q24h SC) (R-3)  
 Oxytetracycline (10 mg/kg IM q24 for at least 4 days) (R-3)

##### Control\*

Danofloxacin (2.5 mg/kg q24h SC over three consecutive days) (R-2)<sup>21</sup>  
 Tulathromycin (2.5 mg/kg SC as single dose)  
 Tilimicosin (10 mg/kg SC as single dose)  
 Gamithromycin (6 mg/kg SC as single dose)  
 Florfenicol (20 mg/kg q48 IM)

Oxytetracycline long-acting formulation  
 (20 mg/kg IM)

##### Vaccination

Vaccination with T1/44 or T1SR MLV vaccines (R-1)

*\*The use of antimicrobials is legally prohibited in many countries affected by CBPP.*

#### CONTROL

There are four essential tools in CBPP control and eradication: **livestock movement control, stamping out, vaccination, and treatment.**<sup>3</sup>

The possible strategies used for control in affected countries or regions are as follows:

- **Slaughter of all sick and in-contact cattle.** This requires full cooperation of cattle owners and an adequate and timely compensation system. This strategy is impractical in developing countries with a pastoral economy.
- **Slaughter of all sick cattle and vaccination of in-contact cattle.** This strategy is used frequently and usually perpetuates the disease.
- **Vaccination of healthy cattle with slaughter of sick cattle in an epidemic and revaccination of cattle at risk.** This method depends on the ability of the authorities to detect epidemics rapidly, most effectively, by abattoir surveillance and to maintain vaccination for at least 3 years. Vaccination in endemic areas must be done annually, whereas newly infected areas require repeat vaccinations aimed at eradication of the disease.

Although the combination of movement control, quarantine, and culling of infected animals, when strictly enforced, can successfully eradicate CBPP, as is documented by numerous examples of the past centuries, this approach requires a financial and logistic effort that is beyond the means of many endemically infected countries in Africa. In these countries social and civil disturbances interfere with effective disease control. Farmers fleeing civil unrest may move their cattle to endemic areas and then return with them when the threat is over, making strict livestock movement control logistically and politically unenforceable. Culling of infected and in-contact animals requires a system of financial reimbursement for farmers that is far beyond the financial resources of many affected countries.

In view of the epidemiologic situation of CBPP and the socioeconomic structure of many African countries, control of the condition is largely based on vaccination in Africa, whereas treatment of affected animals—although widely practiced—is legally prohibited in many countries.<sup>3</sup>

Although there are examples of successful eradication of CBPP on the continent, efforts to contain the disease keep failing in many sub-Saharan countries, which lead to a reemergence of the disease in the region over the past decades and regular recurrent outbreaks in countries where the disease has previously been eradicated.

#### Removal of Sources of Infection

To control or eradicate CBPP, enforcing suitable surveillance strategies is imperative. Surveillance needs to cover the susceptible species (cattle and possibly buffaloes) and should comprise **clinical surveillance, serologic surveillance, and pathologic surveillance.**<sup>1</sup> Because of the limited sensitivity of available tools randomized surveillance is discouraged, and the interpretation of **surveillance results should be interpreted on a herd level rather than an individual animal level.**<sup>1</sup> All infected and suspicious reactors and clinical cases should be destroyed or transported under close control to abattoirs. Where this cannot be done without a chance of spread to animals along the route, destruction on the farm is necessary. Animals that eventually go to abattoirs should be kept under quarantine until slaughter, irrespective of their status.

#### Clinical Surveillance

Clinical surveillance aims at identifying clinical signs consistent with CBPP in a herd by closely examining susceptible individual animals. It requires good knowledge of the possible clinical presentation of the condition particularly in endemic regions, where affected animals may only show mild and subtle signs. Although the diagnosis of CBPP cannot be confirmed solely on the basis of physical examination, clinical surveillance can greatly contribute to the level of confidence in the overall surveillance strategy when a large number of animals in a susceptible herd are regularly examined. Animals suspected to be infected must be followed up, either by serologic or pathologic surveillance.

#### Pathologic Surveillance

Systematic pathologic surveillance conducted on slaughterhouse material, thus including large numbers of clinically unapparent animals is considered the most effective approach to screen for the presence of the disease within a herd and, more important, within a region or a country.<sup>1</sup> Appropriate training of the personnel conducting pathologic surveillance to identify characteristic and suspicious lesions is essential. Suspected cases must be followed up to confirm the presence of the specific pathogen in the tissue.

#### Serologic Surveillance

Because of the limited sensitivity of the available serologic tests, serology is unsuitable as



a stand-alone screening procedure but may be used in the framework of epidemiologic investigations. Serologic surveillance results should primarily be interpreted at a herd level, and positive results should be confirmed by clinical or pathologic examination and identification of the specific pathogen. Because animals in the incubation phase and early stages of the disease may test negative, it is necessary to have two negative tests 2 months apart. After vaccination a positive reaction occurs; this usually disappears within 2 months but may persist for 5 months.

### Vaccination

Vaccination against CBPP has been used in countries where rigorous cattle movement control, quarantine, and stamping out cannot be implemented, as is the case in many African countries that cannot afford the prohibitive costs of culling entire infected herds. Although CBPP vaccination is doomed to fail when used as stand-alone strategy to control CPBB, a systematic vaccination strategy in combination with intense surveillance and removal of infected animals can contribute to the containment of the disease and reduction of the infection prevalence to the point where vaccination can be discontinued and remaining infected animals can be culled to achieve complete eradication of the disease.<sup>3,25</sup> Extensive vaccination in Australia reduced the incidence of the disease to an extremely low level, and complete eradication of the disease was achieved shortly afterward. Vaccine application is usually controlled by local legislation.

All effective CBPP vaccines have been based upon live versions of the disease-causing *MmmSC*, either attenuated or not. Currently the only vaccines in use are live vaccine derived from the T1 strain (**T1/44 and T1SR**) of live attenuated *Mycoplasma mycoides* subsp. *mycoides* SC and attenuated through repeated passage in embryonated eggs before production in artificial growth media.<sup>26</sup> Unfortunately these vaccines are characterized by poor and variable efficacy, with only between 30% and 60% of vaccinated animals being protected. In some situations, the T1/44 vaccine induces a good immunity, especially when herds are revaccinated annually, in which case the level of protection exceeds 85%. Induced immunity is short lived, particularly for the T1SR strain, requiring revaccination at least on a yearly basis. Either systemic or local **adverse reactions are common**, particularly for the T1/44 strain. Within 2 to 4 weeks following injection, an invading edema develops known as the “Willems” reaction. The incidence of these reactions varies from area to another. The reversion to virulence of the T1/44 vaccine has also been observed when it was serially passaged by endobronchial intubation resulting in the development of lesions of CBPP in animals that were

infectious to in-contact animals. This suggests that animals given the currently used vaccines (T1/44 and T1SR) subcutaneously could be reservoirs for *MmmSC* and infect other animals in areas previously free of CBPP.

The value of calthood vaccination is limited because arthritis, myocarditis, and valvular endocarditis occur 3 to 4 weeks after vaccination of calves less than 2 months old. Vaccination of calves after this age is recommended because it avoids the occasional deaths which occur after vaccination of adults.

Historically, pleural exudate from natural cases (natural lymph) was used in an attempt to immunize cattle at risk. Vaccination was carried out by injection into the tough connective tissue at the tip of the tail with a high-pressure syringe. “Natural lymph vaccination” caused severe reactions with sloughing of the tail and extensive cellulitis of the hindquarters, necessitating destruction or causing death of the animal in many instances. Draining infected injection sites may have contributed to the spreading of this disease and others.

Inactivated CBPP vaccines have been field tested but results have been inconclusive. Immunostimulating complex (ISCOM) protein subunit vaccines have been developed, and early results are encouraging. The capsular polysaccharide (CPS) of *MmmSC* is an important surface antigen and pathogenicity factor previously known as a galactan. The immune response in mice of capsular polysaccharide conjugate vaccines against CBPP indicates that protection against *MmmSC* mycoplasmaemia in mice is cell-mediated rather than humoral immunity.

### Antimicrobial Use

As mentioned previously the use of antimicrobials for treatment and control of CBPP is banned in many countries affected by the disease because it is considered to be counterproductive for the control and eradication of the disease because it may result in subclinically infected animals carrying and possibly shedding the pathogen for prolonged period of time. Despite the ban, the use of antimicrobials is widespread mainly because vaccine coverage vaccine efficacy is limited.<sup>5,15</sup> Recent field trials and epidemiologic studies provided evidence corroborating the empirical observation that the use of antimicrobials in infected herds is able to contain disease transmission.<sup>5,15,21</sup> Using a homogeneous model based on publically available data, one study concluded that the potential impact of reducing the infectious period by the use of antimicrobials on disease persistence and mortality was in the same range as the impact of currently available vaccines.<sup>25</sup> In single isolated herds of 500 head of cattle, a 50% reduction in length of the infectious period caused the fade-out of the disease in essentially 100% of herds, a 60% decline in the

number of cases, and a 73% decline in mortality.<sup>25</sup> Accordingly a significant decline in mortality, seropositivity, frequency of morphologic lesions, and severity of clinical scores was observed in herds where all in-contact animals received a treatment with danofloxacin at a dose of 2.5 mg/kg on 3 consecutive days compared with untreated herds.<sup>21</sup> This mounting body of evidence warrants the reconsideration of the use of antimicrobials in an CBPP eradication or control program.

### Disease Control on an Area Basis

The prevention of entry of infected animals into a free area is a difficult task. Only the following classes of cattle should be permitted to enter:

1. Cattle that have neither been in an infected area nor in contact with infected animals for at least 6 months. This may be relaxed to permit entry of cattle going to immediate slaughter after a clinical examination and a period of 1 month in a free area.
2. Cattle that have given negative reactions to the CFT or C-ELISA on two occasions within the preceding 2 months and have not been in contact with infected animals during this period. Less rigid measures than these will permit introduction of the disease.

When the disease is already present in an area, two methods of control are possible: vaccination and eradication by test and slaughter of reactors. The method chosen will depend largely on the economy of the cattle industry in the affected area. A vaccination program may be the first step to reduce the incidence of the disease to the point where eradication becomes possible.

In areas where farms are large, fencing is poor, and the collection of every animal cannot be guaranteed, eradication of the disease by test and slaughter is impractical. Vaccination can be practiced whenever the cattle are brought together. Animals moving out of or into infected areas and groups of cattle that contain active cases must be vaccinated. Moving cattle that develop the disease should be halted, clinical cases slaughtered, and the remainder vaccinated. Results are usually good provided the vaccination is carried out carefully, but some further cases as a result of prevaccination infection are to be expected.

When outbreaks occur in small areas where herds can be adequately controlled, complete eradication should be attempted by periodic testing and the destruction of reactors, and in-contact animals should be vaccinated. To avoid unnecessary contact between cattle, retesting is delayed until 5 to 6 months after the first test when vaccination reactions have usually subsided. Under most circumstances all nonreactors should be

vaccinated. This practice is particularly applicable in feeder cattle that will be slaughtered subsequently and when extensive outbreaks occur in closely settled areas where the chances of spread are great. Simple test and slaughter in these latter circumstances will be too slow to control the rate of spread. In either case the herd should not be released from quarantine until two tests at an interval of more than 2 months are completely negative.

### World Organization for Animal Health (OIE)—CBPP Status for Countries or Regions

CBPP is a so-called “List A” disease, making it a notifiable disease to the OIE.<sup>2</sup> To qualify as a CBPP-free country or zone according to the rules of the OIE the country must fulfill the following requirements:

- Have a record of regular and prompt animal disease reporting
- Submission of a declaration to the OIE on a yearly basis stating the following:
  - There has been no outbreak of CBPP during the past 24 months.
  - No evidence of CBPP infection has been found during the past 24 months.
  - No vaccination has been carried out during the past 24 months.

This declaration has to be supported by evidence documenting that a surveillance program is in operation and that regulatory measures for the prevention and control of CBPP have been implemented.<sup>1</sup> In case a country loses the status as CBPP-free because of an outbreak, one of the following waiting periods applies:

- 12 months after the last case, where a stamping-out policy combined with serologic surveillance and strict movement control is enforced.
- 12 months after slaughter of the last vaccinated animal, where vaccination was used.

As of May 2015 the following countries are recognized by the OIE as CBPP-free: Argentina, Australia, Botswana, Canada, China, France, India, Portugal, Singapore, Switzerland, and the United States.<sup>2</sup>

In Europe, legislation exists to prevent the spread of CBPP. Any outbreak in a previously CBPP-free country must be reported to the European Commission within 24 hours of confirmation of the disease; the Commission will then inform other member states. Unaffected regions may export only to other member states if cattle come from herds in which all animals over 12 months of age have been serologically negative in the previous 12 months. All animals for export must have been serologically tested negative 30 days before being loaded. Cattle from restricted

areas must not be exported to other member states until all herds in the area have passed three clear herd tests on all animals over 12 months of age at intervals greater than 3 weeks apart.

### FURTHER READING

- Food and Agricultural Organization of the United Nations. *Animal Production and Health Division. Recognizing contagious bovine pleuropneumonia. FAO animal health manual*. Rome: FAO; 2002 No. 13, Rev. 1.
- Kusiluka LJM, Sudi FF. Review of successes and failures of contagious bovine pleuropneumonia control strategies in Tanzania. *Prev Vet Med*. 2003;59:113-123.
- Mariner JC, McDermott J, Heesterbeek JAP, Thomson G, Martin SW. A model of contagious bovine pleuropneumonia transmission dynamics in East Africa. *Prev Vet Med*. 2006;73:55-74.
- Newton LG, Norris R. *Clearing a continent. The eradication of bovine pleuropneumonia from Australia. Primary Industries Report Series 74*. CSIRO Publishing/PISC SCARM; 2000.
- Tambi NE, Maina WO, Ndi C. An estimation of the economic impact of contagious bovine pleuropneumonia in Africa. *Rev Sci Tech Off Int Epiz*. 2006;25:999-1012.
- Thiaucourt F, et al. Contagious bovine pleuropneumonia vaccines, historic highlights, present situation and hopes. *Dev Biol (Basel)*. 2003;114:147-160.

### REFERENCES

1. OIE. *Terrestrial manual*, 2008. (Accessed 15.09.15, at: <[http://www.oie.int/fileadmin/Home/eng/Health\\_standards/tahm/2.04.09\\_CBPP.pdf](http://www.oie.int/fileadmin/Home/eng/Health_standards/tahm/2.04.09_CBPP.pdf)>.).
2. OIE, 2013. (Accessed 15.09.15, at: <<http://www.oie.int/en/animal-health-in-the-world/the-world-animal-health-information-system/old-classification-of-diseases-notifiable-to-the-oie-list-a->>>.).
3. Tambi NE, et al. *Rev Sci Tech Off Int Epiz*. 2006;25:999-1012.
4. Amanfu W. *Onderstepoort J Vet Res*. 2009;76:13-17.
5. Marnier JC. *Onderstepoort J Vet Res*. 2009;76:135-140.
6. Kusiluka LJM, Sudi FF. *Prev Vet Med*. 2003;59:113-123.
7. Swai E. *Asian Pac J Trop Biomed*. 2013;3:303-306.
8. Kassaye D, Molla W. *Trop Anim Health Prod*. 2013;45:275-279.
9. Mbengue M, et al. *Bull Soc Pathol Exot*. 2013;106:212-215.
10. Xin J, et al. *Vet J*. 2012;191:166-170.
11. OIE, 2013. (Accessed 15.09.15, at: <<http://www.oie.int/animal-health-in-the-world/official-disease-status/cbbp/list-cbbp-free-members/>>>.).
12. Dupuy V, et al. *PLoS ONE*. 2012;7:e46821.
13. Marobela-Raborokgwe C. *Vet Ital*. 2011;47:397-405.
14. Nicholas R, et al. *Vet Rec*. 2009;165:756-757.
15. Hübschle O, Aschenborn O. *Vet Rec*. 2006;159:464.
16. Mair G, et al. *BMC Vet Res*. 2013;9:108.
17. Muuka G, et al. *Trop Anim Health Prod*. 2011;43:1057-1062.
18. Sidibé CAK, et al. *Trop Anim Health Prod*. 2012;44:1233-1238.
19. Nicholas RAJ, Ayling RF. *Vet Rec*. 2012;171:510-511.
20. Lesnoff M, et al. *Prev Vet Med*. 2004;64:27-40.
21. Hübschle O, et al. *Res Vet Sci*. 2006;81:304-309.
22. Mitchell JD, et al. *Vet J*. 2013;197:806-811.
23. Mitchell JD, et al. *J Med Microbiol*. 2013;62:56-61.
24. Mitchell JD, et al. *PLoS ONE*. 2012;7:e44158.
25. Mariner JC, et al. *Prev Vet Med*. 2006;73:55-74.
26. Totte P, et al. *PLoS ONE*. 2013;8:e57509.

## MYCOPLASMA BOVIS PNEUMONIA, POLYARTHRITIS, MASTITIS, AND RELATED DISEASES OF CATTLE

### SYNOPSIS

**Etiology** *M. bovis*

**Epidemiology** Occurs in dairy and beef cattle of all ages. Pneumonia, otitis, and polyarthritis primarily seen in feedlot cattle and dairy calves; mycoplasmal mastitis in dairy cows.

**Clinical findings** Unresponsive pneumonia, polyarthritis, otitis media/interna, mastitis in dairy herds.

**Diagnostic confirmation** Culture or detection of antigen or bacterial DNA from respiratory secretions, joint fluid, milk.

**Treatment** Antimicrobial therapy, often with poor treatment outcome.

**Control** Biosecurity and biocontainment procedures. Prevent entry of infected animals into herds. Purchase animals free of mycoplasma. Pasteurization of milk of cows with mycoplasma mastitis before feeding to calves. Metaphylactic antimicrobial therapy might be justified in herds with high morbidity and mortality rates. Vaccines have been unsuccessful.

### ETIOLOGY

*Mycoplasma* spp. belong to the class of Mollicutes, a group of bacteria enveloped by a complex plasma membrane but lacking a cell wall.<sup>1</sup> They are characterized by their small size, their tiny genome, and their intimate association with host cells that is essential for their survival. Mycoplasmas typically inhabit mucous membranes, including those of the respiratory tract, urogenital tract, the mammary gland, or the conjunctivae.<sup>1</sup> *M. bovis* is a major cause of disease of cattle causing pneumonia, otitis media, arthritis, tenosynovitis, keratoconjunctivitis, mastitis, meningitis, and reproductive disorders, including abortion.<sup>2</sup> It is the etiologic agent of the so-called **chronic pneumonia and polyarthritis syndrome (CPPS)** of feedlot cattle that has been recognized in the United States and Canada.

*Mycoplasma bovis* is highly adapted to cattle but has occasionally been isolated from small ruminants, buffaloes, and, in rare instances, even from humans with bronchopneumonia.

### EPIDEMIOLOGY

#### Occurrence

*M. bovis* that was first isolated in 1961 from cow with mastitis in the United States, has spread to many countries of the world via animal movements and is now recognized as a worldwide pathogen of intensively farmed cattle.<sup>1</sup> Of 1600 isolates of *Mycoplasma* species recovered from ruminant animals in

Britain over a 10-year period, *M. bovis* was the most common species, mostly from pneumonic calves, but occasionally also from cattle with mastitis and arthritis. A serologic survey of pneumonic cattle found *M. bovis* antibody-positive samples in 18%.

*Mycoplasma bovis* that is a common although not ubiquitous inhabitant of the upper respiratory tract of cattle is considered a major cause of **respiratory disease** affecting beef and dairy calves alike. In England and Wales, serologic screening between 2000 and 2009 revealed a herd seroprevalence of *M. bovis* of over 30% and *M. bovis* was isolated on average in 40% of pneumonic lungs submitted during that time period.<sup>2</sup> In Israel, *M. bovis* was isolated from 26% to 65% of samples from pneumonic calves submitted between 2004 and 2008.<sup>3</sup> *M. bovis* was also the strain isolated from more than half of the 1000 samples from calves with bronchopneumonia that were submitted to different diagnostic laboratories in France between 2003 and 2008.<sup>2</sup> In a recent Italian study, 37% of lung tissue samples from pneumonic dairy calves less than 1 month old submitted to a diagnostic laboratory tested positive on PCR for *Mycoplasma* spp. Of the positive samples, 31% were identified as *M. bovis*.<sup>4</sup>

The **chronic pneumonia and polyarthritis syndrome** (CPPS) of feedlot cattle has been reported in Canada and the United States. It occurs commonly in young feedlot cattle usually affecting many animals a few weeks after arrival and mingling in the lot. In Canada, the disease has been seen commonly in young cattle (6-8 months of age) following shipment from western rangelands to eastern feedlots, which suggests that long transportation and mixing of cattle of different origins may be important epidemiologic characteristics. The morbidity ranges from 20% to 85% and the case-mortality rate from 3% to 50%. Calves affected with arthritis commonly have necropsy evidence of mycoplasmal pneumonia, and it is proposed that the pneumonia precedes the development of the arthritis. In feedlot calves the prevalence of *M. bovis* infection was found to be below 7% at the time animals enter the feedlot but increases dramatically within the first weeks in the feedlot to values between 40% and 100% in most studies.<sup>5</sup> In a group of feedlot cattle, from Alberta, Canada, with chronic unresponsive pneumonia and polyarthritis, *M. bovis* was the most common pathogen isolated, having been detected in 82% of cases, including 71% in lungs and 45% in joints. In a series of cases of chronic, antibiotic-resistant pneumonia, sometimes with concurrent polyarthritis, in feedlot cattle in western Canada, *M. bovis* was present in the lung tissues of more than 90% of cases, and the BVDV was present in 60% of the cases, suggesting a possible synergism between *M. bovis* and the BVDV. Outbreaks of pneumonia and arthritis in beef calves associated with infection attributable to *Mycoplasma*

*bovis* and *Mycoplasma californicum* have been described in a mixed dairy cattle and beef cattle herd kept under extremely poor housing and hygienic conditions.

**Mycoplasma arthritis** of cattle has been reported in a number of countries including Canada, the United States, several European countries and the United Kingdom. Commonly, arthritis occurs in association with respiratory disease or otitis media in calves, or mastitis in adult cattle, and it is proposed that the pneumonia precedes the development of the arthritis. Calves suckling cows with experimental mastitis attributable to this organism may develop mycoplasmal arthritis, and a high incidence is recorded in calves in dairy herds where mycoplasmal mastitis was occurring. In Ireland, infection has occurred in housed adult dairy cattle, without any evidence of pneumonia, producing severe polyarthritis with a clinical incidence in 12 farms that varied from 2% to 66%.

**Otitis media/interna** has been described in preweaned Holstein dairy calves in dairy herds that have expanded in size. Affected calves were 2 to 5 weeks of age, morbidity was 3% to 10%, and case-fatality rates estimated at 50%. In a retrospective study in calves submitted for necropsy in California, affected calves were 2 weeks to 4 months of age, 92% were from dairy herds, and most cases occurred during late winter and spring. *M. bovis*, *M. bovirhinis*, and *M. alkalescens* were isolated from the ears of affected calves. Outbreaks of suppurative otitis media and pneumonia associated with *M. bovis* have been described in calves on a dairy farm in the United Kingdom with a disease incidence of 20%.<sup>6</sup> Outbreaks in beef cattle farms in Japan with morbidity and mortality rates of 8% to 40% and 30% to 100%, respectively have also been reported.

*Mycoplasma bovis* has been recognized as pathogen of the bovine **mammary gland** (see also "Mastitis Caused by *Mycoplasma* spp.") that is widespread within the dairy cattle population in the United States. A national survey conducted in 2002 in the United States determined a prevalence of mycoplasma culture positive bulk tank milk samples of 7.9%, of which 86% were identified as *M. bovis*.<sup>7</sup> In contrast the herd prevalence of *M. bovis* in Canadian dairy herds was estimated to be 1.7%, 1.5% in Belgium, and 0.56% in Japan.<sup>8,9</sup> *M. bovis* was not detected in recent survey in dairy herds in New Zealand.<sup>10</sup>

### Economic Importance

*M. bovis* has been associated with respiratory disease in calves and mastitis in dairy cows, that both have a considerable prevalence at least in some parts of the world. Costs related to infection with mycoplasma include expenses for treatment and diagnosis, death and culling losses and implementation of control measures. The chronicity and poor treatment response of

most diseases associated with *M. bovis* contribute considerably to these expenses. The costs to the U.S. beef industry were estimated with approximately \$32 million per year as result of decreased weight gain and lost carcass value. Mycoplasma mastitis was estimated to cost the U.S. dairy industry approximately \$108 million per year.<sup>11</sup>

### Risk Factors

#### Pathogen Risk Factors

The virulence factors of *M. bovis* and mechanisms of pathogenicity are not well understood, but the organism's ability to vary the expression of **variable surface proteins** (VSPs), a family of lipoproteins on the bacterial surface with high frequency is currently being investigated. The organism has 13 VSP genes involved in antigenic variation that alter the antigenic character of its surface components and may act to enhance colonization and/or adherence to host cells or to evade the host's immune defense systems.<sup>5</sup> These VSP proteins and some unrelated proteins such as pMB67 and P48 are the primary antigenic targets of the host's antibody response, which, however, does not appear to be protective.

*M. bovis* can induce apoptosis of lymphocytes, and a C-terminal fragment of VSP-L is able to impair the lymphocyte proliferative response to mitogens. The bacterium can furthermore adhere to neutrophils and block the oxidative burst in these cells.<sup>5</sup> Several strains of *M. bovis* produce **biofilm**, protecting the organism from heat and desiccation and possibly playing a role in evading the host's immune response and in resistance to antimicrobial therapy in vivo.<sup>5</sup> *M. bovis* produces **hydrogen peroxide** in quantities that vary between strains. Peroxide production can result in oxidative injury to host tissues. The organism is also able to penetrate through lung epithelial junctions and cause systemic infections. There is some evidence of variability of *M. bovis* strains to cause arthritis.

#### Animal Risk Factors

The immune status of the individual animal is important in determining the susceptibility to respiratory disease, particularly in young ruminants. An association between failure of transfer of passive immunity and the risk and severity of respiratory disease in young calves is well established. It is however not clear whether maternal antibodies against *M. bovis* have a protective effect in calves. An association between *M. bovis* specific serum antibody titers in the first weeks of life and the risk of developing respiratory tract disease could thus far not be established.<sup>1</sup>

Age appears to influence the susceptibility at least to some forms of *M. bovis* infection. Otitis media is most commonly observed in calves 2 to 6 weeks of age and is uncommon in older calves. Age-related susceptibility is also observed in other species.<sup>1</sup>



Although a genetic effect on the susceptibility to mycoplasma infection in cattle has not been confirmed, the genetic background is considered an important determinant of resistance to mycoplasma respiratory disease in nonruminants.<sup>1</sup>

### Environmental Risk Factors

With direct animal contact being the main route of infection, introducing infected animals into a herd with no or low *M. bovis* infection prevalence presents a major risk for disease transmission. Similarly, high infection prevalence within the herd or mingling calves from different origins presents a high risk of infection for young calves. Feeding colostrum or waste milk of cows with clinical or subclinical *M. bovis* mastitis was shown to result in colonization of the upper respiratory tract with this pathogen and was associated with increased occurrence rates of mycoplasma otitis.<sup>11</sup>

Specific and nonspecific immune response that is a critical determinant of the susceptibility to respiratory tract infection can be compromised by a number of environmental factors, such as heat or cold stress, overcrowding, poor ventilation, transportation, inadequate nutrition, or stress related to processing procedures.

Concomitant infection of the respiratory tract with other viral or bacterial pathogens may compromise the nonspecific immune response. *M. bovis* infection may predispose to superinfection of the respiratory tract with other bacterial pathogens, and previous infection of the respiratory tract with other pathogens may facilitate progression of *M. bovis* into the lower respiratory tract. Experimental infection studies have confirmed a synergistic effect of *M. bovis* with other common pathogens of the respiratory tract, such as *M. haemolytica* or *P. multocida*.<sup>1</sup>

Environmental temperatures have been found to affect the degree of nasal shedding and the incidence rate of clinical disease. Sudden drops of the environmental temperature were associated with increased rates of nasal shedding of *M. bovis* and higher occurrence rates of respiratory disease caused by *M. bovis*.<sup>1</sup>

### Methods of Transmission

Direct transmission of *M. bovis* from infected to uninfected animals is considered the primary route of disease transmission, an assumption that is corroborated by epidemiologic evidence indicating that the seroprevalence in feedlot cattle increases dramatically in the first weeks in the feedlot. Clinically normal cattle in infected herds harbor *M. bovis* in the upper respiratory tract with no apparent adverse effect and may shed the organism through the nasal discharge for months to years.<sup>5</sup> *M. bovis* might be transmitted with respiratory secretions, via aerosols, direct nose-to-nose contact, or fomites. Although mycoplasmas

in general do not easily survive in the environment, *M. bovis* can survive for prolonged periods outside the host, particularly in cool and humid conditions. Nonetheless the role of fomites and environmental contamination deserves further investigation but, with exception of the transmission of mycoplasma mastitis, is currently considered to be of limited epidemiologic relevance.

Oral ingestion of *M. bovis* contaminated milk or colostrum results in colonization of the oral cavity and upper respiratory tract with this pathogen and increased occurrence of otitis media.<sup>12</sup> Feeding colostrum or milk of cows shedding *M. bovis* through the mammary gland must therefore be considered as an effective route of disease transmission.

Intrauterine infection of calves appears to occur infrequently. Transmission of mycoplasma mastitis is considered to primarily occur in the milking parlor through contaminated milk.

### PATHOGENESIS

As with many mycoplasmas, *M. bovis* is both immune reactive and immunosuppressive. Upon incubation with *M. bovis*, alveolar macrophages are activated and produce TNF-alpha and nitric oxide, two powerful initiators of immune activity. *M. bovis* is also immunosuppressive by inhibiting neutrophil degranulation and oxidative bursts and proliferation of lymphocytes by mitogens. *M. bovis* also induces bovine lymphocyte apoptosis through the production of a protein that is different from other mycoplasmas both pathogenic and nonpathogenic. The protein is an immuno-inhibitory peptide that can suppress Concanavalin A (ConA)-induced proliferation of bovine lymphocytes. This represents a unique immunosuppressive peptide produced by the *M. bovis*.

Despite its deleterious effects on lymphocytes, infected cattle are able to generate measurable humoral and cellular immune responses against *M. bovis*. Serologic analysis indicates that *M. bovis* stimulates increased production of antigen-specific IgG1, whereas very little IgG2 is produced.

There is a systemic phase of *M. bovis* infection, including a potential interaction of the pathogen with endothelial cells. It is one of the most invasive bovine mycoplasmas capable of invading through lung epithelial junctions and causing systemic infections such as arthritis and mastitis following pneumonia. Localized lung vasculitis and the presence of thrombi within subsynovial vessels has been observed, both suggestive of interaction of *M. bovis* with epithelial cells.

**Arthritis** is normally regarded as a sequel to pneumonia or mastitis and infection in the respiratory tract or in the mammary gland is believed to lead to bacteremia and localization in joints. However, arthritis can suddenly occur in regions or countries where

mycoplasma pneumonia has been recognized for many years, suggesting that a new strain with different virulence or tropism has been introduced. The intraarticular injection of *M. bovis* into calves causes severe fibrinopurpurative synovitis and tenosynovitis, erosion of cartilage, and its replacement by polypoid granulation tissue. Erosion of the cartilage is accompanied by chronic osteomyelitis and formation of pannus tissue. Histologically, there is extensive ulceration of synovial membranes of leukocytic infiltration of the subsynovium, congestion, hyperemia, and thrombosis of the subsynovial vessels. Intratracheal inoculation of the organism results in pneumonia and severe lameness, which suggests that *M. bovis* is involved in pneumonia–arthritis syndrome.

In **otitis media/interna** of calves there is facial nerve paralysis because of proximity of CN VII to the tympanic cavity. Although hematogenous spreading of the pathogen to the middle and inner ear is considered a possible route of infection of this organ, an ascending infection from the oral cavity through the Eustachian tubes to the middle ear, resulting in clinical otitis media could be experimentally induced by feeding milk replacer contaminated with *M. bovis*.<sup>11,12</sup> Varying degrees of peripheral vestibulocochlear dysfunction occur because of the involvement of the vestibulocochlear receptors and nerve. The spontaneous regurgitation and dysphagia may be associated with lesions involving the glossopharyngeal nerve (CN IX) with or without the vagus nerve (CN X). These nerves may be affected by the inflammation associated with meningitis because both CN IX and CN X travel through the jugular foramen.

### CLINICAL FINDINGS

Pneumonia and polyarthritis associated with *M. bovis* may occur alone or together in cattle of all ages, including dairy and beef calves in their original herds, in growing dairy and beef cattle heifers, and in mature dairy and beef cows.

### Chronic Pneumonia and Polyarthritis Syndrome

The disease is most common in feedlot calves within a few weeks after arrival in the feedlot. The morbidity rate may be up to 25%. Affected calves commonly have had a history of respiratory disease with poor to no treatment response to antimicrobial therapy. Auscultation of the lungs reveals areas of loud bronchial tones, crackles and wheezes, and areas of muffled lung sounds indicating consolidation and occlusion of the bronchi with exudate. Depression, inactivity, inappetence, coughing, nasal discharge, fever, and progressive weight loss are common.

### Arthritis

Although mycoplasma arthritis is most commonly seen concurrent with

pneumonia, cattle of any age can be affected. Cases tend to occur sporadically, but outbreaks have been reported in calves and adult cows and as part of CPPS in feedlot cattle.<sup>11</sup> There is stiffness of gait, acute, non-weight-bearing lameness, inappetence, moderate fever, and progressive loss of weight. Swelling of the large movable limb joints and distension of tendon sheaths, associated with fibrinous synovitis and synovial fluid effusions, are characteristic. Both forelimbs and hindlimbs can be affected, and involvement of the carpal joints, the fetlocks and the proximal and distal interphalangeal joints commonly can be clinically detected. In calves, pneumonia is a common finding in the affected group. Some affected cattle spend considerable time in recumbency, lose weight, and develop decubitus ulcers, and they must be destroyed. Mildly affected cases recover spontaneously over a period of several weeks, but severe cases become progressively worse, may develop discharging sinuses over affected joints, and must be culled.

### Otitis Media/Interna

Otitis media/interna occurs in young beef and dairy calves as enzootic disease or as outbreaks. Feedlot calves are sporadically affected.<sup>11</sup> Clinical findings depend on the extent of the inflammation, which can involve only the middle ear or middle and inner ear. Varying degrees of depression, coughing, nasal discharge, inappetence, and fever are common in affected groups of calves. Head shaking, scratching, or rubbing of the ear are signs of ear pain. Otitis externa that is characterized by purulent exudate in the external ear may occur as result of a ruptured tympanic membrane. A unilateral head tilt and paralysis of the lip, eyelid, and ear muscles on the same side are common. When the eye on the affected side is threatened, the eyeball may retract, but there is no palpebral fissure closure. An intermittent loss of balance on the affected side may be apparent when the animal attempts to walk. Bilateral peripheral CN VII and VIII deficits (bilateral ear, lip, and eyelid paresis; bilaterally absent menace and palpebral reflexes; normal gait; balance loss to either side) are suggestive of bilateral otitis media/interna. Dysphagia, spontaneous regurgitation of milk and difficulty in sucking from a bottle or prehending feed may occur. Partially chewed feed may accumulate in the oral cavity, along with difficult prehension and mastication. Bilateral vestibular disease (balance loss to either side) may occur. Endoscopy of the pharynx may reveal collapse of the nasopharynx, dorsal displacement of the soft palate, and a widely dilated, hypomotile esophagus. Opisthotonus and nystagmus are common, and ataxia, recumbency, and death in several days may occur. The mortality rate is about 50%.

## CLINICAL PATHOLOGY

Clinical and pathologic signs are not characteristic for *M. bovis* infection, so laboratory diagnosis is necessary for identification. The organism can be detected by culture, identification of specific bacterial DNA by polymerase chain reaction (PCR), or identification of specific bacterial antigen, for example, with a sandwich-ELISA or immunohistochemistry.

### Culture

Culture methods for the detection of *M. bovis* are typically used on lung tissue, nasal swabs, bronchioalveolar lavage (BAL), or transtracheal wash (TTW) fluid and synovial fluid. Culture methods have the advantage that they can isolate multiple mycoplasma species at the same time and may reveal novel or unexpected species. Nonetheless culture methods require complex growth media, special equipment, and technical skills. They are time consuming, laborious, difficult, and expensive.<sup>5</sup> The sensitivity of mycoplasma culture in clinical material is rather low for several reasons. Infected animals may shed the pathogen intermittently and the distribution within affected tissue is uneven. Poor handling of samples and long shipping times will affect the viability of this labile microorganism. Cultures may also fail in cases sampled animals were previously treated with antimicrobials or samples are contaminated with other pathogens, as is commonly the case with samples collected from the respiratory tract. Although mycoplasma colonies can be identified by their characteristic morphology, they cannot readily be differentiated from each other, making speciation by immunologic methods or PCR necessary.<sup>1</sup>

### DNA Probe and Polymerase Chain Reaction

Molecular tests to detect bacterial DNA of *M. bovis* have been developed in recent decades and have been widely adopted for clinical diagnostic *M. bovis* infection. The main advantages of these methods are lower costs per sample, a considerably shortened turnaround time, and the compatibility with molecular testing for other pathogens. Because this method does not require the presence of living organisms, it is suitable to be used on previously stored samples.<sup>1</sup>

### Immunohistochemistry

Immunohistochemical (IHC) techniques can be used to detect the antigen of *M. bovis* in the tissues of cattle. IHC can be performed using formalin-fixed and paraffin-embedded tissue. Histology and immunohistochemistry can be used to analyze the lesions and distribution of the *M. bovis* antigen in the lungs of cattle with pneumonia and can be performed retrospectively.

## Enzyme-Linked Immunosorbent Assay

A monoclonal antibody-based sandwich ELISA (sELISA) for the detection of *M. bovis* in clinical material has been developed in Europe. The sensitivity of this ELISA is similar to that of conventional culture but can be improved when samples are incubated for a short period before antigen capture.<sup>1</sup>

### Serology

Because *M. bovis* infection induces a robust humoral response, several methods of detecting antibodies against *M. bovis* have been developed. Available tests that can be used on serum and other body fluids such as milk or synovia include the passive or indirect hemagglutination (HA) test, the indirect ELISA, and the film inhibition test. A variety of ELISA test kits are now commercially available.

Antibodies against *M. bovis* are detectable with the ELISA as early as 6 to 10 days post experimental inoculation. Notwithstanding correlation between antibody titers and clinical disease was found to be poor, and seroconversion in feedlot cattle is observed in healthy and sick calves alike, suggesting that paired serum samples may not be a good predictor of *M. bovis* respiratory disease.<sup>5</sup> Furthermore, serum antibody titers can remain elevated for months to years after an infection, meaning that a high titer may not necessarily be consistent with ongoing or recent infection.<sup>1</sup> Maternal antibodies may result in high antibody titers in young calves, but with a half-life of 12 to 16 days normally wane within the first months of life.<sup>1</sup>

Serology is currently considered to be of limited diagnostic value on an individual animal level but is useful on a herd level to screen a group of animals.

### Sample Collection and Handling

The choice of the specimen submitted for mycoplasma diagnostics and handling of the sample can have a great impact on the final test result and its validity. A number of ante-mortem diagnostic procedures are available for the diagnosis of respiratory disease that vary in their practicality, their suitability to detect a specific pathogen, the rapidity with which test results are available, their economy, the level of stress for the patient, the quality of the material obtained, and the interpretability of the results. Nasal, nasopharyngeal or conjunctival swabs, bronchioalveolar lavage (BAL), and transtracheal washes (TTW) are the most commonly used procedures to detect *M. bovis* in living animals. Nasal/nasopharyngeal swabs are frequently used under field conditions because this procedure is technically less demanding and less invasive than a TTW or BAL. Although presence of *M. bovis* on swab material is useful to confirm the presence of

the pathogen in a herd, the diagnostic value on an individual animal level is limited because of the high occurrence of upper respiratory tract infection with *M. bovis* in clinically healthy cattle of infected herds. Comparison of paired culture results from nasopharyngeal swabs and BAL samples in cattle with respiratory disease indicate that the correlation between the presence of *M. bovis* in the upper respiratory tract and its presence in the lower respiratory tract or clinical disease is poor.<sup>1</sup> In contrast, excellent agreement between paired BAL fluid samples and corresponding tissue cultures obtained during necropsy have been reported, suggesting that samples collected from the lower respiratory tract such as BAL or TTW fluid are better suited to make a diagnosis on an individual animal.<sup>1</sup>

When using swabs, wooden cotton swabs should be avoided because they can inhibit growth of mycoplasma.<sup>11</sup> The tip of the swab should be inserted approximately to the height of the medial canthus of the eye and must be firmly rotated against the mucosa to harvest many cells to which mycoplasmas are adhered. Swabs should then be stored in aerobic bacterial or mycoplasma transport media. Samples submitted for culture must either be kept refrigerated when shipping time does not exceed 24 hours or otherwise frozen. Because prolonged frozen storage significantly decreases the isolation of *M. bovis*, storage time should not exceed 7 to 10 days.<sup>1</sup>

Tissue samples can be formalin-fixed when used for histology and IHC or must be placed on ice and transported to the diagnostic laboratory immediately for culture.<sup>11</sup>

### NECROPSY FINDINGS

At necropsy, the characteristic lung lesion of *M. bovis* is a **caseonecrotic bronchopneumonia** comprising raised, white, sharply demarcated, friable foci of caseous necrosis within consolidated areas mostly in the cranioventral lung lobes.<sup>13-15</sup> The necrotic foci often range from 1 to 10 mm in size but can coalesce and grow up to 5 cm in diameter. Larger foci are frequently surrounded by pale firm connective tissue. Between 10% and 50% of total lung surface may be consolidated. When the lung is squeezed, the necrotic material falls out as a single or multiple pieces, and sequestra may be seen.<sup>14</sup>

Microscopically, the specific lesions are areas of coagulative to caseous necrosis originating mostly from bronchioles and bronchi. Well-developed foci of necrosis contain an eosinophilic coagulum at the center surrounded by accumulations of mostly degenerate neutrophils, macrophages and an outer zone of plasma cells, lymphocytes, and degenerate bronchiolar/bronchial epithelial cells. Adjacent lung tissue shows typical suppurative bronchopneumonia and atelectasis. Within the necrotic lesions, and especially in the inflammatory cells at the margin, *M.*

*bovis* antigen or DNA can be detected by immunohistochemistry or molecular techniques respectively.

**Fibrinous polysynovitis** is remarkable at necropsy. One or more joints are swollen (as detected clinically). Acute lesions consist of a serofibrinous exudate within joint cavities and tendon sheaths, and the synovium is reddened and hyperplastic. Later, the exudate becomes purulent or fibrinopurulent, and there may be foci of necrosis as described in the lung. Microscopically, large numbers of lymphocytes and plasma cells are found within the hypertrophic synovial villi. Immunohistochemical and molecular techniques are used for specific diagnosis in the tissues of feedlot cattle.

Involvement of the ears by *M. bovis* can lead to **otitis media**. A fibrinous, purulent or caseating exudate is present in one or both middle ears with or without concurrent involvement of the lungs and joints.

### Samples for Confirmation of Diagnosis

- **Histology**—lung, synovial membrane (LM, IHC)
- **Mycoplasma**—lung, culture swab from joint cavity and affected middle ear (MCULT)
- **PCR**—lung, synovial membrane or exudate from middle ear

### DIFFERENTIAL DIAGNOSIS

A diagnosis of infection by *M. bovis* should be considered when pneumonia and arthritis, synovitis, and possibly otitis occur at about the same time. The disease must be differentiated from other causes of joint swelling and lameness in feedlot cattle. With *M. bovis* infection there are usually several animals affected in a short period of time, which serves to distinguish it from other sporadic causes of arthritis.

*Differential clinical diagnosis for respiratory disease:*

- **Pneumonic pasteurellosis of cattle** is an acute, toxemic bronchopneumonia with a high fever and a good response to treatment in the early stages. Depression and anorexia are common. The disease is most common in young beef and dairy calves that have been recently stressed following weaning or mixed in auction markets and shipped to feedlots. The disease can also occur in mature cattle as a primary or secondary pneumonia.
- In **viral interstitial pneumonia** of calves, young and adult cattle there is characteristic dyspnea, a moderate fever, only a mild toxemia, and loud breath sounds over the ventral aspects of the lungs followed by crackles and wheezes in a few days, and recovery may take several days. Pneumonia attributable to BRSV may be mild with uneventful

recovery or severe with dyspnea and subcutaneous emphysema and a high case-fatality rate.

- **Lungworm pneumonia** occurs most commonly in young pastured cattle and is characterized by dyspnea, coughing, only mild toxemia, and a moderate or normal temperature; the course may last several days. Usually many cattle are affected. Crackles and wheezes are usually audible over the dorsal aspects of the lungs, and the response to treatment is usually favorable if treatment is initiated early when signs are first noticed.
- **Atypical interstitial pneumonia (fog fever) and atypical interstitial pneumonia of feedlot cattle.** The former usually occurs in adult pastured cattle that have been moved from dry to lush pasture (or just a different species of pasture or on to a recently harvested cereal grain field); the latter is incidentally observed in feedlot cattle most commonly in the finishing period; the onset is sudden and some cattle may be found dead, whereas others are in severe respiratory distress with an expiratory grunt. This condition is usually not associated with toxemia.
- **Infectious bovine rhinotracheitis (IBR)** is characterized by rhinitis, usually with discrete lesions in the nares, tracheitis, loud coughing, high fever, and no toxemia unless secondary bacterial pneumonia is present. Recovery usually occurs gradually over 4 to 7 days.
- **Contagious bovine pleuropneumonia (CBPP)** resembles pneumonic pasteurellosis but occurs in plague form; there is severe, painful, toxemic pleuropneumonia, and the case-fatality rate is high.

*Differential clinical diagnosis for arthritis:*

- **Traumatic aseptic arthritis** may be associated with history of trauma and sudden onset of lameness without signs of systemic disease. Synovial fluid collected by arthrocentesis is colorless or yellow to red-tinged (as a result of hemorrhage). Synovia is clear with moderate cellularity.<sup>16</sup> Culture of synovia is negative.
- **Traumatic septic arthritis** with bacterial contamination of joint cavity commonly involves a single joint with worsening lameness. A skin lesion over the affected joint might be present. Synovial fluid is cloudy, with decreased viscosity, high cellularity, fibrin content, and a tendency to clot.
- **Septic arthritis as a result of hematogenous infection** is a common complication of omphalitis or septicemia (e.g., diarrhea) in calves. Frequently involves several joints and is associated with clinical omphalitis. Common pathogens are *Trueperella* (formerly *Arcanobacterium*) *pyogene*, *E. coli*, *Salmonella* spp., *Streptococcus* spp.,



*Staphylococcus* spp. *Histophilus somni*, and others.

- For a definitive diagnosis, joint fluid must be placed immediately into laboratory media specially prepared for *Mycoplasma* spp. The failure to isolate the mycoplasma from the fluid of joints that have been affected for more than 14 days does not preclude a diagnosis of mycoplasma arthritis because the organism may have been eliminated from the joint.
- Other pathogens isolated from the ear of animals with otitis include mites, nematodes, *Mycoplasma* spp., and variety of bacteria.<sup>17</sup>

*Differential clinical diagnosis for otitis in cattle:*

- **Bovine parasitic otitis** caused by *Rhabditis bovis*. *Diagnosis is made by identifying the nematode in the secretion of the external ear*
- **Otitis externa caused by mites** such as *Raillietia auris*.
- **Otitis media/interna as a complication of respiratory tract disease** caused by pathogens such as *M. haemolytica*, *P. multocida*, *H. somni*, *Streptococcus* spp., and *Staphylococcus* spp.

## TREATMENT

In general, treatment response to antimicrobial therapy is fair at best for respiratory tract disease and is particularly disappointing for mycoplasmal arthritis. Limited drug distribution into infected caseous lung tissue where *M. bovis* is present in largest numbers and the fibrin deposition and biofilm production that characterizes some *M. bovis* strains all contribute to resistance to antimicrobials in vivo that may contrast in vitro susceptibility.<sup>2</sup> Mycoplasmas have a theoretical susceptibility to antimicrobials that disrupt protein or DNA synthesis, such as tetracyclines, macrolides, florfenicol, and fluoroquinolones. In contrast they are inherently resistant to all  $\beta$ -lactam antibiotics because they lack a cell wall and to sulfonamides because they do not produce folic acid.

Although a large number of studies document the efficacy of different antimicrobials for treatment of cattle experimentally infected with *M. bovis*, little information is available about treatment efficacy under field conditions. Several antimicrobials, including tylosin, oxytetracycline, lincomycin, spectinomycin, and oleandomycin, have been used in the past to treat naturally occurring *M. bovis* infection and were reported to result in clinical improvement. However, because of the common resistance of *M. bovis* against most of these antimicrobials that has been documented in recent years, these substances can no longer be considered appropriate choices.<sup>1,2</sup>

The published results of in vitro antimicrobial testing of isolates of *M. bovis* recovered from various locations are highly variable. The antimicrobial susceptibility of *M. bovis* strains, cultured from cases of pneumonia, arthritis, and mastitis of cattle, measured in vitro indicate that enrofloxacin, florfenicol, and spectinomycin all exhibited good to excellent activity.<sup>18</sup> The in vitro susceptibilities of Belgian field isolates of *M. bovis* to 10 antimicrobials found that tiamulin was the most active against the organism. The fluoroquinolones, danofloxacin, enrofloxacin, and marbofloxacin were effective against strains of *M. bovis*, whereas gentamicin was ineffective. In a series of British isolates of *M. bovis*, most isolates were susceptible to danofloxacin but less susceptible to florfenicol. An industry sponsored study found tulathromycin and florfenicol at label dose to be effective for the treatment of respiratory disease in cattle caused among others by *M. bovis* under field conditions.<sup>19</sup> Gamithromycin at label dose was found to be effective in treating naturally occurring clinical pneumonia caused by *M. bovis*.<sup>20</sup>

In calves with a high incidence of respiratory disease associated with *M. bovis* and *Pasteurella* spp. the use of valnemulin in the milk of the calves for 4 days resulted in improved weight gains and fewer cases of mycoplasmal infection and required fewer treatments with antibiotics than those in the placebo treated group.

Little evidence to support recommendations for an **appropriate treatment duration** with antimicrobials is available in the literature. Common wisdom holds that early treatment and prolonged therapy are the two most important factors contributing to the success of treatment of mycoplasmal infection.<sup>2</sup> Given that *M. bovis* infection often becomes chronic, prolonged use of antimicrobials at least until clinical signs resolves appears warranted.<sup>11</sup> This implies that in many cases antimicrobials would have to be administered in an extra-label manner.

In addition to antimicrobial therapy short-term use of antiinflammatory drugs for management of pain and respiratory distress is certainly indicated in severe cases.

In case of early stage **septic arthritis** involving a single or few joints joint irrigation may be attempted. The objective of this procedure is to drain infected synovial fluid thereby reducing the number of bacteria and removing fibrin, debris, and other harmful products of inflammation. Joint lavage can be performed either by "tidal flush" through the same needle inserted into the infected joint or, preferably, by "through-and-through" lavage in which fluid is injected and drained through different 14-gauge needles that are placed into the joint as far apart as possible. Depending on the size of the joint, a minimum of 250 mL and up to several liters are needed for effective joint lavage.<sup>21-22</sup> Warmed polyionic solutions (e.g., lactated

Ringer's or isotonic saline solution) are commonly flushed through the joint applying pressure until draining fluid becomes clear. Adding polyvidone-iodine to the irrigation solution to obtain a 0.01% to 0.1% solution has been recommended for its bactericidal effect.<sup>23</sup> Aseptic technique is required to prevent secondary bacterial infection. Because treatment efficacy is greatly impaired by fibrin accumulation in the joint, joint irrigation should mainly be considered in early stages of the disease. Arthroscopic joint debridement has been used to treat septic arthritis in cattle in other species, with good outcome. This approach allows to effectively remove fibrin and debride to synovial membrane but requires adequate surgical equipment and skills.<sup>24</sup> Arthroscopy is rarely done because it is a major surgery with long after care and often unrewarding outcome.

In cases of **otitis media** with ruptured tympanic membrane irrigation of the middle ear has been recommended. Irrigation solutions used include various apparently empirical dilutions of povidone iodine, hydrogen peroxide or chlorhexidine.<sup>17</sup> Perforating the still intact tympanic membrane (myringotomy) with a sharp object has been proposed to allow drainage and irrigation of the middle ear. The advantages and risks of this procedure do not appear to have been properly evaluated.

## TREATMENT AND CONTROL

### Treatment

#### Antimicrobial therapy

Tulathromycin (2.5 mg/kg SC as single dose)  
 Florfenicol (20 mg/kg q48 IM)  
 Tilmicosin (10 mg/kg SC as single dose)  
 Gamithromycin (6 mg/kg SC as single dose)  
 Enrofloxacin (2.5–5.0 mg/kg q24 SC)  
 Danofloxacin (6 mg/kg q48h SC)  
 Oxytetracycline (10 mg/kg IM q24)  
 $\beta$ -lactam antibiotics (R-4)  
 Erythromycin (R-4)  
 Sulfonamides (R-4)

#### Antiinflammatory therapy

Flunixin meglumine (2.2 mg/kg IV as single dose) (R-2)  
 Ketoprofen (3 mg/kg IM q24h for 2–3 days) (R-2)  
 Carprofen (1.4 mg/kg SC/IV as single dose) (R-2)  
 Meloxicam (0.5 mg/kg SC/IV as single dose) (R-2)  
 Diclofenac (2.5 mg/kg IM as single dose) (R-2)  
 Tolfenamic acid (2 mg/kg IM/IV q24–48h or 4 mg/kg IM/IV as single dose) (R-2)

#### Metaphylaxis

Tulathromycin (2.5 mg/kg SC as single dose)  
 Florfenicol (40 mg/kg SC as single dose)

*Continued*

Tilmicosin (10 mg/kg SC as single dose)  
 Gamithromycin (6 mg/kg SC as single dose)  
 Oxytetracycline long-acting formulation (20 mg/kg IM as a single dose)  
 Enrofloxacin\* (7.5–12.5 mg/kg SC as single dose)  
 Danofloxacin\* (8 mg/kg SC as single dose)

#### Vaccination

Vaccination against *M. bovis* (R-3)

\*These are classified as critically important antimicrobials in human and veterinary medicine. Use as first-line treatment is discouraged.<sup>25</sup>

## CONTROL Biosecurity

Effective control consists in maintaining a closed herd or screen and quarantine newly purchased animals. Aggressive surveillance and culling of infected animals is advisable for herds with low infection prevalence. In high-prevalence herds and operations where maintaining closed herds or enforcing a quarantine is impractical, as is the case in feedlots, the focus of the control measures must be on limiting stress, controlling concomitant and potentially debilitating diseases such as bovine viral diarrhea (BVD) and segregating clinically affected animals from new arrivals.

Biosecurity and biocontainment procedures should be implemented to prevent the introduction of infection into the herd and to minimize the spread of infection in the herd.

Biosecurity measures applicable to **dairy herds** include the following:<sup>11</sup>

- Bulk-tank cultures from the herd of origin of newly purchased dry cows or heifers
  - Recur to bulk-tank culture history of the herd of origin or if unavailable.
  - Obtain cultures from at least 3 bulk tank samples collected at least 3 to 4 days apart.
- Individual milk samples of newly purchased lactating cows should be submitted for detection of mycoplasma (culture, PCR, C-ELISA) before introducing these animals into the herd. Be aware of low sensitivity of a single milk sample to detect subclinical infection.
- Test for *M. bovis* antibodies in milk or serum to identify infected animals.
- Screen calf health records from herd of origin of newly purchased animals for history of clinical signs consistent with *M. bovis* infection (e.g., polyarthritis or otitis) when available.

Procedures that have been recommended to control ***M. bovis* transmission in calves** include the following:<sup>1</sup>

- Avoid exposure of calves to milk/colostrum contaminated with *M. bovis*.
  - Avoid feeding milk/colostrum from infected cows.
  - Pasteurize milk/colostrum of cows of unknown status in infected herds before feeding to calves.
  - Feed milk replacer.
- Reduce airborne exposure to *M. bovis*.
  - Segregate calves with suspected or confirmed clinical *M. bovis* infection.
  - Prevent overcrowding.
  - Provide adequate ventilation.
  - Promptly treat calves with respiratory disease.
- Prevent fomite transmission.
  - Sanitize nipples, bottles, tube feeders, buckets, and so forth.
  - Wear gloves when feeding newborn calves and assisting sick calves to nurse, and change gloves between animals.
- Consider all-in, all-out procedure and sanitize pens between calves or separate younger from older calves to prevent disease transmission.
- Consider metaphylactic use of antimicrobials in situations with high morbidity/mortality rates.
- Use nonspecific measures to stimulate calf health.
  - Ensure adequate transfer of passive immunity.
  - Provide adequate nutrition.
  - Minimize stress.
  - Control other potentially debilitating pathogens (e.g., other pathogens of the respiratory tract or BVDV).

In dairy herds, pasteurization of mycoplasma mastitis milk at 65°C (149°F) for 1 hour can kill mycoplasmas and reduce the incidence of respiratory disease in calves. A temperature of 65°C (149°F) killed *M. bovis* and *M. californicum* after 2 minutes of exposure, whereas *M. canadense* remained viable for up to 10 minutes. Exposure to 70°C (158°F) inactivated *M. bovis* and *M. californicum* after 1 minute, but *M. canadense* samples were positive for up to 3 minutes.

### Metaphylactic Use of Antimicrobials

Although the prophylactic/metaphylactic use of antimicrobials is undesirable from a standpoint of prudent use of antimicrobials, it is well established that treatment of mycoplasma infection is most effective when initiated early in the course of disease.<sup>11</sup> Metaphylactic use of antimicrobials in animals at high risk of developing respiratory disease of undetermined etiology has

clearly been demonstrated to reduce the incidence and severity of disease in feedlot cattle.<sup>26–28</sup> For the treatment of other mycoplasma infection in cattle such as contagious bovine pleuropneumonia (CBPP), the metaphylactic treatment of in-contact animals was reported to significantly reduce disease transmission, severity scores in affected animals, and mortality rates within herds.<sup>29</sup> This suggests that metaphylactic treatment of mycoplasma infection might be more successful than initiating treatment after disease is clinically apparent. Given limited evidence, available metaphylactic antimicrobial therapy of animals at high risk of developing *M. bovis* infection is probably justified in herds with high morbidity and mortality rates.<sup>11</sup>

### Vaccines

Some vaccines have been developed, but they have not been sufficiently efficacious or have yielded poor results. A quadrivalent inactivated vaccine containing BRSV, PI-3 virus, and *M. dispar* and *M. bovis* provided some protection against naturally occurring outbreaks of bovine respiratory disease. A vaccine containing formalin-inactivated strains of *M. bovis* and *Mannheimia haemolytica* from affected herds reduced losses from pneumonia and the cost of treatment in newly arrived feedlot calves.

A single dose of vaccine for *M. bovis* pneumonia, inactivated with saponin, provided protection against experimental challenge of calves 3 to 4 weeks of age with a virulent isolate of *M. bovis*. The vaccine also reduced the spread of *M. bovis* to internal organs. Attempts to vaccinate against *M. bovis* arthritis have been unsuccessful. Experimental vaccines against mycoplasma vaccines have been unsuccessful and may even exacerbate the mastitis.

Currently there are several *M. bovis* bacterin vaccines that have been licensed in the United States for the control of *M. bovis* pneumonia in calves, and several U.S. companies are permitted to produce custom autogenous bacterin vaccines. No registered *M. bovis* vaccine is currently available in Europe. There is currently no convincing evidence documenting the efficacy of vaccines to control *M. bovis* infection under field conditions.<sup>11</sup>

### FURTHER READING

- Maunsell FP, Donovan GA. *Mycoplasma bovis* infection in young calves. *Vet Clin North Am Food A.* 2009;25:139-177.
- Maunsell FP, Woolums AR, Francoz D, et al. *Mycoplasma bovis* infection in cattle. *J Vet Intern Med.* 2011;25:772-783.
- Nicholas RAJ, Ayling RD. *Mycoplasma bovis*: disease, diagnosis, and control. *Res Vet Sci.* 2003;74:105-112.
- Nicholas RAJ. Bovine mycoplasmosis: silent and deadly. *Vet Rec.* 2011;168:459-462.
- Rosenbusch RF. Bovine mycoplasmosis. *Proc Am Assoc Bov Pract.* 2001;34:49-52.

Step DL, Kirkpatrick JG. Mycoplasma infection in cattle. I. Pneumonia arthritis syndrome. *Bov Pract.* 2001;35:149-155.

## REFERENCES

- Maunsell FP, Donovan GA. *Vet Clin North Am Food A.* 2009;25:139-177.
- Nicholas RAJ. *Vet Rec.* 2011;168:459-462.
- Gerchman I, et al. *Vet Microbiol.* 2009;137:268-275.
- Giovanni S, et al. *Res Vet Sci.* 2013;95:576-579.
- Caswell JL, et al. *Vet Clin North Am Food A.* 2010;26:365-379.
- Foster AP, et al. *Vet J.* 2009;179:455-457.
- NAHMS, 2002. (Accessed 15.09.15, at: <[http://www.aphis.usda.gov/animal\\_health/nahms/dairy/downloads/dairy02/Dairy02\\_is\\_Mycoplasma.pdf](http://www.aphis.usda.gov/animal_health/nahms/dairy/downloads/dairy02/Dairy02_is_Mycoplasma.pdf)>.).
- Francoz D, et al. *Can Vet J.* 2012;53:1071-1078.
- Higuchi H, et al. *Vet Rec.* 2011;169:442.
- McDonald WL, et al. *NZ Vet J.* 2009;57:44-49.
- Maunsell FP, et al. *J Vet Intern Med.* 2011;25:772-783.
- Maunsell F, et al. *PLoS ONE.* 2012;7:e44523.
- Caswell JL, Williams KJ. The respiratory system. In: Maxie MG, ed. *Jubb, Kennedy and Palmer's Pathology of Domestic Animals.* Vol. 2. 5th ed. London: Elsevier Saunders; 2007:523.
- Pancieria RJ, Confer AW. *Vet Clin North Am Food A.* 2012;26:191.
- Hermeyer K, et al. *Acta Vet Scand.* 2012;54:9.
- MacWilliams PS, Friedrichs KR. *Vet Clin Small Anim Pract.* 2003;33:153-178.
- Morin D. *Vet Clin North Am Food A.* 2004;20:243-273.
- Rosenbusch RF, et al. *J Vet Diagn Invest.* 2005;17:436-441.
- Godhino KS, et al. *Vet Ther.* 2005;6:122-135.
- Lechtenberg K, et al. *Int J Appl Res Vet Med.* 2011;9:225-232.
- Jackson PGG, et al. *Cattle Pract.* 1998;6:335-339.
- Jackson P. *In Pract.* 1999;596-60.
- Starke A, et al. *Tierärztl Prax.* 2009;37:20-30.
- Munroe GA, Cauvin ER. *Br Vet J.* 1994;150:439-449.
- World Organization for Animal Health. OIE list of antimicrobial agents of veterinary importance, 2015. (Accessed 15.09.15, at: <[http://www.oie.int/fileadmin/Home/eng/Our\\_scientific\\_expertise/docs/pdf/OIE\\_List\\_antimicrobials.pdf](http://www.oie.int/fileadmin/Home/eng/Our_scientific_expertise/docs/pdf/OIE_List_antimicrobials.pdf)>.).
- Nickel JS, White BJ. *Vet Clin North Am Food A.* 2010;26:285-301.
- Taylor JD, et al. *Can Vet J.* 2010;51:1351-1359.
- Sweiger SH, et al. *Vet Clin North Am Food A.* 2010;26:261-271.
- Hübschle O, et al. *Res Vet Sci.* 2006;81:304-309.

## ENZOOTIC PNEUMONIA OF CALVES

### SYNOPSIS

**Etiology** Bovine respiratory syncytial virus (BRSV), bovine coronavirus (BoCV), Parainfluenza-3 virus (PI-3); less frequently, bovine herpesvirus-1 (BHV-1); infectious bovine rhinotracheitis, IBR) and other viruses; *Mycoplasma bovis*, *Mycoplasma* spp.; secondary opportunistic bacterial infection with *Pasteurella multocida*, rarely with *Mannheimia haemolytica*.

**Epidemiology** Housed dairy calves under 3-5 months; high morbidity low mortality; veal

calves; beef calves crowded in calving grounds; poor colostral immunoglobulin status; inadequately ventilated calf barns; excessive infection pressure on newborn calf because of close proximity to adult cattle in barns; economically important.

**Signs** Mild to severe dyspnea, fever, loud breath sounds over cranioventral lungs (consolidation), coughing, high morbidity; low case-fatality rate, secondary bacterial pneumonia with toxemia.

**Clinical pathology** Isolate pathogens from nasal swabs, transtracheal aspirates. Serology for seroconversion to viruses.

### Differential diagnosis:

- Pneumonic pasteurellosis caused by *Mannheimia haemolytica*
- Histophilus somni* pleuropneumonia
- Aspiration pneumonia
- Dyspnea of enzootic muscular dystrophy
- Chronic cases may resemble congenital cardiac defects

**Treatment** Antimicrobials to prevent and treat secondary bacterial pneumonia.

**Control** Ensure adequate colostrum intake. Good housing and ventilation. Prevent crowding in calf barns. Raise dairy calves separate from adult cattle or in calf hutches.

## ETIOLOGY

The term *enzootic pneumonia* should be considered more as a description than a diagnosis, similar to the term *shipping fever*. **Enzootic pneumonia** refers to clinical respiratory disease in dairy and veal calves raised in confinement under 6 months of age, whereas **shipping fever** refers to clinical respiratory disease in recently weaned beef calves shortly after transportation.

The cause of enzootic pneumonia is multifactorial, associated with various species of viruses, mycoplasma, bacteria, and environmental and host risk factors contributing to the pathogenesis, severity and nature of the pneumonia. Respiratory pathogens such as bovine respiratory syncytial virus (BRSV), bovine coronavirus (BoCV), and mycoplasma act as primary pathogens, and bacterial infection with *Pasteurella multocida* acts as a common secondary opportunistic complication. *Mannheimia hemolytica* is isolated from calves with enzootic pneumonia at a much lower rate than *P. multocida*.<sup>1,2</sup>

### Bovine Respiratory Syncytial Virus

Bovine respiratory syncytial virus (BRSV) causes pneumonia in both dairy and beef cattle of all ages, but primarily in dairy calves under 6 months of age. BRSV isolates belong to an antigenic grouping different from that of Human Respiratory Syncytial Virus (HRSV), and distinct antigenic subgroups of BRSV exist.

### Bovine Coronavirus

Bovine coronavirus (BoCV) is one of the more newly identified viral respiratory pathogens of cattle, being first described in 1993. As a consequence, the clinical significance of BoCV in bovine respiratory disease, and enzootic pneumonia in particular, is still being determined.

The current evidence indicates that BoCV plays a primary and important role in enzootic pneumonia. BoCV was the most commonly identified viral pathogen identified in nasal swabs from calves with respiratory disease in Ireland, being present in 23% of calves.<sup>3</sup> BoCV was identified throughout the year, but at a much lower rate in summer.<sup>3</sup> BoCV was the only virus detected in approximately 75% of respiratory disease outbreaks in two to 3-month calves in Italy.<sup>4</sup>

### Parainfluenza-3 Paramyxovirus

The evidence for viruses as primary etiologic agents is based on virus isolation, serologic evidence of active infection, lesions of viral pneumonia, and experimental infection. The parainfluenza-3 (PI-3) virus has been isolated most commonly from affected calves and inoculation of the virus into colostrum-deprived calves results in a pneumonia that resembles the naturally occurring disease.

### *Mycoplasma bovis* and *Mycoplasma* spp.

*Mycoplasma bovis* is a major cause of calf pneumonia, and in conjunction with BRSV and BoCV, is considered one of the three most important and common etiologic agents of calf pneumonia. In addition, *Mycoplasma dispar*, *M. bovirhinis*, and *Ureaplasma diversum*, are frequently isolated from the lungs of pneumonic calves. *Acholeplasma laidlawii* and *M. arginini* are also found but of dubious significance.

### Mixed Viral and Other Pathogen Infections

A survey of viral infections of the respiratory tract of calves over a 3-year period revealed that BRSV, the PI-3 virus and bovine virus diarrhoea virus (BVDV) were significantly associated with respiratory disease. Seroepidemiologic and clinical surveys of calves raised as herd replacements in dairy herds commonly reveals evidence of BRSV and PI-3 virus infections associated with respiratory disease. The rhinoviruses, adenoviruses, reoviruses, and enteroviruses were also isolated but in much lower frequency, and were considered not to be important. *Chlamydia* spp. has been associated with respiratory disease in calves and usually as part of a mixed infection with viruses and bacteria. A recent metagenomics study identified the presence of bovine adenovirus, bovine rhinitis A virus, and bovine influenza D virus either alone or in combination in 62% of calves with respiratory disease.<sup>5</sup>



## Bacteria

*P. multocida* is frequently isolated from the lungs of calves with enzootic pneumonia. Because it is a commensal of the upper respiratory tract, *P. multocida* is typically considered as an opportunistic pathogen in calves with enzootic pneumonia.<sup>6</sup> *M. haemolytica* and *P. multocida* may both be recovered from the lungs of calves with pneumonia and may act synergistically with the *Mycoplasma* spp. to cause a more severe and fatal pneumonia; however, *M. haemolytica* is not commonly isolated from calves with enzootic pneumonia.<sup>1,2</sup> Several other bacterial species may also be recovered from pneumonic lungs, including *Histophilus somni* (formerly *Hemophilus somnus*), *Trueperella* (formerly *Arcanobacterium* or *Actinomyces* or *Corynebacterium*) *pyogenes*, *Fusobacterium* spp., *Streptococcus* spp., and *Staphylococci* spp., particularly from chronically infected animals.

*Bibersteinia trahalosi* (formerly *P. haemolytica* Biotype T) has been infrequently isolated from young dairy calves and adult cows with respiratory disease. It is currently uncertain whether *B. trahalosi* acts as a primary respiratory pathogen in bovine respiratory disease or plays a secondary and opportunistic role. Calves challenge exposed with a virulent isolate of *B. trahalosi* and previously vaccinated with a modified live leukotoxin positive *M. haemolytica* vaccine had less severe clinical signs of respiratory disease, lower mortality, and reduced lung lesions scores than unvaccinated calves.<sup>7</sup> In contrast, intratracheal inoculation of 2- to 3-month-old dairy calves with leukotoxin positive or negative strains of *B. trahalosi* failed to induce clinical signs of respiratory disease.<sup>8</sup> Interestingly, *B. trahalosi* inhibits the growth of *M. haemolytica* via a proximity-dependent mechanism,<sup>9</sup> leading to speculation that most of the pathology in field cases attributed to *B. trahalosi* pneumonia was actually attributable to *M. haemolytica* infection that has been overgrown. Additional studies are needed to clarify the role of *B. trahalosi* in bovine respiratory disease.

## EPIDEMIOLOGY

### Occurrence

#### Dairy Calves

Enzootic pneumonia occurs most commonly in housed dairy calves from 2 weeks to 5 months of age being raised as herd replacements. Pneumonia can be responsible for up to 30% of all deaths of calves in dairy herds from birth to 16 weeks of age, second to enteritis, which can account for 44% of all deaths. Some farms report many cases of pneumonia, whereas others have none, emphasizing the role that management and environment play in the incidence of enzootic pneumonia.

Pneumonia can be the single largest cause of death in veal calf farms. The calves are purchased at about 10 days of age, assembled

into large groups of 25 to 50 per group and fed a milk substitute diet for about 16 weeks and then sent to slaughter. The peak incidence of disease occurs about 5 weeks after arrival in the calf house during which time PI-3 and BRSV are recovered most often.

#### Beef Calves

Enzootic pneumonia occurs in nursing beef calves and can account for significant reductions in weaning weight and a significant cause of economic loss as a result of disease in the neonatal period. In cow-calf herds in northwestern Quebec, one of the major causes of a low percentage of weaned calf-crop was the occurrence of diarrhea and pneumonia in calves under 2 weeks of age. Pneumonia can also occur after beef calves have been housed.

#### Morbidity and Case Fatality

Morbidity rate and case-fatality rates vary depending on the quality of housing and management provided, and the type and amount of viruses and bacteria that predominate in the environment at any one time. The morbidity rate may reach 100%, and the case-fatality rate is usually less than 5%.

On veal calf farms, pneumonia can be the largest single cause of death, with mortality rates up to 3.7% and culling rates at 5.1%. Peak death and cull losses occur during the 7th and 8th week of production.

In Ontario Holstein dairy herds, 15% of calves were treated for pneumonia before the age of weaning. Treatment rates for pneumonia increased slightly until about the 6th week of life and then declined until weaning. Calves that had pneumonia during the first 3 months of life had an increased risk of mortality before they reached calving age. In Holstein herds in New York, the crude incidence rate for respiratory disease within 90 days of birth was 7.4%. In those same herds, dullness of calves and unspecified diagnosis within 90 days of birth increased the hazard rate of death after 90 days of age 4.3-fold above that for heifers without dullness within 90 days of birth. These data indicate pneumonia in dairy calves in the first 3 months of age can have an adverse effect on long-term survival and subsequent growth rate.

#### Methods of Transmission

**Aerosol infection** and **direct contact** are the methods of transmission and both are accentuated in crowded, inadequately ventilated conditions. Newborn calves raised in individual pens may become infected within 5 to 15 days after an experimentally infected calf is placed in the calf house.

#### Risk Factors

Because most of the pathogens described under etiology can be found in the respiratory tract of normal calves, it has been generally accepted that environmental risk factors, such as ambient temperature, relative

humidity, air quality, and population density, are necessary to precipitate the disease. In addition, several animal risk factors make calves susceptible to the pathogens in their environment. There are also pathogen risk factors that determine the disease outcome.

#### Animal Risk Factors

The onset of calf pneumonia occurs between 2 and 4 weeks of age when the concentration of serum IgG<sub>1</sub>, IgG<sub>2</sub> and IgA in the nasal secretions are lowest. When the concentrations of serum IgG<sub>2</sub> begin to increase at about 2 to 4 months of age, the incidence of new cases of pneumonia begins to decline. The spectrum of colostral antibodies present in home-raised calves will depend on the spectrum of infection in the adult cows. In herds infected with BRSV, newborn calves acquire colostral antibodies to BRSV, which declines to undetectable levels in an average of about 100 days with a range of 30 to 200 days.

Most calves that recover from clinical enzootic pneumonia are resistant to further attacks of the disease associated with the same infectious agents. Herd immunity to one or more viruses develops, and severe outbreaks of disease usually occur following the introduction of animals that may be carriers of infectious agents to which the resident animals are nonimmune. In commercial veal calf units where market-purchased calves are being introduced on a regular basis, there is commonly a succession of minor epidemics of enzootic pneumonia. The incidence is highest in the recently introduced calves and the disease will occur in a small percentage of resident calves.

In a study of range beef calves from birth to 45 days of age, respiratory disease accounted for a total mortality of 1% and was associated with twins, which may result in a less viable calf at birth that may be neglected and abandoned. The risk of respiratory disease was also higher for male calves. The recent advancement of calving dates of beef cattle herds in the cold areas of North America from April–June to January–March results in crowded conditions in calving yards, which creates the environmental conditions similar to those of housed dairy calves. This has increased the incidence risk for enzootic pneumonia in beef calves.

#### Environmental and Management Risk Factors

Environmental risk factors, such as inadequate housing and ventilation are major contributors to the disease process. These include calving area, calf housing, spatial separation between calves, mixing calves of different age groups, and seasonal effects. Dairy herds that do not house calves in groups before weaning, or that house calves in groups of seven or fewer calves per group, are less likely to be affected with high mortality rate as a result of respiratory disease. The

calving area and environment can affect calf health through stress and the degree of exposure to infectious agents. Inadequate ventilation, improper climate control, and poorly constructed facilities can induce stress in calves. Crowding results in close contact and promotes spread of infection, and also results in excess moisture that, in the presence of inadequate ventilation (movement of air) and supplemental heat, causes a high relative humidity and chilling of calves. Many calf barns are old, adapted barns that are occupied for several months without depopulation and disinfection. Monitoring 48 dairy herds over 1 year in the National Animal Health Monitoring System revealed that mortality was lower in herds that used calf hutches compared with those that did not. In commercial veal units, the longer the disinfection and vacancy break, up to 6 to 7 days, the lower the incidence of disease in new calf crops entering the unit. Ventilation is commonly inadequate where dairy calves are raised because of poor design of the building.

Rapid changes in weather, particularly during the winter months, are often followed by outbreaks of acute pneumonia because of inadequate ventilation. A common practice during cold weather is to close the air inlets and turn off the ventilating fans in an attempt to maintain the inside temperature at a comfortable level. This results in increased relative humidity, condensation of moisture on walls and on the calves, leading to wet conditions, and the reduced ventilation results in an increase in the concentration of droplet infection. Attempts to correlate meteorologic data with the daily morbidity rate have not yet provided evidence for the hypothesis that climatic factors have an influence on incidence. This may be because of the difficulties associated with accurately monitoring meteorologic data, and the lack of a direct relationship between the environment outside a calf barn and the microclimate of the calf inside the barn. The disease appears to be most common during the winter months when calves are housed continuously and when ventilation is commonly inadequate.

Humid weather results in a marked increase in the percentage of bacterial colony-forming particles of less than 4 to 7 $\mu$ m in size. This provides the beginnings of a sound physical framework for the explanation of this and other, as yet empirical, relationships between the microenvironment in calf barns and the etiology and epidemiology of calf pneumonia.

The management risk factors that can influence the incidence rate and mortality of calves with pneumonia include the following:

- Colostrum feeding practices
- General feeding practices
- Quality of perinatal care provided by the personnel
- Age at weaning

- Use of prophylactic antimicrobials
- Health management of the dams.

The feeding of a coccidiostat to preweaned calves may be associated with an increase in the risk of enzootic pneumonia because herds with a history of disease would be more likely to feed a coccidiostat.

Factors associated with mortality to 21 days of life in dairy heifers in the United States include:

- First colostrum-feeding method, timing and volume
- Time of separation from dam
- Calving ease
- Twin birth.

**Inadequate transfer of passive immunity** has consistently been identified as a major risk factor for enzootic pneumonia.<sup>10</sup> Optimizing the feeding of colostrum, as summarized in Chapter 20, is an important method for decreasing morbidity and mortality associated with enzootic pneumonia. Up to 31% of mortality is associated with ineffective colostrum feeding. The longer the calf is left with the dam after birth, the greater the mortality, presumably as a result of greater exposure of the calf to pathogens harbored by the dam. Difficult calving also may interfere with the optimum ingestion of colostrum and absorption of immunoglobulins.

A path model of individual-calf risk factors for calthood morbidity and mortality in New York Holstein herds indicated that management appeared to affect, directly and indirectly, the risk of respiratory disease within 90 days of birth. Being born in loose housing is strongly related to development of clinical signs of calf diarrhea within 14 days of birth, which in turn increases the risk of respiratory disease within 90 days of birth.

Calves reared as herd replacements may be born inside and raised indoors until they are about 6 months of age and then turned out to pasture for the summer. In the case of veal calf-rearing units, the calves are kept and fed indoors under intensive conditions from a few days of age until they reach 150 kg body weight (BW) at 12 weeks of age. In the barley-beef units, the calves are fed indoors on an intensive basis from weaning until they reach market weight at 10 to 12 months of age. In all of these situations, young, growing calves are raised together in confined conditions that promote the spread of respiratory disease associated with several viruses, *Mycoplasma* spp., and *Pasteurella* spp.

Based on serologic surveys, most calves raised in close confinement will have become infected by several viruses, including the BRSV, PI-3 virus, adenoviruses, BHV-1, and bovine viral diarrhea virus. If natural exposure to these viruses, *Mycoplasma* spp., and bacteria is so widespread and inevitable, it raises serious questions about the rationale for vaccination. In most cases the effects of the viruses and *Mycoplasma* spp. are minimal. The stress factors associated with inadequate

ventilation, high relative humidity, chilling, and secondary bacterial complications are responsible for the onset of clinical disease.

### Pathogen Risk Factors

The infectious agents are ubiquitous in the respiratory secretions of the animals and in their environment, and more numerous in crowded poorly ventilated conditions. The spectrum of infectious agents that are present and acting in a calf population and the severity of clinical disease will vary between farms, between countries, and from season to season. It has been assumed that older calves and mature animals in a herd are the source of infection for the young calves. This assumes major importance in control measures that are commonly designed to rear calves separate from older animals.

#### *Bovine Respiratory Syncytial Virus*

Infection with BRSV may be subclinical, mildly clinical, or highly fatal. Raising calves in close proximity to older cattle may result in constant exposure to infectious agents to which the mature animals are immune. The disease may be endemic on particular farms in which almost every calf experiences clinical disease. Herd epidemics may occur following the introduction of a different virus, such as BRSV, or following a breakdown in the ventilation system. The disease occurs specifically in nursing beef calves from 1 to 4 months of age while on pasture. Veal calves that are seronegative for BRSV on arrival to the veal unit were twice as likely to develop respiratory disease within the first 3 weeks compared with seropositive calves.<sup>10</sup>

#### *Bovine Coronavirus*

Information regarding pathogen risk factors is just starting to be identified. Veal calves that are seronegative for BoCV on arrival to the veal unit are 1.7 times as likely to develop respiratory disease within the first 3 weeks as are seropositive calves.<sup>10</sup>

#### *Parainfluenza-3 Virus*

This is commonly subclinical in a group of calves, and clinical disease may not occur until other pathogens are present or when adverse environmental conditions precipitate clinical disease. Following natural infection of young calves, the PI-3 virus may persist for several weeks. However, the presence of PI-3 infection may predispose to respiratory disease by interfering with normal pulmonary clearance mechanisms and allowing secondary invasion by bacteria or mycoplasmas. PI-3 decreases the phagocytic ability of alveolar macrophages, enhances the production of arachidonic acid signally cascade, a proinflammatory response, and enhances contraction of respiratory smooth muscle, resulting in bronchoconstriction.<sup>11</sup>

The number and types of *Mycoplasma* spp. that colonize the nose and trachea of calves are influenced by the age of calves and

not by the environmental temperature or relative humidity. *Mycoplasma* spp. start to colonize the upper respiratory tract of calves within days after birth, and the peak isolation rate from their nasal cavities occurs at about 2 to 6 weeks of age, and from the trachea at 6 to 8 weeks of age. Over 92% of calves collected from farms and reared in a controlled environment can harbor *Mycoplasma* spp. in their noses when they are 2 weeks of age. The rate of recovery falls gradually thereafter.

*Mycoplasma dispar* colonizes the respiratory tract of experimentally infected young calves for several months and can be isolated from nasal swabs and transtracheal samples throughout the period of colonization. *M. dispar* and *P. multocida* have been cultured from transtracheal aspirates of dairy calves with pneumonia under 3 months of age. In calves aged 1 to 5 months in calf-rearing farms that purchase calves from dairy farms, the prevalence and level of colonization of the respiratory tracts with *Mycoplasma* spp. can be more than 90% over a 2-year period. *M. dispar*, *M. bovirhinis*, and *Acholeplasma laidlawii* have all been isolated from such calves. A high degree of colonization with *M. dispar* among 1- to 2-month-old calves on these rearing farms indicates the ability of the pathogen to spread among the calves and colonize the respiratory tract. *M. dispar* is able to spread very rapidly among groups of calves, and airborne transmission is considered to be an important mode of transmission in addition to direct contact. The infection rate in the calves at the farms of origin is small.

*Pasteurella multocida* is a normal component of the upper respiratory tract of calves but is frequently isolated from the lungs of calves with enzootic pneumonia. It appears that isolation of *P. multocida* from pneumonic lung reflects the overwhelming of the calf immune system rather than a primary pathogenic response. Different strains of *P. multocida* exist in the upper respiratory tract of calves, particularly if calves come from different sources, and *P. multocida* infection can amplify the severity of lower respiratory tract disease in the presence of impaired defense mechanisms.<sup>12</sup> *P. multocida* is more frequently isolated from the nasal passages of dairy calves less than 10 weeks of age than similarly aged beef calves;<sup>13</sup> this is thought to reflect differences in housing and management and is consistent with the predominance of enzootic pneumonia cases in dairy calves.

#### Mixed Flora

Although a mixed flora of viruses, mycoplasma, and bacteria can be isolated from the respiratory tract of calves with pneumonia, and the unpassed respiratory material can cause disease similar to the naturally occurring disease, the inoculation of pure cultures of *M. bovis*, *M. dispar*, and *Ureaplasma* spp.,

or pure cultures of BRSV, BoCV, or PI-3, into calves does not produce the severe clinical disease seen in the field. The failure of pure cultures of a pathogen to produce a severe pneumonia may be for one of three reasons:

- Combinations of organisms are required for disease
- Laboratory passage of the pathogens, necessary for purification causes their attenuation
- Material in the respiratory secretion other than the pathogens identified is required for disease, which may include agents that were not detected by routine culture techniques.

#### Economic Importance

The economic losses associated with enzootic pneumonia may be considerable. One estimate reports that the disease accounts for 50% of all calf mortality and a reduction of 7% in live weight gain. In commercial veal units, the presence of enzootic pneumonia may be associated with a prolonged time in the unit because of reduced daily weight gain.

The economic loss attributable to calf-hood morbidity and mortality is well recognized by the dairy industry. However, the long-term effects of morbidity from diseases such as enzootic pneumonia on health and performance may constitute an even greater economic loss to the herd. Calf-hood diseases occurring in the first 3 months of life may have serious long-term consequences. Heifer calves that are treated for pneumonia during the first 3 months of life are 2.5 times more likely to die after 90 days of age than heifers that are not treated for pneumonia. Heifer calves without respiratory disease are twice as likely to calve, and calved for the first time 6 months earlier, compared with calves with respiratory illness as calves. Some studies have found no significant independent association with calf-hood disease status with first lactation milk production. However, the population selected did not include all heifers affected as calves; a heifer could have a suboptimal rate of growth or unthrifty appearance and would be removed from the herd before milk production was measured.

#### PATHOGENESIS

##### Viruses

The respiratory viruses can cause a viral interstitial pneumonia affecting the cranial lobes of the lung that may be subclinical, mildly clinical, or severe and highly fatal. The pathogenesis of BRSV and BHV-1 pneumonia is described elsewhere in this chapter. The pathogenesis of experimental respiratory bovine coronavirus infection has not been well described.

##### Parainfluenza-3

Subclinical viral pneumonia associated with the PI-3 virus uncomplicated by secondary bacterial invasion is usually of minor

importance. In subclinical PI-3 infection in calves, seroconversion will occur, and at necropsy there are microscopic lesions consisting of bronchiolitis, bronchial and bronchiolar epithelial hyperplasia, alveolar epithelialization, and giant-cell syncytial formation. In the mild form there are slight clinical signs such as coughing and polypnea. In the severe form of viral pneumonia, such as in respiratory syncytial viral infection, there is severe dyspnea, with mouth breathing and an expiratory grunt, but a marked absence of toxemia compared with a bacterial pneumonia. Death can occur without secondary bacterial bronchopneumonia. Atelectasis and consolidation of the anterior lobes of the lungs are characteristic and account for the loud bronchial tones audible on auscultation over the anterior ventral aspect of thorax.

The experimental intranasal inoculation of the PI-3 virus into colostrum-deprived calves results in a pneumonia that is grossly and histologically similar to the naturally occurring disease. Within 2 to 4 days following infection there is bronchiolitis and bronchitis and cellular exudate in the bronchiolar lumina. These lesions become more severe and are accompanied by alveolar cell thickening and hyperplasia. Beginning at about 14 days following infection, there is healing of the bronchiolar and alveolar lesions. The bronchiolar exudate becomes organized by fibroblasts, and mononuclear cells predominate in the alveolar exudate. Bronchiolitis obliterans is widespread, but reepithelialization of damaged bronchiolar mucosa and alveoli occur.

Experimentally, the PI-3 virus can affect alveolar macrophages, which may impair the lung clearance mechanisms and allow *M. haemolytica* to produce a secondary bacterial bronchopneumonia. However, aerosols of PI-3 followed by *M. haemolytica* 7 days later do not necessarily result in significant pulmonary disease.

After the primary viral pneumonia is established, bacterial invasion may occur and the resulting pneumonia will vary with the species of bacteria that are present. Secondary bacterial pneumonias usually respond to treatment, although relapses are common if the viral pneumonia is extensive. Viruses are capable of reducing the resistance of mucous membranes, allowing bacteria such as pasteurellae to invade tissues. They are also capable of destroying the cilia on the bronchial mucosa that act as an escalator and help to keep the lower respiratory tract free of potential pathogens. In animals where there is an uncomplicated viral pneumonia with very extensive lesions, there may be minimal clinical signs and almost complete resolution.

##### Mycoplasma

The pathogenesis of *M. bovis* pneumonia is described elsewhere in this chapter.



The endobronchial or intratracheal inoculation of gnotobiotic calves with *Mycoplasma* spp. does not usually result in significant clinical disease. However, 2 or 3 weeks following inoculation, there is microscopic evidence of pneumonia. The lesions produced by experimental inoculation of calves with *M. bovis*, *M. dispar*, or *Ureaplasma* spp. are characterized by **peribronchiolar and perivascular “cuffing,”** catarrhal bronchiolitis, and atelectasis. Intranasal inoculation of *Ureaplasma diversum* into SPF calves results in thick cuffs of round cells surrounding the bronchi, bronchioli, and blood vessels and a lobular catarrhal pneumonia. However, clinical signs of pneumonia are not observed. Inoculation of *M. canis* results in only a slight pathologic change that disappears 9 days after infection. *M. dispar* produces an alveolitis without cuffing lesions. It is thought that the *Mycoplasma* spp. are synergistic with each other, viruses, and bacteria in producing the lesions of subclinical and clinical enzootic pneumonia.

### Bacteria

The pathogenesis of *P. multocida* and *M. haemolytica* pneumonia is described elsewhere in this chapter, and the pathogenesis of *Histophilus somni* pneumonia is described in Chapter 22.

### CLINICAL FINDINGS

Regardless of the identity of the causative pathogen, the clinical findings in almost all enzootic pneumonias of calves are similar. In the **experimental viral pneumonia**, a febrile reaction occurs on about day 5 and is followed by the appearance of rhinitis, pneumonia, and mild diarrhea. The fever is only moderate (40–40.5°C [104–105°F]). A harsh, hacking cough, easily stimulated by pinching the trachea, is characteristic.

**Clinical scoring systems** have been developed to assist in the field diagnosis of respiratory disease in calves with enzootic pneumonia.<sup>14,15</sup> Factors considered of potential clinical utility, such as rectal temperature, presence and nature of nasal and ocular discharges, presence and nature of a cough, respiratory rate, and degree of depression, are assigned a whole integer score and the individual scores added to provide a summative score. Ultrasonographic examination of the cranioventral lung fields may provide helpful additional information.<sup>16</sup> Current scoring systems for dairy calves<sup>14,15</sup> have not been well validated,<sup>16</sup> and the use of a summative clinical score is statistically illegal, even when weights are assigned to measured factors. Despite these limitations, appropriately designed and validated clinical scoring systems show promise as providing a practical method for implementing effective treatments earlier to calves with respiratory disease.

In **naturally occurring cases**, the clinical findings are similar, although the fever is

usually higher. This may be attributable to bacterial invasion in the early stages. The nasal discharge is only moderate in amount and is mucopurulent. On auscultation of the thorax the major abnormalities can be detected over the ventral aspects of the apical and cardiac lobes. The breath sounds are loud and harsh and represent breath sounds transmitted through consolidated lung. The intensity of the heart sounds is increased because of shrinkage of lung tissue in the cardiac area. The usual course ranges from 4 to 7 days. Some peracute cases of uncomplicated viral pneumonia die within 1 day after the onset of signs. Infections with the PI-3 virus generally cause mild respiratory disease characterized by coughing, nasal discharge, slight fever, and recovery in a few days.

*M. bovis* pneumonia in young calves is characterized by the sudden onset of severe dyspnea, fever, and rapid deterioration in spite of therapy.

In **BRSV pneumonia** there may be a sudden onset of acute pneumonia in 80% to 90% of a group of calves. The clinical findings are characteristic of a severe viral pneumonia. Affected calves are usually mentally alert, and there is only a mild fever. There is polypnea and dyspnea, which in a few days become worse, with mouth breathing and an expiratory grunt. Loud breath sounds, indicating consolidation, are audible over the anterior lobes of the lung. Squeaky, wheezing sounds as a result of the bronchiolitis are also commonly audible over the periphery of the consolidated areas. Loud, crackling sounds as a result of interstitial emphysema may also be audible over the dorsal aspects of the lungs. Death may occur in 2 to 4 days in spite of intensive therapy.

When secondary bacterial bronchopneumonia occurs, the fever, dyspnea, and

toxemia are usually more severe. When secondary infection with *Pasteurella* spp. occurs, the temperature rises to 41° to 41.5°C (106–107°F), the area of lung affected is much increased, and loud harsh breath sounds as a result of edema are followed by crackles and a pleuritic friction rub. These cases usually respond rapidly to adequate treatment. When *Trueperella pyogenes* is the secondary invader, consolidation is marked, and there is a profound toxemia and loud breath sounds. In cases where *Fusobacterium necrophorum* is present, the clinical findings are similar, and pulmonary abscesses are likely to develop. The calf has lost a substantial amount of weight and stands with its neck stretched out in an attempt to decrease upper airway resistance (Fig. 12-15). Necrotic lesions are often present in the mouth and pharynx in these cases, and the pulmonary infection probably originates from here. With both of these latter infections there may be some response to antibiotic treatment, but there is a predisposition to relapse soon after treatment is terminated. Coughing, dyspnea, anorexia, and emaciation continue, and the animal eventually has to be destroyed.

### CLINICAL PATHOLOGY

The etiologic cause of a case of bovine respiratory disease cannot be differentiated in most cases based on clinical examination in conjunction with consideration of history and signalment.<sup>17</sup> As a result, it is sometimes helpful to submit appropriately collected and transported samples to a laboratory for analysis. Detailed methods for primary respiratory pathogens are described elsewhere in the appropriate section of this book.

Acute-phase reactants, such as serum haptoglobin and haptoglobin-matrix metalloproteinase 9 (Hp-MMP 9), are biomarkers



**Fig. 12-15** Holstein Friesian heifer with enzootic pneumonia. Notice the poor body condition, anxious look, conjunctivitis, nasal discharge, open-mouth breathing with blood-tinged foamy saliva, and extended neck in an attempt to facilitate breathing.

of inflammation and may therefore indicate the presence or absence of active lung pathology in calves at risk of developing respiratory disease.<sup>18</sup> However, the clinical utility of serum biomarkers needs to be compared with tests that can be conducted rapidly and calf-side, such as rectal temperature, presence and nature of nasal and ocular discharges, or ultrasonographic examination of the cranioventral lung fields,<sup>14,15,16</sup> before they are widely adopted.

The oxygen tension ( $P_{O_2}$ ) in arterial (preferably) or venous blood is decreased in calves with respiratory disease, primarily as a result of ventilation-perfusion mismatch.<sup>19,20</sup> The partial pressure of oxygen in arterial blood ( $P_{aO_2}$ ) is negatively associated with the extent of lung lesions in calves with experimentally induced BRSV infection, with a 0.6% to 0.8% increase in the proportion of affected lung for every 1 mm Hg decrease in  $P_{aO_2}$  from the reference value.<sup>20</sup> As such, arterial  $P_{O_2}$  provides an excellent method for quantifying the proportion of diseased lung and monitoring the response to treatment.

### Isolation of Pathogens

Nasopharyngeal swabs, transtracheal aspirates, and lung lavage samples may be taken for isolation of viruses, mycoplasmas, and bacteria, and the methods have been described in detail.<sup>21,22</sup> Special laboratory media are required to isolate *Mycoplasma* spp. Determination of drug sensitivity to the bacteria may be valuable, particularly when a number of calves are involved in an outbreak. The isolation of BRSV from natural infections is difficult because of the labile nature of the virus. The immunofluorescent antibody test for antigen detection is one of the most rapid, reliable, and sensitive tests for BRSV from tracheal aspirates, nasal swabs, and lung samples.

**After experimental infection with PI-3, the median time to shedding is 1 day, the median time to peak shedding is 4 days, and the median time until shedding ceased is 10 days.**<sup>23</sup>

### Serology

Serologic tests have been more extensively used for confirmation of suspected BRSV infections. The standard serologic test is a virus-neutralization test using microtiter plates. Others include a modified indirect fluorescent antibody test, indirect hemagglutination, and an ELISA test, the latter of which is considered to be sensitive and specific and has the advantage of giving test results within several hours, whereas the virus-neutralization test requires 5 to 6 days for completion. The complement fixation test is less specific and less sensitive than the ELISA test.

### NECROPSY FINDINGS

In uncomplicated viral pneumonia, irrespective of the specific cause, there are areas of

atelectasis and emphysema in the apical and cardiac lobes, with little macroscopic involvement of the diaphragmatic lobes. In the later stages, a dark red consolidation featuring a hobnail appearance of the pleural surface affects most of the ventral portions of the apical and cardiac lobes. The lesions are always bilateral. Histologically, there is a bronchiointerstitial pneumonia. Acute inflammation of the nasal mucosa, particularly on the turbinate and ethmoid bones, is usually accompanied by a marked, mucopurulent exudation. In PI-3 infection, intracytoplasmic inclusion bodies are widespread in the lungs; after experimental infection, they are present on day 5, but they have disappeared by day 7 after infection.

In respiratory syncytial viral pneumonia there is severe interstitial pneumonia and interstitial emphysema. Histopathologically, there is severe bronchiolitis, alveolitis with multinucleated syncytia (which often contain eosinophilic intracytoplasmic inclusion bodies), and alveolar epithelial cell hyperplasia.

When bacterial or mycoplasmal invasion has occurred, the lesions vary with the agent present. Extensive hepatization with mottled red and gray lobules and considerable interlobular aggregations of serofibrinous fluid, often accompanied by a fibrinous pleuritis, is characteristic of *P. multocida* infection. Extensive consolidation and suppuration occur with *T. pyogenes* and *F. necrophorum* infections. In the latter case there may be necrotic lesions in the mouth and upper respiratory tract.

Confirmation of this diagnosis at necropsy is somewhat awkward because the population of pathogens responsible may change between the time of disease onset and the death of the calf. In severe outbreaks it may be necessary to euthanize animals early in the course of the disease or to perform serologic surveys for respiratory pathogens among surviving herd mates.

### Samples for Confirmation of Diagnosis

- **Histology**—lung (several sections), trachea, turbinate (LM, IHC)
- **Virology**—lung (several sections), trachea (FAT, ISO)
- **Mycoplasma**—lung (MCULT, FAT)
- **Bacteriology**—lung (CULT)

### DIFFERENTIAL DIAGNOSIS

Clinically, the diagnosis of pneumonia is usually readily obvious, but the causative agents are usually not determined. Young calves raised indoors and affected with a cough, nasal discharge, and pneumonia are usually affected with enzootic pneumonia associated with the agents described under etiology. The common diseases of the

respiratory tract of young calves that may resemble enzootic pneumonia include the following:

Bacterial pneumonia caused by *M.*

*haemolytica* or *H. somni* in young calves is characterized by severe toxemia, fever, dyspnea, grunting, and a poor response to therapy.

*M. bovis* pneumonia is characterized by sudden onset of dyspnea, fever, depression, and poor response to therapy in a group of calves.

Calf diphtheria usually affects a single calf and is characterized by inspiratory dyspnea, stridor, toxemia, fever, and obvious lesions of the larynx.

Lungworm pneumonia occurs in young calves at pasture, and marked dyspnea, coughing, and a few deaths are characteristic. A fever is common in lungworm pneumonia, and there are loud breath sounds over the ventral aspects of the lungs, and loud and moist crackles over the dorsal aspects.

Acute myocardial dystrophy in young calves, following turnout on pasture, is characterized by sudden onset of weakness, polypnea and dyspnea as a result of pulmonary edema and lesions of the diaphragm, tachycardia and arrhythmia, and skeletal muscular weakness.

Aspiration pneumonia occurs occasionally in calves that have been force-fed colostrum or milk. There is a sudden onset of marked dyspnea, anxiety, and distress, and death may occur within a few minutes. However, some calves survive, and there is marked dyspnea with abdominal breathing and loud breath sounds and crackles over the dorsal and ventral aspects of both lungs. Some calves will recover completely in a few days.

BRSV interstitial pneumonia in weaned beef calves must be differentiated from pneumonic pasteurellosis. In BRSV pneumonia there is a sudden onset of marked dyspnea; fever; anxiety, but not toxemia; mouth breathing in advanced cases; loud breath sounds and wheezes over both lung fields, especially over the ventral aspects; and subcutaneous emphysema. Several animals are usually involved. Affected animals fail to respond to treatment with antimicrobials, and the case-fatality rate is usually over 75%. There may be a history of mild respiratory disease in the affected group about 10 days previously. In pasteurellosis, depression, toxemia, fever, loud breath sounds over the ventral aspects of the lungs, and a favorable response to treatment are characteristic.

Chronic enzootic pneumonia is characterized by bronchiectasis and pulmonary abscessation, causing unthriftiness and a poor response to therapy.

## TREATMENT

### Antimicrobial Therapy

Uncomplicated enzootic pneumonia associated with mycoplasma or viruses is unlikely to respond to treatment, but antimicrobial therapy daily for 3 days is indicated because of the high probability of secondary bacterial pneumonia. Any of the antimicrobials used commonly for the treatment of acute undifferentiated bovine respiratory disease (shipping fever) are effective, with a preference for antimicrobials that are effective against *Mycoplasma* spp. and *P. multocida*, *H. somni*, and *M. haemolytica*. These are described in detail in the section on pasteurellosis earlier in the chapter.

Early treatment is necessary to avoid the development of incurable secondary complications, such as pulmonary abscesses, pleuritis, bronchiectasis, and suppurative pneumonia. In commercial veal calf units, the case-fatality rate can be kept to a low level by early and adequate treatment. In some cases it may be sufficient to treat animals once only, but a proportion of cases are likely to relapse after an initial response. Such cases require repeated daily therapy for 3 to 5 days. If the number of relapses in an area or on a farm is excessive, all cases should receive multiple treatments.

### Adjunctive Therapy

Bronchodilators and NSAIDs as adjunctive therapy for enzootic pneumonia in calves are used, but their efficacy is questionable.

### Correction of Adverse Environmental Conditions

The clinical management of an outbreak of enzootic pneumonia in calves must include correction of adverse environmental conditions that may have precipitated the disease.

## CONTROL

### Environmental and Management Practices

Control of the disease in housed calves is dependent on effective animal and environmental management. Overcrowding, drafty or inadequately ventilated housing, exposure to inclement weather, and sudden changes in environmental temperatures are major risk factors. Recently purchased calves should be isolated for several weeks before being introduced to the group.

### Ideal Environmental Conditions

Control is especially difficult and expensive in countries where the calves are housed for several months during the winter months in northern climates. The most comfortable ambient temperature for young calves ranges from 13° to 21°C (55–70°F) with a relative humidity of 70%. To achieve these environmental conditions requires a suitable insulation material in the walls and ceilings, ample bedding to absorb moisture from feces and urine, and adequate movement of air to

remove aerosol particles that may be infectious. This requires an adequate air inlet and outlet system, adequate capacity fans, and supplemental heat during very cold periods. The installation of recirculating air filter units can lead to a substantial reduction in the concentration of airborne bacteria to which calves are exposed. Field studies in veal calf units indicate that mean aerial bacteria concentration in filtered barns can be reduced by 45%, the number of calves requiring treatment reduced by 19%, the number of repeat courses of treatment and the total antibiotic usage reduced by 29% and 35%, respectively. At slaughter, the average area of lung consolidation in calves from filtered barns can be reduced by 35%. In general, air filtration can result in a reduction in both the incidence and severity of clinical and subclinical pneumonia in calves and in improved weight gain.

In spite of ideal hygiene and management it may not be possible to prevent the development of new cases if the infection already exists in a herd, or if cattle from other herds are moved into the herd. At present, it is feasible only to be vigilant and treat new cases urgently and vigorously because a strict hygiene program may not be feasible in the average commercial herd. If management is inadequate and the general resistance of the animals is low, losses resulting from calf pneumonia with significant bacterial or mycoplasmal invasion can be sufficient to make calf-rearing unprofitable.

### Calf Barns or Hutches

Where economics permit, the ideal situation is to construct a calf barn completely removed from the main adult cow barn to minimize the spread of infection from adults that may be symptomless carriers. After the colostrum feeding period, calves are removed from the calving barn and placed in individual pens in the calf barn. The raising of young calves outdoors in calf “hutches” or “igloos” is highly satisfactory and economical, even in countries where the outside temperatures go well below freezing. With adequate bedding, protection from the prevailing winds and adequate nutrition, calves will grow satisfactorily. Dairy herds that have had difficulty controlling enzootic pneumonia of calves have found this system to be an excellent alternative to the construction of a stand-alone, well-ventilated calf house. Nutritional deficiencies, usually of energy and protein, are common in young calves and often accentuate the severity of the pneumonia. Young calves should receive a balanced calf starter grain ration supplemented with essential vitamins and minerals and good-quality hay beginning by at least 3 weeks of age.

### Vaccines and Immunization

There is **insufficient information** available from field trials to make firm recommendations for the use of vaccines for the control

of enzootic pneumonia in calves. It is difficult to evaluate the results of vaccination trials because investigators use so many combinations of vaccines and different vaccination schedules, and there are many different management variables and differences in methods of evaluation. In addition, many vaccination trials are not randomized controlled trials. Recommendations regarding vaccination protocols for BRSV, BHV-1, *M. haemolytica*, *P. multocida*, and *M. bovis* are presented elsewhere in this chapter; recommendations for a BVDV vaccination protocol are presented in [Chapter 9](#), and recommendations for an *H. somni* vaccination protocol are presented in [Chapter 22](#).

Any successful vaccine would have to be multivalent and would have to be effective when given before 2 months of age or earlier in the “**window of susceptibility**” to coincide with the decline in passive (maternal) immunity, the increase in active immunity, and the occurrence of enzootic pneumonia in calves ([Fig. 12-16](#)).

There is good field evidence that the colostrum immunologic status of the calf has a significant effect on the susceptibility of the calf to pneumonia. There is a clear association between low levels of IgG<sub>1</sub>, IgG<sub>2</sub>, and IgA of calves at 2 to 3 weeks of age, and subsequent susceptibility to pneumonia at 2 to 3 months of age. Calves with signs of pneumonia had low levels of IgG<sub>1</sub> compared with nonpneumonic calves that had relatively higher levels. In addition, calves with high levels of serum immunoglobulin do not respond normally to vaccine and any vaccine for enzootic pneumonia would have to be administered during this relatively refractory period. However, for veal calves, which are purchased at a few days of age and with low levels of immunoglobulin, this may not be a problem. A 2015 meta-analysis concluded that in natural exposure trials, 2-week-old to 4-month-old dairy calves vaccinated with commercially available vaccines against BHV-1, BVDV, BRSV, and PI-3 for protection against respiratory disease had **no reduction in morbidity or mortality** compared with age-matched unvaccinated controls.<sup>24</sup>

Vaccines currently available for BoCV are only licensed to control neonatal diarrhea in calves. Their efficacy in controlling respiratory disease is unknown but is likely to be poor. This is because respiratory isolates belong to subclades 2a, 2b, and 2c, whereas enteric isolates and a vaccine strain for control of enteric disease in calves belong to the antigenically different clade 1.<sup>25</sup>

The intranasal inoculation of calves with virulent or a modified strain of PI-3 virus stimulates the development of both serum antibody and nasal secretion antibody. The nasal secretion antibody is dose dependent. Challenge exposure of these calves provides protection against clinical disease. These factors should be considered in the development and administration of PI-3 viral



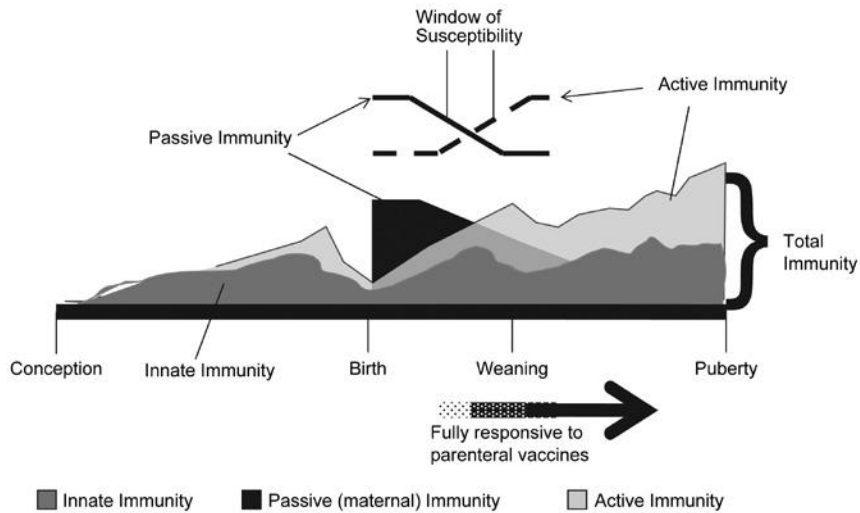

**Fig. 12-16** Development of the immune response in the calf from conception to puberty. The window of susceptible is the optimal time for vaccination against enzootic pneumonia and represents the time during which passive (maternal) immunity is waning and active immunity is increasing. (Reproduced, with permission, from Chase CCL, Hurlley DJ, Reber AJ. Neonatal immune development in the calf and its impact on vaccine response. *Vet Clin Food Anim* 2008; 24:87-104.)

vaccines if the objective is to establish an optimal concentration of antibody in the nasal secretion. The parenteral administration of two sequential doses, 2 weeks apart, of an inactivated PI-3 virus vaccine with adjuvant will induce high levels of serum antibody and prevent virus excretion in nasopharyngeal secretions after challenge. Successful immunization of calves against PI-3 infection may be useful for protection against pneumonic pasteurellosis if PI-3 precedes the bacterial infection. This is presented in greater detail in the section on pneumonic pasteurellosis. A single dose of an experimental vaccine for *M. bovis* pneumonia, inactivated with saponin, given subcutaneously to 3- to 4-week-old calves followed by experimental challenge 3 weeks later with a virulent strain of *M. bovis* provided protection against clinical pneumonia. Unvaccinated calves developed clinical signs of disease as a result of lung lesions. The vaccine also reduced the spread of *M. bovis* to internal organs. Calves tested 6 months after immunization had high levels of humoral immunity. The successful use of saponin in vaccines has been demonstrated for other mycoplasma infections, such as contagious caprine pleuropneumonia (CCPP) and contagious agalactia. The saponin may preserve the major antigens seen in untreated whole cells.

#### TREATMENT AND CONTROL

##### Treatment

Antimicrobial treatment for animals to address concurrent bacterial and *Mycoplasma bovis* pneumonia (see treatment recommendations for *Pasteurella multocida*

and *Mannheimia hemolytica* in this chapter, with a preference for antimicrobials that are also effective against mycoplasma organisms) (R-1)

Anti-inflammatory treatment (see treatment recommendations for *Pasteurella multocida* and *Mannheimia hemolytica* in this chapter)

Non-steroidal anti-inflammatory agents (R-2)

Corticosteroids (R-3)

##### Control

Optimize transfer of passive immunity via colostrum. (R-1)

House in a well ventilated area, preferably in individual calf hutches before weaning, (R-1)

Vaccination of dairy calves less than 6 months of age with killed BRSV vaccine. (R-1)

Vaccination of dairy calves less than 6 months of age with combined modified live or inactivated vaccine against BHV-1, BVDV, BRSV, and PI-3. (R-3)

Vaccination of dairy calves less than 6 months of age with BoCV vaccine. (R-3)

#### FURTHER READING

Chase CCL, Hurlley DJ, Reber AJ. Neonatal immune development in the calf and its impact on vaccine response. *Vet Clin North Am Food A.* 2008;24:87-104.

Cortese VS. Neonatal immunology. *Vet Clin North Am Food A.* 2009;25:221.

Dabo SM, Taylor JD, Confer AW. *Pasteurella multocida* and bovine respiratory disease. *Anim Health Res Reviews.* 2008;8:129-150.

Griffin D. Bovine pasteurellosis and other bacterial infections of the respiratory tract. *Vet Clin North Am Food A.* 2010;26:57-71.

Saif LJ. Bovine respiratory coronavirus. *Vet Clin North Am Food A.* 2010;26:349-364.

#### REFERENCES

- Nikunen S, et al. *Comp Immunol Microbiol Infect Dis.* 2007;30:143.
- Angen O, et al. *Vet Microbiol.* 2009;137:165.
- O'Neill R, et al. *Vet Rec.* 2014;doi:10.1136/vr.102574.
- Decaro N, et al. *J Virol Methods.* 2008;151:167.
- Ng TFF, et al. *J Virol.* 2015;89:5340.
- Taylor JD, et al. *J Vet Diagn Invest.* 2010;22:366.
- Bowersock TL, et al. *Am J Vet Res.* 2014;75:770.
- Hanthorn CJ, et al. *BMC Vet Res.* 2014;10:89.
- Dassanayake RP, et al. *Appl Environ Microbiol.* 2010;76:1008.
- Pardon B, et al. *Prev Vet Med.* 2015;120:169.
- Lazić S, et al. *Biotech Anim Husbandry.* 2009;25:703.
- Hotchkiss EJ, et al. *Vet Microbiol.* 2011;151:329.
- Hotchkiss EJ, et al. *Vet Rec.* 2010;167:555.
- Poulsen KP, McGuirk SM. *Vet Clin North Am Food A.* 2009;25:121.
- Love WJ, et al. *Peer J.* 2014;2:e238. doi:10.7717/peerj.238.
- Buczinski S, et al. *Prev Vet Med.* 2015;119:227.
- Taylor JD, et al. *Res Vet Sci.* 2015;99:41.
- Hanthorn CJ, et al. *BMC Vet Res.* 2014;10:285.
- Ozkanlar Y, et al. *Revue Méd Vét.* 2012;163:123.
- Ellis J, et al. *Can J Vet Res.* 2013;77:205.
- Cooper VL, Brodersen BW. *Vet Clin North Am Food A.* 2010;26:409.
- Caswell JL, et al. *Vet Clin North Am Food A.* 2012;28:419.
- Grissett GP, et al. *J Vet Intern Med.* 2015;29:770.
- Theurer ME, et al. *J Am Vet Med Assoc.* 2015;246:126.
- Fulton RW, et al. *Vaccine.* 2013;31:886.

## BOVINE RESPIRATORY SYNCYTIAL VIRUS

#### SYNOPSIS

**Etiology** Bovine respiratory syncytial virus (BRSV); subtypes A, B, AB, and untyped.

**Epidemiology** Prevalence of infection high; disease most common in calves under 6 months of age but adult cattle also affected; recurrent infections and disease in herds common; persistent infection in few seropositive cows. Immunity following natural infection or vaccination short-lived. Antibodies following natural exposure are different than those following experimental infection or vaccination. Maternal antibody does not prevent infection, but high levels decrease severity of clinical disease.

**Signs** Mild, moderate, or severe dyspnea; fever, agalactia, coughing, wheezes of lungs; most animals recover; small percentage develop severe fatal viral interstitial or bacterial pneumonia. Outbreaks occur in cattle under 6 months of age and also in adult cattle.

**Clinical pathology** Difficult to isolate or detect virus in tissues. Immunohistochemical tests of nasopharyngeal swabs and lung tissue. Serology.

**Differential diagnosis** Bacterial pneumonia. Other viral interstitial pneumonias. Infectious bovine rhinotracheitis. Lungworm pneumonia.

**Treatment** Nothing specific.

**Control** Minimize stressors. Control by natural exposure and treat secondary bacterial pneumonia. Modified live-virus and inactivated virus vaccines available but efficacy uncertain because lack of field trials.

## ETIOLOGY

Bovine respiratory syncytial virus (BRSV) is a cause of a viral pneumonia primarily in calves under 6 months of age and also in yearlings and adult cattle. BRSV is a pneumovirus in the family Paramyxoviridae. Antigenic and genetic subtypes have been identified. Using monoclonal antibodies against a glycoprotein (G protein on the surface of the virus), four subgroups have been identified: A, B, AB, and untyped. There are six genetic subgroups based on G and five subgroups based on F (a fusion protein on the surface of the virus that causes fusion of cell membranes with resultant formation of syncytia) or N (nucleoprotein).<sup>1</sup> The evolution of BRSV into subtypes may have been driven, in part, by selection pressure applied by vaccination.

BRSV is genetically and antigenically related to human respiratory syncytial virus (HRSV). Other pneumoviruses include ovine respiratory syncytial virus (ORSV) and caprine respiratory syncytial virus (CRSV), with BRSV being most closely related to CRSV. BRSV provides a good model for HRSV, and consequently many studies related to identifying virulence factors and understanding the immunopathogenicity of BRSV infection have been conducted.

## EPIDEMIOLOGY

BRSV was first reported in Europe in 1970 and was subsequently reported in the United States in 1974. Distribution is currently worldwide. A case could be made that BRSV is the most important viral cause of respiratory disease in calves less than 6 months of age and in adult dairy cattle.<sup>2</sup> BRSV is a rare cause of respiratory disease in adult beef cows.<sup>3</sup>

## Occurrence

### Prevalence of Infection

The virus is ubiquitous in the cattle population and new infections occur most commonly in autumn and winter annually and may result in severe respiratory disease. In longitudinal studies in dairy herds, 90% of primary infections occur in calves and heifers; very few occur in cattle over 2 years of age, and all cattle in the herds are seropositive when they are over 3 years of age. Recurrent infections occurring annually at the same time, and in cows of all ages, without new introductions into the herd, are characteristic of BRSV infections in a herd. The virus appears to circulate during summer at

very low levels or not at all, with almost all isolations coming from winter and spring.<sup>4</sup> Persistent BRSV infection in some of the cows in a herd might be a means for the virus to survive during the summer, but a steady state of reinfection of seropositive cows throughout the year at a low level might also maintain a reservoir of infection. Monthly data on the prevalence of BRSV antibodies in dairy herds suggest that persistent infection in seropositive cows is more likely than population persistence.

When the prevalence of infection in the cattle population is high, the incidence of clinical disease is much lower.<sup>2</sup> It can be assumed that most mature cattle have been exposed to the virus, but unexposed cattle are susceptible to developing clinical disease after infection. Surveys in the United States, England, Denmark, Sweden, and France found seropositive rates in herds ranging from 50% to 80%. Cattle entering feedlots may seroconvert to the virus, which may be associated with an increased risk to subsequent treatment for respiratory disease. A high percentage of young beef bulls aged about 6 months and entering performance test stations may seroconvert to BRSV and adenovirus, both of which may be associated with clinical respiratory disease.

## Occurrence of Clinical Disease

In general, clinical infection is most common in calves under 6 months of age and some BRSV infections are undoubtedly associated with enzootic pneumonia of housed dairy calves. In **dairy herds**, recent introductions of young cattle purchased from public saleyards may introduce the infection to home-farm cattle that have had no previous exposure to the viruses or those in which their immunity to a previous infection with the virus has declined. Thus adult dairy cows may be affected with a highly fatal pneumonia attributable to the virus. A high prevalence of infection exists in Swedish cattle, and annual outbreaks of disease have occurred in adult cattle, with pregnant or recently calved cows being most severely affected. Outbreaks have occurred in beef cattle on pasture. The disease occurs in **nursing beef calves** 1 to 8 months of age on pasture with their dams without any history of previous stress. A common occurrence is in **weaned beef calves** 6 to 8 months of age within 2 to 3 weeks following weaning and commingling in confinement. Yearling cattle in feedlots are also susceptible.

In North America, herd epidemics of clinical disease usually occur during the **fall** and **winter months**. Nursing beef calves may be affected with clinical disease during the summer months. Some outbreaks have occurred in nursing beef calves between 1 and 2 months of age while they are still in nursery pastures or in the calving areas.

A spontaneous outbreak of respiratory disease in goats attributable to BRSV has

been described, and sheep can be infected with the virus.

## Morbidity and Case Fatality

The morbidity rate in herd epidemics of clinical disease can vary from 30% to 50% or higher. The case-fatality rate is usually low, 3% to 5%, but may be higher.

## Methods of Transmission

The mode of transmission has not been defined, but aerosol infection and direct contact are probable. Infection spreads rapidly among susceptible cattle.

## Risk Factors

### Animal Risk Factors

Naturally occurring BRSV infection affects both dairy and beef cattle, and those under 6 to 10 months of age are most susceptible to clinical disease. Nursing beef calves with colostral BRSV antibody are not protected from infection, but the incidence and severity of clinical disease is inversely related to the level of maternal antibodies in calves younger than 3 months. The highest percentage of reinfections occurs most commonly in cows during their first lactation. Older animals may have a more effective immunity because of previous exposure.

Seroepidemiologic surveys in **feedlot cattle** found that seroconversion to the virus may occur in up to 70% of animals within 1 month after arrival. Animals with low titers to the virus on arrival are at increased risk of subsequent treatment for respiratory disease, which suggests that the virus may be a factor in bovine respiratory disease. In some situations in feedlot cattle, high BRSV serum antibody levels on arrival were related to a lower risk of respiratory disease.

### Environmental Risk Factors

The highest incidence of clinical disease occurs in autumn and winter months. Outbreaks have been associated with changes in weather, especially declining ambient temperatures and atmospheric pressure.

### Pathogen Risk Factors

BRSV has a narrow host range, affecting primarily cattle. Important antigenic differences between BRSV isolates have been described. Subgroups A and AB are associated with severe respiratory disease and circulate in the Dutch cattle population. In natural outbreaks of infection in closed dairy cattle herds and veal calf units in Denmark, using DNA sequence data, identical viruses were isolated within a herd during outbreaks, but viruses from recurrent infections varied by up to 11% even in closed herds. It is possible that a quasispecies variant swarm of BRSV persisted in some of the calves in each herd and that a new and different highly fit virus type (master and consensus sequence) became dominant and spread from a single animal in connection with each outbreak.

Antigenic subtypes may have relevance both in explaining differences in virulence between subtypes and in the development of new vaccines for the control of clinical disease. The production and characterization of monoclonal antibodies to a vaccine strain of BRSV has been described. The respiratory syncytial virus of goats and sheep, caprine respiratory syncytial virus, and ovine respiratory syncytial virus are antigenically related, but not identical, to BRSV.

The BRSV may act synergistically with a concurrent experimental challenge of the virus and 3-methylindole to produce more severe pulmonary disease similar to BRSV pneumonia seen in feedlot cattle, than either agent alone. But vaccination of cattle with BRSV vaccines does not protect the potential synergism between the 3-MI and BRSV infection.

Whether or not the virus persists in individual animals in spite of the presence of maternal or naturally acquired antibodies has been a major question. Serologic findings indicate persistence of the virus, but the virus could not be detected in lung lavage fluid or nasal swabs. Experimentally, the virus persisted in tracheobronchial and mediastinal lymph nodes for up to 71 days after infection. In vitro, the virus was still able to replicate in bovine B-lymphocyte cell lines 6 months after infection. This may explain the absence of the virus between epidemics, recurrent infections in the same individuals and inapparent reinfection of adults.

### Immune Mechanisms

After a natural BRSV infection, the protection is short-lived and multiple reinfections are common. In endemic areas, the absence of BRSV-associated disease in adult cattle is possibly as a result of repeated infections. This places a constraint on vaccine development because one or two vaccinations would have to induce immunity that only repeated natural infections can provide. BRSV infections can occur in the presence of high to moderate levels of maternal antibodies. Maternal antibodies, which are directed against the F, G, and N proteins of BRSV, are commonly present in calves but do not protect against infection. However, the incidence and severity are inversely related to the level of specific maternal antibody, and natural infection does not prevent reinfection but appears to offer good protection against clinical disease after infection. Primary BRSV infections in calves less than 1 month of age are less severe than those in calves 2 to 4 months of age, probably as a result of decreased proinflammatory TNF- $\alpha$  production in calves less than 1 month of age.<sup>5</sup>

The BRSV colostral antibody of dairy calves varies dependent on season of the year when the calves are born. Dairy calves born during the winter months in the Netherlands

have lower BRSV colostral antibody titers than those born during the summer months. Whether this may be attributable to the seasonal periodicity of BRSV circulation or to other factors influencing antibody development or colostrum intake is uncertain. Calves born in the summer have higher antibody titers at 14 to 19 weeks of age, most likely attributable to BRSV exposure. Calves born during the season of infection may be primed with BRSV field virus during the period of maternally derived immunity and may be better protected against disease by cellular immunity during the next season of infection.

IgM and IgA are the predominant antibody isotypes in the respiratory tract after BRSV infection, with IgA especially prominent after reinfection. Both serum antibody responses and local antibody responses are suppressed by maternal antibodies. After natural BRSV infection of cattle, antibodies are predominantly directed against the epitope A, whereas after experimental infection, or vaccination with an inactivated vaccine, antibodies against epitope B and nonneutralizing epitope C are markedly increased compared with the same epitopes in naturally infected cattle.

The subgroups of the virus are based on antigenic differences of the G protein, and BRSV infection protects against reinfection by homologous strains of the virus. It is also known that a complete BRSV can partially protect against a BRSV infection with a strain that contains an antigenic dissimilar G protein. Therefore incorporation of representative viruses of different BRSV subgroups in vaccines for cattle does not seem necessary to achieve cross-protection. Vaccination of calves with a formalin-inactivated BRSV vaccine followed by challenge exposure to virulent virus increased the severity of clinical disease and lesions compared with calves nonvaccinated and challenged. Vaccination did not induce neutralizing antibodies, but IgG antibodies were detected with ELISA. Immunization with formalin-inactivated BRSV vaccine mainly primes a Th2-like inflammatory response characterized by a significant eosinophilic influx in the bronchia alveolar lung field and lung tissues and high levels of immunoglobulin E serum antibodies.

### PATHOGENESIS

BRSV causes rhinitis, tracheitis, bronchitis, bronchiolitis, and mild interstitial pneumonia. In naturally occurring cases, the main lesions are bronchitis and bronchiolitis in the cranioventral portions of the lungs combined with widespread emphysema and edema throughout the lungs. BRSV infection causes airway obstruction and hyperactivity that may persist for up to 30 days following viral exposure. In naturally occurring cases, the cranioventral lung fields are particularly poorly ventilated, and there is arterial

hypoxemia associated with mismatching of ventilation and perfusion. Radiographic and radionuclide lung perfusion imaging reveals the presence of bullous emphysema and areas of marked atelectasis.

The pathogenesis of acute fatal pneumonia as a result of BRSV is not clear. The characteristic lesions are exudative or necrotizing bronchiolitis, atelectasis, interstitial edema, and emphysema. The acute fatal disease is commonly preceded by a mild respiratory disease several days previously, which suggests that hypersensitivity may be a pathogenic mechanism causing lung injury. The second stage may follow initial improvement or recovery from the first stage and is associated with the onset of extreme respiratory distress. The virus-specific IgE antibody may play a role in the pathogenesis of the severe disease as part of a hypersensitivity reaction. The IgM and IgA antibodies are not involved in a hypersensitivity reaction. In experimentally induced infection in calves, there is considerable injury to bronchiolar epithelium including hypertrophy, hyperplasia, and formation of syncytia, which facilitates movement of virus between cells.<sup>1</sup> In the alveoli, BRSV infection results in necrosis of type I pneumocytes; the response of type II pneumocytes includes hypertrophy, hyperplasia, and syncytial formation. It is suggested that an immune-mediated mechanism may be responsible for the widespread lesions over the entire lung.

The severe, highly fatal form of the disease, also known as the "malignant" form, or **paroxysmic respiratory distress syndrome** (PRDS), is associated with extensive pulmonary mast cell degranulation. In a series of naturally occurring paroxysmic respiratory disease in calves, paired serum samples were taken 3 weeks apart and lungs examined at necropsy. The serum concentration of tryptase was used as a marker of mast cell degranulation. Tryptase is a preformed serine protease stored in mast cell granules and causes significant changes in the respiratory tract smooth muscle tone and vascular permeability. The substances released by the mast cells are at least partially responsible for the pulmonary edema, in particular by means of vasoconstriction and the increase in the vascular permeability induced by the histamine. The edema and bronchoconstriction caused by the mast cell leukotrienes impede bronchiolar flow, which causes ventilatory asynchronism. The mechanical constraints caused by the asynchronism are aggravated because the bovine lungs consist of a number of compartments, which prevents any collateral ventilation and any dissipation of interlobular pressure gradients. The breaking point is reached when the level of the mechanical constraints exceeds the level of tissue resistance, causing interstitial emphysema.

Calves that die of the BRSV-associated PRDS have a uniform pattern of gross



lesions. The trachea and bronchi are filled with a white-to-pink froth, and the lungs are heavy and voluminous and fail to collapse. The most characteristic lesions were the dramatic lung distension by edema, alveolar hyperinflation, and severe interstitial and subpleural emphysema, often with large dissecting bullae on the dorsal edge of the diaphragmatic lobes.

Microscopically, the most characteristic lesions are bronchitis, bronchiolitis, alveolar edema, mononuclear cell infiltration, hyaline membrane deposition, and scattered hyperplasia of type-2 pneumocytes. There is a clear gradient in the severity of inflammatory changes in the airway along a craniocaudal axis, with lesions being more frequent and severe in the cranial parts except for hyperinflation and emphysema. Extensive mast cell degranulation occurs in the diaphragmatic lobes, where neither the virus nor the epithelial syncytia nor the bronchiolitis typically observed in cranioventral zones are found.

### Experimental Reproduction of BRSV Pneumonia

Experimental reproduction of the disease has been difficult; in most cases, infection results in only mild clinical disease with limited lesions.

Severe respiratory tract disease and lesions can be reproduced experimentally in conventionally reared calves, and the virus can be recovered from tissues. Severe disease similar to the naturally occurring disease can be induced with a single aerosol of a low-passage clinical isolate of the virus. Moderate to severe BRSV-induced pneumonia can be reproduced in colostrum-fed calves, and nasal shedding of the virus and demonstration of the antigen in the lungs at necropsy provides evidence that the virus causes the disease.

In neonatal calves with experimental acute infection with BRSV, there is increased pulmonary resistance and decreased compliance, which explains the severe dyspnea observed in some calves. There is no evidence that transplacental infection occurs. Experimental infection of young lambs with BRSV can result in severe pathologic changes with only mild clinical disease.

In experimentally infected calves, the virus can be detected in the bronchiolar epithelial cells and in alveolar cells, including bronchial ciliated and mucous cells, and bronchiolar ciliated and nonciliated epithelial (Clara) cells. Syncytia are often observed in the bronchiolar walls and in the alveoli, and such syncytia were always replicating the virus. However, syncytial cell formation is not unique to infection with BRSV because it may also occur in other viral infections of the lung. Ultrastructural studies of experimental BRSV pneumonia reveal that BRSV replicates primarily in the superficial layer of respiratory ciliated epithelium and to a lesser

extent in type II pneumocytes. BRSV infection of ciliated cells in the airway can result in the loss of cilia and ciliated cells, which may interfere with lung clearance mechanisms and predispose to bacterial pneumonia. The severity of clinical signs following experimental BRSV infection in calves is positively associated with the magnitude of decreased clearance of an inhaled protein marker, indicating that BRSV-induced ciliated epithelial damage affects the effectiveness of the mucociliary escalator.<sup>6</sup>

Experimental BRSV infection in calves induces an acute-phase-protein response. Strong and reproducible acute-phase proteins haptoglobin and serum amyloid A will peak at 7 to 8 days after inoculation of the virus. The proinflammatory cytokine, tumor necrosis factor (TNF- $\alpha$ ), can be detected in the bronchoalveolar lung lavage fluids, and high levels appear on the days when severe lung lesions and clinical signs are obvious. It may be involved in mechanisms leading to increased permeability of endothelium.

### CLINICAL FINDINGS

The clinical findings vary considerably from herd to herd and from year to year. In dairy cattle, disease occurs most commonly in young calves under 6 to 10 months of age, although outbreaks of severe disease in mature dairy cattle also occur. Clinical signs of infection in older cattle, particularly those with previous exposure to the virus, are less severe. In large dairy herds, episodes of infection are usually mild and often unnoticed, despite cattle having a fever, slight inappetence, and a corresponding decrease in milk production that lasts 3 to 5 days. Primary infections in lactating dairy cattle may cause a considerable decrease in daily milk production. However, reinfections are not associated with an important loss of milk production.

A **sudden outbreak of acute respiratory disease** in a group of animals is a characteristic of a primary BRSV infection. The disease is more severe in animals with no previous exposure to the virus. A dry, non-productive cough, severe dyspnea and polypnea, and bilateral nasal discharge are characteristic. A fever of 40° to 42° C (104-108° F) is common and milk production in lactating cows declines markedly. Feed consumption in the affected group declines for a few days. The fever usually persists for 3 to 5 days in spite of therapy with antimicrobials. Toxemia is not a feature unless there is secondary bacterial pneumonia. On auscultation of the lungs there are loud breath sounds over the ventral aspects, indicating consolidation, and wheezes that indicate bronchiolitis. These are the findings of a viral interstitial pneumonia. Most animals recover within 5 to 7 days. Approximately 1% to 2% of affected animals will develop a fatal viral pneumonia characterized by severe dyspnea with abdominal breathing and an expiratory grunt, the head stretched

out horizontally, mouth breathing with foamy salivation, marked anxiety, persistent fever, and death within 2 to 5 days after onset. Feed and water consumption are decreased because of severe dyspnea, which results in a gaunt abdomen and dehydration. Affected animals are reluctant to move or lie down. The loud breath sounds audible over the ventral two-thirds of both lung fields indicate that extensive consolidation is becoming pronounced. Subcutaneous emphysema over the withers may also occur. Occasionally, some animals that are not being observed closely will die with peracute pneumonia within a few days and represent the index case of an outbreak.

In outbreaks of BRSV infection in **young dairy cattle** under 12 to 16 months of age, the first clinical abnormalities usually noticed are coughing and a mild nasal discharge in 50% to 75% of the animals. Inappetence with a fever of 40° C (104° F) or higher lasts for about 3 days followed by recovery in most cases. Coughing, nasal discharge, and conjunctivitis may persist for several days or a few weeks in 10% to 30% of the animals with no long-lasting complications. Abdominal breathing, and loud and abnormal lung sounds may occur in approximately 50% of the animals, but these commonly resolve within 10 days.

In an outbreak of BRSV in **recently weaned beef calves** 6 to 8 months of age, nasal and lacrimal discharge, polypnea and dyspnea, fever of 40° to 42° C (104-108° F), decreased feed intake, coughing, and lethargy are common. In a small percentage of affected animals, within a few days the dyspnea becomes marked, with mouth breathing and the production of frothy saliva created by the labored respirations. Subcutaneous emphysema over the withers as a result of severe interstitial emphysema also occurs. Loud breath sounds, wheezing, and crackling sounds are audible over the ventral aspects of the lungs. Death may occur within a few days after the onset of the dyspnea. Secondary bacterial bronchopneumonia may occur but is uncommon.

### CLINICAL PATHOLOGY

It is difficult to obtain a definitive etiologic diagnosis of BRSV infection because the virus is highly labile in tissue samples, and virus detection in specimens is poor because of inadequate laboratory techniques. The virus replicates slowly, classical virus isolation is laborious, and several blind passages are often necessary before any cytopathic effect can be seen. Nasopharyngeal swabs for virus isolation and paired serum samples are necessary to make a definitive etiologic diagnosis. Successful laboratory diagnosis of BRSV is generally based on one of the following four criteria:

- Virus isolation
- Detection of BRSV antigen in suspected tissues

- Indications of BRSV seroconversion
- Histopathology

The high prevalence of antibody titers to the virus and the need for skilled personnel to process and interpret the diagnostic tests have hindered development of a routine diagnostic test. Successful isolation of the virus from typical clinical cases of disease is often unsuccessful and can take 11 to 21 days because of the late appearance of any noticeable cytopathic effect. Because of these difficulties, isolation of the virus is not commonly recommended as a routine diagnostic approach.

### Virus Isolation or Detection

After experimental infection, the median time to shedding is 3 days, the median time to peak shedding is 5 days, and the median time until shedding ceased is 9 days.<sup>7</sup>

The ideal sample for **isolation** of the virus is a transtracheal aspirate in the very early stages of the disease. The sample also provides cells for **immunofluorescent antibody (IFA) staining**. Nasopharyngeal swabs are also useful, but sampling technique must ensure good contact with the most caudal part of the pharyngeal cavity, and the samples must be placed in viral transport medium and shipped on cold packs and not frozen.

The **PCR assay** is rapid and sensitive and is the preferred method for the analysis of clinical specimens because of advantages in speed, sensitivity, sample lability, and cost.<sup>4</sup> The presence of the virus can be determined by using PCR on moistened cotton nasal swabs taken in the acute phase of a suspected outbreak.<sup>4</sup> The virus can be detected and quantified in cell cultures using real-time quantitative RT-PCR and quantitative competitive RT-PCR assays. A rapid patient-side immunomigration assay designed to detect HRSV can accurately detect BRSV in field studies, thereby providing a rapid calf-side diagnostic test.<sup>8</sup>

The fluorescent antibody test for virus **detection** is one of the most rapid, reliable, and sensitive tests for the diagnosis of BRSV infection. For tracheal aspirates, an aliquot of the sample is centrifuged onto a microscopic slide to obtain a cell preparation for the IFA test. The virus can be detected in tissues with monoclonal or polyclonal antibodies and avidin-biotin complex immunohistochemistry. This is typically done on formalin-fixed, paraffin-embedded tissues.

### Serology

The standard serologic test for specific BRSV antibodies is the **virus-neutralization (VN) test**, usually done with microtiter plates. Paired acute and convalescent samples from both affected and normal animals in the herd are desirable. The majority of dairy calves do not have detectable maternal antibodies directed against BRSV after 5 months of age;<sup>9</sup> consequently, a positive titer in cattle aged 6

months or more indicates exposure to infection within the population. The **indirect ELISA** is a rapid and reliable test for detecting antibodies to BRSV in milk, bulk-tank milk, and serum. A **microneutralization ELISA** has been developed that correlates well with other assays and is useful in assessing antibody responses to the virus both in naturally occurring disease and in vaccination studies.

### Arterial Blood Gas Analysis and Blood L-Lactate Concentration

The partial pressure of oxygen in arterial blood ( $P_{aO_2}$ ) is negatively associated with the extent of lung lesions in calves with experimentally induced BRSV infection, with a 0.6% to 0.8% increase in the proportion of affected lung for every 1 mm Hg decrease in  $P_{aO_2}$  from the reference value.<sup>10</sup> As a consequence, measurement of  $P_{aO_2}$  provides clinical useful information regarding the proportion of damaged lung and the response to treatment. In contrast, arterial blood L-lactate concentration was not useful in predicting the proportion of damaged lung and usually remained within the reference interval, even in the presence of severe arterial hypoxemia.

### NECROPSY FINDINGS

Affected lungs are voluminous and heavy, and they fail to collapse when the thoracic cavity is opened. The cranioventral portions of the lung are consolidated and usually dark red or plum-colored. The interlobular septa are edematous, and mucoid exudate can often be expressed from small bronchi. Severe interstitial emphysema and edema are prominent over the dorsal and caudal lobes. Subpleural emphysema is often obvious in the cranial and caudal lobes. The caudodorsal lung regions may be "meaty" in consistency. The caudal lobes are often markedly distended because of interstitial emphysema, and large bullae are common. The interlobular septa of the caudal lobes are usually distended because of emphysema and edema. Subcutaneous emphysema over the withers, thorax, and neck are common. Secondary bacterial bronchopneumonia with pleuritis may occur.

Histologically, there is bronchiolitis and bronchitis. Large multinucleated syncytia are present, projecting from the bronchiolar walls or lying free in the lumen. Hyperplasia is necrosis of the bronchiolar epithelium are common. Exudates consisting of neutrophils, macrophages, desquamated epithelial cells, and syncytia are present in the bronchiolar lumina. Small airways are often occluded with exudate. Alveolar changes include cellular infiltration and thickening of alveolar septae with multinucleate giant-cell syncytia in the alveoli. Epithelial syncytia containing eosinophilic intracytoplasmic inclusion bodies are often present on alveolar walls. The presence of epithelial syncytia is a

useful feature, but the numbers and prominence of these structures can vary considerably. Other viruses can also induce these syncytia. In the caudodorsal lung regions, there is severe emphysema, often with rupture of alveolar walls and alveolar edema, sometimes with hyaline membrane formation and swelling of alveolar epithelial cells.

In experimental BRSV pneumonia, the findings include bronchitis, bronchiolitis, proliferative and necrotizing bronchiolitis, interstitial pneumonia with areas of atelectasis and alveolar edema, epithelial syncytium formation on bronchiolar and alveolar walls, and pneumocyte hyperplasia. Viral antigen can be demonstrated by immunoperoxidase or immunofluorescent staining of bronchiolar and alveolar epithelium.

Isolation of the BRSV from natural field cases has always been difficult because of the long duration required for the appearance of characteristic cytopathic effects. Fluorescent microscopy can be used for detection of the antigen in the cranioventral lung areas, but PCR is a more sensitive technique. It is advisable to collect and **sample several areas of lung** because viral antigen/nucleic acid will be most abundant in areas of acute infection. The virus can also be demonstrated in formalin-fixed paraffin-embedded bovine lung tissue using immunohistochemical techniques.

### Samples for Confirmation of Diagnosis

- **Histology**—fixed lung (several sites) (LM, IHC)
- **Virology**—chilled lung (several sites) (FAT, PCR); nasal swab (ELISA, PCR)

### DIFFERENTIAL DIAGNOSIS

The differential diagnosis includes those infectious diseases of the respiratory tract of young cattle that commonly affect groups of animals in a short period of time.

It is not usually possible to make a definitive etiologic diagnosis based on the clinical findings. However, the combination of the epidemiologic and clinical findings is usually suggestive of an acute viral respiratory disease. It is not usually possible to be more specific than making a clinical diagnosis of acute undifferentiated respiratory disease.

- Acute respiratory disease attributable to BRSV infection in weaned beef calves is characterized by marked dyspnea, anorexia, mouth breathing, fever, subcutaneous emphysema, loud breath sounds, and death in a small percentage of animals in a few days or less. In some cases there may be a history of respiratory disease in the affected group several days previously.
- Infectious bovine rhinotracheitis (IBR) is characterized by outbreak of coughing,

profuse nasal discharge, fever, inappetence, and the presence of typical nasal lesions; pneumonia is not common. Recovery occurs in several days

- Pneumonic pasteurellosis is characterized by anorexia, toxemia, fever, abnormal lung sounds, coughing, nasal discharge, and response to treatment with antimicrobials. fibrinous pneumonia at necropsy is typical.
- Lungworm pneumonia occurs most commonly in groups of young cattle on summer pasture and is characterized by coughing, nasal discharge, tachypnea, abdominal breathing, fever and inappetence, and increased breath sounds with crackles. A necropsy diagnosis is usually necessary.
- BRSV infection in mature dairy cattle may be mild and is characterized by a slight drop in milk production, fever for a few days, inappetence, and recovery in a few days. Adult cattle lacking immunity may develop severe fatal pneumonia, which must be distinguished from bacterial pneumonia, infectious bovine rhinotracheitis, and other causes of interstitial pneumonia.

## TREATMENT

### Antimicrobial Therapy

Broad-spectrum antimicrobials given daily for 3 to 5 days for secondary bacterial pneumonia are commonly administered but may not be necessary. Recovery usually occurs gradually over a period of 3 to 5 days. Severely affected animals will become worse in spite of therapy.

### Corticosteroids and Nonsteroidal Antiinflammatory Agents

Corticosteroids and NSAIDs are used on the basis that widespread dissemination of the virus into the caudodorsal lung field is proinflammatory and results in extensive emphysema and severe respiratory distress. There is no evidence that such treatment is efficacious. Currently, there are no effective postinfection treatments for HRSV infection in humans, other than supportive care.<sup>11</sup>

## CONTROL

The ubiquitous nature of the virus, the persistence of infection in herds, the movement of cattle between herds, the expansion of herds, the replacement practices used in herds, and recurrent infections make control difficult. However, in BRSV-seronegative herds, effective biosecurity measures, including maintaining a closed herd, preventing nose-to-nose contact with cattle on adjacent farms, quarantining and testing new additions to the herd, and providing boots for visitors, may be effective in preventing infection from entering the herd.<sup>9</sup> A rational approach to control would be management

of the herd to minimize stressors such as inadequate ventilation. Herd replacements brought into the herd should be quarantined from the rest of the herd for 2 to 3 weeks before mixing with the remainder of the herd.

### Vaccines and Immunization

An effective vaccine must be able to stimulate an effective immune response in the presence of maternally derived antibody resulting from colostrum ingestion. This is because the majority of adult cattle are seropositive, and clinical disease appears to be most common in calves aged 2 to 4 months. Currently, several types of immune response, influenced by vaccination protocol and vaccine composition, appear to provide protection against BRSV, and optimal protection in the face of maternally derived antibodies may require both live and inactivated vaccines.<sup>12</sup> However, immune responses to parenterally administered modified live-virus (MLV) vaccines appears to be substantially inhibited in neonatal calves. As a result, the parenteral administration of a MLV BRSV vaccine is not expected to engender a protective immune response to BRSV infection.<sup>13</sup>

Several MLV and inactivated virus vaccines are available for the control of respiratory disease resulting from BRSV infection, but appropriately controlled randomized clinical trials evaluating the efficacy of the vaccine under naturally occurring conditions against BRSV infection or clinical disease are lacking. Protection induced by BRSV vaccines is short lived and usually less than 4 months.

A MLV vaccine administered by the intranasal route appears to provide the best vaccine candidate, based on our current understanding of the pathogenesis of BRSV infection. Such a vaccine was first made commercially available in 2007. However, administration of a MLV vaccine runs the risk of reversion to virulence and spread. The risk of reversion is reduced if gene deletion is employed.<sup>12</sup> In addition, maternal antibodies appear to inhibit priming of protective immune responses when intranasal BRSV vaccines are administered.<sup>13,14</sup> Cattle vaccinated with MLV BRSV vaccines generally develop high concentrations of virus neutralizing antibodies (VN) and F (fusion) inhibiting antibodies, compared with low to moderate concentrations of total BRSV-specific IgG. A 2015 meta-analysis concluded that in experimentally induced exposure trials, beef or dairy calves vaccinated with modified live BRSV vaccines had no reduction in morbidity or mortality compared with unvaccinated controls. This meta-analysis included calves vaccinated by the intranasal route.<sup>15</sup> Cattle receiving **inactivated virus vaccines** develop lowered concentrations of VN antibodies and higher concentrations of virus-specific (nonneutralizing) IgG than cattle administered an MLV

vaccine. The clinical significance of this difference has not been determined. Inactivated BRSV vaccines have been successful when tested by experimental challenge of vaccinated calves, which contrasts to the enhanced disease that may occur in children vaccinated with a formalin-inactivated alum adjuvanted HRSV vaccine. A 2015 meta-analysis concluded that in experimentally induced exposure trials, dairy calves less than 6 months of age vaccinated with inactivated BRSV vaccines had no change in morbidity but **decreased mortality** compared with unvaccinated controls.<sup>15</sup>

None of the 81 commercial BRSV vaccines available in 2014 enable the **differentiation of infected from vaccinated animals (DIVA)**.<sup>16</sup> Subunit BRSV vaccines provide an attractive alternative to MLV BRSV vaccines in that there is no potential for reversion to virulence, and vaccinated animals can be distinguished from naturally infected animals based on serologic testing.<sup>12,16</sup> The use of BRSV-**immunostimulating complexes (ISCOMs)** has been evaluated in calves with BRSV-specific maternal antibodies. The vaccine overcame the suppressive effect of colostrum antibodies and induced a strong clinical and virological protection against a BRSV challenge. Clinical protection was associated with a marked reduction in virus replication in the upper and lower respiratory tract and rapid antibody and T-helper-cell responses, which may be attributable to the effects of the adjuvant in antigen presentation.<sup>17</sup>

## TREATMENT AND CONTROL

### Treatment

Antimicrobial treatment for animals with a fever to address concurrent bacterial pneumonia (see treatment recommendations for *Mannheimia hemolytica* in this chapter) (R-1)

Antiinflammatory agents

Nonsteroidal antiinflammatory agents (R-2)

Corticosteroids (R-3)

### Control

Vaccination of dairy calves less than 6 months of age with inactivated BRSV vaccine. (R-1)

Vaccination of beef or dairy calves with modified live BRSV vaccine. (R-3)

## FURTHER READING

- Brodersen BW. Bovine respiratory syncytial virus. *Vet Clin North Am Food A.* 2010;26:323-333.
- Guzman E, Taylor G. Immunology of bovine respiratory syncytial virus in calves. *Mol Immunol.* 2015;66:48-56.
- Meyer G, Deplanche M, Schelcher F. Human and bovine respiratory syncytial virus vaccine research and development. *Comp Immunol Microbiol Infect Dis.* 2008;31:191.
- Valarcher JF, Taylor G. Bovine respiratory syncytial virus infection. *Vet Res.* 2007;38:153-180.



## REFERENCES

- Gershwin LJ. *Comp Immunol Microbiol Infect Dis*. 2012;35:253.
- Raaperi K, et al. *Acta Vet Scand*. 2012;54:4.
- Moore SJ, et al. *J Vet Diag Invest*. 2015;27:6.
- O'Neill R, et al. *Vet Rec*. 2014;10:1136/vr-102574.
- Antonis AFG, et al. *J Gen Virol*. 2010;91:2497.
- Gershwin LJ, et al. *Am J Vet Res*. 2008;69:416.
- Grissett GP, et al. 2015; 29:770.
- Urban-Chmiel R, et al. *Transbound Emerg Dis*. 2015;62:407.
- Klem TB, et al. *Vet Rec*. 2013;doi:10.1136/vr.101936.
- Ellis J, et al. *Can J Vet Res*. 2013;77:205.
- Moore ML, Peebles RS. *Pharmacol Therap*. 2006;112:405.
- Blodörn K, et al. *PLoS ONE*. 2014;9(6):e100392.
- Ellis J, et al. *Can Vet J*. 2014;55:1180.
- Ellis JA, et al. *J Am Vet Med Assoc*. 2010;236:991.
- Theurer ME, et al. *J Am Vet Med Assoc*. 2015;246:126.
- Hägglund S, et al. *Clinical Vaccine Immunol*. 2014;21(7):997.
- Hägglund S, et al. *Vaccine*. 2011;29:8719.

## INFECTIOUS BOVINE RHINOTRACHEITIS (RED NOSE), BOVINE HERPESVIRUS-1 INFECTION

## SYNOPSIS

**Etiology** Bovine herpesvirus-1 subtypes: BHV-1.1 (respiratory); BHV-1.2a and 1.2b (genital); BHV-1.3 (renamed BHV-5; encephalitic).

**Epidemiology** Worldwide occurrence in cattle; high prevalence of infection; low incidence of disease; transmitted directly; latent infection characteristic; economic losses as a result of deaths and abortions, latent infection in breeding animals cause international trade problems and entry into artificial insemination units.

**Signs** Rhinitis with typical nasal lesions, tracheitis, fever, conjunctivitis, coughing, nasal discharge, and recovery in few days; severe systemic disease in newborn calves, abortion outbreaks.

**Clinical pathology** Isolation or detection of virus with tissue culture or polymerase chain reaction (PCR); serology with serum-neutralizing titer, enzyme-linked immunosorbent assay (ELISA). Bulk-tank milk antibodies.

**Lesions** Rhinotracheitis, bronchopneumonia, nonsuppurative encephalitis, alimentary tract necrosis in calves with systemic disease, aborted fetuses autolyzed.

**Differential diagnosis** All diseases associated with bovine respiratory tract disease: pneumonic pasteurella, viral interstitial pneumonia, *Haemophilus pleuropneumoniae*, allergic rhinitis.

**Treatment** Antimicrobials for secondary bacterial infections.

**Control** Vaccination of young breeding herd replacements using modified live virus or

inactivated virus vaccines. Subunit and marker vaccines are preferred to conventional vaccines. Some countries have eradicated infection by identifying and eliminating seropositive animals.

## ETIOLOGY

The bovine herpesvirus-1 (BHV-1), or the infectious bovine rhinotracheitis (IBR) virus, is an alpha-herpesvirus and the cause of the respiratory disease, abortion, conjunctivitis, and other clinical forms of the disease complex. Genetic analyses of various clinical isolates have found at least four distinct **BHV-1 subtypes: a respiratory subtype, two genital subtypes, and an encephalitic subtype** designated as BHV-1.1, BHV-1.2a, BHV-1.2b, and BHV-1.3, respectively. BHV-1.3 as a neuropathic subtype has been renamed as three genotypes, BHV-5a, BHV-5b, and BHV-5non-a/non-b.<sup>1</sup> Antigenic differences between isolates of the virus may account for some of the diverse epidemiologic and pathologic patterns of behavior of this herpesvirus, although development of rhinotracheitis or vulvovaginitis/balanoposthitis depends more on the route of infection than on the subtype of the virus.

Four ruminant alpha-herpesviruses are related to BHV-1 and have the potential for cross-infection of cattle in Europe: bovine herpesvirus-5, caprine herpesvirus-1 (CpHV-1), cervine herpesvirus-1 (CvHV-1), and cervine herpesvirus-2 (CvHV-2). Buffalo herpesvirus-1 and elk herpesvirus are also closely related to BHV-1. BHV-5 is the cause of fatal meningoencephalitis in calves. CpHV-1 causes enteritis and generalized infection in neonatal kids. Most CpHV-1 infections in adults are subclinical, the virus can cause vulvovaginitis, balanoposthitis, or abortion. CvHV-1 can cause ocular disease in red deer and is widespread in free-living and farmed red deer. CvHV-2 has been isolated from reindeer in Finland, and serologic evidence of infection with a virus similar to BHV-1 has been reported in caribou in Canada. Although these viruses differ considerably in their virulence, they are closely related both genetically and antigenically, and they can establish latent infections similar to that of BHV-1. An immunofluorescence assay using monoclonal antibodies can discriminate between these related herpesviruses. Bovine herpesvirus-4 has been associated with mastitis in cattle.

## EPIDEMIOLOGY

### Prevalence of Infection and Occurrence of Disease

Reproductive disease as a result of BHV-1 was first reported in Germany in 1841 as the cause of infectious pustular vulvovaginitis (IPV) and infectious pustular balanoposthitis (IPB). A more virulent disease form attributable to BHV-1.1 (infectious bovine

rhinotracheitis) emerged in Colorado feedlots in the United States in 1950, and this subtype has been widely disseminated, most likely as a result of the export of live cattle. It is believed that this subtype developed because of an adaptation to multiply in respiratory epithelium associated with large susceptible populations congregated on one feedlot. The virus is now distributed worldwide, but it has been eradicated from Austria, Denmark, Finland, parts of Germany, Sweden, parts of Italy, Switzerland, and Norway.<sup>2</sup> Control programs are running in several other countries. The respiratory form of clinical disease is most common in feedlot cattle and cattle on dairy and beef farms without a routine vaccination program.

## Wildlife

Bovine herpesvirus infections exist in wild ruminants. Infections may be endemic in white-tailed deer in certain parts of Canada, and it is suggested a mild form of the disease occurs in these animals. Mule deer are susceptible to infection, the disease has occurred naturally in a goat, and antibodies to the virus have been found in pronghorn antelope in western Canada and in Tanzania in game animals and cattle. According to serologic surveys, the virus is widespread in African wildlife, particularly the buffalo, which may be a reservoir of infection among the wildlife population. The virus has been recovered from the wildebeest in Africa, which suggests further that wildlife may serve as reservoirs. Antibodies to the alpha-herpesviruses were found in reindeer, roe deer, and in red deer in Norway. In Saskatchewan, Canada, 52% of Woodland caribou were seropositive for BHV-1.

## Morbidity and Case Fatality

The uncomplicated form of the respiratory disease in cattle is not highly fatal, with most losses being mainly attributable to secondary bacterial bronchopneumonia. The morbidity and case-fatality rates in dairy cattle are about 8% and 3%, respectively, whereas in feedlot cattle the morbidity rate is usually 20% to 30% in unvaccinated cattle and may rarely reach 100%. The case-fatality rate in feedlot cattle is invariably associated with secondary bacterial tracheitis and bronchopneumonia and may reach 10%, but is usually no more than 1%. Morbidity and mortality are **higher in feedlot cattle** than in dairy herds because of the frequent introduction of susceptible animals into an enzootic situation. The case-fatality rate in the systemic form of the infection in newborn calves is almost 100%.

## Methods of Transmission

The main sources of infection are the nasal exudate and coughed-up droplets, genital secretions, semen, and fetal fluids and tissues. Aerosol infection is the method of spread of the respiratory disease. Experimentally,

BHV-1 can be shed from calves into the environment and transported by air over a distance of at least 3.9 m to sentinel calves housed in a separate building. The virus is stable for at least 1 month at 4°C (39°F), 50 days at 22°C (72°F), 10 days at 37°C (98.6°F), and 21 minutes at 56°C (132°F), and can survive 30 days in feed. Venereal transmission is the method of spread of the genital diseases. The virus may survive for up to 1 year in semen frozen at -196°C (-321°F).

Introduction of animals into a group often precedes an outbreak of the disease. However, it can arise simultaneously in a number of dairy farms in an area and spread from these farms to adjacent farms until the entire area is affected. The same pattern of occurrence simultaneously in a number of foci is seen in feedlots, and from these foci infections it spreads to other pens in the lot. An outbreak usually reaches its peak in week 2 or 3 and ends by week to 6.

## Risk Factors

### Animal Risk Factors

#### *Age and Breed Susceptibility*

All ages and breeds of cattle are susceptible, but the disease occurs most commonly in animals over 6 months of age, probably because of their greater exposure. There is no seasonal variation in incidence, except possibly a higher occurrence in feedlot cattle in the fall and winter months when large numbers of susceptible animals are assembled. The disease complexes associated with the virus occur most commonly in animals that lack acquired immunity from previous natural infection or vaccination. **An unvaccinated herd of breeding cattle or a group of feedlot animals is highly susceptible to epidemics of respiratory disease and abortion.** Newborn calves are highly susceptible to the systemic form of infection if the level of specific antibody to the virus in the colostrum is inadequate or if there is failure of transfer of passive immunity.

The analysis of the relationship between interferon genotype and severity of clinical disease in cattle experimentally inoculated with BHV-1 revealed that certain alleles of the interferon were significantly associated with the more severe clinical phenotype. A second allele at another locus was associated with the milder disease genotype. Thus selective breeding programs aimed at altering the frequency of these alleles in cattle populations may potentially improve animal health and lessen the economic impact of BHV-1 infections. This potential control method has not been pursued with the introduction of national vaccination and eradication campaigns.

### Environmental and Management Risk Factors

Several management factors have been associated with BHV-1 infection in a herd. Infected herds purchase cattle and

participate in cattle shows more often than negative farms. The positive farms have more visitors and are situated closer to other cattle farms. The failure to vaccinate regularly and keep reliable records of vaccination dates is commonly associated with inadequate disease control. In countries with BHV-1 eradication programs, the loss of certification is commonly associated with yearly number of cattle purchased, farm density within a 1-km radius, and cattle density within a 1-km radius.

### Pathogen Risk Factors

The **IBR-like viruses** are now designated **BHV-1.1**, and the **IPV-like viruses** are designated **BHV-1.2**, with the latter subtype being further divided into two groups given the letter designations a and b. **Subtype 1.2a isolates cause abortion**; 1.2b isolates are not abortifacient. **Subtype 1.3 (now renamed BHV-5)**, is the encephalitic strain and consists of three subtypes as identified earlier. Currently available vaccines, which are made with 1.1 subtype vaccines, cannot be given to pregnant cattle because they are abortifacient. The currently available MLV BHV-1 vaccines can cause infertility in cattle infected 14 days after breeding.

The virulence of the virus or its host tissue specificity changes as a result of unknown factors. The BHV-1 genome is not stable during host animal passage, and variations can occur in the restriction endonuclease patterns of the viruses within individual animals during both acute infections and after viral reactivation or after viral reactivation followed by superinfection with a different subtype of BHV-1 than was used for the primary inoculation. The virus of IBR is similar to the virus causing IPV in cows and IPB of bulls. It has been suggested that the IPV was transmitted to North America from Europe in infected cattle, but continued to cause lesions in only the genital tract until its introduction into dense populations of cattle in feedlots encouraged rapid passage through many hosts and thus encouraged adaptation to the respiratory tract. Only rarely do the respiratory and genital forms of the disease occur together. However, by routine methodology it is difficult, and usually impossible, to distinguish between isolates obtained from the reproductive tract and the respiratory mucosa. Likewise, with the exception of temperature-sensitive mutants, vaccine strains cannot be distinguished from field isolates.

The virulence of several strains of one genotype can vary widely. The outcome of BHV-1 infection can vary from subclinical to a systemic infection in neonatal calves that is often highly fatal. Vaccine strains of BHV-1.1 have been associated with outbreaks of meningoencephalitis in feedlot cattle within 7 to 10 days after routine vaccination intranasally with a vaccine intended for the intramuscular route. Newborn calves under 3

days of age are susceptible to the highly fatal systemic form of IBR if vaccinated intramuscularly with a modified live-virus BHV-1 and PI-3 vaccine. An outbreak of a subclinical form of IBR has been described in a dairy herd of high health status and managed under high standards of biosecurity, and known to be serologically negative for the virus for the previous 15 years. Although 70% of the cows had seroconverted to the virus, no clinical signs were observed, with the exception of an ocular discharge in a few cows, and their performance and productivity were unaffected. The causative virus was isolated after reactivation with corticosteroids and had the DNA profile of a BHV-1 strain normally associated with severe respiratory disease.

The glycoprotein E (gE) gene is a virulence factor of BHV-1 is important in the development of **gE-negative marker vaccines** used in eradication programs in Europe. These marker vaccines, either inactivated or live attenuated, are deleted in the gene coding for the nonessential glycoprotein E (gE) of BHV-1 to allow serologic differentiation between vaccinated and infected cattle.

### Immune Mechanisms

**Immunity to the virus is complex and consists of relationships between local and systemic antibody and cell-mediated immunity.** Following natural infection or vaccination with the modified live-virus (MLV) vaccines, both cell-mediated and humoral components of the immune system are activated. The level of humoral immunity has been used as an indicator of previous infection and an indirect measure of resistance to clinical disease. However, the level of serum neutralizing (SN) antibody is not a reliable indicator of resistance to clinical respiratory disease. Animals with low levels of antibody may be immune because of cell-mediated immunity. The level of cell-mediated immunity can be evaluated using the delayed-type hypersensitivity test. Experimentally, the virus-neutralizing (VN) titers are lower in calves inoculated with both the IBR and parainfluenza-3 (PI-3) viruses than in calves infected with a single virus. This suggests that mixed viral infections may result in greater immunosuppression, although infectious virus synthesis may be suppressed by interference.

Following intranasal infection or the use of a MLV IBR virus vaccine intranasally, local secretory antibody and interferon are produced. The interferon appears in 3 days and persists for 10 days. The presence of the interferon does not protect calves against experimental challenge 3 days after vaccination. However, the presence of even low levels of antibody in the serum or nasal secretion, which appears by day 7 following vaccination, provides varying degrees of resistance to clinical disease for 9 months.

### Colostrum Immunity

Calves acquire colostrum antibodies from dams with humoral antibody. The duration of the colostrum immunity varies from 1 to 6 months of age depending on the initial level acquired by the calf. Maternal antibody in the calf may interfere with the successful vaccination of calves before 6 months of age.

### Economic Importance

BHV-1 infection can cause major economic consequences in a dairy or beef cattle breeding herd or in a beef feedlot. Losses are incurred because of epidemics of abortion, infertility as a result of IPV and IPB in bulls, loss of production and deaths from the respiratory form of the disease in all ages of cattle, deaths from the highly fatal systemic form of the disease in newborn calves, and the cost of treatment when secondary bacterial infections of the respiratory tract occur.

### PATHOGENESIS

The virus causes disease through several different pathways including a primary infection restricted to the respiratory tract, eyes, and reproductive tract. Systemic spread to many organs by viremia occurs and neuronal spread. In addition, the virus can establish latency in neuronal or lymphoid cells. Upon reactivation, the viruses reestablish the lytic cycle of replication. The innate immune response is primarily activated in animals infected with IBR through Toll-like receptors 2 and 4, and the development of an effective cytotoxic T-cell response is critical for the elimination of cells infected with virus.<sup>3</sup>

### Respiratory Disease

The BHV-1 virus infects the nasal cavities and upper respiratory tract, resulting in rhinitis, laryngitis, and tracheitis. The pharyngeal tonsil is readily infected by the virus and may be an important lymphoid tissue for early antiviral responses. There is extensive loss of cilia in the trachea, leaving the tracheal epithelium covered by microvilli. Intra-tracheal administration of the virus results in almost complete denudation of tracheal columnar cells, which presumably has an adverse effect on the defense mechanisms of the respiratory tract. Spread from the nasal cavities to the ocular tissues probably occurs by way of the lacrimal ducts and causes conjunctivitis with edema and swelling of the conjunctiva, multifocal plaque formation on the conjunctivae, peripheral corneal edema, and deep vascularization. The virus can also enhance the prevalence and severity of IBR in calves. In neonatal calves, potentially fatal infection, associated with the continued presence of viral antigen and active inflammation, contrasts with repair and clearance of viral antigen in weanling calves. Experimentally, the endobronchial inoculation of calves with the BHV-1 causes an interstitial pneumonia. The viral antigen can be detected

in the desquamated cells and macrophages of bronchoalveolar fluid.

### Encephalitis

The mechanism by which the brain is infected is presumed to be spread of the virus from the nasal mucosa via the trigeminal peripheral nerve to the trigeminal ganglion, resulting in a nonsuppurative encephalitis. However, a viremia has been suspected. Severe encephalitis can be produced experimentally in colostrum-deprived calves with neurovirulent type BHV-1.3. Experimental infection with BHV-1.1 produces respiratory disease and a mild encephalitis. Intranasal inoculation of young calves and adult cows with BHV-1 can result in nonfatal trigeminal ganglionitis and encephalitis, which may be an important mechanism for latent infection.

### Abortion

Systemic invasion by the virus is followed by localization of the virus in several different tissues. The virus may be transported by peripheral leukocytes to the placenta and transferred to the fetus to cause abortion. The fetus is highly susceptible to the virus, which causes a peracute infection that is usually fatal. Infection in the last trimester of gestation may result in mummification, abortion, stillbirth, or weak calves with the usual lesions of IBR and the lesions of the stomachs and intestines that have been produced by experimental administration of the virulent virus to newborn calves.

**The systemic form of the infection in newborn calves** is characterized by severe inflammation and necrosis of the respiratory and alimentary tracts, including the pharynx, esophagus, lungs, larynx, lymph nodes, and liver, and nephritis and encephalitis. There is severe laryngeal edema and respiratory distress that results in difficulty in swallowing and aspiration pneumonia. A severe, highly fatal syndrome characterized by diffuse erosion and ulceration of the upper alimentary tract, including the oral cavity, has occurred in beef feedlot cattle.

### Latency

**The BHV-1 virus can become latent** following a primary infection with a field isolate or vaccination with an attenuated strain. The virus may remain latent indefinitely, and recrudescence, reactivation, and shedding of the virus can occur following the use of large doses of corticosteroids that mimic the effects of stress. Transportation of cattle with latent infection can reactivate the virus, resulting in reexcretion of the virus and a rise in neutralizing antibodies. Attenuated vaccine strains can remain in a latent stage, and vaccination does not provide protection against the establishment of latent infection with a wild strain. Vaccination also does not inhibit reexcretion of a wild strain that was in the latent form at the time of vaccination.

The vaccine virus and the field isolates can be excreted after live-virus vaccination and subsequent field isolate challenge. Colostrum antibodies in calves do not prevent initial virus replication, and latency can persist after the decline in colostrum immunity and the calves are seronegative.

The location of latency of the virus in the body varies; the virus remains localized near the site of its first multiplication and during recrudescence will be reexcreted by the tissue primarily infected. The BHV-1 can be isolated from the **trigeminal ganglion** of clinically normal cattle during the latent period, and trigeminal ganglionitis can be observed during recrudescence. Latent infection with virulent BHV-1 virus may occur in the trigeminal ganglion of calves previously vaccinated with the MLV vaccine. The virulent virus may spread along the trigeminal peripheral nerve despite the presence of humoral antibodies in vaccinated calves. Recrudescence of the virus from the trigeminal ganglion and spread along the peripheral nerves by intraaxonal flow to the nasal mucosa can occur in calves treated with corticosteroids and, presumably, occurs following stress. The virus has been isolated from the trigeminal ganglia of 10% of clinically normal cattle at slaughter, 40% of which had SN antibody to the virus.

The practical aspect of latency is that all cattle from endemic herds must be considered as potential sources of BHV-1 virus and capable of spreading infection to previously unexposed animals. Some latent carriers do not possess detectable antibodies. The only method of identification is by treatment with dexamethasone to initiate recrudescence and detection of the virus from nasal secretions, or the PCR examination of the trigeminal ganglion at necropsy.

A combined serologic and clinical surveillance of 20 dairy herds over three consecutive years revealed wide variations in the circulation of the virus. In some herds there was no identification of active infection, whereas in others one or two cycles of infection occurred in calves and yearlings, often without any clinical evidence of disease. Reactivation and shedding of the virus can occur in known carrier bulls at the time of mating, which may explain the higher incidence of titers in bulls than cows in some beef herds. Breeding bulls in an artificial insemination center that were vaccinated with a MLV vaccine were shedding the vaccine virus in the semen, and the virus could be recovered from preputial washings 2 to 3 months after the last immunization. However, the frequency of recurrent infections and the amount of virus excreted are reduced after vaccination.

The presence of passively acquired antibodies in calves does not prevent virus replication and establishment of latent infection. It is also possible to experimentally produce BHV-1 seronegative passively immunized



calves that do not have antibody response after infection but develop a cell-mediated immune response after infection detected by a specific interferon gamma assay. The failure to easily detect such animals presents an epidemiologic threat for the control of BHV-1 infections. Marker glycoprotein E-negative vaccines can also establish latency not only in naïve but also in passively immunized neonatal calves after a single intranasal inoculation. This indicates that gE-negative vaccines, when used in calves with passive antibodies, can result in seronegative vaccine virus carriers.

The experimental intrapreputial infection of young bulls with BHV-1.2 caused acute balanoposthitis, latent infection, and detection of viral DNA in regional neural (sacral nerve ganglia, pelvic sympathetic plexus) and nonneural tissues (lymph nodes) 50 days after experimental reactivation. Following experimental infection in calves the BHV-5 also can result in latent infection of surviving animals.

Parturition may also be a stimulus for reactivation and shedding of a thermosensitive vaccine strain of the virus in vaccinated animals. Reactivation and shedding of the virus has also been observed in cattle that recovered from the respiratory form of the disease and 5 months later were experimentally infected with *Dictyocaulus viviparus*. The placenta may harbor the virus in a latent stage for up to 90 days without transmitting the virus to the fetus. Recrudescence may be differentiated from primary infection and reexposure by the intranasal route based on the distribution of antiviral antibody activity among serum IgM, IgG<sub>1</sub>, and IgG<sub>2</sub> isotypes.

### Predisposition to Pneumonia

The role of the virus in affecting the lung clearance mechanism of cattle in the pathogenesis of pneumonic pasteurellosis has been reviewed and is presented in the section on shipping fever pneumonia in cattle. Experimental aerosol exposure of calves with the BHV-1 virus impairs the function of alveolar macrophages, which allows *Mannheimia haemolytica* to persist and proliferate in the lung and produce the characteristic lesion. In vitro studies indicate that the BHV-1 virus can interfere with the function of effector cells, such as macrophages, neutrophils, and lymphocytes. Aerosol exposure of calves to BHV-1 can affect the composition of alveolar phospholipids, which can alter the function of lung surfactant and compromise pulmonary defense mechanisms. The BHV-1 can cause alteration in the glycoconjugate composition of bovine nasal epithelial surfaces, which may promote *M. haemolytica* proliferation in the early stages of pneumonic pasteurellosis. The virus also causes varying degrees of obstructive lung disease, resulting in increased resistance to breathing, retention of carbon dioxide, and increased resting

lung volume. Excessive airway constriction and impairment of bronchial relaxation occurs, which may compromise lung defense mechanisms and allow development of secondary bacterial pneumonia. A severe fatal BHV-1 pneumonia can occur.

Experimentally, active BHV-1 infection triggers cytokine expression on bronchial epithelial cells that facilitates recruitment of neutrophils.<sup>4</sup> BHV-1 infection also affects bovine peripheral blood neutrophils, enhances the binding of *M. haemolytica* leukotoxin to bronchoalveolar leukocytes, and increases their killing. The virus increases the number of bronchoalveolar leukocytes, resulting in many more leukotoxin-responsive cells being present in the lung. The net effect is that BHV-1 infection amplifies the detrimental effect of *M. haemolytica* in the lung.<sup>4</sup>

### Reproductive Failure

**The intrauterine inoculation of the BHV-1 into cattle results in an acute necrotizing endometritis** in the uterine body and caudal portions of the uterine horns but minimal lesions in the anterior parts of the horns. Experimental inoculation of the virus into heifers on the day after estrus and insemination can result in lesions of the ovaries consisting of focal necrosis and cellular infiltration. Commercially available vaccinal strains of the BHV-1 virus can produce similar lesions. The ovarian lesions have marked effects on luteal function, and plasma progesterone values in the first estrus after inoculation are markedly lower than those in subsequent normal cycles. Whether the BHV-1 virus causes reproductive failure as a result of necrosis of the corpus luteum or embryonic infection remains to be determined. Recently hatched bovine embryos can be infected with any of several strains of BHV-1 and such infection in vitro is embryocidal. Experimentally induced infection during early pregnancy (7-28 days) will cause oophoritis and, in some cases, embryonic mortality. The effects of the virus on the genital tract and on reproductive performance in cattle have been reviewed.

### Bovine Mastitis

BHV-1 and BHV-4 have been associated with mastitis in cattle. Both viruses, including the foot-and-mouth disease virus, and the PI-3 virus have been isolated from milk. BHV-4 has been isolated from cows with clinical mastitis that also developed antibodies against the virus at the time of the mastitis, and no bacteria were isolated from the milk samples. Bovine umbilical cord endothelial cells were used to culture the virus. Experimental inoculation of the ductus papillaris of the teat has resulted in replication of the virus and subclinical mastitis after BHV-4 infection. Simultaneous intramammary and intranasal inoculation of lactating cows with BHV-4 did not induce clinical but

subclinical mastitis. It is unlikely that BHV-4 is a major mastitis pathogen.

### CLINICAL FINDINGS Rhinitis (Red Nose), Tracheitis, and Conjunctivitis

After experimental infection there is an incubation period of 3 to 7 days, but in infected feedlots the disease occurs 10 to 20 days after the introduction of susceptible cattle.

There is considerable variation in the severity of clinical signs following natural infection, dependent on the strain of the virus, the age susceptibility, and environmental factors. In North America, where the disease is endemic, the clinical disease is usually mild in dairy cattle and in range beef cattle. A severe form of the disease can occur in feedlots where crowding and commingling from several sources occur. A severe form of upper respiratory tract disease and encephalitis has been reported in neonatal beef calves. Clinical disease is most common after 6 months of age in colostrum-fed calves as a result of waning colostral IgG (passive immunity).

There is sudden onset of anorexia, loud coughing, fever (up to 42° C [108° F]), severe hyperemia of the nasal mucosa with numerous clusters of grayish foci of necrosis on the mucous membranes of the nasal septum visible just inside the external nares, a serous discharge from the eyes and nose, increased salivation, and sometimes a slight hyperexcitability. A marked fall in milk yield may be the earliest indication in dairy cattle. The respirations are increased in rate and are shallow, but only an increase in the loudness of breath sounds is audible on auscultation of the lungs unless secondary pneumonia is present. A severe primary viral, or secondary bacterial, tracheitis may cause inspiratory dyspnea with abnormal tracheal breath sounds transmitted to the lungs. Respiratory distress is evident on exercise. A short, explosive cough is characteristic of some outbreaks but not in others. Sudden death within 24 hours after first signs appear can result from extensive obstructive bronchiolitis.

**In dairy cattle**, many animals in a herd become affected within a few days. The disease is usually mild, characterized by inappetence, coughing, profuse bilateral serous nasal discharge, excessive salivation, nasal lesions, moderate fever, moderate drop in milk production, and recovery in a few days. Several animals may have the conjunctival form of the disease with obvious conjunctivitis and profuse ocular discharge. The affected animals as a group do not return to full production for 10 to 14 days. The outbreak of respiratory disease will be followed by abortions in several days up to 90 days after the index case occurred.

**In feedlot cattle** the illness is often more prolonged, the febrile period is longer, the

nasal discharge becomes more profuse and purulent, and the convalescent period is longer. Some deaths may occur in the acute febrile period, but most fatalities are attributable to a secondary bronchopneumonia and occur after a prolonged illness of up to 4 months in which severe dyspnea, complete anorexia, and final recumbency are obvious signs. Some recovered animals may have a persistent snoring respiration and a grossly thickened, roughened nasal mucosa accompanied by nasal discharge.

### Ocular Form of IBR

Conjunctivitis is a common finding in typical “red nose,” but outbreaks of conjunctivitis may occur as the major clinical finding. One or both eyes may be affected, which is easily misdiagnosed as infectious keratoconjunctivitis (pinkeye) associated with *Moraxella bovis*. However, the IBR lesions are confined to the conjunctiva and there are no lesions of the cornea except diffuse edema. The conjunctiva is reddened and edematous, and there is a profuse, primarily serous, ocular discharge. The cornea is initially unaffected, but occasionally may be damaged as a result of secondary bacterial infection. Calves less than 6 months of age may develop encephalitis, which is marked by incoordination, excitement alternating with depression, and a high mortality rate. Salivation, bellowing, convulsions, and blindness are also recorded.

### Systemic Disease in Newborn Calves

In newborn calves under 10 days of age, the systemic form of the disease is severe and highly fatal. Sudden anorexia, fever, excessive salivation, and rhinitis, often accompanied by unilateral or bilateral conjunctivitis, are common. The oral mucous membranes are usually hyperemic, erosions of the soft palate covered by tenacious mucus are common, and an acute pharyngitis covered by tenacious mucopurulent exudate is characteristic. The larynx is usually edematous, and respiratory distress is common. Bronchopneumonia is common, and loud breath sounds, crackles, and wheezes associated with consolidation are present. Outbreaks of the disease commonly occur in highly susceptible herds where the herd immunity has declined, the dams are not vaccinated, and there is minimal, if any, specific colostral immunity. Diarrhea and dehydration, referred to as the alimentary form of BHV-1 infection, occur in some affected calves. The cause of the diarrhea is uncertain, but it may be related to the ruminal lesions.

### Abortion

Abortion is a common sequela and occurs some weeks after the clinical illness or parenteral vaccination of nonimmune pregnant cows with the MLV vaccine of bovine tissue culture origin. Abortion may occur up to 90 days following vaccination if the virus becomes latent in the placenta and infects

the fetus much later than usual. This raises the possibility that vaccination even with safe vaccines may appear to be the cause of abortion if natural infection preceded vaccination. It is most common in cows that are 6 to 8 months pregnant. Retention of the placenta often follows, but residual infertility is unimportant. However, endometritis, poor conception, and short estrus can occur after insemination with infected semen. The infectious bovine rhinotracheitis virus has been isolated from semen 12 months after storage.

Infectious pustular vulvovaginitis is characterized by frequent urination, elevation of the tail, and a mild vaginal discharge. The vulva is swollen, and small papules, then erosions and ulcers, are present on the mucosal surface. Mucosal ulcers may coalesce, and sloughing of brown necrotic tissue may occur. Recovery usually occurs in 10 to 14 days unless there are complications.

Balanoposthitis is characterized by similar lesions of the glans penis and preputial mucosa.

## CLINICAL PATHOLOGY

### Virus Isolation or Detection

After experimental infection, the median time to shedding is 2 days, the median time to peak shedding is 4 days, and the median time until shedding ceases is 14 days.<sup>5</sup> Isolation of the virus from nasal swabs using tissue culture combined with a fourfold rise in antibody titers between acute and convalescent phase sera are desirable for a positive diagnosis of the disease. When using nasal swabs, cotton and polyester swabs are recommended rather than calcium alginate swabs, which are viricidal within 2 hours. The virus can be detected in nasal swabs by the use of an ELISA, direct and indirect immunofluorescence techniques, immunoperoxidase, and by electron microscopic examination that may reveal herpes-like viral particles. The sensitivity of the direct immunofluorescence techniques is comparable to the cell culture technique. The ELISA is highly sensitive. A combination of the indirect immunofluorescence test and virus isolation from both ocular and nasal swabs of several animals will increase the recovery rate.

The PCR assay is as sensitive as virus isolation and is a practical alternative for the rapid detection of the virus. The results are available in 1 day, compared with virus isolation, which requires 7 days. The PCR assay can be used for detection of virus in semen and is considered equivalent to that of standard virus isolation and dot blot hybridization. The PCR assay with Southern blot hybridization is considered to be highly sensitive and can detect the virus in semen before they develop any detectable antibody. The PCR assay can also detect 5 times as many positive semen samples as the virus isolation on egg yolk–extended semen. PCR

is considered the diagnostic test of choice for routine diagnosis of BHV-1 in aborted fetuses.<sup>6</sup>

Using restriction endonuclease analysis of viral DNA, it is now possible to distinguish field isolates of the virus from vaccine strains, which may be useful in the investigation of vaccine-induced epidemics of the disease.

### Serology

Several serologic tests are available for the detection of antibody and a rise in titer between the acute and convalescent phases of the infection.

The primary immune response to BHV-1 experimental inoculation of cattle is characterized by the formation of IgM and IgG antibodies, primarily IgG<sub>1</sub>, by postinoculation day 7. Secondary immune responses are characterized primarily by the formation of IgG<sub>2</sub> antibody. A secondary immune response resulting from abortion induced by intraamniotic virus inoculation is characterized by a substantial increase in IgM antibody. A secondary BHV-1 exposure by the intranasal route does not result in secondary IgM antibody formation.

The VN test has been widely used and is the standard by which other techniques have been evaluated. The ELISA is a specific, sensitive, and practical test for detection of BHV-1 antibodies and has advantages over the SN test. The IgM–ELISA test is useful for the diagnosis of recent infection with BHV-1 in calves.

The detection of latent BHV-1 infection in cattle is important in control programs and in international trade activities. Therefore tests to detect specific antibodies in serum must be highly sensitive to detect low levels of BHV-1-specific antibodies. This emphasizes the need for international standardization of tests to detect BHV-1-specific antibodies in cattle. In endemically infected herds, BHV-1 transmission is not continuous but is sufficient to produce detectable antibodies. A serologic test negative carrier status (latent infection) occurs when there is no reexposure to stimulate humoral immunity. In other words, it remains very challenging to identify latently infected cattle when they are housed in a population with minimal BHV-1 transmission.<sup>7</sup>

An immunofluorescence assay using monoclonal antibodies can discriminate between the four ruminant alpha-herpesviruses related to the BHV-1. They include the bovine herpesvirus-5, caprine herpesvirus-1 (CpHV-1), cervine herpesvirus-1 (CvHV-1), and cervine herpesvirus-2 (CvHV-2). Buffalo herpesvirus-1 and elk herpesvirus are also closely related to BHV-1.

Bulk-tank milk testing for BHV-1 antibodies may be useful in eradication and monitoring programs because it offers the possibility of rapid and inexpensive screening. The correlation between the bulk milk test and the within-herd prevalence of

seropositive animals can be as high as 0.86. If BHV-1 is detected in the bulk milk, there is a high probability that more than one animal in a herd is infected and that the infection has spread. The BHV-1 blocking ELISA is in use on bulk milk samples as part of the Danish surveillance system for BHV-1 infection in dairy herds. The test can detect seropositive herds, with prevalence proportions as low as 1 seropositive cow out of 70 cows.

Specific antibody against BHV-1 may be detectable in fetal fluids and increases the rate of diagnosis of abortion.

### NECROPSY FINDINGS

In **adult cattle**, gross lesions are restricted to the muzzle, nasal cavities, pharynx, larynx, and trachea, and they terminate in the large bronchi. There may be pulmonary emphysema or secondary bronchopneumonia, but for the most part the lungs are normal. In the upper respiratory tract there are variable degrees of inflammation, but the lesions are essentially the same in all anatomic regions. In mild cases there is swelling and congestion of the mucosae. Petechiae may be present, and there is a moderate amount of catarrhal exudate. In severe cases the exudate is profuse and fibrinopurulent. When the exudate is removed, the mucosa is intact except for small numbers of necrotic foci in the nasal mucosa, but there may be diffuse denudation of epithelium in the upper part of the trachea. Lymph nodes in the throat and neck region are usually swollen and edematous. Histologically, there is acute, catarrhal inflammation of the mucosa. Inclusion bodies are rarely seen in natural cases but do occur transiently in the nuclei of respiratory epithelial cells in experimentally infected animals. Secondary bacterial invasion will cause a more severe necrotizing change, which is usually followed by the development of bronchopneumonia. The virus is usually isolated from affected tissues using cell culture techniques. It can also be demonstrated in paraffin-embedded tissues by utilizing immunohistochemical techniques.

In the systemic form in **neonatal calves** a severe epithelial necrosis has been observed in the esophagus and rumen, with the adherent necrotic epithelium having the pultaceous quality of milk curd. The laryngeal mucosa is congested and edematous, with multiple focal lesions in the mucosa. Bronchopneumonia is common, with a thick white exudate coating the tracheal lumen and extending into the bronchi. Histologically, there is necrosis of the pharynx, larynx, associated lymph nodes, esophagus, and liver. Inclusion bodies are evident in many surviving epithelial cells. Systemic infection in neonatal calves may be more common than is currently realized; 2.1% of 2980 calves examined at necropsy between 1 and 30 days of age had lesions consistent with BHV-1

infection, although it was not clear whether BHV-1 was the primary cause of death in all cases.<sup>8</sup>

The **encephalitic form** lacks gross lesions but is characterized microscopically by non-suppurative inflammation, neuronal degeneration and gliosis, located particularly in the cerebral cortex and the internal capsule. Inclusion bodies are sometimes present. Both immunoperoxidase and PCR tests are capable of detecting BHV-5 antigen in formalin-fixed brain tissues affected with bovine herpesvirus encephalitis.

**Aborted fetuses** show moderately severe autolysis and focal necrotizing hepatitis. Microscopically, foci of necrosis rimmed by very few leukocytes are visible in the liver and many other organs. Occasionally, intranuclear inclusion bodies can be seen. Viral antigen can be demonstrated in sections of the lung, liver, spleen, kidney, adrenal gland, placenta, and in mummified fetuses using the avidin-biotin complex system. Using this system, the viral antigen can be found in fetal tissues from which the virus could not be isolated in cell culture.

### Samples for Confirmation of Diagnosis

- **Histology**—formalin-fixed samples: *abortion/neonate*: lung, liver, trachea, kidney, adrenal gland, rumen, esophagus, pharynx; *respiratory form*: nasal turbinate, trachea, pharynx, lung; *encephalitic form*: half of midsagittally sectioned brain (LM, IHC)
- **Virology**—*abortion/neonate*: lung, liver, kidney, rumen; *respiratory form*: lung, trachea, nasal swab; *encephalitic form*: half of midsagittally sectioned brain (FAT, ISO, PCR)

### DIFFERENTIAL DIAGNOSIS

Infectious bovine rhinotracheitis is characterized by acute rhinotracheitis, coughing, profuse nasal discharge, nasal septum lesions, bilateral conjunctivitis, anorexia, fever, and gradual recovery in a few days. Secondary bacterial tracheitis and pneumonia can occur. It must be differentiated from the following:

- Pneumonic pasteurellosis is characterized by marked toxemia and depression, coughing, anorexia, gauntness, fever, abnormal lung sounds, and good response to antimicrobials.
- Bovine virus diarrhea is characterized by depression, anorexia, salivation, oral erosions and ulcers, persistent diarrhea, dehydration, and death in a few days.
- Malignant head catarrh is characterized by remarkable mental dejection, prominent lesions of nares, severe erosive lesions in oral cavity, interstitial

keratitis, enlarged peripheral lymph nodes, high persistent fever, hematuria, terminal encephalitis, and death in several days.

- Calf diphtheria occurs usually in a single animal and there is depression, fever, inability to suck or eat, inspiratory dyspnea and stridor, fetid oral and laryngeal lesions, and severe toxemia.
- Viral pneumonia of calves occurs in a group of calves and is characterized by mild depression, inappetence, fever, coughing, dyspnea, abnormal lung sounds, no nasal lesions, and recovery in a few days.
- Allergic rhinitis occurs in cattle on pasture in summer months and is characterized by sneezing and wheezing with inspiratory dyspnea, mouth breathing, normal temperature, and profuse thickened nasal discharge that is caseous and greenish-orange in color.
- Systemic form of IBR in newborn calves must be differentiated from acute pneumonia, septicemia, and toxemias.

### TREATMENT

#### Antimicrobial Therapy

Broad-spectrum antimicrobials are indicated if secondary bacterial tracheitis and pneumonia are present. Affected cattle should be identified, isolated, and monitored frequently for evidence of secondary bacterial disease accompanied by anorexia and toxemia and treated accordingly. The tracheitis is particularly difficult to treat; antimicrobials daily for several days are necessary.

### CONTROL

The diseases associated with the virus may occur unpredictably at any time, and even closed herds with no introductions may remain free of the disease for several years and suddenly experience an outbreak. The current strategies for control are **natural exposure, biosecurity, vaccination, or eradication** of the virus from a herd or even the cattle population of a country.

### Natural Exposure or Vaccination

#### Natural Exposure

Cattle that have recovered from a natural infection with the virus are immune to further clinical disease. However, to depend on natural exposure of the herd is risky because not all animals will become infected and become immune. Abortion storms occur in herds that are not vaccinated and depend on natural exposure. Vaccination is therefore recommended in areas where the prevalence of infection is high and eradication is not feasible because of the extensive nature of the cattle population and movement of animals from one area to another. The virus is sensitive to many disinfectants including 1% quaternary ammonium bases, 1% phenolic derivatives, and 10% Lugol's iodine.



### Biosecurity

Biosecurity is any practice or system that prevents the spread of infectious agents from infected animals to susceptible animals or that prevents the introduction of infected animals into a herd, region or country in which the infection has not yet occurred. Biosecurity is an integral part of any successful livestock enterprise and reduces the risks and consequences of introducing an infectious disease. The components of biosecurity include management and placement programs, farm layout, decontamination, pest control, and immunization. All of these factors directly affect productivity and profitability.

The introduction of new infections into herds can be prevented or minimized by purchasing animals directly from herds known to be free of a particular disease. The adoption of this principle requires awareness of the possibility of purchasing unknown infected animals and testing animals for the infection before entry into the herd. It may also require keeping the introduced animal in quarantine for several weeks after arrival before it is mixed with the other animals.

Veterinarians need to work with their clients to develop a specific disease control and biosecurity protocol for each farm. The benefits of a rigidly enforced biosecurity program need to be stressed. Veterinarians can assist producers in developing methods to handle livestock and to purchase replacement stock by designing protocols that concentrate on general and specific aspects, such as design and construction of isolation rates.

### Closed Herd

A closed farming system to prevent the introduction of infectious diseases into dairy farms is technically possible and is economical. A closed dairy farming system could prevent the introduction of BHV-1 and can be a good starting point for eradication of infectious diseases from the herd.

In the cattle industry, animals are moved freely from their farms of origin to veterinary clinics, cattle shows and sales, auction markets, 4H club events, and community grazing pastures. Cattle are commonly returned to their farms of origin after being at shows and sales, veterinary clinics and other events where animals from other farms are mixed. Animals may commingle with those from adjacent herds (broken fences or cattle breaching fences from one pasture to another). Breeding bulls may be leased from their farm or origin, used on another farm, and then returned to the farm of origin. The mixing of animals that occurs in all of these circumstances provides opportunities for the transmission of important infectious agents.

### Vaccination

With currently available diagnostic tests, it is not possible to identify animals that have a latent BHV-1 infection. The next best

strategy is to use a well-planned vaccination program.

### Rationale for Vaccination

Vaccination protects animals from severe clinical signs of infection and assists in control and eradication programs. The rationale for vaccination is based on the following:

- The virus is ubiquitous and the occurrence of the disease unpredictable.
- Economic losses from abortion, neonatal disease, and respiratory disease can be high.
- Colostral immunity in calves wanes by 4 to 6 months of age.
- *The vaccine will prevent abortions caused by the virus and provide protection against respiratory disease if given at least 10 days before natural exposure.*

Several attenuated live and inactivated BHV-1 vaccines are currently available, with attenuated vaccines being administered intranasally or intramuscularly. The vaccine strains have usually undergone multiple passages in cell culture to induce attenuation.

**Modified live-virus (MLV) vaccines** offer three advantages over inactivated vaccines:

- Induction of a rapid immune response
- Relatively long duration of immunity
- The induction of local immunity

Protection from infection and disease has been observed within 40 to 96 hours following intranasal or IM vaccination with MLV vaccines. This rapid development may be attributable to interferon induced locally, but intranasal vaccination also induces secretory IgA antibody and cell-mediated immunity. Vaccination trials have found that the traditional MLV vaccines are safe and effective in preventing clinical disease and are more effective than inactivated vaccines.

Both the intranasal and intramuscular stimulate the production of humoral antibody. The **intranasal vaccine** stimulates the production of local interferon and local antibody in the nasal mucosae, is safe for use in pregnant cows, and is highly effective for the prevention of abortion caused by the virus. The **intramuscular vaccine** of bovine tissue culture origin is abortigenic, especially in nonimmune cows. The intranasal vaccine provides protection against respiratory disease induced by experimental challenge 72 hours after vaccination. In general, the intranasal vaccine provides effective protection against the respiratory form of the disease but occasionally disease occurs in vaccinated animals. The intranasal vaccines do not cause a significant systemic reaction and have been used in the face of an outbreak where all in-contact animals are vaccinated in an attempt to reduce the number of new cases. **A major requirement of the**

**intranasal vaccine is that the vaccine virus must multiply on the nasal mucous membranes.** If the vaccine is not administered into the nasal cavities carefully, or if the animal is difficult to handle or snorts out the vaccine, vaccination will not occur. The careful administration of a temperature-sensitive vaccine in 2 mL of diluent into one nostril is as effective as a two-nostril vaccination method using a total of 5 mL of diluent. Serum antibody titers were similar for beef cattle vaccinated in high (>32°C, >90 F) or moderate (21°C, 69 F) ambient temperatures with an intranasal vaccine.<sup>9</sup> The preexistence of some local antibody from natural exposure or coinfection with a virulent strain of the virus may also restrict the multiplication of the vaccine virus, especially the temperature-sensitive mutants.

### Temperature-Sensitive BHV-1 Modified Live Vaccine.

An intranasal BHV-1 vaccine containing an MLV strain whose growth is restricted to the upper respiratory tract has been developed in Europe. The vaccine strain is chemically treated to produce a temperature-sensitive characteristic, so that it cannot replicate at the body temperature of the animal. Prebreeding vaccination of replacement heifers with the vaccine provides fetal protection. The vaccine is efficacious and safe for use in pregnant cattle. Intranasal vaccination stimulates both systemic and local cell-mediated immunity and antibody.

### Disadvantages of Modified Live Vaccines.

The extensive use of MLV vaccines has reduced the incidence of clinical disease but there are some potential disadvantages. MLV vaccines must be stored and handled properly to avoid loss of potency. The parenteral MLV vaccine is potentially abortigenic and cannot be used on nonimmune pregnant cattle. The virus in MLV vaccines can also become latent following vaccination. Fatal, generalized BHV-1 infection has been associated with vaccination of beef calves under 3 days of age with MLV containing BHV-1 and PI-3. An outbreak of meningoencephalitis occurred in purchased Holstein Friesian male calves vaccinated intranasally at 1 and 3 weeks of age with a commercial MLV vaccine containing BHV-1, bovine virus diarrhea virus (BVDV), PI-3, bovine adenovirus infection type-7 and bovine respiratory syncytial virus (BRSV). Parenteral vaccination was recommended as the proper vaccination protocol. The isolated virus was classified as BHV-1.1.

### Shedding of Virus by Vaccinated Animals.

There is some concern that MLV-vaccinated calves may shed the vaccine virus, which could then spread to pregnant cattle, resulting in abortion. In calves vaccinated with the intranasal vaccines, the virus replicates in the respiratory tract and is shed for 7 to 14 days. In nonimmune calves, replicating virus can

be detected 9 hours after vaccination, with peak shedding occurring at 4 days. However, the intranasal vaccination of feeder calves at 7 months of age does not result in transmission of the vaccine virus to nonvaccinated animals comingled with vaccinated calves. Calves vaccinated with a live temperature-sensitive mutant of BHV-1 vaccine were protected against clinical illness from experimental challenge, but excreted the virus 2 months later following treatment with corticosteroids. This emphasizes the general principle that the use of a MLV vaccine implies a continuing commitment to vaccination that may reduce the incidence of disease but is unlikely to eradicate the infection.

**Inactivated Vaccines.** Inactivated virus vaccines were developed because of some of the disadvantages of MLV vaccines. The vaccines contain high levels of inactivated virus or portions of the virus particle (glycoproteins) supplemented with an adjuvant to stimulate an adequate immune response. Inactivated vaccines are given intramuscularly or subcutaneously. They do not cause abortion, immunosuppression, or latency, although they do not prevent the establishment of latency by field strains. They do not cause shedding and are safe for use in and around pregnant animals. They are also relatively stable in storage.

Inactivated vaccines, however, may not be as efficacious as MLV vaccines because of the potential for destruction of some of the protective antigens during the inactivation process. They require two doses of the vaccine and protection is not observed until 7 to 10 days following the second dose of the vaccine, which is usually given 10 to 14 days after the primary vaccination.

A major disadvantage of both the MLV and inactivated vaccines is that neither allows for differentiation between vaccinated and naturally infected animals. These factors render conventional vaccines ineffective for a concurrent vaccination and eradication strategy and inappropriate for use in breeding bulls for export market or artificial insemination units that demand BHV-1-free animals. These limitations, along with major advances in molecular biology and protein purification techniques, have encouraged the development of genetically engineered attenuated vaccines and nucleic acid-free subunit vaccines.

**Subunit Vaccines.** A subunit vaccine contains only one or more of the antigens of the pathogen necessary to evoke protective immunity, and lacks the components that might cause unwanted side effects. The major surface glycoproteins of the BHV-1 are the antigens responsible for stimulating protective immunity. To produce a subunit vaccine containing only surface glycoproteins, the proteins are isolated from the virus of

virus-infected cells, or the peptides can be synthesized. The major glycoproteins of BHV-1 originally designated gI, gIII, and gIV are now named gB, gC, and gD, and they induce high levels of antibody in cattle that are fully protected from experimental disease. The level of immunity based on serum antibody titers and protection against experimental challenge is much greater with the individual glycoproteins than are those immunized with commercially available inactivated vaccines.

**BHV-1 subunit vaccines provide a number of advantages:**

- They do not contain live virus and therefore cannot be shed to other animals, cause abortion, or establish latent infections.
- They prevent infection and disease.
- They are not immunosuppressive.
- Serologic assays, based on one or more antigens not present in the vaccine, provide a potential to differentiate vaccinates from naturally infected animals.

Prevention of infection by the use of a BHV-1 subunit vaccine combined with the use of a diagnostic test to identify infected cattle offers the potential for vaccination of breeding bulls for artificial insemination units and export and for eradication of the virus.

**The potential disadvantages of subunit vaccines include the following:**

- Because of the amount of glycoprotein needed, two immunizations may be necessary for protection.
- Subunit vaccines will have to be compatible with the commonly available multivalent vaccines.
- The efficiency of subunit vaccines is highly dependent on the use of an effective adjuvant.

**Marker vaccines or DIVA (differentiation of infected from vaccinated animals)** attenuated or inactivated vaccines are based on deletion mutants of one or more viral proteins, which allows the distinction between vaccinated and infected animals based on respective antibody responses. This vaccine approach was very successful in eradication programs for pseudorabies. A marker vaccine must be accompanied by a diagnostic test, which enables distinction of infected from vaccinated animals. These tests detect antibodies against a **glycoprotein that is lacking in the vaccine**. The desirable characteristics of the companion diagnostic test include the following:

- Antibodies are detectable in 2 to 3 weeks after infection, both in vaccinated and unvaccinated cattle.
- Antibodies must persist for at least 2 years, preferably lifelong.
- A low level of virus replication gives rise to detectable antibody formation.

- Cattle repeatedly given the matching marker vaccine remain negative in the test.
- The test should be suitable to detect antibodies in milk.
- The test has high sensitivity and specificity in comparison with conventional antibody tests.

Mutants of BHV-1 have been developed by deleting one or more of the nonessential glycoproteins. Marker vaccines offer the advantage of evaluating the effect of vaccination on the circulation of the field virus under naturally occurring conditions. Using a gE-deleted BHV-1 strain, both a killed virus and MLV marker vaccine have been developed. These vaccines induce all the relevant immune responses against BHV-1-specific immune reactions, including antibodies against gE. Both vaccines have the capacity to reduce, and even to stop, the spread of BHV-1. A serologic test that detects gE-specific antibodies in serum and milk is also available. These vaccines have been tested according to the current European requirements for the development of bovine vaccines. The live vaccine is safe in pregnant cattle and is considered safe for all kind of breeding cattle, including bulls. The live-virus marker vaccine is also efficacious in the presence of maternal antibody, and vaccination of very young calves, irrespective of their BHV-1 status, can be recommended. An inactivated BHV-1 gE-negative vaccine resulted in only a slight decrease of about 1.4 liters per cow in milk production after a double vaccination. One concern with this use of modified live BHV-1 gE-negative vaccines is the potential for recombination of vaccine-virus and field-virus strains resulting in the emergence of virulent BHV-1 virus that is gE-negative on serologic testing. This potential can be mitigated by development of double mutant vaccine strains, such as a gE and thymidine kinase mutant Bo-HV-1 strain.<sup>10</sup>

**Combination or Multivalent Vaccines.** The vaccines available for the control of diseases associated with BHV-1 infection are mostly multivalent antigen vaccines containing other respiratory pathogens such as PI-3, BRSV, and BVDV. Some also contain the antigens for the control of leptospirosis and campylobacteriosis. Vaccines containing only BHV-1 are not in common use. A Canadian field trial to compare the serologic responses in calves to eight commercial vaccines against BHV-1, PI-3, BRSV, and BVDV found some differences. Antibody responses to BHV-1 were higher in calves vaccinated with MLV vaccines than in those vaccinated with the inactivated vaccines. There were no differences in seroconversion rates and titers to BHV-1 between intranasal and MLV IM vaccines following a single vaccination. However, after double vaccination with MLV BHV-1 vaccines, both seroconversion rates and changes in titers to the virus were higher

in calves vaccinated IM than in those vaccinated intranasally. Whether or not these differences in antibody titers reflect differences in vaccine efficacy against naturally occurring disease in the field situation is unknown.

The vaccination of calves with multivalent vaccines containing MLV or MLV and inactivated BHV-1 is associated with virus-specific interferon gamma production and protection from clinical disease as a result of challenge 5 days after a single vaccination.

**Immunization and Latency.** Immunization with vaccines, as with natural infection, does not prevent subsequent infection and the possibility of latency.

### Vaccination Programs in Herds

**Beef Breeding Herds.** Beef calves should be vaccinated 2 to 3 weeks before weaning as part of a preweaning preconditioning program. Calves vaccinated with the parenteral MLV BHV-1 vaccine before colostrum BHV-1 antibody titers reach low levels do not develop an immediate, active serologic response, as indicated by serologic titers, but are sensitized to the virus. Revaccination at a later date, when maternal antibodies have decreased to undetectable levels, results in a marked serologic response. **Heifer and bull replacements are vaccinated at least 2 weeks before breeding.** When outbreaks of the respiratory disease occur in unvaccinated beef herds, all cattle in the herd may be vaccinated with the intranasal vaccine. Whether or not beef herds should be vaccinated annually following the initial vaccination is uncertain. There are field reports of outbreaks of abortion as a result of the virus in beef cattle that were vaccinated 3 years previously, which suggests that revaccination of breeding females every 2 years may be indicated. Because both natural infection and vaccination results in latent infection, it may be that the persistence of the virus, combined with natural exposure, may result in persistence of antibody. The duration of protective immunity following vaccination is uncertain, but usually lasts 1 year. Antibodies last for at least 5.5 years in heifers following experimental infection and complete isolation during that time.

The MLV BHV-1 vaccine given intranasally or parenterally can enhance the prevalence of infectious bovine keratoconjunctivitis in beef calves vaccinated between 4 and 10 months of age, when the risk for the ocular disease is highest. The explanation for the pathogenic mechanism is uncertain.

**Feedlot Cattle.** Feedlot cattle should be vaccinated at least 10 days before being placed in the lot, especially one in which the disease may be enzootic. If this is not done, a high incidence of the respiratory form of the disease may occur in recent arrivals. If vaccination before arrival is not possible, the next best procedure is to vaccinate the cattle

on arrival and place them in an isolation starting pen for 7 to 10 days, during which time immunity will develop. A 2015 meta-analysis concluded that in natural exposure trials, beef calves vaccinated with commercially available vaccines against BHV-1, BVDV, BRSV, and PI-3 had slightly less than half the risk of developing clinical signs of pneumonia and approximately 1/5th the risk of dying from respiratory disease. Moreover, vaccination with modified live or inactivated IBR vaccine decreased the risk of developing clinical signs of respiratory disease by 39% to 46%, respectively, in beef and dairy calves to experimental challenge compared with unvaccinated controls.<sup>11</sup> Collectively, this is strong supportive evidence that vaccination against IBR is effective in beef calves in North America.

**Dairy Cattle.** The necessity of vaccinating dairy cattle will depend on the prevalence of the disease in the area and in the herd and the movement of cattle in and out of the herd. A closed herd may remain free of BHV-1 infection indefinitely and vaccination may not be indicated. But to avoid unpredictable abortion storms as a result of the virus in dairy herds, **heifer replacements should be vaccinated for the disease 2 to 3 weeks before breeding.** Vaccination of a large dairy herd with a persistent BHV-1 infection has been successful in controlling the respiratory form of the disease. The intranasal vaccine has been used extensively in newborn calves in problem herds, but its efficacy at such an age is unknown. **The parenteral vaccination of beef calves under 3 days of age with an MLV BHV-1 and PI-3 vaccine caused high mortality.** If the systemic form of the disease poses a threat to a potential calf crop, the pregnant cows could be vaccinated with the intranasal vaccine in late pregnancy; this will increase the level of colostrum antibody available to the newborn calf and will provide newborn calves with protection against the highly fatal systemic form of the disease. A 2015 meta-analysis concluded that in natural exposure trials, dairy calves vaccinated with commercially available vaccines against BHV-1, BVDV, BRSV, and PI-3 had similar risk of developing clinical signs of pneumonia and dying from respiratory disease than unvaccinated controls.<sup>11</sup> The markedly different effect of vaccination in dairy calves to that seen in beef cattle may be because respiratory disease occurs most frequently before 6 months of age in dairy calves. However, as indicated previously, vaccination with modified live or inactivated IBR vaccine decreased the risk of developing clinical signs of respiratory disease to experimental challenge by 39% to 46%, in beef and dairy calves, respectively, compared with unvaccinated controls.<sup>11</sup> Collectively, there is moderate supportive evidence that vaccination against IBR is effective in dairy calves in North America.

**Bulls intended for use in artificial insemination centers** present a special problem of disease control because the virus in semen can have severe consequences on reproductive performance. Bulls that are seropositive to the virus must be considered as carriers and potential shedders of the virus, and should not be allowed entry to these centers. Not all bulls that are seronegative can necessarily be considered free of the virus, and regular attempts at the isolation of the virus must be made from preputial washing and semen. Bulls that become infected while at the centers should be kept isolated, culled, and replaced with clean bulls. Bulls from herds that routinely vaccinate against BHV-1 should not be vaccinated with conventional vaccines if destined for an artificial insemination center. Cattle destined for export should not be vaccinated in case importing countries prohibit the introduction of seropositive cattle. This will not guarantee that such animals will not become positive from natural infection. The use of marker vaccines has some potential in breeding bulls intended for artificial insemination units and for export.

### Eradication

Eradication of the BHV-1 virus from a single herd or the cattle population in a country can be considered as an alternative to vaccination, particularly when the initial prevalence of infection based on serology is low.<sup>2</sup> Serologically positive animals are removed or culled, and only seronegative animals introduced into the herd. Control is focused on segregation and elimination of seropositive animals and reduction of animal movement to prevent spread. This approach is not feasible in countries with extensive cattle populations and where management practices result in movement of cattle from one region to another.

**Eradication Using Marker Vaccines.** Some countries are beginning an immunization program with the marker vaccines, which will protect the cattle against disease but still allow differentiation between vaccinated animals and those that have been naturally infected and are potential carriers of the latent virus. These infected animals could be eliminated over a period of time. Successful eradication depends not only on the efficacy of the vaccine but also on the quality of the tests. False-positive test results can lead to unnecessary culling of cattle, an increase of costs, and reduced cooperation of farmers in the eradication program. As an example, a compulsory eradication program for BHV-1 began in The Netherlands in 1998. The program required that farms either vaccinate all cattle twice yearly or be approved for a certified BHV-1-free or specific-pathogen-free (SPF) status. To become a certified BHV-1 free herd, cattle have to be sampled individually and all seropositive animals



culled as soon as their status is known. The BHV-1-free herd status is monitored by monthly bulk milk samples. The spread of BHV-1 between herds can be prevented using a surveillance system of sampling herds annually, both individual milk samples and blood samples.

Herds with BHV-2 infected (seropositive) animals are required to vaccinate with a glycoprotein E (gE)-negative BHV-1 vaccine. The vaccine may be either an inactivated or live vaccine both based on a spontaneous BHV-1 mutant without the complete gE gene. These so-called marker vaccines or DIVA vaccines allow the identification of cattle infected with the wild-type BHV-1 within a vaccinated population using a gE-ELISA or a commercially available gE-blocking ELISA that both specifically detect gE antibodies. The eradication program is based on the presumption that all BHV-1 wild-type strains express gE and induce antibodies that can be measured with a gE-blocking ELISA.

**Loss of Certification.** The probability of and risk factors for the introduction of BHV-1 into SPF Dutch dairy farms has been examined. A total of 95 SPF dairy farms were monitored for 2 years, during which time 14 introductions of infectious diseases occurred on 13 of the 95 farms, for a total incidence rate per herd-year at risk of 0.09. Outbreaks were usually associated with allowing cattle to return to their farm, cattle grazed more often at other farms, and protective clothing less often provided to the veterinarian. For a successful eradication program, farms should remain BHV-1 free, which can be achieved by a more-closed farming system. A more-closed farming system is one that rules out the possibility of direct contact with other cattle from other farms. Also, the farmer requests that professional visitors such as veterinarians and artificial insemination (AI) technicians to wear protective farm clothing when handling cattle. Protective farm clothing includes coveralls or overcoats and boots that can be worn over “off-farm” clothing and that the farmer provides to the visitors before handling cattle. A sanitary barrier is a covered area outside the barn in which visitors put on protective farm clothing over their off-farm clothes. A sanitary barrier has a “dirty” side, where visitors leave their off-farm boots, and a “clean” side, where visitors wear protective clothing and can enter the barn. All of these measures would be economical.

#### TREATMENT AND CONTROL

##### Treatment

Antimicrobial treatment for animals with a fever to address concurrent bacterial pneumonia (see treatment recommendations in this chapter for *Mannheimia hemolytica*) (R-1)

#### Control

Vaccination of beef calves  $\geq$  6 months of age against BHV-1 (preferably with modified live glycoprotein E–negative vaccine) or with modified live or killed vaccine against BHV-1, BVDV, BRSV, and PI-3 (R-1)

Vaccination of dairy calves less than 6 months of age against BHV-1 (preferably with modified live glycoprotein E–negative vaccine) (R-2)

Vaccination of dairy calves less than 6 months of age with modified live or killed vaccine against BHV-1, BVDV, BRSV, and PI-3 (R-3)

#### FURTHER READING

- Biswas S, Bandtopadhyay S, Dimri U, Patra PH. Bovine herpesvirus-1 (BHV-1)—a re-emerging concern in livestock: a revisit to its biology, epidemiology, diagnosis, and prophylaxis. *Vet Quart.* 2013;33:68–81.
- Graham DA. Bovine herpes virus-1 (BHV-1) in cattle—a review with emphasis on reproductive impacts and the emergence of infection in Ireland and the United Kingdom. *Irish Vet J.* 2013;66:15.
- Muykens B, Thiry J, Kirten P, Schynts F, Thiry E. Bovine herpesvirus 1 infection and infectious bovine rhinotracheitis. *Vet Res.* 2007;38:181–209.
- Nandi S, Kumar M, Manohar M, Chauhan RS. Bovine herpes virus infections in cattle. *Anim Health Res Reviews.* 2009;10:85–98.
- OIE Terrestrial Manual, Chapter 2.4.13, Infectious bovine rhinotracheitis/infectious pustular vulvovaginitis, 2010. (Accessed 15.19.15, at: [http://www.oie.int/fileadmin/Home/eng/Health\\_standards/tahm/2.04.13\\_IBR\\_IPV.pdf](http://www.oie.int/fileadmin/Home/eng/Health_standards/tahm/2.04.13_IBR_IPV.pdf)).

#### REFERENCES

- Mahony TJ. *Vet J.* 2010;184:124.
- Raaperi K, et al. *Vet J.* 2014;201:249.
- Tizioto PC, et al. *PLoS ONE.* 2015;10:1371.
- Rivera-Rivas JJ, et al. *Vet Immunol Immunopathol.* 2009;131:167.
- Grissett GP, et al. *J Vet Intern Med.* 2015;29:770.
- Mahajan V, et al. *J Comp Path.* 2013;149:391.
- Georgy T, et al. *Res Vet Sci.* 2012;93:143.
- Moeller RB, et al. *J Vet Diag Invest.* 2013;25:136.
- Grissett GP, et al. *Am J Vet Res.* 2014;75:1076.
- Kalthoff D, et al. *Vaccine.* 2010;28:5871.
- Theurer ME, et al. *J Am Vet Med Assoc.* 2015;246:126.

## LUNGWORM IN CATTLE

#### SYNOPSIS

**Etiology** The nematode *Dictyocaulus viviparus* (the bovine lungworm).

**Epidemiology** Disease seen mostly in dairy calves; immunity develops relatively quickly, but cattle will succumb if exposed to overwhelming numbers of infective larvae while grazing.

**Signs** Coughing, tachypnea, dyspnea.

**Clinical pathology** Characteristic larvae in feces (but not present during all stages of disease); eosinophilia; enzyme-linked immunosorbent assay (ELISA) tests for serum antibodies.

**Lesions** Large volumes of consolidation in diaphragmatic lobes of lung, emphysema, worms up to 8 cm long in bronchi (only in patent phase of disease).

**Diagnostic confirmation** Clinical pathology as noted; at necropsy, distribution of lesions in lungs and demonstration of worms in bronchi.

**Treatment** Eprinomectin, avermectins/milbemycins and benzimidazoles are active against all parasitic stages of *D. viviparus*; eprinomectin and avermectins also have a persistent protective effect; levamisole also used.

**Control** Vaccination; early-season anthelmintic prophylactic programs using suitable intraruminal boluses or multiple doses of avermectins/milbemycins; keep susceptible animals off potentially dangerous pasture.

#### ETIOLOGY

The nematode *Dictyocaulus viviparus* is the only lungworm of cattle. The disease it causes has many local names, including the following:

- Parasitic bronchitis
- Verminous pneumonia
- Verminous bronchitis
- Husk
- Hoose

Bovine lungworm has a very wide distribution through temperate and cold areas and, depending on climatic conditions and season, can cause serious losses.<sup>1</sup> The disease reaches its greatest importance in mild, damp regions of the British Isles and parts of western Europe. *D. viviparus* is also carried by the European bison, in which it causes a disease with similar pathologic lesions to those in cattle.<sup>2,3</sup> Deer carry similar parasites, including *D. eckerti* and *D. capreolus*. It is uncertain whether deer play a role in the transmission of *D. viviparus* but lungworm species are generally host specific.

#### LIFE CYCLE

Adult lungworms live in the trachea and bronchi. The females are prolific egg producers, and it has been estimated that a single infested calf may contaminate a pasture with 33 million larvae. The eggs are coughed up and swallowed. They hatch in the air passages or alimentary canal, and larvae are passed in the feces. These develop in the dung pat through to the infective third stage, which is protected by cuticles retained from both first and second molts. Because the ensheathed larvae cannot feed, glycogen granules are stored in the intestinal cells. Moisture is essential for the survival and development of the larvae, and a moderate temperature of 18° to 21°C (65–70°F) permits their full development to the infective state in 3 to 7 days. Larvae survive best in cool, damp surroundings, especially when the environment is stabilized by the presence

of long herbage or free water. Under optimum conditions, larvae may persist for over 1 year. They can overwinter in climates as cold as Canada and Germany. When warmer spring weather arrives, the larvae resume their motility but quickly die once their food stores are depleted.

Transmission occurs when cattle ingest third-stage larvae while grazing. These migrate through the intestinal wall to reach the mesenteric lymph nodes. From here they pass via the lymphatics to the venous bloodstream and through the heart to the lungs, where they break into the alveoli. They migrate up the bronchioles to their predilection site in the larger air passages and start to lay eggs some 3 to 4 weeks after infestation. Most adult worms succumb to immune expulsion within a few weeks. These events determine the progression of the clinical syndrome and their approximate timing is as follows:

1. Penetration phase (ingestion to arrival of larvae in lung), days 1 to 7
2. Prepatent phase (larvae in lung), days 7 to 25
3. Patent phase (mature worms in lung) days 25 to 55
4. Postpatent phase (lungworms disappearing from lung), days 55 to 70

### EPIDEMIOLOGY

Bovine parasitic bronchitis is a sporadic and largely unpredictable disease. This is because immunity develops more quickly than is the case with many other nematode infections, but nevertheless can remain incomplete for many weeks and may wane in the absence of reinfection. In most grazing seasons, immunity will develop fast enough to protect calves against the accumulating numbers of infective larvae on the grass. The farmer may not even realize that the land is contaminated. Clinical outbreaks occur when weather patterns, management, or other factors result in sudden exposure to a pasture challenge sufficient to overwhelm any immunity that has already developed. In comparison with the gastrointestinal nematodes of cattle, relatively few worms (i.e., a few hundred or thousand) are required to produce clinical signs. Thus the disease is almost entirely confined to grazing cattle and occurs most frequently in young animals in their first year on grass, although outbreaks are becoming more common in adults.<sup>4</sup> The epidemiology of lungworm disease is largely concerned with factors determining the number of infective larvae on the pasture and the rate at which they accumulate.

Infective *D. viviparus* larvae are relatively inactive and are incapable of traveling more than 5 cm from the dung pat. Factors that disperse the larvae more widely over the pasture include mechanical spread by the following:

- Rain
- Earthworms

- Wheeled vehicles
- Human and animal feet

A fungus, *Pilobolus*, plays a particularly important role in this process and can transfer larvae across field boundaries. Fungal spores on grass pass through the grazing animal and germinate in the feces. *Dictyocaulus* larvae climb onto the sporangium (fruiting body), which fills with water and bursts, propelling the fungal spore and the lungworm larvae for distances of up to 3 m.<sup>5</sup>

Dairy calves are most vulnerable to lungworm disease because they are often reared indoors until 4 to 5 months of age and then placed on paddocks grazed each year by successive calf crops. If the paddocks are heavily contaminated, acute disease may occur in 1 week or so. Usually, however, only sufficient larvae survive the winter to induce low-grade asymptomatic infections in the susceptible calves, which then start to recontaminate the pasture and recycle the infection. With the high stocking densities commonly used, pasture challenge can reach pathogenic levels within 2 to 4 months. This model does not satisfactorily explain all outbreaks, and it has been suggested that larvae may be washed into the soil to emerge later (e.g., onto hay aftermath). Beef calves at grass with their dams are less likely to be affected as this system provides fewer opportunities for large numbers of larvae to accumulate, but outbreaks can occur particularly after weaning in the autumn.<sup>6</sup>

In older animals, larvae ingested in the autumn become hypobiotic and resume their development in the following spring. This event occasionally causes disease in housed cattle<sup>6</sup> but such infections are usually asymptomatic and provide a source of pasture contamination when these carrier animals are put out to graze. This is thought to be the main source of infection in more severe climates where overwintering larvae may not survive on the pasture, but carrier animals have also been incriminated in disease outbreaks in, for example, Louisiana in the United States.

**Immunity to reinfection** occurring after initial exposure to *D. viviparus* is variable in degree and duration. It normally provides protection during the first grazing season and is boosted by exposure to overwintered larvae at the beginning of each subsequent grazing season. Cattle removed from infected pastures for long periods can suffer clinical disease when reexposed. Recently the number of outbreaks of parasitic bronchitis in yearling and adult cattle in the United Kingdom, Denmark and some other countries has been rising. Reasons for this are speculative but include the following:

- A decline in the use of vaccination
- Changes in weather patterns and management systems
- Use of highly effective anthelmintic strategies in the first grazing season

that may prevent adequate antigenic exposure

### PATHOGENESIS

Migrating *D. viviparus* larvae provoke little damage until they reach the lungs. Thereafter, passage of larvae up the bronchioles causes them to become blocked by mucus, eosinophils, and other inflammatory cells, leading to collapse of the alveolae that they supply. Coughing and dyspnea occur if a sufficiently large volume of lung tissue is affected. This is accompanied by pulmonary edema and interstitial emphysema. As no structural damage has yet occurred, treatment at this stage in the disease produces an immediate clinical response. Later, however, when mature parasites are in the major bronchi, eggs and fragments of worms killed by immunity are aspirated and provoke a foreign-body pneumonia. Secondary bacterial infections establish and sequelae such as bronchiectasis occur. Such lesions are slow to resolve, and treated animals will require a long recovery period. Later still, once all or most of the worms have been expelled, the alveolar lining cells of some 25% of recovering animals become cuboidal and nonfunctional. The reason for this is unknown but may be a response to substances released by the dead worms. Because this reaction is irreversible, many animals affected in this way will die.

**The response of the lung** varies widely depending on the number of larvae ingested, the nutritional status and age of the host, and whether or not it is exposed to lungworm infection for the first time. Vaccinated animals or those that have recovered from clinical or subclinical infection may cough and even become tachypneic if grazed on contaminated pasture. This is known as the “reinfection syndrome” and occurs as many larvae reach the lungs before succumbing to the immune response. Exposure of older previously infected animals to massive challenge may invoke a severe or fatal hypersensitivity reaction.

### CLINICAL FINDINGS

Outbreaks vary in severity from sporadic coughing with no apparent production loss to acute cases with a rapidly fatal outcome. Individuals within a group are usually affected to varying degrees. Poorly nourished animals appear less able to withstand lungworm infection. Nevertheless, it is not unusual for severe infestations to be fatal in well-fed calves.

**Acute cases** have rapid shallow abdominal breathing of sudden onset that may reach a rate of 60 to 100 breaths/min. There is a frequent bronchial cough, a slight nasal discharge, a temperature of 40 to 41°C (104–105°F) and a heart rate of 100 to 120 bpm. The animal is bright and active and will attempt to eat, although respiratory distress often prevents this. Progress of the disease is

rapid, and within 24 hours dyspnea may become very severe, accompanied by mouth breathing with the head and neck outstretched, a violent respiratory heave and grunt, cyanosis, and recumbency. On auscultation, lung consolidation is evidenced by loud breath sounds, and crackles are heard over the bronchial tree. The crackling of interstitial emphysema commences over the dorsal two-thirds of the lung but is never as evident as in less acute cases. Fever persists until just before death, which usually occurs in 3 to 14 days and is greatly hastened by exercise or excitement. The case-fatality rate in this form of the disease is high, probably of the order of 75% to 80%.

**Subacute disease** is more common in calves than the very acute form. The onset is usually sudden, the temperature is normal or slightly elevated and there is an increase in the rate (60-70 breaths/min) and depth of respiration. An expiratory grunt is heard in severe cases and expiration may be relatively prolonged. There are frequent paroxysms of coughing. The course of the disease is longer, 3 to 4 weeks, and auscultation findings vary widely with the duration of the illness and the area of lung involved. In general, there is consolidation and bronchitis ventrally and marked emphysema dorsally. Affected animals lose weight very quickly and are very susceptible to secondary bacterial bronchopneumonia. The mortality rate is much less than in the acute form, but many surviving calves have severely damaged lungs. Consequently, they may remain stunted for long periods, and breathing may be labored for several weeks. Some surviving calves may show a sudden exacerbation of dyspnea around 7 to 8 weeks after the initial onset of disease. In these relapsed cases the prognosis is grave.

**Adult dairy cattle** are usually immune but sporadic outbreaks do occur as a result of waning immunity. Mortality is low but morbidity can be high, with reduced milk yields causing significant economic loss.<sup>7-9</sup> Coughing is a constant feature, but other clinical signs are variable and may include dyspnea, nasal discharge, and weight loss.<sup>7</sup> Sudden exposure of immune adults to massive challenge can cause severe interstitial pneumonia.

### CLINICAL PATHOLOGY

The presence of *D. viviparus* larvae in feces confirms lungworm infestation, but their absence does not necessarily exclude the possibility of parasitic bronchitis. No larvae will be passed in the early stages of disease when the causal worms are still immature, nor will they be a constant finding when partially immune animals (e.g., dairy cows) succumb to challenge. In general, larvae can be found about 12 days after signs appear (i.e., around 24 days after infestation occurs). They are few in number at first but may become more numerous later.

**Enzyme-linked immunosorbent assay (ELISA) tests** using adult or larval worm antigen for the detection of *D. viviparus*-specific antibodies in serum and in milk (including bulk tank milk) have been developed.<sup>10,11,12</sup> Care is required with interpretation because antibodies to adult antigen may not be detectable until several weeks after primary challenge and do not correlate with the immune status of the animal. Eosinophilia is a fairly consistent finding but not pathognomonic.

**An alternative method**, if disease is suspected but the lungworms are still in the prepatent stage, is to examine pasture clippings for larvae. This is a laborious procedure because large amounts of herbage (0.5–1 kg) must be used, and the yield of larvae is low.

### NECROPSY FINDINGS

Adult *D. viviparus* are up to 8 cm long and easily seen when the trachea and bronchi are cut open. Worms may also be recovered by lung perfusion. Up to several thousand may be present in severely affected animals. In prepatent disease, however, careful microscopic examination of bronchial mucus is necessary to find larvae. Adult worms may be few or absent if the case is of sufficient duration for immune expulsion to have taken place.

**In acute cases**, morphologic changes include the following:

- Enlargement of the lungs as a result of edema and emphysema
- Widespread areas of collapsed tissue of a dark pink color
- Hemorrhagic bronchitis with much fluid filling all the air passages
- Enlargement of the regional lymph nodes

Histologically, the characteristic signs are as follows:

- Edema
- Eosinophilic infiltration
- Dilation of lymphatics
- Filling of the alveoli and bronchi with inflammatory debris
- Larvae in the bronchioles and alveoli

**In subacute cases**, interstitial emphysema is usually gross. Areas of dark pink consolidation are present in the diaphragmatic lobe and may also occur in other lobes. They can occupy two-thirds of the lung volume. There is froth in the bronchi and trachea. The regional lymph nodes are enlarged. Histologically, eggs and larvae can be seen in the air passages, the bronchial epithelium is much thickened, the bronchioles are obstructed with exudate, and the alveoli show epithelialization and foreign-body giant-cell reaction.

**The reinfection syndrome** is characterized by the presence of numerous 5-mm gray-green nodules formed by lymphoreticular cells clustering around dead larvae.

### DIAGNOSTIC CONFIRMATION

*D. viviparus* larvae may be demonstrated by placing feces on a fine sieve or dental gauze on the top of a water-filled funnel (the Baermann technique). The larvae that swim into the water and collect at the bottom of the funnel are less than 0.5 mm long, sluggish, and often appear curved or coiled. Their most important diagnostic feature is the presence of easily visible refractile granules in the intestinal cells. Because not all animals will be shedding larvae, samples should be taken from all, or at least a representative proportion, of the group. Grass samples are washed in water with a surfactant and the sediment Baermannized as described previously. A technique that effectively separates larvae from plant debris by migration through agar gel has been reported. Gathering grass close to dung pats maximizes chances of finding larvae. Cattle with parasitic bronchitis are likely to have eosinophilia, and serologic tests can be used to rule out some other respiratory diseases, such as infectious bovine rhinotracheitis (IBR).

**In view of the uncertainties** associated with laboratory tests for parasitic bronchitis and the need for prompt treatment, diagnosis often has to be based on clinical history, signs, and auscultation. Affected animals have usually grazed alongside potential carriers or had access to pasture previously used by susceptible calves or older carrier animals. The timing of the outbreak may coincide with that expected from recycling of an infection initiated by overwintered larva (often 2-4 months after turnout) or recent exposure to heavily contaminated land. Many of the clinical signs of parasitic bronchitis are common to pneumonias of bacterial and viral origin. One feature that may be of value in differentiation is the relative softness and paroxysmal nature of the cough in parasitic infection.

### DIFFERENTIAL DIAGNOSIS

- Bacterial bronchopneumonia
- Acute and chronic interstitial pneumonia
- Viral pneumonia
- Acute interstitial pneumonia (fog fever)
- Heavy infestations with ascarid larvae on pastures contaminated with pig feces

**In adult cattle**, the major problem in diagnosis is to differentiate the acute form of the disease from acute interstitial pneumonia attributable to other causes. Clinically, the diseases are indistinguishable, and a history of movement onto a new pasture 1 to 2 weeks before the onset of the disease may be common to both. It is necessary to demonstrate *D. viviparus* antibodies in blood, worms at necropsy, and larvae in the herbage or in the feces of animals that previously grazed the pasture.



## TREATMENT

## TREATMENT AND CONTROL

**Treatment**

Eprinomectin (0.5 mg/kg TOPp, 0.2 mg/kg SC) (R-1)

Ivermectin (0.2 mg/kg, SC, PO; 0.5 mg/kg, TOPp) (R-1)

Doramectin (0.2 mg/kg, SC, IM) (R-1)

Moxidectin (0.2 mg/kg, PO, SC; 0.5 mg/kg, TOPp) (R-1)

Albendazole (10 mg/kg, PO) (R-2)

Oxfendazole (7.5 mg/kg, PO) (R-2)

Febantel (7.5 mg/kg, PO) (R-2)

Fenbendazole (5 mg/kg, PO) (R-2)

Netobimin (7.5 mg/kg) (R-2)

Levamisole (7.5 mg/kg) (R-3)

**Control**

Eprinomectin extended-release formulation (1.0 mg/kg, SC) (R-2)

Ivermectin long-acting formulation (0.63 mg/kg, SC) (R-2)

**Vaccination**

Live irradiated infective *D. viviparus* larvae (1000 larvae/calf, PO) (R-2)

PO, orally; SC, subcutaneously; TOPp, topical pour on formulation.

Anthelmintics may be used prophylactically to prevent disease from occurring, as a curative treatment once disease strikes, or to prevent reinfection following an outbreak. Avermectins and milbemycins are particularly useful for prophylaxis and prevention of reinfection because they are not only highly effective against the lungworms present in the animals at the time of treatment but have prolonged activity against subsequent incoming larvae. The duration of this persistent effect varies with compound and formulation.

**Most modern broad-spectrum drugs** are active against *D. viviparus*. Dosage rates and label claims vary from country to country according to local conditions and regulatory requirements. Avermectins and milbemycins (macrocyclic lactones) are particularly potent against immature and mature stages; doses of ivermectin, for example, as low as 0.05 mg/kg, are effective. At commercial dose rates, ivermectin by injection or as a pour-on formulation provides residual protection for up to 28 days; corresponding figures are up to 35 days for doramectin by injection and 42 days both for doramectin as a pour-on formulation and moxidectin by either route of administration. These compounds are given at 0.2 mg/kg by injection and 0.5 mg/kg as a pour-on formulation. Eprinomectin is the compound of choice for adult dairy cattle because it has a nil milk withdrawal period<sup>14</sup> and provides residual protection of up to 28 days when given topically (0.5 mg/kg). Albendazole (10 mg/kg),

febantel (7.5 mg/kg), fenbendazole (5 mg/kg), netobimin (7.5 mg/kg), and oxfendazole (4.5 mg/kg), which are given orally, are active against all stages of the parasite but have no residual activity. Levamisole (oral or injection—7.5 mg/kg; pour on—10 mg/kg) also has activity against lungworm but no persistent effect.

Sustained-release intraruminal devices (“boluses”) provide extended periods of protection. For example, fenbendazole is released for up to 140 days from one bolus. There are also pulse release boluses containing oxfendazole that release five or six anthelmintic doses at 3-week intervals. Most boluses normally protect against disease but may allow some worms to establish (in the case of the fenbendazole bolus) or to reach the lungs between pulses (oxfendazole bolus), which may allow immunity to develop. Formulations of eprinomectin extended-release injection have been developed that have greater than 98% efficacy against *D. viviparus* and provide protection from reinfestation for up to 150 days in cattle.<sup>13,14,15,16</sup> Similarly, an ivermectin long-acting injectable formulation has been shown to have up to 100% efficacy against *D. viviparus* in cattle for at least 77 days.<sup>17</sup>

**For veterinarians in the field**, the outcome of therapeutic treatment is often unpredictable because it depends on the amount of structural damage in the lungs. Best results are obtained early in the course of disease when most pathologic changes can be quickly resolved. In severe cases, treatment may initially exacerbate clinical signs because the death and disintegration of many worms in the air passages releases antigens and adds to the mass of foreign material that can be aspirated. Because of animal welfare considerations and the high risk of mortality, anthelmintic treatments are often combined with an antihistamine or nonsteroidal antiinflammatory drug (NSAID) such as flunixin to reduce the severity of the reaction to the larvae and an antibiotic or sulfonamide to prevent secondary bacterial infection. Severely affected animals should be brought indoors for nursing and all other members of the group removed from the contaminated pasture and placed on clean grazing ground.

**CONTROL**

Two major strategies of control derive from the premise that the main factor governing the occurrence of disease is the density of *D. viviparus* larvae on pasture grazed by susceptible cattle. First, cattle grazing potentially contaminated pasture can be protected by vaccination or anthelmintic cover. Alternatively, steps can be taken to ensure that pastures are safe for grazing. This is usually achieved by prophylactic anthelmintic programs, but delaying spring turnout until overwintered larvae have died away is a theoretical option on organic farms.

**Sensible grazing management** is important in all systems but cannot be relied upon, per se, for controlling parasitic bronchitis in view of the unpredictable nature of the disease. Although natural immunity provides adequate protection on many farms, it cannot be accurately measured nor predetermined. With the possible exception of beef suckler systems, calves should not be run with or follow older cattle because these may harbor asymptomatic patent infections and contaminate the pasture. An important consideration is that clean pasture can be contaminated by larvae from neighboring fields carried on windborne fungal spores (see epidemiology paragraph earlier). Although the numbers of larvae spread in this way are likely to be small, they can initiate the epidemiologic cycle culminating in disease after some weeks.

**Vaccination** of calves with two doses of 1000 infective larvae attenuated by irradiation is a long-established and effective method of preventing disease. Only healthy calves should be vaccinated and they should be at least 8 weeks old. The vaccine is given 6 and 4 weeks before turnout. Exposure to lightly contaminated pasture will boost immunity, but low-grade patent infections may develop in some animals. Vaccinated and nonvaccinated calves should not be grazed together because the former may contaminate the pasture, enabling lungworm to cycle through the susceptible animals. The vaccine gives a high level of protection under most conditions, but vaccinated calves should not be put onto heavily contaminated pasture. Coughing may occur when immune responses kill lungworm larvae in the lungs. Overt disease can occur in cases of overwhelming challenge. To avoid such problems on severely affected farms, vaccinated calves should be allowed only gradual access to pasture. An experimental recombinant subunit vaccine, based on the parasite's paramyosin as a recombinant antigen, that overcomes the disadvantages of the attenuated vaccine has been developed.<sup>18</sup>

**In some endemic areas**, for example, in the south of Ireland, which has mild winters and an early start to the grazing season, the ideal vaccination program described earlier may be inconvenient and it is possible, by cautiously avoiding periods when massive pasture contamination is likely to occur, to vaccinate at pasture. Calves are sometimes vaccinated at less than 8 weeks old to allow spring-born calves to graze during late summer and autumn, but optimal protection may not be afforded in all cases.

**Strategic anthelmintic programs** provide an alternative to vaccination. The aim is to suppress the infection initiated by overwintered larvae and thereby prevent subsequent contamination of the pasture. This can be done by application of a suitable intraruminal bolus at or just before spring turnout or by giving two or three doses of an avermectin/milbemycin during the early grazing season.

These systems are designed to control parasitic gastroenteritis and lungworm. Clinical field experiments have demonstrated good results with ivermectin, fenbendazole, and oxfendazole boluses and with ivermectin treatments given at 3, 8, and 13 weeks after turnout, or doramectin administered at turnout and again 8 weeks later. Calves may become vulnerable after the period of anthelmintic cover if pasture contamination occurs (e.g., because of fungal spread). An extra anthelmintic treatment may be indicated in regions with a very long grazing season. Calves that are exposed to infection but protected by chemoprophylaxis during their first grazing season generally have substantial resistance to reinfection in their second year. Nevertheless, field experiments have shown that immunity can be compromised to a degree related to the level of protection provided. There is concern that such intensive treatment may provoke anthelmintic resistance, but no resistant strains of *D. viviparus* have yet been reported.

#### FURTHER READING

- Panciera RJ, Confer AW. Pathogenesis and pathology of bovine pneumonia. *Vet Clin North Am Food A.* 2010;26:191.
- Panuska C. Lungworms of ruminants. *Vet Clin North Am Food A.* 2006;22:583.

#### REFERENCES

- Jackson F, et al. *Proc Int Conf World Assoc Adv Vet Parasitol.* 2007;226.
- Krzysiak MK, et al. *Bull Vet Inst Pulawy.* 2014;58:421.
- Pyziel AM. *Acta Parasitol.* 2014;59:122.
- Schunn A-M, et al. *PLoS ONE.* 2013;8:e74429.
- Ploeger HW, Holzhauser M. *Vet Parasitol.* 2012;185:335.
- Matthews J. *Livestock.* 2008;13:23.
- Wapenaar W, et al. *J Am Vet Med Assoc.* 2007;231:1715.
- Holzhauser M, et al. *Vet Rec.* 2011;169:494.
- Dank M, et al. *J Dairy Sci.* 2015;In Press.
- Von Holtum C, et al. *Vet Parasitol.* 2008;151:218.
- Bennema S, et al. *Vet Parasitol.* 2009;165:51.
- Ploeger HW, et al. *Vet Parasitol.* 2014; 199:50.
- Soll MD, et al. *Vet Parasitol.* 2013;192:313.
- Kunkle BN, et al. *Vet Parasitol.* 2013;192:332.
- Rehbein S, et al. *Vet Parasitol.* 2013;192:338.
- Rehbein S, et al. *Vet Parasitol.* 2013;192:321.
- Rehbein S, et al. *Parasitol Res.* 2015;114:47.
- Strube C, et al. *Vet Parasitol.* 2015;8:119.

### ATYPICAL INTERSTITIAL PNEUMONIA OF CATTLE (ACUTE BOVINE RESPIRATORY DISTRESS SYNDROME, ACUTE PULMONARY EMPHYSEMA, AND EDEMA)

#### SYNOPSIS

**Etiology** Uncertain; a number of etiologies such as D,L-tryptophan in forage, inhalation of toxic gases and fumes, hypersensitivity to molds, mycotoxicosis, and plant poisonings or feed supplementation with melengestrol acetate have been discussed.

**Epidemiology** Occurs primarily in adult cattle moved from dry to lush pasture and incidentally in feedlot cattle. Outbreaks or incidental cases of AIP in adult cattle moved from dry to lush pasture in autumn. In feedlot cattle incidental cases are observed toward the end of the finishing period.

**Signs** Outbreaks of acute respiratory distress in pasture form of disease within days of moving to lush pastures; severe dyspnea, open-mouth breathing with extended head and neck, expiratory grunt, subcutaneous emphysema, and rapid death. Subacute form less severe and may survive but develop cor pulmonale later.

**Clinical pathology** None clinically applicable.

**Lesions** Enlarged firm lungs that do not collapse, diffuse congestion and edema, interstitial and bullous emphysema, cranioventral consolidation, hyaline membrane formation, alveolar epithelial hyperplasia, fibrosis.

**Diagnostic confirmation** Lesions at necropsy.

**Treatment** Symptomatic, no effective treatment available.

**Control** Grazing management. Use of antimicrobials to control conversion of tryptophan to 3-methylindole in pastured animals.

Atypical interstitial pneumonia (AIP) of cattle has been known for many years under many different terms, including acute interstitial pneumonia, acute pulmonary emphysema and edema (APEE), acute bovine respiratory distress syndrome (ABRDS), bovine pulmonary emphysema, pulmonary adenomatosis, bovine asthma, pneumocoinosis, and “fog fever.” The syndrome that is characterized by diffuse or patchy damage to alveolar septa is known to occur in an acute and chronic form. The acute presentation, frequently occurring as an outbreak in adult pastured cattle a few days after they are moved from heavily grazed summer pastures to lush fall pastures, is also referred to as “fog fever.” A similarly acute to peracute syndrome in feedlot cattle, primarily affecting animals toward the end of the finishing period, is known as acute or atypical interstitial pneumonia of feedlot cattle. A more chronic form occurring sporadically, often with secondary bacterial involvement, has also been described.

The term *atypical interstitial pneumonia* refers to some clinical characteristics of the syndrome that set it apart from the common acute infectious respiratory tract diseases, especially the viral diseases also causing interstitial pneumonia. Clinically the syndrome is atypical, especially compared with the bacterial pneumonias:

- Presentation can be acute or chronic.
- Acute or chronic respiratory distress in absence of toxemia

- Syndrome is progressive and generally nonresponsive to treatment.
- Pathology consists of varying degrees of pulmonary emphysema, edema, hyaline membrane formation, and alveolar epithelial cell and interstitial tissue hyperplasia.

#### ETIOLOGY

The precise etiology of the condition is currently not entirely understood, but because of the obvious epidemiologic differences between the conditions occurring in pastured, housed, and feedlot cattle, it is assumed the AIP can have several different etiologies, all leading to the characteristic lung lesions. The etiologies presented in the following subsections have been proposed.

#### Ingestion of Excessive Amounts of D,L-Tryptophan With the Forage

Clinical cases of AIP are frequently reported in adult cattle that have been moved from a dry to a lush pasture in the autumn season. Specific forages have not been implicated, but affected cattle have often been consuming alfalfa, kale, rape, turnip tops, rapidly growing pasture grass, and several other feeds. The levels of tryptophan in lush pasture are sufficient to yield toxic doses of 3-methylindole, the product of tryptophan fermentation in the rumen. A 450-kg cow eating grass at an equivalent DM intake of 3.5% of BW/day with a tryptophan concentration of 0.3% of DM would ingest 0.11 g tryptophan/kg BW/day. The total amount ingested over a 3-day period would approximate the single oral dose of 0.35 g/kg BW needed to reproduce the disease experimentally. However, pasture levels of tryptophan are not necessarily higher in those associated with the disease compared with normal pastures.

D,L-tryptophan is converted in the rumen to 3-methylindole (3mI), which, when given orally or intravenously, also produces the lesions characteristic for AIP in cattle and goats. In some naturally occurring cases of AIP in beef cows changed from a dry summer range to a lush green pasture, there is a marked increase in the ruminal levels of 3mI, whereas in other cases the levels are not abnormal. Failure to detect abnormally high levels in the rumen and plasma of naturally occurring cases may be related to the rapid metabolism and elimination of 3mI.

Ingestion of D,L-tryptophan has generally been discounted as a possible cause for AIP in feedlot cattle because of its sporadic occurrence and the lack of an epidemiologic association between occurrence of the disease and ration changes. Nevertheless, significantly higher concentration of a 3mI metabolite in the blood of animals affected by AIP compared with healthy control animals were measured in one study, suggesting a possible etiologic role of D,L-tryptophan in AIP in feedlot cattle.<sup>1</sup>

### Hypersensitivity to Molds

AIP has also been associated with chronic hypersensitivity to moldy hay based on the presence of serum precipitins of the thermophilic antigens of *Thermopolyspora polyspora*, *Micropolyspora faeni*, and *Thermoactinomyces vulgaris* in cattle with allergic alveolitis, a condition also termed as “bovine farmer’s lung.” In Switzerland, a high incidence of serum precipitins against *Micropolyspora faeni* (60%) and moldy hay antigen (80%) was demonstrated in exposed but apparently healthy cattle from an area where the chronic presentation of bovine farmer’s lung is common. Outbreaks of acute respiratory disease in adult cattle as a result of acute allergic pneumonitis can occur 15 hours after the introduction of severely moldy hay. Serologic investigation and provocative challenge may reveal a hypersensitivity pneumonitis attributable to allergens of *Micropolyspora faeni*. A hypersensitivity pneumonitis has been produced experimentally in calves by exposure to aerosols of *Micropolyspora faeni* with or without prior sensitization by subcutaneous injection of the antigen.

Although clinically allergic pneumonitis and AIP share a very similar presentation, there are significant pathologic differences indicating that allergic pneumonitis and AIP are different conditions.<sup>2</sup> Although hyaline membrane formation, which is characteristic for AIP, is rarely seen with allergic pneumonitis, the latter is typically associated with microscopic granuloma formation that is not seen with AIP.<sup>2</sup>

### Inhalation of Toxic Gases and Fumes

Incidental cases of AIP have been reported in cattle exposed to different noxious gases and fumes, such as silo gas, nitrogen dioxide, chlorine gas, or zinc oxide fumes.<sup>3</sup> The experimental inhalation of nitrogen dioxide gas is capable of causing acute interstitial pneumonia in cattle and severe alveolar edema and emphysema in pigs, but it seems unlikely that animals of either species would be exposed naturally to a significant concentration of the gas for a sufficiently long period to produce such lesions.

Pigs that survived experimental exposure to silo gas did not have the lesions seen in silo-fillers’ disease in humans, and experimental exposure of cattle to nitrogen dioxide gas produces lesions that do not occur in naturally occurring AIP. Acute pulmonary emphysema and deaths have occurred in cattle exposed to zinc oxide fumes produced by the welding of galvanized metal in an enclosed barn housing cattle.

### Parasitic Infestation

For many years it was thought that massive infestation of the lungs by large numbers of lungworm larvae in a lungworm-sensitized animal could cause an allergic reaction resulting in the development of AIP. The

possibility of such hypersensitivity as being associated cannot be totally ignored, but at the present time there is no evidence to support such a theory. Such hypersensitivity may occur when the level of larval infestation of pasture is extremely high, but it is not involved in the great majority of cases. In most cases of naturally occurring AIP, there is no laboratory evidence of lungworm infestation of affected and in-contact animals. Reinfection of cattle with lungworm will occur 2 to 3 weeks following introduction to an infected pasture and cause acute respiratory distress that may be indistinguishable clinically from AIP.

The migration of abnormal parasites, particularly *Ascaris suis*, has been observed to cause an acute interstitial pneumonia in cattle that were allowed access to areas previously occupied by swine.

### Mycotoxicosis and Plant Poisonings

The ingestion of sweet potatoes infested with the mold *Fusarium solani* has been incriminated as a cause of AIP in cattle. Growth of the mold on the potatoes produces the toxins ipomeamarone and ipomeamaronol and a lung edema factor. The latter is a collective term for a group of substances capable of causing death associated with severe edema and a proliferative alveolitis of the lungs of laboratory animals. It produces a respiratory syndrome that is clinically and pathologically indistinguishable from AIP.

The fungus *Fusarium semitectum* growing on moldy garden beans, *Phaseolus vulgaris*, which were discarded on pasture, was associated with acute pulmonary emphysema in cattle that consumed the beans and their vines. The fungus produces a pulmonary toxin. The pulmonary toxin 4-ipomeanol (ipomeanol) accumulates in mold-damaged sweet potatoes and induces pulmonary edema, bronchiolar necrosis, and interstitial pneumonia in many mammalian species. Outbreaks have occurred in lactating cows following ingestion of sweet potatoes damaged by *Myzus tersicae*. Other *Fusarium* spp. have been found in peanut-vine hay, which has been associated with acute respiratory distress and atypical interstitial pneumonia in adult beef cattle. The population mortality rate as a result of respiratory disease was about 12% and the case-fatality rate 77%. Clinical signs occurred within a few days to 2 months after the animals were fed the peanut-vine hay.

A weed, *Perilla frutescens*, is considered to be a cause of the disease in cattle in the United States and wherever the plant is found. High morbidity and high case-fatality rates are characteristic, and the plant contains a perilla ketone that can be used to produce the disease experimentally.

Turf-quality perennial ryegrass straw (*Lolium perenne*) infected with the endophyte (*Acremonium lolii*), which yields toxic substances, including lolitrem-B, has been

associated with atypical pneumonia in weaned beef calves. However, feeding the suspect hay resulted in typical ryegrass staggers but not atypical interstitial pneumonia.

### Melengestrol Acetate

Melengestrol acetate (MGA), a feed additive commonly fed to feedlot heifers to suppress estrus, has been associated with AIP based on epidemiologic evidence. Data obtained from Canadian feedlots indicated that the great majority of cases of AIP occurred in heifers and that discontinuing MGA treatment resulted in a reduced number of emergency slaughters, most of which were attributable to AIP.<sup>2</sup> Further work did not reveal any effect of oral MGA administration on plasma 3mI concentration. If MGA does play a role in the etiology of AIP, the mechanism through which this occurs is not clear.

### Bacterial and *Mycoplasma* spp. Infections

There is no evidence that any of the common bacterial pathogens of cattle such as *Mannheimia haemolytica*, *Pasteurella multocida*, *Histophilus (Haemophilus) somni*, or *Mycoplasma* spp. are primarily associated with AIP. In a series of feedlot cattle with clinical findings consistent with AIP, the pathogens were present in the lung tissues of some animals at necropsy, but their presence was not considered as a primary cause of the pneumonia but rather secondary to the initial injury of the lung that was undetermined.

### Viral Infections

Certain viral infections of the lung may result in interstitial pneumonia. In the interstitial pneumonias caused by the bovine respiratory syncytial virus (BRSV) there is a bronchiolitis and alveolitis, and these should be termed bronchiointerstitial pneumonias. The BRSV is an important cause of outbreaks of acute interstitial pneumonia in beef calves 2 to 4 weeks after weaning. Pathologic evaluation of the lung tissues of feedlot cattle that had acute interstitial pneumonia found that BRSV was not a causative agent. In a series of cases of interstitial pneumonia in feedlot cattle in Saskatchewan, the presence of the BRSV antigen was demonstrated in only 7% of cases, and there was more severe bronchiolar epithelial necrosis than in the other cases that were negative for the virus.

### EPIDEMIOLOGY

AIP occurs primarily in adult cows and bulls, usually 4 to 10 days after they are moved abruptly from a dry or overgrazed summer pasture to a lush autumn pasture. The new pasture may or may not have been grazed during that summer, and the species of grass or plants does not seem to make a difference, but usually there is some lush regrowth of



grass, legume, or other palatable plants. Merely changing pasture fields in the autumn has precipitated the disease.

AIP in pastured animals usually occurs in outbreaks, with the morbidity ranging from 10% in some herds up to 50% and higher in others, with a case fatality ranging from 25% to 50%. It is not unusual to observe a mild form of the disease in about one-third of the adults at risk, but only 10% of those at risk may be severely affected. Often, a number of cows are found dead without premonitory signs; many others are severely ill and die within 24 hours. Calves and young growing cattle up to 1 year of age grazing the same pasture are usually unaffected.

A retrospective analysis and random sample survey of cattle ranches in northern California found that the type of forage management has a significant effect on the occurrence of the disease. The greatest occurrence of the disease was in herds where the cattle were moved from summer ranges to second-growth hay fields or to irrigated pastures or from one irrigated field to another. The adult morbidity rate was 2.6% and the case-fatality rate about 55%. The disease did not occur on ranches with limited or no movement of cattle from summer ranges to lush autumn pastures. The timespan over which the disease occurs during the autumn months is only 2 to 4 weeks. The incidence of the disease declines rapidly following the first frost. The disease has also occurred in the same herd on the same pasture in successive years.

AIP in pastured cattle has been recorded in Canada, the United States, Great Britain, Holland, New Zealand, and other countries. The disease is rare in Australia. The disease has been recognized in France for many years as an aftermath disease or aftermath emphysema, especially in the Normandy region.

Some reports have suggested a breed predilection, with Herefords being more commonly affected than the Jersey, Holstein, Shorthorn, and Angus breeds, but there are few exact epidemiologic data to support the observation.

**AIP in feedlot cattle** is recognized as important cause of economic loss in feedlot cattle in western Canada and the United States. The disease occurs sporadically, and the incidence is about 2.8% of all cattle placed in feedlots.<sup>4</sup> Cases occur most commonly during the summer and fall months, with a higher incidence rate toward the end of the finishing period. In southern Alberta, the disease is most common during hot, dry, and dusty spring and summer days, and typically affects animals expected to be ready for slaughter within 15 to 45 days. Some feedlot operators have observed that the disease is more common in cattle exposed to excessive dust from bedding.

In southern Alberta feedlots, the disease occurred late in the finishing period, when animals had been on feed an average of 114 days and weighed 475 kg. All

confirmed cases were in heifers, and plasma concentrations of 3mI metabolites (adducts) were higher in heifers with AIP than in controls. Most of the heifers were receiving melengestrol (MGA) orally to suppress estrus. The odds of an animal with acute interstitial pneumonia being a heifer were 3.1 times greater than the odds that an animal with the disease was a steer. In some large feedlots the estimated relative risk was 4.9.

Other types of atypical interstitial pneumonia occur sporadically and may affect only a single animal or several over a period of time. There is not necessarily a seasonal incidence except in areas where cattle are housed and fed dusty and moldy hay during the winter months. AIP has been reported to occur in weaned beef calves about 4 weeks after weaning.

### PATHOGENESIS

Because of the number and variety of circumstances in which acute or chronic interstitial pneumonia occurs, it is difficult to suggest a basic underlying cause, or to explain the mechanisms for the development of the lesions and the variations that occur from one circumstance to another.

The L-isomer of tryptophan contained in feed is metabolized by ruminal microorganisms to indoleacetic acid, which is then converted to 3-methylindole (3mI). The conversion of L-tryptophan to 3mI is maximal at a ruminal pH near neutrality. The 3mI is absorbed from the rumen and metabolized by a mixed-function oxidase system to an active intermediate, which has pneumotoxic properties.

Bioactivation of 3mI by alveolar Clara cells leads to profound cellular injury in Clara and type-1 alveolar epithelial cells and, ultimately, atypical interstitial pneumonia. It is postulated that the compound responsible for causing the injury is the electrophilic metabolite of 3mI, 3-methylenedolenine (3mEIN), which forms stable adducts with cellular macromolecules. (Adducts are compounds formed by an addition reaction.)

Concentrations of 3mEIN in lung tissue and blood were higher in feedlot cattle that had died of AIP than in healthy feedlot cattle. However, lung tissue concentrations of 3mEIN were similar in samples from cattle with interstitial pneumonia and bronchopneumonia. Mean concentration of 3mEIN-adduct increased to a maximum value on day 33 and then decreased to a minimum on day 54 after arrival in the feedlot. Plasma 3mI concentrations initially decreased and remained low until after day 54. Neither 3mEIN-adduct concentrations nor plasma 3mI concentrations were associated with deleterious effects on weight gains.

The reaction that occurs is a nonspecific but fundamental reaction of the pulmonary parenchyma to a wide variety of insults that may be ingested, inhaled, or produced

endogenously. Pulmonary edema is the first morphologic change occurring in ruminants given 3mI. The edema is preceded by degeneration, necrosis, and exfoliation of type I alveolar septal cells. During the **acute stage**, there is flooding of the alveoli with serofibrinous exudate, congestion, edema of alveolar walls, and hyaline membrane formation. Varying degrees of severity of interstitial emphysema also occur. The interstitial emphysema may spread within the lymphatics to the mediastinum and into the subcutaneous tissues over the withers, over the entire dorsum of the back, and, occasionally, over the entire body, including the legs. If the acute phase is severe enough, there is marked respiratory distress and rapid death from hypoxemia. Unlike the bacterial pneumonias, the emphasis is on edema and proliferation rather than on necrosis.

The lesions have been produced experimentally in cattle, sheep, and goats following oral or IV administration of 3mI. Calves appear to be more resistant to experimental toxicity with 3mI than adults, which supports the observation that the naturally occurring disease is uncommon in calves grazing the same pasture in which adults are affected.

In case the animal survives the acute stage a **proliferative stage** follows that is marked by proliferation of alveolar type II cells. There is alveolar epithelialization and interstitial fibrosis, the latter being progressive and irreversible. The central features of chronic interstitial pneumonia are intra-alveolar accumulation of mononuclear cells, proliferation and persistence of alveolar type 2 cells, and interstitial thickening by accumulation of lymphoid cells and fibrous tissue. Diffuse fibrosing alveolitis is a form of chronic interstitial pneumonia of uncertain etiology, but it is possibly the chronic form of AIP.

AIP has been recorded in **sheep**, and there was extensive alveolar epithelialization. In Norway, an acute respiratory distress syndrome has occurred in lambs moved from mountain pastures onto lush aftermath pasture. The lesions were those of AIP and alveolar epithelial hypersensitivity to molds in the grass is being explored. The experimental oral administration of 3mI to lambs will result in acute dyspnea and lesions similar to those that occur in cattle and adult sheep following dosing with 3mI. However, the lesions in experimental lambs are different from those that occur in lambs affected with the naturally occurring disease.

### CLINICAL FINDINGS

This acute form of **AIP in pastured cattle** is usually obvious. Within 4 to 10 days after adult cattle have been moved onto a new pasture, they may be found dead without any premonitory signs. In the experimental disease, the typical clinical signs of respiratory disease appear within 24 to 36 hours

after the oral administration of L-tryptophan to adult cattle and within 4 days, 50% of the dosed cows will die. One or several cattle may exhibit labored breathing, often with an expiratory grunt, open-mouthed breathing, head and neck extended, frothing at the mouth, and anxiety. Severely affected cattle do not graze, stand apart from the herd, and are reluctant to walk. If forced to walk, they may fall and die within a few minutes. Moderately affected cattle continue to graze, but their respirations are increased above normal. Coughing is infrequent regardless of the severity. The temperature is normal to slightly elevated (38.5–39.5°C [102–103°F]) but may be up to 41 to 42°C (106–108°F) during very warm weather. There is a similar variation in the heart rate (80–120/min), and those with a rate of more than 120/min are usually in the terminal stages of the disease. Bloat and ruminal atony are common in severe cases. Subcutaneous emphysema is common over the withers and may extend to the axillae and ventral aspects of the thorax. The nostrils are flared, and the nasal discharge is normal. Diarrhea may occur but is mild and transient.

Loud, clear breath sounds audible over the ventral aspects of the lung, indicating consolidation without bronchial involvement, are the characteristic findings on auscultation in the early stages of the acute disease. The intensity of the breath sounds may be less than normal over the dorsal parts of the lung if involvement is severe, but in animals that survive for several days the loud crackles characteristic of interstitial emphysema are of diagnostic significance. Most severely affected cases will die within 2 days of onset, but less severe cases will live for several days and then die of diffuse pulmonary involvement. Those that survive longer than 1 week will often have chronic emphysema and remain unthrifty. Of those moderately affected cattle that recover in a few days, some will develop congestive heart failure a few months later, as a result of chronic interstitial pneumonia (cor pulmonale). Calves running with their adult dams will usually not be affected.

**AIP in nonpastured cattle** such as feedlot cattle usually occur sporadically, but several animals may be affected over a period of time. There may or may not be a history of a change of feed or the feeding of moldy or dusty feed. In many cases, a few days will elapse after the appearance of signs before the owner is aware of the affected animals. The animal may have been treated with an antimicrobial for a bacterial pneumonia with little or no response. Dyspnea, increased respiratory effort sometimes with a grunt, deep coughing, a fall in milk production, an absence of toxemia, a variable temperature (38.5–40°C [102–104°F]) and a variable appetite are all common. On auscultation there are loud breath sounds over the ventral aspects of the lungs and crackles over both

dorsal and ventral aspects. The presence of moist crackles suggests secondary bacterial bronchopneumonia. Subcutaneous emphysema is uncommon in these, and most will become progressively worse.

Yearling cattle with acute interstitial pneumonia that may be viral in origin may become much worse and die in a few days in spite of therapy. Mature cattle affected with the chronic form of AIP will survive in an unthrifty state with the chronic disease for several weeks and even months.

The major clinical features of all these other interstitial pneumonias are obvious respiratory disease, lack of toxemia, poor response to treatment, progressive worsening, and abnormal lung sounds distributed over the entire lung fields.

### DIFFERENTIAL DIAGNOSIS

**Atypical interstitial pneumonia (AIP)** is usually obvious when presented with an outbreak of acute respiratory disease in adult cattle that have recently been moved onto a new pasture. The onset is sudden; several cattle may have been found dead, and many are dyspneic.

Clinical differential diagnoses for AIP include:

- **Pneumonic pasteurellosis** (shipping fever, enzootic pneumonia of calves) that is characterized by fever, toxemia, mucopurulent nasal discharge and less dyspnea; young cattle are more commonly affected, and there is a beneficial response to therapy within 24 hours.
- **Organophosphatic insecticide poisoning** may resemble AIP because of the dyspnea, but additionally there is pupillary constriction, mucoid diarrhea, muscular tremor and stiffness of the limbs, and no abnormal lung sounds.
- **Nitrate poisoning** may occur in cows moved into a new pasture with high levels of nitrate. Many cows are affected quickly, they are weak, stagger, gasp, fall down, and die rapidly. The chocolate brown coloration of the mucous membranes, the lack of abnormal lung sounds, and the response to treatment are more common in nitrate poisoning.
- **Other interstitial pneumonias** in cattle are generally not associated with a change of pasture in the autumn and are difficult to diagnose clinically and pathologically, especially when they occur in a single animal. The chronic and subacute types of interstitial pneumonia are difficult to differentiate from each other and from other pneumonias of cattle.
- **Extrinsic allergic alveolitis (bovine farmer's lung)** occurs in housed cattle exposed to dusty or moldy feeds for a prolonged period and is characterized by a history of chronic coughing, weight loss, poor milk production, occasionally

green-colored nasal discharge, and dry crackles over most aspects of the lungs. Not infrequently, acute cases occur, and animals die within a week after the onset of signs.

- **Verminous pneumonia** caused by *Dyctiocaulus viviparus* occurs in young cattle on pasture in the autumn months and causes subacute or acute disease that may resemble AIP clinically but not epidemiologically. Identification of the larvae in the feces or tissues of affected animals should be attempted.
- **Verminous pneumonia** caused by aberrant migration of *Ascaris suis* larvae may be indistinguishable from acute interstitial pneumonia, but a history of previous occupation of the area by pigs may provide the clue to the diagnosis, which can only be confirmed on histologic examination of tissues.

### CLINICAL PATHOLOGY

There are no abnormalities of the hemogram or serum biochemistry that have any diagnostic significance. Examination of feces and forage for lungworm larvae will aid in differentiation from verminous pneumonia if past the prepatent period.

### NECROPSY FINDINGS

In AIP the lungs are enlarged and firm and do not collapse on cutting. In the early stages of acute cases they contain much fluid that is more viscid than usual edema fluid. The pleura is pale and opaque and appears to be thickened. In peracute cases, the entire lungs are homogeneously affected in this way. Such cases usually have edema of the larynx.

In the more common acute case, the lung has a marbled appearance. Adjacent lobes may be affected with any one of four abnormalities. Areas of normal, pink lung are restricted to the dorsal part of the caudal lobes. There are areas of pale tissue indicative of alveolar emphysema, areas of a dark pink color affected by early alveolar exudation, yellow areas in which the alveoli are filled with coagulated protein-rich fluid, and dark red areas where epithelialization has occurred. The latter two lesions are firm on palpation and resemble thymus or pancreas. They are more common in the ventral parts of the cranial lobes.

In chronic cases, as a sequela to the acute form described previously, the obvious differences in the age of the lesions suggest that the disease progresses in steps by the periodic involvement of fresh areas of tissue. In all cases there is usually a frothy exudate, sometimes containing flecks of pus, in the bronchi and trachea, and the mucosa of these passages is markedly hyperemic.

Histologically, the characteristic findings are an absence of inflammation, except in the case of secondary bacterial invasion, and the presence of an eosinophilic, protein-rich

fluid that coagulates in the alveoli or may subsequently be compressed into a **hyaline membrane**. This is more apparent in acute cases, and if animals live for a few days, there is evidence of epithelialization of the alveolar walls. In longstanding cases, there is extensive epithelialization and fibrosis. There is a lack of obvious lesions of the small airways, which differentiates interstitial pneumonia from bronchopneumonia.

Bacteriologic examination of the lungs is often negative, although in longstanding cases in which secondary bacterial pneumonia has developed, *Pasteurella multocida*, *Mannheimia haemolytica*, *Streptococcus* spp., and *Trueperella* (formerly *Arcanobacterium*) *pyogenes* may be found. A careful search should be made for nematode larvae.

### TREATMENT

The treatment of AIP in cattle is empirical and symptomatic because there is no specific therapy available. The lesion is irreversible in severe cases, and treatment is unlikely to be effective. When outbreaks of the disease occur on pasture, the first reaction is to remove the entire herd from the pasture to avoid the development of new cases. However, almost all new cases will usually occur by day 4 after the onset of the outbreak, and removal from the pasture usually will not prevent new cases. Conversely, leaving the herd on pasture usually will not result in additional cases. Severely affected cattle should be removed from the pasture with extreme care, very slowly, and only if necessary, and they should be moved to shelter from the sun. Immediate slaughter for salvage may be indicated in severe cases. Mild or moderately affected cases will commonly recover spontaneously without any treatment if left alone and not stressed, a fact that has not been given due consideration when claims are made for the use of certain drugs. Several different drugs have been advocated and used routinely for the treatment of AIP in cattle. However, none has been properly evaluated, and definitive recommendations cannot be made.

Treatment of the chronic interstitial pneumonias is unsatisfactory because the lesion is progressive and irreversible.

#### TREATMENT AND CONTROL

##### Treatment

No specific treatment is available for AIP.

##### Control

###### AIP in pastured cattle

Monensin (200 mg/head PO q24h from 1 day before pasture change for at least 4 days after moving to fall pasture) (R-2)

Chlortetracycline (2.5 g/head PO q24h from 1 day before pasture change for at least 4 days after moving to fall pasture) (R-2)

Lasalocid (200 mg/head PO q24 from 1 day before pasture change for at least 14 days)

### CONTROL

There are no known reliable methods for the prevention of AIP in pastured cattle, but there are some strategies that merit consideration.

### Grazing Management

If lush autumn pasture contains toxic levels of the substance that causes the acute disease, it would seem rational to control the introduction of cattle to the new pasture. This can be done by controlling the total grazing time during the first 10 days: allow the cattle to graze for 2 hours on the first day, increasing by increments of 1 hour per day, and leave them on full time at the end of 10 to 12 days. If possible, this may be accomplished by rotating cattle back and forth, either between the summer and fall pastures or between the fall pasture and a drylot where ample supply of dry, mature hay is available. Dry, mature hay may be offered ad libitum to adult cattle in the morning before going on pasture for at least 4 days into the grazing period to reduce consumption of pasture forages. Such a management procedure is laborious and may not be practical depending on the size and terrain of the pasture and the holding yards that are available.

### Inhibition of 3-Methylindole Production in Rumen

Controlling the conversion of D,L-tryptophan in forage to 3mI is a plausible control strategy. Experimental tryptophan-induced AIP can be prevented by oral administration of chlortetracycline or polyether antibiotics such as monensin. The daily oral administration of 2.5 g/head of chlortetracycline beginning 1 day before and for 4 days following administration of a toxin of L-tryptophan will prevent clinical signs.

The daily oral administration of monensin at the rate of 200 mg/head/day beginning 1 day before and for 7 days after an abrupt change from a poor-quality hay diet to a lush pasture reduced the formation of 3mI during the 7 days of treatment, but the effect of the drug was diminished on day 10, 3 days after its withdrawal. Because the effects of monensin on ruminal 3mI are diminished within 48 hours after withdrawal of the drug, effective prevention of acute pulmonary edema and emphysema may require continuous administration of monensin for the critical period of approximately 10 days after the mature animals are exposed to the lush pasture. The daily feeding of monensin in either an energy or protein supplement will effectively reduce ruminal 3mI formation in pasture-fed cattle.

Lasalocid at a dose of 200 mg per head once daily in ground grain for 12 days reduced the conversion of tryptophan to 3mI and prevented pulmonary edema.

Any combination of these management practices may reduce 3mI production to a greater extent than just providing monensin

or implementing grazing management techniques alone.

### Other Forms of AIP

The control of nonpasture cases of AIP depends on the suspected cause and removal of it from the environment of the animals. Every attempt must be made to control the concentration of dust and moldy foods to which cattle are exposed. Feed supplies must be harvested, handled, and stored with attention to minimizing dust and molds. In the preparation of mixed ground feed for cattle, the fineness of grind must be controlled to avoid dusty feed particles that may be inhaled. Because of the creation of dust, the grinding and mixing of dry feeds such as hay, straw, and grains should not be done in the same enclosed area in which cattle are housed. If dusty feeds must be used, they should be wetted to assist in dust control.

### FURTHER READING

- Doster AR. Bovine atypical interstitial pneumonia. *Vet Clin North Am Food A*. 2010;26:395-407.
- Pancieria RJ, Confer AW. Pathogenesis and pathology of bovine pneumonia. *Vet Clin North Am Food A*. 2010;26:191-214.
- Woolums AR, McAllister TA, Lonergan GH, et al. Etiology of acute interstitial pneumonia in feedlot cattle: noninfectious causes. *Comp Cont Ed Pract Vet*. 2001;9:S86-S93.

### REFERENCES

1. Lonergan GH, et al. *Am J Vet Res*. 2001;62:1525-1530.
2. Woolums A, et al. *Comp Cont Ed Pract Vet*. 2001;9:S86-S93.
3. Doster AR. *Vet Clin North Am Food A*. 2010;26:395-407.
4. USDA Feedlot 2011, part IV. (Accessed 15.09.15, at: <[http://www.aphis.usda.gov/animal\\_health/nahms/feedlot/downloads/feedlot2011/Feed11\\_dr\\_PartIV.pdf](http://www.aphis.usda.gov/animal_health/nahms/feedlot/downloads/feedlot2011/Feed11_dr_PartIV.pdf)>).

## Diseases of the Ovine and Caprine Respiratory Tract

### ENZOOTIC NASAL ADENOCARCINOMA OF SHEEP AND GOATS (ENZOOTIC NASAL TUMOR)

Intranasal adenocarcinoma has been recorded as a sporadic disease of sheep and goats for many years and is now recognized as a contagious neoplasm in these species.<sup>1</sup> The disease in sheep and goats is associated with related but different retroviruses, the ovine nasal adenocarcinoma virus (ENT-1) and the caprine adenocarcinoma virus (ENT-2), respectively. These retroviruses are highly conserved, with North American and European isolates being 96% homologous.<sup>2</sup> They are homologous with the retrovirus that causes jaagsiekte (JSVR) but can be distinguished by unique sequences of the genome. Nasal adenocarcinoma is not a



component of the disease jaagsiekte, nor are pulmonary tumors present in sheep and goats with nasal adenocarcinoma. Infections with the viruses of enzootic nasal adenocarcinoma and jaagsiekte can occur in the same sheep, and this can potentiate the proliferation of jaagsiekte virus in the infected sheep.

Enzootic nasal adenocarcinoma is recorded in the United States, Canada, Europe, Japan, India, China, and Africa. It is believed to occur on all continents except Australia and New Zealand, but it is not present in the United Kingdom. The disease occurs sporadically but is often clustered in certain flocks and herds, and it is assumed to

transmit by the respiratory route. The prevalence in affected flocks varies in different countries. It is generally less than 2% but can be as high as 10% to 15%.

There is no seasonal occurrence and no apparent breed or genetic predisposition.

There is no apparent influence of nasal myiasis on the prevalence of nasal adenocarcinoma in infected flocks.

**Clinical disease** is recorded occurring as early as 7 months of age, but most occurs in mature sheep between 2 and 4 years of age. Affected animals are afebrile, have a profuse seromucous or seropurulent nasal discharge, and sneeze and shake their heads frequently. There is depilation around the nostrils. The tumor may be unilateral or bilateral.

As the disease progresses, there is dyspnea, stertorous breathing with flaring of the nostrils at rest, and open-mouthed breathing following exercise. Some animals develop facial deformity and protrusion of one or both eyes from tumor growth, and the tumor may protrude from the nostril (Fig. 12-17). There is progressive loss of weight, emaciation, and death after a clinical course of 3 to 6 months. There is no detectable immune response in affected animals.

At **postmortem**, the tumor masses are in the ethmoid turbinates, with metastasis to regional lymph nodes in some cases. The tumors may be unilateral or bilateral and are gray or pink in color with a granular surface. The tumors originate in the serous glands of the turbinates and have the histologic features of adenocarcinoma.

The disease has been transmitted experimentally in both goats and sheep, with challenge of young kids resulting in disease at 12 to 16 months of age.

## REFERENCES

1. Radostits O, et al. *Veterinary Medicine: A Textbook of the Disease of Cattle, Horses, Sheep, Goats and Pigs*. 10th ed. London: W.B. Saunders; 2007:1368.
2. Walsh SR, et al. *Virus Res*. 2010;151:74.

## CONTAGIOUS CAPRINE PLEUROPNEUMONIA

### SYNOPSIS

**Etiology** *Mycoplasma capricolum* subsp. *capripneumoniae*.

**Epidemiology** Highly contagious disease of goats, outbreaks in wild small ruminants do occur

**Clinical findings** Pleuropneumonia.

**Lesions** Pleuropneumonia with no enlargement of the interlobular septa.

**Diagnostic confirmation** Culture, polymerase chain reaction (PCR) on pleural fluid. Latex agglutination test.

**Treatment** Antimicrobials.

**Control** Herd biosecurity; vaccination provides strong immunity but of short duration.

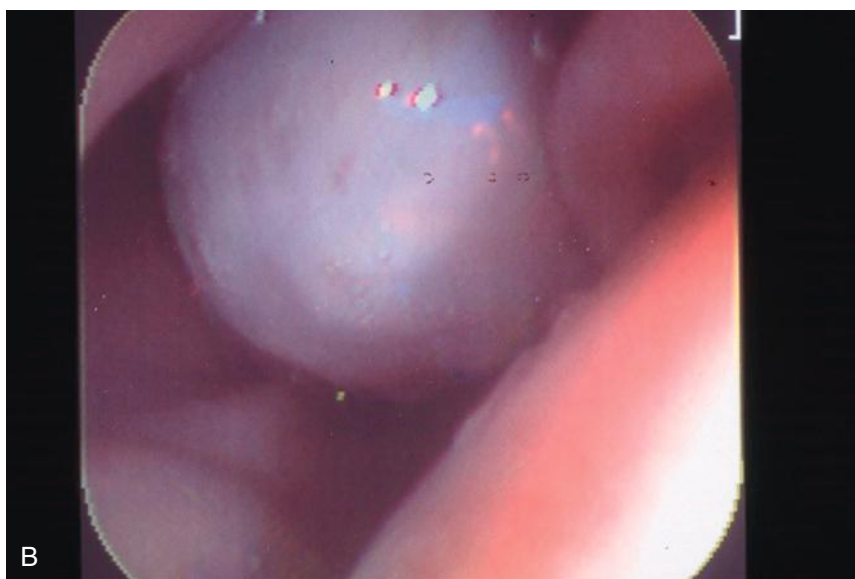

**Fig. 12-17** A, Nasal adenocarcinoma in a Suffolk ewe. Notice the seromucous to seropurulent nasal discharge (left greater than right). Very little air movement was detected from the right nostril. B, Endoscopic view of a nasal adenocarcinoma (dorsal pink gray spherical mass) in a Suffolk ram with clinical signs of an upper respiratory tract obstruction.

Table 12-9 Summary of systemic mycoplasmoses of sheep and goats

Bacterial species	Animals affected	Diseases caused	Pathogenicity
<i>M. agalactiae</i>	Sheep/goats	Contagious agalactia, arthritis, pneumonia, granular vaginitis, pinkeye	High
<i>M. arginini</i>	Sheep/goats	Pneumonia, arthritis, vaginitis, pinkeye, mastitis	Low
<i>M. capricolum</i> subsp. <i>capricolum</i>	Sheep/goats	Mastitis and agalactia, pneumonia, arthritis	High
<i>M. mycoides</i> subsp. <i>capri</i> (formerly <i>M. mycoides</i> subsp. <i>mycoides</i> )	Goats	Contagious agalactia, pneumonia, arthritis, high mortality in young kids	Moderate
<i>M. ovipneumoniae</i>	Sheep/goats	Pneumonia	Commonly precursor to pneumonic pasteurellosis
<i>M. putrefaciens</i>	Goats	Mastitis and arthritis	High
<i>Ureaplasma</i> sp.	Goats	Vaginitis	Low
<i>Mycoplasma capricolum</i> subsp. <i>capripneumoniae</i> (formerly strain F38)	Sheep/goats	Contagious caprine pleuropneumonia	High

## ETIOLOGY

Contagious caprine pleuropneumonia (CCPP) is a classical disease of goats, associated with *Mycoplasma capricolum* subsp. *capripneumoniae* and commonly confused with other serious pneumonias of goats and sheep (first isolated in 1976 and previously known as mycoplasma strain F38) (Tables 12-6 and 12-9). The disease was first described in Algeria in 1873 and presents primarily as a pleuropneumonia. The organism is difficult to grow, which can lead to poor differentiation of the CCPP from pneumonic disease induced by other mycoplasmas (*M. capricolum* subsp. *capricolum* and *M. mycoides* subsp. *capri*). Highly specific PCR tests can differentiate infections within the *M. mycoides* cluster of goats and will provide more information on the distribution and epidemiology of these diseases.

## EPIDEMIOLOGY

### Occurrence

CCPP is one of the most serious fatal diseases of goats in Africa and Asia and has serious socioeconomic effects for subsistence goat herders. It is known as Abu Nini in the Sudan. The exact distribution is uncertain, but clinical disease has been reported from 38 countries, mostly from Africa and Asia, with recent detections in Mauritius (2009), Turkey (2009), and China (2012).<sup>1,2</sup> However, the causative organism has only been isolated in some of these countries because of the difficulty growing it and lack of mycoplasmal laboratories. CCPP has many similarities clinically and at necropsy to contagious bovine pleuropneumonia, caused by *M. mycoides* subsp. *mycoides* SC, but it is not transmissible to cattle. Sheep can be infected experimentally and seroconvert, and they have been reported with respiratory disease in Eritrea. Captive and free-ranging wild ungulates, including deer, gazelles, and ibex, can also become infected and suffer disease.<sup>1,2</sup> *M. capricolum* subsp.

*capripneumoniae* is highly infectious. In newly affected flocks the illness is acute and severe following a brief incubation period (generally 6-10 days, but up to 28 days), with morbidity rates of 90% and case mortality rates of 60% to 100%. The disease is less severe and more sporadic in endemically exposed flocks.

### Transmission

The disease is readily transmitted by inhalation, but the organism does not survive for long in the environment. Infection is brought into the flock by asymptomatic carrier or clinically affected animals.

### Agent

Mycoplasmas are among the fastest evolving bacteria, with high mutation rates.<sup>3</sup> *Mycoplasma capricolum* subsp. *capripneumoniae* shows a degree of heterogeneity not found among other members of the *M. mycoides* cluster. Based on sequencing of several genes, including 16SrRNA and H2 locus and other proteins, 24 haplotypes were identified in 25 strains of *Mycoplasma capricolum* subsp. *capripneumoniae* and placed within six genotyping groups (A to F), with two distinct evolutionary lineages identified.<sup>3</sup> Lineage 1 contains two groups with strains from East Africa, Qatar, Niger, and Mauritius; lineage 2 is subdivided into three groups with strains from the United Arab Emirates, China, and Tajikistan.

### CLINICAL FINDINGS

All ages and sexes are affected. Clinical findings are restricted to the respiratory system and include cough, dyspnea with an extended neck, painful cough, and fever (40.5–41.5°C [104.5–106°F]). Animals often lay down, although they can stand and walk, and continue to eat and ruminate. In the terminal stages there is rapid respiratory rate, mouth breathing, tongue protrusion, and frothy salivation, followed by death in 2 or more days. In less acute infections the clinical signs

are milder, and coughing may only occur following exercise. Under adverse climatic conditions or in kids the disease may occur in a septicemic form, with little clinical or post-mortem evidence of pneumonia.

Outbreaks of CCPP in gazelle in the Middle East had similar clinical and pathologic signs to goats, although there was often sudden death.<sup>2</sup>

### CLINICAL PATHOLOGY

Antigen can be detected in lung tissue and pleural fluid by PCR based upon the 16S rRNA genes. A real-time PCR offers advantages over conventional PCR including speed, greater specificity and sensitivity, and elimination of post-PCR processing.<sup>4</sup> Serologic tests used to identify carrier animals include complement fixation, ELISA, and a latex agglutination test. The latter is robust, available commercially, and suitable for field use. Monoclonal antibody is used in serologic tests to identify caprine isolates by the disc growth inhibition method, which will include *M. agalactiae*, *M. capricolum* subsp. *capricolum*, and the other members of the *M. mycoides* cluster associated with goats. A competitive ELISA using monoclonal antibodies is highly specific for CCPP.<sup>5</sup>

### NECROPSY FINDINGS

The necropsy findings are similar to those of contagious bovine pleuropneumonia except that there is no thickening of the interlobular septa. Lesions are restricted to the lungs (often one lung) and pleura, with hepatization, increased pleural fluid, and a fibrinous pleuritis, which differentiates the disease from that caused by *M. mycoides* subsp. *capri*. Histologically, there is acute serofibrinous to chronic fibrino-necrotic pneumonia with interstitial intralobular edema, rather than a thickening of the interlobular septa that occurs with other mycoplasmal infections. Inflammatory exudate consists mainly of neutrophils. There is also peribronchiolar lymphoid hyperplasia.

## Samples for Confirmation of Diagnosis

- **Bacteriology**—Pleural fluid and lung from the interface of the hepatized and normal lung tissue. These mycoplasmas are fragile and should be freeze dried or placed in transport medium if there is to be a significant transport time (>2 days). Conventional or real-time PCR can be performed on samples of pleural fluid dried on filter paper.
- **Serology**—CFT, Latex agglutination, competitive ELISA<sup>5</sup>

### DIFFERENTIAL DIAGNOSIS

The other pulmonary mycoplasmoses from which this disease needs to be differentiated are those associated with *Mycoplasma mycoides* subsp. *capri* (formerly *M. mycoides* large colony type) and *M. capricolum* subsp. *capricolum*.

### TREATMENT

Clinical cases respond to a range of antibiotics, including intramuscular tylosin (10 mg/kg BW), oxytetracycline (15 mg/kg/d), or tilmicosin, marbofloxacin, and danofloxacin.<sup>6-8</sup> The severity of the disease is reduced, but treated animals are still sources of infection.

### CONTROL

Effective biosecurity measures are needed to prevent the introduction of the disease into a flock via contact with infected carriers. Killed vaccines effectively reduce morbidity and mortality rates. These have been widely used in many countries, although they can be of variable quality.<sup>2</sup> Immunity is generally short lived, and so a booster 1 month after the first vaccination provides additional protection. There is little evidence that maternal antibody interferes with the development of immunity, but kids born to does that have been vaccinated while pregnant are often not vaccinated before 10 to 12 weeks of age. Live attenuated vaccines have been trialed but are not yet commercially available and may not be permitted in some jurisdictions.<sup>9</sup>

### FURTHER READING

- Nicholas R, Churchward C. Contagious caprine pleuropneumonia: new aspects of an old disease. *Transbound Emerg Dis.* 2012;59:189-196.
- Prats-van der Ham M, et al. Contagious caprine pleuropneumonia (CCPP) and other emergent mycoplasmal diseases affecting small ruminants in arid lands. *J Arid Environments.* 2015;119:9-15.
- Radostits O, et al. Contagious caprine pleuropneumonia. In: *Veterinary Medicine: A Textbook of the Diseases of Cattle, Horses, Sheep, Goats and Pigs.* 10th ed. London: W.B. Saunders; 2007:1140-1141.

### REFERENCES

1. Prats-ven der Ham M, et al. *J Arid Environ.* 2015;115:9.

2. Nicholas R, Churchward C. 2012;59:189.
3. Depuy V, et al. *Vet Res.* 2015;46:74.
4. Fitzmaurice J, et al. *NZ Vet J.* 2008;56:40.
5. Peyraud A, et al. *BMC Vet Res.* 2014;10:48.
6. Ozdemir U, et al. *Trop Anim Health Prod.* 2006;156:286.
7. Srivastava AK, et al. *Vet Rec.* 2010;167:304.
8. Balicki E, et al. *Small Rum Res.* 2008;77:75.
9. Tarekegn S, et al. *Afr J Microbiol Res.* 2012;6:3085.

## CHRONIC ENZOOTIC PNEUMONIA OF SHEEP (CHRONIC NONPROGRESSIVE ATYPICAL PNEUMONIA, SUMMER PNEUMONIA, PROLIFERATIVE EXUDATIVE PNEUMONIA)

### SYNOPSIS

**Etiology** Multifactorial, with *Mycoplasma ovipneumoniae*, viruses and secondary bacterial infections implicated.

**Epidemiology** Affects sheep under 12 months of age. Seasonal occurrence, summer and autumn in southern hemisphere. Common disease affecting most flocks, but severity varies between farms.

**Clinical findings** Insidious onset. Coughing, nasal discharge and uneven weight gain in a mob.

**Lesions** Consolidation of anteroventral lobes of lung. Pleuritis.

**Diagnostic confirmation** Postmortem lesions.

**Treatment** Antimicrobials for severely affected individual sheep.

**Control** No effective control procedure established.

Enzootic pneumonia is defined here as the common, lowly pathogenic disease of sheep, particularly lambs, which is common in all sheep populations. The disease is recognized by different names in different areas of the world. It can be differentiated from the acute fibrinous pneumonia and pleurisy associated with *Mannheimia (Pasteurella) haemolytica*, which is often called enzootic pneumonia in the British literature, and from the chronic progressive pneumonias, maedi and jaagsiekte.

### ETIOLOGY

Although the disease is well known, its cause is not well defined. This is partly because of its nonfatal character, which leads to incomplete examination of early cases; most of those submitted for examination or necropsy are distorted by secondary bacterial infections. It has a multifactorial etiology, with a mix of (mainly) *Mycoplasma ovipneumoniae*, *Bordetella parapertussis*, chlamydia, parainfluenza-3 (PI-3) virus, adenovirus, a respiratory syncytial virus, and reovirus

nominated as causes. *M. haemolytica* is a common secondary infection and may lead to more acute, suppurative respiratory disease. The disease, which might be most accurately identified as chronic undifferentiated enzootic pneumonia of sheep, is probably a collection of etiologically specific diseases.

### *M. ovipneumoniae*

*M. ovipneumoniae* is now considered to be one of the more important parts of the disease complex, and may be the initiating cause.<sup>1</sup> It is commonly isolated in large numbers from the lungs of affected sheep, but it can also be isolated from the nasal cavity of some normal sheep and less occasionally from normal lung.<sup>1</sup> Experimental challenge with pure cultures of the organism produces minimal lesions, but aerosol or intrabronchial challenge with homogenates of affected lung that contain the organism produces proliferative interstitial and lymphoid pneumonic lesions indistinguishable from the natural disease. *M. ovipneumoniae* is a facultative pathogen that requires compromised lung defense mechanisms to initiate lesions; infection with this organism subsequently predisposes the lung to secondary infection with organisms such as *Past. haemolytica*. There is considerable heterogeneity in *M. ovipneumoniae*, and several different strains may be isolated from a pneumonic lung.<sup>2</sup> Differences between strains in pathogenicity are not determined. Other mycoplasmas, including *M. mycoides* subsp. *mycoides*, *M. mycoides* subsp. *capri*, *M. putrifasciens*, and *M. arginini*, may be associated with chronic enzootic pneumonia in tropical zones, but *M. arginini* is considered to have no role in atypical pneumonia of lambs in the United Kingdom.<sup>3</sup>

### *B. parapertussis*

*B. parapertussis* is a common isolate from the nasal cavities and lungs of sheep with chronic enzootic pneumonia in New Zealand and is also believed to have an initiating role in the disease. It produces a cytotoxin that damages ciliated epithelium in the trachea and experimental challenge of colostrum-deprived lambs produces mild pulmonary lesions similar to those seen early in the natural disease. *B. parapertussis* also can predispose pneumonic pasteurellosis.

### Parainfluenza-3 (PI-3) Virus

PI-3 is a cause of a mild undifferentiated pneumonia in sheep, and surveys around the world have shown that it is a widespread infection. The disease is clinically mild and marked by the presence of interstitial pneumonia. Antibodies to PI-3 are present in lambs soon after birth, but the half-life is short, and lambs are susceptible by the time they are weaned and mixed with other lambs, which is when clinical disease often occurs. In the experimentally produced



disease in lambs there is a slight seromucosal nasal discharge, coughing, increased sensitivity to tracheal compression, and fever of 40° to 41°C (104–106°F). At necropsy there is obvious hyperemia of the upper respiratory mucosa, including the trachea; the bronchial lymph nodes are enlarged; and there are small foci of catarrhal inflammation of pulmonary parenchyma of the apical and cardiac lobes. However, challenge of lambs at 2 weeks of age with this virus and *M. haemolytica*, although producing disease, did not result in prolonged disease lasting to slaughter, and it was concluded that these agents, without other factors, were not the cause of enzootic pneumonia. This conclusion is supported by the results of vaccine trials with PI-3 against enzootic pneumonia.<sup>4</sup>

### Bovine Respiratory Syncytial Virus

BRSV has resulted in pneumonia following experimental challenge of sheep and is evidenced clinically by fever and hyperpnea and pathologically by multifocal pulmonary consolidation and necrosis of epithelial cells. There is little evidence for BRSV as a cause of significant respiratory disease in sheep.

### Other Agents

*Adenovirus* and a type-3 *reovirus* have been used experimentally to produce pneumonic lesions, and a vaccine has been produced to protect lambs against the adenovirus infection. Similarly, sheep herpesvirus, *caprine herpesvirus-1*, will produce an interstitial pneumonia in experimentally challenged SPF lambs, but there is no evidence of a causal association with chronic enzootic pneumonia.

Autoantibodies to upper respiratory cilia have been detected in sheep colonized with *M. ovipneumoniae*, and it is suggested that they contribute to the pathogenesis of coughing in this disease.

## EPIDEMIOLOGY

### Occurrence

Enzootic pneumonia affects animals up to 12 months but may commence as early as 6 weeks of age. The disease can occur in both lambs at pasture and housed lambs. In many affected flocks, 80% of 4- to 5-month-old lambs have clinical signs and lesions, and the disease is credited with causing a significant depression in growth rate after weaning in lamb flocks with a high prevalence. This has been confirmed in controlled studies on the effect of the experimentally produced disease on weight gain in housed and pasture-fed lambs.

Enzootic pneumonia has a seasonal pattern that differs according to locality and management. In Australia and New Zealand, the period of peak prevalence is in the late summer and autumn. In a longitudinal slaughter study of lambs in New Zealand, the

prevalence of pneumonic lesions was found to increase from early summer to early autumn, with an overall prevalence of pneumonia of 42%. There were significant differences in prevalence between different regions of the country. Factors such as comingling sheep from different sources and environmental stress can precipitate clinical disease.

### Environmental Risk Factors

In Australia and New Zealand, clinical outbreaks of enzootic pneumonia in lambs aged 5 to 8 months are often associated with heat stress, yarding after weaning, use of plunge or shower dips, and transport or mustering of sheep in hot dry conditions. Cases commence within 1 to 3 weeks after transport. In contrast, in the United Kingdom and Europe this disease occurs primarily in the late winter and early spring; in the more intensive production systems of the northern hemisphere, the disease is commonly associated with environmental problems of housing. In Ireland, an association has been made between the occurrence of lesions at slaughter and the extent of rain and wind-chill experienced by the sheep in the 2 months before slaughter.

### Economic Importance

Death loss from this disease is minor, but economic loss is considerable and includes reduced growth rate, prolonged periods on the farm before reaching slaughter weight, the drug and labor costs associated with treatment, slaughterhouse wastage, and downgrading of carcasses with pleural adhesions and an effect on carcass quality. The situation is similar to that with enzootic pneumonia of pigs.

## CLINICAL FINDINGS

The disease is insidious in onset and can persist in a group of lambs for 4 to 7 months. The disease has mild clinical manifestations, with the primary signs being poor and uneven weight gains, an increased nasal discharge, coughing, increased respiratory rate, and respiratory distress with exercise. Increased intensity and a higher pitch of breath sounds are heard on auscultation over the region of the bronchial hilus, and sounds of fluid in the airways are heard in some cases at rest but can usually be elicited by inducing the lamb to cough. There may be periods of fever.

There is a relationship between the proportion of the lung affected with pneumonia and average daily gain, and in one study weight gain was reduced by 50% when greater than 20% of the lung was affected. The weight loss is most apparent clinically soon after the disease commences.

## NECROPSY FINDINGS

At postmortem there are clearly demarcated areas of consolidation in the anteroventral lobes, and there may be pleuritis with pleural

adhesions. The diagnosis is on gross lesions and the presence of typical lesions on histologic examination.

## TREATMENT AND CONTROL

Treatment is not usually undertaken unless there is secondary infection to produce acute respiratory disease. Nevertheless, lincomycin (5 mg/kg IM), given twice or three times at intervals of 2 days, and oxytetracycline (20 mg/kg, IM), given twice at 4-day interval, both gave good clinical cure and increased growth rates in a study in Greece.<sup>5</sup> Control is based on the avoidance of stress factors that can exacerbate existing infection.

## FURTHER READING

- Radostits O, et al. Chronic enzootic pneumonia of sheep (chronic nonprogressive pneumonia, summer pneumonia, proliferative exudative pneumonia). In: *Veterinary Medicine: A Textbook of the Diseases of Cattle, Horses, Sheep, Goats and Pigs*. 10th ed. London: W.B. Saunders; 2007:1361-1362.
- Scott PR. Treatment and control of respiratory disease in sheep. *Vet Clin North Am Food A*. 2011;27:175-186.

## REFERENCES

1. Sheehan M, et al. *The Vet J*. 2007;173:630.
2. Parham K. *Vet Microbiol*. 2006;118:83.
3. Lin Y-C, et al. *Res Vet Sci*. 2008;84:367.
4. Thonney ML, et al. *Small Rum Res*. 2008;74:30.
5. Skoufos J, et al. *Small Rum Res*. 2006;66:214.

## OVINE PROGRESSIVE PNEUMONIA (MAEDI, MAEDI-VISNA)

Ovine progressive pneumonia and maedi are North American and European terms for slow virus diseases of sheep in which a chronic progressive pneumonia is a major manifestation. The name maedi is derived from the Icelandic term for dyspnea. Maedi-visna virus can also produce visna, which is a disease of the nervous system and is discussed elsewhere under that heading. Additional manifestations of infection are arthritis, indurative mastitis, and ill-thrift. These diseases have a close relationship with caprine arthritis encephalitis. La Bouhite and Graff-Reinert disease are local names for maedi in France and South Africa, respectively. In the United States it was originally described as Montana progressive pneumonia, and in Holland as zwoergersiekte.

### SYNOPSIS

**Etiology** Ovine retroviruses

**Epidemiology** Most sheep infected as lambs. Persistent infection. High prevalence of infection in many countries but low prevalence of clinical disease. Transmission is via infected colostrum and milk, but lateral transmission also occurs.

*Continued*

**Clinical findings** Clinical disease of mature sheep, long incubation, long clinical course. Dyspnea and respiratory distress, initially with exercise but eventually also at rest. Some sheep also manifest chronic wasting and/or indurative mastitis.

**Necropsy findings** Lungs uniformly increased in bulk with enlargement of bronchial and mediastinal lymph nodes. Lymphocytic interstitial pneumonia. Discrete or diffuse hardening of mammary glands with lymphoid infiltration.

**Diagnostic confirmation** Clinical signs, pathology and serology. Polymerase chain reaction (PCR) provides confirmation of infection.

**Treatment** None.

**Control** Segregated rearing. Test and cull.

## ETIOLOGY

Maedi-visna virus (MVV) and ovine progressive pneumonia virus (OPPV) are single-stranded RNA nononcogenic ovine lentiviruses within the retrovirus family. They have a tropism for monocytes, macrophages, and dendritic cells, but not T-lymphocytes. This is an important determinant of their pathogenesis because they induce a persistent infection in sheep that can cause lymphoproliferative changes in the lung, mammary tissues, brain, and joints. There is a high degree of relatedness with the lentivirus associated with caprine arthritis encephalitis (CAE), and these ovine and caprine lentiviruses share nucleotide homology and serologic properties. Consequently, MVV, OPPV, and CAE viruses are now regarded as a viral continuum and referred to as small ruminant lentiviruses (SRLV).<sup>1</sup>

Isolates of MVV from naturally infected sheep are genetically heterogeneous, antigenic drift is common, and antigenic variation of the surface protein facilitates the persistence of the virus in the host, both as latent and chronic infections. There is evidence for variation in pathogenic potential between isolates and hosts, and it is estimated that only about 30% of infected animals develop disease.<sup>2</sup>

There is some evidence that the North American strains of ovine lentivirus may have originated from cross-species transmission of caprine arthritis-encephalitis virus rather than from maedi lentivirus. However, the similarity in clinical manifestation of maedi and ovine progressive pneumonia and the evidence that the causative viruses are part of a continuum permit the discussion of these diseases as a single entity.

## EPIDEMIOLOGY

### Occurrence

The earliest reports of the disease were from South Africa and the United States, but it now occurs in all major sheep-producing

countries with the exception of Australia, New Zealand, and Iceland. Maedi virus was present in Iceland, being introduced in 1933 through the importation of infected Karakul sheep, but was eradicated in 1965. Because of the susceptibility of the local sheep and management practices that favored transmission, it developed to a problem of major national significance. In individual flocks the annual mortality was often 15% to 30%, and in these circumstances sheep farming was not economically viable. Approximately 105,000 sheep are believed to have died of the disease, and 650,000 sheep had to be slaughtered to eradicate it from the country.

The international movement of sheep has facilitated the spread of the disease, and it is believed to have been introduced into Denmark, Norway, Sweden, and Great Britain since the 1970s through the importation of infected sheep. However, as yet no other country has experienced the severity of disease that occurred in Iceland.

### Host Range

Sheep and goats are the only species known to be susceptible to MVV, and infection cannot be established by experimental challenge in cattle, deer, pigs, dogs, horses, chickens, mice, and rats. Rabbits are susceptible, but infection is limited to the acute stage before the production of antibody; chronic infection, as seen in sheep and goats, does not occur. Hybrid mouflon-domestic sheep and calves have been experimentally infected with CAE virus, although the infection was cleared naturally in the latter, and SRLV nucleic acid detected in wild ibexes in close contact with goats.<sup>2</sup>

A serologic survey of wildlife in the United States found no evidence of infection in bighorn sheep, elk, white-tail deer, or antelope. All breeds of sheep appear to be susceptible to infection, but there may be differences in breed susceptibility, based on differences in seroprevalence in flocks with more than one breed of sheep. These differences are not consistent and so they may reflect differences in the susceptibility of family lines within a breed. Variations in the gene encoding an ovine transmembrane protein (TMEM 154) are associated with increased or decreased susceptibility of sheep to SRLV; sheep with glutamate at position 35 have increased susceptibility, whereas those with lysine or a deletion have decreased susceptibility.<sup>3</sup> The average frequency of highly susceptible alleles across 74 sheep breeds was 0.51, with more than 25% of mainstream breeds being greater than 0.8.<sup>4</sup> In contrast, frequency of highly susceptible alleles across 3 hill breeds was 0.26 to 0.42, suggesting that they would be less affected by MVV infection.<sup>5</sup>

### Prevalence

The prevalence of infection varies between farms, breeds, and countries. In the United

States, infection is more common in the western and midwestern and uncommon in the southern states. An estimate of flock seroprevalence (flocks with 1 or more positive sheep) of 48%, and overall seroprevalence of 24%, was recorded in samples collected in 2001 from sheep in 29 states. More recently, samples collected in Wyoming in 2011 found a flock prevalence for OPPV of 47.5% and overall seroprevalence of 18%, with open range (unfenced) flocks at significantly higher risk compared those that were fenced in (an odds ratio of 3.5).<sup>6</sup> In Canada, a random survey found a flock prevalence of 63%, with 19% of sheep over 1 year of age being seropositive, and more recently a flock prevalence of 25% in Manitoba. Serologic surveys that use the AGID test will markedly underestimate prevalence, demonstrated by a study in Alberta where 27% of culled ewes were positive on histopathology, but using the AGID there was a seroprevalence of only 13%.<sup>7</sup>

In the United Kingdom, MVV was introduced more recently, and so this country has lower flock and within-flock prevalence rates (estimated at 3% and up to 15%, respectively, in 2010). However, there is concern that the prevalence of maedi-visna may be increasing, demonstrated by a steady increase in the number of introduced infections in approximately 2600 flocks that participate in a maedi-visna accreditation scheme. These breakdowns are usually caused by flocks not adhering to the biosecurity rules of the scheme, such as introducing sheep into a nonaccredited flock on the same holding.<sup>8</sup>

There is considerable variation in the prevalence of seropositive sheep between flocks. Rates of seropositivity increase with age, and so within-flock seroprevalence is influenced by the average age of the flock. Flock seroprevalence also has been positively associated with the use of foster ewes, allowing lambs older than 1 day to have contact with other lambing ewes, flock size, close contact during confinement for lambing, stocking density on pasture, and the length of time that the flock has been in existence. Within flock seroprevalence is much higher in flocks that are also infected with pulmonary adenomatosis compared with those that are not.

### Transmission

The disease is spread most commonly by inhalation of infected aerosols and the ingestion of infected colostrum or milk. Vertical transmission following in utero infection is possible but relatively uncommon. Virus is also shed in the semen of infected rams if there are leukocytes in the semen, and so this risk may be increased in rams that are also infected with *Brucella ovis*.

Lambs may contract the infection at or shortly after birth, either from contact with infected ewes or from ingestion of infected colostrum and milk. The virus then infects

dendritic cells at the mucosal surface, and these migrate to local lymph nodes, where virus is transferred to macrophages and spreads systemically.<sup>2</sup> Alveolar macrophages play a similar role when infection occurs via the respiratory route. Lambs born to seropositive ewes have a significantly greater risk of infection than those from seronegative ewes, and lambs born to ewes that have been infected for a long time are at greater risk of infection. The chance of transmission to lambs from infected ewes increases with the period of contact, but it can occur within the first 10 hours of life.

Lateral transmission can occur in older sheep, and this was probably important in the transmission of the disease in Iceland and the Basque area of Spain, and it has been a significant component of the spread of infection of the virus in flocks in the United Kingdom. In some flocks, the spread of infection can be rapid, and the majority of the flock can seroconvert within a few years of the introduction of infected sheep. The spread of infection is often rapid in flocks that are concurrently infected with the retrovirus causing pulmonary adenomatosis. There are many macrophages in the lungs of these sheep, and so these cells will also be infected with MVV if it is present. In dual-infected sheep, the copious lung fluid produced by sheep with pulmonary adenomatosis contains MVV and can increase the risk of lateral transmission of maedi-visna.

### Economic Importance

Economic loss from this disease is associated with increased mortalities, decreased longevity, decreased value of cull animals, and reduced productivity associated with subclinical infections, such as failure to thrive or to rear lambs. Losses are usually more severe in intensive housed operations, and they can be catastrophic in flocks that derive a large proportion of income from the sale of breeding animals (stud or seedstock flocks).

Clinical disease occurs in sheep 2 years old or older, usually in sheep 3 to 4 years of age. Severe disease is more likely when the within-flock prevalence exceeds 50% and has a case-fatality rate of 100%.<sup>9</sup> Up to 30% of infections are subclinical, and so clinical disease may not be obvious or common in flocks that have a low prevalence. A high proportion of infected sheep, premature culling, and high mortality rates have occurred in flocks in Iceland, the Netherlands (particularly the Texel breed), the United States, the United Kingdom, and other European countries, especially in intensively managed dairy flocks.

It is possible that the major economic loss associated with infection with these viruses rests with the effects of subclinical infection on productivity of infected flocks. Subclinical infection of breeding ewes in some flocks has been associated with a reduction in conception rate and lowered birth weights and/

or reduced growth rates in their lambs. The reduction in growth rate of the lamb is associated with indurative mastitis and a lowered milk intake. This may be expressed by a decreased growth rate of lambs from only older ewes. In other flocks there has been no evidence of effect on the birth weight or growth rate of lambs born of infected ewes. Subclinical infection has no effect on mature ewe body weight or greasy fleece weight.

### PATHOGENESIS

SRLV infections are classed as immunopathologic diseases, whereby the host immune response is responsible for most of the pathology rather than the virus itself.

The virus infects cells of the monocyte/macrophage lineage and attaches to cells by the binding of its envelope glycoprotein to specific receptors on the cell surface. The virus replicates its RNA genome via a DNA intermediate provirus that is integrated into the chromosomal DNA of infected cells. With initial infection there is virus replication; this is followed by an immune response that restricts viral replication but fails to eliminate the virus completely. The immune response occurs between 2 and 8 weeks after infection, with antibody to different viral antigens emerging at different times during this period, although some sheep do not develop an antibody response until several months after infection. The ability to establish latent infection of monocytes, which then transfer virus to other organs, may be related to the fact that SRLV are relatively poor at inducing type 1 interferon (IFN), an important mediator of immunity to viral infection.<sup>2</sup>

In monocytes, replication is restricted and does not proceed beyond the synthesis of provirus in most infected cells. The principal site of virus replication is the macrophage, and pulmonary secretions and milk containing infected macrophages are the main source of virus for natural transmission. Diseases such as pulmonary adenomatosis, which increase the number of macrophages in lung secretions, will facilitate transmission of ovine progressive pneumonia virus via aerosols.

The replication of virus initiates viral-specific immune responses (immune activation), and immune-mediated lesions develop in various organs. Production of viral antigen attracts more monocytes, which become latently infected, and so a cycle of latent infection and immune activation, with lymphocytic hyperplasia, is established.<sup>2</sup> The infected macrophages in the affected tissues are surrounded by a slowly progressing inflammatory response, creating a focus of mononuclear cell aggregation. Many tissues can be involved, but the lungs, mammary gland, central nervous system and joints are most affected. Any or all of these organs can be affected in a single sheep, but genetic differences in host susceptibility and the virus

often lead to a predominance of a single syndrome in a flock. For example, Border Leicesters in the United States and Texels in Holland appear more susceptible to lung infection (maedi), whereas Icelandic sheep are more susceptible to the central nervous disease (visna).

In the lung there is a gradual development of a lymphocytic interstitial pneumonia dominated by CD8+ T lymphocytes, hyperplasia of smooth muscle, and fibrosis.<sup>2</sup> There is no healing or shrinkage of tissue, so the lungs increase in size and weight, alveolar spaces are filled, and dyspnea and anoxia gradually develop. The pathologic lesions develop very slowly during the preclinical and clinical stages of the disease, so that they are widespread and there is little ability to compensate when clinical signs do appear. In the central nervous system there is infiltration of the meninges and white matter with lymphocytes. The demyelination that occurs in visna is believed to result from the direct effect of the virus on oligodendrocytes and astrocytes and is believed to be the result of an inflammatory response provoked by the presence of viral antigen in these cells. Similar infiltrations occur in the udder. Lymphoid follicles are found in the alveolar parenchyma, often with atrophy of the alveolar tissue. Numerous lymphocytic follicles also occur around the lactiferous ducts, some of which may be occluded by lymphocytic aggregates protruding into their lumens.

### CLINICAL FINDINGS

There is a long incubation period. Clinical disease, if it occurs, does not develop before 2 years of age, and most clinically affected sheep are older than 3 years. The clinical signs develop insidiously and progress slowly, and there is a long clinical course.

The earliest signs are usually listlessness and loss of body condition that progresses to emaciation. The presenting syndrome can be one of an increased cull rate of ewes in poor condition. Signs of respiratory involvement are not evident in the initial stages of the disease, but there is exercise intolerance, and affected sheep will fall back behind the flock when the flock is moved. Dyspnea, with an increase in respiratory rate (80–120/min at rest) and flaring of the nostrils, or open-mouth breathing, develops later, but there is no evidence of excess fluid in the lungs. There may be coughing and some nasal discharge, but in most instances this occurs in sheep with secondary bacterial pneumonia. The body temperature is in the high normal range, and there may be inflammation of the third eyelid. Clinical illness lasts for 3 to 10 months, and the disease is always fatal. Clinically affected sheep are more prone to other diseases, such as pregnancy toxemia. In some sheep, clinical respiratory disease is minimal, and the major manifestation is wasting and the thin ewe syndrome.



Indurative mastitis (“hard bag” or “hard udder”) also has an insidious onset, with ewes usually in their third or later lactation before the disease becomes clinically obvious, although histologic changes will be apparent far sooner. In early stages, hardening of the udder is more easily detected at drying off. In advanced cases the udder is enlarged and uniformly very firm, but the teats are limp. There is very little milk in the teat cistern, although it appears normal.<sup>9</sup> Mammary involvement may occur, along with signs of respiratory infection, or affected ewes may show no other clinical abnormality. The lambs of ewes with less severe involvement may have a reduced growth rate.

Arthritis is occasionally seen in naturally infected sheep, usually when they are from 1 to 6 years of age. These sheep become lame and emaciated, with obvious swelling of the carpal joints.

### CLINICAL PATHOLOGY

There is a progressive, moderate hypochromic anemia, with hemoglobin levels falling from 12 to 14 g/dL to 7 to 8 g/dL, and some depression of the red cell count. There is a tendency to leukocytosis, which in experimental infections is quite marked between exposure and the onset of clinical disease, but the count returns to normal when clinical signs appear. There is also hypergammaglobulinemia. There is an increase in the number of lymphocytes and neutrophils in bronchoalveolar lavage fluid, with more CD8+, fewer CD4+, and an inversion of the CD4+/CD8+ cell ratio.

In clinical cases, diagnosis is by the presence of the appropriate clinical syndrome, supported by the presence of a positive serologic test for the virus. A positive serologic test, by itself, has limited value for the diagnosis of individual sheep because there is a high prevalence of seropositivity in many flocks, especially in older animals. A positive test indicates that the animal is infected, but does not indicate that signs or lesions are attributable to infection with the virus.

#### Detection of Antigen

PCR is a sensitive method for detection of small amounts of viral nucleic acid, but it may not be available for routine diagnosis in some jurisdictions. It has been used to detect antigen in the third eyelid of infected sheep.

#### Serologic Tests

Assessing flock status (the presence or absence of infection) and the status of an individual sheep currently relies on serologic testing. The agar gel immunodiffusion (AGID) and ELISA tests are used in most countries. The AGID test is easy to perform and inexpensive, and thus it is often the most commonly used routine diagnostic test. It has a high specificity but often a lower

sensitivity than the indirect and competitive ELISA tests, which may vary depending on the antigen used.<sup>10</sup> Sensitivities of these tests vary from 64% to 97%, and thus they will be unsuited for diagnosis of infection in individual animals or use in test and cull programs if at the lower end of this range. The value of serologic testing rests primarily with the establishment of the infection status of the flock. A negative test in an individual sheep could mean that the sheep is free of infection, but this result can also occur in an infected animal that has not yet responded to infection.

A commercial indirect ELISA using a recombinant core protein and a synthetic transmembrane protein as antigens was developed in the Netherlands. Although it had high sensitivity and specificity, it was labor intensive and expensive, and so a pooling procedure that required modifications to the test was developed.<sup>11</sup> Subsequently, testing of bulk milk tank samples by ELISA or PCR was confirmed as a cost-effective alternative for flock testing and capable of detecting early infection in dairy flocks. The ELISA detected a within-herd prevalence of less than 1% when samples were tested undiluted and less than 3% when using samples diluted 1 in 10.<sup>12</sup> All the bulk milk samples from known SRLV-free flocks (138) tested negative, whereas 50% of samples from flocks with an unknown SRLV status (111) were positive.<sup>12</sup> Agreement between the ELISA and two real-time PCR tests on a subsample of 59 milk samples was 90% for the LTPCR and 98% for the leader-gag PCR.<sup>12</sup>

### NECROPSY FINDINGS

Lesions may be present in the lungs and associated lymph nodes, brain, joints, mammary gland, and blood vessels, but gross lesions in most sheep are confined to the lungs and, in some cases, the mammary glands. In advanced cases, the lungs are larger and 2 to 4 times as heavy as normal lungs. They collapse much less than normal when the chest is opened, and are gray-blue to gray-yellow in color. There is a diffuse thickening of both lungs, with abnormal color and consistency in all lobes and consistent enlargement of the bronchial and mediastinal lymph nodes. Histopathologic changes are characteristic of a chronic interstitial pneumonia, with proliferation of lymphoid tissue and the presence of numerous lymphoid follicles. There is infiltration of lymphocytes and macrophages in the inter-alveolar septa, which are thickened, and the bulk of the alveolar space is replaced by the thickened alveolar walls. Larger airways are unaffected. There is a complete absence of healing, consistent with the progressive nature of the disease, and vasculitis is often present.

Lesions of arthritis, encephalitis, and mastitis are often present. The mastitic lesion

comprises an interstitial accumulation of lymphocytes and the presence of periductal lymphoid nodules with atrophy of alveolar tissue. Culture of the virus is difficult, and confirmation of the diagnosis is often limited to the presence of characteristic microscopic lesions, preferably supported by a positive serologic titer to the virus. Immunohistochemistry is highly specific, but it may not be routinely available.

### Samples for Confirmation of Diagnosis

- **Virology**—lung, mammary gland, synovial membrane, brain (PCR, ISO)
- **Bulk or individual milk**—(PCR, ELISA)
- **Serology**—heart blood serum (AGID, ELISA, PCR)
- **Histology**—formalin-fixed lung, bronchial lymph node, mammary gland, synovial membrane, half of brain section midsagittally (LM, IHC)

### DIFFERENTIAL DIAGNOSIS

There are several chronic pneumonias requiring differentiation from maedi:

- Jaagsiekte
- Parasitic pneumonia
- Chronic suppurative pneumonia
- Caseous lymphadenitis
- Postdipping pneumonia
- Enzootic pneumonia
- Melioidosis
- Chronic wasting conditions:
  - Johne's disease
  - Caseous lymphadenitis

### TREATMENT

No treatment has been successful. Secondary bacterial infections can be treated with commonly used antibiotics, such as tetracyclines, but there will be no improvement in the underlying chronic pneumonia.

### CONTROL

In the past, the only control attempted was eradication by complete destruction of all sheep in a flock or area and subsequently restocking. However, it is possible to greatly reduce the prevalence, and even eradicate the disease, by either (a) testing all sheep and removing seropositive sheep from the flock, or (b) by removal of lambs at birth and rearing them in isolation from other sheep.

Many jurisdictions have developed accreditation programs for flocks to establish that they have a low risk of infection with MVV. Once flocks are seronegative they are subjected to testing at various intervals, typically 1 to 3 years depending on an assessment of the biosecurity risk and the presence of untested sheep on the same farm holding.

## Test and Cull

Test and cull involves the detection and culling of seropositive animals and is the preferred method when lateral transmission is the dominant mode of transmission in the flock. All sheep (and goats) on the farm are serologically tested once or twice a year, and seropositive animals and their progeny of less than 1 year of age are removed (culled), preferably for slaughter. If immediate slaughter is not feasible, the seronegative flock must be kept isolated from infected sheep and clothing and equipment that have been in contact with any seropositive animals. Testing is continued semiannually or annually until there are at least two consecutive negative tests. The offspring of older seronegative ewes are kept for replacements. Using this approach, an initial seroprevalence to MVV of 66% in a Spanish dairy flock was reduced to 0.2% within 2 years and remained below 2.2% for the next 4 years, and the seronegative flock returned to pretest numbers within 8 years.<sup>13</sup>

Testing all animals, not just those greater than 1 year old, using a combination of serology and real-time PCR assay to detect proviral DNA, combined with a shorter testing interval of 3 months, may be able to accelerate eradication.<sup>14</sup> Using this system, antibody and proviral DNA-negative ewes, proviral DNA-negative lambs, and antibody and proviral DNA-negative yearling ewes were retained as breeders. The PCR test can discriminate lambs that are not infected but serologically positive as a result of maternal antibodies.

## Segregated Rearing

Lambs must be separated from the ewes at birth and receive no colostrum from their dam. They can be given bovine colostrum, or colostrum from a known seronegative flock, then reared on milk replacer completely separate from other sheep. This method may be of particular value when lines of sheep of high genetic merit are desirable to maintain. The disadvantage is that it is labor-intensive and expensive, and there is no cash flow unless the infected sheep are maintained in production pending the establishment of a mature infection-free flock. However, retaining infected sheep creates considerable potential for reinfection of the artificially reared flock, either via accidental contact or fomites.

With either method, any future introductions into the flock should be sourced from a known seronegative flock.

## Flock Biosecurity and Other Control Methods

Once infection is introduced it is difficult and expensive to eradicate; thus, establishing and maintaining good biosecurity is a cost-effective way of preventing the introduction of maedi-visna and other important infectious diseases, such as foot

rot. Unfortunately, the specificity and sensitivity of most currently available serologic tests are inadequate to reliably determine the infection status of an individual. Consequently, the results of flock tests from a potential source of replacement sheep should be examined, along with postmortem and other animal health records if these are available. Rams and replacement ewes should be acquired from accredited free flocks in countries where these programs exist and should be transported directly from the source farm rather than through markets or farms of unknown status.

Other control procedures that attempt to limit or delay the spread of infection and, consequently, the occurrence of clinical disease within an infected flock have limited success. Lambing in sheds and close confinement paddocks is conducive to spread of disease, and so ceasing or modifying this practice is recommended for infected flocks. In flocks that have a high incidence of clinical disease, culling animals before the age at which they develop clinical signs can reduce the economic impact of the disease.

In countries where the disease is endemic, there is often a great deal of movement of animals between farms, especially rams but also replacement ewes. Thus restricting movement of animals between farms and preventing comingling in common grazed areas should help limit the spread of the disease.

## Vaccination and Genetic Selection

There is currently no effective vaccine against the SRLVs, including MVV and OPPV, and in some cases candidate vaccines have enhanced viremia and/or the immune-mediated pathology of the disease.<sup>2</sup> The difficulty in developing effective vaccines is common among the lentiviruses, with various approaches, including attenuated vaccines, vector vaccines, and proviral DNA vaccines, having little success. The reasons are obscure but probably relate to the underlying dysfunction in T-cell-mediated immune responses.

However, marker-assisted genetic selection, to identify those sheep less susceptible to infection, has the potential to supplement existing control measures. For example, in a trial involving 187 lambs, the probability of infection following natural exposure to OPPV was 3.6 times greater in crossbred lambs with susceptible or heterozygous diplotype to ovine transmembrane protein gene 154 (TEM154 diplotype “1 3” or “3 3”) compared with lambs with diplotype “1 1.”<sup>15</sup> This is an active research area, and it is expected that additional markers will be identified with additional investigations.

## FURTHER READING

Blacklaws B. Small ruminant lentiviruses: immunopathogenesis of visna-maedi and caprine arthritis and encephalitis virus. *Comp Immunol Infect Dis.* 2012;35:259-269.

- Bowles D. Recent advances in understanding the genetic resources of sheep breeds locally-adapted to the UK uplands: opportunities they offer for sustainable productivity. *Frontiers Genetics.* 2015;6:24. doi:10.3389/fgene.2015.00024.
- Patel JR, et al. Important mammalian veterinary viral immunodiseases and their control. *Vacc.* 2012;30:1767-1781.
- Radostits O, et al. Ovine progressive pneumonia (maedi, maedi-visna). In: *Veterinary Medicine: A Textbook of the Diseases of Cattle, Horses, Sheep, Goats and Pigs.* 10th ed. London: W.B. Saunders; 2007:1362-1366.
- White SN, Knowles DP. Expanding possibilities for intervention against small ruminant lentiviruses through genetic marker-assisted selective breeding. *Viruses.* 2013;5:1466-1499.

## REFERENCES

1. Le Roux C, et al. *Curr HIV Res.* 2010;8:94.
2. Blacklaws B. *Comp Immunol Microbiol Infect Dis.* 2012;35:259.
3. Heaton MP, et al. *PLoS Genet.* 2012;8:e1002467.
4. Heaton MP, et al. *PLoS ONE.* 2013;e55490.
5. Bowles D, et al. *PLoS ONE.* 2014;9:e87823.
6. Gerstner S, et al. *JAVMA.* 2015;247:932.
7. Fournier D, et al. *Can Vet J.* 2006;47:460.
8. Ritchie C, Hosie B. *Vet Rec.* 2014;175:50.
9. Christodoulouplous G. *Small Rumin Res.* 2006;62:47.
10. de Andres X, et al. *Vet Immunol Immunopathol.* 2013;152:277.
11. Brinkhof J, et al. *Small Rumin Res.* 2006;70:194.
12. Brinkhof JMA, et al. *Vet Microbiol.* 2010;142:193.
13. Pérez M, et al. *Prev Vet Med.* 2013;112:423.
14. Brinkhof JMA, et al. *Res Vet Sci.* 2010;88:41.
15. Leymaster KA, et al. *J Anim Sci.* 2013;91:5114.

## OVINE PULMONARY ADENOCARCINOMA (JAAGSIEKTE, PULMONARY ADENOMATOSIS)

### SYNOPSIS

**Etiology** Jaagsiekte sheep retrovirus.

**Epidemiology** Disease of mature sheep with geographic clustering but low prevalence. Spread probably mainly by respiratory route

**Key signs** Dyspnea, profuse watery pulmonary discharge, loud fluid sounds on auscultation, long clinical course with progressive emaciation.

**Pathology** Tumors in lung.

**Diagnostic confirmation** Histologic changes are diagnostic and histopathologic confirmation, including immunohistochemistry, is the only method currently available.

**Treatment** None.

**Control** Culling and strict biosecurity.

Jaagsiekte is Afrikaans for “driving disease” because of the tendency for affected sheep to show clinical signs when driven. The disease manifests clinically as a chronic progressive pneumonia and is a contagious disease of sheep resulting from the development of a bronchioalveolar adenocarcinoma in the lungs.

## ETIOLOGY

The disease is associated with an infectious beta-retrovirus, jaagsiekte sheep retrovirus (JSRV) of the family Retroviridae. JSRV has two forms, an exogenous infectious form that alone can produce the disease and an endogenous RSRV-related provirus that is present in all sheep genomes.<sup>1</sup> The disease has been transmitted experimentally with partially purified retrovirus from infected lungs, by infection with cloned JSRV, and supportive evidence for retrovirus as the causative agent includes an inverse dose relationship between reverse-transcriptase activity in the infectious inoculum and the incubation period of the experimental disease.

The presence of retrovirus has been demonstrated in the lungs of sheep with jaagsiekte in different countries, there is serologic cross-reactivity, and strains from different countries have been sequenced.

A herpesvirus has also been isolated in several countries from the lungs of sheep with jaagsiekte, but epidemiologic studies show that it is not the causative agent.

## EPIDEMIOLOGY

### Occurrence

The disease has worldwide distribution and is recorded in most countries that have significant sheep populations, with the exception of Australia and New Zealand. Until recently there has been no practical method to detect infected sheep, and estimates of the prevalence of jaagsiekte are largely based on clinical or postmortem observations. The prevalence of the disease appears to vary depending on the breed of sheep and the type of flock management. In most endemically infected flocks, annual losses attributable to jaagsiekte are between 2% and 10%, although the tumor is present in a much higher proportion of the flock, and infection without lesions is also common. Annual mortality can be higher in flocks where the infection has recently been introduced and before the disease becomes endemic. PCR analysis of peripheral blood leukocytes of sheep in infected flocks shows significantly higher rates of nonclinical infection.

Prevalence varies between countries, and there can be areas of high prevalence within countries; in Britain, the Borders and the east coast of Scotland, and East Anglia in England, appear to be foci of infection from which other outbreaks arise. The prevalence may be higher than generally recognized; in a biased sample, histologic evidence of jaagsiekte was detected in 25% of cases of pneumonia in sheep submitted to a diagnostic laboratory in Scotland over a 6-year period. In a more recent study, ovine pulmonary adenocarcinoma was confirmed in 0.8% of fallen (culled) adult sheep at a slaughterhouse.<sup>2</sup>

The disease is also a significant cause of mortality in adult sheep in South Africa and Peru, but it is a minor disease in the United

States and Canada. It occurred in epizootic proportions in Iceland during the same period of time as the maedi-visna epizootic but has been eradicated by a rigorous slaughter policy.

## Animal and Environmental Risk Factors

Mature sheep, 2 to 4 years of age, are most commonly affected, but the disease can occur in younger animals. There are reports of the occurrence of jaagsiekte in goats at very low prevalence rates in India and Greece, and the disease has been experimentally transmitted to goat kids. The lesions produced were small and circumscribed, and goats have low susceptibility to infection.

Jaagsiekte has a prolonged clinical course and is uniformly fatal. In some reports there is a greater prevalence of onset of clinical disease in the winter months, but in others there is no seasonal variation in clinical onset. Ewes may show a sudden onset of clinical disease in late pregnancy.

The incubation period in natural cases is 1 to 3 years, but it may be as short as 5 to 12 months after experimental transmission. Clinical disease is rare in sheep younger than 2 years and is most common at 3 to 4 years of age. Very rarely, cases occur in lambs 3 to 6 months old, and disease can be reproduced in lambs of this age by challenge of very young lambs. A genetic or familial susceptibility to the disease is suspected.

Because of the method of spread, the disease is likely to assume more importance in systems of sheep husbandry where there are significant periods of close contact, as, for example, occurs with intensified lamb-rearing systems. Close housing during the winter is a potent predisposing cause and probably accounted for the occurrence of the disease in epizootic form in Iceland. However, the disease occurs commonly in range sheep in other countries. Sheep that have a combined infection with jaagsiekte and the maedi-visna lentivirus have an increased ability to transmit maedi-visna infection, and flocks with the combined infection can suffer high losses from pneumonic disease.

## Transmission

Experimental transmission has been effected by pulmonary or IV injection, or by intratracheal inoculation of infected lung material. The incubation period of the experimental disease in young lambs is much shorter than that in mature sheep. The disease has also been transmitted by inhalation of infected droplets when sheep are kept in close contact, and it is assumed that the natural mode of transmission is by droplet infection from respiratory secretions, which are copious in sheep with clinical disease. A longitudinal study of the natural transmission showed that infection established readily and rapidly in young lambs and also horizontally in adult sheep, but that the majority of infected sheep

did not show clinical disease during their commercial life span.

## PATHOGENESIS

The virus replicates in the type II pneumocytes in the alveolus. Type II pneumocytes and Clara cells in the terminal bronchioles are transformed, and their growth produces intraalveolar and intrabronchiolar polypoid ingrowths. These cells are surfactant-producing secretory cells, and there is also copious production of fluid. The excessive surfactant-like protein produced in the tumor provides a stimulus for the accumulation of macrophages seen in association with this disease. The adenomatous ingrowths of alveolar epitheliums encroach gradually upon alveolar airspace so that anoxic anoxia occurs. The lesions produced by experimental inoculation are identical with those of the naturally occurring disease.

## CLINICAL FINDINGS

Affected sheep are afebrile and show progressive respiratory distress with loss of weight. Clinical signs are not evident until a significant proportion of the lung is compromised by the tumor.<sup>1</sup> Occasional coughing and some panting after exercise are the earliest signs, but coughing is not a prominent sign in this disease unless there is concurrent parasitic pneumonia. Subsequently there is emaciation, dyspnea, lacrimation, and a profuse watery discharge from the nose, with death from 6 weeks to 4 months later. A diagnostic test, colloquially known as the wheelbarrow test, in this disease is to hold the sheep up by the hindlegs: in affected animals a quantity of watery mucus (up to about 200 mL) runs from the nostrils. Moist crackles are audible over the affected lung areas and may be heard at a distance, so that a group of affected animals are said to produce a sound like slowly boiling porridge. There is no elevation of body temperature unless there is secondary infection, and the appetite is normal. Advanced cases may have cor pulmonale. Pasteurellosis (*Mannheimia haemolytica*) is a common complication and often the cause of death.

## CLINICAL PATHOLOGY

No immune reaction can be detected in affected animals, and there is no serologic test. Sheep in advanced stages of the disease may show neutrophilia and lymphocytopenia. The pulmonary fluid contains round or spherical clusters of epithelial cells, which have the hyperplastic adenomatous epithelium typical of pulmonary lesions and increased numbers of macrophages. Earlier reports of a consistent elevation in circulating immunoglobulin concentrations have not been substantiated. JSRV can be detected by exogenous JSRV-specific PCR in peripheral blood leukocytes and can be used to demonstrate that JSRV is not present in flocks or regions.<sup>3</sup>



## NECROPSY FINDINGS

Lesions are usually restricted to the thoracic cavity. As in maedi, the lungs are grossly increased in size and in weight (up to 3 times normal). There are extensive areas of neoplastic tissue, particularly of the anteroventral regions of one or both lungs, with smaller lesions in the diaphragmatic lobes. The affected areas are solid and slightly raised above the adjacent normal lung. This, with the excess frothy fluid in the bronchi, is characteristic. The bronchial and mediastinal lymph nodes are enlarged and hyperplastic, and they occasionally contain small metastases. Pneumonic pasteurellosis is a frequent complication, and secondary pulmonary abscesses and pleurisy may develop. Histologically, the alveolus is lined by cuboidal and columnar epithelial cells that form characteristic adenomatous ingrowths of alveolar epithelium into the alveolar spaces.

Differences between the pathology of classical (progressive) and atypical (nonprogressive) forms of the disease are seen using immunohistochemistry, with an influx of T-cell subsets and expression of MHC class II in the latter.<sup>4</sup>

## Samples for Confirmation of Diagnosis

- **Histology**—formalin-fixed lung, bronchial lymph node (LM)

### DIFFERENTIAL DIAGNOSIS

Chronic pneumonias requiring differentiation from jaagsiekte:

- Maedi
- Parasitic pneumonia
- Chronic suppurative pneumonia
- Caseous lymphadenitis
- Postdipping pneumonia
- Enzootic pneumonia
- Melioidosis

## TREATMENT

No treatment is available.

## CONTROL

In Iceland, where the disease assumed epizootic proportions, eradication was achieved in the 1950s by complete slaughter of all sheep in the affected areas. In areas where the prevalence is lower, the disease can be satisfactorily controlled, but not eradicated, by slaughter of clinically affected sheep. There is evidence that the disease is spreading in sheep populations in some countries, such as the United Kingdom, and flocks that are free of disease should attempt to obtain replacement sheep from flocks that are free of jaagsiekte. Infected flocks can reduce the prevalence of disease by culling sheep at the onset of clinical signs and also culling the progeny of affected ewes. PCR can detect infection in the preclinical stages, but there has been no trial to establish if eradication

from a flock can be achieved with this technology.

Exclusion of the disease from unaffected flocks requires strict biosecurity measures.

## FURTHER READING

- Griffiths DJ, Martineau HM, Cousens C. Pathology and pathogenesis of ovine pulmonary adenocarcinoma. *J Comp Pathol.* 2010;142:260-283.
- Radostits O, et al. Ovine pulmonary adenocarcinoma (jaagsiekte, pulmonary adenomatosis). In: *Veterinary Medicine: A Textbook Of the Disease of Cattle, Horses, Sheep, Goats and Pigs.* 10th ed. London: W.B. Saunders; 2007:1366-1368.

## REFERENCES

1. Scott P, et al. *In Pract.* 2013;35:382.
2. Cousens C, et al. *Vet Rec.* 2015;176:413.
3. Maeda N, et al. *J Vet Med Sci.* 2011;73:1493.
4. Summers C, et al. *Vet Immunol Immunopathol.* 2012;146:1.

## NASAL BOTS INFESTATION

Infestation of sheep and goats with larvae of the nasal bot fly (*Oestrus ovis*) has a serious effect on the productivity and welfare of both sheep and goats. Adult activity induces stress responses and significant behavioral change. Larval infestation induces moderate to severe pathology that reduces productivity.

Similar flies are known to affect horses, donkeys, and mules (*Rhinoestrus* spp.) in the Mediterranean region and to affect camels (*Cephenemyia titillator*) in Africa and Australia. Wild ungulates are affected by nasal bots (e.g., *Cephenemyia* spp.). Very little is known about the pathology and impact of these later groups of flies, but similarities in life history suggest their effects will be similar to those discussed here.

### SYNOPSIS

**Etiology** *Oestrus ovis* inhabits the nasal passages and sinuses of sheep and goats. Similar species affect horses and camels.

**Epidemiology** Larvae are sprayed onto the nares of hosts by passing females. Flies are active during spring and summer, inducing behavioral changes in hosts under attack. In temperate climates there is only a single generation per year, but in warmer climates two generations occur. First instars in the nasal passages undergo hypobiosis during winter or hot summer when survival of pupae or adults is low, resuming development when conditions are more favorable.

**Clinical signs** Shortly after arrival of the larvae an increase in nasal discharge and sneezing are evident. As the infestations develop the amount of discharge increases and the nostrils may become caked with dust and debris, forcing the infested animals to breathe through their mouth.

**Clinical pathology** Changes are noted to the mucosa of the ethmoid and sinus regions.

Inflammation of these surface tissues is evident and increases as the larvae become mature. Changes to the epithelial structure are noted, including the erosion of the surface ciliary covering and a breakdown in epithelial cell integrity. Abrasive action of the body armature and the activity of proteolytic enzymes excreted/secreted by the larvae are responsible for the pathology. Secondary effects include the induction of lung lesions and the activation of latent "orf" infections. Diagnostic confirmation. Behavioral changes during fly season and nasal discharge

**Differential diagnosis** Unthriftiness usually caused by helminth infection.

**Treatment** Macrocytic lactone endectocides, clorsulon.

**Control** Treatment given when fly activity has ceased.

## ETIOLOGY

The sheep nose bot affects sheep and goats in most regions, but it is particularly significant in the Mediterranean basin, central America, southern Africa, and eastern Europe. The larvae inhabit the nasal passages and sinuses, eventually being expelled through the nares. Goats are less dramatically affected than sheep. The slightly dorsoventrally flattened, segmented larvae are light cream in color, but as they reach maturity dark bands appear on each segment. Species affecting horses and camels have distributions that are similar.

## LIFE CYCLE AND EPIDEMIOLOGY

The adult fly is stout, mottled gray in color, and about 1 cm long. Its mouthparts are rudimentary, and it does not feed. In North America, flies emerge in the late spring and mate, and the females begin larviposition activities approximately 2 to 3 weeks later. Adult flies attempting to deposit larvae on the nares annoy the sheep and cause them to bunch or seek shelter. Stamping of the feet and shaking of the head are common. Sheep may bunch together and press their heads into the fleece of others. Fly activity occurs primarily during the warmer parts of the day but still may result in the loss of a good deal of grazing time. Behavioral changes in goats are less dramatic, presumably because of their browsing habit.

Larval development takes place in the dorsal turbinates and frontal sinuses. The period of development can vary 3 weeks to several months, after which they migrate to the nostrils. Larvae feed on the mucosal secretions and cells eroded from the mucosal epithelium. The larvae are thick, yellowish-white in color, and when mature there is a dark dorsal band on each segment. The ventral surface has rows of small spines on each segment. Mature larvae exit the host, usually during a bout of sneezing, and

actively burrow beneath the upper layers of soil and ground litter. Pupation occurs at these locations, and development of the adults requires 4 to 5 weeks but may take longer at low temperatures. In temperate areas there may be one or two generations per year, but several generations may be completed in hot areas. *O. ovis* are adapted to the various climates prevailing wherever sheep and goats are kept. When winters are cold, the larvae can overwinter by remaining dormant in the first instar (hypobiosis), but in warmer climates development may continue throughout the winter. In those regions where summer temperatures are extreme, the larvae will also undergo hypobiosis.

*O. ovis* are an important zoonosis because the females may larviposit in the eye, in the nose, or on the lips of humans. In some countries ophthalmomyiasis or infection of the upper respiratory tract is a common occurrence.

### PATHOGENESIS

The stress of the larviposition attacks can be significant with reduced grazing time and overheating resulting from bunching. Herdsmen find the animals are more nervous and difficult during the fly activity periods.

Larvae induce a gradually increasing rhinitis and sinusitis as the infestation persists. Marked changes in the structure of the epithelial tissues are noted, with a marked cellular degeneration and a loss of the ciliary layer. The changes are a result of both mechanical activity of the larval spines and mouthhooks and the effect of proteolytic enzymes excreted or secreted.<sup>1,2</sup> Varying degrees of mucous discharge are observed in the later stages of the infestation. This can lead to the nostrils being occluded by adherent straw and dust.

### CLINICAL FINDINGS

Early in the infestation there is a distinct rhinitis accompanied by a mucous to mucopurulent discharge.<sup>1</sup> Later as larvae mature a sinusitis is evident. Presence of mature larvae in nasal cavities may induce excessive sneezing, which assists larval exit.

Activity of the larvae in the nasal cavities, and the changes they induce lead to an increase in incidence of secondary pathology. The number and severity of lung abscesses are more significant in nose bot-infested sheep. The presence of bots also is correlated with increased carcinomas and may lead to reactivation of latent "orf" symptoms.

### DIAGNOSIS

The behavioral changes during fly activity, including bunching and burying of noses in neighbors' fleeces, is a reliable indicator of fly attack. Nasal discharge and excessive sneezing are highly suggestive but not definitive. Infested sheep and goats develop some level of immunity from exposure to larval antigens but is unlikely to be used on the farm.<sup>2</sup>

An ELISA for detection of antibodies to larva secretions has been developed but is not currently used.<sup>2</sup>

### TREATMENT

Closantel 5 mg/kg and ivermectin 0.2 mg/kg, in addition to other macrocyclic lactones, are effective, and the use of these compounds for fluke or worm control also controls nasal bots.

### CONTROL

Treatment should preferably be applied after the cessation of fly activity, although it may be necessary to apply treatments during prolonged fly activity to give relief.<sup>1</sup>

### RECOMMENDATION

Treatment should be applied once or twice a year. This is not absolutely necessary but will increase both endurance and the animal's well-being. Population control of the flies is probably not likely.

### REFERENCES

1. Angulo-Valadez CE, et al. *Med Vet Entomol.* 2010;25:117-125.
2. Angulo-Valadez CE, et al. *Vet Parasitol.* 2010;174:19-25.
3. Panadero-Fontan R, Otranto D. *Vet Parasitol.* 2015;208:84-93.

## LUNGWORM INFESTATION IN SHEEP AND GOATS

### SYNOPSIS

**Etiology** The nematode parasites *Dictyocaulus filaria*, *Muellerius capillaris*, and *Protostrongylus rufescens*.

**Epidemiology** Infective *D. filaria* larvae are found on grass, but *M. capillaris* and *P. rufescens* are transmitted when molluscan intermediate hosts are accidentally ingested by grazing animals.

**Signs** *D. filaria* and *P. rufescens* can cause bronchitis and loss of condition. *M. capillaris* is asymptomatic in sheep but may be pathogenic in goats.

**Clinical pathology** Characteristic larvae in feces.

**Lesions** *D. filaria* and *P. rufescens*: scattered patches of consolidation; *M. capillaris*: small fibrous nodules up to 5 mm in diameter.

**Diagnostic confirmation** Characteristic larvae in feces.

**Treatment** Avermectins/milbemycins, benzimidazoles or levamisole.

**Control** No specific measures available.

### ETIOLOGY

Infestations with the nematode *Muellerius capillaris* are ubiquitous. *Dictyocaulus filaria* and *Protostrongylus rufescens* are encountered sporadically. *Cystocaulus ocreatus* and

*Neostrongylus linearis* have been recorded in some countries.

### LIFE CYCLE

*D. filaria* has a direct life cycle like that of *D. viviparus* in cattle. The life cycles of the other (protostrongylid) species are similar except that they have different predilection sites in the lung and have indirect life cycles with molluscan intermediate hosts. Transmission occurs when infected slugs or snails are accidentally ingested during grazing.

### EPIDEMIOLOGY

*D. filaria* infestations in sheep appear to follow the same pattern as those of *D. viviparus* in calves, but the number of lungworms is usually low. The third-stage larvae are long-living in damp, cool surroundings. The lambs of one season are the main source of infection for the next season's lambs, but larvae passed by ewes and yearlings also contribute to pasture contamination. The prevalence of infection is low in spring and summer but rises rapidly in the autumn and winter, when most clinical cases are seen. Warm, wet summers give rise to heavier burdens in the following autumn and winter. Immunity after natural exposure is strong and durable in sheep but less so in goats.

*M. capillaris* infestations in sheep have been recorded from most parts of the world,<sup>1,2,3</sup> and in many temperate areas almost all sheep are infected.<sup>4,5</sup> Massive invasion with larvae is uncommon because the intermediate hosts are not usually ingested in large numbers nor are they grossly infested with larvae. Massive infestations with this worm do not develop acutely, and heavy infestations, when they occur, appear to develop over a long period of time. Infected sheep carry patent infection from 1 year to the next.

### PATHOGENESIS

The relative pathogenicity of each lungworm is dependent on its predilection site. *D. filaria* lives in the trachea and bronchi so aspirated eggs, larvae, and debris can affect a large volume of lung tissue. It is therefore the most pathogenic species and provokes changes resembling those described for *D. viviparus*. The volume of damaged lung is however usually insufficient to cause severe dyspnea. Adult *P. rufescens* are found in smaller bronchioles, and so associated lesions are much smaller. *M. capillaris* is found in the lung parenchyma, where it becomes encysted in fibrous nodules. Lesions are thereby confined to its immediate surroundings. Consequently, this worm is generally considered to be relatively innocuous. Heavy mixed protostrongylid infections can impair pulmonary gaseous exchange.

### CLINICAL FINDINGS

Lambs 4 to 6 months of age are most severely affected with lungworms, but sheep of all

ages are susceptible. Clinically *D. filaria* is associated with bronchial irritation that results in coughing, moderate dyspnea, and loss of condition. There may be added fever and evidence of toxemia if secondary bacterial infection occurs. It is highly pathogenic in young goats. *P. rufescens* infestations in sheep and goats cause clinical signs similar to those of *D. filaria*.

### CLINICAL PATHOLOGY

Laboratory diagnosis depends on the detection of first-stage larvae in the feces by the Baermann technique. *D. filaria* larvae have refractile granules in their intestinal cells and a conical tail. *P. rufescens* has a wavy tail as does *M. capillaris*, which, in addition, has a spine just anterior to the tail.

### NECROPSY FINDINGS

*D. filaria* lesions are similar to those of the subacute form of parasitic bronchitis in calves with exudate in the bronchioles, scattered patches of consolidation, and thickening of the alveolar septa,<sup>6-8</sup> but widespread lesions are not common. *M. capillaris* is found in small fibrous nodules up to 5 mm in diameter. Most of these are in the parenchyma of the lung immediately under the pleura. Many of them are calcified and often contain only one live or dead worm. Infestation of goats leads to a diffuse infection quite different from the nodular reaction in sheep and to the production of an interstitial pneumonia. Whether this is attributable solely to *M. capillaris* infection or whether a chlamydial or viral agent is involved has not been determined. However, cases of nodular reaction in goats attributable to *M. capillaris* larvae have been reported.<sup>6</sup>

### DIAGNOSTIC CONFIRMATION

The presence of larvae in the feces confirms lungworm infection, but their number is often no indication of the degree of infestation.

#### DIFFERENTIAL DIAGNOSIS

Lungworm infestation in sheep needs to be differentiated from maedi and jaagsiekte.

### TREATMENT

#### TREATMENT

Ivermectin (0.2 mg/kg, SC) (R-1)  
Moxidectin (0.2 mg/kg, SC or PO) (R-1)  
Fenbendazole (5 mg/kg PO, every day for 7 days) (R-2)  
Albendazole (7.5 mg/kg BW, PO) (R-2)

Ivermectin, moxidectin, the benzimidazoles, and levamisole are effective against *D. filaria* at normal dose rates. Ivermectin, in addition, has a label claim for *P. rufescens*. It is doubtful whether treatment of sheep for *M. capillaris*

is ever justified. In goats, one or two doses of ivermectin (0.2 mg/kg, SC or rPO) or elevated doses of benzimidazoles destroys the adult worms but not the immature stage, but regular daily oral doses of fenbendazole (up to 5 mg/kg/d) in the feed for 1 to 2 weeks or albendazole (1 mg/kg in the feed for 2 weeks) are highly effective against all stages. The label dose of albendazole (7.5 mg/kg BW, once in sheep and 10 mg/kg BW once in goats) is effective in treating adult lungworms, but is not effective against the immature stage.

### CONTROL

An attenuated vaccine for *D. filaria* is available in a few countries where this worm is a particular problem. With most forms of sheep husbandry, there are few precautionary measures that can be taken, particularly against lungworms with molluscan intermediate hosts.

### REFERENCES

1. Borji H, et al. *Asian Pac J Trop Med*. 2012;5:853.
2. Nematollahi A, et al. *J Vet Res*. 2009;64:339.
3. Regassa A, et al. *Vet Parasitol*. 2010;169:144.
4. Domke AV, et al. *Vet Parasitol*. 2013;194:40.
5. Kouam MK, et al. *Vet J*. 2014;202:146.
6. Panayotova-Pencheva MS, et al. *Vet Med Int*. 2010;2010:741062.
7. Yildiz K, et al. *Helminthologia*. 2006;43:208.
8. Iacob O, et al. *Sci Parasitol*. 2007;1:72.

## Diseases of the Equine Respiratory Tract

### ABNORMALITIES OF THE UPPER RESPIRATORY TRACT OF HORSES

Impairment of ventilation by abnormalities of the upper respiratory tract is an important cause of poor performance in athletic horses. Abnormalities that impair athletic capacity are those that reduce the effective diameter of the upper airway, thereby increasing the work needed to maintain the same level of tidal volume and minute ventilation or, as is the case clinically, reducing the minute ventilation achieved by the horse during maximal exercise. In other words, a reduction in effective diameter of the upper airway increases work of breathing at all exercise intensities, and at maximal intensity, when the effort expended on breathing cannot be increased, decreases maximal minute ventilation. The result is diminished oxygenation of arterial blood and delivery of oxygen to muscle and other tissues, exacerbated hypercapnia, and reduced athletic capacity during high-speed exercise.<sup>1-3</sup>

The work of breathing is, simplistically, determined by the volume of air moved and the pressure required to do so. The relationship between pressure and resistance in the airway is described mathematically by a rearrangement of Poiseuille's law:

$$\begin{aligned} \text{Resistance to flow} &= \text{pressure drop} / \text{flow} \\ &= 8 \times \text{viscosity of the air} \\ &\quad \times \text{length of the airway} / (\pi \times [\text{radius}]^4) \end{aligned}$$

Given that the viscosity of air is constant and the length of the airway does not change for an individual horse, the radius of the airway has a huge effect on resistance to flow. Notice that a change in pressure is inversely proportional to the fourth power of the radius ( $r^4$ ), with the consequence that relatively small changes in radius have large effects on the pressure needed to generate a given flow of air. For this reason, abnormalities of the upper airway that cause only small reductions in airway diameter can have clinically important effects on ventilation during high intensity exercise.

Another consequence of changes in airway diameter and structure is the generation of abnormal airflow patterns that result in production of abnormal respiratory sounds. Such sounds can vary from gurgling through to roaring and can be of diagnostic importance.<sup>4</sup>

Advent of first rigid and then flexible endoscopes allowed greater refinement of diagnosis of disorders of the upper respiratory tract of horses when examined at rest. A further advance was the ability to examine the upper airway during intense exercise. This was first achieved in horses running on a treadmill and has now progressed to examination of horses running over ground. Although there are advantages to each mode of examination (at rest, treadmill, over ground), greatest diagnostic utility is achieved by examination of horses exercising over ground and performing their customary activity wearing their usual tack and with their rider.<sup>5-8</sup>

Laryngeal hemiplegia caused by recurrent laryngeal neuropathy is a well-recognized abnormality of the upper airway associated with impaired performance by racehorses. In many of its forms, it is readily identified in horses at rest. However, more subtle abnormalities or those that develop as the horse fatigues are best detected, or can only be detected, on examination during strenuous exercise. It is now clear that most abnormalities of the upper airway of horses, with the exception of laryngeal hemiplegia, can only reliably be detected by examination of exercising horses.<sup>9</sup>

Abnormalities developing during strenuous exercise by horses are best referred to as "dynamic" abnormalities. This term should not be used to denote the mode of examination (ie, "dynamic endoscopy"), which should be specified as "over ground" or "treadmill." Terms describing abnormalities detected during endoscopic examination of the upper airway of horses have recently been standardized (Table 12-10).<sup>10</sup>

The use of endoscopy during exercise has revealed that dynamic abnormalities of the upper airway are often complex and involve



**Table 12-10** Preferred terms for describing findings on endoscopic examination of the upper airway of horses (modified from<sup>10</sup>)

Preferred term	Preferred abbreviation	Also known as
Recurrent laryngeal neuropathy	RLN	Laryngeal paralysis, laryngeal hemiplegia
Dynamic laryngeal collapse	DLC	Bilateral arytenoid cartilage collapse
Intermittent dorsal displacement of the soft palate	iDDSP	
Persistent dorsal displacement of the soft palate	pDDSP	Permanent DDSP
Palatal instability	PI	
Vocal fold collapse	VFC	Vocal cord collapse
Medial deviation of the aryepiglottic fold	MDAF	Aryepiglottic fold collapse, Axial deviation of the aryepiglottic fold
Nasopharyngeal collapse	NPC	Nasopharyngeal obstruction, pharyngeal wall collapse
Ventromedial luxation of the apex of the corniculate process of the arytenoid	VLAC	Collapse of the apex of the corniculate process of the arytenoid
Cricotracheal ligament collapse		
Collapse of the margins of the epiglottis		
Epiglottic retroversion		
Rostral deviation of the palatopharyngeal arch	RDPA	
High speed treadmill endoscopy	HSTE	
Overground endoscopy	OGE	Dynamic respiratory endoscopy, telemetric endoscopy

multiple structures.<sup>9,11</sup> Up to 50% of horses examined during high-speed exercise have multiple abnormalities of the upper airway. Furthermore, examination of exercising horses has revealed abnormalities not apparent during examination of resting horses, including the full spectrum of manifestations of recurrent laryngeal neuropathy, palatal instability including intermittent dorsal displacement of the soft palate, vocal fold collapse, aryepiglottic fold collapse, axial deviation of the aryepiglottic folds, dynamic nasopharyngeal collapse, collapse of the corniculate process of the arytenoid cartilage, bilateral arytenoid and vocal fold collapse, and epiglottic retroversion.<sup>9</sup>

#### FURTHER READING

Franklin SH, Allen KJ. Assessment of dynamic upper respiratory tract function in the equine athlete. *Equine Vet Educ.* 2015;doi:10.1111/eve.12432.

#### REFERENCES

- Davidson EJ, et al. *J Equine Vet Sci.* 2011;31:475.
- Courouge-Malblanc A, et al. *Equine Vet J.* 2010;42:246.
- Allen K, et al. *Equine Vet J.* 2013;45:350.
- Burn JF, et al. *Equine Vet J.* 2006;38:319.
- Allen KJ, et al. *Equine Vet J.* 2010;42:186.
- Allen KJ, et al. *Equine Vet J.* 2010;42:587.
- Van Erck E. *Equine Vet J.* 2011;43:18.
- Kelly PG, et al. *Equine Vet J.* 2013;45:700.
- Barakzai SZ, et al. *Equine Vet J.* 2012;44:501.
- Barnett TP, et al. *Equine Vet J.* 2015;47:505.
- Van Erck-Westergren E, et al. *Equine Vet J.* 2013;45:376.

### PALATAL DYSFUNCTION (INSTABILITY, DORSAL DISPLACEMENT OF THE SOFT PALATE)

The soft palate of equids is unique in that it provides an airtight seal between the oropharynx and nasopharynx during respiration, rendering equids obligate nasal breathers. During swallowing the soft palate is transiently displaced dorsally to permit passage of the feed bolus as part of the normal act of deglutition. Abnormalities of the soft palate that result in alteration of its anatomic position (displacement) or inability to maintain normal tone during exercise are associated with impaired respiration and exercise intolerance.<sup>1-3</sup> Displacement of the soft palate other than during deglutition is abnormal and can be intermittent, which is usually associated with exercise, or persistent, which is usually associated with disruption of the nerve supply to the pharynx.

#### Palatal Instability and Intermittent Dorsal Displacement of the Soft Palate During Exercise

Dysfunction of the palate during exercise results in a range of structural abnormalities that reduce the functional area of the rima glottidis (the opening of the larynx) and thus impair ventilation during high-speed exercise. Dysfunction during exercise ranges from palatal instability to

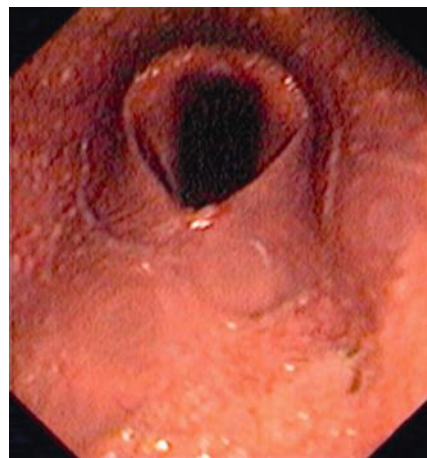

**Fig. 12-18** Endoscopic view of dorsal displacement of the soft palate in a resting Thoroughbred racehorse.

intermittent dorsal displacement of the soft palate.<sup>4</sup> Palatal instability and dorsal displacement of the soft palate cause an expiratory obstruction to airflow through the larynx and pharynx.<sup>4</sup>

Palatal instability is evident as dorsoventral billowing of the soft palate during high speed exercise and flattening of the epiglottis against the palate. Palatal instability is significantly associated with dorsal displacement of the soft palate during exercise.<sup>1</sup> Dorsal displacement of the soft palate is an extreme of palatal instability and results when the caudal border of the soft palate displaces dorsal to the epiglottis (Fig. 12-18). Palatal instability is also associated with axial deviation of the aryepiglottic folds and abnormalities in the conformation of the epiglottis.<sup>1,5</sup>

Estimates of the prevalence of the disease in the wider population are unreliable because of the transient nature of the instability and displacement and the fact that it only occurs during exercise. Additionally, examination of large numbers of horses to determine prevalence in populations of horses has not been performed, with most reports being prevalence rates in horses selected for high-speed endoscopic examination. It is estimated to occur in 0.5% to 1.3% of Thoroughbred racehorses, and of 52 Thoroughbred racehorses examined using overground endoscopy, 25% had dorsal displacement of the soft palate, 40% had axial deviation of the aryepiglottic fold, 35% had vocal fold collapse, and 33% had abnormal arytenoid function.<sup>6</sup> Forty-eight percent of the horses had multiple abnormalities. Nineteen of 57 Thoroughbred yearlings had intermittent dorsal displacement during a single examination using overground endoscopy.<sup>7</sup> Dorsal displacement was detected in 10 of 46 Standardbred racehorses examined using overground endoscopy during racing—these horses were presumably considered healthy before examination.<sup>8</sup> Three

percent of performance horses (nonracing) had dorsal displacement of the soft palate as the sole abnormality during exercise.<sup>9</sup>

Palatal instability and intermittent dorsal displacement of palate are a common part of complex dynamic abnormalities of the upper respiratory tract in harness horses, with 70% of examined horses having a complex disorder.<sup>5</sup> Similarly, 19% of performance horses (nonracing horses) had complex upper respiratory tract abnormalities during exercise.<sup>9</sup>

The cause of intermittent displacement of the soft palate during exercise is unknown, although a number of mechanisms, including palatal myositis, ulcers of the caudal border of the soft palate, caudal retraction of the larynx, and lower respiratory disease, are suggested. Retropharyngeal lymphadenopathy can cause neurogenic paresis of the pharyngeal and palatal muscles, with dorsal displacement of the soft palate the most obvious sign of pharyngeal collapse during exercise. The immediate cause of the displacement is the high turbulent flow and negative intrapharyngeal pressure generated during exercise.<sup>10</sup>

Displacement of the soft palate during strenuous exercise places the soft palate dorsal to the epiglottis, a position in which it impedes flow of air during expiration. Peak expiratory airflow, minute ventilation, tidal volume, and rate of oxygen consumption are all decreased in horses with dorsal displacement of the soft palate, whereas inspiratory flow and breathing rate are not affected.<sup>4</sup>

### Clinical Signs

The clinical signs include exercise intolerance and intermittent production of a gurgling noise during strenuous exercise. **Endoscopic examination** of resting horses usually demonstrates a normal pharynx and larynx. Brief nasal occlusion (30–60 s) that induces displacement of the soft palate (Fig. 12-18), in combination with a history of respiratory noise during exercise, increases the likelihood of the disorder.

Endoscopic examination of affected horses during exercise is the gold standard for diagnosis and reveals signs of palatal instability or dorsal displacement of the soft palate and related abnormalities.

Detection of palatal instability and associated abnormalities is described as follows:<sup>1</sup>

#### *Axial deviation of the aryepiglottic folds:*

Graded as none, mild, moderate or severe.

1. **Mild** ADAF, defined as axial collapse of the aryepiglottic folds with the folds remaining abaxial to the vocal cords.
2. **Moderate** ADAF, defined as axial deviation of the aryepiglottic folds less than halfway between the vocal cord and the midline.

3. **Severe** ADAF, defined as collapse of the aryepiglottic folds more than halfway between the vocal cord and the midline.

*Epiglottic conformation:* Epiglottic conformation is categorized into three groups.

1. Convex epiglottic appearance when the epiglottis maintained a convex shape during exercise; typically only the tip of the epiglottis is in contact with the soft palate.
2. Flattened epiglottis where the epiglottis loses its convex shape and appears to lie flat or slightly concave on the surface of the soft palate, but the tip of the epiglottis remains ventral to the base.
3. A tipped up appearance when the epiglottis has a flattened or concave appearance and during inspiration the tip of the epiglottis is at the same level as or higher than the base of the epiglottis.

*Obstruction of the rima glottidis by the soft palate (soft palate stability):* The stability of the soft palate is graded according to whether the *rima glottidis* is obscured by the billowing soft palate.

1. The soft palate is considered stable when there is no movement or lifting of the soft palate was observed (Fig. 12-19).
2. Palatal instability with no *rima glottidis* obstruction when the soft palate lifts up to the level of the base of epiglottis but the *rima glottidis* is not obscured (Fig. 12-20).
3. Palatal instability with *rima glottidis* obstruction when the soft palate lifts so that the *rima glottidis* becomes obscured (Fig. 12-21).

*Soft palate conformation:* The soft palate of horses with palatal instability is either flaccid, billowing dorsally in front of the

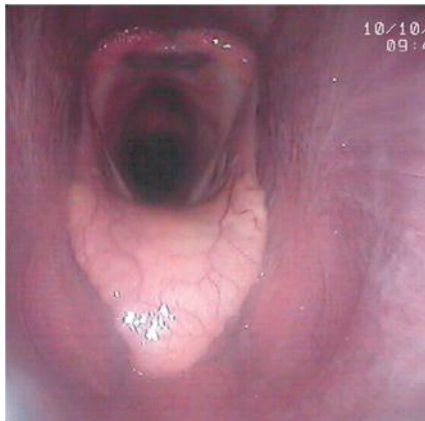

**Fig. 12-19** Normal airway of a horse during exercise. (Reproduced with permission.<sup>1</sup>)

epiglottis or billowing dorsally either side of the epiglottis. The presence or absence of a sling appearance to the ventrolateral pharyngeal walls at the level of the guttural pouch ostia should be noted. The caudal soft palate should be assessed as to whether a concave appearance was present and if so should be graded as absent, small, or large during each of inspiration and expiration.

Radiographic examination of the pharynx reveals a shortened epiglottis (<7 cm) in some affected horses.

### DIFFERENTIAL DIAGNOSIS

Differential diagnoses for exercise intolerance and respiratory noise include **laryngeal hemiplegia, subepiglottic cysts, arytenoid chondritis, and aryepiglottic fold entrapment**. The important differentiating factor is that the noise occurs predominantly during expiration, and it has a more gurgling sound to it than does the noise produced by horses with laryngeal hemiplegia.



**Fig. 12-20** Palatal instability with no *rima glottidis* obstruction. The epiglottis has a flattened appearance, and the soft palate appears flaccid with no concave depression caudally. (Reproduced with permission.<sup>1</sup>)



**Fig. 12-21** Palatal instability with obstruction of the *rima glottidis*. The soft palate is billowing in front of the *rima glottidis*. (Reproduced with permission.<sup>1</sup>)

## Treatment

There is no definitive treatment and no evidence that any one treatment is superior.<sup>11</sup> Usual methods of surgical intervention include augmentation of the epiglottis by injection of polytetrafluoroethylene (Teflon) paste, resection of the caudal edge of the soft palate or sternothyrohyoideus myectomy, and palatal sclerotherapy,<sup>12</sup> although some of these interventions may have deleterious effects on upper airway airflow. A newer surgical technique involves the “laryngeal tie-forward” procedure.<sup>13,14</sup> Reports of success of surgical treatment of the disease are not definitive, in part because horses with the disorder that went untreated are not examined. It is plausible that the response to surgical treatment could be the result of enforced rest rather than the manipulation. Treatment of retropharyngeal lymphadenopathy may be beneficial. Nonsurgical treatment includes the use of antiinflammatory drugs, tongue-ties,<sup>15</sup> a variety of bits, and a laryngochoyoid support apparatus.

## Persistent Dorsal Displacement of the Soft Palate

Persistent dorsal displacement of the soft palate is usually the result of damage to the innervation of the pharyngeal and palatal muscles as a result of the following:

- Guttural pouch mycosis
- Guttural pouch empyema
- Retropharyngeal lymph node abscessation
- Equine protozoal myeloencephalitis
- Otitis media
- Myositis or muscle disease, such as white-muscle disease
- Botulism
- Idiopathic in young foals.<sup>16</sup>

Blockade of the pharyngeal branch of the vagus nerve by injection of local anesthetic causes persistent dorsal displacement of the soft palate, whereas blockade of the hypoglossal and glossopharyngeal nerves does not.

## Clinical Signs

Persistent dorsal displacement of the soft palate causes dysphagia and stertorous respiration. Food material discharges from the nares and there is frequent coughing, probably secondary to the aspiration of feed material. Affected horses may develop aspiration pneumonia. If the condition persists, there is dehydration and weight loss. **Endoscopic examination** of the upper airways reveals dorsal displacement of the soft palate and may reveal other abnormalities, such as guttural pouch mycosis, that provide a cause for the disease.

## Treatment

Treatment should be directed toward resolution of the underlying disease and provision of food and water. It is often necessary to feed affected horses through a nasogastric tube.

## REFERENCES

1. Allen K, et al. *Equine Vet J*. 2013;45:454.
2. Allen K, et al. *Equine Vet J*. 2013;45:350.
3. Courouge-Malblanc A, et al. *Equine Vet J*. 2010;42:246.
4. Barakzai SZ, et al. *Equine Vet Educ*. 2010;22:253.
5. Strand E, et al. *Equine Vet J*. 2012;44:524.
6. Mirazo JE, et al. *J Sth Afr Vet Assoc*. 2015;85.
7. Kelly PG, et al. *Equine Vet J*. 2013;45:700.
8. Priest DT, et al. *Equine Vet J*. 2012;44:529.
9. Davidson EJ, et al. *Equine Vet J*. 2011;43:3.
10. Rakesh V, et al. *Equine Vet J*. 2008;40:272.
11. Allen KJ, et al. *Equine Vet J*. 2012;44:259.
12. Jean D, et al. *Can Vet J*. 2011;52:1203.
13. Ortved KF, et al. *Equine Vet J*. 2010;42:23.
14. Rossignol F, et al. *Vet Surg*. 2012;41:685.
15. Chalmers HJ, et al. *Equine Vet J*. 2013;45:711.
16. Holcombe SJ, et al. *Equine Vet J*. 2012;44:105.

## DISEASES OF THE GUTTURAL POUCHES (AUDITORY TUBE DIVERTICULUM, EUSTACHIAN TUBE DIVERTICULUM)

The guttural pouches are diverticula of the auditory (or eustachian) tubes found in equids and a limited number of other species. The function of the guttural pouch is unclear, although it could have a role in regulation of cerebral blood pressure, swallowing, and hearing. It is unlikely to have a role in brain cooling. Each guttural pouch of an adult horse has a volume of approximately 300 mL and is divided by the stylohyoid bone into lateral and medial compartments.

**The medial compartment** of the guttural pouch contains a number of important structures including the internal carotid artery and glossopharyngeal, hypoglossal, and spinal accessory nerves in addition to branches of the vagus nerve and the cervical sympathetic trunk. Retropharyngeal lymph nodes lie beneath the mucosa of the ventral aspect of the medial compartment, an important factor in the development of guttural pouch empyema.

**In the lateral compartment** the external carotid artery passes along the ventral aspect as do the glossopharyngeal and hypoglossal nerves. Involvement of any of the aforementioned structures is important in the pathogenesis and clinical signs of guttural pouch disease and may result in abnormalities, such as Horner's syndrome, that are not readily recognized as being caused by guttural pouch disease.

The common diseases of the guttural pouch are described here.

## GUTTURAL POUCH EMPYEMA

### ETIOLOGY

Empyema is the accumulation of purulent material in one or both guttural pouches. Initially, the purulent material is liquid, although it is usually viscid, but over time it becomes inspissated and is kneaded into ovoid masses called **chondroids** (Fig. 12-22). Chondroids occur in approximately 20% of



**Fig. 12-22** Chondroids removed at postmortem from the guttural pouch of a horse.

horses with guttural pouch empyema. The condition is most commonly associated with *S. equi* var. *equi* infection and is a recognized sequela to strangles. Therefore any horse with guttural pouch empyema should be isolated and treated as if it were infected with *S. equi* var. *equi* until proven otherwise. The empyema can be associated with other conditions of the guttural pouches, especially if there is impaired drainage of the pouch through the pharyngeal opening of the eustachian tube.

### EPIDEMIOLOGY

The epidemiology, apart from its association with strangles, has not been defined. The disease occurs in all ages of horses, including foals, and all equids, including asses and donkeys. The case-fatality rate is approximately 10%, with one-third of horses having complete resolution of the disease. Guttural pouch empyema occurs in approximately 7% of horses with strangles. The recovery rate for horses with uncomplicated empyema treated appropriately is generally considered to be good, although the presence of chondroids worsens the prognosis.

### PATHOGENESIS

The pathogenesis of guttural pouch empyema is unclear, although when secondary to strangles it is usually attributable to the rupture of abscessed retropharyngeal lymph nodes into the medial compartment. Continued drainage of the abscesses presumably overwhelms the normal drainage and protective mechanisms of the guttural pouch, allowing bacterial colonization, influx of neutrophils, and accumulation of purulent material. Swelling of the mucosa, especially around the opening to the pharynx, impairs drainage and facilitates fluid accumulation in the pouch. The accumulation of material in the pouch causes distension and mechanical interference with swallowing and breathing. Inflammation of the guttural pouch mucosa may involve the nerves that lie beneath it and result in neuritis with subsequent pharyngeal and laryngeal dysfunction and dysphagia.



## CLINICAL FINDINGS

Clinical findings include the following:

- Purulent nasal discharge
- Swelling of the area caudal to the ramus of the mandible and ventral to the ear
- Lymphadenopathy
- Carriage of the head with the nose elevated above its usual position
- Dysphagia and other cranial nerve dysfunction
- Respiratory stertor

The nasal discharge is usually unilateral, as is the disease, intermittent, and white to yellow. Guttural pouch empyema is not usually associated with hemorrhage, although the discharge may be blood tinged. Bilateral disease, and the resultant neuritis and mechanical interference with swallowing and breathing, may cause discharge of feed material from the nostrils, dysphagia, and respiratory stertor.

**Endoscopic examination** of the pharynx reveals drainage of purulent material from the pharyngeal opening of the eustachian tube of the affected side. The guttural pouch contains a variable quantity of purulent material, although in severe cases the quantity of fluid may be sufficient to prevent adequate examination of the pouch with an endoscope.

**Radiographic examinations** demonstrate the presence of radiodense material in the guttural pouch, sometimes the presence of an air-gas interface (fluid line) within the pouch and distension of the pouch with impingement into the nasopharynx. Chondroids are evident as multiple circular radiodensities. Passage of a **catheter** into the guttural pouch via the pharyngeal opening permits aspiration of fluid for cytology and bacterial culture.

## CLINICAL PATHOLOGY

Hematologic examination may reveal evidence of chronic infection, including a mild leukocytosis, hyperproteinemia, and hyperfibrinogenemia. Fluid from the affected guttural pouch contains large numbers of degenerate neutrophils and occasional intracellular and extracellular bacteria. Bacterial culture yields *S. equi* in approximately 30% of cases and *S. zooepidemicus* in approximately 40% of cases.

## NECROPSY FINDINGS

Lesions of guttural pouch empyema include the presence of purulent material in the guttural pouch and inflammation of the mucosa of the affected guttural pouch.

## DIAGNOSTIC CONFIRMATION

Diagnostic confirmation in a horse with clinical signs of guttural pouch disease is achieved by demonstration of purulent

material in the guttural pouch by endoscopic or radiographic examination and examination of the fluid.

### DIFFERENTIAL DIAGNOSIS

Differential diagnosis of guttural pouch empyema includes the following conditions:

- Abscessation of retropharyngeal lymph nodes
- Guttural pouch tympany
- Guttural pouch mycosis

Guttural pouch empyema should also be differentiated from other causes of nasal discharge in horses, including the following:

- Sinusitis
- Recurrent airway obstruction (heaves)
- Pneumonia
- Esophageal obstruction
- Dysphagia of other cause

Infection by *Mycobacterium avium* complex organisms causes nasal discharge and granulomatous lesions in the guttural pouch.

## TREATMENT

The principles of treatment are removal of the purulent material, eradication of infection, reduction of inflammation, relief of respiratory distress, and provision of nutritional support in severely affected horses.<sup>1</sup>

**Removal of purulent material** can be difficult but can be achieved by repeated flushing of the affected guttural pouch. The guttural pouch can be flushed through a catheter (10–20 French, 3.3- to 7-mm male dog urinary catheter) inserted as needed via the nares, or a catheter (polyethylene 240 tubing) with a coiled end inserted via the nares and retained in the pouch for several days. The pouch can also be flushed through the biopsy port of an endoscope inserted into the guttural pouch.

The choice of fluid with which to flush the guttural pouch is arbitrary, but frequently used fluids include normal (isotonic) saline, lactated Ringer's solution, or 1% (v/v) povidone-iodine solution. It is important that the fluid infused into the guttural pouch be non-irritating because introduction of fluids such as hydrogen peroxide or strong solutions of iodine (e.g., 10% v/v povidone iodine) will exacerbate the inflammation of the mucosa and underlying nerves and can actually prolong the course of the disease.<sup>2</sup> The frequency of flushing is initially daily, with reduced frequency as the empyema resolves.

**Infusion of antibiotics** into the guttural pouches is probably without merit although this is debated. Because of the viscous nature of the empyema fluid, it is necessary to infuse large volumes of lavage solution (1–2 L) on consecutive days. It may be necessary to treat for 7 to 10 days. The infusion of **acetylcysteine** (60 mL of a 20% solution) into the pouch after lavage with 1 to 2 L of saline has been reported to be effective in aiding the removal

of purulent material. Removal of **chondroids** usually requires surgery, although dissection and removal of chondroids through the pharyngeal opening has been described. A stone remover inserted through the biopsy channel of the endoscope can be useful for removal of small numbers of chondroids, but is tedious if there are large numbers of them. A rule of thumb is that if the chondroids occupy more than one-third of the volume of the guttural pouch, then removal should be carried out surgically.

**Systemic antimicrobial administration** is recommended for all cases of guttural pouch empyema because of the frequent association of the disease with bacterial infection and especially *S. equi* and *S. zooepidemicus* infection of the retropharyngeal lymph nodes. The antibiotic of choice is **penicillin G** (procaine penicillin G, 20,000 IU/kg intramuscularly every 12 hours for 5–7 days), although a combination of sulfonamide and trimethoprim (15–30 mg/kg orally every 12 hours for 5–7 days) is often used. **Topical application of antimicrobials** into the guttural pouch is probably ineffective because they do not penetrate the infected soft tissues of the pouch and retropharyngeal area.

**NSAIDs** such as flunixin meglumine (1 mg/kg intravenously or orally every 12 hours) or phenylbutazone (2.2 mg/kg intravenously or orally every 12 hours) are used to reduce inflammation and pain. Severely affected horses may require relief of respiratory distress by tracheotomy. Dysphagic horses may need nutritional support, including administration of fluids.

Chronic cases refractory to treatment might require fistulation of the guttural pouch into the pharynx.

## CONTROL

Prevention of guttural pouch empyema is based on a reduction in the frequency and severity of *S. equi* infection in horses (see “Strangles”).

## REFERENCES

1. Perkins JD, et al. *Equine Vet Educ.* 2007;19:356.
2. Sherlock CE, et al. *Equine Vet Educ.* 2007;19:515.

## GUTTURAL POUCH MYCOSIS

### ETIOLOGY

Mycosis of the guttural pouch is caused by infection of the dorsal wall of the medial compartment of the pouch, caudal and medial to the articulation of the stylohyoid bone and the petrous temporal bone. The most common fungi isolated from the lesions are *Aspergillus (Emericella) nidulans*, *Aspergillus fumigatus*, and, rarely, *Penicillium* spp. and *Mucor* spp., although spores of these fungi are present in the guttural pouches of normal horses. Other fungal species isolated include *Fusarium*, *Trichosporon*, *Acremonium*, and *Rhodotorula*.<sup>1</sup>

## EPIDEMIOLOGY

The disease occurs in horses of both sexes and all breeds. Horses are affected at all ages, with the youngest recorded case being a 6-month-old foal. The overall prevalence is low, although precise figures are lacking. Among horses left untreated the case-fatality rate is ~50% to 60%, whereas in those treated medically it is ~45%, and in horses treated surgically the case-fatality rate is 33%.<sup>1,2</sup>

## PATHOGENESIS

The pathogenesis of the disease is unclear, although it is likely that fungal spores gain access to the guttural pouch through the pharyngeal opening. The spores then germinate and proliferate in the mucosa of the dorsal, medial aspect of the medial compartment of the guttural pouch. The location of the lesion is consistent, but the reason for the disease occurring in this particular position is unclear. Factors that predispose to the development of mycotic lesions have not been determined, although it appears unlikely that fungal infection is the initial insult to the mucosa. Invasion of guttural pouch mucosa is followed by invasion of the nerves, arteries, and soft tissues adjacent to it. Invasion of the nerves causes glossopharyngeal, hypoglossal, facial, sympathetic, or vagal dysfunction. Invasion of the internal carotid artery, and occasionally the maxillary or external carotid, causes weakening of the arterial wall and aneurysmal dilatation of the artery, with subsequent rupture and hemorrhage. Death is caused by hemorrhagic shock or, in horses with dysphagia, aspiration pneumonia or starvation.

Guttural pouch mycosis is usually **unilateral**, although in approximately 8% of cases there is erosion of the medial septum and spread of infection into the other pouch. There is no predisposition for either the left or right pouch. Guttural pouch mycosis presents as either **epistaxis** that is not associated with exercise or as **cranial nerve disease**.

## CLINICAL FINDINGS

The clinical signs of guttural pouch mycosis include epistaxis (75% of cases), dysphagia (15%), and purulent nasal discharge (10%).<sup>1-3</sup> **Epistaxis** is usually severe and frequently life-threatening. There is profuse bleeding of bright red blood from both nostrils during an episode, and between episodes there may be a slight, serosanguineous nasal discharge. There are usually several episodes of epistaxis over a period of weeks before the horse dies. Most horses that die of guttural pouch mycosis do so because of hemorrhagic shock.

**Signs of cranial nerve dysfunction** are common in horses with guttural pouch mycosis and can precede or accompany epistaxis.

- **Dysphagia** is the most common sign of cranial nerve disease and is attributable to lesions of the glossopharyngeal and cranial

laryngeal (vagus) nerves. Dysphagic horses may attempt to eat or drink but are unable to move the food bolus from the oral cavity to the esophagus.

- Affected horses frequently have nasal discharge that contains feed material and often develop aspiration pneumonia.
- Lesions of the recurrent laryngeal nerve cause **laryngeal hemiplegia**.
- **Horner's syndrome** (ptosis of the upper eyelid, miosis, enophthalmos, and prolapse of the nictitating membrane) is seen when the lesion involves the cranial cervical ganglion or sympathetic nerve trunk.
- **Facial nerve dysfunction**, evident as drooping of the ear on the affected side, lack of facial expression, inability to close the eyelids, corneal ulceration, and deviation of the muzzle away from the affected side, also occurs.

Signs of cranial nerve and sympathetic trunk dysfunction may resolve with eradication of the infection, but they are frequently permanent.

Guttural pouch mycosis is also associated with **pain** on palpation of the parotid region, **head shyness** and **abnormal head position**. The infection may spread to the atlanto-occipital joint, causing pain on movement of the head, or to the brain, causing encephalitis.<sup>4</sup>

**Endoscopic examination** of the guttural pouch reveals a plaque of dark yellow to black necrotic material in the dorsal aspect of the medial compartment. A sample of the material can be collected through a biopsy port of the endoscope and submitted for culture. The mycotic plaque cannot be easily dislodged by manipulation with biopsy instruments or the end of the endoscope. In cases with ongoing or recent hemorrhage, the presence of large quantities of blood might prevent identification of the mycotic plaque. Both pouches should always be examined because of the occasional occurrence of bilateral disease or extension of the disease through the medial septum. Caution should be exercised in performing endoscopic examination of the guttural pouch of horses with acute or ongoing hemorrhage because of the risk of exacerbating the hemorrhage. These horses are usually referred for urgent surgical intervention.

**Radiographic examination** of the guttural pouches may reveal the presence of a lesion in the appropriate position, but it is frequently unrewarding.

## CLINICAL PATHOLOGY

There are no characteristic findings on the hemogram, nor are there serum biochemical abnormalities. Horses with repeated hemorrhage are often **anemic**. Immunoblot may identify the presence of serum antibodies

specific for *A. fumigatus* in infected horses, although the diagnostic usefulness has not been determined. **Culture** of a sample of the necrotic tissue will frequently yield one of the causative fungi.

## NECROPSY FINDINGS

Lesions of guttural pouch mycosis include the presence of a clearly demarcated, yellowish-brown to black, dry plaque of necrotic tissue in the dorsal aspect of the medial compartment of the guttural pouch. The plaque of tissue is firmly adherent to underlying tissues and may perforate the medial septum and invade the other pouch. The infection may involve the adjacent nerves and blood vessels and spread to soft tissues and bone. Histologic examination reveals the presence of inflammatory cells in nerves and tissues surrounding the gross lesion. There is chromatolysis and degeneration of neurones in affected nerves. The internal carotid artery may have an aneurysmal dilatation, or there may be rupture of the arterial wall without dilatation. There is usually partial thrombosis of the arterial wall.

## DIFFERENTIAL DIAGNOSIS

Differential diagnoses for epistaxis not associated with exercise include **ethmoidal hematoma** or **guttural pouch empyema**, **neoplasia**, **rupture of the longus capitis muscle**, and penetration by a **foreign body**.

## TREATMENT

Treatment of guttural pouch mycosis involves prevention of death from hemorrhage and administration of antifungal agents.

**Prevention of hemorrhage** from the internal carotid or maxillary artery is achieved by surgical ligation, transarterial coil embolization, or occlusion with intra-arterial balloons of one or more of the external carotid, internal carotid, or maxillary artery.<sup>5-8</sup> Because of the high rate of death from hemorrhage in horses with guttural pouch mycosis, some authorities recommend that all horses with the disease have the internal artery ligated or occluded. Medical treatment of horses with hemorrhage secondary to guttural pouch mycosis is rarely successful.

**Administration of antifungal agents** by instillation into the guttural pouch through a catheter or endoscope has been reported, although there is disagreement about the need for such treatment in horses that have had the problematic arteries ligated or occluded. Oral administration of antifungal agents is generally ineffective or prohibitively expensive, although itraconazole (5 mg/kg orally once daily) might be useful. Agents reported to be usefully given by topical administration include enilconazole (60 mL of 33 mg/mL solution once daily for 3

weeks), miconazole (60 mL of 1 mg/mL solution), natamycin, and nystatin. Topical therapy is laborious because it must be continued for weeks and involves placement and maintenance of a catheter in the guttural pouch or instillation of medication by daily endoscopy.

Horses with signs of cranial nerve or sympathetic trunk damage may not recover completely even if cured of the fungal infection because of irreparable damage to the affected nerves. Provision of supportive care, including fluid and nutrient administration to dysphagic horses and administration of antibiotics to prevent or treat aspiration pneumonia, may be indicated.

### CONTROL

There are no recognized effective measures to control or prevent the disease.

### REFERENCES

1. Dobesova O, et al. *Vet Rec.* 2012;171:561.
2. Higuchi T, et al. *J Jap Vet Med Assoc.* 2009;62:39.
3. Archer RM, et al. *NZ Vet J.* 2012;60:203.
4. Hunter B, et al. *Can Vet J.* 2011;52:1339.
5. Delfs KC, et al. *JAVMA.* 2009;235:189.
6. Maninchedda U, et al. *Vet Surg.* 2015;44:322.
7. Munoz J, et al. *Vet Surg.* 2015;44:328.
8. Pollock PJ. *Equine Vet Educ.* 2007;19:522.

## GUTTURAL POUCH TYMPANY

### ETIOLOGY AND EPIDEMIOLOGY

Guttural pouch tympany refers to the gaseous distension of one, rarely both, guttural pouches of young horses. Tympany develops in foals up to 1 year of age but is usually apparent within the first several months of life. Fillies are more commonly affected than are colts by a ratio of 2 to 4:1, and the disease has a heritability of 0.8. The cause is not known, although a polygenic cause has been proposed for Arabians, and genome-wide association studies have identified linked regions in Arabian and Warmblood horses.<sup>1</sup> The presence of a quantitative trait loci on ECA2 in fillies and ECA15 in colts supports the reported sex distribution of the disease.<sup>2</sup>

### CLINICAL FINDINGS

Clinical findings include marked swelling of the parotid region of the affected side, with lesser swelling of the contralateral side. The swelling of the affected side is not painful on palpation and is elastic and compressible. The disease is usually unilateral but can be bilateral. There are stertorous breath sounds in most affected foals as a result of impingement of the distended pouch on the nasopharynx. Respiratory distress can develop. Severely affected foals are dysphagic and develop aspiration pneumonia.

**Endoscopic examination** of the pharynx reveals narrowing of the nasopharynx by the distended guttural pouch. The guttural pouch openings are usually normal. There are usually no detectable abnormalities of the guttural pouches apart from distension.

Radiographic examination demonstrates air-filled pouches, and dorsoventral images permit documentation of which side is affected. There are no characteristic changes in the hemogram or serum biochemical profile.

There are no characteristic lesions, and necropsy examination usually does not demonstrate a cause for the disease.

### TREATMENT

Treatment consists of surgical fenestration of the medial septum allowing drainage of air from the affected pouch into the unaffected side. The usual approach is through Viborg's triangle. Creation of salpingopharyngeal fistulas using transendoscopic laser fenestration is reported in a foal with bilateral disease.<sup>3</sup> The prognosis for long-term resolution after surgery is approximately 60%.

A nonsurgical option for treatment involves placement of Foley catheters (22 or 24 French) into the guttural pouches. Placement is achieved by endoscopic guidance via the ipsilateral nostril and resulted in resolution of the tympany in 5 of 8 foals over a period of weeks to months. The catheters are sutured in position and remain in place for weeks.<sup>4</sup>

### REFERENCES

1. Metzger J, et al. *PLoS ONE.* 2012;7.
2. Zeitz A, et al. *Anim Genet.* 2009;40:917.
3. Krebs W, et al. *Equine Vet Educ.* 2007;19:419.
4. Caston SS, et al. *Equine Vet Educ.* 2015;27:28.

## OTHER GUTTURAL POUCH DISEASES

**Rupture of the longus capitis muscle** or avulsion of its insertion on the basisphenoid bone causes epistaxis and is usually associated with trauma to the head, such as is caused by rearing and falling over backward. **Endoscopic examination** reveals the following:

- Compression of the nasopharynx that is asymmetric
- Blood in the guttural pouch
- Submucosal hemorrhage and swelling of the medial aspect of the medial compartment of the guttural pouch

**Radiographic examination** reveals ventral deviation of the dorsal pharynx and loss of the usual radiolucency associated with the guttural pouch (Fig. 12-23). **Treatment is conservative** and consists of supportive care, monitoring the hematocrit, and administration of broad-spectrum antibiotics if there is concern of the development of secondary infection. The prognosis for complete recovery is guarded.

**Traumatic injury** to the guttural pouch can occur during attempts to pass a nasogastric tube.<sup>1</sup> Clinical signs include swelling of the throatlatch area, pain on palpation, crepitus, and pain on swallowing. Endoscopic and radiographic examination is diagnostic. Treatment is supportive, including administration of antimicrobials and analgesics and ensuring maintenance of hydration and nutrition.

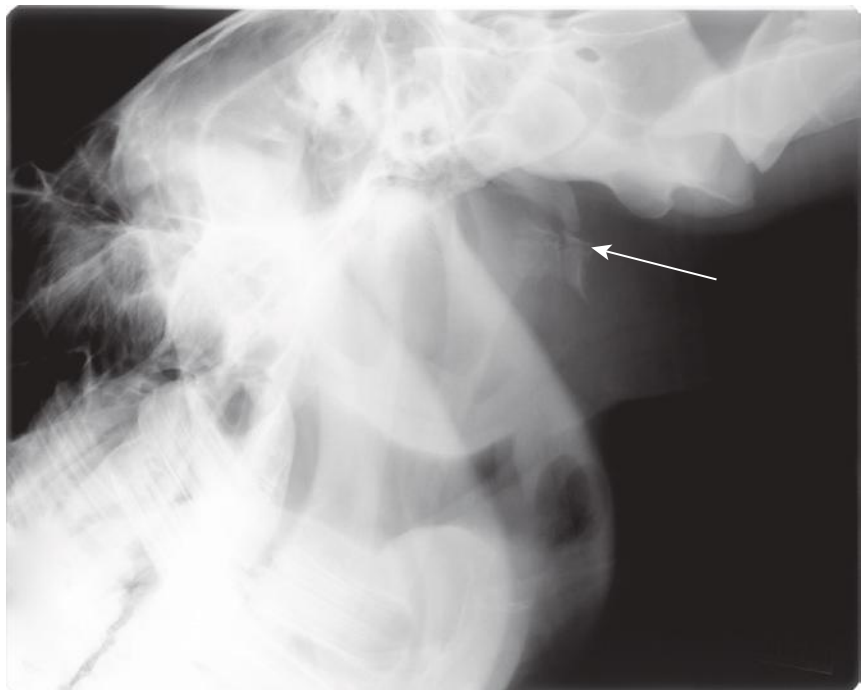

**Fig. 12-23** Lateral radiograph of the head of a horse with rupture of the longus capitis muscle after rearing and falling over backward. There is loss of radiolucency of the guttural pouches and evidence of an avulsion fracture of the basisphenoid bone (white arrow).



Various neoplasms have been recorded as involving the guttural pouches. The presenting signs are swelling of the parotid region, epistaxis, dysphagia, or signs of cranial nerve disease. Neoplasms include melanoma, lymphosarcoma, hemangiosarcoma, squamous-cell carcinoma, and sarcoma. Diagnosis is made by physical, endoscopic, and radiographic examination and biopsy. The prognosis is very poor to hopeless.

## REFERENCE

- Gillen A, et al. *Equine Vet Educ.* 2015;27:398.

## DISEASES OF THE EPIGLOTTIS AND ARYTENOIDS

### Aryepiglottic Fold Entrapment (Epiglottic Entrapment)

Entrapment of the epiglottis in the fold of tissue that extends from the arytenoid cartilage to the ventrolateral aspect of the epiglottis causes exercise intolerance and respiratory noise during exercise in racehorses. The disorder occurs in both young and mature racehorses, and it is found in approximately 1% of Thoroughbred racehorses. The entrapment is often detected during rhinolaryngoscopic examination of racehorses, although it might not be the cause of poor performance. The condition occurs in nonracehorses (13 cases in 23 adult horses with epiglottic disease).<sup>1</sup> The presence of aryepiglottic fold entrapment causes a predominantly expiratory obstruction to airflow across the larynx during exercise. The interference with airflow, if any, does not appreciably impair performance in all horses.

### Clinical Signs

Clinical signs are of exercise intolerance and respiratory noise during exercise. Acute cases can be associated with epiglottitis, whereas chronic cases are usually an incidental finding during endoscopic examination of the upper airway.

**Endoscopic examination** of the upper airway reveals the border of the epiglottis to be obscured by the aryepiglottic folds (Fig. 12-24). Normally, the serrated margin of the epiglottis and dorsal blood vessels extending to the lateral margins of the epiglottis are readily apparent, but when the epiglottis is entrapped, these features are no longer visible. Because of the frequently intermittent nature of the entrapment, the horse should be examined on several occasions and preferably immediately after strenuous exercise. Radiography of the pharynx reveals the entrapped epiglottis.

### Treatment

Treatment consists of surgical revision of the aryepiglottic fold.<sup>2,3</sup> Surgery is reported to have both a high success rate and,<sup>3</sup> in some reports, a complication rate for surgical correction of 60%, indicating that careful

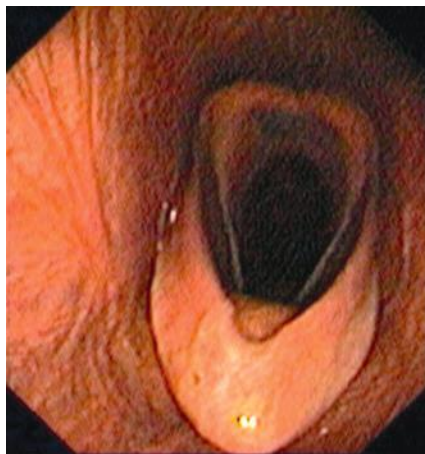

**Fig. 12-24** Endoscopic view of the pharynx and larynx of a horse with entrapment of the epiglottis by the aryepiglottic folds.

consideration should be given to not attempting surgical repair, especially in animals performing to expectation. Entrapment associated with acute epiglottitis should include administration of antimicrobials and anti-inflammatory agents to resolve the epiglottitis.

### Epiglottic Retroversion During Exercise

Retroversion of the epiglottis occurs during exercise in horses. The condition is rare and is associated with poor performance and an inspiratory “grunt” during exercise. Endoscopic examination at rest might reveal that the tip of the epiglottis is pointed more dorsal than normal, but this finding is not conclusive evidence of the disorder. Endoscopy during high-speed exercise demonstrates that the tip of the epiglottis is pointed dorsally or, in severe cases, points caudally through the rima glottidis. Retroversion occurs only during inspiration. Poll flexion during exercise exacerbates the condition. Frequency of retroversion increases as the intensity of exercise increases. There is no definitive treatment, and the prognosis for successful return to athletic performance is poor.<sup>4</sup>

### Epiglottitis

Epiglottitis is usually a disease of racehorses, although animals of any age can be affected. The clinical signs are exercise intolerance, respiratory noise, and coughing. The disease can readily be mistaken for epiglottic entrapment. The epiglottis is thickened and ulcerated, and these changes are apparent on endoscopic examination. Treatment includes topical application of a mixture of nitrofurazone, dimethyl sulfoxide, glycerin, and prednisolone, and systemic administration of anti-inflammatory drugs. The prognosis for recovery is excellent.

### Subepiglottic Cysts

Fluid-filled cysts in the subepiglottic, dorsal pharyngeal, or soft palate tissues cause

exercise intolerance and abnormal respiratory noise in exercising adult horses and mild dysphagia, chronic cough, and nasal discharge in foals. Most cysts are asymptomatic.<sup>5</sup> The cysts are usually embryonic remnants, although cysts may be acquired in adult horses by obstruction or inflammation of mucous glands. Endoscopic examination of the upper airway reveals the presence of smooth-walled cysts. Subepiglottic cysts may only be apparent on careful examination of the epiglottis, although most will cause the epiglottis to assume a more upright posture than is normal. Treatment is surgical removal or intralesion injection with formalin.<sup>6</sup>

### Arytenoid Chondritis

Arytenoid chondritis is a progressive disease of the arytenoid cartilages in which there is distortion of the cartilage with consequent partial occlusion of the lumen of the larynx. The cause of the disease is not known, but it is most common in racehorses in heavy work. Distortion and swelling of the cartilage, combined with restricted abduction, increase resistance to airflow through the larynx and cause respiratory noise during exercise and exercise intolerance. In severe cases respiratory noise and increased respiratory effort are apparent at rest. The disease can occur as a progression of idiopathic mucosal ulceration of the axial aspect of the arytenoid cartilages.

**Endoscopic examination** reveals the cartilage to be enlarged and distorted, and there may be luminal projections of cartilage and granulation tissue. In less severe cases there is mild swelling of the cartilage and ulceration of the mucosa covering the cartilage. Bilateral disease is uncommon. Ultrasonographic examination is useful in determining the extent of the lesion.<sup>7</sup> Affect cartilages are increased in size and echogenicity and have an abnormal contour. The cartilage contains areas of necrosis, dystrophic mineralization, and granulation tissue.

### Treatment

Treatment requires surgical removal of the affected cartilage, although progression of the disease can be achieved in horses with mild lesions by administration of antimicrobials and anti-inflammatory drugs.

The disease also occurs in calves, in which it can be treated by partial arytenoidectomy.<sup>8</sup>

### Mucosal Lesions of the Arytenoid Cartilages

Lesions of the mucosa of the axial aspect of the arytenoid cartilages are observed in Thoroughbred racehorses.<sup>9</sup> The condition occurs in approximately 2.5% of Thoroughbred racehorses and 0.6% of Thoroughbred yearlings. The pathogenesis is unknown. The disorder is recognized during endoscopic examination of the horses for other reasons

(before sale, examination for exercise-induced pulmonary hemorrhage). Endoscopic appearance of the lesion is that of a roughly circular lesion of the mucosa of the axial surface of the arytenoid cartilage, with or without visual evidence of inflammation, and without deformity of the underlying cartilage. The lesions can progress to arytenoid chondritis, although most do not.<sup>9</sup> Because of the risk of progression, medical therapy, including systemic or local administration of antimicrobial and antiinflammatory drugs, is indicated. The prognosis for full recovery is excellent.

### Axial Deviation of the Aryepiglottic Folds

Axial deviation of the aryepiglottic folds is one of the most common abnormalities detected during laryngoscopic examination of horses running on a treadmill and is part of the pharyngeal instability complex of diseases in horses.<sup>10-14</sup> The disorder can only be detected in horses by endoscopic examination of the larynx while the horse is performing strenuous exercise. Collapse of the axial portion of the aryepiglottic folds causes obstruction of the laryngeal airway during inspiration. Treatment is symptomatic.

### Retropharyngeal Lymphadenopathy

Lymphadenopathy of the retropharyngeal lymph nodes is usually associated with *S. equi* var. *equi* infection and is often a sequela to strangles (see “Strangles” in this chapter).<sup>15</sup> Shedding of *S. equi* from clinically inapparent retropharyngeal lymph node abscesses is an important source of new infections in horse barns. Retropharyngeal lymphadenopathy is also caused by trauma to the pharynx, brachial cysts remnants,<sup>16</sup> neoplasia (predominantly lymphosarcoma),<sup>17</sup> and infection by *Actinomyces* spp.<sup>18</sup> Enlargement of the retropharyngeal lymph nodes compresses the nasopharynx, increases resistance to airflow, and may impair swallowing (Fig. 12-25).

### Clinical Signs

Clinical signs are swelling of the parotid region, although this may be slight even in horses with marked respiratory distress, pain on palpation of the parotid region, stertorous respiratory noise, respiratory distress, and dysphagia evident as food material discharging from the nostrils. Affected horses are frequently depressed, inappetent, and pyrexic.

**Endoscopic examination** of the upper airway will reveal ventral displacement of the dorsal wall to the pharynx and narrowing of the nasopharynx. There may be deviation of the larynx to the side away from the mass. Guttural pouch empyema often coexists with retropharyngeal lymph node infection, and the guttural pouches should be examined. Radiography will reveal the presence of a soft tissue density in the retropharyngeal region

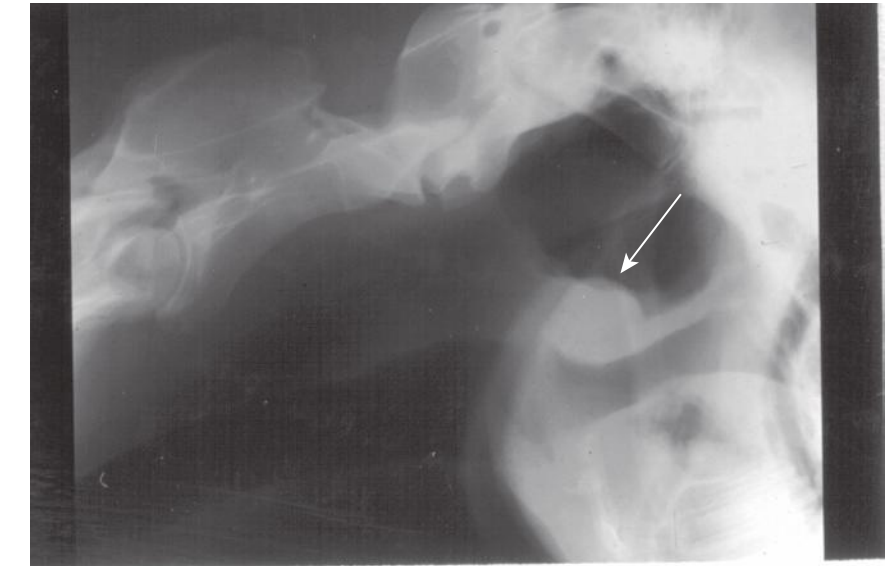

**Fig. 12-25** Lateral radiograph of the head of a yearling horse demonstrating presence of a retropharyngeal mass (identified by white arrow).

with compression of the guttural pouches and pharynx. Hematologic examination often demonstrates a mature neutrophilia and hyperfibrinogenemia.

### Treatment

Treatment consists of administration of penicillin (procaine penicillin 20,000 IU/kg, intramuscularly every 12 hours) until signs of the disease resolve, followed by administration of a combination of sulfonamide and trimethoprim (15-30 mg/kg orally every 12 hours for 7-14 days). Administration of anti-inflammatory drugs such as **phenylbutazone** (2.2 mg/kg intravenously or orally every 12 hours) is important in reducing inflammation and swelling and thereby allowing the horse to eat and drink. Horses that have severe respiratory distress may require a tracheotomy. Dysphagic horses might require fluid and nutritional support. Surgical drainage of the abscess is difficult and should be reserved for cases with large, cavitating lesions evident on radiographic or ultrasonographic examination.

Control consists of preventing infection of horses by *S. equi* var. *equi* and adequate treatment of horses with strangles.

### REFERENCES

- Aitken MR, et al. *JAVMA*. 2011;238:1634.
- Russell T, et al. *Vet Rec*. 2007;161:187.
- Coleridge MOD, et al. *Vet Surg*. 2015;44:348.
- Terron-Canedo N, et al. *Equine Vet Educ*. 2013;25:565.
- Salz RO, et al. *Equine Vet Educ*. 2013;25:403.
- Dougherty SS, et al. *JAVMA*. 2008;233:463.
- Garrett KS, et al. *Equine Vet J*. 2013;45:598.
- Nichols S, et al. *JAVMA*. 2009;235:420.
- Smith RL, et al. *NZ Vet J*. 2006;54:173.
- Barakzai SZ, et al. *Equine Vet J*. 2012;44:501.
- Mirazo JE, et al. *J Sth Afr Vet Assoc*. 2015;85.
- Pollock PJ, et al. *Equine Vet J*. 2009;41:354.

- Strand E, et al. *Equine Vet J*. 2012;44:518.
- Mirazo JE, et al. *J Sth Afr Vet Assoc*. 2014;85:Art. #1140.
- Whelchel DD, et al. *Equine Vet Educ*. 2009;21:135.
- Nolen-Walston RD, et al. *Equine Vet J*. 2009;41:918.
- Marques FJ, et al. *Compendium (Yardley, PA)*. 2012;34:E5.
- Fielding CL, et al. *Vet Rec*. 2008;162:18.

## RECURRENT LARYNGEAL NEUROPATHY (ROARERS)

Neuropathy of the recurrent laryngeal nerve (usually the left one) causes paresis or paralysis of the cricoarytenoid muscle and failure of abduction of the arytenoid cartilages. This is apparent during exercise as obstruction of the upper airway and abnormal respiratory noise during heavy exercise. The idiopathic disease is referred to as recurrent laryngeal neuropathy, thereby describing the lesion, whereas other causes of laryngeal hemiplegia are referred to more specifically.

### ETIOLOGY

The cause of laryngeal hemiplegia is degeneration of the recurrent laryngeal nerve with subsequent neurogenic atrophy of the cricoarytenoid dorsalis and other intrinsic muscles of the larynx. The etiology of **neural degeneration** is unknown, but the pathologic changes are typical of a distal axonopathy. There is evidence of a genetic component to recurrent laryngeal neuropathy, with a genome-wide association study in Thoroughbreds demonstrating a major quantitative trait locus near a known locus for body height and explaining 60% of the recurrent laryngeal neuropathy phenotype.<sup>1</sup> This study follows on from two others that in total identified three significant loci (ECA10, 21, and 31) in Warmblood horses.<sup>2,3</sup> To date,

no studies have identified it as a simple mendelian trait.<sup>4</sup>

The disease is usually idiopathic, but occasional cases are caused by guttural pouch mycosis or inadvertent perivascular injection of irritant material, such as phenylbutazone, around the jugular vein and vagosympathetic trunk. **Bilateral laryngeal paralysis** is usually associated with intoxication (organophosphate, haloxon), trauma from endotracheal intubation during general anesthesia, or as a complication of hepatic encephalopathy.<sup>5</sup>

## EPIDEMIOLOGY

### Prevalence

The disease affects large horses more commonly than ponies, and it is commonly recognized in draft horses, Thoroughbreds, Standardbreds, Warmbloods, and other breeds of large horse. The **prevalence** of laryngeal hemiplegia in Thoroughbred horses in training is between 1.8% and 13% depending, among other factors, on the criteria used to diagnose the condition. Among apparently normal Thoroughbred horses examined after racing, grade 4 laryngeal hemiplegia was detected in 0.3% of 744 horses, grade 3 in 0.1%, and grade 2 in 1.1%. Male horses over 160 cm tall are at most risk of developing the disease. There is evidence of a **familial** distribution of the disease, with offspring of affected parents being more frequently affected (61%) than adult offspring of unaffected parents (40%).

## PATHOGENESIS

Axonal degeneration causes preferential atrophy of the adductor muscles of the larynx, although both the adductor (dorsal cricoarytenoid muscle) and adductor (lateral cricoarytenoid muscle) are involved. Fiber-type grouping of laryngeal muscles, evidence of recurrent laryngeal neuropathy, is present in draft foals as young as 2 weeks of age, indicating an early onset of the disease. The disease is progressive in some horses.

Compromised function of the adductor muscles results in **partial occlusion of the larynx** by the arytenoid cartilage and vocal fold during inspiration. The obstruction is most severe when airflow rates through the larynx are large, such as during strenuous exercise. **Laryngeal obstruction** increases the work of breathing, decreases the maximal rate of oxygen consumption, and exacerbates the hypoxemia and hypercarbia normally associated with strenuous exercise by horses. These effects result in a severe limitation to athletic capacity and performance.

## CLINICAL FINDINGS

Clinical findings include exercise intolerance and production of a whistling or roaring noise during strenuous exercise. The disease can be detected by analysis of respiratory noise.

**Endoscopic** examination of the upper airway provides the definitive diagnosis in most cases. Examination of the larynx is performed with the horse at rest and the position and movement of the arytenoid cartilages assessed. Laryngeal function can also be observed during swallowing, brief (30–60 s) bilateral nasal occlusion, and during and after exercise.

The severity of the disease is graded I through IV with five subgrades; there are therefore seven grades of abnormality:

- **Grade I** is normal, there being synchronous, full abduction and adduction of both arytenoid cartilages.
- **Grade II** presents as weakness of the adductors evident as asynchronous movement and fluttering of the arytenoid cartilage during inspiration and expiration but with full abduction during swallowing or nasal occlusion.
  - *Subgrade 1:* Transient asynchrony, flutter, or delayed movements.
  - *Subgrade:* Asymmetry of the rima glottidis as a result of reduced mobility of the affected arytenoid cartilage and vocal fold but with full symmetric abduction achieved and maintained after swallowing or nasal occlusion.
- **Grade III** has asynchronous movement of the arytenoid cartilage during inspiration or expiration; full abduction is not achieved during swallowing or nasal occlusion.
  - *Subgrade 1:* Asymmetry of the rima glottidis as a result of reduced mobility of the affected arytenoid cartilage and vocal fold but with full symmetric abduction achieved but not maintained after swallowing or nasal occlusion.
  - *Subgrade 2:* Obvious arytenoid abductor deficit and arytenoid asymmetry. Full abduction is never achieved.
  - *Subgrade 3:* Marked but not total arytenoid deficit and asymmetry with little arytenoid movement. Full abduction is never achieved.
- **Grade IV** implies marked asymmetry of the larynx at rest and no substantial movement of the arytenoid cartilage during respiration swallowing or nasal occlusion.

Intraobserver agreement (two observers, 80 recordings) of the same recording of an endoscopic examination on standing draft horses was 76% when the recording was graded twice, and it is thus regarded as excellent.<sup>6</sup> Two observers assigned the same grade and subgrade for 63% of recordings differed by one grade for 32% of recordings and by two grades in 5% of recordings, which is assessed as good agreement. Repeatability of

examination in the same horse was low when the same horse was examined twice, 24 to 48 hours apart. Forty-two percent of horses had the same grade assigned on both examinations, 42% differed by one grade, 17% received an improved grade (ie, less severe) and 26% a worse grade, and 13% of horses differed by two grades. One horse improved by four grades.

Endoscopic examination during **strenuous exercise on a treadmill or over ground** can be beneficial in determining the severity of the disease or detecting disease of lesser severity.<sup>7–10</sup> Horses with early or mild degeneration of the recurrent laryngeal nerve and associated laryngeal musculature can have normal laryngeal function at rest. However, the loss of muscle function becomes apparent during exercise, when the laryngeal muscles of affected animals fatigue more rapidly than do those of normal animals, with the result that laryngeal dysfunction can become apparent during or immediately after exercise. Endoscopic examination during exercise is useful in differentiating the disease from **axial deviation of the aryepiglottic folds**.

Ultrasonographic examination of the larynx and musculature is both sensitive (~90%) and specific (~98%) for detection of atrophy of the cricoarytenoid muscle or abnormal laryngeal function.<sup>11–13</sup>

There are no characteristic changes in the hemogram or in serum biochemical variables in resting horses. During exercise there is a marked exacerbation of the normal exercise-induced hypoxemia and the development of hypercapnia in affected horses.

## NECROPSY FINDINGS

Lesions are confined to an axonopathy of the recurrent laryngeal nerves and neurogenic muscle atrophy of the intrinsic muscles of the larynx.<sup>14,15</sup> A technique for ultrasound guided biopsy of the cricoarytenoid lateralis muscle is described.<sup>16</sup>

## DIAGNOSTIC CONFIRMATION

Diagnostic confirmation is achieved by endoscopic examination of the larynx.

### DIFFERENTIAL DIAGNOSIS

Differential diagnoses of exercise intolerance and exercise-induced respiratory noise include the following:

- Dorsal displacement of the soft palate
- Subepiglottic cysts
- Arytenoid chondritis
- Aryepiglottic fold entrapment
- Axial deviation of the aryepiglottic folds

## TREATMENT

Treatment requires a prosthetic laryngoplasty with or without ventriculectomy.<sup>17</sup> An alternative to prosthetic laryngoplasty is implantation of a nerve-pedicle graft into the



larynx. Effectiveness of the procedure is assessed by the return of the horse to its previous level of athletic activity.<sup>18-21</sup>

The disease is not life-threatening, and horses that are not required to work strenuously or in which respiratory noise associated with mild exercise is not bothersome to the rider may not require surgery. A complication of surgical repair that includes prosthetic laryngoplasty is that horses can no longer close the glottis and therefore do not have an effective cough. This could be the cause of tracheal inflammation and accumulation of debris in the trachea of these horses.

## REFERENCES

1. Boyko AR, et al. *BMC Genomics*. 2014;15.
2. Dupuis MC, et al. *Anim Genet*. 2013;44:206.
3. Dupuis M-C, et al. *Mamm Genome*. 2011;22:613.
4. Gerber V, et al. *Equine Vet J*. 2015;47:390.
5. Hughes KJ, et al. *Vet Rec*. 2009;164:142.
6. Perkins JD, et al. *Equine Vet J*. 2009;41:342.
7. Kelly PG, et al. *Equine Vet J*. 2013;45:700.
8. Lane JG, et al. *Equine Vet J*. 2006;38:401.
9. Allen KJ, et al. *Equine Vet J*. 2010;42:186.
10. Barakzai SZ, et al. *Equine Vet J*. 2012;44:501.
11. Garrett KS, et al. *Equine Vet J*. 2011;43:365.
12. Chalmers HJ, et al. *Vet Radiol Ultra*. 2012;53:660.
13. Karlheim B, et al. *Equine Vet Educ*. 2015;27:86.
14. Hahn CN, et al. *Equine Vet J*. 2008;40:666.
15. Rhee HS, et al. *J Histochem Cytochem*. 2009;57:787.
16. O'Neill HD, et al. *Equine Vet J*. 2014;46:244.
17. Cramp P, et al. *Equine Vet Educ*. 2012;24:307.
18. Barakzai SZ, et al. *Vet Surg*. 2009;38:941.
19. Witte TH, et al. *Equine Vet J*. 2009;41:70.
20. Barnett TP, et al. *Equine Vet J*. 2013;45:593.
21. Raffetto JA, et al. *Equine Vet J*. 2015;47:60.

## EQUINE PLEUROPNEUMONIA (PLEURITIS, PLEURISY)

### ETIOLOGY

Pleuropneumonia of horses is almost always associated with bacterial infection of the lungs, pleura, and pleural fluid. The most common bacterial isolates from tracheal aspirates or pleural fluid of horses with pleuropneumonia are as follows:

- **Aerobes or facultative anaerobes**, including *S. equi* var. *zooepidemicus*, *Pasteurella* spp., *Actinobacillus* spp., Enterobacteriaceae (particularly *E. coli*, *Klebsiella* spp., and *Enterobacter* spp.), *Pseudomonas* spp., *Staphylococcus* spp., and *Bordetella* spp. *S. zooepidemicus* is isolated from over 60%, Enterobacteriaceae from approximately 40% of cases, and *Pasteurella/Actinobacillus* spp. from approximately one-third of cases. *Corynebacterium pseudotuberculosis* can cause septic pericarditis and pleuritis, although this is an uncommon disease. *Mycoplasma felis* is an unusual cause of pleuritis in horses. *R. equi*, usually a cause of pneumonia in foals, rarely causes pleuropneumonia in immunocompetent adult horses.

- **Obligate anaerobes**, including *Bacteroides* spp. (including *B. fragilis* and *B. tectum*), *Prevotella* spp., *Clostridium* spp., *Eubacterium*, *Prevotella* spp., *Peptostreptococcus* spp., *Fusobacterium* spp., and *Bacteroides* sp. are isolated from approximately 20%, *Clostridium* sp. from 10%, and *Eubacterium* sp. from 6% of horses with pleuropneumonia. Obligate anaerobes are cultured from approximately 70% of horses with severe pneumonia.

### SYNOPSIS

**Etiology** Most infections are polymicrobial combinations of *S. equi* var. *zooepidemicus*, *Actinobacillus* sp., *Pasteurella* sp., Enterobacteriaceae, and anaerobic bacteria, including *Bacillus fragilis*. Disease attributable to infection by a single bacterial species occurs. Other causes are *Mycoplasma felis*, penetrating chest wounds and esophageal perforation.

**Epidemiology** Recent prolonged transport, racing, viral respiratory disease and anesthesia increase the likelihood of a horse developing pleuropneumonia. Aspiration of feed material secondary to esophageal obstruction or dysphagia also causes the disease.

**Pathogenesis** Overwhelming challenge of oropharyngeal bacteria or reduced pulmonary defense mechanisms allow proliferation of bacteria in small airways, alveoli, and lung parenchyma. Subsequent inflammation and further spread of infection involve the visceral pleura. Impaired drainage of pleural fluid and increased permeability of pleural capillaries cause the accumulation of excessive pleural fluid, which then becomes infected. Fibrin deposition and necrosis of lung causes formation of intrathoracic abscesses. Death is attributable to sepsis and respiratory failure.

**Clinical signs** Fever, depression, anorexia, respiratory distress, cough, nasal discharge, exercise intolerance, reduced breath sounds on thoracic auscultation, and presence of pleural fluid and pneumonia on thoracic radiology and ultrasonography. Chronic disease is characterized by weight loss, increased respiratory rate, nasal discharge, and exercise intolerance.

**Clinical pathology** Leukocytosis, hyperfibrinogenemia, hypoalbuminemia, hyperglobulinemia. Pleural fluid leukocytosis, hyperproteinemia and presence of intra- and extracellular bacteria. Similar findings in tracheal aspirate.

**Diagnostic confirmation** Clinical signs, examination of pleural fluid.

**Treatment** Systemic administration of broad-spectrum antimicrobials for weeks to

months, chronic effective drainage of the pleural space, infusion of recombinant tissue plasminogen activator (tenecteplase) into pleural space, and nursing care.

**Prevention** Reduce exposure of horses to risk factors including prolonged transportation and viral respiratory disease.

Equine pleuropneumonia is associated with **polymicrobial infections** of the lungs and pleura in 50% to 80% of cases, although disease associated with infection with a single bacterial species occurs. Infections with a single bacterial species are usually by *S. zooepidemicus*, *Pasteurella/Actinobacillus* sp. or one of the Enterobacteriaceae, whereas almost all infections by anaerobes are polymicrobial. Infection by obligate anaerobic bacteria is associated with disease of more than 5 to 7 days' duration.

Pleuritis is also caused by penetrating chest wounds, perforated esophagus, and tracheobronchial foreign bodies.<sup>1,2</sup> **Cryptococcus spp** can cause the disease in horses and other species. Other diseases, such as congestive heart failure or neoplasia, can cause pleural effusion without inflammation.

### EPIDEMIOLOGY

Pleuropneumonia occurs worldwide in horses of all ages and both sexes, although most cases occur in horses more than 1 and less than 5 years of age. Estimates of the incidence or prevalence of the disease are not available. The **case-fatality rate** varies between 5% and 65%, with the higher rate reported in earlier studies.

### Risk Factors

The risk of a horse developing pleuropneumonia is increased factorially in the following cases:

- By a factor of 4 if the horse is a Thoroughbred racehorse
- By a factor of 14 if the horse was transported more than 500 miles in the previous week
- By a factor of 10 if the horse has a recent (< 2 week) history of viral respiratory tract disease or exposure to a horse with such disease
- By a factor of 4 if the horse has raced within the previous 48 hours

Other suggested risk factors include general anesthesia, surgery, disorders of the upper airway, exercise-induced pulmonary hemorrhage, esophageal obstruction, and dysphagia.

### PATHOGENESIS

Bacterial pleuropneumonia develops following bacterial colonization of the lungs with subsequent extension of infection to the visceral pleura and pleural space. Organisms initially colonizing the pulmonary

parenchyma and pleural space are those normally present in the upper airway, oral cavity, and pharynx, with subsequent infection by Enterobacteriaceae and obligate anaerobic bacteria.

**Bacterial colonization** and infection of the lower airway is attributable to either massive challenge or a reduction in the efficacy of normal pulmonary defense mechanisms or a combination of these factors. **Confinement** with the head elevated for 12 to 24 hours, such as occurs during transport of horses, decreases mucociliary transport and increases the number of bacteria and inflammatory cells in the lower respiratory tract and probably contributes to the development of lower respiratory tract disease. **Transport** alters the composition of pulmonary surfactant, which can impair the activity of pulmonary defense mechanisms, allowing otherwise innocuous bacterial contamination to cause disease.

Overwhelming bacterial challenge can occur in dysphagic horses, horses with esophageal obstruction, and racehorses that inhale large quantities of track debris while racing. A single bout of **exercise** on a treadmill markedly increases bacterial contamination of the lower airways. Viral respiratory disease can decrease the efficacy of normal lung defense mechanisms.

**Bacterial multiplication** in pulmonary parenchyma is associated with the influx of inflammatory cells, principally neutrophils, tissue destruction, and accumulation of cell debris in alveoli and airways. Infection spreads both through tissue and via airways. Extension of inflammation, and later infection, to the visceral pleura and subsequently pleural space causes accumulation of excess fluid within the pleural space. Pleural fluid accumulates because of a combination of excessive production of fluid by damaged pleural capillaries (exudation) and impaired reabsorption of pleural fluid by thoracic lymphatics.

**Accumulation of parapneumonic pleural effusions** has been arbitrarily divided into three stages: exudative, fibrinopurulent, and organizational:

1. The **exudative stage** is characterized by the accumulation of sterile, protein-rich fluid in the pleural space as a result of increased pleural capillary permeability.
2. Bacterial invasion and proliferation, further accumulation of fluid, and deposition of fibrin in pleural fluid and on pleural surfaces occurs if the disease does not resolve rapidly and is referred to as the **fibrinopurulent stage**.
3. The **organizational stage** is associated with continued fibrin deposition, restriction of lung expansion, and persistence of bacteria. The pleural fluid contains much cellular debris and bronchopleural fistulas may develop. These categorizations are useful diagnostically and therapeutically.

## CLINICAL SIGNS OF ACUTE DISEASE

The acute disease is characterized by the sudden onset of a combination of fever, depression, inappetence, cough, exercise intolerance, respiratory distress, and nasal discharge.<sup>3</sup> The respiratory rate is usually elevated, as is the heart rate.

**Nasal discharge** ranges from serosanguineous to mucopurulent, is usually present in both nares and is exacerbated when the horse lowers its head. The **breath may be malodorous**, although this is a more common finding in horses with subacute to chronic disease. Horses with pleuritis are often reluctant to cough, and if they do, the cough is usually soft and gentle. Ventral edema occurs in approximately 50% of horses with pleuropneumonia.

The horse may appear **reluctant to move** or may exhibit signs of chest pain, including reluctance to move, pawing, and anxious expression, which may be mistaken for colic, laminitis, or rhabdomyolysis. Affected horses often stand with the elbows abducted.

**Auscultation** of the thorax reveals attenuation of normal breath sounds in the ventral thorax in horses with significant accumulation of pleural fluid. However, the attenuation of normal breath sounds may be mild and difficult to detect, especially in large or fat horses or in horses in which there is only slight accumulation of pleural fluid. Auscultation of the thorax with the horse's respiratory rate and tidal volume increased by having it breathe with a large airtight bag over its nostrils may reveal crackles and wheezes in the dorsal lung fields and attenuation of the breath sounds ventrally. There is often fluid in the trachea detectable as a tracheal rattle.

**Percussion** of the chest wall may reveal a clear line of demarcation, below which the normal resonant sounds are muffled. This line of demarcation represents the dorsal limit of the pleural fluid. Both lung fields should be examined to identify localized areas of consolidation. Careful percussion of the thorax is a cheap and effective way of identifying the presence and extent of pleural fluid accumulation.

**Ultrasonographic examination** of the thorax is a very sensitive technique with which to detect accumulation of pleural fluid, determine the character of the fluid including the presence of accumulations of fibrin<sup>4</sup>, identify localized areas of fluid accumulation or pulmonary consolidation, identify sites for thoracocentesis, and monitor response to treatment. The examination is best performed using a 3.5 to 5.0 sector scanner. Linear probes, such as those used for routine reproductive examination, are adequate to identify fluid but do not allow good examination of all areas of the chest accessible with sector scanners. The entire thorax should be examined in a systematic fashion. The presence of and characteristics of fluid within the pleural space, presence

and location of pulmonary consolidation or abscessation, and potential sites for diagnostic and therapeutic thoracocentesis should be identified. For horses with longstanding disease, the area cranial to the heart should be examined for the presence of cranial thoracic masses (abscesses). This examination requires that the horse's ipsilateral forelimb be placed well forward, usually with the aid of an assistant, to allow adequate visualization of the cranial thorax.

- **Excessive pleural fluid** can be detected by thorough ultrasonographic examination of both hemithoraces. Pleural fluid initially accumulates ventrally in acute cases, but may become localized dorsally in chronic cases with septation of the pleural space and trapping of fluid.
- The pleural fluid may contain **small gas echoes**, an indication of infection with anaerobic bacteria and a poor prognosis, strands of fibrin, or echogenic material consistent with cellular debris. Sterile pleural effusion, such as may be present during the earliest stages of the disease, is clear and homogeneous without fibrin strands. With increasing chronicity the amount of fibrin increases, the parietal and visceral pleura become thickened, and the pleural fluid becomes echogenic consistent with the presence of cellular debris.
- Regions of consolidated or **atelectatic lung** adjacent to the visceral pleura may be evident on ultrasonographic examination, but lung consolidation deeper in the lung is not evident.
- Accumulation of fibrin is associated with a worse prognosis than is accumulation of parapneumonic fluid that does not include fibrin deposits.<sup>4</sup>
- Ultrasonography is more sensitive than radiographic examination in detection of small quantities of pleural fluid.

**Radiographic examination** of horses with excessive pleural fluid reveals ventral opacity that obscures the ventral diaphragmatic and cardiac silhouettes. Radiographic examination might not reveal the presence of small amounts of excessive pleural fluid.<sup>5</sup> It is not possible on radiographic examination to differentiate accumulation of pleural fluid from consolidation of the ventral lung lobes. Radiographic examination may be useful in demonstrating lesions, such as pulmonary abscesses or consolidation, that are not confluent with the visceral pleura and therefore not able to be detected by ultrasonographic examination.

**Collection of pleural fluid by thoracocentesis** of both hemithoraces and of a

**tracheal aspirate** is necessary to characterize the nature of the pleural fluid and determine the bacterial species present (see “**Clinical Pathology**”). Both tracheal aspirates and pleural fluid should be examined in any horse with pleuropneumonia because bacteria may be recovered from one sample but not the other. Examination of bronchiolar lavage fluid is not useful in diagnosing pleuropneumonia in horses.

The **clinical course** of the acute form of the disease may be less than 10 days if effective therapy is instituted before the pleural effusion becomes infected or there is substantial deposition of fibrin in the pleural space. The prognosis for a return to previous function is good in horses that respond. However, most cases, even if appropriate therapy is instituted, progress to at least stage 2 of the disease process, and the disease becomes chronic.

### CLINICAL SIGNS IN CHRONIC DISEASE

The chronic disease is characterized by intermittent fever, weight loss, cough, increased respiratory rate, nasal discharge, malodorous breath, exercise intolerance, and depression. Severely affected horses may display signs of respiratory distress. Signs of thoracic pain are less than in the acute disease.

**Findings on auscultation** of the chest are similar to those of the acute disease, inasmuch as there is attenuation of normal breath sounds ventrally and the presence of crackles and wheezes dorsally. There is frequently ventral edema of the thorax.

**Ultrasonographic** examination reveals the presence of excessive pleural fluid that is very echogenic, consistent with it containing cellular debris, and contains large amounts of fibrin. The visceral and parietal pleura are thickened, and there may be evidence of lung atelectasis, consolidation, or abscessation. Septation of the pleural space by fibrin and fibrous tissue results in localized accumulation of purulent pleural fluid. Air in the pleural space may indicate the presence of one or more bronchopleural fistulae.

**Radiographic examination** reveals a combination of ventral opacity, pulmonary consolidation, pneumothorax, and abscessation.

### Complications

Complications of pleuropneumonia include the following:<sup>4,6</sup>

- Development of jugular thrombophlebitis (~25% of cases)
- Pulmonary, mediastinal, or pleural abscesses (~10%-20% of cases)
- Cranial thoracic mass (5%–10% of cases)
- Bronchopleural fistula (5%)
- Pericarditis (2%)
- Laminitis (1%–14%)
- Appropriate secondary erythrocytosis<sup>7</sup>

**Development of intrathoracic abscesses** is evident as chronic disease, weight loss, cough, and fever, readily detected by a combination of ultrasonographic and radiographic examination.

**Cranial thoracic masses** are evident as an elevation in heart rate, prominent jugular pulse, spontaneous jugular thrombosis, and forelimb pointing. The signs are referable to a mass in the cranial thorax displacing the heart caudally and to the left and impairing venous return to the heart in the cranial vena cava. Ultrasonographic and radiographic examination reveals the presence of the mass.

**Bronchopleural fistulae** develop when a section of pulmonary parenchyma sloughs, leaving an open bronchiole that communicates with the pleural space. Mild pneumothorax develops. The bronchopleural fistula can be diagnosed by infusion of fluorescein dye into the pleural space and detecting its presence at the nares or by pleuroscopic examination.

### Prognosis

The prognosis for life for horses able to be treated aggressively is very good (60%-95%), and the prognosis for return to previous function if the horse survives is reasonable (60%). The prognosis for return to previous function for horses that develop chronic disease and complications is poor (31%). Prognosis for horses with fibrinous pleural effusion is worse than for horses with pleural effusions that do not include ultrasonographically identifiable accumulations of fibrin (100% of 11 cases vs. 62% of 63 cases, respectively).<sup>4</sup>

### CLINICAL PATHOLOGY

Acute pleuropneumonia is characterized by **leukocytosis** with a mature neutrophilia, mild to moderate anemia, hyperfibrinogenemia, and hypoalbuminemia. There are similar findings in horses with chronic disease, and hyperglobulinemia is also usually present. Severely affected horses with acute disease often have hemoconcentration and azotemia. Horses with chronic disease that impairs respiratory gas exchange, causing chronic hypoxemia, can have secondary erythrocytosis.<sup>7</sup>

**Pleural fluid** in acute cases is usually cloudy and red to yellow. It has an increased leukocyte number (>10,000 cells/ $\mu$ L,  $10 \times 10$  cells/L) comprised principally of degenerative neutrophils, and an increased protein concentration (>2.5 g/dL, 25 g/L), and it may contain intracellular and extracellular bacteria. A Gram stain of the fluid should be examined. The pleural fluid should be cultured for aerobic and anaerobic bacteria. A putrid odor suggests infection by anaerobic bacteria. Sterile pleural fluid has a pH,  $P_{O_2}$  and  $P_{CO_2}$ , and lactate, glucose, and bicarbonate concentration similar to that of venous blood. Infected pleural fluid is acidic and

hypercarbic and has an increased concentration of lactate and decreased concentrations of bicarbonate and glucose compared with venous blood.

**Tracheal aspirates** have a leukocytosis comprised of degenerate neutrophils with intra- and extracellular bacteria. Cultures of tracheal aspirates more frequently yield growth than do cultures of pleural fluid (90% vs. 66%).

### DIAGNOSTIC CONFIRMATION

The presence of excessive pleural fluid containing bacteria and degenerate neutrophils in combination with clinical signs of respiratory disease provides confirmation of the disease.

### DIFFERENTIAL DIAGNOSIS

Diseases that may cause respiratory distress and pleural effusion in horses include the following:

- Intrathoracic neoplasia, including mesothelioma, lymphoma, and extension of gastric squamous-cell carcinoma
- Penetrating chest wounds
- Esophageal perforation
- Diaphragmatic hernia
- Congestive heart failure
- Hemangiosarcoma (causing hemothorax)
- African horse sickness
- Pulmonary hydatidosis
- Pulmonary infarction and pneumonia

### NECROPSY FINDINGS

The pneumonia involves all areas of the lungs but is most severe in the cranial and ventral regions. The pleura are thickened and have adherent fibrin tags, and there is excessive pleural fluid. The pleural fluid contains strands of fibrin and is usually cloudy and serosanguineous to yellow. Histologically, there is a purulent, fibrinonecrotic pneumonia and pleuritis.

### TREATMENT

Given early recognition of the disease and prompt institution of appropriate therapy, the prognosis for horses with pleuropneumonia is favorable. However, the long course of the disease and the associated expense often limit therapeutic options and make the outcome a decision based on economic rather than medical grounds.

The **principles of treatment** are prompt broad-spectrum antimicrobial therapy; removal of infected pleural fluid and cellular debris, including necrotic lung; relief of pain; correction of fluid and electrolyte abnormalities; relief of respiratory distress; treatment of complications; and prevention of laminitis.

### Antimicrobial Treatment

The prompt institution of **systemic, broad-spectrum antimicrobial therapy** is the single most important component of



treatment of horses with pleuropneumonia. Antimicrobial therapy is almost always started before the results of bacterial culture of pleural fluid or tracheal aspirate are received and the antimicrobial sensitivity of isolated bacteria are determined. Use of antibiotics or combinations of antibiotics with a broad spectrum of antimicrobial activity is important because of the polymicrobial nature of most infections and because the wide range of gram-positive and gram-negative bacteria that may be associated with the disease makes prediction of the susceptibility of the causative organisms difficult. Furthermore, superinfection with bacteria, especially Enterobacteriaceae and obligate anaerobes, commonly occurs in horses with disease initially associated with

a single bacterial species. Administration of drugs that are effective in the treatment of penicillin-resistant obligate anaerobes is also important.

**Recommended doses for antimicrobials** used in the treatment of pleuropneumonia are provided in Table 12-11. Antimicrobial therapy should be broad spectrum to include coverage of the likely bacteria involved in the disease. It should therefore provide coverage against *Streptococcus* spp., *Actinobacillus/Pasteurella* spp., Enterobacteriaceae, and anaerobes, including *Bacteroides* spp. A **combination of penicillin G, an aminoglycoside, and metronidazole** provides broad-spectrum coverage and is a frequently used empirical therapy until the results of bacterial culture are known. Results of bacterial

culture and subsequent antimicrobial susceptibility testing may aid selection of further antimicrobials. However, superinfection with gram-negative and anaerobic bacteria is common, and there is a sound rationale for continued use of a combination of antimicrobials providing broad-spectrum coverage throughout treatment of the disease.

**Antimicrobial therapy will be prolonged** in most cases, usually being required for at least 1 month and often several months. As the disease resolves it may be possible to change from parenteral antibiotics to orally administered antibiotics such as a combination of trimethoprim-sulfonamide, although the clinical response to this combination is sometimes disappointing, or doxycycline or enrofloxacin.

**Table 12-11** Antimicrobial agents and recommended doses for treatment of pleuropneumonia in horses

Drug	Dose, route, and interval	Comments
Procaine penicillin G	22,000–44,000 IU/kg IM q12h	Effective against <i>Streptococcus</i> sp. and most anaerobes, with the exception of <i>Bacteroides fragilis</i> . Achieves low plasma concentrations but has prolonged duration of action. Cheap. Synergistic with aminoglycosides. Should not be used as sole treatment.
Sodium or potassium penicillin G	22,000–44,000 IU/kg IV q6h	Effective against gram-positive organisms (except penicillinase-producing bacteria such as <i>Staphylococcus</i> spp.) and most anaerobes. Achieves high plasma concentrations. Synergistic with aminoglycosides. Expensive.
Ampicillin sodium	11–22 mg/kg IV or IM q6h	Wider spectrum than penicillin G. Achieves high plasma concentrations.
Ampicillin trihydrate	20 mg/kg IM q12–24h	Synergistic with aminoglycosides Low blood concentrations. Muscle soreness. Not recommended.
Ceftiofur sodium	2.2–4.4 mg/kg IM or IV q12h	Wide spectrum of action against gram-positive and gram-negative organisms and most anaerobes. Can be used as sole treatment, though not recommended. Clinical results sometimes disappointing
Ceftiofur crystalline	7 mg/kg IM q4 days	Prolonged concentration in blood and bronchoalveolar lavage fluid.
Cefotaxime	40 mg/kg IV q6h	Wide spectrum of action against gram-positive and gram-negative organisms and most anaerobes. Can be used as sole treatment, though not recommended.
Cefepime	2.2 mg/kg IV or IM q8h	Wide spectrum of action against gram-positive and gram-negative organisms and most anaerobes. Can be used as sole treatment, although not recommended.
Chloramphenicol	50 mg/kg, PO q6h	Good spectrum of action, including anaerobic bacteria. Poor oral bioavailability and disappointing clinical efficacy. Use prohibited in some countries. Potential human health hazard. Risk of diarrhea
Gentamicin sulfate	7 mg/kg, IV or IM q24h	Active against <i>Staphylococcus</i> spp. and many gram-negative organisms. Inactive against anaerobes. Poor activity against <i>Streptococcus</i> spp. Synergistic with penicillin
Enrofloxacin	7 mg/kg IV or PO q24h	Active against some gram-positive and gram-negative bacteria. Not good or reliable activity against streptococci. Contraindicated in young animals because of risk of cartilage damage.
Amikacin sulfate	10 mg/kg IV or IM q24h	Wider spectrum of gram-negative activity than gentamicin. Expensive
Trimethoprim-sulfonamides	15–30 mg/kg PO q12h	Theoretical wide spectrum of action. Disappointing clinical efficacy.
Rifampin	5–10 mg/kg PO q12h	Penetrates abscesses well. Active against gram-positive and some gram-negative bacteria. Must be used in conjunction with another antibiotic (not an aminoglycoside).
Doxycycline	10 mg/kg PO q12h	Broad spectrum of activity, but resistance unpredictable. Only moderate blood concentrations. Suitable for prolonged therapy but not treatment of the acute disease.
Ticarcillin-clavulanic acid	50 mg/kg IV q6h	Broader spectrum of gram-negative activity than penicillin G. Expensive.
Metronidazole	15–25 mg/kg PO q6–8h	Active against anaerobes only. Used in conjunction with other antimicrobials (especially penicillin and aminoglycosides). Neurotoxicity rare.

IM, intramuscularly; IV, intravenously; PO, orally; q, dose administered every "h" hours.

**The decision to discontinue antimicrobial therapy** should be based on lack of fever, nasal discharge, and respiratory distress or cough; lack of evidence of intrathoracic abscesses on ultrasonographic and radiographic examination of the thorax; and resolution of neutrophilia and hyperfibrinogenemia. There should be no appreciable pleural fluid on ultrasonographic examination.

### Thoracic Drainage

Chronic, effective drainage of the pleural cavity and intrathoracic abscesses is critical for successful treatment of horses with pleuropneumonia. Horses with sterile pleural fluid may require only a single drainage of pleural fluid. More severely affected horses may require intermittent drainage on each of several days, and most cases will require insertion of a tube into the pleural space to provide continuous drainage for several days to several weeks. Horses with chronic disease may benefit from a thoracotomy that provides continuous drainage and the ability to lavage the chest. Ultrasonographic examination of the chest is very useful in identifying the presence of pleural fluid, the optimal sites for drainage, and the efficacy of drainage.

**Intermittent thoracic drainage** can be achieved by inserting a bovine teat cannula or similar blunt cannula into the pleural space. This should be done aseptically and under local anesthesia. If ultrasonographic examination is not available, the cannula should be placed in the sixth to eighth intercostal space on the right side or the seventh to ninth on the left side just above the level of the olecranon. Pleural fluid that does not contain large fibrin clots (which clog the cannula) can be drained and the cannula removed. However, the process is slow if large quantities of fluid must be removed. Intermittent drainage is indicated when the quantities of pleural fluid are small (< 5 L), relatively cell-free, or localized. This situation is most likely to occur in horses with acute disease.

**Insertion of large plastic chest tubes** (20–30 French, 6- to 10-mm outside diameter) facilitates rapid fluid removal, allows drainage of viscid fluid, and provides continuous drainage. The chest tube should be inserted in an aseptic fashion under local anesthesia at sites indicated by ultrasonographic examination or as described previously. A one-way valve should be attached to the external end of the tube to prevent aspiration of air and development of a pneumothorax. A balloon or condom with the end removed is an effective one-way valve. The chest tube is secured to the chest wall with a purse-string suture. The tube may be retained for several days to a week, but it should be monitored frequently (every few hours) and cleared of fibrin clots as needed.

**Complications of drainage** of pleural fluid include collapse of the animal if the

fluid is removed too rapidly, pneumothorax, sudden death as a result of cardiac puncture or laceration of a coronary vessel, and perforation of abdominal viscera. Collapse can be prevented by administering fluids intravenously during pleural fluid drainage and by removing the fluid gradually (over a period of 30 minutes). Some horses develop cellulitis around the chest tube, which requires that the tube be removed.

**Thoracotomy** may be required in recurrent or chronic cases to provide drainage of intrathoracic abscesses or chronic pleural effusion that is refractory to treatment with antimicrobials. Thoracotomy is an effective intervention in many horses, with 14 of 16 horses treated by thoracotomy surviving and 6 returning to athletic activity.<sup>8</sup> Thoracotomy should not be considered an emergency or heroic procedure in such cases.

### Pleural Lavage

Infusion and subsequent removal of 5 to 10 L of warm saline or balance polyionic electrolyte solution into the affected pleural space may be beneficial in the treatment of cases with viscid fluid or fluid containing large amounts of fibrin and cell debris. The fluid can be infused through the chest tube that is used to drain the pleural space. Care should be taken not to introduce bacteria with the infusion.

### Fibrinolytic Therapy

Tissue plasminogen activators have been administered to horses in an attempt to increase activity of plasmin and hence the rate of lysis of fibrin in the pleural cavity. Earlier attempts at fibrinolytic therapy used streptokinase or urokinase and were not beneficial. Use of modified compounds, such as alteplase and tenecteplase, is effective in hastening fibrinolysis, enhancing resolution of accumulated pleural fluid, and improving survival.<sup>6,9,10</sup> There does not appear to be an increased risk of prolonged hemostasis. The procedure in one case involved intrapleural infusion of 12 mg of tenecteplase in 500 ml of isotonic saline after drainage of excessive pleural fluid.<sup>10</sup> The treatment was repeated on three occasions over 10 days. Pharmacokinetics of alteplase in horses are described.<sup>11</sup> A recommended protocol is infusion of tenecteplase (2–10 mg in 1–2 L of isotonic, polyionic fluid) q12 to 24h for 3 days, with a dwell time of 4 hours.<sup>5</sup>

### Supportive Therapy

Acutely or severely ill horses may be dehydrated and azotemic, and they may have acid-base disturbance. These horses should be treated with appropriate **fluids** administered intravenously.

Pleuropneumonia is a painful disease, and every attempt should be made to relieve the horse's chest pain. **NSAIDs**, including flunixin meglumine (1 mg/kg, orally, intramuscularly, or intravenously, every 8 hours)

or phenylbutazone (2.2 mg/kg, orally or intravenously, every 12 hours), often provide effective analgesia and presumably reduce inflammation in the pleural space.

Horses should be provided with good nursing care, including a comfortable stall, free access to palatable water, and a good diet. Affected horses will often not eat adequately and should be tempted with fresh and nutritious fodder.

Attention should be paid to the horse's feet to detect early signs of laminitis and allow appropriate measures to be taken.

### CONTROL

Prevention of pleuropneumonia involves reduction of risk factors associated with the disease. The main risk factors are other infectious respiratory diseases and transportation. Every effort should be made to prevent and treat respiratory disease in athletic horses, including institution of effective vaccination programs. Horses with infectious respiratory disease should not be vigorously exercised until signs of disease have resolved.

Transportation of athletic horses is common and essential for their participation in competitive events. It cannot, therefore, be eliminated. Every effort should be made to minimize the adverse effects of transportation on airway health. Recommendations for transport of horses first made in 1917 are still relevant. Updated, these recommendations include the following:

- Not transporting a horse unless it is healthy. Horses with fever should not be transported
- Knowledgeable staff familiar with the horse should accompany it.
- Suitable periods of rest and acclimation should be provided before recently transported or raced horses are transported.
- The time during which horses are confined for transportation should be kept to a minimum. Horses should be loaded last and unloaded first in flights with mixed cargo.
- The route taken should be the most direct and briefest available.
- Horses should be permitted adequate time to rest at scheduled breaks. If possible, on long journeys horses should be unloaded and allowed exercise (walking) and access to hay and water.
- Horses should have frequent, preferably continuous, access to feed and water during transportation.
- Horses should not be exercised after arrival until they are free of fever, cough, or nasal discharge.
- Horses should not be restrained during transportation such that they are unable or unwilling to lower their heads.

- Air quality should be optimal in the vehicle used to transport the horse.

## REFERENCES

1. Bodecek S, et al. *Equine Vet Educ.* 2011;23:296.
2. Hepworth-Warren KL, et al. *Equine Vet Educ.* 2015;27:283.
3. Ferrucci F, et al. *Equine Vet Educ.* 2008;20:526.
4. Tomlinson JE, et al. *J Vet Int Med.* 2015;n/a.
5. Rush BR, et al. *Equine Vet Educ.* 2011;23:302.
6. Tomlinson JE, et al. *J Vet Int Med.* 2015;n/a.
7. Belli CB, et al. *Vet Rec.* 2011;169.
8. Hilton H, et al. *Vet Surg.* 2010;39:847.
9. Hilton H, et al. *Vet Rec.* 2009;164:558.
10. Rendle DI, et al. *Aust Vet J.* 2012;90:358.
11. Baumer W, et al. *BMC Vet Res.* 2013;9.

## ACUTE BRONCHO-INTERSTITIAL PNEUMONIA IN FOALS

Acute broncho-interstitial pneumonia is a disease of foals less than 7 months of age, and usually less than 2 months of age, characterized by a rapid onset of respiratory distress. The condition is clinically similar to **acute lung injury** identified in other species.<sup>1</sup> The **etiology** is unclear in many cases, but causes or agents associated with the disease include equine influenza virus infection,<sup>2</sup> *R. equi*, equine herpesvirus-2, equine arteritis virus, or *Pneumocystis carinii*. The disease is likely a result of severe pulmonary injury by any of a number of infectious or toxic agents. The respiratory distress results from loss of pulmonary function because of necrosis of the epithelium of alveoli and terminal bronchioles.

Foals typically present with an acute onset (<4 days) of respiratory distress, pyrexia, and tachycardia. Foals are depressed and reluctant to eat. There is a pronounced respiratory effort with a marked abdominal component in most affected foals. Crackles, wheezes, and increased bronchial breath sounds are auscultable in most foals. Radiographic examination reveals a broncho-interstitial pattern that is always diffuse, although in some foals there is also a focal interstitial pattern. The prognosis is guarded, with approximately 50% of affected foals dying of the disease.

There is a neutrophilic leukocytosis and hyperfibrinogenemia in most cases. Arterial hypoxemia is present in severely affected foals. Tracheal aspirate demonstrates neutrophilic inflammation. Culture of the tracheal aspirate yields *Rhodococcus equi*, *S. zooepidemicus*, and *Actinobacillus* sp., in addition to other organisms that are of questionable significance. Serology might demonstrate evidence of infection by equine influenza virus or equine herpesvirus-2. Viral isolation can identify equine influenza virus.<sup>2</sup>

## NECROPSY FINDINGS

**Necropsy** examination reveals the presence of diffusely reddened, wet, and firm lungs that fail to collapse. The predominant

histologic lesion is necrosis of the epithelium of terminal bronchioles and alveoli.

## TREATMENT

Principles of **treatment** are correction of hypoxemia, reduction of inflammation, and removal of inciting causes. Severely affected foals might require nasal insufflation of oxygen to ameliorate or correct hypoxemia. Administration of corticosteroids has been associated with improved survival. Broad-spectrum antibiotics are administered to treat concurrent bacterial infections and prevent secondary infection.

## CONTROL

There are no specific control measures, but reduction of exposure of foals to infectious respiratory disease would be prudent.

## REFERENCES

1. Dunkel B, et al. *Equine Vet J.* 2005;37:435.
2. Patterson-Kane JC, et al. *Equine Vet J.* 2008;40:199.

## CHRONIC INTERSTITIAL PNEUMONIA IN FOALS

Chronic interstitial pneumonia is a sporadic disease of foals less than 10 months of age characterized by respiratory distress of several weeks' duration. The etiology is unknown, but the disease likely represents a common final response to injury caused by any one of a number of infectious or toxic agents (see "Interstitial Pneumonia of Horses" and "Acute Bronchointerstitial Pneumonia of Foals").

Affected foals are bright and alert and have markedly increased respiratory effort. The respiratory rate is elevated, and there is a prominent abdominal component to respiratory effort. Fever is low grade and intermittent. Thoracic auscultation reveals increased intensity of normal breath sounds and the presence of wheezes and crackles in most affected foals. Ultrasonographic examination of the thorax reveals extensive "comet tail" signs in most cases. Radiography demonstrates the presence of moderate to severe interstitial pneumonia that in some cases can include focal opacities suggestive of alveolar disease. The prognosis with appropriate treatment is excellent.

Affected foals have neutrophilic leukocytosis and hyperfibrinogenemia. Serologic examination for antibodies to common respiratory viruses is unrewarding. Culture of tracheal aspirates does not consistently yield growth of known pathogens, although *Nicoletella semolina* is associated with similar clinical signs and presentation.<sup>1</sup> Lung biopsy is not warranted because the characteristic changes on radiographic examination, combined with the clinical signs, are diagnostic for the disease. The risk of adverse events associated with lung biopsy outweighs any diagnostic utility given the good prognosis for complete recovery from the disease.

Treatment consists of administration of corticosteroids such as dexamethasone phosphate at an initial dosage of 0.1 to 0.25 mg/kg intravenously every 24 hours for 3 to 5 days followed by a declining dose administered orally over 2 to 3 weeks. Prednisolone can be substituted for dexamethasone. Broad-spectrum antibiotics (combination of penicillin and aminoglycoside, trimethoprim-sulfonamide, or doxycycline) should be administered for 1 to 2 weeks.

There are no recognized control measures, although control of infectious respiratory disease in the herd is prudent.

## FURTHER READING

- Nout YS, Hinchcliff KW, Samii VF, et al. Chronic pulmonary disease with radiographic interstitial opacity (interstitial pneumonia) in foals. *Equine Vet J.* 2002;34:542.

## REFERENCE

1. McConachie EL, et al. *J Vet Int Med.* 2014;28:939.

## INTERSTITIAL PNEUMONIA IN ADULT HORSES

Interstitial pneumonia can be associated with other systemic disease, such as infection by influenza virus, equine infectious anemia virus, or intoxication by various plants or minerals (silica), or it can be a primary disease. Equine multinodular pulmonary fibrosis (EMPF) was previously included in this topic but is now discussed separately later in this section on diseases of the equine respiratory tract.<sup>1</sup>

## ETIOLOGY

Interstitial pneumonia is a common finding in horses associated with various infectious agents (Hendra virus, equine influenza virus,<sup>2,3</sup> equine infectious anemia,<sup>4</sup> *Rhodococcus equi*, *Aspergillus* sp., *Cryptococcus* sp. and *Histoplasma* sp., *Pneumocystis carinii*, *Parascaris equorum*, and *Dictyocaulus arnfieldi*). Intoxication with perilla ketone, derived from *Perilla frutescens*, causes acute restrictive lung disease of horses. Similarly, ingestion of *Eupatorium* sp. in Australia and Hawaii causes interstitial pneumonia in horses. Ingestion of *Crotalaria* spp. causes interstitial pneumonia in donkeys.<sup>5</sup> Inhalation or ingestion of agricultural chemicals or environmental toxins (e.g., paraquat) has the potential to cause interstitial pneumonia in other species, but this has not been demonstrated in horses.<sup>1</sup> Silicosis causes interstitial pneumonia in horses in California.<sup>6</sup> Lipid pneumonia has an interstitial component.<sup>7</sup>

Chronic **pleuropulmonary fibrosis and elastosis** occurs in aged donkeys in the United Kingdom.<sup>8,9</sup> The disease was present in 32% of over 1100 postmortem examinations of donkeys.<sup>9</sup> The etiology of the disease is unknown.

Hypersensitivity reactions may cause severe respiratory disease in horses. Incriminating allergens include fungi (unspecified)



and chicken dust. Interstitial pneumonia has also been reported subsequent to administration of an immunostimulant containing mycobacterial cell-wall extract.

Chronic eosinophilic pneumonia of adult horses is idiopathic.<sup>10</sup>

## EPIDEMIOLOGY

The disease occurs in adult horses, without apparent breed, sex, or age predisposition. In cases in which the cause is infectious, the epidemiology of the disease is characteristic of that of the causal organism.

## PATHOGENESIS

The initial insult causes injury to parenchymal cells and an acute alveolitis. Alveolitis results from damage to epithelial and endothelial cells by toxic, metabolic (free radicals), or infectious agents. This is followed by a phase of cellular proliferation of type 2 pneumocytes and fibroblasts with connective tissue deposition. At this time there is an influx of inflammatory cells, the exact type depending to some extent on the cause of the disease. Infiltration of neutrophils, lymphocytes, and macrophages is common. Continued injury to the lung results in development of severe interstitial fibrosis and destruction of gas exchange units.

Interstitial pneumonia results in altered pulmonary function including reduced compliance, impaired pulmonary gas exchange, and a reduction in total and vital lung capacity. The work of breathing is increased.

## CLINICAL SIGNS

Horses with interstitial pneumonia have various combinations of: weight loss, recurrent cough, depression, anorexia, fever, or respiratory distress. Signs of respiratory distress are variable between cases and depend on the severity of the disease. The usual history of is a gradual onset of increased respiratory effort. Heart and respiratory rates are usually elevated. Pyrexia is not a constant finding. There may be a nasal discharge. Thoracic auscultation may reveal only increased intensity of normal breath sounds or the presence of occasional crackles and wheezes.

Thoracic radiography reveals pulmonary disease, usually apparent as severe, diffuse interstitial disease. Ultrasonographic examination may reveal the presence of multiple "comet tail" signs in the lung parenchyma confluent with the pleural surface. There is no excess pleural fluid.

Intradermal skin testing may be useful to identify the inciting allergen in cases of allergic interstitial pneumonia.

## CLINICAL PATHOLOGY

Hematologic and serum biochemical abnormalities vary with the inciting cause of the disease. Bronchoalveolar lavage, which is preferred over collection of tracheal aspirates, demonstrates changes consistent with

the underlying disease, which is usually inflammatory.

## NECROPSY FINDINGS

The lungs do not deflate as anticipated, and there may be indentations from the ribs on the surface of the lungs. The histologic changes depend on the etiology of the disease.

## TREATMENT

Treatment should be directed toward any cause of the disease that is identified, such as administration of anthelmintics to horses with parasitic disease. Bronchodilating drugs, such as clenbuterol, can be considered, but bronchoconstriction is not a prominent component of the disease.

## CONTROL

Prevention of exposure to potential infectious, toxic, or environmental causes is prudent.

## FURTHER READING

- Bruce EH. Interstitial pneumonia in horses. *Comp Cont Educ Pract Vet*. 1995;17:1145.
- Buergelt CD. Interstitial pneumonia in the horse: a fledgling morphological entity with mysterious causes. *Equine Vet J*. 1995;27:4.

## REFERENCES

- Radostits O, et al. Interstitial pneumonia of horses. In: *Veterinary Medicine: A Textbook of the Diseases of Cattle, Horses, Sheep, Goats and Pigs*. 10th ed. London: W.B. Saunders; 2007:2004.
- Patterson-Kane JC, et al. *Equine Vet J*. 2008;40:199.
- Begg AP, et al. *Aust Vet J*. 2011;89:19.
- Bolfa P, et al. *J Comp Pathol*. 2013;148:75.
- Pessoa CRM, et al. *Toxicol*. 2013;71:113.
- Arens AM, et al. *Vet Pathol*. 2011;48:593.
- Metcalfe L, et al. *Irish Vet J*. 2010;63:303.
- Miele A, et al. *Chest*. 2014;145:1325.
- Morrow LD, et al. *J Comp Pathol*. 2011;144:145.
- Bell SA, et al. *J Vet Int Med*. 2008;22:648.

## EXERCISE-INDUCED PULMONARY HEMORRHAGE OF HORSES (BLEEDERS)

### SYNOPSIS

**Etiology** Pulmonary hemorrhage during exercise.

**Epidemiology** Present in most (>80%) Thoroughbred and Standardbred racehorses, although clinical signs are less common. Occurs worldwide in any horse that performs strenuous exercise. Case-fatality rate is low, although because of the high incidence of the disease, deaths occur frequently during racing.

**Pathogenesis** Probably associated with rupture of pulmonary capillaries by the high pulmonary vascular pressures generated during exercise. There does not appear to be a contributory role for preexisting inflammation and obstruction of

small airways, although this is unclear. There is tissue damage caused by large and rapid changes in intrathoracic pressure.

**Clinical signs** Epistaxis is an uncommon but very specific sign of EIPH in horses that have just exercised. Endoscopic examination of the trachea and bronchi reveals blood.

**Clinical pathology** Presence of hemosiderin-laden macrophages in tracheal aspirates or bronchial lavage fluid.

**Lesions** Fibrosis and discoloration of the caudodorsal regions of the lungs. Fibrosis, accumulation of hemosiderin-laden macrophages in interstitial tissue, inflammation and bronchial artery angiogenesis. Horses dying acutely have blood-filled airways and heavy, wet lungs.

**Diagnostic confirmation** Demonstration of blood in the trachea or bronchi by endoscopic examination, or cytologic examination of tracheal aspirates or bronchoalveolar lavage fluid.

**Treatment** Furosemide is effective in decreasing the frequency and severity of the disease.

**Control** There are no specific control measures; however, prevention of environmental and infectious respiratory disease might reduce the incidence of the disease.

## ETIOLOGY

Exercise-induced pulmonary hemorrhage of horses (EIPH) is a disease that occurs in horses during strenuous exercise.<sup>1</sup> There is evidence of a genetic component to epistaxis in Thoroughbred racehorses ( $h^2 = 0.27-0.5$ ),<sup>2</sup> but there are no reports of heritability or genetic factors contributing to EIPH.

## EPIDEMIOLOGY

EIPH is primarily a disease of horses, although it occurs in racing camels and Greyhounds.<sup>3</sup> EIPH occurs in horses worldwide, and there does not appear to be any geographic distribution. It is a disorder of horses that run at high speed, such as Thoroughbred or Standardbred racehorses. The disorder is uncommon in endurance horses and is rare in draft breeds, although it does occur in horses used for these activities.<sup>4</sup> There is increasing recognition of its importance in sport horses (3-day event, show jumping, but not in dressage).<sup>5</sup>

The prevalence of EIPH varies with the method used to detect it and the frequency with which horses are examined, as discussed later in this section. Epistaxis associated with exercise is almost always attributable to pulmonary hemorrhage and occurs only in a small proportion of racehorses. Epistaxis occurs in only 3% of horses that have blood detected in the trachea by endoscopic examination performed within 2 hours of racing. The prevalence of epistaxis

in racehorses varies between 0.1% and 9.0%, with the frequency depending on the breed, age and sex of horses selected for study, the type of racing, and the timing and frequency of observation of horses after racing. Epistaxis is more common in older horses. There are conflicting reports of a sex predisposition, although epistaxis may be more common in female Thoroughbreds. Epistaxis is more common after races of less than 1600 m than in longer races, although not all sources agree on this point. However, horses in steeplechase races, which are typically longer than 2000 m, are at greater risk of epistaxis than are horses in flat races. Incidence of epistaxis in steeplechase horses in the United Kingdom is 5.3 per 1000 starts and 3.6 per 1000 starts in hurdle racing.<sup>6</sup> Risk factors for horses in jumps races (steeplechase) include previous epistaxis (odds ratio [OR] 6.1 [4.4–8.3]), racing in a claiming race (OR 5.9 [1.4–25]), greater than 9 starts in previous 4 to 6 months (OR 10 [2–47]), and racing on firmer ground.<sup>6</sup> *Epistaxis is relatively uncommon, and most horses with EIPH do not have epistaxis.*

There are a variety of other methods of detecting EIPH, including endoscopic examination of the airways and microscopic examination of tracheal aspirates or bronchoalveolar lavage fluid.

Almost all Thoroughbred racehorses in active training have hemosiderophages in bronchoalveolar lavage fluid, indicating that all have some degree of EIPH. The prevalence of EIPH decreases when diagnosis is based on endoscopic examination of horses after exercise or racing.

EIPH is very common in Thoroughbred racehorses, with estimates of prevalence, based on a single endoscopic examination of the trachea and bronchi, of 43% to 75%.<sup>7,8</sup> The prevalence increases with the frequency of examination, with over 80% of horses having evidence of EIPH on at least one occasion after examination after each of three consecutive races.<sup>9</sup> There can be considerable variability in severity of EIPH within an individual horse on repeated examination over a racing season.<sup>8</sup> The prevalence of EIPH in Standardbred racehorses is assumed to be lower, with 26% to 34% of horses reported to have blood in the trachea after racing. However, these studies were based on a single examination and one only reported as positive those horses with blood covering more than one half the tracheo-bronchial tree. When examined after each of three races, 87% of Standardbred racehorses have evidence of EIPH on at least one occasion, suggesting that EIPH is as common in Standardbred racehorses as it is in Thoroughbred racehorses.

Exercise-induced pulmonary hemorrhage occurs in approximately 62% of racing Quarter Horses and has been observed in Quarter Horses used for barrel racing. The disorder occurs in racing Appaloosa horses.

Approximately 11% of polo ponies are affected with EIPH. The disease occurs in draft horses but is not well documented.

Age is considered a risk factor for EIPH, with the prevalence of the disorder being higher in older horses, but the risk factor is the amount of racing that a horse has completed, not its age.<sup>10,11</sup> There is no consistent association of sex with prevalence of EIPH. Among Thoroughbred racehorses there is an unclear relationship between the speed of racing and the risk of EIPH.<sup>10,12</sup> Lesions of EIPH are not detected in young Thoroughbred racehorses that have trained at speeds of less than 7 m/s.

The risk of EIPH increases with racing at lower ambient temperatures<sup>10,12</sup> and with the wearing of bar shoes during racing.<sup>12</sup> There is no association between risk of EIPH and track hardness.<sup>10,12</sup>

### PATHOGENESIS

The cause of EIPH is rupture of alveolar capillary membranes with subsequent extravasation of blood into interstitial and alveolar spaces. The source of blood in such instances is the pulmonary circulation. Bleeding from bronchial circulation during exercise has been suggested, based on histologic evidence of bronchial angiogenesis in horses that have experienced previous episodes of EIPH, but contribution of the bronchial circulation to EIPH has not been demonstrated. Regardless of the contribution of bronchial circulation to blood in the airways, the likely initial lesion is in capillaries associated with the pulmonary circulation. There is increasing evidence that the primary lesion is arteriovenous remodeling of pulmonary veins.<sup>13–16</sup> Remodeling of pulmonary veins results in loss of distensibility and partial occlusion to blood flow with subsequent presumed increases in pulmonary alveolar capillary pressure.<sup>13,17</sup> Hemorrhage into the interstitial space and alveoli, with subsequent rostral movement of blood in the airways, results in blood in the trachea and bronchi.

Rupture of alveolar capillaries occurs secondary to an exercise-induced increase in transmural pressure (pressure difference between the inside of the capillary and the alveolar lumen). If the transmural stress exceeds the tensile strength of the capillary wall, the capillary ruptures. The proximate cause of alveolar capillary rupture is the high transmural pressure generated by positive intracapillary pressures, which are largely attributable to capillary blood pressure, and the lower intraalveolar pressure generated by the negative pleural pressures associated with inspiration.

During exercise, the absolute magnitudes of both pulmonary capillary pressure and alveolar pressure increase, with a consequent increase in transmural pressure. Strenuous exercise is associated with marked increases in pulmonary artery pressure in horses.

Values for mean pulmonary arterial pressure at rest of 20 to 25 mm Hg increase to more than 90 mm Hg during intense exercise because of the large cardiac output achieved by exercising horses. The increases in pulmonary artery pressure, combined with an increase in left atrial pressure during exercise, probably result in an increase in pulmonary capillary pressure. Combined with the increase in pulmonary capillary pressure is a marked decrease (more negative) in pleural, and therefore alveolar, pressure during exercise. The pleural pressure of normal horses during inspiration decreases from approximately  $-0.7$  kPa ( $-5.3$  mm Hg) at rest to as low as  $-8.5$  kPa (64 mm Hg) during strenuous exercise. Together, the increase in pulmonary capillary pressure and decrease (more negative) in intrapleural (alveolar) pressure contribute to a marked increase in stress in the alveolar wall. Although the alveolar wall and pulmonary capillaries of horses are stronger than those of other species, rupture may occur because the wall stress in the alveolus exceeds the mechanical strength of the capillary.

Other theories of the pathogenesis of EIPH include: small-airway disease, upper airway obstruction, hemostatic abnormalities, changes in blood viscosity and erythrocyte shape, intrathoracic shear forces associated with gait, and bronchial artery angiogenesis. It is likely that the pathogenesis of EIPH involves several processes, including pulmonary hypertension, lower alveolar pressure, and changes in lung structure, that summate to induce stress failure of pulmonary capillaries.

Obstruction of either the upper or lower airways has been proposed as a cause of EIPH. Inspiratory airway obstruction results in more negative intrapleural, and therefore alveolar, pressures. This effect is exacerbated by exercise, with the result that alveolar transmural pressure is greater in horses with airway obstruction. The higher transmural pressure in such horses may increase the severity of EIPH, although this has not been demonstrated. Moreover, although inspiratory airway obstruction may predispose to EIPH, the prevalence of this condition is much less than that of EIPH, indicating that it is not the sole factor inducing EIPH in most horses.

Horses with moderate to severe EIPH have histologic evidence of inflammation of the small airways, and there is a clear association between the presence of EIPH and inflammatory changes in bronchoalveolar or tracheal aspirate fluid. However, instillation of autologous blood into the airways does not induce a marked inflammatory response in normal horses, and it is therefore unclear whether inflammation alone induces or predisposes to EIPH.<sup>18,19</sup> Theoretically, small-airway inflammation and bronchoconstriction have the potential to produce intrathoracic airway obstruction

and, therefore, a more negative alveolar pressure. Given that small-airway disease is common in horses, there is the potential for an important effect of factors such as viral infections, air pollution, and allergic airway disease to contribute to the initiation or propagation of EIPH.

The characteristic location of lesions of EIPH in the caudodorsal lung fields has led to the proposal that hemorrhage is a result of tissue damage occurring when waves of stress, generated by forelimb foot strike, are focused and amplified into the narrowing cross-sectional area of the caudal lung lobes. According to the theory, the locomotor impact of the forelimbs results in transmission of forces through the scapula to the body wall, from where they pass into the lungs and caudally and dorsally. As the wave of pressure passes into the narrower caudodorsal regions of the lungs it generates progressively greater shearing forces that disrupt tissue and cause EIPH. However, studies of intrapleural pressures have not demonstrated the presence of a systemic pressure wave passing through the lung and do not provide support for this hypothesis.

Horses with EIPH have been suspected of having defects in either hemostasis or fibrinolysis. However, although exercise induces substantial changes in blood coagulation and fibrinolysis, there is no evidence that horses with EIPH have defective coagulation or increased fibrinolysis.

Regardless of the cause, rupture of pulmonary capillaries and subsequent hemorrhage into airways and interstitium causes inflammation of both airways and interstitium with subsequent development of fibrosis and alteration of tissue compliance. Heterogeneity of compliance within the lungs, and particularly at the junction of normal and diseased tissue, results in the development of abnormal shear stress with subsequent tissue damage. These changes are exacerbated by inflammation and obstruction of small airways, with resulting uneven inflation of the lungs. The structural abnormalities, combined with pulmonary hypertension and the large intrathoracic forces associated with respiration during strenuous exercise, cause repetitive damage at the boundary of normal and diseased tissue with further hemorrhage and inflammation. The process, once started, is lifelong and continues for as long as the horse continues to perform strenuous exercise.

## CLINICAL FINDINGS

Poor athletic performance or epistaxis are the most common presenting complaints for horses with EIPH. Although poor performance may be attributable to any of a large number of causes, epistaxis associated with exercise is almost always secondary to EIPH.

Epistaxis as a result of EIPH occurs during or shortly after exercise and is usually first noticed at the end of a race, particularly

when the horse is returned to the paddock or winner's circle and is allowed to lower its head. It is usually bilateral and resolves within hours of the end of the race. Epistaxis may occur on more than one occasion, especially when horses are raced or exercised at high speed soon after an initial episode.

## Exercise-Induced Pulmonary Hemorrhage and Performance

Failure of racehorses to perform to the expected standard (poor performance) is often, accurately or not, attributed to EIPH.<sup>7</sup> Many horses with poor performance have cytologic evidence of EIPH on microscopic examination of tracheobronchial aspirates or bronchoalveolar lavage fluid or have blood evident on endoscopic examination of the tracheobronchial tree performed 30 to 90 minutes after strenuous exercise or racing. However, it is important to recognize that EIPH is very common in racehorses, and it should be considered the cause of poor performance only after other causes have been eliminated. Severe EIPH undoubtedly results in poor performance and, on rare occasions, death of Thoroughbred racehorses.<sup>1,7,20</sup> Thoroughbred horses with EIPH have impaired performance compared with unaffected horses.<sup>7</sup> Affected horses have a lower likelihood of finishing in the first three places, are less likely to be elite money earners, and finish further behind the winner than do unaffected horses.

Results of studies in Standardbred racehorses indicate either a lack of effect of EIPH on performance or an association between EIPH and superior performance. There was no relationship between presence of EIPH and finishing position in 29 Standardbred racehorses with intermittent EIPH examined on at least two occasions, nor in 92 Standardbred racehorses examined on one occasion. However, of 965 Standardbred racehorses examined after racing, those finishing first or second were 1.4 times more likely (95% confidence interval 0.9-2.2) to have evidence of EIPH on tracheobronchoscopic examination than were horses that finished in seventh or eighth position.

## Physical Examination

Apart from epistaxis in a small proportion of affected horses (Fig. 12-26), there are few abnormalities detectable on routine physical examination of horses with EIPH. Rectal temperature and heart and breathing rates may be elevated as a consequence of exercise in horses examined soon after exercise, but values of these variables in horses with EIPH at rest are not noticeably different from those of horses with no evidence of EIPH. Affected horses may swallow more frequently during recovery from exercise than do unaffected horses, probably as a result of blood in the larynx and pharynx. Coughing is common in horses recovering from strenuous exercise and after recovery from exercise; horses with



**Fig. 12-26** Thoroughbred racehorse with epistaxis secondary to exercise-induced pulmonary hemorrhage during racing.

EIPH are no more likely to cough than are unaffected horses.<sup>1</sup> Other clinical signs related to respiratory abnormalities are uncommon in horses with EIPH and, when present, indicates severe hemorrhage or other serious lung disease such as pneumonia, pneumothorax or rupture of a pulmonary abscess. Lung sounds are abnormal in a small number of EIPH-affected horses and, when present, are characterized by increased intensity of normal breath sounds during rebreathing examination. Tracheal rales may be present in horses with EIPH but are also heard in unaffected horses.

## Tracheobronchoscopy

Observation of blood in the trachea or large bronchi of horses 30 to 120 minutes after racing or strenuous exercise provides a definitive diagnosis of EIPH. The amount of blood in the large airways varies from a few small specks on the airway walls to a stream of blood occupying the ventral one-third of the trachea. Blood may also be present in the larynx and nasopharynx. If there is a strong suspicion of EIPH and blood is not present on a single examination conducted soon after exercise, the examination should be repeated in 60 to 90 minutes. Some horses with EIPH do not have blood present in the rostral airways immediately after exercise, but do so when examined 1 to 2 hours later. Blood is detectable by tracheobronchoscopic examination for 1 to 3 days in most horses, with some horses having blood detectable for up to 7 days.

Bronchoscopic examination can be used to estimate the severity of EIPH through the use of a grading system. The interobserver repeatability of tracheobronchoscopic assessment of severity of EIPH using a grading scale of 0 to 4 is excellent, and this scoring system has been widely adopted for use (Fig. 12-27).<sup>7,8,12,21</sup>

- **Grade 0:** No blood detected in the pharynx, larynx, trachea, or mainstem bronchi.
- **Grade 1:** Presence of one or more flecks of blood or two or more short



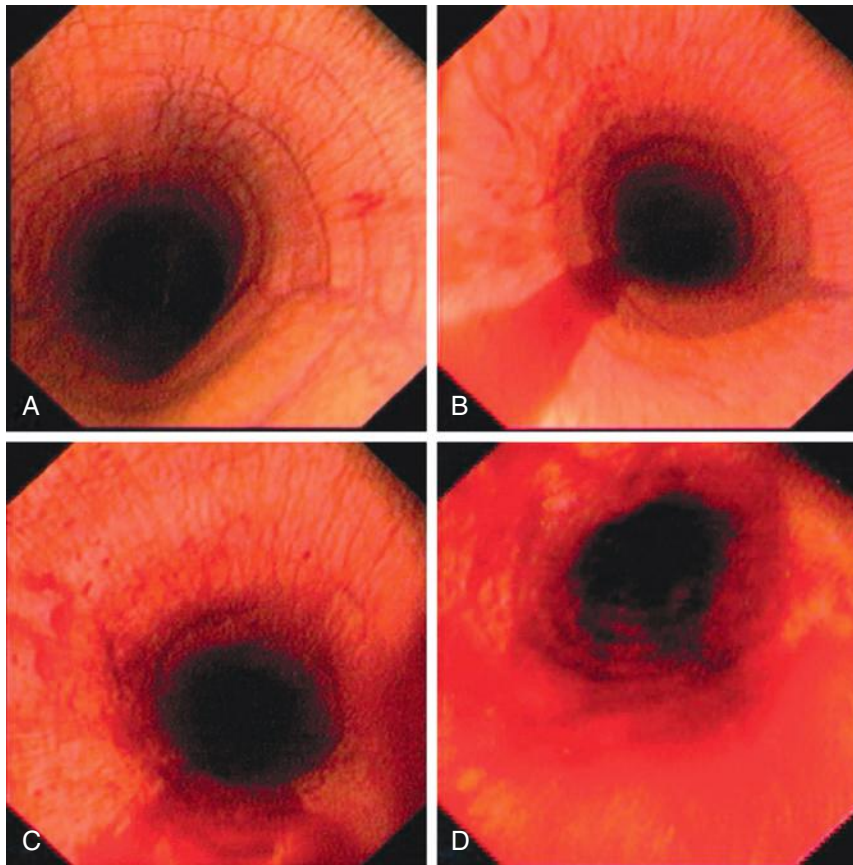

**Fig. 12-27** Grading of EIPH in Thoroughbred racehorses—Grades 1 (A), 2 (B), 3 (C), and 4 (D). (Reproduced with permission Hinchcliff et al. 2005.<sup>21</sup>)

(< one-quarter of the length of the trachea) narrow (<10% of the tracheal surface area) streams of blood in the trachea or mainstem bronchi visible from the tracheal bifurcation.

- **Grade 2:** One long stream of blood (> half the length of the trachea) or greater than 2 short streams occupying less than one-third of the tracheal circumference.
- **Grade 3:** Multiple, distinct streams of blood covering more than one-third of the tracheal circumference. No blood pooling at the thoracic inlet.
- **Grade 4:** Multiple, coalescing streams of blood covering greater than 90% of the tracheal surface with pooling of blood at the thoracic inlet.

It is assumed that a higher score represents more severe hemorrhage, but although the repeatability of this scoring system has been established, the relationship between the amount of blood in the large airways and the actual amount of hemorrhage has not been established.

#### Radiography

Thoracic radiography is of limited use in detecting horses with EIPH. Radiographs

can demonstrate the presence of densities in the caudodorsal lung fields of some horses, but many affected horses have minimal to undetectable radiographic abnormalities.<sup>1</sup> Examination of thoracic radiographs of horses with EIPH can be useful in ruling out the presence of another disease process, such as a pulmonary abscess, contributing to the horse's pulmonary hemorrhage or poor athletic performance.

#### Prognosis

Horses that have experienced one episode of epistaxis are more likely to have a second episode. For this reason most racing jurisdictions do not permit horses with epistaxis to race for a period of weeks to months after the initial instance, with more prolonged enforced rest after a subsequent episode of epistaxis and retirement from racing after a third bout. The recurrence rate after one episode of epistaxis in Thoroughbred horses is approximately 13.5% despite affected horses not being permitted to race for 1 month after the initial episode. This high rate of recurrence suggests that the inciting pulmonary lesions have not healed.

Long-term examination of performance of horses with EIPH indicates the horses with grade 4 EIPH have shorter racing careers, but it is not clear if this is a function

of the biology of the disease or a management decision by owners and trainers.<sup>11</sup> There is no association between measures of long-term performance measured over 10 years and grades 1, 2, or 3 of EIPH in Thoroughbred racehorses.<sup>11</sup>

#### Clinical Pathology

##### Examination of Airway Secretions or Lavage Fluid

The presence of red cells or macrophages containing either effete red cells or the breakdown products of hemoglobin (hemosiderophages) in tracheal or bronchoalveolar lavage fluid provides evidence of EIPH. Detection of red cells or hemosiderophages in tracheal aspirates or bronchoalveolar lavage fluid is believed to be both sensitive and specific in the diagnosis of EIPH. Examination of airway fluids indicates the presence of EIPH in a greater proportion of horses than does tracheobronchoscopic examination after strenuous exercise or racing. The greater sensitivity of examination of airway fluid is probably attributable to the ability of this examination to detect the presence of small amounts of blood or its residual products and the longevity of these products in the airways. Although endoscopic examination may detect blood in occasional horses up to 7 days after an episode of EIPH, cellular evidence of pulmonary hemorrhage persists for weeks after a single episode. Red blood cells and macrophages containing red cells are present in bronchoalveolar lavage fluid or tracheal aspirates for at least 1 week after strenuous exercise or instillation of autologous blood into airways, and hemosiderophages are present for at least 21 days and possibly longer.

Recent studies have reported on the use of red cell numbers in bronchoalveolar lavage fluid as a quantitative indicator of EIPH. However, this indicator of EIPH severity has not been validated nor demonstrated to be more reliable or repeatable than tracheobronchoscopic examination and visual scoring. Furthermore, considerable concern exists over the suitability of red cell counts in bronchoalveolar lavage fluid for assessment of severity of EIPH given that an unknown area, although presumably small, of the lung is examined by lavage and that there is a risk that this area of lung may not be representative of the lung as a whole, similar to the situation of examination of bronchoalveolar lavage fluid of horses with pneumonia. Bronchoalveolar lavage of sections of both lungs, achieved using an endoscope, may obviate some of these concerns.

Tracheal aspirates may be obtained any time after exercise by aspiration either during tracheobronchoscopic examination or through a percutaneous intratracheal needle. Aspirates obtained through an endoscope may not be sterile, depending on the collection technique. Bronchoalveolar lavage fluid

can be obtained through either an endoscope wedged in the distal airway or a cuffed tube inserted blindly into a distal airway. Collection of fluid through an endoscope has the advantage of permitting examination of the distal airways and selection of the area of lung to be lavaged. However, it does require the use of an endoscope that is longer (2 m) than those readily available in most equine practices. Use of a commercial bronchoalveolar lavage catheter does not require use of an endoscope, and this procedure can be readily performed in field situations.

#### DIFFERENTIAL DIAGNOSIS

Epistaxis and hemorrhage into airways can occur as a result of a number of diseases (Table 12-12).

#### Necropsy

Exercise-induced pulmonary hemorrhage is a rare cause of death of racehorses, but among racehorses that die during racing for reasons other than musculoskeletal injuries, EIPH is common.<sup>20</sup> Necropsy examination of horses is usually incidental to examination for another cause of death. Pertinent abnormalities in horses with EIPH are restricted to the respiratory tract. Grossly, horses examined within hours of strenuous exercise, such as horses examined because of catastrophic musculoskeletal injuries incurred during racing, may have severe petechiation in the caudodorsal lung fields. Horses with chronic disease have blue/gray or blue/brown discoloration of the visceral pleural surfaces of the caudodorsal lung fields that is often sharply demarcated, especially on the diaphragmatic surface. The discoloration affects both lungs equally, with 30% to 50% of the lung fields being discolored in severe cases. Affected areas do not collapse to the same extent as

unaffected areas and, in the deflated lung, have a spleen-like consistency. On cut surface, the discolored areas of lung are predominantly contiguous with the dorsal pleural surface and extend ventrally into the lung parenchyma. Areas of affected lung may be separated by normal lung. There is proliferation of bronchial vessels, predominantly arteries and arterioles, in affected areas. Histologically, affected areas exhibit bronchiolitis, hemosiderophages in the alveolar lumen and interstitial spaces, and fibrosis of interlobular septa, pleura, and around vessels and bronchioles.

#### Treatment

Prevention of EIPH is contentious because it can involve the administration of medications on the day of racing. The efficacy of various interventions and medications has recently been evaluated in two systematic reviews, both of which concluded that there was moderately strong to strong evidence

Table 12-12 Causes of epistaxis in horses

Disease	Epidemiology	Clinical signs and diagnosis	Treatment and control
<b>Hemorrhage into trachea or bronchi, sometimes with epistaxis</b>			
Exercise-induced pulmonary hemorrhage (EIPH)	Horses after strenuous exercise. Most common in Thoroughbred and Standardbred racehorses.	Epistaxis is a rare but very specific sign of EIPH. Only occurs after exercise.  Endoscopic examination of the airways is diagnostic,	Efficacy of various drugs used for treatment and control is debated.  Furosemide is used extensively before racing.
Trauma	Sporadic. Associated with trauma to head, neck, or chest.	Physical examination reveals site and nature of the trauma. Can require endoscopic examination of upper airways.	Symptomatic treatment.
Pneumonia	Recent transport or respiratory disease. Can occur as outbreaks though usually individual animals.	Fever, tachypnea, abnormal lung sounds, leukocytosis; radiography demonstrates lung lesions. Cytologic and microbiological examination of tracheal aspirate.	Antimicrobials, NSAIDs, oxygen. Control by vaccination and prevention of respiratory disease.
Lung abscess	Sporadic. Hemorrhage can occur after exercise.	Sometimes no premonitory signs. Fever, depression, anorexia, cough. Hemogram demonstrates leukocytosis.  Hyperfibrinogenemia. Ultrasonography or radiography demonstrates lesion. Tracheal aspirates.	Antibiotics.
Intrabronchial foreign body	Sporadic.	Cough, hemoptysis, fever. Endoscopy or radiography reveals foreign body.	Removal of foreign body—often not readily achieved.
Pulmonary neoplasia	Sporadic. Often older horse, but not always. Hemangiosarcoma.	Cough, hemoptysis. Demonstrate mass on ultrasonographic or radiographic examination.	None.
<b>Epistaxis (in addition to the previously listed diseases)</b>			
Guttural pouch mycosis	Sporadic. Acute-onset epistaxis.	Severe, life-threatening epistaxis. Tachycardia, anemia, hemorrhagic shock.	Surgical ligation or occlusion of arteries in the guttural pouch.
Ethmoidal hematoma	Sporadic.	Epistaxis not associated with exercise. Usually unilateral.	Surgery or injection of mass with formaldehyde.
Thrombocytopenia	Sporadic.	Epistaxis, mild, intermittent. Petechiation and ecchymotic hemorrhages. Thrombocytopenia.	Glucocorticoids.
Neoplasia	Sporadic.	Neoplasia of upper airways.	None.
Trauma	Sporadic.	Injury to head or pharynx.	Symptomatic.
Sinusitis	Sporadic.	Endoscopic or radiographic examination of sinus.	Drainage. Antimicrobials.

that administration of furosemide before racing reduces the frequency and severity of EIPH in Thoroughbred racehorses.<sup>1,22</sup> There was either weak evidence or no evidence of efficacy of other interventions. There is a recommendation for use of furosemide, but because of the regulatory issues related to its use, this is only a weak recommendation.<sup>1</sup>

Therapy of EIPH is usually a combination of attempts to reduce the severity of subsequent hemorrhage and efforts to minimize the effect of recent hemorrhage. Treatment of EIPH is problematic for a number of reasons. First, the pathogenesis of EIPH has not been determined although the available evidence supports a role for stress failure of pulmonary capillaries secondary to exercise-induced pulmonary hypertension. Second, there is a lack of information using large numbers of horses under field conditions that demonstrates an effect of any medication or management practice (with the exception of bedding) on EIPH. There are numerous studies of small numbers of horses (< 40) under experimental conditions but these studies often lacked the statistical power to detect treatment effects and, furthermore, the relevance of studies conducted on a treadmill to horses racing competitively is questionable.<sup>1</sup> Treatments for EIPH are usually intended to address a specific aspect of the pathogenesis of the disease and will be discussed in that context but should be considered in the context of the amount and strength of evidence, which for most treatments is scant and weak.

### Prevention of Stress Failure of the Pulmonary Capillaries

There is interest in reducing the pressure difference across the pulmonary capillary membrane in an effort to reduce EIPH. Theoretically, this can be achieved by reducing the pressure within the capillary or increasing (making less negative) the pressure within the intrathoracic airways and alveolus.

#### *Reducing Pulmonary Capillary Pressure*

Furosemide administration as prophylaxis of EIPH is permitted in a number of racing jurisdictions worldwide, most notably Canada, the United States, Mexico, and most of the South American countries. Within the United States and Canada, almost all Thoroughbred, Standardbred, and Quarter Horse racing jurisdictions permit administration of furosemide before racing.

The efficacy of furosemide in treatment of EIPH is now well documented.<sup>9,22</sup> The mechanism by which furosemide reduces the severity of EIPH is unknown, although it is speculated that furosemide, by attenuating the exercise-induced increase in pulmonary artery and pulmonary capillary pressure of horses, reduces the frequency or severity of pulmonary capillary rupture.

Furosemide is associated with superior performance in both Thoroughbred and Standardbred racehorses, which further complicates assessment of its efficacy in treating EIPH.

An increase in pulmonary capillary pressure secondary to altered rheostatic properties of blood during exercise has been suggested as a possible contributing factor for EIPH.

#### *Increasing Alveolar Inspiratory Pressure*

Airway obstruction, either intrathoracic or extrathoracic, increases airway resistance and results in a more negative intrathoracic (pleural) pressure during inspiration to maintain tidal volume and alveolar ventilation. Causes of extrathoracic airway obstruction include laryngeal hemiplegia and other abnormalities of the upper airway, whereas intrathoracic obstruction is usually a result of bronchoconstriction and inflammatory airway disease. Horses with partial extrathoracic inspiratory obstruction or bronchoconstriction and airway inflammation associated with recurrent airway obstructive disease (heaves) have pleural (and hence alveolar) pressures that are lower (more negative) than those in unaffected horses or in horses after effective treatment. Hypothetical relationships between the horse's bit, airway obstruction and EIPH are not supported to date by empirical evidence.<sup>23,24</sup>

Partial inspiratory obstruction, such as produced by laryngeal hemiplegia, exacerbates the exercise-induced decrease in intrapleural pressures with a consequent increase in transmural capillary pressures. These changes may exacerbate the severity of EIPH, although an association between upper airway obstructive disease and EIPH has not been demonstrated. Surgical correction of airway obstruction is expected to resolve the more negative intrapleural pressure, but its effect on EIPH is unknown.

Recently the role of the nares in contributing to upper airway resistance, and hence lowering inspiratory intrapleural pressure during intense exercise, has attracted the attention of some investigators. Application of nasal dilator bands (Flair strips) reduces nasal resistance by dilating the nasal valve and reduces red cell count of bronchoalveolar lavage fluid collected from horses after intense exercise on a treadmill. Furthermore, application of the nasal dilator strips to horses in simulated races reduces red cell count in bronchoalveolar lavage fluid of some, but not all, horses.

The role of small-airway inflammation and bronchoconstriction in the pathogenesis of EIPH is unclear. However, horses with EIPH are often treated with drugs intended to decrease lower airway inflammation and relieve bronchoconstriction. Beta-adrenergic bronchodilatory drugs such as clenbuterol and albuterol (salbutamol) are effective in

inducing bronchodilation in horses with bronchoconstriction, but their efficacy in preventing EIPH is either unknown or, in very small studies, is not evident. Corticosteroids, including dexamethasone, fluticasone, and beclomethasone, administered by inhalation, parenterally, or enterally, reduce airway inflammation and obstruction but have no demonstrated efficacy in preventing EIPH. Cromolyn sodium (sodium cromoglycate) has no efficacy in preventing EIPH.

Water vapor treatment (inhalation of water-saturated air) has been proposed as a treatment for EIPH because of its putative effect on small-airway disease. However, water vapor treatment has no effect on EIPH.

The use of bedding of low allergenic potential (shredded paper) to prevent EIPH has no apparent effect on prevalence of the condition. Although it is suggested that preventing or minimizing small-airway disease may reduce the severity of EIPH, studies to demonstrate such an effect have not been reported. However, optimizing the air quality in barns and stables and preventing infectious respiratory disease appear to be sensible precautions.

#### *Interstitial Inflammation and Bronchial Angiogenesis*

Hemorrhage into interstitial tissues induces inflammation with subsequent development of fibrosis and bronchial artery angiogenesis. The role of these changes in perpetuating EIPH in horses is unclear but is probably of some importance. Treatments to reduce inflammation and promote healing with minimal fibrosis have been proposed. Rest is an obvious recommendation, and many racing jurisdictions have rules regarding enforced rest for horses with epistaxis. Although the recommendation for rest is intuitive, there is no information that rest reduces the severity or incidence of EIPH in horses with prior evidence of this disorder.

Similarly, corticosteroids are often administered, either by inhalation, enterally or parenterally, in an attempt to reduce pulmonary inflammation and minimize fibrosis. Again, the efficacy of this intervention in preventing or minimizing the severity of EIPH has not been documented.

### Excessive Bleeding

#### *Coagulopathy and Fibrinolysis*

Exercise induces substantial changes in blood coagulation and fibrinolysis. However, there is no evidence that horses with EIPH have defective coagulation or increased fibrinolysis. Regardless, aminocaproic acid, a potent inhibitor of fibrin degradation, has been administered to horses to prevent EIPH. The efficacy of aminocaproic acid in preventing EIPH has not been demonstrated.<sup>1</sup> Similarly, estrogens are given to horses with the expectation of improving hemostasis, although the effect of estrogens on coagulation in any species is unclear.



There is no evidence that estrogens prevent EIPH in horses.

Vitamin K is administered to horses with EIPH, presumably in the expectation that it will decrease coagulation times. However, because EIPH is not associated with prolonged bleeding times, it is unlikely that this intervention will affect the prevalence or severity of EIPH.

### Platelet Function

Aspirin inhibits platelet aggregation in horses and increases bleeding time. Seemingly paradoxically, aspirin is sometimes administered to horses with EIPH because of concerns that increased platelet aggregation contributes to EIPH. There is no evidence that aspirin either exacerbates or prevents EIPH.

### Capillary Integrity

Capillary fragility increases the risk of hemorrhage in many species. Various bioflavonoids have been suggested to increase capillary integrity and prevent bleeding. However, hesperidin and citrus bioflavonoids have no efficacy in prevention of EIPH in horses. Similarly, vitamin C is administered to horses with EIPH without scientific evidence of any beneficial effect.

### Summary of Treatment Options

Selection of therapy for horses with EIPH is problematic. Given that most horses have some degree of pulmonary hemorrhage during most bouts of intense exercise, the decision must be made not only as to the type of treatment and its timing but also which horses to treat. Moreover, the apparently progressive nature of the disease with continued work highlights the importance of early and effective prophylaxis and emphasizes the need for studies of factors such as air quality and respiratory infections in inciting the disorder.

The currently favored treatment for EIPH is administration of furosemide before intense exercise. Its use is permitted in racehorses in a number of countries but is contentious in many. A frequent practice is to administer furosemide before high-speed training, and not on the day of racing, in jurisdictions that do not permit race day administration of medications. There is increasing interest in the effect of furosemide administered 24 hours before racing; its efficacy in this situation remains to be determined. The association between furosemide administration and superior performance in Standardbred and Thoroughbred racehorses should be borne in mind when recommending use of this drug.

### Prevention and Control

There are no documented preventive strategies. Rest is an obvious recommendation for horses with EIPH, but the hemorrhage is likely to recur when the horse is next

strenuously exercised. The duration of rest and the optimal exercise program to return horses to racing after EIPH is unknown, although some jurisdictions require exercise no more intense than trotting for 2 months. Firm recommendations cannot be made on duration of rest because of a lack of objective information.

Although a role for lower airway disease (either infectious or allergic) in the genesis of EIPH has not been demonstrated, control of infectious diseases, and minimization of noninfectious lower airway inflammation appears prudent.

Concern about the role of impact waves in the genesis of EIPH has led to discussion of "low-stress" training protocols, but these have not been adequately evaluated.

### FURTHER READING

- Hinchcliff KW, et al. Exercise-induced pulmonary hemorrhage: American College of Veterinary Internal Medicine consensus statement. *J Vet Intern Med.* 2015;29:743-758.
- Sullivan SL, et al. A systematic review and meta-analysis of the efficacy of furosemide for exercise-induced pulmonary haemorrhage in Thoroughbred and Standardbred race horses. *Equine Vet J.* 2015;47:341-349.

### REFERENCES

- Hinchcliff KW, et al. *J Vet Int Med.* 2015;29:743.
- Velie BD, et al. *Vet J.* 2014;202:274.
- Epp TS, et al. *Comp Exerc Physiol.* 2008;5:21.
- Sullivan S, et al. *Vet Clin Equine.* 2015;31:187.
- Van Erck-Westergren E, et al. *Equine Vet J.* 2013;45:376.
- Reardon RJM, et al. *Vet J.* 2015;205:44.
- Morley PS, et al. *Equine Vet J.* 2015;47:358.
- Preston SA, et al. *Equine Vet J.* 2015;47:366.
- Hinchcliff KW, et al. *JAVMA.* 2009;235:76.
- Hinchcliff KW, et al. *Equine Vet J.* 2010;42:228.
- Sullivan SL, et al. *Equine Vet J.* 2015;47:350.
- Crispe EJ, et al. *Equine Vet J.* 2015;n/a.
- Derksen F, et al. *Compendium (Yardley, PA).* 2011;33:E6.
- Derksen FJ, et al. *Equine Vet J.* 2009;41:586.
- Stack A, et al. *Am J Vet Res.* 2013;74:1231.
- Stack A, et al. *J Appl Phys.* 2014;117:370.
- Williams KJ, et al. *Vet Pathol.* 2008;45:316.
- Derksen FJ, et al. *Equine Vet J.* 2007;39:334.
- Williams KJ, et al. *Equine Vet J.* 2011;43:354.
- Lyle CH, et al. *Equine Vet J.* 2012;44:459.
- Hinchcliff KW, et al. *Am J Vet Res.* 2005;66:596.
- Sullivan SL, et al. *Equine Vet J.* 2015;47:341.
- Cook WR. *Equine Vet Educ.* 2014;26:381.
- Cook WR. *Equine Vet J.* 2014;46:256.

## RECURRENT AIRWAY OBSTRUCTION (HEAVES)

### SYNOPSIS

**Etiology** Combined genetic predisposition with environmental challenge of inhaled barn and feed dust containing inciting agents that can include particles of molds, endotoxin, mites, plant debris, and inorganic material.

**Epidemiology** Predominantly a disease of horses stabled in poorly ventilated barns

and fed quality hay. Occurs worldwide but more commonly in the northern hemisphere. Increased prevalence in older horses. No breed or sex predilection.

**Clinical signs** Range of severity of clinical signs. Chronic cough, mucopurulent nasal discharge, poor athletic performance, increased respiratory rate, increased expiratory effort, wheezes on thoracic auscultation, and abundant mucopurulent material in the trachea on endoscopic examination.

**Clinical pathology** Neutrophilia in tracheal aspirate and bronchoalveolar lavage fluid.

**Lesions** Bronchiolitis with mononuclear cell infiltration, epithelial, and goblet cell hyperplasia, neutrophil accumulation in airway lumens, and alveolar hyperinflation.

**Diagnostic confirmation** Clinical signs, examination of bronchoalveolar lavage fluid, and the response to treatment.

**Treatment** Remove the inciting cause by providing a dust-free environment, and administer corticosteroids. Bronchodilators are useful for treatment of acute bronchoconstriction.

**Control** Prevent exposure to inciting cause. Ensure optimal air quality in stables or maintain horses at pasture.

Recurrent airway obstruction (RAO; heaves) is a recurrent disease of stabled adult horses characterized by neutrophilic airway inflammation and airway obstruction manifest clinically by the presence of coughing, excess mucus accumulation in airways, neutrophilic bronchoalveolar lavage fluid or tracheal aspirate, bronchospasm, tachypnea and increased respiratory effort, and exercise intolerance. Clinical severity ranges from mild coughing with minimal exercise intolerance during infrequent recurrences of the disease through to severe and persistent coughing, airway obstruction, and markedly increased work of breathing and abnormal breathing pattern. Removal of exposure to hay and straw and keeping the horse at pasture results in remission of the disease.

The disease should be differentiated from the usually transient inflammatory airway disease of young adult horses in which there is no clinically significant impairment of pulmonary function. The disease is classically considered to have an allergic component.

### ETIOLOGY

#### Genetics

There is a genetic component to the disease, although the precise pattern of inheritance and gene association is yet to be determined.<sup>1</sup> There is a familial pattern to the disease in some breeds, and for Warmbloods and Lipizzan, affected parents increase the likelihood of off-spring developing recurrent airway obstruction (RAO) by fivefold.<sup>2</sup> Segregation analysis indicates a mixed mode of

inheritance in Warmbloods.<sup>3</sup> It appears likely that multiple genes are involved in the predisposition to RAO and the genes involved might differ with breed of horse or other animal or environmental factors. Evidence for a multigene cause for predisposition to RAO includes the finding of quantitative trait loci (QTL) located on two different chromosomes (ECA 13 and ECA 15) in different families of affected Warmbloods<sup>4,5</sup> and failure to identify a monogenetic predisposition to RAO. Further studies in half-sibling horses and from unrelated horses indicates that at least one causative variant is a QTL region located on ECA 13 that is not associated with any coding variants, suggesting that the cause is a regulatory mutation.<sup>6</sup> The cause does not appear to be abnormalities in the gene encoding DNAH3 (dynein—a component of cilia), although it is located in this QTL and has 53 polymorphisms including 7 nonsynonymous variants.<sup>7</sup> Similarly, mutations in the integrin alpha X gene, which is related to allergy in humans and is located in the region of the QTL in ECA 13, are not associated with RAO.<sup>4,8</sup> However, expression of interleukin 4 receptor gene, which is also located in the region of the QTL, is greater in bronchoalveolar lavage fluid of RAO-affected half-siblings than in unaffected animals, suggesting a role for this cytokine, or a mutation in its gene, in RAO.<sup>9</sup>

### Environmental Factors

RAO is caused by inhalation by susceptible horses of dust particles found in barns, bedding, and feed materials such as dusty hay. The inhaled particles include endotoxin, mites, plant debris, inorganic materials, and conidia and fragments of molds. *Faenia recitvirgula* (formerly known as *Micropolyspora faeni*), *Aspergillus fumigatus*, and *Thermoactinomyces vulgaris* are molds commonly associated with respiratory disease in susceptible horses, as evidenced by experimental studies involving inhalation of mold or mold fragments by horses. Molds contain a number of inflammatory substances, including various allergens, glucans, mycotoxins, and proteases, and it is not clear which of these agents are the inciting cause of RAO. Furthermore, dust containing mold also contains endotoxin. Inhalation of fungal spores, endotoxin and silica microspheres causes RAO in susceptible horses but not in healthy horses.<sup>10</sup> There was neutrophilic inflammation in both healthy and RAO horses but bronchospasm in only RAO horses.<sup>10</sup> Endotoxin contamination of molds contributes to the airway response to inhalation of preparations of molds used in experimental studies and inhalation of endotoxin alone produces airway inflammation and impaired respiratory function in horses in a dose-dependent manner, with RAO-susceptible horses having an exaggerated response at lower doses. Endotoxin concentrations in the breathing zone of horses are eight times higher in

stables than at pasture.<sup>11</sup> However, the response to endotoxin is less than that of susceptible horses exposed to hay dust containing endotoxin, indicating that endotoxin alone is not sufficient to cause the clinical signs of RAO. Other compounds in hay dust are integral to the development of RAO.

It is emphasized that there is not one causative agent acting alone but rather a range of agents that, when inhaled in sufficient concentration by susceptible horses, induce airway disease. It is likely that RAO is associated with the potentiating interactions among several agents present in barn or hay dust and is not simply a response to one agent. The mechanisms underlying development of airway inflammation and respiratory dysfunction are provided under “Pathogenesis.” Viral infections and 3-methylindole intoxication are not considered important causes of RAO.

## EPIDEMIOLOGY

### Occurrence

Although RAO is one of the more common diseases of horses and is a major cause of loss of performance and wastage in European horses, there are few reports of its epidemiologic characteristics. The disease is common in Europe and North America but is rare in Australia. The prevalence of RAO in the Great Britain, based on a random survey of owners who use veterinary surgeons, is 14% (95% confidence interval of 10.7%–17.4%).<sup>12</sup> The 7-day incidence (ie, new occurrence of the disease in an animal) of RAO in horses and ponies in Great Britain is 0.4% (0%–0.8%), and the prevalence of RAO was 5.8% (95% CI 4.2%–7.5%), as reported by owners.<sup>13</sup> In Germany, 83% of horses believed to be healthy at an auction were found to have clinical evidence of chronic pulmonary disease.

Inflammatory airway disease is very common in horses, with 96% of racehorses in Hong Kong examined at necropsy and 27% of healthy racehorses in training having an increased proportion (>20%) of neutrophils in tracheal aspirate, indicating inflammatory airway disease. Among stabled pleasure horses in Michigan, ~17% had cytologic or endoscopic evidence of airway inflammation,<sup>11</sup> and 12% of horses examined in an abattoir in the northern United States had histologic evidence of bronchitis. However, although airway inflammation is a component of RAO, the airway inflammation common in young athletic horses and stabled horses is not generally considered to be RAO or necessarily a prodrome of RAO.

The **case-fatality rate** for moderately to severely affected horses is approximately 20% over a 2- to 4-year period. Among horses greater than 15 years of age, presence of RAO is not significantly associated with death ( $P = 0.73$ , hazard ratio 1.19, 95% CI 0.4–3.2).<sup>14</sup> Most mildly to moderately affected

horses respond well to treatment and continue to perform at a satisfactory level.

## Risk Factors

### Animal Risk Factors

The disease occurs in adult horses and ponies. A survey of horse and pony owners in Great Britain found that the median age of horses and ponies with the disease is 18.2 years versus 12.7 for unaffected animals.<sup>13</sup> Another owner survey found the median age of RAO affected horses as 13 years (interquartile range [IQR] of 9.5–20 years), whereas that of unaffected horses was 10 years (IQR 7–14.4 y).<sup>12</sup> The odds of a horse having RAO (as reported by the owner) increases with greater age (odds ratio of 5.1, 8.1, 11.4, 9.5, and 18.3 for horses 5–7, 7–9, 9–11, 11–15, and greater than 15 years of age compared with horses < 5 years).<sup>12</sup> Examination of a convenience sample stratified random sample of 3000 horses of 1e to 40 years of age in the Netherlands revealed spontaneous coughing during a 10 minute observation period in 1% of horses, nasal discharge in 1.9%, and abnormal respiratory effort in 1%.<sup>15</sup> Of 200 horses and ponies greater than 15 years of age in the United Kingdom randomly chosen for examination by a veterinarian, 13.6% had marked abnormalities (expiratory wheeze, cough and/or increased abdominal effort) during rebreathing examination that are consistent with RAO.<sup>16</sup> A further 17.8% had moderately severe abnormalities. Those horses and ponies with abnormalities identified during rebreathing examination were significantly older (median 21.2 years) than were animals without abnormalities (18.0 years).<sup>16</sup> Similarly, 15% of horses greater than 30 years of age have marked clinical signs consistent with RAO, and a further 19% have moderate abnormalities.<sup>17</sup>

There is no apparent breed, sex, or height predisposition,<sup>12</sup> with the exception that Thoroughbreds are 3 times more likely to be examined for the disease than are ponies, although this could represent a sampling bias in that owners of Thoroughbreds might be more likely to seek veterinary attention than owners of ponies. The finding of increased likelihood of Thoroughbred horses having the disease is not consistent among studies. A survey of donkey owners in the United Kingdom did not elicit any reports of signs consistent with RAO in any of the ~1700 animals.<sup>18</sup> This might represent underreporting of the condition in donkeys or a low prevalence of the disease in donkeys.

There are horses that develop the disease and other horses, maintained in an identical situation, that do not.<sup>12</sup> Development of disease is dependent on the horse being susceptible to the inflammatory effect of inhaled dust but the reasons for this individual susceptibility are poorly understood. As noted earlier (“Etiology—Genes”), familial predisposition has been suggested based on the observation that Lipizaners and German and

Swiss Warmbloods are 3.2 times more likely to have RAO if one parent was affected and 4.6 times as likely if both parents had RAO. There is no association between major histocompatibility markers (equine leukocyte antigens) and occurrence of RAO.

Exposure to inciting agents is associated with a variety of environmental factors, including potentially outdoor concentrations of aeroallergens and climatic factors but most importantly housing and feeding practices.

### Environmental Risk Factors

#### Season

Horses are approximately 2 times more likely to be examined by a veterinarian because of the disease in winter or spring compared with summer, suggesting a seasonality to the occurrence of the disease perhaps as a result of increased stabling during winter. Signs of respiratory disease in horses with RAO are ~2 times more likely to occur in winter months, with peak values of 45% to 50% of RAO-affected horses having clinical signs of the disease in January and February in Great Britain (Fig. 12-28).

#### Housing and Hay Feeding

There is a clear association between housing, feeding of hay, and development of the disease. Typically, susceptible horses are clinically normal when at pasture and develop signs of disease within hours to days of being housed in stables and fed dusty hay. Moving affected horses to pasture, or improving air quality by increasing ventilation and feeding processed feedstuffs, results in resolution of the disease.

Horses living in urbanized environments are approximately twice as likely to have the disease. Although the reason for this association has not been demonstrated, it is reasonable to assume that at least part of the increased risk is attributable to poorer air quality for horses in an urban environment.<sup>12</sup>

Management practices that might contribute to development or exacerbation of RAO vary widely around the world, with differing practices related to duration of stabling, type of bedding, air quality in stables

and such. Within Great Britain, 4% of horses are stabled 24 hours per day year round and 9% stabled all day (24 hours) in winter.<sup>19</sup> 61% are stabled part of each day with pasture turn-out and 36% are turned for 24 hours each day.<sup>19</sup>

Development of disease is related to inhalation of **respirable particles** that gain access to the lower respiratory tract. Respirable particles are less than 5  $\mu\text{m}$  diameter, the principal source of these particles in stalls is hay, and the majority of particles are fungal spores. The concentration of particles in air of the stable is determined by the rate of release of particles from hay, which is dependent in large part on the quality of the hay, concentration of fungal spores in the hay, and the rate of clearance of dust from the stable, a function of the ventilation rate. Concentrations of respirable dust particles in the breathing zone of stabled horses can be as high as 20  $\text{mg}/\text{m}^3$ . The severity of increases in neutrophil count and proportion and decreases in pulmonary function in experimental models of RAO are related in a dose-dependent fashion to the amount of dust inhaled. The presence of dust particles, and not the soluble products in hay dust, is responsible for most of the airway neutrophilia induced by inhalation of hay dust.

**Hay** is the usual original source of spores in stable air. However, **decomposing wood shavings** are also a source of spores of fungi that multiply during degradation of plant-based materials, and housing horses in poorly ventilated stalls deeply bedded with wood shavings may be detrimental to their respiratory health. Spores from hay enter the bedding either directly or after dispersal through the air and multiply in the bedding if it is not removed regularly. **Diced paper** and **wood shavings**, when fresh, usually contain very few spores. Barley and wheat straw are usually free of any small spores such as *A. fumigatus* or *M. faeni*. Bedding horses on fresh wood shavings and feeding a nutritionally complete pelleted ration results in a respirable dust burden 3% of that of horses fed hay and bedded with straw. Dust burdens measured in the air of the stall underestimate the respirable particle challenge of horses

because of the high concentration of particles in hay and bedding, areas from which the horse inhales while eating.

Respiratory health of horses is related to **stable design and ventilation**, with horses in poorly ventilated barns having more respiratory disease than horses in well-ventilated barns. See “**Control**” for recommendations regarding stable design.

### PATHOGENESIS

Susceptible horses, when exposed to adequate concentrations of respirable dust in the breathing zone, develop airway inflammation including neutrophilia in airway secretions, excess mucus accumulation, and bronchospasm within hours to days of exposure. Longer-term changes include bronchiolitis with peribronchial lymphocytic infiltration and increased thickness of submucosal smooth muscle and bronchial epithelium. Notably, eosinophils are not an important component of the inflammatory response in horses with RAO, either in bronchoalveolar lavage fluid or in peribronchial infiltrates.<sup>20</sup> These morphologic changes contribute to the reduction in airway diameter that underpins the physiologic effect of the disease. Emphysema and bronchiectasis develop as the severity of the disease worsens.

The mechanisms underlying these responses to inhalation of dust are not well defined but can be considered in the contexts of immune and inflammatory responses, mucus secretion, and pulmonary dysfunction.

### Inflammatory and Immune Responses

The precise immunologic abnormalities and mechanisms causing airway and peribronchial inflammation in affected horses is unclear.<sup>21</sup> Inflammation is associated with excessive mucus production, airway swelling, and abnormal lung function. The inflammatory response in horses with RAO is neutrophilic, with lesser numbers of mast cells and rarely eosinophils.<sup>20</sup> The mechanisms underlying this inflammatory response have not been fully elucidated, but differing responses in RAO and healthy horses, and differing responses among families of RAO sensitive horses, to antigenic challenge supports an acquired immune-mediated process.<sup>22</sup> Furthermore, upregulated expression of IL1 $\beta$ , IL8, TLR4, TNF $\alpha$ , TGF $\beta$ 1, and NF $\kappa$  $\beta$  transcripts in RAO-affected compared with healthy horses and the strong correlation with clinical variables indicative of disease severity provide support for an immune-mediated disease process.<sup>23</sup> There is currently no clear consensus on the immune mechanisms involved in development or perpetuation of RAO despite numerous studies examining cell types,<sup>20,24-28</sup> cytokines,<sup>23,29-34</sup> gene expression,<sup>23,29,31,35</sup> and antibody isotypes.<sup>36</sup>

The presence of allergen-specific IgE antibodies in bronchoalveolar lavage fluid is supportive of a hypersensitivity reaction (type 1

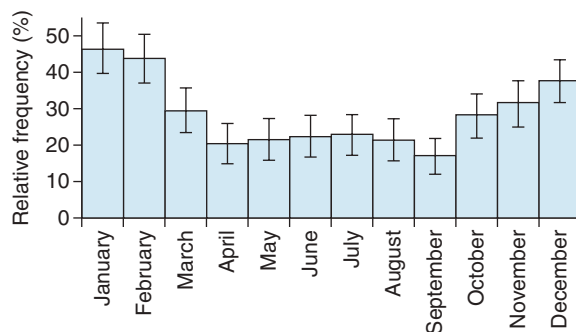

**Fig. 12-28** Proportion of horses in Great Britain with recurrent airway obstruction (RAO) that display clinical signs of respiratory disease in each month. (Reproduced with permission.<sup>12</sup>)



hypersensitivity response), as is the observation that reaginic antibodies (IgE and some classes of IgG) in serum of horses sensitive to *Aspergillus fumigatus* cause mast cell (rat origin) degranulation.<sup>36</sup> Others have proposed type 3 and type 4 immune reactions as the basis of the disease, and there are suggestions of polarized Th1 or Th2 responses. Detection of increased mRNA expression of **thymic stromal lymphopoietin**, a cytokine involved in lymphocyte development and driving a Th2 response, in bronchoalveolar lavage fluid (BALF) and peribronchial cells of horses with RAO is evidence of a contribution of a Th2 mechanism to RAO.<sup>32</sup> One proposed explanation is that RAO-susceptible horses exhibit a Th2-like immune response to inhalation of hay or barn dust characterized by increased expression of interleukins 4 and 5 and decreased expression of interferon- $\gamma$  in cells obtained by bronchoalveolar lavage. Others have not detected a pure Th2-like cytokine profile, finding instead a mixed inflammatory response including increases in expression (mRNA) in cells obtained from bronchoalveolar lavage fluid of affected horses of interferon- $\gamma$ , tumor necrosis factor- $\alpha$ , interleukins 1 $\beta$  and 4, and interleukins 8 and 17 (potent attractors of neutrophils) but not interleukins 2, 5, and 10. However, all the studies cited previously were performed on crude preparations of cells obtained by bronchoalveolar lavage, and the results could have been influenced by the varying proportions of types of cells in these preparations. A study examining just CD4 and CD8 lymphocytes in blood and bronchoalveolar lavage fluid of RAO-affected horses demonstrated a general down-regulation in expression of interferon- $\gamma$ , and interleukins 4, 5, and 13 and no evidence of a cytokine profile consistent with either sole or predominate Th1- or Th2-like responses. The magnitude of the inflammatory response varies depending on the challenge (i.e., nature of the inhaled material) with responses to endotoxin characteristically being less than that of hay dust. Regardless of the underlying mechanism, it is clear that T cells are involved in mediating and likely modulating the response to exposure to inciting agents in susceptible horses<sup>25</sup> and this results in airway inflammation and interference with normal respiratory function. The role of the observed increased rate of T-cell apoptosis in resolution of clinical signs after removal of the inciting agents in RAO-affected horses is uncertain.<sup>27</sup>

Following inhalation of inciting agents there is recruitment of **neutrophils**, but not eosinophils or platelets, into the lungs in most horses that develop changes in lung function. Histologically, there is peribronchiolar accumulation of lymphocytes and luminal accumulations of neutrophils in affected horses. The neutrophilic response in airways is mediated at least in part by IL-8 and IL-17 and by MAPK and PI3K pathways

in horses with heaves.<sup>30</sup> The entry of neutrophils into the airways is associated with activation of neutrophils and platelets. Neutrophil activation occurs in horses with RAO 10 and 24 hours after antigen challenge and is mediated by increased expression of CD13 on circulating neutrophils of susceptible horses exposed to inciting dust.<sup>37</sup> However, there is not increased expression of mRNA for TNF- $\alpha$ , IL- $\beta$ , IL-8, and MIP-2 in horses with RAO, suggesting that release of these cytokines is not necessary for the neutrophilic response characteristic of the disease.<sup>38</sup> The neutrophils of horses during episodes of RAO, but not when the horses are asymptomatic, have increased adherence in vitro to protein coated plastic suggesting a mechanism for the increased migration of neutrophils into airways of affected horses. However, neutrophils of asymptomatic RAO-affected horses (ie, those horses in remission of the disease) have an exaggerated serum concentration of TNF and mRNA expression after lipopolysaccharide exposure compared with cells of healthy horses.<sup>26</sup> A greater proportion of neutrophils in BALF of RAO-affected horses are viable and have a slower rate of apoptosis compared with those of unaffected horses, suggesting a role for increased neutrophil survival in airways in horses with RAO.<sup>28</sup>

Inhibition of neutrophil phosphodiesterase-4 activity does not alleviate clinical signs of RAO or decrease neutrophil numbers in bronchoalveolar lavage fluid in affected horses, suggesting that neutrophils are not primarily involved in the genesis of airway obstruction. The extent to which neutrophils in the airways are activated has not been determined, and their role in the development of respiratory dysfunction is unclear given that glucocorticoid administration attenuates the respiratory dysfunction but not airway neutrophilia in horses with RAO (see under “**Treatment**”).

Airway inflammation is associated with increases in concentration of inflammatory mediators including leukotriene B<sub>4</sub>, prostanooids including thromboxane, and proteases. Activity of matrix metalloproteinase-9 is higher in horses with RAO than in unaffected horses and is induced in a dose-dependent manner by inhalation of inciting substances including hay dust and endotoxin. MMP-9 is likely important in the inflammatory process associated with RAO through excessive gelatinolytic proteolysis that can contribute to lung injury and through a role in lung remodeling. Inflammation is also associated with increased oxidative stress in lungs of horses with RAO as indicated by elevated concentrations of epi-PGF2a and redox ratio of glutathione in pulmonary lavage fluid.

RAO is associated with platelet activation and increases in mean platelet volume, indicating consumption of platelets and bone marrow release of younger thrombocytes.<sup>35,37</sup>

Platelets are consumed in part by formation of neutrophil-platelet aggregates.<sup>37</sup>

### Mucus

Accumulation of excessive quantities of mucus in the large airways is characteristic of horses affected by RAO and can contribute to nonbronchospastic airway obstruction. Accumulation of mucus is attributable to decreased clearance and increased production. The mucus in horses with RAO differs in both composition and viscoelasticity from that of clinically normal horses and this might contribute to its decreased clearance. The viscosity of mucus can increase threefold in RAO susceptible horses stabled and exposed to hay dust. Increased production of mucus is associated with up-regulation of the equine MUC5AC gene, which is responsible for production of mucin, but not with IL-13 or epithelial gene (CLCA1, EGFR, Bcl-2 and MUC5AC expression,<sup>39</sup> in the small airways of horses with RAO.

### Airway Function and Gas Exchange

Inhalation of inciting agents causes changes in lung function characterized by an increase in pulmonary resistance, lower dynamic compliance, altered distribution of ventilation, impaired gas exchange, increased functional residual capacity, and an altered breathing strategy. **Airway obstruction** is a result of bronchospasm, inflammatory thickening of airways, and accumulation of mucus and cells in the airways. Bronchospasm is largely relieved by administration of bronchodilator drugs or removal of the inciting cause, but residual effects on lung function remain and are attributable to inflammation and fibrosis and bronchoconstriction of small airways. **Bronchoconstriction** in both normal and affected horses is caused by parasympathetic activity and release of acetylcholine that reacts with muscarinic receptors on airway smooth muscle. However, the response is exaggerated in horses with RAO. Stimulation of airway sensory receptors results in an exaggerated bronchoconstrictive response, possibly because of the action of inflammatory mediators and/or byproducts. The exaggerated bronchoconstrictive response is not specific for allergens, and any substance that activates airway sensory receptors may incite bronchoconstriction once the sensitivity of the receptors is enhanced by inhalation of the inciting allergens. Exaggerated airway responsiveness to inhaled irritants persists for up to 3 days after a single exposure to the inciting agent and is likely important in the development of clinical signs of the disease. Bronchoconstriction increases work of breathing, but hypoventilation probably contributes little to the hypoxemia of affected horses, given that  $Paco_2$  is rarely increased.

**Hypoxemia**, which can be severe (<60 mm Hg, 8 kPa), is attributable to ventilation-perfusion mismatches and increased

dead-space ventilation. The increased minute ventilation of affected horses, a result of maintained tidal volume and increased respiratory rate, mainly supplies dead space and regions with high V/Q ratios. Pulmonary hypertension in affected horses is probably attributable to hypoxia and perhaps inflammatory mediators with vasoconstrictor activity.

The **elevated functional residual capacity** and characteristic breathing strategy of affected horses is attributable to airway obstruction. Airway obstruction causes trapping of air in alveoli and a higher end-inspiratory volume. The high end-inspiratory volume maximizes airway diameter and facilitates the high expiratory and inspiratory flow rates necessary for affected horses to maintain a normal tidal volume while increasing their respiratory rate.

**Bronchiectasis** (irreversible dilation and deformation of bronchi or bronchioles) occurs in some horses affected with RAO for a prolonged duration. Neutrophilic inflammation is essential for the development of bronchiectasis.

Surfactant of horses with RAO has a lower phospholipid concentration and lower percentage of phosphatidylglycerol that is not a result of leakage of plasma into BALF.<sup>40</sup> The clinical importance of this abnormality is unclear.

RAO causes pulmonary artery hypertension with consequent abnormal cardiac septal motion, decreased left ventricular diameter and stroke volume, and increased pulmonary artery diameter.<sup>41</sup>

## CLINICAL FINDINGS

The degree to which horses are affected varies considerably and is quantifiable by consideration of a combination of clinical signs.<sup>42</sup> Minimally affected horses have airway inflammation evident on endoscopic or cytologic examination of the airways, but few other signs on physical examination, whereas severely affected horses have very obvious clinical signs. Owner-reported scoring systems are useful in staging the disease and predicting onset of clinical signs.<sup>43,44</sup>

The usual **history** is that of chronic cough in a stabled horse, and owner-reported rates of coughing correlate well with the clinical condition and bronchial sensitivity to histamine challenge of horse.<sup>45</sup> Typically, the disease is precipitated by exposure to hay and stabling, and disease remission occurs in most horses when pastured and removed from hay. There may be a history of reduced exercise tolerance.

Affected horses are usually bright and alert and have a normal appetite and rectal temperature. Severely affected horses appear anxious and have a greatly increased respiratory effort.

**Coughing** is common in horses with RAO, although it is neither particularly specific nor sensitive as an indicator of the

disease. Coughing may consist of a single cough every few seconds to minutes, or there may be a paroxysm of coughing. The cough can also be elicited by digital massage of the larynx and proximal part of the trachea because horses with airway inflammation have increased sensitivity of the cough reflex. Stimulation of the larynx or proximal trachea by digital massage does not elicit coughing in normal horses. The cough becomes more pronounced and wheezing with exercise. It also occurs more frequently when the horse is exposed to cold air, physical activity, or excitement; when placed in a dusty environment; or if dusty feed is offered. The amount of coughing, which must be counted over at least 15 minutes and preferably 1 hour for accurate determination of its severity, correlates closely with the amount of mucus in airways, maximal change in pleural pressure (a measure of bronchoconstriction), and neutrophil count in bronchoalveolar lavage fluid. Coughing is more frequent in horses with RAO, and affected horses often have paroxysmal coughing, especially after barn cleaning and feeding.

An intermittent, bilateral, mucopurulent to serous **nasal discharge** is a common sign in affected horses.

The resting **respiratory rate** is increased from a normal of 12/min up to 24 to 36/min. There is a pronounced effort during expiration, and markedly affected horses have an obvious abdominal component to respiration. Normal horses have a biphasic pattern of airflow during inspiration and expiration, whereas affected horses lack the second phase of respiration—evident as lower thoracoabdominal asynchrony.<sup>46</sup> Longstanding cases develop a “heave line” in the flank as a result of hypertrophy of the abdominal oblique musculature. It is evident as a trough or furrow along the costal arch. In advanced cases the nostrils may be visibly dilated during inspiration, and the force of the expiratory effort causes the anus to protrude.

Heart rate is commonly within the normal range or only slightly increased. In horses with RAO, the heart rate is significantly higher during exercise than in healthy horses.

**Abnormal lung sounds** are one of the most frequent abnormalities detected on clinical examination and the sensitivity of this finding can be increased from 70% to almost 90% by auscultating the thorax while the horse breathes for 60 to 120 seconds with an airtight plastic bag over its nostrils. The bag should be large enough to enable the horse to breathe unhindered (10-15 L) and should not leak. Accumulation of carbon dioxide in the bag increases the horse's respiratory rate and tidal volume and accentuates lung sounds. Auscultation of the lungs in the early stages of the disease may reveal only a slight increase in the amplitude of normal breath sounds. Abnormal lung sounds become audible as the disease progresses.

**Wheezing and crackling sounds** occur at the end of inspiration and the end of expiration. These abnormal sounds are audible over most of the lung but are usually easiest to detect over the upper one-half of both lung fields. **Auscultation of the trachea** usually reveals moist sounds characteristic of fluid in the trachea. Some affected horses have quieter than expected lung sounds.

Percussion of the thorax may reveal an increase in the area of resonance by as much as one to two intercostal spaces caudally. However, the area of resonance delineated by percussion is too labile and ill-defined to be of diagnostic value.

**Endoscopic examination** of the upper airways, trachea, and bronchi reveals an abundance of mucopurulent material in the trachea, which, in severe cases, is also present in the nasopharynx. Detection of signs of inflammation in the upper airway does not reflect the presence or severity of inflammation in the lower airway.<sup>47</sup> The amount of mucus can be graded on a scale from 0 to 5 (Fig. 12-29).<sup>48</sup>

- **Grade 0**—no visible mucus.
- **Grade 1**—small blobs of mucus that are not confluent.
- **Grade 2**—multiple blobs of mucus, some of which are confluent.
- **Grade 3**—mucus confluent in a stream in the ventral aspect of the trachea or multiple large blobs around the circumference of the lumen.
- **Grade 4**—large pool of mucus in the ventral aspect of the airway.
- **Grade 5**—Profuse amounts of mucus occupying more than 25% of the tracheal lumen.

Observation of tracheal mucus of grade 4 or 5 has a high specificity (92%) but low sensitivity (52%) for detection of RAO. Assessment of tracheal septum thickness is not useful in determining the severity of RAO.<sup>49</sup>

**Radiographic examination** of the thorax usually reveals evidence of bronchial disease with some evidence of interstitial disease. Radiography is more useful in ruling out other diseases, such as granulomatous or interstitial pneumonia, than in confirming RAO.

Sophisticated techniques for measuring pulmonary function, such as determination of tidal flow–volume loops, nitrogen washout, or forced expiratory flow–volume loops, may identify mildly or subclinically affected animals but have limited day-to-day clinical utility.

Measurement of **pleural pressure changes** by insertion of an esophageal balloon is relatively simple and may be useful in monitoring response to treatment. Affected horses have pleural pressure changes during respiration greater than 6 cm H<sub>2</sub>O. Administration of atropine (0.02 mg/kg, IM or IV), isoproterenol (isoprenaline), or a  $\beta_2$ -adrenergic agonist such as terbutaline

## Scoring System for Tracheal Mucus

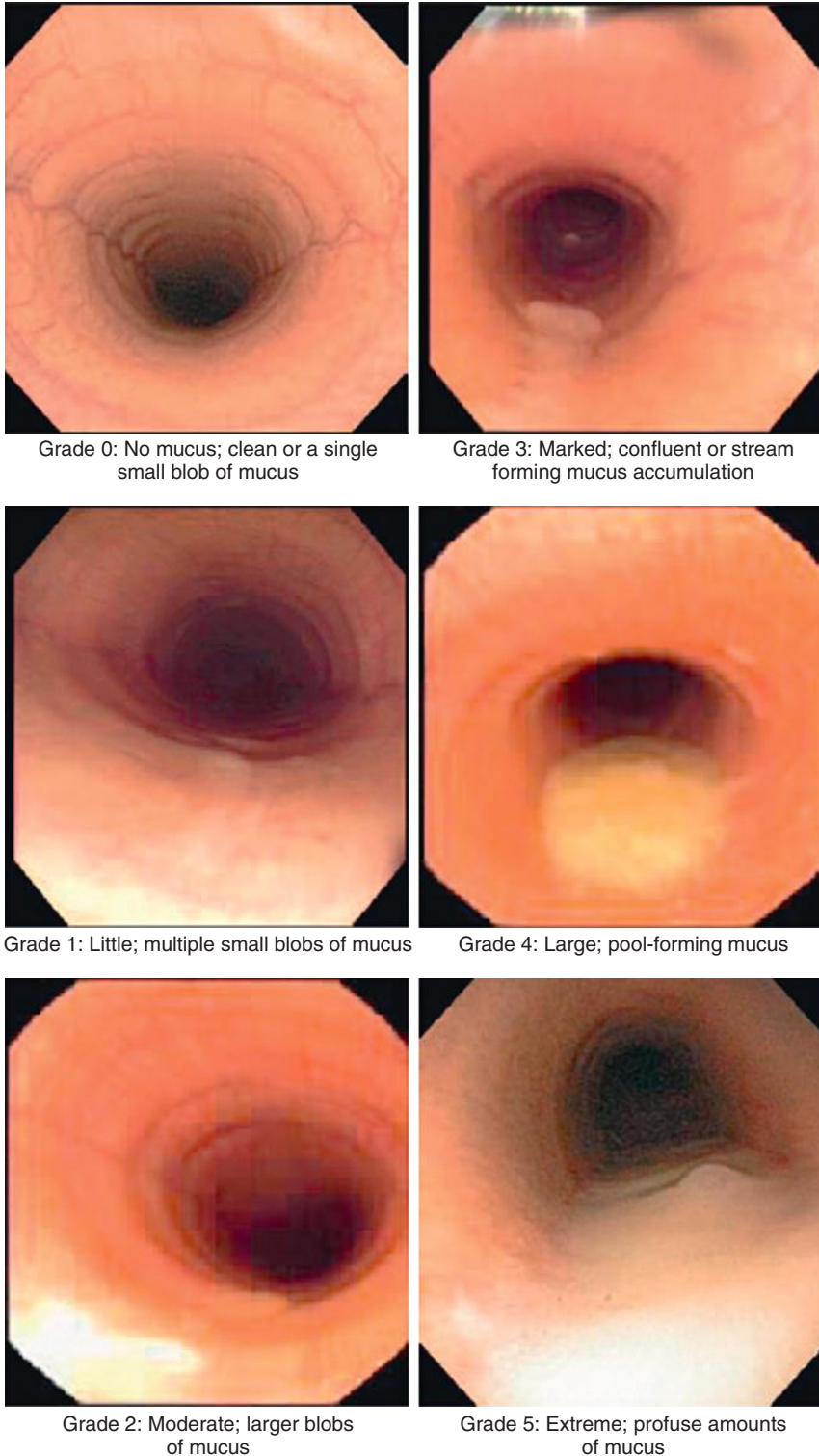

**Fig. 12-29** Endoscopic grading of tracheal mucus in horses. (Modified from Gerber V, Straub R, Marti E et al. Endoscopic scoring of mucus quantity and quality: observer and horse variance and relationship to inflammation, mucus viscoelasticity and volume, *Equine Vet J* 2004;36: 576–582 with permission from the Equine Veterinary Journal.)

(0.002–0.005 mg/kg, IV) reduces the maximal change in pleural pressure of horses with RAO.

Abnormalities in left and right ventricular function are detectable in horses with

RAO. These include reduced early diastolic filling velocities, elevated late diastolic filling velocities, thereby decreased E/A quotient, prolonged electromechanical coupling periods between electrocardiograph Q-wave

and maximal velocities, and compensatory elevated systolic strain in the right heart<sup>50</sup> and abnormal cardiac septal motion, decreased left ventricular diameter and stroke volume, and increase pulmonary artery diameter.<sup>41,51</sup>

The **course of the disease** is dependent on the removal or continual presence of the precipitating cause. If the cause is removed in the early stages, complete recovery can occur. In the continual presence of the precipitating cause relapses occur commonly or the disease becomes progressive and affected horses become severely incapacitated. **Bronchiectasis**, evident on radiographic examination of the thorax, develops in horses with RAO of prolonged duration. With conscientious management and adequate housing, breeding animals and hunters or show jumpers with RAO can remain useful for many years.

Lung biopsy of horses with RAO is described,<sup>52,53</sup> but it is not a clinically relevant diagnostic test because of the risk of adverse events and clinicians' ability to detect and stage the disease based on less invasive clinical and clinicopathologic information.<sup>42,43,45</sup>

### CLINICAL PATHOLOGY AND SPECIAL EXAMINATIONS

There are no significant changes in the hemogram or serum biochemistry of affected horses. The  $PaO_2$  is below normal in moderately to severely affected horses and the  $Paco_2$  is usually normal, although it may be increased in severely affected horses. Blood oxygen tension measurements should be corrected for the temperature of the animal and the altitude. At approximately sea level,  $PaO_2$  values of normal horses are usually greater than 90 mm Hg (12 kPa), whereas affected horses have  $PaO_2$  less than 82 mm Hg (10.9 kPa). With increases in altitude the values in both normal and affected horses decrease. The normal hypoxemia that occurs in horses during intense exercise is exacerbated by RAO.

**Bronchoalveolar lavage fluid** from affected horses during symptomatic episodes has a relative neutrophil count greater than 5% to 10%, and usually over 50%, of the absolute nucleated cell count. It is recommended that horses not be considered to have airway inflammation unless greater than 15% of cells in bronchoalveolar lavage fluid are neutrophils. During periods of remission, the bronchoalveolar lavage fluid of previously affected horses is not different from that of normal horses. Absolute nucleated cell counts in bronchoalveolar lavage fluid of affected horses are reported, but the values depend on the collection technique used. The relative proportions of macrophages and lymphocytes in bronchoalveolar lavage fluid of affected horses are lower than those of normal horses. Eosinophil numbers in bronchoalveolar or tracheal aspirate fluid of affected horses may be mildly elevated (up



to 10%), but are usually low (<3%-5%). Higher values should raise the index of suspicion for *Dictyocaulus arnfieldi* or *Parascaris equorum* infestation. Bronchial collapse, observed endoscopically, during bronchoalveolar lavage is a sign of airway inflammation.<sup>54</sup>

Aspirates of **tracheal fluid** reveal a profound neutrophilia (>90%).

Measurement or identification of **precipitins** in serum of horses is not useful in identifying horses with RAO.

**Intradermal** testing using putative allergens has been investigated as a means of identifying horses with RAO or of identifying antigens with which to hyposensitize affected horses with variable or undetermined efficacy. Retrospective examination of records of horses with a history of RAO suggests that they are more likely to react, and react to a larger number, of intradermally injected allergens than horses without a history of RAO. However, reactions to individual allergens cannot be used to determine hypersensitivity to particular allergens, although it is suggested that overall patterns of reactivity, with a history of exposure of the horse to these allergens, might be useful in guiding management of affected horses. Contrary to these results, a prospective study demonstrated that horses with RAO did not have a greater rate of reaction to intradermal skin tests than did horses not affected by RAO. Intradermal testing did not distinguish clinically relevant reactions from those that were not clinically relevant. Horses with RAO have greater sensitivity to intradermal injection of histamine, which is commonly used as a positive control, than horses without RAO. Overall, intradermal skin testing is neither useful in detecting horses with RAO nor in determining hypersensitivity to particular allergens in individual horses. Results of such testing might be useful in management of horses, but this has not been demonstrated. The usefulness of intradermal skin testing and subsequent administration of preparations of antigens selected on the basis of intradermal testing, in an effort to hyposensitize horses with RAO, has not been determined. The apparent lack of efficacy of intradermal testing might be because the extent of reactivity to intradermal injection of mold preparations does not correlate with the severity of pulmonary dysfunction after inhalation of the same preparation in horses with RAO.

**Lung biopsy** demonstrates peribronchiolar lymphoplasmacytic inflammation, goblet cell metaplasia, alveolar fibrosis, and bronchial lumen exudate and neutrophils. The severity of bronchiolar neutrophil and mast cell infiltration correlates well with the severity of the clinical signs.

### NECROPSY FINDINGS

The major findings are restricted to the lungs, which are pale and voluminous and do

not collapse when the chest cavity is opened. The tissue damage is primarily centered on airways which are less than 2 mm in diameter. Microscopically, a variable degree of alveolar emphysema is accompanied by a chronic bronchiolitis featuring diffuse epithelial hyperplasia, goblet cell metaplasia, peribronchiolar fibrosis, and cellular infiltration by lymphocytes, plasma cells, mast cells, and sometimes eosinophils. Plugs of mucus with entrapped neutrophils often occlude bronchiolar lumina. Changes in airway collagen and elastic fiber content correlate with lung function in horses with RAO.<sup>55</sup>

### Samples for Postmortem Confirmation of Diagnosis

- Formalin-fixed lung for light microscopic examination

### DIAGNOSTIC CONFIRMATION

Confirmation of the disease is based on the presence of a history and clinical signs consistent with the disease, in particular the response to stabling and pasturing, and demonstration of reversible airway obstruction. Objective confirmation can be achieved by measuring the response of maximal changes in pleural pressure in response to bronchodilator drug (atropine or glycopyrrolate) administration.

### DIFFERENTIAL DIAGNOSIS

*Horses with respiratory distress may have the following conditions:*

- Interstitial pneumonia
- Heart failure
- Bacterial pneumonia
- Pleuritis
- Pulmonary or mediastinal neoplasia, including leiomyosarcoma
- Parasitic pneumonia (*D. arnfieldi*)

*Nasal discharge may be caused by the following:*

- Guttural pouch diseases including empyema
- Dysphagia of any cause
- Esophageal obstruction
- Sinusitis
- Pneumonia

### TREATMENT

The principles of treatment are as follows:

- Removal of the inciting cause
- Reduction of airway inflammation
- Bronchodilation
- Correction of hypoxemia

RAO is an inflammatory disease caused by inhalation exposure to inciting agents. Bronchoconstriction is secondary to inflammation. Control of the disease is based upon preventing inhalation of inciting agents and suppression of inflammation by administration of corticosteroids, practices supported by substantial evidence.<sup>56</sup> Relief of bronchoconstriction

should be necessary only during acute exacerbations of the disease, and administration of bronchodilatory drugs for more than several days is not optimal treatment in most horses. Drugs used in the treatment of RAO are summarized in Table 12-13.

It is essential that the horse is **not exposed to the inciting agents** and irritant substances that could provoke or worsen the disease. Even relatively brief exposure of susceptible horses to the inciting agents, such as can occur if a horse is brought into a poorly ventilated barn to be fed, can result in airway hypersensitivity and the development or maintenance of clinical signs. Affected horses should be moved to a clean environment, **ideally pasture**, in which the concentration of airborne allergens is reduced to an absolute minimum. If the horse cannot be kept at pasture, then it should be housed in a well-ventilated barn (see “Control” for details), bedded with clean wood shavings or shredded paper and fed a complete pelleted ration. If affected horses are fed hay, it should be thoroughly wetted to minimize the release of spores. Remission of clinical signs can be expected in 4 to 21 days if the environmental changes are adequate. This may be all that is necessary to control the disease in many horses.

### Antiinflammatory Drugs

The disease is essentially one of inflammation of the airways, and therefore one of the mainstays of treatment is administration of antiinflammatory drugs. Nonsteroidal antiinflammatory drugs such as phenylbutazone and flunixin meglumine are not effective. Corticosteroids including dexamethasone, prednisolone, triamcinolone, and betamethasone are effective in controlling the disease.<sup>57</sup> **Dexamethasone** (0.04-0.1 mg/kg, intravenously, intramuscularly or orally every 24-48 hours) can be given to control the acute signs of the disease, and then the dose reduced and eventually discontinued as environmental alterations have their effect. Similarly, **prednisolone** (1-2 mg/kg, orally once daily), but not prednisone (which is not absorbed after oral administration to horses), can be given initially, then the dose reduced by approximately one half every 5 to 10 days as the disease is controlled. Both prednisolone (2 mg/kg per day) and dexamethasone (0.05 mg/kg day) improve clinical signs of the disease in the face of continued exposure to inciting causes, and prednisolone improves lung function.<sup>58</sup> Often prednisolone or dexamethasone sodium phosphate is effective when administered every second day when the disease has been controlled. **Dexamethasone-21-isonicotinate** (0.04 mg/kg, intramuscularly) is effective when administered every 3 days, but not when administered only once. **Isoflupredone** (0.03 mg/kg, intramuscularly once

Table 12-13 Drugs used in the treatment of heaves in horses

	Drug	Dose and frequency	Route	Comments
<b>Bronchodilators</b>				
$\beta_2$ -agonists	Clenbuterol	0.8–3.2 $\mu$ g/kg q12 hourly	Oral or IV	Initial therapy with lowest dose. Gradual increments depending on response. For short-term therapy pending environmental control and corticosteroid administration.
	Albuterol	50 $\mu$ g/kg	Oral	Unknown and doubtful efficacy.
	Albuterol	1–3 $\mu$ g/kg q6–12 hours	Inhalation	Has short duration of action (1 hour). Can be combined with ipratropium to prolong duration of bronchodilation.
	Fenoterol	2–4 $\mu$ g/kg as needed	Inhalation	Short duration of action.
	Pirbuterol	1–2 $\mu$ g/kg as needed	Inhalation	Short duration of action.
	Salmeterol	0.5–1.0 $\mu$ g/kg q6–12 hours	Inhalation	Longest acting $\beta_2$ -agonist available for inhalation.
	Terbutaline	0.2 mg/kg as needed	Inhalation	Marked adverse effects including tachycardia. Not absorbed after oral administration.
<b>Parasympatholytics</b>	Terbutaline	0.005 mg/kg as needed	IV	Marked adverse effects, including sweating and tachycardia.
	Ipratropium	0.5–3.0 $\mu$ g/kg q4–6 h	Inhalation	Usually combined with albuterol for rapidity of onset of bronchodilation. Duration of action is ~6 h.
	Glycopyrrolate	5 $\mu$ g/kg as needed	IV or IM	Useful for short-term or emergency relief of bronchoconstriction.
Miscellaneous	Atropine	0.01–0.02 mg/kg as needed	IV or IM	Useful for diagnosis of reversible airway obstruction and short-term relief of bronchoconstriction. Can cause colic.
	Theophylline	5–10 mg/kg q8–12 hours	Oral	Antiquated therapy. Moderate bronchodilation, variable absorption, narrow therapeutic index, frequent adverse central nervous system effects. Not recommended.
	Pentoxifylline	10–15 mg/kg q12 hourly	Oral	Not used clinically. Experimental evidence of efficacy.
	<b>Antiinflammatory drugs</b>			
Corticosteroids	Dexamethasone phosphate or in alcohol	0.02–0.1 mg/kg q24 hourly	IV, IM, or oral	Effective at reducing clinical signs within 3 days. Gradually reduce dose and frequency to lowest efficacious dose.
	Dexamethasone-21 isonicotinate	0.04–0.06 mg/kg q3 days	IM	Effective. Infrequent dosing.
	Prednisolone	1–2 mg/kg q24 hourly	Oral or IM	Effective at reducing clinical signs within 3 days. Gradually reduce dose and frequency to lowest efficacious dose.
	Prednisone	1–2 mg/kg q24 hourly	Oral	Variable efficacy and not efficacious in most horses. Do not use.
	Triamcinolone acetonide	0.011–0.022 mg/kg q2–4 weeks	IM, SC	Infrequent dosing and therefore lack of ability to taper dose. Should not be repeated at < 3-month intervals.
	Beclomethasone	1–9 $\mu$ g/kg q12 hourly	Inhalation	Relief of bronchoconstriction within 3 days. Lowest dose does not cause adrenal suppression and is effective in relief of bronchoconstriction.
	Fluticasone	2–12 $\mu$ g/kg q12 hourly	Inhalation	Potent and effective. Expensive.
<b>Other</b>	Cromolyn sodium	200 mg q12 hourly	Inhalation	Undetermined efficacy. Should be used before exposure to inciting agent.
	Montelukast	0.11 mg/kg q24 hourly	Oral	Leukotriene receptor antagonist. Not efficacious at this dose.

Data from: Couetil, L.L. (2014) In Hinchcliff KW, Kaneps AJ, and Geor RJ (eds): *Equine Sports Medicine and Surgery: Basic and clinical sciences of the equine athlete*, ed. 2. Elsevier Health Sciences. p 614.

daily) is as effective as dexamethasone in alcohol in control of exacerbations of RAO, although it does cause hypokalemia. **Triamcinolone** (0.09 mg/kg, intramuscularly) administered once provides long-term (weeks) relief of signs in some horses.

**Inhaled corticosteroids**, such as beta-methasone, beclomethasone, or fluticasone, are useful in controlling the disease. Both inhaled and parenterally administered corticosteroids suppress adrenal function of horses but 500  $\mu$ g of beclomethasone propionate inhaled twice daily effectively

alleviated signs of RAO and causes less adrenal suppression than doses of 1000  $\mu$ g or 1500  $\mu$ g. Inhaled administration of fluticasone suppressed serum cortisol concentrations of horses for 8 to 24 hours after administration, and this effect persists with continued administration over 1 year.<sup>59</sup> The clinical importance of this long-term suppression is unclear, although it does not impair innate or acquired immunity, and adverse clinical signs are not detected.<sup>60</sup> It is important to reiterate that the use of glucocorticoids should only be as an adjunct to

control of the horse's environment and reduction in the inhaled particle burden.

**Clenbuterol** decreases the production of inflammatory cytokines by cells obtained from bronchoalveolar lavage fluid of horses with RAO, suggesting that clenbuterol can have antiinflammatory effects in such horses. The clinical applicability of this finding remains to be determined.

In summary, a number of different corticosteroid preparations are useful in the control of RAO. Drugs administered by inhalation appear to have a reduced

potential for adverse effects including adrenal suppression, but they are more difficult to administer and require more frequent administration than drugs administered orally, intravenously, or intramuscularly. Improvements in respiratory effort and clinical signs are evident in approximately 3 days and persist for the duration of treatment. Cell counts and the neutrophilia in bronchoalveolar lavage fluid are not reliably reduced by administration of corticosteroids. Affected horses, after institution of appropriate measures to control inhalation of hay and barn dust, should be treated with the lowest dose that controls the disease and only for as long as necessary. The dose of corticosteroid can be reduced gradually and the frequency of administration decreased from once daily to once every second or third day (or greater, depending on the preparation) to achieve this end. Administration of the lowest effective dose is important because of the effects of corticosteroids in suppressing immune and adrenal function. It is suggested that dexamethasone and triamcinolone increase the likelihood of horses developing laminitis, but this relationship has not been conclusively demonstrated.

### Bronchodilator Drugs

Bronchodilator drugs might be needed to provide acute relief of airway obstruction but should not be used as maintenance therapy. **Atropine** (0.02-0.04 mg/kg, intramuscularly) can be used to provide short-term relief of bronchoconstriction, but its use is associated with gastrointestinal side effects, including colic, that preclude its long-term use. Use of **N-butylscopolammonium bromide** causes fewer adverse effects than does atropine.<sup>61</sup> **Glycopyrrolate** (0.005 mg/kg intramuscularly every 8-12 hours) is a potent bronchodilator with minimal gastrointestinal effects. **Ipratropium bromide**, a parasympatholytic drug with minimal extrapulmonary effects when given by inhalation, is very effective in relieving airway obstruction in severely affected horses. Similarly, revatropate (1 mg, inhaled), a selective M-1 and M-3 muscarinic antagonist, is as effective as ipratropium (0.3 mg) in relieving clinical signs and improving lung function in horses with RAO.<sup>62</sup>

**$\beta_2$ -adrenergic agonists** are potent bronchodilators frequently used in the management of horses with RAO. They can be administered orally or by inhalation, with the latter being preferred. **Clenbuterol hydrochloride** is used as maintenance therapy at a dose of 0.8 to 3.2  $\mu$ g/kg, orally every 12 hours, and is effective in controlling signs in 75% of affected horses. The lower dose should be used initially and then increased in 0.8- $\mu$ g/kg increments until the desired effect is achieved or side effects of tachycardia, muscle fasciculation, and sweating are apparent. Gradual, incremental

increases in dose lessen the frequency and severity of side effects. **Terbutaline** is not absorbed after oral administration to horses. Terbutaline and clenbuterol can also be given intravenously, at a dose one-tenth of that given orally, to severely affected horses in which the need for bronchodilation is urgent. Adverse effects of  $\beta_2$ -agonist administration include tachycardia, sweating, and apprehension. Prolonged administration of clenbuterol is associated with potentially adverse effects on cardiac structure, alterations in body composition, and an impaired response to training. Delayed parturition may occur in mares treated in late pregnancy.  $\beta_2$ -Adrenergic agonists may transiently exacerbate hypoxemia in severely affected horses. Intratracheal administration does not produce detectable bronchodilation.

Bronchodilators administered by inhalation to horses include the  $\beta_2$ -agonists **albuterol**, **salbutamol**, and **salmeterol**, and the parasympatholytic ipratropium. The efficacy and duration of action of each of these drugs varies somewhat, but all are effective in producing bronchodilation in affected horses. Salmeterol produces bronchodilation in horses with RAO that persists for up to 6 hours, although onset of action requires 30 to 60 minutes. Similarly, ipratropium reduces pleural pressure changes and attenuates clinical signs of airway obstruction in horses with RAO. Efficacy of drugs is influenced by the mode of delivery, with handheld devices available for the delivery of some compounds.<sup>63</sup>

**Theophylline** (aminophylline) is a non-adrenergic bronchodilator given at a dose of 5-10 mg/kg PO every 8-12 hours. Signs of toxicity include tachycardia, excitement, and convulsions. Theophylline is not a drug of first choice for the treatment of RAO and is now used infrequently because of the availability of efficacious antiinflammatory drugs and other bronchodilators.

### Other Drugs

**Sodium cromoglycate** is useful for the prophylaxis of RAO, but it has no direct bronchodilatory activity. Its mechanism of action is unclear, but it may act to prevent the degranulation of mast cells. It can be given at a dose of 80 to 200 mg per 425-kg horse by inhalation once daily for 4 days and then repeated in 1 to 2 weeks.

**Pentoxifylline** at high doses improves respiratory function, but not bronchoalveolar lavage fluid cytology, of horses with RAO. However, bioavailability after oral administration is quite variable, contributing to variations in the responses of horses to the drug.

Drugs that reduce **leukotriene** production or activity do not appear to be useful in the treatment of RAO. An experimental leukotriene D4 receptor antagonist was not effective in relieving signs of RAO. Similarly,

montelukast did not improve respiratory function in 5 horses with RAO.

**Mucolytics** are often used but their efficacy is not established and is doubtful. **Cough suppressants** should not be used because they may impair clearance of mucopurulent material from the airways.

**Antibiotics** are often given to affected horses but are probably not necessary in the vast majority of cases.

**Acupuncture** is not effective in the treatment of RAO.

Administration of large quantities of **isotonic electrolyte solution** intravenously is associated with a decrement in respiratory function in both normal and heavy horses and is not recommended as a treatment for RAO.

An acoustic device ("sound therapy") did not improve clinical signs or lung function in horses with RAO.<sup>64</sup>

### Integrated Therapy

Initial treatment of affected horses usually involves changes to the horse's environment and feed in combination with administration of corticosteroids. Corticosteroids and  $\beta_2$ -adrenergic agonists can be given as combined therapy to severely affected horses until the disease is controlled, at which time therapy should consist of environmental control and, if needed, administration of the lowest effective dose of corticosteroids. Bronchodilators are sometimes used as sole therapy, but their use without correction of the housing and feeding factors, and attempts to control inflammation, is not rational. Long-term administration of bronchodilators is not optimal therapy and, given the documented adverse effects, is not recommended. Long-term control of RAO is achieved by environmental management and administration of corticosteroids.

### CONTROL

Control of RAO centers upon minimizing the exposure of horses to inciting agents. These agents are present in air of stables and barns and, when present in sufficient concentration or combination, induce the disease in susceptible horses. There is considerable evidence supporting the practice of minimizing inhalation by horses of poor-quality air in the control of RAO.<sup>56</sup>

Housing horses in stalls with good air quality is essential in reducing the occurrence of the disease.<sup>65,66</sup> **Adequate ventilation** is critical in maintaining good air quality in stalls. Few horse housing units have adequate ventilation although a well-designed individual box stall can meet the needs of the horse both for air hygiene and thermal comfort. Many horse barns have inadequate open space for ventilation in still air conditions when the doors are closed at both ends of the building. When the release rate of spores is low, ventilation rates of 4 air changes per hour are satisfactory.



However, suggested minima are 8 to 10 air changes per hour, airspace of 44 m<sup>3</sup>/head, and floor space of 9.2 m<sup>2</sup>/head. In practical terms, if the upper half of the stable door is open, and faces open air and not into a barn, the natural ventilation should exceed the minimum specifications. Hay and dusty feed materials should not be stored above stalls or in the same airspace as horses. Bedding should be changed frequently, preferably daily. Use of cardboard as bedding material is effective as part of an overall regimen to improve air quality.

A portable slit sampler is an accurate, quick, and simple semiquantitative method of assessing the mold contamination of source materials such as hay, straw, and other feeds and bedding collected from stables. Newer technology, such as real-time continuous particle monitors, is useful in evaluating the effects of interventions to reduce airborne dust concentrations in the breathing zone of horses.<sup>65</sup> Real-time continuous monitoring also provides information on peak particle counts, which might be more closely related to disease severity than average counts.

The greatest contributor to airborne dust concentrations in stables is hay with straw bedding being an important other source.<sup>65</sup> Dust and presence of molds in hay can be reduced by use of agricultural practices during hay making including early harvest, adequate drying (and lack of rain), and preparation as haylage.<sup>67</sup> The health hazard posed by any moldy source material depends on the types of organisms present and their abundance. The size of the respirable challenge from heated hays and straws arises from the prolificacy of the species involved and their small spore size. The highest respirable challenges are from the presence of thermotolerant and thermophilic mold species. The most critical factors in determining the microbial development in plant-based materials are water content and thermal environment. Hay baled at 15% to 20% moisture heats little; it is virtually dust-free and contains few spores. Baling hay with 20% to 30% moisture leads to temperatures of up to 35° to 45°C (95 to 113 F). At these temperatures, hazardous contamination may develop with the appearance of thermotolerant fungi and actinomycetes. The heaviest contamination of hay and straw occurs with baling at 35% to 50% moisture, when spontaneous heating up to 50° to 60°C (122 to 140 F) may occur. Microscopically, these hays show large numbers of fungal spores in the 2- to 5- $\mu$ m size range.

Dust particle concentrations in the breathing zone can be reduced by feeding of soaked hay.<sup>66</sup>

### FURTHER READING

Ivester KM, Couetil LL. Management of chronic airway inflammation in the horse: a systematic review. *Equine Vet Educ.* 2014;26:647-656.

Pirie RS. Recurrent airway obstruction: a review. *Equine Vet J.* 2014;46:276-288.

### REFERENCES

- Gerber V, et al. *Equine Vet J.* 2015;47:390.
- Gerber V, et al. *J Vet Int Med.* 2009;23:626.
- Ramseyer A, et al. *J Vet Int Med.* 2007;21:149.
- Swinburne JE, et al. *Mamm Genome.* 2009;20:504.
- Jost U, et al. *Equine Vet J.* 2007;39:236.
- Shakhsi-Niaei M, et al. *Anim Genet.* 2012;43:627.
- Shakhsi-Niaei M, et al. *Arch Anim Breed.* 2013;56:1.
- Shakhsi-Niaei M, et al. *Anim Genet.* 2010;41:559.
- Klukowska-Rotzler J, et al. *Anim Genet.* 2012;43:450.
- Beeler-Marfisi J, et al. *Am J Vet Res.* 2010;71:682.
- Berndt A, et al. *Vet J.* 2010;183:54.
- Hotchkiss JW, et al. *Equine Vet J.* 2007;39:301.
- Ireland JL, et al. *Res Vet Sci.* 2013;95:418.
- Ireland JL, et al. *Prev Vet Med.* 2011;101:204.
- Visser EK, et al. *J Anim Sci.* 2014;92:844.
- Ireland JL, et al. *Equine Vet J.* 2012;44:101.
- Ireland JL, et al. *Vet J.* 2012;192:57.
- Cox R, et al. *Vet Rec.* 2010;166:552.
- Wylie CE, et al. *Res Vet Sci.* 2013;95:410.
- Dubuc J, et al. *Vet J.* 2014;202:387.
- Pirie RS. *Equine Vet J.* 2014;46:276.
- Lanz S, et al. *Vet Immunol Immunopathol.* 2013;155:229.
- Padoan E, et al. *Vet Immunol Immunopathol.* 2013;156:190.
- Aharonson-Raz K, et al. *Am J Physiol.* 2012;303:L189.
- Henriquez C, et al. *Vet Immunol Immunopathol.* 2014;158:128.
- Lavoie-Lamoureux A, et al. *Vet Immunol Immunopathol.* 2012;146:35.
- Moran G, et al. *Vet Res Comm.* 2011;35:447.
- Niedzwiedz A, et al. *BMC Vet Res.* 2014;10.
- Beekman L, et al. *J Vet Int Med.* 2012;26:153.
- Bullone M, et al. *J Vet Int Med.* 2013;27:164.
- Hughes KJ, et al. *Vet Immunol Immunopathol.* 2011;140:82.
- Klukowska-Rotzler J, et al. *Vet Immunol Immunopathol.* 2012;146:46.
- Reid CJ, et al. *Res Vet Sci.* 2009;87:20.
- Richard EA, et al. *J Vet Int Med.* 2014;28:1838.
- Iwaszko-Simonik A, et al. *Vet Immunol Immunopathol.* 2015;164:87.
- Moran G, et al. *Vet Res Comm.* 2012;36:251.
- Dunkel B, et al. *Vet Immunol Immunopathol.* 2009;131:25.
- Joubert P, et al. *Vet J.* 2008;178:227.
- Ryhner T, et al. *Vet Immunol Immunopathol.* 2008;125:8.
- Christmann U, et al. *J Vet Int Med.* 2008;22:1452.
- Johansson AM, et al. *J Vet Int Med.* 2007;21:302.
- Tilley P, et al. *Res Vet Sci.* 2012;93:1006.
- Laumen E, et al. *Equine Vet J.* 2010;42:142.
- Bosshard S, et al. *J Vet Int Med.* 2014;28:618.
- Rettmer H, et al. *Equine Vet J.* 2015;47:291.
- Haltmayer E, et al. *Res Vet Sci.* 2013;95:654.
- Koblinger K, et al. *J Vet Int Med.* 2011;25:1118.
- Gerber V, et al. *Equine Vet J.* 2004;36:576.
- Koch C, et al. *Equine Vet J.* 2007;39:107.
- Gehlen H, et al. *J Equine Vet Sci.* 2014;34:1096.
- Heidrun G, et al. *J Equine Vet Sci.* 2014;34:471.
- Relave F, et al. *Vet Surg.* 2008;37:232.
- Relave F, et al. *Vet Surg.* 2010;39:839.
- Koblinger K, et al. *Equine Vet J.* 2014;46:50.
- Setlakwe EL, et al. *Am J Physiol.* 2014;307:L252.
- Ivester KM, et al. *Equine Vet Educ.* 2014;26:647.
- Courouge-Malblanc A, et al. *Vet J.* 2008;175:227.
- Leclere M, et al. *Equine Vet J.* 2010;42:316.
- Munoz T, et al. *Res Vet Sci.* 2015;98:112.
- Dauvillier J, et al. *J Vet Int Med.* 2011;25:549.

61. de Lagarde M, et al. *Equine Vet J.* 2014;46:474.

62. McGorum BC, et al. *Vet J.* 2013;195:80.

63. Bertin FR, et al. *Equine Vet J.* 2011;43:393.

64. Goncarovs KO, et al. *J Vet Int Med.* 2010;24:1503.

65. Clements JM, et al. *Res Vet Sci.* 2007;83:256.

66. Clements JM, et al. *Res Vet Sci.* 2007;83:263.

67. Seguin V, et al. *Ag Ecosystem Environ.* 2010;135:206.

## PASTURE-ASSOCIATED HEAVES (PASTURE-ASSOCIATED RECURRENT AIRWAY OBSTRUCTION OF HORSES)

Summer pasture-associated heaves occurs in horses in the southeastern region of the United States and in Great Britain. It appears to be a disease of adult horses that are on pasture most of the time in the summer. It occurs most commonly in the warm, humid summer months of June to September.<sup>1</sup> Affected horses gradually recover during the cooler months of winter and early spring, and the disease can recur in the same horse each successive summer. Most severe signs occurred during late spring and early summer during times of high airborne pollen counts. Allergy to pollens and fungal spores appears to be a factor and is associated with conditions conducive to production of fungal spores and grass pollens.<sup>1</sup> Affected horses have increased expression of interleukin-4 and interferon- $\gamma$  in cells of bronchoalveolar lavage fluid and peripheral blood mononuclear cells but not increased concentrations of IgE in bronchoalveolar lavage fluid. Endothelin concentrations are higher in the BALF and serum of affected than unaffected horses.<sup>2</sup>

Affected horses have clinical findings typical of heaves including nasal discharge, coughing, tachypnea, labored expiratory effort, and crackles and wheezes on auscultation. There is moderate-to-severe accumulation of mucus in the large airways evident on endoscopic examination. Lung function testing is consistent with bronchoconstriction. Bronchoalveolar lavage fluid contains large numbers of nondegenerate neutrophils and lesser numbers of lymphocytes and mast cells. Necropsy reveals overinflated lungs that do not collapse when the chest is opened and that retain the impressions made by the ribs. The predominant histologic finding is accumulation of mucus in small airways. Inflammation is not severe and most inflammatory cells present are neutrophils and lymphocytes in peribronchial tissues. Treatment includes stabling and administration of corticosteroids and bronchodilators, as discussed for recurrent airway obstruction (see Table 12-13).

### FURTHER READING

McGorum BC, Pirie RS. A review of recurrent airway obstruction and summer pasture associated obstructive pulmonary disease. *Ippologia.* 2008;19:11-19.

## REFERENCES

- Costa LRR, et al. *Am J Vet Res.* 2006;67:1635.
- Costa LRR, et al. *J Vet Int Med.* 2009;23:1239.

## SYNCHRONOUS DIAPHRAGMATIC FLUTTER IN HORSES (THUMPS)

Synchronous diaphragmatic flutter in horses is caused by an abrupt and powerful contraction of the diaphragm synchronous with the heartbeat. Contraction of the diaphragm occurs because of stimulation of the phrenic nerve as it passes over the atria of the heart. Thumps is often associated with electrolyte or acid-base abnormalities in horses. The disease occurs commonly in horses used for strenuous exercise, and in particular horses used for endurance racing, in which approximately 10% of horses eliminated from competing have thumps.<sup>1</sup> The disease occurs in Standardbred and Thoroughbred racehorses, and individual animals can be affected repeatedly. This disease also occurs sporadically in adult horses and ponies that have not exercised, and peripartum mares (as part of lactation tetany).

The syndrome is characterized by a violent hiccough occurring synchronously with every heartbeat. The lateral aspect of the thorax and cranial abdomen appear to jump or “thump” regularly in affected horses. It is often unilateral, with the contraction being felt very much more strongly on one side than the other. The horse is distressed because the hiccough interferes with eating, and to an extent with respiration. In some cases, there are additional signs suggestive of hypocalcemia. These include muscular rigidity and fasciculation, and a high-stepping gait. There is often hypocalcemia, hemoconcentration, alkalosis or mixed acid-base abnormalities, and hypokalemia, hypochloremia, and elevation of creatinine phosphokinase levels in affected horses. Hypocalcemia can be profound. The disease is reported as a consequence of hypocalcemia secondary to primary hypoparathyroidism in two Thoroughbred horses.

The principles of treatment are correction of abnormalities in blood electrolyte concentration, acid-base status, and hydration. Treatment with calcium borogluconate administered slowly intravenously rapidly resolves the condition in some horses that do not have severe abnormalities of electrolyte concentration or acid-base status. Horses might require administration of balanced isotonic polyionic electrolyte solutions intravenously (e.g., Ringer's solution or 0.9% sodium chloride), and consideration should be given to supplementing these fluids with calcium (e.g., 50 mL of 23% calcium borogluconate per liter of fluid).

The **pathogenesis** is thought to be related to hyperirritability of the phrenic nerve caused by metabolic disturbances, including hypocalcemia, and the phrenic nerve being

stimulated by each atrial depolarization to fire with each heartbeat. The stimulation occurs because of the close physical proximity of the heart to the nerve in the horse. Dietary supplementation with calcium and other electrolytes during a ride is recommended, but excessive calcium feeding beforehand may reduce the activity of calcium homeostatic mechanisms and is to be avoided.

Regular veterinary inspection of all horses at the mandatory stops of endurance rides will reveal those animals with “thumps,” and these horses should not be allowed to proceed in the event.

## REFERENCE

- Fielding CL, et al. *J Vet Emerg Crit Care.* 2009;19:473.

## RHODOCOCCLUS EQUI PNEUMONIA OF FOALS

## SYNOPSIS

**Etiology** Virulent strains of *Rhodococcus equi* (*Rhodococcus hoagii/Prescottella equi*)

**Epidemiology** Sporadic disease of 1- to 5-month-old foals that is endemic on some farms. Foals are infected likely by inhalation during first weeks of life.

**Clinical signs** Pneumonia, fever, respiratory distress, cough, lack of nasal discharge, failure to thrive, multiple distended joints and uveitis. Occasionally diarrhea or septic osteomyelitis.

**Clinical pathology** Leukocytosis, hyperfibrinogenemia, inflammatory cells in tracheal aspirate.

**Necropsy lesions** Pulmonary consolidation and abscessation. Nonseptic polyarthritis.

**Diagnostic confirmation** Culture or polymerase chain reaction (PCR) detection of *R. equi* from tracheal aspirate.

**Treatment** Administration of a macrolide in combination with rifampin, for example, azithromycin (10 mg/kg PO q24 h) and rifampin (5 mg/kg PO q12h or 10 mg/kg PO q24h).

**Control** Ensure adequate transfer of passive immunity. Decrease stocking density. Decrease environmental contamination by virulent strains of *R. equi*. Do not use mass medication of foals with subclinical disease.

Disease in foals caused by *Rhodococcus equi* is important because of its high incidence in valuable livestock, widespread distribution, insidious onset, high case-fatality rate in the more severely affected foals, cost of treatment, lack of a protective vaccine, and cost of implementation of control measures.

## ETIOLOGY

*Rhodococcus equi* (*Rhodococcus hoagii/Prescottella equi*) is a gram-positive, pleomorphic rod that is a soil-dwelling

actinomycete.<sup>1,2</sup> The most important manifestation of *R. equi* infection is pneumonia in foals. It also causes pleuropneumonia, pneumonia, osteomyelitis, and abortion in immunocompromised and normal adult horses; abscesses that must be differentiated from tuberculosis in pigs and ruminants; pneumonia in immunosuppressed humans; and lymph node infection in wild boar (*Sus scrofa*), red deer (*Cervus elaphus*), and roe deer (*Capreolus capreolus*).<sup>2,3</sup> There is species tropism for ruminants, pigs, and horses, determined by host-adapted plasmids, whereas infection in humans appears to be zoonotic.<sup>2</sup> The organism is a natural inhabitant of soil, grows well at temperatures ranging from 10° to 40° C, and is readily isolated from the feces of herbivores and their environment. However, isolates of *R. equi* vary in virulence, with many isolates obtained from feces or soil not being pathogenic.

There are a large number of virulent strains of *R. equi*, based on pulsed-field gel electrophoresis of chromosomal DNA, and foals can be infected with multiple strains at the same time, with identical strains located in multiple sites in the body.<sup>4</sup> Although there is evidence of clustering of strains on farms and on most farms one or two strains predominate, there is little evidence of marked regional variations in prevalence of strains of virulent *R. equi*. Only rarely will it be possible to link infections to a given site or region on the basis of analysis of chromosomal DNA.

**Virulence** of *R. equi* is dependent on the ability of the organism to enter, survive in, and replicate in macrophages. It is a facultative intracellular parasite of macrophages, in which it survives by virtue of virulence factors that act to prevent phagosome-lysosome fusion and bacterial death.<sup>2</sup> Virulence is associated in part with the presence of highly immunogenic **virulence associated proteins** (Vap, coded by plasmid gene pVAP), of which pVAPA is apparently the most important, although the precise role of the other Vap proteins has not been determined. The presence of VapA is necessary but not sufficient for pathogenicity, which requires the presence of other virulence factors, including a number of microbial enzymes.<sup>2</sup> Virulence plasmids can be lost by *R. equi* strains and reacquired by conjugation with virulent strains.<sup>5</sup> Genomic analysis has identified additional virulence factors that are chromosomal rather than plasmid based.<sup>2</sup>

Vap A is a surface-expressed, lipid-modified protein that elicits an intense humoral response by foals. Expression of Vap A, C, D, and E is upregulated by incubation at 37° C (98.6 F), consistent with their role as virulence factors. Other genes probably involved in virulence are also upregulated by conditions that mimic those in vivo. The presence of the virulence proteins is associated with enhanced ability of virulent *R. equi* to survive and replicate within macrophages,

whereas avirulent strains replicate poorly or not at all. Virulence is associated with the presence of the plasmid, and loss of the plasmid by a strain of *R. equi* results in loss of virulence. A recent review provides a detailed discussion of the virulence factors of *R. equi*.<sup>2</sup>

## EPIDEMIOLOGY

### Occurrence

*R. equi* pneumonia in foals has a worldwide distribution. Clinical disease is often sporadic but on farms where the disease is endemic, annual **subclinical morbidity** can be high (up to 92%) and can vary widely from year to year. The median percentage of foals that developed clinical disease caused by *R. equi* at farms on which the disease was endemic was 6.6%, with 38% of farms having more than 10% of foals affected. Increased use of ultrasonographic examination of the thorax of all foals on a farm demonstrates the subclinical disease can affect many, if not the vast majority, of foals on farms in which the disease is endemic. For example, of 444 foals born on one stud farm during a breeding season, 426 (92%) had lesions consistent with *R. equi* infection. Eighteen of the foals had lung lesions less than 1 cm (considered unaffected), 128 had lesion scores greater than 1 cm and less than 10 cm, and 280 had lesions greater than 10 cm.<sup>6</sup> The detection of *R. equi* pneumonia in one foal on a farm should prompt an examination of all other foals on that farm.

Case-fatality rates for foals on farms, as opposed to those treated at veterinary teaching hospitals, are 29% to 42% (for 113 and 19 affected foals, respectively). The median case-fatality rate for 32 farms in Texas was 25%, and the case-fatality rate was more than 50% for 22% of farms. The case-fatality rate among foals treated at veterinary teaching hospitals is approximately 28%.

Current evidence supports the hypothesis that foals are exposed and infected within the first 2 weeks of life.<sup>7</sup> The **age at onset** of clinical signs of disease associated with *R. equi* varies between 2 weeks and 6 months, but the peak prevalence for pneumonic disease is between 1 and 3 months. The disease is rare in adult horses. Risk factors in foals for development of *R. equi* pneumonia have not been determined, although a large number of factors have been examined. The month in which the foal was born, gestational age, dam's parity, antimicrobial administration during the first week of life, exposure to pasture at less than 2 weeks of age, need for treatment to correct inadequate transfer of passive immunity, and size of mare/foal groups were not associated with risk of disease on farms in Texas.

The prevalence of virulent *R. equi* in isolates from the environment does not appear to be greater on farms where the disease is endemic. Morbidity varies widely among geographic areas and individual farms, probably because of environmental factors that

affect the number of virulent *R. equi* and the ease of infection. Because aerosol infection by virulent *R. equi* in dust is thought to be the most important route of infection of foals, factors that favor the accumulation and persistence of *R. equi* in soil and its ability to become aerosolized most probably increase the risk of infection. Such factors might include the following:

- Hot and dry weather, favoring formation of dust
- Soil pH and moisture
- Crowding of pastures with young horses
- Poor pasture hygiene, allowing accumulation of feces
- Dusty pastures

However, empirical demonstration of the importance of these risk factors has not been reported, with several exceptions. **Soil** pH, salinity, and concentrations of various elements including iron, zinc, and copper are not associated with the risk of foals developing *R. equi* pneumonia on farms in Texas. These soil-associated risk factors were examined because *R. equi* is a normal inhabitant of the soil and of the intestine of ruminants, horses, and pigs. It is not highly resistant, but it has been found to survive in moist soil for periods of longer than 12 months. The infection is considered to be soil associated and to be maintained through a soil-horse cycle. The number of organisms in the soil and stable areas on horse farms increases with the time that the farms have housed horses, although there is not a strong correlation between *R. equi* concentration in soil and prevalence of pneumonia in foals.

**Farms** of larger size, with more resident mares, greater numbers of foals ( $\geq 15$ ), and greater foal density per acre,<sup>8</sup> and the presence of mares brought on to the farm for breeding, are all associated with greater risk of foals developing *R. equi* pneumonia. *R. equi* pneumonia does not appear to be associated with poor farm management or lack of preventative health practices such as vaccination, deworming, or administration of hyperimmune plasma. The practice of testing for failure of transfer of passive immunity is associated with an increased likelihood of the disease on a farm. However, this association probably reflects the facts that the disease is more likely on larger farms, which are more likely to perform this test, and that farms that have had the disease are more likely to institute preventive care procedures.

### Transmission

Most foals are exposed to infection, as demonstrated by seroconversion or ultrasonographic examination of the thorax, but only a few develop severe disease, although many have subclinical infection and lesions. The organism colonizes the intestine of the normal foal during the first 2 months of life and has been detected in the feces as early as 5 days. Inhalation of the organism in dust is

probably the most important route of transmission for pneumonic disease.<sup>7,9</sup> Intestinal disease, which may be clinically inapparent, usually occurs with pulmonary disease, but the source of the infection is unclear, although it may be ingestion of contaminated material or swallowing of infected respiratory secretions. Foals over 5 weeks of age have generally been resistant to experimental challenge.

### Zoonotic Implications

*R. equi* is an occasional pathogen of humans.<sup>2</sup> Infection is more common in immunocompromised people but is only infrequently associated with strains of *R. equi* that are virulent in foals.

### PATHOGENESIS

Exposure of foals to *R. equi* is common, based on rate of seroconversion, yet the development of clinical disease is much less common, although subclinical disease on farms with endemic disease can be as high as 95% (426 of 444 foals born on one farm in one breeding season).<sup>6</sup> The reason for this is not fully understood, although development of the disease probably depends on exposure to an infectious dose of organism and the susceptibility of the foal. Foals subject to experimental challenge exposure are much more susceptible to infection, and by lower doses, during the first week of life.<sup>10</sup> Higher doses are required to induce disease in 3-week and 6-week-old foals.<sup>10</sup> Lower challenge doses are associated with milder and more slowly progressive disease and spontaneous resolution of infection. For spontaneous disease, exposure presumably occurs within the first few days of life, before waning of maternally derived passive immunity. Infection results in increases in serum concentration of VapA-specific IgG(T) in foals.<sup>11</sup>

In adult horses, in which the disease is rare, protective immunity is associated with both cellular and humoral immune responses characterized by enhanced immunoproliferative responses of CD4 and CD8 cells and presence of IgGa and IgGb antibodies to Vap A. Opsonizing antibody to *R. equi* is an important defense mechanism in experimentally infected foals and administration of *R. equi* hyperimmune plasma or plasma rich in anti-Vap A and C antibodies protects experimentally infected foals from developing pneumonia. Overall, these results suggest that foals that develop *R. equi* pneumonia have a T-helper-cell (Th)2-like response to infection, rather than a Th1-like response. Th1-like responses, which are associated with enhanced CD4 and CD8 responses, are believed to be important in resistance to the disease. Whether the switch to a Th2-like response to infection is a function of virulent *R. equi* or an attribute of susceptible foals has not been determined.

Experimental and clinical studies indicate that the foal is infected several weeks or



months before clinical signs are observed. **Virulent strains** of *R. equi* are facultative intracellular parasites of macrophages, which they ultimately destroy. Neutrophils are bactericidal for *R. equi* but the organism can survive by inclusion in macrophages. Opsonization of *R. equi* by specific antibodies results in enhanced lysosome–phagosome fusion and greater killing of *R. equi* by equine macrophages and monocytes, whereas entry of *R. equi* into macrophages by nonimmune phagocytosis is not associated with enhanced killing. Its survival in the macrophage is associated with absence of phagosome–lysosome fusion. Nonvirulent strains do not proliferate in macrophages and monocytes. The combined action of humoral and cellular immune systems is important in preventing development of the disease after inhalation of bacteria. Without opsonization, the capacity of the pulmonary macrophage of foals to kill *R. equi* is impaired and the organism can persist in the pulmonary macrophage of infected foals. The inability of the pulmonary macrophages to destroy *R. equi* leads to persistent infection in the lung and a chronic bronchopneumonia with extensive abscessation and an associated suppurative lymphadenitis.

**Intestinal infection** is common in foals with *R. equi* pneumonia, although clinical manifestations of the intestinal infection, such as diarrhea, are uncommon. Gastrointestinal tract infection is characterized by ulcerative lesions of the mucosa of the large intestine and cecum. In rare cases bacteremia and subsequent **suppurative foci** may develop in many organs, including bones and joints, liver, kidneys, and subcutis.

### CLINICAL FINDINGS

The most common manifestation of the disease is subclinical infection and pulmonary abscessation detected by ultrasonographic examination of the thorax of apparently healthy foals.<sup>6,12</sup>

### *R. equi* pneumonia

***R. equi* pneumonia** of foals presents as an acute onset of inappetence, fever, depression, and tachypnea or as a more chronic disease characterized by cough and failure to thrive. Apparent acute onset of the clinical disease is preceded by a **long incubation period** during which clinical signs are minimal. Severe clinical disease is evident as respiratory distress, and the foal is reluctant to move and to suckle. Cyanosis can be present in severe cases. **Auscultation** of the chest can reveal crackles and wheezes, but abnormal lung sounds are often much less apparent than the severity of the respiratory disease suggests they should be. Foals with *R. equi* **abscesses** often do not have abnormal lung sounds, and there is usually minimal nasal discharge. It must be emphasized that the classical severe disease represents one end of

**Table 12-14** Frequency and prevalence of extrapulmonary manifestations of infection by *R. equi* in 150 foals. (Reproduced with permission.<sup>15</sup>)

EPD	No. of affected foals (%)	No. of foals with antemortem diagnosis	No. of foals with postmortem diagnosis
Diarrhea	50 (33)	50	0
Immune-mediated polysynovitis	37 (25)	36	1
Ulcerative enterotyphlocolitis	31 (21)	0	31
Intraabdominal abscesses	25 (17)	12	13
Abdominal lymphadenitis	25 (17)	5	20
Uveitis	16 (11)	16	0
Pyogranulomatous hepatitis	16 (11)	0	16
Septic synovitis	14 (9)	12	2
Mediastinal lymphadenitis	12 (8)	7	5
Peritonitis	11 (7)	10	1
Peripheral lymphadenopathy	11 (7)	10	1
<i>R. equi</i> bacteremia	11 (7)	11	0
Subcutaneous abscesses	8 (5)	8	0
Pyogranulomatous nephritis	7 (5)	0	7
Hyperthermia	6 (4)	6	0
Pericarditis	6 (4)	2	4
Osteomyelitis	5 (3)	5	0
Pleural effusion	5 (3)	2	3
Granulomatous meningitis	5 (3)	0	5
Vertebral body osteomyelitis	3 (2)	3	0
Paravertebral abscess	3 (2)	3	0
Cellulitis/lymphangitis	2 (1)	2	0
Immune-mediated hemolytic anemia	2 (1)	2	0

One (1/150 [0.7%]) foal each had an antemortem diagnosis of the following: sinusitis, immune-mediated thrombocytopenia, hyperlipemia, telogen effluvium, granulomatous dermatitis, myositis, lymphoid hyperplasia, omphalitis, bone marrow erythroid hypoplasia, seizures, and right ventricular double apex secondary to pulmonary hypertension. One (1/150 [0.7%]) foal each had a postmortem diagnosis of the following: pyometra, pyogranulomatous stomatitis, pyogranulomatous splenitis, pneumothorax, valvular endocarditis, and myelophthisis.

the spectrum of consequences of infection of foals by *R. equi*, and much more common is subclinical disease that resolves spontaneously and without treatment. However, clinical disease is important because it is these foals that are at risk of death and that require prolonged treatment.

**Ultrasonographic examination** of the chest reveals the presence of pulmonary consolidation before clinical signs are apparent and is a useful means of detecting subclinical disease and triaging foals for treatment.

**Radiographic examination** of affected animals shows evidence of consolidation of lung tissue, lymphadenopathy, and cavitating lesions in the lungs. Odds of survival are inversely related to severity of alveolar pattern and presence and number of cavitating lesions evident on thoracic radiographs.<sup>13</sup> Ultrasonographic examination of foals is more sensitive for detection of lesions than is radiographic examination, with radiography enabling detection of lesions in 20 of 42 affected foals in which disease was confirmed by ultrasonographic examination.<sup>14</sup>

### Extrapulmonary manifestations of *R. equi* infection

Extrapulmonary manifestations of *R. equi* pneumonia are common in foals, and many

are associated with an increased chance of death (Table 12-14).<sup>15</sup> Of 150 foals with *R. equi* pneumonia examined at a referral hospital, 111 (74%) had at least one extrapulmonary manifestation of the disease detected ante or postmortem. Of foals examined postmortem, 76% had an extrapulmonary manifestation of the disease that was not detected, or detectable, antemortem. Common abnormalities include diarrhea (50% of foals), immune-mediated polysynovitis (37%), ulcerative enterotyphlocolitis (31%), intraabdominal abscesses (25%), and abdominal lymphadenitis (25%).<sup>15</sup> *R. equi* infection of other structures includes septic synovitis, peritonitis, bacteremia, subcutaneous abscesses, osteomyelitis of the axial skeleton, and vertebral body osteomyelitis, in addition to other sites. Noninfectious abnormalities include immune-mediated hemolytic anemia,<sup>16</sup> uveitis, and hyperthermia.

**Intraabdominal abscesses** are associated with ill-thrift, weight loss, variable abdominal distension, fever, depression, and, in some cases, colic. Ultrasonographic examination can reveal the abscess.<sup>17</sup>

### PROGNOSIS

The morbidity and case-fatality rates are provided under “Epidemiology.” Presence of an

extrapulmonary manifestation of *R. equi* infection is associated with a case-fatality rate of 57% compared with 18% in foals with only *R. equi* pneumonia. A larger number of extrapulmonary manifestation was associated with an increased chance of death. Presence of uveitis, septic synovitis (but not immune-mediated polysynovitis), abdominal lymphadenitis and intraabdominal abscessation, pleural effusion, *R. equi* bacteremia and pyogranulomatous hepatitis were all independently associated with increased risk of death.

*R. equi* infection in Thoroughbred and Standardbred foals is associated with a reduced chance of racing as an adult compared with the overall population of foals, but affected foals that survive have a similar racing performance as adults to horses that did not have *R. equi* pneumonia.

### CLINICAL PATHOLOGY

**Hematologic evaluation** usually reveals leukocytosis with neutrophilia and monocytosis, and elevation in the concentrations of acute-phase proteins, including plasma fibrinogen and serum amyloid A—changes characteristic, but not diagnostic, of *R. equi* infection. Monitoring of blood white cell concentration and plasma fibrinogen concentration is useful in foals from farms on which the disease is endemic. **White blood cell concentrations** above  $13.0 \times 10^6/L$  (13,000 cells/ $\mu L$ ) have a sensitivity and specificity of 95% and 61%, respectively, for *R. equi* pneumonia. The high sensitivity means that few foals with the disease will be missed, whereas the moderate specificity means that a number of foals will be incorrectly suspected as having the disease. Because a high white cell count can be caused by a number of diseases other than *R. equi* pneumonia, foals with high white cell counts from farms on which the disease is endemic should be further examined for evidence of disease, including detailed clinical examination possibly including ultrasonographic examination, culture or PCR of tracheal aspirates, or thoracic radiography. Measurement of **plasma fibrinogen concentration** is less useful for detecting foals with *R. equi* pneumonia. Plasma fibrinogen concentrations of 400 mg/dL (0.4 g/L) have sensitivity and specificity of 91% and 51%, respectively, whereas concentrations of 600 mg/dL (0.6 g/L) have sensitivity and specificity of 38% and 96%, respectively. The positive and negative predictive values of the tests depend on the prevalence of the disease among the group of foals examined, being low for farms on which the disease is rare and increasing as the prevalence of the disease increases. Serial measurement of **serum amyloid A** concentrations is not useful for detecting foals with clinically inapparent *R. equi* pneumonia,<sup>18</sup> nor do foals with pneumonia reliably have higher serum amyloid A concentrations than normal foals.

Differentiation of pneumonia caused by *R. equi* from that caused by other infectious causes in foals can be challenging. Using microbiological culture as the “gold standard,” identification of gram-positive coccobacilli in tracheal aspirates was highly specific (91%) but poorly sensitive (35%) for *R. equi* infection.<sup>19</sup> White cell counts greater than 20,000 cells/ $\mu L$  (86% specificity), fibrinogen concentrations greater than 700 mg/dL (92% specificity), radiologic evidence of thoracic abscessation (85% specificity), and the presence of gram-positive coccobacilli in tracheal aspirates (91% specificity) in pneumonic foals are highly suggestive of *R. equi* infection.<sup>19</sup>

**Transtracheal aspirates** from affected foals reveal a neutrophilic leukocytosis. Intracellular, gram-positive pleomorphic rods characteristic of *R. equi* may be present in tracheal aspirates, but the sensitivity of this observation has not been determined, and all tracheal aspirates should be cultured.

Although numerous **serologic tests** have been developed, including agar gel immunodiffusion, synergistic hemolysis inhibition, radial immunodiffusion, and various ELISAs, none has demonstrated value in the diagnosis of the disease in individual animals.<sup>20</sup> Currently available serologic tests, either as single or paired samples, are not reliable in confirming or excluding the presence of *R. equi* pneumonia in foals.

Culture of tracheal aspirates is the gold standard for antemortem diagnosis of the disease, although sensitivity of culture is less than that of PCR examination of tracheal aspirates. Culture of tracheal aspirates has a sensitivity of approximately 86%, based on diagnosis of *R. equi* pneumonia at necropsy. A **PCR test** for the rapid detection of *R. equi* in tracheal aspirates has a sensitivity of 100% and a specificity of 91% in foals with a clinical diagnosis of *R. equi* pneumonia. PCR examination of nasal swabs for presence of *R. equi* has a sensitivity of 15%, which is too low to be clinically useful. More recent quantitative real-time PCR assays permit the rapid detection and quantification of virulent (*VapA*-gene-positive) strains of *R. equi* in tracheobronchial aspirates. This assay detects *R. equi* at concentrations as low as 20 cfu/mL of tracheobronchial fluid, providing a specific and highly sensitive test for the presence of this organism. A **multiplex PCR test** simultaneously detects *R. equi* and the presence of virulence factors, thereby permitting rapid differentiation of pathogenic from nonpathogenic strains of *R. equi* in biological samples.

Collection and culturing of breath from foals is not useful in diagnosing *R. equi* pneumonia or in predicting onset of the disease.<sup>21</sup>

### NECROPSY FINDINGS

The predominant lesions are a **pyogranulomatous pneumonia plus lymphadenitis** of

the bronchial lymph nodes. Grossly, the firm, raised lung nodules may reach several centimeters in diameter and can be located anywhere in the lung field, especially in the cranioventral quadrant. If several nodules coalesce, the lesion may be misinterpreted as a suppurative bronchopneumonia. Histologically, organisms are easily demonstrated within the macrophages and giant cells comprising these lesions. Many cases also have ulcerative enterocolitis, with abscessation of mesenteric or cecocolic lymph nodes. Although necropsy may reveal widespread infection, many cases are subclinical.

### Samples for Postmortem Confirmation of Diagnosis

- Bacteriology—chilled lung, affected lymph nodes, and swabs from atypical sites (CULT)
- Histology—formalin-fixed lung, lymph node, and colonic lesions

### DIAGNOSTIC CONFIRMATION

Antemortem diagnosis is by culture of *R. equi* from aspirates of tracheal fluid. Currently available serologic tests do not provide confirmation of disease in individual animals.

### DIFFERENTIAL DIAGNOSIS

The pneumonic form of the disease may be confused with other causes of pneumonia in foals (Table 12-15). Other causes of diarrhea in this age group include parasitism as a result of cyathostomes, infection by *Salmonella* sp., and antibiotic-induced diarrhea.

The aseptic synovitis and joint effusion that frequently accompanies *R. equi* pneumonia should be differentiated from septic arthritis as a result of *S. zooepidemicus*, *Salmonella* spp., *R. equi*, or other bacteria.

### TREATMENT

The principles of treatment are cure of *R. equi* infection, relief of respiratory distress, and correction of associated immune-mediated diseases.

Elimination of infection requires the administration of antimicrobial agents that are both effective against the organism and able to penetrate infected macrophages to gain access to the organism. Customary **in vitro antibiotic sensitivity testing**, using Kirby-Bauer or dilution methodology, has not been demonstrated to be useful in predicting the clinical efficacy of treatment, and *ex vivo* testing of antimicrobial efficacy using macrophage culture systems more closely predicts *in vivo* efficacy.<sup>22</sup> *R. equi* isolates from ill foals are frequently sensitive *in vitro* to a variety of antibiotics, including the aminoglycosides gentamicin and neomycin, tetracycline, sulfonamides, and chloramphenicol, whereas most are resistant to cephalosporins and penicillin. However,

**Table 12-15** Differential diagnosis of respiratory diseases of older (not newborn) foals

Disease	Epidemiology	Clinical findings	Clinical pathology	Necropsy findings	Treatment and response
<i>Rhodococcus equi</i> infection	Enzootic to a farm. Foals up to 6 months. Infection by inhalation. Case-fatality rate ≈30%.	Pneumonia in 1- to 6-month-olds. Occasional diarrhea. Aseptic synovitis and uveitis in affected foal. Septic osteomyelitis.	Inflammatory cells in tracheal aspirate. Culture or PCR detection of <i>R. equi</i> from tracheal fluid. Serum tests not useful in individual animals.	Suppurative bronchopneumonia. May be mesenteric and other lymph node abscess. Rarely septicemia.	Erythromycin estolate, or clarithromycin, plus rifampicin. Advanced cases may be refractory.
Interstitial pneumonia	Sporadic occurrence in foals to 6 months of age. Cause not identified.	Respiratory distress with minimal cough, slight nasal discharge and low grade to non-existent fever. Lungs sounds not remarkable.	None diagnostic. Rule out other diseases. Radiography useful.	Interstitial pneumonia.	Corticosteroids. Broad-spectrum antibiotics (e.g., penicillin and gentamicin). Supportive care.
Viral respiratory disease (see Table 12-16)	Foals usually over 2 months. Rhinitis virus, herpesvirus, and influenza virus infection.	Fever, cough, nasal discharge.	Viral isolation. Serology.	Usually survive although fatal influenza infection reported.	Supportive. Antibiotics for secondary bacterial ( <i>Streptococcus zooepidemicus</i> ) infection
Combined immunodeficiency of Arabian foals	Inherited as autosomal recessive trait. Affected animals are homozygous.	Poor condition, tire easily, cough, ocular and nasal discharge, diarrhea in some.	Severe lymphopenia. Hypogammaglobulinemia as passive immunity declines.	Lymphocytes absent from lymphoid tissue. Adenoviral pneumonia.	None.
Respiratory tract infection with <i>S. zooepidemicus</i>	Outbreaks in foals up to weaning. Likely secondary to viral infection.	Fever, nasal discharge, cough, inappetence. Minimal lymphadenopathy.	<i>S. zooepidemicus</i> in tracheal aspirates.	Usually survive.	Penicillin. Good recovery rate
Parasitic pneumonia	Migrating stages of <i>Parascaris equorum</i> . Foals > 6 weeks old.	Cough, slight nasal discharge. Rarely fever.	Eosinophils in tracheal aspirate.	Death rare.	Anthelmintics, e.g., fenbendazole
<i>Pneumocystis jirovici</i> (formerly <i>P. carinii</i> ) pneumonia	Immunodeficient foals or foals administered corticosteroids.	Cough, mucopurulent nasal discharge, fever, lethargy, tachypnea.	Neutrophils and macrophages and <i>P. jirovici</i> cysts in tracheal aspirate or bronchoalveolar lavage fluid.	Pneumonia, diffuse with neutrophilic or lymphocytic/plasmacytic infiltration and alveolar edema. <i>P. jirovici</i> evident in silver-stained lung sections.	Sulfonamide/trimethoprim 30 mg/kg q12 h recommended but often not effective.

PCR, polymerase chain reaction.

treatment with antibiotics other than a macrolide (erythromycin, azithromycin, clarithromycin, gamithromycin) and rifampin is associated with a lower recovery rate. Treatment with **penicillin**, with or without **gentamicin**, chloramphenicol, or tetracycline, is not effective. **Trimethoprim-sulfadiazine** combinations might be effective in some foals but are not the preferred treatment. Neomycin has been recommended for treatment of *R. equi* pneumonia, but the risk of nephrotoxicosis, need for parenteral administration, and lack of demonstration of clinical efficacy do not support its use at this time.

The **treatment of *R. equi* pneumonia** in foals is achieved by administration of macrolide antibiotics in combination with rifampin. Conventional treatment is administration of the combination of an acid-stable **erythromycin** (preferably estolate) at a dose of 25 mg/kg orally every 12 hours and **rifampin** at a dose of either 5 mg/kg every

12 hours or 10 mg/kg every 24 hours. Other esters or preparations of erythromycin are less well absorbed or have shorter elimination half-lives than the estolate ester and must be administered more frequently. Erythromycin ethylsuccinate does not provide optimal therapy for *R. equi* pneumonia in foals because of poor absorption after oral administration. The macrolide antibiotics **azithromycin** and **clarithromycin** have also been used to treat foals with *R. equi* pneumonia. Treatment of foals with a combination of clarithromycin (7.5 mg/kg orally every 12 hours) and rifampin results in improved survival over foals treated with azithromycin (10 mg/kg orally q24h) and rifampin or erythromycin and rifampin in a veterinary teaching hospital. Azithromycin is typically administered with rifampin at a dose rate of 10 mg/kg q24h for every 24 hours for 5 to 7 days and then once every 48 hours. Gamithromycin (6 mg/kg

intramuscularly [IM] or intravenously [IV] once every 7 days, with or without administration of rifampin) is currently not recommended for routine use pending results of studies demonstrating its equivalence to or superiority over other treatments. Administration of gamithromycin (6 mg/kg IM or IV once every 7 days, with foals administered IV gamithromycin also administered rifampin) was associated with resolution of lesions detected by ultrasonographic examination in 95% of foals with *R. equi* pneumonia.<sup>23</sup> IM was associated with marked lameness in 35% of foals and colic that required administration of analgesics in 45% of foals. Tulathromycin was not as effective as the combination of azithromycin-rifampin in treatment of *R. equi* abscesses in foals in a large prospective field study.<sup>24</sup> Tilmicosin is poorly active against *R. equi*.<sup>25</sup>

**Ultrasonographic examination** of the thorax of foals may permit identification of



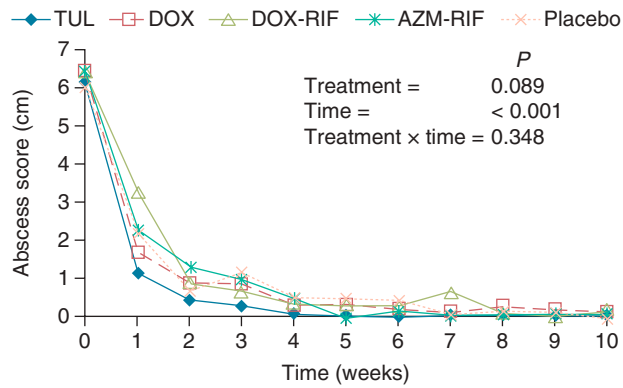

**Fig. 12-30** Abscess score based on ultrasonographic examination of foals on a farm with endemic *R. equi* infection administered a placebo, tulathromycin, doxycycline, doxycycline and rifampin, or azithromycin and rifampin. There was no effect of antimicrobial treatment on resolution of the abscess score. (Modified from Venner M, Astheimer K, et al.: Efficacy of Mass Antimicrobial Treatment of Foals with Subclinical Pulmonary Abscesses Associated with *Rhodococcus equi*, *J Vet Int Med* 27:171, 2013.)

foals with clinically inapparent pulmonary abscesses, providing the opportunity for early intervention in the disease. However, many (~90%) lesions less than 10 cm in diameter will resolve without treatment, and treatment with antimicrobials confers no clear benefit over watchful waiting (Fig. 12-30).<sup>12</sup> Another study demonstrated resolution of lesions in 44% of foals with lesions greater than 1.0 cm administered a placebo—a resolution rate not statistically different from that in foals administered tulathromycin (IM), azithromycin alone, or azithromycin and rifampin.<sup>6</sup>

It is unclear if there is an advantage to combined therapy of rifampin and a macrolide compared with treatment with a macrolide alone. The current recommendation is to use the combination of drugs.

Gallium maltoate has been investigated for treatment of foals with *R. equi* pneumonia. The pharmacokinetics in foals have been determined, and it appears to be safe for administration to foals and was not inferior to administration of clarithromycin and rifampin in treatment of foals with pulmonary lesions consistent with *R. equi* infection.<sup>26-30</sup> However, the study did not include an untreated or placebo treated group, and given the high rate of spontaneous resolution of lesions without treatment in such foals,<sup>6,12,31</sup> it cannot be concluded that either treatment was superior to no treatment.

Therapy should be continued until the foal is clinically normal and has a normal plasma fibrinogen concentration and white blood cell count, which can require treatment for at least 1 month and often longer. Radiographic or ultrasonographic demonstration of resolution of the pulmonary consolidation and abscessation is useful in the decision to stop therapy. The case-fatality rate is approximately 30% (see “Epidemiology”) even with appropriate treatment.

**Adverse effects** of macrolide-rifampin therapy include the development of **diarrhea** in some foals and their dams. Administration of erythromycin to foals is associated with an eightfold increase in the risk of diarrhea. Antibiotic therapy should be temporarily discontinued in foals that develop diarrhea.

During hot weather, some foals treated with erythromycin become **hyperthermic** (40–41°C [104–105.5°F]) and **tachypneic**, and occasional deaths result from this syndrome. The basis for this hyperthermic event, which may occur in healthy foals administered erythromycin, is unknown. Affected foals should be treated urgently with antipyretics, cold water bathing, and housing in a cooler environment.

The emergence of *R. equi* isolates **resistant to rifampin** and one or more macrolides has been documented and underscores the need for monitoring of *R. equi* sensitivity to these antimicrobials. Case-fatality rate is higher (75%) in foals with *R. equi* resistant to one or more of rifampin and a macrolide compared with that in foals infected with susceptible bacteria (30%).<sup>32</sup> The development of resistance during monotherapy with rifampin is a recognized contraindication to the use of this drug alone.

**Ancillary therapy** with NSAIDs, bronchodilators, and mucolytics might be of value. Foals in severe respiratory distress require intranasal or intratracheal administration of oxygen.

## CONTROL

**Control measures** are designed to maximize the resistance of the foal to infection and to reduce the infection pressure on the foal by decreasing contamination of the foal’s environment with virulent *R. equi*. Ensuring adequate transfer of **colostral immunoglobulins** in all foals through routine monitoring of serum immunoglobulin concentrations in

1-day-old foals is an essential part of any control program. To **decrease environmental contamination** with virulent *R. equi*, efforts should be made to reduce fecal contamination of pastures and to reduce or eliminate dusty or sandy areas. These efforts should include grassing or paving of bare areas, removal and composting of fecal material on a regular basis, reduction of stocking density, and reduction in the size of mare/foal bands.

On farms with endemic disease, regular physical examination, including ultrasonographic examination of the thorax of foals and once-daily monitoring of rectal temperature, can permit early identification of affected foals. These foals can then be monitored for resolution or progression of the disease, with animals in the latter group administered antimicrobials. Comments noted earlier about the effectiveness of mass medication of all foals with lung lesions should be noted.<sup>6,12,31</sup> Measurement of blood white cell count, as detailed previously, can be useful in early identification of affected foals. Identification of one foal affected with *R. equi* pneumonia on a farm should prompt an examination of all other foals on the farm.

The administration to foals of a hyperimmune serum, obtained from mares vaccinated with an autogenous vaccine, limits the severity of disease produced by experimental challenge but has not been consistently useful in preventing or decreasing the prevalence of naturally occurring disease. This unpredictable efficacy could be attributable to variable concentrations of *R. equi* anti-Vap-A IgG in batches of plasma.<sup>33</sup>

There are no vaccines effective in prevention of *R. equi* pneumonia in foals.<sup>34,35</sup>

## FURTHER READING

Vázquez-Boland JA, et al. *Rhodococcus equi*: the many facets of a pathogenic actinomycete. *Vet Microbiol.* 2013;167:9-33.

## REFERENCES

- Goodfellow M, et al. *Equine Vet J.* 2015;47:508.
- Vázquez-Boland JA, et al. *Vet Microbiol.* 2013;167:9.
- Rzewuska M, et al. *Vet Microbiol.* 2014;172:272.
- Bolton T, et al. *J Vet Diagn Invest.* 2010;22:611.
- Stoughton W, et al. *J Vet Int Med.* 2013;27:1555.
- Venner M, et al. *Vet J.* 2012;192:293.
- Cohen ND, et al. *Am J Vet Res.* 2013;74:102.
- Cohen ND, et al. *Am J Vet Res.* 2008;69:385.
- Cohen ND, et al. *Am J Vet Res.* 2012;73:1603.
- Sanz M, et al. *Vet Microbiol.* 2013;167:623.
- Sanz MG, et al. *Vet Immunol Immunopathol.* 2015;164:10.
- Venner M, et al. *J Vet Int Med.* 2013;27:171.
- Giguere S, et al. *Vet Radiol Ultra.* 2012;53:601.
- Venner M, et al. *Pferdeheilkunde.* 2014;30:561.
- Reuss SM, et al. *JAVMA.* 2009;235:855.
- Johns IC, et al. *J Vet Emerg Crit Care.* 2011;21:273.
- Reuss SM, et al. *Vet Radiol Ultra.* 2011;52:462.
- Passamonti F, et al. *Vet J.* 2015;203:211.
- Leclere M, et al. *Vet J.* 2011;187:109.
- Witkowski L, et al. *Vet Immunol Immunopathol.* 2012;149:280.
- Chicken C, et al. *Equine Vet J.* 2012;44:203.
- Giguere S, et al. *Vet Microbiol.* 2015;178:275.

23. Hildebrand F, et al. *Pferdeheilkunde*. 2015;31:165.
24. Venner M, et al. *Vet J*. 2007;174:418.
25. Womble A, et al. *J Vet Pharmacol Ther*. 2006;29:561.
26. Chaffin MK, et al. *J Vet Pharmacol Ther*. 2010;33:376.
27. Coleman M, et al. *Vet Microbiol*. 2010;146:175.
28. Martens RJ, et al. *J Vet Pharmacol Ther*. 2010;33:208.
29. Chaffin MK, et al. *Am J Vet Res*. 2011;72:945.
30. Cohen ND, et al. *J Vet Int Med*. 2015;29:932.
31. Venner M, et al. *Vet Rec*. 2013;173:397.
32. Giguere S, et al. *JAVMA*. 2010;237:74.
33. Sanz MG, et al. *Vet Rec*. 2014;175.
34. Lohmann KL, et al. *Can J Vet Res*. 2013;77:161.
35. Giles C, et al. *Equine Vet J*. 2015;47:510.

## **STREPTOCOCCUS ZOOEPIDEMICUS INFECTION**

*Streptococcus equi* var. *zooepidemicus* (*S. zooepidemicus*) is one of the bacteria most commonly isolated from the upper respiratory tract of both clinically normal horses and horses with respiratory disease and from the female genital tract, wounds, and guttural pouch.<sup>1</sup> Almost all horses harbor a number of antigenic types of *S. zooepidemicus* in their tonsils, and this may be the source of opportunistic infections of other body systems, including the lungs and genital tract. Currently, over 300 variants of *S. zooepidemicus* are recognized by multilocus sequence typing, and disease is associated with specific variants.<sup>2,3</sup> *S. zooepidemicus* is the most common beta-hemolytic streptococcus isolated from horses at necropsy examination, representing 72% of isolates.<sup>4</sup> Most isolates are from placenta, fetal tissues, and genital tract of mares, but this likely represents the population of animals examined and would not include clinically normal horses in which *S. zooepidemicus* is commensal in the upper respiratory tract.

Outbreaks of upper or lower respiratory disease are associated with particular variants of *S. zooepidemicus* (eg, ST-24 and ST-307),<sup>2,5</sup> and endometritis is caused by a specific variant genetically distinct to those causing respiratory disease.<sup>6</sup> Pathogenicity of *S. zooepidemicus* in horses is related to the presence of superantigens (szeN and szeP, but not szeF).<sup>7</sup>

*S. zooepidemicus* can cause disease in humans, cats, dogs, and poultry.<sup>8-12</sup> Infection and disease of humans working with horses by *S. zooepidemicus* identical to or closely related to that isolated from horses with which the human cases had contact highlights the zoonotic potential of the organism.<sup>12</sup> An outbreak of disease in chickens was associated with a strain of *S. zooepidemicus* isolated from horses on the same farm,<sup>9</sup> and infection of three dogs, with disease in two, housed on horse stud farms.<sup>8</sup> The disease in dogs is usually a highly contagious often fatal pneumonia.<sup>11</sup> The organism also causes acute, severe pneumonia and systemic illness in cats usually as an outbreak of disease in catteries.<sup>10</sup>

*S. zooepidemicus* is frequently isolated from horses with pleuropneumonia, endometritis, neonatal septicemia, abortion, and mastitis, suggesting a role for this organism in the pathogenesis of these diseases.<sup>4</sup> *S. zooepidemicus* is likely important in the development of respiratory disease in foals and adult horses. *S. zooepidemicus* was isolated from 88% of foals with clinical evidence of lower respiratory tract disease, and isolation of the organism was associated with an increased proportion of neutrophils in bronchoalveolar lavage fluid, suggesting a causal role for this organism. Similarly, the number of *S. zooepidemicus* isolated from tracheal aspirates of adult horses is directly proportional to the number of neutrophils in the aspirate and the probability that they have a cough. The association of *S. zooepidemicus* and inflammatory airway disease in racehorses is independent of previous viral infection, suggesting a role for *S. zooepidemicus* as a primary pathogen. Presence and number of colony forming units (cfu) of *S. zooepidemicus* in tracheal aspirates of horses is significantly associated with the risk of the horse having inflammatory airway disease. Adult horses dying of pneumonia associated with transportation often yield *S. zooepidemicus* on culture of lung lesions, and the disease can be reproduced experimentally. *S. zooepidemicus* with *Chlamydophila caviae* causes conjunctivitis and rhinitis in adult horses.<sup>13</sup> These results clearly demonstrate a role for *S. zooepidemicus* in the pathogenesis of respiratory disease of horses. However, it is unclear whether *S. zooepidemicus* is a primary cause of disease, a secondary contaminant, or an invader of airways compromised by viral infection or other agents.

**Clinical signs** of *S. zooepidemicus* infection of the lower respiratory tract of foals and horses include coughing, mild fever, mucopurulent nasal discharge, and increased respiratory rate. Endoscopic examination of the trachea and bronchi reveals erythema and presence of mucopurulent exudate. Tracheal aspirates or bronchoalveolar lavage fluid of affected horses or foals have an increased (>10%) proportion of neutrophils. *S. zooepidemicus* is a frequent isolate from the cornea of horses with ulcerative keratitis.

**Treatment** consists of the administration of antimicrobials, including penicillin (procaine penicillin, 20,000 IU/kg IM every 12 hours) or the combination of a sulfonamide and trimethoprim (15-30 mg/kg orally every 12 hours). *S. zooepidemicus* isolates from horses in southern England demonstrate increasing resistance to tetracycline but not the combination of trimethoprim and sulfonamide (TMS).<sup>14</sup> Most *S. zooepidemicus* isolates (70%) are resistant to gentamicin, whereas 95% are sensitive to penicillin and 55% sensitive to TMS. Forty-five percent of isolates are resistant to enrofloxacin—a recent phenomenon.<sup>14</sup> Different sensitivity patterns are reported for *S. zooepidemicus*

isolates from Western Canada, although the high proportion of isolates sensitive to penicillin (95%) and ceftiofur (99%) is consistent with that in England.<sup>1</sup> A higher proportion of Canadian isolates are sensitive to gentamicin (85%) or enrofloxacin (91%).

Control consists of isolation to prevent spread of infectious respiratory disease and vaccination to prevent viral respiratory disease.

### **FURTHER READING**

Waller AS. Equine respiratory disease: a causal role for *Streptococcus zooepidemicus*. *Vet J*. 2014;201:3-4.

### **REFERENCES**

1. Clark C, et al. *Can Vet J*. 2008;49:153.
2. Lindahl SB, et al. *Vet Microbiol*. 2013;166:281.
3. Waller AS. *Vet J*. 2014;201:3.
4. Erol E, et al. *J Vet Diagn Invest*. 2012;24:142.
5. Velineni S, et al. *Vet J*. 2014;200:82.
6. Rasmussen CD, et al. *Vet Res*. 2013;44.
7. Rash NL, et al. *Res Vet Sci*. 2014;97:481.
8. Acke E, et al. *Vet Rec*. 2010;167:102.
9. Bisgaard M, et al. *Avian Dis*. 2012;56:561.
10. Blum S, et al. *Vet Microbiol*. 2010;144:236.
11. Priestnall S, et al. *Vet J*. 2011;188:142.
12. Pelkonen S, et al. *Emerg Infect Dis*. 2013;19:1041.
13. Gaede W, et al. *Vet Microbiol*. 2010;142:440.
14. Johns IC, et al. *Vet Rec*. 2015;176:334.

### **STRANGLES**

#### **SYNOPSIS**

**Etiology** *Streptococcus equi* subsp. *equi*.

**Epidemiology** Highly contagious disease that affects horses of all ages but is most common in young animals. Prolonged carrier state in asymptomatic animals. *S. equi* causes disease in only equids.

**Clinical signs** Acute onset of fever, anorexia, depression, submandibular and pharyngeal lymphadenopathy with abscessation and rupture, and copious purulent nasal discharge. Metastatic infection in other organ systems.

**Clinical pathology** Culture of *S. equi* from nasal and abscess discharges. Polymerase chain reaction (PCR) of nasal, pharyngeal or guttural pouch swabs. High serum antibody titer to SeM.

**Lesions** Caseous lymphadenopathy with rhinitis and pharyngitis, pneumonia, and metastatic infection in severe cases.

**Diagnostic confirmation** Culture of *S. equi* or PCR.

**Treatment** Systemic administration of penicillin. Local treatment of abscesses.

**Control** Isolation and quarantine of cases. Serologic testing followed by PCR and culture of nasopharyngeal swabs or guttural pouch lavage of serologically positive horses enabling detection of carrier status. Vaccination might reduce the case attack rate and severity of disease but confounds identification of carrier horses.

## ETIOLOGY

*Streptococcus equi* subsp. *equi* (*S. equi*) is a gram-positive coccobacillus that produces a beta-hemolysin, evident as a zone of clear hemolysis surrounding colonies growing on blood agar. There is evidence that *S. equi* is a biovar or genovar of *S. zooepidemicus*. *S. equi* is highly host-adapted to Equidae. Genetic analysis, particularly of the variable region of the SeM gene, demonstrates the existence of clones that vary geographically.<sup>1-5</sup> For instance, 21 SeM alleles were detected among 145 *S. equi* strains isolated in the United Kingdom,<sup>1</sup> and two SeM alleles detected in horses in New Zealand had distinct geographic distributions.<sup>5</sup> Similar analysis reveals the presence of two major *S. equi* clades in Ireland, with both being also common in the United Kingdom.<sup>4</sup> Individual outbreaks can be caused by *S. equi* of the same SeM type and be restricted geographically or by use of horse.<sup>6</sup> Analysis of SeM mutations in real time allows differentiation or linkage of strangles outbreaks and enables risk assessment of equine events where there is incursion of the disease. It is unclear whether changes in the SeM protein associated with these strains are associated with differing pathogenicity.<sup>1</sup> There is variation in virulence related to the amount of M protein and hyaluronic capsule produced. An atypical milder form of the disease is associated with a capsule-deficient variant of *S. equi*, and an intranasal vaccine is based on a live, attenuated, nonencapsulated SeM-2 strain, although this strain can cause disease.<sup>7</sup>

## EPIDEMIOLOGY

### Occurrence

Strangles occurs in horses, ponies, donkeys, and mules worldwide, with the exception of Iceland. Outbreaks are seen relatively frequently on breeding farms and in polo and racing stables, when the infection is introduced by new arrivals that are often asymptomatic, and in horses taken to fairs and riding schools. An **incidence** of 35% over a 3-year period is reported for horse studs in Australia, and there were approximately 600 recorded outbreaks in the United Kingdom in 2010.<sup>2</sup>

Strangles can affect horses of any age, although the **morbidity rate** is usually greater in younger horses such as foals and weanlings. Age-specific attack rates of strangles of 18% for brood mares, 48% for 1-year-old horses, and 38% for foals during an outbreak on a breeding farm are reported, although higher morbidity rates (100%) can occur, especially in young horses. The risk of occurrence of an outbreak of strangles increases with the size of the group of horses: farms with 100 or more horses have a 26 times greater risk of experiencing an outbreak than farms with fewer than 15 horses.

The **case-fatality rate** without treatment is about 9%, but with adequate early

treatment it may be as low as 1% to 2%. Deaths are usually attributable to pneumonia.

### Source of Infection and Transmission

*S. equi* is an obligate parasite of horses and all infections are attributable to transmission from infected horses, either directly or by fomites. **Nasal and abscess discharge** from infected animals that contaminates pasture, tack, stalls, feed and water troughs, grooming equipment, and hands and clothes of grooms and veterinarians is often the source of infection for susceptible horses. *S. equi* survives in the environment for less than 3 days, and although fomite transfer is important in transmission of infection, prolonged quarantine of facilities is not warranted.<sup>8</sup> Direct transmission from infected animals to susceptible animals occurs through contact.

Approximately 10% to 40% of horses that recover from the clinical disease have **persistent infection** of *S. equi* in the pharynx and guttural pouches for many months and are an important source of infection. Horses with **clinically inapparent disease**, such as some cases of guttural pouch empyema, can shed the organism for over 3 years. The period of infectivity is important in terms of the length of quarantine that needs to be imposed on horses that have apparently recovered from the disease. Because nasal shedding of *S. equi* can be intermittent, repeated culture of nasopharyngeal swabs or use of PCR examination of guttural pouch washings is necessary to document the carrier status of individual horses.

The clinically inapparent nature of the infection makes detection of carriers problematic, especially when considering introduction of horses into a previously closed herd in which strangles is not endemic. Endoscopic or radiographic examination of clinically inapparent shedders can demonstrate lesions in the guttural pouches, paranasal sinuses, or pharynx, but because some persistent carriers of *S. equi* do not have detectable abnormalities of the nasopharynx, the most reliable approach to detecting carriers is PCR examination of nasal swabs or guttural pouch lavage fluid (see “**Control**”).<sup>9</sup>

### Animal Risk Factors

Strangles is more common in young or naive horses, although the disease can occur in horses of any age. Animals that have previously had the disease are less likely than naive animals to develop the disease on subsequent exposure. A proportion (approximately 25%) of horses that recover from the disease do not develop a protective immune response and are susceptible to reinfection and a second bout of strangles. Resistance to the disease is associated with the production of **serum and mucosal IgG antibodies** to the streptococcal M protein. The presence in the nasopharynx of antibodies

to streptococcal M protein is thought to be important in conferring resistance to the disease. Serum IgG antibodies specific for SeM protein, which is important in the anti-phagocytic activities of *S. equi*, are produced by most but not all horses during convalescence. Similarly, IgA and IgG against SeM protein are detectable on nasal and pharyngeal mucosa after *S. equi* infection but not after intramuscular administration of vaccines containing M protein. Serum bactericidal activity alone is not considered to be a good indicator of resistance to the disease, especially if it is induced by administration of a vaccine. Antibodies similar to those found in the nasopharynx after infection with *S. equi* are present in colostrum and milk of mares that have recovered from the disease, are passed to foals via the colostrum, and are secreted into the foal's nasopharyngeal mucosa. These acquired antibodies are important in mediating the resistance of young foals to the disease.

Although **strong immunity** occurs after an attack, this immunity wanes.

### Importance

Strangles is one of the most important diseases of horses in developed countries, accounting for up to 30% of reported infectious disease episodes. The disease is important not only because of the deaths that it causes but more importantly because of the disruption of the management of commercial horse establishments, the time necessary to treat affected horses, and the esthetic unpleasantness of the running noses and draining abscesses.

## PATHOGENESIS

**Virulence** of *S. equi* is attributable to the presence of **M proteins** on the surface of the bacteria, a hyaluronic acid capsule and the production of a leukocidal toxin. M proteins are associated with *S. equi* adhesion to oral, nasal, and pharyngeal tissues; invasion of pharyngeal tonsils and associated lymphoid structures; and evasion of the innate host immune response. *S. equi* produces two M proteins—SeM and SzPSe. SeM is unique to *S. equi* and plays a dominant role in resistance of the organism to phagocytosis. Variations in structure of M protein are associated with decreased virulence. The M proteins interfere with the deposition of complement component 3b on the surface of the bacteria and bind fibrinogen, both of which reduce the susceptibility of the bacteria to phagocytosis by neutrophils. The antiphagocytic activity of *S. equi* reduces the efficacy of neutrophils in engulfing and destroying the bacteria.

The capsule of *S. equi* is associated with resistance to nonimmune phagocytosis and pathogenicity. Strains of *S. equi* that do not produce a capsule do not induce disease, although they are able to infect guttural



pouches and cause seroconversion in experimental studies.

Following exposure of the oral and nasopharyngeal mucosal surfaces to *S. equi*, bacteria lodge in the **pharyngeal and tonsillar lymphoid tissues**, where they multiply rapidly. There is no evidence of colonization of mucosal surfaces and streptococci can be detected in pharyngeal tonsils within hours of exposure.<sup>10</sup> The binding of *S. equi* to pharyngeal cells is caused by fibrinogen binding proteins associated with M protein. The resistance of *S. equi* to nonimmune phagocytosis results in accumulation of large numbers of organisms surrounded by degenerating neutrophils. Release of streptolysin S and streptokinase may contribute to tissue damage by directly injuring cell membranes and indirectly through activation of plasminogen. Bacteremia may occur. Migration of neutrophils into the lymph nodes causes swelling and abscessation within 48 hours of infection,<sup>10</sup> with associated disruption of lymph drainage and development of edema in tissues drained by the affected nodes. Swelling of retropharyngeal lymph nodes may interfere with deglutition and respiration. Most abscesses eventually rupture and drain, and the infection resolves with the development of an effective immune response. Nasal shedding of *S. equi* usually begins 4 to 7 days after infection, or 2 days after onset of fever, and persists for 2 to 3 weeks in most horses but up to years in exceptional cases. Cessation of shedding accompanies development of an effective serum and mucosal immune response.

**Death** is usually attributable to pneumonia caused by aspiration of infected material, although other causes of death include asphyxiation secondary to upper airway swelling and impairment of organ function by metastatic infection. Rare deaths also occur as a result of infarctive purpura hemorrhagica in horses infected with *S. equi*.

**Metastatic infection** of the heart valves, brain, eyes, joints, and tendon sheaths or other vital organs can occur and cause a chronic illness and eventual death. Metastatic infection may occur because of bacteremia or extension of infection along chains of lymph nodes. Purpura hemorrhagica can occur as a sequela to *S. equi* infection and is associated with high serum antibody titers to SeM.

## CLINICAL FINDINGS

The disease manifests as an acute disease of varying severity, chronic infection of retropharyngeal lymph nodes and guttural pouches, and as chronic disease associated with metastatic infection of organs distant to the upper respiratory tract.<sup>11,12</sup> The severity of the acute disease varies with the age and immune status of the animal, the size of the inoculum, and the duration of exposure to infection. The term *strangles* derives from the enlarged retropharyngeal lymph nodes and

guttural pouches causing respiratory distress in severely affected equids.

## Acute Disease

The acute disease is characterized by mucopurulent nasal discharge and abscessation of submandibular and retropharyngeal lymph nodes. After an **incubation period** of 1 to 3 weeks the disease develops suddenly, with complete anorexia, depression, fever (39.5–40.5°C [103–105°F]), a serous nasal discharge that rapidly becomes copious and purulent, and a severe pharyngitis and laryngitis. Rarely there is a mild conjunctivitis.

**Lymphadenopathy** becomes apparent as the submandibular lymph nodes enlarge and palpation elicits a painful response. The pharyngitis may be so severe that the animal is unable to swallow, and there is a soft, moist cough. The head may be extended.

The febrile reaction commonly subsides in 2 to 3 days but returns as the characteristic abscesses develop in the lymph nodes of the throat region. The affected nodes become hot, swollen, and painful. **Swelling of the retropharyngeal lymph nodes** can cause obstruction of the oro- and nasopharynx with subsequent respiratory distress and dysphagia. Death by asphyxiation can occur at this time in severe cases. Obvious swelling of the nodes can take 3 to 4 days to develop; the glands begin to exude serum through the overlying skin at about 10 days and rupture to discharge thick, cream-yellow pus soon afterward. Average cases run a course of 3 weeks; severe cases can last as long as 3 months.

Retropharyngeal abscesses can rupture into the guttural pouches, resulting in guttural pouch empyema and ultimately in prolonged infection and formation of chondroids. Retropharyngeal lymph node abscessation might not be apparent on external evaluation and can often only be detected by radiographic or endoscopic examination of the pharynx. Infection of retropharyngeal lymph nodes and guttural pouches is important in persistent infection and carrier status of some horses.

If the infection is particularly severe, many other lymph nodes, including the pharyngeal, submaxillary, parotid, and retrobulbar nodes, can abscess at the same time. Local abscesses also occur at any point on the body surface, particularly on the face and limbs, and the infection can spread to local lymphatic vessels causing obstructive edema. This occurs most frequently in the lower limbs, where edema may cause severe swelling. Abscess formation in other organs probably occurs at this time.

An atypical form of the disease can occur and is characterized by widespread subclinical infection within a stable or yard and a mild disease. Affected horses have a transient fever for 24 to 48 hours and a profuse nasal discharge, and are anorexic. A moderate enlargement of the mandibular lymph nodes

occurs in only about one-half of the affected horses.

**Strangles in burros** is a slowly developing debilitating disease. At postmortem examination the characteristic lesions consist of caseation and calcification of abdominal lymph nodes.

## Complications

Complications occur in about 20% of cases. The most common fatal complication is the development of **suppurative necrotic bronchopneumonia**, which probably occurs secondary to the aspiration of pus from ruptured abscesses in the upper airway, or metastatic infection of the lungs.

Extension of the infection into the **guttural pouches**, usually as a result of rupture of retropharyngeal lymph nodes into the medial compartment, causes empyema, which can lead to the formation of accretions of inspissated pus (chondroids). Involvement of the guttural pouches is evident clinically as distension and, after resolution of other signs, unilateral or bilateral nasal discharge. Guttural pouches of affected horses should be examined endoscopically for evidence of retropharyngeal abscessation or guttural pouch empyema or chondroid formation.

Retropharyngeal lymphadenopathy can impair the function of the **recurrent laryngeal nerves**, with subsequent unilateral or bilateral laryngeal paresis and consequent respiratory distress.

**Metastatic infection** ("bastard strangles") results in the formation of abscesses in any organ or body site but most commonly in the lungs, mesenteric lymph nodes,<sup>11,13</sup> liver, spleen, kidneys, and brain. Clinical signs depend on the organ affected and the severity of the infection, but intermittent fever, chronic weight loss, and sudden death as a result of rupture of abscesses into a body cavity are common manifestations of metastatic infection. Rectal examination or percutaneous ultrasonographic examination can reveal intra-abdominal abscesses in some horses with metastatic abscesses in the abdomen. Peritoneal fluid from these horses is often abnormal.

Metastatic infections can occur in the **central nervous system**. Extension of infection to the meninges results in suppurative meningitis characterized clinically by excitation, hyperesthesia, rigidity of the neck, and terminal paralysis. Abscesses in the brain cause a variety of clinical signs, depending on location of the abscess, including severe depression, head pressing, abnormal gait, circling, and seizures. Metastatic infections of the ocular and extraocular structures, heart valves and myocardium, joints, bones, tendon sheaths, and veins may occur.

**Purpura hemorrhagica** can occur as a sequela to *S. equi* infection.

Two myopathic syndromes occur with *S. equi* infection in horses. **Muscle infarction**,

which may be extensive, is assumed to result from immune-mediated vasculitis associated with purpura hemorrhagica. Often the muscle lesions in these horses are associated with other lesions consistent with severe purpura hemorrhagica, including infarctions in the gastrointestinal tract, skin, and lungs. **Rhabdomyolysis and subsequent muscle atrophy** results in signs of muscle disease, including stilted gait and elevated serum activity of creatine kinase and other muscle-derived enzymes, and is assumed to be attributable to cross-reactivity of anti-SeM antibodies with myosin.

Myocarditis and glomerulonephritis have been suggested as sequelae to *S. equi* infection but have not been conclusively demonstrated to occur.

### CLINICAL PATHOLOGY

**Hematologic abnormalities** during the acute phase of the disease include leukocytosis, with a neutrophilia reaching a peak as the lymph nodes abscess. **Hyperfibrinogenemia** is characteristic of both the acute and chronic disease. Hematologic and biochemical abnormalities associated with metastatic infection depend on the site of the infection and its severity. Leukocytosis with a **hyperproteinemia** attributable to a polyclonal agammaglobulinemia is characteristic of metastatic and chronic abscessation. **Hypoalbuminemia** may be present. Serum biochemical profile can reveal evidence of specific organ dysfunction. There can be an anemia, which is likely attributable to the hemolytic effect of streptolysin O, immune-mediated hemolysis, or anemia of chronic disease.

A number of serologic tests to measure antibodies to SeM have been developed. An early commercial test that measured the **serum IgG antibody titer to SeM** was used to determine response to vaccination, suitability for vaccination and presence of metastatic infection. This ELISA has a sensitivity and specificity of 90% and 77%, respectively.<sup>14</sup> The test is not useful in diagnosis of the acute disease. Serum antibody titers to SeM are very high (>1:12800) in horses with metastatic infection or purpura hemorrhagica. Further tests have been developed with the aim of detecting horses that have been exposed to *S. equi*, with the intent of enabling quarantine and control measures.<sup>14</sup> ELISA assays for antibodies to SeM that combined analysis of two antigens restricted to *S. equi* provides sensitivity and specificity of 93% and 99%, respectively.<sup>14</sup> Use of this assay allows detection of horses that have been exposed to *S. equi* and therefore might be carriers of the organism. These horses can then be examined using PCR of nasopharyngeal swabs (3 over 3 weeks) or guttural pouch lavage fluid (once).<sup>9,15,16</sup> The high sensitivity of the test means that horses that test negative are unlikely to have been exposed or to be carriers.<sup>14</sup>

PCR testing is useful to detect shedding of *S. equi* DNA and has a greater sensitivity than routine culture.<sup>9,15,16</sup> PCR testing of nasopharyngeal swabs or guttural pouch lavage fluid has a sensitivity of 90% to 95% and specificity of 86% to 97% with turn-around time of approximately 2 hours.<sup>15,16</sup> The test is reported to be more specific than culture for detection of *S. equi* shedding. The PCR does not differentiate between live and dead *S. equi*, and false-negative results occur in the presence of large numbers of *S. equi*.

Culture of nasal, pharyngeal, guttural pouch, or abscess discharge will usually yield *S. equi* in 30% to 40% of horses with active disease or in carriers.<sup>9</sup> Abscesses can rapidly become contaminated with *S. zooepidemicus*, which can impede isolation of *S. equi*, although the two can be differentiated by culture or PCR analysis.<sup>17</sup>

### NECROPSY FINDINGS

In the rare fatalities that occur, necropsy examination usually reveals suppuration in internal organs, especially the liver, spleen, lungs, pleura, and peritoneum. When the last is involved, it is usually as a result of extension from abscesses in the mesenteric lymph nodes. The microscopic changes of abscessation and suppurative lymphadenitis are uncomplicated. The widespread ecchymotic hemorrhages of purpura hemorrhagica are not specific to this infection, but *S. equi* should always be investigated as a potential cause of such lesions.

### Samples for Confirmation of Diagnosis

- Bacteriology—swab of abscess wall, enlarged lymph node (CULT), or PCR

### DIAGNOSTIC CONFIRMATION

**Confirmation** of strangles depends on the detection of *S. equi* from nasopharyngeal swabs, discharges from abscesses, or guttural pouch lavage by PCR or culture. As discussed previously, PCR has greater utility at detecting presence of the organism. Shedding of *S. equi* in nasal discharges begins 1 to 4 days after the onset of fever, and ruptured abscesses often become contaminated with *Streptococcus zooepidemicus* and *S. equisimilis*.

History and clinical findings are usually highly suggestive of the disease, and classical cases of the strangles do not represent a diagnostic challenge. However, outbreaks of milder form of the disease are more challenging to diagnose, and confirmation is based on identification of the organism or demonstration of seroconversion. In acute disease, nasopharyngeal swabs or pus aspirates from abscesses can confirm *S. equi* infection. Because false negative culture results occur in 30% to 40% of cases, and qPCR has a sensitivity 94% and specificity

96%, and combining qPCR with culture will detect more than 90% of infected horses.<sup>9</sup>

Carriers are defined as horses shedding bacteria more than 6 weeks after clinical recovery. These horses will have serologic evidence of infection and can be detected by a series of at least 3 nasopharyngeal swabs at weekly intervals, or a single guttural pouch lavage ideally combined with a single nasopharyngeal swab, submitted for qPCR combined with culture. This will detect greater than 90% of carriers.<sup>18</sup>

Infection by *Actinomyces denticolens* caused submandibular abscessation in horses that can appear clinically similar to strangles. Diagnosis is based on bacterial culture.<sup>19,20</sup>

### TREATMENT

The **specific treatment** of choice for *S. equi* infection of horses is **penicillin**, either as procaine penicillin G (22,000 IU/kg intramuscularly every 12 hours) or potassium or sodium penicillin G (22,000 IU/kg intravenously every 6 hours). Tetracycline (6.6 mg/kg intravenously every 12-24 hours) and sulfonamide-trimethoprim combinations (15-30 mg/kg orally or intravenously every 12 hours) can be efficacious but should only be used if penicillin cannot be administered. Aminoglycosides, such as gentamicin or amikacin, and the fluoroquinolones are not effective. Proportions of a small number (10) *S. equi* isolates from horses in southern England during 2007 to 2012 resistant to various antimicrobials were as follows: enrofloxacin 40%, gentamicin 80%, penicillin or ceftiofur 0%, trimethoprim-sulfonamide combination 20%, doxycycline 10%, oxytetracycline 0%, and resistant to three or more antimicrobials 20%.<sup>21</sup> Similar sensitivities are reported for 22 isolates from Western Canada, with all isolates sensitive to ampicillin, ceftiofur, cephalothin, penicillin, erythromycin, amoxicillin-clavulanic acid, and no isolates sensitive to amikacin or neomycin. Approximately 80% of isolates were sensitive to TMS or tetracycline.<sup>22</sup> Use of ceftiofur, a third-generation cephalosporin, in horses is discouraged on public health grounds.<sup>21</sup>

### DIFFERENTIAL DIAGNOSIS

See Table 12-16 for a list of differential diagnoses of infectious upper respiratory tract disease of horses. Pneumonia should be differentiated from pleuropneumonia associated with transport or other stress. Chronic weight loss as a result of metastatic infection should be differentiated from equine infectious anemia, parasitism, inadequate nutrition and neoplasia, especially gastric squamous-cell carcinoma, alimentary lymphosarcoma, and granulomatous enteritis.

Table 12-16 Differential diagnosis of diseases of the upper respiratory tract of horses

Disease	Epidemiology	Clinical signs		Diagnosis and clinical pathology
		Respiratory tract	Other	
Strangles ( <i>Streptococcus equi</i> infection)	Incubation period 4–8 days. Course 10–21 days. Spreads by inhalation or ingestion. Mostly young horses in recently commingled groups. Long period (many months) of inapparent infection in some horses.	Copious, purulent nasal discharge. Cranial lymphadenitis and rupture. Moist cough. Obstruction of pharynx can cause dyspnea.	Severe illness with suppuration, fever. Atypical cases show involvement of other organs. Serious sequelae include pneumonia, metastatic spread of infection, mesenteric abscess or purpura hemorrhagica.	<i>S. equi</i> in nasal, pharyngeal or guttural pouch swabs, oropharyngeal pus. or lymph node abscess pus. PCR of nasal, pharyngeal or guttural pouch swabs. Serology to detect exposed horses. Leukocytosis. Hyperfibrinogenemia.
Equine viral arteritis (EVA)	Incubation period 1–6 days. Course 3–8 days. Some deaths.	Serous/purulent nasal discharge. Slight cranial lymphadenitis, cough. Conjunctivitis, purulent with edema or petechiae. Dyspnea.	Severe disease. Anasarca. Ventral edema, prepuce, legs, scrotum. May be diarrhea, jaundice. Up to 50% of mares abort.	Virus in blood at fever peak. Serology. Leukopenia.
Equine viral rhinopneumonitis (EHV-1)	Incubation period 2–10 days. Course 2–5 days. Cough may last as long as 3 weeks.	Serous/purulent nasal discharge. Slight cranial lymphadenitis, coughing, conjunctivitis. Mild respiratory disease; in young.	Abortion in mares. Virus may cause myelopathy.	Virus in nasal discharge or peripheral blood buffy coat. PCR of nasal discharge or blood. Tissue culture and serologic tests. Leukopenia. Virus in intranuclear hepatic inclusions of fetus.
Equine viral rhinopneumonitis (EHV-4)	Incubation period 2–10 days. Course 2–5 days. Cough may last as long as 3 weeks.	Serous/purulent discharge. Slight cranial lymphadenitis, coughing, conjunctivitis.	Mild respiratory disease; in young horses.	Virus in nasal discharge. Tissue culture and serologic tests. Leukopenia.
Equine influenza (H3N8 rarely H7N1)	Incubation period 2–3 days. Course 7 days. Cough may persist 3–4 weeks. Enzootic, worldwide (not Australia). Explosive outbreaks; 80%–100% morbidity in young.	Nasal discharge slight, serous only. Slight cranial lymphadenitis. Severe cough. No conjunctivitis and no respiratory distress.	Minimal extrarespiratory signs. Temperature 39–41°C (102–105°F).	Virus in nasal discharge. Good serologic tests available. Rapid ELISA test for viral antigen in nasal secretions. PCR of nasal secretions.
Equine rhinitis virus	Incubation period 3–8 days. Rapid spread, high morbidity (70%). Solid immunity after natural infection. Excreted in urine.	Pharyngitis, pharyngeal lymphadenitis, nasal discharge serous to mucopurulent. Cough persists 2–3 weeks.	Mild disease. Emphasis on coughing. Fever to 39.5°C (103°F).	Equine rhinitis virus on tissue culture. Serologic tests available.
Equine adenovirus	Many inapparent infections. High proportion of population serologically positive.	Mild respiratory signs in adults. Fatal pneumonia in Arabian foals with combined immunodeficiency.	Transient softness of feces. In mares can cause abortion without clinical illness.	Adenovirus in oropharyngeal swabs. Serologic tests available.

ELISA, enzyme-linked immunosorbent assay; PCR, polymerase chain reaction.

There is considerable debate about the treatment of horses with strangles. Folklore and anecdotal reports suggest that antibiotic treatment of horses with strangles is contraindicated because it promotes the development of metastatic infection. There is no experimental or empirical evidence to support this contention, and horses with strangles should be treated with therapeutic doses of an appropriate antibiotic, such as procaine penicillin, for a period of time sufficient to effect a cure, as appropriate.

Treatment for *S. equi* infection depends on the stage of the disease, as follows:

- Horses with **early clinical signs** including fever, anorexia, depression, and purulent nasal discharge should be isolated and treated with therapeutic doses of penicillin for at least 5 days. The purpose of treatment is to prevent further development of the disease in the affected animal and to minimize environmental contamination with *S. equi* and transmission to other horses. Treatment should start as soon as clinical signs are observed, and the full course of treatment

should be completed to minimize the chances of recrudescence of the infection. Treatment at this stage causes rapid resolution of fever, anorexia, nasal discharge, and lymphadenopathy in individual horses and may abort an incipient outbreak of the disease in a stable or yard. However, treated horses may not develop a protective immune response and consequently may be at risk of reinfection if exposed to *S. equi* after completion of the course of treatment, leading one authority to



recommend that only severely affected animals be treated.

- Horses with submandibular **lymph node abscessation** but without other clinical abnormalities probably do not require antibiotic treatment. Such horses should be isolated and efforts made to aid maturation and rupture of affected lymph nodes.
- Systemic antibiotic therapy with penicillin is indicated in horses with **advanced signs of strangles**, including prolonged fever, depression, anorexia, or dyspnea resulting from retropharyngeal lymphadenopathy. Retropharyngeal abscessation frequently responds to antimicrobial therapy, although surgical drainage may be required in some instances.
- Horses with **metastatic infection** require systemic penicillin therapy in combination with specific therapy for the complication. Pulmonary and mesenteric abscesses are problematic because they are usually not amenable to surgical drainage, and prolonged antimicrobial therapy is required to attempt to effect a cure.
- **Guttural pouch empyema** requires either surgical drainage or repeated flushing of the affected pouch through the pharyngeal openings. Removal of pus and inspissated material in the guttural pouches can be achieved under endoscopic guidance. Alternatively, rigid or flexible indwelling catheters can be inserted for repeated flushing of the pouches with sterile isotonic electrolyte solutions (such as 0.9% NaCl) and topical medications. Substances and solutions that are irritating or injurious to mucus membranes, such as iodine,<sup>23</sup> hydrogen peroxide, and similar irritant compounds, should not be infused into the guttural pouches. Combined topical and systemic administration of potassium benzyl penicillin may be beneficial. Chondroids can often be removed using wire snares. Horses with metastatic or guttural pouch infections are likely infectious and should be isolated.
- Treatment of **purpura hemorrhagica** is dealt with elsewhere.
- Management of horses that have been **exposed** to horses with strangles is controversial. Some authorities recommend treatment of such in-contact horses with penicillin until affected horses are isolated and no longer are a source of infection. However, close examination of exposed animals, including monitoring rectal

temperature, and treatment of horses at the first sign of illness is probably a more reasonable approach.

**Ancillary treatment** consists of administration of nonsteroidal antiinflammatory drugs (NSAIDs) to reduce swelling and provide pain relief, application of hot poultices to encourage rupture of abscesses, provision of intravenous hydration in animals unable to drink, and wound care, including cleaning of ruptured abscesses and application of petroleum ointment to surrounding skin to prevent scalding. Horses with severe upper airway obstruction may require placement of a short-term tracheotomy.

### CONTROL

All establishments that house multiple horses, and at which horses both enter and leave, should have biosecurity plans detailing the measures to be taken before new horses enter the facility. The principles of control measures include the prevention of transmission of *S. equi* from infected horses (cases or carriers) to susceptible animals and enhancement of resistance to infection and disease.

There are two basic approaches to strangles prevention: eradication or control.<sup>24</sup> The eradication approach aims to create and maintain a guaranteed disease-free state within the group and is most suited for closed herds. The control approach aims to reduce the frequency and severity of outbreaks but accepts that disease will occur from time to time. In many facilities with large numbers or frequent turnover of horses, such as large training yards or stud farms, a control approach may be more achievable than eradication.<sup>24</sup>

The approach to managing horses entering a facility in which *S. equi* infection is not present involves serologic testing of all horses before entry using an ELISA of known high sensitivity and specificity. Horses that are seropositive on arrival have prima facie evidence of exposure and are considered to be potential carriers of *S. equi* until demonstrated by PCR and culture to be negative for the organism. These horses are then screened for *S. equi* carriage by guttural pouch lavage combined with a nasopharyngeal swab tested by qPCR and culture.<sup>9,15</sup> Horses with negative or equivocal serology on arrival should not be admitted to the facility and should be retested 10 to 14 days later to establish serologic status and then either admitted to the facility if they are seronegative or screened for *S. equi* carriage if they are seropositive.<sup>24</sup> Any horses testing positive for carriage need to be treated (see previous discussion) and cured of infection before entry into the yard.

Vaccination provides a useful adjunct to management changes, especially in groups of horses with open management systems, and may be more appropriate for yards aiming

for control rather than eradication.<sup>24</sup> However, vaccination complicates interpretation of serologic screening of new arrivals because it is not possible at this time to differentiate between serologic responses to vaccination and infection.

### Prevention of Transmission

Methods to control transmission of *S. equi* on affected premises are detailed in [Table 12-17](#) and are as follows:

- Infected animals should be isolated immediately.
- All potential sources of fomites—including pails, brooms, grooming brushes, and blankets—should be thoroughly cleaned and disinfected and the bedding burned. Disinfection with phenolic compounds is preferred because they retain their activity in the presence of some organic matter, whereas bleach and quaternary ammonium compounds are inactivated by organic material.
- Emergency prophylactic treatment, using injections of benzathine penicillin every 48 hours in foals and yearlings that are most susceptible, has been used but most treated animals develop strangles when the treatment is discontinued. This method of prophylaxis is not recommended.
- People who care for affected horses should, ideally, avoid contact with susceptible animals. If this is not practical, then strict isolation protocols, including the wearing of protective boots and clothes that are changed between affected and normal horses, should be implemented.
- Horses with elevated temperatures should have nasopharyngeal or guttural pouch swabs cultured.
- As detailed previously, horses should be examined by nasopharyngeal swab or guttural pouch lavage to detect carriers. Carriers should be treated and demonstrated to be no longer carriers before being allowed access to potentially susceptible horses.

### Enhanced Resistance

The majority of horses develop solid immunity to strangles after recovery from the spontaneous disease. This immunity lasts for up to 5 years in approximately three-quarters of recovered horses. Maximum resistance to disease probably requires both systemic and mucosal immunity to a variety of *S. equi* factors including, but not limited to, M protein. As noted previously, vaccination will result in positive results of serologic testing for exposure to *S. equi*. It is not possible at this time to differentiate between responses

**Table 12-17** Aims and associated measures used to control transmission of *Streptococcus equi* in affected premises and herds

Aim	Measure
Prevent spread of <i>S. equi</i> infection to horses on other premises and to new arrivals on the affected premises	Stop all movement of horses on and off affected premises immediately and until the outbreak is controlled. Horses with strangles and their contacts should be maintained in well-demarcated quarantine areas. Clustering of cases in groups allow parts of the premises to be allocated as contaminated or clean.
Establish whether clinically recovered horses are carriers.	At least three nasopharyngeal swabs or washings taken at weekly intervals from all recovered cases and their contacts and examined by culture and PCR. Horses that are consistently negative are returned to the clean area.
Investigate apparently healthy horses from which <i>S. equi</i> is recovered.	Serology to determine exposure, with positive horses subject to nasopharyngeal swabbing (three times) or guttural pouch lavage and PCR and culture. Serologically negative horses should be retested in 10–14 days.
Eliminate <i>S. equi</i> from guttural pouches.	Treatment of guttural pouches, as detailed under "Treatment."
Prevent infection of uninfected horses by <i>S. equi</i> from infected horses.	Personnel should have dedicated protective clothing when dealing with infected horses. Personnel should not deal with infected and uninfected horses. If this is not possible, then infected horses should be dealt with after uninfected horses. Strict hygiene should be implemented, including provision of disinfection facilities for personnel and diligent and thorough cleaning of stables and barns. If practicable, equipment should be destroyed after use with infected horses. Organic material should be removed from stables and then appropriate phenolic disinfectants or steam should be applied. This cleaning should be repeated. Feces and waste from infected animals should be composted in an isolated location. Uninfected horses should not be introduced to pastures used to house infected horses for 4 weeks. Water troughs should be disinfected daily. Horse vans should be thoroughly cleaned and disinfected after each use.

PCR, polymerase chain reaction.

Source: modified from Sweeney CR et al. *J Vet Intern Med* 2005; 19:123–134.

to vaccination and responses to natural infection. This ambiguity confounds use of serologic tests in control of the disease. The benefits of potential increases in resistance to the disease induced by vaccination should be weighed against the restrictions this imposes on use of serologic testing in control programs.

The efficacy of **vaccination** of adult horses with *S. equi* bacterins or M protein extracts of *S. equi* administered intramuscularly is controversial. Administration of M protein vaccines elicits an increase in the concentration of serum opsonizing antibodies but does not confer a high degree of resistance to natural exposure. However, in a controlled field trial, vaccination with an M protein commercial vaccine three times at 2-week intervals reduced the clinical attack rate by 50% in a population of young horses in which the disease was endemic. Horses vaccinated only once were not protected against strangles. A modified live vaccine induced a strong antibody response but caused substantial morbidity and some deaths among young ponies, highlighting the challenges with use of attenuated vaccines.<sup>25</sup>

Administration of a live, attenuated submucosal vaccine to mares appears to be safe.<sup>26</sup>

This result suggests that, in the face of an outbreak, vaccination might reduce the number of horses that develop strangles but will not prevent strangles in all vaccinated horses. A common vaccination protocol involves the administration of an M protein vaccine intramuscularly for an initial course of three injections at 2-week intervals, with further administration of the vaccine every 6 months in animals at increased risk of contracting the disease. On breeding farms, vaccination of mares during the last 4 to 6 weeks of gestation and of the foals at 2 to 3 months of age might reduce the incidence of the disease.

The vaccines are administered by the intramuscular route and frequently cause swelling and pain at the injection site. **Injection site reactions** are usually less severe with the M protein vaccines. Injection into the cervical muscles may cause the horse to be unable to lower its head to eat or drink for several days—**injection into the pectoral muscles is preferred for this reason.** There are reports of **purpura hemorrhagica**, the

onset of which was temporally associated with administration of a *S. equi* vaccine. Owners should be clearly warned of the limited efficacy and potential adverse effects of vaccination. The effect of vaccination in confounding interpretation of results of serologic testing used in control of the disease should be considered before horses are vaccinated.

**Foals that receive adequate high-quality colostrum** from exposed or vaccinated mares have serum and nasopharyngeal mucosal immunoglobulins (IgGb) that provide them with resistance to *S. equi* infection. This passive immunity wanes at approximately 4 months of age. Vaccination of brood mares 1 month before foaling increases colostral IgG antibodies to M protein, and presumably serum and mucosal immunoglobulin concentrations in their foals, but the efficacy of this approach in preventing strangles in foals is not reported.

An **intranasal vaccine** of an avirulent live strain of *S. equi* has recently been developed and appears useful. Use of the intranasal modified live vaccine can result in strangles caused by the vaccine strain.<sup>7</sup> The vaccine is composed of a live variant (strain 707-27) that does not possess a capsule and is therefore avirulent when administered intranasally. Anecdotal reports suggest that recent manipulation of the genome by deletion of genes HasA and HasB, associated with formation of the capsule, has increased the genetic stability of the vaccine strain. The live attenuated vaccine should only be administered intranasally to healthy horses. The efficacy of the vaccine in field situations, safety in the face of an outbreak and in pregnant mares, incidence of adverse effects, and risk of reversion to virulence have not been reported. It should not be used in potentially exposed horses during an outbreak of the disease. Intramuscular injection of the vaccine results in the formation of abscesses. The vaccine should not be administered to horses concurrently with intramuscular administration of other vaccines because of the risk of contamination of needles and syringes with *S. equi* vaccinal strain and subsequent development of abscesses at injection sites.

An experimental modified live vaccine administered intramuscularly to ponies conferred protection to experimental challenge.<sup>27</sup>

Vaccination by **submucosal** injection of a modified live vaccine is reported to provide short-lived (90-day) immunity to disease. The commercial form of the vaccine is administered into the submucosal tissues of the upper lip and is recommended for use in horses at moderate to high risk of developing strangles. At present there is no evidence of reversion of the vaccinal strain to virulence, and horses developing strangles subsequent to vaccination have all been infected with virulent strains of *S. equi*, apparently before

development of immunity as a result of vaccination. The vaccine appears to be safe for use in pregnant mares.<sup>26</sup>

### FURTHER READING

Mallicote M. Update on *Streptococcus equi* subsp *equi* infections. *Vet Clin North Am Equine*. 2015;31:27-35.

### REFERENCES

- Ivens PAS, et al. *Equine Vet J*. 2011;43:359.
- Parkinson NJ, et al. *Vet Rec*. 2011;168.
- Libardoni F, et al. *Vet Microbiol*. 2013;162:663.
- Moloney E, et al. *Irish Vet J*. 2013;66.
- Patty OA, et al. *NZ Vet J*. 2014;62:63.
- Lindahl S, et al. *Vet Microbiol*. 2011;153:144.
- Cursors R, et al. *Vaccine*. 2015;33:3440.
- Weese JS, et al. *Can Vet J*. 2009;50:968.
- Lindahl S, et al. *J Vet Int Med*. 2013;27:542.
- Timoney JF, et al. *Equine Vet J*. 2008;40:637.
- Whelchel DD, et al. *Equine Vet Educ*. 2009;21:131.
- Whelchel DD, et al. *Equine Vet Educ*. 2009;21:135.
- Mair TS, et al. *Equine Vet J*. 2011;43:123.
- Robinson C, et al. *Vet J*. 2013;197:188.
- Webb K, et al. *Vet J*. 2013;195:300.
- North SE, et al. *Equine Vet J*. 2014;46:56.
- Baverud V, et al. *Vet Microbiol*. 2007;124:219.
- Waller AS. *Vet Clin Equine*. 2014;30:591.
- Albini S, et al. *Vet Rec*. 2008;162:158.
- Beck A, et al. *Can Vet J*. 2011;52:513.
- Johns IC, et al. *Vet Rec*. 2015;176:334.
- Clark C, et al. *Can Vet J*. 2008;49:153.
- Sherlock CE, et al. *Equine Vet Educ*. 2007;19:515.
- Slater J. Strangles—practical management of outbreaks. In: *AVA/NZVA Pan Pacific Conference*. Brisbane: Australian Veterinary Association; 2015:827.
- Borst LB, et al. *Am J Vet Res*. 2011;72:1130.
- Reinhold B, et al. *Equine Vet Educ*. 2010;22:40.
- Robinson C, et al. *Vaccine*. 2015;33:1160.

## GLANDERS

### SYNOPSIS

**Etiology** *Burkholderia mallei*

**Epidemiology** Contagious disease of solipeds (equids) and possibly camels. Important potential zoonosis.

**Clinical findings** Acute or chronic form, and characterized by pneumonia and nodules or ulcers in the respiratory tract and on the skin. The disease is highly fatal.

**Clinical pathology** Complement fixation test, mallein test, isolation of organism

**Necropsy findings** Extensive bronchopneumonia in acute cases. Miliary nodules in internal organs and ulcerated nodules in skin and respiratory tract.

**Treatment and control** Control is by slaughter of clinically affected and carrier animals detected by serologic or mallein tests. Rarely are affected animals treated, and if so it is by prolonged administration of antimicrobials.

### ETIOLOGY

*Burkholderia mallei*, a gram-negative bacterium, is the causative organism of glanders.

It has close genetic and antigenic relatedness to *Burkholderia pseudomallei*. Isolates of *B. mallei* recovered from three continents over a period of 30 years have identical allelic profiles, but phylogenetic determination of strains can be achieved using molecular diagnostic techniques (for example, next-generation whole-genome sequencing and multiple-locus variable-number tandem repeats).<sup>1-3</sup> Determination of phylogenetic relationships is a powerful tool for determining the source, and epidemiologic characteristics, of outbreaks of the disease.

The only natural hosts of the organism are equids, with infection in other species being a result of transmission from infected equids. Humans in close contact with affected equids can be infected and develop an often fatal disease. Infection in humans is also caused through inadvertent exposure in laboratories. The organism is considered a category B biothreat (biologic warfare agent) by the Centers for Disease Control in the United States.<sup>4,5</sup>

### EPIDEMIOLOGY

#### Geographic Occurrence

Glanders is restricted geographically to South America, eastern Europe, Asia Minor, Asia, and North Africa. Recent cases in Western Europe (Germany) are reported in horse imported from Brazil,<sup>6</sup> where the disease is present,<sup>3</sup> and in another horse, some years later, that was born in Germany.<sup>7</sup> These cases highlight the need for vigilance in detection of glanders.<sup>6</sup> Occurrence of outbreaks of the disease since 1986 is cataloged and available.<sup>8</sup> The disease has reemerged, or at least been detected, recently in India and Pakistan.<sup>2,9,10</sup> An outbreak in Bahrain was attributed to multiple introductions of infection, rather than simply one source.<sup>1</sup>

The disease was more widespread but has been **eradicated** from most countries. Glanders was an important disease when there were large concentrations of horses in cities and armies, but now has sporadic occurrence, or occurs in localized outbreaks, even in infected areas.

#### Host Occurrence

Horses, mules, and donkeys are the species usually affected. The disease can occur naturally in camels, although the number of reported cases is low, suggesting that camels are not particularly susceptible to infection.<sup>11</sup>

Humans are susceptible and the infection is often fatal. Carnivores, including lions can be infected by eating infected meat and infections have been observed in sheep and goats.

#### Source of Infection and Transmission

*B. mallei* is an obligate parasite and is readily destroyed by light, heat, and the usual disinfectants and is unlikely to survive in a

contaminated environment for more than 6 weeks.

Infected animals or **carriers** that have made an **apparent recovery** from the disease are the important sources of infection. Carriers can be clinically normal and shed the organism for years. **Chronic nodular lung lesions**, which have ruptured into the bronchi, infect upper airway passages and nasal or oral secretions. Spread to other animals occurs mostly by **ingestion**, the infection spreading on fodder and utensils, particularly **communal watering troughs**, contaminated by nasal discharge or sputum. Rarely the cutaneous form appears to arise through contamination of skin abrasions by direct contact or from harness or grooming tools. Spread by inhalation can also occur, but this mode of infection is probably rare under natural conditions.

### Experimental Reproduction

An experimental model for disease has been reproduced by intratracheal inoculation of horses with cultures of *B. mallei*. Horses showed fever within 24 to 48 hours of challenge followed by the progressive development of signs of respiratory distress with epistaxis and purulent nasal and ocular discharge. On postmortem there was lymphadenopathy, ulcerative lesions in the nasal septa, and pneumonia.

### Host and Pathogen Risk Factors

**Horses** tend to develop the chronic form, **mules and donkeys** the acute form, but all types of equid and all ages are susceptible. The disease is more likely when animals are in a **stressed state** from heavy work, and animals that are poorly fed and kept in a poor environment are more susceptible.

The stress associated with movement of a large number of horses can precipitate an outbreak with high mortality rates. In the few animals that recover, there is a long convalescence with the frequent development of the “**carrier**” state. Animals rarely make a complete recovery.

### Economic Importance

The disease has little current economic importance, although the threat of horse movement reintroducing glanders into countries that have eradicated it is a concern.

### Zoonotic Implications

Although humans are not highly susceptible, the infection can gain access through skin abrasions to produce granulomatous disease and pyemia. Infection can also occur from inhalation of infectious material. The case fatality is high. Horse handlers in general are at risk, and veterinarians conducting postmortem examinations without proper precautions are at particular risk. The organism is identified as a possible agent of bioterrorism.



## PATHOGENESIS

Invasion occurs mostly through the intestinal wall and a septicemia (acute form) or bacteremia (chronic form) is set up. Localization always occurs in the lungs but the skin and nasal mucosa are also common sites. Other viscera can become the site of the typical nodules. Terminal signs are in the main those of bronchopneumonia or, in acute disease, chronic wasting.

## CLINICAL FINDINGS

### Acute Disease

Acute disease presents with high fever, cough, and nasal discharge, with rapidly spreading ulcers appearing on the nasal mucosa and nodules appearing on the skin of the lower limbs or abdomen. Death as a result of septicemia occurs in a few days.

### Chronic Disease

The disease is evident as fever, inappetence, weight loss, enlargement of submandibular lymph nodes, and exercise intolerance in almost all affected horses. Cough, dyspnea, and nasal discharge occur in approximately two-thirds of cases, and greater than 70% of cases have ulcers on the nasal septum or nodules and ulcers in the skin, usually of the legs.<sup>12</sup>

Three major manifestations are described, although one or more of all three can occur in the same animal:

1. Pulmonary
2. Skin
3. Nasal, although the chronic nasal and skin forms commonly occur together.

### Pulmonary Form of Disease

The **pulmonary** form manifests as a chronic pneumonia with cough, frequent epistaxis, and labored respiration.

### Nasal Form of Disease

In the **nasal form**, lesions appear on the lower parts of the **turbinates** and the cartilaginous **nasal septum**. They commence as nodules (1 cm in diameter), which ulcerate and may become confluent. In the early stages there is a serous nasal discharge that may be unilateral and that later becomes purulent and blood stained. Enlargement of the submaxillary lymph nodes is a common accompaniment. On healing, the ulcers are replaced by a characteristic **stellate scar**.

### Skin Form of Disease ("Farcy")

The **skin** form is characterized by the appearance of subcutaneous nodules (1-2 cm in diameter), which soon **ulcerate** and discharge pus of the color and consistency of dark honey. In some cases the lesions are more deeply situated and discharge through fistulous tracts. Thickened **fibrous lymph vessels** radiate from the lesions and connect one to the other. Lymph nodes draining the area become involved and may discharge

to the exterior. The predilection site for cutaneous lesions is the medial aspect of the hock, but they can occur on any part of the body.

Animals affected with the chronic form are usually ill for **several months**, frequently showing improvement but eventually either dying or making an apparent recovery to persist as occult cases.

## CLINICAL PATHOLOGY

Chronic disease caused anemia and a moderate leukocytosis and neutrophilia.<sup>12</sup>

The principal tests used in the diagnosis of glanders are demonstration of presence of the organism by culture or detection of specific DNA (such as by PCR testing),<sup>13</sup> the mallein test, or one of various serologic tests—complement fixation test,<sup>14,15</sup> C-ELISA, immunoblot,<sup>16</sup> Rose Bengal test, indirect hemagglutination, agar-gel immunodiffusion, indirect fluorescent antibody testing, counterimmune electrophoresis, and dot-ELISA.<sup>8</sup> Details of test procedures are available in the *OIE Manual* on diagnostic tests and vaccines.<sup>17</sup>

All serologic tests are dependent on the host mounting an immune response to infection. Detectable immune responses might require a period of up to 2 weeks after infection to develop to the stage where they are detectable. The precise time depends on host factors and the characteristics of the particular serologic test.

The intent of testing affects the test chosen for use. Tests intended to screen horses for international travel must have a high sensitivity, to avoid false negative results, but also high specificity, to ensure that there are few false-positive results. From the point of international movement of horses, tests should first have a high sensitivity to ensure that there are few false-negative results—with the potential for consequent transportation of infected animals—whereas detection of diseased animals in populations of horses in which the disease is rare demands tests with high specificity. The solution is often to first screen with tests of high sensitivity, such as the complement fixation test, followed by a test with much higher specificity (but often lower sensitivity), such as immunoblotting.<sup>16</sup> The outcome of such serial testing is a high sensitivity and specificity. The diagnostic performance of various tests has improved with use of refined reagents (including use of recombinant or purified bacterial proteins or lipopolysaccharide,<sup>16</sup> or antibodies) and optimized tests conditions,<sup>18</sup> such as the temperature at which complement fixation tests are incubated.<sup>15</sup> All serologic tests can be inaccurate for periods up to 6 weeks following performance of the mallein test.

Molecular diagnostic techniques must discriminate between *B. mallei* and the closely related *B. pseudomallei*. Whereas

older molecular diagnostic tests did not do so because of the close genetic relationship between these organisms, more modern tests do discriminate at a level that is clinically useful.<sup>13,19</sup>

Discussion of all the currently available tests is beyond the scope of this text, and readers are referred to recent publications.<sup>5,8</sup>

## Mallein Test

The test is not generally recommended because of animal welfare concerns; however, it can be useful in remote endemic areas where sample transport or proper cooling of samples is not possible.<sup>17</sup> The mallein test involves the intradermal injection of mallein, a purified or semipurified protein of *B. mallei*,<sup>20</sup> into the subcutaneous tissues of the eyelid or lateral side of the neck. Mallein (0.1 mL of a 1.0 mg/mL concentration of mallein) is injected intradermally with a tuberculin syringe. Ideally, the thickness of the skin is measured using calipers before injection of mallein and 48 hours following injection. Some infected animals exhibit a general hypersensitivity reaction after inoculation. The mallein test can be negative in recently infected animals, in those with acute disease, and in advanced cases in horses.<sup>17</sup>

The mallein test has poorer sensitivity (~75%) than does serologic testing (Rose Bengal—90%, complement fixation—97%, and others).<sup>21</sup>

## NECROPSY FINDINGS

In the **acute** form there are multiple petechial hemorrhages throughout the body and a severe catarrhal bronchopneumonia with enlargement of the bronchial lymph nodes.

In the more common **chronic** form, the lesions in the lungs take the form of **miliary nodules**, similar to those of miliary tuberculosis, scattered throughout the lung tissue. **Ulcers** are present on the mucosa of the **upper respiratory tract**, especially the nasal mucosa and to a lesser extent that of the larynx, trachea, and bronchi. Nodules and ulcers may be present in the **skin and subcutis** of the limbs, which may be greatly enlarged. Local lymph nodes receiving drainage from affected parts usually contain foci of pus and the lymphatic vessels have similar lesions. Necrotic foci may also be present in other internal organs. *B. mallei*, and sometimes *Arcanobacterium pyogenes*, are isolated from infected tissues, and this is the main means of confirmation of diagnosis at necropsy.

## DIAGNOSTIC CONFIRMATION

In live animals that could be carriers, the complement fixation test is used as the official test in most countries. The mallein test is used in those horses whose sera is anticomplementary.

### DIFFERENTIAL DIAGNOSIS

- Epizootic lymphangitis
- Ulcerative lymphangitis
- Sporotrichosis
- Melioidosis
  - Strangles
  - *Rhodococcus equi* infection
  - Equine pleuropneumonia
- Other causes of pneumonia

### TREATMENT

There is little information on treatment because control of the disease requires death of affected equids to prevent further spread of infection, and the granulomatous nature of the disease likely requires prolonged administration of antimicrobials capable of penetrating abscesses. Antimicrobial sensitivity of *B. mallei* isolates is reported.<sup>22</sup>

However, in instances in which high-value animals are treated, a treatment protocol of enrofloxacin (8 mg/kg IV q24 h) and trimethoprim-sulfadiazine (32 mg/kg IV q24h) for 7 days, followed by enrofloxacin (4 mg/kg IV q24h) and trimethoprim-sulfadiazine (16 mg/kg IV q24h) for 2 weeks, and then 6 mg/kg doxycycline PO q12h for 9 weeks has been used. Treated horses responded within 1 week to treatment, with reduction of pyrexia and improved appetite. Nodules on the legs had resolved by week 3 of treatment. All 23 treated horses recovered and did not have evidence of disease recrudescence or a carrier status 1 year after the cessation of treatment.<sup>12</sup>

### CONTROL

Control of glanders involves measures to reduce spread of the disease among equids in areas where the disease is endemic and eradication of the disease when desired or when the disease occurs as an emergency disease outbreak in areas where the disease is not endemic.

Control of glanders is based on identification of infected animals by either serologic testing, intradermal mallein testing, or detection of the organism (culture or PCR) (see previous discussion). The mallein test and complement fixation test are the OIE-approved tests for glanders for the purposes of international movement of horses—noting the comments given previously about the characteristics of these tests. When attempting to identify infected animals, the delay in seroconversion or development of a positive mallein test after infection should be considered. Mallein testing can influence the sensitivity of subsequent serologic testing.

If glanders is detected, or suspected, in area free of the disease, then the affected horse and contact animals should be promptly quarantined until their disease

status has been established. Eradication of the disease involves identification of infected animals with subsequent euthanasia and controlled disposal of these equids. Equids that could have been infected but that are negative on serologic or bacteriologic testing should have serologic tests repeated in 2 to 3 weeks. During this time, they should be quarantined.

Complete quarantine of affected premises is necessary. A vigorous disinfection program for food and water troughs and premises generally should be instituted to prevent spread while eradication is being carried out. Carcasses of infected animals and contaminated or potentially contaminated bedding, feed, and tack that cannot be disinfected should be burned or deeply buried, consistent with local culture and laws. *B. mallei* is susceptible to most common disinfectants, including benzalkonium chloride, 1% sodium hypochlorite, 70% alcohol, and others.<sup>5</sup> *B. mallei* does not persist in soil and is destroyed by exposure to sunlight or heating (>55°C >131 F for at least 10 minutes).<sup>5</sup>

*B. mallei* is a potential zoonosis that can cause severe illness and death in people. Barrier precautions, including the wearing of surgical masks, face shields, gloves, and gowns, are strongly recommended for people dealing with infected or suspect equids.<sup>5</sup>

There is currently no vaccine for glanders in animals or people.<sup>17</sup>

### FURTHER READING

- Dvorak GD, Spickler AR. Zoonosis update—Glanders. *JAVMA*. 2008;233:570-577.
- Khan I, et al. Glanders in animals: a review on epidemiology, clinical presentation, diagnosis, and countermeasures. *Transbound Emerg Dis*. 2013;60:204-221.

### REFERENCES

1. Scholz HC, et al. *PLoS Negl Trop Dis*. 2014;8.
2. Hornstra H, et al. *Emerg Infect Dis*. 2009;15:2036.
3. Silva KPC, et al. *Pesquisa Veterinaria Brasileira*. 2009;29:439.
4. Glanders, 2011. (Accessed 19.08.15, at <<http://www.cdc.gov/glanders/>>).
5. Dvorak GD, et al. *JAVMA*. 2008;233:570.
6. Elschner MC, et al. *Equine Vet Educ*. 2009;21:147.
7. Anon. *Vet Rec*. 2015;176.
8. Khan I, et al. *Transbound Emerg Dis*. 2013;60:204.
9. Malik P, et al. *Ind J Anim Sci*. 2009;79:1015.
10. Malik P, et al. *Vet Ital*. 2012;48:167.
11. Wernery U, et al. *Emerg Infect Dis*. 2011;17:1277.
12. Saqib M, et al. *BMC Vet Res*. 2012;8.
13. Janse I, et al. *BMC Infect Dis*. 2013;13.
14. Khan I, et al. *Vet Rec*. 2011;169:495.
15. Khan I, et al. *Rev Sci Techn—OIE*. 2014;33:869.
16. Elschner MC, et al. *BMC Vet Res*. 2011;7.
17. Glanders. OIE Manual of Diagnostic Tests and Vaccines, 2015. (Accessed 20.08.15, at <<http://www.oie.int/international-standard-setting/terrestrial-manual/>>).
18. Sprague LD, et al. *BMC Vet Res*. 2009;5.
19. Schmoock G, et al. *Acta Vet Scand*. 2015;57.
20. de Carvalho MB, et al. *BMC Vet Res*. 2012;8.
21. Naureen A, et al. *J Vet Diagn Invest*. 2007;19:362.
22. Naureen A, et al. *J Equine Vet Sci*. 2010;30:134.

## VIRAL INFECTIONS OF THE RESPIRATORY TRACT OF HORSES

Viral respiratory tract disease is considered by veterinarians in the United States to be second only to colic among medical diseases in importance to the health and welfare of horses. The situation is likely similar in most developed countries and especially those in which equine influenza is endemic. Episodes of upper respiratory tract disease characterized by fever, nasal discharge, and cough are common in horses, especially young animals and horses housed in groups in stables and barns. An estimated 17% of equine operations in the United States have one or more horses affected by upper respiratory disease each year, and 1.5% of horses develop the disease every 3 months.<sup>1</sup> Upper respiratory disease is most common in spring and least common in winter. Strangles was an uncommon cause of disease, occurring in only three horses per 1000 per 3 months. Viral respiratory disease is approximately three times more common in horses less than 5 years of age.

With the exception of *Streptococcus equi* and possibly *Mycoplasma* spp., all the other known or suspected causes of nonparasitic infectious upper respiratory disease of horses are viral and include the following: equine herpesvirus types 1, 2, 3 (rarely), and 4; equine influenza virus; arguably, equine rhinitis virus types A-1 and B-1, 2, and 3; equine adenovirus; equine viral arteritis; and, historically, equine parainfluenza type 3 virus. Equine Hendra virus and African horse sickness cause signs of severe respiratory disease. There is minimal evidence that equine coronavirus causes respiratory disease in horses<sup>2,3</sup> and there is evidence that the Middle Eastern respiratory syndrome (MERS) coronavirus, a disease of humans and camelids, does not cause disease in horses.<sup>4</sup> Both *S. equi* and equine arteritis virus infection can be mild and lack outstanding clinical signs, thus closely resembling disease associated with some viral causes of upper respiratory tract disease. Therefore differentiation among diseases associated with these agents based on clinical signs and epidemiologic characteristics is difficult, and definitive diagnosis is only achieved through serologic or microbiological examination of blood or nasal discharge.

**Isolation and identification** of a causative organism from nasopharyngeal swabs or airway washings of acutely affected horses provides a definitive diagnosis, although on occasion more than one potential pathogen may be isolated. Demonstration of **seroconversion** or a three- to fourfold increase in titer from serum samples collected during the acute and convalescent (usually 3 weeks after onset of clinical signs) phases of disease is persuasive evidence of infection. Immunofluorescence,

enzyme-linked immunosorbent assay (ELISA) and polymerase chain reaction (PCR) tests may provide rapid diagnosis through detection of viral particles in nasal swabs and tissue specimens. The ability to determine the cause of an outbreak of upper respiratory disease in horses is enhanced by the use of multiple diagnostic tests and obtaining samples from more than one horse in an outbreak. However, definitive diagnosis of the cause of nasal discharge, cough, and fever is often not achieved.

All the agents known to cause upper respiratory disease in horses are relatively sensitive to environmental influences, and spread of the agent is dependent on **transmission from infected horses**, either directly or on fomites. Introduction of an infected horse into a susceptible population of horses may result in an explosive outbreak of upper respiratory tract disease. Such events are common on stud farms and in racing stables, where relatively closed bands of horses are maintained for much of the year. The movement of horses over long distances may facilitate the introduction of pathogens to which the local population of horses is naive.

The opposite situation occurs when young horses are introduced into larger bands of mixed aged animals, such as happens in racing stables or barns of pleasure horses. The younger, possibly naive, horse is then exposed to endemic pathogens to which the resident horses have developed resistance.

Young horses are at particular risk of developing infectious disease of the upper respiratory tract. The diseases are usually a problem only in yearlings and 2-year-olds; young foals acquire a passive immunity from the dam and adults have acquired a permanent immunity through exposure or vaccination. In a horse population it is the average age and the mix of ages that largely determine its herd resistance, and when 30% to 40% of that population has not previously been exposed to infection then major outbreaks are likely. All of the diseases are transmitted by droplet infection, and over long distances, so that limitation of their spread is possible only by rigid isolation and intensive sanitary precautions, and even the best protected studs are likely to be infected from time to time.

### Parainfluenza-3 Virus

Upper respiratory tract disease associated with equine parainfluenza-3 (PI-3) is characterized by a mild self-limiting disease that is not clinically distinguishable from the others in the group. The epidemiology and economic importance of disease associated with this agent is unknown.<sup>1</sup>

### Equine Adenovirus Infection

Two antigenic types of equine adenovirus, EAdV-1 and EAdV-2, are recognized that

have been associated with **respiratory disease** in foals and adult horses and **diarrhea** in foals, respectively.<sup>1</sup> The virus causes fatal pneumonia in Arabian foals, and likely Fell pony foals, with severe combined immunodeficiency and has been isolated from otherwise apparently healthy foals with severe pneumonia, but its importance in clinical respiratory disease of immunocompetent foals is uncertain. EAdV-1 can be isolated or detected by PCR from healthy adult horses, although at a very low rate,<sup>5,6</sup> and from 1% to 3% horses with signs of upper respiratory disease.<sup>7,8</sup> Genomic analysis of EAdV-2 indicates markedly different lineage to that of EAdV-1.<sup>9</sup> The virus is readily isolated from, or detected by PCR, in nasal swabs of approximately 50% of sick or healthy foals.<sup>6</sup> Postparturient mares can shed the virus.<sup>6</sup> Infection with EAdV-1 and EAdV-2 is worldwide. Serologic surveys differ in the proportion of seropositive horses, likely at least partially a result of the testing methodology, with serum neutralization tests yielding higher seropositive rates than ELISA tests.<sup>5</sup> Approximately 80% of horses in New South Wales, Australia are positive by serum neutralization assay for either or both of EAdV-1 or EAdV-2.<sup>5</sup> EAdV is considered to cause a mild respiratory disease with fever, coughing, nasal discharge, and conjunctivitis. Foals are assumed to acquire the infection from their dams, which secrete the environmentally stable virus in nasal discharge, urine, and feces. The virus is not associated with inflammatory airway disease in racehorses in England, but it has been associated with small outbreak of upper respiratory tract disease.

**Diagnosis** can be made on cell smears taken from conjunctiva or nasal mucosa that reveal characteristic adenoviral intranuclear inclusion bodies. **Serologic methods** include serum neutralization, hemagglutination inhibition, complement fixation, ELISA, and precipitating antibody tests. The serum neutralization test is most accurate, but the hemagglutination inhibition test is most suitable for a screening test. Virus genetic material can be detected by specific PCR testing.<sup>5,7</sup> No specific **control measures** are indicated for normal foals.

### Reovirus

A reovirus, or a series of serotypes, cause mild upper respiratory tract disease of horses. Infection with these agents appears to be of little clinical or economic importance.

### REFERENCES

1. Radostits O, et al. Viral diseases characterized by respiratory signs. In: *Veterinary Medicine: a Textbook of the Diseases of Cattle, Horses, Sheep, Goats and Pigs*. 10th ed. London: W.B. Saunders; 2007:1307.
2. Pusterla N, et al. *Vet Microbiol*. 2013;162:228.
3. Oue Y, et al. *J Vet Med Sci*. 2013;75:1261.
4. Meyer B, et al. *Emerg Infect Dis*. 2015;21:181.
5. Giles C, et al. *Vet Microbiol*. 2010;143:401.

6. Bell SA, et al. *Equine Vet J*. 2006;38:379.
7. Ataseven VS, et al. *Res Vet Sci*. 2012;92:324.
8. Pusterla N, et al. *Vet Rec*. 2013;172.
9. Giles C, et al. *Vet Microbiol*. 2015;179:184.

## EQUINE INFLUENZA

### SYNOPSIS

**Etiology** Influenza virus H3N8 (previously A/equine 2) of two lineages (Eurasian and American) and numerous, evolving, strains. Currently circulating viruses are of the American lineage, Florida clades 1 and 2. H7N7 has not been identified as a cause of disease for decades.

**Epidemiology** Short incubation period and highly contagious nature of the virus result in explosive outbreaks of disease. Viral shedding by subclinically affected horses is important for introduction of infection to populations. Prolonged carrier state is not recognized.

**Clinical signs** Upper respiratory disease complicated by pneumonia. Abortion is not a feature of the disease.

**Clinical pathology** None characteristic.

**Lesions** Rhinitis, pneumonitis. Rarely causes death.

**Diagnostic confirmation** Demonstration of virus in nasopharyngeal swab either by culture, enzyme-linked immunosorbent assay (ELISA), polymerase chain reaction (PCR), or membrane-bound immunoassay.

**Treatment** Supportive care. There is no specific treatment.

**Control** Quarantine to prevent introduction of the virus. Hygiene and disinfection to prevent fomite spread. Vaccination in enzootic areas with vaccine containing strains or antigens protective against currently circulating strains (Florida clade 1 and clade 2), to prevent clinical disease.

### ETIOLOGY

Equine influenza is associated with infection by influenza A virus—either equine **influenza A/H7N7** or equine **influenza A/H3N8** virus, members of the influenza virus A genus of the family Orthomyxoviridae. Influenza A viruses are typed according to the surface proteins—hemagglutinin (HA) and neuraminidase (NA) of which there are 18 HA subtypes (H1-H18) and 11 NA subtypes (N1-N11).<sup>1</sup> Influenza virus is an RNA virus that has eight segments to its genome that encode 10 proteins. The hemagglutinin and neuraminidase proteins are used for antigenic characterization of virus strains. Mutations in these genes or poor-fidelity RNA copying results in changes in amino acid composition of viral proteins that can be detected by serologic tests (see “**Clinical Pathology**”) and that have important consequences for infectivity and pathogenicity of the virus.



Of the two serologically distinct subtypes of equine influenza virus, all reported outbreaks in the past three decades have been associated with strains of EIV-A/H3N8. There are no reports of disease associated with EIV-A/H7N7 in the past 35 years, and reports of seroconversion might be related to use of vaccines containing EIV-A/H7N7 antigen. There are no reports of other influenza viruses, such as the H1N1 avian virus, causing disease in horses, although the avian-like influenza A/I/jilin89 (H3N8) caused severe disease and high mortality among horses in China in 1989 and there is a single report of avian H5N1 being isolated from sick horses, which also had serologic evidence of exposure to the virus, in Egypt during an outbreak of the disease in birds.<sup>2</sup>

Equine influenza H3N8 virus can infect dogs and cause serious disease and death.<sup>3,4</sup> Canine influenza virus infection, which originated in horses, is now endemic in dogs populations in much of the world.<sup>3</sup> Dogs are also susceptible to infection with equine influenza virus (Florida clade 1) when in close contact with horses infected with, and clinically ill from, the virus.<sup>5</sup> Equine influenza virus H3N8 was isolated from one of ~400 healthy Bactrian camels sampled in Mongolia.<sup>6</sup> The H3N8 virus can infect pigs but is not associated with disease;<sup>7</sup> seals, in which it can cause a fatal respiratory disease; and birds.<sup>8,9</sup> Experimental infection of cats with equine N3H8 influenza virus causes respiratory disease, and the infection can spread to in-contact cats.<sup>10</sup>

Canine influenza, N3N8, which is of equine origin, does not appear to pose a zoonotic risk.<sup>10</sup> At this time, equine H3N8 virus does not appear to be an important zoonotic threat.

Equine influenza H3N8 virus was first detected as a cause of respiratory disease in horses in 1963 in the United States. It subsequently became widely distributed, appearing in the United Kingdom in 1965, and evolved into multiple lineages and sublineages. There are two major lineages of EIV-H3N8 that circulate in horse populations—a Eurasian lineage and an American lineage (the names of which do not reflect the current geographic distribution of the viruses). This divergence in the virus occurred in the early 1980s, and there has been subsequent evolution of the American lineage into Kentucky, Argentinian, and Florida sublineages, with the Florida sublineage composed of two clades—clade 1 and clade 2 (Fig. 12-31).<sup>11</sup> For purposes of vaccine production, clade 1 is represented by A/eq/South Africa/04/2003-like or A/eq/Ohio/2003-like viruses, and clade 2 is represented by A/eq/Richmond/1/2007-like viruses.<sup>12,13</sup>

The predominating virus lineage or strain varies from year to year and from region to region. Both of Florida clades currently cocirculate and coevolve worldwide. Viruses

of the Eurasian lineage have not been detected since 2005 (2015 OIE data).<sup>12,14</sup> The important point is that there is continual change in the viral lineage or strain in some populations of horses and that constant monitoring of viral strains is vital for appropriate composition of vaccines and for molecular epidemiology. For instance, the majority of viruses from Europe (France, Italy and the United Kingdom) and North America characterized antigenically and/or genetically between January 2003 and April 2004 were of the American lineage. This continues to be the case with American lineage, Florida sublineage, clade 2 being the virus detected in Europe,<sup>15</sup> Northern Africa,<sup>16</sup> Asia (India, China, Mongolia),<sup>17-19</sup> Ireland (before 2009), and the United Kingdom.<sup>12,16</sup> Within clade 2, there are at least two identified virus subpopulations with amino acid substitutions in HA1 at either position 144 or position 179. The majority of 2014 viruses characterized had a valine at position 144 and an isoleucine at position 179.<sup>13</sup> Equine influenza viruses detected in recent outbreaks in the United States of America have been Florida sublineage clade 1,<sup>12</sup> although clade 2 was isolated from a horse in California that had been imported from Europe.<sup>20</sup> Although clade 1 viruses predominate in America and clade 2 in Europe, clade 1 viruses have caused outbreaks in Europe (France),<sup>15,21</sup> Australia, Africa, and Asia, and the virus circulating in Ireland in 2014/15 is from clade 1 (although different from the virus that caused outbreaks in Australia and Japan in 2007).<sup>22</sup>

### Viral Evolution

Identification of the lineage and sublineage of the virus is based on nucleotide sequencing of the hemagglutinin gene to detect mutations in the gene resulting in amino acid substitutions in the HA1 domain. These amino acid substitutions alter the charge, acquisition of glycosylation sites, and/or receptor binding avidity of the virus and hence its biologic activity including infectivity, immunogenicity, and virulence.<sup>11</sup> Hemagglutination inhibition assay (HI) has been used to type viruses, but this is now being complemented by genetic testing and determination of amino acid composition of major antigens (HA and NA). For instance, the amino acid composition of clade 1 and clade 2 viruses differs by at least seven amino acids in the HA1 domain of hemagglutinin.<sup>23</sup> Information about EIV strains changes constantly and is available at the equiflunet or OIE websites.<sup>12,13</sup>

The existence of lineages and strains of virus is important in the epidemiology of the disease because the antigenic differences among strains can be sufficient to prevent cross-protection provided by natural infection or vaccination. Cross-protection refers to the ability of one antigen (virus strain) to produce immunity in the horse against

infection with another type of antigen (virus strain). Infection or challenge with the same type of antigen is referred to as homologous challenge, whereas that with a different antigenic type is referred to as heterologous challenge. Strains of influenza virus circulate between and among populations of horses, with more than one strain of virus circulating at any one time in some horse populations, although individual disease outbreaks are associated with a single viral strain. Many, but not all, of these virus strains are constantly evolving, and evolution of the viruses is necessary for perpetuation of cycles of infection through the emergence, or reemergence by cycling, of heterologous strains. Evolutionary stasis, the continued circulation of older strains of virus, occurs and has importance for vaccine composition for many diseases, but not, apparently, for equine influenza virus (EIV), where emergence of new strains is common and of great importance for control of the disease. Evolution of strains of equine H3N8 virus occurs through antigenic drift. **Antigenic drift**, the accumulation of point mutations in the gene coding for the major surface protein hemagglutinin, occurs continuously in virus circulating in horse populations. Antigenic drift occurs most rapidly in hemagglutinin protein but also occurs in M and NS genes. Antigenic drift, by producing heterologous viral strains, contributes to the continuing susceptibility of horses to infection and the reduced efficacy of some vaccines.<sup>11</sup> For example, the 2007 outbreak of equine influenza in Japan in a population of vaccinated horses, was associated with the Florida clade 1 virus, whereas the vaccines in use at that time included viruses of Eurasian and American (Argentinian) strains.<sup>24</sup>

**Antigenic shift** is an event in which there is a dramatic alteration in the viral genome occurring by reassortment of viral genes during coinfection of a cell by two different types of virus (for example infection of a pig by both avian and human influenza viruses). Antigenic shift, which has not been documented for influenza viruses infecting horses, has the potential to produce new viruses with markedly different host infectivity and pathogenicity to either parent virus.

RNA viruses, such as equine influenza virus, are genetically labile, and during an outbreak there is considerable genetic variation of the viruses infecting a single animal, with dominant and one or more less dominant variants of a strain proliferating in the horse and being transmitted to other horses.<sup>25,26</sup> Furthermore, the dominant form of the virus within a horse can change over the course of the infection. This pattern of multiple variants infecting one horse and being transmitted to other horses results in a relatively large number of variants of the virus in a group of horses during an outbreak, constituting a loose bottleneck to viral evolution.<sup>25,26</sup>

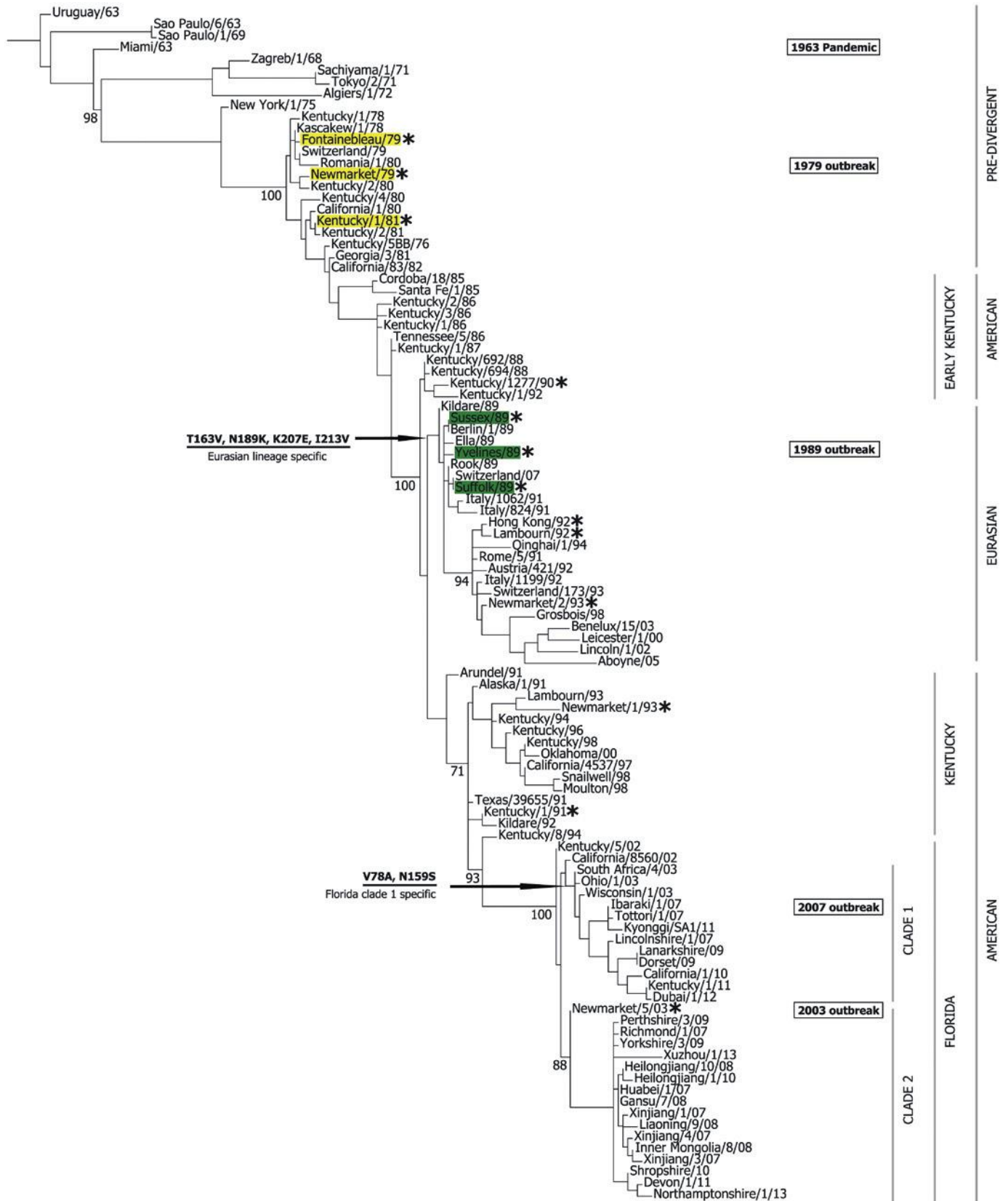

**Fig. 12-31** Phylogenetic tree illustrating evolving nature of equine influenza virus N3H8 from the virus originally detected in 1963. Note that there are two lineages (Eurasian and American) that diverged in the early 1980s; that the American lineage further evolved into Kentucky, Argentinian, and Florida sublineages (clades 1 and 2); and that these continue to evolve. Strains causing substantial outbreaks are highlighted in green, dates of large outbreaks are identified in the boxes, and vaccine strains are identified in yellow. (Reproduced with permission.<sup>11</sup>)

### Persistence in the Environment

According to the Ausvet Plan, equine influenza virus is inactivated by exposure to ultraviolet light for 30 minutes, by heating at 50°C (122°F) for 30 minutes, and by ether and acid (pH 3) treatment.<sup>27</sup> Exposure to sunlight for 15 minutes at 15°C (59°F) also inactivates the virus. The virus persists in canal water (pH 6.9) for up to 18 days at 22°C (72°F) and 14 days at 37°C (98.6°F); in tap water (pH 7.0) for 14 days at 4°C (42°F) and up to 2 days at 37°C (98.6°F); in horse blood for 18 hours at 37°C (98.6°F); in horse urine (pH 8.0) for 5 to 6 days at 4°C (42°F), 15°C (59°F), and 37°C (98.6°F); in soil under dark storage at 18°C (65°F) for 24 hours; and in soil exposed to sunlight for 8 hours at 15°C (59°F).<sup>27</sup> The capacity for the virus to persist in carcasses is unknown.<sup>27</sup>

## EPIDEMIOLOGY

### Occurrence

Worldwide, the only large horse populations in which **influenza virus infection** does not occur are in Australia and New Zealand, although Australia experienced its first outbreak of equine influenza in 2007 and subsequently was declared free of the virus.<sup>28,29</sup> Widespread use of aircraft to move horses between countries in short periods has increased the spread of equine influenza viruses, as exemplified by the 2007 outbreak in Australia allegedly associated with importation of horses and failure to contain the infection in the quarantine facility;<sup>30</sup> the 2003 outbreak in South Africa associated with a virus from North America, and an earlier outbreak in Hong Kong. In all cases virus was introduced by imported horses.

**Epidemics** of equine influenza have occurred in Europe or North America in 1956 (H7N7), 1963 (H3N8), 1969, 1979, and 1989, although this does not represent a comprehensive listing of large-scale outbreaks. Epidemics affecting more than 1 million horses occurred in China in 1989 (associated with the novel H3N8 Jilin virus) and 1993/1994 (associated with a conventional H3N8 virus closely related to 1991 European isolates). Epidemics in Japan, Europe, and North America have been associated with introduction of a novel virus (for example, the 1963 appearance of H3N8 virus in Miami) or antigenic drift of existing viruses and resultant inefficacy of extant vaccines.<sup>14,31,32</sup> The epidemics in Australia (2007) and South Africa (2003) were associated with introduction of the virus into a naïve and unvaccinated population of horses.<sup>30</sup>

**Localized outbreaks** of disease in stables or race courses occur almost annually in countries in which the disease is endemic, likely related to the movement of horses into the training and racing populations, with subsequent introduction of virus and development of disease in at risk horses (see “**Animal Risk Factors**”). Disease associated with equine influenza virus usually occurs as

outbreaks associated with the introduction of virus into a population of susceptible horses. Virus may be introduced by clinically affected horses or, more commonly, by horses that are not noted to be clinically ill. Vaccinated horses can become infected and shed influenza virus while not becoming ill,<sup>33</sup> especially if vaccinated with heterologous strains, and this is likely a common method of introduction of virus into susceptible populations.

Outbreaks of influenza virus infection can cause clinical disease in nearly all (98%) horses in a susceptible population, although in populations of horses of mixed age and with varying serum titers to equine influenza the morbidity rate can be much lower (16%–28%). The incidence of disease in one race track population was approximately 130 cases per 1000 horses at risk per month, although this rate likely varies widely among outbreaks. The mortality rate is usually very low (<1%) with most deaths associated with secondary bacterial infections. However, an outbreak of disease in China associated with a novel H3N8 (Jilin virus) strain was associated with a morbidity rate of 80% and mortality rate of 20% to 35%.

The disease in populations of vaccinated or previously exposed horses is associated with a lower morbidity and mortality and slower spread, as a result of the milder disease induced by influenza virus infection of immune or partially immune horses. In an outbreak among vaccinated racehorses in Hong Kong, 75% of horses had serologic evidence of infection, 37% had clinical signs of infection, and 0.2% died. Horses imported from Australia and New Zealand, where the disease does not occur, had a morbidity rate of 52%, whereas horses from the northern hemisphere had a morbidity rate of 20%, likely reflecting the effect of previous exposure to influenza virus or repeated vaccination. The attack rate of infection (proportion of at risk horses infected by the virus) during an outbreak in a large population of naïve horses in Australia was ~98% (mean) varying from 10% to 100%, with farms with lower numbers of horses generally having a higher attack rate.<sup>34</sup> The mortality rate attributable to equine influenza was 0.6% and case-fatality rate 6%, based on a questionnaire of more than 1200 horse owners in Australia during the influenza outbreak (46% return rate) that involved self-reporting and was therefore at risk of sampling bias.<sup>35</sup> The mortality rate appeared to be highest among foals (68% of reported deaths).<sup>35</sup>

The profile of an epidemic can vary from explosive with a large proportion of a small group of susceptible horses housed in close proximity, such as a small band, developing clinical disease within 24 to 48 hours, to much more prolonged outbreaks lasting several weeks in larger groups of horses of varying susceptibility housed in multiple barns. During larger outbreaks among horses

of varying susceptibility there is a characteristic three phase pattern. The first stage is associated with the first cases of disease and slow spread over 10 to 14 days. This stage is followed by one of rapid spread of the disease to horses clustered in stalls around horses affected during the first phase of the outbreak. The third phase is characterized by declining numbers of cases.

### Origin of Infection and Transmission

Equine influenza virus is relatively susceptible to environmental conditions, and during an outbreak infection must originate from an infected horse, although the proximate source of virus can be contaminated equipment or other fomites, including people. **Transmission** of equine influenza virus occurs by direct contact, inhalation of aerosols of infected material, and on fomites. Survival of the virus on clothing and surfaces, including vehicles used to transport horses shedding the virus, can result in transmission of infection in the absence of horse to horse contact. **Fomite transfer** on veterinary clothing, equipment, or vehicles was likely responsible for the spread of infection from quarantined horses in both South African outbreaks. However, in most instances, horses are infected by other horses that are in close proximity or have physical contact, for instance, exercise ponies (horses or ponies used to accompany racehorses from the stable to the track in preparation for racing or training gallops) or stable mates. Aerosol spread occurs over distances of 35 m, possibly further (see “**Meteorologic factors**” on this page), and is enhanced by the frequent coughing characteristic of the disease. Equine influenza virus in aerosols survives longer (24–36 hours) than human or porcine strains (15 hours).

Clinically affected horses excrete more virus than do horses in which the infection is inapparent. The duration of infectivity of clinically affected horses is 3 to 8 days and with the short incubation period of 2 to 3 days combine to produce the potential for a very rapid new infection rate and a characteristic explosive outbreak.

## Risk Factors

### Animal Factors

All age groups of horses, including newborn foals, are susceptible. The greatest risk appears to be between the ages of 2 and 6 months, serum levels of passively acquired antibodies being lost by foals at 2 months of age. A recent survey of more than 8000 horses in the United States revealed that only 20.2% of horses aged 6 to 17 months had a detectable influenza antibody titer (HI), compared with 89.0% of horses aged 20 years or more. The percentage of horses that had a high equine influenza antibody titer increased as the horse's age increased such that 45% to 51% of horses older than 5 years had high titers. This observation is consistent



with most cases of the disease occurring in 2-year-old or younger horses, probably because older horses are immune through either natural exposure or vaccination. Thoroughbred racehorses 2 years of age or older were 5 to 8 times more likely to develop influenza than were horses 5 years of age in a well-characterized series of outbreaks. Seronegativity to a H3N8 virus (Saskatoon/90) was associated with a 13- to 38-fold increase in likelihood of developing influenza, independent of the effect of age. It is probable that outbreaks occur as a result of a natural accumulation of young animals that have not been previously exposed, the comingling of these susceptible animals with older infected ones at race and show meetings, and the significant level of antigenic "drift." This capacity of the virus to change slightly and continuously in antigenic composition leads to the frequent appearance of new strains that are likely to breach existing natural and induced immunologic barriers.

Outbreaks can occur at any time of year, and their timing probably depends on husbandry and management practices, such as yearling sales, transport of horses for racing and sale, and movement of show and breeding animals. These events often provide the combination of a population of susceptible animals housed in crowded, poorly ventilated barns that facilitate transmission of the virus.

**Immunity** depends on the means of exposure (vaccination or natural infection), the strain of the virus, and the time since exposure. After infection, protective immunity to homologous strains of the virus is present and persists for 1 year, possibly up to 2 years. Field studies of disease outbreaks indicated that the concentration of antibodies in serum that provide some resistance to disease might be less than that suggested from experimental studies. Protective immunity induced by natural infection is characterized by production of IgA in nasal secretions and IgG and IgG<sub>b</sub> in serum, whereas administration of an inactivated, alum-adsorbed commercial vaccine induces only a serum IgG(T) response that is not protective against challenge. Immunity after vaccination lasts for a much shorter period of time, 3 to 4 months, and is specific for the subtypes, and their strains, of virus included in the vaccine. Immunity following infection or vaccination is less protective against infection by a heterologous strain. Similarly, vaccination exposure to a heterologous virus may induce only a poor anamnestic immune response. These observations are consistent with the concurrent circulation of multiple viral strains influenza virus in horse populations and the cycling of virus strains causing disease in consecutive years.

### Management Factors

Housing of large numbers of horses in close contact, or in enclosed environments such as

large barns or stables, provides optimum conditions for facilitating contact and aerosol spread of the virus. Shed barns, which characteristically have poorer ventilation and greater stocking density than pole barns, are associated with a fourfold increase in risk of influenza.

Presence of small numbers of horses with access to large numbers of at risk horses might affect the course of an epidemic. Track ponies, which have close contact with large numbers of horses on a daily basis, are important in spread of influenza in racing barns.

### Meteorologic Factors

The influence of weather and wind on spread of equine influenza has not been extensively investigated. During the outbreak in Australia, the hazard of equine influenza infection was higher when relative humidity was less than 60% and lowest on days when daily maximum air temperature was 20° to 25° C (68 to 77 F).<sup>36</sup> The increased risk of spread at lower relative humidity is mediated by both virion and aerosol droplet nuclei stability.<sup>36</sup> In cool, dry conditions, droplets are desiccated and remain small, which may stabilize influenza aerosols and facilitate longer range transmission, whereas at high relative humidity, the droplets absorb water and settle, thereby decreasing the time aloft available for dispersion by wind.<sup>36</sup>

There was a relationship between the direction of **prevailing winds** and spread of equine influenza infection during the 2007 outbreak in Australia. There was a clear trend for appearance of newly infected premises to occur to the west of previously infected premises, consistent with predominant wind patterns.<sup>37</sup> It is likely that wind carriage of the virus facilitated dispersal of infection. In a cluster of 437 infected premises, 81% were not contiguous to a previously infected premise and the mean distance from newly infected premises to the closest previous infected premises was 0.85 +/- 1.50 km, with a range of 0.01 to 12.94 km.<sup>37</sup> Wind speeds greater than 30 km per hour from the direction of nearby infected premises were associated with increased hazard of infection.<sup>36</sup> At wind speeds of greater than 30 km per hour, an aerosol of influenza droplet nuclei would only need to be stable for minutes to be able to infect horses on nearby premises.<sup>36</sup> This is consistent with spread of equine influenza virus over 1 to 2 km, or possibly up to 13 km, via wind-borne aerosol.<sup>37,38</sup>

### Economic Importance

Influenza causes minimal loss through death of horses, but it causes much inconvenience in racing stables because it occurs in explosive outbreaks and affected horses have to break training. Such outbreaks have the capacity to close down the racing industry in a country for a period of months. An additional cost is incurred because of restrictions

on international movement of horses and associated quarantine periods.

### Zoonotic Potential

There is evidence that humans can be infected by equine influenza virus H3N8, especially among individuals working with horses, although such seroconversion appears to be uncommon.<sup>39-41</sup>

### AUSTRALIAN OUTBREAK (2007)

Australia experienced its first ever outbreak of equine influenza in 2007 as a result of equine influenza in horses in a quarantine station and a breach in the quarantine of these infected imported horses.<sup>42,43</sup> Equine influenza virus H3N8, American subtype, Florida clade 1 lineage, with an HA sequence identical to that of a virus isolated from a contemporaneous outbreak in Japan,<sup>44</sup> was introduced into a population of horses that were naïve to the infection and unvaccinated for the disease. Over the course of 4 months, nearly 70,000 horses were infected on over 9,000 premises in New South Wales and Queensland, with a mean attack rate of 98%.<sup>34</sup> In the first 10 days of the equine influenza outbreak in Australia, horses on 197 premises were infected.<sup>38</sup> Timely and complete implementation of a horse movement ban ("standstill") is widely credited as the most effective of the control measures that facilitated the rapid eradication of this disease from the Australian horse population. The effectiveness of this ban was impressive: of 1052 horse movements in a contact-tracing data set, 978 occurred during the first 10 days of the epidemic.<sup>38</sup> Vaccination was introduced in an attempt to control spread of the disease, but this began 6 weeks into the outbreak, well after the peak of reported daily infections.<sup>45</sup> Modeling indicates that vaccination could have contributed to abbreviating the duration and reducing the geographic size of the outbreak by 8% to 9%.<sup>45</sup>

A comprehensive series of articles describing aspects of this epizootic is available.<sup>5,28-30,34,35,37,38,43-98</sup>

### PATHOGENESIS

The disease is principally one of inflammation of the upper respiratory tract, although pulmonary lesions are common in adult horses, and the disease can cause severe, fatal pneumonia in foals. The virus is inhaled and attaches to respiratory epithelial cells with its hemagglutinin spikes, fuses with the cell, and is released into the cytoplasm, where it replicates. New virions are released from the cell surface and infect other cells or are expelled into the environment. Initial viral infection and replication occurs mainly in the nasopharyngeal mucosa, but by 3 to 7 days after infection, virus can be recovered from cells throughout the respiratory tract. Infection of the respiratory mucosa results in death of epithelial cells, inflammation, edema, and loss of the protective mucociliary clearance.

Death of cells is a result of influenza virus-induced apoptosis of respiratory epithelial cells and local and systemic increases in interferon and interleukin-6. Proliferation by opportunistic bacteria, commonly *Streptococcus zooepidemicus*, occurs because of the disruption of normal clearance mechanisms and can exacerbate the inflammation and cause bronchopneumonia. Viremia, if it occurs, is mild and brief, although it may be related to some of the systemic signs of the disease. Some speculate that myocarditis, myositis, and encephalitis occur occasionally in response to influenza virus infection, but definitive proof is lacking and was not evident in horses in the Australian epizootic<sup>97</sup> or in ponies experimentally infected with equine influenza virus.<sup>99</sup> Influenza virus has not been isolated from tissues other than those of the respiratory tract. Enteritis was reported in horses in the 1989 Chinese outbreak (Jilin/89), but is not reported for disease associated with conventional virus strains.

### CLINICAL FINDINGS

**Outbreaks of equine influenza** are characterized by a sudden onset and rapid spread of disease. Typically, in a large group of susceptible horses the incidence of the disease peaks about 1 week after the first case is noticed, and new cases do not develop after 21 to 28 days. The disease may have an attenuated clinical course in a population of vaccinated or previously exposed horses, and there is evidence that disease severity varies widely among even naïve horses, with some horses having severe signs of disease and others having no clinical evidence of infection.<sup>71,78,90,92</sup>

The mild disease in immune animals may be clinically indistinguishable from upper respiratory diseases associated with other common agents such as EHV-4, equine rhinitis virus, and arteritis virus.

Clinically, the disease starts with a fever (38.5–41°C [101–106°F]) after an incubation period of 24 to 72 hours. Horses may be depressed, refuse feed, and be reluctant to move. The dominant sign is cough, which is dry and hacking in the beginning and moist later, and that commences soon after the temperature rise and lasts for 1 to 3 weeks. It is easily stimulated by manual compression of the upper trachea. During the early stages of the disease, nasal discharge is not a prominent sign and, if it occurs, is watery. There is no marked swelling of the submaxillary lymph nodes but they may be painful on palpation in the early stages of the disease, especially in younger horses. Limb edema or swelling is unusual in horses with influenza. Abnormal lung sounds, characterized by crackles, wheezes, and increased intensity of normal breath sounds, may be apparent in both uncomplicated disease and in horses with secondary bacterial pneumonia. Ultrasonographic examination of lungs of horses

with influenza, even clinically mild disease, reveals pulmonary consolidation, fluid bronchograms, and peripheral irregularities. Tracheal aspirates are neutrophilic, yield heavy growth of *S. zooepidemicus*, and are consistent with bronchitis and pneumonia. Horses, unwisely, forced to exercise have reduced endurance. Horses that are protected against environmental stress pursue an uncomplicated course, with most horses have complete recovery in 7 to 14 days, although a mild cough can persist for weeks.

The previous paragraphs provide a description of the classical disease. However, in outbreaks there is a range of disease severity. Mucopurulent nasal discharge is observed in 75% to 90% of horses, cough in approximately 60%, fever in 20% to 50%, inappetence in 20% to 30%, and signs of depression in 20% to 40%. Undoubtedly, the proportion of horses showing each of these signs will vary from outbreak to outbreak depending on the age and susceptibility of horses in the population, among other factors.

Late term mares and young foals were the groups of horses that appeared to have large numbers or proportion of severely affected individuals during the Australian epizootic. Late term mares appeared to have a greater frequency of severe, paroxysmal coughing and a higher-than-expected incidence of dystocia, although these reports are largely anecdotal.<sup>83,90,92</sup> Young foals had the highest case-fatality rate (see below) and death was often attributable to interstitial pneumonia.<sup>100,101</sup>

**Complications** and a more severe disease occurs in a small number of horses. Horses that are worked, transported, or exposed to adverse climatic conditions can experience a worsening of the cough, and severe bronchitis, pneumonia, and edema of the legs may develop. Complications are usually associated with secondary bacterial infection, usually *Strep. zooepidemicus*, that results in a mucopurulent nasal discharge, persistent fever, and markedly abnormal lung sounds. Icterus, encephalitic signs, incoordination, and myoglobinuria are reported as rare complications. Electrocardiographic abnormalities have been reported in horses with influenza and were attributed to myocarditis. However, there is no objective evidence of myocarditis secondary to influenza infection of horses,<sup>97,99</sup> nor is there a clear association between influenza infection and electrocardiographic abnormalities.

A more severe form of the disease, associated with an antigenically distinct strain of equine influenza 2, is reported from China. The mortality rate is 35%, and death is attributable to pneumonia and enteritis.

A severe form of the disease is also reported in young foals.<sup>100,101</sup> Foals develop fever, severe respiratory distress, and acute interstitial pneumonia that is commonly fatal. The disease is not invariably associated with failure of transfer of passive immunity.

### CLINICAL PATHOLOGY

There are no characteristic changes on hematologic or serum biochemical examination of horses clinically affected by equine influenza virus infection.

**Confirmation of the diagnosis** of infection by equine influenza virus is achieved through virus isolation, indirect demonstration of virus in nasopharyngeal swabs by detection of viral genome (RT-PCR or variations) or proteins (ELISA), and/or serology.<sup>102</sup>

### Serology

Measurement of antibody concentrations against the viral hemagglutinin antigen is important in determining susceptibility to infection, vaccine efficacy, and exposure—factors important in implementing control measures (see following discussion). Documentation of seroconversion, a three- to fourfold increase in **hemagglutination inhibition** (HI) antibody titer, or a doubling in antibody titer measured by the **single radial hemolysis test**, in paired sera collection 14 to 21 days apart provides retrospective confirmation of the diagnosis. The single radial hemolysis test is more reproducible than the hemagglutination inhibition test, is the preferred test for determining concentrations of antibody against the hemagglutinin antigen, and better correlates with susceptibility to infection.<sup>102</sup> For the single radial hemolysis test, the virus is coupled to red blood cells that are then included in agarose. Wells are punched in the agar plate filled with test sera. Influenza antibodies then cause lysis of red cells, with the diameter of the zone of hemolysis proportional to the concentration of the strain specific antibody in the serum. Antibodies against the nonstructural protein (nucleocapsid protein, NS1) are detectable in horses after natural infection, but not after vaccination with an inactivated virus, thereby permitting differentiation of immunologic responses to infection and vaccination by canary pox–vectored vaccines,<sup>74</sup> but not by other subunit vaccines.<sup>103</sup>

ELISA tests for detection of antibodies to equine influenza virus are available and have been characterized. A blocking ELISA for influenza A was accurate (area under curve = 0.993 ± 0.003 standard error), informative ( $z = -32.0$ ;  $p < 0.0001$ ) and had sensitivity and specificity at cut-point percentage inhibition greater than or equal to 50 of 0.99 (95% CI: 0.98–0.99) and 0.97 (95% CI: 0.96–0.98), respectively, and detected seroconversion as early as day 3 after onset of clinical signs and in 50% of horses by day 5.<sup>104,105</sup> Other commercially available ELISA tests have similar diagnostic test characteristics.<sup>106</sup>

### Rapid Detection of Virus

**Rapid identification** of the cause of the outbreak is important when instituting control measures. Timely demonstration of virus in

nasopharyngeal swabs can be achieved by use of tests that detect viral antigen (ELISA or similar tests) or viral genome (real-time reverse-transcription polymerase chain reaction [rtRT-PCR or qRT-PCR]) or a reverse-transcription loop-mediated isothermal amplification assay. Such tests can be invaluable in confirming an outbreak or occurrence of disease, in monitoring infection rates, and in achieving control.<sup>54,62,65,74,76,77,87,107</sup> Detection of viral antigen by ELISA or similar methods and of viral genome by RT-PCR is not necessarily associated with shedding of live (infectious) virus (a false-positive test result). Both methodologies can detect non-viable remnants of viruses, often for long periods of time, and detection of low levels of viral RNA or antigen should be considered in the context of available clinical and epidemiologic data. Viral RNA has been detected in nasal swabs of horses for up to 34 days after natural infection, with RNA detected in all of 36 horses tested for the first 10 days after onset of clinical signs.<sup>105</sup>

Virus can be detected rapidly in clinical specimens by a reverse-transcription PCR (RT-PCR) test for nucleoprotein gene, hemagglutinin gene of H3N8 viruses and hemagglutinin gene of H7N7 virus. The rtRT-PCR is widely available, is the most sensitive of the currently available tests, and is suited for throughput of large numbers of samples when rapid decision making is required, such as during outbreaks of the disease.<sup>87,108-110</sup> rtRT-PCR can detect virus as early as 1 day after experimental infection of horses, at the same time as virus isolation detected the virus, and before onset of clinical signs.<sup>111</sup> RT-PCR is highly sensitive and can result in detection of even very small quantities of viral RNA, such as can occur when nasal swabs are contaminated with inactivated intramuscular vaccine.<sup>94</sup>

Recent development of **field tests** (on-site tests) to detect viral genome will further enhance diagnosis and control of the disease. The insulated isothermal RT-PCR (iiRT-PCR) method on the POKKIT<sup>TM</sup>, a field-deployable device, is about 100-fold more sensitive than the rRT-PCR assay targeting the NP gene of EIV subtype H3N8 (Miami 1/63/H3N8).<sup>112</sup> The iiRT-PCR assay identified accurately 15 EIV H3N8 strains and two canine influenza virus (CIV) H3N8 strains, and it did not cross-react with H6N2, H7N7, and H1N1 subtypes or any other equine respiratory viral pathogens. There was 100% agreement between the iiRT-PCR assay and the universal influenza virus type A rRT-PCR assay in detecting the EIV A/equine/Kentucky/7/07 strain in 56 nasal swab samples collected from experimentally inoculated horses.<sup>112</sup> The utility of this test in field situations remains to be demonstrated.

The **Directigen Flu A** test (Becton Dickinson) is a rapid test designed for use with humans that identifies influenza viral nucleoprotein (NP, which is highly conserved

among influenza A viruses) by a membrane-bound enzyme immunoassay. It has been validated for use in horses and is effective because of the conserved nature of the target antigen across influenza A strains. Results are available in as little as 15 minutes. The test had sensitivity of 68% to 83% and specificity of 78% to 95%, compared with RT-PCR or virus culture.<sup>113</sup> Sensitivity was 54%, but specificity and positive predictive value were 100% compared with serologic diagnosis. The low sensitivity compared with serology was ascribed to inadequate collection of nasopharyngeal swabs, or collection of samples when horses were not excreting virus. The high specificity and positive predictive value of the test mean that a positive result confirms the diagnosis of influenza infection. The relatively low specificity means that samples should be collected from a number of horses in various stages of the disease. Nasopharyngeal swabs should be collected by inserting a cotton gauze swab approximately 30 cm (12 in.) into the nostril or, preferably, nasopharynx of an adult horse and leaving it in place for 60 seconds. The swab should then be transferred to specialized transport media and shipped to the laboratory.

Other rapid diagnostic tests include the **Flu OIA (BioStar)** assay for influenza A and B viral antigen. The test cross reacts with equine herpesvirus 2 and is therefore not useful for diagnosis of upper respiratory disease of horses. Other ELISA diagnostic assays, including an antigen capture ELISA, are available.<sup>114</sup>

Use of rapid tests is not a substitute for viral isolation, which is important for typing of the isolate and subsequent epidemiologic studies and vaccinal applications. Isolation of the virus provides a definitive diagnosis and is best achieved when samples are collected during the first 48 hours after onset of clinical signs. Material for viral culture should be inoculated into the transport medium quickly. The transport medium should contain phosphate buffered saline (PBS) containing either 40% glycerol or 2% tryptose phosphate broth with 2% antibiotic solution (penicillin [10,000 units], streptomycin [10,000 units] in sterile distilled water [100 mL]), and 2% fungizone (250 mg/mL stock).<sup>115</sup> If the samples are to be inoculated within 1 to 2 days they may be held at 4°C (39°F), but, if kept for longer, they should be stored at -70°C (-94°F) or below. Samples should be kept cool during transport to the laboratory.

### NECROPSY FINDINGS

Necropsy material is rarely available for adult horses, and the lesions in these fatalities are usually complicated by other pathogens. Histologically, a necrotizing bronchiolitis accompanies widespread pulmonary edema. Foals dying of acute respiratory distress associated with influenza infection have severe

diffuse interstitial pneumonia that is characterized histologically by necrotizing bronchitis and bronchiolitis and multifocal interstitial pneumonia.<sup>97</sup>

### Samples for Postmortem Confirmation of Diagnosis

- **Nasal swabs** in viral transport media, and sections of lung and trachea should be submitted for virus isolation or demonstration by fluorescent antibody or PCR testing.
- **Formalin-fixed nasopharynx, trachea, and lung** should be submitted for light microscopic examination.

### DIFFERENTIAL DIAGNOSIS

See Table 12-16.

### TREATMENT

Currently, there is no specific treatment of influenza virus infection of horses.

**Amantadine** is used in humans for prophylaxis and treatment of influenza infection in high-risk populations, and it has been investigated for use in horses. Amantadine administered intravenously caused transient neurologic abnormalities in experimental horses. **Rimantidine** (30 mg/kg PO q12 hour) administered 12 hours before experimental inoculation of horses with equine influenza KY/91 mitigated signs of disease but did not eliminate viral shedding. Administration of **peramivir** (~8 mg/kg IV once) to horses experimentally infected with equine influenza virus attenuated the severity of clinical signs.<sup>116,117</sup> The safety and efficacy of permavir, amantadine, and rimantidine in horses with naturally occurring disease have not been demonstrated at this time. Until these issues are resolved, and because the infection has such a low case-fatality rate, the use of these drugs in horses cannot be recommended.

**Antibiotic treatment** of uncomplicated cases is probably not warranted, but horses that develop prolonged fever (longer than 5 days), signs of pneumonia, or a profuse mucopurulent nasal discharge should be treated with broad-spectrum antibiotics, such as potentiated sulfonamides (15-30 mg/kg, PO, IM, or IV, every 12 h), ceftiofur (2.2 mg/kg, IM, every 12 hours), or procaine penicillin (20,000 IU per kg, IM, every 12 hours) with or without gentamicin (6.6 mg/kg, IM, every 24 hours). The usual cause of secondary bacterial infection is *S. zooepidemicus*, which is susceptible to penicillin.

**Supportive treatment** includes rest, provision of a dust-free environment and, on occasion, administration of nonsteroidal antiinflammatory drugs (NSAIDs). However, NSAIDs should be used judiciously, as their analgesic properties may mask signs of



complications, such as pleuritis. Corticosteroids are contraindicated in the treatment of this disease. Cough suppressants are also contraindicated because coughing is a normal protective mechanism that aids in the clearance of material from the airway. Mucolytics can be administered but their efficacy is unknown. Clenbuterol administration does not alter the course of the disease and is not recommended.

## CONTROL

The fundamental aims of a control program are the following:

- Increase the immunity of both individual animals and the population to infection.
- Reduce the opportunities for spread of infection between horses.
- Prevent the introduction of infection or of novel strains of the virus into a population.

These aims are achieved by vaccination, hygiene, and quarantine. It is important to note that effective quarantine that includes isolation of horses for 4 weeks before introduction into a new population of horses prevents introduction of the disease.<sup>115</sup>

## Immunity and Vaccination

The aim of vaccination in enzootic areas is to prevent clinical disease caused by infection with equine influenza virus. This aim includes two components—induction of herd immunity by widespread vaccination of almost all horses in a population and induction of protective immunity in individual horses.<sup>102,118</sup>

The first aim is actually more difficult to achieve because of the perception by horse owners in enzootic areas that influenza is not an important disease or that their horse(s) are not at risk and the inability of regulators to mandate vaccination on a country-wide scale.<sup>118</sup> The result is that an insufficient proportion of horses in a population are vaccinated to confer herd immunity on the population as a whole, with consequential localized outbreaks or epizootics of the disease.<sup>102,118</sup>

Induction of protective immunity in individual horses through vaccination is achievable with certain limitations. Immunity induced by vaccination, especially vaccination using inactivated virus, is not as durable as that conferred by natural infection, nor does it induce the same type of immune response,<sup>1</sup> although this might not apply for modified live vaccines.<sup>119</sup> Furthermore, many factors influence the onset, duration, spectrum, and efficacy of vaccination programs, including the product administered, frequency of administration, frequency with which different equine influenza vaccines are administered to horses, age, and sex.<sup>120-128</sup> That said, the responses of most horses to vaccination are predictable, and with increasing knowledge of the immune responses to vaccination, vaccination programs can be

expected to confer immunity to clinical disease when properly applied.<sup>1,33,102,119,127-129</sup> Reports of vaccine failure might in actuality be failures of vaccination programs.<sup>118</sup>

Vaccination does not induce sterile immunity to equine influenza virus, and this is important in understanding of the epidemiology and control of the clinical disease.<sup>27,33,115</sup> The extent of cross-protection against infection and/or disease by each of two influenza virus strains depends on the antigenic distance between the strains (see Fig. 12-31).<sup>1</sup> Infection by equine influenza virus or vaccination using an effective vaccine can induce immunity and resistance to infection and development of disease as a result of a homologous virus. For example, vaccination with an inactivated Florida clade 2 virus, or vaccine containing the relevant HA antigen, confers considerable resistance to infection by a Florida clade 2 strain of the virus, but limited immunity, or immunity only at peak antibody titers, to infection by a Eurasian lineage virus or a Florida clade 1 virus.<sup>102</sup> Therefore, the level of protection provided by vaccines is often critically dependent on how closely the vaccine strain matches the virus encountered by the horse. This phenomenon is the basis for the recommendation that contemporary vaccines contain both Florida clade 1 (A/equi2/South Africa/4/03 or Ohio/03) and a clade 2 (Richmond/1/07) virus strains or HA antigens.<sup>12,13,118</sup>

A large number of vaccines to prevent disease as a result of infection by equine influenza virus and recommendations for vaccination programs are available.<sup>12,13,118,130,131</sup> These include vaccines that include whole inactivated virus or viruses,<sup>110,126</sup> virus subunits (e.g., HA protein) either as the purified protein or in a live vector (canary pox),<sup>122,123,129</sup> and vaccines containing various adjuvants and immune stimulating complexes,<sup>132</sup> or live attenuated virus for intranasal administration.<sup>119,133</sup> There are numerous reports of the efficacy of one or more of these vaccines.<sup>33,103,110,119-127,129,132-134</sup> A comparison of each vaccine is beyond the scope of this text, but several principles should be considered when selecting a vaccine: the vaccine should induce a measurable immune response and demonstrable protection against disease (natural or experimental), it should contain pertinent viral strains, it should be safe, and it should be practical (i.e., readily administered). Ideally, it should be possible to differentiate naturally infected horses from those that are seropositive as a result of vaccination.

Immunity to influenza through administration of inactivated vaccines can be assessed by measurement of serum antibody concentrations against hemagglutinin, using the single radial hemolysis test, whereas immunity gained through natural infection is independent of serum antibody concentration and appears to be mediated largely by cell.

However, serum antibody concentration is currently used as an indicator of susceptibility of individual horses to infection, and as a guide in the development and application of vaccination protocols, including monitoring of need for vaccination in individual horses. Serum antibody concentrations to hemagglutinin measured by single radial hemolysis are specific for the strain of virus and are strongly predictive for resistance to disease associated with that virus in both experimental and field challenge. Failure of a commercial inactivated virus multivalent vaccine to induce detectable increases in antibody concentration in Thoroughbred racehorses was associated with lack of protection against natural infection by a heterologous influenza virus. It is important to reiterate that resistance to disease after vaccination or natural infection is greatest for homologous virus and less for challenge by heterologous virus. Thus horses with antibody concentrations protective to disease associated with homologous virus can be susceptible to disease associated with heterologous virus.

**Vaccination** against equine influenza is now in general use in countries where the disease occurs, and use of efficacious vaccines is effective in limiting the severity of clinical illness and morbidity during an outbreak.<sup>12,13</sup> Administration of a subunit, canary pox–vectored vaccine, is partially credited with abbreviating the equine influenza epizootic in Australia and for allowing continued commercial racing.<sup>63,81,98</sup> Vaccine efficacy is limited by the short duration of immunity induced by vaccination, the presence in horse populations of multiple viral strains and of antigenic drift in these strains, and the poor immunity induced by vaccines (and natural infection) to challenge by heterologous virus. Furthermore, the immune responses induced by administration of inactivated virus or subunit vaccines, which are primarily an increase in serum IgG(T) antibody titer, differ markedly from the immune responses to natural infection, which are production of IgA in nasal secretions and IgG and IgM in serum.

Multiple factors are important in determining the efficacy of a vaccine in protecting against disease. Factors include efficacy of the vaccine in stimulating an immune response, viral strains included in the vaccine amount of antigen in a dose of vaccine adjuvant, and timing and frequency of administration of the vaccine.

## Vaccines

A complete listing of current commercially available vaccines, the viral stains or antigens included, and the adjuvant used is available at the equiflunet website.<sup>13</sup> This site should be consulted for up-to-date information on equine influenza vaccines as this is a rapidly developing field. At time of writing, there was only one vaccine that included both Florida clade 1 and Florida clade 2 virus

antigens (clade 1 is represented by A/eq/South Africa/04/2003-like or A/eq/Ohio/2003-like viruses, and Clade 2 is represented by A/eq/Richmond/1/2007-like viruses<sup>12,13</sup>), consistent with the most recent OIE recommendations.<sup>13</sup> The OIE recommends that H7N7 and H3N8 (Eurasian lineage) virus no longer be included in vaccines.

Most vaccines are comprised of inactivated or subunits of virus combined with an adjuvant. Inclusion of an adjuvant is important in maximizing the immune response to vaccination. The important factor in vaccine composition is the inclusion of adequate amounts of antigen of pertinent strains of virus. H7N7 virus is no longer a cause of clinical disease, and it should not be included in contemporary vaccines. Inclusion of antigen from both American and Eurasian lineages of H3N8 virus is essential, and vaccine composition should be regularly updated to reflect those viruses currently circulating in the horse population. The vaccine must include an adequate amount of antigen, measured by the single radial diffusion assay, preferably, the single radial hemolysis assay, because there is a clear relationship between dose of antigen and magnitude and duration of antibody response. There is increasing concern, and some evidence, that inclusion of multiple antigens in vaccines (for example, tetanus toxoid, equine herpesvirus, encephalomyelitis virus) reduces the efficacy of influenza vaccines. Although this concern has yet to be proved conclusively, it should be borne in mind when formulating vaccine programs for horses at high risk of influenza.

A modified live-virus vaccine is available in North America and has proven to be effective in experimental studies in preventing disease against heterologous virus challenge (both American and Eurasian lineages).<sup>122</sup> Furthermore, the duration of protection is at least 6 months after completion of a course of vaccination and there is a strong anamnestic response.<sup>122</sup> Vaccinated ponies had had significantly lower clinical scores, had smaller increases in rectal temperature, and shed less virus over fewer days than did the unvaccinated controls in response to challenge 6 months after vaccination. After challenge at 12 months, vaccinates had rectal temperatures and duration and concentration of virus shed significantly reduced compared with those in unvaccinated animals.

A live recombinant canary pox–vectored vaccine has been used in Europe, America, South Africa, and Australia.<sup>70,129</sup> The vaccine uses the viral vector to introduce influenza hemagglutinin genes into host cells. The recombinant virus expresses the hemagglutinin gene of both Florida clade 1 H3N8-Ohio/03 and Florida clade 2 H3N8-Richmond/1/07.<sup>13</sup> The canary pox infection of the host cell is abortive, with no virus produced, but influenza viral gene is expressed and presented through MHC class 1 by the

host cell, with subsequent induction of an immune response. A form of this vaccine, including both European and American lineages, was used to aid in the control of the 2003 influenza outbreak in South Africa and the 2007 epizootic in Australia.<sup>63</sup> An advantage of use of this vaccine is the ability to differentiate vaccinated horses from horses that seroconvert as a result of natural infection. This is achieved by detection of antibodies to both HA and internal viral proteins (NP) in naturally infected horses and only antibodies to HA in vaccinated horses.<sup>54,74</sup> There are variations of this testing, based on the same principle of differential induction of antibodies, that can differentiate infected horses from those receiving an inactivated virus vaccine.

Other novel vaccine strategies include use of DNA or vector vaccines.<sup>135</sup> Although effective in inducing a protective response, technological issues currently limit the widespread use of DNA vaccines.

### Objective

The objective of a vaccination program is to ensure that horses have maximal immunity at the times of greatest risk of exposure to influenza virus. Therefore young horses should be adequately vaccinated before being introduced into larger populations of horses. Older horses should receive frequent booster vaccinations before, and during, the racing or show season. Mares should be revaccinated before being shipped to breeding farms. It is important in any control program that all horses in a herd be vaccinated so that the population immunity to infection is maximal.

The objective of vaccination during the epizootic in Australia was to first control and then eliminate infection from the continent.<sup>63</sup> As such, the program of vaccination involved prophylactic vaccination, implemented before a disease outbreak, and reactive vaccination, implemented as part of a response to a disease outbreak, in conjunction with quarantine and movement control measures, as set out in the Ausvet Plan.<sup>27</sup> Reactive strategies include ring vaccination around identified sources of infection to limit further spread by producing an immune buffer, blanket (mass) vaccination and predictive vaccination whereby selective groups of horses are vaccinated because they are identified as having the potential to contribute most to future spatial transmission of infection. Ring vaccination was implemented through the creation of vaccination buffer zones 10-km wide or wider around foci of infection where lateral spread of infection was occurring. Predictive vaccination was used where there were large accumulations of horses and/or movement of personnel or fomites (vehicles) in contact with horses. Groups of horses suitable for predictive vaccination include racehorses, breeding horses, police horses, and other essential groups.

Blanket vaccination refers to vaccination of all horses in an area, thereby permitting limited movement and use of horses in that area.<sup>27,63</sup>

### Timing

#### Foals

Timing of vaccination of foals depends on the immune status of the mare and consequent acquisition of passive immunity by the foal. The presence of even small amounts of maternally derived antibody interferes with the immune response of foals to vaccination. Furthermore, vaccination of foals while they continue to have passive immunity can result in impaired responses to subsequent vaccinations. The practical significance of this latter observation is unknown but because of its potential importance should be considered when developing vaccination protocols for foals. Therefore vaccination of foals born to mares vaccinated more than once yearly should be delayed until the foals are at least 24 weeks of age when the immunity resulting from the vaccination is much better; this might leave some foals unprotected because passively acquired immunity is short lived, and some foals of recently vaccinated dams are seronegative by 4 weeks of age. Foals of unvaccinated mares can be vaccinated at less than 1 month of age. Vaccinations are carried out at 6- to 12-week intervals for at least two injections. Subsequently, booster injections are given at least once a year, although more frequent vaccination confers a greater immunity.

#### Racehorses and Show Horses

Yearlings and young horses are at increased risk of disease, and careful attention to their vaccination status is important in reducing the incidence of disease in this group. Yearlings and 2 year olds in racing stables in Great Britain typically have antibody concentrations against influenza before vaccination on arrival at the stable that are not protective. Vaccination increases antibody titer such that approximately three quarters of yearlings and 2 year olds have protective titers. For yearlings entering training the important predictors of antibody titer before vaccination on arrival at the stable were the time since a previous vaccination, total number of previous vaccinations, and the age at first vaccination. This study demonstrates the need for appropriate vaccination of young horses before they enter larger populations of horses, both to protect the young horse from disease and also to confer herd immunity on the population that they are entering.

Vaccination of racehorses and show horses and other horses at increased risk of exposure should be frequent. Booster vaccines should be timed to maximize immunity at the time of greatest exposure, such as introduction to a new stable or at the beginning of the show season. For maximal protection subsequent booster injections should

be administered at intervals of 6, or even 4, months. Measurement of antibody concentrations by single radial hemolysis can be useful in determining the need for booster vaccination. Previously, vaccination during the racing season was disliked by trainers because of transitory swellings at injection sites and an infrequent mild systemic reaction; however, administration of contemporary vaccines is rarely associated with these adverse effects. In general, vaccination appears to have no adverse effect on performance.

### Schedule

Various schedules have been proposed for influenza vaccinations of horses, with different regulatory bodies having specific recommendations. The FEI requires all horses competing in FEI competition to provide evidence of sufficient vaccination against equine influenza.<sup>136</sup> This involves regular six monthly booster vaccinations following a primary vaccination course. All horses and ponies for which an FEI Passport or a National Passport approved by the FEI has been issued must have the vaccination section completed and endorsed by a veterinarian, stating that it has received two injections for primary vaccination against equine influenza, given between 1 and 3 months apart. In addition, a booster vaccination must be administered within each succeeding 6 months ( $\pm$  21 days) following the second vaccination of the primary course. None of these injections must have been given within the preceding 7 days, including the day of the competition or of entry into the competition stables.

The British Horse Racing Authority has strict vaccination requirements that must be complied with to enter horses in their competitions or onto its premises.<sup>130</sup> The program includes a first equine influenza vaccination to be followed by a second vaccination 21 to 92 days later, with a third vaccination 150 to 215 days from the second vaccination. Thereafter vaccinations should be annually, with the last permissible day being the same date as the previous year's vaccination.

A schedule proposed for control of influenza in a large area includes the following rules:

- Mandatory vaccination for all horses entering racing premises
- Horses not to race in the 10-day period following vaccination
- Horses coming from international locations must be vaccinated before departure.
- All horse events, including shows, sales, and gymkhanas, should apply the same restrictions.
- The recommended vaccination program using inactivated or subunit vaccine is as follows:
  - Mares should be vaccinated during the final 4 to 6 weeks of

gestation to ensure adequate passage of passive immunity to the foal.

- Vaccination of foals at 6 months of age
- Two vaccinations initially at 21 days, and not more than 92 days apart
- A booster vaccination 5 to 7 months later
- Annual boosters or, in the face of increased infection pressure or when the risk of infection is high, boosters should be at 6-month or even 4-month intervals.
- When vaccination schedules break down and a horse goes longer than 12 months without a booster, recommence with a two-vaccination schedule.
- Yearlings and 2-year-olds may require an additional vaccination between the second vaccination of the primary series and the booster at 6 months.

### Control Measures

Spread of equine influenza virus is by infected horses, fomites (humans, equipment, and vehicles), and by dispersion of infected aerosols by wind or, more proximately, by coughing and sneezing. Control is achieved by preventing movement of infected or potentially infect horses and their contact with uninfected horses (i.e., quarantine), disinfection of fomites or personnel or prevention of contact of potentially contaminated fomites or personnel with susceptible horses, and reduction of ambient contamination of the virus.

**Hygienic precautions** can be of value in limiting the spread of the disease, as was documented during the epizootic in Australia.<sup>57,64,72,82,86,89,98</sup> Vehicles used for the transport of horses are thought to play a large part in transmission and should be thoroughly disinfected between shipments.

The surfactant action of soaps and detergents is an effective decontaminant for EI virus because of the susceptibility of the virus's outer lipid envelope. Soap and water or alcohol-based hand rubs, applied for at least 20 seconds are satisfactory for personal disinfection of human influenza virus and likely equine influenza virus.<sup>137,138</sup> Virkon® and quaternary ammonium compounds are suitable for decontaminating surfaces and equipment and for foot dips. Virkon® is not approved for use on skin and is unsuitable for disinfecting vehicles because it is corrosive.

A comprehensive description of means of decontaminating personnel, vehicles, and equipment is provided in a number of references,<sup>27,115</sup> and evidence of efficacy in preventing spread of infection is documented in some instances.<sup>72,86</sup>

**Quarantine** is imperative to prevent introduction of virus by animals in the

incubation period of the disease or subclinically infected horses. The most common introduction of infection, especially internationally, is through importation of subclinically infected horses. Also, because vaccinated animals can be infected and be shedding virus but not have signs of infection, isolation of introduced animals is an essential precaution, especially when an outbreak is in progress. The period of isolation should be at least 21 days and ideally 28 days.<sup>115</sup> The degree of isolation required cannot be specified because of lack of basic information, but it is suggested that droplet infection can occur over a distance of 32 m and wind-borne spread of up to 13 km.<sup>38</sup> There should be maximum biosecurity with regard to clothing, utensils, and personnel because this is effective in preventing spread of infection.<sup>86,89</sup>

It is important to recognize that abrupt imposition of quarantine and "standstill" of horses during an epizootic of the disease is associated with considerable psychological, emotional, logistic, and economic impact to owners, trainers, and horse-related businesses.<sup>50-52,57,60,66,80,93</sup>

**Control measures during an outbreak** are intended to eliminate sources of infection, reduce transmission of virus, enhance the resistance of at-risk horses, and decrease the number of horses at risk. Infected horses (identified by stall-side or rapid laboratory tests), and clinically affected horses should be removed from the group and isolated for 3 to 4 weeks. Ventilation of shed rows and barns should be optimal to minimize aerosol spread of the virus. No horses should be introduced or allowed to leave until the outbreak is over, probably about 4 weeks after the first case is identified. Movement of horses between barns or paddocks should be avoided. Training and racing should be suspended. The opportunity for fomite transfer on clothing, tack, feed utensils, or vehicles should be minimized by strict hygiene. Vaccination of clinically normal horses in the face of an outbreak can enhance the immunity of at-risk horses and is probably safe.

A comprehensive plan for management of incursion of equine influenza into an area free of the infection is provided in Austvet Plan for equine influenza and in the special issue of the *Australian Veterinary Journal* (2011, Volume 89, Supplement) describing responses to the 2007 incursion of equine influenza into Australia and its prompt eradication.<sup>27</sup>

### FURTHER READING

- Landolt GA. Equine influenza. *Vet Clin North Am Equine*. 2014;30:507-521.
- Slatter J, et al. Report of the International Equine Influenza Roundtable Expert Meeting at Le Touquet, Normandy, February 2013. *Equine Vet J*. 2013;46:645-650.
- Special Issue. Equine Influenza in Australia in 2007. *Aust Vet J*. 2011;89(suppl 1):1-173.



## REFERENCES

1. Landolt GA. *Vet Clin Equine*. 2014;30:507.
2. Hamed MI, et al. *J Adv Vet Res*. 2014;4:161.
3. Collins PJ, et al. *Proc Nat Acad Sci*. 2014;111:11175.
4. Daly JM, et al. *Emerg Infect Dis*. 2008;14:461.
5. Crispe E, et al. *Aust Vet J*. 2011;89:27.
6. Yondon M, et al. *Emerg Infect Dis*. 2014;20:2144.
7. Tu J, et al. *Arch Virol*. 2009;154:887.
8. Patrono LV, et al. *J Gen Virol*. 2015;96:969.
9. Solorzano A, et al. *J Virol*. 2015;89:11190.
10. Krueger WS, et al. *Influenza Respiratory Viruses*. 2014;8:99.
11. Woodward A, et al. *Virology*. 2015;481:187.
12. OIE Expert Surveillance Panel on Equine Influenza Vaccine Composition, OIE Headquarters, March 6, 2015. OIE, 2015. (Accessed 10.01.16, at <<http://www.oie.int/en/our-science-expertise/specific-information-and-recommendations/equine-influenza/>>).
13. Equiflunet, 2015. (Accessed 10.01.16, at <<http://www.equiflunet.org.uk/>>).
14. Elton D, et al. *Equine Vet J*. 2013;45:768.
15. Legrand LJ, et al. *Equine Vet J*. 2013;45:776.
16. Laabassi F, et al. *Transbound Emerg Dis*. 2015;62:623.
17. Bera BC, et al. *Ind J Virol*. 2013;24:256.
18. Zhu C, et al. *Genome Ann*. 2013;1:e00654.
19. Yondon M, et al. *Influenza Respiratory Viruses*. 2013;7:659.
20. Pusterla N, et al. *Equine Vet Educ*. 2014;26:453.
21. Legrand LJ, et al. *Equine Vet J*. 2015;47:207.
22. Gildea S, et al. *Equine Vet J*. 2012;44:387.
23. Bryant NA, et al. *Vet Microbiol*. 2011;147:19.
24. Ito M, et al. *J Vet Med Sci*. 2008;70:899.
25. Hughes J, et al. *PLoS Pathog*. 2012;8.
26. Murcia PR, et al. *J Virol*. 2010;84:6943.
27. Disease strategy: Equine influenza (Version 3.1), 2011. (Accessed 17.01.16, at <<http://www.animalhealthaustralia.com.au/our-publications/ausvetplan-manuals-and-documents/>>).
28. Scott-Orr H. *Aust Vet J*. 2011;89:163.
29. Sergeant ESG, et al. *Aust Vet J*. 2011;89:164.
30. Webster WR. *Aust Vet J*. 2011;89:3.
31. Yamanaka T, et al. *J Vet Med Sci*. 2008;70:623.
32. Barbic L, et al. *Vet Microbiol*. 2009;133:164.
33. Paillot R, et al. *Vet Microbiol*. 2013;166:22.
34. Dhand NK, et al. *Aust Vet J*. 2011;89:70.
35. Smyth GB, et al. *Aust Vet J*. 2011;89:23.
36. Firestone SM, et al. *PLoS ONE*. 2012;7.
37. Davis J, et al. *Transbound Emerg Dis*. 2009;56:31.
38. Firestone SM, et al. *Prev Vet Med*. 2012;106:123.
39. Burnell FJ, et al. *J Clin Virol*. 2014;59:100.
40. Larson KRL, et al. *J Clin Virol*. 2015;67:78.
41. Khurelbaatar N, et al. *PLoS ONE*. 2014;9.
42. Equine influenza: the August 2007 outbreak in Australia. Australian Government, Department of Agriculture and Water Resources, 2008. (Accessed 10.01.16, at <<http://www.agriculture.gov.au/about/publications/eiinquiry/>>).
43. Watson J, et al. *Aust Vet J*. 2011;89:4.
44. Watson J, et al. *Aust Vet J*. 2011;89:35.
45. Garner MG, et al. *Aust Vet J*. 2011;89:143.
46. Wong D. *Aust Vet J*. 2011;89:15.
47. Wilson G, et al. *Aust Vet J*. 2011;89:116.
48. Webster WR. *Aust Vet J*. 2011;89:92.
49. Watson J, et al. *Revue Scientifique Et Technique-Office International Des Epizooties*. 2011;30:87.
50. Taylor MR, et al. *BMC Public Health*. 2008;8.
51. Taylor M, et al. *Aust Vet J*. 2011;89:158.
52. Smyth GB, et al. *Aust Vet J*. 2011;89:151.
53. Sergeant ESG, et al. *Aust Vet J*. 2011;89:103.
54. Sergeant ESG, et al. *Aust Vet J*. 2011;89:43.
55. Scott-Orr H. *Aust Vet J*. 2011;89:113.
56. Schemann K, et al. *Aust Vet J*. 2014;92:93.
57. Schemann K, et al. *Prev Vet Med*. 2013;110:37.
58. Schemann K, et al. *Transbound Emerg Dis*. 2014;61:449.
59. Schemann K, et al. *BMC Vet Res*. 2013;9.
60. Schemann K, et al. *Transbound Emerg Dis*. 2012;59:503.
61. Ryan D. *Aust Vet J*. 2011;89:25.
62. Read AJ, et al. *Aust Vet J*. 2011;89:42.
63. Perkins NR, et al. *Aust Vet J*. 2011;89:126.
64. Paskin R. *Aust Vet J*. 2011;89:89.
65. Oakey J, et al. *Aust Vet J*. 2011;89:39.
66. Myers J. *Aust Vet J*. 2011;89:161.
67. Morton JM, et al. *Aust Vet J*. 2011;89:86.
68. Moloney BJ. *Aust Vet J*. 2011;89:50.
69. Moloney B, et al. *Aust Vet J*. 2011;89:56.
70. Minke JM, et al. *Aust Vet J*. 2011;89:137.
71. Major DA, et al. *Aust Vet J*. 2011;89:13.
72. Major DA. *Aust Vet J*. 2011;89:124.
73. Kung N, et al. *Aust Vet J*. 2011;89:78.
74. Kirkland PD, et al. *Aust Vet J*. 2011;89:45.
75. Kirkland PD, et al. *Aust Vet J*. 2011;89:6.
76. Kirkland PD, et al. *Aust Vet J*. 2011;89:38.
77. Kirkland PD. *Aust Vet J*. 2011;89:29.
78. Kannegieter NJ, et al. *Aust Vet J*. 2011;89:139.
79. Hoare R, et al. *Aust Vet J*. 2011;89:101.
80. Hoare R. *Aust Vet J*. 2011;89:147.
81. Happold J, et al. *Aust Vet J*. 2011;89:135.
82. Glanville RJ, et al. *Aust Vet J*. 2011;89:97.
83. Gilkerson JR. *Aust Vet J*. 2011;89:11.
84. Gilchrist P, et al. *Aust Vet J*. 2011;89:75.
85. Garner MG, et al. *Aust Vet J*. 2011;89:169.
86. Frazer JL, et al. *Aust Vet J*. 2011;89:120.
87. Foord AJ, et al. *Aust Vet J*. 2011;89:37.
88. Firestone SM, et al. *Prev Vet Med*. 2014;116:243.
89. Firestone SM, et al. *Prev Vet Med*. 2013;110:28.
90. Faehrmann P, et al. *Aust Vet J*. 2011;89:22.
91. East IJ. *Aust Vet J*. 2011;89:88.
92. Dups JN, et al. *Aust Vet J*. 2011;89:17.
93. Drury M. *Aust Vet J*. 2011;89:159.
94. Diallo I, et al. *Aust Vet J*. 2011;89:145.
95. Dhand NK, et al. *Aust Vet J*. 2011;89:73.
96. Croft MG, et al. *Aust Vet J*. 2011;89:47.
97. Begg AP, et al. *Aust Vet J*. 2011;89:19.
98. Arthur RJ, et al. *Aust Vet J*. 2011;89:109.
99. Durando MM, et al. *J Vet Int Med*. 2011;25:339.
100. Axon JE, et al. *J Vet Int Med*. 2008;22:819.
101. Patterson-Kane JC, et al. *Equine Vet J*. 2008;40:199.
102. Slater J, et al. *Equine Vet J*. 2014;46:645.
103. Galvin P, et al. *Influenza Respiratory Viruses*. 2013;7:73.
104. Sergeant ESG, et al. *Prev Vet Med*. 2009;92:382.
105. Read AJ, et al. *Vet Microbiol*. 2012;156:246.
106. Kittelberger R, et al. *Vet Microbiol*. 2011;148:377.
107. Nemoto M, et al. *J Virol Meth*. 2011;178:239.
108. Aeschbacher S, et al. *Schweiz Arch Tierheilkd*. 2015;157:191.
109. Lu Z, et al. *J Clin Micro*. 2009;47:3907.
110. Paillot R, et al. *Vet Immunol Immunopathol*. 2010;136:272.
111. Foord AJ, et al. *Vet Microbiol*. 2009;137:1.
112. Balasuriya UBR, et al. *J Virol Meth*. 2014;207:66.
113. Galvin P, et al. *Influenza Respiratory Viruses*. 2014;8:376.
114. Ji Y, et al. *J Virol Meth*. 2011;175:120.
115. Equine influenza. OIE, 2015. (Accessed 16.01.16, at <[http://www.oie.int/fileadmin/Home/eng/Health\\_standards/tahm/2.05.07\\_EQ\\_INF.pdf](http://www.oie.int/fileadmin/Home/eng/Health_standards/tahm/2.05.07_EQ_INF.pdf)>).
116. Yamanaka T, et al. *Vet J*. 2012;193:358.
117. Daly JM. *Vet J*. 2012;193:313.
118. Horspool LJI, et al. *Equine Vet J*. 2013;45:774.
119. Tabynov K, et al. *Vaccine*. 2014;32:2965.
120. Bryant NA, et al. *Vet Res*. 2010;41.
121. Heldens JGM, et al. *Vaccine*. 2010;28:6989.
122. Soboll G, et al. *Vet Immunol Immunopathol*. 2010;135:100.
123. Adams AA, et al. *Vet Immunol Immunopathol*. 2011;139:128.
124. Gildea S, et al. *Vaccine*. 2011;29:9214.
125. Gildea S, et al. *Vaccine*. 2011;29:3917.
126. Yamanaka T, et al. *J Vet Med Sci*. 2011;73:483.
127. Gildea S, et al. *Vaccine*. 2013;31:5216.
128. Cullinane A, et al. *Equine Vet J*. 2014;46:669.
129. El-Hage CM, et al. *Equine Vet J*. 2013;45:235.
130. Vaccination against equine influenza. British Horse Racing Authority, 2015. (Accessed 16.01.16, at <[http://rules.britisshorseracing.com/Orders-and-rules&staticID=126683&depth=3](http://rules.britisshorseracing.com/Orders-and-rules&staticID=126683&depth=3>)>).
131. Durham A. *Vet Times*. 2015;45:10.
132. Paillot R, et al. *Vet Immunol Immunopathol*. 2012;145:516.
133. Tabynov K, et al. *Aust Vet J*. 2014;92:450.
134. Ryan M, et al. *Equine Vet J*. 2015;47:662.
135. Ault A, et al. *Vaccine*. 2012;30:3965.
136. Cooke G. *Equine Vet J*. 2013;45:770.
137. Grayson ML, et al. *Clin Infect Dis*. 2009;48:285.
138. Yamanaka T, et al. *J Equine Vet Sci*. 2014;34:715.

## EQUINE RHINITIS (EQUINE RHINITIS VIRUS)

The equine rhinitis viruses are ubiquitous in populations of horses. Infection has been associated with mild respiratory disease, although their role in the common infectious respiratory diseases of horses is uncertain.

The equine rhinitis viruses are of four types—ERAV-1 and ERBV-1, 2, and 3. Equine rhinitis A virus (formerly equine rhinovirus-1) is a species within the genus *Aphthovirus* containing a single serotype, equine rhinitis A virus-1 (ERAV-1). There is little genetic variation in this virus.<sup>1</sup> The genus includes foot-and-mouth disease virus and bovine rhinitis virus, of the Picornaviridae. Equine rhinovirus 2 and equine rhinovirus 3 are now classified in the genus *Erbovirus* as equine rhinitis B virus (ERBV) types 1 and 2, respectively.<sup>2,3</sup> A third equine rhinitis B virus has been identified—ERBV-3.<sup>4</sup>

The viruses are widely distributed in horse populations globally and infect substantial proportions of horses worldwide. For example, antibodies to ERBV were detected in 86% of 50 weanling Thoroughbred from three stud farms in Australia, with 48%, 10%, and 62% of yearlings being seropositive for ERBV-1, ERBV-2, and ERBV-3, respectively.<sup>5</sup> Fifty-six percent of the horses had evidence of infection by two serotypes, and 12% had evidence of infection by all three serotypes.<sup>5</sup> Others find similar seroprevalence for ERBV-1 and ERBV-2 in Australia.<sup>6</sup> Virus genome is detected by PCR in nasal swabs in a much smaller proportion of horses (0%–16%), suggesting differences in sensitivity of the assay, minimal or intermittent shedding of the virus or differences in the populations of horses sampled.<sup>7-9</sup>

Serologic evidence of infection with ERAV is present in 50% to 100% of horses, although the prevalence of seropositive animals varies from almost zero in yearlings, to 8% in horses newly introduced to a training yard, to 61% in the same horses 7 months later.<sup>6</sup> Twenty-eight percent of 113 horses in

Ontario with signs of respiratory disease were seropositive for ERAV.<sup>10</sup>

ERAV is present in nasal discharge, feces, and/or urine of experimentally infected clinically normal horses and can be shed in the urine for at least 37 days.<sup>11,12</sup> Virus was detected in 23% of 215 urine samples collected from Thoroughbred racehorses as part of postrace drug monitoring.<sup>11</sup> These horses were therefore presumed to not have signs of infectious respiratory disease, and this represents a shedding rate in clinically normal horses.<sup>11</sup> The importance of urine shedding of the virus in transmission of infection is unclear, although the inhalation of aerosols of infected urine might transmit the virus. The virus has been detected in semen of a stallion.<sup>13</sup>

The role of ERAV or ERBV in genesis of respiratory disease of horses is unclear. The disease can be reproduced experimentally in seronegative ponies,<sup>12</sup> and there are a small number of reports of ERV association with respiratory disease, but clear causal association with common naturally occurring respiratory disease is lacking. High titers to ERAV are detected in horses with disease caused by equine influenza virus in Ontario, and it is suggested that this could be important in the development of respiratory disease, but without conclusive evidence.<sup>10</sup> The high prevalence of ERV infection in horses means that detection of the virus in horses with signs of respiratory disease could occur by chance in a proportion of individuals with ERV not being causative. None of 52 horses with signs of infectious respiratory disease in New Zealand had ERAV or ERBV virus (by tissue culture) or viral DNA (by PCR) detected in nasal swabs.<sup>9</sup> Similarly, ERAV was not detected in nasal swabs of any of 336 horses with respiratory disease (or in any of the 39 healthy controls) in the western United States, and ERBV was detected in 9 of 336 samples.<sup>14</sup> Although there is some evidence to indicate a causative role for ERAV and ERBV in common infectious respiratory disease of horses, the importance of the virus remains to be determined.

The **disease** thought to be associated with ERAV is characterized by an incubation period of 3 to 8 days, fever, pharyngitis, pharyngeal and submandibular lymphadenitis, and a copious nasal discharge that is serous early and becomes mucopurulent later. A cough persists for 2 to 3 weeks. The uncomplicated disease is mild and self-limiting. Among a group of susceptible horses, there is rapid spread of infection and disease. Studies in England have not identified the virus as an important cause of inflammatory airway disease in racehorses.

The virus has been associated with abortion in dromedary camels.<sup>15</sup>

Virus neutralizing antibody develops within 7 to 14 days of infection and persists for long periods.<sup>11</sup> Immunity after

natural infection is said to be solid and long-lasting.

**Diagnosis** is based on serologic testing, detection of viral DNA, or tissue culture of the virus, which is environmentally resistant.

There is no specific treatment, and a commercial vaccine is not available. Planned exposure of young horses to infection has been recommended, but this should be reconsidered in light of current knowledge of the prolonged shedding of the virus in urine and feces. The virus appears to have minimal zoonotic potential.

## REFERENCES

1. Diaz-Mendez A, et al. *Virus Genes*. 2013;46:280.
2. Equine rhinitis A virus. The Purbright Institute, 2013. (Accessed 12.09.13, at <<http://www.picornaviridae.com/aphthovirus/erav/erav.htm>>).
3. Black WD, et al. *J Gen Virol*. 2006;87:3023.
4. Horsington JJ, et al. *Virus Res*. 2011;155:506.
5. Horsington J, et al. *J Vet Diagn Invest*. 2013;25:641.
6. Black WD, et al. *Vet Microbiol*. 2007;119:65.
7. Mori A, et al. *J Virol Meth*. 2009;155:175.
8. Quinlivan M, et al. *Equine Vet J*. 2010;42:98.
9. McBrearty KA, et al. *NZ Vet J*. 2013;61:254.
10. Diaz-Mendez A, et al. *Can J Vet Res*. 2010;74:271.
11. Lynch SE, et al. *Comp Immunol Micro Infect Dis*. 2013;36:95.
12. Diaz-Mendez A, et al. *Am J Vet Res*. 2014;75:169.
13. Johnson DJ, et al. *J Vet Diagn Invest*. 2012;24:801.
14. Pusterla N, et al. *Vet Rec*. 2013;172.
15. Wernery U, et al. *J Gen Virol*. 2008;89:660.

## EQUINE VIRAL RHINOPNEUMONITIS (EQUINE HERPESVIRUS-1 AND -4 INFECTIONS)

### SYNOPSIS

**Etiology** EHV-4, and EHV-1, alpha-herpesvirus.

**Epidemiology** Transmission between horses and by mediate contagion. Lifelong latency of infection with putative periodic reactivation of virus shedding. Respiratory disease occurs as sporadic disease and as outbreaks. Younger animals more commonly affected by disease. Immunity following vaccination or infection is apparently short lived.

**Clinical signs** Upper respiratory disease; rarely, abortion or myeloencephalopathy.

**Clinical pathology** Seroconversion or increase in titer detected by enzyme-linked immunosorbent assay (ELISA) able to differentiate EHV-1 from EHV-4.

**Diagnostic confirmation** Virus isolation from, or polymerase chain reaction test on, blood, nasopharyngeal swabs, or tissue. Seroconversion or increase in titer detected by ELISA able to differentiate EHV-1 from EHV-4.

**Treatment** There is no specific treatment.

**Control** Vaccination (of minimal efficacy). Quarantine. Hygiene.

## ETIOLOGY

Upper respiratory disease of foals and adults is associated with equid herpesvirus-4 (EHV-4) or, less commonly, EHV-1, an alpha-herpesvirus. The DNA sequence of EHV-4 has been determined. There appear to be strains of EHV-4 that vary in virulence, based on severity of clinical disease, but at present it is not possible to differentiate between strains of low and high virulence by laboratory methods.

## EPIDEMIOLOGY

### Occurrence

**Infection** with EHV-4 is endemic in horse populations worldwide.<sup>1-8</sup> The serologic surveys of prevalence of serologic evidence of infection are of limited value because earlier studies used techniques that were unable to differentiate between antibodies to EHV-1 and EHV-4. Recent serologic surveys using ELISA tests capable of differentiating between antibodies to EHV-1 and EHV-4 demonstrate that almost all horses and foals greater than 60 days of age have evidence of infection by EHV-4. Young foals can be seropositive as a result of transfer of immunoglobulins from seropositive dams, making determination of the time of first infection, and active seroconversion, difficult. Furthermore, serologic tests are also unable to differentiate between responses to natural infection and to vaccination.

EHV-4 can be isolated from both clinically normal foals and those with signs of upper respiratory disease with similar frequency. Shedding of virus is more likely in foals with nasal discharge. There is a marked seasonal distribution to the pattern of shedding, with the most frequent detection of shedding being in early autumn (March).

**Upper respiratory tract disease** attributable to EHV-4 is very common and probably affects almost all horses during the first 2 years of life. EHV-4 rarely causes abortion in mares, septicemia in newborn foals, or myeloencephalopathy in adult horses. The frequency of respiratory disease attributable to EHV-1 is unclear but is apparently much less common than that for EHV-4.<sup>1,2,5,7</sup> Sero-prevalence of EHV-1 specific antibodies is 9% to 28% in adult Thoroughbred horses, 26% of Thoroughbred brood mares, 11% of Thoroughbred foals, and 46% to 68% of 1- and 2-year-old Thoroughbred racehorses in Australia. Sixty-one percent of 82 normal horses and horses with upper respiratory tract disease had antibodies to EHV-1 in New Zealand. Prevalence of serum antibodies to EHV-4 and EHV-1 were 93% and 1%, respectively, in young Thoroughbreds presented for sale as yearlings in South Africa.<sup>5</sup> EHV-4 DNA was detected in 14% of animals, whereas EHV-1 DNA was not detected in any horses at sale.<sup>5</sup> Similarly, in England, EHV-1 was not associated with clinical respiratory disease in Thoroughbred racehorses.

### Method of Transmission

EHV-4 is highly infectious, and transmission probably occurs by the inhalation of infected droplets or by the ingestion of material contaminated by nasal discharge. Foals infected with EHV-4 have prolonged and profuse shedding of virus in nasal secretions. Mediate infection may occur, the virus surviving for 14 to 45 days outside the animal.

Infections always arise from other horses, both by direct contact and via fomites. Horses and foals are infectious during the active stage of disease and, because horses become latently infected, presumably during subsequent periods of viral reactivation and shedding. The duration of latency is unknown but is assumed to be lifelong. EHV-4 establishes latency in the trigeminal ganglion, which is the origin of the maxillary branch of the trigeminal (5th cranial) nerve that provides sensory innervation to the nasal mucosae. It is assumed that reactivation of the virus and subsequent virus shedding poses a risk to in-contact, susceptible animals, but this has not been definitively demonstrated in field situations. If this were the case, then clinically normal animals harbor latent virus that during periods of reactivation can infect susceptible animals. If true, this feature of the disease has obvious importance in the prevention, control, and management of outbreaks of disease.

### Risk Factors

#### Immunity

Immunity resulting from natural infection of the respiratory tract is of short duration despite the persistence of serum virus-neutralizing (VN) antibodies. If similar to EHV-1, immunity to EHV-4 is likely associated with cytotoxic T-cell responses because of the importance of cell-associated virus in dissemination of infection throughout the horse. Because of the short duration of immunity an animal can become clinically affected a number of times during its life, although subsequent disease tends to be milder. Foals born to mares with serum antibodies to the virus acquire a protective passive immunity that persists for up to 180 days, provided that they ingest sufficient high-quality colostrum. Unfortunately, VN antibodies are not necessarily an indication of resistance to infection.

#### Age

Foals are infected by EHV-4, presumably from the dam or other mares in the band of mares and foals, early in life and excrete large quantities of virus in nasal secretions. Horses are infected repeatedly throughout life, with episodes of disease being less frequent and milder with increasing age. EHV-4 is isolated more frequently from younger than from older horses, suggesting an age-associated decrease in susceptibility to disease.

### Economic Importance

Disease associated with EHV-4 is apparently of considerable economic importance because of the loss of training time and opportunities to perform during convalescence and quarantine. Although the upper respiratory disease is a mild inflammation of the respiratory tract of horses, characterized by coughing and nasal discharge, the importance of the disease is the large numbers of animals affected in an outbreak. Fatalities in uncomplicated cases of rhinopneumonitis are rare.

### PATHOGENESIS

The pathogenesis of EHV-4 infection and disease is assumed to be similar to that of EHV-1, with the exception that the virus does not commonly cause abortion, neonatal septicemia, or myeloencephalopathy. The virus is inhaled and binds to epithelium of the upper respiratory tract, enters epithelial cells, and reproduces. The infection then spreads throughout the respiratory tract, including trachea and bronchioles, and to lymphoid tissues associated with the respiratory tract. There is a viremia, although this may be of short duration. There is cell death and development of intranuclear inclusion bodies in the respiratory tract and associated lymphoid tissues. The EHV-4 virus then becomes latent, as evidenced by isolation of virus from lymph nodes associated with the respiratory tract and detection of viral genome in trigeminal ganglia, although this has not been a consistent finding. The factors causing viral recrudescence from these latent sites have not been determined. It should be noted that definitive evidence of viral recrudescence of EHV-4 as a cause of outbreaks of disease is lacking, and experimental induction of recrudescence is achieved only by administration of large doses of corticosteroids.

### CLINICAL FINDINGS

The classical respiratory tract form of the disease (rhinopneumonitis) is virtually indistinguishable on the basis of clinical signs from the other respiratory tract diseases of horses. There is an incubation period of 2 to 20 days. Fever, conjunctivitis, coughing, and mild inflammation of the upper respiratory tract are the cardinal manifestations of the disease, but inapparent infection is common. The temperature varies from 39° to 40.5° C (102.5–105.5° F). There is enlargement, but not abscessation, of the submandibular lymph nodes, especially in foals and yearlings. These signs are more likely to occur in young horses or when horses are assembled in sale barns. Edema of the limbs and diarrhea occur rarely. The length of the illness is usually 2 to 5 days, although the nasal discharge and cough may persist for 1 to 3 weeks. Secondary bacterial invasion, usually *Streptococcus equi* subsp. *zoepidemicus*, may exacerbate the clinically

inapparent viral pneumonia. Young foals can develop primary viral pneumonia.

EHV-4 only rarely causes abortion or neurologic disease.

### CLINICAL PATHOLOGY

Results of hematologic and serum biochemical examinations are neither specific nor diagnostic. In adult horses with rhinopneumonitis there may be pronounced leukopenia, largely attributable to depression of neutrophils.

**Serologic tests** are of critical importance in diagnosis and control of equine herpesvirus infections. Serum antibody levels to EHV-1/4 may be determined by ELISA, virus neutralization (VN), or complement fixation (CF) tests. The CF and VN tests are not able to differentiate between seroconversion associated with EHV-1 and EHV-4, whereas an ELISA using recombinant antigens specific for EHV-1 and EHV-4 is able to differentiate infection by each of these types of equine herpesvirus. Many, if not all, adult horses have serum antibodies to EHV-4 as a result of previous infection or vaccination. Thus the demonstration of antibodies is not in itself sufficient to confirm a diagnosis of the disease. **Complement-fixing antibody** appears on the 10th to 12th day after experimental infection but persists for only a few months. Demonstration of a three- to four-fold increase in the serum concentration of specific complement-fixing antibodies in acute and convalescent serum samples provides persuasive evidence of recent infection, albeit by either EHV-1 or EHV-4. Complement-fixing antibodies persist for only a short time (several months), whereas VN antibodies persist for over a year, and testing for them is therefore a more reliable means of determining that previous infection with the virus has occurred. Until recently, serologic differentiation of antibodies to EHV-1 and EHV-4 was not possible. However, highly specific ELISA tests based on the variable region of the C terminus of glycoprotein G, at least one of which is commercially available, have been developed that can differentiate between antibodies to EHV-1 and EHV-4 in horse serum. The ELISA is reported to be more sensitive, easier to perform, more rapid, and more reproducible than the virus neutralization test. Importantly, the ELISA test is able to differentiate between infections associated with EHV-1 and EHV-4.

**Identification of the virus** in nasal swabs or blood buffy coat by culture or a PCR test provides confirmation of infection.<sup>9</sup> The use of seminested or multiplex PCR provides rapid identification of EHV-4 viral genome in pharyngeal swabs. The test is at least as sensitive as viral isolation in identifying presence of virus. However, the use of rapid and innovative diagnostic techniques based on ELISA, PCR, immunohistochemical staining with peroxidase, or nucleic acid hybridization probes is often restricted to specialized



reference laboratories. Therefore the method of choice for diagnosis of rhinopneumonitis by diagnostic virology laboratories handling many routine samples continues to be the traditional methodology of cell culture isolation followed by sero-identification of the isolated viruses. The virus can be isolated in tissue culture, chick embryos, and hamsters, from either nasal washings or aborted fetuses.

Samples of nasopharyngeal exudate for virus isolation are best obtained from horses during the very early, febrile stages of the respiratory disease, and they are collected via the nares by swabbing the nasopharyngeal area with a 5 × 5 cm gauze sponge attached to the end of a 50-cm length of flexible, stainless steel wire encased in latex rubber tubing. A guarded uterine swab device can also be used. After collection, the swab should be removed from the wire and transported promptly to the virology laboratory in 3 mL of cold (not frozen) fluid transport medium (serum-free minimal essential medium [MEM] with antibiotics). Virus infectivity can be prolonged by the addition of bovine serum albumin or gelatine to 0.1% (w/v).

### NECROPSY FINDINGS

Fatalities are extremely rare in the respiratory forms of EHV-4 infection or EHV-1 disease restricted to the respiratory tract.

### Samples for Confirmation of Diagnosis

- **Virus isolation or identification** by fluorescent antibody testing or PCR of nasal swabs or blood

### DIFFERENTIAL DIAGNOSIS

The upper respiratory diseases of horses are listed in Table 12-16. There is no specific treatment, although antibiotics are often administered to horses with respiratory tract disease to prevent or treat secondary bacterial infection. There is, however, no evidence that antibiotic treatment shortens the duration of the disease or prevents complications.

### CONTROL

Principles of a control program include the following:

- Enhancing the immunity of individual horses by vaccination
- Minimizing the risk of introducing EHV-4 infection to the farm or stable
- Hygiene to prevent spread of virus on fomites such as clothes and tack
- Rapid isolation of any horse with disease that could be attributable to EHV-4

### Vaccination

Vaccines for protection against rhinopneumonitis contain both inactivated EHV-1 and

EHV-4 virus, presumably because both viruses cause respiratory disease in horses. None of the currently available vaccines consistently prevents infection of vaccinated horses or provide complete protection against disease associated with EHV-4, although a combined EHV-1/EHV-4 inactivated virus vaccine attenuated the clinical signs of disease in experimentally infected foals. The development of modified live-virus vaccines administered intranasally holds promise for effective control of both EHV-1 and EHV-4 in foals and adults.

### Hygiene

Standard hygienic procedures should be adopted to avoid spread of the disease, with particular attention being given to the isolation of introduced horses.

### REFERENCES

1. Aharonson-Raz K, et al. *J Equine Vet Sci.* 2014;34:828.
2. Amer HM, et al. *Afr J Microbiol Res.* 2011;5:4805.
3. Equine herpesvirus 1 and 4 related diseases. American Association of Equine Practitioners, 2013. (Accessed 07.02.16, at <<http://www.aaep.org/custdocs/EquineHerpesvirusFinal030513.pdf>>.)
4. Avci O, et al. *Acta Scientiae Veterinariae.* 2014;42.
5. Badenhorst M, et al. *BMC Vet Res.* 2015;11.
6. Jimenez D, et al. *Open Vet J.* 2014;4:107.
7. McBrearty KA, et al. *NZ Vet J.* 2013;61:254.
8. Yildirim Y, et al. *Iran J Vet Res.* 2015;16:341.
9. Hu Z, et al. *Appl Microbiol Biotech.* 2014;98:4179.

## EQUINE MULTINODULAR PULMONARY FIBROSIS

Equine multinodular pulmonary fibrosis (EMPF) is a recently described progressive fibrosing lung disease of adult horses.<sup>1</sup>

### ETIOLOGY

EMPF is strongly associated with infection by equine herpesvirus-5 (EHV-5), a gamma-herpesvirus.<sup>1-10</sup> Most cases of EMPF have detectable EHV-5 in the lung lesions or in bronchoalveolar lavage fluid, the virus is most abundant in lesions compared with unaffected areas or lung from unaffected horses, and inoculation of healthy horses with EHV-5 derived from affected horses results in nodular pulmonary fibrosis.<sup>6</sup>

EHV-5 antigen can be detected in lungs of unaffected horses, and the virus is widely distributed in horses worldwide, with both healthy horses and horses with evidence of non-EMPF respiratory disease having detectable virus in respiratory secretions.<sup>11-16</sup> The ubiquity of EHV-5 infection in horses raises the possibility that infection with EHV-5 in horses with EMPF is coincidental and not causative or contributory to the disease. However, the almost universal detection of EHV-5 in horses with EMPF and the similarity of distribution of EHV-5 antigen in lungs and lesions of horses inoculated with the virus and naturally occurring cases of EMPF suggests a role for

EHV-5 in the genesis of the lesions. It is plausible, but increasingly unlikely, that EHV-5 infects the abnormal tissues of lungs of horses with EMPF after development of the lesions and is not a contributory agent to the disease. Although Koch's postulates have not been fulfilled for EHV-5 and EMPF, the weight of evidence supports a role for EHV-5 in the initiation, development, or proliferation of nodular pulmonary fibrosis in horses.

Both asinine gammaherpesvirus-5 and equine gammaherpesvirus-5 were isolated from two horses with EMPF.<sup>4,17</sup> The importance of this finding is unclear and might just represent the high frequency of infection of horses by asinine gammaherpesvirus-5.

EHV-5 is also associated with skin and ocular disease and lymphoma in horses, and both EMPF and lymphoma can occur in the one animal.<sup>18-21</sup>

### EPIDEMIOLOGY

The epidemiology of EMPF is not well established, and current knowledge is based on individual reports of small numbers of cases with the resultant potential for reporting and case-selection bias. The disease has been reported from Australia, New Zealand, Brazil, Europe, the United Kingdom and North America and appears to have a worldwide distribution.<sup>1,2,4,5,7,8,17,19,22-25</sup> Horses most commonly reported as affected are middle-aged to older light breeds (Thoroughbreds) and Warmbloods, although the disease is reported in horses as young as 2 years of age.<sup>5,7,17,26,27</sup> There are no readily apparent risk factors.

The case-fatality rate is high (>50%) in untreated and treated horses. There are no estimates of cause-specific mortality or morbidity rates.

### PATHOGENESIS

The molecular pathogenesis of EMPF is unknown, although parallels are drawn between Epstein-Barr virus associated interstitial (fibrosing) pneumonia in people and the disease in horses.<sup>6</sup> The lesion in horses progresses through proliferation of type 2 pneumocytes to alveolar fibrosis and focal obliteration of normal lung architecture. There is systemic evidence of inflammation, and the fever, weight loss, lethargy, and exercise intolerance of affected horses demonstrate a systemic response to the disease. Exercise tolerance could be attributable to diminished gas exchange in damaged lungs, the systemic inflammatory effects of the disease, or, more likely, a combination of both.

### CLINICAL SIGNS

Horses with EMPF have various combinations of weight loss, recurrent cough, depression, anorexia, fever, tachycardia, tachypnea, or respiratory distress.<sup>5,7,8,22,27</sup> Signs of respiratory disease might not be apparent at

initial examination, but as the disease progresses respiratory distress develops in most, but not all, cases. The usual history is of a gradual onset of increased respiratory effort, although some horses have a sudden onset of respiratory distress. Heart and respiratory rates are often elevated. Pyrexia is not a constant finding and can be intermittent in affected horses. There can be a nasal discharge but this is not invariable or characteristic. Thoracic auscultation might reveal only increased intensity of normal breath sounds or the presence of occasional crackles and wheezes. Typically, there is tachypnea with an increased respiratory effort.

Thoracic radiography reveals pulmonary disease, usually apparent as severe, diffuse interstitial disease with nodular opacities.<sup>7</sup> The interstitial opacity can be diffuse or nodular with multiple well-defined opacities against an overall background of increased interstitial density. Ultrasonographic examination often reveals the presence of multiple nodules in the lung parenchyma confluent with the pleural surface.<sup>7</sup> There is no excess pleural fluid.

Lymphoma in horses with EMPF and lymphoma associated with EHV-5 infection and treated with acyclovir have been reported, raising the possibility of a common etiology of the two diseases.<sup>19,20</sup>

## CLINICAL PATHOLOGY

Hematologic examination usually reveals a neutrophilic leukocytosis, mild anemia, lymphopenia, and hyperfibrinogenemia.<sup>2,7,8,22</sup> Pancytopenia occurs in a small proportion of cases.<sup>2</sup> Hypoproteinemia and hypoalbuminemia are common. Arterial oxygen tension is not invariably abnormal but declines as the disease progresses.

Examination of a tracheal aspirate reveals neutrophil inflammation. Macrophages contain occasional intranuclear inclusions.<sup>7,8,28</sup>

Serologic testing for antibodies to fungi including *Blastomyces*, *Coccidioides*, *Histoplasma*, *Aspergillus*, and *Cryptococcus* spp. assists with ruling out diseases caused by these organisms. EHV-5 can be detected by PCR examination of bronchoalveolar lavage fluid in most affected horses.<sup>7</sup>

## NECROPSY FINDINGS

Gross lesions are restricted to the lungs and occur in two distinct forms, the more common form being numerous coalescing nodules of fibrosis with little unaffected lung present (diffuse nodular form).<sup>1</sup> Individual nodules are up to 5 cm in diameter, pale tan to white, and moderately firm. The less common lesion consists of multiple discrete nodules up to 10 cm in diameter and separated by grossly normal lung (discrete nodular form). The nodules are otherwise similar in appearance and texture to those of the diffuse form. Bronchial lymph nodes may be markedly enlarged.

Histopathologic findings are restricted to the lungs and bronchial lymph nodes, and the lesions are similar regardless of the gross pathology. Nodules are sharply demarcated from unaffected lung tissue, and they consist of marked interstitial expansion of alveolar parenchyma by well-organized mature collagen.<sup>1,7</sup> In most cases, the alveolar architecture is preserved, but in rare cases, fibrosis is arranged in broad interlacing bundles without preserving the alveolar structure. Affected alveoli are lined by cuboidal cells, and the lumen contains inflammatory cells, primarily neutrophils and macrophages, the latter occasionally containing intranuclear inclusion bodies consistent with a herpesvirus infection. Changes in bronchial lymph nodes consist of marked lymphoid hyperplasia, often with nonspecific sinus histiocytosis.

## Specimen for Laboratory Diagnosis

Specimens for diagnosis include lung nodules for histopathology, in situ hybridization, and PCR.

## DIFFERENTIAL DIAGNOSIS

The differential diagnoses include the following: lung abscess, chronic pleuropneumonia, silicosis, lipid pneumonia, eosinophilic pneumonia, fungal pneumonia, pulmonary neoplasia (either primary—granular cell tumor—or secondary such as metastatic squamous-cell carcinoma), congestive heart failure, or chronic kidney disease.

## DIAGNOSTIC CONFIRMATION

Diagnosis is confirmed by demonstration of compatible lesions in lungs at necropsy or on biopsy.

## TREATMENT

There are no treatments with established efficacy, and management of the disease is based on first principles and empirical treatment with antiviral drugs, antiinflammatory drugs, and antimicrobials.

Reduction of inflammation and relief of pain is achieved by administration of nonsteroidal antiinflammatory drugs (phenylbutazone, flunixin meglumine, ketoprofen) or corticosteroids (dexamethasone or prednisolone). Antimicrobials are administered to treat secondary bacterial infection and include penicillin, penicillin in combination with an aminoglycoside, or tetracycline or doxycycline.

Antiviral drugs have been administered to horses with EMPF, and some of these treated horses have survived.<sup>7,28</sup> Acyclovir and valacyclovir (a metabolite of acyclovir) are both active in vitro against gamma-herpesviruses. Acyclovir is administered orally (20 mg/kg PO q8h) but has variable absorption compared with valacyclovir, and one cannot be confident that adequate

concentrations in the blood are achieved in all horses.<sup>29-31</sup> The preferred drug, based on pharmacokinetic properties, is valacyclovir (30–40 mg/kg PO q8h).<sup>30,31</sup> A 2-week course of treatment with valacyclovir was associated with resolution of the disease in one horse.<sup>28</sup>

## CONTROL

There are no known control measures.

## FURTHER READING

Dunkel B. Pulmonary fibrosis and gammaherpesvirus infection in horses. *Equine Vet Educ.* 2012;24:200.

## REFERENCES

- Williams KJ, et al. *Vet Pathol.* 2007;44:849.
- Hart KA, et al. *Equine Vet Educ.* 2008;20:470.
- Marenzoni M, et al. *J Vet Diagn Invest.* 2011;23:802.
- Back H, et al. *Acta Vet Scand.* 2012;54.
- Spelta CW, et al. *Aust Vet J.* 2013;91:274.
- Williams KJ, et al. *PLoS ONE.* 2013;8:e77754.
- Wong D, et al. *JAVMA.* 2008;232:898.
- Schwarz B, et al. *Acta Vet Hung.* 2013;61:319.
- Kubiski SV, et al. *JAVMA.* 2009;235:381.
- Williams KJ. *Vet Pathol.* 2014;51:372.
- Fortier G, et al. *Vet J.* 2010;186:148.
- Diallo IS, et al. *Arch Virol.* 2008;153:1643.
- Fortier G, et al. *Vet J.* 2009;182:346.
- Ataseven VS, et al. *Transbound Emerg Dis.* 2010;57:271.
- McBrearty KA, et al. *NZ Vet J.* 2013;61:254.
- Hue ES, et al. *J Virol Meth.* 2014;198:18.
- De Witte FG, et al. *J Vet Int Med.* 2012;26:1064.
- Herder V, et al. *Vet Microbiol.* 2012;155:420.
- Schwarz B, et al. *Equine Vet Educ.* 2012;24:187.
- Vander Werf K, et al. *J Vet Int Med.* 2013;27:387.
- Bawa B, et al. *J Equine Vet Sci.* 2014;34:694.
- Niedermaier G, et al. *Vet Rec.* 2010;166:426.
- Soare T, et al. *Vet Rec.* 2011;169:313A.
- Dunowska M, et al. *NZ Vet J.* 2014;62:226.
- Panziera W, et al. *Brazilian J Vet Pathol.* 2014;7:17.
- Marenzoni ML, et al. *J Vet Diagn Invest.* 2011;23:802.
- Soare T, et al. *Vet Rec.* 2011;169:313.
- Schwarz B, et al. *Equine Vet Educ.* 2013;25:389.
- Garre B, et al. *Antimic Agents Chemother.* 2007;51:4308.
- Maxwell LK, et al. *J Vet Pharmacol Ther.* 2008;31:312.
- Garre B, et al. *J Vet Pharmacol Ther.* 2009;32:207.

## EQUINE HENDRA VIRUS INFECTION

### ETIOLOGY

An acute disease of horses transmissible to humans and characterized in horses by fever and respiratory distress, but with capacity for pleiotropic clinical expression, occurs in northeastern Australia. The disease is associated with infection by equine Hendra virus (henipavirus, HeV, in the family Paramyxoviridae), which is closely related to Nipah virus (classified as the same genus).<sup>1,2</sup> There is very little genomic variation in HeV.<sup>3</sup> Infection by HeV, or Nipah virus, causes meningoencephalitis or, less frequently, respiratory disease in humans in contact with infected horses.<sup>4</sup>

A disease syndrome in horses and humans in the Philippines in 2014 was

associated with infection by a henipavirus closely related to Nipah virus.<sup>5</sup> The disease caused encephalitic signs and death in both horses and humans, there was horse–human and human–human spread, and the source of infection appeared to be fruit bats. The case-fatality rate in humans was approximately 50%, with a higher fatality rate among those with an acute encephalitic disease. At least 10 horses died, although this number likely underrepresents the actual number of horse deaths. Infection in some humans was associated with butchering or eating horses.<sup>5</sup>

## EPIDEMIOLOGY

The disease in horses is uncommon, in that the morbidity or mortality rate within the population of at risk horses is low, with approximately two to four outbreaks reported each year involving a small number of horses. Between 1994 and 2013 there were 48 outbreaks of disease in horses, of which approximately 6 involved human disease.<sup>2</sup> The case-fatality rate was high in early outbreaks, and because of control measures that involve test and slaughter of infected horses, all horses infected in outbreaks are destroyed.

The disease is important because of the zoonotic nature of the infection and the high case-fatality rate in infected humans.

## Transmission

The source of the virus is a wildlife host, the frugivorous pteropoid bats (fruitbats and flying foxes, *Pteropus* spp.). Approximately 25% of pteropoid bats, including representatives of all four main species in eastern Australia (the grey-headed flying-fox, *Pteropus poliocephalus*; the black flying-fox, *Pteropus alecto*; the little red flying-fox, *Pteropus scapulatus*; and the spectacled flying-fox, *Pteropus conspicillatus*), were identified as being seropositive for HeV. The bats are seropositive for antibodies to the virus, the only seropositive mammals of 34 wildlife species sampled, and the virus can be isolated from pteropoid postpartum uterine fluid and fetal tissue. Mechanism of spread from bats to horses is uncertain, but it is speculated that ingestion by horses of infected bat fetal fluids and tissues might transfer infection from bats to horses. Fruit bats are consistently present when the disease occurs in horses.<sup>6</sup>

The disease spreads from bats to horses, and there is considerable interest in determining risk factors associated with transmission.<sup>7–11</sup> Infection of horses likely involves contact with virus soon after (hours) it is excreted from bats.<sup>9</sup> This is consistent with the 40× increase in risk of disease for horses in postal codes where fruit bats roost.<sup>8</sup> Serologic evidence indicates waxing and waning infection on a seasonal basis, and epidemiologic evidence and modeling favors an effect of anthropogenic changes in bat habitat favoring urbanization of bat colonies and

reduced migration of bats. Urbanization increases the risk of spread of infection to horses, and reduced migration of bats reduces herd immunity in flocks, resulting in outbreaks of virus shedding and spread to horses.<sup>12,13</sup>

Dissemination of infection between horses by mechanical spread of infected nasal discharge likely occurred in the largest outbreak, and this could have been the route of infection of the human fatality. The virus is present in nasal discharges and urine of infected horses, and spread from horse to horse might also occur through inhalation of infected urine. Horse-to-horse transmission of infection is uncommon,<sup>6</sup> likely because the virus does not persist in the environment but can occur. Human-to-human transmission of infection has not been reported.

Disease occurs in horses, humans, cats, and guinea pigs, although in the latter two species the disease was a result of experimental infection. Dogs can become infected, but they do not appear to be at high risk of developing the disease, if they are at any risk at all, and there is no evidence that they propagate infection. Fruit bats do not develop clinical disease when experimentally infected.

## Zoonotic Potential

The disease has important zoonotic implications; there have been four human deaths (~60% case-fatality rate) as a result of meningoencephalitis or pneumonitis and respiratory failure. Deaths all occurred in people who had close contact with infected horses, and the high risk associated with treating infected horses, or performing postmortem examinations on horses that have died of the disease, has prompted some veterinarians in endemic areas to exit from equine practice.<sup>14</sup> The reasons are concern about personal safety or legal liability for the safety of coworkers and owners of horses. However, the virus is not easily transmitted to humans, as evidenced by the observation that most people in contact with clinically affected horses do not develop antibodies to the virus.

## CLINICAL SIGNS

The **incubation period** of the spontaneous disease is 8 to 11 days, but it is much shorter in experimentally induced disease. Death usually occurs within 24 to 48 hours of first onset of clinical signs, and affected horses housed in paddocks are often found dead.<sup>6</sup> **Clinical signs** of the disease in horses include lethargy, which is often marked, depression, loss of appetite, fever, ataxia, blindness, head pressing, aimless wandering, tachycardia, tachypnea, and copious frothy nasal discharge. Horses can show aimless pacing and can become entangled in fence—which can be mistaken for an accident rather than a consequence of neurologic disease associated with HeV infection.<sup>6</sup> There can

also be hemorrhagic nasal discharge and swelling of the head. Some horses have muscle tremor. Death in acutely affected horses is sometimes associated with severe respiratory distress. Clinically inapparent infections of horses can occur.

An important understanding is that HeV can cause protean clinical signs, which might be interpreted as evidence of respiratory (dyspnea), neurologic (ataxia, blindness), muscular (muscle fasciculations), hepatic (head pressing) or gastrointestinal (terminal colic) disease.

## CLINICAL PATHOLOGY

Characteristic changes in the hemogram or serum biochemical profile are not reported. If infected animals survive more than a few days after the onset of clinical signs, they develop serum-neutralizing antibodies. The recommended range of samples for HeV exclusion from the live horse are 10 mL of clotted, EDTA, and heparin blood; pooled nasal swabs from each nostril; swabs from other mucosal surfaces (e.g., oral cavity, rectum, or conjunctiva); or urine collected in, preferably, phosphate-buffered glycerol saline or isotonic sterile saline.<sup>6</sup> Antibodies are detectable by immunofluorescence microscope immunoassays, or rapid immune plaque assay.<sup>15</sup> Viral genome can be detected by RT-PCR that is highly specific. Viral isolation in Vero cells or imaging using electron microscopy demonstrate presence of the virus. Details of diagnostic tests are available from the OIE.

## NECROPSY

**Necropsy** examination reveals pulmonary edema with hemorrhage and froth in the airways. Histologic examination reveals an interstitial pneumonia characterized by extensive vascular damage and necrosis of alveolar macrophages. Pulmonary vascular changes include edema and hemorrhage within alveoli, plus necrosis and thrombosis of alveolar capillaries and small arterioles. The distinctive histologic feature is the presence of syncytial giant cells within blood vessels of the lungs and other organs. Retrospective diagnosis of the disease can be documented using an immunohistochemical technique or demonstration of viral nucleic acid in tissue by a test based on the PCR. Postmortem, 10 mL of blood can be collected from the jugular vein in addition to the submandibular lymph node and swabs as per a live horse. Field experience suggests that it is relatively easy to safely collect jugular blood from recently dead horses.<sup>6</sup>

## TREATMENT AND CONTROL

There is **no specific treatment** for this disease. Ribavirin has been investigated for use in infected or exposed humans but is not used in horses, for which control measures are implemented.<sup>2</sup>



The **control measures** in the described outbreaks included slaughter of all infected horses, extensive serologic testing, and control of movement of horses within a defined disease control zone. The disease in index cases is likely attributable to contact of susceptible horses with infected fluids of pteropoid bats, and interventions that prevent or reduce the frequency of this occurrence are sensible, although the efficacy of this control technique has not been determined.

An effective vaccine is available, and its use is strongly advised in horses living or visiting areas where the disease is endemic.<sup>16-18</sup> In addition to preventing disease in horses, the vaccine provides veterinarians attending horses in endemic areas with some level of confidence that the horse is not infected with HeV.<sup>17</sup>

Strict biosecurity measures must be used by veterinarians examining potentially infected horses in areas where the disease is endemic, although this practice is often met with resistance.<sup>18</sup> Because of the protean nature of the disease, all sick horses should be considered as sources of infection. Biosecurity practices should be in place for examination of all horses, and the degree to which personal protective equipment is used can be adjusted based on the risk that the horse being examined is infected. Detailed guidelines for personal biosecurity are available.<sup>19</sup>

## REFERENCES

1. Croser EL, et al. *Vet Microbiol.* 2013;167:151.
2. Aljofan M. *Virus Res.* 2013;177:119.
3. Marsh GA, et al. *Emerg Infect Dis.* 2010;16:1767.
4. Nakka P, et al. *Clin Radiol.* 2012;67:420.
5. Ching PKG, et al. *Emerg Infect Dis [Internet].* 2015;21.
6. Ball MC, et al. *Aust Vet J.* 2014;92:213.
7. Smith C, et al. *PLoS ONE.* 2014;9.
8. McFarlane R, et al. *PLoS ONE.* 2011;6.
9. Martin G, et al. *J Gen Virol.* 2015;96:1229.
10. Field H, et al. *PLoS ONE.* 2011;6.
11. Edson D, et al. *PLoS ONE.* 2012;7:420.
12. Plowright RK, et al. *Proc Royal Soc B.* 2011;278:3703.
13. Breed AC, et al. *PLoS ONE.* 2011;6.
14. Mendez DH, et al. *Emerg Infect Dis.* 2012;18:83.
15. McNabb L, et al. *J Virol Meth.* 2014;200:22.
16. Pallister JA, et al. *Virology J.* 2013;10.
17. Middleton D, et al. *Emerg Infect Dis.* 2014;20:372.
18. Mendez DH, et al. *BMC Vet Res.* 2014;10.
19. Australian Veterinary Association guidelines for veterinary personal biosecurity, 2013. (Accessed 14.09.15, at <[http://www.ava.com.au/sites/default/files/AVA\\_website/pdfs/Biosecurity%20Guidelines%202013%20FINAL.pdf](http://www.ava.com.au/sites/default/files/AVA_website/pdfs/Biosecurity%20Guidelines%202013%20FINAL.pdf)>).

## PULMONARY AND SYSTEMIC ASPERGILLOSIS (ASPERGILLUS SPP.)

Diseases of horses and cattle associated with infection with *Aspergillus* spp. are characterized by either localized infections with slow progression or fulminant systemic or pulmo-

nary disease. Localized infections are of the nasal cavities and paranasal sinuses;<sup>1-3</sup> eye; reproductive tract, including placenta;<sup>4</sup> mediastinum; or guttural pouch (see “Guttural Pouch Mycosis”). Systemic disease can affect any organ, including the brain, liver, and kidney,<sup>5</sup> but the most common manifestation is as acute pulmonary disease with or without infection of other tissues.<sup>3,5-9</sup>

## ETIOLOGY

The causative organism is *Aspergillus* spp., usually *A. fumigatus* but occasionally one of *A. flavus*, *A. deflexus*, *A. nidulans*, *A. niger*, *A. clavulatus*, *A. nidulans*, or *A. sydowii*.<sup>3,5,7,8,10,11</sup> Aspergilli reproduce both sexually and asexually and hence are classified as dimorphic fungi. Asexual reproduction is by production of conidiophores and conidia. The organism is ubiquitous in organic material, and infections are opportunistic and associated with heavy contamination with the organism or decreased host defenses, although obvious risk factors are not always identified. Because its ubiquitous, the organism is often recovered from tracheal aspirates performed using contaminated equipment in horses with mild signs suggestive of noninfectious respiratory disease, such as heaves. In this instance recovery of the organism is of no clinical importance.

## EPIDEMIOLOGY

Risk factors for development of aspergillosis include heavy environmental contamination with conidia and decreased host resistance, such as in horses with immune suppression associated with myeloproliferative disease (lymphoma), enterocolitis, or administration of immunosuppressive drugs such as corticosteroids. Specific risk factors for guttural pouch mycosis and infections of the nasal cavity or paranasal sinuses have not been identified, with the exception of an association between surgical resection of ethmoidal hematoma and subsequent nasal aspergillosis. Systemic or pulmonary aspergillosis is commonly associated with rumenitis, third-compartment ulceration in camelids,<sup>7</sup> enterocolitis, or administration of immunosuppressive drugs in adult horses. An outbreak pulmonary aspergillosis causing death of five albino Asinara donkey foals aged 20 to 30 days, but not of nonalbino herdmates, occurred without history of intercurrent disease or drug administration.<sup>6</sup>

## CLINICAL FINDINGS

*Aspergillus* spp. causes both localized and systemic disease in horses, cattle, camelids, and likely other species. Localized diseases include **guttural pouch mycosis**, which is discussed in detail elsewhere in this text. Fungal granulomas in the **paranasal sinuses** or **nasal passages** in any species of farm animal are caused by a number of organisms, including *Cryptococcus neoformans*, *Conidiobolus* spp., *Rhizomucor*

*pusillus*, *Scedosporium apiospermum*, and, rarely, *Aspergillus* spp.<sup>1-3,11-13</sup> The disease is evident as nasal discharge that is usually unilateral, distortion of the contour of the head over the affected sinus, and lesions detectable on endoscopic examination of the nasal passages. Radiography can reveal the presence of a mass in the paranasal sinuses or nasal cavity associated with lysis and proliferation of bone. There is hyperfibrinogenemia and leukocytosis.

**Systemic aspergillosis**, including aspergillus **pneumonia**, is a severe disease usually evident as acute death without localizing signs in animals with other preexisting systemic disease, such as enterocolitis, neonates with inadequate passive immunity, or those receiving immunosuppressive drugs.<sup>3,8,9</sup> Horses with aspergillus pneumonia often have a very brief clinical course once signs of respiratory disease develop. Most commonly, horses with pulmonary aspergillosis die without signs of respiratory disease. Signs of pulmonary aspergillosis include fever, tachypnea, crackles and wheezes on thoracic auscultation, epistaxis, and frothy nasal discharge. Radiography reveals diffuse, miliary, nodule interstitial pneumonia (Fig. 12-32). Ultrasonographic examination demonstrates numerous small intrapulmonary masses adjacent to the pleural surface. Affected horses have hyperfibrinogenemia and leukocytosis at the time of development of the disease, but usually they have had neutropenia as a result of the enterocolitis. *Aspergillus* spp. can be isolated from tracheal aspirates of affected horses. The prognosis is very poor.

*Aspergillus fumigatus* can cause solitary, cavitated lesions in the lungs of foals.<sup>5</sup>

**Disseminated aspergillosis** has a variety of manifestations but is always a severe disease with a brief clinical course. Affected horses often have severe depression and can have signs of brain disease as a result of mycotic vasculitis and encephalitis.<sup>5</sup> The prognosis is very poor.

*Aspergillus* spp. is also associated with development of granulomas in the **mediastinum** of horses without apparent predisposing factors. Affected horses have progressively worsening respiratory distress, cough, fever, and occasional nasal discharge. Horner's syndrome can develop if the mass encroaches on the vagosympathetic trunk within the thorax. The mass is evident on radiographic examination of the thorax. Cultures of tracheal aspirates yields *Aspergillus* spp. Affected horses have neutrophilia, hyperfibrinogenemia, hyperglobulinemia, and mild anemia.

**Keratomycosis** attributable to *Aspergillus* spp. infection is infrequent in horses. The disease is characterized by blepharospasm, photophobia, epiphora, and corneal ulceration and opacity. *Aspergillus* spp. infections of the reproductive tract include mycotic **placentitis** and abortion and mycotic

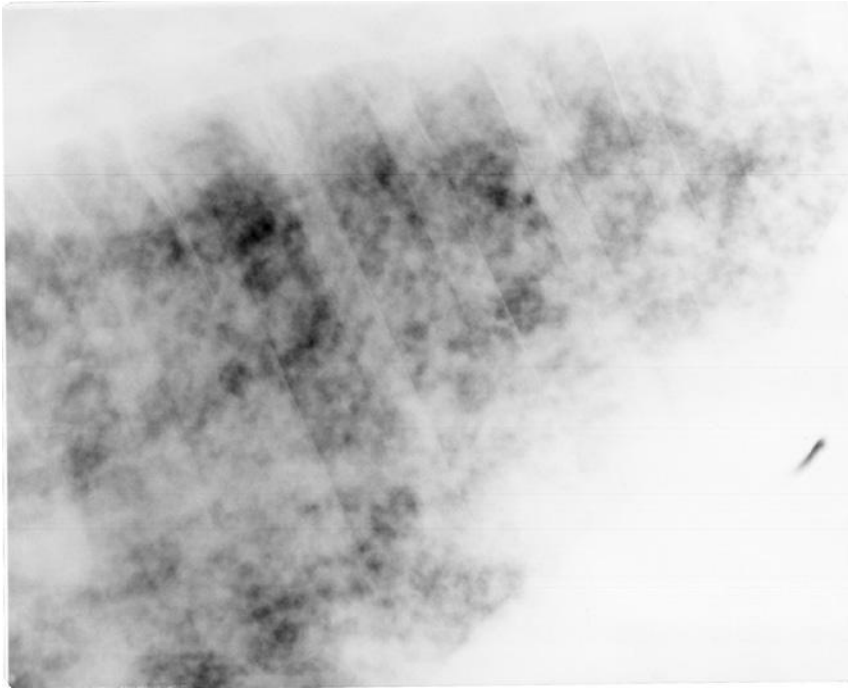

**Fig. 12-32** Radiograph of the caudal thorax of an adult horse with pulmonary aspergillosis secondary to acute enterocolitis. Note the military and interstitial densities.

**endometritis.**<sup>4</sup> Fungal osteomyelitis of the proximal sesamoid occurs in horses that have received intraarticular administration of corticosteroids.<sup>14</sup>

### CLINICAL PATHOLOGY

Definitive diagnosis of the disease is based on demonstration of organisms within lesions, either by histologic examination, culture, or use of PCR to demonstrate fungal DNA.<sup>2</sup> Antemortem demonstration of high concentrations of antibodies to *Aspergillus* spp. provides persuasive, but not definitive, evidence of infection. Both agar gel immunodiffusion assays and ELISA assays are available. These assays might not be useful in immunocompromised animals or in those with fulminant disease.

### NECROPSY FINDINGS

Acute lesions are characterized by purulent, necrotizing inflammation. Chronic lesions are granulomas that contain macrophages, neutrophils, and giant cells. Pulmonary lesions are characterized by an acute necrohemorrhagic alveolitis. Organisms morphologically consistent with *Aspergillus* spp. are detected in the lesions as fungal hyphae, although these must be differentiated from *Pseudoallescheria boydii* or *Fusarium* spp. Reagents for immunofluorescent detection of *Aspergillus* spp. in lesions are available and useful in confirming the diagnosis.

### TREATMENT AND CONTROL

**Treatment** of systemic or pulmonary disease is usually unrewarding, although surgical

resection of a single large cavitating lesion in the lungs of a foal followed by administration of voriconazole (10 mg/kg PO q24h for 2–4 weeks) effected a cure.<sup>8</sup> A dose of voriconazole of 4 mg/kg orally q24h produces concentrations of drug greater than 0.5 µg/mL in body fluids. This concentration is greater than the concentration of voriconazole required to inhibit growth of filamentous fungi.<sup>15</sup>

Localized disease can be treated by surgical resection and administration of antifungal agents. Antifungal agents reported to be effective in treatment of localized disease in horses associated with *Aspergillus* spp. include itraconazole (3 mg/kg q12h, PO for 3–5 months) or enilconazole (0.2%–2.0% solution administered topically via an indwelling intranasal catheter q12h for 2–5 weeks). The lesions were debulked before treatment with enilconazole was started.<sup>1</sup> Seven of eight horses with nasal aspergillosis treated in this way recovered.<sup>1</sup> Topical treatment with enilconazole (10 mg/mL of solution) after surgical resection resulted in resolution of aspergillosis of the frontal sinus of a horse. Topical administration of natamycin (25 mg) was used for varying periods of time to treat mycotic rhinitis in three horses.

Amphotericin is likely effective against *Aspergillus* spp. and is cheaper than the azole class of drugs, but it is potentially nephrotoxic and must be administered intravenously. Fluconazole is not effective against the filamentous fungi, including *Aspergillus* spp.



**Fig. 12-33** Granulomatous lesion caused by *R. seeberi* in a Belgian Warmblood horse. (Reproduced with permission.)

There are no specific control measures or means of preventing disease associated with *Aspergillus* spp.

### REFERENCES

1. Kendall A, et al. *J Vet Int Med.* 2008;22:1239.
2. do Carmo PMS, et al. *J Comp Pathol.* 2014;150:4.
3. Breuer W, et al. *Schw Arch Tierh.* 2015;157:407.
4. Moretti A, et al. *Large Anim Rev.* 2013;19:155.
5. Headley SA, et al. *Mycopathologia.* 2014;177:129.
6. Stefanetti V, et al. *J Equine Vet Sci.* 2015;35:76.
7. Hughes K, et al. *J Vet Diagn Invest.* 2008;20:672.
8. Hilton H, et al. *J Vet Int Med.* 2009;23:375.
9. Breshers MA, et al. *Vet Pathol.* 2007;44:215.
10. Lee SK, et al. *J Equine Vet Sci.* 2012;32:835.
11. Fiske-Jackson AR, et al. *Equine Vet Educ.* 2012;24:126.
12. Ubiali DG, et al. *J Comp Pathol.* 2013;149:137.
13. Tremaine WH, et al. *Equine Vet J.* 2001;33:274.
14. Sherman KM, et al. *JAVMA.* 2006;229:1607.
15. Passler NH, et al. *J Vet Pharmacol Ther.* 2010;33:35.

### RHINOSPORIDIOSIS

Rhinosporidiosis is a chronic disease of the nasal mucosa in cattle and nasal mucosa, pharynx, and larynx in horses that causes formation of large polyps or granulomatous lesions (Fig. 12-33).<sup>1,2</sup> The causative agent, *Rhinosporidium seeberi*, is an aquatic protist that typically causes disease in amphibians. Its exact taxonomy is the subject of debate.<sup>2,3</sup>

Exposure to the organism is almost universal, based on serologic studies, in buffalo, cats, cattle, dogs, goats, horses, and in some areas with high prevalence of the disease, humans (such as Sri Lanka).<sup>4,5</sup> The disease is not endemic in western Canada or the United Kingdom, and affected horses in those areas were imported from Argentina.<sup>2,6-8</sup> The disease is reported in a Warmblood horse in Belgium that had never left the country.<sup>1</sup> Other cases in horses are reported from the Costa Rica, the southern United States, South Africa, and South America.<sup>7,9</sup>

The disease is evident as single or multiple, pedunculated or sessile, pink to red masses in the mucous membranes of the

nose and nasopharynx. The lesions can bleed and become evident as epistaxis.<sup>7</sup> No uniformly effective treatment is described, and surgical removal in three horses with pharyngeal or laryngeal lesions was not associated with cure—the disease progressing slowly over many months.<sup>1,2,7</sup> Excision of a single mass in the rostral nares of a mule was curative.<sup>9</sup> There is no effective pharmacotherapy.

Confirmation of disease is achieved by examination of biopsy material demonstrating moderate multifocal hyperplasia and ulceration of the mucosa, mild to moderate, multifocal, lymphoplasmacellular inflammatory infiltrate multiple and spherical to polygonal organisms of variable appearance, consistent with *R. seeberi*, in the lamina propria mucosae.<sup>7</sup> PCR analysis of affected tissue reveals presence of *R. seeberi* DNA.<sup>2,7</sup>

A related condition in cattle also thought to be caused by an unidentified fungus, similar to *Rhinosporeidium* spp., is nasal granuloma, in which the lesions are small (0.5–2.0 cm diameter) mucosal nodules in the anterior third of the nasal cavity. Histologically, there is a marked eosinophilic reaction, and yeast-like bodies are present in cells or free in the tissue spaces. Clinical signs include severe dyspnea with loud stertor and a mucopurulent or blood-stained nasal discharge. A high incidence of the disease may occur on some farms and in particular areas.

Other diseases with similar clinical profiles include nasal obstruction associated with the blood fluke *Schistosoma nasalis* and chronic allergic rhinitis.<sup>1</sup>

## REFERENCES

- Nollet H, et al. *Zoonoses Public Health*. 2008;55:274.
- Burgess HJ, et al. *J Vet Diagn Invest*. 2012;24:777.
- Vilela R, et al. *Revista Iberoamericana De Micologia*. 2012;29:185.
- Sudasinghe T, et al. *Acta Trop*. 2011;120:72.
- Das S, et al. *Med Mycol*. 2011;49:311.
- Peaty M. *Vet Rec*. 2007;160:883.
- Leeming G, et al. *Emerg Infec Dis*. 2007;13:1377.
- Leeming G, et al. *Vet Rec*. 2007;160:552.
- Berrocal A, et al. *Can Vet J*. 2007;48:305.

## LUNGWORM IN HORSES

### SYNOPSIS

**Etiology** The nematode parasite *Dictyocaulus arnfieldi*.

**Epidemiology** Infection is by ingestion of larvae on herbage; donkeys and foals shed most larvae, but adult horses can perpetuate life cycle.

**Signs** Chronic cough in adult horses.

**Clinical pathology** Eggs or larvae in feces (but often absent in affected adults); eosinophils in tracheal mucus.

**Lesions** Discrete areas of hyperinflation in lung tissue.

**Diagnostic confirmation** Response to treatment if no eggs/larvae in feces.

**Treatment** Eprinomectin, ivermectin, fenbendazole (elevated dose); mebendazole over 5 days for donkeys.

**Control** Avoid grazing donkeys and horses on same pasture.

## ETIOLOGY

Lungworm disease in horses is associated with the nematode parasite *Dictyocaulus arnfieldi*.

## LIFE CYCLE

The life cycle of *D. arnfieldi* is direct and is almost identical to that of *D. viviparus*, except that the eggs do not hatch until shortly after they are passed in the feces.

## EPIDEMIOLOGY

Infestations with *D. arnfieldi* are recorded more commonly in donkeys than in horses, and the former are considered to be the more normal host. Patent infections may persist in donkeys throughout their lives but in horses are generally confined to foals. These animals therefore provide the most important sources of pasture contamination. Nevertheless, a small proportion of infected adult horses shed low numbers of eggs, and this may be sufficient to perpetuate the life cycle even in the absence of donkeys and foals. As with *D. viviparus*, larvae can cross field boundaries by fungal transfer.

## PATHOGENESIS

Adult worms are found in the smaller bronchi, which they almost completely block. In adult horses however, few larvae reaching the lungs develop to this stage. Bronchioles in affected areas are surrounded by dense infiltrations of inflammatory cells, the epithelium becomes hyperplastic, and excessive mucus is produced. The consequent interference with airflow leads to patches of hyperinflation in the lung tissue.

## CLINICAL FINDINGS

Lungworm disease in horses is characterized by a chronic cough. Experimental infections produce an afebrile condition with coughing, increased respiratory rates, and forced expiration being most intense during weeks 3 to 5 after infection. Thereafter the signs decrease in severity but coughing may persist for several months. Heavy infestations in donkeys do not cause clinical illness. Horse foals may also be symptomless, although some show clinical signs.

## CLINICAL PATHOLOGY

Characteristic eggs may be found in the feces of a small proportion of cases. Eosinophils and sometimes eggs or larvae may be demonstrated in tracheal mucus.

## NECROPSY FINDINGS

The most obvious lesions at necropsy are discrete patches of overinflation.

## DIAGNOSTIC CONFIRMATION

*D. arnfieldi* eggs in fresh feces are oval, are thin shelled, and contain a larva. Because the eggs may have hatched before arrival at the laboratory, it is usual to harvest larvae with the Baermann technique. The larvae resemble those of *D. viviparus*, but the tail ends in a small spine. Because many clinical cases are nonpatent and because tracheal mucus is difficult to sample, confirmation of diagnosis is often dependent on response to treatment.

## DIFFERENTIAL DIAGNOSIS

- Recurrent airway obstruction (heaves)
- Pulmonary abscessation and pneumonia
- Inflammatory airway disease

## TREATMENT

### TREATMENT

Eprinomectin (0.5 mg/kg, top.) (R2)  
Ivermectin (0.2 mg/kg SQ) (R2)  
Mebendazole (20 mg/kg, q1d for 5 days) (R3)

Eprinomectin, as a pour-on formulation (0.5 mg/kg), has 100% efficacy in eliminating fecal larvae in donkeys within 7 days after treatment.<sup>1</sup> Ivermectin at the standard equine dose is highly effective against immature and mature stages. For donkeys, mebendazole may be used at 15 to 20 mg/kg daily for 5 days, but this should not be attempted within the first 4 months of pregnancy.

## CONTROL

Donkeys and horses should not be grazed on the same pasture. If this is impossible, the former should be treated regularly for lungworm. If there is a problem in a closed herd of adult horses, individuals with patent infection can be identified by fecal screening and treated.

## REFERENCE

- Veneziano V, et al. *Vet J*. 2011;190:414.

## Diseases of the Swine Respiratory Tract

### PROGRESSIVE ATROPHIC RHINITIS (CONCHAL ATROPHY OF SWINE)

Atrophic rhinitis is a disease affecting primarily young pigs but causing anatomic lesions that may persist for life. The term *nonprogressive atrophic rhinitis* is used for the



slight to severe rhinitis and usually transient atrophy of the conchal bones (formerly called the turbinates) in which no toxigenic *P. multocida* are found, when there are no clinical signs and no obvious growth retardation. This mild form is probably as a result of infection with *Bordetella bronchiseptica* (BB) or nontoxigenic *P. multocida* (PM).

The term *progressive atrophic rhinitis* is proposed for the infection with toxigenic *P. multocida* (PM) (capsular serotype D and A strains) characterized by shortening or distortion of the snout, sneezing, nasal discharge, and epistaxis. Progressive atrophic rhinitis is often accompanied by reduced growth rates in severe cases.

The organism is a zoonosis,<sup>1</sup> but this is rarely from the pig,<sup>2</sup> although pig farmers often have PM in their nasal cavities.<sup>3</sup>

## SYNOPSIS

**Etiology** Toxigenic strains of *Bordetella bronchiseptica* and *Pasteurella multocida*

**Epidemiology** Young growing pigs. High percentage of pigs reared under intensive conditions may have some degree of atrophic rhinitis. Infection is widespread and transmitted by carrier sow to piglet. Housing and ventilation risk factors. Immunity develops in herd. Major economic importance because may affect growth rate and predispose to pneumonia.

**Signs** Initially sneezing when piglets 3 to 9 weeks of age. Nasal discharge. Deformity of face with nasal bones (twisted snout). Growth rate may be decreased.

**Clinical pathology** Culture organism from nasal swabs; polymerase chain reaction (PCR)

**Lesions** Varying degrees of severity of atrophic rhinitis.

**Diagnostic confirmation** Necropsy examinations of snouts.

Differential diagnosis list

- Inclusion-body rhinitis
- Necrotic rhinitis
- Inherited prognathia

**Treatment** Antimicrobials in early stages; nothing later.

**Control** Eliminating toxigenic strains of *P. multocida*. Depopulation and repopulation. Reduction of infection. Mass medication. Medicated early weaning. Vaccination.

## ETIOLOGY

Infection of the nasal cavities with BB followed by toxigenic strains of PM—primarily capsular type D and occasionally type A—results in progressive turbinate atrophy. PM has four subspecies (*multocida*, *septica*, *gallicida*, and *tigris*), but *multocida* is usually isolated from pigs<sup>4</sup>. There are five capsular serotypes (A-F) of PM. PM type A strains were formerly thought to be associated

entirely with lung infections but there is increasing evidence that some strains of PM type A are toxin producers and may be involved in atrophic rhinitis. Toxin production appears to be independent of serotype. The strains of PM isolated from the lungs are usually nontoxigenic and of capsular type A but a small proportion are toxigenic and are capsular type D. Serotype B is probably the most common one associated with septicemic pasteurellosis.

The majority of cases of progressive atrophic rhinitis were associated with toxA-containing capsular type D strains.

Somatic antigens reflecting differences in lipopolysaccharides have also been used, in addition to a variety of other techniques.<sup>5</sup> The poultry type of analysis<sup>6</sup> based on multilocus sequence typing will be adapted for use for the pig eventually. There may be a limited genetic heterogeneity in both the healthy pig strains and the PAR strains.<sup>7</sup>

## EPIDEMIOLOGY Occurrence

Atrophic rhinitis occurs worldwide where pigs are reared under intensive conditions. It has, however, become much less important with the onset of vaccination, improvement in resistance by pig breeding companies, and general attention to the environment in the farrowing house.

Some surveys have shown that 50% of finished pigs and sows at slaughter have lesions of atrophic rhinitis. The incidence of clinical disease varies from 5% to 30%, which in part depends on the method of detection of the gross lesions. Abattoir surveys of the snouts of slaughtered pigs indicate that the incidence of gross lesions ranges from 14% to 50%. However, the incidence of gross lesions in abattoir surveys is biased by the source of the pigs; the incidence may be low in pigs from herds that have attempted to control the disease and high in some commercial herds with no control program. In pigs slaughtered from pig testing stations the incidence of lesions may be uniform over a long period. The published data on the incidence of gross lesions are also variable because of the lack of a uniform method of evaluating and quantifying the lesions.

The incidence and severity of the lesions may vary with the season and the type of facility in which pigs are reared. In a slaughter survey of the snouts and lungs of pigs from 21 pig herds over one winter and one summer, the lesions of atrophic rhinitis were more severe among pigs slaughtered in the summer, whereas lesions of pneumonia were more severe among pigs slaughtered in the winter. Lesions of atrophic rhinitis were also more severe in pigs farrowed in central, enclosed farrowing houses and finished in enclosed, mechanically ventilated buildings than in pigs farrowed individually in sow huts and finished on dirt lots. It is possible that the incidence and severity of the lesions

at slaughter may be a reflection of the condition of the housing facilities when the animals were piglets several months previously, but many other factors could have been involved.

## Prevalence of Infection

*B. bronchiseptica* readily colonizes the ciliated mucosa of the respiratory tract of pigs and infection of the nasal cavities of pigs is present in almost every pig herd, with the prevalence of infection in pigs in commercial herds varying from 25% to 50%. Serologic surveys of individual herds have found that up to 90% of the pigs are positive, which indicates that there is no reliable correlation between the frequency of isolation of the organism and the percentage of animals with antibody. The prevalence of infection is just as high in specific-pathogen-free herds as in nonspecific-pathogen-free herds.

The prevalence of infection of toxigenic PM type D is higher in herds with clinical disease. The organism can be present in 50% to 80% of weaned pigs in a herd with clinical disease in the finishing pigs. Toxigenic type D PM was first detected in New South Wales, Australia, in 1986; in all herds examined, the introduction of pigs from an infected herd in South Australia was associated with an increased risk of infection. Toxigenic PM type D has been isolated rarely from herds free of atrophic rhinitis.

Whereas BB is eliminated from the respiratory tract of most infected pigs, leaving only a few infected at slaughter, PM often persists.

## Method of Transmission

Direct contact and droplet infection are presumed to be the most likely methods of transmission. The reservoir of infection is the infected sow, and litters of piglets become infected at an early age. Colonization of the tonsil by PM in conventionally reared pigs is common. In the Netherlands, it has been recognized that infection is usually by one of four possibilities. These are artificial insemination centers, laborers, neighborhood infection by direct aerosol or indirect local contact, and the presence of carrier animals and birds.

The infection is usually introduced into a herd by the purchase of infected pigs. Spread between piglets is probably enhanced after weaning when mixing of litters occurs, and 70% to 80% of a large weaned group may become infected. Infection persists for up to several weeks and months, followed by a gradual reduction in the intensity and rate of infection. In herds where BB is the initiating agent, up to 90% of pigs 4 to 10 weeks of age will have nasal infection, but this infection rate falls to approximately 15% by 12 months of age, and the proportion of carrier pigs within the breeding herd decreases with increasing age of sow. The

prevalence of infection is also much higher during the period from October to March than at other times of the year, and the prevalence of serologically positive animals is highest from July to December. This is most probably a result of the winter housing conditions, with few air changes per hour, fluctuating temperatures, and high humidity.

The epidemiology of toxigenic strains of PM as a causative agent of atrophic rhinitis is not as well understood. The organism colonizes the tonsils of clinically normal pigs. In contrast to BB, which is ubiquitous in pig herds, the toxigenic isolates of PM appear to be restricted to herds affected with progressive atrophic rhinitis. The organism is invariably present in herds with progressive atrophic rhinitis but may also be present in about 5% of the pigs in a herd with no clinical history of atrophic rhinitis. The main source of toxigenic isolates of PM for young pigs appears to be the pharyngeal tissues of the breeding stock. About 10% to 15% of sows in farrowing houses may be infected with toxigenic isolates, and piglets become infected within a week after birth. In contrast to BB, infection of piglets at 12 to 16 weeks of age with toxigenic PM will still result in varying degrees of severity of lesions.

It is possible for growing pigs to develop lesions of atrophic rhinitis well beyond the age of 3 weeks if they are exposed to pigs affected with disease and infected with PM and BB.

## Risk Factors

### Animal Risk Factors

The age at which piglets first become infected with BB has an important effect on the development of lesions. The most severe lesions occur in nonimmune animals infected during the first week of life. Animals infected at 4 weeks of age develop less severe lesions, whereas those infected at 10 weeks do not develop significant lesions.

### Immune Mechanisms

The level of immunity in the young pigs will influence the level of infection and the incidence of clinical disease. Colostral immunity from sows serologically positive to BB is transferred to piglets and provides protection for 2 to 5 weeks. Clinical disease does not occur in piglets with high levels of passive antibody. Older pigs from 10 to 12 weeks of age may become infected but are less likely to develop severe turbinate atrophy and may develop inapparent infection and become carriers.

Vaccination of the sow before parturition to increase colostrum immunity or vaccination of the young pig will increase the rate of clearance of the organism from the nasal cavity and reduce the incidence of clinical disease. In chronically affected herds a level of immunity develops with increasing age of the breeding herd.

## Pathogen Factors

The virulence characteristics of BB and the toxigenic isolates of PM are important risk factors. Both organisms are required to produce lesions similar to the naturally occurring progressive disease. The virulence of BB is dependent on the ability to produce heavy, persistent colonization in the nasal cavity and the production of a heat-labile toxin. *Bordetella* spp. produce several virulence factors and toxins, which are regulated by a two-component sensory transduction system encoded by the *bvg* locus. These virulence factors include adhesins such as filamentous agglutinin, pertactin, and fimbriae; the adenylate cyclase-hemolysin toxin; and the dermonecrotic toxin. In cell cultures the dermonecrotic toxin stimulates DNA and protein synthesis and assembly of actin stress fibers while inhibiting cell division, resulting in polynucleation of cells. It mediates these through the modification and activation of the small guanosine 5'-triphosphate (GTP)-binding protein Rho.

There are both toxigenic and nontoxigenic strains of BB. Colonization of the nose was greater with the dermonecrotic-toxin-positive strains than with the dermonecrotic-toxin-negative mutant strains. This was maintained for the first, second, and third weeks postinoculation, but by the fourth week the position had changed to the opposite. All dermonecrotic-toxin-positive pigs had pneumonia but the dermonecrotic-toxin-negative animals were able to colonize the lung more freely. There is an outer membrane protein P68 perlectin (BB perlectin gene [*prn*]), an adhesin, that may play a part in the protective immunity and may be extremely variable. The most important experiment is one that shows that PM mutant strains without the capacity to produce PM type D toxin did not produce turbinate atrophy. Only certain porcine phase 1 cultures possess both properties. However, even the most virulent of 10 isolates of BB did not cause progressive turbinate atrophy or significant snout deformation in experimental infections. The severe lesions of atrophic rhinitis cannot be attributed to this organism alone. Experimental inoculation of specific-pathogen-free or gnotobiotic pigs with the organism results in a nonprogressive moderately severe turbinate atrophy 2 to 4 weeks after infection, followed frequently by regeneration of the turbinates. These virulence characteristics of BB are consistent with the observations that in herds where the organism is common it can provoke sneezing and coughing but no evidence of clinical turbinate atrophy. Examination of the turbinates within 2 weeks after the sneezing will reveal some mild lesions, but no lesions will be evident when the pigs are examined at slaughter. It may be that the adhesins left over in the nasal cavity from an infection of BB are subsequently available for the attachment of other bacteria.

Toxigenic isolates of PM colonize the nasal cavities, elaborate several toxins, and produce progressive lesions of the turbinate bones and snout. Toxigenic PM can colonize the upper respiratory tract of pigs, and the presence of the capsule is a virulence factor. The presence of BB can enhance the colonization of PM, particularly the toxigenic type D strains isolated from pigs. The cytotoxin of BB is required for optimum growth by toxigenic PM; other products of phase 1 BB growth assist colonization by PM, and the degree of atrophy of the turbinates in these mixed infections is related to the numbers of toxigenic PM in the nasal cavity. Severe turbinate damage and shortening of the snout can be reproduced in specific-pathogen-free and gnotobiotic pigs by combined infection with BB and certain strains of PM. Following experimental infection both organisms may persist in the nasal cavities for up to 64 days. The cell envelope proteins and lipopolysaccharides of PM strains associated with atrophic rhinitis have been characterized and compared. At least three protein patterns and six lipopolysaccharide patterns can be distinguished, which can be used to predict the pathogenic character of some of the strains. This will obviate the need to use the guinea-pig skin test to distinguish those strains that are associated with atrophic rhinitis and those that are not.

The gene for the osteolytic toxin of PM has been cloned and expressed in *E. coli*; the protein expressed has been shown to have the same properties as the native toxin. The toxin is the main colonization factor produced by toxigenic strains of the organism and antitoxin made from the toxin is protective experimentally and cross-protective between toxins from different capsule types. The toxin can produce turbinate atrophy when injected intranasally and also when given intramuscularly, intraperitoneally, intravenously, or intradermally. Fingerprinting techniques have been used to show that outbreaks of atrophic rhinitis since 1985 in Australia have been associated primarily with a single strain of toxigenic type D PM.

## Environmental Factors

The effects of housing, population density, and adequacy of ventilation on the prevalence of infection of BB and toxigenic isolates of PM and on the incidence and severity of atrophic rhinitis have not been examined in detail. Atmospheric ammonia, dust, and microbial concentrations in the farrowing house and dust in weaner barns have a significant role in the severity of atrophic rhinitis. The mean daily gain of gilts with atrophic rhinitis exposed to ammonia may be smaller than that of those not affected. Undocumented field observations suggest that the disease is more common and severe when pigs are confined, overcrowded, and housed in poorly ventilated unsanitary

barns, all of which promote the spread of infection.

There is no effect of high levels of ammonia on the severity of turbinate atrophy. It has been shown that high levels of ammonia have no effect on the disease progression of atrophic rhinitis and pneumonia but do enhance the colonization of the nasal turbinates by toxigenic PM. A recent experiment has shown that higher numbers of PM bacteria were isolated from the tonsil than the nasal membranes per gram of tissue. Aerial pollutants contribute to the severity of lesions associated with atrophic rhinitis by facilitating colonization of the upper respiratory tract by PM.

Management factors such as confinement farrowing and the use of continual through-put farrowing houses and weaner houses are also considered to be important risk factors. Adverse climatic conditions (below thermoneutrality with drafty periods) can result in a lower amount of energy available for production because of increased maintenance requirements, which results in growth retardation associated with lowered feed intake.

### Economic Importance

Historically, it was accepted as dogma that atrophic rhinitis was an important cause of economic loss in pig herds because of decreased growth rate, less-than-optimal feed efficiency, and the fact that it was a major risk factor in enzootic swine pneumonia. A number of field studies have found an association between atrophic rhinitis and reduced growth rate in some herds, whereas other observations were unable to show an association between the presence of the disease and growth rate. The lack of a standard system for evaluation of conchal lesions may be a factor in the variable results between observations.

Some field studies have failed to show that the disease has an effect on growth rate in finishing pigs or that there is a cause and effect relationship between atrophic rhinitis and pneumonia. The presence of pneumonia in pigs from a test station reduced mean daily weight gains by 33% for each 10% of affected lung, but atrophic rhinitis did not affect daily gain and there was no association between the development of atrophic rhinitis and the development of pneumonia. Pigs vaccinated against BB had turbinate atrophy scores or mean daily gains no different from those of unvaccinated pigs. In another study there was a low positive correlation between the herd mean turbinate atrophy score and the herd mean percentage pneumonia score. A recent report from Illinois indicates that the prevalence of clinical atrophic rhinitis in farrow-to-finish herds ranged from 0% to 20%, and in pigs from those herds examined at the abattoir the incidence of turbinate lesions ranged from 5 to 92%. In some of the herds the mean daily weight gain was 15% to

18% higher than in herds where pigs had severe turbinate lesions. In an Australian report there was no correlation between the severity of atrophic rhinitis and growth rate or back-fat thickness.

In one study of three commercial pig herds, the snouts and lungs of individual pigs were examined and scored at slaughter, and the results were correlated with growth indicators for each pig (average daily gain during the growing and finishing phases, and days to reach market). Scores for lung lesions were also correlated to scores for snout lesions. Contrary to findings in many other studies, pigs that reached market weight at the youngest age did not have the lowest score for lung lesions, nor the lowest grade for snout lesions, nor the least extensive or severe lesions. It was concluded that lung lesions and grades for snout lesions in pigs at slaughter are not valid indicators for determining the economic effect of either pneumonia or atrophic rhinitis on growth performance of pigs.

### PATHOGENESIS

Following infection of the nasal cavity, BB becomes closely associated with the ciliated epithelium of the respiratory tract. It can bind to respiratory tract mucus. The organism produces a heat-labile toxin that results in a nonprogressive, moderately severe turbinate atrophy that is apparent within 2 to 4 weeks after infection, followed frequently by regeneration of the conchae. There is, initially, ciliary loss and ciliary stasis, followed by reduction in mucociliary clearance, followed by hyperplasia and metaplasia of the nasal epithelium, fibrosis in the lamina propria, and resorption and replacement fibrosis of the osseous core. Experimental infection with BB alone does not result in severe persistent conchal atrophy or twisting or shortening of the snout. The strains of BB that produce cytotoxin may predispose to the colonization of PM in the nasal cavities.

The preferred habitat of PM appears to be the tonsillar crypt, but following damage by BB, it can inhabit the epithelium of the URT.

Infection and colonization of the nasal cavities, particularly the mucus, with the toxigenic strains of PM results in the elaboration of a toxin that causes progressive conchal atrophy. The toxin is thermolabile and dermonecrotic and is called the dermonecrotic toxin of PM. It interferes with G-protein and Rho-dependent signaling pathways in the cells. It is encoded by the *toxA* gene. The inoculation of a toxin from a toxigenic strain of type D PM into the nasal cavities of gnotobiotic pigs results in severe bilateral atrophy of the conchae. Atrophy of the ventral conchae can be produced experimentally with pathogenic BB in piglets at 6 weeks of age and with toxigenic PM strains in piglets as old as 16 weeks of age.

The toxin enhances osteoclastic resorption and impairs osteoblastic synthesis of the

conchal osseous core; irreversible changes can occur within a few days. The toxin is a one chain toxin of 1285 amino acids, and different domains of the toxin are involved in cell uptake and intracellular activities. The toxin is able to subvert cell cycle progression and cell-cell signaling systems in osteoblasts and osteoclasts. The toxin is the sole agent responsible for the conchal atrophy, and the effect appears to be related to the total exposure to the toxin; that is, it is dose dependent. The toxin PMT activates various heterotrimeric G proteins, which causes the deamidation of the alpha-subunits of the G proteins.<sup>8-11</sup> More important, this also appears to have an immunomodulatory effect. There is an inverse relationship between the number of PM and the total concentration of immunoglobulin. This may in part be one of the reasons that local changes in the nose produce such adverse growth effects, and they may be a result of the fact that the PM type D toxin has in fact changed the immune functions and that the PM may have predisposed to many other agents. These authors' conclusion is that PM significantly suppresses the antigen-specific IgG immune responses of pigs to parenteral antigen challenge. The epithelium and the submucosa undergo secondary atrophy, and the conchae may disappear almost completely within 10 to 14 days. These lesions can persist until the animal is 90 kg in body weight. The conchal atrophy is not accompanied by an inflammatory reaction. The effect of the PM toxin is restricted to the nasal cavity; this is supported by the intriguing observation that the parenteral injection of the toxin into gnotobiotic piglets results in turbinate lesions and shortening and twisting of the snout. The parenteral injection of the dermonecrotic toxin of PM capsular type D into specific-pathogen-free adult pigs will result in moderate conchal atrophy. In piglets 7 days of age, the intramuscular injection of the purified dermonecrotic toxin will result in severe atrophy of the conchae. The culture filtrate of a nonatrophic-rhinitis pathogenic PM will not cause lesions after intramuscular injection. The disappearance of the conchae and the involvement of the bones of the face lead to deformity of the facial bones with the appearance of dishing and bulging of the face and, if the lesion is unilateral, to lateral deviation of the snout.

The effect on growth rate, if any, may be attributable to the chronic irritation and interference with prehension. Experimentally, atrophic rhinitis suppressed the health of pigs, reducing their activity and feed intake. Experimentally, parenteral injections of the toxin decrease physal area and reduce chondrocyte proliferation in long bones, in addition to conchal atrophy.

Reliable experimental models of atrophic rhinitis in gnotobiotic pigs are now available and are useful for studying the pathogenesis of the disease and testing vaccine strategies.



A sterile sonicate of a toxigenic strain of BB is instilled into the nasal cavities of piglets at 5 days of age followed by intranasal inoculation of toxigenic strains of PM at 7 days of age.

The toxin can also affect the liver and urinary tract and decrease the physal area in the long bones.

### CLINICAL FINDINGS

The clinical findings of atrophic rhinitis depend on the stage of the lesions. In acute cases in piglets 3 to 9 weeks of age, irritation of the nasal mucosa causes sneezing, some coughing, small amounts of serous or mucopurulent nasal discharge, and transient unilateral or bilateral epistaxis. The frequency of sneezing may be a measure of the incidence and severity of the disease. In piglets born from sows vaccinated with BB and PM vaccine before farrowing, followed by two vaccinations within 3 weeks of age, the frequency of sneezing at 3 to 9 weeks of age was much less than in piglets given only BB vaccine. There may be rubbing of the nose against objects or on the ground. A watery ocular discharge usually accompanies this and may result in the appearance of dried streaks of dirt below the medial canthus of the eyes. There may be a decrease in growth rate. In infection with BB these clinical signs will disappear spontaneously in a few weeks, when the pigs will appear normal. In severe cases, respiratory obstruction may increase to the point of dyspnea and cyanosis, and sucking pigs may have great difficulty in nursing. The nasal secretions become thicker and nasal bleeding may also occur.

In the more chronic stages, inspissated material may be expelled during paroxysms of sneezing. During this chronic stage, there is often pronounced deformity of the face as a result of arrested development of the bones, especially the conchae, and the accumulation of necrotic material in the nasal cavities. The nasal bones and premaxillae turn upward and interfere with approximation of the incisor and, to a lesser extent, the molar teeth. There are varying degrees of brachygnathia superior and protrusion of the lower incisor teeth. Prehension and mastication become difficult, with a resulting loss of body condition. Facial distortion in the final stages takes the form of severe "dishing" of the face with wrinkling of the overlying skin. If the condition is unilateral, the upper jaw may be twisted to one side. These visible facial deformities develop most commonly in pigs 8 to 10 weeks old within 3 to 4 weeks after infection, but they may occur in younger pigs.

The most serious effects of the advanced disease are depression of growth rate and unthriftiness. The appetite may be unaffected, but much feed is lost by spillage, and feed efficiency may be reduced in some instances.

## CLINICAL PATHOLOGY

### Culture and Detection of Bacteria

It is important to be able to detect infected animals in a herd, especially the carrier animal. Nasal swabs are used to detect the bacteria and to determine their drug sensitivity. The collection of the nasal swabs must be done carefully and requires a special transport medium to ensure a high recovery rate. A sampling technique and a special culture medium to facilitate the isolation and recognition of BB are described. The external nares are cleaned with alcohol, and a cotton-tipped flexible wire is pushed into the nasal cavity (of each side in turn) until it reaches a point midway between the nostril and the level of the medial canthus of the eye. On removal, the cotton tip is cut off into 0.5 mL of an ice-cold sterile transport medium comprising phosphate-buffered saline (PBS, pH 7.3) with fetal calf serum (5% v/v). The samples are then placed on special media, preferably within 4 hours. Normally the organism grows well on conventional culture media, especially when younger pigs are sampled. However, in the carrier pig the organism may be sparse, and the selective medium is recommended.

The nasal culturing procedure has been used as an aid in the control of atrophic rhinitis associated with BB. A series of three nasal swabs from each animal is considered to be about 77% efficient in detecting infected animals for possible culling and elimination from the herd. However, in some studies there may be no marked difference in the prevalence of BB or PM in pig herds with or without clinical atrophic rhinitis.

Toxigenic PM grow readily in the laboratory but are difficult to isolate from nasal swabs because they are frequently overgrown by commensal flora. Selective laboratory media containing antimicrobial agents have been developed to promote the isolation of PM from nasal swabs. Inoculation of cotton swabs to selective medium on the same day as the sampling provides the best isolation of toxigenic PM. Immersion of pigs at slaughter in the scalding tank can result in a marked reduction in the isolation of toxigenic PM.

A cell culture assay using embryonic bovine lung cell cultures is available and is a sensitive *in vitro* test for the differentiation of toxigenic from nontoxigenic isolates of PM. This test can replace the lethal tests in mice or the dermonecrotic tests in guinea pigs.

### Serology

Agglutination tests and an ELISA test are available for the detection of pigs infected with BB, especially carrier animals. Serology is of value in the assessment of the response of pigs vaccinated with the BB vaccines. There are currently no reliable serologic tests for *Pasteurella*.

### Antigen Detection

A PCR method originally described in 1996 for the enhanced detection of toxigenic PM directly from nasal swabs has been described and upgraded. This was shown to be 10 times more sensitive than PM type D toxin (PMT) ELISA and 5 times more sensitive than clinical bacteriology with subsequent use of PMT ELISA. A nested PCR has also been described. Similarly, a PCR method for the detection of BB has been described that produces 78% more positives than culture, particularly with swabs with a high mixed bacterial load. Recently a nested-PCR has been described that was reported to be more specific and sensitive than the other PCR methods previously described. It does not require culture, it is less laborious, and the results can be provided within 24 hours. The authors concluded that this test was suitable for breeding company evaluations and for eradication schemes.

### Radiography

Some aids to the clinical diagnosis have been examined but are not highly accurate. Radiography of the nose is not reliable in detecting the severity of conchal atrophy.

### NECROPSY FINDINGS

The typical lesions of atrophic rhinitis are restricted to the nasal cavities, although concurrent diseases, especially virus pneumonia of pigs, may produce lesions elsewhere. In the early stages there is acute inflammation, sometimes with the accumulation of pus, but in the later stages, there is evidence only of atrophy of the mucosa and decalcification and atrophy of the conchae and ethmoid bones, which may have completely disappeared in severe cases. The inflammatory and atrophic processes may extend to involve the facial sinuses. There is no evidence of interference with the vascular supply to the affected bones. The changes in the nasal cavities are most readily seen if the head is split in the sagittal plane but for accurate diagnosis the degree of conchal symmetry, volume, and atrophy and medial septum deviation should be assessed by inspection of a vertical cross-section of the skull made at the level of the second premolar tooth.

The clinical diagnosis is confirmed and the severity of the lesions is assessed by the postmortem examination of a cross-section of the snout. The snout must be sectioned at the level of the second premolar tooth because the size of the conchal bone reduces anteriorly and may give a false-positive result if the section is taken too far forward. Quantification of the severity of the lesions has been of value for monitoring the incidence and severity of the disease in a herd. Several systems have been used for grading the severity of lesions of the snout. Most of them have used a subjective visual scoring system in which snouts are grade 0 (complete normality) to 5 (complete conchal atrophy).

Reasonable agreement among observers recording morphologic changes of nasal conchae is achievable with some training.

The standards for each grade are as follows:

- **Grade 0:** No deviation from absolute normality, with nasal septum straight and conchae symmetric and filling nasal cavities.
- **Grade 1:** Slight irregularity, asymmetry, or distortion of the nasal structures without atrophy.
- **Grade 2:** Marked distortion of nasal structure but without marked atrophy.
- **Grade 3:** Definite atrophy of the conchae with or without distortion.
- **Grade 4:** More severe atrophy with severe atrophy of one or more conchae.
- **Grade 5:** Very severe atrophy in which all conchae have virtually disappeared.

Such a discontinuous grading system does not provide a direct quantitative relationship. Regular examination of the snouts from heads of pigs sent to slaughter can be used to assess the level of conchal atrophy in the herd. Morphometric methods, using either point counting or semiautomated planimetry applied to photographic or impression prints of sections of the snout to measure the extent of conchal atrophy on a continuous scale as a morphometric index, are now available. Cross-sections of the snout are photographed or used to make impression prints, which are then measured. A morphometric index is determined, which is the ratio of free space to total cross-sectional area of the nasal cavity. The system correlates well with the visual grading system of 0 to 5 but is labor-intensive and relatively expensive. The conchal perimeter ratio may be a more reliable morphometric measure of atrophic rhinitis and also provides parametric data suitable for quantitative analysis. A morphometric analysis using conchal area ratio is the best method for quantifying gross morphologic turbinate changes. Descriptions of the methods for making snout impressions are available. Computed tomography has been described.

A major limitation of the grading system is that conchal atrophy occurs as a continuous spectrum, and it is difficult to decide, for example, if a pig with a grade 3 lesion represents the more severe manifestation of BB infection, which may not progress further, or an early manifestation of infection with toxigenic PM, which could develop into a severe herd problem.

Histologically, the lesions vary according to the stage of the disease; initially there is a neutrophilic infiltrate followed by more chronic mononuclear cell infiltration. The conchal bones are eroded by osteoclasts, and new bone formation is reduced with degeneration dystrophy and reparative processes.

### Samples for Confirmation of Diagnosis

- Bacteriology—nasal swabs are not as good as tonsil swabs but are easier to obtain. The highest isolation rates are achieved with Knight medium or KPMD. Conventional biochemistry can then be used to identify.<sup>12</sup>
- Histology—formalin-fixed cross-section of snout at level of second premolar
- Antigen detection—nasal swabs. ELISAs based on the use of PMT-specific monoclonal AB are rapid, sensitive and specific. The *kmt1* gene has been used as a target for the loop-mediated isothermal amplification method.<sup>13</sup> Diagnostic tests have been reviewed.<sup>14</sup>

Computer tomography can be helpful.<sup>15</sup>

### DIFFERENTIAL DIAGNOSIS

The occurrence of sneezing in the early stages and of facial deformity in the later stages are characteristic of this disease. Diagnosis depends on clinical signs, pathology, and demonstration of PM and its toxin.

Inclusion-body rhinitis as a result of a cytomegalovirus is a common infection in young piglets in which there is sneezing and conjunctivitis. However, by itself it does not progress to produce turbinate atrophy and facial distortion. Under good hygienic conditions the course of the disease is about 2 weeks, and the economic effects are minimal. In the early acute stages, atrophic rhinitis may be mistaken for swine influenza, which, however, usually occurs as an outbreak affecting older pigs and accompanied by a severe systemic reaction without subsequent involvement of facial bones.

Necrotic rhinitis is manifested by external lesions affecting the face, and virus pneumonia of pigs is characterized by coughing rather than sneezing.

The inherited prognathic jaw of some breeds of pigs has been mistaken for the chronic stage of atrophic rhinitis; protrusion of the lower jaw is quite common in adult intensively housed pigs and has been attributed to behavioral problems of pushing the snout against fixed equipment such as bars and nipple drinkers.

### TREATMENT

Treatment early in the course of the disease will reduce the severity of its effects, but it is of little value in chronically affected pigs, and these pigs are best culled at an early age because of their persistent poor growth rate and high food conversion.

Tylosin at 20 mg/kg BW, oxytetracycline at 20 mg/kg BW, or trimethoprim-sulfadoxine (40 mg/200 mg/mL) at 0.1 mL/kg BW may be given parenterally, or the creep feed may be medicated with sulfamethazine and/

or tylosin at 200 and 100 mg/kg of feed respectively. Parenteral injections need to be repeated every 3 to 7 days for at least three injections, and feed medication should be given for 3 to 5 weeks. The problem with early creep medication is in obtaining adequate intakes of the antibacterial. This is seldom achieved before 2 weeks of age, and parenteral antibiotics may be required if significant infection occurs before this stage.

The parenteral administration of antimicrobial agents to individual piglets at 7-day intervals beginning at 3 days of age for a total of three to five injections per piglet has been recommended for the treatment and control of atrophic rhinitis. However, in a large herd such a treatment regimen would be a major task, and until a cost-benefit analysis indicates a beneficial effect over other methods, we cannot recommend such a practice.

The treatment of experimental BB infection in young pigs has been successful with the use of trimethoprim-sulfadiazine in the drinking water at levels of 13.3 and 77.6 µg/mL respectively, for 3 weeks. This method would remove the necessity to inject pigs repeatedly.

Tilmicosin has proved useful; fed continuously over 6 weeks at concentrations of 200 g per ton of feed, it controlled transmission of atrophic rhinitis, weight gains were positively affected, and fewer nasal swabs were positive for PM at the end of the study period. A resistance to some antibiotics has recently been reported.<sup>12,16</sup>

### CONTROL

Effective control depends on developing methods of eliminating or controlling the prevalence of toxigenic isolates of PM, which cause progressive atrophic rhinitis if they become established in the nasal cavity. Previous infection of the nasal cavity with BB may enhance the establishment of toxigenic PM and result in progressive atrophic rhinitis.

Although there is considerable information available on the ecology of BB and the methods by which it might be eliminated or controlled in a herd, there is little documented information available on methods that can be used for control of the toxigenic isolates of PM associated with atrophic rhinitis.

Control of atrophic rhinitis can be attempted in at least four ways:

- Total eradication
- Reduction of infection pressure
- Mass medication with antimicrobials to reduce the severity and adverse effects of infection
- Vaccination

Regardless of the method employed, any effective control program must have a system for monitoring the incidence of clinical disease in the herd and the incidence and severity of conchal lesions of the pigs sent to slaughter. Accurate and reliable methods for monitoring clinical disease are not available,

but the incidence of acute rhinitis and facial deformities could be recorded regularly. At slaughter, snouts can be examined for lesions of conchal atrophy and for assessing a mean snout score for each group of pigs slaughtered.

### Eradication

Total eradication can only be achieved with confidence by complete depopulation for a 4-week period and repopulation with primary or purchased specific-pathogen-free stock. This approach has the added advantage of also eliminating enzootic pneumonia, which may be a significant contributing factor to the economic importance of this disease. However, this method of control is extremely costly, and the economic importance of the disease would need to be carefully evaluated in relation to this cost before this method was instituted. Other techniques of obtaining pigs free of atrophic rhinitis, such as the isolated farrowing of older and presumed noncarrier sows with subsequent clinical and postmortem examinations of a proportion of the litters, have had a significant failure rate in the field and are not recommended. Eradication by repopulation with cesarean-derived stock may be essential in breeding nucleus herds where a high generation turnover results in a low herd sow age and a low herd level of immunity. The breakdown rate of herds established by this method can be significant, presumably because the initiating organisms are not solely confined to pigs.

A pilot control scheme was initiated in Britain in which a herd had to meet the following conditions:

- It must be inspected by a veterinarian every 6 months over a period of 2 years, over which time there must be no clinical evidence of atrophic rhinitis.
- The herd owner must certify that atrophic rhinitis has not been suspected over the same time period.
- Cross-sections of snouts taken from at least 30% of marketed pigs must be examined regularly by a veterinarian, and over a 2-year probationary period the average six-month snout score must not exceed 0.5.
- There must be no vaccination or treatment for atrophic rhinitis.
- New breeding stock can be introduced only from other qualified herds or herds derived by hysterectomy, artificial insemination, or embryo transfer techniques.

Over a 5-year period 45 herds qualified at some stage, and 34 were still qualified at the end of 5 years. As of 1988, some herds had exceeded the snout score limit of 0.5, with their average scores increasing to 2.24. In these herds, there was no clinical, epidemiological, or bacteriologic evidence that they

were at risk of developing severe atrophic rhinitis. It is suggested that the higher scores were associated with a group of recurrent husbandry factors, especially overstocking and unsatisfactory conditions in the weaner barns. These increased scores suggested the possibility that the upper limit for the snout scores in qualifying herds could be raised and allow bacteriologic testing to be confined to more doubtful herds.

Eradiation in the Netherlands was based on the fact that they thought that there were four main possibilities for the spread of toxigenic PM: artificial insemination centers, laborers, neighborhood infection either by aerosol or by local spread, and carrier animals or birds. They assumed that most herds were closed or buying certified stock and that the major source of infection was therefore the boar. In this study they tested boars; in herds with less than 50 boars they tested all, and in those with more than 50 they tested 50 as the minimum. They took nasal and tonsil samples, which were placed in cold transport medium and sent to the laboratory within 24 hours under cooled conditions for overnight culture followed by PCR.

### Reduction of Infection

Reduction of infection pressure can be attempted. Infection of piglets occurs primarily either from carrier sows or from other infected piglets in the immediate environment and severe atrophic rhinitis generally results from infection of piglets under 3 weeks of age. If these factors can be minimized, the incidence and severity of the disease can be reduced. An all-in, all-out pig flow is one of the most effective methods of control of atrophic rhinitis. Changing to an all-in, all-out pig flow from continuous flow management can improve snout scores by 50%, lung scores by 55%, average daily gain by 0.14 lb, and days to market by 13 days.

Because severe lesions depend on infection of the piglet under 3 weeks of age, every attempt should be made to minimize the severity of the challenge to young piglets. It is a common observation that the effects of atrophic rhinitis are minimal under good systems of management and adequate ventilation, nondusty conditions, and good hygiene. The use of continual-throughput farrowing houses and weaner houses allows a buildup of infection with the presence of actively infected pigs that can provide a high infection pressure on piglets born into or introduced into these areas. The use of all-in, all-out systems of management in these areas is recommended, and young piglets should be kept in a separate area from older pigs.

### Mass Medication

The prophylactic use of antimicrobials is frequently employed to reduce the incidence of the disease within the herd. Antimicrobials are used both within the breeding herd to

reduce the prevalence of carriers and in young suckling and weaner pigs to reduce the severity of the infection. The medication is begun about 2 weeks before farrowing, continued throughout lactation, and incorporated in the creep feed for the sucking pigs and the starter feeds for the weaned pigs. In this way there is continuous medication of the sow and the piglets during the most susceptible period. For the breeding herd, sulfamethazine at levels of 450 to 1000 mg/kg feed, with the higher levels being given to dry sows on restricted feeding, has been recommended. Sulfonamide resistance has proved a problem in some countries but beneficial results may still be achieved with these levels. It is recommended that medication be continued for a 4- to 6-week period. Carbadox at a level of 55 ppm in combination with sulfamethazine at 110 ppm is reported to be effective in clearing experimentally induced BB infection, and when used alone improved growth rate and feed efficiency in pigs with naturally occurring atrophic rhinitis. In the starter period, carbadox fed alone or in combination with sulfamethazine improved average daily gain in piglets from herds with naturally occurring atrophic rhinitis. Use of the medication, however, did not result in a reduction of mean nasal lesion scores as a result of atrophic rhinitis. Sulfamethazine at 110 mg/kg of feed is more effective than sulfathiazole at the same concentration for the control of experimentally induced atrophic rhinitis attributable to BB. Sulfamethazine may also be incorporated in creep rations, and the use of tetracyclines (200 mg/kg), tylosin (50-100 mg/kg), and penicillin (200 mg/kg) has also been suggested.

Medicated early weaning is recommended to obtain pigs free from pathogens, including BB that are endemic in the herd of origin. The sows are fed medicated feed from 5 days before to 5 days after weaning, and the piglets are dosed from birth to 10 days of age.

### Vaccination

There has been considerable interest in the development of vaccines for the control and prevention of atrophic rhinitis attributable to BB. Inactivated vaccines have been used to vaccinate the pregnant sow 4 to 6 weeks before farrowing; in some cases, this is followed by vaccination of the piglets at 7 and 28 days of age. In general, the use of the vaccine in pregnant sows in herds where the disease has been endemic has reduced the incidence of clinical atrophic rhinitis. However, the results from one study to another have been highly variable. Vaccination of the pregnant sow results in an increase in colostral antibody titer, which does improve the clearance rate of BB in the piglets. However, it has been difficult to evaluate the efficacy of the BB used alone because the conchal atrophy associated with infection of piglets with BB experimentally or naturally heals and regenerates completely



when they are reared to about 70 to 90 kg BW in good housing conditions.

Vaccination with both components (BB and PM) in a vaccine reduces lesions considerably compared with a placebo and a group with only PM type D toxin in the vaccine, but neither vaccine eliminated toxigenic PM from the upper respiratory tract.

Experimentally, piglets born from sows vaccinated with PM are protected from a challenge with atrophic rhinitis toxin. This indicates that artificial immunization for atrophic rhinitis should be possible. Vaccination of sows at least three times before farrowing for the first time and during each subsequent pregnancy with a vaccine containing BB and PM was highly successful in reducing the incidence of atrophic rhinitis in the pigs. The incidence in affected herds was reduced from 7.5% to about 2%. Experimentally, the vaccine provides good protection against challenge in piglets from vaccinated sows.

A recombinant PM toxin derivative vaccine given to gilts 4 to 5 weeks before farrowing and again 2 to 3 weeks later provided excellent protection in their piglets against experimental challenge with BB and toxigenic PM. This indicates the excellent immunoprotective properties of the nontoxic derivative of the PM toxin. In five field trials, a single-component vaccine containing a nontoxic but highly immunogenic protein, as the antigen, provided much better protection than the control vaccine containing killed PM and killed BB.

Experimental infection and vaccination of pregnant minimum-disease sows with BB resulted in much higher agglutinins in serum and colostrum than in sows only vaccinated or control animals, and the piglets were provided with protection against experimental disease. Vaccination of pregnant gilts with purified inactivated PM toxin resulted in a high degree of protection of their progeny against progressive atrophic rhinitis.

A new vaccine has been described using a truncated PM type D toxin that is immunogenic and nontoxic, a toxoid for BB, and an adjuvant. Sows were vaccinated at 8 to 6 weeks and 4 to 2 weeks before farrowing. The vaccinated animals had fewer organisms.

### FURTHER READING

Horiguchi Y. Swine atrophic rhinitis caused by *Pasteurella multocida* and *Bordetella dermonecrotica* toxin. *Curr Top Microbiol Immunol*. 2012;36:1113-1129.

### REFERENCES

1. Wilkie W, et al. *Curr Top Microbiol Immunol*. 2012;36:1.
2. Migliore E, et al. *Adv Med Sci*. 2009;54:109.
3. Marois C, et al. *J Appl Microbiol*. 2009;107:1830.
4. Varga Z, et al. *Acta Vet Hung*. 2007;55:425.
5. Dziva E, et al. *Vet Microbiol*. 2008;128:1.
6. Subaaharan S. *Vet Microbiol*. 2010;141:354.
7. Bethe A, et al. *Vet Microbiol*. 2009;139:97.
8. Orth JH. *Proc Natl Acad Sci United States*. 2009;106:7179.
9. Orth JH. *Curr Top Microbiol Immunol*. 2012;361:73.
10. Orth JH, et al. *FASEB J*. 2013;27:832.
11. Bergmann S, et al. *Infect Immun*. 2013;81:2459.
12. Lizarazo YA, et al. *Am J Vet Res*. 2006;67:663.
13. Sun D, et al. *Vet Res Comm*. 2010;34:649.
14. Stepniewska K, Markowska-Daniel I. *Bull Vet Inst Pulawy*. 2012;56:483.
15. Jablonski A, et al. *Vet Rec*. 2011;168:329.
16. Tang X, et al. *J Clin Microbiol*. 2009;47:951.

### FACIAL NECROSIS (FACIAL PYEMIA)

Facial necrosis (facial pyemia) was formerly called necrotic rhinitis or bullnose or paranasal abscessation and is often confused with atrophic rhinitis (AR). It occurs in growing pigs usually before 1 week of age and may occur in herds where AR is present and even in the same pig, but there appears to be no relationship between the two diseases. The diseases differ by the presence of oral and facial lesions. Necrotic ulcer in pigs may involve the mouth and face, but the lesions are erosive rather than necrotic.

There are a variety of other conditions of the face of the young pig that can be confused. The common occurrence of *Fusobacterium necrophorum* in the lesions suggests that any injury to the face or nasal or oral cavities may lead to bacterial invasion, especially if the environment is dirty and heavily contaminated. The disease is now rarer following a general improvement in hygiene in piggeries but possibly also as a result of the declining occurrence of AR following vaccination and eradication of *P. multocida* toxigenic type D and much greater care in teeth clipping of the young pig. It is also associated with fighting in piglets trying to reach a teat, especially when milk is in short supply.

The lesions develop as a necrotic cellulitis of the soft tissues of the nose and face but may spread to involve bone and produce osteomyelitis. Local swelling is obvious, and extensive lesions may interfere with respiration and mastication. The lesions may be ulcerated, crusty, and extensive. Depression of food intake and toxemia may result and poor growth, and some deaths result. Treatment by the local application of debridement, disinfection with substances such as chlorhexidine or iodophors and the use of antibiotic creams and parenteral antibacterial drugs, and the oral administration of sulphonamides is satisfactory in early cases. Oral dosing with sulphadimidine has been effective in young pigs. Improvement of sanitation, elimination of injuries, and disinfection of pens usually result in a reduction of incidence, and cross-fostering will reduce competition and fighting.

### FURTHER READING

Done JT. Facial deformities of the pig. *Vet Ann*. 1977;17:96.

### BORDETELLE RHINITIS

*Bordetella bronchiseptica* (BB) is capable of causing two major disorders on its own. The first is *Bordetella* rhinitis, and the second *Bordetella* bronchitis. It is also capable of infecting man but the contribution of pig strains to human disease is unknown.

### ETIOLOGY

It is a small, aerobic, gram-negative bacterium that produces a beta hemolytic 1- to 2-mm gray colony on some nutrient blood agars but is nonhemolytic on some enriched media. On MacConkey media it produces nonlactose fermenting colonies in 48 hours. Nearly all the strains express one of two antigenically distinct O-antigen serotypes (O1/O2) that are not cross-reactive.<sup>1</sup> Variation in virulence can result from strain variation<sup>2,3</sup> and may be related to different phylogenetic lineages.<sup>4</sup>

### EPIDEMIOLOGY

The bacterium is often isolated from healthy animals.<sup>5</sup> Carrier animals usually introduce it to a herd. Strains from other animals (dogs, rodents, etc.) are not so likely to colonize the pig because only a few strains occur in the pig, and these tend to be different from other species. Spread is by aerosol from sneezing and through direct and indirect contact.

Infection usually occurs early in life and what happens then depends usually on the state of immunity. Maternal antibody usually lasts long enough to cover the establishment of infection and prevents pathology but does not lead to removal of the agent.

Cross-fostering; multiple ages in the same house; multisourcing to a nursery or finishing house; poor ventilation and environmental control and, in particular, lack of an all-in, all-out policy followed by effective cleaning, disinfection, and drying policy are conducive to the spread of the condition.

### PATHOGENESIS

*Bordetella* is a complicated organism with several virulence factors. It exists in four colony phases. Expression of the virulence genes requires cooperation of the BvgAS (virulence genes system).<sup>6</sup>

Phase I colonies contain fully virulent organisms (Bvg +) expressing genes for flagellae (*fla*), the mannose-resistant filamentous hemagglutinin,<sup>7,8</sup> and the outer membrane protein pertactin (PN), all of which are involved in adhesion. Other factors include a hemolysin that is adenylate cyclase, a cytotoxin, an osteocytic toxin, and the dermonecrotic toxin (*dnt*). The adenylate cyclase may modulate cytokine production in dendritic cells and alter immunomodulatory function.<sup>9</sup> The tracheal cytotoxin is likely to act on the cilia and cause ciliostasis. The Bvg + organisms also possess the *bfrZ* gene for the exogenous ferric siderophore receptor, which

is essential because BB has huge requirements for iron.

Phases II and III do not have all these. Reversion to phase I only takes place *in vivo*. The organisms also differ between strains in the presence of genes for flagellae and fimbriae. The organisms colonize the cilia of the URT and then proliferate, and then the cilia are lost as the organisms increase further in number. Pertactin may be required for this.<sup>9</sup> Toxic substances then diffuse from the BB into the epithelium and below and damage the osteoblasts. Mild turbinate atrophy may then begin but usually resolves by about 70 days postinfection.

In the lung, BB causes a pneumonia similar to *Mycoplasma hyopneumoniae* (EP), and the organism lives in large numbers in the main bronchi (formerly called bronchitis X), where it may cause a mucopurulent tracheitis and bronchitis.

The organism also enhances the ability of other organisms to colonize the respiratory tract, notably *P. multocida*,<sup>10</sup> *S. suis*, and *H. parasuis*. In turn, PRRSV predisposes to infection with BB. Coinfection of BB with PRCV and SIV leads to a longer outbreak of more severe pneumonia.<sup>11</sup>

## CLINICAL SIGNS

Clinical signs may be severe in newly established herds, rapidly expanding herds, or in herds with poor immunity or where there are immunosuppressive disorders.

Normally, outbreaks of sneezing will occur in baby pigs. It may be paroxysmal or be accompanied by epistaxis. There may be tear staining. The signs of progressive atrophic rhinitis are rarely seen with just BB infection.

In the pneumonic form there may be fever to 40°C (104°F), anorexia and loss of condition, and possibly a high mortality. It may cause a reduction in growth rate that may reach 20% to 30%. Coinfection with other agents contributes to an increased severity of signs, and respiratory viruses may favor the colonization by BB.<sup>12</sup>

## PATHOLOGY

In an uncomplicated infection there is a mild catarrhal rhinitis. There may be some degree of conchal (turbinate) atrophy with deviation of the nasal septum, and excess mucus production.

In the lung infection there may be consolidation of cranial and middle lobes of the lung. Histologically, the nasal epithelium is infiltrated with inflammatory cells, it sometimes shows mucous metaplasia, and there may be fibrosis that is almost pathognomonic for BB infection. In the lung there may be a catarrhal exudate with neutrophilic infiltration.

## DIAGNOSIS

In early cases, severe sneezing and tear staining will be a good indication. Sneezing is

the method of clearing the nasal cavity of irritation (infection, noxious gases such as ammonia or heavy burdens of dust) and is the clinical sign indicating the nasal cavity is stressed. In early cases of bronchial infection there may be a cough, which indicates that the trachea, main-stem bronchi, and the major part of the bronchial tree are clogged with exudate that needs to be physically removed because the normal mucociliary clearance mechanism is overcome.

In early infections BB can be isolated from the whole of the respiratory tract, but in chronic or recovered cases it may only be isolated from the nasal cavity (ethmoturbinate in particular). Nasal swabs using cotton tips can be collected, placed in transport media, and cultured on special media.

At postmortem the BB can be grown on blood agar plates with 48 hours of incubation.

PCR tests based on the dermonecrotic toxin have been used successfully<sup>13</sup> and in multiplex PCRs with *P. multocida*.

Antibody tests (agglutination and ELISAs) can also be used to assess the herd status.

## IMMUNITY

There is an IgM immunity to the hemagglutinin within 7 days and IgG appears 4 to 5 weeks later. This immunity usually prevents turbinate atrophy and pneumonic damage. It is necessary for a good IgA response to clear the URT of infection,<sup>14</sup> but vaccine protection is not as good as natural infection protection.<sup>15</sup>

## TREATMENT

Parenteral treatment with almost all antibiotics is possible for severe acute case because *in vitro* sensitivity to most antibiotics is high. Only after this should treatment via water and food should be considered. BB are, however, largely resistant to Ceftiofur, and there is evidence that they are becoming more resistant to trimethoprim-sulphonamide combinations

## CONTROL

Medication can be used to control the onset of the problem.

Threatened pigs in a single airspace should all be given antibiotics in the feed after weaning (trimethoprim/sulphonamides at 30 mg/kg daily) or tetracyclines.

Strategic medication using the same antibiotics, given parenterally, at 3, 10, and 21 days of age will also reduce the clinical signs.

Medicated early weaning techniques and long-term treatment in the water for 28 days have also been used to eradicate the agent.

Vaccination using formalin killed alum adjuvanted vaccines usually combined with *P. multocida* toxoid have been successfully

used for a long time.<sup>16</sup> They can be given to sows 6 and 2 weeks before farrowing to stimulate maternal antibody and to piglets at 7 and 28 days of age, but in this case they may be negated by maternal antibodies.

All-in, all-out management, with good ventilation reduces the level of infection. Purchasing clean stock with a period of isolation and quarantine will also remove the infection, as will treating incoming stock. It is sensitive to several on-farm disinfectants.<sup>17</sup>

## REFERENCES

1. Buboltz AM, et al. *Infect Immun*. 2009;77:3249.
2. Buboltz AM, et al. *J Bacteriol*. 2008;190:5502.
3. Buboltz AM, et al. *Infect Immun*. 2009;77:3969.
4. Cummings CA, et al. *J Bacteriol*. 2006;188:1775.
5. Palzer A, et al. *Vet Rec*. 2008;162:267.
6. Beier D, Gross R. *Adv Exp Med Biol*. 2008;631:149.
7. Irie Y, Yuk MH. *FEMS Microbiol Lett*. 2007;275:191.
8. Nicholson TL, et al. *Infect Immun*. 2009;77:2136.
9. Vojtova J, et al. *Curr Opin Microbiol*. 2006;9:69.
10. Brockmeier SI, Register KB. *Vet Microbiol*. 2007;125:284.
11. Brockmeier SI, et al. *Vet Microbiol*. 2008;128:36.
12. Loving CL, et al. *Microb Pathog*. 2010;49:237.
13. Register KB, De Jong KD. *Vet Microbiol*. 2006;117:201.
14. Wolfe DN, et al. *Infect Immun*. 2007;75:4416.
15. Gopinathan I, et al. *Microbes Infect*. 2007;9:442.
16. Hsuan SI, et al. *Vaccine*. 2009;27:2923.
17. Thomson JR, et al. *Pig J*. 2007;60:15.

## PLEUROPNEUMONIA OF PIGS ASSOCIATED WITH *ACTINOBACILLUS PLEUROPNEUMONIAE*

### ETIOLOGY

*Actinobacillus pleuropneumoniae* (APP), formerly known as *Haemophilus pleuropneumoniae*, is the causative organism of pleuropneumonia in pigs. Some strains require V factor (NAD) for growth (biotype I), but some strains do not require this factor (type II). It forms small translucent mucoid beta-hemolytic colonies around staphylococcal streaks on sheep blood agar. It is a small gram-negative, encapsulated rod. The organism causes severe, rapidly fatal fibrohemorrhagic and necrotizing pleuropneumonia. The survivors often have bacteria-laden sequestra in the lungs that are poorly penetrated by antibiotics but do act as sources of the organism for later outbreaks. It does not affect humans and has no public health significance.

Recently a completely nonpathogenic species, *A. porcitonisillarum*, has been identified.

### EPIDEMIOLOGY Occurrence

It is widely distributed worldwide. The primary reservoir is domesticated pigs, but wild boar are also affected.<sup>1</sup>

The only natural host is the pig but it has been isolated from cattle, deer, lambs, and

some rodents can be infected experimentally. It is probably not carried by birds and rodents. The diversity of strains isolated from healthy pigs could be higher than that of strains recovered from diseased pigs.

It appears that few pigs are infected from their sows, and then the organism spreads after weaning as the maternal antibodies disappear. The disease occurs worldwide in growing pigs from 2 to 6 months of age, with rapid spread both within the initially affected group and subsequently to other older or younger pigs in a herd. There are probably large numbers in the nose of affected animals. Abattoir surveys have found that the lungs of pigs from about 50% of herds monitored for several months may have lesions attributable to APP. This chronic pleurisy is presumably associated with APP.<sup>2,3</sup> Sero-epidemiologic surveys have found that pigs in 70% of herds may have antibodies to one or more of several recognized serotypes of the organism. The prevalence of infection continues to increase—presumably as a result of confinement rearing, crowding, inadequate ventilation, close contact, and commingling of pigs of various age groups. The incidence of clinical disease is much less than the prevalence of infection. In most countries, the more dense the pig population, the more prevalent the APP is likely to be, and this has been documented in Belgium. In the United States it may not be as important as in Eurasia, and it was not reported to be of major importance at the Iowa clinic.<sup>4</sup> In Europe, it may have become more common in recent years.

Most herds have one or more types but these are usually avirulent. In some countries there may have been a shift from virulent to avirulent serotypes. In Canada, over 75% of the pigs were positive for APP in the upper respiratory tract.<sup>5</sup> There is a relative homogeneity within a particular serotype.<sup>6</sup>

A strain may be virulent in one country but not in another depending on the genetic makeup determining the presence of virulence factors.

### Morbidity and Case Fatality

The morbidity rate can exceed 50%, and the mortality may vary from 1% to 10%.

### Methods of Transmission

Transmission is usually by pig to pig contact or more correctly nose-to-nose contact. Aerosol droplets only carry over short distances before they are precipitated. In Denmark it was suggested that the paramount factor in the spread of APP was the aerosol spread from infected neighbors.<sup>7</sup> In this study, the trading of subclinically infected animals, the frequency of stock purchases, the use of multiple sources, and poor biosecurity were factors associated with the spread of APP in the Danish SPF herds. Most of the herds use AI and bring in pigs in sterile containers. The organism can be spread in the air for a distance of 1 m. Aerosol

transmission of APP9 was possible over 2.5 m. An experiment with transferring air from a group of pigs with serotype 2 showed that if 10% of the air was transferred, then there was no transmission, but if 70% was transferred, then the APP did spread. Experimental aerosol exposure of pigs to serotype 9 results in infection and induces protection to subsequent challenge from the homologous strain.

Only a few organisms need to be carried in the tonsil and nasopharynx for a pig to become infectious during travel. Pigs may carry the APP in the nose, and the carriage occurs for both low- and high-virulence strains. The carrier state can be activated by stress or other pathogens. The subclinically infected carrier pig is the most common source of infection. It has been suggested that shedding only takes place at the time of active infection, not when the organism is just carried.

Transmission is by the respiratory route, principally via nose-to-nose contact. Overcrowding and inadequate ventilation may facilitate spread. Peak transmission may occur at around 11 weeks. Experimental intranasal challenge has been followed by death in a period as short as 24 hours. The mixing of infected pigs (seeder pigs) with normal susceptible pigs for 48 hours can mimic field infection, with the development of clinical disease, febrile responses, lung lesions, and mortality.

The subclinically infected carrier pig is the most common means by which the infection is transmitted between herds. Severe outbreaks may occur unexpectedly in susceptible breeding herds with no previous history of the disease or in intensive feeder pig operations in which pigs are introduced on a regular basis from a variety of sources. Herds that continuously introduce replacement stock are highly susceptible to an outbreak. Following the initial outbreak, general herd immunity develops, but the infection persists, and sporadic cases may continue to occur. The organism is not readily isolated from normal respiratory tissues, but persists in chronic lesions within the lungs of recovered and apparently clinically healthy pigs. These pigs provide a source of infection, especially in a finishing herd buying from diverse sources. The indirect transmission of infection has been proposed but may be rare. An on-farm study described five cases of being transmitted by aerosol or boots or clothes, but the other three cases could have been any combination of these three or even other indirect sources.

### Risk Factors

#### Pathogen Factors

##### *Biotypes*

There are two biotypes. Biotype 1 requires NAD (NAD dependent) (13 serotypes), and biotype 2 does not (NAD independent; 2 serotypes). Biotype I should be differentiated

from other *Actinobacillus* species. The isolation of biotype 2 may be increasing. It easily grows on blood agar plates, as does *A. suis* (see later discussion), which may also under some circumstances produce pleuropneumonia.<sup>5</sup> In addition, atypical biotype II strains belonging to APP serotypes 2, 4, 7, 9, and 11 have also been identified.<sup>8</sup> In Canada, two biotype I APP13 strains have been found (should be biotype II).<sup>9</sup>

### Serotypes

In 1997, two new serotypes were proposed: APP14 and APP15. Serotypes APP1 to APP12 form biotype 1 together with APP15. Biotype 2 is composed of APP13 and 14. Within these categories there are variations because strains may acquire characteristics of other strains. Some of the serotypes are heterogeneous (they share antigenic determinants with other serotypes). Heterogeneity has been reported for APP3, 6, and 8; APP4 and 7; and APP1, 9, and 11. Restriction endonuclease fingerprinting analysis can be used for comparison of serotypes.

Serotype 5 is subdivided into subtypes A and B. Serotype 1 has also been divided into antigenic subtypes 1A and 1B. The prevalence of serotypes of APP varies considerably according to geographic location. APP1, 5, and 7 are common in North America; APP2 and 9 are common in continental Europe; and APP3 is common in England and Ireland. APP8 is also found in Ireland. In the British Isles, APP2 and 8 were most common, with 3, 6, and 7 also occurring frequently. APP5, 9, 10, and 12 occurred only rarely. APP1 and 4 were not isolated.

In Denmark they routinely find 9 strains of the 15. It is usually APP2 followed by 6, 5, and 12. APP1, 7, 8, and 14 are infrequent, and APP3, 4, 9, 11, 13, and 15 have not yet been found. APP2 is the dominant isolate in Sweden and Switzerland. APP 10 is common in France (also Brazil). APP4 is common in Spain as APP7 and many are nontypeable, but APP4 rarely appears elsewhere.<sup>8</sup> And in Spain, biotype II is also quite common.

APP1, 7, and 12 are common in Australian pigs, with APP1 being the most common, and APP 15 is also found there and in Japan.<sup>10</sup>

In North America, the most common serotypes, in order of frequency, are APP1, 5, and 7. APP1 is most common in eastern Canada, accounting for 66% to 83% of the isolates, and is the second most prevalent isolate in western Canada and the United States. APP2 is of low frequency in Canada. However, serotype 2 has now been reported as causing disease in growing and finishing pigs in the United States. Serotype 3 has a low incidence in Canada and the United States. Serotype 5 isolations are common in Canada and the United States. The most common serotypes isolated in Quebec were 1, 5, 2, and 7 in that order. Serotype 6 has not been reported in North America.



The serotyping of isolated strains is important in the epidemiologic and immunologic study of APP infection. It is also important when comparing or analyzing the effectiveness of different treatments to know the virulence of the strains and sensitivity to antimicrobials. An effective immunization program also depends on consideration of the multiplicity of immunogenic types that occur in a particular area or country.

It is important to realize that some strains share lipopolysaccharide O-chains and may therefore cross-react. The antigenic cross-reactions between APP3, 8, and 15 can also be explained by the presence of structural similarities.<sup>11</sup>

In one study it was suggested that the presence of APP9 may go clinically unnoticed as *M. hyopneumoniae* as this potentiates the APP infection.<sup>12</sup>

### Virulence Factors

APP attaches to tonsillar epithelium. It also adheres to tracheal rings in vitro and alveolar epithelial cells. Genes that are involved in energy metabolism, nutrient uptake, and stress response are essential for the survival of APP in the pig host. These would include enzymes that are produced in vivo to ensure that there is oxygen. A metalloprotease has been found that can degrade porcine IgA and IgG.

Several other virulence attributes and their biological effects have been described. Multiple virulence factors are involved in the development of the disease, and lesions are likely caused by toxic factors associated with the organism.

The capsular components are antiphagocytic and inhibit bactericidal activity of the serum but do not cause any lesions themselves. Discovery of mutants without capsules that were no less able to adhere to respiratory tract tissues suggests that the outer membrane proteins were then unmasked (without the capsule), and these were able to adhere to epithelial cells. It is therefore an LPS independent adherence. The outer membrane proteins (OMPs) (60 kDa) adhere to fibers of type III collagen in the lung. The outer membrane proteins appear to be common to all serotypes. Some of the outer membrane proteins are also involved in iron uptake, which is essential for proliferation.

The lipopolysaccharides (LPS) of APP are serotype specific but will cross-react with one another. LPS of APP is an important adhesin. It also induces inflammation by stimulating TNF- $\alpha$ , IL-1, IL-6, and IL-8. However, the construction of antibodies to LPS blocked adherence to tracheal cells, so our understanding is not yet complete. The LPS causes an endotoxemia and reproduces certain typical lesions of the natural disease but not the hemolytic or necrotizing effects. Some LPS also help APP to stick to mucus, tracheal rings, and lung, but they do not

### Box 12-2 Relative virulence of strains of *A. pleuropneumoniae* in pigs

Very highly virulent	Highly virulent	Moderately virulent	Low virulence
1	2, 4, 6, 8, 15, 9, 11 (10 + 14)	2, 5, 9, 10, 11	3, 7, 12

seem to be involved in adherence to cultured porcine alveolar epithelial cells.

Porcine hemoglobin also binds to LPS with APP, and this is a property of the APP OMP.

Under iron-deficiency growth conditions, APP expresses 2 transferrin binding proteins. Recently a ferrichrome receptor in APP has been described.

There are adhesins (fimbriae) involved in attachment. They are particularly associated with serotype 1 but also 3 and 5 and are usually a feature of subculture 1 (56% of strains), but only 8% on subculture 2 and none on 3.

### Apx Toxins

Not all the differences in virulence are explained by capsules, LPS, hemolysins, and Apx toxins. Certainly, all strains need ApxIV and two out of Apx II or III. There is no certain way to differentiate virulent from avirulent strains

Several exotoxins are produced including hemolysins. The hemolytic activity of this organism is characteristic of this species of bacteria. This range of exotoxins is part of the pore-forming RTX group known as the Apx toxins. The latest is Apx IVA, and the gene is present in all APP strains and is species specific and therefore can be used to confirm identification of the organism. The Apx IVA gene is found in all APP serotypes and is absent in the other related species in the *Pasteurellaceae* and, therefore, is considered species specific for APP and is thus being used in a PCR to identify APP strains. It is secreted by a type I secretion system.

The Apx toxins are described in the following discussion: I through III can be produced in vitro, but Apx IVA is only produced in vivo and is specific to APP. All 90 strains investigated in one study had Apx IVa genes. Mutants without the capacity to produce Apx toxins do not cause disease. There are basically four different patterns. Both ApxI and II are essential for the production of lesions. Apx III specifically targets leukocytes by binding CD18<sup>13</sup> The Apx gene is present in all APP strains.

Major RTX toxins in APP are as follows:

- **ApxI** 110 kDa is strongly hemolytic and weakly cytotoxic.
- **ApxII** 102 kDa is weakly hemolytic and moderately cytotoxic.
- **ApxIII** 120 kDa is not hemolytic but strongly cytotoxic.
- **ApxIV** 202 kDa has largely unknown actions but is essential for full virulence of APP.<sup>14</sup>

Serotypes 1, 5a, 5b, 9, and 11 produce I and II; serotypes 2, 3, 4, 6, and 8 produce II and III; serotypes 7 and 12 produce II; serotype 10 only produces Apx I.

There are differences in opinion as to what constitutes virulence. Generally, the following is representative, but it does vary considerably from country to country and isolate to isolate (Box 12-2).

These are toxic to alveolar macrophages, neutrophils, and endothelial cells. In small doses they are stimulatory but in large doses lethal. The gene expression is controlled over the growth curve by a novel regulating pathway. Several genes have recently been identified that have helped in survival, including the knowledge that it can produce toxins under anaerobic conditions. The LPS of APP can also stimulate the release of nitric oxide from macrophages by virtue of the enzyme nitric oxide synthase that damages tissues and may disrupt vascular tone, neuronal signaling, and host defense mechanisms. Nitric oxide synthase 2 and cyclooxygenase 2 have been found in swine experimentally infected with APP. Urease activity may also be required for APP to establish infection in the respiratory tract.

The increase in antimicrobial drug resistance that has occurred is an indirect virulence factor and an important disease-promoting mechanism. The ability of the organism to resist complement killing in vitro may reflect a virulence mechanism in vivo that assists bacteria in avoiding the pulmonary defenses of swine and promotes bacterial invasion of the lung.

Differences in pathogenicity exist between serovar 1 and serovars 7, 3, and 2. The differences between serotypes 1, 2, and 7 are low. Serotype 3 seems less virulent than 1. The differences in capsular structure and biochemical composition between virulent and avirulent isolates may contribute to virulence. A smooth-type lipopolysaccharide and a rough-type lipopolysaccharide have been isolated and characterized from serotype 5. The intrabronchial infusion of the preparations into pigs induces lesions typical of those in pigs that die of acute pleuropneumonia.

APP may interact with *P. multocida* to produce a severe pneumonia, whereas *P. multocida* alone is relatively nonpathogenic. Experimentally, a combination of *P. multocida* and the crude toxin of APP resulted in moderate-to-severe pneumonic pasteurellosis.

Of increasing importance and recognition is the formation of biofilms at mucosal

surfaces. It is part of the extracytoplasmic stress response to the presence of APP.<sup>15</sup> Many strains of APP under appropriate growth conditions form biofilms.<sup>16</sup> Serovars 5b and 11 may exhibit biofilm formation, and a histone-like protein H-NS regulates biofilm formation and virulence of APP.<sup>17</sup>

### Animal Risk Factors

The major animal risk factors are related to the immune mechanisms and the immune status of pigs of varying ages. A major animal risk factor is that clinically recovered pigs commonly serve as carriers of the organism and never fully recover from the infection. Normally, the APP is detected in mixed bacterial samples from the tonsils and/or nasal samples by PCR from the age of 4 weeks on, but it has been detected as early as 11 days in tonsil samples, so it is possible for the sow to infect the piglet. Isolations become more common from 4 to 12 weeks as maternal antibody wanes. The median length of tonsillar carriage may be 7 to 8 weeks. Colonization of the lungs can develop from around 12 to 16 weeks in some herds to as late as 23 weeks in others.

Factors associated with pleurisy in pigs in a case-control analysis of slaughter pigs in England and Wales<sup>18</sup> showed that risk factors included the following:

- No all-in/all-out policy
- Pigs with more than 1-month age difference in the same shed
- Repeated mixing
- Moving during the rearing phase

Decreased incidence was associated with the following:

- Grow to finish or wean to finish in a house filled with less than 3 sources
- With cleaning and disinfection of grower and finisher groups between groups and extended down time of grower or finisher units

Noninfectious factors in the occurrence of pleurisy have been investigated in France.<sup>19</sup> This study was in 143 farrow to finish herds, where management, husbandry, and housing conditions were recorded. An increased risk for extensive pleuritis occurred where there was a short temperature range for the ventilation control, lack of disinfection in the farrowing room, late surgical procedures on the piglets, a mean temperature below 23° C (75 F) in the finishing room, and a herd size above 200 sows.

### Immune Mechanisms

Colostrum immunity lasts from 2 weeks (usually 5) to 3 months. After an experimental or natural infection antibodies occur 10 to 14 days postinfection and reach their height at 4 to 6 weeks postinfection. In the animals that are subclinically affected there may be no antibodies produced to the toxins.

In most herds, high antibody levels in 4-week-old piglets can still be detected, and

this maternal antibody (AB) continues to decrease until about 12 weeks, and then the AB starts to rise with the acquisition of a pathogenic burden. The presence and decay of acquired colostrum antibodies between 2 weeks and 2 months determines the age at which APP infection is most likely to occur. The maternal antibody titers halve every 3 weeks and therefore may remain for 12 to 56 days.

Nasal colonization can occur as early as 4 weeks, and APP can be found in the lungs from 12 weeks; it is usually 12 to 23 weeks before there is any seroconversion to Apx toxins. In other words, nasal colonization does not always produce antibodies.

Active immunity to disease usually follows experimentally induced and naturally occurring infections, and infection with one serotype of APP confers a strong immunity to the same serotype and a partial protection against heterologous strains. Most recovered pigs have a strong humoral immunity but it does not necessarily stop them from becoming carriers and thence possible shedders of APP. Vaccination with killed bacteria produces partial protection against the homologous strain and none against heterologous strains. Second-generation vaccines with Apx toxins produce good protection against clinical disease caused by any serotype but do not prevent animals from becoming carriers through subclinical infections. However, vaccine immunity is serotype specific.

The antibody response to APP infections or vaccination is demonstrated by the complement fixation test or other serologic tests. There is a good correlation between a CF titer and resistance to infection, and the organism usually cannot be isolated from seropositive animals. Susceptibility to APP can be predicted by the absence of neutralizing antibodies to the organism, whereas protection can be predicted by the presence of these antibodies. An aerosol exposure of pigs to viable or inactivated serotype 9 induced antibodies in pulmonary fluids and serum, and protected against homologous challenge. However, the organism may persist in necrotic foci in the lungs or tonsils of pigs considered immune to the infection. Within 2 to 3 weeks of an acute disease outbreak, the morbidity decreases because of the development of immunity. Clinical disease is unlikely in adult immune animals, and immune sows confer passive immunity to their piglets that provides protection for the first weeks of life. However, acute disease may occur in piglets 3 to 8 weeks of age if colostrum immunity is initially low and wanes to below protective levels. Also, severe cases can occur in nonimmune gilts and boars introduced into infected herds.

Pigs infected with hemolytic *Actinobacillus* spp. may become false-positive reactors for APP. Such pigs may also be less susceptible to pleuropneumonia caused by APP.

### Environmental and Management Factors

Outbreaks of the disease appear to occur in pigs that lack immunity, are overcrowded, or have been subjected to recent stressors, such as marked changes in ambient temperature or a failure in the ventilation system. The organism survives better when conditions are wet or in mucus and may last days or even weeks. It survives in water for 30 days at 4° C (39° F) but has a very short survival under dry and warm conditions. Outbreaks may occur in breeding herds following transportation to and from livestock shows and sales. Presumably, the infection was contracted by commingling with clinically healthy but infected pigs. The hypothalamic-pituitary-adrenal axis is stimulated in response to a wide variety of stressors, and this may lead to activation of the organism from the tonsils. The highest risk is associated with the introduction of pigs from sales barns and the lowest risk from stock whose health status is known to the purchaser.

### Economic Importance

The economic losses associated with the disease are considered to be attributable to peracute deaths, the costs of treatment of individually affected pigs and mass medication of the feed and water, and chronic disease that delays the marketing of finishing pigs. Field observations indicate that 5.64 additional days are required for pigs with subclinical infection to reach market weight of 113.6 kg compared with uninfected herd-mates. However, other observations and investigations indicate that average daily gain is not significantly affected by infection with APP. Undoubtedly, there are major economic losses associated with the endemic nature of the disease, which is characterized by peracute deaths that recur sporadically, sometimes punctuated by outbreaks.

### PATHOGENESIS

The interactions of APP with host epithelial cells seem to involve complex interactions resulting in the regulation of various bacterial genes, including some coding for putative adhesins.<sup>20</sup>

The natural route of infection is aerogenous. In growing pigs the disease appears to be a respiratory infection without septicemia, producing a fibrinous necrotizing hemorrhagic pleuropneumonia with pleuritis. Early after intranasal inoculation the bacteria were mainly associated with the stratified squamous epithelium and detached epithelial cells in the tonsil. If only a few organisms are inhaled, probably they are trapped in the tonsil and remain there until they are activated. If large numbers are inhaled or if spread from the tonsil reservoir occurs, then a bacteremia probably results. Vacuolation and desquamation of the tonsillar epithelium was observed and there were many migrating neutrophils and these distend the

tonsillar crypts. They do not bind to the tracheal (perhaps in the newborn) or to the bronchial epithelium, but they can stick to the alveolar wall.<sup>20</sup> The ApxI of APP10 induces apoptosis in porcine alveolar epithelial cells.<sup>21</sup> The adhesion of bacteria to cells appears to be essential and seems to be mediated by polysaccharides and proteins.<sup>22</sup> The role of the fimbriae is not clear. Discharge of vesicles containing proteases and Apx toxins from APP1 has been described. Later the bacteria are associated with the crypt walls and detached cells in the crypts. Experimental aerosol exposure of pigs to APP results in a severe fibrinous hemorrhagic necrotizing pleuropneumonia that simulates the natural disease. The organism expresses a number of factors that help to acquire iron and it can use a variety of compounds, including hemoglobin.<sup>22</sup> Normally, the APP are kept out of the alveoli by the mucociliary clearance mechanism but not if there are large numbers of APP or there is preexisting damage to the clearance such as occurs as in *M. hyopneumoniae* infection.<sup>12</sup> It is a very determined battle in the alveolus between the APP virulence factors and the host defense mechanisms. The cytokine production excites the defenses and increases the permeability of the alveolar capillary walls and allows access of antibodies and complement. The macrophages need opsonins to help phagocytosis as APP is resistant to the action of complement. The Apx 1 toxin induces apoptosis in the macrophages, which are then killed by leukotoxins, and these then release further amounts of proteases etc. The characteristics of the pathogenesis have been described.<sup>23-25</sup> Within a few hours following endobronchial inoculation of various doses of the organism into 12-week-old pigs, clinical evidence of dyspnea and fever are obvious. An aerosol infection with the organism results in pulmonary edema with multifocal petechial hemorrhages and a diffuse neutrophilic bronchiolitis and alveolitis within hours of infection. In the lung, the recruitment of neutrophils is directed toward the viable APP organisms, and possibly 30% of the lung neutrophils respond. This is further enhanced by IL-8 activity. The porcine mononuclear cell phagocytic populations during inflammation produced by APP have been described.<sup>26</sup> The lesion is particularly marked in the dorsocaudal regions of the lung. The ability of APP hemolysin to debilitate pulmonary macrophages may enhance the multiplication of the organism, but experimentally the hemolysin of serovar 2 is not an essential factor for the production of the lesions. In the acute stages there are marked vascular changes in the lungs. The lesions resemble infarcts because of the vasculitis, thrombosis, and hemorrhage. There are many necrotic foci that serve as reservoirs of the organism in pigs that recover. In the experimental disease, the leukogram is typical of acute inflammation; however, hypoxemia and

alveolar hypoventilation are not features of the disease. The hematologic and physiologic findings indicate that the peracute disease resembles septic shock. Immediately after infection the levels of IL-1, IL-6, and TNF- $\alpha$  begin to rise. Moderate levels help in defense, but high levels make things worse. At the same time the IL-10 suppresses TNF- $\alpha$  and IL-1 production in macrophages and monocytes, which up-regulates the other inflammatory cytokines. Pretreatment of the pig with IL-10 reduces the severity of the pleuropneumonia. The prolonged survival of APP during the infections may be attributable to the effect the organism has in downgrading the protective responses of the host.

The distribution of porcine monocytes in different lymphoid tissues and the lungs during experimental *A. pleuropneumoniae* infection and the role of chemokines has been described.<sup>27</sup> This study showed that monocyte counts in various organs changed during inflammation. The CD163 + monocyte counts were found in the lungs and TBLN from APP-infected pigs, suggesting that monocytes migrate just to these organs.

### CLINICAL FINDINGS

The clinical signs vary with the immune status and environmental stress and customarily may be seen between 6 and 20 weeks of age. In all cases there is a reduced growth rate and reduced feed intake, therefore leading to reduced weight gain. There is no relationship between average daily gain and serologic response to APP. The illness may be peracute, acute, subacute, or chronic. In all stages there is very little exercise tolerance, with varying degrees of increase in respiratory rate. The onset is sudden. Several pigs that were not seen ill may be found dead, and others show severe respiratory distress. Affected pigs are disinclined to move and are anorexic. A fever of up to 41°C (105.8°F) is common, and labored respirations with an exaggerated abdominal component ('thumps'), cyanosis, and frequently a blood-stained frothy discharge from the nose and mouth are characteristic, particularly just before death. In peracute cases, the clinical course may be as short as a few hours, but in the majority of pigs it is 1 to 2 days. In many cases, the animals "dog-sit" with elbows abducted to relieve pressure on the lungs, and they show dyspnea. Chronic cases, which usually appear after the acute phase has disappeared, are febrile and anorexic initially, but respiratory distress is less severe, and a persistent cough may develop. If affected pigs are not treated, there will be a high case-fatality rate. Otitis media in a weaned pig caused by infection of the middle ear with the organism has been described. There may also be lesions in the joints with fluctuating swellings of the hocks and the synovial membranes replaced by granulation tissue.

The course of the disease in a herd may last for several weeks, during which time new acute cases develop and chronic cases become obvious by an unthrifty appearance and chronic coughing.

Abortions may occur and the disease may cause sudden deaths in adult pigs, particularly those that are kept outdoors during the summer months and exposed to very warm weather.

Computer tomography and radiography have been described as aids to diagnosis.<sup>28</sup>

Recently a very mild condition very similar to swine influenza, with just a slight increase in respiratory rate, has been described.<sup>29</sup>

### CLINICAL PATHOLOGY

Plasma cortisol rises 24 hours postchallenge. Haptoglobin is increased. Within 48 hours IL-1 $\alpha$ , IL-1 $\beta$ , and IL-8 were increased, and there was a 50% reduction in iron and zinc. Plasma IGF-1 concentrations were reduced in response to the APP challenge as they were with endotoxin challenge. The LPS of APP produces rises in inflammatory cytokines (TNF- $\alpha$ , IL-6, and IL-10). Band neutrophils are significantly increased in early infections from 18 to 48 hours, and the early changes have been described.<sup>30</sup>

### Culture of Organism

In an outbreak, the diagnosis is preferably made by culture at necropsy. Carrier pigs can be identified by culturing the organism from the upper respiratory tract using nasal swabs from live pigs on the farm and samples from tonsils at slaughter. A selective medium for the culture of the organism from the airways of slaughtered pigs may increase the isolation rate because of the high degree of contamination. The culture of APP has recently been complicated by the identification of the non-pathogenic *A. porcitonisillarum*.

### Serotype of Organism

Tests to determine the serotype include slide agglutination, immunodiffusion, ring precipitation, indirect hemagglutination, immunofluorescence, coagglutination, and counterimmunoelectrophoresis. The latter is quicker, more sensitive, and more easily performed than direct immunofluorescence and immunodiffusion procedures. The coagglutination test is simple and rapid, the immunodiffusion test is considered to be the most serotype-specific, and there is a good correlation between the rapid slide agglutination test and the indirect fluorescent antibody tests. The rapid slide agglutination test is the method of choice of some workers, but the coagglutination test is serotype-specific, sensitive, simple, rapid, reproducible, and easier to read and interpret than the rapid slide or tube agglutination tests. The International Pig Veterinary Society has recommended that the coagglutination test is currently the method of choice for routine



serotyping of field strains. This technique does not allow separation of the heterogeneous serovar 8 from serovars 3 and 6, the heterogeneous serovar 9 from serovar 1, or the heterogeneous serovar 7 from 4. The results are reported as group 9-1, group 8-3-6, and group 7-4, respectively. The final identification of heterogeneous serovars can only be achieved by the agar gel diffusion test and by indirect hemagglutination. Reference strains and the corresponding antisera are available to bring some uniformity into serotyping.

### Detection of Antigen

The polymerase chain reaction (PCR) is a highly sensitive test for the detection of the organism from tissue samples. A PCR for type 4 has been developed. Some detect OMP; others detect Apx genes. Apx IVA based ELISAS can be used for evaluating APP status in commercial herds, but some appear limited by high carriage rates of low-virulence APP.<sup>31</sup> Immunomagnetic separation of APP1 and 2 has been described with greater sensitivity than possible with isolation or even PCR. A PCR-based RFLP analysis of the OMIA gene may also be of value in differentiating APP serotypes. A multiplex PCR has been developed. There is often disparity between immunologic and PCR-based serotyping.<sup>32</sup>

### Serology

Serology is the best method for surveillance purposes and is the best way to detect sub-clinical infections but may give unexplained results.<sup>33</sup> In addition, some of the strains do not produce ApxIV do not produce antibodies.<sup>34</sup> Sometimes diagnostic interpretation is difficult.<sup>22,33</sup>

Tests for antibodies to toxins and/or capsular antigens have a low specificity and can also be positive for *A. suis* infection. Most commonly used are antigens using O-chain LPS.<sup>35</sup> They tend to be grouped together: (1, 9, 11), (2, 3, 6), (8, 4, 7), (10 and 12), (3 and 5), (15, 3, 6).<sup>11</sup>

For the serologic diagnosis of infection in live animals the complement fixation test is reliable, but an enzyme-linked immunosorbent assay (ELISA) test is highly specific and more sensitive than the complement fixation test.

The **complement fixation test** has been used routinely in the past in some countries and has a high degree of sensitivity and specificity. It is, however, a cumbersome test, and many laboratories find it difficult to perform, and so it is rarely used nowadays. Pigs being imported into China and Russia still require a CFT negative test.

The **ELISA** is a rapid and sensitive test and can be adapted to automation. The ELISA for serotypes 1, 2, 5, and 7 distinguishes exposed from unexposed pigs or herds. Because of cross-reactivity with other serotypes and *A. suis*, the serodiagnosis of

serotype infections cannot be made with certainty. A blocking ELISA is available for detection of antibodies against serotype 2 and also 2, 6, 8, and 12, which is the dominating serotype in Danish swine herds, causing approximately 70% of diagnosed outbreaks of pleuropneumonia. A similar test is available for serotype 8. A mixed-antigen ELISA for serodiagnosis of serotypes 1, 5, and 7 has a sensitivity of 96% and specificity of 99.5% and can be used for herd health monitoring programs. The long-chain lipopolysaccharide of serotypes 4, 5, and 7 is a superior antigen to the crude extracts used as antigens in the ELISA for the serodiagnosis of pleuropneumonia.

There are now ELISAs for the detection of antibodies to the Apx toxins, and the one for type II Apx was described as sensitive, inexpensive, and highly discriminatory. A multiplex PCR for all toxins in one test is a reliable typing system. A new ELISA for the Apx IV produced by all 15 serotypes means that you can detect all APP with one test. It has a specificity of 100% and a higher sensitivity than culture (93.8%). This is important because you can find Apx I to III in pigs associated with *A. suis* and *A. rossii*, but Apx IV is only produced by APP in vivo. It will detect the toxin from 2 to 3 weeks postinfection.

An inhibition enzyme immunoassay for the serodiagnosis of serotypes 2 and 5 had a sensitivity and specificity of 100% and 98.9%, respectively. The detection of antibodies to APP is an essential feature in the epidemiologic study and control of pleuropneumonia in pigs. Serologic testing can be used to monitor the level of infection in a breeding herd over a period of time and as the piglets become older. A minimum of 30 serum samples from adult pigs is necessary to provide a reliable assessment of the herd's infection status. None of these serologic tests is completely reliable, and in certain situations a combination of two tests is needed for interpretation of low titers in some pigs. In most instances, serologic diagnosis is type-specific, and protection obtained by vaccination is type-specific and will protect only against the serotype contained in the vaccine. Thus it is important to determine the serotypes that are causing disease in the herd.

An important strategy of control of this disease is to detect infected pigs in a herd or to exclude infected pigs from being imported into a herd. Because there is no reliable method for the detection of every infected pig, the effectiveness of this barrier is reduced whenever pigs, such as breeding stock or weanlings, are allowed into a herd. There is a need for a highly sensitive and specific test for the identification of infected pigs. Although bacteriologic culture is specific it is not sensitive. The ELISA test may be a useful test for the antemortem diagnosis of infected herds.

### NECROPSY FINDINGS

Characteristic lesions are confined to the thoracic cavity and consist of hemorrhagic and fibrinous pleuropneumonia with a tendency to sequestration in the chronic form. In peracute cases the lungs are swollen, firm, and dark red. In peracute cases the trachea and bronchi are full of frothy fluid. Fluid and blood ooze from the cut surface, and there may be marked edema of the interlobular septa, reflecting widespread thrombosis and alterations in capillary permeability. There may be hemorrhagic areas of necrosis that are very variable. In acute cases there are layers of fibrin on the pleural surface and pericardium. In pigs that die less acutely, focal black or red raised areas of pneumonia are present. Lesions may occur throughout the lung, including the diaphragmatic lobes. The quantitative morphology of peracute pulmonary lesions induced by the organism has been described. In chronic cases there is fibrosis of the fibrinous pleurisy and adhesions result between the visceral and parietal pleura, and on removal of the lungs from the thorax portions of lung may remain adherent to the thoracic cage.<sup>36</sup> A fibrinous pleuritis overlies the affected lung tissue, and a fibrinous pericarditis may also be present. The organism can be isolated from affected lung tissue, but generally not from other internal organs. Occasionally, otitis, endocarditis, pericarditis, and serous arthritis may follow, particularly when infection involves serotype 3. An osteomyelitis and arthritis caused by APP has been demonstrated using fluorescent in situ hybridization.

Histologically, vasculitis and widespread thrombosis is usually evident, in addition to an abundance of fibrin and neutrophils within alveoli. A fibrinous thrombosis with IHC demonstration of APP has been described. In situ hybridization can be used to detect IL-1, IL-6, and TNF- $\alpha$  in streaming degenerate alveolar leukocytes (oat cells) and the boundary zone of oxidative necrosis. A less intense signal was seen in the dense zone of degenerate cells in granulation tissue surrounding the necrotic areas. IL-1 was also seen in the scattered endothelial cells bordering zones of coagulative necrosis. IL-6 is the cytokine that is most elevated, and serum amyloid and haptoglobin are also elevated.

In a chronically infected herd, fibrous pleural adhesions may be present in a large proportion of the pigs at market as a result of infection several months earlier. Subacute to chronic lung lesions are encapsulated by fibrous tissue, and sequestra may be present. A high prevalence of fibrous or fibrinous pleuritic lesions on inspection at the abattoir is very suggestive of APP infection.<sup>37,38</sup>

### DIAGNOSIS

The provisional diagnosis of pleuropneumonia associated with APP in the pig is usually based on history, clinical signs, and the post-mortem picture. The acute cases then require

laboratory investigation to confirm, and chronic cases may prove antigen negative (the lesions are usually fibrous or fibrinous) but possibly antibody positive. A variety of samples need to be taken from acute cases and should be from lesions not from inflammatory exudates and particularly not from the lungs.

### Samples for Confirmation of Diagnosis

The evolution of diagnostic tests has been described as follows:<sup>39</sup>

- Bacteriology—lung culture is relatively easy if the carcass is freshly dead. The culture is achieved on 55 sheep blood agar with a cross-streak of *Staphylococcus epidermidis* or *S. aureus*. The plates are incubated overnight with 5% CO<sub>2</sub>, and a clear zone of complete hemolysis results. Typing will confirm the identity of APP1-15 and if atypical PCRs can be used. PCRs for 3, 6, and 8 were described;<sup>40</sup> 1, 7, and 12;<sup>41</sup> 15 and 7;<sup>42</sup> and also 1, 2, and 8. Sometimes serotypes cannot be differentiated. Toxin typing using a PCR can be used to determine which Apx toxin genes are carried by a certain isolate. They can also be isolated from pure and mixed bacterial cultures by immunomagnetic separation.
- Histology—formalin-fixed lung (LM). APP can be further identified by IHC, which is particularly useful in chronic cases and ISH.
- Serology—used to check the herd status. Coagglutination can be used first, with confirmation by agar gel diffusion and indirect hemagglutination.

### DIFFERENTIAL DIAGNOSIS

The rapidity of onset and spread with fever, anorexia, severe dyspnea, and high mortality differentiates APP from the majority of respiratory diseases in pigs.

**Enzootic pneumonia** is more insidious in its occurrence and has distinctively different epidemiologic, clinical, and pathologic features.

**Pasteurellosis** is characterized by a necrotizing bronchopneumonia.

**Swine influenza** is characterized by an explosive outbreak of respiratory disease. However, this is not restricted to growing pigs and the mortality is low. There is a distinct difference in the respiratory lesion on necropsy examination.

**Glasser's disease** is characterized by serositis, arthritis, and meningitis, and occurs in younger pigs.

**Mulberry heart disease** may present with similar clinical findings, but there is no pneumonia on necropsy examination.

**A. porcitosillarum** also produces and secretes ApxII by an operon that does not occur in APP

**Actinobacillus suis** shares cross reactions with APP 3, 6, and 8.

**Actinobacillus lignieresii** have some cross reactions with APP serotypes.

### TREATMENT

#### Antimicrobial Therapy

The results of treatment are often disappointing because of the severity of acute disease and persistence of infection in recovered pigs. It is best to assume that APP cannot be eliminated using antibiotic therapy.<sup>41</sup> Although antimicrobials may reduce mortality and improve average daily gain, treated animals often continue to harbor the organism and are a source of infection to other animals. If animals are clinically ill, then injection of antimicrobials is necessary. Affected and in-contact pigs should be treated parenterally with antimicrobials. Tetracycline, spectinomycin, and penicillin have been effective and are recommended unless drug resistance has occurred. Penicillin may have inconsistent results.<sup>43</sup> Fluoroquinolones are distributed to bronchial secretions, bronchial mucosa, and alveolar macrophages. The pharmacokinetics of danofloxacin are favorable for APP treatment. In fact, elevated C-reactive protein, IL-6, and haptoglobin (all elevated rapidly after infection) all return to normal, as do the reduced plasma zinc, ascorbic acid, and alpha tocopherol rapidly after treatment. Ceftiofur and fluoroquinolones were the most active agents against APP. APP is only eliminated from the respiratory tract in animals medicated with enrofloxacin. Tilmicosin is useful for treating outbreaks.

In a large study in Switzerland of 83APP and 58 *A. porcitosillarum* (PT) strains screened for susceptibility to 20 antimicrobial agents, it was found that there was resistance to sulphamethoxazole, sulphonamide-trimethoprim, tiamulin, tilmicosin, tetracycline, and ampicillin. A few of the PT strains showed increased susceptibility to enrofloxacin.<sup>44</sup> Both APP and PT remain susceptible to cephalosporins, fluoroquinolones, and phenicols, which are not used except in special cases. In the last few years resistance to tetracyclines and trimethoprim-sulphonamide has increased.<sup>45-47</sup> There is no clear association between antimicrobial susceptibility and serotype.<sup>44</sup> There have been enrofloxacin-resistant APP isolates found in Taiwan.<sup>48</sup>

In finishing units, where outbreaks of the disease have been confirmed, the twice-daily intramuscular injection of pigs early in the course of the disease with antimicrobials, based on drug sensitivity tests, daily until clinical recovery occurred, was superior to the mass medication of feed and water. A

considerable amount of labor is required, but it is considered to be the most cost-effective method.

In a study of SPF pigs experimentally infected with APP2 and treated with enrofloxacin(E), tetracycline(T), or penicillin(P) at the onset of disease or left untreated, it was found that the animals treated with E and T recovered rapidly. All except the E group developed antibodies. They were later challenged with APP2 again, but here the E group developed serious disease. The implication is that the E was so successful initially in eradicating the APP that it did not allow an antibody response to develop to resist the rechallenge.<sup>43</sup>

#### Antimicrobial Sensitivities

The antimicrobial sensitivities of isolates of APP have been monitored, and there is some variation based on geographic location. The large expansion in the size of swine herds, and the introduction of breeding stock from many different sources, has led to an increase in the incidence of porcine pleuropneumonia and extensive use of parenteral antimicrobials. To ensure an optimal response to therapy, it is necessary to monitor antimicrobial sensitivity on a herd basis.

The antimicrobial sensitivity of the organism was determined in isolates from Europe, Japan, South Africa, and North America between 1989 and 1991. They were highly susceptible to danofloxacin and moderately susceptible to amoxicillin, ceftiofur, and trimethoprim-sulfamethoxazole. There was widespread resistance to other currently available antimicrobials. In another study, thiamphenicol and metronidazole had good activity, and the cephalosporins and fluoroquinolones were most active. A comparison of the minimum inhibitory concentrations (MICs) of several antimicrobials against several bacterial pathogens of swine, including APP, from the United States, Canada, and Denmark found that ceftiofur and enrofloxacin were the most active antimicrobials.

Plasmid-mediated antimicrobial resistance has been found in isolates of the organism that are resistant to certain antimicrobials.

#### Antimicrobials in Experimental Disease

In these experimental infections enrofloxacin and ceftiofur are particularly effective and also tulathromycin.<sup>49</sup>

The therapeutic efficiency of some commonly used antimicrobials has been evaluated for the treatment of experimentally induced pleuropneumonia using serotype 1 APP. Florfenicol in the feed at 50 ppm prevented pneumonia when pigs were experimentally inoculated with serotype 1, 2, and 5 strains and thiamphenicol-resistant strains of the organism. The combination of trimethoprim and sulfamethoxazole is superior to

a combination of trimethoprim and sulfadimethoxine. Oxytetracycline in the water at 222 mg/L for 7 days beginning 24 hours before experimental challenge reduced the case-fatality rate, lung lesions, and the isolation of the organism compared with the unmedicated group. Treatment of chronically affected pigs did not improve rate or gain, nor did it eliminate the infection. Enrofloxacin at 150 ppm in the feed provided effective control of the experimental disease.

### Mass Medication of Feed

In-feed medication with sulfadimethoxine and sulfamethoxazole in combination with trimethoprim has been described.

Oxytetracycline in the feed at 1600 mg/kg of feed for 6 days before experimental challenge and for 9 days after challenge, provided 100% protection from clinical disease, but 400, 800, or 1200 mg/kg of feed did not prevent subsequent shedding and transmission to seronegative animals. Tetracycline should be administered through the feed of all in-contact pigs during the outbreak, but the persistence of the organism in chronically affected pigs may result in clinical disease when the medication is withdrawn.

Doxycycline in feed at 250 ppm for 8 consecutive days is useful for the control of APP.

Tilmicosin fed to pigs at 200 to 400 µg/g is effective in controlling and preventing APP-induced pneumonia, using seeder pigs, when administered in the feed for 21 days. In commercial herds, 400 µg/g of feed for 21 days is no more effective than 200 µg/g of feed for the control of naturally acquired pneumonia caused by APP and *P. multocida*. Sulfathiazole at the rate of 28 g/3.8 L of drinking water for 12 days has also been successful. Tiamulin in the drinking water at a concentration to deliver 23 mg/kg BW for 5 days after an initial individual treatment of affected pigs has also been recommended.

### CONTROL

It is impossible to guarantee freedom because the detection of carriers is almost totally impossible. There are no techniques as yet for identifying the animal that may have only a few organisms in the tonsil. You can guarantee freedom from clinical disease at the time of inspection but little else. In a recent study of 980 pigs there was no evidence of an APP clinical or pathologic case until the occurrence of PMWS resulted in the isolation of an APP7 from the series of pigs in a unit that had until that time been considered free.

There are two options for the control and prevention of porcine pleuropneumonia:

1. Control at an economical level using good management combined with the possible use of vaccines
2. Eradication of the infection from the herd

Determining which option to select requires careful consideration of the advantages and disadvantages of each option. With an understanding of the factors that result in clinical disease, it is possible to maintain an infected breeding herd and produce pigs with a small risk of clinical disease.

### Control by Management

Management and housing improvements can prevent clinical episodes. One of the most important things to do is to make sure that there is vaccination for enzootic pneumonia.

Control is difficult and unreliable because pigs that recover from clinical disease provide a source of future infection for finishing operations that purchase all of their introductions. The all-in, all-out system of purchasing, feeding, and marketing pigs, with a thorough cleaning between groups of animals in a finishing operation, should be adopted. The disease is highly contagious, and control measures must be directed toward identifying infected pigs and eliminating their introduction into uninfected herds. When moving pigs between herds, it is critically important that the herds be matched according to their infection status. Source herds for feeder animals are serotyped, and then pigs of like immune status are commingled to produce a population that is compatible immunologically. By commingling only animals from seronegative herds, the risk of disease is greatly decreased and growth performance improved. The mixing of animals from herds known to be infected with homologous serotypes is also effective.

Every economical effort must be made to identify and isolate infected pigs and to exclude the importation of clinically normal but infected pigs into herds in which the infection is not present. This is a major challenge that is dependent on the availability of a highly sensitive and specific laboratory test. The acquisition of new breeding stock for herds free of the infection should include a period of quarantine and two serologic tests 3 weeks apart. Only seronegative animals should be introduced into the herds. A seropositive animal should be considered a potential carrier. Field trials have shown that it is not possible to rear seronegative animals within a breeding and rearing herd heavily infected with serotype 2 of the organism. Neither medication of the sows and piglets with trimethoprim-sulfonamides, nor a strictly applied all-in, all-out system reduced the percentage of seropositive animals.

Management practices must emphasize the rearing of weaned pigs in pens separate from older stock that are carriers of the organism. Large breeding herds and finishing units should subdivide the total herd into separate units, which minimizes the spread of infection. Early weaning and segregation

of gilts from infected stock have been used to develop a seronegative herd.

Herds can be classified into one of three categories depending on their infection status:

**CATEGORY 1.** Serologically positive for APP without a history of clinical disease. A majority of herds are serologically positive but do not have clinically apparent disease. Good management and environmental quality control can minimize the incidence of clinical disease. Good ventilation, the use of all-in, all-out management practices, and appropriate stocking densities are important.

**CATEGORY 2.** Serologically negative and clinically free of APP. These herds can be maintained free of infection with good biosecurity practices. New breeding stock must be obtained from herds free of infection. Artificial insemination can be used to limit the introduction of live pigs. Pigs sold from these herds to herds with endemic infection are highly susceptible to infection.

**CATEGORY 3.** History of clinical disease caused by APP, which has been pathologically and microbiologically confirmed. In these herds, acute disease outbreaks occur most commonly in pigs 9 to 20 weeks of age. Pigs are usually protected by colostral immunity for the first 8 weeks of life. The severity of outbreaks can be reduced by mass medication of the feed, treatment of individual pigs, and good management practices to ensure adequate ventilation.

### Eradication

The Danish SPF system was the first to try to eradicate APP. Each month 20 serum samples were tested for APP 2 and 6 and were collected at the monthly clinical inspection. This happened every 3 months also for APP12 and annually for APP 1, 5, 7, and 10. Recurring outbreaks of pleuropneumonia is the most common reason for an eradication strategy. Eradication is done by depopulating the entire herd, followed by repopulation with animals from herds that are clinically and serologically negative. Eradication can be successful but the risk of introducing infections into the herd is high unless biosecurity measures are adopted and strictly implemented.

An alternative to depopulation is medicated early weaning, in which pigs are weaned at 10 to 15 days of age, treated with antimicrobials, and reared in isolation. Transmission of infection between the sow and piglets does not occur before 11 days of age, about half of the piglets are infected at 16 days of age, and if weaned at 21 days of age most of the piglets are infected.



The early weaning program can be expanded to the three-site system of rearing. Adults and nursing piglets are housed in one site. At weaning, piglets are moved to the nursery barn for growth to 25 kg, and then moved to a third site for the final growing period. The adults may be serologically positive for infection, but the nursery pigs, growing pigs, and finishing pigs are negative.

Age segregation, distance that prevents aerosol transmission, and adherence to strict biosecurity practices can reduce the prevalence of infection and the incidence of disease.

### Vaccination

A wide range of vaccines have been developed over the years.<sup>50</sup> There are two main groups of vaccines. One is killed organisms the bacterins, and these are serotype specific. The second group are subunit toxin-based vaccines. These contain Apx I, II, III with or without OMP and show a high degree of protection all APP1-12 serotypes. The *in vivo* ApxIV works well but has not yet been commercialized,<sup>48</sup> although ApxIV is not needed for effective vaccination. An Apx 1A mutant has potential for a live attenuated APP vaccine.<sup>51</sup> Animals vaccinated with bacterins will produce antibodies that will cross-react with ELISA tests that use polysaccharides as antigens. There is a considerable effect of adjuvants in these vaccines.

Natural or experimental infection with a serotype of APP induces a strong immunity to both homologous and heterologous serotypes. Vaccination has been attempted to prevent pleuropneumonia in pigs. However, the protection obtained by parenteral vaccination is serotype specific, and vaccines must therefore contain the serotype existing in the swine population. The mortality rate is lower in vaccinated animals, but they are still carriers of the organism.

Serotype 8 is closely related to serotypes 3 and 6, and parenteral revaccination using a capsular extract or killed APP serotype 8 provides a high degree of protection against challenge with serotypes 3 or 6. A tetravalent vaccine containing serotypes 1, 2, 5, and 7 stimulated titers to all four serotypes and an anamnestic response was induced by a second vaccination. This suggests that the serologic and cross-protective properties of APP serotypes should be identified before they are used as antigen in the complement fixation test and in vaccines.

The protein associated with the capsule of APP is responsible for serotype-specific protection against mortality in mice. Further purification and characterization of this protein antigen is needed to determine whether it is the specific antigen responsible for protection against mortality in swine or if it is a necessary carrier for a serotype-specific capsular disaccharide antigen.

The vaccines that have been evaluated are killed vaccines with an adjuvant. In one

experimental trial, two and three vaccinations using a bacterin containing serotypes 1 and 5 prevented mortality following an aerosol challenge with the same serotypes as present in the vaccine. However, all vaccinated pigs had severe signs of respiratory disease and the vaccine did not prevent the development of lung lesions. The use of a formalin-inactivated alum-precipitated vaccine containing serotype 1 was effective in decreasing the morbidity and mortality rates from naturally occurring pleuropneumonia. The adjuvanted vaccines have caused considerable tissue reaction, resulting in abscesses and granulomas. The mineral oil adjuvants are highly irritant and cause granulomas, which are present 8 weeks after vaccination but result in high titers. The aluminum hydroxide adjuvants are less irritating but result in lower titers. Vaccines containing a lecithin-base oil at 5% are non-irritating and stimulate high complement fixation titers.

Subunit vaccines containing purified or partially purified antigens provide better protection than whole cell vaccines. Capsular antigens, outer membrane proteins, lipopolysaccharide, and soluble toxic factors are immunogenic in pigs. An acellular vaccine containing multiple virulence factors provided complete protection from mortality and significantly reduced morbidity to homologous challenge. Pigs vaccinated with the cell extract had fewer clinical signs of pleuropneumonia than pigs vaccinated with three other commercial vaccines and challenged with serotype 1. A vaccine containing the LiCi cell extracts and a crude hemolysin isolated from serotype 1 provided protection against both mortality and morbidity in vaccinated pigs challenged by intratracheal inoculation. An experimental vaccine using bacterial "ghosts," which are empty cells produced by bacteriophage lysis appears to be successful. A better cellular response was observed to inactivated bacteria than to ghost vaccines. Bacteria grown in conditions resulting in high *in vitro* adhesion levels induced better protection than those grown in NAD rich medium. An APP type 2 vaccine has been described with deletions in the Apx IIA gene, which can then function as a negative marker vaccine, which appears to be capable of protecting pigs without shedding.

Antigenic variation within a capsular serotype, for example in subtypes 1A and 1B, as a result of antigenic variation within the lipopolysaccharide, can result in the failure of whole cell bacterins to provide protection against the same capsular serotype. This lack of cross-protection within a capsular serotype provides a partial explanation for vaccination failures observed under field conditions.

A polyvalent bacterin containing serotypes 1, 3, 5, and 9 provided satisfactory protection against homologous challenge 14

days after the second vaccination. Mortality was reduced, and lung lesions, pleural adhesions, and isolations of the organism from the tonsils and lungs were reduced.

It is possible in the future that a differentiation from vaccinated animals test may be based on the ApxIVA gene.<sup>52</sup>

Live vaccines using laboratory-obtained nonvirulent mutants have also been developed and shown to protect against homologous and heterologous serotypes.<sup>53-55</sup>

### REFERENCES

- Vengust G, et al. *J Vet Med B Infect Dis Vet Publ Hlth*. 2006;53:24.
- Hoeltig D, et al. *BMC Vet Res*. 2009;5:14.
- Sjölund M, Wallgren P, et al. *Acta Vet Scand*. 2010;52:23.
- Opriessnig T, et al. *Anim Hlth Res Rev*. 2011;12:133.
- MacInnes JL, et al. *Can J Vet Res*. 2008;72:242.
- Kokotovic K, Angen O. *J Clin Microbiol*. 2007;45:3921.
- Zhuang Q, et al. *Vet Rec*. 2007;160:258.
- Maldonado J, et al. *J Vet Diag Invest*. 2009;21:854.
- Gottschalk M, et al. *Proc Cong Int Pig Vet Soc*. 2010a;21:290.
- Koyama T, et al. *J Vet Med Sci*. 2007;69:961.
- Gottschalk M, et al. *Proc Cong Int Pig Vet Soc*. 2010b;21:289.
- Marois C, et al. *Vet Microbiol*. 2009;135:283.
- Vanden Bergh PG, et al. *Vet Res*. 2009;40:33.
- Liu JL, et al. *Vet Microbiol*. 2009;137:282.
- Bosse J, et al. *J Bacteriol*. 2010;192:244.
- Labrie J, et al. *Vet Res*. 2009;41:03.
- Dalai B, et al. *Microb Pathogen*. 2008;46:128.
- Jager HC, et al. *PLoS ONE*. 2012;7:e29655.
- Fablet C, et al. *Epidemiol Sante Anim*. 2013;63:13.
- Auger E, et al. *Infect Immun*. 2009;77:1426.
- Chien M-S, et al. *Vet Microbiol*. 2009;135:327.
- Chiers K, et al. *Vet Res*. 2010;41:65.
- Footo SJ, et al. *J Bacteriol*. 2008;190:495.
- Goure J, et al. *BMC Genomics*. 2009;10:88.
- u Z, et al. *PLoS ONE*. 2009;3:e1450.
- Ondrackova P, et al. *Vet Res*. 2010;41:64.
- Ondrackova P, et al. *Vet Res*. 2013;44:98.
- Brauer C, et al. *BMC Vet Res*. 2012;8:47.
- Tobias TJ, et al. *Vet Rec*. 2009;164:402.
- Hedegaard J, et al. *Acta Vet Scand*. 2007;49:11.
- Eamens GJ, et al. *Aust Vet J*. 2012;90:225.
- O'Neill C, et al. *Vet Rec*. 2010;167:661.
- Broes A, Gottschalk M. *Proc Ann Meet Am Assoc Swine Vet*. 2007;193.
- Tegetmeyer HE, et al. *Vet Microbiol*. 2009;137:392.
- Klausen J, et al. *J Vet Diag Invest*. 2007;19:244.
- Merialdi G, et al. *Vet J*. 2012;193:234.
- Fraille L, et al. *Vet J*. 2010;184:325.
- Meyns T, et al. *Vet J*. 2011;187:388.
- Costa G, et al. *Vet Microbiol*. 2011;148:246.
- Zhou L, et al. *J Clin Microbiol*. 2008;46:800.
- Angen O, et al. *Vet Microbiol*. 2008;132:312.
- Ito H. *J Vet Med Sci*. 2010;72:653.
- Sjölund M, et al. *Vet Rec*. 2009;164:550.
- Matter D, et al. *Vet Microbiol*. 2007;122:146.
- Gutiérrez-Martín CB, et al. *Vet Microbiol*. 2006;115:218.
- Hendricksen RS, et al. *Acta Vet Scand*. 2008;50:19.
- Marioka A, et al. *J Vet Med Sci*. 2008;70:1261.
- Wang Y-C, et al. *Vet Microbiol*. 2010;142:309.
- Hart F, et al. *Vet Rec*. 2006;158:433.
- Ramjeet M, et al. *Anim Hlth Res Rev*. 2008;280:39104.
- Xu F, et al. *Vet Microbiol*. 2006;118:230.
- O'Neill C, et al. *Vaccine*. 2010;28:4871.
- Bei W, et al. *Vet Microbiol*. 2007;125:120.

54. Lin L, et al. *FEMS Microbiol Lett.* 2007;274:55.  
 55. Park C, et al. *J Vet Med Sci.* 2009;71:1317.

## MYCOPLASMA PNEUMONIA (MYCOPLASMA HYOPNEUMONIAE)

### ETIOLOGY

*Mycoplasma hyopneumoniae* (once also called *Mycoplasma suis pneumoniae*) is the primary causative agent. *M. hyopneumoniae* (MH) inhabits the respiratory tract of pigs, appears to be host specific and survives in the environment for only a very short period of time. The disease has been reproduced with pure cultures, and the organism can be demonstrated directly or indirectly in pigs with enzootic pneumonia worldwide. The isolation of MH is complicated by the presence of other mycoplasmas in the upper respiratory tract of pigs including *M. hyopharyngis*, *M. hyorhinis*, *M. suis*, and *Acholeplasma* species. The nonpathogenic *M. flocculare* also complicates the culture of *M. hyopneumoniae*. The strains of MH are antigenically and genetically diverse. Multilocus sequence typing has been used to estimate genetic diversity,<sup>1,2</sup> and it showed that specific MH strains are responsible for local outbreaks as they are in geographic contact or operative contact.

A wide variety of genetic diversity was found in U.S. strains using comparative genomic hybridization. Significant variation at the genetic level has also been found,<sup>3</sup> and it has not yet been established as to what constitutes cross protection and virulence.<sup>4</sup> MH varies its surface proteins through varied proteolytic events.<sup>5,6</sup> A proteomic survey of MH identified a total of 31 different coding DNA sequences.<sup>7</sup> Genotyping of MH in wild boar samples showed that variability was high, but there was geographic relatedness; they were related to the domestic pigs, but no matching types were found.<sup>8</sup>

### EPIDEMIOLOGY

#### Occurrence and Prevalence of Infection

Enzootic pneumonia occurs in pigs worldwide, and the incidence is high in intensive pig rearing enterprises. Lesions may be present in 40% to 80% of the lungs of pigs at abattoirs. The peak incidence of pneumonia occurs at 16 to 20 weeks of age, which is likely related to the increased stocking density in this period. In northern climates, the incidence of clinical disease and prevalence of lesions at slaughter are higher in the summer months. The prevalence of lung lesions is often highest in pigs slaughtered in the winter months compared with autumn-slaughtered pigs. The amount of bronchopneumonia lesions in individual lungs ranged from 0% to 69%, with an average of 7.8%. A 2002 survey in the United States showed that 82.3% of finishing sites had at

least one animal positive on antibody testing and 94.4% of breeding sites. Seroprevalences were higher in the clinically affected herds, and most of the pigs were infected with MH at a younger age. A study in the United Kingdom showed that geographic location of the finishing unit appeared to be a statistically significant risk factor for EP-like lesions and pleurisy.<sup>9</sup> In addition, they also found that part-slatted floors were a potential risk factor. In a study of colonization at weaning and the infection at slaughter, average lung lesion scores, percentage of affected lungs, presence of MH on the bronchial epithelium, and seroconversion, it was found that the severity of the disease can be predicted by the prevalence at weaning in segregated systems. Strategies focused on reducing colonization at weaning may help to control MH in segregated production systems.<sup>10</sup> Vaccination does not prevent transmission to sentinel pigs in contact with infected animals. Transmission of MH from asymptomatic carriers to unvaccinated and vaccinated sentinels was not different.<sup>11</sup>

#### Morbidity and Case Fatality

In infected herds, the morbidity rate is high during the growing period, but the case-fatality rate is low. There is however, an increase in the number of treatments of sick pigs in comparison with herds free from the disease. The morbidity rate falls markedly with increasing age, and there is a much lower incidence of pneumonic lesions in sows, even though they may still harbor the organism. However, when MH gains entry into a herd that has been previously free of the disease, all ages of pigs are affected, and mortality, even in adults, can occur.

#### Methods of Transmission

The organism is an inhabitant of the respiratory tract of pigs, and transmission occurs by direct nose-to-nose contact, which is the main form of transmission. Airborne transmission and fomites are less important. *Mycoplasma* can be transmitted over 1, 75, and 150 m, and recently aerosol has been seen to be transmitted over 9.2 km.<sup>12</sup> *M. hyopneumoniae* was found to travel long distances from an infected experimentally infected group of pigs.<sup>13</sup> Airborne transmission was suggested on 80% of farms where acute respiratory disease was present. No airborne organisms were found on farms without acute respiratory disease. There is no other known host for the organism, although infection and breakdown of closed pneumonia-free herds has occurred without any pig introductions. The number of organisms required for infection is very small, and the possibility of wind-borne infection has been suggested. Transmission is by the respiratory route and in infected herds occurs primarily from the sow to the suckling piglets. In a study of shedding of MH in different parities: gilts were 73% positive, parity 2 to 4 sows

were 42% positive, parity 6 to 7 sows 50% positive, and parity 8 to 11 sows were 6% positive. Generally, the nursery is considered the area where transmission occurs and infection spreads slowly. Within pen transmission measured by PCR is very slow. Animals can be PCR positive and not infectious for long periods of time and then can become very infectious up to 119 days, as has been recorded.<sup>11</sup> There is therefore a nonlinear excretion of MH. It is thought that one infected nursery pig will infect on average one littermate. Boars can also infect sows when they are kept together in service areas, but in these areas the disease spreads slowly. The disease is also transmitted and exacerbated during the grouping and stress of pigs that occurs at weaning. Transmission can occur as early as 1 week of age, but usually it is not observed under 6 weeks of age.<sup>14</sup> The highest clinical and pathologic incidence occurs in the postweaning and growing period, and in most herds this is maintained through the growing period to market age. The start of finishing is the critical point. Direct exposure (nose-to-nose contact) of pigs at 9 to 11 weeks of age to seropositive gilts results in seroconversion to the organism by 21 days and is most frequent by about 11 weeks after exposure. The presence of gross lesions of pneumonia correlated with the seroconversion.

Frequent coughing by infected, intensively reared pigs suggests that repeated aerosol exposure occurs and is an important natural mode of transmission of respiratory pathogens. There is general agreement that management and environmental conditions considerably influence the severity of the disease.

The reinfection of enzootic pneumonia-free herds, recurrences or so-called breakdowns, occurs at a rate of about 3% of herds every 6 months. In a study of swine herds that had participated in the Pig Health Control Association Scheme in the United Kingdom, the close proximity of the uninfected herds to infected herds appeared to be the most important risk factor that could explain the introduction of the infection. The size of the herd, the density of the pig population in the area, the distance to the next road regularly used for transportation of pigs, and differences in topography were risk factors associated with reinfection. There was little evidence to indicate that unexplained breakdowns occurred in association with long-term latent infection in other herds from which animals had been imported. Clinical signs of enzootic pneumonia in these herds commonly did not occur for several months after the introduction of infected pigs.

MH was not transmitted during a 20-week period when personnel weekly contacted susceptible pigs in a naïve herd after they had been in contact with pigs in an infected herd. A comprehensive herd specific

prevention program is necessary to reduce transmission of disease caused by MH.<sup>15</sup>

### Risk Factors

The prevalence, incidence, and severity of pneumonia in swine herds are determined by interactions among infectious agents, the host, the environment, and management practices. This being said a large survey of the seroprevalence of MH in 50 finishing herds showed that there were no risk indicators. Each farm is an individual one, with the farm itself exerting a great effect. A recent study in suckling pigs at the age of weaning in the United Kingdom<sup>16</sup> has suggested that an increase in the number of live pigs born alive was linked to a lower incidence of MH in suckling pigs at weaning. Grinding the piglets' teeth also reduced the incidence of MH. A second dose of iron was also associated with a reduced level of MH. A low environmental temperature also produced an increase in the incidence of pneumonia.

In a study of MH in coughing piglets (3-6 weeks of age) from 50 herds with endemic respiratory disease in Germany,<sup>17</sup> it was found that MH was detected in the lavage fluid in 12.3% of the suckling piglets and 10.6% of the weaned piglets. The study showed that the detection of MH in young piglets is associated with one or two site production and inappropriate gilt acclimatization. In a study of nasal carriage in farmers using PCR it was found that 15% of farmers carried MH in their nose, but it is not possible to say that they were colonized.<sup>18</sup>

### Animal Risk Factors

Several factors such as breed, age, presence of diarrhea, the prevalence of atrophic rhinitis, birth weight, and weaning weight, have been examined as animal risk factors. In some herds, the risk of coughing and pneumonic lesions increased with increasing age of pigs within a herd. In a survey of two different groups of pigs slaughtered at different ages, the age-specific prevalence of pneumonic lesions was 2.7% in pigs less than 16 weeks of age at slaughter, but it increased rapidly when pigs were between 16 and 22 weeks of age at slaughter. Infection at an early age has a greater effect than infection later in life. Pigs coughing by 14 weeks of age were, on average, 6.2 to 6.9 kg lighter than those with onset of disease near market age. The highest seroconversion rate occurs between 3 to 4 months of age. In a recent experimental infection, 77.7% of the infected animals were still positive 185 days later, and 100% of the naturally infected animals were still infected at the same time. There may be selective differences in the colonization rates between litters. There may also be a sex effect on colonization. A longitudinal study of the diversity and dynamics of MH infection has been described.<sup>19</sup>

In a study of a large number of sows in northwestern Germany, it was found that the

risk of a sow being seropositive was increased in herds with two- or three-site production, when piglets were not vaccinated, when herds had 2-week farrowing intervals, and in herds without AI/AO management of the farrowing units. The lack of an acclimatization period for boars was also associated with the risk of a sow being seropositive.<sup>20</sup>

### Immune Mechanisms

Pigs that recover from experimentally induced enzootic pneumonia are resistant to subsequent challenge. The nature of the immunity induced by MH, whether serum or local antibody mediated, T-cell mediated, or a combination of these factors, is not clear. Based on lymphocyte transformation tests of experimentally infected pigs, it is possible that cell-mediated immunity correlates with protective immunity. The median half-life of passively acquired antibodies to MH is 16 days, the persistence of antibodies is related to the initial antibody concentration, and antibodies waned by 30 to 63 days after birth depending on initial concentration. It has been detected as late as 155 days of age. The titer of maternal antibodies is a major concern when pigs are vaccinated. The age of the piglet vaccinated is not the key factor. The level of the sow's antibodies approximately 4 weeks prepartum are at their highest and similar to the levels in colostrum. Immunity is not conferred through colostrum immunoglobulins, and thus piglets born from immune dams are susceptible to infection and clinical disease. No significant correlations have been found between the colostrum antibody levels and the colonization status of the sows. The level of immunoglobulins to MH can be used to monitor infection in the herd. Pigs usually seroconvert to APP and then MH.

Pigs raised under unfavorable conditions develop pneumonic lesions more frequently than pigs raised under better conditions, regardless of their immune status. Pigs vaccinated with inactivated MH organisms develop both a cell-mediated and humoral immune response, but they are not protected from challenge exposure by natural infection. Local immunity, particularly secretory IgA, is considered to be important in protection against mycoplasma infection. MH may suppress alveolar macrophage function, which may predispose the lung to secondary infection. The organism is very clever in evading the immune response, probably by changing the nature of the immune response to one that is less effective. To do this it causes the production of cytokines IL-1 $\alpha$  and beta, IL-6, and TNF- $\alpha$  by macrophages and monocytes and induces local inflammation. This is essentially moving the immune response from a TH1 type response to a T-helper type 2 response.

In an experimental study it was shown that PRRSV vaccine strain and the natural infection were able to induce T-regs in pigs

naturally infected with MH. This suggests that the exacerbation of MH following PRRS may be attributable to the ability of PRRSV vaccination and viral infection to induce regulatory T cells.<sup>21</sup>

### Pathogen Risk Factors

MH adheres to the tracheal and bronchial mucosae and causes an extensive loss of cilia. An evaluation of the virulence factors of MH field isolates has been made.

### Environmental and Management Risk Factors

#### Pathogenesis

MH colonizes the respiratory epithelium for a long time and produces a prolonged inflammatory response and suppresses and modulates the immune reactions. Little is as yet known about the virulence factors of MH. A wide variety of proteins are produced. *Mycoplasma* have the smallest genomes of organisms capable of separate existence. This genome encodes for several immunogenic proteins including a cytosolic protein p36 (which may have lactic dehydrogenase activity); membrane proteins P46, P65, and P74 (can produce neutralizing antibodies); and an adhesin P97. The P97 adhesin mediates adherence of MH to swine cilia. An adhesin-like protein (P110) composed of a P54 and 2 P28 units has also been found. Attachment is a complex process involving many gene products. A recent study of the total protein profile, glycoprotein profile, and size differences in the amplified PCR product of P97 adhesin genes suggests that there is an intraspecies variation in the MH population in the United States. Combination with the P102 adjacent gene allows the two proteins to contribute to cellular adherence.<sup>5,6</sup> A highly immunogenic MH lipoprotein Mhp366 was identified by peptide-spot array,<sup>22</sup> and this may be a useful method for detecting MH infections. The in vivo virulence of MH isolates does not correlate with in vitro adhesion assessed by a microtiter adherence assay.<sup>23</sup> These observations suggest that mechanisms other than adherence may be responsible for observed differences in virulence.

The *Mycoplasma* penetrate the mucus layer and attach to cilia. They appear only to attach to the cilia. They release calcium<sup>++</sup> ions from the endoplasmic reticulum of the ciliated cells. As a result there is a clumping and a loss of cilia and excess production of mucus by goblet cells.<sup>24</sup> This results in a dysfunction of mucociliary clearance. The secondary bacteria attach to the damaged epithelium.

In experimental infections of tracheal explants with MH, it was shown that IL-10, IL-6, and IL-8 were produced.<sup>25,26</sup> There is also a production of TNF- $\alpha$  and IL-1<sup>27</sup> and IL-18, but the production of IFN- $\gamma$  is inhibited.<sup>28</sup> These are possible mechanisms for the down-regulation of cell-mediated immunity



that allows for the enhancement of the duration and severity of pneumonia with PRRSV and a mechanism to modulate the immune response.

Macrophages have an impaired phagocytic activity after MH infection. MH also alters the function of B- and T-cell lymphocytes.

The experimental inoculation of the J strain of MH into piglets causes gross pneumonic lesions that are detectable 7 to 10 days later. Moderately extensive pneumonia is present 6 weeks after inoculation, progressive recovery can be observed after 10 weeks, and residual lung lesions are detectable in a few pigs up to 37 weeks after inoculation. Experimental infections vary in their effects in clinical signs and pathology.<sup>29</sup>

MH causes peribronchiolar lymphoreticular hyperplasia and mononuclear accumulation in the lamina propria, which causes obliteration of the bronchial lumina. There is also perivascular lymphoid hyperplasia. The bronchial mucous glands undergo hypertrophy; there are increased numbers of polymorphonuclear cells in the bronchial lumina and macrophages in the alveoli. Lymphocytes, together with plasma cells and macrophages are responsible for the increase in the thickness of the interlobular septa as the disease progresses. The hyperplastic BALT (bronchial and bronchiolar associated lymphoid tissue) in enzootic pneumonia cases consisted of macrophages, dendritic cells, T- and B-lymphocytes, and IgG<sup>+</sup> and IgA<sup>+</sup> cells. In these aggregates CD4<sup>+</sup> predominated over CD8<sup>+</sup> cells. The cells in the BALT released IL-2, IL-4, TNF- $\alpha$ , and, to a lesser extent IL-1 $\alpha$  and  $\beta$ . IL-1 $\alpha$  and TNF- $\alpha$  were also released in bronchoalveolar lavage fluids, and IL-6 and IL-8 were found in the mononuclear cells of the alveolar septa.

Hyperplasia of type II alveolar epithelial cells is progressive as the disease becomes worse. Affected pigs cough persistently, show labored respiration and reduced exercise tolerance. The lesions are similar to those of chronic bronchitis. After infection, MH multiplies in tracheal and bronchial mucosae, adheres to the ciliated cells, and causes a cytopathic effect and exfoliation of epithelial cells. There is a significant increase in the gland/wall ratio and a decrease in the ratio of respiratory to expiratory resistance.

The effects of this chronic pulmonary lesion have been the subject of considerable investigation. It is thought that the presence of mycoplasmal lesions uncomplicated by secondary bacterial infections has minimal effect on the production of the pig if the environmental conditions are suitable. The lesions will heal, and any loss in production from the initial infection will be regained by compensatory regrowth. Severe lesions or those accompanied by secondary bacterial bronchopneumonia and pleuritis will usually cause a significant decrease in average daily gain and feed efficiency. Secondary infection

with *Pasteurella* spp. results in acute episodes of toxemic bronchopneumonia and pleuritis. Dual infections are usually more severe than single infections. For example, SIV and MH together are more severe.

A longitudinal study was made in four herds until slaughter. The percentage of pigs testing positive increased from 35% at 6 weeks to 96% at slaughter at 26 weeks. Within each herd only one distinct strain was detected<sup>19</sup> and was present in the same animal for at least 12 weeks.

The pulmonary and hematologic changes in experimental MH pneumonia cause no significant changes in heart rate, respiratory rate, and rectal temperature, even though at necropsy well-demarcated pulmonary lesions were present. There were several measurable changes in respiratory functions as a result of the atelectasis: partial occlusion of the bronchioles with exudate, localized pulmonary edema, and a reduction in oxygen perfusion to the alveoli leading to a decrease in the partial pressure of oxygen in the arterial blood. There are no remarkable changes in the hematology. The body weight gains are decreased compared with the control animals.

The distribution of lesions is characteristic. They occur in the right middle lobe, the right cranial and left middle lobes, and the left cranial and diaphragmatic lobes, in that order of frequency. The differences in pathogenicity between high- and low-virulence isolates is associated with a faster in vitro growth, a raised capacity to multiply in the lungs, and the induction of a more severe inflammatory process.<sup>30</sup> It has been shown recently that MH-derived lipid-associated proteins induce apoptosis in alveolar macrophages by increasing nitric oxide production, oxidative stress and caspase-3 activation.<sup>31</sup>

In a study to assess the duration of infection with MH 60 pigs were infected and studied until the population became negative on estimation of DNA in bronchial swabs. DNA was detected in 100% of the animals at 94 days postinfection, 615 at 214 days, and 0% at 254 days PI. Experimentally infected pigs transmitted to sentinels at 80 and 200 days post infection.<sup>32</sup>

### CLINICAL FINDINGS

The appearance of clinical pneumonia depends on the number of organisms, their virulence, and the involvement of secondary agents. The more pathogenic strains induce more pneumonia.<sup>30</sup> It is also influenced and made more severe by PCV2<sup>33,34</sup> and together with PRRSV is also more severe.

A natural incubation period of 10 to 16 days is shortened to 5 to 12 days in experimental transmission. Two forms of the disease are described. In the relatively rare acute form, a severe outbreak may occur in a susceptible herd when the infection is first introduced. In such herds pigs of all ages are

susceptible and a morbidity of 100% may be experienced. Suckling piglets as young as 10 days of age have been infected. Acute respiratory distress with or without fever is characteristic and increased mortality may occur. The usual course of this form of the disease within a herd is usually about 3 months, after which it subsides to the more common chronic form.

The chronic form of the disease is much more common and is the pattern seen in endemically infected herds. Young piglets are usually infected when they are 3 to 10 weeks of age, and clinical signs may be seen in suckling piglets. More commonly, the disease shows greatest clinical manifestation after weaning and in the growing period. The onset of clinical abnormality is insidious and coughing is the major manifestation. Initially only a few pigs within the group may show clinical abnormality, but then the incidence generally increases until coughing may be elicited from most pigs. It may disappear in 2 to 3 weeks or persist throughout the growing period. In affected herds, individual pigs may be heard to cough at any time, but coughing is most obvious at initial activity in the morning and at feeding time. Coughing may also be elicited by exercising the pigs around the pen, and it occurs with greater frequency in the period immediately following the exercise. A dry or crackling, hacking cough, which is usually repetitive, is characteristic. Respiratory embarrassment is rare and there is no fever or obvious inappetence. Subsequently there is retardation of growth that varies in severity between individuals so that uneven group size is common. Clinical disease becomes less obvious with increasing age and is rarely detected in the sow herd, although gilts and young sows frequently harbor MH.

### CLINICAL PATHOLOGY

Raised haptoglobin levels have been found in pigs with lung conditions resembling *Mycoplasma* infection but not *A. pleuropneumoniae*-type lesions.<sup>35</sup>

### Serologic Tests

Serologic tests are best used to assess the herd status. All the three assays in use in the United States have excellent specificity, but the sensitivity is low, from 37% to 49%. The tests vary in their efficacy in different experimental infections.<sup>36</sup>

Serologic tests have included the CFT (low sensitivity), indirect hemagglutination test (good for early detection as it detects IgM), and the latex agglutination test. The unsatisfactory sensitivities and specificities of these tests led to the development of ELISA systems, DNA probe technology, and PCR to accurately diagnose enzootic pneumonia. The ELISAs detect all classes of IgG and are very sensitive, but they detect the onset of seroconversion rather than infection. An SIgA-ELISA has been developed for

detecting secretory IgA from nasal swabs,<sup>37</sup> and it is capable of detecting MH infection from MH vaccinated pigs.

An ELISA using a commercially available antigen (Auspharm) is highly sensitive (95.6%) and specific (98.8%) for antibodies against MH when pig sera from commercial herds of known infection status were evaluated. An improved ELISA is also available, and the two ELISAs are able to distinguish populations of gross pathology-negative pigs in endemic herds from pigs in true specific pathogen-free (SPF) herds. Pigs from the former group have significantly higher ELISA activity with both tests and would represent recovered or exposed nondiseased pigs, or pigs with only histologic lesions in endemic herds. The ELISA is ideal for diagnostic laboratories and should obviate much of the need for culture and immunofluorescent histopathology, reducing the cost of diagnosis. The ELISA can also detect antibodies in the colostrum of sows with a high specificity. A recent study comparing three ELISAs has shown that the sensitivities of the tests were lower than previously reported especially for vaccinated animals. Animals within 21 days postinfection were also not easily detected. The blocking ELISA was the most sensitive. All three were highly specific. There is also a blocking ELISA against a p40 protein.

Colostrum has also been used for the certification of freedom from MH but must be achieved during the first 2 hours after parturition. High-parity sows are a better source for the detection of antibodies.

### Detection of Organism

For the highest level of accuracy in detecting the organism the use of a number of tests would be best.

The organism can be detected in lung tissues by culture, immunofluorescence, PCR, and antigen-ELISA, and all have high sensitivity in the acute stages of pneumonia. A PCR-based assay can differentiate MH, *M. flocculare*, and *M. hyorhinitis* and also detect low numbers of organisms. It can also be used on the bronchoalveolar lavage. The identification of the p36 and p46 protein genes has enabled them to be used in a PCR for MH, with a sensitivity of 86.6% and a specificity of 96.7%. Nested PCR is much better. There is a good correlation between the results of nested-PCR and histology. In situ hybridization shows MH on the surface of the epithelial cells, not in the cytoplasm, with an occasional signal in the cytoplasm of the alveolar and interstitial macrophages. A PCR<sup>38</sup> had a diagnostic sensitivity of 97.3% and a specificity of 93.0%.

### Herd Certification

The determination of the presence or absence of MH within a herd for certification purposes can be difficult and should be approached with caution. It should not be

based on a single examination procedure. It requires a surveillance system that combines regular farm visits and serologic, cultural, and tissue examination of selected pigs and of those sent to slaughter. The herd should be examined clinically for evidence of the disease, and the lungs from several shipments of pigs should be examined at the abattoir and subsequently histologically. There can be seasonal variation in the severity of lung lesions and at certain times market-age pigs may not have visible gross lesions, even though infection may be present in the herd. If doubt exists, the lungs of younger pigs, preferably clinically suspect pigs, or recently weaned pigs, should be examined after elective slaughter. The herd should also be examined for the presence of antibody to MH.

### NECROPSY FINDINGS

Except in severe cases, the damage is confined to the cranial and middle lobes, which are clearly demarcated from the normal lung tissue. The lesions are commonly more severe in the right than in the left lung (simply because it is larger, has a larger supply of main-stem bronchi and a greater arterial supply). Plum-colored or grayish areas of lobular consolidation are evident. Enlarged, edematous bronchial lymph nodes are characteristic. In acute cases, there is intense edema and congestion of the lung and frothy exudate in the bronchi. When secondary invasion occurs, pleuritis and pericarditis are common, and there may be severe hepatization and congestion with a suppurative bronchopneumonia.

Evaluation of the pneumonic lesions at slaughter has been used extensively for herd health monitoring. Scoring of the lesions is typically done on both lungs (the entire pluck). To overcome the logistical problems associated with examining entire plucks during the slaughtering procedure, an alternate system based on scoring the right lung only has been investigated. The overall right lung relative sensitivities for the detection of catarrhal pneumonia or chronic pleuritis were 81% and 72%, respectively. It is suggested that an evaluation of the right lung pathology is a useful alternative when the purpose of the survey is to demonstrate the presence or absence of lesions, or when scoring the severity of the lesion is the objective.

The microscopic changes of enzootic pneumonia include lymphohistiocytic peribronchiolar cuffing with increased numbers of mononuclear leukocytes in the bronchial lamina propria. There is hyperplasia of the bronchiolar epithelium and filling of alveoli with macrophages, protein-rich fluid and small numbers of lymphocytes and plasma cells. Hyperplasia of type II alveolar epithelial cells occurs as the disease progresses.

These histologic changes were most marked from 7 to 28 dpi coinciding with a

significant increase in the immunohistochemical demonstration of IL-1 $\alpha$ , IL-1 $\beta$ , IL-8, TNF- $\alpha$  and INF- $\gamma$ , lymphoid markers CD4+ and CD8+, muramidase, and IgG and IgA.<sup>39</sup> The lesions and immunohistochemical signals declined in intensity after 35 days.

In one study, a definitive diagnosis of *Mycoplasma* pneumonia of swine was based on the demonstration of MH in lung sections using specific antisera or successful culture of the organism. Utilizing these techniques, it was found that up to 19% of grossly normal lungs may be infected with MH. Conversely, the organism could not be demonstrated in about 33% of the lungs of pigs from herds thought to be affected with MH pneumonia, even though typical gross lesions were present. The sensitivity of these techniques may be surpassed by newer PCR methods. The organism can also be detected in formalin-fixed paraffin-embedded porcine lung by the indirect immunoperoxidase test. The results of immunofluorescence tests performed on piglets with experimentally induced pneumonia revealed that MH organisms are located primarily on bronchial and bronchiolar epithelial surfaces of lungs with gross lesions of pneumonia. Fluorescence was most intense 4 to 6 weeks after infection and began to decrease at 8 to 12 weeks. This suggests a decrease in the number of MH in the more advanced stages of the disease. When assessing plucks at slaughter to determine the severity of pneumonia in a group, it must be remembered that in most instances the lesions observed represent a chronic, partially resolved disease process. Therefore the clinical effects of the infection may have caused a greater degree of respiratory compromise than is apparent at slaughter.

In a recent study the histopathology of lungs in slaughter pigs vaccinated with different vaccines has been described.<sup>40</sup> Lung lesion scores and MH loads differed widely between the three different vaccine groups but were correlated with each other.

### DIAGNOSIS

Typical epidemiology and a dry hacking cough are suggestive of MH. Typical lesions need to be investigated at the margins of the lesions and culture attempted. Recently farms have been described that have more than 1 strain of MH.<sup>1</sup>

Tracheal bronchial swabbing associated with RT-PCR could be an accurate diagnostic method.<sup>41</sup>

The most sensitive sampling methods for detecting MH in live, naturally infected pigs were tracheobronchial swabbing or washing compared with oropharyngeal brushing and nasal swabbing.<sup>42</sup>

### Samples for Confirmation of Diagnosis

- **Touch preparations** using Giemsa stained slides have been used.

- **Histology**—formalin-fixed lung (LM, IHC). Simple histopathology may not always indicate MH infection. For example, Aujeszky's disease together with *P. multocida* may be difficult to differentiate from MH. Lesions may be characteristic but not pathognomonic.

Detection in lung tissue is either by FA or IHC, and these are rapid and cheap and more often used than ISH. The more fresh the material or immediately fixed material gives better results.

In experimentally infected pigs MH could be reisolated from liver and spleen of experimentally infected pigs and contact pigs.<sup>43</sup>

Indirect immunofluorescence (IF) and indirect immunoperoxidase (IHC) for MH in tissues are extremely useful. However, IF has a lack of sensitivity and IHC is time consuming and expensive.

**Mycoplasmology** lung (MCULT, FAT, PCR). Isolation of MH is complicated by the overgrowth that occurs from *M. hyorhinis* and *M. flocculare*. The organism is fastidious, and 4 to 8 weeks are sometimes needed for growth. It also requires specialized media, including swine serum. For these two reasons it is not so commonly used now. Many animals that are culture positive do not have gross or microscopic lesions.

PCRs have become a sensitive and specific method for identifying MH.<sup>38,41</sup> Lung tissue, bronchial swabs, or bronchial washings are the best sites. Nested PCRs raise the sensitivity and may detect as few as four to five organisms. A real-time TaqMan PCR that simultaneously detected the proteins P46, P97, and P102 has been designed<sup>44</sup> that can detect 10<sup>8</sup> *Mycoplasma* per pig.

In addition, a multiplex PCR has been developed that can be used on culture broth for several mycoplasma.<sup>45</sup>

A number of RT-PCRs have been developed that allow quantification.<sup>44,46</sup> The PCR can be used as a one-step test but is not good for nasal swabs. The nested PCR can be used for these, but it does tend to produce some false positives. Correct samples give a better diagnosis. Samples from lavage and tracheo-bronchial sites were the best for nested PCR, and lung tissue and nasal swabs are not the most reliable.<sup>43</sup>

## TREATMENT

There is no effective treatment to eliminate infection with MH, although the severity of the clinical disease may be reduced.

Isolates of the organism from the United States were susceptible to lincomycin-spectinomycin, tylosin, and oxytetracycline. Isolates from the United Kingdom were susceptible to doxycycline and oxytetracycline. Doxycycline, a semisynthetic tetracycline, has a greater antimicrobial activity, is better absorbed orally and is more widely distributed in tissues than the

first-generation tetracyclines (oxytetracycline, tetracycline, and chlortetracycline). Tetracyclines given as a preventative in-feed are more effective than giving tetracyclines once clinical signs of coughing have started.<sup>47</sup> This is particularly true when using the drug around times of stress and acquisition of the organisms (ie, in the nursery and at weaning). A recent study has shown that CTC when administered at the onset of clinical signs via the feed at a dosage of 500 ppm during two alternate weeks was able to decrease the prevalence of pneumonia lesions and numerically reduced the performance losses and clinical signs.<sup>48</sup>

In some early studies, a mixture of tylosin tartrate at a dose of 50 mg/kg BW and tiamulin at 10 mg/kg BW orally daily for 10 days significantly reduced the pulmonary lesions associated with the experimental disease. However, the use of 60, 120, or 180 mg of tiamulin per liter of drinking water for 10 days was not effective in suppressing the lesions of experimentally induced MH pneumonia or infection in disease-free pigs.

The newer fluoroquinolones have good in vitro activity against MH and exhibit superior activity to tylosin, tiamulin, oxytetracycline, and gentamicin. Ciprofloxacin is particularly active against MH.

Tilmicosin is particularly effective because it appears to prevent the attachment of MH to the surface of the epithelial cells.

Tetracyclines will either prevent transmission or suppress lesion formation in experimental pigs but the levels required are high and in an infected herd continuous administration would be necessary, which would be uneconomic. Treatment is generally restricted to individual pigs showing acute respiratory distress as a result of a severe infection or secondary invaders. Broad-spectrum antimicrobials are used, usually tetracyclines, but the response is only moderately good. The occurrence of severe signs within a group of pigs may necessitate treatment. Tetracyclines, tylosin, or spiramycin fed at 200 mg/kg feed for 5 to 10 days is recommended. A combination of 300 g of oxytetracycline and 30 g of tiamulin per ton of finished feed fed for 2 to 3 days/week over a 16-month period has been used to reduce the incidence of enzootic pneumonia in a large herd. Lung lesions were reduced, average daily gain increased, and efficiency of feed conversion increased, with an overall increase in profitability. Valnemulin may prove to be effective in the treatment of enzootic pneumonia. There is a higher susceptibility to valnemulin and tiamulin when used in conjunction with doxycycline as a treatment.

Tulathromycin administered as a single injection at a standard dosage of 2.5 mg/kg is effective in the treatment of swine pneumonia associated with mycoplasmosis.

Oral florfenicol feed supplementation (20 g/ton) reduces the effects of MH infection.<sup>49</sup>

There is no evidence for resistance to lincomycin/spectinomycin, oxytetracycline, doxycycline, gentamicin, flufenicol, and tiamulin. There is evidence for some resistance from the field to tetracyclines, macrolides, lincosamides, and fluoroquinolones.<sup>50,51</sup>

## CONTROL

Control strategies have been reviewed.<sup>52</sup> In all cases recommended management procedures such as all in/all out pig flow, medicated and segregated early weaning, and multisite operations further facilitate control of respiratory disease.

MH infects only pigs and transmission requires close pig-to-pig contact. If transmission can be prevented, it is possible to limit or even eradicate the disease from a herd. There are thus two levels at which control can be practiced: (1) Complete eradication of the disease or (2) Controlling the disease and its effects at a low level.

The principles of control of MH include the following strategies:

- Regular inspection of the herd for clinical evidence of disease and slaughter checks of lungs
- Rigorous biosecurity of animals being introduced into the herd and control of visitors
- Provision of adequate environmental conditions, including air quality, ventilation, temperature control, and stocking density
- The use of the all-in, all-out system of production in which groups of pigs by age or stage of production are moved through the herd from the gestation barn, farrowing barn, nursery rooms, and finishing units as groups and the pens previously occupied are cleaned, disinfected, and left vacant for several days before animals are reintroduced. Because most infection is believed to occur between 4 to 12 weeks, nursery depopulation has become an effective way of controlling the infection in nursery pigs.

## Control by Eradication

Control by eradication is the most satisfactory and is probably mandatory for large breeding companies, herds supplying replacement stock to other herds, and for large intensive farrow-to-finish enterprises. It is based on the principle that the source of infection for the young pig is the gilt or the sow and this chain of infection must be interrupted to prevent infection. In the past, the 10-month cutoff point has been used in eradication programs, but in view of the colonization studies, this may be too soon. This is especially so in off-site production systems where the time of infection is delayed.



There are three different principle methods. First, there is total depopulation followed by restocking with noninfected stock (Danish SPF system). Second, the test and removal of all positives and inconclusives. Third, complete eradication without total depopulation and restocking.

Eradication without restocking has been described, and here the secret was to wait until farrowing finished, then vaccinate all sows and treat with tiamulin at 6 mg/kg daily for 3 weeks and then monitor with blood tests.

### Specific Pathogen-Free or Minimal-Disease Pigs

Several methods of eradication have been attempted, but the most satisfactory is repopulation with specific-pathogen-free (SPF) pigs. The principle underlying this method is that the piglet in utero is free of infection with MH. If it is taken from the uterus at term by suitable sterile hysterectomy or hysterotomy techniques and reared artificially in an environment free of pigs, it will remain free of this infection. In practice this has been carried out in special units, and the piglets have been subsequently used to repopulate existing farms where all pigs have been removed 30 days before the introduction of the SPF pigs and a thorough cleaning program completed. This method was initially developed for the control of MH and atrophic rhinitis. Moreover, if suitable precautions are taken and if the piglets are used to populate new units that have had no previous exposure to pigs, then freedom from other important diseases such as internal and external parasitism, leptospirosis, brucellosis, swine dysentery, and others can be achieved. The progeny of these primary SPF herds can subsequently be used to repopulate other or secondary SPF herds known as minimal disease pigs.

Because of the cost and technical difficulty of this method, other methods of eradicating MH have been attempted, but they are generally less satisfactory and have a higher failure rate. These include "snatching" of pigs at birth and isolated farrowing. In the former the piglets are caught and removed from the sow immediately at birth and reared as previously described or foster-suckled on SPF sows in another environment. Although MH may be eliminated by this method, fecal contamination during parturition of the vulva and vagina and consequently of the piglet is common, and this method is less satisfactory for disease control than removal by hysterectomy.

### Isolated Farrowing

Isolated farrowing techniques have proved successful in small herds but have a high failure rate when practiced on a large scale. Older sows believed to be free of infection are farrowed in isolation in individual pens erected outside on pasture and each sow and

litter is kept as a separate unit. The litter is inspected clinically at regular intervals, and subsequently a proportion of the litter, usually excess males and gilts undesirable for breeding, will be examined at slaughter for evidence of pneumonia. Any litters with clinical, pathologic, or laboratory evidence of pneumonia are eliminated from the program. Litters that pass inspection are kept for repopulation of the herd. Because of the difficulties in detecting carrier pigs without lesions, eradication by methods using these principles frequently fails.

### Minimal Disease Herds

Minimal disease herds have been established in most countries with significant pig populations, either by breeding companies or private purebred breeders. As a result, in most countries there is a nucleus of MH-free stock. The establishment of primary SPF herds is technically difficult and very costly and should not be undertaken lightly. There is also a considerable delay in cash flow between the time of initial population and buildup of herd numbers to the time when significant numbers of pigs are available for sale. If eradication by repopulation is intended, it is preferable to purchase pregnant gilts from established primary SPF herds unless the maintenance of existing genetic lines dictates otherwise. Before recommending eradication by this method it is essential that the pig owner understands the principles of this method of control and the restrictions that will need to apply if it is to be successful. Farrow-to-finish enterprises established by this method should be run as closed herds, and if further genetic material is required it should be introduced by hysterectomy techniques or by purchase from the initial source herd. The use of artificial insemination is an alternate method; however, isolation of MH from semen has been recorded.

The problem of certifying and maintaining herds free of MH is a major task.

### Reinfection of Herds

Reinfection of MH-free pig herds occurs despite high standards of isolation and strict precautions when complete protective clothing and showering routines are required for all visitors entering the unit. All visitors are debarred entry if they have been to a possible source of infection during the previous 48 hours and even up to 7 days. Also, the majority of breakdowns occur in herds that have not imported infected stock recently. In reinfected herds that imported stock there was no concurrent evidence of breakdown in the parent herds, which supported the contention that the importation of infected pigs was an unlikely source of the infection. An epidemiologic investigation of these reinfections suggests that close proximity of uninfected herds to infected herds may be an important factor. The organism does not

survive for more than a few days under dry conditions; however, it can survive in diluted tap water and rainwater for 2 to 3 weeks, and it has been suggested that the organism may be transported in moist air and that airborne infection between piggeries is a possible method of transmission. In Switzerland, 107 farms were reinfected of the 3983 that were eradicated during the period 1996 to 1999 (2.6%). The significance of known risk factors such as farm size, high density of pigs, and farm type was confirmed in this analysis.

Some preliminary estimates of risk indices based on the proximity of other pig units has indicated that the most important factor was the reciprocal of the square of distance to the nearest other unit. The crucial distance for maximum survival was about 3.2 km. A breakdown was described recently in which a whole variety of measures were included in an attempt to control the disease.

### Antimicrobial Prophylaxis

Eradication has also been attempted by antimicrobial treatment of newborn piglets with oxytetracycline on days 1, 7, and 14, which were weaned on day 14 and moved to offsite nursery. This is known as a low-cost modified medicated-early-weaning program. This can be followed by serologic testing of the breeding herd and culling of positive reactors. Control by vaccination on the one hand and by the use of tilmicosin on the other produced similar results when measured by serologic results and the prevalence of macroscopic lung lesions. Lincocin with or without vaccination considerably improves the growth and performance. Doxycycline in the feed at 11 mg/kg BW is effective in controlling pneumonia caused by *P. multocida* and MH in feeder pigs.

### Low-Level Disease

The alternative to eradication is to limit the effects of the disease in those herds where eradication is either not desirable or feasible. The effects of the disease are generally less severe in nonintensive rearing situations, in small herds where individual litters are reared separately, and where litters from older sows can be reared separately from other pigs. Where litters are grouped at weaning, a low stocking density with less than 25 pigs in initial pen groups and 100 pigs in a common airspace may also reduce the severity of the disease.

Temperature, humidity and ventilation also have an important influence on the disease. It is possible to determine an optimal air temperature zone for growing-finishing pigs based on the measurement of behavioral and health-related problems. They are interrelated with stocking density and housing. The subject is too broad for treatment here, and the requirements for pigs at different ages and under different housing situations may be found in standard texts on pig

housing and production. The environmental risk factors associated with the incidence of MH should be assessed in each circumstance. Some important environmental variables that should be assessed and modified include the following:

- Number of pigs per shed
- Number of pigs per pen
- Airspace per pig
- Floor space per pig
- Cleaning and disinfection techniques used
- Number of air changes per hour
- Waste disposal system
- Number of temperature fluctuations in a 24-hour period
- Direction of the flow of air in the building
- Concentrations of ammonia and hydrogen sulfide in the building
- Dust levels
- Feeding and watering systems
- Whether or not the all-in, all-out system is being used effectively

### Medication of Breeding Stock

The original medicated early weaning program was based on medication of the sows with tiamulin at the time of farrowing and the early weaning of the piglets to an off-site location. A variation of this method is to prevent the spread of infection by the following means:

- Isolation of the breeding stock
- Strategic antimicrobial medication of the breeding stock
- Reintroduction of the breeding stock to the original but empty and disinfected gestation barn
- Separate rearing of the piglets before and after initiating the program
- Regulation of flow of animals through the herd. Farrowing barns are emptied out when possible and cleaned, disinfected, and left empty. After weaning their piglets, sows are transferred to the dry sow barns. Sows about to farrow are treated with tiamulin and moved to the farrowing barn.

Medication and vaccination was used to eradicate MH without total depopulation.<sup>53</sup>

### Source of Feeder Pigs

Where possible the purchase of weaners or pigs for finishing units should be from herds free of the disease or from a single source. Purchase through saleyards or the purchase of coughing or uneven litters is not advisable. When pigs from infected herds are purchased it may be necessary to medicate the feed prophylactically with one of the tetracycline group of antibiotics or tylosin or spiramycin at 100 to 200 mg/kg of feed for a 2-week period after introduction. Medication of the feed of finishing pigs with tiamulin at 20 and 30 mg/kg of feed over an 8-week period on farms with histories of severe

complicated enzootic pneumonia resulted in improved weight gains and feed efficiency, but the extent and severity of the lung lesions did not change. The level of 30 mg/kg in the feed was superior to the level of 20 mg/kg. Tiamulin at 100 mg/kg combined with chlortetracycline at 300 mg/kg of feed for 7 days was effective in herds with a history of MH complicated by the presence of *P. multocida* and *Actinobacillus pleuropneumoniae*.

Introduced pigs should be isolated from the rest of the herd and preferably they should be reared as a batch through a house on the all-in, all-out system. A high stocking density should be avoided and internal parasites should be controlled.

### Vaccination

A general observation was that *Ascaris sum* infection affected the response to vaccination for MH.<sup>54</sup> Vaccination reduces the macrophage infiltration in bronchus associated lymphoid tissue infected with a virulent MH strain.<sup>55</sup> In the same study MH was reduced in the lungs in the vaccinated pigs, and the high-virulence strain was inhibited more than the low virulence strain. Vaccination significantly reduces clinical signs macroscopic and microscopic lung lesions especially infected with avirulent strain.<sup>56</sup> The effect was less pronounced with a less virulent strain. Vaccination does not, however, reduce the transmission to other pigs.<sup>57</sup>

MH vaccines are generally bacterins consisting of outer membrane proteins or whole organisms. The vaccines give little protection against initial infection and often incomplete protection against clinical pneumonia. The vaccines produce a TH1 response and also IgA and IgG in the lavage fluids. Natural maternal antibodies do not seem to inhibit vaccination, but vaccination of sows may inhibit subsequent immunity.

Vaccination with killed MH induces protection in pigs against experimental challenge exposure with the organism. A cost-benefit analysis shows that the vaccination is economically beneficial. The relationships between maternally derived antibodies, age, and other factors in vaccine response have been discussed.

Intranasal vaccination of attenuated MH adjuvanted with bacterial DNA may be effective in evoking the local cellular and humoral response and the systemic immune response.<sup>58</sup>

A killed MH vaccine evaluated in a single herd reduced the prevalence of pneumonic lesions in slaughter pigs from 69% to 36% and the prevalence of pleuritis from 20% to 13%. There was a small decrease in the number of days to market. It usually results in a 2% to 8% increase in daily gain. The mortality rate is usually only better numerically. Feed conversion efficiency increases by about 2% to 3%. Other limited studies indicate that vaccination can reduce the severity and prevalence of lung lesions detected at

slaughter (4%–6% compared with 12% in controls). It improves feed efficiency and increases average daily gain during the finishing period. In other studies the average daily gain was not improved. Under experimental conditions the transmission in nursery pigs was only numerically lower in vaccinated pigs and the vaccination does not prevent the establishment of MH in the lung.<sup>59</sup>

Vaccination of piglets improved pulmonary health, but vaccination of sows alone did not prove to be sufficient.<sup>60</sup>

Vaccination of sows against MH reduced the prevalence of positive piglets at weaning and could be used to control MH infections as judged by a nested PCR. PRRS vaccination does not interfere with MH vaccination. Needle-less intradermal vaccination has also been described. Double-vaccinated pigs show a lower percentage of MH-compatible gross lesions and a lower MH prevalence in the URT compared with single vaccinated animals.<sup>61</sup>

Both dual and single injection vaccines are available, but the protection obtained is similar. The single dose vaccine gives protection for up to 23 weeks. The level of protection will probably last 4 months. Vaccination is economically attractive.

DNA vaccination using a p42 heat-stable protein gene has also been used, and this induces rises in IL-2, IL-4, and IFN- $\gamma$ , which indicates that it induces both a Th1 and a Th2 response. Vaccination for mycoplasma generally induces local mucosal immunity, humoral and cellular immunity. A recent study has shown that inactivated vaccine produced both systemic and mucosal cellular and humoral immune responses.<sup>62</sup> It appears to prime the immune response, but this may not become fully operational until natural exposure takes place.<sup>63</sup>

Sow vaccination strategies are still undergoing study but it has been shown that the severity of the pneumonia in piglets born to vaccinated sows was reduced.<sup>64</sup> It increased the percentage of seropositive sows and piglets at weaning but did not affect the sow or piglet colonization. Maternal antibodies do not interfere with vaccination unless they are very high.

PRRSV infection may reduce the response to vaccination, but this may depend on the strains of both agents. In a study there were no significant differences between the protective efficacy of a combined PRRSV/MH vaccine and the two single vaccines.<sup>65</sup>

Intradermal vaccination was successful in reducing lesions by 10.4% compared with controls, and 6% in the intramuscular injection group. Intradermal vaccination afforded greater protection especially with regard to morbidity, lung lesion, and pleuritis scores.<sup>66</sup>

Subunit vaccines may be developed in the future, and other immunodominant antigens other than P97 should be taken into account.<sup>67</sup>

## FURTHER READING

Desrosiers R. A review of some aspects of the epidemiology, diagnosis and control of *M. hyopneumoniae* infections. *J Sw Hlth Prod*. 2001;9:233-237.

## REFERENCES

1. Mayor D, et al. *Vet Res*. 2007;38:391.
2. Mayor D, et al. *Vet Microbiol*. 2008;127:63.
3. Stakenborg T, et al. *Vet Res Commun*. 2006;30:239.
4. Villareal I, et al. *Vaccine*. 2009;27:1875.
5. Burnett TA, et al. *Mol Microbiol*. 2006;60:669.
6. Wilton J, et al. *Mol Microbiol*. 2009;71:566.
7. Pinto PM, et al. *Vet Microbiol*. 2007;121:83.
8. Kuhnert P, et al. *Vet Microbiol*. 2011;152:191.
9. Sanchez-Vazquez MJ, et al. *Pig J*. 2010;63:25.
10. Fano E, et al. *Can J Vet Res*. 2007;71:195.
11. Pieters M, et al. *Can J Vet Res*. 2010;74:157.
12. Sanchez-Vazquez MJ, et al. *Pig J*. 2010;63:25.
13. Dee S, et al. *Vet Res*. 2009;40:30.
14. Sibila M, et al. *Vet Microbiol*. 2007;121:352.
15. Nathues H, et al. *Acta Vet Scand*. 2013;55:30.
16. Nathues H, et al. *Acta Vet Scand*. 2013;55:44.
17. Moorkamp L, et al. *Transbound Emerg Dis*. 2009;56:54.
18. Nathues H, et al. *Vet Rec*. 2012;170:623.
19. Vranckx K, et al. *Vet Microbiol*. 2012;156:315.
20. Beilage Eg, et al. *Prev Vet Med*. 2009;88:259.
21. LeRoith T, et al. *Vet Immunol Immunopathol*. 2011;140:312.
22. Meens J, et al. *Vet Microbiol*. 2010;142:293.
23. Calus D, et al. *J Appl Microbiol*. 2009;106:1951.
24. Kim CH, et al. *Vet J*. 2012;192:120.
25. Choi C, et al. *J Comp Pathol*. 2006;134:40.
26. Lorenzo H, et al. *Vet Immunol Immunopathol*. 2006;109:199.
27. Ahn KK, et al. *J Vet Med Sci*. 2009;71:441.
28. Muneta Y, et al. *J Interferon Cytokine Res*. 2006;26:637.
29. Woolley LK, et al. *Vet Microbiol*. 2012;161:186.
30. Meyns T, et al. *Vet Microbiol*. 2007;120:87.
31. Bai F, et al. *Vet Immunol Immunopathol*. 2013;155:155.
32. Pieters M, et al. *Vet Microbiol*. 2009;134:261.
33. Dorr PM, et al. *J Am Vet Med Assoc*. 2007;230:244.
34. Wellenberg GJ, et al. *Vet Microbiol*. 2010;142:217.
35. Amory JR, et al. *Res Vet Sci*. 2007;83:428.
36. Strait EL, et al. *J Clin Microbiol*. 2008;46:2491.
37. Feng Z-X, et al. *Vet Microbiol*. 2010;143:410.
38. Cai HY, et al. *J Vet Diag Invest*. 2007;19:91.
39. Redondo E, et al. *J Comp Path*. 2009;140:260.
40. Hillen S, et al. *Prev Vet Med*. 2014;doi.org/10.1016/j.prevetmed.2013.12.012.
41. Fablet C, et al. *Vet Microbiol*. 2010;143:238.
42. Fablet C, et al. *Epidem Sante Anim*. 2012;61:149.
43. Marois C, et al. *Vet Microbiol*. 2007;120:96.
44. Marois C, et al. *J Appl Microbiol*. 2010;108:1523.
45. Stakenborg T, et al. *J Microb Methods*. 2006;66:263.
46. Strait EL, et al. *J Swine Hlth Prod*. 2008;16:200.
47. Thacker B, et al. *J Swine Hlth Prod*. 2006;14:140.
48. Del Pozo Sacristan R, et al. *Vet Rec*. 2012;171:645.
49. Ciprian A, et al. *Res Vet Sci*. 2012;92:191.
50. Le Carrour J, et al. *Antimicrob Agents Chemother*. 2006;50:1959.
51. Vicca J, et al. *Microb Drug Resist*. 2007;13:166.
52. Maes D, et al. *Vet Microbiol*. 2008;149:41.
53. Heinonen M, et al. *Vet J*. 2011;188:110.
54. Steenhard NR, et al. *Vaccine*. 2009;27:5161.
55. Vranckx K, et al. *BMC Vet Res*. 2012;8:24.
56. Villareal I, et al. *Vaccine*. 2011;29:1731.
57. Villareal I, et al. *Vet J*. 2011;188:48.
58. Li Y, et al. *Vaccine*. 2012;30:2153.
59. Meyns T, et al. *Vaccine*. 2006;24:7081.
60. Strauss C, et al. *Tierartzl Prax*. 2007;35:283.
61. Sibila M, et al. *Vet Microbiol*. 2007;122:97.

62. Marchioro SB, et al. *Vaccine*. 2013;31:1305.
63. Martelli P, et al. *J Vet Med B*. 2006;53:229.
64. Sibila M, et al. *Vet Microbiol*. 2008;127:165.
65. Drexler CS, et al. *Vet Rec*. 2010;166:70.
66. Tassis PD, et al. *Vet Rec*. 2012;170:261.
67. Okamba FR, et al. *Vaccine*. 2010;28:4802.

## PORCINE RESPIRATORY DISEASE COMPLEX AND MYCOPLASMA PNEUMONIA OF PIGS

*Mycoplasma hyopneumoniae* (MH) is a significant contributor to the porcine respiratory disease complex (PRDC), together with PRRS, PCV2, SIV, and secondary bacterial agents such as *Pasteurella multocida*<sup>1</sup>(PM), *Actinobacillus pleuropneumoniae* (APP) and *H. parasuis* (HPS), *E. coli*, *Klebsiella*, *Trueperella pyogenes*, *Bordetella bronchiseptica*, *Streptococci*, and *Staphylococci*.<sup>2-6</sup> In the study in Denmark,<sup>3</sup> five bacterial species, five viruses, and two *Mycoplasma* species were found in different combinations. The study in Germany<sup>4</sup> found that among a variety of pathogens, PCV2 and alpha-hemolytic streptococci were most frequently detected. There were also more associations between the organisms in clinical cases than in the healthy pigs. Porcine respiratory disease complex is a better name for what was once called enzootic pneumonia. This term really means pneumonia that occurs naturally in the population and includes a complex of many bacterial and viral agents with the occasional addition of parasites and protozoa.

Some primary pathogens such as MH and APP are not usually isolated from healthy pigs and may be responsible for sub-clinical infections. A Danish study found that *Actinomyces hyovaginalis* was a common isolate from pyemic lungs in pigs. The authors did a study in the 1960s involving full viral, bacteriologic, and environmental and management analyses, which showed that each farm was an individual with its own set of variables, and that the only significant factor was that MH was associated with clinical disease and economic loss.

Simultaneous occurrence of Aujeszky's disease does increase the severity of acute mycoplasmal pneumonia. The jury is still out as to whether TTV has a role to play in PRDC.<sup>7</sup> In a recent study, lipoteichoic acid from *Staphylococcus aureus* exacerbated respiratory disease in porcine-coronavirus infected pigs.<sup>8</sup>

Normally, the bacteria live in symbiosis with the host. The three major enzootic pig viruses (PRRS, PCV2, and SIV)<sup>9-13</sup> destabilize the situation through direct pathologic effects or disturbances of the immune system. This complex is characterized by slow growth, decreased food conversion efficiency, anorexia, fever, cough, and dyspnea in grower finisher pigs typically around 16 to 22 weeks of age. It corresponds to what was originally called enzootic pneumonia.

## ETIOLOGY

Some of the bacteria live happily in the upper respiratory tract, for example, *Bordetella bronchiseptica* (BB), some strains of *Hemophilus parasuis* (HPS), and *M. flocculare*, and, *M. hyorhinis*.<sup>14</sup> Other organisms are inhaled directly or more likely introduced by nose-to-nose contact (MH) or even aerosols, whereas others flare up in times of stress from small numbers normally harbored in the nasopharynx and tonsils, such as APP and PM.

There is variation in the strains of many of these organisms and this determines the outcome of infection in many cases. Similarly, there may be breed dispositions to some of the agents.<sup>15,16</sup>

The presence of PRRS, *P. multocida*, *H. parasuis*, *M. hyorhinis*, or *S. suis* correlated with a higher probability of also finding MH.<sup>17</sup>

## EPIDEMIOLOGY

The combination of pathogens involved in the respiratory disease complex is legendary and varies from country to country, region to region, and even farm to farm.<sup>18</sup> When a new agent enters the field (e.g., the pandemic SIV2009<sup>19-23</sup> or Torque teno virus), then the position becomes even more complicated until the population at large becomes immune.

Secondary bacterial pneumonia can be a significant cause of mortality in the weaning-to-market period. Some of the risk factors for pleuritis and cranioventral pneumonia have recently been reviewed.<sup>24,25</sup> The relationships between the infectious and noninfectious factors in PRDC have been reviewed.<sup>26</sup>

Atrophic rhinitis may also be present along with enzootic pneumonia, and the two diseases in combination may have a greater economic effect than either disease alone. When outbreaks of respiratory disease in pigs occur, they are frequently the result of complex interactions between many agents. The importance of MH is not only its effect as a primary pathogen but also its ability to act synergistically with other infecting agents to produce significant respiratory disease. MH causes a mild pneumonia, whereas *P. multocida* is not pathogenic alone but aggravates the pneumonia initiated by the former pathogen. The epidemiologic associations between MH and *Actinobacillus pleuropneumoniae* antibody titers, and lung lesions in pigs at slaughter have been examined. Only titers to the *Mycoplasma pneumoniae* were associated with lesions.

The extent of the lesions produced by MH in PRDC may be influenced by other contributing factors to account for the variations in severity of lesions. Concurrent infection with lungworm, migrating ascarids, and an adenovirus has resulted in lesions of greater severity and secondary invasion of pneumonic lesions by *Pasteurellae*, *Streptococci*, *Mycoplasma*, and *Bordetella bronchiseptica*;



*Klebsiella pneumoniae* is very common and largely influences the outcome of the disease in individual pigs. In some abattoir surveys of lungs, *P. multocida* can be cultured from 16% of normal lungs and from 55% of lungs with lesions resembling those of enzootic pneumonia. *P. multocida* and *Haemophilus* spp. may also be found in conjunction with MH in the lungs of slaughter-weight swine affected with pneumonia and examined at the abattoir. Those lungs with both MH and *P. multocida* had the most macroscopic pneumonia, and those lungs with either of the agents alone had much less pneumonia. MH renders the lungs susceptible to *P. multocida* colonization and infection.

Along with MH, other *Mycoplasma* species, such as *M. hyorhinis*, *Acholeplasma granularum* and *Acholeplasma laidlawii*, have been isolated from the lungs of pigs at slaughter, but their significance is unclear. MH and *Mycoplasma hyorhinis* have been isolated from 30% and 50% of pneumonic lungs, respectively, from pigs examined at slaughter. MH was also isolated from 12% of lungs with no gross lesions of pneumonia. In a survey in Norway, MH, *P. multocida* and *M. hyorhinis* were detected in 83%, 43%, and 37% of the pneumonic lungs respectively. Most of the macroscopic pneumonia—up to 25%—occurred in lungs with all three pathogens. *M. flocculare* was the most frequently isolated organism in the nonpneumonic lungs.

MH potentiates the severity of PCV2-associated lung and lymphoid lesions and increases the amount and perhaps the presence of PCV2 antigen. It also increases the incidence of PMWS in pigs.

Several environmental and management factors are associated with a high prevalence of pneumonic lesions at slaughter. They include continuous versus all-in, all-out production, open herds, large temperature fluctuations, semisolid pen partitions, and large numbers of pigs in a common airspace. These factors may operate individually or in combination synergistically. Housing pigs in a clean, isolated, disease-free and low-stress environment positively influences the health of pigs. Complex animal production systems in the industrialized world have been reviewed.<sup>27</sup>

The primary and secondary pathogens of the disease produce their most detrimental economic effects and the highest level of morbidity and mortality during the finishing period when the economics of production necessitate indoor housing and intensification.

Four main groups of environmental factors that contribute to high levels of clinical disease and lesions at slaughter include:

1. Meteorological
2. Population and social
3. Management
4. Airborne pollution

**Meteorological factors** include wide fluctuations in the temperature indoors, wide variations in relative humidity, irregular ventilation rates, and winter housing. However, experimentally, elevated concentrations of ammonia and fluctuating ambient temperature did not influence the severity of the pneumonia or its effect growth rate. The noninfectious factors associated with pneumonia and pleuritis in slaughtered pigs in 143 farrow-to-finish farms in France were analyzed.<sup>28,29</sup>

**Population factors** that contribute to an increased prevalence of pneumonia are increasing herd size, increased population density, and decreased airspace and floor space per pig. All management practices influence the microclimate, and the quality of housing and management influences the incidence of pneumonic lesions at slaughter. Larger-than-average swine farms milling their own feed and with characteristics of modern buildings (mechanized inlets, slatted floors) and in close proximity to other farms tend to have a higher risk of enzootic pneumonia. Extensively housed pigs with above-average pen space and air volume have a reduced prevalence of enzootic pneumonia lesions.

**Management factors** associated with enzootic pneumonia include family farms that feed pigs on the floor and feeder barns that obtain pigs from multiple sources compared with those with good facilities and where the pigs originate directly from breeding units. The disease is a particular problem in continuous-flow herds. In pigs reared in all-in, all-out groups in the farrowing house, nursery, and growing-finishing unit, any *Mycoplasma* transmitted from sows to pigs or between pigs do not necessarily result in clinical signs or lesions of pneumonia. Pigs reared in all-in, all-out systems do not have lesions or minimal lesions at slaughter and gained at a faster rate than litter-mate pigs reared in a continuous system. Risk factors in suboptimal housing in Australia were described.<sup>30</sup>

In small herds, the factors commonly associated with a high prevalence of enzootic pneumonia were larger numbers of pigs per pen section, larger group sizes, and drafty farrowing and weaner accommodation.

A study of housing density on species diversity and number of airborne microorganisms at fattening facilities has shown that the total number of bacteria and fungi did not exceed  $10^4$  and  $10^3$  CFU per  $m^3$  respectively. The number of organisms correlated with housing density. The most numerous were gram-positive bacteria and then gram-negative bacteria and fungi.<sup>31</sup>

**Airborne pollution in pig houses** is thought to contribute to an increased incidence of clinical disease and prevalence of lesions at slaughter.<sup>32</sup> The pollutants include microorganisms, endotoxin cell wall constituents, and ammonia.<sup>29</sup> Ammonia is the

most important because it is a powerful ciliotoxic agent in its own right before determining its effects on microorganisms. Toxic levels of ammonia, high concentrations of aerial dust, and high colony counts of aerial bacteria may contribute to an increased incidence and prevalence of pneumonia, but these factors have not been quantified and are commonly based on subjective evaluations by the observer. A large study of 960 pigs has shown that there are no influences of ammonia or dust on the respiratory health of pigs. Environmental air contaminants such as dust, ammonia, carbon dioxide, and microbes in swine barns measured over a period of 12 months were associated with lesions of pneumonia and pleuritis at slaughter.

In a study of experimentally infected animals, it was found that 6/114 long-distance samples were positive for MH. Three samples collected at 3.5, 6.8, and 9.2 km from the herd of origin were infectious.<sup>33</sup>

In large herds, factors associated with a high prevalence were higher pen stocking rate, airspace stocking rate, and a trend toward higher atmospheric ammonia levels in the summer months. The trend to increased herd size has not been accompanied by the satisfactory control of pneumonia. It has been shown that pig-shed air polluted by alpha-hemolytic cocci and ammonia causes subclinical disease and production losses.<sup>34</sup>

### Combination and Interaction of Environmental Risk Factors

A computer-based guide can indicate how the prevalence of the disease can be influenced by the combined effect of risk factors. The expected prevalence is estimated by consideration of 11 risk factors that include the following:

1. Number of pigs in the same room
- 2/3. All-in, all-out versus continuous flow of pigs
4. Type of partitions separating adjacent pens
- 5/6. Presence or absence of diarrhea as a clinical problem
- 7/8. Liquid versus solid manure disposal
9. Ascarid control efficiency
- 10/11. Presence or absence of active Aujeszky's disease.

The temperature and humidity influence the penetration into the lungs of both primary and secondary pathogens by influencing the size of infected aerosol particles and the protective mechanism in the respiratory tract. Temperature and humidity also influence the sedimentation of infected particles in the air and the ventilation and stocking density. Pigs kept at high stocking densities and subjected to environmental temperature fluctuations, cold drafty conditions, and poor nutrition are more likely to suffer greater adverse effects from this disease.

In a study of the effect of different housing and feeding systems considering liquid versus dry feeding in fully slatted and straw-based housing, there were no differences between in the lung lesions.<sup>35</sup>

### Economic Losses and Importance

In annual surveys completed by the American Association of Swine Practitioners, pneumonia consistently ranks as the most economically important disease in finishing pigs. The prime importance of enzootic pneumonia is in its economic effects on pig rearing. The disease adversely affects feed conversion efficiency and daily rate of gain under certain circumstances. However, the magnitude of these effects depends on the conditions in which the pigs are reared and has been a subject of much controversy. The complexity of pneumonia and its interactions with the environment make measuring the effect of pneumonia on performance very difficult.

An accurate assessment of the biological and economic effects of enzootic pneumonia has been challenging because of the difficulty of conducting a controlled experiment in which pigs of equivalent genetic merit, both free of the disease and infected, are raised in an identical manner. In addition, studies on the association between performance parameters and the severity of lesions of the lungs have yielded widely variable results dependent on the management and environmental conditions and the different research design and techniques used. In general, there is a proportional relationship between severity of pneumonia and depression of performance but in other observations, this relationship was not found. Where pigs are raised under good management, infection of herds previously free of the disease has resulted in no adverse economic effect other than during the initial period of acute infection in the herd. However, in other situations adverse economic effects are associated with the disease. One study estimated a reduction of feed conversion efficiency as high as 22%, and although the effect of the disease is probably not this severe in most piggeries, a significant economic reduction can occur even under good management conditions.

Because there is no universally accepted method of measuring the extent or prevalence of pneumonia in pigs at slaughter, the results of studies of correlations between the lesions and performance have been difficult to compare. In general, the economic loss associated with respiratory disease ranges from a 2% to 25% reduction in average daily gains. Some methods have been compared and the most informative procedure is to assess the percentage of lung involved and calculate a mean value for the herd sample. The relationship between the weight of pneumonic lesions from pigs at slaughter and their performance indicated that within a range between 3.32% and 74.5% for the

weight of a pneumonic lung, a 10% increase in the weight of pneumonic lung was associated with a decrease in mean daily gain of 31.4 g and a 13.2-day increase to slaughter at 104 kg live weight. There is a high correlation between rapid gross lung scores and detailed examination, which indicates that lungs can be visually scored accurately as they pass on a slaughter line. On average, mean daily gain decreases from 23 to 37 g for every 10% of the lung affected by pneumonia. However, the rapid subjective scoring of the lungs, adjusted for lung proportions, is considered adequate for estimating naturally occurring pneumonia and just as informative as detailed dissection of the lungs.

Because the prevalence of pneumonia peaks at about 60 to 65 kg BW and then declines steadily to a very low level in pigs that are 125 kg or more, the age and weight at slaughter must be considered when evaluating the effects of the lesions on performance and when comparing results between different observations. Weight losses are more substantial in pigs affected early in life. In some studies, lung lesion scores detected at slaughter did not significantly correlate to growth indicators during any season. The gross lesions of mycoplasmal pneumonia heal over a 2-month period, which may explain why significant correlations are not found between growth indicators and lung lesion scores. The effects of the lesions on mean daily gains over an entire growth period may vary from one study to another because of the different times during growth when the lesions exerted their effects and in part to compensatory regrowth following recovery from the lesions. Radiographic examination of the lungs of pigs from 21 to 150 days of age, and gross examination of the lungs at slaughter revealed that lesions progress and regress dynamically throughout the life of the animals and examination at slaughter is an inadequate indicator of lifetime pneumonia.

### CLINICAL SIGNS

There are very basically four signs of respiratory disease:

- **Sneezing** is indicative of affliction of the nasal cavity gas, dust, or infection (PRCV, PCMV, or PAR).
- **Coughing** is indicative of affliction of the larynx, trachea, and mainstem bronchi and upper bronchial tree because coughing is the only way to clear large amounts of infected debris (SIV, MH).
- **Dyspnea or difficult breathing** is indicative of the terminal bronchioles and alveoli being affected (APP, PM, PRRS, and PCV2)
- **Parameters of growth may be affected when fever is involved or tissue damage is extensive**, in which case the CNS (hypothalamus) instructs the systems to shut down

so appetite, and therefore, growth, is reduced. Growth rate is reduced, daily gain falls, days to slaughter increases, and feed efficiency falls as growth is replaced by immunologic recovery.

The principle sign of PRDC is pneumonia manifested as coughing, labored breathing, fever, lethargy, recumbency, anorexia, discoloration of the extremities/cyanosis, weight loss and slow growth, nasal and ocular discharges, and death. In small batches the disease may affect the group over a short period of time, and most may recover, leaving a few to become chronically affected, hospitalized, or having to be euthanized. In the larger batches with different age groups, there may be rolling waves of infection, or pneumonias may progress to pleurisy.

Some pigs affected with the chronic form of mycoplasmosis may later develop acute pneumonia as a result of secondary invasion with *Pasteurella* or other organisms.

A series of investigations has shown that PRRSV does not predispose to MH infection, although lesions are more severe in those pigs that both infections. MH does potentiate PRRSV induced disease and lesions. There may be an association between the seroconversion to PRRSV and the transmission of MH.

### PATHOLOGY

Proliferative and necrotizing pneumonia (PNP) is a form of interstitial pneumonia that occurs in weaning and postweaning pigs. In an Italian study of 28 pigs PRRSV was found in 11 pigs, PCV2 in 4 pigs, and both viruses in the lungs of 8 pigs; in the other 5 pigs nothing was detected.<sup>36</sup> A granulomatous lymphadenitis and pneumonia has been associated with *Actinobacillus porcinosillarum* in a slaughter pig.<sup>37</sup> This organism was previously thought to be nonpathogenic.

In the study in Denmark,<sup>3</sup> no clear cut associations were found between pathogens and histologic lesions. They came to the conclusion that PRDC was more common than *Mycoplasma pneumoniae* in Danish finishing pigs.

### TREATMENT

There are many variables in an outbreak of PRDC, and it is essential to approach the problem in a sensible way. The first thing to do is to establish a diagnosis, probably using postmortem examinations and a variety of laboratory aids, such as IHC, ISH, and PCR. The definition of the primary pathogens from the secondaries and opportunists is the next major step. The third step is to treat the pigs quickly and effectively. The fourth step should be to assess the immune status of the herd and how to improve it. The fifth step is to understand the epidemiology of the agents in the herd and the health background of the herd. The last step is use the latest

knowledge, strong biosecurity techniques, and modern vaccines correctly and to manage the units to use the best in management and environmental control.

## MONITORING

Monitoring of respiratory disease has been achieved principally by slaughter checks. These involve snout inspection for the presence of progressive atrophic rhinitis. A cross section of the snout at the level of the 1st or 2nd premolar is examined. For the examination of the lungs, the percentage of the lung that is consolidated is calculated that is firm to the touch.<sup>18,38</sup> Recently examination of digital images has been used.<sup>39</sup> There is a significant negative association between pneumonia score and growth.<sup>40</sup>

In addition, the site of pleuritic lesions on the lungs can also be marked on cards and can be recorded as fresh or old fibrotic adhesions.

## CONTROL

By definition PRDC is chronic respiratory disease (although there are periods of acute respiratory disease) in the continual production units of breeder/weaner and breeder/feeder herds. In PRDC there are many potential agents, but there are some guiding principles that will help to maintain health. Maternal antibodies from sows on the same farm as the piglets will provide some protection, which wanes quickly. Young pigs then become susceptible, and if the numbers of pathogens are not too high they will develop active immunity without succumbing to disease. Infection follows the usual pattern of colonization, replication, excretion, and immune development. Disease may follow after replication and excretion, and the duration will depend on the level of replication and the agents involved. Older pigs are always a source of infection for younger pigs and will maintain a cycle of infection; therefore, they should be kept away from younger pigs, although sows should not be kept away entirely from young stock because their immunity is not then maintained.

### All-in, All-Out

The first rule is all-in, all-out by age by building or by room. Complete disinfection after cleaning is then carried out, followed by drying and resting. The pig flow through the buildings must be established and maintained.

### Buildings

- Make the production to suit the building provision, identifying bottlenecks.
- Where necessary, alter the buildings (new divisions, new buildings, etc.).
- Consider what the correct stocking rates are for the buildings.

- Ensure buildings are adequately ventilated to remove polluted air and excess heat without draughts or overventilation.

### Production

Review productivity and consider batch production (i.e., a larger number of pigs less often) to enable filling and emptying of buildings. It is effective to artificially construct a batch of different ages and hospitalized pigs. Evenness of production from the breeding units will prevent overstocking or understocking.

### Sick Pigs

The sick pig is a welfare problem and a hazard in itself, so always hospitalize a sick pig as early as possible, treat, and cull it if no response. The hospital area should be well away from other pigs, and recovered pigs should not be returned to the mainstream.

### Diagnosis

On farm or laboratory postmortem examinations should be used to achieve diagnosis if there are sudden acute cases. Cross-sectional blood sampling of the herd to establish epidemiologic patterns of pathogens is sometimes necessary. The use of slaughter pig information from the abattoir will indicate patterns of pathology.

### Active Control

Lack of sound management cannot be compensated by use of medication and vaccination, but these may help. Partial depopulation with medication in Denmark has been described.<sup>41</sup> Protection of your unit by the imposition of effective biosecurity from without and within the unit can be extremely beneficial in limiting the ingress of pathogens. The use of bird-proofing and rodent control is becoming much more important and in many cases the repair of the buildings is more important than other factors because cleaning and disinfection are pointless if there are areas where the organic matter can collect. Prophylactic or metaphylactic medication will help if targeted at the correct bacterial agent in feed or water.

Vaccination for PRRS, PCV2, *Mycoplasma hyopneumoniae*, *Hemophilus parasuis*, and *A. pleuropneumoniae*, Aujeszky's disease, and *S. suis* will also help.

The effect of vaccination for PCV2 in pigs suffering from PRDC has been described.<sup>42</sup> Additional strategies for PRDC will include partial depopulation and full depopulation as discussed for MH.

## REFERENCES

1. Ross RF. *Anim Hlth Res Rev.* 2006;7:13.
2. Nicholson TL, et al. *Infect Immun.* 2009;77:2136.
3. Hansen MS, et al. *J Comp Pathol.* 2010;143:120.
4. Palzer A, et al. *Vet Rec.* 2008;162:267.
5. Opiessnig T, et al. *Anim Hlth Res Rev.* 2011;12:133.
6. Fablet C, et al. *Res Vet Sci.* 2012;91:627.
7. Taira O, et al. *Vet Microbiol.* 2009;139:347.
8. Atanasova K, et al. *Vet J.* 2011;188:210.
9. Brockmeier S, et al. *Vet Microbiol.* 2008;128:36.
10. Ellis JA, et al. *Am J Vet Res.* 2008;69:1608.
11. Loving CI, et al. *Microb Pathog.* 2010;49:237.
12. Maes D, et al. *Proc Cong Int Pig Vet Soc.* 2010;30.
13. Dorr PM, et al. *J Am Vet Med Ass.* 2007;230:244.
14. Lin JH, et al. *Vet Microbiol.* 2006;115:111.
15. Hoeltig D, et al. *Proc Cong Int Pig Vet Soc.* 2010;196.
16. Probst I, Hoeltig D. *Proc Cong Int Pig Vet Soc.* 2010;602.
17. Nathues H, et al. *Vet Rec.* 2010;166:194.
18. Thacker BJ, et al. *Proc Cong Int Pig Vet Soc.* 2010;144.
19. Capuccio JA, et al. *Proc Cong Int Pig Vet Soc.* 2010;587.
20. Kim S, et al. *Proc Cong Int Pig Vet Soc.* 2010;584.
21. Lange E, et al. *J Gen Virol.* 2009;90:2119.
22. Smith GJD, et al. *Nature.* 2009;459:1122.
23. Valheim M, et al. *Proc Cong Int Pig Vet Soc.* 2010;588.
24. Fraile L, et al. *Vet J.* 2010;184:326.
25. Meyns T, et al. *Vet J.* 2011;187:368.
26. Martinez J, et al. *Vet J.* 2009;179:240.
27. Sorensen JT, et al. *Revue Sci Tech.* 2006;25:493.
28. Fablet C, et al. *Vet Microbiol.* 2012;157:152.
29. Fablet C, et al. *Prev Vet Med.* 2012;104:271.
30. Banhazi T, et al. *J Agric Saf Hlth.* 2008;14:21.
31. Pavicic Z, et al. *Acta Vet Brno.* 2006;75:533.
32. Renandeu D. *Trop Anim Hlth Prod.* 2009;41:589.
33. Otake S, et al. *Vet Microbiol.* 2010;145:198.
34. Murphy T, et al. *Vet Rec.* 2012;doi:10.1136/vr.100413.
35. Scott K, et al. *Anim Welf.* 2007;16:53.
36. Morandi F, et al. *J Comp Pathol.* 2010;142:74.
37. Ohba T, et al. *J Comp Pathol.* 2007;137:82.
38. Bollo JM, et al. *Proc Cong Int Pig Vet Soc.* 2010;205.
39. Baysinger A, et al. *Proc Cong Int Pig Vet Soc.* 2010;659.
40. Pagot E, et al. *Rev Med Vet.* 2007;158:253.
41. Szancer J. *Pig J.* 2008;61:1.
42. Fachinger V, et al. *Vaccine.* 2008;26:1488.

## PORCINE CYTOMEGALIC VIRUS (INCLUSION-BODY RHINITIS, GENERALIZED CYTOMEGALIC INCLUSION-BODY DISEASE OF SWINE)

Porcine cytomegalic virus rhinitis (formerly inclusion-body rhinitis), associated with a beta herpesvirus (family Herpesviridae), is an extremely common, but generally minor, disease in young pigs. It was first recognized in 1955. The virus is now called porcine herpesvirus-2. It is associated with the porcine respiratory disease complex-1.

### ETIOLOGY

The virus (PCMV; SuHV-2) belongs to the subfamily of beta-herpesviruses of the family Herpesviridae. The virions exhibit typical morphology of herpesviruses. There are believed to be no serotypes or genotypes, although there is some antigenic variability. It has not yet been found as a problem in xenotransplantation although it does grow in human fibroblast cultures.<sup>1</sup>

### EPIDEMIOLOGY

The virus is present in the upper respiratory tract of nearly all herds and pigs (in excess of 90%), and the major infection site is the



conchal (turbinate) epithelium. It does not affect other species. SPF herds established by hysterectomy techniques are not necessarily exempt, and congenital transmission of the virus has been demonstrated. High excretion occurs predominantly in the 2- to 4-week period after infection. Transmission is via the respiratory route through direct contact and aerosol infection, possibly also via urine, and usually perinatally.

When the virus first enters a susceptible herd, both transplacental and horizontal virus transmission takes place. Antibody responses start quickly, so there are often no clinical signs but widespread infection.

### PATHOGENESIS

The virus invades epithelial cells, especially those of the nasal mucous glands, to produce destruction of acinar cells and metaplasia of the overlying epithelium, and the major clinical manifestation is that of upper respiratory disease. Following infection, the virus may become generalized. In older pigs, generalization is restricted to epithelial cells of other organ systems, especially those of the renal tubules, and is clinically inapparent. However, in very young pigs the virus also shows a predilection for reticuloendothelial cells, and generalization may result in further clinical abnormality.

The virus also crosses the placenta, so it is possible for intrauterine infection to produce fetal death, along with runting after birth and very early pneumonia, rhinitis, and poor piglet weights at weaning. Congenitally infected animals excrete for life.

### CLINICAL SIGNS

The incubation period is generally 10 to 21 days. Clinically, the disease affects piglets up to approximately 10 weeks of age, but the age at manifestation in any herd can depend on the method of husbandry. The disease usually occurs when the virus is introduced into the susceptible herd or if for some reason there is a huge increase in the number of susceptible pigs. A wide age-spectrum of involvement may be seen initially when the disease is introduced into the herd for the first time. In most herds the disease affects pigs in the late suckler and early weaner stage. It is at its most severe in pigs under 2 weeks of age. Sneezing is the most prominent sign and frequently occurs in paroxysms and following play fighting. There is a minor serous nasal discharge that rarely may be blood-stained and also sometimes muco-purulent, with a brown or black exudation around the eyes. There may be coughing. The clinical course varies approximately from 2 to 4 weeks. All pigs within the group are affected, but there is usually no mortality. Neonatal pigs may die without showing signs.

Generalized cytomegalic inclusion-body disease may occur in pigs exposed to intrauterine infection and usually occurs as an outbreak involving several litters. The

syndrome is characterized by sudden death and anemia. There is often a history of scouring within the group within the first week of life, and affected pigs show skin pallor and often superficially appear plump and well developed as a result of edema, especially in the neck and forequarter regions. Death, resulting primarily from anemia, occurs during the week 2 to 3 of life, and mortality within the group may approach 50%. Petechial hemorrhages have been a feature of the experimentally produced disease in gnotobiotic pigs but do not necessarily occur in field outbreaks. A moderate anemia producing a check to growth, but without significant mortality, which may be seen in recently weaned pigs experiencing the disease. Many survivors may be stunted.

More serious effects from generalized infection are seen when piglets are exposed to heavy infection at a very young age. It also occurs when there are new imports and when intercurrent disease and poor nutrition reduce resistance. This commonly occurs in large herds with high-density continual throughput farrowing and weaning houses. In addition to upper respiratory disease, infection at this age may result in enteric disease, sudden death, anemia, and wasting, with a marked unevenness of growth within the litters.

There may be complete blockage of the nasal passages. It is believed that the olfactory epithelium may be damaged so that there is no sense of smell and that piglets may not then eat, explaining the that so many die.

### PATHOLOGY

Gross changes are not seen often in pigs over 3 weeks of age. In pigs under 3 weeks it may be possible to see catarrhal rhinitis, hydrothorax, and edema in various tissues. In fetal infections there may be stillbirths, mummification, embryonic death, and infertility. Interstitial nephritis and random focal gliosis in the CNS with inclusion bodies can be additional findings, with petechiation in the choroid plexuses, cerebellum, and olfactory lobes. In the acute fatal syndrome most of the basophilic inclusions are seen in the capillary endothelium and sinusoidal cells of the lymphoid tissues. Multifocal hemorrhage and edema results from the vascular damage.

### DIAGNOSIS

Inclusion-body rhinitis is not a primary cause of atrophic rhinitis. However, it is probably contributory in lowering local resistance to infection and in predisposing to more severe infection with *Bordetella bronchiseptica* and other respiratory pathogens.

The diagnosis of inclusion body rhinitis is commonly made following the demonstration of typical intranuclear inclusion bodies in histologic sections from electively slaughtered piglets. Large basophilic inclusion bodies are found in the mucous gland cells of the conchal mucosa and may also be

demonstrated in exfoliated cells obtained via nasal swabs from live pigs. Small intranuclear inclusion bodies are found in the reticuloendothelial cells. These are best taken from several pigs at the height of clinical infection. Diagnosis by virus isolation is uncommon because the virus has proved difficult to grow, but it will establish in porcine lung macrophage cultures and immortalized cells.

Antibody to infection may be detected by indirect immunofluorescent techniques. ELISAs have been developed to show both IgM and IgG responses. Recently a PCR has been developed and this showed that 59% of pigs tested positive. However, only 59% of PCR positive pigs had clinical signs and lesions consistent with inclusion-body rhinitis. The original experimentalists described the presence of intranuclear inclusions, cytomegaly, and karyomegaly as being pathognomonic. Virus isolation and PCRs can be used. The best PM samples are conchal mucosa, lungs, pulmonary macrophages collected by lavage, and the kidneys. PCMV can occasionally be demonstrated in the brain, liver, and bone marrow. Virus isolation is possible on primary or immortalized cells.

Antibodies can be detected by IFA, which peaks at 6 weeks postinfection and remains quite high for 10 to 11 weeks. The development of serum antibody levels coincides with the disappearance of viremia.

### DIFFERENTIAL DIAGNOSIS

Differential diagnosis includes CSF, enteroviruses, parvoviruses, PRRSv, PCV2, and PRV.

### TREATMENT

There is no effective treatment, and none is warranted in most herds. With severe rhinitis, antibiotics may temporarily reduce the severity of secondary bacterial infection.

### CONTROL

Control of severe disease rests with management procedures that avoid severe challenge to very young piglets. It is also possible to produce virus-free pigs from hysterotomy-derived pigs, but it is necessary to monitor.

### REFERENCE

- Whitaker JL, et al. *Transplantation*. 2008;86:155.

## SWINE INFLUENZA

### SYNOPSIS

**Etiology** Influenza A virus subtypes H1N1, H1N2, and H3N2 of *Orthomyxovirus*.

**Epidemiology** United States, England, Japan, Canada, Belgium. Worldwide. Young pigs. High morbidity, low mortality. During cold months. Antigenic diversity of virus. Aquatic birds are natural reservoirs. Spread between pigs, New strains develop,

*Continued*

**Signs** High incidence of anorexia, fever, thumps, muscle stiffness; recovery in several days.

**Clinical pathology** Polymerase chain reaction (PCR) test to detect virus. Hemagglutination test and enzyme-linked immunosorbent assay (ELISA).

**Lesions** Marked congestion of upper respiratory tract. Exudate in bronchi. Atelectasis. Suppurative bronchiolitis.

**Diagnostic confirmation** Demonstrate virus in tissues.

**Differential diagnosis list:**

- Enzootic pneumonia
- Hog cholera
- Inclusion-body rhinitis
- Atrophic rhinitis

**Treatment** Antimicrobials for secondary infection.

**Control** No effective measures available. Vaccines are in use in certain parts of the world.

## INTRODUCTION

Swine influenza is an important cause of broncho-interstitial pneumonia throughout all pig-keeping areas of the world. Real problems are associated with the changing viruses that cause the disease and the ability of rapid genetic change to occur by genetic drift or shift.

## ETIOLOGY

Classical clinical swine influenza is associated with influenza A virus subtypes H1N1, H1N2, and H3N2 belonging to the *Orthomyxovirus* genus of the Orthomyxoviridae family. The three types occur together as in Korea.<sup>1</sup> Other types have been isolated from pigs, but as yet have not established as widespread endemic strains. Only influenza A viruses are important in pigs. They occur in a large number of species, including humans, primates, pigs, horses, sea mammals, and birds. Avian viruses are more stable than mammalian viruses, where the rate of evolution is much greater. Specific subtypes vary in their ability to cross species barriers. Specific gene combinations do have a part to play in influenza virus species specificity.<sup>2</sup> Unstable gene constellations in avian species become stable only in secondary hosts but may then adapt and circulate freely.<sup>3</sup>

The methods by which they cross the species barrier are not well understood and are probably polygenic.<sup>4,5</sup> An isolate of a Korean H1N1 virus was very similar to a U.S. virus, suggesting that it had been transmitted possibly by birds.<sup>6</sup>

When new variants occur in pig husbandry they are usually found in the pig population before they acquire the ability to spread rapidly and become associated with disease. They are named using the following convention: A/species/localization/

isolate number/year of isolation, for example, A/Wisconsin/125/98. If no species is indicated, it is a human virus. They are described with reference to the hemagglutinin (HA or H) and the neuraminidase (NA or N) that project from the surface of the viral envelope. There are 16 HA and 9NA forms that can be distinguished antigenically and genetically, and all of these have occurred in waterfowl and shore birds. They provide a permanent source of infection, as does the water on which they float. The H binds to sialic acid and mediates the virus infection of the host and contains most of the antigenic sites. It is the viral receptor-binding protein and mediates fusion with the host-cell membrane. It is an alpha2-3-galactose linkage in avians and an alpha2-6-galactose linkage on the glycocalyx of epithelial cells in mammals.<sup>7</sup> The HA and NA are associated with receptor binding and virus release.<sup>8</sup> No combination of HA and NA has as yet been identified that will increase viral stability during interspecies transmission. The distribution of these receptors and the limited replication of avian viruses in swine complicate the picture.<sup>9</sup> The pig possesses both types of receptor and has therefore been considered as a “mixing vessel” because it can be infected by both avian and mammalian viruses. The N protein catalyzes cleavage of sialic acid and thereby facilitates the virus cell entry by degradation of mucins. The NA and HA are also the main targets of the host immune responses.

The segmented nature of the virus facilitates the changes in the virus. The surface HA and NA antigens undergo two types of change: antigenic drift and antigenic shift. Antigenic drift involves small changes but the shift may involve whole segments of the genome being changed. If a cell is infected with two or more viruses, interchange of genetic material can take place. The 8 RNA segments encode for 10 or 11 proteins.<sup>10,11</sup>

It may take multiple mutations to make a distinct HA,<sup>12</sup> and then this has to link with other gene segments compatibly to facilitate survival, replication, and transmission.<sup>13</sup> For example, in the spread of the pandemic 2009, it appeared that the M segment was crucial to the transmission of the virus.

It is possible that within the currently circulating strains, a reassortant will occur every 2 to 3 years.<sup>14</sup>

Three types are found worldwide H1N1, H3N2, and H1N2. In Europe three SIV subtypes are cocirculating: (a) an avian-like H1N1 that came from wild birds in 1979, (b) a humanlike H3N2 with HA and NA genes originating from human virus descendants of the Hong Kong/68 pandemic virus, and (c) a subtype H1N2 reassortant that acquired H1 from human influenza in the 1980s.

## H1N1—CLASSICAL

In the United States, these were found on their own until 1998. They were very similar to the 1918 pandemic virus.<sup>15</sup> Since the

appearance of other viruses, particularly the triple reassortants, there seems to have been an increase in the genetic diversity of the H1N1 strains in the United States (as also in the H1N2).

A typical reassortant found in Ohio<sup>16</sup> had genes from human (PB1), swine (NA, HA, NP, M and NS), and avian (PB2 and PA). Even though the viruses were isolated over only 3 years, there was evidence of antigenic drift.

## H1N1—OTHERS

Humanlike H1N1 viruses have been found in Canada,<sup>17</sup> and H1N1 viruses with the human H1 have spread across North America; these have commonly been isolated from swine disease outbreaks in the United States.

A triple-reassortant H1N1 virus was found in China with the NP and NS genes from a classical swine influenza virus, PB1 from a human virus and HA, NA, M, PB2, and PA genes from an avian virus. Five genes were also closely related to H1N2 viruses found in China (NS, NP, PB2, PB1, and PA).<sup>18</sup>

## H1N1 AVIAN-LIKE

Wild bird H1N1 viruses were transmitted to pigs in the late 1970s and established a stable lineage displacing the classical H1N1 swine lineage; once this had happened, interspecies transmission was facilitated. An H1N1 isolated from a turkey farm in northern Germany in 2009 showed a high affinity with avian-like porcine H1N1 viruses circulating and suggested that turkeys may be a possible bridge between avian and mammalian hosts.<sup>19</sup>

The predominance of avian-like swine genes in the Thai pig population has been described.<sup>20</sup> An experimental transmission of avian-like swine H1N1 has been described, and the virus transmitted through naïve and vaccinated pigs without causing clinical signs.<sup>21</sup>

## H1N1 HUMANLIKE VIRUSES IN PIGS

Humanlike viruses were reported in pigs in China before the pandemic,<sup>22</sup> and it was concluded that pigs may act as reservoirs for older human H1N1 viruses.

## H1N1-PANDEMIC 2009

There is no evidence that the 2009 pig H1N1 pandemic existed in pigs before May 2009<sup>23</sup> and before it was reported in humans. Soon after its discovery in Canada in 2009,<sup>24</sup> it spread rapidly around the world, and most pig cases are believed to originate from humans, although there was often no real proof until 2011.<sup>25</sup> It has been shown that the virus is fully capable of causing a global problem for swine.<sup>26</sup> The initial incursions of this virus into European pigs has been described<sup>27</sup> from separate nonlinked sites, suggesting infection of pigs from humans. The global spread from an animal source has

been described.<sup>28</sup> It has established itself in pig populations in face of relatively high levels of herd immunity to other viruses. In the Norwegian pig population, there was no prevalence of influenza until the infection of pigs from humans with (H1N1) pdm09.<sup>29</sup>

The virus is a reassortant of genes from the most recent triple reassortant in North America and the European avian-like subtype H1N1 viruses.<sup>30</sup>

The precursors of this virus may have existed in swine for a long time, which suggests that the evolution has occurred over a long period.<sup>30,31</sup> A direct precursor has not been recognized.<sup>32,33</sup> The situation was summarized.<sup>34</sup> It transmits very effectively between pigs.<sup>35</sup> The evolutionary characteristics of the H1 gene of the pdm2009 virus are different from the seasonal human viruses and the swine H1N1 viruses.<sup>36</sup>

The pandemic virus seems to cocirculate and interact more intensely with the endemic SIVs lineages and gives rise, it seems, to more reassortants, the properties of which have yet to be seen.<sup>37</sup> A mono-reassortant of the NA from an H1N1 with the pandemic occurred in Hungary.<sup>38</sup> In a study in Germany, the N2 was from three different porcine lineages in an H1N1pdm backbone.

Six new strains of the pdm-like (H1N1) 2009 strain of H1N1 were isolated and characterized in Poland. They belong to one lineage.<sup>39</sup> The pigs in finishing and growing sectors experienced acute onset of respiratory signs. There was anorexia, poor conception rates (50% lower), high morbidity (up to 100%), and low mortality at 2% to 3% in growers and 1% to 2% in finishers. At postmortem there were depressed, well-demarcated, pale purple areas of consolidation in all lobes.

Novel reassortants have followed with this 2009 virus, and it was pointed out in 2010 that although the virus may be of swine origin, significant viral evolution may still be ongoing<sup>40</sup> and others starting with a 2010 virus in Hong Kong.<sup>41</sup> In this virus, only the NA gene of the 2009 pandemic was reassorted. A novel swine reassortant has been described in the United Kingdom with all the internal genes from the 2009 virus and HA and NA genes from a swine subtype H1N2 virus.<sup>42</sup> It is not clear if this virus can be transmitted between pigs. A novel reassortant has been found in Canada from ab H3N2 and a pandemic (H1N1) 2009 virus on several pig farms and also in mink.<sup>43</sup>

In another reassortant, the NA glycoprotein of the pdm09 virus has been replaced by the NA gene from either H1N2 or H3N2 European swine viruses.<sup>44</sup>

Other reassortants of the 2009 virus have been discovered since from a variety of countries Italy, Argentina, Germany, China, Thailand, and the United States.<sup>44-50</sup>

Nine reassortants have been described across the United States.<sup>51</sup>

A reassortant of the pdmH1N1 2009 virus with an H3N2 virus from healthy pigs has been reported in Thailand.<sup>52</sup>

### H1N2

Since 2005, the human HA gene in H1N2 has spread across North America.

A novel reassortant in H1N2 had the NA and HA from the recent H1N2 isolates in the United States and four internal genes (PB2, PB1, PA, and NS) from the contemporary swine triple reassortants in circulating strains, known as the TRIG, but the NP and the M genes were derived from the 2009 pandemic H1N1.<sup>53</sup>

An avian-like H1N2 SIV generated by reassortment of circulating avian-like H1N1 and H3N2 subtypes in Denmark has been described.<sup>54</sup> The Danish H1N2 has an avian-like H1 and differs from most other H1N2s in Europe and North America. These have H1 genes of human or classical swine origin, respectively. The variant is also circulating in Italy and Sweden. The infection dynamics are similar to the those of the assorted H1N2s and similar to the older avian-like H1N1 subtype. A novel reassortant influenza A (H1N2) virus derived from A (H1N1) virus Japanpdm09 has been described for the first time in Japan.<sup>219</sup>

### H3N2—CLASSICAL

H3N2 variants arrived in the United States from 1998 onward (North Carolina, Iowa, Minnesota, Texas), although they may have circulated previously and had been unable to establish a stable lineage. Most are triple reassortants from human (HA, NA, and PB1), swine (NS, NP, and M), and avian (PB2 and PA) lineages. By 1999 these were widespread in the United States, and a double reassortant that had also been found had not spread widely. These are capable of being placed in one of three phylogenetically distinct humanlike lineages (clusters). The third cluster seems to be dominant and some have developed into a fourth cluster.<sup>55</sup> A study of 97 isolates showed that genetic and serologic differences existed between North American isolates<sup>56</sup> and that they show tendencies to reassortment. Once established, these have spread rapidly and evolved.<sup>57</sup>

### H3N2—NOVEL

A noncontemporary H3N2 virus was found to be a wholly human H3N2 virus.<sup>58</sup> Triple-reassortant H3N2 SIVs were isolated from pigs<sup>59</sup> and have formed a stable lineage in Canadian swine.

Novel H3N2 viruses in the United States in humans have been linked visits to state fairs and contact with pigs. Similar occurrences have been found in the past, but these have not had a component of H1N1 in the virus, as does this 2011 variant.

Seven novel H3N2 viruses were isolated from U.S. pigs between winter 2010 and

spring 2011 containing internal gene segments from the pandemic H1N1 2009.<sup>60</sup> The evolution of novel H3N2 viruses in North American swine has been described.<sup>61</sup>

A novel avian-like H3N2 containing an H5N1 highly pathogenic segment has been described in southern China.<sup>62</sup>

An influenza A (H3N2) virus from pigs was isolated from pigs and its biological properties reported.<sup>63</sup> The virus produced mild interstitial pneumonia with marked oronasal shedding for about 14 days. Because there is likely to be little cross immunity to these strains, they may cause disease in both humans and pigs in the future.

### OTHER VIRUSES

Two H5N1 influenza viruses have been isolated from swine in Jiangsu Province in China, and the authors have suggested that swine are naturally infected with H5N1 virus.<sup>220</sup> This was similar to the situation in Indonesia.<sup>64</sup> Quite often these reach pigs from avians, particularly ducks, including H1N1, H3N2, H3N3, H4N6, H5N1,<sup>64-66</sup> and H9N2.

H2N3 viruses were isolated from farms in central United States<sup>67,68</sup> and were probably of waterfowl origin. The ability of this virus to live in three different mammalian hosts suggests that it is well adapted.

An H3N1 SIV has been isolated from pigs with respiratory disease in Korea<sup>69</sup> and also in Italy,<sup>70</sup> where the HA has been acquired from a human virus, and the other genes came from the currently circulating viruses in the swine population.

Novel viruses can occur in pigs at any point in time. An avian H4N6 virus appeared in Canada in 1999 and was associated with a lake on which there were large numbers of waterfowl. Ducks shed large amounts of virus, and this can be recovered from lake water.

An avian-like H4N8 SIV was discovered in southern China.<sup>62</sup>

An assessment of the reassortant rates of the European strains of SIV suggested that there was one reassortment every 2 to 3 years, and we should expect these to occur in the future between the swine strains and the new human pandemic strain (2009).<sup>14</sup>

A high level of genetic compatibility between swine-origin H1N1 and highly pathogenic avian H5N1 influenza virus was shown.<sup>71</sup>

The avian H5N1 viruses in birds in Indonesia have been transmitted to pigs on numerous occasions<sup>72</sup> but appear to become attenuated.

H5N2 reassortant viruses have been characterized from pigs in Korea.<sup>73</sup> A serologic surveillance of H1N1 viruses in China showed that there was no naturally occurring H5N1 infection in pigs.<sup>74</sup> A highly pathogenic turkey H5N1 virus failed to infect pigs cohoused with infected chicks or chickens.<sup>75</sup>



A H6N6 virus was found in swine in China and seems to have adapted from domestic ducks.<sup>76</sup>

The isolation and characterization of two H5N1 influenza viruses from swine in Jiangsu Province in China has been described.<sup>220</sup> The H5N1 virus has spread to a range of avian and mammalian species but has not been fully characterized in the pig. Both swine viruses bound preferentially to avian-type receptors. The findings suggest that pigs are naturally infected with avian H5N1 viruses and are a potential zoonotic threat. In a study of enhanced infectivity of H5N1 highly pathogenic avian influenza virus in pig *ex vivo* respiratory tract organ cultures following adaptation by *in vitro* passage.<sup>221</sup> It was suggested that the mutations in the H5N1 virus may provide a replication or infection advantage in pigs *in vivo* and that pigs may continue to play an important part in the ecology of influenza viruses, including those of avian origin.

An H7N2 virus was isolated in South Korea and was a recombinant from an avian H7N2 and H5N3 virus.<sup>77</sup>

H9N2 SIVs have been described in China,<sup>78</sup> where the six internal genes are from H5 viruses and the HA and NA from the H9 lineages. In a survey in China, 54 genotypes were identified including 19 novel genotypes,<sup>79</sup> and there is a continuing evolution of these viruses. In this study, at least five antigenic groups were recognized, and during the period of 2002 to 2003 there was a considerable antigenic drift.

Human H7N9 IV replicates in swine respiratory tissue explants.<sup>80</sup> Three Chinese isolates all replicated in tracheal and bronchial explants. These viruses were originally avian viruses that appeared in humans in China with over 130 cases, with a mortality of 32%. The surface proteins are probably from ducks and the internal genes possibly from chickens. There are two lineages reported at the moment. Collectively these viruses could lead to another pandemic. The infectivity, transmission, and pathology of these viruses in pigs has been described.<sup>81</sup>

An H10N5 virus has been isolated from pigs in central China.<sup>82</sup> There is no evidence as yet that the “bird” viruses H10N8 and H7N9 poultry viruses that have killed people in China are as yet occurring in pigs in China.

## EPIDEMIOLOGY

The segmented nature of the viral genome is a critical structural feature that enables the viruses to be reassorted. Since 1998, H, N, and PB1 polymerase genes from human viruses; M, NS, and NP genes from classical swine viruses; and PA and PB2 polymerase genes from avian viruses have also been found.

## Occurrence

Influenza viruses are ubiquitous in pigs worldwide with the exception of Norway until the 2009 pandemic.<sup>83</sup>

A seroprevalence and genetic characterization of five subtypes of influenza A viruses (H1, H3, H5, H7, and H9) in the Chinese pig population has been described.<sup>84</sup> H1 is the most common, followed by H3.

A study in the United Kingdom suggested that at least 52% of farms had antibodies to at least one type.<sup>85</sup>

A Belgian study involving seven European countries<sup>86</sup> showed all had antibodies, but the Czech Republic, Ireland, and Poland had relatively lower levels.

Both H1N1 and H3N2 are found in Poland but at quite low levels.<sup>87</sup>

Chinese studies suggested that there was 31.1% positive to H1 and 28.6% positive for H388. In a recent study in southern China, over 50% of the pigs tested had a HI titer to one or more influenza H1N1 viruses, and most commonly pdm/09-like viruses. One group had Eurasian avian-like swine H1N1 surface genes and pdm/09 internal genes.<sup>50</sup>

The viruses were similarly widespread in Korea<sup>88,89</sup> and also in Malaysia.<sup>90</sup>

In Canada, 83.1% of the sows and 40.3% of the finishing pigs were positive for H1N1<sup>91</sup> but less than 10% to the Colorado and Texas strains of H3N293. In Argentina, over 70% were positive for H1N1 and H3N294. In Brazil, 46% were positive for H1N1.<sup>93</sup>

Swine influenza first appeared in the United States immediately following the 1918 pandemic of human influenza (Spanish flu), and it was generally believed that it was caused by adaptation of the human influenza virus to swine. Nucleotide sequencing of the genes coding for the internal virus proteins indicates that the human pandemic H1N1 strain and the classic swine strain H1N1 have a common avian ancestor. It is suggested that a virulent avian strain H1N1 entered the human population in 1918, causing the pandemic. The pandemic virus was then introduced into the swine population, where it has persisted unchanged. In contrast, this classical swine influenza was seen in the United Kingdom in 1941 but then disappeared until it was seen in Czechoslovakia in 1950 and Germany in 1959. Influenza was not seen again until observed in swine in Europe in 1979, possibly following importation of pigs from North America, associated with a virus antigenically related to contemporary avian H1N1 strains found in ducks. These avian-like strains have been the most common since 1979.

Swine influenza still occurs in the United States, and viruses of the H1N1 lineage were the dominant cause of SIV from 1930 to the 1990s. These were highly conserved (relatively unchanged), but new antigenic and genetic variants did occur. Classical H1N1 viruses have also been isolated from pigs from South America, Europe, and Asia. Wild pigs also have H1N1. In the 1980s there were many genetic mixings between avian-like H1N1 and human-like H3N2 viruses. In

1992 many outbreaks of classical swine influenza occurred in England, associated with a group of H1N1 viruses that were distinguishable from classical swine viruses, the European swine viruses, and human H1N1 viruses, all of which are known to be circulating in pigs. Influenza A virus subtypes H1N1 and H3N2 are endemic in pigs in Great Britain. Two distinct antigenic variants of H1N1 viruses have been associated with outbreaks of swine influenza, one of which was probably transmitted from birds to pigs in the early 1990s. The H1N2 subtypes isolated from pigs in Great Britain appear to have originated from a human H1N1 virus, which was circulating in the pig population in the 1980s, and from swine H3N2. It is suggested that the H1N1 viruses have disappeared from the human population, and the pig population provides a reservoir for the virus. Serologic surveys indicate that a swine H1N1 influenza virus has circulated in the swine population in North America for many years. Recent isolates from Quebec possess a hemagglutinin distinguishable from subtype H1N1.

Transmission of viruses between pigs and humans and vice versa have shaped the current epidemiology of influenza viruses in North America.

Epidemics of swine influenza have also occurred in Japan, Canada, Belgium, and France. In North America, human H3N2 have been found much less often than in the rest of the world, but the very recent introduction of H3N2 from humans to pigs was probably the major factor in the emergence of the recent strains.

Mixtures of human and classical virus genes have been isolated from pigs in Asia and the United States. H3N2 viruses with human H and N genes and avian internal protein genes have been isolated from pigs in Asia. This type of H3N2 has been found in Korea and is currently the dominant H3N2 virus in pigs in Europe. Since 1998 double and triple reassortants have been isolated from pigs in the United States. The North Carolina virus had three human genes and five swine genes. They include human H and N genes, genes from swine H1N1 viruses, and two others from avians.

All the reassortant viruses found in North America have the triple-assortant gene complex (avian PA, PB2; the NS, NP, and M genes of classical swine lineage; and the PB1 of human gene lineage). This suggests that this set of reassortants can more readily accept changes in NA and HA)

Prior infection with swine influenza viruses is a barrier to infection with avian influenza viruses.<sup>94</sup>

## SEASONALITY

A study of circulating viruses in five European countries showed that isolation of viruses was possible throughout the year, especially during winter and spring.<sup>95</sup>

Soon after the occurrence of the H3N2 viruses, new H1N2 viruses arose in the United States, where the human H3 had been replaced by a porcine H1 and then spread. They had been known elsewhere in the world for some time: Japan, France, Germany, and Taiwan. They were described in the United Kingdom, where they were found to be the most severe cause of pathology associated with the SIV viruses. These were all reassortants between human H3N2 and classical H1N1.

Human H3N2 and avian H1N1 were isolated in the United Kingdom and were then found to have spread to Europe. They are usually human H and N and the rest avian genes, but one Italian virus has an avian H1. They have shown considerable genetic drift in Europe.

Subtype H3N2 has been isolated in Canada from pigs with severe proliferative and necrotizing pneumonia (PNP), although this PNP is probably associated with PRRS and PCV2. Serologic surveys indicate the infection is widespread in the swine populations in some countries.

The first unusual virus to be found in pigs was an H9N2 introduced to pigs in South East Asia, probably from land-based poultry.

Further problems occurred in the autumn of 1999 when an avian H4N6 was found in pigs with pneumonia on a commercial swine farm in Canada. Since then the avian H5N1 has appeared in pigs in China and is being carried west by bird migrations into Russia. The potential of avian viruses to spread to pigs and persist in pigs is unknown. Even if the viruses do not replicate, they can contribute viral genes to other pig viruses. This is the reason for continual surveillance of SIV viruses. These were wholly avian viruses that were of North American lineage. It was the first report of an interspecies transmission of an avian H4 virus to domestic pigs under natural conditions.

The disease usually affects young pigs, but all ages may be affected. Typically, sudden-onset epidemics occur with a high morbidity rate but with a low case-fatality rate of less than 5%. Loss of body condition is marked, which is usually the important cause of financial loss, although occasionally death losses may be extensive if the pigs are kept under inadequate conditions or if secondary bacterial infections occur. Abortions and deaths of newborn pigs have also been reported as causes of loss in this disease.

A low level of infection was reported in Poland in 2007 in pigs, wild boar, and animal keepers.<sup>96</sup>

The 2009 pandemic first affected pigs in Canada<sup>97</sup> and has since been found worldwide: Norway,<sup>98</sup> Italy,<sup>99</sup> Canada,<sup>100,104</sup> Argentina,<sup>101</sup> South Korea,<sup>102</sup> Thailand,<sup>103</sup> and Europe.<sup>27</sup>

## Risk Factors

### Animal Risk Factors

In a study in the Netherlands, it was shown that at the end of the finishing period, the seroprevalences in farrow to finish herds and specialized finishing herds were 44.3% and 62.0% for H1N1, 6.6% and 19.3% for H3N2, and 57.2% and 25.6% for H1N2. The incidence for all three types was highest at the beginning of finishing in farrow to finish and at the end in finishing herds.<sup>105</sup>

Risk factors include high pig density, large herd size, high replacement rates, and purchase of pigs.<sup>90,91,106,107</sup>

Young, growing pigs are most susceptible. The viral infection is commonly complicated by bacterial infection caused by *Haemophilus parasuis*, *A. pleuropneumoniae*, and possibly other opportunists of the upper respiratory tract of the pig. When an epidemic occurs, most of the pigs in the herd are affected within a few days, which suggests that all animals are previously infected and that some risk factor, such as inclement weather, precipitates the epidemic.

The agent also contributes to the PRDCx. In a study in Korea, 14 of 105 cases had SIV, whereas in Iowa it has been reported in 19% of the cases of PRDC.

### Environmental Risk Factors

Epidemics occur mainly during the cold months of the year, commencing in the late autumn or early winter and terminating with a few outbreaks in early spring. Several days of inclement weather often precede an outbreak. Three risk factors for SIV were identified on a survey of Belgian finishing farms, where H1N1 was found in 71% and H3N2 was found in 22%. There was a close association between H1N1 and H3N2. H1N1 appeared to be associated with fully slatted floors, increasing numbers of pigs in the locality, and dry feeding. H3N2 was associated with the purchase of pigs from more than two herds, increasing numbers of pigs locally, and natural ventilation.

### Pathogen Factors

It has been shown that prior infection with swine influenza viruses in pigs is a barrier to subsequent infection with avian influenza viruses.<sup>94</sup>

Molecular microbiology has now revealed the antigenic diversity of the virus. Several different H and N antigens have been identified and grouped on the basis of serologic tests, which refine the diagnosis and reveal more about the epidemiologic relationships. The H3N2 strain similar to H3N2 strains found in the human population has been isolated from an outbreak in England.

Two antigenically distinct H1N1 influenza A viruses were isolated during an outbreak of respiratory disease in swine in Canada in 1990 to 1991. One is a variant of the swine H1N1 influenza virus that is widespread in the American Midwest, whereas

the other is similar to the virus isolated from swine in 1930. This suggests that influenza viruses can be maintained for long periods in swine herds, especially in certain geographic areas. It is proposed that the antigenic diversity of these viruses may be attributable to the result of drifts in the population of circulating swine influenza viruses in an area.<sup>7</sup> The antigenic diversity oligonucleotide analysis of strains isolated from outbreaks in Sweden indicated a similarity with the Danish strain. One of the Swedish strains was closely related to the U.S. strain.

The H1N1 strain of the virus can be found in pig tissues at slaughter but it does not persist for more than 2 to 3 weeks in deep frozen or refrigerated storage.

Virus circulation in weaned pigs may maintain infections in herds,<sup>108</sup> and the introduction of susceptible pigs at regular intervals will maintain this circulation.

### Methods of Transmission

Of most importance is that in birds, influenza viruses mainly affect the intestinal tract (without clinical effects), but in mammals, replication occurs mainly in the respiratory tract (with illness).

The right combination of NA and M genes is necessary for the replication and transmissibility of influenza virus infections in pigs.<sup>109</sup>

The natural reservoir of influenza A virus is aquatic birds. Various subtypes have been established in other species, such as influenza A H1N1 viruses, which infect human and different animal species. The influenza viruses may be transmissible between humans and pigs. Swine are the sole animals known to be susceptible to influenza A viruses of human, swine, and avian origin. Swine may become infected with related type A human influenza strains during epidemics of human influenza, but they show no clinical signs of infection. The human strains have been isolated from pigs in Hong Kong, and pigs may serve as a reservoir for pandemics in humans and a source of genetic information for recombination between human and porcine strains. In Japan, pigs may be seropositive to the H1N1 human viruses relative to human H1N1 influenza epidemics and seropositive to human H3N2 viruses unassociated with human epidemics of disease. In Czechoslovakia, influenza A viruses are brought into pig herds by carrier people.

Pigs can be naturally infected with a range of avian influenza viruses. There have been at least three independent introductions of distinct wholly avian viruses into pigs. The virus in the late 1970s spread throughout Europe and the United Kingdom and became a major cause of SI. These viruses also undergo drift.

Elsewhere in the world antibodies against H4, H5, and H9 viruses have been isolated from Asian pigs and avian H4N6, H3N3, and

H1N1 viruses have been recovered from pigs in Canada.

Aerosol transmission is more efficient at low temperatures and low humidity because the virus is more stable under these conditions.<sup>110</sup> Aerosol transmission of a novel swine origin H1N1 virus was shown in China.<sup>111</sup>

In water the avian viruses survive better at low temperature and salinity and high pH.<sup>112,113</sup>

The avian virus survives better on nonporous surfaces rather than porous ones<sup>114</sup> and, if there is mucus, much longer.<sup>115</sup>

Swine are susceptible to both human and avian viruses because they have receptors on their respiratory epithelial cells for both avian (receptor SA 2, 3 Gal) and human (receptor SA  $\alpha$  2, 6 Gal). Several reassortants have been isolated from pigs in the United States and other parts of the world.

Thus swine have an important role in the ecology of influenza A viruses and are regarded as a “mixing vessel” for the introduction of reassorted viruses into the human population.

There is a report claiming that outbreaks of influenza in turkeys followed outbreaks of swine influenza in pigs from nearby swine herds. Swine and other influenza viruses have also been isolated from cattle, and experimental inoculation of calves has been successful. The swine influenza virus may cause natural infection in cattle and the virus can be transferred to uninoculated calves.

The primary route of infection is through pig-to-pig contact<sup>116,117</sup> via the nasopharyngeal route. Peak shedding occurs 2 to 5 days postinfection ( $>10^7$  infectious particles/mL at a peak) but also by aerosols and contaminated fomites.<sup>118</sup>

The rapid spread of infection from pig to pig occurs by inhalation of infective droplets. The disease may appear almost simultaneously in several herds within an area following the first cold period in late autumn. The virus can persist in infected swine, which can act as convalescent carriers and be the reservoir of the virus between epidemics. However, the experimental inoculation of a swine influenza virus into specific-pathogen-free (SPF) pigs resulted in a mild disease and the period of viral shedding was shorter than 4 weeks.

Water contaminated with bird droppings has been implicated as a source of influenza virus in several swine outbreaks.<sup>68</sup> Fomites and aerosols<sup>92</sup> are probably important in the transmission of influenza.<sup>119-122</sup>

Insects may be important (certainly in avian influenza<sup>123</sup>) and blowflies have been implicated.<sup>124,125</sup>

Long-distance pig travel via transport may help spread.<sup>126</sup>

International trade may also facilitate the intercontinental spread of viruses.<sup>127</sup>

### Immunity

An infection with live virus also stimulates mucosal immunity and cellular immunity,

whereas inactivated vaccines only stimulate a limited serologic (HI) response. Preexisting immunity in European pigs to established SIV strains may partially protect against (H1N1) 2009 virus, but the extent of such protection needs to be assessed.<sup>128</sup>

Many of the host defense cells have sensors that ultimately up-regulate the production of interferons, up-regulate other cells, and activate them through cytokines and in general increase the production of host antiviral proteins. The flu virus survives in part by blocking the release of interferons.

Both cell-mediated immunity and humoral responses are important. A high HI titer provides better protection against challenge than a low HI titer. The levels of IgA seem to be more important in providing some protection against heterologous viral strains. It is the antibody-mediated immune reactions at the mucosal level, not the systemic level, that are important in protecting the respiratory tract. Improved adjuvants may aid the efficacy of inactivated vaccines. They do not prevent infection, but they can mediate the killing of infected cells. The immune response is rapid and completes elimination of the virus within 1 week. Antibodies decline by 8 to 10 weeks. The IgA levels in nasal washes are the most important defense. There is limited cross-protection between different viruses, and protection after vaccination is more virus specific.

Maternal antibody rarely prevents infection with influenza viruses and only provides partial protection. Maternal protection will last from 4 to 14 weeks, with no pigs being completely protected from nasal virus shedding upon challenge, but at least the lung is protected. Pigs with a high maternal antibody level did not develop an immune response. It was reported that there was enhancement of pneumonia by inactivated vaccine used in the face of an H1N1 challenge.<sup>129</sup> Maternal antibody does not cross protect between subtypes.

Pigs infected or vaccinated with European SIVs frequently have cross-reactive antibodies to pandemic (H1N1) 2009 virus and related North American SIVs.

Prior infection with an H1N1 SIV partially protects pigs against a low-pathogenic H5N1 avian influenza virus.<sup>130</sup>

### ZOONOTIC IMPLICATIONS

Only influenza A viruses are zoonotic. The suspected cases were reviewed.<sup>131</sup> It is highly likely that in the future, further viruses will emerge from animal species to infect humans and vice versa. People who work with pigs are at an increased risk of zoonotic influenza virus infection<sup>132</sup> (including farmers, meat processing workers, and veterinarians)<sup>133,134</sup> and should be vaccinated.<sup>135</sup> The Ohio outbreak of H1N1 at a state fair is an example.

H2 viruses have been absent from the human population since 1968 and as such

will present a huge problem if they suddenly turn up as a zoonosis. However, an H2N3 infection in pigs was not transmitted to humans from ill pigs.<sup>136</sup>

In the United States, there were only 11 reported zoonotic cases between 2005 and 2009.<sup>137</sup>

The human pandemic 2009 H1N1 virus has its closest relatives in strains of H1N1 in swine from North America and occasionally from turkeys. There are probably at least two swine ancestors for this 2009 pandemic.

Subclinical infections at Ohio fairs from 2009 to 2011 were described.<sup>138</sup> The influenza A virus (OH07) isolated from humans that attended an Ohio state fair is pathogenic in pigs and fails to cross-react with many swine H1 antisera. The virus gene segments were similar to those circulating in swine viruses, although there were numerous nucleotide changes leading to differences in amino acid composition.<sup>139</sup>

Swine influenzas pose a significant health risk to humans ever since the first human and porcine outbreaks in the United States in 1918. By 1970, there was evidence that people who came into contact with pigs through their jobs became infected with the viruses, and a virus was isolated from pigs and workers. There is very little evidence of maintenance of human H1N1 in the pig populations, but human H3N2 strains have been recovered regularly from pigs in Asia and Europe. The drift that has taken place in pigs of former human H3N2 has also been minimal compared with the rate of drift in the human population. The viruses from pigs found in humans have been reviewed. Poultry and swine workers should be vaccinated in swine pandemic planning.<sup>135</sup>

### PATHOGENESIS

Classical swine influenza was originally described as a disease of the upper respiratory tract, the trachea and bronchi being particularly affected, with secondary bacterial pneumonia as a result of *Pasteurella multocida*. However, recent descriptions of the lesions in naturally occurring cases and in the experimental disease indicate that the primary lesion is a viral interstitial pneumonia. Viral replication takes place in the epithelial cells of the nasal mucosa, tonsils, trachea, lungs, and tracheo-bronchial lymph nodes. No other sites have been detected, and viremia is of low titer. Inoculation of the H1N1 strain of influenza virus isolated in England from pigs with clinical disease into 6-week-old pigs caused fever, coughing, sneezing, and anorexia. A widespread interstitial pneumonia, with lesions in the bronchi and bronchioles, and hemorrhagic lymph nodes were characteristic. The H3N2 swine influenza virus isolated in Canada is associated with a proliferative and necrotizing pneumonia (PNP) of pigs, and there is evidence the strain may be related to A/Sw/Hong Kong/76H3N2 swine influenza virus.



There is recent evidence that this PNP is more a feature of PRRS and PCV2 than SIV. A new antigenic variant of H1N1 swine influenza A virus isolated in Quebec has been associated with proliferative and necrotizing pneumonia of pigs.

In the United Kingdom, there has also been recorded an H1N7 that included both equine and human influenza genes. It was of low pathogenicity for pigs, found on only one farm, and did not establish in the pig world. Reassortant H3N1 viruses from human and classical swine H1N1 have also been seen in the United Kingdom and also in Taiwan.

The virus causes an acute infection with shedding beginning on day 1 and finishing by day 7. Infected cells in the respiratory tract are reduced by 2 to 3 days postinoculation. Most of the effects of the infection are caused by the production of proinflammatory cytokines (IFN- $\alpha$ , TNF- $\alpha$ , IL-1, and IL-6).

Pigs have receptors for both avian (sialic acid- $\alpha$ -2,3 terminal saccharides (SA- $\alpha$ -2,3) and mammalian viruses (SA- $\alpha$ -2,6) in the upper respiratory tract. Both types have been detected in major porcine organs.<sup>140,141</sup> In experimental infections, SIV was widely distributed in bronchi, but it was also present in epithelial cells of the nose, trachea, bronchioles, and alveolar type I and II cells in severely affected animals. The avian virus was found in the lower respiratory tract, especially in alveolar type II cells and occasionally in bronchiolar epithelial cells. Receptor 2,6 was the predominant receptor in all levels of the tract, but the 2,3 was found only in small numbers in the bronchioles and in the alveoli. The receptor expression of both types of receptors was reduced in influenza-affected areas compared with nonaffected areas.<sup>142</sup> The distribution of receptors is similar in the pig to that of humans, and as in humans, avian viruses prefer to infect the alveolar cells. The in vitro attachment of virus to the upper and lower respiratory tract tracts of pigs has been characterized.<sup>143</sup>

The pathogenicity of SIV lies in its ability to elude host antiviral immune responses. In pigs SIV infection induced long-lived increase of CD8+ T cells and local lymphoproliferative responses.<sup>144</sup> The activation of cell-mediated immunity or cytotoxic T-lymphocytes depends on the efficient delivery of signals by antigen presenting cells. Dendritic cells are the most potent APCs. A study on porcine dendritic cells (DCs) has recently been published.<sup>145</sup> In one study,<sup>146</sup> it was shown that DCs could infect susceptible cells by close contact. The swine, human, or avian viruses differentially activate porcine dendritic cell cytokine profiles.<sup>147</sup>

There is an important role for IFN- $\alpha$  (induces fever and a transient rise in neutrophil counts) with IL-6 and IL-12 induction and an important role of these three

cytokines in the symptoms of swine influenza.<sup>148</sup> There is a strong up-regulation of additional cytokines (IFN- $\alpha$  and IL-12) and several acute-phase proteins during the acute stages of a swine influenza virus infection. These produce inflammation, fever, malaise, and loss of appetite. The depth of infection in the lung probably determines how much of these cytokines are produced. Contrary to widespread belief, there is no evidence that the virus causes reproductive failure in swine. The experimental inoculation of seronegative pregnant gilts did not reveal any evidence of transplacental transmission of the virus to the fetus.

The pandemic H1N1 influenza virus causes disease in pigs and up-regulates genes related to inflammatory and immune responses. The virus is effectively shed from the nasal passages. Pigs infected with the pandemic virus mounted an early potent immune response, and it has been shown that such a response is associated with an increased viral pathogenesis. It also produced a higher proinflammatory cytokine response when given to macaques.<sup>149</sup> The PB1-F2, which is expressed from a +1 reading frame of the viral RNA polymerase subunit PB1, is able to induce apoptosis and promote inflammation.<sup>150</sup> Dysregulation of lipid metabolism also occurs at the site of primary infection.<sup>151</sup>

The pandemic 2009(H1N1) virus was shown to be more pathogenic in ferrets than the standard seasonal H1N1 virus with more extensive viral replication taking place in trachea, bronchi, and bronchioles and the more normal nasal cavity.<sup>152</sup> The virus replicates to higher titers in the lung tissues. It showed less efficient respiratory droplet transmission in ferrets.<sup>153</sup>

In patients with pandemic A (H1N1) pdm09, it was found that the numbers of dendritic cells and T cells were significantly reduced compared with controls. On the other hand, the frequency of natural killer cells and T-regulatory cells increased. The concentrations of plasma interferon (IFN- $\alpha/\gamma$ ) and interleukin (IL-15) were significantly higher than in the control group.<sup>154</sup>

## CLINICAL FINDINGS

The patterns of disease in farms may vary considerably from an endemic form, with waves of infection to single epidemic outbreaks depending on the strains of virus involved.<sup>155</sup>

It is essentially a herd disease. The signs have not changed over the 80 years. After an incubation period of 1 to 7 days (usually 1-3), the disease appears suddenly, with a high proportion of the herd showing fever (up to 41.5°C [107°F]), anorexia, and severe prostration. The animal is disinclined to move or rise because of muscle stiffness and pain. Labored, jerky breathing ("thumps") is accompanied by sneezing and a deep, painful cough that often occurs in paroxysms. There

is congestion of the conjunctivae with a watery ocular and nasal discharge. Sometimes there is open-mouth breathing and dyspnea, especially if the pigs are forced to move. Morbidity is usually 100%, but mortality is rarely above 1%. In general, the severity of the illness appears greater than it truly is, and after a course of 4 to 6 days, signs disappear rapidly, depending, in part, on the level of colostrum antibody. However, there is much loss of weight, which is slowly regained. Clonic convulsions are common in the terminal stages in fatal cases. The condition may continue to affect the herd for several weeks as the disease spreads, especially so if the herd is outdoors and the population dispersed. The new H3N2 reassortants in the United States have been associated with respiratory disease but also spontaneous abortion in sows and death of adult pigs. The clinical signs are dependent on immune status but are also influenced by age, infection pressure, concurrent infections, climatic conditions, housing, and, most of all, by the secondary infections, particularly bacteria.

The clinical and epidemiologic characteristics of pdmH1N1 2009 virus in pigs have been described.<sup>156</sup> There are differences in disease presentation, spread, and duration of infection. These factors include whether they were outdoors or housed, age of the pigs, intercurrent disease, and management. In breeding pigs the infection was mild or inapparent, with a more typical clinical appearance detected in their progeny. Mortality was low unless complicated by other diseases, especially *S. suis* infections. The virus transmitted very easily. The clinical signs were usually sneezing and coughing.

## CONCURRENT INFECTIONS

There is some question as to whether other viruses can predispose to SIV, but experimentally infection with PRCV and H1N1 or H3N2 SIV has not shown this. Pigs with both *M. hyopneumoniae* and SIV coughed more and had more pneumonia than either of the two agents on their own.

Preinfection with *M. hyopneumoniae* modifies the outcome of infection with SIV H1N1 but not H1N2. The H1N2 was more pathogenic than the H1N1 with an earlier shedding and greater spread in the lungs. The *M. hyo* and H1N1 seemed to act synergistically, but the *M. Hyo* and H1N2 seemed to compete because H1N2 appeared to eliminate *M. hyo* in the caudal lobes.<sup>157</sup>

The occurrence of SIV in pigs presents opportunities for an increased impact of bacterial infections such as *H. parasuis* (HPS). It has been shown that coinfection between H3N2 and both a virulent and nonvirulent strain of HPS and porcine bone marrow dendritic cells was heightened because it raised the levels of IL-1 $\beta$ , TNF- $\alpha$ , IL-6, IL-12, and IL-10 compared with SIV or mock infections.<sup>158</sup> With the virulent strain of HPS, IL-12 and IFN- $\alpha$  increased differentially.

## CLINICAL PATHOLOGY

### Experimental Infections

Following experimental H1N1 infection, it was found that IFN- $\alpha$ , IL-6, IL-1, and TNF- $\alpha$  peaked in bronchoalveolar lavage fluid (BALF) at 24 to 30 hours postinfection, when virus titers and the severity of the clinical signs were maximal.<sup>159</sup> Serum cytokine concentrations were not detectable or 100-fold lower than the BALF readings, but IFN- $\gamma$  and IL-12 in serum followed the lavage pattern. The acute-phase protein (APP), C-reactive protein, and haptoglobin were raised 24 hours after the cytokine response, and the lipopolysaccharide binding protein only increased in the BALF. The findings suggested that IFN- $\alpha$  and IL-12 play an important part in the pathogenesis of SIV and that APPs are induced by cytokines.<sup>164</sup> Acute-phase proteins and serum amyloid were raised when pigs were simultaneously infected with H1N1 virus and *P. multocida*.<sup>160</sup>

Experimental infections with the human 1918 pandemic influenza virus produced only a mild disease and pigs, and they did not become moribund, whereas in other mammalian species the effects were lethal.<sup>161</sup> The findings suggested that the virus entered the swine population from humans and then established the classical H1N1 lineage in pigs.

Experimental infection with H1N1 European swine influenza virus protects pigs from infection with the 2009 pandemic H1N1 human virus.<sup>162</sup> Experimental infections with the U.S. isolates of the p(H1N1) 2009 were described,<sup>163</sup> and all the pigs developed clinical signs similar to those induced by endemic SIV viruses.

Within 24 hours of the onset of clinical signs there is a switch of cells in the bronchial lavage from macrophages to over 50% neutrophils.

### Serologic Tests

After infection has ceased to circulate in the herd, SIV AB could still be demonstrated after 28 months postinfection.

It is extremely important to make sure that the antigens that are used in the serologic tests are contemporary to the viral strains that may be found in the country. Diagnosis of acute SIV infections requires the use of paired serum samples.

The hemagglutination inhibition test has been the recommended test for many years and still remains so. However, it is tedious and has only moderate sensitivity but high specificity. It has been adapted and modified. One HI test for H1N1 will detect other H1N1 strains, but this is not true for H3N2 when the Midwest strains are compared with the North Carolina strains because they differ considerably. Above 1:80 is usually considered positive, and within 5 to 7 days the titers may reach 1:320 to 1:640 by 2 to 3 weeks postinfection. An ELISA-based test is now available to estimate the hemagglutination titer and can be used at the herd

screening level.<sup>164</sup> Antiinfluenza A nucleoprotein antibodies have been detected in pigs using a commercial ELISA developed for avian species.<sup>165</sup>

### Detection of Virus

Virus is likely to be found in the nasopharyngeal area during the acute phase of the disease. Swabs should be taken on Dacron, placed in transport medium, and stored at 4°C for no more than 48 hours; if storage will be longer, samples should be frozen at -70°C (-94°F). Viruses can also be isolated from trachea or lung tissues of pigs. They can be grown in hens' eggs or increasingly in tissue culture. Samples need to be cool and moist. The virus is then detected by hemagglutinating activity in egg fluids about 5 days after inoculation. There are some strains that may not grow in hens' eggs or require more than one cell line to isolate and identify the virus, which may require 1 to 2 weeks.

### Oral Fluids

Pen-based oral fluids provide an easy, effective, and safe collection method for the detection of SIV with rapid testing methods, such as RT-PCR.<sup>166</sup> Virus isolation from nasal swabs was more successful than using oral fluids.<sup>167</sup>

The sensitivity of oral fluids for detecting influenza A virus in populations of vaccinated and nonvaccinated pigs has been described. The overall sensitivity of oral fluids was 80%, and virus was isolated from 51% of RRT-PCR positive oral fluids. The method can detect SIV even when pen prevalence is low and when pigs have been vaccinated.<sup>168</sup>

### Antigen Detection

A PCR test can be used to detect virus in nasal swab specimens and gives results similar to virus isolation. Recently a gel-based multiplex RT-PCR assay was developed to detect H1 and H3 subtypes of SIV. An RT-n-PCR for the identification of SIV in clinical samples has been described.<sup>71</sup> A real-time RT-PCR assay for differentiating the pandemic H1N1 2009 pandemic from SIVs has also been described.<sup>170</sup> A real-time RT-PCR has been developed for the detection of p(H1N1)2009 and European SIV A infections.<sup>171</sup> A real-time RT-PCR for pandemic influenza A virus (H1N1) 2009 matrix gene has been described.<sup>172</sup>

A multiplex RT-PCR assay for differentiating European SIV subtypes H1N1, H1N2, and H3N2 has been described<sup>169,173</sup> and used in North American pigs.<sup>174</sup>

Loop-mediated isothermal amplification has been used for the rapid and specific detection of H3 SIV.<sup>175</sup>

There are rapid detection methods for the 2009p(H1N1) using multiplex rRT-PCR.<sup>176,177,222</sup>

The virus can be detected by direct immunofluorescence of lung tissue or lavage fluids.

Immunohistochemistry on fixed tissue is also useful. The positivity is mainly in the bronchial and bronchiolar epithelial cells and less intense in the interstitial cells and alveolar macrophages.

### NECROPSY FINDINGS

Swelling and marked edema of cervical and mediastinal lymph nodes are evident. There is congestion of the mucosae of the pharynx, larynx, trachea, and bronchi. A tenacious, colorless, frothy exudate is present in the air passages. Copious exudate in the bronchi is accompanied by collapse of the ventral parts of the lungs. This atelectasis is extensive and often irregularly distributed, although the apical and cardiac lobes are most affected, and the right lung more so than the left. It may reach 50% by 4 to 5 days postinfection. The affected tissue is clearly demarcated, dark red to purple, and often reminiscent of enzootic pneumonia. Surrounding the atelectatic areas the lung is often emphysematous and may show many petechial hemorrhages.

Histologically, in acute swine influenza the major feature is necrotizing bronchiolitis. There is a suppurative bronchiolitis and widespread interstitial pneumonia characterized by the early appearance of neutrophils followed by the accumulation of macrophages and mononuclear cells in the alveolar walls. After a few days there is a peribronchial and peribronchiolar infiltration of lymphocytes. In the variant of H1N1 swine influenza in Canada, there is more diffuse damage to the respiratory epithelium, resulting in firm to meaty lungs that appear thymus-like on cut surface.

Microscopically, there is marked proliferation of type II pneumocytes, in addition to the presence of macrophages and necrotic inflammatory cells in the alveoli. The influenza type A virus can be demonstrated by indirect immunofluorescence staining using monoclonal antibody directed to certain protein parts of the human type A influenza virus. The influenza type A virus can be detected and differentiated from the virus of porcine reproductive and respiratory syndrome in formalin-fixed, paraffin-embedded lung tissue using immunogold staining.

### Samples for Confirmation of Diagnosis

**These are best collected** from animals with high fevers and clear nasal discharge. Most pigs may excrete virus for 5 to 7 days postinfection, but the peak load may be around 24 hours postinfection

- **Histology**—formalin-fixed lung, trachea, turbinate (LM, IHC). After 72 hours there is little IFA or IHC positivity. Histopathology may help in the diagnosis for 2 weeks postinfection.
- **Virology**—nasopharyngeal swab in viral transport media; lung and

trachea (ISO, FAT, PCR) fresh chilled but not frozen. Keep cool. Do not use cotton.

#### DIFFERENTIAL DIAGNOSIS

The explosive appearance of an upper respiratory syndrome, including conjunctivitis, sneezing, and coughing, with a low mortality rate, serves to differentiate swine influenza from the other common respiratory diseases of swine.

Enzootic pneumonia of pigs is most commonly confused with swine influenza, but it is more insidious in its onset and chronic in its course.

Hog cholera is manifested by less respiratory involvement and a high mortality rate.

Inclusion-body rhinitis in piglets may resemble swine influenza quite closely.

Atrophic rhinitis has a much longer course and is accompanied by characteristic distortion of the facial bones.

#### TREATMENT

No specific treatment is available. Treatment with penicillin, sulfadimidine, or, preferably, a broad-spectrum antibiotic may be of value in controlling possible secondary invaders. The provision of comfortable, well-bedded quarters, free from dust, is of major importance. Clean drinking water should be available, but feed should be limited during the first few days of convalescence. Medication of the feed or water supplies with a broad-spectrum antibiotic for several days is a rational approach to minimizing secondary bacterial pneumonia.

A novel monoclonal antibody was shown to be effective against lethal challenge with swine lineage and 2009 pandemic H1N1 influenza viruses.<sup>178</sup>

#### CONTROL

Treatment of human influenza is possible with oseltamivir, but some viruses have become resistant; however, there is no evidence that natural oseltamivir resistance in swine and wild waterbirds is common.<sup>179</sup>

There are only two options: vaccination and biosecurity. Biosecurity is difficult because there is always the possibility of aerosol infections and wild fowl/poultry infections. It should be aimed at preventing transmission from people to pigs and vice versa.

Eradication following herd closure and partial depopulation has been achieved.<sup>180</sup> There was no introduction of replacement animals, replacement gilt deliveries were seronegative and went to quarterly instead of monthly, and the nursery was totally depopulated along with the finishing sites once shedding had finished.<sup>181</sup>

The perceptions of the pig producers in Australia in response to the occurrence of

the pandemic<sup>182</sup> suggests that ongoing communications about biosecurity are very important when new outbreaks occur.

Vaccination against swine influenza in a herd experiencing an outbreak of PCVAD is of questionable value.<sup>183</sup>

A study of vaccination in pigs infected with PRRS at the time of vaccination against SIV showed increased levels of macroscopic and microscopic lesions and also increased clinical disease and shedding of the virus.<sup>184</sup>

All-in, all-out systems may remove infection with each group of pigs, and the subsequent disinfection may wipe out the virus. Good housing and protection from inclement weather help to prevent the occurrence of severe outbreaks. Once the disease has appeared on a unit, there is little that can be done to prevent spread to other pigs. Recovered animals are immune to subsequent infection for up to 3 months.

The air filtration systems proposed for PRRSV and *M. hyopneumoniae*<sup>185</sup> may also be able to control SIV.

#### VACCINATION

Whole inactivated virus may not be the best adjuvant for the induction of cross-reactive cellular and mucosal immunity against antigenic variants.

Live attenuated vaccines could prime pigs for better cross-reactivity. One method of achieving this is to use truncation of the NS1 gene<sup>200</sup> that encodes an immune-modulating interferon antagonist. It replicates poorly but elicited neutralizing serum antibodies and mucosal antibodies and provided robust protection against homologous challenge given a single intranasal (IN) application. These vaccines provide in a single IN dose a better protection than an inactivated vaccine given intramuscularly (IM). A concern with inactivated adjuvanted vaccines is the phenomenon of vaccine-associated enhanced respiratory disease.<sup>186,187</sup>

Another obstacle is the presence of maternally derived immunity. It can reduce clinical disease, but passive antibodies are less effective in blocking viral shedding from the upper respiratory tract because the main Ig in colostrum is IgG. Pigs with maternally derived antibodies have suppressed adaptive antibody responses to homologous infection or vaccination. This interference affects IgM and HI titers in serum or nasal mucosa. The cellular response is less susceptible to maternally derived antibodies. The perception is that live attenuated IN vaccines are less likely to be interfered with by MDA.<sup>188</sup>

Virus transmission is reduced in neonatal pigs with homologous maternal immunity compared with seronegative neonatal pigs and pigs with heterologous maternal immunity.<sup>189</sup> Vaccine development has been described.<sup>190</sup>

The genetic homology of the vaccine and the challenge virus is not the ultimate

predictor for swine influenza vaccine performance.<sup>191</sup>

Vaccination with currently approved commercial vaccines in the United States did not fully prevent transmission, but certain vaccines may provide a benefit by limiting shedding, transmission, and zoonotic spillover at agricultural fairs.<sup>192</sup>

Vaccination decreases lesions and clinical signs and may eliminate virus shedding.<sup>193</sup> Vaccines may well reduce transmission but do not eliminate infection.<sup>194</sup>

In the United States, a large number of producers vaccinate sows (~67%), and many vaccinate weaner pigs (20%). A large proportion vaccinated breeding pigs with autogenous vaccines, not commercial vaccines, and these by law are prepared by inactivating virus cultures. The main reason is that commercial vaccines are not upgraded fast enough. Vaccines (1) need to be developed quickly to keep pace with the virus changes, (2) need to have better cross-protection against new isolates, and (3) need to be able to overcome maternal antibody, which may negate vaccine use.

Vaccines may use only one or two circulating strains of H3N2 in the vaccine, but the wide variation in H3N2 present in the swine population may mean that only a small percentage of currently circulating strains may be protected against by the current vaccine<sup>194</sup> and that regular challenge studies may be necessary to determine the effectiveness of vaccines.

Vaccination with influenza A virus decreased transmission rates in pigs,<sup>195</sup> but it was not completely prevented when a heterologous vaccine was used.

#### INACTIVATED VACCINES

Inactivated whole-virus vaccines have limited ability or complete failure to protect against homologous challenge and even poorer cross-protection to heterologous strains.<sup>196</sup> They can stimulate both humoral and cellular immunity.<sup>197</sup>

A trivalent inactivated swine flu vaccine was shown to be protective for all three strains (H1N1, H1N2, and H3N2).<sup>198</sup>

Inactivated vaccines from U.S. viruses and the new pandemic showed partial protection, but none was able to prevent all shedding or clinical disease.<sup>199</sup>

#### MODIFIED LIVE

Modified live vaccines or vectored subunit vaccines induce a balanced immune response (humoral and cell-mediated) and will improve homologous and heterologous protection. All vaccinated pigs developed a significant level of HI titer and serum IgG and IgA antibodies.<sup>200,201</sup>

A modified live vaccine as a master donor strain has been developed for the 2009 pandemic virus,<sup>202</sup> and a pandemic virus vaccine was developed that was superior to commercial vaccines.<sup>203</sup>



Adjuvanted and nonadjuvanted A(H1N1) pdm/09 influenza vaccines were shown to produce strong antibody responses and included high levels of specific IgG1 and HI titers to H1 virus. The adjuvanted vaccines produced a greater response.<sup>204</sup>

An eight-segment SIV with H1 and H3 was found to be attenuated and protective against both H1N1 and H3N2 subtypes in pigs.<sup>205</sup>

Vaccines, both commercial inactivated and adjuvanted SIV for IM use, are available in the United States and Europe. Active immunization occurs in the face of maternal derived antibody when titers are less than 10 for H1N1 and less than 40 for H3N2. Some of the vaccines contain the original H1N1 viruses, but others such as those used in the United States, contain a monovalent H1N1 virus. Following the outbreaks of H3N2 in the United States in 1998, both monovalent and bivalent H1N1/H3N2 SIV vaccines became available. Autogenous vaccines are used in the United States.

In Europe, although the viruses have changed, the old vaccines are still used because they produce high antibody titers. There is a need to add H1N2 to the vaccines, however, because there is no cross protection between the European H1N2 and H1N1 and H3N2 viruses and because it was shown that there is no current vaccine protection against H1N2. There is evidence from the United States showing that there is cross protection with the U.S. strain of H3N2 for H1N2 infections. Most animals with titers greater than 160 are probably protected against viral replication in the lungs and disease. Sow vaccination is important in controlling infection in suckling pigs and often controls the infection in nursery pigs. Intranasal or IN/IM vaccination of pigs with formalin-inactivated SIV induces very specific IgM, IgG, and IgA antibodies in their nasal secretions and sera, resulting in complete protection.

A recent trial of a new H1N1/H3N2 vaccine was successful, with reduced viral shedding and reduced clinical signs and pneumonia.

Experimental vaccines continue to be produced, including a human adenovirus 5 recombinant expressing the hemagglutinin and nucleoprotein of H3N2 SIV that has been used experimentally to provide protection against challenge with H3N2. Complete protection was shown by lack of nasal shedding and by lack of lung lesions following subsequent challenge.

A DNA vaccine elicited robust serum antibody and cellular responses after three immunizations and conferred significant protection against influenza virus challenge.<sup>206</sup> Vaccination with human adenovirus vector vaccines has been shown to induce both cell-mediated and humoral immunity, making them more effective than inactivated vaccines and nearly as good as live vaccines.

They can also prime the immune response in the presence of maternal antibody.<sup>207</sup>

Recently an avian-like H1N1 influenza virus was shown to be able to transmit efficiently through four pairs of vaccinated pigs at antibody levels that were thought to be protective.<sup>208</sup>

Immunity induced by infection with European avian-like H1N1 SIV affords protection for pigs against North American SIVs with a classical H1 and possibly also protects against the pH1N1.<sup>209</sup>

Pandemic (H1N1)2009 influenza virus-like particles are immunogenic.<sup>210</sup> The vaccinated pigs were protected and showed reduced lung lesions, reduced viral shedding, and inhibition of viral replication in the lungs.

### NEWER OPTIONS

Elastase-dependent SIV mutants can be used as live-virus vaccines against swine influenza in pigs.<sup>211,212</sup>

Use of the M2 conserved matrix protein may have potential as a vaccine but requires an immune response to the HA protein to reduce shedding.<sup>213</sup>

Replicon particle vaccine protects swine against influenza.<sup>214-216</sup>

Vaccination with NS1-truncated H3N2 SIV primes T cells and confers cell-mediated cross-protection against a H1N1 heterosubtypic challenge in pig.<sup>217</sup> In addition, there was a significantly lower level of Th1-associated cytokines in infected lungs. A similar vaccine can be used to differentiate between infected and vaccinated animals.<sup>218</sup>

### FURTHER READING

- Ma W, Richt JA. Swine. Influenza vaccines: current status and future perspectives. *Anim Health Res Rev*. 2010;11:81-96.
- Torremorell M, et al. Transmission of influenza A virus in pigs. *Transbound Emerg Dis*. 2012;59(suppl 1):68-84.
- Vincent A, et al. Swine influenza viruses: a North American perspective. *Adv Virus Res*. 2008;72:127-154.

### REFERENCES

- Jung K, Song DS. *Vet Rec*. 2007;161:104.
- Neumann G, Kawaoka Y. *Emerg Infect Dis*. 2006;12:881.
- Morens DM, Taubenberger JK. *Influenza Other Respir Viruses*. 2010;4:327.
- Parrish CR, et al. *Microbiol Mol Biol Rev*. 2008;457-470.
- Taubenberger JK, Morens DM. *Rev - Off Int Epizoot*. 2009;28:187.
- Song DS, et al. *Virus Res*. 2007;125:98.
- Medina RA, Garcia-Sastre A. *Natl Rev Microbiol*. 2011;9.
- Rossman JS, Lamb RA. *Virology*. 2011;411:229.
- Taubenberger JK, Kash JC. *Cell Host Microbe*. 2010;7:440.
- Vincent AI, et al. *Adv Virus Res*. 2008;72:127-154.
- Conenello GM, Palese P. *Cell Host Microbe*. 2007;2:207.
- Wolf YI, et al. *Biol Direct*. 2006;1:34.
- Rambaut A, et al. *Nature*. 2008;453:615.
- Lycett SJ, et al. *J Gen Virol*. 2012;93:2326.

- Memoli MJ, et al. *Virology*. 2009;393:338.
- Yassin HM, et al. *Vet Microbiol*. 2009;139:132.
- Karasin AL, et al. *J Clin Microbiol*. 2006;44:1123.
- Xu M, et al. *Vet Microbiol*. 2011;147:403.
- Starick E, et al. *Influenza Other Respir Viruses*. 2011;5:276.
- Takemae N, et al. *Influenza Other Respir Viruses*. 2008;2:181.
- Lloyd LE, et al. *Influenza Other Respir Viruses*. 2011;5:3570.
- Yu H, et al. *Virus Res*. 2009;140:85.
- Nfon CK, et al. *J Virol*. 2011;85:8667.
- Howden KJ, et al. *Can Vet J*. 2009;50:1153.
- Forgie SE, et al. *Clin Infect Dis*. 2011;52:10.
- Brookes SM, et al. *PLoS ONE*. 2010;5:39068.
- Welsh MD, et al. *Vet Rec*. 2010;166:642.
- Irvine RM, Brown IH. *Vet Rec*. 2009;164:577.
- Grontvedt CA, et al. *Prev Vet Med*. 2013;110:429.
- Garten RJ, et al. *Science*. 2009;325:197.
- Smith GJ, et al. *Nature*. 2009;459:1122.
- Lam T, et al. *J Virol*. 2011;85:10279.
- Vijaykrishna D, et al. *Nature*. 2011;473:519.
- Gray GC, Baker WS. *Clin Infect Dis*. 2011;52:19.
- Brookes SM, et al. *Vet Rec*. 2011;164:760.
- Furuse Y, et al. *Virology*. 2010;405:314.
- Starick E, et al. *J Gen Virol*. 2012;93:1658.
- Banyai K, et al. *J Virol*. 2012;86:13133.
- Markowska-Daniel I, et al. *Bull Vet Inst Pulawy*. 2013;57:293.
- Weingartl HM, et al. *J Virol*. 2010;84:2245.
- Vijaykrishna D, et al. *Science*. 2010;328:1529.
- Howard WA, et al. *Emerg Infect Dis*. 2011;17:1049.
- Tremblay D, et al. *J Clin Microbiol*. 2011;49:4386.
- Moreno A, et al. *Vet Microbiol*. 2011;149:472.
- Kitikoon P, et al. *Virus Genes*. 2011;43:1.
- Kitikoon P, et al. *J Virol*. 2012;86:6804.
- Kitikoon P, et al. *J Gen Virol*. 2013;94:1236.
- Pereda A, et al. *Influenza Other Respir Viruses*. 2011;5:409.
- Starick E, et al. *J Gen Virol*. 2011;92:1184.
- Zhu H, et al. *J Virol*. 2011;85:10432.
- Ducatez MF, et al. *Emerg Infect Dis*. 2011;17:1624.
- Hiramoto Y, et al. *Virus Res*. 2012;169:175.
- Ali A, et al. *Vet Microbiol*. 2012;158:60.
- Trebbien R, et al. *Virus J*. 2013;10:290.
- Olsen CW, et al. *Emerg Infect Dis*. 2006;12:1132.
- Gramer MR, et al. *Can J Vet Res*. 2007;71:201.
- de Jong JC, et al. *J Virol*. 2007;81:4315.
- Cappuccino JA, et al. *J Gen Virol*. 2011;92:2871.
- Nfon C, et al. *Transbound Emerg Dis*. 2011;58:394.
- Liu Q, et al. *Arch Virol*. 2012;157:555.
- Nelson MI, et al. *J Virol*. 2012;86:8872.
- Su S, et al. *J Virol*. 2012;17:9542.
- Kim S-H, et al. *Arch Virol*. 2013;158:2351.
- Nidom CA, et al. *Emerg Infect Dis*. 2010;16:1515.
- Lipatov AS, et al. *PLoS Pathog*. 2008;4:e1000102.
- Kwon TY, et al. *Vet Microbiol*. 2007;153:393.
- Killian MI, et al. *Avian Dis*. 2011;55:611.
- Ma W, et al. *Proc Natl Acad Sci United States*. 2007;104:20940.
- Shin J-Y, et al. *J Clin Microbiol*. 2006;44:3923.
- Moreno A, et al. *Vet Microbiol*. 2009;138:361.
- Octaviani CP, et al. *J Virol*. 2010;84:10918.
- Takano R, et al. *Arch Virol*. 2009;154:677.
- Lee JH, et al. *J Virol*. 2009;83:4205.
- Song X-H, et al. *Zoonoses Public Health*. 2010;57:291.
- Londt BZ, et al. *Vet Microbiol*. 2013;162:944.
- Zhao G, et al. *Res Vet Sci*. 2013;95:434.
- Kwon TY, et al. *Vet Microbiol*. 2011;1253:393.
- Cong YL, et al. *J Gen Virol*. 2007;88:2035.
- Sun Y, et al. *Vet Microbiol*. 2010;146:215.
- Jones JC, et al. *J Virol*. 2013;87:12496.
- Zhu H, et al. *Science*. 2013;341:183.
- Wang N, et al. *J Virol*. 2012;86:13866.

83. Hofshagen M, et al. *Euro Surveill*. 2009;14:19406.
84. Liu W, et al. *Vet J*. 2011;187:200.
85. Mastin A, et al. *PLoS Curr*. 2011;3:RRN1209.
86. Van Reeth K, et al. *Influenza Other Respir Viruses*. 2008;2:99.
87. Markowska-Daniel I, Kowalczyk A. *Med Wet*. 2007;61:669.
88. Jung K, et al. *Prev Vet Med*. 2007;79:294.
89. Pascua PN, et al. *Virus Res*. 2008;138:43.
90. Suriya R, et al. *Zoonoses Public Health*. 2008;55:342.
91. Poljak Z, et al. *Can J Vet Res*. 2008;72:7.
92. Poljak Z, et al. *Prev Vet Med*. 2008;83:24.
93. Mancini D, et al. *Virus Rev Res*. 2006;11:39.
94. De Vleeschauwer A, Van Reeth K. *Vet Microbiol*. 2010;146:340.
95. Kyriakis S, et al. *Zoonoses Public Health*. 2011;58:93.
96. Markowska-Daniel I, Kowalczyk A. *Med Wet*. 2007;61:669.
97. Howden KJ, et al. *Canad Vet J*. 2009;50:1153.
98. Hofshagen M, et al. *Euro Surveill*. 2009;14:19406.
99. Moreno A, et al. *Open Virol J*. 2010;4:52.
100. Pasma T, Joseph T. *Emerg Infect Dis*. 2010;16:706.
101. Pereda A, et al. *Emerg Infect Dis*. 2010;16:304.
102. Song MS, et al. *J Clin Microbiol*. 2010;48:3204.
103. Sreta D, et al. *Emerg Infect Dis*. 2010;16:1587.
104. Fergie SE, et al. *Clin Infect Dis*. 2011;52:10.
105. Loeffen WLA, et al. *Vet Microbiol*. 2009;137:45.
106. Mastin A, et al. *PLoS Curr*. 2011;3:RRN1209.
107. Simon-Grife M, et al. *Vet Microbiol*. 2011;149:56.
108. Larsen LE, et al. *Proc 21st Int Pig vet Soc Cong*. 2010;80.
109. Ma W, et al. *J Gen Virol*. 2012;93:1261.
110. Lowen AC, et al. *PLoS Pathog*. 2007;3:1470.
111. Zhang H, et al. *Vet J*. 2013;10:204.
112. Brown JD, et al. *Avian Dis*. 2007;51:285.
113. Brown JD, et al. *Vet Microbiol*. 2009;136:20.
114. Tiwari A, et al. *Avian Dis*. 2006;50:284.
115. Thomas Y, et al. *Appl Environ Microbiol*. 2008;74:3002.
116. Brookes SM, et al. *Vet Rec*. 2009;164:760.
117. Lange E, et al. *J Gen Virol*. 2009;90:2119.
118. Tellier R. *Emerg Infect Dis*. 2006;12:1657.
119. Lowen AC, et al. *Proc Natl Acad Sci United States*. 2006;103:9988.
120. Mubareka SJ, et al. *Infect Dis J*. 2009;199:858.
121. Yee KS, et al. *Avian Pathol*. 2009;38:59.
122. Yee KS, et al. *Virology*. 2009;394:19.
123. Romijn PC, et al. *Vet Rec*. 2009;124:224.
124. Sawabe K, et al. *Am J Trop Med Hyg*. 2006;75:327.
125. Sawabe K, et al. *J Med Entomol*. 2009;46:852.
126. Nelson MI, et al. *PLoS Pathog*. 2011;7:e1002077.
127. Vijaykrishna D, et al. *Nature*. 2011;473:519.
128. Kyriakis CS, et al. *Emerg Infect Dis*. 2010;16:96.
129. Kitikoon P, et al. *Vet Immunol*. 2006;112:117.
130. Van Reeth K, et al. *Vaccine*. 2009;27:6330.
131. Myers KP, et al. *Clin Infect Dis*. 2007;44:1084.
132. Gerloff NA, et al. *Emerg Infect Dis*. 2011;17:403.
133. Myers KP, et al. *Clin Infect Dis*. 2006;42:14.
134. Terebuh P, et al. *Influenza Other Respir Viruses*. 2010;4:387.
135. Gray GC, et al. *Vaccine*. 2007;25:4376.
136. Beaudoain A, et al. *Influenza Other Respir Viruses*. 2010;4:163.
137. Shinde V, et al. *N Engl J Med*. 2009;360:2616.
138. Bowman AS, et al. *Emerg Infect Dis*. 2012;18:1945.
139. Vincent AL, et al. *Vet Microbiol*. 2009;137:51.
140. Nelli RK, et al. *Vet Res*. 2010;6:4.
141. Poucke SGM, et al. *Virol J*. 2010;7:38.
142. Trebbien R, et al. *Virol J*. 2011;8:434.
143. Detmer SE, et al. *Vet Pathol*. 2013;50:648.
144. Charley B, et al. *Ann New York Acad Sci*. 2006;1081:130.
145. Michael B, et al. *Viruses*. 2011;3:312.
146. Mussa T, et al. *Virology*. 2011;420:125.
147. Mussa T, et al. *Vet Immunol Immunopathol*. 2013;154:25.
148. Barbe F, et al. *Res Vet Sci*. 2010;88:172.
149. Safronetz D, et al. *J Virol*. 2011;85:1214.
150. Krumbholz A, et al. *Med Microbiol Immunol*. 2011;200:69.
151. Ma W, et al. *J Virol*. 2011;85:e11626.
152. Munster VJ, et al. *Science*. 2009;325:481.
153. Maines TR, et al. *Science*. 2009;325:484.
154. Huang Y, et al. *Arch Virol*. 2013;158:2267.
155. Simon-Grife M, et al. *Vet Res*. 2012;43:24.
156. Williamson SM, et al. *Vet Rec*. 2012;171:271.
157. Deblanc C, et al. *Vet Microbiol*. 2012;157:96.
158. Mussa T, et al. *Vet Res*. 2012;43:80.
159. Barbe F, et al. *Vet J*. 2013;187:48.
160. Pomorska-Mol M, et al. *Vet Res*. 2013;9:14.
161. Weingartl HM, et al. *J Virol*. 2009;83:4287.
162. Busquets N, et al. *Vet Res*. 2010;41:74.
163. Vincent AL, et al. *Influenza Other Respir Viruses*. 2010;4:53.
164. Barbe F, et al. *J Vet Diag Invest*. 2009;21:88.
165. Ciacci-Zanella JR, et al. *J Vet Diag Invest*. 2010;22:3.
166. Detmer SE, et al. *J Vet Diag Invest*. 2011;23:241.
167. Goodell CK, et al. *Vet Microbiol*. 2013;166:450.
168. Romagosa A, et al. *Influenza Other Respir Viruses*. 2012;6:110.
169. Kowalczyk A, et al. *Med Wet*. 2007;63:810.
170. Hiromoto Y, et al. *J Virol Meth*. 2010;170:169.
171. Slomka MJ, et al. *Influenza Other Respir Viruses*. 2010;4:277.
172. Lorusso A, et al. *J Virol Meth*. 2010;164:83.
173. Chiapponi C, et al. *J Virol Meth*. 2012;184:117.
174. Nagarajan MM, et al. *J Vet Diag Invest*. 2010;22:402.
175. Gu H, et al. *J Appl Microbiol*. 2010;108:1145.
176. Harmon K, et al. *Influenza Other Respir Viruses*. 2010;4:405.
177. Hofmann B, et al. *Berl Munch Tierarztl Wschr*. 2010;123:286.
178. Shao H, et al. *Virology*. 2011;417:379.
179. Stoner TD, et al. *J Virol*. 2010;84:9800.
180. Torremorell M, et al. *Vet Rec*. 2009;165:74.
181. Schafer N, Morrison RBJ. *Sw Health Prod*. 2007;15:152.
182. Hernandez-Jover M, et al. *Prev Vet Med*. 2012;106:284.
183. Poljak Z, et al. *Can J Vet Res*. 2010;74:108.
184. Kitikoon P, et al. *Vet Microbiol*. 2009;139:235.
185. Dee S, et al. *Virus Res*. 2010;154:177.
186. Gauger PC, et al. *Vaccine*. 2011;29:2712.
187. Vincent AL, et al. *Vet Microbiol*. 2008;126:310.
188. Vincent AL, et al. *J Virol*. 2012;86:10597.
189. Allerson M, et al. *Vaccine*. 2013;31:500.
190. Chen Q, et al. *Anim Health Res Rev*. 2012;13:181.
191. Kyriakis CS, et al. *Vet Microbiol*. 2010;144:67.
192. Loving CL, et al. *J Virol*. 2013;87:9895.
193. Lee JH, et al. *Can J Vet Res*. 2007;71:207.
194. Gramer MR, et al. *Can J Vet Res*. 2007;71:201.
195. Romagosa A, et al. *Vet Res*. 2011;42:120.
196. Vincent AL, et al. *Vet Microbiol*. 2008;126:310.
197. Platt R, et al. *Vet Immunol Immunopathol*. 2011;142:252.
198. Durrwald R, et al. *Tierarztl Prax*. 2009;37:103.
199. Vincent AL, et al. *Vaccine*. 2010;28:2782.
200. Richt JA, et al. *J Virol*. 2006;80:11009.
201. Vincent AL, et al. *Vaccine*. 2007;25:2999.
202. Pena L, et al. *J Virol*. 2011;85:456.
203. Loeffen WLA, et al. *Vet Microbiol*. 2011;152:304.
204. Lefevre EA, et al. *PLoS ONE*. 2012;7:e32400.
205. Masic A, et al. *J Virol*. 2013;87:10114.
206. Gores JP, et al. *Clin Vaccine Immunol*. 2011;18:1987.
207. Wesley RD, Lager KM. *Vet Microbiol*. 2006;118:67.
208. Lloyd LE, et al. *Influenza Other Respir Viruses*. 2011;5:357.
209. De Vleeschauwer AR, et al. *Influenza Other Respir Viruses*. 2010;5:115.
210. Pyo H-M, et al. *Vaccine*. 2012;30:1297.
211. Masic A, et al. *J Virol*. 2009;83:10198.
212. Masic A, et al. *Vaccine*. 2010;28:7098.
213. Kitikoon P, et al. *Vaccine*. 2010;28:523.
214. Erdman MM, et al. *Vaccine*. 2010;28:594.
215. Bosworth B, et al. *Comp Immunol Microbiol Infect Dis*. 2010;33:e99.
216. Vander Veen RL, et al. *Vet Rec*. 2013;doi:1136/vr.101741.
217. Kappes MA, et al. *Vaccine*. 2012;30:280.
218. Richt JA, et al. *J Virology*. 2006;80:11009.
219. Kobayashi M, et al. *Emerg Infect Dis*. 2013;19:1972.
220. He LO, et al. *Arch Virol*. 2013;158:2531.
221. Londt B, et al. *Virus Res*. 2013;178:383.
222. Ma W, et al. *Influenza Other Respir Viruses*. 2010;4:397.

## PORCINE RESPIRATORY CORONAVIRUS

Infection with coronavirus causes a rapid seroconversion to some of the tests for TGE and is responsible for “vaccinating” large populations of pigs worldwide against the threat of TGE. This has coincided with the great reduction in TGE in most countries. It was first identified in Belgium in 1986 and since then has spread worldwide.

### ETIOLOGY

The virus is very similar to TGE, and the major difference is a 621- to 628-base-pair deletion in the S protein gene causing a truncated S protein and loss of the ability of the TGE to bind sialic acid. It has a tropism for the respiratory tract. It is one of the four swine coronaviruses and is a mutant of TGE, first isolated in 1984. The virus has been fully or partially sequenced and has 96% to 98% homogeneity with TGE.<sup>1</sup> Lipoteichoic acid from *S. aureus* exacerbates respiratory disease in PRCV-infected pigs,<sup>2</sup> and coinfection with *B. bronchiseptica* is reported.<sup>3</sup> PRRSV-induced immunosuppression exacerbates the inflammatory response to PRCV in pigs.<sup>4</sup> PRCV-infected pigs produce antibodies that neutralize TGE virus.

### EPIDEMIOLOGY

The virus distribution is affected by the season and the density of pig farms, and in a dense area there is rapid local spread probably by aerosol. The virus infects pigs of all ages by contact or airborne transmission and in areas of high density can probably spread several kilometers. The virus circulates in the herd, infects pigs less than 10 to 15 weeks of age after the maternal antibodies have declined, and becomes endemic. Experimentally, infected pigs shed virus from the nose for less than 2 weeks. The infection can be maintained in herds, cycle regularly, or appear in waves. In Europe, these waves often coincide with the rainy season. There is no evidence of fecal/oral transmission.

## PATHOGENESIS

The virus has a tremendous ability to replicate in the respiratory tract in most of the airway but rarely the alveolar macrophage.<sup>5-8</sup> The main targets are type 1 and type 2 alveolar epithelial cells, and it induces necrosis in these cells, causing a rise in cytokines that induces a rise in nitric oxide and IFN- $\alpha$ . The shedding from the nose lasts 4 to 6 days. The pneumonia produced and the viral replication peak at 7 to 10 days postinoculation and then resolve with the increasing levels of neutralizing antibody.

## CLINICAL SIGNS

Most infections are inapparent, but in a susceptible population there may be respiratory signs such as labored breathing and coughing, followed by depression, anorexia, and decreased growth rates.

## LESIONS

The lesions are usually self-limiting. The major lesions are broncho-interstitial pneumonia with cuffing and syncytial formation from type 2 hyperplasia, followed by necrosis and lymphoid hyperplasia. Necrotic cells and inflammatory cells may obstruct the lumen of the alveoli.

## DIAGNOSIS

Virus isolation in PK and swine testicle cells is necessary using nasal fluid or lung homogenates, and frequently PRCV produces syncytia in culture.

Respiratory samples are required for diagnosis of PRCV. Currently, RT-PCR or qRT-PCR is needed to differentiate TGEV and PRCV. The primers target the S protein. Multiplex PCR has now been developed for TGEV, PRCV, and PEDV<sup>9</sup> and up to eight viruses. Multiplex microarray has also been developed for the rapid differentiation of eight coronaviruses.<sup>10</sup>

Blocking ELISAs have been developed to differentiate antibodies of PRCV from TGE and should be used on a herd basis. Recently, new ELISAs have been developed that will also differentiate TGE, PRCV, and the new TGE-like coronaviruses.<sup>11,12</sup>

## TREATMENT

There is no treatment for PRCV infections except supportive therapy and control of secondary infections.<sup>13</sup>

## CONTROL

Neonatal pigs require 6 to 8 days after PRCV exposure to produce partial immunity to TGE. Sows naturally exposed to PRCV reinfected with PRCV during pregnancy secreted TGEV antibodies in milk and provided a high degree of protection.

## REFERENCES

- Zhang X, et al. *Virology*. 2007;358:424.
- Atanasova K, et al. *Vet J*. 2011;188:210.
- Brockmeier SL, et al. *Vet Microbiol*. 2008;128:36.

- Renukaradhya GJ, et al. *Viral Immunol*. 2010;23:457.
- Atanasova K, et al. *Open Vet Sci J*. 2008;2:117.
- Jung K, et al. *J Virol*. 2007;81:13681.
- Jung K, et al. *J Gen Virol*. 2009;90:2713.
- Jung K, et al. *Vet Immunol Immunopathol*. 2010;136:335.
- Ogawa H, et al. *J Virol Meths*. 2009;160:210.
- Chen q, et al. *Intervirology*. 2010;53:95.
- Elia G, et al. *J Virol Methods*. 2010;163:309.
- Lopez I, et al. *J Vet Diag Invest*. 2009;21:598.
- Zhang X, et al. *J Virol*. 2008;82:4420.

## LUNGWORM IN PIGS

### ETIOLOGY

The lungworms that infest pigs are *Metastrongylus apri* (*M. elongatus*), *M. salmi*, and *M. pudendotectus*. *M. apri* is the most common species, but mixed infestations are not uncommon.

### LIFE CYCLE

Adult *Metastrongylus* spp. appear much like *D. viviparus* in the bronchi of their host. Their life cycles are also similar, except that *Metastrongylus* spp. eggs are passed in the feces and earthworms act as intermediate hosts. Here development to infective larvae takes about 2 weeks, and transmission occurs when the earthworm is eaten by a pig.

### SYNOPSIS

**Etiology** The nematode parasites *Metastrongylus apri* (*M. elongatus*), *M. salmi*, and *M. pudendotectus*.

**Epidemiology** Transmission is by ingestion of the earthworm intermediate host.

**Signs** Check in growth rate; barking cough.

**Clinical pathology** Characteristic eggs in feces.

**Lesions** Grayish nodules near the ventral border of the diaphragmatic lobes of the lung.

**Diagnostic confirmation** Characteristic eggs in feces.

**Treatment** Doramectin, ivermectin, fenbendazole, flubendazole, levamisole.

**Control** Difficult, unless pigs reared on concrete.

### EPIDEMIOLOGY

The disease is most prevalent in pigs 4 to 6 months of age in husbandry systems that allow access to earthworms. The eggs first appear in the feces 3 to 4 weeks after infestation and at their peak reach levels of 25 to 50 eggs per gram of feces. The eggs are very resistant to cold temperatures and can survive for over 1 year in the soil. Larvae may survive in the earthworm for up to 7 years. The primary host must ingest an intermediate host to become infested, and this is an important factor influencing the spread of the disease. Once ingested the infective larvae migrate to the lungs in much the same manner as do *D. viviparus* larvae. Many

infestations are asymptomatic and induce immunity against reinfection.

## PATHOGENESIS

The pathogenesis is similar to that of *D. viviparus*. These worms may provide a route of transmission for swine influenza virus, and possibly hog cholera virus, from pig to pig, but this is unproven.

## CLINICAL FINDINGS

Lungworm infection in pigs can cause a marked check in growth rate. The bronchitis is accompanied by sporadic bouts of a barking cough, which is easily stimulated by exercise. Pneumonia is a feature of severe cases. Fatal bronchopneumonia can occur in coinfections of porcine circovirus type 2 and *Metastrongylus* spp.<sup>1</sup>

## CLINICAL PATHOLOGY

Laboratory diagnosis is by demonstration of the characteristic eggs in feces.

## NECROPSY FINDINGS

Early lesions comprise small areas of consolidation as a result of verminous pneumonia. More chronic cases have bronchitis, emphysema, peribronchial lymphoid hyperplasia, and bronchiolar muscular hypertrophy, often accompanied by areas of overinflation. The lesions are small and discrete, appearing as grayish nodules up to 1 cm in diameter, and are present particularly at the ventral border of the diaphragmatic lobes.

## DIAGNOSTIC CONFIRMATION

The *Metastrongylus* egg is embryonated (larvated) and has a thick shell and a wavy outline. They may be missed on routine screening as they are usually passed in small numbers and do not float well in saturated salt (NaCl) solution. A flotation fluid with a higher specific gravity should be used. There will always be a history of access to yards or paddocks where earthworms exist.

### DIFFERENTIAL DIAGNOSIS

- Other swine pneumonias
- Migrating larvae in heavy *Ascaris* infestation

## TREATMENT

### TREATMENT

Abamectin (0.1 mg/kg, PO) (R1)  
 Ivermectin (0.3 mg/kg, SC) (R2)  
 Fenbendazole (9 mg/kg, PO qd for 3 days) (R2)  
 Flubendazole (4.0 mg/kg, PO) (R2)  
 Levamisole (8 mg/kg, PO)

A number of anthelmintics are effective at normal pig dose rates, including abamectin,



ivermectin,<sup>2</sup> doramectin, fenbendazole, and flubendazole. Levamisole (8 mg/kg) has been used in the water or feed.

## CONTROL

Rearing pigs on concrete reduces the risk considerably but, in view of the longevity of the eggs and larvae in the earthworm, little can be done if pigs are kept on contaminated land. Pastures that are known to be contaminated should be left for at least 6 months before restocking, although infested earthworms may persist in hog lots for up to 4 years.

## FURTHER READING

Roepsdorff A, Mejer H, Nejsum P, Thamsborg SM. Helminth parasites in pigs: new challenges in pig production and current research highlights. *Vet Parasitol.* 2011;180:72.

## REFERENCES

1. Lopes WD, et al. *Res Vet Sci.* 2014;97:546.
2. Marruchella G, et al. *Res Vet Sci.* 2012;93:310.

## Respiratory System Toxicoses

### FURAN (IPOMEANOL AND 3-METHYLINDOLE) TOXICOSIS

4-Ipomeanol (4-IPO) is a furanoterpinoid mycotoxin produced by *Fusarium solani* (synonym *F. javanicum*) and *F. semitectum* growing on garden refuse. It has the effect of causing lesions indistinguishable from those of atypical interstitial pneumonia. Other known causes of these lesions are 3-methylindole and the ketone produced by *Perilla frutescens*, *Zieria arborescens*, and one of the fungi *Fusarium solani* or *Oxysporum* spp. on *Ipomoea batatas* (sweet potatoes) tubers and tryptophan-containing plants.<sup>1</sup> Catabolism by the fungus of phytoalexins induced in the tubers produces four closely related ipomeanols: ipomeanine (IPO), 4-ipomeanol (4-IPO), 1-ipomeanol (1-IPO), and 1,4-ipomeadiol (DIOL).<sup>2</sup> These are not toxic until activated by pulmonary microsomal enzymes; 4-IPO and IPO are ultimately the most toxic. Experimental administration of infected potatoes to calves is associated with bronchiolitis and interstitial pneumonia. Unweaned, nursing calves may not be affected.<sup>3</sup>

Animals are exposed to these toxins in a number of ways. Cows gain access to moldy sweet potatoes by grazing plowed potato fields or being fed spoiled sweet potatoes. The toxic dose is 7.5 mg IPO/kg BW, which converts to about 6 kg of spoiled sweet potatoes per adult cow.<sup>1</sup> The mortality rate is often high.<sup>4</sup> Perilla mint (purple mint or beefsteak plant) is widespread in the southeastern United States<sup>4</sup> and found in Asia and several other parts of the world.<sup>1,5</sup> All large animal species are susceptible, but poisoning is most widely reported in cattle.

Cows are exposed by eating the leaves and seeds; toxicity is highest in the seed portion of the plant.<sup>4</sup>

In a similar fashion, tryptophan toxicosis occurs in cows grazing on lush pastures with elevated concentrations of tryptophan. Outbreaks often develop several days to a week after cows are moved from poor pastures or forage to early summer pastures with high tryptophan content in the grasses. Rumen microflora convert tryptophan to 3-methylindole, which is then activated by cytochrome p450 in the lung to a reactive compound.<sup>4</sup>

The clinical signs present in ipomeanol and 3-methylindole toxicosis are similar to acute respiratory distress syndrome and atypical interstitial pneumonia. The reactive compounds produced in the lung damage the pulmonary endothelial cells and result in acute pulmonary emphysema and edema.<sup>1,4</sup> Affected animals have labored breathing, frequently standing with an open mouth and extended neck. Frothy foam from the nostrils or a foam-covered tongue may be present. Treatment is aimed toward reducing edema, supporting respiration, and reducing physical stress. Animals living longer than 48 hours have a good prognosis for survival.<sup>4</sup>

## FURTHER READING

- Kerr LA, Johnson BJ, Burrows GE. Intoxication of cattle by *Perilla frutescens* (purple mint). *Vet Hum Toxicol.* 1986;28:412-416.
- Yokoyama MT, Carlson JR, Dickinson EO. Ruminal and plasma concentrations of 3-methylindole associated with tryptophan-induced pulmonary edema and emphysema in cattle. *Am J V.* 1975;36:1349-1352.

## REFERENCES

1. Parkinson OT, et al. *J Vet Pharmacol Therp.* 2012;35:402.
2. Chen LJ, et al. *Chem Res Toxicol.* 2006;19:1320.
3. Mawhinney I, et al. *Cattle Pract.* 2009;17:96.
4. Nicholson SS. *Vet Clin North Am Food A.* 2011;27:456.
5. Lee Y-J, et al. *J Taiwan Agric Res.* 2009;58:2114.

### GALEGINE TOXICOSES

Galegine, an isoprenoid guanidine, is found in the following plants:

- Galega officinalis*: French honeysuckle<sup>1</sup>  
*Schoenus asperocarpus*: poison sedge (Australia)  
*S. rigens* (Australia)  
*Verbesina encelioides*: crown beard (North America and Australia)<sup>1</sup>

Ingestion of galegine-containing plants is associated with a syndrome of severe dyspnea, frothing from the nose, convulsions, and sudden death in ruminants as a result of pulmonary edema with large fluid accumulations in the thoracic cavity, the result of a direct effect on pulmonary vascular permeability.<sup>1</sup> Sheep may find access via

these plants being mixed in with hay or among a standing crop.

## REFERENCE

1. Jai SC, et al. *Indian J Trad Know.* 2008;7:511.

### MANURE GAS POISONING AND CONFINEMENT EFFECTS

#### ETIOLOGY

Confinement housing of cattle and swine is accompanied by manure storage for varying periods of time, often in large holding pits under slatted floors. Oxygen is excluded from the storage so that anaerobic bacteria degrade the organic and inorganic constituents of manure, yielding hydrogen sulfide, ammonia, methane, and carbon dioxide as major gases.<sup>1,2</sup> When diluted with water to facilitate handling, liquid manure in storage separates by gravity. The solid wastes form sediment, the lightweight particles float to the top, leaving a middle layer that is relatively fluid. Thorough remixing is necessary before pits are emptied to prevent the fluid fraction from flowing out and the solids remaining. The remixing or agitation results in the release of large quantities of toxic gases from the slurry.<sup>2</sup>

Besides the well-established gaseous toxicants listed, certain other agents with detrimental inhalation risks are present in confinement operations and have been best characterized for swine confinement operations. Total dust is a major contaminant in swine barns<sup>3</sup> and may range from 2 to 7 mg/m. Particulates may adsorb gases and be part of the objectionable odors released and reaching neighbors near confinement operations. Respirable dusts may be 10% or more of the total dusts generated in swine barns. Such dust is contaminated with bacteria, fungi, endotoxins, and glucans.<sup>3</sup> Dusts are primarily composed of feed or fecal material. Both endotoxins and glucans have been suggested as potential contributors to swine respiratory disease and respiratory complications for workers in swine buildings. So far, however, high mortality and acute death losses in confinement operations are most commonly caused by excessive concentrations of hydrogen sulfide and carbon dioxide, whereas subacute or chronic irritation and disease of the upper respiratory tract may also be contributed by elevated ammonia levels. Methane is explosive and may act as an asphyxiant, but is not implicated as a toxicant.

Additional factors that must be considered in a differential diagnosis include possible power loss during electrical storms or equipment failure; this results in the cessation of the artificial ventilation required to cool the building and exhaust carbon dioxide from the animals' respiration. In these situations, CO<sub>2</sub> levels build rapidly, and environmental temperatures increase dramatically as well, especially when weather conditions

are hot and humid.<sup>1</sup> Acute losses from hyperthermia or heat stroke may be mistaken for manure gas poisoning.<sup>1</sup> This is important for veterinarians because they may be called to establish a diagnosis that affects insurance claims for many thousands of dollars. Besides overheating and CO<sub>2</sub> accumulation, electrocution should be considered whenever there are large numbers of acute losses in a confinement building.

### PATHOGENESIS

The exposure of humans, cattle, and swine to high concentrations (above 700 ppm of H<sub>2</sub>S) of manure gases, particularly hydrogen sulfide, can be associated with peracute deaths in cattle and swine. Hydrogen sulfide is both an irritant and an acute toxicant. Fatal or severe exposure often is associated with respiratory distress and pulmonary edema. Exposure to low concentrations of hydrogen sulfide over long periods is thought to be associated with reduced performance in cattle and swine. At high concentrations, from 500 to 1000 ppm, carotid-body receptors are stimulated, causing rapid breathing. As high concentrations continue or increase, the respiratory center is depressed, and animals become depressed and die. High concentrations of H<sub>2</sub>S depress olfactory sensors, and the offensive rotten-egg odor is no longer detected as a warning sign.

Ammonia is either an irritant or corrosive agent depending on the concentration. Ammonia combines with tissue moisture to produce ammonium hydroxide, a strong alkali capable of causing tissue necrosis.

### CLINICAL FINDINGS

In acute hydrogen sulfide poisoning the animals die suddenly. Affected animals may be found dead throughout a building in various postures of lateral or sternal recumbency. There may be little or no evidence of struggle or excitement because high concentrations can be associated with nearly immediate respiratory paralysis. In acute ammonia poisoning the syndrome includes conjunctivitis, sneezing, and coughing for a few days, but pigs will soon acclimatize, after which no effects may be detectable. An increased incidence of pneumonia and reduced daily weight gains in pigs are associated with exposure to a combination of gaseous ammonia at levels of 50 to 100 ppm and the presence of atmospheric dust in barns. Higher concentrations of ammonia (100–200 ppm) are associated with irritation to the conjunctiva and respiratory mucosa. At very high ammonia concentrations (>500 ppm), there is pharyngeal and laryngeal irritation, laryngospasm, and coughing. Concentrations above 2000 ppm can be associated with death within 30 minutes. Carbon dioxide overexposure first is associated with mild to moderate excitement, followed by depression, weakness, coma, and

death. Concentrations above 30% in air are serious, and 40% CO<sub>2</sub> for more than a few minutes can cause death.

### NECROPSY FINDINGS

In cattle that have died from acute hydrogen sulfide poisoning, lesions include pulmonary edema, extensive hemorrhage in muscles and viscera, and bilaterally symmetric cerebral edema and necrosis. Ammonia exposure results in lacrimation, conjunctivitis, corneal opacity, tracheal hyperemia or hemorrhages, and pulmonary edema. Secondary bacterial pneumonia may be evident in exposed animals. For carbon dioxide, the principal lesions are of cyanosis.

### CONTROL

Production of hydrogen sulfide in manure can be inhibited by aeration using air as the oxidizing agent or the use of chemical oxidizing agents. The use of ferrous salts virtually eliminates hydrogen sulfide evolution. Adequate ventilation with all doors and windows wide open during remixing and agitation of the slurry will reduce the concentration of hydrogen sulfide to nontoxic levels. Animals and personnel should not enter closed barns when the pits are being emptied. In confinement buildings, ammonia usually does not accumulate to fatal levels, but much of the economic loss is from reduced feed consumption and possibly increased susceptibility to acute or chronic respiratory disease. Limiting protein supplementation to actual needs has been considered a means for reducing nitrogen losses and the resultant production of ammonia in feces and urine.

### FURTHER READING

- Hartung J, Phillips VR. Control of gaseous emissions from livestock buildings and manure stores. *J Agr Eng Res.* 1994;57:173-189.
- Hooser SB, et al. Acute pit gas (hydrogen sulfide) poisoning in confinement cattle. *J Vet Diagn Invest.* 2000;12:272-275.
- Radostits O, et al. Manure gas poisoning. In: *Veterinary Medicine: A Textbook of the Disease of Cattle, Horses, Sheep, Goats and Pigs.* 10th ed. London: W.B. Saunders; 2007:1848.

### REFERENCES

- Barrasa M, et al. *Ann Agr Environ Med.* 2012;19:17-24.
- Ni JQ, et al. *Sci Total Environ.* 2010;408:5917.
- Basinas I, et al. *J Expo Sci Environ Epidemiol.* 2013;doi:10.1038/jes.2013.83.

### PLANTS CAUSING PULMONARY DISEASE (UNIDENTIFIED TOXINS)

The following plants have been associated with pulmonary disease. The toxins currently are unidentified.

- Dyspnea and pulmonary edema:
- Glechoma hederacea* (= *Nepeta hederacea*: ground ivy)
  - Gyrostemon* spp.: camel poison

Pulmonary consolidation and fibrosis, characterized by dyspnea and cough (horses):

- Eupatorium* (= *Ageratina adenophorum*: crofton weed)
- E. riparium*: mist flower
- Lactuca scariola*: prickly lettuce

## Neoplastic Diseases of the Respiratory Tract

Neoplasms arising as a result of viral infection (nasal adenocarcinoma of sheep, ovine pulmonary adenocarcinoma) and non-neoplastic tumors (equine ethmoidal hematoma) are dealt with under those headings in this chapter.

### PULMONARY AND PLEURAL NEOPLASMS

Primary neoplasms of the lungs, including carcinomas and adenocarcinomas, are rare in animals and metastatic tumors also are relatively uncommon in large animals. Primary tumors reported in lungs or pleura of the farm animal species include the following:

#### Horses

- Granular cell tumors are the most common tumor arising in the pulmonary tissue of horses.
- Malignant melanomas in adult gray horses
- Pulmonary adenocarcinoma (either primary or as metastatic disease)
- Pulmonary leiomyosarcoma
- Bronchogenic carcinoma, pulmonary carcinoma, bronchogenic squamous-cell carcinoma, pulmonary chondrosarcoma, and bronchial myxoma are all rare tumors in lungs of horses.
- Mesothelioma arise from the visceral or parietal pleura.

#### Cattle

- Pulmonary adenocarcinoma is the most commonly reported primary lung tumor in cattle. The ultrastructure and origin of some of these have been characterized.
- Lymphomatosis in young cattle may be accompanied by pulmonary localization

#### Sheep

- Ovine pulmonary adenocarcinoma (jaagsiekte sheep retrovirus) is locally common in some areas.

#### Goats

- An asymptomatic, squamous-cell-type tumor, thought to be a benign papilloma, has been observed in 10 of a series of 1600 adult Angora goats. The lesions were mostly in the diaphragmatic lobes, were

multiple in 50% of the cases, and showed no evidence of malignancy, although some had necrotic centers.

- Bronchoalveolar carcinoma not related to ovine adenocarcinoma virus is reported.<sup>1</sup>

A wide variety of tumors metastasize to the lungs, and these tumors can originate in almost any tissue or organ. A series of thoracic neoplasms in 38 horses included lymphosarcoma, metastatic renal cell carcinoma, primary lung carcinomas, secondary cell carcinoma from the stomach, pleural mesothelioma, and malignant melanoma.

The etiology of the tumors is unknown in most cases, apart from those arising from viral infections. Equine granular cell tumors arise from the Schwann cells of the peripheral nervous system in the lungs.

Characteristically, primary pulmonary or pleural tumors arise in middle-aged to old animals. The prevalence of these tumors is not well documented, although they are rare in abattoir studies of horses. The tumors occur sporadically, with the exception of those associated with infectious agents (bovine lymphomatosis, ovine pulmonary adenocarcinoma).

The pathogenesis of pulmonary tumors includes impairment of gas exchange, either by displacement of normal lung with tumor tissue and surrounding atelectasis and necrosis or by obstruction of the large airways (e.g., granular cell tumor in horses).

### CLINICAL FINDINGS

Clinical findings are those usually associated with the decrease in vital capacity of the lungs and include dyspnea that develops gradually, cough, and evidence of local consolidation on percussion and auscultation. There is no fever or toxemia, and a neoplasm can be mistaken for a chronic, encapsulated pulmonary abscess. Major clinical findings included weight loss, inappetence, and dyspnea and coughing. An anaplastic small-cell carcinoma of the lung of a 6-month-old calf located in the anterior thorax caused chronic bloat, anorexia, and loss of body weight. Some tumors, notably mesothelioma and adenocarcinoma, cause accumulation of pleural fluid. Hypertrophic pulmonary osteopathy occurs in some animals with pulmonary tumors.

Ovine pulmonary adenocarcinoma can metastasize to liver, kidneys, skeletal muscle, gastrointestinal tract, spleen, skin, and adrenal glands.<sup>2</sup>

**Granular cell tumors** in horses present as chronic coughing and exercise intolerance in horses without signs of infectious disease. As the disease progresses, there is increased respiratory rate and effort and weight loss, suggestive of severe heaves. However, horses are unresponsive to treatment for heaves. The disease can progress to cor pulmonale and right-sided heart failure. A bronchial

mass is evident on endoscopic or radiographic examination (Figs. 12-34 and 12-35). There are no characteristic hematologic or serum biochemical changes.

Hemangiosarcomas of the thoracic cavities of horses occur and are evident as excess pleural fluid with a high red blood cell count.<sup>3</sup>

**Thymoma**, or **lymphosarcoma** as a part of the disease bovine viral leukosis, is not uncommon in cattle and can resemble pulmonary neoplasm, but there is usually displacement and compression of the heart, resulting in displacement of the apex beat and congestive heart failure. The presence of



Fig. 12-34 Endoscopic view of a granular cell tumor in a horse.

jugular engorgement, ventral edema, tachycardia, chronic tympany, and hydropericardium can cause a mistaken diagnosis of traumatic pericarditis. Mediastinal tumor or abscess (cranial thoracic masses) can have a similar effect. Metastasis to the bronchial lymph nodes can cause obstruction of the esophagus with dysphagia, and in cattle chronic ruminal tympany. This tumor is also common in goats, many of which show no clinical illness.

**Radiographic or ultrasonographic** examination is useful in demonstrating the presence of a mass in the lungs or thorax. **Endoscopic examination** is useful for detection of tumors that invade the larger airways, such as granular cell tumors of horses. Thoracoscopy and pleural biopsy can be useful in the diagnosis of lesions at the pleural surfaces.

The nature of the tumor can sometimes be determined by examination of **pleural fluid**, into which some tumors shed cells, or of tumor tissue obtained by biopsy. Examination of pleural fluid for the presence of tumor cells is not very sensitive because many tumors do not shed sufficient numbers of cells to be detectable, but it is quite specific in that detection of abnormal cells is diagnostic.

### TREATMENT

There is no effective treatment, with the exception of resection of localized tumors. Granular cell tumors in horses have been successfully treated by lung resection or transendoscopic electrocauterization.<sup>4,5</sup>



Fig. 12-35 Lateral thoracic radiograph of an adult horse demonstrating presence of a granular cell tumor (outline by black arrows).



**FURTHER READING**

Davis EG, Rush BR. Diagnostic challenges: equine thoracic neoplasia. *Equine Vet Educ.* 2013;25:96-107.

**REFERENCES**

1. Ortin A, et al. *Vet Pathol.* 2007;44:710.
2. Minguijon E, et al. *J Comp Pathol.* 2013;148:139.
3. Taintor J. *Equine Vet Educ.* 2014;26:499.
4. Sullins KE. *Equine Vet Educ.* 2015;27:306.
5. Van Heesewijk N, et al. *Equine Vet Educ.* 2015;27:302.

## Congenital and Inherited Diseases of the Respiratory Tract

**CONGENITAL DEFECTS**

Primary congenital defects are rare in the respiratory tracts of animals. Congenital

defects of the soft palate of foals have been sporadically reported; horses with minor defects can grow normally and may be able to have a successful athletic career for their intended use.<sup>1</sup> Hypoplasia of the epiglottis is detected occasionally in horses. Tracheal hypoplasia is recognized in calves and Miniature horses. Bronchogenic cysts are rare in foals<sup>2</sup> and calves<sup>3</sup> and result from the abnormal development of the tracheobronchial system during the embryonic period. Bronchogenic cysts can cause respiratory distress and dysphagia, particularly when located in the cervical region. Secondary defects, which are associated with major defects in other systems, are more common. Most of the defects are associated with defects of the oral cavity, face, and cranial vault, particularly cleft palate. Accessory lungs are recorded occasionally, and if their bronchi are vestigial, the lungs can present themselves as tumor-like masses occupying most of the

chest. Pulmonary hypoplasia has been associated with congenital diaphragmatic hernia. Retrosternal hernia (Morgagni hernia), which is a right ventral diaphragmatic defect, has been surgically corrected in adult horses as a result of incarceration of the large colon; in all cases the defect was thought to be congenital.<sup>4</sup>

**REFERENCES**

1. Barakzai SZ, et al. *Equine Vet J.* 2014;46:185.
2. Matsuda K, et al. *Vet Pathol.* 2010;47:351.
3. Lee JY, et al. *J Vet Diagn Invest.* 2010;22:479.
4. Pauwels FF, et al. *J Am Vet Med Assoc.* 2007;231:427.

# Index

To access the comprehensive index for volumes 1 and 2 of VETERINARY MEDICINE, 11e please refer to the end of Volume 2.

This page intentionally left blank



# How to Use This Book

We would like you to get the most out of this book. To do that, you should follow the directions provided in this section. And if you keep doing this every time you use the book, you will develop a proper diagnostic routine of going from:

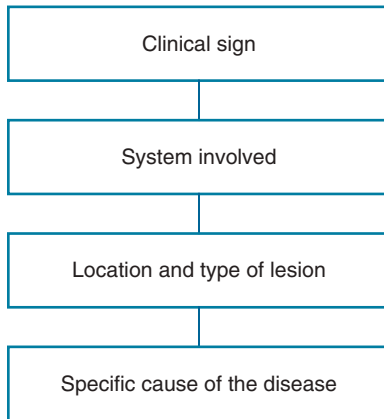

... and become what we wish for every one of you: a thinking clinician.

## FOR EXAMPLE

A yearling bull has a sudden onset of dyspnea, fever, anorexia, abnormal lung sounds, and nasal discharge.

**Step 1** The bull's problem is dyspnea. Go to the index and find the principal entry for dyspnea.

**Step 2** The discussion on dyspnea will lead you to respiratory tract dyspnea and cardiac dyspnea.

**Step 3** Via the index, consult these and decide that the system involved is the respiratory system and that the lungs are the location of the lesion in the system.

**Step 4** Proceed to diseases of the lungs and decide on the basis of the clinical and other findings that the nature of the lesion is inflammatory and is pneumonia.

**Step 5** Proceed to pneumonia, and consult the list of pneumonias that occur in cattle. Consult each of them via the index and decide that pneumonic pasteurellosis is the probable specific cause.

**Step 6** Proceed to the section on pneumonic pasteurellosis and determine the appropriate treatment for the bull and the chances of saving it.

**Step 7** Don't forget to turn to the end of the section on pneumonic pasteurellosis and remind yourself of what to do to protect the rest of the herd from sharing the illness.

## Guidelines for Selection and Submission of Necropsy Specimens for Confirmation of Diagnosis

In this edition we continue with the subheading *Samples for Confirmation of Diagnosis* to serve as a rough guideline for the collection of samples at necropsy. Several points must be emphasized with regard

to this section. First and foremost, **collection of these samples is not advocated as a substitute for a thorough necropsy examination.** Furthermore, the samples listed are selected to confirm the diagnosis, but a conscientious diagnostician should also collect samples that can be used to rule out other disease processes. Even the best of practitioners can make an incorrect tentative diagnosis, but it is an even more humbling experience if there are no samples available to pursue alternate diagnoses. Also, recall that some diseases may be the result of several different etiologic factors (e.g., neonatal diarrhea of calves), and the veterinarian who samples to confirm one of these factors but does not attempt to investigate others has not provided a good service to the client.

A huge variety of veterinary diagnostic tests have been developed, but each veterinary diagnostic laboratory (VDL) offers only a selected panel, chosen after consideration of a number of factors. Such factors may include cost, demand, reliability, sensitivity and specificity, and the availability of appropriate technology at the lab. The array of diagnostic tests is constantly improving, and it is beyond the scope of this text to list all the tests available for a given disease or to recommend one test method to the exclusion of others. Under the *Samples for Confirmation of Diagnosis* sections, we have merely listed some of the more common tests offered. Advances in molecular biology are providing exciting avenues for disease diagnosis, but many of these tests have limited availability in VDLs at present. For optimal efficiency in the confirmation of a diagnosis at necropsy, the practitioner must contact the VDL to determine what tests are offered and to obtain the preferred protocol for sample collection and submission to that particular laboratory. Most VDLs publish user guidelines, which include the tests available and the samples required. The guidelines listed here are broad, and individual VDLs may have very specific requirements for sample handling.

Several general statements can be made with regard to the submission of samples to VDLs:

- The samples should be accompanied by a clearly written and concise clinical history, including the signalment of the animal and feeding and management information. Failure to provide this information deprives the owner of the full value of the expertise available from the laboratory staff.
- If a potentially zoonotic disease is suspected, this should be clearly indicated in a prominent location on the submission form.
- All specimens should be placed in an appropriate sealed, leak-proof container and clearly labeled with a waterproof marker to indicate the tissue/fluid collected, the animal sampled, and the owner's name. At some VDLs, pooling of tissues within a single bag or container is permitted for specific tests (such as virus isolation), but in general, all fresh samples should be placed in separate containers. When packaging samples for shipment, recognize that condensation from ice packs and frozen tissues will damage any loose paper within the package; the submission sheet should be placed within a plastic bag for protection or taped to the outside of the shipping container.
- Samples for histopathology can be pooled within the same container of 10% neutral-buffered formalin. An optimal tissue sample of a gross lesion should include the interface between normal and abnormal tissue. For proper fixation, tissue fragments should not be more than 0.5 cm in width, and the ratio of tissue to formalin solution should be 1:10. If necessary, large tissues such as brain can be fixed in a larger container and then transferred to a smaller one containing only a minimal quantity of formalin for shipping to the laboratory. To speed fixation and avoid artifactual changes, formalin containers should not be in direct contact with frozen materials during shipment.

- In the *Samples for Confirmation of Diagnosis* sections, the tests are listed under various discipline categories (bacteriology, virology, etc.). The appropriate sample(s) is noted, followed by the types of test that might be applied to these samples. The following is a list of these different tests, including any abbreviation used in this section of the text. A brief discussion of how the samples collected for each test should be handled is also provided. Again, it must be emphasized that this is by no means a complete listing of diagnostic tests available, and different VDLs often have differing sample handling procedures.
  - **Aerobic culture** = (CULT). These samples should generally be kept chilled during shipment. If a transit time of greater than 24 hours is anticipated the samples should be frozen, then packaged appropriately so that they are still frozen upon arrival at the VDL. Various bacterial species cannot be recovered using routine culture techniques, and most of these are highlighted in the text by the phrase “special culture requirements.”
  - **Agar gel immunodiffusion** = (AGID). A type of serologic test. Chilled or frozen serum may be submitted.
  - **Anaerobic culture** = (ANAEROBIC CULT). Confirmation of the diagnosis requires that any swabs be transported in special transport media and that the VDL attempts to grow bacteria from the samples under anaerobic culture conditions. Transport requirements are as for (CULT) (aerobic culture) specimens.
  - **Analytical assay** = (ASSAY). This refers to a broad range of tests in which a substance is quantitatively measured. The substance to be assayed is listed in brackets, e.g. (ASSAY [Ca]) denotes a test for calcium levels. The method used to perform the assay is not listed, but in general, frozen samples may be submitted for most of these analytical assays.
  - **Bioassay** = (BIOASSAY). This typically refers to tests in which the sample material is administered to an animal under experimental conditions. Preserved material is inappropriate, and some bioassays cannot be performed using samples that have been frozen. The VDL performing the test should be contacted for instructions prior to sample collection
  - **Complement fixation** = (CF). A serologic test. Ship chilled or frozen serum.
  - **Cytology** = (CYTO). Air-dried impression smears are usually adequate. Keep dry during transport.
  - **Direct smear** = (SMEAR). The type of test is usually given in brackets (e.g., [Gram]). Air-dried smears are usually adequate but must be kept dry during shipment.
  - **Enzyme-linked immunosorbent assay** = (ELISA). Chilled or frozen samples are usually acceptable. There are many variants of ELISA (e.g., antigen-capture, kinetic, indirect, direct, etc.), and the specific type used is not specified in this portion of the text.
  - **Electron microscopic examination** = (EM). Appropriate sample collection and handling varies with the specimen being examined. Most of the diagnostic specimens submitted to VDLs for EM are fecal samples, and these do not require any special preservative.
- **Fecal floatation** = (FECAL). Sample can be fresh, chilled, or frozen.
- **Fluorescent antibody test** = (FAT). This may refer to either a direct or indirect method of antigen detection. Generally, cryostat sections are utilized, and therefore the tissue received by the laboratory should still be frozen upon arrival to provide the best results. Freeze/thaw cycles should be avoided. If impression smears are being shipped, they should be kept dry.
- **Fungal culture** = (FCULT). Special media is required. Transport as per (CULT) specimens.
- **Immunohistochemical testing** = (IHC). Many of these tests can be performed on formalin-fixed material, but in some instances frozen tissues must be delivered to the laboratory. In such instances the test is listed under a heading distinct from histology (e.g., virology, bacteriology, etc.).
- **Indirect hemagglutination** = (IHA). A serologic test. Ship chilled or frozen serum.
- **In-situ hybridization** = (IN-SITU HYBRID). Samples should be shipped chilled, although some test methods can use formalin-fixed material. These tests utilize nucleic acid probes that bind with complementary nucleic acid sequences in the specimen. Although not widely used in routine diagnostics at present, these methods may gain more prominence as their use is refined,
- **Virus isolation** = (ISO). Samples should be kept chilled during shipment or maintained in a frozen state if prolonged transit times are anticipated,
- **Latex agglutination** = (LATEX AGGLUTINATION). Fresh, chilled, or frozen samples are acceptable.
- **Light microscopic examination** = (LM). Formalin-fixed tissues are preferred. The shipment of fresh tissues to the VDL permits more tissue autolysis prior to fixation, resulting in less useful specimens. If Bouin's fixative is available, it is the preferred preservative for eye globes.
- **Microagglutination test** = (MAT). A type of serologic test. Ship chilled or frozen serum.
- **Mycoplasma culture** = (MCULT). These types of organism have specific growth requirements that are usually not met by standard bacteriologic culture techniques. Transport as per (CULT) specimens. Culture swabs cannot be submitted in media containing charcoal or glycerol.
- **Polymerase chain reaction** = (PCR). Tissues should be frozen and maintained in that state until arrival at the VDL. Swabs and fluids submitted for PCR testing should be chilled but not frozen. These tests are capable of detecting minute quantities of nucleic acid, so if multiple animals are tested, the samples should be “clean” to avoid false positives through cross-contamination (i.e., blood/tissue from one animal contaminating the sample from another)
- **Serum urea nitrogen** = (SUN). A useful test to determine degree of renal compromise. Sample can be shipped chilled or frozen.
- **Virus neutralization** = (VN). A serologic test. Ship chilled or frozen serum.





# VETERINARY MEDICINE

EDITION

11

A Textbook of the Diseases of  
Cattle, Horses, Sheep, Pigs, and Goats

PETER D. CONSTABLE    KENNETH W. HINCHCLIFF  
STANLEY H. DONE    WALTER GRÜNBERG



ELSEVIER



# VETERINARY MEDICINE

EDITION

11

A Textbook of the Diseases of  
Cattle, Horses, Sheep, Pigs, and Goats

VOLUME TWO

PETER D. CONSTABLE  
KENNETH W. HINCHCLIFF  
STANLEY H. DONE  
WALTER GRÜNBERG

ELSEVIER

ELSEVIER

3251 Riverport Lane  
St. Louis, Missouri 63043

VETERINARY MEDICINE: A TEXTBOOK OF THE DISEASES OF CATTLE, HORSES, SHEEP, PIGS, AND GOATS, ELEVENTH EDITION

Copyright © 2017 Elsevier Ltd. All Rights Reserved.  
Previous editions copyrighted: 2007, 2000, 1999, 1994, 1983, 1979, 1974  
First published 1960

No part of this publication may be reproduced or transmitted in any form or by any means, electronic or mechanical, including photocopying, recording, or any information storage and retrieval system, without permission in writing from the publisher. Details on how to seek permission, further information about the Publisher's permissions policies and our arrangements with organizations such as the Copyright Clearance Center and the Copyright Licensing Agency, can be found at our website: [www.elsevier.com/permissions](http://www.elsevier.com/permissions).

This book and the individual contributions contained in it are protected under copyright by the Publisher (other than as may be noted herein).

#### Notices

Knowledge and best practice in this field are constantly changing. As new research and experience broaden our understanding, changes in research methods, professional practices, or medical treatment may become necessary.

Practitioners and researchers must always rely on their own experience and knowledge in evaluating and using any information, methods, compounds, or experiments described herein. In using such information or methods they should be mindful of their own safety and the safety of others, including parties for whom they have a professional responsibility.

With respect to any drug or pharmaceutical products identified, readers are advised to check the most current information provided (i) on procedures featured or (ii) by the manufacturer of each product to be administered, to verify the recommended dose or formula, the method and duration of administration, and contraindications. It is the responsibility of practitioners, relying on their own experience and knowledge of their patients, to make diagnoses, to determine dosages and the best treatment for each individual patient, and to take all appropriate safety precautions.

To the fullest extent of the law, neither the Publisher nor the authors, contributors, or editors, assume any liability for any injury and/or damage to persons or property as a matter of products liability, negligence or otherwise, or from any use or operation of any methods, products, instructions, or ideas contained in the material herein.

Main ISBN: 9780702052460  
Volume 2 ISBN: 978-0-7020-7056-3

Content Strategist: Penny Rudolph  
Content Development Specialist: Laura Klein  
Content Development Manager: Jolynn Gower  
Publishing Services Manager: Hemamalini Rajendrababu  
Senior Project Manager: Kamatchi Madhavan  
Design Direction: Renee Duenow

Printed in China

Last digit is the print number: 9 8 7 6 5 4 3 2 1



Working together  
to grow libraries in  
developing countries

[www.elsevier.com](http://www.elsevier.com) • [www.bookaid.org](http://www.bookaid.org)

# Contents

Contributors, ix  
Preface to the Eleventh Edition, x  
Introduction, xii  
List of Tables, xxiv  
List of Illustrations, xxvii

## 1 Clinical Examination and Making a Diagnosis, 1

Introduction, 1  
Making a Diagnosis, 2  
Clinical Examination of the Individual Animal, 5  
Prognosis and Therapeutic Decision Making, 26

## 2 Examination of the Population, 29

Approach to Examining the Population, 29  
Examination Steps, 30  
Techniques in Examination of the Herd or Flock, 32  
Role of the Integrated Animal Health and Production Management Program, 34

## 3 Biosecurity and Infection Control, 36

Definitions and Concepts, 36  
Development of a Biosecurity Plan, 37  
Practices to Aid in Maintaining Biosecurity, 38

## 4 General Systemic States, 43

Hypothermia, Hyperthermia, and Fever, 43  
Acute Phase Response, 56  
Sepsis, Septicemia, and Viremia, 57  
Toxemia, Endotoxemia, and Septic Shock, 59  
Toxemia in the Recently Calved Cow, 67  
Hypovolemic, Hemorrhagic, Maldistributive, and Obstructive Shock, 71  
Localized Infections, 76  
Pain, 78  
Stress, 84  
Disturbances of Appetite, Food Intake, and Nutritional Status, 87  
Weight Loss or Failure to Gain Weight (Ill-Thrift), 90  
Physical Exercise and Associated Disorders, 96  
Sudden or Unexpected Death, 99  
Diseases Associated With Physical Agents, 103  
Diagnosis of Inherited Disease, 111

## 5 Disturbances of Free Water, Electrolytes, Acid-Base Balance, and Oncotic Pressure, 113

Dehydration, 113  
Water Intoxication, 115  
Electrolyte Imbalances, 116  
Acid-Base Imbalance, 123  
Oncotic Pressure and Edema, 128  
Naturally Occurring Combined Abnormalities of Free Water, Electrolyte, Acid-Base Balance, and Oncotic Pressure, 130  
Principles of Fluid and Electrolyte Therapy, 137

## 6 Practical Antimicrobial Therapeutics, 153

Principles of Antimicrobial Therapy, 153  
Antibiotic Resistance, 156  
Antibiotic Metaphylaxis to Control Respiratory Disease, 158  
Practical Usage of Antimicrobial Drugs, 158  
Classification of Antimicrobial Agents: Mechanisms of Action and Major Side Effects, 169  
 $\beta$ -Lactam Antibiotics: Penicillins, Cephalosporins, and  $\beta$ -Lactamase Inhibitors, 170

## 7 Diseases of the Alimentary Tract: Nonruminant, 175

Principles of Alimentary Tract Dysfunction, 176  
Manifestations of Alimentary Tract Dysfunction, 178  
Special Examination, 183  
Principles of Treatment in Alimentary Tract Disease, 190  
Diseases of the Buccal Cavity and Associated Organs, 192  
Diseases of the Pharynx and Esophagus, 196  
Diseases of the Nonruminant Stomach and Intestines, 203  
Diseases of the Peritoneum, 215  
Abdominal Diseases of the Horse Including Colic and Diarrhea, 220  
Abdominal Diseases of the Pig Including Diarrhea, 287  
Noninfectious Intestinal Disease of Swine, 290  
Bacterial and Viral Diseases of the Alimentary Tract, 292  
Parasitic Diseases of the Alimentary Tract, 397  
Control, 421  
Toxins Affecting the Alimentary Tract, 421  
Neoplasms of the Alimentary Tract, 431

Congenital Defects of the Alimentary Tract, 432  
Inherited Defects of the Alimentary Tract, 434

## 8 Diseases of the Alimentary Tract—Ruminant, 436

Diseases of the Forestomach of Ruminants, 436  
Special Examination of the Alimentary Tract and Abdomen of Cattle, 445  
Diseases of the Rumen, Reticulum and Omasum, 457  
Diseases of the Abomasum, 500  
Diseases of the Intestines of Ruminants, 523  
Bacterial Diseases of the Ruminant Alimentary Tract, 531  
Viral Diseases of the Ruminant Alimentary Tract, 572  
Parasitic Diseases of the Ruminant Alimentary Tract, 603  
Toxic Diseases of the Ruminant Alimentary Tract, 618  
Diseases of the Ruminant Alimentary Tract of Unknown Cause, 621

## 9 Diseases of the Liver, 622

Diseases of the Liver: Introduction, 622  
Principles of Hepatic Dysfunction, 622  
Manifestations of Liver and Biliary Disease, 623  
Special Examination of the Liver, 625  
Principles of Treatment in Diseases of the Liver, 629  
Diffuse Diseases of the Liver, 629  
Diseases Characterized by Systemic Involvement, 639  
Hepatic Diseases Associated With Trematodes, 641  
Diseases Associated With Major Phytotoxins, 645  
Poisoning by Mycotoxins, 649  
Focal Diseases of the Liver, 655  
Diseases of the Pancreas, 656

## 10 Diseases of the Cardiovascular System, 657

Principles of Circulatory Failure, 657  
Manifestations of Circulatory Failure, 659  
Special Examination of the Cardiovascular System, 663  
Arrhythmias (Dysrhythmias), 675  
Diseases of the Heart, 685  
Cardiac Toxicities, 697  
Cardiac Neoplasia, 703  
Congenital Cardiovascular Defects, 703  
Inherited Defects of the Circulatory System, 706  
Diseases of the Pericardium, 707  
Diseases of the Blood Vessels, 709  
Vascular Neoplasia, 715



## 11 Diseases of the Hemolymphatic and Immune Systems, 716

Abnormalities of Plasma Protein Concentration, 716  
 Hemorrhagic Disease, 718  
 Lymphadenopathy (Lymphadenitis), 751  
 Diseases of the Spleen and Thymus, 752  
 Immune-Deficiency Disorders (Lowered Resistance to Infection), 753  
 Amyloidoses, 755  
 Enzootic Bovine Leukosis (Bovine Lymphosarcoma), 785  
 Nutritional Deficiencies, 814  
 Toxins Affecting the Hemolymphatic System, 823  
 Neoplasia, 834  
 Congenital Inherited Diseases, 837  
 Inherited Immunodeficiency, 839  
 Diseases of Unknown Etiology, 842

## 12 Diseases of the Respiratory System, 845

Principles of Respiratory Insufficiency, 846  
 Principal Manifestations of Respiratory Insufficiency, 848  
 Special Examination of the Respiratory System, 855  
 Principles of Treatment and Control of Respiratory Tract Disease, 868  
 Diseases of the Upper Respiratory Tract, 874  
 Diseases of the Lung Parenchyma, 880  
 Diseases of the Pleural Cavity and Diaphragm, 895  
 Diseases of the Bovine Respiratory Tract, 901  
 Diseases of the Ovine and Caprine Respiratory Tract, 969  
 Diseases of the Equine Respiratory Tract, 981  
 Diseases of the Swine Respiratory Tract, 1047  
 Respiratory System Toxicoses, 1087  
 Neoplastic Diseases of the Respiratory Tract, 1088  
 Congenital and Inherited Diseases of the Respiratory Tract, 1090

## 13 Diseases of the Urinary System, 1095

Introduction, 1095  
 Clinical Features of Urinary Tract Disease, 1097  
 Special Examination of the Urinary System, 1099  
 Principles of Treatment of Urinary Tract Disease, 1108  
 Diseases of the Kidney, 1110  
 Infectious Diseases of the Kidney, 1115  
 Toxic Agents Affecting the Kidney, 1135  
 Renal Neoplasia, 1137  
 Congenital and Inherited Renal Diseases, 1137

Diseases of the Ureters, Bladder, and Urethra, 1139  
 Diseases of the Prepuce and Vulvovaginal Area, 1152

## 14 Diseases of the Nervous System, 1155

Introduction, 1156  
 Principles of Nervous Dysfunction, 1157  
 Clinical Manifestations of Diseases of the Nervous System, 1158  
 Special Examination of the Nervous System, 1164  
 Diffuse or Multifocal Diseases of the Brain and Spinal Cord, 1178  
 Focal Diseases of the Brain and Spinal Cord, 1189  
 Plant Toxins Affecting the Nervous System, 1194  
 Fungal Toxins Affecting the Nervous System, 1201  
 Other Toxins Affecting the Nervous System, 1202  
 Diseases of the Cerebrum, 1219  
 Bacterial Diseases Primarily Affecting the Cerebrum, 1224  
 Viral Diseases Primarily Affecting the Cerebrum, 1227  
 Prion Diseases Primarily Affecting the Cerebrum, 1286  
 Parasitic Disease Primarily Affecting the Cerebrum, 1301  
 Metabolic Diseases Primarily Affecting the Cerebrum, 1302  
 Metabolic and Toxic Encephalomyelopathies, 1321  
 Inherited Diseases Primarily Affecting the Cerebrum, 1322  
 Congenital and Inherited Encephalomyelopathies, 1324  
 Diseases Primarily Affecting the Cerebellum, 1328  
 Diseases Primarily Affecting the Brainstem and Vestibular System, 1329  
 Diseases Primarily Affecting the Spinal Cord, 1337  
 Parasitic Diseases Primarily Affecting the Spinal Cord, 1341  
 Toxic Diseases Primarily Affecting the Spinal Cord, 1346  
 Inherited Diseases Primarily Affecting the Spinal Cord, 1346  
 Diseases Primarily Affecting the Peripheral Nervous System, 1358

## 15 Diseases of the Musculoskeletal System, 1371

Principal Manifestations of Musculoskeletal Disease, 1372  
 Diseases of Muscles, 1377  
 Diseases of Bones, 1388  
 Diseases of Joints, 1406  
 Infectious Diseases of the Musculoskeletal System, 1425  
 Nutritional Diseases Affecting the Musculoskeletal System, 1458

Toxic Agents Affecting the Musculoskeletal System, 1503  
 Congenital Defects of Muscles, Bones, and Joints, 1510  
 Inherited Diseases of Muscles, 1514  
 Inherited Diseases of Bones, 1530  
 Inherited Diseases of Joints, 1538

## 16 Diseases of the Skin, Eye, Conjunctiva, and External Ear, 1540

Introduction, 1541  
 Principles of Treatment of Diseases of the Skin, 1543  
 Diseases of the Epidermis and Dermis, 1543  
 Diseases of the Hair, Wool, Follicles, and Skin Glands, 1552  
 Diseases of the Subcutis, 1555  
 Non-Infectious Diseases of the Skin, 1559  
 Bacterial Diseases of the Skin, 1564  
 Viral Diseases of the Skin, 1580  
 Dermatomycoses, 1600  
 Protozoal Diseases of the Skin, 1607  
 Nematode Infections of the Skin, 1608  
 Cutaneous Myiasis, 1611  
 Mite Infestations, 1618  
 Ked and Louse Infestations, 1623  
 Miscellaneous Skin Diseases Caused by Flies, Midges, and Mosquitoes, 1625  
 Tick Infestations, 1631  
 Deficiencies and Toxicities Affecting the Skin, 1634  
 Cutaneous Neoplasms, 1640  
 Congenital and Inherited Defects of the Skin, 1643  
 Eye and Conjunctival Diseases, 1648  
 External Ear Diseases, 1660

## 17 Metabolic and Endocrine Diseases, 1662

Introduction, 1662  
 Metabolic Diseases of Ruminants, 1662  
 Inherited Metabolic Diseases of Ruminants, 1727  
 Metabolic Diseases of Horses, 1727  
 Disorders of Thyroid Function (Hypothyroidism, Hyperthyroidism, Congenital Hypothyroidism, Thyroid Adenoma), 1739  
 Diseases Caused by Nutritional Deficiencies, 1747  
 Deficiencies of Energy and Protein, 1753  
 Diseases Associated with Deficiencies of Mineral Nutrients, 1754

## 18 Diseases Primarily Affecting the Reproductive System, 1758

Infectious Diseases Primarily Affecting the Reproductive System, 1758  
 Infectious Diseases Primarily Affecting the Reproductive System, 1761

Toxic Agents Primarily Affecting the Reproductive System, 1821  
 Congenital and Inherited Diseases Primarily Affecting the Reproductive System, 1828

## 19 Perinatal Diseases, 1830

Introduction, 1830  
 Perinatal and Postnatal Diseases, 1830  
 Perinatal Disease—Congenital Defects, 1835  
 Physical and Environmental Causes of Perinatal Disease, 1840  
 Failure of Transfer of Passive Immunity (Failure of Transfer of Colostral Immunoglobulin), 1848  
 Clinical Assessment and Care of Critically Ill Newborns, 1856  
 Neonatal Infectious Diseases, 1874  
 Neonatal Neoplasia, 1903

## 20 Diseases of the Mammary Gland, 1904

Introduction, 1904  
 Bovine Mastitis, 1904  
 Diagnosis of Bovine Mastitis, 1914  
 Mastitis Pathogens of Cattle, 1930

Mastitis of Cattle Associated With Common Contagious Pathogens, 1930  
 Mastitis of Cattle Associated With Teat Skin Opportunistic Pathogens, 1942  
 Mastitis of Cattle Associated With Common Environmental Pathogens, 1943  
 Mastitis of Cattle Associated With Less Common Pathogens, 1960  
 Control of Bovine Mastitis, 1964  
 Miscellaneous Abnormalities of the Teats and Udder, 1985  
 Mastitis of Sheep, 1991  
 Mastitis of Goats, 1993  
 Contagious Agalactia in Goats and Sheep, 1994  
 Mastitis of Mares, 1996  
 Postpartum Dysgalactia Syndrome of Sows, 1996

## 21 Systemic and Multi-Organ Diseases, 2002

Diseases of Complex or Undetermined Etiology, 2003  
 Multi-Organ Diseases Due to Bacterial Infection, 2011

Multi-Organ Diseases Due to Viral Infection, 2058  
 Multi-Organ Diseases Due to Protozoal Infection, 2137  
 Multi-Organ Diseases Due to Trypanosome Infection, 2150  
 Multi-Organ Diseases Due to Fungal Infection, 2158  
 Multi-Organ Diseases Due to Metabolic Deficiency, 2161  
 Multi-Organ Diseases Due to Toxicity, 2176

## APPENDICES, 2215

Appendix 1  
 Conversion Tables, 2215  
 Appendix 2  
 Reference Laboratory Values, 2217  
 Appendix 3  
 Drug doses and intervals for horses and ruminants, 2220  
 Appendix 4  
 Drug doses and intervals for pigs, 2232

## Index, 2235

This page intentionally left blank



# Diseases of the Urinary System

## INTRODUCTION 1095

Principles of Renal Insufficiency 1095  
Renal Insufficiency and Renal Failure 1096

## CLINICAL FEATURES OF URINARY TRACT DISEASE 1097

Abnormal Constituents of the Urine 1097  
Variations in Daily Urine Flow 1097  
Abdominal Pain and Painful and Difficult Urination (Dysuria and Stranguria) 1098  
Morphologic Abnormalities of Kidneys and Ureters 1098  
Palpable Abnormalities of the Bladder and Urethra 1098  
Acute and Chronic Renal Failure 1098  
Uremia 1098

## SPECIAL EXAMINATION OF THE URINARY SYSTEM 1099

Tests of Renal Function and Detection of Renal Injury 1099  
Collection of Urine Samples 1099  
Tests of Urine Samples 1100  
Tests of Serum 1103  
Tests of Urine and Serum 1104  
Diagnostic Examination Techniques 1106

## PRINCIPLES OF TREATMENT OF URINARY TRACT DISEASE 1108

**DISEASES OF THE KIDNEY 1110**  
Glomerulonephritis 1110

Pyelonephritis 1111  
Nephrosis 1111  
Ischemic Nephrosis 1112  
Toxic Nephrosis 1112  
Renal Tubular Acidosis 1113  
Hemolytic Uremic-Like Syndrome 1114  
Hydronephrosis 1114  
Interstitial Nephritis 1114  
Embolic Nephritis 1115

## INFECTIOUS DISEASES OF THE KIDNEY 1115

Leptospirosis 1115  
Bovine Pyelonephritis 1129  
Urinary Disease in Swine 1131  
Porcine Cystitis and Pyelonephritis 1132  
Kidney Worm Disease in Pigs Caused by *Stephanurus dentatus* 1134

## TOXIC AGENTS AFFECTING THE KIDNEY 1135

Citrinin Toxicosis 1135  
Ethylene Glycol Toxicosis 1136  
Ochratoxins (Ochratoxicosis) 1136  
Plant Poisonings Caused by Known Toxins 1137  
Plant Poisonings From Unidentified Toxins 1137  
Fungi Lacking Identified Toxins 1137

## RENAL NEOPLASIA 1137

## CONGENITAL AND INHERITED

### DISEASES OF THE KIDNEY 1137

Renal Hypoplasia 1137  
Polycystic Kidneys 1138  
Renal Dysplasia 1138  
Renal Lipofucinoses of Cattle 1139  
Equine Renal Cortical Tubular Ectasia 1139

### DISEASES OF THE URETERS, BLADDER, AND URETHRA 1139

Ectopic Ureter and Ureteral Defects 1139  
Paralysis of the Bladder and Overflow Incontinence 1139  
Eversion of the Bladder 1140  
Patent Urachus 1140  
Rupture of the Bladder (Uroperitoneum) 1140  
Uroperitoneum in Foals 1140  
Cystitis 1143  
Urolithiasis in Ruminants 1144  
Urolithiasis in Horses 1150  
Urethral Tears in Stallions and Geldings 1151  
Urethral Defects 1151  
Urinary Bladder Neoplasms 1151  
Bovine Enzootic Hematuria 1151

### DISEASES OF THE PREPUCE AND VULVOVAGINAL AREA 1152

Enzootic Posthitis (Pizzle Rot, Sheath Rot, Balanoposthitis) and Vulvovaginitis (Scabby Ulcer) 1152

## Introduction

Diseases of the bladder and urethra are more common and more important than diseases of the kidneys in farm animals. Occasionally, renal insufficiency develops as a sequel to diseases such as pyelonephritis, embolic nephritis, amyloidosis, and nephrosis. Knowledge of the physiology of urinary secretion and excretion is required to properly understand disease processes in the urinary tract. The principles of renal insufficiency presented here are primarily extrapolated from research in other species, particularly human medicine. Although generally these principles probably apply to farm animals, the details of renal function and renal failure in farm animals have just started to be studied in depth.

## PRINCIPLES OF RENAL INSUFFICIENCY

The kidneys excrete the end products of tissue metabolism (except for carbon dioxide), and maintain fluid, electrolyte, and acid-base balance, by varying the volume of water and the concentration of solutes in the urine. For conceptual purposes it is helpful to think of the kidney as composed of many similar nephrons, which are the basic functional units of the kidney. Each nephron is composed of blood vessels, the glomerulus, and a tubular system that consists of the proximal tubule, the loop of Henle, the distal tubule, and the collecting duct.

The glomerulus is a semipermeable filter that allows easy passage of water and low molecular weight solutes, such as electrolytes, glucose, and keto acids, but restricts

passage of high molecular weight substances, such as plasma proteins. Glomerular filtrate is derived from plasma by simple passive filtration driven by arterial blood pressure. Glomerular filtrate is identical to plasma except that it contains little protein or lipids. The volume of filtrate, and therefore its content of metabolic end products, depends on the hydrostatic pressure and the plasma oncotic pressure in the glomerular capillaries and on the proportion of glomeruli, which are functional. Because these factors are only partially controlled by the kidney, in the absence of disease, the rate of filtration through the glomeruli is relatively constant.

Epithelial cells in the renal tubules actively and selectively reabsorb substances from the glomerular filtrate while permitting the excretion of waste products. Proximal

tubular cells are therefore metabolically very active and, consequently, are susceptible to injury from ischemia (decreased blood flow) or hypoxia. Glucose is reabsorbed entirely, within the normal range of plasma concentration; phosphate is reabsorbed in varying amounts depending on the needs of the body for phosphorus conservation; other substances, such as inorganic sulfates and creatinine, are not reabsorbed in appreciable amounts. The tubules also actively secrete substances, particularly electrolytes, as they function to regulate acid-base balance. As a result of the balance between resorption and secretion, the concentration of solutes in the urine varies widely when the kidneys are functioning normally.

The principal mechanism that regulates water reabsorption by the renal tubules is antidiuretic hormone (ADH). Tissue dehydration and an increase in serum osmolality stimulate the secretion of ADH from the posterior pituitary gland. The renal tubules respond to ADH by conserving water and returning serum osmolality to normal, producing concentrated urine.

Diseases of the kidneys, and in some instances of the ureters, bladder, and urethra, reduce the efficiency of the kidney's functions, resulting in disturbances in protein, acid-base, electrolyte, and water homeostasis and in the excretion of metabolic end products. A partial loss of function is described as **renal insufficiency**. When the kidneys can no longer regulate body fluid and solute composition, **renal failure** occurs.

## RENAL INSUFFICIENCY AND RENAL FAILURE

Renal function depends on the number and functionality of the individual nephrons. Renal insufficiency can occur from abnormalities in the

- Rate of renal blood flow
- Glomerular filtration rate
- Efficiency of tubular reabsorption.

Of these three abnormalities, the latter two are intrinsic functions of the kidney, whereas the first depends largely on vasomotor control, which is markedly affected by circulatory emergencies such as shock, dehydration, and hemorrhage. Circulatory emergencies may lead to a marked reduction in glomerular filtration, but they are extrarenal in origin and cannot be considered as true causes of renal insufficiency. However, prolonged circulatory disruption can cause renal ischemia and ultimately renal insufficiency.

Glomerular filtration and tubular reabsorption can be affected independently in disease states, and every attempt should be made to clinically differentiate glomerular disease from tubular disease. This is because the clinical and clinicopathologic signs of renal dysfunction depend on the anatomic location of the lesion and the imbalance in function between glomeruli and tubules.

Renal dysfunction tends to be a dynamic process so the degree of dysfunction varies with time. If renal dysfunction is so severe that the animal's continued existence is not possible, it is said to be in a state of renal failure, and the clinical syndrome of uremia will be present.

## CAUSES OF RENAL INSUFFICIENCY AND UREMIA

The causes of renal insufficiency, and therefore of renal failure and uremia, can be divided into prerenal, renal, and postrenal groups.

**Prerenal causes** include congestive heart failure and acute circulatory failure, either cardiac or peripheral, in which acute renal ischemia occurs in response to a decrease in renal blood flow. Proximal tubular function is affected by renal ischemia to a much greater extent than the glomerulus or distal tubules; this is because of the high metabolic demands of the proximal tubules. However, those parts of the tubules within the medulla are particularly susceptible to hypoxic damage because of the low oxygen tension in this tissue, the dependency of blood flow on glomerular blood flow, and the high metabolic rate of this tissue. Renal medullary necrosis is a direct consequence of these factors.

**Renal causes** include glomerulonephritis, amyloidosis, pyelonephritis, embolic nephritis, and interstitial nephritis. Acute renal failure can be produced in any of the farm animal species by administration of a variety of toxins (see the section **Toxic Nephrosis**). The disease is also secondary to sepsis and hemorrhagic shock. Experimental uremia has also been induced by surgical removal of both kidneys but the results, especially in ruminants, are quite different from those in naturally occurring renal failure. The clinical pathology is similar, but there is a prolonged period of normality after the surgery.

**Postrenal uremia** may also occur, specifically complete obstruction of the urinary tract by vesical or urethral calculus, or more rarely by bilateral urethral obstruction by transitional cell carcinoma located in the trigone region of the bladder. Internal rupture of any part of the urinary tract, such as the bladder, ureters, or urethra, will also cause postrenal uremia.

## PATHOGENESIS OF RENAL INSUFFICIENCY AND RENAL FAILURE

Damage to the glomerular epithelium destroys its selective permeability and permits the passage of plasma proteins into the glomerular filtrate. The predominant protein is initially albumin, because of its negative charge and a lower molecular weight than globulins; however, with advanced glomerulonephritis (such as renal amyloidosis) all plasma proteins are lost. Glomerular filtration may cease completely when there is

extensive damage to glomeruli, particularly if there is acute swelling of the kidney, but it is thought that anuria in the terminal stages of acute renal disease is caused by back diffusion of all glomerular filtrate through the damaged tubular epithelium rather than failure of filtration. When renal damage is less severe, the remaining nephrons compensate to maintain total glomerular filtration by increasing their filtration rates. When this occurs, the volume of glomerular filtrate may exceed the capacity of the tubular epithelium to reabsorb fluid and solutes. The tubules may be unable to achieve normal urine concentration. As a result, an increased volume of urine with a constant specific gravity is produced and solute diuresis occurs. This is exacerbated if the tubular function of the compensating nephrons is also impaired. The inability to concentrate urine is clinically evident as polyuria and is characteristic of developing renal insufficiency.

Decreased glomerular filtration also results in retention of metabolic waste products such as urea and creatinine. Although marked increases in serum urea concentration are probably not responsible for the production of clinical signs, because urea readily crosses cell membranes and therefore is an ineffective osmole, the serum urea nitrogen (SUN) concentration can be used to monitor glomerular filtration rate. However, the utility of SUN concentration as a measure of glomerular filtration rate is reduced because serum urea concentrations are influenced by the amount of protein in the diet, by hydration, and by gastrointestinal metabolism of urea. Serum urea concentrations are substantially higher in animals on high-protein diets, and dehydration increases serum urea concentration by increasing resorption of urea in the loop of Henle, which is independent of effects of hydration of the glomerular filtration rate. Urea is excreted into saliva of ruminants and metabolized by ruminal bacteria. In contrast, creatinine is excreted almost entirely by the kidney, creatinine originates from the breakdown of creatine phosphate in muscle, and serum concentrations of creatinine are a useful marker of glomerular filtration rate. The relationship between serum creatinine concentration and glomerular filtration rate is hyperbolic (a reduction in glomerular filtration rate by half results in a doubling of the serum creatinine concentration). Phosphate and sulfate retention also occurs when total glomerular filtration is reduced and sulfate retention contributes to metabolic acidosis in renal insufficiency. Phosphate retention also causes a secondary hypocalcemia, due in part to an increase in calcium excretion in the urine. In horses, the kidneys are an important route of calcium excretion; thus the decreased glomerular filtration rate present in horses with chronic renal failure usually results in hypercalcemia. Variations in serum potassium concentrations also occur and appear to

depend on potassium intake. Hyperkalemia is not usually a serious complication of renal insufficiency in ruminants because affected animals often have decreased appetites and therefore reduced potassium intakes, and excess saliva can be excreted by the salivary glands and ultimately the feces.

Loss of tubular resorptive function is evidenced by a continued loss of sodium and chloride; hyponatremia and hypochloremia eventually occur in all cases of renal failure. The continuous loss of large quantities of fluid from solute diuresis can cause clinical dehydration. More often it makes the animal particularly susceptible to dehydration when there is an interruption in water availability or when there is a sudden increase in body water loss by another route, as in diarrhea.

The terminal stage of renal insufficiency, renal failure, is the result of the cumulative effects of impaired renal excretory and homeostatic functions. Sustained excretion of large volumes of dilute urine results in dehydration. If other circulatory emergencies arise, acute renal ischemia might result, leading to acute renal failure. Prolonged hypoproteinemia results in rapid loss of body condition and muscle weakness. Acidemia secondary to metabolic acidosis and hyponatremia can also be a contributing factor to muscle weakness and mental attitude. All these factors play some part in the production of clinical signs of renal failure, which are typically manifested as weakness, lethargy, inappetence and, with extensive glomerular lesions, dependent edema caused by hypoproteinemia. However, the clinical syndrome is variable and rarely diagnostic for renal failure. Bleeding diathesis can also be present in severely uremic animals and has been associated with a lack of antithrombin (a small protein readily lost through the damaged glomerulus), platelet factor 3, platelet dysfunction, or disseminated intravascular coagulation.

Renal failure is seen as the clinical state of uremia. Uremic animals exhibit clinical signs of disease, which should be compared with azotemic animals that have an increase in the plasma or serum concentrations of urea and creatinine and retention of other solutes as described earlier, but do not necessarily have clinical signs of disease.

## Clinical Features of Urinary Tract Disease

The major clinical manifestations of urinary tract disease are

- Abnormal constituents of urine
- Variations in daily urine flow
- Abdominal pain, painful urination (dysuria), and difficult urination (dysuria and stranguria)
- Abnormal sized kidneys

- Abnormalities of the bladder and urethra
- Acute and chronic renal failure

### ABNORMAL CONSTITUENTS OF THE URINE

Laboratory analysis of urine is initially done using dipstick and refractometry on a voided or catheterized urine sample and microscopic examination of the sediment from a centrifuged urine sample. Urine dipsticks and refractometry (optical and digital) provide excellent low-cost point-of-care tests for evaluation of the urinary system. Widely available urine dipsticks typically measure 1 factor (acetoacetate), 5 factors (blood, glucose, acetoacetate, pH, and protein) or 10 factors (blood, glucose, bilirubin, acetoacetate, pH, protein, specific gravity, urobilinogen, nitrite, and leukocytes). Specific information regarding tests of renal function and injury conducted on urine, such as specific gravity and osmolality, enzymuria, and quantitative proteinuria and glycosuria, are discussed later in this chapter.

### VARIATIONS IN DAILY URINE FLOW

An increase or decrease in urine flow is often described in animals, but accuracy demands physical measurement of the amount of urine voided over a 24-hour period. This is not usually practicable in large-animal practice, and it is often necessary to guess whether the flow is increased or decreased. Accurate measurement of the amount of water consumed is often easier and is usually used to estimate 24-hour urine production. Care should be taken to differentiate increased daily urine flow from increased frequency in urination without increased daily flow. The latter is much more common. Decreased urine output rarely, if ever, presents as a clinical problem in agricultural animals.

Normal urine production is highly variable in large animals and is dependent to a large extent on diet, watering systems, and the palatability of the water. Pregnant mares housed in tie stalls consume approximately  $53 \pm 6$  mL of water per kilogram body weight (BW) per day, of which  $50 \pm 8$  mL/kg is from drinking water with the remainder being water in feed. However, most of this water is excreted in the feces, with fecal and urinary water excretion being  $34 \pm 8$  (mL/kg)/day and  $8 \pm 2$  (mL/kg)/day, respectively. Neonatal foals produce urine at an average rate of 150 (mL/kg)/day.

#### Polyuria

Polyuria occurs when there is an increase in the volume of urine produced over a 24-hour period. Polyuria can result from extrarenal causes, such as when horses habitually drink excessive quantities of water (**psychogenic polydipsia**) and, much less common, in

**central diabetes insipidus**, when there is inappropriate secretion of ADH from the pituitary, or when there is failure of the tubules to respond to ADH (**nephrogenic diabetes insipidus**). Polyuria occurs in horses with tumors of the pars intermedia of the pituitary gland. Although the cause of the polyuria is not known, it might be secondary to osmotic diuresis associated with the glucosuria or to central diabetes insipidus. Central diabetes insipidus is reported in sibling colts but is extremely rare in other species with isolated reports in a ram and a cow. Another extrarenal cause is administration of diuretic drugs, including corticosteroids.

Kidney disease results in polyuria when the resorptive capacity of the remaining tubules is exceeded. Polyuria can also occur when the osmotic gradient in the renal medulla is not adequate to produce concentrated urine. Nephrogenic diabetes insipidus causes polyuria because the tubules fail to respond to ADH.

When polyuria is suspected, a urine sample should be collected to determine specific gravity or osmolality. If urine is isosthenuric with a constant specific gravity of 1.008 to 1.012 (the specific gravity of plasma), then the presence of renal disease should be strongly considered. Serum urea and creatinine concentrations should be determined to evaluate glomerular filtration. If serum urea and creatinine concentrations are within normal limits, a water deprivation test can be performed to assess the animal's ability to produce concentrated urine.

#### Oliguria and Anuria

Reduction in the daily output of urine (**oliguria**) and complete absence of urine (**anuria**) occur under the same conditions and vary only in degree. In dehydrated animals, urine flow naturally decreases in an effort to conserve water as plasma osmolality increases. Congestive heart failure and peripheral circulatory failure may cause a reduction in renal blood flow that oliguria follows. Complete anuria is most common in urethral obstruction, although it can also result from acute tubular nephrosis. Oliguria occurs in the terminal stages of all forms of nephritis. Anuria and polyuria lead to retention of solutes and disturbances of the acid-base balance that contribute to the pathogenesis of uremia.

#### Pollakiuria

This is an increase in the daily number of postures for urination and is usually accompanied by a decreased volume of urine. Pollakiuria may occur with or without an increase in the volume of urine excreted and is commonly associated with disease of the lower urinary tract such as cystitis, the presence of calculi in the bladder, urethritis, and partial obstruction of the urethra. Other causes of pollakiuria include equine



herpesvirus infection, sorghum cystitis, neuritis of the cauda equina in horses, neoplasia, obstructive lesions and trauma to the urethra, abnormal vaginal conformation, and urachal infection.

**Dribbling** is a steady, intermittent passage of small volumes of urine, sometimes precipitated by a change in posture or increase in intraabdominal pressure, reflecting inadequate or lack of sphincter control. Dribbling occurs in large animals with incomplete obstructive urolithiasis and from persistent urachus.

**Persistent urachus** is also called pervious or patent urachus. Failure of the urachus to obliterate at birth in foals causes urine to dribble from the urachus continuously. Urine may also pass from the urethra. Retrograde infection from omphalitis is common, resulting in cystitis. Persistent urachus is extremely rare in calves, lambs, and kids.

**Abnormalities of micturition** are classified as neurogenic or nonneurogenic. Micturition is mediated principally by the pelvic and pudendal nerves through lumbosacral spinal cord segments under the involuntary control of centers in the brainstem and voluntary control of the cerebrum and cerebellum. Reported neurogenic causes of urinary incontinence in horses include cauda equine neuritis, herpesvirus-1 myelitis, Sudan grass toxicosis, sorghum poisoning, trauma, and neoplasia. Nonneurogenic causes of urinary incontinence in horses include ectopic ureter, cystitis, urolithiasis, hypostrogenism, and abnormal vaginal conformation.

### ABDOMINAL PAIN AND PAINFUL AND DIFFICULT URINATION (DYSURIA AND STRANGURIA)

Abdominal pain and painful urination (**dysuria**) and difficult and slow urination (**stranguria**) are manifestations of discomfort caused by disease of the urinary tract. Acute abdominal pain from urinary tract disease occurs only rarely and is usually associated with sudden distension of the renal pelvis or ureter, or infarction of the kidney. None of these conditions is common in animals, but occasionally cattle affected with pyelonephritis may have short episodes of acute abdominal pain caused by either renal infarction or obstruction of the pelvis by necrotic debris. During these acute attacks of pain, the cow may exhibit downward arching of the back, paddling with the hind feet, rolling, and bellowing. Abdominal pain from urethral obstruction and distension of the bladder is manifested by tail switching, kicking at the belly, and repeated straining efforts at urination accompanied by grunting. Horses with acute tubular nephrosis following vitamin K3 administration might show renal colic with arching of the back, backing into corners, and rubbing of the perineum and tail head.

**Dysuria** or **painful/difficult urination** occurs in cystitis, vesical calculus, urethritis, and is caused by the presence of periurethral masses such as pelvic lymphoma.<sup>1</sup> Dysuria is manifested by the frequent passage of small amounts of urine. Grunting may occur with painful urination, and the animal may remain in the typical posture after urination is completed. Differentiating pain caused by urinary disease from pain caused by other causes depends largely on the presence of other signs indicating urinary tract involvement.

**Stranguria** is slow and painful urination associated with disease of the lower urinary tract including cystitis, vesical calculus, urethral obstruction, and urethritis. The animal strains to pass each drop of urine. Groaning and straining may precede and accompany urination when there is urethral obstruction. In urethritis, groaning and straining occur immediately after urination has ceased and gradually disappear and do not recur until urination has been repeated.

**Urine scalding of the perineum or urinary burn** is caused by frequent wetting of the skin with urine. It may be the result of urinary incontinence or the animal's inability to assume normal posture when urinating.

### MORPHOLOGIC ABNORMALITIES OF KIDNEYS AND URETERS

Enlarged or decreased size of kidneys may be palpable on rectal examination or detected by ultrasonography. In cattle, gross enlargement of the posterior aspect of the left kidney may be palpable in the right upper flank. Abnormalities of the kidneys, such as hydronephrosis in cattle, may also be palpable on rectal examination. Increases in the size of the ureter may be palpable on rectal examination and indicate ureteritis or hydroureter.

### PALPABLE ABNORMALITIES OF THE BLADDER AND URETHRA

Abnormalities of the bladder that may be palpable by rectal examination include gross enlargement of the bladder, rupture of the bladder, a shrunken bladder following rupture, and palpable abnormalities in the bladder such as cystic calculi. Abnormalities of the urethra include enlargement and pain of the pelvic urethra and its external aspects in male cattle with obstructive urolithiasis and obstruction of the urethral process of male sheep with obstructive urolithiasis.

### ACUTE AND CHRONIC RENAL FAILURE

The clinical findings of urinary tract disease vary with the rate of development and stage of the disease. In most cases, the clinical signs are those of the initiating cause. In horses, depression, colic, and diarrhea are common with oliguria or polyuria. Clinical

signs in cattle with uremia are similar and in addition are frequently recumbent, and in severe and terminal cases cattle may have a bleeding diathesis. In chronic renal disease of all species, there is a severe loss of BW, weakness, anorexia, polyuria, polydipsia, and ventral edema.

### UREMIA

Uremia is the systemic state that occurs in the terminal stages of renal insufficiency. Anuria or oliguria may occur with uremia. Oliguria is more common unless there is complete obstruction of the urinary tract. Chronic renal disease is usually manifested by polyuria, but oliguria appears in the terminal stages when clinical uremia develops. The uremic animal is depressed and anorexic with muscular weakness and tremor. In chronic uremia, the body condition is poor, probably as a result of continued loss of protein in the urine, dehydration, and anorexia. The respiration is usually increased in rate and depth but is not dyspneic; in the terminal stages it may become periodic in character. The heart rate is markedly increased because of terminal dehydration, but the rectal temperature remains normal except in infectious processes and some cases of acute tubular nephrosis. An ammoniacal or uriferous smell on the breath is often described in textbooks but is rarely clinically detectable. **Uremic encephalopathy** occurs in a small proportion of cattle, goats, and horses with chronic renal failure that involves an unknown metabolic pathway. It is associated with seizures, tremors, abnormal behavior, and muscle weakness, and histologic evidence of myelin vacuolation may be present.<sup>1</sup>

The animal becomes recumbent and comatose in the terminal stages of uremia. The temperature falls to below normal and death occurs quietly; the whole course of the disease is one of gradual intoxication. Necropsy findings, apart from those of the primary disease, are nonspecific and include degeneration of parenchymatous organs, sometimes accompanied by emaciation and moderate gastroenteritis.

Uremia has been produced experimentally in cattle by bilateral nephrectomy and urethral ligation. There is a progressive increase in serum urea concentration (mean daily increase of 53 mg/dL), serum creatinine concentration (mean daily increase of approximately 3.5 mg/dL), and serum uric acid concentration. Similar findings are reported in prerenal uremia in cattle. Interestingly, serum phosphate and potassium concentrations were for the most part unchanged because of increased salivary secretion of both factors, and acidemia and metabolic acidosis were not evident. Serum potassium concentrations were mildly increased after 5 to 7 days of bilateral nephrectomy.

## Special Examination of the Urinary System

Lack of accessibility limits the value of physical examination of the urinary tract in farm animals. Palpation per rectum can be performed on horses and cattle and is described in Chapter's 7 and 8. In small ruminants and calves the urinary system is largely inaccessible to physical examination, although the kidneys may be palpated transabdominally and the urethra palpated digitally with the finger for periodic contractions that are common in male sheep and goats with obstructive urolithiasis. Urinalysis and determination of the serum or plasma concentration of urea nitrogen or creatinine is a required component of any examination of the urinary system.

### TESTS OF RENAL FUNCTION AND DETECTION OF RENAL INJURY

The simplest and most important test of urinary function is the determination of whether or not urine is being voided. This can be accomplished in large animals by keeping them on a clean, dry floor that is examined periodically. Placing an absorbent cloth under recumbent foals and calves will also help determine whether urine is being passed.

Renal function tests evaluate the functional capability of the kidney and generally assess blood flow to the kidneys, glomerular filtration, and tubular function. These tests depend on whether they are based on the examination of **serum/plasma, urine**, or both, and assess either **function** or the presence of **injury**. The most practical screening tests for the presence of decreased renal function are determination of serum creatinine concentration and urine specific gravity. Determination of both factors assists differentiation of renal azotemia from prerenal azotemia. In prerenal azotemia, tubular function remains intact and renal conservation of water is optimized, resulting in the production of concentrated urine. Animals with prerenal azotemia therefore have increased serum concentrations of creatinine and urea and increased urine specific gravity. For comparison, animals with some degree of renal azotemia have increased serum concentrations of creatinine and urea and a lower than expected value for urine specific gravity. Determination of urine specific gravity should therefore be routinely performed in all dehydrated animals before the initiation of treatment, because oral or intravenous (IV) fluid therapy will directly change urine specific gravity.

### COLLECTION OF URINE SAMPLES

Collection of urine samples can be difficult. Free-flow and catheterized samples are

equally useful for routine urinalysis. Urine samples for analysis should be collected by midstream voiding, or cystocentesis in small male ruminants, preferably with ultrasonographic guidance. Bethanechol (0.075 mg/kg subcutaneously) has occasionally been used to produce urine in reluctant individuals, but a spontaneously voided sample is preferred for initial screening, which is routinely done using urine dipsticks.

Horses will often urinate shortly after they are walked into a freshly bedded box stall. Cows urinate if they are relaxed and have their perineum and vulval tip massaged upward very gently, without touching the tail. Success rates in obtaining a urine sample can approach 100% if cows are recumbent and quietly encouraged to stand before attempting perineal stimulation to induce urination. Steers and bulls may urinate if the preputial orifice is massaged and splashed with warm water. Ewes often urinate immediately after rising if they have been recumbent for some time. Occluding their nostrils and threatening asphyxia may also induce urination just as they are released and allowed to breathe again; however, this is a stressful procedure and should not be performed in sick or debilitated sheep. An IV injection of furosemide (0.5–1.0 mg/kg BW) produces urination in most animals in about 20 minutes. The sample is useful for microbiologic examination but its composition has been drastically altered by the diuretic. Diuretics should be used with extreme caution in dehydrated animals.

Urine samples obtained by **bladder catheterization** using a urethral catheter are

preferred for microbiologic examination, provided aseptic technique is applied, including bandaging the tail of female horses or holding the tail of cattle out of the way. The perineal region should then be cleaned with dilute povidone iodine or chlorhexidine to minimize urinary tract contamination, and there should be routine use of sterile surgical gloves and lubrication. Rams, boars, and young calves usually cannot be catheterized without fluoroscopy because of the presence of a suburethral diverticulum and the small diameter of the urethra. A precurved catheter and fluoroscopic guidance can be used to facilitate catheterization of rams and bucks. Ewes and sows can be catheterized, but their vulvas are often too small relative to hand size to allow access to the urethra. Cows can be catheterized relatively simply provided that a fairly rigid, small-diameter (0.5-cm) catheter is used, such as an artificial insemination pipette. A finger can be inserted into the suburethral diverticulum on the ventral aspect to direct the tip of the catheter over the diverticulum and into the external urethral orifice (Fig. 13-1). For longer term catheterization of adult cattle (3 days), 24- to 28-French Foley catheters are placed into the bladder using the same insertion method; however, insertion of Foley catheters is facilitated by application of sterile lube on the outside of the catheter and placement of an insemination pipette into the catheter lumen to increase rigidity. Retention of Foley catheters in cows is facilitated by using a balloon volume of 60 to 75 mL; use of smaller balloon volumes permits the catheter to move into the urethra, leading to pollakiuria,

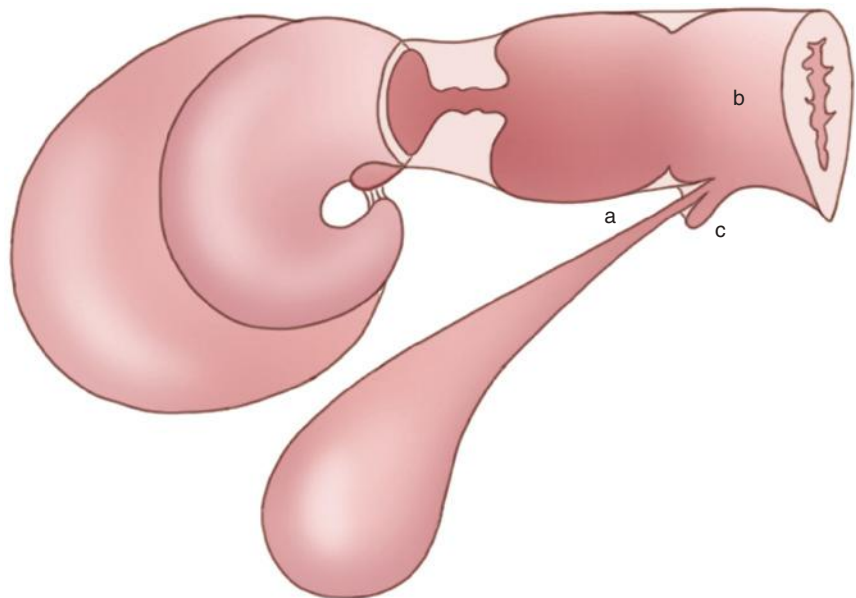

**Fig. 13-1** Lateral view of the urethra (a), vagina (b), and suburethral diverticulum (c) in adult female cattle as viewed from the left. A finger is inserted into the suburethral diverticulum on the ventral aspect to direct the tip of the catheter over the diverticulum and into the external urethral orifice. (Reprinted with permission from Rosenberger G. *Clinical examination of cattle*. Berlin: Parey; 1979; 453.)

stranguria, and potential catheter extrusion. The incidence of urinary tract infection with indwelling Foley catheters in dairy cows is 3% per catheterized day;<sup>2</sup> the urine should therefore be periodically examined for evidence of cystitis and antimicrobial treatment instituted whenever indicated. Mares can be catheterized easily, either by blindly passing a rigid catheter into the external urethral orifice or by using a finger as a guide for a flexible catheter. Long-term catheterization of the bladder of the mare requires a similar technique to that described for cows.

Male horses can also be catheterized easily if the penis is relaxed. When urethral obstruction is present, the penis is usually relaxed, but administration of an ataractic drug (acepromazine is often used) makes manipulation of the penis easier and often results in its complete relaxation. Because of the long urethra, the catheter must be well lubricated. The catheter should be rigid enough to pass through the long urethra but flexible enough to pass around the ischial arch. In all species, catheterization overcomes the natural defense mechanisms that prevent infectious organisms from ascending the urinary tract. As a result, attention to hygiene during catheterization is essential.

## TESTS OF URINE SAMPLES

Urinalysis is an essential component of the examination of the urinary system. The reader is referred to a textbook of veterinary clinical pathology for details of the biochemical and microscopic examination of the urine. Cytologic examination of urine should take place as soon after collection as possible because casts (cylindrically shaped molds that indicate tubular injury) are fragile and can rapidly disintegrate. The common abnormalities of urine are discussed later.

The urine sample should be centrifuged; the supernatant should be used for laboratory analysis and the sediment and remaining supernatant for routine urine analysis.

### Specific Gravity

Specific gravity of urine is the simplest test to measure the capacity of renal tubules to conserve fluid and excrete solute. For most species, the normal specific gravity range is 1.015 to 1.035, and in azotemic animals, specific gravity should be greater than 1.020 if the azotemia is prerenal in origin. In chronic renal disease the urine specific gravity decreases to 1.008 to 1.012 and is not appreciably altered by either deprivation of water for 24 hours or the administration of large quantities of water by stomach tube. It is important to recognize that a specific gravity of less than 1.008 indicates that the kidney can produce dilute urine and, if sustained, indicates better renal function than a fixed urine specific gravity of 1.008 to 1.012.

Specific gravity can be inaccurate when other refractive particles are present in urine,

such as glucose or protein. Urine specific gravity should therefore be used with caution in animals with proteinuria or glucosuria. As an alternative to specific gravity, osmolality of a fluid directly measures the concentration of solute in the fluid. Urine osmolality therefore provides a more accurate assessment of the tubule's ability to conserve or excrete solute than urine specific gravity and is the preferred test of urine concentrating ability for research studies. However, urine specific gravity is sufficiently accurate for clinical use in animals without proteinuria or glucosuria, because there is a linear relationship between urine specific gravity and osmolality and urine specific gravity explains 52% of the variation in urine osmolality. The 95% confidence interval for predicting osmolality from the specific gravity measurement is  $\pm 157$  mOsmol/kg.

### pH

The pH of urine can be measured using pH papers calibrated in 0.2 to 0.3 pH units or urine dipstick point-of-care tests that are calibrated in 0.5 pH units. The physiologic range of urine pH is 4.5 to 9.0, with herbivore urine typically being between 7.0 and 8.5. Cattle on high-grain diets may have slight aciduria (pH 6.0–7.0), and ruminants and horses ingesting an acidogenic diet will have aciduria, with urine pH as low as 5.0. Urine pH on free-catch samples is typically 0.1 to 0.2 pH units lower than anaerobically collected samples; the difference is most likely caused by the loss of CO<sub>2</sub> from urine during voided, which is accompanied by an increase in pH. It is for this reason that some research studies collect urine using a Foley catheter into a glass jar with mineral oil on the surface. For clinical use, it is sufficient to completely fill a screw top container with urine and minimize the air at the top of the container before urine pH is measured.

An interesting and consistent finding is that aciduria is always accompanied by increased urine excretion of calcium. Low luminal pH in the distal convoluted tubule and connecting tubule decreases the number of epithelial Ca channels (transient receptor potential vanilloid member 5 [TRPV5]); the TRPV5 channel is considered to be the primary gatekeeper of active calcium reabsorption in the distal region of the urinary tract. Low luminal pH also decreases the pore size of the TRPV5 channel, resulting in decreased calcium uptake from the tubular lumen into the epithelial cell. The low luminal pH-induced decrease in TRPV5 number and activity result in decreased calcium absorption in the distal convoluted tubule and connecting tubule, directly resulting in hypercalciuria.

### Net Acid Excretion

The kidney plays a central role in acid-base homeostasis by adjusting urine electrolyte excretion to maintain constant blood pH.

Measurement of urinary net acid excretion (NAE) provides a sensitive and clinically useful method for evaluating acid-base balance. This is because NAE provides an estimate of endogenous acid production and the magnitude of dietary acidification when an acidogenic diet is fed. The term NAE is commonly used in studies of renal physiology in humans, other omnivores, and carnivores, in which urine pH is typically acidic, compared with plasma pH in a healthy animal (7.40). The term net base excretion (NBE) is more appropriate in cattle and other herbivores because urine pH is usually alkaline. It should be recognized that  $NBE = -NAE$ , with both measured in milliequivalents per liter.<sup>3</sup>

Urinary NAE is the most sensitive index of acid-base status and is clinically underutilized. The Jørgensen method is often used to measure NAE and involves laboratory titration of urine to a standardized endpoint in which the temperature is 37°C, P<sub>CO<sub>2</sub></sub> is 0 mm Hg, and pH is 7.40 (equivalent to plasma pH in a clinically normal animal). The method involves acidification of the urine sample to pH <4.0 to convert all HCO<sub>3</sub><sup>-</sup> to CO<sub>2</sub> and dissolve the phosphate sediment, heating to a boil, cooling, and alkalization back to pH 7.40 to determine measured titratable acidity (TA).<sup>3</sup> Measured TA is defined as the number of milliequivalents of OH<sup>-</sup> (as NaOH) that must be added to a bicarbonate-free urine sample to increase the pH to 7.40. Formaldehyde is then added to the urine sample (which decreases the urine pH to below 7.40) and the sample titrated with NaOH back to pH 7.40 to determine the ammonium concentration ([NH<sub>4</sub><sup>+</sup>]). NAE is then calculated as  $NAE = TA + [NH_4^+]$ . Accurate results are obtained with the Jørgensen method if urine is anaerobically stored at -20°C for up to 30 days and thawed at room temperature (20°C) for 2 hours, or anaerobically stored at 4°C for <3 days.

NAE for healthy pasture-fed or silage-fed cattle is usually less than -210 to -90 mEq/L, but is usually expressed as the negative of NAE, which is called NBE, where  $NBE = -NAE$  (i.e., NBE is usually +90 to +210 mEq/L). Mean NAE for grain-fed cattle with subclinical rumen acidosis (mean rumen pH 5.8–6.0) ranged from +80 to +140 mEq/L (i.e.,  $NBE = -80$  to  $-140$  mEq/L). Urine pH and -NAE are related in herbivores, where  $pH \approx 6.1 + \log_{10}(NBE + [NH_4^+])$ , with NBE expressed in mEq/L and the urine ammonium ion concentration ([NH<sub>4</sub><sup>+</sup>]) expressed in mEq/L (Fig. 13-2).<sup>3</sup>

### Hematuria

Hematuria can be from prerenal causes when vascular damage occurs, such as trauma to the kidney, septicemia, and purpura hemorrhagica. Renal causes include acute glomerulonephritis, renal infarction, embolism of the renal artery, tubular damage from toxic insult, and pyelonephritis. Postrenal



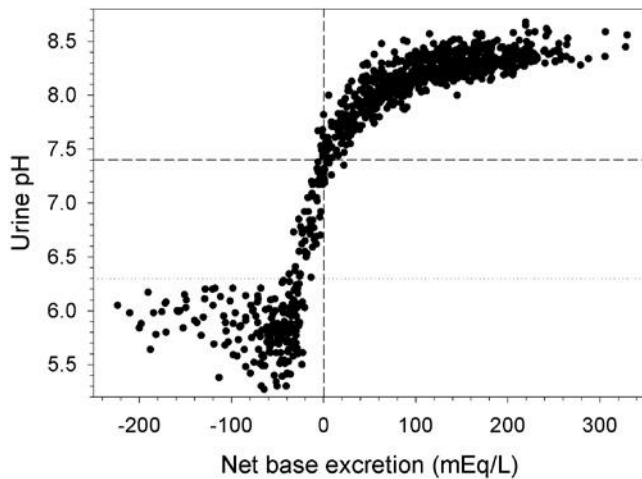

**Fig. 13-2** Relationship between urine pH and net base excretion (equivalent to the negative value for net acid excretion) for cows fed diets of different dietary cation-anion difference. The dashed lines indicate that net base excretion = 0 mEq/L (by definition) when pH 7.40. Notice that urine pH is poorly associated with net base excretion at pH <6.3 (dotted line); at this urine pH renal ammonium ion concentration ( $\text{NH}_4^+$ ) becomes markedly increased. (Reproduced with permission from Constable PD, Gelfert CC, Füll M et al. *Am J Vet Res* 2009; 70(7):915-925.)

hematuria occurs particularly in urolithiasis and cystitis. A special instance of hematuria is enzootic hematuria of cattle when hemorrhage originates from tumors of the urinary bladder. In affected cattle, the strength of the urine dipstick reaction for blood is associated with the number and severity of tumor nodules (hemangiomas).<sup>4</sup> Hematomas of the bladder wall (cystic hematoma) cause hematuria in neonatal foals.<sup>5</sup> Treatment of foals with cystic hematoma can include medical and surgical approaches based on the degree of urinary tract obstruction and other signs.

Typically, lesions of the kidney, bladder, and proximal urethra cause hemorrhage throughout or toward the end of urination, whereas lesions of the middle and distal urethra are responsible for bleeding at the beginning of urination. In severe cases of hematuria, blood may be voided as grossly visible clots, but more often hematuria causes a deep red to brown coloration of the urine. Less severe cases may show only cloudiness that settles to form a red deposit on standing. The hematuria may be so slight that it is detectable only on microscopic examination of the sediment from a centrifuged urine sample. In females, free-flow urine samples may be contaminated by blood from the reproductive tract, and it may be necessary to collect a sample by urethral catheterization to avoid the chance of contamination of the urine occurring in the vagina.

Blood in urine is always positive on biochemical tests for hemoglobin and myoglobin. Because red blood cells can be lysed in dilute urine, red-colored urine should be examined microscopically for the presence of erythrocytes. The presence of a heavy brown deposit is not sufficient for a diagnosis of hematuria, because this may also occur in hemoglobinuria. If the bladder or urethra is

involved in the process that causes hematuria, abnormalities may be detectable on physical examination.

Gross hematuria persisting for long periods may result in severe blood loss anemia. Severe urinary tract hemorrhage of undetermined origin in aged mares has been recorded. The syndrome is widely recognized, although not well documented, in Arabian mares. Endoscopic examination reveals hemorrhage in one ureter, but ultrasonographic examination of the kidneys does not reveal any significant abnormalities. Surgical removal of the affected kidney is not recommended, because the hemorrhage sometimes recurs in the remaining kidney. Treatment is nonspecific. Severe hematuria can also occur in horses with pyelonephritis.

### Hemoglobinuria

False hemoglobinuria can be seen in hematuria when erythrocytes are lysed and release their hemoglobin. In this case erythrocytes can be detected only by microscopically examining urine sediment for cellular debris.

True hemoglobinuria causes a deep red to brown coloration of urine and gives a positive reaction to biochemical tests for hemoglobin. There is no erythrocyte debris in sediment. Dipstick tests for proteinuria may not be positive unless the concentration of hemoglobin is very high. There are many causes of intravascular hemolysis, which is the source of hemoglobinuria. The specific causes are listed later.

Normally, hemoglobin liberated from circulating erythrocytes is converted to bile pigments in the cells of the reticuloendothelial system. If hemolysis exceeds the capacity of this system to remove the hemoglobin, it accumulates in the blood until it exceeds a certain renal threshold and then passes into

the urine. Some hemoglobin is reabsorbed from the glomerular filtrate by the tubular epithelium but probably not in sufficient amounts to appreciably affect the hemoglobin content of the urine. Hemoglobinuria will only be present when the plasma concentration exceeds the renal threshold. Consequently, hemoglobin is grossly visible in plasma by the time hemoglobinuria is visible. Hemoglobin precipitates to form casts in the tubules, especially if the urine is acidic, resulting in some plugging of tubules, but the chief cause of uremia in hemolytic anemia is ischemic tubular nephrosis.

### Myoglobinuria

The presence of myoglobin (myohemoglobin) in the urine is evidence of severe muscle damage. The only notable occurrence in animals is azoturia of horses. Myoglobinuria is not common in enzootic muscular dystrophy, possibly because there is insufficient myoglobin in the muscles of young animals. The myoglobin molecule (molecular weight 16,500 g) is much smaller than hemoglobin (molecular weight 64,000 g) and passes the glomerulus much more readily, so a detectable dark brown staining of the urine occurs without very high plasma levels of myoglobin. There is no detectable discoloration of the serum as seen in hemoglobinemia. Inherited congenital porphyria is the other disease that causes a red-brown discoloration of urine. In porphyria, the plasma is also normal in color, but it is differentiated from myoglobinuria based on a negative reaction to the guaiac test and the characteristic spectrograph. The porphyrins in inherited congenital porphyria are the only pigments that fluoresce under ultraviolet light.

The presence and type of pigment in the urine can be determined accurately by spectrographic examination, but this is rarely clinically available. Myoglobinuria is usually accompanied by clinical signs and clinical biochemistry abnormalities of acute myopathy, and clinical differentiation of myoglobinuria from hemoglobinuria is usually made on the basis of the clinical signs and serum biochemical findings, including measurement of muscle-derived enzymes such as creatine kinase. As with hemoglobin, myoglobin can precipitate in tubules and may contribute to uremia.

### Ketonuria

Ketonuria is a common finding in sick ruminants and is seen in starvation; acetonemia of lactating dairy cattle; and pregnancy toxemia of ewes, does, and beef cattle. A small amount of ketonuria is normally present in dairy cows in early lactation. As a result, it is important that the assay method used to demonstrate ketonuria is appropriate for urine, because there may be a risk for false-positive reactions on some tests. The standard test is **sodium nitroprusside**, which turns an intense purple color in the

presence of **acetoacetate**, one of the three keto acids.

### Glucosuria

Glucosuria occurs in acute tubular nephrosis as a result of failure of tubular resorption, and is one of the most sensitive indices for the presence of a proximal tubule. Glucosuria is occasionally detected in severely ill ruminants, particularly those with abomasal volvulus or a small intestinal obstruction. Glucosuria in combination with ketonuria occurs only in diabetes mellitus, an extremely rare disease in ruminants. Glucosuria might be seen in ruminants in association with enterotoxemia caused by *Clostridium perfringens* type D and can occur after parenteral treatment with dextrose solutions, adrenocorticotrophic hormones, or glucocorticoid analogs. Horses with tumor of the pars intermedia of the pituitary gland often have glucosuria.

Glucose is freely filtered by the glomerulus and reabsorbed from the filtrate in the proximal tubules, with the renal threshold approximating 150 mg/dL in horses and cattle. Glucosuria in the face of a normal serum glucose concentration therefore indicates the presence of abnormal proximal tubular function. Glucosuria occurs early in the development of aminoglycoside-induced proximal tubule nephropathy and provides a useful inexpensive and practical screening test for nephrotoxicity in animals without hyperglycemia.

### Proteinuria

Proteinuria can be prerenal, renal, or postrenal in origin, and it is clinically helpful to identify the anatomic source of protein loss. **Prerenal proteinuria** is caused by an abnormal plasma content of proteins that traverse glomerular capillary walls, and the proteins have normal permselectivity properties (such as hemoglobin, myoglobin, and immunoglobulin light chains). **Renal proteinuria** is caused by abnormal renal handling of normal plasma proteins and is functional or pathologic. **Functional renal proteinuria** is mild and transient as a result of altered renal physiology during or in response to a transient phenomenon, such as high-intensity exercise or fever. **Pathologic renal proteinuria** is caused by structural or functional lesions within the kidney, regardless of their magnitude or duration. There are three subcategories of pathologic renal proteinuria: glomerular, which is caused by lesions altering the permselectivity properties of the glomerular capillary wall; tubular, which is caused by lesions that impair tubular recovery of plasma proteins that ordinarily traverse glomerular capillary walls that have normal permselectivity properties (typically low molecular weight proteins); and interstitial, which is caused by inflammatory lesions or disease processes (such as acute interstitial nephritis) that result in exudation of proteins

from the peritubular capillaries into the urine. **Postrenal proteinuria** is caused by entry of protein into the urine after it enters the renal pelvis and is urinary or extraurinary. **Urinary postrenal proteinuria** is caused by the entry of proteins derived from hemorrhagic or exudative processes affecting the renal pelvis, ureter, urinary bladder, and urethra. **Extraurinary postrenal proteinuria** is caused by entry of proteins derived from the genital tract or external genitalia during voiding or in the process of collecting urine for analysis.

Constituents in glomerular filtrate depend on the size, shape, and charge of the filtered particles, with most plasma constituents (such as electrolytes and glucose) readily filtered by the glomerulus; consequently, glomerular filtrate concentrations are usually similar to that of plasma. Proteins with molecular (formula) weights less than 60 kilodaltons (kDa = 60,000 g) pass through the glomerulus to some extent, but albumin (molecular weight 65 kDa) is usually not present in glomerular filtrate. Hemoglobin and myoglobin are small pigmented proteins (17 kDa) that are freely filtered and present in the glomerular filtrate; ultimately they are visible as hemoglobinuria or myoglobinuria. **Tamm-Horsfall protein** is a glycoprotein produced by tubular cells in the loop of Henle. The urine concentration of Tamm-Horsfall protein is usually low but may be increased in inflammatory diseases of the kidney, and the glycoprotein can be incorporated into urinary casts.

Normal urine contains only small amounts of protein that are insufficient to be detected using standard dipstick tests. It should be noted that the highly alkaline urine produced by herbivores always produces a false-positive reaction (trace or 1+) for protein on urine dipstick tests. Prerenal proteinuria may be detected using standard dipstick tests in animals with hemoglobinuria and myoglobinuria, because both compounds are proteins. Functional renal proteinuria is observed in normal foals, calves, kids, and lambs in the first 40 hours after they receive colostrum. Pathologic renal or postrenal proteinuria and hematuria may be present when urinary tract infections are present. Postparturient cows usually have protein present in a free-catch urine sample as a result of washout of uterine fluids that are expelled during urination or traces remain in the caudal vagina; this is a classic example of extraurinary postrenal proteinuria. Demonstration that proteinuria originates in the kidney is easier if abnormal elements that form in the kidney, such as tubular casts, are also present in the urine, or morphologic abnormalities of the kidneys are palpable per rectum or identified ultrasonographically.

Proteinuria is most accurately quantified by determining the amount of protein passed in a 24-hour period, but this is impractical

in clinical cases. Proteinuria is more easily quantified by indexing the protein concentration to creatinine concentration in a single urine sample; this has been shown to provide an accurate representation of 24-hour protein loss in the urine.

Chronic pathologic renal proteinuria may cause hypoproteinemia as in chronic glomerulonephritis and acute tubular nephrosis in horses and in amyloidosis of cattle. When proteinuria originates from pyelonephritis or cystitis, other clinical and clinicopathologic evidence of these diseases is usually present.

Urine protein concentrations in animals without lower urinary tract disease or hematuria are normally much lower than serum protein concentrations and similar to cerebrospinal fluid (CSF) protein concentration. Glomerular filtrate normally contains low concentrations of low molecular weight proteins such as  $\beta_2$ -microglobulin (molecular weight 11,800 g) and lysozyme (molecular weight 14,400 g). This is because the healthy glomerulus excludes high molecular weight proteins such as albumin (molecular weight, 65,000 g) and globulins from the glomerular filtrate; normally functioning proximal tubules reabsorb these low molecular weight proteins, leading to very low urine protein concentrations. Alterations in tubular function can therefore lead to proteinuria, but typically glomerular injury produces much larger increases in urine protein concentration than those produced by altered proximal tubule function. A transient and marked proteinuria is reported in foals for the first 2 days of life after ingestion of colostrum; the proteinuria is attributed to the presence of low molecular weight proteins in colostrum that, after active absorption by small intestinal epithelial cells, end up in the glomerular filtrate.

Determination of urine protein concentrations requires a sensitive analytical test, such as the Coomassie brilliant blue method. Urinary protein concentrations may be indexed to the urine creatinine concentration to account for denominator effects of changes in urine volume. Dividing the urinary protein concentration (mg/dL) by the creatinine concentration (mg/dL) produces a unitless ratio, which provides a sensitive and reliable diagnostic method for the detection and quantification of proteinuria and is well correlated with 24-hour protein excretion in urine samples without evidence of blood.

The normal urinary protein to creatinine ratio in the horse appears to be less than 1.0,<sup>6</sup> and small increases in the ratio (from 0.1–0.4) are observed in horses during the developmental stage of experimentally induced laminitis in horses.<sup>7</sup> In animals with massive proteinuria, a urinary protein to creatinine concentration ratio of less than 13 is considered to be more indicative of tubular than glomerular proteinuria. Generally, increased

urinary concentrations of albumin and  $\beta_2$ -microglobulin indicate **glomerular proteinuria** and **tubular proteinuria**, respectively. Proteinuria is massive and sustained in cattle and sheep with advanced renal amyloidosis and animals with advanced glomerulonephritis (glomerular proteinuria) but is mild in animals without glomerular disease but with proximal tubular injury (tubular proteinuria). Microalbuminuria does not appear to have been evaluated as an early and sensitive test of glomerular disease in large animals, but increases in urine albumin concentration would be expected in animals with glomerular disease.

### Casts

Casts are organized, tubular structures that vary in appearance depending on their composition. They occur only when the kidney is involved in the disease process. Casts are present as an indication of inflammatory or degenerative changes in the kidney, where they form by agglomeration of desquamated cells and **Tamm-Horsfall proteins**. Casts may not form in all cases of renal disease. In addition, casts readily dissolve in alkaline urine and are best detected in fresh urine samples.

### Cells and Pyuria

Leukocytes, erythrocytes, and epithelial cells in urine may originate in any part of the urinary tract. Leukocytes or pus in urine (pyuria) indicates inflammatory exudation at some point in the urinary tract, usually the renal pelvis or bladder. Pyuria may occur as grossly visible clots or shreds, but is often detectable only by microscopic examination of urine sediment. Individual cells and leukocytic casts may be present. Pyuria is usually accompanied by the presence of bacteria in urine.

### Bacteriuria

Diagnosis of a urinary tract infection is based on finding a clinically relevant bacteriuria in urine collected by free catch (mid-stream collection into a sterile container), catheterization, or cystocentesis. In horses and adult cattle, collection of urine is limited to free catch and transurethral catheterization of the bladder, because the size of the animal and intrapelvic position of the bladder prevents cystocentesis. In contrast, cystocentesis can be performed under ultrasonographic guidance in calves, small ruminants, and pigs. When culturing a urine sample obtained by catheterization, the first 20 mL or so should be discarded because of the potential for contamination from vaginal or distal urethral flora.

Marked bacteriuria suggestive of bacterial infection is usually defined as more than 30,000 colony forming units (cfu)/mL from free-catch specimens (some laboratories use 10,000 or 100,000 cfu/mL), and more than 1000 cfu/mL from catheterized specimens. It

is important to quantify the number of bacteria in urine samples, because the number of cfu is usually associated with disease severity in animals with bacterial cystitis or pyelonephritis. For example, 13% of urine samples obtained directly from the bladder of slaughtered male and female cattle using a sterile needle and syringe were positive for bacteria associated with urinary tract infection in cattle; however, gross or histologic evidence of infection was not identified in any animal.<sup>8</sup>

Rapid detection of urinary tract infection can be accomplished using the Uriscreen test, which is a solution of 10%  $H_2O_2$  and a coloring agent. It provides a low-cost point-of-care test that detects catalase activity in a fluid sample placed in a tube by the development of a ring of foam within the tube within 2 minutes. The Uriscreen test has been used successfully to identify bacteriuria in septic calves<sup>9</sup> and has the potential for wider use in the detection of bacteriuria in other large animals.

### Crystalluria

Crystalluria should not be overinterpreted in farm animals. Crystals in the urine of herbivorous animals have no special significance unless they occur in very large numbers and are associated with clinical signs of irritation of the urinary tract. Calcium carbonate and triple phosphate crystals are common in normal urine. If they occur in large numbers, it may suggest that the urine is concentrated and indicate the possible future development of urolithiasis. The presence of calcium carbonate crystals in the peritoneal fluid of a neonatal foal has been used to confirm a diagnosis of ruptured bladder.

The ventral aspect of the equine bladder may contain a calcium carbonate-rich sediment (called **sabulous material**), especially when horses are fed alfalfa hay. This sediment is observed toward the end of urination when the bladder is fully contracted, as evidenced by a change in urine clarity from clear to opaque.

### Enzymuria

A clinically useful index of proximal tubular injury is determining the  $\gamma$ -glutamyl transferase (GGT) activity in urine.<sup>10</sup> Most enzymes present in serum and plasma have a molecular weight greater than that of albumin (i.e., >65,000 g) and are normally not detectable in the glomerular filtrate; the presence of high molecular weight enzymes in urine such as GGT (molecular weight 330,000 g) is called **parenchymatous enzymuria**. For comparison, the presence of low molecular weight enzymes (such as lysozyme) in urine is called **tubular enzymuria** because damage to the proximal tubule impairs its ability to reabsorb enzymes from the glomerular filtrate.

Most of the GGT activity in urine originates from the luminal brush border of the

proximal tubular epithelial cells of the kidney. High levels of GGT activity in the urine result from an increase in the rate of proximal tubular epithelial cell destruction, and GGT is released into the urine during the active phase of tissue destruction; an increase in urine GGT activity therefore reflects parenchymatous enzymuria. The activity of GGT (or other high molecular weight enzymes such as  $\beta$ -N-acetylglucosaminidase,  $\beta$ -glucuronidase, and N-acetyl- $\beta$ -glucosaminidase [NAD]) in urine can therefore be used to detect the presence of proximal renal tubular epithelial cell damage before the onset of renal dysfunction. GGT is the preferred enzyme for identifying the presence of parenchymatous enzymuria, because the assay is inexpensive and widely available and the kidney has the highest content of GGT of any organ in the body, increasing the sensitivity of the test.

Urine GGT activity is frequently indexed to an indicator of urine concentration, such as urine creatinine concentration, to correct for denominator effects induced by changes in urine volume, and a GGT to creatinine ratio higher than 25 IU/g creatinine is considered abnormal in the horse. However, it may be more appropriate to calculate the fractional clearance of GGT (which compares the extent of tubular damage with the amount of functioning kidney mass) instead of the urinary GGT to creatinine ratio (which compares the amount of tubular damage with muscle mass). Indexing serum/plasma GGT activity to serum/plasma creatinine concentration is not physiologically valid, because enzymes present in urine are not normally filtered through the glomerulus; using the urine GGT activity alone therefore appears to be more appropriate. Interestingly, urine GGT activity appears more sensitive as an index of tubular injury than the urine GGT to creatinine ratio in horses and sheep and appears to be the most sensitive indicator of tubular injury in animals treated with aminoglycosides.

Other enzymes, such as alkaline phosphatase, lactate dehydrogenase, NAD, matrix metalloproteinase (gelatinases localized to renal tubules, such as MMP-2), and membrane-associated carbonic anhydrase VI<sup>11</sup> have been examined in urine as potential indicators of tubular injury.<sup>12</sup> None of these enzymes have consistently proven superior to urine GGT activity in detecting tubular injury, and a systematic review of acute renal injury in humans identified urine GGT activity (indexed to urine creatinine concentration) as the preferred test.

## TESTS OF SERUM

These tests depend on either the accumulation, in cases of renal insufficiency, of metabolites normally excreted by the kidney or the excretion of endogenous substances by the kidney.



### Serum Urea Nitrogen and Creatinine Concentration

Determination of SUN and creatinine concentration is an essential component of any evaluation of the urinary system. These serum indices of function are simple estimates of glomerular filtration because urea and creatinine are freely filtered by the glomerulus. Serum concentrations of urea and creatinine do not rise appreciably above the normal range until 60% to 75% of nephrons are destroyed.

Serum urea and creatinine concentrations are influenced by blood flow to the kidneys and may be increased in prerenal uremia. They also suffer from the disadvantage that their serum concentrations can vary with the rate of protein catabolism (and protein intake in the case of serum urea concentration) and are not dependent only on renal function. In cattle, for example, serum urea concentrations caused by prerenal lesions may be higher than those resulting from renal disease, because salivary secretion of urea, rumen metabolism of urea, and decreased feed intake (and therefore decreased protein intake) may lower serum urea concentration in chronic disease. Urea is usually expressed in terms of urea nitrogen, but the term blood urea nitrogen (BUN) should no longer be used when analysis is performed on serum (SUN). The units for urea are reported as mg/dL or mmol/L and different when expressed in terms of urea nitrogen or urea, and are most commonly expressed as urea nitrogen, where 1 mg/dL = 0.357 mmol/L.

Creatinine in herbivores is essentially totally derived from endogenous creatine. Creatine is produced by the liver from amino acids and circulates in the plasma before being taken up by skeletal muscle, in which it stores energy in the form of phosphocreatine. Creatine is converted to creatinine by a nonenzymatic irreversible process and is distributed throughout the body water. Creatinine is therefore released from skeletal muscle at a constant rate in animals without myonecrosis and is therefore an indirect index of muscle mass; this is the reason why serum creatinine concentrations are highest in intact males, intermediate in adult females, and lowest in neonates and cachectic animals. Serum creatinine concentrations are constant within an animal because they reflect muscle mass, which does not change rapidly; an increase in serum creatinine concentration of more than 0.3 g/dL should be considered to be clinically significant. The units for creatinine are reported as mg/dL or  $\mu\text{mol/L}$ , where 1 mg/dL = 88.4  $\mu\text{mol/L}$ .

Serum creatinine concentration is routinely measured using the Jaffe reaction, in which a colored product is formed from creatinine and picrate in an alkaline solution. However, the alkaline picrate reaction has poor specificity, because it also detects a number of noncreatinine chromogens in

serum, which do not appear to be present in urine. In other words, the creatinine concentration may be overestimated in serum but is accurately measured in urine. The former induces some error in the calculation of fractional clearance of electrolytes. The progression of renal failure may be monitored by plotting the reciprocal of serum creatinine concentration against time. Extrapolation of the resultant linear relationship to the  $x$ -axis intercept provided some clinically useful prognostic information in a horse with advanced renal failure.

### Glomerular Filtration Rate

The accepted gold standard measurement for renal function is measurement of the glomerular filtration rate using **inulin clearance**. Inulin, a metabolically inert carbohydrate, crosses freely across the glomerulus and is neither absorbed nor secreted by renal tubules. **Endogenous creatinine clearance** has also been used to estimate glomerular filtration rate; however, this test suffers from inaccuracies related to the presence of noncreatinine chromogens in plasma and the tubular secretion of creatinine in some species. **Exogenous creatinine clearance** minimizes the errors induced by noncreatinine chromogens in plasma but requires the IV injection of creatinine and is therefore complicated and expensive. Although the renal clearances of inulin or creatinine are the preferred research methods for measuring renal excretory function, these techniques are impractical in clinical patients and male ruminants because they require urethral catheterization, rinsing and removal of the bladder contents, and timed urine collections.

Renal excretory function is more practically assessed in clinical patients by measuring the **plasma clearance** of water-soluble, nonmetabolized compounds of exogenous origin that have low plasma protein binding (such as **iohexol**, **iodixanol**, **phenolsulfonphthalein**, or **sodium sulfanilate**), because these techniques do not require urine collection. A practical test to determine glomerular filtration rate is the IV injection of the radiologic contrast agent iohexol at 150 mg/kg, followed by collection of serum samples at 3 and 4 hours, or 4 and 6 hours, postinjection. An alternative test protocol used in calves is the IV injection of the radiologic contrast agent iodixanol at 40 mg/kg, followed by collection of serum samples at 1, 2, and 3 hours postinjection.<sup>13</sup> Plasma clearance of technetium-diethyleneaminopentaacetic acid or technetium-mercaptoacetyltriglycine has also been evaluated in horses, but the technique requires measurement by a gamma camera and is therefore not suitable for use in the field. Plasma clearance tests have been evaluated in cattle, goats, sheep, and horses and provide a useful clinical test to monitor renal function in an individual animal over time, particularly iohexol clearance. Iohexol has become the most popular of these tests

because iohexol is freely filtered at the glomerulus, neither secreted nor absorbed by the kidneys, has a low degree of protein binding, and is not toxic, but is widely available, relatively inexpensive, and easily assayed.<sup>14</sup> However, the accuracy of plasma clearance techniques of exogenously administered compounds may not be sufficiently adequate for research studies.

## TESTS OF URINE AND SERUM

### Urine Osmolality to Serum Osmolality Ratio

A urine to plasma osmolality ratio of 1 indicates isoosmotic clearance of materials by the kidney. A ratio less than 1 indicates that the kidneys are diluting the urine, and a ratio more than 1 indicates that the urine is being concentrated. Because the plasma osmolality is much more constant than urine osmolality, the important clinical factor is whether urine osmolality is less than, equal to, or greater than, 300 mOsm/kg. Measurement of urine osmolality requires a dedicated laboratory unit and is rarely indicated in the clinical management of renal disease because of the widespread availability of handheld refractometers; measurement of urine osmolality is needed only in research studies.

### Water Deprivation Test

This can be used to assess renal concentrating ability in animals that have isosthenuria with urine specific gravity of 1.008 to 1.012 but do not have azotemia. Water deprivation tests should not be performed on animals that are already azotemic and should be undertaken with extreme caution and frequent (hourly to every 2 hours) monitoring in animals that are polyuric but not azotemic. Animals that are unable to conserve water because of renal disease can rapidly become dehydrated and develop prerenal uremia as a result.

In brief, the water deprivation test monitors the animal's ability to detect an increase in serum osmolality, release ADH, and produce a concentrated urine as a result of the action of ADH on the kidney. The test usually requires documentation that the animal has polyuria and polydipsia, with water consumption greater than cohorts of the same age, lactation stage, and diet, when housed under the same conditions. Before conducting the water deprivation test, the animal is weighed and a Foley catheter is placed in the bladder (females), or the animal is housed in a dry stall (males). Access to water is prevented and the urine and serum are tested every 1 to 2 hours or when voided in males. The test should be stopped when the urine specific gravity increases to more than 1.015 to 1.020, when there is an increase in serum/plasma creatinine concentration of 0.3 g/dL or greater, or when there has been a decrease in BW of 5% or more.

Animals that concentrate their urine after water deprivation are diagnosed with **psychogenic polydipsia** and their water availability is gradually decreased. Animals that fail to concentrate their urine after water deprivation are diagnosed with diabetes insipidus; **nephrogenic diabetes insipidus** can be ruled out if the animal produces concentrated urine within a few hours of an intramuscular (IM) injection of exogenous vasopressin (0.15–0.30 U/kg BW). In the latter case, the diagnosis is **neurogenic diabetes insipidus** as a result of inadequate release of ADH. Such cases are extremely rare in large animals and have been attributed to pituitary neoplasia (particularly pituitary adenoma in horses) or encephalitis. Determination of plasma vasopressin concentrations using a radioimmunoassay may assist in differentiation of nephrogenic from neurogenic diabetes insipidus; in the former the plasma vasopressin concentration increases during the water deprivation test. However, because the assay for plasma vasopressin concentration is not widely available and has not been validated for all large animals, the response to exogenous vasopressin is the preferred clinical test for differentiating nephrogenic from neurogenic diabetes insipidus. Two related horses have been diagnosed with nephrogenic diabetes insipidus, suggesting that this may be inherited as an X-linked disorder.

Water deprivation tests are not needed if urine specific gravity is below 1.008, because the presence of hyposthenuria indicates that tubular function is acting to conserve solute and produce dilute urine. In other words, a specific gravity below 1.008 is a better clinical sign than a constant specific gravity of 1.008 to 1.012, because a low specific gravity indicates the presence of some tubular function. Low specific gravity may occur in diabetes insipidus, following excessive water intake or fluid administration, or following diuretic administration. Neonatal animals on fluid diets and dairy cows in early lactation often produce dilute urine.

### Renal Clearance Studies

In animals with renal disease, serum/plasma creatinine and urea nitrogen concentrations are insensitive indicators of renal dysfunction and exceed the upper limit of the reference range only after extensive loss of nephron function. Increases in serum concentrations of creatinine or urea nitrogen cannot be used to distinguish between prerenal, renal, and postrenal azotemia. Urine specific gravity can be used to differentiate prerenal from renal azotemia. However, results of urinalysis do not reflect the magnitude of the disease and they are not specific for specific renal disease.

Calculation of renal clearance of creatinine, urea nitrogen, and electrolytes, along with measurement of specific enzyme activity in the urine, is a more sensitive indicator of damage to the tubules than serum

biochemical analysis. Urinary diagnostic indices have been used to evaluate renal function and to detect and estimate the extent of renal damage in agricultural animals. For example, it can be clinically useful to determine the urine to serum concentration, the ratio of urinary creatinine to urea nitrogen, the renal clearance of creatinine and urea nitrogen, the urine to serum osmolality ratio, the urine protein concentration or urine protein to creatinine ratio, the fractional clearances of electrolytes, and urine enzyme activity. Early diagnosis of renal injury facilitates initiation of appropriate treatment and reduces the incidence of irreversible renal failure. Sequential measurement of these indices can aid in the determination of prognosis and allows monitoring and evaluation of the extent of recovery of renal function.

The tests require simultaneous sampling of blood and urine. Samples can also be collected daily for several days and weekly to determine any age-related changes. Analytical methods can have a large impact on measured values for urinary electrolytes. Urine samples need to be acidified (usually with HCl) to accurately measure urine calcium concentration<sup>15</sup>; however, this can be problematic if measurement of urine chloride concentration is required. Accurate measurement of urine sodium and potassium concentrations using ion-selective potentiometry requires at least 20-fold dilution to minimize salt type binding in urine. Occasionally such dilution is not sufficient to provide accurate potassium measurements because of the formation of zwitterion complexes. Accurate measurement of urine chloride concentration by ion-selective potentiometry because the electrode used is also sensitive to bicarbonate concentration, which is abundant in herbivore urine. As a consequence, urine chloride concentrations measured by potentiometry should be assumed to be an undermeasurement when performed in alkaline urine.

### Fractional Clearance

The fractional clearance from plasma of a given substance is calculated by comparing the amount of the substance excreted in the urine with the amount filtered through the glomerulus. The formula used to calculate fractional clearance of substance X ( $FC_X$ ) is

$$FC_X (\%) = \left( \frac{[U_X]/[S_X]}{[U_{\text{creatinine}}]/[S_{\text{creatinine}}]} \right) \times 100$$

where  $[U_X]$  and  $[S_X]$  are the urine and serum (or plasma) concentrations of X, respectively, and  $[U_{\text{creatinine}}]$  and  $[S_{\text{creatinine}}]$  are the urine and serum (or plasma) concentrations of creatinine, respectively. The fractional clearance provides information regarding the action of tubular transport mechanisms on the filtered substances; a value below 100% indicates net reabsorption, whereas a ratio above 100% indicates net secretion. Fractional clearance

has been erroneously called fractional excretion; the latter term is confusing, inappropriate, and has no scientific basis.

Sodium and inorganic phosphate are reabsorbed from the glomerular filtrate by the renal tubules; therefore, the fractional clearance of sodium and phosphate provide clinically useful indices of tubular function and both can be accurately measured. Sodium retention is an important proximal tubular function, and the fractional clearance of Na is usually less than 1% for animals (and often <0.2%) unless they have a high oral or IV sodium intake, when fractional clearance values can be increased to 4%. Renal phosphorus excretion is affected by acid-base status and body calcium and phosphate status and is therefore a less specific indicator of tubular function than fractional clearance of sodium. Values for the fractional clearance of phosphorus normally vary from 0.1% to 0.4%, although higher values may be seen in ruminants with high phosphate intakes. Typically, tubular function can be adequately characterized by determining the fractional clearance of sodium alone, or sodium and phosphorus; the fractional clearance of chloride rarely adds useful information in clinical cases because it is highly correlated to the fractional clearance of sodium, and determination of the fractional clearance of potassium is hampered by methodologic limitations associated with zwitterion formation in urine. Determination of the fractional clearance of calcium can be useful when dietary intake and metabolism of calcium are evaluated. Substantial variations in fractional clearance values are present in horses over a 24-hour period as a result of the electrolyte load ingested with feed. Some standardization of the time of urine collection in relation to feeding is therefore needed in research studies but is clearly impractical in clinical cases.

Fractional clearance values for a number of electrolytes have been determined for horses, foals, cattle, and sheep. The urinary excretion of endogenous substances and other urinary diagnostic indices of renal function have been measured in healthy neonatal foals. The urine volume of neonatal foals is proportionately greater than that of calves, and the normal neonatal foal produces dilute urine. Compared with normal values in adult horses, fractional clearance of electrolytes was similar for sodium but higher for potassium, phosphorus, and calcium. Renal function in newborn calves is similar to adult cattle within 2 to 3 days of birth, and calves can excrete large load volumes in response to water overload and conserve water in response to water deprivation as efficiently as adult cattle.

Animals with acute renal azotemia have a low urinary creatinine to serum creatinine and urine nitrogen to serum nitrogen; animals with acute prerenal azotemia have a

normal to high urinary creatinine to serum creatinine ratio and urinary nitrogen to serum nitrogen ratio. However, animals with acute renal azotemia also have a low urine specific gravity relative to the serum creatinine concentration, and it remains to be determined whether measurement of urinary creatinine and urea concentrations and serum urea concentrations provide any more information in clinical cases than that provided by urine specific gravity and serum creatinine concentration.

### Summary of Renal Function Tests

In summary, the serum (or plasma) creatinine or urea nitrogen concentration provides a useful screening test for the presence of urinary tract disease, with an increase in serum creatinine concentration of 0.3 mg/dL or more over baseline providing a useful clinical test for the presence of nephrotoxicosis in normally hydrated animals treated with potentially nephrotoxic agents. Azotemia can be prerenal, renal, or postrenal in origin; the cause is most practically differentiated in azotemic animals by measuring the specific gravity of urine before any treatment has been administered. In animals suspected of having urinary tract disease, the urinary protein concentration and protein to creatinine ratio provide clinically useful indices of glomerular and tubular function and injury, the urine specific gravity and fractional clearance of sodium and phosphorus provide clinically useful indices of tubular function in animals not on IV or oral fluids and consuming a normal diet, and determination of urine GGT activity and analysis of urine for the presence of casts provide clinically useful and sensitive indices of tubular injury. The results of most other laboratory tests rarely provide additional information in an animal suspected to have urinary tract disease and are not currently recommended for routine clinical use. A summary table for indices of renal function in the horse is presented in Table 13-1.

## DIAGNOSTIC EXAMINATION TECHNIQUES

### Ultrasonography

Transcutaneous and transrectal ultrasonography is commonly used to detect and characterize anatomic abnormalities of the kidneys, ureters, bladder, and urethra in horses, cattle, and small ruminants. Ultrasonography is an effective screening test for diagnosing obstructive conditions of the urinary tract, including hydronephrosis, hydroureter, and bladder distension and can be used to visualize the kidney and guide the biopsy needle during renal biopsy. Removal of the hair coat and the use of an ultrasonographic coupling gel assist in obtaining acceptable acoustic coupling, whereas saturation of a foal's hair coat with alcohol or coupling gel may be adequate when clipping

**Table 13-1** Indices of renal function in healthy adult horses and foals less than 30 days of age

Factor	Adult	Foal <30 days of age
Serum urea nitrogen (mg/dL)	12–25	4–15
Serum creatinine (mg/dL)	0.8–2.2	0.7–1.2
Urine specific gravity	>1.020	<1.008
Urine osmolality (mOsm/kg)	700–1500	<250
Fractional clearance sodium (%)	0.01–1.0	0.01–0.2
Fractional clearance phosphorus (%)	0.0–0.5	0.5–5.0
Urine pH	7.0–9.0	5.5–7.0
Urine production (l/mL/kg BW/h)	0.7–1.5	4.0–8.0

Adapted from Toribio RE. *Vet Clin North Am Equine Pract* 2007; 23:533.

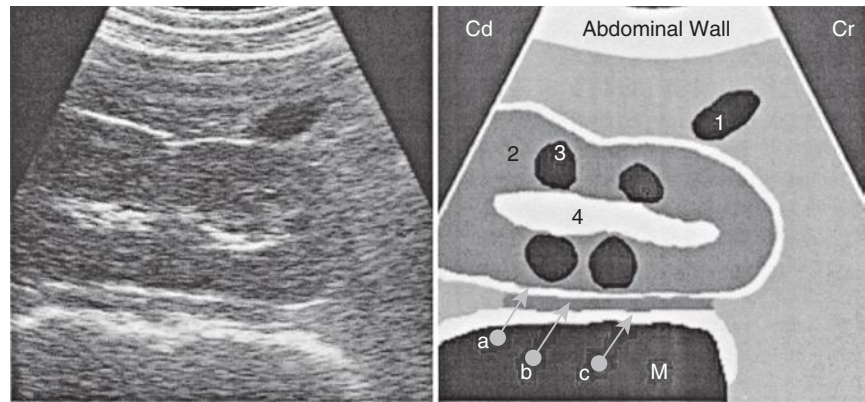

**Fig. 13-3** Ultrasonographic image (left) and drawing (right) that illustrates a bovine left kidney imaged from the right paralumbar fossa obtained by placing the transducer parallel to the longitudinal axis of the cow just below the transverse processes of the lumbar vertebrae 3 to 5. The kidney is moved toward the right paralumbar fossa by palpation per rectum. 1, caudal vena cava; 2, renal cortex; 3, medullary pyramid; 4, renal sinus; a, hyperechoic line representing the perirenal fat; b, hypoechoic line representing the medial wall of the rumen; c, hyperechoic line (internal reverberation artifact) reflecting from the tissue-gas interphase superimposed on the image of the medial wall of the rumen; Cr, cranial; Cd, caudal; M, medial. (Reproduced with permission from Imran S, Sharma S. *Veterinarni Medicina* 2014; 59:29-32.)

is not desirable. Ultrasonography should be performed before endoscopy, because the latter introduces air into the bladder and urethra, which interferes markedly with ultrasonographic images.

Techniques for ultrasonographic evaluation of the urinary system of the horse have been described,<sup>16</sup> and extensive information is available that documents age-related changes in renal dimensions. Generally, a 5- to 10-MHz linear probe is used transrectally to image the left kidney and a 2.5- to 3-MHz sector transducer used transcutaneously to image the right kidney in adult horses. The right kidney is easy to visualize through the dorsolateral aspect of the last two to three right intercostal spaces. The left kidney is harder to visualize transcutaneously and is usually located medial to the spleen in the paralumbar region between horizontal lines drawn from the tuber coxae and tuber ischii. A translumbar approach using a 3.5-MHz transducer has also been used for ultrasonography in adult horses.<sup>17</sup> Kidneys are imaged in both cross-sectional and axial planes and are usually <18 cm long. Ureteral tears have been identified using transrectal

ultrasonography. Uroperitoneum is readily diagnosed in foals by ultrasonographic examination of the ventral abdomen, as is the underlying lesion in the bladder or urachus. Ultrasonography has been used to visualize the renal changes in foals following administration of phenylbutazone.

In cattle, the right kidney is easily accessible to ultrasonography from the body surface. Generally, a 5- to 10-MHz linear probe is used transrectally and a 2.5- to 3.5-MHz sector transducer used transcutaneously in adult cattle. Images of the right kidney are visualized best using a transcutaneous approach with the transducer placed in the lumbar or paralumbar region,<sup>18</sup> whereas images of the left kidney are best obtained using a transrectal approach. A report of a transcutaneous approach for imaging the left kidney is available (Fig. 13-3).<sup>19</sup> Ultrasonographic changes in the cow with pyelonephritis include a dilated renal collecting system, renal or ureteral calculi, echogenic material within the renal collecting system, and subjective enlargement of the kidney with acute disease or a small irregular kidney with chronic disease. Cattle



with enzootic bovine hematuria caused by chronic bracken fern ingestion have a thickened bladder wall (normally <2 mm) on transrectal ultrasonography and irregular sessile masses (transitional cell papilloma) extending into the bladder lumen. A complete description of the ultrasonographic examination of the bovine urinary tract is available.<sup>20</sup>

Techniques for ultrasonographic evaluation of the urinary system of the sheep and more recently the goat<sup>21</sup> have been described using a 5-MHz linear transducer. Kidneys were most easily detected from the 12th intercostal space on the right side and dorsal right flank. The right kidney was  $8.0 \pm 0.7$  cm long (mean  $\pm$  SD) and the left kidney was  $8.4 \pm 0.6$  cm long. The bladder was  $5.1 \pm 1.4$  cm in length, and the largest cross-sectional diameter was  $2.6 \pm 1.1$  cm. The ureters could not be identified, but the urethra could be identified in most goats as echogenic lines with no visible lumen.

### Endoscopy

Transurethral endoscopy can be easily performed in mares, stallions, geldings, and cows to examine the urethra and bladder and flow of urine from both ureters. Horses and cows are sedated and adequately restrained for the procedure, using a flexible endoscope of 12 mm or less outer diameter and a minimum length of 1 m for stallions and geldings. The tail of female horses and cattle should be bandaged or held out of the way and the perineal region cleaned with dilute povidone iodine or chlorhexidine to minimize urinary tract contamination. The endoscope should be disinfected using a glutaraldehyde-based product, including the accessory channel, and rinsed with sterile water.

The endoscope should pass easily along the urethra into the bladder. Air insufflation of the bladder is needed for adequate visualization. Biopsy of diseased tissue or mechanical disruption of calculi can be attempted under endoscopic guidance. Identification of an ectopic ureter may be assisted by IM administration of azosulfamide (2 mg/kg BW, provides a red color) or IV administration of sodium fluorescein (10 mg/kg BW, provides a green color), phenolsulfonphthalein (1 mg/kg BW, provides a red color), or indigo carmine (0.25 mg/kg BW, provides a purple blue color) to color the urine being produced, 5 to 20 minutes before endoscopy, which assists visualization of the urine stream. The ureters are identified at 10 and 2 o'clock and empty periodically in spurts; separate urine samples can be collected from each ureter to evaluate left and right kidney function.

Venous embolism has been reported during urinary tract endoscopy of a standing gelding.<sup>22</sup> Routine sedation and endoscopic procedures were used with the bladder and urethra distended to 20 mm Hg. The horse

collapsed 30 minutes after the start of the procedure, exhibiting ataxia, generalized muscle twitching, and horizontal nystagmus. The horse recovered after an additional 30 minutes, and ultrasonographic examination the next day revealed the presence of gas in both ureters and the renal pelvis of both kidneys. Venous air embolism is reportedly more likely to occur in humans when the operative site is more than 5 cm above the right atrium, which was the case in this gelding.

### Renal Biopsy

Percutaneous renal biopsy can be performed in sedated and adequately restrained cows and horses. A coagulation profile should be run before renal biopsy is attempted in animals with severe and chronic renal disease or those animals suspected to have a coagulopathy. Renal biopsy is contraindicated in animals with documented pyelonephritis because of the risk of perirenal abscessation after the biopsy procedure.

The left kidney is usually biopsied because it is more accessible. In cows, the left kidney is moved to the right paralumbar fossa and fixed in position by rectal manipulation. In horses, the left kidney is identified using transabdominal ultrasonography and fixed in position by palpation per rectum. The skin over the biopsy site is aseptically prepared and 5 to 10 mL of local anesthetic is infiltrated along the proposed track for the biopsy needle. A small stab incision is made in the skin with a scalpel, and a renal biopsy sample is collected by introducing a biopsy needle through the abdominal wall and manipulating it into the caudal pole of the kidney. The depth of insertion is typically 3 cm for the right kidney and approximately 7 cm for the left kidney (depth is more variable). The renal biopsy is fixed in 10% formalin and submitted for examination and histologic diagnosis. Biopsy of the caudal pole is thought to minimize the risk of trauma to the renal pelvis, renal artery, and renal vein, but a biopsy location effect has not been demonstrated in large animals. Laparoscopic biopsy of the kidneys, with or without the development of pneumoperitoneum, with the horse in a standing position has been reported.<sup>23</sup> Clear advantages of laparoscopic biopsy over an ultrasound-guided percutaneous biopsy method have not been identified.

Possible complications of renal biopsy are hemorrhage and bowel penetration in all animals and abscessation in animals with pyelonephritis. Hemorrhage after renal biopsy can be extensive, is usually perirenal, and can be life-threatening, with fatality rates reported of 2.1% (1/48)<sup>24</sup> in cattle using laparoscopic biopsy, 0% (0/82) in cattle using nonultrasound-guided biopsy<sup>25</sup> and 0% (0/25) in cattle using percutaneous ultrasound-guided biopsy of the right kidney,<sup>18</sup> and 0.7% (1/151)<sup>26</sup> in horses using

percutaneous biopsy. These fatality rates should be compared with a fatality rate of 0.2% in humans undergoing renal biopsy. Occasionally, severe hematuria is present for hours after the biopsy procedure but usually resolves within a few days. Because of the potential for life-threatening sequelae, renal biopsy should only be performed when the etiology is uncertain and histologic examination will direct treatment or when an early and accurate prognosis is desired. In animals with acute tubular injury, electron microscopic examination of the basement membrane is required to provide an accurate prognosis on return to normal function.

### Test of Uroperitoneum and Bladder Rupture

Ultrasonographic examination of the abdomen is most useful in detecting the presence of excessive fluid, and this examination frequently allows visualization of the lesion in the bladder or urachus. Further testing is sometimes needed to confirm that the fluid is urine. Generally, in uroperitoneum, substantial quantities of fluid can be easily obtained by abdominocentesis. Warming the fluid may facilitate detection of the urine odor, although this is a subjective and poorly sensitive diagnostic test. If there is doubt that the fluid is urine, its creatinine concentration can be compared with that in serum. If creatinine in the fluid is at least twice the serum value, the fluid is confirmed as urine, although ruptured bladder should be suspected whenever the abdominal fluid creatinine concentration exceeds that of serum. In animals with uroabdomen or suspected to have uroabdomen, the administration of 30 mL of sterile 1% methylene blue into the bladder via a urethral catheter or cystocentesis has been used to confirm that the bladder is the site of urine leakage. Abdominal paracentesis is performed some minutes after administration and the fluid examined visually for the presence of a blue tinge. Absence of a blue color suggests the presence of ureteral or renal rupture.

### Radiography

Radiographic examination has limited value for the diagnosis of urinary tract disease in farm animals with the potential exception of radiolucent particles in the bladder of ruminants with urolithiasis. Contrast studies may be used to examine the lower urinary tract in neonatal animals. With the widespread availability of ultrasonography and endoscopy, the indications for radiography have become more limited. A positive-contrast urethrogram was of value in diagnosing urethral recess dilatation in a bull calf, and IV urography was successful in diagnosing a dilated ureter in a 4-month-old heifer calf. Historically, excretory urography, positive contrast cystography, and urethrography have been used, particularly in foals, but these tests are expensive, not widely available, and

time-consuming. Radiography is currently being performed on animals with equivocal results using other cheaper, faster, and more widely available tests such as ultrasonography.

### Cystometry and Urethral Pressure Profile

Urodynamic tests in the mare permit comparison of the normal micturition reflex with that of the incontinent patient. **Cystometry** involves measurement of luminal pressure during inflation of the bladder with measured volumes of 0.9% NaCl or carbon dioxide. The pressure–volume relationship during filling with fluid or gas provides information on bladder capacity, maximal luminal pressure during the detrusor reflex, and stiffness of the bladder wall. The **urethral pressure profile** involves measurement of pressure along the urethra while withdrawing a fluid-filled or gas-filled catheter at constant rate. The catheter tip pressure is graphed against distance, and the **maximum urethral closure pressure** is determined as the maximum urethral pressure minus bladder luminal pressure. The **functional urethral length** is defined as the length of the urethra in which urethral pressure exceeds bladder luminal pressure.

The test can be performed in restrained mares with or without xylazine sedation (1.1 mg/kg BW, intravenously), but sedation is recommended. Values for cystometry and urethral pressure profiles in female horses and pony mares are available.

### Computed Tomography

Computed tomography (CT) is considered the method of choice in human medicine for the imaging diagnosis of pyelonephritis, renal tumors, and renal trauma. CT urography is also the preferred technique for evaluating urinary tract disorders in humans.<sup>27</sup> Consequently, there is interest in applying CT to urinary tract diseases of large animals, such as obstructive urolithiasis in goats and sheep. A CT study of 28 healthy female Saanen goats indicated that CT was a useful imaging modality that provided visualization of the kidneys, ureters, and urinary bladder.<sup>27</sup> The clinical utility of CT in obstructive urethral conditions of large animals remains to be determined.

## Principles of Treatment of Urinary Tract Disease

### Fluid and Electrolytes

Treatment of acute renal failure in all species is aimed at removing the primary cause and restoring normal fluid balance by correcting dehydration, acid-base disorders, and electrolyte abnormalities. The prognosis for acute renal failure will depend on the initiating cause and severity of the lesion. If the acute disease process can be stopped, the

animal may be able to survive on its remaining functional renal tissue. When toxic nephrosis is suspected, an attempt should be made to identify and remove the initiating cause or to move the animal from the suspect environment.

**Ruminants** with chronic renal failure typically have mild to marked **hyponatremia** and **hypochloremia**; the serum calcium and potassium concentrations may be decreased because of inappetence, serum magnesium concentration may be normal or increased, and serum phosphate concentration may be normal or increased, because urine provides a route of excretion of magnesium and phosphorus. The acid-base status is characterized by acidemia and **metabolic acidosis** in severely affected cases to metabolic alkalosis in mildly affected cases. Ruminants with acute renal failure have similar clinicopathologic changes, although the serum phosphorus concentration is usually markedly elevated in acute renal failure, because many cases are initiated by decreased renal blood flow.

**Horses** with acute or chronic renal failure have similar electrolyte changes to those in ruminants, with the marked difference being the presence of **hypercalcemia** and **hypophosphatemia** in some horses. Hypercalcemia in horses with renal disease is attributed to poorly regulated intestinal calcium absorption, with urine being the predominant route of calcium excretion. Decreases in the function of nephrons in the horse will therefore decrease the urinary loss of calcium and result in hypercalcemia. The hypercalcemia is marked and is thought to result directly in hypophosphatemia in horses with renal failure.

Balanced electrolyte solutions or isotonic (0.9% NaCl) saline supplemented with potassium (if hyperkalemia is not present) and calcium (if hypercalcemia is not present) can be used to correct fluid and electrolyte deficits. The required volume of replacement fluid can be determined on the basis of clinical signs as outlined in Chapter 5. As the fluid deficit is corrected, the patient should be observed for urination. The healthy horse produces 15 to 30 mL urine/kg BW each day, which is equivalent to 7.5 to 15.0 L/day for a 500-kg horse. If anuria or oliguria is present, the rate of fluid administration should be monitored to prevent overhydration. If the patient has anuria or oliguria after the fluid volume deficit is corrected, a diuretic should be administered to help restore urine flow. **Furosemide** (1–2 mg/kg BW IV or IM every 2–6 hours) or **mannitol** (0.25–2.0 g/kg BW in a 20% solution administered IV over 15–20 minutes) may be used, but furosemide is preferred because of its much lower cost and ease of administration. Mannitol administration has not been proven to be effective in humans and is no longer recommended for treatment of oliguric acute renal failure in humans. Diuretics should not be used

until dehydration has been corrected and furosemide administration should be used with caution in horses with acute renal failure caused by aminoglycoside toxicity, because furosemide may augment the nephrotoxicity. After urine flow is restored, the resulting diuresis will increase the maintenance fluid requirement. **B vitamins** should be frequently administered because their rate of loss in the urine is anticipated to be higher than normal in animals with renal failure.

Animals nonresponsive to fluid loading and diuretics could be administered low-dose (“renal dose”) **dopamine** as a continuous IV infusion (3–5 µg/kg BW/min) with dopamine diluted in 0.9% NaCl, 5% dextrose, or lactated Ringer’s solution. Dopamine is an  $\alpha_1$ ,  $\beta_1$ ,  $\beta_2$ ,  $DA_1$ , and  $DA_2$  agonist and therefore has a complex pharmacodynamic profile that is dependent on species, organ, and cardiovascular status. Dopamine is theoretically the preferred pharmacologic agent to selectively increase renal blood flow and therefore glomerular filtration rate in animals with renal failure, although low-dose dopamine infusion does not alter creatinine clearance (an index of glomerular filtration rate) in healthy adult horses and has not been shown to be of benefit in treating renal failure in humans. Dopamine acts primarily as an inotropic agent at low doses (<5 µg/kg BW/min) and primarily as a vasopressor at higher doses. The mean arterial blood pressure and electrocardiogram should therefore be monitored during dopamine administration to ensure that dopamine infusion does not lead to hypertension or clinically significant cardiac arrhythmias. Although there are good theoretical grounds for use of dopamine in animals with renal failure, this is no longer the practice in human medicine because of the lack of efficacy of the drug in preventing or treating acute renal failure. Fenoldopam mesylate, a dopamine-1 receptor agonist, at 0.04 µg/kg BW/min may have a role in the treatment of anuria and oliguria in sick foals, because this rate of infusion increased urine output without altering systemic hemodynamics and cardiac output in healthy foals.<sup>27</sup> IV infusion of norepinephrine (0.1 µg/kg BW/min), with or without dobutamine (5 µg/kg BW/min), does not alter urine output, endogenous creatinine clearance, or fractional clearance of electrolytes in neonatal foals,<sup>28</sup> suggesting minimal therapeutic effects in foals with anuria or oliguria. Animals that remain anuric after IV fluid administration of furosemide/mannitol and dopamine have a grave prognosis and can only be managed with peritoneal dialysis or hemodialysis.

**Intermittent-flow peritoneal dialysis** has been used successfully in a foal with a ruptured urinary bladder. A urinary catheter was placed in the bladder and secured to the perineal region. An area of the ventral midline was clipped and prepared for aseptic surgery. Local anesthetic was infused, and a

stab incision was made in the skin with a scalpel blade. An 11-French peritoneal dialysis catheter was placed in the stab incision then forced into the abdomen. The rigid stylet was removed, the catheter was secured to the skin, and the stab incision site was bandaged. Peritoneal fluid was allowed to drain; dialysis was then accomplished by infusing 2 L of a hypertonic dialysis solution, clamping the catheter for 1 hour, then opening the catheter and allowing drainage to occur for 2 to 3 hours. Dialysis was repeated 9 times over a 36-hour period. Intermittent-flow peritoneal dialysis has also been used in 4 adult horses with acute renal failure using a similar catheterization technique (24-French de Pezzer or 28-French catheter secured using a purse-string suture followed by a Chinese finger trap suture pattern) and periodic infusion of 10 to 15 L of warmed, sterile, acetated Ringer's or lactated Ringer's solution.<sup>29</sup> The fluid was left for 0.5 to 1 hour and then allowed to drain back into the fluid bag from which it was delivered. Not all of the infused fluid is usually recovered; attachment of a Heimlich valve to the catheter for several hours permits drainage of additional fluid.

**Continuous-flow peritoneal dialysis** has been used successfully in an adult horse with azotemia refractory to IV fluids, furosemide, dopamine infusion, and intermittent-flow peritoneal dialysis. A 28-French indwelling thoracic tube was placed in the ventral abdomen and a 2.2-mm diameter, 15-cm long spiral fenestrated catheter was placed in the left flank via peritoneoscopy to allow for inflow of dialysate (Fig. 13-4).<sup>30</sup> Acetated

Ringer's with 1.5% glucose was continuously infused through the catheter in the left flank at approximately 3 L/h, with abdominal fluid collected into a sterile closed collection system from the catheter in the ventral midline of the abdomen. The quantity of intraabdominal fluid was controlled by positioning the collection bags relative to the level of the withers to maintain a constant and modest intraperitoneal pressure.

**Hemodialysis** (renal replacement therapy) has been used successfully to treat a foal with presumed oxytetracycline nephrotoxicosis. Venovenous hemodialysis was performed under isoflurane anesthesia after surgical placement of a Teflon/Silastic arteriovenous shunt in the median artery and vein using a dialysis delivery system, a hollow-fiber artificial kidney, and acetate-base dialysate. Anticoagulation during dialysis was accomplished with a loading dose of heparin (100 U/kg BW IV) and then hourly boluses of 20 U/kg BW or a continuous rate infusion of 50 IU/kg each hour to prolong the activated clotting time. Three dialysis treatments, lasting 4 to 6 hours, were administered over a 4-day period, resulting in a marked reduction in azotemia. The safety and efficacy of venovenous hemodialysis has been investigated in five adult horses.<sup>31</sup> Renal replacement therapy is more efficient than intermittent or continuous-flow peritoneal dialysis and requires shorter treatment intervals but does require vascular access, anticoagulation treatment, sterile filters and tubing, a peristaltic pump, and potentially a method for warming the fluids to core body temperature immediately before IV infusion.

The treatment of chronic renal failure will depend on the stage of disease and the value of the animal. In chronic failure, therapy is aimed at prolonging life. In food-producing animals, emergency slaughter is not recommended because the carcass is usually unsuitable for human consumption. Animals in chronic failure should have free access to water and salt, unless edema is present. Stresses such as sudden environmental and dietary changes should be avoided. The ration should be high in energy-giving food and properly balanced for protein. Acute renal failure may occur in patients in chronic failure and can be treated like other cases of acute renal failure.

### Antimicrobial Agents

Selection of antimicrobial agents for the treatment of urinary tract infections should be based on quantitative urine culture of a catheterized urine sample. A clinically relevant bacterial concentration indicative of cystitis or pyelonephritis is 1000 cfu/mL or 30,000 cfu/mL of urine from a catheterized or midstream free-catch sample, respectively.

The ideal antimicrobial for treatment of urinary tract infections should meet several criteria. It should

- **Be active against the causal bacteria**
- **Be excreted and concentrated in the kidney and urine**
- **Be active at the pH of urine**
- **Have low toxicity, particularly nephrotoxicity**
- **Be easily administered**
- **Be low in cost**
- **Have no harmful interactions with other concurrently administered drugs**

Appropriate first-line antimicrobials include penicillin, ampicillin, amoxicillin, ceftiofur, and cefquinome in ruminants and trimethoprim-sulfonamides and ceftiofur in horses. Antimicrobial therapy for lower urinary tract infections should continue for at least 7 days; for upper urinary tract infections 2 to 4 weeks of treatment is often necessary. Success of therapy can be evaluated by repeating the urine culture 7 to 10 days after the last treatment.

Manipulation of urine pH should be considered as part of the treatment of bacterial urinary tract infections. Generally, *Escherichia coli* attach best to urinary epithelial cells at pH 6.0, whereas *Corynebacterium renale* attaches best in alkaline urine. In other words, when treating an *E. coli* pyelonephritis or cystitis, the diet should be altered to ensure an alkaline urine pH. Likewise, urine pH should be acidic when treating urinary tract infections caused by *C. renale*.

### FURTHER READING

- Anon. European urinalysis guidelines. *Scand J Clin Lab Invest.* 2000;60:1-96.
- Geor RJ. Acute renal failure in horses. *Vet Clin North Am Equine Pract.* 2007;23:577-591.
- McKenzie EC. Polyuria and polydipsia in horses. *Vet Clin North Am Equine Pract.* 2007;23:641-653.

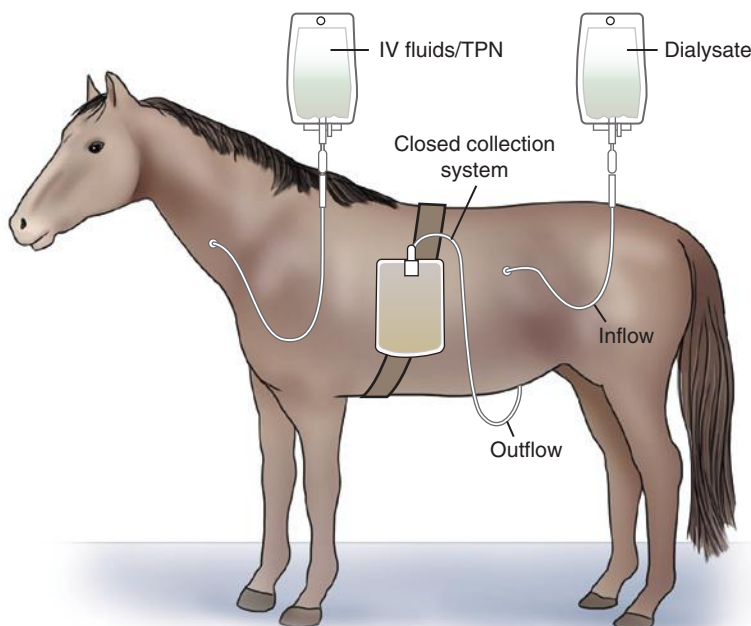

**Fig. 13-4** Drawing of the system for continuous-flow peritoneal dialysis in an adult horse. TPN, total parenteral nutrition. (Reproduced with permission from Gallatin LL et al. *J Am Vet Med Assoc* 2005; 226:756-759.)



- Menzies-Gow N. Diagnostic endoscopy of the urinary tract of the horse. *In Pract.* 2007;29:208-213.
- Mueller K. Urinary tract disease in cattle. *UK Vet.* 2007;12:1-10.
- Savage CJ. Urinary clinical pathologic findings and glomerular filtration rate in the horse. *Vet Clin North Am Equine Pract.* 2008;24:387-404.
- Schott HC. Chronic renal failure in horses. *Vet Clin North Am Equine Pract.* 2007;23:593-612.
- Schumacher J. Hematuria and pigmenturia of horses. *Vet Clin North Am Equine Pract.* 2007;23:655-675.
- Toribio RE. Essentials of equine renal and urinary tract physiology. *Vet Clin North Am Equine Pract.* 2007;23:533-561.
- Wilson ME. Examination of the urinary tract in the horse. *Vet Clin North Am Equine Pract.* 2007;23:563-575.

## REFERENCES

- Montgomery JB, et al. *Can Vet J.* 2009;50:751.
- Tamura T, et al. *J Vet Med Sci.* 2014;76:819.
- Constable PD, et al. *Am J Vet Res.* 2009;70:915.
- Pavelski M, et al. *Semina Ciências Agrárias, Londrina.* 2014;35:1369.
- Arnold CE, et al. *J Am Vet Med Assoc.* 2005;227:778.
- Uberti B, et al. *Am J Vet Res.* 2009;70:1551.
- Uberti B, et al. *Am J Vet Res.* 2010;71:1462.
- Hajikolaei MRH, et al. *Comp Clin Pathol.* 2015;24:251.
- Raboison D, et al. *J Vet Intern Med.* 2010;24:1532.
- Mathur S, et al. *Toxicol Sci.* 2001;60:385.
- Nishita T, et al. *Vet J.* 2014;202:378.
- Raekallio MR, et al. *Am J Vet Res.* 2010;71:1246.
- Imai K, et al. *Vet J.* 2012;193:174.
- Wilson KE, et al. *Am J Vet Res.* 2009;70:1545.
- O'Connor CI, Nielsen BD. *J Anim Vet Adv.* 2006;5:165.
- Diaz OS, et al. *Vet Radiol Ultrasound.* 2007;48:560.
- Habershon-Butcher J, et al. *Vet Radiol Ultrasound.* 2014;55:323.
- Mohamed T, Oikawa S. *J Vet Med Sci.* 2008;70:175.
- Imran S, Sharma S. *Vet Med (Praha).* 2014;59:29.
- Floek M. *Vet Clin North Am Food Anim Pract.* 2009;25:651.
- Steininger K, Braun U. *Schweiz Arch Tierheilkd.* 2012;154:67.
- Romagnoli N, et al. *Equine Vet Ed.* 2014;26:134.
- Kassem MM, et al. *Int J Morphol.* 2014;32:1234.
- Braun U, et al. *Schweiz Arch Tierheilkd.* 2011;153:321.
- Chiesa OA, et al. *Can J Vet Res.* 2006;70:87.
- Tyner GA, et al. *J Vet Intern Med.* 2011;25:532.
- Hollis AR, et al. *J Vet Intern Med.* 2006;20:595.
- Hollis AR, et al. *J Vet Intern Med.* 2006;20:1437.
- Han JH, McKenzie HC. *Equine Vet Educ.* 2008;20:256.
- Gallatin LL, et al. *J Am Vet Med Assoc.* 2005;226:756.
- Wong DM, et al. *J Vet Intern Med.* 2013;27:308-316.

## Diseases of the Kidney

### GLOMERULONEPHRITIS

Glomerulonephritis can occur as a primary disease or as a component of diseases affecting several body systems, such as equine infectious anemia and chronic swine fever. In primary glomerulonephritis, the disease involves only the kidney, predominantly affecting the glomeruli, although the inflammatory process extends to affect the surrounding interstitial tissue and blood vessels.

Primary and secondary glomerulonephritis are rare causes of clinical disease in farm animals. The disease is sometimes associated with other chronic, systemic illness such as in cows with John's disease, bovine virus diarrhea, fascioliasis,<sup>1</sup> or leptospirosis; pigs with hog cholera or African swine fever; and horses with equine infectious anemia. Proliferative glomerulonephritis is reported as an incidental finding in normal sheep, cattle, goats, and pigs. Clinical disease from glomerulonephritis is rare in these species but has been reported in cattle and as a congenital condition in sheep, as described later. Proliferative glomerulonephritis can cause chronic renal failure in horses. Glomerulonephritis is present in animals with amyloidosis, which is a generalized deposition of antibody-antigen complexes. Amyloidosis is discussed in detail in Chapter 11.

The immune system plays a major role in the pathogenesis of glomerular lesions. Glomerular injury can be initiated by an immune response in which antibodies are directed against intrinsic glomerular antigens or by foreign antigens planted in the glomerulus. Alternatively, and more commonly, circulating antigen-antibody complexes may be deposited in the glomerulus. As the complexes accumulate, they stimulate an inflammatory response that damages the glomerular filtration system. Inflammatory damage to the glomerulus alters the selective permeability of the filtration system allowing plasma protein, particularly albumin, to pass into the glomerular filtrate. In horses, the glomerular lesion is thought to be caused by the deposition of circulating antigen-antibody complexes, but the origin of these complexes is unknown. Infections with streptococci and equine infectious anemia virus may be involved but are not likely to be involved in all cases.

Glomerulonephritis is a common cause of chronic renal failure in horses. Several forms of glomerulonephritis are recognized in horses: membranous glomerulonephritis, poststreptococcal glomerulonephritis, membranoproliferative glomerulonephritis, and focal glomerulosclerosis. As discussed earlier, most are probably immune mediated and associated with circulating antibody-antigen complexes. Over 80% of horses with equine infectious anemia have glomerular lesions, and viral antigen-antibody complexes are present in the glomerular basement membrane. Purpura hemorrhagica is associated with glomerulonephritis.

The **nephrotic syndrome** is seen in some advanced cases of glomerulonephritis and is a clinical syndrome characterized by proteinuria, hypoproteinemia leading to generalized edema, and hypercholesterolemia. Nephrotic syndrome is rarely diagnosed in large animals for unknown reasons, relative to the dog and human, but is most common in cattle with advanced renal amyloidosis. Hypercholesterolemia is attributed to increased hepatic

synthesis of proteins in response to chronic proteinuria, but appears to be an inconsistent finding in cattle.<sup>1</sup> **Dermatitis-nephropathy syndrome** is a systemic necrotizing vasculitis and glomerulonephritis syndrome of growing pigs in the UK and Canada. The cause is unknown, but an immune-mediated pathogenesis is suspected. Growing pigs are affected with a morbidity ranging from 1% to 3%. The skin is affected with a papular dermatopathy with a characteristic distribution of bluish red spots at least 1 cm in diameter beginning first in the perineal region and then extending to the pelvic limbs and along the ventral body wall to the neck and ears. In the glomeruli, there are extensive granular complement deposits with scattered immunoglobulins.

**Porcine dense deposit disease**, porcine membranoproliferative glomerulonephritis type II, is a common cause of early loss of newborn piglets in the Norwegian Yorkshire breed. The disease is associated with extensive complement activation caused by a deficiency of factor H, a plasma protein that regulates complement. Affected piglets are clinically normal at birth and for the first few weeks of life. Thereafter they become unthrifty and die of renal failure within 72 days of birth. In the kidneys there is extensive glomerular proliferation and marked thickening of the glomerular capillary wall. Large amounts of dense deposits are consistently found within the glomerular basement membrane. This disease is inherited with a simple autosomal recessive pattern and complete penetrance. A pathogenetic mechanism of a defective or missing complement regulation protein is hypothesized. A spontaneous glomerulonephritis of unknown etiology and unrelated to any breed has been recorded in pigs. A necrotizing glomerulonephritis is listed as occurring in pigs fed a waste product from an industrial plant producing a proteolytic enzyme. Glomerulonephritis has also been recorded in pigs in the absence of clinical illness, although an association with the "thin sow" syndrome is suggested.

In **Finnish Landrace lambs** less than 4 months of age there is an apparently inherited mesangiocapillary glomerulonephritis that is remarkably similar to forms of human glomerulonephritis. Affected lambs appear to absorb an agent from colostrum that induces an immunologic response, followed by the granular deposition of immune complexes and complement within the glomerular capillary walls; this initiates a fatal mesangiocapillary glomerulonephritis. Many affected lambs are asymptomatic until found dead. Some have signs of tachycardia, edema of the conjunctiva, nystagmus, walking in circles, and convulsions. The kidneys are enlarged and tender. There is severe proteinuria and low plasma albumin. SUN concentration is markedly increased with hyperphosphatemia and hypocalcemia. At necropsy the kidneys are large and pale and

have multifocal pinpoint yellow and red spots throughout the cortex. On histopathologic examination, there are severe vascular lesions in the choroid plexuses and the lateral ventricles of the brain. The disease is thought to be conditioned in its occurrence by inheritance and to be limited to the Finnish Landrace breed; however, cases have also occurred in crossbred lambs.

**Glomerulopathy and peripheral neuropathy in Gelbvieh calves** is a familial and probably heritable disease causing illness in calves of this breed of less than 13 months of age. The initial physical abnormality is posterior ataxia that progresses to generalized paresis and recumbency. The neurologic deficits include loss of conscious proprioception and diminished or absent peripheral reflexes but maintained consciousness. Affected animals continue to eat and drink normally. Serum creatinine and urea concentrations are markedly elevated. Necropsy examination reveals neuropathy, myelopathy, and glomerulopathy. The disease is terminal.

## REFERENCE

- Murray GM, Sharpe AE. *Vet Rec.* 2009;164:179.

## PYELONEPHRITIS

Pyelonephritis usually develops by ascending infection from the lower urinary tract. Clinically pyelonephritis is characterized by pyuria, hematuria, cystitis, ureteritis, and suppurative nephritis.

## ETIOLOGY

Pyelonephritis may develop in a number of ways:

- Secondary to bacterial infections of the lower urinary tract
- Spread from embolic nephritis of hematologic origin such as septicemia in cattle associated with *Pseudomonas aeruginosa*
- Specific pyelonephritis associated with *C. renale*, *C. pilosum* (formerly *C. renale* type 2), and *C. cystitidis* (formerly *C. renale* type 3) in cattle and *C. suis* in pigs
- Secondary to anatomic abnormalities of the kidneys or distal structures permitted ascending infection of the kidney
- In association with nephroliths, although whether the nephrolith or the pyelonephritis occurred first is uncertain

## PATHOGENESIS

Pyelonephritis develops when bacteria from the lower urinary tract ascend the ureters and become established in the renal pelvis and medulla. Bacteria are assisted in ascending the ureters by urine stasis and reflux of urine from the bladder. Urine stasis can occur as a result of blocking of the ureters by inflammatory swelling or debris, by

pressure from the uterus in pregnant females, and by obstructive urolithiasis. Initially the renal pelvis and medulla are affected because they are relatively more hypoxic, and localized tissue hypertonicity depresses the phagocytic function of leukocytes. Infection in advanced cases may extend to the cortex. Pyelonephritis causes systemic signs of toxemia and fever and, if renal involvement is bilateral and sufficiently extensive, uremia develops. Pyelonephritis is always accompanied by pyuria and hematuria because of the inflammatory lesions of the ureters and bladder.

Pyelonephritis in cattle caused by *C. renale* used to be very common, but clinical disease has decreased markedly, with the majority of pyelonephritis cases in cattle now caused by *E. coli*. The reason for the decrease in *C. renale* isolation from clinical cases is unclear but is probably related to a change in diet toward concentrates with an associated decrease in urine pH. Other potential reasons could be the widespread use of  $\beta$ -lactam antibiotics and the marked decrease in urethral catheterization to obtain a urine sample in cows suspected to be ketotic. Transmission of *C. suis* in pigs may occur after mating with infected boars, because many boars carry *C. suis* in their preputial sac fluid. Field observations suggest that slight trauma at breeding, especially in small gilts, may be an important factor in transmission.

## CLINICAL FINDINGS

The clinical findings in pyelonephritis vary between species. In sows there may be an initial period during which a vaginal discharge is noted, but most affected animals die without premonitory illness. Characteristically, affected pigs will lose weight and eventually become emaciated. The disease in cattle usually has a protracted course and is characterized by fever, pyuria or hematuria, and intermittent episodes of abdominal pain (see previous section **Bovine Pyelonephritis**).

The disease in horses is often chronic, although acute disease occurs. Gross hematuria is recognized in some horses with pyelonephritis, although this is not a common finding. Ultrasonographic examination of the kidneys can confirm the diagnosis, based on the presence of abnormally shaped kidneys with loss of the corticomedullary gradient, hypochoic or hyperechoic abnormalities in the renal cortex, and increased echogenicity. These findings should prompt examination of the urine for leukocytes, casts, protein, and bacteria.

## CLINICAL PATHOLOGY

Erythrocytes, leukocytes, and cell debris are present in the urine on microscopic examination and may be grossly evident in severe cases, particularly in horses. Quantitative urine culture is necessary to determine the causative bacteria.

## NECROPSY FINDINGS

The kidney is usually enlarged, and lesions in the parenchyma are in varying stages of development. Characteristic lesions are necrosis and ulceration of the pelvis and papillae. The pelvis is usually dilated and contains clots of pus and turbid urine. Streaks of gray, necrotic material radiate out through the medulla and may extend to the cortex. Affected areas of parenchyma are necrotic and may be separated by apparently normal tissue. Healed lesions appear as contracted scar tissue. Infarction of lobules may also be present, especially in cattle. Histologically the lesions are similar to those of embolic nephritis except that there is extensive necrosis of the apices of the papillae. Necrotic, suppurative lesions are usually present in the bladder and ureters.

## TREATMENT

General principles of treatment of urinary tract infections were presented earlier. A specific treatment for severe asymmetric pyelonephritis is unilateral nephrectomy, but this should only be done in nonazotemic animals. An overlooked component of treatment is alteration in urinary pH, which will affect the ability of the bacteria to attach to epithelial cells. As a generalization, *C. renale* attaches best in alkaline urine and *E. coli* attaches best in acidic urine.

## DIFFERENTIAL DIAGNOSIS

The presence of pus and blood in the urine may suggest cystitis or embolic nephritis as well as pyelonephritis. It may be difficult to distinguish between these diseases, but renal enlargement or pain on rectal palpation of the kidney indicates renal involvement. Ultrasonographic changes associated with pyelonephritis include a dilated renal collecting system, renal or ureteral calculi, increased echogenicity, loss of corticomedullary echogenicity, and subjective enlargement of the kidney with acute disease or a small irregular kidney with chronic disease.<sup>1</sup> Parenchymal hyperechogenicity can be caused by tubular degeneration and replacement fibrosis.

## REFERENCE

- Braun U, et al. *Vet J.* 2008;175:240.

## NEPHROSIS

Nephrosis includes degenerative and inflammatory lesions primarily affecting the renal tubules, particularly the proximal convoluted tubules. Nephrosis is classified into two main groups: (1) tubular injury caused by ischemic insult and (2) cell death or damage to the tubules caused by nephrotoxins (toxic agents that preferentially damage renal

tubular epithelial cells). Nephrosis is the most common cause of acute kidney failure and often multiple animals are affected if there is exposure to nephrotoxins, such as plant toxicities. Uremia from nephrosis may develop acutely or may occur in the terminal stages of chronic renal disease.

## ISCHEMIC NEPHROSIS

Reduced blood flow through the kidneys usually is caused by general circulatory failure. There is transitory oliguria followed by anuria and uremia if the circulatory failure is not corrected.

### ETIOLOGY

Any condition that predisposes the animal to marked hypotension and release of endogenous pressor agents potentially can initiate hemodynamically mediated acute renal ischemia and renal failure. Ischemia may be acute or chronic.

#### Acute Renal Ischemia

- General circulatory emergencies such as shock, dehydration, acute hemorrhagic anemia, and acute heart failure; renal failure secondary to calf diarrhea has been described
- Embolism of renal artery, recorded in horses
- Extreme ruminal distension in cattle

#### Chronic Renal Ischemia

- Chronic circulatory insufficiency such as congestive heart failure

### PATHOGENESIS

Acute ischemia of the kidneys occurs when compensatory vasoconstriction affects the renal blood vessels in response to a sudden reduction in cardiac output. As mean arterial blood pressure decreases below 60 mm Hg (the lower limit for autoregulation of renal blood flow), glomerular filtration decreases, and metabolites that are normally excreted accumulate in the bloodstream. The concentration of urea nitrogen in plasma or serum increases, giving rise to the name prerenal uremia. As glomerular filtration falls, tubular resorption increases, causing reduced urine flow. Up to a certain stage, the degenerative changes are reversible by restoration of renal blood flow, but if ischemia is severe enough and of sufficient duration, the renal damage is permanent. Proximal tubules are highly sensitive to ischemia because they are one of the energetically most active cells in the body. Acute circulatory disturbances are more likely to be followed by degenerative lesions than chronic congestive heart failure.

The parenchymatous lesions vary from tubular necrosis to diffuse cortical necrosis in which both tubules and glomeruli are affected. The nephrosis of hemoglobinuria appears to be caused by the vasoconstriction

of renal vessels rather than a direct toxic effect of hemoglobin on renal tubules. Uremia in acute hemolytic anemia and in acute muscular dystrophy with myoglobinuria may be exacerbated by plugging of the tubules with casts of coagulated protein, but ischemia is also an important factor.

### CLINICAL FINDINGS

Renal ischemia does not appear as a distinct disease, and its signs are masked by the clinical signs of the primary disease. Oliguria and azotemia will go unnoticed in most cases if the circulatory defect is corrected in the early stages. However, renal insufficiency may cause a poor response to treatment with transfusion or the infusion of other fluids in hemorrhagic or hemolytic anemia, in shock or dehydration. In these cases, unexplained depression or a poor response to therapy indicates that renal involvement should be investigated. The general clinical picture is one of acute renal failure and is described under uremia.

### CLINICAL PATHOLOGY

Laboratory tests can be used to evaluate renal function once the circulatory condition has been corrected. Urinalysis as well as SUN and creatinine concentrations are common indices. Serum biochemistry on serially collected samples may also be used to monitor the response to therapy. On urinalysis, proteinuria is an early indication of damage to the renal parenchyma. The passage of large volumes of urine of low specific gravity after a period of oliguria is usually a good indication of a return of normal glomerular and tubular function.

### NECROPSY FINDINGS

Lesions of renal ischemia are present primarily in the cortex, which is pale and swollen. There may be a distinct line of necrosis visible at the corticomedullary junction. Histologically there is necrosis of tubular epithelium and, in severe cases, of the glomeruli. In hemoglobinuria and myoglobinuria hyaline casts are present in the tubules. Severe ischemic injury can disrupt the basement membranes of the proximal tubules.

### TREATMENT

Treatment must be directed at correcting fluid, electrolyte, and acid-base disturbance as soon as possible. If renal damage has occurred, supportive treatment as suggested for the treatment of acute renal failure should be instituted.

### DIFFERENTIAL DIAGNOSIS

Evidence of oliguria and azotemia in the presence of circulatory failure suggests renal ischemia and the possibility of permanent renal damage. It is important to attempt to differentiate the early reversible prerenal stage from the stage in which degeneration of renal

parenchyma has occurred. When ischemic renal lesions are present, urinalysis may be helpful in diagnosis, particularly if the urine is not appropriately concentrated in a dehydrated patient. After irreversible ischemic changes have occurred, it is impossible to differentiate clinically between ischemia and other primary renal diseases such as glomerulonephritis and toxic nephrosis. History and clinical signs of chronic disease will help determine whether the acute syndrome is superimposed on chronic renal disease.

## TOXIC NEPHROSIS

The kidneys are particularly vulnerable to endogenous and exogenous toxins because they receive a large proportion of the total cardiac output (typically 20%) and because substances are concentrated in the kidney for excretion.

### ETIOLOGY

Most cases of nephrosis are caused by the direct action of toxins, but hemodynamic changes may contribute to the pathogenesis.

#### Toxins

- Metals: mercury, arsenic, cadmium, selenium, and organic copper compounds; nephrosis can be reproduced experimentally in horses by the oral administration of potassium dichromate and mercuric chloride, including topical blistering agents containing mercuric chloride
- Antimicrobials, such as aminoglycosides, and overdosing with neomycin and gentamicin in the treatment of calves; treatment with tetracycline preparations accidentally contaminated by tetracycline degradation compounds and repeated daily dosing with long-acting oxytetracycline preparations may induce toxicity; treatment with sulfonamides
- Horses treated with vitamin K3 (menadione sodium bisulfite) administered by IM or IV injection
- Horses treated with vitamin D2 (ergocalciferol) and cholecalciferol (D3)
- Treatment of horses with nonsteroidal antiinflammatory drugs (NSAIDs), including phenylbutazone and flunixin meglumine; dose rates of more than 8.8 mg/kg BW of phenylbutazone per day for 4 days are likely to cause nephrosis; doses of 4.4 mg/kg BW are considered to be safe, but toxicity is enhanced by water. The usual presentation of NSAID toxicosis in horses is gastrointestinal ulceration, including right dorsal colitis
- Ketoprofen in sheep at 30 mg/kg IV, once<sup>3</sup>; renal toxicity may be facilitated



by concomitant activation of the alternative complement pathway

- Benzimidazole compounds used as anthelmintics; only some of them but including thiabendazole
- Monensin in ruminants
- Low-level aldrin poisoning in goats
- Highly chlorinated naphthalenes
- Oxalate in plants
- Oxalate in fungi, e.g., *Penicillium* spp. and mushrooms
- Oxalate in ethylene glycol or ascorbic acid, which is a metabolic precursor to oxalate
- Primary hyperoxaluria caused by an inherited metabolic defect in Beefmaster calves
- Tannins in the foliage of oak trees and acorns
- Unidentified toxin in *Amaranthus retroflexus* in pigs, cattle, and lambs,<sup>2</sup> in *Nartheicum asiaticum* fed to cattle and *Isotropis forrestii* in ruminants
- Mycotoxins, such as ochratoxins and citrinins, fumonisins in ruminants
- Ingestion of *Lophyrotoma interrupta* (sawfly) larvae by cattle
- Cantharidin in horses following ingestion of dead blister beetles in alfalfa hay and hay products
- Most nonspecific endogenous or exogenous toxemias cause some degree of temporary nephrosis

### PATHOGENESIS

In acute nephrosis there is obstruction to the flow of glomerular filtrate through the tubules caused by interstitial edema and intraluminal casts. If there is sufficient tubular damage, there may be back leakage of glomerular filtrate into the interstitium. There may also be a direct toxic effect on glomeruli, which decreases glomerular filtration. The combined effect is oliguria and uremia. In subacute cases, impaired tubular resorption of solutes and fluids may lead to polyuria.

### CLINICAL FINDINGS

Clinical signs may not be referable to the urinary system. In peracute cases, such as those caused by vitamin K3 administered by injection, there may be colic and stranguria. In acute nephrosis there is oliguria and proteinuria with clinical signs of uremia in the terminal stages. These signs include depression, dehydration, anorexia, hypothermia, a slow or an elevated heart rate, and weak pulse. Diarrhea may be present that is sufficiently intense to cause severe clinical dehydration. In cattle there is a continuous mild hypocalcemia with signs reminiscent of that disease, which responds, in a limited way, to treatment with calcium. Cattle with advanced and severe nephrosis may exhibit a bleeding diathesis. Polyuria is present in chronic cases.

Many systemic diseases such as septicemia cause temporary tubular nephrosis. The

degree of renal epithelial loss is not sufficient to cause complete renal failure and, provided the degree of renal damage is small, complete function is regained.

### CLINICAL PATHOLOGY

In acute tubular nephrosis, urinalysis abnormalities are usually present before serum or plasma urea and creatinine concentrations are increased. Proteinuria, glucosuria, enzymuria, and hematuria are initial changes on urinalysis in experimental toxic nephrosis. The earliest indication of tubular epithelial damage in experimentally induced nephrosis is the detection of the proximal tubule enzyme GGT in urine. Hypoproteinemia may be present. In acute renal disease of horses, hypercalcemia and hypophosphatemia can be present, although this is not the usual finding. In the chronic stages the urine is isosthenuric and may or may not contain protein. Azotemia occurs when uremia is present. Ultrasonographically, renal changes are seen in foals receiving high daily doses of phenylbutazone.

### NECROPSY FINDINGS

In acute cases the kidney is swollen and wet on the cut surface and edema, especially of perirenal tissues, may be apparent. Histologically there is necrosis and desquamation of tubular epithelium, and hyaline casts are present in the dilated tubules. In phenylbutazone poisoning the renal lesion is specifically a renal medullary necrosis. There may also be ulcers in all or any part of the alimentary tract from the mouth to the colon if phenylbutazone was administered orally.

### TREATMENT

Treatment should be directed at general supportive care for acute renal disease as outlined earlier. If the toxin can be identified, it should be removed. Treatment for specific toxins may be available, as described elsewhere in the text. Hemodialysis was used successfully to treat a foal with presumed oxytetracycline nephrotoxicosis.

### DIFFERENTIAL DIAGNOSIS

Clinical differentiation from acute glomerulonephritis is difficult, but clinical signs of involvement of other organs in the toxic process may be present.

- A combination of polyuria and glycosuria is an uncommon finding in large animals and is usually caused by nephrosis.
- Diabetes mellitus is rare in horses and extremely rare in ruminants.
- Cushing's syndrome (chronic hyperadrenocorticism pituitary pars intermedia dysfunction) is more common in horses and includes characteristic signs of polyuria, glycosuria, debilitation, hirsutism, polyphagia, and hyperglycemia.
- Diarrhea in terminal stages of uremia in a horse can be confused with the other

causes of acute diarrhea. It requires a blood urea and creatinine estimation and a urinalysis for differentiation.

### FURTHER READING

Schmitz DG. Toxins affecting the urinary system. *Vet Clin North Am Equine Pract.* 2007;23:677-690.

### REFERENCES

1. Palviainen MJ, et al. *Acta Vet Scand.* 2015;57:15.
2. Kessell AE, et al. *Aust Vet J.* 2015;93:208.

### RENAL TUBULAR ACIDOSIS

Renal tubular acidosis (RTA) is a rare disease of large animals that is characterized by normal glomerular function but abnormal tubular function. RTA should be suspected whenever there is a hyperchloremic strong ion (metabolic) acidosis and normal anion gap with no discernible extrarenal cause<sup>1</sup>; it is important to note that a common extrarenal cause of hyperchloremic strong ion acidosis is aggressive IV administration of 0.9% NaCl. This means that extreme caution needs to be exercised when attempting to diagnose RTA in sick animals receiving IV fluids.

Four major types of tubular functional defect exist in humans: (1) **nephrogenic diabetes insipidus**, in which the collection ducts do not respond to ADH (vasopressin); (2) **distal RTA (type I)**, which is a defect in the ability to secrete hydrogen ions in the distal convoluted tubules against a concentration gradient (in humans, type III is now considered a variant of type I); and (3) **proximal RTA (type II)**, which is characterized by decreased bicarbonate reabsorption in the proximal convoluted tubules. A variant of proximal RTA that does not appear to have been reported in large animals is Fanconi's syndrome, which is a genetic defect in humans related to the tubular resorption of glucose, various amino acids, urate, and phosphate. (4) **hyperkalemic distal RTA (type IV)** is caused by the resistance of distal nephron cells to aldosterone, resulting in hyperkalemia, natriuresis, and the inability to concentrate urine. Type IV RTA has not been reported in domestic animals.

Only a small number of RTA cases have been documented in horses, and these have been predominantly distal RTA (type I). Differentiating between RTA type I and type II is difficult and unreliable in horses,<sup>1</sup> and a report exists of a horse that may have both types.<sup>2</sup> The urine of humans with proximal RTA (type II) is acidic, whereas the urine of humans with distal RTA (type I) is very alkaline, regardless of the serum bicarbonate concentration, but aciduria is rarely present in herbivores suspected to have proximal RTA (type II). There is one report of RTA in a lethargic 3-month-old calf with *Salmonella enterica* serovar Agona that was more consistent with RTA type I than type II. The calf responded to IV sodium bicarbonate.<sup>3</sup>

### Nephrogenic Diabetes Insipidus

This is a very rare condition with reports in three colts, of which two were related.<sup>1</sup> Clinical signs are chronic and extreme polydipsia and polyuria, poor body condition, and growth rate. Diagnosis in nonazotemic normally hydrated animals includes the inability to concentrate urine in response to IV hypertonic saline (7.5% NaCl, 1–2 mL/kg BW), which increases plasma osmolality and triggers release of ADH. Another diagnostic test is the administration of exogenous aqueous vasopressin (0.25–0.5 U/kg BW, IM) or desmopressin acetate (0.05 µg/kg, IV), a potent synthetic analog of vasopressin. An increase in urine specific gravity to greater than 1.025 within 2 hours is supportive of a diagnosis of central diabetes insipidus, and the failure to concentrate urine is supportive of a diagnosis of nephrogenic diabetes insipidus or medullary washout. Water deprivation can also be used, because it is expected to increase plasma vasopressin concentration.<sup>4</sup> Water deprivation typically rapidly dehydrates animals with nephrogenic diabetes insipidus, and their hydration status, BW, and urine specific gravity and volume should be monitored frequently.

Specific treatment protocols in horses with nephrogenic diabetes insipidus have not been identified but should focus on restricted water and sodium intake and the long-term administration of thiazide diuretics.

### Distal Renal Tubular Acidosis (Type I)

Horses with distal RTA (type I) have a profound strong ion acidosis caused by hyperchloremia (normal anion gap metabolic acidosis), hypokalemia, an alkaline urine pH (typically >8.0), and increased fractional clearance of sodium. A practical diagnostic test for distal RTA (type I) involves examining the ability of the distal convoluted tubules to excrete hydrogen ions by the oral administration of ammonium chloride (0.1 g/kg BW in 6 L of water via nasogastric tube).<sup>1,5</sup> Inability to achieve an acidic urine (pH <6.5) after oral ammonium chloride administration is consistent with a diagnosis of distal RTA (type I).

Treatment of horses and a calf with distal RTA (type I) has been symptomatic and focuses on oral or IV administration of sodium bicarbonate.<sup>3,5</sup> Spontaneous recovery has been reported in horses.

### Proximal Renal Tubular Acidosis (Type II)

The classic explanation for this disorder is a failure to reabsorb bicarbonate in the proximal tubules, resulting in excessive loss of bicarbonate in the urine and metabolic acidosis (decreased plasma bicarbonate concentration) but variable urine pH. Because the molecular basis for this defect has not been identified, it has been proposed that proximal RTA (type II) may result from channel dysfunctions of strong electrolytes

in proximal renal tubule cells.<sup>1</sup> Reabsorption of bicarbonate requires energy, therefore, disease processes that lead to proximal tubular damage have the potential to result in proximal RTA (type II).

A practical diagnostic test for proximal RTA (type II) in humans is measuring the change in urine  $PCO_2$  during oral or IV sodium bicarbonate administration, but this test does not appear to have been performed in horses. Normally, urine and plasma  $PCO_2$  are similar but, during bicarbonate diuresis, urine  $PCO_2$  becomes greater than plasma  $PCO_2$ . The urine to plasma  $PCO_2$  gradient during IV sodium bicarbonate administration is therefore measured; one horse with proximal RTA developed a urine to plasma  $PCO_2$  gradient of 29 mm Hg during bicarbonate loading. Treatment of horses with proximal RTA (type II) is uncertain.

### FURTHER READING

McKenzie EC. Polyuria and polydipsia in horses. *Vet Clin North Am Equine Pract.* 2007;23:641–653.

### REFERENCES

1. Arroyo LG, Stampfli HR. *Vet Clin North Am Equine Pract.* 2007;23:631.
2. van der Kolk JH, et al. *J Vet Intern Med.* 2007;21:1121.
3. Hardefeldt LY, et al. *Vet Clin Pathol.* 2011;40:253.
4. Brashier M. *Vet Clin North Am Equine Pract.* 2006;22:219.
5. Gull T. *Vet Clin North Am Equine Pract.* 2006;22:229.

### HEMOLYTIC UREMIC-LIKE SYNDROME

Glomerular and tubulointerstitial disease, consistent with profound microangiopathy and glomerular degeneration in humans with hemolytic-uremic syndrome, has been diagnosed in two horses. Both horses were in oliguric renal failure and had clinicopathologic evidence of intravascular hemolysis and morphologic evidence of arteriolar microangiopathy and intravascular coagulation. The mortality rate is expected to be extremely high. The pathogenesis in horses is unclear, although hemolytic-uremic syndrome in humans is caused by toxins produced by *E. coli* O157:H7.

### HYDRONEPHROSIS

Hydronephrosis is a dilatation of the renal pelvis with progressive atrophy of the renal parenchyma. It occurs as a congenital or an acquired condition following obstruction of the urinary tract. Any urinary tract obstruction can lead to hydronephrosis, but the extent and duration of the obstruction are important in determining the severity of the renal lesion. Urinary tract obstructions that are chronic, unilateral, and incomplete are more likely to lead to hydronephrosis. Acute obstructions of bladder or urethra that are corrected promptly are not usually associated with significant kidney damage. As a result,

recurrence of the obstruction rather than renal failure is the major sequel to urolithiasis in ruminants. In cases of acute complete obstruction the clinical picture is dominated by signs of anuria, dysuria, or stranguria.

Chronic or partial obstructions cause progressive distension of the renal pelvis and pressure atrophy of the renal parenchyma. If the obstruction is unilateral, the unaffected kidney can compensate fully for the loss of function and the obstruction may not cause kidney failure. Unilateral obstruction may be detectable on palpation per rectum of a grossly distended kidney. Chronic bilateral obstructions, although they are rare in large animals, can cause chronic kidney failure. Hydronephrosis and chronic renal failure have been recorded in a steer suffering from chronic partial obstruction of the penile urethra by a urolith. Partial obstruction of the ureters by papillomas of the urinary bladder has been recorded in a series of cows. Compression by neoplastic tissue in cases of enzootic bovine leukosis may also cause hydronephrosis. Ultrasonography can be used as an aid to diagnosis.

### INTERSTITIAL NEPHRITIS

Interstitial nephritis is rarely recognized as a cause of clinical disease in farm animals, although it is a frequent postmortem finding in some species. Interstitial nephritis may be diffuse or have a focal distribution. In calves, focal interstitial nephritis (white-spotted kidney) is a common incidental finding at necropsy but does not present as a clinical urinary tract disease. Focal interstitial nephritis of cattle is not associated with leptospirosis or active bacterial infection. In pigs, diffuse interstitial nephritis is observed following infection by *Leptospira* sp. and is important clinically because of the resultant destruction of nephrons that occurs. The kidney is an important reservoir for *Leptospira* spp. in other species, particularly cattle, but renal disease is not a common clinical problem in carrier animals.

Chronic interstitial fibrosis is a common postmortem finding in horses suffering from chronic renal failure. This is thought to represent an end-stage condition rather than primary interstitial disease. The initiating cause of the renal disease is usually not evident, but most cases are thought to begin with acute tubular nephrosis. Horses with chronic interstitial nephritis have the clinical syndrome of chronic renal failure with uremia.

Chronic interstitial nephritis with diffuse zonal fibrosis (CINF) occurs in Japanese Black cattle (Wagyu) as an autosomal recessive disorder leading to death before puberty. Clinically there is growth retardation between 3 and 5 months of age. A genome-wide scan using microsatellite markers in a Wagyu pedigree segregated for CINF mapped the CINF locus to bovine chromosome 1.

## EMBOLIC NEPHRITIS

Embolic lesions in the kidney do not cause clinical signs unless they are very extensive, in which case septicemia may be followed by uremia. Even though embolic nephritis may not be clinically evident, transient proteinuria and pyuria may be observed if urine samples are examined at frequent intervals.

### ETIOLOGY

Embolic suppurative nephritis or renal abscess may occur after any septicemia or bacteremia when bacteria lodge in renal tissue.

Emboli may originate from localized septic processes such as

- Valvular endocarditis, in all species
- Suppurative lesions in uterus, udder, navel, and peritoneal cavity in cattle or be associated with systemic infections such as:
  - Septicemia in neonatal animals, including *Actinobacillus equuli* infection in foals and *E. coli* septicemia in calves
  - Erysipelas in pigs and *C. pseudotuberculosis* in sheep and goats
  - Septicemic or bacteremic *Streptococcus equi* infection in horses

### PATHOGENESIS

Bacterial emboli localize in renal tissue and cause the development of focal suppurative lesions. Emboli can block larger vessels and cause infarction of portions of kidney, with the size varying with the caliber of the occluded vessel. Infarcts are not usually so large that the residual renal tissue cannot compensate fully and they usually cause no clinical signs. If the urine is checked repeatedly, the sudden appearance of proteinuria, casts, and microscopic hematuria, without other signs of renal disease, suggests the occurrence of a renal infarct. The gradual enlargement of focal embolic lesions leads to the development of toxemia and gradual loss of renal function. Clinical signs usually develop only when multiple emboli destroy much of the renal parenchyma, or when there are one or more large infected infarcts.

### CLINICAL FINDINGS

Usually there is insufficient renal damage to cause signs of renal disease. Signs of toxemia and the primary disease are usually present. The kidney may be enlarged on rectal examination. Repeated showers of emboli or gradual spread from several large, suppurative infarcts may cause fatal uremia. Spread to the renal pelvis may cause signs similar to pyelonephritis. Large infarcts may cause bouts of transient abdominal pain.

### CLINICAL PATHOLOGY

Hematuria and pyuria are present in embolic nephritis, but microscopic examination may

be necessary to detect these abnormalities when the lesions are minor. Proteinuria is present but is also normally present in neonatal animals in the first 30 to 40 hours of life. Culture of urine at the time when proteinuria occurs may reveal the identity of the bacteria infecting the embolus. Hematology usually reveals evidence of an acute or chronic inflammatory process.

### NECROPSY FINDINGS

In animals that die of intercurrent disease, the early lesions are seen as small gray spots in the cortex. In later stages these lesions may have developed into large abscesses, which may be confluent and in some cases extend into the pelvis. Fibrous tissue may surround long-standing lesions, and healed lesions consist of areas of scar tissue in the cortex. These areas have depressed surfaces and indicate that destruction of cortical tissue has occurred. Extensive scarring may cause an obvious irregular reduction in the size of the kidney.

### TREATMENT

General information on treatment of urinary tract infections was presented earlier. Antimicrobials should be selected on the basis of quantitative urine culture and susceptibility testing. In treating septicemic neonatal animals, particular care must be taken to avoid the use of potentially nephrotoxic drugs. Antimicrobial treatment should be continued for a fairly lengthy period (7–14 days). In embolic nephritis, the primary disease and the renal disease must be controlled to prevent recurrence of the embolic lesions. In neonatal animals this may involve treatment for septic shock. The urine culture should be repeated at intervals after treatment is completed to ensure that the infection has been completely controlled.

### DIFFERENTIAL DIAGNOSIS

Differentiation from pyelonephritis is difficult unless the latter is accompanied by signs of lower urinary tract infection such as cystitis or urethritis. The kidney is enlarged in both conditions, and the findings on urinalysis are the same when embolic nephritis invades the renal pelvis. Many cases of embolic nephritis go unrecognized clinically because of the absence of overt signs of renal involvement.

Severely dehydrated neonatal animals may experience prerenal uremia and are susceptible to ischemic tubular nephrosis. The presence of other signs of sepsis should increase suspicion of the presence of embolic nephritis.

The sudden occurrence of bouts of acute abdominal pain in some cases of renal infarction may suggest acute intestinal obstruction, but defecation is usually unaffected and rectal examination of the intestines is negative.

## Infectious Diseases of the Kidney

### LEPTOSPIROSIS

#### SYNOPSIS

**Etiology** *Leptospira interrogans* (many distinct serovars) and *L. borgpetersenii* (many distinct serovars) are found.

**Epidemiology** Worldwide distribution, most commonly in warm, wet climates. Occurs in cattle, sheep and goats, pigs, and horses. Host-adapted (maintenance or reservoir) and non-host-adapted (accidental or incidental) leptospirosis is dependent on the response of each species to particular serovars. Prevalence of infection is greater than incidence of clinical disease. Transmission by urine of infected animals; some wildlife species may transmit to cattle. Ground surface moisture is the most important factor for persistence of the organism; major zoonosis.

**Signs** Acute, subacute, and chronic forms; there is fever, acute hemolytic anemia, changes in milk, stillbirths, abortion in all species (especially pigs), weak neonates, infertility, milk drop syndrome, and periodic ophthalmia (recurrent uveitis in horse).

**Clinical pathology** Demonstration and/or culture of organism in blood, urine, cervicovaginal mucus, body fluids, and tissues. Serologic tests, primarily macroscopic agglutination test, and ELISA and DNA probes are done.

**Lesions** Anemia, jaundice, hemoglobinuria, serous hemorrhages, autolysis of aborted fetuses, fetal hepatitis, and nephritis are observed.

**Diagnostic confirmation** Culture or demonstrate organism in body fluids or tissues, and there are high serum titers.

**Treatment** Antimicrobials used to treat acute infection and eliminate leptospiruria.

**Control** Antimicrobials are used to eliminate carriers; vaccination is done with vaccines containing serovars that are causing the disease in that geographic area.

### ETIOLOGY

Leptospire, which are spirochetes pertaining to the family Leptospiraceae are the causative agents of leptospirosis. They are motile, gram-negative, obligate aerobic microorganisms with an optimal growth temperature of 28°C to 30°C (82.4°F–86°F). The organism is characterized by its distinctive hooked ends. The genus *Leptospira* was initially divided into two species: *L. interrogans* sensu lato, which comprised the pathogenic strains, and *L. biflexa* sensu lato, comprising all saprophytic strains of the organism.<sup>1</sup> Within the



two *Leptospira* spp., different serovars are differentiated based on the **cross-agglutination absorption test (CAAT)**. For this classification two strains are considered different if, after cross-absorption with adequate amounts of heterologous antigen, 10% or more of the heterologous titer regularly remains in either of the two antisera. The serovar is considered the basic systematic unit for *Leptospira* spp., and antigenically related serovars are grouped into serogroups. Currently over 250 pathogenic serovars and 24 pathogenic serogroups are recognized.<sup>1</sup> However, the CAAT is cumbersome and time-consuming to perform and few diagnostic laboratories are able to perform it. Isolated strains are therefore not routinely identified at the serovar but only at the serogroup level, which can be determined by means of the microagglutination test (MAT). Serogroups have no taxonomic status, but are convenient for application such as diagnosis and epidemiology.

With molecular typing techniques becoming more available the taxonomy of *Leptospira* spp. has been reorganized based on genomic DNA-DNA hybridization, and the pathogenic strains previously comprised in the *Leptospira interrogans* sensu lato complex are now divided into 13 different species based on DNA hybridization studies. These are *L. alexanderi*, *L. alstonii*, *L. borgpetersenii*, *L. inadai*, *L. interrogans* (sensu stricto), *L. fainei*, *L. kirschneri*, *L. licerasiae*, *L. noguchi*, *L. santarosai*, *L. terpstrae*, *L. weilii*, and *L. wolffii*. However, the correlation between the serologic and the genotypic classification is poor, which makes the taxonomy of *Leptospira* spp. confusing. Not only can pathogenic and saprophytic strains be part of the same genotypic species, but a single serovar and serogroup can also pertain to different genotypic species. So are the antigenically similar serovars *Hardjo-bovis* and *Hardjo-prajitno* (serogroup *Hardjo*) now classified into two different genotypic species, which are *L. borgpetersenii* (for serovar *Hardjo-bovis*) and *L. interrogans* (sensu stricto, for serovar *Hardjo-prajitno*). The novel molecular classification is often conceived as impractical by clinical microbiologists, which is the reason the serologic taxonomy is still widely used.<sup>2</sup>

## EPIDEMIOLOGY

### Risk Factors

#### Animal Risk Factors

##### *Serovars and Species Susceptibility*

The epidemiology of leptospirosis is most easily understood by classifying the disease into two broad categories: **host-adapted** and **non-host-adapted** leptospirosis. An animal infected with a host-adapted species of the organism, is a “**maintenance**” or “**reservoir**” host. Exposure of susceptible animals to non-host-adapted serovars results in **accidental** or **incidental disease**. Each *Leptospira* species is adapted to one or a few particular **maintenance host(s)**, although it may cause disease in any mammalian species. The

organism is maintained in nature by chronic infection of renal tubules of maintenance hosts.<sup>2</sup>

A specific species behaves differently within its maintenance host species than it does in other, incidental or accidental hosts. A **maintenance host** is characterized by

- A high susceptibility to infection
- Endemic transmission within the host species through direct contact
- Relatively low pathogenicity for its host
- A tendency to cause chronic rather than acute disease, producing insidious economic loss through reproductive losses
- Persistence of the strain in the kidney and sometimes the genital tract with chronic excretion of the pathogen in urine
- Prevalence of chronic excretion in urine increases with age
- A low antibody response to infection, with difficulties in diagnosis

Examples of this relationship are serovar Bratislava in swine, and serovar Hardjo-bovis in cattle. In contrast, an **incidental host** is characterized by

- Relatively low susceptibility to infection but high pathogenicity for the host
- A tendency to cause acute, severe rather than chronic disease
- Sporadic transmission within the host species and acquisition of infection from other species, sometimes in epidemic form
- A short kidney phase
- A marked antibody response to infection, making for ease of diagnosis
- An example of this relationship is serovar Pomona (*kennewicki*) infection in cattle.

Some common leptospiral serovars and their maintenance hosts are seen in [Box 13-9](#).

Serovar	Maintenance hosts
Hardjo:	Cattle
Bratislava:	Pig, horse
Pomona ( <i>kennewicki</i> ):	Pig, cattle, skunk, raccoon, opossum
Grippotyphosa:	Raccoon, opossum, squirrel, vole
Icterohaemorrhagiae:	Rat
Canicola:	Dog

Some common leptospiral serovars and their accidental hosts are seen in [Box 13-10](#).

Serovar	Accidental hosts
Hardjo:	Sheep, man
Grippotyphosa:	Sheep, cattle, pig
Bratislava:	Horse
Icterohaemorrhagiae:	Cattle, pig, horse

Calves and lambs are highly susceptible to infection, and septicemia is likely to occur.

### Pathogen Risk Factors

The mechanisms through which leptospires cause host tissue damage and disease are currently not well understood. Virulent strains were found to adhere to cultured renal tubular epithelial cells, and adhesion is enhanced by subagglutinating concentrations of homologous antibody because they are commonly found in infected maintenance hosts. The corresponding **adhesin** allowing this attachment has not been identified.<sup>3</sup> Leptospires are phagocytosed by macrophages and neutrophils in the presence of specific antibody and complement but are resistant to complement and killing in nonimmune hosts. Virulent strains were found to attach to neutrophils without being killed, suggesting that the outer membrane of such strains may possess an antiphagocytic component.<sup>2</sup>

There is no unequivocal evidence for a classical exotoxin that would be secreted by *Leptospira* spp., but the outer membrane of the organism contains a **lipopolysaccharide (LPS or endotoxin)** that resembles the standard gram-negative LPS chemically and immunogenically. However leptospiral LPS was found to be considerably less potent than LPS from gram-negative bacteria in standard tests for endotoxin activity such as the rabbit pyrogenicity or the mouse lethality test.<sup>3</sup> Leptospiral LPS possesses an antiphagocytic component and stimulates adherence of neutrophils to endothelial cells and platelets causing aggregation and suggesting a role in the development of thrombocytopenia.<sup>2</sup> In mice, apoptosis of lymphocytes is elicited by LPS via induction of tumor necrosis factor- $\alpha$  (TNF- $\alpha$ ).<sup>2</sup>

Along with LPS, the leptospiral outer cell membrane contains several **outer membrane proteins (OMPs)** that are highly immunogenic. Indeed an inverse association between the expression of OMPs and virulence has been demonstrated for the serovar grippotyphosa. Downregulation of the expression of OMPs reduces the humoral immune response, facilitating the evasion from the host's immune system.

Some virulent strains were found to produce either cell-associated or extracellular sphingomyelinases, a class of substances that functions as **hemolysin**. Furthermore, these strains exhibit chemotaxis toward hemoglobin. The presence of a specific antibody prevents hemolysis.

### Environmental and Management Risk Factors

The prevalence of a specific leptospiral serovar depends on the availability of a maintenance host species, which can be a domestic or wildlife species.

The occurrence of indirect disease transmission through contaminated soil, water, or other fomites is determined by a number of

environmental factors. *Leptospira* spp. can survive for prolonged periods in a moist environment at warm temperatures (optimal around 28°C (82°C) and neutral or mildly stagnant water. In contrast, survival is impaired at temperatures below 10°C (50°F) or above 35°C (95°F) or on dry soil. **Ground surface moisture and water** is the most important factor governing the persistence of the organism in bedding or soil; it can persist for as long as 183 days in water-saturated soil but survives for only 30 minutes when the soil is air dried. In soil, under average conditions, survival is likely to be at least 42 days for *L. Pomona*. It survives in free, surface water for long periods; the survival period is longer in stagnant than in flowing water, although persistence in the latter for as long as 15 days has been recorded. Contamination of the environment and capacity of the organism to survive for long periods under favorable conditions of dampness may result in a high incidence of the disease on heavily irrigated pastures, in areas with high rainfall and temperate climate, in fields with drinking water supplies in the form of easily contaminated surface ponds, and in marshy fields and muddy paddocks or feedlots. Numerous outbreaks of leptospirosis have occurred following heavy rainfall events and floods.<sup>4</sup> Stagnant waters have been incriminated as a possible source of infection in pastured animals in tropical regions.<sup>5</sup> Exposure of humans, pets, or livestock to rodents and rats that are adapted hosts for certain serovars (e.g., *Icterohaemorrhagiae* or *Grippityphosa*) has been shown to be an important risk factor for infection in many species.<sup>4</sup>

**Certain management factors** have been identified that pose risks of *L. Hardjo* infection being introduced into dairy herds:

- Purchase of infected cattle
- Cograzing or common grazing with infected cattle or sheep
- Purchase or loan of an infected bull
- Access of cattle to contaminated water supplies such as streams, rivers, flood, or drainage water

### Occurrence and Prevalence of Infection

Leptospirosis is a disease affecting most animal species, including humans, and has a worldwide occurrence. It is considered the most common bacterial zoonosis worldwide with increasing incidence in industrialized and developing countries and has been classified as a reemerging infectious disease of humans, particularly in tropical and subtropical regions.<sup>6</sup> Leptospirosis has a higher prevalence in tropical and subtropical regions with seasonal occurrence. Peaks in disease incidence are observed during the warm months of the year in temperate climates and during the rainy season in the tropics.<sup>4</sup> Although more than 250 pathogenic serovars have been identified, generally few serovars prevail in a particular

region, which largely depends on the presence of an adapted host species. Most leptospiral infections are subclinical, and infection is more common than clinical disease.

Numerous infection prevalence studies have been published for different species in different geographic regions. Reported values are, unfortunately, not easy to compare because some studies are based on serology, whereas others determine the occurrence of bacterial DNA in urine or renal tissue. Furthermore, there is no consensus on the criteria for positive or negative serology, and cutoff values for seropositivity differ between studies. It is generally assumed that serologic studies tend to underestimate the infection prevalence because isolation of bacterial DNA from seronegative individuals was commonly reported in different animal species.<sup>7-9</sup> The occurrence and infection prevalence of leptospirosis will be discussed for different animal species.

Serologic surveys of cattle in the African continent reveal evidence of antibodies against numerous leptospiral serovars and some previously not described strains of serovars. In West Africa, serosurveys of dairy herds revealed 45% of cattle were positive to one or more serovars, which probably represented natural infection because vaccination had not been practiced.

Leptospirosis is common in farm animals in Portugal. Outbreaks of clinical disease have been recorded in cattle and pigs, in sheep and goats and, to a lesser extent, in horses. In Italy, serologic surveys indicate that sheep, horses, pigs, and dogs have the highest number of positive responses.

### Cattle

Serovars of *Leptospira* spp. of major importance in cattle include *L. Hardjo* and *L. Pomona*. Depending on the geographic region other serovars such as *Icterohaemorrhagiae*, *Grippityphosa*, and *Bratislava* may occur with considerable prevalence. The serovar ***L. Hardjo*** is adapted to cattle, and **cattle are the only maintenance host** for this serovar. The serovar *Hardjo* of which two types, *Hardjo-bovis* and *Hardjo-prajitno*, are recognized has been split into two separate genospecies. Serovar *Hardjo* type *Hardjo-bovis* is now classified in the genospecies *L. borgpetersenii* serovar *Hardjo*, and serovar *Hardjo*, type *Hardjo-prajitno* now belongs to the genospecies *L. interrogans* serovar *Hardjo*. *L. borgpetersenii* serovar *Hardjo* (formerly serovar *Hardjo-bovis*) occurs worldwide, whereas *L. interrogans* serovar *Hardjo* (formerly *Hardjo-prajitno*) has been isolated primarily from cattle in the UK.

*Hardjo* and *Pomona* are the most prevalent serovars in the cattle population of North and South America, Australia, and New Zealand; in Europe, *Hardjo* is the most prevalent serovar in cattle.<sup>10</sup> Seroprevalences among cattle in the United States were

estimated with 29% for serovar *Hardjo*, 23% for serovar *Pomona*, 19% for serovar *Icterohaemorrhagiae*, and 11% for serovar *Canicola*.<sup>10</sup> Seroprevalence surveys in Ontario found *Hardjo* was most common in beef cattle, whereas *Pomona* was most common in dairy cattle. In Prince Edward Island, 14% of dairy cows were serologically positive for serovar *Hardjo*. Serologic surveys of cattle farms in Alberta found infection with *Hardjo* was widespread across the province, and the prevalence has increased. In contrast, *Pomona* reactors were found usually on single premises within a locality compared with the clustering of *Hardjo* reactor herds. Surprisingly, the seroprevalence of unvaccinated beef cattle kept on community pastures in western Canada was 9.6% for serovar *Pomona*, 6.7% for serovar *Grippityphosa*, 6.1% for serovar *Icterohaemorrhagiae*, and 5.2% for serovar *Canicola* but only 0.2% for serovar *Hardjo*.<sup>11</sup>

In beef cattle in Queensland, Australia, the major serovars in order of decreasing crude seroprevalence were *Hardjo* (15.8%), *Tarassovi* (13.9%), *Pomona* (4.0%), and *Szwajzak* (2%). Vaccinates were not included in the *Hardjo* and *Pomona* seroprevalence; and the seroprevalence for *Hardjo* and *Pomona* tended to increase with the age of the animals. The data indicate that serovars other than *Hardjo*, *Pomona*, and *Tarassovi* are unlikely to have a significant role in bovine infertility, and cattle are unlikely to be a source of human infection in central Queensland. In New Zealand, a seroprevalence rate in beef cattle of 40% for serovar *Hardjo* and 7% for serovar *Pomona* has been reported.<sup>12</sup>

The morbidity rate for clinical disease may vary from 10% to 30%, depending on the clinical manifestation of infection, and the case-fatality rate is usually low at about 5%. The case-fatality rate in calves is much higher than in adult cattle. A high rate of abortions (up to 30%) and loss of milk production are the major causes of loss, but deaths in calves may also be significant.

Recent serologic studies from Europe revealed comparatively low seroprevalence rates in dairy cattle below 1.6% in dairy cattle in Sweden and Bosnia-Herzegovina.<sup>13,14</sup> The most prevalent serovars in Bosnia-Herzegovina were *Pomona*, followed by *Hardjo* and *Grippityphosa*; in Sweden cattle were found to be free of serovar *Hardjo*. In a serologic survey of dairy cows conducted in herds with suboptimal reproductive efficiency in a region in Spain, *L. Bratislava* and *L. Grippityphosa* were the most prevalent serovars. The risk of seroconversion against *L. Grippityphosa* was higher during the spring season, whereas *L. Bratislava* did not differ among seasons. The prevalence of *L. Hardjo* was low, which indicates that the reproductive inefficiency was unassociated with *Hardjo*. In surveys of dairy and beef cattle in Spain, *L. Bratislava* is the most

frequently detected serovar, whereas Hardjo is at a relatively low seroprevalence compared with similar studies in western European countries.

In Spain, serovars Grippotyphosa, Tarassovi, and Copenhageni are more frequent in dairy herds, probably related to management practices and geographic location of these herds, which facilitate the contact with maintenance hosts for these serovars.

In Turkey, *L. Hardjo* is the dominant serovar identified in serologic surveys of cattle, but *L. Grippotyphosa* is the dominant serovar causing clinical disease in cattle, the disease is uncommon in sheep.

In South Africa a seroprevalence of leptospirosis in cattle originating from communal grazing areas of 19.4% has been reported. Although serovar Pomona was most prevalent (22%), a wide variety of other serovars including Tarassovi (19%), Bratislava (15%), Canicola (13%), Hardjo (13%), Icterohaemorrhagiae (12%), Szwajizak (4%), and Grippotyphosa (2%) were common.<sup>15</sup>

### Farmed Deer

Leptospirosis is a well-established clinical disease in farmed deer in New Zealand. Slaughterhouse surveys of farmed deer in New Zealand found serologic evidence of serovar Hardjo in 73.6%, Pomona in 41.5%, Copenhageni in 11.3%, and Tarassovi in 15.1% of farms.

A more recent study reported a herd seroprevalence of 42% for serovar Hardjo alone, 7% for serovar Pomona alone, and 23% for serovars Hardjo and Pomona combined. The individual animal seroprevalence was reported with 21% tested for serovar Hardjo alone, 9% for serovar Pomona alone, and 4% for both serovars.<sup>12</sup> Because of the high prevalence of serovar Hardjo in farmed deer in New Zealand, it has been proposed that farmed deer may function as maintenance hosts for this serovar.<sup>16</sup>

### Sheep and Goats

The disease in sheep and goats has been reported in many countries. Reported prevalences range from 5% to 42%. Predominant serovars isolated in Australia and Italy included Castellonis, Poi, Sejroe, Hardjo, Copenhageni, and Cynopteri.<sup>17,18</sup> In Guyana, serovars Pomona, Grippotyphosa, Hardjo, and Bratislava, and in Trinidad serovars Copenhageni and Autumnalis were predominant.<sup>19,20</sup> Infection with *L. Hardjo* occurs but is unlikely to be a source of infection for cattle herds. Sheep are not natural maintenance hosts for pomona or hardjo and are likely to have infections of relatively short duration, producing severe pathologic effects. However, persistent leptospiruria caused by Hardjo in sheep in which no contact with cattle has occurred suggests that sheep may be a maintenance host for this serovar. This could complicate control of Hardjo infection in cattle,

which are free of this serovar, and infected sheep are a potential zoonotic risk to abattoir workers, sheep farmers, and shearers, which previously had not been considered. Infection with serovar Hardjo is widespread in Merino stud rams in South Australia.

Seroprevalences reported for goats range among 2.1% in northern Italy, over 13.1% in Nigeria, and 20.8% in Brazil,<sup>17,21,22</sup> which involved Icterohaemorrhagiae and Copenhageni serovars.

### Pigs

Leptospira serovars most common in pigs are Bratislava, for which this species is the maintenance host, and Pomona, and grippotyphosa; less common serovars include Icterohaemorrhagiae, Canicola, and Hardjo. In infected herds the prevalence of positive serologic reactors is high, and in large infected pig populations it is about 20%. In Iowa, 38% of sera from National Animal Health Monitoring System herds were positive for 1 or more of 12 serovars. The most common serovar antibodies found in pigs in Prince Edward Island swine herds were *L. Icterohaemorrhagiae*, *L. Bratislava*, *L. Autumnalis*, and *L. Pomona*. In Trinidad an individual animal seroprevalence of 5% with a farm prevalence of 33.3% has been reported. Predominant serovars were Bratislava of the Australis serogroup (2.0%) and members of the Icterohaemorrhagiae serogroup (2.5%).<sup>19</sup>

The Australis serogroup of leptospires is now important because of an increasing awareness that antibodies to Bratislava are widespread in the pig populations of many countries, the recovery of Lora, Muenchen, and Bratislava from pigs, and the involvement of Bratislava and Muenchen in reproductive problems of swine herds. All of the pig isolates of the Australis serogroup have been identified as either Bratislava or Muenchen, and there are also differences at the subserovar level, which may be important in understanding the epidemiology of the Australis serogroup, the development of efficacious vaccines, and the pathogenesis of disease. Economic losses are about equally divided between abortions and deaths of weak and unthrifty newborn pigs. Infection of pigs at slaughter is associated with multifocal interstitial nephritis, which results in condemnation of kidneys.

Swine are affected by several leptospiral serovars, and the clinical signs often associated with these infections include poor reproductive performance. Seropositive sows have a greater risk of weak newborn pigs and have more weak newborn piglets per litter. In some areas suboptimal reproductive performance was associated with certain serovars, such as Grippotyphosa, and not others, such as Autumnalis, Bratislava, Pomona, and Icterohaemorrhagiae.

Pigs in intensive housing present a different problem from those in more

conventional housing or at pasture. In large pig units the possibility for cross-infection is high because of high population density. The movement of pigs from pen to pen and access to effluent from other pens are the critical means of spread in these circumstances. The spread of infection within piggeries is encouraged by mixing infected pigs with uninfected pigs, which results in epidemics within the pens. Transmission from infected to susceptible grower pigs occurs continuously in grower houses, with a constant proportion of pigs becoming infected each week. Introduction onto a farm may be via an imported boar; boars are frequently found to harbor leptospires in the genital tract. Leptospira were found commonly in the kidneys of slaughter fattening pigs in Vietnam but are not considered to be the cause of the white-spotted kidneys of pigs.

### Horses

Although the precise prevalence of infection in horse populations of different geographic regions is not known, serologic evidence suggests leptospiral infection is common in horses. Predominant serovars occurring in this species include the serovars Bratislava, Pomona, Icterohaemorrhagiae, and Grippotyphosa. Because of the relatively frequent occurrence of *L. Bratislava*, horses are thought to be maintenance hosts for this serovar.

Serologic surveys of Thoroughbred and Standardbred horses in Ontario revealed a higher prevalence of Bratislava, which increased with age. In a survey of horses in Alberta, titers to *L. Icterohaemorrhagiae*, Bratislava, Copenhageni, and Autumnalis were common (94.6, 56.6, 46.5, and 43.5%, respectively). The prevalence to other serovars ranged from 0.8% to 27.2%. The probability of being seropositive increased by approximately 10% with each year of life. Horses managed as individuals (e.g., race-track horses) were about half as likely to be seropositive as those managed in groups (e.g., rodeo horses).

A Swedish study determined a seroprevalence of 16.6% for Bratislava, 8.3% for Icterohaemorrhagiae, 1.2% for Sejroe, 0.5% for Pomona, and 0.4% for Grippotyphosa. An increase of the seroprevalence with age was found for serovars Bratislava and Icterohaemorrhagiae.<sup>23</sup> A bacteriologic survey of kidneys from abattoir horses in Portugal found serogroups *L. australis* and *L. pomona*, which were identified as *L. Bratislava*, and *L. kirschneri* serovar Tsaratsovo, respectively.

Rodent exposure was associated with risk of exposure to all serovars. Management was associated positively with the risk of exposure to serovars Pomona and Bratislava, but not with risk of exposure to Autumnalis. Soil and water had a positive association with risk of exposure to Pomona and Autumnalis but not to Bratislava. The wildlife index value and the population density of horses turned out



together were associated with risk of exposure to *Autumnalis*. For the serovar Bratislava a Swedish study reported highest seroprevalences from April to June and from October to December and for serovar *Icterohaemorrhagiae* from October to December.<sup>23</sup>

### Economic Importance

Leptospirosis is not only considered the most important bacterial zoonosis worldwide but also presents a major cause of economic loss in farm animals. The majority of leptospiral infections are subclinical and associated with fetal infections causing abortions, stillbirths, and the birth of weak neonates with a high death rate in cattle, sheep, horses, and pigs. In cattle, epidemics of abortions, infertility, and increased culling rate cause major economic losses. Epidemics of agalactia in dairy herds (the **milk drop syndrome**) are associated with infection with *L. hardjo*.

### Zoonotic Implications

Leptospirosis is probably the most prevalent zoonotic disease in the world predominantly affecting tropical and subtropical regions. It is now recognized as an emerging, potentially epidemic disease associated with excess rainfall in tropical settings, representing a significant public health hazard. Most recent outbreaks were reported from Nicaragua in 2007, Sri Lanka in 2008, and the Philippines in 2009.<sup>24</sup>

Annual incidences of clinical leptospirosis vary greatly with highest rates on the Seychelles (43.2/100,000 population), Trinidad and Tobago (12/100,000), Barbados (10/100,000), Jamaica (7.8/100,000), and Costa Rica (6.7/100,000).<sup>25</sup> In the United States the Centers for Disease Control and Prevention estimate that between 100 and 200 clinical cases are diagnosed every year (0.1/100,000), half of which are in Hawaii. In Europe, the highest incidence rates have been reported from Croatia (1.7/100,000), Portugal (0.7/100,000), Denmark (0.6/100,000), and Slovenia (0.5/100,000).

Although most cases of leptospiral infection are asymptomatic or only associated with mild clinical disease, mortality in humans remains significant, particularly in developing countries because of delays in diagnosis caused by lack of diagnostic infrastructure and adequate clinical suspicion when patients are presented for medical diagnosis and care. The overall case-fatality rate ranges between 1% and 5%, depending on the clinical presentation and the age of the patient. The icteric form of the disease, which occurs in 5% to 10% of all patients, has an overall mortality of 5% to 15%, whereas mortality rates of over 50% have been reported in cases with myocardial involvement. Mortality is higher in the elderly.<sup>26</sup>

Leptospirosis can be prevented through appropriate hygiene, sanitation, and animal husbandry. It is essential to educate people

working with animals or animal tissues about measures for reducing the risk of exposure to such zoonotic pathogens as leptospira.

Humans are considered to be purely incidental hosts for leptospirae and have rarely been implicated in spreading the disease.<sup>27</sup> Leptospirosis is an important zoonosis and is an occupational hazard to butchers, farmers, hunters, pet traders, rodent catchers, veterinarians, and sewer workers. In recent decades the epidemiology has undergone major changes, with a shift away from the traditional occupational disease in developed countries to a disease associated with recreational exposures. Human infection is most likely to occur by contamination with infected urine or uterine contents. Veterinarians may become infected by handling the tissues and urine of sows that have aborted from pomona infection. Although leptospirae may be present in cow's milk for a few days at the peak of fever in acute cases, the bacteria do not survive for long in the milk and are destroyed by pasteurization. However, farm workers who milk cows are highly susceptible to *L. interrogans* serovar Hardjo infection, and one New Zealand survey found 34% of milkers were seropositive, mostly to *L. interrogans* serovar Hardjo, but a high proportion were also positive to *L. interrogans* serovar Pomona. This has aroused alarm, and leptospirosis became known as "New Zealand's No.1 dairy occupational disease." A campaign of vaccination of dairy cattle across the country resulted in a marked decrease in the incidence of the disease in humans. In most situations, dogs, cats, and horses are unlikely to contribute to human infection.

The epidemiology of leptospirosis in New Zealand has been changing. The annual incidence of human leptospirosis in New Zealand from 1990 to 1998 was 4.4 per 100,000. Incidence was highest among meat-processing workers (163/100,000), livestock farm workers (91/100,000), and forestry-related workers (24/100,000). The most commonly detected serovar was ballum (11.9%). The annual incidence of leptospirosis declined from 5.7/100,000 from 1990 to 1992 to 2.9/100,000 from 1995 to 1998. The incidence of serovar Hardjo and serovar Pomona infection declined, whereas the incidence of serovar Ballum infection increased. The increasing incidence of serovar Ballum suggests changing transmission patterns via direct or indirect exposure to contaminated water.

Veterinary students may be exposed to leptospirosis by taking courses in food inspection and technology, on-farm clinical work experiences, contact with pets (especially carnivores), and contact with animal traders. In a 1-year period, the seroprevalence of leptospirosis in veterinary students in a veterinary school in Spain increased from 8.1% to 11.4%. The incidence of the disease during the study was 0.039.

### Methods of Transmission

The source of infection is an infected animal that contaminates pasture, drinking water, and feed by infective urine, aborted fetuses, and uterine discharges. All of the leptospiral types are transmitted within and between species in this way. A viable infected neonate can harbor the infection for several weeks after birth. The semen of an infected bull may contain leptospirae, and transmission by natural breeding or artificial insemination can occur but is uncommon. In rams, the semen is likely to be infective for only a few days during the period of leptospiremia; in boars there is no evidence of coital transmission. *L. interrogans* serovar Hardjo is excreted from the genital tract of aborting cows for as long as 8 days after abortion or calving and is detectable in the oviducts and uterus for up to 90 days after experimental infection and in naturally infected cows. It may also be present in the genital tract of bulls, and venereal spread of the infection is possible. Young pigs may act as carriers for 1 year and adult sows for 2 months. Because of the high intensity and long duration of the infection in pigs, they play an important role in the epidemiology of leptospirosis.

### Leptospiuria

**Urine is the chief source of contamination** because animals, even after clinical recovery, may shed leptospirae in the urine for long periods. All animals that have recovered from infection may intermittently shed organisms in the urine and act as "carriers." In cattle, leptospiuria may persist for a mean period of 36 days (10–118 days) with the highest excretion rate in the first half of this period. Sheep and horses are not common sources of infection because of low-grade and intermittent leptospiuria. In any species, the leptospirae may persist in the kidney for much longer periods than they can be recovered from the urine by routine laboratory methods. Urine drinking by calves is not an uncommon form of pica in some dairy herds and is a means of transmission.

### Wildlife as Source of Infection

Although surveys of the incidence of leptospirosis in wildlife have been conducted and the pathogenic effects of *L. Pomona* on some species (particularly deer and skunks) have been determined, the significance of wildlife as a source of infection for domestic animals is uncertain. Variable rates of seroprevalence to leptospirae have been documented in white-tailed deer, mule deer, pronghorns, moose, red deer, and elk. There is a high prevalence of infection in feral pigs, and in wild brown rats trapped on farms in the UK the prevalence of *L. icterohaemorrhagiae* and Bratislava was about 14%. *L. Canicola* is known to spread from domestic dogs and jackals to cattle and, when hygiene is poor, even from humans to cattle. The serovar Bratislava has been associated with severe

interstitial nephritis in raccoons in a recreational area in Quebec, which were also serologically positive to Pomona, Hardjo, and Grippotyphosa.

The expanding wild boar population in urban and suburban areas has been incriminated as a possible source of infection for humans, domestic animals, and livestock in some countries. Infection prevalence rates in wild boars have been reported from Japan and Germany with 15.2% (positive polymerase chain reaction [PCR] on kidney tissue) and 18% (serology), respectively.<sup>26,27</sup> The most prevalent serovars in the German study were Pomona and Bratislava; in the Japanese study the predominant genospecies were *L. interrogans* and *L. borgpetersenii*.

### Portal of Entry of Organism

Entrance of the organism into the body occurs most probably through cutaneous or mucosal abrasions. Transplacental transmission is uncommon, but neonatal infection in utero has occurred. Oral dosing is an unsatisfactory method for experimental transmission compared with injection and installation into the nasal cavities, conjunctival sac, and vagina.

### PATHOGENESIS

Leptospirosis manifests itself as a disease in several different ways. Leptospire invade the host across mucosal surfaces or softened skin. They have the ability to bind to epithelial cells and attach to the constituents of the extracellular matrix through an active process involving surface proteins. Pathogenic leptospire are found extracellularly between cells of the liver and kidney. Release of lymphokines such as TNF- $\alpha$  from monocytes through the endotoxic activity of the leptospiral LPS may be an important virulence mechanism. Induction of TNF- $\alpha$  release may help explain the damage to endothelial cells with resultant hemorrhage seen in severe leptospirosis.

Leptospirosis can occur as an acute and severe disease caused by septicemia with evidence of endotoxemia such as hemorrhages, hepatitis, nephritis, meningitis; as a subacute moderately severe disease with nephritis, hepatitis, agalactia, and meningitis; or as a chronic disease characterized by abortion, stillbirth, and infertility. In the occult form, there is no clinical illness. The form of the disease depends largely on the species of the host as set out in Table 13-2. Variations between serotypes of *L. interrogans* in their pathogenicity also affect the nature of the signs that appear. For example, in *L. Pomona* infections, intravascular hemolysis and interstitial nephritis are important parts of the disease. However, *L. Hardjo* does not produce hemolysin and does not cause interstitial nephritis, but it does cause clinical infection in sexually mature, lactating or pregnant females. Thus infection occurs in the pregnant uterus and lactating mammary

**Table 13-2** Forms of leptospirosis in the animal species

VetMed10	Acute form	Subacute form	Chronic form
Cattle	+	+	+
	(Calves only)		(Abortion)
Sheep and goat	+	–	–
	(Includes abortion)		
Pig	+	–	+
	(Rarely and only in piglets)		(Abortion)
Horse	–	+	+
			(Abortion and periodic ophthalmia)

gland resulting in septicemia, abortion, and mastitis. The pathogenesis of the disease associated with *L. Pomona* is set out as follows.

### Acute Form

After penetration of the skin or mucosa, the organisms multiply in the liver and migrate to, and can be isolated from, the peripheral blood for several days until the accompanying fever subsides. At this time, serum antibodies begin to appear and organisms can be found in the urine.

### Septicemia, Capillary Damage, Hemolysis, and Interstitial Nephritis

During the early period of septicemia, sufficient hemolysin may be produced to cause overt hemoglobinuria as a result of extensive intravascular hemolysis. This is an unlikely event in adult cattle but is common in young calves. If the animal survives this phase of the disease, localization of the infection may occur in the kidney. Hemolysis depends on the presence of a serovar that produces hemolysin. Capillary damage is common to all serovars and during the septicemic phase petechial hemorrhages in mucosae are common. Vascular injury also occurs in the kidney and if the hemolysis is severe, anemic anoxia and hemoglobinuric nephrosis may occur. There is some evidence that the leptospiral LPS may exacerbate the vascular lesions. The infection localizes in the renal parenchyma, causing an interstitial nephritis, and persistence of the leptospire in these lesions results in prolonged leptospiuria. The renal lesion develops because the infection persists there long after it has been cleared from other tissue sites. In the acute phase of the disease, the animal may die of septicemia or hemolytic anemia or both. Subsequently, the animal may die of uremia caused by interstitial nephritis.

Focal chronic interstitial nephritis, also called white-spotted kidney, is a common finding in clinically healthy cattle at slaughter and has frequently been assumed to be related to current or prior infection with *Leptospira* spp. However, studies of white-spotted kidney in cattle at the abattoir indicate that neither *Leptospira* spp. nor active infection by other bacteria are associated with the lesions.

### Abortion

Following systemic invasion, abortion may occur because of fetal death, with or without placental degeneration. Abortion usually occurs several weeks after septicemia because of the time required to produce the changes in the fetus, which is usually autolyzed at birth. Abortion occurs most often in the second half of pregnancy, probably because of the greater ease of invasion of the placenta at this stage, but may occur at any time from 4 months on. Although abortion often occurs in both cattle and horses after either the acute or the subacute form of the disease, abortion without prior clinical illness is also common. This is particularly the case in sows and occurs to a lesser extent in cows and mares; this may be from degenerative changes in the placental epithelium. Leptospire are rarely present in the aborted fetuses; however, if the aborted fetus has survived the infection long enough to produce antibodies, these may be detectable.

Experimental infection of serologically negative pregnant cattle with a north Queensland strain of *L. borgpetersenii* serovar Hardjo resulted in seroconversion and shedding of the organism in the urine. Elective cesarean sections were done 6 weeks after challenge. There was no evidence of *L. Hardjo* infection of the fetuses. Some of the fetuses had histopathologic lesions consistent with *Neospora* sp. infection.

### Encephalitis

Localization of leptospire in nervous tissue is common in sheep and goats and may result in the appearance of signs of encephalitis.

### Subacute and Occult Forms

In the subacute form, the pathogenesis is similar to that of the acute septicemic form, except that the reaction is less severe. It occurs in all species, but the common form is found in adult cattle and horses. Occult cases, with no clinical illness but with rising antibody titers, are common in all animals. These are difficult to explain but may be associated with strains of varying pathogenicity, but with leptospirosis, characteristically, differences between groups may be associated with prior immune status,

environmental conditions, or number of carriers in relation to severity of exposure.

### Periodic Ophthalmia (Recurrent Uveitis) in the Horse

There is some evidence of a causal relationship between leptospiral infection and periodic ophthalmia in the horse. The incidence of serologically positive reactors is higher in groups of horses affected with periodic ophthalmia than in normal animals. Agglutinins are present in the aqueous humor in greater concentration than in the serum. Serologic surveys indicate that leptospira infection is not a major factor in the etiology of equine anterior uveitis in the UK, but serologic evidence of Pomona is associated with uveitis in horses in the United States. The opacity in both cornea and lens is a consequence of the antigenic relationship between leptospira and components of the ocular tissues and does not require the presence of living bacteria. A 52-kDa protein appears to be involved in the antigenic relationship between the leptospira and equine ocular tissues and is located inside the bacterium. The uveitis alters the composition of the aqueous humor and impedes the nutrition of the ocular structures, leaving sequelae such as iris atrophy, synechia, and corneal opacity.

Retinal immunopathology in horses with uveitis has been described and may be a primary immunologic event in equine uveitis, providing evidence that leptospira-associated uveitis may be a distinct subset of equine uveitis.

### Pulmonary Hemorrhage

Respiratory manifestation of leptospirosis associated with severe respiratory distress, pulmonary hemorrhage, and high case fatality has been described in humans, dogs, and horses.<sup>28-30</sup> The pathogenesis of this clinical presentation only occurs in a small subset of infected patients and is poorly understood. Endothelial damage of small pulmonary blood vessels and fibrin deposition along alveolar walls have been reported as consistent findings. Furthermore, lung lesions were found to be associated with the expression of TNF and endothelial nitric oxide synthase in experimentally induced leptospirosis in hamsters, suggesting a role of local or systemic inflammatory mechanism in the pathogenesis of this pulmonary form of the disease.<sup>33</sup> Immune-mediated mechanisms have also been proposed as a possible cause for pulmonary hemorrhage, but corroborating evidence is not yet available.

### Immune Mechanisms

Following infection, specific antibodies are induced that opsonize leptospira, facilitating their elimination from most parts of the body. However, leptospira that reach the proximal renal tubules, genital tract, and mammary glands appear to be protected from circulating antibodies. They persist and

multiply in these sites and may be excreted and transmitted to susceptible, in-contact animals, primarily by urine. Furthermore, and of major importance, the level of serum antibody commonly declines to undetectable levels in animals that are persistently infected.

The first serologic response with *L. Hardjo* infection is the production of immunoglobulin M (IgM) antibodies. These rise rapidly but usually decline to undetectable concentrations by 4 weeks after infection. Within 1 to 2 weeks of infection, IgG<sub>1</sub> antibodies appear, and at 3 months they represent 80% of antibodies detected in the MAT. The MAT titer peaks 11 to 21 days after infection but may vary from 1:3200 to an undetectable concentration. It declines gradually over 11 months, but the persistence is variable. Vaccination induces antibodies that are mainly of the IgG class with levels peaking at 2 weeks after a two-dose vaccination but decreasing rapidly to levels lower than those after natural infection. Approximately 95% of vaccinated heifers do not have MAT antibodies 20 weeks after the second of two vaccinations given 4 weeks apart, but the absence of titers is not necessarily an indication that protection has waned. Vaccinated animals are protected from natural challenge for many months after their MAT titers become undetectable. The serologic response of calves vaccinated at 3 months of age is lower than those vaccinated at 6 months of age because of the presence of maternal antibody. Transfer of passive immunity antibodies to newborn calves occurs via the colostrum, and the antibodies persist in the calves for 2 to 6 months.

Although antibodies against leptospiral LPS give passive protection in some animal models, cattle vaccinated against serovar hardjo with pentavalent vaccines are vulnerable to infection with serovar hardjo despite the presence of high titers of anti-LPS antibody. It is now known that peripheral blood mononuclear cells (PBMCs) from cattle vaccinated with an *L. interrogans* serovar Hardjo vaccine, which protects against serovar Hardjo, proliferated in vitro in response to Hardjo antigens. Thus a cell-mediated immune response to serovar Hardjo is probably necessary for protection. A protective killed vaccine against serovar Hardjo induces a strong antigen-specific proliferative response by PBMC from vaccinated cattle 2 months after the first dose of vaccine. This response was absent from unvaccinated cattle. The mean response peaked by 2 months after completion of the two-dose vaccination regimen, and substantial proliferation was measurable in *in vitro* cultures throughout 7 months of the study period. Up to one-third of the PBMCs from vaccinated animals produced interferon gamma (IFN- $\gamma$ ) after 7 days in culture with antigen. One-third of the IFN- $\gamma$ -producing cells were gamma delta lymphocytes, with the remainder cells being CD4+ T

cells. Thus a very potent Th1-type immune response was induced and sustained following vaccination with a killed bacterial vaccine adjuvanted with aluminum hydroxide and the involvement of gamma delta T cells in the response. The induction of this Th1-type **cellular immune response** is associated with the protection afforded by the bovine leptospiral vaccine against *L. borgpetersenii* serovar Hardjo.

The immune response of naive and vaccinated cattle following challenge with a virulent strain of *L. borgpetersenii* serovar Hardjo has been examined. Beginning at 2 weeks after challenge, IFN- $\gamma$  was measured in antigen-stimulated PBMC cultures from nonvaccinated animals, although the amount produced was always less than that in cultures of PBMC from vaccinated animals. IFN- $\gamma$ <sup>+</sup> cells were also evident in antigen-stimulated cultures of PBMC from vaccinated but not from nonvaccinated animals throughout the postchallenge period. Naive and vaccinated animals had similar levels of antigen-specific IgG<sub>1</sub> following challenge; vaccinated animals had twofold more IgG<sub>2</sub>. It is evident that although infection may induce a type 1 response, it is too weak to prevent establishment of chronic infection.

### CLINICAL FINDINGS

The clinical findings in leptospirosis are similar in each animal species and do not vary greatly with the species of *Leptospira*, except that infection with *icterohaemorrhagiae* usually causes a severe septicemia. For convenience the various forms of the disease are described as they occur in cattle, and comparisons are made with the disease in other species. In all animals the incubation period is 3 to 7 days.

### Cattle

Leptospirosis in cattle may be subclinical, acute, subacute, or chronic and is most often associated with serovars hardjo or pomona.

### Acute Leptospirosis Associated With pomona

Calves up to 1 month old are most susceptible to the acute leptospirosis. The disease is manifested by septicemia, with high fever (40.5–41.5°C; 105–107°F), anorexia, petechiation of mucosae, depression, acute intravascular hemolysis with hemoglobinuria, jaundice, and pallor of the mucosae. Because of the ensuing anemia, tachycardia, loud heart sounds, and a more readily palpable apex beat are present; dyspnea is also prominent. The case-fatality rate is high, and if recovery occurs then convalescence is prolonged. In adult cattle, abortion caused by the systemic reaction may occur at the acute stage of the disease. Milk production is markedly decreased, and the secretion is thickened, red-colored, or may contain blood clots. The mammary gland is limp and soft. Mastitis as



part of leptospirosis has often been described in cattle and a high somatic cell count in grossly abnormal milk suggests mastitis, but these changes are caused by a general vascular lesion rather than local injury to mammary tissue. Severe lameness caused by synovitis is recorded in some animals and a necrotic dermatitis, probably caused by photosensitization, is recorded in others.

#### Subacute Leptospirosis Associated With *L. pomona*

The subacute form of leptospirosis differs from the acute form only in degree. Similar clinical findings are observed in a number of affected animals, but not all of the findings are present in the same animal. The fever is milder (39–40.5°C; 102–105°F), and depression, anorexia, dyspnea, and hemoglobinuria are common, but jaundice may or may not be present. Abortion usually occurs 3 to 4 weeks later. One of the characteristic findings is the marked drop in milk production and the appearance of bloodstained or yellow-orange, thick milk in all four quarters without apparent physical change in the udder.

#### Chronic Leptospirosis Associated With *L. pomona*

The clinical findings in the chronic form of leptospirosis are mild and may be restricted to abortion. Severe “storms” of abortions occur most often in groups of cattle that are at the same stage of pregnancy when they are exposed to infection. The abortions usually occur during the last trimester of pregnancy. Apart from the abortion, there is no depression of reproductive efficiency in cattle affected by leptospirosis. Many animals in the group develop positive MATs without clinical illness.

There are occasional reports of leptospiral meningitis in cattle. In coordination, excessive salivation, conjunctivitis, and muscular rigidity are the common signs.

#### Leptospirosis Associated With *L. hardjo*

**Infertility and milk drop syndrome** occurs only in pregnant or lactating cows because the organism is restricted to proliferation in the pregnant uterus and the lactating mammary gland. There is a sudden onset of fever, anorexia, immobility, and agalactia. The milk is yellow to orange and may contain clots. The udder is flabby, there is no heat or pain, and all four quarters are equally affected. The sudden drop in milk production may affect up to 50% of cows at one time and cause a precipitate fall in the herd's milk yield. The decline may last for up to 8 weeks but an individual cow's milk production will return to normal within 10 to 14 days. The milk may have a high leukocyte count, which subsides over a period of about 14 days as milk production returns. In some cases, there is no evidence of mastitis, no change in the consistency of the milk, and no changes in the

udders of affected cows, but leptospiruria may be present in up to 30% of affected cows.

The herd fertility status incorporating the first service conception rate, the number of services per conception for cows conceiving, the calving-to-conception interval, and the culling rate usually reveals a low reproductive performance, especially during the year of the diagnosis. The effect is also temporary and not easily detected. Exposure of nonvaccinated dairy cows to *L. Hardjo* can be associated with a subsequent reduction in fertility, as indicated by a greater time from calving to conception and a higher number of breeding times per conception.

**Abortion** may occur **several weeks after the initial infection** and may also occur as the only evidence of the disease; in some areas or circumstances it is the principal clinical manifestation of leptospirosis caused by serovar *Hardjo* and the principal cause of abortion in cattle. In others it is thought to be an uncommon cause of abortion. This may be related to different strains of the serotype or to the degree to which the disease has become enzootic. Thus outbreaks of milk yield drop and systemic illness appears to be the characteristic clinical picture when the disease first appears in an area. However, as natural immunity develops in adult cows only heifers become newly infected, and the only sign is abortion. Furthermore, many cows have subclinical infections with *hardjo* in which only a fall in milk yield may be detectable.

#### Pigs

*Leptospira* serovars *Pomona* and *Bratislava* are the most common causes of infection, and chronic leptospirosis is the most common form of the disease in pigs. Pigs are the maintenance host for serovar *Bratislava*, which generally does not cause clinical disease other than reproductive failure, including occasional abortions and stillbirths. Serovar *Pomona* is of intermediate pathogenicity for pigs and is characterized by abortion and a high incidence of stillbirths. Acute disease may be observed in young pigs infected with serovar *Pomona*. Clinical signs include fever, anorexia, hemolytic anemia with hemoglobinuria, and jaundice. In an infected herd, the rearing rate may fall as low as 10% to 30%. An abortion “storm” may occur when the disease first appears in a herd, but abortions diminish as herd immunity develops. Most abortions occur 2 to 4 weeks before term. Piglets produced at term may be dead or weak and die soon after birth. Serovar *Hardjo* may be a sporadic cause of reproductive disease. There was no association between infertility and antibodies to serovars *autumnalis* and *icterohaemorrhagiae*. *Icterohaemorrhagiae* infection causes septicemic leptospirosis with a high mortality rate.

#### Sheep and Goats

The disease is rare in sheep and goats so that good descriptions of the naturally occurring

disease in them are lacking; most affected animals are found dead, apparently from septicemia. Affected animals are febrile, dyspneic, snuffle, and hang their heads down. Some have hemoglobinuria, pallor of mucosae, and jaundice and die within 12 hours. Lambs, especially those in poor condition, are most susceptible. The chronic form may occur and is manifested by loss of bodily condition, but abortion seems to be almost entirely a manifestation of the acute form when the infection is *pomona*. With *Hardjo*, abortion has been recorded as the only clinical sign, and oligolactia and agalactia, similar to the bovine milk drop syndrome, have been observed in lactating ewes.

#### Horses

Although clinical leptospirosis in horses is uncommon, serologic surveys suggest that subclinical infection frequently occurs. These serologic studies revealed that *bratislava* is among the most prevalent serovars in the horse population in many countries, and it has been proposed that horses are the reservoir host for this serovar, which is rarely associated with clinical disease. Clinical leptospirosis is in most cases caused by serovars *Pomona* and *Grippotyphosa* and is associated with abortions, stillbirths, severe systemic disease in foals, intravascular hemolysis, renal and liver disease, and recurrent uveitis.

#### Abortion

*L. interrogans* serovar *Pomona* is a major cause of abortions and stillbirths in the equine population. The gestational ages at which abortion occurs ranges from 140 days to full-term mean (250 days) and typically follows 2 to 3 weeks after an episode of mild clinical illness with fever, anorexia, and in rare instances with jaundice.

#### Periodic Ophthalmia

Recurrent uveitis in horses (**periodic ophthalmia, moon blindness, or recurrent iridocyclitis**) is a late complication of systemic leptospirosis in horses with signs beginning months to years after naturally acquired or experimentally induced infection. It is often associated with infection with *L. interrogans* serovar *Pomona*. Clinically there are recurrent episodes of ocular disease including photophobia, lacrimation, conjunctivitis, keratitis, a pericorneal corona of blood vessels, hypopyon, and iridocyclitis. Recurrent attacks usually terminate in blindness in both eyes. There is a strong relationship between uveitis and leptospiral seroactivity in horses. Seropositive horses with uveitis are at increased risk of losing vision, compared with seronegative horses with uveitis, and Appaloosas are at an increased risk of developing uveitis and associated blindness, compared with that in non-Appaloosas. The disease has been produced experimentally by

producing infection with Pomona. Infection with pomona in foals has been observed in association with *Rhodococcus equi* to cause a very heavy mortality rate. The foals died of a combination of interstitial nephritis and uremia and pulmonary abscessation and chronic enteritis. Leptospirosis has been suspected as a cause of renal dysfunction in a horse and hematuria and leptospiruria described in a foal.

Nonulcerative keratouveitis associated with leptospiral infection has been described in horses. Photophobia, epiphora, and blepharospasm are common. Hyperemia of the bulbar conjunctiva, edema of the paralimbal cornea, pupillary block, and iris bombe are also present. As the disease progresses, there may be hyphema, hypopyon, and organized fibrin in the anterior chamber, miosis, and dyscoria caused by posterior synechiae, and the cornea may become opaque and vascularized. The cornea retains no fluorescein dye.

### Neonatal Foal Disease

Acute leptospirosis in foals is the most severe form of the disease in horses characterized by vasculitis with petechial hemorrhages and intravascular hemolysis with hemoglobinuria, jaundice, and anemia. Renal failure, severe hepatopathy, and severe pulmonary hemorrhage have been reported in some instances.<sup>32</sup>

## CLINICAL PATHOLOGY

### General Considerations

Laboratory procedures used in the diagnosis of leptospirosis include culture or detection of leptospire or leptospiral DNA in blood or body fluids and detection and measurement of antibody in blood and body fluids such as urine, CSF, and cervicovaginal mucus. Culture of leptospire is laborious and can take up to 13 weeks. Serologic and microbiologic detection of chronically infected animals is difficult, as is the confirmation of leptospirosis as a direct cause of reproductive losses in a herd. A positive diagnosis of leptospirosis in individual animals is often difficult because of the variation in the nature of the disease, the rapidity with which the organism dies in specimens once they are collected, and their transient appearance in various tissues. During the septicemic stage, leptospirae are present only in the blood and there may be laboratory evidence of acute hemolytic anemia and increased erythrocyte fragility and often hemoglobinuria. A leukopenia has been observed in cattle, and in other species there is a mild leukocytosis. However, the only positive diagnostic measure at this stage of the disease is culture of the blood. If abortion occurs, the kidney, lung, and pleural fluid of the aborted fetuses should be examined for the presence of the organism. Serologic testing at the time of abortion is often unreliable because the acute titers have already peaked and are declining.

In the stage immediately after the subsidence of the fever, antibodies begin to develop and the leptospirae disappear from the blood and appear in the urine. The leptospiruria is accompanied by albuminuria of varying degrees and persists for varying lengths of time in the different species.

The diagnosis of leptospirosis is much easier on a herd basis than in a single animal, because in an infected herd some animals are certain to have high titers and the chances of demonstrating or isolating the organism in urine or milk are increased with samples being taken from many animals. On the other hand, in a single animal, depending on when the infection occurred, the titer may have declined to a low level and be difficult to interpret. This becomes particularly important for the clinician confronted with a diagnosis of abortion caused by leptospirosis in which the infection may have occurred several weeks previously and the serum may be negative or the titers too low for an accurate interpretation. Examination of the urine may be useful in these cases, but intermittent shedding of the pathogen by chronically infected animals must be taken into account.

### Serologic and Related Tests

Acute and convalescent sera taken 7 to 10 days apart should be submitted from each clinically affected animal, or from those with a history of abortion, and sera should also be taken from 15% to 25% of apparently normal animals. Ten blood samples should be taken from each of the yearlings, the first-calf dams, the second-calf dams, and the mature age group to determine the infection status across the herd. If possible, wildlife or rodents known to inhabit the farm and use nearby water supplies should be captured and laboratory examinations of their tissues and blood performed and the results compared with those obtained in the farm animals.

MAT is the most common serologic test for the diagnosis of leptospirosis. It is the reference test against which all other serologic tests are evaluated and is the prescribed diagnostic test for international trade.<sup>32</sup> It is a serogroup-specific test, and a serovar representative of each expected serogroup in the region should be tested. Although the MAT does not usually cross-react with antibodies against other bacteria, there is significant cross-reactivity between serovars and serogroups of *Leptospira*. Therefore, MAT cannot be used to definitively identify a serovar causing infection.<sup>32</sup>

In animals that survive infection, acute leptospirosis can readily be diagnosed on the basis of demonstrating a rising antibody titer against specific serovars in acute and convalescent sera. MAT is particularly useful in diagnosis of disease associated with incidental, non-host-adapted serovars or acute disease associated with host-adapted serovars. It is less useful in the diagnosis

of chronic disease in maintenance hosts, because antibody response to infection may be negligible in chronic infections or may persist from subclinical infections. In pigs, MAT has an adequate sensitivity for some serovars, such as pomona, but is insensitive to infection associated with bratislava. The herd serologic response to infection is often more helpful than the individual's response in chronic infections in maintenance hosts.

A major concern is the failure of the MAT to differentiate between titers after vaccination and those after natural infection because the titers may be of similar magnitude; however, titers after infection are generally higher and persist longer than vaccination titers. In any case, the vaccination history must be taken into account when interpreting positive MAT results.<sup>34</sup> MAT is not a measure of immunity to infection because vaccination results primarily in an IgG response, with low (1:100–1:400) and transient (1–4 months) titers, but immunity is common in vaccinated animals long after MAT titers are negative. There is no consensus on the appropriate cutoff value for seropositivity; a MAT titer of  $\geq 1:100$  is frequently considered positive, and a fourfold rise in titer on a paired sample taken 2 weeks apart is diagnostic. In abortion associated with incidental serovars, MAT titers against pomona and other incidental serovars are high, often  $\geq 1:3000$ . Paired sera are of limited value in chronic infections or in cases of aborting cattle because abortion occurs after infection and titers are static or declining. If several aborting cows have high titers ( $\geq 1:300$ ), this is evidence for the diagnosis of leptospirosis in unvaccinated herds.

The antibody enzyme-linked immunosorbent assay (ELISA) test is sensitive but lacks the serovar specificity of the MAT.<sup>34</sup> It has convenient technical features including automation and can be used efficiently as a screening test for large numbers of serum samples. ELISA can be useful for detection of recent infection (IgM) before agglutinating antibodies (IgG) are present, but it is of limited use in regions where vaccination with leptospiral vaccine is common practice.<sup>34</sup> Specific ELISAs for IgM or IgG antibodies are available. A positive IgM-specific ELISA result can therefore indicate that infection occurred within the previous month. For a diagnosis of leptospiral abortion in cattle, a titer of 1:3000 is proposed as the threshold for Pomona, but no similar critical figure is available for Hardjo. ELISAs have also been developed for the use in milk of individual cows or in bulk milk to detect antibodies against serovar Hardjo.

An indirect ELISA has been developed for the detection of bovine antibodies to multiple *Leptospira* serovars including Canicola, Copenhageni, Grippotyphosa, Hardjo, Pomona, and Sejroe.

An antibody capture ELISA is available to detect antibodies to a protective LPS

fraction of *L. borgpetersenii* serovar Hardjo in cattle.

An ELISA has been used to detect a specific antibody to *L. Hardjo* in the cervicovaginal mucus as early as 2 weeks after natural or experimental infection and may reach high levels after 8 weeks. This may show some promise in diagnosis but has not yet been evaluated.

A commercially available ELISA and the **ImmunoComb Leptospirosis Kit**, which detect *L. hardjo* antibodies, have been compared with the MAT. The ImmunoComb and ELISA tests both exceeded the positive results obtained with the MAT. The ImmunoComb is very simple and quick, requiring no sophisticated equipment.

### Aqueous Humor Antibody

Measurement of aqueous humor antibody titers against leptospire in horses offers a more accurate means of establishing a diagnosis of leptospiral-associated uveitis than serology alone.

### Demonstration or Culture of Organism

A number of tests are available to detect leptospire or leptospiral DNA in tissues or body fluids.

### Culture of Urine

Of all the laboratory diagnostic tests for leptospirosis, the examination of urine samples for the organism probably offers the best opportunity to demonstrate the presence of infection. Failure to demonstrate the presence of *Leptospira* in a urine sample does not rule out chronic infection because intermittent shedding is common. In individual animals, negative tests on three consecutive weekly urine samples has been considered to be good evidence that the animal is not a chronic renal carrier.<sup>34</sup> Collection of urine following treatment with a diuretic such as furosemide was found to increase the chances of detecting the organism in voided urine.<sup>34</sup> Treatment with antimicrobials in the recent past decreases the chances to recover the pathogen from urine of a chronically infected patient. For maximum efficiency, one-half of each urine sample should be submitted with added formalin (1 drop to 20–30 mL of urine) and the other half submitted in the fresh state. The formalin prevents bacterial overgrowth, and the fresh urine sample may be used for culture. A liquid culture medium of 1% bovine serum albumin solution containing 5-fluorouracil at 100 to 200 µg/mL should be used as transport medium.<sup>34</sup> *Leptospira* are fastidious and slow growing and culture requires incubation on special growth media for at least 16 and preferably 26 weeks.<sup>34</sup> The time required for detection varies with the serovar and the number of organisms present in the sample.

Examination of urine using **dark-field microscopy or fluorescent antibody test** are useful tests. The fluorescent antibody test is more sensitive than dark-field microscopy, detects degenerated as well as intact leptospire, and may be serovar specific.

*Leptospira* in tissue can be identified by a variety of **immunochemical staining** techniques, such as immunofluorescence, or by various immunohistochemical techniques. These immunostain techniques are rapid and can be performed on material unsuitable for culture but require a minimum amount of bacterial antigen. Because the number of *Leptospira* present in tissue of chronically infected animals is low and often localized these methods are less suitable to identify chronic carrier states.<sup>34</sup>

**PCR-based assays** provide rapid and sensitive diagnostic techniques for detection of leptospiral DNA in body fluids and tissues. A variety of primers are used, some of which are only specific for the genus *Leptospira* and others designated to identify only pathogenic species. These PCR assays do not identify the infecting serovar, although it is possible to identify a specific species by sequencing the PCR amplicons.<sup>34</sup> Detection of leptospiral DNA with PCR-based assays in urine was found to be highly sensitive and specific to identify chronically infected and shedding cattle and horses. Several studies reported a considerable number of seronegative individuals that were *Leptospira* positive by urine PCR.<sup>7-9</sup> A multiplex PCR is highly sensitive for detection of the organism in aborted bovine fetuses. Using a *Leptospira* PCR assay, *L. kirschneri* has been identified as a potential cause of abortion in a fetal foal born on a farm with a history of repeated abortions. Further confirmation of *L. kirschneri* was done by DNA sequence analyses of the PCR-amplified DNA fragment.

Using PCR to detect the presence of *Leptospira* DNA, 70% of horses with uveitis were positive for *Leptospira* DNA, and 28% were culture positive for leptospire from the aqueous humor; only 6% of horses free of uveitis used as controls were positive. The serologic results did not correlate well with the presence of *Leptospira* DNA or organisms in the aqueous humor.

### NECROPSY FINDINGS

Acute bovine leptospirosis is characterized by anemia, jaundice, hemoglobinuria, and subserosal hemorrhages. There may be ulcers and hemorrhages in the abomasal mucosa. Pulmonary edema and emphysema are also common in this species. Histologically, there is focal or diffuse interstitial nephritis and centrilobular hepatic necrosis and in some cases, there are vascular lesions in the meninges and brain in subacute to chronic infections. Leptospirae may be visible in silver-stained sections, especially in the proximal convoluted tubules of the kidney. In acute infections, there may be minimal

inflammation, with only hemoglobin-filled renal tubules and centrilobular hepatic necrosis evident microscopically.

In the later stages, the characteristic finding is a progressive interstitial nephritis manifested by small, white, cortical foci that are initially raised but become slightly depressed as the lesion ages. Many clinically normal cattle presented to abattoirs have these lesions, which may represent sequela to episodes of bacteremia from a variety of pathogens and should not be considered pathognomonic for leptospirosis.

Aborted bovine fetuses are usually autolyzed to the point where no lesions or bacteria can be demonstrated. Even in a fresh fetus the positive identification of leptospirae in lesions is not an easy task. Culture of these organisms is difficult, and *L. interrogans* serovar Hardjo is particularly fastidious in its cultural requirements. The use of a fluorescent antibody technique assists in the demonstration of organisms, but false positives are common unless the test is interpreted by an experienced diagnostician. Dark-field microscopy may be attempted but is not well suited to tissues collected at necropsy. PCR techniques show considerable promise, although sample processing requirements are stringent, and the use of multiple primer sequences may be required in some cases. Immunoperoxidase techniques are highly useful in the demonstration of leptospirae in formalin-fixed tissues, although this test is not serovar specific. Traditional silver-based staining of fixed material is also successful in a few cases. Antibodies to leptospirae are detectable in the serum of some aborted fetuses.

Gross placental lesions in cases of equine abortion and stillbirth associated with leptospirosis include nodular cystic allantoic masses, diffuse edema, and areas of necrosis with a mucoid exudate on the chorionic surface. The liver is enlarged, mottled, and pale-red to yellow. The kidneys are swollen and edematous with pale, radiating streaks in both cortex and medulla. Microscopic changes may include a suppurative and non-suppurative nephritis, dissociation of hepatocytes, a mixed leukocytic infiltration of portal triads, a giant cell hepatopathy, pneumonia, and myocarditis. Thrombosis, vasculitis, and a mixed population of inflammatory cells are evident in the placenta. A variety of tests, as described for cattle, are available to try to confirm the diagnosis.

Aborted piglets are usually severely autolytic, with bloodstained fluid in the subcutis and filling the body cavities. Multiple necrotic foci, 1 to 4 mm in diameter and irregular in outline, are found in the liver of approximately 40% of aborted fetuses. Microscopic inflammatory changes may also be found in the kidneys. The fetal membranes are thick and edematous. Leptospirae can be demonstrated using the battery of tests already mentioned for cattle.



## Samples for Confirmation of Diagnosis

- **Bacteriology:** chilled kidney, liver, placenta [CULT (has special growth requirements), fluorescent antibody test [FAT], PCR]
- **Histology:** formalin-fixed kidney, liver, brain, heart, lung, placenta (LM, immunohistochemistry [IHC])
- **Serology:** heart-blood serum or pericardial fluid from fetus (MAT, ELISA).

The zoonotic potential of this organism should be noted when handling carcasses and submitting specimens.

### DIFFERENTIAL DIAGNOSIS

The differential clinical diagnosis of the common forms of leptospirosis in each species is as follows.

#### Cattle

- Acute leptospirosis: Must be differentiated from those diseases causing hemolytic anemia with or without hemoglobinuria (Table 13-3), which include babesiosis, anaplasmosis, rape and kale poisoning postparturient hemoglobinuria, and bacillary hemoglobinuria.
- Chronic leptospirosis causing abortion: Must be differentiated from all other causes of abortion in cattle; most diagnostic surveys reveal that a specific cause is identifiable in only about 30% of fetuses submitted to a diagnostic laboratory. The vaccination history of the aborting cattle is a crucial part of the history since, for example, outbreaks of abortions caused by infectious bovine rhinotracheitis occur primarily in unvaccinated cows. The specific causes of abortion in cattle vary depending on geographic location. Other common causes of abortion in cattle include infectious bovine rhinotracheitis and protozoal abortion (*Sarcocystis* sp., *Toxoplasma gondii*, and *Neospora caninum*). Less common causes are brucellosis, bovine viral diarrhea, pine needle abortion, mycotic placentitis, campylobacter, ureaplasma, and possibly mycoplasma.
- Milk drop syndrome: Characterized by a sudden drop in milk yield in up to 30%-50% of the cows within several days. Must be differentiated from other causes of a decline in milk production of the herd including (1) change of feed, (2) change of management, and (3) epidemic of infectious disease such as bovine respiratory disease.

#### Sheep and goats

Chronic copper poisoning and poisoning caused by rape in sheep may present a clinical picture similar to that in leptospirosis, but there will be no febrile reaction. Anaplasmosis associated with *Anaplasma ovis* may be accompanied by fever and hemoglobinuria

but is more commonly a chronic, emaciating disease.

#### Horses

- Abortion, stillbirths, and perinatal deaths of foals: Causes include *Streptococcus zooepidemicus*, *Salmonella abortusovae*, *Escherichia coli*, and *Actinobacillus equuli*. Other bacterial infections include equine herpes virus, equine viral arteritis, and fungal infections. Diagnosis depends on laboratory examination of fetal tissues and fluids including bacterial culture, direct fluorescent antibody test for equine herpes virus and leptospires, serologic examination of fetal fluids for leptospiral antibodies using the microagglutinin test, and special stains to demonstrate leptospires in fetal tissues.
- Isoimmune hemolytic anemia: Within 36 hours after birth, there is weakness, hemoglobinuria, pallor, failure to suck, tachycardia, high case-fatality rate, and cross-matching blood tests.
- Infectious equine anemia: Symptoms include chronic relapsing fever, anemia, weakness, jaundice, edema, oral mucous membrane hemorrhages, and a Coggins serologic test is used for diagnosis.
- Exertional rhabdomyolysis: Symptoms include acute onset of stiff gait, weakness, sweating, distress, myoglobinuria, and creatine kinase test is used for diagnosis.
- Periodic ophthalmia: Differentiate from other causes of iridocyclitis of horses, and conjunctivitis, keratitis, and hypopyon, which may occur in equine viral arthritis.

#### Pigs

Abortion in the last trimester: The common manifestation of leptospirosis in pigs must be differentiated from all other causes of abortion, mummification, and stillbirths in swine. Other common causes of abortion in swine are parvovirus and porcine reproductive respiratory syndrome. Less common causes are brucellosis; pseudorabies; and the stillbirth, mummification, embryonic death, infertility virus.

### TREATMENT

Treatment objectives can be to treat individuals with clinical disease or to treat chronically infected animals that may be clinically normal but chronically or intermittently shedding leptospires in urine.

#### Antimicrobial Therapy

In vitro studies indicate that leptospires are highly susceptible to ampicillin, amoxicillin, penicillin G, cefotaxime, erythromycin, and fluoroquinolone ciprofloxacin and have a good susceptibility to streptomycin, tylosin, and tetracyclines.

For infections caused by pomona, dihydrostreptomycin (12 mg/kg IM twice daily for 3 days) is effective in the treatment of the systemic infection. For the elimination of leptospiruria in cattle and pigs, a single dose of dihydrostreptomycin (25 mg/kg IM)

has been recommended. In an outbreak in cattle, the simultaneous treatment of all animals with dihydrostreptomycin (25 mg/kg IM as single dose) and vaccination has been successful in preventing new cases and abortion when pregnant cattle are involved. A similar approach is recommended for outbreaks in swine. **Annual revaccination and regular serologic testing** for new infections, combined with controlling the source of new infections, will usually successfully control further outbreaks. A surveillance system in the area is necessary; however, to detect the introduction of new serotypes. The use of streptomycin/dihydrostreptomycin in food-producing animals has been discouraged because their administration, even at label dose, had the potential to lead to residue violations, and these substances are no longer available for the use in food-producing animals in some countries.<sup>35</sup> Oxytetracycline, amoxicillin, tilmicosin, and ceftiofur are also effective for resolving leptospirosis in cattle.

Dihydrostreptomycin G (25 mg/kg IM for 1 day, 3 days, or 5 days), or oxytetracycline (40 mg/kg IM daily for 3 days or 5 days), tylosin (44 mg/kg IM daily for 5 days), or erythromycin (25 mg/kg IM daily for 5 days) are all effective for treatment of persistent leptospirosis caused by Pomona in swine, although these dose protocols exceed label recommendations. In groups of pigs, the feeding of oxytetracycline (800 g/t of feed for 8–11 days) is claimed to eliminate carriers. Antimicrobial feeding should begin 1 month before farrowing to avoid the occurrence of abortion.

For outbreaks of **leptospirosis abortion in horses**, treatment of pregnant mares with dihydrostreptomycin (50 mg/kg) IM daily for 3 to 5 days can minimize further abortions; this treatment regimen, however, has not been extensively evaluated.

For **equine periodic ophthalmia**, most recommended treatments have little effect on the course of the disease. A course of a suitable antibiotic systemically, and the administration of a corticosteroid, either parenterally in an acute episode or subconjunctivally in a chronic case, is most likely to be satisfactory. Nonulcerative keratouveitis requires long-term and intensive medication and recurs with tapering of treatment. Topical and subconjunctival corticosteroids are recommended in controlling nonulcerative keratouveitis. Intravitreal implantation of cyclosporine is effective. Atropine eye ointment is also usually applied three times daily to maintain dilatation of the pupil.

#### Blood Transfusions

Blood transfusions (5–10 L/450 kg BW) are indicated as treatment for the hemolytic anemia in acute leptospirosis in cattle. The clinical indications for a blood transfusion include obvious pallor of the mucous membranes, weakness, and tachycardia.

**Table 13-3** Differential diagnosis of diseases of cattle characterized by acute hemolytic anemia with or without hemoglobinuria

Disease	Epidemiology	Clinical findings	Laboratory findings
Leptospirosis	All ages, cattle on pasture	Acute fever, red-colored milk Hemoglobinuria abortion; may die in 24–48 hours	Leptospira titers
Postparturient hemoglobinuria	High-producing lactating cows 4–6 weeks postpartum	Acute; no changes in milk; no fever; die in 12–48 hours; marked hemoglobinuria	Hypophosphatemia
Bacillary hemoglobinuria	Usually mature cattle on summer pasture in enzootic area	Acute fever, abdominal pain; may die in 2–4 days; hemoglobinuria	Leukopenia or leukocytosis
Babesiosis	Enzootic areas, tick borne, young animals	Acute fever, jaundice, abortion, course of 2–3 weeks; marked hemoglobinuria	Blood smear, complement fixation test, transmission tests
Anaplasmosis	Yearling and mature cattle, common in summer, insect borne, common in feedlots	No hemoglobinuria, jaundice common, fever	Anaplasms on blood smear, complement fixation test
Chronic copper poisoning	Follows long-term oral administration of medicines or feeds containing copper	Severe jaundice; no fever Hemoglobinuria	Toxic levels of copper in blood, liver, and feces
Cold-water hemolytic anemia of calves	Following consumption of large quantities of cold water after period of limited intake	Sudden onset within 1 hour after ingestion; no fever; may die in a few hours; hemoglobinuria	Acute hemolytic anemia
Rape and kale poisoning	All ages of cattle on rape crop grown for fodder in fall	Peracute hemolytic anemia, may die in a few hours after onset; no fever Hemoglobinuria	Acute hemolytic anemia
Drug induced	Some drug preparations when given IV	Mild hemoglobinuria; no hemolytic anemia	Nil
Blood transfusion reaction	Using blood from same donor more than 1 week after initial transfusion	Sudden onset, dyspnea, hiccoughs, trembling, responds to adrenalin	Nil

The common causes of hematuria in cattle are pyelonephritis and cystitis caused by *Corynebacterium renale*, nonspecific cystitis, and enzootic hematuria. Myoglobinuria occurs occasionally in young cattle affected with enzootic-nutritional muscular dystrophy and may be confused with hemoglobinuria.

### Treatment and Control Cattle

Dihydrostreptomycin (25 mg/kg IM every 24 hours for 3–5 days) (R-2)

Oxytetracycline (20 mg/kg IM every 24 hours for 3–5 days) (R-2)

Oxytetracycline, long acting (20 mg/kg IM as a single or repeated dose) (R-2)

Tilmicosin (20 mg/kg SC as a single dose) (R-2)

Tulathromycin (2.5 mg/kg SC as single dose) (R-2)

Tylosin (18 mg/kg every 24 hours for 3–5 days) (R-2)

Erythromycin 8 mg/kg IM every 24 hours for 5 days (R-2)

### Horses (abortion)

Dihydrostreptomycin (50 mg/kg IM every 24 hours for 3–5 days) (R-2)

### Swine

Dihydrostreptomycin (25 mg/kg IM every 24 hours for 3–5 days) (R-2)

Oxytetracycline<sup>a</sup> (40 mg/kg IM every 24 hours for 3–5 days) (R-2)

Tylosin<sup>a</sup> (44 mg/kg every 24 hours IM for 5 days) (R-2)

Erythromycin<sup>a</sup> (25 mg/kg IM for 5 days) (R-2)

### Control

Dihydrostreptomycin (25 mg/kg IM as a single dose) to all positive reactors (R-2)

Oxytetracycline, long acting (20 mg/kg IM as a single dose to all positive reactors) (R-2)

Tilmicosin (20 mg/kg SC as a single dose to all positive reactors) (R-2)

Tulathromycin (2.5 mg/kg SC as single dose to all positive reactors) (R-2)

Vaccination with multivalent vaccines<sup>b</sup> of exposed animals in an infected herd (R-2)

Vaccination with multivalent vaccines<sup>b</sup> of replacement heifers within 4–6 months of age (R-2)

<sup>a</sup>Dosage protocol exceeds label recommendations.

<sup>b</sup>Limited efficacy against infection with serovar hardjo.

IM, intramuscular; SC, subcutaneous.

## CONTROL Biosecurity and Biocontainment

The first step in control is to identify the source of the original source of infection and to interrupt transmission. Sources of infection include clinically affected animals, aborted fetuses, placentas, carrier animals, wildlife, dogs and cats, and environmental sources such as water supplies. Education about leptospirosis is an effective method for reducing its incidence and its effects. Intensive well-directed education and publicity campaigns in New Zealand, used in conjunction with a campaign for immunization of cattle, reduced the incidence of leptospirosis. Groups to which educational efforts should

be directed include professionals in human and veterinary medicine and public health, primary human and animal health care practitioners, wildlife and conservation scientists, water and sewage engineers and planners, health administrators and educators, and last but not least, the public at risk.

**Three main considerations** are important when assessing the risks and likely financial implications of the disease to dairy producers:

1. Likelihood of a herd being infected
2. Likely effects of the disease on the dairy enterprise, both physically and financially, following the initial infection compared with a leptospirosis-free herd
3. Likely longer term effects of the disease

The probability of infection of cattle by *L. Hardjo* is increased by **four factors**:

1. Purchase of infected cattle
2. Cograzing or common grazing with infected cattle or sheep
3. Use of natural service with an infected bull
4. Access of cattle to contaminated water such as streams, rivers, flood, or drainage water

Assessment of the risks facing different types of herds suffering losses from *L. hardjo* can then be used to help support decisions concerning control of the disease.

Producers with one or more of the main risk factors should consider strategies that

(1) directly remove or diminish those risk factors or (2) indirectly diminish their importance for the herd, for example, by vaccination. Strategies that successfully diminish one or more of the risk factors but leave one other will yield little benefit because of the importance of each of the identified risk factors.

Vaccination is one strategy that can diminish all of the risk factors and provide some degree of assurance against potentially high and costly disease losses. Producers with high-risk herds are likely to choose vaccination. If a herd continues to have any of the risk factors, then whole-herd vaccination is likely to be the preferred option; otherwise the disease could easily be reintroduced. Decision tree analysis of leptospirosis vaccination in beef cattle in Australia indicates that the beneficial economic effects of vaccination depend on the value of the calf and the probability of calf loss caused by leptospirosis.

### Eradication

**Detection and elimination of carrier animals presents some difficulties.** Positive reactors to the MAT do not necessarily void infective urine continuously, and chronically infected animals may shed leptospires while being serologically negative.<sup>7-9</sup> Repeated examination of the urine for the organism, either by culture or PCR, may be necessary to identify carrier animals. For practical purposes, serologically suspicious and positive reactors should be considered carriers and culled or treated as described previously.

In groups of pigs, it should be assumed that infection is herdwide and all pigs should be treated as though they were carriers. In these circumstances, the feeding of antimicrobials provides some protection, although it is not guaranteed to eliminate the carrier state. Leptospirosis has been eradicated from commercial pig herds by treating all pigs with dihydrostreptomycin at 25 mg/kg IM at one time. However, if the pigs have been exposed to heavy infection, not all of them are completely cleared of leptospiuria, and further treatment will be necessary.

In cattle herds, if the bulls are infected then they should not be used naturally or for artificial insemination even though the antimicrobials in the semen diluent is sufficient to ensure that no spread occurs. Elimination of infection can be difficult, especially in large commercial herds in an endemic area in which replacement cows and bulls are introduced from saleyards and cattle mingle with other herds on the range. Eradication of **Hardjo** is a possibility in purebred herds in which intensive measures are economically feasible, and owners should be urged to undertake a program to eliminate leptospirosis from the herd and to prevent its entry. **The following measures** can be taken to eliminate hardjo infection:

1. Judicious combination of group serologic testing
2. Segregation of age classes
3. Selective vaccination
4. Possibly artificial insemination
5. Isolation of the herd from outside sources of infection.

Bulls suspected of spreading infection should be treated to reduce the level of urinary shedding regardless of subsequent vaccination. Exposure of cattle to herds, heavily infected with leptospirosis, for example, on communal grazing pastures should be avoided. The herd should be monitored periodically, coincident with other serologic testing. In endemic areas, all cattle over 6 to 9 months of age should be vaccinated, and vaccination should be continued for up to 5 years to minimize the number of susceptible cattle until no long-term shedders remain in the herd.

Simple management procedures to limit the infection in beef cows until their second calves are born and the culling of older carriers can greatly decrease and possibly eradicate the infection from a herd. Virgin yearling bulls are used on virgin yearling heifers, and young cows are segregated from older cows until 38 to 39 months of age when they go to pasture after being bred with their second calf. This delays direct exposure of heifers to infected cattle until their third breeding. These practices must be combined by monitoring infection by serologic and other laboratory methods.

If eradication is attempted and completed, introduced animals should be required to pass a serologic test on two occasions at least 2 weeks apart before allowing them to enter the herd. Urine examination for leptospires should be performed if practicable.

### Hygiene

Control of the source of the organism is achieved by appropriate hygienic strategies. If the environmental sources of infection are identifiable, in the form of yards, marshes, and damp calf pens, every attempt must be made to avoid animal contact with these infective surroundings. Wet areas should be drained or fenced and pens disinfected after use by infected animals. The possibility that rats and other wild animals may act as a source of infection suggests that contact between them and farm animals should be controlled.

### Vaccination

Vaccination against leptospirosis in cattle and swine is in general use and an effective method for control of the disease. In New Zealand, a publicity campaign to promote the widespread vaccination of cattle resulted in a marked reduction in the incidence of human leptospirosis. Most of the vaccines are formalin-inactivated bacterins containing one or more serotypes. Vaccines containing Freund's complete adjuvant induce higher serologic responses but not

necessarily superior protection. The immune response is serotype specific and protection is dependent on the use of bacterins containing serotypes prevalent in the area. The bacterins induce a low titer to the MAT, which appears early and declines after several weeks; however, protective immunity against the disease and renal infection persists for at least 12 months in cattle. Regular serologic testing in herds vaccinated annually can be used to monitor new infections because these will induce a titer to the MAT. However, neither the ELISA nor the MAT can reliably differentiate serologic responses in cattle after leptospiral vaccination from those following natural infections.

### Cattle

The difficulty of keeping purebred herds free of Hardjo infection increases as the reservoir of infection increases. Several control measures can be applied, especially in large herds that are at high risk. In endemic areas, transmission in commercial herds can be suppressed by annual vaccination of bulls, replacement heifers, and 2- and 3-year-old females a few weeks before release of the bulls. Potential replacement heifer calves should be handled and raised in segregation from the adult herd after weaning and vaccinated a month before exposure to older cattle. Herd sires should be purchased from uninfected herds or at least purchased subject to a negative serologic test.

Vaccination as part of a herd health program should start with the calves at 4 to 6 months of age, followed by revaccination annually. Such programs should provide significant rises in calving rates, but have little or no effect on perinatal or postnatal losses.

### Bovine Leptospiral Vaccines and Their Efficacy

Current bovine multivalent leptospiral bacterins are inactivated whole-cell vaccines containing *L. interrogans* serovar Hardjo, Canicola, Pomona, and Icterohaemorrhagiae and *L. kirschneri* serovar Grippotyphosa and generally induce protective immunity against infection with non-host-adapted strains. In contrast, protection against the host-adapted serovar Hardjo is more elusive with conflicting evidence about vaccine efficacy. Vaccination of cattle with a pentavalent leptospiral vaccine containing either Hardjo-bovis or Hardjo-prajitno failed to protect cattle from experimental infection with hardjo-bovis 6 months after vaccination. They also failed to prevent abortion, stillbirth, and vertical transmission of infection when vaccinated cows were challenged with *L. borgpetersenii* serovar Hardjo during pregnancy, and the infection rates for control and vaccinated cattle did not differ. The Hardjo-bovis vaccine is more antigenic than the hardjo-prajitno as measured by higher antibody titers in vaccinated animals. Calves as young as 4 weeks of age, vaccinated in the



presence of maternally derived antibody, can be fully protected against homologous virulent challenge.<sup>36</sup> However, monovalent vaccines with a field isolate of *L. borgpetersenii* serovar Hardjo and another with *L. interrogans* serovar Hardjo found these vaccines prevented infection and colonization following challenge with *L. borgpetersenii* serovar Hardjo strains from the United States and Europe.

A protective killed vaccine against serovar hardjo induced a strong, sustained Th1 or cell-mediated response. The vaccine is composed of a whole-cell bovine isolate of *L. borgpetersenii* serovar Hardjo and aluminum hydroxide and is given as two doses subcutaneously 4 weeks apart. Following vaccination, a Th1 cell-mediated response occurred characterized by the production of IFN- $\gamma$  cells including CD4+ and WC1 gamma delta T cells.

A monovalent *L. borgpetersenii* serovar Hardjo (type Hardjo-bovis) vaccine commercially available in Australia, New Zealand, Ireland, and the UK, given as two doses, 4 weeks apart, protected heifers against renal colonization and urinary shedding when challenged with *L. borgpetersenii* serovar Hardjo strain 203, 4 months after vaccination. None of the animals shed leptospires in their urine or kidneys at necropsy. In contrast, all nonvaccinated control heifers became infected with serovar Hardjo and shed organisms in their urine. A pentavalent leptospiral vaccine with serovar Hardjo (type Hardjo-bovis) also containing BHV1, BVDV, PI-3, and BRSV fractions against important viral respiratory pathogens was found to protect heifers vaccinated at 1 month of age from colonization of the kidney and to reduce leptospiral shedding with urine in experimentally challenged animals for at least 1 year.<sup>37</sup>

Two monovalent hardjo vaccines provided protection from infection against *L. borgpetersenii* serovar Hardjo, whereas a pentavalent vaccine containing the Hardjo organisms did not. The protective monovalent vaccines produced strong cell-mediated immune responses in vaccinated cattle as demonstrated by proliferation of lymphocytes and production of IFN- $\gamma$  by their PBMCs in response to culture with serovar hardjo antigens. This response is generally much lower or absent in antigen-stimulated cultures of PBMC from cattle vaccinated with the pentavalent vaccine and nonvaccinated cattle.

In conclusion, protective immunity to serovar Hardjo correlates with induction of a substantial immune response that is characterized by antigen-specific IFN- $\gamma$ -producing T cells. There is no cross-immunity between *L. Pomona* and Hardjo, and in areas where both diseases occur, a bivalent vaccine is used routinely. If separate vaccines are used the *L. Pomona* vaccine should be administered at least once

annually, but the *L. Hardjo* vaccine provides some protection against *L. szwajizak*.

### Swine

Vaccination of sows and gilts before breeding with a bivalent vaccine, containing pomona and tarassovi, protects them against infection and the development of leptospiuria and is widely practiced, especially in large intensive piggeries. In the United-States, vaccination of gilts and sows with two doses of a bacterin containing five or six leptospiral serovars, one of which contained Bratislava, before the first breeding and thereafter before each breeding improves reproductive performance. *L. Bratislava* is an important cause of abortions in sows in North America and Europe, and vaccination is effective. Vaccination of pregnant gilts and sows can provide protection to the piglets for the first several weeks after birth.

### Vaccination and Antimicrobial Strategies

Whether or not to vaccinate depends on the cost of the procedure relative to the losses that can be anticipated. If the disease is spreading rapidly, as evidenced by the frequent appearance of clinical cases with a high range of titers or rising titers in a number of animals, then (1) all clinical cases and positive reactors should be treated, (2) the negative animals vaccinated, and (3) the herd should be moved on the first day of treatment to a clean field. Retesting a group to determine the rate of spread would be an informative procedure, but active measures must usually be commenced before this information is available. Another variation of this program, and a highly practical one, is the vaccination of all cattle in the herd and the treatment with one dose of dihydrostreptomycin (25 mg/kg IM) of all pregnant cows to eliminate renal infection and leptospiuria. However, antimicrobial therapy is not highly efficacious, especially in cattle infected with Hardjo.

A successful control strategy has been described for Hardjo infection in a large, closed beef herd. All animals were treated with dihydrostreptomycin once followed by removal to a clean pasture to prevent new cases and annual vaccination of the whole herd for 5 years. All cattle introduced into the herd were treated with the antimicrobial and quarantined; at the end of the trial the entire herd was treated prophylactically with the antimicrobial to minimize the risk of residual infection. By the end of the trial all young stock entering the breeding program were seronegative. There was serologic evidence of a high level of control, and bacteriologic monitoring at the end of the trial indicated that Hardjo had been eliminated from the herd.

Vaccination is also recommended to protect animals continuously exposed to infection from wildlife, other domestic species, and rodents. The serologic status of these

groups can also be determined as necessary before a decision is made to vaccinate.

If only sporadic cases occur, it may be more profitable to attempt to dispose of reactors or treat them to ensure that they no longer act as carriers. A degree of immunity is likely to occur in pigs after natural infection, and when the disease is endemic "herd immunity" may significantly decrease incidence of clinical disease.

One of the theoretical disadvantages of vaccination is the possible development of renal carrier animals that are sufficiently immune to resist systemic invasion but not colonization of the kidney, which leads to the development of a carrier animal with transient leptospiuria. This may occur but not frequently enough to invalidate vaccination.

### FURTHER READING

- Adler B. *History of Leptospirosis and Leptospira*. *Leptospira and Leptospirosis*. Berlin: Springer; 2015:1-9.
- Adler B. Pathogenesis of leptospirosis: cellular and molecular aspects. *Vet Microbiol*. 2014;172:353-358.
- Adler B, Pena-Moctezuma de la A. *Leptospira*. In: Gyles CL, Prescott JF, Songer JG, Thoen CO, eds. *Pathogenesis of Bacterial Infections in Animals*. 3rd ed. Oxford, UK: Blackwell; 2004:385-396.
- Bharti AR, Nally JE, Ricaldi JN, et al. Leptospirosis: a zoonotic disease of global importance. *Lancet Infect Dis*. 2003;3:757-771.
- Ellis WA. Leptospirosis as a cause of reproductive failure. Diagnosis of abortion. *Vet Clin North Am Food Anim Pract*. 1994;10:463-478.
- Faine SB, Adler CA, Bolin CA, Perolat P. *Leptospira and Leptospirosis*. 2nd ed. Melbourne: MedSci Press; 1999.

### REFERENCES

1. Cerqueira GM, Picardeau M. *Infect Genet Evol*. 2009;9:760.
2. Levett PN. *Clin Microbiol Rev*. 2001;14:296.
3. Adler B, de la Peña-Moctezuma A. *Vet Microbiol*. 2010;140:287.
4. Lau CL, et al. *Trans R Soc Trop Med Hyg*. 2010;104:631.
5. Martins G, et al. *Vet Rec*. 2010;167:629.
6. Jansen A, et al. *Emerg Infect Dis*. 2005;11:1048.
7. Otaka DY, et al. *Vet Rec*. 2012;170:338.
8. Hammond C, et al. *Vet Rec*. 2012;171:105.
9. Hernández-Rodríguez P, et al. *J Microbiol Methods*. 2011;84:1.
10. Bolin CA. *Proc North Am Vet Conf*. 2005.
11. Van de Weyer LM, et al. *Can Vet J*. 2011;52:619.
12. Subharat S, et al. *New Zeal Vet J*. 2012;60:215.
13. Lindahl E, et al. *Acta Vet Scand*. 2011;53:53.
14. Rifatbegovic M, Maksimovic Z. *Turk J Vet Anim Sci*. 2011;35:459.
15. Heesterber UW, et al. *J S Afr Vet Assoc*. 2009;80:45.
16. Ayanegui-Alcerreca MA, et al. *New Zeal Vet J*. 2007;55:102.
17. Ciceroni L, et al. *J Vet Med B*. 2000;47:217.
18. Ellis GR, et al. *Aust Vet J*. 2008;71:203.
19. Suepaul SM, et al. *Trop Anim Health Prod*. 2011;43:367.
20. Motte A, Myers DM. *Trop Anim Health Prod*. 2006;18:113.
21. Agunloye CA. *Israel J Vet Med*. 2002;57:2.
22. Lilienbaum W, et al. *Res Vet Sci*. 2008;84:14.
23. Baverud V, et al. *Acta Vet Scand*. 2009;51:15.
24. Hartskeerl RA, et al. *Clin Microbiol Infect*. 2011;17:494.
25. Pappas G, et al. *Int J Infect Dis*. 2008;12:351.

26. The Center of Food Security and Public Health. At <<http://www.cfsph.iastate.edu/Factsheets/pdfs/leptospirosis.pdf>>; 2005 Accessed 15.02.04.
27. Monahan AM, et al. *J Appl Microbiol.* 2009;107:707.
28. Jansen A, et al. *Emerg Infect Dis.* 2007;13:739.
29. Koizumi N, et al. *J Vet Med Sci.* 2009;71:797.
30. Marchiori E, et al. *Lung.* 2011;115:155.
31. Kohn B, et al. *J Vet Intern Med.* 2010;24:1277.
32. Broux B, et al. *J Vet Intern Med.* 2012;26:684.
33. Marinho M, et al. *Am J Trop Med Hyg.* 2009;80:832.
34. OIE terrestrial manual. At <[http://www.oie.int/fileadmin/Home/eng/Health\\_standards/tahm/2.01.09\\_LEPTO.pdf](http://www.oie.int/fileadmin/Home/eng/Health_standards/tahm/2.01.09_LEPTO.pdf)>; 2008 Accessed 21.06.15.
35. Australian pesticides and veterinary medicine authority. At <<http://apvma.gov.au/node/15006>>; 2005 Accessed 21.06.15.
36. Zuerner RL, et al. *Clin Vacc Immunol.* 2011;18:684.
37. Zimmernan AD, et al. *J Am Vet Med Assoc.* 2013;242:1573.

## BOVINE PYELONEPHRITIS

### SYNOPSIS

**Etiology** *Corynebacterium renale* and *Escherichia coli* are the most common causative agents.

**Epidemiology** There is incidental disease with worldwide occurrence. Organisms pertain to normal flora of the lower urogenital tract. Ascending infection is most common in adult cows within weeks after calving, occasionally in calves as a complication of omphalourachitis. Predisposing factors are vaginal/uterine infection or immunosuppression.

**Clinical findings** Periodic episodes of hematuria, pyuria, colic, straining to urinate, fever, loss of condition, and drop in milk production are observed. Palpable abnormality of kidney, ureters, and bladder on rectal examination. Cystitis is determined by endoscopic examination and pyelonephritis by ultrasound examination.

**Clinical pathology** Cloudy urine with hematuria, proteinuria; on microscopic examination there is increased cellularity of sediment with bacteria. Elevated serum total protein, globulin and fibrinogen, and low serum albumin. Cases with markedly elevated serum creatinine and urea nitrogen concentrations have poor prognosis.

**Necropsy findings** Cystitis and pyelonephritis are found.

**Diagnostic confirmation** Gross changes in urine, together with palpable abnormalities in the urinary tract, and the presence of bacteria in the urine are seen.

**Treatment** Prognosis is fair at best, prolonged course of antimicrobial therapy, and nephrectomy in unresponsive cases.

**Control** Avoidance of urinary catheterization and artificial insemination.

## ETIOLOGY

Pyelonephritis is an inflammation of the renal pelvis and renal parenchyma resulting

from an ascending bacterial urinary tract infection. *C. renale* and *E. coli* are the pathogens most commonly isolated from cattle with pyelonephritis. Other bacteria that have been associated with bovine pyelonephritis include *C. pilosum*, *C. cystitidis*, *Trueperella* (formerly *Arcanobacterium*) *pyogenes*, *Proteus* spp.,  $\alpha$ -hemolytic *Streptococcus* spp., and *Staphylococcus*.<sup>1,2</sup> *C. pilosum* and *C. cystitidis* are commonly isolated in conjunction with *C. renale* but are considered part of the normal flora of the vulva.

Infection with *C. renale* may stimulate production of an antibody that causes cross-reactions with the complement-fixing test for Johne's disease.

## EPIDEMIOLOGY

### Occurrence

Although the disease is widespread in Europe, North America, Australia, Africa, Japan, and Israel and probably occurs all over the world, it seldom constitutes an important problem in any herd or area. As a rule, clinical cases are **sporadic**, even in herds found to harbor a significant number of carriers. Differences in disease prevalence can probably be explained by differences in predisposing management factors. One study in 7 herds found an annual incidence that varied from 0.5% to 1.5% and in one herd was 16%. A slaughterhouse survey conducted in the United States estimated the prevalence of pyelonephritis in the dairy cattle population with less than 1%.<sup>3</sup> Subclinical infection may be more frequent than first recognized, and 13% of adult cattle have bacteria associated with pyelonephritis in their bladder at slaughter, in the absence of gross or histologic evidence of pyelonephritis or cystitis.<sup>4</sup> Chronic cystitis and pyelonephritis (etiology unstated) have been found in 5.3% and 0.2% of cattle at slaughter.

Although pyelonephritis is considered to be a predominantly a bovine disease, sheep are occasionally affected.

### Source of Infection and Transmission

Both *C. renale* and *E. coli* pertain to the resident flora of the lower urogenital tract of cattle. *C. renale* can be isolated from urine of affected or **carrier** animals and in Japan has been isolated from the vagina or vaginal vestibule of approximately 6% of healthy cows. Clinically and subclinically infected cattle can shed *C. renale* with urine for prolonged periods into the environment, in which it can survive for over 50 days. The incidence of cows excreting *C. renale* in their urine is higher in herds where the disease occurs than in herds where the disease is unknown.

In cattle, infection can be **transmitted** by direct contact, by the use of contaminated brushes, or by the careless use of **catheters**.

**Venereal transmission** of *C. renale* infection has also been proposed. This is suggested by the occasional occurrence of a

series of cases in a herd, usually related to the use of a particular bull, and the cessation of cases when artificial insemination is used. The organism can often be isolated from the prepuce, urethra, and semen of bulls that have no detectable lesions in the prepuce. *C. renale* can be a cause of balanoposthitis in bulls.

Ascending infection of the urinary tract with *E. coli* has generally attributed to fecal contamination of the urinary tract, frequently in association with impaired urinary tract defense.<sup>1</sup>

## Risk Factors

### Animal Risk Factors

Pyelonephritis is most common in adult cows in the weeks to months following parturition. In young calves pyelonephritis can often be traced back to an ascending umbilical infection.<sup>2</sup> Female cattle are more susceptible to ascending urinary tract infections than males presumably because of a shorter and wider urethra. In bulls and steers pyelonephritis may occur as a complication of a urinary tract obstruction.

Approximately 75% of clinical cases occur in postparturient cows following abortion, dystocia, or puerperal infection, suggesting that inflammation and infection of the lower urogenital tract presents as an important predisposing factor.<sup>2</sup>

### Pathogen Risk Factors

*C. renale* and *E. coli* are normal inhabitants of the lower urogenital tract of ruminants, but certain strains possess pili, a virulence factor facilitating the colonization of the mucosa of the urinary tract and the progression of the infection. Piliated strains of both bacteria occur and have a greatly enhanced ability to adhere to epithelial cells of the urinary tract.

### Environmental Risk Factors

An increase in clinical cases is usually found in the colder seasons of the year and heavily fed, high-producing dairy herds appear to show an increased susceptibility.

The systematic use of urinary catheters to collect urine from cows in early lactation with suspect ketosis has been associated with increased occurrence rates of pyelonephritis. Although not intentionally produced, the disease occurred in 10% of a group of cattle used to teach veterinary students the technique of urinary catheterization.

In Israel, the ingestion of rock rose (*Cistus salvifolius*) is reported to produce urinary retention and predisposes cattle to pyelonephritis.

### Economic Importance

Unless appropriate treatment is instituted early, the disease is highly fatal and economic loss is mainly caused by the deaths of affected animals.

## PATHOGENESIS

Pyelonephritis usually develops as an **ascending urinary tract infection** involving successively the bladder, ureters, and kidneys. Trauma to the urethra, urine stasis, or a patent urachus in calves may facilitate ascending infection. The destruction of renal tissue and obstruction of urinary outflow ultimately result in uremia and the death of the animal.

Piliated and nonpiliated forms of *C. renale* are present in infected animals, but their relative importance to the pathogenesis of the disease is uncertain. Piliated forms of *C. renale* and *E. coli* have a greater ability to attach to urinary tract epithelium, are more resistant to phagocytosis, and are probably important to the carriage of the organism and to the initial ascending infection. However, in the course of an infection there is a shift from piliated to nonpiliated forms, which may reflect a response to the development of antipilus antibodies.

## CLINICAL FINDINGS

Early signs vary considerably from case to case. The first sign observed may be the passage of **bloodstained or cloudy urine** in an otherwise normal cow. In other cases, the first sign may be an attack of acute **colic**, manifested by swishing of the tail, treading of the feet and kicking at the abdomen, and straining to urinate. The attack passes off in a few hours. Such attacks are caused by obstruction of a ureter or renal calyx by pus or tissue debris and may be confused with acute intestinal obstruction. More often the onset is gradual with a **fluctuating temperature** (about 39.5°C; 103°F), **capricious appetite**, loss of condition, and **drop in milk yield** over a period of weeks. Other than this, there is little systemic reaction, and the diagnostic signs are associated with the urinary tract.

The most **obvious sign** is the presence of **blood, pus, mucus, and tissue debris in urine**, particularly in the last portion voided (Fig. 13-5). Urination is frequent, may occur in a dribble rather than a stream, and may be painful. Periods during which the urine is abnormal may be followed by apparent recovery with later remissions.

In the early stages, **rectal examination** may be unremarkable, but later there is usually detectable thickening and contraction of the bladder wall and enlargement of one or both ureters. These are not normally palpable, but in chronic cases they may be felt in their course from the renal pelvis of the left kidney to the bladder. The terminal portion of the ureters may also be palpated through the floor of the vagina over the neck of the bladder. The palpable left kidney may show enlargement, absence of lobulation, and pain on palpation; the right kidney may be palpable in small ruminants if it is significantly enlarged. In many cases there are no distinct clinical signs referable to the urinary tract, and the history and clinical signs may



**Fig. 13-5** Change in urine appearance during voiding in a Holstein-Friesian cow with chronic cystitis. Top left is from the initial urine stream, followed by the bottom left, and bottom right, and the top right is the last urine voided. Notice the presence of blood clots in the last urine sample.

be weight loss and suspected gastrointestinal disease. In these cases, examination of the urine is essential to diagnosis. The course is usually several weeks or even months and the terminal signs are those of uremia.

**Endoscopic examination** of the urethra and bladder can be diagnostic. **Ultrasound** examination shows cystic changes in the affected kidney, a reduction in renal pelvis diameter, a reduction in renal parenchyma, a widened ureter, and a hyperechoic bladder wall.<sup>5</sup>

## CLINICAL PATHOLOGY

Urine analysis reveals proteinuria and hematuria, and the latter is grossly apparent in most cases. Urine pH is greater than 8.5 in most but not all cases, whereas the specific gravity has been recorded between 1.008 and 1.021.<sup>2</sup> Microscopic examination will show pyuria. The presence of bacteria in suspected urine can be confirmed by culture, specific immunofluorescence, or direct microscopic examination.

Hematologic and blood biochemical examination reveals hypoalbuminemia and hypergammaglobulinemia in advanced cases. Neutrophilia may be present but is not constant in all cases. Serum creatinine and BUN are elevated in advanced and severe cases, but these parameters are not reliable indicators for the presence of pyelonephritis in mild or early cases.<sup>2</sup> Serum creatinine and BUN concentrations above 1.5 and 100 mg/dL, respectively, carry a grave prognosis.

Ultrasonography was found useful to confirm the diagnosis and determine the extent of the disease. In particular this allows examination of the right kidney, which is not accessible by rectal examination. Ultrasonography may demonstrate cystic changes in the affected kidney, dilated renal sinuses and ureters, and a thickened echogenic bladder.<sup>2,5</sup>

## NECROPSY FINDINGS

With pyelonephritis, the kidneys are usually enlarged and the lobulation less evident than normal (Fig. 13-6). The renal calyces and

grossly enlarged ureters contain blood, pus, and mucus. Light-colored necrotic areas may be observed on the kidney surface. Changes visible on the cut surface include excavation of papillae, abscessation, and wedge-shaped areas of necrosis that extend from the distal medulla into the cortex. The bladder and urethra are thick walled and their mucous membranes are hemorrhagic, edematous, and eroded (Fig. 13-7). Histologically, the renal lesions are a confusing mixture of acute suppurative changes and various degrees of fibrosis with mononuclear cell infiltration.

## Samples for Confirmation of Diagnosis

- Bacteriology: kidney; culture swab from ureter (CULT)
- Histology: formalin-fixed kidney, ureter, bladder (LM)

## DIFFERENTIAL DIAGNOSIS

Cases characterized by acute colic

- Acute intestinal obstruction
- Urinary tract obstruction in bulls and steers

Chronic cases

- Traumatic reticulitis

Blood in urine

- Cystitis
- Urolithiasis
- Enzootic hematuria
- Postparturient hemoglobinuria
- Anaplasmosis/babesiosis
- Leptospirosis

## TREATMENT

Treatment recommendations for pyelonephritis reported in the literature are empirical, and unfortunately strong data supporting their clinical efficacy are not available. Common wisdom holds that pyelonephritis caused by *C. renale* is best treated with penicillin administered parenterally daily for at least 2 to 3 weeks. For cases of suspected or confirmed infection with *E. coli* a broad-spectrum antimicrobial should be chosen. A number of antimicrobials, including ampicillin, amoxicillin, tetracycline, trimethoprim-sulfas, ceftiofur, and gentamycin have been proposed.

In early cases where little structural damage has occurred, permanent recovery can be expected following such a course of treatment. Generally, a good prognosis is suggested by an improvement in condition, appetite, and milk yield and clearing of the urine. However, in well-established cases with extensive tissue destruction the prognosis is fair at best, relief is only transient, and relapses are common. For valuable animals, in which ultrasound has established the diagnosis and confirmed that the contralateral kidney is unaffected, unilateral nephrectomy may be an alternative with reasonable prognosis.<sup>6</sup> The surgical technique



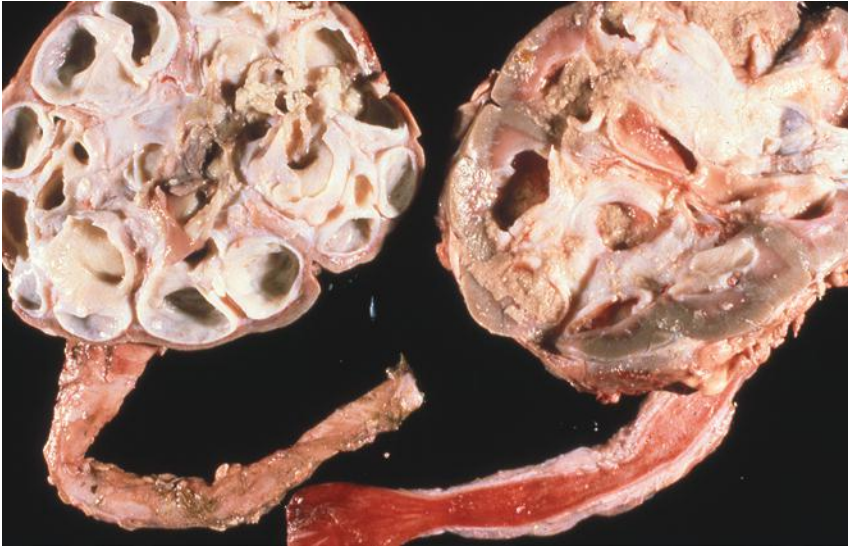

**Fig. 13-6** Bilateral, severe, chronic pyelonephritis and ureteritis in an old Holstein-Friesian cow with profound azotemia and severe renal failure. Notice the extensive cortical thinning in response to hydronephrosis, particularly in the left kidney (*left*). (Photograph graciously provided by Dr. D. Michael Rings, United States.)

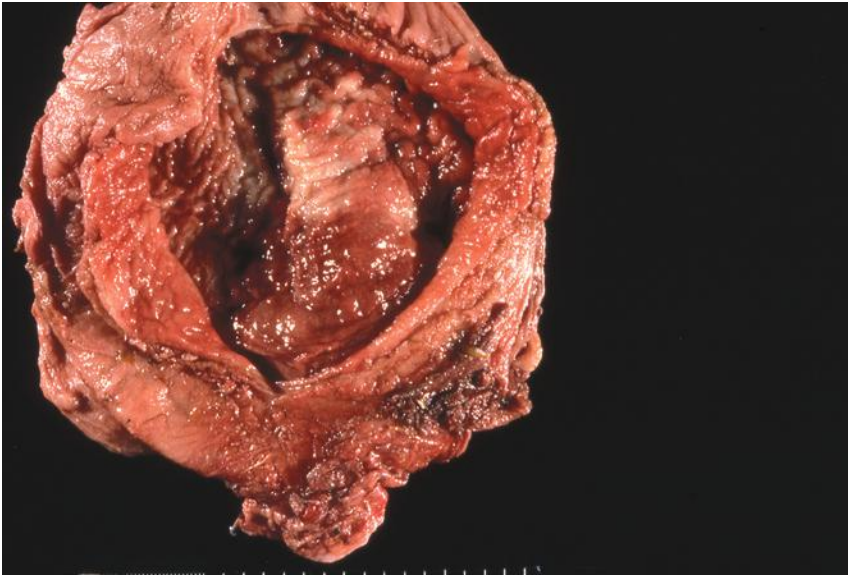

**Fig. 13-7** Severe chronic cystitis in the same animal. The bladder is opened and focal areas of cystitis are evident. (Photograph graciously provided by Dr. D. Michael Rings, United States.)

has been described, and the surgery can be performed in the standing animal under local anesthesia.<sup>7</sup>

#### TREATMENT AND CONTROL

##### Treatment

Procaine penicillin (22,000 IU/kg IM every 12 hours or 44,000 IU/kg IM every 24 hours for 2–3 weeks) (R-2)

Ampicillin (10 mg/kg IM every 24 hours for 2–3 weeks) (R-2)

Amoxicillin (10 mg/kg IM every 24 hours for 2–3 weeks) (R-2)

Oxytetracycline (10 mg/kg IM every 24 hours for 2–3 weeks) (R-2)

Trimethoprim-sulfadoxine (16 mg combined per kg slow IV injection or IM every 12 hours for 2–3 weeks) (R-2)

Ceftiofur sodium (1.2–2.2 mg/kg IM or SC every 24 hours for 2–3 weeks) (R-2)

##### Control

Adhere to aseptic technique when catheterizing the bladder of the cow. (R-1)

Consider changing to artificial insemination in herd outbreaks of pyelonephritis with bull breeding. (R-2)

*IM*, intramuscular; *SC*, subcutaneous.

#### CONTROL

One specific control measure usually practiced is isolation of affected animals.

Procedures such as urinary catheterization should be avoided, and routine vaginal examinations should be conducted with proper hygienic precautions. Where natural breeding is practiced, some reduction in occurrence may be achieved by the introduction of artificial insemination.

#### REFERENCES

1. Yeruhma I, et al. *Vet J.* 2006;171:172.
2. Braun U, et al. *Vet J.* 2008;175:240.
3. Rosenbaum A, et al. *Vet Rec.* 2005;157:652.
4. Hajikolaei M, et al. *Comp Clin Pathol.* 2015;24:251.
5. Floeck M. *Vet Clin North Am Food Anim Pract.* 2009;25:651.
6. Vogel SR, et al. *Vet Surg.* 2011;40:233.
7. Miesner M, Anderson DE. *Vet Clin North Am Food Anim Pract.* 2008;24:497.

#### URINARY DISEASE IN SWINE

##### Glomerulonephritis

In pigs, glomerulonephritis occurs sporadically and may be associated with immunologic, thrombotic, toxic, or unknown mechanisms. It has been seen as a sporadic event following infectious diseases such as African swine fever, classical swine fever, streptococcal infections, and cytomegalic virus infections. There is also a specific condition of glomerulonephritis in Yorkshire pigs in Norway. The condition of porcine dermatitis and nephropathy syndrome is a specific condition seen in many countries after the advent of porcine circovirus 2 infections but reaching its most severe in the UK. It is immune mediated, possibly through a type III hypersensitivity reaction, and is discussed in more detail in relation to porcine circovirus.

##### Nephrosis

Acute tubular necrosis (nephrosis) is a feature of a number of pig disorders including pig weed toxicity, nephrotoxins, and antibiotic use.

##### Embolic Nephritis

It is important to remember that the pig kidney has a wide range of congenital deformities, such as cystic kidneys, which persist into adult life. Most importantly it has a nephrogenic zone, which gives rise to new glomerular units in the 3 months after birth, and these are readily visible under the capsule of the kidney. They are readily involved in kidney lesions associated with septicemia and thrombosis, and involvement of these pathologic processes in the occurrence of the “Turkey egg” kidney has now been associated with over 30 different etiologic agents. The most important of these conditions are *Actinobacillus suis*, *Streptococcus suis*, streptococci, staphylococci, *E.coli*, *Erysipelothrix rhusiopathiae*, and *T. pyogenes*.

##### Interstitial Nephritis

One of the common causes of interstitial nephritis is leptospirosis and another is PCV2 infection. They may only be visible on histologic examination.

### Other Conditions

These include urolithiasis, which is found in pigs that are sometimes on unusual diets or where there is a shortage of water. The bladder of sows sometimes also contains some sediment and there may be infection-induced calculi. Uric acid and urates are sometimes found in the kidneys of piglets. The kidney worm (*Stephanurus*) is a cause of kidney problems in some parts of the world, and mineralization of the kidneys in vitamin D toxicosis may also be seen very occasionally. Chronic salt intoxication has recently been seen in growing pigs and is characteristically seen as diffuse bilateral interstitial fibrosis.<sup>1</sup>

## PORCINE CYSTITIS AND PYELONEPHRITIS

### SYNOPSIS

**Etiology** *Actinobaculum suis* is the specific cause, but a range of other bacteria (principally *Escherichia coli*) may also cause the condition.

**Epidemiology** Infection of male pigs causes the disease in sows. The organism is in the prepuce and environment. Transmission is venereal and through dirty farrowing houses. Trauma to the urogenital tract of females predisposes to disease.

**Clinical findings** Unexpected death in acute cases. There is pain on urination, bloodstained, turbid urine accompanied by vaginal discharge; often after service; cystitis on endoscopic examination.

**Clinical pathology** Hematuria, pyuria, proteinuria, bacteremia are seen. Urine pH >8.5. Demonstration of organism by culture or immunofluorescence; azotemia, increased concentrations of urea and creatinine, hyperkalemia, and hyponatremia.

**Necropsy findings** Purulent cystitis and pyelonephritis.

**Diagnostic confirmation** Urinalysis, endoscopic examination, and demonstration of *A. suis*.

**Treatment** Unrewarding unless early in the course of the disease—antimicrobials and supportive therapy; humane destruction of cases.

**Control** Antimicrobials by injection, in water, or in feed; ensure adequate water supply for lactating sows to aid urination and improve postfarrowing hygiene.

### ETIOLOGY

Cystitis and pyelonephritis are associated with a variety of agents including *E. coli* and others (*Pseudomonas aeruginosa*, staphylococci, streptococci, *Proteus* spp., *Klebsiella* spp., enterococci, and *A. pyogenes*). Infections with most of these organisms result in catarrhal/purulent cystitis.

The genotypic and phenotypic characterization of *E. coli* strains associated with porcine pyelonephritis has been described.<sup>2</sup> The specific disease is most commonly associated with *Actinobaculum suis*. This was formerly known as *Eubacterium suis* and before that as *Corynebacterium suis*. This organism is a large gram-positive rod that is difficult and slow to grow and requires special culture media.

### EPIDEMIOLOGY

All these organisms causing cystitis and pyelonephritis are thought to produce the condition as a result of ascending infection. The disease is a particular problem when sows are in stalls or tethered. The condition may not be so serious when associated with all the species other than *A. suis* and in these cases may be seen as frequent urination, the presence of blood or pus in the urine, and a progressive loss of condition. It is in postparturient sows that have bred.

### Occurrence

The infection may be common but the disease is better viewed as sporadic. The disease is probably worldwide in outdoor and indoor units. There are no details of prevalence, although it has been described as the most important cause of sow deaths, with up to 25% associated with urinary tract infection. It probably occurs more frequently than is recognized because there is a considerable subclinical infection rate. In a recent study in the United States, *A. suis* was isolated from 4.7% of the bladders of sows collected at random at a slaughterhouse.

In small herds, the disease tends to occur in small outbreaks when a small number of sows become infected after being mated to a single boar. Often, the clinical outbreak may be 2 to 3 weeks after the use of the suspected boar. More serious outbreaks can occur in large, intensive piggeries. The disease can also occur sporadically and be a normal feature of sow mortality.

In a recent study of 1745 pregnant sows, 28.3% were found to have urinary infections and *A. suis* was found in 20.6% of these. It was less prevalent (13.7%) in the sows with urinary infections than in those without (23.1%). In an abattoir survey in the Netherlands, the prevalence of cystitis in slaughtered sows was 11%, with a variation depending on group from 0% to 35%. In this study of 114 bladders, *A. suis* was not isolated, but *E. coli* was the most commonly isolated together with *S. dysgalactiae*, *A. pyogenes*, *Aerococcus viridans*, and *S. suis*.

### Source of Infection and Transmission

*A. suis* is a normal inhabitant of the porcine prepuce and can be isolated from the preputial diverticulum of boars of various ages. The prevalence of the infection in adult males may be as high as 90%, and the

organism can be isolated from the floor of the pens containing infected boars.

Infection and colonization of the preputial diverticulum may occur in pigs as early as 5 weeks of age if they are housed with older pigs. Frequently, this infection may occur from pen floor contamination because of poor hygiene. Piglets can also become infected, at an early age, from sows that have chronic cystitis and pyelonephritis, and the infection can spread rapidly to other male pigs when they are grouped at weaning. Although infection is common in the male pig, cystitis and pyelonephritis is extremely uncommon in females. *A. suis* is rarely isolated from the urogenital tract of the healthy female pig.

Clinical disease is almost entirely restricted to the female pig that has bred. Venereal transmission is thought to be the primary if not the sole method of infection of the sow. Trauma to the vagina may be an important predisposing factor allowing infection to establish, and trauma at parturition with infection from the environment may also be important.

There is no doubt that, where the conditions in stall houses are rife with fecal contamination and poor drainage from the rear half of the stall, perineal and vulval contamination is much greater.

### Risk Factors

Clinical signs may occur at any age but are common at 3 to 4 weeks postservice. The disease is more common in sows kept in intensive confinement conditions than in those that are kept in open lots, pens, or pasture, but it does occur in these systems if the hygiene is poor. Differences in feeding patterns and exercise that occur in the different management systems can influence the frequency and volume of water intake. This in turn has an important effect on the frequency of urination and the residual volume of urine in the bladder following micturition, which is one of the factors that may predispose to the establishment of urinary tract infection. Because many lactating sows will only stand when they are fed, usually twice a day, they will also only urinate and drink twice a day. If they cannot take in enough water from either a trough or a tap during this period at the correct flow rate, they may be suffering from an inadequate water intake. It has also been shown that crystalluria may well damage the mucosa and aid the formation of cystitis and that the crystals also support infection of the bladder, particularly where there is an insufficient water supply.

### Economic Importance

In one of the best studies of sow mortality in the UK it was reported that the principal cause of death in up to 25% of the sows was urinary tract infection. If the sow mortality is below 5% then cystitis/pyelonephritis

is unlikely to be an important problem in the herd.

Cystitis and pyelonephritis is of great importance because it is a major cause of death (annual death rate may be in excess of 5%) in sows in both Great Britain and the United States and, even more important, a cause of serious culling; the recommendation is to cull affected sows because they will always be a source of infection. Considerable prevention, treatment, and hygiene costs will also ensue.

### PATHOGENESIS

The organism is widespread in the prepuce of boars, is introduced into the sow at service, but it usually rapidly dies out. In healthy sows, *A. suis* can be isolated from the vagina, but not from the bladder, for a short period after an infected service. In experimental infections of normal sows, it rapidly dies out. The factors that allow it to establish in the urogenital tract are unknown, but trauma to the vagina and urethral opening and service into the bladder are supposed factors. The other organisms listed may also act synergistically to damage the mucosa and facilitate colonization by *A. suis*. This may be true, because *A. suis* possesses two sorts of pili by which it attaches to damaged bladder epithelium. Cystitis results in damage to the ureterovesical junction facilitating ascending infection from the bladder to the kidneys. In infected sows, tortuosity and blockage of the ureters is fairly common. This and the changes in the kidney may lead to chronic renal failure and the inability to retain sodium with potassium retention in the blood and sudden death and even acute renal failure if the blockage is complete and bilateral.

### CLINICAL FINDINGS

Mildly affected sows may only show transient inappetence, and other animals are recognized because they are uremic. In the more severely affected groups, the presentation is either as an acute case, usually postservice, or as a chronic one, which can occur at any time.

Most commonly sows present as acute renal failure and sudden death. Sows are suddenly severely ill, unwilling to rise, show profound depression and circulatory collapse, and die within 12 hours. In one series of cases, 40% of the affected sows presented as unexpected deaths, and in the remainder the mean interval between presenting signs and death was 1.6 days and the longest interval was 5 days. The condition may occur in older sows (fourth parity sows and above).

Where the surveillance is good, the sows are observed to be depressed, anorectic, mildly febrile (normal to 39.5°C; 103°F), and sometimes show arching of the back, twitching of the tail, and painful urination. There is frequent passage of bloodstained, turbid urine accompanied by vaginal discharge. Examination with a vaginal speculum will

confirm the bladder as the source of the bloody discharge.

The case-fatality rate is high. Sows that survive the acute disease develop chronic renal failure with weight loss and polydipsia and polyuria. They are usually culled for poor performance.

Endoscopic examination of the bladder in acute cases may show little other than mild inflammation, but in more serious cases there are ulcerative and erosive bladder lesions. In sows large enough to allow rectal examination, it may be possible to feel the large and thickened bladder and dilated tortuous ureters in chronic cases. Boars are usually unaffected clinically but intermittent, hematuric episodes lasting several days have been recorded.

The condition can be seen as a sequel to any locomotor, particularly central brain or spinal, condition in which there is an inability to stand to drink or micturate, e.g., organophosphorus poisoning.

### CLINICAL PATHOLOGY

Sows' urine is frequently turbid (83.1%) and usually this can be associated with the presence of crystals (96.1%).

Urinalysis usually shows hematuria, pyuria, proteinuria, and a pronounced bacteriuria (usually in excess of  $10^5$  cfu/mL of urine). A Gram stain on a smear of the urine or pus may show the organisms. The urine is alkaline with a pH of more than 8.5 and usually approaching 9 as a result of the urease, which cleaves urea to produce ammonia. Midstream urine contains  $10^5$  cfu/mL or more. A number of species of bacteria may be found as suggested in the introduction, but *A. suis* requires special culture media. It is now possible to use immunofluorescence for a more rapid and specific diagnosis. Examination of blood shows a pronounced azotemia, with increased concentrations of urea and creatinine and also hyperkalemia and hyponatremia. NAD concentrations are elevated, indicating proximal renal tubular damage.

### NECROPSY FINDINGS

A very varied pathology may be visible in these cases. In some sows, there may be an extensive purulent nephritis and pyelitis with similar changes in the dilated ureters and the bladder. In others there may be severely hemorrhagic kidneys and blood in the pelvis.

In acute cases, the bladder wall is swollen, edematous, and hyperemic and may be covered by a gritty, mucinous material. In other cases, the bladder wall may just be thickened, inflamed, and covered by extensive thick mucus. In some of these cases, the ureterovesical valves may have been completely destroyed by necrosis. There may be minimal gross changes in the kidneys in acute cases but there may be microscopic changes of a diffuse tubular and interstitial nephritis. In the chronic case, there are ulcerative and

erosive lesions in the bladder wall and there may be pus in the bladder, thick-walled ureters, and an obvious pyelonephritis.

### Samples for the Confirmation of Diagnosis

- Bacteriology: kidney, bladder, and ureter for aerobic and anaerobic culture and special media for *A. suis*. A special urea-enriched medium with polymixin or nalidixic acid is necessary in which dry colonies of *A. suis*, about 2 to 3 mm in diameter, grow after 2 days' incubation
- Histology: formalin-fixed bladder, ureter, and kidney

### DIAGNOSIS

Diagnosis is based on high mortality; clinical findings; history of service; and clinical pathology, particularly bacteriology, immunofluorescence for specific bacteria, or isolation by culture have a similar sensitivity and specificity.

### DIFFERENTIAL DIAGNOSIS

- Other causes of sudden and unexpected deaths
- Hematuria
- *Shewanella dentatus* (where it occurs)
- The separation of the condition associated with *Actinobaculum suis* from those associated with other bacteria can only be achieved by bacterial culture and other laboratory techniques.

### TREATMENT

Early treatment with antibiotics is recommended, but if there is acute renal failure then the case-fatality rate is high. Penicillin given at 15,000 IU/kg IM daily for 7 to 10 days has been successful in early cases. The IM injection of streptomycin at 10 mg/kg has also been used successfully. The isolation of other organisms may indicate the need for other broad-spectrum antibiotics. A recent outbreak of cystitis and endometritis associated with a falling conception rate from 88% to 75% and thought to be caused by *E. coli* (together with staphylococci and streptococci) was successfully treated with an ammonium chloride urinary acidifier, whereas the amoxicillin used previously was without effect. Enrofloxacin at the rate of 10 mg/kg BW in the feed for a period of 10 days has also proved effective, as has 2.5 mg/kg in the food for at least 20 days.

The response can be monitored by the reduction in the urine pH. Treated sows should be loose housed with access to plenty of water. The treatment should be continued for at least 2 to 3 weeks after the outbreak has appeared to finish clinically. Oral electrolyte therapy is also beneficial. In chronic cases, the lesions are well advanced and the organisms may be contained in the calculi and



then therapy is not successful and relapses may occur. In many cases, humane destruction is the best option, especially because it is not possible, except in very early cases, to eliminate the organism. Preputial washing on a regular basis may prevent the carriage of organisms by boars, especially because it has been shown that semen may be frequently contaminated by *A. suis*, and up to 50% of boars in some studs may be affected.

### CONTROL

Routine prophylactic administration of antibiotics has proved of little value in the long-term control of the disease. A temporary solution has been the use of sow treatment with oxytetracycline followed by in-feed medication with 400 g/t for 21 days. It is not possible to eradicate the infection from the prepuce of a boar, although daily infusions may help reduce the infection. Artificial insemination with the semen treated with antibiotics is a further option.

Trauma to the vagina at mating should be reduced by boar management and the supervision of mating. There should be nonslip floors in the service areas. Animals showing distress, pain, or bleeding after mating should be treated.

The service areas should have very good hygiene with regular cleaning and disinfection after every use. The perineal region of each sow should be cleaned before mating. Farrowing accommodation and crates should also be properly cleaned and disinfected and allowed to dry before sows are introduced. The major organism (*A. suis*) will persist on bad floors but is susceptible to phenolic, quaternary ammonium, and formalin-based products.

Other control procedures involve the provision of an adequate water intake. This should preferably be from the mains without impurities or toxins or bacterial contamination. Loose housing and twice-a-day feeding will encourage the consumption of water. The provision of adequate numbers of drinkers for the stage of the breeding cycle and providing the necessary flow rate for each age of pig is essential (at least 1.5 L/min for gestating sows and 2.2 L/min for lactating sows). A simple check on water supply can be to check appetite: if the sows are not consuming 10 kg of food on day 18 of lactation then there is probably something wrong with water provision. Similarly, troughs must contain at least a reasonable supply of water. In the welfare codes, all animals have to be provided with a fresh supply of high-quality water.

### FURTHER READING

Done SH, Carr JC. The urinary tract. In: Sims LD, Glastonbury JRW, eds. *Pathology of the Pig*. Victoria, Australia: Agriculture Victoria; 1996:359-384.

### REFERENCES

- Alonso C, et al. *Proc Cong Int Pig Vet Soc*. 2010;21(1):98.
- Krag L, et al. *Vet Microbiol*. 2009;134:318.

## KIDNEY WORM DISEASE IN PIGS CAUSED BY *STEPHANURUS DENTATUS*

### ETIOLOGY

Stephanurosis is a disease of swine caused by the migration of larvae and young adults of the nematode parasite *Stephanurus dentatus* through the body.

### SYNOPSIS

**Etiology** The nematode parasite *Stephanurus dentatus*.

**Epidemiology** Eggs are shed in urine; infective larvae enter pig when swallowed or by skin penetration; earthworms can act as transport hosts; prepatent period is at least 6 months.

**Signs** Poor growth; emaciation in severe cases with stiffness of gait.

**Clinical pathology** Eggs in urine; eosinophilia.

### LIFE CYCLE

*S. dentatus* are large (2- to 5-cm) thick roundworms that inhabit the perirenal tissues and less often inhabit the other abdominal organs and spinal canal of the pig. Adult worms lie in cysts around the renal pelvis and the wall of the ureter. The cysts communicate with the urinary passages, and the eggs are passed out into the urine of the host. They are very prolific egg layers; an infective adult sow may void as many as a million eggs in a day. Under suitable environmental conditions the eggs hatch and, after undergoing two molts, the larvae develop to the infective third stage in about 4 days. The eggs and larvae are very sensitive to cold and desiccation; eggs in a dry situation die within an hour. Exposure to temperatures below 10°C (50°F) is damaging and 4°C (40°F) is lethal. Most larvae in optimum conditions of moisture, warmth, and shelter from sunlight survive for about 3 months and some for as long as 5 months. Larvae may survive for long periods as facultative parasites in earthworms, and this may enable the larvae to survive even when the soil microclimate is adverse.

Larvae may penetrate the skin or be ingested. Larvae that are ingested cross the wall of the stomach, or more commonly the small intestine, and reach the liver via the portal vessels; from the skin the larvae reach the systemic circulation and pass to the liver via the lungs in 1 to 6 weeks. In the liver the larvae migrate from the blood vessels through the parenchyma and eventually, about 3 months after infestation, having undergone a fourth molt, penetrate the capsule of the liver and reach the perirenal tissues to establish themselves as adults. Egg laying usually commences about 6 months after infestation, but the prepatent period

may be very much longer and individual worms appear to live as long as 2 years.

During their migration the larvae often follow an erratic path and cause the development of atypical lesions and clinical signs. These larvae often reach maturity in these aberrant sites, and prenatal infection can occur in this way.

### EPIDEMIOLOGY

Kidney worms are common in most tropical and subtropical countries such as Africa, the East and West Indies, Brazil, Hawaii, the Philippines, the southern United States, and Australia, where the climate is sufficiently mild to permit the survival of eggs and larvae.

### PATHOGENESIS

The principal effect of these worms is the damage caused by the migrating larvae and young adults. The migrating worms cause a great deal of necrosis, fibrosis, and occasional abscess formation along the path of their migration. This is most marked in the perirenal tissues and the liver. *S. dentatus* have been observed rarely in cattle. Experimentally dosed calves develop severe hepatic injury similar to that which occurs in pigs, but the life cycle is not completed and no perirenal lesions develop.

### CLINICAL FINDINGS

The mortality rate is not high; production losses and condemnation of parts or all of the infested carcass are of greatest economic significance. Poor growth in spite of a good appetite may be the only sign in mild cases. Badly affected animals become emaciated and develop ascites. In the early stages, nodules in the skin of the belly wall and enlargement and soreness of the peripheral lymph nodes may be evident. Many apparently unrelated clinical signs are produced by aberrant larvae. For example, thrombi may be induced in blood vessels, such as the portal veins, hepatic artery, and posterior vena cava, and paralysis may result if larvae invade the spinal cord. Involvement of the psoas muscles causes local pain and stiffness of gait. The passage of larvae through the peritoneum and pleura gives rise to adhesions. Larvae may also become encysted in the lung. Weakness and eventual paralysis of the hindlegs occur in a number of cases. Passage through the peritoneum and pleura causes the formation of adhesions, and many larvae become encysted in the lung.

### CLINICAL PATHOLOGY

Large, thin-walled, embryonated eggs are present in the urine when adult worms are present in the ureter wall. An eosinophilia is seen 2 to 3 weeks after infection, peaking at 6 to 7 weeks and still elevated at 20 weeks. However, this has little specific diagnostic significance. Anemia does not occur. Only a transient rise in aspartate aminotransferase

is seen, and serum enzymes seem to be of little value in diagnosis.

### NECROPSY FINDINGS

The common findings include fibrosis and abscess formation in perirenal tissues with large adult worms present and occasionally in the pelvis of the kidney and ureter; infarcts and scars in the kidney; and enlargement and scarring of the liver, sometimes accompanied by ascites. The hepatic lesions include irregular whitish tracks in the parenchyma, extensive fibrosis, hemorrhage, and eosinophilic abscess formation. The liver may be covered with a diphtheritic membrane. Larvae may also be present in peripheral lymph nodes and cutaneous nodules, in small abscesses in the lung and pancreas, and in thrombi of blood vessels, particularly in the liver and lungs. Pleurisy and peritonitis, if they are present, are usually manifested by adhesions.

### DIAGNOSTIC CONFIRMATION

A definite diagnosis of stephanurosis may be made by finding eggs in the urine or by necropsy. Young pigs with a heavy infestation of larvae may present a problem in diagnosis because adult worms and characteristic renal lesions may not yet be present. An ELISA test can detect infection from 2 weeks after infection, but serologic tests are not likely to become a routine diagnostic procedure.

#### DIFFERENTIAL DIAGNOSIS

- Other causes of poor growth and emaciation in pigs, e.g., poor nutrition and chronic bacterial diseases such as necrotic enteritis and swine dysentery, but these are accompanied by intermittent diarrhea.
- Other parasitic diseases such as ascariasis and hyostromylosis.
- Other causes of posterior weakness in pigs such as vitamin A deficiency, osteodystrophia, sometimes fracture of a lumbar vertebra, brucellosis, erysipelas when intervertebral joints are involved, or by spinal cord abscess or lymphoma.

### TREATMENT

Single doses of ivermectin (SC) or doramectin (IM) at 0.3 mg/kg, or fenbendazole at 3 mg/kg in the feed for 3 days, are effective against migrating and adult stages, whereas levamisole at 8 mg/kg removes the adults only, preventing egg output for at least 4 weeks.

### CONTROL

Regular anthelmintic treatment of all pigs with fenbendazole or ivermectin at 4-month intervals should prevent further contamination of the environment with eggs. The free-living stages should then eventually die out, but this may take some time as infected earthworms may survive for at least 1 year.

Management techniques may also be used for controlling kidney worm. Because

the prepatent period of *S. dentatus* is at least 6 months, one method is to breed entirely from gilts until the transmission cycle is broken. Under this system the gilts are raised, allowed to farrow, and sent to market as soon as the litter is weaned and before any eggs are shed. Boars are confined on concrete to prevent contamination of the soil by eggs in their urine. This technique has the advantage of maintaining a fully stocked farm while control is achieved, but it has obvious economic penalties.

Other management techniques depend on the provision of dry ground in which eggs and larvae are less likely to survive. Sleeping shelters should be placed on high ground, preferably bare of vegetation. Because pigs in yards commonly urinate against fences, a 2- to 3-m strip of earth inside the boundary should be kept free of herbage. Muddy spots and water holes should be filled in and drainage provided. Water and feed troughs should be on a concrete apron. Young animals should be segregated from adults and fields rested for 3 to 6 months after the adults are removed. Such programs are rewarding if performed diligently and intelligently, but the extra work involved has militated against general acceptance of this approach. Because of the importance of mature animals as sources of infestation, early replacement of breeding stock is recommended in problem herds.

## Toxic Agents Affecting the Kidney

### CITRININ TOXICOSIS

Citrinin (CTN or CIT) is most widely known as a nephrotoxin produced by *Penicillium citrinum*, *P. verrucosum*, *Monascus ruber*, *Aspergillus ochraceus*, and *A. terreus*.<sup>1-3</sup> It is commonly found in combination with ochratoxin A (OTA) as a contaminant in human and animal feeds,<sup>2,4,5</sup> and the concentration of CTN often exceeds that of OTA.<sup>6</sup> When present as cocontaminants the effects of OTA and CTN are generally additive; at higher concentrations, the effects may be more than additive.<sup>1</sup>

The signs and lesions associated with poisoning by OTA and CTN are generally similar. The target organ is the kidney, but the liver and bone marrow have been implicated as well.<sup>2</sup> In mice and rats, CTN is embryocidal, fetotoxic, and has an adverse effect on reproduction.<sup>2,7</sup> An increase in testicular and preputial weight, abnormal sperm, and decreased numbers of live sperm were noted in mice treated with CTN.<sup>7</sup> Females mated to CTN-treated mice had a lower pregnancy rate. Information on carcinogenicity is rare, with benign renal tumors reported in mice receiving CTN for 60 to 80 weeks.<sup>1</sup>

CTN is rapidly absorbed and distributed, in particular to the liver and kidney.<sup>1</sup> In

humans it is metabolized to dihydrocitrininone (DH-CIT), which may be the primary method of detoxification. Excretion is through the urine and feces. The presence of CTN in human and animal food and food products can be identified by several methods<sup>5,8</sup> and in human urine and plasma by liquid chromatography mass spectrometry (LC-MS/MS).<sup>3</sup>

CTN may play a different role in the pyrexia-pruritus-hemorrhagic syndrome in cattle.<sup>9</sup> Serious outbreaks of this idiopathic disease have been recorded in the UK since 1977 and may be related to CTN in moldy citrus pulp cubes. Clinical signs in affected cows include pruritus, hair loss, papular dermatitis, variable appetite with roughage being taken but not concentrates, fever (40–41.5°C; 104–106.7°F), and mucosal petechiation. Dermatitis is widespread, exudative, initially papular, and itchy. It occurs principally on the head, neck, perineum, and udder. Pruritus is variable in degree, but is often so marked that the skin becomes raw and bleeds. The dermatitis subsides but the fever persists, and over a period of 4 to 7 weeks the animal becomes so unthrifty that it is usually sent for slaughter. The morbidity rate is usually 10%, but may be as high as 100%. Seriously affected animals die. A similar but more severe syndrome occurs in which there is petechiation in all tissues, especially subserosally. In these cases, there are multiple hemorrhages in all mucosae and free blood at the anus and other orifices.

Postmortem examination shows petechiation in all organs and tissues, although it is absent altogether in some cases. Histologic findings include low-grade, long-standing interstitial nephritis and very little else of significance. Hematology, blood chemistry, and serum enzymes are similarly normal. Antibody reactivity to some components of ruminal contents may be elevated but not apparently significantly.

### FURTHER READING

- Krogh P, Hald B, Pederson EJ. Occurrence of ochratoxin A and citrinin in cereals associated with mycotoxic porcine nephropathy. *Acta Pathol Microbiol Scand [B] Microbiol Immunol.* 1973;81(6):689-695.
- Radostits O, et al. *Citrinin. Veterinary Medicine: A Textbook of the Disease of Cattle, Horses, Sheep, Goats and Pigs.* 10th ed. London: W.B. Saunders; 2007:1901.
- Saunders GK, Blodgett DJ, Hutchins TA, et al. Suspected citrus pulp toxicosis in dairy cattle. *J Vet Diagn Invest.* 2000;23:269-271.

### REFERENCES

1. Föllmann W, et al. *Arch Toxicol.* 2014;88:1097.
2. Flajs D, et al. *Arch Ind Hyg Toxicol.* 2009;60:457.
3. Blaszekiewicz M, et al. *Arch Toxicol.* 2013;87:1087.
4. Bragulat MR, et al. *Int J Food Microbiol.* 2008;126:43.
5. Xu B, et al. *Food Control.* 2006;17:271.
6. Kononenko GP, et al. *Agric Sci.* 2013;4:34.
7. Qingqing H, et al. *Exp Toxicol Pathol.* 2012;64:465.
8. Ramesh J, et al. *Int J Curr Microbiol App Sci.* 2013;2:350.
9. Fink-Gremmels J. *Vet J.* 2008;176:84.

## ETHYLENE GLYCOL TOXICOSIS

Accidental poisoning with ethylene glycol may occur in swine, goats, cattle, and horses.<sup>1,2</sup> Although the most common source is antifreeze or windshield deicers, ethylene glycol is also found in paints, solvents, detergents, and some pharmaceuticals.<sup>1</sup> The toxic dose rates determined experimentally for cattle are 5 to 10 mL/kg BW in adults and 2 mL/kg in nonruminant calves.<sup>1</sup>

The pathogenesis of the disease is dependent on the development of acidosis and oxalate nephrosis. In swine this is manifested by ascites, hydrothorax and hydropericardium, depression, weakness, and posterior paresis. In cattle there is dyspnea, incoordination, paraparesis, recumbency, and death.

Metabolic acidosis, hypocalcemia, and uremia are hallmarks of intoxication. Calcium oxalate crystals are present in large numbers in the kidney (renotubular) and vasculature. Signs of acute renal failure are seen within the first 24 hours.<sup>1</sup> The treatment recommended for companion animals, ethanol or more often 4-methylpyrazole (fomepizole), is worth considering, especially in small pet ruminants.<sup>2</sup>

A variety of diagnostic tests are available including quantitation in serum. The presence of the chemical in tissue can be detected by chromatography. Kidney cortex (5–10 g) should be frozen in a Whirl-Pak before submission.<sup>3</sup>

### FURTHER READING

Oswieiler GD, Eness PG. Ethylene glycol poisoning in swine. *J Am Vet Med Assoc.* 1972;160:746-749.

### REFERENCES

1. Barigye R, et al. *Can Vet J.* 2008;49:1018.
2. Van Metre DC. *Proc Central Vet Conf.* 2010.
3. Varga A, et al. *Vet Med.* 2012;3:111.

## OCHRATOXINS (OCHRATOXICOSIS)

### SYNOPSIS

**Etiology** Ochratoxin A produced primarily by *Aspergillus ochraceus* and *Penicillium verrucosum*.

**Epidemiology** Worldwide distribution; pigs and chickens are commonly affected.

**Clinical pathology** Increased serum concentrations of creatinine and urea nitrogen; glucosuria and proteinuria; decreased urine specific gravity.

**Lesions** Renal toxicity with damage to epithelial cells of proximal tubules.

**Diagnostic confirmation** High-performance liquid chromatography or liquid chromatography mass spectrometry on tissues (kidney, liver, and muscle).

**Treatment** Remove contaminated feed.

**Control** Nonspecific other than attention to harvesting and storage procedures.

### ETIOLOGY

Ochratoxins are a group of isocoumarin derivative mycotoxins (A, B, and C) produced primarily by *Aspergillus ochraceus* and *Penicillium verrucosum* and less often by several other species of *Aspergillus* and *P. nordicum*.<sup>1-3</sup> Ochratoxin A (OTA) is the most toxic member of the group; ochratoxin B (OTB) and ochratoxin C (OTC) are less toxic and rarely occur.<sup>3</sup> OTA is a well-known nephrotoxin with neurotoxic, carcinogenic, genotoxic, immunotoxic, and teratogenic properties.<sup>2,4</sup>

### EPIDEMIOLOGY

#### Occurrence

Cereal and cereal products are most often contaminated, but OTA can be found in a variety of other products including beer, chocolate, pork and pork products, poultry, raisins, and wine.<sup>4,5</sup> Feed contamination by OTA occurs worldwide from temperate to tropical climates with the incidence in the Northern Hemisphere considerably higher than the Southern Hemisphere.<sup>6</sup> *Aspergillus* spp. are present in the more tropical regions of the world and *Penicillium* spp. in temperate regions.<sup>4</sup> *P. verrucosum*-contaminated cereals are found more frequently in northern European countries as opposed to those in southern Europe.<sup>5</sup>

#### Risk Factors

##### Animal Risk Factors

Swine, dogs, other monogastric animals, and chickens are most often affected from ingestion of OTA-contaminated feeds.<sup>4,7</sup> Ruminant animals are more resistant to OTA toxicosis with goats the possible exception.<sup>3,7</sup> The oral LD<sub>50</sub> of acute OTA toxicity in pigs is 1 mg/kg BW, that of cockerel chicks 3.3 to 3.9 mg/kg BW, and that of turkeys 5.9 mg/kg BW.<sup>7</sup>

##### Environmental Factors

The amount of OTA in feeds and thus residual in body organs varies from year to year depending on climate conditions, harvesting, and storage.

##### Human Risk Factors

Ochratoxin residues have been detected as a carryover in pigs and poultry meats and have significance for persons eating contaminated pork. Information regarding the presence of OTA in cow's milk is scarce, but the carryover is estimated to be less than 1%.<sup>1,4,8</sup>

##### Farm or Premise Risk Factors

The fungus grows primarily on stored barley or corn. Raw animal feed, especially

unprocessed feeds, contain much higher levels of OTA than foods for human consumption. Experimentally, pigs fed diets containing OTA in concentrations as low as 25 µm/kg feed developed decreased feed efficiency and weight loss.<sup>4</sup>

### PATHOGENESIS

In pigs, OTA is rapidly absorbed, highly protein bound (99%), undergoes enterohepatic recirculation, and is distributed to kidney, liver and muscle, and fat.<sup>3,8,9</sup> It is metabolized in the liver by carboxypeptidase and trypsin to a less toxic ochratoxin-α (OTα).<sup>1,3</sup> Elimination is slow, primarily because of high protein binding and renal reabsorption. Excretion is biliary and renal. The serum half-life in pigs is very long (72–150 hours).<sup>3</sup>

Ruminant resistance to OTA toxicity may be caused by decreased absorption and degradation of OTA to less toxic OTα by rumen protozoa and microbes.<sup>1,3,7,8</sup>

Nephrotoxicity from OTA involves several different mechanisms. The principal lesion is a degenerative change in the epithelial cells in the proximal convoluted tubules with impairment of tubular function and fibrosis.<sup>1,6</sup> Several other mechanisms such as inhibition of RNA synthesis, disruption of renal and hepatic mitochondria, and impairment of antioxidant enzymes also may be involved.<sup>3,10,11</sup>

### CLINICAL FINDINGS

Affected pigs show a reduced daily weight gain, decreased feed efficiency, lower final BWs, polyuria, and polydipsia.<sup>4,6,10</sup> Ochratoxin is associated with poor sperm quality in boars, and is thought to be associated with fetal death and resorption, and thus abortion.<sup>7</sup>

### CLINICAL PATHOLOGY

Creatinine and BUN levels are elevated, glucosuria and proteinuria are evident, and urine specific gravity is low.<sup>7,8</sup>

### NECROPSY FINDINGS

The most obvious abnormalities are found in the kidneys with renal enlargement, fibrosis, and necrosis of renal tubular epithelium. Microscopic lesions in the proximal tubules included cloudy swelling, granular or vacuolar degeneration, and desquamation of the epithelial cells.<sup>10</sup> Poisoning by ochratoxin in pigs resembles Balkan endemic nephropathy, a naturally occurring disease of humans.<sup>8</sup>

### DIAGNOSIS

Assessment of OTA levels in tissue is performed with a variety of methods including immunoassay and spectrometry.<sup>12,13</sup> LC-MS/MS has been demonstrated to be more sensitive and specific for OTA in pig tissues than high-performance liquid chromatography.<sup>13</sup>



## DIFFERENTIAL DIAGNOSIS

### Differential diagnosis list:

Citrinin toxicosis  
 Hereditary glomerular disease(s)  
 Melamine toxicosis  
 Polycystic kidney disease  
 Porcine dermatitis and nephropathy syndrome

## TREATMENT

There is no specific treatment other than removing pigs from the contaminated feed and providing clean, mycotoxin-free food. Residues in the tissue persist for a long period of time, and it may take several months for them to decrease to an acceptable level.

## CONTROL

Animal feeds should not be used unless they have levels of OTA less than 10 parts per billion. Several different gastrointestinal adsorbents (activated charcoal, bentonite, and cholestyramine) have been evaluated, but no single product has been effective against most mycotoxins.<sup>4</sup> Strategies should be used to decrease fungal growth (and thus OTA production) during harvesting and storage.

## FURTHER READING

- Galtier P, Alvinerie M, Charpentier JL. The pharmacokinetic profiles of ochratoxin A in pigs, rabbits and chickens. *Food Cosmet Toxicol.* 1981;19:735-738.
- Petzinger E, Weidenbach A. Mycotoxins in the food chain: the role of ochratoxins. *Livestock Prod Sci.* 2002;76:245-250.
- Radostits O, et al. *Ochratoxin. Veterinary Medicine: A Textbook of the Disease of Cattle, Horses, Sheep, Goats and Pigs.* 10th ed. London: W.B. Saunders; 2007:1906.

## REFERENCES

- Fink-Gremmels J. *Vet J.* 2008;176:84.
- Cabanes FJ, et al. *Toxins (Basel).* 2010;2:1111.
- Ringot D, et al. *Chem Biol Interact.* 2006;159:18.
- Muzaffer D, et al. *Toxins (Basel).* 2010;2:1065.
- Bragulat MR, et al. *Int J Food Microbiol.* 2008;126:43.
- Freitas BV, et al. *J Anim Prod Adv.* 2012;2:174.
- Duarte SC, et al. *Vet Microbiol.* 2011;143:1.
- Pfohl-Leszkowicz A, et al. *Mol Nutr Food Res.* 2007;51:61.
- Milićević DR, et al. *Arch Oncol.* 2009;17:59.
- Stoer SD, et al. *Exp Toxicol Pathol.* 2012;64:733.
- Boesch-Saadatmandi C, et al. *Food Chem Toxicol.* 2008;46:2665.
- Matrella R. *Food Control.* 2006;17:114.
- Milićević DR, et al. *J Environ Sci Heal B.* 2009;44:781.

## PLANT POISONINGS CAUSED BY KNOWN TOXINS

### IFORRESTINE

Iforrestine, a heterocyclic nephrotoxin, is present in six species of *Isotropis*. Lamb

poison or Bloom poison, e.g., *I. forrestii*, *I. atropurpurea*, and *I. cuneifolia*, is associated with severe renal damage and uremia in cattle and sheep. Clinical signs include anorexia, depression, diarrhea, oliguria, anuria, recumbency, and death. Proteinuria and glycosuria are constant, and there is severe renal tubular necrosis.

## PLANT POISONINGS FROM UNIDENTIFIED TOXINS

### UREMIA, NEPHROSIS—WITH HIGH BLOOD UREA NITROGEN

- Amaranthus* spp.
- Anagallis arvensis*
- Azadirachta indica*
- Cassine buchanani*
- Catha edulis* (khat)
- Dimorphandra gardneriana*
- Lythrum hyssopifolia*
- Petiveria alliacea* (anamu)
- Psilostrophe* spp. (paperflowers)
- Sapinum sebiferum* (Chinese tallow tree)
- Sarcobolus globosus*
- Sartwellia flaveriae*

### POLYDIPSIA, POLYURIA

- Orobancha minor* (broom rape).

### RED URINE CAUSED BY A PIGMENTED SUBSTANCE FROM THE PLANT

- Haloragis odontocarpa* (raspwort)
- Swartzia madagascariensis*
- Trifolium pratense* (red clover); in deer
- Xanthorrhoea minor*; in cattle; probably associated with plant resins.

### CYSTITIS

- Gyrostemon* (= *Didymotheca cupressiformis*) (double-seeded emu bush).

## FUNGI LACKING IDENTIFIED TOXINS

Grain infected with *Tilletia tritici* (wheat smut) fungus should not be included in rations for pigs because it is thought to be associated with glomerulonephritis and failure to gain weight. Estimates of the maximum safe content of infected grain that can be fed in the ration vary from 5% to 30%.

## FURTHER READING

- Colegate SM, Dorling PR, Huxtable CR, et al. Iforrestine: a novel heterocyclic nephrotoxin from *Isotropis forrestii*. *Aust J Chem.* 1989;42:1249-1255.
- Gardiner MR, Royce RD. Poisoning of sheep and cattle in Western Australia due to species of *Isotropis* (Papilionaceae). *Crop Pasture Sci.* 1967;18:505-513.

## Renal Neoplasia

Primary tumors of the kidney are rare. Renal carcinomas occur in cattle and horses and

nephroblastomas occur in pigs. Enlargement of the kidney is the characteristic sign; in cattle and horses neoplasms should be considered in the differential diagnosis of renal enlargement. In pigs, nephroblastomas may be so big they cause visible abdominal enlargement. Renal adenocarcinomas are very slow growing but are not usually diagnosed until the disease is well advanced. The gross and histologic description of a series of primary renal cell tumors in slaughter cattle has been recorded.

In horses, the most common signs are weight loss, reduced appetite, hematuria, and intermittent bouts of abdominal pain.<sup>1,2</sup> Some affected horses have massive ascites and hemoperitoneum. Metastasis of the tumor to the axial skeleton can result in lameness, which can be the clinical abnormality that is recognized first. The tumor can also metastasize to the lungs and mouth. Masses on the left kidney of horses are usually readily palpable on rectal examination. Horses with renal carcinoma can have clinically apparent periods of hypoglycemia, which is confirmed by measurement of serum glucose concentration and is attributable to production of insulin-like growth factor by the neoplastic tissue. Ultrasonographic examination of the kidney and renal biopsy confirm the diagnosis. Unilateral nephrectomy was successful in the treatment of an 11-year-old female alpaca with hematuria caused by a transitional cell papilloma in the renal pelvis.<sup>3</sup>

Metastatic neoplasms are fairly common in the kidney, particularly in enzootic bovine leukosis, but they do not cause clinical renal disease. Tumor masses may be palpable as discrete enlargements in the kidneys of cattle or may involve the kidney diffusely, causing generalized enlargement of the kidney.

## REFERENCES

- Wise LN, et al. *J Vet Intern Med.* 2009;23:913.
- Swain JM, et al. *J Vet Intern Med.* 2005;19:613.
- Gerspach C, et al. *J Am Vet Med Assoc.* 2008;232:1206.

## Congenital and Inherited Renal Diseases

### RENAL HYPOPLASIA

Developmental abnormalities of the kidneys are classified as renal agenesis, hypoplasia, and dysplasia, with agenesis and hypoplasia representing different degrees of the same condition. Renal hypoplasia is defined as a decrease in total renal parenchyma of one-third or more, with a proportionately greater loss of medullary than cortical tissue. The diagnosis of renal hypoplasia is straightforward in neonates but can be difficult to differentiate from renal dysplasia in adults.

Renal agenesis results from failure of the ureteral bud to contact the metanephric blastema during organogenesis and has been

reported to occur in cattle and alpacas.<sup>1</sup> Bilateral renal agenesis is fatal shortly after birth, but unilateral renal agenesis may be clinically undetectable except for compensatory hypertrophy of the remaining kidney.

Bilateral renal hypoplasia with or without agenesis is recorded in Large White piglets; the piglets die at birth or die in the first 3 months of life. Clinical signs exhibited by older pigs included lethargy, shivering, anorexia, diarrhea, and a slow rate of growth. The disease was suspected to be inherited in a simple autosomal recessive manner, and the basic defect appeared to be failure of development of mesonephric mesenchyme.

Cases of bilateral renal hypoplasia have been recorded in four horses 1 day to 3 years of age that had common histories of stunting, poor growth rate, anorexia, depression, and lethargy. Evidence of chronic renal failure was present on clinicopathologic examination. Transrectal and transabdominal ultrasonography revealed small kidneys and small renal medulla and pelves and was considered a useful diagnostic test.

Renal hypoplasia is part of a congenital multisystem disorder of Poll Merino/Merino sheep that has been named **brachygnathia, cardiomegaly, and renal hypoplasia syndrome (BCRHS)**.<sup>2,3</sup> The abnormalities are described in detail in [Chapter 21](#).

## REFERENCES

1. Sugiyama A, et al. *J Comp Pathol*. 2007;137:71.
2. Shariflou MR, et al. *Aust Vet J*. 2011;89:254.
3. Shariflou MR, et al. *Anim Genet*. 2012;44:231.

## POLYCYSTIC KIDNEYS

In most species this is a common congenital defect. If it is extensive and bilateral the affected animal is usually stillborn or dies soon after birth. In some cases, bilateral defects are compatible with life, and clinical signs may not present until the residual nephron mass is gradually exhausted and the animal is adult. If it is unilateral no clinical signs appear because of compensatory activity in the other kidney, but in an adult the enormously enlarged kidney may be encountered during rectal examination.

In adult horses, polycystic disease may also be acquired rather than congenital. The disease is rare, but affected animals present in varying stages of chronic renal failure.

A high incidence of renal defects has been recorded in sucking pigs from sows vaccinated during early pregnancy with attenuated hog cholera virus; bilateral renal hypoplasia has been observed as a probably inherited defect in Large White pigs. Most polycystic kidneys in pigs appear to be inherited in a polygenic manner and have no effect on the pig's health or renal function. However, there is a record of the defect in newborn pigs in one herd in which it caused gross abdominal distension caused by moderate ascites and gross cystic distension of

the kidneys and tract. There was no evidence that the disease was inherited in this instance, and a toxic origin was surmised.

Isolated cysts occur in the kidneys of all species and are of no clinical significance. The increased availability of ultrasonographic examination of the kidneys of animals facilitates antemortem identification of these cysts. The cysts are usually solitary and unilateral.

**Congenital polycystic kidney disease of lambs** occurs as an autosomal recessive trait.<sup>1</sup> The disease is recognized in Romney, Perendale, and Coopworth sheep in New Zealand and most likely originated in the Romney breed 50 years ago. Lambs die at or shortly after birth and there is no apparent sex predisposition. Necropsy examination reveals an abdomen distended by the enlarged kidneys (3.5–14 cm in length), which contain large numbers of fluid-filled 1- to 5-mm cysts. There are gross and histologic abnormalities of the liver and pancreas, and dysplastic changes and associated cyst formation are observed in bile ductal, pancreatic, and epididymal tissues. A likely candidate gene for the disorder is polycystic kidney hepatic disease 1. A pathologically similar disease is reported in a Nubian goat.

## REFERENCE

1. Johnstone AC, et al. *New Zeal Vet J*. 2005;53:307.

## RENAL DYSPLASIA

Renal dysplasia is defined as disorganized development of the renal parenchyma caused by anomalous differentiation. Each kidney is formed from separate metanephric and uterine buds, and an appropriate interaction between these buds is required for the development of normal renal architecture.<sup>1</sup> Histologically, renal dysplasia is characterized by persistence of abnormal mesenchymal structures, including undifferentiated cells, cartilage, immature collecting ductules, and abnormal lobar organization, and the lack of normal nephrons and collecting ducts. Affected kidneys do not function normally and azotemia develops.

Renal dysplasia is very rare in horses with isolated reports in several breeds. It is most commonly identified in foals but less severely affected animals can survive to adulthood. Clinicopathologic findings include azotemia, oliguria, and increased serum phosphorus and potassium concentrations in affected foals.<sup>1</sup> Renal dysplasia can occur as an apparent spontaneous disease in foals and in foals born to mares treated with sulfadimidine, pyrimethamine, and folic acid during pregnancy. Renal dysplasia has been diagnosed in a 4-month-old foal with benign ureteropelvic polyps associated with hydronephrosis. Renal dysplasia has also been diagnosed in two adult horses with weight loss, azotemia, hypercalcemia, and increased fractional clearance of sodium. Ultrasonographic

examination of the kidneys revealed a poor distinction between the cortex and medulla caused by a hyperechoic medulla, which was caused by fibrosis. Histologic changes in both horses were indicative of interruption of nephrogenesis after the initiation, but before the complete differentiation, of the metanephric blastema. There is one report of **multiple renal cysts** being present in a 9-day-old Thoroughbred filly with renal dysplasia.<sup>2</sup>

**Inherited cystic renal dysplasia** has been identified in lambs sired by carrier Suffolk rams out of mixed ewes. Signs include recumbency and coma by days 2 to 3. Abortions and stillbirths occurred in the flocks at the same time. The kidneys are enlarged and cystic. The condition may have been caused by an autosomal dominant gene.

Congenital renal dysplasia has been recorded in two successive years in a Leicester sheep flock crossbred with Suffolk and Swaledale rams. Affected lambs were born alive, were reluctant to stand or move, sucked poorly, and had wet coats. Lambs improved with nursing and provision of warmth, but none with clinical signs at birth survived beyond 5 days after birth. At necropsy, the kidneys were bilaterally small with fine intracortical cysts and distinct cortical and medullary zones. An inherited dominant trait with complete penetrance is suspected.

Renal tubular dysplasia has been diagnosed in Japanese Black cattle (Wagyu) with renal failure, poor growth, and long hooves. Calves were undersized at birth and had repeated episodes of diarrhea during the neonatal period. They began to show signs of growth retardation from 2 to 5 months of age but had a normal appetite. Clinicopathologic findings included azotemia, increased serum phosphorus concentrations, and oliguria. At necropsy, the main lesion was dysplasia of the proximal tubule epithelial cells, with secondary interstitial fibrosis with a reduction in the numbers of glomeruli and tubules in older cattle. An autosomal recessive mode of inheritance has been determined associated with a deletion of the paracellin-1 gene on chromosome 1,<sup>3</sup> which has been renamed the claudin-16 (CL-16) gene. Bovine CL-16 deficiency is classified as type 1 or type 2 depending on the site of the gene mutation.<sup>4</sup> The CL-16 gene encodes a protein that is part of the tight junction of renal epithelial cells that restricts diffusion of solutes through the paracellular pathway. Deletion of the CL-16 gene is considered to be the cause for the renal tubular dysplasia, and a DNA-specific test for this mutation has been developed. Heterozygotes are usually clinically normal and have normal renal function, although one report indicated that some heterozygotes have histologic renal lesions.<sup>4</sup> Renal dysplasia with nephrosclerosis appears to be a different condition in cattle and has been reported in six calves with poor growth rates aged 3 to 6 months.<sup>5</sup> Renal dysplasia has also

been diagnosed in Japanese Black cattle that are of normal gene type,<sup>6</sup> suggesting that although the renal lesions may be associated with a homozygous deletion of the CL-16 gene, there may be accompanying defects that have not been characterized.

## REFERENCES

1. Philbey AW, et al. *Vet Rec.* 2009;165:626.
2. Medina-Torres CE, et al. *Can Vet J.* 2014;55:141.
3. Hardefeldt LY, et al. *Aust Vet J.* 2007;85:185.
4. Naylor RJ, et al. *Equine Vet Educ.* 2009;21:358.
5. Ohba Y, et al. *Genomics.* 2000;68:229.
6. Sugiyama A, et al. *J Comp Pathol.* 2007;137:71.

## RENAL LIPOFUCINOSIS OF CATTLE

Dark brown or black discolored kidneys (“black kidneys”) have been reported as incidental findings in slaughter cattle for more than 100 years,<sup>1</sup> and has been termed **renal lipofuscinosis** of Danish cattle. A pigment with characteristics similar to those lipofuscin is present in secondary liposomes in epithelial cells of the proximal tubules. Cases occurred only in Holstein cattle or the Red Danish Dairy Breed and mainly in animals aged 3 years or older. The prevalences of the abnormality were 0.3–0.4% and 1.3–2.5%, respectively in Holstein and Red Danish Dairy breeds.<sup>2</sup> Affected animals produce slightly less milk than similarly aged animals without renal lipofuscinosis. Epidemiologic, genealogic, and genotype analyses indicate an autosomal recessive inheritance on chromosome 17, with incomplete penetrance of the genotype in Danish Holsteins.<sup>2</sup>

## REFERENCES

1. Rude H, et al. *J Comp Pathol.* 2005;132:303.
2. Agerholm J, et al. *Acta Vet Scand.* 2009;51:7.

## EQUINE RENAL CORTICAL TUBULAR ECTASIA

A 16-year-old Thoroughbred pregnant mare with hemoabdomen, laminitis, and unilateral epistaxis was examined. Her physical condition deteriorated rapidly and the horse was euthanized. A ruptured ovarian artery was found to be the cause of the hemoabdomen, and variably sized, firm, light brown nodular cortical masses that did not extend past the corticomedullary junction were an incidental finding in both kidneys. Histologically, the masses were diagnosed as renal cortical tubular ectasia,<sup>1</sup> which has some similarities to medullary sponge kidney (Cacchi–Ricci syndrome) in humans. The renal cortical masses are thought to represent disruption at the “ureteric bud–metanephric mesenchyme” interface.

## REFERENCE

1. Jackson C. *J Equine Vet Sci.* 2015;35:80.

## Diseases of the Ureters, Bladder, and Urethra

### ECTOPIC URETER AND URETERAL DEFECTS

**Ectopic ureter** has been recorded in cattle and horses. The condition may be unilateral or bilateral with **urinary incontinence** present since birth as the major clinical manifestation. Reported neurogenic causes of urinary incontinence in horses include cauda equina neuritis, herpesvirus-1 myelitis, Sudan grass toxicosis, sorghum poisoning, trauma, and neoplasia. Nonneurogenic causes of urinary incontinence in horses include ectopic ureter, cystitis, urolithiasis, hypoestrogenism, and abnormal vaginal conformation.

The ectopic ureter opens into the urogenital tract at a place other than the bladder such as the cervix, urethra, or vagina. The condition is often complicated by ascending infections, hydronephrosis, and dilatation of the ureter. Definite diagnosis requires excretory urography or endoscopy; visualization of the ureteral openings during endoscopy can be assisted by IV administration of phenolsulfonphthalein (0.01 mg/kg BW) or indigo carmine (0.25 mg/kg BW) to impart a red or blue color, respectively, to the urine being produced. Surgical treatment involving ureterovesical anastomosis or unilateral nephrectomy has been successful.

Unilateral and bilateral **ureteral defects** have been reported in newborn foals. The clinical presentation is similar to rupture of the urinary bladder, but ureteral defects may be more common in filly foals than in colts.

### PARALYSIS OF THE BLADDER AND OVERFLOW INCONTINENCE

Paralysis of the bladder is uncommon in large animals. It usually occurs as a result of neurologic diseases affecting the lumbosacral spinal cord such as equine herpes myelopathy and cauda equina syndrome, and particularly ascending spinal meningitis in lambs after tail docking. In all species, compression of the lumbar spinal cord by neoplasia (lymphosarcoma and melanoma) or infected tissue (vertebral osteomyelitis) can cause paralysis of the bladder. Excessive tension on the tail, such as by application of tail ropes or use of the tail for restraint in cattle, can injure the cauda equina and result in bladder paralysis. In horses, spinal cord degeneration following consumption of sorghum can lead to bladder paralysis and posterior ataxia. Iatrogenic bladder paralysis occurs in horses in which there has been epidural injection of an excessive quantity of alcohol. Equine protozoal myeloencephalitis and equine

polyneuritis can cause signs of cauda equina dysfunction in horses. In some horses, idiopathic bladder paralysis and overflow incontinence may occur sporadically in the absence of other neurologic or systemic signs. When the bladder is markedly distended from a urinary tract obstruction, it may take several days after removal of the obstruction before normal bladder tone returns.

When bladder paralysis arises from spinal cord disease, other upper or lower motor neuron signs are usually present. Bladder involvement is indicated by incontinence with constant or intermittent dribbling of urine. Urine flow is often increased during exercise. The bladder is enlarged on examination per rectum, and urine can be easily expressed by manual compression. In horses, chronic distension of the atonic or hypotonic bladder leads to accumulation of a sludge of calcium carbonate crystals called **sabulous urolithiasis**.<sup>1</sup> Urine stasis produces ideal conditions for bacterial growth, and cystitis is a common sequel. Treatment is supportive and aimed at relieving bladder distension by regular catheterization and lavage. During catheterization, care must be taken to avoid introducing infection. Manual or pharmacologically induced emptying of the bladder is incomplete so there is a constant risk of cystitis. Pharmacologic enhancement of bladder emptying can sometimes be achieved by administration of parasympathomimetic agents such as bethanechol (parasympathetic stimulation via the pelvic nerve stimulates detrusor contraction; 0.2 to 0.4 mg/kg every 6 to 8 hours, orally) and sympatholytics such as prazosin and phenoxybenzamine (sympathetic stimulation via the hypogastric nerve causes detrusor relaxation and internal sphincter contraction). The administration of antimicrobial agents as a prophylaxis against the development of cystitis is advisable. The prognosis for paralysis associated with spinal cord disease depends on the prognosis for the primary disease. Paralysis in the absence of spinal cord disease has a poor prognosis.

Cattle ingesting *Cistus salvifolius*, a shrub found in the Mediterranean region, had urinary retention as the primary clinical sign. Cattle had decreased appetites and rumen motility, weight loss, and persistent elevation of the tail head and difficulty in urination. A greatly distended urinary bladder was always detected on palpation per rectum. The mortality rate in advanced cases was high, and affected animals have severe cystitis, pyelonephritis, and a marked increase in bladder wall thickness. No evidence of neurologic injury was present, and it is likely that urine retention was secondary to severe cystitis and swelling of the bladder wall that prevented normal urination.

## REFERENCE

1. Saulez MN, et al. *J Am Vet Med Assoc.* 2005;226:246.



## EVERSION OF THE BLADDER

Bladder eversion through the urethra into the vagina and through the vulva occurs very rarely in mares and cows, and is most common immediately after parturition. Eversion is secondary to severe straining in the periparturient period, an increase in intraabdominal pressure, and the presence of a short wide urethra in mares or concomitant hypocalcemia in cows. Bladder eversion observed immediately after parturition must be differentiated from uterine prolapse. There is a report of bladder eversion in a nonpregnant mare secondary to chronic cystitis.<sup>1</sup> Treatment is administration of an epidural or sedation, aseptic cleaning of the perineal region and exposed tissue, examination of the prolapsed tissue to ensure lacerations or full thickness necrotic sections are not present, application of sterile lube to assist movement of tissues, and gentle retropulsion.

Umbilical evagination of the bladder has been reported in a neonatal filly. The bladder prolapsed through the umbilicus such that the mucosa of the bladder was outside (bladder eversion). Correction is surgical.

## REFERENCE

1. Kumas C, Maden M. *J Equine Vet Sci.* 2014;34:329.

## PATENT URACHUS

Failure of the urachus to close at birth is most common in foals and is very rare in other species. Patent urachus occurs as three syndromes in foals: congenital and present at birth; acquired and secondary to urachal infection or inflammation; or secondary to severe systemic illness, usually sepsis. The urachus is part of the umbilicus during fetal development and drains urine into the allantoic fluid during intrauterine life; after birth, a patent urachus will therefore manifest as urine leaking from the umbilicus. The urine flow varies from a continuous stream during micturition to constant or intermittent dribbling, or a continuous moistening of the umbilical stalk. Healthy foals with congenital patent urachus heal in several days, and no specific treatment is required. Formerly, cauterization with phenol or silver nitrate was practiced, but this treatment has the theoretical potential to induce necrosis and increases susceptibility to infection.

Foals with patent urachus secondary to umbilical disease usually have an enlarged umbilicus, and some have a purulent discharge. Foals that have patent urachus secondary to other umbilical disease might require surgical correction, although most respond to a 7- to 14-day course of antimicrobials. Foals with patent urachus secondary to systemic disease, usually sepsis, should have their other disease treated aggressively and the urachus allowed to close spontaneously, which it usually does.

Ultrasonographic examination of the umbilicus of all foals with patent urachus is essential to determine the extent of disease and presence of intraabdominal disease. As with all sick foals, the immune status of foals with patent urachus secondary to umbilical or systemic disease should be determined by measurement of serum IgG concentration, and foals with low serum IgG concentration should receive a blood or plasma transfusion. Cystitis is an occasional sequel to patent urachus, but omphalitis and urachal abscess may also develop as complications. Patent urachus is rarely diagnosed in neonatal ruminants but has been recorded in a lamb.

Urachal abscess is discussed as a subgroup of umbilical abscess in Chapter 19. When the infection is localized in the urachus, there are usually signs of cystitis, especially increased frequency of urination.

## RUPTURE OF THE BLADDER (UROPERITONEUM)

Rupture of the bladder is most common in castrated male ruminants as a sequel to obstruction of the urethra by calculi. Rare cases are recorded in cows as a sequel to a difficult parturition, in mares after normal parturition, possibly because of compression of a full bladder during foaling, and in a gelding caused by penile and preputial squamous cell carcinoma.<sup>1</sup> In cattle, abnormal fetal position during prolonged dystocia is suspected to obstruct the urethra and distend the bladder. Subsequent manipulation within the pelvic canal during correction of the dystocia is suspected to lead to rupture of a distended bladder. Occasionally, the urachal remnant can rupture spontaneously in adult cattle, resulting in uroperitoneum. The urachal remnant may be identified using transrectal ultrasonography and a 7.5-MHz transducer.<sup>2</sup> Uroperitoneum in foals is discussed in the next section.

After the bladder ruptures, uroperitoneum results in a series of abnormalities that arise from failure of the excretory process combined with solute and fluid redistribution between the peritoneal fluid and extracellular fluid. The peritoneal membrane serves as a semipermeable membrane through which low molecular weight solutes readily pass. High molecular weight compounds also diffuse across the peritoneal membrane but at a much slower rate. Urine is usually hypertonic, especially in animals whose water intake is decreased by uremia. Osmotic pressure from hypertonic urine promotes movement of extracellular water into the peritoneal cavity. This movement, combined with reduced intake, results in clinical dehydration. Urine usually has a lower concentration of sodium and chloride and higher concentrations of urea, creatinine, potassium, and phosphate than plasma. Diffusion along these concentration gradients across the peritoneal membrane results in a general

pattern of azotemia with hyponatremia, hypochloremia, hyperkalemia, and hyperphosphatemia. There are minor differences between species in these general biochemical changes. In particular, the blood concentration of urea rises much more slowly in ruminants than in horses, and hyperkalemia is not as common in ruminants as in horses because excessive potassium can be excreted in the saliva and therefore eliminated in the feces.

Bladder rupture leads to gradual development of ascites from uroperitoneum, ruminal stasis, constipation, and depression. In cattle, uremia may take 1 to 2 weeks to develop to the point in which euthanasia is necessary. The degree of uremia between individual patients can be highly variable. With therapy, the survival rate of steers in one study was 49%. The best predictor of survival among clinical pathology tests was the serum phosphate concentration: all animals with levels greater than 9.0 mg/dL (2.9 mmol/L) died. In mature horses, clinical signs of depression, anorexia, colic, abdominal distension, and uremia develop within 1 to 2 days following rupture.

In cases of ascites or when urinary tract obstruction is evident, it is important in considering treatment and prognosis to determine whether the bladder has ruptured. The urea and creatinine concentrations in plasma or serum can be compared with the values in the peritoneal fluid. The ratio of urea in peritoneal fluid to that in serum is a good guide in the early stages, but after 40 hours the ratio of the peritoneal to serum creatinine greater than 2:1 is diagnostic of uroperitoneum. Treatment is surgical with a goal of bladder repair. To avoid the costs of laparotomy in feedlot animals, a urethrostomy is created or an indwelling catheter is placed and the rupture is allowed to repair itself.

## REFERENCES

1. May KA, et al. *Equine Vet Educ.* 2008;20:135.
2. Braun U, et al. *Vet Rec.* 2006;159:780.

## UROPERITONEUM IN FOALS

### ETIOLOGY

Uroperitoneum, the accumulation of urine in the peritoneal cavity, occurs in foals as a result of a variety of situations:

- Congenital (i.e., present at birth) rupture of the bladder
- Bladder rupture associated with sepsis
- Rupture of the urachus, often secondary to sepsis
- Avulsion of the bladder from its urachal attachment, presumably as a result of trauma or strenuous exercise
- Rarely, as embryologic failure of the halves of the bladder to unite (schistocystitis)
- Ureteral defects

The etiology of congenital rupture is unclear, but its association with birth, markedly greater prevalence in colts, and the traumatic

nature of the lesion suggest that it occurs during birth as a result of compression of a distended bladder. Intraabdominal pressures of the mare during parturition are large, and these compressive forces are experienced by the foal during phase 2 of parturition. Compression of a distended bladder can cause rupture. The greater prevalence in colts is speculated to be a result of the greater resistance to bladder emptying conferred by the longer urethra of male foals.

Rupture of the bladder occurs as a distinct entity in **septic foals**. The underlying reason for bladder rupture is unclear but is usually related to infection, inflammation, and necrosis of the lower urinary tract. This cause of uroperitoneum in foals is increasingly recognized as the most common, especially among hospitalized foals.

Rupture of the urachus occurs in septic foals. It is probably of similar etiology to rupture of the bladder in septic foals. The urachus of affected foals almost always has infection, inflammation, and necrosis evident on histologic examination.

Avulsion of the bladder from its urachal attachments is presumed to occur as a result of trauma, such as might occur with vigorous exercise. The possibility also exists that there is an underlying defect in affected foals, such as urachitis or omphalitis.

Embryologic failure of the halves of the bladder to unite during organogenesis has been reported anecdotally and in case reports, although adequate documentation of its occurrence is lacking. This defect would be a true congenital anomaly, arising during gestation.

Ureteral defects are an uncommon cause of uroperitoneum in foals. The defects appear to be congenital and more common in fillies. Both ureters can be affected.

The relative frequency of these diseases is that approximately 20% of foals with uroperitoneum do so because of urachal rupture, approximately 30% because of rupture of the dorsal bladder wall, 18% because of rupture of the ventral bladder wall, and the remainder because of multiple defects involving combinations of the urachus and dorsal and ventral bladder. One report of rupture of the urethra and bladder exists in a colt foal.<sup>1</sup>

Uroperitoneum also occurs rarely in **calves** as a consequence of umbilical infection.

## EPIDEMIOLOGY

The epidemiology of uroperitoneum is not well documented. The incidence in foals appears to be approximately 0.2%, although this estimate is based on a study conducted 50 years ago. The prevalence in hospitalized foals is 2.5%. Male foals are at greater risk than are females for congenital rupture; more than 80% of foals with this disease are colts. In contrast, there is no sex predilection for development of uroperitoneum in foals with sepsis. The age at diagnosis ranges from 2 to more than 60 days, with most cases

recognized within the first 2 weeks of life. The average age at diagnosis is approximately 4 to 5 days, although the age at presentation depends on the underlying cause. Foals with congenital rupture of the bladder or ureteral defects are usually recognized at about 3 to 5 days of age, whereas foals with uroperitoneum secondary to sepsis are usually older (5–9 days of age, but up to 60 days). The prognosis for survival for foals with uroperitoneum depends on the underlying cause and availability of appropriate treatment. Foals with congenital rupture of the bladder that are recognized and treated in a timely fashion have an excellent prognosis (>80%) for survival, whereas those with uroperitoneum secondary to sepsis have a more guarded prognosis (50%–60%) because of the sepsis.

## PATHOPHYSIOLOGY

The pathophysiology of uroperitoneum is that of postrenal azotemia. Regardless of the underlying cause of the uroperitoneum, accumulation of urine within the peritoneal cavity results in substantial electrolyte, acid-base, and cardiovascular effects in affected foals. The basic principle is that affected foals are unable to excrete metabolic waste products that are normally excreted in the urine, and are unable to maintain water and electrolyte balance. Young foals derive almost all of their nutritional needs, including water, from mare's milk. Mare's milk has a low sodium concentration (approximately 12 mEq/L) and a higher potassium concentration (25 mEq/L) compared with serum and a dry matter content of 11%. Therefore foals ingest a diet that contains a large quantity of water and potassium but little sodium. Consequently, the urine of foals contains little sodium (7 mEq/L) and has a low osmolality (100 mOsm/kg). Leakage of urine into the peritoneum, a semipermeable membrane, results in considerable fluid and electrolyte shifts. Partial equilibration of water and electrolytes across the peritoneal membrane results from diffusion of water from the peritoneum with resultant dilution of serum and reductions in serum sodium and chloride concentrations. The low concentration of sodium in uriniferous peritoneal fluid favors diffusion of sodium from the blood into the peritoneal fluid, resulting in a reduction in intravascular sodium content and a consequent reduction in effective circulating volume. Excretion of relatively large quantities of potassium in urine and accumulation of potassium-rich fluid in the peritoneum allows diffusion of potassium into the blood and an increase in plasma potassium concentration.

The peritoneal membrane is permeable to creatinine and urea, as evidenced by the efficacy of peritoneal lavage in the treatment of renal failure in a variety of species, including horses. Consequently, serum creatinine and urea concentrations are higher in foals with

uroperitoneum than in unaffected foals. However, equilibration of concentrations of these compounds is not complete and peritoneal fluid concentrations of urea, creatinine, and potassium are higher than those in serum.

Foals with uroperitoneum have compromised circulatory function because of reduced effective circulating plasma (blood) volume, despite having an increase in total body water content. Circulatory function is further impaired by a combination of hyperkalemia, abdominal distension, and accumulation of fluid in the pleural space, resulting in foals with uroperitoneum that have signs of mild to moderate circulatory compromise.

Hyperkalemia and acidosis associated with uroperitoneum predispose affected foals to development of malignant cardiac rhythm disturbances, including ventricular tachycardia and fibrillation. This abnormal cardiac rhythm is a common cause of death of affected foals.

## CLINICAL SIGNS

Clinical signs in foals with uroperitoneum depend in part on the underlying disease. Foals with congenital rupture or mild sepsis have progressive signs of lethargy, decreased appetite, mild abdominal discomfort, and abdominal distension. These signs usually first become apparent at 2 to 4 days of age. These foals do not typically have a fever. As the disease progresses and the amount of urine accumulated in the peritoneum increases, foals have progressive distension of the abdomen and make frequent attempts to urinate. Foals that attempt to urinate ventroflex their back (mild lordosis) and have a wide-based stance. This should be contrasted with foals with tenesmus, which characteristically have a narrow-based stance (all four limbs being under the body) and arch their back. Affected foals sometimes produce small quantities of urine, but usually there is lack of urination. Abdominal distension is most apparent when the foal is standing. In moderate to severe cases, there is a readily appreciable fluid wave on ballottement of the abdomen. As abdominal distension increases, the foal's tidal volume is impaired and breathing becomes rapid and shallow. The extremities become cool as cardiovascular function is impaired.

Ventral edema and preputial swelling occur in some foals. Foals with urachal rupture close to or within the abdominal wall or in the subcutaneous tissues will have subcutaneous accumulation of urine (which can be mistaken for ventral edema).

Foals with uroperitoneum secondary to sepsis usually have signs of sepsis as the initial and predominant sign of disease. These signs can range from mild fever and enlargement of the umbilical structures to septic shock and its attendant abnormalities. Initial signs of uroperitoneum in these foals are easily overlooked. As the disease

develops, these foals have progressive abdominal distension. Signs of cardiovascular dysfunction can be incorrectly attributed to worsening of sepsis. It is important when treating septic foals to maintain a high index of suspicion and constant vigilance for development of uroperitoneum.

Infusion of contrast agents, such as methylene blue or fluorescein, into the bladder with subsequent detection of these compounds in the peritoneal fluid has been used to diagnose uroperitoneum. However, use of this method of diagnosis is now obsolete except in those instances in which ultrasonographic examination of the foal is not possible.

### Imaging

**Ultrasonographic** examination of the abdomen of foals has simplified detection of uroperitoneum in foals and is the **preferred imaging modality for the detection of excessive peritoneal fluid in foals**. The ultrasound examination is best performed with a 5-MHz sector scan probe, with more detailed examination of the umbilical structures performed using a 7-MHz linear or sector scan probe. However, diagnosis of the presence of excessive peritoneal fluid can be achieved using a 7-MHz linear sector scan probe, such as is routinely used for examination of the mare's reproductive tract. The examination is performed transcutaneously.

Ultrasonography reveals the presence of an excessive quantity of fluid that is minimally echogenic. Intestine, mesentery, and omentum are readily visualized floating in this fluid. The presence of a large quantity of minimally echogenic fluid in the peritoneum of foals is very specific (effectively 100%) for uroperitoneum. The procedure is also sensitive, especially if performed repeatedly to detect changes in the amount of fluid, especially when the initial examination is equivocal. The umbilical structures should be examined closely and the urachus tracked to the bladder. Frequently a defect in the urachus or umbilicus is identified. The thorax of affected foals should also be examined, because foals with large quantities of urine in the peritoneum often have a substantial accumulation of pleural fluid. This can be important when considering anesthesia in these foals.

**Radiographic** examination of foals with suspected uroperitoneum is rarely performed because of the utility of ultrasonographic examination in this disease. Plain abdominal radiography is of limited usefulness in the detection of uroperitoneum or localizing the source of urine. Positive contrast cystography using a 10% solution of iohexol or similar water-soluble contrast agent administered into the bladder through a Foley catheter can be useful in detection of leaks, especially small leaks that cannot be visualized on ultrasonographic examination. Care should be taken to ensure that the

bladder is sufficiently distended to ensure that any leak is visualized. Use of barium contrast medium, or negative-contrast cystography (infusion of air into the bladder), are contraindicated. IV pyelography is of very limited usefulness in the detection of ureteral defects because of the difficulty in localizing the site of the leak.

**Electrocardiographic** examination can reveal cardiac arrest, atrioventricular block, presumed intraventricular block, ventricular premature complexes, ventricular tachycardia, and ventricular fibrillation. These abnormalities are most likely to occur in foals that are hyperkalemic at the time of induction of anesthesia.

### CLINICAL PATHOLOGY

Foals with uncomplicated uroperitoneum have hyponatremia, hypochloremia, hypobicarbonatemia (metabolic acidosis), acidemia, hyperkalemia, and azotemia. Severely affected foals can be profoundly hyponatremic (<110 mEq/L) and hyperkalemic (>7.0 mEq/L). Serum or plasma creatinine and urea nitrogen concentrations are elevated. When interpreting SUN concentrations in foals, it should be kept in mind that the urea concentration in normal foals is much lower than in adults.

Diagnosis based on serum electrolyte abnormalities is confounded in hospitalized foals that are being treated with IV fluids. Administration of fluids prevents the development of hyponatremia and hypochloremia in septic foals that develop uroperitoneum during the course of their disease. However, fluid administration does not prevent the increases in serum creatinine or urea nitrogen concentration.

Hematologic abnormalities reflect any underlying sepsis.

Analysis of **peritoneal fluid** reveals that it has a low specific gravity (<1.010), low total protein concentration (<2.5 g/dL; 25 g/L), and low white cell count (<1000 cells/ $\mu$ L,  $1 \times 10^9$  cells/L). Peritoneal fluid can have a urinous odor, but this is not a reliable diagnostic sign. Peritoneal fluid from foals with uroperitoneum has elevated concentrations of creatinine (usually twice that in a contemporaneous serum sample), urea nitrogen (twice that of serum), and potassium. Microscopic examination of the fluid can reveal calcium carbonate crystals, the presence of which is diagnostic for urine.

### NECROPSY FINDINGS

Necropsy examination confirms the presence of uroperitoneum and the structural defect allowing leakage of urine into the abdomen. The defect can have signs of healing, which can make it readily confused with a malformation, because affected foals can survive for days after the rupture occurs, which is sufficient time for partial healing of the defect.

### DIFFERENTIAL DIAGNOSIS

Ultrasonographic demonstration of an excessive quantity of poorly echogenic fluid in the abdomen of a foal that is passing little if any urine and that has hyponatremia and hyperkalemia is diagnostic of uroabdomen.

Confirmation of the diagnosis can be achieved by measurement of creatinine concentration in the peritoneal fluid.

Ultrasonographic examination greatly facilitates the diagnosis.

The principal differential diagnoses for azotemia in foals are uroperitoneum and renal disease. **Primary renal disease** in foals can cause hyponatremia, hyperkalemia, and azotemia, but there is no accumulation of fluid in the peritoneum. Additionally, in primary renal disease there are abnormalities in urine composition (presence of blood, protein, leukocytes, and casts). Hyponatremia and hyperkalemia can occur in foals with **enterocolitis**, but the other clinical signs are diagnostic of this disease. **Addison's disease** (mineralocorticoid deficiency) does occur in foals but is rare, and there is no accumulation of fluid in the abdomen.

### TREATMENT

Definitive treatment of uroperitoneum in foals is surgical repair of the defect. However, there is no need for surgery on an emergency basis. Instead, care should be taken to correct life-threatening electrolyte and fluid abnormalities before the foal is subjected to anesthesia. Principles of medical treatment are prevention of potentially lethal cardiac arrhythmia; correction of electrolyte, fluid, and acid-base abnormalities; and relief of abdominal distension.

Potentially life-threatening electrolyte abnormalities, especially hyperkalemia, should be corrected urgently and before any attempted surgical correction of the anatomic defect.

Correction of fluid and electrolyte abnormalities is best achieved by draining the abdomen and ensuring continued voiding of urine while administering isotonic fluids intravenously. Because the foal has normal kidney function, draining urine from the abdomen allows the foal to restore normal serum electrolyte concentrations and fluid balance provided it is allowed to nurse and/or is administered parenteral fluids.

Peritoneal drainage is achieved by placement of a catheter into the abdomen. It should be placed so it remains in place until the electrolyte abnormalities have been corrected and the foal is a suitable candidate for surgical repair of the anatomic defect. An ideal catheter is a Foley balloon-tipped catheter placed into the abdomen through a small (5-mm) incision in the skin and external abdominal wall. The catheter should be placed in the inguinal region and to one side of the linear alba to avoid injury and contamination of a future surgical site and to



minimize the chances of the catheter being plugged by omentum. The catheter is inserted under local anesthesia, and the balloon is inflated to secure the catheter in the abdomen. The catheter can be further secured by a suture. Sedation or tranquilization should be avoided in foals at risk of cardiac or respiratory distress because of the electrolyte abnormalities. Urine should be allowed to drain from the catheter into a closed collection system that minimizes the chances of ascending infection of the peritoneum.

Hyperkalemia is usually readily corrected by peritoneal drainage and administration of potassium-free fluid, such as 0.9% sodium chloride. Serum potassium concentration declines quickly when effective peritoneal drainage is obtained, and serum potassium concentrations can normalize in 8 to 12 hours. If emergency management of hyperkalemia is required, administration of 5% dextrose either alone or, if hyponatremia is also present, in 0.9% sodium chloride, is effective in reducing serum potassium concentration. Sodium bicarbonate (1–3 mEq/kg BW, IV) will also decrease serum potassium concentration. Calcium gluconate antagonizes the effect of hyperkalemia on cardiac function and is useful in the treatment of hyperkalemic arrhythmias. The serum potassium concentration should be lower than 5.5 mEq/L before the foal is anesthetized. Mare's milk, which is rich in potassium, should be withheld until the serum potassium concentration is below the required level.

Hyponatremia is resolved by drainage of the peritoneum and administration of 0.9% to 1.8% sodium chloride intravenously. Serum sodium concentration, especially if markedly low, should be corrected slowly to prevent the development of hyponatremic encephalopathy. Serum sodium concentrations should be increased by approximately 1 (mEq/L)/h.

Affected foals should be administered broad-spectrum antibiotics because of the risk of peritonitis and because many foals with uroperitoneum have sepsis. The immune status of young foals should be examined by measurement of serum IgG concentration and, if it is less than 800 mg/dL (8 g/L), the foal should receive 20 to 40 mL/kg of plasma.

Correction of the defect in the bladder, urachus, or urethra is surgical. Nonsurgical management has been described in a foal in which a Foley catheter was inserted in the bladder and left in place for 5 days. The bladder was constantly drained of urine and this allowed the tear to heal. This technique offers an alternative to surgical repair of bladder rupture. However, surgical repair is definitive and is the recommended method of treatment.

Subcutaneous rupture of the urachus can similarly be treated by placement of a Foley

catheter through the patent urachus and into the bladder. The defect in the urachus is then allowed to heal and the catheter is removed in 3 to 6 days.

### PREVENTION AND CONTROL

There are no recognized means of preventing or controlling this disease. Minimizing the risk of foals developing septic disease is expected to reduce the incidence of uroperitoneum secondary to sepsis.

### REFERENCE

1. Castagnetti C, et al. *Equine Vet Educ.* 2010;22:132.

### CYSTITIS

Inflammation of the bladder is usually associated with bacterial infection and is characterized clinically by frequent, painful urination (pollakiuria and dysuria) and the presence of blood (hematuria), inflammatory cells, and bacteria in the urine.

### ETIOLOGY

Cystitis occurs sporadically as a result of the introduction of infection into the bladder when trauma to the bladder has occurred or when there is stagnation of the urine. In farm animals, the common associations are

- Cystic calculus
- Difficult parturition
- Contaminated catheterization
- Late pregnancy
- As a sequel to paralysis of the bladder; a special case of bladder paralysis occurs in horses grazing sudax or Sudan grass and in horses with equine herpesvirus myoencephalopathy.

In the previous cases, the bacterial population is usually mixed but is predominantly *E. coli*. There is also the accompaniment of specific pyelonephritides in cattle and pigs, associated with *C. renale* and *Eubacterium suis*, respectively. Many sporadic cases also occur in pigs, especially after farrowing. Common isolates from these are *E. coli*, *Streptococcus*, and *Pseudomonas* spp. *C. matrucotii* causes encrusted cystitis in horses.

Enzootic hematuria of cattle resembles cystitis.

### PATHOGENESIS

Bacteria frequently gain entrance to the bladder but are usually removed by the flushing action of voided urine before they invade the mucosa. Mucosal injury facilitates invasion, but stagnation of urine is the most important predisposing cause. Bacteria usually enter the bladder by ascending the urethra, but descending infection from embolic nephritis may also occur.

### CLINICAL FINDINGS

The urethritis that usually accompanies cystitis causes painful sensations and the desire to urinate. Urination occurs frequently and is

accompanied by pain and sometimes grunting; the animal remains in the urination posture for some minutes after the flow has ceased, often manifesting additional expulsive efforts. The volume of urine passed on each occasion is usually small. In very acute cases, there may be moderate abdominal pain, as evidenced by treading with the hindfeet, kicking at the belly and swishing with the tail, and a moderate febrile reaction. Acute retention may develop if the urethra becomes blocked with pus or blood, but this is unusual.

Chronic cases show a similar syndrome, but the signs are less marked. Frequent urination and small volume are the characteristic signs. In chronic cases, the bladder wall may feel thickened on rectal examination and, in horses, a calculus may be present. In acute cases, no palpable abnormality may be detected but pain may be evidenced. Endoscopic examination of the bladder of affected horses reveals widespread inflammation of the cystic mucosa and occasionally the presence of a cystic calculus.

### CLINICAL PATHOLOGY

Blood and pus in the urine is typical of acute cases, and the urine may have a strong ammonia odor. In less severe cases, the urine may be only turbid, and in chronic cases there may be no abnormality on gross inspection. Microscopic examination of urine sediment will reveal erythrocytes, leukocytes, and desquamated epithelial cells. Quantitative bacterial culture is necessary to confirm the diagnosis and to guide treatment selection.

### NECROPSY FINDINGS

Acute cystitis is manifested by hyperemia, hemorrhage, and edema of the mucosa. The urine is cloudy and contains mucus. In subacute and chronic cases, the wall is grossly thickened and the mucosal surface is rough and coarsely granular. Highly vascular papillary projections may have eroded, causing the urine to be bloodstained or contain large clots of blood. In the cystitis associated with Sudan grass, soft masses of calcium carbonate may accumulate in the bladder, and the vaginal wall may be inflamed and coated with the same material.

### TREATMENT

Antimicrobial agents are indicated to control the infection, and determination of the antimicrobial susceptibility of the causative bacteria is essential. Relapses are common unless treatment is continued for a minimum of 7 and preferably 14 days. Repeated bacterial culture of urine at least once during and again within 7 to 10 days after completion of treatment should be used to assess the success of therapy. Recurrence of the infection is usually caused by failure to eliminate foci of infection in the accessory glands and in the bladder wall.

## DIFFERENTIAL DIAGNOSIS

The clinical and laboratory findings of cystitis resemble those of pyelonephritis and cystic urolithiasis.

- **Pyelonephritis** is commonly accompanied by bladder involvement and differentiation depends on whether there are lesions in the kidney. This may be determined by rectal examination but in many cases it is not possible to make a firm decision. Provided the causative bacteria can be identified, this is probably not of major importance as the treatment will be the same in either case. However, the prognosis in pyelonephritis is less favorable than in cystitis. Thickening of the bladder wall, which may suggest a diagnosis of cystitis, occurs also in enzootic hematuria and in poisoning by the yellow-wood tree (*Terminalia oblongata*) in cattle and by sorghum in horses.
- **The presence of calculi** in the bladder can usually be detected by rectal examination, by ultrasonographic examination, by endoscopic examination in female ruminants and in both sexes of horses, or by radiographic examination in smaller animals.
- **Urethral obstruction** may also cause frequent attempts at urination, but the urine flow is greatly restricted, usually only drops are voided and the distended bladder can be felt on rectal examination.

The prognosis in chronic cases is poor because of the difficulty of completely eradicating the infection and the common secondary involvement of the kidney. Free access to water should be permitted at all times to ensure a free flow of urine.

## UROLITHIASIS IN RUMINANTS

Urolithiasis is common as a subclinical disorder among ruminants raised in management systems where the ration is composed primarily of grain or where animals graze certain types of pasture. In these situations, 40% to 60% of animals may form calculi in their urinary tract. Urolithiasis becomes an important clinical disease of castrated male ruminants when calculi cause urinary tract obstruction and usually obstruction of the urethra. Urethral obstruction is characterized clinically by complete retention of urine, frequent unsuccessful attempts to urinate, and distension of the bladder. Urethral perforation and rupture of the bladder can be sequelae. Mortality is high in cases of urethral obstruction, and treatment is surgical. As a result, prevention is important to limit losses from urolithiasis.

## ETIOLOGY

Urinary calculi, or uroliths, form when inorganic and organic urinary solutes are

precipitated out of solution. The precipitates occur as crystals or as amorphous “deposits.” Calculi form over a long period by a gradual accumulation of precipitate around a nidus. An organic matrix is an integral part of most types of calculus. Several factors affect the rate of urolith formation, including conditions that affect the concentration of specific solutes in urine, the ease with which solutes are precipitated out of solution, the provision of a nidus, and the tendency to concretion of precipitates. These are presented in the following section. Factors that contribute to the clinical syndrome of obstructive urolithiasis are dealt with separately.

## EPIDEMIOLOGY

### Species Affected

Urolithiasis occurs in all ruminant species but is of greatest economic importance in feeder steers and wethers (castrated lambs) fed heavy concentrate rations and animals on range pasture in particular problem areas. These range areas are associated with the presence of pasture plants containing large quantities of oxalate, estrogens, or silica. When cattle graze pasture containing plants with high levels of silica, uroliths occur in animals of all ages and sexes. The prevalence of uroliths is about the same in cows, heifers, bulls, and steers grazing on the same pasture, and they may even occur in newborn calves. Females and bulls usually pass the calculi, and obstructive urolithiasis is primarily a problem in castrated male animals.

Obstructive urolithiasis is the most common urinary tract disease in breeding rams and goats. There are three main groups of factors that contribute to urolithiasis:

- Those that favor the **development of a nidus** about which precipitation and concretion can occur
- Those that **facilitate precipitation of solutes** on to the nidus
- Those that favor **concretion by cementing precipitated salts** to the developing calculus

### Nidus Formation

A nidus favors the deposition of crystals about itself. It may be a group of desquamated epithelial cells or necrotic tissue that may be formed as a result in occasional cases from local infection in the urinary tract. When large numbers of animals are affected, it is probable that some other factor, such as a deficiency of vitamin A or the administration of estrogens, is the cause of excessive epithelial desquamation. When stilbestrol was used as a growth promoter, mortality rates of 20% from obstructive urolithiasis were recorded in wethers receiving stilbestrol implants compared with no mortalities in a control group. Diets low in vitamin A have been suspected as a cause of urolithiasis, but vitamin A deficiency does not appear to be a major causative factor.

## Precipitation of Solutes

Urine is a highly saturated solution containing a large number of solutes, many of them in higher concentrations than their individual solubilities permit in a simple solution. Urinary stone formation is currently attributed to supersaturation, crystal growth, and aggregation, with supersaturation and the urinary concentration of promoters and inhibitors playing dominant roles in stone formation.<sup>1</sup> Several factors may explain why solutes remain in solution. Probably the most important factor in preventing precipitation is the presence of **protective colloids** that convert urine into a gel. These colloids are efficient up to a point, but their capacity to maintain the solution may be overcome by abnormalities in one or more of a number of other factors. Even in normal animals, crystals of a number of solutes may be present in the urine intermittently and urine must be considered to be an unstable solution. The physical characteristics of urine, the amount of solute presented to the kidney for excretion, and the balance between water and solute in urine all influence the ease of calculus formation. In most cases, these factors can also be influenced by management practices.

**The pH of urine** affects the solubility of some solutes, with mixed phosphate and carbonate calculi more readily formed in an alkaline than an acid medium. More important, the urine pH in ruminants is dependent on the urinary strong ion difference, with urine pH increasing with higher urine concentrations of potassium, sodium, magnesium, and calcium (with the effect of potassium predominating). Likewise, urine pH decreases in ruminants with higher urine concentrations of chloride and sulfate.<sup>2</sup> The high urine potassium concentration in herbivores is the main reason that they have an alkaline urine.

**Ammonium chloride** or phosphoric acid added to the rations of steers increases the acidity of the urine and reduces the incidence of calculi. The mechanism is uncertain but is probably related to the effect of pH on the stability of the urinary colloids or the effect of diuresis. In contrast, variations in pH between 1 and 8 have little influence on the solubility of silicic acid, the form of silica excreted in the urine of ruminants. As a result, dietary supplementation with ammonium chloride does not consistently prevent the formation of siliceous calculi.

**The amount of solute presented to the kidney for excretion is influenced by the diet.** Some pasture plants can contain up to 6% silica. Although ruminants grazing on these plants absorb only a small portion of the ingested silica, the kidney is the major route of excretion of absorbed silicic acid. The urine of these animals often becomes supersaturated with silicic acid, which promotes the polymerization or precipitation of the silicic acid and calculus formation.

**Feeding sodium chloride prevents the formation of silica calculi** by reducing the concentration of silicic acid in the urine and maintaining it below the saturation concentration. An excessive intake of minerals may occur from highly mineralized artesian water, or from diets containing high concentrations, particularly of phosphates in heavy-concentrate diets. Sheep with a high dietary intake of phosphorus have an increased concentration of phosphorus in their urine and an increased development of calculi. In cattle, sediment begins to appear in urine when concentrates reach 1.5% of the BW, and urolithiasis formation begins when concentrates have been fed for 2 months at the rate of 2.5% of the animal's BW.

**Diets high in magnesium** such as some calf milk replacers have been frequently associated with an increasing incidence of obstructive urolithiasis.<sup>3</sup> Supplemental calcium in the diet helps prevent calculus formation when phosphate or magnesium intake is high.

**Ingestion of plants with a high oxalic acid** content can be a risk factor for formation of calcium carbonate calculi in sheep. Although dietary excesses contribute to certain types of urolithiasis, calculus formation can rarely be recreated experimentally by simple overfeeding. The process of formation of urinary calculi is more complex than a simple dietary excess. However, recognition of associations between diet and some types of urolithiasis has been useful in developing preventive strategies.

**Feeding practices** can influence the function of the kidney and may contribute to calculus formation. In sheep fed grain in a few large meals, there is a marked reduction in urine volume and a marked increase in urine concentration and calcium excretion at the time of feeding. These short-term changes in urine composition may be factors in the development of uroliths.

**The concentration of urine is an important determinant** of the concentration of individual solutes in the urine. Although it is difficult to induce urolithiasis by restricting access to water, concentrated urine is a risk factor for calculus formation. Animals can be forced to produce concentrated urine because of lack of easy access to water, a particular problem in pastured animals; lack of familiarity with water delivery systems; and poor quality of available water. Water deprivation can be exacerbated by heavy fluid loss by sweating in hot, arid climates.

### Factors Favoring Concretion

Most calculi, and siliceous calculi in particular, are composed of organic matter as well as minerals. This organic component is mucoprotein, particularly its mucopolysaccharide fraction. It acts as a cementing agent and favors the formation of calculi when precipitates are present. The mucoprotein content of urine of feeder steers and lambs is

increased by heavy concentrate–low roughage rations, by feeding pelleted rations, even more so by implantation with diethylstilbestrol and, combined with a high dietary intake of phosphate, may be an important cause of urolithiasis in this class of livestock. These high levels of mucoprotein in urine may be the result of a rapid turnover of supporting tissues in animals that are making rapid gains in weight.

### Miscellaneous Factors in the Development of Urolithiasis

Stasis of urine favors precipitation of solutes, probably by virtue of the infection that commonly follows, providing cellular material for a nidus. Certain feeds, including cottonseed meal, rice straw, and milo sorghum, are credited with causing more urolithiasis than other feeds. Alfalfa is in an indeterminate position: by some observers it is thought to cause the formation of calculi, by others it is thought to be a valuable aid in preventing their formation. Pelleting appears to increase calculi formation if the ration already has this tendency.

Attempts to produce urolithiasis experimentally by varying any of the previous factors are usually unsuccessful, and natural cases most probably occur as a result of the interaction of several factors. In feedlots a combination of high mineral feeding and a high level of mucoprotein in the urine associated with rapid growth are probably the important factors in most instances. In range animals a high intake of mineralized water, or oxalate or silica in plants, are most commonly associated with a high incidence of urinary calculi, but again other predisposing factors, including deprivation or excessive loss of water, may contribute to the development of the disease. Limited water intake at weaning and in very cold weather may also be a contributory factor.

### Composition of Calculi

The chemical composition of urethral calculi varies and appears to depend largely on the dietary intake of individual elements. In semiarid areas such as the great plains of North America and parts of Australia, the dominant pasture grasses have a high content of silica. Cattle and sheep grazing these pastures have a high prevalence of siliceous calculi. Calculi containing calcium carbonate are more common in animals on clover-rich pasture or when oxalate-containing plants abound. Calcium, ammonium, and magnesium carbonate are also common constituents of calculi in cattle and sheep at pasture.

Cattle, sheep, and goats eating a high grain diet in feedlots usually have calculi composed of struvite (magnesium ammonium phosphate,  $\text{NH}_4\text{MgPO}_4 \cdot 6\text{H}_2\text{O}$ ). Cattle, water buffalo, and Boer goats in China fed grain, cottonseed meal, or rice straw as part of their diet may also have crystals present in their urine composed of magnesium

potassium phosphate ( $\text{KMgPO}_4 \cdot 6\text{H}_2\text{O}$ ),<sup>1,3,4</sup> but these crystals do not appear to precipitate to form calculi. High concentrations of magnesium in feedlot rations also cause a high prevalence of struvite calculi in lambs and goats. Experimental feeding of a ration with high magnesium content increases the prevalence of struvite urolithiasis in goats<sup>3</sup> and calcium apatite urolithiasis in calves. Oxalate calculi are extremely rare in ruminants but have been observed in goats and induced experimentally in feedlot cattle. Xanthine calculi in sheep are recorded in some areas in New Zealand where pasture is poor.

**Estrogenic subterranean clover** can cause urinary tract obstruction in wethers in a number of ways. Soft, moist, yellow calculi containing 2-benzocoumarins, isoflavones and indigotin–indirubin, have been observed. Calculi or unformed sediments of benzocoumarins (urolithins) and 4'-O-methylequol, either singly or in various combinations with equol, formononetin, biochanin A, indigotin, and indirubin, also occur. Obstruction is promoted by estrogenic stimulation of squamous metaplasia of the urethral epithelium, accessory sex glandular enlargement, and mucous secretion. Pastures containing these plants are also reputed to cause urinary obstruction by calculi consisting of calcium carbonate. Feedlot lambs receiving a supplement of stilbestrol (1 mg/kg of feed or 2 mg per lamb daily) developed urethral obstruction thought to be caused primarily by plugs of mucoprotein. The accessory sex glands were also enlarged.

### Risk Factors for Obstructive Urolithiasis

The risk factors important in the formation of urinary calculi are also important in the development of obstructive urolithiasis.

**The size of individual calculi and the amount of calculus material** are both important in the development of urethral obstruction. Often the obstruction is caused by one stone, although an aggregation of many small struvite calculi often causes obstruction in sheep fed high-concentrate rations.

Once calculi form, the most important factor contributing to the occurrence of obstruction is the diameter of the urethra. Wethers (castrated lambs) and steers (castrated cattle) are most commonly affected because of the relatively small diameter of the urethra in these animals. Castration significantly impacts the diameter of the urethra in steers. When the urethral diameter of late castrates (6 months old) was compared with early castrates (2 months old), it was found to be 8% larger and would be able to expel a calculus that was 13% larger than a calculus passed by early castrates. Bulls can usually pass calculi that are 44% larger than those that could be passed by an early castrated steer.



## Occurrence

**Urethral obstruction** may occur at any site but is most common at the distal sigmoid flexure in steers near the insertion of the retractor penis muscle, and in the vermiform appendage, distal to the sigmoid flexure, at the distal sigmoid flexure, or subschially in wethers or rams; these are all sites where the urethra narrows.<sup>5</sup> Urolithiasis is as common in females as in males, but obstruction rarely if ever occurs because of the shortness and large diameter of the urethra. Repeated attacks of obstructive urolithiasis are not uncommon in wethers and steers and at necropsy up to 200 calculi may be found in various parts of the tract of one animal. However, generally, a single calculus causes obstruction in cattle, whereas multiple calculi are common in sheep.

In North America, obstructive urolithiasis caused by siliceous calculi is most common in beef feeder cattle during the fall and winter months. The calves are weaned at 6 to 8 months and moved from pasture to a feedlot in which they are fed roughage and grain. The incidence of obstructive urolithiasis is highest during the early part of the feeding period and during cold weather, when the consumption of water may be decreased.

Although the occurrence of obstructive urolithiasis is usually sporadic, with cases occurring at irregular intervals in a group of animals, outbreaks may occur, affecting a large number of animals in a short time. In outbreaks it is probable that factors are present that favor the development of calculi, as well as the development of obstruction. For example, multiple cases of obstructive urolithiasis can occur in lambs within a few weeks of introducing a concentrated ration. Obstructive urolithiasis increases in occurrence with age but has occurred in lambs as young as 1 month of age.

## PATHOGENESIS

Urinary calculi are commonly observed at necropsy in normal animals and in many appear to cause little or no harm. Calculi may be present in the kidneys, ureters, bladder, and urethra. In a few animals, pyelonephritis, cystitis, and urethral obstruction may occur. Obstruction of one ureter may cause unilateral hydronephrosis, with compensation by the contralateral kidney. The major clinical manifestation of urolithiasis is urethral obstruction, particularly in wethers and steers. This difference between urolithiasis and obstructive urolithiasis is an important one. Simple urolithiasis has relatively little importance, but obstructive urolithiasis is a fatal disease unless the obstruction is relieved. Rupture of the urethra or bladder occurs within 2 to 3 days if the obstruction is not relieved and the animal dies of uremia or secondary bacterial infection. Rupture of the bladder is more likely to occur with a spherical, smooth calculus that causes

complete obstruction of the urethra. Rupture of the urethra is more common with irregularly shaped stones that cause partial obstruction and pressure necrosis of the urethral wall.

## CLINICAL FINDINGS

Calculi in the renal pelvis or ureters are not usually diagnosed antemortem, although obstruction of a ureter may be detectable on rectal examination, especially if it is accompanied by hydronephrosis.<sup>6</sup> Occasionally the exit from the renal pelvis is blocked and the acute distension that results may cause acute pain, accompanied by stiffness of the gait and pain on pressure over the loins. Calculi in the bladder may cause cystitis and are manifested by signs of that disease.

## Obstruction of the Urethra by a Calculus

This is a common occurrence in steers and wethers and causes a characteristic syndrome of abdominal pain with kicking at the belly, treading with the hindfeet, and swishing of the tail. Repeated twitching of the penis, sufficient to shake the prepuce, is often observed, and the animal may make strenuous efforts to urinate, accompanied by straining, grunting, and grating of the teeth, but these result in the passage of only a few drops of bloodstained urine. A heavy precipitate of crystals is often visible on the preputial hairs or on the inside of the thighs (Fig. 13-8). Some animals with urethral obstruction will have a dry prepuce because of the absence of urination, although this sign is not specific for urolithiasis.

The passage of a flexible catheter up the urethra, after relaxing the penis by lumbosacral epidural anesthesia, by pudendal nerve block or by administering an ataractic

drug, may make it possible to locate the sites of obstructions that are anterior to the sigmoid flexure. However, catheterization of the urethra from the glans penis to the bladder is almost impossible in cattle and ruminants because of the urethral diverticulum and its valve. A precurved coronary catheter has been used to catheterize the bladder of calves and goats but requires fluoroscopic guidance.

Cattle with incomplete obstruction (“dribblers”) will pass small amounts of bloodstained urine frequently. Occasionally a small stream of urine will be voided followed by a complete blockage. This confuses the diagnosis. In these animals the calculus is triangular in shape and allows small amounts of urine to move past the obstruction at irregular intervals. However, these instances are rare.

The entire length of the penis must be palpated for evidence of a painful swelling from the preputial orifice to the scrotum, above the scrotum to locate the sigmoid flexure, and proximally up the perineum as far as possible.

In rams, bucks, and wethers the urethral process of the exteriorized penis must be examined for enlargement and the presence of multiple calculi. Extrusion of the penis is difficult in prepubertal sheep and goats because of the presence of an attachment from the prepuce to the glans penis; loss of this attachment is mediated by testosterone and is usually complete by the onset of puberty, although separation may not occur in castrated animals. Penile extrusion is facilitated by xylazine sedation and positioning the animals with lumbosacral flexion. Abnormal urethral processes should be amputated, and in many animals grit is detected during urethral transection.



**Fig. 13-8** Extensive precipitation of crystals on the preputial hairs of a steer with obstructive urolithiasis.

**On rectal examination**, when the size of the animal is appropriate, the urethra and bladder are palpably distended and the urethra is painful and pulsates on manipulation.

**In rams** with obstructive urolithiasis, sudden depression, inappetence, stamping the feet, tail swishing, kicking at the abdomen, bruxism, and anuria or the passage of only a few drops of urine are common. Clinical examination must include inspection of the ventral abdomen for edema, inspection and palpation of the preputial orifice for crystals, palpation of the penis in the area of the sigmoid flexure, and inspection and palpation of the urethral process (vermiform appendage) of the exteriorized penis.

### Rupture of Urethra or Bladder

If the obstruction is not relieved, **urethral rupture** or **bladder rupture** usually occurs within 48 hours. With urethral rupture, the urine leaks into the connective tissue of the ventral abdominal wall and prepuce and causes an obvious fluid swelling, which may spread as far as the thorax (Fig. 13-9). This results in a severe cellulitis and toxemia. The skin over the swollen area may slough, permitting drainage, and the course is rather more protracted in these cases. When the bladder ruptures, there is an immediate relief from discomfort but anorexia and depression develop as uremia develops. Two types of bladder rupture have been described: multiple pinpoint perforations in areas of necrosis or discrete tears in the bladder wall. The site of leakage is almost always on the dorsal aspect of the bladder. Complete urethral obstruction therefore results in urethral rupture or bladder rupture and never both in the same animal because pressure is released once rupture occurs.

**A fluid wave is detectable on tactile percussion**, and the abdomen soon becomes distended. The animal may continue in this state for as long as 2 to 3 days before death occurs. Fibrin deposition around the dorsal surface of the bladder may be palpated per rectum in steers. In rare cases death occurs soon after rupture of the bladder as a result of severe internal hemorrhage.

In rare cases calculi may form in the prepuce of steers. The calculi are top shaped and, by acting as floating valves, cause obstruction of the preputial orifice, distension of the prepuce, and infiltration of the abdominal wall with urine. These cases may be mistaken for cases of urethral perforation.

### CLINICAL PATHOLOGY

#### Urinalysis

Laboratory examinations may be useful in the diagnosis of the disease in its early stages when the calculi are present in the kidney or bladder. The urine usually contains erythrocytes and epithelial cells and a higher than normal number of crystals, which are sometimes accompanied by larger aggregations described as sand or sabulous deposit. Bacteria may also be present if secondary invasion of the traumatic cystitis and pyelonephritis has occurred.

#### Serum Biochemistry

SUN and creatinine concentrations will be increased before either urethral or bladder rupture occurs and will increase even further afterward. Rupture of the bladder will result in uroabdomen. Because urine has a much lower sodium and chloride concentration and higher osmolality than plasma, equilibration of electrolytes and free water into the

abdomen of the ruminant will always result in hyponatremia, hypochloremia, hyperphosphatemia, and hypoosmolality in serum, with the magnitude of the changes reflecting the volume of urine in the abdomen. Hypermagnesemia appears to be a common finding in weaned lambs with urolithiasis,<sup>7</sup> although few studies have reported changes in plasma magnesium concentrations in affected animals. Similar changes in serum biochemistry are present in steers with ruptured urethras, with the magnitude of the changes being smaller than in steers with ruptured bladders. Interestingly, steers with ruptured bladder or urethra typically have serum potassium concentrations within the normal range; this result most probably reflects the combined effects of increased salivary potassium loss in the face of hyponatremia and inappetence. A minority of ruminants with urolithiasis will have hyperkalemia.<sup>8</sup> Prolonged duration of urolithiasis usually results in hypophosphatemia in goats, presumably from increased phosphorus secretion by the salivary glands.<sup>8</sup>

#### Abdominocentesis and Needle Aspirate of Subcutaneous Tissue

Abdominocentesis is necessary to detect uroperitoneum after rupture of the bladder or needle aspiration from the subcutaneous swelling associated with urethral rupture. However, it is often difficult to identify the fluid obtained from the peritoneal cavity or the subcutaneous tissues as urine other than by appearance and smell or by biochemical examination. Generally, in uroperitoneum, substantial quantities of fluid can be easily obtained by abdominocentesis. Warming the fluid may facilitate detection of the urine odor, although this is a subjective and poorly sensitive diagnostic test.

#### Ultrasonography

Ultrasonography is an extremely useful aid for the diagnosis of obstructive urolithiasis in rams and bucks, with a 10- to 15-MHz linear probe used to assess the urethra for dilatation proximal to the obstruction or rupture at the site of obstruction and a 5-MHz microconvex or linear probe used to evaluate the bladder and kidneys.<sup>5,9</sup> All parts of the urinary tract must be examined for urinary calculi. The kidneys are examined from the paralumbar fossa and the bladder and urethra transrectally. The kidneys are examined for enlargement, and the renal pelvis, medullary pyramids, and urethra examined for dilatation. The size of the bladder should be noted and its contents examined. Distended bladders can reach 20 cm in diameter in adult rams, wethers, and bucks, and ultrasonographically appear as an anechoic (black) area surrounded by a bright white (hyperechoic) line. The bladder diameter should be measured in two dimensions at right angles to each other because the bladder shape changes with



**Fig. 13-9** Holstein-Friesian steer with obstructive urolithiasis, urethral rupture, and urine collecting ventrally to the site of rupture. (Photograph graciously provided by Dr. Bruce L. Hull, United States.)

animal movement.<sup>9</sup> A ruptured bladder does not always empty completely. Fibrin tags may be visualized ultrasonographically in animals with uroabdomen or on the dorsal surface of the bladder, which is the usual site for rupture. In rams with obstructive urolithiasis, the urethra and bladder are markedly dilated. Because of severe cystitis, the contents of the bladder appear as multiple, tiny, uniformly distributed echoes. The renal pelvis are commonly dilated, and in experimentally induced urethral ligation in male goats, ultrasonographically determined renal dimensions increased after 24 hours of obstruction.<sup>9</sup>

### Radiography

Plain radiography is very helpful in small ruminants in which radiopaque calculi (calcium carbonate, calcium oxalate, and silica) are common.<sup>5</sup> Plain radiography helps to identify the best method for surgical correction and confirm resolution of the obstruction, but it is not effective in small ruminants with struvite calculi because the stones are radiolucent and very small in diameter.<sup>5</sup> Contrast radiography using excretory urography, retrograde urethrography, cystourethrography, and normograde cystourethrography via tube cystotomy have also been used because of concerns that the rumen and abdominal viscera (and wool in sheep) obscures the bladder in plain radiographs.

### NECROPSY FINDINGS

Calculi may be found in the renal pelvis or bladder of normal animals or of those dying of other diseases. In the renal pelvis they may cause no abnormality, although in occasional cases there is accompanying pyelonephritis. Unilateral ureteral obstruction is usually accompanied by dilatation of the ureter and hydronephrosis. Bilateral obstruction causes fatal uremia. Calculi in the bladder are usually accompanied by varying degrees of chronic cystitis. The urethra or urethral process may be obstructed by one or more stones or may be impacted for a number of centimeters with a fine sabulous deposit.

When rupture of the urethra has occurred, the urethra is eroded at the site of obstruction, and extensive cellulitis and accumulation of urine are present in the ventral abdominal wall. When the bladder has ruptured the peritoneal cavity is distended with urine and there is mild to moderate chemical peritonitis. In areas where urolithiasis is a problem, it is an advantage to determine the chemical composition of the calculi.

### DIFFERENTIAL DIAGNOSIS

Obstruction of the urethra in ruminant animals is almost always caused by a calculus and is characterized clinically by anuria or

dribbling, swishing of the tail, abdominal pain with kicking at the abdomen or stamping the feet, and a progressively worsening condition.

Nonobstructive urolithiasis may be confused with **pyelonephritis** or **cystitis**, and differentiation may be possible only by rectal examination in the case of vesical calculi or by radiographic examination in smaller animals. Subsequent development of hydronephrosis may enable a diagnosis to be made in cattle. Ultrasonographic examination is extremely useful in sheep and goats.

A rectal examination, if possible, may reveal distension of the bladder and dilatation and pulsation of the urethra if the bladder has not ruptured.

In adults, **rupture of the bladder** is usually the result of obstructive urolithiasis, although other occasional causes of urethral obstruction are observed.

**Rupture of the urethra** in cattle is characterized by diffuse swelling of the subcutaneous tissues of the ventral body wall, and the skin is usually cooler than normal. It must be differentiated from other causes of swelling of the ventral abdominal wall, including abscesses and herniation of abdominal wall, which can be determined by close physical examination and needle aspiration.

**Dilatation of the urethral recess** in young cattle is characterized by a midline perineal swelling and may resemble pulsation of the perineal urethra in obstructive urolithiasis. The urethral recess arises from the junction of the pelvic and spongy parts of the urethra at the level of the ischial arch. A fold of urethral mucosa proximal to the recess acts as a valve to prevent the retrograde flow of urine into the pelvic urethra. An abnormally large urethral recess has been described in a calf. When there is dilatation of the urethral recess, during urination the proximal urethra pulses and the swelling may enlarge slightly. There is no urethral obstruction, and urine flows passively from the penis for several minutes after the urethral pulsation ceases. The dilatation can be radiographed using contrast media.

### TREATMENT

The treatment of obstructive urolithiasis has traditionally been primarily surgical, including urethral process amputation (rams, wethers, bucks, llamas, and alpacas), prepubic and perineal urethrostomy, laser lithotripsy, tube cystotomy, and bladder marsupialization. Cattle or lambs with obstructive urolithiasis that are near the end of their feedlot feeding period and close to being marketed can be slaughtered for salvage if the result of an ante-mortem inspection is satisfactory. Animals in the early stages of obstruction before urethral or bladder rupture will usually pass inspection at an abattoir. The presence of uremia warrants failure to pass inspection. Recent studies suggest reasonable treatment response to medical treatment of bucks with urolithiasis.<sup>10</sup>

Rams, bucks, and wethers should all have their glans penis exteriorized and inspected and the urethral process amputated using a scalpel blade. This is best accomplished by having an assistant restrain the animal in a sitting position. The penis is exteriorized by grasping the shaft of the penis within the prepuce and retracting the prepuce to expose the tip of the penis, which is then grasped with a gauze sponge.<sup>10</sup> Exteriorization of the penis can be very difficult in prepubertal rams and bucks because of the presence of a persistent frenulum. Xylazine administration may facilitate exteriorization of the penis but increases urine production and therefore shortens the time to urethral or bladder rupture in animals with a complete obstruction.

It was thought that calculi cannot be dissolved by medical means, but recent studies suggest that administration of specific solutions into the bladder can rapidly dissolve most uroliths, although one report stated that radiopaque calculi (calcium carbonate, calcium oxalate, and silica) do not dissolve readily by urinary acidification by dietary means or infusion of Walpole's solution into the bladder through a tube cystotomy<sup>5</sup> or directly through a long needle.<sup>10</sup> Successful outcomes have occurred following instillation of 30 to 200 mL of an acetic acid solution (Walpole's buffer, pH adjusted to 4.3–4.8; contains 1.16% sodium acetate, 1.09% glacial acetic acid, and 97.75% distilled water) or hemiacidrin solution through a cystotomy catheter or long needle into the bladder after removal of most but not all the urine in the bladder; hemiacidrin is an acidic gluconocitrate solution with magnesium carbonate used for dissolution of magnesium ammonium phosphate and calcium phosphate uroliths in humans. The advantage of hemiacidrin is that it is reportedly less irritating to the urothelium than other acids of similar pH, such as Walpole's solution. The cystotomy tube can be placed surgically or transcutaneously using abdominal ultrasound. The latter technique involves placement of a 12-French sleeved trocar into the lumen of the bladder, followed by removal of the trocar and placement of a 10-French silicone Foley catheter through the sleeve of the trocar into the lumen of the bladder. The balloon on the Foley catheter is then inflated using 0.9% NaCl, the trocar sleeve removed from the abdomen, and the Foley catheter secured to the abdomen. The cystotomy catheter provides an alternative route for urine to leave the bladder and is allowed to drip continuously. The cystotomy catheter is occluded for 30 minutes to 2 hours after infusion of a low pH solution to retain the solution in the bladder and urethra, after this time the solution is drained from the bladder via the cystotomy tube. Checking the pH of the fluid in the bladder using pH strips is thought to be helpful in verifying that the target pH of <5.0 has been reached.<sup>10</sup>



In early stages of the disease or in cases of incomplete obstruction, treatment with smooth muscle relaxants such as phenothiazine derivatives (aminopromazine, 0.7 mg/kg of BW) has been tried to relax the urethral muscle and permit passage of the obstructing calculus; however, treatment efficacy is unknown. Animals treated medically should be observed closely to ensure that urination occurs and that obstruction does not recur. However, field observations indicate that these relaxants are ineffective, and it is difficult to believe that smooth muscle relaxants could be efficacious given that the urethral and periurethral tissue contains very little smooth muscle. Slight sedation induced by acepromazine (0.02 mg/kg IV every 4–6 hours) is of unknown benefit, and if used the sedation should not prevent the animal from standing when approached. A more rational treatment includes parenteral NSAIDs or infiltration of local anesthetic around the origin of the retractor penile muscles or a pudendal nerve block; this theoretically relaxes the retractor penis muscle and straightens the sigmoid flexure, creating a wider and straighter urethral passageway.

Retrograde hydropulsion is only occasionally successful, although it is frequently used as part of the initial treatment. This technique involves catheterization of the urethral orifice with a suitably sized urinary catheter and intermittent injection of 0.9% NaCl containing 2% lidocaine into the urethra in an attempt to flush out the calculi. Frequently, a gritty feeling is detected during this procedure, and one usually is left with the impression that the procedure is creating additional urethral trauma that may contribute to urethral stricture. The addition of lidocaine is thought to decrease urethral spasm but its efficacy and safety are unknown. Retrograde hydropulsion may also pack small crystals more tightly into the urethra. Cystotomy and normograde hydropulsion appear to have a higher success rate than retrograde hydropulsion.

**Surgical treatment includes perineal urethrostomy** to relieve bladder pressure and for the removal of calculi. This is a salvage procedure, and treated animals can be sent to slaughter for salvage when they have recovered sufficiently to pass antemortem inspection. In a series of 85 cases of surgical treatment of urethral obstruction in cattle, only 35% of animals recovered satisfactorily. In small ruminants, which invariably have multiple calculi, amputation of the urethral process may restore urine flow but usually provides only temporary relief, and the long-term prognosis in sheep and goats is poor because there is a high rate of recurrence of obstruction with stricture formation at the urethrostomy site. A recent surgical modification suggests that urethral stricture formation can be decreased in goats with transection of the penile body attachments from the pelvis and careful apposition of

the urethra to the skin.<sup>11</sup> If perineal urethrostomy is unsuccessful, **tube cystotomy** is indicated. Urethroscopy and **laser lithotripsy** have successfully dissolved uroliths in a small number of small ruminants and one steer, but the technique is expensive and not widely available. **Prepubic urethrostomy** has been performed in a small number of small ruminants that have undergone stricture formation following perineal urethrostomy, whereas **urinary bladder marsupialization** by laparotomy or using a laparoscopy-assisted surgical technique<sup>12</sup> offers an alternative surgical method for correction. There is one report of erection failure in a male goat as a sequela to obstructive urolithiasis; erection failure was attributed to vascular occlusion of the corpus cavernosum penis. Surgical correction of urethral dilatation associated with the urethral recess in cattle has been described.

### PREVENTION

A number of agents and management procedures have been recommended in the prevention of urolithiasis in feeder lambs and steers. First, and probably most important, the diet should contain an adequate balance of calcium and phosphorus to avoid precipitation of excess phosphorus in the urine. This is the major difficulty in controlling urolithiasis in feedlot ruminants, because their diets are grain rich (and therefore phosphorus rich). The ration should have a Ca:P ratio of 1.2:1, but higher calcium inputs (1.5–2.0:1) have been recommended, as have formulation of low oxalate and silica diets<sup>5</sup> and low-magnesium diets. Every practical effort must be used to increase and maintain water intake in feeder steers that have just been moved into a feedlot situation. The addition of salt at the level of 4% of the total ration of feeder calves has been shown experimentally to have this effect on both steers and lambs. Under practical conditions, salt is usually fed at a concentration of 3% to 5%, higher concentrations causing lack of appetite. It is thought that supplementary feeding with sodium chloride helps to prevent urolithiasis by decreasing the rate of deposition of magnesium and phosphate around the nidus of a calculus, but it is possible that salt-related diuresis may also play an important role. Feeding of pelleted rations may predispose to the development of phosphate calculi (such as struvite or apatite) by reducing the salivary secretion of phosphorus.

The control of siliceous calculi in cattle fed native range grass hay, which may contain a high level of silica, is dependent primarily on increasing the water intake. The feeding of alfalfa hay is considered to increase urine flow and lower the incidence of urolithiasis but the important reason may be that it contains considerably less silica. As in feedlot animals, water intake can be promoted by supplementing the ration with salt. For yearling (300 kg) steers the daily

consumption of 50 g of salt does not prevent the formation of siliceous calculi; at a 200-g daily intake the occurrence of calculi is significantly reduced, and at 300 g daily calculus formation is almost eliminated. For calves on native range, providing supplements (“creep feeds”) containing up to 12% salt is effective in eliminating siliceous calculi. This effect is caused by the physical diluting effect of increased water intake promoted by salt supplementation. If the calves consume sufficient quantities of salt to increase the water intake above 200 g/kg BW per day, the formation of siliceous calculi will be completely suppressed. Because siliceous calculi form in the last 60 days before weaning, it is recommended that calves on range be started on creep feed without salt well before weaning and, once calves are established on the supplement, the salt concentration should be gradually increased to 12%. It is usually necessary to increase the salt gradually to this level over a period of several weeks and incorporate it in pellets to facilitate mixing.

An alkaline urine (pH >7.0) favors the formation of phosphate-based stones (struvite and apatite) and calcium carbonate-based stones. Struvite crystallization is reported to occur at urine pH >7.2, and dissolution is reported to occur at urine pH <6.5.<sup>13</sup> Feeding an agent that decreases urine pH to a target range of 6.0 to 6.5 will therefore protect against phosphate and calcium carbonate-based stones. The feeding of ammonium chloride (at 0.5%–2.0% of dry matter intake, approximately 45 g/day to steers, 10 g daily to sheep, and 0.4–0.5 g/kg BW each day to male goats) may prevent urolithiasis caused by struvite or calcium carbonate, but the magnitude of urine acidification achieved varies markedly depending on the acidogenic nature of the diet. The safety of long-term feeding of these diets has not been well documented. A potentially practical method to prevent urolithiasis in goats is to feed a dietary cation anion difference (DCAD) of 0 mEq/kg dry matter, where  $DCAD = [Na] + [K] - [Cl] - [S]$  with constituents measured in milliequivalents per kilogram of feed on a dry matter basis.<sup>13</sup> Depending on the aggressiveness of the dosage of ammonium chloride and acidogenicity of the DCAD diet formulation, urine pH decreases over 2 to 5 days before stabilizing.<sup>14</sup> Urine pH should always be closely monitored when adding ammonium chloride to the ration, because clinically relevant acidemia, metabolic acidosis, depression, and inappetence can result from overzealous administration rates, and bone demineralization can theoretically occur with sustained feeding because aciduria promotes hypercalciuria. For range animals, ammonium chloride can be incorporated in a protein supplement and fed at about two-thirds of the earlier dosage. An acidic urine (pH <7.0) favors the formation of silicate stones, so ammonium chloride manipulation

of urine pH is not indicated in animals at risk of developing siliceous calculi. However, ammonium chloride may prevent the formation of silica calculi in sheep, which may have been caused by the urine-diluting effects of additional chloride intake.

When urolithiasis is caused by pasture exposure, females can be used to graze the dangerous pastures because they are not as susceptible to developing urinary tract obstruction. In areas where the oxalate content of the pasture is high, wethers and steers should be permitted only limited access to pasture dominated by herbaceous plants. Adequate water supplies should be available, and highly saline waters should be regarded with suspicion. Sheep on lush pasture commonly drink little if any water apparently because they obtain sufficient in the feed. Although the importance of vitamin A in the production of the disease has been decried in recent years an adequate intake should be ensured, especially during drought periods and when animals are fed grain rations in feedlots. Deferment of castration, by permitting greater urethral dilatation, may reduce the incidence of obstructive urolithiasis, but the improvement is unlikely to be significant.

#### FURTHER READING

Ewoldt JM, et al. Surgery of obstructive urolithiasis in ruminants. *Vet Clin North Am Food Anim Pract.* 2008;24:455.

#### REFERENCES

1. Sun WD, et al. *Res Vet Sci.* 2010;88:461.
2. Constable PD, et al. *Am J Vet Res.* 2009;70:915.
3. Wang JY, et al. *Res Vet Sci.* 2009;87:79.
4. Sun WD, et al. *Vet J.* 2010;186:70.
5. Kinsley MA, et al. *Vet Surg.* 2013;42:663.
6. Braun U, et al. *Vet Rec.* 2006;159:750.
7. VinodhKumar OR, et al. *Afr J Agric Res.* 2010;5:2045.
8. George JW, et al. *J Am Vet Med Assoc.* 2007;230:101.
9. Ghanem MA, et al. *Alex J Vet Sci.* 2010;31:85.
10. Janke JJ, et al. *J Am Vet Med Assoc.* 2009;234:249.
11. Tobias KM, van Amstel SR. *Vet Surg.* 2013;42:455.
12. Hunter BG, et al. *J Am Vet Med Assoc.* 2012;241:778.
13. Jones ML, et al. *Am J Vet Res.* 2009;70:149.
14. Mavangira V, et al. *J Am Vet Med Assoc.* 2010;237:1299.

### UROLITHIASIS IN HORSES

Urolithiasis occurs sporadically in horses. The prevalence is low at about 0.04% to 0.7% of all horse accessions or diagnoses. Animals from about 5 to 15 years of age and older are most often affected, and 76% are males (27% intact and 49% geldings) and 24% are females. The uroliths are most commonly in the bladder (cystic), although they also occur in the renal pelvis, ureters, and urethra. In most cases, there is a single discrete yellowish stone, but a sandy sludge accumulates in cases of paralysis of the bladder. Almost all equine uroliths are composed of calcium

carbonate ( $\text{CaCO}_3$ ) in the form of calcite, which is the most stable hexagonal crystal form, although other  $\text{CaCO}_3$  forms such as vaterite (a metastable hexagonal crystal form) and aragonite (an orthorhombic form) have been identified that may be more gray-white in color. The factors that contribute to urolith formation in horses are not understood. Urine from healthy adult horses is characterized by a substantial quantity of mucoprotein, a high concentration of minerals, considerable insoluble sabulous material, and alkalinity. Equine urine is normally supersaturated with calcium carbonate, and it is normal for crystals of calcium carbonate to be present; this is related in some manner with the occurrence of calcium carbonate uroliths in horses. Nephrolithiasis may arise as a sequel to degenerative or inflammatory processes in the kidney in which inflammatory debris serves as a nidus for calculus formation.

**The clinical findings** of urolithiasis in the horse include:

- Stranguria (straining to urinate)
- Pollakiuria (frequent passage of small amounts of urine), hematuria, and dysuria (difficult urination)
- Incontinence resulting in urine scalding of the perineum in females or of the medial aspect of the hindlimbs in males
- Painful urination with hematuria associated with cystitis
- Weight loss, particularly in horses with nephroliths and chronic renal failure
- Uroabdomen is horses with rupture of the bladder, or less frequently, kidney or ureter
- Bacterial infection of urine is common, usually caused by *E. coli*, *Staphylococcus* spp., and *Streptococcus* spp.

The bladder wall may be thickened and large calculi in the bladder may be palpable per rectum, just as the hand enters the rectum. Calculi are usually spheroid and have an irregular surface. Large calculi may be observed using transrectal ultrasonography and cystoscopy. Calculi may also be palpated in the ureters, per rectum, or enlarged ureters may be present.

**In males**, urethral calculi may present with signs of complete or partial obstruction that may be confused with colic of gastrointestinal origin. Horses with urethral obstructions make frequent attempts to urinate but pass only small amounts of blood-tinged urine. Unless rupture has occurred, the bladder is grossly enlarged. The calculus can be located by palpation of the penile urethra and by passage of a lead wire or catheter. If a catheter or lead wire is passed, care should be taken to prevent damage to the urethral mucosa. Bladder rupture leads to uroperitoneum but, if the rupture occurs at the neck of the bladder, urine may accumulate retroperitoneally and produce a large, diffuse, fluid swelling that is

palpable per rectum. When rupture occurs, acute signs disappear and are replaced by depression, immobility, and pain on palpation of the abdominal wall. The heart rate rises rapidly, and the temperature falls to below normal.

Urinalysis reveals evidence of erythrocytes, leukocytes, protein, amorphous debris, and calcium carbonate crystals.

Renal calculi are frequently bilateral and affected animals have often progressed to chronic renal failure by the time of diagnosis without having displayed signs of urinary tract obstruction. A history of chronic weight loss and colic in a horse with renal failure indicates the possible presence of renal calculi. Treatment is supportive as for all cases of chronic renal failure.

**Treatment** for cystic calculi is surgical removal of all calculi and correction of any defect in the bladder. Recurrence of cystic and urethral calculi is common in the horse, which may be related to the failure to remove all calculi. Perineal urethrotomy has been used for removal of cystic calculi in a gelding. Urethral calculi in males are removed through the external urethral orifice or by urethrotomy at the site of obstruction. Some cystic calculi can be removed with the aid of electrohydraulic lithotripsy, laser lithotripsy under endoscopic visualization, or surgery. Extracorporeal shock wave lithotripsy does not appear to have been used in the horse. In large mares with bladder calculi less than 10 cm in diameter, it is possible to remove the calculi manually by passing a very small well-lubricated gloved hand through the urethra into the bladder and retrieving the calculi after administration of epidural analgesia and sedation. Simultaneous palpation per rectum can assist in bringing the calculus to the neck of the bladder. There is one report of laparoscopic removal of a large bladder urolith in a standing gelding.<sup>1</sup> Percutaneous nephrostomy of the right kidney under ultrasonic guidance has been used for short-term diversion of urine in a horse with ureteral calculi.

Control measures typically focus on dietary modifications including decreasing calcium intake, but there appears to be an absence of studies documenting efficacy in control. Water intake should be facilitated and high calcium content feeds, such as alfalfa and clover hay, should be avoided. Ammonium chloride, at 200 mg/kg BW orally twice daily and decreased at biweekly intervals until a dosage of 20 to 60 mg/kg BW is reached, is recommended to maintain the urine pH below 7.0. Urine pH needs to be frequently monitored during supplementation with oral ammonium chloride because of the variability in individual response. Ascorbic acid (1–2 g/kg daily) administered orally is reported to acidify equine urine, but recommended dose rates vary widely and studies documenting treatment efficacy in urolithiasis appear to be lacking.

## FURTHER READING

- Duesterdick-Zellmer KF. Equine urolithiasis. *Vet Clin North Am Equine Pract.* 2007;23:613-629.
- Edwards B, Archer D. Diagnosis and treatment of urolithiasis in horses. *In Pract.* 2011;33:2-10.
- Foley A, Brounts SH, Hawkins JF. Urolithiasis. *Comp Contin Ed Pract Vet.* 2009;4:125-133.

## REFERENCE

- Lund CM, et al. *J Am Vet Med Assoc.* 2013;243:1323.

## URETHRAL TEARS IN STALLIONS AND GELDINGS

Urethral rents are lesions in the convex surface at the level of the ischial arch in geldings and stallions. The lesions communicate with the corpus spongiosum and cause hemorrhage at the end of urination in geldings or during ejaculation by stallions. Stallions do not have hematuria, despite having a lesion identical to that in geldings, presumably because of the lower pressure in the corpus spongiosum of stallions at the end of urination compared with that in geldings. The disease is apparently caused by contraction of the bulbospongiosus muscle at the end of urination, with a consequent increase in pressure in the corpus spongiosum and expulsion of blood through the rent. The cause of the rent has not been determined. The diagnosis is confirmed by endoscopic examination of the urethra with visualization of the rent in the urethral mucosa. Treatment of the disease is by temporary subschial urethrostomy and sexual rest. Sexual rest alone was successful in one stallion.

## URETHRAL DEFECTS

An **anomalous vas deferens** caused a chronic partial urethral obstruction in a 2-year-old Limousin bull, resulting in bilateral hydronephrosis, pyelonephritis of the left kidney, and bilateral ureteral dilatation. There are two reports of a ruptured urinary bladder in neonatal calves apparently caused by a **congenital urethral obstruction** that was corrected by passing a urethral catheter. Congenital urethral obstruction with subsequent hydronephrosis and uroperitoneum is reported in a lamb.

**Urethral atresia** is recorded rarely in calves and is manifested by failure to pass urine and distension of the patent proximal portion of the urethra.

Imperfect closure of the external male urethra in a series of newborn lambs (**hypospadias**) is recorded with other neonatal defects including atresia ani and diaphragmatic hernia. No genetic influence was suspected, and the cause was unidentified.

Continuous urethral spasm has been reported in a Standardbred mare with a 3-year history of stranguria and pollakiuria.<sup>1</sup>

Physical examination, including ultrasonography of the bladder and urethra, was unremarkable. The condition resolved following treatment for 1 month with oral acepromazine (0.04 mg/kg, every 8 hours) and did not recur.

## FURTHER READING

- Chaney KP. Congenital anomalies of the equine urinary tract. *Vet Clin North Am Equine Pract.* 2007;23:691-696.

## REFERENCE

- Abutarbush SM. *J Equine Vet Sci.* 2014;34:569.

## URINARY BLADDER NEOPLASMS

Tumors of the urinary bladder are common only in cattle, and they are associated with bracken poisoning (see the section **Bovine Enzootic Hematuria**), but they do occur in other circumstances. For example, 18 cows are recorded in one series, with angioma, transitional epithelial carcinoma, and vascular endothelioma as the most common tumors. Abattoir surveys in Canada, the United States, and Australia identified papillomas, lymphomas, adenomas, hemangiomas, and transitional cell tumors of the bladder occurring at low frequencies in slaughter cattle, accounting for 0.01% of all bovine malignancies.<sup>1</sup> Papillomas appear to be associated with the bovine papillomavirus (BPV), and BPV type 1 (BPV-1) and BPV type 2 (BPV-2) are the only viruses known to infect the urothelium of the urinary bladder of healthy cattle. A recent report of a Kaposi-like vascular tumor of the urinary bladder in a cow is available.<sup>2</sup> Most bladder neoplasms develop from focal areas of hyperplasia within the transitional cell layer, and approximately 80% of these can be classified as carcinomas and 17% are papillomas. Because these neoplasms arise from a common site, they can be very similar in gross and histologic appearance and very difficult to differentiate. The immunoenzymatic labeling of intermediate filaments in bovine urinary bladder tumors is an accurate indicator of histogenesis.

Bladder neoplasia caused by squamous cell carcinoma, transitional cell carcinoma, lymphosarcoma, fibromatous polyp, and rhabdomyosarcoma occurs rarely in the horse.<sup>3</sup> Clinical signs included hematuria, weight loss, stranguria, and the secondary development of cystitis. Prognosis is usually poor because of the rapid growth of the neoplasia, likelihood of metastasis, and challenges with obtaining adequate surgical access.

## REFERENCES

- Roperto S, et al. *J Comp Pathol.* 2010;142:95.
- Pires I, et al. *J Vet Med Sci.* 2009;71:831.
- Barrell E, Hendrickson DA. *Equine Vet Educ.* 2009;21:267.

## BOVINE ENZOOTIC HEMATURIA

### SYNOPSIS

**Etiology** Long-term ingestion of bracken fern, *Pteridium aquilinum*, in cattle with latently infected with bovine papillomavirus type 2.

**Epidemiology** Enzootic to areas with significant growth of bracken fern; fatal, chronic disease of adult cattle.

**Clinical signs** Hematuria, anemia, and sometimes palpable lesions in bladder.

**Clinical pathology** Hematuria.

**Necropsy findings** Hemangiomas and other neoplastic lesions in bladder mucosa.

**Diagnostic confirmation** Endoscopic examination of the bladder and biopsy; bladder lesion histopathology.

**Treatment** None.

**Control** Eradication of bracken.

## ETIOLOGY

Chronic ptaquiloside poisoning caused by the ingestion of *Pteridium aquilinum* (primarily), but also *Pteridium* spp., *Cheilanthes sieberi*, or *Onychium contiguum* is associated with enzootic hematuria in cattle. In the past, the genus was commonly treated as having only one species, *P. aquilinum*, but more recently the genus is being subdivided into approximately 10 species. A high incidence of vesicular carcinomas, similar to the bladder lesions of enzootic hematuria in cattle, has also been recorded in sheep grazing bracken for long periods.

## EPIDEMIOLOGY

Enzootic hematuria is an area problem on all continents where bracken grows. Bracken fern is a very common plant worldwide and the only higher order plant known to cause cancer in animals when ingested. There is a strong association between BPV-2 and chronic bracken fern ingestion in cattle with naturally acquired and experimentally induced bladder cancer. The overall prevalence of cancer can reach 10% in endemic areas, such as Sao Miguel Island in the Azores, and the disease may be associated with heavy losses in areas where bracken is a common plant.<sup>1</sup> The disease is usually fatal. Cattle over 3 years of age are most often affected, and the disease has also been recorded in sheep and water buffalo exposed to infested pastures for periods exceeding 2 years. The disease occurs mainly on poor, neglected, or recently opened up land and tends to disappear as soil fertility and land management improves. It is not closely associated with a particular soil type, although it is recorded most commonly on lighter soils. The ptaquiloside content of bracken varies considerably between geographic locations, and there is good correlation between its



concentration and neoplasia in rats fed bracken from those areas.

### PATHOGENESIS

BPV-2 infects the bladder mucosa, producing a latent infection. Chemical carcinogens and immunosuppressants from bracken fern act in a synergistic manner with BPV-2, resulting in neoplastic disease.<sup>2,3</sup> Ptaquiloside from bracken is excreted in the urine and converts to an aglycone dienone intermediate at high urine pH and this substance is the ultimate carcinogen, explaining the location of tumor formation in the bladder. It has been suggested that the dienone reacts with DNA, particularly with adenosine, to initiate carcinogenesis. BPV-2 appears to undergo major changes on cancer development through expression of a viral oncoprotein called E5 and modifying telomerase activity.<sup>4,5</sup>

Hemorrhage from the bladder wall lesions occurs intermittently resulting in ongoing blood loss. Deaths are caused by hemorrhagic anemia.

### CLINICAL FINDINGS

Severe cases are manifested by the passage of large quantities of blood, often as clots, in the urine. Hemorrhagic anemia develops and the animal becomes weak and recumbent, and may die after an illness lasting 1 to 2 weeks. Less severe cases are characterized by intermittent, mild clinical hematuria or persistent subclinical hematuria. In these cases, there is a gradual loss of condition over several months and eventually clinical evidence of anemia. On rectal examination, there may be thickening of the bladder wall. Secondary bacterial infection of the bladder may lead to the development of cystitis and pyelonephritis. Cystoscopy reveals the presence of multiple different-sized white to reddish colored nodules protruding into the bladder lumen<sup>2,6</sup> (Fig. 13-10).

### CLINICAL PATHOLOGY

Urine dipstick reaction to blood is positively associated with the number and severity of lesions in the bladder.<sup>6</sup> In the absence of

gross hematuria, a urine sample should be centrifuged and the deposit examined for erythrocytes. Repeated examinations may be necessary. Nonspecific anemia is detectable by hematologic examination, but clotting time indices (activated partial thromboplastin time, prothrombin time, and D-dimer) are within reference range.<sup>7</sup> Granulocyte and thrombocyte numbers are typically normal. At least one of the viral proteins of BPV-2 (E5 oncoprotein) is expressed in tumors and can be detected using PCR.

### NECROPSY FINDINGS

All tissues of the carcass are pale, and the animal is usually emaciated. The urinary bladder contains blood clots or bloodstained urine. The presence of premalignant hemangiomas in the submucosa of the urinary bladder is typical of the disease. A range of other neoplasms may be present, including malignant hemangiosarcoma, hemangioendotheliomas (tumors that are histologically intermediate in appearance between hemangioma and hemangiosarcoma), transitional cell carcinoma, adenoma, fibroma, and papilloma.<sup>2,3,8</sup> The malignant types may have invaded the deeper structures of the bladder and have metastasized to the lumbo-aortic lymph node (the regional lymph node)<sup>3</sup> or lungs. Tumors expressing p53 mutations appear to be more aggressive.<sup>9</sup> The neoplastic changes in the bladder are accompanied by inflammatory changes of the mucosa and submucosa, including proliferative changes of mucosal epithelium, lymphocytic infiltrates, congestion, edema, and hemorrhage. In some cases, lesions are seen in the ureters and renal pelvis. The severity of the blood loss is not necessarily related to the size or extent of the lesions, and animals may bleed to death when only small localized lesions are present.

### DIFFERENTIAL DIAGNOSIS

Diagnosis confirmation is by signs in animals grazing fern-infested pasture and preferably

by histopathology of bladder lesions. The differential list includes:

- Cystitis
- Pyelonephritis

Both are usually accompanied by fever, frequent urination, and the presence of pus and debris in the urine. Bacteriologic examination of the urine will reveal the presence of infection.

### TREATMENT

#### Primary

No treatment should be attempted and affected animals should be disposed of at the first opportunity.

#### Supportive

Blood transfusion may be justified in severe cases and hematinic mixture should be provided in other cases.

### CONTROL

A general improvement in nutrition is often followed by a decrease in the number of animals affected. A specific recommendation is to apply gypsum (225–335 kg/hectare) to the pasture as a fertilizer, which is a measure reputed to delay the onset of the disease. Bracken eradication is difficult and should not be undertaken without the advice of the local weed control officer.

### FURTHER READING

- Dawra RK, Sharma OP. Enzootic bovine haematuria—past, present and future. *Vet Bull.* 2001;71:1R-27R.  
 Roperto S, Borzacchiello G, Brun R, et al. A review of bovine urothelial tumours and tumour-like lesions of the urinary bladder. *J Comp Pathol.* 2010;142:95.

### REFERENCES

1. Resendes AR, et al. *Res Vet Sci.* 2011;90:526.
2. Carvalho T, et al. *J Comp Pathol.* 2006;134:336.
3. Carvalho T, et al. *Vet Pathol.* 2009;46:211.
4. Borzacchiello G, et al. *Oncogene.* 2006;25:1251.
5. Yuan Z, et al. *Vet J.* 2007;174:599.
6. Pavelski M, et al. *Semina Ciências Agrárias, Londrina.* 2014;35:1369.
7. Di Loria A, et al. *Res Vet Sci.* 2012;93:331.
8. Roperto S, et al. *J Comp Pathol.* 2010;142:95.
9. Cota JB, et al. *Vet Pathol.* 2014;51:749.

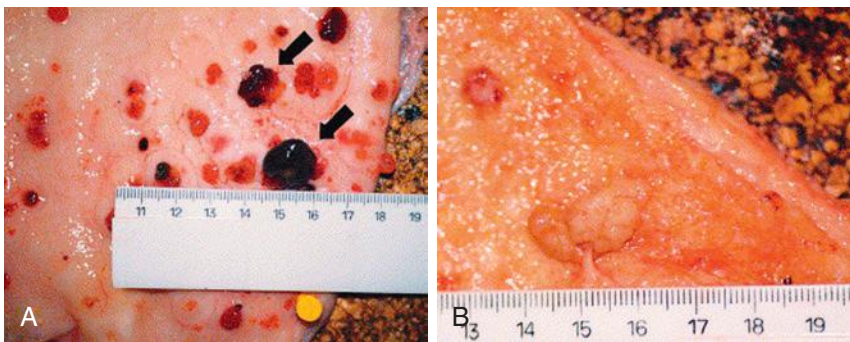

**Fig. 13-10** Luminal surface of bladders from cattle with bovine enzootic hematuria. **A**, The bladder contains multiple tumors, with the two tumors (arrows) diagnosed as hemangiosarcoma. **B**, The bladder contains a transitional cell carcinoma. (Reproduced with permission from Carvalho T, Pimto C, Peleteiro MC. *J Comp Pathol* 2006; 134:336-346.)

## Diseases of the Prepuce and Vulvovaginal Area

### ENZOOTIC POSTHITIS (PIZZLE ROT, SHEATH ROT, BALANOPOSTHITIS) AND VULVOVAGINITIS (SCABBY ULCER)

#### SYNOPSIS

**Etiology** Multifactorial; organisms that produce urease, usually *Corynebacterium renale*, produce lesions only in certain

circumstances of management and urinary composition.

**Epidemiology** Disease of wether sheep and occasional disease of bulls and goats; may occur as enzootic disease in sheep on high-protein diets and following good rains.

**Clinical findings** Pustules and scabs at preputial orifice; extension to involve internal prepuce in severe disease with signs of urinary obstruction; ulcers and scabs at the mucocutaneous junction of vulva in ewes; and urine staining of wool predisposes to fly strike. In large mobs of wethers these strikes are often not obvious ("covert strikes"), but are an important means of multiplying *Lucilia cuprina* flies early in the fly season.

**Diagnostic confirmation** Clinical.

**Treatment** Dietary restriction, topical disinfectants, and surgical opening of ventral prepuce.

**Control** Reduction of protein intake; testosterone; hemicastrate or cryptorchid castration.

## ETIOLOGY

The etiology of these diseases is **multifactorial**. High urea concentrations in urine, associated with high protein in pasture, result in cytotoxic levels of ammonia when the urea is split by urease-producing organisms present in the prepuce and vagina. Estrogens in pasture, causing swelling and congestion of the prepuce, may predispose to disease. Most often the organism is *C. renale*, but outbreaks of posthitis in sheep associated with other urease-producing organisms (e.g., *R. equi* and *C. hofmannii*) have been described.

*Mycoplasma mycoides* LC has also been incriminated as a cause of posthitis and vulvovaginitis in sheep.

## EPIDEMIOLOGY

The disease is reported primarily from Australia, South Africa, and South America but occurs in all countries with large pastoral sheep industries.

### Host Occurrence Sheep

In Australia, enzootic posthitis occurs most often in Merino sheep, particularly **wethers** over 3 years of age and young rams, but in a severe outbreak young wethers and old rams may also be affected. An ulcerative **vulvitis** often occurs in ewes in the same flocks in which posthitis occurs in wethers and is thought to be a venereal extension of that disease. The disease also occurs in **goats**.

### Cattle

Posthitis is uncommon in bulls but is reported to occur at high rates and to be economically important in South America.

There appears to be no counterpart to ovine vulvitis in cows.

## Source of Infection and Transmission

The causative organism can be recovered from lesions and from the clinically normal prepuce of most sheep. It is also present in the lesions of vulvitis in ewes and posthitis in bulls and Angora goat wethers.

Flies are considered to be probable **mechanical vectors**, and contact with infected soil and herbage is a likely method of spread. Infection at dipping or shearing seems not to be important. Transmission to ewes appears to occur **venereally** from infected rams. Although the natural disease in cattle is usually benign, they may act as reservoirs of infection for sheep on the same farm.

## Host and Environmental Risk Factors

**Diet and season** are the major risk factors. Enzootic posthitis occurs most extensively on lush, **improved pasture** with a high **legume** content and reaches its highest incidence in the autumn in summer rainfall areas and in the spring where the major rainfall is in winter. In these circumstances it can occur in epizootic proportions in wethers. The incidence in affected flocks may be as high as 40%, and in some areas the disease is so common that it is not possible to maintain flocks of wethers.

Factors of lesser importance are continued wetness of the area around the prepuce caused by removal of preputial hairs at shearing; a high-calcium, low-phosphorus diet; and the ingestion of large quantities of alkaline water.

The high incidence in castrates and young rams is probably related to the close adherence of the preputial and penile skins, which separate in mature animals, and to a lesser understood influence of **testosterone**.

## Experimental Reproduction

Implantation of the organism on a scarified prepuce in the presence of urine is capable of causing the external ulceration that is characteristic of the disease.

## Economic Importance

Many deaths occur because of uremia and secondary bacterial infections and all affected sheep show a severe setback in growth rate and wool production. Young rams that are affected are incapable of mating.

## PATHOGENESIS

The organism is capable of hydrolyzing urea with the production of ammonia. It is thought the initial lesion in the wether (the external lesion) is caused by the **cytotoxic effect of ammonia**, produced from urea in the urine by the causative bacteria. This lesion may remain in a static condition for a

long period but, when there is a high urea content of the urine associated with a high-protein diet, and continued wetting of the wool around the prepuce, the lesion proceeds to invade the interior of the prepuce, producing the "internal lesion." A similar pathogenesis is postulated for vulvar lesions.

## CLINICAL FINDINGS

The primary lesion starts as a pustule, which breaks and forms a soft scab. Small scabs are found on the skin dorsal to the preputial orifice (**external lesion**) and around the external orifice on the nonhaired part of the prepuce. These may persist for long periods without the appearance of any clinical signs. The scab is adherent and tenacious. When extension to the interior of the prepuce occurs (**internal lesion**), there is extensive ulceration and scabbing of the preputial opening, and a hard core can be palpated extending 1 to 2 inches into the prepuce. With pressure, a semisolid core of purulent material can be extruded from the preputial orifice. Affected sheep may show restlessness, kicking at the belly, and dribbling urine as in urethral obstruction. The area is often infested by blowfly maggots. In rams, the development of pus and fibrous tissue adhesions may interfere with urination and protrusion of the penis and cause permanent impairment of function.

Some deaths occur from obstructive uremia, toxemia, and septicemia. During an outbreak many sheep may be affected without showing clinical signs and are detected only when they are subjected to a physical examination. Others recover spontaneously when feed conditions deteriorate.

In ewes the lesions are confined to the lips of the vulva and consist of pustules, ulcers, and scabs. These extend minimally into the vagina. Their presence may distort the vulva, and the ewe may urinate onto the wool with a consequent increased susceptibility to fly strike.

In bulls, lesions are similar to the external lesions, which occur in wethers but rarely there may be invasion of the interior of the prepuce. The external lesions occur at any point around the urethral orifice and may encircle it. Their severity varies from local excoriation to marked ulceration with exudation and edema. There is a tendency for the lesions to persist for several months without treatment and with highly alkaline urine.

## CLINICAL PATHOLOGY

Isolation of the causative diphtheroid bacterium may be necessary if there is doubt as to the identity of the disease.

## NECROPSY AND DIAGNOSTIC CONFIRMATION

Necropsy is not required, and the diagnosis is clinical.

### DIFFERENTIAL DIAGNOSIS

- Ulcerative dermatosis in sheep
  - Herpes balanoposthitis in bulls
- Obstructive urolithiasis in wethers may superficially resemble posthitis, but there is no preputial lesion.

### TREATMENT

The principal measures are restriction of the diet to reduce the urea content of the urine, removal of the wool around the prepuce or vulva to reduce the risk of fly strike, segregation of affected sheep and disinfection of the preputial area, and surgical treatment of severe cases.

Sheep can be removed onto dry pasture and their feed intake restricted to that required for subsistence only. They should be inspected at regular intervals, the wool should be shorn from around the prepuce, and affected animals should be treated individually. Weekly application of a 10% copper sulfate ointment is recommended for external lesions; when the interior of the prepuce is involved, it should be irrigated twice weekly with a 5% solution of copper sulfate, cetrimide (20% in alcohol or water with or without 0.25% acid fuchsin), or 90% alcohol.

Penicillin topically, or oxytetracycline or penicillin parenterally, may assist recovery.

In severe cases the only satisfactory treatment is surgical, and surgical treatment is necessary if the prepuce is obstructed. The recommended procedure is to open the ventral sheath by inserting one blade of a pair of scissors into the external preputial orifice and cutting the prepuce back as far as the end of the urethral process; extension beyond this leads to trauma of the penis. Badly affected rams should be disposed of as they are unlikely to be of value for breeding.

### TREATMENT AND PROPHYLAXIS

#### Treatment

Testosterone enanthate (150 mg SC) (R1)

Long-acting Oxytetracycline (20 mg/kg IM) (R2)

#### Prophylaxis

Testosterone enanthate (75 mg SC) (R1)

*IM, intramuscular; SC, subcutaneous.*

### CONTROL

Subcutaneous implantation with a mix of testosterone esters is highly effective as a preventive, but testosterone propionate is no longer permitted for use in sheep that will

be used for human food. Testosterone enanthate is available in some jurisdictions. A single injection of 75 mg is used for prevention and 150 mg for treatment. It is most economical to use preventive treatments coincident with the periods of maximum incidence, the flush of pasture growth in spring and autumn, but timing will vary from district to district.

Alternative control procedures investigated include running male lambs as cryptorchids, called **short scrotum** lambs, in which the testes are pushed into the inguinal canal and a rubber ring is applied to remove the scrotum. Another is to run male lambs as hemicastrates. The prevalence of posthitis is significantly reduced in Merino short scrotum lambs and hemicastrates. There is an increase in live weight, with no increase in fleece weight, but there are obvious masculine characteristics such as horn growth.

### FURTHER READING

Radostits O, et al. *Enzootic Posthitis (Pizzle Rot, Sheath Rot, Balanoposthitis); Vulvovaginitis (Scabby Ulcer)*. *Veterinary Medicine: A Textbook of the Disease of Cattle, Horses, Sheep, Goats and Pigs*. 10th ed. London: W.B. Saunders; 2007: 793-795.



# Diseases of the Nervous System

## INTRODUCTION 1156

### PRINCIPLES OF NERVOUS

#### DYSFUNCTION 1157

Modes of Nervous Dysfunction 1158

### CLINICAL MANIFESTATIONS OF DISEASES OF THE NERVOUS SYSTEM 1158

Altered Mentation 1158

Involuntary Movements 1159

Abnormal Posture and Gait 1160

Paresis and Paralysis 1162

Altered Sensation 1162

Blindness 1163

Abnormalities of the Autonomic Nervous System 1163

### SPECIAL EXAMINATION OF THE NERVOUS SYSTEM 1164

Neurologic Examination 1164

Signalment and Epidemiology 1164

History 1164

Head 1164

Posture and Gait 1170

Neck and Forelimbs 1170

Trunk and Hindlimbs 1171

Tail and Anus 1172

Palpation of the Bony Encasement of the Central Nervous System 1172

Collection and Examination of Cerebrospinal Fluid 1172

Examination of the Nervous System With Serum Biochemical Analysis 1175

Examination of the Nervous System With Imaging Techniques 1175

Endoscopy (Rhinolaryngoscopy) 1177

Ophthalmoscopy 1177

Electromyography 1177

Electroencephalography 1177

Electroretinography 1177

Brainstem Auditory Evoked Potentials 1177

Intracranial Pressure Measurement 1178

Kinetic Gait Analysis 1178

### DIFFUSE OR MULTIFOCAL DISEASES OF THE BRAIN AND SPINAL CORD 1178

Cerebral Hypoxia 1178

Increased Intracranial Pressure, Cerebral Edema, and Brain Swelling 1179

Hydrocephalus 1181

Meningitis 1182

Encephalitis 1184

Epilepsy 1186

Myelitis 1186

Encephalomalacia 1187

Myelomalacia 1189

### FOCAL DISEASES OF THE BRAIN AND SPINAL CORD 1189

Traumatic Injury to the Brain 1189

Brain Abscess 1191

Tumors of the Central Nervous System 1193

### PLANT TOXINS AFFECTING THE NERVOUS SYSTEM 1194

Indole Alkaloids 1195

Indolizidine Alkaloid Toxicosis (Locoism, Peastruck) 1195

Neurogenic Quinolizidine Alkaloids (*Lupinus* spp.) 1197

Nitrocompound Plant Toxicosis (Milk Vetch) 1197

Piperidine Alkaloid Plant Toxicosis 1198

Corynetoxins (Tunicaminylluracils) (Annual Ryegrass Staggers, Flood Plain Staggers, Stewart Range Syndrome) 1199

Miscellaneous Plant Toxins Affecting the Nervous System (Unidentified Toxins) 1201

### FUNGAL TOXINS AFFECTING THE NERVOUS SYSTEM 1201

Tremorgenic Mycotoxins 1201

Miscellaneous Fungal Toxins Affecting The Nervous System (Unidentified Toxins) 1202

### OTHER TOXINS AFFECTING THE NERVOUS SYSTEM 1202

Inorganic Toxins Affecting the Nervous System 1202

Lead Toxicosis (Plumbism) 1202

Mercury Toxicosis 1208

Boron Toxicosis 1209

Bromide Toxicosis 1210

Organic Toxins Affecting the Nervous System 1210

Macrocytic Lactone (Ivermectin, Moxidectin, etc.) Toxicosis 1212

Organophosphorus Compounds and Carbamate Insecticides 1214

Industrial Organophosphates 1216

Rotenone Toxicosis 1216

Organochlorine Insecticides 1216

Sodium Fluoroacetate (Compound 1080) Toxicosis 1218

Molluscicide Toxicosis 1218

### DISEASES OF THE CEREBRUM 1219

Psychoses, Neuroses, and Stereotypy 1219

Head-Shaking in Horses 1220

Tail-Biting in Swine 1222

### BACTERIAL DISEASES PRIMARILY AFFECTING THE CEREBRUM 1224

Enterotoxemia Associated With *Clostridium Perfringens* Type D (Pulpy Kidney, Overeating Disease) 1224

Focal Symmetric Encephalomalacia 1227

Cerebrospinal Angiopathy 1227

### VIRAL DISEASES PRIMARILY AFFECTING THE CEREBRUM 1227

Rabies 1227

Pseudorabies (Aujeszky's Disease) 1239

Sporadic Bovine Encephalomyelitis (Buss Disease and Transmissible Serositis) 1247

Border Disease (Hairy Shaker Disease of Lambs, Hairy Shakers, Hypomyelination Congenita) 1248

Visna 1252

Caprine Arthritis Encephalitis 1253

Ovine Encephalomyelitis (Louping-III) 1256

West Nile, Kunjin, and Murray Valley Encephalitis 1259

Japanese Encephalitis 1262

Eastern and Western Equine Encephalomyelitis 1265

Venezuelan Equine Encephalomyelitis 1269

Equid Herpesvirus-1 Myeloencephalopathy, Abortion, and Neonatal Septicemia 1272

Peruvian Horse Sickness Virus 1282

Powassan Virus 1282

Nigerian Equine Encephalitis 1282

Main Drain Virus Encephalitis 1282

Borna Disease 1282

Teschovirus Infections 1283

### PRION DISEASES PRIMARILY AFFECTING THE CEREBRUM 1286

Introduction 1286

Bovine Spongiform Encephalopathy (Mad Cow Disease) 1287

Bovine Spongiform Encephalopathy and Sheep 1293

Scrapie 1294

Chronic Wasting Disease 1300

### PARASITIC DISEASE PRIMARILY AFFECTING THE CEREBRUM 1301

Coenurosis (Gid, Sturdy) 1301

*Halicephalobus* 1302

### METABOLIC DISEASES PRIMARILY AFFECTING THE CEREBRUM 1302

Polioencephalomalacia (Cerebrocortical Necrosis) of Ruminants 1302

Thiamine Deficiency (Hypothiaminosis) 1310

Thiaminase Toxicosis 1311  
Salt Toxicity (Sodium Chloride Toxicosis) 1312

Vitamin A Deficiency (Hypovitaminosis A) 1314

Nicotinic Acid Deficiency (Hyponiacinosis) 1320

Pyridoxine (Vitamin B<sub>6</sub>) Deficiency (Hypopyridoxinosis) 1321

Pantothenic Acid Deficiency (Hypopantothenosis) 1321

### **METABOLIC AND TOXIC ENCEPHALOMYELOPATHIES 1321**

### **INHERITED DISEASES PRIMARILY AFFECTING THE CEREBRUM 1322**

Inherited Congenital Hydrocephalus 1322

Inherited Hydranencephaly and Arthrogryposis 1322

Inherited Prosencephaly 1323

Inherited Multifocal Symmetric Encephalopathy 1323

Maple Syrup Urine Disease (Branched-Chain Keto Acid Dehydrogenase Deficiency) 1323

Inherited Citrullinemia 1323

Inherited Neonatal Spasticity 1323

Doddler Calves 1323

Inherited Idiopathic Epilepsy of Cattle 1323

Familial Narcolepsy 1323

### **CONGENITAL AND INHERITED ENCEPHALOMYELOPATHIES 1324**

Inherited Lysosomal Storage Diseases 1324

Inherited Nervous System Abiotrophies 1325

Neuronal Ceroid Lipofuscinosis 1326

Congenital Necrotizing Encephalopathy in Lambs 1326

Lavender Foal Syndrome 1326

Inherited Hypomyelinogenesis (Congenital Tremor Syndromes of Piglets) 1327

### **DISEASES PRIMARILY AFFECTING THE CEREBELLUM 1328**

Inherited Cerebellar Defects 1328

### **DISEASES PRIMARILY AFFECTING THE BRAINSTEM AND VESTIBULAR SYSTEM 1329**

Otitis Media/Interna 1329

Listeriosis 1331

### **DISEASES PRIMARILY AFFECTING THE SPINAL CORD 1337**

Traumatic Injury 1337

Spinal Cord Compression 1339

Back Pain in Horses 1341

### **PARASITIC DISEASES PRIMARILY AFFECTING THE SPINAL CORD 1341**

Equine Protozoal Myeloencephalitis 1341

Cerebrospinal Nematodiasis (Elaphostrongylosis) 1345

Setaria 1345

### **TOXIC DISEASES PRIMARILY AFFECTING THE SPINAL CORD 1346**

Stringhalt 1346

### **INHERITED DISEASES PRIMARILY AFFECTING THE SPINAL CORD 1346**

Spastic Paresis of Cattle (Elso Heel) 1346

Inherited Spinal Dysmyelination 1348

Inherited Neurodegeneration (Shaker Calf Syndrome) 1348

Inherited Spinal Dysraphism 1348

Inherited Congenital Posterior Paralysis 1349

Inherited Bovine Degenerative Axonopathy 1349

Degenerative Axonopathy of Tyrolean Grey Cattle 1349

Central and Peripheral Axonopathy of Maine Anjou (Rouge-Des-Prés) Cattle 1349

Inherited Progressive Degenerative Myeloencephalopathy (Weaver Syndrome) of Brown Swiss Cattle 1349

Inherited Progressive Ataxia 1349

Inherited Spinal Myelinopathy 1349

Inherited Periodic Spasticity of Cattle 1349

Neuraxonal Dystrophy 1350

Caprine Progressive Spasticity 1350

Inherited Spontaneous Lower Motor Neuron Diseases 1350

Inherited Spinal Muscular Atrophy 1350  
Inherited Hypomyelinogenesis (Congenital Tremor of Pigs) 1351

Porcine Congenital Progressive Ataxia and Spastic Paresis 1351

Equine Degenerative Myeloencephalopathy (Equine Neuraxonal Dystrophy) 1351

Equine Cervical Vertebral Compressive Myelopathy (Wobbler, "Wobbles," Foal Ataxia, Equine Sensory Ataxia, Cervical Vertebral Instability) 1351

Equine Motor Neuron Disease 1357

Equine Motor Neuron Disease 1357

### **DISEASES PRIMARILY AFFECTING THE PERIPHERAL NERVOUS SYSTEM 1358**

Tetanus 1360

Botulism 1363

Tick Paralysis 1367

Ovine "Kangaroo Gait" and Fenugreek Staggers 1368

Polyneuritis Equi (Cauda Equina Syndrome) 1369

Scandinavian Knuckling Syndrome (Acquired Equine Polyneuropathy) 1370

Peripheral Nerve Sheath Tumors 1370

## **Introduction**

This chapter focuses on the diagnosis, treatment, and control of large animal diseases primarily affecting the nervous system. In general, the principles of clinical neurology and their application to large animal neurology has not kept pace with the study of neurology in humans and small animals, although remarkable progress has been made in equine neurology over the last 30 years. To a large extent this shortfall is caused by the failure of large-animal clinicians to relate observed clinical signs to a **neuroanatomical location** of the lesion. In many cases this failure has been because of adverse environmental circumstances, or the large size or nature of the animal, all of which adversely impact the quality of the neurologic examination. It may be very difficult to do an

adequate neurologic examination on an ataxic belligerent beef cow that is still able to walk and attack the examiner. An aggressive, paretic bull in broad sunlight can be a daunting subject if one wants to examine the pupillary light reflex; ophthalmoscopic examination of the fundus of the eye in a convulsing steer in a feedlot pen can be an exasperating task. Thus at one end of the spectrum is the clinical examination of pigs affected with nervous system disease, which is limited to an elementary clinical examination and necropsy examination. At the other end, neurologic examination of the horse with nervous system disease is very advanced. The global occurrence of bovine spongiform encephalopathy (BSE) has highlighted the importance of accurate clinical diagnosis in adult cattle with neurologic abnormalities.

Discrete lesions of the central nervous system (CNS) resulting in well-defined

neurologic signs are not common in agricultural animals. Many diseases are characterized by diffuse neurologic lesions associated with bacteria, viruses, toxins, nutritional disorders, and embryologic defects, and the clinical findings of each disease are similar. Rather than attempting to localize lesions in the nervous system, large-animal practitioners more commonly devote much of their time to attempting to identify whether an animal has diffuse brain edema or increased intracranial pressure, as in polioencephalomalacia (PEM); whether it has clinical signs of asymmetric brainstem dysfunction and depression of the reticular activating system, as in listeriosis; or whether the dysfunction is at the neuromuscular level, as in hypomagnesemic tetany.

Radiographic examination, including myelography, is not used routinely as a diagnostic aid in large-animal practice. The

collection of cerebrospinal fluid (CSF) from the different species and ages of large animal without causing damage to the animal or contaminating the sample with blood is a technique that few large-animal veterinarians have mastered. However, the collection of CSF from the lumbosacral cistern is not difficult if the animals are adequately restrained, and the information obtained from analysis of CSF can be very useful in the differential diagnosis of diseases of the brain and spinal cord. Referral veterinary centers are now providing detailed neurologic examinations of horses with nervous system disease, and the clinical and pathologic experience has expanded the knowledge base of large-animal clinical neurology.

In spite of the difficulties, the large-animal practitioner has an obligation to make the best diagnosis possible using the diagnostic aids available. The principles of large-animal neurology are presented in this chapter, and the major objective is to recognize the common diseases of the nervous system by correlating the clinical findings with the location and nature of the lesion. **Accurate neuroanatomical localization of the lesion(s)** remains the fundamental requirement for creating a differential diagnosis list and diagnostic and treatment plan.

A disease such as rabies has major public health implications, and it is important for the veterinarian to be able to recognize the disease as early as possible and to minimize human contact. It is also important to be able to recognize treatable diseases of the nervous system, such as polioencephalomalacia (PEM), listeriosis, and nervous ketosis, and to differentiate these diseases from untreatable and globally important diseases such as Bovine Spongiform Encephalopathy (BSE).

The nontreatable diseases must also be recognized as such, and slaughter for salvage or euthanasia recommended if necessary. There must be a major emphasis on prognosis because it is inhumane and uneconomic to hospitalize or continue to treat an adult cow or horse with incurable neurologic disease for an indefinite period. If they are recumbent, the animals commonly develop secondary complications such as decubitus ulcers and other self-inflicted injuries because of repeated attempts to rise. Very few diseases of the nervous system of farm animals are treatable successfully over an extended period of time. This has become particularly important in recent years with the introduction of legislation prohibiting the slaughter of animals that have been treated with antibiotics until after a certain withdrawal period, which may vary from 5 to 30 days. This creates even greater pressure on the clinician to make a rapid, inexpensive, and accurate diagnosis and prognosis.

Because of limitations in the neurologic examination of large animals, there must be

much more emphasis on the history and epidemiologic findings. Many of the diseases have epidemiologic characteristics that give the clinician a clue to the possible causes, thus helping to narrow the number of possibilities. For example, viral encephalomyelitis of horses occurs with a peak incidence during the insect season, lead poisoning is most common in calves after they have been turned out on to pasture, and PEM occurs in grain-fed feedlot cattle and sheep.

The functions of the nervous system are directed at the maintenance of the body's spatial relationship with its environment. These functions are performed by the several divisions of the nervous system including the following:

- Sensorimotor system, responsible for the maintenance of normal posture and gait
- Autonomic nervous system, controlling the activity of smooth muscle and endocrine glands, and thus the internal environment of the body
- Largely sensory system of special senses
- Psychic system, which controls the animal's mental state

The nervous system is essentially a reactive one geared to the reception of internal and external stimuli and their translation into activity and consciousness; it is dependent on the integrity of both the afferent and efferent pathways. This integrative function makes it often difficult to determine in a sick animal whether abnormalities are present in the nervous system; the musculoskeletal system; or acid-base, electrolyte, and energy status. Accordingly, the first step when examining an animal with apparent abnormalities in the nervous system is to determine whether other relevant systems are functioning normally. A decision to implicate the nervous system is often made on the exclusion of other systems.

The nervous system itself is not independent of other organs, and its functional capacity is regulated to a large extent by the function of other systems, particularly the cardiovascular system. Inadequate oxygen delivery caused by cardiovascular disease commonly leads to altered cerebral function because of the dependence of the brain on an adequate oxygen supply.

It is important to distinguish between primary and secondary diseases of the nervous system because both the prognosis and the treatment will differ with the cause.

**In primary disease** of the nervous system, the lesion is usually an anatomic one with serious, long-range consequences. **In secondary disease**, the lesion, at least in its early stages, is more likely to be functional and therefore more responsive to treatment, provided the defect in the primary organ can be corrected. The clinical findings that should arouse suspicion of neurologic disturbance include abnormalities in the three main functions of the system.

## Posture and Gait

An animal's ability to maintain a normal posture and to proceed with a normal gait depends largely on the tone of the skeletal muscle but also on the efficiency of the postural reflexes. Abnormalities of posture and gait are among the best indications of nervous system disease because these functions are governed largely by the coordination of nervous activity. Along with contributing to posture and gait, skeletal muscle tone is characteristic in its own right. However, its assessment in animals is subject to great inaccuracy because of our inability to request complete voluntary relaxation by the patient. In humans it is a very valuable index of nervous system efficiency, but in animals it has serious limitations. The most difficult step whenever there is a defect of gait or posture is to decide whether the defect originates in the skeleton, the muscles, or the nervous system.

## Sensory Perception

Tests of sensory perception in animals can only be objective and never subjective, as they can be in humans, and any test used in animals is based heavily on the integrity of the motor system.

## Mental State

Depression or enhancement of the psychic state is not difficult to judge, particularly if the animal's owner is observant and accurate. A helpful method for evaluating mental state is to answer the question: Is the animal responding appropriately for its environment? The difficulty usually lies in deciding whether the abnormality is caused by primary or secondary changes in the brain.

## Principles of Nervous Dysfunction

Nervous tissue is limited in the ways in which it can respond to noxious influences. Because of its essentially coordinating function, the transmission of impulses along nerve fibers can be enhanced or depressed in varying degrees, with the extreme degree being complete failure of transmission. Because of the structure of the system, in which nerve impulses are passed from neuron to neuron by relays at the nerve cells, there may also be excessive or decreased intrinsic activity of individual cells giving rise to an increase or decrease in nerve impulses discharged by the cells. The end result is the same whether the disturbance is one of conduction or discharge, and these are the only two ways in which disease of the nervous system is manifested. Nervous dysfunction can thus be broadly divided into two forms, **depressed activity** and **exaggerated activity**. These can be further subdivided into four common modes of nervous dysfunction; **excitation (irritation) signs**,



**release of inhibition signs, paresis or paralysis caused by tissue damage, and nervous shock.**

## MODES OF NERVOUS DYSFUNCTION

### Excitation (Irritation) Signs

Increased activity of the reactor organ occurs when there is an increase in the number of nerve impulses received either because of excitation of neurons or because of facilitation of passage of stimuli.

The **excitability** of nerve cells can be increased by many factors, including stimulant drugs, inflammation, and mild degrees of those influences that in a more severe form may cause depression of excitability. Thus early or mild hypoxia may result in increased excitability, whereas sustained or severe hypoxia will cause depression of function or even death of the nerve cell.

**Irritation phenomena** may result from many causes, including inflammation of nervous tissue associated with bacteria or viruses, certain nerve poisons, hypoxia, and edema. In those diseases that cause an increase in intracranial pressure, irritation phenomena result from interference with circulation and the development of local anemic hypoxia. The major manifestations of irritation of nervous tissue are tetany, local muscle tremor, and whole-body convulsions in the motor system and hyperesthesia and paresthesia in the sensory system. For the most part the signs produced fluctuate in intensity and may occur periodically as nervous energy is discharged and reaccumulated in the nerve cells.

The area of increased excitability may be local or sufficiently generalized to affect the entire body. Thus a local lesion in the brain may cause signs of excitatory nervous dysfunction in one limb, and a more extensive lesion may cause a complete convulsion.

### Release of Inhibition Signs

Exaggeration of normal nervous system activity occurs when lower nervous centers are released from the inhibitory effects of higher centers. The classic example of a release mechanism is experimental decerebrate rigidity caused by transection of the brainstem between the colliculi of the mid-brain. This results in an uninhibited extensor tonus of all the antigravity muscles. The head and neck are extended markedly in a posture of opisthotonus, and all four limbs in the quadruped are extended rigidly. The tonic mechanism or myotactic reflex involving the lower motor neuron has been released from the effects of the descending inhibitory upper motor neuron pathways.

Cerebellar ataxia is another example of inhibitory release. In the absence of cerebellar control, combined limb movements are exaggerated in all modes of action including rate, range, force, and direction. In general, release phenomena are present constantly

while the causative lesion operates, whereas excitatory phenomena fluctuate with the building up and exhaustion of energy in the nerve cells.

### Paresis or Paralysis Caused by Tissue Damage

Depression of activity can result from depression of metabolic activity of nerve cells, and the terminal stage is complete paralysis when nervous tissue is destroyed. Such depression of activity may result from failure of supply of oxygen and other essential nutrients, either directly from their general absence or indirectly because of failure of the local circulation. Infection of the nerve cell itself may cause initial excitation, then depression of function, and finally complete paralysis when the nerve cell dies.

Signs of paralysis are constant and are manifested by muscular paresis or paralysis when the motor system is affected and by hypoesthesia or anesthesia when the sensory system is involved. Deprivation of metabolites and impairment of function by actual invasion of nerve cells or by toxic depression of their activity produce temporary, partial depression of function that is completely lost when the neurons are destroyed.

### Nervous Shock

An acute lesion of the nervous system causes damage to nerve cells in the immediate vicinity of the lesion but there may be, in addition, a temporary cessation of function in parts of the nervous system not directly affected. The loss of function in these areas is temporary and usually persists for only a few hours. Stunning is an obvious example. Recovery from the flaccid unconsciousness of nervous shock may reveal the presence of permanent residual signs caused by the destruction of nervous tissue.

Determining the type of lesion is difficult because of the limited range of modes of reaction to injury in the nervous system. Irritation signs may be caused by bacterial or virus infection, by pressure, by vascular disturbance or general hypoxia, by poisons, and by hypoglycemia. It is often impossible to determine whether the disturbance is structural or functional. Degenerative lesions produce mainly signs of paresis or paralysis but unless there are signs of local nervous tissue injury, such as facial nerve paralysis, paraplegia, or local tremor, the disturbance may only be definable as a general disturbance of a part of the nervous system. Encephalopathy is an all-embracing diagnosis, but it is often impossible to go beyond it unless other clinical data, including signalment of the animal, epidemiology, and systemic signs, are assessed or special tests, including radiographic examination and examination of the CSE, are undertaken.

Some information can be derived from a study of the **sign-time relationship** in the development of nervous disease. A lesion that develops suddenly tends to produce

maximum disturbance of function, sometimes accompanied by nervous shock. Slowly developing lesions permit a form of compensation in that undamaged pathways and centers may assume some of the functions of the damaged areas. Even in rapidly developing lesions partial recovery may occur in time, but the emphasis is on maximum depression of function at the beginning of the disease. Thus a slowly developing tumor of the spinal cord will have a different pattern of clinical development from that resulting from an acute traumatic lesion of the vertebrae. Another aspect of the rapidity of onset of the lesion is that irritation phenomena are more likely to occur when the onset is rapid and less common when the onset is slow.

## Clinical Manifestations of Diseases of the Nervous System

The major clinical signs of nervous system dysfunction include the following:

- **Altered mentation**
- **Involuntary movements**
- **Abnormal posture and gait**
- **Paresis or paralysis**
- **Altered sensation**
- **Blindness**
- **Abnormalities of the autonomic nervous system**

### ALTERED MENTATION

#### Excitation States

Excitation states include **mania**, **frenzy**, and **aggressive behavior**, which are manifestations of general excitation of the cerebral cortex. The areas of the cortex that govern behavior, intellect, and personality traits in humans are the frontal lobes and temporal cortex. The clinical importance of these areas, which are poorly developed in animals, is not great. The frontal lobes, temporal cortex, and limbic system are highly susceptible to influences such as hypoxia and increased intracranial pressure.

#### Mania

In mania the animal acts in a bizarre way and appears to be unaware of its surroundings. Maniacal actions include licking, chewing of foreign material and sometimes themselves, abnormal voice, constant bellowing, apparent blindness, walking into strange surroundings, drunken gait, and aggressiveness in normally docile animals. A state of delirium cannot be diagnosed in animals, but mental disorientation is an obvious component of mania.

Diseases characterized by mania include the following:

- Encephalitis, e.g., the furious form of rabies, Aujeszky's disease in cattle (pseudorabies, mad itch)

- Degenerative diseases of the brain, e.g., mannosidosis, early PEM, poisoning by *Astragalus* sp.
- Toxic and metabolic diseases of brain, e.g., nervous ketosis, pregnancy toxemia, acute lead poisoning, poisoning with carbon tetrachloride, and severe hepatic insufficiency, especially in horses

### Frenzy

Frenzy is characterized by violent activity and with little regard for surroundings. The animal's movements are uncontrolled and dangerous to other animals in the group and to human attendants, and are often accompanied by aggressive physical attacks.

Examples of frenzy in diseases of the nervous system include the following:

- Encephalomyelitides, e.g., Aujeszky's disease.
- Toxic and metabolic brain disease, e.g., hypomagnesemic tetany of cattle and sheep, poisoning with ammoniated roughage in cattle.

Examples of frenzy in diseases of other body systems include the following:

- Acute pain of colic in horses.
- Extreme cutaneous irritation, e.g., photosensitization in cattle. Apparently reasonless panic, especially in individual horses or groups of cattle, is difficult to differentiate from real mania. A horse taking fright at a botfly or a swarm of bees and a herd of cattle stampeding at night are examples.

### Aggressive Behavior

Aggression and a willingness to attack other animals, humans, and inert objects is characteristic of the early stages of rabies and Aujeszky's disease in cattle, in sows during postparturient hysteria, in the later stages of chronic hypoxia in any species, and in some mares and cows with granulosa-cell tumors of the ovary. The latter are accompanied by signs of masculinization and erratic or continuous estrus. It is often difficult to differentiate between an animal with a genuine change in personality and one that is in pain or is physically handicapped, e.g., pigs and cattle with atlantoaxial arthroses.

### Depressive States

Depressive mental states include somnolence, lassitude, narcolepsy/cataplexy, syncope, and coma. They are all manifestations of depression of cerebral cortical function in various degrees and occur as a result of those influences that depress nervous system function generally, as well as those that specifically affect behavior, probably via the limbic system. It is not possible to classify accurately the types of depressive abnormality and relate them to specific causes, but the common occurrences in farm animals are listed next.

### Depression Leading to Coma

In all species this may result from the following:

- Encephalomyelitis and encephalomalacia
- Toxic and metabolic diseases of the brain such as uremia, hypoglycemia, hepatic insufficiency, toxemia, septicemia, and most toxins that damage tissues generally
- Hypoxia of the brain, as in peripheral circulatory failure of periparturient hypocalcemia in dairy cows
- Heat stroke
- Specific poisons that cause somnolence, including bromides, amitraz in horses, methyl alcohol, *Filix mas* (male fern), and kikuyu grass

### Syncope

The sudden onset of fainting (syncope) may occur as a result of the following:

- Acute circulatory and heart failure leading to acute cerebral hypoxia
- Spontaneous cerebral hemorrhage, a most unlikely event in adult animals
- Traumatic concussion and contusion
- Lightning strike, electrocution

### Narcolepsy (Cataplexy)

Affected animals experience episodes of uncontrollable sleep and literally "fall" asleep. The disease is recorded in Shetland ponies and is thought to be inherited in them, in other horses, and in cattle.

### Compulsive Walking or Head Pressing

Head-pressing is a syndrome characterized by the animal pushing its head against fixed objects and into a corner of a pen as well as leaning into a stanchion or between fence posts. Head-pressing should be differentiated from compulsive walking, in which affected animals put their heads down and walk slowly while appearing blind. If they walk into an object, they lean forward and indulge in head-pressing; if confined to a stall they will often walk around the pen continuously or head-press into a corner. The syndrome represents a change in behavior pattern caused by an unsatisfied compulsive drive characteristic of a disorder of the limbic system. Causes include the following:

- Toxic and metabolic brain disease, especially PEM and hepatic encephalopathy
- Diseases manifested by increased intracranial pressure
- Encephalomyelitides

### Aimless Wandering

A similar but less severe syndrome to compulsive walking is aimless walking, severe mental depression, and apparent blindness with tongue protrusion and continuous chewing movements, although the animal is unable to ingest feed or drink water. Causes include the following:

- Toxic and metabolic diseases of brain, including poisoning by *Helichrysum* sp. and tansy mustard

- Degenerative brain diseases, e.g., nigropallidal encephalomalacia in horses, ceroid lipofuscinosis in sheep, hydrocephalus in the newborn

## INVOLUNTARY MOVEMENTS

Involuntary movements are caused by involuntary muscle contractions, which include gradations from fasciculations, shivering and tremor, to tetany, seizures, or convulsions. Opisthotonus or "backward tone" is a sustained spasm of the neck and limb muscles resulting in dorsal and caudal extension of the head and neck with rigid extension of the limbs.

### Tremor

This is a continuous, repetitive twitching of skeletal muscles that is usually visible and palpable. The muscle units involved may be small and cause only local skin movement, in which case the tremor is described as fasciculations; or the muscle units may be extensive and the movement much coarser and sufficient to move the extremities, eyes, or parts of the trunk. The tremor may become intensified when the animal undertakes some positive action. This is usually indicative of cerebellar involvement and is the counterpart of intention tremor in humans. True tremor is often sufficiently severe to cause incoordination and severe disability in gait. Examples of causes of tremor include the following:

- Diffuse diseases of the cerebrum, cerebellum, and spinal cord
- Degenerative nervous system disease, e.g., hypomyelinogenesis of the newborn as in congenital tremor of pigs and calves, poisoning by *Swainsona* sp.
- Toxic nervous system disease caused by a large number of poisons, especially poisonous plants and fungi, *Clostridium botulinum* toxin in shaker foal syndrome; metabolic disease such as hyperkalemic periodic paralysis in the horse; early stages of hypocalcemia in the cow (fasciculations of the eyelids and ears).

### Tics

Tics are spasmodic twitching movements made at much longer intervals than in tremor. The intervals are usually at least several seconds in duration and often much longer. The movements are sufficiently widespread to be easily visible and are caused by muscles that are ordinarily under voluntary control. They are rare in large animals but may occur after traumatic injury to a spinal nerve.

### Tetany

Tetanus is a sustained contraction of muscles without tremor. The most common cause is *C. tetani* intoxication following localized infection with the organism. The degree of muscular contraction can be exaggerated by

stimulation of the affected animal, and the limbs are rigid and cannot be passively flexed easily (“lead pipe” rigidity).

**Myoclonus** is a brief, intermittent tetanic contraction of the skeletal muscles that results in the entire body being rigid for several seconds, followed by relaxation. Inherited congenital myoclonus (hereditary neuraxial edema) of polled, horned, and crossbred Hereford calves is a typical example. Affected calves are bright and alert and can suck normally, but if they undertake a voluntary movement or are handled their entire body becomes rigid for 10 to 15 seconds.

### Convulsions

Convulsions, seizures, fits, or ictus are violent muscular contractions affecting part or all of the body and occurring for relatively short periods as a rule, although in the late stages of encephalitis they may recur with such rapidity they give the impression of being continuous.

Convulsions are the result of abnormal electrical discharges in forebrain neurons that reach the somatic and visceral motor areas and initiate spontaneous, paroxysmal, involuntary movements. These cerebral dysrhythmias tend to begin and end abruptly, and they have a finite duration. A typical convulsion may have a prodromal phase or aura that lasts for minutes to hours, during which the animal is oblivious to its environment and seems restless. The beginning of the convulsion may be manifested as a localized partial convulsion of one part of the body that soon spreads to involve the whole body, when the animal usually falls to the ground thrashing rhythmically. Following the convulsion there may be depression and temporary blindness, which may last for several minutes up to a few hours.

The convulsion may be clonic with typical “padding” (involuntary movement in which repeated muscle spasms alternate with periods of relaxation). Tetanic or tonic convulsions are less common and are manifested by prolonged muscular spasm without intervening periods of relaxation. True tetanic convulsions occur only rarely, chiefly in strychnine poisoning and in tetanus, and in most cases they are a brief introduction to a clonic convulsion.

Convulsions can originate from disturbances anywhere in the prosencephalon, including cerebrum, thalamus, or even the hypothalamus alone. However, the initiating cause may be in the nervous system outside the cranium or in some other system altogether; convulsions are therefore often subdivided into intracranial and extracranial types. Causes are many and include the following.

Intracranial convulsions are caused by

- Encephalomyelitis, meningitis
- Encephalomalacia
- Acute brain edema
- Brain ischemia, including increased intracranial pressure

- Local lesions caused by trauma (concussion, contusion), abscess, tumor, parasitic injury, hemorrhage
- Inherited idiopathic epilepsy

**Extracranial convulsions** are caused by brain hypoxia, as in acute circulatory or cardiac failure, and toxic and metabolic diseases of the nervous system, including the following:

- Hepatic encephalopathy
- Hypoglycemia (as in newborn piglets and in hyperinsulinism caused by islet cell adenoma of the pancreas as described in a pony)
- Hypomagnesemia (as in lactation tetany in cows and mares)
- Inorganic poisons, poisonous plants, and fungi; there are too many to give a complete list, but well-known examples are the chlorinated hydrocarbons, pluronics used in bloat control in cattle, *Clostridium* spp.; intoxications, e.g., *C. perfringens* type D and *C. sordellii*, and subacute fluoroacetate poisoning
- Congenital and inherited defects without lesions, e.g., familial convulsions and ataxia in Angus cattle

### Involuntary Spastic Paresis

Involuntary, intermittent contractions of large muscle masses may result in spasmodic movements of individual limbs or parts of the body. In most, contractions occur when voluntary movement is attempted. Diseases in this category include the following:

- Stringhalt and Australian stringhalt of horses
- Inherited spastic paresis (Elso heel) of cattle
- Inherited periodic spasticity (stall cramp) of cattle
- Inherited congenital myotonia of cattle
- Inherited myotonia of goats

## ABNORMAL POSTURE AND GAIT

### Posture

Posture is evaluated with the animal at rest. Abnormal postures may be adopted intermittently by animals in pain, but in diseases of the nervous system the abnormality is usually continuous and repeatable. Deviation of the head and neck from the axial plane or rotation of the head and neck from the horizontal plane (head tilt); drooping of the lips, eyelids, cheeks, and ears; and opisthotonus and orthotonos are examples, although the latter two are often intermittent because they occur as part of a convulsive seizure. Head pressing and assumption of a dog-sitting posture are further examples. Abnormalities of posture and gait are the result of lesions of the brainstem, cerebellum, all levels of the spinal cord, spinal nerve roots, peripheral nerves, neuromuscular junctions, and muscles. The clinical emphasis is on vestibular disease, cerebellar disease,

and spinal cord disease. It is important to emphasize that cerebral lesions do not cause abnormalities in posture and gait.

### Vestibular Disease

The vestibular system is a special proprioceptive system that assists the animal in maintaining orientation in its environment with respect to gravity. It helps to maintain the position of the eyes, trunk, and limbs in relationship to movements and positioning of the head.

From the vestibular nuclei, the vestibulospinal tracts descend ipsilaterally through the length of the spinal cord. These neurons are facilitatory to ipsilateral motor neurons going to extensor muscles of the limbs, are inhibitory to ipsilateral motor flexor muscles, and are inhibitory to contralateral extensor muscles. The principal effect of unilateral stimulation of this system on the limbs is a relative ipsilateral extensor tonus and contralateral flexor tonus, which promote ipsilateral support of the trunk against gravity. Conversely, a unilateral vestibular lesion usually results in ipsilateral flexor and contralateral extensor tonus, forcing the animal toward the side of the lesion.

The nuclei of cranial nerves (CNs) III, IV, and VI, which control eye movement, are connected with the vestibular system by way of a brainstem tract called the medial longitudinal fasciculus. Through this tract, coordinated eye movements occur with changes in positioning of the head. Through these various pathways, the vestibular system coordinates movements of the eye, trunk, and limbs with head movements and maintains equilibrium of the entire body during motion and rest.

Signs of vestibular disease vary depending on whether there is unilateral or bilateral involvement and whether the disease involves peripheral or central components of the system.

The vestibular influence on balance can be affected

- At the inner ear
- Along the vestibular nerve or
- At the vestibular nucleus in the medulla.

Unilateral excitation or loss of function can be caused by lesions at any of these points.

General signs of vestibular system dysfunction are staggering, leaning, rolling, circling, drifting sideways when walking and a head tilt, and various changes in eye position such as strabismus and nystagmus. The walking in a circle toward the affected side is accompanied by increased tone in the contralateral limbs, which is most easily observed in the contralateral forelimb. Rotation or tilt of the head occurs, and severely affected animals fall to the affected side.

When the lesion affects the inner ear, as in some cases of otitis media, the affected side is turned down, the animal falls to that side, and there may be facial paralysis on the same side if the lesion is extensive and affects CN VII. In



the recumbent position, the affected side is held to the ground, and if these animals are rolled over to the opposite side they quickly roll back to the affected side. When the vestibular nuclei are affected, as in listeriosis, the animal falls to the affected side.

Nystagmus and forced circling are common when there is irritation of the vestibular nucleus or the medial longitudinal fasciculus.

Causes of vestibular disease include the following:

- Otitis media interna with involvement of the inner ear
- Focal lesion at the vestibular nucleus, e.g., listeriosis
- Traumatic injury to the vestibular apparatus in the horse caused by fracture of the basisphenoid, basioccipital, and temporal bones; the clinical signs include lack of control of balance, rotation of the head, circling to the affected side, nystagmus, and facial paralysis

In **paradoxical vestibular syndrome** there is also head tilting, but circling in a direction away from the side of the lesion. Deviation of the head and neck must be distinguished from a head tilt. Asymmetric lesions of the forebrain such as a brain abscess, some cases of PEM, verminous larval migration, or head trauma may cause an animal to hold its head and neck turned to one side, but there is no head tilt and the circle is large in diameter. In fact, the presence of a head tilt (deviation of eyes away from a horizontal plane) accompanied by a tight circle provide clinically useful methods of differentiating a cerebral lesion from a vestibular lesion.

### Gait

Gait is assessed when the animal is moving. Neurologic gait abnormalities have two components, **weakness** and **ataxia**. Weakness (paresis) is evident when an animal drags its limbs, has worn hooves, or has a low arc to the swing phase of the stride. When an animal bears weight on a weak limb, the limb often trembles and the animal may even collapse on that limb because of lack of support. While circling, walking on a slope, and walking with the head elevated, an animal frequently will stumble on a weak limb and knuckle over at the fetlock. During manipulation of the limb, the clinician will usually make the subjective observation that the muscle tone is reduced.

### Ataxia

Ataxia is an unconscious, general proprioceptive deficit causing incoordination when the animal moves. It is manifested as a swaying from side to side of the pelvis, trunk, and sometimes the whole body (truncal sway). Ataxia may also appear as a weaving of the affected limb during the swing phase of the stride. This often results in abducted or adducted foot placement, crossing of the limbs, or stepping on the opposite foot.

**Hypermetria** is an increased range of movement and is seen as an overreaching of the limbs with excessive joint movement. Hypermetria without paresis is characteristic of spinocerebellar and cerebellar disease. It is a decreased range of movement that is characterized by a stiff or spastic movement of the limbs with little flexion of the joints, particularly the carpal and tarsal joints.

**Dysmetria** is a term that includes both hypermetria and hypometria, with goose-stepping being the most common sign. It usually is caused by a lesion in the cerebellum or cerebellar pathway.

In equine degenerative myeloencephalopathy (EDM), there is dysmetria of the hindlimbs and tetraparesis caused by neuroaxonal dystrophy originating in the accessory cuneate nuclei. Severely affected horses lift their feet excessively high and stamp them to the ground.

### Cerebellar Disease

When cerebellar function is abnormal there is ataxia, which is an incoordination when the animal moves. In general terms, there are defects in the rate, range, and direction of movement. In typical cerebellar diseases, ataxia of the limbs is common and no weakness is evident. In true cerebellar ataxia (e.g., cerebellar hypoplasia), the affected animal stands with the legs wide apart, sways, and has a tendency to fall. Ataxia of the head and neck are characterized by wide, swinging, head excursions; jerky head bobbing; and an intention tremor (nodding) of the head.

The head tremor may be the most obvious sign in mild cases of cerebellar hypoplasia in young foals. The limbs do not move in unison, the movements are grossly exaggerated, muscular strength is usually preserved, and there is a lack of proper placement of the feet (hypermetria and hypometria); falling is common. The fault in placement is the result of poor motor coordination and not related in any way to muscle weakness or proprioceptive deficit. Attempts to proceed to a particular point are usually unsuccessful, and the animal cannot accurately reach its feed or drinking bowl. Examples of cerebellar disease include the following:

- Inherited defects of cerebellar structure or abiotrophy in most breeds of cattle and in Arabian horses<sup>1</sup>
- Congenital cerebellar defects resulting from maternal viral infections such as bovine virus diarrhoea (BVD) infection in cattle
- Dysplastic disease of the cerebellum of the horse
- Traumatic injury, e.g., by parasite larvae such as *Hypoderma bovis*, which have caused unilateral cerebellar ataxia in adult cattle
- Tremorgenic mycotoxicoses and ryegrasses
- Cerebellar degeneration in cattle in Uruguay caused by grazing the

perennial shrub *Solanum bonariense* ("Naranjillo")<sup>2</sup>

- Encephalomyelitis in which other localizing signs also occur

### Spinal Cord Disease

Ataxia caused by cerebellar dysfunction can be difficult to differentiate from the proprioceptive defects and partial motor paralysis (weakness) that occur in animals with spinal cord lesions, and it is most important that this differentiation is made. Spinal cord disease, causing varying degrees of weakness, and ataxia are common in large animals. The weakness is caused by damage to the upper or lower motor neurons and the proprioceptive deficit by damage to the ascending sensory neurons. With a mild or even moderate cervical spinal cord lesion in an adult cow or horse, signs of ataxia and weakness may be evident in the pelvic limbs only, and it can be difficult to determine whether the thoracic limbs are involved.

Close examination of the gait, posture, and postural reactions in the limbs, together with a search for localizing abnormalities, will often be productive in localizing the lesion. Signs of weakness or ataxia may be elicited by gently pushing the hindquarters to one side or pulling the tail to one side as the animal is walked (the sway response). The normal animal resists these movements or steps briskly to the side as it is pushed or pulled. The weak animal can be easily pulled to one side and may stumble or fall and may also tend to buckle or collapse when strong pressure is applied with the hand over the withers and loin regions. The ataxic animal may sway to one side, be slow to protract a limb, cross its hindlegs, or step on its opposite limb.

It is often difficult to distinguish paresis from ataxia, but in most instances it is unimportant because of the close anatomic relationship of the ascending general proprioceptive and descending upper motor neuron tracts in the white matter of the spinal cord. These same abnormal sway responses can be elicited in the standing animal.

**The ataxic animal** may abduct the outside pelvic limb too far as it is pushed to one side or moved in a small circle. This may appear as a hypermetric movement similar to a stringhalt action and is assumed to be a sign of a general proprioceptive tract lesion. The pushed or circled animal may keep a clinically affected pelvic limb planted in one position on the ground and pivot around it without moving it. The same failure to protract the limb may be seen on backing. It may even force the animal into a "dog-sitting" posture.

Examples of ataxia caused by spinal cord disease include the following:

- Limited trauma to the spinal cord
- The early stages of a developing compression lesion in the vertebral canal

- Degenerative and inflammatory diseases of the nervous system, especially those causing enzootic incoordination in horses and staggers in sheep (both of them dealt with under their respective headings)
- Functional diseases in toxic and metabolic diseases of the nervous system in which lesions have not yet been identified and that are caused mainly by poisons, especially plant materials; typical examples are poisoning by the fungi *Claviceps paspali*, *Diplodia* spp., *Acremonium lolii*, the grass *Phalaris aquatic*, the ferns *Zamia* and *Xanthorrhoea* spp., and herbaceous plants such as *Kallstroemia*, *Vicia*, *Baccharis*, *Solanum*, *Aesculus*, and *Ficus* spp.
- Heat stress in lambs<sup>3</sup>
- Nutritional deficiency especially of thiamine, occurring naturally in horses poisoned by bracken and horsetail, and experimentally in pigs
- Developmental defects including congenital abnormalities and abiotrophic abnormalities that develop sometime after birth; examples are Brown Swiss weavers and Pietrain creeper pigs.

In many of these diseases, incoordination and paresis are a stage in the development of tetraplegia or paraplegia.

## PARESIS AND PARALYSIS

The motor system comprises the following:

- Pyramidal tracts, which originate in the motor cortex
- Extrapyramidal system, which originates in the corpus striatum, red nucleus, vestibular nucleus, and roof of the midbrain
- Peripheral nerves, which originate in the ventral horn cells

The pyramidal tracts are of minor importance in hoofed animals (ungulates), reaching only to the fourth cervical segment. Accordingly, lesions of the motor cortex in farm animals do not produce any deficit of gait. There is also no paresis, although in an acute lesion weakness may be evident for the first day or two. If the lesion is unilateral, the paresis will be on the contralateral side. This is in marked contradistinction to the severe abnormalities of posture and gait that occur with lesions of the pons, medulla, and spinal cord.

The main motor nuclei in these animals are subcortical and comprise the extrapyramidal system, and most combined movements are controlled by nerve stimuli originating in the tectal nuclei, reticular nuclei, vestibular nuclei, and possibly red nuclei. The pyramidal and extrapyramidal tracts comprise the upper motor neurons, which reach to the ventral horn cells of the spinal cord, whose cells, together with their peripheral axons, form the lower motor

neurons. Paralysis is a physiologic result in all cases of motor nerve injury, which if severe enough is expressed clinically. The type of paralysis is often indicative of the site of the lesion.

A lesion of the upper motor neuron causes the following:

- **Spasticity with loss of voluntary movement**
- **Increased tone of limb muscles**
- **Increased spinal reflexes**

The spasticity of an upper motor neuron lesion usually occurs with the affected limb in extension. These are all release phenomena resulting from liberation of spinal reflex arcs from higher control.

A lesion of the lower motor neuron causes:

- **Paresis or paralysis with loss of voluntary movement**
- **Decreased tone of the limb muscles**
- **Absence of spinal reflexes**
- **Wasting of the affected muscle (neurogenic atrophy)**

Because injuries to specific peripheral nerves are treated surgically, these are dealt with in surgical textbooks and are not repeated here.

A special form of paralysis is the **Schiff-Sherrington syndrome**, which is common in dogs but recorded rarely in large animals. It is caused by acute, severe compressive injury of the thoracolumbar spinal cord and manifested by extensor rigidity or hypertonia of the forelimbs and hypotonic paralysis of the hindlimbs. Neurons located in the lumbar spinal cord are responsible for the tonic inhibition of extensor muscle alpha motor neurons in the cervical intumescence. The cell bodies of these neurons are located in the ventral gray column from L1-L7, with a maximum population from L2-L4. Their axons ascend to the cervical intumescence. Acute severe lesions cranial to these neurons and caudal to the cervical intumescence will suddenly deprive the cervical intumescence neurons of this source of tonic inhibition, resulting in a release of these latter neurons. This results in extensor hypertonia observed in the thoracic limbs, which can function normally in the gait and postural reactions, except for the hypertonia.

**The degree of paresis or paralysis** needs to be defined. Paralysis is identified as an inability to make purposeful movements. Thus convulsive, uncontrolled movements as they occur in PEM may still fit a description of paralysis. Paresis, or weakness short of paralysis, can be classified into four categories:

- Animals that cannot rise or support themselves if helped up but can make purposeful movements in attempting to rise
- Animals that cannot rise but can support themselves if helped up
- Animals that can rise but are paretic and can move the limbs well and stumble only slightly on walking

- Animals that move with difficulty and have severe incoordination and stumbling.

Probably the most difficult decision in farm animal neurology is whether a patient's inability to move is because of a nervous or muscular deficit. For example, the horse recumbent because of exertional rhabdomyolysis often resembles a horse with an injured spinal cord. Examples of paresis and paralysis include the following:

- Focal inflammatory, neoplastic, traumatic lesions in the motor pathway. These lesions usually produce an asymmetric nervous deficit.
- Toxic and metabolic diseases of the nervous system in their most severe form, e.g., flaccid paralysis associated with tick bite (*Ixodes holocyclus*, *Ornithodoros* sp.), poisoning, botulism, and snakebite. Comparable tetanic paralyzes include tetanus, lactation tetany of mares, and hypomagnesemic tetany of cows and calves. In contrast to inflammatory, neoplastic, and traumatic lesions in the motor pathway, toxic and metabolic lesions usually produce a symmetric nervous deficit.

## Neurogenic Muscular Atrophy

Destruction of the lower motor neurons either within the vertebral canal or peripheral to it causes neurogenic atrophy. Whether or not the atrophy is visible depends on how many neurons and therefore how many muscle fibers are affected.

## ALTERED SENSATION

Lesions of the sensory system are rarely diagnosed in animals, except for those affecting sight and the vestibular apparatus, because of the impossibility of measuring subjective responses.

Although animals must experience paresthesia, as in Aujeszky's disease (pseudorabies) in cattle and sheep, the animal's response of licking or scratching does not make it possible to decide whether the diagnosis should be paresthesia or pruritus. Lesions of the peripheral sensory neurons cause hypersensitivity or decreased sensitivity of the area supplied by the nerve. Lesions of the spinal cord may affect only motor or only sensory fiber tracts or both, or may be unilateral.

Although it is often difficult to decide whether failure to respond to a normally painful stimulus is caused by failure to perceive or inability to respond, certain tests may give valuable information. The test usually used is pricking the skin with a needle, or pinching the skin with a pair of forceps, and observing the reaction. In exceptional circumstances, light stroking may elicit an exaggerated response. The **"nibbling"** reaction stimulated by stroking the lumbar back of sheep affected with scrapie is a striking example of hypersensitivity.

In every test of sensitivity, it must be remembered that there is considerable variation between animals and in an individual animal from time to time, and much discretion must be exercised when assessing the response. In any animal, there are also cutaneous areas that are more sensitive than others. The face and the cranial cervical region are highly sensitive, the caudal cervical and shoulder regions less so, with sensitivity increasing over the caudal thorax and lumbar region and to a high degree on the perineum. The proximal parts of the limbs are much less sensitive than the distal parts and sensitivity is highest over the digits, particularly on the medial aspect.

**Absence of a response** to the application of a painful stimulus to the limbs (**absence of the withdrawal reflex**) indicates interruption of the reflex arc; absence of the reflex with persistence of central perception, as demonstrated by groaning or body movement such as looking at the site of stimulus application, indicates interruption of motor pathways and that central perception of pain persists. In the horse, the response can be much more subtle than in other species, and movements of the ears and eyelids are the best indicators of pain perception. Increased sensitivity is described as **hyperesthesia**, decreased as **hypoesthesia**, and complete absence of sensitivity is described as **anesthesia**. Special cutaneous reflexes include the anal reflex, in which spasmodic contraction of the anus occurs when it is touched, and the corneal reflex, in which there is closure of the eyelids on touching the cornea. The (cutaneous trunci) panniculus reflex is valuable in that the sensory pathways, detected by the prick of a pin, enter the cord at spinal cord segments T1-L3, but the motor pathways leave the cord only at spinal cord segments C8, T1, and T2. The quick twitch of the superficial cutaneous muscle along the whole back, which is the positive response (**panniculus reflex**), is quite unmistakable. Examination of the eye reflexes and hearing are discussed under the section **Cranial Nerves** (see later).

## BLINDNESS

Blindness is manifested as a clinical abnormality by the animal walking into objects that it should avoid. Vision is a cerebral cortical function and is evaluated using the pupillary light reflex, the menace response, and the ability to navigate around a novel obstacle course.

The **pupillary light reflex** is present at birth in large animals but does not need an intact cerebral cortex. This is the reason why ruminants with thiamine-responsive polioencephalomalacia appear blind but have an intact pupillary light reflex; in contrast, ruminants with lead poisoning and a greater extent of cerebral dysfunction appear blind but have a depressed or absent pupillary light

reflex. The pupillary light reflex measures the integrity of the retina, optic nerves and chiasm, and oculomotor and pretectal nuclei in the midbrain, and then to a descending motor pathway that includes the oculomotor nerve, ciliary ganglion, and constrictor pupillae muscle.

The **menace or blink response** is used to test the integrity of the entire visual pathway (retina, optic nerves, optic chiasm, optic tract, lateral geniculate nucleus, and internal capsule to the visual area in the cerebrum [occipital lobe]). The visual cortex processes the information and relays signals to the motor cortex. The descending motor pathway receives some input from the cerebellum and proceeds from the ipsilateral pons to the contralateral facial nerve nucleus in the medulla oblongata, and then to the facial nerve, and finally the orbicularis oculi muscle. A threatening gesture of the hand (or even better by the index finger in a pointing manner) toward the eye elicits immediate closure of the eyelids. The finger must come close enough to the eye without touching the tactile hairs of the eyelids or creating a wind that can be felt by the animal. Some stoic, depressed, or even excited animals may not respond to a menace reflex with closure of the eyelids; others may keep the eyelids partially or almost closed. It may be necessary to alert the patient to the risk of injury by touching the eyelids first. The menace response is a learned response that is absent in neonates. Most foals have a menace response by 9 days after birth and most calves by 5 to 7 days after birth. Group housing of neonatal calves appeared to facilitate faster learning of the menace response as a result of more visual threats.<sup>4</sup>

The most definitive test is to make the animal walk an **obstacle course** and place objects in front of it so that it must step over the objects easily. A similar procedure is the only way to test for **night blindness (nyctalopia)**. The area should be dimly lit, but the observer should be able to see the obstructions clearly. A decision that the animal is blind creates a need for examination of the visual pathways.

### Central or Peripheral Blindness

Blindness may be central or peripheral. Animals with forebrain lesions are centrally blind, with depressed menace response in one or both eyes, whereas the pupillary light reflexes are usually intact. In peripheral blindness, such as hypovitaminosis A, the menace reflex is absent, and the pupillary light reflexes are also absent.

Blindness can be caused by lesions along the visual pathway, from the eye to the cerebral cortex:

- **Diseases of the orbit** include keratoconjunctivitis, hypopyon, cataract, panophthalmia, mixed ocular defects inherited in white Shorthorn and Jersey cattle, night blindness in Appaloosa

horses, and sporadic cases of blindness caused by idiopathic retinal degenerative disease in cattle.

- **Diseases of the retina** include retinal dysplasia of goats, lenticular cataracts caused by poisoning with hygromycin in pigs, and congenital ocular malformations in calves after intrauterine infection with BVD virus (usually accompanied by cerebellar defects).
- **Diseases of the optic nerve and chiasma**, e.g., abscess of pituitary rete mirabile, constriction of optic nerve by diet deficient in vitamin A, tumor of pituitary gland, and injury to the optic nerve, especially in horses after rearing and falling backward. There is a sudden onset of unilateral or bilateral blindness with no ophthalmologic change until 3 to 4 weeks after the injury, when the optic disc becomes paler and less vascular.
- **Metabolic or ischemic lesions of the cerebral cortex** as in PEM, cerebral edema, and hydrocephalus.
- **Localized infectious or parasitic lesions** caused by abscesses or migrating larvae.
- **Functional blindness** in which there is complete, often temporary, apparent blindness in the absence of any physical lesions is seen. Causes are acetoneemia, pregnancy toxemia, and acute carbohydrate indigestion (hyper D-lactatemia) of ruminants.
- **Specific poisonings** causing blindness include *F. mas* (male fern), *Cheilanthes* spp. (rock fern), and rape. *Stypandra* spp. cause a specific degeneration of the optic nerves. Lead poisoning in cattle can also cause blindness.

## ABNORMALITIES OF THE AUTONOMIC NERVOUS SYSTEM

Lesions affecting the cranial parasympathetic outflow do so by involvement of the oculomotor, facial, vagus, and glossopharyngeal nerves or their nuclei. The effects produced are discussed in the **Cranial Nerves** section of **Special examination of the Nervous System**.

In general, the lesions cause abnormality of pupillary constriction, salivation, and involuntary muscular activity in the upper part of the alimentary and respiratory tracts. Lesions of the spinal sympathetic system interfere with normal function of the heart and alimentary tract. For the most part, affections of the autonomic nervous system are of minor importance in farm animals. Central lesions of the hypothalamus can cause abnormalities of heat exchange, manifested as neurogenic hyperthermia or hypothermia and obesity, but they are also of minor importance.

Some manifestations of autonomic disease are important. Autonomic imbalance



is usually described as the physiologic basis for spasmodic colic of horses; grass sickness of horses is characterized by degenerative lesions in the sympathetic ganglia; and involvement of the vagus nerve in traumatic reticuloperitonitis of cattle can lead to impaired forestomach and abomasal motility as well as the development of vagus indigestion.

Defects of sphincter control and motility of the bladder and rectum may also be of importance in the diagnosis of defects of sacral parasympathetic outflow and the spinal sympathetic system. The sacral segments of the spinal cord are the critical ones, and loss of their function will cause incontinence of urine and loss of rectal tone. The parasympathetic nerve supply to the bladder stimulates the detrusor muscle and relaxes the sphincter; the sympathetic nerve supply has the reverse function. A spinal cord lesion may cause loss of the parasympathetic control and result in urinary retention. Incontinence, if it occurs, does so from overflow. When the sympathetic control is removed, incontinence occurs but the bladder should empty. Similar disturbances of defecation occur. Both micturition and defecation are controlled by medullary and spinal centers, but some measure of control is regained even when the extrinsic nerve supply to the bladder and rectum is completely removed.

## Special Examination of the Nervous System

Veterinarians commonly include several components of a neurologic examination in a complete clinical examination. Most often a diagnosis and differential diagnosis can be made from consideration of the history and the clinical findings. However, if the diagnosis is uncertain it may be necessary to conduct a complete neurologic examination, which may uncover additional clinical findings necessary to make a diagnosis and give a prognosis.

The accuracy of a clinical diagnosis of neurologic diseases in the horse is high. In a study of 210 horses in which a definitive pathologic diagnosis was confirmed, the overall accuracy of clinical diagnosis for all diseases was 0.95; the accuracy ranged from 0.79 to 1.00, the sensitivity varied from 0.73 to 0.95, and the specificity varied from 0.88 to 1.00 for individual disease categories. Some neurologic diseases are therefore underdiagnosed, whereas others are overdiagnosed. The use of careful and thorough clinical examinations and diagnostic techniques, combined with confirmed pathologic diagnoses, will result in more accurate diagnosis and therapy. Retrospective studies of series of ataxic horses, for example, will add to the body of knowledge and improve diagnosis.

## NEUROLOGIC EXAMINATION

The primary aim of the neurologic examination is to confirm whether or not a neurologic abnormality exists and to determine the neuroanatomical location of the lesion. A clinicoanatomic diagnosis is necessary before one can develop a list of differential diagnoses and decide whether or not treatment is possible. The format for a precise practical examination procedure that is logical in sequence, easy to remember with practice, and emphasizes the need for an anatomic diagnosis is outlined later. The rationale for the sequence is that the examination starts from a distance to assess posture and mentation and then proceeds to a closer examination that may require placing the animal in stocks or a chute. The examination sequence is therefore suitable for minimally handled beef cattle, dairy cattle, horses, sheep, goats, and New World camelids. The results of the neurologic examination should be documented and not left to memory. There are many standard examination forms available that outline each step in the examination and provide for documentation of the results.

## SIGNALMENT AND EPIDEMIOLOGY

The age, breed, sex, use, and value of the animal are all important considerations in the diagnosis and prognosis of neurologic disease. Some diseases occur more frequently under certain conditions, for example, lead poisoning in nursing beef calves turned out to pasture in the spring of the year. *Histophilus somni* meningoencephalitis is most common in feedlot cattle from 6 to 10 months of age, and hypovitaminosis A is most common in beef calves 6 to 8 months of age after grazing dry summer pastures. In the horse, there are several clearly defined diseases that affect the spinal cord including cervical stenotic myelopathy, degenerative myeloencephalopathy, protozoal myelitis, equine rhinopneumonitis myelopathy, rabies poliioencephalomyelitis, and equine motor neuron disease. Some of these diseases have distinguishing epidemiologic characteristics that are useful in diagnosis and differential diagnosis. The neurologic examination of the newborn foal is fraught with hazards because of the different responses elicited from those in adults. The differences relate mostly to the temporary dysmetria of gait and exaggerated responses of reflexes.

## HISTORY

Special attention should be given to the recording of an accurate history. The questioning of the owner should focus on the primary complaint and when it occurred and how it has changed over time (**the sign-time relationship**). The duration of signs; the

mode of onset, particularly whether acute with later subsidence, or chronic with gradual onset; the progression of involvement; and the description of signs that occur only intermittently should be ascertained. When the disease is a herd problem, the morbidity and mortality rates and the method of spread may indicate an intoxication when all affected animals show signs within a very short period. Diseases associated with infectious agents may have an acute or chronic onset. Neoplastic diseases of the nervous system may begin abruptly but are often slowly progressive. For some diseases, such as epilepsy, consideration of the history may be the only way to make a diagnosis. Traumatic injuries have a sudden onset and then often stabilize or improve.

When obtaining a history of convulsive episodes, an estimate should be made of their duration and frequency. The pattern is also important and may be diagnostic, e.g., in salt poisoning in swine. The occurrence of pallor or cyanosis during the convulsion is particularly important in the differentiation of cardiac syncope and a convulsion originating in the nervous system.

## HEAD

### Behavior

The owner should be questioned about the animal's abnormal behavior, which can include bellowing, yawning, licking, mania, convulsions, aggressiveness, head-pressing, wandering, compulsive walking, and head-shaking. Head-shaking may be photic in origin and can be tested by the application of blindfolds, covering the eyes with a face mask, and observing the horse in total darkness outdoors. In one horse, head-shaking ceased with blindfolding or night darkness outdoors, and became less with the use of gray lenses. Outdoor behavior suggested efforts to avoid light.

### Mental Status

Assessment of mental status is based on the animal's level of awareness or consciousness. Coma is a state of complete unresponsiveness to noxious stimuli. Other abnormal mental states include stupor, somnolence, deliriousness, lethargy, and depression. Animals may exhibit opisthotonus, either spontaneously or in response to stimulation (Fig. 14-1). Large animals that are recumbent because of spinal cord disease are usually bright and alert unless affected with complications, which may cause fever and anorexia. Mature beef cattle that are recumbent with a spinal cord lesion and not used to being handled may be quite aggressive and apprehensive.

### Head Position and Coordination

Lesions of the vestibular system often result in a head tilt. Lesions of the cerebrum often result in deviation of the head and neck. In

cerebellar disease, there may be jerky movements of the head, which are exaggerated by increasing voluntary effort. These fine jerky movements of the head are called intention tremors. Animals with severe neck pain will hold their neck in a fixed position and be reluctant to move the head and neck. Head-shaking in horses has been associated with ear mite infestation, otitis externa, CN dysfunction, cervical injury, ocular disease,

guttural pouch mycosis, dental periapical osteitis, and vasomotor rhinitis. However, idiopathic head-shaking in the horse is often associated with evidence of nasal irritation, sneezing and snorting, nasal discharge, coughing, and excessive lacrimation.

### Cranial Nerves

Abnormalities of CN function assist in localizing a lesion near or within the brainstem.

Some of the information on CN dysfunction is presented in tabular form (Tables 14-1 through 14-6) in addition to the more detailed examination described here.

### Olfactory Nerve (Cranial Nerve I)

Tests of smell are unsatisfactory in large animals because of their response to food by sight and sound.

### Optic Nerve (Cranial Nerve II)

The only tests of visual acuity applicable in animals are testing the eye preservation (menace) reflex (provoking closure of the eyelids and withdrawal of the head by stabbing the finger at the eye) and by making the animal run a contrived obstacle course. Both tests are often difficult to interpret and must be performed in such a way that other senses are not used to determine the presence of the obstacles or threatened injury. In more intelligent species, a good test is to drop some light object, such as a handkerchief or feather, in front of the animal. It should gaze at the object while it is falling and continue to watch it on the ground. The same method can be applied to young ruminants, which demonstrate normal vision by following the examiner's moving hand at an age so early that they have not yet developed a menace reflex. Ophthalmoscopic examination is an integral part of an examination of the optic nerve.

### Oculomotor Nerve (Cranial Nerve III)

This nerve supplies the pupilloconstrictor muscles of the iris and all the extrinsic



**Fig. 14-1** Abnormal mentation in Simmental calf with bacterial meningitis. The calf is exhibiting opisthotonus and is acting inappropriately for its surroundings.

**Table 14-1** Correlation between clinical findings and location of lesions in the nervous system of farm animals: abnormalities of mental state (behavior)

Principal sign	Secondary signs	Location of lesion	Example
Mania hysteria/ hyperexcitability	Continuous, leading to paralysis; aggression, convulsions	Cerebrum-limbic system	Peracute lead poisoning, rabies, encephalitis
	Intermittent, acetonuria, signs of hepatic insufficiency	Cerebrum-limbic system	Hypoglycemia, hypoxia
Coma (recumbency with no response to stimuli; dilated pupils)	Gradual development	Cerebral-brainstem reticular formation (ascending reticular activating system)	Hepatic insufficiency, uremia, toxemia, septicemia
	Hypothermia, peripheral vascular collapse. Clinicopathologic tests Sudden onset Normal temperature, pulse/heart rate slow to normal, nosebleed, skin laceration, bruising middle of forehead or poll	Cerebral-brainstem reticular formation (ascending reticular activating system)	Accidental, severe blunt trauma with edema, concussion, contusion of brain
Narcolepsy/catalepsy Uncontrollable sleep	With or without sudden loss of consciousness, intermittent falling caused by loss of voluntary motor function	Brainstem control of cerebral cortex	Inherited in Shetland ponies, American Miniature horses, and Suffolk horses
Compulsive walking and head-pressing, aggressive behavior, grinding of teeth.	Apparent blindness, nystagmus	Cerebral-visual cortex and limbic system	Increased intracranial pressure in polioencephalomalacia
No ataxia	Apparent blindness, no nystagmus, hepatic insufficiency shown on clinical pathology tests	Cerebral-visual cortex and limbic system	Hepatic insufficiency (i.e., ammonia intoxication; in pyrrolizidine poisoning)
Imbecility in neonate; lack of response to normal stimuli; can walk, stand	Blindness	Cerebral cortex absent; hydranencephaly	Intrauterine infection with Akabane or bovine virus diarrhea virus in calves

**Table 14-2** Correlation between clinical findings and location of lesion in the nervous system of farm animals: involuntary movements

Principal sign	Secondary signs	Location of lesion	Example
Tremor (continuous repetitive movements of skeletal muscles)	Moderate tetany	No specific focal lesion Generalized disease, e.g., hypomyelinogenesis	Congenital tremor of Herefords Hypomyelinogenesis, shaker pigs, lambs with border disease
	Intention tremor, sensory ataxia With head rotation	Cerebellum Vestibular apparatus	Cerebellar hypoplasia Otitis media and interna Fracture of petrous temporal bone
Nystagmus	Usually with tetraparesis, impaired consciousness, abnormal pupils, opisthotonus, facial palsy, dysphagia Pendular nystagmus	Cerebellopontine and midbrain areas  No lesion	Injury, increased intracranial pressure, polioencephalomalacia, listeriosis  Benign sporadic occurrence in dairy cattle, inherited in Finnish Ayrshire bulls
	Independent episodes	Focus of irritation in cerebral cortex or thalamus, with spread of excitation	Idiopathic or traumatic epilepsy
	Convulsions	Continuous, leading to paralysis Intermittent, related to periods of metabolic stress	Cerebral cortex Cerebral cortex
Tenesmus (straining)	Later paralysis of anus, sometimes tail head Sexual precocity in male	Caudal cord segments and cauda equina, stimulation of nerve cells, later paralysis	Rabies, subacute local meningitis
Compulsive rolling	Disturbance of balance, cannot stand, must lie on one side Nystagmus	Vestibular apparatus	Brain abscess, otitis media

**Table 14-3** Correlation between clinical findings and location of lesion in the nervous system of farm animals: abnormalities of posture

Principal sign	Secondary signs	Location of lesion	Example
Paresis (difficulty in rising, staggering gait, easily falling)	Persistent recumbency, muscle tone and reflexes variable depending on site of lesion General loss of muscle tone including vascular, alimentary systems	Loss of function in nervous tissue, e.g., spinal cord, may be upper or motor neuron lesion Depression of synaptic or neuromuscular transmission for metabolic reasons or toxic reasons	Lymphosarcoma affecting spinal cord Periparturient hypocalcemia, botulism, peracute coliform mastitis, tick paralysis
Flaccid paralysis (1) Pelvic limbs only	Thoracic normal Pelvic limbs flaccid, no tone, or reflexes, no anal reflex, urinary incontinence straining initially Thoracic limbs normal Pelvic limbs normal tone and reflexes, anal reflex normal No withdrawal reflex caudally	Tissue destruction, myelomalacia at lumbosacral cord segments L4 to end osteomyelitis, fracture Cord damage at thoracolumbar cord segments T3-L3	Paralytic rabies Spinal cord local meningitis, vertebral body Spinal cord local meningitis as previously mentioned, damage by vertebral fracture, lymphosarcoma
	(2) Thoracic and pelvic limbs	Flaccid paralysis, normal tone and reflexes hindlimbs Absent tone and reflexes in front limbs Atrophy only in front No withdrawal reflex caudally Intact perineal reflex Flaccid paralysis all four legs and neck Unable to lift head off ground Normal tone and reflexes all legs Pain perception persists No withdrawal reflex caudally	Cord damage at cervicothoracic segments C6-T2 Cord damage at upper cervical segments C1-C5
Spastic paralysis (permanent, no variation, all four limbs in extension, increased tone, exaggerated reflexes, opisthotonus)	Cranial nerve deficits trigeminal to hypoglossal Loss of central perception of pain Depression	Medulla, pons and midbrain	Abscess, listeriosis



**Table 14-3** Correlation between clinical findings and location of lesion in the nervous system of farm animals: abnormalities of posture—cont'd

Principal sign	Secondary signs	Location of lesion	Example
Tremor	Tremor (fine or coarse; no convulsions)	Red nucleus and reticular apparatus and midbrain/basal ganglia area tracts	Congenital disease of calves, e.g., hypomyelinogenesis, neuraxial edema
Tetany (all four limbs extended, opisthotonus)	Intense hyperesthesia, prolapse third eyelid	Decreased synaptic resistance generally	Tetanus
Tetanus (variable intensity modifiable by treatment)	Exaggerated response to all external stimuli, i.e., hyperesthesia	Increased neuromuscular transmission	Hypomagnesemia
Paralysis of anus	No anal or perineal reflex May be straining	Damage to spinal cord at segments S1-S3	Injury or local meningitis, early rabies
Paralysis of tail	Flaccid tail with anesthesia	Injury to caudal segments	Injury or local meningitis, early rabies
Opisthotonus	With spastic paralysis, tremor, nystagmus, blindness Part of generalized tetanic state or convulsion	Cerebrum, cerebellum and midbrain Neuromuscular transmission defect, tetanus, hypomagnesemia	Polioencephalomalacia, trauma Tetanus
Falling to one side	Mostly with circling Also with deviation of tail	No detectable lesion in spinal cord	<i>Xanthorhea hostile</i> poisoning

**Table 14-4** Correlation between clinical findings and location of lesion in the nervous system of farm animals: abnormalities of gait

Principal sign	Secondary signs	Location of lesion	Example
Circling (1) Rotation of the head	Nystagmus, circles, muscle weakness, falls easily, may roll, other cranial nerves affected	Vestibular nucleus	Brain abscess, listeriosis
	Nystagmus, walks in circles, falls occasionally, animal strong Falls easily if blindfolded, sometimes facial paralysis	Inner ear (vestibular canals), cranial nerve VII, facial nerve	Otitis media, otitis interna, fracture petrous temporal bone (horse)
(2) Deviation of the head	Deviation of head and gaze, compulsive walking, depression Can walk straight Balance may be normal	Cerebrum	Brain abscess in calf (infection from dehorning or umbilicus)
	Unable to walk straight Facial paralysis, other cranial nerve deficits, head may be rotated	Medulla	Listeriosis
Cerebellar ataxia	Exaggerated strength and distance of movement, direction wrong Hypermetria Incoordination because of exaggerated movement No paresis	Cerebellum	Inherited cerebellar hypoplasia in all species, especially Arabian horses; <i>Claviceps paspali</i> poisoning; Gomen disease a probable plant poisoning; destruction by a virus, especially BVD in cattle; hematoma in the fourth ventricle causes cerebellar displacement Idiopathic cerebellar degeneration in adult cattle
Sensory ataxia	No loss of movement or strength but timing movement wrong, legs get crossed, feet badly placed when pivoting	Damage to sensory tracts in spinal cord	Cervical cord lesion, thoracolumbar if just pelvic limb
Sensorimotor ataxia	Weakness of movement, e.g., scuffing toes, knuckling, incomplete flexion, extension causes wobbly, wandering gait, falls down easily, difficulty in rising	Moderate lesion to spinal cord tracts	Plant poisonings, e.g., sorghum Cervical vertebral compression of spinal cord Degenerative myelopathy

BVD, bovine viral diarrhea.

**Table 14-5** Correlation between clinical findings and location of lesion in the nervous system of farm animals: abnormalities of the visual system

Principal sign	Secondary signs	Location of lesion	Example
Blindness (bumps into objects)	Pupillary dilatation No pupillary light reflex No menace reflex	Optic nerve (examine fundus of eye)	Vitamin A deficiency Pituitary rete mirabile abscess Congenital retinal dysplasia of goats
Peripheral blindness or night blindness		Retina	Nutritional deficiency of vitamin A Inherited defect of Appaloosa foals
Central blindness	Pupil normal size Pupillary light reflexes normal	Cerebral cortex	Polioencephalomalacia, lead poisoning
Abnormal dilatation of pupils (mydriasis)	Absence of pupillary light reflex Can see and does not bump into objects	Motor path of oculomotor nerve	Snakebite, atropine poisoning, milk fever
	Absent pupillary light reflex No vision Retinal damage on ophthalmoscopic examination	Retinal lesion	Toxoplasmosis, trauma, ophthalmitis
Abnormal constriction of pupil (miosis)	Absent pupillary light reflex No vision Retina normal	Optic nerve atrophy and fibrosis	Avitaminosis A in cattle
	Diarrhea, dyspnea	Failure to activate acetylcholine	Organophosphate poisoning
Horner's syndrome Drooping upper eyelid, miosis, enophthalmos	Blindness, coma, semicoma, spastic paralysis	Diffuse lesion	Polioencephalomalacia, acute lead poisoning
	Hemilateral sweating and temperature rise side of face and upper neck Unilateral exophthalmos; nasal obstruction	Damage to cranial thoracic and cervical sympathetic trunk	Mediastinal tumor Guttural pouch mycosis Neoplastic space-occupying lesions of the cranium involving the periorbit; perivascular injection around jugular vein or normal intravenous injection of xylazine hydrochloride in normal horses, melanoma at the thoracic inlet in a horse
Nystagmus	See Table 14-2		
Abnormal position of eyeball and eyelids	Dorsomedial deviation of eyeball and eyelid	Trochlear (cranial nerve IV) Facial (cranial nerve VII)	Polioencephalomalacia Listeriosis
	Ventrolateral fixation	Oculomotor (cranial nerve III)	
	Protrusion and medial deviation	Abducent (cranial nerve VI)	Abscess/tumor, e.g., bovine viral leukosis
No palpebral reflex		Deficit sensory branch of cranial nerve V	Trauma
Absence of menace response		Facial nerve (provided vision is present)	Listeriosis
Absence of pupillary light reflex		Oculomotor (provided vision is present)	

**Table 14-6** Correlation between clinical findings and location of lesion in the nervous system of farm animals: disturbances of prehension, chewing, or swallowing

Principal sign	Secondary signs	Location of lesion	Example
Inability to prehend or inability to chew	Facial (nasal septal) hypalgesia	Sensory branch of trigeminal (cranial nerve V) dysfunction	Poisoning by <i>Phalaris aquatica</i> in cattle Local medullary lesion
	Inappropriate movements of tongue	Hypoglossal (cranial nerve XII) nerve dysfunction	Poisoning by <i>P. aquatica</i> in cattle Listeriosis, local medullary lesion
	Inappropriate movements of lips	Facial (cranial nerve VII) nerve dysfunction	Traumatic injury to petrous temporal bone, otitis media and interna, listeriosis, guttural pouch mycosis
	Inadequate chewing movements of jaw	Motor branch of the trigeminal (cranial nerve V) nerve dysfunction	Poisoning by <i>P. aquatica</i> in cattle, listeriosis
Inability to swallow (in absence of physical foreign body; in pharyngeal paresis or paralysis)	Regurgitation through nose and mouth, inhalation into lungs causing aspiration pneumonia	Glossopharyngeal (cranial nerve IX) nerve dysfunction. Also vagus (cranial nerve X)	Abscess or tumor adjacent to nerve Listeriosis, abscess in medulla Poisoning by <i>Centaurea</i> sp.
	Inappropriate swallowing movements	Nuclei in medulla globus pallidus and substantia nigra	

muscles of the eyeball except the dorsal oblique, the lateral rectus, and the retractor muscles. Loss of function of the nerve results in pupillary dilatation and defective pupillary constriction when the light intensity is increased, abnormal position (ventrolateral deviation) or defective movement of the eyeballs, and palpebral ptosis.

The pupillary light reflex is best tested by shining a bright point source of light into the eye, which causes constriction of the iris of that eye (direct pupillary reflex). Constriction of the opposite eye (consensual pupillary light reflex) will also occur. The consensual light reflex may be used to localize lesions of the optic pathways.

Examination of the menace reflex (eye preservation reflex to a menace) and the results of the pupillary light reflex can be used to distinguish between blindness caused by a lesion in the cerebral cortex (central blindness) and that caused by lesions in the optic nerve or other peripheral parts of the optic pathways (peripheral blindness).

**As examples**, in PEM (central blindness) the menace reflex is absent, but the pupillary light reflex is present. In the ocular form of hypovitaminosis A (peripheral blindness) in cattle, the menace reflex is also absent, the pupils are widely dilated, and the pupillary light reflex is absent. In PEM, the optic nerve, oculomotor nucleus, and oculomotor nerve are usually intact but the visual cortex is not; in hypovitaminosis A, the optic nerve is usually degenerate, which interferes with both the menace and pupillary light reflexes.

**Testing** of ocular movements can be performed by moving the hand about in front of the face. In paralysis of the oculomotor nerve, there may also be deviation from the normal ocular axes and rotation of the eyeball. There will be an absence of the normal horizontal nystagmus reaction with a medial jerk of the eyeball in response to quick passive movement of the head. Failure to jerk laterally indicates a defect of the abducens nerve.

#### Trochlear Nerve (Cranial Nerve IV)

This nerve supplies only the dorsal oblique muscle of the eye so that external movements and position of the eyeball are abnormal (dorsolateral fixation) when the nerve is injured. This is common in PEM in cattle, resulting in a dorsomedial fixation of the eyeball. In other words, the medial angle of the pupil is displaced dorsally when the head is held in normal extension.

#### Trigeminal Nerve (Cranial Nerve V)

The sensory part of the trigeminal nerve supplies sensory fibers to the face and can be examined by testing the palpebral reflex and the sensitivity of the face. The motor part of the nerve supplies the muscles of mastication and observation of the act of chewing may reveal abnormal jaw movements and asymmetry of muscle contractions.

There may also be atrophy of the muscles, which is best observed when the lesion is unilateral.

#### Abducent Nerve (Cranial Nerve VI)

Because the abducent nerve supplies motor fibers to the retractor and lateral rectus muscles of the eyeball, injury to the nerve may result in protrusion and medial deviation of the globe. This is not readily observable clinically. An inherited exophthalmos and strabismus occurs in Jersey cattle.

#### Facial Nerve (Cranial Nerve VII)

The facial nerve supplies motor fibers for movement of the ears, eyelids, lips, and nostrils, in addition to the motor pathways of the menace, palpebral, and corneal reflexes. The symmetry and posture of the ears, eyelids, and lips are the best criteria for assessing the function of this nerve. Ability to move the muscles in question can be determined by creating a noise or stabbing a finger at the eye. Absence of the eye preservation reflex may be caused by facial nerve paralysis or blindness. Facial paralysis is evidenced by ipsilateral drooping of the ear, ptosis of the upper eyelid, drooping of the lips, and pulling of the philtrum to the unaffected side. There may also be drooling of saliva from the commissures of the lips, and in some cases a small amount of feed may remain in the cheeks of the affected side.

The common causes of damage to the nerve are fracture of the petrous temporal bone, guttural pouch mycosis, and damage to the peripheral nerve at the mandible. A common accompaniment is injury to the vestibular nerve or center. A diagnosis of central, compared with peripheral, nerve involvement can be made by identifying involvement of adjacent structures in the medulla oblongata. Signs such as depression, weakness, and a head tilt would result, and are frequently present in ruminants and New World camelids with listeriosis.

#### Vestibulocochlear Nerve (Cranial Nerve VIII)

The cochlear part of the vestibulocochlear nerve is not easily tested by simple clinical examination, but failure to respond to sudden sharp sounds, created out of sight and without creating air currents, suggests deafness. The cochlear portion can be tested electronically (the brainstem auditory evoked response, or BAER, test) to diagnose a lesion of the auditory nerve, eliminating the possibility of a central brain lesion. Abnormalities of balance and carriage of the head (rotation around the long axis and not deviation laterally) accompany lesions of the vestibular part of the vestibulocochlear nerve, and nystagmus is usually present.

In severe cases, rotation of the head is extreme, the animal is unable to stand and lies in lateral recumbency; moving to achieve this posture is compulsive and forceful.

There is no loss of strength. In some species there is a relatively common occurrence of paralysis of the facial and the vestibular nerves as a result of otitis interna and otitis media. This does occur in the horse but is less common than traumatic injury to the skull as a result of falling.

Pendular nystagmus should not be mistaken as a sign of serious neurologic disease. It is characterized by oscillations of the eyeball that are always the same speed and amplitude and appear in response to a visual stimulus, e.g., a flashing light. Pendular nystagmus is observed most frequently in Holstein Friesian cattle (prevalence of 0.51% in 2932 Holstein Friesian and Jersey cows), is not accompanied by other signs, and there is no detectable histologic lesion. A familial relationship was observed in Ayrshire bulls in Finland.

#### Glossopharyngeal Nerve (Cranial Nerve IX) and Vagus Nerve (Cranial Nerve X)

The glossopharyngeal nerve is sensory from the pharynx and larynx, and the vagus nerve is motor to these structures. Dysfunction of these nerves is usually accompanied by paralysis of these organs with signs of dysphagia or inability to swallow, regurgitation through the nostrils, abnormality of the voice, and interference with respiration.

Because of the additional role of the vagus nerve in supplying nerve fibers to the upper alimentary tract, loss of vagal nerve function will lead to paralysis of the pharynx and esophagus. Parasympathetic nerve fibers to the stomach are also carried in the vagus, and damage to them could cause hypomotility of that organ. The principal clinical finding in vagus nerve injury is laryngeal and pharyngeal paralysis.

#### Spinal Accessory Nerve (Cranial Nerve XI)

Damage to this nerve is extremely rare and the effects are not documented. Based on its anatomic distribution, loss of function of this nerve could be expected to lead to paralysis of the trapezius, brachiocephalic, and sternocephalic muscles and lack of resistance to lifting the head.

#### Hypoglossal Nerve (Cranial Nerve XII)

As the motor supply to the tongue, the function of this nerve can be best examined by observing the motor activity of the tongue. There may be protrusion and deviation or fibrillation of the organ, which all result in difficulty in prehending food and drinking water. The most obvious abnormality is the ease with which the tongue can be pulled out. The animal also has difficulty in getting it back into its normal position in the mouth, although diffuse cerebral disease can also produce this clinical sign. In lesions of some duration, there may be obvious unilateral atrophy.



## POSTURE AND GAIT

The examiner evaluates posture and gait to give a general assessment of brainstem, spinal cord, and peripheral nerve and muscle function. Evaluation of posture and gait consists of determining which limbs are abnormal and looking for evidence of lameness suggesting a musculoskeletal gait abnormality. Weakness and ataxia are the essential components of gait abnormality. Each limb is examined for evidence of these abnormalities. This is done while the animal is standing still, walking, trotting, turning tightly (pivoting), and backing up. To detect subtle asymmetry in the length of the stride, the observer should walk parallel to or behind the animal, step for step. If possible, the gait should also be evaluated while the animal is walking up and down a slope or walking with the head and neck held extended, while blindfolded and while running free in an enclosure.

The best observations are made when the animal is running free, preferably at a fast gait, to avoid abnormalities resulting from being led. Also, slight abnormalities such as a high-stepping gait, slight incoordination of movement, errors of placement of feet, stumbling, and failure to flex joints properly are all better observed in a free animal.

**Weakness or paresis** is evident when an animal drags its limbs, has worn hooves, or has a low arc to the swing phase of the stride. When an animal bears weight on a weak limb, the limb often trembles and the animal may even collapse on that limb because of lack of support. While circling, walking on a slope, and walking with the head held elevated, an animal frequently will stumble on a weak limb and knuckle over on the fetlock.

The presence of weakness in the limbs of horses or cattle can be determined by pulling the tail while the animal is walking forward. A weak animal is easily pulled to the side and put off stride. While the animal is circling, the examiner can pull on the lead rope and tail simultaneously to assess strength. Ease in pulling the animal to the side occurs because of weakness caused by lesions of the descending upper motor neuron pathway, the ventral horn gray matter level with the limb, or peripheral nerves or muscle. With lower motor neuron lesions, the weakness is often so marked that it is easy to pull an animal to the side while it is standing or walking. In contrast, a weak animal with a lesion of the upper motor neuron pathways will often fix the limb in extension, reflexly, when pulled to one side. It resists the pull and appears strong.

**Severe weakness in all four limbs**, but with no ataxia and spasticity, suggests neuromuscular disease. Obvious weakness in only one limb is suggestive of a peripheral nerve or muscle lesion in that limb.

**Ataxia** is an unconscious, general proprioceptive deficit causing poor coordination when moving the limbs and the body.

It results in swaying from side to side of the pelvis, trunk, and sometimes the entire body. It may also appear as a weaving of the affected limb during the swing phase. This often results in abducted or adducted foot placement, crossing of the limbs, or stepping on the opposite foot, especially when the animal is circling or turning tightly. Circumduction of the outside limbs when turning and circling is also considered a proprioceptive deficiency. Walking an animal on a slope, with the head held elevated, often exaggerates ataxia, particularly in the pelvic limbs. When a weak and ataxic animal is turned sharply in circles, it leaves the affected limb in one place while pivoting around it. An ataxic gait may be most pronounced when an animal is moving freely, at a trot or canter, especially when attempting to stop. This is when the limbs may be wildly abducted or adducted. Proprioceptive deficits are caused by lesions affecting the general proprioceptive sensory pathways, which relay information on limb and body position to the cerebellum (unconscious proprioception) and to the thalamus and cerebral cortex (conscious proprioception).

**Knuckling the flexed foot** while the animal stands on the dorsum to determine how long the animal leaves the foot in this state before returning it to a normal position is a test for conscious proprioception in dogs and cats. The test has not been useful in horses and adult cattle but is useful in sheep, goats, New World camelids, and calves. Depressed animals will often allow the foot to rest on the dorsum for prolonged periods. Crossing the limbs and observing how long the animal maintains a cross-legged stance has been used to test conscious proprioception.

**Hypermetria** is used to describe a lack of direction and increased range of movement, and is seen as an overreaching of the limbs with excessive joint movement. Hypermetria without paresis is characteristic of spinocerebellar and cerebellar disease.

**Hypometria** is seen as stiff or spastic movement of the limbs with little flexion of the joints, particularly the carpal and tarsal joints. This generally is indicative of increased extensor tone and of a lesion affecting the descending motor or ascending spinocerebellar pathways to that limb. A hypometric gait, particularly in the thoracic limbs, is best seen when the animal is backed up or when it is maneuvered on a slope with the head held elevated. The thoracic limbs may move almost without flexing.

**Dysmetria** is a term that incorporates both hypermetria and hypometria. Animals with severe cerebellar lesions may have a high-stepping gait but have limited movement of the distal limb joints, especially in thoracic limbs.

The degree of weakness, ataxia, hypometria, and hypermetria should be graded for each limb. The types of gait abnormalities

and the degree of weakness reflect various nervous and musculoskeletal lesions. Generally, with focal, particularly compressive, lesions in the cervical spinal cord or brainstem, neurologic signs are one grade more severe in the pelvic limbs than in the thoracic limbs. Thus with a mild, focal, cervical spinal cord lesion, there may be more abnormality in the pelvic limbs with no signs in the thoracic limbs. The anatomic diagnosis in such cases may be a thoracolumbar, cervical, or diffuse spinal cord lesion.

A moderate or severe abnormality in the pelvic limbs, and none in the thoracic limbs, is consistent with a thoracolumbar spinal cord lesion. With a mild and a severe change in the thoracic and the pelvic limb gaits, respectively, one must consider a severe thoracolumbar lesion plus a mild cervical lesion, or a diffuse spinal cord disease.

Lesions involving the brachial intumescence (spinal cord segments C6-T2) with involvement of the gray matter supplying the thoracic limbs, and diffuse spinal cord lesions may both result in severe gait abnormality in the thoracic limbs and the pelvic limbs.

A severely abnormal gait in the thoracic limbs, with normal pelvic limbs, indicates lower motor neuron involvement of the thoracic limbs; a lesion is most likely to be present in the ventral gray columns at spinal cord segments C6-T2 or thoracic limb peripheral nerves of muscle.

Gait abnormalities can occur in all four limbs, with lesions affecting the white matter in the caudal brainstem, when head signs, such as CN deficits, are used to define the site of the lesion. Lesions affecting the cerebrum cause no change in gait or posture.

It is important for clinicians to recognize that a poor level of agreement exists between skilled and experienced observers of gait abnormalities in horses.<sup>5</sup> There is also poor agreement between pathology and clinical signs. The level of agreement is particularly poor when gait abnormalities are subtle. Consequently, there is an important need to develop a set of objective parameters that quantify the severity of ataxia in horses, with appropriate repeatability.

## NECK AND FORELIMBS

If a gait abnormality was evident in the thoracic limbs and there was no evidence of brain involvement, then examination of the neck and forelimbs can confirm involvement of the spinal cord, peripheral nerves (spinal cord segments C1-T2), or thoracic limb muscles. The neck and forelimbs are examined for evidence of gross skeletal defects, asymmetry of the neck, and muscle atrophy. The neck should be manipulated from side to side and up and down to detect any evidence of resistance or pain. Localized unilateral sweating of the neck and cranial shoulder is evidence of **Horner's syndrome**, in which

there are varying degrees of ptosis; prolapse of the third eyelid; miosis; enophthalmos; and increased temperature of the face, neck, and shoulder. The syndrome is associated with lesions affecting the descending sympathetic fibers in the white matter of the spinal cord or gray matter in the cranial thoracic segments, thoracocervical sympathetic trunk, cervical vagosympathetic trunk, or cranial cervical ganglion and its preganglionic and postganglionic fibers.

**Sensory perception from the neck and forelimbs** is assessed using a painful stimulus such as a blunt needle or forceps. The local responses as well as the cerebral responses are noted when the skin over the shoulders and down the limbs is pricked.

**Gait deficits** are evaluated by making the horse or halter-broken ruminant perform a series of movements. Such exercises should include walking and trotting in a straight line, in large circles, in tight circles, backing on a level ground and on a slight slope, walking and trotting over curbs or low obstacles, walking in straight lines and circles, and walking on a slope with the head held elevated. The sway reaction for the thoracic limb is assessed by pushing against the shoulders and forcing the animal first to resist and then to take a step laterally. This can be done while the animal is standing still and walking forward. Pulling the tail and lead rope laterally at the same time will assess the strength on each side of the body. Making the animal turn in a tight circle by pulling the lead rope and tail at the same time will indicate strength; an adult horse should be able to pull the examiner around and should not pivot on a limb or be pulled to the side. Pressing down with the fingers on the withers of a normal animal causes some arching, followed by resistance to the downward pressure. An animal with weakness in the thoracic limbs may not be able to resist this pressure by fixing its vertebral column but will arch its back more than normal and often buckle in the thoracic limbs.

In smaller farm animal species, other postural reactions can be performed. These include wheelbarrowing and the hopping response test. The spinal reflexes are assumed to be intact in animals that are ambulating normally.

If a large mature horse, cow, or pig has a gait abnormality, it is very rare to cast the animal to assess the spinal reflexes. However, spinal reflexes are usually examined in calves, sheep, and goats.

A **recumbent animal** that can use its thoracic limbs to sit up in the dog-sitting position may have a lesion caudal to spinal cord segment T2. If a recumbent animal cannot attain a dog-sitting position, the lesion may be in the cervical spinal cord. In lambs aged between 4 and 10 weeks with thoracic vertebral body abscesses extending into the epidural space causing spinal cord compression, the thoracic limbs are normal and the lambs

frequently adopt a dog-sitting position and move themselves around using the thoracic limbs only. Lambs with a cervical spinal cord lesion are unable to maintain sternal recumbency and have paresis of all four limbs.

However, mature cattle with the downer cow syndrome secondary to hypocalcemia may be unable to use both the thoracic and pelvic limbs. If only the head, but not the neck, can be raised off the ground, there may be a severe cranial cervical lesion. With a severe caudal cervical lesion, the head and neck can usually be raised off the ground but thoracic limb function is decreased and the animal is unable to maintain sternal recumbency.

**Assessment** of limb function is done by manipulating each limb separately, in its free state, for muscle tone and sensory and motor activity. A limb that has been lain on for some time cannot be properly evaluated because there will be poor tone from the compression. A flaccid limb, with no motor activity, indicates a lower motor lesion to that limb. A severe upper motor neuron lesion to the thoracic limbs causes decreased, or absent, voluntary effort, but there is commonly normal or increased muscle tone in the limbs. This is caused by release of the lower motor neuron, which reflexly maintains normal muscle tone from the calming influence of the descending upper motor neuron pathways.

**The tone of skeletal muscle** may be examined by passively flexing and extending the limbs and moving the neck from side to side and up and down. Increased muscle tone, spasticity, or tetany may be so great that the limb cannot be flexed without considerable effort. If the spastic-extended limb does begin to flex but the resistance remains, this is known as lead-pipe rigidity, which is seen in tetanus. If after beginning to flex an extended spastic limb the resistance suddenly disappears ("clasp-knife release"), then this suggests an upper motor neuron lesion, which occurs in spastic paresis in cattle.

**Flaccidity, or decreased muscle tone**, indicates the presence of a lower motor neuron lesion with interruption of the spinal reflex arc.

Localized atrophy of muscles may be myogenic or neurogenic and the difference can be determined only by electromyography (EMG), a technique not well suited to large-animal practice. If the atrophic muscle corresponds to the distribution of a peripheral nerve, then it is usually assumed that the atrophy is neurogenic. In addition, neurogenic atrophy is usually rapid (will be clinically obvious in a few days) and much more marked than either disuse or myogenic atrophy.

### Spinal Reflexes of the Thoracic Limbs

Spinal reflexes of the thoracic limbs include the flexor reflex, the biceps reflex, and the triceps reflex. The flexor reflex is tested by

stimulation of the skin of the distal limb and observing for flexion of the fetlock, knee, elbow, and shoulder. The reflex arc involves sensory fibers in the median and ulnar nerves, spinal cord segments C6-T2, and motor fibers in the axillary, musculocutaneous, median, and ulnar nerves. Lesions cranial to spinal cord segment C6 may release this reflex from the calming effect of the upper motor neuron pathways and cause an exaggerated reflex with rapid flexion of the limb, and the limb may remain flexed for some time. A spinal reflex may be intact without cerebral perception. Cerebral responses to the flexor reflex include changes in the facial expression, head movement toward the examiner, and vocalization. Conscious perception of the stimulus will be intact only as long as the afferent fibers in the median and ulnar nerves, the dorsal gray columns at spinal cord segments C6-T2, and the ascending sensory pathways in the cervical spinal cord and brainstem are intact.

**The laryngeal adductory reflex** is of special interest in the examination of ataxic horses. In normal horses, a slap on the saddle region just caudal to the withers causes a flickering adductory movement of the contralateral arytenoid cartilage that is visible by an endoscope. Reflex muscle contraction can be palpated on the dorsolateral surfaces of the larynx. The reflex is absent when there is damage to afferent tracts up the spinal cord, when there is damage to the recurrent laryngeal nerves, and in tense or frightened horses. Elicitation of the reflex is called the **slap test**.

## TRUNK AND HINDLIMBS

If examination of the posture, gait, head, neck, or thoracic limbs reveals evidence of a lesion, then an attempt should be made to explain any further signs found during examination of the trunk and hindlimbs that could have been caused by the lesion. If there are only signs in the trunk and hindlimbs, then the lesion(s) must be either between spinal cord segments T2 and S2 or in the trunk and pelvic limb nerves or muscles. It must be remembered that a subtle neurologic gait in the pelvic limbs may be anywhere between the midsacral spinal cord and the rostral brainstem.

The trunk and hindlimbs are observed and palpated for malformations and asymmetry. Diffuse or localized sweating, the result of epinephrine release and sympathetic denervation, is often present in horses affected with a severe spinal cord injury.

**Gentle pricking** of the skin over the trunk and over the lateral aspects of the body wall on both sides, including on either side of the thoracolumbar vertebral column, will test-stimulate the cutaneous trunci reflex. The sensory stimulus travels to the spinal cord in thoracolumbar spinal nerves at the level of the site of stimulation. These impulses

are transmitted up the spinal cord to spinal cord segments C8-T1, where the lateral thoracic nerve is stimulated, causing contraction of the cutaneous trunci muscle, which is seen as a flicking of the skin over the trunk. Lesions anywhere along this pathway will result in suppression or absence of this reflex caudal to the site of the lesion. Degrees of hypalgesia and analgesia have been detected caudal to the sites of thoracolumbar spinal cord lesions, especially if they are severe. In mature cattle with fractured thoracolumbar vertebrae associated with traumatic injury or vertebral body abscesses in calves, the site of the lesion may be able to be localized with this reflex. Sensory perception of pinpricking the trunk and hindlimbs may also be absent caudal to the lesion.

**The sway reaction** for the pelvic limbs involves pushing against the pelvis and pulling on the tail with the animal standing still and walking forward. An animal that is weak in the pelvic limbs will be easily pulled and pushed laterally, especially while walking. Proprioceptive deficits can be observed as overabduction and crossing of the limbs when a step is taken to the side.

**Pinching** and pressing down on the thoracolumbar or sacral paravertebral muscles with the fingers causes a normal animal to extend slightly, then fix, the thoracolumbar vertebral column. It also resists the ventral motion and usually does not flex the thoracic or pelvic limbs. A weak animal usually is not able to resist the pressure by fixing the vertebral column; thus it overextends the back and begins to buckle in the pelvic limbs.

**In the recumbent animal**, examination of the pelvic limbs includes the pelvic limb spinal reflexes, the degree of voluntary effort, and the muscle tone present. Observing the animal attempting to rise on its own or following some coaxing will help to assess the pelvic limbs. The **flexor spinal reflex** is performed by pricking the skin and observing the flexion of the limb; central perception of the painful stimulus is also noted. The afferent and efferent pathways for this reflex are in the sciatic nerve and involve spinal cord segments L5-S3.

**The patellar reflex** is evaluated by placing the animal in lateral recumbency and supporting the limb in a partly flexed position. The intermediate patellar ligament (horses) or patellar ligament (ruminants, pigs, and New World camelids) is then tapped with a heavy metal plexor. This results in extension of the stifle joint. The sensory and motor fibers for this reflex are in the femoral nerve, and the spinal cord segments are L4 and L5. The patellar reflex is hyperactive in newborn farm animals. The gastrocnemius reflex and the cranial tibial reflex are not evaluated because they cannot be reliably induced.

The spinal cord of the calf has more control of basic physical functions than in humans, dogs, and horses. For example, calves are able to retain control of the pelvic

limb in spite of experimentally induced lesions that cause hemiplegia in dogs and humans. Also, transection of the spinothalamic tract in the calf cord does not produce an area of hypalgesia or analgesia on the contralateral side as such a lesion would do in a human.

**Skin sensation** of the pelvic limbs should be assessed independently from reflex activity. The femoral nerve is sensory to the skin of the medial thigh region, the peroneal nerve to the dorsal tarsus and metatarsus, and the tibial nerve to the plantar surface of the metatarsus.

## TAIL AND ANUS

Tail tone is evaluated by lifting the tail and noting the resistance to movement. A flaccid tail, with no voluntary movement, is indicative of a lesion of the sacrococcygeal spinal cord segments, nerves, or muscles. Decreased tone in the tail can be detected with severe spinal cord lesions cranial to the coccygeal segment.

**The perineal reflex** is elicited by lightly pricking the skin of the perineum and observing reflex contraction of the anal sphincter and clamping down of the tail. The sensory fibers are contained within the perineal branches of the pudendal nerve (spinal cord segments S1-S3). Contraction of the anal sphincter is mediated by the caudal rectal branch of the pudendal nerve, and tail flexion is mediated by the sacral and coccygeal segments and nerves (spinal cord segments S1-coccyx). An animal with a flaccid tail and anus, caused by a lower motor neuron lesion, will not have an anal or tail reflex. However, it may still have normal sensation from the anus and tail provided that the sensory nerves and spinal cord and brainstem white matter nociceptive pathways are intact.

Observation of defecation and urination movements and postures contributes to knowledge of the state of the cauda equina. Thus neuritis of the cauda equina is characterized by flaccid paralysis and analgesia of the tail, anus and perineum, rectum, and bladder. There is no paresis or paralysis of the hindlimbs unless lumbosacral segments of the cord are damaged.

## PALPATION OF THE BONY ENCASEMENT OF THE CENTRAL NERVOUS SYSTEM

Palpable or visible abnormalities of the cranium or spinal column are not commonly encountered in diseases of the nervous system, but this examination should not be neglected. There may be displacement, abnormal configuration, or pain on deep palpation. These abnormalities are much more readily palpable in the vertebral column and if vertebrae are fractured. Abnormal rigidity or flexibility of the vertebral column, such as

occurs in atlantooccipital malformations in Arabian horses and cattle, may also be detectable by manipulation.

## COLLECTION AND EXAMINATION OF CEREBROSPINAL FLUID

The collection and laboratory analysis of CSF from farm animals with clinical evidence of nervous system disease can provide useful diagnostic and prognostic information. A case series involving 102 cattle highlighted the clinical utility of CSF analysis in the ante-mortem diagnoses of nervous diseases.<sup>6</sup>

CSF is formed mostly from the choroid plexuses of the lateral, third, and fourth ventricles by the ultrafiltration of plasma and the active transport of selected substances across the blood-brain barrier; as such CSF should be regarded as a modified ultrafiltrate of plasma. A small amount of CSF is formed from the ependymal lining of the ventricular system, the pia arachnoid and meningeal blood vessels, and the central canal of the spinal cord. The rate of CSF turnover is approximately 1% per minute; accordingly, it takes many minutes for systemic electrolyte or acid-base changes (such as an increase in plasma magnesium concentration in hypomagnesemic beef cattle) to result in detectable and clinically relevant changes in CSF concentrations. CSF in the ventricular system flows caudally and diffuses out of the lateral recess in the fourth ventricle to circulate around the brain and spinal cord. The presence of CSF in the subarachnoid space separates the brain and spinal cord from the bony cranium and vertebral column, which reduces trauma to the underlying delicate nervous tissue. CSF flows within the subarachnoid space of leptomeninges, and it is primarily in this location that CSF equilibrates with the extracellular fluid (ECF) compartment of CNS parenchyma.<sup>6</sup> It also helps regulate intracranial pressure, maintains electrolyte and acid-base homeostasis, serves as an intracerebral transport system for neurotransmitters and hormones, and has excretory functions with the removal of products of cerebral metabolism. CSF analysis therefore provides a clinically valuable insight into diseases of the CNS.

### Collection of Cerebrospinal Fluid

CSF can be collected from the **lumbosacral cistern** with sedation (horses) or restraint (ruminants) and the **atlantooccipital cistern (cisterna magna)** using injectable general anesthesia. For collection it is necessary to puncture the subarachnoid space in either the lumbosacral space or cisterna magna. Although there is no substantial difference between the composition of lumbosacral or cisternal CSF samples unless there is a compressive lesion of the spinal cord, the general policy is to sample as close to the lesion as possible, with the exception that



atlantooccipital sampling should not be attempted in animals suspected to have increased intracranial pressure. CSF should be collected into a sterile tube and there is no need to add an anticoagulant, even in samples visibly contaminated with blood. Cytology should be performed as soon as possible after collection (ideally within 15 minutes) because the cells rapidly degenerate after collection. The reason for this rapid degeneration appears to be associated with the low oncotic pressure in CSF; the addition of autologous serum to make a 11% serum solution permitted storage of bovine CSF samples for 24 hours at 4°C before cytologic examination was performed with no loss in cell integrity.<sup>7</sup> The addition of serum to CSF in a ratio that provides an approximate final serum solution of approximately 11% should therefore be considered if there is an unavoidable delay before cytologic examination can be performed.<sup>8</sup>

### Collection From the Lumbosacral Cistern

The lumbosacral site is preferred because general anesthesia is not required. CSF can be collected from the lumbosacral cistern with relative ease provided that adequate restraint can be achieved and the anatomic landmarks can be identified. It can be collected from the standing or recumbent animal. If recumbent, the animal should be placed in sternal recumbency with hips flexed and the pelvic limbs extended alongside the abdomen. This widens the lumbosacral space to permit correct placement of the spinal needle. Ultrasonographic guidance has been described but is rarely needed.<sup>9</sup>

The site for collection is the midpoint of the lumbosacral space, which can be identified as the midline depression between the last palpable dorsal lumbar spine (L6 in cattle, goats, and horses; L6 or L7 in sheep and pigs; L7 in New World camelids) and the first palpable sacral dorsal spine (usually S2). In well-conditioned animals, these landmarks cannot always be identified; in which case the site is identified as the midpoint of a line connecting the caudal aspect of the tuber coxae. The site is clipped, surgically prepared, and 1 to 2 mL of local anesthetic is administered subcutaneously. Sterile surgical gloves should be worn. Hypodermic spinal needles with stylettes are recommended because ordinary needles commonly plug with tissue. The length and gauge of needle depends on the size of the animal, but at least 15-cm (6-inch) 18-gauge needles are needed for adult horses and cattle. These needles can bend considerably with animal movement, requiring the use of at least an 18-gauge needle; very tall horses may need a 20-cm needle because the depth needed maybe 16 to 18 cm. The following guide is recommended (Table 14-7).

Provided the animal is well restrained and care is exercised in introducing the

**Table 14-7 Needle length gauge for lumbosacral cerebrospinal fluid collection**

Species and body weight	Length (cm) and gauge of needle
Lambs < 30 kg	2.5 and 20
Ewes 40–80 kg	4.0 and 20
Rams > 80 kg	5.0 and 20
Calves < 100 kg	4.0 and 20
Calves 100–200 kg	5.0 and 18
Cattle > 200 kg	10.0–15.0 and 18

needle, little difficulty should be encountered. For collection from the lumbosacral space the needle is slowly advanced perpendicular or up to 15 degrees caudal to perpendicular to the plane of the vertebral column. The needle must be introduced in a perfectly vertical position relative to the plane of the animal's vertebral column because of the danger of entering one of the lateral blood vessels in the vertebral canal. Changes in tissue resistance can be felt as the needle point passes sequentially through the subcutaneous tissue and interarcuate ligament; then there is a sudden "pop" caused by the loss of resistance as the needle point penetrates the ligamentum flavum into the epidural space. Once the needle point has penetrated the dorsal subarachnoid space, CSF will well up in the needle hub within 2 to 3 seconds. Failure to appreciate the changes in resistance as the needle moves down may result in puncture of the conus medullaris, which may elicit an immediate pain response and some discomfort. Movement of the pelvic limbs may dislodge the needle point, with the risk of causing local trauma and hemorrhage in the leptomeninges, which results in blood in the sample. Repeated CSF taps of the lumbosacral space may make it more difficult to obtain an adequate sample volume because of fibrosis of epidural tissue.

Careful aspiration with a syringe attached to the needle held between the thumb and index finger is usually required to obtain a sample of 2 to 3 mL, which is sufficient for laboratory analysis. This can be facilitated by firmly resting the forearms and wrists on the animal's back. Failure to obtain fluid is usually caused by incorrect direction of the needle, in which the case the bony landmarks of the lumbosacral space (depression) must be rechecked and, with the needle correctly realigned, the procedure repeated. Occasional small rotations of the needle to change the direction of the bevel can be successful in obtaining CSF, particularly in smaller animals.

In animals with a vertebral body abscess and neurologic disease confined to the hindlimbs, CSF may be difficult to obtain

from the lumbosacral space because flow is occluded. In these circumstances, if a sample is obtained, the CSF protein may be increased as a result of stagnation of CSF distal to the lesion with exudation or transudation of protein from the lesion (**Froin's syndrome**).

### Collection From the Atlantooccipital Cistern (Cisterna Magna)

This site is preferred for intracranial lesions because the fluid is produced in the subarachnoid space and flows caudally down the spinal cord. However, this site is rarely used because of the inherent risk of needle penetration of the brainstem. Xylazine at 0.20 mg/kg body weight (BW) intramuscularly is effective in providing adequate sedation and analgesia for this procedure in cattle. A general anesthetic (such as combined intravenous administration of xylazine and ketamine) is recommended for horses. Ultrasonographic guidance has been described but is rarely needed.

The site is prepared as with the lumbosacral cistern. Ventriflexion of the head and neck of cattle enlarges the space of the cisterna magna and allows easy entry using a styletted spinal needle inserted at a point created by the transection of the transverse line of the cranial rim of the wing of the atlas and the dorsal midline. The needle is advanced carefully and steadily, and the tip is directed rostrally toward the symphysis of the lower jaw. The needle point goes through the skin, ligamentum nuchae, and leptomeninges. In most mature cattle with a BW over 500 kg, a 20-gauge, 10-cm (4-inch) spinal needle will enter the cisterna magna at 5 to 7 cm after going through the ligamentum nuchae, which provides some increased resistance. A 20-gauge 3.8-cm (1.5-inch) needle can be used in sheep, goats, foals, and neonatal calves. The entrance to the cisterna magna is at a depth of approximately 4 to 6 cm in adult horses and 1.5 to 2.5 cm in neonatal foals. Once at the lower range of the anticipated depth to enter the cisterna magna, the spinal needle is advanced 1 to 2 mm at a time. When the needle point punctures the leptomeninges, the animal may move its head slightly. At that point the needle is advanced only 1 to 2 mm and the stylette is then removed. If the end of the needle is in the cisterna magna, CSF will flow out of the needle freely and the manometer can be attached and the pressure measured.

### Cerebrospinal Fluid Pressure

CSF pressure can be determined by the use of a manometer attached to the spinal needle. Normal CSF pressures of the cisterna magna in cattle and xylazine/ketamine-anesthetized horses range from 5 to 15 cm H<sub>2</sub>O (unknown reference point) and 28 ± 4 cm H<sub>2</sub>O (referred to the right atrium), respectively. When the fluid system is properly connected, occlusion of both jugular veins causes a marked rise in CSF pressure; this is called

**Queckenstedt's test.** This test involves bilateral jugular vein compression, which results in a sudden increase in intracranial subarachnoid pressure that is transmitted to the cranial subarachnoid space. The resultant CSF pressure wave is transmitted to the lumbar area (when obtaining CSF from the lumbosacral space) in the absence of an obstruction in the spinal subarachnoid space, resulting in an increased flow of CSF.

Variations in CSF pressure are not of much use in clinical diagnosis except in hypovitaminosis A, and measurement of CSF pressure is only indicated in animals with signs of cerebral disease (abnormal mentation) that may have cerebral edema. Care is needed in interpreting results because the pressure is greatly affected by voluntary movement such as tenesmus. CSF pressure is increased in a number of diseases, including PEM, bacterial meningitis, and hypovitaminosis A, reflecting the presence of increased intracranial pressure. Xylazine given intravenously causes a decrease in intracranial pressure in healthy conscious horses. Intracranial pressure is increased in anesthetized horses when their head is placed lower than their heart because of an increase in the hydrostatic pressure gradient.<sup>10</sup> Epidural pressure of cattle changes with change in position from standing to lateral recumbency to dorsal recumbency, and epidural pressure is positive in laterally recumbent animals.

### Analysis of Cerebrospinal Fluid

Analysis of CSF has greater diagnostic value than hematology in animals with nervous system disease. CSF can be examined for the presence of protein, cells, and bacteria. The white blood cell count in normal animals is usually less than 5 cells/ $\mu$ L.<sup>11</sup> An increase in the CSF leukocyte count above 5 cells/ $\mu$ L is termed a pleocytosis and is categorized as mild (6 to 49 cells/ $\mu$ L), moderate (50 to 200 cells/ $\mu$ L), or marked ( $>200$  cells/ $\mu$ L). The differential white cell count comprises mostly lymphocytes and monocytes (mononuclear cells predominate); there are no erythrocytes in the CSF of healthy animals with an atraumatic CSF tap. Cytologic examination of CSF is usually done after a Cytospin preparation that carefully concentrates the cells without destroying their architecture. This is needed because the cell count in CSF is usually very low. With bacterial infections of the nervous system, the CSF concentration of protein will be increased and the white blood cell count increased up to 2000 cells/ $\mu$ L with more than 70% neutrophils. A neutrophilic pleocytosis is considered 95% to 100% indicative of an inflammatory process within the CNS. Samples that show visible turbidity usually contain large numbers of cells ( $>500$  cells/ $\mu$ L) and a great deal of protein.

The CSF glucose concentration is usually 60% to 80% of serum glucose concentration; this steady-state value reflects facilitated

transport across the blood-brain barrier, absence of binding proteins for glucose in CSF, and nervous tissue metabolism of glucose. However, sudden changes in plasma glucose concentrations are not immediately reflected in CSF glucose concentrations, because CSF turns over at around 1% per minute. Typically, a lag time of up to 3 hours is needed for CSF glucose concentration to be in equilibrium with plasma glucose concentrations. Therefore hyperglycemia from the stress of handling and restraint may not be reflected by an increased CSF glucose concentration.

In cattle, protein concentrations range from 23 to 60 mg/dL, sodium concentrations from 132 to 144 mmol/L, potassium 2.7 to 3.2 mmol/L, magnesium 1.8 to 2.1 mEq/L, and glucose concentrations 37 to 51 mg/dL. In the horse, the reference values for CSF are similar. Neonatal foals under 3 weeks of age have higher CSF protein concentrations than do adult horses. Glucose concentrations peak in the first 48 hours after birth and then decrease to adult values by the second week of life. Concentrations of sodium and potassium are not affected by age and are similar to values reported for adult horses and ponies. In sheep, protein concentrations range from 12 to 60 mg/dL and glucose concentrations from 38 to 63 mg/dL.

Cytokine concentrations in CSF may have prognostic value,<sup>11</sup> and the cytokine gene expression in nucleated cells in CSF may have clinical utility in the diagnosis of specific nervous diseases.<sup>13</sup> The presence of one or more eosinophils in CSF is extremely unusual and should be assumed to indicate the presence of aberrant parasite migration or fungal encephalitis. Theoretically, the CSF glucose concentration will be decreased and CSF lactate concentration will be increased in animals with bacterial meningitis because of bacterial metabolism, but these are unreliable signs and usually do not provide additional information to that provided by determination of CSF leukocyte and protein concentrations. Bacteria may also be cultured from the CSF.

The creatine kinase and lactate dehydrogenase activities in CSF have been examined as an aid in the differentiation of some neurologic diseases. However, creatine kinase activity is considered to be unreliable in the horse; contamination of the sample with epidural fat and dura may increase CSF creatine kinase activity. In contrast, CSF creatine kinase activity  $>19.5$  U/L provided an excellent prognostic test of nonrecovery in sheep with Listeriosis.<sup>12</sup> Insufficient information is available to evaluate the clinical utility of CSF lactate dehydrogenase activity in large animals.

Blood contamination of CSF can make interpretation difficult. A formula has been developed that "corrects" the CSF values for the degree of blood contamination, based on the red blood cell count (RBC) in CSF

( $RBC_{CSF}$ ) and blood ( $RBC_{blood}$ ), in which the corrected value for substance X in CSF ( $X_{corrected}$ , where X is a concentration or activity) is derived from the measured value of X in CSF ( $X_{CSF}$ ) and blood ( $X_{blood}$ ) and applying the following formula:

$$X_{corrected} = X_{CSF} - (X_{blood} \times RBC_{CSF} / RBC_{blood}).$$

Calculation of a "corrected" value rarely provides additional insight into the CSF analysis and is not commonly practiced in large animals. Xanthochromia is a slight yellow tinge to CSF that indicates previous erythrocyte lysis or more commonly increased protein concentration. A foamy appearance to the CSF is also suggestive of increased protein concentration.

Protein fractionation of CSF is not routinely performed because it requires sensitive electrophoresis methodology or species-specific radial immunodiffusion assays. Albumin (ALB) concentration in CSF can also be measured using an immunologic technique based on the detection of albumin-antialbumin immune complexes by nephelometry.<sup>7</sup> Calculation of the **albumin quotient** and **IgG index** may be informative in specific neurologic diseases. Theoretically, these calculations can differentiate four blood-brain permeability patterns, normal blood-brain barrier permeability (normal albumin quotient and IgG index), intrathecal IgG production with normal blood-brain barrier permeability (normal albumin quotient and increased IgG index), increased blood-brain barrier permeability without intrathecal IgG production (increased albumin quotient and normal IgG index), and increased blood-brain barrier permeability with intrathecal production of IgG (increased albumin quotient and increased IgG index). The albumin quotient is calculated from the albumin concentration in CSF ( $ALB_{CSF}$ ) and serum ( $ALB_{serum}$ ), in which:

$$Albumin\ Quotient = (ALB_{CSF} / ALB_{serum}) \times 100.$$

The normal range for albumin quotient in the adult horse is 0.6 to 2.2 for atlantooccipital CSF samples and 0.7 to 2.3 for lumbosacral CSF samples, but the mean is 0.4 to 0.5 in cattle and adult llamas. Because CSF protein is most often derived by disturbance of the blood-brain barrier and inflammation (resulting in an increased CSF albumin concentration), an increased CSF protein concentration is usually accompanied by an increased albumin quotient.

In animals suspected to have increased immunoglobulin production in the CNS (a rare occurrence, and almost always accompanied by disturbance of the blood-brain barrier), the IgG index can be calculated from the IgG concentration in CSF ( $IgG_{CSF}$ ) and serum ( $IgG_{serum}$ ), and the albumin

concentration in CSF ( $ALB_{CSF}$ ) and serum ( $ALB_{serum}$ ), in which:

$$IgG\ Index = \frac{(IgG_{CSF} / (IgG_{serum} \times (ALB_{serum} / ALB_{CSF})))}{(ALB_{serum} / ALB_{CSF})}$$

An IgG index of more than 0.3 is suspected to indicate intrathecal IgG production in the adult horse. This formula corrects the CSF IgG concentration for an increased permeability of the blood-brain barrier; therefore, theoretically it provides a more sensitive method for detecting local production of IgG within the CNS. Calculating the albumin quotient and IgG index is expensive and rarely provides additional information to that provided by CSF protein concentration alone, and for this reason is not commonly performed in large animals.

When antigen-specific titers are measured, two modified CSF indices, the **Goldmann–Witmer coefficient (C-value)** and the **antibody index (AI)**, can be calculated to distinguish intrathecal versus passively acquired antibodies in the CSF.<sup>14,15</sup> The C-value is calculated as

$$C\text{-value} = \frac{(IgG_{serum} \times \text{reciprocal CSF titer})}{(IgG_{CSF} \times \text{reciprocal serum titer})}$$

The AI is calculated as the ratio of the specific antibody quotient to the albumin quotient, in which

$$AI = \frac{\{\text{reciprocal CSF titer}\} / \{\text{reciprocal serum titer}\}}{\{\text{CSF albumin concentration}\} / \{\text{serum albumin concentration}\}}$$

The **urine dipstick protein test** provides a useful on-farm assessment of CSF protein concentration and is underutilized in clinical practice. Most dipsticks use the following gradations of trace (<25 mg/dL), 1+ (28–75 mg/dL), 2+ (115–240 mg/dL), and 3+ (470–590 mg/dL), and a study of dog CSF samples indicated that all dogs with a urine dipstick protein of 2+ or greater had increased CSF protein concentration.<sup>16</sup> Similar studies do not appear to have been conducted in large animals.

The **Pandy test** also provides a useful on-farm assessment of CSF protein concentration. The basis for the test is that proteins (globulin and albumin) are precipitated by a saturated solution of phenol in water. The Pandy test uses a 10% solution of carbolic acid crystals dissolved in water (providing a saturated aqueous solution of phenol); the solution is termed Pandy's solution. One milliliter of Pandy's solution is placed in a glass tube and one drop (approximately 0.05 mL) of CSF is carefully layered on top. A turbid appearance at the interface signifies the presence of elevated concentrations of globulin or albumin in the CSF and is regarded as a positive Pandy's reaction (usually a total protein concentration greater than approximately 50 mg/dL). A variant of the test has the sample thoroughly mixed and the degree of turbidity ranked from 1+ (faint turbidity)

to 4+ (dense milk-colored precipitate). A negative Pandy's reaction shows no turbidity or precipitate, and this is the expected result in normal CSF samples. A positive control (4+) can be run at the same time by adding a drop of serum or plasma to 1 mL of Pandy's solution. Because Pandy's solution contains phenol, clinicians should wear gloves and protective eyewear when handling the solution, and dispose of used reagents appropriately.

In summary, collection and analysis of CSF from the lumbosacral region provides a practical, safe, and informative diagnostic tool in conscious large animals with neurologic disease. Analysis of CSF in animals with CNS disease has greater diagnostic value than analysis of the leukon or serum biochemical analysis. Routine assessment of CSF should include total protein concentration (including the semiquantitative Pandy test and urine dipstick measurement), erythrocyte count, leukocyte count, and leukocyte differential count. Other analytical procedures on CSF can be performed in specific diseases related to the nervous system.

## EXAMINATION OF THE NERVOUS SYSTEM WITH SERUM BIOCHEMICAL ANALYSIS

### Arterial Plasma Ammonia Concentration

In animals suspected of having hepatic encephalopathy, measurement of the arterial plasma ammonia concentration provides a clinically useful diagnostic test and a means of monitoring the response to treatment. In monogastrics, ammonia is produced by bacterial degradation of amines, amino acids, and purines in the gastrointestinal tract, by the action of bacterial and intestinal urease on urea in the gastrointestinal tract, and by the catabolism of glutamine by enterocytes. In ruminants, ammonia is derived predominantly from bacterial metabolism in the rumen and catabolism of amino acids in tissue. Absorbed ammonia is normally converted to urea by the liver and to glutamine by the liver, skeletal muscle, and brain. In the presence of hepatic dysfunction, ammonia is inadequately metabolized, resulting in high plasma ammonia concentrations. Ammonia is a direct neurotoxin that alters inhibitory and excitatory neurotransmission in the brain.

Hyperammonemia can be used as a specific indicator of hepatic dysfunction. Normal values for arterial plasma ammonia concentration are less than 29  $\mu\text{mol/L}$  in adult cattle but may reach higher values in the immediate periparturient period. Arterial values are higher than venous values and are preferred for analysis.

Blood gas analysis and serum electrolyte determination should be routinely undertaken in animals with clinical signs of

encephalopathy to rule out metabolic causes of cerebral dysfunction.

## FURTHER READING

- Aleman M. Miscellaneous neurologic or neuromuscular disorders of horses. *Vet Clin North Am Equine Pract.* 2011;27:481-506.
- Constable PD. Clinical examination of the ruminant nervous system. *Vet Clin North Am Food Anim Pract.* 2004;20:215-230.
- Levine JM, Levine GJ, Hoffman AG, Mez J, Bratton GR. Comparative anatomy of the horse, ox, and dog: the vertebral column and peripheral nerves. *Equine Comp Cont Educ Pract Vet.* 2007;2:279-292.
- Schwarz B, Piercy RJ. Cerebrospinal fluid collection and its analysis in equine neurologic disease. *Equine Vet Educ.* 2006;18:243-248.
- Scott PR. Cerebrospinal fluid collection and analysis in suspected sheep neurological disease. *Small Rumin Res.* 2010;92:96-103.

## REFERENCES

1. Cavalleri JMV, et al. *BMC Vet Res.* 2013;9:105.
2. Verdes JM, et al. *J Vet Diagn Invest.* 2006;18:299.
3. Sprake PM, et al. *J Vet Intern Med.* 2013;27:1242.
4. Raoofi A. *Vet J.* 2009;181:296.
5. Olsen E, et al. *J Vet Intern Med.* 2014;28:630.
6. Stokol T, et al. *Vet Clin Pathol.* 2009;38:103.
7. Goehring LS, et al. *J Vet Diagn Invest.* 2006;18:251.
8. D'Angelo A, et al. *Vet Rec.* 2009;164:491.
9. Aleman M, et al. *J Am Vet Med Assoc.* 2007;230:378.
10. Brosnan RJ, et al. *Am J Vet Res.* 2008;69:737.
11. Ameri M, Mousavian R. *Vet Res Commun.* 2007;31:77.
12. El-Boshy ME, et al. *Small Rumin Res.* 2012;104:179.
13. Pusterla N, et al. *Am J Vet Res.* 2006;67:1433.
14. Furr M, et al. *J Vet Intern Med.* 2011;25:138.
15. Reed SM, et al. *J Vet Intern Med.* 2013;27:1193.
16. Jacobs RM, et al. *Can Vet J.* 1990;31:587.

## EXAMINATION OF THE NERVOUS SYSTEM WITH IMAGING TECHNIQUES

### Radiography

Examination of the bony skeleton of the head and vertebral column to detect abnormalities that are affecting the nervous system of large animals is commonly used in referral centers. Conventional diagnostic radiography remains the best method for the initial evaluation of trauma to the brain and spinal cord, but usually the trauma needs to have displaced bone for the lesion to be readily visible on a radiograph. Lesions that can be identified on plain radiographs include fractured, luxated, or subluxated vertebra; intervertebral disk prolapse; discospondylitis; osteomyelitis; and neoplasia.<sup>1</sup> The injection of contrast media into the CSF system (**myelography**) is used for the detection of spinal cord compression but is not often performed in large animals because spinal cord depression surgery is rarely undertaken and because sensitivity and specificity estimates are low depending on criteria used for interpretation.<sup>2</sup> In cases of peripheral nerve injury the radiograph of the appropriate limb may reveal the presence of a fracture or space-occupying lesion that has caused dysfunction of the peripheral nerve.



Radiography has been used to diagnose lesions of the tympanic bullae in cattle (otitis interna) characterized by thickening of the bulla wall, increased soft tissue opacity within the bulla, and osteolysis of the bulla wall and trabeculations.<sup>3</sup> Radiography is not as sensitive as computed tomography (CT) for the diagnosis of otitis media, however, because CT provides more detailed information regarding the bony structures of the middle ear<sup>4</sup> and is more sensitive and specific than radiography in the diagnosis of otitis media in calves.<sup>3</sup>

### Computed Tomography

CT of the skull has several advantages over radiography because structures are viewed in cross section without superimposition. The use of contrast agents and development of computer software and technology that permit rapid acquisition times and three-dimensional reconstruction allows a large amount of information to be obtained from a CT examination. Numerous diseases of the head of the horse, including those of the brain and cervical spine, can be diagnosed using this technique, but the limiting factors are the weight of the patient (a custom-designed table is required for adult horses and cattle), accessibility for large animals, and the need for general anesthesia.

CT provides an excellent image of skeletal cranial defects and soft tissue defects that differ considerably from surrounding tissue. CT has been used for the antemortem diagnosis of many conditions in foals, horses, and cattle, including cerebral abscess, porencephaly, meningoencephalocele, pituitary adenoma, cervical stenotic myelopathy, spinal cord rupture, and otitis interna/media, and has been used to guide brain biopsy for in vivo diagnosis of an intracranial mass.<sup>4-7</sup> CT provides less contrast resolution than magnetic resonance imaging (MRI), but CT provides better spatial resolution (i.e., is more able to differentiate fine anatomic features such as bone trabeculae), is more widely available, and has a shorter scan acquisition time. In a case series of 57 cases, CT was a useful diagnostic test in horses with abnormal mentation or a history of trauma followed by a period of unconsciousness. In contrast, CT did not provide clinically helpful information in horses with seizures.<sup>8</sup>

### Magnetic Resonance Imaging

MRI scanning uses nuclear magnetic resonance to create cross-sectional images based on the magnetic properties of tissues. In general, MRI provides an excellent image of soft tissue defects and is considered superior to CT for intracranial and intraspinal lesions because MRI provides a high contrast between soft tissues and better anatomic detail. MRI can be performed in standing sedated horses; however, these MRI units (typically 0.25 T) produce low-resolution

images that may not have sufficient detail to be diagnostic for many nervous diseases. Higher resolution images are produced by more expensive magnets (typically 1.0–3.0 T) that require the patient be immobile. The limiting factors for MRI use are therefore cost (MRI is more expensive than CT), the weight of the patient, accessibility for large animals, and the need for general anesthesia for higher resolution images (usually MRI has a longer imaging time than CT). Other challenges specific to MRI are that the environment provides considerable challenges for the monitoring of anesthesia and the placement of limbs to minimize postanesthetic myopathy/neuropathy syndrome, particularly in horses.<sup>9</sup>

MRI has been used for the antemortem diagnosis of a number of neurologic conditions in foals and horses, including brain abscess, hydrocephalus, nigropallidal encephalomalacia,<sup>10</sup> cerebellar abiotrophy in Arabian horses,<sup>11</sup> cervical stenotic myelopathy,<sup>2</sup> and peripheral nerve sheath tumor (PNST) in the tongue.<sup>12</sup> MRI has also been used to diagnose PEM and cerebellar hypoplasia in calves<sup>13</sup> and PEM, leukoencephalomalacia, and porencephaly and demyelination in sheep and goats.<sup>14</sup> More studies are required documenting the clinical superiority of MRI versus other diagnostic modalities. For instance, MRI can differentiate horses with cervical stenotic myelopathy (CSM) and cervical vertebral stenosis from healthy horses and horses with other causes for ataxia; however, MRI cannot accurately localize the site of cord compression.<sup>2</sup> MRI will be more widely used in the diagnosis of nervous diseases, particularly intracranial and cervical spinal cord disease, as equipment and acquisition costs decrease.

### FURTHER READING

- Aleman M. Miscellaneous neurologic or neuromuscular disorders of horses. *Vet Clin North Am Equine Pract.* 2011;27:481-506.
- Scrivani PV. Advanced imaging of the nervous system in the horse. *Vet Clin North Am Equine Pract.* 2011;27:439-453.

### REFERENCES

- Hughes KJ. *Equine Vet Educ.* 2007;19:460.
- Mitchell CW, et al. *Vet Radiol Ultrasound.* 2012;53:613.
- Finnen A, et al. *J Vet Intern Med.* 2011;25:143.
- Lee K, et al. *Vet Rec.* 2009;165:559.
- Ohba Y, et al. *J Vet Med Sci.* 2008;70:829.
- Pease AP, et al. *J Vet Intern Med.* 2011;25:1144.
- Vanschandevijl K, et al. *J Am Vet Med Assoc.* 2008;233:950.
- Sogaro-Robinson C, et al. *J Am Vet Med Assoc.* 2009;235:176.
- Franci P, et al. *Equine Vet J.* 2006;38:497.
- Jose-Cunilleras E, Piercy RJ. *Equine Vet Educ.* 2007;19:179.
- Cavalleri JMV, et al. *BMC Vet Res.* 2013;9:105.
- Schneider A, et al. *Equine Vet Educ.* 2010;22:346.
- Tsuka T, et al. *Vet Radiol Ultrasound.* 2008;49:149.
- Schenk HC, et al. *J Vet Intern Med.* 2007;21:865.

### Ultrasonography

Ultrasonography of the cricoarytenoideus lateralis muscle has been used as part of the examination of horses with suspected laryngeal hemiplegia and compared with endoscopic findings obtained at rest and during exercise. An 8.4-MHz curvilinear transducer was applied over the larynx and four acoustic windows evaluated. Subjectively assessed increased echogenicity of this muscle had a sensitivity of 94.6% and a specificity of 94.5% for detecting laryngeal hemiplegia.<sup>1</sup> The reported advantages of ultrasonography are that it is widely available, noninvasive, and depicts a real-time view of the tissues.

The supraspinous ligament has been evaluated in horses with and without back pathology using ultrasonography. Linear and sector array transducers (5–10 MHz) were used to obtain longitudinal and cross-sectional views of the supraspinous ligament, and lesions were identified and categorized. All 39 horses studied had at least one site of supraspinous ligament desmitis, and there was no association between desmitis lesions and clinical signs of pain that could be localized to this region.<sup>2</sup>

Ultrasonography has been used to diagnose syringohydromyelia and segmental hypoplasia of the lumbar spinal cord in a 4-day-old Holstein Friesian calf that had been unable to stand since birth. The calf was placed in right lateral recumbency, and lumbosacral flexion was induced to enable widening of ultrasound windows. Diagnostic images of the lumbar spinal cord were obtained in sagittal and transverse orientations at the lumbosacral junction (L6-S1), as well as the proximal lumbar intervertebral junctions up to L2-L3, using a 6- to 10-MHz linear transducer.<sup>3</sup>

An ultrasound imaging technique of the tympanic bullae has been developed for the diagnosis of otitis media in calves.<sup>4</sup> A 7.5-MHz linear probe is applied to the base of the ear without the use of coupling gel and with the calf in a standing position. The probe is applied ventral to the base of the ear and caudal to the mandible. Abnormalities detected included anechoic to hyperechoic content; trabeculae lysis; and thinning, deformation, and rupture of the bulla wall. In calves, ultrasonography has also been used to identify the femoral nerve in calves to assist in the diagnosis of spastic paresis cases that involve the quadriceps muscle (such as in Belgian Blue cattle with a cranially directed hyperextension of the limb) instead of the more common form of spastic paresis that involves the gastrocnemius muscle and a caudally directed hyperextension of the hindlimb.<sup>5,6</sup> Placement of a 5-MHz curved linear array transducer over the dorsal paravertebral space between the fifth and sixth lumbar transverse processes provided the best view of the femoral nerve and permitted selective blocking of the femoral nerve using 4% procaine solution.

## ENDOSCOPY (RHINOLARYNGOSCOPY)

Endoscopy (rhinolaryngoscopy) is now a routine technique for the examination of horses with suspected laryngeal hemiplegia, which is a distal axonopathy of the left recurrent laryngeal nerve.

Endoscopic examination of the epidural and subarachnoid space from the atlantooccipital space to the eighth cervical nerve has been performed safely in healthy adult horses.<sup>7</sup> The procedure was performed under general anesthesia. The technique may have clinical utility in the diagnosis of cervical vertebral stenotic myelopathy because physical constraints do not currently permit imaging of the caudal cervical vertebral column by MRI or CT.

Endoscopy has also been used to examine the anatomic structures in the sacrococcygeal area of adult cattle. Cows were restrained and sedated with xylazine (0.03 mg/kg, intravenously). A lidocaine epidural was administered and a flexible endoscope (outside diameter, 2.3 mm) introduced through an introducer set and a small amount of air introduced. The procedure permitted visualization of blood vessels, connective tissue, fat, nerves, and the spinal dura mater.<sup>8</sup>

## OPHTHALMOSCOPY

Ophthalmoscopy for the examination of the structures of the eye is important in the diagnosis of diseases affecting the optic nerve such as in vitamin A deficiency and the optic disc edema (papilledema) associated with diffuse cerebral edema.

## ELECTROMYOGRAPHY

Electromyographic needle examination is a technique that records the electrical activity generated by single muscle fibers and the summated electrical activity of muscle fibers in individual motor units. The technique involves inserting a recording needle into the muscle of interest and recording the resultant EMG. Typically, animals are unsedated and restrained in stocks or a chute. An abnormal EMG signals include short-duration and low-amplitude motor unit action potentials, which indicate diseased muscle fibers of early or incomplete reinnervation after denervation. Other abnormalities include the presence of fibrillation potentials, positive sharp waves, and complex repetitive discharges that occur when the skeletal cell membrane becomes unstable because of denervation or myopathy.

EMG provides a more practical diagnostic test than electroencephalography (EEG) and provides a sensitive indicator of neurologic dysfunction and assists in the neuroanatomic localization of the lesion.<sup>8</sup> It is especially useful for evaluating peripheral nerve injury and diagnosing hyperkalemic

periodic paresis in horses and should be helpful in additional studies on calving-associated paralysis and other peripheral nerve injuries in cattle. EMG can discriminate between lower motor neuron and myogenic disorders, and **nerve conduction studies** can differentiate axonal loss from demyelination. In addition, repetitive stimulation can provide information regarding neuromuscular transmission. Reference values for motor nerve conduction velocity have been developed for calves and, as expected, conduction velocities are related to the nerve fiber diameter.<sup>10</sup>

**Somatosensory evoked potentials** of the trigeminal complex using the infraorbital nerve have been used in horses to assist in the diagnosis of idiopathic head-shaking. An electrical surface stimulus is applied at a set stimulus rate but variable stimulus currents to a focal area of the buccal mucosa. Recording electrodes placed along the sensory pathway of the trigeminal complex detect the presence or absence of **sensory nerve action potentials** (SNAPs) and nerve conduction velocity.<sup>11</sup> The threshold current required to trigger a SNAP provides clinically useful information about the sensitivity of the anatomic location to stimuli.

EMG has been coupled with transcranial magnetic stimulation to induce magnetic **motor evoked potentials** in the horse. This provides a useful noninvasive evaluation of cervical spinal cord dysfunction in horses with radiologic abnormalities of the cervical vertebrae by detecting the presence of a neuropathy involving the descending motor tracts. However, EMG does not provide information on upper motor neurons; therefore it is not useful in the clinical evaluation of horses suspected to have hindlimb neurologic deficits caused by cervical spinal cord disease.<sup>9</sup>

## ELECTROENCEPHALOGRAPHY

EEG has not been used to any significant degree in large animals. It requires sophisticated equipment, a quiet dim environment free from electrical interference, and a quiet patient that has minimal muscular activity. Because of the difficulty in obtaining quality recordings in a conscious large animal, it is preferred that the animal is sedated or anesthetized for the recording, which confounds interpretation of the EEG pattern depending on the anesthetic protocol. Thorough and repeated observations of simultaneously recorded EEG and video may facilitate interpretation of the EEG,<sup>12,13</sup> but the clinical utility of EEG remains uncertain in large animals exhibiting nervous signs consistent with an intracranial lesion. Therefore EEG has been primarily used in large animals as an antemortem or research tool, and its use will probably remain as a complementary test to other neurologic examinations and diagnostic tests at referral institutions.

Recommendations have been made to standardize EEG techniques for animals; these typically involve meticulous preparation of the recording sites on the scalp, and placement of electrodes over the left and right frontal areas, the left and right occipital areas, and the vertex area, and a reference electrode is placed behind the tip of the nose. The addition of other recording sites increases the ability to localize a focal lesion.<sup>12</sup> Neurologic disease is associated with changes in EEG frequency or amplitude, or both, and frequency changes are a more reliable indicator of disease. In general, focal EEG abnormalities indicate a focal lesion in the cortex, whereas diffuse EEG abnormalities indicate diffuse cortical or subcortical lesions or focal subcortical lesions.

EEG has been used to study epilepsy in goats and cattle, congenital hydranencephaly and hydrocephalus in cattle, scrapie in sheep, thiamine-responsive PEM in cattle, and BSE in cattle. When performed under controlled conditions, EEG has been shown to be a useful diagnostic tool for the early diagnosis of equine intracranial diseases, with adequate sensitivity and specificity.

## ELECTRORETINOGRAPHY

Flash electroretinography (ERG) is a recording of rod and cone function of the eyes. The animal is sedated (usually with xylazine) and topical 0.5% proparacaine is applied to both eyes to permit the placement of a contact lens electrode on both eyes. Subcutaneous electrodes are then placed at the lateral canthus and midline at the nostrils to provide reference and ground electrodes, respectively. A period of dark adaptation is then implemented, and a standardized flash sequence applied.<sup>10</sup> Decreased B-wave amplitudes during flash ERG have been identified in horses with equine motor neuron disease and attributed to lipofuscin deposits on the retina.

## BRAINSTEM AUDITORY EVOKED POTENTIALS

The brainstem auditory evoked potential (BAEP) is a recording of the electrical activity of the brainstem following an acoustic stimulation; as such, BAEP can be used to evaluate the integrity of the auditory pathway. The use of the BAEP permits differentiation of cochlear pathology (including otitis media/interna) from retrocochlear pathology (auditory nerve or brainstem).

BAEP is obtained on a sedated patient (xylazine is frequently used) by recording neuroelectrical activity from generators in the auditory pathway immediately following an acoustic click stimulus, and BAEP waveforms for horses,<sup>14</sup> ponies, foals,<sup>15,16</sup> and calves have been recorded. Such recordings can be useful in evaluating horses suspected

to have deafness, vestibular disease, brain-stem disease, or temporohyoid osteoarthropathy,<sup>17</sup> as well as calves with otitis media and facial paralysis,<sup>18</sup> and to monitor the response to treatment.<sup>17</sup>

## INTRACRANIAL PRESSURE MEASUREMENT

Intracranial pressure has been measured in neonatal foals, although the clinical utility of such measurements in foals has not been demonstrated. Increases in intracranial pressure can cause decreases in cerebral perfusion pressure and irreversible injury to the CNS.

The head-down position in the horse increases the hydrostatic pressure gradient between the heart and brain, increasing mean intracranial pressure in isoflurane-anesthetized horses from 31 to 55 mm Hg when placed in the Trendelenburg position to facilitate abdominal surgery.<sup>19</sup> Similar directional changes in intraocular pressure were measured in adult horses sedated with detomidine.<sup>20</sup> Hydrostatic pressure effects on intracranial pressure have also been observed in isoflurane-anesthetized adult cattle.<sup>21</sup> In other words, large animals suspected to have increased intracranial pressure should be encouraged to keep their heads elevated to prevent cerebral edema formation. In addition, head position must be standardized when intracranial pressure is measured.

## KINETIC GAIT ANALYSIS

Lameness is common in large animals and usually results in asymmetric gait abnormalities; lameness caused by selected musculoskeletal abnormalities is discussed in [Chapter 15](#). Ataxia caused by spinal cord disease also causes gait abnormalities that are usually symmetric and particularly evident in the hindlimbs. Diagnostic differentiation of lameness and neurologic causes of gait abnormalities can be challenging, even to experienced practitioners. Consequently, kinetic gait analysis offers an objective quantitative test that may assist in the differentiation of neurologic from musculoskeletal causes for a gait abnormality. Two indices appear to have the greatest clinical utility in identifying the presence of a neurologic gait abnormality: higher lateral force peak and increased variation in vertical force peak in both hindlimbs.<sup>22</sup>

## FURTHER READING

- Aleman M. Miscellaneous neurologic or neuromuscular disorders of horses. *Vet Clin North Am Equine Pract.* 2011;27:481-506.
- Constable PD. Clinical examination of the ruminant nervous system. *Vet Clin North Am Food Anim Pract.* 2004;20:215-230.
- MacKay RJ. Brain injury after head trauma: pathophysiology, diagnosis, and treatment. *Vet Clin North Am Equine Pract.* 2004;20:199-216.

Scott PR. Diagnostic techniques and clinicopathologic findings in ruminant neurologic disease. *Vet Clin North Am Food Anim Pract.* 2004;20:215-230.

## REFERENCES

- Chalmers HJ, et al. *Vet Radiol Ultrasound.* 2012;53:660.
- Henson FMD, et al. *BMC Vet Res.* 2007;3:3.
- Testoni S, et al. *J Vet Intern Med.* 2012;26:1485.
- Gosselin VB, et al. *J Vet Intern Med.* 2014;28:1594.
- De Vlaminck C, et al. *Vet Rec.* 2013;196:451.
- De Vlaminck CA, et al. *Am J Vet Res.* 2013;74:750.
- Prange T, et al. *Equine Vet J.* 2011;43:404.
- Franz S, et al. *Am J Vet Res.* 2008;69:894.
- Mitchell CW, et al. *Vet Radiol Ultrasound.* 2012;53:613.
- Schenk HC, et al. *J Vet Intern Med.* 2014;28:646.
- Aleman M, et al. *J Vet Intern Med.* 2014;28:250.
- Williams DC, et al. *J Vet Intern Med.* 2008;22:630.
- Finno CJ, et al. *Vet Ophthalmol.* 2012;15(suppl 2):3.
- Aleman M, et al. *J Vet Intern Med.* 2014;28:1310.
- Aleman M, et al. *J Vet Intern Med.* 2014;28:1318.
- Lecoq L, et al. *J Vet Intern Med.* 2015;29:362.
- Aleman M, et al. *J Vet Intern Med.* 2008;22:1196.
- Kawasaki Y, et al. *Vet Rec.* 2009;165:212.
- Brosnan RJ, et al. *Am J Vet Res.* 2008;69:737.
- Komaromy AM, et al. *Am J Vet Res.* 2006;67:1232.
- Arai S, et al. *J Vet Med Sci.* 2006;68:337.
- Ishihara A, et al. *J Am Vet Med Assoc.* 2009;234:644.

## Diffuse or Multifocal Diseases of the Brain and Spinal Cord

There are many different causes of diffuse or multifocal nervous system disease in large domestic animals.

- Infectious causes include bacteria, viruses, fungi, and helminth, arthropod, and protozoan parasites.
- Exogenous substances such as lead, salt, selenium, organophosphate insecticides, feed additives such as urea, poisonous plants, and many other chemicals are common causes.
- Endogenous substances such as products of disease in other body systems or of abnormal metabolism such as bacterial toxins, ammonia, and carbon dioxide can cause abnormalities of the nervous system.
- Metabolic and nutritional causes include ischemia secondary to cardiopulmonary disease; hypoglycemia; hypomagnesemia; copper deficiency in pregnant animals; and hyper D-lactatemia in calves, lambs, and kids with neonatal diarrhea and adult ruminants with grain overload.
- Chronic acidemia associated with diarrhea can cause mental depression and ataxia (whereas experimentally induced acute acidemia does not cause mental depression in neonatal calves).
- Idiopathic diseases account for several diseases of the spinal cord of horses.
- Malformation occurs primarily in the developing fetus and results in

congenital nervous system disease, which is usually present at birth. Many different teratogens can cause congenital defects. In some cases of inherited disease, the clinical signs do not manifest until sometime after birth.

## Responses of Central Nervous System to Injury

The CNS may respond to injury by morphologic changes that include cerebral edema and brain swelling, inflammation, and demyelination. Malformations occur when the CNS is affected during fetal life.

The remainder of this chapter will present the general clinical aspects of the diseases of the nervous system according to anatomic sites and causative agent. The salient features of the etiology, pathogenesis, clinical findings, diagnosis, and treatment of these clinicoanatomic diseases are described. Cerebral hypoxia, hydrocephalus, cerebral edema, meningitis, encephalitis, myelitis, encephalomalacia, and myelomalacia are common to many diffuse or multifocal diseases of the nervous system and are described here.

## CEREBRAL HYPOXIA

Cerebral hypoxia occurs when the supply of oxygen to the brain is reduced for any reason. An acute or chronic syndrome develops depending on the acuteness of the deprivation. Initially there are irritation signs followed terminally by signs of loss of function.

## ETIOLOGY

All forms of hypoxia, including anemic, anoxic, histotoxic, and stagnant forms cause some degree of cerebral hypoxia, but signs referable to cerebral dysfunction occur only when the hypoxia is severe. Hypoxia of the brain may be secondary to a general systemic hypoxia or be caused by lesions restricted to the cranial cavity.

## Cerebral Hypoxia Secondary to General Hypoxia

- Poisoning by hydrocyanic acid or nitrite
- Acute heart failure in severe copper deficiency in cattle
- Anesthetic accidents
- Terminally in pneumonia, congestive heart failure
- During or at birth in foals, hypoxic-ischemic encephalopathy in foals (also known as neonatal encephalopathy, perinatal asphyxia, dummy foal syndrome, or neonatal maladjustment syndrome),<sup>1</sup> or intrapartum hypoxia in calves and lambs caused by prolonged parturition

## Cerebral Hypoxia Secondary to Intracranial Lesion

- In increased intracranial pressure
- In brain edema



## PATHOGENESIS

The CNS is extremely sensitive to hypoxia, and degeneration occurs if the deprivation is extreme and prolonged for more than a few minutes. The effects of the hypoxia vary with the speed of onset and with the severity. When the onset is sudden, there is usually a transitory period during which excitation phenomena occur, and this is followed by a period of loss of function. If recovery occurs, a second period of excitation usually develops as function returns. In more chronic cases the excitation phase is not observed, and the signs are mainly those of loss of function. These signs include dullness and lethargy when deprivation is moderate and unconsciousness when it is severe. All forms of nervous activity are depressed, but the higher centers are more susceptible than medullary centers and the pattern of development of signs may suggest this.

## CLINICAL FINDINGS

Acute and chronic syndromes occur depending on the severity of the hypoxia. Acute cerebral hypoxia is manifested by a sudden onset of signs referable to paralysis of all brain functions, including tetraparesis and unconsciousness. Muscle tremor, beginning about the head and spreading to the trunk and limbs, followed by recumbency, clonic convulsions, and death or recovery after further clonic convulsions is the most common pattern, although affected animals may fall to the ground without premonitory signs. In chronic hypoxia, there is lethargy, dullness, ataxia, weakness, and blindness and in some cases muscle tremor or convulsions. In both acute and chronic hypoxia, the signs of the primary disease will also be evident. Cerebral hypoxia of fetal calves is thought to be a cause of weakness and failure to suck after birth, leading to the eventual death of the calf from starvation. Such hypoxia can occur during the birth process, especially if it is difficult or delayed, or during late pregnancy.

## CLINICAL PATHOLOGY AND NECROPSY FINDINGS

There is no distinctive clinical pathology or characteristic necropsy lesion other than those of the primary disease.

### DIFFERENTIAL DIAGNOSIS

Clinically there is little to differentiate cerebral hypoxia from hypoglycemia or polioencephalomalacia in which similar signs occur. Irritation and paralytic signs follow one another in many poisonings including lead and arsenic and in most diffuse diseases of the brain including encephalitis and encephalomalacia. The differential diagnosis of cerebral hypoxia depends on the detection of the cause of the hypoxia.

## TREATMENT

An increase in oxygen delivery is essential and can usually only be provided by removing the causative agent. A respiratory stimulant (the most effective is doxapram, 2 mg/kg BW, intravenously)<sup>2</sup> may be advantageous in acute cases, and artificial respiration may be necessary and effective.

## INCREASED INTRACRANIAL PRESSURE, CEREBRAL EDEMA, AND BRAIN SWELLING

Diffuse cerebral edema and brain swelling usually occur acutely and cause a general increase in intracranial pressure. Cerebral edema is rarely a primary disease, but is commonly an accompaniment of other diseases. Cerebral edema is often a transient phenomenon and may be fatal, but complete recovery or recovery with residual nervous signs also occurs. It is manifested clinically by blindness, opisthotonus, muscle tremor, paralysis, and clonic convulsions.

## ETIOLOGY

Diffuse cerebral edema and brain swelling may be **vasogenic**, when there is increased permeability of capillary endothelium, and **cytotoxic** when all the elements of brain tissue, glia, neurons, and endothelial cells undergo swelling. Causes include the following.

### Vasogenic Edema

- Brain abscess, neoplasm, hemorrhage, lead encephalopathy, purulent meningitis
- Minor edema after most traumatic injuries, in many encephalitides and many poisonings, including propylene glycol in the horse; probably contributes to the pathogenesis
- Accidental intracarotid injection of promazine in horses
- Leukoencephalomalacia in horses caused by fumonisin consumption
- Septicemia in neonatal foals

### Cytotoxic Edema

- Hypoxia
- PEM of ruminants (thiamine deficiency or sulfur toxicosis)
- Salt poisoning of swine

### Interstitial Edema

- Hydrocephalus

## PATHOGENESIS

### Cerebral Edema and Brain Swelling

This disease is potentially life-threatening because of the limited ability for accommodation of increased volume within the confines of the dura and the cranium. CNS parenchyma does not possess a lymphatic system, and the interstitial space between cells, especially in the gray matter, is much narrower than in other tissues. When CNS

edema develops, of necessity it largely accumulates within cells, although interstitial fluid will form if cells lyse or if the edema is severe.

Cerebral edema usually occurs to some degree in all pathologic states, whether degenerative or inflammatory or traumatic or neoplastic. Edema around chronic, focal lesions such as abscesses, parasitic cysts, and primary or metastatic tumors in white matter often produce marked swelling. Cerebral hemispheric swelling compresses the underlying brainstem, flattening the rostral colliculi and distorting the aqueduct. As the swollen brain expands and fills the confines of the calvaria, some regions are prone to herniation. If this occurs, the accompanying blood vessels are likely to become occluded, which may result in hemorrhage or infarction. Commonly with brain swelling the caudal lobe of the cerebellar vermis protrudes as a flattened lip over the medulla oblongata toward the foramen magnum.

**In vasogenic edema** the primary insult is to the wall of cerebral capillaries, allowing the escape of plasma fluid and proteins under the hydrostatic pressure of the circulation. The inciting vascular injury may be brain or spinal cord trauma, vasculitis, a neoplasm, or a cerebrovascular accident. Vasogenic edema affects predominantly the white matter, in which fluid accumulates within the cytoplasm of astrocytes and spreads in the interstitial spaces. Vasogenic edema moves over very long distances and from one hemisphere to the other via the corpus callosum. A chronic epidural abscess involving the frontal lobe can produce sufficient brain swelling from vasogenic edema to induce herniation of the occipital cortex beneath the tentorium cerebelli.

**Cytotoxic edema** results from an injury to a glial cell that disturbs osmoregulation of that cell by depletion of energy stores and failure of energy-dependent ionic pumps. This leads to cell swelling with fluid and differs from edema in other tissues in which fluid accumulation is interstitial. Cytotoxic edema reflects a specific cellular insult and may result from ischemia or hypoxia, nutritional deficiency, an intoxication, or an inherited metabolic abnormality. Brain swelling from cytotoxic edema is less dramatic than that seen in vasogenic edema. It may affect just the gray matter, just the white matter, or both.

The ECF volume in vasogenic edema is increased by the edema fluid, which is a plasma filtrate containing plasma protein. In cytotoxic edema it is the cellular elements themselves that increase in size. In hypoxia this is because of failure of the adenosine triphosphate (ATP)-dependent sodium pump within the cells. As a result sodium accumulates within the cells and water follows to maintain osmotic equilibrium. In PEM and salt poisoning, the edema of the

brain is primary. In salt poisoning in pigs there is an increase in concentration of cations in brain tissue with a sudden passage of water into the brain to maintain osmotic equilibrium. The cause of the edema in PEM of ruminants, associated with a thiamine inadequacy, is unknown. When promazine is injected accidentally into the carotid artery of the horse, it produces a vasogenic edema and infarction generally, but especially in the thalamus and corpora quadrigemina on the injected side. The vasogenic edema surrounding an abscess is localized and is not evident in the white matter.

Cerebral edema and cerebellar herniation have been described in neonatal foals admitted to an intensive care unit for treatment. All foals had septicemia. It was suggested that hypoglycemia, hypoxia, or the alterations in cerebral blood flow associated with septicemia might have initiated injury to cell membranes, resulting in vascular damage and subsequent edema. It is hypothesized that cerebellar herniation occurs in neonatal foals with sepsis because of the inelastic nature of the dural folds and the anatomic rigidity of the neonatal equine skull. This is in contrast to the human infant, in whom cerebral edema occurs in bacterial meningitis but cerebral or cerebellar herniation is not normally a feature. The relatively small brain of the newborn foal is only 1% of total body mass compared with the human infant, which is 12% and in which the brain is enclosed within a large but relatively thin calvarium with sutures that, in the preterm infant at least, can be separated by excess internal pressure.

An increase in intracranial pressure occurs suddenly and, as in hydrocephalus, there is a resulting ischemic anoxia of the brain caused by compression of blood vessels and impairment of blood supply. This may not be the only factor that interferes with cerebral activity in PEM and salt poisoning. The clinical syndrome produced by the rapid rise in intracranial pressure is manifested by involuntary movements such as tremor and convulsions followed by signs of weakness. If the compression of the brain is severe enough and of sufficient duration, ischemic necrosis of the superficial layers of the cortical gray matter may occur, resulting in permanent nervous defects in those animals that recover. Opisthotonus and nystagmus are commonly observed and are probably caused by the partial herniation of the cerebellum into the foramen magnum.

### CLINICAL FINDINGS

Although the rise of intracranial pressure in diffuse edema of the brain is usually more acute than in hydrocephalus, the development of clinical signs takes place over a period of 12 to 24 hours and nervous shock does not occur. There is central blindness, and periodic attacks of abnormality occur in which **opisthotonus**, **nystagmus**,

**muscle tremor**, and **convulsions** are prominent.

In the intervening periods, the animal is dull, depressed, and blind, and optic disc edema may be present. The involuntary signs of tremor, convulsions, and opisthotonus are usually not extreme, but this varies with the rapidity of onset of the edema. Because of the involvement of the brainstem, in severe cases muscle weakness appears, the animal becomes ataxic, goes down and is unable to rise, and the early signs persist. Clonic convulsions occur terminally, and animals that survive may have residual defects of mentality and vision.

### CLINICAL PATHOLOGY

Clinicopathologic observations will depend on the specific disease causing the edema.

### NECROPSY FINDINGS

Microscopically the gyri are flattened and the cerebellum is partially herniated into the foramen magnum with consequent distortion of its caudal aspect. The brain has a soft, swollen appearance and tends to sag over the edges of the cranium when the top has been removed. Caudal portions of the occipital lobes herniate ventral to the tentorium cerebelli.

### DIFFERENTIAL DIAGNOSIS

Diffuse brain edema causes a syndrome not unlike that of encephalitis, although there are fewer irritation phenomena. Differentiation from encephalomalacia and vitamin A deficiency may be difficult if the history does not give a clue to the cause of the disease. Metabolic diseases, particularly pregnancy toxemia, hypomagnesemic tetany of calves, and lactation tetany, resemble it closely, as do some cases of acute ruminal impaction. In the history of each of these diseases, there are distinguishing features that aid in making a tentative diagnosis. Some of the poisonings, particularly lead, organic mercurial and arsenicals, and enterotoxemia associated with *Clostridium perfringens* type D produce similar nervous signs, and gut edema of swine may be mistaken for diffuse cerebral edema.

### TREATMENT

Decompression of the brain is desirable in acute edema. The treatment will depend in part on the cause; the edema associated with PEM will respond to early treatment with thiamine. In general terms, edema of the brain responds to parenteral treatment with hypertonic solutions (mannitol and hypertonic sodium chloride are most often used) and corticosteroids (specifically dexamethasone). Hypertonic solutions are most applicable to cytotoxic edema and corticosteroids to vasogenic edema. This is in addition to treatment for the primary cause of the disease.

Hypertonic solutions open the blood-brain barrier by shrinking endothelial cells and widening the tight junctions.<sup>3</sup> The magnitude of the opening is dependent on the type of hypertonic solution (mannitol and hypertonic saline are used most frequently with mannitol as the first choice treatment) and the achieved plasma concentration. The magnitude of the opening is also dependent on age, with neonates having a “leakier” blood-brain barrier than adults.<sup>3,4</sup> This supports clinical observations that mannitol treatment appears to be more successful in treating neonates suspected to have cerebral edema than adults. The preferred treatment is mannitol given as a 20% solution in a series of bolus intravenous infusions of 0.25 to 1 g/kg BW every 4 to 6 hours. The suggested dose rate has been derived from those recommended for humans and dogs but is very expensive. There are dangers with mannitol: it should not be repeated often, it must not be given to an animal in shock, and it should be given intravenously slowly. A recent meta-analysis suggested that hypertonic saline (1.5–23.5% NaCl at 10–30 mL/kg BW total dose) may be as effective as 20% mannitol in the treatment of cerebral edema, with 7.5% NaCl as the most commonly used osmolality.<sup>5</sup>

Dexamethasone administration (1 mg/kg BW intravenously every 24 hours) is no longer recommended for the treatment of cerebral edema in human infants,<sup>6</sup> and its efficacy in large animals with cerebral edema is uncertain. Dexamethasone is thought to decrease cerebral edema and CSF production and inhibit tumor-induced angiogenesis in patients with intracranial tumors. Hypertonic glucose given intravenously is not recommended because an initial temporary decompression is followed after a 4- to 6-hour interval by a return to pretreatment CSF pressure when the glucose is metabolized.

Diuretics usually produce tissue dehydration too slowly to be of much value in acute cases, but they may be of value as an adjunct to hypertonic solutions or in early or chronic cases. The removal of CSF from the cisterna magna in an attempt to provide relief may cause complications. In some cases the removal of 25 to 75 mL of CSF provides some temporary relief, but the condition becomes worse later because portions of the swollen brain herniate into the foramen magnum. There is no published information available on how much CSF can be safely removed; therefore recommendations cannot be made.

### REFERENCES

1. Ringger NC, et al. *J Vet Intern Med.* 2011;25:132.
2. Bleul U, et al. *Theriogenology.* 2010;73:612.
3. Stonestreet BS, et al. *Am J Physiol Regul Integr Comp Physiol.* 2006;291:R1031.
4. Bengtsson J, et al. *Br J Pharmacol.* 2009;157:1085.
5. Mortazarvi MM, et al. *J Neurosurg.* 2012;116:210.
6. Anon. *Pediatr Crit Care Med.* 2012;13:S61.

## HYDROCEPHALUS

Obstructive hydrocephalus may be congenital or acquired and is manifested in both cases by a syndrome referable to a general increase in intracranial pressure. Irritation signs of mania, head-pressing, muscle tremor, and convulsions occur when the onset is rapid, and signs of paralysis including dullness, blindness, and muscular weakness are present when the increased pressure develops slowly.

### ETIOLOGY

Obstructive hydrocephalus may be congenital or acquired, but in both instances it is caused by defective drainage or absorption of CSF. In the congenital disease, there is an embryologic defect in the drainage canals and foramina between the individual ventricles or between the ventricles and the subarachnoid space, or in the absorptive mechanism, the arachnoid villi.

### Congenital Hydrocephalus

Causes include the following:

- Alone, with lateral narrowing of the mesencephalon
- Inherited defects of Hereford, Holstein, Ayrshire, and Jersey cattle
- Inherited combined defects with chondrodysplasia, or in white Shorthorn cattle combined with hydrocephalus, microphthalmia, and retinal dysplasia
- Virus infections of the fetus suggest themselves as possible causes of embryologic defects in the drainage system, but there are no verified examples of this; the cavitation of brain tissue and subsequent accumulation of fluid, hydranencephaly, which occurs after infection with bluetongue virus in lambs, and Akabane virus in calves, is compensatory, not obstructive
- Vitamin A deficiency may contribute
- Other occurrences, sometimes at high levels of prevalence, but without known cause

### Acquired Hydrocephalus

Causes include the following:

- Hypovitaminosis A in young growing calves causing impaired absorption of fluid by the arachnoid villi
- Cholesteatoma in choroid plexuses of the lateral ventricles in the horse; these may produce an acute, transient hydrocephalus on a number of occasions before the tumor reaches sufficient size to cause permanent obstruction
- Other tumor or chronic inflammatory lesion obstructing drainage from the lateral ventricles

### PATHOGENESIS

Increased intracranial pressure in the fetus and before the syndesmoses of the skull have

fused causes hydrocephalus with enlargement of the cranium. After fusion of the suture lines the skull acts as a rigid container, and an increase in the volume of its contents increases intracranial pressure. Although the increase in volume of the contents may be caused by the development of a local lesion such as an abscess, tumor, hematoma or cestode cyst, which interferes with drainage of the CSF, the more common lesion is a congenital defect of CSF drainage.

Clinical and pathologic hydrocephalus has been produced experimentally in animals by creating granulomatous meningitis. The clinical signs included depression, stiffness of gait, recumbency, and opisthotonus with paddling convulsions. The general effects in all cases are the same, the only difference is that local lesions may produce localizing signs as well as signs of increased intracranial pressure. These latter signs are caused by compression atrophy of nervous tissue and ischemic anoxia caused by compression of blood vessels and impairment of blood supply to the brain.

In congenital hydrocephalus the signs observed are usually those of paralysis of function, whereas acquired hydrocephalus, being more acute, is usually manifested first by irritation phenomena followed by signs of paralysis. Edema of the optic papilla is a sign of increased intracranial pressure and may be detected using an ophthalmoscope. Bradycardia occurs inconstantly and cannot be considered to be diagnostic.

### CLINICAL FINDINGS

In acquired hydrocephalus there is, in most cases, a gradual onset of general paresis. Initially there is depression, disinclination to move, central blindness, an expressionless stare, and a lack of precision in acquired movements. A stage of somnolence follows and is most marked in horses. The animal stands with half-closed eyes, lowered head, and a vacant expression and often leans against or supports itself on some solid object. Chewing is slow, intermittent, and incomplete, and animals are often observed standing with food hanging from their mouths. The reaction to cutaneous stimulation is reduced, and abnormal postures are frequently adopted. Frequent stumbling, faulty placement of the feet, and incoordination are evidenced when the animal moves, and circling may occur in some cases. Bradycardia and cardiac arrhythmia have been observed.

Although the emphasis is on depression and paresis, signs of brain irritation may occur, particularly in the early stages. These signs often occur in isolated episodes during which a wild expression, charging, head-pressing, circling, tremor, and convulsions appear. These episodes may be separated by quite long intervals, sometimes of several weeks' duration. In vitamin A deficiency in calves, blindness and papilledema are the

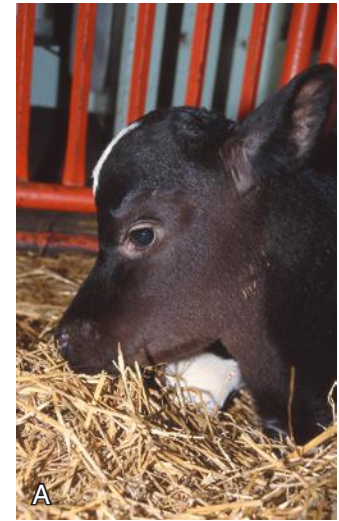

**Fig. 14-2** A, Holstein Friesian calf with hydrocephalus caused by in utero infection with bovine viral diarrhea virus. The calf was able to suckle but appeared to have diminished responsiveness to its environment. B, Piglet with meningocele secondary to in utero hydrocephalus.

early signs and an acute convulsive stage occurs terminally.

Congenitally affected animals are usually alive at birth but are unable to stand and most die within 48 hours. The cranium is sometimes domed, the eyes protrude, and nystagmus is often evident (Fig. 14-2). Meningocele is an infrequent accompaniment.

### CLINICAL PATHOLOGY

Examination of the composition and pressure of the CSF will be of value. The fluid is usually normal biochemically and cytologically but the pressure is increased. A marked increase in serum muscle enzyme activity has been observed in calves with congenital hydrocephalus, caused probably to an accompanying muscular dystrophy. Convulsions, if they occur, may contribute to this increase.

### NECROPSY FINDINGS

On necropsy the cranium may be enlarged and soft in congenital hydrocephalus. The ventricles are distended with CSF under pressure and the overlying cerebral tissue is thinned if the pressure has been present for some time.



## DIFFERENTIAL DIAGNOSIS

Congenital hydrocephalus resembles vitamin A deficiency in newborn pigs, toxoplasmosis, and hydranencephaly if there is no distortion of the cranium.

Acquired hydrocephalus needs to be differentiated from other diffuse diseases of the brain, including encephalitis and encephalomalacia, and from hepatic dystrophies, which resemble it very closely. In these latter diseases, there may be other signs of diagnostic value, including fever in encephalitis and jaundice in hepatic dystrophy. In most cases it is necessary to depend largely on the history and recognition of individual disease entities.

## MENINGITIS

Inflammation of the meninges occurs most commonly as a complication of a preexisting disease. Meningitis is usually associated with a bacterial infection and is manifested clinically by fever, cutaneous hyperesthesia, and rigidity of muscles. Although meningitis may affect the spinal cord or brain specifically, it commonly affects both and is dealt with here as a single entity. Meningoencephalitis is common in neonatal farm animals. Primary bacterial meningitis is extremely rare in adult farm animals, with the exception of listeriosis and *H. somni* (formerly *Haemophilus somnus*) infection, although the latter is more a vasculitis than a primary meningitis. The possibility of immunodeficiency should be considered in adult horses with bacterial meningitis. Compared with adults, bacterial meningitis is more common in neonates because their immune system is immature, the blood-brain barrier is incomplete, and umbilical infections are common, providing a nidus of infection.

## ETIOLOGY

Most significant meningitides are bacterial, although most viral encephalitides have some meningitic component.

### Cattle

- Viral diseases including bovine malignant catarrh, sporadic bovine encephalomyelitis
- Bacterial diseases including listeriosis, *H. somni*, chronic lesions elsewhere in the body possibly associated with meningitis in adult animals; rarely tuberculosis
- Facial paralysis syndrome of calves in the Franklin district of New Zealand<sup>1</sup>

### Sheep

- Melioidosis, *S. aureus* (tick pyemia) in newborn lambs
- *Pasteurella multocida* in lambs
- *Mannheimia (Pasteurella) haemolytica* in lambs

### Horses

- Strangles, *Pasteurella haemolytica* (also donkeys and mules), *Streptococcus suis*, *S. equi*, *Actinomyces* spp., *Klebsiella pneumoniae*, *Staphylococcus aureus*,<sup>2</sup> coagulase-negative staphylococci, *Anaplasma phagocytophilum* (equine granulocytic ehrlichiosis, formerly named *Ehrlichia equi*), *Borrelia burgdorferi*,<sup>3</sup> *Sphingobacterium multivorum*, and *Cryptococcus neoformans*.

### Pigs

- Glasser's disease, erysipelas, salmonellosis; *S. suis* type 2 in weaned and feeder pigs

Coliform and streptococcal septicemias are probably the most common causes of meningitis in neonatal farm animals. The infection may originate from omphalophlebitis, bacteremia, or bacterial translocation across the gastrointestinal tract in neonates less than 24 hours of age or with enteritis. Septicemia occurs in all species, especially calves, and may be accompanied by polysynovitis, endocarditis, and hypopyon. The causative bacteria are usually a mixed flora.

Hematogenous infection occurs from other sites also. In neonatal animals, some of the common infections include the following:

- **Calf:** *Escherichia coli*; the disease is most common in calves under several days of age and can occur in less than 24 hours after birth; failure of transfer of colostral immunoglobulins is a common contributing factor
- **Piglet:** *S. zooepidemicus*, *S. suis* type 1
- **Lamb:** *S. zooepidemicus*

## PATHOGENESIS

Inflammation of the meninges causes local swelling and interference with blood supply to the brain and spinal cord but as a rule penetration of the inflammation along blood vessels and into nervous tissue is of minor importance and causes only superficial encephalitis. Failure to treat meningitis associated with pyogenic bacteria often permits the development of a fatal choroiditis, with exudation into CSF, and ependymitis. There is also inflammation around the nerve trunks as they pass across the subarachnoid space. The signs produced by meningitis are thus a combination of those resulting from irritation of both central and peripheral nervous systems. In spinal meningitis, there is muscular spasm with rigidity of the limbs and neck, arching of the back, and hyperesthesia with pain on light touching of the skin. When the cerebral meninges are affected, irritation signs, including muscle tremor and convulsions, are the common manifestations. Because meningitis is usually bacterial in origin, fever and toxemia can be expected if the lesion is sufficiently extensive.

Defects of drainage of CSF occur in both acute and chronic inflammation of the meninges and produce signs of increased intracranial pressure. The signs are general although the accumulation of fluid may be localized to particular sites such as the lateral ventricles.

A newly described mild nonsuppurative meningitis is associated with facial paralysis in calves in a specific geographic location in New Zealand.<sup>1</sup> Affected animals have a fever with unilateral or bilateral dysfunction of the facial nerve (CN VII; buccal and auriculo-palpebral branches). The case-fatality rate ranges from 38% to 52%, and affected calves do not have listeriosis or *M. bovis* infection.

## CLINICAL FINDINGS

Acute meningitis usually develops suddenly and is accompanied by fever and toxemia in addition to nervous signs. Vomiting is common in the early stages in pigs. There is trismus, opisthotonus, and rigidity of the neck and back. Motor irritation signs include tonic spasms of the muscles of the neck causing retraction of the head, muscle tremor, and paddling movements. Cutaneous hyperesthesia is present in varying degrees, with even light touching of the skin causing severe pain in some cases. There may be disturbance of consciousness manifested by excitement or mania in the early stages, followed by drowsiness and eventual coma.

Blindness is common in cerebral meningitis but not a constant clinical finding. In young animals, ophthalmitis with hypopyon may occur, which supports the diagnosis of meningitis. The pupillary light reflex is usually much slower than normal. Examination of the fundus of the eyes may reveal evidence of optic disc edema, congestion of the retinal vessels, and exudation.

In uncomplicated meningitis the respiration is usually slow and deep, and often phasic in the form of **Cheyne–Stokes breathing** (a breathing pattern characterized by a period of apnea followed by a gradual increase in the depth and rate of respiration) or **Biot's breathing** (an irregular breathing pattern characterized by groups of quick, shallow inspirations followed by periods of apnea). Terminally there is quadriplegia and clonic convulsions.

The major clinical finding of meningoencephalitis in calves under 2 weeks of age was depression, which progressed rapidly to stupor, but the mental state changed to hyperesthesia, opisthotonus, and seizures in unresponsive terminal cases. Meningoencephalitis should be considered in calves that have been treated for the effects of diarrhea with fluid therapy but fail to respond and remain depressed.

In a series of 32 cases of meningitis in neonatal calves, the mean age at admission was 6 days (range, 11 hours to 30 days). The major clinical findings were lethargy (32/32), recumbency (32/32), anorexia and loss of the

suck reflex (26/32), and stupor and coma (21/32). The frequencies of other clinical findings were as follows: opisthotonus (9/32), convulsions (7/32), tremors (6/32), and hyperesthesia (6/32). The case–fatality rate was 100%; this case series was accumulated before the widespread availability of third-generation cephalosporins labeled for use in food animals.

Although meningitis in farm animals is usually diffuse, affecting particularly the brainstem and upper cervical cord, it may be quite localized and produce localizing signs, including involvement of the cranial or spinal nerves. Localized muscle tremor, hyperesthesia, and rigidity may result. Muscles in the affected area are firm and board-like on palpation. Anesthesia and paralysis usually develop caudal to the meningitic area. Spread of the inflammation along the cord is usual. Reference should be made to the specific diseases cited under Etiology in this section for a more complete description of their clinical manifestations.

In newborn calves, undifferentiated diarrhea, septic arthritis, omphalophlebitis, and uveitis are frequent concurrent clinical findings. Bacterial meningitis has been reproduced experimentally in calves, resulting in typical clinical signs consisting of convulsions, depression, circling and falling to one side, ataxia, propulsive walking, loss of saliva, tremors, recumbency, lethargy, and nystagmus.

## CLINICAL PATHOLOGY

### Cerebrospinal Fluid

CSF collected from the lumbosacral space or cisterna magna in meningitis contains elevated protein concentrations, has a high cell count, and usually contains bacteria. The collection of CSF from the lumbosacral space of calves has been described under the section [Special Examination of the Nervous System](#). Culture and determination of antimicrobial susceptibility is strongly recommended because of the low antimicrobial concentrations achieved in the CSF. In a series of meningitis in neonatal calves, the CSF revealed marked pleocytosis (mean 4,000 leukocytes/ $\mu$ L; range, 130–23,270 leukocytes/ $\mu$ L), xanthochromia, turbidity, and a high total protein concentration.

### Hematology

Hemogram usually reveals a marked leukocytosis, reflecting the severity of the systemic illness secondary to septicemia.

## NECROPSY FINDINGS

Hyperemia, the presence of hemorrhages, and thickening and opacity of the meninges, especially over the base of the brain, are the usual macroscopic findings. The CSF is often turbid and may contain fibrin. A local superficial encephalitis is often present. Additional morbid changes are described under the specific diseases and are often of importance in

differential diagnosis. In neonatal calves with meningitis, lesions of septicemia are commonly present at necropsy and *E. coli* is the most common isolated organism.

### DIFFERENTIAL DIAGNOSIS

Hyperesthesia, severe depression, muscle rigidity, and blindness are the common clinical findings in cerebral meningitis, but it is often difficult to differentiate meningitis from encephalitis and acute cerebral edema. Examination of the CSF is the only means of confirming the diagnosis before death. Analysis of CSF is very useful in the differential diagnosis of diseases of the nervous system of ruminants. Details are presented in the section [Collection and Examination of Cerebral Spinal Fluid](#). Subacute or chronic meningitis is difficult to recognize clinically. The clinical findings may be restricted to recumbency, apathy, anorexia, slight incoordination if forced to walk, and some impairment of the eyesight. Spinal cord compression is usually more insidious in onset and is seldom accompanied by fever; hyperesthesia is less marked or absent, and there is flaccidity rather than spasticity.

## TREATMENT

Most of the viral infections of the nervous system are not susceptible to chemotherapeutics. Some of the larger organisms such as *Chlamydia* spp. are susceptible to broad-spectrum antimicrobial agents such as the tetracyclines and chloramphenicol.

Bacterial infections of the CNS are usually manifestations of a general systemic infection as either bacteremia or septicemia. Treatment of such infections is limited by the existence of the blood-brain and blood-CSF barriers, which prevent penetration of some substances into nervous tissue and into the CSF. Very little useful data exist on the penetration of parenterally administered antibiotics into the CNS of either normal farm animals or those in which there is inflammation of the nervous system.

In humans it is considered that most antimicrobials do not enter the subarachnoid space in therapeutic concentrations unless inflammation is present, and the degree of penetration varies among drugs. Chloramphenicol is an exception; levels of one-third to one-half of the plasma concentration are commonly achieved in healthy individuals; chloramphenicol administration is now much reduced in developed countries because of the idiosyncratic occurrence of aplastic anemia in humans. The relative diffusion of gram-negative antimicrobial agents from blood into CSF in humans is shown in [Table 14-8](#).

The most promising antimicrobial agents for the treatment of bacterial meningitis in farm animals are trimethoprim-sulfonamide combinations, the third-generation cephalosporins, and fluoroquinolones. When

**Table 14-8** Relative diffusion of gram-negative antimicrobials

Excellent with or without inflammation	Good only with inflammation
Sulfonamides	Ampicillin
Third-generation	Carbenicillin
Cephalosporins	Cephalothin
Cefoperazone, cefotaxime	Cephaloridine
Minimal or not good with inflammation	No passage with inflammation
Tetracycline	Polymyxin B
Streptomycin	Colistin
Kanamycin	
Gentamicin	

treating bacterial meningitis, pharmacodynamic principles suggest that CSF antimicrobial concentrations should have a peak concentration that is at least five times the minimum bactericidal concentration (MBC) of the pathogen, and concentrations above the MBC are required during the entire dosing interval for optimal bactericidal activity.

In most instances of bacterial encephalitis or meningitis in farm animals, it is likely that the blood-brain barrier is not intact and that parenterally administered drugs will diffuse into the nervous tissue and CSF to a greater extent than in healthy animals. Certainly, the dramatic beneficial response achieved by the early parenteral treatment of *H. somni* meningoencephalitis in cattle using intravenous oxytetracycline or intramuscular penicillin suggests that the blood-brain barrier may not be a major limiting factor when inflammation is present. Another example of an antibiotic that does not normally pass the blood-brain barrier well but is able to do so when the barrier is damaged is penicillin in the treatment of listeriosis. When cases of bacterial meningoencephalitis fail to respond to antimicrobial agents to which in vitro testing indicates that the organisms are susceptible, other reasons should also be considered. Often the lesion is irreversibly advanced or there is a chronic suppurative process that is unlikely to respond.

Intrathecal injections of antimicrobial agents have been suggested as viable alternatives when parenteral therapy appears to be unsuccessful. However, there is no evidence that such treatment is superior to appropriate parenteral therapy. In addition, intrathecal injections can cause rapid death and therefore are not recommended.

Glucocorticoids may be administered in an attempt to decrease nerve damage resulting from inflammation. Appropriate randomized clinical trials have not

been performed in large animals, but steroid administration in adult humans with meningitis was associated with decreased mortality.<sup>4</sup>

### FURTHER READING

- Fecteau G, George LW. Bacterial meningitis and encephalitis in ruminants. *Vet Clin North Am Food Anim Pract.* 2004;20:363-378.
- Johnson AL. Update on infectious diseases affecting the equine nervous system. *Vet Clin North Am Equine Pract.* 2011;27:573-587.
- Kessell AE, Finnie JW, Windsor PA. Neurological diseases of ruminant livestock in Australia. III: bacterial and protozoal infections. *Aust Vet J.* 2011;89:289-296.
- Scott PR. Diagnostic techniques and clinicopathologic findings in ruminant neurologic disease. *Vet Clin North Am Food Anim Pract.* 2004;20:215-230.
- Whitehead CE, Bedenice D. Neurologic diseases in llamas and alpacas. *Vet Clin North Am Food Anim Pract.* 2009;25:385-405.

### REFERENCES

- McFadden AMJ, et al. *New Zeal Vet J.* 2009;57:63.
- Mitchell E, et al. *Equine Vet Educ.* 2006;18:249.
- Imai DM, et al. *Vet Pathol.* 2011;48:1151.
- van de Beek D, et al. *Lancet Infect Dis.* 2004;4:139.

## ENCEPHALITIS

Encephalitis is, by definition, inflammation of the brain, but in general usage it includes those diseases in which inflammatory lesions occur in the brain, whether there is inflammation of the nervous tissue or primarily of the vessel walls. Clinically, encephalitis is characterized initially by signs of involuntary movements, followed by signs caused by loss of nervous function. The meninges and spinal cord may be involved in an encephalitis, causing varying degrees of meningoencephalomyelitis.

### ETIOLOGY

Many encephalitides of large animals are associated with viruses but other infectious agents are also common. Some causes are as follows.

#### All Species

- Viral infections including rabies, pseudorabies, Japanese B encephalitis, West Nile virus encephalomyelitis
- Bacterial infections of neonatal farm animals
- Toxoplasmosis, which is not a common cause in any species
- Sarcocystosis
- Verminous encephalomyelitis, which is migration of larvae of parasitic species that normally have a somatic migration route, e.g., *Halickephalobus gingivalis* (previously *H. delectrix* or *Micronema delectrix*) and *Setaria* spp.

#### Cattle

- BSE
- Viral infections including malignant catarrhal fever, BVD virus, sporadic

bovine encephalomyelitis, Akabane virus, and bovine herpesvirus-5 (BHV-5), rarely louping-ill virus,<sup>1</sup> and astrovirus (BoAstV-NeuroS1)<sup>2</sup>

- Bacterial infections including *Listeria monocytogenes*, *H. somni* (formerly *Haemophilus somnus*), heartwater, and clostridial infections following dehorning of calves
- Migration of *Hypoderma bovis* occasionally to brain and spinal cord
- Newborn calves with in utero protozoal infection of *Neospora caninum*<sup>3</sup>

#### Sheep

- Scrapie
- Viral infections including louping-ill, visna (associated with maedi-visna virus [MVV]), BVD virus (border disease), and Akabane virus
- Thrombotic meningoencephalitis associated with *H. somni* (formerly *H. ovis*) in lambs
- Bacterial meningoencephalitis in lambs 2 to 4 weeks of age
- Migration of *Oestrus ovis*

#### Goats

- Scrapie
- Caprine arthritis encephalitis (CAE) virus, Akabane virus

#### New World Camelids

- Viral infection caused by Eastern equine encephalitis virus<sup>4</sup>
- Bacterial infection caused by *L. monocytogenes*
- Verminous encephalomyelitis caused by *Parelaphostrongylus tenuis* ("meningeal worm" of white-tailed deer)

#### Horses

- Viral infections including infectious equine encephalomyelitis; Borna disease; equine herpesvirus-1 (EHV-1) myeloencephalopathy; equine infectious anemia; eastern, western, Venezuelan, and West Nile equine encephalomyelitis; Murray Valley encephalitis virus<sup>5,6</sup>; Shuni virus<sup>7</sup>; and rarely louping-ill virus
- Bacterial meningoencephalitis caused by *Anaplasma phagocytophilum* (equine granulocytic ehrlichiosis) and *Borrelia burgdorferi*<sup>8</sup>
- Protozoal myeloencephalitis caused by *Sarcocystis neurona* infection
- Verminous encephalomyelitis caused by *Strongylus vulgaris*, *P. tenuis* (meningeal worm of white-tailed deer), and *Draschia megastoma*; *Angiostrongylus cantonensis*, which normally migrates through the CNS of the rat, has been found as a cause of verminous encephalomyelitis in foals

#### Pigs

- Bacterial infections as part of the systemic infections with *Salmonella*

and *Erysipelas* spp., rarely *L. monocytogenes*

- Viral infections including hog cholera, African swine fever, encephalomyocarditis, swine vesicular disease, hemagglutinating encephalomyelitis virus, and porcine encephalomyelitis virus

### PATHOGENESIS

Compared with other extraneural tissues, the inflammatory response mounted by the nervous system is unique. The CNS is in a sequestered and immunologically dormant state within the body. The capillary endothelial blood-brain barrier restricts free access by blood constituents. The CNS lacks specialized dendritic antigen-presenting cells, and the intrinsic expression by CNS cells of major histocompatibility complex molecules, especially class II, is low. There is no lymphatic system within nervous tissue, but cells and antigens within the CNS drain into the circulation and into the cervical lymph nodes.

The CNS has unique populations of cells consisting of parenchymal cells, which are **neurons** and **neuroglia**. The neuroglia are supporting cells and are subdivided into macroglia and microglia. The macroglia are **astrocytes** and **oligodendrocytes**; the third glial cell type is a **microglial cell**. The brain and spinal cord are enclosed by meninges (**dura**, **arachnoid**, and **pia**), which provide protection, a compartment for CSF circulation (the subarachnoid space), support for blood vessels, and a sheath for the cranial and spinal nerves. Within the brain and spinal cord are the ventricular system and central canal, which are lined by **ependymal cells**, and the **choroid plexuses**, which produce the CSF. Circulation of the CSF moves from the lateral, third, and fourth ventricles into the central canal or through lateral apertures at the cerebellomedullary angle into the subarachnoid space of the brain. CSF in the subarachnoid space drains via specialized **arachnoid granulations** into intracranial venous sinuses, with some draining into venous plexuses associated with cranial and spinal nerves. CSF may also cross the ventricular surface into the adjacent parenchyma.

The histologic characteristics of CNS inflammation include the following:

- Perivascular cuffing
  - Gliosis
  - Neuronal satellitosis and neuronophagia
- A perivascular compartment, actual or potential, exists around all CNS arteries, arterioles, venules, and veins. A characteristic feature of CNS inflammation is perivascular cuffing, which is the accumulation of leukocytes of one or multiple types in the perivascular space. All perivascular cuffing results in vasculitis of some degree. In bacterial diseases, polymorphonuclear cells predominate with a minor component of mononuclear cells. In general, viral diseases



are characterized by lymphocyte-rich cells with some plasma cells and monocytes; some arbovirus infections cause a polymorphonuclear cell response. In immune-mediated diseases, there are mixtures of polymorphonuclear and mononuclear cells. In thrombotic diseases, such as thrombotic meningoencephalitis, vascular occlusion precludes the development of cuffing around injured vessels.

**Gliosis** is the increased prominence of glial cells, resulting from cytoplasmic swelling and the acquisition of more cell processes, from cell proliferation, or both. Either of the macroglia (oligodendrocytes or astrocytes) or microglia may participate in gliosis.

**Neuronal satellitosis** occurs when oligodendrocytes react and proliferate in response to degenerating neurons, which may be infected by a virus.

**Neuronophagia** is the progressive degeneration of the neuron characterized by its piecemeal division and phagocytosis, eventually leaving a dense nodule of glial cells and fragments of the former neuron. Details of the form, functions, and roles of astrocytes in neurologic disease have been reviewed.

**Primary demyelination** is characteristic of only a small number of inflammatory neurologic diseases and is associated with only a few viruses. The inflammatory neuraxial diseases of large animals include visna in sheep and caprine arthritis encephalitis. The demyelinating process may be initiated directly by the infectious agent alone or by an immunologic response initiated by the agent.

With the exception of the viruses of bovine malignant catarrh and EHV-1, which exert their effects principally on the vasculature, those viruses that cause encephalitis do so by invasion of cellular elements, usually the neurons, and cause initial stimulation and then death of the cells. Those bacteria that cause diffuse encephalitis also exert their effects primarily on vascular endothelium. *L. monocytogenes* does so by the formation of microabscesses. In some diseases, such as meningoencephalitis in cattle associated with *H. somni*, the lesions may be present in the brain and throughout the spinal cord.

**Entrance of the viruses** into the nervous tissue occurs in several ways. Normally the blood-brain barrier is an effective filtering agent, but when there is damage to the endothelium infection readily occurs. The synergistic relationship between the rickettsias of tick-borne fever and the virus of louping-ill probably has this basis. Entry may also occur by progression of the agent up a peripheral nerve trunk, as occurs with the viruses of rabies and pseudorabies and with *L. monocytogenes*. Entry via the olfactory nerves is also possible.

**The clinical signs** of encephalitis are usually referable to a general stimulatory or lethal effect on neurons in the brain. This may be in part due to the general effect of inflammatory edema and in part to the direct

effects of the agent on nerve cells. In any particular case, one or the other of these factors may predominate, but the tissue damage and therefore the signs are generalized. Clinical signs are often diverse and can be acute or chronic, localized or diffuse, and progressive or reversible. Because of diffuse inflammation in encephalitis, the clinical signs are commonly multifocal and asymmetric. This is not the case in listeriosis, in which damage is usually localized in the pons-medulla. Localizing signs may appear in the early stages of generalized encephalitis and remain as residual defects during the stage of convalescence. In calves with thromboembolic meningoencephalitis caused by *H. somni*, prolonged recumbency may be associated with widespread lesions of the spinal cord. Visna is a demyelinating encephalitis, and caprine leukoencephalomyelitis is both demyelinating and inflammatory and also invades other tissues including joints and lung.

**In vermicious encephalomyelitis**, destruction of nervous tissue may occur in many parts of the brain and in general the severity of the signs depends on the size and mobility of the parasites and the route of entry. One exception to this generalization is the experimental "visceral larva migrans" produced by *Toxocara canis* in pigs when the nervous signs occur at a time when lesions in most other organs are healing. The signs are apparently provoked by a reaction of the host to static larvae rather than trauma caused by migration. Nematodes not resident in nervous tissues may cause nervous signs caused possibly by allergy or by the formation of toxins.

## CLINICAL FINDINGS

Because the encephalitides are associated with infectious agents, they are often accompanied by fever, anorexia, depression, and increased heart rate. This is not the case in the very chronic diseases such as scrapie and BSE. In those diseases associated with agents that are not truly neurotropic, there are characteristic signs, which are not described here.

The clinical findings that can occur in encephalitis are combinations of the following:

- **Subtle to marked changes in behavior**
- **Depression**
- **Seizures**
- **Blindness**
- **Compulsive walking**
- **Leaning on walls or fences**
- **Circling**
- **Ataxia**

Bacterial meningoencephalitis in lambs 2 to 4 weeks of age is characterized by lack of suck reflex, weakness, altered gait, and depression extending to stupor, but hyperesthesia to auditory and tactile stimuli. Opisthotonus is common during the terminal stages.

There may be an initial period of **excitement or mania**. The animal is easily startled

and responds excessively to normal stimuli. It may exhibit viciousness and uncontrolled activity including blind charging, bellowing, kicking, and pawing. Self-mutilation may occur in diseases such as pseudorabies. Mental depression, including head-pressing, may occur between episodes.

Involuntary movements are variable in their occurrence or may not appear at all. When they do occur, they include convulsions, usually clonic, and may be accompanied by nystagmus, champing of the jaws, excessive frothy salivation, and muscle tremor, especially of the face and limbs. In cattle with malignant catarrhal fever, there is severe depression for a few days followed by the onset of tremors associated with the terminal encephalitis. Unusual irritation phenomena are the paresthesia and hyperesthesia of pseudorabies and scrapie.

**Signs caused by loss of nervous function** follow and may be the only signs in some instances. Excessive drooling and pharyngeal paralysis are common in rabies. In horses with equine encephalomyelitis, feed may be left hanging from the mouth, although swallowing may not be impaired. The loss of function varies in degree from paresis with knuckling at the lower limb joints, to spasticity of the limbs with resultant ataxia, to weakness and recumbency. Recumbency and inability to rise may be the first clinical finding encountered as in many cases of meningoencephalitis associated with *H. somni*. Hypermetria, a staggering gait and apprehensiveness progressing to belligerency, may occur in a disease such as BSE.

Clinical signs referable to certain anatomic sites and pathways of the brain and spinal cord are manifested by deviation of the head, walking in circles, abnormalities of posture, ataxia, and incoordination but these are more often residual signs after recovery from the acute stages. Progressive ascending spinal cord paralysis, in which the loss of sensation and weakness occur initially in the hindlimbs followed by weakness in the forelimbs, is common in rabies. Residual lesions affecting the CNs do not commonly occur in the encephalitides, except in listeriosis and protozoal encephalitis of horses, both infections predominating in the caudal brainstem.

In the horse with cerebral nematodiasis caused by *S. vulgaris*, the clinical signs are referable to migration of the parasite in the thalamus, brainstem, and cerebellum. There is incoordination, leaning and head-pressing, dysmetria, intermittent clonic convulsions, unilateral or bilateral blindness, and paralysis of some CNs. The onset may be gradual or sudden. The clinical diagnosis is extremely difficult because examination of CSF and hematology are of limited value. A pathologic diagnosis is necessary. In foals with neural angiostrongylosis, tetraparesis was the result of progressive and multifocal neurologic disease.

## CLINICAL PATHOLOGY

Clinical pathology may be of considerable assistance in the diagnosis of encephalitis, but the techniques used are for the most part specific to the individual diseases.

### Hemogram

In the horse, complete and differential blood counts and serum chemistry profiles are recommended for most neurologic cases.

### Serology

Acute and convalescent sera can be submitted when a specific infectious disease is suspected for which a serologic diagnosis is possible.

### Cerebrospinal Fluid

Laboratory examination of CSF for cellular content and pathogens may also be indicated. In bacterial meningoencephalitis, analysis of CSF obtained from the lumbosacral space reveals a highly significant increase in protein concentration with marked neutrophilic pleocytosis.

## NECROPSY FINDINGS

In some of the common encephalitides there are no gross lesions of the brain apart from those that occur in other body systems and that are typical of the specific disease. In other cases, on transverse section of the brain, extensive areas of hemorrhagic necrosis may be visible, as in meningoencephalitis in cattle caused by *H. somni*. Histologic lesions vary with the type and mode of action of the causative agent. Material for laboratory diagnosis should include the fixed brain and portions of fresh brain material for culture and for transmission experiments.

## DIFFERENTIAL DIAGNOSIS

The diagnosis of encephalitis cannot depend entirely on the recognition of the typical syndrome because similar syndromes may be caused by many other brain diseases. Acute cerebral edema and focal space-occupying lesions of the cranial cavity, and a number of poisonings, including salt, lead, arsenic, mercury, rotenone, and chlorinated hydrocarbons, all cause similar syndromes, as do hypovitaminosis A, hypoglycemia, encephalomalacia, and meningitis.

**Fever** is common in encephalitis but is not usually present in rabies, scrapie, or bovine spongiform encephalopathy; but it may occur in the noninflammatory diseases if convulsions are severe.

In general, the clinical diagnosis rests on the recognition of the specific encephalitides and the elimination of the other possible causes on the basis of the history and clinical pathology, especially in poisonings, and on clinical findings characteristic of the particular disease. In many cases a definite diagnosis can only be made on necropsy. For differentiation

of the specific encephalitides, reference should be made to the diseases listed under the previous section **Etiology**.

Infestation with nematode larvae causes a great variety of signs depending on the number of invading larvae and the amount and location of the damage.

## TREATMENT

Specific treatments are dealt with under each disease. Antimicrobials are indicated for bacterial meningoencephalomyelitis. In general, the aim should be to provide supportive treatment by intravenous fluid and electrolyte therapy or stomach tube feeding during the acute phase. Sedation during the excitement stage may prevent the animal from injuring itself, and nervous system stimulants during the period of depression may maintain life through the critical phase. Although there is an increase in intracranial pressure, the removal of CSF is contraindicated because of the deleterious effects of the procedure on other parts of the brain.

## FURTHER READING

- Johnson AL. Update on infectious diseases affecting the equine nervous system. *Vet Clin North Am Equine Pract.* 2011;27:573-587.
- Kessell AE, Finnie JW, Windsor PA. Neurological diseases of ruminant livestock in Australia. III. Bacterial and protozoal infections. *Aust Vet J.* 2011;89:289-296.
- Kessell AE, Finnie JW, Windsor PA. Neurological diseases of ruminant livestock in Australia. IV. Viral infections. *Aust Vet J.* 2011;89:331-337.
- Whitehead CE, Bedenice D. Neurologic diseases in llamas and alpacas. *Vet Clin North Am Food Anim Pract.* 2009;25:385-405.

## REFERENCES

- Benavides J, et al. *Vet Pathol.* 2011;48:E1.
- Li L, et al. *Emerg Infect Dis.* 2013;19:1385.
- Malaguti JMA, et al. *Rev Bras Parasitol Vet Jaboticabal.* 2012;2:48.
- Nolen-Watson R, et al. *J Vet Intern Med.* 2007;21:846.
- Gordon AN, et al. *J Vet Diagn Invest.* 2012;24:431.
- Holmes JM, et al. *Aust Vet J.* 2012;90:252.
- van Eeden C, et al. *Emerg Infect Dis.* 2012;18:318.
- Imai DM, et al. *Vet Pathol.* 2011;48:1151.

## EPILEPSY

Seizures occur most frequently in conjunction with other signs of brain disease. The syndrome of inherited, recurrent seizures, which continues through life with no underlying morphologic disease process, is true epilepsy, which is extremely rare in farm animals. Familial epilepsy has been recorded in Brown Swiss cattle and Arabian foals.<sup>1</sup>

Residual lesions after encephalitis may cause symptomatic epileptiform seizures, but there are usually other localizing signs. A generalized seizure is manifested by an initial period of alertness, the counterpart of the aura in human seizures, followed by falling in a state of tetany, which gives way after a few seconds to a clonic convulsion with

padding, opisthotonus, and champing of the jaws. The clonic convulsions may last for some minutes and are followed by a period of relaxation. The animal is unconscious throughout the seizure, but appears normal shortly afterward.

Some seizures may be preceded by a local motor phenomenon such as tetany or tremor of one limb or of the face. The convulsion may spread from this initial area to the rest of the body. This form is referred to as Jacksonian epilepsy and the local signs may indicate the whereabouts of the local lesion or point of excitation. Such signs are recorded very rarely in dogs and not at all in farm animals. The seizures are recurrent, and the animal is normal in the intervening periods.

EEG has been performed but there are significant challenges in obtaining and interpreting the EEG from a conscious foal. It is not clear whether the EEG recording changed the initial treatment protocol for affected foals, and it should be noted that a diagnosis of epilepsy in humans is made primarily on clinical grounds.<sup>1</sup>

## TREATMENT

Treatment is empirical. Seizures in foals can be initially controlled with intravenous diazepam (0.1–0.4 mg/kg; the large dose range suggests that some seizures are of short duration). Long-term seizure control emphasizes oral phenobarbital because of its cost and proven efficacy in humans and dogs. A loading intravenous phenobarbital dose that has been used in foals is 12 to 20 mg/kg diluted in 1 L of 0.9% NaCl and administered over 30 minutes, followed by oral phenobarbital at 6 to 12 mg/kg every 12 hours. The oral dose is adjusted based on clinical response and measured peak and trough serum phenobarbital concentrations. Therapeutic phenobarbital concentrations for horses are unknown, but the therapeutic range in humans is 15 to 40 µg/mL. Once seizure control is established with oral phenobarbital and the foal is seizure free for 6 months, the phenobarbital dose can be decreased by 20% every 2 weeks and the horse closely monitored. If phenobarbital does not provide adequate seizure control, potassium bromide can be tried at a tentative initial oral dose of 25 mg/kg every 24 hours. Clients should wear gloves during administration of potassium bromide.

## FURTHER READING

McBride S, Hemmings A. A neurologic perspective of equine stereotypy. *J Equine Vet Sci.* 2009;29:10-16.

## REFERENCE

- Aleman M, et al. *J Vet Intern Med.* 2006;20:1443.

## MYELITIS

Inflammation of the spinal cord (myelitis) is usually associated with viral encephalitis. Clinical signs of myelitis are referable to the

loss of function, although there may be signs of irritation. For example, hyperesthesia or paresthesia may result if the dorsal root ganglia are involved. This is particularly noticeable in pseudorabies and to a lesser extent in rabies. However, paresis or paralysis is the more usual result of myelitis. There are no specific myelitides in farm animals, with most viral infections producing an encephalomyelitis with variations on the predominance of clinical signs being intracranial or extracranial. Viral myelitis associated with EHV-1 (the equine rhinopneumonitis virus) is now commonplace, and equine infectious anemia and dourine include incoordination and paresis in their syndromes. In goats, CAE is principally a myelitis, involving mostly the white matter.

**Equine protozoal myeloencephalitis** (EPM) causes multifocal lesions of the CNS mostly on the spinal cord. The most accurate diagnosis is based on histologic findings:

- Necrosis and mild to severe, nonsuppurative myeloencephalitis
- Infiltration of neural tissue by mononuclear cells
- Sometimes giant cells, neutrophils, and eosinophils
- Infiltration of perivascular tissue by mononuclear cells including lymphocytes and plasma cells.

EPM is caused primarily by *S. neurona*, which has the opossum (*Didelphis virginiana*) as the definitive host, raccoons as the most likely intermediate host, and the horse acting as a dead end host. Occasional cases of protozoal myeloencephalitis in horses are associated with *Neospora hughesi*.

Myelitis associated with *N. caninum* infection in newborn calves has been described. Affected calves were recumbent and unable to rise but were bright and alert. Histologically, there was evidence of protozoal myelitis.

## ENCEPHALOMALACIA

The degenerative diseases of the brain are grouped together under the name encephalomalacia. By definition encephalomalacia means softening of the brain. It is used here to include all degenerative changes. **Leukoencephalomalacia** and **PEM** refer to softening of the white and gray matter, respectively. **Abiotrophy** is the premature degeneration of neurons caused by an inborn metabolic error of development and excludes exogenous insults of neurons. The underlying cellular defect in most abiotrophies is inherited. The syndrome produced in most degenerative diseases of the nervous system is essentially one of loss of function.

## ETIOLOGY

Some indication of the diversity of causes of encephalomalacia and degenerative diseases of the nervous system can be appreciated from the examples that follow, but many

sporadic cases occur in which the cause cannot be defined.

## All Species

- Hepatic encephalopathy is thought to be caused by high blood levels of ammonia associated with advanced liver disease. This is recorded in experimental pyrrolizidine alkaloid poisoning in sheep, in hepatic arteriovenous anomaly, and thrombosis of the portal vein in the horse. Congenital portacaval shunts are also a cause of hepatic encephalopathy.
- Abiotrophy involves multisystem degenerations in the nervous system as focal or diffuse lesions involving the axons and myelin of neuronal processes. These include a multifocal encephalopathy in the Simmental breed of cattle in New Zealand and Australia and progressive myeloencephalopathy in Brown Swiss cattle, known as “weavers” because of their ataxic gait.
- Poisoning by organic mercurials and, in some instances, lead; possibly also selenium poisoning; a bilateral multifocal cerebrospinal poliomalacia of sheep in Ghana.
- Cerebrovascular disorders corresponding to the main categories in humans are observed in animals, but their occurrence is chiefly in pigs, and their clinical importance is minor.
- Congenital hypomyelinogenesis and dysmyelinogenesis are recorded in lambs (hairy shakers), piglets (myoclonia congenita), and calves (hypomyelinogenesis congenita). All are associated with viral infections in utero. EHV-1 infections in horses cause ischemic infarcts.
- Cerebellar cortical abiotrophy occurs in calves and lambs.

## Ruminants

- BSE
- Plant poisons, e.g., *Astragalus* spp., *Oxytropis* spp., *Swainsona* spp., *Vicia* spp., *Kochia scoparia*
- Focal symmetric encephalomalacia of sheep, thought to be a residual lesion after intoxication with *C. perfringens* type D toxin
- PEM caused by thiamine inadequacy in cattle and sheep and sulfur toxicosis in cattle; poliomalacia of sheep caused possibly by an antimetabolite of nicotinic acid
- Progressive spinal myelopathy of Murray Grey cattle in Australia
- Spongiform encephalopathy in newborn polled Hereford calves similar to maple syrup urine disease
- Neuronal dystrophy in Suffolk sheep
- Shakers in horned Hereford calves associated with neuronal cell body chromatolysis

- The abiotrophic lysosomal storage diseases including progressive ataxia of Charolais cattle, mannosidosis, gangliosidosis, and globoid cell leukodystrophy of sheep
- The inherited defect of Brown Swiss cattle known as weavers, and presented elsewhere, is a degenerative myeloencephalopathy
- Swayback and enzootic ataxia caused by nutritional deficiency of copper in lambs
- Prolonged parturition of calves causing cerebral hypoxia and the weak calf syndrome
- Idiopathic brainstem neuronal chromatolysis in cattle
- Bovine bonkers caused by the consumption of ammoniated forages
- Inherited neuronal degeneration in Angora goats

## Horses

- Leukoencephalomalacia caused by feeding moldy corn infested with *Fusarium moniliforme*, which produces primarily fumonisin B<sub>1</sub> and, to a lesser extent, fumonisin B<sub>2</sub><sup>1,2</sup>
- Nigropallidal encephalomalacia caused by feeding on yellow star thistle (*Centaurea solstitialis*)<sup>3</sup>
- Poisoning by bracken and horsetail causing a conditioned deficiency of thiamine
- Ischemic encephalopathy of neonatal maladjustment syndrome of foals
- EDM,<sup>4,5</sup> which is associated with vitamin E deficiency

## Ruminants and Horses

### Neurotoxic Mycotoxins

Swainsonine and slaframine produced by *Rhizoctonia leguminicola* cause mannose accumulation and parasympathomimetic effects. Lolitrems from *A. lolii* and paspalitrems from *C. paspali* are tremorgens found in grasses.

## Pigs

- Leukoencephalomalacia in mulberry heart disease
- Subclinical attacks of enterotoxemia similar to edema disease
- Poisoning by organic arsenicals, and salt.

## PATHOGENESIS

The pathogenesis of the degenerative diseases can be subdivided into the following:

- **Metabolic and circulatory disorders**
- **Intoxications and toxic-infectious diseases**
- **Nutritional diseases**
- **Hereditary, familial, and idiopathic degenerative diseases**

## Metabolic and Circulatory

Hepatic encephalopathy is associated with acquired liver disease, and the resultant



hyperammonemia and other toxic factors are considered to be neurotoxic. Disorders of intermediary metabolism result in the accumulation of neurotoxic substances such as in maple syrup urine disease of calves. Lysosomal storage diseases are caused by a lack of lysosomal enzymes, which results in an accumulation of cellular substrates and affecting cell function.

CNS hypoxia and ischemia impair the most sensitive elements in brain tissue, especially neurons. Severe ischemia results in necrosis of neurons and glial elements and areas of infarcts. Gas anesthesia-related neurologic disease occurs in animals that have been deprived of oxygen for more than 5 minutes. The hypoxia is lethal to neurons, and on recovery from anesthesia affected animals are blind and seizures may occur. The typical lesion consists of widespread neuronal damage. Postanesthetic hemorrhagic myelopathy and postanesthetic cerebral necrosis in horses are typical examples.

Hypoglycemia occurs in neonates deprived of milk and in acetonemia and pregnancy toxemia and clinical signs of lethargy, dullness progressing to weakness, seizures, and coma have been attributed to hypoglycemia. However, there are no studies of the CNS in farm animals with hypoglycemia and the effects, if any, on the nervous tissue are unknown.

### Intoxications and Toxic-Infectious Diseases

A large number of poisonous substances including poisonous plants, heavy metals (lead, arsenic, and mercury), salt poisoning, farm chemicals, antifreeze, herbicides, and insecticides can directly affect the nervous system when ingested by animals. They result in varying degrees of edema of the brain, degeneration of white and gray matter, and hemorrhage of both the central and peripheral nervous system. Toxic-infectious diseases such as edema disease of swine and focal symmetric encephalomalacia of sheep are examples of endotoxins and exotoxins produced by bacterial infections, which have a direct effect on the nervous system resulting in encephalomalacia.

### Nutritional Diseases

Several nutritional deficiencies of farm animals can result in neurologic disease:

- **Vitamin A deficiency** affects bone growth, particularly remodeling of the optic nerve tracts, and CSF absorption. The elevated CSF pressure and constriction of the optic nerve tracts results in edema of the optic disc and wallerian-type degeneration of the optic nerve resulting in blindness.
- **Copper deficiency** in pregnant ewes can result in swayback and enzootic ataxia of the lambs. Copper is an integral element in several enzyme systems such as ceruloplasmin and lysyl oxidase, and

copper deficiency affects several organ systems. The principal defect in swayback appears to be one of defective myelination probably caused by interference with phospholipid formation. However, some lesions in the newborn are more extensive and show cavitation with loss of axons and neurons rather than simply demyelination. In the brain, there is a progressive gelatinous transformation of the white matter, ending in cavitation that resembles porencephaly or hydranencephaly. In the spinal cord the lesions are bilateral, and it is suggested that the copper deficiency has a primary axonopathic effect

- **Thiamine deficiency** in ruminants can result in **PEM** or **cerebrocortical necrosis**. Thiamine, mainly as thiamine diphosphate ([TDP]; pyrophosphate), has an important role as a coenzyme in carbohydrate metabolism, especially the pentose pathway. Diffuse encephalopathy may occur characterized by brain edema and swelling, resulting in flattening of the gyri, tentorial herniation, and coning of the cerebellar vermis. Bilateral areas of cerebral cortical laminar necrosis are widespread.

### Hereditary, Familial, and Idiopathic Degenerative Diseases

A large number of neurologic diseases of farm animals are characterized by abnormalities of central myelinogenesis. In most instances, the underlying abnormality directly or indirectly affects the oligodendrocyte and is reflected in the production of CNS myelin of diminished quantity or quality or both. Many of these are inherited and manifest from or shortly after birth. They include leukodystrophies, hypomyelination, spongy degeneration, and related disorders. Neuronal abiotrophy, motor neuron diseases, neuronal dystrophy, and degenerative encephalomyelopathy of horses and cattle are included in this group.

### Polioencephalomalacia and Leukoencephalomalacia

PEM appears to be, in some cases at least, a consequence of acute edematous swelling of the brain and cortical ischemia. The pathogenesis of leukoencephalomalacia appears to be related to vasogenic edema as a result of cardiovascular dysfunction and an inability to regulate cerebral blood flow. Whether the lesion is in the gray matter (PEM) or in the white matter (leukoencephalomalacia) the syndrome is largely one of loss of function, although as might be expected irritation signs are more likely to occur when the gray matter is damaged.

### CLINICAL FINDINGS

Weakness of all four limbs is accompanied by the following:

- **Dullness or somnolence**
- **Blindness**
- **Ataxia**
- **Head-pressing**
- **Circling**
- **Terminal coma**

In the early stages, particularly in ruminant PEM, there are involuntary signs including muscle tremor, opisthotonus, nystagmus, and convulsions.

**In equine leukoencephalomalacia**, which may occur in outbreaks, initial signs include anorexia and depression. In the neurotoxic form, which is the most common, the anorexia and depression progresses to ataxia, circling, apparent blindness, head-pressing, hyperesthesia, agitation, delirium, recumbency, seizures, and death. An early and consistent sign in affected horses is reduced proprioception of the tongue, which manifests as delayed retraction of the tongue to the buccal cavity after the tongue has been extended. In the hepatotoxicosis form, clinical findings include icterus, swelling of the lips and nose, petechiation, abdominal breathing, and cyanosis. Horses with either syndrome may be found dead without any premonitory signs.

In many of the leukoencephalomalacias, the course may be one of gradual progression of signs, or more commonly a level of abnormality is reached and maintained for a long period, often necessitating euthanasia of the animal. For example, EDM is a diffuse degenerative disease of the equine spinal cords and caudal portion of the brainstem and primarily affects young horses. There is an insidious onset of symmetric spasticity, ataxia, and paresis. Clinical signs may progress slowly to stabilize for long periods. All four limbs are affected, but the pelvic limbs are usually more severely affected than the thoracic limbs. There is no treatment for the disease, no spontaneous recovery and, once affected, horses remain atactic and useless for any athletic function.

### CLINICAL PATHOLOGY

There are no clinicopathologic tests specific for encephalomalacia, but various tests may aid in the diagnosis of some of the specific diseases mentioned in this section under **Etiology**.

### NECROPSY FINDINGS

Gross lesions including areas of softening, cavitation, and laminar necrosis of the cortex may be visible. The important lesions are described under each of the specific diseases.

### TREATMENT

The prognosis depends on the nature of the lesion. Early cases of thiamine deficiency-induced PEM can recover completely if treated with adequate levels of thiamine. Encephalomalacia caused by sulfur-induced PEM and lead poisoning is more difficult to

treat. Young calves with acquired in utero hypomyelination and horses with myelitis associated with EHV-1 infection can make complete recoveries.

### DIFFERENTIAL DIAGNOSIS

The syndromes produced by encephalomalacia resemble very closely those caused by most lesions that elevate intracranial pressure. The onset is quite sudden, and there is depression of consciousness and loss of motor function. One major difference is that the lesions tend to be nonprogressive, and affected animals may continue to survive in an impaired state for long periods.

### FURTHER READING

- Cebra CK, Cebra ML. Altered mentation caused by polioencephalomalacia, hypernatremia, and lead poisoning. *Vet Clin North Am Food Anim Pract.* 2004;20:287-302.
- De Lahunta A. Abiotrophy in domestic animals: a review. *Can J Vet Res.* 1990;54:65-76.

### REFERENCES

- Smith GW, et al. *Am J Vet Res.* 2002;63:538.
- Foreman JH, et al. *J Vet Intern Med.* 2004;18:223.
- Chang HT, et al. *Vet Pathol.* 2012;49:398.
- Finno CJ, et al. *J Vet Intern Med.* 2011;25:1439.
- Wong DM, et al. *Vet Pathol.* 2012;49:1049.

### MYELOMALACIA

Degeneration of the spinal cord (myelomalacia) occurs rarely as an entity separate from encephalomalacia. One recorded occurrence is focal spinal poliomalacia of sheep, and in enzootic ataxia the lesions of degeneration are often restricted to the spinal cord. In both instances there is a gradual development of paralysis without signs of irritation and with no indication of brain involvement. Progressive paresis in young goats may be associated with the virus of CAE and other unidentified, possibly inherited causes of myelomalacia.

Degeneration of spinal cord tracts has also been recorded in **poisoning** by *Phalaris aquatica* in cattle and sheep, by *Tribulus terrestris* in sheep,<sup>1</sup> by sorghum in horses, by 3-nitro-4-hydroxyphenylarsonic acid in pigs, and by selenium in ruminants; the lesion is a symmetric spinal poliomalacia. Poisoning of cattle by plants of *Zamia* spp. produces a syndrome suggestive of injury to the spinal cord but no lesions have been reported. Pantothenic acid (PA) or pyridoxine deficiencies also cause degeneration of the spinal cord tract in swine.

A spinal myelinopathy, possibly of genetic origin, is recorded in Murray Grey calves. Affected animals develop ataxia of the hindlegs, swaying of the hindquarters, and collapse of one hindleg with falling to one side. Clinical signs become worse over an extended period.

Sporadic cases of degeneration of spinal tracts have been observed in pigs. One

outbreak is recorded in the litters of sows on lush clover pasture. The piglets were unable to stand, struggled violently on their sides with rigid extension of the limbs and, although able to drink, usually died of starvation. Several other outbreaks in pigs have been attributed to selenium poisoning.

**Neuraxonal dystrophy** is a progressive degenerative process of CNS axons characterized initially by discontinuous swellings (called spheroids) along the distal section of axons. The spheroids reflect an inability of the neuron to maintain a normal structure and function. Neuraxonal dystrophy has been diagnosed in a number of sheep breeds, including Suffolks in the United States, Coopworth and Romney lambs in New Zealand, and Merino sheep in New Zealand and Australia, where it was previously been called Murrurrundi disease or ovine segmental axonopathy. The disease is consistent with an autosomal recessive disorder.<sup>2</sup>

**EDM (neuraxonal dystrophy)** affects young horses and has been recorded in the United States, Canada, the UK, and Australia. EDM appears to be inherited with vitamin E intake during growth modifying the clinical expression and is pathologically more advanced form of neuraxonal dystrophy.<sup>3,4</sup> The major clinical signs are referable to bilateral leukomyelopathy involving the cervical spinal cord. There is abnormal positioning and decreased strength and spasticity of the limbs as a result of upper motor neuron and general proprioceptive tract lesions. Hypalgesia, hypotonia, hyporeflexia, muscle atrophy, or vestibular signs are not present, and there is no evidence of CN, cerebral, or cerebellar involvement clinically. Abnormal gait and posture are evident, usually initially in the pelvic limbs but eventually also in the thoracic limbs. There are no gross lesions, but histologically there is degeneration of neuronal processes in the white matter of all spinal cord funiculi, especially the dorsal spinocerebellar and sulcomarginal tracts. The lesion is most severe in the thoracic segments and is progressive.<sup>5</sup>

**Motor neuron diseases** are a group of nervous disorders characterized by selective degeneration of upper motor neurons and/or lower motor neurons. Common characteristics of motor neuron diseases are muscle weakness or spastic paralysis. Motor neuron diseases have been identified in a number of species and are currently considered incurable.<sup>6</sup> An inherited **motor neuron disease** has been identified in an extended family of Romney lambs. Lower motor neuron signs predominated and affected lambs were euthanized at 4 weeks of age. The disorder was inherited in a simple autosomal recessive manner.<sup>6</sup> **Bovine spinal muscular atrophy** is an inherited motor neuron disease of Brown Swiss cattle characterized by progressive weakness and severe neurogenic muscle atrophy with early postnatal onset and death within the first few months of life.<sup>2</sup>

An **inherited lower motor neuron disease** has been recorded in pigs. Clinical findings of muscular tremors, paresis, or ataxia developed at 12 to 59 days of age. There is widespread degeneration of myelinated axons in peripheral nerves and in the lateral and ventral columns of lumbar and cervical segments of the spinal cord. Axonal degeneration is present in ventral spinal nerve roots and absent in dorsal spinal nerve roots when sampled at the same lumbar levels.

**Equine motor neuron disease** is a neurodegenerative condition that affects horses from 15 months to 25 years of age of many different breeds and has been associated with oxidative stress and vitamin E deficiency.<sup>7,8</sup> Progressive weakness, short-striding gait, trembling, long periods of recumbency, and trembling and sweating following exercise are characteristic clinical findings. The weakness is progressive and recumbency is permanent. Appetites remain normal or become excessive. At necropsy, degeneration or loss of somatic motor neurons in the spinal ventral horns, angular atrophy of skeletal muscle fibers, and the presence of lipofuscin deposits in the ventral horns of the spinal cord and retina are characteristic.

Sporadic cases of spinal cord damage in horses include hemorrhagic myelomalacia following general anesthesia and acute spinal cord degeneration following general anesthesia and surgery. Following recovery from the anesthesia, the horse is able to assume sternal recumbency but not able to stand. A hemorrhagic infarct assumed to be caused by cartilage emboli, and a venous malformation causing spinal cord destruction, have also occurred in the horse. The disease must be differentiated from myelitis and spinal cord compression caused by space-occupying lesions of the vertebral canal and cervical, vertebral malformation/malarticulation.

### REFERENCES

- Bourke CA. *Aust Vet J.* 2006;84:53.
- Krebs S, et al. *Mamm Genome.* 2006;17:67.
- Finno CJ, et al. *J Vet Intern Med.* 2011;25:1439.
- Finno CJ, Valberg SJ. *J Vet Intern Med.* 2012;26:1251.
- Wong DM, et al. *Vet Pathol.* 2012;49:1049.
- Zhao X, et al. *Heredity.* 2012;109:156.
- Wijnberg ID. *Equine Vet Educ.* 2006;18:126.
- Mohammed HO, et al. *Am J Vet Res.* 2012;73:1957.

## Focal Diseases of the Brain and Spinal Cord

### TRAUMATIC INJURY TO THE BRAIN

The effects of trauma to the brain vary with the site and extent of the injury, but initially nervous shock is likely to occur followed by death, recovery, or the persistence of residual nervous signs. Traumatic lesions of the skull or vertebral column were the most

commonly diagnosed nervous diseases of horses at necropsy in a large case series of 4,319 horses with clinical signs of nervous disease, accounting for 34% of all diagnoses.<sup>1</sup>

### ETIOLOGY

Traumatic injury to the brain may result from direct trauma applied externally, by violent stretching or flexing of the head and neck, or by migration of parasitic larvae internally. Recorded causes include the following:

- Direct trauma is an uncommon cause because of the force required to damage the cranium. Accidental collisions, rearing forward, falling over backward after rearing are the usual reasons.
- Periorbital skull fractures in horses are caused by direct traumatic injury commonly from colliding with gate posts.
- Cerebral injury and CN injury accounted for a large percentage of neurologic diseases in horses. Young horses under 2 years of age seem most susceptible to injuries of the head.
- Injury by heat in goat kids is achieved with prolonged application of a hot iron used for disbudding
- Pulling back violently when tethered can cause problems at the atlantooccipital junction.
- Animals trapped in bogs, sumps, cellars, and waterholes and dragged out by the head, and recumbent animals pulled onto trailers can suffer dire consequences to the medulla and cervical cord, although the great majority of them come to surprisingly little harm.
- The violent reaction of animals to lightning stroke and electrocution causing damage to central nervous tissue; the traumatic effect of the electrical current itself also causes neuronal destruction.
- Spontaneous hemorrhage into the brain is rare but sometimes occurs in cows at parturition, causing multiple small hemorrhages in the medulla and brainstem.
- Brain injury at parturition, recorded in lambs, calves, and foals, is possibly a significant cause of mortality in the former.

### PATHOGENESIS

The initial reaction in severe trauma or hemorrhage is nervous shock. Slowly developing subdural hematoma, a common development in humans, is accompanied by the gradual onset of signs of a space-occupying lesion of the cranial cavity, but this seems to be a rare occurrence in animals. In some cases of trauma to the head, clinical evidence of injury to the brain may be delayed for a few days until sufficient swelling, callus

formation, or displacement of the fracture fragments has occurred. Trauma to the cranial vault may be classified, from least to most severe, as **concussion**, **contusion**, **laceration**, and **hemorrhage**.

### Concussion

Concussion is usually a brief loss of consciousness that results from an abrupt head injury, which produces an episode of rapid acceleration/deceleration of the brain.

### Contusion

With a more violent force, the brain is contused. There is maintenance of structure but loss of vascular integrity, resulting in hemorrhage into the parenchyma and meninges relative to the point of impact. Bony deformation or fracture of the calvaria results in two different kinds of focal lesions:

- Direct (**coup**) contusions immediately below the impact site
- Indirect (**contrecoup**) contusions to the brain at the opposite point of the skull; these hemorrhages result from tearing of leptomeningeal and parenchymal blood vessels.

### Laceration

The most severe contusion is laceration in which the CNS tissue is physically torn or disrupted by bony structures lining the cranium or by penetrating objects such as bone fragments. Focal meningeal hemorrhage is a common sequel to severe head injury. Subdural hematomas usually follow disruption of bridging cerebral veins that drain into the dural venous sinuses, but subarachnoid hemorrhages are more common. The importance of these hemorrhages is that they develop into space-occupying masses that indent and compress the underlying brain. Progressive enlargement of the hematoma can result in secondary effects such as severe, widespread brain edema, areas of ischemia, herniations, midline shift, and lethal brainstem compression.

In birth injuries the lesion is principally one of hemorrhage subdurally and under the arachnoid.

### Experimental Traumatic Craniocerebral Missile Injury

Traumatic insult of the brains of sheep with a .22 caliber firearm results in a primary hemorrhagic wound track with indriven bone fragments and portions of muscle and skin. There is crushing and laceration of tissues during missile penetration; secondary tracks caused by bone and bullet fragments; widely distributed stretch injuries to blood vessels, nerve fibers, and neurons as a consequence of the radial forces of the temporary cavity that develops as a bullet penetrates tissue; marked subarachnoid and intraventricular hemorrhage; and distortion and displacement of the brain. The lesions are consistently severe and rapidly fatal.

### CLINICAL FINDINGS

Clinical signs of neurologic disease usually follows the pattern of greatest severity initially with recovery occurring quickly but incompletely to a point where a residual defect is evident, with this defect persisting unchanged for a long period and often permanently. This failure to improve or worsen after the initial phase is a characteristic of traumatic injury.

With severe injury there is cerebral shock in which the animal falls unconscious with or without a transient clonic convulsion. Consciousness may never be regained, but in animals that recover it returns in from a few minutes up to several hours. During the period of unconsciousness, clinical examination reveals dilatation of the pupils; absence of the eye preservation and pupillary light reflexes; and a slow, irregular respiration, with the irregularity phasic in many cases. There may be evidence of bleeding from the nose and ears, and palpation of the cranium may reveal a site of injury. Residual signs vary a great deal. Blindness is present if the optic cortex is damaged, hemiplegia may be associated with lesions in the midbrain, and traumatic epilepsy may occur with lesions in the motor cortex.

**Fracture of the petrous temporal bone** is a classic injury in horses caused by rearing and falling over backward. Both the facial and the vestibular nerves are likely to be damaged so that at first the animal may be unable to stand and there may be blood from the ear and nostril of the affected side. When the animal does stand, the head is rotated with the damaged side down. There may be nystagmus, especially early in the course of the disease. The ear, eyelid, and lip on the affected side are also paralyzed and sag. Ataxia with a tendency to fall is common. Some improvement occurs in the subsequent 2 or 3 weeks as the horse compensates for the deficit, but there is rarely permanent recovery. An identical syndrome is recorded in horses in which there has been a stress fracture of the petrous temporal bone resulting from a preexisting inflammation of the bone. The onset of signs is acute but unassociated with trauma.

**Fracture of the basisphenoid and/or basioccipital bones** is also common. These fractures can seriously damage the jugular vein; carotid artery; and glossopharyngeal, hypoglossal, and vagus nerves. The cavernous sinus and the basilar artery may also be damaged and lead to massive hemorrhage within the cranium. Large vessels in the area are easily damaged by fragments of the fractured bones, causing fatal hemorrhage. A midline fracture of the frontal bones can also have this effect.

Other signs of severe trauma to the brain include opisthotonus with blindness and nystagmus and, if the brainstem has been damaged, quadriplegia. There may also be localizing signs, including head rotation,



circling, and falling backward. Less common manifestations of resulting hemorrhage include bleeding into the retropharyngeal area, which may cause pressure on guttural pouches and the airways and lead to asphyxia. Bleeding may take place into the guttural pouches themselves.

Newborn lambs affected by birth injury to the brain are mostly dead at birth, or die soon afterward. Surviving lambs drink poorly and are very susceptible to cold stress. In some flocks it may be the principal mechanism causing perinatal mortality.

## DIAGNOSIS

Radiography of the skull is important to detect the presence and severity of fractures, which may have lacerated nervous tissue; however, CT is a much more sensitive method for detecting fractures of the calvarium and basilar bone than radiography.<sup>1</sup>

## CLINICAL PATHOLOGY

CSF should be sampled from the cerebello-medullary cistern and examined for evidence of RBCs. Extreme care must be taken to ensure that blood vessels are not punctured during the sampling procedure because this would confound the interpretation of the presence of RBCs. The presence of heme pigments in the CSF (xanthochromia) suggests the presence of preexisting hemorrhage; the presence of eosinophils or hypersegmented neutrophils suggests parasitic invasion.

## NECROPSY FINDINGS

In most cases a gross hemorrhagic lesion will be evident, but in concussion and nematodiasis the lesions may be detectable only on histologic examination.

### DIFFERENTIAL DIAGNOSIS

Unless a history of trauma is available diagnosis may be difficult.

## TREATMENT

The principles of treatment of animals exhibiting neurologic abnormalities after a traumatic event are derived from the results of large, controlled, multicenter clinical trials in humans. Similar studies have not been performed in large animals. The general principles are (1) stabilize the patient by ensuring a patent airway, obtaining vascular access and attending to wounds; (2) specific treatment for hyperthermia, because brain defects may result in an inability to regulate core temperature; (3) prevent or treat systemic arterial hypotension; (4) optimize oxygen delivery; (5) ensure adequate ventilation by placing in sternal recumbency whenever possible; (6) decrease pain; (7) monitor plasma glucose concentration and maintain euglycemia; and (8) prevent or treat cerebral edema by having the head elevated or by the intravenous administration of a hyperosmolar agent (20% mannitol as a series of bolus

infusions of 0.25–1.0 g/kg BW every 4–6 hours, the latter is an expensive treatment; hypertonic saline, 7.2% NaCl, 2 mL/kg BW every 4 hours for five infusions). Intravenous catheterization should be confined to one jugular vein, and the neck should not be bandaged in an attempt to minimize promotion of cerebral edema by jugular venous hypertension.

Seizures should be treated when they occur by initially administering diazepam at 0.1 mg/kg intravenously. If no improvement is noticed within 10 minutes, then one or two additional doses of diazepam (0.1 mg/kg, intravenously; total dose 0.3 mg/kg, intravenously) should be administered at 10-minute intervals. Midazolam could be substituted for diazepam, but dose rates are not well defined. If this dosage protocol of diazepam does not provide adequate seizure control, then phenobarbitone (20 mg/kg intravenously over 20 minutes) should be administered to effect; the phenobarbitone can be diluted in 0.9% NaCl solution. This should provide seizure control for a number of hours. If seizures return, then oral phenobarbitone (6 mg/kg every 8 hours) can be administered to foals and horses, with a reduction in the oral dose to 3 mg/kg every 8 hours if seizures are controlled. An alternative protocol in horses is a mixture of 12% chloral hydrate and 6% magnesium sulfate to effect at an intravenous administration rate not exceeding 30 mL/min. Euthanasia should be considered to adult ruminants with seizures that are only responsive to intravenous phenobarbitone.

Many anecdotal treatments have been used in large animals, but evidence attesting to their efficacy is lacking. Among the more popular empiric antioxidant treatments are dimethyl sulfoxide (1 g/kg BW IV as a 10% solution in 0.9% NaCl) administered intravenously or by nasogastric tube every 12 hours, vitamin E ( $\alpha$ -tocopherol, 50 IU/kg BW administered orally every day), vitamin C (ascorbic acid, 20 mg/kg BW administered orally every day), and allopurinol (5 mg/kg BW administered orally every 12 hours). Corticosteroids have also been advocated; promoted treatments include an antiinflammatory dose of dexamethasone (0.05 mg/kg BW IV every day) or a high dose of methylprednisolone sodium succinate (30 mg/kg BW initial IV bolus, followed by continuous infusion of 5.4 mg/kg BW per hour for 24–48 hours); the latter treatment is prohibitively expensive in large animals and must be given within a few hours of the traumatic event to be effective. Intravenous magnesium sulfate (50 mg/kg BW) in the first 5 to 10 L of intravenous fluids has also been advocated on the basis that it inhibits several aspects of the secondary injury cascade.

The overall short-term survival rate in one case series of 34 cases was 62%.<sup>2</sup> In those animals that recover consciousness within a few hours or earlier, the prognosis is

favorable and little or no specific treatment may be necessary other than nursing care. When coma lasts for more than 3 to 6 hours, the prognosis is unfavorable, and slaughter for salvage or euthanasia is recommended. Horses with basilar bone fractures are 7.5 times more likely not to survive as horses without this type of fracture.<sup>2</sup> Treatment for cerebral edema of the brain as previously outlined may be indicated when treatment for valuable animals is requested by the owner. Animals that are still in a coma 6 to 12 hours following treatment are unlikely to improve, and continued treatment is probably not warranted.

## FURTHER READING

MacKay RJ. Brain injury after head trauma: pathophysiology, diagnosis, and treatment. *Vet Clin North Am Equine Pract.* 2004;20:199-216.

## REFERENCES

1. Laugier C, et al. *J Equine Vet Sci.* 2009;29:561.
2. Feary DJ, et al. *J Am Vet Med Assoc.* 2007;231:259.

## BRAIN ABSCESS

Abscesses of the brain are rare, but occur most commonly in young farm animals under 1 year of age and rarely in older animals. They appear to be more common in ruminants than in horses. Brain abscesses were not observed at necropsy in a large case series of 4,319 horses with clinical signs of nervous disease in France.<sup>1</sup> They produce a variety of clinical signs depending on their location and size. Basically the syndrome produced is one of a space-occupying lesion of the cranial cavity with some motor irritation signs. Localized or diffuse meningitis is also common, along with the effects of the abscess.

## ETIOLOGY

Abscesses in the brain originate in a number of ways. Hematogenous infections are common, but direct spread from injury to the cranium or via the nasopharynx may also occur.

## Hematogenous Spread

The lesions may be single, but are often multiple, and are usually accompanied by meningitis. The infection usually originates elsewhere.

- *Actinobacillus mallei* from glanders lesions in lung
- *Streptococcus zooepidemicus* var. *equi* as a complication of strangles in horses
- *Corynebacterium pseudotuberculosis* in a goat causing an encapsulated abscess in the left cerebellar peduncles
- *Actinomyces bovis* and *Mycobacterium bovis* from visceral lesions in cattle
- *Fusobacterium necrophorum* from lesions in the oropharynx of calves
- *Pseudomonas pseudomallei* in melioidosis in sheep

- *Staphylococcus aureus* in tick pyemia of lambs
- Systemic fungal infections such as cryptococcosis may include granulomatous lesions in brain.

### Local Spread

- Via peripheral nerves from the oropharynx, the one specific disease is listeriosis in ruminants and New World camelids.
- Multifocal meningoencephalitis associated with lingual arteritis induced by barley spikelet clusters.
- Space-occupying lesions of facial and vestibulocochlear nerves and geniculate ganglion secondary to otitis media in calves.
- Abscesses of the rete mirabile of the pituitary gland are seen secondary to nasal septal infection after nose-ringing in cattle. *Trueperella* (*Arcanobacterium* or *Actinomyces* or *Corynebacterium*) *pyogenes* is the most common isolate, and several other species of bacteria that cause chronic suppurative lesions have been recovered. Similar abscesses, usually containing *T. pyogenes*, occur in the pituitary gland itself.
- Extensions from local suppurative processes in cranial signs are seen after dehorning from otitis media. The lesions are single and most commonly contain *T. pyogenes* and are accompanied by meningitis.

### PATHOGENESIS

Infectious agents can invade the CNS by four routes:

- **Retrograde infection via peripheral nerves**
- **Direct penetrating injuries**
- **Extension of adjacent suppurative lesions**
- **By way of the systemic circulation**

Single abscesses cause local pressure effects on nervous tissue and may produce some signs of irritation, including head-pressing and mania, but the predominant effect is one of loss of function caused by destruction of nerve cells. Multiple abscesses have much the same effect. In single abscesses the signs usually make it possible to define the location of the lesion, whereas multiple lesions present a confusing multiplicity of signs and variation in their severity from day to day, suggesting that damage has occurred at a number of widely distributed points and at different times.

The **pituitary abscess syndrome** has an uncertain pathogenesis. The pituitary gland is surrounded by a complex mesh of intertwined arteries and capillary beds known as the rete mirabile, which has been identified in cattle, sheep, goats, and pigs but not horses. This extensive capillary network surrounding the pituitary gland makes it susceptible to localization by bacteria that

originate from other sources of infection. Nose-ringing of cattle may result in septic rhinitis, which could result in infection of the dural venous sinus system, which communicates with the subcutaneous veins of the head. Bacteria may also reach the rete mirabile by way of lymphatics of the nasal mucosa and cribriform plate. CN deficits occur as a result of the extension of the abscess into the adjacent brainstem.

### CLINICAL FINDINGS

General signs include mental depression, clumsiness, head-pressing, and blindness, often preceded or interrupted by transient attacks of motor irritation including excitement, uncontrolled activity, and convulsions. A mild fever is usually present, but the temperature may be normal in some cases.

The degree of blindness varies depending on the location of the abscess and the extent of adjacent edema and meningoencephalitis. The animal may be blind in one eye and have normal eyesight in the other eye or have normal eyesight in both eyes. Unequal pupils and abnormalities in the pupillary light reflex, both direct and consensual, are common. Uveitis, iris bombé, and a collection of fibrin in the anterior chamber of an eye may be present in some cases of multiple meningoencephalitis in cattle. Nystagmus is common when the lesion is near the vestibular nucleus; strabismus may also occur.

Localizing signs depend on the location of lesions and may include cerebellar ataxia, deviation of the head with circling and falling, and hemiplegia or paralysis of individual or groups of CNs often in a unilateral pattern. In the later stages, there may be papilledema. In calves with lesions of the facial and vestibulocochlear nerves and geniculate ganglion, clinical signs may include drooping of the ears and lips, lifting of the nose, slight unilateral tilting of the head, and uncontrolled saliva flow. Inability to swallow may follow and affected calves become dehydrated.

These localizing signs may be intermittent, especially in the early stages, and may develop slowly or acutely.

**Pituitary gland abscesses** are most common in ruminants, primarily cattle 2 to 5 years of age, but are relatively rare. The most common history includes anorexia, ataxia, depression, and drooling from the mouth with inability to chew and swallow. The most common clinical findings are depression, dysphagia, dropped jaw, blindness, and absence of pupillary light reflexes. Terminally, opisthotonus, nystagmus, ataxia, and recumbency are common. Characteristically, the animal stands with a base-wide stance with its head and neck extended and its mouth not quite closed; there is difficulty in chewing and swallowing, and drooling of saliva. Affected animals are usually non-responsive to external stimuli. CN deficits are common, and usually asymmetric,

multifocal, and progressive. These include reduced tone of the jaw, facial paralysis, strabismus, and a head tilt. There may also be ptosis and prolapse of the tongue. Bradycardia has been recorded in about 50% of cases. Terminally there is opisthotonus, nystagmus, and loss of balance, followed by recumbency.

### CLINICAL PATHOLOGY

#### Cerebrospinal Fluid

Leukocytes, protein, and bacteria may be present in the CSF, but only when the abscess is not contained.

#### Hematology

In pituitary gland abscessation there may be hematologic evidence of chronic infection including neutrophilia, hyperproteinemia, and increased fibrinogen, although it is unlikely that a pituitary abscess itself is sufficiently large enough to induce these changes.

#### Imaging

Radiographic examination will not detect brain abscesses unless they are calcified or cause erosion of bone. CT has been used to diagnose a brain abscess in the horse. MRI is the preferred imaging modality to diagnose a cerebral abscess, with mature abscesses having an isointense to hypointense core on T1-weighted images and an isotense to hyperintense core with a hypointense capsule on T2-weighted images.<sup>2</sup>

#### Electroencephalography

Electroencephalographic assessment of central blindness caused by brain abscess in cattle has been reported.

### NECROPSY FINDINGS

The abscess or abscesses may be visible on gross examination and if superficial are usually accompanied by local meningitis. Large abscesses may penetrate to the ventricles and result in a diffuse ependymitis. Microabscesses may be visible only on histologic examination. A general necropsy examination may reveal the primary lesion.

### DIFFERENTIAL DIAGNOSIS

Brain abscess is manifested by signs of involuntary movements and loss of function, which can occur in many other diseases of the brain, especially when local lesions develop slowly. This occurs more frequently with tumors and parasitic cysts but it may occur in encephalitis. The characteristic clinical findings are those of a focal or multifocal lesion of the brain, which include the following:

- Localizing signs of hemiparesis and ataxia
- Postural reaction deficit
- Vestibular signs, including head tilt and positional nystagmus
- Cranial nerve deficits

There may be evidence of the existence of a suppurative lesion in another organ, and a high cell count and detectable infection in the CSF to support the diagnosis of abscess. Fever may or may not be present. The only specific disease in which abscess occurs is listeriosis, in which the lesions are largely confined to the medulla oblongata and the characteristic signs include circling and unilateral facial paralysis. Occasional cases may be associated with fungal infections, including cryptococcosis. Toxoplasmosis is an uncommon cause of granulomatous lesions in the brain of most species.

Many cases of brain abscess are similar to otitis media but there is, in the latter, rotation of the head, a commonly associated facial paralysis and an absence of signs of cerebral depression.

The pituitary gland syndrome in cattle should be differentiated from listeriosis, polioencephalomalacia, lead poisoning, other brain abscesses, and thrombomeningoencephalitis. In sheep and goats, *Parelaphostrongylus tenuis* infection and caprine arthritis encephalomyelitis syndrome may resemble the pituitary gland abscess syndrome.

## TREATMENT

Parenteral treatment with antimicrobials is indicated but the results are often unsatisfactory because of the inaccessibility of the lesion, with the clear exception being listeriosis. Treatment of pituitary gland abscess is not recommended, and an antemortem diagnosis is rarely obtained. There is one successful report of recovery after surgical excision of the complete abscess in a 1-month-old alpaca.<sup>2</sup>

## FURTHER READING

Kessell AE, Finnie JW, Windsor PA. Neurological diseases of ruminant livestock in Australia. III. Bacterial and protozoal infections. *Aust Vet J.* 2011;89:289-296.

Morin DE. Brainstem and cranial nerve abnormalities: listeriosis, otitis media/interna, and pituitary abscess syndrome. *Vet Clin North Am Food Anim Pract.* 2004;20:243-274.

## REFERENCES

1. Laugier C. *J Equine Vet Sci.* 2009;29:561.
2. Talbot CE, et al. *J Am Vet Med Assoc.* 2007;231:1558.

## TUMORS OF THE CENTRAL NERVOUS SYSTEM

Primary tumors of the CNS are extremely rare in farm animals. They produce a syndrome indicative of a general increase in intracranial pressure and local destruction of nervous tissue. Tumors of the peripheral nervous system are more common.

## ETIOLOGY

The reader is referred to the review literature for a summary of available references on the

tumors of the CNS of farm animals, which include the following:

- Meningeal tumors in cattle
- Oligodendroglioma in a cow<sup>1</sup>
- Ependymoblastoma in a heifer<sup>2</sup>
- Primitive neuroectodermal tumor with ependymal differentiation in a cow<sup>3</sup>
- Cerebellar medulloblastoma in a calf<sup>4</sup>
- Choroid plexus carcinoma in a goat<sup>5</sup>
- Equine papillary ependymoma
- Lymphoma confined to the CNS in a horse.<sup>6</sup>

## PATHOGENESIS

The development of the disease parallels that of any space-occupying lesion, with the concurrent appearance of signs of increased intracranial pressure and local tissue destruction. Many lesions found incidentally at necropsy may not have had any related clinical findings.

## CLINICAL FINDINGS

The clinical findings are similar to those caused by a slowly developing abscess and localizing signs depending on the location, size, and speed of development of the tumor. Clinical signs are usually representative of increased intracranial pressure, including opisthotonus, convulsions, nystagmus, dullness, head-pressing, and hyperexcitability. Common localizing signs include circling, deviation of the head, and disturbance of balance.

## CLINICAL PATHOLOGY

There are no positive findings in the clinicopathologic examination, which aids in diagnosis.

## NECROPSY FINDINGS

The brain should be carefully sectioned after fixation if the tumor is deep-seated.

## TREATMENT

There is no treatment.

## DIFFERENTIAL DIAGNOSIS

Differentiation is required from the other diseases in which space-occupying lesions of the cranial cavity occur. The rate of development is usually much slower in tumors than with the other lesions.

## REFERENCES

1. Kleinschmidt S, et al. *J Comp Pathol.* 2009;140:72.
2. Miyoshi N, et al. *J Vet Med Sci.* 2009;71:1393.
3. Patton KM, et al. *J Am Vet Med Assoc.* 2014;244:287.
4. Bianchi E, et al. *J Vet Intern Med.* 2015;29:1117.
5. Klopfleisch R, et al. *J Comp Pathol.* 2006;135:42.
6. Morrison LR, et al. *J Comp Pathol.* 2008;139:256.

## CENTRAL NERVOUS SYSTEM-ASSOCIATED TUMORS

The **pituitary gland (hypophysis)** consists of the adenohypophysis (pars distalis, intermedia, tuberalis) and the neurohypophysis

(pars nervosa). Tumors of the pituitary gland are common in older horses. Cushing's syndrome in horses almost invariably originates from an **adenoma of the pars intermedia** of the pituitary gland. Initially, these animals exhibit only one remarkable sign, namely, hirsutism. Horses with Cushing's disease only do not manifest polyuria and polydipsia. Major sequelae of an adenoma of the pars intermedia of the pituitary gland are type 2 diabetes mellitus and laminitis. Diagnosis of an adenoma of the pars intermedia of the pituitary gland in the horse mainly depends on dynamic endocrinologic function tests. The sensitivity of the adrenocorticotropin test is about 80%.

Pituitary adenomas can arise from other parts of the pituitary gland; there is a report of a nonfunctional chromophobe adenoma located in the pars distalis of an alpaca with depression and compulsive walking.<sup>1</sup>

## FURTHER READING

McFarlane D. Equine pituitary pars intermedia dysfunction. *Vet Clin North Am Equine Pract.* 2011;27:93-113.

## REFERENCE

1. Gilsenan WF, et al. *J Vet Intern Med.* 2012;26:1073.

## METASTATIC TUMORS OF THE CENTRAL NERVOUS SYSTEM

Many primary tumors of nonnervous tissue have the potential for metastasis or localized growth into the CNS.

- **Ocular squamous cell carcinoma** of cattle may invade the cranium through the cribriform plate
- **Lymphomas** of cattle may metastasize to the CNS with either a multicentric distribution or occasionally as the only lesion. Most commonly bovine lymphoma occurs as an epidural mass in the vertebral canal. Intracranial lymphoma usually involves the leptomeninges or the choroid plexus. Clinical signs are related to the progressive compression of the nervous tissue at the site of the mass. Lymphoma in the horse has occurred in the epidural space with spinal cord compression.
- **Thymic lymphosarcoma** rarely metastasizes to the cerebellum and intracranial extradural sites in yearling cattle.<sup>1</sup>
- **Rhabdomyosarcoma** invaded the thoracic spinal cord of a heifer, resulting in posterior paresis.<sup>2</sup>
- **Schwannomas** (also called neuromas) originate from the Schwann cells of cranial or spinal nerve roots except CNs I and II, which are myelinated by oligodendroglia. Local growth of a schwannoma into the thoracic or sacral spinal cord produced clinical signs of spinal cord dysfunction in two adult cattle.<sup>3</sup> Schwannomas occur in adult



horses with no apparent breed or sex predisposition. There is one report of successful treatment of a dermal schwannoma using localized radiation therapy.<sup>4</sup> In domestic animals, schwannomas can be difficult to differentiate from neurofibromas, and consequently, schwannomas and neurofibromas are categorized as PNSTs by the WHO.

- **Malignant melanoma** has been diagnosed in a cow with hindlimb ataxia<sup>3</sup> and in gray horses where they are usually metastases from skin tumors.

### CENTRAL NERVOUS SYSTEM-ASSOCIATED MASSES

Cholesterinic granulomas, also known as cholesteatomas, may occur in up to 20% of older horses without any clinical effects. However, they can be associated with significant neurologic disease. Affected horses are usually obese. Cholesterinic granulomas occur in the choroid plexus of the fourth ventricle or in the lateral ventricles and mimic cerebrocortical disease. It has been suggested that cholesterol granulomas result from chronic hemorrhage into the plexus stroma, but the underlying pathogenesis is unknown.

Brownish nodular thickening of the plexuses with glistening white crystals is a common incidental finding in mature and aged horses. Occasionally, deposits in the plexuses of the lateral ventricles are massive and fill the ventricular space and cause secondary hydrocephalus caused by the buildup of CSF behind the mass. CSF may be xanthochromic with an elevated total protein.

**Clinical findings** include episodes of abnormal behavior such as depression and bolting uncontrollably and running into fences and walls. Some horses exhibit profound depression, somnolence, and reluctance to move. Seizures have also been reported. Other clinical findings reported include decreased performance, aggression, head tilt, incoordination, intermittent convulsions, hindlimb ataxia progressing to recumbency, intermittent circling in one direction, and spontaneous twitching along the back and flank. There are often serious changes in temperament, with previously placid animals becoming violent and aggressive. In others there are outbursts of frenzied activity followed by coma. The horse may be normal between attacks, and these may be precipitated by moving the head rapidly.

These signs are referable to cerebrocortical disease and the differential diagnosis of cholesterol granulomas must include diffuse cerebral encephalopathy caused by abscess, tumor, toxicosis, metabolic disease, encephalomyelitis, trauma, and hydrocephalus. At necropsy, large cholesterol granulomas are present in the choroid plexus.

### REFERENCES

1. Tawfeeq MM, et al. *J Vet Med Sci.* 2012;74:1501.
2. Kajiwara A, et al. *J Vet Med Sci.* 2009;71:827.
3. Braun U, Ehrensperger F. *Vet Rec.* 2006;158:696.
4. Saulez MN, et al. *Tydskr S Afr Vet Assoc.* 2009;80:264.

## Plant Toxins Affecting the Nervous System

### CANNABINOIDS

Cannabinoids are resinoids found in the plant *Cannabis sativa* (marijuana). The toxic principle is the alkaloid tetrahydrocannabinol. Most reports of poisoning are in dogs and humans, but cattle and horses have also been affected. Clinical signs of poisoning in horses include restlessness, hypersensitivity, tremor, sweating, salivation, dyspnea, staggering gait, and death or recovery after a few hours. No significant necropsy lesions are recorded. The toxin is detectable in stomach or rumen contents.

### CYNANCHOSIDE

Cynanchoside is found in *Cynanchum* spp. (monkey rope),<sup>1</sup> and a very similar toxin is found in *Marsdenia rostrata* (milk vine), *M. megalantha*,<sup>1</sup> *Sarcostemma brevipedicellatum* (= *S. australe*; caustic vine), and *S. viminalis* (caustic bush). It is associated with hypersensitivity; ataxia; muscle tremors; recumbency; tetanic and clonic convulsions; opisthotonus; and death in horses, donkeys, pigs, and ruminants.<sup>1,2</sup> Other less common signs include teeth grinding, dyspnea, salivation, and vomiting.

### DITERPENOID (KAURENE) GLYCOSIDES (ATRACTYLOSIDE, CARBOXYATRACTYLOSIDE, PARQUIN, CARBOXYPARQUIN, AND WEDELOSIDE)

Diterpenoid glycoside toxins have been found in the following species:

*Atractylis*  
*Atractylodes*  
*Callilepis*  
*Cestrum*  
*Iphia*  
*Wedelia*  
*Xanthium*

*Xanthium strumarium* (cocklebur, Noogoora burr) includes the taxa *X. canadense*, *X. italicum*, *X. orientale*, *X. pungens*, and *X. chinense*, and is poisonous to pigs and ruminants. *X. spinosum* (Bathurst burr) is also toxic and assumed to contain diterpenoid glycosides. The two cotyledonary leaves, either within the spiny burrs or just after sprouting, contain the largest amount of toxin and are the usual source of poisoning. The cockleburs occur on most continents. Poisonings are reported from North America, UK, Europe, and Australia. Most deaths occur on flood plains on which the weed is allowed to grow in abundance. After heavy

rain the seeds in the burrs sprout and are palatable to all species, especially calves and pigs. Mortalities are also recorded in adult cows and sheep. Burrs may contaminate feed grains and poison livestock fed on the compounded ration.

*Cestrum* spp. (e.g., *C. parqui*, *C. laevigatum*), are garden plants originating from South and Central America which, except for *C. diurnum*, also contain a carboxyatractyloside toxin.

*Wedelia asperima* (yellow daisy), *W. biflora*, and *W. glauca* contain wedeloside. Severe hepatic necrosis is the principal necropsy finding, and the clinical syndrome and clinical pathology are characteristic of hepatic encephalopathy.

Poisoning by diterpenoid glycoside toxins in pigs and calves is acute, manifested by hyperexcitability, so that the entire herd appears restless, followed by severe depression, rigidity of the limbs and ears, weakness and a stumbling gait, falling easily and recumbency, and clonic convulsions with opisthotonus. Calves may be belligerent. Acute cases die during the first convulsive episode. The course may be as long as 48 hours and terminate in recovery, but death is the usual outcome. The characteristic lesion is hepatic necrosis.

Treatment is not undertaken. Control depends on keeping livestock away from pasture dominated by these weeds, especially when there are large quantities of sprouted *Xanthium* spp. seeds available.

### STYPANDROL

Stypandrol (syn. hemerocallin), a binaphthoquinone (binaphthalene tetrol) is found in *Dianella revoluta* (flax lily), *Stypandra glauca* (= *S. imbricata*, *S. grandiflora*—nodding blue lily), and *Hemerocallis* spp. (day lily). Field cases occur only with *S. glauca* and are characterized by blindness, incoordination, posterior weakness and, eventually, flaccid paralysis and recumbency in grazing ruminants. Dilatation and immobility of the pupil, with retinal vascular congestion, hemorrhage, and papilledema visible ophthalmoscopically, are characteristic. At necropsy there is diffuse status spongiosis in the brain, general neuronal vacuolation, and axonal degeneration of optic nerve fibers and the photoreceptor cells of the retina.<sup>3</sup> Only the young green shoots are poisonous, so that outbreaks occur only in the spring when the plant is flowering.

### TROPANE ALKALOIDS

Tropane alkaloids include atropine, hyoscyamine, hyoscyne, and scopolamine, found in the following:<sup>4,5</sup>

*Atropa belladonna* (deadly nightshade)  
*Datura stramonium* (common thorn apple, jimsonweed, gewone stinkblaar)<sup>4</sup>  
*D. ferox* (large thornapple, groot stinkblaar)<sup>4</sup>

*Duboisia leichhardtii*  
*D. myoporoides* (corkwoods)  
*Hyoscyamus niger* (henbane).

*D. stramonium* grows universally but cases of poisoning are few, possibly because of its unpalatability, its high toxic dose, and because it produces ruminal atony in cattle. All parts of *Datura* spp. contain belladonna alkaloids with the highest amount in the flowers, followed by the stem, seeds, leaves, and roots.<sup>5</sup> The seeds of the plant are likely to contaminate grain supplies and may be associated with poisoning.<sup>4</sup>

Clinical signs are primarily caused by blockade of peripheral muscarinic receptors innervating smooth muscle, cardiac muscle, and exocrine glands. Ingestion of these plants in sufficient quantity is associated with a syndrome of mydriasis (pupil dilation and blindness), dry mouth, restlessness, tremor, tachycardia, hyperthermia, and frenzied actions.<sup>5</sup> Colic, in particular impaction colic, is reported in horses.<sup>4</sup> Convulsions, recumbency, and death may occur. Cholinesterase inhibitors such as physostigmine may be used to reverse the anticholinergic effects.<sup>4</sup> There are no significant necropsy lesions.

## TUTIN

Tutin is a poisonous constituent of the *Coriaria* spp. (tutu trees) in New Zealand. It is associated with a short course of hypersensitivity, restlessness, and convulsions followed by death, with no visible lesions at necropsy.

## FURTHER READING

- Botha CJ, Naude TW. Plant poisonings and mycotoxicoses of importance in horses in southern Africa. *J S Afr Vet Assoc.* 2002;73:91-97.
- Jain MC, Arora N, Ganja (*Cannabis sativa*) refuse as cattle feed. *Indian J Anim Sci.* 1988;58:865-867.
- Naudé TW, Gerber R, Smith R, et al. *Datura* contamination of hay as the suspected cause of an extensive outbreak of impaction colic in horses. *J S Afr Vet Assoc.* 2005;76:107-112.

## REFERENCES

1. Neto SAG, et al. *Toxicol.* 2013;63:116.
2. Pessoa CRM, et al. *Toxicol.* 2011;58:610.
3. Finnie JW, et al. *J Aust Vet Assoc.* 2011;89:24.
4. Gerber R, et al. *J S Afr Vet Assoc.* 2006;77:86.
5. Krenzelok E. *Clin Toxicol (Phila).* 2010;48:104.

## INDOLE ALKALOIDS

A large number of indole alkaloids occur in fungi, especially the *Claviceps* and *Acremonium* spp. In plants there are also some groups of toxins with similar toxic effects, and similar to those of the fungi. The important two are the  $\beta$ -carbolines and the dimethyl tryptamines; followed by the hydroxyl methyl tryptamines, and a miscellaneous group of alstonine and related toxins. Plants included in the latter group that are associated with an incoordination syndrome like phalaris staggers are *Gelsemium semper-virens* (yellow jessamine), *Alstonia constricta* (bitter bark tree), and the mushroom

*Psilocybe* spp. (mad or magic mushroom). *Poa hueca* and *Urtica* spp. (stinging nettle) are associated with a more acute syndrome of convulsions and sudden death. *Phalaris* spp. are unusual in that they contain both  $\beta$ -carbolines and methylated tryptamines. Related indole alkaloids of the pyrrolidinindoline type have poisoned livestock in Australia (idiospermuline in *Idiospermum australiense*) and North America (calycanthine in *Calycanthus* spp.), producing tetanic convulsions.

## $\beta$ -CARBOLINE INDOLEAMINE ALKALOID POISONING

$\beta$ -Carboline indole alkaloids (harmala alkaloids) in plants include harmaline, tetrahydroharmine, harman, norharman, tetrahydroharmine, harmine, harmol, harmalol, peganine, and deoxypeganine.<sup>1</sup> The mechanism of action for these alkaloids is competitive inhibition of monoamine oxidase (primarily MAO-A) resulting in increased serotonin activity.<sup>2</sup> Synthetic forms of these alkaloids are associated with clinical signs similar to those occurring in natural plant poisonings with *Peganum harmala* (African or Turkish rue), *P. mexicana* (Mexican rue), *Phalaris* spp., *T. terrestris* (caltrop, catshead burr), *T. micrococcus* (yellow vine), *Kallstroemia hirsutissima* (hairy caltrop, carpet weed), and *K. parviflora*.<sup>1-3</sup>

The characteristic syndrome, similar to that of an upper motor neuron lesion, includes hypermotility or hypomotility, sometimes sequentially in the same patient, muscle tremor, partly flexed paresis of the thoracic and/or the pelvic limb, hypermetria, a wide-based stance, crossing of the limbs, extension of the neck, swaying of the head, walking backward, sudden jumping movements, sham eating, and terminal convulsions. The net effect, seen in all farm animal species and camels, is one of easy stimulation, by stimulating gait incoordination and stumbling, fetlock knuckling, falling, and recumbency. The signs appear gradually; are similar to, but less severe than, those associated with the methylated tryptamines; and are irreversible. There is axonal degeneration in peripheral nerves. Long-term cases of *T. terrestris* poisoning pivot on their front limbs while their hindlimbs trace a circle. The pivoting is related to the unilateral muscle atrophy of limbs of one side or the other.

## FURTHER READING

- Allen JRE, Holmstedt BR. The simple  $\beta$ -carboline alkaloids. *Phytochemistry.* 1980;19:1573-1582.
- Bourke CA. A novel nigrostriatal dopaminergic disorder in sheep affected by *Tribulus terrestris* staggers. *Res Vet Sci.* 1987;43:347-350.
- Moran EA, Couch JF, Clawson AB. *Peganum harmala*, a poisonous plant in the Southwest. *Vet Med.* 1940;35:234-235.

## REFERENCES

1. Burrows GE, Tyril RJ, eds. *Nitrariaceae Lindl. Toxic Plants of North America.* 2nd ed. Hoboken, NJ: Wiley-Blackwell; 2013:833.

2. Herraiz T, et al. *Food Chem Toxicol.* 2010;48:839.
3. Finnie JW, et al. *Aust Vet J.* 2011;89:247.

## INDOLIZIDINE ALKALOID TOXICOSIS (LOCOISM, PEASTRUCK)

The two indolizidine alkaloids of plant origin are castanospermine and swainsonine and both of them affect cellular enzyme activity.

## CASTANOSPERMINE POISONING

Castanospermine, an indolizidine alkaloid found in the seeds of *Castanospermum australe* (Moreton Bay chestnut tree), is structurally and functionally similar to swainsonine.<sup>1</sup> It inhibits  $\alpha$ -glucosidase activity so that affected cattle have been misdiagnosed as heterozygotes for generalized glycogenosis type II (Pompe's disease). The seeds are also associated with hemorrhagic gastroenteritis with myocardial degeneration and nephrosis in cattle and sheep if eaten in large quantities.<sup>1</sup>

## SWAINSONINE POISONING

### SYNOPSIS

**Etiology** Poisoning by some plants in the genera of *Astragalus*, *Oxytropis*, and *Swainsona*. It is associated with induced mannosidosis.

**Epidemiology** Grazing toxic plants for 2–6 weeks is associated with signs, reversible if pasture is changed.

**Clinical pathology** Urine content of mannose-containing oligosaccharides is elevated.

**Lesions** Vacuolation of neurons.

**Diagnostic confirmation** Swainsonine can be detected in serum, urine, or animal tissues; the endophyte may be detected in the plant.

**Treatment** No treatment is available.

**Control** Restrict both the amount of plant and time animals allowed to graze infected pastures.

## ETIOLOGY

Swainsonine is an indolizidine alkaloid found in many *Astragalus* spp., *Oxytropis* spp., and *Swainsona* spp. legumes.<sup>2,3</sup> Some *Ipomoea* spp.<sup>4</sup> as well as *Turbinia cordata*<sup>5</sup> and *Sida carpinifolia*<sup>6,7</sup> contain swainsonine either alone or in combination with mixtures of other alkaloids. Ingestion of the toxic plants over a long period is associated with an induced lysosomal storage disease in all animal species. Not all plants in a particular species contain swainsonine. In North America there are over 354 different species of *Astragalus* and 22 species of *Oxytropis*, yet only 20 of them are known to contain swainsonine or are associated with locosim.<sup>2</sup> The common plants in which the alkaloid's

presence has been identified include the following:

- *Astragalus lentiginosus*, *A. mollissimus*, *A. wootonii*, *A. emoryanus*.<sup>2</sup> Other plants of this genus that are associated with a similar disease, and in which the presence of swainsonine is assumed, are *A. northoxys*, *A. lentiginosus* var. *waheapensis*, *A. lusitanicus*, and *A. thurberi*.
- *Oxytropis sericea*, *O. ochrocephala*.<sup>2</sup> Other plants of this genus that are associated with a similar disease, and in which the presence of swainsonine is assumed, are *O. besseyi*, *O. condensata*, *O. lambertii*, and *O. puberula*.
- *Swainsona canescens*, *S. galegifolia*, *S. brachycarpa*, *S. greyana*, *S. luteola*, *S. procumbens*, *S. swainsonioides*.<sup>3</sup>

*Undifilum oxytropis* (formerly *Embellisa* spp.), a fungal endophyte present in the seeds, has been identified in the genera of *Astragalus* spp. and *Oxytropis* spp. as well as in *S. canescens* and is currently thought to be responsible for the production of swainsonine.<sup>6,8,9</sup> Swainsonine is also synthesized by the fungus *R. leguminicola*, but the disease associated with this fungus is caused by its slaframine content.

## EPIDEMIOLOGY

### Occurrence

Poisoning is most common in North America (as locoism associated with *Astragalus* spp. and *Oxytropis* spp.) and in Australia as Darling pea or peastruck (*Swainsona* spp.), but it occurs worldwide.<sup>2,3,8</sup> Toxicity from *Oxytropis* spp. has been reported in China, *Ipomea* spp. in goats in Brazil,<sup>4</sup> *T. cordata* in goats in Brazil,<sup>5</sup> *S. carpinifolia* in horses in Brazil,<sup>10</sup> and unknown swainsonine source in a horse in Belgium.<sup>7</sup>

## Risk Factors

### Animal Risk Factors

All animal species are affected, and experimental administration of the alkaloid to monogastric, farm, and laboratory animals is associated with the typical neuronal *A. lentiginosus* lesions. Horses are highly sensitive to swainsonine and develop clinical signs when fed 0.2 mg swainsonine/kg BW for 60 days followed by cattle and sheep at 0.25 mg/kg BW for 30 to 45 days.<sup>7,11</sup>

Grazing animals must ingest the plants for at least 2 weeks, and more often 6 weeks, before clinical signs appear.<sup>7</sup> The plants are not addicting, but animals appear to have a preference for them over other plants. It may be that the plants are more palatable to them at certain times of the year compared with what other forage is available.<sup>2</sup>

Swainsonine is excreted in the milk and may intoxicate nursing animals.<sup>2</sup>

## PATHOGENESIS

Swainsonine is a specific inhibitor of lysosomal  $\alpha$ -mannosidase causing accumulation

of mannose in lysosomes and thus widespread neurovisceral cytoplasmic vacuolation.<sup>2,3,7</sup> The vacuoles are accumulations of mannose-rich oligosaccharides, including abnormal glycoproteins. Vacuolation reaches its greatest intensity in the CNS, and this is probably related to the predominance of nervous signs in the disease. Vacuolation of the chorionic epithelium may be related to the occurrence of abortion, and a transient infertility is suspected in rams to be the result of a similar lesion in the epithelium of the male reproductive tract. The lesion appears quickly and is reversible if the swainsonine intake ceases. In addition, swainsonine inhibits mannosidase II resulting in an alteration of glycoprotein synthesis, processing, and transport. The net result is a dysfunction of membrane receptors and circulating insulin, as well as impairment of cellular adhesion.<sup>2,7</sup>

## CLINICAL FINDINGS

After several weeks of grazing affected pasture adult animals begin to lose condition and young animals cease to grow. The appetite is diminished, and the coat becomes dull and harsh.<sup>2,7,10,11</sup> Several weeks later nervous signs of depression; gait incoordination; muscle tremor; and difficulty in rising, eating, and drinking become apparent. Sheep commonly adopt a “star-gazing” posture, and horses may show nervousness, excitation, rearing over backward when handled, tremors, colic, recumbency, and death.<sup>7,11</sup> Cases may become overexcited if stressed or stimulated. Recovery is likely if the animal is removed from the source of the toxin soon after signs appear. Recovery may be complete or there may be a residual gait incoordination if the animal is excited. Advanced cases may show no improvement, and others become recumbent and die. Calves at high altitudes fed *A. lentiginosus* or *O. sericea* develop a higher incidence of congestive heart failure than calves not fed on the plants.

Pregnant ewes ingesting *Astragalus* spp. plants may abort or produce abnormal offspring with contractures. The defects take the form of small, edematous, or dead fetuses or skeletal deformity.<sup>2,12</sup> There are no such abnormalities recorded with *Swainsona* spp.

## CLINICAL PATHOLOGY

Vacuolation in circulating lymphocytes occurs in poisoning caused by *Swainsona* spp., and may have diagnostic significance. Serum levels of  $\alpha$ -mannosidase are significantly reduced and swainsonine levels increased. Swainsonine levels reflect the amount being ingested and not the duration of exposure, and quickly return to normal when ingestion of the plants ceases.<sup>7</sup> The urine content of mannose-containing oligosaccharides is greatly increased during the period of intake of swainsonine.

## NECROPSY FINDINGS

The characteristic microscopic lesion is fine vacuolation of the cytoplasm in neurons throughout the CNS. Similar vacuolation is present in cells of other organs, especially the kidney, and the fetus in animals poisoned by *Astragalus* spp. High blood and tissue levels of swainsonine are detectable, including in frozen material.

In aborted calves, lambs, and foals there is extensive vacuolation of the chorionic epithelial cells. The skeletal deformities include arthrogryposis and rotation of the limbs about their long axis.

Diagnosis is made by documenting exposure to a swainsonine-containing plant, identifying the clinical signs, and swainsonine serum or tissue concentrations. Recently a quantitative polymerase chain reaction (PCR) method was identified that can measure fungal endophytes in the *Astragalus* spp. and *Oxytropis* spp.<sup>13</sup>

## DIFFERENTIAL DIAGNOSIS

### Differential diagnosis list

- *Conium* spp. piperidine alkaloids
- Inherited mannosidosis
- *Lupinus* spp. quinolizidine alkaloids
- *Nicotiana* spp. alkaloids

## TREATMENT

There is no effective treatment for Swainsonine poisoning. Removal of the affected animals from access to source plants may result in partial or complete recovery, provided the cases are not too advanced.

## CONTROL

Pregnant animals should not be exposed to sources of swainsonine, but other stock may be grazed on the plant without ill effect for short, specified periods, namely 4 weeks for sheep and cattle and 2 weeks for horses. The most important factor is the amount of plant material ingested and the amount of time the animal is exposed to the toxin. Animals should not be allowed to graze when toxic plants are palatable and other forage is in short supply. In the western part of the United States, cattle should not be allowed to graze on locoweed-infected pastures until late May or early June, when other grasses have begun to grow. Pastures should not be overstocked because a lack of adequate forage will force animals to graze on locoweed. Animals grazing on locoweed pastures should be monitored closely and moved to a different pasture if they begin to show signs of poisoning. Herbicides may be used to control *Astragalus* spp. and *Oxytropis* spp., but the endophyte is contained in the seeds and they are drought resistant and able overwinter, allowing only for control and not elimination. Attempts to reduce consumption of the toxic plants by creating conditioned reflex aversion, to reduce absorption



of ingested swainsonine or by supplementing the diet with bentonite, have not been rewarding.

### FURTHER READING

- Radostits O, et al. Indolizidine alkaloid poisoning. In: *Veterinary Medicine: A Textbook of the Disease of Cattle, Horses, Sheep, Goats and Pigs*. 10th ed. London: W.B. Saunders; 2007:1870.
- Stegelmeyer BL, James LF, Panter KE, et al. The pathogenesis and toxicokinetics of locoweed (*Astragalus* and *Oxytropis* spp.) poisoning in livestock. *J Natural Toxins*. 1999;8:35-45.

### REFERENCES

1. Stegelmeyer BL, et al. *Toxicol Pathol*. 2008;36:651.
2. Cook D, et al. *Rangelands*. 2009;31:16.
3. Finnie JW, et al. *Aust Vet J*. 2011;88:247.
4. Barbosa RC, et al. *Pesq Vet Res*. 2007;27:409.
5. Dantas AFM, et al. *Toxicon*. 2007;49:111.
6. Cook D, et al. *J Agric Food Chem*. 2011;59:1281.
7. Nollet H, et al. *Equine Vet Ed*. 2008;20:62.
8. Grum DS, et al. *J Nat Prod*. 2013;76:1984.
9. Ralphs MH, et al. *J Chem Ecol*. 2008;34:32.
10. Lima EF, Riet-Correa B, Riet-Correa F, et al. Poisonous plants affecting the nervous system of horses in Brazil. In: Riet-Correa F, Pfister J, Schild AL, Wierenga TL, eds. *Poisoning by Plants, Mycotoxins, and Related Toxins*. Oxfordshire, UK: CAB International; 2011:290.
11. Stegelmeyer BL, Lee ST, James LF, et al. The comparative pathology of locoweed poisoning in livestock, wildlife, and rodents. In: Pater KE, Ralphs MH, Pfister JA, eds. *Poisonous Plants: Global Research and Solutions*. Oxfordshire, UK: CAB International; 2007:59.
12. Panter KE, Welch KD, Lee ST, et al. Plants teratogenic to livestock in the United States. In: Riet-Correa F, Pfister J, Schild AL, Wierenga TL, eds. *Poisoning by Plants, Mycotoxins, and Other Toxins*. Oxfordshire, UK: CAB International; 2011:236.
13. Cook D, et al. *J Agric Food Chem*. 2009;57:6050.

## NEUROGENIC QUINOLIZIDINE ALKALOIDS (*LUPINUS* SPP.)

### ETIOLOGY

Alkaloids causing the nervous syndrome include sparteine, lupinine, lupanine, hydroxylupanine, spathulatine, and thermopsine. These vary widely in their toxicity and their concentration in plant species, and within the same species between years, depending largely on the climate. Species of lupin known to contain them are *Lupinus angustifolius* and *L. cosentinii* (synonym *L. digitatus*). Species that are associated with the characteristic nervous syndrome and in which the presence of the alkaloids in the plant is assumed include the following:

- L. argenteus*
- L. caudatus*
- L. cyaneus*
- L. greenei*
- L. laxiflorus*
- L. leucophyllus*
- L. leucopsis*
- L. onustus*
- L. pusillus*

### EPIDEMIOLOGY

The alkaloids are present in all parts of the plant but are in their greatest concentration in the seeds and pods; most outbreaks of poisoning occur when livestock graze mature, standing lupins, carrying many pods. Sheep eat the plant more readily and are more commonly affected than cattle or horses. The mortality rate in sheep is high. In cattle, it is usually low but may be as high as 50%.

Other plants in which the alkaloids occur and which are associated with the nervous disease include the following:

- Cytisus* (synonym *Laburnum*, *Sarothamnus* spp.)
- Baptisia* spp.
- Sophora* spp.
- Spartium junceum* (Spanish broom)
- Thermopsis* spp.

### CLINICAL FINDINGS

In the nervous disease, affected animals may develop dyspnea and depression, followed by coma and death without a struggle. More acute cases have convulsive episodes in which they are dyspneic and staggering, and show frothing at the mouth, clonic convulsions, and grinding of the teeth. A more prolonged disease is reported in cattle poisoned experimentally with *Thermopsis montana*. There is anorexia, depression, edematous swelling of the eyelids, tremor, a stilted gait, arching of the back and a tucked-up abdomen, rough hair coat, and prolonged recumbency.

### PATHOLOGY

Severe myopathy results in high aspartate aminotransferase (AST), creatine kinase (CK) and lactic acid dehydrogenase (LDH) activities. The possibility of a myopathy being associated with lupins has been raised because the prevalence of enzootic muscular dystrophy appears to be much higher on lupin than on other pasture. Lupins are low in selenium and vitamin E content, and classical white muscle disease may also occur. Histologic and biochemical examination of affected calves discount myopathy as the primary lesion. In poisoning by *Cytisus* spp., both *C. laburnum* (laburnum) and *C. scoparius* (broom) are associated with fatalities.

### FURTHER READING

- Panter KE, Maryland HF, Gardner DR, et al. Beef cattle losses after grazing *Lupinus argenteus* (silvery lupine). *Vet Hum Toxicol*. 2001;43:279-282.

## NITROCOMPOUND PLANT TOXICOSIS (MILK VETCH)

### SYNOPSIS

**Etiology** Several different toxins; miserotoxin in certain *Astragalus* spp. is the most important.

**Epidemiology** Limited to geographic distribution of the toxic plants; mostly North America but other countries affected depending on specific plant.

**Clinical pathology** Nonspecific; methemoglobin values >20%.

**Lesions** Degenerative lesions in peripheral nerves and spinal cord.

**Diagnosis confirmation** Associated with isolation of nitrotoxins in tissues and fluids.

**Treatment** None.

**Control** Management of pasture to avoid grazing pasture when relevant plants are abundant.

### ETIOLOGY

Nitrocompounds (nitrotoxins) poisonous to animals occur in a number of plants, especially in some species of *Astragalus*. They are all glycosides of 3-nitropropionic acid (NPA) or of 3-nitro-ropanol (NPOH). Miserotoxin is the most common and well known toxin; other toxins include cibarian, corollin, coronarian, coronillin, and karakin.<sup>1</sup> The best known occurrences of the nitrocompounds include the following:

- *A. canadensis* (Canadian milk vetch), *A. emoryanus* (Emory's milk vetch), *A. miser* (forest or woody milk vetch), *A. pterocarpus* (winged milk vetch), *A. tetrapterus* (four-wing milk vetch), and others; contain miserotoxin.<sup>1</sup>
- *Corynocarpus laevigatus* (karak tree); contains karakin.<sup>2</sup>
- *Oxytropis* spp., a plant genus very similar botanically to *Astragalus* spp., is associated with the same diseases as the latter but its toxic agent has not been identified.
- *Securigera varia* (*Coronilla varia*), contains cibarian and others.<sup>1</sup>
- *Indigofera linnaei* (Birdsville indigo), contains karakin and other nitrocompounds.<sup>3</sup>

### EPIDEMIOLOGY

#### Occurrence

The occurrence of these plant poisonings is determined by the presence and ingestion of the specific plants. *Astragalus* and *Oxytropis* spp. are, for the most part, limited in distribution to North America, but poisoning of sheep by *A. lusitanicus* is recorded in Morocco, and of all species by *O. puberula* in Kazakhstan. *Corynocarpus* spp. occur in New Zealand and *Indigofera* spp. are widespread, occurring in North America, Australia, Africa, and Southeast Asia.

*Astragalus* and *Oxytropis* spp. are herbaceous legumes, most of them are perennial, and they dominate the desert range over large areas of the United States. They provide excellent forage. Only some species contain miserotoxin, but this makes them very destructive and very heavy losses of sheep and cattle may occur.

## Risk Factors

### Animal Risk Factors

Cattle are the more susceptible. Lactating animals are more susceptible than dry animals. There are reports of the disease in horses in North America and a similar disease in horses in China after grazing *O. kansuensis*.

### Human Risk Factors

Miserotoxin and its metabolic end products may be excreted in the milk of cows eating these plants.

## PATHOGENESIS

In ruminants the glycosides are hydrolyzed in the rumen to NPOH and NPA. Both are absorbed from the rumen and once in the liver, NPOH is further biodegraded to NPA. Nitrous dioxide (NO<sub>2</sub>) formed during biodegradation may account for methemoglobinemia.<sup>1</sup> Some nitrite may also be formed resulting in methemoglobinemia in horses and ruminants. The onset of clinical signs is associated with the accumulation of NPA and a resulting neurologic syndrome, characterized principally by nervous signs and the development of degenerative lesions in the CNS. In experimental animals the dose rate and length of exposure to the toxin determine whether the acute or chronic disease occurs. Typically, animals must have consumed nitrotoxin plants for a week or more before showing signs. Morbidity is 10% to 15%; case-fatality rate may be up to 30%.<sup>1</sup>

## CLINICAL FINDINGS

### Acute Poisoning

Death may occur as soon as 3 hours after the commencement of signs, but the course is usually about 24 hours. Common signs include ataxia or a staggering walk, recumbency, and death from respiratory or cardiac arrest.

### Chronic Poisoning

The syndrome in cattle is often referred to as “cracker heels,” because of the noise made when rear hooves strike each other.<sup>1</sup> Affected animals lose weight, and develop a poor hair coat, nasal discharge, and poor exercise tolerance. Respiratory distress, with loud stertor (roaring), is more marked in sheep than in cattle and knuckling of the fetlocks and incoordination, followed in some by paraplegia, is more common in cattle. Temporary blindness and drooling of saliva may also be evident. The mortality rate is very high, with the course lasting over several months. Animals that recover have a long convalescence. Death may occur suddenly if affected animals are stressed.

*I. linnaei* poisoning in horses (synonym Birdsville horse disease) is associated with weight loss, gait incoordination, easy falling, toe dragging, dyspnea, and convulsions.<sup>3</sup> The plant is equally poisonous when dry or green, although most cases occur in the spring when

the plant is succulent. Horses need to graze the plant for about 10 days before signs appear. Characteristic signs include segregation and somnolence, with the animal often standing out in the open in the hot sun, apparently asleep when unaffected horses have sought the shade. There is marked incoordination, with the front legs being lifted and extended in an exaggerated manner. The hocks are not flexed, causing the fronts of the hind hooves to be dragged on the ground. The head is held in an unnaturally high position and the tail is held out stiffly. There is difficulty in changing direction, and incoordination increases as the horse moves. The horse commences to sway and at the canter there is complete disorientation of the hind legs so that the animal moves its limbs frantically but stays in the one spot with the legs becoming gradually abducted until it sits down and rolls over. Terminally there is recumbency with intermittent tetanic convulsions, which may last for up to 15 minutes and during which death usually occurs.

A chronic syndrome may develop in some horses subsequent to an acute attack. Affected animals can move about, but there is incoordination and dragging of the hind feet with wearing of the toe, and inspiratory dyspnea (roaring) may also occur. No lesions have been described in the nervous system of affected animals. *I. linnaei* contains the toxic amino acid, indospicine, an analog of arginine, and NPA.<sup>3</sup> Poisoned horses may not always develop the liver damage typical of intoxication by indospicine<sup>3</sup>; however, supplementation of the diet with arginine-rich protein feeds prevents development of the disease.<sup>4</sup> Peanut meal (0.5–1 kg/day) and gelatin provide readily available and cheap sources of arginine.

## CLINICAL PATHOLOGY

Methemoglobinemia concentrations greater than 20% may occur in cattle and horses. Laboratory procedures for the determination of blood levels of miserotoxin, some other nitrotoxins, and NPOH and NPA are available.

## NECROPSY FINDINGS

Brown discoloration of the blood, and extensive petechiation in tissues, are common findings in the acute form of the disease. In the chronic disease, there are degenerative changes in the spinal cord and peripheral nerves, especially the sciatic nerve, as well as areas of necrosis in the thalamus and Purkinje cells in some cerebellar folia, white matter spongiosis in the globus pallidus, and distension of the lateral ventricles.<sup>1</sup> Nonspecific gross lesions include pulmonary emphysema and pneumonia, abomasal ulceration, and pericardial/pleural fluid.

Diagnosis confirmation depends on the identification of the poisonous plants in the environment and the toxins in the plants and animal tissues

## DIFFERENTIAL DIAGNOSIS

### Differential diagnosis list (chronic form)

- Chronic cyanide poisoning
- Paspalum staggers
- Phalaris staggers
- Ryegrass staggers

## TREATMENT

Treatment includes removing animals from the suspected pastures and providing an alternate food source. The use of injectable thiamine has not shown to be of any value. There is no specific treatment for the chronic form of the disease, and some animals may ultimately recover.

## CONTROL

Control of the growth of the plants by stimulating growth of competitive grasses, or the widespread use of selective herbicides, is recommended but unlikely to be a practicable procedure in many of the situations in which the plants occur. Experimentally, the use of some herbicides significantly reduces the content of miserotoxin in *A. miser* var. *oblongifolia* in pasture. Variations between species of *Astragalus* spp. in their capacity to produce miserotoxin and store seleno-compounds (some of them, e.g., *A. toanus*, do both) provides opportunities to manipulate the grazing of particular fields to best advantage.

## FURTHER READING

- Anderson RC, Majak W, Rasmussen MA, et al. Toxicity and metabolism of the conjugates of 3-nitropropanol and 3-nitropropionic acid in forages poisonous to livestock. *J Agric Food Chem*. 2005;53:2344-2350.
- Benn M, McEwan D, Pass MA, et al. Three nitropropanoyl esters of glucose from *Indigofera linnaei*. *Phytochemistry*. 1992;7:2393-2395.
- Majak W, Benn M. Additional esters of 3-nitropropanoic acid and glucose from fruit of the New Zealand karaka tree, *Corynocarpus laevigatus*. *Phytochemistry*. 1994;35:901-903.
- Majak W, Stroesser L, Lysyk T, et al. Toxicity and development of tolerance in cattle to timber milkvetch. *J Range Manage*. 2003;56:266-272.

## REFERENCES

1. Burrows GE, Tyril RJ. Nitrotoxicosis (cracker heels). In: *Toxic Plants of North America*. 2nd ed. Hoboken, NJ: Wiley-Blackwell; 2013:515.
2. Noori MA, et al. *Toxicol Environ Chem*. 2007;89:479.
3. Ossedryver SM, et al. *Aust Vet J*. 2013;91:143.
4. Lima EF, et al. *Toxicol*. 2012;60:324.

## PIPERIDINE ALKALOID PLANT TOXICOSIS

### ETIOLOGY

The important, identified piperidine alkaloids include coniine, cynapine, nicotine,

and lobeline. These alkaloids are primarily neurotoxins; some alkaloids present in *Conium maculatum* and *Nicotiana* spp. are also teratogens and are dealt with separately in Chapter 18.

### CONIUM

*C. maculatum* (poison hemlock) contains five major acetate-based piperidine alkaloids—coniine, *N*-methylconiine, conhydrine, pseudoconhydrine, and  $\gamma$ -coniceine—and a number of other, lesser, alkaloids.  $\gamma$ -Coniceine is likely a precursor of the others and is much more toxic.<sup>1</sup> The concentration of each of the alkaloids in different parts of the plant, in different climates, and at different times of the year is quite variable. For example, the concentration of the  $\gamma$ -coniceine is high in the fruits when they are formed, but there is no significant content in the roots. In the dormant stage, the toxicity of the roots is very high.

### EPIDEMIOLOGY

Poison hemlock occurs in most parts of the world. All animal species are affected, with cattle, sheep, goats, horses, and pigs showing the nervous form of the disease. Poisoned cattle, pigs, and sheep also produce deformed offspring, with ewes being much less susceptible than cows and sows. Grazing animals are poisoned by eating the standing plant, the seeds, or roots at the appropriate time of their development. The plant may also be fed in hay or green feed or the seeds may contaminate harvested grain. Milking cows secrete the alkaloids in their milk.

### PATHOGENESIS

The alkaloids are associated with two modes of poisoning, paralysis of skeletal muscle by blocking transmission at neuromuscular junctions and by acting as teratogens. All of the major alkaloids are associated with the acute disease. Only coniine and  $\gamma$ -coniceine are known to be teratogenic.

### CLINICAL FINDINGS

Clinical signs in the acute, neurologic form of poisoning include tremor, staggering gait, knuckling of fetlocks, belching, vomiting, frequent urination and defecation, drooling of saliva, tachycardia, and pupillary dilation.<sup>2,3</sup> In cows and sows, prolapse of the nictitating membrane occurs, and in affected cows, a characteristic mousy odor of the milk and urine is described. The course in cattle, goats, and horses is only a few hours and terminates in recumbency and death by respiratory paralysis, without convulsions. Sheep are least affected and recovery is common.

### CYNAPINE

Cynapine, a piperidine alkaloid found in *Aethusa cynapium* (fool's parsley, lesser hemlock) is associated with dyspnea

and gait incoordination in cattle, goats, and pigs.

### NICOTIANA

The most common poisonous members of the tobacco family of plants include the following:

*Nicotiana tabacum* (commercial tobacco)  
*N. attenuata* (wild tobacco)  
*N. exigua*  
*N. glauca* (tree tobacco)  
*N. megalosiphon*  
*N. trigonophylla* (wild tobacco)  
*N. velutina*

The principal toxins include nicotine, anabasine, and anagryne.<sup>4</sup> Other alkaloids occurring in *Nicotiana* spp., but which are not recorded as having poisoned animals, are nornicotine and anatabine. *Duboisia hopwoodii* (pituri) is another plant with these alkaloids. Several alkaloids may be present in the one plant, but most plant species have a particular alkaloid that predominates. The concentration of the alkaloid varies between parts of the plant and between different stages of growth.

Acute poisoning of livestock ingesting *Nicotiana* spp. or *D. hopwoodii* is associated with muscle tremor, weakness, incoordination, pupil dilation, and recumbency with limb paddling progressing to paralysis. Diarrhea may be present. The alkaloid anabasine is teratogenic.

Tobacco-specific nitrosamines, formed from *Nicotiana* spp. alkaloids, are known to be carcinogenic to laboratory animals, but there is no record of this association in agricultural animals.

### LOBELINE

The piperidine alkaloid lobeline is found in the plant *Lobelia berlandieri*. Ingestion of the plant is associated with mouth erosions, salivation, and diarrhea. Necropsy lesions are limited to the lesions of enteritis.

### FURTHER READING

- Galey FD, Holstege DM, Fisher EG. Toxicosis in dairy cattle exposed to poison hemlock (*Conium maculatum*) in hay: isolation of Conium alkaloids in plants, hay, and urine. *J Vet Diagn Invest.* 1992;4:60-64.
- Panter KE, Keeler RF, Baker DC. Toxicoses in livestock from the hemlocks (*Conium* and *Cicuta* spp. *J Anim Sci.* 1988;66:2407-2413.

### REFERENCES

- Odrozola E. Poisoning by plants, mycotoxins, and algae in Argentina livestock. In: Riet-Correa F, Pfister J, Schild AL, Wierenga TL, eds. *Poisoning by Plants, Mycotoxins, and Other Toxins.* Oxford, UK: CAB International; 2011:35.
- Binev R, et al. *Trakia J Sci.* 2007;5:40.
- Nicholson SS. *Vet Clin North Am Food Animal Pract.* 2011;27:447.
- Schep LJ, et al. *Clin Toxicol (Phila).* 2009;47:771.

## CORYNETOXINS (TUNICAMINYLRACILS) (ANNUAL RYEGRASS STAGGERS, FLOOD PLAIN STAGGERS, STEWART RANGE SYNDROME)

### SYNOPSIS

**Etiology** Corynetoxins (tunicaminylracils) present in infected grass (*Lolium rigidum*, *Lachnagrostis filiformis*, *Polypogon monspeliensis*) eaten by all species. A similar tunicaminylracil has been isolated from water-damaged wheat eaten by pigs.

**Epidemiology** Outbreaks in Australia (summer to early fall) and South Africa when grazing animals ingest infected seedhead galls. Occurs anytime of the year in animals fed infected hay.

**Clinical pathology** Increased activity of hepatic enzymes in serum; prolonged prothrombin and activated partial thromboplastin time.

**Lesions** Perivascular edema in meninges and brain; hemorrhages in multiple tissues.

**Diagnosis confirmation** Tunicaminylracil in pasture seed heads.

**Treatment** Magnesium sulfate in horses or small herds. Removal of animals from infected fields or hay; reduce stress.

**Control** Keep animals off infected pastures; decrease prevalence of infection by various methods (see text); test hay before purchasing.

### ETIOLOGY

Nematode larvae infest and are associated with galls in the seedheads of *Lolium rigidum* (Wimmera or annual ryegrass), *Polypogon monspeliensis* (annual beard grass), and *Lachnagrostis filiformis* (formerly *Agrostis avenacea* and commonly referred to as blown or blowaway grass).<sup>1,2</sup> Nematodes in the genus *Anguina* (*A. agrostis*, *A. funesta*, *A. paludicola*) transport the corynetoxin producing bacteria *Rathayibacter toxicus* into the cuticle of grass seeds.<sup>1,3,4</sup> Bacteriophages were originally felt to play an integral part, but that may no longer be the case.<sup>2</sup> Corynetoxins (tunicaminylracils) are glycolipid tunicaminylracil antibiotics produced in the seedhead gall and sheep, cattle, and horses grazing the pasture are poisoned when they are ingested.<sup>1,3,5</sup> Animals eating corynetoxin-infected hay are poisoned.<sup>1,2</sup>

Other outbreaks have been recorded. In the 1960s, sheep and cattle in the northwestern United States developed a similar neurologic condition when fed fescue infected with *A. agrostis* and *Rathayibacter*-like organisms.<sup>1</sup> Tunicaminylracil has been isolated from water-damaged wheat, which when fed to pigs is associated with clinical signs and deaths similar to those associated with the tunicaminylracil on grasses.<sup>1</sup>



## EPIDEMIOLOGY

### Occurrence

Poisoning that occurs in livestock pastured on *L. rigidum* (termed annual ryegrass toxicity or ARG) or in those grazing *L. filiformis* (flood plain staggers) has become a very important cause of death losses on farms in western and southern Australia, southern New South Wales, and also in South Africa.<sup>1,3,5</sup> Toxicity associated with ingestion of *P. monspeliensis* (termed Stewart range syndrome) is found in flood-prone portions in southeastern South Australia.<sup>1</sup> Typically, in Australia, infected seed heads are toxic beginning with the dry summer period and continuing until the onset of fall rains.<sup>1,2</sup> Clinical signs do not occur until the stock has been on pasture for several days or up to 12 weeks.<sup>1</sup> Forced exercise and high ambient temperatures precipitate or exacerbate clinical signs.<sup>1,5</sup>

### Risk Factors

#### Animal Risk Factors

The oral dose of tunicamycins in sheep associated with the onset of clinical signs following investigational intraduodenal administration is 150 µg/kg.<sup>6</sup> The subcutaneous lethal dose is much smaller, 30 to 40 µg/kg as a single dose or a set of small sequential doses. The toxins are cumulative if the interval between doses are few days.

#### Plant Risk Factors

Pasture improvement based on annually alternating crop-pasture rotations seem to predispose to the disease, with the worst outbreaks occurring after the end of a cropping year. This can be avoided by burning the pasture in the autumn. The organism is introduced onto farms by the introduction of infested grass seed or contaminated agricultural implements.<sup>2</sup> *L. rigidum* has become a weed in southern Australia and herbicide-resistant strains have evolved, complicating control measures. Hay made from infested grass remains poisonous for 5 to 6 years. Poisoning associated with *L. filiformis* has occurred in cattle on extensive pasture recently subjected to severe flooding, hence the name flood plain staggers.<sup>1</sup>

## PATHOGENESIS

Corynetoxins are similar structurally to tunicamycin antibiotics originally isolated from an actinomycete (*Streptomyces lysosuperificus*).<sup>1</sup> Collectively the group, including corynetoxins, is referred to as tunicaminyluracil antibiotics. They are potent inhibitors of lipid linked *N*-glycosylation of glycoproteins<sup>1</sup> and capable of causing cerebral vascular lesions in experimental animals. Interference with cardiovascular function and vascular integrity leads to interference with oxygenation of tissues, particularly the brain.

## CLINICAL FINDINGS

Signs appear when the cattle or sheep are disturbed or stressed, especially by driving.

The animals fall in a convulsion with paddling of limbs, nystagmus, opisthotonus, jaw champing and salivation, head nodding, tetanic extension of limbs and, in sheep, posterior extension of the hindlimbs.<sup>1-3</sup> Death may occur during a convulsion or, if left alone, the animal may recover to the point of being able to stand, but there may be gait incoordination caused by hypermetria, stiff gait, a broad-based stance, head swaying, rocking backward and forward, and loss of balance. Intermittent convulsive episodes recur and the animals soon go down again. Death occurs in up to 24 hours. Further cases occur for up to 10 days after affected animals are removed from the pasture.<sup>2</sup> Morbidity and mortality rates may reach as high as 100% in sheep flocks. In surviving ewes, abortion may occur in up to 10% of pregnant sheep.<sup>1</sup>

Poisoning occurs less frequently in horses and stress is often a precipitating factor.<sup>5</sup> Colic with tachycardia, borborygmi, and congested mucous membranes, is often the first sign observed followed by hypermetria, ataxia, muscle tremors, recumbency, convulsions with limb paddling, and death.<sup>5</sup>

## CLINICAL PATHOLOGY

Blood levels of liver enzymes, bilirubin, and bile acids are elevated. Prothrombin time and activated partial thromboplastin time are prolonged.<sup>1</sup>

## NECROPSY FINDINGS

Necropsy findings are inconsistent and non-specific. The liver may be enlarged and pale or icteric. There may be hemorrhages in a range of tissues. Histologically, there may be perivascular edema in the brain, particularly in cerebellar meninges. Other lesions may include significant liver damage.

## DIFFERENTIAL DIAGNOSIS

### Differential diagnosis list:

- Lead poisoning
- Perennial ryegrass staggers
- Phalaris staggers
- Poisoning by any one of a large number of plants in which the toxic agent has not been identified.

## TREATMENT

Affected flocks or herds should be removed from a toxic pasture as slowly and as quietly as possible to good-quality feed with shade and water in a place free of disturbance.<sup>1,5</sup> Stress should be kept to a minimum.

No specific antidote or antitoxin is available.<sup>1,5</sup> An antidote was developed by CSIRO in Australia for use early in outbreaks of poisoning, but field trials were disappointing.<sup>7</sup> Pharmacologic measures are impractical in herd situations, although intravenous administration of magnesium sulfate could be used for individual animals. Horses have

been treated successfully with an intravenous injection of magnesium sulfate (approximately 100 mg/kg BW; range of 60–200 mg/kg) and supportive measures including flunixin meglumine, dimethyl sulfoxide, and intravenous fluids.<sup>5</sup> Doses of 25 to 150 mg/kg intravenously have been used for hypomagnesemia in horses and may be useful in managing equine cases.<sup>8</sup> It is recommended that magnesium not be administered concurrently with calcium-containing intravenous fluids. Used in combination, calcium is used preferentially at the neuromuscular junction, limiting the effectiveness of magnesium in preventing muscle contractions.<sup>5</sup>

## CONTROL

Pasture management in endemic areas should aim to reduce exposure of livestock to mature pastures with seedheads. This may be achieved by a variety of measures such as heavy stocking during winter and spring, harvesting pasture for silage or hay before seeding followed by heavy grazing to remove ryegrass seedlings, burning crop and pasture residues, and herbicide application.<sup>2</sup>

Methods exist for testing hay and are used for hay exported from Australia.<sup>2,9</sup> Recent improvements in testing have shortened the turnaround time considerably.<sup>10</sup> Hay purchased for use within Australia should be tested and accompanied by a declaration stating that testing occurred and the hay is safe for use.<sup>2</sup>

Two cultivars of *L. rigidum* (Guard and Safeguard) resistant to *A. funesta* have been developed that significantly reduce the number of galls per kilogram of hay and the risk of developing ARG.<sup>2</sup> Pasture application of *Dilophospora alopecuri*, a fungal pathogen of *A. funesta*, has been studied, but the results are mixed and may be uneconomical.<sup>11</sup> Immunization against the toxin is promising but difficult as glycolipids are poor immunogens.<sup>1</sup>

## FURTHER READING

- Bourke CA, Carrigan MJ, Love SCJ. Flood plain staggers, a tunicaminyluracil toxicosis of cattle in north New South Wales. *Aust Vet J*. 1992;69:228-229.
- Cockrum PA, Culvenor CCJ, Edgar JA, et al. Toxic tunicaminyluracil antibiotics identified in water-damaged wheat responsible for the death of pigs. *Aust J Agric Res*. 1988;39:245-253.
- Riley IT, Gregory AR, Allen JG, et al. Poisoning of livestock in Oregon in the 1940s to 1960s attributed to corynetoxins produced by *Rathayibacter* in nematode galls in Chewings fescue. *Vet Hum Toxicol*. 2003;45:160-162.

## REFERENCES

1. Finney JW. *Aust Vet J*. 2006;84:271.
2. Allen JJ. *Microbiology*. 2012;8:18.
3. Finnie JW, et al. *Aust Vet J*. 2011;89:247.
4. Bertozzi T, et al. *Zootaxa*. 2009;2060:33.
5. Grewar JD, et al. *J S Afr Vet Assoc*. 2009;80:220.
6. Haply SL, et al. Dose response of tunicamycins in sheep following intra-duodenal administration. In:

Panther KE, Wierenga TL, Pfister JA, eds. *Poisonous Plants: Global Research and Solutions*. Oxford, UK: CABI; 2007:242.

7. Allen JG, et al. *8th International Symposium on Poisonous Plants (ISOPP8)*, João Pessoa, Paraíba, Brazil, May 2009. Oxford UK: CABI; 2011.
8. Plumb DC. Magnesium. In: Plumb DC, ed. *Veterinary Drug Handbook*. 7th ed. Ames, IA: Wiley-Blackwell; 2011:618.
9. Masters AM, et al. *Crop Pasture Sci*. 2006;57:731.
10. Masters AM, et al. *Crop Pasture Sci*. 2011;62:523.
11. Barbetti MJ, et al. *Plant Dis*. 2006;90:229.

## MISCELLANEOUS PLANT TOXINS AFFECTING THE NERVOUS SYSTEM (UNIDENTIFIED TOXINS)

**Plants with ingestions resulting in signs of gait incoordination**, with or without recumbency, convulsions, or lesions of nervous system include the following:

*Ageratina altissima*  
*Araujia hortorum* (cruel vine)  
*Berula erecta*  
*Brachychiton populneus* (kurrajong tree)  
*Brachyglottis repanda* (rangiora)  
*Catharanthus* spp.  
*Centella uniflora*  
*Combretum platypetalum*  
*Craspedia chrysantha*  
*Doronicum hungaricum* (wild sunflower)  
*Echinopogon* spp. (roughbearded grass)<sup>1</sup>  
*Ervum* spp.  
*Euphorbia mauritanica*  
*Gomphrena celosioides* (soft khaki weed)  
*Hoya* spp. (wax flower)<sup>1</sup>  
*Idiospermum australiense*  
*Melanthrium hybridum*  
*M. virginicum* (bunchflower)  
*Melica decumbens* (dronkgras)  
*Melochia pyramidata*  
*Modiola caroliniana* (creeping mallow)  
*Pennisetum clandestinum* (kikuyu grass)<sup>2,3</sup>  
*Rhodomyrtus macrocarpa* (finger cherry; also is associated with blindness).

*E. mauritanica* is associated with hypersensitivity, stiffness, tremor, incoordination, recumbency, and convulsions in sheep.<sup>1</sup> *Echinopogon ovatus* poisoning in calves and lambs is characterized by stress-induced episodes of stiff-legged incoordination and easy falling and bellowing followed by spontaneous recovery.

*G. celosioides* is associated with outbreaks of incoordination in horses in northern Australia. Spontaneous recovery follows removal from the pasture.

*P. clandestinum* poisoning was originally attributed to rumen acidosis, but the current suggestion is that it is a poisoning associated with the fungi *Fusarium torulosum* growing on the grass, which is an unlikely association in some outbreaks.<sup>2,3</sup> Epidemiologically, the disease occurs concurrently with circumstances conducive to fungal growth, including warmth, moisture, and litter under the grass, often caused by the depredations of

heavy infestations of sod webworms (grass caterpillars), African black beetles, leaf hoppers, and armyworm caterpillars (*Pseudoleptia separata*, *Pseudocalymma elegans*, *Spodoptera exempta*).<sup>2</sup>

Cattle, sheep, and to a lesser extent, goats, show signs of poisoning in late summer and autumn.<sup>2</sup> Clinical signs include depression, hypersalivation, abdominal pain, ruminal tympany and stasis, paralysis of the tongue and pharynx, sham drinking, muscle tremors, incoordination, recumbency, diarrhea, dehydration, and death.<sup>2</sup> In the forestomachs there is distension, mucosal reddening, and extensive microscopically visible necrosis in the rumen and abomasum.

**Plant ingestions associated with paralysis in ewes and horses**, with lesions of a lysosomal storage disease and prominent neuronal pigmentation in the brain and spinal cord include the following:

*Romulea* spp. (onion weed)<sup>1</sup>  
*Solidago chilensis*  
*Stachys arvensis* (stagger weed)  
*Stephania* spp.  
*Trachyantra* spp.  
*T. laxa*  
*T. divaricata*.

*Romulea bulbocodium* is associated with a high incidence of phytobezoars, a level of fertility in ewes as low as 20%, and a severe gait incoordination when stimulated to move.<sup>1</sup> Affected sheep walk with their heads held high, fall easily, struggle momentarily, then relax and get up and walk normally. If they are left on the same pasture for 3 or 4 weeks, they become permanently recumbent.

**Plant ingestions resulting in signs of mania** (e.g., wild running, hyperexcitability, incoordination, circling, aimless wandering, blindness) include the following:

*Burttia prunoides*  
*Pisum sativum*

### FURTHER READING

Peet RL, Dickson J. Kikuyu poisoning in sheep. *Aust Vet J*. 1990;67:229.

### REFERENCES

1. Finnie JW. *Aust Vet J*. 2011;89:247.
2. Bourke CA. *Aust Vet J*. 2007;85:261.
3. Ryley MJ, et al. *Australas Plant Dis Notes*. 2007;2:133.

## Fungal Toxins Affecting the Nervous System

*Diplodia maydis* (synonym *D. zaeae*, *Stenocarpella maydis*) is associated with a serious disease of maize crops called corn cob rot. Infected cobs fed to cattle, sheep, goats, and horses are associated with diplodiosis, a neuromycotoxicosis, reported in Australia, Argentina, Brazil, and most often in South Africa.<sup>1</sup> The toxin has been identified as diploinine; a second toxin, diplodiatxin, has been identified but may not be related to

poisoning.<sup>1</sup> The fungus develops its toxin only after a prolonged (more than 6 weeks) period of growth. This may explain frequent reports that the fungus is not poisonous. The same applies to cultured fungus used to produce the disease experimentally; it must be a culture that is at least 8 weeks old.

Clinical signs in adults include lacrimation, salivation, tremor, ataxia, paresis, and paralysis, but signs disappear when the corn is removed from the diet. If the subjects are females in the second and third trimesters of pregnancy, there may be a very high mortality rate (up to 87%) in stillborn or newborn lambs or calves; many of the dead neonates have widespread degeneration of the CNS. Affected animals recover if feeding of the infected grain is stopped.

At postmortem, a status spongiosus lesion may occur in the brain of affected animals, but in most cases there are no necropsy lesions. Fetuses are much more susceptible, and spongiform lesions in the brain are present in most. Their BWs are less than normal, and the gestation period is also reduced.

### FURTHER READING

Odriozola E, Odeon A, Canton G, et al. Diplodia maydis: a cause of death of cattle in Argentina. *New Zeal Vet J* 2005;53:160-161.

### REFERENCE

1. Snyman LD, et al. *J Agric Food Chem*. 2011;59:9039.

## TREMORGENIC MYCOTOXINS

Tremorgenic mycotoxins are produced by fungi belonging to the *Penicillium*, *Aspergillus*, *Claviceps*, and *Neotyphodium* genera.<sup>1</sup> Over 20 different mycotoxins, all containing a tryptophan indole moiety, affect many different mammals including cattle, sheep, goats, and horses. The fungi grow on a wide variety of foodstuffs including spoiled food, garbage, stored grains, forages (grasses and legumes), malt (beverage) residues, and compost piles.<sup>2,3</sup> Despite the different fungi and mycotoxins, the common neurologic signs of prolonged muscle tremors, ataxia, and stress-exacerbated weakness are similar in most species.<sup>2</sup> Hyperexcitability or depression, tetanic seizures, recumbency, paralysis, and rarely death may occur.<sup>2,4</sup>

Tremorgenic mycotoxins are rapidly absorbed from the gastrointestinal tract, and signs occur anywhere from a few hours to several days, depending on the species and particular mycotoxin. Age is important with younger animals more susceptible than older.<sup>5</sup> They are lipid soluble and easily move across the blood-brain barrier and into the CNS. Excretion is primarily biliary and fecal; little hepatic metabolism occurs.<sup>6</sup>

The mechanism of action is unknown, but generally tremorgenic mycotoxins interfere with inhibitory neurotransmitters

( $\gamma$ -amino butyric acid [GABA] and glycine) and stimulate excitatory neurotransmitters. Treatment is supportive and symptomatic.

### Aspergillus-Associated Mycotoxins

*Aspergillus clavatus*, other *Aspergillus* spp., and *Penicillium* spp. produce several tremorgenic mycotoxins associated with outbreaks in cattle and sheep. Verruculogen is the most widely recognized mycotoxin; less recognized mycotoxins produced by these fungi include tryptoquivaline, territrems A and B, and aflatrem. *A. clavatus*-associated mycotoxins have been incriminated in several neurologic outbreaks in sheep and cattle.<sup>2,7,8</sup> Common clinical signs included tremors, posterior paresis, knuckling at the fetlocks, recumbency, and death. The specific mycotoxin may be patulin, although that was not present in all cases.<sup>2</sup>

### Bermudagrass Staggers

Cattle in California, Oklahoma, and Texas have developed tremors and neurologic signs after grazing on mature bermudagrass (*Cynodon dactylon*) infected with *C. cynodontis*. Analysis of infected seedheads showed high concentrations of the tremorgens paspalitrems and paspaline-like indole-diterpenes and low concentrations of ergine and ergonovine.<sup>1</sup>

### Claviceps-Associated Mycotoxins (Paspalum or Dallis Grass Staggers)

Cattle, sheep, and horses may develop “grass staggers” after several days after grazing on mature Bahia grass (*Paspalum notatum*) or Dallis grass (*P. dilatatum*) infected with *C. paspali*.<sup>2,4,8,9</sup> The tremorgenic mycotoxins paspaline and paspalitrems A, B, and C are present in the sclerotia (ergots); paspalitrem B is most commonly associated with the onset of signs in cattle and sheep. Affected animals develop exercise-induced nervousness, odd facial expressions, tremors, ataxia, seizures, and death.

### Neotyphodium-Associated Mycotoxins (Perennial Ryegrass Staggers)

Horses, deer, cattle, alpacas, and in particular, sheep grazing on perennial ryegrass (*L. perenne*) in the northwestern United States, Australia, New Zealand, and some parts of Europe have developed neurologic signs similar to other stagger-producing grasses.<sup>2,5,10</sup> Lolitrems A, B, and D and other lolitrem precursors produced by the endophyte *Neotyphodium lolii* are the tremorgenic mycotoxins most involved.<sup>9,10</sup> Lolitrem B (maximum tolerable dose 2 mg/kg BW) is the predominant mycotoxin associated with the onset of signs in sheep and cattle.<sup>2</sup> Signs most often occur in the late summer/early fall when animals are on overgrazed pastures. Tremors begin in the head, progress to the neck and shoulder, and finally include the extremities. Affected animals are

uncoordinated and become recumbent or develop seizures when stressed. If removed from infected grasses and not stressed, affected animals recover in 7 days or so.

### Penicillium-Associated Mycotoxins

Penitrem A and roquefortines, produced by *Penicillium* spp., are the most common mycotoxins associated with tremors. In general, toxicosis with these mycotoxins are more common in small animals ingesting spoiled food (meats, cheese, nuts, eggs, etc.) and garbage, but cases have occurred in horses, cattle, and sheep. Janthitrem A, B, and C produced by *P. janthinellum* have been associated with outbreaks of staggers in sheep grazing on ryegrass.

### FURTHER READING

- Cole RJ, et al. Paspalum staggers: isolation and identification of tremorgenic metabolites from sclerotia of *Claviceps paspali*. *J Agric Food Chem*. 1977;25:1197-1201.
- Scudamor K, et al. Occurrence and significance of mycotoxins in forage crops and silage: a review. *J Sci Food Agric*. 1998;77:1-17.

### REFERENCES

- Uhlig S, et al. *J Agric Food Chem*. 2009;57:1112.
- Moström MM, et al. *Vet Clin North Am Food Anim Pract*. 2011;27:344.
- Riet-Correa F, et al. *J Vet Diagn Invest*. 2013;25:692.
- Moyano MR, et al. *Vet Med (Praha)*. 2010;55:336.
- Sampaio N, et al. *Anim Prod Sci*. 2008;48:1099.
- Hooser SB, Talcott PA. Mycotoxins. In: Peterson ME, Talcott PA, eds. *Small Animal Toxicology*. 3rd ed. London, UK: Elsevier; 2013:925.
- Fink-Gremmels J. *Food Add Contam*. 2008;25:172.
- Finnie JW, et al. *Aust Vet J*. 2011;89:247.
- Cawdell-Smith AJ, et al. *Aust Vet J*. 2010;88:393.
- Di Menna ME, et al. *New Zeal Vet J*. 2012;60:315-328.

## MISCELLANEOUS FUNGAL TOXINS AFFECTING THE NERVOUS SYSTEM (UNIDENTIFIED TOXINS)

### BLACK SOIL BLINDNESS

This is a mycotoxicosis of grazing cattle, associated with the fungus *Coralocystostroma ornicopreoides* growing on Mitchell grass (*Astrelba* spp.) in pastures on heavy basalt (black soil) soil in tropical northwest Australia. The disease has occurred only once, in a year marked by heavy seasonal rainfall and a longer than usual growing season. Morbidity and mortality were high at the peak of the outbreak. Clinical characteristics include blindness and death within 24 hours. Necropsy lesions include renal tubular nephrosis, rumenoreticulitis, and moderate liver cell damage.

### NERVOUS SIGNS

Nervous signs of tremor, gait incoordination, recumbency, and convulsions are the primary toxic effects present after ingestion of *Trichothecium roseum* and *Penicillium cyclospium*.

### FURTHER READING

- Jubb TF, et al. Black soil blindness: a new mycotoxicosis of cattle grazing *Coralocystostroma*-infected Mitchell grass (*Astrelba* spp.). *Aust Vet J*. 1996;73:49-51.

## Other Toxins Affecting the Nervous System

### INORGANIC TOXINS AFFECTING THE NERVOUS SYSTEM

#### LEAD TOXICOSIS (PLUMBISM)

##### SYNOPSIS

**Etiology** Accidental ingestion of lead metal or lead-containing substances, ingestion of lead-contaminated feed, or grazing pastures containing excessive lead in the soil.

**Epidemiology** Occurs in all age groups. One of the most common poisonings of farm livestock, especially in young calves after turn out in spring. In cattle, usually sporadic and caused by ingestion of a single source of lead but outbreaks occur when feed is contaminated. High case-fatality rate if untreated. Sources include discarded lead batteries, lead-based paints, industrial sources of lead, ash residues, pastures near motor vehicle highways, and smelters. Occurs in sheep and horses grazing contaminated pastures.

**Clinical pathology** Lead levels in blood, feces, liver, kidney; elevated porphyrins in blood.

**Lesions** Encephalopathy, degeneration of liver and kidney; pale musculature, brain laminar cortical necrosis, intranuclear renal inclusion bodies.

**Diagnostic confirmation** Toxic levels of lead in blood and tissues.

**Treatment** Supportive care, removal of large amounts of lead from the gastrointestinal tract, chelation therapy.

**Control** Identify and prevent access of animals to sources of lead.

### ETIOLOGY

Lead poisoning is associated with the accidental ingestion of lead metal or lead-containing compounds; ingestion of feed, usually forage, containing lead; or grazing lead-contaminated pastures.<sup>1,2</sup> The latter two are often associated with environmental pollution. Both organic and inorganic lead are toxic, with organic lead the most bioavailable followed by inorganic lead and then metallic lead.<sup>1,3</sup>

### EPIDEMIOLOGY

Where groups of animals have access to the same source of lead, outbreaks occur and the morbidity rate ranges from 10% to 30%. The case-fatality rate may reach 100% but



early intensive therapy can be successful and reduce the figure to less than 50%. In one recorded outbreak, in which a discarded 24-V battery was accidentally mixed and ground up into the feed of 80 heifers, 55 of the animals died or were euthanized.

### Occurrence

Lead is one of the most common poisonings in farm animals, especially young cattle.<sup>1</sup> Sheep and horses are also affected but not as often.<sup>3,4</sup> Pigs, because of housing conditions, are not often exposed to lead and appear to be more tolerant than other species.

### Risk Factors

#### Animal Risk Factors

##### Cattle

Data from diagnostic toxicology laboratories illustrate that lead poisoning is one of the most common toxicosis in cattle. In Alberta, Canada, over a period of 22 years, lead poisoning was the most frequently diagnosed toxicoses of cattle, representing 0.68% of all bovine submissions to the provincial diagnostic laboratories. Most cases of poisoning occur during the summer months from May to August, when the cattle have ready access to lead-containing materials such as crankcase oil and batteries that are being changed in agricultural machinery. In many countries the incidence of the disease is highest in cattle in the spring of the year a few days after the animals have been turned out onto pasture.<sup>5</sup> Poisoning is most common in younger cattle, with 52% of the cases reported in animals 6 months of age or less.<sup>6</sup> Younger animals are more susceptible to lead toxicosis presumably because of a higher rate of gastrointestinal tract absorption. In addition, young cattle are especially curious and seem to seek out and find sources of lead. Confined housing of calves with or without overcrowding is often followed by the appearance of pica, which may be associated with boredom and an increase ingestion of lead-containing objects.

Lead poisoning in cattle is usually acute and caused by accidental ingestion of a toxic quantity of lead over a short period of time.<sup>7</sup> The natural curiosity, licking habits, and lack of oral discrimination of cattle makes any available lead-containing material a potential source of poisoning. Cattle will readily drink motor oil; lick older machinery grease, peeling paint, and paint ashes; and chew lead-based batteries. Many countries currently ban leaded gasoline, and in these areas used motor oil may not contain lead as well as motor oil from diesel engines or present-day machinery grease.<sup>8</sup> In ruminants, there is a tendency for metallic lead particles to settle in the reticulum, and poisoning results from the gradual conversion of lead particles to soluble lead acetate. Several epidemics of lead poisoning in domestic animals have been recorded throughout the world in which the source of the metal was

contamination of pasture or crops by nearby lead mining or industrial lead operations.<sup>9,10</sup> Animals eating vegetation in these areas may accumulate amounts of lead sufficient to produce clinical signs of lead poisoning.

##### Buffalo

Lead poisoning in buffalo has been reported and provides interesting comparative data; they may have a higher tolerance to lead than cattle.

##### Sheep

Sheep are usually affected by eating soil or forage contaminated by environmental sources of lead.

##### Horses

Horses are much more selective in their eating habits. They usually do not lick old paint cans, lead storage batteries, and peeling paint, and they do seem to find the taste of used motor oil attractive. Lead poisoning in horses is most common when they graze lead-contaminated pastures rather than by the accidental ingestion of a toxic amount of lead.<sup>2,4,10</sup> Young horses are particularly more susceptible than older horses and cattle grazing on the same pasture.

#### Environmental Risk Factors

Environmental pollution with lead is a common occurrence in cities and surrounding suburbs. For farm animals, significant pollution is more likely to occur near smelters or other industrial enterprises or near major highways where pasture is contaminated by exhaust fumes of automobiles if leaded gasoline is still used in the region. Much of the poisoning is subclinical because of the low level of absorption, but lead-intoxicated animals have served as sentinels for human lead exposure.<sup>11</sup>

Lead is still commonly found in pastures near highways. The lead levels in the whole blood of sheep grazing near main highways in three areas of the Nile delta region of Egypt were 0.062, 0.067, and 0.083 parts per million (ppm). Pasture adjacent to heavily used roads may carry as much as 390 mg/kg of lead, in contrast to 10 mg/kg on lightly used roads.<sup>9,10</sup> The concentration of lead on pasture varies markedly with proximity to the traffic, falling rapidly the greater the distance and with the time of the year. Pastures contaminated by smelters are recorded as carrying 325 mg/kg of lead (equivalent to a daily intake for an animal of 6.4 mg/kg BW).<sup>12</sup> In some locations near lead smelters, lead poisoning is considered to be a predictable occurrence in horses that are allowed to graze on local pastures.<sup>4</sup> As a result horses are either not raised in these areas or hay is imported from other areas. Although ingestion is the principal method of poisoning of animals, inhalation may also be a significant method of entry for cattle grazing close to smelters or highways.

Lead as an environmental contaminant is often combined with cadmium, which has some effects similar to those of lead, thus the effects may be somewhat additive. Experimental poisoning with both elements is associated with reduced weight gain in calves at dose levels up to 18 mg/kg BW of each contaminant, and clinical signs appear at levels above 18 mg/kg BW of each. Lead is also combined with chromate for industrial purposes. The combination is nontoxic when combined with lead at lead intake levels of less than 100 mg/kg BW.

Environmental pollution in the vicinity of lead and zinc-ore processing factories can result in varying degrees of poisoning with lead, zinc, and cadmium.<sup>13</sup> These can be monitored by the analysis of blood, hair, and tissues obtained at necropsy.

#### Farm or Premise Risk Factors

The relationship between lead concentrations in blood of cattle with lead poisoning and those in the milk is exponential.<sup>14</sup> The lead level in milk is relatively constant up to a blood level of 0.2 to 0.3 mg/L, and increases sharply at higher blood levels. The biological half-life of lead excretion in cattle is between 6 and 14 weeks.<sup>15</sup> Studies in six affected dairy herds reported a variable half-life ranging from 48 to 2507 days.<sup>2</sup> One probable reason for this great variance is the ability of the ruminant to retain variable amounts of metallic lead in the rumen, which acts as a continuing reservoir. Half-life studies do not account for variable intake and retention of a persistent reservoir of toxicant, so the concept of using half-life excretion in dealing with lead-poisoned cattle is not likely accurate. Owners of such cattle should be advised of the potentially long withdrawal period. It may be advisable to test periodically and allow marketing based on actually measured levels or to estimate the costs of such a plan and consider salvage. This recent work casts doubt on the economic utility of holding recovered animals. In acutely sick cows that were emergency slaughtered, the range of lead levels in edible muscle tissue was 0.23 to 0.50 mg/kg. The concentrations in the kidneys ranged from 70 to 330 mg/kg and in the livers 10 to 55 mg/kg.

#### Human and Public Health Risk Factors

The source of lead intoxication in animals must be identified so humans are not inadvertently poisoned. In one recent study, investigations involving cattle deaths from lead poisoning led to elevated blood levels in a pregnant woman, dog, cat, and remaining cattle.<sup>11</sup>

A major concern with the treatment of lead-poisoned animals, particularly food-producing animals, is the assurance that the edible tissues of recovered animals do not contain toxic levels of lead. The length of time required after successful treatment of

cattle with typical clinical lead poisoning before such animals can be sent to slaughter or before the milk can be used safely is not known. It is suggested that treated animals should be appropriately identified<sup>9</sup> and blood lead levels determined once or twice monthly for several months. When the blood lead levels have dropped to background levels for three consecutive samplings at least 2 weeks apart, the animals are assumed to be safe for slaughter. Undocumented field observations suggest that at least 6 months are necessary for background levels to be achieved. Decisions about reaching acceptable residue levels will depend on national or local regulations as well as the economics of maintaining a herd for long periods without sales of milk or meat, and appropriate food safety and public health officials should be consulted in this decision. The lead concentrations in blood and milk from periparturient heifers 7 months after an episode of acute lead poisoning revealed no lead in the milk. Animals that had been severely affected by lead poisoning experienced a transient increase in whole-blood lead concentration at parturition that was not high enough to be considered toxic.

### Transmission (Sources of Lead)

Lead poisoning is most common in cattle on pasture, particularly if the pasture is poor and the animals are allowed to forage in unusual places, such as trash dumps.<sup>15,16</sup> Phosphorus deficiency may also be a predisposing factor, because affected animals will chew solid objects as a manifestation of osteophagia. However, cattle on lush pasture may also seek out foreign material to chew. Discarded lead batteries are one of the most common sources of lead poisoning in cattle.<sup>13</sup> In Alberta, Canada, over a period of 22 years, discarded batteries or used crankcase oil accounted for more than 80% of cases for which the source of lead was determined: batteries, 39.5%; used crankcase oil, 31.6%. The batteries are commonly placed in garbage dumps on the farm and, in temperate climate countries, the batteries freeze during the winter months and break open, exposing the plates, which are attractive and palatable for cattle to lick and chew.

The contamination of forage supplies with shotgun lead pellets used in hunting and shooting exercises can serve as a source of lead for cattle grazing the pasture or consuming haylage or silage made from the contaminated field.<sup>16</sup> Automobile batteries have been accidentally added to feed mixers in which they are ground by powerful augers and mixed into the feed supply of cattle. Discarded lead-based paint cans are particularly dangerous but fences, boards, the walls of pens, painted canvas, and burlap are also common sources in calves. Painted silos may cause significant contamination of the ensilage. One outbreak of lead poisoning in cattle was associated with silage containing

1200 mg/kg dry matter lead, which had become contaminated by ash and debris left after burning an old lead-containing electrical cable in the silo before it had been filled.

Metallic lead in the form of lead shot, solder, or leaded windows has been associated with mortalities, although, experimentally, sheet lead is not toxic.<sup>1,2,4</sup> Lead sheeting that has been exposed to the weather or subjected to acid corrosion appears to be more damaging, possibly because of the formation of a fine coating of a soluble lead salt. Lead poisoning can be a major hazard in the vicinity of oil fields, and engine sump oil may contain over 500 mg lead per 100 mL. Automotive and other mineral oils are very palatable to young beef calves. As lead use becomes restricted in many countries, grease and lead-contaminated engine oil have become less common sources of lead.<sup>8</sup> Less common but still potent sources of lead are linoleum, roofing felt, putty, automobile oil filters, and aluminum paint. Some of the latter paints contain large quantities of lead, and others none at all. Only lead-free aluminum paint should be used on fixtures to which animals have access.

Lead parasiticide sprays, particularly those containing lead arsenate, were once associated with heavy losses in cattle grazing in recently sprayed orchards or vegetable crops. These are not commonly used now, except in some countries, but cattle may accidentally ingest old stores of the compound.

### PATHOGENESIS

The absorption, distribution, and elimination of lead vary depending on the chemical form of lead, amount ingested, age and species of animal, and other physiologic factors. Deficiencies in calcium, iron, and zinc are associated with increased lead absorption and increased toxicity. Lead from salts such as lead sulfate are absorbed more than metallic lead from battery plates.<sup>13</sup> Regardless of the chemical form of the ingested lead, only a small proportion (2%–10%) is absorbed because of the formation in the alimentary tract of insoluble lead complexes, which are excreted in the feces.<sup>1,15</sup> Once absorbed, 60% to 90% of lead is found in erythrocytes and the rest bound to albumin and other proteins.<sup>3</sup> Very little lead is found unbound in the serum. Lead is distributed to first to the soft tissues, especially kidneys and liver, and ultimately to bone, which serves as a storage or “sink” for excess lead. Excretion is slow and primarily through bile and the milk of lactating animals with little excreted in the urine.<sup>1,3,14</sup>

Blood lead concentrations are an excellent marker of exposure in animals. In cows, blood-level concentrations greater than 0.35 ppm have been associated with poisoning<sup>1</sup> and blood lead levels less than 0.1 ppm with normal background exposure. In horses, blood lead levels greater than 0.2 to

0.35 ppm have been associated with poisoning<sup>4</sup> and blood lead levels less than 0.2 ppm with background exposure. Correlation between blood lead levels and milk levels is good; correlation between blood lead levels and the presence or severity of clinical signs is often poor.<sup>14,17</sup>

Lead is transferred across the placental barrier,<sup>17</sup> and high liver levels occur in the lambs of ewes fed more than normal amounts of lead. Calves born from cows experimentally poisoned with lead have elevated levels of lead in bone, kidney, and liver. In a naturally occurring case of lead poisoning in a pregnant heifer, the blood and liver concentrations in the fetus were 0.425 and 4.84 ppm, respectively, which was 72% and 84% of the same tissue lead concentrations of the dam. Hepatic lysosomes of the fetus contained metallic electron densities, which may have been lead.

Several biochemical processes are affected by lead. Lead is a neurotoxicant and at elevated doses it disrupts the blood-brain barrier allowing albumin, water, and electrolytes to enter, resulting in edema. The complete mechanism of action associated with lead's neuropathy is unknown, but its ability to substitute for calcium and/or zinc is involved.<sup>3</sup> Lead mimics or inhibits the action of calcium altering the release of neurotransmitters and activating protein kinases.<sup>3</sup> It also binds to a sulfhydryl group on proteins resulting in inhibition of enzymes, conformational changes in proteins, and alterations in calcium/vitamin D metabolisms.<sup>16</sup> Lead inhibits  $\delta$ -aminolevulinic acid dehydratase (D-ALAD) and ferrochelatase activity, thus decreasing heme synthesis and hemoglobin production.<sup>2,3,18</sup> This not only plays a role in lead-associated anemia but results in decreased oxygen carrying capacity with the nervous system susceptible to the resulting tissue ischemia.

### CLINICAL FINDINGS

Lead is toxic to a number of organ systems including the nervous, gastrointestinal, hematologic, cardiovascular, renal, musculoskeletal, and reproductive systems.<sup>3</sup> The major effects of lead toxicity are often manifested in three main ways<sup>7</sup>:

- Lead encephalopathy
- Gastroenteritis
- Degeneration of peripheral nerves

Clinical signs vary depending on the species, type and amount of lead involved, and duration of exposure. Typically, acute nervous system involvement occurs following the ingestion of large doses in susceptible animals such as calves, alimentary tract irritation following moderate doses, and peripheral nerve lesions following long-term ingestion of small amounts of lead. The nervous signs of encephalopathy and the lesions of peripheral nerve degeneration are caused by the degenerative changes of nervous system tissue. Gastroenteritis is

associated with the caustic action of lead salts on the alimentary mucosa.

### Cattle

The signs of acute lead poisoning are more common in calves and younger cattle and have a sudden onset and short duration, usually lasting only 12 to 24 hours. Many animals, especially those on pasture, are found dead without any observable signs. Staggering and muscle tremors particularly of the head and neck, with champing of the jaws (chewing gum fits) and frothing at the mouth are obvious. Snapping of the eyelids, rolling of the eyes, and bellowing are common. Blindness and cervical, facial, and auricular twitching are consistent in acute lead poisoning of cattle.<sup>15</sup> The animal eventually falls and intermittent tonic-clonic convulsions occur and may continue until death. Pupillary dilation, opisthotonus, and muscle tremors are marked and persist between the convulsive episodes (Fig. 14-3). There is hyperesthesia to touch and sound, and the heart and respiratory rates are increased. In some cases, particularly in adults, the animal remains standing, is blind, maniacal, charges into fences, attempts to climb or jump over walls, and head-presses strongly against walls or fences. Frenzy is common and some animals appear to attack humans, but the gait is stiff and jerky and progress is impeded. Death usually occurs during a convulsion and is caused by respiratory failure.

The subacute form is more common in adult cattle, and in this form the animal remains alive for 3 to 4 days. Gastrointestinal tract dysfunction is one of the most common abnormalities. Ruminal atony is

accompanied by constipation in the early stages. Later a fetid diarrhea occurs in most cases. Grinding of the teeth is common, and hypersalivation may occur. Neurologic signs include dullness, blindness, and some abnormality of gait including incoordination and staggering, and sometimes circling. The circling is intermittent and not always in the same direction and usually occurs when the animal is confined in a small space like a box stall. Muscle tremor and hyperesthesia are common but not as pronounced as in the acute form.

### Sheep

Lead poisoning in sheep is usually manifested by a subacute syndrome similar to that seen in adult cattle. There is anorexia and scant feces followed by the passage of dark, foul-smelling feces. Weakness and ataxia follow, often with abdominal pain, but there is no excitement, tetany, or convulsions. Polyuria occurs when the intake of lead is small but with large amounts there is oliguria.

Chronic toxicity is rare, but two syndromes of posterior paresis have been described in young lambs in old lead-mining areas, and tissue levels of lead are abnormally high in both instances. In both syndromes there is gait impairment. Osteoporosis is present in one but in the other there is no suggestion of skeletal changes. In the osteoporotic disease the signs occur only in lambs 3 to 12 weeks of age and never in adults. There is stiffness of gait, lameness, and posterior paralysis. Affected lambs are unthrifty and the bones, including the frontal bones, are very fragile. The paralysis is caused by

lesions of the vertebrae, usually affecting one or more of the lumbar bones, resulting in compression of the spinal cord. In the other form, gait abnormalities occur in the same lamb age group and are manifested initially by incomplete flexion of the limb joints so that the feet drag while walking. In a later stage the fetlocks are flexed, the extensor muscles paretic, and the lamb soon becomes recumbent. Recovery is common, although many lambs die of concurrent disease.

### Horses

Acute and chronic lead poisoning occurs in horses and ponies, although more rarely than other species. Signs occur most often in horses ingesting contaminated forage or soil found near old lead mines, smelters, and battery recycling depots.<sup>3,4</sup> The clinical findings are extremely variable, but include ataxia, weakness, hypotonia, muscle tremors, rough hair coat, dysphagia, weight loss, dyspnea, roaring or stridor, seizure like movements, colic, and maniacal behavior.<sup>3</sup> A roughened hair coat, pharyngeal dysfunction, and weight loss were the most common clinical findings in 10 case reports involving a total of 68 animals. Some horses died without any previous clinical illness but where clinical signs are apparent they were usually distinct and dramatic rather than subtle. Inspiratory dyspnea associated with paralysis of the recurrent laryngeal nerve is the most common finding. This may be accompanied by pharyngeal paralysis in which recurrent choke and regurgitation of food and water through the nostrils occur. Aspiration pneumonia may result after inhalation of ingesta through the paralyzed larynx. Paralysis of the lips occasionally accompanies the other signs.

### Pigs

Early signs include squealing as though in pain, mild diarrhea, grinding of the teeth, and salivation. The disease is usually a prolonged one and listlessness, anorexia, and loss of weight develop followed by muscle tremor, incoordination, partial or complete blindness, enlargement of the carpal joints, and disinclination to stand on the front feet. Convulsive seizures occur in the terminal stages.

## CLINICAL PATHOLOGY

### Hematology

In chronic lead poisoning, hematologic examination may reveal a normocytic, normochromic anemia in some, and, although basophilic stippling does not occur often enough to be diagnostic, it is recorded in some experimental poisonings.<sup>3</sup> It is recorded as occurring in lead-exposed pigs and a horse. In some, poikilocytosis and anisocytosis were marked. The CSF is approximately normal with slightly elevated leukocyte numbers but no increase in protein or other biochemical components.



**Fig. 14-3** Holstein Friesian steer with acute lead toxicity. Notice the abnormal mentation, contraction of facial muscles, and marked dilatation of the pupils. The bandage around the neck protected an intravenous catheter that was used for daily intravenous Ca-EDTA treatment. The steer recovered following treatment.



### Blood Lead

Whole-blood levels are generally the best sample for determining the lead status of the animal. Bovine blood lead reference materials are available and have been certified for many years. Whole-blood levels of lead in normal ruminants are usually below 0.05 to 0.25 ppm; poisoned animals, including horses, usually have levels above 0.35 ppm and deaths begin at 1.0 ppm.<sup>1,3,4</sup> Buffalo may have blood levels above 1.0 ppm and still survive, which suggests that they have a higher tolerance level than cattle. Blood lead concentrations also fluctuate markedly after administration of lead and, consequently, the clinical importance of blood lead concentrations is often questionable and a diagnosis based on this single determinant is equivocal.

Blood lead concentration also has limited value for assessing the effectiveness of therapy for lead poisoning. Blood level concentrations may change rapidly during chelation therapy, often decreasing by 50% or more within 24 hours after initiation of treatment despite certain body tissues still containing high concentrations of lead. Thus the evaluation of biochemical indicators such as **aminolevulinic acid dehydratase (ALA-D)** may be useful. The blood and liver levels of fetuses from pregnant cattle with lead poisoning may be higher than what are considered toxic levels in adults, which suggests concentration in the fetus.

### Milk Lead

Only limited information is available on the concentrations of lead that occur in cattle affected with field cases of lead poisoning. Lead levels of 0.13 mg/L of milk have occurred in natural cases with a half-life of 4.6 days. The regulatory limit for lead in bovine milk in the Netherlands is 0.05 mg/L milk. In acute lead poisoning in lactating buffalo pastured near smelters in India, the lead concentrations in milk were 1.13 ppm compared with 0.24 ppm in the milk from buffalo in unpolluted areas. The mean lead concentrations in the forage of poisoned animals were  $706 \pm 73.0$  ppm, compared with the unpolluted area of  $78 \pm 12$  ppm.

### Fecal Lead

Fecal levels of lead represent unabsorbed and excreted lead deriving from the bones, and are of limited value unless considered in conjunction with blood levels because ingested lead may have been in an insoluble form and harmless to the animal. When fecal levels are high, it can be assumed that the lead has been ingested in the preceding 2 to 3 weeks, but high blood levels may be maintained for months after ingestion. Thus high blood and low fecal levels indicate that the lead was taken in some weeks previously, but high blood and high fecal levels suggest recent ingestion and significant absorption.

### Urinary Lead

Urine lead levels are variable, rarely high (0.2–0.3 mg/L), and although elevated urine levels are usually associated with high blood levels, this relationship does not necessarily hold.

### $\delta$ -ALA-D

Because of some of the limitations of blood lead, other indirect measurements of lead poisoning, such as the levels of  $\delta$ -ALA-D in blood, are used to supplement blood lead determinations. For example, the best method of detecting the presence of lead poisoning in its early stages, except in the horse, is the estimation of  $\delta$ -ALA-D in the blood. The evaluation of  $\delta$ -ALA-D and blood lead concentrations together can assist in resolving diagnostic situations in which the blood lead concentration is in the questionable range of 0.25 to 0.35 ppm.

$\delta$ -ALA-D is important in the synthesis of heme and is probably the most sensitive enzyme in the heme pathway. Inhibition of the enzyme results in a block in the utilization of  $\delta$ -ALA, a subsequent decline in heme synthesis and a marked increase in the urinary excretion of  $\delta$ -ALA.<sup>17</sup> In cattle, sheep, and pigs affected with chronic lead poisoning, the plasma levels of  $\delta$ -ALA-D are decreased, and the urinary levels of  $\delta$ -ALA are increased before clinical signs are detectable. In sheep, erythrocyte  $\delta$ -ALA-D is recommended as the most sensitive diagnostic test available.

The disadvantages of the assay for blood  $\delta$ -ALA-D include age-related variations, particularly in calves<sup>12,18</sup>; the methods used for analysis are not yet uniform and blood must be collected in polystyrene or polyethylene tubes rather than glass tubes and an anticoagulant other than ethylenediaminetetraacetic acid (EDTA) must be used. The levels of  $\delta$ -ALA-D increase in calves from birth to 10 weeks of age and age-matched controls should be evaluated simultaneously when conducting the test in calves of younger than 6 months of age. In cattle under 1 year of age,  $\delta$ -ALA-D values of less than 200 mmol of porphobilinogen (PBG)/mL of RBC/h should raise suspicion of their having ingested lead. In this same age range values below 100 mmol would confirm ingestion of lead. In cattle equal to or less than 2 years of age, values of  $\delta$ -ALA-D of less than 100 mmol of PBG/mL of RBC/h would indicate ingestion of lead.

The  $\delta$ -ALA-D is so sensitive to lead that it remains inhibited even after lead exposure has ceased. Following treatment with a chelating agent the blood lead levels will often decline giving a false indication of a positive treatment effect. If the  $\delta$ -ALA-D levels do not decrease following therapy, it indicates that there is sufficient lead present to continue to suppress the enzyme.

### Erythrocyte Protoporphyrin

The levels of free erythrocyte zinc protoporphyrin increase in lead poisoning, and this is indicative of the chronic metabolic effect of lead on the erythroid cells being released from bone marrow into the peripheral circulation. A mean value of 22  $\mu$ g coproporphyrin per 100 mL of erythrocytes has been determined. It may be of some value along with determinations of blood lead and  $\delta$ -ALA-D. The use of  $\delta$ -ALA-D activity and erythrocyte protoporphyrin content as cumulative lead exposure indicators in cows environmentally exposed to lead is recommended.

### Plasma $\delta$ -Aminolevulinic Acid

In human beings,  $\delta$ -ALA is suggested as a sensitive marker of trace exposures to lead.<sup>18</sup> Plasma  $\delta$ -aminolevulinic acid has been evaluated in cattle as a biomarker for acute lead poisoning and the results showed it to be a promising tool.<sup>2,18</sup> Further work is necessary, however, to establish concentrations in unexposed, intermittently exposed, and chronically exposed animals.

### NECROPSY FINDINGS

In most acute cases there are no gross lesions at necropsy. In cases of longer standing there may be some degree of abomasitis and enteritis, diffuse congestion of the lungs, and degeneration of the liver and kidney. Epicardial hemorrhages are common. Congestion of meningeal and cerebral vessels may also be observed and hemorrhages may be present in the meninges. An increase in CSF is often recorded but is of minor degree in most cases.

In chronic cases, gross lesions in cattle include cerebrocortical softening, cavitation, and yellow discoloration with the most severe lesions in the occipital lobes. Histologic lesions were most severe at the tips of the gyri. Similar lesions were produced experimentally. Acid-fast inclusion bodies deep in the renal cortex have diagnostic significance. Examination of the contents of the reticulum in ruminants for particulate lead matter is essential. Flakes of paint, lumps of red lead, or sheet lead usually accumulate in this site. Their absence is not remarkable, especially if animals have licked fresh paint, but their presence does give weight to the provisional diagnosis.

### Liver and Kidney Lead

The submission of alimentary tract contents and tissues for analysis forms an important part of the diagnosis of lead poisoning, but results must be interpreted with caution.

### Cattle

In the kidney cortex 25 mg/kg (ppm) of lead wet weight (WW) is diagnostic and is a more reliable tissue for assay than liver, which may contain 10 to 20 mg/kg WW. The concentrations in the kidney are always much higher

than in the liver. A diagnostic laboratory found mean levels in livers of poisoned cattle of 93 µg/g WW, and 438 µg/g WW in kidneys. Tissue lead levels in cattle from industrial areas are significantly higher (liver 0.23 mg/kg WW, kidney 0.42 mg/kg WW) than in cattle from clear air zones (liver and kidney less than 0.1 mg/kg WW).

### Horses

Levels of lead at 4 to 7 mg/kg (ppm) WW have been found in the livers of horses dying of chronic lead poisoning but 25 to 250 mg/kg are more likely, and 40 mg/kg WW may occur in the livers of affected pigs.

### Samples for Confirmation of Diagnosis

- **Toxicology:** 50 g liver, kidney, and reticulum content (determine lead concentration)
- **Histology:** formalin-fixed cerebral cortex, kidney (light microscopy)

### DIFFERENTIAL DIAGNOSIS

In all cases, the possibility of access to lead and the environmental circumstances that may arouse suspicion of other poisonings or errors in management should be considered. Estimation of the lead content of blood and feces should be performed at the earliest opportunity and tissues for necropsy specimens submitted for analysis.

#### Differential diagnosis list

##### Cattle (see Table 14-12)

Arsenic poisoning

*Claviceps paspali* toxicity

Diseases resulting in blindness (hypovitaminosis A, ophthalmitis, polioencephalomalacia)

Hypomagnesemic tetany

Meningoencephalitis

Nervous acetonemia

##### Sheep

Enzootic ataxia caused by copper deficiency

Enzootic muscular dystrophy

Polyarthritis caused by bacterial infection

##### Horses (see Table 14-11)

Botulism

Equine degenerative myeloencephalopathy

Equine motor neuron disease

*Equisetum* spp. (horsetail toxicosis)

Fumonisin toxicosis (equine leukoencephalomalacia)

Hepatoencephalopathy caused by hepatotoxic plants

Laryngeal hemiplegia

Protozoal encephalomyelitis

Rabies

Viral encephalomyelitis, including West Nile virus

### TREATMENT

Treatment in most animals includes supportive care, preventing further exposure to lead, surgical removal of large amounts of lead from the gastrointestinal tract, and chelation therapy. Supportive care should include the use of tranquilization for those animals with neurologic signs and intravenous fluids to prevent and treat dehydration. Chelation therapy may be used to lower blood level concentrations but may not remove it completely from tissues or affect tissue damage. Large amounts of lead left in the gastrointestinal tract before chelation may result in enhanced or increased absorption of lead. Lead mobilized from tissue sites during chelation may transiently increase blood lead levels and exacerbate clinical signs.

### Calcium Versenate

Calcium versenate (calcium disodium EDTA [CaEDTA]) has been used successfully in cases of lead poisoning produced experimentally in calves and in natural cases in cattle and horses.<sup>3,4,14</sup> Cattle may be treated with 73.3 mg/kg/day slow intravenously divided two to three times a day for 3 to 5 days.<sup>19</sup> If necessary, after a rest period of 2 days, an additional 3 to 5 days of treatment may be used. Other doses and dosage regimens are available.<sup>14,19</sup> Horses may be treated with CaEDTA at 75 mg/kg BW divided two to three times a day by slow intravenous infusion for 4 to 5 days.<sup>4,19</sup> If necessary, after a rest period of 2 days, an additional 4 to 5 days of therapy may be used.

The disadvantages of CaEDTA is that it must be given intravenously and there are side effects. Renal and gastrointestinal toxicity may occur with long-term therapy, and essential minerals such as copper and iron may be removed with multiple treatments.<sup>3</sup> Severe neurologic signs and dyspnea occurred in a horse receiving a second round of CaEDTA therapy.<sup>4</sup>

### Succimer (Dimercaptosuccinic Acid)

Dimercaptosuccinic acid has been used for many years in human medicine as a specific chelator for arsenic, lead, and mercury. Published doses are available for dogs, cats, and birds but not large animals.<sup>19</sup> Succimer has the advantages of heavy metal specificity, oral administration, and lack of nephrotoxicity.<sup>3</sup>

### Thiamine Hydrochloride

When used in combination with CaEDTA, thiamine is a valuable agent for the treatment of lead poisoning. Thiamine hydrochloride reduced the deposition of lead in most tissues, especially liver, kidney, and the central and peripheral nervous system of experimentally poisoned calves. The recommended dose is 2 mg/kg BW intramuscularly, given at the same time as CaEDTA, with a total daily dose not to exceed 8 mg/kg BW.<sup>19</sup>

### Magnesium Sulfate

Oral dosing with small amounts of magnesium sulfate has been used on the basis that soluble lead salts will be precipitated as the insoluble sulfate and excreted in the feces.<sup>14</sup> However, the lead is often present in large quantities and in the form of particles, which are only slowly dissolved.

### Rumenotomy

Rumenotomy to remove the ingested lead has been used but may be unsatisfactory because of the difficulty in removing particulate material from the recesses of the reticular mucosa. However, it may be appropriate when a valuable animal is affected and it is known that the animal ingested a certain compound of lead, which may be removable from the reticulum and rumen.

### TREATMENT AND CONTROL

#### Cattle

Calcium versenate (73 mg/kg/day slow IV divided two to three times a day for 3–5 days. Rest × 2 days. Repeat 4–5 days of therapy if need be) (R-2)

Thiamine HCl (2 mg/kg BW IM, given at the same time as CaEDTA; max 8 mg/kg BW/day) (R-2)

#### Horses

Calcium versenate (75 mg/kg BW divided two to three times a day slow IV for 4–5 days. Rest × 2 days. Repeat 4–5 days of therapy if need be) (R-2)

Thiamine HCl (2 mg/kg BW IM, given at the same time as CaEDTA; max 8 mg/kg BW/day) (R-2)

BW, body weight; CaEDTA, calcium disodium ethylenediaminetetraacetic acid; IM, intramuscular; IV, intravenous.

### CONTROL

The following practices are recommended to reduce the incidence of lead poisoning:

- Limit grazing on pastures near lead mines, smelters, or battery recycling depots.
- Use phosphate rock treatment on contaminated pastures (phosphate salts bind to lead yielding low solubility lead phosphates).<sup>4</sup>
- Keep trash out of pastures.
- Do not burn wood or other substances in pastures, and keep animals away from ashes.
- Provide adequate nutrition and consistent feeding practices to minimize pica or abnormal feeding behavior in livestock.
- Consider temporarily adding calcium phosphate to the diet to decrease lead absorption.<sup>4</sup>
- Dispose of or store used lead batteries, motor oil, and leaded petroleum products in areas animals cannot access.

- Use vehicle service and machinery storage areas separate from areas used by livestock.
- Use only lead-free paints on fencing, boards, and buildings.
- Dispose of contaminated carcasses according to Environmental Protection Agency regulations.
- Identify the source of lead intoxication.

### FURTHER READING

Radostits O, et al. *Veterinary Medicine: A Textbook of the Disease of Cattle, Horses, Sheep, Goats and Pigs*. 10th ed. London: W.B. Saunders; 2007:1799.

### REFERENCES

1. Varga A, et al. *Vet Med Res Rep*. 2012;3:111.
2. Roegner A, et al. *Vet Med Res*. 2013;4:11.
3. Puschner B, et al. *Equine Vet Educ*. 2010;22:526.
4. Allen KJ. *Equine Vet Educ*. 2010;22:182.
5. Mavangira V, et al. *J Am Vet Med Assoc*. 2008;233:955.
6. Sharpe RT, et al. *Vet Rec*. 2006;159:71.
7. Krametter-Froetscher R, et al. *Vet J*. 2007;174:99.
8. Burren BG, et al. *Aust Vet J*. 2010;88:240.
9. Swarup D, et al. *Small Rum Res*. 2006;63:309.
10. Madejón P, et al. *Ecotoxicology*. 2009;18:417.
11. Bischoff K, et al. *J Med Toxicol*. 2010;6:185.
12. Rodríguez-Estival J, et al. *Environ Pollution*. 2012;160:118.
13. Yabe J, et al. *Environ Toxicol Chem*. 2011;30:1892.
14. Aslani MR, et al. *Iran J Vet Sci Technol*. 2012;4:47.
15. Miranda M, et al. *J Vet Med Ser A*. 2006;53:305.
16. Finnie JW, et al. *Austr Vet J*. 2011;89:247.
17. Reis LSLS, et al. *J Med Medical Sci*. 2010;1:560.
18. Kang HG, et al. *J Vet Diagn Invest*. 2010;22:903.
19. Plumb DC. Edetate calcium disodium; thiamine. In: Plumb DC, ed. *Veterinary Drug Handbook*. 7th ed. Ames, IA: Wiley-Blackwell; 2011:366, 970.

## MERCURY TOXICOSIS

### SYNOPSIS

**Etiology** Ingestion, inhalation, or dermal exposure to mercury compounds including fungicides, phenylmercury treated grain, contaminated ashes, etc.

**Epidemiology** Generally organic preparations used in seed grain fed accidentally to livestock.

**Clinical pathology** High levels of mercury in all tissues; elevated serum urea nitrogen and creatinine concentration; decreased osmolarity, glycosuria, proteinuria, and phosphaturia.

### Lesions

- Inorganic salts: acute, gastroenteritis; chronic, nephrosis.
- Organomercurials: neuronal necrosis in brain and spinal nerves.

**Diagnostic confirmation** High blood, urine, tissue, hair levels of mercury.

**Treatment** Supportive and symptomatic care; judicious use of chelation in acute cases; treatment of chronic intoxication generally unrewarding.

**Control** Care in the handling of agricultural and pharmaceutical mercury compounds.

### ETIOLOGY

Mercury is a naturally occurring element (heavy metal) that occurs in three different forms.<sup>1</sup> Metallic mercury, an environmental pollutant, comes from sources such as mining, smelting, fossil fuels, volcanoes, and forest fires.<sup>2</sup> It is used in a variety of products including thermometers, button batteries, barometers, and dental fillings. Inorganic mercury (mercury salts) is produced when mercury is combined with a salt such as sulfur or chlorine. Fungicides, disinfectants, antiseptics, and older anthelmintics may contain inorganic mercurial compounds. Organic mercury (organomercurials) is formed when mercury combines carbon to form, among others, methylmercury, ethylmercury, and phenylmercury.

### EPIDEMIOLOGY Occurrence

Stringent state and national standards have made mercury poisoning in animals a rare occurrence. Toxicosis, when it occurs, is most often associated with oral ingestion of an organic mercury compound. In general, this is chronic and caused by accumulation of grain contaminated with mercury in the form of phenylmercury.<sup>3</sup> Acute or chronic poisoning can occur from either inorganic or organic mercury compounds but is generally accidental in nature.<sup>4</sup>

Because of the availability of fungicidal agents other than mercury it is possible to limit the use of mercuric agents by legislation to those excreted rapidly by animals, the phenylmercury compounds, and prohibit those that are most highly retained in animal tissues, the ethyl and methyl compounds.<sup>5</sup> Worldwide use of mercurial fungicides has declined, and poisoning is much less common than in the past. The most common products, when used, are dusts of 5.25% methoxyethylmercury silicate or methylmercury dicyandiamide. These and ethylmercuric chloride are toxic when fed to pigs at the rate of 0.19 to 0.76 mg of mercury per kilogram BW per day for 60 to 90 days. Methylmercury dicyandiamide fed to pigs at the rate of 5 to 15 mg/kg is associated with illness, and 20 mg/kg is associated with some deaths with a delay of 3 weeks between dosing and illness.

Treated seed is usually not harmful if it comprises only 10% of the ration and must be fed in large amounts for long periods before clinical illness occurs. A single feeding even of large amounts of grain is thought to be incapable of causing mercury poisoning in ruminants, but horses may be susceptible.

Accidental administration of medicines containing mercury, licking of skin dressings (e.g., mercuric oxide), and absorption from liberally applied skin dressings or combined with dimethyl sulfoxide may be associated with sporadic cases that may occur in horses after application of mercury-containing

“blisters.” Inorganic mercury salts contaminating lakes or other anaerobic ecologic areas can be reduced and converted to methylmercury and serve as a source of organic mercurial poisoning or food contamination through accumulation in fish or fish meal.

### Risk Factors

#### Animal Risk Factors

The toxicity of mercury compounds depends on their solubility and the susceptibility of the animals. Cattle are highly susceptible, with toxicosis occurring on an average daily intake of mercury, in organic mercury form, of 10 mg/kg BW/day, whereas toxic effects are only obtained in sheep with intakes of 17.4 mg/kg BW/day. In horses, the acute toxic dose inorganic mercury is 5 to 10 g.<sup>5</sup> Chronic ingestion of inorganic mercuric chloride (0.8 g/kg BW/day) for 14 weeks resulted in mercury toxicity.<sup>5</sup>

#### Human Risk Factors

Meat, liver, and kidneys from animals poisoned by mercury are unsuitable for human consumption. Depending on the form of mercury, milk may not be safe.

### PATHOGENESIS

The toxicokinetics of mercury depends on the form and route of exposure. Metallic mercury is primarily absorbed through the respiratory tract with very little by ingestion.<sup>1</sup> It is lipophilic and once distributed to the kidneys it crosses both the blood-brain and placental barriers in which it can remain for extended periods of time. Excretion is via urine and feces and a small amount in milk. Inorganic mercury has limited gastrointestinal absorption (<40%), is not lipophilic, is distributed to several body organs, and accumulates in the kidney.<sup>5</sup> Excretion is via urine and feces with very small amounts in the milk. Organic mercury is almost completely absorbed from the gastrointestinal tract (90%–95%). It is rapidly distributed to the circulatory system, is lipophilic, and crosses both the blood-brain and placental barriers in which it is trapped and accumulates in the brain and fetus, accumulates in RBCs, and undergoes further distribution to body tissues, reaching equilibrium in approximately 4 days. Excretion is very slow and primarily fecal, although some urine and milk excretion occurs.

The mechanism of action relates to the specific form of mercury. Metallic mercury and organic mercury accumulate in the brain and are potent neurotoxicants.<sup>1,5,6</sup> Toxicity from methylmercury is multifactorial. It inhibits protein synthesis in the brain by interfering with aminoacyl tRNA synthetase enzymes, generates excess free radicals, and inhibits antioxidant enzymes resulting in cell death. All forms of mercury accumulate in the kidney, concentrating in the proximal renal tubular cells, producing cell membrane permeability, excess free radical formation,



inhibition of antioxidant enzymes, and induction of glutathione and glutathione-dependent enzymes.<sup>1,5</sup> Acute toxicity results in acute tubular necrosis and renal failure; chronic toxicity results in renal interstitial fibrosis and renal failure.<sup>5</sup>

### CLINICAL FINDINGS

The toxic effects of mercury depend on the form, route of exposure, dose, and duration of exposure.<sup>1,5</sup> The target organs of both inorganic and organic mercury are the brain and kidney, and this is where the most damage occurs.<sup>1,6,7</sup>

Acute inorganic mercury toxicosis occurs when large amounts of inorganic mercury are ingested. There is an acute gastroenteritis with vomiting of bloodstained material and severe diarrhea.<sup>4</sup> Death occurs within a few hours from shock and dehydration. In less acute cases the patient survives several days. The syndrome includes salivation, a fetid breath, anorexia, oliguria, tachycardia, hyperpnea, and, in some cases, posterior paralysis and terminal convulsions.

Chronic inorganic mercury toxicosis occurs when small amounts of inorganic mercury are ingested over longer periods. Damage to the kidney and nervous system in addition to the gastrointestinal tract is likely to occur.<sup>4</sup> Signs include depression, anorexia, emaciation, a stiff, stilted gait that may progress to paresis, alopecia, scabby lesions around the anus and vulva, pruritus, petechiation and tenderness of the gums and shedding of the teeth, persistent diarrhea, weakness, incoordination, and convulsions.

Chronic organic mercurial poisoning is associated with neurologic syndromes.<sup>1,5</sup> In pigs blindness is accompanied by staggering, gait instabilities, lameness, recumbency, and inability to eat, although the appetite is good. Cattle poisoned in this way show ataxia, neuromuscular incoordination, paresis, recumbency, convulsions, evidence of renal failure, and death. Clinical signs may not develop until 20 days after feeding is commenced. Sheep are similar to cattle, although signs of tetraplegia may occur. Horses show renal disease, neurologic abnormalities, colic, and laminitis.

### CLINICAL PATHOLOGY

Mercury can be detected at higher levels than normal in the blood, urine, feces, milk, tissues, and hair of affected animals and in the toxic source material.<sup>1,4,8</sup> Urine is the best source for metallic and inorganic mercury and hair for organic mercury. Generally, blood is useful only for the first 3 to 5 days postexposure as distributed to other tissues occurs.<sup>1</sup> Creatinine and serum urea nitrogen concentrations will be elevated and urinalysis may show reduced osmolarity, glycosuria, proteinuria, and phosphaturia. Less than 0.2% of ingested mercury is excreted in cow's milk.

### NECROPSY FINDINGS

In acute cases, there is severe gastroenteritis with edema, hyperemia, and petechiation of the alimentary mucosa. The liver and kidneys are swollen, and the lungs are congested and show multiple hemorrhages. There may be an accompanying catarrhal stomatitis. A crusting focus of dermatitis may be identified if exposure was percutaneous.

Histologically, the renal tubular epithelial cells are swollen and vacuolated, and proteinuria is evident. An ulcerative colitis may also be visible. In chronic toxicity associated with organic mercury compounds there are also degenerative changes in nerve cells in the cortex of the cerebrum, brainstem, and spinal cord. The lesions include neuronal necrosis, neuronophagia, cortical vacuolation, and gliosis. Fibrinoid necrosis of leptomeningeal arterioles may be seen. Other common microscopic changes include degeneration of granular cells of the cerebellar cortex and of Purkinje cells of the myocardium.

Mercury reaches its greatest concentration in the kidney, and this tissue should be submitted for assay. In horses with acute mercury toxicosis, renal tissue with mercury at more than 10 µg/g of mercury is diagnostic.<sup>4</sup> Concentrations of 100 mg/kg may be present in the kidney of animals poisoned with inorganic mercury. With chronic organic mercurial poisoning in swine, levels of mercury up to 2000 mg/kg may be present in the kidney.

### Samples for Confirmation of Diagnosis

- **Toxicology:** 50 g kidney, brain is half fresh and half in formalin, 500 g of suspect feed (ASSAY [Hg]); muscle tissue for potential residues in food animal edible tissues
- **Histology:** formalin-fixed kidney, heart, oral and/or skin lesions; half of midsagittally sectioned brain (LM)

### DIFFERENTIAL DIAGNOSIS

#### Differential diagnosis list

- Arsenic toxicosis (especially organic arsenicals in swine)
- Lead toxicosis

### TREATMENT

Treatment should be aimed toward removal of the source and providing supportive care. Activated charcoal followed by mineral oil or another laxative should be used in acute cases. Further care includes intravenous fluids to enhance hydration, promote excretion, and correct electrolyte abnormalities, gastrointestinal protectants, and pain medications. Antioxidants, including selenium, have been used in human beings.<sup>9</sup>

There is no true antidote, and the use of chelation agents is controversial. In acute

toxicity in horses, intramuscular dimercaprol (BAL) at 3 mg/kg BW every 4 hours × 2 days, followed by 3 mg/kg BW every 6 hours on day 3, and then 3 mg/kg BW twice a day × 10 days has been used.<sup>4</sup> Penicillamine, 3 mg/kg BW orally every 6 hours has also been used effectively.<sup>4</sup> In cattle and swine, intramuscular dimercaprol at 3 mg/kg BW every 6 hours for 4 days, followed by every 12 hours for 10 days has been recommended.<sup>10</sup>

### CONTROL

Seed grains dusted with mercury compounds should not be fed to animals.

### FURTHER READING

- Graeme MD, et al. Heavy metal toxicity, part I: arsenic and mercury. *J Emerg Med.* 1988;16:45-56.
- Neathery MW, Miller WJ. Metabolism and toxicity of cadmium, mercury, and lead in animals: a review. *J Dairy Sci.* 1975;58:1767.
- Radostits O, et al. Mercury poisoning. In: *Veterinary Medicine: A Textbook of the Disease of Cattle, Horses, Sheep, Goats and Pigs.* 10th ed. London: W.B. Saunders; 2007:1814.

### REFERENCES

- Bernhoft RA. *J Environ Public Health.* 2012;2012:460-508.
- Krametter-Froetscher R, et al. *Vet J.* 2007;174:99.
- Bilandzic N, et al. *Food Addit Contam.* 2010;2:172.
- Schmitz DB. *Vet Clin North Am Equine Pract.* 2007;23:677.
- Raikwar MK, et al. *Vet World.* 2008;1:28.
- Chen C, et al. *Sci Total Environ.* 2006;366:627.
- Chen C, et al. *Environ Health Perspect.* 2006;114:297.
- Rudy M, et al. *Med Weter.* 2007;63:1303-1306.
- Shukla SV, et al. *Tox Int.* 2007;14:67.
- Plumb DC. Dimercaprol. In: Plumb DC, ed. *Veterinary Drug Handbook.* 7th ed. Ames, IA: Wiley-Blackwell; 2011:220.

### BORON TOXICOSIS

Boron, an essential element for plant growth, is added to many agricultural fertilizers and presents yet another toxic chemical in the list of farm hazards for animals. Boron compounds such as boric acid or sodium borate are generally of low toxicity and reports of poisoning in cattle rare. In some fertilizers, a solubilized form of boron is used to increase availability thus increasing its toxicity and palatability. Cattle accidentally ingesting a boron-containing fertilizer developed depression, weakness, tremor, and ataxia; other reported signs include short periods of gait spasticity, dorsiflexion of the head, and flutter of the periorbicular muscles, followed by stumbling backward and sternal recumbency, then lateral recumbency, and a quiet death. The case-fatality rate is 100%. There are no gross lesions on necropsy examination.

Experimental dosing with the fertilizer in goats is associated with the previously mentioned syndrome plus head-shaking, ear-flicking, star-gazing (staring), phantom dodging, oral champing, restless weight shifting from foot to foot, sawhorse stance,

mild diarrhea, and frequent urination. The goats do not eat or drink but paw food and water as though they are hungry but unable toprehend.

### FURTHER READING

Radostits O, et al. *Veterinary Medicine: A Textbook of the Disease of Cattle, Horses, Sheep, Goats and Pigs*. 10th ed. London: W.B. Saunders; 2007:1830.

Sisk DBB, et al. Acute, fatal illness in cattle exposed to boron fertilizer. *J Am Vet Med Assoc*. 1988;193: 943-946.

### BROMIDE TOXICOSIS

Bromide salts are available in several forms including sodium bromide, potassium bromide, and methyl bromide.<sup>1-3</sup> Potassium bromide has been added to horse feed and studied in horses for treatment of epilepsy.<sup>1,2</sup> Sodium bromide is commonly used in swimming pools as an alternative to chlorine and in the petroleum industry around oil wells. Methyl bromide is a soil fumigant once commonly used worldwide. Because of its effect on the ozone layer, a planned phase out of methyl bromide will be complete in 2015.<sup>3</sup>

Ingestion of methyl bromide-contaminated oat hay by horses, goats, and cattle and sodium bromide-pelleted feed by cattle has resulted in toxicosis. Clinical signs are neurologic in nature and include ataxia, weakness, and lethargy.

### FURTHER READING

Knight HD, Costner GC. Bromide intoxication of horses, goats, and cattle. *J Am Vet Med Assoc*. 1977;171:446.

Knight HD, Reina-Guerra M. Intoxication of cattle with sodium bromide-contaminated feed. *Am J Vet Res*. 1977;38:407.

Lynn G, et al. Grain fumigant residues, occurrence of bromides in the milk of cows fed sodium bromide and grain fumigated with methyl bromide. *J Agric Food Chem*. 1963;11:87-91.

### REFERENCES

1. Peacock RE, et al. *Aust Vet J*. 2013;91:320.
2. Raidal SL, et al. *Aust Vet J*. 2008;86:187.
3. Ruza LO. *Pest Manag Sci*. 2006;62:99.

## ORGANIC TOXINS AFFECTING THE NERVOUS SYSTEM

### ANTHELMINTIC TOXICOSIS

Anthelmintics are drugs used to treat infections with parasitic worms. This includes both flat worms (e.g., flukes and tapeworms) and round worms (i.e., nematodes). Poisoning associated with most of the newer anthelmintics is rare and usually caused by an accidental overdose in individual animals or a mixing error when added to feed. Older anthelmintics carry the burden of higher toxicity, but fortunately their use has declined dramatically.

### COMMONLY USED ANTHELMINTICS

Commonly used anthelmintics include the following groups:

- Amino-acetonitrile derivatives (monepantel)
- Benzimidazoles and probenzimidazoles (albendazole, fenbendazole, etc.)
- Cyclic octadepsipeptides (emodepside)
- Imidazothiazoles (levamisole)
- Macrocyclic lactones ([MLs] ivermectin, moxidectin, doramectin)
- Miscellaneous (Piperazine, clorsulon)
- Praziquantel/epsiprantel
- Salicylanilides/substituted phenols (closantel, rafoxanide, oxclozanide)
- Tetrahydropyrimidines (pyrantel and morantel)

### OLDER ANTHELMINTICS

Older, rarely used anthelmintics include:

- Carbon tetrachloride
- Hexachloroethane
- Hexachlorophene
- Nicotine
- Phenothiazines
- Somicidin (fenvalerate)
- Tetrachlorethylene

### CURRENTLY USED ANTHELMINTICS

#### Amino-Acetonitrile Derivatives (Monepantel)

Amino-acetonitrile derivatives (ADD) are a group of synthetic compounds with activity against intestinal nematodes. Anthelmintics in this group work by binding to an MPTL-1, nematode-specific acetylcholine receptor.<sup>1</sup> Monepantel, an ADD, was originally marketed in New Zealand as a drench for sheep, but it is now used in Australia, South America, Europe, and other countries.<sup>1,2</sup> Oral administration to sheep at 5× the recommended dose every 3 weeks × 8 treatments did not result in any adverse effects.<sup>1</sup> No adverse effects were noted in ewes when given 3× the recommended dose every 5 days for their entire reproductive cycle.<sup>2</sup>

#### Benzimidazoles (Albendazole, Fenbendazole, and Thiabendazole) and Probenzimidazoles (Febantel, Netobimin, etc.)

The benzimidazoles are generally not water soluble and thus poorly absorbed from the gastrointestinal tract. Probenzimidazoles must be absorbed and metabolized into their respective active compounds. The mechanism of action of this group is inhibition of parasitic  $\beta$ -tubulin, which generally makes them safe drugs.<sup>3</sup> Many of them, however, are contraindicated in pregnancy because of antimetabolic activity with resultant embryo toxicity and teratogenicity.<sup>3,4</sup>

#### Albendazole, Cambendazole, and Parbendazole

Albendazole at four times the standard dose produces some fetal abnormalities if given early in pregnancy. Cambendazole and parbendazole are teratogens and are specifically contraindicated in pregnant animals, especially during the first third of the pregnancy

and at dose rates higher than normal. The safety margin is small, and their use at any dose level is not recommended in these females. Defects produced include rotational and flexing deformities of the limbs, overflexion of the carpal joints, abnormalities of posture and gait, vertebral fusion and asymmetric cranial ossification, cerebral hypoplasia, and hydrocephalus.

#### Fenbendazole

A dose of fenbendazole and the flukicide bromsalans to cattle either simultaneously or within a few days of each other may be accompanied by deaths. Because fenbendazole and the other tertiary benzimidazole, oxfendazole and albendazole, are extremely valuable in removing dormant *Ostertagia ostertagi* larvae, it is suggested that Fascol (bromsalans) should not be used when this is an important problem or if 2 weeks should elapse between treatments.

#### Thiabendazole

At an oral dose rate of 800 mg/kg BW in sheep, transient signs of salivation, anorexia, and depression appear. There are similar signs at larger dose rates, and death is likely at a dose rate of 1200 mg/kg BW. Toxic nephrosis is the cause of death and is reflected in the clinical and pathologic findings of hypokalemia, hypoproteinemia, and uremia.

#### Cyclic Octadepsipeptides (Emodepside)

Currently emodepside is the only commercially available member of this group, and it is registered in the United States and Europe for use in dogs and cats.<sup>1</sup> It has been used experimentally in sheep and cattle and found to be effective and safe.<sup>1,5</sup> Anthelmintics in the groups have a dual mechanism of action, binding to a SLO-1, calcium-activated potassium channel SLO-1 and binding to an HC110R, latrophilin-like receptor. The result is inhibition of pharyngeal muscle activity in parasites resulting in death.<sup>1,5</sup>

#### Imidazothiazoles (Levamisole)

All commercial preparations of levamisole consist of the levo isomer. Its mechanism of action is similar to nicotine by causing prolonged depolarization and neuromuscular junction blockade resulting in parasympathetic stimulation and cholinergic type signs.<sup>6,7</sup> The absorption of levamisole is rapid regardless of the route of administration. Elimination is rapid with an elimination half-life of 2.34 hours (intramuscularly) and 5.44 hours (orally) in sheep, 1.44 hours (orally) in goats, and 6.9 hours (intramuscularly) and 9.3 hours (orally) in swine.<sup>8</sup>

There are some human health implications because levamisole may be found in meat, milk, and cheese especially in toxic situations. The withdrawal period of sheep is 13 days, goats 9 days, swine 11 days, and beef

and milk from dairy cows 48 hours.<sup>8</sup> A recent study involving six dairy cows receiving levamisole at 5 mg/kg BW and oxclozanide at 10 mg/kg BW showed levamisole residues greater than 0.83 µg/kg for the first 10 milkings and concentration of levamisole residues in soft, hard, and whey cheeses.<sup>9</sup>

Accidental injection of pigs caused vomiting, salivation, ataxia, recumbency, and a high mortality within a few minutes of injection. In pigs, concurrent treatment with levamisole and pyrantel tartrate resulted in enhanced toxicity of the levamisole.<sup>6</sup>

Sheep accidentally receiving a double dose of levamisole as a drench developed depression, head-shaking, muscle tremors, spastic movements, and diarrhea.<sup>7</sup> Levamisole used during the breeding season has an adverse effect on the semen quality in rams when used as an anthelmintic and on pregnancy in ewes when used as an immunomodulatory agent.<sup>10</sup>

Double doses in goats produce mild depression and ptosis, whereas higher doses produce, in addition, head-shaking, twitching of facial muscles, grinding of teeth, salivation, tail-twitching, increased micturition, and straining.

Following treatment at standard doses, some cattle show signs of lip-licking, increased salivation, head-shaking, skin tremors, and excitability. The excitability is more marked in calves; when released they tend to raise their tails and run around the paddock. Coughing may commence within 15 to 20 minutes, but this is from the death and expulsion of lung worms and stops in 24 hours. With higher doses, the signs are more pronounced, defecation is frequent, and hyperesthesia in the form of a continuous twitching of the skin may be seen.

### Macrocyclic Lactones (Ivermectin, Moxidectin, and Doramectin)

Macrocyclic lactones are insecticides, acaricides, and nematocides in a number of species and are covered in a separate chapter.

### Miscellaneous (Piperazine and Clorsulon)

#### Piperazine

Piperazine acts to block neuromuscular transmission in the parasite resulting in flaccid paralysis and rapid expulsion of parasites. Piperazine should not be used in animals with a heavy parasite load, in particular foals, because it may result in an ascarid-impaction colic or intestinal perforation.

Piperazine compounds are relatively non-toxic but poisoning can occur in horses on normal or excessive doses. Signs follow a delay of 12 to 24 hours and include incoordination, pupillary dilation, hyperesthesia, tremor, somnolence, and either swaying while at rest or lateral recumbency. Recovery follows in 48 to 72 hours without treatment.

#### Clorsulon

Clorsulon is a sulfonamide used primarily in the treatment of liver flukes in cattle and sheep. It has a high margin of safety and few reports of toxicosis. Infected sheep treated with 100 mg/kg showed no adverse effects and neither did uninfected sheep treated with 200 mg/kg and 400 mg/kg. No acute toxic dose is recorded for cattle, although cows treated with 25× the label dose showed no changes in weight gain or feed consumption.<sup>11</sup> Uninfected goats treated with 35 mg/kg every other day for three doses showed no adverse effects.<sup>11</sup> Clorsulon is distributed to muscle and secreted into milk so appropriate precautions need to be taken both with normal use and in overdose situations.

#### Praziquantel/Epsiprantel

Praziquantel and epsiprantel are effective against cestode parasites in most species of animals and humans.<sup>12</sup> Both products have a wide margin of safety, and reports of toxicity in large animals are scarce.

#### Salicylanilides/Substituted Phenols (Closantel, Rafoxanide, and Oxclozanide)

Closantel, rafoxanide, and oxclozanide are halogenated salicylanilides effective against *Fasciola* spp. in sheep and have approximately the same low level of toxicity if dosed appropriately. They are capable of causing CNS signs including temporary or permanent blindness if overdosed, especially in small ruminants.<sup>13,14</sup> Overdosed sheep and goats developed retinal lesions characterized by necrosis, loss of the photoreceptor layer, and retinal separation.<sup>14</sup> Status spongiosus of the cerebral and cerebellar white matter were consistent findings at postmortem.<sup>14</sup>

All three drugs are highly protein bound and have very long terminal half-lives (closantel, 14.5 days; rafoxanide, 16.6 days; oxclozanide, 6.4 days) in sheep. Associated with their use are tissue residues and the need for long withholding times.

#### Tetrahydropyrimidines (Pyrantel and Morantel)

Pyrantel, either as pamoate or tartrate salt, is widely used in horses and pigs and, to a lesser extent, ruminants. Morantel tartrate, the methyl ester, is more widely used in ruminants. There are two mechanisms of action.<sup>15</sup> The first mechanism is inhibition of fumarate reductase, whereas the second mechanism is a direct action on acetylcholine receptors at the neuromuscular junction. It is the second mechanism that is responsible for paralysis and death of the parasite.

All of these drugs have been on the market for over 30 years and are considered safe in most species studied. Pyrantel pamoate is labeled for administration to mares a month before foaling; no adverse reactions were reported when it was administered at the recommended dose to pregnant

mares or breeding stallions. No adverse reactions were reported when pyrantel tartrate was administered at the recommended dose to pregnant mares or breeding stallions. Horses dosed with pyrantel tartrate at 100 mg/kg BW developed incoordination, sweating, and an increased respiratory rate. Cattle dosed at 200 mg/kg morantel tartrate (20× the recommended dose) did not exhibit any adverse effects. Morantel tartrate has a 14-day meat withdrawal in cattle, but no milk withholding time.

### OLDER ANTHELMINTICS

#### Carbon Tetrachloride

Carbon tetrachloride is sometimes accidentally administered in excessive quantities but deaths are more common when sheep are given standard doses or cattle are dosed by mouth instead of by injection. Standard doses of 2 mL per sheep to kill adult *Fasciola hepatica* or 1 mL/10 kg BW to obtain efficacy against immature forms, have been widely used but in some circumstances these doses can be highly toxic. Doses as low as 0.5 mL/10 kg BW can be associated with liver damage in calves, and clinical effects are apparent at 1 mL/10 kg BW in goats.

Inhalation of carbon tetrachloride is associated with an immediate and acute depression of the CNS and peripheral and circulatory collapse. Diffuse pulmonary edema occurs and sheep that survive show hepatic and renal damage. Ingestion of toxic doses may result in death within 24 hours because of anesthetic depression and severe pulmonary edema, or may occur 3 to 7 days later resulting from renal and hepatic insufficiency. Deaths are associated with almost complete liver and kidney failure.

In gross overdosing or inhalation there is an immediate onset of staggering, falling, progressive narcosis, collapse, convulsions, and death caused by respiratory failure. Animals that survive this stage or, as in the most common form of carbon tetrachloride poisoning in which animals absorb insufficient dose to produce narcosis, additional signs may be manifested in 3 to 4 days. These include anorexia, depression, muscle weakness, diarrhea, and jaundice. After a further 2 to 3 days affected sheep go down and mild-to-moderate clonic convulsions may occur, but death is always preceded by a period of coma. Survivors are emaciated and weak, and may develop photosensitization or shed their wool. They are very susceptible to environmental stresses, particularly inclement weather, and isolated deaths may occur for several months.

Animals dying after inhalation of the drug show marked pulmonary, hepatic, and renal damage. Those dying of massive oral overdosing may show abomasitis and inflammation of the duodenum. In addition acute hepatic swelling, pallor, and mottling accompanied by centrilobular necrosis and fatty degeneration, and renal lesions of extensive



tubular necrosis and degeneration, are observed in animals that die after the ingestion of small doses.

### Hexachloroethane

Hexachloroethane is preferred to carbon tetrachloride for the treatment of fascioliasis in cattle, but it is not completely without danger. Deaths are rare (1 in 20,000) cattle treated and in sheep (1 in 40,000), but nonfatal illness is not uncommon. Susceptible groups may show narcosis, muscle tremor, and recumbency after administration of the standard dose (cattle, 15 g per 6 months of age up to a maximum of 60 g; sheep, 0.4 g/kg BW); such animals should be given half this dose on two occasions at 48-hour intervals.

Animals with large overdoses show ataxia, dullness, anorexia, dyspnea, ruminal tympany, and sometimes abdominal pain, diarrhea, and dysentery. Necropsy lesions include acute abomasitis and enteritis, edema of the abomasal mucosa, and hepatic centrilobular necrosis. Treatment with calcium borogluconate as in milk fever elicits a good response.

### Hexachlorophene

At high dose rates (25–50 mg/kg BW) hexachlorophene is associated with atrophy of seminiferous epithelium of the testis of young adult rams. Repeated dosing is associated with periportal fatty changes in liver.

### Nicotine

Nicotine poisoning seldom occurs in animals except in lambs and calves in which nicotine sulfate is still incorporated in some vermifuges. Doses of 0.2 to 0.3 g nicotine sulfate have been toxic for lambs weighing 14 to 20 kg. Animals in poor condition are more susceptible than well-nourished animals. Animals are affected within a few minutes of dosing and show dyspnea with rapid shallow respirations, muscle tremor and weakness, recumbency, and clonic convulsions. Animals that survive the acute episode may show abdominal pain, salivation, and diarrhea. At necropsy there may be abomasitis and inflammation of the duodenum.

### Phenothiazine

Exposure to phenothiazine has occurred in the past from its extensive use as an anthelmintic. Keratitis, a noteworthy sign of poisoning, is most common in calves, rarely in pigs and goats, and usually after a heavy single dose of phenothiazine, but it can occur in a program of daily intake in a dietary premix. Phenothiazine is absorbed from the rumen as the sulfoxide, conjugated in the liver and excreted in the urine as leukophenothiazine and leukothionol. As urine is voided, further oxidation turns the metabolic products to a red-brown dye, phenothiazine and thionol, which may be confused as hematuria or hemoglobinuria.

Cattle are unable to detoxify all the sulfoxide and some escapes into the circulation and can enter the aqueous humor of the eye, causing photosensitization. Other photodynamic agents that cannot enter the eye may also be produced, and they, with the sulfoxide, are associated with photosensitization of light-colored parts of the body. Hyperlacrimation with severe blepharospasm and photophobia commences 12 to 36 hours after treatment and is followed by the development of a white opacity on the lateral or dorsal aspects of the cornea, depending on which is exposed to sunlight. Most animals recover within a few days, particularly if kept inside or in a shaded paddock. If the animals continue to be exposed, a severe conjunctivitis with keratitis may result.

### Sumicidin

Sumicidin (fenvalerate) is a synthetic pyrethroid anthelmintic capable of causing non-fatal restlessness, yawning, frothing at the mouth, dyspnea, ear and tail erection, pupillary dilation, ruminal tympany, regurgitation of ruminal contents, staggering, tremor, clonic convulsions, and recumbency after a single oral dose. Single oral doses of >450 mg/kg are lethal. Repeated daily dosing (113 mg/kg BW or 225 mg/kg BW) also causes death after 5 to 15 days.

### Tetrachlorethylene

Tetrachlorethylene rarely produces incoordination, which may be evident for 1 or 2 hours after dosing in cattle or sheep. Treatment is not usually necessary.

### FURTHER READING

- Cornwell RL, Jones RM. Controlled laboratory trials with pyrantel tartrate in cattle. *Br Vet J*. 1970;126:134-141.
- Dayan AD. Albendazole, mebendazole and praziquantel. Review of non-clinical toxicity and pharmacokinetics. *Acta Trop*. 2003;86:151-159.
- Delatour P, Parish R. *Benzimidazole Anthelmintics and Related Compounds: Toxicity and Evaluation of Residues*. Orlando, FL: Academic Press; 1986.
- McKellar QA, Jackson F. Veterinary anthelmintics: old and new. *Trends Parasitol*. 2004;20:456.
- McSherry BJ, et al. The hematology of phenothiazine poisoning in horses. *Can Vet J*. 1966;7:3.
- Radostits O, et al. Poisoning by anthelmintics. In: *Veterinary Medicine: A Textbook of the Disease of Cattle, Horses, Sheep, Goats and Pigs*. 10th ed. London: W.B. Saunders; 2007:1830.
- Van Cauteren H, Vandenberghe J, Hérin V, et al. Toxicological properties of closantel. *Drug Chem Toxicol*. 1985;8(3):101-123.
- Von Samson-Himmelstjerna G, et al. Efficacy of two cyclooctadepsipeptides, PF1022A and emodepside, against anthelmintic-resistant nematodes in sheep and cattle. *Parasitology*. 2005;130:343-346.

### REFERENCES

- Epe N, et al. *Trends Parasitol*. 2013;29:129.
- Malikides N, et al. *New Zeal Vet J*. 2009;57:192.
- Danaher M, et al. *J Chromatography*. 2007;845:1.
- Teruel M, et al. *Biocell*. 2011;35:29.
- Crisford A, et al. *Mol Pharmacol*. 2011;79:1031.

- Hsu WH, Martin RJ. Antiparasitic agents. In: Hsu WH, ed. *Handbook of Veterinary Pharmacology*. Ames, IA: Wiley-Blackwell; 2013:379.
- Rahimi S, et al. *Iran J Vet Med*. 2008;6:12.
- Zanon RB, et al. *J Vet Pharmacol Ther*. 2013;36:298.
- Whelan M, et al. *J Agric Food Chem*. 2010;58:12204.
- Pancarci SM, et al. *Bull Vet Inst Pulawy*. 2007;51:253.
- Lanusse CE, et al. Anticestodal and antitrematodal drugs. In: Riviere JE, Papich MG, eds. *Veterinary Pharmacology and Therapeutics*. 9th ed. Ames, IA: Wiley-Blackwell; 2009:1095.
- Slocombe J, et al. *Vet Parasitol*. 2007;144:366.
- Ecco R, et al. *Vet Rec*. 2006;159:564.
- Van der Lugt JJ, et al. *Comp Pathol*. 2007;136:87.
- Elsheikha HM, McOrist S. Antiparasitic drugs: Mechanisms of action and resistance. In: Elsheikha HM, Khan NA, eds. *Essentials of Veterinary Parasitology*. Norfolk, UK: Caister Academic Press; 2011:87.

## MACROCYCLIC LACTONE (IVERMECTIN, MOXIDECTIN, ETC.) TOXICOSIS

### SYNOPSIS

**Etiology** Exposure to any of the macrocyclic lactone compounds including abamectin, doramectin, eprinomectin, ivermectin, and moxidectin.

**Epidemiology** Wide application as insecticides, nematocides, and ascaricides. Ivermectin is most popular because of safety and efficacy. Agricultural uses include miticides, ascaricide, and insecticide.

**Clinical pathology** Nonspecific changes in CBC and elevations in liver enzymes; increases in plasma and milk concentrations of specific compound.

**Lesions** Nonspecific postmortem lesions.

**Diagnostic Confirmation** Clinical signs, history of exposure, analysis of tissue or body fluids.

**Treatment** No antidote, supportive care; intravenous intralipid emulsion in individual cases.

**Control** Use appropriate dose for size and weight of animal; keep agricultural and crop products stored where animals cannot access them.

CBC, complete blood count.

### ETIOLOGY

Ivermectin, the most widely recognized of the group, is a semisynthetic ML originally obtained from *Streptomyces avermitilis*.<sup>1</sup> It is approved for oral or injectable use as an endectocide in horses, cattle, sheep, goats, swine, and many other species but not lactating cattle, sheep, and goats.<sup>1,2</sup> Abamectin is a mixture of ivermectin B<sub>1a</sub> and B<sub>1b</sub> used primarily as an injectable product in cattle. Other ML endectocides used in livestock include doramectin (injectable and pour-on), eprinomectin (pour-on), and moxidectin (oral, injectable, pour-on).<sup>3-7</sup> They are

also agricultural products used on crops and fields as miticides, ascaricides, and insecticides.<sup>8</sup>

## EPIDEMIOLOGY

The MLs have a wide margin of safety in most species when used at the recommended doses and according to label directions. Clinical signs of toxicosis in all species involve neurologic dysfunction as well as some gastrointestinal disturbances.<sup>9</sup> Many of the case reports involve younger animals and are caused by an incomplete blood-brain barrier, failure to adequately estimate weight, or massive overdoses.<sup>5,10</sup> There have been case reports of adult horses developing neurologic signs when administered the recommended dose of ivermectin. These may be caused by the presence of a toxic plant, other medications, low body fat, or other physiologic reasons.

Eight-month-old Jersey bull calves receiving 600 µg/kg BW either intravenously or subcutaneously developed neurologic signs including depression, ataxia, and miosis. Calves receiving 8 mg/kg BW developed neurologic signs and became recumbent 24 hours after dosing with ivermectin.<sup>11</sup> Horses receiving 6 to 10 times the recommended dose of ivermectin developed ataxia, depression, and vision impairment within 24 hours of dosing. Three horses displayed classic signs of ivermectin toxicosis after receiving the normal recommended dose and consuming toxic plants in the *Solanum* family.<sup>12</sup>

## Occurrence

Poisoning associated with MLs has been reported worldwide in a large number of animal species most often secondary to an inadvertent overdose or misuse of the product. Agricultural use of the product as a miticide, insecticide, or ascaricide opens the door to herd problems should animals be exposed to bulk quantities.

## Risk Factors

### Animal Risk Factors

Reports of toxicosis are most common in horses and often in foals. In general, a dosing error has occurred and the animal has received several times the recommended dose.<sup>9,10</sup> Signs of toxicosis have been reported with normal doses, but these often occur in conjunction with another compound or substance.<sup>11</sup>

### Environmental Risk Factors

MLs are excreted in the feces of treated animals and may contaminate the field or act as a poison to nontarget species either directly through defecation or when manure is spread in a pasture or field.<sup>13,14</sup>

## PATHOGENESIS

The pharmacokinetic properties of MLs depend on the dose, specific formulation, and route of administration. In general, MLs

are slowly absorbed, widely distributed throughout the body to fat and liver, poorly metabolized, and excreted primarily unchanged in the feces.<sup>1,5</sup> Up to 90% of ivermectin and 77% of moxidectin are excreted via bile into the feces.<sup>1,6</sup> At normal doses they do not cross the blood-brain barrier of healthy, adult large animals, which is due primarily to action of the P-glycoprotein transporter system.<sup>5,6</sup> They are lipophilic, in particular moxidectin, and thus the lack of body fat may play a role in the elimination half-life and toxicity in debilitated animals.<sup>5</sup> In the absence of body fat, MLs concentrate in the serum and may reach levels high enough to overcome the blood-brain barrier.<sup>5</sup>

They exert their toxic effects by binding to GABA and glutamate-gated chloride channels. Binding to glutamate-gated chloride channels results in hyperpolarization and paralysis of the parasite's pharyngeal pump musculature.<sup>1,5,6</sup> Glutamate-gated chloride channels are present only in nematodes and arthropods. In animal species, GABA-gated channels are only found in the CNS and poisoning does not occur unless the P-glycoprotein transporter is overwhelmed or compromised and MLs are allowed to enter.

## CLINICAL FINDINGS

Clinical signs in horses are primarily those of neurologic dysfunction.<sup>9,10,12,15</sup> Intoxicated horses are ataxic and stand base wide with the head down. Muscle tremors, head-pressing, impaired vision, and facial nerve abnormalities including ptosis, have been reported. Mydriasis is commonly reported. Other signs include hyperthermia, colic, seizures, and recumbency. Similar signs have been reported in other species including cattle and pigs.<sup>1</sup>

## NECROPSY FINDINGS

Postmortem findings are nonspecific. Tissues and body fluids (serum and milk) may be analyzed for the presence of ML compounds using high-performance lipid chromatography.<sup>16</sup> Gastrointestinal contents, feces, fat, and liver are the best specimens to submit for postmortem analysis.<sup>6</sup>

## DIFFERENTIAL DIAGNOSIS

### Differential diagnosis list

- Blue-green algae toxicosis
- Central nervous system trauma
- Encephalitis
- Hepatic encephalopathy
- Organophosphorus compound or carbamate toxicosis

## TREATMENT

There is no antidote for ML toxicosis and treatment is symptomatic and supportive. Activated charcoal should be administered in recent overdoses when the animal is stable;

multiple doses are recommended because MLs undergo enterohepatic recirculation. Methocarbamol has been recommended for tremors, diazepam or phenobarbital for seizures, and intravenous fluids for rehydration.<sup>9,10,12</sup> Physostigmine is no longer recommended because of the incidence of seizures. Sarmazenil, a benzodiazepine agonist effective at GABA receptor sites, at 0.04 mg/kg BW intravenously every 2 hours × 6 doses has been used with equivocal success.<sup>5,10</sup>

An intravenous intralipid emulsion (ILE) containing 20% soybean oil in water has been used successfully in the treatment of ivermectin and moxidectin overdoses in dogs<sup>17,18</sup> and was successful in treating a large overdose in a miniature Shetland pony.<sup>10</sup> The mechanism of action of ILEs in drug overdoses is not completely understood. When associated with lipophilic drug overdoses, it may act as a vascular "lipid sink," pulling drugs from the CNS back into the systemic circulation in which they can be metabolized and/or excreted.<sup>10</sup> There currently is no specified dose in large animals; the recommended small animal dose is a bolus of 1.5 mL/kg BW slowly over 1 to 3 minutes, followed by an infusion of 0.25 to 0.5 mL/kg BW over 30 to 60 minutes.<sup>19</sup> The dose (0.25 mL/kg BW) may be repeated in 4 to 6 hours if there is no evidence of lipemia in the serum.<sup>10</sup>

## TREATMENT AND CONTROL

Sarmazenil (0.04 mg/kg BW IV every 2 hours × 6 doses) (R3)

Intralipid emulsion (20% soybean oil) (1.5 mL/kg BW as IV bolus over 1–3 minutes, followed by an infusion of 0.25–0.5 mL/kg BW over 30–60 minutes) (R2)

BW, body weight; IV, intravenous.

## CONTROL

Careful attention should be paid to administration as most of the case reports revolve around errors in administration, primarily because of miscalculation of an animal's weight or failure to read and follow directions. As with all anthelmintics and insecticides, MLs should be kept in an area where animals cannot access them.

## FURTHER READING

Anderson RR. The use of ivermectin in horses: research and clinical observations. *Comp Cont Edu.* 1994;6:S517-S520.

Toutain PL, Upson DW, Terhune TN, et al. Comparative pharmacokinetics of doramectin and ivermectin in cattle. *Vet Parasitol.* 1997;72:3-8.

## REFERENCES

1. Canga AG, et al. *Vet J.* 2009;179:25.
2. Sheridan R, et al. *J Assoc Anal Comm Int.* 2006;89:1088.
3. Durden DA. *J Chromatogr B.* 2007;850:134-146.

4. Gokbulut C, et al. *J Vet Pharmacol Ther.* 2013;36:302.
5. Schumacher J, et al. *Equine Vet Educ.* 2008;20:546.
6. Cobb R, et al. *Parasit Vectors.* 2009;2:1756.
7. Gokbulut C, et al. *Vet Parasitol.* 2010;170:120.
8. Wislocki PG, et al. Environmental aspects of abamectin use in crops. In: Campbell WC, ed. *Ivermectin and Abamectin.* 2nd reissue. Springer-Verlag; 2011:182.
9. Plummer CE, et al. *Vet Ophthalmol.* 2006;9:29.
10. Bruenisholz H, et al. *J Vet Intern Med.* 2012;26:407.
11. Cankas GR, Gordon LR. Toxicology. In: Campbell WC, ed. *Ivermectin and Abamectin.* 2nd reissue. Springer-Verlag; 2011:89.
12. Norman TE, et al. *J Vet Intern Med.* 2012;26:143.
13. Fernandez C, et al. *Soil Sed Contam.* 2009;18:564.
14. Floate KD. *Can J Vet Res.* 2006;70:1.
15. Swor TM, et al. *J Am Vet Med Assoc.* 2009;125:558.
16. Kaoliang P, et al. *Vet Res Commun.* 2006;30:263.
17. Bates N, et al. *Vet Rec.* 2013;172:339.
18. Crandall DE, et al. *J Vet Emerg Crit Care.* 2009;19:181.
19. Plumb DC. Fat emulsion. In: Plumb DC, ed. *Veterinary Drug Handbook.* 7th ed. Ames, IA: Wiley-Blackwell; 2011:409.

## ORGANOPHOSPHORUS COMPOUNDS AND CARBAMATE INSECTICIDES

### SYNOPSIS

**Etiology** Poisoning by accidental exposure or overdosing with any one of the very large number of insecticides in these two groups of organic compounds.

**Epidemiology** Outbreaks occur from overdosing, use of oil-based preparations formulated for use on nonanimal surfaces, dehydrated animals, drift of spray from orchards, field crops to pasture.

**Clinical pathology** Marked depression of blood cholinesterase levels.

#### Lesions

*Acute disease:* no diagnostic lesions.

*Delayed neurotoxicity:* degenerative lesions in peripheral nerves and spinal cord.

**Diagnostic confirmation** Depressed cholinesterase levels in blood; organophosphate or carbamate in feed or environment.

**Treatment** Atropine in large doses to effect or atropine plus 2-PAM; remove residual toxin from hair coat; prevent absorption from gastrointestinal tract with activated charcoal and cathartics.

**Control** Avoid use in stressed, especially dehydrated, animals. Special constraints with chlorpyrifos.

### ETIOLOGY

Organophosphorus (OP) compounds and carbamates act in essentially the same manner therapeutically and toxicologically, but bonding of the compound to the esterase enzyme is irreversible in the OP compounds and spontaneously degradable with the carbamates, rendering the carbamates potentially less dangerous. A large number of

compounds are included in the group, and those used for the direct treatment of animals have been selected for their low toxicity. A vast amount of information is available on the relative toxicities of the many compounds but it is not possible to provide details here and the information does not lend itself to summarization.<sup>1</sup>

### EPIDEMIOLOGY

#### Occurrence

All animal species are affected. OP compound and carbamate poisoning in animals may occur less frequently as safer insecticides are developed.<sup>2</sup>

#### Source of Toxin

- Grazing in recently sprayed areas, particularly orchards in which the most toxic compounds are frequently used
- Spray used on cereal crops and in orchards carried by wind onto pasture fields
- Hay or cubes made from plants sprayed with organophosphate compounds
- Inadvertent access to granular insecticides intended for crops
- Use of old insecticide containers as feeding utensils
- Contamination of water supplies
- Too high a concentration of the insecticide in a spray
- Storage toxicity of some compounds appears to increase with storage
- Application to animals of products containing oily bases designed specifically for spraying on walls or plants

### Risk Factors

#### Animal Risk Factors

Susceptible groups include the following:

- Young animals (but with some compounds adults are more so), stressed, water-deprived, and chilled animals; the increased susceptibility caused by restriction of water intake is noted especially after oral treatment to control warble fly infestations.
- Pregnant females in that congenital defects occur in their offspring.
- Brahman and Brahman-cross cattle appear to be more susceptible to some compounds than other cattle.
- Dorset Down sheep may be especially susceptible.
- Chlorpyrifos is more toxic for male animals with high blood levels of testosterone and is not recommended for use in bulls over 8 months of age.

#### Environmental Risk Factors

The introduction of these compounds into animal therapeutics as treatments for nematode, botfly, sheep nasal botfly, and warble fly infestations and as insecticidal sprays on plants and soil has increased their importance as possible causes of poisoning and as

causes of pollution of milk, meat, and eggs. They also have a role in the poisoning of native birdlife and other nontarget animals.<sup>2</sup>

### Transmission

- Formulation used, especially the solvent or vehicle used and droplet size
- Method of application, e.g., the toxicity of pour-ons is delayed by 24 hours compared with sprays

### PATHOGENESIS

OP compounds are highly toxic and readily absorbed by ingestion, inhalation, and by percutaneous and perconjunctival absorption. Once absorbed, sulfur-containing OPs (phosphorothioates and phosphorodithioates) are metabolized by mixed function oxidases (MFOs) and sulfur is exchanged for oxygen, thus increasing toxicity. There are two forms of toxicity: cholinesterase inactivation and an OP-induced, delayed neurotoxicity.

#### Cholinesterase Inactivation

The inactivation of cholinesterase by these OP compounds is associated with an increase in acetylcholine in tissues and increased activity of the parasympathetic nervous system and of the postganglionic cholinergic nerves of the sympathetic nervous system. The toxic effects thus reproduce the muscarinic and nicotinic responses of acetylcholine administration. Differences between the toxicities of compounds depend on the stability of this bonding between esterase and compound, and the toxicity of the substance formed by the bonding.

The muscarinic effects of acetylcholine are the visceral responses of the respiratory system and include marked respiratory distress caused by a decrease in dynamic lung compliance and arterial oxygen tension and an increase in total pulmonary resistance; there is bronchial constriction and increased mucous secretion by bronchiolar glands. In the alimentary tract there is increased peristalsis and salivation. Effects in other systems include hypotension and bradycardia, pupillary constriction, sweating, and abortion.

The nicotinic effects are the skeletal muscle responses of twitching, tremor and tetany, convulsions, opisthotonus, weakness, and flaccid paralysis. There is a difference in the relative muscarinic and nicotinic responses between species, and the visceral effects are more marked in ruminants and the muscular effects more evident in pigs in which posterior paralysis is the common manifestation.

#### Organophosphorus-Induced Delayed Neurotoxicity

This form of toxicity is manifested by distal axonopathy commencing 1 or 2 weeks after the poisoning incident. There is a dieback of neurons causing regional flaccid paralysis,



especially in long neurons. The pathogenesis of this lesion is the toxic end product produced by the interaction between some OP compounds and the esterase, a phosphorylated neurotoxic esterase. The most severe effects are associated with industrial OP compounds. Typical examples include the following:

- Congenital defects in young carried by poisoned pregnant females.
- Bilateral laryngeal hemiplegia in horses.
- Paralytic ileus may possibly be associated with chlorpyrifos toxicosis.

Haloxon, in particular, has this neurotoxic effect because it is associated with only a slight depression in cholinesterase levels, but a neurotoxic response in the form of hindlimb ataxia has been reported in a proportion of treated sheep and pigs. The susceptibility of sheep is determined by each individual's genetic ability to metabolize this class of OP compound.

## CLINICAL FINDINGS

### Acute Poisoning

In general, signs of acute toxicity in animals may occur within minutes of inhalation or ingestion of solutions of the more toxic compounds and deaths 2 to 5 minutes later. After cutaneous application of dichlorvos to calves clinical signs appear within 30 minutes, peak at about 90 minutes, and disappear in 12 to 18 hours. With less toxic compounds in solid form, signs may not appear for some hours and deaths may be delayed for 12 to 24 hours.

### Cattle, Sheep, and Goats

#### Acute Toxicosis

In acute cholinesterase inactivation the premonitory signs, and the only signs in mild cases, are salivation, lacrimation, restlessness, nasal discharge, cough, dyspnea, diarrhea, frequent urination, and muscle stiffness with staggering. Grunting dyspnea is the most obvious, often audible from some distance because of the number affected. Additional signs include protrusion of the tongue, constriction of the pupils with resulting impairment of vision, muscle tremor commencing in the head and neck and spreading over the body, bloat, collapse, and death with or without convulsions or severe respiratory distress. In sheep and goats, the signs also include abdominal pain. Signs disappear at 12 to 18 hours.

#### Delayed Neurotoxicity

In these cases, the signs do not appear for at least 8 days and up to 90 days after the poisoning. Signs include posterior incoordination and paralysis. Chlorpyrifos is a specific example of this kind of poisoning. It should not be applied to adult dairy cattle or to mature bulls. The signs include anorexia, depression, recumbency, a distended abdomen, ruminal stasis and diarrhea, and

fluid splashing sounds on percussion of the right flank. Severe dehydration develops and may result in death.

### Pigs

#### Acute Toxicosis

In pigs acute cholinesterase inactivation visceral effects (except vomiting) are less pronounced than in ruminants and salivation, muscle tremors, nystagmus, and recumbency are characteristic. In some instances, the syndrome is an indefinite one with muscle weakness and drowsiness the only apparent signs. Respiratory distress and diarrhea do not occur.

#### Delayed Neurotoxicity

Outbreaks of posterior paralysis occur 3 weeks after dosing with an OP anthelmintic; clinical signs vary in severity from knuckling in the hindlimbs to complete flaccid paralysis. The hindlimbs may be dragged behind while the pigs walk on the front legs. Affected pigs are bright and alert and eat well.

### Horses

#### Acute Toxicosis

Signs include abdominal pain and grossly increased intestinal sounds, a very fluid diarrhea, muscle tremors, ataxia, circling, weakness, and dyspnea. Increased salivation occurs rarely. In foals, fluid diarrhea, which is a transient sign in moderate intoxication, may be expanded to a severe gastroenteritis with heavier dose rates.

#### Delayed Neurotoxicity Syndrome

Bilateral laryngeal paralysis develops in foals after dosing with an OP anthelmintic.

### Miscellaneous Signs of Organophosphorus Poisoning

- Piglets with congenital defects of the nervous system manifested clinically by ataxia and tremors are produced by sows dosed with OP compounds during pregnancy. Teratogenicity may be a characteristic of only some OP compounds, e.g., trichlorfon is teratogenic and dichlorvos is not.
- A significant drop in conception rate when the administration is at the beginning of estrus.
- Most OP compounds are associated with only temporary interference with cholinesterase and are not associated with any permanent effects in recovered animals. With some compounds, especially coumaphos and ronnel, the recovery period may be quite long (up to 3 months in the case of ronnel) because of slow excretion of the compound and the combined compound-esterase complex.
- Absorption of an OP compound may also be associated with significant changes in the patient's cholinesterase status without causing clinical signs.

- Potentiation of the action of succinylcholine chloride can occur for up to 1 month after the administration of the OP compound in horses; the administration of the relaxant to a sensitized horse can be followed by persistent apnea and death. This, and a number of other interactions with drugs that may themselves have toxic effects, means that the manufacturer's instructions for OP compounds must be followed explicitly.

## CLINICAL PATHOLOGY

The estimation of cholinesterase in body tissues and fluids is the most satisfactory method of diagnosing this poisoning, but it is essential that proper methods and standards of normality be used. Convincing figures are of the order of 50% to 100% reduction from normal controls. The degree and the duration of the depression of blood cholinesterase levels varies with the dose rate and the toxicity of the compound used. Blood cholinesterase levels are depressed for much longer than clinical signs are apparent, e.g., after dichlorvos poisoning the depression of cholinesterase level in the blood does not reach bottom until 12 hours after application, and the return to normal levels takes 7 to 14 days. Similarly, cholinesterase levels in cattle poisoned with terbufos, an agricultural insecticide, do not commence to rise toward normal until 30 days and are not normal for 150 days after the poisoning incident. Unlike organophosphate insecticides, carbamate insecticide cholinesterase inhibitors may spontaneously reverse binding, and cholinesterase depression may not be detectable in recently poisoned animals.

Suspected food material can be assayed for its content of OP compounds but assays of animal tissues or fluids are virtually valueless and may be misleading.

## NECROPSY FINDINGS

There are no gross or histologic lesions at necropsy in acute cholinesterase inactivation cases, but tissue specimens could be collected for toxicologic analysis. Material sent for laboratory analysis for cholinesterase should be refrigerated but not deep frozen.

Distinctive degenerative lesions in peripheral nerves and spinal cord can be seen in delayed neurotoxicity cases, and hypoplasia is visible in the cerebrum, cerebellum, and spinal cord in congenitally affected piglets.

## DIFFERENTIAL DIAGNOSIS

Outbreaks of a syndrome of dyspnea, salivation, muscle stiffness, and constriction of the pupils after exposure plus a history of exposure and depressed blood levels of cholinesterase suggest intoxication with these organophosphorus compounds, but diagnostic confirmation requires positive assay results on

*Continued*

suspected toxic materials. In cattle the morbidity and case–fatality rates are approximately 100%, but in pigs the recovery rate is good and all pigs may recover if intake has been low and access is stopped. With the other poisons listed next, death is much more common in pigs, and residual defects, including blindness and paralysis, occur in a proportion of the survivors.

#### Differential diagnosis list

##### Cattle

- Early stages of nicotine poisoning
- Groups of cattle affected by acute bovine pulmonary emphysema and edema (fog fever)
- Sporadic cases of anaphylaxis

##### Horses

- Lead toxicosis

##### Pigs

- Arsenic toxicosis
- Avitaminosis A
- Mercury poisoning
- Sodium chloride (salt) poisoning

## TREATMENT

Animals that have been dipped or sprayed should be washed with water to which soap or a detergent is added to remove residual OP material. When oral intake has occurred, activated charcoal will adsorb residual toxin in the gut.

Primary treatment is urgent and critical, especially in cattle because of the usually high case–fatality rate. Atropine is the antidote for muscarinic effects, but does not reverse the nicotinic effects of the OP compound, i.e., tremors, spasms, and convulsions. The recommended dose in sheep and goats is 0.5 mg/kg BW with  $\frac{1}{4}$  given intravenously and the remainder intramuscularly or subcutaneously.<sup>3</sup> This should be repeated every 3 to 4 hours for 1 to 2 days with salivation and heart rate guiding therapy. Atropine appears to have low efficacy in sheep. This is not a serious drawback because sheep are much less susceptible than cattle to larger doses of atropine. The recommended dose of atropine in horses is 0.02 to 0.2 mg/kg BW intravenously to effect,<sup>3</sup> but it needs to be given with care because horses are very susceptible to the gastrointestinal effects of atropine.

Oximes, if available and economically feasible, may be useful in the early treatment of poisoning from OP compounds. Their usefulness as antidotes declines rapidly with the passage of time after the poisoning occurs, and they are of doubtful use after 24 hours. The most common oxime is pralidoxime chloride (2-PAM). The recommended dose rate for 2-PAM in ruminants is 25 to 50 mg/kg BW given intravenously as a 20% solution over 6 minutes.<sup>4</sup> In horses 2-PAM at doses of 20 mg/kg BW has given good results.<sup>4</sup> Treatment may need to be repeated for up to 10 days to counteract slower acting compounds such as coumaphos.

## TREATMENT AND CONTROL

### Ruminants

Atropine sulfate (0.5 mg/kg BW with  $\frac{1}{4}$  given IV and the remainder IM or SC; repeat every 3–4 hours for 1–2 days) (R1)

Pralidoxime chloride (2-PAM) (25–50 mg/kg BW IV as a 20% solution over 6 minutes. Repeat as needed) (R2, depending on economics; not for herd use)

### Horses

Atropine sulfate (0.02 to 0.2 mg/kg BW IV to effect; repeat judiciously SC every 1.5–2 hours) (R1, only if needed)

Pralidoxime chloride (2-PAM) (20 mg/kg BW IV; repeat every 4–6 hours as needed) (R2)

BW, body weight; IM, intramuscularly; IV, intravenously; SC, subcutaneously.

## CONTROL

Most outbreaks occur after accidental access to compounds. Animals to be treated orally with OP insecticides should be permitted ample fresh drinking water beforehand. Use of chlorpyrifos is restricted to beef cattle and not in calves less than 12 weeks old or in bulls over 8 months of age.

## FURTHER READING

- Abdelsalam EB. Factors affecting the toxicity of organophosphorus compounds in animals. *Vet Bull.* 1987;57:441-448.
- Barrett DS, et al. A review of organophosphorus ester-induced delayed neurotoxicity. *Vet Human Toxicol.* 1985;27:22-37.
- Radostits O, et al. Organophosphorus compounds and carbamates. In: *Veterinary Medicine: A Textbook of the Disease of Cattle, Horses, Sheep, Goats and Pigs.* 10th ed. London: W.B. Saunders; 2007:1834.
- Savage EP, et al. Chronic neurological sequelae of acute organophosphate pesticide poisoning. *Arch Environ Health.* 1988;43:38.

## REFERENCES

1. Karami-Mohajeri S, et al. *Hum Exp Toxicol.* 2011;30:1119.
2. Poppenga RH. *Vet Clin North Am Food Anim Pract.* 2011;27:379.
3. Plumb DC. Atropine. In: Plumb DC, ed. *Veterinary Drug Handbook.* 7th ed. Ames, IA: Wiley-Blackwell; 2011:94.
4. Plumb DC. Pralidoxime chloride (2-PAM chloride). In: Plumb DC, ed. *Veterinary Drug Handbook.* 7th ed. Ames, IA: Wiley-Blackwell; 2011:842.

## INDUSTRIAL ORGANOPHOSPHATES

Principal industrial uses of organophosphates are as fire-resistant hydraulic fluids, as lubricants, and as coolants. A number of compounds including tri-*o*-tolyl phosphate, tri-*o*-cresyl phosphate (TOCP), and triaryl phosphates (TAP) have come to veterinary notice as being associated with poisoning in animals. TAPs contain a number of isomers as well as TOCP (e.g., *m*-cresol, *p*-cresol, *o*-cresol), and all of them are more poisonous

than TOCP. Poisoning may occur by ingestion or cutaneous absorption.

Clinical signs of delayed neurotoxicity do not occur until several weeks after contact and include irreversible neurologic signs of respiratory stertor, dyspnea, dysuria, knuckling, leg weakness, and posterior paralysis.

Diagnostic confirmation depends on evidence of exposure to the toxicant, signs referable to the nervous system lesions, and a positive assay for the toxicant in the animal's tissues. Necropsy lesions characteristically include neuronal degeneration in the spinal cord and peripheral nerves.

## ROTENONE TOXICOSIS

Rotenone has been extensively used in the past to control bovine *Hypoderma* larvae (cattle grubs). It is a neurotoxicant; chronic exposure results in degeneration of neuronal cells, especially dopaminergic neurons.<sup>1</sup> Use as a pesticide and insecticide in the United States is being phased out, in part because of its link to Parkinson's disease in humans.<sup>2</sup>

It has a reputation for low mammalian toxicity but relatively high toxicity to aquatic life. The mammalian oral LD<sub>50</sub> is 100 to 300 mg/kg, whereas the LD<sub>50</sub> for fish is less than 100 µg/L of water. Oral absorption in mammals is limited but enhanced by fat in the diet.

Ingesta at necropsy may contain as much as 2000 ppm of rotenone. Signs include salivation, muscle tremor, vomiting, ascending paralysis, incoordination, quadriplegia, respiratory depression, coma, and death. Accidental oral exposure may be treated with activated charcoal, and an osmotic cathartic for decontamination followed by control of seizures is needed. Phenothiazine tranquilizers are contraindicated in rotenone toxicosis.

## FURTHER READING

- Lapointe N, et al. Rotenone induces non-specific central nervous system and systemic toxicity. *FASEB J.* 2004;18:717-719.
- Graham OH, et al. The potential of animal systemic insecticides for eradicating cattle grubs, *Hypoderma* spp. *J Econ Entomol.* 1967;60:1050.

## REFERENCES

1. Watabe M, et al. *Mol Pharmacol.* 2008;74:933.
2. Tanner CM, et al. *Environ Health Perspect.* 2011;119:866.

## ORGANOCHLORINE INSECTICIDES

### SYNOPSIS

**Etiology** Poisoning by any of the group of insecticides including aldrin, hexachloride, chlordane, DDT, dieldrin, endrin, heptachlor, isodrin, lindane, methoxychlor, or toxaphene.

**Epidemiology** Accidental or misinformed overdosing. Usage on animals now

superceded by other less toxic compounds. Stored or leftover products may accidentally be accessed by animals. It is important because of residues in animal products used in the human food chain.

**Clinical pathology** Assay of compounds in animal tissues.

**Lesions** No consistent significant lesions; some animals show pale musculature.

**Diagnostic confirmation** Chemical assay of liver or brain for acute poisoning; fat or other animal tissue for chronic poisoning.

**Treatment.** Supportive care only; control hyperthermia and seizures. Removal of residual chemical; activated charcoal for oral detoxification.

**Control** Do not use these insecticides and store them appropriately.

DDT, *dichlorodiphenyltrichloroethane*.

## ETIOLOGY

This group of poisons includes dichlorodiphenyltrichloroethane (DDT), benzene hexachloride (and its pure gamma isomer, lindane), aldrin, dieldrin, chlordane, toxaphene, methoxychlor, dichlorodiphenyldichloroethane, isodrin, endrin, and heptachlor. Methoxychlor is less toxic than DDT, and isodrin and endrin are more toxic than aldrin and dieldrin. Camphor (2-bornanone) is chemically similar to toxaphene and is associated with a similar syndrome when fed accidentally.

## EPIDEMIOLOGY

### Occurrence

Poisoning with these compounds has been recorded in all animal species. The chlorinated hydrocarbons have come under so much criticism as environmental contaminants that they are rarely used directly on animals, so outbreaks of clinical illness associated with them are much less common than they were.

### Risk Factors

#### Animal Risk Factors

The compounds vary in their ability to pass the skin barrier. Benzene hexachloride, aldrin, dieldrin, and chlordane are readily absorbed. Species susceptibility to skin absorption also varies widely. Very young animals of any species are more susceptible than adults, and lactating and emaciated animals also show increased susceptibility.

#### Farm or Premise Risk Factors

Many outbreaks are associated with the application to animals of products intended for crops, e.g., endosulfan, and labeled specifically "Not For Animal Use." These insecticides may contaminate soil and persist there for many years. Rooting animals such as pigs are particularly susceptible to this source of poisoning. These compounds are

also sometimes fed accidentally and in large amounts in lieu of feed additives, and are associated with acute poisoning. In feedlot animals, signs may continue for as long as a year because of repeated contamination from the environment. Insect baits, e.g., grasshopper baits containing toxaphene and chlordane, used on pasture and for leaf-eating insects on market gardens can be associated with poisoning in livestock, which may eat large quantities of them. These insecticides, especially heptachlor, are incorporated in the soil before the crop of potatoes or maize is sown to control soil pests. Subsequent grazing of the field will cause contamination of the livestock for several years.

### Environmental Risk Factors

Organochlorines are closely regulated and banned in many countries primarily because of their persistence in the environment, but some are still widely used in agriculture, principally on growing plants to control insect pests and on stored seed grain to control fungi. If the plants or grain, even milled and by-products, e.g., bran, are fed to animals, they can be associated with problems of tissue residues; if they are fed in sufficient quantities they can be associated with clinical illness.

### Human Risk Factors

Because the compounds are soluble in fat and accumulate in body stores they are formidable threats to the meat industry. They are also excreted in significant amounts in milk and enter the human food chain at this point. They are concentrated still further in cream and butter.

### Transmission

Ingestion, inhalation, aspiration, and percutaneous absorption are all possible portals of entry so that contamination of feed and application of sprays and dips can all be associated with poisoning.

### Method of Application

Dipping of animals is the most hazardous method of application because entry may occur through all portals. Spraying is safer because percutaneous absorption and inhalation are the only portals of entry. The small particle size of the compound and concentration of animals in confined spaces while spraying increase the possibility of poisoning. Oily preparations are not used for animal treatment but are used inadvertently and are readily absorbed through the skin.

### Formulation Used

Concentrations of insecticide in formulations used for spraying barns are much higher than those used for animals. Among spray preparations simple solutions are most dangerous followed by emulsions and, least of all, suspensions of wettable powder. Dusting is safest and is preferred to other

methods. Preparations for use on plants are often unstable emulsions, which come out of suspension quickly when they reach the plant. If these preparations are used in animal dips, the first few animals through the dip can be heavily contaminated and suffer acute, lethal toxic effects. Although the treatment of pastures to control their insect pests is usually safe to animals grazing, the treated pasture or hay made from it can cause contamination of animal products. This contamination can be avoided by incorporating the insecticide into superphosphate granules ("prills") instead of applying it as sprays or dusts.

## PATHOGENESIS

The mechanism of action of organochlorines is to induce repetitive discharge of motor and sensory neurons by interference with axonal transmission of nerve impulses. After absorption, cyclodiene insecticides are activated by the MFO system, and any prior chemical or environmental exposures that increase the MFO system may exacerbate the onset of poisoning. The diphenyl aliphatic (DDT) organochlorines affect sodium channels, prolonging sodium influx and inhibiting potassium efflux at the nerve membrane. The cyclodiene organochlorines competitively inhibit the binding of GABA at receptor sites, resulting in loss of GABA inhibition and resultant stimulation of the neuron. In all organochlorine poisonings recovery may occur, but with smaller animals paralysis follows and finally collapse and death ensue.

Most of the substances accumulate in the fat depots, where they are a potential source of danger in that sudden mobilization of the fat may result in liberation of the compound into the bloodstream and the appearance of signs of poisoning.

## CLINICAL FINDINGS

The speed of onset of illness after exposure varies from a few minutes to a few hours, depending on the portal of entry and the compound and its formulation, but it is never very long.

The toxic effects produced by the members of this group include complete anorexia, increased excitability and irritability followed by ataxia, muscle tremor, weakness and paralysis, and terminal convulsions in severe cases. Salivation and teeth grinding occur in large animals and vomiting occurs in pigs. Variations on this clinical syndrome, which is common to all organochlorine intoxications, include the following:

- DDT and methoxychlor chronic poisoning may be associated with moderate liver damage.
- Benzene hexachloride, lindane, chlordane, toxaphene, dieldrin, endrin, aldrin, and heptachlor are associated with an exaggerated syndrome including teeth grinding, champing of jaws, dyspnea, tetany, snapping of the eyelids,



auricular spasms, opisthotonus, frequent micturition, frenzied movements, walking backward, climbing walls, violent somersaults, and aimless jumping. Fever of 5% to 7% above normal may occur, possibly as a result of seizure activity. Seizures may persist for 2 or 3 days if the animal does not die.

### CLINICAL PATHOLOGY

Blood, hair, and ingesta can be assayed chemically for specific toxins. The removal of a biopsy from the fat pad near the cow's tail offers a satisfactory means of providing samples for tissue analysis. Organochlorine residues in acutely poisoned animals may reach 4 to 7 ppm in brain or liver.

### NECROPSY FINDINGS

At necropsy there are no specific major lesions in the nervous system, but toxic hepatitis and tubular nephritis appear in some cases. Tissue levels need to be high to be good indicators of recent intoxication. If possible, the specimens should be deep frozen, and the suspected compound should be nominated because assay procedures are long and involved.

### Samples for Postmortem Confirmation of Diagnosis

- Specimens of hair, if the portal is percutaneous
- Ingesta, if oral intake is probable

### DIFFERENTIAL DIAGNOSIS

#### Differential diagnosis list

- Lead poisoning
- Rabies
- Pseudorabies of cattle
- Polioencephalomalacia
- Thromboembolic meningoencephalitis
- Salt poisoning in pigs

### TREATMENT

There is no specific primary treatment. Activated charcoal (2 g/kg) given early by stomach tube will bind pesticide in rumen and reduce further absorption. The use of mineral oil should be avoided because it will increase the absorption of lipid organochlorines. Residual chemical should be removed from the coat with a degreasing soap and copious water rinse. Supportive treatment includes sedation with diazepam or pentobarbital sodium until signs disappear, monitoring and treating hyperthermia, and replacing fluid losses.

Treatment to reduce the contamination of tissues is unsuccessful and in most cases the time required for the contamination to subside varies between compounds but is lengthy, taking 3 to 6 months or longer. For example, cows fed DDT prepartum need an average of 189 days from parturition for the

level in the milk fat to decline to 125 ppm. After the source of contamination is removed, drenching of cows with up to 2 kg of activated charcoal followed by daily incorporation in their feed for 2-week intervals has been recommended for this purpose. Neither of these procedures is really practical in the average farm operation. The common procedure for reducing the level of tissue contamination in animals is to put them in a feedlot without any contact with pasture and feed them on energy-intensive rations. Sheep decontaminate much more quickly than cattle, and animals on a high plane of nutrition eliminate the toxins more quickly.

### CONTROL

Avoidance of the use of the compounds is recommended.

### FURTHER READING

- Aslani MR. Endosulfan toxicosis in calves. *Vet Human Toxicol.* 1996;38:364.
- Booth NH, McDowell JR. Toxicity of hexachlorobenzene and associated residues in edible animal tissues. *J Am Vet Med Assoc.* 1975;166:591-595.
- Marth E, Stunzner D. Toxicokinetics of chlorinated hydrocarbons. *J Hyg Epidemiol Microbiol Immunol.* 1989;33:514-520.
- Radostits O, et al. Chlorinated hydrocarbons. In: *Veterinary Medicine: A Textbook of the Disease of Cattle, Horses, Sheep, Goats and Pigs.* 10th ed. London: W.B. Saunders; 2007:1832.
- The history of organochlorine pesticides in Australia. (Accessed 10.12.2013, at [http://www.apvma.gov.au/products/review/completed/organochlorines\\_history.php](http://www.apvma.gov.au/products/review/completed/organochlorines_history.php)).
- Uzoukwu M, Sleight SD. Effects of dieldrin in pregnant sows. *J Am Vet Med Assoc.* 1972;160:1641-1643.

## SODIUM FLUOROACETATE (COMPOUND 1080) TOXICOSIS

### ETIOLOGY

Sodium fluoroacetate in the form of compound 1080 is used as a potent rodenticide in agriculture. It is currently used in the United States against coyotes and in Australia and New Zealand against introduced species such as possums.<sup>1,2</sup> It is also formed naturally by fluoride uptake from the soil and water in many plants that are native to Africa, Australia, and Brazil. The toxic dose level for domestic animals including sheep is 0.3 mg/kg BW,<sup>3</sup> and 0.4 mg/kg BW is lethal for cattle. Sublethal doses may be cumulative if given at sufficiently short intervals.

### EPIDEMIOLOGY

The use of fluoroacetate in agriculture poses a hazard for grazing farm animals because it is usually spread out across fields combined with cereals, carrots, or bread as bait and is attractive to ruminants.

### PATHOGENESIS

Fluoroacetate in the body is converted to fluorocitrate, which inhibits the enzymes aconitase and succinate dehydrogenase in

the tricarboxylic acid cycle (Krebs cycle) leading to the accumulation of significant amounts of citrate in tissues and to irreversible cardiac damage. Two actions are manifest: CNS stimulation producing convulsions and myocardial depression with ventricular fibrillation. In sheep the predominant effect with acute poisoning is on the myocardium and the pulmonary system; in pigs and dogs it is the nervous system.

### CLINICAL SIGNS

Clinical signs vary widely among species. In herbivores, sudden death in acute cases typically occurs. The animals are found dead without evidence of a struggle, or there are tetanic convulsions and acute heart failure with the animals showing weakness and dyspnea accompanied by cardiac arrhythmia, a weak pulse, and electrocardiographic evidence of ventricular fibrillation.

In sheep with subacute poisoning, the signs are similar but are not apparent when the animal is at rest. When they are disturbed, the nervous signs of tremor and convulsions appear but disappear when the sheep lies down.

Pigs manifest the nervous form of the disease, including hyperexcitability and violent tetanic convulsions. In all cases there is a period of delay of up to 2 hours after ingestion before signs appear.

### CLINICAL PATHOLOGY/ NECROPSY FINDINGS

There are no specific lesions, but the tissues contain elevated levels of citrate.

### TREATMENT/CONTROL

No specific treatment is available. In cats, calcium gluconate and sodium succinate have been used successfully in the treatment of experimental intoxication.<sup>4</sup> Care in the disposition of baits and highly dependable retrieval of uneaten baits before allowing livestock access to baited fields preempts most mortalities.

### FURTHER READING

- Radostits O, et al. *Veterinary Medicine: A Textbook of the Disease of Cattle, Horses, Sheep, Goats and Pigs.* 10th ed. London: W.B. Saunders; 2007:1839.

### REFERENCES

1. Proudfoot AT, et al. *Tox Rev.* 2006;25:213.
2. Eason C, et al. *New Zeal J Ecol.* 2011;35:1.
3. Gooneratne SR, et al. *Onderstepoort J Vet Res.* 2008;75:127.
4. Collicchio-Zuanze RC, et al. *Hum Exp Toxicol.* 2006;25:175.

## MOLLUSCIDICIDE TOXICOSIS

### Metaldehyde

Metaldehyde is the active ingredient in products used to control slugs and snails (mollusks), mites, and insects.<sup>1-3</sup> It is often used in combination with a carbamate, such as methiocarb, and historically with calcium

arsenate.<sup>3</sup> Metaldehyde is often bran based with molasses frequently added to attract snails and slugs. It is a neurotoxicant to all mammals by inhalation, ingestion, and dermal exposure. The mechanism of action is unknown, but it may be related to changes in the concentration of neurotransmitters in the brain. Outbreaks have occurred in cattle, goats, sheep, and horses.<sup>1-3</sup> The acute lethal dose in adult cattle is 0.2 g/kg BW and less in calves<sup>3</sup>; in horses it is 0.1 g/kg BW. The onset of signs varies depending on the concentration and amount ingested, but in cattle it is reported to be 15 minutes to 24 hours postingestion.<sup>3</sup> Prolongation may be caused by delayed rumen absorption.

Ingestion of a toxic amount of metaldehyde causes CNS stimulation with profound muscle tremors and hyperthermia. Other reported signs in ruminants include incoordination, hyperesthesia, hypersalivation, dyspnea, diarrhea, partial blindness, unconsciousness, cyanosis, and death caused by respiratory failure.<sup>2,3</sup> All the signs are exacerbated by excitement or activity. A mortality rate of 3% may be expected. Signs in horses are similar plus heavy perspiration and death in 3 to 5 hours.

There is no antidote, and treatment is largely supportive. Mineral oil and activated charcoal (1–3 doses) may be used to decrease absorption. Muscle tremors and seizures should be controlled with a tranquilizer and/or muscle relaxant. Intravenous fluids should be used to replace and restore fluids and electrolytes. Rumenotomy may be effective if performed before the onset of clinical signs.

### Methiocarb

Methiocarb is a carbamate molluscicide used alone or in combination with metaldehyde. It has anticholinesterase and nicotinic and muscarinic activities.<sup>4</sup> The compound is usually in pellet form and dyed blue or yellow so that affected animals can be detected by the blue/yellow staining of their mouths.<sup>3,4</sup>

The signs can vary widely depending on the degree of receptor stimulation. Poisoning of sheep is associated with depression, hypersalivation, diarrhea, dyspnea, aimless wandering, and ataxia. Death is caused by pulmonary edema. Horses show sweating, lacrimation, urine dribbling or polyuria, muscle tremor, hypersalivation, and finally recumbency and death caused by pulmonary edema.<sup>4</sup>

Binding to acetylcholinesterase is reversible so recovery can occur with supportive care. Atropine is an effective antidote but likely will need to be repeated several times, especially if the amount ingested is large. Additional treatment is supportive and aimed toward specific system involvement.

### FURTHER READING

- Booze TF, Oehme FW. Metaldehyde toxicity: a review. *Vet Human Toxicol.* 1985;27:11-15.  
Giles CJ, et al. Methiocarb poisoning in a sheep. *Vet Rec.* 1984;114:642.

### REFERENCES

1. Daniel R, et al. *Vet Rec.* 2009;165:575.
2. Guitart R, et al. *Vet J.* 2010;183:249.
3. Valentine BA, et al. *J Vet Diagn Invest.* 2007;19:212.
4. Kaye BM, et al. *Aust Vet J.* 2012;90:221.

### STRYCHNINE

Strychnine has been used for years as a rodenticide and avicide. Historically it has been used as an appetite stimulant and laxative and most recently, as a contaminant in LSD and other street drugs. It is an alkaloid derived primarily from seeds and bark of the *Strychnos nux-vomica* tree, although it is found in various amounts in many *Strychnos* spp.

Strychnine poisoning is an uncommon occurrence in large animals and usually associated with accidental overdosing with strychnine preparations or accidental access to strychnine treated bait meant for rodent control. Cattle are particularly susceptible to parenteral administration (30–60 mg of strychnine hydrochloride may be fatal) but less susceptible to oral administration because of destruction of the drug in the rumen. Lethal doses by parenteral injection are 200 to 250 mg in horses, 300 to 400 mg in cattle, and 15 to 50 mg in pigs.

Strychnine is rapidly absorbed from the gastrointestinal tract in monogastric animals and less so by ruminants. Distribution to tissues is rapid as is hepatic metabolism. In most animals, 50% of strychnine is eliminated in 6 hours following a sublethal dose.

It is a potent neurotoxicant and convulsant, exerting its action at the postsynaptic membrane. In the spinal cord, strychnine interferes with the inhibition of motor cell stimulation resulting in simultaneous muscle contraction. In the brain, it interferes with inhibitory responses of the motor neurons resulting in neuronal excitation. The convulsant effects of strychnine are caused by interference with glycine-mediated postsynaptic inhibition. The net effect is that all skeletal muscles become hyperexcited, and tetanic seizures may be provoked by the application of minor external stimuli. In these convulsive episodes there is extension of the limbs, opisthotonus, and protrusion of the eyeballs. The seizures may last for 3 to 4 minutes and are followed by periods of partial relaxation, which become progressively shorter as the disease develops. Hyperthermia may be extreme. Respiratory arrest leads to death.

There is no antidote and treatment is supportive. Animals should be kept in a dark, calm area and not stimulated in any manner. Seizures should be treated with diazepam or a barbiturate. If seizures can be adequately controlled, animals may survive.

### FURTHER READING

- Boyd RE, et al. Strychnine poisoning. *Am J Med.* 1983;74:507-512.

- Ward JC, Garlough FE. Strychnine IV: lethal dose studies on cattle and sheep. *J Am Pharm Assoc.* 1936;125:422-426.

## Diseases of the Cerebrum

### PSYCHOSES, NEUROSES, AND STEREOTYPY

Psychoses or neuroses are rarely documented in farm animals, whereas **stereotypy** is common, particularly in horses. Stereotypic behavior is repetitive behavior induced by frustration, repeated attempts to cope, or CNS dysfunction. Primary equine stereotypies include crib-biting, weaving, box walking, tongue rolling, and lip movement.

#### Crib-Biting and Windsucking

**Crib-biting** or “cribbing” is an oral stereotypic behavior in which the horse grasps an object, usually the feed box or any solid projection, with the incisor teeth, then arches the neck and, by depressing the tongue and elevating the larynx, pulls upward and backward and swallows air, emitting a loud grunt at the same time. This results in erosion of the incisor teeth and intermittent bouts of spasmodic colic and flatulence. Crib-biting must be distinguished from chewing wood from boredom and from pica caused by a mineral deficiency. **Windsucking** (aerophagia) is an oral stereotypic behavior in which the horse flexes and arches the neck and swallows air and grunts, but there is no grasping of objects.

Crib-biting is viewed as a vice and potentially “contagious” problem and affected horses are usually not welcome in stables. Once established, crib-biting is primarily postprandial. Treatments include environmental enrichment (move horse to a stall where they can view more activity; change stall door/walls so that other horses can be seen) and feeding more hay and less concentrate so that feeding takes longer. More aggressive treatments include placement of a crib-strap (a strap placed around the neck of the horse that has two pieces of metal hinges at the ventral area; during arching of the neck the crib-strap tightens around the pharynx) or neurectomy or myectomy. Weaning in a box stall appears to increase the risk of developing crib-biting.

#### Weaving

Weaving is a locomotor behavior during which the horse moves its head and neck laterally while its weight is moved to the contralateral forelimb, usually while the horse is positioned at the stall door with its head over the stable door into the aisle. There is no specific treatment and closing the top half of the stable door merely moves the activity back into the stall. Feeding hay ad libitum may decrease the time devoted to this activity (anecdotal reports).

### Box Walking

The term **box walking** refers to persistent walking around the perimeter of the stall in a circular, repetitive manner. There is no specific treatment, but anecdotal reports suggest that feeding hay ad libitum may decrease the time devoted to this activity. Other stereotypical behavior includes persistent kicking of the stall, in the absence of pruritic lesions of the lower limbs, and cutaneous and subcutaneous mutilation by self-biting.

### Farrowing Hysteria in Sows

Hysteria in sows at farrowing is a common occurrence. This syndrome is most common in gilts. Affected animals are hyperactive and restless and they attack and savage their piglets as they approach the head during the initial teat sucking activity after birth. Serious and often fatal injuries result. Cannibalism is not a feature.

When the syndrome occurs, the remaining piglets and freshly born piglets should be removed from the sow and placed in a warm environment until parturition is finished. The sow should then be tested to see if she will accept the piglets. If not, ataractic or neuroleptic drugs should be administered to allow initial sucking, after which the sow will usually continue to accept the piglets.

Azaperone (2 mg/kg BW IM) is usually satisfactory, and pentobarbital sodium administered intravenously until the pedal reflex is lost has been recommended. Promazine derivatives are effective but subsequent incoordination may result in a higher crushing loss of piglets. The piglets' teeth should be clipped.

Affected gilts should be culled subsequently because the syndrome may recur at subsequent farrowing. Where possible, gilts should be placed in their farrowing accommodation 4 to 6 days before parturition and the farrowing environment should be kept quiet at the time of parturition.

### Tail-Biting, Ear-Chewing, and Snout-Rubbing in Pigs

The incidence of cannibalism has increased with intensification of pig rearing, and it is now a significant problem in many pig-rearing enterprises. Tail-biting is the most common and occurs in groups of pigs, especially males, from weaning to market age.

Ear-chewing is less common and is generally restricted to pigs in the immediate postweaning and early growing period, although both syndromes may occur concurrently. The incidence of ear-chewing has increased with the practice of docking piglet tails at birth. The lesions are usually bilateral and most commonly involve the ventral part of the ear. Lesions from bite wounds may also occur on the flanks of pigs. There is frequently an association with mange infestation with both of these vices.

A syndrome of snout-rubbing to produce eroded necrotic areas on the flanks of pigs

has been described. Affected pigs were invariably colored, although both white and colored pigs acted as agonists.

The causes of these forms of cannibalism in pigs are poorly understood, but they are undoubtedly related to an inadequate total environment. Affected groups are usually more restless and have heightened activity. Factors such as a high population density, both in terms of high pen density and large group size; limited food and competition for food; low protein and inadequate nutrition; boredom; and inadequate environment in terms of temperature, draft, and ventilation have been incriminated in precipitating the onset of these vices.

When a problem is encountered, each of these factors should be examined and corrected or changed if necessary. **Prevention** is through the same measures. Chains or tires are frequently hung for displacement activity but are not particularly effective.

The problem may recur despite all attempts at prevention. Also for economic reasons it is not always possible to implement the radical changes in housing and management that may be necessary to avoid the occurrence of these vices. Because of this, the practice of tipping or docking the piglets' tails at birth has become common as a method of circumventing the major manifestation of cannibalism.

## HEAD-SHAKING IN HORSES

Head-shaking by horses is a troubling syndrome associated with hypersensitivity of the trigeminal nerve in most affected horses. The disorder is characterized by repeated, sudden shaking or tossing of the head. It is proposed that a subgroup of horses with defined trigeminal hypersensitivity be classified as having trigeminal-mediated facial dysesthesia.<sup>1</sup>

### ETIOLOGY

The etiology is complex and often unclear and conditions associated with head-shaking include the following<sup>2</sup>:

- Ear mites
- Otitis interna/externa
- Ophthalmic disease (uveitis)
- *Trombicula autumnalis* (chiggers) infestation of the muzzle
- Guttural pouch disease (mycosis)
- Stylohyoid arthropathy
- Osteitis of the petrous temporal bone
- Dental disease (wolf teeth, ulceration, periodontal disease, periapical abscess)
- Behavioral abnormalities
- Trigeminal neuralgia
- Optic neuritis
- Photic head-shaking (optic-trigeminal summation)
- Neck pain
- Rhinitis or sinusitis (including fungal sinusitis)<sup>3</sup>
- Ethmoidal disease including hematoma

- Infraorbital neuritis
- Excessive neck flexion by rider
- Equine protozoal myeloencephalitis
- Ill-fitting tack including bit and bridle
- Obstructive airway disease (heaves, laryngeal hemiplegia, epiglottic cysts, etc.)
- Fractures of the nuchal crest<sup>4</sup>
- Surgery of the paranasal sinuses<sup>5</sup>

Most cases of the disease are idiopathic despite intensive investigation of affected horses. Photic head-shaking is a common cause of the disease. Most cases have some seasonal distribution, although the reason for this is undetermined. Trigeminal neuralgia is considered an important cause of the disease. It is not associated with EHV-1 infection of the trigeminal ganglia.<sup>6</sup>

### EPIDEMIOLOGY

The epidemiology of the disease is not well defined. The syndrome occurs in horses throughout the world. The syndrome is sporadic, usually affects only one horse on a farm, and does not occur as outbreaks. It has a seasonal occurrence in approximately 60% of horses with the majority first demonstrating head-shaking, or being most affected, during spring and summer. Head-shaking is worst on sunny days, and less severe on cloudy days, in approximately 60% of horses. Sunshine and windy weather worsen the condition in many horses.<sup>7</sup> Seventy-five percent and 80% of affected horses have less severe signs at night or when ridden indoors, respectively.

Affected horses are usually mature adults with onset of head-shaking at 7 to 9 years of age in over half of the cases, although signs can occur in horses as young as 1 year.<sup>2</sup> The disease is reported twice as often in geldings as in mares. There is an apparent predisposition to the disease in Thoroughbreds, but this is not consistently reported. Most affected horses are used for general riding, although this might represent an age effect because the syndrome tends to occur in older horses that are not used for racing. There is no apparent association of temperament and risk of head-shaking.

### PATHOGENESIS

The pathogenesis of head-shaking depends on the cause, but it is increasingly persuasive that the majority of cases involve hypersensitivity of the trigeminal nerve.<sup>1,8-10</sup> The trigeminal nerve provides sensory function of the nose and nasal mucosa. Horses affected by head-shaking have low stimulus thresholds for the trigeminal nerve than do healthy horses, although once stimulated nerve conduction is not different between the groups.<sup>9</sup> The lower stimulus threshold likely makes affected horses more sensitive to noxious stimuli. A method is also described for assessment of the trigeminocervical reflex in normal horses.<sup>11</sup> This technique might be useful in head-shaking horses.<sup>10-12</sup>



Head-shaking is related to exposure to bright light in some animals. This is a condition referred to as photic or optic-trigeminal summation because of its similarity to a syndrome in people. Trigeminal neuralgia is thought to cause acute, sharp, and intense pain in the face. Although this cannot be definitively diagnosed in horses, its presence is inferred from the horse's behavior and response to analgesia of the infraorbital or posterior ethmoidal nerves.

### CLINICAL FINDINGS

The **clinical signs** of head-shaking are unmistakable. Movements of the head are sudden and apparently spontaneous and involve lateral, dorsal, ventral, or rotatory movement of the nose usually during exercise. Horses rarely have the behavior only at rest, with most affected both at rest and during exercise and about 10% exhibiting signs only during exercise. The action often resembles that of a horse trying to dislodge something from its nose. Approximately 90% of horses have vertical movement of the head (as if flipping the nose). The head-shaking can be so severe it causes lateral, dorsal, or ventral flexion of the neck to the level of the caudal cervical vertebrae, although more commonly only the rostral one-third of the neck is involved, if it is involved at all. Some horses rub their nose on objects, the ground, or their front limbs, sometimes during exercise. Affected horses often snort or sneeze. There can be twitching of the facial muscles and flipping of the upper lip. The movements are sudden and at times appear to catch the horse by surprise. The frequency and/or severity of movements are usually increased during exercise. Severely affected horses can stumble and fall if head-shaking occurs during exercise, rendering the horse unsafe to ride.

A grading system to classify the severity of signs is as follows:

- 0 No signs of head-shaking
- 1 Intermittent and mild clinical signs: facial muscle twitching; rideable
- 2 Moderate clinical signs: definable conditions under which head-shaking occurs; rideable with some difficulty
- 3 Rideable to unpleasant to do so: difficult to control
- 4 Unrideable and uncontrollable
- 5 Dangerous with bizarre behavior patterns

This system might be useful for assessing response to therapy and concisely describing the severity of the signs.

**Ancillary testing** involves radiography of the skull; endoscopic examination of both nostrils and ethmoidal regions, nasopharynx, larynx, and guttural pouches; otoscopic examination of the external auditory canal and tympanic membrane (difficult to achieve in a conscious horse, a small endoscope is necessary); desensitization of the infraorbital and posterior ethmoidal nerves; biopsy of the nasal mucosa (in horses with suspected

rhinitis); radiographic examination of the head and neck; measurement of stimulus threshold for action potentials in the trigeminal nerve,<sup>9</sup> and therapeutic trials including application of contact lenses or masks, or administration of medications (see the following section **Treatment**).

### CLINICAL PATHOLOGY

There are no characteristic hematologic or serum biochemical abnormalities.

### NECROPSY FINDINGS

There are no characteristic findings on necropsy, apart from those of any underlying disease. Evidence of lesions in the trigeminal nerve is lacking.

### DIFFERENTIAL DIAGNOSIS

The disease must be differentiated from the stereotypic weaving that occurs during stabling and not during exercise.

### TREATMENT

The principles of treatment include relief of specific underlying diseases, removal of management or environmental conditions that cause head-shaking, and administration of medications. There is the potential for an important placebo effect, in the owners, for treatment of head-shaking.<sup>13</sup>

If underlying conditions are detected, such as ear mites, dental disease, and other conditions listed in the previous section **Etiology**, then these conditions should be treated effectively. Effective treatment will alleviate head-shaking, if in fact the condition was the cause of the disease. However, most horses with head-shaking have seasonal or photic disease and treatment is more difficult. A survey of owners of 254 horses with head-shaking revealed that only 129 horses had been treated by a veterinarian and, of those, only 6% had complete resolution of head-shaking, whereas 72% had no response to treatment. Other treatments used were on the advice of lay "back specialists," homeopathy, alternative therapies, or face or head masks. Success rates for these interventions varied between 6% and 27%, with the most success obtained by use of a nose net (27%). Nose nets provided better control of signs than did face or eye masks. These figures on the success of treatment illustrate the refractory, and therefore frustrating, nature of the disease.

Fitting of **nose masks** alleviates or lessens head-shaking in some horses. The design of the nose mask does not appear to be important regarding whether it covers the entire rostral face or just the nostrils. The nose masks were most effective for treatment of up-and-down head-shaking, but not for side-to-side or rubbing behavior.

Blue-tinted **contact lenses** have been suggested for use in horses with photic head-shaking. Others have not found this

intervention useful. Administration of sodium cromoglycate eye drops has demonstrated potential in a small number of horses for treatment of seasonal head-shaking, presumably because of the amelioration of the effects of seasonal allergy.<sup>14</sup>

**Sclerosis** of the infraorbital or posterior ethmoidal nerves is performed in those horses that have reduced or eliminated head-shaking after injection of local anesthetic into the infraorbital foramen or around the posterior ethmoidal nerve. Sclerosis is achieved by injection of 5 mL of 10% phenol in oil. Care must be taken to ensure that the phenol is deposited only around the nerve. The procedure should be done under general anesthesia.

**Cyproheptadine** (0.3 mg/kg, orally every 12 hours) improved head-shaking in 43 of 61 horses, based on owner-reported efficacy. Responses were usually observed within 1 week of the start of therapy. Others have not replicated this success but found that the combination of **carbamazepine** (4 mg/kg orally every 6 to 8 hours) and cyproheptadine improved clinical signs in seven horses within 3 to 4 days of starting treatment.

**Acupuncture** and **chiropractic** manipulation appear to be minimally effective.

Prevention of exposure to bright light is an obvious recommendation, but not practical for most horse owners.

**Caudal compression** of the infraorbital nerve with platinum coils provides a surgical treatment option for horses that do not respond to medical treatment or environmental modification.<sup>15</sup> Of 58 horses treated using caudal compression of the infraorbital nerve a successful outcome was initially achieved in 35 of 57 (63%) horses, but recurrence occurred between 9 and 30 months later in 9 (26%). Surgery was repeated in 10 of 31 (32%) horses. Final success rate, considering only response to the last performed surgery, was 28 of 57 (49%) horses with median follow-up time of 18 months (range 266 months). Nose-rubbing was reported postoperatively in 30 of 48 (63%) horses and resulted in euthanasia of four horses.<sup>16</sup>

Administration of dexamethasone in a pulsed dose schedule (60 mg orally every 24 hours  $\times$  4 days, every 3 weeks for 4 months) to 12 horses did not result in improvement of clinical signs in a randomized, placebo-controlled, blinded field trial.<sup>7</sup>

Addition of an unspecified feed supplement to the diet of 44 affected horses in a randomized, blinded placebo controlled study did not detect a beneficial effect of the supplement.<sup>13</sup>

### CONTROL

There are no recognized measures for preventing development of the disease.

### FURTHER READING

Pickles K, Madigan J, Aleman M. Idiopathic headshaking: is it still idiopathic? *Vet J*. 2014;201:21-30.

## REFERENCES

- Pickles K, et al. *Vet J*. 2014;201:21.
- Radostits O, et al. Headshaking in horses. In: *Veterinary Medicine: A Textbook of the Disease of Cattle, Horses, Sheep, Goats and Pigs*. London: W.B. Saunders; 2006:2022.
- Fiske-Jackson AR, et al. *Equine Vet Educ*. 2012;24:126.
- Voigt A, et al. *J S Afr Vet Assoc*. 2009;80:111.
- Gilsenan WF, et al. *Vet Surg*. 2014;43:678.
- Aleman M, et al. *J Vet Intern Med*. 2012;26:192.
- Tomlinson JE, et al. *J Vet Intern Med*. 2013;27:1551.
- Roberts V. *Vet J*. 2014;201:7.
- Aleman M, et al. *J Vet Intern Med*. 2014;28:250.
- Aleman M, et al. *J Vet Intern Med*. 2013;27:1571.
- Veres-Nyeki KO, et al. *Vet J*. 2012;191:101.
- Mayhew J. *Vet J*. 2012;191:15.
- Talbot WA, et al. *Equine Vet J*. 2013;45:293.
- Stalin CE, et al. *Vet Rec*. 2008;163:305.
- Roberts VLH, et al. *Equine Vet J*. 2009;41:165.
- Roberts VLH, et al. *Equine Vet J*. 2013;45:107.

## TAIL-BITING IN SWINE

Tail-biting, which is the chewing or biting or sucking of a tail of a fellow pig, is an example of cannibalism. It is a very complex problem that is widespread and has demanded more attention with time. It is an intractable problem<sup>1,2</sup> that is very unpredictable. It has a high economic impact because of euthanasia, medical costs, other infections, and condemnations. This has increased with intensive farming and is the most serious of the vices of the domestic pig. It is much more important than flank-biting, nosing, or ear-biting. It has been seen in outdoor pigs and on organic units. About 60% of farms in the UK have at one time or another experienced tail-biting in single pigs or as a group problem. It is a serious welfare issue because it often leads to systemic infections from a whole variety of opportunist bacteria, principally *Trueperella pyogenes* and *Streptococcus* spp., which lead to septicemias and particularly spinal abscessation. Both ear-chewing and tail-biting have also increased in recent years.<sup>3</sup> It is assumed that contented pigs do not tail-bite.

Three stages of tail-biting have been recognized<sup>3</sup>:

- Two-stage initial phase that includes predamage and damage probably related to having no substrates or play items
- A second stage called sudden or forceful in which there are probably inadequate resources
- An obsessive phase that includes many of the factors described in stages 1 and 2, principally those associated with genetics, attraction to blood, and protein metabolism upsets

The diagnosis of the condition is very difficult. It occurs under all conditions including outdoors. Possibly 0.5% to 0.7% of docked pigs are bitten and 2% to 4% of undocked pigs. A recent survey in the UK suggested that 90% of farms had pigs that were not bitten, 6% had small problem, and 4% had big problems. Most abattoirs do not record pigs bitten, and many bitten pigs are sent to

small abattoirs. There are probably three mild lesions to every one serious lesion and these are probably not recorded.

## ETIOLOGY

There are said to be three basic scenarios: (1) gentle chewing that escalates; (2) two-stage biting; and (3) sudden forceful biting, which may be sudden frustration over a lack of a resource.<sup>5,6</sup>

Tail-biting usually begins with one pig doing the biting and one pig being bitten in an environment that for some reason has caused stress. It then spreads rapidly through the whole group as the bitten tail becomes more attractive.

The inadequate total environment for an animal that naturally requires the opportunity to socially interact and demonstrate its natural behavior of inquisitiveness and rooting is often the underlying cause. Abnormal foraging behavior has been suggested as the underlying cause.<sup>6</sup> Abnormalities of ventilation, particularly drafts, appear very unsettling to pigs. The normal pig group is probably under 20 and over that number the individual's place in the hierarchy is probably lost.

## EPIDEMIOLOGY

"Belly-nosing" may be one of the behavior patterns that predispose to tail-biting. It is often associated with early weaning and is the persistent rubbing of the snout on the belly of another pig. It may be misdirected suckling behavior.<sup>7</sup> This behavior is not eliminated by providing environmental enrichment, suckling devices, of extra drinkers or nipple feeders. There is a genetic linkage with Landrace pigs<sup>8</sup> and with weight for age.<sup>9</sup>

The condition is found worldwide. It is often more prevalent in males than females and may be part of natural aggressiveness. The real cause is still unknown but is probably a mental reaction on the part of the pig to unsavory living conditions. Under normal circumstances happy pigs root for 18% of the time and probably doze for about 82% of the time. They are really the "couch potatoes" of the domesticated farm animals. If they have nothing to do, they cause trouble. Recent studies have suggested that the "troublesome" pig may be lighter, more active, and possess more "nosing" behavior patterns.<sup>10</sup> Others have suggested that it is the heavier pigs that are bitten.

The causes for tail-biting are multifactorial, but it has to be considered that there may be a bad "psychologically disturbed pig." Once the behavior has started it behaves like an epidemic. Recent studies have suggested that the way the tail is held has a very considerable influence on whether it is bitten or not.

Anal biting may or may not be related to tail-biting. It has certainly been a feature of a few cases of anal irritation in response to oral dosing with Lincocin.

## RISK FACTORS

These have been reviewed.<sup>4,5</sup> Traits related to foraging, exploration feeding, motivation to feed, and sociability are heritable.<sup>11,12</sup>

Because of modern genetics, pigs grow faster and are more aggressive. Aggression is also heritable.<sup>13</sup> Some of the breeds may be more heavily bitten, but Hampshires are less frequently bitten. Some pigs may be unable to use food properly because of a metabolic deficiency.

There is a subset of pigs called the fanatical biters who are generally small males with low lightweight gain. These biters have a low growth rate from weaning to finishing. They spend more time chewing than they do rooting. In a poor environment, they will chew other pigs rather than root. Some of these biters have respiratory or alimentary diseases or porcine circovirus type 2 (PCV2) infections. There are other types of pigs that bite.

The tail-biting hypothesis suggests that there may be a big protein demand that is not being met, so there is a protein deficiency as a result of poor intake of food. There may be a dysfunctional autonomic nervous system regulation involving the general sense responses, interrelated illnesses, and suppressed thyroid hormone T<sub>3</sub> production. It may be that there is a lack of tyrosine for serotonin production, which is an important neurotransmitter. Pigs with higher levels of serotonin spend more time rooting, and in the "bit tail blood model" it is found that serotonin-deficient pigs do more biting.

- There may be breed, line, or family predispositions.
- White pigs have more of a problem than colored breeds.
- There is a genetic tendency to be a biter or to bitten.
- Tail-biting is associated with lean tissue growth and backfat thickness

## FACTORS INCREASING BITING

- Tails are bitten more frequently when there is a low weight gain (nutrition).
- Males may be more predisposed, but there is less biting in single sex rearing.
- When there are no interests provided and there are no toys with which to play.
- High-density stocking.
- Over stocking.
- Large group sizes.
- Mixing and moving.
- Space postweaning.<sup>14</sup>
- If you move pigs from a straw-based system to a slatted system they will bite much more.
- Insufficient trough space, if feeders are blocked then pigs will bite to get at the feeder.
- Insufficient drinkers.
- Inadequate nutrition.
- Change in ration formulation leading to food sensing.

- Low-protein diets encourage biting and chewing.
- Not enough amino acids (lysine, tryptophan, but true position unknown).
- Low salt.
- Nonsatisfying environments, particularly those with a poor layout, on nonstraw systems are badly affected.
- Boredom (lack of toys).
- Inadequate environment.
- Low temperatures: cold and damp is bad on straw-based systems, and poor-quality straw is a problem.
- High temperatures.
- Fluctuating temperatures.
- Drafts.
- Too high a humidity.

Variable tail docking length is also a factor. The variation in tail anatomy and position is also important.<sup>15</sup>

Concurrent disease, particularly PCV2 infection and skin, disease may predispose to biting.

In a summary, overstocking was thought to be important in 60% of cases, inadequate ventilation in 50%, wrongly positioned ventilation in 50%, and cold drafts in 40%. Sick pigs that are not moved promptly were thought to be important in 60% of outbreaks and boredom in 50%. The other factors were considered to be of lesser importance (below 20%).

## CLINICAL FINDINGS

At the start there is no effect on the bitten pig because the end of the tail is relatively insensitive, but as the bitten area extends toward the anus it becomes more painful and the bitten pig shows signs of distress. With continuation the pig may be reluctant to feed, reluctant to move, and eventually become paralyzed as spinal abscessation becomes the reality.

## CLINICAL PATHOLOGY

There may be chewed, gnawed, and partially or completely removed tails. In an early study at an abattoir 19.9% of the lesions on the carcasses were related to tail-biting and 61.75 of carcass abscesses were associated with tail-biting.

## NECROPSY

At necropsy or in the abattoir it is a bitten tail as well as the abscessation that is most noticeable along the length of the spine as infection tracts along lymphatics and longitudinal spinal veins. In some cases, the carcass is so badly affected that the whole carcass is condemned. In some cases, there will be evidence of flank-biting and ear-biting (sometimes the ear is completely bitten off), which are part of the same disturbed pig syndrome.

## TREATMENT

Remove affected pigs to hospital accommodation, pen separately, and treat the

wounds by cleaning, disinfection, and topical palliatives and possibly parenteral broad-spectrum antibiotics. Shoot badly affected or paraplegic pigs. Casualty slaughter is not very useful because of the carcass damage.

## CONTROL

There is no really successful plan for control that will work all the time. There is a husbandry advisory tool with 100 possible risk factors. The spreadsheet lists 83 factors. Weighted for risk factors the tool shows that a quarter of the farms have no problems and a quarter of the farms have a serious problem. Attend to all the listed factors and even then you will not always remove the problem, but it will certainly be reduced. Nothing is ever completely effective.

First, observe pigs several times a day and remove the biter as soon as it is seen to bite and put it into separate accommodation.

Elevating the salt level to 0.8% often works even though there is already 0.4% in the diet, which is thought to be sufficient. Make sure there is plenty of water available.

The improved environment is one of the most important items, particularly the application of negative pressure systems. Lowering light levels reduces the “glowing effect” of blood-covered surfaces similar to housing broiler birds in infrared lights to reduce “vent pecking.”

The provision of an improved environment by providing “playthings” that satisfy the desire of the pig to sniff, inquire, taste, and chew is most important. These items should be malleable, which is why straw or peat, or spent mushroom compost or rubber cords, or even tires<sup>16</sup> are more satisfying than chains. The chains are no good because they slap other pigs and increase the restlessness. Straw provision has the ability to keep pigs occupied for longer than other substrates,<sup>17,18</sup> and it is better if it is provided daily.<sup>19</sup> Housing systems that have had ad libitum feeding systems with multiple feed spaces have had a reduced prevalence of the problem.

This attention to sucking and chewing is the basis of all the saliva tests that have been developed to detect viruses such as porcine reproductive and respiratory syndrome (PRRS) and PCV2 and antibodies to them. Hanging a set of cotton cords in a pen that will soon be sucked by most pigs as part of play will provide a readily accessible sample source for saliva antigens antibodies and many other substances such as acute phase proteins. This does not involve disturbing the pigs or requiring handling and invasive techniques for the individual pig for investigating herd profiles.

The provision of straw is no guarantee that tail-biting will be stopped.<sup>20</sup>

Tail docking is the only technique that does reduce the presence of tail-biting. The

conditions attached to use of this practice vary from country to country and often mean that the technique has to be prescribed by a veterinarian only after the presence of a tail-biting problem has been established on that farm. Even tail-docked pigs have evidence of being tail-bitten.<sup>21</sup>

The ideal length of tail docking is not really known. One of the major problems is that tails differ in thickness and length before any consideration of the length to be cut off. Too short a tail, i.e., cut very short, interferes with the nervous control around the anus, may lead to fecal incontinence, and exposes the anus itself to being bitten.

Tail docking produces a neuroma at the site of nerve transection, which results in the formation of many sensitive nerve endings that enable the pig to react more sensitively to any nosing of its tail.

In a recent survey,<sup>18</sup> 62% thought that docking was effective in preventing tail-biting, 47% thought adding straw was helpful, 46% thought that playthings were effective, but only 18% thought reducing stocking density was helpful. The latter may be because of the economic implications of reducing stocking. All in all, reducing stocking density and adding straw together was considered to be the best option.<sup>22</sup>

## FURTHER READING

- Taylor NR, et al. Tail biting: a new perspective. *Vet J.* 2009;186:137-147.
- Taylor NR, et al. The prevalence of risk factors for tail biting. *Vet J.* 2012;194:77-88.
- Zonderland JJ Thesis. Talking tails-quantifying the development of tail biting in pigs. 2010; <http://edepot.wur.nl/151535>.

## REFERENCES

1. Edwards SA. *Pig J.* 2011;66:81.
2. Edwards SA. *Vet J.* 2006;171:198.
3. Kritas SK, Morrison RB. *Vet Rec.* 2007;160:149.
4. Taylor NR, et al. *Vet J.* 2012;194:77.
5. Taylor NR, et al. *Vet J.* 2010;186:137.
6. Peeters E, et al. *Appl Anim Behav Sci.* 2006;98:234.
7. Widowski T, et al. *Appl Anim Behav Sci.* 2008;110:109.
8. Bensch CJ, Gonyou HW. *Appl Anim Behav Sci.* 2007;105:26.
9. Torrey S, Widowski TM. *Appl Anim Behav Sci.* 2006;101:288.
10. Zonderland JJ, et al. *Animal.* 2011;5:767.
11. Baumung R. *Archiv Tierzucht.* 2006;49:77.
12. Renadeu D, et al. *Asian Australas J Anim Sci.* 2006;19:593.
13. Turner SR, et al. *Anim Sci.* 2006;82:615.
14. <http://www.thepigsite.com/pighealth/article/366/vice-abnormal-behaviour-tail-biting-flank-chewing-ear-biting/> Accessed August 2016.
15. Zonderland JJ, et al. *Appl Anim Behav Sci.* 2009;121:165.
16. Day JEL, et al. *Appl Anim Behav Sci.* 2008;109:249.
17. Scott K, et al. *Appl Anim Behav Sci.* 2006;99:222.
18. Scott K, et al. *Anim Welfare.* 2007;16:53.
19. Scott K, et al. *Appl Anim Behav Sci.* 2007;105:51.
20. Statham P, et al. *Anim Behav Sci.* 2011;134:100.
21. Smulders D, et al. *Anim Welfare.* 2008;17:61.
22. Paul ES, et al. *Vet Rec.* 2007;160:803.



## Bacterial Diseases Primarily Affecting the Cerebrum

### ENTEROTOXEMIA ASSOCIATED WITH *CLOSTRIDIUM* *PERFRINGENS* TYPE D (PULPY KIDNEY, OVEREATING DISEASE)

#### SYNOPSIS

**Etiology** An acute toxemia of ruminants associated with the proliferation of *Clostridium perfringens* type D in the intestines and the liberation of  $\epsilon$ -toxin that produces vascular damage and the damage to the nervous system typical of this disease.

**Epidemiology** Lambs 3–10 weeks of age and lambs and calves after weaning. Goats of all ages. Affected animals in good condition and on a rising plane of nutrition.

**Clinical findings** The disease in lambs and calves and young goats has a rapid course with diarrhea, depression, and convulsions. At this age animals are often found dead. Adult goats show more chronic disease with abdominal pain and bloody diarrhea.

**Clinical pathology** Hyperglycemia and glycosuria in sheep.

**Necropsy findings** None specific to all cases. Sheep and some goats may have gross or histologic areas of malacia in internal capsule, lateral thalamus, and cerebellar peduncles.

**Diagnostic confirmation** Epidemiology, clinical and necropsy findings, demonstration of  $\epsilon$ -toxin

**Treatment** Anti- $\epsilon$  antitoxin.

**Control** Feed restriction, antitoxin, vaccination.

#### ETIOLOGY

Enterotoxemia results from the proliferation of *C. perfringens* type D in the small intestine. This organism produces a number of toxins, of which the epsilon toxin is the most important and results in vascular damage and the damage to the nervous system typical of this disease. The presence of *C. perfringens* type D in the intestine does not in itself result in disease unless other factors intercede that promote proliferation and the production of toxin. The natural habitat of the organism is in the intestine and in soil contaminated by feces, although it does not persist in soil for long periods of time.

#### EPIDEMIOLOGY

##### Occurrence

Enterotoxemia associated with *C. perfringens* type D is a disease of ruminant animals, primarily of lambs, and is worldwide in its distribution. The common practice of

vaccination against this disease has reduced its prevalence, but it is still a common disease.

Although most common in lambs, it is also an important disease of calves and goats. It occurs rarely in adult cattle, deer, domesticated camels, and possibly horses. In pastured sheep, it causes heavy losses, particularly in flocks managed for the production of lamb and mutton. The prevalence in flocks varies a great deal but seldom exceeds 10%. The case-fatality rate approximates 100%. In North America enterotoxemia ranks as one of the main causes of loss among feedlot lambs. In a survey in two feedlots the disease had an annual prevalence of 3.1% and 1.5%; it ranked third in importance as a cause of death despite a policy of vaccination, and the costs of prevention programs were the largest expenditure of all disease prevention programs in the feedlots.

#### Experimental Reproduction

The disease can be produced experimentally in susceptible sheep, goats, and cattle by the injection into the duodenum of whole culture of *C. perfringens* type D and dextrin or starch. Clinical disease occurs as early as 30 minutes and usually within 6 to 8 hours of the start of duodenal infusion and death 1 to 9 hours following the onset of clinical signs. The disease has also been reproduced by intravenous infusion of epsilon toxin.

#### Animal and Management Risk Factors

*C. perfringens* type D normally inhabits the alimentary tract of sheep and other ruminants but only in small numbers. The extent to which it occurs in the alimentary tract varies widely between flocks, although this accounts only in part for the variable prevalence. The organism does not persist for more than 1 year in the soil.

Under certain conditions, the organisms proliferate rapidly in the intestines and produce lethal quantities of epsilon toxin. In most, if not all circumstances, the affected animals are on **highly nutritious diets** and are in very good condition. The husbandry conditions in which the disease occurs include grazing on lush, rapidly growing pasture or young cereal crops, and heavy grain feeding in feedlots. Lambs on well-fed, heavy-milking ewes are particularly susceptible. The occurrence of the disease under these conditions has given rise to the name "overeating disease."

#### Sheep

The highest incidence of the disease is in suckling lambs between 3 and 10 weeks of age, although lambs as young as 1 to 5 days old can be affected.<sup>1</sup> The risk for disease in this age group is highest when ewes are grazed on lush pastures that result in profuse lactation. The disease can occur following

rain in set stocked flocks, and in flocks newly introduced to lush pastures it is often manifested 5 to 14 days after introduction. Larger and more rapidly growing single lambs are more susceptible than twins. Weaned lambs up to 10 months of age are the second most susceptible age group, and again the occurrence of disease is associated with highly nutritious diets. Feeder lambs are most commonly affected soon after they are introduced into feedlots.

#### Calves

Enterotoxemia in calves is most common between 1 and 4 months of age and the same risk factors pertain as for lambs. Veal calves are particularly at risk. Feeder cattle may develop disease shortly after introduction to the lot. It is a common belief among cattlemen and veterinarians that many unexplained sudden deaths in feeder cattle after the period of acclimatization are caused by this type of enterotoxemia. However, there is no laboratory evidence to support such field observations, and a controlled trial found no protective effect of vaccination.

#### Goats

Enterotoxemia is a common disease in goats under intensive or extensive grazing systems, occurring in many countries, and is particularly important in countries with a large goat population.<sup>2</sup> The peracute disease in goat kids has the same age occurrence as in lambs, but less acute and chronic forms of enterotoxemia occur in adult goats. Sudden changes in diet appear to be the most common predisposing factor. Disease can occur in vaccinated goats because vaccination is poorly protective against the enteric and chronic form of the disease in this species.<sup>2</sup>

Outbreaks in sheep and goats have followed the administration of phenothiazine and other anthelmintics, and a high incidence has been observed in association with heavy tapeworm infestation.

#### Horses

Type D enterotoxemia is rare in horses, but it has been suspected in mature horses fed concentrates during a drought. *C. perfringens* type D can be isolated in high numbers from gastric reflux of horses with anterior enteritis.

#### PATHOGENESIS

In the normal course of events, ingested *C. perfringens* type D are destroyed in large numbers in the rumen and abomasum, although some survive to reach the duodenum, in which multiplication occurs and toxin is produced. Toxemia does not occur because the movement of ingesta keeps the bacterial population and toxin content down to a low level. In certain circumstances, this does not hold and multiplication of the organisms and the production of toxin proceeds to the point in which toxemia occurs.

One of the circumstances has been shown to be the passage of large quantities of starch granules into the duodenum when sheep overeat on grain diets or are changed suddenly from a ration consisting largely of roughage to one consisting mainly of grain. Other factors such as heavy milk feeding may have the same effect. A slowing of alimentary tract movement has also been thought to permit excess toxin accumulation and it may be that any factor that causes intestinal stasis will predispose to the disease. The importance of diet in the production of ruminal stasis has been discussed in diseases of the forestomachs of ruminants.

The epsilon toxin of *C. perfringens* type D is a pore-forming protein that increases the permeability of the intestinal mucosa to this and other toxins, facilitating its own absorption.<sup>3</sup>

A receptor for epsilon toxin has been identified on vascular endothelial cells, and the clinical signs and pathologic findings can be explained by the widespread vascular damage and increase in vascular permeability.

Acute cases are characterized by the development in the brain of degeneration of vascular endothelium; perivascular and intercellular edema; and microscopic foci of necrosis in the basal ganglia, thalamus, internal capsule, substantia nigra, subcortical white matter, and cerebellum. The damage to the vascular endothelium leads to the accumulation of protein-rich fluid effusions observable in heart, brain, and lung. The postmortem autolysis of kidney tissue that occurs so rapidly and is the characteristic of "pulpy kidney" has the same basis.

There is a pronounced hyperglycemia caused by the mobilization of hepatic glycogen; severe hemoconcentration; and elevation of blood concentrations of pyruvate, lactate, and  $\alpha$ -ketoglutarate.

In contrast to sheep, goats with enterotoxemia produced by *C. perfringens* type D also have a hemorrhagic enterocolitis that is present in both the natural and the experimental disease. The genesis of this lesion is uncertain, but it is responsible for the major clinical signs that present in goats with this disease.

A degree of natural immunity may be attained by nonlethal exposure to the toxin. Because a proportion of lambs, calves, and kids appear to be exposed to subclinical but antigenic levels of *C. perfringens* toxin, they become immune without having shown signs of illness or without having been vaccinated.<sup>4</sup>

## CLINICAL FINDINGS

### Lambs

The course of the illness is very short, often less than 2 hours and never more than 12 hours. Many lambs are found dead without previously manifesting signs. In closely observed flocks the first signs may be dullness, depression, yawning, facial movements,

and loss of interest in feed. Acute cases may show little more than severe clonic convulsions with frothing at the mouth and rapid death. Cases that survive for a few hours show a green, pasty diarrhea, staggering, recumbency, opisthotonus, and severe clonic convulsions. The temperature is usually normal but may be elevated if convulsions are severe. Death occurs during a convulsion or after a short period of coma.

### Adult Sheep

These usually survive for longer periods of up to 24 hours. They lag behind the flock and show staggering and knuckling; champing of the jaws; salivation; and rapid, shallow, irregular respiration. There may be bloat in the terminal stages. Irritation signs, including convulsions, muscle tremor, grinding of the teeth, and salivation, may occur but are less common than in lambs.

### Calves

The syndrome is similar to that seen in adult sheep, with nervous signs predominating. Peracute cases are found dead without having shown premonitory signs of illness and with no evidence of struggling. The more common, acute cases show a sudden onset of bellowing, mania, and convulsions, with the convulsions persisting until death occurs 1 to 2 hours later. Subacute cases, many of which recover, do not drink, are quiet and docile, and appear to be blind, although the eye's preservation reflex persists. They may continue in this state for 2 to 3 days and then recover quickly and completely. In an outbreak of the disease in calves all three forms of the disease may be seen. Experimental inoculation of whole or washed cultures of *C. perfringens* type D into the duodenum of 9-month-old calves produced severe clinical signs within 2 to 5 hours of inoculation.<sup>5</sup>

### Goats

Diarrhea is a prominent sign in affected goats, especially in those that survive for more than a few days.<sup>2</sup> In the peracute form, which occurs most frequently in young kids, there are convulsions after an initial attack of fever (40.5°C, 105°F) with severe abdominal pain and dysentery; death occurs in 4 to 36 hours. In the acute form, which is more common in adults, there is usually no fever, and abdominal pain and diarrhea are prominent with death or recovery within 2 to 4 days. In chronic cases, the goats may be ill for several weeks and show anorexia, intermittent severe diarrhea and, in some cases, dysentery and the presence of epithelial shreds in the feces. Chronic wasting, anemia, and eventual emaciation also occur with chronic disease in goats.

## CLINICAL PATHOLOGY

A high plasma glucose concentration of 8.3 to 11.1 mmol/L (150 to 200 mg/dL) and

marked glycosuria are characteristic of the terminal stages of enterotoxemia in sheep, and are supportive for a diagnosis but are not pathognomonic.<sup>6</sup> Hyperglycemia and glycosuria are variably present in goats with the disease and calves with experimentally induced disease.<sup>5</sup>

## NECROPSY FINDINGS

The body condition of the animal is usually good, but there is often fecal staining of the perineum and rapid decomposition of the carcass. In peracute cases there may be no gross lesions. More frequently, there is an excess of clear, straw-colored pericardial and thoracic fluid that clots on exposure to air. Many petechiae are present in the epicardium and endocardium, and there is pulmonary edema. Patchy congestion of the abomasal and intestinal mucosae is usual, and the small intestine often contains a moderate amount of thin, creamy ingesta. The content of the large intestine may be watery and dark green.

The characteristic finding of soft, pulpy kidneys is only useful in animals necropsied within a few hours after death because it is nonspecific and merely correlates to a more rapid rate of autolysis. Microscopy of experimentally induced ovine type D enterotoxemia cases confirms that the renal changes represent autolysis and not a true nephrosis.

The liver is dark and congested. The rumen and abomasum of feedlot lambs may be overloaded with concentrates. In goats there is acute fibrinonecrotic and hemorrhagic enterocolitis, although microscopic examination may be needed to detect this change.

In sheep that have not died acutely there may be symmetric areas of hemorrhage, edema, and liquefaction in the brain, especially in the area of the basal nuclei. Again, microscopic evaluation of the tissue is critical.

Gram-stained smears of ingesta from several levels in the small intestine should be examined. In affected animals the short, fat, gram-positive rods dominate the slide to the almost complete exclusion of other bacteria. Bowel filtrates can be tested for toxicity by injection into mice. If the filtrate is toxic, the type of toxin can be determined by protection of the mice with specific antisera. This does not determine the type of clostridia, but detection of  $\beta$ -toxin indicates the presence of types B or C, and  $\epsilon$ -toxin indicates the presence of B or D.

The time taken for diagnosis by mouse neutralization tests, as well as humanitarian considerations, has promoted the development of alternative tests. Commercial enzyme-linked immunosorbent assay (ELISA) kits and multiplex PCR assays have become available for toxin detection and require minimal amounts of intestinal content.<sup>6</sup> Nevertheless, it is important to base

a diagnosis on epidemiologic, clinical, and pathologic information, not just the detection of toxin at postmortem.

ε-Toxin is stable if frozen, but at average temperatures it is possible to identify the toxin from the intestine of a sheep dead for up to 12 hours. The addition of one drop of chloroform to each 10 mL of ingesta will stabilize the toxin for up to 1 month. Alternatively, intestinal contents can be absorbed on filter paper and shipped at environmental temperatures, with little loss of activity for as long as 74 days as detected by immunoassay. Hyperglycemia and glucosuria may also be detected in necropsy material.

### Samples for Confirmation of Diagnosis

- Bacteriology: 20 to 30 mL of intestinal content, frozen in a leak-proof glass or plastic container (ELISA, latex agglutination, bioassay, anaerobic culture, PCR); air-dried smears of ingesta from several levels of gut (cyto-Gram stain)
- Clinical pathology: urine (assay–glucose) (best performed at time of necropsy)
- Histology: fixed colon, ileum, jejunum, entire brain

### DIFFERENTIAL DIAGNOSIS

#### Lambs

- Acute pasteurellosis
- Septicemia associated with *Histophilus somni* (formerly *Haemophilus agni*)
- *Clostridium sordellii*
- Polioencephalomalacia
- Rumen overload

#### Sheep

- Hypocalcemia
- Hypomagnesemia
- Focal symmetric encephalomalacia (chronic enterotoxemia)
- Rabies
- Pregnancy toxemia
- Louping-ill

#### Calves

- Lead poisoning
- Polioencephalomalacia
- Hepatoencephalopathy
- *H. somni* (formerly *Haemophilus somni*)

#### Goats

- Salmonellosis
- Coccidiosis

In lambs, but not in goats, a history of vaccination against the disease is a significant consideration in the ranking of a list of differential diagnoses.

### TREATMENT

In general, the clinical course of the disease is too acute for effective treatment. Hyperimmune serum, an efficient short-term prophylactic, is unlikely to be of much value in sick animals because of the acute nature of the

disease. In goats the course is longer, and antitoxin in combination with orally administered sulfadimidine may be effective in treatment.<sup>2</sup>

### CONTROL

There are three major control measures available: reduction of the food intake, administration of antitoxin, and vaccination. These may be used individually or in combination.

#### Reduction in Food Intake

Reduction in food intake is the cheapest but least effective in control and is used as a short-term control while waiting for immunity to develop after vaccination. Reduction in food intake will cause a setback in the growth of the lambs and for this reason farmers tend to rely more on vaccination as a control measure. However, exercise of lambs, by mustering or herding around the paddock, may help slow the course of an outbreak.

#### Antitoxin

Antitoxin can be administered to all sheep as soon as an outbreak commences. The administration of ε-antitoxin 200 IU/kg BW will provide for protective circulating antitoxin levels for 21 to 29 days. Immediate losses are prevented, and in most instances the disease does not recur. Toxoid is cheaper, but to administer it alone at such times may result in further serious losses before active immunity develops.

#### Vaccination

Immunity in sheep is readily produced by suitable vaccination. A blood level of 0.15 Wellcome unit of ε-antitoxin per milliliter of serum is sufficient to protect sheep. Vaccines available are toxoids, and adjuvants generally improve the antigenicity. Activated alum-precipitated toxoid is the common vaccine in use. A recombinant *C. perfringens* type D toxoid has been shown to induce antibody titers comparable to a traditional toxoid and may offer a more consistent or cost-effective method of vaccine production.<sup>7</sup>

Vaccination of maiden ewes twice at an interval of at least 1 month and with the last vaccination approximately 4 weeks before lambing will result in good passive immunity in young lambs, with 97% of lambs having protective antibody levels at 8 weeks of age and a significant proportion at 12 to 16 weeks of age. This is sufficient to protect lambs during their highest risk period. Older ewes that have been vaccinated the previous year receive a single booster vaccination 4 weeks before lambing. Sheep vaccinated for 3 consecutive years can be considered to be permanently immune and to require no further vaccination.

When faced with an outbreak in lambs, the recommended procedure is to administer antiserum and toxoid immediately and

repeat the toxoid in a month's time. The simultaneous administration of hyperimmune serum with this vaccine does not interfere with the stimulation of antibody production, nor does the presence of passively derived colostral immunity.

Lambs can be vaccinated with toxoid when 4 to 10 weeks of age and again a month later.

Any vaccination of sheep is not without risk of precipitating blackleg or other clostridial disease, and if these are a severe problem in an area it may be wise to vaccinate a portion of the flock as a pilot test and proceed with vaccination of the remainder only when no complications arise. A multivalent bacterin-toxoid containing antigens to all of the clostridial diseases is commonly used in sheep in these circumstances or where all of these diseases are likely to occur. Vaccination should not be done in sheep with wet fleeces.

Vaccination with toxoid is effective in calves but is not highly effective in goats, having a limited effect in preventing the disease although reducing its incidence and severity.<sup>2</sup> The anti-ε titer in goats following vaccination is variable, sometimes equivalent, but often lower or of shorter duration to that induced in sheep. The reasons for decreased protection following the use of commercial vaccines against type D infections in goats are not fully understood.<sup>2</sup> Thus, goat owners should be advised that vaccination with the current commercial vaccines often provides limited protection against type D infections, even if multiple booster vaccines are given at 3- to 6-month intervals. This occurs especially when a high level of concentrate feeding occurs, such as in dairy production. The use of hyperimmune serum must also be performed with caution in goats, particularly Saanens, which are very prone to anaphylactic reactions. Despite the limitations of protection against the enteric manifestations of the disease, vaccination is protective against the peracute form of the disease and kids should be vaccinated twice, a month apart, commencing at 4 weeks of age with booster vaccinations at 6-month intervals.

Local reactions to vaccination are common in both sheep and goats and may be visible for at least 6 months. In sheep these are generally hidden by the wool, but the vaccination site should be high on the neck and close to the base of the ear to minimize carcass blemish. With goats, especially show goats, the owner should be warned of this occurrence. Goats, especially show goats, should be vaccinated under the loose skin of the axilla, where local reactions will be hidden by the elbow.

### FURTHER READING

Allaart JG, van Asten AJAM, Gröne A. Predisposing factors and prevention of *Clostridium perfringens*-associated enteritis. *Comp Immunol Microbiol Infect Dis.* 2013;36:449-464.



- Alves GG, et al. Clostridium perfringens epsilon toxin: the third most potent bacterial toxin known. *Anaerobe*. 2014;30:102-107.
- Bokori-Brown M, Savva CG, et al. Molecular basis of toxicity of *Clostridium perfringens* epsilon toxin. *FEBS J*. 2011;23:4589-4601.
- Morris WE, Dunleavy MV, et al. Effects of *Clostridium perfringens* alpha and epsilon toxins in the bovine gut. *Anaerobe*. 2012;18:143-147.
- Radostits O, et al. Enterotoxemia associated with *Clostridium perfringens* type D (pulpy kidney, overeating disease). In: *Veterinary Medicine: A Textbook of the Diseases of Cattle, Horses, Sheep, Goats and Pigs*. 10th ed. London: W.B. Saunders; 2007:841-844.
- Uzal FA, Vidal JE, et al. *Clostridium perfringens* toxins involved in mammalian veterinary diseases. *Open Toxicol*. 2010;3:24-42.
- Wioland L, Dupont J-L, Bossu J-L, et al. Attack of the nervous system by *Clostridium perfringens* epsilon toxin: from disease to mode of action on neural cells. *Toxicon*. 2013;75:122-135.

## REFERENCES

- Scholes SFE, et al. *Vet Rec*. 2007;160:811.
- Sumithra TG, et al. *Small Rum Res*. 2013;114:1.
- Alves GG, et al. *Anaerobe*. 2014;30:102.
- Veschi JLA, et al. *Vet Immunol Immunopathol*. 2008;125:198.
- Filho EJE, et al. *Vet Pathol*. 2009;46:1213.
- Uzal FH, Songer JG. *J Vet Diagn Invest*. 2008;20:253.
- Lobato FCF, et al. *Vaccine*. 2010;28:6125.

## FOCAL SYMMETRIC ENCEPHALOMALACIA

### SYNOPSIS

**Etiology** The disease is a chronic neurologic manifestation of enterotoxemia associated with *Clostridium perfringens* type D  $\epsilon$ -toxin, with vascular damage and damage to the nervous system.

**Epidemiology** Sporadic disease in weaners and mature sheep, usually following a change of pasture, anthelmintic treatment, or supplementary feeding with grain and incomplete vaccination regimens.

**Clinical findings** Aimless wandering, an inability to eat, and a dummy syndrome are predominant findings

**Clinical pathology** None reported.

**Necropsy findings** Gross or histologic areas of malacia in internal capsule, lateral thalamus, and cerebellar peduncles.

**Diagnostic confirmation** Epidemiology, clinical and necropsy findings.

**Treatment** Supportive.

**Control** Complete vaccination.

## ETIOLOGY

Lesions of focal symmetric encephalomalacia have been produced in experimental enterotoxemia and by infusion with  $\epsilon$ -toxin of *C. perfringens* type D. Similar brain lesions have been described in an experimentally induced case of enterotoxemia in a 9-month-old calf that survived for 8 days.<sup>1</sup>

## EPIDEMIOLOGY

Focal symmetric encephalomalacia occurs most often in lambs, weaners, and mature sheep, but lesions consistent with focal symmetric encephalomalacia have also been reported in calves and goats.<sup>2</sup> In grazing sheep. It has the same seasonal occurrence as enterotoxemia but may occur in sheep of poor body condition. In weaners and mature sheep, there is often a history of supplementary feeding of highly fermentable carbohydrate, such as cereal grains, a move to fresh pasture, or of anthelmintic administration 5 to 14 days preceding the occurrence of initial cases. This is often combined with an incomplete history of vaccination, and outbreaks have been associated with the grazing of young green cereal crops. The morbidity is usually low but may approach 15%. The case-fatality rate is high.

## CLINICAL FINDINGS

Most often, because of infrequent observation of sheep of this age, the finding of dead sheep is the first indication of the disease. Clinically affected sheep are separate from the group or can be detected by slow movement of the flock. They show no fear of humans or dogs and can be examined without restraint. Blindness, aimless wandering, head-pressing, and incoordination are the predominant findings. More severely affected sheep lie quietly in lateral recumbency with moderate dorsiflexion of the head and show infrequent nystagmus with paddling convulsions. The sheep are unable to eat and most cannot drink, although some affected lambs may still retain a suck reflex. The clinical course varies from 1 to 14 days, with the majority of affected sheep surviving for 5 to 7 days.

## NECROPSY FINDINGS

Lesions are confined to the brain, and formalin-fixed samples of this tissue are required for confirmation of the diagnosis. In many cases the characteristic lesions can be detected on macroscopic examination and consist of areas of hemorrhage and softening in the internal capsule, lateral thalamus, and cerebellar peduncles. Malacia, edema, and hemorrhage are visible histologically. Glycosuria is not a feature, and toxin cannot be demonstrated in gut contents.

## TREATMENT AND CONTROL

There is no treatment. Less severely affected cases may recover if they are maintained with fluids and nutrients given by stomach tube. Outbreaks cease if the sheep are vaccinated with pulpy kidney vaccine.

## FURTHER READING

- Finnie JW. Pathogenesis of brain lesions produced in sheep by *Clostridium perfringens* type D epsilon toxin: a review. *Aust Vet J*. 2003;81:219-221.

- Wioland L, Dupont J-L, Bossu J-L, et al. Attack of the nervous system by *Clostridium perfringens* epsilon toxin: from disease to mode of action on neural cells. *Toxicon*. 2013;75:122-135.

## REFERENCES

- Filho EJE, et al. *Vet Pathol*. 2009;46:1213.
- Anon. *Vet Rec*. 2012;171:168.

## CEREBROSPINAL ANGIOPATHY

Cerebrospinal angiopathy is a sporadic disease of recently weaned pigs manifested primarily by neurologic signs and wasting. It is probably a form of edema disease. It affects only one or a few pigs within a litter up to 5 weeks after weaning, although a similar condition has been reported in finishing and adult pigs. The disease is characterized by the variety of neurologic signs that it presents. Incoordination and a decreased central awareness are common presenting signs but abnormal head position, aimless wandering, and persistent circling may also be observed. There is usually apparent impairment of vision. Fever is not a feature, and the clinical course may last for several days. Affected animals may die but are often euthanized because of emaciation. Wasting without neurologic disorder may also occur. They are also prone to savaging by unaffected penmates.

Histologically, the disease is characterized by an angiopathy that is not restricted to the CNS. The similarity of the angiopathy to that seen in chronic edema disease has led to postulation that this disease is a sequel to subclinical edema disease. The disease has been reported occurring in pigs 15 to 27 days after experimental *E. coli* infection. The characteristic feature is the presence of perivascular eosinophilic droplets.

The main differential diagnosis is that of spinal or brain abscess and the porcine viral encephalomyelitides. Affected pigs should be housed separately as soon as clinical signs are observed. In view of the nature of the lesion, therapy is unlikely to be of value; however, recovery following treatment with oxytetracycline has been reported.

## FURTHER READING

- Harding DJD, et al. Cerebrospinal angiopathy in pigs. *Vet Rec*. 1966;79:388.

## Viral Diseases Primarily Affecting the Cerebrum

### RABIES

#### SYNOPSIS

**Etiology** *Lyssavirus* of family Rhabdoviridae

**Epidemiology** Occurs in all farm animals worldwide except Australia and New

*Continued*

Zealand. Major zoonoses. Transmitted by bites of infected animal. Different animals are vectors depending on geographic location: foxes in Europe and North America, skunks and raccoons in North America, mongoose in Africa, vampire bats in South America.

**Signs** Incubation period varies from 2 weeks to several months.

**Cattle:** *Paralytic form:* bizarre mental behavior (yawning, bellowing), incoordination, decreased sensation of hindquarters, drooling saliva, recumbency, and death in 4–7 days.

*Furious form:* hypersensitive, belligerent, then paralysis and death as in paralytic form.

**Sheep:** Outbreaks common; sexual excitement, wool pulling, attacking, incoordination, and then paralysis.

**Horses:** Abnormal postures, lameness or weakness, depression, ataxia, pharyngeal paralysis, recumbency, hyperesthesia, biting, loss of anal sphincter tone, death in 4–6 days.

**Pigs:** Excitement, attack, twitching of nose, clonic convulsions, paralysis.

**Clinical pathology** No antemortem test.

**Lesions** Nonsuppurative encephalomyelitis.

#### Differential diagnosis list

- **Cattle:** Lead poisoning, lactation tetany, hypovitaminosis A, listerial meningoencephalitis, polioencephalomalacia, nervous acetonemia.
- **Sheep:** Enterotoxemia, pregnancy toxemia, louping-ill, scrapie.
- **Horse:** Viral encephalomyelitis, herpes viral paralysis, cerebrospinal nematodiasis, equine degenerative myeloencephalopathy, protozoal encephalomyelitis, neuritis of cauda equina, horsetail poisoning, Borna, Japanese encephalitis, botulism.
- **Pig:** Pseudorabies, Teschen disease, Glasser's disease, and other meningitides (*Escherichia coli* and *Streptococcus suis*).

**Diagnostic confirmation** Fluorescent antibody test of brain. Negri bodies histologically.

**Treatment** None. All rabies cases are fatal.

**Control** Prevention of exposure. Vaccination of domestic animals and wildlife. Quarantine and biosecurity to prevent entry of virus into country.

## ETIOLOGY

Rabies is caused by single-stranded RNA viruses in the genus *Lyssavirus* of the family Rhabdoviridae. The *Lyssavirus* genome contains about 12 kb, and five separate genes encode for two membrane-associated proteins: matrix (M); glycoprotein (G); and three structural proteins, nucleoprotein (N), phosphoprotein (P), and polymerase (L).<sup>1</sup>

Currently, seven distinct genetic lineages are identified in the genus *Lyssavirus*: classical

rabies virus (RABV, genotype 1, which includes a number of variants), Lagos bat virus (LBV, genotype 2), Mokola virus (MOKV, genotype 3), Duvenhage virus (DUUV, genotype 4), European bat lyssavirus (EBLV, subdivided into genotype 5 and genotype 6), and the Australian bat lyssavirus (ABLV, genotype 7). It was recognized long ago that the strain of virus known as the “street” rabies virus differed in some way from “fixed” strains that had been cultivated for vaccine production (grown in cell culture or passaged through serial generations of laboratory animals). A large number of rabies virus strains are adapted to particular host species but remain infective for any mammal.

## EPIDEMIOLOGY

### Occurrence

Rabies occurs in all warm-blooded animals. The disease occurs in cattle, sheep, horses, and pigs, in most countries, except the insular countries that exclude it by rigid quarantine measures or prohibition of the entry of dogs. However, the genus *Lyssavirus* can still cause surprises. In 1996 and 1998, two women died in Queensland, Australia, from infections with a newly discovered rabies-related virus (Australian bat lyssavirus). In 2002 a man died in Scotland after contracting European bat lyssavirus rabies indicating that after a century of apparent freedom from rabies, the disease is now enzootic in the UK.

### Europe

In Europe, sylvatic rabies is a major problem for which the **red fox** is the principal vector. The disease is still spreading from a focal point that developed in Poland in the mid-1930s. It is endemic in Yugoslavia and Turkey, and has spread westward to Germany, Denmark, Belgium, Czechoslovakia, Austria, Switzerland, and France. Spread continues at the rate of about 30 to 60 km (18–37 miles) per year, and the threat to the UK increases each year.<sup>2</sup> Finland had been free of rabies since 1959, but in 1988 sylvatic rabies occurred with the raccoon dog as the vector.

### United States

Information on rabies surveillance in the United States is published annually by the Centers for Disease Control and Prevention (CDC). In 2013, 92% of cases occurred in wild animals, 4.2% in cats, 1.5% in cattle, and 1.5% in dogs. The disease occurred in raccoons, bats, skunks, foxes, sheep and goats, horses and mules, mongoose, rodents and lagomorphs, and humans.

The most frequently reported rabid wildlife cases occurred in raccoons, skunks, bats, and foxes. The relative contributions of those species continue to change in recent decades because of fluctuations in enzootics of rabies among animals infected with several distinct variants of the rabies virus. Endemic raccoon rabies occurs in the Appalachian mountain

range and the entire eastern seaboard of the United States. Endemic skunk rabies occurs mainly in three geographic regions: the north central United States and the Canadian provinces of Manitoba, Saskatchewan, and Alberta; south central United States; and California. Within these broad areas, the disease persists in enzootic foci and erupts every 6 to 8 years. Experimental studies suggest that the species specificity of endemic rabies is caused by differences in the pathogenicity of variants of rabies virus. Skunk rabies peaks in the spring and early winter, which is probably a reflection of certain life history events within the skunk population.

The prevalence of rabies in bats in the United States is about 7%, and transmission to humans is rare even though sensational journalism has caused many people to consider bats as a serious threat to health. Trends in national surveillance for rabies among bats in the United States from 1993 to 2013 have consistently found a diffuse geographic pattern of rabies in bats throughout the continental United States. Although spillover infection of bat variants of rabies among terrestrial animals such as dogs and cats are rare, these variants of rabies virus have been associated with 92% of the indigenously acquired human rabies infections in the United States since 1990.

### Canada

The arctic fox variant of rabies invaded most of Canada south of 60°N and east of the Rocky Mountains in the early 1950s largely by the migration of **arctic foxes** into the populated areas. It died out in most of that range, but persisted for over 40 years in southern Ontario with sporadic incursions into narrow adjacent strips in western Quebec and northern New York. The principal vectors were red foxes (*Vulpes vulpes*) and, to a lesser extent, striped skunks (*Mephitis mephitis*). From 1957 to 1989, Ontario experienced more animal rabies cases than almost every North American jurisdiction almost every year, and over 95% of those cases were limited to the southernmost 10% of the province's land area.

A second major outbreak, involving striped **skunks**, progressed from North Dakota into the Prairie Provinces during the late 1950s and 1960s. In the 1990s, the endemic areas in Canada are southern Ontario, which accounts for 85% of the Canadian diagnoses, and the Prairie Provinces where rabies is endemic in skunks. In western Canada, the main reservoirs of the rabies virus are skunks, bats, and foxes.

### Africa

Rabies occurs in most countries in the African continent, but the reported incidence is surprisingly low for an area with such a high population of wild carnivores. The incidence of rabies, and the range of species involved, is increasing in Africa, and a number of wildlife

hosts has been identified, including wild dogs, jackals, and mongooses.

In South Africa over a 4-year period, of all the domestic animal rabies cases reported, cattle accounted for half of the rabies cases in domestic animals. The **mongoose** accounted for 70% of the wild animal cases reported. Widespread distribution of the rabies virus occurs when the young mongooses are evicted from their parents' territory during the winter months, forcing them to scatter over a wide area. This increases the probability of domestic animals coming in contact with rabid animals.

### South America, Latin America, and the Caribbean

Rabies in cattle is a major economic and public health problem in South America, where vampire bat-transmitted rabies results in cyclic outbreaks. Bovine paralytic rabies is endemic in the tropical regions extending from northern Mexico, to northern Argentina, and on the island of Trinidad.

### Distribution of Virus Variants

The *Lyssavirus* genus belongs to the Rhabdoviridae family of the Mononegavirales order and includes unsegmented RNA viruses causing rabies encephalomyelitis. They are well fitted to vectors belonging to the orders Carnivora (flesh-eating mammals including skunks) and Chiroptera (the order which comprises all of the 178 genera in 16 families of bats). Seven genotypes have been delineated within the genus. These genotypes are divided into two immunopathologically and genetically distinct phylogroups. Phylogroup I includes two African genotypes: *Mokola virus*, which has been isolated from shrews and cats, although its reservoir remains unknown, and *Lagos bat virus*, which has been found mainly in frugivorous bats but also in an insectivorous bat. Phylogroup II has five genotypes: *DUUV* (Africa), *EBLV-1* (Europe), *EBLV-2* (Europe), *Australian bat lyssavirus* (Australia), and the classical *RABV* (worldwide). Members of the genotypes *Duvenhage virus*, *EBLV-1*, and *EBLV-2* are exclusively found in insectivorous bats, members of the genotype *Australian bat lyssavirus* are found in both insectivorous and frugivorous bats, and members of the genotype *RABV* are found in carnivorous and American bats (insectivorous, frugivorous, and hematophagous). The fact that lyssaviruses are well established in two ecologically distinct mammal orders may very likely be the consequence of successful host switching.

Analysis of 36 carnivoran and 17 chiropteran lyssaviruses representing the main genotypes and variants strongly supports the hypothesis that host switching occurred in the history of the lyssaviruses. In fact, lyssaviruses evolved in chiroptera long before the emergence of carnivoran rabies, very likely following spillover from bats. Using dated

isolates, the emergence of carnivoran rabies from chiropteran lyssaviruses is estimated to have occurred 888 to 1459 years ago. In Europe, bat rabies is associated with two specific virus strains: European bat lyssavirus type 1 and European bat lyssavirus type 2. European bat lyssavirus type 1 isolates have been found in serotine bats in France. European bat lyssavirus type 2 has now been found in Daubenton's bats in England and Scotland.

In North America, variants of rabies virus are maintained in the wild by several terrestrial carnivore species, including raccoons, skunks, and a number of bat species. Each antigenically and genetically distinct variant of the virus in mammalian species occurs in geographically discrete areas and is strongly associated with its reservoir species. Within each area, a spillover of rabies into other species occurs, especially during epidemics. Temporal and spatial analysis of skunk and raccoon rabies in the eastern United States indicated that epidemics in raccoons and skunks moved in a similar direction from 1990 to 2000. However, there is no evidence that the raccoon rabies virus variant is cycling independently in the skunk population of the eastern United States or that the variant has undergone any genetic adaptations among skunks.

Within broad geographic regions, rabies infections in terrestrial mammals can be linked to distinct virus variants, identified by panels of monoclonal antibodies or by genetic analysis. These analyses have demonstrated substantial differences between isolates from various parts of the world and conventional vaccines do not fully protect against some of the naturally occurring antigenic variants that exist in nature. Most outbreaks of rabies tend to be host species specific. Each variant is maintained primarily by **intraspecific transmission** within a dominant reservoir, although spillover infection of other species may occur within the region. Geographic boundaries of the currently recognized reservoirs for rabies in terrestrial mammals have been established. Reservoirs for rabies virus are found worldwide. The virus is maintained at endemic and epidemic levels in a wide variety of Carnivora and Microchiroptera (bats) species.

The geographic boundaries of the currently recognized reservoirs for rabies in terrestrial species in North America are as follows:

- Raccoons in the southeastern United States
- Red and arctic foxes in Alaska, resulting in spread across Canada as far east as Ontario, Quebec, and the New England states
- Striped skunks in California, the north central states, and the south central states
- Gray foxes in small reservoirs in Arizona

- Coyotes in south Texas as a result of spread from domestic dogs in a long-standing reservoir at the Texas-Mexico border

In Ontario, wildlife rabies persists in two predominant species: the red fox and the striped skunk. Molecular epidemiology studies indicate that there is no host specificity, but there are very clear and consistent differences in the virus from distinct geographic regions. In Canadian studies, two major antigenic groups can be distinguished among the rabies virus isolates examined. One group is found in Ontario, Quebec, and the Northwest Territories and is represented in the wild by endemic red fox and striped skunk rabies that originated in northern Canada. The second group is found in Manitoba where striped skunk rabies is endemic.

Overlying the disease in terrestrial mammals are multiple, independent reservoirs for rabies in several species of insectivorous bats. Distinct viral variants can be identified for different bat species, but geographic boundaries cannot be defined for rabies outbreaks in the highly mobile bat species.

### Methods of Transmission

The source of infection is always an infected animal, and the method of spread is almost always by the **bite** of an infected animal, although contamination of skin wounds by fresh saliva may result in infection. Not all bites from rabid animals result in infection because the virus is not always present in the saliva; the virus may not gain entrance to the wound if the saliva is wiped from the teeth by clothing. The virus may appear in the milk of affected animals, but spread by this means is unlikely as infection. The rabies virus is relatively fragile, susceptible to most standard disinfectants, and dies in dried saliva in a few hours.

One of the most important parameters in rabies models is the transmission rate, or the number of susceptible animals infected by a diseased animal per unit of time. In a population of 19 raccoons feeding at a concentrated, common food source available during the summer in rural eastern Ontario, raccoons bite and are bitten an average of 1.0 to 1.3 times per hour, respectively.

Because of the natural occurrence of rabies in animals in caves inhabited by infected insectivorous bats, inhalation as a route of infection came under suspicion. It is now accepted that interbat spread, and spread from bats to other species is principally by bites, but that infection by inhalation also occurs. That infection can occur by ingestion has been put to use in devising systems of vaccinating wildlife by baiting them with virus-laden baits.

### Animal Vectors

Traditionally, the dog, and to a minor extent the cat, have been the main source animals.



However, native fauna, including foxes, skunks, wolves, coyotes, vampire, insectivorous and fruit-eating bats, raccoons, mongoose, and squirrels provide the major source of infection in countries where domestic Carnivora are well controlled. In general, foxes are less dangerous than dogs, because foxes tend to bite only one or two animals in a group, whereas dogs will often bite a large proportion of a herd or flock. Raccoons and skunks are major reservoirs of rabies in North America.

Bats are the most important species in which subclinical carriers occur. Multiplication of the virus without invasion of the nervous system is known to occur in fatty tissues in bats and may be the basis of the “reservoiring” mechanism in this species. Violent behavior is rare in rabid animals of this species, but it has been observed. Bats represent a serious threat of spread of rabies because of their migratory habits. Most spread is within the species, but the threat to humans and animal species by bats cannot be completely disregarded. Although rodents can be infected with the rabies virus they are not thought to play any part in the epidemiology of rabies, either as multipliers or simply as physical carriers of the virus. Many of the viruses they carry are rabies-like rather than classical rabies.

Rabies has occurred in swine herds where the skunk population is high, where farms were settled from rough terrain resulting in considerable interface between wildlife and domestic animals, and in which the management system allows the pigs to run free on the premises. The disease has occurred in pigs reared in a closed feeder barn where access by wildlife was very unlikely.

There is a difference in the role between vectors. For example, in Europe it is thought that foxes carry the infection into a new area, but other species disseminate it within an area. Foxes are the principal vectors and, as in Canada, cattle are the principal receptors. In western Canada, the main reservoirs of infection are skunks, bats, and foxes. This would have important consequences for control programs based on wildlife surveillance.

Domestic livestock like cattle are rarely a source of infection, although chance transmission to humans may occur if the mouth of a rabid animal is manipulated during treatment or examination. The virus may be present in the saliva for periods up to 5 days before signs are evident.

### Seasonal Spread

Spread of the disease is often seasonal, with the highest incidence in the late summer and autumn because of large-scale movements of wild animals at mating time and in pursuit of food. In Canada, the frequency of rabies infection in livestock populations increases in the fall when adolescent foxes mature, begin mating behavior, and travel over large areas.

### Latent Infection

Because of rapid developments in virologic techniques, especially serologic screening of animal populations to obtain presumptive diagnoses of the presence of a virus in the population, the question of latent infection and inapparent carriers of rabies has assumed some importance. The presence of rabies antibodies in animals in a supposed rabies-free area is likely to arouse concern. Inapparent carriers do occur in bats and there is some evidence that latent infections can occur in other species.

### Zoonotic Implications

The disease in unvaccinated and untreated humans has always been considered **fatal**. The prime importance of rabies is its transmissibility to humans, with veterinarians being at special risk. European data indicate that by far the greatest proportion of humans requiring pretreatment for rabies have been exposed to a rabid domestic animal, and not a wild one. Human rabies is extremely rare in countries where canine rabies is controlled by regular vaccination.

### Economic Importance

Rabies is not of major economic importance in farm animals, although individual herds and flocks may suffer many fatalities. The economic costs of rabies in a country are associated with pet animal vaccinations, animal bite investigations, confinement and quarantine of domestic animals that bite humans or that are suspected of exposure to rabid animals, salaries of animal control officers, laboratory diagnosis, the costs of preexposure and postexposure prophylaxis and treatment and consultation, public education, staff training, and clerical costs.

### PATHOGENESIS

Following the deep introduction of rabies virus by the bite of a rabid animal, initial virus multiplication occurs in striated muscle cells at the site. The neuromuscular spindles then provide an important site of virus entry into the nervous system, which may also occur at motor end plates. In the olfactory end organ in the nares, neuroepithelial cells are in direct contact with the body surface, and these cells extend without interruption into the olfactory bulb of the brain. Following entry of the virus into nerve endings, there is invasion of the brain by passive movement of the virus within axons, first into the spinal cord, and then into the brain. The immune response during this phase of the infection is minimal and explains why neutralizing antibody and inflammatory infiltration are usually absent at the time of onset of encephalitic signs. Antibody titers reach substantial levels only in the terminal stages of the disease. Following entry of rabies virus to the CNS, usually in the spinal cord, an ascending wave of neuronal infection and neuronal dysfunction occurs.

The primary lesions produced are in the CNS, and spread from the site of infection occurs only by way of the peripheral nerves. This method of spread accounts for the extremely variable incubation period, which varies to a large extent with the site of the bite. Bites on the head usually result in a shorter incubation period than bites on the extremities. The severity and the site of the lesions will govern to a large extent whether the clinical picture is primarily one of irritative or paralytic phenomena. The two extremes of the paralytic or dumb form and the furious form are accompanied by many cases that lie somewhere between the two. Gradually ascending paralysis of the hind-quarters may be followed by severe signs of mania, which persist almost until death. Destruction of spinal neurons results in paralysis, but when the virus invades the brain, irritation of higher centers produces manias, excitement, and convulsions. Death is usually caused by respiratory paralysis. The clinical signs of salivation, indigestion and pica, paralysis of bladder and anus, and increased libido all suggest involvement of the autonomic nervous system, including endocrine glands. At death, there are viral inclusions and particles in almost all neurons in the brain, spinal cord, and ganglia, but none in the supportive cells of the CNS. Electron microscopic examination also shows the presence of the virus in the cornea, which it reaches centrifugally along the peripheral nerves.

Virus reaches the salivary glands and many other organs in the same way, but the highly infective nature of saliva arises from passage of the virus along the olfactory nerve to taste buds and other sensory end organs in the oropharynx, rather than from the salivary glands. Experimentally, infection of nonnervous tissues in skunks and foxes has been reproduced in the adrenal medulla, cornea, and nasal glands. The virus may be found in milk, in some organs and in fetuses, but the virus cannot be demonstrated in the blood at any time.

Variations in the major manifestations as mania or paralysis may depend on the source of the virus. Virus from vampire bats almost always causes the paralytic form. “Fixed” virus that has been modified by serial intracerebral passage causes ascending paralysis in contrast to “street” virus, which more commonly causes the furious form. The site of infection and the size of the inoculum may also influence the clinical course. There is also a geographic difference in the proportion of animals affected by the furious or paralytic form of the disease. In the Americas most cases are paralytic. In Africa and India most cases in farm animals are the furious form.

The disease is always fatal, but infrequently an experimentally infected animal shows clinical signs of the disease but recovers. There are two recent records of

spontaneous recovery in man, and the occurrence of nonfatal rabies in all species has been reviewed. There appears to be no field occurrence in domestic animals of the finding in experimentally infected mice that some strains of virus invade only peripheral nerves and spinal ganglia leaving a number of survivors with permanent nervous disability. The pathogenesis of recovery from rabies is important relative to vaccination and serologic testing to determine the incidence and prevalence of the disease.

## CLINICAL FINDINGS

Among farm animals, cattle are most commonly affected. The incubation period in naturally occurring cases is about 3 weeks, but varies from 2 weeks to several months in most species, although incubation periods of 5 and 6 months have been observed in cattle and dogs.

### Cattle

Experimentally, in cattle the average incubation period was 15 days and the average course of the disease was 4 days. Unvaccinated cattle had shorter incubation and clinical duration of disease than vaccinated cattle. Major clinical findings included excessive salivation (100%), behavioral change (100%), muzzle tremors (80%), vocalization (bellowing 70%), aggression, hyperesthesia and/or hyperexcitability (70%), and pharyngeal paralysis (60%). The furious form occurred in 70%.

In the **paralytic form**, knuckling of the hind fetlocks, sagging and swaying of the hindquarters while walking, and often deviation or flaccidity of the tail to one side, are common early signs. Decreased sensation usually accompanies this weakness and is one of the best diagnostic criteria in the detection of rabies. It is most evident over the hindquarters. Tenesmus, with paralysis of the anus, resulting in the sucking in and blowing out of air, usually occurs late in the incoordination stages just before the animal becomes recumbent. This is a characteristic finding but it may be transient or absent. Drooling of saliva is one of the most constant findings. The **yawning movements** are more accurately described as voiceless attempts to bellow, and voiceless bellowing is considered a helpful clinical sign for distinguishing rabid cows from nonrabid cows, and when sound is generated in rabid cattle, the bellowing is of a higher pitch than normal.<sup>3</sup> When paralysis occurs, the animal becomes recumbent and unable to rise. Bulls in this stage often have paralysis of the penis. Death usually occurs 48 hours after recumbency develops and after a total course of 6 to 7 days.

In **furious rabies**, the animal has a tense, alert appearance, is hypersensitive to sounds and movement, and is attracted to noise so that it may look intently or approach as though about to attack. In some cases, it will

violently attack other animals or inanimate objects. These attacks are often badly directed and are impeded by the incoordination of gait. Frequently, loud bellowing is usual at this stage. The sound is characteristically hoarse and the actions are exaggerated. Sexual excitement is also common, with bulls often attempting to mount inanimate objects. Multiple collections of semen for artificial insemination have been made during very short periods from bulls that later proved to be rabid. With this violent form of the disease, the termination is characteristically sudden. Severe signs may be evident for 24 to 48 hours and the animal then collapses suddenly in a paralyzed state, dying usually within a few hours.

There is no consistent pattern in either the development or the range of signs. Body temperatures are usually normal but may be elevated to 39.5°C to 40.5°C (103°F-105°F) in the early stages by muscular activity. Appetite varies also. Some animals do not eat or drink, although they may take food into the mouth. There is apparent an inability to swallow. Others eat normally until the terminal stages. The course may vary from 1 to 6 days. So wide is the variation in clinical findings that any animal known to be exposed and showing signs of spinal cord or brain involvement should be considered rabid until proved otherwise.

### Sheep and Goats

In sheep experimentally infected, the average incubation period was 10 days, and the average course of the disease was 3 days. Major clinical findings included muzzle and head tremors (80%); aggressiveness, hyperexcitability, and hyperesthesia (80%); trismus (60%); salivation (60%); vocalization (60%); and recumbency (40%). The furious form occurred in 80% of sheep. In one large-scale outbreak in sheep, deaths occurred 17 to 111 days after exposure.

Rabies often occurs in a number of animals at one time because of the ease with which a number of sheep can be bitten by a dog or fox. Clinically, the picture is similar to that seen in cattle. The minority of animals show sexual excitement, attacking humans or each other, and vigorous wool pulling; sudden falling after violent exertion, muscle tremor, and salivation are characteristic. Excessive bleating does not occur. Most sheep are quiet and anorectic. Goats are commonly aggressive, and continuous bleating is common.

### Horses

Most recorded cases in horses are lacking in distinctive nervous signs initially, but incline to the paralytic form of the disease. Experimentally, the average incubation period was 12 days and the average duration of disease was 6 days. Unvaccinated animals had shorter incubation periods and duration of clinical disease. Muzzle tremors were the

most frequently observed and most common initial signs. Other clinical findings included pharyngeal paresis (71%), ataxia or paresis (71%), and lethargy or somnolence (71%). The furious form occurred in 43% of cases, some of which began as the dumb form. The paralytic form was not observed.

In naturally occurring cases, the initial clinical findings may include abnormal postures, frequent whinnying, unexplained aggressiveness and kicking, biting, colic, sudden onset of lameness in one limb followed by recumbency the next day, high-stepping gait, ataxia, apparent blindness, and violent head-tossing. Lameness or weakness in one leg may be the first sign observed, but the usual pattern of development starts with lassitude, then passes to sternal recumbency and lateral recumbency, followed by paddling convulsions and terminal paralysis.

In a series of 21 confirmed cases in horses, the clinical findings at the time of initial examination included ataxia and paresis of the hindquarters (43%), lameness (24%), recumbency (14%), pharyngeal paralysis (10%), and colic (10%). The major clinical findings observed over the course of hospitalization included recumbency (100%), hyperesthesia (81%), loss of tail and anal sphincter tone (57%), fever ~38.5°C (52%), and ataxia and paresis of the hindquarters (52%). Mean survival time after the onset of clinical signs was 4 days (range, 1-7 days). Clinical findings of the furious form of rabies, such as aggressiveness (biting), compulsive circling, and abnormal vocalization, were evident in only two horses. Supportive therapy, given to nine horses, had no effect on survival time and did not correlate with the detection of Negri bodies at necropsy. Horses developing the furious form show excitement, become vicious, and bite and kick. Their uncontrolled actions are often violent and dangerous and include blind changes, sudden falling, and rolling and chewing of foreign material or their own skin. Hyperesthesia and muscular twitching of the hindlimbs followed by crouching and weakness are also recorded in the horse.

### Pigs

Pigs manifest excitement and a tendency to attack, or dullness and incoordination. Affected sows show twitching of the nose, rapid chewing movements, excessive salivation, and clonic convulsions. They may walk backward. Terminally, there is paralysis and death occurs 12 to 48 hours after the onset of signs. The clinical findings in pigs are extremely variable, and individual cases may present in a variety of ways and only one or two of the classical findings may occur.

## CLINICAL PATHOLOGY

No antemortem laboratory examination is of diagnostic value, but tests for lead on blood, urine, and feces may help to eliminate lead poisoning as a possible diagnosis. Virus

neutralization tests are available, but the presence of antibodies is not diagnostic. Other available tests are passive hemagglutination, complement fixation, radioimmunoassay, and indirect fluorescent antibody staining. These are used to determine immune status rather than as a diagnostic aid. An ELISA is available for measurement of rabies-specific antibody in the sera of major domestic and wildlife reservoirs in North America.

### NECROPSY FINDINGS

Confirmation of a diagnosis of rabies depends on careful laboratory examination of fresh brain. The recommended laboratory procedure includes the following tests and it is recommended that at least two of them be used on all specimens.

- The most widely used test is the fluorescent antibody test (FAT) on impression smears from the brain. Current recommendations include sampling of the hippocampus, **medulla oblongata**, cerebellum, or gasserian ganglion.<sup>4</sup> However, a recent publication stipulates that the hippocampus and cerebellum are less desirable samples than the thalamus, pons, or medulla for the detection of viral antigen, and that the current sampling recommendations stem from the visibility of Negri bodies, rather than the true distribution of viral antigen. An FAT can be completed in approximately 2 hours and is accurate when done routinely by experienced personnel because it detects all genotypes if a potent conjugate is used.<sup>5</sup> The reliability of FAT confirmed by the mouse inoculation test is over 99%. Those specimens that are negative on FAT, and have contact with humans, are inoculated into experimental mice. The incubation period in mice before clinical signs are seen averages 11 to 12 days (range of 4–18 days), and death occurs in 7 to 21 days. The mouse brain is harvested as soon as signs appear and is submitted to the same tests described earlier. Thus a positive result can be obtained as soon as 4 to 7 days after inoculation. Some mice must be left for the full 21 days because only a negative result at that time can give a complete negative to the test. A tissue culture infection test is now available, which allows demonstration of the virus in stained tissue culture cells within 4 days. This may replace the mouse inoculation test.
- A dot **ELISA** is available for the detection of rabies antigen in animals. It is rapid, simple, economical and, in comparison with the FAT, the agreement is 95%.
- A **histologic search** for Negri bodies in tissue sections has results available in 48 hours. Because of false-positive

diagnoses the technique is in some disrepute.

- An **immunohistochemical (IHC)** test for rabies can be used on formalin-fixed, paraffin-embedded brain tissues of domestic animals and wild animals when fresh tissues are not available. In some cases, the brain tissue may be negative for the rabies virus using standard diagnostic techniques, but IHC tests may detect the presence of antigen.
- A **reverse transcriptase (RT-)PCR** test has been found of value in detecting rabies infection in decomposed brain samples that were negative by the direct FAT.

The histopathologic changes of rabies infection include a nonsuppurative encephalomyelitis and ganglioneuritis, with neuronal necrosis and the formation of glial nodules. Negri bodies are most commonly found in the Purkinje cells of the cerebellum in ruminants. Spongiform change has also been reported in the brain of a heifer infected with rabies virus.

### Samples for Confirmation of Diagnosis

- **Histology:** half of midsagittally sectioned brain, cervical spinal cord (including root ganglia), gasserian ganglion, parotid salivary gland (LM, IHC)
- **Virology:** half of midsagittally sectioned brain, cervical spinal cord (FAT, BIOASSAY).

**Note the zoonotic potential of this organism when handling carcass and submitting specimens.**

### DIFFERENTIAL DIAGNOSIS

The diagnosis of rabies is one of the most difficult and important duties that a veterinarian is called on to perform. Because in most cases there is a probability of human exposure, failure to recognize the disease may place human life in jeopardy. It is not even sufficient to say that if rabies occurs in the area one will classify every animal showing nervous signs as rabid, because nervous signs may not be evident for some days after the illness commences. In addition, many animals suffering from other diseases will be left untreated. The best policy is to handle all suspect animals with extreme care but continue to treat them for other diseases if such treatment appears to be indicated. If the animal is rabid, it will die and the diagnosis can then be confirmed by laboratory examination.

Several diseases are characterized by signs of abnormal mental state or paralysis, or a combination of both (see [Table 14-9](#) for the horse; [Table 14-10](#) for cattle). Rabies must be differentiated from the following common diseases affecting the nervous system, according to species.

### Cattle and sheep

- **Lead poisoning.** In acute and subacute lead poisoning in cattle the clinical findings are similar to those of furious and dumb rabies. In acute lead poisoning, the common clinical findings are blindness, convulsions, champing of the jaws with the production of frothy saliva, and twitching of the eyelids and ears. In subacute lead poisoning in cattle there is blindness, stupor, head-pressing, grinding of the teeth, and almost no response to treatment. Rabid cattle are usually not blind, and signs of motor irritation such as convulsions and twitching of the facial muscles usually do not occur. However, there are signs of bizarre mental behavior, such as wild gazing, bellowing, yawning, attacking, and compulsive walking.
- **Lactation tetany** occurs in lactating cattle on lush pasture in the spring during cold wet and windy weather, and is characterized by hyperesthesia, tremors, convulsions, recumbency, and rapid death.
- **Vitamin A deficiency** occurs in groups of young cattle from 6 months to 18 months of age not receiving adequate carotene intake or vitamin A supplementation and is characterized by blindness in the ocular form and episodes of tremors and convulsions.
- **Polioencephalomalacia** in cattle and sheep is characterized by blindness, nystagmus, opisthotonus, and convulsions; bellowing, loss of sensation, and tenesmus do not occur.
- **Listeriosis** in cattle and sheep is manifested by localizing signs of circling and facial nerve paralysis.
- **Enterotoxemia** in sheep is usually confined to lambs on heavy carbohydrate diets.
- **Pregnancy toxemia** is a disease of pregnant ewes and is readily differentiated by the presence of ketonuria.
- **Louping-ill** in sheep is transmitted by insects, has a seasonal occurrence, and a localized geographic distribution.

### Horses

In horses, rabies must be differentiated from several diseases of the nervous system (summarized in [Table 14-11](#)).

The most common include diseases include viral encephalomyelitis, herpes virus myeloencephalopathy, cerebrospinal nematodiasis, equine degenerative myeloencephalopathy, equine protozoal myeloencephalitis, neuritis of the cauda equina, horsetail poisoning, Borna, Japanese encephalitis, and botulism.

### Pigs

In pigs, rabies must be differentiated from pseudorabies, Teschen disease, and involvement of the brain in several other diseases of the pigs, such as hog and African swine fever, meningitis associated with *Streptococcus suis* type II, *Haemophilus* spp., Glasser's disease, *Escherichia coli*, septicemia, and erysipelas.

*Text continued on p. 1237*



**Table 14-9** Diseases of horses characterized by signs of intracranial or disseminated lesions of the central nervous system

Disease	Etiology and epidemiology	Clinical and laboratory findings	Treatment and control
<b>Infection causes</b>			
Viral encephalomyelitis (WEE, EEE, VEE)	Summer season Insect vector, usually mosquitoes Young nonvaccinated horses at greatest risk, outbreaks may occur	Stage of slight hyperexcitability and mild fever initially, impaired eyesight, circling and walking Stage of mental depression, somnolence, leaning, feed hanging from mouth, unsteady Stage of paralysis, unable to swallow, weakness, recumbency; dies 2–4 days after onset Serology for diagnosis	Supportive therapy, thick bedding Recovery rate 60%–75% Vaccinate foals at 6 months of age and other horses for the first time, twice 2 weeks apart and once or twice annually thereafter
Rabies	All age groups, knowledge of disease in area, wildlife Usually single animal affected Not common	Ascending paralysis, hypersalivation, will bite Ataxia and paresis of hindlimbs, lameness, recumbency, pharyngeal paralysis, colic, loss of tail and sphincter tone, fever Dies in 1 week Immunofluorescent antibody testing on brain for positive diagnosis	No treatment All die Vaccinate horses if anticipate outbreak
Herpesvirus myeloencephalopathy (EHV-1)	Can occur as outbreaks Neurologic disease usually preceded by fever Mature horses	Symmetric ataxia and paresis, bladder paralysis, recumbency may occur, spontaneous recovery possible, CSF (hemorrhage or xanthochromia) Vasculitis with subsequent focal malacia in gray and white matter of brain and spinal cord	No specific therapy Antiinflammatory drugs may be useful Use of corticosteroids is controversial Recovery may occur spontaneously
WNE	West Nile virus Late summer in temperate regions Can occur as epizootics Now enzootic in most of North America	Fever, muscle fasciculations, weakness, ataxia, depression, cranial nerve disease, recumbency Prominent signs of spinal cord precede sign of intracranial disease in most cases	Supportive Antiserum Interferon Antiinflammatory drugs including corticosteroids Prevention by vaccination
Borna	Virus Direct transmission Germany and other European countries Disease is recorded in Japan Low morbidity, high case–fatality rate	Pharyngeal paralysis, muscle tremor, flaccid paralysis, course 1–3 weeks Viral encephalomyelitis with inclusion bodies	No treatment
Japanese encephalitis	Japanese encephalitis virus Sporadic Asia including Japan and China, parts of Oceania including New Guinea and Torres Strait Pig is mammalian amplifying host Vector mosquitoes, birds infected	Fever, lethargy, jaundice, dysphagia, incoordination, staggering, recovery in 1 week Serology	Spontaneous recovery Vaccination in endemic areas
Protozoal myeloencephalitis	<i>Sarcocystis neurona</i> Single animal affected Infectious but not contagious	Any central nervous system disorder. Usually causes ataxia but can cause cerebral and cranial nerve disease	Antiprotozoal medications (pyrimethamine + sulphonamide, ponazuril, or nitazoxanide) Vaccine available in the United States, but not recommended
Cerebrospinal nematodiasis (verminous encephalitis)	Migration of larval stages of <i>Strongylus vulgaris</i> , <i>Habronema</i> sp., and <i>Filaroides</i> <i>Micronema deletrix</i> ( <i>Helicephalobolus</i> ) <i>deletrix</i> Not common	Clinical signs referable to gray matter lesions are common Hypalgesia, hyporeflexia, hypotonia, muscle atrophy and cerebral, cerebellar and cranial nerve involvement Progressive encephalitis, incoordination, sensory deficits, blindness in one or both eyes, course of several days Pleocytosis of CSF Hemorrhage and malacia of thalamus, brainstem, cerebellum	Ivermectin or moxidectin at usual doses High dose benzimidazole Antiinflammatory drugs Parasite control
Brain abscess	Sporadic Often a complication of strangles	Obtunded mentation, variable signs of intracranial disease Leukocytosis Variable pleocytosis and increased protein concentration in CSF CT scan	Antimicrobials Surgical drainage Prognosis is poor

Continued

Table 14-9 Diseases of horses characterized by signs of intracranial or disseminated lesions of the central nervous system—cont'd

Disease	Etiology and epidemiology	Clinical and laboratory findings	Treatment and control
<b>Physical</b>			
Traumatic injury to the brain	History of traumatic injury (falling, rearing-up and falling backward)	Coma, depression, hemorrhage from nose and ears, blindness, cranial nerve deficits Often rupture of longus capitus muscle	Antiinflammatory drugs, mannitol Fair to poor prognosis
Facial nerve paralysis	Associated with prolonged surgical recumbency and compression of facial nerve	Facial nerve paralysis lasting several days Paralysis of ear, eyelid, lip, nostril on one side No alteration in sensation or vestibular function	Supportive
Lightning strike	Observed lightning strike or history of recent thunderstorm activity	Death is most common Horses that survive strike often have prominent signs of vestibular disease	Supportive Recovery is possible
Fracture or arthritis of the temporal-stylohyoid articulation, otitis media	Sporadic in older horses	Acute onset circling, head tilt, nystagmus, unilateral facial paralysis, dysphagia	Antibiotics, antiinflammatory drugs, supportive care
<b>Intoxications</b>			
Horsetail poisoning ( <i>Equisetum arvense</i> )	Ingestion of plants mixed with hay Not common	Incoordination, swaying from side to side, muscle tremor recumbency, bradycardia, cardiac arrhythmia	Thiamine parenterally. Good response
Equine leukoencephalomalacia (fumonisin toxicosis)	Horses eating moldy corn grain contaminated with <i>Fusarium moniliforme</i> fungus	Muscle tremor, weakness, staggering gait, dysphagia, depression	None
Hepatoencephalopathy associated with hepatotoxic plants ( <i>Crotalaria</i> , <i>Senecio</i> and <i>Amsinckia</i> )	Horses on inadequate pasture forced to eat poisonous plants More than one animal may be affected Geographic distribution	Develops slowly, commonly ill for 2–3 weeks previously, depression, pushing, ataxia, hypertonic face and lips, yawning, compulsive walking, loss of weight, icterus, photosensitization occasionally Serum liver enzymes elevated and liver function tests abnormal Hyperammonemia Gross and histopathologic liver lesions	No treatment Prevent access to poisonous plants
Lead poisoning	Grazing on pastures contaminated by atmospheric lead from nearby factories, not common now	Usually a chronic disease Inspiratory dyspnea caused by paralysis of recurrent laryngeal nerve Pharyngeal paralysis, dysphagia, aspiration pneumonia, paralysis of lips, weakness and recumbency Ingestion of large amounts causes subacute form similar to that seen in cattle	Calcium versenate
Yellow-star thistle poisoning ( <i>Centaurea</i> sp., anigropallidal encephalomalacia of horses)	Ingestion of yellow-star thistle in California and Australia Summer months on weedy pasture	Difficult prehension, fixed facial expression with mouth held half open, hypertonic face and lips, persistent chewing movements and rhythmic protrusion of tongue, yawning and somnolence but easily aroused, aimless walking, slight stiffness of gait, high mortality Malacia of globus pallidus and substantia nigra	No treatment Prevent access to poisonous plants
Botulism	Ingestion of preformed toxin of <i>Cl. botulinum</i> in decaying grass or spoiled silage, hay or grain. Sporadic in horses. Endemic in foals in some areas of North America	Flaccid paralysis of skeletal muscles leading to weakness, stumbling and recumbency. Mentation normal. Skin sensation normal. Paralysis of tongue and thoracic muscles. Die in 2–4 days. Some recover. Filtrates of intestinal tract into laboratory animals	Supportive therapy, antitoxins. Vaccination in enzootic areas. Prevent contamination of feed by animal carcasses
Tetanus	Wounds infected with <i>Clostridium tetani</i> Sporadic	Generalized tetany of all skeletal muscles Fever, hyperesthesia, protrusion of third eyelid, trismus, recumbency followed by tetanic convulsions, die in 5–10 days	Prognosis unfavorable Dark stall, penicillin, muscle relaxants, supportive therapy and antitoxin parenterally or into subarachnoid space Toxoid vaccination
<b>Metabolic and idiopathic</b>			
Lactation tetany	Lactating mares, suckling foals Hypocalcemia	Acute onset of generalized stiffness, trismus, no hyperesthesia, no prolapse of third eyelid, diaphragmatic flutter, soft heart sounds Serum hypocalcemia	Rapid response to calcium borogluconate intravenously

**Table 14-9** Diseases of horses characterized by signs of intracranial or disseminated lesions of the central nervous system—cont'd

Disease	Etiology and epidemiology	Clinical and laboratory findings	Treatment and control
Idiopathic epilepsy of Arabians	Single horse First noticed from shortly after birth up to 6 months of age Etiology unknown	Recurrent episodes of typical clonic-tonic convulsions lasting 10–15 minutes, loss of consciousness, sweating, tachycardia, spontaneous defecation No lesions	Control seizures with phenobarbital or potassium bromide Spontaneous recovery as foals mature
Idiopathic epilepsy of adult horses	Sporadic disease Unknown cause Can be associated with brain lesions detectable on EEG or CT	Tonic-clonic convulsions Variable periodicity and intensity	Control seizures acutely with diazepam and in the long term with phenobarbital and/or potassium bromide Spontaneous recovery unlikely
Cerebellar hypoplasia of Arabian and Swedish Gotland foals	Inherited Signs noticeable from 2–6 months of age	Defective eye blinks, ataxia, head-nodding, slight tremor of head and neck, intention tremor of the head, high-stepping gait, difficulty in rising, legs wide apart, difficulty in jumping over obstacles, fall backward if dorsiflex head and neck Cerebellar hypoplasia grossly or histologically	Eliminate carrier animals
Lower motor neuron disease	Associated with stabling and no access to pasture Sporadic North America and Europe Low serum vitamin E concentrations	Weight loss, weakness, muscle fasciculations, maintained appetite Normal mentation Low serum vitamin E concentration Diagnosis by muscle biopsy	No definitive cure Some cases stabilized with administration of oral vitamin E Poor prognosis for return to function

*Note: Other less common diseases affecting the nervous system of horses include space-occupying lesions (cholesteatomas of old horses, tumors), intracranial myiasis caused by migration of Hypoderma bovis, hydrocephalus in young horses, the accidental injection of an ataractic drug into the carotid artery, and bacterial meningitis in young horses as a sequel to streptococcal infection.*

*CSF, cerebrospinal fluid; CT, computed tomography; EEE, eastern equine encephalitis; EEG, electroencephalogram; EHV-1, equine herpesvirus-1; VEE, Venezuelan equine encephalitis; WEE, western equine encephalitis; WNE, West Nile encephalomyelitis.*

**Table 14-10** Differential diagnosis of diseases of cattle with clinical findings referable to brain dysfunction

Disease	Epidemiology	Clinical findings	Clinical pathology and pathology	Response to treatment
Lead poisoning	All ages of calves and cows on pasture with access to dumps Discarded lead batteries, used crankcase oil, lead-based paint common sources Case–fatality rate high	Acute in calves Blindness and “chewing gum” champing of jaws, convulsions, charging, rapid death Subacute in adults: blindness, stupor, head-pressing, grinding teeth, rumen static, protozoa dead	Blood and tissue for lead Encephalomalacia	Will respond favorably to treatment in early stages if not too severe but most cases do not return to normal Calcium versenate and thiamine hydrochloride Must be concerned about disposition of meat and milk of treated animals
Polioencephalomalacia	Grain-fed rapidly growing feedlot cattle May occur on pasture containing plants and water high in sulfates Outbreaks occur	Sudden onset, blindness, tremors and shaking of head, twitching of ears, head-pressing, opisthotonus, nystagmus, strabismus, rumen contractions normal, CSF pressure increased	Blood biochemistry (see text) Brain for histopathology	Responds to thiamine in early stages Cases caused by sulfate toxicity may not respond
Hypovitaminosis A	Calves 6–8 months of age most commonly but mature cows too off dry summer pasture (CSF form) Young rapidly growing cattle fed deficient ration for several months (ocular form)	CSF form: sudden onset; syncope and convulsions followed by recovery, eyesight and pupils normal Nyctalopia CSF pressure increased Ocular form: blindness in daylight, pupils dilated and fixed, optic disc edema Syncope and convulsions may also occur Usually preceded by nyctalopia but missed by owner	Plasma and liver vitamin A Optic nerve constriction Squamous cell metaplasia of parotid ducts	CSF form: recover in 48 hours following treatment with vitamin A injections Ocular form: will not recover because of optic nerve degeneration

*Continued*



Table 14-10 Differential diagnosis of diseases of cattle with clinical findings referable to brain dysfunction—cont'd

Disease	Epidemiology	Clinical findings	Clinical pathology and pathology	Response to treatment
<i>Haemophilus</i> meningoencephalitis (thromboembolic meningoencephalitis)	Feedlot cattle (8–12 months), outbreaks, preceded by respiratory disease in group High case fatality if not treated early	Found down, fever common, ataxic, not usually blind, fundic lesions, irritation signs uncommon, weakness and paresis common, synovitis, laryngitis, pleuritis May die in 8–10 hours Myocardial abscesses may also occur	Neutrophilia CSF contains neutrophils Typical gross lesions in brain Pleuritis, pneumonia, synovitis, myocardial abscesses	Respond favorably to antimicrobials if treated early Later, high case–fatality rate
<i>Listeria</i> meningoencephalitis	Sporadic Fed silage Yearlings and adults	Unilateral facial paralysis, deviation of head and neck, mild fever, endophthalmitis, may be recumbent	CSF for cells Brain for histopathology	Recovery may occur. Antimicrobials Residual signs in survivors common
Nervous signs with coccidiosis (see text)	In 20% of young cattle affected with dysentery caused by coccidiosis Case fatality may exceed 50%	Tonic-clonic convulsions, normal eyesight, hyperesthesia, normal temperature, dysentery, may live 2–4 days	Oocysts in feces	Unfavorable response to treatment Must control coccidiosis
Rabies	Cattle exposed to wildlife, one or more affected, all ages, incubation 3 weeks to few months	Quiet and dull (dumb form) or excitable and easily annoyed (furious form) Bellowing, yawning, drooling, saliva, eyesight normal, tenesmus, ascending paralysis beginning with anesthesia over tail head, progressive course, dies in 4–6 days, usually no gross muscular tremors or convulsions, mild fever early	Hemogram normal Brain for laboratory diagnosis	None
Bovine spongiform encephalopathy (BSE)	Mostly in dairy cattle; epizootic began in Britain in 1986; long incubation period; caused by scrapie-like agent in protein concentrate made from sheep carcasses following change in processing procedures	Insidious onset, clinical course several weeks, change in behavior, hyperesthesia, ataxia, loss of body weight, stare, agnostic behavior, kick during milking, knuckling, falling, progressive weakness leading to recumbency	None	None
Pseudorabies	Disease of pigs transmitted to cattle by bites	Intense, local pruritus at site of bite, excitement, bellowing, convulsions, paralysis, death 2–3 days	Tissues for injection into rabbit Histopathology of brain	None
Hypomagnesemic tetany (lactation tetany)	Lactating dairy cows on lush pasture, late pregnant beef cows, cold, windy weather in spring May be precipitated by long transportation or deprivation of feed and water Outbreaks occur Seen in yearlings too Case mortality can be high	Acute: sudden onset of irritability, hyperesthesia; convulsions, recumbency, loud heart sounds, tachycardia, polypnea. Subacute: gradual onset (2–4 days), hyperirritable, difficult to handle, stilted gait, falling, stumbling, sudden movement may precipitate convulsion	Serum magnesium level slow	Responds to magnesium sulfate early
Nervous acetonemia	2–6 weeks postpartum High-producing cow Single animal	Sudden onset, bizarre mental behavior, chewing, licking, bellowing, hyperesthesia, sweating	Ketonuria, hypoglycemia	Responds to glucose parenterally and/or propylene glycol orally
Bovine bonkers (bovine hysteria)	Mature cattle and calves consuming ammoniated feeds (lucerne hay, bromegrass hay, fescue hay, wheat hay, maize stalks or silage) May also occur when animals have access to molasses-urea-protein blocks Toxic agent may be substituted imidazole formed by combination of soluble carbohydrates and ammonia Usually occurs when high-quality forage treated with ammonia concentrate of more than 3% dry matter by weight Can occur in nursing cows fed ammoniated feedstuffs	Periodic episodes of hyperexcitability, bellowing, running, charging, circling, convulsions, weaving, episodes last 30 seconds and may recur every 5–10 minutes Some die Most recover following removal of feed	Information not available	Recover spontaneously following removal of feed source

**Table 14-10** Differential diagnosis of diseases of cattle with clinical findings referable to brain dysfunction—cont'd

Disease	Epidemiology	Clinical findings	Clinical pathology and pathology	Response to treatment
Hepatic encephalopathy (i.e., ragwort poisoning)	Cattle with access to plants containing pyrrolizidine alkaloids Many cattle may be affected	Loss of body weight, gradual onset of aggressive behavior, ataxia, muscular tremors, recumbency, convulsions, tenesmus and bellowing	Hyperbilirubinemia, decreased excretion of bromsulphthalein (BSP) Liver lesions	No treatment
Brain abscess	Sporadic, young cattle (6 months to 2 years of age) may have history of previous infections	Localizing signs, rotation or deviation of head and neck, loss of equilibrium, circling, mild fever, may be blind in one eye, nystagmus one eye	Neutrophilia, neutrophils in CSF	Unfavorable response to therapy
Enterotoxemia caused by <i>Clostridium perfringens</i> type D	Calves 2–4 months of age sucking high producing cows grazing on lush pastures Outbreaks occur Uncommon	Peracute: found dead. Acute: bellowing, mania, convulsions, blindness, death in 1–2 hours Subacute: dull, depressed, blind	Hyperglycemia (150–200 mg/dL), glycosuria marked Smear intestinal contents Recover toxin (mouse protection tests)	Hyperimmune serum Most die Vaccination effective
Whole-milk hypomagnesemic tetany of calves	Calves 2–4 months of age on whole milk Also in calves on milk replacers, concentrates and hay and occasionally in nursing calves on pasture	Sudden alertness, hyperesthesia, head-shaking, opisthotonus, muscular tremors, frothing at mouth, convulsions, heart rate 200–250 beats/min	Serum magnesium levels usually below 0.8 mg/dL	Magnesium sulfate intravenously gives good response, must follow up daily because of previous depletion of bone reserves

## TREATMENT

No treatment should be attempted after clinical signs are evident. If the bite is seen, immediately after exposure, irrigation of the wound with 20% soft soap solution or a solution of benzalkonium chloride for at least 5 minutes may prevent the establishment of the infection. The area exposed to potential infection should be doused with iodine solution or a 40% to 50% alcohol solution if iodine is unavailable.<sup>2</sup> Immediate and thorough washing of all bite wounds and scratches with soap and water is perhaps the most effective measure for preventing rabies in veterinarians bitten by rabid animals. In experimental animals, simple local wound cleansing has been shown to markedly reduce the likelihood of rabies. Postexposure vaccination is unlikely to be of value in animals, because death usually occurs before appreciable immunity has had time to develop. Euthanasia of suspect animals must be avoided, particularly if human exposure has occurred, because the development of the disease in the animals is necessary to establish a diagnosis. Antirabies serum may become available for animal treatment at some future date. **In some countries, cases of rabies in farm animals are notifiable to the animal health and disease regulatory bodies.**

## CONTROL

The major goal of rabies control in domestic and wild animals is the reduction or elimination of human rabies. The most rational approach to reducing human rabies is to reduce the prevalence and incidence of

disease in animals. In developed countries, this has been accomplished by vaccination of dogs and cats, leaving much rabies in wildlife to be controlled. In countries without wildlife reservoirs, such as the Philippines, it would be economically advantageous to eliminate dog rabies. In Africa, where the incidence of rabies as well as the range of species involved is increasing, there is a need to develop new and economical methods of vaccinating domestic animals.

Dogs remain the major vector for transmission to humans in developing countries and are responsible for an estimated 59,000 human deaths worldwide annually.<sup>6,7</sup> Preexposure immunization for individuals, like veterinarians, who are at high risk to rabies, has been recommended by the World Health Organization (WHO), because it reduces risk and provides a more rapid anamnestic response, eliminating the need for human globulin should exposure occur. Rabies preexposure vaccination is now mandatory in many veterinary colleges. Despite some mild adverse reactions, immunization against rabies is an important prophylaxis measure well accepted by veterinary students.

For farm animals, there are two useful control techniques: the **prevention of exposure** and **preexposure vaccination**.

### Prevention of Exposure to the Virus

This can be achieved by controlling access of wildlife species that are likely to come into contact with the farm livestock in particular areas or through vaccination of the wildlife. Foxes accounted for a very large proportion (85% in Europe) of wildlife rabies, and a

control program aimed at reducing their population using poison or traps was attempted until the 1970s. This method of population reduction failed to control outbreaks or reduce enzootic rabies.

**Point infection control** has been shown to be highly successful in controlling raccoon rabies. This involves the use of three tactics: population reduction, trap-vaccinate-release, and oral vaccination with baits to control the spread of raccoon rabies.

### Preexposure Vaccination of Humans

The most successful form of rabies prevention is preexposure vaccination. In human medicine, there are no reported cases of rabies deaths in anyone who has had preexposure vaccination followed by a booster vaccination if exposed. The CDC has published the recommendations of the Advisory Committee on Immunization Practices (ACIP) for human rabies prevention, which indicate that rabies preexposure vaccination should be offered to persons more likely to be exposed to rabies virus than the population of the United States at large. The recommendations of the ACIP for preexposure prophylaxis and maintenance of a detectable antibody titer differ depending on the estimated degree of risk of exposure to the virus. Four risk categories have established: continuous, frequent, infrequent, and rare. The classification depends on factors such as the occupation of the individual and geography.

With directed continuing education, common sense, first aid, and the availability of modern biologic agents, human rabies is nearly always preventable. Rabies

preexposure vaccination is recommended for anyone at increased risk of exposure to rabies, including veterinarians, veterinary students who work in university veterinary teaching hospitals, laboratory staff working with rabies, vaccine producers, animal and wildlife control personnel, and zoologists. The standard preexposure regimen is three doses of vaccine intramuscularly or intradermally on days 0, 7, and 28 (or 21). A booster dose after 1 year increases and prolongs the antibody response. This preexposure vaccination permits postexposure vaccination to consist of two doses of vaccine on days 0 and 3 instead of five doses on days 0, 3, 7, 14, and 28 and avoids the need for postexposure of administration of human rabies immunoglobulin.

### Postexposure Vaccination of Humans

Modern postexposure treatment is highly successful if done adequately. Wound care with infiltration of the wound with human rabies immunoglobulin and active rabies immunization is essential, especially after severe exposure. Postexposure treatment is assumed to neutralize or inactivate virus while it is still in the wounds, before it gains access to the nervous system where it is protected from the immune system. Therefore treatment after exposure to rabies virus is very urgent, even if the patient was bitten months before.

### Postexposure Vaccination of Domestic Animals

An effective postexposure protocol for unvaccinated domestic animals exposed to rabies includes immediate vaccination against rabies, a strict isolation period of 90 days, and administration of booster vaccinations during the third and eighth weeks of the isolation period. The protocol has been effective in dogs, cats, cattle, and horses.

### Vaccination of Domestic Animals

A *Compendium of Animal Rabies Control* is published annually by the National Association of State Public Health Veterinarians in the United States and Canada. It provides recommendations for immunization procedures in domestic animals and the vaccines licensed and marketed in the United States. Detailed information is provided on preexposure vaccination, management of dogs and cats and livestock, postexposure management, and control methods in wild animals. Such publications should be consulted when necessary. In general, for cattle, sheep, and horses, the primary vaccination is given at 3 months of age and boosters given annually. Farm livestock in endemic areas where clinical cases of rabies occur are common should be vaccinated.

In countries where vampire bats are a major vector for rabies in farm livestock, vaccination of livestock is necessary, but in

countries such as Argentina vaccination does not support a cost-benefit analysis.

### Vaccines

Almost all rabies vaccines for domestic animals are inactivated. Inactivated tissue culture cell vaccines given to cattle result in neutralizing antibodies in 1 month after the primary vaccination. A booster given 1 year later increases the titers, which are detectable 1 year after the booster. A vaccine inactivated with binary ethylenimine, and containing aluminum hydroxide adjuvant, provides excellent protection for up to 3 years and is very useful for the control of rabies in cattle in Latin America where the vampire bat is the main vector.

Vaccinal antibodies are present in the colostrum of vaccinated cows and it is recommended that, where cattle are vaccinated annually, calves be vaccinated at 4 months of age and again when 10 months of age, but vaccination should be delayed 6 months for calves born to and receiving colostrum from previously vaccinated dams.<sup>8</sup> However, in areas with endemic and epizootic rabies, calves can be vaccinated as early as 2 months of age and be protected in the presence of passive immunity from colostrum antibodies provided they are revaccinated 4 months later.<sup>9</sup> Calves from unvaccinated dams can be protected by vaccinating them at 17 days of age. Postvaccinal paralysis does not occur after its use. Coadministration of levamisole (6 mg/kg, subcutaneously) with vaccination does not increase the vaccine titer; however, the effect on cell-mediated immunity was not specifically evaluated in that study.<sup>10</sup>

### Vaccination of Wildlife

Mass oral vaccination of terrestrial wild animals is a rabies control method that is feasible, effective, and internationally accepted. It is based on the concept of applied herd immunity. The vaccines are efficacious when fed as vaccine baits. The factors affecting acceptance of baits for delivery of oral rabies vaccine to raccoons have been examined.

The oral immunization of foxes has resulted in a substantial decrease in the number of rabies cases in Europe. As a result of oral vaccination of the red fox (*V. vulpes*) against rabies, using hand and aerial distribution of vaccine-laden baits, the rabies virus has almost been completely eradicated from Western and Central Europe. The same dramatic decrease occurred in southern Ontario, Canada. In most countries, vaccine baits were distributed twice yearly during the spring (March to May) and autumn (September to October). Several European countries have become rabies free: Belgium, Luxembourg, France, Italy, Switzerland, Finland, and the Netherlands.

Progress has been made in applying oral rabies vaccination to contain and eliminate some strains of terrestrial rabies in North

America. Raboral V-RG is the only rabies vaccine licensed for use in the United States. It has not produced sufficient levels of population immunity in skunks in the wild at the current dose, and it may be less effective in skunks than in other species. Skunks are a major contributor to rabies in North America and this has raised concerns about an independent maintenance cycle for raccoon rabies in skunks. The national rabies management goals of virus containment and elimination will likely remain elusive until an oral vaccine is licensed that is immunogenic in all terrestrial rabies reservoir species. Vaccination will succeed in reducing or eradicating rabies only if a sufficient proportion of the target population can be immunized. Mathematical modeling techniques are now being tested to examine the population biology of rabies in wildlife species such as raccoons and skunks.

It is notable that no practical vaccination methods have been developed for bats. Phylogenetic analyses of viruses from bats and carnivores suggest a historical basis for still existing viral origins caused by interactions between these taxa. Thus the possibility for pathogen emergence resulting from transmission by rabid bats with subsequent perpetuation among other animals cannot be discounted easily on any continent.

### Quarantine and Biosecurity

The most effective method of preventing the entry of rabies into a country free of the disease is the imposition of a quarantine period of 4 to 6 months on all imported dogs. This system has successfully prevented the entry of the disease into island countries, but has obvious limitation in countries that have land borders. The occurrence of the disease in two dogs in the United Kingdom in 1969 to 1970 in which the incubation period appeared to last 7 to 9 months suggests that the more usual period of 6 months may give incomplete protection. Therefore vaccination on two occasions with an inactivated vaccine while the animal is still in quarantine for 6 months is the current recommendation. To require a longer period of quarantine would encourage evasion of the law by smuggling. The situation in the UK, and in any country where the disease does not occur, is a vexed one. It is possible to rely chiefly on quarantine and act swiftly to stamp the disease out if it occurs. The shock eradication program would include quarantine of, and vaccination in, a risk area, ring vaccination around it, and destruction of all wildlife. This procedure is likely to be adopted in countries where the risk is small, such as Australia. Where the risk is great, consideration must be given to mass vaccination of wildlife by baits, because wildlife are the cracks in the defense armor. The use of combined vaccines containing rabies vaccine in other vaccines used in dogs would be an



effective and panic-free way of increasing the immune status of the pet population.

## FURTHER READING

- Bellotto A, et al. Overview of rabies in the Americas. *Virus Res.* 2005;111:5-12.
- Dyer JL, Yager P, Orciari L, et al. Rabies surveillance in the United States during 2013. *J Am Vet Med Assoc.* 2014;245:1111-1123.

## REFERENCES

- Papaneri AB, et al. *Virus Res.* 2015;197:54.
- Banyard AC, et al. *Virus Res.* 2010;152:79.
- Den K, et al. *Am J Trop Med Hyg.* 2012;86:528.
- Chandrasekhara N, et al. *Indian J Field Vet.* 2013;8:49.
- Shankar BP. *Veterinary World.* 2009;2:74.
- Reddy RVC, et al. *Infect Genet Evol.* 2014;27:163.
- Hampson K, et al. *PLoS Negl Trop Dis.* 2015;9:e0003709.
- Yakobson B, et al. *Prev Vet Med.* 2015;121:170.
- Filho OA, et al. *Res Vet Sci.* 2012;92:396.
- Cazella LN, et al. *Vet Rec.* 2009;165:722.

## PSEUDORABIES (AUJESZKY'S DISEASE)

The disease was first described in cattle and was known then as pseudorabies because of the similarity to rabies and thereafter Aujeszky's disease after the Hungarian physician who first isolated the virus.

### SYNOPSIS

**Etiology** Aujeszky's disease virus (suid herpesvirus 1) (SuHV-1).

**Epidemiology** Found in pigs worldwide and major economic importance in swine-raising areas. High prevalence of infection; lower incidence of disease. Infected pig source of infection; latent infection is characteristic; spread occurs within herds, between herds, and from infected carriers; long-distance aerosol transmission occurs from area to area; immunity follows infection or vaccination.

**Signs** Fever, incoordination, recumbency, convulsion, and death in piglets. Coughing, nasal discharge, sneezing, and dyspnea in older growing pigs. In cattle and sheep, intense pruritus at site of bite, excitement, circling, convulsions, fever, recumbency, paralysis, and death in 48 hours or less.

**Clinical pathology** Serology for virus-neutralizing antibodies. Detection of virus in tissues.

**Lesions** Viral encephalitis.

**Diagnostic confirmation** Detection of virus in tissues; serology; inclusion bodies in nervous tissue and respiratory tract.

### Differential diagnosis

#### Swine

- Viral encephalomyelitis (Teschen disease)
- Rabies
- Streptococcal meningitis
- Hog cholera
- African swine fever

- Glasser's disease
- Septicemias (*Escherichia coli*, erysipelas, salmonella)
- Bowel edema
- Salt poisoning
- Reproductive insufficiency (parvovirus).

#### Cattle and sheep

- Nervous form acetonemia
- Rabies C
- Acute lead poisoning.

**Treatment** None.

**Control** Depopulation and repopulation, test and removal, segregation of progeny, and vaccination with subunit vaccines that distinguish between infected and vaccinated pigs.

## ETIOLOGY

Pseudorabies is caused by porcine herpesvirus-1 (SuHV-1), Aujeszky's disease virus, or pseudorabies virus (PRV), of the genus *Varicellovirus*, a member of the family of Herpesviridae,<sup>1</sup> subfamily Alphaherpesvirinae. It exists as a single serotype. Many cell lines are used for PRV culture. There are four major genome types; Type 1 is found in the United States and Europe; Type 2 is found in central Europe, Type 3 is found in Eastern Europe, and Type 4 is found only in Asia.

## EPIDEMIOLOGY Occurrence

PRV primarily affects pigs and occurs incidentally in other species. It has a worldwide distribution except for Norway, Australia, and most of the islands of Southeast Asia. Control programs have eliminated the condition in many countries,<sup>2</sup> leaving isolated pockets in Northern Ireland and in France. It is still endemic in eastern and southeastern Europe, Latin America, Africa, and Asia. For example, in Poland from 2005 to 2009 around 0.4% of the population was infected.<sup>3</sup> In countries where the disease has been eradicated vaccination is not allowed.

The disease persists in feral pigs, wild boar, and hybrids<sup>4,5</sup> at quite high levels in many European countries and also in the United States<sup>2</sup> and these permanently threaten the domestic pig population.

The reservoir of Aujeszky's disease has shifted from domestic pigs to wild and feral pig populations and circulates unchecked in many countries.<sup>6</sup> Thus the identification of reservoirs and the epidemiologic surveillance is becoming more difficult.

PRV is primarily a disease of pigs, and naturally occurring cases in cattle, sheep, dogs, cats, rats, and horses are rare and usually fatal. Many other species have also been affected, but only pigs survive the infection. Infection in other species often occurs when pigs cohabit with other species.

## Morbidity and Case Fatality

Typically, the disease spreads rapidly in infected herds over a period of 1 to 2 weeks, and the acute stage of the outbreak lasts 1 to 2 months. In sucking pigs, the morbidity and mortality rates approach 100%, but in mature swine there may be no clinical signs, and affected animals usually recover. The highest morbidity occurs initially in unweaned piglets, but as the outbreak continues and piglets become passively immunized through the sow's colostrum, the major incidence may occur in weanlings.

In recent years, there has also been an increase in the morbidity and case-fatality rates in older pigs associated with the intensification of pig rearing and the dominance of more virulent strains.

## Risk Factors

### Animal Risk Factors

The seroprevalence of infection varies widely between herds, and between breeding and finishing pigs within herds. The most important animal risk factors of virus persistence are herd size and the population density of the sows in the herd. Endemic infection is more likely in herds of breeding sows with more than 66 sows. In breeding herds, spread of infection is positively associated with increasing size of the herd, having the gilts in the same barn as the sows (gestation barn), and serologic evidence of infection in the finishing pigs. The seroprevalence of infection is low in quarantined breeding herds, which makes them prime candidates for elimination of the disease by test and removal.

In the early period of a compulsory vaccination program with gI-deleted vaccines, in an area endemically infected with the disease, the seroprevalence of infected breeding females is higher in farrow-finish than farrow-feeder herds. Mandatory vaccination is beneficial in both herds but the pattern is linear in farrow-feeder herds and curvilinear in farrow-finish herds, and is more rapid in the early period of the program. In the farrow-finish herds, the odds of infected breeding females were associated positively with seropositivity in the finishing pigs of the herd and with the density of the pigs in the county in which the herd is located. In Belgium the presence of finishing pigs in the same herd increased the chances of being infected. The spread and transmission of the virus between herds can be reduced by a reduction in the contact rate between the herds and their size and by a reduction of the transmission within the herd.

The factors associated with circulation of the virus within herds include confinement of finishing pigs, concurrent infection with *Actinobacillus pleuropneumoniae*, the length of time since the herd has been under quarantine, and the presence of clinical disease.

In general, PRV does not increase the susceptibility of animals to infection with other pathogens.

The primary risk factors associated with seroprevalence of the virus in 500 swine herds in Illinois included total confinement and density of infected herds in the geographic area. It was calculated in Belgium that if there were over 455 pigs per squared kilometer, then there was a 10-fold increase in the risk of PRV. Total confinement is associated with higher seroprevalence, presumably because of increased density of population and increased risk of transmission. Seroprevalence is higher in vaccinated herds, increases over the course of the eradication program, and decreases with an increased time between quarantine and the development of a herd plan. In the Netherlands, the risk factors contributing to seroprevalence of infection in breeding herds included the presence of finishing pigs, production type (producers of finishing pigs had a higher prevalence than producers of breeding stock), vaccination of sows during nursing (compared with vaccinating all sows simultaneously at 5-month intervals, or vaccination during the second half of gestation), pig density in the municipality in which the herd was located (seroprevalence increased with higher pig density), herd size of fewer than 100 sows, average within-herd parity (seroprevalence increased with higher within-herd parity), replacement pigs raised on the premises, and vaccine strain administered to the sows.

#### Environmental Risk Factors

The virus is resistant to environmental conditions depending on pH, humidity, and temperature. The virus may survive for 2 to 7 weeks in an infected environment and for up to 5 weeks in meat. The infectivity of the virus in an aerosol decreases by 50% in 1 hour. Environments at 4°C supported the survival of the virus in aerosol better than at 22°C. The virus is lipophilic and sensitive to several commonly used disinfectants. Sodium hypochlorite (5.25%) is the most desirable and practical disinfectant. Suspensions of the virus in saline G solution and on the solid fomites, whole corn, and steel remained infectious for at least 7 days. Loam soil, straw, and concrete supported survival of the virus at 25°C for up to 1 week. During shipment of pigs, bedding material and surfaces in contact with pigs may become contaminated. Rinsing a needle between sampling may reduce the probability of mechanically transmitting the disease.

#### Pathogen Factors

Field strains of the virus differ in virulence. Numerous genomically different strains of the virus exist, and restriction endonuclease (RE) analysis can distinguish between virus isolates, which is useful for identifying new isolates of the virus as they appear in pig populations. In Denmark, restriction fragment analyses of older clinical isolates, and of isolates from all the virologically confirmed outbreaks since 1985, indicated the

introduction of foreign strains. Strain variation in virulence has been observed in field isolates and produced by laboratory attenuation. Virulence also affects the tropism of the virus. Many of the highly virulent strains are neuroinvasive; many of the moderately virulent or mild strains are not neuroinvasive but affect the respiratory tract. The highly adapted or vaccinal strains often acquire a tropism for the reproductive systems. Inactivation of several genes that are not essential for viral replication can reduce the virulence of the virus.

Some field strains of the virus from Poland and Hungary have been identified by restriction fragment pattern analysis as derivatives of conventionally attenuated vaccine strains. This is considered a rare event but must be considered in relationship to trade in semen from vaccinated boars or trade in live animals between disease-free areas and areas in which vaccination with live attenuated strains is practiced.

#### Methods of Transmission

Pseudorabies is not very contagious and large quantities of the virus are required to infect pigs except very young piglets. Larger doses of virus are needed for oral infection than nasal infection. In feral pig and wild boar populations it appears to be venereal transmission that is more important.<sup>7</sup> It can be transmitted transplacentally, especially in the last third of gestation. It can also be passed through the colostrum. In milk excretion of virus takes place for 2 to 3 days following infection. Virus can be transmitted for up to 12 days in semen following infection. Venereal transmission of latent infection in sows and boars has been suspected, but there is no direct evidence. The virus cannot usually be isolated from urine.

In a study of PRV in wild swine in the United States it was found that the virus was found in the oral cavity of feral pigs and was widely distributed in the tonsils, salivary glands, taste buds, and even mucosa in the region of the tusks.<sup>8</sup>

Infected swine shed virus in large quantities from all body excretions, secretions, and aerosols. Virus shedding starts 1 to 2 days after infection, reaches a peak at 2 to 5 days, and may last up to 17 days. Virus can be isolated from the oropharynx for 18 to 25 days.

Pigs, and possibly rodents, appear to be the primary host for the virus. The virus is present in the nasal discharge and in the mouth of affected pigs on the first day of illness and for up to 17 days after infection. This suggests that short-length aerosol transmission is a common occurrence within buildings or units but long distance transmission is still doubted. After infection and recovery pigs may be regarded as carriers.

#### Within Herds

Transmission within herds occurs by direct oral–nasal contact between infected and

susceptible pigs and aerosols from projection of discharges during sneezing, but it may also occur via contaminated drinking water and feed. Transmission within herds is independent of the size of the population.

The transmission of virus decreases rapidly following the start of a vaccination program, but extensive spread can still occur even among finishing pigs vaccinated twice. Vaccinated pigs may shed more virulent virus but there are no significant differences in magnitude of transmission. Mixing of chronically infected pigs with seronegative pigs may not result in seroconversion in the seronegative pigs until a clinical outbreak of disease occurs.

#### Between Herds

Transmission between herds is caused by the introduction of infected animals, and the virus may still be introduced into vaccinated breeding herds. Other methods of transmission have been suggested, including farm laborers, vehicles, feedstuffs, rodents, and wild or domestic animals, the carcasses of dead infected animals, and infected food and water.

#### Within an Area

Transmission within an area is a major problem and not well understood. Some evidence indicates that area spread may be associated with markets and the frequency of delivery of pigs to market per year. In France, it has been suggested that the presence of an infected herd within 1 km is an important factor in the spread of PRV. The concurrent occurrence of an outbreak of disease on many farms in the same area in Denmark suggested long-distance airborne transmission of the virus.

Infection is spread by airborne transmission. Sneezing probably generates the airborne virus. In a series of outbreaks in Britain between 1981 and 1982, 7 of 11 were found likely to have been transmitted by aerosol on meteorologic grounds. Airborne spread occurred between herds 2 to 9 km apart. An epidemic in Denmark in 1987 to 1988, associated with foreign strains of the virus, suggests that airborne transmission occurred across the German–Danish border, especially as a southerly wind was blowing during the period of transmission.

Computer modeling based on the mean dose of virus received by an animal at a farm downwind can be used to predict the airborne spread of the virus.

The virus is inactivated in meat after 35 days of storage at –18°C (0.5°F). Meat from infected pigs may cause infection when fed to dogs.

#### Latency

Pigs that recover from infection are latent carriers of the virus for life. Reactivation, followed by shedding and spreading the virus, may occur following stress such as transport or farrowing, or by the administration of

corticosteroids. Serologic testing of latent carriers detects the antibody response to the whole virus or to a PRV virus glycoprotein. During natural infection, the virus replicates at the site of infection, usually in the oronasal areas. The virus gains entry into the nerve endings and ascends by retrograde axonal transport to the cell body in the trigeminal ganglion. Viral components can be found in both the trigeminal ganglion and the tonsils. The tonsil is a primary site of virus replication and serves as an area for monitoring virus shedding during acute infection and reactivation. The virus can be isolated from tissue fragments of pigs clinically recovered from disease for up to 13 months and followed by a challenge with the live virus, which may be shed by sows for up to 19 months after initial infection. Virus gene products can be found in the trigeminal ganglia and tonsils for many weeks following acute infection. Latent infection can also occur in vaccinated pigs.

### Other Species

The rarity of spread to other species is caused by scanty nasal discharge and the improbability of the discharge coming into contact with abraded skin or nasal mucosa of animals other than pigs. The disease has occurred in sheep and cattle following the use of a multidose syringe previously used in infected swine. It may spread from normal or clinically affected pigs to animals of other species, but does not usually spread between animals of the other species. For example, sheep and calves can be infected experimentally, but there is no evidence that they excrete the virus. The disease may occur in pigs, sheep, and cattle on the same farm. Brown rats may be a minor source of infection but are unlikely to be an important reservoir; they are capable of spreading the disease to dogs. The wild Norway rat is thought to have only a minor role in the transmission of the disease to farm animals. The virus causes fatal disease in dogs, which are usually infected from close association with infected pigs. The raccoon can be infected experimentally, but is not considered to be a long-term subclinical carrier of the virus. The possible role of wild animals in transmission of PRV in swine has been examined with inconclusive results. It has been seen in Kodiak, polar, and Himalayan bears fed on a diet of raw pig's heads. Five viral isolates were recovered from latently infected wild boar originating from two regions of East Germany, but in the Netherlands the wild boar were said to be rarely affected. The PRV infections in the wild boar in Germany are said to exist in the country as an endemic infection and persist completely separately from the domestic population and also do not appear to affect it. The sacral ganglia and trigeminal ganglia of wild pigs were said to be a source of infection. The latency was shown in 9/16 sacral ganglia, 7/16 trigeminal ganglia, and 5/13 tonsils from feral swine in

the United States, but even so most of the transmission in feral swine is expected to be venereal. The experimental infection of wild boars and domestic pigs with different strains has been performed and the clinical signs depended on the strain but the wild boar could infect the domestic strains and vice versa. The low virulence strains were highly adapted to the wild boar.

### Immune Mechanisms

When infected with a virulent strain of the virus, pigs develop an immune response that can completely, or almost completely, prevent the virus from replicating after the pig becomes reinfected. Following natural infection, sows acquire immunity, which is transferred to their piglets in the colostrum and persists in the piglets until 5 to 7 weeks of age. Following intranasal challenge, piglets with colostrum immunity from naturally infected sows are protected from clinical disease, but not against subclinical infection.

Vaccination of pigs with attenuated PRV virus prevents clinical disease and death that may otherwise follow exposure to the virulent virus. Vaccination does not, however, prevent either acute or latent infection with virulent virus. Consequently, vaccinated pigs, as well as nonvaccinated pigs that survive infection with the virulent virus, can become virus carriers and a source of the virus following reactivation of a latent infection. This is of vital importance in eradication programs in which it is necessary to identify infected pigs regardless of their vaccination status. Maternal immunity interferes with inactivated virus vaccination much more than with live virus vaccination.

Vaccination of pregnant sows induces a maternal immunity, which protects piglets from experimental disease. However, latent infection of young pigs with highly virulent virus can develop in the absence of clinical signs. The virus can reach the uterine and fetal tissues, via infected mononuclear cells, which is the presence of circulating antibodies induced on vaccination. Vaccination of piglets before challenge exposure has little or no effect on the rate of establishment of virus latency, but vaccination does reduce shedding after subsequent experimental reactivation of the virus with dexamethasone. Attenuated tyrosine kinase-negative vaccine strains of the virus can also establish a reactivatable, latent infection.

In growing and finishing pigs in quarantined herds, the serologic status is unpredictable because the infection may continue to spread, may cease temporarily, or may cease altogether. Evaluation of the serologic status of the boars in a breeding herd does not accurately reflect the serostatus of the herd.

It has been suggested that the T cells are more important than the B cells in the clearance of PRV from the host, and it has been

shown that strong T-cell-mediated responses after challenge produce the best protection.

### Economic Importance

The economic losses associated with pseudorabies in swine are caused by clinical disease and the costs of serologic analysis and vaccination programs. Economic loss estimates must include the measurement of losses during and immediately after clinical outbreaks of disease and the indirect losses incurred until after eradication of the disease. Losses have been estimated at \$25 to \$50 per sow per year; these include only losses during the period of the outbreak and the direct losses attributable to death and abortions. When expanding the observations of economic losses to 3 months after the termination of the outbreak, estimated losses may be as high as \$145 per sow per year. Economic analyses of the losses in a commercial farrow-finish herd of 240 breeding-age sows in the United States revealed that the major part of the loss was caused by death of suckling pigs at 76% of total loss, nursery pig mortality accounted for 12.6% of total net loss, sow culling and deaths accounted for 9.4% of net loss, and market pig deaths accounted for 1.2% of net losses.

The costs of eradicating PRV vary depending on the methods used. Depopulation-repopulation is the most expensive method because it requires culling of animals, clean-up costs, and downtime, which represents the largest proportion of expense. In addition, the probability of reinfection following repopulation is a risk.

Test and removal is the most inexpensive, and segregation of offspring is an intermediate cost. The cost of eradicating the virus from a swine herd can be in excess of \$220 per inventoried sow; some estimates are much higher. In large breeding herds or finishing herds with the continual influx of susceptible pigs, the disease may become endemic. PRV may also be a significant cause of reproductive inefficiency in pig herds, and infection within the herd may be initially manifested by abortions in the sow herd, followed later by the more typical occurrence of neurologic disease in suckling and growing pigs. The economic losses from the disease can be very high because of mortality in young pigs, decreased reproductive performance, and the necessity to depopulate to eradicate the disease from a herd. An economic assessment of an epidemic of PRV in a 150-sow farrow-finish operation on selected production and economic variables has been made. The mean litter size remained the same throughout the period of observation, but there was a twofold increase in suckling pig mortality and 3.5-fold increase in stillbirths during the months of the epidemic compared with the period before the epidemic. Following the epidemic, suckling pig mortality was 14% greater and stillbirth rate was 71% greater than during the months preceding the outbreak. The major economic



losses (88% of the total loss) were related to breeding herd removal/depopulation and production downtime.

## PATHOGENESIS

The portal of entry is through abraded skin, oral mucosa, or via the intact nasal mucosa. Strain differences in the effect of historical PRV strains in porcine respiratory nasal mucosa explants shows that there were differences in the strains.<sup>8</sup> The virus is pantropic and affects tissues derived from all embryonic layers. Receptor and receptor-binding virion proteins that can mediate the virus entry into the cell and cell-to-cell spread have been described. The various glycoproteins of the virus are required for various stages of virion morphogenesis. For example, deletion of glycoproteins gE, gI, and gM inhibits the virion maturation. Pseudorabies glycoprotein gK is a virion structural component involved in virus release from the cell but not viral entry, and its presence is important to prevent immediate reinfection. Viremia occurs with localization of the virus in many viscera, but with multiplication occurring primarily in the upper respiratory tract. Viral and cell interactions have been described in detail.<sup>9</sup> Spread to the brain occurs by way of the olfactory, glossopharyngeal, or trigeminal nerves, i.e., via the autonomic nerves. It can pass across synapses and infect higher level neurons.<sup>10</sup> Cells with the common leukocyte antigen CD45+ populate the CNS-infected areas from the local capillaries, and the number of cells is increased in proportion to the number of infected neurons. Virus disappears from the brain by the eighth day, coinciding with the appearance of neutralizing antibody in the blood. When the virus gains entry through a skin abrasion, it quickly invades the local peripheral nerves, passing along them centripetally and causing damage to nerve cells. It is this form of progression that causes local pruritus in the early stages of the disease, and encephalomyelitis at a later stage when the virus has invaded the CNS. In pigs, pruritus does not develop after intramuscular injection, but a local paralysis indicative of damage to low motor neurons occurs before invasion of the CNS in some pigs. In cattle, pruritus of the head and neck is usually associated with respiratory tract infection, whereas perianal pruritus is usually caused by vaginal infection.

The inoculation of PRV into the nasal cavities or brain results in signs of encephalitis instead of local pruritus. With oral inoculation, there is an initial stage of viral proliferation in the tonsillar mucosa, followed by systemic invasion, localization, and invasion of the CNS along peripheral and autonomic nerve trunks and fibers. Lesions of Auerbach's myenteric plexus and the skin may also occur. The peripheral blood mononuclear cells, tonsils, lymph nodes, and bone marrow are a poor source of virus after

experimental infection. The trigeminal ganglia and olfactory bulb are good sources of virus. The virus may be present in the trigeminal ganglion of a naturally infected sow without any history of clinical disease. Experimental inoculation of the virus into young pigs can result in a mild pneumonia, which may progress to a severe suppurative bronchopneumonia.

The virus can invade the uterus and infect preimplantation embryos, which can lead to degeneration of the embryo and reproductive failure. Virulent PRV virus can cause lesions in the uterine endothelium and ovarian corpora lutea of pigs in early pregnancy, and gene-deleted mutant virus vaccine given intravenously during estrus can cause ovarian lesions, which may affect fertility. Through the use of embryo transfer procedures, infected embryos may disseminate the virus from donors to recipients.

In other species the virus tends to be restricted to the nervous system.

## CLINICAL FINDINGS

### Pigs

The incubation period in natural outbreaks is about 1 day but may be from 1 to 8 days. The major signs are referable to infection of the respiratory, nervous, and reproductive systems. There is considerable variation in the clinical manifestation, depending on the virulence and tropism of the infecting strain. Nervous system disease is the major manifestation, but with some strains, respiratory disease may be the initial and prime presenting feature. There is also strain variation in the pattern of age susceptibility.

Young pigs a few days to a month old are most susceptible. Very young sucklings develop an indistinct syndrome, but prominent nervous signs occur in older piglets. A febrile reaction, with temperatures up to 41.5°C (107°F), occurs before the onset of nervous signs. Incoordination of the hindlimbs causing sideways progression is followed by recumbency, fine and coarse muscle tremors, and paddling movements. Lateral deviation of the head, frothing at the mouth, nystagmus, slight ocular discharge, and convulsive episodes appear in a few animals. A snoring respiration with marked abdominal movement occurs in many, and vomiting and diarrhea in some affected pigs. Deaths occur about 12 hours after the first signs appear. In California, a consistent sign has been blindness caused by extensive retinal degeneration.

In growing and adult pigs, the disease is much less severe but there is considerable variation depending on the virulence of the infecting strain. In growing pigs, mortality falls with increasing age and is generally less than 5% in pigs at 4 to 6 months of age. With some strains, fever is a prominent sign, whereas depression, vomiting, and sometimes marked respiratory signs, including sneezing, nasal discharge, coughing, and

severe dyspnea are common. Trembling, incoordination, and paralysis and convulsions follow, and precede death. With others, the disease may be manifested at this age by mild signs of posterior incoordination and leg weakness. In adults, fever may not be present, and the infection may cause only a mild syndrome of anorexia, dullness, agalactia, and constipation. However, virulent strains may produce acute disease in adults, characterized by fever, sneezing, nasal pruritus, vomiting, incoordination and convulsions, and death. Infection in early pregnancy may result in embryonic death, or abortion, and early return to estrus. An abundant vaginal discharge may occur. Infection in late pregnancy may result in abortion, or in the subsequent birth of mummified fetuses, which may involve all or only part of the litter. Abortion may result from the effects of fever or from viral infection of the fetus.

Concurrent infection has been described with PCV2, and PRRS and swine influenza virus, and in these cases the resultant disease is more likely to be a severe proliferative and necrotizing pneumonia.<sup>11</sup>

### Cattle, Sheep, and Goats

There may be sudden death without obvious signs of illness. More commonly, there is intense, local pruritus with violent licking, chewing, and rubbing of a particular body part. Itching may be localized to any part of the body surface, but is most common about the head, the flanks, or the feet, which are the sites most likely to be contaminated by virus. There is intense excitement during this stage, and convulsions and constant bellowing may occur. Maniacal behavior, circling, spasm of the diaphragm, and opisthotonus are often evident. A stage of paralysis follows in which salivation, respiratory distress, and ataxia occur. The temperature is usually increased, sometimes to as high as 41°C to 41°C (106°F–107°F). Final paralysis is followed by death in 6 to 48 hours after the first appearance of illness. A case of nonfatal PRV in a cow is recorded. There is also a report of PRV occurring in feedlot cattle in which there were nervous signs, bloat, and acute death, but no pruritus. In young calves, it is characterized clinically by encephalitis, no pruritus, erosion in the oral cavity and esophagus, and a high case-fatality rate. An outbreak in sheep was associated with skin abrasions acquired at shearing. Affected ewes were dull, inappetent, and had a fever of 41.1°C. About 23 of 29 affected sheep developed the "mad itch," with nibbling of their fleece and frenzied attempts to bite one area of the skin and rub it against the wall and bars of their pen. Terminally, recumbency, tremors, and opisthotonus were common, and death occurred within 12 to 24 hours after onset. Five farm cats also became ill and died; the virus was isolated from the brain of one cat. In goats, rapid deaths, unrest, lying down and rising frequently, crying plaintively,

profuse sweating, and spasms and paralysis terminally are characteristic. There may be no pruritus.

The clinical findings in dogs and cats are similar to those in cattle, with death occurring in about 24 hours. In France, cases in dogs have been linked to strains of virus from wild boars.

## CLINICAL PATHOLOGY

### Serology

The commonly used serologic tests for PRV-specific antibodies are the serum neutralization (SN) and ELISA tests.

### Serum Neutralization Test

The SN test using the Shoppe strain has been the gold standard against which other serologic tests are compared and has been most widely used because of its sensitivity and specificity. Specific virus-neutralizing (VN) antibodies are detectable in the serum of recovered pigs, and this test is in routine use for herd diagnosis and survey purposes. Antibody is detectable on the seventh day after infection, reaches a peak about the 35th day, and persists for many months. Paired serum samples taken as early as possible, and about 3 weeks later, show a marked antibody rise. However, the SN test lacks the sensitivity necessary for detection of pigs with low levels of humoral titers of specific SN antibodies, which can be enhanced by using the Bartha gIII strain.

Some herds may have no serologic evidence of previous infection or current spread of the virus but have single reactors in the herd that may be infected with the virus. Such singleton reactors may be found in herds being monitored serologically for presence of infection. These singleton reactors may be infected with strains of the virus that are relatively avirulent.

### Enzyme-Linked Immunosorbent Assay

The ELISA test is more sensitive than the SN test, especially early in the immune response to PRV antigens. However, because of its high sensitivity, screening ELISAs yield some false positives, which must be confirmed by another test, such as another ELISA, SN test, or latex agglutination test. False positives are unlikely to be caused by infection with other herpesviruses. ELISA has also been used as a meat juice test with high sensitivity (93%) and specificity (98%).

The indirect ELISA is a more rapid and convenient procedure, offering many advantages over the SN test for routine serodiagnostic work. An indirect ELISA, using whole blood collected onto paper disks, is a rapid and convenient test and eliminates the costs of using vacutainer tubes and separating the blood. An indirect ELISA based on recombinant and affinity-purified glycoprotein E of PRV to differentiate vaccinated from naturally infected animals has been developed. An indirect ELISA has been developed in the

Czech Republic that can be used because of its high sensitivity and specificity for blood serum on frozen pork samples. It has allowed the demonstration of PRV in meat juice with only marginal titers in the blood.

Commercial ELISA kits are available and some are more specific than others. A highly sensitive and specific competitive ELISA based on baculovirus-expressed PRV glycoprotein gE and gI complex has been described. This allows detection as early as 2 weeks postinfection and can handle large numbers of tests without the need to handle live virus.

In countries where vaccination is regularly used for control of the disease, an assay to serologically distinguish infected from vaccinated pigs is critical. Although a vaccination program will reduce the circulation of virus in the field, it will not eliminate the virus from the pig population. To eradicate the virus, the ability to differentiate infected from vaccinated pigs is crucial. Several commercial ELISA kits can differentiate between vaccinated and naturally infected pigs. Differentiation is possible when vaccine virus strains have either a natural, or a genetically engineered, deletion that encodes for either gI, gIII, or gX genes. Commercial ELISA kits that specifically detect antibody responses to gI of the virus offer considerable advantages as diagnostic tests for the virus, with a sensitivity of 99.2% and specificity of 100%. The gI ELISA is able to distinguish infected pigs from those vaccinated with gI-negative vaccines. The field strains of the virus produce antibodies to gI when inoculated into pigs. Unvaccinated pigs, or pigs vaccinated with gI-negative vaccines, that become subclinically infected with field strains of the virus may be detected with the gI-ELISA for a long time after infection. Thus pigs that are seropositive in the gI-ELISA have either been infected with PRV or have been vaccinated with gI-positive vaccines; gI-seronegative pigs can be considered to be uninfected. Eradication of the virus from swine herds is possible by gI-ELISA testing, and culling gI-seropositive pigs in herds using gI-negative vaccines.

Detection of pigs in the latent phase of infection can be done serologically. Pigs of any age that survive the acute infection phase become latent carriers for life, and serologic testing consistently detects animals in the latent phase of infection if the test detects the antibody response to the whole virus or to a reliable PRV glycoprotein. Of several serologic tests examined, the gI and gIII marker systems, which performed with similar sensitivity as the screening tests, were superior to the gX marker system in detecting antibodies in infected pigs.

### Detection of Virus

In infected pigs the virus is usually present in nasal secretions for up to 10 days. A common method for the diagnosis of PRV in

sows is to take swabs from the nasal mucosa and vagina. Polyester and wire swabs shipped in 199 tissue culture medium supplemented with 2% fetal bovine serum (FBS) buffered with 0.1% sodium bicarbonate and HEPES will yield optimum recovery of the virus. Wooden applicator sticks with cotton wool have antiviral activity and recovery of the virus may not be possible after 2 days, which is of practical importance if the samples are shipped by mail. The virus can be demonstrated in nasal cells by immunofluorescence and immunoperoxidase techniques. It can be detected by direct filter hybridization of nasal and tonsillar specimens from live pigs. The virus survives on tonsil swabs taken with Dacron-tipped applicators for up to 72 hours in cell culture medium under transport.

New PCR techniques have been used and they can differentiate between true and false serologic positives when single reactor pigs have been found. A molecular beacon RT-PCR for the detection of PRV, African swine fever (ASF), PCV2, and Porcine Parvovirus has been described<sup>12</sup> and for the detection of PRV, ASF, and PRRS.<sup>13</sup> A multiplex PCR for PRV, porcine respiratory coronavirus, and PCV2 has been described.<sup>14</sup>

Loop-mediated isothermal amplification (LAMP) for rapid detection and differentiation of wild-type PRV and gene-deleted virus vaccines was described.<sup>15</sup>

## NECROPSY FINDINGS

There are no gross lesions typical and constant for the disease, and in some cases lesions are absent or minimal and diagnosis must rely on laboratory examination. When pruritus has occurred, there is considerable damage to local areas of skin and extensive subcutaneous edema.

Gross lesions in the upper respiratory tract are the most obvious and these include necrotic rhinitis, conjunctivitis, laryngitis, and tracheitis. The lungs show congestion, edema, and some hemorrhages. Hemorrhages may be present under the endocardium and excess fluid is often present in the pericardial sac. In pigs, there are additional lesions of visceral involvement. Slight splenomegaly, meningitis, and excess pericardial fluid are observed, and there may be small necrotic foci in the spleen and liver. In sows, there may be a necrotizing placentitis and endometritis. Foci of hepatic, splenic, or pulmonary necrosis may be seen in aborted fetuses.

Histologically, in all species, there is severe and extensive neuronal damage in the spinal cord, paravertebral ganglia, and brain. Perivascular cuffing and focal necrosis are present in the gray matter, particularly in the cerebellar cortex. Intranuclear inclusion bodies occur infrequently in the degenerating neurons and astroglial cells, particularly in cerebral cortex in the pig. These inclusions are of considerable importance in differential diagnosis. Necrotizing lesions with

inclusion-body formation in the upper respiratory tract and lungs is strongly suggestive of porcine pseudorabies. Ultrastructural observations have been made that included syncytia, cellular debris and macrophages, and lymphocytes with vacuoles in their cytoplasm. Virus may be detected by direct fluorescent antibody examination or by growth in tissue culture. The tissues of the head and neck regions of nonimmune pigs yield virus most consistently and in the highest concentration after challenge. The immunoperoxidase test can be used to study the distribution of the virus in different tissues. Latent virus can be detected using a DNA hybridization dot blot assay. Whenever possible, whole carcasses and fetuses should be submitted for laboratory examination. The location of the optimal neural samples, including the paravertebral ganglia, has been described for sheep. The placental lesions in pregnant sows that have aborted from natural infection with pseudorabies consist of necrotizing placentitis and the presence of intranuclear inclusions. In an experimental infection of loops of intestine it was shown that there was necrosis of the follicles in the Peyer's patches and degeneration of the epithelial cells in the crypts and villi and degeneration of the cells in the myenteric plexuses. Intranuclear inclusion bodies were found 2 to 4 days after inoculation. The primary target of the wild PRV was the macrophages of the subepithelial area of the dome of the Peyer's patch.

### Samples for Confirmation of Diagnosis

- **Histology:** half of midsagittally sectioned brain, spinal cord with paravertebral ganglia, gasserian ganglion, placenta, liver, lung, spleen, tonsil, and retropharyngeal lymph node (LM) should be collected. IHC has been used to confirm cases in countries where the disease is rare and other corroborating evidence is lacking. In situ hybridization has also been used. Can also collect muscle samples for meat juice ELISAs.
- **Virology:** brain, spinal cord, liver, spleen, tonsil, retropharyngeal lymph node (FAT, ISO). CSF is not good for virus isolation. The best source is the trigeminal ganglion in the domestic pig and the sacral ganglia in feral pigs. Viral isolation takes about 2 to 5 days. There are several PCRs available<sup>5</sup> and also nested PCRs and RT-PCRs.<sup>16,17</sup>

### DIFFERENTIAL DIAGNOSIS

The different clinical forms of pseudorabies in pigs and ruminants resemble several diseases.

Teschen disease occurs in similar forms in certain areas; the diagnosis is dependent on serology and pathology.

Rabies is rare in pigs and is usually accompanied by pruritus at the site of the bite.

Streptococcal meningitis is restricted to sucking pigs of 2–6 weeks of age, the lesions are usually obvious at necropsy, and the causative organism is readily cultured from the meninges. The response to treatment with penicillin is good and is of value as a diagnostic test.

Encephalopathy associated with hog cholera, African swine fever, salmonellosis, Glasser's disease, *Escherichia coli* septicemia and erysipelas are considerations, and are usually obvious at necropsy.

Bowel edema causes typical edema of the head and eyelids in weaner pigs as well as a rapid death.

Salt poisoning causes typical intermittent nervous signs, with a typical history of water deprivation.

Respiratory form of pseudorabies should be considered in any outbreak of respiratory disease that is poorly responsive to usually effective therapeutic measures.

Reproductive inefficiency associated with enterovirus (SMEDI) and parvovirus infections closely resembles that associated with pseudorabies and requires laboratory differentiation by virus isolation and serologic testing.

In cattle the local pruritus is distinctive, but the disease may be confused with the nervous form of acetoneemia in which paresthesia may lead to excitement. The rapid recovery that ordinarily occurs in this form of acetoneemia is an important diagnostic point. The furious form of rabies and acute lead poisoning cause signs of mania, but pruritus does not occur.

SMEDI, stillbirth, mummification, embryonic death, and infertility.

### TREATMENT

There is no treatment.

### CONTROL

The control of pseudorabies is difficult and currently unreliable because normal healthy pigs may be infected and shed the virus for up to several months. One of the most important future concerns is the infection in wild boar<sup>18</sup> and their illegal transportation across countries.<sup>19</sup>

An important principle in control and eradication of the disease is the reproduction ratio,  $R_0$ , which is defined as the average number of new infections caused by one typical infectious animal. When  $R_0 > 1$ , the infection can spread; when  $R_0 < 1$ , the infection will disappear. In eradication programs it is essential that  $R$  be less than 1 and the infection will die out in the herd.

### Strategies Available

The methods of control or eradication include depopulation and repopulation, test and removal, segregation of progeny, and

vaccination. The selection of a strategy for the control or elimination of the disease depends on the following: (1) source of the herd infection; (2) method of transmission of the virus; (3) survival of the virus in the environment; (4) sensitivity and specificity of the diagnostic test; (5) risk factors in the herd, which include type of operation, degree of herd isolation, prevalence of infection, value of the genetic material, level of management expertise, and availability of suitable virus-free replacement swine if depopulation and repopulation is chosen as a strategy.

The eradication of the disease from small herds was described in Hungary. In this country the shared use of boars, the pig density, and the infection in the surrounding area were the most significant influences on the spread and control of the disease.

Breeding stock producers favor eradication, farrow–finish producers that do not sell breeding stock or feeder pigs are generally more concerned with the reduction of losses from clinical PRV infection than with eradication. In the United States offsite all in/all out finishing was more frequent among the successful farms than the unsuccessful ones. The unsuccessful farms also had other infected herds within 3.2 km (2 miles) and often no cleaning or disinfection.

### Economics of Control and Eradication

Depopulation–repopulation is the most expensive form of eradication, the segregation of progeny method the is next expensive, and the test and removal method is the most inexpensive per sow. A computerized decision-tree analysis and simulation modeling can evaluate the economics of control and eradication strategies. The optimal alternative is to test and remove seropositive animals if the initial prevalence is ~57%; otherwise vaccination of sows only is preferred. Vaccination may be recommended at lower prevalence rates as a conservative approach. Eradication by test and removal combined with the use of gene-deleted vaccines is advantageous at any prevalence rate of infection. Depopulation and repopulation is not the best option under any circumstances. Once formulated, a decision-tree analysis can be adapted to the prevailing economic or epidemiologic conditions.

### Determination of Prevalence of Infection

In large herds, the virus must be eliminated from the growing–finishing pigs and the breeding herd. Large herds that are virus positive are infected in both groups; smaller herds are frequently infected in only the breeding herd. An initial step in eradication is to determine the prevalence of infection. Representative samples of finishing pigs older than 4 months, and of breeding sows, gilts, and boars are tested. On the basis of the test results and the risk factors in the herd, a



cost-effective plan can be devised for the individual herd.

### Depopulation and Repopulation

When the prevalence of infection in the herd is over 50%, eradication can be achieved by depopulation and repopulation with virus-free breeding stock. However, depopulation is the most expensive method and is not compatible with the retention of valuable pedigree stock. The entire herd is depopulated over a period of months as the animals reach market weight. After removal of the animals the entire premises are cleaned and disinfected. Repopulation should be delayed at least 30 days after the final disinfection, and swine should originate from a pseudorabies-free qualified herd and be isolated on the premises and retested 30 days after introduction. All herd additions should be isolated and tested 30 days after introduction.

### Test and Removal

The test and removal program is recommended when the prevalence of infection in the herd is below 50%. This method requires testing of the entire breeding herd and immediate removal of all seropositive animals; 30 days after removal of seropositive animals, the herd is retested, and if necessary at 30-day intervals, until the entire herd tests are negative. Following a second negative test, the testing regimen may be changed to test only 25% of the herd every 4 months. Seropositive animals are identified and culled. The test and removal method is superior to the vaccination system as a method of control. Valuable genetic material from breeding stock that is seropositive may be salvaged using embryo transfer techniques. Embryos may be transferred safely to susceptible recipient gilts from sows that have recovered from infection, but not from sows that are in the active stages of infection. The virus does not penetrate the outer covering of the embryo, but it can become attached to it so that it may physically transfer to the uterus of the recipient. This transfer of infection may occur if the donor sow is in the active phase of infection.

### Offspring Segregation

The objective of this strategy is to raise a PRV-negative breeding herd to replace the infected herd. Once the herd is diagnosed as PRV infected, a regular schedule of vaccination is instituted. Gilts are vaccinated at first breeding, and both sows and gilts are vaccinated 2 to 4 weeks before farrowing to provide a high level of colostral immunity to their piglets. Offspring are removed at weaning and raised apart from the infected herd. At 4 months of age, and then again before breeding, the segregated replacements are tested for antibody. Because colostral immunity is no longer detectable by 4 months of age, any animals over 4 months of

age that are seropositive are considered pseudorabies infected. As the gilts reach reproductive maturity, the old sow herd is replaced. Segregation between the infected sow herd and the clean gilt herd is maintained until all positive sows have been removed and the facilities disinfected. Groups of seronegative pigs are identified and combined into larger groups to establish a new herd. The original herd is gradually depopulated and the premises cleaned and disinfected. The new herd is then monitored on a regular basis.

### Control Programs in Effect

PRV was first diagnosed in the North Island of New Zealand in 1976, an eradication program was started in 1989, and the virus was cleared from the North Island in 1997.

A pseudorabies control program was introduced in England in 1983 when the infection was spreading rapidly. New legislation imposed restrictions on the movement of pigs where clinical signs of the disease were present in the herd. The first part of the eradication scheme involved testing all of those herds previously known to have PRV. Within several months after the beginning of the eradication campaign, 417 herds had been slaughtered, involving 342,275 pigs, of which 72.5% were salvaged. Only 121 herds had been known to be previously infected, while the remaining 296 herds had been identified through trace backs and reports of new cases. By 1985 it was concluded that the disease was well controlled in England with only 10 to 14 infected herds remaining. Farmers were compensated for all animals slaughtered and also for consequential loss associated with the loss of stock. The cost of the eradication program was financed by a levy on all pigs normally marketed for slaughter in England. In 1995 England was free of Aujeszky's disease. Following the successful use of the gene-deletion vaccination and an eradication program the Netherlands and Germany are free of the disease. In Sweden the herds were declared free from 12 to 53 months after the start of the program. Now, in Northern Ireland, PRV is more widespread than it ever was in Britain before the eradication program. Because the infection rate is over 50%, an eradication program based on slaughter of infected herds would destroy the swine industry. Thus the control program in Northern Ireland is based on the use of vaccination, the culling of seropositive animals, and the gradual introduction of seronegative animals.

In the United States the national pseudorabies eradication program was implemented in 1989 as a joint State-Federal-Industry-sponsored program. Pilot projects were conducted in Iowa, Illinois, Pennsylvania, Wisconsin, and North Carolina from 1984 to 1987. In the pilot projects, 97.5% of 116 herds that were initially PRV positive were successfully cleared of infection. This indicated that eradication of PRV virus from

herds of swine can be efficiently achieved and is most effective applied on an area basis. The introduction of the gene-deleted PRV vaccines in the program was the technical breakthrough needed to be able to offer the national eradication program, since it was now possible to distinguish between naturally infected and vaccinated animals. The program consisted of the following: stage I, preparation; stage II, control; stage III, mandatory herd clean-up; stage IV, surveillance; and stage V, free. As of 2004, commercial swine operations in all 50 states of the US were considered free of PRV; however, endemic infection exists in feral pigs in a number of states. Endemic PRV infection remains a concern for commercial herds.

When an outbreak of the disease occurs in a susceptible herd the mortality may be very high, and the first consideration is to prevent spread to uninfected sows and litters and pregnant sows from infected pigs. They should be attended by separate personnel, or adequate barriers to mechanical transmission of infection should be arranged. On affected premises, cattle should be separated from pigs, and dogs and cats should be kept from the area. The affected herd should be quarantined, and all pigs sold off the farm should be for slaughter only.

### Vaccines and Vaccination

Vaccination is used to reduce clinical disease when outbreaks occur or when the disease is endemic in the herd. An effective immunity develops after natural infection or vaccination, and piglets from immune sows are protected from clinical disease during the nursing period by colostral immunity. However, the presence of circulating antibody does not prevent infection, the development of latency, and subsequent activation and excretion of the virus. However, vaccination reduces viral shedding after natural infection. On farms in which the disease is endemic or outbreaks have occurred, vaccination of the sows, and management procedures to reduce the spread of infection, have markedly reduced preweaning mortality and reproductive failures. Field studies in large numbers of herds in which the sows were vaccinated three times annually show that the reproduction ratio was below 0.66, which is significantly below,<sup>1</sup> and massive spread of the virus does not occur.

It is often virtually impossible to prevent the spread of infection in a susceptible herd and vaccination of all pigs at risk, especially pregnant sows, is recommended. The vaccine reduces losses in infected herds, limits the spread of infection, and decreases the incidence in endemic areas. With a properly controlled and monitored vaccination and culling program in a breeding herd, it is possible to control clinical disease and reduce the infection pressure. All breeding stock present during an outbreak are subsequently vaccinated regularly until they are all culled,

which removes the major sources of virulent virus. Following this phase, newly introduced gilts and boars are tested, and monitored regularly. This is considered to be less costly than the test and slaughter policy.

However, in vaccinated herds, the virus continues to circulate and an accurate epidemiologic analysis is not possible because titers caused by vaccination cannot be distinguished from those caused by natural infections.

Control of the diseases in many countries has always been based on compulsory intensive vaccination of the entire population.

### Vaccines

Conventional modified live virus and inactivated virus vaccines have been available. Both vaccines will reduce the incidence rate and severity of clinical disease in an infected herd. They also reduce the field virus shedding and latency in the trigeminal ganglion after exposure to field virus. The vaccine efficiency is, however, markedly influenced by the modified live virus vaccine strain and the route of administration. The vaccine genotype plays a very important role in the effectiveness of the vaccine program. Recently needle-free transdermal vaccination using a modified live PRV vaccine has been described, preventing the loss of any needles in the carcass. Cell-mediated immunity in the form of cytotoxic T cells may play an important part in the effectiveness of the vaccine. The deficiencies of inactivated vaccines in producing virus-specific interferon- $\gamma$  (IFN- $\gamma$ ) can be enhanced by the use of simultaneous administration of interleukin-12, which appears to upregulate Th1/Th2 expression.

### Pregnant Sows

Vaccination of pregnant sows induces SN antibodies, which are transferred to the newborn piglets and provide protection against infection. Vaccination during pregnancy produces more protection against PRV for piglets than sow vaccination before mating. A better protection was observed in sows vaccinated with an attenuated virus than in sows vaccinated with inactivated virus. Piglets rely on colostrum and milk antibodies for protection, and the vaccination of piglets born from vaccinated sows does not produce a significant serologic response until the piglets are about 12 weeks of age. Maternally derived antibodies may disturb or even block the development of active humoral responses.<sup>20</sup> Earlier vaccination of piglets from infected or vaccinated sows is ineffective because high levels of maternal antibodies interfere with a serologic response stimulated by the vaccine. Maternal immunity interferes with the development of active immunity from vaccination until at least 15 weeks of age, even when the colostrum titers are low. Thus in a situation in which the majority of sows have been infected or

vaccinated, vaccination of weaned pigs may not yield desirable results. Both inactivated virus and attenuated live virus vaccines provide similar results when piglets born from vaccinated sows are vaccinated before colostrum immunity has waned.

### Growing and Finishing Pigs

The optimal vaccination strategy for growing and finishing pigs in an eradication program is controversial. In eight persistently infected herds' vaccinations, both intranasally and intramuscularly, were made at 4 and 10 weeks of age. Only one vaccination is given to finishing pigs in endemic areas in Europe. However, this does not reduce the prevalence of infection in finishing pigs in herds with a high prevalence. Double vaccination of finishing pigs will reduce the spread of the virus, but extensive spread can still occur. The presence of maternal antibodies may interfere with the induction of antibodies, and double vaccination 4 weeks later may boost immunity. Mean daily weight gain was also improved by a second vaccination with a direct economic benefit.

### Marker or Subunit Vaccines

A major development in vaccination against pseudorabies has been the introduction of genetically engineered live vaccine strains used to make marker or subunit vaccines. Vaccination with modified live gene-deleted vaccines is now an integral part of pseudorabies eradication programs worldwide. The most common gene deletions are for glycoproteins E (gE) or gI and G (gG) or gX, and gIII. A gD/gE-negative vaccine was described. In Europe, use of gE vaccines has become the standard. These vaccines, in conjunction with a companion diagnostic test, can distinguish between naturally infected and vaccinated animals. Colostrum can also be used to monitor antibodies against gI protein of the virus.

A study comparing intranasal and intramuscular vaccination showed that pigs given both vaccines (intranasally and intramuscularly) had a significantly better clinical and virologic protection after challenge than the single intranasal vaccination. The recombinant vaccines are able to circumvent the inhibition of active immunity that occurs when maternally derived antibody is still present. Animals vaccinated with a deleted vaccine are not able to mount an immune response against the protein whose gene has been deleted in the vaccine virus genome. In contrast, wild-type virus-infected animals produce antibodies against all the viral glycoproteins. Differentiating ELISAs, specific for the deleted marker protein, then allow discrimination between infected animals, which can be culled from the herd, and vaccinated animals. These vaccines reduce the severity of clinical disease and viral shedding. However, the presence of colostrum antibodies in growing pigs may interfere with an

immune response, which may result in increased virus excretion on challenge exposure. Repeated vaccination is needed to provide some protective immunity against challenge exposure to virulent virus.

These mutants have also been rendered thymidine kinase-deficient (TK-) mutants, and are avirulent and immunogenic. Pigs inoculated with these mutants are resistant to experimental challenge with the virulent virus, and the virulent virus cannot be recovered from the ganglia, which suggests that vaccination reduced colonization of the ganglia. The ideal vaccine strain should prevent clinical disease and mortality, should not be transmitted to nonimmunized animals, and should prevent colonization of the ganglia by a potential superinfecting virulent virus reducing the natural reservoir of the virus. The TK- mutant virus possesses these desirable characteristics. The high efficacy of recently constructed gI-negative deletion mutant vaccines of PRV virus provide a sound basis for implementing the "gI" approach to the future control of the disease.

Piglets born from sows vaccinated with deleted (gIII, TK) strains at 3 days and 9 and 11 weeks of age developed detectable antibodies that lasted up to 100 days of age when vaccinated. Maternal antibodies in piglets from sows vaccinated with gIII-deleted vaccine decay to undetectable levels at 7 weeks of age. The vaccination of piglets at 3 days of age with the same vaccine results in a priming effect, which protects the piglets against virulent virus challenge at 7 weeks of age. Thus effective protection could be provided by active immunization from birth through weaning, in the nursery, and into the growing and finishing stages of production. Piglet vaccination at 10 and 14 weeks was considered to be the optimal time for vaccination.<sup>21</sup>

Although genetically engineered live virus vaccines have been shown to be efficacious and safe, there is a possibility of spread between vaccinated and unvaccinated animals, of persistence in the field and of recombination between different vaccine strains, which can lead to enhanced virulence. New viral mutants lacking glycoproteins gD, gE, gG, and gI may form the basis for the development of new vaccines that do not recombine. A gB deletion vaccine has been described for intranasal use and has been shown to produce both local and serum antibodies. Recently a DNA vaccine was shown to give as good a response as gD plasmid vaccine, but the DNA vaccine had to be given intradermally. It can overcome maternally derived antibody, and the vaccine described in this case still gave protection against infectious PRV challenge at the end of the finishing period.

Even more radical is a vaccine with a granulocyte-macrophage colony stimulating factor.

Experimentally, immunized pigs can be latently infected with the wild-type virus without being detected by the gE-specific ELISA routinely used to discriminate between infected and vaccinated pigs. Thus gE seronegative pigs may still be infected and be a source of infection.

Remarkable progress has been made with the use of gI-deleted vaccines. Intensive regional vaccination of finishing pigs with a gI-deleted vaccine, along with companion diagnostic tests, reduced the seroprevalence in infected finishing herds from 81% to 19% in 2 years. Vaccination increases the virus dose needed for establishment of infection and decreases the level and duration of virus excretion after infection. In the control group, with routine disease control, no significant change in seroprevalence occurred. The consistent application of intensive vaccination of all breeding herds in a region, including those herds participating in a production chain, can also decrease the prevalence of infection in heavily infected areas. The intensive regional vaccination did not completely eliminate virus infections within these herds; the source of infection was not determined. It is suggested that the virus either circulated at a low level within herds, or its introduction or reactivation did not lead to an extensive spread of the virus. A voluntary vaccination program on individual farms was unsuccessful in reducing the prevalence of virus-infected breeding pigs. The importation of breeding stock from outside the area is associated with a higher prevalence of virus-infected pigs because of lack of vaccination. The introduction of infections can be reduced by purchasing virus-free animals and by increasing farm biosecurity procedures.

Vaccination of breeding herds three times annually to ensure a high level of immunization can lead to elimination of the disease when the reproduction ratio is less than one.

The method used for vaccination may influence the effect of the vaccine. Using glycoprotein vaccines, intramuscular vaccination in the neck, and six-point intradermal vaccination in the back provided the best protection; six-point intradermal injections resulted in a better vaccination than two-point injections. BW changes and viral excretion after challenge were compared with VN titers, antigen-specific IgG and IgA responses in serum, and virus-specific lymphoproliferative responses in peripheral blood during the immunization period.

An intensive eradication program in farrow–finish herds using a gI-deleted vaccine in breeding and growing–finishing pigs, and decreases of movement and mixing of growing–finishing pigs was successful in 3 years. The initial goal was to decrease viral spread in the growing–finishing pigs, which enabled production of seronegative replacement gilts. Increases in the number of sows culled, combined with an increase

in the number of seronegative replacement gilts, resulted in a decrease in seroprevalence of sows. Bimonthly serologic monitoring indicated minimal spread of the virus in the growing–finishing pigs after 1 year. Eighteen months after the initiation of the program, the test and removal of seropositive sows commenced in all herds. All herds were released from quarantine within 3 years, indicating that eradication can be achieved by vaccination and management changes designed to minimize the spread of virus combined with test-and-removal procedures.

An attenuated gI-deleted–TK-deleted vaccine was used to eradicate the virus from a large farrow–finish herd in Sweden. At the start of the program, 86% of the breeding animals were seropositive. The breeding stock was vaccinated every 4 months and monitored serologically. Seropositive sows and boars were culled at an economic rate. The herd was declared gI negative 39 months after the start of the program. Monitoring the herd for another 4 years, until all vaccinated animals had been culled, revealed the herd free of the virus.

In New Zealand, progress toward eradication using a subunit vaccine is reported. Those farms that combined vaccination with good management techniques, intensive testing, and culling eradicated the wild virus infection within 2 years; those that made little or no progress has less than satisfactory standards of hygiene and did not practice an intensive testing and culling program.

Vaccination of both breeding stock and growing pigs is recommended. A combined vaccination–eradication program for the disease would generally comprise four phases:

1. A systematic and intensive vaccination campaign
2. Screening of pigs for gI antibodies
3. Economic culling of infected breeding pigs
4. Final ending of vaccination.

Piglets at 3 days of age can be vaccinated with one of these genetically engineered vaccines and be protected from experimental challenge at 5 weeks of age.

A recent study has shown that infection with PRRS virus does not inhibit the development of a vaccine-induced protection against PRV.

Vaccination of wild boar with an attenuated live vaccine has been shown to protect against infection.<sup>22</sup>

Vaccination of cattle with an inactivated vaccine is recommended where they are in close contact with swine and where a low level of exposure is likely.

## REFERENCES

1. Davison AJ. *Vet Microbiol.* 2010;143:52.
2. Hahn EC, et al. *Vet Microbiol.* 2010;143:45.
3. Lipowski A, et al. *Medycyna Wet.* 2009;85:771.
4. Muller T, et al. *Epidemiol Infect.* 2010;12:1.
5. Muller T, et al. *Arch Virol.* 2011;156:1691.
6. Toma B. *Epidemiol Sante Anim.* 2013;63:141.
7. Smith G. *Prev Vet Med.* 2012;103:145.
8. Glorieux S, et al. *Vet Microbiol.* 2009;136:141.
9. Nauwynck H, et al. *Vet Res.* 2007;38:229.
10. Pomeranz L, et al. *Microbiol Mol Biol Rev.* 2006;69:462.
11. Morandi F, et al. *J Comp Pathol.* 2010;142:74.
12. McKillen J, et al. *J Virol Methods.* 2007;140:155.
13. Sami L, et al. *Acta Vet Hung.* 2007;55:267.
14. Lee C-S, et al. *J Virol Methods.* 2007;139:39.
15. Zhang C-F, et al. *J Virol Methods.* 2010;169:239.
16. Tombacz D, et al. *BMC Genomics.* 2009;10:491.
17. Ma WJ, et al. *J Vet Diagn Invest.* 2008;20:440.
18. Boadella M, et al. *BMC Vet Res.* 2012;8:7.
19. Wilson S, et al. *J Wildl Dis.* 2009;45:874.
20. Pomorska-Mol M, et al. *Vet Microbiol.* 2010;144:450.
21. Markowska-Daniel I, et al. *Bull Vet Inst Pulawy.* 2009;53:169.
22. Maresch C, et al. *Vet Microbiol.* 2013;161:20.

## SPORADIC BOVINE ENCEPHALOMYELITIS (BUSS DISEASE AND TRANSMISSIBLE SEROSITIS)

Sporadic bovine encephalomyelitis (SBE) is associated with a chlamydia, and characterized by inflammation of vascular endothelium and mesenchymal tissue. There is secondary involvement of the nervous system, with nervous signs, in some cases.

### ETIOLOGY

The disease is associated with specific strains of *Chlamydia* (*Chlamydia*) *pecorum*.<sup>1,2</sup> It resists freezing but is highly susceptible to sodium hydroxide, cresol, and quaternary ammonium compounds in standard concentrations. The chlamydia can be passaged in guinea pigs and hamsters and adapted to grow in the yolk sac of developing chick embryos.

### EPIDEMIOLOGY

#### Occurrence

The disease has been reported only from the United States, Europe, Japan, Israel, and Australia,<sup>3</sup> but a provisional diagnosis has been made in Canada and South Africa. In the United States it was most common in the midwestern and western States, but there have been no reports of its occurrence for the last 30 years.

Sporadic cases or outbreaks occur in individual herds. Although the disease has not reached serious economic proportions in the endemic infection, there is some serologic evidence that widespread subclinical infections occur.

Only cattle and buffalo are affected, and calves less than 6 months of age are most susceptible. Other domestic and experimental species appear to be resistant. There is no seasonal incidence and cases appear at any time of the year. A strong and apparently persistent immunity develops after an attack of the disease.



## Prevalence of Infection

### Morbidity and Case–Fatality Rates

The occurrence is sporadic, but outbreaks have occurred resulting in severe loss from both deaths of animals and loss of condition. Morbidity rates average 12.5% (5–50%) and are highest in calves (25%) and lowest in animals over a year old (5%). Mortality rates average about 31% and are higher in adults than in calves. In affected herds a stage of herd immunity is reached when only introduced animals and newborn calves are susceptible.

### Method of Transmission

The method of spread is not known but is suspected to be fecal–oral.<sup>1</sup> Spread from farm to farm does not occur readily. On some farms only sporadic cases may occur, but on others one or two cases occur every year. In still other herds the disease occurs in outbreak form, with a number of animals becoming affected within a period of about 4 weeks. The epidemiology of SBE resembles in many ways that of malignant catarrhal fever in cattle. The organism can be isolated from many organs, including liver, spleen, and CNS, and from the blood, feces, urine, nasal discharges, and milk in the early stages of the disease. There is some evidence that the organism is eliminated in the feces for several weeks after infection.

## PATHOGENESIS

The causative agent is not specifically neurotropic and attacks principally the mesenchymal tissues and the endothelial lining of the vascular system, with particular involvement of the serous membranes. Encephalomyelitis occurs secondarily to the vascular damage. Neurologic signs may be caused by infection with specific strains; *C. pecorum* genotype ST 23 has been associated with SBE cases from Australia, England, and the United States,<sup>1</sup> whereas other strains have been isolated from cattle with pneumonia and polyarthritis<sup>2</sup> and calves with poor weight gain.<sup>3</sup>

## CLINICAL FINDINGS

Affected calves are depressed and inactive, but the appetite may be unaffected for several days. Nasal discharge and salivation with drooling are frequently observed. A **fever is common** (40.5°C–41.5°C, 105°F–107°F), and remains high for the course of the disease. Dyspnea, coughing, a mild catarrhal nasal discharge, and diarrhea may occur. During the ensuing 2 weeks, difficulty in walking and lack of desire to stand may appear. Stiffness with knuckling at the fetlocks is evident at first, followed by staggering, circling, and falling. Opisthotonus may occur but there is no excitement or head-pressing. The course of the disease varies between 3 days and 3 weeks. Animals that recover show marked loss of condition and are slow to regain the lost weight.

## CLINICAL PATHOLOGY

### Hematology

In experimental cases, leukopenia occurs in the acute clinical stage. There is a relative lymphocytosis and depression of polymorphonuclear cells.

### Detection of Agent

The causative agent can be isolated from the blood in the early clinical phase, and can be used for transmission experiments in calves and guinea pigs, and for culture in eggs. Elementary bodies are present in the guinea pig tissues and yolk-sac preparations.

### Serology

Serologic methods, including a complement fixation test for the detection of circulating antibody, are available although there is difficulty in differentiating antibodies to the chlamydia from those to the typical psittacosis virus.

## NECROPSY FINDINGS

A fibrinous peritonitis, pleurisy, and pericarditis, accompanied by congestion and petechiation, are characteristic. In the early stages, thin serous fluid is present in the cavities, but in the later stages this has progressed to a thin fibrinous net covering the affected organs, or even to flattened plaques or irregularly shaped masses of fibrin lying free in the cavity. Histologically, there is fibrinous serositis involving the serosa of the peritoneal, pleural, and pericardial cavities. A diffuse encephalomyelitis involving particularly the medulla and cerebellum, and a meningitis in the same area, are also present. Minute elementary bodies are present in infected tissues and in very small numbers in exudate. The necropsy findings are diagnostic for SBE, and confirmation can be obtained by the complement fixation test or SN tests.

## DIFFERENTIAL DIAGNOSIS

Clinically, the disease resembles other encephalitides of cattle. The epidemiology and pathogenesis resembles malignant catarrhal fever in cattle, but the mortality rate is much lower, there are no ocular or mucosal lesions, and the serositis of SBE does not occur in bovine malignant catarrh. A viral encephalomyelitis of calves (Kunjin virus) has been identified, but has not been associated with clinical signs of disease of the nervous system. An encephalomyocarditis virus, a primary infection of rodents that also occurs in primates and causes myocarditis in pigs, has been transmitted experimentally to calves but without causing significant signs of disease.

**Listeriosis** is usually sporadic and is accompanied by more localizing signs, especially facial paralysis and circling.

**Rabies** may present a very similar clinical picture, but the initial febrile reaction and the characteristic necropsy findings as well as the

epizootiologic history of SBE should enable a diagnosis to be made.

**Lead poisoning** can be differentiated by the absence of fever, the more severe signs of motor irritation, and the shorter course of the disease. Because of the respiratory tract involvement, SBE may be easily confused with pneumonic pasteurellosis, especially if outbreaks occur, but in the latter disease nervous signs are unusual and the response to treatment is good.

SBE, *sporadic bovine encephalomyelitis*.

## TREATMENT

Broad-spectrum antimicrobials control the agent *in vitro*. However, clinical results with chlortetracycline and oxytetracycline have been irregular, but may be effective if used in the early stages of the disease.

## CONTROL

Control measures are difficult to prescribe because of lack of knowledge of the method of transmission. It is advisable to isolate affected animals. No vaccine is available.

## REFERENCES

1. Jelocnik M, et al. *BMC Vet Res*. 2014;10:121.
2. Kaltenboeck B, et al. *Vet Microbiol*. 2009;135:175.
3. Poudel A, et al. *PLoS ONE*. 2012;7:e44961.

## BORDER DISEASE (HAIRY SHAKER DISEASE OF LAMBS, HAIRY SHAKERS, HYPOMYELINOGENESIS CONGENITA)

### SYNOPSIS

**Etiology** Pestivirus strains in the border disease and bovine virus diarrhea genotypes.

**Epidemiology** Congenital disease transmitted by persistently infected sheep, rarely cattle.

**Clinical findings** Abortions, stillbirths, barren ewes, and the birth of small weak lambs, some of which have an abnormally hairy birth coat, gross tremor of skeletal muscles, inferior growth, and a variable degree of skeletal deformity.

**Clinical pathology** None specific.

**Lesions** Hypomyelination in brain and spinal cord of lamb.

**Diagnostic confirmation** Detection of virus and/or demonstration of serologic response.

**Treatment** Supportive.

**Control** Avoid infection of pregnant sheep. Identify and cull persistently infected animals.

## ETIOLOGY

The causal agent, border disease virus (BDV), is a pestivirus within the family Flaviviridae. Four members of the pestivirus genus have been identified; bovine virus diarrhea virus

(BVDV) types 1 and 2, classical swine fever virus, and BDV. Isolates from border disease predominantly fall within the BDV genotype, but sheep and goat isolates also fall in the BVDV genotypes. Pestiviruses consist of a single strand of RNA and were originally named after the host from which they were isolated. However, their interspecies transmissibility means an increasing reliance on phylogenetic studies based on sequences generated from relatively well conserved regions of the viral genome, such as the 5' untranslated region. On this basis BDV can be phylogenetically segregated into at least seven clusters, subtypes BDV-1 to BDV-7.<sup>1</sup>

Strains of BDV have differing pathogenicity, and variations in pathogenicity also result from interactions between the virus and different host genotypes, specifically between different breeds of sheep. Persistent infections in sheep are associated with non-cytopathic strains of virus. An isolate of BDV, now designated as BDV-5, caused a leukopenic enterocolitis in sheep and growing lambs in the Aveyron region of France (Aveyron disease).<sup>2</sup> The disease caused high mortality in sheep in this region in 1984 but has not occurred since then.

## EPIDEMIOLOGY

### Occurrence

Border disease was originally described in the border country between England and Wales. It has subsequently been reported from most of the major sheep-producing countries and probably occurs in all of them. The disease occurs primarily in sheep, and less often in goats and free-living ruminants, such as chamois.<sup>3</sup> The prevalence of infection is much higher than the incidence of clinical disease because the latter only occurs when there is infection during pregnancy. BDV-1 has been detected in sheep from Australia, New Zealand, UK, and United States; BDV-2 from ruminants in Germany; BDV-3 in Switzerland and Austria; BDV-4 in Spain; BDV-5 and BDV-6 in France; and BDV-7 in Turkey.<sup>1</sup>

Studies on seroprevalence suggest that pestivirus infections in sheep and goats are less common than in cattle, but there are considerable differences in seroprevalence between different geographic areas and flocks. Flock seroprevalence in different regions or countries generally falls within the range of 5% to 50%. The prevalence of seropositive females within positive flocks is influenced by age, with a lower seroprevalence in sheep 4 to 8 months of age than in older sheep. Seroprevalence is higher in flocks with persistently infected sheep, but there can still be a significant proportion of seronegative sheep present in a flock containing persistently infected sheep.

### Source of Infection

Infection can be introduced into a flock with the purchase of persistently infected replacement sheep. Persistently infected sheep

excrete virus in nasal secretions, saliva, urine, and feces, and provide the major source of infection. A proportion of persistently infected sheep may survive to adulthood and may breed successfully to produce further persistently infected sheep. However, the breeding efficiency of persistently infected sheep is poor, and the probability of establishing lines of persistently infected sheep appears less than with the equivalent infection in cattle.

Virus is also present in the placenta and fetal fluids at the birth of persistently infected lambs and in the products of abortion resulting from infection with the virus in early pregnancy. In flocks where there is a long lambing period it is possible that this could provide a source for clinical disease in late-lambing ewes. Field observations suggest that transmission during the lambing period is limited.

Calves persistently infected with BVDV can infect sheep, and in countries where pregnant sheep and cattle are housed in close proximity during the winter this can be an important source of infection for outbreaks of border disease. In some countries this appears to be the major source, and studies in both Northern Ireland and the Republic of Ireland suggest that cattle are the primary source of infection for sheep in those countries. There is also evidence that bovine strains are important in goat infections. In contrast BDV is the predominant ovine pestivirus in Great Britain and New Zealand.

Free-living deer are also a potential source of infection. Outbreaks of disease have also occurred after vaccinating pregnant goats with an Orf vaccine contaminated with a pestivirus.

### Transmission

Natural transmission is by sheep-to-sheep contact, but successful experimental transmission has followed both oral and conjunctival challenge.

The spread of infection within a susceptible flock is facilitated by factors such as close contact at mating time or mustering and aggregating sheep for any purpose. There is an increased risk for explosive outbreaks of border disease where animals are housed in early pregnancy.

### Host Risk Factors

Border disease may occur as an outbreak or as a sporadic disease. When infection is introduced into a susceptible flock in early pregnancy, an outbreak with infertility, abortion, and congenital disease in lambs from all ages of ewes is likely. Subsequently, older sheep in the flock will have acquired immunity and disease occurs only in introduced sheep and maiden ewes. Persistently infected ewes have reduced fertility but will give birth to congenitally affected lambs throughout their breeding life. The disproportional occurrence of outbreaks of clinical disease in

certain breeds suggests that they may have higher rates of persistently infected individuals.

### Experimental Reproduction

Border disease is readily reproduced by the experimental oral, conjunctival, and parental infection of pregnant ewes before 80 days' gestation. Experimental disease can be produced with both BDV and BVDV strains.

The following have been produced experimentally, although there are strain differences in clinical and pathologic manifestations:

- Placentitis
- Abortions
- Mummified fetuses
- Congenital malformations, including hydrocephalus, pencephaly, cerebellar hypoplasia and dysplasia, and arthrogyposis
- Fetal growth retardation
- Hypomyelination
- Birth of weak lambs with nervous disorders
- A hairy birth coat

Experimental infections of pregnant cows with BDV results in similar defects with placentitis, mummification, and abortion of fetuses; intrauterine growth retardation with abnormal osteogenesis; and hypomyelination.

The disease has also been produced experimentally in goat kids by inoculation of pregnant goats but there are no abnormalities of hair coat, and embryonic mortality and abortion are more common than in the experimental disease in ewes.

### Economic Importance

The effect of infection varies with the immune status of the flock and whether infection occurs during pregnancy. In fully susceptible flocks, abortion and neonatal lamb loss resulting from infection can be 25% to 75% of the expected lamb crop depending on the strain of the virus. An assessment of the economic losses caused by infertility, abortion, neonatal losses, and low carcass weight indicate that an outbreak of border disease can result in a potential reduction of income in excess of 20%.

Where sheep and cattle are comingled, the presence of BDV in sheep could also jeopardize efforts to control and eradicate pestivirus (BVDV) from cattle herds. Persistently infected sheep readily transmit BDV to seronegative calves; thus the antigenic similarity between the two viruses will complicate attempts to demonstrate freedom from BVD in cattle by serology.<sup>4</sup>

## PATHOGENESIS

### Nonpregnant Sheep

In adolescent and adult nonpregnant sheep, infection and viremia are subclinical. The intramuscular inoculation of immunocompetent lambs with BDV results in a mild

transient disease and a subsequent reduction in growth rate, but no gross or microscopic lesions.

### Pregnant Sheep

When BDV infects susceptible pregnant ewes the virus infects the placenta to produce an acute necrotizing placentitis and it subsequently invades the fetus. This may result in early embryonic death, abortion and still-birth, the birth of lambs with malformations and/or neurologic abnormalities, the birth of small weak lambs that are immunosuppressed, or the birth of lambs with no clinical abnormality. The ultimate outcome of the infection depends on the age of the fetus, the properties of the strain of the virus, the dose of the virus, the genotype of the host, and the ability of the fetus to respond to the virus. Immune competence to the virus in the fetus develops between approximately 61 and 80 days' gestation; thus fetal age at the time of infection determines the outcome of infection.

### Infection in Early Pregnancy

Fetal death occurs when there is infection of the fetus with virulent strains before the development of immune competence and uncontrolled viral replication. Prenatal death is more likely to follow infections in early pregnancy, but is recorded with infections from 45 to 72 days' gestation.

Persistent infections occur in lambs that survive infection in early pregnancy before the development of immune competence and result from maternal infections between 21 and 72 days' gestation but never later. The virus is present in all organs, and lambs born persistently infected will remain so for their lifetime, with few exceptions; persistent infections have been recorded to at least 5 years of age.

Most persistently infected sheep are unable to produce a specific antibody to BDV, but some show intermittent seropositivity with low antibody levels or occasionally undergo frank seroconversion. The humoral response to other pathogens and antigens is normal. However, cell-mediated immunity is compromised, with change in T-cell populations and a deficiency in lymphocyte function. Persistently infected lambs are more susceptible to intercurrent disease and commonly die before reaching maturity.

Hypomyelinogenesis occurs in persistently infected lambs and resolves spontaneously in lambs that survive to the age of 6 months. Most of these lambs exhibit neurologic dysfunction at birth, varying from a continuous light tremor to tonic-clonic contraction of the skeletal muscles involving the whole body and head (shakers).

A deficiency of the thyroid T<sub>3</sub> and T<sub>4</sub> hormones has been detected in lambs affected with border disease and may be the basic cause of the lack of myelination. The enzyme

2,3-cyclic nucleotide-3-phosphodiesterase is associated with normal myelination and depends on normal amounts of thyroid hormone. The deficiency in thyroid hormones may also result in the reduced rate of weight gain that occurs in infected lambs. Other studies suggest a direct infection of oligodendroglia with the virus as the cause of the defective myelination.

Fleece abnormality also occurs in persistently infected lambs and results from an enlargement of the primary hair follicles and a concurrent reduction in the number of secondary follicles. The resulting hairiness is caused by the presence of large medullated primary fibers. BDV appears to have no effect on the skin and birth coat of coarse-fleeced breeds of sheep or on goats.

Intrauterine growth retardation is a common feature of infection with BDV and is initiated shortly after infection. Deformities of the skeleton include abnormally shortened long bones and a reduction in crown-rump length and the long axis of the skull, which results in lambs appearing more compact and short-legged than normal (goat lambs). In the long bones there is evidence of growth arrest lines and disturbed osteogenesis and ossification.

Some persistently infected lambs do not have nervous signs or abnormalities of the fleece and are phenotypically normal. This limits the value of identification of infected lambs based on the presence of clinical abnormality at birth.

### In Midpregnancy

When fetal infection occurs during the period of development of the ability to mount an immune response (between approximately 61 and 80 days' gestation), the effect is variable. Some fetuses infected at this stage respond with a severe inflammatory process in the CNS with nodular periarteritis, necrosis, and inflammation of the germinal layers of the brain. Resultant lesions are hydranencephaly, cerebellar dysplasia, and multifocal retinal atrophy; such lambs exhibit behavioral abnormalities and more severe neurologic disease than shaker lambs.

### Infection in Late Pregnancy

Infection of the fetus after 80 days' gestation is likely to be controlled or eliminated by a fetal immune response. These lambs are born without clinical disease, and are virus negative, but have precolostral circulating antibody.

### Goats

In goats, fetal death is the major outcome of infection of the pregnant doe with both BDV and BVDV, and infections before 60 days' gestation almost invariably result in reproductive failure. Persistently infected shaker kids and clinically normal kids are born with infections around 60 days' gestation but are a less common manifestation of the disease

than occurs in sheep. The caprine fetus develops immune competence against pestiviruses between 80 and 100 days' gestation.

### Enteric Disease

Experimental inoculation of a homologous strain of the BDV into persistently infected but clinically recovered lambs results in a severe clinical syndrome. This is characterized by persistent diarrhea and respiratory distress associated with an inflammatory lymphoproliferative response in the CNS, intestines, lungs, heart, and kidney. A similar syndrome is seen in some persistently infected sheep that survive early life and reach weaning. This syndrome resembles certain aspects of mucosal disease in cattle, in which it is postulated that superinfection of persistently viremic immunotolerant cattle with a homologous strain of BVDV results in fatal mucosal disease. In such animals a specific and dynamic equilibrium exists between an attenuated form of the virus and the immunotolerant host. Disturbance of this equilibrium either by injection of the homologous strain of BDV, or some other factor, results in fatal disease.

### CLINICAL FINDINGS

The most obvious and characteristic features of border disease are evident at birth and relate to conformation and growth, fleece type, and neurologic dysfunction. An increased proportion of barren ewes will also be apparent in severe outbreaks.

### Conformation

Affected lambs may have a lower birth weight than uninfected lambs, a decreased crown-rump length, and a shorter tibia/radius length so that they have a boxy appearance. The head has a shortened longitudinal axis and the cranium may be slightly domed (goat, lambs).

### Fleece

The fleece, when dry, appears hairy and rough because of long hairs rising above the fleece to form a halo, especially over the nape, back, flanks, and rump. This feature is most evident in medium-wool and fine-wool breeds and is not observed in the coarse kempy-fleeced breeds, such as the Scottish Blackface. The halo kemp fibers are shed with time and are most evident in the first 3 weeks of life. Some lambs have abnormal pigmentation occurring as patches of pigmented fleece or hair, or a totally pigmented fleece. This can occur in white-faced sheep.

### Neurologic Dysfunction

Neurologic dysfunction is manifest, with rhythmic tremors of the muscles of the pelvis and upper parts of the hindlimbs, or of the whole body, resulting in a characteristic jerking movement, and of the head and neck with rhythmic bobbing of the head (shaker lambs). In some less severe cases, only fine



tremors of the ears and tail are evident. Tremors are most apparent during movement, and are absent while the lamb is sleeping. The tremors usually decline in severity as the lamb matures and may seem to disappear unless the animal is stressed. More severely affected lambs have difficulty in rising, and if able to stand with assistance exhibit an erratic gait especially of the hind-quarters. Paralysis does not occur. Affected lambs are often unable to nurse the ewe because they cannot hold onto the teat. They appear languid and lie around listlessly. They do not suck as they should and bloat continuously, and the ewes' udders become engorged with milk.

Behavioral and visual defects with circling, head-pressing, nystagmus, and gross incoordination are seen in lambs with the type of infection producing hydranencephaly and cerebellar dysplasia. These lambs are of lighter birth weight but have normal birth coats.

### Growth Rate

Growth rate is reduced, affected lambs are unthrifty, and the majority will die before or at weaning time from parasitism, pneumonia, a mucosal disease-like syndrome, or nephritis. With good nursing care, they can be reared, but deaths may occur at any age. Puberty may be delayed and, in males, the testes are flabby and may not develop normally. A study of lambs in a Spanish feedlot found that BDV-positive lambs (by RT-PCR or ELISA) were 12% (3.3 kg) lighter after 41 days of lot feeding because of significantly lower average daily gain, 260 g per head per day compared with 320 g per head per day in BDV-negative lambs.<sup>5</sup> BDV-positive lambs also had double the chance of having diarrhea or respiratory signs.

### Reproductive Performance

Impaired reproductive performance of the flock occurs from low fertility, abortion, and poor viability of lambs. Abortions usually are not noticed until lambing when it is evidenced by an unexpected increase in barren ewes. In goats, where there is often closer observation, the aborted fetuses may be reasonably well developed, small and underdeveloped, or autolyzed and unrecognizable as a fetus in expelled fetal fluid.

### CLINICAL PATHOLOGY

There are no consistent changes in hematology or blood chemistry. Persistently infected lambs have changes in lymphocyte subpopulations, with a reduction in T lymphocytes and an altered CD8:CD4 ratio.

Virus can be detected in blood and tissues by virus isolation, antigen ELISAs, and RT-PCR techniques (both conventional and real time). These are specialist techniques, but an RT-PCR ELISA may be a cost-effective and sensitive alternative for nonspecialist laboratories.<sup>6</sup> Antibody can be detected by

antibody ELISAs or SN tests, and a combination of serology and virus isolation is usually used in the diagnosis of border disease.

### Detection of Persistently Infected Sheep

For diagnosis of border disease in newborn lambs, precolostral blood samples should be taken from both clinically normal and affected lambs. Persistently infected sheep are seronegative and BDV can be isolated from leukocytes in the blood buffy coat. Lambs infected late in gestation will be seropositive but virus negative. Persistently infected lambs that have received colostrum from their dam will be seropositive until they lose maternal passive immunity.

Persistently infected adolescent and adult sheep in a flock can be identified by the detection of virus in blood; however, this is expensive in large flocks and an alternative is to test all sheep for antibody and then culture the buffy coat of seronegative sheep. Antigenic differences between laboratory strains and field virus can result in false-negative serology, and serologic studies are best done with the homologous virus.

### Abortion

Serologic tests are of limited value as an aid to the diagnosis of abortion associated with BDV infection. The infection of the ewe that results in abortion occurs several weeks before clinical disease is apparent, and unless prospective samples can be taken there is little chance of a rise in antibody titers in paired samples. Seropositivity in ewes indicates that the flock has been exposed to pestivirus but does not incriminate it in a disease process. Seronegativity indicates that BDV is not the cause of the abortion, with the exception that aborting ewes, who themselves are persistently infected, will have no antibody titer.

### NECROPSY FINDINGS

Gross findings may be normal, or may include an abnormal wool coat and a reduction in the size of the brain and spinal cord. Arthrogryposis, hydranencephaly, porencephaly, and cerebellar dysplasia may also be present. Histologically, there is a deficiency of stainable central myelin, with neurochemical and histochemical evidence of demyelination or myelin dysmorphogenesis. In most sheep the myelin defect resolves substantially during the first few months of life. The brain, which has been very small, returns to normal weight, and chemical composition and degree of myelination. The histologic lesions of the skin consist of primary follicle enlargement, increased primary fiber size, and an increased number of medullated primary fibers.

Virus can be demonstrated by immunofluorescent staining of cryostat sections of tissues from affected lambs or by IHC staining of formalin-fixed material. Preferred

tissues for such tests include brain, thyroid gland, and skin. Virus titers reach high levels in the placentomes, so caruncles or cotyledons should be cultured for virus. Isolates are noncytopathic and the presence of viral antigens must be demonstrated by direct or indirect immunofluorescence or immune peroxidase techniques.

Because of the closely related character of this pestivirus and BVDV, diagnostic tests to confirm infection parallel those for BVDV. Fetal serology can be useful for confirming exposure in abortions and stillbirths. PCR and ELISA techniques may be substituted for virus isolation if available.

In the brain of naturally infected cases, viral antigens and RNA are found in the neuropil, glial, and neuronal cells, especially in periventricular areas, cerebellum, and brainstem.<sup>7</sup> Cell death occurs in both BDV-infected and adjacent cells by the activation of pathways that cause apoptosis, which are associated with the increased expression of nitric oxide synthases.<sup>8,9</sup>

### Samples for Confirmation of Diagnosis

- **Histology:** formalin-fixed skin, spinal cord, half of midsagittally sectioned brain, skin, thyroid, distal ileum, colon, cecum, thymus, spleen, liver, heart, kidney (LM, IHC)
- **Serology:** heart blood serum/thoracic fluid (virus neutralization)
- **Virology:** placenta/caruncle, thymus, lymph node, spleen, thyroid, brain, ileum (ISO, FAT, ELISA, PCR).

### DIFFERENTIAL DIAGNOSIS

#### Congenital disease

- Swayback (copper deficiency)
- Caprine encephalomyelitis

#### Abortion

- Enzootic abortion
- Listeriosis
- Toxoplasmosis
- Leptospirosis
- Rift Valley fever
- Akabane disease

### TREATMENT

There is no specific treatment for border disease. With care and nursing, many affected lambs will survive the immediate neonatal period, but they grow poorly, are very susceptible to intercurrent disease during the growing period, and it is generally not economic to attempt to raise these lambs.

### CONTROL

The principles are to attempt to engender flock immunity and to avoid exposing sheep to infection in early pregnancy. Persistently infected sheep are a continuous source of infection and those that survive to breeding age can perpetuate the disease. They should be identified and culled.

The problem is with their identification, because some persistently infected lambs show no clinical or phenotypic abnormality. Lambs that are clinically affected at birth should be permanently identified because the tremor and fleece abnormality disappear at 1 to 2 months of age and the lambs may no longer be recognizable as infected. Persistently infected animals can be identified by serologic screening of the ewe lambs intended for replacement stock at 6 months of age (after maternal passive immunity has waned), followed by virus isolation in seronegative animals, but this is expensive and only practical in small flocks. An alternative is to keep no replacement ewes from an affected lamb crop.

Persistently infected sheep can be run with the flock when it is not pregnant, particularly with the replacement ewes, in an attempt to produce infection and immunity before pregnancy. They should be removed before breeding. Although this can result in “natural vaccination,” the rates of infection and seroconversion in replacement females can be low. In theory, cattle BVDV vaccines could be used to produce immunity but their efficacy would depend on a significant relatedness to the BDV under consideration.

In most flocks a serious outbreak of the disease is followed by minor disease in subsequent years, with the flock developing immunity in the initial outbreak.

In flocks that are free of infection, replacement ewes and rams should be screened for infection before purchase or quarantined after arrival on the farm. Newly introduced sheep should be kept separate from the main flock until after lambing. Ideally, cattle should not be pastured or housed with pregnant sheep.

#### FURTHER READING

Radostits O, et al. Border disease (hairy shaker disease of lambs, hairy shakers, hypomyelination congenita). In: *Veterinary Medicine: A Textbook of the Diseases of Cattle, Horses, Sheep, Goats and Pigs*. 10th ed. London: W.B. Saunders; 2007:1414-1418.

#### REFERENCES

- Strong R, et al. *Vet Microbiol*. 2010;141:208.
- Dubois E, et al. *Vet Microbiol*. 2008;130:69.
- Marco I, et al. *Res Vet Sci*. 2009;87:149.
- Braun U, et al. *Vet Microbiol*. 2015;168:98.
- González JM, et al. *Vet Rec*. 2014;174:69.
- Dubey P, et al. *J Virol Methods*. 2015;213:50.
- Toplu N, et al. *Vet Pathol*. 2011;48:576.
- Dincel GC, Kul O. *PLoS ONE*. 2015;10:e0120005.
- Dincel GC, Kul O. *Histol Histopathol*. 2015;30:1233.

## VISNA

### SYNOPSIS

**Etiology** Neurovirulent strains of maedi-visna virus, a lentivirus.

**Epidemiology** Occurs in association with maedi but endemic visna only recorded in Iceland.

**Clinical findings** Afebrile disease with insidious onset. Progressive ataxia and wasting, long clinical course.

**Clinical pathology** Pleocytosis and elevated protein, virus, virus proteins, and antiviral antibody in cerebrospinal fluid.

**Lesions** Chronic demyelinating encephalomyelitis.

**Diagnostic confirmation** Histology, demonstration of virus, PCR.

**Treatment** None.

**Control** As for ovine progressive pneumonia.

## ETIOLOGY

Visna is the neurologic manifestation of maedi-visna disease caused by infection with Maedi-Visna Virus (MVV). This virus is a single-stranded RNA, nononcogenic lentivirus within the retrovirus family. There are neurovirulent and nonneurovirulent strains of MVV, and neurovirulence is enhanced by intracerebral passage of virus. There is a high degree of relatedness between MVV, the ovine lentivirus associated with ovine progressive pneumonia (OPP), and the Caprine Arthritis Encephalitis (CAE) virus. These ovine and caprine lentiviruses share nucleotide homology and serologic properties and are now regarded as a viral continuum and referred to as small ruminant lentiviruses (SRLV).<sup>1</sup>

Visna usually occurs in conjunction with maedi lesions in the lungs, with up to 18% of sheep affected by maedi having histologic lesions of visna in the brain.

## EPIDEMIOLOGY

### Occurrence

Visna is a disease of sheep and rarely of goats. It was originally a significant cause of death in the epizootic of maedi-visna that occurred in Iceland from 1933 to 1965. It always occurred in association with maedi, but was sporadic and generally less important than the pulmonary manifestation of the infection. The exception was in some flocks in which it was the major manifestation of the maedi-visna disease complex, but visna not been seen in Iceland since 1951 and maedi-visna has since been eradicated from that country.

Despite the widespread occurrence of maedi-visna or OPP in many countries, visna is now an uncommon disease, and a high prevalence of neurologic disease has seldom been recorded in countries other than Iceland. The reason for this is not known but might be from an increased susceptibility of the Icelandic breed of sheep to the neurologic form of the disease, or to differences in the neurovirulence of different strains of the virus. In Britain, MVV was first detected in the late 1970s, and the initial clinical expression was largely maedi (dyspnea), but occasionally with coexistent visna.

## Experimental Transmission

Sheep experimentally infected by intracerebral inoculation spread MVV to commingled sheep. The incubation period and the course of the disease are both protracted, with clinical signs not appearing until 2 years after experimental inoculation.

## PATHOGENESIS

The virus infects cells of the monocyte-macrophage lineage and replicates its RNA genome via a DNA intermediate provirus, which is integrated into the chromosomal DNA of the host cell. Replication is limited and does not proceed beyond the synthesis of provirus in most cells. Persistent production of viral antigen results in lymphocytic hyperplasia.

There are two basic lesions, an inflammatory lesion that is not related to the occurrence of nervous signs, and a focal demyelination in the brain and spinal cord, the occurrence of which is related to the appearance of paresis. Experimental immunosuppression reduces the severity of lesions by suppressing the cellular proliferative response without suppressing the growth of the virus, whereas postinfection immunization enhances the severity of experimental visna. Viral nucleic acid and proteins are present in oligodendrocytes, and demyelination is thought to be a direct effect of the virus on these cells as well as a sequel to the inflammatory response they provoke.

## CLINICAL FINDINGS

The disease has an insidious onset, and the early clinical signs include lagging behind the flock because of ataxia and body wasting. The body wasting and the hindlimb ataxia are progressive. Affected animals show hypermetria and may stumble or fall as they traverse uneven ground or when making sudden turns. There is no fever, and a normal appetite and consciousness are retained. Additional signs include severe tremor of the facial muscles and knuckling of the distal limbs so that the animal stands on the flexed tarsi. Some animals may show a head tilt, aimless wandering, circling, and blindness.<sup>2</sup>

The clinical picture is not unlike that of scrapie without the pruritus. During the course of the disease, periods of relative normality may occur. Affected animals may show clinical signs for several months before final paralysis necessitates slaughter. The disease is always fatal, and the clinical syndrome in goats is the same as for sheep.

## CLINICAL PATHOLOGY

There are an increased number of mononuclear cells in the CSF, an elevated protein, and positive Pandy test. The pleocytosis is variable during the course of the disease. Virus, virus antigen, and antibody are also demonstrable in CSF. Serologic tests are detailed under the section on ovine progressive pneumonia in chapter 12.

## NECROPSY FINDINGS

Muscle wasting and an interstitial pneumonia may be visible but there are no gross changes in the CNS. The characteristic histologic lesion is patchy, demyelinating encephalomyelitis. The inflammatory infiltrate is predominantly composed of lymphocytes and macrophages. Demyelination occurs in the white matter of the cerebrum and cerebellum, and in the spinal cord. The histologic character of the lung is typical of ovine lentivirus-associated pneumonia. Isolation of the virus is difficult. Typical neural lesions and a positive serologic titer usually suffice for confirmation of the diagnosis. IHC tests and PCR-based assays have been successfully used to confirm this lentiviral infection in lung, mammary gland, and even third eyelid, but the use of these tests to confirm of the infection in CNS tissues is not well documented.

## Samples for Confirmation of Diagnosis

- **Histology:** fixed spinal cord, half of midsagittally sectioned brain, lung, mammary gland, joint synovium (IHC, LM)
- **Serology:** serum (Agar gel immunodiffusion test, ELISA)
- **Virology:** chilled brain, spinal cord, lung, mammary gland (PCR, ISO).

## DIFFERENTIAL DIAGNOSIS

Visna is a sporadic disease of mature sheep with an insidious onset of muscle wasting, progressive ataxia, and a long clinical course. These characteristics differentiate it from other diseases of sheep manifest with ataxia.

### Differentials include

- Scrapie
- Delayed organophosphate toxicity
- Cerebrospinal nematodiasis
- Segmental axonopathy (Murrurrundi disease)

## TREATMENT AND CONTROL

There is no treatment for visna. It usually occurs in conjunction with signs of maedi and is a comparatively rare disease by itself. Control procedures are as for those suggested for OPP/maedi. It is possible to greatly reduce the prevalence, and even eradicate the disease, by either (1) testing all sheep with an ELISA and removing seropositive sheep from the flock, or (2) by removal of lambs at birth and rearing them in isolation from other sheep. Testing all sheep at shorter intervals (3–6 months) with a combination of serology and PCR tests can reduce the prevalence more rapidly but is more costly.

Many jurisdictions have developed accreditation programs for flocks to establish that they have a low risk of infection with MVV. Once flocks are seronegative they are subjected to testing at various intervals,

typically 1 to 3 years depending on an assessment of the biosecurity risk and the presence of untested sheep on the same farm holding.

There is currently no effective vaccine against MVV, and in some cases candidate vaccines have enhanced viremia and/or the immune-mediated pathology of the disease.<sup>3</sup> The difficulty in developing effective vaccines is common among the lentiviruses, with various approaches including attenuated vaccines, vector vaccines, and proviral DNA vaccines having little success.

Marker-assisted genetic selection, to identify those sheep less susceptible to infection with MVV, has the potential to supplement existing control measures. For example, in a trial involving 187 lambs, the probability of infection following natural exposure to OPP virus (a related virus that is part of the SRLV continuum) was 3.6 times greater in crossbred lambs with susceptible or heterozygous diplotype to ovine transmembrane protein gene 154 (TEM154 diplotype “1 3” or “3 3”) compared with lambs with diplotype “1 1.”<sup>4</sup> This is an active research area and it is expected that additional markers will be identified with future investigations.

## FURTHER READING

- Blacklaws B. Small ruminant lentiviruses: immunopathogenesis of visna-maedi and caprine arthritis and encephalitis virus. *Comp Immunol Infect Dis.* 2012;35:259-269.
- Radostits O, et al. Visna. In: *Veterinary Medicine: A Textbook of the Diseases of Cattle, Horses, Sheep, Goats and Pigs.* 10th ed. London: W.B. Saunders; 2007:1413-1414.

## REFERENCES

1. Le Roux C, et al. *Curr HIV Res.* 2010;8:94.
2. Christodoulouplous G. *Small Rumin Res.* 2006;62:47.
3. Blacklaws B. *Comp Immunol Microbiol Infect Dis.* 2012;35:259.
4. Leymaster KA, et al. *J Anim Sci.* 2013;91:5114.

## CAPRINE ARTHRITIS ENCEPHALITIS

### SYNOPSIS

**Etiology** Retrovirus (a small ruminant lentivirus).

**Epidemiology** Persistent infection with perinatal and horizontal spread. Management of herd influences extent of seropositivity.

**Clinical findings** This disease of goats is characterized by arthritis, especially of the carpal joints (big knee), in mature goats, and acute leukoencephalomyelitis in young goats. Indurative mastitis, and less commonly chronic pneumonia and chronic encephalomyelitis, occur in older goats.

**Clinical pathology** Increased mononuclear cell count in cerebrospinal fluid. Lower or inverted CD4:CD8 ratio in peripheral blood.

**Lesions** Chronic polysynovitis, degenerative joint disease in adults. Nonsuppurative demyelinating encephalomyelitis. Interstitial pneumonia.

**Diagnostic confirmation** Microscopic lesions and agar gel immunodiffusion test.

**Treatment** None.

**Control** Segregation of the newborn from seropositive animals, and feeding of virus-free colostrum and milk. Prevention of horizontal transmission. Regular testing with segregation or culling.

## ETIOLOGY

Caprine arthritis encephalitis (CAE), maedi-visna, and Ovine Progressive Pneumonia (OPP) viruses are single-stranded RNA, nononcogenic lentiviruses within the retrovirus family. They have a tropism for monocytes, macrophages, and dendritic cells, but not T lymphocytes. This is an important determinant of their pathogenesis because they induce a persistent infection that can cause lymphoproliferative changes in the lung, mammary tissues, brain, and joints. There is a high degree of relatedness between these lentiviruses, with shared nucleotide homology and serologic properties. Consequently, CAE, maedi-visna, and OPP viruses are now regarded as a viral continuum known as SRLV.<sup>1</sup>

There are genetically distinct isolates of CAE virus and they may differ in virulence. Because of the nature of the virus, recombination during replication, hence antigenic drift, is common and may facilitate persistence of the virus in the host and the development of disease. Based on analysis of *gag* and *pol* genomic regions, SRLVs have been placed into five clusters (A to E), with A and B further divided into at least 13 and 3 subtypes, respectively. Some of these are geographically restricted, such as cluster C in Norway, whereas others appear more dispersed, probably reflecting the active trading of animals. In Canada, molecular analysis of goat and sheep isolates of SRLV from herds or flocks with only sheep or goats reveals a relatively simple arrangement, with goats infected with B1 subtype and sheep with A2 subtype, respectively. However, on farms with both goats and sheep, there is evidence of crossover between sheep and goats, and vice versa, and mixed infections in both species.<sup>2</sup> Consequently, mixed flocks of goats and sheep may represent an active source for the evolution of these viruses, with a CAE-like virus responsible for severe outbreaks of arthritis in sheep in Spain and mixed infections confirmed in many European countries and North America.<sup>2-4</sup>

## EPIDEMIOLOGY

### Geographic Occurrence

There is serologic evidence of infection in most areas of the world, including Europe,



the UK, North America, Africa, Arabia, Australia, New Zealand, and South America. Although there is sampling bias, one study found marked differences in prevalence between countries, with a lower prevalence in developing countries that did not import dairy-type goats from North America or Europe. This may also reflect the absence of management factors that have a high risk of propagating infection in some countries, such as the pooling of colostrum. Other countries, such as New Zealand, have a low prevalence with the occurrence of CAE mainly in exotic importations.

There may also be variation in seroprevalence within countries. For example, in the United States, the prevalence of infection in goats in the western and middle parts of the country is approximately 50% of all goats tested, which is about twice that in the eastern and Rocky Mountain areas. Herd seroprevalence is greater than 60% in all regions. The seroprevalence within herds shows clustering, with most herds falling into either high or low seroprevalence groups. There are area differences in age prevalence of seropositivity, with some surveys showing no difference and others showing an increasing prevalence with increasing age.

Clinical disease is much less common than infection, and the annual incidence of disease in heavily infected flocks is usually low and approximates 10%.

### Host Risk Factors

#### Breeds

All breeds are susceptible to infection but several studies have recorded apparent differences in breed susceptibility, which may reflect differences in management practices such as feeding practices of colostrum and milk, or genetic differences in susceptibility. There is often a higher prevalence of seropositive goats in family-owned farms compared with institutional herds, which might reflect a greater movement of goats or comingling with other herds among the former.

Housed Rocky Mountain goats (*Oreamnos americanus*) have developed clinical disease attributed to infection with CAE virus, including interstitial pneumonia and synovial changes. Three of four affected goats had been fed raw goat milk from a source later found to have CAE virus.<sup>5</sup>

#### Age

There is no age difference in susceptibility to experimental infection. Some herds show similar seroprevalence across age groups, whereas others show an increasing seroprevalence with increasing age. These differences probably reflect differences in management between herds and differences in the relative importance of the mechanisms of transmission between herds. Increasing prevalence with age reflects management systems that increase the risk of acquiring

infection from horizontal transmission. Leukoencephalomyelitis occurs predominantly in young kids and arthritis in older goats.

### Method of Transmission

More than 75% of kids born to infected dams may acquire infection, which can be potentially transmitted to them by several routes. Infection can also occur in older goats.

### Colostrum and Milk

Observation of the natural disease and experimental studies indicate that the primary mode of transmission is through the colostrum and milk. The presence of antibody in colostrum does not prevent infection. The virus can be isolated both from the cells in the milk and from cell-free milk from infected dams. Kids born of noninfected dams, but fed colostrum and/or milk from infected dams, can become infected. A single feeding of infected milk can be sufficient to infect a kid. Conversely, the risk of infection is much lower in kids that are removed from the doe immediately after birth and reared on pasteurized milk, and many can be reared free from infection.

### Other Perinatal Transmission

Intrauterine infection can occur, but appears to be infrequent and not of major significance in the control of the disease. The disease can be transmitted by contact both during and following the perinatal period, and perinatal transmission is most important in the epidemiology of the disease. Perinatal transmission can result from contact with vaginal secretions, blood, saliva, or respiratory secretions, with the relative importance of these not clearly known.

### Contact Transmission

Horizontal transmission occurs at all ages, and older goats can be infected by oral challenge with virus. Contact transmission will result in the spread of the disease when an infected animal is introduced into an infection-free herd and has been one cause of spread in countries in which the infection has been introduced with imported animals.

Prolonged comingling of uninfected with infected animals is likely to promote horizontal transmission.

### Other Routes

Milk contains virus-free and virus-infected cells and shared milking facilities increase the risk of cross-infection. This possibly results from the transfer of infected cells in milk during the milking process. Both iatrogenic and venereal transmissions are possible but are probably of limited significance.

### Experimental Reproduction

Arthritis and mastitis have been reproduced by oral, intravenous, and intraarticular challenge with CAE virus, although pneumonia is often not a feature of the experimental

disease. Leukoencephalomyelitis in young lambs can be reproduced by intracerebral challenge, but this form of the disease has not been reproduced by more natural challenge routes. Strains of the virus can be neuroadapted by passage and show increased neurovirulence but not neuroinvasiveness, suggesting that these are separate characteristics.

The relatedness between caprine and the ovine lentiviruses was first evident with experimental infections, with the CAE-type virus transferred to lambs by feeding them infected colostrum. This experimental infection was followed by viremia and seroconversion, but some strains of the virus produced no clinical or histopathologic evidence of disease. Goat kids have been similarly infected with the maedi virus. The arthritic form of the disease has been produced experimentally in cesarean-derived kids injected with virus isolated from the joints of infected goats.

### Economic Importance

There is a high prevalence of infection in many countries, and several have opted for national or breed-associated control programs. There is a higher cull rate in infected herds, with as many as 5% to 10% of goats culled each year for arthritis, and affected animals cannot be entered for show. Seropositive herds have a higher incidence of disease.

There are conflicting reports on the effect of infection on productivity in goat herds, but seropositive goats can have significantly lower milk production (around 10%), a reduced length of lactation, lower 300-day yields of milk, and impaired reproductive performance compared with seronegative goats.

### PATHOGENESIS

Animals infected at birth remain persistently infected for life, although only a proportion, typically from 10% to 30%, will develop clinical disease. The virus persistently infects some cells of the monocyte-macrophage type, and the expression and shedding of virus occurs as infected monocytes mature to macrophages.<sup>1</sup> Disease is associated with the host's immune response to the expressed virus. The development of neutralizing antibody does not arrest viral replication because of ongoing expression of antigenic variants of the virus with differing type-specific neutralization epitopes. However, the immune complexes are thought to be the basis for the chronic inflammatory changes in tissues. Goats vaccinated with CAE virus develop more severe clinical disease following challenge compared with nonvaccinated controls. The lesions are lymphoproliferative and followed by a multisystem disease syndrome. This primarily involves synovial-lined connective tissue, causing chronic arthritis, in the udder, causing swelling and hardening of

the glands (with or without mastitis), and in the lungs causing a chronic interstitial pneumonia.

A retrovirus infection, detected by electron microscopy and the presence of RT activity, is suspected as the cause of an immunodeficiency syndrome in llamas characterized by failure to thrive, anemia, leukopenia, and recurrent infection, but this has not been reported since 1992.

## CLINICAL FINDINGS

### Joints

Arthritis occurs predominantly in adult goats and is a chronic hyperplastic synovitis, which is usually noticeable only in the carpal joints. This gives rise to the lay term of big knee, although tarsal joints may also be affected. The onset may be insidious or sudden, and unilateral or bilateral. Goats may be lame in the affected leg, but this is usually not severe. Affected goats may live a normal life span but some gradually lose weight, develop poor hair coats, and eventually remain recumbent most of the time and develop decubitus ulcers. Dilatation of the atlantal and supraspinous bursae occurs in some cases. The course of the disease may last several months. The arthritis may be accompanied by enlargement and hardening of the udder and by interstitial pneumonia, although this may be clinically inapparent. There can be herd and area differences in the clinical expression of the disease. For example, in some outbreaks in Australia pneumonia, rather than arthritis, has been the predominant clinical sign.

Radiographically, there are soft tissue swellings in the early stages and calcification

of periarticular tissues and osteophyte production in the later stages. Quantitative joint scintigraphy provides an accurate noninvasive method for assessing the severity of the arthritis in a live animal.

### Brain

Leukoencephalitis occurs primarily in 1- to 5-month-old kids. The syndrome is characterized by unilateral or bilateral posterior paresis and ataxia. In the early stages, the gait is short and choppy, followed by weakness and eventually recumbency. In animals that can still stand, there may be a marked lack of proprioception in the hindlimbs (Fig. 14-4). Brain involvement is manifested by head tilt, torticollis, and circling. Affected kids are bright and alert and drink normally. Kids with unilateral posterior paresis usually progress to bilateral posterior paresis in 5 to 10 days. The paresis usually extends to involve the forelimbs, so that tetraparesis follows, and most kids are euthanized. The interstitial pneumonia that often accompanies the nervous form of the disease is usually not severe and not clinically obvious.

### Udder

Indurative mastitis, or hard bag, is often initially detected a few days after kidding. The udder is firm and hard but no milk can be expressed. There is no systemic illness and no bacterial mastitis. Recovery is never complete but there may be some gradual improvement.

## CLINICAL PATHOLOGY

The synovial fluid from affected joints is usually brown to red-tinged, and the cell

count is increased up to 20,000  $\mu\text{L}$  with 90% mononuclear cells. The CSF may contain an increased mononuclear cell count. There is a reduction in monocytes in peripheral blood, a decrease in the number of CD4+ lymphocytes, and a lower or inverted CD4:CD8 ratio.

## Serologic Testing

For the live animal, there are a number of test systems available whose sensitivity and specificity varies. The agar gel immunodiffusion test (AGID) and a variety of commercial ELISA tests are the most widely used, and the latter usually has a higher sensitivity and specificity. Differences in the performance of the ELISA tests may be related to the peptides they use and the types of SRLV present.<sup>6</sup> Maternal antibody is lost by approximately 3 months of age, hence a seropositive test in a goat older than 6 months is considered evidence of infection. Most animals have a persistent antibody response and remain seropositive for life, although some infected goats may become seronegative over time.

A negative test does not rule out the possibility of infection because there may be a considerable delay between infection and the production of detectable antibody. It is possible that in some infected goats there is insufficient virus expression to lead to an antibody response.

A competitive-inhibition ELISA, which detects antibody to the surface envelop of the virus, has very high sensitivity and specificity and may be more useful in determining the status of individual animals, such as before the movement of goats. Other tests with potentially greater sensitivity and/or specificity are described, but are not generally available. For example, serum adenosine deaminase activity is used as a biochemical marker of HIV infection in humans, and is elevated in goats infected with CAE, but is not a routinely available veterinary test.<sup>7</sup>

## Other Tests

A more cost-effective way of monitoring CAE in dairy goats may be testing the bulk tank milk. In Norwegian dairy flocks, an ELISA for testing bulk tank milk detected a within-herd prevalence of CAE of at least 2%, with a sensitivity of 73% and specificity of 87%.<sup>8</sup> Identification of the presence of CAE is usually provided by isolation of the virus from tissue explants into tissue culture. PCR can be used to detect the presence of viral antigen or proviral DNA. Most primers for diagnostic purposes are selected to detect the broadest possible range of SRLV strains, whereas those selected for research purposes may take a type-specific approach.<sup>2</sup> A rapid detection assay based on LAMP has been developed for detecting CAEV proviral DNA in whole blood and whole-blood samples and separated mononuclear cells.<sup>9</sup> This assay can be performed in less well-equipped laboratories as well as in the field.



**Fig. 14-4** A 3-month-old Toggenburg kid with advanced progressive neurologic signs caused by infection with caprine arthritis encephalitis virus. The goat has normal mentation but is exhibits asymmetric weakness (hindlimbs worse than forelimbs) and proprioceptive abnormalities.

## NECROPSY FINDINGS

In the arthritic form of CAE, there is emaciation and chronic polysynovitis, with degenerative joint disease affecting most of the joints of animals submitted for necropsy. Periarticular tissues are thickened and firm and there is hyperplasia of the synovium. The local lymph nodes are grossly enlarged and a diffuse interstitial pneumonia is usually present. Mammary glands are frequently involved, although gross changes are restricted to induration and increased texture. Microscopically, lymphoplasmacytic infiltrates of the interstitial tissues of mammary gland, lung, and synovium are characteristic. In the neural form the diagnostic lesions are in the nervous system and involve the white matter, especially of the cervical spinal cord and sometimes the cerebellum and the brainstem. The lesion is a bilateral, nonsuppurative demyelinating encephalomyelitis. The infiltrating mononuclear leukocytes tend to be more numerous in the periventricular and subpial areas. There is usually also a mild, diffuse, interstitial pneumonia in this form of the disease. In some cases, a severe lymphoplasmacytic interstitial pneumonia with extensive hyperplasia of type II pneumocytes can occur in the absence of neurologic disease.

Culture of the virus is difficult but can be attempted. A variety of nucleic acid recognition tests, including in situ hybridization, PCR, and IHC, have been developed. For most cases, confirmation of the diagnosis is based on the characteristic microscopic lesions, preferably supported by antemortem serology.

## Samples for Confirmation of Diagnosis

- **Histology:** formalin-fixed lung, bronchial lymph node, mammary gland, synovial membranes, half of midsagittally sectioned brain, spinal cord (LM, IHC)
- **Serology:** blood (ELISA, AGID, PCR)
- **Virology:** lung, synovial membrane, mammary gland, hindbrain (PCR, virus isolation).

## DIFFERENTIAL DIAGNOSIS

The differential diagnosis of the arthritic form of the disease includes the other infectious arthritides, such as those associated with mycoplasma and chlamydia.

Leukoencephalitis must be differentiated from:

- Swayback caused by copper deficiency
- Spinal abscess
- Cerebrospinal nematodiasis
- Listeriosis
- Polioencephalomalacia

## TREATMENT

There is no treatment likely to be of value for any form of CAE.

## CONTROL

A measure of control can be achieved by testing the herd every 6 months, and segregating or culling of seropositive animals. More complete control is dependent on preventing/minimizing perinatal transmission of infection to the kid, particularly colostrum and milk transmission, coupled with identifying infected animals and maintaining them physically separated from the noninfected animals or culling them from the herd.

Because of the evidence of transmission of SRLV between sheep and goats, the presence of each species needs to be considered when developing control programs for CAE of goats or OPP of sheep.

## Prevention of Perinatal Transmission

Early recommendations for control concentrated on reducing transmission via milk and colostrum, but it is now recognized that this must be coupled with segregation. Newborn kids should be removed from the dam immediately at birth. There should be no contact with the dam, and fetal fluids and debris should be rinsed off the coat. Heat-treated goat colostrum or cow colostrum should be fed, followed by pasteurized milk or a commercial milk replacer. The kid should be segregated from the doe and other infected animals. In herds that feed pasteurized colostrum and milk there is a significant difference in subsequent seroconversions between those that segregate the kids at birth and for rearing and those that do not.

## Test and Segregate/Cull

Animals over 3 months of age should be tested by ELISA or AGID every 6 months, and seropositive animals segregated or (preferably) culled from the herd. The interval between infection and seroconversion varies between goats, and the optimal interval for testing has not been determined. More frequent testing may be needed for large herds with a high seroprevalence. Segregation of seropositive and seronegative goats is essential because horizontal spread in adult goats is important in maintaining and increasing infection rates in some herds, and even a brief contact time can allow transmission. Where culling is not practiced, seropositive goats should be milked after seronegative ones, and the use of common equipment, such as for ear-tagging, tattooing, and vaccinating, should be avoided.

Several countries have programs for herd accreditation of freedom from infection. The stringency of these schemes varies, and they may be governmental or breed society accreditation programs. Typically, they require that all adults in the herd test negative on two herd tests at a 6-month interval. There are also restrictions on the movement and purchase of animals, and periodic serologic surveillance. For example, a scheme in Norway has been quite successful, with only

5 of 406 flocks (1.2%) being reinfected over a 10-year period.<sup>8</sup>

## Vaccination and Genetic Selection

There is currently no effective vaccine against the SRLVs, including CAE, maedi-visna, or OPP viruses, and in some cases candidate vaccines have enhanced viremia and/or the immune-mediated pathology of the disease.<sup>1</sup> The difficulty in developing effective vaccines is common among the lentiviruses, with various approaches, including attenuated vaccines, vector vaccines, and proviral DNA vaccines having little success. The reasons are obscure, but probably relate to the underlying dysfunction in T-cell-mediated immune responses.

However, marker-assisted genetic selection, to identify animals less susceptible to infection, has the potential to supplement existing control measures. For example, in a trial investigating the control of OPP in lambs, the probability of infection following natural exposure to OPP virus was 3.6 times greater in crossbred lambs with susceptible or heterozygous diplotype to ovine transmembrane protein gene 154 (TEM154 diplotype 1 3 or 3 3) compared with lambs with diplotype 1 1.<sup>10</sup> Similar studies have not yet been undertaken in goats, but this is an active research area and it is expected that additional markers for conditions caused by SRLV will be identified in future.

## FURTHER READING

- Blacklaws B. Small ruminant lentiviruses: immunopathogenesis of visna-maedi and caprine arthritis and encephalitis virus. *Comp Immunol Infect Dis.* 2012;35:259-269.
- Hermann-Hoising LM, et al. Diagnostic assays used to control small ruminant lentiviruses. *J Vet Diagn Invest.* 2010;22:843-855.
- Radosits O, et al. Caprine arthritis encephalitis (CAE). In: *Veterinary Medicine: A Textbook of the Diseases of Cattle, Horses, Sheep, Goats and Pigs.* 10th ed. London: W.B. Saunders; 2007:1410-1413.

## REFERENCES

1. Blacklaws B. *Comp Immunol Microbiol Infect Dis.* 2012;35:259.
2. Fras M, et al. *Infect Genet Evol.* 2013;19:97.
3. Glaria I, et al. *Vet Microbiol.* 2009;138:156.
4. Gjerset B, et al. *Virus Res.* 2007;125:153.
5. Patton KM, et al. *Vet Diagn Invest.* 2012;24:392.
6. de Andrés X, et al. *Vet Immunol Immunopathol.* 2013;152:277.
7. Rodrigues LF, et al. *Small Rumin Res.* 2012;108:120.
8. Nagel-Alne GE, et al. *Vet Rec.* 2015;176:173.
9. Huang J, et al. *Arch Virol.* 2012;157:1463.
10. Leymaster KA, et al. *J Anim Sci.* 2013;91:5114.

## OVINE ENCEPHALOMYELITIS (LOUPING-ILL)

### SYNOPSIS

**Etiology** Louping-ill virus, flavivirus.

**Epidemiology** Disease of sheep (and red grouse), and occasionally other domestic



animals and man, transmitted by *Ixodes ricinus*. Occurs predominantly in lambs and yearling sheep in Great Britain and Europe in the spring, associated with tick rise.

**Clinical findings** Fever, neurologic dysfunction, muscle tremor, incoordination, bounding gait. Recovery or convulsions and death.

**Lesions** Nonsuppurative encephalitis.

**Diagnostic confirmation** Serology, demonstration of virus.

**Control** Vaccination, tick control.

## ETIOLOGY

Louping-ill virus belongs to the genus *Flavivirus*, which is divided into eight groups, one of which is the tick-borne encephalitis group. Louping-ill is antigenically related to the tick-borne encephalitis viruses. The latter circulate in Europe and Asia and are a serious zoonotic disease for humans, but do not infect sheep.<sup>1</sup> Louping-ill virus occurs in Great Britain, Ireland and Norway, but similar disease occurs elsewhere and there is antigenic diversity between isolates from different geographic areas. Viruses that are closely related to louping-ill virus, and that cause very similar disease but in different regions of the world, include Russian spring-summer encephalitis, Turkish sheep encephalitis, Spanish sheep encephalitis, Spanish goat encephalitis,<sup>2</sup> and Greek goat encephalitis viruses. In sheep, concurrent infection with the agent of tick-borne fever *Ehrlichia (Cytoecetes) phagocytophila* enhances the pathogenicity of the virus.

## EPIDEMIOLOGY

### Occurrence

#### Geographic Occurrence

Louping-ill was originally considered to be restricted to the border counties of Scotland and England but is now recognized as also occurring in upland grazing areas of Scotland, in Ireland, southwest England, and in Norway; related viruses and diseases occur in Spain, Bulgaria, Greece, and Turkey. The distribution of the disease is regulated by the occurrence of the vector tick *Ixodes ricinus*, which requires suitable hosts and a ground layer microclimate of high humidity throughout the year. In these areas, louping-ill can be a common infection and may be a significant cause of loss.

#### Host Occurrence

Louping-ill virus can infect and produce disease in a wide variety of vertebrates including man, but predominantly sheep are affected because of their susceptibility and the fact that they are the main domestic animal species that graze the tick-infested areas. Nonruminant species, such as alpaca and horses, and wild ungulates such as chamois,<sup>3</sup> have also been infected.

Although sheep (and red grouse) are the only animals that commonly develop clinical disease, *I. ricinus* feeds on a number of different hosts and the adult tick requires a large mammalian host. As a consequence, seropositivity and occasional clinical disease occur in all other domestic species, especially goat kids, but also cattle, horses, alpaca,<sup>4</sup> pigs, and humans.

Traditionally, pigs have not been free-ranged on upland tick-infested areas, but they are susceptible to experimental infection by all routes.

Red deer (*Cervus elaphus*) and roe deer (*Capreolus capreolus*) are hosts for the tick in Scotland, and the elk (*Alces alces*) may be in Sweden. Infection in these species is usually subclinical; however, when these animals are subjected to the stress of captivity, clinical illness is more likely to occur. This may be important to commercial deer farmers.

## Transmission

### Tick Transmission

The reservoir for the disease and the major vector is the three host tick *I. ricinus*, which requires a single blood meal at each stage of development. Changes in the distribution of the tick are probably introducing this and other tick-borne disease into previously unaffected areas. The tick feeds for approximately 3 weeks every year and completes its life cycle in 3 years. The larval and nymphal stages will feed on any vertebrate, but the adult female will engorge and mate only on larger mammals. The tick becomes infected by feeding on a viremic host and the virus translocates to the salivary gland of the subsequent stage to provide a source of infection at feeding in the following year. Transstadial transmission of the virus occurs, but transovarial transmission does not; thus only the nymph and adult ticks are capable of transmitting the disease. The tick is seasonally active at temperatures between 7°C and 18°C. Most ticks feed in the spring, with peak activity dependent on the latitude and elevation of the pasture, but generally occurring in April and May. In some areas there is a second period of activity of a separate population of *I. ricinus* in the autumn during August and September. Although infected ticks can transmit the infection to a large number of vertebrate hosts, only sheep, red grouse (*Lagopus scoticus*), and possibly horses, attain a viremia sufficient to infect other ticks and act as maintenance hosts. Grouse amplify the virus, deer amplify the vector, and hares (*Lepus timidus*) amplify both. Infection in red grouse is accompanied by a high mortality, and the louping-ill virus is essentially maintained in an area by a sheep-tick cycle and hare tick cycle.

### Nontick Transmission

Although the major method of spread is by the bites of infected ticks, spread by droplet infection is of importance in man, and the

infection can be transmitted in animals by hypodermic needle contamination and other methods. The virus is not very resistant to environmental influences and is readily destroyed by disinfectants. Pigs fed the carcasses of sheep that had died of louping-ill become infected with the louping-ill virus. The virus is excreted in the milk of experimentally infected female goats, and infects sucking kids to produce an acute disease. Virus is also excreted in the milk of ewes during the acute stages of infection but, paradoxically, does not result in the transmission of the infection to lambs. Grouse can be infected by eating infected ticks, and this is considered a major mechanism of infection for grouse.

## Host and Environmental Risk Factors

The epidemiology of disease is dictated by the biology of the tick and so disease is seasonal, occurring during spring when the ticks are active. The prevalence of infection, as measured by seropositivity, is high in areas where the disease is enzootic. In these areas, the annual incidence of disease varies but there are cases every year and they occur predominantly in yearlings and in lambs. In enzootic areas, the majority of adult sheep have been infected and are immune. Colostral immunity from these ewes will protect their lambs for approximately 3 months, and these lambs are resistant to infection during the spring rise of the ticks. Ewe lambs that are retained in the flock are susceptible to infection at the second exposure the following spring. In the UK there are concerns that the density and range of ticks is increasing because of changes in climate and land management; thus the distribution of tick-borne disease is also changing.<sup>5</sup>

The proportion of infected animals that develop clinical disease in any year is estimated to vary from 5% to 60% and is influenced by the intensity of the tick vector; the immune status of the flock; the age at infection; nutritional status; and factors such as cold stress, herding, and transport, and the occurrence of intercurrent disease. Naive animals introduced to an enzootic area are at high risk for infection and clinical disease.

Intercurrent infection with *E. (Cytoecetes) phagocytophila* and *Toxoplasma gondii* have been shown to increase the severity of experimental tick-borne fever in young lambs, but the relevance of this association to naturally occurring disease is uncertain. It would appear that concurrent infection with louping-ill and tick-borne fever is unlikely to occur in the field in young lambs because colostral immunity will protect against infection with the louping-ill virus, whereas colostral immunity is not protective against tick-borne fever. Similarly, the superinfection of *Rhizomucor pusillus* on this concurrent infection has been observed in experimental conditions, but is not a

commonly recorded observation in natural disease.

### Zoonotic Implications

Louping-ill is a zoonosis. The major risk for veterinarians is with the postmortem examination and handling of tissues from infected animals. Laboratory workers, and shepherds and abattoir persons who handle infected sheep, are also at risk. The occurrence of virus in the milk of goats and sheep is a risk for human disease where raw milk is consumed.

### PATHOGENESIS

After tick-borne infection, the virus proliferates in the regional lymph node to produce a viremia that peaks at 2 to 4 days and declines with the development of circulating antibody before the development of clinical disease. Invasion of the CNS occurs in the early viremic stage in most if not all infected animals, but in most the resultant lesions are small and isolated and there is no clinical neurologic disease. The occurrence of clinical disease is associated with the replication of the virus in the brain, severe inflammation throughout the CNS, and necrosis of brainstem and ventral horn neurons. The reason for more severe disease in some animals appears to be related to the rapidity and extent of the immune response. Animals that survive exposure to louping-ill virus have an earlier immune response to the infection and have high concentrations of antibody in the CSF.

In experimental studies, there is a more severe and prolonged viremia and a higher mortality from louping-ill when there is concurrent infection with tick-borne fever. Sheep with tick-borne fever have severe neutropenia, lymphocytopenia, defective cellular and humoral immunologic responses, and high mortality associated with concurrent infection with this agent is thought to be from enhanced viral replication of the louping-ill virus. The dual infection in experimental sheep also facilitates fungal invasion and a systemic mycotic infection with *R. pusillus*.

### CLINICAL FINDINGS

In most sheep, infection is inapparent. There is an incubation period of 2 to 4 days followed by a sudden onset of high fever (up to 41.5°C, 107°F) for 2 to 3 days followed by a return to normal. In animals that develop neurologic disease, there is a second febrile phase during which nervous signs appear. Affected animals stand apart, often with the head held high and with twitching of the lips and nostrils. There is marked tremor of muscle groups and rigidity of the musculature, particularly in the neck and limbs. This is manifested by jerky, stiff movements and a bounding gait, which gives rise to the name louping-ill. Incoordination is most marked in the hindlimbs. The sheep walks into objects and may stand with the head pressed against them. Hypersensitivity to noise and

touch may be apparent. Some animals will recover over the following days, although there may be residual torticollis and posterior paresis. In others, the increased muscle tone is succeeded by recumbency, convulsions, and paralysis, and death occurs as early as 1 to 2 days later. Young lambs may die suddenly with no specific nervous signs.

The clinical picture in cattle is very similar to that observed in sheep, with hyperesthesia, blinking of the eyelids, and rolling of the eyes, although convulsions are more likely to occur in cattle, and in the occasional animals that recover from the encephalitis there is usually persistent signs of impairment of the CNS.

Horses also show a similar clinical picture to sheep, with some showing a rapidly progressing nervous disease with a course of approximately 2 days and others a transient disorder of locomotion with recovery in 10 to 12 days.

The infection is usually subclinical in adult goats but the virus is excreted in the milk and kids may develop severe acute infections. In humans an influenza-like disease followed by meningoencephalitis occurs after an incubation period of 6 to 18 days. Although recovery is common, the disease can be fatal and residual nervous deficiencies can occur.

### CLINICAL PATHOLOGY

The initial viremia that occurs with infection declines with the emergence of serum antibody and virus is no longer present in the blood at the onset of clinical signs. Hemagglutination inhibition (HI), complement-fixing, and neutralizing antibodies can be detected in the serum of recovered animals. HI and complement-fixing antibodies are relatively transient, but neutralizing antibodies persist. HI IgM antibody develops early in the disease and can be used as an aid to diagnosis in animals with clinical disease. Analysis of CSF is usually not considered because of the zoonotic risk.

Molecular tests, including conventional and real-time RT-PCR, can target specific viruses in this tick-borne encephalitis virus group, and a pan-flavivirus test has been developed.<sup>6</sup>

### NECROPSY FINDINGS

No gross changes are observed. Histologically, there are perivascular accumulations of cells in the meninges, brain, and spinal cord, with neuronal damage most evident in cerebellar Purkinje cells and, to a lesser extent, in the cerebral cortex. Louping-ill virus can be demonstrated in formalin-fixed tissues by the avidin-biotin-complex immunoperoxidase technique.

### Samples for Confirmation of Diagnosis

- **Virology:** chilled brain, halved midsagittally (VI, RT-PCR)

- **Histology:** fixed brain, other half (LM, IHC)
- **Molecular:** CNS tissue, blood, ticks (conventional and real-time RT-PCR)

### DIFFERENTIAL DIAGNOSIS

The disease is restricted to areas in which the vector tick occurs.

- In lambs, the disease has clinical similarities with delayed swayback, spinal abscess, and some cases of tick pyemia. Spinal abscess occurs shortly following a management procedure such as docking or castration or with tick pyemia; it has a longer clinical course, is commonly present at C7-T2, and can be established by radiographic examination. Tick pyemia can also occur in flocks that have louping-ill, and the determination of the contribution of each disease to flock mortality relies on clinical, epidemiologic, and postmortem examination.
- In yearlings, the disease has similarities to spinal ataxia caused by trauma, to gid (*Coenurus cerebralis*), and to the early stages of poliomyelomalacia.
- In adults, the disease in sheep resembles some stages of acute neurologic diseases, including scrapie, tetanus, hypocalcemia, hypomagnesemia, pregnancy toxemia, and listeriosis.

### TREATMENT

An antiserum has been used and is protective if given within 48 hours of exposure, but is of no value once the febrile reaction has begun. However, it is not commercially available. Animals with clinical disease should be sedated if necessary during the acute course of the disease and kept in a secluded and dark area with general supportive care.

### CONTROL

The prevention of louping-ill requires either the prevention of exposure of sheep to tick-infested pastures or the immunization of animals before exposure. Immunization has been the traditional approach.

Historically, a formalinized tissue vaccine derived from brain, spinal cord, and spleen was used and provided excellent immunity in enzootic areas. The vaccine was not without risk for persons manufacturing it and at one stage led to an outbreak of scrapie where the vaccine was prepared from sheep incubating the disease. Currently, vaccination is with a formalin-killed tissue culture-derived vaccine administered in an oil adjuvant. A single dose of this vaccine will give protection for at least 1 year and possibly up to 2 years. The vaccine is used in the autumn, or in the early spring 1 month before the anticipated tick rise, in all ewe lambs that will be held for flock replacements. Vaccination of pregnant ewes twice in late pregnancy is recommended to ensure adequate passive immunity to the lambs via

the colostrum. A recombinant vaccine has also been shown to offer protection against infection.

The limited geographic occurrence of this disease and commercial economics has, and may, restrict the availability of vaccines. Consequently tick control, or the elimination of infection from pastures, may be required in the future. The intensity of tick infestation of pastures can be reduced by influencing the microclimate that they require for survival. In some areas this can be achieved by ditching and drainage of the pastures. The control of the causative tick using acaricides provides some protection against disease.

Epidemiologic, modeling, and experimental studies indicate that sheep, red grouse, and hares are the only maintenance hosts for the virus and this, coupled with the fact that there is no transovarial transmission of the virus in the tick, offers a potential method for eradication of the infection from an area. However, this approach (the elimination of wildlife hosts) is increasingly unacceptable in relationship to game and wildlife conservation, may have unintended consequences and is probably of dubious benefit—cost in relationship to alternate methods of control.<sup>7</sup>

#### FURTHER READING

Estradapena A, Farkas R, Jaenson TGT, et al. *Ticks and Tick-Borne Diseases: Geographical Distribution and Control Strategies in the Euro-Asia Region*. Wallingford, UK: CABI Publishing; 2003.

Radostits O, et al. Ovine encephalomyelitis (louping-ill). In: *Veterinary Medicine: A Textbook of the Diseases of Cattle, Horses, Sheep, Goats and Pigs*. 10th ed. London: W.B. Saunders; 2007:1414-1418.

#### REFERENCES

1. Jeffries CL, et al. *J Gen Virol*. 2014;95:1005.
2. Mansfield KL, et al. *J Gen Virol*. 2015;96:1676.
3. Ruiz-Fons F, et al. *Eur J Wildl Dis*. 2014;60:691.
4. Cranwell MP, et al. *Vet Rec*. 2008;162:28.
5. Sarginson N, et al. *In Pract*. 2009;31:58.
6. Johnson N, et al. *Vector Borne Zoonotic Dis*. 2010;10:665.
7. Harrison A, et al. *J Appl Ecol*. 2010;47:926.

### WEST NILE, KUNJIN, AND MURRAY VALLEY ENCEPHALITIS

#### SYNOPSIS

**Etiology** Flavivirus including West Nile virus (lineages 1 and 2) including Kunjin virus, and Murray Valley encephalitis virus. Closely related to Japanese encephalitis virus.

**Epidemiology** Maintained in a bird-mosquito cycle. Mammals are incidentally infected. Enzootic in Africa, North America, Pakistan, southern Europe, and Australia. Epizootics. Affects a wide variety of species with a major impact on humans and horses.

**Clinical signs** Weakness, incoordination, altered mentation, muscle fasciculations, recumbency.

**Clinical pathology** MAC-ELISA for diagnosis.

**Lesions** Polioencephalomyelitis.

**Diagnostic confirmation** MAC-ELISA, PCR, clinical signs, lesions.

**Treatment** None specific. Supportive care.

**Control** Vaccination. Mosquito control.

MAC-ELISA, *M* antibody-capture enzyme-linked immunosorbent assay.

#### ETIOLOGY

Encephalitis in horses, humans, and other species is associated with West Nile virus, an arthropod-borne flavivirus in the Japanese encephalitis virus group. Other viruses in the group include Japanese encephalitis virus (Japan and Southeast Asia), St. Louis encephalitis virus (United States), Kunjin virus (now considered a subtype of West Nile virus, Australia),<sup>1,2</sup> Murray Valley encephalitis virus (Australia),<sup>3-5</sup> and Rocio virus (Brazil). Murray Valley virus causing encephalomyelitis in horses in southeastern Australia is endemic to northern Australia.<sup>4</sup> Viruses causing, or suspected of causing encephalomyelitis in equids, are listed in Table 14-11.<sup>6</sup>

The virus was first isolated in 1937 from a human with fever in Uganda. There are at least two lineages of the virus, with one lineage (Lineage 1) isolated from animals in central and North Africa, Europe, Israel, and

**Table 14-11** Viruses causing encephalomyelitis in horses. reproduced with permission.<sup>6</sup>

Virus species	Geographic location	Reservoir species	Equine syndrome
<b>Alphavirus</b>			
Eastern equine encephalitis virus	North/South/Central America, Caribbean	Birds, rodents, snakes	Encephalomyelitis
Western equine encephalitis virus	North/South America	Birds, rodents, snakes	Encephalomyelitis
Venezuelan equine encephalitis virus	Central/South America, Caribbean	Cotton rat	Encephalomyelitis
Ross River virus	Australia, Papua New Guinea	Marsupial and placental mammals	Systemic: hemolympathic Neurologic ataxia
Semliki Forest virus	East and West Africa	Unknown	Encephalomyelitis
<b>Flavivirus</b>			
Japanese encephalitis	Asia, India, Russia, Western Pacific	Birds, swine	Encephalomyelitis
Murray Valley	Australia, Papua New Guinea	Birds, horses, cattle, marsupials, and foxes	Encephalomyelitis
Kunjin virus	Australia	Water birds: herons and ibis	Encephalomyelitis
St. Louis encephalitis	North, Central and South America	Birds	Serologic only recorded
Usutu	Europe, Africa	Birds	Serologic only recorded
West Nile	Africa, Middle East, Europe, North, Central and South America, Australia	Passerine birds (crows, sparrows, robins)	Encephalomyelitis
Louping-ill	Iberian Peninsula, UK	Sheep, grouse	Encephalomyelitis
Powassan	North American, Russia	Lagomorphs, rodents, mice, skunks, dogs, birds	Encephalomyelitis
Tick-borne encephalitis	Asia, Europe, Finland, Russia	Small rodents	Encephalomyelitis
<b>Bunyavirus</b>			
California serogroup: California encephalitis, Jamestown Canyon, La Crosse, Snowshoe hare	North America (United States and Canada), parts of eastern Asia	Rodents and lagomorphs	Encephalomyelitis



North America, whereas the other (Lineage 2) is enzootic in central and southern Africa with outbreaks of disease in humans in central Europe, Greece, and Russia.<sup>6-10</sup> The recent outbreak in North America was associated with a Lineage 1 (Clade a) virus of African origin almost identical to that isolated from diseased geese in Israel, and which subsequently acquired a mutation that enhanced its capacity to reproduce in mosquitoes and its virulence in corvid birds and other species.<sup>11</sup> Viruses of both lineages can circulate at the same time in the same geographic region. Virus of either lineage can cause disease, although that of Lineage 1 appears to be associated with more severe disease in horses and other species. Kunjin virus, a West Nile virus (Lineage 1, Clade b), causes encephalomyelitis in horses in Australia.<sup>12,13</sup> An outbreak in Australia in 2011 was associated with unusually wet weather (see later) and emergence of a strain of West Nile virus (WNVNSW2011) that had at least two amino acid changes associated with increased virulence of WNVNY99 (the strain associated with the epidemic in North America in 1999).<sup>12</sup> The WNV(KUN) NSW2011 strain also had adaptations that increased the amount of virus in material (saliva) regurgitated by mosquitoes, which could have increased the rate of vector transmission of the virus.<sup>14</sup> The WNVNSW2011 strain did not have all the virulence attributes of the WNVNY99 strain.<sup>15</sup>

Murray Valley encephalitis virus causes encephalomyelitis in horses in Australia.<sup>3</sup>

The West Nile virus causes disease in humans, horses, birds (including geese, raptors, and corvids), sheep, alpaca, and dogs. Experimental inoculation of little ravens (*Corvus mellori*) with WNVKUN resulted in infection and viremia but not clinical disease.<sup>13</sup>

## EPIDEMIOLOGY

### Distribution

West Nile encephalitis virus is enzootic to Africa and sporadic outbreaks of the disease occurred in the 1960s in Africa, the Middle East, and southern Europe. Recently outbreaks affecting horses and other animals have occurred in southern France, Tuscany, Israel, and other parts of southern Europe. There is serologic evidence of common and widespread infection of equids with West Nile virus in Pakistan and Tunisia.<sup>16,17</sup>

The virus was introduced into New York City in North America in 1999 and subsequently spread widely across the continent, including Canada, Mexico, and the Caribbean, reaching the west coast by 2004. The virus caused widespread deaths of wild birds and disease and death in humans, horses, and other species in North America during this period.

Introduction of the infection to North America was associated with an epizootic of disease that over several years moved across

the continent. During the initial years of the epizootic there were large numbers of cases in horses (15,000) and humans (4,000) and death of at least 16,500 birds. As the front of the epizootic moved across the country, the infection became enzootic and the number of cases in horses in these regions decreased markedly over those in the first year.

Infection by Kunjin virus (a strain of West Nile virus) rarely causes disease of horses in areas in which it is endemic (northern Australia) but was associated with an outbreak of neurologic disease in horses in southeastern Australia after a decade-long drought broke with record rains resulting in sixfold increases in vector density.<sup>1,12</sup> The outbreak did not extend into the subsequent year.<sup>12</sup> There is serologic evidence of infection by flaviviruses (including Kunjin and/or Murray Valley encephalitis virus in 15%–18% of horses in southeast Queensland, where infection is presumed to be endemic and clinical disease is rare.<sup>18</sup>

### Viral Ecology

The virus is maintained by a cycling between amplifying hosts, usually birds, and insect vectors. Large mammals, including horses and humans, are incidentally infected and are not important in propagation of the virus. Amplifying hosts are those in which the viremia is of a sufficient magnitude and duration (1–5 days) to provide the opportunity to infect feeding mosquitoes. Mammals, and in particular horses, are generally not amplifying hosts because of the low level of viremia.

The virus is spread by the feeding of ornithophilic mosquitoes, usually of the genus *Culex* with mosquitoes of the *C. pipiens* group being effective vectors.<sup>19,20</sup> The principal vectors for West Nile virus include Africa, *C. univittatus*; Europe, *C. pipiens*, *C. modestus*, and *Coquillettidia richiardii*; Asia, *C. quinquefasciatus*, *C. tritaeniorhynchus*, and *C. vishnui*; United States, *C. pipiens* complex including *C. pipiens* and *C. restuans* in the northeastern and north central United States, *C. tarsalis* in the Great Plains and western United States; and *C. nigripalpus* and *C. quinquefasciatus* in southeastern United States.<sup>21</sup> *C. annulirostris* and a variety of other native and introduced species of mosquitoes are actual or potential vectors of West Nile virus in Australia.<sup>21</sup>

Infected mosquitoes carry the virus in salivary glands and infect avian hosts during feeding. The virus then multiplies in the avian host causing a viremia that may last for up to 5 days. Mosquitoes feeding on the avian host during the viremic phase are then infected by the virus. This pattern of infection of amplifying hosts and mosquitoes is repeated such that the infection cycles in these populations. Increases in mosquito number, such as occur at the end of the summer, and enhanced viral replication in mosquitoes at higher ambient temperatures,

increase the likelihood that avian hosts, or incidental hosts, will become infected. This results in an increase in the incidence of disease in late summer and early autumn.

The principal avian host and vector species vary markedly between geographic regions. In North America the house sparrow (*Passer domesticus*) is the principal amplifying host and *C. pipiens* is the principal vector. *C. pipiens*, and other mosquito vectors, feed almost exclusively on passerine and columbiform birds early in the season, but later in the summer in temperate regions switch to feeding on mammalian hosts. This change in feeding behavior is associated with increased frequency of infection and disease in mammals, including horses and humans, in the late summer.

The virus cycles between the avian host and insect vectors year round in tropical regions. However, in temperate regions in which mosquitoes do not survive during the winter the mechanism by which the virus survives over winter is unknown.

The primary vector involved in Murray Valley encephalitis virus transmission is the mosquito *C. annulirostris*.<sup>13</sup> Wading birds, particularly the rufous night heron (*Nycticorax caledonicus*) appear to be the principal natural reservoirs of Murray Valley encephalitis virus and West Nile virus in Australia.<sup>1</sup>

### Transmission

Transmission is only by the bite of infected insect vectors. There is no evidence of horizontal spread of infection among horses. The disease can be spread in humans by transfusion of blood or transplantation of organs obtained from an infected person.

### Animal Risk Factors

The disease occurs in parts of the world as epidemics, apparently associated with sporadic introduction of the virus into nonendemic regions, such as the Mediterranean littoral and parts of central Europe.<sup>22</sup> Introduction of the virus to these regions occurs infrequently enough that horses have no active immunity and are susceptible to infection and disease. Horses immune through either natural infection or vaccination are resistant to the disease. The effect of immunity was evidenced in North America by the marked decrease in morbidity and mortality among horses after the epizootic waned and the disease became enzootic. The decrease in morbidity was attributed to both natural and vaccinal immunity. Interestingly, although the number of cases in horses decreased rapidly, there was not a similar decrease in the number of human cases, perhaps because of the lack of a vaccine for use in humans.

Horses of all ages appear to be equally susceptible to infection. Disease is reported in horses aged from 5 months to >20 years. There does not appear to be any predilection based on breed or sex. Polymorphism in horse genome is associated with

susceptibility to disease, including a haplotype associated with the promoter region of the OAS1 gene.<sup>23</sup>

### Morbidity and Case Fatality

The incidence of the disease during an epizootic can be as high as 74 cases per 1000 horses at risk. The case-fatality rate for West Nile virus encephalomyelitis in horses in North America treated in the field is 22% to 44%, whereas it is 30% to 43% of horses in referral centers.<sup>24</sup> The case-fatality rate for West Nile virus (Kunjin) and Murray Valley encephalitis virus infected horses in Australia with signs of disease is 5% to 20%.<sup>1</sup>

### Zoonotic Implications

Infection of humans by West Nile virus or Murray Valley encephalitis virus can result in fatal encephalitis, although less severe disease or inapparent infection is more common.<sup>7,12,25</sup> The virus has zoonotic potential and tissues from potentially infected animals and virus cultures should be handled in containment level 3 facilities, particularly material from potentially infected birds.

### PATHOGENESIS

Horses are infected by the bite of infected mosquitoes. Feeding by as few as seven infected mosquitoes is sufficient to cause infection in seronegative horses. Viremia, which persists for less than 2 days, occurs 2 to 5 days after feeding by infected mosquitoes. West Nile encephalitis occurs in only a small proportion of infected horses. The virus localizes in cells in the CNS where it induces a severe poliomyelitis with the most severe lesions being in the spinal cord. Lesions are often evident in the ventral horn of the spinal cord, which is consistent with clinical signs of weakness.

### CLINICAL FINDINGS

The incubation period of West Nile virus after natural infection is estimated to be 8 to 15 days. Fever occurs early in the disease but is uncommon at the time that signs of neurologic disease become evident. Affected horses are often somnolent, listless, or depressed, although hyperexcitability has been reported. The signs of neurologic disease, including muscle fasciculation, weakness, and incoordination, develop within a period of hours and can progress over several days. Muscle fasciculations are common in the head and neck, but can occur in any muscle group. Weakness is most pronounced in limb and neck muscles and severely affected horses are recumbent with flaccid paralysis. Signs of neurologic disease are usually, but not reliably, bilaterally symmetric. Altered mentation, blindness, and cranial nerve abnormalities, if they occur, usually become evident after signs of spinal cord disease are apparent.

Weakness with or without ataxia is present in almost all affected horses, whereas

altered mentation is detected in approximately 66% of horses. Cranial nerve abnormalities are evident in approximately 40% of horses, whereas apparent blindness or lack of menace reflex occurs in 3% to 7% of horses.

Median recovery time for horses treated in the field is 7 days, with a range of 1 to 21 days.

The prognosis depends on the severity of clinical signs. Horses that become recumbent and unable to rise are approximately 50 times more likely to die than are horses that remain able to stand while affected by the disease. Most horses that survive the initial disease do not have signs of neurologic dysfunction 6 months later.

Murray Valley encephalitis in horses causes signs consistent with encephalitis including fever, depressed mentation, abnormalities in cranial nerves including paralysis of the facial muscles, ataxia, and recumbency.<sup>3,5</sup> The clinical course can be prolonged.

### Other Species

Disease associated with West Nile virus is documented in small numbers of other species, including squirrels, chipmunks, bats, dogs, cats, reindeer, sheep, alpaca, alligators, and a harbor seal during intense periods of local viral activity. West Nile virus infection in dogs is usually subclinical.<sup>26</sup> The disease in camelids is characterized by acute recumbency and altered mentation.

### CLINICAL PATHOLOGY

Affected horses are often mildly lymphopenic, and hyperbilirubinemic (likely from anorexia), and occasionally azotemic. These changes are not diagnostic of West Nile or Murray Valley encephalitis.

CSF is abnormal in approximately 70% of horses with signs of neurologic disease. Abnormalities include mononuclear pleocytosis and elevated total protein concentration.<sup>6</sup>

### Serologic Tests

Antibody can be identified in equine serum by IgM capture ELISA (IgM capture ELISA, M antibody-capture ELISA [MAC-ELISA]), HI, IgG ELISA, or plaque reduction neutralization (PRN).<sup>27,28</sup> Equine West Nile-specific IgM antibodies are usually first detectable 7–10 days after infection and persist for 1 to 2 months. Because the incubation period of the disease after infection by bite of infected mosquitoes is at least 8 days, West Nile-specific IgM is usually present at the time of development of clinical signs of the disease. MAC-ELISA is therefore a useful test in the diagnosis of the disease.

West Nile virus neutralizing antibodies are detectable in equine serum by 2 weeks postinfection and can persist for more than 1 year. In some serologic assays, antibody cross-reactions with related flaviviruses (St. Louis encephalitis virus or Japanese

encephalitis virus), can be encountered. The PRN test is the most specific among West Nile serologic tests and all affected horses have titers  $\geq 1:100$  4 to 6 weeks after recovering from the disease, and 90% of horses maintain this titer 5 to 7 months after recovery.

Detection by MAC-ELISA of West Nile-specific IgM in serum at dilutions greater than 1:400, in the presence of appropriate clinical signs, is considered diagnostic of West Nile virus. Similarly, a fourfold increase in PRN titer in serum collected during the acute and convalescent stages of the disease, in the absence of vaccination and in the presence of appropriate clinical signs, is considered diagnostic.

### Identification of West Nile Virus

The virus can be grown in cell culture, and viral nucleic acid can be demonstrated in tissues of infected animals by RT-PCR.<sup>29,30</sup> Note that infected horses have much lower concentrations of virus than do infected birds, and failure to demonstrate viral antigen in infected horses is not uncommon, especially if less sensitive techniques, such as IHC, are used.

### NECROPSY FINDINGS

Gross lesions are infrequently seen. When present they consist of multifocal areas of congestion and hemorrhage within the medulla oblongata, midbrain, and spinal cord. Histopathologic changes include a nonsuppurative poliomyelinoencephalomyelitis with multifocal glial nodules and neuronophagia. The inflammatory changes and viral distribution are concentrated in the rhombencephalon and spinal cord, with comparatively little damage to the cerebrum. One IHC study of naturally infected horses concluded that examination of the spinal cord is required to accurately identify West Nile virus infection. Another report, in which RT-PCR was used, concluded that high-quality samples of medulla were sufficient to detect the presence of the virus. Post-mortem confirmation of the diagnosis through virus isolation is possible, but the sensitivity is generally inferior to molecular biology-based techniques. RT-PCR is generally superior to IHC. The processing of tissue from multiple CNS sites is recommended to increase the chances of finding a virus-rich focus. High concentrations of West Nile virus are not found in non-CNS tissues of infected equids, in contrast to the distribution of the virus in many other species.

### Samples for Confirmation of Diagnosis

- **Virology:** minimum sample is half of sagittally sectioned hindbrain (must include medulla). Ideally a segment of thoracolumbar spinal cord as well. Submit samples chilled (VI, RT-PCR)
- **Histology:** same samples, fixed in formalin (LM, IHC, RT-PCR).

**Note the zoonotic potential of this disease when collecting and submitting specimens. Some authorities recommend using containment level 3 precautions when handling potentially infected tissues, such as that from birds.**

### DIFFERENTIAL DIAGNOSIS

Differential diagnoses for West Nile encephalitis include (Table 14-11) the following:

- Eastern and Western encephalitis
- Venezuelan equine encephalitis
- Equine herpesvirus-1 myeloencephalopathy
- Hendra virus infection
- Rabies
- Botulism
- Hepatic encephalopathy
- Borna disease
- Equine protozoal myeloencephalitis
- Leukoencephalomalacia
- Lower motor neuron disease

### TREATMENT

There is no specific treatment for West Nile encephalitis, although administration of IFN or hyperimmune globulin has been advocated. Affected horses are often administered nonsteroidal antiinflammatory drugs such as flunixin meglumine, dimethyl sulfoxide, or corticosteroids in an attempt to reduce inflammation in neural tissue. Administration of corticosteroids minimally but statistically significantly increases the likelihood of survival, but this practice is controversial. Treatment is based on supportive care and prevention of complications of neurologic disease and includes assistance to stand, including use of a sling support, administration of antimicrobials, and maintenance of hydration and nutrition.

### CONTROL

Control of disease associated with West Nile virus and other flaviviruses is achieved by vaccination and minimization of exposure. It is important to recognize that factors affecting vector density, as happened in Australia in 2011, introduction of new vectors, or emergence of virus strains with higher virulence can affect incidence of the disease and require revision of existing control measures.<sup>12,25,31</sup> Elimination of the virus is not practical given that it cycles through avian and insect vectors and that the horse is incidentally infected.

**Vaccination** is effective in preventing development of disease, and reduces the likelihood of death in horses with West Nile encephalitis by approximately two to three times.<sup>32-34</sup> Vaccination is an important aspect of controlling the disease. There is no evidence that administration of the inactivated virus vaccine increases the risk of fetal loss in mares. Vaccination prevents viremia in most horses following exposure to West Nile virus-infected mosquitoes. Vaccination induces an IgG, but not an IgM, response in

horses providing a means of identifying recently naturally infected horses from those with vaccine-induced serologic results.<sup>32</sup>

Both inactivated virus vaccine and a live canarypox-vectored recombinant vaccine are available in North America.<sup>6</sup> The inactivated virus vaccine should be administered in two doses at an interval of 3 to 6 weeks in early summer in the first instance, and then again once to twice yearly before the season of peak disease incidence. Foals from unvaccinated mares should be administered the vaccine beginning at 2 to 3 months of age, and foals of vaccinated mares should be administered the vaccine beginning at 7 to 8 months of age. Vaccination of foals that acquired passive immunity from the dam can be effective at inducing active immunity when the first dose of vaccine is administered at 3 months of age.<sup>35</sup>

Administration of the recommended two doses of inactivated virus vaccine fails to induce an adequate plaque reduction titer in approximately 14% of horses 4 to 6 weeks after vaccination and in 30% of horses 5 to 7 months after vaccination. This effect was especially evident in horses >10 years of age. These results indicate that some horses will not develop protective immunity against West Nile virus despite administration of vaccine in the recommended dose and interval.

**Minimization of exposure** of horses to the virus includes reducing the population density of mosquitoes and protecting horses from being bitten. Reducing the population of mosquitoes includes widespread spraying with insecticides and elimination of mosquito breeding sites. Widespread spraying in cities is used when the disease is a risk for humans but is not practical for controlling mosquitoes in rural areas. Environmental concerns make this approach to control unacceptable in many regions.

Removal of larval habitat by draining standing water is recommended for control of West Nile virus, although the efficacy of this approach has not been demonstrated. Standing water includes not just dams and ponds but also poorly maintained outdoor swimming pools, bird baths, discarded vehicle tires, and other receptacles that could hold water. Use of larvicidal compounds in standing water is recommended by some authorities.

Minimizing the frequency with which horses are bitten by mosquitoes has the potential to reduce the risk of contracting the disease. However, specific recommendations are not available. Housing during periods of peak mosquito activity, especially at dawn and dusk, might reduce the risk of disease.

### FURTHER READING

- Long MT. West Nile virus and equine encephalitis viruses new perspectives. *Vet Clin North Am Equine Pract.* 2014;30:523-540.
- McVey DS, et al. West Nile Virus. *Rev - Off Int Epizoot.* 2015;2:431-439.

### REFERENCES

1. Roche SE, et al. *Aust Vet J.* 2013;91:5.
2. Frost MJ, et al. *Emerg Infect Dis.* 2012;18:792.
3. Barton AJ, et al. *Aust Vet J.* 2015;93:53.
4. Mann RA, et al. *J Vet Diagn Invest.* 2013;25:35.
5. Gordon AN, et al. *J Vet Diagn Invest.* 2012;24:431.
6. Long MT. *Vet Clin North Am Equine Pract.* 2014;30:523.
7. McVey DS, et al. *Rev Sci Tec.* 2015;34:431.
8. Chaintoutis SC, et al. *Emerg Infect Dis.* 2013;19:827.
9. Ciccozzi M, et al. *Infect Genet Evol.* 2013;17:46.
10. McMullen AR, et al. *J Gen Virol.* 2013;94:318.
11. Añez G, et al. *PLoS Negl Trop Dis.* 2013;7:e2245.
12. Prow NA. *Int J Environ Res Public Health.* 2013;10:6255.
13. Tee SY, et al. *Aust Vet J.* 2012;90:321.
14. van den Hurk AF, et al. *Parasit Vectors.* 2014;7.
15. Setoh YX, et al. *J Gen Virol.* 2015;96:1297.
16. Bargaoui R, et al. *Transbound Emerg Dis.* 2015;62:55.
17. Zohaib A, et al. *Epidemiol Infect.* 2015;143:1931.
18. Prow NA, et al. *Int J Environ Res Public Health.* 2013;10:4432.
19. Amraoui F, et al. *PLoS ONE.* 2012;7.
20. Andreadis TG. *J Am Mosq Control Assoc.* 2012;28:137.
21. Jansen CC, et al. *Int J Environ Res Public Health.* 2013;10:3735.
22. Sedlak K, et al. *Epid Mik Imun.* 2014;63:307.
23. Rios JJ, et al. *PLoS ONE.* 2010;5:e10537.
24. Epp T, et al. *Can Vet J.* 2007;48:1137.
25. Selvey LA, et al. *PLoS Negl Trop Dis.* 2014;8:2656.
26. Bowen RA, et al. *Am J Trop Med Hyg.* 2006;74:670.
27. Long MT, et al. *J Vet Intern Med.* 2006;20:608.
28. Wagner B, et al. *Vet Immunol Immunopathol.* 2008;122:46.
29. Brault AC, et al. *J Med Entomol.* 2015;52:491.
30. Toplu N, et al. *Vet Pathol.* 2015;52:1073.
31. Kock RA. *Rev - Off Int Epizoot.* 2015;34:151.
32. Khatibzadeh SM, et al. *Am J Vet Res.* 2015;76:92.
33. Long MT, et al. *Equine Vet J.* 2007;39:491.
34. Minke JM, et al. *Vaccine.* 2011;29:4608.
35. Davis EG, et al. *Equine Vet J.* 2015;47:667.

### JAPANESE ENCEPHALITIS

Japanese encephalitis is a neurologic disease of humans, horses, and cattle caused by Japanese encephalitis virus. The disease is an important zoonosis in Asia, arising as a result of virus infection of amplifying hosts (pigs) transmitted by mosquitoes from the avian wildlife reservoir. Horses, cattle, and humans are not important in the propagation of the disease because of the low levels of viremia in these species. There is an effective vaccine.

### ETIOLOGY

**Japanese encephalitis flavivirus (JEV)**, a member of the Flaviviridae family (which also includes Murray Valley encephalitis virus, Kunjin virus, and West Nile virus), all of which cause disease in humans, horses, and other mammals, and Usutu virus, which causes disease only in birds.<sup>1-3</sup> JEV, an enveloped virus of about 50 nm in diameter, has a nonsegmented, single-stranded, positive-sense RNA genome of about 11 kb in length.<sup>3</sup> The genome has one long open reading frame (ORF) that encodes a single poly-



protein is cleaved cotranslationally and posttranslationally into three structural proteins and seven nonstructural proteins. The three structural proteins are the capsid (C), precursor to membrane (prM), and envelope (E) proteins.<sup>3</sup> Based on the nucleotide sequence of genomic RNA, JEV is classified into five major genotypes.<sup>4-9</sup> Genotype 1 occurs in the People's Republic of China, Vietnam, South Korea, Northern Thailand, Cambodia, Japan, Australia, India, and Chinese Taipei; Genotype 2 occurs in Southern Thailand, Malaysia, Indonesia, Northern Australia, and Papua New Guinea; Genotype 3 is present in Indonesia, Malaysia, Nepal, Sri Lanka, India, Indochinese Peninsula, Philippines, Chinese Taipei, South Korea, People's Republic of China, Vietnam, and Japan; Genotype 4 was isolated only during 1980 and 1981 in Indonesia; and Genotype 5 occurs Malaysia, Tibet (China), and South Korea (Fig. 14-5).<sup>2,4,5,9</sup> JEV RNA has been detected in dead birds and a *C. pipiens* mosquito in Italy.<sup>10</sup>

The virus cycles between avian and mammalian amplifying hosts and the mosquitoes (Fig. 14-6).<sup>2</sup> The natural maintenance reservoir for JEV are birds of the family Ardeidae (herons and egrets), which do not demonstrate clinical disease but do have high levels of viremias. The pig is the principal mammalian amplifying host among domestic animals. Horses, cattle, sheep, goats, dogs,

cats, and humans become infected but likely play only a minor role in the spread of the virus because of the low level of viremia in these species. There are a number of species of mosquito important in the biology of the virus:<sup>11,12</sup> *C. tritaeniorhynchus* is the primary

vector, whereas *C. gelidus*, *C. fuscocephala*, and *C. annulirostris* are considered as secondary/regional vectors. The virus has been detected in *Anopheles pedtaeniatus Leicester*, *A. barbirostris (van der Walp)*, and *A. subpictus* in India.

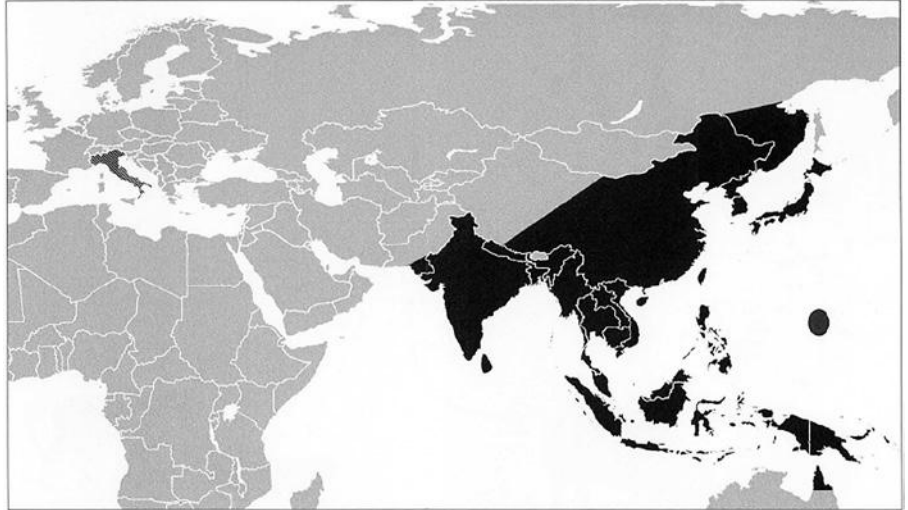

**Fig. 14-5** Distribution of Japanese Encephalitis Virus as of 2015. Viral genome has been detected in dead birds and mosquitoes in Italy, but the virus has not been isolated nor disease consistent with Japanese encephalitis detected in that country. (reproduced with the permission of the World Organisation for Animal Health (OIE, [www.oie.int](http://www.oie.int)). Fig. 2 of Morita K., et al., Japanese encephalitis. In New developments in major vector-borne diseases. Part II: Important diseases for veterinarians (S. Zientara, D. Verwoerd & P.-P. Pastoret..., eds). *Rev. Sci. Tech. Off. Int. Epiz.*, 34 (2), page 443. doi: 10.20506/rst.34.2.2370.)

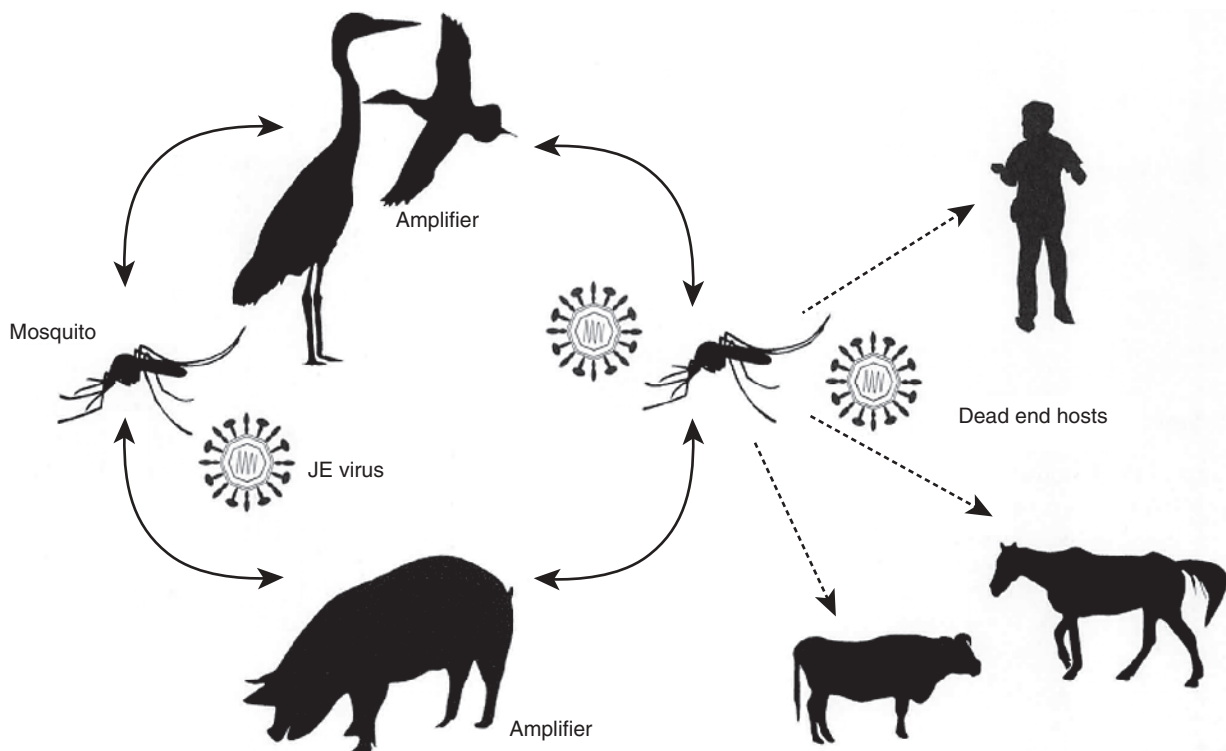

**Fig. 14-6** Transmission cycle of Japanese encephalitis virus between amplifiers (pigs and wild birds) and mosquito vectors (especially *Culex tritaeniorhynchus*), including the infection of dead-end hosts (humans, horses, cattle). (reproduced with the permission of the World Organisation for Animal Health (OIE, [www.oie.int](http://www.oie.int)). Fig. 3 of Morita K., et al., Japanese encephalitis. In New developments in major vector-borne diseases. Part II: Important diseases for veterinarians (S. Zientara, D. Verwoerd & P.-P. Pastoret..., eds). *Rev. Sci. Tech. Off. Int. Epiz.*, 34 (2), page 444. doi: 10.20506/rst.34.2.2370.)

*Aedes koreicus*, a potential vector of JEV, is reported for the first time in northern Italy/Switzerland (it has been reported in Belgium and parts of central Europe), continuing a pattern of climate change-induced incursions of insect vectors of important viral diseases into Europe.<sup>13</sup> *Ochlerotatus detritus* (syn. *Aedes detritus*), a temperate zone (British) mosquito can be infected by JEV in laboratory settings and might be a competent vector in the field, although this remains to be established.<sup>11</sup>

The virus is destroyed by heating for 30 minutes above 56°C and the thermal inactivation point (TIP) is 40°C. It is inactivated in acid environment of pH 1 to 3 but stable in alkaline environment of pH 7 to 9. The virus is very labile, is sensitive to ultraviolet light and gamma irradiation, and does not survive well in the environment.

### EPIDEMIOLOGY

The disease in humans, horses, pigs, or cattle occurs **throughout the Orient and Southeast Asia** and has extended into Papua New Guinea, the Torres Strait, and northern Australia. Outbreaks of disease occurred in the Torres Strait in 1995, and disease in humans has occurred rarely in northern Australia. Outbreaks of disease have not occurred in Australia, despite large populations of wild pigs, wading birds, and mosquitoes probably because the mosquitoes prefer to feed on marsupials, which are poor hosts for JEV.

Sporadic clinical cases of JEV in horses have been reported in various countries including Japan, Hong Kong, Taiwan, and India.<sup>4,14,15</sup> Horse deaths are now uncommon in Japan with few to none reported in several decades,<sup>2,15</sup> because of vaccination of most horses, but 15% to 70% of race horses have antibodies to JEV that are not induced by vaccination. Antibodies against JEV were detected in 67 of 637 (10.5%) horses in India screened between 2006 and 2010.<sup>14</sup> Seroepidemiologic surveys of cattle in Japan reveal that about 68% of animals are positive. Disease in horses and humans occurs in China. The prevalence of the disease is related to the population of pigs, the main amplifying host; the mosquito vector; and susceptible human and equine hosts. Japanese encephalitis virus HI seroprevalence was 74.7% (95% CI = 71.5%–77.9%), JEV IgM seroprevalence was 2.3% (95% CI = 1.2%–3.2%) in pigs at slaughter in Laos, with greater prevalence during the monsoonal season.<sup>16</sup> Factors affecting the number of mosquitoes include availability of suitable habitat, such as a rice field in which survival of mosquito larvae is enhanced by application of nitrogenous fertilizers and the presence of phytoplankton, which provide food and shelter for the larvae.

### CLINICAL SIGNS

The **clinical manifestations** of the disease in horses vary widely in severity.<sup>15</sup> Mild cases

show fever up to 39.5°C (103°F), anorexia, sluggish movements, and sometimes jaundice for 2 to 3 days only. A more severe form of the disease includes lethargy with variable febrile periods (as high as 41°C), with a pronounced stupor, bruxism and chewing motions, difficulty in swallowing, petechiation of mucosa, incoordination, neck rigidity, apparent impaired vision, paresis, and paralysis. Recovery usually occurs within about a week. More severe cases show pronounced lethargy, mild fever, and somnolence. Jaundice and petechiation of the nasal mucosa are usual. There is dysphagia, incoordination, staggering, and falling. There is also a hyperexcitable form of the disease characterized by high fevers (41°C or higher), profuse sweating and muscle tremors, aimless wandering, behavioral changes manifested by aggression, loss of vision, collapse, coma, and death. This severe type of the disease is uncommon, representing only about 5% of the total cases, but is more likely to terminate fatally. In most cases complete recovery follows an illness lasting from 4 to 9 days. The disease occurs in foals and can manifest as encephalitis.<sup>14</sup>

Infection of **cattle, sheep, and goats** is usually clinically inapparent and of little overall significance, although rare cases of clinical disease occur in these species.<sup>2,17,18</sup> Widespread losses, however, have been reported in **swine**, particularly in Japan. The disease occurs as a nonsuppurative encephalitis in pigs under 6 months of age. Sows abort or produce dead pigs at term, and the disease has economic importance because of these losses.

### CLINICAL PATHOLOGY

A variety of tests are available to detect antibodies to JEV or viral RNA. A latex agglutination test provides accurate detection of antibodies in the field. However, definitive diagnosis of Japanese viral encephalitis should not be based exclusively on serology because infection with antigenically related viruses including Murray Valley encephalitis virus, Kunjin virus, and West Nile virus can cause false-positive (from the perspective of JEV) results. Isolation of this flavivirus is difficult, and bioassay techniques are comparatively slow. As a result, detection via PCR is likely to be increasingly utilized. Tests to detect viral RNA in mammalian tissues or mosquitoes are available.<sup>19–23</sup>

### NECROPSY FINDINGS

There are no characteristic gross changes. As is typical of most viral encephalitides, microscopic changes include a nonsuppurative encephalomyelitis, focal gliosis, neuronal necrosis, and neuronophagia. Lesions in piglets following experimental infection are glial cell aggregates and perivascular cuffing throughout the olfactory tract and pyriform cortex. JEV antigens were detected in the cytoplasm and neuronal processes of small nerve cells in the granule cell layer of the

olfactory bulb, in the neuronal processes of the olfactory tract, and in the cytoplasm of neurons in the pyriform cortex.<sup>24</sup>

IHC can be used to demonstrate this virus in formalin-fixed, paraffin-embedded sections.

### ZOONOSIS<sup>25,26</sup>

Japanese encephalitis virus is endemic in 24 countries in the WHO Southeast Asia and Western Pacific regions with more than 3 billion people at risk of infection. Japanese encephalitis is the main cause of viral encephalitis in people in many countries of Asia occurring in almost 68,000 clinical cases yearly. Children are at greatest risk, with adults in endemic areas having protective immunity as a consequence of childhood infection. Most JEV infections are mild (fever and headache) or without apparent symptoms, but approximately 1 in 250 infections results in severe disease characterized by rapid onset of high fever, headache, neck stiffness, disorientation, coma, seizures, spastic paralysis, and death.<sup>25</sup> Although symptomatic JEV is rare, the case-fatality rate among those with encephalitis can be as high as 30%. Permanent neurologic or psychiatric sequelae occur in 30% to 50% of people with clinical encephalitis. There is no effective, specific treatment and care of affected people includes symptomatic treatment. Safe and effective vaccines are available to prevent JEV in people and consequently the WHO recommends JEV vaccination in all regions in which the disease is a recognized public health problem.<sup>25</sup>

### Samples for Confirmation of Diagnosis

- **Virology:** 5 mL chilled CSF fluid, chilled brain (split along midline) (ISO, BIOASSAY, PCR)
- **Histology:** fixed samples of the other half of brain, lung, spleen, liver, heart (LM, IHC)

**Note the zoonotic potential of this organism when handling carcass and submitting specimens.**

### DIFFERENTIAL DIAGNOSIS

Differential diagnosis in horses include<sup>27</sup> other equine viral encephalitides (Eastern, Western, Venezuelan, Murray Valley, West Nile), African horse sickness, Borna disease, EHV infection, equine infectious anemia, acute babesiosis, hepatic encephalopathy, rabies, tetanus, botulism, cerebral nematodiasis or protozoodiasis, or leukoencephalomalacia (*F. moniliforme*).

Differential diagnoses for pigs include<sup>27</sup> Menangle virus infection, porcine parvovirus infection, classical swine fever, porcine reproductive and respiratory syndrome, Aujeszky's disease (pseudorabies), La Piedad Michoacan paramyxovirus (blue eye paramyxovirus), hemagglutinating encephalomyelitis, encephalomyocarditis virus,

porcine brucellosis, Teschen/Talfan, water deprivation/excess salt, and any other causative agent of stillbirth, mummification, embryonic death, and infertility (SMEDI) or encephalitis in newborns.

## TREATMENT AND CONTROL

There is no specific treatment for the disease.

**Control** is by vaccination. Formalinized vaccines afford excellent protection in pigs and horses. A delta inulin-adjuvanted, inactivated cell culture-derived JEV vaccine was safe and well tolerated and induced a strong JEV-neutralizing antibody response in all foals and pregnant mares. The neutralizing activity was passively transferred to their foals via colostrum. Foals that acquired passive immunity to JEV via maternal antibodies had evidence of maternal antibody interference to subsequent vaccination at ~35 days, but not at 1 year of age.<sup>28</sup>

The virus is inactivated by organic and lipid solvents, common detergents, iodine, phenol iodophors of 70% ethanol, 2% glutaraldehyde, 3% to 8% formaldehyde, and 1% sodium hypochlorite.<sup>27</sup>

## REFERENCES

- Ziegler U, et al. *Vector Borne Zoonotic Dis.* 2015;15:481.
- Morita K, et al. *Rev - Off Int Epizoot.* 2015;34:441.
- Unni SK, et al. *Microbes Infect.* 2011;13:312.
- Cherian SS, et al. *Arch Virol.* 2015;160:3097.
- Li M-H, et al. *PLoS Negl Trop Dis.* 2011;5:1231.
- Nabeshima T, et al. *Future Virol.* 2010;5:343.
- Schuh AJ, et al. *J Gen Virol.* 2010;91:95.
- Su C-L, et al. *PLoS Negl Trop Dis.* 2014;8:e3122.
- Takhampunya R, et al. *Virol J.* 2011;8.
- Ravanini P, et al. *Eurosurveillance.* 2012;17:2.
- Mackenzie-Impoimvil L, et al. *Med Vet Entomol.* 2015;29:1.
- van den Hurk AF, et al. *Annu Rev Entomol.* 2009;54:17.
- Suter T, et al. *Parasit Vectors.* 2015;8:402.
- Gulati BR, et al. *J Vet Sci.* 2012;13:111.
- Yamanaka T, et al. *J Vet Med Sci.* 2006;68:293.
- Conlan JV, et al. *Am J Trop Med Hyg.* 2012;86:1077.
- Kako N, et al. *BMC Vet Res.* 2014;10.
- Katayama T, et al. *J Clin Microbiol.* 2013;51:3448.
- Cha G-W, et al. *PLoS ONE.* 2015;10:e0127313.
- Chen YY, et al. *Transbound Emerg Dis.* 2014;61:37.
- Deng J, et al. *J Virol Methods.* 2015;213:98.
- Dhanze H, et al. *Arch Virol.* 2015;160:1259.
- Glushakova LG, et al. *J Virol Methods.* 2015;214:60.
- Yamada M, et al. *J Comp Pathol.* 2009;141:156.
- Japanese encephalitis fact sheet 386. World Health Organisation, 2014. (Accessed 06.12.2015, at <http://www.who.int/mediacentre/factsheets/fs386/en/>).
- Ghosh D, et al. *PLoS Negl Trop Dis.* 2009;3:e437.
- Japanese encephalitis. 2013. (Accessed August, 2016, at [www.oie.int/fileadmin/Home/eng/Animal\\_Health\\_in\\_the\\_World/docs/pdf/Disease\\_cards/JAPANESE\\_ENCEPHALITIS.pdf](http://www.oie.int/fileadmin/Home/eng/Animal_Health_in_the_World/docs/pdf/Disease_cards/JAPANESE_ENCEPHALITIS.pdf)).
- Bielefeldt-Ohmann H, et al. *Vet Res.* 2014;45.

## EASTERN AND WESTERN EQUINE ENCEPHALOMYELITIS

### SYNOPSIS

**Etiology** Eastern encephalitis and Western encephalitis viruses.

**Epidemiology** Disease limited to the Americas. Arthropod, usually mosquito-borne virus. Mammals, including horses, are accidental hosts. Horse is dead-end host for EEE and WEE. Case-fatality rate 5%–70%. WEE and EEE occur as sporadic cases and as outbreaks. Both diseases affect humans.

**Clinical signs** Fever, muscle fasciculation, severe depression, head-pressing, incoordination, recumbency, opisthotonus and paddling, and death.

**Clinical pathology** Leukopenia.

**Lesions** Nonsuppurative encephalomyelitis.

**Diagnostic confirmation** Virus isolation and identification. Identification of viral antigen by indirect immunofluorescence. Serologic confirmation of exposure, preferably demonstrating an increase in hemagglutination inhibition, virus neutralization, or complement fixation titer.

**Treatment** No specific treatment. Supportive care.

**Control** Vaccination with formalin-inactivated vaccines (EEE, WEE). Insect control.

EEE, eastern equine encephalitis; WEE, western equine encephalitis.

## ETIOLOGY

Equine encephalomyelitis is associated with one of the two immunologically distinct arthropod-borne alphaviruses (family Toga- viridae): **eastern equine encephalomyelitis virus (EEE)** and **western equine encephalomyelitis virus (WEE)**.

- There is one EEE virus strain, but two antigenic variants: North American and South American.<sup>1</sup>
- WEE likely arose as a recombinant of EEE and Sindbis virus. There are strains of WEE from Argentina, Brazil, and South Dakota that differ antigenically, and there are four major lineages of WEE in California whose geographic distributions overlap.

All the viruses are extremely fragile and disappear from infected tissues within a few hours of death. Both EEE and WEE cause disease in humans.<sup>2</sup> WEE is the least virulent of these viruses in horses and humans and incidence of disease in humans appears to be declining.<sup>3,4</sup> Transmission cycles are depicted in Fig. 14-7.

## EPIDEMIOLOGY

These encephalitis viruses cause disease in horses, humans, pigs, and various birds including ratites<sup>5,6</sup> and domestic pheasants.

### Distribution

Equine eastern and western encephalomyelitis viruses are restricted to the Americas. The two viruses have distinct geographic ranges that may overlap: EEE is restricted to South America and North America typically east of the Mississippi River, whereas WEE is found

west of the Mississippi River and predominantly in the western United States and Canada, although it also occurs in Florida and South America. There is recent evidence of extension of the range of EEE into northern Maine and Vermont and the emergence of the disease in Tennessee.<sup>6-11</sup>

## Viral Ecology

Humans, horses, cattle, pigs, dogs, and ratites are accidental hosts of the virus. The EEE and WEE viruses are normally maintained in a host-vector relationship by cycling between mosquitoes, and some other hematophagous insects, and the definitive host. However, there are some important differences in the ecology of the different viruses.

### Western Equine Encephalomyelitis

The definitive hosts of endemic WEE are wild birds, which are not clinically affected, and the vectors are the mosquitoes *C. tarsalis* (in the western United States) and *Culiseta melanura* (in the eastern and southern United States). Infected mosquitoes bite susceptible birds, usually nestlings or fledglings that then develop viremia. Mosquitoes are infected by feeding on viremic birds or by vertical transmission. Vertical transmission is likely an important overwintering mechanism in WEE, and possibly EEE.

Epidemics of WEE are uncommon, but sporadic individual cases are not. Epidemics of WEE are associated with factors that increase the number of infected mosquitoes or their feeding on susceptible (unvaccinated) horses. The disease in horses occurs in midsummer and fall, and is associated with a change in the feeding habits of *C. tarsalis*. Horses, and humans, are dead-end hosts because the viremia in these species is not sufficiently severe to allow infection of feeding mosquitoes.

### Eastern Equine Encephalomyelitis

The primary **maintenance cycle of EEE virus** is transmission between passerine birds by the mosquito *C. melanura*, an inhabitant of drainage ditches and swamps. However, other mosquitoes, including *Aedes sollicitans* and *A. vexans*, can propagate the virus through infection of large shore birds. The Carolina chickadee and yellow-crowned night heron are the most common avian hosts in the southeastern United States. Virus is detected in *C. melanura* and *Anopheles quadrimaculatus* mosquitoes in Florida in February, both of which feed on the black-crowned night heron (*Nycticorax nycticorax*). The yellow-crowned night heron (*Nyctanassa violacea*), anhinga (*Anhinga anhinga*), and great blue heron (*Ardea Herodias*), suggesting a means for the virus cycle to overwinter.<sup>12</sup> There is increasing evidence that snakes could be a reservoir for the virus, with high seroprevalence rates for antibody to EEE.<sup>13,14</sup> The reservoir of the virus during winter might involve the vertical



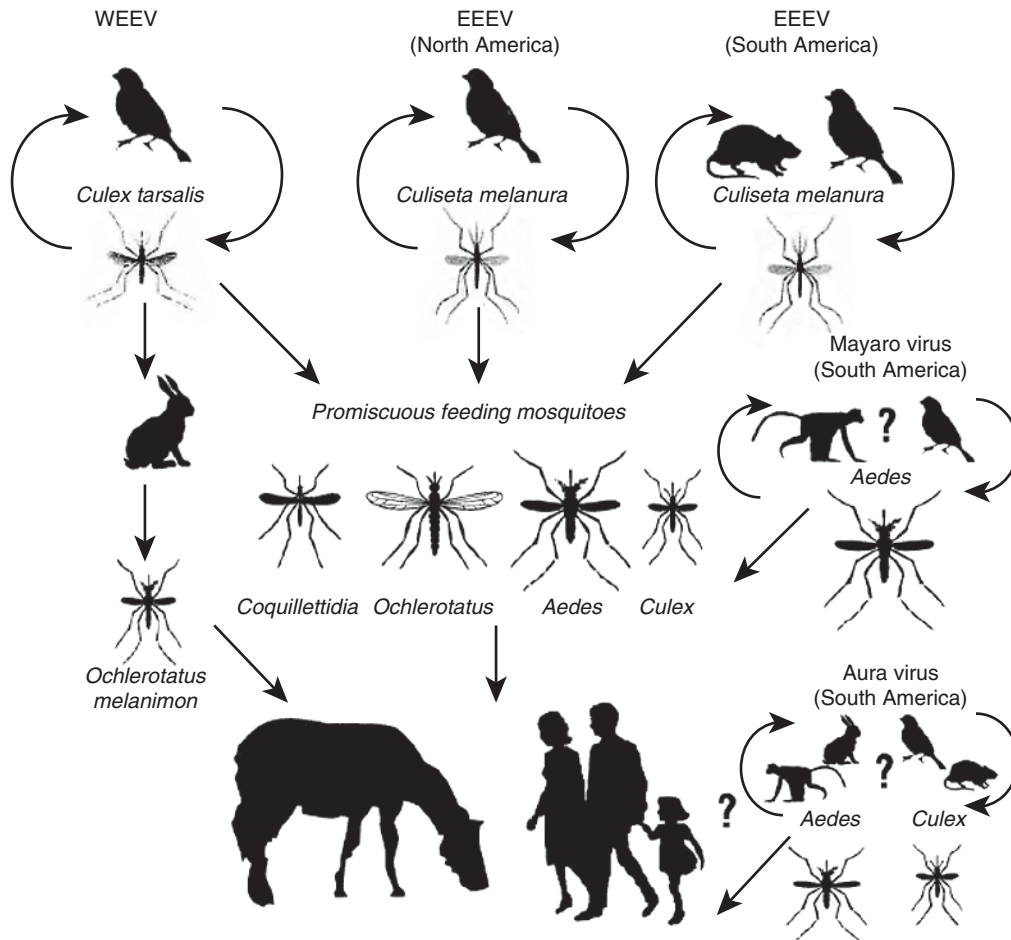

**Fig. 14-7** Transmission cycles for infection with Western Equine Encephalitis Virus and Eastern Equine Encephalitis Virus in the Americas. (reproduced with the permission of the World Organisation for Animal Health (OIE, [www.oie.int](http://www.oie.int)). Adapted from Fig. 1 of Arechiga-Ceballos N. & A. Aguilar-Setien, Alphaviral equine encephalomyelitis (Eastern, Western and Venezuelan). In *New developments in major vector-borne diseases. Part II: Important diseases for veterinarians* (S. Zientara, D. Verwoerd & P.-P. Pastoret..., eds). *Rev. Sci. Tech. Off. Int. Epiz.*, 34 (2), page 492. doi: 10.20506/rst.34.2.2374.)

transmission of infection to larvae that survive the winter.

The vertebrate host in South America has not been identified, but cotton rats and house sparrows both have the potential to be vectors.<sup>15</sup> The virus in North America likely has Florida as its overwintering site with subsequent seasonal spread into other states of the United States and into Eastern Canada.<sup>1,12</sup>

Horses are usually dead-end hosts, although viremia can be sufficiently severe in some horses to permit infection of mosquitoes.

**Epidemics** of EEE have occurred in the provinces of Ontario and Quebec; in virtually all the states of the United States east of the Mississippi River; in Arkansas, Minnesota, South Dakota, and Texas; in many of the Caribbean Islands; in Guatemala, Mexico, and Panama; and in Argentina, Brazil,<sup>2,16</sup> Columbia, Ecuador, Guyana, Peru, Suriname, and Venezuela. EEE continues to cause significant death losses annually in horses in Florida, primarily in unvaccinated

horses. It is suggested that the incidence of clinical disease caused by EEE in Florida is much higher than reported, and there is a need to increase public awareness about the importance of vaccination, particularly in foals. **Unexpected epizootics** occur in inland states of the United States, and frequently the source of the infection is undetermined, although **meteorologic factors** that allow rapid movement of infected mosquitoes may be important.<sup>5</sup> For instance, in 1972, outbreaks of EEE occurred in Quebec, Canada, and in Connecticut, which originated with mosquitoes carried on surface winds from Connecticut to Quebec, a distance of 400 km, in 14 to 16 hours at a speed of 25 to 30 km/h and a temperature of 15°C. There may be a continual cycle of EEE virus in mosquitoes and birds in the southeastern United States, from where the virus could be distributed by infected mosquitoes on the wind along the Gulf and Atlantic Coasts and up the Mississippi Valley.

There is an increased likelihood of detecting the virus in mosquitoes near wooded

areas in Florida, an observation that is consistent with the patchy occurrence of the disease in that state.<sup>17</sup> An outbreak of EEE in equids, a llama, and pheasants in Maine was associated with unusually high numbers of *C. melanura* that year.<sup>8</sup>

### Animal Risk Factors

**Recovered horses** are resistant to infection for at least 2 years, and vaccination confers immunity of variable duration (see under the section **Control**). **Unvaccinated horses** are at increased risk of disease; the risk of a vaccinated horse contracting EEE is only 0.14 that of an unvaccinated horse. The disease is more severe, and case fatality is higher, in unvaccinated horses than in vaccinated horses. The case fatality in young foals from nonimmune mares, which are infected with WEE, is always high, often as high as 100%.

**Housing and exposure to mosquitoes** are important risk factors for EEE, and presumably WEE. During an outbreak in 1831, only horses kept at pasture were affected. The use of **insect repellants** reduces the odds of

a horse being infected with EEE to 0.04 that of an unprotected horse. Similarly, keeping horses at pasture near woods increases the risk of disease by almost four times, and the presence of **swamp land** increases the risk by over two times. Horses kept in areas with **high precipitation** have an increased risk of the disease, presumably because of the density of mosquitoes in these areas.

### Morbidity and Case Fatality

Morbidity varies widely depending on seasonal conditions and the prevalence of insect vectors; cases may occur sporadically or in the form of severe outbreaks affecting 20% or more of a group. The prevalence of infections, as judged by serologic examination, is much higher than the clinical morbidity with ~9% of horses in Quebec serologically positive for EEE but with a much lower rate of occurrence of clinical disease.<sup>18</sup> The **case-fatality rate** differs with the strain of the virus; in infection with the WEE virus it is usually 20% to 30% and with the EEE it is usually between 40% and 80% and may be as high as 90%.

### Zoonotic Implications

The **susceptibility of humans** to the causative virus gives the disease great public health importance. Humans can become infected with the EEE and the WEE virus.<sup>2</sup>

### PATHOGENESIS

**Inapparent infection** is the mildest form of the disease and may be characterized by only a transient fever. A more severe form of the disease is manifested by tachycardia, depression, anorexia, occasional diarrhea, and fever.

A transitory **viremia** occurs at the height of the fever. Penetration of the virus into the **brain** does not occur in all cases, and the infection does not produce signs, other than fever, unless involvement of the CNS occurs. The lesions produced in nervous tissue are typical of a viral infection and are localized particularly in the **gray matter of the cerebral cortex, thalamus, and hypothalamus**, with minor involvement of the medulla and spinal cord. It is this distribution of lesions that is responsible for the characteristic signs of mental derangement, followed at a later stage by paralysis. The early apparent blindness and failure to eat or drink appear to be cortical in origin. True blindness and pharyngeal paralysis occur only in the late stages.

### CLINICAL FINDINGS

The diseases associated with EEE and WEE viruses are **clinically indistinguishable**. The **incubation period** for EEE is 1 to 3 days and is 2 to 9 days for WEE. Uncomplicated disease usually lasts about 1 week. In the initial viremic stage there is fever, which may be accompanied by anorexia and depression, but the reaction is usually so mild that it goes unobserved. In the experimental disease, the temperature may reach 41°C (106°F)

persisting for only 24 to 48 hours, with signs of neurologic dysfunction appearing at the peak of the fever. Animals that have signs of neurologic disease for more than 24 hours are often not pyrexia.

Initial signs of neurologic disease include hypersensitivity to sound and touch, and in some cases transient periods of excitement and restlessness, with apparent blindness. Horses can have a period of anorexia and colic before onset of signs of neurologic disease. Affected horses may walk blindly into objects or walk in circles and in severe cases can mimic signs of horses with catastrophic intestinal disease. Involuntary muscle movements occur, especially tremor of shoulder and facial muscles and erection of the penis. A stage of severely depressed mentation follows. Affected horses stand with the head hung low; they appear to be asleep and may have a half-chewed mouthful of feed hanging from the lips. At this stage the horse may eat and drink if food is placed in its mouth. The pupillary light reflex is still present. The animal can be aroused, but soon relapses into a state of somnolence.

A stage of **paralysis** follows. There is inability to hold up the head, and it is often rested on a solid support. The lower lip is pendulous and the tongue protrudes from the mouth. Unnatural postures are adopted, with the horse often standing with the weight balanced on the forelegs or with the legs crossed. Head-pressing or leaning back on a halter are often seen. On walking, there is obvious incoordination, particularly in the hindlegs, and circling is common. Defecation and urination are suppressed, and the horse is unable to swallow. Complete paralysis is the terminal stage. The horse goes down, is unable to rise, and usually dies within 2 to 4 days from the first signs of illness. A proportion of affected horses do not develop paralysis and survive, but have persistent neurologic deficits.

### Pigs

EEE causes an encephalitis and myocarditis of piglets less than 2 weeks of age. The disease is characterized by incoordination, seizures, vomiting, weight loss, and paddling. Recovered piglets can have retarded growth.

### Ratites and Pheasants

The disease in emus is characterized by vomiting, bloody diarrhea, and depression with absent to minimal signs of neurologic disease.<sup>5</sup> Pheasants display signs of neurologic disease and aberrant behavior such as excessive aggressive pecking and mortality rates of 30%.<sup>8</sup> Wild turkeys are rarely clinically infected, although they can become infected.<sup>8</sup>

### CLINICAL PATHOLOGY

There are no characteristic hematologic or biochemical abnormalities. The absence of biochemical indication of liver disease

(hyperbilirubinemia, increased activity in serum of liver-specific enzymes such as sorbitol dehydrogenase or  $\gamma$ -glutamyl transferase, absence of hyperammonemia) rules out hepatic encephalopathy.

**Diagnostic confirmation** is achieved by one or more of the following:

- Isolation of virus from an affected animal
- Detection of viral antigen or nucleic acid in an animal with appropriate clinical signs
- Seroconversion or an increase in serum titer of sick or recovered animal

**Virus isolation** provides definitive proof of infection. However, viremia may have resolved by the time nervous signs have developed, and it can be advantageous to sample febrile animals instead of animals showing more advanced signs of the disease. Virus can be cultured in intracranially inoculated suckling mice, weanling mice, guinea pigs, cell culture, newly hatched chicks, or embryonated eggs. Viral genome can be detected, and isolates can be identified, by quantitative RT-PCR,<sup>19-21</sup> or by complement fixation, HI, virus neutralization, immunofluorescent assay (IFA), and antigen capture ELISA.

Acute and convalescent sera taken 10 to 14 days apart for the presence of neutralizing, hemagglutination-inhibiting, or complement-fixing antibodies in the serum of affected or in-contact horses, is of value in detecting the presence of the virus in the group or in the area. A fourfold increase in complement-fixing antibodies is considered positive.

Demonstration of viral nucleic acid in tissue, blood, or insects by PCR test may be a useful indicator of the presence of the virus. There may be sufficient viral antigen to be detected by ELISA in clinical material, and this may provide a useful test in the early stages of an epidemic.

The presence of a high HI, complement fixation and neutralizing antibody in a **single serum sample** obtained from a horse during the acute phase of illness associated with the WEE virus can be used as presumptive evidence of infection with this virus. However, antibodies against the WEE virus can persist for years, are produced after vaccination with WEE or WEE/EEE bivalent vaccines, and in foals might be caused by colostral immunity. Therefore a single serum sample cannot be used to make a confirmed diagnosis of WEE using the HI, complement fixation or neutralization tests. Horses infected experimentally or naturally with either the WEE or the EEE virus do not produce detectable HI or neutralizing antibody for 5 to 10 days after infection.

Circulating antibody appears on or near the day of onset of clinical illness. Infection with the WEE virus results in the production of serum IgM specific to WEE, and the ELISA test is a rapid, sensitive, and specific

test for IgM against WEE and EEE viruses. Additionally, the ratio of titers of EEE and WEE can be useful in detecting infection by EEE; ratios of >8:1 are highly suggestive of EEE infection.

### NECROPSY FINDINGS

The brain meninges may appear congested, but there are generally no gross changes. Histologic examination of the brain reveals perivascular accumulations of leukocytes and damage to neurons. The gray matter of the forebrain and midbrain are the most severely affected areas. Lesions associated with EEE antigen are also present in myocardium, stomach, intestine, urinary bladder, and spleen.

Cell culture and transmission experiments using brain tissue as an inoculum are the traditional means of confirming a diagnosis and require that the brain be removed within an hour of death. Transmission is by intracerebral inoculation of brain tissue into suckling mice or duck embryo tissue culture. Fluorescent antibody tests have been developed to detect EEE virus in brain tissue. A PCR-based diagnostic test is available for EEE virus. Lesions similar to those seen in horses have also been described in a beef cow infected with EEE. **The disease in piglets** is characterized by disseminated perivascular cuffing, gliosis, focal necrosis of the cerebral cortex, and multifocal myocardial necrosis.

### Samples for Postmortem

#### Confirmation of Diagnosis

- Half of midsagittally sectioned brain and liver and spleen should be submitted for fluorescent antibody and PCR testing, virus isolation and bioassay.
- Half of midsagittally sectioned brain, fixed in formalin, should be submitted for light microscopic examination.

**Note the zoonotic potential of these organisms when handling the carcass and submitting specimens.**

### DIFFERENTIAL DIAGNOSIS

Clinically, the disease has very great similarity to the other viral encephalomyelitides, from which it can often be discriminated by the geographic location of the horse, and to the hepatic encephalopathies and a number of other diseases (see later and in Table 14-12).

West Nile encephalitis is predominantly a myelitis with later development of signs of neurologic disease, whereas EEE and WEE have predominant signs of encephalopathy.

- Rabies.
- Born disease (occurs in Europe).
- Japanese encephalitis (occurs in Asia).
- Various other viral infections that are geographically restricted.
- Hepatic encephalopathy, such as that associated with poisoning by *Crotalaria*,

*Senecio*, and *Amsinckia* spp.; acute serum hepatitis or hepatopathy.

- Botulism causes weakness evident as muscle fasciculation, recumbency, and dysphagia, but does not cause cerebral signs (irritation, behavioral abnormalities).
- Yellow star thistle poisoning (*Centaurea solstitialis*), and poisoning by fumonisins (*Fusarium moniliforme*) can produce similar clinical signs to that of the encephalitides, with the exception of fever.

### TREATMENT

There is no definitive or specific treatment. Supportive treatment may be given with the intention to prevent self-inflicted injury and maintain hydration and nutritional status.

### CONTROL

Control of viral encephalomyelitis of horses is based on the following:

- Accurate clinical and laboratory diagnosis of the disease in horses
- Use of sentinel animals to monitor the presence of the virus in the region
- Quarantine of infected horses to stop movement of virus donors
- Insect abatement when deemed necessary
- Vaccination of all horses.

### Vaccination

Vaccination of horses is important for the control of EEE and VEE.<sup>3,22</sup> Formalin-inactivated EEE and WEE virus vaccines are available (see Table 14-14 in Venezuelan Equine Encephalitis) and are effective, although over 50% of horses with EEE had been vaccinated within the previous year. This apparent poor protection can be explained by many horses not developing a detectable change in antibody titer after vaccination with a bivalent vaccine and rapid decreases in antibody titer from a peak value achieved 2 to 4 weeks after vaccination. Vaccines are available as univalent or bivalent preparations and in combination with other antigens (for instance, tetanus toxoid). Horses should be vaccinated well in advance of the anticipated encephalomyelitis season in a given area. Vaccination against both strains of the virus is advisable in areas where the strain has not been identified or where both strains exist. The currently recommended vaccination schedule consists of two doses of the vaccine initially, 10 days apart, followed by annual revaccination using two or three doses.<sup>22</sup> **Annual revaccination** is currently recommended because the duration of effective immunity beyond 1 year is not known. It is probable that the initial two-dose vaccination lasts for up to 3 to 4 years. The emphasis in a vaccination program should be on the young horses.

**Colostrum antibody** can be detected in the blood of foals from vaccinated dams for up to 6 to 7 months, after which time it declines rapidly. Foals from vaccinated dams

should be vaccinated at 6 to 8 months of age and revaccinated at 1 year of age. Foals from unvaccinated dams may be vaccinated at 2 to 3 months of age and again at 1 year of age. Colostral antibodies in the foal will prevent the development of autogenous antibodies, and foals vaccinated when less than 6 months should be revaccinated when they are 1 year old or, in high-risk areas. Foals from vaccinated mares should be vaccinated at 3, 4, and 6 months of age.

Experimental DNA vaccines hold promise for the prevention of WEE.

### Protection From Insects

Housing of horses indoors at night, especially in fly-proofed stables, and the use of insect repellents may restrain the spread of the virus. Use of insect repellents decreases the risk of EEE in horses to 0.04 that of unprotected horses.

Widespread spraying of insecticides to reduce the population of the vector insects has been used in the control of VEE; however, such measures are not practical for preventing sporadic cases of EEE or WEE, and the environmental impact of widespread insecticide use should be considered.

Complete eradication of the virus appears to be impossible because of the enzootic nature of the ecology of the virus. The horse is an accidental host for EEE and WEE virus making elimination of the virus impossible with methods currently available.

### Zoonotic Aspects of Control

**Control of the disease in humans** in areas where the disease may occur is dependent on insect control, and a monitoring and surveillance early warning system is necessary to decide whether or not to take control measures. In areas where WEE occurs, clinical cases of the disease in unvaccinated horses usually precede the occurrence of the disease in humans. The establishment of a reporting system in which practicing veterinarians report all clinical cases of the disease in horses will also assist in predicting potential epidemics of WEE virus infection in the human population. Serologic surveys of wildlife may also serve as good indicators of the geographic distribution and seasonality of circulation of these viruses and provide an early warning system before the detection of human cases.

### FURTHER READING

- Arechiga-Ceballos N, et al. Alphaviral equine encephalomyelitis (Eastern, Western and Venezuelan). *Rev - Off Int Epizoot.* 2015;34:491-510.
- Long MT. West Nile virus and equine encephalitis viruses new perspectives. *Vet Clin North Am Equine Practice.* 2014;30:523-533.

### REFERENCES

1. White GS, et al. *Am J Trop Med Hyg.* 2011;84:709.
2. Carrera J-P, et al. *N Engl J Med.* 2013;369:732.
3. Arechiga-Ceballos N, et al. *Rev - Off Int Epizoot.* 2015;34:491.



4. Zacks MA, et al. *Vet Microbiol.* 2010;140:281.
5. Chenier S, et al. *Can Vet J.* 2010;51:1011.
6. Saxton-Shaw KD, et al. *PLoS ONE.* 2015;10:e0128712.
7. Mukherjee S, et al. *J Med Entomol.* 2012;49:731.
8. Lubelczyk C, et al. *Am J Trop Med Hyg.* 2013;88:95.
9. Lubelczyk C, et al. *Vector Borne Zoonotic Dis.* 2014;14:77.
10. Molaie G, et al. *Parasit Vectors.* 2015;8:516.
11. Mutebi J-P, et al. *Vector Borne Zoonotic Dis.* 2015;15:210.
12. Bingham AM, et al. *Am J Trop Med Hyg.* 2014;91:685.
13. White G, et al. *Am J Trop Med Hyg.* 2011;85:421.
14. Graham SP, et al. *Am J Trop Med Hyg.* 2012;86:540.
15. Arrigo NC, et al. *Emerg Infect Dis.* 2010;16:1373.
16. de Novaes Oliveira R, et al. *Arch Virol.* 2014;159:2615.
17. Vander Kelen PT, et al. *Int J Health Geogr.* 2012;11:47.
18. Rocheleau J-P, et al. *Vector Borne Zoonotic Dis.* 2013;13:712.
19. Armstrong PM, et al. *Vector Borne Zoonotic Dis.* 2012;12:872.
20. Brault AC, et al. *J Med Entomol.* 2015;52:491.
21. Zink SD, et al. *Diag Microbiol Infect Dis.* 2013;77:129.
22. Long MT. *Vet Clin North Am Equine Pract.* 2014;30:523.

## VENEZUELAN EQUINE ENCEPHALOMYELITIS

### SYNOPSIS

**Etiology** Venezuelan encephalitis virus (types IAB, IC, and, to a lesser extent, IE), an alphavirus.

**Epidemiology** Disease limited to the Americas. Arthropod-borne, usually mosquito-borne, virus. VEE occurs as epidemics associated with mutation of virus and associated movement from enzootic to epizootic cycles. Virus cycles between sylvatic rodents (and probably not birds) and mosquitos in enzootic areas. Equids and humans are amplifying hosts important in propagation of VEE in epizootics. Care–fatality rate 5%–70% for equids.

**Clinical findings** Fever, muscle fasciculation, severe depression, head-pressing, incoordination, recumbency, opisthotonus and paddling, and death.

**Clinical pathology** Leukopenia.

**Lesions** Nonsuppurative encephalomyelitis.

**Diagnostic confirmation** Virus isolation and identification. RT-PCR provides more rapid identification of virus. Identification of viral antigen by indirect immunofluorescence. Serologic confirmation of exposure, preferably demonstrating an increase in hemagglutination inhibition, virus neutralization, or complement fixation titer.

**Treatment** No specific treatment. Supportive care.

**Control** Vaccination with formalin-inactivated or modified live virus is effective. Vaccines

being developed with newer technologies. Insect control.

RT-PCR, reverse transcriptase-polymerase chain reaction.

### ETIOLOGY

Venezuelan equine encephalomyelitis (VEE) is associated with an arthropod-borne alphavirus (family *Togaviridae*) VEE. The VEE complex has one virus, VEE, with six antigenically related subtypes: I, VEE; II, Everglades; III, Mucambo; IV, Pixuna; V, Cabassou; and VI, AG80-663. Within subtype I are at least five variants (IAB, IC, ID, IE, and IF). Epidemic (pathogenic) VEE in horses is associated with variants IAB (originally identified as distinct variants, A and B are now considered the same variant) IC, and IE; all other subtypes of I (D-F), and other variants of VEE virus (II-VI), are usually nonpathogenic for horses and are found in sylvatic or enzootic, nonequine cycles, although they can cause disease in humans.<sup>1</sup> The pathogenic variant, IAB, has been detected in cryptic circulation up to 8 years after an epizootic.<sup>2</sup> The infection cycles between rodents and mosquitos as an enzootic cycle not associated with disease in equids or humans (Fig. 14-8). Birds might be involved in this enzootic cycling. Disease occurs when pathogenic variants of the virus become established and cycle between humans or horses, both of which have high levels of viremia, and mosquitos.<sup>1,3</sup>

**Outbreaks** of disease in horses and humans occur infrequently, but can affect large numbers of equids and humans when they do occur. Outbreaks were documented in Mexico in 1993 and 1996, and in Venezuela and Columbia in the autumn of 1995. The Columbian outbreak affected 90,000 people and killed an estimated 4000 horses. The strain involved in the Columbian outbreak was IC, whereas that involved in the Mexican outbreaks was a variant of the usually nonpathogenic IE. The outbreak in Mexico was associated with a variant of VEE that did not cause viremia in horses, although it was capable of causing neurologic disease in this species, and it might have been this attribute that abbreviated the course of the epidemic. There is evidence of continuing enzootic circulation of VEE IE in southern Mexico.<sup>4,5</sup>

The virus is extremely fragile and disappears from infected tissues within a few hours of death.

### EPIDEMIOLOGY

Venezuelan equine encephalitis virus infects a range of species including rodents, humans, equids, cattle and dogs.<sup>5</sup> It causes disease in humans and equids.

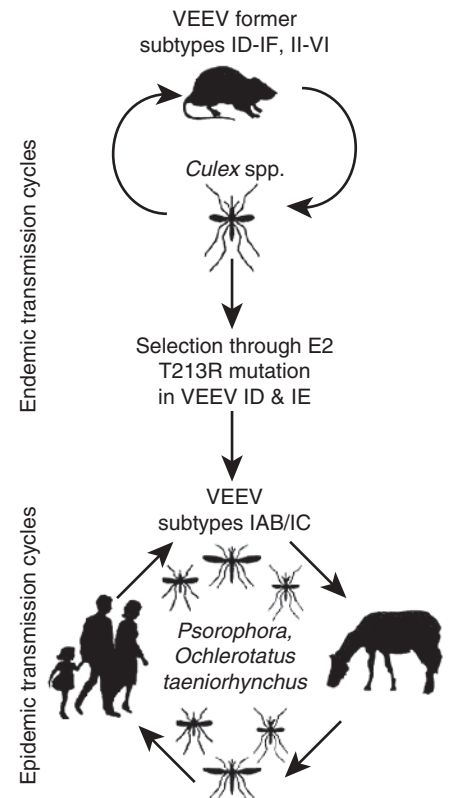

**Fig. 14-8** Epidemiology of Venezuelan Equine Encephalitis virus in enzootic (endemic) and epizootic (epidemic) cycles. Note the need for mutation of the virus for development and establishment of epizootics. (reproduced with the permission of the World Organisation for Animal Health (OIE, [www.oie.int](http://www.oie.int)). Adapted from Fig. 1 of Arechiga-Ceballos N. & A. Aguilar-Setién, Alphaviral equine encephalomyelitis (Eastern, Western and Venezuelan). In New developments in major vector-borne diseases. Part II: Important diseases for veterinarians (S. Zientara, D. Verwoerd & P.-P. Pastoret..., eds). *Rev. Sci. Tech. Off. Int. Epiz.*, 34 (2), page 492. doi: 10.20506/rst.34.2.2374.)

### Distribution

Pathogenic or epizootic VEE is found in northern South America, Central America, Mexico and, rarely, in the southern United States. The epizootic variants are currently exotic to the United States. Enzootic VEE strains have been identified in the Florida Everglades (subtype II), Mexico (variant IE), Central American countries (variant IE), Panama (variants ID and IE), Venezuela (variant ID), Colombia (variant ID), Peru (variants ID, IIIC, and IIID), French Guiana (variant IIIB and subtype V), Ecuador (variant ID), Suriname (variant IIIA), Trinidad (variant IIIA), Brazil (variants IF and IIIA and subtype IV), and Argentina (subtype VI). In an atypical ecological niche, variant IIIB has been isolated in the United States (Colorado and South Dakota) in an unusual association with birds.<sup>3</sup>

### Viral Ecology

VEE exists as both nonpathogenic and pathogenic strains. **Nonpathogenic VEE viruses** persist in sylvatic cycles in northern South America, Central America, and parts of the southern United States, and are important because they are the source of the epizootic strains of the virus that emerge at infrequent intervals. The enzootic strains also confound the diagnosis of VEE because of the extensive serologic cross-reactivity among endemic and epidemic VEE viruses. However, recent advances in diagnostic techniques may have solved this diagnostic problem. The nonpathogenic viruses are maintained in rodents associated with swamps, and transmitted by mosquitoes of the genus *Culex*, and perhaps other hematophagous insects. Humans, horses, cattle, pigs, dogs, and ratites are accidental hosts of the virus. **Epidemics of VEE** occur irregularly, the latest being in northern Columbia in 1995, and Mexico in 1993 and 1996. The source of virus during outbreaks is infected horses. **Horses** develop a profound viremia and are **amplifying hosts** that aid in the spread of the epizootic; other domestic species, including cattle, pigs, and goats, are not considered to be amplifiers of the virus. During epizootics, all species of mosquitoes that feed on horses, including *Aedes*, *Psoorophora*, and *Deinocerites* species, are thought to be capable of spreading the infection, although *O. taeniorhynchus* is thought to be the principal vector responsible for transmission of VEE virus during outbreaks, whereas *Culex (Melanoconion)* species mosquitoes transmit enzootic strains of VEE virus.<sup>6</sup> Epizootics end as the population of susceptible horses decreases below a critical level, either by death or vaccination. The **reservoir of the virus between outbreaks**, which may be up to 19 years, was unknown until it was demonstrated that epidemic VEE type IAB virus arises by **mutation of endemic strains** (types ID-F and II-VI), or that type IE (enzootic) mutates into an epizootic form serologically very similar to IE. This mutation of the endemic virus into the epidemic form has occurred on at least three occasions associated with epidemics of VEE. It is likely that pathogenic strains of VEE will continue to emerge in areas where the nonpathogenic strains of the virus are endemic.

### Animal Risk Factors

**Recovered horses** are resistant to infection for at least 2 years, and vaccination confers immunity of variable duration (see under the section **Control**). **Housing and exposure to mosquitoes** are important risk factors for EEE, and presumably VEE.

Morbidity varies widely depending on seasonal conditions and the prevalence of insect vectors; cases may occur sporadically or in the form of severe outbreaks affecting 20% or more of a group. The prevalence of infections, as judged by serologic

examination, is much higher than the clinical morbidity; for example, up to 72% of horses examined in the Gulf region of Mexico had antibodies to VEE virus (variant IE).<sup>5</sup> Only 0.8% of horses in Trinidad have serologic evidence of infection.<sup>7</sup>

The **case-fatality rate** is usually 40% to 80% and may be as high as 90% with VEE.

### Zoonotic Implications

The **susceptibility of humans** to the causative virus gives the disease great public health importance. Humans can become infected with sylvatic and epizootic VEE subtypes. A recent outbreak of VEE in Columbia caused 75,000 human cases, 300 fatalities, and killed approximately 4000 horses. **Human infections** generally follow equine infections by approximately 2 weeks. The infection in humans is usually a mild, influenza-like illness in which recovery occurs spontaneously. When clinical encephalitis does occur, it is usually in very young or older people. Occurrence of the disease in humans can be limited by the use of a vaccine in horses, thus limiting the occurrence of the disease in horses in the area. There is a strong relationship between the **mosquito population** and the incidence of the disease in horses and in humans. The occurrence of the disease in humans may be predicted by an unusually high activity of virus in mosquitoes. There are usually, but not always, widespread mortalities in horses before the disease occurs in humans. VEE infections, and disease, of epizootic or enzootic virus have occurred among **laboratory workers** as a result of aerosol infections from laboratory accidents, from handling of infected laboratory animals, or inhalation of cage debris of infected laboratory animals.<sup>3</sup> Human VEE virus infections have originated by aerosol transmission from the cage debris of infected laboratory rodents and from laboratory accidents. Those who handle infectious VEE viruses or their antigens prepared from infected tissues or cell cultures should be vaccinated and shown to have demonstrable immunity in the form of a VEE virus-specific neutralizing antibody.

All procedures producing aerosols from VEE virus materials should be conducted in biosafety cabinets at containment level 3.<sup>3</sup>

VEEV viruses are highly infectious via the aerosol route for humans and has been developed as a biologic weapon in the United States and in the former Soviet Union.<sup>6</sup>

The TC83 live attenuated VEE virus vaccine may be **teratogenic** in humans.

### PATHOGENESIS

**Inapparent infection** is the mildest form of the disease and may be characterized by only a transient fever. A more severe form of the disease is manifested by tachycardia, depression, anorexia, occasional diarrhea, and fever.

**Viremia** persists throughout the course of the disease in VEE, and the blood provides a source of infection for biting insects. Transplacental transmission of the VEE virus can occur in pregnant mares infected near term. The virus is present in saliva and nasal discharge, and this material can be used to transmit the disease experimentally by intranasal instillation.

Penetration of the virus into the **brain** does not occur in all cases and the infection does not produce signs, other than fever, unless involvement of the CNS occurs. The lesions produced in nervous tissue are typical of a viral infection and are localized particularly in the **gray matter of the cerebral cortex, thalamus, and hypothalamus**, with minor involvement of the medulla and spinal cord. It is this distribution of lesions that is responsible for the characteristic signs of mental derangement, followed at a later stage by paralysis. The early apparent blindness and failure to eat or drink appear to be cortical in origin. True blindness and pharyngeal paralysis occur only in the late stages.

### CLINICAL FINDINGS

The diseases associated with the different viruses are **clinically indistinguishable**. The **incubation period** for VEE is 1 to 6 days. Uncomplicated disease usually lasts about 1 week. In the initial viremic stage there is fever, which may be accompanied by anorexia and depression, but the reaction is usually so mild that it goes unobserved. In the experimental disease, the temperature may reach 41°C (106°F) persisting for only 24 to 48 hours, with nervous signs appearing at the peak of the fever. Animals that have shown nervous signs for more than 24 hours may then have a temperature within the normal range.

**Early nervous signs** include hypersensitivity to sound and touch, and in some cases transient periods of excitement and restlessness, with apparent blindness. Affected horses may walk blindly into objects or walk in circles. **Involuntary muscle movements** occur, especially tremor of shoulder and facial muscles and erection of the penis. A stage of **severe mental depression** follows. Affected horses stand with the head hung low; they appear to be asleep and may have a half-chewed mouthful of feed hanging from the lips. At this stage the horse may eat and drink if food is placed in its mouth. The pupillary light reflex is still present. The animal can be aroused, but soon relapses into a state of somnolence.

A stage of **paralysis** follows. There is inability to hold up the head, and it is often rested on a solid support. The lower lip is pendulous and the tongue may hang out. Unnatural postures are adopted, with the horse often standing with the weight balanced on the forelegs or with the legs crossed. **Head-pressing** or leaning back on a halter are often seen. On walking, there is obvious incoordination, particularly in the hindlegs,

and circling is common. Defecation and urination are suppressed, and the horse is unable to swallow. Complete paralysis is the terminal stage. The horse goes down, is unable to rise, and usually dies within 2 to 4 days from the first signs of illness. A proportion of affected horses do not develop paralysis and survive but have persistent neurologic deficits.

In the experimental infection of horses with the endemic strain of the **VEE virus**, a fever and mild leukopenia occurs. Following infection with the epidemic strain of the virus, a high fever and severe leukopenia are common, and a high level of neutralizing antibodies develop about 5 to 6 days after infection. Clinical findings include profound depression, accompanied by flaccidity of lips, partially closed eyelids, and drooped ears; some horses chew continuously and froth at the mouth. In the terminal stages, there is recumbency and nystagmus.

### CLINICAL PATHOLOGY

There are no characteristic **hematologic or biochemical abnormalities**. The **absence of biochemical indication of liver disease** (hyperbilirubinemia, increased activity in serum of liver-specific enzymes such as sorbitol dehydrogenase and  $\gamma$ -glutamyl transferase, absence of hyperammonemia) rules out hepatic encephalopathy.

**Diagnostic confirmation** is achieved by one or more of the following:

- Isolation of virus from an affected animal
- Detection of viral antigen or nucleic acid in an animal with appropriate clinical signs
- Seroconversion or an increase in serum titer of sick or recovered animal.

**Virus isolation** provides definitive proof of infection. However, viremia may have resolved by the time nervous signs have developed, and it may be advantageous to sample febrile animals instead of animals showing more advanced signs of the disease. Virus can be cultured in intracranially inoculated suckling mice, weanling mice, guinea pigs, cell culture, newly hatched chicks, or embryonated eggs. Virus isolates can be identified by complement fixation, HI, virus neutralization, PCR, IFA, and antigen capture ELISA. A recently developed indirect fluorescent test using monoclonal antibodies enables the differentiation of endemic from epidemic strains of VEE. Interpretation of the results of serologic tests of horses in an area where endemic, nonpathogenic VEE virus exists is difficult because of the cross-reaction between endemic and epidemic strains of the virus. Therefore in areas where there is endemic, nonpathogenic VEE, demonstration of the presence of antibodies should not be considered persuasive evidence of the presence of the disease.

**Acute and convalescent sera** taken 10 to 14 days apart for the presence of

neutralizing, hemagglutination-inhibiting, or complement-fixing antibodies in the serum of affected or in-contact horses, is of value in detecting the presence of the virus in the group or in the area. A fourfold increase in complement-fixing antibodies is considered positive.

**Demonstration of viral nucleic acid** in tissue, blood, or insects by PCR test is a useful indicator of the presence of the virus.<sup>8</sup> Use of modern bioinformatic techniques can enable viral genotyping, facilitating diagnosis and forensic and epidemiologic investigations.<sup>9</sup> There can be sufficient viral antigen to be detected by ELISA in clinical material, and this may provide a useful test in the early stages of an epidemic.

### NECROPSY FINDINGS

The brain meninges may appear congested, but there are generally no gross changes. Histologic examination of the brain reveals perivascular accumulations of leukocytes and damage to neurons. The gray matter of the forebrain and midbrain are the most severely affected areas. In some cases of VEE, liquefactive necrosis and hemorrhage are visible in the cerebral cortex. Cell culture and transmission experiments using brain tissue as an inoculum are the traditional means of confirming a diagnosis and require that the brain be removed within an hour of death. Transmission is by intracerebral inoculation of brain tissue into sucking mice or duck embryo tissue culture. Fluorescent antibody tests have been developed to detect VEE virus and EEE virus in brain tissue.

### Samples for Postmortem Confirmation of Diagnosis

- Half of midsagittally sectioned brain and liver and spleen should be submitted for fluorescent antibody and PCR testing, virus isolation and bioassay.
- Half of midsagittally sectioned brain, fixed in formalin, should be submitted for light microscopic examination.

**Note the zoonotic potential of these organisms when handling the carcass and submitting specimens.**

### DIFFERENTIAL DIAGNOSIS

Clinically, the disease has very great similarity to the other viral encephalomyelitides, from which it can often be discriminated by the geographic location of the horse, and to the hepatic encephalopathies and a number of other diseases (see next).

- Rabies.
- West Nile virus encephalomyelitis.
- Hendra disease (occurs in Australia).
- Borna disease (occurs in Europe).
- Japanese encephalitis (occurs in Asia).
- Various other viral infections that are geographically restricted.

- Hepatic encephalopathy, such as that associated with poisoning by *Crotalaria*, *Senecio*, and *Amsinckia* spp.; acute serum hepatitis or hepatopathy.
- Botulism causes weakness that is evident as muscle fasciculation, recumbency, and dysphagia, but does not cause cerebral signs (irritation, behavioral abnormalities).
- Yellow star thistle poisoning (*Centaurea solstitialis*) and poisoning by fumonisins can produce similar clinical signs to that of the encephalitides, with the exception of fever.

### TREATMENT

There is no definitive or specific treatment. Supportive treatment may be given with the intention to prevent self-inflicted injury and maintain hydration and nutritional status.

### CONTROL

Control of VEE of horses is based on the following:

- Accurate clinical and laboratory diagnosis of the disease in horses
- Use of sentinel animals to monitor the presence of the virus in the region
- Quarantine of infected horses to stop movement of virus donors
- Insect abatement when deemed necessary
- Vaccination of all horses

### Vaccination

**Vaccination** of horses is important not only because it minimizes the risk of disease in vaccinated horses but also because it prevents viremia, subsequent infection of feeding mosquitoes, and propagation spread of VEE. There are a number of commercial vaccines available (Table 14-12).

One of the most important aspects of the control of VEE is the vaccination of the horse population to minimize the number of horses that are viremic and serve as amplifying hosts. A **tissue culture-attenuated virus vaccine, TC83**, is available for immunization of horses against VEE. The vaccine is considered to be safe and efficacious. Concerns about reversion to virulence and safety have prompted the development of DNA and chimeric vaccines, of which a number of experimental vaccines are reported.<sup>10-15</sup> The World Organization for Animal Health specifies vaccination by the TC83 attenuated virus vaccine or a formalin-killed virus vaccine.<sup>3</sup>

A **highly effective immunity** is produced within a few days following vaccination, and serum-neutralizing antibodies persist for 20 to 30 months. The vaccine causes a mild fever, leukopenia, and a viremia and, because of conflicting reports about its capacity to cause abortion, should not be used in pregnant mares. Antibodies to the heterologous alphaviruses, WEE and EEE, existing at the time of TC83 vaccination, may suppress the VEE antibody response to the vaccine.



**Table 14-12** Commercial vaccines against alphaviral equine encephalomyelitis available for equines

Name*	Uses	Administration**
Equiloid Innovator: Encephalomyelitis vaccine-tetanus toxoid	For the vaccination of healthy horses as an aid in the prevention of equine encephalomyelitis caused by Eastern and Western viruses, and tetanus	Inject one 1-mL dose intramuscularly using aseptic technique Administer a second 1-mL dose 3–4 weeks after the first dose
Fluvac Innovator 4 Encephalomyelitis-influenza vaccine-tetanus toxoid	For vaccination of healthy horses as an aid in the prevention of equine encephalomyelitis caused by Eastern and Western viruses, equine influenza from type A2 viruses, and tetanus	Inject one 1-mL dose intramuscularly using aseptic technique Administer a second 1-mL dose 3–4 weeks after the first dose
Fluvac Innovator 5 Encephalomyelitis-rhinopneumonitis-influenza vaccine-tetanus toxoid	For vaccination of healthy horses as an aid in the prevention of equine encephalomyelitis caused by Eastern and Western viruses, equine rhinopneumonitis caused by type 1 and 4 herpesviruses, equine influenza caused by type A2 viruses, and tetanus	Inject one 1-mL dose intramuscularly using aseptic technique Administer a second 1-mL dose 3–4 weeks after the first dose
Fluvac Innovator 6 Encephalomyelitis-rhinopneumonitis-influenza vaccine-tetanus toxoid	For vaccination of healthy horses as an aid in the prevention of equine encephalomyelitis caused by Eastern, Western, and Venezuelan viruses, equine rhinopneumonitis caused by type 1 and 4 herpesviruses, equine influenza caused by type A2 viruses, and tetanus	Inject one 1-mL dose intramuscularly using aseptic technique Administer a second 1-mL dose 3–4 weeks after the first dose
Fluvac Innovator Triple-E FT Encephalomyelitis-influenza vaccine-tetanus toxoid	For vaccination of healthy horses as an aid in the prevention of equine encephalomyelitis caused by Eastern, Western, and Venezuelan viruses, equine influenza caused by type A2 viruses, and tetanus	Inject one 1 mL dose intramuscularly using aseptic technique Administer a second 1-mL dose 3–4 weeks after the first dose
Triple-E T Innovator Encephalomyelitis vaccine-tetanus toxoid	For intramuscular vaccination of healthy horses as an aid in the prevention of equine encephalomyelitis caused by Eastern, Western, and Venezuelan viruses, and tetanus	Inject one 1-mL dose intramuscularly using aseptic technique Administer a second 1-mL dose 3–4 weeks after the first dose
WEST Nile Innovator + EW Encephalomyelitis-West Nile virus vaccine	For vaccination of healthy horses as an aid in the prevention of viremia caused by West Nile virus, and as an aid in the prevention of equine encephalomyelitis caused by Eastern and Western viruses	Inject one 1-mL dose intramuscularly using aseptic technique Administer a second 1-mL dose 3–4 weeks after the first dose
West Nile Innovator + EWT Encephalomyelitis-West Nile virus-tetanus toxoid	For vaccination of healthy horses as an aid in the prevention of viremia caused by West Nile virus, and as an aid in the prevention of equine encephalomyelitis caused by Eastern and Western viruses and tetanus	Inject one 1-mL dose intramuscularly using aseptic technique Administer a second 1-mL dose 3–4 weeks after the first dose
West Nile-Innovator + VEWT Encephalomyelitis-West Nile virus-tetanus toxoid	For vaccination of healthy horses as an aid in the prevention of viremia caused by West Nile virus, and as an aid in the prevention of equine encephalomyelitis caused by Eastern, Western, and Venezuelan viruses and tetanus	Inject one 1-mL dose intramuscularly using aseptic technique Administer a second 1-mL dose 3–4 weeks after the first dose

\*Commercial name and vaccine components

\*\*Recommended vaccination protocol

However, the response to the vaccine is adequate to provide protection against VEE, and the interference is not considered significant. There is inconclusive evidence that WEE and EEE antibodies protect horses against infection with virulent VEE virus, or conversely that VEE antibodies protect against infection with WEE and EEE viruses. Simultaneous vaccination using formalin-inactivated EEE, WEE, and VEE (the TC83 strain of VEE) is effective and recommended in areas where all three viruses may be present.

### Protection From Insects

**Housing of horses indoors at night**, especially in fly-proofed stables, and the use of **insect repellents** might restrain the spread of the virus.

Widespread spraying of insecticides to reduce the population of the vector insects has been used in the control of VEE in humans, along with vaccination of horses. **Complete eradication** of the virus appears

to be impossible because of the enzootic nature of the ecology of the virus: epidemic VEE arising by chance mutation of endemic strains of VEE, makes elimination of the virus impossible with methods currently available.

### REFERENCES

1. Arechiga-Ceballos N, et al. *Rev - Off Int Epizoot.* 2015;34:491.
2. Medina G, et al. *Am J Trop Med Hyg.* 2015;93:7.
3. Venezuelan equine encephalitis. OIE, 2008. (Accessed August, 2016, at [www.oie.int/fileadmin/Home/eng/Animal\\_Health\\_in\\_the\\_World/docs/pdf/Disease\\_cards/VEE.pdf](http://www.oie.int/fileadmin/Home/eng/Animal_Health_in_the_World/docs/pdf/Disease_cards/VEE.pdf)).
4. Deardorff ER, et al. *Am J Trop Med Hyg.* 2010;82:1047.
5. Adams AP, et al. *PLoS Negl Trop Dis.* 2012;6:31875.
6. Zacks MA, et al. *Vet Microbiol.* 2010;140:281.
7. Thompson NN, et al. *Vector Borne Zoonotic Dis.* 2012;12:969.
8. Belen Pisano M, et al. *J Virol Methods.* 2012;186:203.
9. Gardner SN, et al. *J Virol Methods.* 2013;193:112.
10. Paessler S, et al. *Vaccine.* 2009;27:D80.
11. Fine DL, et al. *J Virol Methods.* 2010;163:424.
12. Dupuy LC, et al. *Clin Vaccine Immunol.* 2011;18:707.
13. Tretyakova I, et al. *Vaccine.* 2013;31:1019.
14. Carossino M, et al. *Vaccine.* 2014;32:311.
15. Rossi SL, et al. *PLoS Negl Trop Dis.* 2015;9:e0003797.

## EQUID HERPESVIRUS-1 MYELOENCEPHALOPATHY, ABORTION, AND NEONATAL SEPTICEMIA

### SYNOPSIS

**Etiology** EHV-1 causes respiratory disease of adults, abortion, neonatal septicemia, and myeloencephalopathy. Infection by specific variants of the virus increases the likelihood of the clinically important manifestations of infection—myeloencephalopathy and/or abortion.

**Epidemiology** Transmission between horses and by mediate contagion. Lifelong latency of infection with periodic reactivation of virus shedding. Respiratory disease, abortion, and myeloencephalopathy occur prominently as outbreaks, but can affect sole animals.

**Clinical signs** Upper respiratory disease, abortion, neonatal septicemia, and neurologic disease with incontinence, ataxia, and recumbency.

**Clinical pathology** No pathogenic changes in hemogram or serum biochemistry profile. Detection of viral DNA and variant genotyping by RT-PCR in nasal swabs or white blood cells, seroconversion or increase in titer using an ELISA able to differentiate between EHV-1 and EHV-4.

**Diagnostic confirmation** Virus isolation from, or polymerase chain reaction test on, blood, nasopharyngeal swabs or tissue. Seroconversion or increase in titer.

**Treatment** There is no specific treatment, although acyclovir, an antiviral agent, has been administered. Symptomatic treatment of neurologic signs in horses with myeloencephalopathy.

**Control** Infection is ubiquitous. Management including quarantine, maintaining mares in small bands, and education of staff about importance of control measures to prevent outbreaks of abortion or myeloencephalopathy. Vaccination for prevention of abortion. Quarantine. Hygiene.

EHV-1, *equid herpesvirus-1*; RT-PCR, reverse transcriptase-polymerase chain reaction.

Herpesviruses infecting equids (such as horses, donkeys, mules, and zebra) are all viruses with a linear, double-stranded DNA genome in the order Herpesvirales, family Herpesviridae.<sup>1</sup> Equid herpesviruses (EHV)-1, 3, 4, 8 (syn. asinine herpesvirus-3), and 9 (a virus infecting gazelle) are Alphaherpesvirinae (alphaherpesviruses) in the genus *Varicellovirus*. EHV-6 (syn. asinine herpesvirus-1) is tentatively assigned to this genus. EHV-2, 5, and 7 (syn. asinine herpesvirus-2) are Gammaherpesvirinae (gammaherpesviruses).<sup>1</sup> There is also a zebra gammaherpesvirus, which appears to be associated with disease in nonequids housed in proximity to zebras (see later).<sup>2,3</sup>

Five herpesviruses have been associated with various diseases of horses and foals (EHV-1 to 5). Common names are “equine abortion virus” for EHV-1, “cytomegalovirus” for EHV-2, “equine coital exanthema virus” for EHV-3, and “rhinopneumonitis virus” for EHV-4 (although this term is sometimes used, confusingly, for EHV-1). Related herpesviruses (asinine herpesvirus-1 to 6, some of which have been recently classified or identified as EHV-1) infect, and some cause disease in, donkeys, mules, or horses.<sup>4-7</sup>

Some asinine herpesviruses cause a fatal interstitial pneumonia or neurologic disease in donkeys.<sup>8</sup>

Infection by EHV-1, EHV-4, or both is common, if not ubiquitous, in equids worldwide with most animals infected while juveniles and latent virus in trigeminal ganglia<sup>9</sup> and other tissues maintaining that infection. EHV-4 causes respiratory disease and, rarely, abortion. EHV-1 causes respiratory disease but also causes individual cases or outbreaks of myeloencephalopathy, abortion, and neonatal septicemia. Certain variants of EHV-1, detectable by examination of viral genome, are associated with increased risk of myeloencephalopathy, abortion, or both.

A partial list of disease syndromes attributed to EHV and asinine herpesvirus infection and the viruses associated with them include the following:

- **Upper respiratory tract disease** of adult horses, weanlings, and older foals is caused principally by EHV-4, although disease attributable to EHV-1 occurs. EHV-2 causes respiratory disease, including pneumonia, of foals, and rarely upper respiratory disease of adults.
- **Abortion** in horses is almost always associated with EHV-1, although rare sporadic cases are associated with EHV-4. EHV-7 (syn. asinine herpesvirus-2, a gammaherpesvirus) was associated with abortion in a donkey.<sup>4</sup>
- **Perinatal disease** of foals, including birth of sick and weak foals and development of viral septicemia within 48 hours of birth, is associated with EHV-1.
- **EHV-1 myeloencephalopathy** (EHM) is associated with EHV-1 and rarely, if ever, with EHV-4. In donkeys it has been associated with an asinine gammaherpesvirus.<sup>8</sup>
- **Coital exanthema** is associated with EHV-3, and genital disease is an unusual manifestation of EHV-1 infection.
- **Equine multinodular pulmonary fibrosis** in horses is associated with infection by EHV-5.<sup>10,11</sup>
- **Lymphoma** in horses is tentatively associated with infection by EHV-5.<sup>12,13</sup>
- **Chorioretinitis** is associated with EHV-1 infection.<sup>14</sup>
- **Dermatitis** (erythema multiforme) is associated with EHV-5 infection in horses.<sup>15</sup>
- **Neurologic disease or abortion** in gazelle, onagers, and polar bears is caused by EHV-9 or EHV-1 originating from zebra.<sup>2,3,16,17</sup>

The following discussion focuses on myeloencephalopathy, abortion, and neonatal septicemia in equids associated with infection by EHV-1. Respiratory disease caused by EHV-4 and EHV-1 is discussed

elsewhere in this text as are other manifestations of EHV infection.

## ETIOLOGY

EHV-1 is an alphaherpesvirus, a DNA virus with 76 ORFs. EHV-1 and EHV-4 are closely related and have extensive antigenic cross-reactivity but are genetically and biologically distinct viruses with different disease profiles.<sup>18,19</sup> Phylogenetic mapping (“trees”) and genetic fingerprinting for EHV-1 are not available, as they are for many other viruses (see the section on Equine Influenza in Chapter 12 as an example), and are needed to investigate links between outbreaks and associations with virulence.

Although EHV-1 virus is genetically stable, with limited genetic divergence and differences in strains of less than 0.1%, genetic variants of EHV-1 exist and some have differing biologic characteristics.<sup>20</sup> Analysis of ORF 68 reveals at least 19 distinct DNA sequences allowing identification of 6 major strain groups of EHV-1.<sup>20</sup> Importantly, a single nucleotide polymorphism (SNP) (A-G) at position 2254 in the DNA polymerase gene (DNA<sub>pol</sub>, ORF 30) that results in substitution of asparagine (N) by aspartic acid (D) at position 752 in the DNA polymerase protein is not limited to any one strain. Variants of the virus are therefore classified as N752 or D752, irrespective of the particular strain.<sup>20</sup> This suggests that the D752/N752 mutation has occurred multiple times.<sup>21</sup> The original isolation of EHV-1 in 1941 was of the D752 phenotype.<sup>21</sup>

The D752 variant is isolated more frequently than is N752 from horses with myeloencephalopathy and, increasingly, abortion.<sup>22-27</sup> Infection with the D752 variant increases the risk of myeloencephalopathy by 160× compared with that of infection with N752.<sup>28</sup> These data are based on retrospectively collected data that were not randomly collected, and this relative risk estimate could change markedly, although the association between increased risk of EHM and infection by D752 is well accepted.<sup>18,19,21,23,24,29</sup> However, horses can develop EHM when infected by the N752 variant in approximately 25% of cases (noting the uncertainty around this estimate).<sup>28</sup>

The N752 variant is the one most commonly reported as infecting asymptomatic horses.<sup>28,30</sup> Although estimates are potentially biased by the sampling method used in various epidemiologic studies, the D752 variant was identified in 3%, 10.8%–19.4%, 7.4%, 24%, and 10.6% of horses positive for EHV-1 sampled in Japan, the United States, Argentina, France, and Germany, respectively.<sup>31</sup> Horses can be infected by both variants of the disease simultaneously, and each variant can cause disease (D752 variant causing neurologic disease in the dam and N752 causing abortion).<sup>32</sup> Both D752 and N752 variants were both isolated from trigeminal ganglia of 12 of 153 horses

examined postmortem for reasons other than EHV-associated disease, indicating that symptomatic dual infection is common. One or the other variant, but not both, were isolated from a further 9/153 horses.<sup>9</sup> Similarly, of 70 Thoroughbred racehorses examined postmortem because of death secondary to catastrophic musculoskeletal injuries, 2 carried only a latent neurotropic strain of EHV-1, 6 carried a nonneurotropic genotype of EHV-1, and 10 were dually infected with neurotropic and nonneurotropic EHV-1.<sup>33</sup> Among 132 mares from central Kentucky sampled postmortem, latent EHV-1 DNA was detected in the submandibular lymph node tissues of 71 (54%). Thirteen (18%) of the 71 latently infected horses were infected with the D752 variant, of which 11 were also infected with the N752 variant.<sup>30</sup> The remainder were infected with only the N752 variant.

The D752 variant of EHV-1 differs from the N752 variant in that it causes higher levels of white blood cell-associated viremia (up to 10-fold), infects CD4+ and CD8+ cells to a greater extent but CD14+ and B cells to a lesser extent, and is less sensitive to aphidicolin, a drug targeting the viral polymerase.<sup>34</sup> The D752 variant is also more virulent in experimentally infected horses, with those infected with the D752 variant having higher rectal temperatures, a longer period of pyrexia after infection (3 days versus 1 day), and greater severity of nasal discharge, but no difference in nasal shedding of virus. Horses experimentally infected with D752 variant developed EHM, whereas those infected with the N752 variant did not, although uniform development of EHM in horses or ponies experimentally infected with D752 variant is not present in other studies of the disease.<sup>34</sup> The D752 variant infects submucosal immune cells in respiratory explants to a greater extent than does the N752 variant.<sup>35</sup> CSF from horses infected by D752 was abnormal, whereas that from horses infected with N752 was not abnormal.<sup>34</sup>

It is unclear whether viral load is associated with the outcome of clinical disease, although one study of a small number of horses (seven) treated at a referral institution, identified viral loads in nasal fluid and blood that were 1000× and 100× greater in nonsurviving horses with EHM. These findings require confirmation because of the small number of horses examined and in surviving (five) and nonsurviving groups (two).<sup>36</sup>

Both N752 and D752 variants can cause disease. Virulence is associated with presence of a functional gp2 protein, which is apparently responsible for viral egress from infected cells, and glycoprotein D and cell-surface glycosaminoglycans that are needed for efficient entry of EHV-1 into cells.

The most important clinical syndromes associated with EHV-1 infection are abortion, neonatal septicemia, and

myeloencephalopathy. Genital disease is an unusual manifestation of EHV-1 infection. Infection with EHV-1 causes retinitis and fatal disease in camelids. It also causes disease in wild equids including zebras and neurologic disease in black bears (*Ursus americanus*), Thomson's gazelles (*Eudorcas thomsonii*), guinea pigs (*Cavia porcellus f. dom.*) Indian rhinoceros (*Rhinoceros unicornis*), and polar bears in zoologic parks in which these animals are in proximity to equids (such as zebra).<sup>37-39</sup> It is associated with abortions and stillbirths in guinea pigs.<sup>37</sup>

## EPIDEMIOLOGY

### Occurrence

**Infection** with EHV-1 is endemic in horse populations worldwide, and many adult horses have serologic evidence of infection. Serologic surveys, which provide an index of the extent of infection in the sampled population, performed before 1995 were hindered by the lack of an assay able to differentiate immune responses to EHV-1 from those to EHV-4. Furthermore, the advent of vaccines eliciting serum antibodies against EHV-1/4, and the inability of diagnostic tests to differentiate between antibodies induced by vaccination or natural infection, complicates assessment of the prevalence of serum antibodies to EHV-1/4. Seroprevalence of EHV-1-specific antibodies is 9% to 28% in adult Thoroughbred horses, 26% of Thoroughbred broodmares, 11% of Thoroughbred foals, and 46% to 68% of 1- and 2-year-old Thoroughbred race horses in Australia. Sixty-one percent of 82 normal horses and horses with upper respiratory tract disease had antibodies to EHV-1 in New Zealand. Of 70 Thoroughbred race horses examined postmortem, 18 (26%) and 58 (83%) horses were PCR positive for the gB gene of EHV-1 and EHV-4, respectively, in at least one of trigeminal ganglia, bronchial, or submandibular lymph nodes sampled. Twelve horses were dually infected with EHV-1 and EHV-4.<sup>33</sup>

The EHV-1 D752 variant has been detected in equids in North America, Europe (the Netherlands, France, Belgium, and Germany), Australia, New Zealand, and South America.<sup>18,27,30-32,40-43</sup> It likely occurs worldwide given that it is not a recent mutation, having been detected in samples collected in the 1940s.<sup>21</sup> EHM is rarely reported in the Southern Hemisphere with the first case described in New Zealand in 2013.<sup>18</sup>

**Upper respiratory tract disease** associated with EHV-1 infection has been suggested to occur as outbreaks, although this is not well documented. Signs of infectious upper respiratory disease affected 20% of Thoroughbred race horses at one race track in Canada over a 3-year period, and seroconversion to EHV-1 occurred in 5% to 18% of these horses, whereas the vast majority of horses seroconverted to influenza. However,

all horses that seroconverted to EHV-1 also either seroconverted to influenza virus or had been recently vaccinated with a vaccine containing EHV-1. These results suggest that the stress of influenza disease may have triggered reactivation of latent EHV-1 infection in some horses, suggesting that EHV-1 did not have a primary role in the outbreak of respiratory disease. Similarly, in England, EHV-1 was not associated with clinical respiratory disease in Thoroughbred racehorses. EHV-1 was isolated from foals with purulent nasal discharge and respiratory disease concurrent with neurologic disease among the dams in Australia.

**Abortion** caused by EHV-1 occurs as both sporadic cases and as epizootics (abortion storms).<sup>27,40,44</sup> Approximately 3% of abortions in mares are attributable to EHV-1 infection, although the actual incidence probably varies widely among years and geographic regions. Outbreaks of EHV-1 abortion and birth of nonviable foals occurs sporadically on farms with sometimes catastrophic losses. Loss of foals through abortion or birth of nonviable foals can be as high as ~60% of pregnant mares on the farm.<sup>27,40,44</sup> Initial cases can, in the absence of appropriate control measures, rapidly spread the infection and prompt diagnosis, and implementation of control measures is important to limit the spread of infection.<sup>27,29</sup> Vaccination with killed EHV-1 vaccine during late gestation does not reliably prevent the disease, although conventional wisdom is to ensure that mares are well vaccinated (see the section **Control**).<sup>27</sup> EHV-4 rarely causes abortion in mares. Disease of neonates associated with EHV-1 occurs both sporadically and as outbreaks in which up to 25% of foals may be affected. Foals infected in utero usually die soon after birth, whereas those infected in the period after birth may have milder disease and a lower mortality rate (6%). One-third of viremic foals may not seroconvert, based on the complement fixation test.

**Myeloencephalopathy** occurs as sporadic cases but more often presents as an epizootic within a stable or barn or within a localized area. Morbidity rates in exposed horses range from 1% to 90%, mortality rates of 0.5% to 40%, and case-fatality rates of ~15%–75%.<sup>25,32,41,43,45,46</sup> The attack rate (number of horses with disease/number of horses infected) in outbreaks of the D752 variant is 22% to 50%.<sup>20</sup> Pregnant or nursing mares are suggested to be at greater risk of this disease, but outbreaks occur on premises, such as riding schools or race tracks, where there are no foals or pregnant mares.

### Method of Transmission

EHV-1 is highly infectious, as evidenced by transmission of infection despite stringent biosecurity measures in referral hospitals, riding schools, and so on.<sup>32,46,47</sup> Transmission occurs by the inhalation of infected droplets



or by the ingestion of material contaminated by nasal discharges or aborted fetuses/placenta/fetal fluids. Viral loads in nasal fluids in horses with EHM or aborted fetuses and associated tissues and fluids can be very high.<sup>36,48</sup> Other routes of infection are not recognized, although EHV-1 binds *in vitro* to embryos, and binding persists after 10 cycles of washing, suggesting that embryo transfer has the potential to transmit infection.<sup>49</sup> This route of infection has not been demonstrated as being important, or indeed possible, in the spread of spontaneous disease. EHV-1 DNA, but not EHV-4, was detected in semen samples of 51 of 390 stallions, illustrating the potential for spread of the virus during mating or artificial insemination.<sup>50</sup>

The virus is efficiently transmitted to in-contact animals, and rapid spread of infection results from close contact of an infected animal with susceptible horses. Infection can be spread over short distances in the absence of physical contact or fomite transmission. This likely occurs by airborne spread of virus in droplets of aerosolized nasal secretions.

Infections always arise from other horses, either by direct contact or via fomites. Mediate infection from virus on fomites such as tack, veterinary equipment, vehicles, and housing occurs because the virus survives for 14 to 45 days outside the animal. The source of the virus is always one of the following:

- A horse or foal with active infection
- A fetus, fetal membranes, or reproductive tract secretions of a mare immediately after abortion or birth of a weak foal
- Virus shed by horses in which latent infection has reactivated.

Horses and foals are infectious during the active stage of disease and, because horses become **latently infected**, during subsequent periods of viral reactivation and shedding. Latent infection occurs by inclusion of virus in immune cells (CD8+ T cells) in trigeminal ganglia, submandibular lymph nodes, and likely other immunologically active tissues.<sup>9,30,51</sup> Latent infection by EHV-1 virus can be reactivated by administration of corticosteroids or other immunosuppressants but, at least in experimental situations, the resulting level of viremia is very low and in-contact susceptible horses were not infected.<sup>51</sup>

Virus is detectable in nasal fluids of approximately 70% of horses when they first exhibit clinical signs of EHM and for up to 9 days after development of it.<sup>32,47</sup> The duration of nasal shedding is not related to age, duration of fever, or severity of clinical signs.<sup>32</sup>

There is good circumstantial evidence, such as the occurrence of abortion, neonatal disease, or myeloencephalopathy in closed herds, to support a role for latency and reactivation in the genesis of the disease, although the importance of reversion from latency has been questioned. The duration of latency is

unknown but is assumed to be lifelong. Latent EHV-1 virus is detectable in the trigeminal ganglion and CD5/CD8 lymphocytes. Reactivation of the virus might not result in clinical signs in the host animal, but there is shedding of virus in nasal secretions. Consequently, clinically normal animals harbor latent virus that can infect susceptible animals during periods of reactivation. This feature of the disease has obvious importance in the prevention, control, and management of outbreaks of disease.

**Abortion storms** are usually attributable to an index case with the following:

- A latently infected mare that sheds virus from the respiratory tract, but does not abort
- A mare that aborts an infected conceptus
- A mare that sheds virus from the respiratory tract, and then aborts

Mares usually, but not always, abort from EHV-1 infection only once in their lifetime. A likely scenario in abortion storms is the reactivation of latent virus in a resident horse with subsequent shedding of virus in nasal secretions or, if the mare aborts, fetal tissues and uterine fluids. Contamination of the environment or horse-to-horse contact spreads infection to susceptible cohorts (primary transmission). The infected cohorts then further spread the virus to other horses in that band of mares (secondary transmission), which then spread infection among other bands of mares and foals, paddocks or fields of horses, or farms (tertiary transmission).

Outbreaks of **myeloencephalopathy** likely occur through similar mechanisms. Most outbreaks are associated with an index case or introduction of a horse with signs of infectious respiratory disease, with subsequent development of new cases in horses that have either direct or indirect (aerosol or fomite) contact with the index case.<sup>25,43,46,47</sup> Horses with clinical signs of myeloencephalopathy excrete the virus in nasal fluids, often in high concentrations,<sup>36</sup> and for periods of time up to 14 days (nasal shedding of the virus has been demonstrated up to 9 days after the onset of clinical signs of EHM)<sup>32</sup> and can spread the disease, contrary to previous supposition. This has important implications for handling and care of affected horses, especially those severely affected horses that may be referred for intensive or specialized care. Extreme care should be exercised when accepting horses with EHM, or suspected EHM, to referral facilities or hospitals because these animals can cause nosocomial spread of infection and disease among hospitalized equids.<sup>46,47</sup> Furthermore, equids infected nosocomially can spread the infection when they return home.

### Cycling of Infection

Studies on Thoroughbred stud farms in Australia have demonstrated the temporal

sequence of events that contribute to spread of EHV-1 infection in that region and these studies likely have relevance to other regions of the globe. There is a cyclical pattern in which horses are infected at a young age and the source of infection is, depending on the age of the foal, either its dam or other foals. Foals are infected by EHV-1 and shedding virus in nasal secretions as young as 11 days of age, often without development of clinical signs but usually associated with mucopurulent nasal discharge. Peak incidences of cases of respiratory disease associated with EHV-1 are late during the foaling season before weaning, and again after weaning when foals from several groups are housed together. The source of infection in foals before weaning is mares and, as the number of foals in the herd increases over the course of the foaling season, other foals. Weanlings spread the disease among their herd during the period shortly after weaning when foals from more than one group are mixed. The incidence density of new cases among weanlings can be as high as 13 new cases per 1000 foal weeks. The disease associated with these outbreaks is mild and without long-term consequences to the foal or weanling. However, the presence of foals excreting large quantities of EHV-1 has the potential to increase the risk of viral abortion in late-term mares in contact with these foals. Furthermore, the presence of respiratory disease associated with EHV-1 and shedding of virus by foals is associated with development of myeloencephalopathy in mares.

### Risk Factors

Risk factors for EHM include the following<sup>21</sup>:

- Presence of susceptible equids: based largely on age (>5 years) and immune status (there are no reports of horses affected twice by the disease, suggesting long-lasting immunity).
- Introduction of EHV-1: almost always associated with a horse shedding the virus, either as a result of new infection or recrudescence of latent infection.
- Presence of the D752 variant: although disease can occur associated with infection by N752.
- Season: there appears to be higher incidences of the disease in the Northern Hemisphere in autumn, winter, and spring.
- Pyrexia: horses that are pyrexial during an outbreak are more likely to develop EHM.
- Movement of new horses onto the property, or use of horses in riding schools.<sup>32</sup>
- Possible associations with sex (increased risk if female) or breed (pony), although these associations are not consistent in all or most studies and are of limited usefulness in controlling or managing the disease.<sup>43,46,47</sup>

## Immunity

Immunity to EHV-1 is mediated by cytotoxic T cells, which explains the limited efficacy of inactivated virus vaccines that have minimal effect in stimulating cytotoxic T cells despite being capable of inducing a humoral immune response.<sup>52</sup> The presence of EHV-1 cytotoxic T-cell precursors correlates well with protection from experimental infection, and some of the EHV-1 antigens responsible for this resistance have been identified.<sup>53-55</sup> Mares usually only abort from EHV-1 infection once in their lifetime, and there are no reports of horses developing myeloencephalopathy more than once.

Lack of antibodies to EHV-1 was identified as a risk factor in an outbreak of EHM in a herd of mares with foals at foot. Mares with strong antibody responses to EHV-1 did not develop disease.

## Economic Importance

Disease associated with EHV-1 is of considerable economic importance because of the loss of training time and opportunities to perform during convalescence and quarantine, the loss of pregnancies during abortion storms, and deaths caused by myeloencephalopathy and infection of neonates.

## PATHOGENESIS

The three organ systems involved in clinical disease associated with EHV-1 infection are the respiratory tract, uterus and placenta, and CNS. The common final pathway for injury in each of these body systems is damage to vascular endothelium with subsequent necrosis, thrombosis, and ischemia.

Following EHV-1 exposure to the upper respiratory tract, virus can be detected in the soft palate and mainstem bronchus within 12 hours, and at all levels of the respiratory tract by 24 hours. The virus gains access to the body after binding to respiratory mucosal epithelium where it forms plaques that do not extend into submucosal tissues.<sup>35</sup> In the respiratory tract there is an initial phase after infection of nasal epithelium<sup>56</sup> in which there is rapid proliferation of the virus in the nasal, pharyngeal, and tonsillar mucosae, with subsequent penetration and infection of local blood vessels. This is followed by a systemic, viremic phase in which the virus is closely associated with blood lymphocytes (especially CD172a(+)),<sup>56</sup> from which it can be isolated. Infection induces increased production of IFN- $\gamma$  by T lymphocytes.<sup>54</sup> Absence of viral antigens on the surface of EHV-1-infected peripheral blood mononuclear cells explains their ability to avoid complement-mediated lysis. This activity, combined with the immunosuppression that accompanies EHV-1 infection,<sup>55,57-59</sup> allows dissemination of the infection to the reproductive tract and CNS. Immunosuppression is mediated by production in EHV-1-infected cells of an “early protein” that interferes with peptide

translocation by the transporter associated with antigen processing. Immunosuppression is evident as reduced in vitro proliferation of peripheral blood monocytes and downregulation of expression of major histocompatibility complex class I molecules on the surface of infected cells. It is from this point that the invasion of lungs, placenta, fetus, and nervous tissue occur. Movement of infected mononuclear cells into target tissues is associated with expression of adhesion molecules by endothelium in the gravid uterus and in leukocytes.

Viral infection of endothelium results in death of endothelial cells, inflammation, activation of clotting factors and platelets, increases in markers of fibrin degradation, and formation of blood clots in small vessels.<sup>60-62</sup> This thrombotic disease causes ischemia of neighboring tissues with subsequent necrosis and loss of function. Another theory is that deposition of antigen-antibody complexes in small vessels results in an Arthus reaction with subsequent ischemia, necrosis, and loss of function. However, recent demonstration that mares with no antibody titer to EHV-1 were at increased risk of developing myeloencephalopathy does not support a role for type III hypersensitivity in this disease. Regardless of the underlying mechanism, clinical signs are a result of vasculitis and necrosis of tissue in the CNS and reproductive tract. This is in contrast to neurologic disease associated with herpesvirus in other species, in which the nervous system disease is a direct result of infection of neural tissues.

Abortion is caused by damage to the placenta, endometrium, or fetus. Placental lesions include vasculitis, focal thrombosis, and infarction of the microcotyledons of the pregnant uterus. The fetus is infected and there are diagnostic lesions present in many aborted foals, including massive destruction of lymphocytes in the spleen and the thymus. In those abortions in which there is no lesion or evidence of virus infection in the foal, there may be extensive damage to the endometrium caused by an endothelial lesion and its attendant vasculitis, thrombosis, and secondary ischemia.

**Foals** that are infected in utero but survive to full term may be stillborn or weak and die soon after birth with pulmonary, hepatic, and cardiac lesions. EHV-1 infection in foals not infected before or at birth is usually a self-limiting, mild infection of the upper respiratory tract with an accompanying leukopenia and a transitory immune suppression, although uveitis and occasionally death occur in a small number of foals. Virus can be isolated from the nasal mucus and the buffy coat of the blood for some time after clinical signs have disappeared.

The pathogenesis of **myeloencephalopathy** in horses contrasts with herpesvirus encephalitis of other species in which there is viral infection of neuronal tissue. The

myeloencephalopathy in horses is, as discussed earlier, the result of vasculitis, thrombosis, and subsequent ischemia of neural tissue. Impairment of blood flow results in hypoxia and dysfunction or death of adjacent neural tissue.

## CLINICAL FINDINGS

EHV-1 infection manifests as several forms of disease on a farm such that nervous system involvement can occur in an outbreak in which abortion and respiratory disease also feature, although more commonly one form of the disease (myeloencephalopathy or abortion) occurs alone or with mild respiratory disease. Foals, stallions, and mares can be affected with one or the other form of the disease, although it is most commonly seen in adult horses. Onset of neurologic signs is usually, but not invariably, preceded by cases of respiratory disease, fever, limb edema, or abortion.

## Myeloencephalopathy

Myeloencephalopathy initially occurs in an index case, which might or might not have had signs of infectious respiratory disease alone or with signs of neurologic disease. Signs of neurologic disease develop in other horses approximately 6 to 14 days after disease in the index case. Disease then develops in a number of horses over a short period of time (3–10 days). Outbreaks in a stable can evolve rapidly.<sup>25,43,46,47</sup>

Fever, without signs of respiratory disease, often precedes signs of neurologic disease by 24 to 72 hours. The onset of neurologic signs is usually rapid, with the signs stabilizing within 1 to 2 days. Fever is more common (odds ratio 20 $\times$ , 95% CI 3.4–390) in horses that go on to develop EHM, but the presence of limb edema or severity of nasal discharge are not associated with the likelihood of developing EHM during an outbreak of the disease.<sup>32,46</sup> Thirteen percent of 61 horses with fever recorded during an outbreak of abortion and EHM developed signs of EHM.<sup>25</sup> Six of seven pregnant mares aborted.

Signs are variable but usually referable to spinal white matter involvement. Affected horses have variable degrees of ataxia and paresis manifest as stumbling, toe dragging, pivoting, and circumduction that is most severe in the hindlimbs. Signs are usually symmetric. There is often hypotonia of the tail and anus.

Fecal and urinary incontinence are common and affected horses often dribble urine, have urine scalding of the skin of the perineum and legs, and require manual evacuation of the rectum. The severity of signs can progress to hemiplegia or paraplegia manifesting as recumbency and the inability to rise. Less commonly, CN deficits, such as lingual or pharyngeal paresis, head tilt, nystagmus, or strabismus, are present. Affected horses are usually alert and maintain their appetite.

Severity of neurologic disease varies among horses within an outbreak, and the prognosis is related to the severity of disease. In general, horses that become recumbent have a poor prognosis for both short-term and long-term survival despite intensive nursing care.<sup>43,46,47</sup> However, less severely affected horses have a good prognosis for survival, with case-fatality rates as low as 2% to 3% in some outbreaks. Horses with mild signs of neurologic disease often recover completely and return to their previous level of performance, although some have persistent neurologic deficits after 1 year.

**Abortion**

Outbreaks of abortion might not be preceded by clinically apparent respiratory disease. The incidence of abortion is highest in the last third of pregnancy, particularly in the 8- to 10-month period but can occur as early as the fifth month. Abortion occurs without premonitory signs, and the placenta is usually not retained. Frequently there is no mammary development. Affected mares sometimes have prolapse of the uterus. Some foals are stillborn, whereas others are weak and die soon after birth.

Abortion storms are often long-lasting, with a period of 17 to 22 days separating the index case from cases caused by secondary transmission of the virus, suggesting an incubation period of 2 to 3 weeks. Experimental infections induce abortion 15 to 65

days after intranasal inoculation of the virus. Although most abortions then occur within 1 month of the first secondary cases, abortions on a farm can continue for many months.<sup>27</sup>

**Neonatal Viremia and Septicemia**

In utero EHV-1 infection causes abortion or the birth of infected foals, some of which are normal at birth, but become weak and die within 3 to 7 days of birth with signs of respiratory distress and septicemia. A less severe form of the disease, characterized by pyrexia, nasal discharge, and chorioretinitis, occurs in slightly older foals that are apparently infected after birth. Affected foals that survive sometimes do not have serum antibodies to EHV-1. Death may be associated with secondary bacterial infection with *E. coli* or *Actinobacillus equuli*, although EHV-1 infection alone is sufficient to cause death.

**Respiratory Disease**

The classical respiratory tract form of the disease (rhinopneumonitis) is virtually indistinguishable on the basis of clinical signs from the other upper respiratory tract diseases of horses and is identical to that associated with EHV-4.

**CLINICAL PATHOLOGY**

Results of hematologic and serum biochemical examinations are neither specific nor diagnostic. EHV-1 infection of adult horses

results in leukopenia that is attributable to both neutropenia and T-cell lymphopenia, with B-cell lymphocytosis occurring during the recovery period. EHV-1 septicemia of foals is characterized by profound leukopenia, neutropenia with a left shift, and lymphopenia. An approach to achieving prompt antemortem diagnosis of EHM is suggested in Fig. 14-9.<sup>63</sup>

CSF of horses with EHV-1 encephalomyelopathy is characteristically xanthochromic and has an increased total protein concentration (>1 g/L) with a normal white cell count.<sup>32,64</sup> The interpretation of EHV-1 antibody in CSF is uncertain, although normal horses are not expected to have detectable antibodies to EHV-1 in the CSF.

**Serologic tests** are of critical importance in diagnosis and control of EHV infections. Many horses have serum antibodies to EHV-1 and EHV-4 as a result of previous infection or vaccination. Thus the demonstration of antibodies is not in itself sufficient to confirm a diagnosis of the disease. Complement-fixing antibody appears on the 10th to 12th day after experimental infection but persists for only a limited period. Demonstration of a threefold to fourfold increase in the serum concentration of specific complement-fixing antibodies in acute and convalescent serum samples provides persuasive evidence of recent infection. Complement-fixing antibodies persist for only a short time (several months) while VN

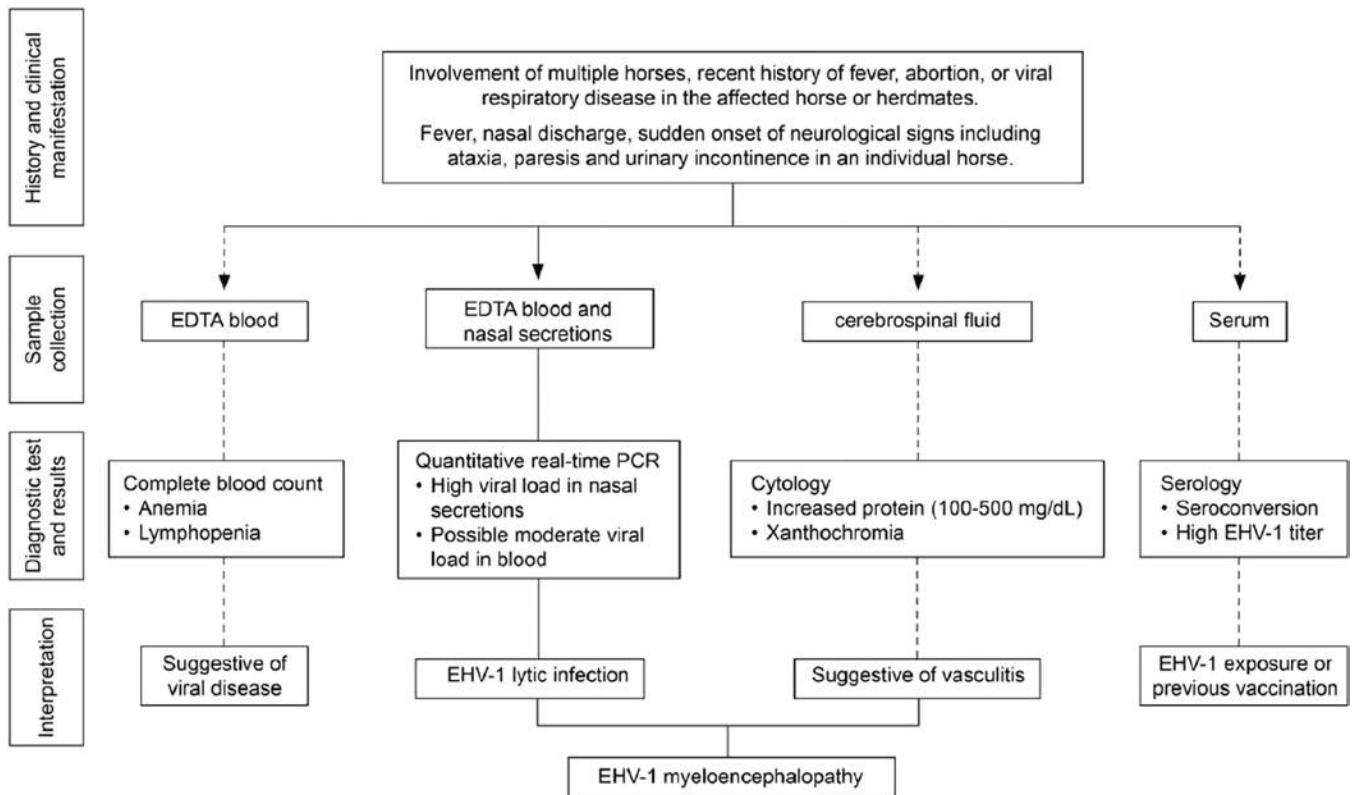

**Fig. 14-9** Methodology for rapid antemortem diagnosis of equine herpesvirus-1 (EHV-1) myeloencephalopathy in horses with signs of nervous system disease. Solid lines represent a diagnostic pathway. EDTA, ethylenediaminetetraacetic acid. (Reproduced, with permission, from Pusterla N, Wilson WD, Madigan JE, Ferraro GL. Equine herpesvirus-1 myeloencephalopathy: a review of recent developments. *Vet J* 2009;180:279-289.)



antibodies persist for over a year, and testing for them is therefore a more reliable means of determining that previous infection with the virus has occurred. Until recently, serologic differentiation of antibodies to EHV-1 and EHV-4 was not possible. However, highly specific **ELISA** tests based on differences between EHV-1 and EHV-2 in the variable region of the C terminus of glycoprotein G, at least one of which is commercially available, have been developed that can differentiate between antibodies to EHV-1 and EHV-4 in horse serum. The ELISA is reported to be more sensitive, easier to perform, more rapid, and more reproducible than the virus neutralization test. Importantly, the ELISA test is able to differentiate between infections associated with EHV-1 and EHV-4.<sup>65,66</sup>

**Identification of the virus** in nasal swabs, or blood buffy coat, or tissue by culture or a PCR test provides confirmation of infection.<sup>67-71</sup> The use of seminested or multiplex PCR or qPCR, which avoids the risk of carryover contamination, provides rapid identification of EHV-1 viral genome in nasopharyngeal swabs, blood, and other tissues. The test is at least as sensitive as viral isolation in identifying presence of virus. Rapid identification of virus shedding using qPCR can facilitate monitoring and interventions to prevent spread of infection and additional examination or prophylactic treatment of infected horses.

Appropriate PCR testing can determine whether the EHV-1 is the D752 or N752 variant. This information can be important in epidemiologic investigations and might have implications for administration of antiviral therapy, although this is unclear, but generally does not influence management of a disease outbreak.<sup>21,72</sup>

The virus can be isolated in tissue culture, chick embryos and hamsters, from either nasal washings or aborted fetuses, and has growth characteristics that differentiate it from EHV-4.<sup>73</sup>

Samples of nasopharyngeal exudate for virus isolation are best obtained from horses during the very early, febrile stages of disease, and are collected via the nares by swabbing the nasopharyngeal area with a 5 × 5-cm gauze sponge attached to the end of a 50-cm length of flexible, stainless steel wire encased in latex rubber tubing. A guarded uterine swab device can also be used. After collection, the swab should be removed from the wire and transported promptly to the virology laboratory in 3 mL of cold (not frozen) fluid transport medium (serum-free minimal essential medium with antibiotics). Virus infectivity can be prolonged by the addition of bovine serum albumin or gelatin to 0.1% (w/v).

## NECROPSY FINDINGS

Macroscopic findings in **aborted fetuses** include petechial and ecchymotic hem

orrhages, especially beneath the respiratory mucosae. The most consistent finding is an excess of clear yellow fluid in the pleural and peritoneal cavities. Focal hepatic necrosis and slight icterus may also be present. In some aborted fetuses the cut surface of the spleen reveals unusually prominent lymphoid follicles, which are swollen from necrosis and edema. Acidophilic intranuclear inclusion bodies may be evident histologically in a variety of cell types, including the bronchiolar and alveolar epithelium, hepatocytes, and dendritic cells of the lymphoid tissues. Although the microscopic pathology is unimpressive, examination of the placenta via IHC techniques can be a useful aid in the diagnosis of EHV-1–induced and EHV-4–induced abortions. In foals that are alive at birth but die soon afterward there is usually massive pulmonary congestion and edema, with collapse of the lung and hyaline membrane development in those that survive longer.

In the **nervous or paralytic form** of the disease there is an acute disseminated myeloencephalopathy. Hemorrhages may be visible grossly but often there are no macroscopic changes. Disseminated vasculitis occurs in the experimental disease, and the malacic lesions present in the nervous tissue are the result of leakage from these damaged vessels. The virus can be isolated from the brain, and the isolation is facilitated by use of an indirect peroxidase stain to establish the location of the virus. The virus infects endothelial cells within the CNS but has also been demonstrated within neurons and astrocytes and has been linked to chorioretinitis in a foal. In rare cases the virus may cause lesions in other tissues, such as the intestinal mucosa and spleen or pharynx.

The laboratory examination of aborted fetuses should include a search for virus by tissue culture and IHC or PCR techniques, as well as a histologic examination of the lung and liver for the presence of inclusion bodies. A direct FAT has also been used. A serologic examination of the foal may provide useful information in those cases in which attempts at isolation are negative but seroconversion has occurred. However, a recent study found that fetal serology was an unreliable means of diagnosing EHV-1 abortion, and that IHC was slightly more sensitive than virus isolation.

## Samples for Confirmation of Diagnosis

- **Virology:** chilled lung, liver, spleen, thymus, and thoracic fluid of aborted fetuses or neonates. Spinal cord or brain of horses with nervous disease (VI, PCR, FAT, serology).
- **Histology:** fixed lung, liver, spleen, thymus, and trachea from fetuses or neonates.
- Fixed brain and spinal cord from several sites, as well as Bouin's fixed eye should

be examined in adults with nervous disease (LM, IHC).

## DIFFERENTIAL DIAGNOSIS

Respiratory disease in horses is associated with a variety of agents (Table 12-14).

Abortion can be associated with leptospirosis, *Salmonella abortusequi*, placentitis associated with *Streptococcus zooepidemicus* or *Escherichia coli*, associated with mare reproductive loss syndrome, or congenital abnormalities, among other causes. When other pregnant mares are at risk, abortion in a late-term mare should always be considered to be caused by EHV-1 until proved otherwise.

Neurologic diseases with clinical presentations similar to that associated with EHV-1 include rabies, equine protozoal myeloencephalitis, neuritis of the cauda equina (equine polyneuritis), trauma, acute spinal cord compression (cervical stenotic myelopathy), and equine degenerative myelopathy. Fever is rare in other neurologic diseases of horses, and any horse with neurologic disease and fever or a history of fever within the previous week should be considered to have EHV-1 myeloencephalopathy. Outbreaks of posterior paresis or ataxia, especially in horses without fever, should prompt consideration of ingestion of intoxicants such as *Astragalus* spp., *Swainsona* spp., or sorghum. Ryegrass staggers can produce similar signs of ataxia.

Neonatal septicemia can be associated with *E. coli*, *Streptococci* spp., and other bacteria, especially in foals with failure of transfer of maternal immunoglobulins.

*EHV-1, equid herpesvirus-1.*

## TREATMENT

Because of the highly contagious nature of EHV-1 infections, horses with respiratory disease, abortion, or neurologic disease, especially if these occur as an outbreak, should be isolated until the cause of the disease is identified.

There is **no specific treatment** for the diseases associated with EHV infection, although acyclovir and other antiviral drugs are used on occasion to treat horses in outbreaks of myeloencephalopathy.<sup>46</sup>

Horses with EHM require intense supportive care. Nursing care to prevent urine scalding, pressure sores, and pneumonia is important in horses with myeloencephalopathy. Recumbent or severely ataxic horses should be supported to stand if at all possible. Although a rope tied to the tail and slung over an overhead beam may be used to assist the horse to stand, a sling may be necessary to support more severely affected horses. Nursing care is important to prevent development of pressure sores in recumbent horses or those supported by slings. The perineum of incontinent horses should be cleaned frequently, and salves or ointments

to protect the skin applied. Some horses require catheterization of the bladder to relieve distension. Enemas, accompanied by careful manual evacuation of the rectum, might be needed to promote passage of feces.

Administration of corticosteroids to these horses is controversial, but many clinicians administer dexamethasone sodium phosphate (0.05–0.25 mg/kg intramuscularly every 12–24 hours) or prednisolone (1–2 mg/kg orally or parenterally every 24 hours) for 2 to 3 days. Administration of corticosteroids may be contraindicated because of the presence of replicating virus in affected horses. The use of antiplatelet drugs or antithrombotic compounds has received anecdotal support, but there is no evidence that they do not harm affected horses and similarly no evidence of efficacy.

Administration of drugs to inhibit viral replication has merit and is attempted during outbreaks of disease. The challenges of this approach are that the infection is well advanced by the time clinical signs of neurologic disease are detected, especially in cases early in the disease outbreak before purposeful monitoring is in place, pharmacokinetics and pharmacodynamics of the available drugs are unknown or imperfectly known, and the drugs are expensive. Antiviral drugs considered for use in horses with EHM include acyclovir, valacyclovir, penciclovir (after oral administration of its prodrug famciclovir), ganciclovir, and valganciclovir.<sup>74-78</sup> Acyclovir is effective against EHV-1 *in vitro*, and pharmacokinetic studies suggest that administration of 10 mg/kg orally every 4 to 6 hours (five times daily) or 10 mg/kg intravenously every 8 hours results in acceptable concentrations of drug in the blood. However, further investigation reveals that there is a large variation between individual horses in the absorption of acyclovir with consequent failure to obtain therapeutic concentrations in many horses.<sup>79</sup> The *in vitro* activity of acyclovir, ganciclovir, cidofovir, adefovir, 9-(2-phosphonylmethoxyethyl)-2,6-diaminopurine (PMEDAP) and foscarnet against three abortigenic isolates and three neuropathogenic isolates of EHV-1 revealed variable activity of cidofovir and limited to no activity of foscarnet.<sup>80</sup>

Current recommendations for the prophylaxis and treatment of horses with EHM include administration of acyclovir (10–20 mg/kg every 5–8 hours, orally for 7 days) or ganciclovir IV at 2.5 mg/kg every 8 h for 24 h followed by maintenance dosing of 2.5 mg/kg every 12 h, or orally at 30–40 mg/kg every 8–12 h for 7 days.<sup>72</sup> The efficacy of these compounds has not been demonstrated in appropriate clinical trials, and earlier comments about the variability in oral bioavailability of acyclovir should be noted.

**Neonatal** foals with septicemia should be treated aggressively with **antibiotics** and **supportive care**, including enteral or

parenteral nutrition and fluid administration (see the section Clinical Assessment and Care of Critically Ill Newborns in [Chapter 19](#)). Treatment with acyclovir has been reported. Failure of transfer of passive immunity should be rectified with oral or intravenous administration of colostrum or plasma, respectively.

## CONTROL

Recommendations for programs to prevent introduction of infection and to control EHM and abortion outbreaks are available from several sources and might vary between countries.<sup>18,21,29,81</sup>

## Prevention of Infection

The general principles include the following:

- Enhanced immunity, currently attempted by vaccination
- Subdivision and maintenance of the farm population in groups of horses to minimize spread of the infection
- Minimize risk of introduction of infection by new horses
- Minimize risk of reactivation of latent infection in resident horses
- Develop plans for implementation of these routine control measures, and for actions in the event of an abortion
- Educate management and staff as to the importance of strict adherence to these procedures

The relative importance of each of these measures has not been determined, but implementation of control measures, including allocation of mares to small bands based on anticipated foaling date, quarantine of new introductions, and vaccination of pregnant mares, has reduced the incidence of EHV-1 abortion in central Kentucky. The most striking association has been an apparent reduction in the incidence of abortion storms. It must be emphasized that vaccination does not replace any of the other management procedures in control of this disease and that abortions have occurred among vaccinated mares on farms on which the other management procedures have been ignored.

## Vaccination

Vaccination against respiratory disease and abortion associated with EHV-1 is widely practiced despite lack of clear-cut evidence that vaccination reduces the incidence or severity of either of these diseases. Information regarding field efficacy of EHV vaccines is lacking, and that derived from experimental challenge models is often contradictory or incomplete. Give these caveats, the following recommendations are made based on generally accepted practices.

None of the currently available vaccines, of which there are approximately 14 worldwide, consistently prevent infection of vaccinated horses or provide complete protection against disease associated with EHV-1.<sup>21,52,72</sup>

The principal objective of vaccination has been to protect mares against abortion associated with EHV-1, although vaccines intended to prevent rhinopneumonitis and containing both EHV-1 and EHV-4 are available. Additionally, vaccination of mares is intended to reduce transmission of EHV-1 to foals in an attempt to interrupt the cyclical nature of infection on stud farms. Vaccines consisting of a modified live EHV-1, inactivated EHV-1, or a mixture of inactivated EHV-1 and EHV-4 are available for intramuscular or intranasal administration to horses. Both inactivated and modified live EHV-1 vaccines elicit virus-neutralization and complement fixation antibody responses in horses, although high antibody titers are not necessarily related to resistance to infection.

Resistance to infection might be more closely related to cytotoxic T-cell responses. Widespread use of a combined EHV-1 and EHV-4 killed virus vaccine in Australia has not reduced serologic evidence of infection in foals on farms where mares are vaccinated, although the vaccine was effective in preventing disease induced by experimental infection. Complicating assessment of vaccine efficacy is the variable response to vaccination by some mares and foals, with certain animals having minimal responses to vaccination, which in other horses elicits a strong immune response. Efforts are underway to develop modified live vaccines that can be administered intranasally. Intranasal administration of one such EHV-1 vaccine induced protection against experimentally induced EHV-1 (and EHV-4) respiratory disease and abortion in mares, and prevented infection of foals even when administered in the presence of maternally derived antibodies. An alternative approach is the development of subunit vaccines using the envelope glycoprotein D, which has been shown to elicit protective immunity in laboratory animal models of EHV-1 disease and administration of which induces VN antibody and glycoprotein D-specific ELISA antibodies in horses. Current modified live vaccines appear to induce a more restricted IgG isotype than does natural infection, which could partly account for their limited efficacy.<sup>53</sup>

Despite the incomplete protection afforded by vaccines, vaccination against EHV-1 is an important part of most equine herd health programs in the vaccination of pregnant and nonpregnant mares, foals, and adult horses. The intent of vaccination of mares is to prevent abortion associated with EHV-1. One inactivated virus vaccine is reported to decrease the incidence of abortion by 65%, although others have not been able to replicate this success and there are reports of abortion storms on farms of well-vaccinated mares. An inactivated virus vaccine containing EHV-1 and EHV-4 prevented abortion in five of six mares exposed experimentally to EHV-1, whereas all six nonvaccinated mares aborted. Mares are

vaccinated with the inactivated vaccine during the fifth, seventh, and ninth months of gestation. Additional vaccinations at breeding and 1 month before foaling are recommended by some authorities.

No vaccines are currently licensed with the claim of preventing EHM, and the disease occurs in well-vaccinated horses. Concerns that the disease might represent a “second hit” as a result of vaccination and subsequent infection have not received widespread support and do not have empirical evidence that is in any way supportive.<sup>21</sup>

**Foals** are an important source of infection and control of infection in foals is considered critical to control of infection on a farm. Consequently, attention has been paid to the responses of foals to vaccination at various ages, given the risk of passive immunity interfering with vaccination and the early age at which foals are infected by EHV-1. Current recommendations vary with some authorities recommending vaccination of foals after 5 months of age, to avoid the interfering effect of passive immunity on response to vaccination. However, vaccination of foals at this age likely misses the period of time when foals are first infected by EHV-1 from their dam or other mares in the band. One recommendation is that foals should be vaccinated in their third month, with revaccination 1 month and 6 months later. Modified live virus vaccine is given to foals at 3 to 4 months of age, and nonpregnant mares and other horses are given two doses administered 3 months apart followed by revaccination every 9 months. Because of the short duration of immunity following vaccination, frequent vaccination, perhaps at intervals as short as 3 months, of horses at high risk is recommended. However, the efficacy of such a program is uncertain.

#### Subdivision of Horses on a Farm

Maintenance of small groups of horses of similar age and reproductive status is recommended to minimize the chances of spread of infection. Pregnant mares, after weaning of foals, should be maintained in a herd that does not have access to foals, weanlings, nonpregnant mares, or other equids (donkeys). Similarly, weaned foals should be separated from horses of other ages in recognition of the high rate of infection and viral shedding in weanlings. Failure to adhere to these procedures can result in rapid spread of infection and abortions among at-risk mares. Pregnant mares should be combined into small groups (~10) early in pregnancy based on their anticipated foaling dates. Multiparous mares should not be mixed with mares that are pregnant for the first time.

Management practices should be introduced that minimize the opportunities for viral spread. Ideally, pregnant mares are handled using facilities separate from those used to handle mares with foals or weanlings. If common facilities must be used,

pregnant mares should be handled first, after thorough cleaning of the facility, followed by mares with foals and finally weanlings and other horses.

#### Minimize Risk of Introduction of Infection

The only sources of virus are recrudescence of latent infection and introduction by newly arrived horses shedding virus. All horses must be considered as potentially shedding EHV-1 on arrival at a farm and should be isolated from resident horses. Introduction of new horses to the small groups of pregnant mares should be avoided if at all possible, or if absolutely necessary preceded by a 21-day isolation period. If at all possible, avoid mingling resident and nonresident mares even after quarantine of nonresident animals.

#### Prevention of Reactivation of Latent Infection

The factors inciting reactivation of latent infection and viral shedding are unknown. However, stressful events, such as transportation or other disease, have the potential to cause reactivation of latent infection. For this reason pregnant mares should not be shipped within 8 weeks of expected foaling and all efforts, including vaccination, should be made to prevent other infectious diseases.

#### Control of Outbreaks

The principles underlying control of abortions or EHM caused by EHV-1 include the following:

- Early and rapid diagnosis
  - Prevention of spread of infection
  - Treatment of individual cases
- These aims are approached through six stages:

1. **Preliminary recognition of the problem (outbreak):** typically by owners or trainers recognizing the presence of sick horses.
2. **Preliminary veterinary investigation:** conducted by a veterinarian on, usually, their first response to the owner's concerns and leading to a presumptive clinical diagnosis.
3. **Establishing the diagnosis:** use of appropriate laboratory and other testing to confirm or rule out specific diagnoses.
4. **Understanding and managing the outbreak:** this is complex because it involves an understanding of the biology and epidemiology of the disease, the financial and social context of the outbreak, and assessment of the feasibility, and cost-effectiveness, of potential interventions.
5. **Establishing freedom of infection:** documenting the end of the outbreak and confirming freedom from infection by the offending agent.

#### 6. Return the premise to normal function and activity.

#### Control of Outbreaks of Myeloencephalopathy

Diagnostic criteria for EHM are set out in the six stages list earlier. Adult horses with rapid onset of signs of nervous system disease, with or without fever, should be considered to have EHM until proven otherwise.

Outbreaks of EHV-1-induced neurologic disease often occur in riding schools and similar situations where there is constant movement of horses on and off the property. As such it is exceedingly difficult to institute control measures that prevent introduction of the disease and that are compatible with the use of the horses. Having said that, the principles outlined earlier for preventing introduction of infection onto breeding farms also apply for prevention of myeloencephalopathy at riding stables.

Reports of outbreaks of EHM in stables and veterinary hospitals have underscored the highly infectious nature of the disease.<sup>25,46,47</sup> EHV-1 is spread from infected horses, which can have virus in nasal fluid before onset of clinical signs, by aerosol, and on fomites. It is critical to prevent spread by diligent attention to biosecurity, including spread by personnel and aerosol. Infected horses should be isolated in a separate air space to uninfected or at risk horses.

Detailed instructions for handling outbreaks of neurologic disease attributable to EHV-1 are available and provide advice on quarantine, disinfection, and sample collection. There is no “one size fits all,” and the recommendations should be modified or adopted with a full understanding of the financial, social, and psychologic context of managing the outbreak. Guidelines for managing an outbreak of EHM include the following<sup>21,29,72,82</sup>:

- Affected horses should be isolated because they are infectious.
- The diagnosis should be confirmed by virus isolation, PCR, or histologic examination of tissues from affected horses that die or are euthanized.
- Potentially affected horses should be tested to determine whether they are excreting the virus (nasal swabs).
- There should be no movement of horses on or off the premises for at least 21 days after the last case has occurred.
- Movement among bands of horses on the farm should be avoided.
- Animals should leave or move between bands only when there is no evidence of continued active infection in their group.
- Vaccination in the face of an outbreak of EHM is not recommended. Clinically affected horses should not be vaccinated.
- Prophylactic use of acyclovir has been reported, although the efficacy of this practice is unknown.



**Table 14-13** Three-tiered approach to managing an outbreak of equine herpesvirus myeloencephalopathy.

Action	Three tiers of approach		
	Gold tier	Silver tier	Bronze tier
<b>Segregate</b> the population into small discrete groups that can be managed discretely to avoid infection transferring between them	<b>Yes</b> The smaller the groups the better to minimize the impact of ongoing disease and possibly reduce later laboratory test costs	<b>Yes</b> The smaller the groups the better to minimize the impact of ongoing disease and possibly reduce later laboratory test costs	<b>Yes</b> The smaller the groups the better to minimize the impact of ongoing disease and possibly reduce later laboratory test costs
<b>Collect</b> samples	<b>Collect full set from all animals</b> NP swab in VTM, serum (5–10 mL) and heparinized whole blood (30 mL)	<b>Collect partial set from all animals</b> NP swab in VTM and serum (5–10 mL)	<b>Collect partial set from all animals</b> NP swab in VTM and serum (5–10 mL)
<b>Test</b> samples	<b>Test full set from all animals</b> NP swab by qPCR, serum by CFT and heparinized blood by virus isolation	<b>Test partial set from all animals</b> NP swab by qPCR and serum by CFT	<b>Do not test, but freeze</b> the partial set from all animals for possible testing later
<b>Observe</b> for clinical disease (neurologic disease and/or abortion noting that pregnant mares should only be considered clear once they have a foaled successfully and have a healthy foal at foot)	<b>Observe all groups for 3–4 weeks:</b> If no clinical disease is observed in a group: collect NP swabs and sera (pair with already tested sample in CFT) and test, consider EHV-1 free if all results are negative If clinical disease is observed in a group: immediately collect and test a full set of samples from all horses in the affected group Remove positives to an isolation area Repeat after 2–3 weeks and only consider EHV-1 free when all results are negative	<b>Observe all groups for 3–4 weeks:</b> If no clinical disease is observed in a group: collect NP swabs and sera (pair with already tested sample in CFT) and test, consider EHV-1 free if all results are negative If clinical disease is observed in a group: immediately collect and test a full set of samples from all horses in the affected group Remove positives to an isolation area Repeat after 2–3 weeks and only consider EHV-1 free when all results are negative	<b>Observe all groups for 3–4 weeks:</b> If no clinical disease is observed in a group: collect NP swabs and sera (pair with frozen samples in CFT) and test, consider EHV-1 free if all results are negative If clinical disease is observed in a group: immediately collect a full set of samples from all the affected group and test all, including frozen, samples Remove positives to an isolation area Repeat after 2–3 weeks and only consider EHV-1 free when all results are negative

CFT, complement fixation test; NP, nasopharyngeal; qPCR, quantitative polymerase chain reaction; VTM, virus transport medium.  
Reproduced from Gonzalez-Medina S et al: *Equine Vet J* 2015; 47:142.

A suggested, three-tiered approach to managing an outbreak of EHM is depicted in [Table 14-13](#).

## Abortion

### Rapid Diagnosis

Every abortion in a late-term mare should be considered to be associated with EHV-1 until proven otherwise. Therefore rapid and early diagnosis of the abortion or of EHM is important to instituting control measures. In regions with large numbers of breeding mares, **all** abortions in mares should be investigated by detailed postmortem examination of the fetus and serologic examination of the mare.

### Prevention of Spread

Diligent and concerted efforts must be made to prevent dissemination of infection from the initial focus in cases of abortion. Delay in doing so increases the incidence of abortion and prolongs the outbreak.<sup>27</sup> Infected fetal tissues and fluids, and contaminated materials such as bedding, should be placed in impervious containers and either transported to a laboratory for examination or destroyed by incineration. Samples for laboratory examination should be handled to prevent spread of infection. Facilities and

equipment that might have been contaminated should be disinfected by thorough cleaning followed by application of a phenolic or iodophor disinfectant.

The mare should be isolated until results of laboratory examination are negative for EHV-1 or until the second estrus, at which time it is unlikely that there is shedding of virus from the reproductive tract. Other mares in the same band as the mare that aborted should be considered exposed and at risk of abortion. These mares should be held in strict isolation until the results of laboratory examination are negative for EHV-1, or until they foal or abort. Other recommendations for horse movement include the following:

- When an abortion occurs on the stud, no mares should be allowed to enter or leave it until the possibility of EHV-1 infection is excluded. However, maiden and barren mares, i.e., mares that have foaled normally at home but that are not in foal, coming from home studs where no signs of the disease are occurring, may be admitted because they are considered not to be infected.
- If EHV-1 infection is identified on the stud, all pregnant mares ready to foal that season (i.e., late-pregnant mares)

should remain at the stud until they have foaled. The incubation period for EHV-1 abortion ranges between 9 and 121 days.

- All nonpregnant animals and mares that have foaled should remain at the stud for 30 days after the last abortion.

The main problem that arises in this program is in deciding what to do with mares that come into contact with the respiratory disease but not the abortion disease. This may occur very early in pregnancy and prolonged isolation would be onerous. The decision usually depends on the owner's risk aversion and the availability of facilities to maintain long-term isolation.

### FURTHER READING

- Gonzalez-Medina S, Newton JR. Equine herpesvirus-1: dealing pragmatically but effectively with an ever present threat. *Equine Vet J*. 2015;47:142-144.
- Lunn DP, et al. Equine herpesvirus-1 consensus statement. *J Vet Intern Med*. 2009;23:450-461.
- Pusterla N, Hussey GS. Equine herpesvirus 1 myeloencephalopathy. *Vet Clin North Am Equine Pract*. 2014;30:489-506.

### REFERENCES

1. Davison AJ, et al. *Arch Virol*. 2009;154:171.
2. Schrenzel MD, et al. *Emerg Infect Dis*. 2008;14:1616.
3. Rebelo AR, et al. *Can J Vet Res*. 2015;79:155.

4. LeCuyer TE, et al. *J Vet Diagn Invest.* 2015;27:749.
5. De Witte FG, et al. *J Vet Intern Med.* 2012;26:1064.
6. Bell SA, et al. *Vet Microbiol.* 2008;130:176.
7. Rushton JO, et al. *Vet J.* 2014;200:200.
8. Vengust M, et al. *J Vet Diagn Invest.* 2008;20:820.
9. Pusterla N, et al. *Vet Rec.* 2010;167:376.
10. Wong D, et al. *JAVMA.* 2008;232:898.
11. Williams KJ, et al. *PLoS ONE.* 2013;8:e63535.
12. Vander Werf KA, et al. *J Equine Vet Sci.* 2014;34:738.
13. Vander Werf K, et al. *J Vet Intern Med.* 2013;27:387.
14. Hussey GS, et al. *Vet Res.* 2013;44:118.
15. Herder V, et al. *Vet Microbiol.* 2012;155:420.
16. Abdelgawad A, et al. *PLoS ONE.* 2015;10:e0138370.
17. Ibrahim ESM, et al. *Arch Virol.* 2007;152:245.
18. Dunowska M. *New Zeal Vet J.* 2014;62:171.
19. Ma G, et al. *Vet Microbiol.* 2013;167:123.
20. Nugent J, et al. *J Virol.* 2006;80:4047.
21. Lunn DP, et al. *J Vet Intern Med.* 2009;23:450.
22. Allen GP. *Am J Vet Res.* 2008;69:1595.
23. Pronost S, et al. *Equine Vet J.* 2010;42:672.
24. Pronost S, et al. *Vet Microbiol.* 2010;145:329.
25. Walter J, et al. *Acta Vet Scand.* 2013;55.
26. Stasiak K, et al. *BMC Vet Res.* 2015;11.
27. Schulman ML, et al. *Equine Vet J.* 2015;47:155.
28. Perkins GA, et al. *Vet Microbiol.* 2009;139:375.
29. Gonzalez-Medina S, et al. *Equine Vet J.* 2015;47:142.
30. Allen GP, et al. *Equine Vet J.* 2008;40:105.
31. Tsujimura K, et al. *J Vet Med Sci.* 2011;73:1663.
32. Burgess BA, et al. *J Vet Intern Med.* 2012;26:384.
33. Pusterla N, et al. *Vet J.* 2012;193:579.
34. Goodman LB, et al. *PLoS Pathog.* 2007;3:e160.
35. Vandekerckhove AP, et al. *J Gen Virol.* 2010;91:2019.
36. Estell KE, et al. *Equine Vet J.* 2015;47:689.
37. Wohlsein P, et al. *Vet Microbiol.* 2011;149:456.
38. Abdelgawad A, et al. *Vet Microbiol.* 2014;169:102.
39. Guo X, et al. *J Vet Med Sci.* 2014;76:1309.
40. Damiani AM, et al. *Vet Microbiol.* 2014;172:555.
41. Gryspeerdt A, et al. *Vlaams Diergeneeskundig Tijdschr.* 2011;80:147.
42. Mori E, et al. *Rev - Off Int Epizoot.* 2011;30:949.
43. van Galen G, et al. *Vet Microbiol.* 2015;179:304.
44. Bazanow BA, et al. *Polish J Vet Sci.* 2014;17:607.
45. Pronost S, et al. *Transbound Emerg Dis.* 2012;59:256.
46. Henninger RW, et al. *J Vet Intern Med.* 2007;21:157.
47. Goehring LS, et al. *J Vet Intern Med.* 2010;24:1176.
48. Gardiner DW, et al. *Vaccine.* 2012;30:6564.
49. Hebia I, et al. *Theriogenology.* 2007;67:1485.
50. Hebia-Fellah I, et al. *Theriogenology.* 2009;71:1381.
51. Pusterla N, et al. *J Vet Intern Med.* 2010;24:1153.
52. Paillot R, et al. *Open Vet Sci J.* 2008;2:68.
53. Goodman LB, et al. *Clin Vaccine Immunol.* 2012;19:235.
54. Paillot R, et al. *Dev Comp Immunol.* 2007;31:202.
55. Wimer CL, et al. *Vet Immunol Immunopathol.* 2011;140:266.
56. Gryspeerdt AC, et al. *Vet Microbiol.* 2010;142:242.
57. Luce R, et al. *Equine Vet J.* 2007;39:202.
58. Ma G, et al. *J Virol.* 2012;86:3554.
59. Sarkar S, et al. *Vet Immunol Immunopathol.* 2015;167:122.
60. Andoh K, et al. *Virus Res.* 2015;195:172.
61. Goehring LS, et al. *J Vet Intern Med.* 2013;27:1535.
62. Stokol T, et al. *PLoS ONE.* 2015;10:e0122640.
63. Pusterla N, et al. *Vet J.* 2009;180:279.
64. Goehring LS, et al. *Vet J.* 2010;186:180.
65. Amer HM, et al. *Afr J Microbiol Res.* 2011;5:4805.
66. Yildirim Y, et al. *Iranian J Vet Res.* 2015;16:341.
67. Hu Z, et al. *Appl Microbiol Biotech.* 2014;98:4179.
68. Pusterla N, et al. *J Vet Diagn Invest.* 2009;21:836.
69. Pusterla N, et al. *Vet J.* 2009;179:230.
70. Smith KL, et al. *J Clin Microbiol.* 2012;50:1981.
71. Stasiak K, et al. *Polish J Vet Sci.* 2015;18:833.
72. Pusterla N, et al. *Vet Clin North Am Equine Pract.* 2014;30:489.
73. Equine rhinopneumonitis (equine herpesvirus 1 and 4). OIE, 2015. (Accessed 07.02.2016, at [http://www.oie.int/fileadmin/Home/eng/Health\\_standards/tahm/2.05.09\\_EQUINE\\_RHINO.pdf](http://www.oie.int/fileadmin/Home/eng/Health_standards/tahm/2.05.09_EQUINE_RHINO.pdf)).
74. Carmichael RJ, et al. *J Vet Intern Med.* 2010;24:712.
75. Carmichael RJ, et al. *J Vet Pharmacol Ther.* 2013;36:441.
76. Garre B, et al. *Vet Microbiol.* 2009;135:214.
77. Maxwell LK, et al. *J Vet Pharmacol Ther.* 2008;31:312.
78. Tsujimura K, et al. *J Vet Med Sci.* 2010;72:357.
79. Wong DM, et al. *Equine Vet Educ.* 2010;22:244.
80. Garre B, et al. *Vet Microbiol.* 2007;122:43.
81. Dunowska M. *New Zeal Vet J.* 2014;62:179.
82. Equine herpesvirus 1 and 4 related diseases. American Association of Equine Practitioners, 2013. (Accessed 07.02.2016, at <http://www.aeep.org/custdocs/EquineHerpesvirusFinal030513.pdf>).

### PERUVIAN HORSE SICKNESS VIRUS

Peruvian horse sickness virus is an Orbivirus associated with causing neurologic disease in horses in Peru with a mortality rate of approximately 1.25% and a case-fatality rate of 78%.<sup>1</sup> A genetically identical virus has been isolated from horses dying of neurologic disease in northern Australia.<sup>2</sup> Serologic surveillance in that area demonstrates antibody to Peruvian horse sickness virus in 11% of horses. The disease is described as causing motor incoordination, sagging jaw, tooth grinding, and stiff neck with death in 8 to 11 days.

### REFERENCES

1. Attoui H, et al. *Virology.* 2009;394:298.
2. Mendez-Lopez MR, et al. *J Vector Ecol.* 2015;40:355.

### POWASSAN VIRUS

The **Powassan virus**, a flavivirus that is spread by the bite of infected ticks,<sup>1</sup> occurs in Ontario and the eastern United States, and produces a nonsuppurative, focal necrotizing meningoencephalitis in horses. Approximately 13% of horses sampled in Ontario in 1983 were serologically positive to the virus. Experimental intracerebral inoculation of the Powassan virus into horses resulted in a neurologic syndrome within 8 days. Clinical findings include a “tucked-up” abdomen, tremors of the head and neck, slobbering and chewing movements resulting in foamy saliva, stiff gait, staggering, and recumbency. There is a nonsuppurative encephalomyelitis, neuronal necrosis, and focal parenchymal necrosis. The virus has not been isolated from the brain.

### REFERENCE

1. Dupuis AP II, et al. *Parasit Vectors.* 2013;6:185.

### NIGERIAN EQUINE ENCEPHALITIS

Nigerian equine encephalitis, a disease with low morbidity but high mortality, is characterized by fever, generalized muscle spasms,

ataxia, and lateral recumbency of 3 to 5 days' duration. The virus has not been identified, but the only report describes the lesions as consistent with an alphavirus, although Lagos bat virus, a pathogenic lyssavirus, is highly endemic in this area.

### MAIN DRAIN VIRUS ENCEPHALITIS

The **main drain virus** has been isolated from a horse with severe encephalitis in California.<sup>1</sup> Clinical findings included incoordination, ataxia, stiffness of the neck, head-pressing, inability to swallow, fever, and tachycardia. The virus is transmitted by rabbits and rodents and by its natural vector, *Culicoides variipennis*.

### REFERENCE

1. Wilson WC, et al. *Rev - Off Int Epizoot.* 2015;34:419.

### BORNA DISEASE

Borna disease is an **infectious encephalomyelitis** of horses and sheep first recorded in Germany. It is associated with a negative sense, single-stranded RNA virus classified as *Bornavirus* within the order Mononegavirales. There is a recently recognized avian variant of Borna disease virus, which causes disease in birds.<sup>1</sup>

The disease and the virus in horses are indistinguishable from EEE. Borna disease is now recognized as a subacute meningoencephalitis in horses, cattle, sheep, rabbits, and cats in Germany, Sweden, and Switzerland.<sup>2</sup> There are reports of encephalitis with Borna disease virus genome detected in lesions by PCR in a horse and a cow in Japan. The disease apparently occurs in New World camelids.<sup>3</sup> Encephalitis associated with Borna disease virus was detected in young ostriches in Israel. The disease does not appear to be a common cause of nonsuppurative encephalitis in pigs.<sup>4</sup> Serologic evidence of infection by Borna disease virus is widespread both geographically and in the range of species.<sup>5,6</sup>

**Borna disease virus** is suspected of causing disease in humans, including lymphocytic meningoencephalitis, but infection is not associated with an increased prevalence of psychiatric disorders. Others suggest that the presence of circulating Borna disease virus immune complexes (Borna disease virus antigen and specific antibodies) is associated with severe mood disorders in humans. The role, if any, of Borna disease virus in human neurologic or psychiatric disease has not been established with any certainty and is the subject of considerable debate.<sup>1</sup>

Detection of Borna disease virus **genome** by PCR analysis suggests that, although the spontaneous disease in horses and sheep occurs predominantly if not exclusively in Europe, clinically unapparent Borna disease

virus infection is widespread in a number of species including horses, cattle, sheep, cats, and foxes. However, concern has been raised that some of these reports might be based on flawed laboratory results as a consequence of contamination of PCR assays. **Antibodies** to Borna disease virus in serum or CSF have been detected in horses in the eastern United States, Japan, Iran, Turkey, France, and China, and in healthy sheep and dairy cattle in Japan. In areas in which the disease is not endemic, between 3% (United States) and 42% (Iran) of horses have either antibodies or Borna disease virus nucleic acid, detected by PCR, in blood or serum. Similarly, approximately 12% to 20% of horses have serologic evidence of exposure to Borna disease virus in areas of Europe in which the disease is endemic. Antibodies to Borna disease virus and nucleic acid have been detected in humans in North America, Europe, and Japan. Closed flocks of sheep and herds of horses have evidence of persistent infection of some animals, based on serologic testing. It is worth noting that animals infected with the virus and those who are clinically ill may have undetectable to very low antibody titers.

The method of transmission of infection between animals is unknown, but it is thought to be horizontal by inhalation or ingestion. Seropositive, clinically normal horses and sheep can excrete virus in conjunctival fluid, nasal secretions, and saliva, suggesting that they might be important in the transmission of infection. Removal of all seropositive and Borna disease virus RNA-positive sheep from a closed flock did not prevent seroconversion of other animals in the flock the following year. The possibility of vertical transmission is raised by the finding of Borna disease virus RNA in the brain of a fetal foal of a mare that died of Borna disease.

There is a seasonal distribution to the prevalence of the disease, with most cases in horses occurring in spring and early summer. The virus has not been isolated from arthropods, including hematophagous insects.

The **morbidity** in Borna disease is not high, approximately 0.006% to 0.23% of horses affected per year in endemic areas of Germany, but most affected animals die.

The **pathogenesis** of the disease involves infection of cells of the CNS. It is assumed that the virus gains entry to the CNS through trigeminal and olfactory nerves, with subsequent dissemination of infection throughout the brain. Viral transcription and replication occurs within the cell nucleus. Viral replication does not appear to result in damage to the infected neuron. However, infected cells express viral antigens on their surface, which then initiate a cell-mediated immune response by the host that then destroys infected cells (immunosuppression prevents development of the disease). The inflammatory response is largely composed of CD3

lymphocytes. The disease is subacute; infection and the development of lesions may take weeks to months. Clinically inapparent infection appears to be common in a number of species, including horses.

In **field outbreaks** the incubation period is about 4 weeks and possibly up to 6 months.

**Clinical signs** of the disease in horses include the following:

- Moderate fever
- Pharyngeal paralysis
- Lack of food intake
- Muscle tremor
- Defects in proprioception
- Hyperesthesia
- Blindness or visual defects<sup>7</sup>

Lethargy, somnolence, and flaccid paralysis are seen in the terminal stages, and death occurs 1 to 3 weeks after the first appearance of clinical signs. Infection without detectable clinical signs is thought to be common on infected premises. The frequency with which Borna disease virus is detected in horses with gait deficits is greater than in clinically normal horses, suggesting a role for the virus in inducing subtle disease.

The presentation of the disease in cattle is similar to that in horses, with affected animals having reduced appetite, ataxia, paresis, and compulsive circling. The disease ends in the death of the animal after a 1- to 6-week course.

Hematology and routine serum biochemistry are typically normal, with the exception of fasting-induced hyperbilirubinemia in anorexic horses. Clinicopathologic identification of exposed animals is achieved with complement fixation, ELISA, Western blot, or indirect immunofluorescent tests.

At  **necropsy** there are no gross findings, but histologically there is a lymphocytic and plasmacytic meningoencephalitis, affecting chiefly the brainstem, and a lesser degree of myelitis. The highest concentration of virus is in the hippocampus and thalamus. The diagnostic microscopic finding is the presence of intranuclear inclusion bodies within neurons, especially in the hippocampus and olfactory bulbs. The virus can be grown on tissue culture and demonstrated within tissues by immunofluorescence and immunoperoxidase techniques. Borna disease virus can also be detected in formalin-fixed, paraffin-embedded brain tissues using a nested PCR.

Specific **control measures** cannot be recommended because of the lack of knowledge of means of transmission of the virus. The role of inapparently infected horses in transmission of the disease is unknown, and there is no widespread program for testing for such horses. An attenuated virus vaccine was produced by continued passage of the virus through rabbits and used in the former East Germany until 1992. However, its use was discontinued because of questionable efficacy.

## FURTHER READING

Lipkin WI, et al. Borna disease virus—Fact and fantasy. *Virus Res.* 2011;162:162-172.

## REFERENCES

1. Lipkin WI, et al. *Virus Res.* 2011;162:162.
2. Lutz H, et al. *J Feline Med Surg.* 2015;17:614.
3. Jacobsen B, et al. *J Comp Pathol.* 2010;143:203.
4. Bukovsky C, et al. *Vet Rec.* 2007;161:552.
5. Bjornsdottir S, et al. *Acta Vet Scand.* 2013;55:77.
6. Kinnunen PM, et al. *J Clin Virol.* 2007;38:64.
7. Dietzel J, et al. *Vet Pathol.* 2007;44:57.

## TESCHOVIRUS INFECTIONS

Important enteric viruses of the pig belong to the Picornaviridae particularly enteroviruses, teschoviruses and sapeloviruses (formerly porcine enterovirus A or porcine enterovirus).

## SEROTYPES

The most important disease of this group is Teschen itself, which was restricted to a particular region around the town of Teschen in Czechoslovakia and the surrounding parts of Eastern Europe.<sup>1,2</sup> The mild forms of the disease have occurred elsewhere and are referred to as Talfan or in the past poliomyelitis suum or benign enzootic paresis, and these are probably present worldwide.

## SYNOPSIS

**Etiology** Porcine enteroviruses capable of causing encephalomyelitis. Teschen virus, Talfan virus, and others.

**Epidemiology** Certain European countries, Scandinavia, and North America. Morbidity 50%; case fatality 70%–90%. Teschen in Europe. Talfan in UK. Viral encephalomyelitis in North America. Transmitted by direct contact.

**Signs Acute** Teschen: fever, stiffness, unable to stand, tremors, convulsions, and death in few days

**Subacute** Talfan: milder than acute form. Most common in pigs under 2 weeks of age. Morbidity and case-fatality rate 100%. Outbreaks. Hyperesthesia, tremors, knuckling of fetlocks, dog-sitting, convulsions, blindness, and death in a few days. Milder in older growing pigs and adults.

**Clinical pathology** Virus-neutralization tests.

**Lesions** Nonsuppurative encephalomyelitis.

**Diagnostic confirmation** Demonstrate lesion and identify virus.

### Differential diagnosis list

- Pseudorabies
- Hemagglutinating encephalomyelitis virus

**Treatment** None.

**Control** Outbreaks will cease and herd immunity develops.



## ETIOLOGY

Originally, there were at least 13 enterovirus members, and these are now reclassified. The viruses are resistant to environmental effects (in one study of disinfectants only sodium hypochlorite was effective), are stable, and easily cultivated. The only known host is the pig, and the viruses are not zoonotic.

Important enteric viruses belong to the Picornaviridae and the genera *Enterovirus*, *Teschovirus*, and *Sapelovirus* (these were formerly known as porcine enterovirus A or porcine enterovirus serotype B.<sup>1</sup> In a survey of 206 viral isolates 97 (47%) were identified as teschoviruses, 18% as sapeloviruses, and 3% as adenoviruses.<sup>3</sup>

Porcine enteric picornaviruses produce asymptomatic infections as well as reproductive disorders, diarrhea, pneumonia, and dermal lesions. These viruses were previously classified as enteroviruses. They are now reclassified into three groups on the basis of genomic sequences: (1) porcine teschoviruses (PTVs) with 11 different serogroups; (2) porcine enterovirus B, which corresponds to the former enterovirus serotypes 9 and 10; and (3) porcine sapelovirus (PSV), which corresponds to former enterovirus type 8 and has a single serotype that is divided into antigenic variants (PEV 8a, 8b, and 9c). It is associated with reproductive disease, diarrhea, and pneumonia.

It appears that PTV-1, the most virulent type, is only found in Central Europe (there have been a number of independent isolates, such as the Konratice and Reporyje strains) and Africa. Talfan virus, isolated from England, and other unnamed isolates appear less virulent. Teschen and Talfan virus occur in subgroup 1, which is now called porcine enterovirus group 1 (PEV-1), but isolates from encephalomyelitis are also associated with other subgroups. The other PTVs and PSV are ubiquitous. Porcine enterovirus B (PEV-9 and PEV-10) is found in Italy, UK, and Japan.<sup>4</sup>

A PTV caused respiratory distress and acute diarrhea in China in 50- to 70-day-old pigs.<sup>5</sup> PTV-8 (a sapelovirus in the new classification) caused a SMEDI-like syndrome in China,<sup>6,7</sup> in which approximately 80 gilts aborted and many piglets were stillborn or died soon after birth; samples from most were PTV positive.

Within subgroups, strains may be further differentiated using a complement fixation test and monospecific sera. There is variation in virulence between strains, and with many strains, clinical encephalitis following infection appears to be the exception rather than the rule. Most of the infections are subclinical.

Polioencephalomyelitis is associated with PTV-1, 2, 3, and 5; reproductive disease is associated with PTV-1, 3, and 6; diarrhea is associated with PTV-1, 2, 3, and 5; pneumonia is associated with PTV-1, 2, and 3; pericarditis and myocarditis have been associated

with PTV-2 and 3; and cutaneous lesions are associated with PTV-9 and 10.

## EPIDEMIOLOGY

### Occurrence and Prevalence of Infection

There is serologic evidence that the disease occurs throughout the world. The most severe form of the disease, Teschen disease, appears to be limited to Europe and Madagascar, but the milder forms occur extensively in Europe (Hungary, 2012), Scandinavia, and North America (2002–2007) and recently in Japan (2012). The recent outbreak in the United States (Indiana) was ascribed to porcine enterovirus Serogroup 5 or 6 with the only characteristic feature being the histologic lesions of polioencephalomyelitis. Losses caused by the disease result primarily from deaths.

Serologic surveys in areas where the disease occurs indicate that a high proportion of the pig population is infected without any clinical evidence of the disease. In the majority of field occurrences, porcine encephalomyelitis is a sporadic disease affecting either one or a few litters, or a small number of weaned pigs.

### Morbidity and Case Fatality

The morbidity rate is usually about 50% and the case–fatality rate 70% to 90% in Teschen. Talfan is much milder, and the morbidity rate below 6%.

### Methods of Transmission

Infection is transmitted by the fecal–oral route and therefore by ingestion and possibly by aerosol. The virus replicates primarily in the intestinal tract, particularly the lower intestine and the ileum but also in the respiratory tract. Replication is thought to be in the reticuloendothelial cells of the lamina propria. There may be a viremia in the Teschen type of disease but not in the mild forms. Piglets may pick up the infection after weaning when the maternal antibody disappears. Many strains can infect the pig. They can be infected at any age with a strain that they have not been exposed to before. When infection first gains access to a herd, the spread is rapid and all ages of pigs may excrete virus in their feces.

### Risk Factors

#### Animal Risk Factors

Depending on the virulence of the infecting strain, clinical disease primarily affects young pigs but may occur in older pigs at the same stage. As infection becomes endemic and herd immunity develops, excretion of the virus is largely restricted to weaned and early grower pigs. Adults generally have high levels of serum antibody, and suckling piglets are generally protected from infection by colostrum and milk antibody. Sporadic disease in suckling pigs may occur in these circumstances in the litters of nonimmune or

low-antibody sows, and may also occur in weaned pigs as they become susceptible to infection. In the recent outbreak in the United States, the major factor was the rapid decline of the maternal antibody in the piglets (<21 days). Seroconversion then coincided with the increased mortality in the herd.

### Pathogen Risk Factors

The causative viruses will infect only pigs and are not related to any of the viruses that cause encephalomyelitis in other species. They are resistant to environmental conditions, including drying, and are present principally in the CNS and intestine of affected pigs.

### PATHOGENESIS

The virus multiplies in the intestinal and respiratory tracts and Teschen produces a viremia. Invasion of the CNS may follow, depending on the virulence of the strains and the age of the pig at the time of infection. There is some strain difference in the areas of the CNS primarily affected, which accounts for variations in the clinical syndrome. Histopathologic evidence of encephalitis may be the only evidence of disease.

### CLINICAL FINDINGS

#### Acute Viral Encephalomyelitis (Teschen Disease)

An incubation period of 10 to 12 days is followed by several days of fever (40°C–41°C, 104°F–106°F). Signs of encephalitis follow, although these are more extensive and acute after intracerebral inoculation. They include stiffness of the extremities, and inability to stand, with falling to one side followed by tremor, nystagmus, and violent clonic convulsions. Anorexia is usually complete, and vomiting has been observed. There may be partial or complete loss of voice caused by laryngeal paralysis. Facial paralysis may also occur. Stiffness and opisthotonus are often persistent between convulsions, which are easily stimulated by noise and often accompanied by loud squealing. The convulsive period lasts for 24 to 36 hours. A sharp temperature fall may be followed by coma and death on the third to fourth day, but in cases of longer duration the convulsive stage may be followed by flaccid paralysis affecting particularly the hindlimbs. In milder cases, early stiffness and weakness are followed by flaccid paralysis without the irritation phenomena of convulsions and tremor. In a recent case in the UK, the pigs were off-color, showed anterior limb paralysis, and were reluctant to rise and were therefore euthanized. Pigs were bright and keen to eat and drink.

#### Subacute Viral Encephalomyelitis (Talfan Disease)

The subacute disease is milder than the acute form, and the morbidity and mortality rates are lower. The disease is most common and

severe in pigs less than 2 weeks of age. Older sucking pigs are affected too, but less severely and many recover completely. Sows suckling affected litters may be mildly and transiently ill. The morbidity rate in very young litters is often 100% and nearly all the affected piglets die. In litters over 3 weeks old there may be only a small proportion of the pigs affected. The disease often strikes suddenly—all litters in a piggery being affected within a few days—but disappears quickly, with subsequent litters being unaffected. Clinically, the syndrome includes anorexia, rapid loss of condition, constipation, frequent vomiting of minor degree, and a normal or slightly elevated temperature. In some outbreaks, diarrhea may precede the onset of nervous signs, which appear several days after the illness commences. Piglets up to 2 weeks of age show hyperesthesia, muscle tremor, knuckling of the fetlocks, ataxia, walking backward, a dog-sitting posture and terminally lateral recumbency, with paddling convulsions, nystagmus, blindness, and dyspnea.

The Dresden type of teschovirus caused an ataxia and recumbency in a large group of pigs about 5 days after removal of the sows and housing in the production unit. Older pigs (4 to 6 weeks of age) showed transient anorexia and posterior paresis, manifested by a swaying drunken gait, and usually recovered completely and quickly. In the Japanese outbreak, the pigs had at 40 days of age a flaccid paralysis of the hindlimbs and became recumbent, although they could move using their forelegs. After the initial group of affected piglets the disease disappeared.

Individual instances or small outbreaks of “leg weakness” with posterior paresis and paralysis in gilts and sows may also occur with this disease.

## CLINICAL PATHOLOGY

### Serology

Virus-neutralization and complement fixation are useful serologic tests. Antibodies are detectable in the early stages and persist for a considerable time after recovery. Because nearly all pigs are positive, it is only meaningful when paired serum samples are examined. There is a good ELISA for the detection of teschovirus serology.

### Detection of Virus

It is absolutely necessary to collect tissues from acutely ill animals. If they have been ill for several days, the viruses have probably disappeared.

The virus is present in the blood of affected pigs in the early stages of the disease and in the feces in very small amounts during the incubation period before the signs of illness appear. Isolated viruses can be identified by virus neutralization, complement fixation, and immunofluorescence. Brain tissue is usually used as a source of virus in transmission experiments. A nested PCR has

recently been described in which all 13 serotypes and field isolates were detected using three sets of primer pairs. It is more rapid and less time-consuming as a test than tissue culture and serotyping. Now RT-PCR can be used to detect viral RNA. New nested RT-PCRs have been developed to differentiate the viruses from each other.

## NECROPSY FINDINGS

There are no gross lesions except muscle wastage in chronic cases. The lesions are only found by the microscope and are most severe in cases of Teschen. Microscopically, there is a diffuse nonsuppurative encephalomyelitis and ganglioneuritis with involvement of gray matter predominating. This takes the form of perivascular cuffing with mononuclear cells, focal gliosis, neuronal necrosis, and neurophagia. The brainstem and spinal cord show the most extensive lesions, often with the most severe lesions in the cord. These take the form of degenerated or necrotic nerve cells in the ventral horns, glial nodules, occasional hemorrhage, and a diffuse infiltration of mononuclear cells. In the white matter the changes were not so severe. Infiltration of mononuclear cells was also seen in the dorsal root ganglia (together with degenerated ganglion cells and neuronophagia) spinal nerves, and sciatic nerves. Swollen myelin sheaths and axonal spheroids were seen in the peripheral nerves. Meningitis, particularly over the cerebellum, is an early manifestation of the disease. No inclusion bodies are visible in neurons, in contrast to many cases of pseudorabies. Virus can be isolated from the brain and spinal cord early in the disease course, and from the blood during the incubation period. Recovery of the virus from the gastrointestinal tract does not confirm the diagnosis because asymptomatic enteric infection is common. Isolation attempts may prove unrewarding, necessitating the correlation of clinical, serologic, and necropsy findings to confirm the diagnosis. Recently an experimental infection with PEV-3 produced tremors and paralysis 3 to 7 days postinfection with all the animals having pericarditis and myocarditis.

## Samples for Confirmation of Diagnosis

- Histology: half of midsagittally sectioned brain, spinal cord including spinal ganglia, gasserian ganglion (LM)
- Virology: half of midsagittally sectioned brain, spinal cord (ISO, FAT)

In the recent German cases the virus was isolated from all the tissues examined but not from the blood. A technique using monoclonal antibodies has been described that can be used either as an immunofluorescent agent or for immunoelectron microscopy. In the recent Japanese description cytopathogenic agents were recovered from the tonsil, brainstem, and cerebellar homogenates. The PCR

products from these were then sequenced and the isolate confirmed as PTV. Isolation of virus is not easy and needs to be from the brain and spinal cord. There are no firm indications of when to take material and a good consistent site in the brain for isolation.

## DIFFERENTIAL DIAGNOSIS

The diagnosis of diseases causing signs of acute cerebral disease in pigs is difficult because of the difficulty in neurologic examination of pigs, and the diagnosis usually depends on extensive diagnostic laboratory work particularly in histopathology.

Pseudorabies and hemagglutinating encephalomyelitis virus disease are similar clinical syndromes. In general, viral diseases, bacterial diseases, and intoxications must be considered as possible groups of causes; careful selection of material for laboratory examination is essential. The differentiation of the possible causes of diseases resembling viral encephalomyelitis is described in the section [Pseudorabies](#).

## IMMUNITY

Pigs mount a classical humoral response with IgM and IgG and it may be that IgA is important to prevent entry beyond the intestinal epithelium.

## TREATMENT

There is no treatment.

## CONTROL

The sporadic occurrence of the disease in a herd is usually an indication that infection is endemic. When outbreaks occur, the possibility that introduction of a new strain has occurred should be considered. However, by the time clinical disease is evident, it is likely that infection will be widespread and isolation of affected animals may be of little value. A closed-herd policy will markedly reduce the risk of introduction of new strains into a herd, but there is evidence that they can gain access by indirect means. The sporadic nature of the occurrence of most incidents of porcine encephalomyelitis does not warrant a specific control program.

Tesch disease is a different problem. Vaccines prepared by formalin inactivation of infective spinal cord and adsorption onto aluminium hydroxide have been used extensively in Europe. Two or three injections are given at 10- to 14-day intervals and immunity persists for about 6 months. A modified live virus vaccine is also available.

In the event of its appearance in a previously free country, eradication of the disease by slaughter and quarantine should be attempted if practicable. Austria reported eradication of the disease, which had been present in that country for many years. A slaughter policy was supplemented by ring vaccination around infected premises.

## FURTHER READING

Kouba V. Teschen disease, eradication in Czechoslovakia: a historical report. *Vet Med (Praha)*. 2007;54:550-560.

## REFERENCES

1. Tseng CH, Tsai HJ. *Virus Res*. 2007;129:104.
2. Kouba V. *Vet Med (Praha)*. 2007;54:550.
3. Tseng CH, Tsai HJ. *Virus Res*. 2007;129:104.
4. Buitrago D, et al. *J Vet Diagn Invest*. 2007;22:763.
5. Sozzi E, et al. *Transbound Emerg Dis*. 2010;57:434.
6. Zhang CF, et al. *J Virol Methods*. 2010;167:208.
7. Lin W, et al. *Arch Virol*. 2012;157:1387.

## Prion Diseases Primarily Affecting the Cerebrum

### INTRODUCTION

The transmissible spongiform encephalopathies (TSEs) are a group of progressive neurologic disorders that are transmissible and affect a number of animal species and humans (Table 14-14). They are nonfebrile with long incubation periods and a long course of disease.

There is a debate about the nature of the infective agent causing TSEs. An abnormal folded isoform, designated PrP<sup>Sc</sup>, of a host-encoded cell-surface glycoprotein (prion protein, PrP<sup>C</sup>) accumulates during disease and is associated closely with infectivity. The function of PrP<sup>C</sup> is not known and the mechanism by which PrP<sup>C</sup> is converted to PrP<sup>Sc</sup> is uncertain. PrP<sup>Sc</sup> is rich in  $\beta$ -sheets and can be isolated as insoluble aggregates. A theory is that the transmissible agent is the abnormal isoform of the prion protein and that, in the infected host, this can recruit further alternatively folded prion protein by acting as a template for protein folding. With this theory the long incubation period of prion diseases reflects the rise in level and deposition of PrP<sup>Sc</sup> in a variety of tissues, including

brain, eventually resulting in fatal spongiform encephalopathy.

Scrapie affects sheep and goats and is the prototypic disease for the group in domestic and wild animals.

Although scrapie in sheep has been recognized for over 200 years, the recent epidemic of Bovine Spongiform Encephalopathy (BSE) has focused public attention and scientific research on the TSEs. With scrapie, and other TSEs, transmission can be effected by crude or purified extracts of brain or other tissues from affected animals, and the infective agent is very resistant to ionizing and ultraviolet irradiation and to reagents that damage or modify nucleic acids. This, along with other experimental findings, has led to proposals that the infectious agent in scrapie, and other TSEs, is the PrP<sup>Sc</sup> itself, and not a small, unconventional virus or virino as previously proposed. The structure of the infecting PrP<sup>Sc</sup> is thought to imprint on the normal cellular precursor PrP<sup>C</sup>, resulting in a change to the abnormal isoform, which is protease resistant and accumulates in cells.

Naturally occurring TSEs, such as sporadic Creutzfeldt–Jakob (vCJD) in humans or transmissible mink encephalopathy in mink, are associated with individual species or with closely related species as with scrapie in sheep, goats, and mouflon (*Ovis orientalis musimon*) and chronic wasting disease (CWD) in mule deer (*Odocoileus hemionus*), white-tailed deer (*O. virginianus*), and elk (*Cervus elaphus nelsoni*).

The results of attempts at interspecies transmission of these diseases are variable. Although, by definition, each TSE is transmissible, the species to which they will transmit varies between the TSE, and can be influenced by the route of challenge; the tissues that contain infection also vary according to the particular TSE. Frequently they do not transmit. Successful primary

transmission between different mammalian species typically requires a larger dose to affect disease than would be required for transmission to the same species. Also, usually, parenteral or intracerebral routes are required and success is greater with young animal recipients. This is the so-called “species barrier,” which may be absolute or partial because it will affect only a proportion of animals on first passage, or may result in an extended incubation period on first passage.

When using transmission studies to detect the presence of one of these agents, optimal sensitivity is with a recipient host of the same species. Transgenic mice may eliminate this barrier.

The gold-standard technique for the diagnosis of TSE agents is the passage of tissue in panels of inbred mice, which is a technique known as “strain typing.” Until recently this was the only way to differentiate scrapie and BSE. BSE presents with a characteristic incubation period, pattern of distribution, and relative severity of the changes in the brain of the different mouse strains (the lesion profile), which is distinct from all scrapie strains tested.

When examining TSEs as a group, one cannot extrapolate the transmission particulars of one TSE to another and one cannot extrapolate risk factors or epidemiology from one to another, and certainly generalizations from an experimental model to a natural disease across a species barrier is scientifically inappropriate.

The literature on this subject is large. This section will discuss scrapie in sheep and goats, and BSE, which are the two TSEs of agricultural animals. It will also discuss the risk for BSE in sheep. CWD in deer is briefly described but has not shown any evidence for transmission to agricultural animals other than deer.

**Table 14-14** Transmissible spongiform encephalopathies in animals and humans

Disease	Acronym	Species	Etiology	First described
Creutzfeldt–Jakob disease	CJD	Man	Sporadic familial iatrogenic	1920
Gerstmann–Straussler–Scheinker	GSS	Man	Familial	1936
Kuru		Man	Acquired	1957
Fatal familial insomnia	FFI	Man	Familial	1992
Variant Creutzfeldt–Jakob disease	vCJD	Man	Acquired	1996
Scrapie		Sheep, goats, mouflon	Natural	1738
Transmissible mink encephalopathy	TME	Mink	Acquired	1964
Chronic wasting disease	CWD	Deer, elk	Natural	1980
Bovine spongiform encephalopathy	BSE	Cattle	Acquired	1986
Zoo ungulate transmissible spongiform encephalopathy	Zoo ungulate TSE	Nyala, kudu, gemsbok, oryx	Acquired	1986
Feline spongiform encephalopathy	FSE	Zoo cats (puma, cheetah and domestic cats)	Acquired	1990



## BOVINE SPONGIFORM ENCEPHALOPATHY (MAD COW DISEASE)

Classical BSE is an afebrile, slowly progressive neurologic disorder affecting adult cattle. It is a subacute TSE that is uniformly fatal once cattle show signs of nervous disease. TSEs are caused by accumulation of  $\beta$ -sheets of prion proteins in nervous tissue, leading to slowly progressive neurodegeneration and death. Current knowledge suggests that classical BSE originated from a sporadic spongiform encephalopathy preexistent in the cattle population, and that the causative prion was fed to genetically susceptible cattle in contaminated animal protein feeds.

### SYNOPSIS

**Etiology** Epizootic disease was most likely caused by a bovine prion called the classical bovine spongiform encephalopathy strain that was fed back to genetically susceptible cattle in contaminated meat-and-bone meal. Major concern for zoonotic potential. Some countries have documented the presence of atypical bovine prion strains (H-type, L-type) at an extremely low prevalence.

**Epidemiology** Has occurred as an epidemic in Great Britain associated with the feeding of infected meat-and-bone meal. Sporadic in other countries.

**Clinical findings** Nonfebrile disease of adult cattle, with long clinical course. Disturbance in behavior, sensitivity, and locomotion.

**Clinical pathology** None specific.

**Diagnostic confirmation** Histology, demonstration of prion protein.

**Treatment** None.

**Control** Slaughter eradication. Avoidance of feeding ruminant-derived protein to ruminants.

The disease is of considerable importance mainly because it has zoonotic potential and has spread to many countries. The cost of control is very high.

### ETIOLOGY

Classical BSE is a prion-associated TSE that causes disease primarily in cattle and also in a number of other species, including humans.

The stability of the lesion profile in cattle and experimental infection studies strongly suggests that the bovine epidemic in the UK, and the subsequent extended epizootic in other countries, was caused by transmission of a single stable bovine prion.<sup>1</sup>

A number of alternative hypotheses were originally offered for the epidemic in the UK. The most popular initial theory was that BSE was caused by transmission of a strain of scrapie that was modified to infect cattle. However, BSE has many characteristics that distinguishes it from conventional scrapie

strains, and there is no evidence that cattle develop infection or neurologic disease after 8 or 10 years of oral administration of the scrapie agent.<sup>1,2</sup> Another hypothesis was that the agent could have entered into meat-and-bone meal (MBM) from the carcass of an animal that died in a zoo or a safari park in the UK. This hypothesis was based on the method of carcass disposal for these animals (many were rendered and not incinerated) and because of the high susceptibility of certain African ungulates and zoo carnivores to BSE infection. An additional hypothesis proposed that MBM from the Indian subcontinent was the source. The UK government has conducted several inquiries into the source of the BSE agent and the cause of the outbreak including the Phillips report in 2000 and the Horn report in 2001, but these reports were not conclusive.

The mass exposure of cattle in the UK to this agent, and the subsequent development of a disease epizootic in cattle in the latter half of the 1980s and the early 1990s, is currently thought to have been the consequence of a change in the method of processing of MBM prepared from slaughtered cattle latently infected with the classical BSE strain. This change in processing permitted the prion to persist in the feed, which was fed back to cattle to create a positive feedback loop. Subsequent recycling of the agent in MBM prepared from latently infected slaughter cattle amplified its occurrence until an epidemic of neurologic disease in adult cattle was identified. In hindsight, it was not a wise decision to turn an evolutionary herbivore into a carnivore by feeding contaminated MBM to cattle.

There appear to be at least three different strains of prions identified from cattle with BSE. Discriminatory testing of 370 BSE cases in the EU between 2001 and 2011 indicated that 83% were classical BSE, which transmits to humans as vCJD, 7% were atypical high-type (H-type) BSE first diagnosed in the United States in 2004, and 10% were atypical low-type (L-type) BSE.<sup>1</sup> The L-type has been identified in cattle from Belgium, Canada, Germany, Italy, and Japan, whereas the H-type has been identified in cattle from France, Germany, Japan, the Netherlands, Poland, Sweden, Switzerland, the UK, and the United States. It is likely that atypical forms of BSE (H-type, L-type) represent a rare, sporadic, spontaneous disease in cattle related to old age, with some similarities to sporadic CJD in humans or the Nor98 variant of scrapie in sheep and goats.<sup>3</sup> Only 42 cases of atypical BSE had been reported by 2010, and all were in cattle at least 8 years of age with the exception of a possible case in a 23-month-old heifer.<sup>4</sup>

### EPIDEMIOLOGY

#### Occurrence

#### Geographic Occurrence

Classical BSE was first described in Great Britain in 1987, but the BSE inquiries

considered it likely that there had been several undetected cycles of BSE in the southwest England in the 1970s and early 1980s. Following its description in 1987, the disease developed to an epizootic with over 183,000 cases, of which more than 95% were detected before 2000. The epidemic in the UK peaked at an annual total of more than 37,000 clinical cases in 1992. The disease was recognized in Northern Ireland in 1998 and in the Republic of Ireland in 1999. The disease was subsequently recognized in Switzerland, Portugal, and France in the early 1990s and then became widespread to involve 27 countries by 2015.

Cases have occurred in imported British cattle in Oman and the Falkland and Channel Islands. Countries that have had cases of BSE in native-born cattle are Austria, Belgium, Canada, Czech Republic, Denmark, Finland, Germany, Greece, Ireland, Israel, Italy, Japan, Luxembourg, the Netherlands, Poland, Portugal, Slovakia, Slovenia, Spain, Switzerland, UK, and the United States.

#### Occurrence in Cattle

##### Great Britain

In Great Britain, the first known clinical case of classical BSE probably occurred in 1985. The annual incidence subsequently increased and the disease became a major epizootic in the late 1980s. The disease was declared notifiable, and a statutory ban on the feeding of ruminant-derived protein to ruminants was introduced in 1988. A more extensive ban on feeding any animal protein to any agricultural animal was later implemented to avoid feed cross-contamination. The annual incidence peaked in 1992 and has fallen every year since to produce a bell-shaped epidemic curve at approximately the year 2010, with some cases every year since (Fig. 14-10). The reduction from the peak in 1992 is attributed to the 1988 ruminant-feed ban with the delay in response an effect of the incubation period of this disease. Britain has had the greatest number of affected cattle and, consequently, provides the majority of information on the disease.

##### Herd Type

A great proportion of cases have occurred in **dairy and dairy crossbred herds**, and by 2002 62% of dairy herds in Great Britain had experienced one or more cases. In contrast, 17% of **beef herds** had cases in the same time period. There has been no apparent breed predisposition. In both herd types, the risk for cases increased significantly with increasing herd size. A significant proportion of the cases in beef cattle herds have occurred in animals purchased into the herds from dairy herds. The reason for this difference in herd type is thought to be the greater use of concentrates in dairy cattle.

The disease has occurred in all regions of the country but was most prevalent in southwest England. Although the disease

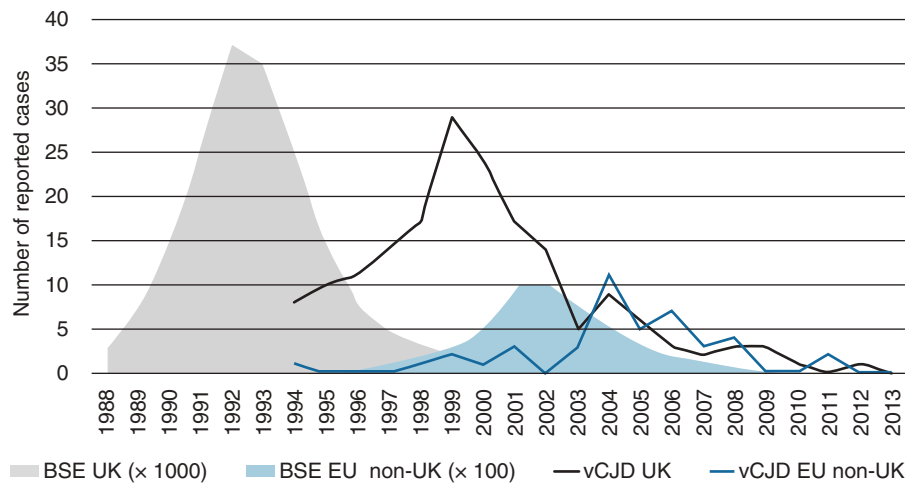

**Fig. 14-10** The number of reported bovine spongiform encephalopathy (BSE) cases in cattle and variant Creutzfeldt–Jakob (vCJD) cases in humans by date of onset in the UK and in the European Union (EU) excluding the UK from 1988 to 2013. Note the different multiplier for BSE and vCJD cases in the UK and EU non-UK. (Published with permission from the European Centre for Disease Prevention and Control. [http://ecdc.europa.eu/en/healthtopics/Variant\\_Creutzfeldt-Jakob\\_disease\(vCJD\)/Pages/factsheet\\_health\\_professionals.aspx](http://ecdc.europa.eu/en/healthtopics/Variant_Creutzfeldt-Jakob_disease(vCJD)/Pages/factsheet_health_professionals.aspx).)

developed to an epizootic within the country, the disease does not occur as an epizootic within affected herds and most experience either single cases or a limited number of cases. The average **within-herd incidence** has remained below 2% since the disease was first described.

#### Northern Ireland and Republic of Ireland

In Northern Ireland classical BSE was recognized in 1998 and in the Republic of Ireland in 1999, but epizootic disease occurred Great Britain and Northern Ireland. The epidemiologic features in both countries were similar to that in Great Britain, but the incidence has been lower. In Northern Ireland the incidence was approximately one-tenth of that in Great Britain. The yearly incidence of the disease peaked in 1994 in Northern Ireland but jumped unexpectedly in the Republic of Ireland in 1996 to 1998 and has remained high since. The source of infection in both countries is thought to have been MBM imported from Great Britain. In the Republic of Ireland there has been geographic clustering with a higher incidence in two counties possibly associated with the location of feed suppliers.

#### European Continent and Iberian Peninsula

On the European continent classical BSE was recognized in Switzerland in 1999 and shortly after on the Iberian peninsula in Portugal. Both countries showed a case incidence with evidence of an epidemic curve. However this was not mirrored in EU member states in the continent, in which only sporadic cases were reported in the 1990s, and it appears that the disease in this region was unrecognized, underreported,

and was more widespread than recorded. Apparently cattle with typical clinical manifestations and fallen stock with clinical signs that should have led to a suspicion of BSE were misdiagnosed or not reported.

Switzerland established a surveillance system in 1999 testing fallen cattle, emergency slaughter, and normal cattle using Prionics Western blot rapid testing methods. This surveillance method was rapidly adopted by EU member countries so that all but two had recorded cases by the end of 2001. In France, between the first notified case in 1991 and the establishment of mandatory testing in 2000, there were 103 cases detected by passive surveillance, but it is estimated that 301,200 cattle were infected with BSE during this period. The first report of L-type BSE was from Italy in 2004.

#### North America

Canada experienced a case of classical BSE in a cow imported from Great Britain in 1993, but the first case in an indigenous Canadian cow occurred in 2003 in Alberta. Trace back on 40 herds and slaughter of over 2000 suspects were all negative. The molecular profile of the BSE agent from this case was very similar to the UK BSE strains and had no relationship to the agent associated with CWD in deer and elk. In 2003 a Canadian cow that had been exported to the United States as a young calf developed complications at parturition, was shipped as a nonambulatory cow, and was discovered as a classical BSE case under a routine monitoring program of downer cows. Canada had two more cases of classical BSE in 2005. By 2009, Canada had reported 14 cases of classical BSE, with 1 H-type and 1 L-type.

The United States had a case of atypical H-type BSE in a native-born cow in 2004.

The affected cow had a new prion coding gene (E211K) that suggested the possible existence of a genetic susceptibility to developing clinical signs.<sup>5</sup> A second case of atypical H-type BSE has been reported in the United States. Genetic studies have indicated that susceptibility to classical BSE does not appear to be related to genetic differences in the prion coding gene.<sup>6</sup>

#### Japan

Japan had reported 33 cases of BSE (32 classical and 1 atypical in a 16-year-old Japanese black cow) by 2007. Cases were attributed to imported infected cattle and imported fat that was used in a milk replacer formulation fed to calves.<sup>7</sup>

#### Age Incidence

TSEs as a group have long and variable incubation periods, with genetic susceptibility to clinical disease playing a major role in the age of onset of clinical signs. BSE, like scrapie, has a **long incubation period**, 2.5 to at least 8 years and possibly for the life span of cattle and is a disease that affects mature animals. Epidemiologic studies suggest that most affected cattle have been infected as calves, with the mean incubation period decreasing with increasing dose. Risk is greatest in the first 6 months of life and between 6 and 24 months of age risk is related to feeding patterns of proprietary concentrates. Adult cattle are at low risk for infection.

The **modal age at onset** of clinical signs is between 4 and 5 years, but there is a skewed distribution with the youngest age at onset recorded at 22 months and the oldest at 15 years. During the course of the outbreak in the UK there has been a change in the age distribution of cases in both Britain and Northern Ireland, consistent with a sudden decrease in exposure as a result of the bans on ruminant protein feeding. The clinical course is variable, but the case fatality is 100%. There is a variation in risk associated with the calendar month of birth-related to seasonal differences in calf management and exposure to ruminant protein in calf feeds.

The majority of the occasional cases of BSE currently being diagnosed in the UK are attributed to residual contamination of raw feed, but may also reflect a very low level prevalence of atypical BSE cases.<sup>1,8</sup>

#### Other Species

Spongiform encephalopathies have been identified in seven species of **ungulates** in zoos or wildlife parks in Great Britain since the occurrence of the disease in cattle. These animals had been fed MBM, but the apparently shorter incubation period suggests that they might be more susceptible to infection than cattle and there is evidence for horizontal transmission.

**Feline spongiform encephalopathy** (FSE) also has been recorded in **domestic cats** in Great Britain since 1990 and in zoo

felids. The **zoo felids** had been fed cattle carcasses unfit for human consumption, or the zoo had a history of BSE in exotic ruminants and fed culled carcasses to other zoo animals. Transmission studies in mice with the agents associated with these encephalopathies in zoo ungulates and felids suggest that they are the same strain that causes BSE. The initial concern that there would be an outbreak of FSE in domestic cats did not occur, and only 89 cases were confirmed to the end on 2003.

### Method of Natural Transmission Ingestion of Meat-and-Bone Meal

The initial epidemiologic studies suggested that the disease in the UK was an extended common-source epidemic, and the only common source identified in these initial studies was the feeding of proprietary concentrate feedstuffs. Epidemiologic studies also suggested that the presence of MBM in proprietary concentrates was the proxy for affected cattle to have been exposed to a scrapie-like agent, and this conclusion is supported by case-control studies examining feeding practices to calves that subsequently developed the disease. This hypothesis explains **breed differences** in incidence because concentrates are not commonly fed to beef calves in the UK; it also can account for geographic differences in incidence. The oral route of challenge is known to be an inefficient route for the transmission of the agents associated with spongiform encephalopathies, and this is thought to be the reason for the low within-herd incidence of the disease in the face of a common exposure.

**MBM** is manufactured by the rendering industry from tissues discarded in slaughterhouses and from down and dead livestock. The outbreak of BSE in Great Britain was temporarily preceded by a change in the method of processing of MBM to a continuous process with a cessation of the use of hydrocarbon fat solvents. It is postulated that this change permitted the cycling of unrecognized but extremely low-incidence cases of classical BSE. The initial exposure probably occurred from 1981 to 1982 and, subsequently, the agent recycled from infected cattle carcasses and offal used in the preparation of MBM. Rendering procedures have subsequently been devised to minimize survival of the agent.

The marked fall in disease incidence following the introduction of the feed ban in 1987 in the UK substantiated the importance of ingestion of MBM as the major method of infection. Bans in Europe were largely introduced in 1990.

### Born-After-the-Ban

In the UK and in other countries a number of cattle that were born-after-the-ban (BAB; French acronym NAIF) have developed the disease. Most of these were born in the years immediately following the ban and their numbers have decreased in subsequent years

but still continue at low levels. A case-control study found that vertical or horizontal transmission was not an important cause of these cases. It is thought that MBM that was already in the food chain at the time, in mills and on the farm, was fed until it was depleted.

In several countries the occurrence of BAB cases has been geographically clustered, and also associated with certain birth cohorts. In the UK the clustering was related to areas with high concentrations of pigs and poultry, and it is thought that there was cross-contamination of feedstuffs in feed-mills. This is certainly possible with an infective dose of 1 g or less for cattle.

More recently, there has been concern about cattle in the UK that have developed BSE but that were born after the implementation of the reinforced feed ban in 1996 (BARBs). Up to 2005, there have been approximately 100 cases. Again there is no evidence of maternal or lateral transmission and the inadvertent use of illegal feed material residual on farms is suspected.<sup>9</sup>

### Non-Feed-Borne Transmission

There is no epidemiologic evidence for significant horizontal or vertical transmission of the disease in cattle, although the studies suggest that minor horizontal transmission may occur to birth cohorts of calves that subsequently develop BSE. This type of transmission is of minor importance to the perpetuation of the disease in a country, but it may be of significance to human health, and birth cohorts are included in trace backs of infection in the United States and Canada.

### Vertical Transmission

In the absence of other mechanisms of transmission, vertical transmission is not considered significant for the perpetuation of the disease in an epidemic form. There is an **enhanced risk** for the disease in calves born to infected cows, and this is higher in calves born after the onset of clinical disease in the cow. This may be the result of exposure, at birth, to high infectivity in birth products because there is no evidence for infection and transmission in embryo transplants. However, no detectable infectivity has been found in placentas from cows with the disease.

A very elegant experiment that examined the risk for transmission of BSE via embryo transfer that used recipient cattle sourced from New Zealand and donor cows clinically affected with BSE, bred to bulls that did and did not have clinical BSE, concluded, after a 7-year observation period on the progeny, that embryos were unlikely to carry BSE.

Modeling the BSE epidemic in the UK indicated a constant and relatively high basic reproduction number ( $R_0$ ) that is defined as the expected number of secondary infections produced in a susceptible population by a typical infected host. If  $R_0 > 1$ , then the agent can persist indefinitely; initial estimates for

$R_0$  before the first feed ban in 1988 ranged from 10 to 12. This degree of infectivity was consistent with the potential that a maximally infectious animal could infect up to 400 other cattle. Since the feed ban, the value for  $R_0$  is thought to have decreased to 0 to 0.25, indicating that the disease will soon disappear.

### Risk for Occurrence of Disease in Countries

Changes in the method of processing MBM have occurred in countries other than the UK, and scrapie occurs in sheep in other countries. However, the major risk for the occurrence of the disease in other countries is the importation of latently infected cattle and/or the importation of infected MBM. This risk can be substantially avoided by prohibiting the feeding of MBM to cattle.

An assessment in 1996 of risk for the occurrence of BSE in the United States concluded that the potential risk of an epizootic was small and that there are substantial differences in the strength of the risk factors between the United States and the UK. These result from differences in proportional numbers of sheep and cattle, differences in the nature of the beef and dairy industries, the type of animal used for beef production and the age at slaughter, and differences in the practice of feeding ruminant-derived protein in calf rations, which is uncommon in the United States. Thus the risk of an outbreak similar to that in the UK was considered negligible. However, a case in a native-born cow in the United States occurred in 2005. This, and contemporary cases in Canada suggested that infected MBM was imported to the North American continent at some time, or that in the United States, the case reflected the very low incidence of spontaneous atypical BSE in cattle. The cases in both countries occurred in cattle that were born before the ban on feeding MBM imposed in both countries in 1997.

Countries with largely pastoral cattle are at low risk.

The International Animal health code of the OIE describes five BSE risk categories for countries based on the importation of cattle from at-risk countries, the importation of potentially infected MBM, the consumption of MBM by cattle and other animals, animal feeding practices, livestock population structure, rendering practices, and the potential for recycling of BSE. In order of increasing incidence of BSE these categories are BSE free, BSE provisionally free, minimal BSE risk, moderate BSE risk, and high BSE risk.

### Experimental Reproduction

Although studies on the transmissibility and experimental reproduction of BSE were established before the occurrence of human cases of BSE (vCJD), they have been **critical in determining the risk** of cattle products



for human disease and the risk for disease in other species.

In cattle, disease has been experimentally reproduced by oral and intracerebral inoculation with infected cattle brain homogenates.

Oral, intravenous, and intracerebral inoculation of sheep with infected cattle brain homogenates also results in disease. Disease has also been reproduced in goats and mink by parenteral challenge. In pigs, disease has been produced by intracerebral challenge with infected brain homogenates but not oral challenge. It has not been produced by any route of challenge in poultry and is not produced by oral challenge in farmed deer.

### Infectivity of Tissues

Brain, spinal cord, and retina are tissues that are infective to cattle or laboratory animals from natural cases of BSE. The tissues that are infective to cattle or laboratory animals from experimentally infected cattle are brain, spinal cord, retina, distal ileum, bone marrow, trigeminal nerve, and lingual lymph tissue. The infective dose of brain material from a cow with classical BSE appears to be <1 mg of brain tissue.<sup>10</sup>

#### Parenteral injection of BSE brain:

- Transmits from cattle to cattle, mice, goats, sheep, pigs, mink, guinea pig

#### Orally fed BSE brain:

- Transmits from cattle to cattle, mice, mink, sheep and goats
- Not to pigs or farmed deer

Other tissues including the major visceral organs, striated muscle, and tissue common for human consumption were negative by mouse bioassay, indicating that no infectivity could be detected. These tissues are currently being reexamined for infectivity using the most sensitive assay known, intracerebral infection into the host species, which in this case the host is cattle. These studies are ongoing but, at last report have only confirmed the results of the negative mouse bioassays. There is no evidence of infectivity in milk based on the fact that calves suckling cows with clinical BSE do not themselves develop BSE when mature and also on the lack of infectivity with intracerebral injection of mice.

Strongest evidence of absence of infection in milk is the study that examined and found no increase in incidence of BSE in calves born to dams with BSE that suckled these cows during clinical disease compared with calves that suckled clinically normal dams. There is species susceptibility (no barrier) strength in this study.

BSE, *bovine spongiform encephalopathy*.

### Economic Importance

BSE is not of major economic significance to individual herds in countries in which it is endemic because of the low within-herd incidence. In most countries, compensation will cover cases detected by passive surveillance and, with active surveillance, most of the costs if there is selective culling in affected and trace back herds. However, it is arguable that this disease is the **most economically devastating** agricultural animal disease in the developed world.

The disease has been of major economic importance in the UK and is estimated to have cost £600 billion. This has been from the national cost associated with detection and control procedures, the cost of compensation, and the cost of disposal of affected animals. These costs, along with the cost of loss of export markets, are very high.

Worldwide, the public has developed an extreme concern for the public health risk associated with BSE infection in cattle and, consequently, all countries have been mandated or encouraged to develop active surveillance programs. Not to do so runs the risk of loss of overseas markets and loss of home consumption of beef in favor of other meats. Further, the detection of a single case of BSE by these active surveillance programs results in the loss of export markets for the country and a severe fall in cattle prices for countries that rely on exports in their cattle industries.

BSE is also arguably the disease that has been used most to influence trade in live cattle and cattle products with no science-base or attention to the internationally adopted OIE Terrestrial Animal Health Code. This is largely because of the success of local political influence of ranches and farmers.

It is further arguable that the money spent, for reasons of public health, on this relatively minor zoonotic disease, by far outweighs its relative importance as a cause of human disease.

### Zoonotic Implications

Concerns that this disease could transmit to man were raised a very short time after its initial diagnosis. These unfortunately proved true in 1996 when a new form of CJD was reported. Although, with the initial cases, there was reservation as to causality, studies showed the agent associated with this disease is similar to that associated with BSE and the FSEs; there is now no doubt that this is a form of BSE in man. It differs from CJD in that it affects young people with a mean age onset in the third decade of life. In humans there is evidence for genetic susceptibility, and all cases have been homozygous for methionine at codon 129. The disease has been termed **variant CJD** (vCJD).

The disease occurred in the UK despite the progressive bans on human consumption of beef products that contained infectivity

that were implemented in 1998 and subsequently tightened further as new information on potential infectivity became available. It is possible that exposure of affected humans occurred in the early and mid-1980s, before the recognition of the disease. There was initially extreme concern that there would be a very large outbreak in humans. However, this has not occurred. The total number of deaths from vCJD in the UK has reached 150. The peak number of deaths occurred in the year 2000, and the outbreak appears to have reached a plateau and is possibly in decline, although the nature of the outbreak will be dependent on the range of incubation periods in humans. More than 200 individuals had succumbed to this infection worldwide by 2015.

Although there is no evidence of direct transmission to humans, veterinarians and animal handlers should take appropriate precautions when handling nervous system tissues of infected animals. Cow's milk appears to provide a negligible risk of contracting vCJD disease.<sup>11</sup>

### PATHOGENESIS

Information on the pathogenesis and development of BSE in cattle was initially derived from studies published from Great Britain in the 1990s that studied the spatial and temporal development of infectivity and pathologic change in cattle after oral challenge with a 100-g dose of BSE-affected brain homogenate sourced from naturally clinically affected cattle. The experimental cattle were killed sequentially following challenge, and infectivity in tissues was subsequently determined initially by infectivity assays by intracerebral and intraperitoneal injection into panels of inbred mice and subsequently by infectivity studies by intracerebral challenge of cattle to exclude any species barrier effects.

- Long incubation period (5 years)
- Oral infection
- Infection of Peyer's patches, to brainstem via vagus nerve
- Accumulation of abnormal prions destroys brain slowly

BSE prions spread by two antegrade pathways from the gastrointestinal tract to the CNS: (1) via the splanchnic nerves, mesenteric and celiac ganglion complex, and lumbar/caudal thoracic spinal cord and (2) via the vagus nerve.<sup>12</sup> Following oral challenge of calves, infectivity was initially detectable in the distal ileum, in the Peyer's patches, but no infection is demonstrable in other lymphoreticular organs. Infectivity was identified at 4 months postinfection and was unchanged in magnitude at 24 months postinfection, revealing no decline or clearance of the agent from ileal Peyer's patches.<sup>13</sup> Infectivity was demonstrable in the cervical and thoracic dorsal root ganglia at 32 to 40

months after infection and in the trigeminal ganglion at 36 to 38 months. Traces of infectivity were shown in sternal bone marrow in cattle killed 38 months postexposure. The earliest presence of abnormal PrP and infectivity in the CNS occurred 32 months post-exposure, before any typical diagnostic histopathologic changes in the brain. The onset of clinical signs and pathologic change in the brain occur at approximately the same time. Infectivity of peripheral nerves such as the sciatic nerve appears to be a secondary event after infection of the CNS.<sup>12,13</sup>

More recent reports of the oral experimental dosing studies have indicated that the 50% infective dose for classical BSE was 0.15 g of brain homogenate, with higher oral doses increasing the likelihood of developing BSE.<sup>14</sup> In addition, the incubation period decreased as the infective dose increased. In other words, an increase in the incidence of classical BSE disease indicates an increase in exposure, and a decrease in the age of clinical signs indicates a larger infective dose.

### CLINICAL FINDINGS

The disease is insidious in onset and the clinical course progresses over several weeks, varying from 1 to 6 months in duration. There is a **constellation of clinical signs** with alterations in behavior, temperament, posture, sensorium, and movement, but the clinical signs are variable from day to day, although they are progressive over time. Cattle that show behavioral, sensory, and locomotor abnormality together are highly suspect for BSE. The predominant **neurologic signs** are apprehensive behavior, hyperesthesia, and ataxia, and a high proportion of cases lose body condition and have a diminishing milk yield during the clinical course of the disease. Cattle with BSE do not always show neurologic signs in the initial stages of the disease, and animals with BSE may be sent to slaughter for poor production before the onset of clinical nervous signs. Cattle with vacuolar changes in the brainstem usually have more severe clinical abnormalities; this observation is consistent with vacuolar change reflecting a more advanced histologic lesion.<sup>15</sup>

#### Clinical signs in BSE

- Change in temperament and behavior
  - Apprehension, excitable, unusual kicking, head-tossing when haltered, separation from group
- Change in posture and movement
  - Abnormal posture and ataxia
- Fall in milk production
- **No antemortem test available**

**Behavioral changes** are gradual in onset and include changes, such as a reluctance to pass through the milking shed or to leave a vehicle or a pen, a change in milking order, and a reluctance to pass through passageways. Affected cattle are disoriented and may

stare, presumably at imaginary objects, for long periods. There is hyperesthesia to sound and touch, with twitching of the ears or more general muscle fasciculation and tremors. Many throw their head sideways and show head-shaking when the head or neck is touched.

Other changes in **temperament** include the avoidance of other cows in loose housing but antagonistic behavior to herdmates and humans when in confined situations. Affected animals may kick during milking and show resistance to handling. Some cows show excessive grooming and licking and may show the equivalent of the scrapie scratch reflex.

Bradycardia, associated with increased vagal tone and not occurring because of decreased food intake, is reported and may persist despite the cow's nervousness during clinical examination.

Relatively early in the course of the disease there is **hindlimb ataxia** with a shortened stride, swaying gait, and difficulty in negotiating turns. This should be especially examined as animals exit transport vehicles or are trotted through an area. Knuckling, stumbling, and falling, with subsequent difficulty in rising, is common in the later stages of the disease. Cows show **progressive weakness**, with ataxia and weight loss, and before the common recognition of the disease, they were sent to slaughter because of locomotor disabilities or changes in temperament.

It has been recommended that the reaction of the animal to sudden noise, sudden light, sudden movement, and sudden touch be used as a test. Sudden noise is tested by clanging two metal objects together out of sight of the animal (the **bang test**), sudden light is tested with a camera flash (the **flash test**), sudden movement is tested by waving a clipboard toward the cow from a short distance (the **clipboard test**), and sudden touch is tested by touching the animal on the hindlimbs with a soft stick (**stick test**). Abnormal reactions to these tests include being startled, head-tossing, salivation, snorting, running away, or panicky circling and kicking out on touch. These tests have been found positive in BSE suspects that had a history of behavioral change but did not show abnormalities of gait.

Cattle infected with atypical BSE (H-type, L-type) appear more dull and to have a greater degree of difficulty in rising than cattle with classical BSE; otherwise they have similar clinical findings.<sup>16</sup> Abnormal BAEPs have been reported at the onset of neurologic signs in classical BSE-infected cattle and manifest as prolonged peak latency of waves III and V and prolonged I-V latency.<sup>17</sup> Prion accumulation in the auditory brainstem nuclei of BSE-infected cattle<sup>18</sup> may contribute to their hyperresponsiveness to the bang test.

Electroencephalographic and evoked potential diagnostic methods have been

proposed as antemortem diagnostic test methods but require further evaluation and would seem impractical for routine use. Antemortem assessment of retinal function and morphology identified changes 11 and 5 months before the onset of unequivocal clinical signs in cattle experimentally infected by intracranial inoculation with classical BSE and H-type BSE.<sup>19</sup> Strain-specific differences in retinal function, the amount of prion accumulated in the retina, and the retinal glial response to disease were also identified.

### Clinical Signs and Passive Surveillance

There is no reliable preclinical test for BSE, and clinical recognition of BSE is the major component of passive surveillance.

At the peak of the outbreak in Great Britain, BSE was confirmed in 85% of suspects picked by passive surveillance. This percentage fell to 56% later in the outbreak. Farmers were fully compensated at notification and well informed and so were probably motivated to contact their veterinarian. Veterinarians were also very aware of the clinical presentation of BSE and observant at live-stock markets and while testing for tuberculosis and at abattoirs. Relatively high success rates were also found in Switzerland in which approximately 59% of animals notified with BSE were confirmed. However, in other countries, passive surveillance was an utter failure.

Although an aid to surveillance of a disease, passive surveillance of BSE based on clinical signs is an insensitive method of disease detection; targeting surveillance of emergency slaughtered cattle and fallen stock is 40 times more likely to detect cases of BSE than notification on the basis of clinical signs. One study found that the odds of finding a BSE case was 49 times higher in the fallen stock and 58 times higher in emergency slaughtered cattle greater than 24 months of age compared with passive surveillance of clinical disease.

### CLINICAL PATHOLOGY

There is no specific test for the antemortem diagnosis of this disease. Apolipoprotein E and two unidentified proteins are present in the CSF from clinical cases but not normal cattle, and the presence of a 30-kDa, 14-3-3 protein in CSF in affected cows is reported, but there is no information of specificity.

### NECROPSY FINDINGS

There are no abnormalities in gross pathology, and diagnosis is dependent on histologic findings or testing of brainstem samples using validated tests based on in situ IHC or Western immunoblots, with the obex and rostral brainstem being the subsampled region of choice.<sup>12</sup> The preferred method for determining prevalence is immunology-based rapid tests, which are validated to

detect classical BSE disease-associated prions. These tests typically apply proteinase K to destroy the cellular isoform of the prion protein (PrP<sup>c</sup>) while maintaining a proteinase K-resistant disease-associated isoform (PrP<sup>sc</sup>). This approach has identified three types of BSE: classical type (C-type), H-type, and L-type, with the H and L designation referring to the apparent molecular weights of the proteins.<sup>20</sup>

Major histologic changes are in the brainstem, and the pathognomonic lesion is a bilaterally symmetric intracytoplasmic vacuolation of neurons and gray matter neuropil. The occurrence of vacuolation in the solitary tract and the spinal tract of the trigeminal nerve in the medulla oblongata is the basis of the statutory diagnosis of the disease in Great Britain. In Great Britain, statutory diagnosis is achieved by an examination of a single brainstem section obtained via the foramen magnum and obviating the need of extracting the brain with the associated risk of aerosol production. This sampling location has the potential to miss some cattle infected with atypical BSE.<sup>21</sup>

Scrapie-associated fibrils can be visualized by electron microscopy. Government regulatory agencies are usually responsible for the confirmation of this diagnosis and typically distribute specific protocols regarding the collection of samples and disposal of carcasses from suspect animals.

### Samples for Confirmation of Diagnosis

- Immunology-based rapid tests: fresh brainstem
- Histology: formalin-fixed brain, including midbrain and entire medulla oblongata (LM).

**Note the zoonotic potential of this disease when handling carcass and submitting specimens.**

#### DIFFERENTIAL DIAGNOSIS

The disease should be considered in the differential diagnosis of any progressive neurologic disease in cattle. Primary differentials on clinical signs include the following:

- Hypomagnesemia
- Nervous acetonemia
- Rabies
- Lead poisoning
- Listeriosis
- Polioencephalomalacia
- Tremorgenic toxins

### TREATMENT AND CONTROL

There is no treatment for the disease.

#### Detection of BSE in Surveillance and Control Programs

**Passive surveillance** has been used in many countries. Suspect disease is notifiable with compulsory slaughter and compensation and

disposal of the carcass by incineration. The limitations of passive surveillance were described earlier and, in most countries, passive surveillance has been replaced with some form of active surveillance.

**Active surveillance** was initially directed at a targeted proportion of culled animals, animals manifesting neurologic disease, rabies suspects negative for rabies, fallen (down) cattle, and emergency slaughter categories, and a proportion of cattle, or all cattle, over 24 to 30 months (depending on country) that were presented for slaughter for human consumption. In slaughter cattle, **the sampling frame was set to detect BSE at a prevalence rate of one mature animal in a million mature animals.** The ability to conduct active surveillance, particularly on slaughter cattle, has been allowed by the development of rapid tests that can be conducted and read while the carcass is being held so that positive test cattle are not released for human consumption. Positive rapid tests need to be confirmed by histology and IHC. More recently, because the average age of BSE cases has been over 11 years, meaning that they were born before the date of the reinforced feed ban, the majority of EU countries have now raised the age limit for testing to 72 months for healthy slaughtered cattle (or even stopped testing) and to 48 months for fallen stock and emergency slaughter categories.<sup>1</sup>

In the United States, following the case of BSE in an imported cow, the United States Department of Agriculture (USDA) implemented an intensive national testing program for BSE that concentrated on a targeted high-risk population. The purpose is to help discover if BSE is in the United States and, if so, at what level. The intention is to sample as many cattle over a 12- to 18-month period as possible with the goal of examining 268,500 cattle. This would allow a detection rate of 1 in 10 million with a 99% confidence level. The cattle will be over 30 months of age and include nonambulatory cattle, cattle that are too weak to walk, cattle that are moribund, cattle with neurologic signs, rabies suspects that are negative, and dead cattle.

#### Control of BSE in Cattle

Control programs use the following assumptions:

- Infection and disease in cattle is introduced through feeding contaminated feed containing infected MBM or greaves.
- The source of infection to cattle can be eliminated by effective prohibition on feeding infected feed.
- There is no significant horizontal or vertical transmission.

Based on this, most countries have established a ban on the feeding of ruminant protein to ruminants. This was done in 1987 in the UK, the mid-1990s in most European countries, and in 1997 in Canada, the United

States and Mexico. There is, however, a strong argument for banning all mammalian protein for feeding to all livestock. The experience of several countries with animals that were born after the ban shows that cross-contamination in feed mills can occur. Although the removal of **specified risk materials** (SRMs), (brain, spinal cord, eyes, tonsil, thymus, spleen, and intestines) from cattle carcasses should reduce the risk of the BSE agent being in the subsequent rendered carcass, it obviously does not eliminate it. More detail of the regulations and of control procedures is available.

These control procedures, initiated in the UK, were effective in changing the course of their epidemic, which is now on the wane.

#### Measures to Protect Human Health

High-risk animals, such as **downer cows**, should be kept out of the human food chain and not rendered for MBM. Infection is present in the tissues listed as **SRMs** (brain, spinal cord, eyes, tonsil, thymus, spleen, and intestines), which are removed from the carcass at slaughter. The removal of SRMs also protects against the risk posed by cattle that may be incubating the disease yet do not show any clinical signs. Together with a ban on products such as mechanically recovered meat that could be contaminated with SRMs, excluding SRMs from the human food chain is the most important food safety measure to protect public health.

However, this may not be sufficient. The method of slaughter with captive bolt guns can result in the widespread dissemination of brain within the carcass with dissemination by blood into the pulmonary tissues and elsewhere. Also, the method of splitting the carcass and spinal cord can result in significant carcass contamination and contamination of the slaughterhouse environment. Methods to decrease the risk of contamination of the carcass at slaughter have been suggested.

Based on transmission and infectivity experiments cattle under 30 months of age are considered to have very low risk of being infected, but there can be a risk in endemic countries with cattle over this age. Some countries with a high incidence of BSE have banned cattle over 30 months of age for human consumption.

#### FURTHER READING

- Al-Zoughool M, Cottrell D, Elsaadany S, et al. Mathematical models for estimating the risks of bovine spongiform encephalopathy (BSE). *J Toxicol Environ Health B Crit Rev.* 2015;18:71-104.
- Hamir AN, Kehrli ME, Kunkle RA, et al. Experimental interspecies transmission studies of the transmissible spongiform encephalopathies to cattle: comparison to bovine spongiform encephalopathy in cattle. *J Vet Diagn Invest.* 2011;23(3):407.
- Harmon JL, Silva CJ. Bovine spongiform encephalopathy. *J Am Vet Med Assoc.* 2009;234:59-72.



## REFERENCES

1. Acin C. *Vet Rec.* 2013;173:114.
2. Konold T, et al. *Vet Rec.* 2013;173:118.
3. Gavier-Widén D, et al. *J Vet Diagn Invest.* 2008;20:2.
4. Dobby A, et al. *BMC Vet Res.* 2010;6:26.
5. Richt JA, Hall SM. *PLoS Pathog.* 2008;4:e1000156.
6. Goldmann W. *Vet Res.* 2008;39:30.
7. Yoshikawa Y. *J Vet Med Sci.* 2008;70:325.
8. Ortiz-Pelaez A, et al. *Vet Rec.* 2012;170:389.
9. Wilesmith JW, et al. *Vet Rec.* 2010;167:279.
10. Wells GA, et al. *J Gen Virol.* 2007;88:1363.
11. Tyshenko MG. *Vet Rec.* 2007;160:215.
12. Hoffman C, et al. *J Gen Virol.* 2007;88:1048.
13. Masujin K, et al. *J Gen Virol.* 2007;88:1850.
14. Fast C, et al. *Vet Res.* 2013;44:123.
15. Konold T, et al. *BMC Vet Res.* 2010;6:53.
16. Konold T, et al. *BMC Res Notes.* 2012;8:22.
17. Arai S, et al. *Res Vet Sci.* 2009;87:111.
18. Greenlee MHW, et al. *PLoS ONE.* 2015;10:e0119431.
19. Fukada S, et al. *J Comp Pathol.* 2011;145:302.
20. Polak MP, Zmudzinski JE. *Vet J.* 2012;191:128.
21. Konold T, et al. *BMC Res Notes.* 2012;5:674.

## BOVINE SPONGIFORM ENCEPHALOPATHY AND SHEEP

There is considerable speculation and concern that the agent of BSE could have become established in small ruminants. BSE can be readily experimentally transmitted to sheep and goats and produces clinical signs and lesions similar to scrapie. There is further concern following a recent report of the transmission of the agent from challenged ewes to their lambs. Further, the risk to human health from the ingestion of meat from sheep may be even greater than that from cattle because of the widespread distribution of the BSE agent in the lymphoid tissue of infected sheep.

In the UK and Europe concentrates are commonly fed to meat-producing breeds of sheep in late pregnancy and early lactation and less commonly to their lambs. They are also fed to milk-producing sheep breeds and to lactating goats. Concentrates fed during the 1980s and 1990s could have contained infected MBM, and this risk would have lasted until the total ban on feeding MBM to all farm animals in 1996 in the UK and 2001 in Europe.

The inclusion of MBM in concentrate rations for small ruminants was less than that for cattle, and the proportion of concentrate ration fed was also lower. This, coupled with the fact that prion diseases require a larger infective dose to produce disease in a cross-species to that required to produce the disease in the same species (the **species barrier** effect) may have resulted in an infective dose to sheep that was too low to establish infection.

The possibility that BSE did establish in sheep during the BSE epidemic in Britain is not supported by a study that examined the incidence and new infection rates of scrapie flocks in Britain covering the period from 1962 to 1998. This study found no evidence of a change in scrapie occurrence before, during, or following the BSE epidemic and

no temporal or spatial correlations of scrapie occurrence with the BSE epidemic. There have been other studies that have examined the risk factors for transmission of BSE to sheep and the possibility that it could be perpetuated by sheep-to-sheep transmission. Most have concluded that the risk that BSE has established in sheep is low but, with current knowledge, cannot rule out the possibility.

There are no reports of naturally occurring cases of BSE detected in sheep. However, there is one report of a TSE in a goat in France that was found to have IHC and immunoblotting characteristics compatible with BSE, and, following injection into mice, incubation times compatible with those recorded for experimental ovine BSE.<sup>1</sup>

### Experimental Transmission

BSE can be experimentally transmitted to sheep and goats by intracerebral, oral, and intravenous routes using BSE-infected cow brain. The PrP genotype affects the incubation period in both Cheviot and Romney sheep. PrP genotypes ARQ/ARQ and AHQ/AHQ are associated with short incubation periods (approximately 18–36 months) following challenge and also with disease susceptibility. One study further suggests that AHQ/ARQ sheep have a similar susceptibility to infection, and that sheep homozygous for alanine (A) at codon 131 and glutamine (Q) at codon 171 are more susceptible to BSE than any other genotype. In contrast, the PrP genotype ARR/ARR is associated with a long incubation period in sheep challenged intracerebrally, and ARR/ARR sheep are resistant to BSE challenged orally and do not have infectivity in their tissues. The ARR allele appears dominant in this respect because sheep carrying at least one ARR allele in combination with any other allele have a longer incubation period. PrP genotype VRQ/VRQ appears to have an intermediate incubation period.

Texel and Lacaune sheep with PrP ARQ/ARQ genotypes are susceptible. However, in these studies the survival of some sheep with susceptible genotypes suggests that factors other than the PrP genotype has influence on survival. Challenge dose in all of these studies has been high.

In a recent study, 30 ewe lambs were dosed orally, at 6 months of age, with 5 g of infected cattle brain and subsequently mated. Twenty-four developed clinical disease between 655 and 1065 days postinoculation and two lambs, born before their dams had clinical disease, also subsequently developed clinical disease. This study indicated that the agent of BSE can transmit either in utero or perinatally in sheep. There is no information on other routes of transmission and if they exist.

### PATHOGENESIS

Following challenge of sheep with BSE, infectivity has been found in intestinal

Peyer's patches as early as 5 months postinfection and in enteric nerves and spinal cord after 10 months with widespread dissemination throughout the lymphoreticular system and peripheral nervous system by 21 months.<sup>1</sup>

### CLINICAL SIGNS

The clinical signs reported in affected experimental animals are not well described in many of the experimental challenge studies but have varied in different studies. In one study, sheep and goats showed sudden onset of ataxia, which progressed rapidly to recumbency. There was little evidence of pruritus and the clinical course was very short, lasting between 1 and 5 days in the majority of animals with one goat showing progressive weight loss over 3 weeks before it was culled. Genotype had no influence on the duration of the clinical course. In another study in sheep only, the clinical course was approximately 3 months and affected sheep showed pruritus with fleece loss and ataxia and behavioral change. Ataxia, weight loss, and pruritus were considered constant in another.

In an experiment designed to test specifically if clinical signs could be used for differentiation between scrapie and BSE, two different groups of sheep were inoculated with each agent. The duration of clinical signs varied quite markedly within both groups with a mean of approximately 9 days for each group but a variation in both from 1 to over 80 days. As with natural scrapie, there was considerable variation in the nature of the clinical signs, but there was no marked difference in the frequencies of clinical signs between the two groups, except that ataxia was the first sign noticed in a significantly greater proportion of the BSE-challenged group, whereas pruritus was the first noticed sign in a significantly greater proportion of the scrapie-challenged group.

### DISPOSITION OF DISEASE-ASSOCIATED PRP

Genotype and route of inoculation influence the disposition of disease-associated PrP in lymphoreticular system tissues (tonsil, spleen, and mesenteric lymph node). The most conspicuous effect is the absence of disease-associated PrP in peripheral lymph tissue in ARR/ARR genotype sheep and lack of infectivity, and there appears to be an inverse relationship between this disposition and the incubation period. Route of inoculation influences the relative intensity of disposition in tonsil, spleen, and mesenteric lymph node.

Following experimental infection of sheep with BSE, disease-associated PrP can be detected in tonsil biopsies 11 to 20 months after challenge but, in contrast to scrapie, disease-associated PrP is not detected in biopsies of lymphoid tissue from the third eyelid.

## DIAGNOSIS

The diagnosis of BSE in clinically affected cattle can be achieved with several techniques, including the analysis of symptoms, histopathology, and the detection of the disease-associated form of the prion protein, by immunocytochemistry, Western blot, or ELISA. The profiling of vacuoles in the affected host had shown a remarkable uniformity over the year and from different geographic regions. However, this is not true with scrapie and the variation in the host brain with scrapie would not allow differentiation from BSE on histologic findings. The diagnosis of BSE in sheep presents problems, and the similarity of the clinical signs and pathology between scrapie and BSE could easily result in naturally occurring cases of BSE in sheep being misdiagnosed as scrapie.

### Strain Typing

The gold-standard technique for the diagnosis of TSE agents is the passage of tissue in panels of inbred mice, a technique known as strain typing. Until recently this was the only way to differentiate the two diseases. BSE presents with a characteristic range of incubation periods and a pattern of distribution and relative severity of changes in the brain of the different mouse strains (the lesion profile), which is distinct from all scrapie strains tested. However, this method of diagnosis is both expensive and time-consuming.

There has been a wide search for a differential test system in including prion protein profiling, studies in glycosylation and glycoform ratios, and other molecular and biochemical studies that are detailed elsewhere. A recent promising set of studies suggests that the site of truncation of disease-associated PrP during partial digestion by proteases located in lysosomes appears different for sheep scrapie and experimental BSE. After digestion by exogenous enzymes, the BSE PrP molecule is shorter than that of scrapie stains giving rise to different IHC patterns, and this is supported by Western blot studies. Unlike scrapie, the intracellular truncation site of ovine BSE PrP is influenced by the cell type in which it accumulates, giving distinct patterns of immunolabeling with different PrP antibodies. Epitope labeling shows that the shortest fragment of disease-associated PrP occurs in tangible body macrophages followed by glial cells and neurons. It appears that this difference in truncation of PrP in experimentally infected BSE sheep is not influenced by route of inoculation or by genotype or by sheep bred, and it is proposed that truncation patterns, as detected by immunoblotting and IHC, can be used in surveys for BSE in sheep.

### CONTROL

If BSE is or does establish in small ruminants in a country, there is significant concern for human health. The distribution of BSE

infection in the carcasses of cattle is limited and can be removed by the ban of the use of SRMs (largely brain, spinal cord, and offal). In contrast, the distribution of the BSE agent in infected sheep is widespread, and it would be virtually impossible to remove this by trimming or selective organ removal from a carcass for human consumption. Also, lymphocytes in milk could be infected.

Active surveillance for TSEs in sheep and goats has been increased in the EU, and several rapid tests for use in sheep and goats are now available.<sup>2</sup> In the UK, a worst-case scenario, published in 2001 in a contingency plan to address BSE in sheep, threatened the national herd with slaughter, largely on the grounds that an epidemic of BSE in sheep could be harder to contain than was the case for BSE in cattle and that lamb could present a greater risk to consumers than beef. A more recent UK contingency plan would allow PrP genotype ARR homozygous sheep and ARR heterozygous sheep for human consumption. This plan is the same as the EU, except that there are differences in the maximum age allowed at slaughter between the UK and the EU recommendations.

The risk for BSE in sheep was a major incentive for the development of national breeding programs for the control of scrapie, and possible BSE, including the National Scrapie Plan in the UK, launched in 2001, and the National Scrapie Eradication Program in the United States. The purpose in these breeding programs is to select against highly susceptible genotypes and select for the highly resistant genotype.

### REFERENCES

1. Harmon JL, Silva CJ. *J Am Vet Med Assoc.* 2009;234:59.
2. van Keulen LJM, et al. *Arch Virol.* 2008;153:445.

## SCRAPIE

### SYNOPSIS

**Etiology** A transmissible agent (prion, a proteinaceous infectious particle) that is highly resistant to chemical and physical agents, and appears not to contain DNA. Susceptibility of sheep to developing clinical disease after infection is determined by genetics.

**Epidemiology** Transmitted primarily by contact with infected sheep and from environmental contamination; very long incubation period.

**Clinical findings** Nonfebrile disease of adult sheep, goats, and mouflons with insidious onset and long clinical course. Clinical disease is rare in goats and mouflons. Affected animals show behavioral change, tremor, pruritus and locomotor disorder, and wasting.

**Clinical pathology** Demonstration of scrapie prion protein by immunostaining of the

obex in brain and selected lymphoid tissue elsewhere.

**Lesions** Vacuolation of gray matter neuropil and neuronal perikarya, neuronal degeneration, gliosis.

**Diagnostic confirmation** Demonstration of scrapie prion protein.

**Treatment** None.

**Control** Slaughter eradication. Genetic testing and selection/culling.

Scrapie is a nonfebrile, fatal, chronic disease of adult sheep, goats, and mouflons (one of two ancestors of all modern sheep breeds) characterized clinically by pruritus and abnormalities of gait, and by a very long incubation period. It is the prototypic disease for a group of diseases known as TSEs. This group also includes CWD of deer and elk; **transmissible mink encephalopathy**; and FSE, CJD, and other spongiform encephalopathies of humans, and the relatively new disease, **BSE**, which is described separately under that heading. In Iceland scrapie is known as *rida*, in France as *la tremblante*, and in Germany as *traberkrankheit*.

### ETIOLOGY

There has been a significant historical debate over the etiology of this disease. The current consensus view is that scrapie is associated with an infectious agent, but that the incubation period for clinical manifestation of the disease and the susceptibility of the host to developing clinical disease after infection is determined by genetics. In other words, to develop clinical disease caused classical scrapie, an animal must be exposed to the infectious agent and have a susceptible genotype.

Scrapie can be transmitted experimentally to other sheep and to certain laboratory animals, and infection induces the production in the brain, and some other tissues, of amyloid fibrils called scrapie-associated fibrils or prion rods. The main constituent of these is a disease-specific, protease-resistant neuronal membrane glycoprotein termed the **prion protein**, or PrP<sup>Sc</sup>. PrP<sup>Sc</sup> is an abnormal isoform of a host-coded membrane glycoprotein, PrP<sup>C</sup>, and the TSEs are characterized by the accumulation of PrP<sup>Sc</sup> in neuronal and other tissue.

Transmission can be effected by crude or purified extracts of brain or other tissues from affected sheep, and the infective agent is very resistant to ionizing and ultraviolet irradiation and to reagents that damage or modify nucleic acids. This, along with other experimental findings, has led to the accepted view that the infectious agent in scrapie is PrP<sup>Sc</sup> itself, and not a small, unconventional virus or virino as previously proposed. The structure of the infecting PrP<sup>Sc</sup> is thought to imprint on the normal cellular precursor PrP<sup>C</sup>, with the template resulting in a change

to the abnormal isoform which is protease-resistant and accumulates in cells.

More than 20 different **strains** of scrapie have been identified based on the following:

- Strain typing by differences in incubation time of the experimental disease in inbred strains of mice of different genotype
- The type, pattern, severity, and distribution of lesions in the brain of the different strains of experimental animals (lesion profiles)
- Resistance to thermal inactivation
- The type of disease produced in sheep and experimental animals (e.g., drowsy versus pruritic manifestations in goats)
- The ability of a strain to produce disease in different species of experimental animals

It is proposed that strain differences reflect differences in replicating information carried within the conformational state of the PrP<sup>Sc</sup>. The more important strains identified are called **classical scrapie strains**, comprising strain A and strain C (thought to be the most prevalent strain in the United States), and **atypical (or discordant or nonclassical) scrapie strains**, comprising the Nor98 strain and other discordant strains. Coinfection of strains can occur with scrapie.

Nor98 was first reported in 1998 in five unrelated Norwegian sheep that had PrP<sup>Sc</sup> in a different location (cerebellum) than usually reported with scrapie. Nor98 has now been identified in sheep in a number of countries. Atypical scrapie is thought to arise spontaneously and not be associated with an infective source.<sup>1</sup> Interestingly, atypical scrapie is usually not clinically apparent, but there are reports of sheep infected with atypical scrapie strains exhibiting some of the typical clinical signs of classical scrapie, particularly rear limb ataxia.<sup>1,2</sup> Atypical scrapie caused by Nor98 has been diagnosed in sheep in Australia and New Zealand; these are two countries that do not have classical scrapie.<sup>3</sup> Atypical scrapie is not considered rare compared with classical scrapie and appears to occur at a constant prevalence in different countries.<sup>4</sup>

## EPIDEMIOLOGY

### Occurrence

**Geographic Occurrence and Incidence**  
Scrapie in sheep occurs enzootically in the UK, Europe, and North America. Outbreaks have been reported in Australia, New Zealand, India, the Middle East, Japan, and Scandinavia, principally in sheep imported from enzootic areas. Australia and New Zealand used vigorous importation, quarantine, and culling policies to prevent subsequent entry of the disease and are considered free of disease.

The true prevalence of the disease both within and between countries is not known because there has been no test to detect the

presence of infection in individual sheep or in flocks at all stages of infection. This is further confounded by secrecy about the existence of scrapie in many flocks and breeds. This secrecy results from a fear of economic penalties that could result from the admission of infection.

In Great Britain, where the disease is enzootic and has been recognized for over 250 years, the true incidence is unknown, although a questionnaire survey in 1988 suggests that one-third of sheep flocks are infected. In infected flocks the annual incidence ranges from 0.4 to 10 cases per 100 sheep per year, with a mean of 1.1 cases per 100 sheep per year. However, the annual incidence can approach 20% of the adult flock, on occasions up to 40%, and in flocks where there is no selection against the disease the annual incidence and mortality can reach a level that results in disbandment of the flock or its nonsurvival.

Farmer consultation with a veterinarian about a case of scrapie and farmer reporting of cases of scrapie are notoriously low. Historically, this is because factors such as the stigma associated with having scrapie diagnosed in a purebred flock and concerns for future sales or, in the case of commercial flocks, a lack of incentive to consult and a lack of concern because nothing can be done to cure the present case or prevent future cases. In England, it has been estimated that only 13% of farmers who had a suspected case of scrapie in the past 12 months reported it. Possibly, the chance of improvement through genetic selection will alter this farmer trait.

In the United States the disease is thought to have been introduced in 1947, and by 1992 was found in 657 flocks in 39 states. In 2007 the prevalence of infection in the United States was estimated at 0.1% to 0.3%.

### Host Occurrence

#### Age

Scrapie is a disease of **mature sheep**, although most are exposed as young sheep, and the incidence decreases with age at exposure. The age-specific incidence in **sheep** is highest between 2.5 and 4.5 years of age and cases rarely occur under 18 months of age. Natural disease in **goats** is rare. The age at death is similar to that in sheep, with a range from 2 to 7 years. The **case-fatality rate**, with time, is 100%. The death loss is added to by the slaughter of infected and in-contact animals in countries where control and eradication is a practice.

#### Breed

Scrapie occurs in both sexes and in the majority of breeds, although the incidence is higher in some breeds than others. Breed differences in prevalence occur in several countries; an example would be the high prevalence in the Suffolk breed in the United States relative to white-faced breeds and in

some Hill breeds in the UK. These probably reflect breed and flock differences in genetic susceptibility to the development of clinical disease. Similarly, the occurrence of outbreaks of scrapie may result from the introduction of infection to a genetically susceptible flock or to a change in the genetic structure of flocks that are infected.

### Methods of Transmission

Knowledge of transmission of scrapie is based primarily on the experimental disease and observations of the natural disease in experimental flocks.

### Sources and Routes of Infection

The usual method of introduction into uninfected flocks is by the purchase of preclinically infected sheep. Infectivity can be demonstrated in the placenta, fetal fluids, saliva, colostrum, and milk of naturally occurring cases,<sup>5-7</sup> and in the oral cavity of sheep with preclinical scrapie,<sup>8</sup> but has not been demonstrated in the urine or feces of natural cases, even though it can be demonstrated in the intestine. Ingestion of infected material appears the most likely route of infection, but scarification of the skin and conjunctival inoculation will also allow infection. Hay mites have been found to harbor the agent on scrapie-infected properties and have been proposed as a reservoir for infection.

### Horizontal Transmission

This is the usual method of spread, and the placenta is considered the major source of infection for the mother to her lamb, and to other lambs in close contact. Under natural conditions the disease in flocks often runs in families, and whether or not a lamb contracts scrapie appears to depend primarily on the current or future scrapie status of its dam. It is common for all the VQR/VQR lambs from dams dying of classical scrapie to develop scrapie.

Scrapie can also transmit between sheep in close contact, and this can occur from sheep in the preclinical phase of the disease. Scrapie can be transmitted by blood transfusion. The importance of this route of infection in field infections appears low because successful transmission appears to require at least 400 mL of blood.

Under natural conditions, scrapie occurs in sheep and occasionally spontaneously in goats. Under experimental conditions, scrapie has been observed to spread from sheep to goats by contact, and the little evidence available on the natural disease in goats is consistent with the view that the scrapie can be maintained by contagion in a herd of goats living apart from infected sheep.

### Vertical Transmission

There is a greater risk for scrapie in lambs born to infected dams, but this most



probably reflects horizontal transmission at birth from placentas. There are conflicting results between studies that have examined transmission by embryo transfer, and the importance of vertical transmission to the epidemiology of the natural disease remains to be determined. However, epidemiologic studies suggest that it is of rare occurrence, and there is significant evidence against the occurrence of in utero transmission. The agent has not been demonstrated in the testes or semen of rams.

### Environment

An infected environment can also be the source, and scrapie-free sheep can develop disease after grazing pasture previously grazed by scrapie-infected sheep, with infection by ingestion or possibly via abrasive lesions. Environmental infection can occur from the products of parturition and, although the scrapie agent has not been demonstrated in feces, it is suspected as being so in infected animals. The duration of infectivity on inanimate materials such as pasture has not been defined, but field and experimental observations indicate that it is a long time, probably in excess of 16 years under some conditions.<sup>9,10</sup>

### Iatrogenic Transmission

An outbreak of scrapie occurred in the 1930s following the use of a vaccine against louping-ill prepared from the brains of sheep. More recently, the use of a vaccine against contagious agalactia has been epidemiologically linked to an outbreak of scrapie in sheep and goats in Italy where there was a high attack rate and high mortality affecting several birth cohorts.

### Genetics

Scrapie is recorded in most breeds of sheep, but there are breed, family, and individual differences in susceptibility. There is substantial genetic control of the incidence of disease, and in both the natural and experimental disease, genetics is a major determinant of susceptibility with the susceptibility of sheep strongly linked to certain polymorphisms in the sheep PrP gene.

In earlier studies, experimental challenge and breeding showed that sheep could exhibit a long or short incubation period following challenge, and that this difference in incubation period or susceptibility was determined by a single gene called **scrapie incubation period** (*Sip*). There is a similar gene in mice (*Sinc*) that determines incubation period and susceptibility following experimental challenge. The *Sip* gene has two alleles, *sA* and *pA*, which, respectively, shorten or prolong the experimental incubation period for most strains of the scrapie agent. The subsequent recognition of prion protein (PrP) and its association with scrapie led to the recognition of the gene that encodes PrP, which was found congruent to

*Sip* in sheep, and *Sip* genetics have been entirely superseded by PrP genetics.

Sheep have one pair of genes that influence susceptibility to scrapie known as the prion protein genes. These code for a normal prion protein in the cell (PrP<sup>C</sup>), which has 254 amino acids with each codon in the gene encoding for a specific amino acid at a particular location on PrP<sup>C</sup>. PrP<sup>C</sup> can be converted to a scrapie prion protein molecule (PrP<sup>Sc</sup>) in infected sheep which, when it accumulates in the CNS, causes disease. The susceptibility of sheep to this conversion, and thus to scrapie, is **strongly associated with certain polymorphisms at codons 136, 154, and 171**. It is thought that there are at least two groups of scrapie TSE strains, one of which is influenced primarily by the amino acid at codon 136 and the other group by the amino acid at codon 171. Within these there may be subtypes because resistance to some 136-type TSEs can be affected by the amino acid at codon 154.

- At codon 136 valine (V) is linked to scrapie susceptibility and alanine (A) is linked with resistance
- At codon 154 histidine (H) is linked to susceptibility and arginine (R) to resistance
- At codon 171 glutamine (Q) and histidine (H) are linked to susceptibility and arginine (R) to resistance.

- The notations used for descriptions of the prion protein (PrP) genotype vary in different countries.
- The susceptibility of sheep to scrapie is strongly associated with polymorphisms at codons 136, 154, and 171 in the prion protein gene.
- The amino acids associated with these polymorphisms are alanine, valine, histidine, arginine, and glutamine.
- In the description of the PrP genotype these are given the letters A, V, H, R, and Q, respectively.
- The PrP genotype is listed in the order of codon 136 followed by 154 and then 171.
- The amino acid at each codon is listed according to the letter designation for each of the two alleles separated by a backslash. Examples are ARR/ARR or ARR/VQR. These could also be expressed as AA<sub>136</sub>RR<sub>154</sub>RR<sub>171</sub> and AV<sub>136</sub>RQ<sub>154</sub>RR<sub>171</sub>.
- In sheep in the United States the polymorphisms at codon 171 are the major determinant of scrapie susceptibility. Polymorphisms at codon 154 play a minor role and are usually not listed as part of the PrP genotype.
- Genotypes in the United States are usually referred to using the letters of the amino acids in numerical order codon 136 followed by codon 171.
- The previous examples would be AA RR and AV RR.
- They can also be referred to using the codon number followed by the

corresponding amino acid 136AA, 171RR and 136AV, 171RR or the amino acid followed by the codon.

- Often only the amino acids at codon 171 are listed.

Of the possible alleles from these polymorphisms, only five, ARR, ARQ, VRQ, AHQ, ARH, are commonly seen. The relationship between PrP genotype and susceptibility to scrapie is shown in [Table 14-15](#) using the groupings of the British National Scrapie Plan.

It can be seen from [Table 14-15](#) that in the Britain, the VQR allele confers the greatest degree of susceptibility and that ARR is associated with resistance. Estimates that quantify risk in the British national flock based on genotypes of the sheep, and those of scrapie-affected sheep, are available but they are not strongly concordant. There is also an effect of PrP genotype on the incubation period, with the most susceptible genotypes (VQR) having the shortest incubation period and dying of scrapie at a younger age.

The frequency and distribution of the various PrP genotypes varies considerably between flocks and between breeds of sheep. There are also some marked between-breed differences in susceptibility with the same PrP genotype.

Susceptibility in the Suffolk and other black-faced breeds in the United States appears less complex than in other breeds and is strongly associated with sheep that are homozygous for glutamine at the 171 codon (171QQ) of the PrP gene, but is rare in sheep heterologous for glutamine and arginine (171QR) or homozygous for arginine (171RR) at codon 171. Suffolks are the predominant breed affected with scrapie in the United States. They lack the VRQ allele, and the ARQ/ARQ genotype is the genotype that confers the greatest susceptibility. The association between genotype and susceptibility, as defined in the scrapie eradication plan of the USDA, in the United States is shown in [Table 14-16](#).

Factors other than the PrP genotype influence susceptibility to scrapie because not all sheep with a susceptible genotype challenged with scrapie subsequently develop the disease. Also, there are some breed differences in the level of resistance or susceptibility conferred by a given genotype. For example, ARQ/ARQ Suffolk sheep are highly susceptible to scrapie, whereas ARQ/ARQ Cheviots are relatively resistant. Breed differences in PrP genotype scrapie disease linkage and disease pattern differences with atypical strains of scrapie may be associated with polymorphisms in the PrP gene promoter. Atypical scrapie caused by the Nor98 strain is most common in sheep in Europe carrying phenylalanine (F) at position 141 or the PrP genotypes ARR/ARR, ARR/ARQ, and AHQ/ARQ.<sup>11-13</sup>

**Table 14-15** PrP genotype and susceptibility to scrapie in national scrapie program in Great Britain

NSP Type	Main characteristic	Genotypes	Comments
1	ARR homozygous	ARR/ARR	Genetically most resistant
2	ARR heterozygous non-VQR	ARR/AHQ ARR/ARQ ARR/ARH	Sheep that are genetically resistant to scrapie, but will need careful selection when used for further breeding
3	<b>Non-ARR and non-VQR</b>	AHQ/AHQ ARQ/AHQ AHQ/ARH ARH/ARH ARQ/ARH ARQ/ARQ	Sheep that genetically have little resistance to scrapie and will need careful selection when used for further breeding Group 3 risk varies and can depend on breed, e.g., ARQ/ARQ Suffolk are highly susceptible ARQ/ARQ Cheviots are relatively resistant
4	<b>ARR/VQR heterozygous</b>	ARR/VRQ	Sheep that are genetically susceptible to scrapie and should not be used for breeding unless in the context of a controlled breeding
5	<b>VQR and non-ARR</b>	AHQ/VRQ ARQ/VRQ ARH/VRQ VRQ/VRQ	Sheep that are highly susceptible to scrapie and should not be used for breeding

NSP, National Scrapie Program.

**Table 14-16** Scrapie susceptibility and genotype as defined by the U.S. Scrapie Eradication Plan

Genotype	Susceptibility
1. AA RR	Sheep that are resistant
2. AA QR	Sheep that are rarely susceptible
3. AV QR	Sheep that are susceptible to some scrapie strains that are thought to occur with low frequency in the United States
4. AA QQ	Sheep that are highly susceptible
5. AV QQ	Sheep that are highly susceptible
6. VV QQ	Sheep that are highly susceptible

There is less information on the genetics of scrapie in **goats**. There is high variability in the goat PrP gene that possibly can be exploited to select for goat-specific scrapie-resistant PrP genotypes. An initial report indicated that the H<sub>154</sub>, Q<sub>211</sub>, and K<sub>222</sub> single nucleotide polymorphisms were associated with a high resistance to classical scrapie.<sup>14</sup>

### Risk Factors

#### Exposure Factors

There is a dose–response relationship in naturally occurring scrapie. The high incidence in some Icelandic flocks is attributed to a high level of exposure, resulting from a long winter housing period with a higher risk for disease in lambs born in the winter housing period.

Factors that influence exposure risk will vary with the management systems, which can vary markedly between countries. With that caveat, risk factors that have been

identified in case–control studies include the following:

- A higher risk for scrapie in larger flocks and in pedigree flocks
- A greater risk in flocks that lamb communally in group pens compared with those that lamb in individual pens or outside on pasture
- A greater risk in flocks that disposed of the placenta in the compost and spread sheep compost on the land
- A lower risk in flocks in which cow compost is spread on the land
- A greater risk in flocks that purchased replacement sheep through the market
- A greater risk where different flocks share pastures or rams

#### Age at Exposure

Lambs exposed at birth have a shorter incubation period and higher risk for scrapie than lambs exposed at 6 to 9 months of age. Similarly, lambs or goats removed from infected dams at birth to a scrapie-free environment have a lower incidence of scrapie than those removed at later times.

#### Infection Status of Parents

Lambs born to affected ewes are at increased risk for scrapie, and the offspring from an infected ewe and an infected ram are at greater risk than those born from an infected ewe and an uninfected ram. However, even in high-incidence herds a considerable proportion of disease cannot be attributed to parental scrapie status and results from horizontal transmission. Also, the number of genetically susceptible sheep in an affected flock can increase the infection pressure.

### Goats

**Scrapie in goats** is rare, and most cases arise in goats that are in close contact with infected sheep. Scrapie can spread from goat to goat with no sheep contact.

#### Experimental Reproduction

The agent is present in the brain, spinal cord, lymph nodes, intestinal tract tissue, and spleen of infected sheep, and has been extracted from sheep and goat brain. Experimentally, the disease can be transmitted to sheep, goats, mice and other laboratory animals using these tissues, and by a variety of routes of inoculation. The experimental disease has a long incubation period that varies with the strain of the agent and the genetics of the recipient. Transmission of the disease to sheep has also been effected by the oral or intracerebral administration with fetal membrane material from known infected ewes. Accidental transmission is recorded following vaccination against louping-ill, with vaccine contaminated by the agent of scrapie, and resulted in widespread dissemination of the disease.

#### Pathogen Risk Factors

The scrapie agent can be maintained in tissue culture, and infectivity is retained with passage. It can also be perpetuated in experimental animals. Infectivity also survives for remarkable periods in dead and formalinized tissues; infected brain homogenates buried in soil for 3 years retain their infectivity. It is highly resistant to physical and chemical influences and can survive decontamination processes that are effective against conventional viruses. It is capable of withstanding the usual virucidal procedures and is not destroyed by boiling, by rapid freezing and thawing, or by exposure to ether or 20% formalin. Conventional heat treatments may reduce infectivity, but the agent is remarkable resistant to heat and steam sterilization at 27 psig (132°C) is required to totally destroy it. Chemical inactivation can be achieved with sodium hypochlorite providing 2% (20,000 ppm) of available chlorine acting for 1 hour, and by 4% sodium hydroxide.

#### Economic Importance

Scrapie is of major concern to pedigree flocks and, if present and public, will curtail the sale of sheep and effectively result in the dissolution of the flock. Some countries have, or have had, eradication schemes. The disease is also of major international importance because of the embargos maintained by several countries against sheep from enzootic areas.

#### Zoonotic Implications

There is no evidence for transmission of scrapie to humans or for a risk to public health.

## PATHOGENESIS

In both sheep and mice, the agent shows a predilection for tissues of the lymphoreticular system in which it replicates during the incubation period before invading the nervous system. In naturally infected sheep, replication begins in the tonsil, retropharyngeal lymph node and Peyer's patches, and gut-associated lymphoid tissue, which probably reflects the oral route of infection. PrP<sup>Sc</sup> subsequently becomes disseminated to other lymph nodes and the spleen. There may be a considerable period, ranging from 14 months to 7 years, before there is infection of the brain, and during this infection in the lymphoreticular system probably provides the reservoir for maternal and horizontal transmission. The action of the PrP genotype may be to delay neural invasion, in which case it is possible that a nonclinical carrier state may exist for scrapie.

How the scrapie agent reaches the CNS is not certain, but it is probably through transportation across intestinal villous enterocytes<sup>15</sup> and subsequent infection of the autonomic nervous system. Gut-associated lymphoid nodules in the Peyer's patches have a substantial network of nerve fibers and are probably the site for neuroinvasion. The scrapie agent has been detected in lymphoid nodules of the Peyer's patches of the gut as early as 5 months after oral infection.

Infection in the brain of sheep is initially in the diencephalon and medulla oblongata, with subsequent spread and replication in other areas of the brain. Characteristically, there is a noninflammatory, vacuolar degeneration of gray matter and the presence of PrP<sup>Sc</sup> in scrapie-associated fibrils. Infection results in the posttranslational modification of this protein so that it becomes resistant to proteinases and to normal clearance and, consequently, accumulates in the cell.

PrP<sup>Sc</sup> is also present in the placenta and in the trophoblast cells of the placentomes but not in the endometrium, myometrium, associated nerve plexuses, or in the fetus. The presence of PrP<sup>Sc</sup> in the placenta is determined by the fetal PrP gene, and PrP<sup>Sc</sup> is not present in the placenta of fetuses carrying one or two ARR alleles.

## CLINICAL FINDINGS

### Incubation

**The incubation period** varies from several months to several years. Scrapie is a non-febrile disease and the onset is insidious, but as the disease progresses clinical signs become more obvious and severe. The **clinical course** is protracted, varying from 2 to 12 months, but lasting in most cases for about 6 months. Affected animals usually show **behavioral change, tremor, pruritus, and locomotor disorder**. A clinical examination protocol to detect classical and atypical scrapie in sheep has been developed.<sup>16,17</sup>

### Early Signs

**The earliest signs are transient**, nervous phenomena occurring at intervals of several weeks or under conditions of stress. These episodes include sudden collapse and sudden changes of behavior, with sheep charging at dogs or closed gates.

Rubbing and biting at the fleece then begins but are often unobserved because of their infrequent occurrence. The apparent **pruritus** is manifested chiefly over the rump, thighs, and tail base. The poll and dorsum of the neck may also be involved and, less commonly, the neck in front of the shoulder and the ribs behind the elbow. The affected areas have approximate bilateral symmetry. In this early stage a stilted gait is often observed. A general loss of condition may also be observed as an early sign, although the appetite may not be severely affected.

### Advanced Cases

**More advanced cases** show intense pruritus, muscle tremor and marked abnormalities of gait, and severe emaciation. **Persistent rubbing** causes loss of wool over the areas mentioned previously. Scratching with the hindfeet and biting at the extremities also occurs. Hematoma of the ears and swelling of the face may result from rubbing. Light or deep pressure, pinpricking, and application of heat or cold may elicit the characteristic "nibbling or scrapie scratch" reaction, during which the animal elevates the head and makes nibbling movements of the lips and licking movements with the tongue (Fig. 14-11). The sheep's expression suggests that the sensations evoked are pleasant ones. The reaction may not be observed consistently, often disappearing when the sheep is excited or in new surroundings.

Simultaneously with the development of pruritus there is serious **impairment of locomotion**. Hindlimb abnormalities appear first. There is incomplete flexion of the hock, shortening of the step, weakness, and lack of balance. The sense of spatial relationship appears to be lost, and the sheep is slow to correct abnormal postures. Adduction occurs during extension, and abduction occurs during flexion. When the animal is attempting to evade capture, gross incoordination of head and leg movements is likely and the animal often falls. Convulsions, usually transient but occasionally fatal, may occur at this time.

General hyperexcitability is evident. In the animal at rest an intermittent nodding and jerking of the head and fine tremor of superficial muscles may also be observed. In some cases, nystagmus can be produced by rotating the head sideways. Other clinical signs include inability to swallow, although prehension is unaffected; vomiting; loss of bleat; and blindness. A change of voice to a trembling note is often most noticeable.

Anorexia is not evident in most cases until the last 4 to 5 weeks and results in rapid

loss of BW. Abomasal distension and impaction occurs in a small number of cases. Pregnancy toxemia may occur as a complication in pregnant ewes during this stage of scrapie. Finally, the sheep reaches a stage of extreme emaciation and inability to move without becoming readily fatigued. Sternal recumbency follows and lateral recumbency with hyperextension of the limbs is the final stage. Pyrexia is not evident at any time.

In a detailed study in 129 sheep with scrapie the proportional occurrence of signs was hindlimb ataxia 71%, head tremor 61%, altered mental status 57%, positive nibble reflex 51%, crouching position 51%, teeth grinding 44%, low head carriage 38%, body condition score of less than 1.5, 38%, and conscious proprioceptive deficits of limbs 36%. The occurrence of clinical signs was examined in relationship to the PrP genotype. The nibble reflex was strongly associated with PrP genotypes ARQ/ARQ and ARQ/ARH.

**In goats**, the clinical course in naturally occurring cases lasts from 2 to 24 weeks. Clinical signs are similar to those in sheep, and hyperesthesia, ataxia, and pruritus are common, but loss of weight is less common. In lactating goats the first sign may be a reluctance to permit milking. Dribbling and regurgitation of ruminal contents are also recorded in one-third of cases.

In most countries the disease is reportable to government authorities.

## CLINICAL PATHOLOGY

There are no changes in hematologic or serum biochemistry parameters. The **IHC test on the obex** and other parts of the brain is the confirmatory test at some laboratories of the OIE and is considered the gold standard test in the United States. At least four ELISA tests are approved for scrapie surveillance at slaughter in the EU. Western blots on retropharyngeal lymph nodes obtained at slaughter have a sensitivity approaching that of IHC.<sup>18</sup> Atypical scrapie is best diagnosed using cerebellum as the tissue for analysis.

Until recently there has been no **antemortem** test for scrapie; however, PrP<sup>Sc</sup> can be detected in cells by IHC methods and is present in the lymphoid tissue of some sheep with scrapie in the preclinical phase of the disease. **Palatine tonsillar biopsy** has detected PrP<sup>Sc</sup> in lambs of susceptible genotypes as young as 5 months of age and in the tonsils of nonchallenged susceptible lambs at 9 to 10 months of age that were born and maintained in a scrapie environment. However, tonsil biopsy requires general anesthesia and is not a practical on-farm technique.

**Biopsy of lymphoid follicles in the third eyelid or rectum** is more practical, requires only restraint, sedation using xylazine, and local analgesia, and the techniques are being investigated for the preclinical diagnosis of scrapie in surveillance programs. In scrapie-positive sheep, PrP<sup>Sc</sup> can be detected in third





A



B

**Fig. 14-11** **A**, Clinical signs of scrapie in Suffolk ewes located in the midwest region of the United States. The ewe on the left is pruritic, which is manifested as rubbing against the tree. The same ewe is also showing a positive nibble reflex (scrapie scratch reaction) with an upper lip curl and protruded tongue. The ewe on the right is losing weight and has an abnormally low head carriage. **B**, A positive result to the scrapie scratch reaction test. Rubbing/scratching the back over the thoracic vertebrae results in a slight elevation of the head, an upper lip curl, licking of the lips, and a pleasing look in the eyes of sheep with scrapie.

eyelid biopsies by 14 months of age, obtained from the palpebral side of the third eyelid. Histamine-containing eye drops improve the success of collecting a sample with adequate lymphoid follicles for examination. However, lymphoid follicles may not be present in sufficient numbers in third eyelid biopsies for evaluation in up to 60% of adult sheep

sampled, and the sensitivity of third eyelid biopsy and rectal mucosa biopsy in detecting scrapie-infected sheep is 40% and 36%.<sup>19</sup> It is unlikely that lymphoid tissue will ever achieve an adequately high test sensitivity because a large number of infected animals have minimal or no PrP<sup>Sc</sup> in lymphoid tissue.

Research is ongoing about developing an accurate test that can detect serum biomarkers of early and late phase scrapie or PrP<sup>Sc</sup> in blood.<sup>20</sup> It has been suggested that the disease could be diagnosed antemortem by EEG, but this has been disputed.

### NECROPSY FINDINGS

Significant gross findings are restricted to traumatic lesions caused by rubbing, and to emaciation and loss of wool; gross distension of the abomasum has been recorded in some natural cases.

The essential histopathologic lesion in scrapie is the **vacuolation of gray matter neuropil** in the spinal cord, medulla, pons, and midbrain, and the consequential wallerian degeneration in dorsal, ventral and ventrolateral columns of the spinal cord, and in nerve fibers in the cerebellar peduncles and the optic nerve. In addition, there is degeneration of the cerebellar and hypothalamoneurohypophyseal systems. There are different strains of the scrapie agent that can result in differing clinical signs and pathology. Scrapie-associated fibrils are present in infected brain. Histologic findings are diagnostic in many cases but can be supplemented with the immunodetection of PrP<sup>Sc</sup> in brain tissue by in situ IHC and Western immunoblots. The breed of the sheep affects the magnitude of neuropil vacuolation, and variation also is associated with the PRP genotype within breeds.

Atypical strains of scrapie (Nor98) are recognized that differ from the usual strains in their vacuolation patterns and their disease-specific, protease-resistant PrP<sup>Sc</sup> disposition patterns. These strains can also produce disease in PrP genotypes not normally affected, including Prp genotype ARR/ARR.

### DIFFERENTIAL DIAGNOSIS

The characteristic signs of behavioral change, tremor, pruritus, and locomotor disorder occurring during a period of prolonged illness should suggest the possibility of this disease. The long incubation period, slow spread, and high case–fatality rate should also be considered when making a diagnosis. Diseases that may require differentiation include the following:

#### Diseases with signs of nervous dysfunction

- Louping-ill
- Pregnancy toxemia
- Rabies
- Pseudorabies
- Visna.

#### Skin diseases

- External parasites
- Wool loss

**Treatment** No treatment has proved capable of changing the course of the disease.

## CONTROL

### Individual Flocks

The maintenance of a closed ewe flock is critical to the control of this disease. If ewes need to be purchased from outside flocks, they should be from certified flocks or, better still, selected by PrP genotype testing for 171RR or 171QR genotype. The rams should be 171RR or 171QR genotypes. Ewes should be isolated at lambing and lambled individually with disposal of placenta by burning.

### National Eradication

In countries that do not have the disease, and where it is inadvertently introduced with imported sheep, the approach is slaughter eradication of the infected flock and all in-contact animals. The aim is to eliminate the disease from the country, and the approach is usually successful because it has the full support of the sheep industry and the government.

### Flock Eradication

The eradication of scrapie in countries where it is enzootic has less chance of success. Eradication programs vary and may involve the whole flock or just the family lines of the infected sheep. Programs in the United States since 1952 have varied from compulsory slaughter eradication of the affected flock and source flocks, to bloodline eradication, and finally from discontinuation to a voluntary certification scheme.

During this period there was no ante-mortem diagnostic test for scrapie and the identification of infected farms and flocks relied on owners submitting suspect or clinical cases for postmortem and histologic diagnosis. Owners are unlikely to put their flocks at risk if there is inadequate compensation for the results of their action, if they perceive that other flock owners are not cooperating with the control program, or if they question the validity of the eradication policy, which is attested to by the experience in the United States.

Iceland is currently attempting an eradication program that involves depopulation of infected farms and areas. The farms are left without sheep for a 2-year period during which there is extensive cleaning and disinfection of the farm area before repopulation with scrapie-free sheep. The program is a national thrust but very expensive. This approach has also been apparently successful in virtually eliminating, if not eradicating, the disease in Iceland. Norway is also attempting eradication in a similar manner. In both countries the disease was geographically clustered.

### Genetic Control and National Programs

The occurrence of scrapie and the concern for BSE in sheep has led many countries to develop national breeding programs for the control of scrapie and potential BSE.

Examples are the National Scrapie Plan in the UK and the National Scrapie Eradication Program in the U.S. National Scrapie Plan. The overall aim is to identify sheep genetically resistant to scrapie on the basis of their genotype (ARR) and to and breed them to create a national flock with scrapie resistance. Genetic testing will allow the selection of resistant sheep for breeding and the culling of susceptible sheep, particularly in breeds such as the Suffolk in which the genetics of susceptibility appear relatively simple.

The UK has a Voluntary **National Scrapie Flocks Scheme** and a National Scrapie Plan which, under EU regulations, become compulsory for flocks that have had a case of scrapie after July 2004. Under the Compulsory Scrapie Flocks Scheme farmers with confirmed scrapie cases on their farms will either have their sheep flocks genotype tested so that those animals more susceptible to disease can be identified and removed or the whole flock slaughtered and disposed of. All goats on affected holdings also will be slaughtered and disposed of. Testing of breeding rams will also become compulsory for all purebred flocks and any other flocks producing and selling homebred rams for breeding. All rams carrying VRQ PrP genotypes will be slaughtered or castrated. Allied to this will be a voluntary ewe-testing scheme.

A mathematical model of the program has examined the time that it would take to eliminate scrapie from the national flock. The results suggest eradication is feasible but the process could take decades and would be expensive. Surprisingly whole-flock culling was more efficient in terms of time to eradication than genetic typing and selective culling. Not surprising was the finding that the **most important factor** influencing the efficacy of control at the national level was the ability to identify affected flocks. It was suggested that investing money in obtaining better notifications and in conducting trace backs and active surveillance of animals slaughtered for human consumption and animals found dead on farms would be a good investment.

In the **United States**, all breeding sheep must be individually identified with a unique flock and individual number. The **Scrapie Flock Certification** program monitors flocks over time and assigns certified status to flocks with no evidence of scrapie. Although this program has strict requirements of identification and reporting, it is not based on genetic testing.

The **United States** also has a **USDA Genetics-Based Flock Cleanup and Monitoring Plan**. This program targets scrapie-infected and source flocks. The sheep in these flocks are genotyped, sheep with susceptible genotypes are removed (as are all goats), and the flock is placed under surveillance for 5 years. Flocks that are exposed to

scrapie are placed on a monitoring program, and if scrapie is detected the genetics-based cleanup program would begin.

There is concern that breeding for the selection for certain PrP genotypes and reduction or elimination of other PrP genotypes could affect other **desirable genetic characteristics** and reduce the overall “genetic pool.” This will need to be determined for individual breeds, but preliminary analyses that have involved several breeds suggest that reproductive traits, muscle mass, wool quality, live weight gain, and carcass characteristics are not affected, at least in some breeds.

There has also been concern that **rare breeds** could be threatened in the face of an occurrence of scrapie and subsequent disposition of the flock based on the PrP genotype. Interestingly, there is a good representation of ARR and some breeds have very high frequencies.

## FURTHER READING

- Bulgin MS, Melson SS. What veterinary practitioners should know about scrapie. *J Am Vet Med Assoc.* 2007;230:1158-1164.
- Fast C, Groschup MH. Classical and atypical scrapie in sheep and goats. In: *Prions and Diseases*. Vol. 2. New York: Springer; 2013.
- Hunter N. Scrapie—uncertainties, biology and molecular approaches. *Biochim Biophys Acta.* 2007;1772:619-628.
- Prusiner SB. Molecular biology of prion diseases. *Science.* 1991;252:1515-1522.

## REFERENCES

1. Simmons HA, et al. *BMC Vet Res.* 2009;5:8.
2. Benestad SL, et al. *Vet Res.* 2008;39:19.
3. Kittelberger R, et al. *J Vet Diagn Invest.* 2010;22:863.
4. Fediaevsky A, et al. *BMC Vet Res.* 2008;4:19.
5. Vascellari M, et al. *J Virol.* 2007;81:4872.
6. Konold T, et al. *BMC Vet Res.* 2008;4:14.
7. Konold T, et al. *BMC Vet Res.* 2013;9:99.
8. Maddison BC, et al. *J Infect Dis.* 2010;201:1672.
9. Georgsson G, et al. *J Gen Virol.* 2006;87:3737.
10. Seidel B, et al. *PLoS ONE.* 2007;2:e435.
11. Lühken G, et al. *Vet Res.* 2007;38:65.
12. Andréoletti O, et al. *PLoS Pathog.* 2011;7:e1001285.
13. Saunders GC, et al. *J Gen Virol.* 2006;87:3141.
14. Corbière F, et al. *J Gen Virol.* 2013;94:241.
15. Jeffrey M, et al. *J Pathol.* 2006;209:4.
16. Konold T, Phelan L. *J Vis Exp.* 2014;83:e51101.
17. Konold T, Phelan L. *Vet Rec.* 2014;174:257.
18. Langeveld JPM, et al. *BMC Vet Res.* 2006;2:19.
19. Monleón E, et al. *Vet Microbiol.* 2011;147:237.
20. Batkelli-Molina I, et al. *BMC Vet Res.* 2010;6:49.

## CHRONIC WASTING DISEASE

CWD has recently emerged, or been recognized, in the United States as a TSE of captive and free-ranging cervids. The ability of this infection to transmit laterally between cervids, coupled with the longevity of the agent in the environment and the common grazing land of infected cervids and cattle and sheep, has resulted in concern that CWD in cervids might be a risk to livestock, and subsequently to humans, similar to BSE. There has also been concern that it might be



transmitted directly from infected cervids to hunters dressing carcasses or consuming deer meat. There is no evidence for either of these risks.

The known natural hosts for CWD are mule deer (*O. hemionus*), white-tailed deer (*O. virginianus*), Rocky Mountain elk (*C. elaphus nelsoni*), and less frequently Shiras moose (*Alces alces shirasi*). CWD was originally recorded in the late 1960s as a chronic wasting syndrome of unknown etiology in captive mule deer in research facilities in Colorado and Wyoming. It was subsequently established that the disease was a TSE, and CWD has subsequently been found affecting cervids in captivity in several states in the United States and also in the provinces of Saskatchewan and Alberta, Canada. The occurrence in captive and farmed cervids in these different geographic areas is likely the result of transfer of animals between them, and the disease has recently been reported in Korea in cervids imported from North America. The disease continues to expand in prevalence and range in North America.

CWD has a focus and may have originated in free-ranging deer and elk in north central Colorado and southeastern Wyoming; however, in recent years it has been detected in free-ranging cervids east of the Mississippi and in a much broader area of North America. It is not certain whether this is caused by spread or because of improved surveillance. Based on comparisons of the CNS lesions and the glycoform patterns, the CWD agent is the same in captive and free-ranging deer.

There is strong evidence from outbreaks in captive deer that lateral transmission is of major importance in the transmission of CWD. The agent accumulates in gut-associated lymphoid tissues early in the infection, and saliva and feces are the likely source of horizontal infection with contamination of the environment.

The disease can be transmitted experimentally between cervids, and there is evidence for genetic susceptibility. The prion associated with CWD is not the same as that associated with BSE. In a recent study, it was shown that infection, with amplification of prion protein in brain tissue, can be transmitted to cattle by intracerebral inoculation of CWD-infected deer brain. Six years following challenge less than 50% of the challenged cattle showed amplification of the infection and none had histologic evidence of spongiform encephalopathy. It was concluded that if infection via the oral route did occur in cattle it would be unlikely that it would result in amplification of the abnormal prion within the life span of cattle.

Clinically the disease in cervids is manifested initially by changes in behavior not commonly observed in free-ranging cervids, and the major manifestation is a marked fall in body condition. In the terminal stages, there may be ataxia and excitability. The

clinical course varies from a few days to a year but averages 4 months. Diagnosis is by histologic examination of the brain or more commonly by the demonstration of PrP<sup>CWD</sup> in brain tissue by IHC. Antemortem biopsy of lymphatic tissue in tonsils and retropharyngeal lymph nodes as well as rectal biopsy have all been proven to be useful in diagnosing preclinical and subclinically infected animals, with diagnostic performance approaching testing brain tissue. Because prions in cervids with CWD are heavily shed in saliva and ocular secretions, diagnostic tests are currently under development using these fluids.

Control of CWD appears to be unsuccessful because of its horizontal transmission, as well as occurrence in wildlife that migrate over large distances and that are naturally shy. Eradication appears very unlikely.

#### FURTHER READING

- Gilch S, Chitoor N, Taguchi Y, et al. Chronic wasting disease. *Top Curr Chem*. 2011;305:51-78.  
 Sigurdson CJ. A prion disease of cervids: chronic wasting disease. *Vet Res*. 2008;39:41.

## Parasitic Disease Primarily Affecting the Cerebrum

### COENUROSIS (GID, STURDY)

Coenurosis is the disease caused by invasion of the brain and spinal cord by the intermediate stage of *Taenia multiceps*. The syndrome produced is one of localized, space-occupying lesions of the CNS. In most countries the disease is much less common than it used to be and relatively few losses occur.

#### ETIOLOGY

The disease is associated with *Coenurus cerebralis*, the intermediate stage of the tapeworm *T. multiceps*, which inhabits the intestine of dogs and wild Canidae. The embryos, which hatch from eggs ingested in feed contaminated by the feces of infested dogs, hatch in the intestine and pass into the bloodstream. Only those embryos that lodge in the brain or spinal cord survive and continue to grow to the coenurid stage. *C. cerebralis* can mature in the brain and spinal cords of sheep, goats, cattle, horses, and wild ruminants, and occasionally humans, but clinical coenurosis is primarily a disease of sheep and occasionally goats<sup>1</sup> and cattle.<sup>2</sup> Infection in newborn calves, acquired prenatally, has occasionally been observed.

#### PATHOGENESIS

The early stages of migration through nervous tissue usually passes unnoticed, but in heavy infections an encephalitis may be produced. Most signs are caused by the

mature coenurus, which may take 6 to 8 months to develop to its full size of about 5 cm. The cystlike coenurus develops gradually and causes pressure on nervous tissue, resulting in its irritation and eventual destruction. It may cause sufficient pressure to rarefy and soften cranial bones, leading to a larger volume of calvarium, compared with uninfected controls.<sup>3</sup>

#### CLINICAL FINDINGS

In acute outbreaks caused by migration of larval stages, sheep show varying degrees of blindness, ataxia, muscle tremors, nystagmus, excitability, and collapse. Sheep affected with the mature *Coenurus* show an acute onset of irritation phenomena including a wild expression, salivation, frenzied running, and convulsions. Deviation of the eyes and head may also occur. Some animals may die in this stage, but a large number proceed to the second stage of loss of function phenomena, the only stage in most affected animals. The most obvious sign is slowly developing partial or complete blindness in one eye. Dullness, clumsiness, head-pressing, ataxia, incomplete mastication, and periodic epileptiform convulsions are the usual signs. Papilledema may be present. Localizing signs comprise chiefly deviation of the head and circling; there is rotation of the head with the blind eye down, and deviation of the head with circling in the direction of the blind eye.

In young animals local softening of the cranium may occur over a superficial cyst and rupture of the cyst to the exterior may follow, with final recovery. When the spinal cord is involved, there is a gradual development of paresis and eventually inability to rise. Death usually occurs after a long course of several months.

#### CLINICAL PATHOLOGY

Clinicopathologic examinations are not generally used in diagnosis in animals, and serologic tests are not sufficiently specific to be of value. Radiologic examinations are helpful in defining the location of the cyst, especially if there is a prospect of surgical intervention. MRI provides more detailed information regarding cyst size and location.<sup>3</sup>

#### NECROPSY FINDINGS

Thin-walled cysts may be present anywhere in the brain but are most commonly found on the external surface of the cerebral hemispheres. In the spinal cord the lesions are most common in the lumbar region but can be present in the cervical area. Local pressure atrophy of nervous tissue is apparent, and softening of the overlying bone may occur.

#### DIFFERENTIAL DIAGNOSIS

The condition needs to be differentiated from other local space-occupying lesions of the

*Continued*



cranial cavity and spinal cord, including abscess, tumor, and hemorrhage. In the early stages the disease may be confused with encephalitis because of the signs of brain irritation. Clinically there is little difference between them and, while clinical signs and local knowledge may lead to a presumptive diagnosis, demonstration of the metacystode is essential.

### TREATMENT AND CONTROL

Surgical drainage of the cyst may make it possible to fatten the animal for slaughter, and surgical removal with complete recovery is possible in a majority of cases. The life cycle can be broken most satisfactorily by control of mature tapeworm infestation in dogs. Periodic treatment of all farm dogs with a tenicide is essential for control of this and other more pathogenic tapeworms. Carcasses of livestock infested with the intermediate stages should not be available to dogs.

Anthelmintic agents appear to have efficacy in treating coenurosis in naturally infected sheep, as demonstrated by degeneration of the cysts in treated animals.<sup>4</sup> Best results were obtained with oral albendazole (25 mg/kg), or combined oral fenbendazole (500 mg) and oral praziquantel (500 mg). The clinical effect of such treatment is undetermined.

### REFERENCES

1. Nourani H, Kheirabadi KP. *Comp Clin Pathol*. 2009;18:85.
2. Giadinis ND, et al. *Vet Rec*. 2009;164:505.
3. Manunta ML, et al. *Am J Vet Res*. 2012;73:1913.
4. Ghazaei C. *Small Rumin Res*. 2007;71:48.

### HALICEPHALOBUS

*H. gingivalis* (*H. delectrix*; *Micronema delectrix*) is a small nematode that has been found in horses on rare occasions. Like *Pelodera*, it is a free-living saprophytic organism that has the ability to become an opportunistic parasite. *H. gingivalis*, however, invades the deeper tissues where it reproduces. Enormous numbers may be seen in granulomatous lesions that grow to several centimeters in diameter. Lesions may be found near the eye, in the prepuce, nares, or the maxilla. The latter may be sufficiently large to cause the hard palate to bulge, displacing the molars and causing difficulty in mastication.<sup>1</sup> Putative hematogenous spread gives rise to similar lesions in the kidney,<sup>2</sup> which may be misdiagnosed as renal neoplasia. The worm also invades the brain,<sup>3-5</sup> spinal cord, and heart,<sup>6</sup> but here the lesions are usually microscopic and consist of discrete granulomata with a vascular orientation. In the brain lesions are predominantly in the cerebrum with numerous intralésional worms.<sup>5</sup> Affected horses may show a wide variety of clinical signs including lethargy, ataxia, and incoordination leading to recumbency and

death.<sup>1,6</sup> Diagnosis of superficial lesions is by demonstration of worms and larvae in biopsy samples, but more often *H. gingivalis* infection is identified retrospectively in histologic sections following necropsy.<sup>7</sup> The worms are 250 to 430  $\mu\text{m}$  long, have a characteristic bilobed pharynx, and often contain a single large egg. PCR and sequencing have been used to identify *H. gingivalis* definitively.<sup>3</sup> This infection must be considered in the differential diagnosis of equine cerebrospinal nematodosis.<sup>3,4</sup> Treatment with ivermectin at the maximum safe dose has been attempted, although the susceptibility of the worm to this compound is uncertain.<sup>1</sup> Experimental tests have indicated that *H. gingivalis* adult worms and larvae have remarkable tolerance to ivermectin.<sup>8</sup>

### REFERENCES

1. Henneke C, et al. *Acta Vet Scand*. 2014;2:22.
2. Henneke C, et al. *Dansk Vettisskr*. 2014;56:56.
3. Akagami M, et al. *J Vet Med Sci*. 2007;69:1187.
4. Hermsilla C, et al. *Equine Vet J*. 2011;43:759.
5. Jung JY, et al. *Vet Med Sci*. 2014;76:281.
6. Aedeji AO, et al. *Vet Clin Pathol*. 2015;44:171.
7. Sant'Ana FJE, et al. *Bra J Vet Res Anim Sci*. 2012;5:12.
8. Fonderie P, et al. *Parasitology*. 2012;139:1301.

## Metabolic Diseases Primarily Affecting the Cerebrum

### POLIOENCEPHALOMALACIA (CEREBROCORTICAL NECROSIS) OF RUMINANTS

#### SYNOPSIS

**Etiology** Several different causes including thiamine inadequacy, sulfate toxicity.

**Epidemiology** Sporadic disease in young well-nourished ruminants on high-level grain diets and not synthesizing sufficient thiamine. Ingestion of preformed thiaminase in certain plants or production by ruminal microbes may also cause destruction of thiamine. May also occur in cattle and sheep of all ages ingesting excess amounts of sulfates in feed and water.

**Signs** Sudden blindness, ataxia, staggering, head-pressing, tremors of head and neck, ear-twitching, champing fits, clonic-tonic convulsions, recumbency, opisthotonus, rumen contractions normal initially, pupils usually normal and responsive, nystagmus, death may occur in 24–48 hours. Hydrogen sulfide odor of ruminal gas in sulfate toxicity.

**Clinical pathology** Erythrocyte transketolase activity decreased and thiamine pyrophosphate effect increased but both measurements difficult to interpret; blood thiamine concentrations decreased but are not reliable in thiamine inadequacy form.

Increased hydrogen sulfide content in rumen gas and increased thiosulfate concentration in urine in sulfur-induced form.

**Lesions** Diffuse cerebral edema, flattened dorsal gyri, coning of cerebellum, multifocal to linear areas of fluorescence in gray and white matter borders of cortical gyri and sulci.

**Diagnostic confirmation** Fluorescence of gray and white matter of cortical gyri and sulci of brain.

#### Differential diagnosis list

##### Cattle

- Lead poisoning
- Hypovitaminosis A
- Sodium chloride toxicity
- *Histophilus somni* meningoencephalitis

##### Sheep

- Pregnancy toxemia
- *Clostridium perfringens* type D enterotoxemia
- Focal symmetric encephalomalacia
- Lead poisoning.

##### Goats

- Pregnancy toxemia
- *C. perfringens* type D enterotoxemia
- Closantel overdosage<sup>1</sup>
- Lead poisoning

**Treatment** Thiamine hydrochloride parenterally.

**Control** Thiamine supplementation of diet. Avoid excess feeding or access to sulfate in feed and water supplies.

### ETIOLOGY

Historically, PEM was considered to be caused by a thiamine inadequacy. It is important to realize that PEM is a histologic description of a cerebral injury affecting predominantly the gray matter, and that there are several different causes of PEM in ruminants. The current preference is to discuss PEM in relationship to a suspected etiology.

#### Thiamine Inadequacy

Thiamine (vitamin B<sub>1</sub>) is synthesized only in bacteria, fungi, and plants but is an essential nutrient for animals. Consequently, animals must obtain thiamine from their diet. The evidence that a thiamine inadequacy can be associated with the disease includes the following:

- Affected animals respond to the parenteral administration of thiamine if given within a few hours after the onset of clinical signs
- Affected animals have biochemical findings consistent with thiamine pyrophosphate ([TPP], also known as TDP) inadequacy (TPP is the biologically active form of thiamine)
- The clinical signs and pathologic lesions can be reproduced in sheep and cattle by the administration of large daily

doses of pyrimidine containing structural analogs of thiamine, principally amprolium, given orally or intraperitoneally.

### Excess Dietary Sulfur

Elemental sulfur in the rumen is metabolized by two pathways: (1) reduction of sulfate ( $\text{SO}_4^{2-}$ ) to sulfide ( $\text{S}^{2-}$ ), which is then incorporated into sulfur-containing compounds such as cysteine and methionine that are used by rumen bacteria and (2) reduction of sulfate to sulfide, which is converted to hydrosulfide ( $\text{HS}^-$ ) at normal rumen pH (pKa of  $\text{S}^{2-} + \text{H}^+ \leftrightarrow \text{HS}^-$  is 11.96). Hydrosulfide is in equilibrium with hydrogen sulfide in the rumen because the pKa for the equilibrium reaction:  $\text{HS}^- + \text{H}^+ \leftrightarrow \text{H}_2\text{S}$  is 7.04.<sup>2</sup> The practical significance of these equilibrium reactions is that sulfate metabolism results in higher levels of  $\text{H}_2\text{S}$  in rumen gas (and  $\text{H}_2\text{S}$  is assumed to be the toxic agent) at lower rumen values for pH. These equilibria reactions help to explain the association between high sulfate intakes, high-grain diets, and increased risk of sulfur-associated PEM. The ingestion of excessive quantities of sulfur from the diet and water supply can cause the disease in cattle and sheep without any change in the thiamine status of the tissues. An increased dietary sulfur intake may increase the metabolic demand for thiamine, possibly to offset the damaging effect of hydrogen sulfide on brain tissue.<sup>3</sup>

## EPIDEMIOLOGY

### Occurrence

PEM occurs sporadically in young cattle, sheep, goats, and other ruminants. In North America, UK, Australia, and New Zealand, the disease is most common in cattle and sheep that are being fed concentrate rations under intensified conditions such as in feedlots. An inadequate amount of roughage can result in a net decrease in the synthesis of thiamine. The disease is most common in well-nourished thrifty cattle 6 to 18 months of age (peak incidence 9–12 months of age) that have been in the feedlot for several weeks. Feedlot lambs may also be affected only after being on feed for several weeks. The disease also occurs in goats and in antelope and whitetail deer. It may affect goats from 2 months to 3 years of age and is commonly associated with milk-replacer diets in kids or concentrate feeding in older goats. The disease occurs only rarely in adult cattle, which may be a reflection of the greater quantities of roughage they usually consume. However, there are recent reports of the disease occurring in adult cows on pasture with access to drinking water containing excessive concentrations of sulfates.

### Morbidity and Case Fatality

Accurate morbidity and case-fatality data are not available, but outbreaks can occur suddenly in which up to 25% of groups of

feeder cattle may be affected, with case-fatality rates from 25% to 50%. Case-fatality rates are higher in young cattle (6–9 months) than in the older age group (12–18 months), and mortality increases if treatment with thiamine is delayed for more than a few hours after the onset of signs. In feedlot lambs, it has been suggested that approximately 19% of all deaths are caused by PEM.

### Risk Factors

When PEM was first described in 1956, and for about 30 years, it was considered to be a thiamine deficiency conditioned by dietary factors such as high-level grain feeding and inadequate roughage. PEM was most common in well-nourished young cattle from 6 to 12 months of age that were being fed high-level grain rations. The scientific investigations centered on the effects of dietary factors, such as grain diets, and the presence of thiaminases in certain diets on thiamine metabolism in the rumen. In recent years, it has become clear that the disease is not etiologically specific because many different dietary factors have been associated with the occurrence of the disease, and in some instances the thiamine status of the affected animals is within the normal range. Notable examples are the recent observations linking dietary sulfate with the occurrence of the disease.

### Dietary Risk Factors

Although there has been general agreement that thiamine inadequacy is associated with the cause of PEM, the possible mechanisms by which this occurs are uncertain. Thiamine inadequacy in ruminants could, theoretically, occur in any of the following situations in which inadequate net microbial synthesis of thiamine in the rumen may occur:

- Concentrate-fed animals receiving inadequate roughage
  - Impaired absorption and/or phosphorylation of thiamine
  - Presence of a thiamine inhibitor in the tissues of the host
  - Lack of sufficient or appropriate apoenzyme or coenzyme-apoenzyme binding for thiamine-dependent systems
  - Increased metabolic demands for thiamine in the absence of increased supply
  - Increased rate of excretion of thiamine resulting in its net loss from the body
- Thiamine can be destroyed by thiaminases of which significant amounts can be found in the rumen contents and feces of cattle and sheep affected with naturally occurring PEM.

### Thiamine Inadequacy

In cattle under farm conditions, using erythrocyte transketolase activity as a measurement of thiamine status, up to 23% of cattle under 2 years of age and 5% over 2 years may be in a thiamine-low state. Newly weaned

beef calves on a hay diet are not subject to a thiamine deficiency, but a low and variable proportion of young cattle on barley-based feedlot diets (1.7%) may have some evidence of thiamine deficiency based on a TPP activity effect in excess of 15%. The supplementation of the diet of feedlot steers on an all-concentrate barley-based diet with thiamine at 1.9 mg/kg dry matter resulted in an increase in average daily gain and final carcass weights. Thus some animals may be marginally deficient in thiamine, which may be associated with decreased performance in cattle fed all-concentrate diets. However, thiamine supplementation of cattle on all-concentrate diets does not consistently result in improved animal performance. The experimental disease can be produced in young lambs fed a thiamine-free milk diet, and it may be unnecessary to postulate that thiamine analogs produced in the rumen are essential components of the etiology.

### Thiaminases

A major factor contributing to PEM in cattle and sheep is a progressive state of thiamine deficiency caused by the destruction of thiamine by bacterial thiaminases in the rumen and intestines. Certain species of thiaminase-producing bacteria have been found in the rumen and intestines of animals with PEM. *Bacillus thiaminolyticus* and *Clostridium sporogenes* produce thiaminase type I and *B. aneurinolyticus* produces thiaminase type II. Although there is good circumstantial evidence that the thiaminases from these bacteria are the real source of thiaminases associated with the disease, it is not entirely certain. The experimental oral inoculation of large numbers of thiaminase type I producing *C. sporogenes* in lambs did not result in the disease.

Certain species of fungi from moldy feed are also thiaminase producers, but the evidence that they destroy thiamine and are associated with PEM is contradictory and uncertain.

The factors that promote the colonization and growth of thiaminase-producing bacteria in the rumen are unknown. Attempts to establish the organism in the rumen of healthy calves or lambs have been unsuccessful. Thiaminases have also been found in the rumen contents and feces of normal animals, which may suggest the existence of a subclinical state of thiamine deficiency. Poor growth of unweaned and weaned lambs can be associated with a thiaminase-induced subclinical thiamine deficiency. Weekly testing of young lambs over a period of 10 weeks revealed that 90% of unthrifty lambs were excreting high levels of thiaminase in their feces; low levels of thiaminase activity were present in 20% of clinically normal animals, and there were significant differences in the mean erythrocyte transketolase activity of the unthrifty animals excreting

thiaminase compared with the thiaminase-free normal animals.

Field and laboratory investigations have supported an association between inferior growth rate of weaner sheep in Australia and a thiaminase-induced thiamine deficiency. Thiaminase activity has been detected in the feces of lambs at 2 to 5 days of age, with the levels increasing for 10 days and then declining over the next 3 to 4 weeks. Decreased erythrocyte transketolase activity indicated a thiamine insufficiency in lambs with high thiaminase activity, and mean growth rates were 17% less than lambs with low thiaminase activity. The oral supplementation with thiamine at 2 to 3 weeks of age was the most appropriate prevention and treatment for subclinical thiamine deficiency.

The parenteral or oral administration of thiamine to normal calves raised under farm conditions resulted in a marked reduction in the percentage TPP effect, which is an indirect measurement of thiamine inadequacy. Goats with PEM were found to have elevated ruminal and fecal thiaminase activities, low erythrocyte transketolase activity, elevated TPP effect, low liver and brain thiamine levels, and elevated plasma glucose levels compared with goats not affected with the disease. With the increased interest in goat farming, some breeders attempted to improve body condition of breeding stock for sale or show by feeding grain or concentrate, which creates a situation similar to feedlot rearing of sheep and cattle that is conducive to the establishment of thiaminases in the rumen and the occurrence of PEM.

High levels of thiaminase type I are present in the rhizomes of bracken fern (*Pteridium aquilinum*) and horsetail (*Equisetum arvense*). The feeding of the bracken fern rhizomes (*P. esculentum*) to sheep will cause acute thiamine deficiency and lesions similar to those of PEM, but neither of these plants is normally involved in the natural disease. The disease has occurred in sheep grazing the Nardoo fern (*Marsilea drummondii*) in flood-prone or low-lying wet areas in Australia. The fern contains a high level of thiaminase type I activity.

*Amaranthus blitoides* (prostrate pigweed) may contain high levels of thiaminase and be associated with PEM in sheep.

**Sulfur-Induced Polioencephalomalacia** PEM has been associated with diets high in sulfur, particularly in the form of sulfate. A high concentrate of sulfates in the diet of cattle has been associated with episodes of the disease in 6- to 18-month-old cattle. Inorganic sulfate salts in the form of gypsum (calcium sulfate) added to feedlot rations to control the total daily intake of the diet may cause PEM. Seasonal outbreaks have occurred in feedlot beef cattle between 15 and 30 days after introduction to a **high-sulfur diet**, and the risk may increase when water is an important source of dietary

sulfur, and during hot weather, when the ambient temperatures exceeded 32°C.

Initial outbreaks may follow the use of a **new well of water containing more sulfate** than water used previously from another well, increasing from a monthly incidence of 0.07% to 0.88%. Growing cattle consume 2.4 times more water when the temperature is 32°C than at 4°C; consequently total ingestion of sulfur by consumption of high-sulfate water increases during hot weather. The feed contained 2.4 g of SO<sub>4</sub>/kg dry matter with a total sulfur content of 0.20%. Samples of drinking water contained between 2.2 and 2.8 g of SO<sub>4</sub>/L. During hot weather daily sulfur ingestion from feed and water combined was estimated to be 64 g per animal corresponding to total dietary sulfur of approximately 0.67% of dry matter. Daily SO<sub>4</sub> ingestion was approximately 160 g per animal. The ruminal sulfide levels were much higher 3 weeks after entering the feedlot, when the incidence of the disease was greatest, than 2 months after entering the feedlot when the risk of the disease was low.

In western Canada, there is an association between PEM and high levels of sodium sulfate in water, and range cows are usually affected when certain waters become concentrated with this salt during the summer months. Water containing high levels of magnesium sulfate, often called **gyp water** (for gypsum water) is common in the western plains and intermountain areas of the United States and Canada. Ideally, water for livestock consumption should contain less than 500 ppm sulfate, and 1000 ppm is considered the maximum safe level in water for cattle exposed to moderate dietary sulfur levels or high environmental temperatures. A level of 2000 ppm of sulfate in drinking water is the taste discrimination threshold for cattle. Performance of feedlot cattle is reduced when offered water with sulfate levels of 2000 ppm or higher. The National Research Council states that the requirement of sulfur in feed to be 1500 to 2000 ppm for both growing and adult beef cattle; 4000 ppm is considered the maximum tolerated dose. Ruminant diets normally contain between 1500 to 2000 ppm (0.15%–0.20% sulfur).

Based on National Research Council guidelines, 30 g of sulfur is the calculated maximum tolerated dose of sulfur for a 650-lb (294-kg) steer consuming 16.25 lb (7.39 kg; 2.5% BW) of feed daily. If the ambient temperature reaches 32°C, a 650-lb steer can drink 14.5 gallons (53.9 L) of water daily. Consumption of 14.5 gallons of water containing 3000 ppm sulfate results in a daily intake of 55 g of sulfur. A feed intake of 2.5% BW would also consume 22.2 g of sulfur from feed containing 3000 ppm sulfur for a total daily intake of 77.2 g of sulfur from both feed and water, which is 2.5 times the maximum tolerated dose.

In some surveys, water supplies in western Canada contained 8447 ppm of total dissolved solids and 5203 ppm of sulfate. A survey of the sulfate concentrations in water on farms found that high levels of sulfate can have a detrimental effect on the thiamine status of the cattle on those farms. Cattle exposed to sulfate concentrations >1000 ppm had blood thiamine levels lower than those drinking water with low levels <200 ppm. This raises the possibility that a subpopulation of cattle under such circumstances could be marginally deficient in thiamine.

**The total dietary intake of sulfur** by cattle must be considered when investigating sulfur as a cause of PEM. In a study of one farm, water from a 6.1-m well containing 3875 mg/L of total dissolved solids with 3285 mg/L of sodium sulfate was associated with PEM in heifers 6 months of age. However, the water contributed about 20% of the total sulfur content in the diet of the heifers, and 60% of the dietary sulfur intake was supplied by the hay and 20% by the grain supplement. The hay contained 0.4% total sulfur, which is at the maximum tolerable level for cattle and at the upper limit for hay. The hay consisted of variable amounts of kochia (*Kochia scorpia*) and Canada thistle (*Cirsium arvense*). *K. scorpia* (summer cypress or Mexican fireweed) is high in sulfur content and has been associated with the disease in range cattle.

The levels of sulfate in water that have affected feed intake in cattle have varied from 2800 to 3340 mg sulfate/L, whereas other studies found no reduction in feed intake with levels up to 7000 mg/L. It appears that the different effects of sulfur toxicity for similar sulfur contents in saline water are attributed to the total sulfur intake. Outbreaks of the disease may occur in adult cattle on pasture drinking water containing 7200 ppm of sodium sulfate. Thus established guidelines for saline drinking water are not applicable when cattle are fed feeds grown in saline areas.

A combination of excessive intake of sulfur and a low dietary intake of trace minerals, especially copper, may affect the thiamine status of a cattle herd and contribute to PEM. Sulfur adversely affects both thiamine and copper status in sheep. A nutritionally related PEM has also been reproduced in calves fed a semipurified, low-roughage diet of variable copper and molybdenum concentrations and it was not related to copper deficiency. The disease has occurred in cattle in New Zealand fed chou moellier (*Brassica oleracea*), which contained sulfur concentrations of 8500 mg/kg dry matter. The morbidity was 25% and mortality 46% despite rapid conventional therapy. Sulfur-associated PEM has also occurred in Australia when cattle grazed extensive stands of *Sisymbrium irio* (London rocket), *Capsella bursapastoris* (shepherd's purse), and *Raphanus raphanistrum* (wild radish), which all contain high



sulfur content and are in the Brassicaceae (Cruciferae) family.<sup>4</sup>

**Ammonium sulfate** used as a urinary acidifier in the rations of cattle and sheep has been associated with outbreaks of PEM. Morbidity rates ranged from 16% to 48% and mortality rates from 0% to 8%. Affected animals did not respond to treatment with thiamine.

Outbreaks have occurred in sheep exposed to an alfalfa field previously sprayed with 35% **suspension of elemental sulfur**. The disease can be induced experimentally in lambs by the administration of sodium hydrosulfide into the esophagus and has occurred in lambs 3 to 4 weeks after being fed a concentrate ration containing 0.43% sulfur. Feeding experimental diets containing inorganic sulfur to young lambs was associated with PEM, and supplementation of those diets with thiamine decreased the severity of the lesions. Rumen microbes are able to reduce sulfate to sulfides, which may be directly toxic to the nervous system. Feeding calves (115–180 kg) a semipurified diet high in readily fermentable carbohydrate, without long fiber, and with added sodium sulfate for a total sulfur content of 0.36% resulted in PEM within 21 days of the introduction of the experimental diet. An odor of hydrogen sulfide was frequently detected on passage of a stomach tube into the rumen of all calves during the experiment. The total thiamine concentrations in affected and control calves remained within normal limits.

The dietary content of copper, zinc, iron, and molybdenum may also have important modifying influences on sulfur toxicosis. Molybdenum and copper can combine with sulfur to form insoluble copper thiomolybdate. Copper, zinc, and iron form insoluble salts with sulfide, and their expected effect would be to decrease the bioavailability of sulfide in the rumen. Conversely, low, but not necessarily deficient, dietary contents of these divalent metals could be prerequisites for excess absorption of sulfide to occur. PEM is not associated with copper deficiency, but copper and sulfur metabolism are interdependent. An excess of dietary sulfur may result in depression of serum copper, or alternatively, low serum copper may potentiate the actions of toxic levels of sulfur. Chronic copper poisoning in a lamb has been associated with PEM. It is suggested that the copper toxicity may have caused decreased hepatic function resulting in increased plasma concentration of sulfur containing amino acids which, may have predisposed to sulfur toxicity encephalomalacia.

Major dietary sulfur sources are inorganic salts that are fed in acidogenic diets to control periparturient hypocalcemia in dairy cattle, the by-products of grain processing, such as distillers grains, corn gluten meal, and brewers grain, and molasses, beet pulp,

and alfalfa hay. Prolonged feeding of barley malt sprouts to cattle in Turkey has resulted in PEM caused by the high sulfur content of barley sprouts.<sup>5</sup> Similarly, molasses toxicity occurred in Cuba in cattle fed on a liquid molasses-urea feeding system with limited forage. The clinical and necropsy findings were identical to PEM; however, molasses toxicity is not thiamine responsive and can be reversed by feeding forage.

#### Other Dietary Circumstances

**Deprivation of Feed and Water.** In some outbreaks there is a history of deprivation of feed and water for 24 to 28 hours, because of either a managerial error or frozen water supplies. In other cases, a rapid change in diet appears to precipitate an outbreak. Some outbreaks are associated with a temporary deprivation of water for 24 to 36 hours, followed by sudden access to water and an excessive supply of salt, a situation analogous to salt poisoning in pigs, but these require more documentation to ensure that they indeed are not salt poisoning.

In sheep flocks, a drastic change in management, such as occurs at shearing time, will precipitate outbreaks in which only the yearlings are affected. Changing the diet of sheep from hay to corn silage resulted in a decrease in thiamine concentrations in ruminal fluid to about 25% of control values on hay. The cause of the drop in thiamine concentrations is unknown.

#### *Phalaris Aquatica* “PEM-Like” Sudden Death in Sheep and Cattle.

The Mediterranean perennial grass *P. aquatica* (formerly *P. tuberosa*) can cause sudden death in sheep and cattle throughout southern Australia. The nervous form of the disease is similar clinically to PEM but atypical because of the very rapid onset and the absence of either neuronal necrosis or malacia in cerebral cortical sections from affected animals. The available evidence suggests that this form of phalaris sudden death is more likely to involve a peracute form of ammonia toxicity than a peracute form of PEM.

#### PATHOGENESIS

##### Thiamine Inadequacy Polioencephalomalacia

High levels of thiaminases are formed in the rumen, which destroy thiamine that is naturally synthesized. The circumstances in the diet or in the rumen that allow for the development of high levels of thiaminases are unknown but may be related to the nature of the ruminal microflora in young cattle and sheep fed concentrate rations, which results in the development of ruminal acidosis. These rations may also allow for the development and growth of thiaminase-producing bacteria which, combined with a smaller net synthesis of thiamine in the rumens of concentrate-fed ruminants, could explain the higher incidence in feedlot animals.

Experimentally PEM has been produced in lambs by continuous intraruminal infusion of a highly fermentable diet. Animals changed very rapidly to high-concentrate rations develop increased ruminal thiaminase levels.

The possibility that intraruminal thiaminases may also create thiamine analogs capable of acting as thiamine antimetabolites and accentuating the disease has been studied, but the results are inconclusive. The presence of naturally occurring second substrates (cosubstrates) in the rumen could produce, by the thiaminase type I reaction, a potent thiamine antimetabolite capable of accentuating the condition. In vitro studies have shown that thiaminase only caused rapid destruction of thiamine when a second substrate was added, and a large number of drugs commonly used as anthelmintics or tranquilizers may be active as second substrates. Many compounds found in the rumen of cattle are potential cosubstrates.

Amprolium has been used extensively to produce the lesions in the brains of cattle and sheep that are indistinguishable from the naturally occurring disease. However, because amprolium has been found in the brain tissue, the experimental disease should perhaps be known as “amprolium poisoning encephalopathy.” The administration of other antagonists such as oxythiamine and pyriothiamine does not produce the disease. This suggests that PEM is a particular form of thiamine deficiency in which the supply of thiamine is reduced by the action of intraruminal thiaminase. Thus the thiamine status of the animal will be dependent on dietary thiamine intake, thiamine synthesis, the presence of thiaminase in the rumen, and the effects of possible antimetabolites. Subclinical states of thiamine deficiency probably exist in apparently normal cattle and sheep being fed diets that are conducive to the disease. This suggests that in outbreaks of the disease the unaffected animals of the group should be considered as potential new cases and perhaps treated prophylactically.

Thiamine is an essential component of several enzymes involved in intermediary metabolism and a state of deficiency results in increased blood concentration of pyruvate, a reduction in the lactate to pyruvate ratio and depression of erythrocyte transketolase. These abnormalities affect carbohydrate metabolism in general, but in view of the specific requirements of the cerebral cortex for oxidative metabolism of glucose, it is possible that a thiamine inadequacy could have a direct metabolic effect on neurons. The brain of the calf has a greater dependence on the pentose pathway for glucose metabolism, in which pathway the transketolase enzyme is a rate-limiting enzyme. Ultrastructural examination of the brain of sheep with the natural disease reveals that the first change that occurs is an edema of the intracellular compartment, principally

involving the astrocytes and satellite cells. This is followed by neuronal degeneration, which is considered secondary. It has been suggested that the edema may be caused by a reduction in ATP production following a defect of carbohydrate metabolism in the astrocyte. There are three basic lesions that are not uniform: compact necrosis, edema necrosis, and edema alone. This may suggest that a uniform etiology such as thiamine deficiency cannot be fully supported.

In the cerebral cortex of affected animals, autofluorescent spots are observed under ultraviolet 365-nm illumination and are a useful diagnostic aid. The distribution of autofluorescence corresponds to that of mitochondria in cerebrocortical neurocytes in affected calves, suggesting that metabolic impairment occurs and the autofluorescent substance is produced in the mitochondria. Mitochondrial swelling and disorganization of cristae are also observable in brain tissue, but are not specific to PEM.

### Sulfate-Induced Polioencephalomalacia

Diets high in sulfur result in hydrogen sulfide production in the rumen and anaerobic bacteria from rumen samples of cattle fed high-carbohydrate, short-fiber diets with added sulfate will generate hydrogen sulfide in rumen fluid broth medium. Rumen microflora adapt to higher dietary sulfate content over a period of 10 to 12 days before they are capable of generating potentially toxic concentrations of sulfide. In experimental sulfate diets, which induce PEM, the rumen pH decreases during the transition to the experimental diet and acidic conditions in the rumen favor increased rumen gas cap concentrations of hydrogen sulfide. With a change of pH from 6.8 to 5.2, the percentage of hydrogen sulfide in the rumen gas cap increased from 47% to 97%.

Hydrogen sulfide gas concentration gradually increases in the rumen of sheep during the first 4 weeks on ingesting a medium-concentrate corn and alfalfa-based diet that contained substantial amounts of distillers grains.<sup>6</sup> Hydrogen sulfide is thought to be detoxified by the liver via oxidation to sulfate. Hydrogen sulfide absorbed across the ruminal wall into the portal circulation is not considered a likely mechanism of toxicity because absorbed hydrogen sulfide will be detoxified. However, a portion of the eructated hydrogen sulfide can be absorbed across the alveolar membrane directly into pulmonary capillaries, effectively bypassing hepatic detoxification before reaching the brain. If ruminants inhale 60% of eructated gases, inhalation of hydrogen sulfide could be a route of systemic sulfide absorption, in addition to gastrointestinal absorption. Sulfide inhibits cellular respiration leading to hypoxia, which may be sufficient to create neuronal necrosis in PEM. The nervous system lesions of sulfur toxicosis are

indistinguishable from lesions in the naturally occurring disease.

### Acute Cerebral Edema and Laminar Necrosis

Acute cerebral edema and laminar necrosis occur and the clinical signs are usually referable to increased intracranial pressure from the edema and the widespread focal necrosis. Recovery can occur with early treatment, which suggests that the lesions are reversible up to a certain point. EEGs of buffalo calves with amprolium-induced PEM found decreased frequency patterns, occasional spindles, and decreased voltage patterns during the onset of clinical signs. In the comatose stage, there was little evidence of electrical activity. EEGs of animals treated with thiamine hydrochloride found normal awake patterns.

## CLINICAL FINDINGS

### Cattle

Animals may be found dead without premonitory signs, especially beef cattle on pasture. The clinical findings are variable but characteristically, there is a sudden onset of **blindness; walking aimlessly; ataxia; muscle tremors**, particularly of the head with ear-twitching; **champing of the jaws** and frothy salivation; and **head-pressing** (which is really compulsive forward walking stopped by a wall), and the animal is difficult to handle or move (Fig. 14-12). Dysphagia may be present when one attempts to force feed hay by hand. Grinding of the teeth is common. Initially, the involuntary movements may occur in episodes, and convulsions may occur, but within several hours

they become continuous. The animal usually then becomes recumbent, and there is marked opisthotonus; nystagmus; clonic-tonic convulsions, particularly when the animal is handled or moved; and tetany of the forelimbs is common. The temperature is usually normal but elevated if there has been excessive muscular activity. The heart rate may be normal, subnormal, or increased and is probably not a reliable diagnostic aid.

Rumen movements remain normal for a few days, which is an important distinguishing feature from lead poisoning in which the rumen is static.

The **menace reflex is always absent** in the acute stage, and its slow return to normal following treatment is a good prognostic sign. The **palpebral eye-preservation reflex is usually normal**. The pupils are usually of normal size and responsive to light. In severe cases the pupils may be constricted. Dorsal strabismus caused by stretching of the trochlear nerve is common. Nystagmus is common and may be vertical or horizontal. Optic disc edema is present in some cases but is not a constant finding.

Calves 6 to 9 months of age may die in 24 to 48 hours, whereas older cattle up to 18 months of age may survive for several days. Recovery is more common in the older age group.

In less severe cases, affected animals are blind, head-press into walls and fences, and remain standing for several hours or a few days. In outbreaks, some cattle will be sternally recumbent; others remain standing with obvious blindness, whereas others are anorexic, mildly depressed, and have only partial impairment of eyesight. Those with



**Fig. 14-12** Weaned Polled Hereford calf with polioencephalomalacia. The calf has been walking in the same direction in the stall for many hours (as indicated by the straw). The diameter of the circle is determined by the width of the stall. The calf was blind and depressed, but was neurologically normal 48 hours later after aggressive treatment with intramuscular thiamine.



some eyesight will commonly return to almost normal. Some survivors are permanently blind to varying degrees but may begin to eat and drink if assisted. Some cases will recover following treatment and may grow and develop normally.

Evidence of recovery within a few hours following treatment with thiamine indicates that the disease is associated with thiamine inadequacy. A failure of response indicates the possibility of sulfur toxicity PEM.

### Sheep

Sheep usually begin to wander aimlessly, sometimes in circles, or stand motionless and are blind, but within a few hours they become recumbent with opisthotonus, extension of the limbs, hyperesthesia, nystagmus, and periodic tonic-clonic convulsions (Fig. 14-13). Hoggets affected at shearing time may show blindness and head-pressing but, if fed and watered, usually recover within a few days. Occasional animals show unilateral localizing signs, including circling and spasmodic deviation of the head. In goats, early signs may include excitability and elevation of the head. Blindness, extreme opisthotonus, and severe extensor rigidity and nystagmus are common.

In sulfur-induced PEM in sheep introduced to a diet containing 0.43% sulfur, clinical signs occurred 15 to 32 days later and consisted of depression, central blindness, and head-pressing, but no hyperesthesia, nystagmus, or opisthotonus were observed. In sulfur toxicity in lambs with PEM, the rumen contents may have a strong odor of hydrogen sulfide (rotten egg smell).

There are some reports from Australia of unthriftiness in unweaned and weaned lambs associated with thiamine deficiency caused by the presence of thiaminases in the alimentary tract. In affected flocks the incidence of ill-thrift in lambs is much higher than the usual incidence and other causes of unthriftiness were ruled out. Affected lambs lose weight, may have chronic diarrhea, and become emaciated and die of starvation. In some flocks, clinical signs of PEM may occur in a small percentage of animals. The disease is most common in early July, which is the coldest part of the year in Australia for lambs that are born in May and June. In affected lambs the fecal thiaminase levels are high and the blood transketolase level activity is increased above normal. Treatment of affected lambs with thiamine resulted in an increase in growth rate.

### CLINICAL PATHOLOGY

**Thiamine Inadequacy Polioencephalomalacia.** The biochemical changes occurring in cattle and sheep with the thiamine-deficiency PEM have not been well defined diagnostically based on thoroughly investigated naturally occurring clinical cases. However, some estimates are available including the changes that occur in the experimental disease. Interpretation of the values may also be unreliable if the animals have been treated before death. Because of challenges with the availability and cost of laboratory tests, the most practical method to confirm a diagnosis of PEM caused by thiamine inadequacy is the clinical response to treatment with thiamine.

In animals, thiamine is present as free thiamine, thiamine monophosphate (TMP), TDP (more commonly known as TPP, which is the biologically active form), and thiamine triphosphate (TTP). The role of TMP and TTP is not well known at this time. The critical forms to measure are therefore free thiamine and TPP.<sup>3</sup> The **thiamine concentrations** of blood of animals with PEM have varied widely and may be difficult to interpret because of the possibility of thiamine analogs inducing deficiency even when blood thiamine levels are normal. However, this would not apply when blood thiamine concentrations are below normal. A normal reference range of 75 to 185 nmol/L is suggested for both cattle and sheep, and levels below 50 nmol/L are considered indicative of deficiency. In normal goats, the mean thiamine content of blood was 108 nmol/L, with a range of 72 to 178 nmol/L. In goats with PEM, blood thiamine levels were less than 66 nmol/L with a mean of 29 nmol/L. Levels as low as 1.8 to 3.6 µg/dL (6–12 nmol/L) have been found in suspected cases of PEM. The thiamine concentrations of liver, heart, and brain of cattle and sheep with PEM are decreased. The levels of blood pyruvate and lactate are also increased and thiamine pyrophosphate-dependent enzymes such as pyruvate kinase are decreased. The thiaminase activity of the feces is increased. Laboratory reference ranges should be used to evaluate blood thiamine concentrations because of analytical differences related to whether the measurement relates to free thiamine, total thiamine, or TPP.

The **erythrocyte transketolase activity** is decreased in confirmed cases of thiamine-inadequacy PEM. Transketolase is an important enzyme in the pentose pathway and requires TPP. Measurement of transketolase activity in erythrocytes is attractive because a blood sample is readily obtained and this is a biologic assay. Unfortunately, the assay must be run soon after blood collection and is not widely available. Erythrocyte transketolase activities in normal sheep range from 40 to 60 IU/mL RBCs. A variant of the transketolase test involves the addition of a standard amount of TPP, with the percentage increase in erythrocyte transketolase activity

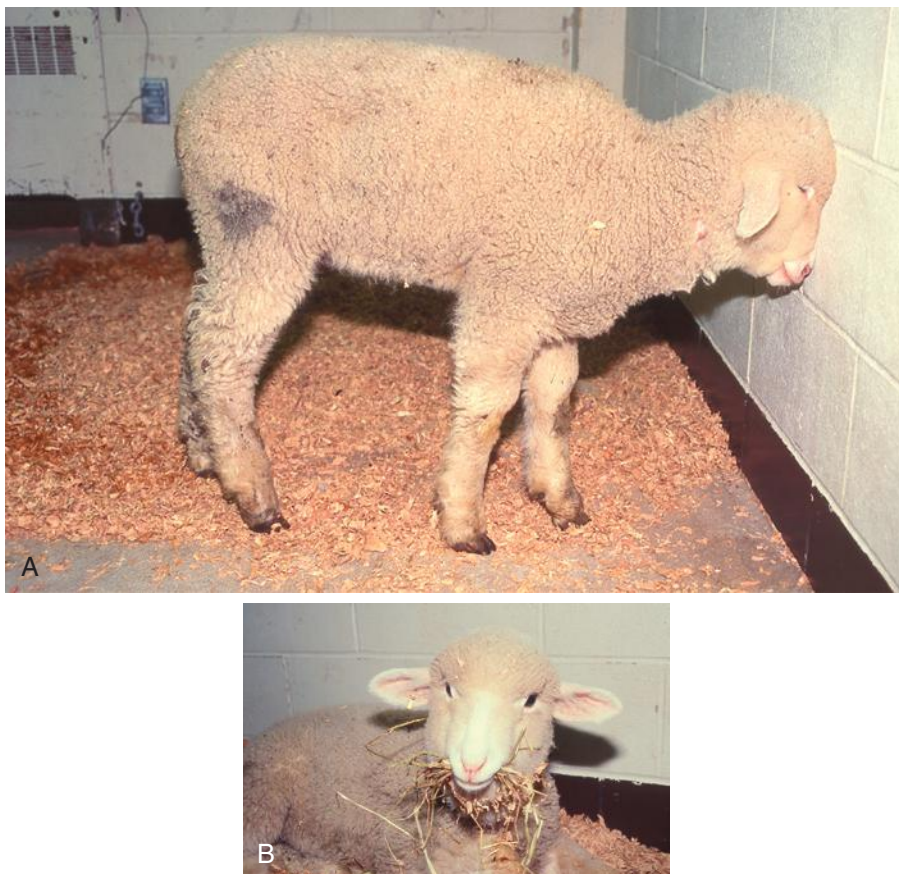

**Fig. 14-13** A, Weanling sheep with acute polioencephalomalacia demonstrating slow progressive walking that is interrupted by a wall. This is mistakenly called head-pressing. B, The same weanling sheep 24 hours later after repeated intravenous thiamine injections. The sheep has stopped progressive walking and the appetite has partially returned; however, the sheep is not fully aware and could not identify that it was still eating. It made a full recovery.



being recorded; this is called the TPP effect. A TPP effect of 30% to 50% is commonly found in normal healthy cattle and sheep, and an increase to above 70% to 80% occurs in animals with PEM.

It is important to note that decreased erythrocyte transketolase activities, an increased TPP effect, and decreased blood thiamine concentrations would be expected in animals that have been inappetent for a number of days because thiamine is a water-soluble vitamin within minimal body stores. For example, cattle with pneumonia or simple indigestion had lower plasma thiamine concentrations (1.00 and 0.50  $\mu\text{g}/\text{mL}$ , respectively) than healthy cattle (1.70  $\mu\text{g}/\text{mL}$ ).<sup>7</sup> Sheep with acute ruminal lactic acidosis had a mean TPP effect on erythrocyte transketolase activity of 109% compared with 22% in a health control group.<sup>8</sup> Measurements of erythrocyte transketolase activity, increased TPP effect, and blood TPP concentration should therefore be obtained from healthy animals in the same pen as the affected animal to adjust for the effect of feed intake on the measured values.

The **hemogram** is usually normal; the total and differential leukocyte counts may indicate a mild stress reaction, a finding that may be useful in differentiation from encephalopathies caused by bacterial infections.

**CSF pressure** taken at the cisterna magna is increased from a normal range of 12 to 16 cm  $\text{H}_2\text{O}$  to levels of 20 to 35 cm  $\text{H}_2\text{O}$ . The level of protein in the CSF may be normal to slightly or extremely elevated. A range from 15 to 540 mg/dL with a mean value of 90 mg/dL in affected cattle is recorded. There may also be a slight to severe pleocytosis in the CSF in which monocytes or phagocytes predominate.

**Brain Imaging Function.** MRI of a 2-month-old Holstein Friesian calf with thiamine-inadequacy PEM indicated a laminar hyperintense T2-weighted image of the cerebral cortex from the parietal to occipital lobes that predominantly affected the gray matter.<sup>9</sup> The visual evoked potentials are abnormal in ruminants with thiamine-responsive PEM.

### Sulfate-Induced Polioencephalomalacia

Sulfur-induced PEM is most commonly differentiated from other causes of PEM in ruminants by the lack of responsiveness to thiamine injections and calculation of total sulfur intake from feed and water. Measurement of ruminal hydrogen sulfide content or urinary thiosulfate concentration offers promise as useful diagnostic tests.

**Ruminal Hydrogen Sulfide Measurement.** Changes in rumen gas cap  $\text{H}_2\text{S}$  concentrations are larger than changes in rumen fluid  $\text{H}_2\text{S}$  concentrations, and estimation of

rumen gas  $\text{H}_2\text{S}$  concentration may be a practical method of detecting pathologic increases in ruminal hydrogen sulfide gas. A simple and rapid method has been developed for measuring the  $\text{H}_2\text{S}$  concentration of ruminal gas under field conditions, and an excellent description of the procedure is available.<sup>2,6</sup> In brief, the left paralumbar fossa is clipped and aseptically prepared. A sterile 7.6- to 10.2-cm 12- to 18-gauge needle with stylet is introduced into the gas cap of the rumen by way of the left paralumbar fossa. The needle is then connected to a calibrated  $\text{H}_2\text{S}$  detector tube. In cattle with sulfate-induced PEM increases in ruminal gas  $\text{H}_2\text{S}$  may be as high as 100 times more than control animals; however, ruminal pH has a marked effect on the measured value for  $\text{H}_2\text{S}$ ,<sup>2</sup> suggesting that test interpretation needs to be adjusted for rumen pH to improve diagnostic accuracy. The hydrogen sulfide test is more accurate when applied to healthy animals in the same pen as an animal showing clinical signs of sulfate-induced PEM, because affected animals have a markedly reduced appetite and therefore lower sulfate intake and higher ruminal pH.

**Urine thiosulfate concentrations** appear to provide a useful diagnostic tool for sulfate-induced PEM in ruminants. Thiosulfate ( $\text{S}_2\text{O}_3^{2-}$ ) is produced by incomplete oxidation of sulfide and by partial reduction of sulfate and therefore an increase in urine or plasma thiosulfate concentration reflects an increase in dietary sulfate intake or ruminal sulfide concentration. Thiosulfate concentrations in urine are stable for 8 hours at room temperature and 24 hours when stored at 4°C, and marked increases in urine thiosulfate concentrations occur when cattle are fed a high-sulfate diet, with the greatest increase occurring after feeding.<sup>2</sup> The urine thiosulfate concentration does not need to be normalized to urine creatinine concentration.

**Brain Function.** The effects of high dietary sulfur on brain function have been examined using evoked potentials techniques. Altered nerve conduction pathways occur in sheep fed high-sulfur diets without supplemental thiamine compared with animals that have received thiamine.

### NECROPSY FINDINGS

Diffuse cerebral edema with compression and yellow discoloration of the dorsal cortical gyri is evident, and the cerebellum is pushed back into the foramen magnum with distortion of its posterior aspect.

In recovered animals, there is macroscopic decortication about the motor area and over the occipital lobes. The lesion can be identified grossly using ultraviolet illumination, which results in a fluorescence that indicates necrosis of brain and engulfment of necrotic tissue by lipophages. In general, there is a good correlation between the presence of characteristic fluorescence and the

biochemical changes in cases of PEM. A small percentage of false negatives may occur.

Histologically, the lesions are widespread but most common in the cerebral cortex. There is bilateral laminar necrosis and necrosis of deeper cerebral areas. The necrosis is most prominent in the dorsal occipital and parietal cortex, but bilateral areas of necrosis are also seen less frequently in the thalamus, lateral geniculate bodies, basal ganglia, and mesencephalic nuclei. Lesions of the cerebellum are also present. The severity and distribution of the lesions probably depend on the interrelationships between clinical severity, age of affected animal, and length of illness before death.

Subnormal levels of thiamine are detectable in the liver and brain of calves with the natural disease, and low levels are also found in the experimental disease. In the molasses-induced disease in Cuba, the tissue thiamine levels were within the normal range.

In some cases of sulfur-associated PEM, the rumen contents have a strong odor of hydrogen sulfide (the rotten egg smell).

### DIFFERENTIAL DIAGNOSIS

The biochemical tests described under the section [Clinical Pathology](#) are not practical. The diagnosis must be made on the basis of clinical findings and the readily available simple tests that rule out other diseases that resemble polioencephalomalacia. A careful consideration of the epidemiologic history often assists in the diagnosis.

#### Cattle

The differential clinical diagnosis for cattle is summarized in [Table 14-12](#). Polioencephalomalacia in cattle occurs primarily in young growing animals 6–9 months of age on concentrate rations and is characterized clinically by a sudden onset of blindness, muscular tremors of the head and neck, head-pressing, nystagmus, and opisthotonus. The disease also occurs in mature beef cattle on pasture containing a high level of sulfate in their water and feed.

In cattle the disease must be differentiated from the following:

- **Acute lead poisoning**, which is most common in calves after spring turnout but occurs in adult cattle too and is characterized by central blindness, tremors, convulsions, uncontrollable activity with bellowing, champing fits, hyperexcitability, rumen stasis, and death in several hours. Early treatment may be successful.
- **Subacute lead poisoning** characterized by blindness, stupor, head-pressing, rumen stasis, weak palpebral reflexes, and no response to therapy.
- **Hypovitaminosis A** is characterized by a history of a vitamin A-deficient diet and nyctalopia, peripheral blindness, dilated and fixed pupils, optic disc edema, and transient convulsions followed by recovery.

- ***Histophilus somni* meningoencephalitis** characterized by sudden onset of ataxia, recumbency, fever, depression with eyes closed, lesions of the fundus, marked changes in hemogram, enlarged joints, and death in several hours if not treated early.

#### Sheep

In sheep polioencephalomalacia must be differentiated from the following:

- **Enterotoxemia (pulpy kidney disease) caused by *Clostridium perfringens* type D** in unvaccinated sheep, especially feedlot lambs, in which the clinical findings are almost identical; it occurs under the same management conditions as polioencephalomalacia. Enterotoxemia in lambs usually develops within several days after being placed on a grain ration, whereas polioencephalomalacia occurs after several weeks of grain feeding. Glycosuria in pulpy kidney disease may assist the diagnosis, but a necropsy is usually more informative
- **Focal symmetric encephalomalacia** also resembles polioencephalomalacia but is sporadic, usually involves only a few animals, and will not respond to treatment.

#### Goats

In goats the disease must be differentiated from enterotoxemia, pregnancy toxemia, lead poisoning, and meningoencephalitis.

## TREATMENT

### Thiamine Hydrochloride

The treatment of choice for thiamine-inadequacy PEM is thiamine hydrochloride at 10 mg/kg BW by slow intravenous injection initially and followed by similar doses every 3 hours for a total of five treatments. Bolus intravenous thiamine injections have been associated with collapse but are not usually fatal. Intramuscular injections of thiamine can be given instead of intravenous injections in animals that are difficult to handle with no discernable effect on treatment efficacy. When treatment is given within a few hours of the onset of signs, a beneficial response within 1 to 6 hours is common, and complete clinical recovery can occur in 24 hours. Goats and sheep will commonly respond within 1 to 2 hours. For those that take longer to recover, the eyesight and mental awareness will gradually improve in a few days and the animal will usually begin to eat and drink by the third day after treatment. Transfaunation of rumen fluid from roughage-fed cattle may improve appetite and rumen function in those responding slowly. In sheep, following treatment with thiamine, the blood transketolase activity begins to return to normal in 2 to 4 hours and is considered normal 24 hours after treatment.

Some cattle improve to a subnormal level within a few days and fail to continue to improve. These are usually affected with diffuse cortical and subcortical necrosis and

will usually not improve further in spite of continued treatment. Those that return to a clinically normal state will usually do so by 48 hours or sooner after initial treatment. Those that are still clinically subnormal and anorexic by the end of the third day will usually remain at that level and should be slaughtered for salvage.

General treatment of cerebral edema (such as intravenous infusions of 20% mannitol at 0.25–1 g/kg BW or 7.2%–7.5% NaCl solution at 4–5 mL/kg BW, and parenteral dexamethasone (1 mg/kg BW, intravenous, see the section **Increased Intracranial Pressure, Cerebral Edema, and Brain Swelling**, earlier in this chapter) is theoretically indicated as part of the initial treatment of severely affected animals; however, clinical trials have not been conducted as to whether general treatment for cerebral edema provides a beneficial response above that provided by thiamine administration alone for ruminants with PEM caused by thiamine inadequacy. Both mannitol and dexamethasone are very expensive when administered to adult cattle, sheep, and goats.

Treatment is ineffective in advanced cases, but unless an accurate history is available on the length of the illness, it is usually difficult to predict the outcome until 6 to 12 hours following treatment. Thus it is usual practice to treat most cases with thiamine at least twice and monitor the response. If there is no beneficial response in 6 to 8 hours, emergency slaughter for salvage should be considered.

The oral administration of thiamine or thiamine derivatives is indicated when thiaminases are thought to be in the alimentary tract. Thiamine hydrochloride, at a rate of 1 g for lambs and kids and 5 g for calves in a drench, is recommended. However, because the action of thiaminase type I on thiamine may result in the production of thiamine analogs, which may act as inhibitors of thiamine metabolism, thiamine derivatives, which are resistant to thiaminases, lipid soluble and absorbed from the intestine, are being explored as therapeutic and prophylactic agents. Thiamine propyl disulfide can depress the thiaminase activities in the ruminal fluid of sheep with PEM within 2 hours after oral administration. The blood pyruvate levels and transketolase activities are also restored to normal and treated animals recovered clinically.

### Outbreak Management

In outbreaks, the in-contact unaffected animals on the same diet as the affected animals may be on the brink of clinical disease. The diet should be changed to one containing at least 50% roughage or 1.5 kg of roughage per 100 kg BW. Thiamine may be added to the ration at the rate of 50 mg/kg of feed for 2 to 3 weeks as a preventive against clinical disease, followed by a level of 20 to 30 mg/kg of feed (cattle and sheep) if the

animals remain on a diet that may predispose them to the disease.

### Sulfur-Induced Polioencephalomalacia

There is no specific treatment for PEM caused by sulfate toxicity. The use of thiamine hydrochloride in doses given earlier is recommended, and may be successful in some cases, particularly when administered early in the disease course.

## TREATMENT AND CONTROL

### Treatment

#### Thiamine inadequacy form

- Thiamine HCl (10 mg/kg BW by slow IV or IM every 3 hours for at least five treatments) (R-1)
- In severe acute cerebral edema
  - 20% mannitol IV (0.25–1.0 g/kg) or 7.2%–7.5% NaCl IV (4–5 mL/kg) (R-2)
  - Dexamethasone (1 mg/kg, IV, once) (R-2)
- Rumen transfaunation if prolonged off feed (R-2)
- Oral drench with thiamine (1 g to lambs/kids, 5 g to calves) if thiaminases are suspected (R-2)

#### Sulfur-induced form

- Thiamine HCl (10 mg/kg BW by slow IV or IM every 3 hours for at least five treatments) (R-2)
- Treat suspected cerebral edema (R-2)

### Control

#### Thiamine inadequacy form

- Alter intraluminal environment by increasing roughage or changing source of roughage (R-2)
- Supplement ration with thiamine at 3 mg/kg dry matter of feed (R-2)
- Remove amprolium from diet (R-2)

#### Sulfur-induced form

- Decrease overall sulfur intake in ration and water (R-1)
- Restrict access to pastures with Brassicaceae family plants that have high sulfur content (R-1)

BW, body weight; IM, intramuscularly; IV, intravenously.

## CONTROL

### Thiamine Supplementation

A rational approach to the control of PEM associated with thiamine inadequacy is to supplement the rations of concentrate-fed cattle and sheep with thiamine on a continuous basis. The daily requirements for protection have not been determined using controlled feeding trials, but a rate of 3 mg/kg dry matter of feed for cattle and sheep has been recommended. This level may not be protective in all situations, and response trials may be necessary to determine protective levels for different situations. Levels up to 20 to 30 mg/kg of feed may be necessary for protection. Most natural feedstuffs for ruminants contain thiamine at about

2 mg/kg dry matter, which when combined with the thiamine synthesized in the rumen will meet the requirements. However, the presence of thiaminases in the rumen will necessitate dietary supplementation with thiamine, but the optimal amount that will provide protection under practical conditions is uncertain.

The intramuscular injection of 500 mg thiamine three times weekly into 6-month-old calves raised under practical farm conditions will steadily reduce the percentage TPP effect to zero in about 6 weeks. The daily oral administration of 100 mg thiamine to young calves fed initially on milk substitutes and then on concentrates and hay results in a decrease in percentage pyrophosphate effect.

For animals fed diets associated with thiamine inadequacy, it is recommended that thiamine be added to the diet at the rate of 5 to 10 mg/kg dry matter. Cattle and sheep on concentrate-fed rations must also receive supplements containing all necessary vitamins and minerals, especially cobalt, a deficiency of which may be associated with some outbreaks of the disease.

### Feeding Roughage

The minimum amount of roughage, which should be fed to feedlot cattle and sheep to prevent the disease and still maintain them on high levels of concentrates is unknown. A level of 1.5 kg of roughage per 100 kg BW has been recommended, but this may not be economical for the feedlot whose profits are dependent on rapid growth in grain-fed cattle. Supplementation of the diet with thiamine appears to be the only alternative.

The prevention of the disease in sheep that are being moved long distances or gathered together for shearing and other management practices will depend on ensuring an ample supply of roughage and water and avoiding drastic changes in management.

### Sulfate Toxicity PEM

The prevention of the disease associated with a high sulfur intake in the feed and water supplies will depend on analysis of the feed and water for sulfate and making appropriate adjustments in the sources of feed and water to decrease the intake of sulfur to safe levels.

### FURTHER READING

- Apley MD. Consideration of evidence for therapeutic interventions in bovine polioencephalomalacia. *Vet Clin North Am Food Anim Pract.* 2015;31:151-161.
- Burgess BA. Polioencephalomalacia. *Large Animal Veterinary Rounds.* 2008;8:3.
- Niles GA, Morgan SE, Edwards WC. The relationship between sulfur, thiamine and polioencephalomalacia—a review. *Bovine Pract.* 2002;36:93-99.

### REFERENCES

- Sakhaee E, Derakhshanfar A. *J S Afr Vet Assoc.* 2010;81:116.
- Drewnoski ME, et al. *J Vet Diagn Invest.* 2012;24:702.
- Amat S, et al. *Res Vet Sci.* 2013;95:1081.
- McKenzie RA, et al. *Aust Vet J.* 2009;87:27.

- Kul O, et al. *J Vet Med A Physiol Pathol Clin Med.* 2006;53:123.
- Neville BW, et al. *J Anim Sci.* 2010;88:2444.
- Irmak K, et al. *Kafkas Univ Vet Fak Derg.* 1998;4:63.
- Karapinar T, et al. *J Vet Intern Med.* 2008;22:662.
- Tsuka T, et al. *Vet Radiol Ultrasound.* 2008;49:149.

## THIAMINE DEFICIENCY (HYPOTHIAMINOSIS)

The disease caused by deficiency of thiamine in tissues is characterized chiefly by signs of neurologic disease. PEM of ruminants is discussed in the previous section.

### ETIOLOGY

Thiamine deficiency can be primary; caused by deficiency of the vitamin in the diet; or secondary, because of destruction of the vitamin in the diet by thiaminase. A primary deficiency is unlikely under natural conditions because most plants, especially seeds, yeast, and milk contain adequate amounts.

Thiamine is normally synthesized in adequate quantities in the rumen of cattle and sheep on a well-balanced roughage diet. The degree of synthesis is governed to some extent by the composition of the ration, a sufficiency of readily fermentable carbohydrate causing an increase of synthesis of most vitamins of the B complex, and a high intake in the diet reducing synthesis. The etiology of PEM has been discussed in detail previously. Microbial synthesis of thiamine also occurs in the alimentary tract of monogastric animals and in young calves and lambs, but not in sufficient quantities to avoid the necessity for a dietary supply, so that deficiency states can be readily induced in these animals with experimental diets. Thiamine is relatively unstable and easily destroyed by cooking.

The coccidiostat, amprolium, is a thiamine antagonist and others are produced by certain plants, bacteria, fungi, and fish.

### EPIDEMIOLOGY

One of the best examples of secondary thiamine deficiency is inclusion of excess raw fish in the diet of carnivores, resulting in destruction of thiamine because of the high content of thiaminase in the fish.

Two major occurrences of secondary thiamine deficiency are recorded. In horses, the ingestion of excessive quantities of **bracken fern** (*P. aquilinum*) and **horsetail** (*E. arvense*) causes nervous signs because of the high concentration of thiaminase in these plants. The disease has been induced in a pig fed bracken rhizomes, and the possibility exists of it occurring under natural conditions. It also occurs in horses fed large quantities of turnips (*Beta vulgaris*) without adequate grain. The second important occurrence of thiamine deficiency is in the etiology of PEM and is discussed under that heading.

A thiaminase-induced subclinical thiamine deficiency causing suboptimal growth rate of weaner lambs has been described. Higher levels of thiaminase activity were present in the feces and rumen contents of lambs with poor growth rate compared with normal lambs. *B. thiaminolyticus* was isolated from the feces and ruminal fluids of affected lambs and supplementation of thiaminase-excreting lambs with intramuscular injections of thiamine hydrochloride was associated with significantly improved growth rate.

Thiamine deficiency occurs in sheep being subjected to live export from Australia to the Middle East. Sheep that died or were clinically ill and euthanized had significantly lower hepatic and ruminal thiaminase concentrations than clinically healthy control sheep. A high proportion had thiamine concentrations comparable with those found in sheep that die with PEM. The evidence indicates that the thiamine deficiency is a primary one associated with deprivation of feed during transportation to the preembarkation feedlots. The low feed intake and failure of the ruminal microbes to adapt, thrive, and synthesize a net surplus of thiamine during alterations in the ruminal environment are considered to be major contributing factors.

### PATHOGENESIS

The only known function of thiamine is its activity as a cocarboxylase in the metabolism of fats, carbohydrates, and proteins and a deficiency of the vitamin leads to the accumulation of endogenous pyruvates. Although the brain is known to depend largely on carbohydrates as a source of energy, there is no obvious relationship between a deficiency of thiamine and the development of the nervous signs that characterize it. PEM has been produced experimentally in preruminant lambs on a thiamine-free diet. There are other prodromal indications of deficiency disease. For example, there is a decrease in erythrocyte precursors and in erythrocyte transketolase. Additional clinical signs are also in the circulatory and alimentary systems, but their pathogenesis cannot be clearly related to the known functions of thiamine. Subclinical thiamine deficiency caused by thiaminases in the alimentary tract is associated with low erythrocyte transketolase activities and elevated TPP effects, which may explain the poor growth rate.

### CLINICAL FINDINGS

#### Bracken Fern (*P. aquilinum*) and Horsetail (*E. arvense*) Poisoning in the Horse

Incoordination and falling and bradycardia caused by cardiac irregularity are the cardinal clinical signs of bracken fern poisoning in the horse. These signs disappear after the parenteral administration of thiamine. Similar clinical effects occur with horsetail.



Swaying from side to side occurs first, followed by pronounced incoordination, including crossing of the forelegs and wide action in the hindlegs. When standing, the legs are placed well apart and crouching and arching of the back are evident. Muscle tremor develops and eventually the horse is unable to rise. Clonic convulsions and opisthotonus are the terminal stage. Appetite is good until late in the disease when somnolence prevents eating. Temperatures are normal and the heart rate slow until the terminal period, when both rise to above normal levels. Some evidence has also been presented relating the occurrence of hemiplegia of the vocal cords in horses with a below normal thiamine status. Neither plant is palatable to horses and poisoning rarely occurs at pasture. The greatest danger is when the immature plants are cut and preserved in meadow hay.

### Experimental Syndromes

These syndromes have not been observed to occur naturally but are produced readily on experimental rations.

In **pigs**, inappetence; emaciation; leg weakness; and a fall in body temperature, respiratory rate, and heart rate occur. The ECG is abnormal and congestive heart failure follows. Death occurs in 5 weeks on a severely deficient diet. In calves, weakness, incoordination, convulsions, and retraction of the head occur, and in some cases there is anorexia, severe scouring, and dehydration.

**Lambs** 1 to 3 days old placed on a thiamine-deficient diet show signs after 3 weeks. Somnolence, anorexia, and loss of condition occur first, followed by tetanic convulsions.

**Horses** fed amprolium (400–800 mg/kg BW daily) developed clinical signs of thiamine deficiency after 37 to 58 days. Bradycardia with dropped heartbeats, ataxia, muscle fasciculation and periodic hypothermia of hooves, ears, and muzzle were the common signs, with blindness, diarrhea, and loss of BW occurring inconstantly.

### CLINICAL PATHOLOGY

Blood pyruvic acid levels in horses are raised from normal levels of 2 to 3 µg/dL to 6 to 8 µg/dL. Blood thiamine levels are reduced from normal levels of 8 to 10 µg/dL to 2.5 to 3.0 µg/dL. ECGs show evidence of myocardial insufficiency. In pigs, blood pyruvate levels are elevated and there is a fall in blood transketolase activity. These changes occur very early in the disease. In sheep subjected to export, liver and rumen thiamine concentrations and erythrocyte transketolase activities were all below levels found in clinically normal sheep.

### NECROPSY FINDINGS

No macroscopic lesions occur in thiamine deficiency other than nonspecific congestive heart failure in horses. The myocardial

lesions are those of interstitial edema, and lesions are also present in the liver and intestine.

In the experimental syndrome in pigs, there are no degenerative lesions in the nervous system, but there is multiple focal necrosis of the atrial myocardium accompanied by macroscopic flabbiness and dilatation without hypertrophy of the heart.

### DIFFERENTIAL DIAGNOSIS

Diagnosis of secondary thiamine deficiency in horses must be based on the signs of paralysis and known access to bracken fern or horsetail. A similar syndrome may occur with poisoning by the following:

- *Crotalaria* spp.
- Perennial ryegrass
- *Indigofera enneaphylla*
- Ragwort (*Senecio jacobaea*)

It is accompanied by hepatic necrosis and fibrosis. The encephalomyelitides are usually accompanied by signs of cerebral involvement, by fever, and by failure to respond to thiamine therapy.

### TREATMENT

In clinical cases the injection of a solution of the vitamin produces dramatic results (5 mg/kg BW given every 3 hours). The initial dose is usually given intravenously followed by intramuscular injections for 2 to 4 days. An oral source of thiamine should be given daily for 10 days and any dietary abnormalities corrected.

### CONTROL

The daily requirement of thiamine for monogastric animals is generally 30 to 60 µg/kg BW. The addition of yeast, cereals, grains, liver, and meat meal to the ration usually provides adequate thiamine.

### THIAMINASE TOXICOSIS

#### SYNOPSIS

**Etiology** Thiaminases occur naturally in *Marsilea* spp., *Cheilanthes* spp., *Pteridium* spp., and *Equisetum* spp. ferns or fernlike plants.

**Epidemiology** Horses fed hay containing bracken; pigs eating bracken, especially rhizomes.

**Clinical pathology** Low blood concentrations of thiamine; high blood concentrations of pyruvate.

**Lesions** Similar to vitamin B<sub>1</sub> (thiamine) deficiency in horses; cardiac lesions in pigs.

**Diagnostic confirmation.** Low blood and urine levels of thiamine.

**Treatment** Injectable thiamine gives excellent results, provided thiamine source is withdrawn.

**Control** Limit access to plants.

### ETIOLOGY

The identified thiaminases that are important to animals occur in ferns or fernlike plants and catalyze the decomposition of thiamine. Thiaminases are of two types, methyltransferase and hydrolase. The hydrolases are not found in plants but only in the rumen, presumably as metabolites produced by ruminal bacteria from specific precursors in the plants. The thiaminase content of the ferns varies widely, being highest at a period of rapid growth and after being grazed severely. Thiaminase activity occurs in the fronds of the ferns *M. drummondii*, *Cheilanthes sieberi*, and *P. aquilinum* in descending order of magnitude. Plants containing thiaminases are usually deficient in thiamine.

The ferns that are sources of thiaminase and the animal species affected are as follows:

- Horses: *Pteridium* spp. (bracken fern), *E. arvense* (horsetail), *E. fluviatile*, *E. hyemale*, *E. palustre*, *E. ramosissimum*, *E. sylvaticum*, *M. drummondii* (Nardoo)<sup>1</sup>
- Sheep: *M. drummondii*, *C. sieberi* (mulga or rock fern)<sup>1</sup>
- Cattle: *C. sieberi*, *Dryopteris borreri*, *D. filix-mas*

### EPIDEMIOLOGY

#### Occurrence

Thiaminase poisoning associated with *Pteridium* spp. and *Equisetum* spp. occurs most often in horses fed hay contaminated by the ferns and is most toxic if the hay is cut when the fronds are very young. The standing plants are unpalatable and rarely eaten by these animals unless no other feed is available. In grazing horses ingesting 20% to 25% of their diet as thiaminase-containing plants, signs occur in 3 to 4 weeks; horses grazing on a pasture with thiaminase-containing plants providing close to 100% of their diet may show signs in as little as 10 days.<sup>2,3</sup> Stabled horses fed heavily contaminated hay may show signs in a short period of time, depending on how much thiaminase is present in the hay.

Thiaminase deficiency is less common in pigs and the clinical signs not as obvious.<sup>3</sup> Grazing pigs may root out and eat *Pteridium* rhizomes, which contain a much higher concentration of the thiaminase than the fronds. Sheep grazed on pastures dominated by *M. drummondii* on floodplains in inland Australia or forced to graze *C. sieberi* are poisoned.<sup>1</sup>

Grazing cattle may be forced to eat the ferns because of lack of other feed and when the fern is at a toxic, rapidly growing stage, but they are not affected by thiamine deficiency. They succumb to a hemorrhagic disease.<sup>4</sup>

### PATHOGENESIS

A state of thiamine deficiency is created by the destruction of thiamine in the alimentary

tract. The activities of enzymes that require thiamine, are impaired and there is an accumulation in tissues of pyruvate and lactate.<sup>3</sup> The relationship between the intake of the thiaminase and the nervous signs is not adequately explained. That a relationship exists is suggested by the development of brain lesions of PEM in sheep poisoned by *M. drummondii* and in those fed experimentally on the rhizomes of *P. aquilinum*.<sup>3</sup>

### CLINICAL FINDINGS

Affected horses sway from side to side, show gait incoordination, including crossing the forelimbs and a wide action in the hindlimbs. Abnormal postures include a wide stance, arching of the back, and crouching. Muscle tremor, cardiac irregularity, and bradycardia are evident. Terminally, the animal falls easily, becomes recumbent and hyposensitive to external stimuli, and makes convulsive movements. The heart rate and the temperature become elevated. Additional signs seen in horses poisoned by *M. drummondii* include carrying the head close to the ground, whinnying, partial blindness, nodding of the head, twitching of the ears, and frequent yawning.

Pigs fed bracken fern rhizomes (33% of diet) developed anorexia and nonspecific signs. At 8 weeks they deteriorated rapidly and death occurred at 10 weeks.<sup>3</sup> Post-mortem lesions were cardiac in nature. In another report, 4 of 22 piglets died when a pregnant sow was poisoned with bracken fern.<sup>3</sup>

Sheep poisoned by *M. drummondii* may be affected by an acute or a chronic syndrome. The acute form of the disease is characterized by the sudden onset of dyspnea, depression, and recumbency and death in 6 to 8 hours. The chronic syndrome is indistinguishable from PEM. Sheep affected by *Cheilanthes* spp. poisoning are hyposensitive to external stimuli, including being blind, and walk slowly and with an uncoordinated gait.

Cattle poisoned by *Dryopteris* spp. are also blind and hyposensitive. Many recover but remain blind.

### CLINICAL PATHOLOGY

The characteristic findings attributable to a nutritional deficiency of thiamine are present. These include depression of blood levels of thiamine and transketolase and elevation of levels of blood pyruvate.

### NECROPSY FINDINGS

In naturally occurring cases in horses, there are no lesions recorded other than the nonspecific ones of acute or congestive heart failure. PEM has been seen in sheep and, in pigs, an enlarged mottled heart and congestion of the lungs and liver indicate the presence of congestive heart failure.

Diagnostic confirmation is based on low blood thiamine levels.

### DIFFERENTIAL DIAGNOSIS

#### Differential diagnosis list

- Hepatic encephalopathy
- Infectious encephalitis
- *Crotalaria* spp., *Senecio jacobea* toxicosis
- Staggers syndromes, e.g., ryegrass staggers, paspalum staggers, phalaris staggers

### TREATMENT

In the early stages, the administration of thiamine and removal of the dietary source of thiaminase are the critical procedures and recovery is to be expected. In horses, an intravenous injection of 0.5 to 1 g of thiamine followed by intramuscular administration for 3 to 5 days is recommended.<sup>2,5</sup> The response to treatment is usually excellent.

### CONTROL

Large-scale control is attempted by a combination of pasture management, application of herbicide, and mowing in early spring, but it is expensive and subject to error; thus professional agrochemical advice is desirable. Draining water from marshy areas and improving drainage will encourage grasses and legumes to compete with and outgrow these plants.

### FURTHER READING

Radostits O, et al. Thiaminase poisoning. In: *Veterinary Medicine: A Textbook of the Disease of Cattle, Horses, Sheep, Goats and Pigs*. 10th ed. London: W.B. Saunders; 2007:1882.

### REFERENCES

1. Finnie JW, et al. *Aust Vet J*. 2011;89:247.
2. Martinson K, et al. Horsetail and brackenfern. In: Martinson K, Hovda LR, Murphy M, eds. *Plants Poisonous or Harmful to Horses in North Central United States*. Minneapolis, MN: University of Minnesota Press; 2007:17.
3. Vetter J. *Acta Vet Hung*. 2009;18:183.
4. Plessers E, et al. *Vlaams Diergeneeskundig Tijdschr*. 2013;82:31.
5. Plumb DC. Thiamine HCl (Vitamin B1). In: Plumb DC, ed. *Veterinary Drug Handbook*. 7th ed. New York: Wiley and Sons; 2011:970.

### SALT TOXICITY (SODIUM CHLORIDE TOXICOSIS)

#### SYNOPSIS

**Etiology** Ingestion of excessive amounts of sodium chloride or normal intake of sodium but limited water intake.

**Epidemiology** Multiple sources of excess salt in the diet and limitations of drinking water.

**Clinical pathology** High serum levels of sodium and chloride; increased plasma osmolarity; eosinopenia in pigs. High salt content in water or feed.

#### Lesions

**Acute:** gastroenteritis plus neurologic abnormalities.

**Chronic:** eosinophilic meningitis in pigs; polioencephalomalacia in pigs and cattle. High rumen, brain, and CSF levels of sodium.

**Diagnostic confirmation** Elevated sodium content of rumen and brain. CSF sodium exceeds serum sodium. Elevated sodium in aqueous or vitreous humor.

#### Treatment

**Peracute with no signs:** remove source of salt and allow free choice water; monitor closely.

**Acute and chronic with signs:** remove source of salt, restrict water intake, IV fluid replacement.

**Control** Limit intake of salt-rich water, whey, concentrate mixes; ensure adequate drinking water supply at all times.

CSF, cerebrospinal fluid; IV, intravenous.

### ETIOLOGY

Sodium and chloride are the main ions responsible for maintaining osmotic balance in the ECF. Any alteration in serum concentrations, either through increased salt intake or decreased water consumption is likely to result in salt toxicity.<sup>1,2</sup>

Feed and water containing excessive quantities of salt are unpalatable to animals but excessive quantities of salt are sometimes ingested, especially in saline drinking waters. Specific details about the degree of salinity of drinking water compatible with health in animals are difficult to provide, because of the variation in the kinds of salts that occur in natural saline waters. Hyponatremia may also occur secondary to limited water intake such as occurs in cold environments when there is no access or water has frozen.

### EPIDEMIOLOGY

#### Occurrence

Salt poisoning will occur wherever bore water is used for livestock drinking. It is reported principally from Australia, North America, and South Africa. Other sources of excessive salt include the following:

- Saline drinking water, especially after a change from fresh water, and especially if the animals are thirsty.<sup>3</sup>
- Water accumulating in salt troughs during drought periods.
- Grazing on salt marshes or drinking water obtained from salt marshes.<sup>3</sup>
- Swill fed to pigs containing excessive amounts of salt from bakery dough residues, butcher shop brine, cheese factory salt whey, or salted fish waste.
- Excessive sodium sulfate given to pigs as treatment for gut edema if the water intake is restricted.
- Oil field brine.<sup>2</sup>

Salt poisoning associated with water deprivation may occur from:

- Temporary restriction of the water supply to pigs of 8 to 12 weeks of age and lambs and calves fed prepared feeds containing the standard recommendation of 2% salt; poisoning occurs when the animals are again allowed access to unlimited water.
- Pigs brought into new pens where drinking water is supplied in automatic drinking cups that are not be accustomed to their use and fail to drink for several days until they learn to operate the cups.
- Feeder lambs and calves may also be deprived of water when their water troughs are frozen over.

### Risk Factors

#### Animal Risk Factors

Swine are the most susceptible animals and have generated the most clinical reports of toxicity.<sup>4</sup> Sheep, beef cattle, and dry dairy cattle appear to be less susceptible than milking dairy cows, which are in turn less susceptible than horses. Heavy milking cows, especially those in the early stages of lactation, are highly susceptible to salt poisoning because of their unstable fluid and electrolyte status.

Many animals may be clinically affected and the mortality rate may be high when animals are kept under range conditions and have to depend on saline water supplies for drinking purposes. In animals kept under intensive conditions salt poisoning occurs only sporadically, but most affected animals die and heavy losses may occur in groups of pigs.

High salt intakes may be used in sheep to restrict food intake during drought periods and in the control of urolithiasis in feeder wethers, but salt poisoning does not occur if there is free access to water. Rations containing up to 13% of sodium chloride have been fed to ewes for long periods without apparent ill-effects, although diets containing 10% to 20% and water containing 1.5% to 2% sodium chloride do reduce food consumption. This may be of value when attempting to reduce feed intake but can be a disadvantage when sheep are watered on saline artesian water.

Toxic doses for acute sodium chloride poisoning in pigs, horses, and cattle are 2.2 g/kg BW and in sheep 6 g/kg. The toxicity of salt is significantly influenced by the age and BW of the subject. For example, dose rates that kill pigs of 6.5 to 10 kg BW have little effect on pigs of 16% to 20 kg BW. Water concentrations of 1000 mg Na/L water are associated with chronic problems in dairy cattle, including decreased production.<sup>2</sup>

#### Farm Risk Factors

Saline waters often contain a mixture of salts and those containing high levels of

magnesium or fluorine may be quite toxic. Water containing 0.2% to 0.5% magnesium chloride may be associated with reduced appetite and occasional diarrhea in sheep, especially if the sodium chloride content is also high, but water containing similar quantities of sodium sulfate does not have any harmful effect. Variation between bore waters includes differences in the relative proportions of the acid radicals, particularly sulfates, carbonates, and chlorides.

#### Environmental Risk Factors

Environmental temperatures have an effect on toxicity, with signs occurring in the summer on water containing levels of salt that appear to be nontoxic in the winter. Australian recommendations are that the maximum concentration for sodium chloride or total salts in drinking water should not exceed 1.3% for sheep, 1% for cattle, and 0.9% for horses. South African and Canadian recommended levels are much lower, but there does not appear to be any proof that such low levels of total and individual salts are necessary.

### PATHOGENESIS

#### Acute Poisoning

When excessive amounts of salt are ingested, gastroenteritis occurs because of the irritating effects from the high concentrations of salt. Dehydration and diarrhea result and are exacerbated by the increased osmotic pressure of the alimentary tract contents. Salt is absorbed from the gastrointestinal tract and may be associated with the involvement of the CNS.

#### Chronic Poisoning

Where the defect is one of decreased water but normal salt intake, there is an accumulation of sodium ions in tissues, including the brain, over a period of several days. An initial high sodium accumulation may inhibit anaerobic glycolysis, preventing active transport of sodium out of the cerebrospinal compartment. When water is made available in unlimited quantities, it migrates to the tissues to restore normal salt-water equilibrium. This is associated with acute cerebral edema and the appearance of signs referable to a sudden rise in intracranial pressure. The response is the same in all species, but in pigs there is also an accumulation of eosinophils in nervous tissue and the meninges. The sodium ion is the one that accumulates in the tissues, and identical syndromes are produced by the feeding of sodium propionate or sodium sulfate. It has also been observed that the feeding of soluble substances such as urea, which are excreted unchanged by the kidney, may be associated with anhydremia and an increase in the sodium ion concentration in brain tissue and the development of encephalomalacia.

This form of salt poisoning is chronic only in the sense that the sodium ion

accumulates gradually. The clinical syndrome is acute in much the same way as the syndrome is acute in chronic copper poisoning. There is an apparent relationship between this form of salt poisoning and PEM in all species.<sup>5,6</sup> Many outbreaks of the latter disease occur in circumstances that suggest chronic salt poisoning. Sheep adapt to a continuous high salt intake (up to 1.3% sodium chloride in the drinking water) by significant changes in numbers of microflora in the rumen, but this is not usually accompanied by any change in total metabolic activity. The same level of intake in sheep is associated with some mortality; chronic diarrhea; and reduction in fertility, weight gain, and wool growth.

### CLINICAL FINDINGS

#### Subclinical Salt Poisoning

Lower levels of intake can suppress food intake and growth without overt clinical signs. This occurs in heifers drinking water containing 1.75% sodium chloride; the animals only maintain weight at a salt level of 1.5% and show suboptimal weight gains when the water contains 1.25% sodium chloride. Drinking water containing 0.25% salt significantly reduces the milk yield of high-producing dairy cows.

#### Acute Salt Poisoning

With large doses, vomiting, diarrhea with mucus in the feces, abdominal pain, and anorexia occur. The more common syndrome, occurring 1 to 2 days after ingestion, includes opisthotonus, nystagmus, tremor, blindness, paresis, and knuckling at the fetlocks.<sup>7</sup> There may be a nasal discharge and polyuria. A period of recumbency with convulsions follows and affected animals die within 24 hours of first becoming ill. Sheep show similar signs. In swine the signs include weakness and prostration, muscle tremor, clonic convulsions, coma, and death after a course of about 48 hours.

#### Subacute Poisoning

This syndrome in cattle and sheep on saline drinking water includes depression of appetite; thirst; constant bawling, especially in calves; loss of BW; dehydration; hypothermia; weakness; and occasional diarrhea. Incoordination, collapse, and tetanic convulsions with frothing from the mouth and nose may occur if the animals are forced to exercise. Acetonemia may be a complication in lactating cows.

#### Chronic Salt Poisoning

Chronic toxicity occurs most often in pigs. Lack of appetite, constipation, thirst, restlessness, and pruritus occur 2 to 4 days after exposure. A characteristic nervous syndrome follows within 12 to 24 hours. Initially there is apparent blindness and deafness, with the pig remaining oblivious to normal stimuli and wandering about aimlessly, bumping



into objects, and pressing with the head. There may be circling or pivoting on one front leg. Recovery may occur at this stage or epileptiform convulsions begin, recurring at remarkably constant time intervals, usually 7 minutes, accompanied by tremor of the snout and neck. Clonic contractions of the neck muscles may be associated with jerky opisthotonus until the head is almost vertical causing the pig to walk backward and assume a dog-sitting posture. This may be followed by a clonic convulsion in lateral recumbency, with jaw champing, salivation, and dyspnea. Death may occur from respiratory failure or the pig relaxes into a state of coma for a few moments, revives, and wanders about aimlessly until the next episode occurs. The pulse and temperature are normal except in convulsive pigs when both may be elevated.

### CLINICAL PATHOLOGY

Serum sodium concentrations are elevated appreciably above normal levels (135–145 mmol/L) to about 160/170 to 210 mmol/L.<sup>1,8</sup> An eosinopenia is also evident during this stage and a return to normal levels usually indicates recovery. In cattle the same changes occur but there is no eosinopenia. CSF sodium concentration exceeds serum sodium concentration.

### NECROPSY FINDINGS

In acute salt poisoning of cattle, there is marked congestion of the mucosa of the omasum and abomasum. The feces are fluid and dark. Animals that have survived for several days show hydropericardium and edema of the skeletal muscles. Gastroenteritis may be evident in some pigs poisoned with large doses of salt, but in chronic poisoning there are no gross lesions. Histologically, the neurologic lesions of acute poisoning are restricted to expansion of perivascular spaces in the brain. In contrast, the microscopic changes in chronic salt poisoning in pigs are quite diagnostic. The expansion of perivascular spaces typical of acute cerebral edema is accompanied by meningitis featuring large numbers of eosinophils, which extend along Virchow–Robin spaces into the brain tissue. In pigs that survive there may be residual PEM, especially of the cerebral cortex. Chemical estimation of the amount of sodium and chloride in tissues, especially brain, may be of diagnostic value. Brain sodium levels exceeding 1,800 ppm are considered diagnostic in cattle and swine.<sup>2</sup>

### Samples for Confirmation of Diagnosis

- **Toxicology:** 50 g liver, skeletal muscle, brain, serum, CSF, aqueous, or vitreous humor, feed, water (assay for sodium concentration)
- **Histology:** formalin-fixed half of sagittally sectioned brain (LM)

### DIFFERENTIAL DIAGNOSIS

#### Differential diagnosis list

Bacterial meningoencephalitis  
Gut edema occurs in rapidly growing pigs  
Mulberry heart disease in older pigs  
Polioencephalomalacia  
Pseudorabies  
Viral encephalomyelitis

### TREATMENT

Treatment of both acute and chronic salt poisoning is the immediate removal of the toxic feed or water.<sup>8</sup> Further treatment involves correcting hypernatremia and serum hyperosmolality.

#### Acute Toxicity

If the animals have not yet shown clinical signs, allow access to water and monitor closely for several days. In those animals showing an acute onset of clinical signs (less than 12–24 hours), serum sodium concentration may be lowered by 1 mmol/L/h.<sup>8</sup> Intravenous fluids of choice include 5% dextrose in water or 0.45% sodium chloride in well-hydrated animals and 0.9% sodium chloride or an isotonic crystalloid in hypovolemic animals.<sup>1,8</sup>

#### Chronic Toxicity

Initially, access to fresh water should be restricted to small amounts at frequent intervals; unlimited access may be associated with a sudden increase in the number of animals affected. In advanced cases animals may be unable to drink and water may have to be administered by stomach tube. Serum sodium levels in those animals with toxicity of several days' duration or those with an unknown duration of hypernatremia should be decreased by no more than 0.5 mmol/L/h.<sup>8</sup> Fluid choices again depend on whether the animal is volume depleted or well hydrated.

If possible, serum sodium concentration should be measured and the following formula used to calculate the free-water deficit:

$$\text{Free-water deficit (L)} = 0.6 \times \text{BW (kg)} \\ \times \left( \frac{\text{current serum sodium concentration}}{\text{reference range serum sodium concentration}} - 1 \right)$$

No more than 50% of the free-water deficit should be replaced in the first 24 hours, with the remainder replaced over the subsequent 24 to 48 hours.

Supportive treatment includes gastrointestinal protectants, diuretics for pulmonary edema, and mannitol or hypertonic saline to decrease brain edema should it occur.

### CONTROL

Both salt and water should be freely available at all times. Drinking water for all classes of

livestock should not contain more than 0.5% sodium chloride or total salts. Water containing a high concentration of fluoride or magnesium is particularly dangerous to livestock and should be avoided. In cold weather, access to water should be monitored on a daily basis. Diets fed to pigs should not contain more than 1% salt. The manner in which whey is fed to pigs (with minimum water intake) makes prevention difficult unless the whey can be kept salt free at the cheese factory.

### FURTHER READING

- Radosiits O, et al. Sodium chloride poisoning. In: *Veterinary Medicine: A Textbook of the Disease of Cattle, Horses, Sheep, Goats and Pigs*. 10th ed. London: W.B. Saunders; 2007:1824.
- Senturk S, Huseyin C. Salt poisoning in beef cattle. *Vet Hum Toxicol*. 2004;46:26-27.
- Weeth HJ, Haverland LH. Tolerance of growing cattle for drinking water containing sodium chloride. *J Anim Sci*. 1961;20:518-521.

### REFERENCES

1. Goldkamp C, et al. *Comp Contin Educ Vet*. 2007;29:140.
2. Morgan SE. *Vet Clin North Am Food Animal Pract*. 2011;27:286.
3. Ollivett TL, et al. *J Vet Intern Med*. 2013;27:592.
4. Heydarpour F, et al. *Toxicol Environ Chem*. 2008;90:1115.
5. de Sant'Ana FJE, et al. *Braz J Vet Pathol*. 2010;3:70.
6. Macri SM, et al. *Vet Pathol Online*. 2013;0300985813498782.
7. Heydarpour F, et al. *Toxicol Environ Chem*. 2008;90:1035.
8. Abutarbus SM, et al. *Can Vet J*. 2007;48:184.

### VITAMIN A DEFICIENCY (HYPOVITAMINOSIS A)

A deficiency of vitamin A may be caused by an insufficient supply of the vitamin in the ration or its defective absorption from the alimentary canal. In young animals, the manifestations of the deficiency are mainly those of compression of the brain and spinal cord. In adult animals, the syndrome is characterized by night blindness, corneal keratinization, ptyriasis, defects in the hooves, loss of weight, and infertility. Congenital defects are common in the offspring of deficient dams. Vitamin A may also provide a protective effect against various infectious diseases and enhance many facets of the immune system.

### SYNOPSIS

**Etiology** Dietary deficiency of vitamin A or its precursors.

**Epidemiology** Primary vitamin A deficiency in animals fed diet deficient in vitamin A or its precursors. Common in cattle grazing dry pastures for long periods. Occurs when diet of hand-fed animals is not supplemented with vitamin A.

**Signs**

**Cattle:** Night blindness. Loss of body weight. Convulsions followed by recovery. Episodes of syncope. Permanent blindness with dilated pupils and optic disc edema.

**Pigs:** Convulsions, hindleg paralysis, congenital defects.

**Clinical pathology** Low levels plasma vitamin A.

**Necropsy findings** Squamous metaplasia of interlobular ducts of parotid gland. Compression of optic nerve tracts and spinal nerve roots. Degeneration of testes.

**Diagnostic confirmation** Low levels of plasma vitamin A and squamous metaplasia of interlobular ducts of parotid glands.

**Differential diagnosis list****Cattle**

- Polioencephalomalacia
- Hypomagnesemic tetany
- Lead poisoning
- Rabies
- Meningoencephalitis
- Peripheral blindness caused by bilateral ophthalmitis.

**Pigs**

- Salt poisoning
- Pseudorabies
- Viral encephalomyelitis
- Spinal cord compression caused by vertebral body abscess

**Treatment** Vitamin A injections.

**Control** Feed diets with adequate carotene. Supplement diet with vitamin A. Parenteral injections of vitamin A at strategic times.

**ETIOLOGY**

Vitamin A deficiency may be primary disease, caused by an absolute deficiency of vitamin A or its precursor carotene in the diet, or a secondary disease, in which the dietary supply of the vitamin or its precursor is adequate, but their digestion, absorption, or metabolism is interfered with to produce a deficiency at the tissue level.

**EPIDEMIOLOGY****Primary Vitamin A Deficiency**

Primary vitamin A deficiency is of major economic importance in groups of young growing animals on pasture or fed diets deficient in the vitamin or its precursors. In the UK, primary vitamin A deficiency occurs in housed cattle fed a ration containing little or no green forage. Animals at pasture receive adequate supplies of the vitamin, except during prolonged droughts, but animals confined indoors and fed prepared diets may be deficient if not adequately supplemented. For example, a diet of dried sugar beet pulp, concentrates, and poor-quality hay can result in hypovitaminosis A in confined beef cattle.

**Ruminants on Pasture**

Primary vitamin A deficiency occurs in beef cattle and sheep on dry range pasture during periods of drought. Clinical vitamin A deficiency does not always occur under these conditions because hepatic storage is usually good and the period of deprivation not sufficiently long for these stores to reach a critically low level. Young sheep grazing natural, drought-stricken pasture can suffer serious depletion of reserves of the vitamin in 5 to 8 months, but normal growth is maintained for 1 year at which time clinical signs develop. Adult sheep may be on a deficient diet for 18 months before hepatic stores are depleted and the disease becomes evident. Cattle may subsist on naturally deficient diets for 5 to 18 months before clinical signs appear. However, during the annual dry season (October to June), herds of cattle, sheep, and goats in the Sahelian region of West Africa are managed on dry grasses and shrubby ligneous plants, which fail to provide maintenance levels of crude protein and vitamin A. These substandard conditions result in vitamin A deficiency characterized by night blindness, xerophthalmia, retarded growth rates, reproductive failures, and increased mortality. The pastoral herders associate the cure of night blindness with the consumption of green vegetation and will purposefully herd livestock into green vegetation areas when available. Certain ethnic groups of pastoral herders depend on ruminant milk as their principal source of vitamin A, and night blindness in lactating and pregnant women as well as in young children appears after the onset of night blindness in their cattle and sheep during the latter half of the dry season. Therefore increasing vitamin A levels in the milk of cows may alleviate the clinical signs of vitamin A deficiency in herder families.

Primary vitamin A deficiency is still relatively common in beef cattle that depend on pasture and roughage for the major portion of their diet. Beef calves coming off dry summer pastures at 6 to 8 months of age are commonly marginally deficient.

**Maternal Deficiency**

A maternal deficiency of vitamin A can result in herd outbreaks of congenital hypovitaminosis A in calves. In one such occurrence, out of 240 heifers fed a vitamin A-deficient ration, 89 calves were born dead and 47 were born alive but blind and weak and died within 1 to 3 days after birth. Blindness with dilated pupils, nystagmus, weakness, and incoordination were characteristic. In another occurrence in the UK, 25% of the calves born from maternally vitamin A-deficient heifer dams had ocular abnormalities.

The status of the dam is reflected in the status of the fetus only in certain circumstances because carotene, as it occurs in green feed, does not pass the placental barrier, and a high intake of green pasture

before parturition does not increase the hepatic stores of vitamin A in newborn calves, lambs, or kids and only to a limited extent in pigs. However, vitamin A in the ester form, as it occurs in fish oils, will pass the placental barrier in cows. Feeding of these oils, or the parenteral administration of a vitamin A injectable preparation before parturition, will cause an increase in stores of the vitamin in fetal livers. Antepartum feeding of carotene and the alcohol form of the vitamin does, however, cause an increase in the vitamin A content of the colostrum. Young animals depend on the dam's colostrum for their early requirements of the vitamin, which is always highest in colostrum and returns to normal levels within a few days of parturition. Pigs weaned very early at 2 to 4 weeks may require special supplementation. Pregnant beef cows wintered on poor-quality roughage commonly need supplementation with vitamin A throughout the winter months to ensure normal development of the fetus and an adequate supply of the vitamin in the colostrum at parturition.

**Adequacy of Supplements**

The addition of vitamin A supplements to diets may not always be sufficient to prevent deficiency. Carotene and vitamin A are readily oxidized, particularly in the presence of unsaturated fatty acids. Oily preparations are thus less satisfactory than dry or aqueous preparations, particularly if the feed is to be stored for any length of time. Pelleting of feed may also cause a serious loss up to 32% of the vitamin A in the original feedstuff.

Heat, light, and mineral mixes are known to increase the rate of destruction of vitamin A supplements in commercial rations. In one study, 47% to 92% of the vitamin A in several mineral supplements was destroyed after 1 week of exposure to the trace minerals, high relative humidity, sunlight, and warm temperatures.

**Feedlot Cattle**

The disease still occurs in feedlot cattle in some parts of North America when feedlot cattle are fed rations low in carotene or vitamin A over a period of several months. The onset of clinical signs in growing feedlot cattle is typically seen 6 to 12 months after feeding a diet deficient in carotene or vitamin A. Small farm feedlots may feed their cattle a cereal grain such as barley and barley straw with no vitamin supplementation or inadequate supplementation. Grains, with the exception of yellow corn, contain negligible amounts of carotene, and cereal hay is often a poor source. Any hay cut late, leached by rain, bleached by sun, or stored for long periods loses much of its carotene content. The carotene content of yellow corn also deteriorates markedly with long storage. Moreover, under conditions not yet completely understood, the conversion by

ruminants of carotene present in feeds such as silage may be much less complete than was formerly thought.

In feedlot cattle, the disease is most common in steers fed the same ration as heifers that may remain clinically normal. It is suggested that sexual dimorphism may be caused by the production of vitamin A by the corpus luteum of heifers.

### Pigs

Young pigs on a deficient diet may show signs after several months, but as in other animals, the length of time required before signs appear is governed to a large extent by the status before depletion commences. As a general rule it can be anticipated that signs will appear in pigs fed deficient rations for 4 to 5 months; variations from these periods are probably caused by variations in the vitamin A status of the animal when the deficient diet is introduced. Congenital defects occur in litters from deficient sows, but the incidence is higher in gilts with the first litter than in older sows. It is presumed that the hepatic stores of vitamin A in older sows are not depleted as readily as in young pigs. Feeding white maize bran without supplementation can result in congenital defects in litters and paralysis in adult pigs.

### Horses

Adult horses may remain clinically normal for as long as 3 years on a deficient diet.

### Secondary Vitamin A Deficiency

Secondary vitamin A deficiency may occur in cases of chronic disease of the liver or intestines because much of the conversion of carotene to vitamin A occurs in the intestinal epithelium and the liver is the main site of storage of the vitamin. Highly chlorinated naphthalenes interfere with the conversion of carotene to vitamin A, and animals poisoned with these substances have a very low vitamin A status. The intake of inorganic phosphorus also affects vitamin A storage, low phosphate diets facilitating storage of the vitamin. This may have a sparing effect on vitamin A requirements during drought periods when phosphorus intake is low and an exacerbating effect in stall-fed cattle on a good grain diet. However, phosphorus deficiency may lower the efficiency of carotene conversion. Vitamins C and E help to prevent loss of vitamin A in feedstuffs and during digestion. Additional factors, which may increase the requirement of vitamin A, include high environmental temperatures and a high nitrate content of the feed, which reduces the conversion of carotene to vitamin A and rapid rate of gain. Both a low vitamin A status of the animal and high levels of carotene intake may decrease the biopotency of ingested carotene.

The continued ingestion of mineral oil, which may occur when the oil is used as a preventive against bloat in cattle, may cause

a depression of plasma carotene and vitamin A esters and the carotene levels in buffer fat. Deleterious effects on the cattle are unlikely under the conditions in which it is ordinarily used because of the short period for which the oil is administered and the high intake of vitamin A and carotene.

### PATHOGENESIS

Vitamin A is essential for the regeneration of the visual purple necessary for dim-light vision, for normal bone growth, and for maintenance of normal epithelial tissues. Deprivation of the vitamin produces effects largely attributable to disturbance of these functions. The same tissues are affected in all species. However, there is a difference in tissue and organ response in the different species and particular clinical signs may occur at different stages of development of the disease. The major pathophysiologic effects of vitamin A deficiency are as follows.

#### Night Vision and Ocular Abnormalities

Ability to see in dim light is reduced because of interference with regeneration of visual purple. Ocular abnormalities occur because of disruption to ocular, retinal, and optic nerve development from midpregnancy onward.<sup>1</sup>

#### Cerebrospinal Fluid Pressure

An increase in CSF pressure is one of the first abnormalities to occur in hypovitaminosis A in calves. It is a more sensitive indicator than ocular changes and, in the calf, it occurs when the vitamin A intake is about twice that needed to prevent night blindness. The increase in CSF pressure is caused by impaired absorption of the CSF from reduced tissue permeability of the arachnoid villi and thickening of the connective tissue matrix of the cerebral dura mater. The increased CSF pressure is responsible for the syncope and convulsions, which occur in calves in the early stages of vitamin A deficiency. The syncope and convulsions may occur spontaneously or be precipitated by excitement and exercise. It is suggested that the CSF pressure is increased in calves with subclinical deficiency and that exercise further increases the CSF pressure to convulsive levels.

#### Bone Growth

Vitamin A is necessary to maintain normal position and activity of osteoblasts and osteoclasts. When deficiency occurs, there is no retardation of endochondral bone growth, but there is incoordination of bone growth in that shaping, especially the finer molding of bones, does not proceed normally. In most locations this has little effect but may cause serious damage to the nervous system. Overcrowding of the cranial cavity occurs with resulting distortion and herniations of the brain and an increase in CSF pressure up to four to six times normal. The characteristic

nervous signs of vitamin A deficiency, including papilledema, incoordination, and syncope, follow. Compression, twisting, and lengthening of the cranial nerves and herniations of the cerebellum into the foramen magnum, causing weakness and ataxia, and of the spinal cord into intervertebral foramina results in damage to nerve roots and localizing signs referable to individual peripheral nerves. Facial paralysis and blindness caused by constriction of the optic nerve are typical examples of this latter phenomenon. The effect of excess vitamin A on bone development by its interference with vitamin D has been discussed elsewhere. Dwarfism in a group of pigs in a swine herd was suspected to be caused by vitamin toxicosis.

### Epithelial Tissues

Vitamin A deficiency leads to atrophy of all epithelial cells, but the important effects are limited to those types of epithelial tissue with a secretory as well as a covering function. The secretory cells are without power to divide and develop from undifferentiated basal epithelium. In vitamin A deficiency these secretory cells are gradually replaced by the stratified, keratinizing epithelial cells common to nonsecretory epithelial tissues. This replacement of secretory epithelium by keratinized epithelium occurs chiefly in the salivary glands, the urogenital tract (including placenta but not ovaries or renal tubules), and the periocular glands and teeth (disappearance of odontoblasts from the enamel organ). The secretion of thyroxine is markedly reduced. The mucosa of the stomach is not markedly affected. These changes in epithelium lead to the clinical signs of placental degeneration, xerophthalmia, and corneal changes.

Experimental vitamin A deficiency in lambs results in changes in the epithelium of the small intestine characterized by vesicular microvillar degeneration and disruption of the capillary endothelium. Diarrhea did not occur.

### Embryologic Development

Vitamin A is essential for organ formation during growth of the fetus. Multiple congenital defects occur in pigs and rats and congenital hydrocephalus in rabbits on maternal diets deficient in vitamin A. In pigs, administration of the vitamin to depleted sows before the 17th day of gestation prevented the development of eye lesions but administration on the 18th day failed to do so. A maternal deficiency of vitamin A in cattle can result in congenital hypovitaminosis A in the calves, characterized by blindness with dilated pupils, nystagmus, weakness, and incoordination. Constriction of the optic canal with thickening of the dura mater results in ischemic necrosis of the optic nerve and optic disc edema resulting in blindness. Retinal dysplasia also occurs. Thickening of the occipital and sphenoid



bones and doming of the frontal and parietal bones with compression of the brain also occur. Dilated lateral ventricles may be present and associated with increased CSF pressure.

### Immune Mechanisms

The effects of vitamin A and  $\beta$ -carotene on host defense mechanisms have been uncertain and controversial for many years. Some workers claim that the incidence and severity of bacterial, viral, rickettsial, and parasitic infections are higher in vitamin A-deficient animals. It is possible that vitamin A and  $\beta$ -carotene afford protection against infections by influencing both specific and non-specific host defense mechanisms. The protective effect of vitamin A may be mediated by enhanced polymorphonuclear neutrophil function, but this effect is also influenced by the physiologic status of the animal such as lactation status in dairy cattle. Experimentally, a severe vitamin A deficiency in lambs is associated with alterations in immune function, but the exact mechanism is unknown.

### CLINICAL FINDINGS

Similar syndromes occur in all species, but because of species differences in tissue and organ response, some variations are observed. The major clinical findings are set out in the following sections.

#### Night Blindness

Inability to see in dim light (twilight or moonlit night) is the earliest sign in all species, except in the pig, in which it is not evident until plasma vitamin A levels are very low. This is an important diagnostic sign.

#### Xerophthalmia

True xerophthalmia, with thickening and clouding of the cornea, occurs only in the calf. In other species, a thin, serous mucoid discharge from the eyes occurs, followed by

corneal keratinization, clouding and sometimes ulceration, and photophobia.

### Ocular Abnormalities

A range of ocular deformities, including cataract formation, lens luxation, microphthalmia, and reduction in the size of the optic nerve head, occurred in calves with low serum vitamin A and E concentrations (Fig. 14-14).<sup>1</sup> Mean vitamin A concentration was  $0.47 \mu\text{mol/L}$  (reference range 0.87 to  $1.75 \mu\text{mol/L}$ ) and the mean vitamin E concentration was  $2.28 \mu\text{mol/L}$  (reference range 3.0 to  $18 \mu\text{mol/L}$ ).

### Changes in the Skin

A rough, dry coat with a shaggy appearance and splitting of the bristle tips in pigs is characteristic, but excessive keratinization, such as occurs in cattle poisoned with chlorinated naphthalenes, does not occur under natural conditions of vitamin A deficiency. Heavy deposits of branlike scales on the skin are seen in affected cattle. Skin disease occurs in Angus calves (~8 months of age) with vitamin A deficiency and is characterized by alopecia, severe epidermal and follicular orthokeratosis, and acanthosis. Affected animals responded to vitamin A supplementation.<sup>2</sup>

Dry, scaly hooves with multiple, vertical cracks are another manifestation of skin changes and are particularly noticeable in horses.

A seborrheic dermatitis can be observed in deficient pigs but is not specific to vitamin A deficiency.

### Body Weight

Under natural conditions, a simple deficiency of vitamin A is unlikely to occur and the emaciation commonly attributed to vitamin A deficiency may be largely caused by multiple deficiencies of protein and energy. Although inappetence, weakness, stunted growth, and emaciation occur under experimental conditions of severe deficiency,

in field outbreaks severe clinical signs of vitamin A deficiency are often seen in animals in good condition. Experimentally, sheep maintain their BW under extreme deficiency conditions and with very low plasma vitamin A levels.

### Reproductive Efficiency

Loss of reproductive function is one of the major causes of loss in vitamin A deficiency. Both the male and female are affected. In the male, libido is retained but degeneration of the germinative epithelium of the seminiferous tubules causes reduction in the number of motile, normal spermatozoa produced. In young rams, the testicles may be visibly smaller than normal. In the female, conception is usually not interfered with, but placental degeneration leads to abortion and the birth of dead or weak young. Placental retention is common.

Dairy ewes on a diet low in vitamin A have increased somatic cell counts, possibly indicating a predisposition to mastitis in animals with hypovitaminosis A.<sup>3</sup>

### Nervous System

Signs related to damage of the nervous system include the following:

- **Paralysis** of skeletal muscles caused by damage of peripheral nerve roots
- **Encephalopathy** caused by increased intracranial pressure
- **Blindness** caused by constriction of the optic nerve canal

These defects occur at any age but are most common in young, growing animals; they have been observed in all species except horses.

#### Paralysis

The paralytic form is manifested by abnormalities of gait caused by weakness and incoordination. The hindlegs are usually affected first and the forelimbs later. In pigs, there may be stiffness of the legs, initially with a stilted gait or flaccidity, knuckling of the fetlocks and sagging of the hindquarters. Complete limb paralysis occurs terminally.

#### Convulsions

Encephalopathy, associated with an increase in CSF pressure, is manifested by convulsions, which are common in beef calves at 6 to 8 months, usually following removal from a dry summer pasture at weaning time. Spontaneously, or following exercise or handling, affected calves will collapse (syncope) and during lateral recumbency a clonic-tonic convulsion will occur, lasting for 10 to 30 seconds. Death may occur during the convulsion or the animal will survive the convulsion and lie quietly for several minutes, as if paralyzed, before another convulsion may occur. Affected calves are usually not blind and the menace reflex may be slightly impaired or hyperactive. Some calves are hyperesthetic to touch and sound. During

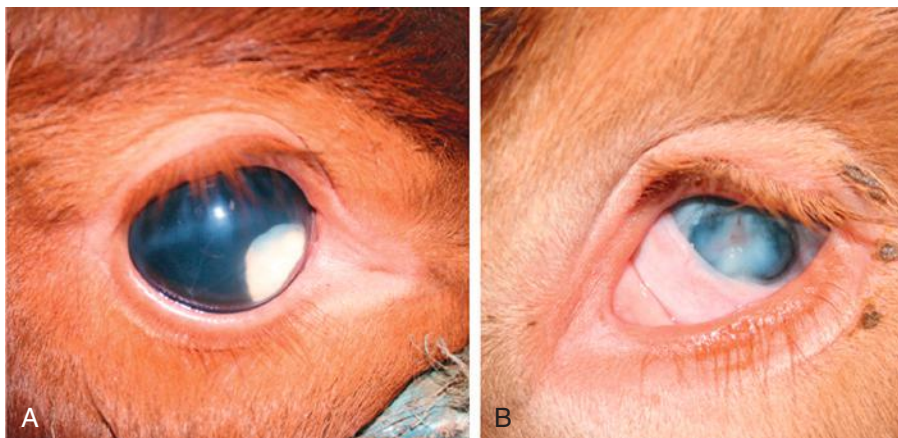

**Fig. 14-14** Lens dislocation (A) and ocular rupture (B) in Simmental calves with hypovitaminosis A. (Reproduced with permission from Anon. *Vet Rec* 2014;174:244.)

the convulsion there is usually ventroflexion of the head and neck, sometimes opisthotonus and, commonly, tetanic closure of the eyelids and retraction of the eyeballs. Outbreaks of this form of hypovitaminosis A in calves have occurred and the case-fatality rate may reach 25%. The prognosis is usually excellent; treatment will effect a cure in 48 hours, but convulsions may continue for up to 48 hours following treatment.

Seizures and acute death attributable to hypovitaminosis A and D have occurred in feeder pigs fed ground red wheat and whole milk and housed in a barn with no exposure to sunlight. Lethargy, inappetence, diarrhea, and vomiting and progression to convulsions were characteristic.

### Blindness

The ocular form of hypovitaminosis A occurs usually in yearling cattle (12–18 months old) and up to 2 to 3 years of age. These animals have usually been on marginally deficient rations for several months. Night blindness may or may not have been noticed by the owner. The cattle have usually been fed and housed for long periods in familiar surroundings and the clinical signs of night blindness may have been subtle and not noticeable. A computer-based algorithm for using pupillary light reflex responses to detect cattle with incipient visual loss or mild impairment of vision caused by hypovitaminosis A was not effective in detecting affected cattle.<sup>4</sup> The first sign of the ocular form of the disease is blindness in both eyes during daylight. Both **pupils** are **widely dilated and fixed** and will not respond to light. Optic disc edema may be prominent and there may be some loss of the usual brilliant color of the tapetum. Varying degrees of peripapillary retinal detachment, papillary and peripapillary retinal hemorrhages, and disruption of the retinal pigment epithelium may also be present. The **menace reflex** is usually totally absent, but the **palpebral and corneal reflexes** are present. The animal is aware of its surroundings and usually eats and drinks, unless placed in unfamiliar surroundings. The CSF pressure is increased in these animals, but not as high as in the calves described earlier. Convulsions may occur in these cattle if forced to walk or if loaded onto a vehicle for transportation. The prognosis for the ocular form with blindness is unfavorable and treatment is ineffective because of the degeneration of the optic nerves. Exophthalmos and excessive lacrimation are present in some cases.

### Congenital Defects

Congenital defects have been observed in piglets and calves. In piglets, complete absence of the eyes (**anophthalmos**) or small eyes (**microphthalmos**), incomplete closure of the fetal optic fissure, degenerative changes in the lens and retina, and an abnormal proliferation of mesenchymal tissue in front of

and behind the lens are some of the defects encountered.

Ocular abnormalities in newborn calves from maternally vitamin A-deficient heifers included corneal dermoid, microphthalmos, aphakia (absence of lens) and in some cases, both eyes covered by haired skin.<sup>5</sup> Cardiac defects, including ventricular septal defect and overriding aorta, are reported in a limited number of cases of calves with hypovitaminosis A, but the relationship is unclear.<sup>5</sup>

Other congenital defects attributed to vitamin A deficiency in pigs include cleft palate and harelip, accessory ears, malformed hindlegs, subcutaneous cysts, abnormally situated kidneys, cardiac defects, diaphragmatic hernia, aplasia of the genitalia, internal hydrocephalus, herniations of the spinal cord, and generalized edema. Affected pigs may be stillborn, or weak and unable to stand, or may be quite active. Weak pigs lie on their sides, make slow paddling movements with their legs, and squawk plaintively.

### Other Diseases

Increased susceptibility to infection is often stated to result from vitamin A deficiency. The efficacy of colostrum as a preventive against diarrhea in calves was originally attributed to its vitamin A content, but the high antibody content of colostrum is most important.

**Anasarca.** Edema of the limbs and brisket has been associated with vitamin A deficiency in feedlot cattle, especially steers. The pathogenesis is not understood. The edema can be extensive, include all four limbs, ventral body wall, and extend to the scrotum. Heifers were unaffected.

## CLINICAL PATHOLOGY

### Plasma Vitamin A

Vitamin A levels in the plasma are used extensively in diagnostic and experimental work. Plasma levels of 20 µg/dL are the minimal concentration for vitamin A adequacy. Papilledema is an early sign of vitamin A deficiency, which develops before nyctalopia and at plasma levels below 18 µg/dL. Normal serum vitamin A concentrations in cattle range from 25 to 60 µg/dL. In pigs, levels of 11.0 µg/dL have been recorded in clinical cases, with normal levels being 23 to 29 µg/dL. In experimental vitamin A deficiency in lambs, serum levels declined to 6.8 µg/dL (normal lambs at 45.1 µg/dL).

The clinical signs may correlate with the serum concentrations of vitamin A. In one outbreak, feedlot cattle with serum concentrations between 8.89 and 18.05 µg/dL had only lost BW, those between 4.87 and 8.88 µg/dL had varying degrees of ataxia and blindness, and those below 4.88 µg/dL had convulsions and optic nerve constriction. Clinical signs can be expected when the levels fall to 5 µg/dL. For complete safety, optimum levels should be 25 µg/dL or above.

### Plasma Retinol

Some information on the plasma retinol values in stabled Thoroughbred horses is available. The mean plasma level of retinol in 71 horses 2 to 3 years of age was 16.5 µg/dL. The serum retinol levels in racing Trotters in Finland are lower than during the summer months, which is a reflection of the quality of the diets.

### Plasma Carotene

Plasma carotene levels vary largely with the diet. In cattle, levels of 150 µg/dL are optimum and, in the absence of supplementary vitamin A in the ration, clinical signs appear when the levels fall to 9 µg/dL. In sheep, carotene is present in the blood in only very small amounts even when animals are on green pasture.

### Hepatic Vitamin A

A direct relationship between plasma and hepatic levels of vitamin A need not exist because plasma levels do not commence to fall until the hepatic stores are depleted. A temporary precipitate fall occurs at parturition and in acute infections in most animals. The secretion of large amounts of carotene and vitamin A in the colostrum of cows during the last 3 weeks of pregnancy may greatly reduce the level of vitamin A in the plasma.

Hepatic levels of vitamin A and carotene can be estimated in the living animal from a biopsy specimen. Biopsy techniques have been shown to be safe and relatively easy, provided a proper instrument is used. Hepatic levels of vitamin A and carotene should be of the order of 60 and 4.0 µg/g of liver, respectively. These levels are commonly as high as 200 to 800 µg/g. Critical levels at which signs are likely to appear are 2 and 0.5 µg/g for vitamin A and carotene, respectively.

### Cerebrospinal Fluid

CSF pressure is also used as a sensitive indicator of low vitamin A status. In calves, normal pressures of less than 100 mm of saline rise after depletion to more than 200 mm. In pigs, normal pressures of 80 to 145 mm rise to above 200 mm in vitamin A deficiency. An increase in pressure is observed at a blood level of about 7 µg vitamin A per deciliter of plasma in this species. In sheep, normal pressures of 55 to 65 mm rise to 70 to 150 mm when depletion occurs. In the experimentally induced disease in cattle, there is a marked increase in the number of cornified epithelial cells in a conjunctival smear and distinctive bleaching of the tapetum lucidum as viewed by an ophthalmoscope. These features may have value as diagnostic aids in naturally occurring cases.

### NECROPSY FINDINGS

Gross changes are rarely observed at necropsy. Careful dissection may reveal a decrease in the size of the cranial vault and

of the vertebrae. Compression and injury of the cranial and spinal nerve roots, especially the optic nerve, may be visible. In outbreaks in which night blindness is the primary clinical sign, atrophy of the photoreceptor layer of the retina is evident histologically, but there are no gross lesions.

Congenital ocular abnormalities in newborn calves from vitamin A-deficient heifer dams included aphakia, absence of a uveal tract and aqueous humor, microphthalmos, bony outgrowths of the occipital bone, compression of the cerebellum, and cardiac abnormalities similar to the tetralogy of Fallot.

Squamous metaplasia of the interlobular ducts of the parotid salivary gland is strongly suggestive of vitamin A deficiency in pigs, calves, and lambs, but the change is transient and may have disappeared 2 to 4 weeks after the intake of vitamin A is increased. This microscopic change is most marked and occurs first, at the oral end of the main parotid duct. Abnormal epithelial cell differentiation may also be observed histologically in a variety of other sites such as the tracheal, esophageal, and ruminal mucosae; preputial lining; pancreatic ducts; and urinary epithelium. Hypovitaminosis A has also been associated with an increased incidence of pituitary cysts in cattle. Secondary bacterial infections, including pneumonia and otitis media, are also common, due at least in part to the decreased barrier function of the lining epithelia.

The abnormalities that occur in congenitally affected pigs have already been described.

### Samples for Confirmation of Diagnosis

- **Toxicology:** 50 g liver, 500 g feed ASSAY (Vit A)
- **Histology:** formalin-fixed parotid salivary gland (including duct), rumen, pituitary, pancreas, brain (including optic nerves), cervical spinal cord (including nerve roots); Bouin's fixed eye (LM).

### DIFFERENTIAL DIAGNOSIS

When the characteristic clinical findings of vitamin A deficiency are observed, a deficiency of the vitamin should be suspected if green feed or vitamin A supplements are not being provided. The detection of papilledema and testing for night blindness are the easiest methods of diagnosing early vitamin A deficiency in ruminants. Incoordination, paralysis, and convulsions are the early signs in pigs. Increase in CSF pressure is the earliest measurable change in both pigs and calves. Laboratory confirmation depends on estimations of vitamin A in plasma and liver, with the latter being most satisfactory. Unless the disease has been in existence for a considerable time, response to treatment is rapid. For confirmation at necropsy, histologic

examination of parotid salivary gland and assay of vitamin A in the liver are suggested.

The salient features of the differential diagnosis of diseases of the nervous system of cattle are summarized in Table 14-12.

#### Cattle

Convulsive form of vitamin A deficiency in cattle must be differentiated from the following:

- **Polioencephalomalacia:** characterized by sudden onset of blindness, head-pressing, and tonic-clonic convulsions, usually in grain-fed animals but also in pastured animals ingesting an excess of sulfate in water and grass
- **Hypomagnesemic tetany:** primarily in lactating dairy cattle on pasture during cool windy weather; characterized by hyperesthesia, champing tonic-clonic convulsions, normal eyesight and tachycardia, and loud heart sounds
- **Lead poisoning:** in all age groups, but most commonly in pastured calves in the spring; characterized by blindness, tonic-clonic convulsions, champing of the jaw, head-pressing, and rapid death
- **Rabies:** in all age groups; characterized by bizarre mental behavior, gradually progressive ascending paralysis with ataxia leading to recumbency, drooling saliva, inability to swallow, normal eyesight, and death in 4–7 days.

**Ocular form of vitamin A deficiency in cattle** must be differentiated from those diseases of cattle characterized by central or peripheral blindness:

- Central blindness: Polioencephalomalacia  
Lead poisoning  
Meningoencephalitis
- Peripheral blindness: Bilateral ophthalmitis caused by ocular disease

**Loss of body condition** in cattle, failure to grow, and poor reproductive efficiency are general clinical findings not limited to vitamin A deficiency.

#### Pigs

**Convulsive form of vitamin A deficiency** in pigs must be differentiated from the following:

- Salt poisoning
- Pseudorabies
- Viral encephalomyelitis
- Organic arsenic poisoning.

**Paralytic form of vitamin A deficiency** in pigs must be differentiated from the following:

- Spinal cord compression caused by vertebral body abscess.

**Congenital defects** similar to those caused by vitamin A deficiency may be caused by deficiencies of other essential nutrients, by inheritance or by viral infections in early pregnancy in all species. Maternal vitamin A deficiency is the most common cause of congenital defects in piglets. Final diagnosis depends on the necropsy findings, analysis of feed and serum vitamin A of the dams.

## TREATMENT

### Vitamin A

Animals with curable vitamin A deficiency should be treated immediately with vitamin A at a dose rate equivalent to 10 to 20 times the daily maintenance requirement. As a rule, 440 IU/kg BW is the dose used. Parenteral injection of an aqueous rather than an oily solution is preferred. The response to treatment in severe cases is often rapid and complete, but the disease may be irreversible in chronic cases. Calves with the convulsive form caused by increased CSF pressure will usually return to normal in 48 hours following treatment. Cattle with the ocular form of the deficiency and that are blind will not respond to treatment and should be slaughtered for salvage.

### Hypervitaminosis A

Daily heavy dosing (about 100 times normal) of calves causes reduced growth rate, lameness, ataxia, paresis, exostoses on the planter aspect of the third phalanx of the fourth digit of all feet, and disappearance of the epiphyseal cartilage. Persistent heavy dosing in calves causes lameness, retarded horn growth, and depressed CSF pressure. At necropsy, exostoses are present on the proximal metacarpal bones and the frontal bones are thin. Very high levels fed to young pigs may cause sudden death through massive internal hemorrhage and excessive doses during early pregnancy are reputed to result in fetal anomalies. However, feeding vitamin A for prolonged periods at exceptionally high levels is unlikely to produce severe embryotoxic or teratogenic effects in pigs.

## CONTROL

### Dietary Requirement

The minimum daily requirement in all species is 40 IU of vitamin A per kilogram BW, which is a guideline for maintenance requirements. In the formulation of practical diets for all species, the daily allowances of vitamin A are commonly increased by 50% to 100% of the daily minimum requirements. During pregnancy, lactation, or rapid growth the allowances are usually increased by 50% to 75% of the requirements. The supplementation of diets to groups of animals is governed also by their previous intake of the vitamin and its probable level in the diet being fed. The rate of supplementation can vary from 0 to 110 IU/kg BW per day (1 IU of vitamin A is equivalent in activity to 0.3 µg of retinol; 5 to 8 µg β-carotene has the same activity as 1 µg of retinol).

Nutrient studies have indicated that pre-ruminant Holstein calves being fed milk replacer should receive 11,000 IU of vitamin A per kilogram dry matter for optimum growth and to maintain adequate liver vitamin A stores.

The amounts of the vitamin to be added to the ration of each species to meet the requirements for all purposes should be



Table 14-17 Daily dietary allowances of vitamin A

Animal	Vitamin A (IU/kg BW daily)
<b>Cattle</b>	
Growing calves	40
Weaned beef calves at 6–8 months	40
Calves 6 months to yearlings	40
Maintenance and pregnancy	70–80
Maintenance and lactation	80
Feedlot cattle on high energy ration	80
<b>Sheep</b>	
Growth and early pregnancy and fattening lambs	30–40
Late pregnancy and lactation	70–80
<b>Horses</b>	
Working horse	20–30
Growing horse	40
Pregnant mare	50
Lactating mare	50
<b>Pigs</b>	
Growing pigs	40–50
Pregnant gilts and sows	40–50
Lactating gilts and sows	70–80

obtained from published recommended nutrient requirements of domestic animals. Some examples of daily allowances of vitamin A for farm animals are set out in Table 14-17.

### Supplementation Method

The method of supplementation will vary depending on the class of livestock and the ease with which the vitamin can be given. In **pigs**, the vitamin is incorporated directly into the complete ration, usually through the protein supplement. In **feedlot and dairy cattle** receiving complete feeds, the addition of vitamin A to the diet is simple. In **beef cattle**, which may be fed primarily on carotene-deficient roughage during pregnancy, it may not be possible to supplement the diet on a daily basis. However, it may be possible to provide a concentrated dietary source of vitamin A on a regular basis by feeding a protein supplement once weekly. The protein supplement will contain 10 to 15 times the daily allowance, which permits hepatic storage of the vitamin.

### Parenteral Injection

An alternative method to dietary supplementation is the intramuscular injection of vitamin A at intervals of 50 to 60 days at the rate of 3,000 to 6,000 IU/kg BW. Under most conditions, hepatic storage is good and optimum plasma and hepatic levels of vitamin A are maintained for up to 50 to 60 days. In pregnant beef cattle the last injection should not be more than 40 to 50 days before parturition to ensure adequate levels of vitamin A in the colostrum. Ideally, the last injection should be given 30 days before parturition, but this may not be practical under some management conditions. Administration of vitamin A palmitate by intramuscular

injection (3500 IU/kg BW) increased plasma vitamin A concentrations by 24 hours and these elevated concentrations persisted for at least 8 days.<sup>6</sup> The effect of a single administration of vitamin A on liver vitamin A concentrations, the biologic reservoir for the vitamin, was not determined.

The most economical method of supplementing vitamin A is, in most cases, through the feed and when possible should be used.

The use of injectable mixtures of vitamins A, D, and E is not always justifiable. The injection of a mixture of vitamins A, D, and E of feeder cattle in northern Australia before transport did not, contrary to anecdotal evidence, reduce weight loss associated with transportation. Cattle in Queensland and northwestern Australia have very high concentrations of hepatic vitamin A and in fact, drought-stricken cattle in the terminal stages of malnutrition have also had high liver concentration. The indiscriminate use of vitamin A preparations in cattle is a public health concern because some bovine livers may contain high levels of vitamin A, which are potentially teratogenic for pregnant women.

### Oral Vitamin A

The oral administration of a single bolus of vitamin A at a dose of 2.8 mg/kg BW to debilitated Sahelian cattle during the dry season was effective in raising the milk levels of vitamin A and was as effective as adding 10 g of the powder to the drinking water. Both the powder and bolus products provided high levels of vitamin A in milk within 3 days of treatment and according to herder testimonials, night-blind people consuming milk from cattle previously treated with either oral vitamin A preparation were no longer affected with night blindness.

## REFERENCES

1. Anon. *Vet Rec.* 2014;174:244.
2. Baldwin TJ, et al. *J Vet Diagn Invest.* 2012;24:763.
3. Koutsoumpas AT, et al. *Small Rumin Res.* 2013;110:120.
4. Han S, et al. *Comput Electron Agric.* 2014;108:80.
5. Millemann Y, et al. *Vet Rec.* 2007;160:441.
6. Koutsoumpas AT, et al. *Small Rumin Res.* 2013;109:28.

## NICOTINIC ACID DEFICIENCY (HYPONIACINOSIS)

Nicotinic acid or niacin is essential for normal carbohydrate metabolism. Because of the high content in most natural animal feeds, deficiency states are rare in ordinary circumstances, except in pigs fed rations high in corn. Corn has both a low niacin content and a low content of tryptophan, which is a niacin precursor. A low-protein intake exacerbates the effects of the deficiency, but a high-protein intake is not fully protective.

In ruminants, synthesis within the animal provides an adequate source. Even in young calves, signs of deficiency do not occur, and because rumen microfloral activity is not yet of any magnitude, extraruminal synthesis appears probable. There are preliminary indications that dietary supplementation with niacin alters muscle fiber composition (increased type 1 (oxidative) versus type 2) in pigs and sheep.<sup>1,2</sup>

The oral supplementation of niacin in the diet of periparturient dairy cows may result in an increase in serum inorganic phosphorus and a decrease in serum potassium, calcium, and sodium concentrations. Niacin has been used to study the effects of artificially induced ketonemia and hypoglycemia in cattle through inducing changes in non-esterified fatty acid concentrations.<sup>3</sup>

The daily requirements of niacin for mature pigs are 0.1 to 0.4 mg/kg BW, but growing pigs appear to require more (0.6–1 mg/kg BW) for optimum growth.

Experimentally induced nicotinic acid deficiency in pigs is characterized by inappetence, severe diarrhea, a dirty yellow skin, with a severe scabby dermatitis and alopecia. Posterior paralysis also occurs. At necropsy, hemorrhages in the gastric and duodenal walls, congestion and swelling of the small intestinal mucosa, and ulcers in the large intestine are characteristic and closely resemble those of necrotic enteritis caused by infection with *Salmonella* spp.

Histologically, there is severe mucoid degeneration followed by local necrosis in the wall of the cecum and colon. Experimental production of the disease in pigs by the administration of an antimetabolite to nicotinamide causes ataxia or quadriplegia, accompanied by distinctive lesions in the gray matter of the cervical and lumbar enlargements of the ventral horn of the spinal cord. The lesions are malacic and

occur in the intermediate zone of the gray matter. The identical lesions and clinical picture have been observed in naturally occurring disease.

The oral therapeutic dose rate of nicotinic acid in pigs is 100 to 200 mg; 10 to 20 g/tonne of feed supplies have sufficient nicotinic acid for pigs of all ages. Niacin is low in price and should always be added to pig rations based on corn.

## REFERENCES

1. Khan M, et al. *Acta Vet Scand.* 2013;55:85.
2. Khan M, et al. *BMC Vet Res.* 2013;9:177.
3. Pires JAA, et al. *J Dairy Sci.* 2007;90:3725.

## PYRIDOXINE (VITAMIN B<sub>6</sub>) DEFICIENCY (HYPOPYRIDOXINOSIS)

A deficiency of pyridoxine in the diet is not known to occur under natural conditions. Experimental deficiency in pigs is characterized by periodic epileptiform convulsions and at necropsy by generalized hemosiderosis with a microcytic anemia, hyperplasia of the bone marrow, and fatty infiltration of the liver. Less severe deficiency impairs weight gain and alters biochemical markers of sulfur-containing amino acid metabolism.<sup>1</sup> The daily requirement of pyridoxine in the pig is of the order of 100 µg/kg BW or 1 mg/kg of solid food, although higher levels have been recommended on occasion. Certain strains of chickens have a high requirement for pyridoxine and the same may be true of pigs.

Experimentally induced deficiency in calves is characterized by anorexia, poor growth, apathy, dull coat, and alopecia. Severe, fatal epileptiform seizures occur in some animals. Anemia with poikilocytosis is characteristic of this deficiency in cows and calves.

## REFERENCE

1. Zhang Z, et al. *Animal.* 2009;3:826.

## PANTOTHENIC ACID DEFICIENCY (HYPOPANTOTHENOSIS)

PA is essential in metabolism because of its incorporation into coenzyme A and acyl carrier protein, both of which are central to energy metabolism. PA is ubiquitous in fodder, in addition to which microorganisms in the rumen synthesize the compound.<sup>1</sup> However, it is not clear if synthesis meets the requirements of dairy cows. The role of PA in ruminant nutrition is reviewed.<sup>1</sup>

Deficiency under natural conditions has been recorded mainly in pigs on rations based on corn.

In pigs, a decrease in weight gain caused by anorexia and inefficient food utilization occurs first. Dermatitis develops with a dark brown exudate collecting about the eyes and there is a patchy alopecia. Diarrhea and

incoordination with a spastic, goose-stepping gait are characteristic. At necropsy, a severe, sometimes ulcerative, colitis is observed constantly, together with degeneration of myelin.

Calcium pantothenate (500 µg/kg BW/day) is effective in treatment and prevention. As a feed additive, 10 to 12 g/tonne of calcium pantothenate is adequate.

Experimentally induced PA deficiency in calves is manifested by rough hair coat, dermatitis under the lower jaw, excessive nasal mucus, anorexia and reduced growth rate, and is eventually fatal. At necropsy, there is usually a secondary pneumonia, demyelination in the spinal cord and peripheral nerves, and softening and congestion of the cerebrum.

## REFERENCE

1. Ragaller V, et al. *J Anim Physiol Nutr.* 2011;95:6.

## Metabolic and Toxic Encephalomyelopathies

A number of metabolic defects and a very large number of poisons, especially poisonous plants and farm chemicals, cause abnormalities of function of the nervous system. Those plants that cause degenerative nervous system disease are listed under the section **Encephalomalacia**; those that cause no detectable degenerative change in tissue are listed here. More detailed information on toxins that are primary neurotoxins are addressed in this chapter based on the predominant neuroanatomic location affected. This section includes those toxins that do not have a predilection for a specific neuroanatomic location.

An incomplete list of metabolic abnormalities and toxins that can cause nervous system dysfunction are as follows.

### Abnormalities of Consciousness and Behavior

- Hypoglycemia and ketonemia of pregnancy toxemia (with degenerative lesions in some) and acetonemia
- Depression caused by hyponatremia and strong ion (metabolic) acidosis associated with diarrhea and dehydration, particularly in neonatal animals
- Hypomagnesemia of lactation tetany
- Hyper-D-lactatemia in neonatal calves, lambs, and kids and adult ruminants with grain overload
- Primary hyperammonemia and hepatic encephalopathy<sup>1,2</sup>
- Unspecified toxic substances in uremic animals
- Exogenous toxins, including carbon tetrachloride, hexachloroethane, and trichloroethylene

- Plants causing anemic and histotoxic hypoxia, especially plants causing cyanide or nitrite poisoning
- Poison plants, including *Helichrysum* spp., tansy mustard, male fern, kikuyu grass (or a fungus, *Myrothecium* sp. on the grass)

### Abnormality Characterized by Tremor and Ataxia

- Weeds, including *Conium* spp. (hemlock), *Eupatorium* spp. (snakeroot), *Sarcostemma* spp., *Euphorbia* spp. and *Karwinskia* spp.
- Ivermectin toxicosis in horses<sup>3</sup>
- Bacterial toxins in shaker foal syndrome (probably)
- Fungal toxins, e.g., *Neotyphodium* (*Acremonium*) *lolii*, the endophyte fungus of ryegrass staggers

### Convulsions

- Metabolic deficits, including hypoglycemia (piglets, ewes with pregnancy toxemia), hypomagnesemia (of whole milk tetany of calves, lactation tetany, cows and mares), hypernatremia
- Nutritional deficiencies of vitamin A (brain compression in calves and pigs), pyridoxine (experimentally in calves)
- Inorganic poisons, including lead (calves),<sup>4</sup> mercury (calves), farm chemicals such as organic arsenicals (pigs), organophosphates, chlorinated hydrocarbons, strychnine, urea, metaldehyde
- Bacterial toxins, including *C. tetani*, *C. perfringens* type D
- Fungal toxins, e.g., *C. purpurea*
- Grasses, including *Wimmera* ryegrass (*Lolium rigidum*) or the nematode on it, *Echinopogon ovatus*
- Pasture legumes: lupines
- Weeds: *Oenanthe* spp. (hemlock water dropwort), *Indigofera* spp. (in horses), *Cicuta* spp. (water hemlock), *Albizia tanganyicensis*, *Sarcostemma* spp., *Euphorbia* spp.
- Trees: laburnum, oleander, supplejack (*Ventilago* spp.)

### Ataxia Apparently Caused by Proprioceptive Defect

- Grasses: *Phalaris tuberosa* (aquatica) (and other *Phalaris* spp.), *Lolium rigidum*, *E. ovatus*
- Weeds: *Romulea bulbocodium*, sneezeweed (*Helenium* spp.), *Indigofera* spp., Iceland poppy (*Papaver nudicaule*), *Gomphrena* spp., *Malva* spp., *Stachys* spp., *Ipomoea* spp., *Solanum esuriale*
- Trees: *Kalmia* spp., *Erythrophloeum* spp., *Eupatorium rugosum*
- Ferns: *Xanthorrhoea* spp., *Zamia* spp.; induced thiamine deficiency caused by bracken and horsetail poisoning

### Involuntary Spastic Contraction of Large Muscle Masses

This includes, for example, acquired (Austrian) equine reflex hypertonia (formerly known as Australian stringhalt) associated with ingestion of the Australian dandelion *Hypochaeris radicata*, European dandelion *Taraxacum officinale*, or mallow *Malva parviflora*.

### Tremor, Incoordination, and Convulsions

There is an additional long list of plants that cause diarrhea and nervous signs, especially ataxia, together, but whether the latter are caused by the former or caused by neurotoxins is not identified.

The nervous signs include tremor, incoordination, and convulsions.

### Paresis or Paralysis

Many of the toxic substances and metabolic defects listed previously cause paresis when their influence is mild and paralysis when it is severe. Some of the items appear in both lists. Because an agent appears in one list and not the other list is not meant to suggest that the agent does not cause the other effect. It is more likely that it occurs in circumstances that are almost always conducive to the development of a mild syndrome (or a severe one, as the case may be).

- **Disturbance of function** at neuromuscular junctions, e.g., hypocalcemia, hypomagnesemia, hypokalemia (as in downer cows), tetanus, botulism and hypoglycemia of pregnancy toxemia in cows and ewes, and tick paralysis. Hypophosphatemia has not been demonstrated to be a definitive cause of weakness in cattle.
- **Nutritional deficiency**, but including only experimentally induced deficiency of nicotinic and PAs: biotin and choline, cause posterior paresis and paralysis in pigs and calves.
- **Toxic diseases** of the nervous system, including disease associated with many chemicals used in agriculture, e.g., piperazine, rotenone, 2,4-D and 2,4,5-T, organophosphates, carbamates, chlorinated hydrocarbons, propylene glycol, metaldehyde, levamisole, toluene, carbon tetrachloride, strychnine, and nicotine sulfate.

### FURTHER READING

- Dawson DR. Toxins and adverse drug reactions affecting the equine nervous system. *Vet Clin North Am Equine Pract.* 2011;27:507-526.
- Divers TJ. Metabolic causes of encephalopathy in horses. *Vet Clin North Am Equine Pract.* 2011;27:589-596.
- Finnie JW, Windsor PA, Kessell AE. Neurological diseases of ruminant livestock in Australia. II: toxic disorders and nutritional deficiencies. *Aust Vet J.* 2011;89:247-253.

### REFERENCES

1. Hughes KJ, et al. *Vet Rec.* 2009;164:142.
2. Pillitteri CA, Craig LE. *Vet Pathol.* 2012;50:177.
3. Swor TM, et al. *J Am Vet Med Assoc.* 2009;235:558.
4. Krametter-Froetscher R, et al. *Vet J.* 2007;174:99.

## Inherited Diseases Primarily Affecting the Cerebrum

### INHERITED CONGENITAL HYDROCEPHALUS

Hydrocephalus is the distention of the ventricular system of the brain, caused by increased production of CSF by the choroid plexus, obstruction of normal CSF flow, or decreased absorption of CSF at the arachnoid villi in the venous sinuses.<sup>1</sup>

#### Cattle

Congenital hydrocephalus without abnormality of the frontal bones occurs sporadically but is also known to be an inherited defect in Holstein and Hereford and possibly in Ayrshire and Charolais cattle. Two specific inherited entities have been described. In one there is obstruction of drainage of the CSF from the lateral ventricles, which become distended with fluid and may cause bulging of the forehead, often sufficient to cause fetal dystocia. Hereford calves with this defect have partial occlusion of the supraorbital foramen, a domed skull, and poorly developed teeth; at necropsy the cerebellum is found to be small and there may be microphthalmia and skeletal muscle myopathy. They are usually born a few days prematurely, are small in size, and are unable to stand or suck. In some cows the amniotic fluid is increased in volume.

Another form of inherited hydrocephalus caused by malformation of the cranium and with no enlargement of the cranium has also been observed in Hereford cattle. The ventricular dilatation is not marked, and microphthalmia and cerebellar hypoplasia are not features. Affected calves may be alive at birth but are blind and unable to stand. Some bawl continuously and some are dumb. They do not usually survive for more than a few days. At necropsy there is internal hydrocephalus of the lateral ventricles with marked thinning of the overlying cerebrum. Other lesions include constriction of the optic nerve, detachment of the retina, cataract, coagulation of the vitreous humor, and a progressive muscular dystrophy. The condition is inherited as a recessive character.

Internal hydrocephalus inherited in combination with multiple eye defects in White Shorthorns is dealt with elsewhere, as are noninherited forms of the disease.

#### Sheep

A defect comparable to the Dandy-Walker syndrome in humans and characterized by internal hydrocephalus caused by obstruction of the foramina of Magendie and Lushka occurs in several breeds of sheep, especially Suffolk, and in cattle. Affected lambs are still-born or die within a few hours of birth; because of the grossly enlarged cranium many cause dystocia, which can only be relieved by a fetotomy.

#### Horses

A Standardbred stallion sired a number of hydrocephalic foals in a pattern that suggested the inheritance of a dominant mutation in the germline and in the form of a single locus defect. Affected foals caused dystocia and were all stillborn. There is one report of an unsuccessful outcome following placement of ventriculoperitoneal shunt in an attempt to manage hydrocephalus in a Quarter Horse colt.<sup>2</sup>

Hydrocephalus has been observed more commonly in Friesian horses than other breeds. Affected foals have a malformed petrosal bone, which causes a narrowing of the jugular foramen.<sup>1</sup> Hydrocephalus in Friesian foals is thought to be caused by diminished absorption of CSF into the systemic circulation at the venous sinus because of the abnormally small jugular foramen. This type of hydrocephalus has been genetically linked in humans and dogs to chondrodysplasia.<sup>1</sup>

#### Pigs

Congenital hydrocephalus in Yorkshire and European pigs has been recorded. The abnormality varies from a small protrusion of dura (meningocele) to an extensive brain hernia in which the cerebral hemispheres protrude through the frontal suture, apparently forced there by increased fluid pressure in the lateral and third ventricles. The condition is thought to be inherited in a recessive manner, but exacerbated in its manifestation by a coexisting hypovitaminosis A. An outbreak of congenital meningoencephalocele in Landrace pigs is recorded in circumstances suggesting that it was inherited.

### REFERENCES

1. Sipma KD, et al. *Vet Pathol.* 2013;50:1037.
2. Bentz BG, Moll HD. *J Vet Emerg Crit Care.* 2008;18:170.

### INHERITED HYDRANENCEPHALY AND ARTHROGRYPOSIS

The defect is recorded in Corriedale sheep, and breeding trials indicate that it is inherited as an autosomal recessive character. Most affected lambs are found dead but facial deformity, including shortening of the mandible and distortion of the facial bones will be evident. At necropsy the predominant finding is the fixation and deformity of the joints of the limbs and vertebral column, and



the almost complete absence of a cerebral cortex.

### **INHERITED PROSENCEPHALY**

Recorded in Border Leicester sheep, this defect takes the form of fusion of the cerebral hemispheres and a single lateral ventricle. It is widespread in the breed in Australia and is inherited as an autosomal recessive character. Most affected lambs are stillborn. Live ones have dyspnea caused by gross shortening of the nasomaxillary region creating a severely overshot mandible and interference with sucking. Blindness, nystagmus, and recumbency are constant signs. The cerebrum and the cranial cavity are much smaller than normal.

### **INHERITED MULTIFOCAL SYMMETRIC ENCEPHALOPATHY**

Two forms of the disease are recorded, in **Simmental** and in **Limousin** and Limousin-cross cattle. The Limousin calves are normal at birth but from about 1 month of age develop a progressive forelimb hypermetria, hyperesthesia, blindness, nystagmus, weight loss, and behavioral abnormalities, especially aggression. The signs gradually worsen for up to 4 months when euthanasia is necessary. Necropsy lesions include brain swelling; optic chiasma necrosis; and multifocal, symmetric areas of pallor, up to 0.5 cm diameter in the brain. These lesions show partial cavitation and multiple, pathologic abnormalities, especially myelin lysis and vacuolation and demyelination. The distribution of cases suggests an inherited defect.

The disease in Simmental and Simmental-cross cattle recorded in Australia and New Zealand also has a distribution suggesting an inherited defect. The disease is clinically similar to that in Limousin cattle except that affected animals are not blind and it develops later at 5 to 8 months. Calves may survive longer, up to 12 months and, although the characteristic abnormality of gait is hypermetria, the hindlimbs are affected, not the forelimbs. Other signs observed are dullness, a swaying gait and, terminally, gradually developing opisthotonus and forelimb hypertonia in extension. Necropsy lesions are also similar to those in the Limousins, but the distribution is in the midbrain and the entire brainstem.

A multifocal symmetric necrotizing encephalomyelopathy in Angus calves has been described. Clinically affected calves exhibited ataxia, nystagmus, strabismus, muscular tremors, opisthotonus, bruxism, hyperesthesia, tetanic spasms, and episodic convulsions at 2 to 6 weeks of age. Death occurred 4 to 7 days after the onset of clinical signs. Lesions consisted of symmetric degenerative foci affecting the dorsal vagal motor, lateral cuneate, and olivary nuclei in the medulla oblongata, and occasionally in the

spinal cord, substantia nigra, and cerebellar peduncles. Although an inherited basis for the disease is suspected, the etiology is unknown.

### **MAPLE SYRUP URINE DISEASE (BRANCHED-CHAIN KETO ACID DEHYDROGENASE DEFICIENCY)**

Calves affected by this disease may be stillborn. Live calves are normal at birth and develop signs only at 1 to 3 days of age. It is inherited as an autosomal recessive and occurs principally in Poll Hereford, Hereford, and Poll Shorthorn cattle but probably also occurs in other breeds. There is molecular heterogeneity between the breeds, and tests based on detection of the mutation could be prone to error. Hair roots are good sources of target DNA for genotyping cattle for the mutation in one of the genes coding for the branched-chain  $\alpha$ -keto acid dehydrogenase enzyme. This avoids the errors created by hemopoietic chimerism when blood is used for the test.

The disease is caused by an accumulation of branched-chain amino acids, including valine, leucine, and isoleucine. The mutation responsible for maple syrup urine disease in Poll Shorthorns and genotyping Poll Shorthorns and Poll Herefords for the maple syrup urine disease alleles has been determined. The mutations responsible for maple syrup urine disease and inherited congenital myoclonus are present in the Australian Poll Hereford population.

Clinical signs include dullness, recumbency, tremor, tetanic spasms and opisthotonus, a scruffy coat, blindness, and severe hyperthermia. When held in a standing position, some calves have tetanic paralysis and others have flaccid paralysis. Terminal coma is followed by death after a course of 48 to 72 hours. The urine smells of burnt sugar (because of the presence of branched-chain amino acids), and this smell is the source of the name.<sup>1</sup>

At necropsy there is a characteristic severe spongiform encephalopathy similar to that found in comparable hereditary aminoacidurias in humans.<sup>1</sup> Final identification can be made based on the elevated ratios of branched: straight chain amino acids in nervous tissue.

#### **REFERENCE**

1. O'Toole D, et al. *J Vet Diagn Invest.* 2005;17:546.

### **INHERITED CITRULLINEMIA**

This autosomal recessive disease is inherited in Australian Holstein Friesians, American Holstein Friesians, and Red Holstein Friesians in Europe.

Affected calves are normal at birth but develop signs in the first week of life and die 6 to 12 hours after the onset of illness. The signs are depression, compulsive walking,

blindness, head-pressing, tremor, hyperthermia, recumbency, opisthotonus, and convulsions. Argininosuccinate synthetase deficiency is the likely cause. Blood citrulline levels are of the order of 40 to 1200 times normal, and the assay can be used to detect heterozygotes. The alternative method of detecting heterozygotes is to use a PCR test, which RE test designed to identify the mutation that causes the disease. Prenatal diagnosis has been achieved by examination of cell cultures derived from amniotic fluid.

### **INHERITED NEONATAL SPASTICITY**

The defect is recorded in Jersey and Hereford cattle. Affected calves are normal at birth but develop signs 2 to 5 days later. The signs commence with incoordination and bulging of the eyes and a tendency to deviation of the neck causing the head to be held on one side. Subsequently, the calves are unable to stand and on stimulation develop a tetanic convulsion in which the neck, trunk, and limbs are rigidly extended and show marked tremor. Each convulsion is of several minutes' duration. Affected calves may survive for as long as a month if nursed carefully. There are no gross or histologic lesions at necropsy. Inheritance of the defect is conditioned by a single, recessive character.

### **DODDLER CALVES**

This is an inherited congenital defect in Hereford cattle produced by intensive breeding of half-siblings, and it is no longer recorded. It was characterized by continuous clonic convulsions, nystagmus, and pupillary dilatation. Stimulation by touch or sound exacerbated the convulsions.

### **INHERITED IDIOPATHIC EPILEPSY OF CATTLE**

Idiopathic epilepsy has been reported as an inherited condition in Brown Swiss cattle and appears to be inherited as a dominant character. Typical epileptiform convulsions occur, especially when the animals become excited or are exercised. Attacks do not usually commence until the calves are several months old and disappear entirely between the ages of 1 and 2 years.

### **FAMILIAL NARCOLEPSY**

Affected horses, including Lipizzaners,<sup>1</sup> Shetlands, Miniature Horses, Icelandic foals, and Suffolk foals, suffer recurrent episodes of several minutes' duration during which they fall and lie motionless, without voluntary or involuntary movements except respiratory and eye movements. Between episodes there is no clinical abnormality. Handling or the excitement of feeding may precipitate

an attack, and a sharp blow may terminate one.

A genetic cause is suspected in horses based on the occurrence of the disease in three fillies born to the same sire.<sup>1</sup> A physostigmine provocation test (0.06 mg/kg BW intravenously) has been used, and a positive result is a cataleptic attack or clinical worsening of the sleepiness over the following hour. The genetic basis has not been confirmed in horses but is suspected to be an autosomal dominant trait with incomplete penetrance.<sup>1</sup>

### FURTHER READING

Mignot EJM, Dement WC. Narcolepsy in animals and man. *Equine J.* 1993;25:476.

### REFERENCE

1. Ludvikova E, et al. *Vet Q.* 2012;32:99.

## Congenital and Inherited Encephalomyelopathies

### INHERITED LYOSOMAL STORAGE DISEASES

These are diseases in which there is a genetically determined deficiency of a specific lysosomal hydrolase enzyme causing a defective degradation of carbohydrates, proteins, and lipids within lysosomes. These diseases are currently grouped into glycoproteinoses, mucopolysaccharidoses, sphingolipidoses, and mucopolysaccharidoses. Enzyme deficiencies associated with lysosomal storage diseases in agricultural animals include  $\alpha$ -mannosidase,  $\beta$ -mannosidase, GM<sub>1</sub> gangliosidosis, GM<sub>2</sub> gangliosidosis,<sup>1,2</sup>  $\beta$ -glucocerebrosidase (Gaucher disease),<sup>3</sup>  $\alpha$ -N-acetylglucosaminidase (NAGLU),<sup>4</sup> acid-sphingomyelinase (Niemann–Pick disease),<sup>5</sup> and an incompletely characterized form.<sup>6,7</sup> The lysosomes themselves are concerned with hydrolyzing polymeric material, which enters the vacuolar system, and converting it to monomeric units, such as monosaccharides, amino acids, and nucleotides, which can be dealt with by the better known metabolic processes. As a result of the deficiency, upstream metabolic substrates accumulate in the lysosomes and downstream metabolites are markedly reduced.

Lysosomal storage diseases can also be caused by poisonings, and these are addressed elsewhere in this chapter. The best known ones are caused by poisoning with *Swainsona*,<sup>8</sup> *Astragalus*, *Oxytropis*, and *Ipomoea* spp.<sup>9-12</sup>, *Side* spp.<sup>13</sup>, and *Phalaris* spp. (the chronic form of that disease).

The diseases included in this section are not strictly diseases of the nervous system because the lysosomes in both **neuronal** and **visceral** sites are affected, but the effects of the disease are most obvious in terms of nervous system function.

### MANNOSIDOSIS

Mannosidosis is the best known group of the inherited lysosomal storage diseases in agricultural animals.

#### $\alpha$ -Mannosidosis

This is a lysosomal storage disease in which a deficiency of the enzyme  $\alpha$ -mannosidase results in the accumulation of a metabolite rich in mannose and glucosamine in secondary lysosomes in neurons, macrophages, and reticuloendothelial cells of lymph nodes, causing apparent vacuolations in these cells. Similar vacuoles are found in exocrine cells in pancreas, abomasum, and lacrimal and salivary glands. Storage appears to be cumulative in the fetus, but after birth stored material is lost from the kidney into the urine via desquamated tubular epithelium. On the other hand, postnatal storage continues in the brain, pancreas, and lymph nodes. The disease occurs in Angus, Murray Grey, and Galloway cattle, is inherited as a simple recessive, and is recorded as occurring in the United States, Australia, and New Zealand.

**Clinically** it is characterized by ataxia, fine lateral head tremor, slow vertical nodding of the head, intention tremor, an aggressive tendency, failure to thrive, and death or the necessity of euthanasia at about 6 months of age. These signs appear almost immediately after birth up to several months later and worsen over a period of up to 3 to 4 months. The signs are bad enough to require euthanasia during the first week of life in many cases. The first sign observed is a swaying of the hindquarters, especially after exercise or with excitement. The stance becomes wide based and the gait jerky, stilted and high stepping, with slight overflexion of the hindquarters so that the animal appears to be squatting as it moves.

The nervous signs are exacerbated by excitement, diarrhea is common, and the calves are usually stunted and unthrifty. They are also aggressive and attempt to charge but are usually impeded by their incoordination. Many calves die after having shown general ill-thrift and with minimal nervous signs. Death may occur from paralysis and starvation, or to misadventure, and some calves appear to die during a “fit” following a period of excitement. Many others are euthanized because of persistent recumbency. The nervous syndrome of mannosidosis is well known; affected calves will die. An  $\alpha$ -mannosidosis is recorded in Galloway cattle and is manifested by stillbirth, moderate hydrocephalus, enlargement of the liver and kidneys, and arthrogryposis.

Normal heterozygotes carrying genes for mannosidosis are identifiable because of their reduced tissue or plasma levels of  $\alpha$ -mannosidase. The mannosidase test for  $\alpha$ -mannosidase in goats is specific and does not cross-react with  $\alpha$ -mannosidase.

Advances in molecular biology have now led to the development of a more accurate

test based on DNA technology. DNA tests based on the PCR have been developed for the detection of two breed-specific mutations responsible  $\alpha$ -mannosidosis. One of the mutations is responsible for  $\alpha$ -mannosidosis in Galloway cattle. The other mutation is uniquely associated with  $\alpha$ -mannosidosis in Angus, Murray Grey, and Brangus cattle from Australia. The latter mutation was also detected in Red Angus cattle exported from Canada to Australia as embryos. The two breed-specific mutations may have arisen in Scotland and by the export of animals and germplasm disseminated to North America, New Zealand, and Australia.

A control program can be based on the identification of heterozygotes using PCR-based assays for detection of breed-specific mutations. A program of screening cattle in herds that produce bulls for sale to commercial herds should stop the spread of the disease very quickly, because the number of heterozygous females in the population will be irrelevant to the continuation of the disease in the absence of affected sires.

The  $\alpha$ -mannosidosis gene prevalence is now insignificant and disease incidence has been reduced from an estimated 3000 cases/year to negligible levels.

#### $\beta$ -Mannosidosis

$\beta$ -Mannosidosis occurs in Salers cattle and Anglo-Nubian goats and has been recorded in a sheep. In cattle, some affected calves are stillborn. The remainder of calves are euthanized forthwith because of the severity of the congenital defects.

Calves are affected at birth with craniofacial deformity and inability to stand. The cranium is domed and there is mild prognathism; narrow palpebral fissures; and a tough, hidebound skin. When in sternal recumbency, the head is moved in a combined motion of circling and bobbing, eventually converting the calf to lateral recumbency, in which it remains until passively returned to the sternal position, where nystagmus and tremor become evident. There is no suck reflex at any time. In lateral recumbency there is opisthotonus and paddling convulsions.

In the goats the condition is present at birth and characterized clinically by tetraplegia, tremor, deafness, and nystagmus, and an inexorably fatal termination. Additional signs include bilateral Horner's syndrome, carpal contractures, pastern joint hyperextension, thickened skin, and a dome-shaped skull. Although retinal ganglion cells are badly affected, there appears to be no defect of vision. It is an autosomal recessive defect that is very similar to  $\alpha$ -mannosidosis.

The diagnosis is confirmed by a reduced level of  $\beta$ -mannosidase in the blood.

Necropsy findings include a deficiency of cerebral cortical and cerebellar substance, distended lateral ventricles, and bilateral

renomegaly. The biochemical defect is one of acidic  $\beta$ -mannosidase, and is conditioned by an autosomal recessive character. The carrier rate of the causative gene is very high in the Salers breed.

## REFERENCES

1. Porter BF, et al. *Vet Pathol.* 2011;48:807.
2. Torres PA, et al. *Mol Genet Metab.* 2010;101:357.
3. Karageorgos L, et al. *J Inherit Metab Dis.* 2011;34:209.
4. Karageorgos L, et al. *J Inherit Metab Dis.* 2007;30:358.
5. Saunders GK, Wenger DA. *Vet Pathol.* 2008;45:201.
6. Mikami O, et al. *J Vet Med A Physiol Pathol Clin Med.* 2006;53:77.
7. Masoudi AA, et al. *Anim Sci J.* 2009;80:611.
8. Dantas AFM, et al. *Toxicon.* 2007;49:111.
9. Barbosa RC, et al. *Toxicon.* 2006;47:371.
10. Armien AG, et al. *Vet Pathol.* 2007;44:170.
11. Mendonca D, et al. *Acta Vet Brno.* 2011;80:235.
12. Armien AG, et al. *J Vet Diagn Invest.* 2011;23:221.
13. Furlan FH, et al. *Vet Pathol.* 2009;46:343.

## GANGLIOSIDOSIS

At least five types of gangliosidosis are known to occur in humans and animals. Two ( $GM_1$  and  $GM_2$  gangliosidosis) have thus far been identified in agricultural animals.

### $GM_1$ Gangliosidosis

$GM_1$  gangliosidosis occurs in cattle and sheep. In Friesian cattle it is inherited as a lysosomal storage disease in which the activity of an enzyme,  $\beta$ -galactosidase, in nervous tissue is greatly reduced. As a result, there is an accumulation of the ganglioside ( $GM_1$ ) in the tissue. Clinical signs of progressive neuromotor dysfunction and a reduction in growth rate appear at about 3 months of age. The growth rate is reduced, and the animal is in poor condition, blind, and has a staring coat. The neuromotor signs include lack of response to external stimuli, sluggish mastication and swallowing, hindquarter sway while walking, a wide stance, a tendency to fall, reluctance to move, stiff high-stepping gait, aimless walking, head-pressing, and convulsions. Abnormal electrocardiogram (ECG) tracings are common. The blindness results from lesions in the retina and the optic nerve. Ophthalmoscopic examination of the retina is recommended as an aid to diagnosis. A positive diagnosis is made on the grounds of intraneuronal lipid storage plus reduced  $\beta$ -galactosidase activity plus identification of the stored lipid. The stored ganglioside is visible under the electron microscope as stacks and concentric whorls of lamellae. In the live animal enzyme assays are performed on leukocytes. The enzymatic defect is also detectable in liver, skin, and leukocytes.

$GM_1$  gangliosidosis is also present in Suffolk and Suffolk-cross sheep. Visceral and neuronal lysosomal storage are both evident but the neuronal lesion is more severe. Deficiencies of  $\beta$ -galactosidase and  $\alpha$ -neuraminidase are evident. Affected sheep

become ataxic at 4 to 6 months old and worsen to recumbency and death in up to 2 months.

$GM_1$  gangliosidosis has been reported from England in "Coopworth Romney" lambs closely related to a ram imported from New Zealand.

### $GM_2$ Gangliosidosis

$GM_2$  gangliosidosis (Tay-Sachs disease) occurs in sheep and pigs and is an autosomal recessive lysosomal storage disease caused by defects in the genes that code for hexosaminidase. In Jacob sheep, progressive accumulation of  $GM_2$  ganglioside results in cortical blindness, proprioceptive deficits, and ataxia in all four limbs within 6 to 8 months of birth.<sup>1,2</sup>

$GM_2$  gangliosidosis has also been identified in Yorkshire pigs and also causes decreased growth rate, incoordination appearing after 3 months of age, gray-white spots in the retina and dark blue granules in neutrophils, and azurophilic granules in lymphocytes. A serum enzyme assay is a suitable method of detecting "carrier" heterozygous pigs. The test is based on the amount of *N*-acetyl- $\beta$ -D-hexosaminidase in tissues.

## REFERENCES

1. Porter BF, et al. *Vet Pathol.* 2011;48:807.
2. Torres PA, et al. *Mol Genet Metab.* 2010;101:357.

## GAUCHER DISEASE TYPE 2

Gaucher disease is an autosomal recessive lysosomal storage disease caused by mutations in the  $\beta$ -glucocerebrosidase gene. Gaucher disease is the most common lysosomal storage disorder in humans and is divided into three subtypes based on the level of neurologic involvement and clinical signs: (1) type 1, nonneuropathic; (2) type 2, acute neuropathic; and (3) type 3 (subacute neuropathic).<sup>1</sup>

Type 2 Gaucher disease has been reported in Southdown sheep in Victoria, Australia.<sup>1</sup> Affected lambs were unable to stand and exhibited continued shaking and shivering. Lambs could be bottle-fed but their neurologic status did not improve. Affected lambs also had a thickened leathery skin in the abdominal and cervical regions. Glucocerebrosidase activity was markedly reduced in leukocytes and cultured skin fibroblasts and glucocerebrosidase content was increased in the brain, liver, and blood.

## REFERENCE

1. Karageorgos L, et al. *J Inherit Metab Dis.* 2011;34:209.

## BOVINE MUCOPOLYSACCHARIDOSIS TYPE IIIB

Mucopolysaccharidosis IIIB is an autosomal recessive lysosomal storage disease caused by mutations in the NAGLU gene. NAGLU is intimately involved with the degradation of

heparin sulfate in lysosomes; gene mutations therefore result in intralysosomal storage of heparin sulfate.

Mucopolysaccharidosis IIIB has been reported in cattle in Queensland, Australia.<sup>1</sup> Animals were normal at weaning at 6 to 8 months of age; clinical signs developed progressively from 12 months onward and included loss of herding instinct, aimless wandering, tendency to stand alone, becoming very placid and sedate in nature, and development of excessively hairy ears. Animals survived to 3 to 5 years of age, and terminally developed progressive ataxia, a stumbling gait, and excessive weight loss.

## REFERENCE

1. Karageorgos L, et al. *J Inherit Metab Dis.* 2007;30:358.

## SPHINGOMYELINASE DEFICIENCY (NIEMANN-PICK DISEASE TYPE A) IN CATTLE

Sphingomyelinase deficiency (Niemann-Pick disease) is a lysosomal storage disease caused by mutations in the sphingomyelinase gene and is described as three forms in humans: type A (early onset of neurologic disease in infancy), B, and C. Sphingomyelinase is involved with catalyzing the conversion of sphingomyelin to ceramide and phosphorylcholine.

Sphingomyelinase deficiency (type A) has been diagnosed in a 5-month-old Hereford calf in Virginia.<sup>1</sup> The calf had a 4-week history of abnormal and progressive neurologic signs, including hypermetria, wide-based stance, ataxia, and positional strabismus.

## REFERENCE

1. Saunders GK, Wenger DA. *Vet Pathol.* 2008;45:201.

## GLOBOID CELL LEUKODYSTROPHY (GALACTOCEREBROSIDOSIS)

Globoid cell leukodystrophy has been identified in Poll Dorset sheep in Australia. Incoordination in the hindlimbs progresses until the animals are tetraplegic. Only histologic changes are evident at necropsy. These include myelin destruction and the accumulation of characteristic globoid cells in nervous tissue. There is greatly decreased galactocerebrosidase activity in affected tissue.

## INHERITED NERVOUS SYSTEM ABIOTROPHIES

These diseases are characterized by **pre-mature, progressive loss of functionally related and discrete populations of neurons**. As a result, most affected animals are born normal but develop signs of a progressive neurologic disease that is either fatal or leads to such a serious neurologic deficit that euthanasia is the only reasonable solution. In a few rare diseases the patient is abnormal at birth but worsens, and usually



dies, during the neonatal period. Again there are exceptions, and in rare cases complete recovery has been reported. The genetic nature of some of the cases included may not be certain; they are included here if the evidence that they are inherited can be reasonably presumed. An important distinction is that **abiotrophy implies premature aging**, which is different from degeneration, which is a term that implies an extrinsic etiology. From a clinical perspective nervous system degeneration can appear identical to nervous system abiotrophy, and a firm diagnosis of abiotrophy usually requires histologic examination unless the species, breed, or availability of specific diagnostic tests permits antemortem diagnosis of abiotrophy. At the moment the abiotrophic diseases cannot be treated. The lysosomal storage diseases, listed in the preceding section, represent a specific group of abiotrophic diseases.

#### FURTHER READING

Siso S, Hanzlicek D, Fluehmann G, et al. Neurodegenerative diseases in domestic animals: a comparative review. *Vet J*. 2006;171:20-38.

### NEURONAL CEROID LIPOFUSCINOSIS

The neuronal ceroid lipofuscinoses are a group of inherited neurodegenerative lysosomal storage diseases of humans and other animals, inherited as autosomal recessive traits. They are grouped together because of common clinical and pathologic phenomena related to brain and retinal atrophy, premature death, and accumulation of a fluorescent lipopigment in neurons and many other cell types within the body. Molecular genetic studies have identified mutations in eight different genes (*CLN1*, *CLN2*, *CLN3*, *CLN5*, *CLN6*, *CLN6*, *CLN8*, and *CTSD*) that can result in neuronal ceroid lipofuscinoses.<sup>1-4</sup>

The disease is recorded in Devon cattle,<sup>1</sup> South Hampshire sheep,<sup>2,3,4</sup> Rambouillet sheep, Borderdale sheep,<sup>5</sup> Merino sheep, Nubian goats, and Vietnamese pot-bellied pigs.<sup>6</sup> It resembles neuronal ceroid lipofuscinosis of humans and is not strictly a primary lysosomal disorder; it is classified as a proteolipid proteinosis, and provides a good animal model for discussing the similar disease (Batten disease) of humans. Secondary lysosomes in animals with neuronal ceroid lipofuscinoses fill with subunit c of mitochondrial ATP synthase because of excessive peroxidation of polyunsaturated fatty acids. The mechanism of the accumulation is that protein is formed, which is normal for mitochondria, but is misdirected so that it accumulates in the lysosome. The disease in Devon cattle is caused by a single base duplication in the bovine *CLN5* gene.<sup>1</sup> The disease in Merino sheep is a subunit c-storing abnormality, clinically and pathologically similar to ceroid lipofuscinosis in

South Hampshire sheep, which is caused by a missense mutation in the ovine *CLN6* gene.<sup>2,3</sup> The disease in Borderdale sheep is caused by a nucleotide substitution in the ovine *CLN5* gene.<sup>5</sup>

The occurrence of neuronal ceroid lipofuscinosis in South Hampshire and Borderdale sheep in New Zealand have been well described. The severity of neurodegeneration and minor differences in the ultrastructure of storage material suggests this is a different disease from other forms of ovine ceroid lipofuscinosis, which accumulate the subunit c of mitochondrial ATP synthase. An autosomal recessive mode of inheritance is considered probable.

**Clinical findings** include slowly progressive ataxia of the hindlimbs, commencing usually at about 4 months but possibly as late as 18 months of age, and lasting for 6 months leading to euthanasia at up to 4 years. Inability to keep up with the flock is noticed first, followed by a sawhorse stance, obvious ataxia, severe depression, and an increasing failure of the menace and pupillary light reflexes. Terminal blindness is a constant sign. Positional nystagmus, circling, and head-pressing occur in some. Eating, drinking, and defecation are normal, but there is slight weight loss. A blood test has been developed to detect the genetic mutation in South Hampshire sheep.<sup>2</sup> CSF is altered in sheep with advanced disease, characterized by increased lactate, acetate, and tyrosine concentrations and decreased myo-inositol and scyllo-inositol and citrate concentrations.<sup>3</sup>

The lesion in lambs and calves is atrophy of the cerebrum, especially the optic cortex, with eosinophilic granulation of neurons and macrophages in the CNS followed by progressive retinal atrophy. There is a progressive storage of lipopigment in nervous tissue, especially retinal photoreceptors; its presence can be demonstrated by quantitative autofluorescence using a modified slit lamp microscope. Other clinicopathologic aids include lysosomal enzyme assay, organ biopsy, and CT, which reveals the enlargement of the lateral ventricles of the brain resulting from cerebral atrophy.

Neuronal ceroid lipofuscinosis has been described in three horses. Clinically, there was developmental retardation, slow movements, and loss of appetite at 6 months of age. Torticolis, ataxia, head tilt, and loss of eyesight were present at 1 year of age. There were abnormalities in posture and movements, decreased spinal reflexes, and some CN dysfunction, dorsal strabismus, and absence of the menace reflex. At necropsy, there was flattening of the gyri and discoloration of the brain. Histologically, eosinophilic, autofluorescent material in the perikarya of neurons was present throughout the brain, spinal cord, neurons of the retina, submucosa, and myenteric ganglia and in glial cells.

Neuronal ceroid lipofuscinosis has been described in a 2-year-old Vietnamese pot-bellied pig.<sup>6</sup> Ataxia had progressed to tetraparesis over a 3-month period, with terminal development of a head tilt and intermittent nystagmus. The pig did not appear to be blind.

#### REFERENCES

- Houweling PJ, et al. *Biochim Biophys Acta*. 2006;1762:890.
- Tammen I, et al. *Biochim Biophys Acta*. 2006;1762:898.
- Pears MR, et al. *J Neurosci Res*. 2007;85:3494.
- Kay GW, et al. *Neurobiol Dis*. 2011;41:614.
- Frugier T, et al. *Neurobiol Dis*. 2008;29:306.
- Cesta ME, et al. *Vet Pathol*. 2006;43:556.

### CONGENITAL NECROTIZING ENCEPHALOPATHY IN LAMBS

This condition, defined by its pathology, was a common diagnosis of neurologic disease in lambs under 7 days of age by the Veterinary Laboratories Agency in the north of England.<sup>1</sup> Affected flocks had single or multiple cases, with up to 10% morbidity of lambs in a flock. All cases came from ewes carrying multiple fetuses, but there is variation in the clinical signs of sibling lambs. The most severely affected may be stillborn, with less severely affected lambs born weak, small, and unable to rise with ataxia and head tremor. Some lambs survive but may have residual signs of cerebellar dysfunction. The common lesion is superficial cerebrocortical neuronal necrosis. A significant proportion also has necrosis of the Purkinje cells in the cerebellum and leukoencephalopathy of the thalamus and brainstem. It is possible that this syndrome reflects hypoglycemia consequent to negative energy balance in late pregnancy.

#### REFERENCE

- Scholes SFE, et al. *Vet Rec*. 2007;160:775.

### LAVENDER FOAL SYNDROME

Lavender foal syndrome is a congenital, inherited, autosomal recessive disease of Egyptian Arab foals characterized by signs of neurologic disease evident at birth and unusual dilute coat color.<sup>1</sup> The disease is caused by a mutation in the *MYO5A* gene that is a single-base deletion in a conserved region of the tail domain.<sup>2</sup> The deletion produces a truncated protein product through the insertion of a premature stop codon (p.Arg1487AlafsX13). There is a prevalence of carriers in Egyptian Arabian horses of 10.3% (heterozygotes),<sup>3</sup> and within Arabs the allele frequency is estimated at 0.0162, with no alleles detected in Thoroughbred, Standardbred, Morgan, Quarter Horse, or Percheron horses.<sup>4</sup> The carrier prevalence of LFS in Arabian foals in South Africa for the 2009/2010 season was 11.7% (95% confidence interval [CI] 7.6–17.0%).<sup>5</sup>

There is a dilute (lavender) coat color and signs of central neurologic disease including inability to stand, paddling, opisthotonus, and torticollis with apparently normal peripheral reflexes (blink to bright light, triceps, patellar, and cutaneous truncal).<sup>1</sup> There are no characteristic hematologic and serum biochemical abnormalities. There is no effective treatment.

Gross necropsy examination does not reveal any consistent or diagnostic abnormalities apart from the dilute hair coat. An assay for the genetic mutation is available and provides confirmation of diagnosis. Testing of Egyptian Arabians enables avoidance of carrier-to-carrier matings, and thus the disease.<sup>3</sup>

**REFERENCES**

1. Page P, et al. *J Vet Intern Med.* 2006;20:1491.
2. Bierman A, et al. *Anim Gen.* 2010;41:199.
3. Brooks SA, et al. *PLoS Genet.* 2010;6:e000909.
4. Gabreski NA, et al. *Anim Gen.* 2012;43:650.
5. Tarr CJ, et al. *Equine Vet J.* 2014;46:512.

**INHERITED HYPOMYELINOGENESIS (CONGENITAL TREMOR SYNDROMES OF PIGLETS)**

Congenital tremor of pigs has a multiple etiology and some of the causes are not yet identified. The disease is also known as *myoclonia congenita* or trembling pig syndrome or jumpy pig disease. Gilts are particularly affected. The types are shown in Table 14-18 and the features in Table 14-19. They can only be differentiated by pathology and particularly neurochemistry. The essential lesion is the same in all cases and is a hypomyelination of the brain and spinal cord. The infectious forms are discussed elsewhere.

There are two inherited forms. One is congenital tremor Type A-III, which is found in Landrace pigs and Landrace crosses. It is sometimes known as Landrace trembles. Type A-III is a sex-linked recessive gene carried by the sow. It is associated with females, high growth rates, lean carcasses,

and pale colored meat characterized by the presence of poorly myelinated axons in all parts of the CNS. It is also known as congenital cerebrospinal hypomyelination. The sows produce piglets that have reduced numbers of oligodendrocytes and therefore cannot myelinate nerve fibers. The tremor disappears when the piglets are asleep.

The other inherited form is Type A-IV of British Saddleback pigs. It is not common. The specific defect in A-IV is one of fatty acid metabolism, which results in hypomyelination and demyelination. (A similar disorder but a monogenic autosomal recessive tremor has also been described in Saddleback /Large White crosses).

The structural abnormalities in the type A-III disease have been identified; playleg is a common accompaniment.

Both diseases are characterized by muscle tremor, incoordination, difficulty in standing, and some squealing. The A-III disease occurs only in males. Both are inherited as recessive characteristics.

**Table 14-18** Diagnostic taxonomy of congenital tremor in pigs

Cause	AI	AII	AIII	AIV	AV	B
	Virus hog cholera	Virus unknown	Genetic S-L recessive	Genetic autosomal recessive	Chemical trichlorfon	Unknown
Field observations						
Proportion of litters affected	High	High	Low	Low	High	Variable
Proportion of pigs affected within litter (approximately)	>40%	>80%	25%	25%	>90%	Variable
Mortality among affected pigs	Medium to high	Low	High	High	High	Variable
Sex of affected pigs	Both	Both	Male	Both	Both	Any
Breed of dam (pure or crossbred)	Any	Any	Landrace	Saddleback	Any	Any
Recurrence in successive litters of same parents	No	No	Yes	Yes	Yes	?
Duration of outbreak	<4 months	<4 months	Indefinite	Indefinite	<1 month	?

**Table 14-19** Key features of the six types of congenital tremor described in pigs

Type	Cause	Key features
A1	Hog Cholera	Dysgenesis Cerebellar hypoplasia Small cord Demyelination Swollen oligodendrocytes
AII	Congenital tremor virus PCV2	Swollen oligodendrocytes
AIII	Inherited autosomal recessive sex linked in landrace	Reduced oligodendrocytes Reduced myelination Hypoplasia of cord
AIV	As previously noted in Saddleback Also Landrace/Saddleback cross syndrome	Demyelination Cerebral, cerebellar and cord hypoplasia
AV	Trichlorfon toxicity	Cerebellar hypoplasia affected 45–79 days' gestation, particularly 75–79
B	Unknown	No special features

## FURTHER READING

Harding DJD, et al. Congenital tremor AIII in pigs, an hereditary sex-linked cerebrosplinal myelinogenesis. *Vet Rec.* 1973;92:527.

Kidd ARM, et al. A-IV A new genetically-determined congenital nervous disorder in pigs. *Br Vet J.* 1986;142:275.

## Diseases Primarily Affecting the Cerebellum

### INHERITED CEREBELLAR DEFECTS

Several inherited cerebellar defects occur congenitally in calves, lambs, and foals. Lesions of the cerebellum may or may not be grossly or clinically obvious. They all need to be differentiated from similar defects known to be caused by intrauterine viral infections such as swine fever, bovine mucosal disease, and bluetongue.

#### Cerebellar Hypoplasia

This occurs in Herefords, Guernseys, Holsteins, Shorthorns, and Ayrshires and appears to be conditioned by a factor inherited in a recessive manner. Most calves are obviously affected at birth. While lying down, there is no marked abnormality, although a moderate lateral tremor of the neck occurs, causing a gentle side-to-side swaying of the head. Severely affected calves are blind; they have widely dilated pupils and their pupils do not react to light. Such calves are unable to stand, even when assisted, because of flaccidity of limb muscles. When less severely affected animals attempt to rise, the head is thrown back excessively, the limb movements are exaggerated in force and range and are grossly incoordinated, and many calves are unable to rise without assistance. If they are placed on their feet, the calves adopt a straddle-legged stance with the feet wide apart and the legs and neck extended excessively. On attempting to move, limb movements are incoordinated and the calf falls, sometimes backward because of overextension of the forelimbs. Affected animals drink well but have great difficulty in getting to the teat or pail, with attempts usually wide of the mark. There are no defects of consciousness and no convulsions. Tremor may be evident while standing and there may be postrotational nystagmus after rapid lateral head movements. Sight and hearing are unimpaired and, although complete recovery does not occur, the calf may be able to compensate sufficiently to enable it to be reared to a weaning weight. Diagnosis can be confirmed by MRI.

At necropsy the most severe defect comprises complete absence of the cerebellum; hypoplasia of the olivary nuclei, the pons, and optic nerves; and partial or complete absence of the occipital cortex. Less severe

defects include a reduction in size of the cerebellum and absence of some neuronal elements in a cerebellum of normal size.

Although the disease is dealt with generally as an inherited one. There is no firm evidence to substantiate this view, and there are sporadic, noninherited cases in other breeds.

#### Cerebellar Atrophy of Lambs (Daft Lamb Disease 1)

This has been recorded in many sheep breeds in Britain, Corriedales in Canada and New Zealand, and in Drysdale. Affected lambs are normal at birth but are weak and unable to rise without assistance. At 3 days of age it is obvious that there is severe incoordination of limb movement, opisthotonus, tremor, and a straddle-legged stance. At necropsy the cerebellum may be of normal size but on histologic examination there is gross atrophy of cerebellar neurons. The disease appears to be conditioned by a recessive gene but not as a simple homozygous recessive. A clinically similar disease has been observed in Border Leicester lambs. There is no histopathologic lesion in the cerebellum, but there are significant lesions in the cervical muscles and the nerve supply to them. The disease is inherited, most likely as an autosomal recessive trait.

#### Star-Gazing Lambs (Daft Lamb Disease 2)

A hereditary disease clinically similar to cerebral cortical atrophy has been described in newborn Leicester lambs in the UK but without histologic evidence of Purkinje cell loss, which is considered the hallmark of “cerebellar abiotrophy.” Affected lambs exhibit “dorsal arching of the neck with the head being pressed backward,” which is also described as star-gazing. Histologic lesions are present in neck muscles and nerves, but it is uncertain if these are primary or secondary.

#### Hereditary Lissencephaly and Cerebellar Hypoplasia in Churra Lambs

Lissencephaly is a very rare developmental intracranial disorder of animals that results from defects in neuronal migration. The gross result is a very simplified folding of the cerebrum and cerebellum with the presence of only a few broad gyri.

Lissencephaly and cerebellar hypoplasia have been identified in Churra lambs in Spain. Affected lambs were abnormal at birth, exhibiting weakness, inability to stand, and muscular rigidity. The cerebral cortex was disorganized histologically and the cerebellum was reduced in size. Pedigree analysis indicated a monogenic autosomal pattern of inheritance.<sup>1</sup> The genetic defect was a 31 base pair deletion in the coding area for the RELN gene, which plays an important role in neuronal migration and layer formation.<sup>2</sup> The deletion results in formation of a

premature termination codon, resulting in the absence of protein expression.

## REFERENCES

1. Perez V, et al. *BMC Vet Res.* 2013;9:156.
2. Suarez-Vega A, et al. *PLoS ONE.* 2013;8:e81072.

#### Inherited Ataxia of Calves

This is a true cerebellar ataxia inherited as a recessive character in Jerseys, Shorthorns, and Holsteins. Clinically the condition resembles cerebellar hypoplasia except that signs may not occur until the calves are a few days to several weeks old. At necropsy the cerebellum is normal in size but histologically aplasia of neurons is evident in the cerebellum and also in the thalamus and cerebral cortex. An inherited condition, manifested by cerebellar ataxia that does not develop until calves are 6 weeks to 5 months old, has also been recorded but the cerebellum is small and macroscopically abnormal. Conspicuous degeneration of cerebellar Purkinje cells is evident on histologic examination.

#### Familial Convulsions and Ataxia in Cattle

A neurologic disease is recorded as being inherited in Aberdeen Angus cattle and their crossbreeds and Charolais. In young calves there are intermittent attacks of convulsions, and in older animals these are replaced by a residual ataxia. The first signs appear within a few hours of birth; up to several months later there are single or multiple tetanic convulsions lasting for 3 to 12 hours. As these episodes disappear a spastic goose-stepping gait becomes apparent in the forelimbs and there is difficulty placing the hindlimbs. The characteristic necropsy lesion is a very selective cerebellar cortical degeneration. A proportion of cases make a complete recovery. The epidemiology of the disease is consistent with the operation of an autosomal dominant gene with incomplete penetrance.

#### Inherited Congenital Spasms of Cattle

This condition has been recorded only in Jersey cattle and appears to be conditioned by a factor inherited in a recessive manner. Affected calves show intermittent, vertical tremor of the head and neck, and there is a similar tremor of all four limbs that prevents walking and interferes with standing. Although the calves are normal in all other respects, they usually die within the first few weeks of life. No histologic examinations have been reported, but a cerebellar lesion seems probable.

#### Cerebellar Abiotrophy

This disease occurs in Holstein and Poll Hereford cross calves, Aberdeen Angus cattle and their crossbreeds and Charolais cattle, Merino sheep, alpaca,<sup>1</sup> Arabian horses,<sup>2-6</sup> and pigs. The pathologic feature of cerebellar



abiotrophy is disorganization of the Purkinje cells in the granular layer of the cerebellum, with subsequent disorganization of the molecular and granular layers. The etiology is thought to be abnormal migration of the Purkinje cells through the cerebellum during development, resulting in premature neuronal degeneration of Purkinje cells.<sup>4</sup>

### Cattle

In the calves, ataxia appears for the first time when they are 3 to 8 months old. The calves are not blind but they often fail to exhibit a menace reflex. The onset of clinical signs is sudden but progression is slow or inapparent. Some become recumbent. Those that remain standing have a spastic, dysmetric ataxia and a broad-based stance and they fall easily and have a fine head tremor. All are strong and have good appetites. Abiotrophy, or premature aging, is evident only microscopically and consists of axonal swellings and segmental degeneration and loss of cerebellar Purkinje cells. The disease appears to be inherited, but recovery of some late cases is recorded.

**Familial convulsions and ataxia** is characterized as being inherited in Aberdeen Angus cattle and their crossbreds and Charolais. In young calves there are intermittent attacks of convulsions, and in older animals these are replaced by a residual ataxia. The first signs appear within a few hours of birth; up to several months later there are single or multiple tetanic convulsions lasting for 3 to 12 hours. As these episodes disappear a spastic goose-stepping gait becomes apparent in the forelimbs and there is difficulty placing the hindlimbs. The characteristic necropsy lesion is a very selective degeneration of the cerebellar cortex. A proportion of cases make a complete recovery. The epidemiology of the disease is consistent with the operation of an autosomal dominant gene with incomplete penetrance.

### Sheep

The disease in sheep does not appear until about 3 years of age. There is incoordination and dysmetria so that the gait is awkward and disorganized and there is frequent falling. There are also a reduced menace response, an apprehensive manner, and a wide-based stance in the hindlimbs. At necropsy there is diffuse cerebellar degeneration and severe loss of Purkinje cells.

### Alpaca

Neurologic abnormalities were first detected at 18 months of age, at which time intention tremors, hypermetria, and a wide-based stance were evident.<sup>1</sup> CSF analysis was within normal limits and the cerebellum appeared smaller than expected on CT.

### Horses

The disease is recorded principally in Arabian horses but occurs also in the Australian

pony, which was developed from the Arab, and in the Gotland breed from Sweden. A similar clinical syndrome occurs in the Old-english breed, but the pathologic picture is quite different.

The disease may be present at birth but is often not observed until the foal is 2 to 6 months old with the latest recognition being between 9 and 24 months of age. The characteristic signs are vertical head-nodding (some cases show horizontal head tremors), especially when excited, and ataxia, which is most noticeable at a fast gait. It may not be evident while the foal is walking. Very badly affected foals are unable to stand or suckle at birth, less severe ones are normal until about 4 months of age when head-nodding becomes obvious. The degree of ataxia varies from slight incoordination to inability to stand. A goose-stepping gait, which slams the front feet into the ground, occurs in some. All foals can see but there is an absence of the menace reflex in many. Nystagmus is not recorded as occurring in this disease. The first antemortem confirmatory test to be developed was **computer-assisted MRI brain morphometry**, which is used to determine the presence of a relatively smaller cerebellum and relatively larger cerebellar CSF space compared with size-matched horses.<sup>3</sup> Diagnosis has historically been made on the basis of breed and age of the animal, clinical signs, slow progression of disease, and elimination of other differential diagnoses.<sup>2</sup> The recent development of a DNA test on hair roots that detects the presence of the putative cerebellar abiotrophy gene mutation<sup>4-6</sup> should make antemortem diagnosis much more straightforward in Arabian horses.

Necropsy findings are limited to histopathologic lesions in the cerebellum. These include widespread loss of Purkinje cells and the presence of a gliosis. There are no degenerative lesions in the spinal cord. In the similar disease in Oldenberg horses the cerebellum is often reduced in size. The disease is an abiotrophy—a premature aging of tissues.

The disease is inherited as an autosomal recessive trait in Arabian horses.<sup>4</sup> An SNP has been identified in affected Arabian horses and may induce the disease by decreasing MUTYH expression, which is a DNA glycosylase that removes adenine residues.<sup>5</sup> The frequency of the allele is estimated at approximately 10.5% in the U.S. Arabian population, which is high.<sup>6</sup> The gene mutation has been identified at a low level in three breeds with Arabian ancestry (Trakehner; Bashkir Curly Horses, also known as North American Curly horses; and Welsh ponies).<sup>6</sup>

### Pigs

A congenital progressive cerebellar abiotrophy is also reported in piglets of the offspring of Saddleback sows and an unrelated Large White boar. The disorder behaves epidemiologically like an inherited disease

conditioned by a simple autosomal recessive trait. Clinical signs include dysmetria, ataxia, and tremor at standing but not at rest. There is gradual adjustment so that the piglets can walk and stand at 5 weeks of age, but by 15 weeks they are no longer able to do so. Affected pigs also have a coarse matted hair coat caused by a disproportionate number of coarse hairs to fine hairs. Histopathologic lesions are confined to the cerebellum in which there is a significant loss of Purkinje cells.

### REFERENCES

1. Mouser P, et al. *Vet Pathol.* 2009;46:1133.
2. Foley A, et al. *Equine Vet Educ.* 2011;23:130.
3. Cavalleri JMV, et al. *BMC Vet Res.* 2013;9:105.
4. Brault LS, et al. *Am J Vet Res.* 2011;72:940.
5. Brault LS, et al. *Genomics.* 2011;97:121.
6. Brault LS, Penedo MCT. *Equine Vet J.* 2011;43:727.

## Diseases Primarily Affecting the Brainstem and Vestibular System

### OTITIS MEDIA/INTERNA

Infection of the middle ear (**otitis media**) occurs in young animals of all species but especially dairy calves and pigs, to a lesser extent feedlot cattle and lambs, and rarely foals. The infection may gain entrance from the external ear (e.g., caused by ear mite infestation) or hematogenously, but the spread is chiefly an ascending infection of the eustachian tubes in a young animal from a respiratory tract infection. Extension of infection into the inner ear leads to **otitis interna**.

### Pigs

Otitis media was present in 68% of 237 pigs that were slaughtered because of illness. It is suggested that otitis media in pigs develops first as an acute inflammation in the auditory tube and then extends to other parts of the ear and brain. When abscesses form at the ventrum of the brainstem, the vestibulocochlear nerve is usually involved in the lesion. Infection in the ear may extend into the brain by following the auditory nerve. Perilymph filling the scala vestibuli and scala tympani is also a possible tract for the extension of the infection because there is a communication between the perilymph-filled spaces of the bony labyrinth and the subarachnoid space.

### Calves and Lambs

The highest prevalence is in suckling dairy calves and weaned cattle and sheep in feedlots where the disease is probably secondary to respiratory tract infection. Outbreaks of otitis media/interna have occurred in beef calves from 6 to 10 weeks of age on pasture with their dams; mixed cultures of *E. coli*, *Pseudomonas* spp., and *Acinetobacter*

spp. were isolated. Otitis media/interna in suckling dairy calves can also occur in outbreaks, and *M. bovis* is frequently isolated from the middle and inner ears of affected calves.

The onset of clinical signs commonly includes dullness, fever, inappetence, tachypnea, and a purulent discharge from the affected ear accompanied by rotation of the head (in otitis interna) and drooping of the ear a few days later because of involvement

of the facial nerve in the inflammation. Deep palpation at the base of the ears may elicit a pain response.

Rotation of the head, with the affected side down, and facial paralysis may occur on the same side, and walking in circles with a tendency to fall to the affected side is common. In most cases the animals are normal in other respects, although depression and inappetence can occur in advanced cases (Fig. 14-15).

## Horses

Otitis media/interna occurs in horses, and two clinical syndromes have been described. **The first syndrome** is primary otitis media characterized by abnormal behavior, including head-tossing, head-shaking, and ear-rubbing. Violent, uncontrollable behavior includes throwing themselves on the ground, rolling, and thrashing. This may progress to involve the bony structures of the temporal and proximal stylohyoid bones, resulting in a degenerative arthritis and eventual fusion of the temporohyoid bone.

**The second syndrome** is characterized by an acute onset of neurologic deficits. Commonly, there is vestibulocochlear nerve and often facial nerve dysfunction characterized by head tilt to the side of the lesion, nystagmus with the slow component to the affected side, and weakness of the extensor muscles on the affected side resulting in an ataxia or reluctance or refusal to stand. Horses that can stand often will lean on walls for support of the affected side.

Definitive diagnosis is dependent on either a positive tympanocentesis or, in the majority of cases, bony proliferation of the temporal bone and proximal part of the stylohyoid bone, or lysis of the tympanic bulla, as determined by radiography or CT. Otoloscopic examination should be performed to determine whether there is purulent material in the auditory canal and whether the tympanic membrane is ruptured or bulging outward.

Radiography has been used to diagnose lesions of the tympanic bullae in cattle (otitis interna), characterized by thickening of the bulla wall, increased soft tissue opacity within the bulla, and osteolysis of the bulla wall and trabeculations.<sup>1</sup> Radiography is not as sensitive as CT for the diagnosis of otitis media; however, because CT provides more detailed information regarding the bony structures of the middle ear<sup>2,3</sup> and is more sensitive and specific than radiography in the diagnosis of otitis media in calves.<sup>1</sup> CT was used to provide an excellent anatomic description of the external acoustic meatus, tympanic cavity, and tympanic bulla of the llama.<sup>4</sup> Ultrasonography has also been used to diagnose otitis media in calves.<sup>5</sup> A 7.5-mHz linear probe is applied to the base of the ear without the use of coupling gel and the calf in a standing position. The probe is applied ventral to the base of the ear and caudal to the mandible. Abnormalities detected included anechoic to hyperechoic content; trabeculae lysis; and thinning, deformation, and rupture of the bulla wall. The lesions can be subtle in early cases and, consequently, test sensitivity is low in animals with acute or subacute clinical presentations.

**Tympanocentesis** is done under general anesthesia in horses or sedation in ruminants by directing a 15-cm needle through the tympanic membrane visualized with the aid of an otoscope. The technique is



**Fig. 14-15** Otitis media/interna on the right side of a recently weaned Suffolk sheep. Notice the marked deviation of the line between the two eyes from horizontal.



somewhat difficult because of the long and angled external auditory canal. Sterile 0.9% NaCl (0.5–1 mL) is injected into the tympanic cavity and then, after a few seconds, withdrawn. A positive tap consists of withdrawal of a cloudy or yellow fluid, which on analysis may contain evidence of pus and can be sampled for culture and antimicrobial susceptibility. An alternative method uses a 15-cm sterile polypropylene catheter that has the appropriate stiffness for puncturing the tympanic membrane but sufficient flexibility to advance along the external acoustic meatus.<sup>3</sup>

### DIFFERENTIAL DIAGNOSIS

The disease needs to be differentiated from otitis externa, in which the head may be carried in a rotated position, but usually intermittently, and this is accompanied by head-shaking and the presence of exudate and an offensive smell in the ear canal, and from cerebral injury or abscess, and similar lesions of the upper cervical cord. All of these are characterized by deviation of the head, not rotation. At necropsy the tympanic bulla contains pus, and a variety of organisms, such as staphylococci, streptococci, *Pasteurella haemolytica*, and *Neisseria catarrhalis*, may be isolated.

### TREATMENT

Treatment consists of broad-spectrum antimicrobials daily for 4 weeks and antiinflammatory agents. The prognosis with treatment with fluoroquinolones is very good in calves, although a 50% mortality rate has been reported in calves that were not treated with other antimicrobial agents. The use of lincomycin at 6.5 mg/kg BW combined with spectinomycin at 10 mg/kg BW intravenously twice daily for 5 days has been reported to be successful for the treatment of otitis media in beef calves. Anecdotal reports exist of the use of a knitting needle to rupture the tympanic membrane in cattle, with rapid resolution of the head tilt because of the decreased pressure in the middle ear. Bilateral tympanic bulla osteotomy has been performed in an affected calf, resulting in a rapid resolution of the head tilt.

### FURTHER READING

- Duarte ER, Hamdan JS. Otitis in cattle, an etiological review. *J Vet Med B*. 2004;51:1-7.
- Morin DE. Brainstem and cranial nerve abnormalities: listeriosis, otitis media/interna, and pituitary abscess syndrome. *Vet Clin North Am Food Anim Pract*. 2004;20:243-273.

### REFERENCES

1. Finnen A, et al. *J Vet Intern Med*. 2011;25:143.
2. Lee K, et al. *Vet Rec*. 2009;165:559.
3. Kawasaki Y, et al. *Vet Rec*. 2009;165:212.
4. Concha-Albornoz I, et al. *Am J Vet Res*. 2012;73:42.
5. Gosselin V, et al. *J Vet Intern Med*. 2014;28:1594.

## LISTERIOSIS

### SYNOPSIS

**Etiology** *Listeria monocytogenes*. Ubiquitous in farm environment.

**Epidemiology** Ruminants, particularly sheep. Prime occurrence is seasonal associated with feeding silage with high listerial growth. Also following management-induced stress. Commonly manifest with multiple cases in a group.

**Clinical findings** Most commonly encephalitis with brainstem and cranial nerve dysfunction or abortion in last third of pregnancy. Less commonly septicemia in periparturient and neonatal sheep and goats, enteritis in weaned sheep, spinal myelitis, uveitis, and occasionally mastitis.

**Clinical pathology** Culture, PCR. Pleocytosis and elevated protein in cerebrospinal fluid with encephalitis.

**Lesions** Microabscesses in brainstem in listerial encephalitis, spinal cord in spinal myelitis, abomasum, intestine, liver, and mesenteric lymph nodes in enteritis. Visceral lesions in septicemia.

**Diagnostic confirmation** Culture and histopathology.

**Treatment** Penicillin or oxytetracycline. Must be given early in clinical disease.

**Control** Control of listerial growth in feeds. Vaccination.

### ETIOLOGY

There are currently six species classified within the genus *Listeria*, but only *L. monocytogenes* and *L. ivanovii* (previously classified as *L. monocytogenes* serotype 5) are pathogenic for domestic animals. *L. ivanovii* is only mildly pathogenic and is an occasional cause of abortion in sheep and cattle. Aborted fetuses have suppurative bronchopneumonia and lack the multifocal hepatocellular necrosis commonly seen in abortions associated with *L. monocytogenes*. *L. innocua* is occasionally associated with encephalitis in ruminants that is clinically and pathologically similar to that associated with *L. monocytogenes*. Most, but not all, reports of both infections record that the animals were being fed silage.

*L. monocytogenes* is widespread in nature and has characteristics that allow its survival and growth in a wide variety of environments. There is a highly diverse range of strains, some of which have the capability of causing disease in animals and humans.

Optimal growth temperatures are between 30°C and 37°C but the organism can grow and reproduce at temperatures between 1°C and 45°C. It can grow between pH 4.5 and 9.6 although growth at low pH is minimal at low temperatures. The organism is susceptible to common disinfectants.

*L. monocytogenes* can be divided into 16 serovars on the basis of somatic and flagellar antigens, and there is considerable genetic diversity between serovars. Serovars 4b, 1/2a and 1/2b, and 3 are most commonly isolated from diseased animals but there are geographic differences. Virulent strains can multiply in macrophages and monocytes and produce a hemolysin, listeriolysin O, which is thought to be a major virulence factor.

### EPIDEMIOLOGY

#### Occurrence Geographic

Although the organism is widespread in nature, clinical disease in animals occurs mainly in the northern and southern latitudes and is much less common in tropical and subtropical than in temperate climates. The disease is important in North America, Europe, the UK, New Zealand, and Australia.

#### Seasonal

In the northern hemispheres listeriosis has a distinct seasonal occurrence, probably associated with seasonal feeding of silage, with the highest prevalence in the months of December through May, but seasonal occurrence is not a feature in Australia.

#### Host

Listeriosis is primarily a disease of ruminants, particularly sheep, and the major diseases associated with *L. monocytogenes* are encephalitis and abortion. In ruminants it also produces syndromes of septicemia, spinal myelitis, uveitis, gastroenteritis, and mastitis. Occasional septicemic disease occurs in horses and pigs.

- **Encephalitis/meningitis** usually occurs sporadically, affecting a single animal in a herd or flock or a few individuals over several weeks. The mean attack rate in 50 affected flocks in Britain was 2.5% with a range of 0.1% to 13.3%. More serious outbreaks can occur with attack rates as high as 35% and cases occurring over a 2-month period. The disease occurs in sheep older than 6 weeks but may be more prevalent in lambs between 6 and 12 weeks of age and ewes over 2 years of age. The case-fatality is high, especially in sheep, because the short clinical course often precludes treatment.
- **Abortion** may also occur sporadically, which is usually true in cattle, but in sheep and goats it is more common as an outbreak with an attack rate that frequently approaches 10%.
- **Spinal myelitis** is an uncommon manifestation but is recorded as occurring in 0.8% to 2.5% of sheep in affected flocks and in all ages of sheep 4 weeks following spray dipping. Spinal myelitis also occurs sporadically in cattle 12 to 18 months of age.



- **Septicemic disease** is also a less common manifestation of infection with *L. monocytogenes* but can occur as an outbreak with a high case fatality in newborn lambs and kids and also in periparturient ewes and does.
- **Keratoconjunctivitis/uveitis** occurs in both sheep and cattle and has been associated with silage feeding from big bales or ring feeders. This condition presents a distinct entity that is not associated with systemic infection with *Listeria*.
- **Gastroenteritis** has been reported primarily by veterinary diagnostic labs in Great Britain and New Zealand as a sporadic disease affecting sheep after weaning. It occurs during the winter months most commonly in sheep fed baleage or silage. Cases occur 2 days or more after the onset of feeding. Less commonly, cases occur in sheep on root crops or on pasture where the quality of the pasture is poor and they are at high stocking densities.
- **Mastitis** is uncommon but can occur in cattle, sheep, and goats. It results in contamination of milk with *L. monocytogenes*. The more common source of *L. monocytogenes* in raw milk is fecal contamination. In a Danish study of quarter milk samples from over a million cows in 36,199 herds, 0.4% of cows had listerial mastitis and 1.2% of herds had infected cows.

### Source of Infection

The organism is common in the environment and infection is not limited to agricultural animals. *L. monocytogenes* has been isolated from 42 species of mammals and 22 species of birds as well as fish, crustaceans, and insects. It is truly **ubiquitous in the environment** and can be commonly isolated from animal feces, human feces, farm slurry, sewerage sludge, soil, farm water troughs, surface water, plants, animal feeds, and the walls, floors, drains, and so forth of farms and other environments. The ability to form biofilms may assist in its survival in the environment and may assist in perpetuating its presence in water troughs on infected farms.

Most feed hays, grains, and formulated feeds have the potential to contain *L. monocytogenes* but, with most, low levels of available water restrict its multiplication.

In ruminants *L. monocytogenes* can be isolated from the feces and nasal secretions of healthy animals and has been isolated from the feces of cattle in 46% of 249 herds examined and from 82% of samples of feed-stuffs. In a French survey 5% of small ruminant fecal samples were found positive for *L. monocytogenes*. Fecal material from wild birds in agricultural regions may also contain large amounts of *L. monocytogenes* that can contribute to the contamination of feed, water, bedding material, and soils.<sup>1</sup> Exposed

sheep may become latent carriers, shedding the pathogen in feces and milk.<sup>1</sup>

In temperate climates the prevalence of *L. monocytogenes* in the feces of ruminants appears to vary with the season, being higher in the winter period. It is also increased during periods of environmental stress and in association with the stress of lambing and transport. The presence in feces and secretions can also be influenced by the number of the organism in feeds fed to the animals. In herds where there is a high proportion of cattle excreting in feces, the organism can be isolated from dried fecal dust on walls and most farm surfaces.

*L. monocytogenes* is not isolated from the feces or environment in all farms and its presence in isolable numbers is largely a reflection of its presence in feed, or the presence of animals with intestinal carriage. It is apparent that in some healthy herds and flocks there may be a multitude of different strains in the silage and feed, water troughs, feces, and environment in a single herd.

The presence of *L. monocytogenes* in bulk tank milk or milk filters is used as a measure of farm infection prevalence. Obviously this measure is influenced by the management and environmental conditions on farms that might result in fecal contamination of the teats. Although bulk tank and milk filter infection rates provide information of possible value to measures of environmental contamination and risk for human exposure, there is no evidence that this measure has any relationship to risk for animal disease on the farm being studied.

### Silage

*L. monocytogenes* is commonly present in silage, but it does not multiply to any significant extent in effectively preserved silage, which is characterized by anaerobic storage, high density, a high concentration of organic acids, and a pH below 4.5. *Listeria* can multiply in silage above pH 5.0 to 5.5, the critical pH depending on the dry matter content. *L. monocytogenes* may be present in silage that is **poorly fermented**, but it can also occur in pockets of **aerobic deterioration** in otherwise good silage and this is most common. These areas are often indicated by mold growth and occur at the edges of the clamp and in the top few inches of the surface in plastic-covered clamps where air has circulated under the plastic. Thus the growth of *L. monocytogenes* is a surface problem in silage, except those that are poorly fermented, and occurs in small areas sporadically over the surface of a silage.

The risk for contamination of silage with *Listeria* is higher when it contains **soil**, which may be incorporated from molehills present in the field and in the front of the clamp during final packing. An **ash content** of greater than 70 mg/kg dry matter indicates soil contamination.

**Big bale silage** may have a higher risk for listerial infection than conventional silage because of its lower density, poor fermentation, greater surface area relative to clamp silage, and greater risk for mechanical damage to the plastic covering.

**Moist preserved feeds** other than grass silage are at risk for listerial growth; listeriosis is recorded, for example, in association with the feeding of moist brewers grains, wet spoiled hay bales, and silage made from commodity by-products such as orange and artichoke waste. A relatively rapid method for the quantitative assessment of the occurrence and distribution of *Listeria* in suspect silage is available.

Infective material also derives from infected animals in the feces, urine, aborted fetuses and uterine discharge, and in the milk. Although immediate spread among animals in a group has been demonstrated, field observations suggest that mediated contagion by means of inanimate objects also occurs. **Woody browse** may be a risk factor for goats.

### Transmission

With septicemic disease and abortion, the organism is transmitted by ingestion of contaminated material. Lambs that develop septicemic disease may acquire infection from contamination on the ewe's teat, from the ingestion of milk containing the organism from ewes or does with subclinical bacteremia, through the navel from the environment, and also as a congenital infection. The encephalitic form of the disease results from infection of the terminals of the trigeminal nerve consequent to abrasions of the buccal mucosa from feed or browse or from infection of tooth cavities. Spinal myelitis is thought to result from growth up spinal nerves subsequent to body area infections.

Outbreaks of encephalitis that occur in sheep after introduction to silage usually commence about 3 to 4 weeks later, although there is wide variation, and one study of a large number of outbreaks found the median time of this period to be 44 days. This delay reflects the time for ascending infection.

Commonly, the serotype isolated from the brain of an affected animal is also present in the silage being fed. However, the recent development of methods for genetic analyses of *L. monocytogenes* has demonstrated that serotyping is a relatively crude tool for epidemiologic studies and in many instances, although the isolate from brain may be the same serotype as that from silage, there is no relationship on genetic analysis. Possibly this reflects differences in strains at different sites in silage and the difference between the time of sampling of the silage and the time when the affected cow ate it.

Septicemic disease in sheep and goats usually occurs within 2 days of introduction to silage and abortions 6 to 13 days later.

## Risk Factors

Despite the ubiquity of *L. monocytogenes*, only a small proportion of animals develop clinical disease. A number of predisposing factors have been observed, or proposed, as risk factors for disease. These include factors that cause a lowering of the host animal's resistance and factors that increase the infection pressure of the organism. In farm animals the latter appear the most important.

## Host Management Risk Factors

Observed risk factors include the following:

- Poor nutritional state
- Sudden changes of weather to very cold and wet
- Stress of late pregnancy and parturition
- Transport
- Long periods of flooding with resulting poor access to pasture

Differences in susceptibility between species are apparent with sheep being considerably more likely to develop clinical disease than cattle. Area outbreaks affecting several flocks can occur in sheep on poorly drained and muddy pastures following floods, but outbreaks are also described in droughts. Overcrowding and unsanitary conditions with poor access to feed supplies may predispose housed sheep.

Breed difference in susceptibility (Angora goats and Rambouillet sheep) has been observed in some studies but not in others.

## Pathogen Risk Factors

Factors that increase the infection pressure largely involve a massive multiplication of *L. monocytogenes* in the feed or environment. The feeding of grass or corn silage as a major risk factor for the occurrence of listeriosis has been recognized for many decades. The increase in use of silage for feed in ruminants may be the reason for the apparent increase in the prevalence of the disease in recent years. Silage may also exert its effect by increasing the susceptibility of the host to listerial infection, although this has been disputed.

The organism persists for as long as 3 months in sheep feces and has been shown to survive for up to 11.5 months in damp soil, up to 16.5 months in cattle feces, up to 207 days on dry straw, and for more than 2 years in dry soil and feces. It is resistant to temperatures of  $-20^{\circ}\text{C}$  ( $-6^{\circ}\text{F}$ ) for 2 years and is still viable after repeated freezing and thawing.

## Experimental Reproduction

Oral or parenteral challenge of nonpregnant sheep and goats will produce a bacteremia with minor clinical signs of pyrexia and depression in animals with no preexisting antibody. Clinical disease is more severe in young animals and the infection clears with the development of an immune response. The challenge of animals with preexisting antibody is not associated with clinical disease, although there may be a bacteremia.

Lactating animals secrete the organism in milk during the bacteremic period. Prior challenge of goats with *L. ivanovii* or *L. innocua* does not protect against subsequent challenge with *L. monocytogenes*.

Several studies have shown that oral, conjunctival, and parenteral challenge of **pregnant animals** results in more severe signs of septicemia and can be followed by **abortion**, although this is not an invariable sequel. Encephalitis has not been reproduced experimentally by intravenous challenge, although meningoencephalitis may occur following this route of challenge in young lambs. **Encephalitis** has been reproduced experimentally by the injection of organisms into the buccal mucosa or the tooth pulp cavity, with the organism traveling centripetally via the trigeminal nerve to reach the brainstem.

## Zoonotic Implications

In humans, listeriosis is considered a food-borne infection of sporadic occurrence producing septicemia, meningoencephalitis, abortion, and infection in other organs as well as neonatal infection. Although outbreaks of listeriosis associated with contaminated food receive the most public attention, **sporadic listeriosis** is the more common presentation. Although all age groups are susceptible the disease incidence is the highest among people 65 years and older followed by young children (0–4 years) and immunocompromised patients.<sup>2</sup> In the EU a disease incidence of 0.3 and in the United States of 0.8 per 100,000 population have been reported.<sup>1–4</sup> The case fatality is high, and overall approximately 25% of reported cases die. Although the incidence increased at the beginning of the millennium, incidence rates have been stable over the last years.<sup>4</sup>

Although there is a potential for zoonotic transmission, the majority of human exposures to the organism, and the risk for disease, result from contamination of foods during processing and from the particular ability of the organism to grow at refrigerator temperature and in organic material with high salt content.

High disease prevalence and numbers of *L. monocytogenes* have been linked to certain foods such as soft cheese, smoked fish, pate, deli meats, unpasteurized milk, fermented raw meat sausages, hot dogs, and deli salads.<sup>2,3</sup>

**Milk** products have been incriminated in some outbreaks of the disease. Numerous studies have shown that *L. monocytogenes* is commonly present in low numbers (usually less than 1 organism per milliliter) in raw milk from some herds. In the vast majority of herds this is the result of fecal contamination during the milking process or other environmental contamination. Rarely, its presence in raw milk is from an animal with subclinical mastitis and in this case its numbers in bulk tank milk are much higher

(2,000–5,000 organisms per milliliter), even when there is a single cow or goat with *L. monocytogenes* mastitis. In goats and sheep the presence in raw milk may also be the result of a subclinical bacteremia.

There have been concerns that the organism might survive pasteurization, especially if present in phagocytes. D-values for *Listeria* in milk have been determined to be in the range of 0.9 seconds at  $71.1^{\circ}\text{C}$ . The legal limit for high-temperature/short-time pasteurization in the United States is  $71.7^{\circ}\text{C}$  for 15 seconds, and this temperature is sufficient to inactivate numbers far beyond those present in raw milk. There is no evidence that the organism will survive correct pasteurization procedures.

**Bulk tank infection rates** are higher in winter and spring and cross-sectional and case-control studies have shown that the risk for detecting *L. monocytogenes* in bulk milk is higher in those herds that used a bucket milking system rather than a pipeline system. It is also higher in herds fed component feeds, fed leftover feed, fed from plastic feed bunks, and from feed bunks with a low frequency of cleaning. It is lower in herds that practice premilking teat disinfection.

Farmers or others who consume **raw milk** need to be aware of the risk of infection, especially if they fall within at-risk categories. There may be a particular risk with milk from goats and sheep fed silage. People associated with agriculture are also more liable to direct zoonotic transmission of listerial disease. **Dermatitis** with a papular and pustular rash occurs on the arms of **veterinarians** following the handling of infected dystocia cases and aborted fetuses. **Conjunctivitis** is also recorded in agricultural workers handling infected livestock.

Although *L. monocytogenes* rarely causes disease in **pigs**, it is present in the tonsils and feces of some pigs at slaughter and this presence is a potential source of contamination of the carcass and the slaughterhouse environment. There is a significantly higher prevalence in the tonsils of fattening pigs than in those of sows. The organism can be isolated from the floors, walls, and feed in pig units. Wet feeding, poor hygiene, and a short spelling period between batches of pigs in the finishing house have been found to be risk factors for infection in pigs. Paradoxically, disinfecting the pipeline used for wet feeding was associated with a higher risk of fecal contamination than no disinfection at all.

A further concern for indirect zoonotic risk of *L. monocytogenes* is the presence of the organism in the feces on infected farms and the potential for fecal or windborne dust spread to adjacent fields that may contain crops for human consumption.

## PATHOGENESIS

In most animals, ingestion of the organism, with penetration of the mucosa of the intestine, leads to an inapparent infection with

prolonged fecal excretion of the organism and to a subclinical bacteremia, which clears with the development of immunity. The bacteremic infection is frequently subclinical and may be accompanied by excretion of the organism in milk. Septicemic listeriosis, with or without meningitis, is most common in neonatal ruminants and in adult sheep and goats, particularly if they are pregnant and when the infection challenge is large.

The organism is a facultative intracellular pathogen that can infect cells, including intestinal cells, by directed endocytosis. It can survive and grow in macrophages and monocytes. Bacterial superoxide dismutase protects against the bactericidal activity of the respiratory burst of the phagocyte and listeriolysin O disrupts lysosomal membranes, allowing the organism to grow in the cytoplasm. The experimental mouse model indicates that cell-mediated immunity is important in protection against listerial infection, but studies in goats suggest that the clearance of bacteremic infection and resistance to infection are also strongly associated with humoral antibody.

In **pregnant animals**, invasion of the placenta and fetus may occur within 24 hours of the onset of bacteremia. Edema and necrosis of the placenta lead to **abortion**, usually 5 to 10 days postinfection. Infection late in pregnancy results in **stillbirths** or the delivery of young that rapidly develop a fatal septicemia. Maternal **metritis** is constant and if the fetus is retained a fatal listerial septicemia may follow. Infection of the uterus causing abortion and intrauterine infection occurs in all mammals.

### Encephalitis/Meningitis

Encephalitis/meningitis in ruminants occurs as an acute inflammation of the brainstem or the meningeal membranes and is usually focal. Invasion of the CNS can occur by at least three different mechanisms.<sup>5</sup> These include the following:

- Retrograde (centripetal) migration into the brain within the axon of CNs
- Transport across the blood-brain barrier within parasitized leukocytes
- Direct invasion of endothelial cells by blood-borne bacteria

In cases without systemic infection centripetal translocation of the pathogen along the trigeminal or other CNs following penetration of the traumatized buccal mucosa, the shedding of deciduous or permanent teeth, and following periodontitis may result in encephalitis. Meningitis is thought to be associated with hematogenous translocation of the pathogen through parasitized endothelial cells or leukocytes.

The incubation period after experimental inoculation of the tooth pulp was at least 3 weeks even though lesions were detectable in the brainstem within 6 days of inoculation.<sup>5</sup> Clinical signs are characterized most strongly by an **asymmetric** disorder of CN function, in particular the trigeminal, facial,

vestibular, and glossopharyngeal nerves, but there is some variation in the involvement of individual CNs depending on the distribution of lesions in the brainstem. Lesions in the sensory portion of the trigeminal nucleus and the facial nucleus are common and lead to ipsilateral facial hypalgesia and paralysis; involvement of the vestibular nucleus is also common and leads to ataxia with circling and a head tilt to the affected side. The additional signs of dullness, head-pressing, and delirium are referable to the more general effects of inflammation of the brain developing in the agonal stages. Spread of the infection along the optic nerve may result in endophthalmitis in sheep and cattle.

### Spinal Myelitis

Spinal myelitis possibly results from ascending infection in the sensory nerves of the skin following dermatitis from prolonged wetting of the fleece.

### Mastitis

*L. monocytogenes* is rarely found to be a cause of **clinical mastitis** in cattle, despite the fact that it can be common in the dairy environment, suggesting that this pathogen is not a particularly invasive or perpetuating organism for the udder. Infection of the mammary gland appears to primarily occur hematogenously.<sup>1</sup>

### Enteritis

An acute diarrheal condition in sheep with clinical signs and morphologic changes resembling salmonellosis from which *L. monocytogenes* can be recovered has been recognized since the early 1990s.<sup>6</sup> Cases are frequently linked to feeding poor-quality silage and may occur within 2 days of feeding silage heavily contaminated with *L. monocytogenes*. The mechanisms through which *Listeria* invade the gastrointestinal mucosa are not yet understood, but infection seems to depend more on the ingested dose and the age of the animal than on predisposing conditions or immune status of the animal.<sup>7</sup> Lesions occur in the abomasum, small intestine, large intestine, mesenteric lymph nodes, and liver.<sup>6</sup>

### CLINICAL FINDINGS

When disease occurs it is usual to have an outbreak of either encephalitis or abortion. Encephalitis is the most prevalent manifestation in sheep. Septicemia in lambs may occur in conjunction with abortion but it is rare to have all three syndromes on the same farm, at least in the same temporal period. There are always exceptions to such generalities, and the occurrence of septicemia, abortion, and encephalitis in a flock of sheep is possible.

### Listerial Encephalitis/Meningitis Sheep

In sheep, early signs are separation from the flock and depression with a hunched stance.

Sheep approached during this early stage show a frenetic desire to escape but are uncoordinated because they run and fall easily. The syndrome progresses rapidly with more severe depression to the point of somnolence and the development of signs of CN dysfunction. Fever, usually 40°C (104°F) but occasionally as high as 42°C (107°F), is common in the early stages of the disease but the temperature is usually normal when overt clinical signs are present.

Signs vary between individual sheep but incoordination, head deviation sometimes with head tilt, walking in circles, unilateral facial hypalgesia, and facial paralysis are usually present. Facial hypalgesia can be detected with pressure from a hemostat, and the facial paralysis is manifested with drooping of the ear, paralysis of the lips, and ptosis on the same side of the face as the hypalgesia. This may be accompanied by exposure keratitis, often severe enough to cause corneal ulceration. Strabismus and nystagmus occur in some. Panophthalmitis, with pus evident in the anterior chamber of one or both eyes, is not uncommon in cattle that have been affected for a number of days. Also there is paresis of the muscles of the jaw, with poor tone or a dropped jaw, in which case prehension and mastication are slow and the animal may stand for long periods drooling saliva and with food hanging from its mouth.

The position of the head varies. In many cases there is deviation of the head to one side with the poll-nose relationship undisturbed (i.e., there is no rotation) but in others there is also head tilt. The head may be retroflexed or ventroflexed depending on the localization of the lesions and in some cases may be in a normal position. The deviation of the head cannot be corrected actively by the animal, and if it is corrected passively the head returns to its previous position as soon as it is released. Progression is usually in a small-diameter circle in the direction of the deviation. There is ataxia, often with consistent falling to one side, and an affected sheep may lean against the examiner or a fence. The affected animal becomes recumbent and is unable to rise, although often still able to move its legs. Death is caused by respiratory failure.

### Cattle

In cattle, the clinical signs are essentially the same but the clinical course is longer (Fig. 14-16). In adult cattle the course of the disease is usually 1 to 2 weeks, but in sheep and calves the disease is more acute, with death occurring in 2 to 4 days.

### Goats

In goats the disease is similar to that in the other species, but in the young goat the onset is very sudden and the course short, with death occurring in 2 to 3 days (Fig. 14-17).



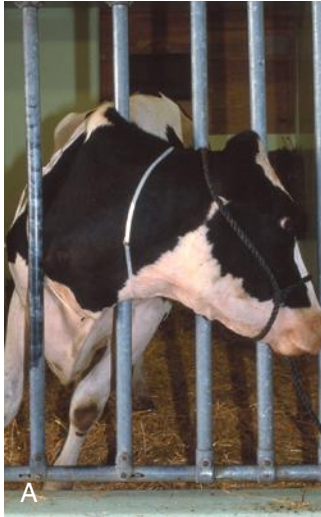

**Fig. 14-16** **A**, Two-year-old Holstein Friesian heifer with listeriosis. The heifer is exhibiting clinical signs of a left brainstem lesion in the vicinity of the vestibulocochlear nerve nucleus (cranial nerve VIII) manifested as extensor thrust from the right side and tight circles to the left (circling is impeded by placement in the headgate). **B**, Three-year-old Simmental cow with listeriosis. The cow is exhibiting depression, weakness of the tongue and jaw muscles, and lack of sensation that she has hay in her mouth. Some of these clinical signs are also seen in cattle with rabies or esophageal obstruction (choke). Both animals responded well to intravenous oxytetracycline treatment.

### Listerial Abortion

Outbreaks of abortion are recorded in cattle but are more common in sheep and in goats. Abortion caused by this organism is rare in pigs.

#### Cattle

In cattle, abortion or stillbirth occurs sporadically and usually in the last third of pregnancy; retention of the afterbirth is common, in which case there is clinical illness and fever of up to 40.5°C (105°F). Abortion has



**Fig. 14-17** Two-year-old goat with listeriosis. The goat has depression of the right corneal branch of the trigeminal nerve (cranial nerve V) because it does not detect the straw on its right eye, and the right facial nerve (cranial nerve VII) because it has a right ear droop, deviation of the philtrum to the left, and flaccid right upper lip. The goat was unable to stand and appeared depressed.

been observed soon after the commencement of silage feeding but does not always have this association.

#### Sheep and Goats

In sheep and goats abortions occur from the 12th week of pregnancy onward, the afterbirth is usually retained, and there is a blood-stained vaginal discharge for several days.

There may be some deaths of ewes from septicemia if the fetus is retained. In both species the rates of abortion in a group are low but may reach as high as 15%. On some farms, abortions recur each year.

#### Abortion Caused by *Listeria Ivanovii*

This occurs as a sporadic disease in cattle and has no distinguishing clinical features

from that associated with *L. monocytogenes*. Outbreaks in sheep are manifested with abortion and stillbirth but particularly with the birth of live infected lambs, which seldom survive long enough to walk or suck.

### Septicemic Listeriosis

Acute septicemia caused by *L. monocytogenes* is not common in adult ruminants but does occur in monogastric animals and in newborn lambs and calves. There are no signs suggestive of nervous system involvement, the syndrome being a general one comprising depression, weakness, emaciation, pyrexia, and diarrhea in some cases, with hepatic necrosis and gastroenteritis at necropsy. The same syndrome is also seen in ewes and goats after abortion if the fetus is retained. A better defined but less common syndrome has been described in calves 3 to 7 days old. Corneal opacity is accompanied by dyspnea, nystagmus, and mild opisthotonus. Death follows in about 12 hours. At necropsy there is ophthalmitis and serofibrinous meningitis. Septicemic listeriosis is recorded in a foal.

### Mastitis

Infection in the udder may involve a single quarter or both quarters; it is chronic and poorly responsive to treatment. There is a high somatic cell count in milk from the affected quarter, but the milk appears normal.

### Spinal Myelitis

There is fever, ataxia with initial knuckling of the hindlimbs progressing to hindlimb weakness, and paralysis. In some cases, both in sheep and cattle, there is also paresis and paralysis of the front limbs. There is no evidence of CN involvement, and affected animals are initially mentally alert, bright, and continue to eat. However, there is rapid deterioration and affected animals are commonly humanely destroyed.

### Keratoconjunctivitis, Uveitis

There is swelling of the iris and constriction of the pupil; white focal lesions are evident on the internal surface of the cornea with floccular material in the anterior chamber. Advanced cases have pannus and corneal opacity.

### Enteritis in Sheep

Reported clinical signs include lethargy, anorexia, and diarrhea or sudden death. Pregnant ewes may abort.

### CLINICAL PATHOLOGY

The CSF in cases of encephalitis has a moderately to markedly increased protein concentration and leukocyte count. Neutrophils are the predominant cell type with lymphocytes contributing not more than 20% of cells.<sup>8</sup> *L. monocytogenes* is not detectable by culture or PCR.

The organism can be cultivated from vaginal secretions for up to 2 weeks after abortion, and a proportion of aborting animals also have *L. monocytogenes* in the milk and feces.

Serologic tests (agglutination and complement fixation tests) have been used but lack the predictive value required for diagnostic use. Ruminants commonly have antibody to *Listeria* and high titers are often encountered in normal animals in flocks and herds where there have been clinical cases. Nucleic acid–based techniques can be used to determine the source of a strain of *L. monocytogenes* in an outbreak.

### NECROPSY FINDINGS

Typically, there are no distinctive gross changes associated with listerial encephalitis. Histologic examination of CNS tissue is necessary to demonstrate the microabscesses that are characteristic of the disease. These are present in the brainstem in listerial encephalitis and in the cervical and/or lumbar spinal cord in outbreaks of spinal myelitis. Sampling of the forebrain will typically result in a false-negative diagnosis. Cold enrichment techniques are advisable when attempting to isolate the organism. Gram staining of paraffin-embedded tissue may permit confirmation of the diagnosis in cases for which suitable culture material is unavailable. Alternative test methods such as fluorescent antibody or immunoperoxidase tests are available in some laboratories. In one retrospective study comparing diagnostic methods, immunoperoxidase staining was superior to bacterial culture when correlated with histopathologic changes.

Visceral lesions occur as multiple foci of necrosis in the liver, spleen, and myocardium in the **septicemic form** and in **aborted fetuses**. Aborted fetuses are usually edematous and autolyzed, with very large numbers of bacteria visible microscopically in a variety of tissues. In aborting dams, there is placentitis and endometritis in addition to the lesions in the fetus.

Sheep with **enteritis** show ulcerative and hemorrhagic abomasitis and reddening of the small intestinal mucosa.<sup>6</sup> In a small number of cases typhlocolitis is diagnosed at necropsy; histologically, there are microabscesses throughout the intestine and a characteristic infiltration of degenerating neutrophils in the mucosa lamina muscularis of the abomasum.<sup>6</sup>

### Samples for Confirmation of Diagnosis

#### Central Nervous System Listeriosis

- **Bacteriology:** half of midsagittally sectioned brain, **including brainstem**, chilled or frozen (CULT, FAT)
- **Histology:** formalin-fixed half of midsagittally sectioned brain, **including brainstem**; appropriate segment of

spinal cord if spinal myelitis suspected (LM, IHC)

### Septicemia and Abortion

- **Bacteriology:** chilled liver, spleen, lung, placenta, fetal stomach content (CULT, FAT)
- **Histology:** formalin-fixed liver, spleen, lung, brain, placenta, fetal intestine (LM, IHC).

### Enteritis

- **Bacteriology:** abomasum, small intestine, large intestine, mesenteric lymph nodes (CULT)
- **Histology:** formalin-fixed abomasum, small intestine, large intestine, mesenteric lymph nodes (LM, IHC).

### DIFFERENTIAL DIAGNOSIS

#### Encephalitis

- Pregnancy toxemia in sheep
- Nervous ketosis in cattle
- Rabies
- Gid
- Polioencephalomalacia
- Middle ear disease
- Scrapie

#### Abortion

- Sheep
- Cattle

#### Gastroenteritis

- Salmonellosis

#### Keratoconjunctivitis/Uveitis

- Contagious ophthalmia
- Infectious bovine keratoconjunctivitis

### TREATMENT

Penicillin is considered the drug of choice for treatment of listeriosis but it only has a bacteriostatic effect on *L. monocytogenes*.<sup>2</sup> Cephalosporins are ineffective because of minimal or nonexistent affinity of listerial penicillin-binding protein 3 and 5.<sup>2,5</sup>

A recent study exploring the prevalence of in vitro resistance of *L. monocytogenes* strains isolated from dairy farms found all strains to be resistant to cephalosporins, streptomycin, and trimethoprim. Over 90% of isolated strains were resistant to ampicillin and 66% were resistant to florfenicol. Resistance to penicillin G was determined for 40% of isolated strains.<sup>9</sup>

Penicillin administered at a dose of 44 000 IU/kg BW every 12 hours or every 24 hours given intramuscularly for 10 to 14 days is among the most commonly used treatments for listerial encephalitis/meningitis. Initiating the therapy with a loading dose of penicillin of 200,000 IU/kg as a water-soluble formulation given intravenously has been proposed.<sup>10</sup> The intravenous treatment of oxytetracycline (10 mg/kg BW every 12 hours or 20 mg/kg BW every 24 hours for 10 days) has been reported as being



reasonably effective in meningoencephalitis of cattle but less so in sheep.

The use of nonsteroidal antiinflammatory drugs (NSAIDs) to address pain resulting from meningitis may be indicated but warrants close monitoring of the patient's hydration status to prevent renal damage. The use of glucocorticoids has been proposed with the objective to prevent abscess formation in the CNS.<sup>1</sup> Concerns have been raised since increased listerial shedding through milk was reported in cattle infected with *L. monocytogenes* treated with dexamethasone.<sup>11</sup>

The recovery rate depends largely on the time that treatment is started after the onset of clinical signs. If severe clinical signs are already evident, death usually follows in spite of treatment. Usually the course of events in an outbreak is that the first case dies but subsequent cases are detected sufficiently early for treatment. Dehydration, acid-base imbalances, and electrolyte disturbances must also be corrected. Cases of spinal myelitis are poorly responsive to treatment.

Treatment of listerial iritis is with systemic antibiotics in the early stages coupled with subpalpebral corticosteroid and atropine to dilate the pupil.

Supportive treatment with thiamine, to compensate for decreased thiamine production during the disease, and glucocorticoids to prevent formation of microabscesses in the CNS have been proposed. Correction of metabolic acidosis, resulting from excessive bicarbonate loss with drooling saliva, may be indicated.

#### TREATMENT AND CONTROL

##### Treatment

###### Encephalitis

Procaine penicillin G (200,000 IU/kg IV as initial loading dose) (R-2)

Procaine penicillin G (22,000 IU/kg every 12 hours or 44,000 IU/kg every 24 hours IM, for 10–14 days) (R-2)

Oxytetracycline (10 mg/kg IV every 12 hours or 20 mg/kg IV every 24 hours for 10–14 days) (R-2)

Cephalosporins (R-4)

Thiamine (10 mg/kg slow IV every 24 hours) (R-2)

Flunixin meglumine (1 mg/kg every 24 hours IV) (R-2)

Dexamethasone (1 mg/kg IV single treatment) (R-3)

##### Control

Ensure pH of silage is < 5.0 (R-2)

Don't feed strongly spoiled sections of silage (R-2)

IM, intramuscularly; IV, intravenously.

#### CONTROL

Control is difficult because of the ubiquitous occurrence of the organism, the lack

of a simple method of determining when it is present in high numbers in the environment, and a poor understanding of the risk factors other than silage. Where the risk factor is silage, there may be some merit in the recommendation that a change of diet to include heavy feeding of silage should be made slowly, particularly if the silage is spoiled or if listeriosis has occurred on the premises previously. Tetracyclines can be fed in the ration of animals at risk in a feedlot. When possible, the obviously spoiled areas of silage should be separated and not fed.

Other recommendations on the feeding of silage include avoid making silage from fields in which molehills may have contaminated the grass; avoid soil contamination when filling the clamp; avoid using additives to improve fermentation; and avoid silage that is obviously decayed, or with a pH of greater than 5 or an ash content of more than 70 mg/kg of dry matter.

Silage removed from the clamp should be fed as soon as possible.

Where uveitis is a problem, feeding systems that avoid eye contact with silage should be used.

A live attenuated **vaccine** has been shown to induce protection against intravenous challenge, and a live attenuated vaccine in use in Norway for several years is reported to reduce the annual incidence of the disease in sheep from 4% to 1.5%. An economic model is available for determining whether vaccination should be practiced. Commercial killed vaccines are available for the control of the disease in some countries, and some companies will also produce autogenous vaccines on request. The efficacy of vaccination still requires further determination; however, when economics or food availability on the farm dictate that contaminated silage must be fed, consideration might be given to vaccination as a means of providing some protection.

#### FURTHER READING

- Anon. *Listeria monocytogenes*. Recommendations by the national advisory committee on microbiological criteria for foods. *Int J Food Microbiol*. 1991;14:185-246.
- Drevets DA, Bronze MS. *Listeria monocytogenes*: epidemiology human disease, and mechanisms of brain invasion. *Immunol Med Microbiol*. 2008;53:151-165.
- Farber JM, Peterkin PI. *Listeria monocytogenes*, a food-borne pathogen. *Microbiol Rev*. 1991;55:476-511.
- Fenlon DR. *Listeria monocytogenes* in the natural environment. In: Ryser ET, Martin EH, eds. *Listeria, Listeriosis and Food Safety*. 2nd ed. New York: Marcel Dekker; 1998.
- Gitter M. Veterinary aspects of listeriosis. *PHLS Microb Dig*. 1989;6(2):38-42.
- Gray ML, Killinger AH. *Listeria monocytogenes* and listeric infections. *Bacteriol Rev*. 1966;30:309.
- Low JC, Donachie W. A review of *Listeria monocytogenes* and listeriosis. *Vet J*. 1997;153:9-29.
- Scarratt WK. Ovine listeric encephalitis. *Compend Contin Educ Pract Vet*. 1987;9:F28-F32.

#### REFERENCES

- Brugere-Picoux J. *Small Rum Res*. 2008;76:12.
- Allerberger F, Wagner M. *Clin Microbiol Infect*. 2010;16:16.
- Kramarenko T, et al. *Food Control*. 2013;30:24.
- European centre for disease prevention and disease control. Annual epidemiological report 2012. (Accessed 29.09.2013, at <http://www.ecdc.europa.eu/en/publications/Publications/Annual-Epidemiological-Report-2012.pdf>).
- Drevets DA, Bronze MS. *Immunol Med Microbiol*. 2008;53:151.
- Fairley RA, et al. *J Comp Pathol*. 2012;146:308.
- Zundel E, Bernard S. *J Med Microbiol*. 2006;55:1717.
- Scott PR. *Small Rum Res*. 2010;92:96.
- Srinivasan V, et al. *Foodborne Pathog Dis*. 2005;2:201.
- Scott PR. *Small Rum Res*. 2013;110:138.
- Welsley IV, et al. *Am J Vet Res*. 1989;50:2009.

## Diseases Primarily Affecting the Spinal Cord

### TRAUMATIC INJURY

Sudden severe trauma to the spinal cord causes a syndrome of immediate, complete, flaccid paralysis caudal to the injury because of spinal shock. This is so brief in animals it is hardly recognizable clinically. Spinal shock is soon followed by flaccid paralysis in the area supplied by the injured segment and spastic paralysis caudal to it.

### ETIOLOGY

Trauma is the most common cause of monoplegia in large animals. There are varying degrees of loss of sensation, paresis, paralysis, and atrophy of muscle.

### Physical Trauma

- Animals falling off vehicles, through barn floors
- Osteoporotic or osteodystrophic animals, especially aged broodmares and sows, spontaneously while jumping or leaning on fences
- Spondylosis and fracture of thoracolumbar vertebrae in old bulls in insemination centers
- Cervical vertebral fractures account for a large percentage of spinal cord injuries in horses
- Trauma caused by excessive mobility of upper cervical vertebrae may contribute to the spinal cord lesion in wobbles in horses
- Dislocations of the atlantooccipital joint are being reported increasingly
- Stenosis of the cervical vertebral canal at C2-C4 in young rams, probably as a result of head-butting
- Fracture of T1 vertebra in calves turning violently in an alleyway wide enough to admit cows
- Vertebral fractures in 7- to 10-month-old calves escaping under the headgate of a chute and forcefully hitting their



backs (just cranial to the tuber coxae) on the bottom rail of the gate

- Vertebral fractures in neonatal calves associated with forced extraction during dystocia
- Lightning strike may cause tissue destruction within the vertebral canal.

### Parasitic Invasion

- Cerebrospinal nematodiasis, e.g., *P. tenuis*, *Setaria* spp. in goats and sheep, *Stephanurus dentatus* in pigs, *P. tenuis* in moose, causing moose sickness
- *Toxocara canis* experimentally in pigs
- *S. vulgaris* in horses and donkeys
- *Hypoderma bovis* larvae in cattle

### Local Ischemia of the Spinal Cord

- Obstruction to blood flow to the cord by embolism, or of drainage by compression of the caudal vena cava, e.g., in horses during prolonged dorsal recumbency under general anesthesia; in pigs caused by fibrocartilaginous emboli, probably originating in injury to the nucleus pulposus of an intervertebral disk

### PATHOGENESIS

The lesion may consist of disruption of nervous tissue or its compression by displaced bone or hematoma. Minor degrees of damage may result in local edema or hyperemia or, in the absence of macroscopic lesions, transitory injury to nerve cells, classified as concussion. The initial response is that of spinal shock, which affects a variable number of segments on both sides of the injured segment and is manifested by complete flaccid paralysis. The lesion must affect at least the ventral third of the cord before spinal shock occurs. When the shock wears off, the effects of the residual lesion remain. These may be temporary in themselves and completely normal function may return as the edema or the hemorrhage is resorbed. In sheep, extensive experimental damage to the cord may be followed by recovery to the point of being able to walk, but not sufficiently to be of any practical significance.

Traumatic lesions usually affect the whole cross-section of the cord and produce a syndrome typical of complete transection. Partial transection signs are more common in slowly developing lesions. Most of the motor and sensory functions can be maintained in 3-month-old calves with experimental left hemisection of the spinal cord.

In a retrospective study of dystocia-related vertebral fractures in neonatal calves, all the fractures were located between T11 and L4, with 77% occurring at the thoracolumbar junction. All but one case was associated with a forced extraction using unspecified (53%), mechanical (28%), or manual (17%) methods of extraction. Traction is most commonly applied after the fetus has entered the pelvic canal. Manual traction

varies from 75 kg of pressure applied by one man to 260 kg of pressure applied by three or more men. The forces applied in mechanical traction vary from 400 kg for a calf puller to over 500 kg for a tractor. The transfer of these forces to the vertebrae and to the physal plates at the thoracolumbar junction could readily cause severe tissue damage. In a prospective study of vertebral fractures in newborn calves, all fractures were located at the thoracolumbar area, especially the posterior epiphysis of T13.

### CLINICAL FINDINGS

**Spinal shock** develops immediately after severe injury and is manifested by flaccid paralysis (reflex loss) caudal to a severe spinal cord lesion. There is a concurrent fall in local blood pressure caused by vasodilatation and there may be local sweating. Stretch and flexor reflexes and cutaneous sensitivity disappear but reappear within a half to several hours, although hypotonia may remain. The extremities are affected in most cases and the animal is unable to rise and may be in sternal or lateral recumbency. The muscles of respiration may also be affected, resulting in interference with respiration. The body area supplied by the affected segments will eventually show flaccid paralysis and disappearance of reflexes and muscle wasting, all representative of a lower motor neuron lesion.

When the injury is caused by invasion by parasitic larvae, there is no stage of spinal shock but the onset is acute, although there may be subsequent increments of paralysis as the larva moves to a new site.

Neonatal calves with dystocia-related vertebral fractures are weak immediately after birth or remain recumbent and make no effort to rise.

Sensation may be reduced at and caudal to the lesion, and hyperesthesia may be observed in a girdle-like zone at the cranial edge of the lesion as a result of irritation of sensory fibers by local inflammation and edema. Because of interference with the sacral autonomic nerve outflow there may be paralysis of the bladder and rectum, although this is not usually apparent in large animals. The vertebral column should be examined carefully for signs of injury. Excessive mobility, pain on pressure, and malalignment of spinous processes may indicate bone displacements or fractures. Rectal examination may also reveal damage or displacement, particularly in fractures of vertebral bodies and in old bulls with spondylosis.

Residual signs may remain when the shock passes off. This usually consists of paralysis, which varies in extent and severity with the lesion. The paralysis is apparent caudal to and at the site of the lesion. The reflexes return except at the site of the lesion. There is usually no systemic disturbance but pain may be sufficiently severe to cause an increase in heart rate and prevent eating.

Recovery may occur in 1 to 3 weeks if nervous tissue is not destroyed, but when extensive damage has been done to a significantly large section of the cord there is no recovery and disposal is advisable. In rare cases animals that suffer a severe injury continue to be ambulatory for up to 12 hours before paralysis occurs. In such instances it may be that a fracture occurs but displacement follows at a later stage during more active movement. Recovered animals may be left with residual nervous deficits or with postural changes such as torticollis.

### Fracture of the Cervical Vertebrae in Horses

In horses fracture/dislocation of cranial cervical vertebrae is fairly common. Affected animals are recumbent and unable to lift the head from the ground. However, they may be fully conscious and able to eat and drink.<sup>1</sup> It may be possible to palpate the lesion, but a radiograph is usually necessary. Lesions of the caudal cervical vertebrae may permit lifting of the head but the limbs are not moved voluntarily. In all cases the tendon and withdrawal reflexes in the limbs are normal to supernormal.

### Spondylosis in Bulls

Old bulls in artificial insemination centers develop calcification of the ventral vertebral ligaments and subsequent spondylosis or rigidity of the lumbar area of the vertebral column. When the bull ejaculates vigorously, the calcified ligaments may fracture, and this discontinuity may extend upward through the vertebral body. The ossification is extensive, usually from about T2-L3, but the fractures are restricted to the midlumbar region. There is partial displacement of the vertebral canal and compression of the cord. The bull is usually recumbent immediately after the fracture occurs but may rise and walk stiffly several days later. Arching of the back, slow movement, trunk rigidity, and sometimes unilateral lameness are characteristic signs. Less severe degrees of spondylosis have been recorded in a high proportion of much younger (2- to 3-year-old) bulls, but the lesions do not appear to cause clinical signs.

### CLINICAL PATHOLOGY

Radiologic examination may reveal the site and extent of the injury, depending on the amount of surrounding muscle mass. CSF obtained from the lumbosacral space may reveal the presence of xanthochromia or intact RBCs, suggesting preexisting hemorrhage.

### NECROPSY FINDINGS

The abnormality is always visible on macroscopic examination. In neonatal calves with dystocia-related vertebral fractures, hemorrhage around the kidneys, around the adrenal glands, and in the perivertebral muscles is a common finding and a useful indicator that

a thoracolumbar fracture is present. In addition to the vertebral fracture, subdural and epidural hemorrhage, myelomalacia, spinal cord compression, severed spinal cord, and fractured ribs are common findings.

#### DIFFERENTIAL DIAGNOSIS

Differentiation from other spinal cord diseases is not usually difficult because of the speed of onset and the history of trauma, although spinal myelitis and meningitis may also develop rapidly. Other causes of recumbency may be confused with trauma, especially if the animal is not observed in the immediate preclinical period. In most diseases characterized by recumbency, such as azoturia, acute rumen impaction, and acute coliform mastitis, there are other signs to indicate the existence of a lesion other than spinal cord trauma. White muscle disease in foals is characterized by weakness, and the serum creatine kinase activity will be increased.

#### TREATMENT

Treatment is expectant only, and surgical treatment is rarely attempted. Large doses of corticosteroids or nonsteroidal antiinflammatory agents are not recommended to minimize the edema associated with the spinal cord injury. Careful nursing on deep bedding with turning at 3-hour intervals (ideally, but at least 3 times a day in animals that are not “creepers”), massage of bony prominences, and periodic slinging may help to carry an animal with concussion or other minor lesion through a long period of recumbency. In well-muscled cattle especially, recumbency beyond a period of about 48 hours is likely to result in widespread necrosis of the caudal muscles of the thigh and recovery in such cases is improbable. A definitive diagnosis of a vertebral fracture with paralysis usually warrants a recommendation for euthanasia.

#### FURTHER READING

Divers TJ. Acquired spinal cord and peripheral nerve disease. *Vet Clin North Am Food Anim Pract.* 2004;20:231-242.

Dyson SJ. Lesions of the equine neck resulting in lameness of poor performance. *Vet Clin North Am Equine Pract.* 2011;27:417-437.

#### REFERENCE

1. Muno J, et al. *Equine Vet Educ.* 2009;21:527.

### SPINAL CORD COMPRESSION

The gradual development of a space-occupying lesion in the vertebral canal produces a syndrome of progressive weakness and paralysis. A preexisting inflammatory or neoplastic lesion of the vertebral body may result in spontaneous fracture of the vertebral body and compression of the spinal cord.

#### ETIOLOGY

Compression of the spinal cord occurs from space-occupying lesions in the vertebral canal; the common ones are as follows.

#### Tumors

The most commonly occurring tumor in animals is lymphomatosis in which the nerve trunks and invades the vertebral canal, usually in the lumbosacral region and less commonly in the brachial and cervical areas. This tumor is particularly common in adult cattle with multicentric lymphosarcoma caused by bovine leukosis virus infection (Fig. 14-18).

Rare tumors include fibrosarcomas, metastases, plasma cell myeloma, angioma, melanoma in a horse, hemangiosarcoma in a horse, neurofibroma, and lymphosarcoma, e.g., in horses, vascular hamartoma in a goat.

#### Vertebral Body or Epidural Abscess

Vertebral body abscesses (osteomyelitis) are most common in neonatal farm animals and are generally in association with a chronic suppurative lesion elsewhere in the body.

- Docking wounds in lambs, bite wounds in pigs, and chronic suppurative pneumonia in calves are common occurrences for vertebral body abscesses. Polyarthritis and endocarditis may also be present. The original site of infection may have resolved when the clinical signs referable to the spinal cord abscess appear.
- Compression of the spinal cord is caused by enlargement of the vertebral body abscess into the vertebral canal and there may or may not be deviation of the vertebral canal and its contents.<sup>1</sup> Epidural abscesses causing compression



**Fig. 14-18** **A**, Bilateral posterior paresis in a 5-year-old Holstein Friesian cow with spinal lymphosarcoma caused by infection with enzootic bovine leukosis virus. **B**, Caudal view of the same cow, demonstrating marked paresis of the tail and hindlegs and poor milk production.

of the spinal cord, and not associated with vertebral bodies, occur in lambs.

- Hematogenous spread may also occur from *Trueperella* (*Arcanobacterium* or *Actinomyces* or *Corynebacterium*) *pyogenes* in cattle, *A. bovis* in cattle with lumpy jaw, and *Corynebacterium pseudotuberculosis* in sheep.
- Multiple cases of compressive myelopathy have been reported in cattle following intramuscular injection of an oil containing vaccine in the lumbar area.<sup>2</sup>
- Cervical myelomalacia in a lamb and an alpaca developed after attempted intramuscular injections in the neck<sup>3</sup>
- A pyogranulomatous lesion in the sacral region of horse extended into the sacral vertebral canal, resulting in reduced anal and tail tone and urinary overflow incontinence.<sup>4</sup>

### Bony Lesions of Vertebra

- Exostoses over fractures with no displacement of vertebral bodies.
- Similar exostoses on vertebral bodies of lambs grazing around old lead mines.
- Hypovitaminosis A in young growing pigs causing compression of the nerve roots passing through the vertebral foramina.
- Congenital deformity or fusion of the atlantooccipital axial joints in calves, foals, and goats.
- Congenital spinal stenosis of calves.
- Protrusion of an intervertebral disk is identifiable by myelogram or at necropsy,<sup>5</sup> although rare in large animals. The degenerative lesions in disks in the neck of the horse resemble the Hansen type 2 disk prolapses in dogs.
- Progressive paresis and ataxia also occur rarely in diskospondylitis in horses, an inflammatory condition focused on a single intervertebral joint that often results from a septic process.<sup>6,7</sup> Diskospondylitis has been diagnosed in a 4-month-old calf with a stiff gait and umbilical abscess,<sup>8</sup> an adult goat with paraplegia,<sup>9</sup> and an alpaca with paraparesis.<sup>10</sup>
- Spondylosis occurs, which is a degenerative condition characterized by extensive osteophytes on the vertebral body axis. *Spondylus* is an old Greek name meaning vertebra. Spondylosis usually affects the ventral or lateral aspects of multiple adjacent vertebrae. It is a progressive disease affecting contiguous vertebrae because of biomechanical stresses.<sup>6</sup> Ankylosing spondylosis typically cause lameness rather than compression of cord and paresis/paralysis.

**Adult sows and boars** may have degeneration of intervertebral disks and surrounding vertebral osteophytes. Less commonly

are ankylosing spondylosis, arthrosis of articular facets, defects in annulus fibrosus and vertebral end plates, and vertebral osteomyelitis or fracture. These lesions of ankylosing spondylosis cause lameness in boars and sows rather than compression of cord and paresis/paralysis. These are not to be confused with the many extravertebral causes of posterior lameness or paralysis in adult pigs, which are discussed in [Chapter 15](#).

### Vertebral Subluxation or Compressive Myelopathy

- Cervicothoracic vertebral subluxation in Merino sheep in Australia and Columbia lambs in the United States
- Compressive cervical myelopathy in yearling Texel and Beltex sheep caused by fatty nodules encroaching into the dorsal vertebral canal at C6-C7<sup>11</sup>

### Ataxia in Horses

This is a major problem and has numerous potential causes:

- Nonfatal fractures of the skull (basisphenoid, basioccipital, and petrous temporal bones)
- Nonfatal cervical fractures
- Atlantooccipital instability
- Cervical vertebral malformation (equine cervical vertebral stenotic myelopathy) caused by stenosis of the cranial vertebral orifice of C3-C7<sup>12</sup>; this may be effective as a compression mechanism only if the vertebrae adopt exaggerated positions
- Abnormal growth of interarticular surfaces
- Dorsal enlargement of caudal vertebral epiphyses and bulging of intervertebral disks
- Formation and protrusion of false joint capsules and extrasynovial bursae
- Spinal myelitis caused by parasitic invasion or EHV-1 virus, even louping-ill virus and probably others
- Spinal abscess usually in a vertebral body
- *Onchocerca* sp.-induced spinal cord compression and axonopathy<sup>13</sup>
- Spinal hematomas<sup>14</sup> causing ataxia, paresis, and neck pain
- Cerebellar hypoplasia (most commonly the inherited version in Arabian foals)
- Degenerative myelomalacia/myelopathy (cause unknown)
- Fusion of occipital bone with the atlas, which is fused with the axis
- Hypoxic-ischemic neuromyopathy in aortoiliac thrombosis
- Tumors of the meninges

### PATHOGENESIS

The development of any of the lesions listed previously results in the gradual appearance of motor paralysis or hypoesthesia, depending on whether the lesion is ventrally or dorsally situated. In most cases there is

involvement of all motor and sensory tracts, but care is necessary in examination if the more bizarre lesions are to be accurately diagnosed. There may be hemiparesis or hemiplegia if the lesion is laterally situated. Paraparesis or paraplegia is caused by a bilateral lesion in the thoracic or lumbar cord and monoplegia by a unilateral lesion in the same area. Bilateral lesions in the cervical region cause tetraparesis to tetraplegia (quadriplegia).

**Vertebral osteomyelitis in young calves** is most common in the thoracolumbar vertebrae and less commonly in the cervical vertebrae. The abscess of the vertebral body gradually enlarges and causes gradual compression of the spinal cord, which causes varying degrees of paresis of the pelvic limbs and ataxia. The abscess may extend into adjacent intervertebral spaces and result in vertebral arthritis with lysis of the articular facets. The onset of paresis and paralysis may be sudden in cases of abscessation or osteomyelitis of the vertebrae, which may fracture and cause displacement of bony fragments into the vertebral canal with compression and traumatic injury of the spinal cord. Vertebral body abscesses between T2 and the lumbar plexus will result in weakness of the pelvic limbs and normal flexor withdrawal reflexes of the pelvic limbs. Lesions at the site of the lumbar plexus will result in flaccid paralysis of the pelvic limbs.

**In horses** with cervical vertebral malformation, compression of the spinal cord results in necrosis of white matter and some focal loss of neurons. With time, secondary wallerian-like neuron fiber degeneration in ascending white matter tracts cranial to the focal lesion and in descending white matter tracts caudal to the lesion occurs. Astrocytic gliosis is a prominent and persistent alteration of the spinal cord of horses with chronic cervical compressive myelopathy and is associated with nerve fiber degeneration at the level of the compression and in well-delineated areas of ascending and descending nerve fiber tracts. It is possible that the persistent astrocytic gliosis may prevent, or slow, recovery of neurologic function in affected horses.

### CLINICAL FINDINGS

Varying degrees of progressive weakness of the thoracic limbs or pelvic limbs may be the initial clinical findings. With most lesions causing gradual spinal cord compression, difficulty in rising is the first sign, then unsteadiness during walking caused by weakness, which may be more marked in one of a pair of limbs. The toes are dragged along the ground while walking and the animal knuckles over on the fetlocks when standing. Finally, the animal can rise only with assistance and then becomes permanently recumbent. These stages may be passed through in a period of 4 to 5 days.

The paralysis will be flaccid or spastic depending on the site of the lesion and reflexes will be absent or exaggerated in the



respective states. The dog-sitting position in large animals is compatible with a spinal lesion caudal to the second thoracic vertebral segment. Calves with vertebral osteomyelitis caudal to T2 are usually able to sit up in the dog-sitting position; they are bright and alert and will suck the cow if held up to the teat. In some cases, extensor rigidity of the thoracic limbs resembles the Schiff–Sherrington syndrome and indicates a lesion of the thoracic vertebrae.

Lesions involving the lumbar plexus will result in flaccid paralysis of the pelvic limbs and an absence of the flexor withdrawal reflexes. Lesions involving the sacrococcygeal vertebrae will cause a decrease in tail tone, decreased or absent perineal reflex, and urinary bladder distension.

**Pain and hyperesthesia** may be evident before motor paralysis appears. The pain may be constant or occur only with movement. In vertebral body osteomyelitis in the horse, vertebral column pain and a fever may be the earliest clinical abnormalities. With neoplasms of the epidural space, the weakness and motor paralysis gradually worsen as the tumor enlarges.

**Considerable variation** in signs occurs depending on the site of the lesion. There may be local hyperesthesia around the site of the lesion and straining to defecate may be pronounced. Retention of the urine and feces may occur. There is usually no detectable abnormality of the vertebrae on physical examination.

**Calves** with congenital spinal stenosis are usually unable to stand or can do so only if assisted. There are varying degrees of weakness and ataxia of the pelvic limbs. They are bright and alert and will suck the cow if assisted. Those that survive for several weeks will sometimes assume the dog-sitting position.

**In the wobbler horse**, circumduction of the limbs with ataxia is typical. The ataxia is usually pronounced in the pelvic limbs, and weakness is evident by toe dragging and the ease with which the horse can be pulled to one side while walking. Ataxia with hypometria is often evident in the thoracic limbs, especially while walking the horse on a slope and with the head elevated.

## CLINICAL PATHOLOGY

**Radiographic** examination of the vertebral column should be performed if the animal is of a suitable size. Myelography is necessary to demonstrate impingement on the spinal cord by a stenotic vertebral canal. The CSF may show a cellular reaction if there is some invasion of the spinal canal.

## NECROPSY FINDINGS

Gross abnormalities of the vertebrae and the bony spinal canal are usually obvious. Those diseases of the spinal cord characterized by degeneration without gross changes require histologic techniques for a diagnosis.

## DIFFERENTIAL DIAGNOSIS

Differentiation between abscess, tumor, and exostosis in the vertebral canal is usually not practicable without radiographic examination. Vertebral osteomyelitis is difficult to detect radiographically, particularly in large animals, because of the overlying tissue. In bovine lymphosarcoma there are frequently signs caused by lesions in other organs. A history of previous trauma may suggest exostosis. The history usually serves to differentiate the lesion from acute trauma.

- Spinal myelitis, myelomalacia, and meningitis may resemble cord compression but are much less common. They are usually associated with encephalitis, encephalomalacia, and cerebral meningitis, respectively.
- Meningitis is characterized by much more severe hyperesthesia and muscle rigidity.
- Rabies in the dumb form may be characterized by a similar syndrome but ascends the cord and is fatal within a 6-day period.

**In the newborn** there are many congenital defects in which there is defective development of the spinal cord. Most of them are not characterized by compression of the cord, because the diminished function is caused in most cases by an absence of tissue. **Spina bifida, syringomyelia,** and **dysraphism** are characterized by hindquarter paralysis or, if the animal is able to stand, by a wide-based stance and overextension of the legs when walking. Some animals are clinically normal.

**A generalized degeneration of peripheral nerves** such as that described in pigs and cattle causes a similar clinical syndrome and so does **polyradiculoneuritis**. A nonsuppurative **ependymitis, meningitis,** and **encephalomyelitis**, such as occurs in equine infectious anemia, may also cause an ataxia syndrome in horses.

**Paresis or paralysis of one limb (monoplegia)** is caused by lesions in the ventral gray matter, nerve roots, brachial and lumbosacral plexus, and peripheral nerves and muscles of the limbs.

## TREATMENT

Successful treatment of partially collapsed lumbar vertebra by dorsal laminectomy has been performed in calves.<sup>1</sup> Surgical treatment of cervical vertebral malformation (fusion of affected cervical vertebrae) is performed in horses, but in farm animals treatment is usually not possible and in most cases slaughter for salvage is recommended. Spinal hematomas of the cervical cord in horses can recover spontaneously but surgical decompression may be helpful in chronic cases.<sup>14</sup>

## FURTHER READING

Divers TJ. Acquired spinal cord and peripheral nerve disease. *Vet Clin North Am Food Anim Pract.* 2004;20:231-242.

## REFERENCES

1. Zani DD, et al. *Vet Surg.* 2008;37:801.
2. Ubiali DG, et al. *Pesq Vet Bras.* 2011;31:997.
3. Johnson AL, et al. *J Vet Intern Med.* 2012;26:1481.
4. Cudomre LA, et al. *Aust Vet J.* 2012;90:392.
5. Fews D, et al. *Vet Comp Orthop Traumatol.* 2006;19:187.
6. Denoix JM. *Equine Vet Educ.* 2007;19:72.
7. Wong DM, et al. *J Am Vet Med Assoc.* 2015;247:55.
8. Hammond G, et al. *Vet Rec.* 2006;158:600.
9. Levine GJ, et al. *Vet Radiol Ultrasound.* 2006;47:585.
10. Zanolari P, et al. *J Vet Intern Med.* 2006;20:1256.
11. Penny C, et al. *J Vet Intern Med.* 2007;21:322.
12. Hoffman CJ, Clark CK. *J Vet Intern Med.* 2013;27:317.
13. Hestvik G, et al. *J Vet Diagn Invest.* 2006;18:307.
14. Gold JR, et al. *J Vet Intern Med.* 2008;22:481.

## BACK PAIN IN HORSES

The subject of back pain, and its relationship to lameness, is a very important one in horses. There is often a lesion in the vertebral canal and by pressing on the cord or peripheral nerves it causes gait abnormalities that suggest the presence of pain, or they actually cause pain. Spondylosis, injury to dorsal spinous processes, and sprain of back muscles are common causes of the same pattern of signs. Because these problems are largely orthopedic ones, and therefore surgical, their discussion is left to other authorities.

It is necessary in horses to differentiate spinal cord lesions from acute nutritional myodystrophy and subacute tying-up syndrome. Those diseases are characterized by high serum creatine kinase and AST activities.

## Parasitic Diseases Primarily Affecting the Spinal Cord

### EQUINE PROTOZOAL MYELOENCEPHALITIS

#### SYNOPSIS

**Etiology** *Sarcocystis neurona*, a protozoon. *Neospora hughesi* is an uncommon cause.

**Epidemiology** Sporadic disease occasionally occurring as localized epidemics. Endemic throughout most of the Americas. Disease is infectious but not contagious. The definitive host in North America is the opossum (*Didelphis* spp.), and other opossum species in South America.

**Clinical signs** Variable, but commonly asymmetric spinal ataxia, focal, neurogenic muscle atrophy, with or without cranial nerve dysfunction.

**Clinical pathology** No characteristic changes in blood or cerebrospinal fluid. Demonstration of intrathecal production of

*Continued*

antibodies to specific surface proteins (especially SnSAG2, 4/3) by measurement of antibodies in paired serum and CSF samples (ELISA).

**Diagnostic confirmation** Histologic demonstration of *S. neurona* or *N. hughesi* in nervous tissue.

**Lesions** Nonsuppurative myeloencephalitis with schizonts and merozoites in neurons, glial cells, and leukocytes.

**Treatment** Antiprotozoal agents, including ponazuril, diclazuril, or a combination of a sulfonamide and pyrimethamine.

**Control** Prevent exposure to *S. neurona* by minimizing fecal contamination by opossums of feed. No vaccine available.

## ETIOLOGY

The cause is *S. neurona*, an apicomplexan protozoan that causes myeloencephalitis in equids, sea otters, cats, raccoons, red pandas, dogs, and a small number of other mammalian species.<sup>1-3</sup> Fatal encephalitis in Southern sea otters and EPM in horses is strongly linked to *S. neurona* sporocysts shed by opossums.<sup>4,5</sup> Isolates of *S. neurona* can vary in their antigenic composition because some immunodominant surface proteins (SnSAG 1, 2, 3, and 4) vary in either or both of their presence or antigenicity among strains of *S. neurona*. For instance, some strains of *S. neurona* (e.g., SN4), including some that are virulent in horses, lack the major surface antigen SnSAG-1.<sup>6</sup> This heterogeneity in the surface antigen composition of different *S. neurona* isolates could be an important consideration for development of serologic tests and prospective vaccines for EPM.<sup>5</sup>

*Neospora* spp., including *N. hughesi*, cause myeloencephalitis in horses less frequently than does *S. neurona*.<sup>7-9</sup>

The subsequent discussion refers to EPM caused by *S. neurona*, with specific points made in respect to *N. hughesi*.

## EPIDEMIOLOGY

EPM occurs in horses and ponies in Canada, the United States, Central America, and Brazil. Reports of neurologic disease in horses with antibodies to *S. neurona* in France have yet to be confirmed but might represent cases of EPM in native horses outside of the Americas. The disease is reported in other countries in only horses imported from the Americas, and seroprevalence to *S. neurona*-specific antigens in Europe is rare in horses not imported from the Americas.<sup>10</sup> Distribution of the disease appears to correlate with the range of the definitive host, *Didelphis virginiana* in North America, or the related species *D. marsupialis* and *D. albiventris* in South America. The disease has not been reported in donkeys and mules. Neurologic disease associated with *S. neurona* has been reported in armadillos, sea otters, harbor seals, skunks, rac-

coons, zebra, lynxes, dogs, porpoises, and cats.<sup>2,3,11,12</sup>

The disease usually occurs sporadically in endemic areas, although epidemics on individual farms are reported. The incidence of EPM is estimated to be 14 new cases per 10,000 horses per year. The **case-fatality rate** is approximately 7%, although up to 14% of horses are sold or given away because they are affected by EPM. Approximately 40% of horses recover completely and another 37% improve but do not recover from the disease. Another study reports that only 55% of horses with EPM examined at a referral hospital were alive a minimum of 3 years after diagnosis and treatment.

Seroepidemiologic studies, based on detection by Western immunoblot test of multiple antibodies to *S. neurona* in serum, indicate that 45% to 60% of horses in the United States are exposed to the agent but do not develop disease.<sup>13</sup> Antibodies to *S. neurona* are present in ~49% of 495 horse sera tested with the rSnSAG2/4/3 trivalent ELISA in the Durango state of Mexico, and antibodies to *N. hughesi* are present in 3.0% of horse sera tested (rNhsAG1 ELISA and confirmed by Western blot of *N. hughesi* tachyzoite antigen) in the same region.<sup>14</sup> Approximately 26% of horses in Argentina have antibodies to *S. neurona*, and 39% of horses with neurologic disease are positive versus 22% of clinically normal horses.<sup>15</sup> Four percent of horses in southern Brazil have serum antibodies to *N. hughesi*.<sup>16</sup> Among horses in Israel, 12% of healthy horses are seropositive for antibodies to *N. hughesi*, and 21% of horses with neurologic disease and 38% of mares that aborted are seropositive.<sup>17</sup>

Rates of seropositivity to *S. neurona*, *N. hughesi*, or both in North America are reported, and differences in proportion of submitted samples are positive for either or both species identified based on month of submission and various animal-related factors. However, the sample was not random and results could have been heavily affected by sampling bias.<sup>18</sup>

Vaccination with a product containing killed *S. neurona* induces a detectable antibody response in both serum and, in approximately 50% of horses, in the CSF.

## Risk Factors

Risk factors for development of EPM include season of the year, with the highest incidence of new cases in the summer and fall; age; use; protection of feed; and presence of opossums on the farm.<sup>19</sup> The disease occurs in horses from 2 months to 19 years of age. Horses <1 year of age are at lower risk of developing disease than are horse 1 to 4 years of age. Older horses are less likely to develop the disease. Protection of feed from contamination by opossum feces is associated with a decreased risk of disease, whereas the presence of opossums on the premises was

associated with an increased risk of disease. Horses used primarily for racing and showing are at increased risk for developing EPM with an annual incidence of 38 new cases per 10,000 horses for horses used for racing compared with an incidence of 6 cases per 10,000 horses for horses used for pleasure or farm work. Horses used for showing or competition have the highest annual incidence of 51 cases per 10,000 horses per year. The presence of previous illness is a risk factor for development of EPM. Transportation for 55 hours increases the susceptibility to EPM of horses experimentally infected with *S. neurona*. Relative to neurologic (non-EPM) control horses, horses with EPM are more likely to be ≥2 years old and to have a history of cats residing on the premises. Relative to nonneurologic control horses, horses with EPM are more likely to be used for racing or Western performance.<sup>20</sup>

## Transmission

*S. neurona* has the two-host life cycle (predator-prey) typical of other *Sarcocystis* and *Toxoplasma* spp.<sup>21,22</sup> The definitive host is the opossum, *D. virginiana*, and intermediate hosts include raccoons,<sup>23</sup> cats, skunks, sea otters, armadillos, and cowbirds (*Molothrus ater*).<sup>24</sup> The domestic cat, nine-banded armadillo, raccoon, cowbird, and skunk can be infected by ingestion of sporocysts and develop sarcocysts in muscle, which when fed to opossums, induces shedding of sporocysts, confirming the potential for these species to serve as intermediate hosts. Cats living on farms at which EPM has been diagnosed in horses have a higher rate of seroprevalence (40%) than do cats living in a city (10%), providing evidence for a role of cats in the epidemiology of the disease. However, others have detected a lower prevalence of seropositivity (5%) to *S. neurona* among cats in Texas and conclude that cats are not likely to play an important role in the epidemiology of EPM. At least in those areas where raccoons are present they are probably the most important intermediate host.

The definitive host is infected by ingestion of sarcocysts of *S. neurona* encysted in muscle of the intermediate host. The intermediate host is infected by ingestion of sporocysts derived from ruptured oocysts passed in the feces of the definitive host. Sporocysts can remain infective in the environment for months, but are probably, based on behavior of other *Sarcocystis* spp. oocysts, killed by drying, high humidity, or freezing and thawing. Birds and insects also serve as transport hosts. Sporocysts ingested by the intermediate host undergo schizogony and ultimately form infective sarcocysts in muscle. *S. neurona* sarcocysts have been detected in the muscle of a 4-month-old filly, suggesting that horses might serve as intermediate hosts of the organism. This finding needs to be confirmed because the

conventional wisdom is that in horses *S. neurona* does not complete schizogony and remains as uninfected merozoites in neural tissue. *S. neurona* sarcocysts do not occur in the muscle of horses; therefore horses are not infective to other animals.

There is no evidence of transplacental infection of foals.

The definitive and intermediate hosts of *N. hughesi* have not been determined. Dogs are the definitive host of the closely related *N. caninum*. *N. hughesi* can be transmitted transplacentally from mares to foals, and it is suggested that infection with this organism can persist in a band of horses by vertical transmission.<sup>25,26</sup>

## PATHOGENESIS

Details of the pathogenesis of EPM are unknown. It is assumed that after infection, probably by ingestion, sporocysts excyst and release sporozoites, which penetrate the gastrointestinal tract and enter endothelial cells. Subsequently, meronts (schizonts) develop and on maturation rupture and release merozoites. Schizonts are present in cells of the CNS, including neurons, glial cells, and intrathecal macrophages. Schizonts multiply in the infected cells, as evidenced by the presence of merozoites. Infection induces a nonsuppurative inflammation, characterized by accumulations of lymphocytes, neutrophils, eosinophils, and gitter cells. Infection of neurons, and the associated inflammatory reaction, disrupt normal nervous function and contribute to the clinical signs of weakness, muscle atrophy, and deficits in proprioception.

Mechanisms permitting infection and proliferation of the organism have not been well defined. Horses with EPM have lesser cell-mediated immunity than do asymptomatic horses, and the decrease in cell-mediated immunity appears to be caused by *S. neurona* suppressing immune responses to parasite-derived antigens. However, foals with severe combined immunodeficiency administered *S. neurona* do not develop neurologic disease, despite prolonged parasitemia and infection of visceral organs by the organism, whereas immunocompetent horses do not have prolonged parasitemia but do develop neurologic disease.

## CLINICAL FINDINGS

The incubation period after experimental infection of young horses ranges between 28 and 42 days, but is not known for the spontaneous disease.

The clinical findings of EPM in horses are protean, and in endemic areas EPM should be considered as a diagnosis in any horse with clinical signs referable to the nervous system. *S. neurona* can infect any area of the brain and spinal cord, and may affect more than one site in an individual horse, resulting in the wide range of neurologic abnormalities associated with this disease.

Clinical signs of EPM range from barely perceptible changes in gait or behavior to recumbency, muscle atrophy, or seizures. The onset of **signs** can be insidious and gradual, or acute and rapidly progressive. Affected horses do not have increased temperature or heart rate, unless complications of the nervous disease occur.

**Spinal ataxia**, evident as weakness, hypometria, or hypermetria, and defects in proprioception are common manifestations of EPM. Multifocal spinal or cervical disease causes all four limbs to be affected, whereas lesions caudal to the cervical intumescence cause signs in the rear limbs only. Signs of spinal ataxia range from subtle changes in gait, which are difficult to differentiate from obscure lameness caused by musculoskeletal disease, through obvious spinal ataxia evident as truncal sway, toe dragging, and circumduction of feet, to spontaneous falling and recumbency. **Asymmetry** of clinical signs, in which one limb is affected more than the contralateral limb, is highly suggestive of EPM because CSM and equine degenerative myelopathy usually cause symmetric ataxia.

Lesions in the sacral cord cause signs of **cauda equina syndrome**, including tail paresis and urinary and fecal incontinence.

Lesions affecting spinal cord gray matter cause focal, **asymmetric muscle atrophy**, absent reflexes, or focal areas of **sweating**. Muscles frequently affected include the quadriceps, biceps femoris, epaxial muscles, and the supraspinatus/infraspinatus group. EPM can present as a brachial plexus injury evident as radial nerve paralysis.

**CN disease** is a common manifestation of EPM. Common syndromes include the following:

- **Vestibular disease** (CN VIII), evident as circling, nystagmus, head tilt, and falling toward the affected side
- **Unilateral facial nerve paralysis** (CN VII), evident as ear droop, lack of palpebral or corneal reflex and menace on the affected side, and displacement of the upper lip and nares away from the side of the lesion
- **Dysphagia** (CNs IX, X, XII) and persistent dorsal displacement of the soft palate
- **Tongue paralysis** (CN XII)
- **Masseter atrophy** and weakness (CN V)
- **Hypalgesia** (lack of sensation) of the nostrils and skin of the face (CN V)

EPM might also manifest as changes in personality and behavior, head-shaking, and seizures.

Clinical disease caused by infection by *N. hughesi* is clinically indistinguishable from that associated with *S. neurona*.<sup>8,9</sup>

## CLINICAL PATHOLOGY

There are no characteristic changes in the hemogram or serum biochemical variables. **Diagnosis** has focused on the demonstration

of antibodies to *S. neurona* in serum or CSF by Western blot, indirect fluorescence testing, or ELISA. The important concept is use of paired serum and CSF samples to demonstrate intrathecal production of antibodies to differentiate infection associated with neurologic disease from clinically inapparent infection.<sup>13,27-29</sup>

The sensitivity and specificity of Western blot (Sn 80%–89%, Sp 38%–87% on serum, and Sn ~88% and Sp 44%–89% in CSF); indirect FAT (IFAT) (Sn 59%–94%, Sp 71%–100% in serum, and Sn 65%–100%, Sp 90%–99% in CSF); SAG1 ELISA (Sn 13%–68%, Sp 71%–97% in serum); and SAG2,4/3 ELISA (Sn 30%–86%, Sp 37%–88% in serum, Sn 77%–96% and Sp 58%–96% in CSF) for detection of EPM have been recently reviewed.<sup>13,28,29</sup> The combination of serum and CSF testing using tests to detect antibodies to SAG2, 4/3 surface proteins were the most sensitive and specific for diagnosis of horses with clinical signs of neurologic disease.<sup>28,29</sup>

Interpretation of the results of **Western blot** analysis of CSF for IgG antibodies to *S. neurona* is problematic because of the potential for blood contamination of the sample during collection, and the high sensitivity but low specificity of the test. Blood contamination of the sample is problematic in horses that are seropositive for antibodies to *S. neurona* and in which it is desired to know if antibodies are present in CSF. Contamination of CSF with blood can introduce antibodies from serum into the otherwise antibody-free CSF, causing a “false”-positive test. Contamination of CSF with small quantities of blood with high concentrations of antibodies to *S. neurona* might not be detectable using RBCs, albumin quotient, or immunoglobulin index, but could yield a positive result on Western blot testing.

Foals of seropositive mares acquire antibodies, but not infection, by ingestion of colostrum from the dam. These antibodies can be detected in both serum and CSF of foals. The mean time for foals to become seronegative for antibodies to *S. neurona* is 4.2 months. Detection of antibodies to *S. neurona* in serum or CSF of foals less than 4 to 6 months of age, even those with neurologic disease, should be interpreted with caution as the antibodies are likely derived from the dam.

An **IFAT** reliably detects antibodies to *S. neurona* in serum and CSF of infected horses.<sup>28</sup> This test has the advantages of providing quantitative results, is cheaper to perform, and is more accurate than immunoblots in the detection of antibodies.

Examination of other variables in CSF is of limited use in the diagnosis of EPM, and measurement of creatine kinase activity in CSF has no diagnostic usefulness. The use of the **albumin quotient** or **IgG index** to detect blood contamination of CSF, or the



intrathecal production of IgG, is unreliable and not useful in the diagnosis of EPM.

### NECROPSY

Lesions are limited to the spinal cord and brain, with the exception of neurogenic muscle atrophy. Gross lesions of hemorrhage and malacia may be visible in the CNS tissue. The lesions are asymmetric, but may be more frequently encountered in the cervical and lumbar intumescences of the spinal cord. Histologic examination reveals multifocal necrosis of the nervous tissue with an accompanying infiltration of macrophages, lymphocytes, neutrophils, and occasional eosinophils. This reaction is predominantly nonsuppurative and usually includes a degree of perivascular cuffing. Schizonts or free merozoites may be evident in tissues but are difficult to locate without IHC stains. The sensitivity of screening for the parasite in hematoxylin and eosin-stained sections of nervous tissue from cases with histologic changes suggestive of EPM was only 20%. The sensitivity improved to 51% when IHC staining of the tissue was used. The same interpretative problems encountered when testing antemortem CSF samples apply when the fluid is collected at postmortem. Isolation in cell culture systems is possible but rarely attempted in diagnostic laboratories. PCR tests for these apicomplexan parasites can yield false negatives because of the random distribution of the parasite within CNS tissue.

### Samples for Confirmation of Diagnosis

- **Histology:** fixed spinal cord (several levels, including cervical and lumbar intumescences) and half of brain, including the entire brainstem, CN VII in some cases (LM, IHC, PCR).

### DIFFERENTIAL DIAGNOSIS

The clinical diagnosis of EPM should be based on the detection of unequivocal neurologic abnormalities consistent with EPM, ruling out of other causes of neurologic disease (listed next) and the detection of antibodies to *S. neurona* or *N. hughesi* in uncontaminated samples of cerebrospinal fluid and serum to confirm intrathecal production of specific antibodies.<sup>13</sup> A favorable response to treatment specific for EPM increases the likelihood that the horse has EPM. A definitive diagnosis can only be achieved by necropsy.

- Spinal ataxia.
- Cauda equina syndrome: EPM should be differentiated from polyneuritis equi, equine herpesvirus-1 myelopathy, and injection of long-acting anesthetics or alcohol around sacral nerve roots.
- Peripheral nerve lesions: other causes of focal muscle atrophy, such as brachial plexus injury, damage to the supraspinatus nerve, or disuse atrophy can be

differentiated from EPM on history and clinical signs.

- Cranial nerve disease: signs of vestibular disease, facial or trigeminal nerve dysfunction, and dysphagia associated with EPM should be differentiated from the following:
  - Middle ear infection
  - Guttural pouch mycosis
  - Arthritis and fracture of the temporohyoid articulation
  - Head trauma

### TREATMENT

**Specific treatment** of EPM involves the administration of **antiprotozoal drugs** including ponazuril, diclazuril, nitazoxanide, or the combination of pyrimethamine and sulfadiazine.

Administration of the combination of sulfadiazine (or similar drug, 20 mg/kg, orally) and pyrimethamine (1–2 mg/kg, orally) every 24 hours given 1 hour before feeding is effective in approximately 60% to 70% of cases.<sup>13</sup> This treatment is continued for at least 90 days if complete resolution of clinical abnormalities occurs, or longer if the signs of EPM do not resolve. **Adverse effects** of the administration of a combination of a sulfonamide and pyrimethamine include enterocolitis, anemia, and abortion. Folic acid is often added to the diet of horses being treated for EPM, but this cannot be recommended because of its lack of efficacy in preventing anemia in treated horses and its ability to cause severe congenital abnormalities in foals born to treated mares and anemia and leukopenia in adult horses. Orally administered synthetic folates interfere with normal folate metabolism in horses being administered antifolate drugs resulting, paradoxically, in folate deficiency. Adequate intake of folates in antiprotozoal-treated horses can be assured by feeding a diet containing good quality green foliage.

**Ponazuril**, an active metabolite of toltrazuril, is usually administered at a dosage of 5 mg/kg BW orally once daily for 28 days. At this dosage, and at 10 mg/kg orally once daily for 28 days, administration of the drug results in resolution of clinical signs in approximately 60% of horses with EPM. The initial dosage is 5 mg/kg every 24 hours, which is continued for 28 days if signs of improvement are evident after 14 days. If signs of improvement are not seen after 14 days, the dosage is increased to 10 mg/kg orally every 24 for 14 days. Few adverse effects are noted, even at 30 mg/kg orally once daily for 28 days. **Diclazuril**, which is available in the United States as a pelleted product for oral administration to horses, is similarly effective and free of serious adverse effects.<sup>13,30–32</sup>

**Nitazoxanide** administration was associated with adverse effects including fever, anorexia, diarrhea, and worsening of clinical

signs of neurologic disease. It is no longer recommended for treatment of EPM.

The decision to **stop treatment** in horses that do not completely recover is difficult. Some authorities recommend resampling CSF and continuing treatment until antibodies to *S. neurona* are no longer detectable. However, given that normal horses often have antibodies in their CSF, and that some treated horses never lose their positive Western blot test, the decision to stop treatment should not be based entirely on this variable.

Some horses have a transient worsening of clinical signs in the first week of treatment. This is presumed to be from the effect of the antiprotozoal agent causing death of protozoa with subsequent inflammation and further impairment of neurologic function. Relapse of the disease occurs in some horses when administration of antiprotozoal medication is stopped.

**Supportive treatment** of affected horses includes antiinflammatory drugs (flunixin meglumine, 1 mg/kg intravenously, every 8–12 hours; dimethyl sulfoxide, 1 g/kg as a 10% solution in isotonic saline intravenously, every 24 hours for 3 days) and nutritional support for horses that cannot eat. Flunixin meglumine is often administered twice daily for the first 3 to 5 days of treatment with ponazuril or nitazoxanide, purportedly to reduce the inflammatory effects of death of protozoa in the CNS.

Treatment of EPM associated with infection by *N. hughesi* is based on the same principles and medications as treatment of disease associated with *S. neurona*.<sup>8</sup>

### CONTROL

Preventing contamination of feed and water with opossum feces is essential for preventing EPM in animals. Sporocysts of *S. neurona* are resistant to the usual concentrations of many of the conventional disinfectants including sodium hypochlorite (bleach), 2% chlorhexidine, 1% betadine, 5% benzyl chlorophenol, 13% phenol, 6% benzyl ammonium chloride, and 10% formalin. The organism is killed by heating to 55°C for 15 minutes or 60°C (140°F) for 1 minute. Although survival of sporocysts in different environmental conditions outdoors has not been tested, sporocysts remained viable at 4°C (131°F) for months.<sup>22</sup>

Because protection of feed from contamination by opossums has been demonstrated to reduce the risk of horses developing EPM, it is prudent to use measures to reduce the exposure of animals and feed to opossum feces, and possibly feces of birds that might act as transport hosts.

There is interest in pharmacologic means of preventing infection of horses by *S. neurona*. Pyrantel pamoate has some efficacy against *S. neurona* in vitro but daily administration (2.6 mg/kg BW in feed) does not prevent *S. neurona* infection of horses. Daily

administration of low doses of **diclazuril** to foals in endemic areas significantly reduces the rate of seroconversion.<sup>30-32</sup>

There is no vaccine available for prevention of EPM associated with either *S. neurona* or *N. hughesi*.<sup>22</sup>

### FURTHER READING

Dubey JP, et al. An update on *Sarcocystis neurona* infections in animals and equine protozoal myeloencephalitis (EPM). *Vet Parasitol.* 2015;209:1-42.

Reed SM, et al. Equine protozoal myeloencephalitis: an updated consensus statement with a focus on parasite biology, diagnosis, treatment and prevention. *J Vet Intern Med.* 2016;30.

### REFERENCES

- Dubey JP, et al. *Vet Parasitol.* 2014;202:194.
- Dubey JP, et al. *Vet Parasitol.* 2011;183:156.
- Cooley AJ, et al. *Vet Pathol.* 2007;44:956.
- Sundar N, et al. *Vet Parasitol.* 2008;152:8.
- Rejmanek D, et al. *Vet Parasitol.* 2010;170:20.
- Howe DK, et al. *Int J Parasit.* 2008;38:623.
- Wobeser BK, et al. *Can Vet J.* 2009;50:851.
- Finno CJ, et al. *J Vet Intern Med.* 2007;21:1405.
- Finno CJ, et al. *Vet Ophthalmol.* 2010;13:259.
- Arias M, et al. *Vet Parasitol.* 2012;185:301.
- Ellison S, et al. *Intern J Appl Res Vet Med.* 2012;10:243.
- Hsu V, et al. *J Parasitol.* 2010;96:800.
- Reed S, et al. *J Vet Intern Med.* 2016;30:491.
- Yeargan MR, et al. *Parasite.* 2013;20:29.
- More G, et al. *J Equine Vet Sci.* 2014;34:1051.
- de Moura AB, et al. *Rev Bras Parasitologia Vet.* 2013;22:597.
- Kligler EB, et al. *Vet Parasitol.* 2007;148:109.
- Pusterla N, et al. *Vet J.* 2014;200:332.
- Morley PS, et al. *J Vet Intern Med.* 2008;22:616.
- Cohen ND, et al. *JAVMA.* 2007;231:1857.
- Howe DK, et al. *Vet Clin North Am Equine Pract.* 2014;30:659.
- Dubey JP, et al. *Vet Parasitol.* 2015;209:1.
- Dryburgh EL, et al. *J Parasitol.* 2015;101:462.
- Mansfield LS, et al. *Vet Parasitol.* 2008;153:24.
- Pusterla N, et al. *J Parasitol.* 2011;97:281.
- Antonello AM, et al. *Vet Parasitol.* 2012;187:367.
- Johnson AL, et al. *J Vet Intern Med.* 2010;24:1184.
- Johnson AL, et al. *J Vet Intern Med.* 2013;27:596.
- Reed SM, et al. *J Vet Intern Med.* 2013;27:1193.
- Hunyadi L, et al. *J Vet Pharmacol Ther.* 2015;38:243.
- MacKay RJ, et al. *Am J Vet Res.* 2008;69:396.
- Pusterla N, et al. *Vet J.* 2015;206:236.

## CEREBROSPINAL NEMATODIASIS (ELAPHOSTRONGYLOSIS)

Cerebrospinal nematodiasis, cerebrospinal elaphostrongylosis (CSE) or neurofilariasis are disease of sheep, goats, and camelids caused by infestation of the brain and spinal cord with the nematode *Elaphostrongylus* and related genera. This genus is closely related to the lungworms of small ruminants but is found in the cranial subarachnoid space, cranial venous sinuses, and occasionally in the spinal subarachnoid space. *Paralaphostrongylus tenuis* occurs in white-tailed deer<sup>1</sup> and moose<sup>2</sup> in eastern North America and parts of western Canada, *E. cervi* in deer, sheep, and goat in Europe<sup>3-5</sup> and New Zealand, and *E. rangiferi* in reindeer in

Scandinavia. *P. odocoilei* has been found to infect bighorn sheep in North America.<sup>6</sup> Eggs or larvae are carried to the lungs, undergo a tracheal migration, and the first-stage larvae are passed in the feces. The larvae are quite resistant to adverse environmental conditions and enter slugs or snails to develop into infective larvae. The lifecycle is complete when infected molluscs are ingested by deer and the larvae penetrate the abomasum and migrate, possibly along spinal nerves, to the spinal cord where they develop into adults and migrate into the subarachnoid space.

Clinical signs are not seen in infected deer, but in sheep, goats and New World Camelids the worm continually moves through nervous system tissue causing limping and incoordination followed by almost complete paralysis of the hindlimbs or of the neck, body, and all four legs.<sup>3,7-9</sup> There are usually no signs of cerebral involvement, and affected animals remain bright and continue to eat. If given supportive treatment, they may survive for at least 1 month. *P. tenuis* also transmits to moose and is responsible for the nervous signs in “moose sickness,” including the following<sup>4</sup>:

- Weakness
- Incoordination
- Circling
- Impaired vision
- Blindness
- Abnormal carriage of the head
- Paralysis
- Lack of fear of man
- Aggressiveness

Histopathologic lesions include axonal degeneration and swelling, perivascular cuffing, presence of hemosiderin-laden macrophages, and increased numbers of eosinophils.<sup>9,10</sup>

Clinical signs of spinal cord disease attributed to *Parelaphostrongylus tenuis* appear to diminish after treatment with high doses of oral fenbendazole (50 mg/kg, daily for five days), although randomized clinical trials have not been completed to confirm this impression.

**No reliable treatment** is available for CSE. Ivermectin has no effect on the adult worms, possibly because the large molecules of this compound cannot pass the blood-brain barrier.<sup>5</sup> One clinical report describes the treatment of 17 light to moderately affected goats with an NSAID (flunixin meglumine) together with ivermectin and fenbendazole for 5 days.<sup>6</sup> Complete recovery occurred in three, partial recovery in eight, but euthanasia was necessary for the remainder.

### REFERENCES

- Jacques CN, et al. *J Wildl Dis.* 2015;51:670.
- Maskey JJ Jr, et al. *J Wildl Dis.* 2015;51:670.
- Alberti EG, et al. *J Helminthol.* 2011;85:313.
- Morandi F, et al. *J Wildl Dis.* 2006;42:870.
- Sironi G, et al. *Parasitologia.* 2006;48:437.
- Huby-Chilton F, et al. *J Wildl Dis.* 2006;42:877.

7. Tschuor AC, et al. *Schweiz Arch Tierheilkd.* 2006;148:609.

8. Dobey CL, et al. *J Vet Diagn Invest.* 2014;26:748.

9. Whitehead CE, Bedenice D. *Vet Clin North Am Food Anim Pract.* 2009;25:385.

10. McIntosh T, et al. *Can Vet J.* 2007;48:1146.

## SETARIA

*Setaria* spp. are long (5- to 10-cm) thread-like filarial nematodes commonly found in the peritoneal cavity of most domestic animals. *S. labiato-papillosa* is a cosmopolitan parasite of cattle, whereas *S. digitata* and the closely related, and perhaps synonymous, species *S. marshalli* occur only in Asia.<sup>1</sup> *S. equina* is found worldwide in horses. *S. tundra* infects and causes significant economic losses in reindeer in Finland.<sup>2,3</sup> Adult females produce motile embryos (microfilariae) that circulate in the peripheral blood of the infected animal and are taken up by mosquitoes. Infective larvae develop in the intermediate host and are released when the mosquito subsequently feeds. *S. labiato-papillosa* reaches maturity in cattle in 8 to 10 months. Despite their size, the presence of these worms in the abdominal cavity causes no significant clinical effect.

**Serious disease** may result if *S. labiato-papillosa* or *S. digitata* infect animals other than their own natural host, especially horses, sheep, goats, and humans. In these hosts, they migrate in an abnormal manner causing epizootic cerebrospinal nematodosis (with local names including lumbar paralysis and kumri) when they invade the brain and spinal cord. Juvenile *S. digitata* may also invade the eye. Although *Setaria* is found in cattle in many countries, cerebrospinal nematodosis is largely restricted to Israel, Japan, China, Korea, India, and Sri Lanka. The incidence is increasing in Taiwan, and a single case has been reported from the United States. Ocular filariasis is seen most commonly in Japan. These diseases occur during summer and autumn when the vectors are most prevalent. The cerebrospinal form sometimes occurs in epidemic proportions, causing the death of horses, sheep, and goats.

**Cerebrospinal nematodosis** may be rapid in onset with affected animals dying within a few days or it may occur gradually over a few days. There may be acute or subacute paresis with weakness and incoordination or paralysis involving the hindlegs most commonly, but sometimes all four legs are involved. Recovery is only partial in many animals but others show only a mild neurologic disorder, which gradually becomes indiscernible. There are no systemic signs and the animals may continue to eat. Other diseases causing similar clinical signs include enzootic equine ataxia in horses and paralytic rabies in sheep and goats as lesions as well as traumatic injury, spinal cord abscess, warble fly larvae, *S. vulgaris*, or *H. gingivalis*.

At necropsy, there are no macroscopic changes and sections need to be taken from many levels of the spinal cord to find histologic lesions. Focal areas of malacia or microcavitation are seen and in adjacent sites there may be loss of myelin, axonal swelling, degeneration, and gitter cell formation. Migratory pathways are indicated by necrotic tracts. Where nervous signs have been present for only a few days, a worm or worm fragments may occasionally be found. Molecular techniques have been developed for identifying the responsible species.

*S. tundra* causes peritonitis, perihepatitis, and significant decrease in body condition score in reindeer calves.<sup>2,3</sup> Treatment of infected reindeer with ivermectin (0.2 mg/kg, subcutaneously) has up to 95% efficacy of worm elimination.<sup>2</sup> Application of biting insect repellent (deltamethrin) significantly decreases *S. tundra* infections in reindeer.<sup>2</sup>

Anthelmintics will not resolve existing lesions but may prevent further damage. Little has been published on treatment or control. Ivermectin gave moderate efficacy (80%–88%) against adult *S. equina* in ponies. In a field study, none of 221 goats and sheep injected twice with ivermectin at a dose of 0.2 mg/kg developed setariasis, whereas 17 of 303 noninjected animals suffered from the disease.

#### FURTHER READING

Taylor MA, Coop RL, Wall RL. *Veterinary Parasitology*. Oxford, UK: Wiley-Blackwell; 2007.

#### REFERENCES

1. Laaksonen S, et al. *Acta Vet Scand*. 2008;50:49.
2. Laaksonen S, et al. *Vet Rec*. 2007;160:835.
3. Nakano H, et al. *J Vet Med Sci*. 2007;69:413.

## Toxic Diseases Primarily Affecting the Spinal Cord

### STRINGHALT

Stringhalt is an involuntary, exaggerated flexion of the hock during walking. It can affect one or both hindlimbs. Classic stringhalt occurs sporadically, is usually unilateral, and is usually irreversible without surgical intervention. Stringhalt can also occur secondarily to injury to the dorsal metatarsus.

A clinically identical disease, Australian stringhalt, occurs in outbreaks in Australia, New Zealand, California, Japan, Europe, the UK, Brazil, and Chile.<sup>1-5</sup> The outbreaks tend to occur in late summer or autumn and are related to drought conditions or overgrazing of pasture with consequent ingestion of plants that would otherwise not be eaten. Outbreaks in Australia, California, and Virginia are related to the ingestion of *Hypochaeris radicata* (flatweed, cats ear).<sup>4</sup> Other plants suspected to play a role in the etiology include *Taraxacum officinale* (dandelion), *Arctotheca calendula* (capeweed), or *Malva*

*parviflora* (mallow) but good evidence of the role of any of these latter plants is lacking.

The **pathogenesis** of the disorder is likely related to the presence of toxins in *H. radicata*, especially after it is stressed.<sup>6</sup> The toxin or toxins have not been identified but are unlikely to be mycotoxins.<sup>4</sup> The disease has been **experimentally induced** by feeding a colt 9.8 kg per day for 19 days of *H. radicata* harvested fresh from a pasture on which horses had developed disease.<sup>5</sup> The disease resolved when the colt was fed *H. radicata* from a pasture with unaffected horses. Signs in the colt resolved within 15 days of last feeding the toxic plant.<sup>5</sup>

**Clinical signs** are distinctive. The abnormal movement is only elicited when the horse begins to move forward. The characteristic movement occurs in mildly affected horses when they are backed or turned. Most cases are manifested by a flexion of the hock that can be violent enough for the horse to kick itself in the abdomen. The hoof is held in this position for a moment and then stamped hard on the ground. If both hindlegs are affected, progress is very slow and difficult and the horses often use a bunny-hopping gait. In the most severe cases the horse is unable to rise without assistance. The horse's general health is unaffected, although it may be difficult for it to graze. Some cases have other signs of neurologic disease such as stiffness of the forelimbs or respiratory distress caused by laryngeal paralysis. Many affected horses have unilateral (usually left) laryngeal hemiplegia evident on endoscopic examination of the larynx.

EMG examination reveals markedly abnormal activity including prolonged insertion activity, fibrillation potentials, and positive waves at rest and enhanced EMG activity in the right lateral digital extensor muscle on muscle contraction consistent with denervation. The changes are most severe in the long digital extensor muscle. Most horses recover without treatment, although complete recovery might not occur for over 1 year.

Biopsy of the superficial peroneal nerve and the long digital extensor muscle can be useful in providing an antemortem diagnosis. The superficial peroneal nerve of an affected horse had loss of large myelinated fibers, axonal degeneration, and myelin splitting.<sup>7</sup>

There are no characteristic abnormalities in a complete blood count or serum biochemical profile. Pathologic findings are restricted to a peripheral neuropathy in the tibial, superficial peroneal, and medial plantar nerves and in the left and right recurrent laryngeal nerves. Lesions in affected muscles are consistent with denervation atrophy and fiber type grouping.

The signs of the disease are characteristic. Differential diagnosis of the disease involving one leg is ossifying myopathy of the semimembranosus and semitendinosus muscles. Lead toxicosis can induce similar signs in horses.

Recovery is spontaneous in most cases (50% over an 8-month period in one large case series).<sup>2</sup>

Treatment with phenytoin (15 mg/kg orally daily for 14 days) effects some improvement but the signs recur within 1 or 2 days after treatment is discontinued.<sup>2</sup> Myotectomy of the lateral digital extensor muscle and tendon is reported to provide immediate relief in affected horses, even in those horses with severe bilateral disease.

Control involves the prevention of overgrazing of pastures, particularly during droughts, and restricting or eliminating access to *H. radicata*.

#### REFERENCES

1. de Pennington N, et al. *Vet Rec*. 2011;169:476.
2. Domange C, et al. *J Anim Physiol Nutr*. 2010;94:712.
3. Schultze C, et al. *Pferdeheilkunde*. 2009;25:115.
4. El Hage C. *Investigation Into the Cause of Australian Stringhalt*. Canberra: Rural Industries Research and Development Corporation; 2011:1.
5. Araujo JAS, et al. *Toxicol*. 2008;52:190.
6. MacKay RJ, et al. *Toxicol*. 2013;70:194.
7. Armengou L, et al. *J Vet Intern Med*. 2010;24:220.

## Inherited Diseases Primarily Affecting the Spinal Cord

### SPASTIC PARESIS OF CATTLE (ELSO HEEL)

This disease occurs in the Holstein, Aberdeen Angus, Red Danish, Ayrshire, Beef Shorthorn, Poll Hereford, Murray Grey, and many other breeds of cattle. It has been observed in crossbred Brahman cattle and in an Ayrshire × Beef Shorthorn crossbred steer. The disease occurs principally in calves, with signs appearing from several weeks to 6 months or more after birth. Occasional cases are reported as developing in adult European cattle, and there is one report of the occurrence of the disease in adult Indian cattle. The disease was first termed Elso heel based on its first description in 1922 as a heritable disease from an East Friesian bull named Elso II. The preferred name spastic paresis was first used in 1932 to emphasize the primary defect.<sup>1</sup>

It has been held for a long time that the disease is inherited, and the principal argument has centered on the mode of inheritance. Attempts to determine this have shown that the rate of occurrence in planned test matings is so low that, if inheritance is involved, it can only be the inheritance of a susceptibility to the disease. It is suggested that different time appearances represent a single disease entity with varying expressivity, with the late forms affected by cumulative environmental factors. A proposed hypothesis is of a gene with increased penetrance in the homozygote, with weak penetrance in the heterozygote, acting on a polygenic basis





**Fig. 14-19** Spastic paresis in an 8-month-old Holstein Friesian heifer. Both hindlegs are excessively straight, the left hindleg is held caudally and above the ground, and the tail is characteristically held away from the body.

dependent on external factors. Males appear to be affected more often than females, but a clear sex predilection has not been identified. The prevalence of disease appears to be <1% in all breeds.<sup>1</sup> Infectious agents causing transmissible subacute spongiform encephalopathies interacting with trace elements such as lithium have been suggested as etiologic agents, but there is no evidence to support this hypothesis.

In all forms of the disease in most cattle breeds (exceptions being the Belgian Blue and Romagnola in which the excessive tone occurs in the quadriceps femoris muscle; the lesion is usually bilateral) there is excessive tone of the gastrocnemius muscle and straightness of the hock, usually more marked in one hindleg. If only one leg is affected, it may be thrust out behind while the calf is walking and advanced with a restricted, swinging motion often without touching the ground. There is no resistance to passive flexion of the limb and the animal appears normal while sitting. Clinical signs are most exaggerated after immediately encouraging a sitting animal to stand. The gastrocnemius and perforatus muscles are rigid and in a state of spastic contraction. There is a characteristic elevation of the tail (Fig. 14-19). The lameness becomes progressively worse and affected animals spend much time lying down. Much BW is lost and the animal is usually destroyed between 1 and 2 years of age.

Minor lesions described as regressive changes in the neurons of the red nucleus, in the reticular substance, and in the lateral vestibular nucleus are of doubtful significance, as are the observed reduction in inorganic phosphate and ascorbic acid levels in the

blood and CSF of affected calves. A lower than normal CSF concentration of a central neurotransmitter, dopamine, could also be an effect rather than a cause.

There are demonstrable lesions on radiologic examination of the tarsus with remodeling of the calcaneus bone and development of an enlarged and irregular epiphysis of the calcaneus caused by chronic and repetitive strain that straightens the hindlimb. Extensive examinations of muscles and tendons have failed to reveal histologic abnormalities. The absence of any structural lesion and the variation in intensity of the abnormality suggests that it is a functional one. An **overactive stretch reflex** is thought to be responsible for the clinical signs, possibly caused by defective glycinergic synaptic transmission and alteration of calcium signaling proteins (Fig. 14-20).<sup>1,2</sup>

The diagnosis of spastic paresis is based on history, signalment, clinical signs, and progressive nature of the disease. A genetic test is currently unavailable because the underlying gene defect(s) have yet to be identified. An epidural injection of 0.38% procaine solution diminishes the clinical signs of spastic contracture within 10 to 15 minutes and has provided a useful supporting diagnostic test when the gastrocnemius is the principal muscle of contracture; it is less helpful in cases of spastic contraction of the quadriceps. In the latter case ultrasound-guided infiltration around the femoral nerve with local anesthetic solution may be attempted.<sup>1,3</sup>

In Europe, affected animals are kept for breeding purposes, especially if they are double-muscled. They are kept because of the efficacy of the curative surgical operation

(partial tibial neurectomy) and for the high incidence of double-muscling in such calves. In the Holstein breed, and several German breeds, bulls that sire affected calves have been observed to have very straight hocks and to suffer from various forms of stifle and hock lameness early in life.

The only effective treatment is surgical. Several surgical techniques including tenectomy, partial tibial neurectomy, and triple tenectomy have been described. The most effective technique appears to be partial tibial neurectomy performed under caudal epidural anesthesia with electrical stimulation used to identify the tibial nerve.<sup>4</sup> In a large case series on 113 Belgian Blue calves with spastic paresis, a telephone follow-up of the owners 3 months later revealed good results in 83%, a considerable improvement in 4%, severe hyperflexion of the hock necessitating early culling for slaughter in 5%, and in 8% there was little or no improvement.

#### FURTHER READING

De Vlaminck C. Bovine spastic paresis: current knowledge and scientific voids. *Vet J*. 2014;202:229-235.

#### REFERENCES

1. De Vlaminck C. *Vet J*. 2014;202:229.
2. Pariset L, et al. *BMC Vet Res*. 2013;9:122.
3. De Vlaminck CA, et al. *Am J Vet Res*. 2013;74:74-75.
4. Milne MH. *UK Vet*. 2007;12:1.

### INHERITED CONGENITAL MYOCLONUS (HEREDITARY NEURAXIAL EDEMA)

This congenital defect of the nervous system has been reported only in Poll Hereford cattle or their crossbreds and appears to be transmitted by inheritance in an autosomal recessive pattern. A similar disease has been tentatively recorded in Peruvian Paso horses. At birth affected calves are unable to sit up or rise and are very sensitive to external stimuli, manifested by extreme extensor spasm, including fixation of thoracic muscles and apnea, especially if lifted and held upright. The response is one of hyperesthesia with myoclonic jerks of skeletal muscles in response to external stimuli or spontaneously. The intellect of the calves seems unaffected, vision is normal, they drink well, and can be reared but at a great cost in time. Intercurrent disease is common and calves usually die of pneumonia or enteritis before they are 1 month old.

All affected calves have subluxations of the hip joints or epiphyseal fractures of the femoral head caused by muscle spasms in the fetus. Their gestation length is shorter than that of normal calves by 9 days.

There are no microscopic lesions in the CNS, but there is a biochemical defect—severe alterations in spinal cord glycine-mediated neurotransmission. The specific and marked defect in glycine receptors and the increase in neuronal uptake of glycine are

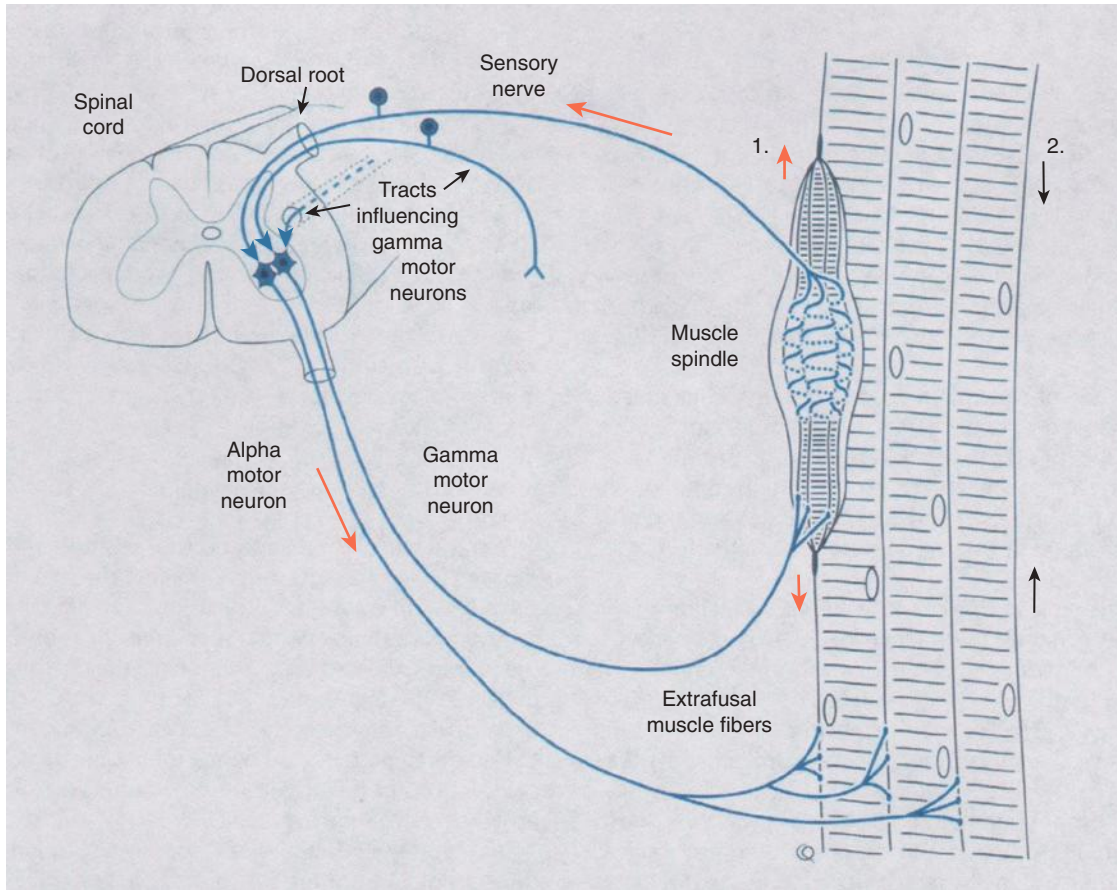

**Fig. 14-20** Simplified drawing of the  $\gamma$ -motor neuron system. In cattle with spastic paresis, spinal cord neurons are thought to provide defective control to the  $\gamma$ -motor neuron system, most likely by overstimulation or sufficient inhibition. During the normal stretch reflex the extrafusal skeletal muscle fibers are lengthened, stretching the muscle spindle. This stretch is detected and a signal sent via the afferent axon to the dorsal root. The signal is then sent directly to the  $\alpha$ -motor neurons, resulting in muscle contraction.  $\gamma$ -Motor neurons in the ventral spinal cord that are controlled by the central nervous system appear to inappropriately modulate the sensitivity of the stretch reflex system, resulting in sustained and excessive contraction. (Reproduced with permission from De Vlaminck C. *Vet J* 2014; 202:229-235.)

accompanied by a change in the major inhibitory system in the cerebral cortex. It has also been shown that there is a specific and marked deficit of [ $^3\text{H}$ ] strychnine-binding sites in the spinal cord. The disease needs to be differentiated from two other congenital, presumed hereditary, diseases of newborn Herefords—maple syrup urine disease and “congenital brain edema”—in which spongy degeneration of the CNS is accompanied by severe edema of the gray and white matter. These two diseases are assumed to represent those cases of congenital disease, originally bracketed with inherited congenital myoclonus, in which there was vacuolation of nervous tissue in the CNS.

### **INHERITED SPINAL DYSMYELINATION**

Bovine spinal dysmyelination is a congenital neurologic disease occurring in several national cattle breeds upgraded with American Brown Swiss cattle. The disease was first described in the Red Danish Dairy breed. In Denmark, all cases are genetically related to

the ABS bull White Cloud Jason's Elegant. It is inherited as an autosomal recessive trait. Genetic mapping of the gene in crossbred American Brown Swiss cattle to the bovine chromosome II has been done.

Clinically, in calves there is lateral recumbency, opisthotonus, limb extension, normal to increased reflexes, and mental alertness. Dysmyelination is present, including axonal degeneration and astrogliosis, in spinal tracts, especially the ascending gracile funiculus and dorsolateral spinocerebellar tracts and the descending sulcomarginal tract. This is probably the same defect as spinal muscular atrophy.

### **INHERITED NEURODEGENERATION (SHAKER CALF SYNDROME)**

This is an inherited, degenerative disorder of horned **Hereford** calves. Newborn calves show severe tremor, difficulty in rising, spastic gait, and aphonia. Terminally there is spastic paraplegia. Histologically, there are accumulations of neurofilaments within

neurons. A similar disease in **Holstein Friesians** occurs only in males. There are severe degenerative changes in the spinal cord with spongiform lesions and some cavitation. It has the epidemiologic distribution of a sex-linked recessive mutation.

### **INHERITED SPINAL DYSRAPHISM**

This is found as a congenital defect in Charolais calves and is associated with arthrogryposis and cleft palate. Spinal cord anomalies can be associated with a large number of vertebral abnormalities because of the close association of spinal cord and vertebral column during embryology. Other developmental defects that lead to congenital abnormalities include spinal cord hypoplasia and syringomyelia (tubular cystic cavitation containing CSF that extends over several spinal cord segments) in calves<sup>1,2</sup>; however, many of these developmental abnormalities are accidents of embryology and do not necessarily imply the presence of an inherited condition.

## REFERENCES

1. Binanti B, et al. *Anat Histol Embryol*. 2012;42:316.
2. Burnside WM, et al. *J Am Vet Med Assoc*. 2014;244:661.

## INHERITED CONGENITAL POSTERIOR PARALYSIS

Two inherited forms of congenital posterior paralysis are recorded in cattle. In Norwegian Red Poll cattle posterior paralysis is apparent in affected calves at birth. Opisthotonus and muscle tremor are also present. No histologic lesions have been found. The disease is conditioned by an inherited recessive factor. In Red Danish and Bulgarian Red cattle a similar condition occurs but there is spastic extension of the limbs, particularly the hindlimbs, and tendon reflexes are exaggerated. Histologic examination has revealed degenerative changes in midbrain motor nuclei. Both defects are lethal because of prolonged recumbency.

An inherited posterior paralysis has been recorded in several breeds of swine in Europe. Affected pigs are able to move their hindlimbs but are unable to stand on them. They are normal in other respects. Degeneration of neurons is evident in cerebral cortex, midbrain, cerebellum, medulla, and spinal cord. The disease is conditioned by the inheritance of a recessive character. An inherited progressive ataxia is also recorded in Yorkshire pigs.

## INHERITED BOVINE DEGENERATIVE AXONOPATHY

Reported in Holstein Friesian calves in Australia, most affected calves are affected at birth by recumbency; hyperesthesia or depression; rigidity of limbs; tremor, especially of the head; nystagmus, apparent blindness, and the development of opisthotonus and tetanic spasms when stimulated. At necropsy the consistent lesion is a severe, diffuse, axonal swelling and loss in the spinal cord and brainstem. The cause is unknown but the indicators point to an inherited cause.

## DEGENERATIVE AXONOPATHY OF TYROLEAN GREY CATTLE

A new neurologic disease was identified in Tyrolean Grey cattle in Switzerland in 2003 and was initially named Demetz syndrome.<sup>1</sup> The clinical presentation is similar to that seen in weaver syndrome of Brown Swiss cattle but clinical signs are first evident at 4 to 6 weeks of age. Calves exhibit mild ambulatory paraparesis with moderate to severe ataxia being more severely affected in the hindlimbs. The disease is progressive and affected calves are usually slaughtered by 10 months of age.

A mutation in the mitofusin 2 gene (a mitochondrial membrane protein) was

identified that truncates the last 22 amino acids. Pedigree analysis indicated that the gene mutation occurred before 1972, and gene testing indicated a current carrier frequency of approximately 10%. Marker assisted selection is currently being used to eliminate degenerative axonopathy from this breed.

## REFERENCE

1. Drogemuller C, et al. *PLoS ONE*. 2011;6:e18931.

## CENTRAL AND PERIPHERAL AXONOPATHY OF MAINE ANJOU (ROUGE-DES-PRÉS) CATTLE

A new neurologic disease was identified in Maine Anjou cattle in France in 2008. Affected calves were 1 to 4 months of age and exhibited mild to severe truncal ataxia with mild to moderate paraparesis. The pelvic limbs were much more severely affected than the thoracic limbs. Clinical signs were rapidly progressive and calves became recumbent within 1 to 3 weeks of being examined, at which time they were euthanized. Mentation remained normal for the calves.

Histopathologic examination revealed marked degeneration of axons and myelin and the dorsolateral and ventromedial funiculi of the distal spinal cord (important tracts for transmitting proprioceptive information from the hindlimbs), lateral vestibular nuclei, caudal cerebellar peduncles, and thoracic nuclei.

## INHERITED PROGRESSIVE DEGENERATIVE MYELOENCEPHALOPATHY (WEAVER SYNDROME) OF BROWN SWISS CATTLE

The defect is inherited in Brown Swiss cattle. It appears first in calves when they are 6 months to 2 years old, with a small number more than 2 years, and is manifested by progressive bilateral hindlimb weakness and proprioceptive deficits causing difficulty in rising and a weaving, hypermetric gait, goose-stepping with the forelimbs, and dragging the hindlimbs. The limb reflexes are normal. The calves are bright and alert throughout. There is a broad-based stance and finally recumbency and, after a course of 12 to 18 months, inevitable euthanasia. Necropsy lesions include axonal degeneration, including spheroid formation, and vacuolation of white matter in the cerebellum and at all levels of the spinal cord but especially in the thoracic segment. There is some neurogenic atrophy of muscles but there is no muscular dystrophy. The defect can be identified by examination of chromosomes. It appears to be linked chromosomally with high milk yield traits.

## INHERITED PROGRESSIVE ATAXIA

This well-recognized disease occurs in Charolais cattle. The first onset of signs is at about 12 months of age when the gait is seen to be stiff and stumbling, especially in the hindlimbs, and the hindtoes are dragged. The ataxia may be asymmetric, and the animal cannot back up. The ataxia progresses over a period of 1 to 2 years. Affected animals tend to be down a lot and have difficulty in rising and posturing for urination. Urination is abnormal; it is a squirting but continuous flow that soils the tail. Some affected animals nod their heads from side to side when excited. Both males and females are affected. It has been described occurring in 2-year-old Charolais steer in New Zealand. Characteristic necropsy lesions are confined to the CNS and are histopathologic. The white matter of the cerebellum and internal capsule contains multiple foci of oligodendroglial dysplasia. The somatic lymph nodes contain nodules of hyperplastic lymphoid follicles, some catarrh of the medullae of the nodes, and an accumulation of eosinophils.

## INHERITED SPINAL MYELINOPATHY

There is a progressive spinal myelinopathy of Murray Grey cattle, similar to that seen in Charolais cattle. It is possibly genetic in origin. Some calves are affected at birth; others do not become affected until 1 year old. The syndrome is one of a progressing paresis, without significant ataxia leading to paresis and permanent recumbency. There are degenerative lesions in spinal cord, midbrain, and cerebellum. The disease is conditioned by an autosomal recessive gene.

## INHERITED PERIODIC SPASTICITY OF CATTLE

Inherited periodic spasticity has been observed in Holstein and Guernsey cattle and usually does not appear until the animals are adults. A recent report described it in a Canadian Hereford bull with an early onset between 1 and 2 years of age. It is a particular problem in mature bulls maintained in artificial insemination centers. In the early stages the signs are apparent only on rising; the hindlimbs are stretched out behind and the back depressed (Fig. 14-21). Marked tremor of the hindquarters may be noted. Initially the attacks persist only for a few seconds but are of longer duration as the disease progresses and may eventually last for up to 30 minutes. Movement is usually impossible during the attacks. The tetanic episodes fluctuate in their severity from time to time but there is never any abnormality of consciousness. Lesions of the vertebrae have been recorded but no lesions have been found in the nervous system. Idiopathic muscle





**Fig. 14-21** Inherited periodic spasticity in a Holstein Friesian bull. The signs are apparent only on rising; the hindlimbs are stretched out behind and the back depressed.

cramps have been suggested as a cause. The disease is familial and the mode of inheritance appears to be by inheritance of a single recessive factor with incomplete penetrance.

Administration of the spinal cord depressant, mephenesin (3–4 g/100 kg BW given orally in three divided doses and repeated for 2–3 days) controls the more severe signs. A single course of treatment may be effective for some weeks.

## NEURAXONAL DYSTROPHY

Neuraxonal dystrophy represents a heterogeneous group of degenerative diseases of genetic or acquired etiology that is characterized by spheroidal swellings of axons called spheroid bodies, which is the result of accumulation of axoplasmic organelles including neurofilaments. The change may be physiologic (caused by normal aging) or pathologic and are categorized as primary (familial) or secondary (acquired).<sup>1</sup> EDM is considered a more severe variant of neuraxonal dystrophy and is discussed separately.

### NEURAXONAL DYSTROPHY OF SHEEP (SEGMENTED AXONOPATHY)

This is reported in Suffolk, Merino, Romney, Perendale, Coopworth, and crossbred sheep.<sup>1</sup> An inherited defect (autosomal recessive) is suspected in all cases. Abnormalities appear related to abnormal axonal transport and the inability to maintain integrity of the axon and their associated myelin sheaths.<sup>2</sup>

In **Coopworth sheep** the lambs are affected at birth but have a progressive syndrome in which cerebellar and proprioceptive signs predominate. Most die by 6 weeks of age. Large axonal spheroids are present in the spinal cord and midbrain, and there is a severe depletion of Purkinje cells in the cerebellum.

In **Suffolk sheep** the disease does not appear until 1 to 6 months; signs are a gradual onset of ataxia, followed by recumbency, leading to death or euthanasia. Spheroids in CNS axons are characteristic, mostly in the spinal cord and cerebellum, and contain large amounts of amyloid precursor protein.<sup>1</sup>

The disease in **Merinos** is in fine-wool sheep, is probably the same disease as that previously called **Murrurrundi disease**, and does not appear until 4 to 6 years of age. Most cases require euthanasia after about 2 months but some mild cases survive for up to 3 years. The clinical signs include a wide-based stance, dysmetria of all limb movements with a pronounced hypermetria of the forelimbs resulting in frequent falling, a fine intention tremor of the head, and a diminished menace reflex. A similar disease of medium-wool Merinos, characterized by progressive posterior ataxia and degeneration of sensory tracts in thoracic segments of spinal cord, commencing after 5 months of age and terminating fatally before 2 years of age, is also recorded in Australia. It is probably also an inherited defect

### NEURAXONAL DYSTROPHY OF HORSES

In horses, neuraxonal dystrophy has been reported in **Quarter Horses, Haflingers, Morgans, Appaloosas, Paso Finos, and Standardbreds** with a familial occurrence present in a number of breeds.<sup>3,4</sup> The onset of clinical signs can be as early as a few months of age. Common neurologic abnormalities include ataxia, proprioceptive positioning deficits, dysmetria, a wide-based stance, obtundation, and an inconsistent menace response with no detectable visual impairment.<sup>3</sup> Clinical progression can be very slow over a few months to years, and in some cases stabilization of clinical signs may occur.<sup>3</sup> It can be difficult to clinically differentiate neuraxonal dystrophy from **EDM**; however, the latter is considered a more severe clinical variant of neuraxonal dystrophy.<sup>5</sup> Clinical signs of ocular disease are not detectable and the results of ERG and EEG are within the normal range.<sup>6</sup> Lesions at necropsy are only apparent microscopically and include specific tracts and nuclei in the caudal medulla and spinal cord, with occasional involvement of the cerebellum.

### REFERENCES

1. Finnie JW, et al. *Aust Vet J.* 2014;92:389.
2. Jolly RD, et al. *New Zeal Vet J.* 2006;54:210.
3. Aleman M, et al. *J Am Vet Med Assoc.* 2011;239:823.
4. Brosnahan MM, et al. *J Vet Intern Med.* 2009;23:1303.
5. Finno CJ, et al. *J Vet Intern Med.* 2013;27:177.
6. Finno CJ, et al. *Vet Ophthalmol.* 2012;15(suppl 2):3.

### CAPRINE PROGRESSIVE SPASTICITY

A possibly inherited progressive paresis of Angora goats is recorded in Australia. Signs first appear at about 2 months of age, commencing with lethargy, followed by ataxia, then paresis progressing to sternal recumbency and eventual euthanasia. Tendon reflexes are normal but the kids have difficulty getting to their feet, especially in the hindlimbs. The gait is ataxic with frequent stumbles, and the kids are unwilling to run.

At necropsy there are many large, clear vacuoles in many neurons of the spinal cord, posterior brainstem and midbrain, and degeneration of nerve fibers in the same areas and peripheral nerves.

### INHERITED SPONTANEOUS LOWER MOTOR NEURON DISEASES

Motor neuron diseases involve selective degeneration of upper and/or motor neurons. Upper motor neurons originate in the cranial vault, where they stimulate contraction of muscles. In comparison, lower motor neurons connect the brainstem and spinal cord to the muscle fibers.<sup>1</sup> Effective treatments for motor neuron diseases have yet to be identified.

A lower motor neuron disease in newborn Romney lambs has been described.<sup>1</sup> Lambs are normal at birth but within 1 week they developed weakness and ataxia, which progressed until they were unable to stand. The principal histologic lesions were degeneration and loss of neurons in the ventral horns of the spinal cord and brainstem, wallerian degeneration of ventral rootlets and motor nerves, and associated denervation atrophy of skeletal muscle fibers. Large fibrillar spheroids were found in white and gray matter including nuclei in the brainstem. One missense mutation on the sheep called the ATP/GTP-binding protein 1 gene was identified in all affected animals, exhibiting recessive pattern of inheritance.<sup>1</sup> This binding protein plays a role in protein turnover by cleaving peptides into amino acids. A similar, though not identical, disease of newborn lambs has been recorded in a Dorset Down flock affecting about 20% of lambs. They lay with hindlimbs tucked under the body and forelimbs splayed sideways.

This progressive disease of Yorkshire piglets 5 to 10 weeks of age is presumed to be inherited. Clinical signs include hindlimb tremor, weakness, and ataxia appearing at 2 to 5 weeks of age. The gait includes fetlock knuckling, short choppy steps, and a tendency to collapse after a few steps. Segmental and postural reflexes are normal. By 10 weeks there is complete hindlimb paralysis, the pig is in sternal recumbency, and front limb paralysis has begun. The appetite is good and the pig is bright and alert. On necropsy there is symmetric degeneration and loss of motor neurons in the spinal cord in some ventral spinal nerve roots.

### REFERENCE

1. Zhao X, et al. *Heredity.* 2012;109:156.

### INHERITED SPINAL MUSCULAR ATROPHY

A progressive ataxia, weakness, muscle atrophy, and recumbency develops in young calves, mostly during the first 2 weeks of life.

Sensory functions are unimpaired. Some are already affected at birth and some may be stillborn. No new cases occur after 3 months of age. Conditioned by an autosomal recessive gene the defect occurs in Red Danish cattle, which originated from Brown Swiss, German Braunvieh, and American Brown Swiss. The primary lesion is degeneration of ventral horn cells of the spinal cord, without involvement of the brainstem or cerebellum. The visible lesion is the secondary atrophy of the denervated muscles.

### INHERITED HYPOMYELINOGENESIS (CONGENITAL TREMOR OF PIGS)

Congenital tremor of pigs has a multiple etiology and some of the causes are not yet identified. The two inherited diseases are noted here: congenital tremor type A-IV of British Saddleback pigs and congenital tremor type A-III, a sex-linked inherited form of cerebrospinal hypomyelination of Landrace pigs. The A-IV disease is characterized by the presence of poorly myelinated axons in all parts of the CNS. The specific defect in A-IV is one of fatty acid metabolism. The structural abnormalities in the A-III disease have been identified; splayleg is a common accompaniment.

Both diseases are characterized by muscle tremor, incoordination, difficulty in standing, and some squealing. The A-III disease occurs only in males. Both are inherited as recessive characters.

### PORCINE CONGENITAL PROGRESSIVE ATAXIA AND SPASTIC PARESIS

This is an autosomal recessive disorder of pigs in Switzerland with a yet to be identified gene defect. Clinical signs of a spastic gait with progressive ataxia become evident within 3 days of birth, and the condition is lethal. Male and female pigs are equally affected. Pedigree analysis has identified a boar born in 1978 that was used widely for artificial insemination as the originator of the genetic defect.

#### REFERENCE

1. Genini S, et al. *J Anim Breed Genet.* 2007;124:269.

### EQUINE DEGENERATIVE MYELOENCEPHALOPATHY (EQUINE NEURAXONAL DYSTROPHY)

EDM is characterized by **symmetric, slowly progressive spasticity and ataxia** in foals and horses less than 2 years of age. The disease occurs in most breeds in North America and Europe and is reported in captive zebra and Mongolian Wild Horses in North America. Neuronal dystrophy of the cuneate and gracilis nuclei is considered a

form of EDM and is likely the underlying pathophysiologic process of EDM.<sup>1</sup>

The prevalence of the disease varies widely, with up to 40% of susceptible animals on a farm being affected, although the disease is usually sporadic. There is a familial predisposition to the disease apparently involving an increased requirement for vitamin E, although other factors, including housing, are contributory. Foals from dams that had an EDM-affected foal were at a significantly higher risk (relative risk = 25) of developing EDM than foals from other dams. The occurrence of clusters of cases involving related horses is supportive of a genetic component with inheritance as in an autosomal dominant with variable expression or polygenic manner, although this has not been confirmed in all breeds.<sup>2-4</sup> The disease in Quarter Horses is highly heritable and appears to be polygenic.<sup>2,4</sup>

EDM occurs in Standardbreds, Paso Finos, Quarter Horses, Mongolian horses, Appaloosas, Haflingers, Arabians, Morgans, Lusitanos, Thoroughbreds, Paint horses, Tennessee Walking Horses, Norwegian Fjord Horses, Welsh Pony, and various mixed breeds.<sup>1</sup> There is no sex predilection.

The pathogenesis of the disease is unknown. Abnormal expression of integral synaptic vesicle, synaptic vesicle-associated presynaptic plasma membrane, and cytosolic proteins was observed in two Arabian horses with equine degenerative myeloencephalopathy; however, abnormal  $\alpha$ -tocopherol transfer protein does not appear to contribute to the disease.<sup>4</sup> These proteins have a role in trafficking, docking, and fusion of neuronal synaptic vesicles, and this finding suggests that there is disruption of axonal transport in equine degenerative myeloencephalopathy. A role for oxidative stress and damage to neurons is supported by documentation of markers of oxidative stress in nervous tissue and low serum and/or CSF vitamin E concentrations in two horses with EDM and not in healthy control horses.<sup>5</sup> Low vitamin E concentrations in serum are often associated with the disease, but in one small study only foals with a genetic predisposition to the disease, and having a low serum vitamin E concentration, developed the disease. Foals with low serum vitamin E concentrations that did not have the genetic predisposition to the disease did not develop EDM.<sup>6</sup> Loss of axons leads to defects in neurologic function and consequent gait abnormalities.

The clinical signs are those of a slowing progressive spinal ataxia that stabilizes when the animal is 2 to 3 years of age. Age of onset ranges from birth to 36 months, although most cases have clinical signs by 6 to 12 months of age. Affected foals and yearlings have symmetric signs that are most severe in the hindlimbs, of ataxia characterized by pivoting, circumduction, truncal sway, and difficulty performing complex movements such

as backing or walking with the head elevated. At rest, severely affected horses may have an abnormal posture. The cutaneous trunci reflex may be absent. Spontaneous recovery does not occur, but progression to death is unusual. Radiography and myelography of the cervical spine does not reveal evidence of compression of the spinal cord. The disease is not associated with abnormalities detected on ocular examination, ERG or EEG.<sup>7</sup>

Serum vitamin E concentrations can be normal or low in affected horses, and this is not a reliable test for diagnosis of the disease.<sup>1,3</sup> The hemogram, serum biochemical profile, and CSF analysis are normal. There are no gross lesions on necropsy. Histologic lesions include neuronal atrophy, accumulation of lipofuscin-like pigment, and glial cell proliferation.

Differential diagnoses are listed in [Table 14-20](#) later in the chapter, under the Equine Cervical Vertebral Compressive Myelopathy section. Diagnosis is achieved by exclusion of other causes, of abnormal gait without fever or disease in other body systems in horses, such as compressive myelopathy and equine protozoal myeloencephalopathy.

No treatment is curative, but vitamin E (6000 IU orally once daily) may prevent progression of signs. Supplementation of at-risk foals and yearlings with vitamin E can prevent the disease, although results are not equivocal.<sup>1,6</sup>

#### REFERENCES

1. Finno CJ, et al. *J Vet Intern Med.* 2012;26:1251.
2. Aleman M, et al. *JAVMA.* 2011;239:823.
3. Finno CJ, et al. *J Vet Intern Med.* 2011;25:1439.
4. Finno CJ, et al. *J Vet Intern Med.* 2013;27:177.
5. Wong DM, et al. *Vet Pathol.* 2012;49:1049.
6. Finno CJ, et al. *J Vet Intern Med.* 2015;29:1667.
7. Finno CJ, et al. *Vet Ophthalmol.* 2012;15:3.

### EQUINE CERVICAL VERTEBRAL COMPRESSIVE MYELOPATHY (WOBBLER, "WOBBLER," FOAL ATAXIA, EQUINE SENSORY ATAXIA, CERVICAL VERTEBRAL INSTABILITY)

#### SYNOPSIS

**Etiology** Unknown. The clinical signs are the result of cervical spinal cord compression as a result of abnormalities in the cervical spine.

**Epidemiology** Two predominant manifestations. Sporadic or endemic disease of young horses with young, rapidly growing male horses most commonly affected. Separate presentation in middle-aged and older horses in which it is sporadic.

**Clinical signs** Spinal ataxia evident as truncal sway, ataxia, and paresis usually more

*Continued*

severe in the hindlimbs. Radiographic evidence of narrow spinal canal.

**Clinical pathology** None.

**Lesions** Malacia and wallerian degeneration in the cervical spinal cord.

**Differential diagnosis** Equine degenerative myelopathy, equine protozoal myeloencephalitis, trauma, equine infectious anemia, cerebrospinal nematodiasis, West Nile encephalomyelitis, equine herpesvirus-1 myelopathy, osteomyelitis, cervical vertebral epidural hematoma, aortoiliac thrombosis, congenital vertebral malformation, diskospondylitis, and ryegrass staggers.

**Diagnostic confirmation** Radiography. Positive contrast myelography. Necropsy.

**Treatment** Antiinflammatory drugs. Surgical fusion of vertebrae.

**Control** None.

## ETIOLOGY

The cause of neurologic disease is extradural compression of the cervical spinal cord, hence the term **compressive myelopathy**. The compression may be **static**, that is, the compression is present constantly with the neck in a neutral position, or **dynamic** and only present intermittently when the neck is either flexed or extended. The second situation is often referred to as cervical vertebral instability.

The etiology of CSM in most cases is not known. The disease in young horses is caused by malformation and malarticulation of the cervical vertebrae and could represent part of the osteochondritis dissecans spectrum of diseases.<sup>1,2</sup> There can be combinations of articular process osteophytosis, interarcuate ligament hypertrophy, dorsal laminal thickening, vertebral body end plate flaring, and synovial cysts. Importantly, changes in soft tissue associated with the bony lesions can contribute to the compressive myelopathy. Dynamic instability is associated with vertebral instability and subluxation and is most common in the cranial vertebrae (C3-C5).

Copper deficiency has been mooted as one cause of the bony lesions, as have high calorie rations and diets high in soluble carbohydrate.<sup>2</sup>

The disease in older horses is secondary to osteoarthritis of the articular processes. An inciting cause has not been identified.

Several basic syndromes of compressive myelopathy, based on age of occurrence, are recognized:

- CSM in immature horses (<3 years of age, depending on breed) that is often associated with developmental joint disease in the axial and appendicular skeleton. A fundamental underlying predisposing defect appears to be a narrow diameter of the cervical vertebral canal. Compression is a result of the lesions described earlier.

- Cervical vertebral instability is a disease of horses less than 1 year of age that is often associated with malformations of one or more of the cervical vertebrae.<sup>3</sup>
- Compressive myelopathy in mature horses, >4 years (usually >7 years) of age, associated with osteoarthritis of the articular facets of the caudal cervical vertebrae, with subsequent impingement of the vertebral canal by bony and soft tissue proliferative lesions.
- Miscellaneous causes of cervical cord compression by neoplasia (melanoma, sarcoma, lymphoma), trauma (cervical vertebral fractures), arachnoid or synovial cysts, epidural hematoma<sup>4</sup> or, rarely, diskospondylitis.<sup>5</sup>

An alternative categorization is based on the nature of the bony lesion and not on the cause of compression of the spinal cord. **Type I cervical vertebral malformation** occur in horses <2 years of age that have vertebral changes that likely began in the first few months of life, including malformations causing stenosis of the vertebral canal, malformations at the articulations of the vertebrae including osteochondrosis, and enlarged physal growth regions. **Type II cervical vertebral malformations** tend to occur in older horses with severe osteoarthritic lesions of the vertebral articulations.

## EPIDEMIOLOGY

### Occurrence

The disease in mature horses occurs sporadically throughout the world.

The disease in young horses is sometimes endemic on farms or studs and in particular

lines of horses. There is a suggestion of a familial tendency for the disease, although this has not been well documented.

The **morbidity rate** can be as high as 25% of each foal crop on individual Thoroughbred farms, although the overall frequency of the disease in the general horse population is much lower. Among Thoroughbreds born on four stud farms in Europe and North America, the disease has an annual prevalence of diagnosis of 1.3% (range of 0.7%–2.1% over the study period) and annual prevalence on farms varying from 0% to 5.8%.<sup>6</sup>

Compressive myelopathy was detected in 83 of 4318 horses subject to necropsy examination in Normandy, France.<sup>7</sup> Fifteen percent of horses with a diagnosis of neurologic disease had cervical compressive myelopathy. There were more males affected than females.<sup>7</sup>

## Risk Factors

### Animal Risk Factors

Risk factors for CSM identified in a study of 1618 horses at 22 veterinary teaching hospitals in North America are summarized in [Table 14-20](#).

The **disease in young horses** is commonly recognized in Thoroughbred, Standardbred, Warmblood, and Quarter horses, with Arabians and other breeds less likely to be diagnosed with the disease.<sup>8</sup> Ponies are rarely, if ever, affected. Horses less than 4 years of age are at greater risk of the disease, with most cases occurring in 1- to 3-year-old horses. Males, either intact or gelded, are more likely to be affected than are females.<sup>8</sup>

**Table 14-20** Association of horse factors associated with a diagnosis of cervical stenotic myelopathy in 811 horses with cervical stenotic myelopathy and 805 control horses

Variable	Or (95% CI)	P value
<b>Sex</b>		
Gelding	2.0 (1.5–2.6)	<0.001
Sexually intact male	2.4 (1.8–3.2)	<0.001
Female	1 (Referent)	NA
<b>Breed</b>		
Arabian	0.6 (0.3–0.9)	0.035
Standardbred	0.5 (0.3–0.7)	<0.001
Thoroughbred	1.7 (1.3–2.3)	<0.001
Tennessee Walking Horse	2.3 (1.1–4.7)	0.019
Warmblood	1.9 (1.1–3.1)	0.020
Other breeds	0.6 (0.4–0.8)	0.006
Quarter Horse	1 (Referent)	NA
<b>Age</b>		
<6 mo	2.4 (1.4–3.9)	<0.001
6–11 mo	6.6 (3.8–11.5)	<0.001
12 to 23 mo	16.4 (10.5–25.8)	<0.001
2 to <4 y	7.2 (4.9–10.5)	<0.001
4 to <7 y	3.1 (2.1–4.6)	<0.001
7–10 y	1.1 (0.7–1.8)	0.65
≥10 y	1 (Referent)	NA

OR, odds ratio; NA, not applicable.

From Levine JM, et al. *JAVMA* 2008;233:1453



The **disease in older horses** is characterized by a slight predominance of male horses with overrepresentation of Warmbloods, which could represent a breed or use predisposition, and median age at diagnosis of 8 years.<sup>1</sup>

Horses with CSM have a narrower spinal canal than do unaffected animals and this condition, with degenerative joint disease of the articular facets and thickening of the ligamentum flavum, contributes to the greater likelihood that the horse will have spinal cord compression.

It is suspected that predisposition to the disease is heritable, but this has not been demonstrated by appropriate studies.

The disease in mature horses tends to be in horses used for athletic endeavors and is uncommon in broodmares or retired animals.

## PATHOGENESIS

The disease is attributable to injury to the spinal cord as a result of compression by either soft tissue (joint capsule, intervertebral ligaments, or, rarely, intervertebral disk material) or cartilage and bone.

Constant or intermittent pressure on the spinal cord causes dysfunction or necrosis of white matter and neurons at the site of compression, degeneration of fibers of ascending tracts cranial to the site of compression, and of descending tracts caudal to the compression. The ascending tracts are those associated with general proprioception, whereas the descending tracts are upper motor neurons. These tracts are located superficially in the dorsolateral aspect of the cervical spinal cord and damage to them results in signs of ataxia and weakness. Tracts from the caudal limbs are more superficial, and therefore more easily injured, than tracts associated with the cranial limbs. Consequently, clinical signs are usually more severe in the hindlimbs. The spinal cord lesions are usually, but not always, bilaterally symmetric, as are the clinical signs. Proprioceptive pathways are disrupted, causing the signs of ataxia (incoordination) typical of the disease. Clinical signs vary depending on the site of the lesion (see later).

## CLINICAL FINDINGS

The onset of clinical signs is sometimes acute in young horses with CSM and there can be a history of trauma, such as falling. However, the onset of clinical signs of CSM in both young and mature horses is usually gradual and insidious, and in mildly affected horses the nervous disease can be mistaken for lameness of musculoskeletal origin. Affected horses are bright and alert and have a normal appetite. There can be evidence of pain on manipulation of the neck or on firm pressure over the lateral facets, especially in mature horses with osteoarthritis of the caudal cervical vertebral facets.<sup>1</sup> There can be focal muscle atrophy adjacent to affected cervical vertebrae in older horses.

The severity of clinical signs varies from barely detectable to recumbency. There are no defects of al nerves, with the occasional exception of the cervicofacial reflex. The severity of signs of CSM are often graded according to the following:

**Grade 0:** no gait deficits at the walk

**Grade 1:** no gait deficits identified at the walk and deficits only identified during further testing (head elevation, backing, walking on a slope, stepping over obstacles, circling, tail pull at rest and while walking)

**Grade 2:** deficits noted at the walk

**Grade 3:** marked deficits noted at the walk

**Grade 4:** severe deficits noted at the walk and might fall or nearly fall at normal gaits

**Grade 5:** recumbent and unable rise without assistance

The **two primary defects in gait** in affected horses are related to defects in upper motor neuron function and general proprioception. These two primary deficiencies in neurologic function contribute to clinical signs characterized as ataxia, paresis, dysmetria, and spasticity. **Ataxia** is the incoordinated movement of limbs and is evident as interference of one limb with another (such as one foot stepping on another when the horse is tightly circled), knuckling of the fetlock joint (which can also be a sign of weakness), unusual placement of feet (excessively wide-based or narrow-based stance, incomplete or delayed return of the foot to its normal position after it is relocated to an abnormal position, excessive circumduction of the outside foot during tight circling), stumbling, and/or swaying of the trunk during walking in a straight line. **Paresis** is weakness and is evident in its most extreme form as inability of the horse to rise. In less extreme manifestations it is evident as knuckling of the fetlock joint, stumbling when walking downhill or over obstacles, and ease of pulling the horse to one side by the tail when it is walking. **Dysmetria** refers to uneven gait typified by undershoot or overshoot of the limb such that the hoof is in an incorrect position. **Spasticity** is a result of loss of inhibition of lower spinal reflexes by the upper motor neurons and results in a stilted or stiff gait.

**Mildly affected horses** may have deficits that are difficult to detect and only apparent under saddle or at high speed. The owner might complain of poor performance of a racehorse or dressage animal, of an animal that frequently changes leads, or that is poorly gaited. Careful examination can reveal excessive circumduction of the hindfeet, stumbling, and pacing when the head is elevated.

**Moderately affected** animals have truncal sway (the body of the horse and hindquarters swaying laterally when the horse is walked in a straight line) and

excessive circumduction of the hindfeet. There can be a floating gait of the hindlimbs and scuffing of the toe. Having the horse move in a very tight circle about the examiner often causes the circumduction to become worse in the outside hindleg and the horse to place one foot on top of the other. Affected horses will sometimes pace when walked in a straight line with the head elevated. Blindfolding the horse does not exacerbate the signs. Affected horses will stumble when walked over low objects, such as a curb, and will knuckle at the fetlocks and stumble when walked down a steep hill.

**Severely affected** horses often fall easily when moved or are unable to stand. The horses are bright and alert, but anxious, and display marked truncal sway and ataxia. When standing, they will often have their legs in markedly abnormal positions.

Horses with lesions in the cervical spinal cord cranial to C6-C7 have signs in both forelimbs and hindlimbs. The hindlimbs are more severely affected and the signs are usually, but not always, bilaterally symmetric.<sup>9</sup> Approximately 43% of affected horses have asymmetric gait abnormalities.<sup>9</sup> Lesions of the cervical intumescence (C6 to T2) may cause signs that are more severe in the forelimbs than in the hindlimbs. Lesions at this site may also cause signs typical of brachial plexus injury. Focal muscle atrophy is not characteristic of CSM or cervical vertebral instability and there are never signs of CNC, cerebral, or cerebellar disease.

After initial progression the clinical signs usually stabilize or partially resolve. However, complete spontaneous recovery is very unusual. Death is unusual unless it is by misadventure, although many affected animals are killed for humane or economic reasons.<sup>8</sup>

## Neurologic Examination

A tentative diagnosis of cervical compressive myelopathy is often made based on the clinical examination. Although this assessment is relatively straightforward for severely affected horses, the detection of neurologic abnormalities on physical examination is more challenging for horses with milder forms of the disease. This becomes important as additional diagnostic investigations might not be warranted in all cases of horses with clear-cut signs of cervical compressive myelopathy, but might be indicated in horses with less severe signs of the disease.

The reliability of the neurologic examination of horses has been investigated very little. The agreement between expert or trained observers for overall grade of neurologic abnormality was good (intraclass correlation coefficient of 0.74) when horses of all grades were considered (grades 0–4), but very poor for horses  $\leq$  Grade 1 (intraclass coefficient (ICC) = 0.08) and only moderate (0.43) for horses  $\geq$  Grade 2.<sup>10</sup> The higher ICC for the overall assessment was because observers could easily agree on differences

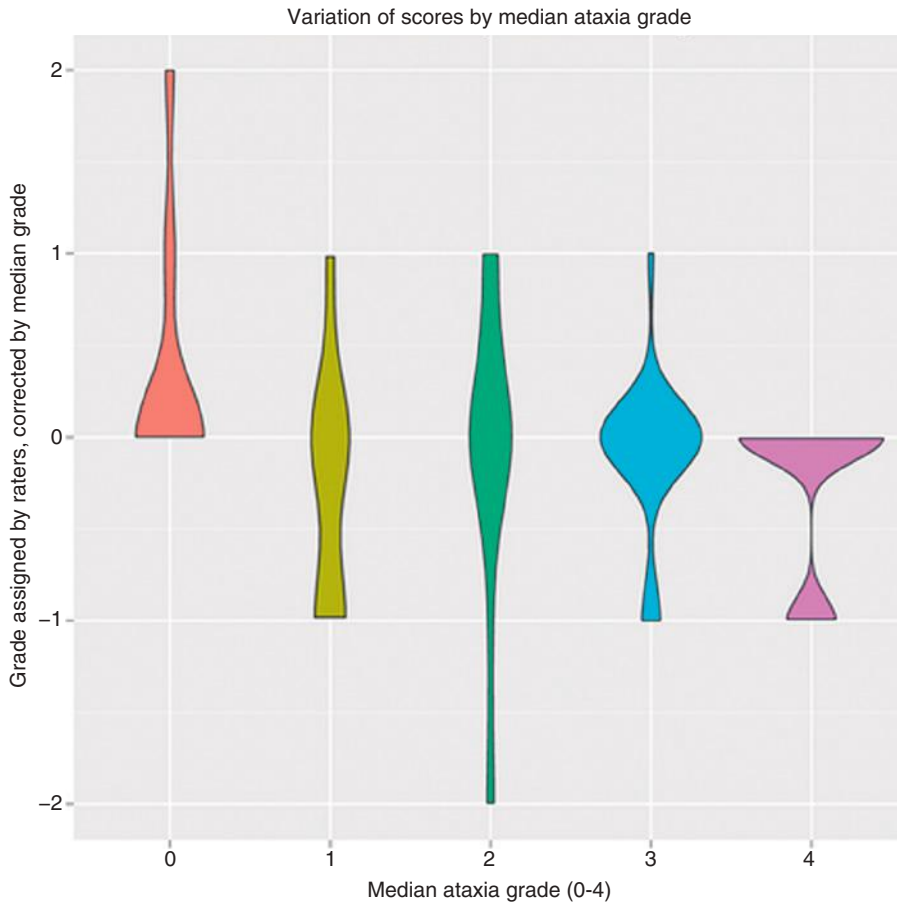

**Fig. 14-22** Violin plot of the variation in individual ratings grouped by the median rating for each horse during live scoring only. To align the ratings around 0, each score was subtracted from the median score of the horse. A violin plot is similar to a boxplot, with the addition of the density of data points illustrated by an increase in width. This figure reveals that most grades have a fluctuation of 1 degree more or less than the median; however, grades 0 and 3 are condensed around the median illustrating better agreement, whereas grade 2 stretches from -2 to +1 grades from the median. (From Olsen E, Dunkel B, Barker WHJ, et al. Rater Agreement on Gait Assessment During Neurologic Examination of Horses. *J Vet Int Med* 2014;28:630.)

between severely affected and unaffected horses. Greatest lack of agreement was for horses that had Grade 2 neurologic signs (Fig. 14-22).<sup>10</sup>

It is recommended in human medicine that an ICC must be  $>0.9$  for it to be useful for decision making in individual patients,<sup>11</sup> and on this basis the current methods for neurologic examination for horses are not acceptable for clinical use.<sup>10</sup> It is the authors' opinion that the current neurologic grading system for examination of horses continue to be used because it provides a structured way of completing the examination. The results of the examination should be considered in light of its poor reliability, especially for horses with severity of median Grade 2, and interpreted with caution.

#### Ancillary Diagnostic Tests

The "slap test," in which the response of the arytenoid cartilages to a slap on the thorax is examined through an endoscope, has poorer sensitivity and specificity for detecting spinal

cord disease than does a routine neurologic examination.

Acupuncture has no proven value in the diagnosis of cervical compressive myelopathy and should not be used for this purpose.

#### Radiographic Examination

Radiographic examination of the cervical vertebral column of potentially affected horses is often undertaken because there are frequently lesions of the bone associated with cervical compressive myelopathy. Radiographic examination includes plain radiographs taken from the lateral aspect with the horse standing or myelography using injection of radiopaque dye to allow visualization of the subarachnoid space and detection of extradural compression of this space.

Examination of both plain and contrast radiographs is potentially enhanced by use of one or more of a number of measures and ratios intended to detect and quantify extradural compression of the cord.

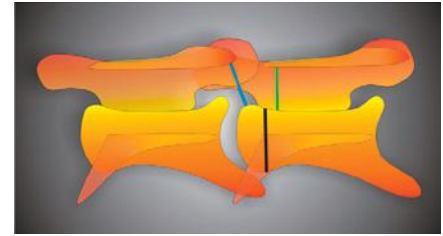

**Fig. 14-23** Schematic drawing of the cervical vertebrae illustrating the sagittal ratios: the intravertebral sagittal ratio is calculated as the ratio of the minimum sagittal diameter of the spinal canal (green line) to the maximum sagittal diameter of the vertebral body, taken at the cranial aspect of the vertebra and perpendicular to the spinal canal (black line). The intervertebral sagittal ratio is the ratio of the minimal distance taken from the most cranial aspect of the vertebral body to the most caudal aspect of the vertebral arch of the more cranial vertebra (blue line) and the maximal sagittal diameter of the vertebral body (black line). (Reproduced with permission from Van Biervliet J. An evidence-based approach to clinical questions in the practice of equine neurology. *Vet Clin Nth Am Equine Pract* 2007;23(2):317-328.)

Radiographic signs detectable on plain radiographs of the cervical spine in horses with compressive myelopathy include the following:

- Encroachment of the caudal vertebral physis dorsally into the spinal canal ("ski jump lesion") caused by physal enlargement
- Extension of the arch of the vertebra over the cranial physis of the next vertebra
- Sclerosis of the spinal canal
- Kyphosis, or subluxation, between adjacent vertebra
- Degenerative joint disease of the articular facets evident as osteoarthritis and bony proliferation

However, these signs are also common in normal horses and have poor predictive value. The overall agreement, relative sensitivity, and relative specificity, respectively, for identification of radiographic abnormalities (compared with the gold standard of necropsy examination) in affected horses is 66% (76/116 horses); 63% and 67% for identification of articular process osteophytosis; 61% (71/116), 42%, and 83% for vertebral canal stenosis; and 78% (91/116), 56%, and 85% for vertebral column subluxation.<sup>9</sup> Radiography appears to have useful specificity but limited sensitivity in the diagnosis of bony lesions associated with cervical compressive myelopathy. Use of additional views, such as oblique views of the caudal cervical vertebrae, can enhance the diagnostic value of radiography.<sup>12</sup>

Intervertebral and intravertebral ratios have been calculated to assist with diagnosis of CSM (Fig. 14-23). The ratios in and of

themselves have variable intraobserver and interobserver reliability with ratios varying by 5% to 10% within and between observers.<sup>13,14</sup> Interobserver agreement in measurements is poor and intraobserver agreement is good across the six most cranial sites but poor for caudal sites.<sup>14</sup> Intraobserver and interobserver variability is sufficient to affect clinical interpretation of radiographs and should be considered when interpreting radiographic examinations with suspected spinal cord disease.

An intravertebral sagittal ratio of the spinal canal to vertebral body diameter of less than 50% for C4-C6 is associated with a 26- to 41-fold increase in the probability of a compressive myelopathy for horse >320 kg; in a separate study all horses with a value of this ratio of less than 0.485 had at least one compressive lesion.<sup>15</sup> An intervertebral ratio can also be calculated and it has diagnostic utility that might be slightly greater than that of the intravertebral ratio.<sup>2,15</sup> The results of these tests are not definitive and a healthy horse can have ratios below this cutoff and affected horses can have normal ratios.<sup>16,17</sup> It is important to recognize that the utility of **intravertebral** (and other) ratios is dependent on the pretest likelihood that the horse has cervical compressive myelopathy. The ratios should therefore be considered in light of other clinical findings. Importantly, neither the intravertebral nor intervertebral ratios predict the site of compression, which can only be detected by myelographic examination.<sup>2</sup>

**Myelography** has been considered to provide the definitive antemortem confirmation of spinal cord compression, but recent studies demonstrate that it is not a perfect diagnostic test and that results should be interpreted cautiously.<sup>2</sup> The sensitivity of this technique, using a 50% reduction in the width of the dorsal dye column as a cutoff for diagnosis of the disease, is 53% (95% CI 34%–72%,  $n = 22$ ) and the specificity is 89% (95% CI of 84%–93%,  $n = 228$ ) (Fig. 14-24).<sup>2</sup> Others have found similar values for sensitivity and specificity with values of 47% and

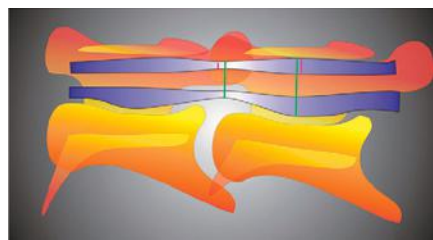

**Fig. 14-24** Schematic drawing of cervical myelogram illustrating the dural diameter reduction (green lines) and the dorsal myelographic column reduction (pink lines). (Reproduced with permission from Van Biervliet J. An evidence-based approach to clinical questions in the practice of equine neurology. *Vet Clin Nth Am Equine Pract* 2007;23(2):317-328.)

78%, respectively, for older horses with compressive myelopathy at caudal cervical sites.<sup>1</sup> These values indicate a test with a relatively high false-negative rate but low false-positive rate for neutral views and indicate that a positive finding on myelography is highly suggestive of the disease, but that a negative finding does not eliminate the possibility of the disease. The **false-positive rate** is increased to 12% to 27% for compression at midcervical sites during neck flexion. Myelography is superior in diagnosing compressive lesions at C6-C7 than at more proximal sites. Occasionally the compression is lateral rather than dorsoventral and is not readily apparent on routine myelography.

Myelography has been described in standing, conscious horses, but this technique is not sufficiently well described to allow its recommendation at this time.<sup>18</sup>

Ex situ (postmortem) MRI examination of cervical vertebrae and spinal cord of normal and CSM-affected horses is more accurate than is interpretation of standing lateral radiographs.<sup>17</sup> However, both **CT and MRI** of horses with CSM are limited by the restricted views of the neck of adult horses. This prevents comprehensive examination of the cervical spine.<sup>19,20</sup>

Endoscopy of the epidural and subarachnoid spaces is reported in a horse with confirmed cervical compressive myelopathy.<sup>21,22</sup> The diagnostic or therapeutic value of this procedure is yet to be established.

The **prognosis** for horses with CSM is guarded. Sixty-four percent of affected horses were euthanized, presumably for economic or humane reasons.<sup>9</sup> However, the prognosis depends on the severity of clinical signs and the intended use of the horse. The criteria for euthanasia depend on the danger of the horse to itself (for instance, falling and injuring itself) or its attendants. Horses that are at high risk of self-injury or of injuring their attendants might qualify for humane euthanasia. However, horses with milder signs of disease compatible with their intended use, such as stallions or females with low-grade signs of the disease and reproductive potential, can be treated conservatively and live long lives.

It is imperative to consider the risk to riders or handlers associated with care or competing the horse when deciding on the fate of an affected horse.

The prognosis for horses intended for **athletic use** is less clear. Twenty-one of 70 Thoroughbred racehorses with cervical compressive myelopathy went on to race.<sup>23</sup> The likelihood of a horse racing was inversely related to the severity of its clinical signs.<sup>23</sup>

### CLINICAL PATHOLOGY

Hematologic and serum biochemical values are usually within reference ranges in affected horses. CSF from affected horses can have increased protein concentration, but this finding is neither characteristic nor specific

for compressive myelopathy. However, other causes of spinal ataxia can cause characteristic changes in the CSF and examination of the fluid might assist in ruling out these diseases.

Measurement of creatine kinase activity in CSF has no diagnostic value in horses.

### NECROPSY FINDINGS

Gross examination reveals degeneration of the articular facets in many affected horses.

Impingement of soft tissues, especially the ligamentum flavum and joint structures, or cartilage and osteophytes into the spinal canal may be apparent. The spinal canal may be narrow. It may be indented and soft at the site or sites of compression. Histologically, there is nerve fiber swelling, widespread degeneration of myelin, and astrocytic gliosis. Cranial to the compressive lesion, wallerian degeneration is evident in the dorsal and lateral funiculi, although caudal to the compression these changes are most evident in the ventral and central lateral funiculi. Slight atrophy of cervical muscles is sometimes evident. There is histologic evidence of stretching and tearing of the ligamentum flavum and joint capsule at affected joints, especially C6 or C7.

### DIFFERENTIAL DIAGNOSIS

Equine degenerative myelopathy, equine protozoal myeloencephalitis, trauma, equine infectious anemia, cerebrosplinal nematodiasis (*Hypoderma* spp., *Setaria* sp., *Halicephalobus deletrix*), equine herpesvirus-1 myelopathy, aortoiliac thrombosis, West Nile encephalomyelitis, congenital vertebral malformation (especially in Arabian foals), discospondylitis, tumors involving the spinal canal (melanoma, lymphoreticular neoplasia, hemangiosarcoma),<sup>5,24</sup> extradural hematoma,<sup>25</sup> vertebral osteomyelitis, fibrocartilaginous embolic, postanesthetic myelopathy,<sup>26</sup> and ryegrass staggers (see Table 14-21).

### TREATMENT

Medical treatment of the acute disease consists of rest and administration of antiinflammatory drugs (dexamethasone 0.05–0.25 mg/kg intravenously or intramuscularly every 24 hours; flunixin meglumine 1 mg/kg intravenously every 8–12 hours; phenylbutazone 2.2–4.4 mg/kg orally every 12–24 hours; and/or dimethyl sulfoxide, 1 g/kg as a 10% solution in isotonic saline intravenously every 24 hours for three treatments).

Treatment of arthritis of the facets of mature horses can be achieved by injection of the articular facet joints with corticosteroids (40 mg of methylprednisolone acetate).<sup>27</sup> Injection of the joint is facilitated by ultrasonographic guidance. Injection of the joints with antiinflammatory drugs is assumed to result in reduction in inflammation and soft



Table 14-21 Differential diagnosis of disease causing spinal ataxia in adult horses

Disease	Etiology and epidemiology	Clinical signs and lesions	Treatment and prognosis
Cervical compressive myelopathy (cervical stenotic myelopathy, cervical vertebral instability)	Sporadic; young, rapidly growing males; more common in Thoroughbreds, Standardbreds, and Warmblood horses; syndrome in mature horses caused by arthritis or articular facets.	Symmetric ataxia often of sudden onset; may be associated with trauma; hindlimbs most severely affected; compression of cervical spinal cord demonstrated by myelography; CSF normal	Medical treatment of rest and antiinflammatory drugs; poor prognosis; surgical correction by ventral stabilization
Equine degenerative myelopathy	Young horses (<3 years); familial incidence of increased requirement for vitamin E	Gradual onset symmetric ataxia that stabilizes at about 3 years of age; no radiographic abnormalities in cervical spinal cord; CSF normal	Guarded prognosis; vitamin E 5–20 IU/kg per day in feed may prevent progression; no cure; death uncommon
Equine protozoal myeloencephalitis	<i>Sarcocystis neurona</i> or <i>Neospora hughesi</i> in spinal cord or brain; Americas only; infectious but not contagious	Any sign of central nervous system dysfunction; usually gradual onset of asymmetric spinal ataxia, focal muscle atrophy or weakness; CSF contains antibody to <i>S. neurona</i> , but also found in normal horses	Ponazuril 5–10 mg/kg orally daily for 28 days; older, but effective, treatment is pyrimethamine, 1 mg/kg orally and sulfadiazine, 20 mg/kg orally every 24 hours for 90–120 days; Nitazoxanide 25 mg/kg orally once daily for 2 days followed by 50 mg/kg orally for 26 days; Vaccination not recommended
Equine herpesvirus-1 myeloencephalopathy	EHV-1; infectious and contagious. Sporadic; outbreaks occur often preceded by fever or upper respiratory tract disease	Ascending paralysis with fecal and urinary incontinence, recumbency, normal mentation; CSF xanthochromic and increased protein concentration; lesion is vasculitis and malacia	Valacyclovir for prophylactic therapy at a dose of 30 mg/kg orally every 8 hours for 2 days, then 20 mg/kg every 12 hours for 1–2 weeks Corticosteroids controversial Nursing care; poor prognosis Vaccination potentially effective
West Nile encephalitis	West Nile virus; transmitted by bite of infected mosquito; horse is dead-end host and does not develop sustained viremia; enzootic to Mediterranean littoral and North America; Increased recognition in other areas (Australia, Kunjin); peak disease risk is late summer	Weakness, muscle fasciculations, altered mentation; recumbency	No specific treatment; nursing care; corticosteroids controversial; hyperimmune serum available in some areas; interferon has been used but efficacy uncertain
Trauma	Sudden onset; more common in young horses	Spinal ataxia, varying degrees of weakness and proprioceptive deficits; recumbency Radiographic lesions present occasionally CSF may contain red blood cells	Antiinflammatory drugs; rest
Ryegrass staggers	Intoxication by lolitrems produced by <i>Acremonium lolii</i> growing on perennial ryegrass; outbreaks of disease in horses on affected pasture	Ataxia, stiff gait, tremor, hypersensitivity, recumbency; no histologic lesions	Remove source of toxin; rapid recovery without other treatment
Parasite migration	Sporadic. <i>Strongylus</i> sp., <i>Hypoderma</i> sp., and filaroids ( <i>Setaria</i> sp.).	Wide variety of clinical signs; progressive ataxia; CSF may contain eosinophils	Ivermectin 0.2 mg/kg orally Antiinflammatory drugs
Congenital anomalies	Sporadic; cause spinal cord compression or lack of neural tissue, e.g., spina bifida	Recumbency, ataxia present at birth	No treatment
Neoplasia	Melanoma, lymphosarcoma, hemangiosarcoma, metastatic neoplasia, multiple myeloma	Variable depending on site; usually extradural tumor although can be secondary to vertebral body involvement and pathologic fracture	No practicable treatment

tissue swelling with consequent reduced compression of the cervical spinal cord. There is no objective prospective assessment of the efficacy of this treatment

A “paced growth” program of slowed growth achieved by nutritional restriction of young horses (foals and weanlings) has

been suggested as conservative treatment for immature horses with compressive myelopathy or at high risk of developing the disease.

**Surgical fusion** of cervical vertebrae is useful in the treatment of mild to moderately affected horses, although because of issues of

safety of future riders there are concerns by some authorities about the advisability of this treatment.

#### CONTROL

Control measures are not usually used, although ensuring an appropriate diet and

growth rate of at-risk animals would be prudent.

## FURTHER READING

Nout YS, Reed SM. Cervical stenotic myelopathy. *Equine Vet Educ.* 2003;15:212.

## REFERENCES

- Levine JM, et al. *J Vet Intern Med.* 2007;21:812.
- Van Biervliet J. *Vet Clin North Am Equine Pract.* 2007;23:317.
- Unt VE, et al. *Equine Vet Educ.* 2009;21:212.
- Gold JR, et al. *J Vet Intern Med.* 2008;22:481.
- Nout YS. *Equine Vet Educ.* 2009;21:569.
- Oswald J, et al. *Vet Rec.* 2010;166:82.
- Laugier C, et al. *J Equine Vet Sci.* 2009;29:561.
- Levine JM, et al. *JAVMA.* 2008;233:1453.
- Levine JM, et al. *JAVMA.* 2010;237:812.
- Olsen E, et al. *J Vet Intern Med.* 2014;28:630.
- Kottner J, et al. *J Clin Epidemiol.* 2011;64:96.
- Withers JM, et al. *Equine Vet J.* 2009;41:895.
- Scrivani PV, et al. *Equine Vet J.* 2011;43:399.
- Hughes KJ, et al. *J Vet Intern Med.* 2014;28:1860.
- Hahn CN, et al. *Vet Radiol Ultrasound.* 2008;49:1.
- Hudson NPH, et al. *Equine Vet Educ.* 2005;17:34.
- Janes JG, et al. *Equine Vet J.* 2014;46:681.
- Rose PL, et al. *Vet Radiol Ultrasound.* 2007;48:535.
- Mitchell CW, et al. *Vet Radiol Ultrasound.* 2012;53:613.
- Sleutjens J, et al. *Vet Q.* 2014;34:74.
- Prange T, et al. *Equine Vet J.* 2012;44:116.
- Prange T, et al. *Equine Vet J.* 2011;43:317.
- Hoffman CJ, et al. *J Vet Intern Med.* 2013;27:317.
- Raes EV, et al. *Equine Vet Educ.* 2014;26:548.
- Santos FCCD, et al. *Equine Vet Educ.* 2014;26:306.
- Ragle C, et al. *Equine Vet Educ.* 2011;23:630.
- Birmingham SSW, et al. *Equine Vet Educ.* 2010;22:77.

## EQUINE MOTOR NEURON DISEASE

Equine motor neuron disease is a **neurodegenerative disease** of horses in the United States, Canada, Europe, UK, and South America.<sup>1-3</sup> The disease is associated with low intake, and abnormally low serum concentrations, of vitamin E, possibly exacerbated by excessive intake of copper or iron.<sup>4-6</sup> The disease can be induced by feeding horses a diet with a low concentration of vitamin E, with development of clinical signs of the disease taking at least 18 months and up to 38 months.<sup>5,7</sup>

The disease affects horses of all breeds, with Quarter Horses most commonly affected, and the incidence of the disease increases with age (horses older than 2 years). The disease is associated with stabling and lack of access to pasture, and the risk of the disease increases with decreasing serum vitamin E concentration.

The pathogenesis of the disease is unknown but is suspected to be caused by oxidative injury to neurons subsequent to vitamin E deficiency. However, not all horses that develop the disease have a clear oxidant stress or decrease in antioxidant capacity.<sup>8</sup> The clinical signs are attributable to degeneration of motor neurons in the ventral horns of the spinal cord, with subsequent

peripheral nerve degeneration and widespread neurogenic muscle atrophy.

The onset of **clinical signs** is usually gradual, but in a small proportion of affected horses the first sign is an acute onset of profound muscle weakness. Chronically affected horses have weight loss in spite of a normal or increased appetite, pronounced trembling and fasciculation of antigravity muscles, increased recumbency, and a short-strided gait. They often assume a posture with all feet under the body and a low head carriage, and frequently shift weight, which are all signs attributable to muscle weakness. The tail head is elevated in a large proportion of severely affected horses, which is likely a result of atrophy of the sacrocaudalis dorsalis medialis muscle. Profound flaccidity (weakness) of the tongue with lesions in the hypoglossal nuclei is reported and must be differentiated from botulism.<sup>9</sup> Retinal examination often reveals accumulation of lipofuscin-like pigment in the tapetal fundus.

EMG, under either general or regional anesthesia, is a useful diagnostic aid.<sup>8</sup> Characteristic findings include spontaneous fibrillation potentials and trains of positive sharp waves.

Lesions of redistribution of mitochondrial enzyme stain and anguloid atrophy of myofibers in sacrocaudalis dorsalis medialis muscle of adult horses with vitamin E-responsive muscle atrophy might represent a variant, or early stage, of equine motor neuron disease.<sup>10</sup>

The prognosis is poor for horses with advanced disease and most of these horses do not return to normal function and are destroyed, although the disease stabilizes in some cases that can then live for a number of years after diagnosis. Approximately 40% of cases will have stable clinical signs (no improvement) and 20% will continue to deteriorate after diagnosis and initiation of treatment. Early recognition and correction of diet with or without supplementation with vitamin E can result in recovery.

There is often a mild increase in serum creatine kinase activity. Horses with equine motor neuron disease have abnormal oral and intravenous glucose tolerance tests characterized by peak glucose concentrations that are lower than expected. The lower peak plasma glucose concentration is attributable to a 3× greater rate of glucose metabolism (removal from blood) in affected horses compared with normal horses. There is also evidence that horses with equine motor neuron disease are more sensitive to insulin than are normal horses.

Affected horses often have **serum vitamin E concentrations** that are below the reference range (<1.0–2.0 µg/dL, <1.0–2.0 µmol/L). Horses with equine motor neuron disease have higher spinal cord copper concentrations than do normal horses, but the diagnostic or clinical significance of this observation is unclear.

Examination of CSF is not useful in arriving at a diagnosis.

Examination of muscle from horses with equine motor neuron disease reveals a coordinated shift from characteristics of slow muscle to those of fast twitch muscle including contractile and metabolic functions of muscle. There is a lower percentage of myosin heavy chain type 1 fibers, higher percentages of hybrid IIX and IIX fibers, atrophy of all fibers, and reduced oxidative capacity, increased glycolytic capacity, and diminished intramuscular glycogen concentrations, among other changes, in affected horses compared with normal horses.

The disease must be differentiated from botulism and other causes of weakness in adult horses. **Diagnostic confirmation** can be achieved by examination of a biopsy of the sacrocaudalis dorsalis medialis muscle or the spinal accessory nerve. The sacrocaudalis dorsalis medialis muscle is preferred because that muscle is predominantly composed of type 1 fibers and is severely affected by the disease. Examination of biopsy of this muscle has a sensitivity of approximately 90%.

Necropsy examination reveals moderate to severe diffuse muscle atrophy. Predominant histologic findings at necropsy examination include degeneration of neurons in ventral horns at all levels of the spinal cord. Muscle atrophy is evident because angular fibers, with predominantly type 1 fibers, or a combination of type 1 and type 2 fibers, are affected. There is accumulation of lipofuscin in the fundus and in capillary endothelium of the nervous tissue.

**Treatment** consists of administration of vitamin E. There are eight isoforms of vitamin E, and RRR- $\alpha$ -tocopherol, the naturally occurring form, is the most potent antioxidant. Synthetic vitamin E contains all isomers, whereas “natural” vitamin contains only one, the RRR isomer. Administration of lyophilized, water-soluble D- $\alpha$ -tocopherol (RRR- $\alpha$ -tocopherol) is apparently superior to administration of the DL- $\alpha$ -tocopherol acetate in increasing concentrations of vitamin E in blood of horses.<sup>4</sup> The usual dose is 4 IU of D- $\alpha$ -tocopherol (RRR- $\alpha$ -tocopherol) per kilogram BW orally once daily or 5000 to 7000 IU of  $\alpha$ -tocopherol per 450-kg horse per day.<sup>4</sup> Supplementation results in improvement in 40% of affected horses within 6 weeks, with some appearing normal at 12 weeks.<sup>4</sup>

Control measures should ensure that horses have adequate access to pasture or are supplemented with good quality forage and/or vitamin E. Horses without access to green pasture should be supplemented with 1 U of vitamin E per kilogram BW per day.<sup>4</sup>

## FURTHER READING

Finno CJ, Valberg SJ. A comparative review of vitamin E and associated equine disorders. *J Vet Intern Med.* 2012;26:1251-1266.

Wijnberg ID. Equine motor neurone disease. *Equine Vet Educ.* 2006;18:126-129.

## REFERENCES

1. McGowan CM, et al. *Vet J.* 2009;180:330.
2. Delguste C, et al. *Can Vet J.* 2007;48:1165.
3. McGorum BC, et al. *Equine Vet J.* 2006;38:47.
4. Finno CJ, et al. *J Vet Intern Med.* 2012;26:1251.
5. Divers TJ, et al. *Am J Vet Res.* 2006;67:120.
6. Syrja P, et al. *Equine Vet Educ.* 2006;18:122.
7. Mohammed HO, et al. *Acta Vet Scand.* 2007;49:17.
8. Wijnberg ID. *Equine Vet Educ.* 2006;18:126.
9. Robin M, et al. *Equine Vet Educ.* 2016;28:434.
10. Bedford HE, et al. *JAVMA.* 2013;242:1127.

## Diseases Primarily Affecting the Peripheral Nervous System

The **peripheral nervous system** consists of **cranial** and **spinal nerve** components. As such, the peripheral nervous system includes the dorsal and ventral nerve roots, spinal ganglia, spinal and specific peripheral nerves, CNs and their sensory ganglia, and the peripheral components of the autonomic nervous system.

### ETIOLOGY

There are several different causes of peripheral nervous system disease.

#### Inflammatory

**Polyneuritis equi**, also known as **neuritis of the cauda equina** or **cauda equina syndrome**, is a rare and slowly progressive demyelinating granulomatous disease affecting peripheral nerves in the horse. Polyneuritis equi is characterized by signs of lower motor neuron lesions, primarily involving the perineal region but also affecting other peripheral nerves, especially CNs V and VI. CNs VIII, IX, X, and XII also may be involved. Clinical signs of perineal region paresis/paralysis predominate and manifest as varying degrees of hypotonia; hypalgesia; and hyporeflexia of the tail, anus, and perineal region. Degrees of urinary bladder paresis and rectal dilatation are also present. Differential diagnoses include sacral or coccygeal trauma, equine herpes myeloencephalopathy, equine protozoal myeloencephalitis, rabies, and equine motor neuron disease.

**Cranial neuritis with guttural pouch mycosis** and **empyema** in the horse may cause abnormalities of swallowing, laryngeal hemiplegia, and Horner's syndrome if the glossopharyngeal and vagal nerves are involved in the inflammatory process of the guttural pouch.

Acquired **myasthenia gravis** has been diagnosed in a 7-month-old Hereford heifer with a 5-day history of recumbency caused by symmetric generalized neuromuscular weakness.<sup>1</sup> The heifer stood with no assistance within 1 minute of edrophonium chloride (0.1 mg/kg intravenously) and was able

to stand for 24 hours. Three additional episodes of prolonged recumbency responded to edrophonium, with an increasing period between episodes. Additional treatment was dexamethasone intramuscularly for 5 days. Acquired myasthenia gravis was diagnosed and attributed to an autoimmune disease directed against acetylcholine receptors at the neuromuscular junction. Congenital myasthenia gravis, caused by a homozygous mutation in the acetylcholine receptor gene, has been diagnosed in Brahm calves in South Africa.<sup>2</sup>

#### Degenerative

**Equine laryngeal hemiplegia**, often called **roaring**, is a common disease of the horse in which there is paralysis of the left cricoarytenoid dorsalis muscle resulting in an inability to abduct the arytenoid cartilage and vocal fold, which causes an obstruction in the airway during inspiration. Endoscopic examination reveals asymmetry of the glottis. On exercise, inspiratory stridor develops as the airflow vibrates a slack and adducted vocal fold. The abnormality is caused by idiopathic distal degeneration of axons in the left recurrent laryngeal nerve, with the disease characterized as a bilateral mononeuropathy.<sup>3</sup> The left recurrent laryngeal nerve is more severely affected than the right because it is longer and is the longest nerve in the horse (see Chapter 12 for more details).

**Diaphragmatic paralysis** has been identified in 11 alpacas aged 2 to 12 months. Respiratory dysfunction was present, manifested as tachypnea, pronounced inspiratory effort, and arterial hypercapnia and hypoxemia.<sup>4</sup> The paralysis appeared bilateral in all seven alpacas imaged using fluoroscopy. Histologic examination revealed phrenic nerve degeneration in all six alpacas necropsied, with long nerves also demonstrating degeneration in two alpacas. The etiology was not identified.<sup>4</sup>

#### Traumatic

**Injection injuries to peripheral nerves** may result from needle puncture, the drug deposited, pressure from an abscess or hematoma, or fibrous tissue around the nerve. The sciatic nerve has been most commonly affected in cattle because historically most intramuscular injections were given deep in the hamstring muscles. Young calves were particularly susceptible because of their small muscle masses. Current recommendations in cattle are that intramuscular injections should be administered cranial to the shoulder.

**Femoral nerve paralysis in calves** occurs in large calves born to heifers with dystocia. The injury occurs when calves in anterior presentation fail to enter the birth canal because their stifle joints become engaged at the brim of the pelvis. Traction used to deliver these calves causes hyperextension of the femur and stretching of the quadriceps

muscle and its neural and vascular supplies. In most cases the right femoral nerve is affected. Such calves are unable to bear weight on the affected leg within days after birth, the quadriceps muscle is atrophied, and the patella can be luxated easily. The patellar reflex is absent or markedly reduced in the affected limb because this reflex requires an intact femoral nerve and functional quadriceps muscle. Varying degrees of rear limb paresis result, accompanied by varying degrees of hindlimb gait abnormality. Skin analgesia maybe present over the proximal lateral to cranial to medial aspect of the tibia. At rest, the affected leg is slightly flexed and the hip on the affected side is held slightly lower. During walking, the animal has difficulty in advancing the limb normally because the limb collapses when weight bearing. In severe cases of muscle atrophy, the patella is easily luxated both medially and laterally. Injury to the femoral nerve is relatively easy to clinically identify, and there is usually no need to perform EMG studies of atrophied quadriceps muscle to document denervation.

**Calving paralysis** is common in heifers that have experienced a difficult calving. Affected animals are unable to stand without assistance; if they do stand, the hindlimbs are weak and there is marked abduction and inability to adduct. It has always been erroneously thought that traumatic injury of the obturator nerves during passage of the calf in the pelvic cavity was the cause of the paresis; however, detailed pathologic and experimental studies have demonstrated that most calving paresis/paralysis is caused by damage to the sciatic nerve. Experimental transection of the obturator nerves does not result in paresis. The term **obturator nerve paralysis** should only be used for postparturient cattle with an inability to adduct one or both hindlimbs, and calving paralysis in the preferred descriptive term for hindlimb paresis/paralysis occurring in the immediate postparturient period.

Damage to the sciatic nerve results in rear limb weakness and knuckling of the fetlocks; the latter clinical sign is an important means for differentiating sciatic nerve damage from obturator nerve damage (Fig. 14-25). The patellar reflex in ruminants with sciatic nerve damage is normal or increased, because the reflex contraction of the quadriceps muscle group by the femoral nerve is unopposed by the muscles of the hindlimb innervated by the sciatic nerve.

The peroneal nerve is most frequently damaged by local trauma to the lateral stifle where the peroneal nerve runs in a superficial location lateral to the head of the fibular bone. Damage to the peroneal nerve leads to knuckling over of the fetlock joint from damage to the extensor muscles of the distal limb, resulting in the dorsal aspect of the hoof resting on the ground when the animal is standing. Full weight can be borne on the





**Fig. 14-25** Three-year-old Holstein Friesian cow with mild paresis of the right sciatic nerve. The hock is dropped relative to the normal unaffected left leg, and the fetlock has the characteristic knuckling. The cow has had a left displaced abomasum surgically corrected by a right flank incision and is being treated for concurrent mastitis.

affected limb when the digit is placed in its normal position, but immediately on walking the digit is dragged. There is a loss of skin sensation on the anterior aspect of the metatarsus and digit.

Damage to the tibial nerve causes mild hyperflexion of the hock and a forward knuckling of the fetlock joint. Tibial nerve damage is very rare, and most cases described as tibial nerve damage are actually sciatic nerve damage.

The radial nerve is most susceptible to traumatic damage because it courses distally and laterally over the lateral condyle of the humerus. Radial nerve paresis is most common when heavy adult cattle are placed in lateral recumbency, such as corrective foot trimming in bulls. Care must be taken in these animals to pad the area around the elbow and to ensure that the time spent in lateral recumbency is minimized. Clinical signs of radial nerve paresis include inability to advance the front limb with the ability to bear weight when the limb is placed directly under the animal in the normal position (Fig. 14-26). In advanced cases, the cranial aspect of the fetlock is dragged along the ground and the area needs to be protected from severe abrasion injury using a splint or cast.

Brachial plexus injury, including avulsion, is rare in large animals, because the muscle mass is usually sufficient to prevent overextension of the front limb. It is a rare outcome of correction of dystocia in goats, particularly when relatively excessive traction is applied to one front limb during delivery. Clinical signs of brachial plexus avulsion include a complete inability to bear weight



**Fig. 14-26** Mild radial nerve paresis in a Holstein Friesian bull. Swelling is present over the lateral aspect of the elbow. Paresis was present immediately after taking the animal off a foot table for corrective foot trimming.

on the limb and a dropped elbow relative to the unaffected limb (Fig. 14-27).

#### Metabolic and Nutritional

**PA deficiency** may occur in pigs fed diets based solely on corn (maize). Affected animals develop a goose-stepping gait caused by degenerative changes in the primary sensory neurons of the peripheral nerves.

#### Toxic

**Heavy metal poisoning** including lead and mercury poisoning in horses has been



**Fig. 14-27** One-week-old kid with brachial plexus avulsion of the right forelimb. The right limb "appears" longer than the unaffected left limb and the right elbow appears dropped. The right front leg cannot support weight and is not advanced in a normal manner during walking. The right leg received excessive traction during correction of a dystocia.

associated with clinical signs of degeneration of peripheral CNs, but these are not well documented.

#### Tumors

A multicentric schwannoma causing chronic ruminal tympany and forelimb paresis has been recorded in an aged cow. Neoplastic masses were present throughout the body, and both right and left brachial plexuses were involved. The peripheral nerves of each brachial plexus were enlarged. Large tumor masses were present on the serosal surfaces of the esophagus, pericardial sac and epicardium, and within the myocardium, endocardium, and the ventral branches of the first four thoracic spinal nerves. A large mass was present in the anterior mediastinum near the thoracic inlet.

#### Autonomic Nervous System

**Equine grass sickness (equine dysautonomia, grass sickness, mal Seco) in the horse** is a polyneuropathy involving both the peripheral nervous system (autonomic and enteric nervous systems) as well as the CNS.<sup>5-7</sup> Equine grass sickness occurs primarily in Scotland, although cases have been reported elsewhere in Europe, and in Patagonia and the Falkland Islands.<sup>8</sup> The disorder is characterized by a peracute to chronic alimentary tract disease of horses on pasture (hence the name). Gastrointestinal stasis is partial or complete. Peracute cases are in shock and in a state of collapse with gastric refluxing. Acute, subacute, and chronic cases also occur. Degenerative changes occur in the autonomic ganglia (especially the celiac-mesenteric, and stellate), thoracic sympathetic chain, ciliary, cranial and caudal cervical, the craniospinal sensory ganglia, and selected nuclei in the CNS. EMG reveals the presence of a neuropathy of skeletal muscles.<sup>8</sup> The etiology is unknown but neurotoxin involvement is suspected, possibly *Clostridium botulinum* type C/D.

## FURTHER READING

- Constable PD. Clinical examination of the ruminant nervous system. *Vet Clin North Am Food Anim Pract.* 2004;20:185-214.
- Divers TJ. Acquired spinal cord and peripheral nerve disease. *Vet Clin North Am Food Anim Pract.* 2004;20:231-242.

## REFERENCES

1. Wise LN, et al. *J Vet Intern Med.* 2008;22:231.
2. Thompson PN, et al. *J Anim Sci.* 2007;85:604.
3. Dupuis MC, et al. *Mamm Genome.* 2011;22:613.
4. Byers S, et al. *J Vet Intern Med.* 2011;25:380.
5. Shotton HR, et al. *J Comp Pathol.* 2011;145:35.
6. Wales AD, Whitwell KE. *Vet Rec.* 2006;158:372.
7. Lyle C, Pirie RS. *In Pract.* 2009;31:26.
8. Wijnberg ID, et al. *Equine Vet J.* 2006;38:230.

## TETANUS

### ETIOLOGY

Tetanus is caused by *C. tetani*, a gram-positive, spore-forming obligate anaerobe bacillus. It is a ubiquitous organism and a commensal of the gastrointestinal tract of domestic animals and humans. The organism forms highly resistant spores that can persist in soil for many years. The spores survive many standard disinfection procedures, including steam heat at 100°C (212°F) for 20 minutes but can be destroyed by heating at 115°C (239°F) for 20 minutes. After a period of anaerobic incubation spores germinate to their vegetative form, which starts replicating and producing a complex of exotoxins causing the clinic signs characteristic for this condition. The toxins produced are **tetanolysin**, **tetanospasmin**, and **neurotoxin** or nonspasmolytic toxin.

### SYNOPSIS

**Etiology** Muscle spasm from action of the exotoxin tetanospasmin produced by the vegetative stage of *Clostridium tetani*.

**Epidemiology** Marked difference in species susceptibility with horses being most and cattle being least susceptible. Usually a history of a wound or other tissue trauma. Occurs as isolated cases but also as outbreaks in young ruminants following castration and docking.

**Clinical findings** Generalized muscular rigidity and spasms, hyperesthesia, prolapse of third eyelid, trismus, ears pulled caudally, bloat in ruminants, convulsions, respiratory arrest, and death. High case fatality.

**Necropsy findings** None. May demonstrate the organism in necrotic tissue in some cases.

**Diagnostic confirmation** Diagnosis is based on characteristic clinical signs and wound history. No definitive antemortem test or pathognomonic postmortem lesion. A bioassay consisting of injecting mice with infectious material to induce characteristic clinical signs is used.

**Treatment** Objectives are to prevent further production of exotoxin, neutralize residual toxin, control muscle spasms until the toxin is eliminated or destroyed, maintain hydration and nutrition, provide supportive treatment.

**Control** Regular prophylactic vaccination with tetanus toxoid of susceptible animals, vaccination and administration of tetanus antitoxin to unvaccinated animals with fresh wounds, antibiotic therapy in animals with wounds that are contaminated or at risk to be contaminated.

## EPIDEMIOLOGY

### Occurrence

Tetanus occurs in all parts of the world and is most common in closely settled areas under intensive cultivation. It occurs in all farm animals, mainly as individual, sporadic cases, although outbreaks are occasionally observed in young cattle, young pigs, and lambs following wound management procedures.<sup>1</sup>

### Case–Fatality Rate

In young ruminants the case–fatality rate is over 80%, but the recovery rate is high in adult cattle. In horses it varies widely between areas. In some areas almost all animals die acutely, and in others the mortality rate is consistently about 50%.<sup>2,3</sup>

### Source of Infection

*C. tetani* organisms are commonly present in the feces of animals, especially horses, and in the soil contaminated by these feces. Surveys in different areas of the world show it is present in 30% to 42% of soil samples. The survival period of the organism in soil varies widely from soil to soil.

### Transmission

The **portal of entry** is usually through deep puncture wounds, but the spores may lie dormant in the tissues for some time and produce clinical illness only when tissue conditions favor their proliferation. For this reason, the portal of entry is often difficult to identify. Puncture wounds of the hooves are common sites of entry in horses. Introduction to the genital tract at the time of parturition is the usual portal of entry in cattle. A high incidence of tetanus may occur in young pigs following castration and in lambs following castration, shearing, docking, vaccinations, or injections of pharmaceuticals, especially anthelmintics. Docking by the use of elastic band ligatures is reputed to be especially hazardous. **Neonatal tetanus** occurs when there is infection in the umbilical cord associated with unsanitary conditions at parturition. Cases of tetanus in ruminants after thermic dehorning and ear-tagging have been reported.<sup>1</sup>

Outbreaks of “**idiopathic tetanus**” occur occasionally in young cattle without a wound

being apparent, usually in association with the grazing of rough, fibrous feed, and it is probable that toxin is produced in wounds in the mouth or gastrointestinal tract or is ingested preformed in the feed. Proliferation in the rumen may also result in toxin production.

### Animal Risk Factors

The neurotoxin of *C. tetani* is exceedingly potent, but there is considerable variation in susceptibility between animal species, and horses are the most susceptible and cattle the least susceptible. The variation in prevalence of the disease in the different species is partly caused by this variation in susceptibility but is also because exposure and wound management practices are more likely to occur in some species than in others.

### Importance

Tetanus is important because of its high case fatality and the very long convalescence in the survivors. In regions of the world where horses, donkeys, and mules still play an important role in the rural economy and where vaccination is uncommon, the economic impact of tetanus can be considerable.<sup>2</sup>

## PATHOGENESIS

The tetanus spores remain **localized** at their site of introduction and do not invade surrounding tissues. Spores germinate to their vegetative form to proliferate and produce **tetanolysin**, **tetanospasmin**, and **neurotoxin** only if certain environmental conditions are attained, particularly a lowering of the local tissue oxygen tension. Toxin production may occur immediately after introduction if the accompanying trauma has been sufficiently severe, or if foreign material has also been introduced to the wound, or may be delayed for several months until subsequent trauma to the site causes tissue damage. The original injury may be inapparent by then. Of the three mentioned exotoxins, **tetanospasmin is the most relevant** for the pathophysiology of the condition. Although **tetanolysin** was found to promote local tissue necrosis, its role in the pathogenesis of tetanus remains doubtful. The role of the more recently identified neurotoxin, or nonspasmogenic toxin, which is a peripherally active for the pathophysiology of tetanus, is currently unknown.

**Tetanospasmin** diffuses to the systemic circulation, is bound to motor end plates, and travels up peripheral nerve trunks via retrograde intraaxonal transport to the CNS. The exact mechanisms by which the toxin exerts its effects on nervous tissue are not known, but it blocks the release of neurotransmitters such as GABA and glycine, which are essential for the synaptic inhibition of gamma motor neurons in the spinal cord. There it leads to an unmodulated spread of neural impulses produced



by normally innocuous stimuli, causing exaggerated responses and a state of constant muscular spasticity. No structural lesions are produced. Death occurs by asphyxiation caused by fixation of the muscles of respiration.

### CLINICAL FINDINGS

The **incubation period** varies between 3 days and 4 weeks, with occasional cases occurring as long as several months after the infection is introduced. In sheep and lambs cases appear 3 to 10 days after shearing, docking, or castration.

**Clinical findings** are similar in all animal species. Initially, there is an increase in **muscle stiffness**, accompanied by muscle tremor. There is **trismus** with restriction of jaw movements; **prolapse of the third eyelid**; stiffness of the hindlimbs causing an unsteady, straddling gait; and the tail is held out stiffly, especially when backing or turning. Retraction of the eye and prolapse of the third eyelid (a rapid movement of the third eyelid across the cornea followed by a slow retraction) is one of the earliest and consistent signs (with the exception of sheep) and can be exaggerated by sharp lifting of the muzzle or tapping the face below the eye. Additional signs include an anxious and alert expression contributed to by an erect carriage of the ears, retraction of the eyelids and dilation of the nostrils, and hyperesthesia with exaggerated responses to normal stimuli (Fig. 14-28).

The animal may continue to eat and drink in the early stages but mastication is soon prevented by tetany of the masseter muscles and saliva may drool from the mouth. If food or water is taken, attempts at swallowing are followed by regurgitation from the nose. Constipation is usual and the urine is retained, partly as a result of the inability to assume the normal position for urination. The rectal temperature and pulse rate are within the normal range in the early stages but may rise later when muscular tone and activity are further increased. In cattle, particularly young animals, bloat is an early sign but is not usually severe and is accompanied by strong, frequent rumen contractions.

As the disease progresses, muscular tetany increases and the animal adopts a **sawhorse posture** (Figs. 14-29 and 14-30). Uneven muscular contractions may cause the development of a curve in the spine and deviation of the tail to one side. There is great difficulty in walking and the animal is inclined to fall, especially when startled. Falling occurs with the limbs still in a state of **tetany** and the animal can cause itself severe injury. Once down it is almost impossible to get a large animal to its feet again. Tetanic convulsions begin in which the tetany is still further exaggerated. Opisthotonus is marked, the hindlimbs are stuck out stiffly behind and the forelegs forward. Sweating may be profuse and the



**Fig. 14-28** Polled Hereford cow exhibiting early signs of tetanus with healthy calf. The tail is held slightly away from the perineum, the ears are back, the eyes have a surprised expressed with slight prolapse of the nictitating membrane, and saliva is drooling from the mouth. The cow calved 7 days previously and had a retained placenta and metritis.



**Fig. 14-29** Suffolk lamb with tetanus after castration using a band. The lamb is exhibiting a sawhorse stance caused by generalized muscle rigidity and drooling of saliva.

temperature rises, often to 42°C (107°F). The convulsions are at first only stimulated by sound or touch but soon occur spontaneously. In fatal cases there is often a transient period of improvement for several hours before a final, severe tetanic spasm during which respiration is arrested.

The **course of the disease** and the **prognosis** vary both between and within species. The **duration** of a fatal illness in horses and cattle is usually 5 to 10 days, but sheep usually die on about the third or fourth day. A long incubation period is usually associated with a mild syndrome, a long course,

and a favorable prognosis. **Mild cases** that recover usually do so slowly, with the stiffness disappearing gradually over a period of weeks or even months. The prognosis is poor when signs rapidly progress. Animals vaccinated in the past year have a better prognosis, as do horses that have received parenteral penicillin and tetanus antitoxin and in which the wound was aggressively cleaned when fresh.

### CLINICAL PATHOLOGY

There are no specific abnormalities in blood or CSF and no antemortem test confirming





**Fig. 14-30** Corriedale lamb with tetanus after tail docking. Note the ear and eyelid retraction and generalized stiffness.

the diagnosis. Blood levels of tetanus toxin are usually too low to be detected. Gram-stain of wound aspirates is considered of limited value because sporulated as well as vegetative forms of *C. tetani* resemble other anaerobic bacteria. Culturing the pathogen is difficult because of the low number of organisms normally present and the strict anaerobic conditions required for culture. Culture in combination with PCR has been used for identification of *C. tetani*.<sup>1</sup> A bioassay consisting of injecting infectious material into the tail base of mice and observing for onset of characteristic clinical signs is possible.<sup>2</sup>

### NECROPSY FINDINGS

There are no gross or histologic findings by which a diagnosis can be confirmed, although a search should be made for the site of infection. Culture of the organism is difficult but should be attempted. If minimal autolysis has occurred by the time of necropsy, the identification of large gram-positive rods with terminal spores (“tennis-racket morphology”) in smears prepared from the wound site or spleen is supportive of a diagnosis of tetanus.

### Samples for Confirmation of Diagnosis

- Bacteriology: air-dried impression smears from spleen, wound site (cyto, Gram stain), culture swab from wound site in anaerobic transport media; spleen in sterile, leak-proof container (anaerobic CULT, bioassay).

### DIFFERENTIAL DIAGNOSIS

Fully developed tetanus is so distinctive clinically that it is seldom confused with other diseases. The muscular spasms, the prolapse

of the third eyelid, and a recent history of accidental injury or surgery are characteristic findings. However, in its early stages or mild forms, tetanus may be confused with other diseases.

#### All species

- Strychnine poisoning
- Meningitis

#### Horses

- Hypocalcemic tetany (eclampsia)
- Acute laminitis
- Hyperkalemic periodic paralysis
- Myositis, particularly after injection in the cervical region.

#### Ruminants

- Hypomagnesemia (cows, sheep and calves)
- White muscle disease
- Polioencephalomalacia
- Enterotoxemia.

### TREATMENT

These are the main principles in the treatment of tetanus:

- Eliminate the causative bacteria
- Neutralize residual toxin
- Control muscle spasms until the toxin is eliminated or destroyed
- Maintain hydration and nutrition
- Provide supportive treatment

There are no structural changes in the nervous system, and the management of cases of tetanus depends largely on keeping the animal alive through the critical stages.

**Elimination of the organism** is usually attempted by the parenteral administration of penicillin in large doses (44,000 IU/kg), preferably by intravenous administration. Other antimicrobials that have been proposed include oxytetracycline (15 mg/kg), macrolides, and metronidazole. If the infection site is found, the wound should be aggressively cleaned and debrided but only after antitoxin has been administered, because debridement, irrigation with hydrogen peroxide, and the local application of penicillin may facilitate the absorption of the toxin.

The objective of administering **tetanus antitoxin** is to neutralize circulating toxin outside the CNS. The use of tetanus antitoxin is most appropriate in wounded animals that are susceptible to but unvaccinated against tetanus or with uncertain vaccination history. Because binding of tetanospasmin to neural cells is irreversible and because the tetanus antitoxin is unable to penetrate the blood-brain barrier, administration of antitoxin is of little value once signs have appeared. After the experimental administration of toxin, antitoxin is of limited value at 10 hours and ineffective by 48 hours. The recommended doses vary widely and range from 10,000 to over 300,000 IU per treatment, given intravenously, intramuscularly, or subcutaneously once or repeatedly, but reported treatment outcomes are inconsistent. Local injection of

some of the antitoxin around the wound has also been proposed. There have been a number of attempts to justify the treatment of early cases of equine tetanus by intrathecal injection of antitoxin, but there is limited evidence of therapeutic value and the procedure carries risk.

The use of **tetanus toxoid** has also been recommended for patients with tetanus, but an antibody response may take 2 to 4 weeks and a booster vaccination is required in previously unvaccinated animals. The effectiveness of this treatment in previously unvaccinated animals is therefore doubtful. When combining tetanus toxoid and antitoxin, both compounds should be administered on different sites using different syringes.

**Relaxation of the muscle tetany** can be attempted with various drugs. Chlorpromazine (0.4–0.8 mg/kg BW intravenously, or 1.0 mg/kg BW intramuscularly, three or four times daily) and acepromazine (0.05 mg/kg BW three to four times daily) administered until severe signs subside, are widely used in horses. A combination of diazepam (0.1–0.4 mg/kg) and xylazine (0.5–1.0 mg/kg intravenously or intramuscularly) may be effective in horses refractory to phenothiazine tranquilizers.

**Hydration** can be maintained by intravenous or stomach-tube feeding during the critical stages when the animal cannot eat or drink. The use of an indwelling tube should be considered because of the disturbance caused each time the stomach tube is passed. Feed and water containers should be elevated, and the feed should be soft and moist.

**Additional supportive treatment** includes slinging of horses during the recovery period, when hyperesthesia is diminishing. Affected animals should be kept as quiet as possible and provided with dark, well-bedded quarters with nonslip flooring and plenty of room to avoid injury if convulsions occur. Administration of enemas and catheterization may relieve the animal's discomfort. This level of nursing, plus penicillin, ataractic drugs, and antitoxin for an average of 14 days, can deliver something like a 50% recovery by an average of 27 days, but the cost is high. A rumenostomy may be required in ruminant patients with recurrent bloat.

Horses that fall frequently sustain bone fractures and may need to be destroyed.

### TREATMENT AND CONTROL

#### Treatment

Penicillin G (30,000 IU/kg IM or IV every 12–24 hours) (R-1)

Procaine penicillin (44,000 IU/kg IM every 12–24 hours) (R-1)

Oxytetracycline (15 mg/kg IV every 24 hours) (R-2)

Tetanus antitoxin (10,000–50,000 IU per dose IM or IV once or repeatedly) (R-2)

Tetanus antitoxin (30,000–50,000 IU per dose intrathecal) (R-3)

#### Sedation horses

Chlorpromazine (0.4–0.8 mg/kg IV or IM every 6–8 hours) (R-1)

Acepromazine (0.05–0.1 mg/kg IV or IM every 6–8 hours) (R-1)

Diazepam (0.01–0.4 mg/kg IV or IM) (R-1)

Xylazine (0.5–1 mg/kg IV or IM) (R-1)

#### Sedation cattle

Diazepam (0.5–1.5 mg/kg IV or IM)

Xylazine (0.05–0.15 mg/kg IV or 0.1–0.3 mg/kg IM)

#### Sedation sheep

Acepromazine (0.05–0.1 mg/kg IV or IM every 6–8 hours) (R-1)

Diazepam (0.2–0.5 mg/kg IV or IM (every 6–8 hours) (R-1)

#### Control

Regular vaccination if tetanus toxoid (R-1)

Tetanus antitoxin (1500 IU per dose IM in unvaccinated animals with fresh wounds) (R-1)

IM, intramuscularly, IV, intravenously.

## CONTROL

Many cases of tetanus could be avoided by proper skin and instrument disinfection at castrating, docking, and shearing time. These operations should be performed in clean surroundings; in the case of lambs docked in the field, temporary pens are preferred over permanent yards for catching and penning.

## Passive Immunity

Short-term prophylaxis can be achieved by the injection of 1500 IU of tetanus antitoxin. The immunity is transient, persisting for only 10 to 14 days.

## Tetanus Antitoxin

Tetanus antitoxin should be given to any horse with a penetrating wound or deep laceration, and the wound should also be cleaned aggressively. Tetanus toxoid can be administered at the same time as tetanus antitoxin, provided they are injected at different sites and using different syringes. Animals that suffer injury are usually given an injection of antitoxin and one of toxoid to ensure complete protection.

Tetanus antitoxin is often routinely given to **mares** following foaling and to newborn foals. In some areas the risk for tetanus in young foals is high and repeated doses of antitoxin at weekly intervals may be required for protection.

On farms where the incidence of tetanus in **lambs** is high, antitoxin is usually given at the time of docking or castration; 200 IU has been shown to be effective. The risk for tetanus in calves is lower than in lambs and

tetanus antitoxin is not commonly given at the time of castration.

There is a risk for **serum hepatitis** in horses that have been given tetanus antitoxin and, while this risk is small, a policy of routine active immunization of the mare to provide the mare with active immunity and the foal with passive colostral immunity is preferred to one that relies on antitoxin. Provided foals get an adequate supply of colostrum they are protected during the first 10 weeks of life by active vaccination of the mare during the last weeks of pregnancy. Prevention of tetanus in newborn lambs is also best effected by vaccination of the ewe in late pregnancy.

## Active Immunity

Available vaccines are formalin-inactivated adjuvanted toxoids; they induce long-lasting immunity. Primary vaccination requires two doses 3 to 6 weeks apart. Protective titers are obtained within 14 days of the second injection and last for at least a year and up to 5 years.

Traditionally **foals** have received primary vaccination at 3 to 4 months of age; however, there is evidence that maternal antibodies acquired by foals born to mares vaccinated shortly before parturition significantly inhibit the antibody response of the foal to primary vaccination until it is 6 months of age and that primary vaccination should be delayed until that age.

Although immunity lasts longer than 1 year, it is common to revaccinate horses yearly with a single booster injection. Pregnant mares should receive a booster injection 4 to 6 weeks before foaling to provide adequate colostral immunity to the foal.

**Ewes** are immunized with a similar schedule except that the primary doses are usually given at a managementally convenient time when the flock is yarded. A prelambling booster vaccination is given yearly. Commonly, commercial vaccines for sheep also contain antigens for other clostridial diseases for which sheep are at high risk.

Vaccination of **cattle** is usually not considered unless an outbreak of the disease has occurred in the immediate past and further cases may be anticipated.

## REFERENCES

1. Valgaeren B, et al. *Vlaams Tiergeneesk Tijdschr.* 2011;80:351.
2. Kay G, Knottenbelt DC. *Equine Vet Educ.* 2007;19:107.
3. Reichmann P, et al. *J Equine Vet Sci.* 2008;28:518.

## BOTULISM

### SYNOPSIS

**Etiology** Neurotoxin produced by *Clostridium botulinum* during vegetative growth. C.

*botulinum* types B, C, and D and, on rare instances, type A are associated with disease in animals but the type prevalence varies geographically.

**Epidemiology** Ingestion of preformed toxin in which feed preparation or storage allows multiplication of the organism in the feed with toxin production. Contamination of feed with carrion containing toxin. Consumption of carrion on pasture by phosphorus-deficient animals. Risk factors often result in multiple cases. Toxicoinfections with toxin production from organisms in the intestine or wounds are more uncommon.

**Clinical findings** Early muscle tremor, progressive symmetric weakness, and motor paralysis leading to recumbency. Mydriasis, ptosis, weak tongue retraction; sensation and consciousness retained until death.

**Necropsy findings** None specific.

**Diagnostic confirmation** Demonstration of toxin in intestinal contents, serum, or feed. Demonstration of organisms in feed, intestinal contents, or wounds.

**Treatment** Type-specific antiserum and supportive treatment.

**Control** Avoidance of exposure by feed management. Vaccination.

## ETIOLOGY

The causative organism *C. botulinum*, a spore-forming obligate anaerobe, produces neurotoxins during vegetative growth. Spores can survive in the environment for over 30 years. Under favorable conditions of warmth and moisture the spores germinate and vegetative cells multiply rapidly, elaborating a stable and highly lethal neurotoxin (BoTN) which, when ingested, or absorbed from tissues, causes the disease. The toxin is also capable of surviving for long periods, particularly in bones. Seven antigenically distinct **toxin types** (A-G), some with subtypes, have been identified. Farm animal disease is produced primarily by types B, C, D, and occasionally type A. Type A, B, E, and F toxins are generally related to human botulism.<sup>1</sup> Botulinum neurotoxin forming *C. botulinum* species are divided into groups I to IV depending on their physiologic properties.<sup>1</sup>

- **Group I:** proteolytic *C. botulinum* type A, B and F. These types degrade protein such as milk, serum, meat, and chicken protein
- **Group II:** nonproteolytic *C. botulinum*, includes nonproteolytic type B and F and all type E
- **Group III:** *C. botulinum* type C and D
- **Group IV:** *C. botulinum* type G.

The **geographic distribution** of these types varies considerably. In a study in the United States, type A was found in neutral or alkaline soils in the west, whereas types B

and E were in damp or wet soil all over, except that B was not found in the south. Type C was found in acid soils in the Gulf coast, and type D in alkaline soils in the west. Microorganisms capable of inhibiting *C. botulinum* were present, with or without the clostridia, in many soils. Type B is also common in soils in the UK and in Europe. Types C and D are more common in warm climates.

The organism is present in the **alimentary tract** of animals that have recently ingested contaminated material and may be introduced into new areas in this way, or by birds and blowflies. In healthy animals with normal intestinal fauna and motility *C. botulinum* does not multiply in the gastrointestinal tract.

## EPIDEMIOLOGY

### Occurrence

Botulism has **no geographic limitations**, with isolated cases and sporadic outbreaks occurring in most countries. The source of exposure to toxin and the risk for disease differ between regions because of differences in food storage, feeding, and management practices. **Outbreaks** associated with ingestion of toxin in conserved feeds are more common in the northern states of the United States and in Europe, whereas outbreaks in animals on pasture are reported primarily from South Africa, Australia, and the Gulf coast area of the United States. The disease usually occurs in a number of animals at one time and has a high case–fatality rate.

### Source of Infection

Most incidents of botulism are associated with the ingestion of preformed toxin (**forage botulism**). Toxin in feeds may result from the primary growth of *C. botulinum* in the feed or from the contamination of the feed with toxin-containing carrion (**carrion-associated botulism**). Less common sources are growth with toxin production in wounds (**wound botulism**) or growth and toxin production in the alimentary tract (**toxicoinfectious botulism**).

### Forage Botulism

Forage botulism occurs when pH, moisture, and anaerobic conditions in the feedstuff allow the vegetative growth of *C. botulinum* and the production of toxin. This can occur in a number of spoiled stored forages. Cereal silages carry a risk in the United States. Silage and hay may spoil to a stage suitable for the growth of *C. botulinum*. This is most likely if the forage is very succulent or is wet by rain when it is made.

**Big bale silage** is a particular risk. The type of forage ensiled in big bales often has insufficient water-soluble carbohydrate for adequate lactic acid fermentation to achieve a stable low pH, and the higher dry matter content can also lead to a higher pH. Clostridial multiplication is inhibited below pH

4.5. Most non-carrion-associated botulism is caused by type B strains, and horses appear to be especially susceptible.

Proliferation of the organism can occur in **decaying vegetable material**. The disease has also occurred in horses fed on spoiled vegetables and potatoes contaminated by *C. botulinum* and on alfalfa haylage packed in airtight aluminum foil envelopes. Grass clippings allowed to accumulate and decay in a pile have poisoned horses, as has round bale hay that spoiled after rain. Decaying grass at the base of old tussocks and in trampled stubble are known to be suitable sites for growth of *C. botulinum*. Cases have occurred with brewers grains, and high-moisture grain has the potential for toxicity.

### Carrion-Associated Botulism

This is almost always the cause of botulism in animals on pasture, and carrion is also a common cause of botulism in animals on conserved feeds. Carrion includes domestic and wild animals and birds. In endemic botulism areas, the carcasses of dead animals are invaded by *C. botulinum*, and high concentrations of toxin are produced such that very small amounts of flesh or bone have lethal concentrations. Most outbreaks of carrion-associated botulism are associated with **type C and D strains**; these strains produce much higher concentrations of toxin in carrion than type A and B strains. Toxin can persist in carrion for at least 1 year. Where the carcasses of rodents, cats, and birds contaminate hay or silage, toxin can leach out and contaminate surrounding hay or other feeds to cause multiple cases of botulism. In one instance a single mouse carcass is thought to have contaminated 200,000 tons of alfalfa cubes. A common source in Australia is hay made at the time of a mouse plague. At such times even good, fresh hay can contain a great deal of carrion. In another recorded incident 427 of 444 dairy cattle died after ingesting feed contaminated with BoTN type C from a cat carcass.

**Poultry manure** and ensiled **poultry litter** have caused outbreaks of botulism when used as fertilizers, as has poultry litter used for bedding cattle.<sup>2</sup> Outbreaks of botulism have occurred in cattle and sheep grazing pastures that have been fertilized with poultry manure or poultry litter. Cattle and sheep may eat poultry litter piled on a pasture before disposal. It is probable that the source of toxin in poultry litter is from poultry carcasses. Disease is usually caused by *C. botulinum* type D and occasionally type C.<sup>2</sup>

**Direct carrion ingestion** can occur where **cattle** subsist on a **chronically phosphorus-deficient diet** and manifest osteophagia, with subsequent ingestion of carrion. The disease is likely to occur in outbreak form. In **sheep**, pica is more usually associated with a dietary **deficiency of protein** or net energy. Occasional outbreaks

occur that are caused by drinking of **water** contaminated by carcasses of dead animals. A not uncommon occurrence is livestock drinking lake water contaminated by the carcasses of ducks and other waterfowl that have died of botulism. Wetlands where outbreaks of avian botulism have occurred are likely to have repeated occurrences because of soil contamination.

### Wound Botulism

Wound botulism is a **toxicoinfectious form of botulism** where the toxin is produced in wounds infected by *C. botulinum*.<sup>3</sup> Wound botulism is rare but is recorded in horses following castration, with omphalophlebitis, umbilical hernias treated with clamps, with an infected wound and in association with an injection abscess.

### Toxicoinfectious Botulism

This results when toxin is produced by *C. botulinum* present in the intestine. Two conditions in horses, **equine grass sickness** (see Equine grass sickness in Chapter 7) and the **shaker foal syndrome**, are potential forms of toxicoinfectious botulism. The **shaker foal syndrome** is a disease of young foals up to 8 months of age with the highest prevalence in foals 3 to 8 weeks of age.

The disease occurs sporadically in the United States, Australia, and the UK but may occur repeatedly on some farms. *C. botulinum* type B has been isolated from the feces of naturally occurring cases of the disease, and the condition has been produced experimentally by the intravenous injection of *C. botulinum* toxin.

In cattle a toxicoinfection with *C. botulinum* is suspected to be the cause of a CWD reported to occur with increased incidence in northern and eastern Germany.<sup>4,5</sup> The condition was coined as **chronic or “visceral” botulism** and is thought to be caused by an enteral dysbiosis, allowing *C. botulinum* to grow in the ruminant intestinal tract and to expose the organism to subclinical doses of BoTN over a long time.<sup>4,5</sup> Symptoms associated with this condition are very unspecific including indigestion, lameness and ataxia, weight loss and drop in milk production, tucked-up abdomen, labored breathing, edema in brisket and legs, recumbency, and even death in advanced stages.<sup>4</sup> Although in many reported cases of herd outbreaks the diagnosis was solely based on clinical presentation and by ruling out other differential diagnosis, in several cases feces and intestinal content of affected or death animals were positively tested for *C. botulinum*.<sup>4</sup> The causative relationship is nonetheless under contentious debate because *C. botulinum* spores can routinely be isolated from feces of clinically healthy cattle.<sup>6</sup>

### Experimental Reproduction

Cows challenged with type C botulinum toxin intravenously showed initial signs of



constipation and straining at defecation 48 hours after injection and weakness, decreased tail tone, decreased tongue tone, and muscle fasciculation of large-muscle groups between 76 and 92 hours. Weakness progressed to total posterior paresis between 80 and 140 hours in these cattle. On a weight-for-weight basis, cattle were considered to be 13 times more sensitive than mice to type C botulinum toxin.

## Risk Factors

### Animal Risk Factors

Botulism is most common in birds, particularly the domestic chicken and wild waterfowl. Cattle, sheep, and horses are susceptible but pigs, dogs, and cats appear to be resistant. The horse appears to be particularly susceptible to type B toxin. Cattle and sheep are usually affected by types C and D.

### Environment Risk Factors

Botulism in range animals has a seasonal distribution. Outbreaks are most likely to occur during drought periods when feed is sparse, phosphorus intake is low, and carrion is plentiful. Silage-associated botulism is also seasonal with the feeding of silage. A key epidemiologic factor identified during recent botulism outbreaks in Europe and Great Britain was the proximity to broiler chicken litter.<sup>2</sup> The variation that occurs in the geographic distribution of the various types, and in carrion versus non-carrion-associated botulism is an important factor when considering prophylactic vaccination programs.

### Importance

Severe outbreaks with high case-fatality rates can occur when contaminated feed is fed to large numbers of animals. Under extensive grazing conditions massive outbreaks of carrion-associated botulism also occur unless the animals are vaccinated.

### Zoonotic Implications

BoTN is identified as a possible agent for bioterrorism. Furthermore an increasing number of large botulism outbreaks in cattle herds in the past decades have raised public health concerns associated with the consumption of meat or milk originating from affected herds.<sup>1,7,8</sup> In Germany, anecdotal reports of farmers having developed clinical signs resembling symptoms observed in their livestock suspected to suffer of a chronic form of botulism have contributed to these concerns.<sup>9</sup> Notwithstanding there is no evidence to support the assumption that there could be transmission between humans and animals.<sup>1,7</sup> Even the cases in which farm personnel and cattle were affected by a condition thought to be associated with *C. botulinum* different types of *C. botulinum* were isolated from people and cattle.<sup>4,9</sup>

The available evidence for the occurrence of human cases associated with meat and milk consumption has been reviewed.<sup>7</sup> No

human cases of clinical botulism that were associated with the consumption of meat or milk derived from animals with botulism or healthy animals from herds affected by botulism were identified.<sup>7</sup> No cases of calves contracting clinical botulism from the consumption of raw milk in herds affected by botulism or cases of other species (dogs) contracting botulism from the consumption of fresh meat were available.<sup>7</sup>

Only one report of a cow affected by clinical botulism has been published in which BoTN was found in one mastitic quarter. The interpretation of this result is complicated by the fact that the BoTN affecting this animal was BoTN type C, whereas the BoNT type E was isolated in milk.<sup>1</sup> Furthermore the toxin was retrieved in a mastitic quarter but not the remaining three clinically healthy quarters. It has therefore been suggested that the BoNT retrieved in this quarter was either produced locally or is the result of contamination.<sup>1</sup> Cows are relatively sensitive to BoTN, whereas the toxin is rarely detectable in the blood of clinical cases. The excretion of BoTN in relevant amounts through the mammary gland is therefore considered to be unlikely. Nonetheless because of the mentioned uncertainties the meat and milk from cattle that have botulism should not be used for human consumption.

## PATHOGENESIS

The toxins of *C. botulinum* are neurotoxins and produce functional paralysis without the development of histologic lesions. Botulinum toxins are absorbed from the intestinal tract or the wound and carried via the bloodstream to peripheral cholinergic nerve terminals including neuromuscular junctions, postganglionic parasympathetic nerve endings, and peripheral ganglia. The heavy chain of the toxin is responsible for binding to the receptors and translocation into the cell and the light chain of the toxin for resultant blockade of the release of acetylcholine at the neuromuscular junction. Flaccid paralysis develops and the animal may die of respiratory paralysis.

## CLINICAL FINDINGS

### Cattle and Horses

Signs usually appear 3 to 17 days after the animals gain access to the toxic material, but occasionally as soon as day 1, the incubation period is shorter as the amount of toxin available is increased. **Peracute cases** die without prior signs of illness, although a few fail to take water or food for a day beforehand. The disease is not accompanied by fever, and the characteristic clinical picture is one of progressive symmetric muscular paralysis affecting particularly the limb muscles and the muscles of the jaw, tongue, and throat. Muscle weakness and paralysis commence in the hindquarters and progress to the forequarters, head, and neck. The onset is marked by very obvious muscle

tremor and fasciculation, often sufficient to make the whole limb tremble. Colic may be an initial sign in horses.

In most cases the disease is **subacute**. Restlessness, incoordination, stumbling, knuckling, and ataxia are followed by inability to rise or to lift the head. Mydriasis and ptosis occur early in the clinical course; mydriasis can be prominent in type C botulism in the horse. Skin sensation is retained. Affected animals lie in sternal recumbency with the head on the ground or turned into the flank, not unlike the posture of a cow with parturient paresis. Tongue tone is reduced, as is the strength of tongue retraction. In some cases the tongue becomes paralyzed and hangs from the mouth, the animal is unable to chew or swallow, and it drools saliva. In others there is no impairment of swallowing or mastication and the animal continues to eat until the end. This variation in signs is often a characteristic of an outbreak; either all the cases have tongue paralysis or all of them do not have it. Ruminal movements are depressed. Defecation and urination are usually unaffected, although cattle may be constipated. Paralysis of the chest muscles results in a terminal abdominal-type respiration. Sensation and consciousness are retained until the end, which usually occurs quietly, and with the animal in lateral recumbency, 1 to 4 days after the commencement of illness.

Occasional field cases and some experimental cases in cattle show **mild signs** and recover after an illness of 3 to 4 weeks. These chronic cases show restlessness and respiratory distress followed by knuckling, stumbling, and disinclination to rise. Anorexia and adipsia are important early signs but are often not observed in pastured animals. In some there is a pronounced roaring sound with each respiration. The roaring persists for up to 3 months. During the major part of the illness the animals spend most of their time in sternal recumbency. In some animals there is difficulty in prehending hay but concentrate and ensilage may be taken. This disability may persist for 3 weeks.

A syndrome ascribed to toxicosis with BoTN type B and manifested with anorexia, decline in milk production, dysphagia, a fetid diarrhea, regurgitation, and profuse salivation without myesthesia, paresis, and recumbency is reported in cattle in the Netherlands and Israel. In these cases death occurred as a result of aspiration pneumonia.

With **toxicoinfectious botulism** in foals, muscle tremor is often a prominent early sign. If the foal can walk, the gait is stiff and stilted and the toes are dragged. If the foal sucks, milk drools from the mouth; if it attempts to eat hay some of the material is regurgitated through the nostrils. Constipation occurs consistently. There is a rapid progression to severe muscular weakness and prostration, with the foal going down and

being unable to rise. If it is held up, there is a gross muscle tremor, which is not evident when the foal is lying down. Prostrate foals are bright and alert, have normal mentation and pain perception, and have dilatation of the pupils with a sluggish pupillary light reflex. During the latter period of the illness there is a complete cessation of peristalsis. The temperature varies from being slightly elevated to slightly depressed. Death occurs about 72 hours after the onset of signs and is caused by respiratory failure.

### Sheep

Sheep do not show the typical flaccid paralysis of other species until the final stages of the disease. There is stiffness while walking and incoordination and some excitability in the early stages. The head may be held on one side or bobbed up and down while walking (**limber neck**). Lateral switching of the tail, salivation, and serous nasal discharge are also common. In the terminal stages there is abdominal respiration, limb paralysis, and rapid death.

### Goats

Because of different feeding habits of sheep and goats the risk of exposure to BoTN of goats is considerably lower compared with sheep or cattle. Although goats look for bushes and shrubs on which to browse, cattle and sheep graze along the ground and are therefore more likely to ingest BoTN from contaminated waste spread over pasture.<sup>8</sup>

### Pigs

Authentic reports in this species are rare. Clinical signs include staggering followed by recumbency, vomiting, and pupillary dilatation. The muscular paralysis is flaccid and affected animals do not eat or drink.

## CLINICAL PATHOLOGY

There are no changes in hematologic values or serum biochemistry that are specific to botulism. In many cases under field conditions the diagnosis is solely based on clinical presentation and by ruling out potential differential diagnoses.

Laboratory diagnosis of botulism in the live or dead animal is difficult because of the lack of sensitive confirmatory laboratory tests. Laboratory confirmation is attempted by the following:

- Detection of preformed toxin in serum, intestinal tract contents, or feed
- Demonstration of spores of *C. botulinum* in the feed or gastrointestinal contents
- Detection of antibody in recovering or clinically normal at-risk animals.

**Detection of toxin** using bioassay in mice where mice are inoculated intraperitoneally coupled with toxin neutralization with polyvalent antitoxin is considered the most sensitive test currently available. Nonetheless the rate of positivity in clinical cases particularly

when testing serum is low, which has been explained by the much higher sensitivity to BoNT of cattle and horse compared with mice and the rapid binding of BoNT in the neuromuscular junctions, leaving low to no amounts of free BoNT in blood. Currently gastrointestinal content or fecal material is preferred over fecal material for the detection of BoNT.<sup>5,7</sup>

In outbreaks of botulism it is not uncommon to have only a proportion of clinically affected animals, or none, test positive. Protection with monovalent antitoxin allows type identification. Toxin detection by an ELISA test appears less sensitive than mouse bioassay. Toxin production or carriage contamination can potentially occur in a number of feeds; however, the majority of outbreaks are associated with contamination in hay or silage and suspect feeds should be tested in mice for toxin. To get around the problem of lack of sensitivity with the mouse test, suspect feed has been fed to experimental cattle. Alternatively, one can make an infusion of the feed sample and use this as the sole drinking water supply for experimental animals. The problem with all feeding experiments is that the BoTN is likely to be very patchy in its distribution in the feed.

Failure to produce the disease in animals vaccinated against botulism, when deaths are occurring in the unvaccinated controls, has also been used as a diagnostic procedure.

**Demonstration of spores of *C. botulinum*** in the feed being fed or the feces of affected animals supports a diagnosis of botulism because botulism spores are rarely detected in the feces of normal foals and adult horses. Although the testing of gastrointestinal contents from clinically suspect cases in cattle is frequently used as diagnostic tool particularly when toxicoinfectious botulism is suspected, this approach is considered to lack specificity because the postmortem growth of environmental *C. botulinum* spores would result in false-positive results.<sup>2,4,9</sup> Furthermore *C. botulinum* can be isolated from the majority of fecal samples of healthy slaughter cows.

**The detection of antibody** in chronically affected animals and at-risk herd mates or as retrospective diagnosis by an ELISA test has been used to support a diagnosis in outbreaks of type C and type D botulism. Increased antibody prevalence over time or increased antibody prevalence in an affected group compared with a similar group nearby was reported by some authors.<sup>10</sup>

## NECROPSY FINDINGS

There are no specific changes detectable at necropsy, although the presence of suspicious feedstuffs in the forestomachs or stomach may be suggestive. There may be nonspecific subendocardial and subepicardial hemorrhages and congestion of the intestines. Microscopic changes in the brain

are also nonspecific, consisting mainly of perivascular hemorrhages in the corpus striatum, cerebellum, and cerebrum. Nonetheless, unless classic flaccid paralysis was observed clinically, the brain should be examined histologically to eliminate other causes of neurologic disease. The presence of *C. botulinum* in the alimentary tract is a further test. The presence of toxin in the gut contents is confirmatory if found but is often misleading, because the toxin may have already been absorbed. The presence of the toxin in the liver at postmortem examination is taken as evidence that the disease has occurred. In addition to traditional bioassays, such as the mouse protection test, newer methods for toxin detection include ELISA techniques, and a recently described immuno-PCR assay.

## Samples for Confirmation of Diagnosis

- Bacteriology: suspected contaminated feed material, feces, rumen and intestinal contents, plus serum from clinically affected herd mates (bioassay, anaerobic CULT, ELISA)
- Histology: formalin-fixed brain.

## DIFFERENTIAL DIAGNOSIS

A presumptive diagnosis is made on the clinical signs and history, occurrence in unvaccinated animals, and the ruling out of other diseases with a similar clinical presentation. The symmetric motor paralysis of botulism with muscle paralysis that progresses to recumbency in 1–4 days is a major differential for botulism from other causes of neurologic dysfunction in large animals.

### Ruminants

- Periparturient hypocalcemia, characterized by low serum calcium concentrations and responsiveness to parenteral calcium administration
- Hypokalemia, characterized by marked hypokalemia
- Tick paralysis
- Paralytic rabies
- Poisoning by *Phalaris aquatica*
- Organophosphate/carbamate poisoning
- Louping-ill in sheep

### Horses

- Equine encephalomyelitis
- Equine herpesvirus-1 myeloencephalopathy
- Atypical myopathy of unknown etiology; the condition that presents frequently fatal myopathy can be differentiated by the characteristic increase in serum creatine kinase activity and the presence of hemoglobinuria
- Equine motor neuron disease
- Hyperkalemic periodic paralysis
- Hepatic encephalopathy
- Paralytic rabies
- Ionophore toxicity
- Myasthenia gravis

## TREATMENT

Recent studies report a survival rate in foals of 96% which was achieved by the early administration of antitoxin (before complete recumbency) coupled with a high quality of intensive care fluid therapy, enteral or parenteral feeding, nasal insufflation with oxygen, and mechanical ventilation if required. Duration of hospitalization was approximately 2 weeks. Antitoxin was considered essential to the high success rate in this report and this would limit the success of treatment geographically because antitoxin to the various BoTN types is not available universally. Specific or **polyvalent antiserum** is available in some countries and, if administered early in the course at a dose of 30,000 IU for a foal and 70,000 IU for adult horses, can improve the likelihood of survival. A single dose is sufficient, but it is expensive.

Animals should be confined to a stall with **supportive fluid therapy** and enteral feeding. Muzzling may be required to prevent aspiration pneumonia and frequent turning to prevent muscle necrosis and decubital ulcers. Bladder catheterization may be required in horses that do not urinate, and mechanical ventilation may be necessary for recumbent horses. Mineral oil is used to prevent constipation, and antimicrobial drugs are used to treat secondary complications such as aspiration pneumonia. Therapy should avoid the use of drugs that deplete the neuromuscular junction of acetylcholine, such as neostigmine, and those, such as procaine penicillin, tetracyclines, and aminoglycosides, that potentiate neuromuscular weakness.

A rapid progression of signs suggests a poor prognosis, and treatment should only be undertaken in subacute cases in which signs develop slowly and there is some chance of recovery. The prognosis in recumbent horses is grave.

Where groups of animals have had the same exposure factor, the remainder of the animals in the group should be vaccinated immediately.

Vaccination with either type-specific or combined BoNT toxoid in clinically affected animals is ineffective because binding of BoNT to neuromuscular junctions is irreversible.

### TREATMENT AND CONTROL

#### Treatment

Polyvalent antiserum (30,000 IU for a foal and 70,000 IU for an adult horse, single dose) (R-2)

#### Control

Vaccinate with multivalent BoTN toxoid IM (R-2)

BoTN, botulin toxin, IM, intramuscularly.

## CONTROL

In range animals, **correction of dietary deficiencies** by supplementation with phosphorus or protein should be implemented if conditions permit. Hygienic **disposal of carcasses** is advisable to prevent further pasture contamination but may not be practicable under range conditions. **Vaccination** with type-specific or combined (bivalent C and D) toxoid is practiced in enzootic areas in Australia and southern Africa. Type B and C vaccines would be more appropriate for prevention of disease in North America and Europe. The immunity engendered by vaccination is type specific. The number and interval of vaccinations required varies with the vaccine, and the manufacturer's directions should be followed. In horses, the disease is usually sporadic and caused by accidental contamination of feed or water; vaccination is seldom practiced in this species. Some local reactions are encountered after vaccination in horses but they are seldom serious. Vaccination of the mare may not prevent the occurrence of botulism in foals.

A common problem that arises when the disease appears to have resulted from feeding contaminated silage, hay, or other feed is what to do with the residue of the feed. In these circumstances the stock should be vigorously vaccinated with a toxoid on three occasions at 2-week intervals and then feeding of the same material can be recommenced.

## FURTHER READING

- Jones T. Botulism. *In Pract.* 1996;18:312-313.  
 Lindström M, Myllykoski J, Sivelä S, et al. *Clostridium botulinum* in cattle and dairy products. *Crit Rev Food Sci Nutr.* 2010;50:281-304.  
 Smith LDS, Sugiyama H. *Botulism, the Organisms, Its Toxins, the Disease.* Springfield, IL: Charles C Thomas; 1988.  
 Whitlock RH. Botulism, type C: experimental and field cases in horses. *Equine Pract.* 1996;18(10):11-17.  
 Whitlock RH, Buckley C. Botulism. *Vet Clin North Am Equine Pract.* 1997;13:107-128.

## REFERENCES

- Lindström M, et al. *Crit Rev Food Sci Nutr.* 2010;50:281.
- Kennedy S, Ball H. *Vet Rec.* 2011;168:638.
- Whitlock RH, McAdams S. *Clin Tech Equine Pract.* 2006;5:37.
- Krüger M, et al. *Anaerobe.* 2012;18:221.
- Böhlhoff H, Gessler F. *Vet Rec.* 2013;172:397.
- Brooks CE, et al. *Vet Microbiol.* 2010;144:226.
- ACMSF (Advisory committee on the microbiological safety of food) 2006. (Accessed August, 2016, at [http://acmsf.food.gov.uk/sites/default/files/mnt/drupal\\_data/sources/files/multimedia/pdfs/botulismincattlereport1206.pdf](http://acmsf.food.gov.uk/sites/default/files/mnt/drupal_data/sources/files/multimedia/pdfs/botulismincattlereport1206.pdf)).
- ACMSF (Advisory committee on the microbiological safety of food) 2009. (Accessed August 2016, at [http://acmsf.food.gov.uk/sites/default/files/mnt/drupal\\_data/sources/files/multimedia/pdfs/botulisminsheepgoats.pdf](http://acmsf.food.gov.uk/sites/default/files/mnt/drupal_data/sources/files/multimedia/pdfs/botulisminsheepgoats.pdf)).
- Rodloff AC, Krüger M. *Anaerobe.* 2012; 18:226-228.
- Mawhinney I, et al. *Vet J.* 2012;192:382-384.

## TICK PARALYSIS

Infestations with a several species of ticks are associated with paralysis of animals. Dogs are most commonly affected but losses can occur in cattle, sheep, goats, llamas, horses, and a variety of wild animals. At least 31 species in seven genera of ixodid ticks and seven species in three genera of argasid ticks have been implicated in tick paralysis. The most important tick species for livestock are given in [Table 14-22](#). *D. andersoni* is the most common cause of tick paralysis in livestock in North America; *D. occidentalis* is associated with paralysis in cattle, horses, and deer.<sup>1</sup> In Australia, *I. holocyclus* is the predominant tick associated with paralysis, whereas *I. rubicundus* and *Rhipicephalus evertsi* are common in Africa.<sup>1</sup> Animals in Europe and Asia have developed tick paralysis from *I. ricinus* and *Hyalomma punctata*.<sup>1</sup>

The toxin of *D. andersoni* interferes with liberation or synthesis of acetylcholine at the muscle fiber motor end plates.<sup>2</sup> The disturbance is functional and paralysis of the peripheral neurons is the basis for clinical

**Table 14-22** Ticks reported to cause paralysis in livestock

Animal	Tick	Country
Sheep, calves, goats	<i>Dermacentor andersoni</i>	United States, Canada
	<i>D. occidentalis</i>	United States
Calves, lambs, foals, goats	<i>Ixodes holocyclus</i>	Australia
Sheep, goats, calves	<i>I. pilosus</i>	South Africa
Sheep, goats, calves, antelopes	<i>I. rubicundus</i>	South Africa
Sheep, goats	<i>I. ricinus</i>	Crete, Israel
Lambs	<i>Rhipicephalus evertsi</i>	South Africa
Calves, sheep, goats	<i>Hyalomma punctata</i>	South Africa, Europe, Japan
Sheep	<i>H. aegyptium</i>	Yugoslavia
Sheep	<i>Ornithodoros lahorensis</i>	Central Asia
Cattle, sheep, goats	<i>Amblyomma cajannense</i>	Central, South America
Cattle	<i>R. evertsi</i>	Africa



signs. Continuous secretion of toxin by a large number (35–150) of partly engorged female ticks that have been attached for 5 to 8 days is necessary to produce paralysis, with complete recovery occurring within 24 hours when the ticks are removed. The disease is generally confined to calves and yearlings. Clinically, there is an ascending, flaccid paralysis commencing with incoordination of the hindlimbs, followed by paralysis of the forelimbs and chest muscles, causing lateral recumbency.<sup>1</sup> Respiration is grossly abnormal; there is a double expiratory effort and the rate is slow (12–15 breaths per minute) but deep. Death, caused by respiratory failure, may occur in 1 to 2 days, but the course is usually 4 to 5 days. The mortality rate may be as high as 50% in dogs, but is usually much lower in farm animals.

*I. holocyclus* have been shown to paralyze calves of 25 to 50 kg BW. Between 4 and 10 adult female ticks are required to produce this effect and paralysis occurs 6 to 13 days after infestation occurs. The ticks under natural conditions parasitize wild fauna, and infestations of other species occur accidentally. The disease is limited in its distribution by the ecology of the ticks and the natural host fauna. The paralysis characteristic of the disease is associated with a toxin secreted by the salivary glands of female ticks, which is present in much greater concentration in the glands of adults than in other stages. The severity of the paralysis is independent of the number of ticks involved; susceptible animals may be seriously affected by a few ticks.<sup>1</sup>

Hyperimmune serum is used in the treatment of dogs, but in farm animals removal of the ticks in the early stages is usually followed by rapid recovery. Control necessitates eradication of the ticks or host fauna. The general principles of tick control are outlined in Chapter 11. The use of appropriate insecticides is an effective preventive.

### FURTHER READING

Sonenshine DE, Lane RS, Nicholson WL. Ticks (*Ixodia*). In: Mullen G, Durden L, eds. *Medical and Veterinary Entomology*. New York: Academic Press; 2002:517–558.

### REFERENCES

- Gwaltney-Brant SM, Dunayer E, Youssef H. Terrestrial zootoxins. In: Gupta RC, ed. *Veterinary Toxicology*. Amsterdam: Elsevier; 2012:969.
- Lysyk TJ. *J Med Entomol*. 2009;46:358.

## OVINE “KANGAROO GAIT” AND FENUGREEK STAGGERS

### SYNOPSIS

**Etiology** Not known.

**Epidemiology** Seasonal occurrence involving only adult female sheep that are lactating, or in some cases, pregnant. Spontaneous recovery following cessation of lactation in

most cases, but sometimes only 50%, but not always all affected sheep.

**Clinical findings** Bilateral forelimb locomotor disorder.

**Lesions** Edema of brain and spinal cord in early cases; axonal degeneration of the radial nerve followed by regeneration in more chronic cases (those greater than 6 weeks' duration).

**Treatment** Supportive.

**Control** None recognized.

### ETIOLOGY

This is a neuropathy with no known cause. In Australia similar clinical and pathologic signs are associated with grazing mature plants or the stubble of fenugreek (*Trigonella foenum-graecum*), which is an annual winter-spring legume from which the seed is harvested as a condiment for human food.<sup>1</sup>

### EPIDEMIOLOGY

#### Occurrence

This condition is recorded in Australia, New Zealand, and the UK. It is manifested by incoordination, including an acute onset of a high-stepping forelimb gait and bounding hindlimb gait.

#### Risk Factors

It occurs only in adult ewes with an onset in late pregnancy or early lactation. Spontaneous recovery occurs following cessation of lactation, and occasionally while ewes are still nursing lambs, although in Australia often only 50% of ewes recover completely.<sup>1</sup> The cumulative annual incidence varies between flocks but is usually less than 1%.

In the areas of northern England and southern Scotland the condition is significantly more common in upland and lowland flocks than in those hill grazing. Stocking density is higher in affected flocks than that in nonaffected flocks. Onset occurs while on pasture between March and June with a separate smaller peak in October. This seasonal occurrence could be a reflection of the parturition status of flocks or an effect of seasonal influences.

In Australia cases have been recorded in lactating ewes grazing improved pastures from June (winter) to February (summer) and the grazing of fenugreek crop or stubble in summer.

### PATHOGENESIS

Clinical signs can be attributed to the generalized neuropathy affecting principally the radial nerves. Subsequent to the axonal degeneration a remyelination of the radial nerve occurs, explaining the clinical recovery. For cases not associated with ingestion of fenugreek, bilateral compression of the radial nerves is suggested as a cause, but there is no knowledge of how such an injury can occur. Despite the differences in diet, the

similar clinical and pathologic presentation of kangaroo gait and fenugreek staggers has prompted the suggestion that these may be related entities.<sup>1</sup> Nevertheless there are some key differences; the initial acute stage of fenugreek staggers in Merino sheep is sometimes lethal and is later associated with weight loss, whereas kangaroo gait is not and seems to be restricted to larger meat breeds.

### CLINICAL FINDINGS

These include incoordination, a high-stepping forelimb and bounding hindlimb gait, arched back, and proprioceptive deficits (knuckling of fore and occasionally hind fetlocks). There is bilateral forelimb paresis and palpable loss of muscle bulk in the forelimbs. The forelimbs and hindlimbs of affected sheep are positioned centrally under the body and so when they are pressed affected sheep move with a characteristic hopping or kangaroo gait. Affected ewes lie down more frequently and may graze on their knees but continue to eat and effectively suckle their lambs.

### CLINICAL PATHOLOGY

There are no consistent abnormalities in hematology, blood biochemistry, or trace element analysis of affected sheep.

### NECROPSY FINDINGS

In early cases there are signs of acute edema in the brain and spinal cord (wallerian degeneration of ventral motor tracts, spongy changes in the neuropil, and swollen astrocytes). This progresses to a peripheral neuropathy, with axonal degeneration of the myelinated fibers of the radial nerve fibers in longer standing cases (6 weeks or more), and then regeneration in recovering cases.

### DIFFERENTIAL DIAGNOSIS

Romulosis, a condition associated with grazing fungus-infected onion grass (*Romulea rosea*), can cause incoordination and a similar hopping gait (bunny-hopping).

Foot rot or foot abscess involving the front feet can induce the same grazing behavior, but there is no problem in differentiation when the limbs and feet are examined.

Hypocalcemia in sheep occurs in late pregnancy or during lactation, and in the developing stages there is incoordination and muscle weakness. However, there is rapid progression to complete muscular paresis and a dramatic response to treatment.

Spinal abscess or fracture.

### TREATMENT

Without the knowledge of etiology there is no specific treatment. Easy access to food and water should be provided.

### FURTHER READING

Radostits O, et al. Ovine “kangaroo gait.” In: *Veterinary Medicine: A Textbook of the Disease of Cattle*,

Horses, Sheep, Goats and Pigs. 10th ed. London: W.B. Saunders; 2007:2019.

## REFERENCE

1. Bourke C. *Aust Vet J.* 2009;87:99.

## POLYNEURITIS EQUI (CAUDA EQUINA SYNDROME)

Polyneuritis equi (formerly cauda equina neuritis) is a demyelinating, inflammatory disease of peripheral nerves of adult horses. The **etiology** of the disease is unknown although infectious (adenovirus, EHV-1), immune (autoimmune disease), and toxic etiologies have been suggested, without conclusive substantiation. Adenovirus was isolated from two of three horses with the disease, but this observation has not been repeated, and it appears unlikely at this time that adenovirus is the cause of polyneuritis equi. EHV-1 is not consistently isolated from affected horses.

The disease occurs in adult horses in Europe and North America but has not been reported from the Southern Hemisphere. The prevalence in a group of 4319 horses subject to postmortem examination in Normandy was 0.2% (one case).<sup>1</sup> The disease is usually sporadic with single animals on a farm or in a stable affected. However, outbreaks of the disease can affect multiple horses from the same farm over a number of years.

The **pathogenesis** of the disease involves nonsuppurative inflammation of the extradural nerves and demyelination of peripheral nerves. Initial inflammation of the nerves causes hyperesthesia, which is followed by loss of sensation as nerves are demyelinated. Both motor and sensory nerves are affected, with subsequent weakness, paresis, muscle atrophy, urinary and fecal retention and incontinence, and gait abnormalities.

The inflammatory response is characterized by an abundance of **T lymphocytes**, in addition to B lymphocytes, macrophages, giant cells, eosinophils, and neutrophils in the perineurium and endoneurium.<sup>2</sup> The T cells are CD8+ cytotoxic T lymphocytes with rare CD4+ helper T lymphocytes.<sup>3</sup> This, with electron microscopic imaging, evidence of “myelin stripping” by macrophages and the presence of antibodies to the myelin P2 protein has been interpreted as indicative of immune-mediated activity against myelin.<sup>2,4</sup> This immune response might be toward the myelin as a primary target or could be the result of bystander activity in which other agents, potentially viruses, induce an immune response that is directed against myelin.

The **acute disease** is evident as abrupt onset of hyperesthesia of the perineum and tail head, and perhaps the face, evident as avoidance of touching, and chewing or rubbing of the tail. The hyperesthesia

progresses to hypalgesia or anesthesia of the affected regions.

The disease usually has a more **insidious onset** with loss of sensation and function occurring over days to weeks. The most common presentation is that of cauda equina syndrome with bilaterally symmetric signs of posterior weakness, tail paralysis, fecal and urinary incontinence and retention, and atrophy of the gluteal muscles. Tail tone is decreased or absent and the tail is easily raised by the examiner. The anus is usually atonic and dilated. There are signs of urinary incontinence with urine scalding of the escutcheon and hindlegs. Rectal examination reveals fecal retention and a distended bladder that is readily expressed. Male horses can have prolapse of the penis with maintained sensation in the prepuce, which is a finding consistent with the separate innervation of these anatomic regions. Affected horses can also have ataxia of the hindlimbs, but this is always combined with signs of cauda equina disease.

Signs of **CN dysfunction** occur as part of the disease, but not in all cases. CN dysfunction can be symmetric, but is usually asymmetric. Nerves prominently involved in the genesis of clinical signs are the trigeminal (CN V), facial (CN VII), and hypoglossal nerve (CN XII), although all CNs can be affected to some extent. Involvement of the CNs is evident as facial paralysis (CN VII), weakness of the tongue (CN XII), and loss of sensation in the skin of the face (CN V). There can be loss of movement of the pinnae (CN VII) and head tilt (CN VIII). Laryngeal paralysis can be present (CN X). The buccal branches of CN VII can be enlarged and palpable over the masseter muscles ventral to the facial crest.

Not all clinical signs occur in all horses and, depending on the stage and severity of the disease, some animals can have loss of sensation as the only abnormality, especially during the early stages of the disease.

EMG is consistent with denervation with prolonged insertion potentials, positive sharp waves, and fibrillation. Per rectal **ultrasound examination** of the extradural sacral nerve routes as they exit the ventral sacral foramina reveals enlargement and a diffusely mottled, hypoechoic appearance.<sup>3</sup>

**Biopsy** of the sacrocaudalis dorsalis lateralis muscle can provide antemortem diagnosis of the disease. Affected horses have intense lymphocytic and histiocytic infiltration around the terminal nerves within the muscle, often obliterating architecture of the nerves but sparing the myofibers.<sup>3</sup> There is neurogenic atrophy of the muscle fibers.

The disease is inexorably progressive, the prognosis for life is hopeless, and the course of the disease is usually less than 3 months.

**Clinical pathologic** abnormalities are not diagnostic. There is sometimes a mild neutrophilic leukocytosis and hypergammaglobulinemia. Serum vitamin E

concentrations are usually normal. Analysis of CSF demonstrates mild mononuclear pleocytosis and increased protein concentrations, but these changes are not diagnostic of the disease. Horses with polyneuritis equi have antibodies to P2 myelin protein in serum, but the diagnostic value of this test has not been determined.

**Necropsy findings** are definitive for the disease. Gross findings include thickening of the epidural nerve roots that is most severe in the cauda equina. The bladder and rectum can be distended. There can be evidence of fecal and urine scalding and self-trauma of the perineum. There can be thickening of the facial nerves. Microscopic changes are characterized by a granulomatous inflammation of the extradural nerves, although radiculoganglioneuritis and myelitis can also occur. There is loss of axons with demyelination and signs of remyelination. There is profound infiltration of nerves by macrophages, moderate to marked infiltration of cytotoxic T lymphocytes, and lesser infiltration of B lymphocytes.<sup>3</sup> Inflammatory cells are initially lymphocytes, plasma cells, and macrophages. As the inflammation becomes more severe or chronic there is extensive proliferation of fibroblasts and fibrocytes in addition to infiltration of lymphocytes and macrophages. There is axonal degeneration with proliferation of the perineurium. The chronic inflammatory changes result in loss of peripheral neural architecture. Lesions are present in many regions of the spinal cord, but are most severe in the sacral division and cauda equina. Lysosomal accumulations are present in the semilunar, geniculate, and sympathetic chains and granulomatous lesions in the celiac-mesenteric ganglion. Lesions of the CNs similarly involve infiltration with lymphocytes and histiocytes, and the inflammation can extend to the terminal branches of the nerves.

The **diagnosis** of polyneuritis equi is based on the presence of clinical signs of the disease, ruling out other diseases causing similar clinical signs, and necropsy examination. Diseases with manifestations similar to polyneuritis equi include the following:

- EHV-1 myeloencephalopathy
- Migrating parasites ([Table 14-21](#), **differential diagnosis of disease causing spinal ataxia in horses**)
- Sorghum-Sudan grass neuropathy
- Equine protozoal myeloencephalitis
- Ryegrass staggers (*A. lolii*)
- Dourine
- Trauma to the sacral vertebral column
- Abscess or neoplasia involving the sacral or caudal lumbar vertebral column
- Meningitis
- Intentional alcohol sclerosis of tail head nerves in Quarter Horses.

There is no definitive **treatment** for polyneuritis equi. Administration of antiinflammatory agents, including corticosteroids, appears to be without sustained benefit.

Supportive care includes evacuation of the rectum and bladder and maintenance of hydration and provision of adequate nutrition. Feeding a diet that softens feces, or administration of fecal softeners or lubricants, can be beneficial. Bethanecol (0.05–0.1 mg/kg every 8–12 hours, orally) might increase bladder tone. Topical administration of petroleum jelly or similar products can protect the skin of the perineum and scutcheon from fecal and urine scalding.

## REFERENCES

1. Laugier C, et al. *J Equine Vet Sci.* 2009;29:561.
2. van Galen G, et al. *Equine Vet J.* 2008;40:185.
3. Aleman M, et al. *J Vet Intern Med.* 2009;23:665.
4. Hahn CN. *Equine Vet J.* 2008;40:100.

## SCANDINAVIAN KNUCKLING SYNDROME (ACQUIRED EQUINE POLYNEUROPATHY)

This is a recently recognized syndrome of metatarsophalangeal joint extensor paresis in horses in Scandinavia.<sup>1–3</sup> The disease appears to be widespread in Sweden, Norway, and Finland occurring as clusters of disease outbreaks on farms.<sup>1</sup> The etiology is uncertain, although preserved feed is considered the source of an unidentified toxin.

A report described the risk factors and outcome of 42 cases distributed over 13 farms in Scandinavia from 2007 to 2009. Cases occurred between December and May with an overall prevalence of 27% and on-farm prevalence of 11% to 71% (for farms with >6 horses) although the number of cases, and affected farms, varies markedly from year to year.<sup>2,4</sup> The case–fatality rate was 29% in the epidemiology study<sup>1</sup> and 53% (40 of 75) in a case series.<sup>2</sup> The disease was less prevalent in horses >12 years of age, and younger horses had a greater chance of surviving the disease.

Clinical signs were typified by bilateral knuckling of the hindlimbs, which was most apparent on circling. Mild to moderate pelvic limb weakness was detected in 16 of 42 horses.<sup>1</sup> A small proportion of cases (3/42) had mild forelimb signs of weakness and

knuckling. There was focal muscle atrophy of hindlimb musculature in seven cases. Mentation and vital signs (temperature, pulse, and respiratory rate) were within normal limits. The disease usually has a slow onset, but some affected horses developed severe signs with hours.<sup>2</sup> The median duration of clinical signs in affected horses that recover is 4.4 months (range 1–17 months) and survivors can recover completely.

Routine hematology and serum biochemical analysis do not reveal consistent abnormalities, apart from increased creatine kinase and AST activity in recumbent horses.<sup>2</sup>

Lesions are restricted to the peripheral nervous system and are evident in sciatic, peroneal, radial, and plantar digital nerves.<sup>2,3</sup> Lesions include areas of thick, swollen axons with subperineural accumulation of mucoid material. There is lymphohistiocytic infiltration of nerves and mild to moderate loss of myelinated nerve fibers.<sup>3</sup> Swollen axons and large vacuoles were present in sections of the lumbar tumescence. There are no lesions detected in the brain.<sup>2</sup>

Treatment consists of supportive and nursing care. Control measures are not reported.

## REFERENCES

1. Grondahl G, et al. *Equine Vet J.* 2012;44:36.
2. Hanche-Olsen S, et al. *J Vet Intern Med.* 2008;22:178.
3. Hahn CN, et al. *Equine Vet J.* 2008;40:231.
4. Wolff C, et al. *BMC Vet Res.* 2014;10:265.

## PERIPHERAL NERVE SHEATH TUMORS

PNSTs are most commonly benign tumors of the peripheral nervous system with a rare occurrence in veterinary medicine.<sup>1</sup> Most commonly affected species are dogs and cattle.<sup>1</sup> Tumors are composed of components of the peripheral nerve, including Schwann cells, perineural cells, fibroblasts and collagen. While in human medicine PNSTs are subdivided into **neurofibromas** and **schwannomas**, dependent on the predominant cell type and other histologic

characteristics, this distinction is less clearly defined in veterinary medicine.<sup>2,3</sup> The existence of true neurofibromas as described in humans has been questioned.<sup>1,2</sup> PNSTs that can occur on any location of the peripheral nervous system most commonly originate from autonomic nerves such as cardiac and intercostal nerves or the brachial plexus.

## CLINICAL FINDINGS

In cattle, PNSTs are generally asymptomatic and found incidentally during physical examination or slaughter. Clinical signs are uncommon but can include limb paresis or paralysis, recurrent bloat and vagal indigestion, cardiac insufficiency, and chronic wasting.<sup>1,3,4</sup> The cutaneous presentation is rare but can present as single or multiple indolent cutaneous masses between 1 and over 15 cm in diameter that are well demarcated. In some instances PNSTs may infiltrate surrounding tissue, immobilizing the mass and complicating surgical excision.

## CLINICAL PATHOLOGY

Diagnosis must be confirmed histologically. Important features included the concurrent presence of highly and poorly cellular areas of Schwann cells. Nerve fibers are absent in schwannomas but may be found in neurofibromas. Immunohistostaining is used to confirm the presence of Schwann cells and to differentiate between schwannomas and neurofibromas.<sup>1,2</sup>

## TREATMENT

Treatment of accessible masses (cutaneous form) is rarely required but may be indicated either for cosmetic reasons as an excisional biopsy or to remove the mass integrally. Although the prognosis in most cases is excellent, tumors with infiltrative growth may recur because of incomplete excision of abnormal cells.

## REFERENCES

1. Schöniger S, Summer BA. *Vet Pathol.* 2009;46:904.
2. Nielsen AB, et al. *J Comp Pathol.* 2007;137:224.
3. Pavarini SP, et al. *Acta Vet Scand.* 2013;55:7.
4. Beytut E. *J Comp Pathol.* 2006;134:260.



# Diseases of the Musculoskeletal System

## PRINCIPAL MANIFESTATIONS OF MUSCULOSKELETAL DISEASE 1372

Lameness 1372  
 Abnormal Posture and Movement 1372  
 Deformity 1372  
 Spontaneous Fractures 1375  
 Painful Aspects of Lameness 1375  
 Examination of the Musculoskeletal System 1376

## DISEASES OF MUSCLES 1377

Myasthenia (Skeletal Muscle Asthenia) 1377  
 Myopathy 1377  
 Myopathy of Horses 1381  
 Myositis 1387

## DISEASES OF BONES 1388

Osteodystrophy 1388  
 Hypertrophic Osteopathy (Marie's Disease) 1391  
 Osteomyelitis 1391  
 Tail-Tip Necrosis in Beef Cattle 1394  
 Laminitis of Horses 1395  
 Laminitis in Ruminants and Swine 1404

## DISEASES OF JOINTS 1406

Degenerative Joint Disease (Osteoarthropathy) and Osteochondrosis 1406  
 Septic Arthritis Synovitis 1411  
 Lameness in Pigs and Degenerative Joint Disease (Osteochondrosis, Osteoarthritis, Epiphysiolysis and Apophysiolysis, Leg Weakness in Pigs) 1418

## INFECTIOUS DISEASES OF THE MUSCULOSKELETAL SYSTEM 1425

Borreliosis (Lyme Borreliosis, Lyme Disease) 1425  
 Malignant Edema, Clostridial Myonecrosis (Gas Gangrene) 1428  
 Blackleg 1430  
 Bovine Footrot (Infectious Bovine Pododermatitis, Interdigital Phlegmon, Interdigital Necrobacillosis, Foul in the Foot) 1432  
 Bovine Digital Dermatitis, Papillomatous Digital Dermatitis of Cattle (Mortellaro's Disease), Foot Warts, Hairy Foot Warts, "Heel Warts" 1435  
 Infectious Footrot in Sheep 1441  
 Foot Abscess in Sheep 1448  
 Lamb Arthritis 1449  
 Chlamydial Polyarthritis 1449  
 Chronic Pectoral and Ventral Midline Abscess in Horses (Pigeon Fever) 1449

Infectious Polyarthritis (Glasser's Disease, Porcine Polyserositis, and Arthritis) 1450  
 Arthritis Resulting From Erysipelas 1455  
 Hyosynoviae in Pigs 1455  
 Footrot in Pigs (Bush Foot) 1456  
 Ross River Virus 1458

## NUTRITIONAL DISEASES AFFECTING THE MUSCULOSKELETAL SYSTEM 1458

Selenium and/or Vitamin E Deficiencies 1458  
 Masseter Myonecrosis 1479  
 Sporadic Exertional Rhabdomyolysis in Horses (Azoturia, Tying-Up) 1479  
 Dietary Deficiency of Phosphorus, Calcium, and Vitamin D and Imbalance of the Calcium:Phosphorus Ratio 1482  
 Calcium Deficiency 1483  
 Phosphorus Deficiency 1485  
 Vitamin D Deficiency 1491  
 Vitamin D Intoxication 1494  
 Rickets 1494  
 Osteomalacia 1496  
 Osteodystrophia Fibrosa 1497  
 "Bowie" or "Bentleg" in Lambs 1499  
 Degenerative Joint Disease and Osteoarthritis 1499  
 Manganese Deficiency 1500  
 Biotin (Vitamin H) Deficiency (Hypobiotinosis) 1502

## TOXIC AGENTS AFFECTING THE MUSCULOSKELETAL SYSTEM 1503

Hyena Disease of Cattle 1503  
 Calcinogenic Glycoside Poisoning (Enzootic Calcinosis) 1504  
 Hypoglycin A Intoxication of Horses (Atypical Myopathy [Myoglobinuria] in Grazing Horses) 1505  
 Plant Poisonings With Known Toxins 1506  
 Plant Poisonings With Suspected or Unidentified Toxins 1506  
 Aluminum Toxicosis 1506  
 Fluoride Toxicosis 1506

## CONGENITAL DEFECTS OF MUSCLES, BONES, AND JOINTS 1510

Weakness of Skeletal Muscles 1510  
 Congenital Hyperplasia of Myofiber 1510  
 Obvious Absence or Deformity of Specific Parts of the Musculoskeletal System 1510  
 Fixation of Joints 1510

Congenital Arthrogyposis and Hydranencephaly, Akabane Disease, Cache Valley Virus Disease, Schmallenberg Virus 1514  
 Hypermobility of Joints 1514

## INHERITED DISEASES OF MUSCLES 1514

Glycogen Storage Diseases 1514  
 Generalized Glycogenosis (Glycogen Storage Disease Type II) 1514  
 Glycogen Storage Disease Type V (Muscle Glycogen Phosphorylase Deficiency) 1515  
 Inherited Diaphragmatic Muscle Dystrophy 1515  
 Congenital Myasthenia Gravis 1515  
 Bovine Familial Degenerative Neuromuscular Disease 1515  
 Inherited Umbilical Hernia 1516  
 Myofiber Hyperplasia (Double Muscling, Doppelender, Culard) 1516  
 Inherited Splayed Digits 1517  
 Inherited Progressive Muscular Dystrophy 1517  
 Pseudomyotonia of Cattle, Congenital Muscular Dystonia-1 1517  
 Ovine Humpyback 1518  
 Myotonia of Goats (Fainting Goats) 1518  
 Myotonia Congenita and Myotonic Dystrophy 1519  
 Recurrent Exertional Rhabdomyolysis in Thoroughbred and Standardbred Horses 1519  
 Polysaccharide Storage Myopathy of Horses 1522  
 Equine Hyperkalemic Periodic Paralysis 1523  
 Malignant Hyperthermia in Horses 1524  
 Porcine Stress Syndrome (Malignant Hyperthermia) 1525  
 Pietrain Creeper Pigs 1529  
 Asymmetric Hindquarter Syndrome of Pigs 1529  
 Porcine Congenital Splayleg (Splayleg Syndrome in Newborn Pigs) 1529

## INHERITED DISEASES OF BONES 1530

Inherited Osteogenesis Imperfecta 1532  
 Inherited Dwarfism 1532  
 Congenital Osteopetrosis 1534  
 Inherited Proptocephaly (Sheepshead) 1534  
 Inherited Atlanto-Occipital Deformity 1534  
 Inherited Agnathia 1534  
 Inherited Displaced Molar Teeth 1534  
 Inherited Jaw Malapposition 1534

Inherited Cranioschisis (Cranium Bifidum) 1535  
 Inherited Craniofacial Deformity 1535  
 Inherited Arachnomelia (Inherited Chondrodysplasia) 1535  
 Complex Vertebral Malformation in Holstein Calves 1536  
 Inherited Reduced Phalanges (Amputates, Acroteriasis, Ectromelia) 1537  
 Inherited Claw Deformity 1537

Inherited Multiple Exostosis 1537  
 Inherited Congenital Hyperostosis (Thick Forelimbs of Pigs) 1537  
 Inherited Rickets 1537  
 Inherited Taillessness and Tail Deformity 1538  
 Congenital Chondrodystrophy of Unknown Origin (“Acorn” Calves, Congenital Joint Laxity and Dwarfism, Congenital Spinal Stenosis) 1538

## INHERITED DISEASES OF JOINTS 1538

Inherited Arthrogyposis (Inherited Multiple-Tendon Contracture) 1538  
 Inherited Multiple Ankyloses 1539  
 Inherited Patellar Subluxation 1539  
 Inherited Hypermobility (Laxity) of Joints 1539  
 Inherited Hip Dysplasia 1539

Diseases of the organs of support, including muscles, bones, and joints, have much in common in that the major clinical manifestations of diseases that affect them are lameness, failure of support (weakness), insufficiency of movement, and deformity. Insufficiency of movement affects all voluntary muscles, including those responsible for respiratory movement and mastication, but lameness and failure of support are manifestations of involvement of the limbs.

Various classifications of the diseases of the musculoskeletal system, based on clinical, pathologic, and etiologic differences, are in use, but the simplest is that which divides the diseases into **degenerative** and **inflammatory** types. This classification system is used in this chapter.

- The degenerative diseases of muscles, bones and joints are distinguished as myopathy, osteodystrophy, and arthropathy, respectively.
- The inflammatory diseases are myositis, osteitis and osteomyelitis, and arthritis, respectively.

## Principal Manifestations of Musculoskeletal Disease

### LAMENESS

Lameness is an abnormal gait or locomotion characterized by limping or not bearing full weight on a leg, usually associated with localized pain in the musculoskeletal system. Lameness must be distinguished from **ataxia**, which is an abnormal gait characterized by lack of coordination of muscular action, usually because of a lesion of the central or peripheral nervous system.

**Weakness** (paresis) is the inability to maintain a normal posture and gait, usually because of a lesion of muscle or generalized weakness as a result of an abnormal systemic state (e.g., shock), a metabolic abnormality (e.g., hypocalcemia or hypokalemia), or starvation. Weakness can also be caused by a lesion in the spinal cord or peripheral nerves.

The incidence and severity of lameness in livestock populations varies tremendously because of differences in management

systems (grazing versus confinement, concrete versus slatted floors, free stall design and use by dairy cattle, frequency of foot trimming, etc.), nutrition, genetics, age, body weight, and many other factors. For example, certain breeds may be more susceptible to diseases of the feet and legs than others. Osteoarthritis occurs most commonly in old animals. Diseases of the legs of dairy cattle occur most commonly at the time of parturition and during the first 50 days of lactation. Diseases of the feet of dairy cattle occur most commonly in days 50 to 150 of the lactation period. Often the etiology is complex, and a definitive etiologic diagnosis cannot be made. This makes clinical management difficult and often unrewarding. The direct monetary costs for the treatment of lame animals are not high, but the actual treatment of either individual animals or groups of animals is time-consuming and laborious. The condemnation of animals to slaughter because of lesions of the musculoskeletal system also contributes to the total economic loss.

When lameness is a herd problem, not only are the economic losses increased, but clinical management becomes very difficult. The epidemiologic factors that contribute to lameness include the following:

- Injuries as a result of floor surfaces
- Persistently wet, unhygienic ground conditions
- Overcrowding and trampling during transportation and handling
- Nutritional inadequacies
- Undesirable skeletal conformation
- Failure to provide regular foot trimming

Because of the difficulty inherent in the differentiation of diseases causing lameness, and other abnormalities of gait and posture, a summary is presented in [Table 15-1](#). It does not include lameness in racing horses, which is described in textbooks on lameness in horses, or diseases of the nervous system that interfere with normal movement and posture. These are discussed in [Chapter 14](#).

### ABNORMAL POSTURE AND MOVEMENT

As a group, diseases of the musculoskeletal system are characterized by reduced activity in standing up and moving and by the adoption of unusual postures.<sup>1</sup> Abnormal

movements include weakness (limpness) or stiffness and lack of flexion. Abnormal postures include persistent recumbency, including lateral recumbency. There may be signs of pain on standing, moving, or palpation. There is an absence of signs specifically referable to the nervous system. Differentiation from diseases of the nervous system and from each other may be aided by specific biochemical, radiologic, or hematologic findings that indicate the system involved. Specific epidemiologic findings may indicate the location of the lesion (which may be secondary) in muscle, bones, or joints, as set out in [Table 15-1](#).

### DEFORMITY

Atypical disposition, shape, or size of a part of the musculoskeletal system constitutes a deformity. This may occur in a number of ways, and be caused by the following defects.

#### Muscle and Tendon Defects

- Congenital hypermobility of joints, inherited and sporadic
- Congenital flexed or stretched tendons of limbs causing contracture of joints or hyperextension
- Inherited congenital splayleg of pigs
- Muscle hypertrophy (doppelender, cular) of cattle
- Acquired asymmetric hindquarters of pigs

#### Defects of the Skeleton

- Dwarfism—inherited miniature calves, achondroplastic dwarves; short legs of inherited congenital osteopetrosis; nutritional deficiency of manganese; acorn calves
- Giant stature—inherited prolonged gestation, not really giantism, only large at birth
- Asymmetry—normal wither height, low pelvis height of hyena disease of cattle
- Limbs—complete or partial absence, inherited or sporadic amputates; curvature of limbs in rickets; bowie or bentleg of sheep poisoned by *Trachymene* spp.
- Head—inherited and sporadic cyclopean deformity; inherited probatocephaly (sheep's head) of calves; inherited moles,

Table 15-1 Differential diagnosis of diseases of the musculoskeletal system

Disease and clinical findings	Epidemiologic findings	Clinical pathology	Necropsy findings	Examples
<b>Myasthenia</b> Paresis, paralysis, and incoordination	Ischemia or reduced supply of energy or electrolytes.	Hypoglycemia, hypocalcemia, hypokalemia, hypomagnesemia	Reversible malfunction	Iliac thrombosis, toxemia, milk fever, lactic acidosis, some poisonous plants
<b>Myopathy</b> <i>Either</i> stiff gait, disinclination to move, board-like muscles <i>or</i> weakness, pseudoparesis <i>or</i> paralysis, difficulty rising, staggy gait, flabby muscles. Always bilateral, mostly hindlimbs.	Often precipitated by sudden increase in muscular work. Usually diet-dependent and related to: (1) high carbohydrate intake (2) deficiency in selenium/vitamin E intake (3) Ingestion of myopathic agents (e.g., in poisonous plants, cod liver oil)	Marked elevations in serum activity of CPK and AST. Myoglobinemia and possibly myoglobinuria.	White, waxy, swollen, "fish flesh" muscle.	<i>Horses</i> : Azoturia (equine paralytic myoglobinuria, tying up, equine rhabdomyolysis, equine atypical myopathy); postanesthetic myositis. <i>Pigs</i> : Porcine stress syndrome, selenium deficiency, inherited splaylegs. <i>Cattle</i> : Selenium/vitamin E deficiency (enzootic muscular dystrophy), poisoning by <i>Cassia occidentalis</i> , <i>Karwinskia humboldtiana</i> , ischemic necrosis of recumbency. <i>Sheep</i> : Approximately the same; exertional rhabdomyolysis.
<b>Myositis</b> Acute inflammation, swelling, pain; may be associated with systemic signs if infectious. Chronic manifested by atrophy, contracture of joint, incomplete extension.	Related to trauma or specific infectious disease. Atrophy, pallor in chronic.	As for myopathy, plus hematologic response when infection present.	Bruising, edema, and hemorrhage in acute.	Blackleg, false blackleg (malignant edema). Eosinophilic myositis in beef cattle. Traumatic injury by strain of muscle or forceful impact.
<b>Osteodystrophy</b> Stiff gait, moderate lameness often shifting from leg to leg, arched back, crackling sounds in joints while walking. Disinclination to move; horses affected early race very poorly.  Severely affected animals disinclined to stand, recumbent much of time. Fractures common. Bones soft (e.g., frontal bones) to digital pressure. Deformities of bones (e.g., bowing, pelvic collapse). Ready detachment of tendons and ligaments.	Absolute deficiency and/or relative imbalance of dietary calcium, phosphorus, and vitamin D. Most apparent in rapidly growing, working, and heavy milk-producing animals.	Radiographic evidence of osteoporosis, deformed epiphyseal lines, broadness of epiphyses. Subperiosteal unossified osteoid.	Osteoporosis, subepiphyseal collapse of bone at pressure points. Fracture of soft bones. Bone ash determinations of Ca, P, and Mg content of bones.	<i>Cattle</i> : Phosphorus deficiency, Marie's disease. Hypovitaminosis D. Calcium deficiency. Poisoning by <i>Trachymene glaucifolia</i> (bowie or bentleg).  <i>Horses</i> : Osteodystrophia fibrosa as a result of low calcium diet, or to poisonous plants containing large amounts of oxalate (see under oxalate poisoning). <i>Pigs</i> : Osteodystrophia fibrosa attributable to low Ca and high P in diet.
<b>Osteomyelitis</b> Pain, swelling (little), toxemia, fever; may be discharge through sinus.	Only of specific disease.	Radiographic evidence of rarefaction, new bone growth.	Osteomyelitis.	Actinomycosis, brucellosis in pigs and cattle. Necrotic and atrophic rhinitis disease in pigs.
<b>Arthropathy (osteoarthritis)</b> Lameness with pain on walking, standing, palpation. Some enlargement but not gross.	(1) Inherited predisposition in cattle (2) Dietary excess of phosphorus, relative deficiency of calcium	Excessive sterile brownish fluid with floccules. Radiologic evidence of joint erosion, epiphyseal deformity, new bone growth peripherally.	Erosion of cartilage and bone, ligament rupture, new bone growth (epiphyses) around edge of joint.	<i>Cattle</i> : Degenerative joint disease (of young beef bulls), inherited osteoarthritis. <i>Horses</i> : As early part of osteodystrophy syndrome.

Continued



Table 15-1 Differential diagnosis of diseases of the musculoskeletal system—cont'd

Disease and clinical findings	Epidemiologic findings	Clinical pathology	Necropsy findings	Examples
Slackness in joints, may be ligament rupture, crepitus.	(3) Very rapid increase in body weight in young (4) Heavy milk production during many lactations		Excess brownish sterile clear fluid containing floccules.	<i>Pigs:</i> Epiphysiolysis of femurs of young breeding boars. Osteochondrosis.
<b>Arthritis</b> <i>Acute:</i> Sudden onset, severe pain, very lame, sore to touch, swelling and heat in joint.  <i>Chronic:</i> Continuous pain, recumbency, may be toxemia if infectious. Joint may be visibly swollen but may be normal in appearance. Pain may be evident only when animal stands on joint.	Most commonly in young via navel infection and bacteremia, or residual from septicemia of neonate.	Aspiration of fluid under very sterile conditions shows leukocytes and somatic cells in large numbers. Culture may be positive but often negative.  Joint fluid may appear normal in chronic case	<i>Acute:</i> Inflammation or suppuration, increased fluid content. <i>Chronic:</i> Thickened synovial membrane.  Increased amount of clear fluid. Erosion of articular cartilage	<i>Cattle:</i> <i>Mycoplasma</i> spp., <i>Erysipelothrix rhusiopathiae</i> , <i>Streptococcus</i> and <i>Staphylococcus</i> spp., <i>Escherichia coli</i> ,  <i>Salmonella</i> spp. in newborn. <i>Brucella abortus</i> , <i>Mycoplasma</i> spp. and <i>Chlamydophila</i> spp. <i>Pigs:</i> <i>E. Erysipelothrix rhusiopathiae</i> , <i>Mycoplasma</i> spp. <i>Sheep:</i> <i>Corynebacterium pseudotuberculosis</i> , <i>E. rhusiopathiae</i> , <i>Histophilus somni</i> , <i>Mannheimia haemolytica</i> , <i>Actinobacillus seminis</i> , <i>Chlamydophila</i> spp., <i>Mycoplasma</i> spp. <i>Horses:</i> Foal septicemias.
<b>Tenosynovitis, cellulitis, lymphangitis, bursitis</b> Inflammation of other supporting tissues. Visible, painful enlargements.	Sporadic as a result of trauma or localization of systemic infection.	Culture of aspirate from local lesion.	Inflammation of affected part. Acute hemorrhagic or chronic, suppurative.	<i>Horses and cattle:</i> Bursitis— <i>B. abortus</i> . Tenosynovitis— <i>Histophilus somni</i> , cattle, <i>Streptococcus equi</i> horse, <i>Histophilus somni</i> , sheep.
<b>Interdigital dermatitis (footrot)</b> Severe foot lameness. Visible local lesion at skin-horn junction, necrotic smell, horn underrun. Allied similar conditions have less severe lesions.	Severe epidemics in wet, warm weather in sheep. Infection soil-borne. Some farms have disease persistently.	Culture of infectious agent, swab from depth of lesion.	Necrosis of soft tissue.	<i>Sheep:</i> Footrot— <i>Bacteroides nodosus</i> ; foot scald—avirulent <i>B. nodosus</i> ; foot abscess— <i>F. necrophorus</i> ; <i>Trueperella pyogenes</i> ; interdigital dermatitis— <i>F. necrophorum</i> . <i>Cattle:</i> Footrot— <i>F. necrophorum</i> , <i>B. nodosus</i> .
<b>Laminitis</b> Severe foot pain, separation of horn from sensitive laminae, rotation of the pedal bone. Metabolic, traumatic, or infectious types.	Sporadic except infectious type in sheep related to dipping. Possibly inherited susceptibility to metabolic laminitis in cattle.	Very high blood pressure. Radiologic demonstration of P <sub>3</sub> rotation.	Infection or hemorrhage/edema, sensitive laminae.	<i>Sheep:</i> <i>Erysipelothrix rhusiopathiae</i> —postdipping laminitis. <i>Horses</i> —traumatic as a result of continuous pawing. <i>All species:</i> Metabolic associated with heavy grain feeding—in mares with retained placenta and metritis.
<b>Damage to horn of hoof</b> Severe foot pain if sensitive laminae affected. Horn damage obvious.	Related to hard, abrasive surfaces—pigs and dairy cattle; soft underfoot—cows indoors on wet bedding.	None.	Foot-horn lesion only.	<i>Cattle:</i> Stable footrot on soft footing; sole wear on rough concrete. <i>Pigs:</i> Sole wear on rough concrete, predisposed by biotin deficiency in diet. <i>Horses:</i> Thrush and canker on soft wet underfoot.

Table 15-1 Differential diagnosis of diseases of the musculoskeletal system—cont'd

Disease and clinical findings	Epidemiologic findings	Clinical pathology	Necropsy findings	Examples
<b>Traumatic injuries of feet of newborn piglets</b>				
Severe lameness in piglets 1–8 days of age. Bruising of sole, congestion, and swelling followed by peeling, erosion, and cracking of horn of sole; both claws and accessory digits injured more often on medial aspect, and incidence in hindfeet twice that of forefeet; abrasions of skin of carpal joints common; accessory digits involved too. Ascending secondary bacterial infection resulting in tenosynovitis and septic arthritis. Most piglets recover following antibacterial therapy.	Newborn piglets raised on concrete or slatted floors. Distribution of lesions related to sucking behavior of piglets, the backward, outward, and downward thrusting movements of the hindlegs while sucking.	None.	Erosion, necrosis, congestion, fissures, and hemorrhage of horn of sole and sensitive laminae of digit. Secondary tenosynovitis and arthritis.	<i>Piglets:</i> Newborn piglets raised on concrete, expanded metal, or plastic slatted floors.
<b>Coronitis dermatitis at coronet</b>				
Lesions vary from granuloma through vesicles, erosions. Lameness in all, but severity varies with type of lesion. Essential to examine oral mucosa.	Acute outbreaks of lameness as a result of coronitis in any species raises specter of food-and-mouth disease.	Microbiology of material from local lesion.	Local lesions only.	<i>Sheep:</i> Bluetongue, foot-and-mouth disease, vesicular stomatitis, ecthyma, strawberry footrot, ulcerative dermatosis, heel dermatitis ( <i>B. nodosus</i> ), strongyloidosis. <i>Cattle:</i> Foot-and-mouth disease, vesicular stomatitis, bovine virus diarrhea, bovine malignant catarrh, epitheliogenesis imperfecta. <i>Pigs:</i> Foot-and-mouth disease, vesicular exanthema of swine, swine vesicular disease, vesicular stomatitis. <i>Horses:</i> Vesicular stomatitis, greasy heel, chorioptic mange.

AST, aspartate aminotransferase; CPK, creatine phosphokinase.

bulldog calves; acquired atrophic rhinitis of pigs

### Joint Defects

- Inherited congenital ankylosis of cattle causing fixation of flexion
- Joint enlargement of rickets and chronic arthritis

### SPONTANEOUS FRACTURES

Spontaneous fractures occur uncommonly in farm animals, with the exception of physeal fractures of the metacarpus and metatarsus in young ruminants, and preexisting diseases are usually present in fractures not associated with a traumatic incident, such as the following:

- Nutritional excess of phosphorus causing osteodystrophia in horses
- Nutritional deficiency of calcium causing osteodystrophia in pigs

- Nutritional deficiency of phosphorus or vitamin D in ruminants causing rickets and/or osteomalacia; hypervitaminosis A may contribute
- Nutritional deficiency of copper
- Chronic fluorine intoxication

### PAINFUL ASPECTS OF LAMENESS

**Musculoskeletal pain** can be caused by lacerations and hematomas of muscle, myositis, and space-occupying lesions of muscle. Osteomyelitis, fractures, arthritis, joint dislocations, and sprains of ligaments and tendons are also obvious causes of severe pain. Among the most painful of injuries are swollen, inflammatory lesions of the limbs caused by deep penetrating injury or in cattle by extension from footrot. Amputation of a claw, laminitis, and septic arthritis are in the same category. Ischemia of muscle and generalized muscle tetany, as occurs in

electroimmobilization, also appear to cause pain.

Research on the pathophysiology and pharmacology of pain associated with lameness in animals indicates that the thresholds to painful stimuli change in response to pain (wind-up), and this change is seen as an indication of an alteration in nerve function or in nociceptive processing at higher levels. In flocks of sheep with severe lameness as a result of footrot, affected sheep had a lower threshold to a mechanical nociceptive stimulus than matched controls, and their thresholds remained low when tested 3 months later, after the apparent resolution of the foot lesions. Thus hyperalgesia persisted in severely lame sheep for at least 3 months. It is suggested that *N*-methyl-D-aspartate receptors are involved in the development of this long-term hypersensitivity. Similar findings have been reported in dairy heifers affected with claw lesions during the peripartum period.

### Relief of Musculoskeletal Pain

Several aspects of relieving pain in agricultural animals are important. Cost has always been a deterrent to the use of local anesthetics and analgesics, but with changing attitudes, the need to control pain is more apparent. Treatment of the causative lesion is a major priority, but the lesion may be painful for varying lengths of time.<sup>2</sup> Relief and the control of pain should be a major consideration. Details on the use of analgesics are presented in Chapter 4.

### REFERENCES

1. Shearer JK, et al. *Vet Clin North Am Food A.* 2012;28:535.
2. Shearer JK, et al. *Vet Clin North Am Food A.* 2013;29:135.

## EXAMINATION OF THE MUSCULOSKELETAL SYSTEM

The clinical examination of the musculoskeletal system and the feet of farm animals includes the following special examinations.

### Analysis of Gait and Conformation

Inspection of the gait of the animal is necessary to localize the site of lameness. Evaluation of its conformation may provide clues about factors that may contribute to lameness. Information related to gait and abnormalities of the nervous system is presented in Chapter 15. Details on the examination of farm animals for lameness are available in textbooks on lameness in horses and cattle. Computer-assisted analysis of gait (kinematics) and hoof loading (via force plates) are commonly used in equine practice and are increasingly being used in research studies related to lameness in cattle and pigs.<sup>1</sup>

### Close Physical Examination

A close detailed physical examination of the affected area is necessary to localize the lesion. This includes passive movements of limbs to identify fractures, dislocations, and pain on movement. Muscles can be palpated for evidence of enlargement, pain, or atrophy.

### Radiography

Radiography remains an extremely useful diagnostic method for diseases of bones and joints and soft tissue swelling of limbs, which cannot be easily defined by physical examination. Detailed radiographic information about the joint capsule, joint cavity, or articular cartilage can be obtained using negative (air), positive, or double-contrast arthrography.

The widespread availability of digital imaging systems (direct radiography [DR]) now permits radiographs to be immediately examined on-site, rather than following development in the clinic. This ensures that good-quality images are obtained in all views, and the information is used in real time to direct treatment.<sup>2</sup> The price of

digital radiography systems continues to decrease but is still significant relative to ultrasonography.

### Ultrasonography

Most large animal veterinary practices have an ultrasound machine that is used for transrectal pregnancy diagnosis in cattle and horses and transabdominal pregnancy diagnosis in sheep and goats. Use of these machines with a 5.0- or 7.5-MHz linear transducer provides a rapid on-farm method for evaluating musculoskeletal, tendon, and joint diseases. Ultrasonography is cheaper and provides different information than that provided by radiography; it is also less invasive than joint fluid aspiration and analysis. Detailed information about the use of ultrasonography to diagnose bovine musculoskeletal disorders is available.<sup>3,4</sup> Recent advances in ultrasound technology, including harmonic imaging, compound imaging, three-dimensional (3D) imaging, elastography, and fusion imaging will increase the clinical utility of ultrasonography in ambulatory practice.<sup>5,6</sup>

Ultrasonographic examination of the stifle region in cattle has successfully imaged homogeneously echogenic patellar and collateral ligaments, the combined tendon of the long digital extensor and peroneus tertius muscles, the popliteal tendon, the anechoic articular cartilage of femoral trochlea, the echogenic menisci, and the hyperechoic bone surfaces were imaged successfully. The boundaries of the joint pouches became partially identifiable only when small amounts of anechoic fluid were present in the medial and lateral femorotibial joint pouches. The main indication for ultrasonography of the bovine stifle is evaluation of acute septic and traumatic disorders of the region, when specific radiographic signs are often nonspecific or absent. The cruciate ligaments could not be imaged in live cattle. The cruciate ligaments are identifiable using ultrasonography in the horse, in which flexion of the hindlimb is a routine procedure necessary for identification of these structures.

The main indication for ultrasonographic examination of the carpal region in cattle is the evaluation of septic and traumatic disorders of the carpal joints and tendon sheaths. Each tendon and tendon sheath in the carpal region must be scanned separately. The use of a stand-off pad is recommended because it permits adaptation of the rigid transducer to the contours of the carpus. The carpal joint pouches and tendon sheath lumina are not clearly defined in healthy cattle. Thus the ability to image these structures indicates the presence of synovial effusion. Ultrasonographic imaging can be used to differentiate the pathologic changes in the soft tissue structures of digital flexor tendon sheaths of cattle.

Ultrasonography is a valuable diagnostic aid for septic arthritis. Joint effusion, which is one of the earliest signs of septic arthritis;

the accurate location of soft tissue swelling; the extent and character of joint effusion; and involvement of concurrent periarticular synovial cavities or other soft tissue structures can be imaged by ultrasonography. The ultrasonogram can image the presence of small hyperechogenic fragments within the joint, which appear very heterogeneous. Normal synovial fluid is anechoic and appears black on the sonogram. A cloudy appearance is usually associated with the presence of pus.

Ultrasonography has been used to evaluate the anatomy of the elbow, carpal, fetlock, and stifle joints of clinically normal sheep using a 7.5-MHz linear transducer with a stand-off pad. The anatomic structures that could be consistently identified in normal ovine joints included bone, articular cartilage, ligaments, and tendons. In sheep with chronic arthritis/synovitis, the gross thickening of the joint capsule is visible as a hyperechoic band up to 20 mm thick.

### Arthrocentesis and Synovial Fluid Interpretation

Joint fluid is collected by needle puncture of the joint cavity (arthrocentesis) and examined for the presence of cells, biochemical changes in the joint fluid, and the presence of infectious agents.

Analysis of synovial fluid is a fundamental requirement for differentiating septic arthritis from degenerative arthritis, and fluid parameters are summarized in [Table 15-3](#) later in this chapter. A number of inflammatory biomarkers in synovial fluid have been evaluated in research studies, but the leukocyte count and differential, erythrocyte count, total protein concentration, and an index of viscosity usually provide sufficient information for clinical use.

Arthrocentesis can result in joint contamination with hair when a 20-g needle is inserted. Angled needle insertion reduces joint contamination relative to perpendicular insertion.<sup>6</sup> Insertion of a spinal needle with the stylet in place also reduces joint contamination with hair, relative to insertion without the stylet. A larger-diameter needle (19 g) had a higher risk of hair contamination after arthrocentesis than a 20-g needle.<sup>7</sup>

### Arthroscopy

Special endoscopes are available for inspection of the joint cavity and articular surfaces (arthroscopy). Diagnostic and surgical arthroscopy are now commonplace in specialized equine practice. Surgical arthroscopy is rapidly replacing conventional arthrotomy for the correction of several common surgical conditions of the musculoskeletal system of the horse. Accurate quantification of equine carpal lesions is possible when the procedure is performed by an experienced arthroscopist. Convalescent time following surgery is decreased and the cosmetic appearance



improved compared with arthrotomy. A synovial membrane biopsy can be examined histologically and for infectious agents and may yield useful diagnostic information. Surgical arthroscopy is being increasingly used in referral cattle practice.<sup>8</sup>

### Serum Biochemistry and Enzymology

When disease of bone or muscle is suspected, the serum concentration of calcium and phosphorus, the serum alkaline phosphatase activity, and the serum activity of two muscle-derived enzymes, creatinine kinase (CK) and aspartate aminotransferase (AST), also known as serum glutamic oxaloacetic transaminase (SGOT), may be useful. Both CK and AST are sensitive indicators of muscle cell damage, with CK also being specific. Equations have been developed that relate the change in serum CK activity to grams of skeletal muscle tissue damaged; this methodology should be widely applied in the clinical management of livestock with musculoskeletal injury because it is sufficiently sensitive to pick up skeletal muscle damage as a result of an intramuscular (IM) antibiotic injection.<sup>9</sup>

Other serum biochemical indicators of muscle damage that have been used in experimental studies include myoglobin, a low-molecular-weight protein that is an early marker of muscle damage, and two indices of muscle damage: myosin, a high-molecular-weight protein, and 3-methylhistidine, a posttranslationally modified amino acid released after myosin or actin degradation.<sup>9</sup> In normally hydrated animals with normal renal function, it is important to understand that serum creatinine concentration provides a useful index of skeletal muscle mass. This is covered in more detail in [Chapter 13](#).

The serum concentrations of calcium and phosphorus and the serum alkaline phosphatase activity are much less sensitive indicators of osteodystrophy.

### Muscle Biopsy

A muscle biopsy may be useful for microscopic and histochemical evaluations.

### Infrared Thermography

Infrared thermography has been increasingly applied to the diagnosis of inflammatory conditions of muscles and tendons, in that acute inflammation is associated with localized heat that can be detected by using a camera capable of imaging the infrared spectrum.<sup>10,11,12</sup>

### Nuclear Scintigraphy

Technetium-labeled bone scanning has been available for decades at major referral institutions, but the use of nuclear scintigraphy has declined with the increased availability and resolution of ultrasonographic and magnetic resonance imaging (MRI) units. Nevertheless, scintigraphy is still a valuable diagnostic method for bone diseases such as

osteomyelitis of the vertebral column in adult horses and cattle when the lesion is surrounded by a large mass of superimposing muscle.<sup>13</sup>

### Magnetic Resonance Imaging

MRI is increasingly being used for the diagnosis of musculoskeletal disease and related research studies.<sup>14,15</sup> As a cross-sectional imaging modality, it provides outstanding tissue contrast and multiple views of the region of interest. Because of the high cost of purchasing and maintaining MRI equipment, this modality is only available at large referral centers, and even then, specially constructed tables have to be made to permit imaging of adult horses and cattle under general anesthesia. High-quality images can usually be obtained from the carpus and hock to the hoof or foot. It is anticipated that rapid advances will be made in the clinical application of MRI to the diagnosis of specific musculoskeletal injuries, such as evaluating cartilage damage and navicular disease in horses.<sup>14,15</sup>

### Computed Tomography

Computed tomography (CT) has not been used much for the clinical analysis of musculoskeletal tissue. It is anticipated that continued advances in MRI technology will continue to make this the preferred anatomic technology, despite the development of CT units in Europe that can accommodate the standing horse.<sup>16</sup>

### Nutritional History

Because the most important osteodystrophies and myopathies are nutritional in origin, a complete nutritional history must be obtained. This should include an analysis of the feed and determination of the total amount of intake of each nutrient, including the ratio of one nutrient to another in the diet.

### Environment and Housing

When outbreaks of lameness occur in housed cattle, sheep, goats, and pigs, the quality of the floor must be examined to evaluate the possibility of floor-related injuries.

### REFERENCES

1. Stavarakakis S, et al. *Livestock Sci.* 2014;165:104.
2. Nelson NC, Zekas LJ. *Vet Clin Equine.* 2012;28:483.
3. Kofler J. *Vet Clin North Am Food A.* 2009;25:687.
4. Kofler J, et al. *Vet Clin North Am Food A.* 2014;30:11.
5. Neelis DA, Roberts GD. *Vet Clin Equine.* 2012;28:497.
6. Wahl K, et al. *Vet Surg.* 2012;41:391.
7. Waxman SJ, et al. *Vet Surg.* 2015;44:373.
8. Lardé H, Nichols S. *Vet Clin North Am Food A.* 2014;30:225.
9. Lefebvre HP, et al. *Vet Res.* 1996;27:343.
10. Stokes JE, et al. *Vet J.* 2012;193:674.
11. Alsaad M, et al. *Vet J.* 2014;199:281.
12. Alsaad M, et al. *Sensors (Basel).* 2015;15:14513.
13. Selberg K, Ross M. *Vet Clin Equine.* 2012;28:527.
14. Winter MD. *Vet Clin Equine.* 2012;28:599.

15. Pease A. *Vet Clin Equine.* 2012;28:637.

16. van Weeren PR, Firth EC. *Vet Clin Equine.* 2008;24:153.

## Diseases of Muscles

### MYASTHENIA (SKELETAL MUSCLE ASTHENIA)

The differential diagnosis of paresis, paralysis, and incoordination should include a consideration of skeletal muscle weakness unrelated to primary neurogenic hypotonia or to permanent muscle injury, including myopathy and myositis. Most of the syndromes that fall into this group of myasthenia have been described in detail elsewhere in this book and are referred to briefly here only to complete the list of abnormalities of skeletal muscle that affect gait and posture. Unlike myopathy and myositis, they are reversible states.

The common causes of myasthenia in farm animals are as follows:

- **Ischemia** in iliac thrombosis in the horse and neonatal calf and after recumbency in cows with parturient paresis. The end stage is myonecrosis and is not reversible.
- **Metabolic effect on muscle fibers**—causes include hypokalemia, hypocalcemia, and possibly hypophosphatemia (in parturient paresis of dairy cows), hypomagnesemia (in lactation tetany), hypoglycemia of newborn pigs, and lactic acidemia after engorgement on grain.
- **Toxins**—general toxemia is a cause. Also, many plant toxins exert an effect on skeletal muscle activity. Although in most cases the mode of the action of the toxin is unknown (hypoglycin A is a notable exception), the toxins have been listed as neurotoxins.

### MYOPATHY

The term *myopathy* describes the noninflammatory degeneration of skeletal muscle that is characterized clinically by muscle weakness and pathologically by hyaline degeneration of the muscle fibers. The serum activities of some muscle enzymes are elevated, and myoglobinuria is a common accompaniment.

### ETIOLOGY AND EPIDEMIOLOGY

The most important myopathies in farm animals are a result of nutritional deficiencies of vitamin E and selenium and the effects of unaccustomed exercise. In humans, in contrast, the muscular dystrophies occur as inherited defects of muscle or degenerative lesions caused by interruption of their nerve supply. The skeletal myopathies can be classified into primary and secondary myopathies.

A retrospective analysis of the case records in a veterinary teaching hospital over a 9-year period revealed that the most common myopathy in horses was exercise-associated muscle disorder (69%). The remainder consisted of postexhaustion syndrome (9%), infectious myopathies (11%), immunologic myopathy (6%), nutritional myopathy (5%), and hyperkalemic periodic paralysis (2%).

The major causes of myopathy in farm animals and their epidemiologic determinants are as follows.

### Enzootic Nutritional Muscular Dystrophy

A nutritional deficiency of vitamin E and/or selenium is a common cause of enzootic nutritional muscular dystrophy in young calves, lambs, foals, and piglets. Factors enhancing or precipitating onset include rapid growth, highly unsaturated fatty acids in the diet, and unaccustomed exercise. The disease also occurs in adult horses.

### Exertional or Postexercise Rhabdomyolysis

Exertional or postexercise rhabdomyolysis is not known to be conditioned by vitamin E (selenium) deficiency and occurs as equine paralytic myoglobinuria (tying-up syndrome, azoturia) in horses after unaccustomed exercise or insufficient training. It also occurs in sheep chased by dogs, in cattle after running wildly for several minutes, and as capture myopathy during capture of wildlife.

### Equine Atypical Myopathy (Seasonal Pasture Myopathy)

Equine atypical myopathy was originally referred to as *atypical myoglobinuria*, but was renamed to *atypical myopathy* to reflect the underlying pathologic process rather than a possible clinical sign. The first reports were in the United Kingdom, and following a large outbreak in northern Germany in fall 1995, the disease has now been recognized in most of Europe. A similar disease has been reported in the United States and named *seasonal pasture myopathy*. Cases have also been reported from Australia and New Zealand.

Affected horses at pasture have a sudden onset of clinical signs consistent with an acute, non-exercised-related myopathic process. The causative toxin appears to be **hypoglycin A**, which is found in the seeds of maple trees.

### Equine Polysaccharide Storage Myopathy

Equine polysaccharide storage myopathy is a metabolic disease being recognized with increasing frequency in many breeds of horse. It occurs in Quarter horses, Appaloosa, and Paint-related breeds. The disease represents a group of diseases with similar clinical signs and pathology but different

etiology. Some horses have a mutation in the glycogen synthase 1 (*GYS1*) gene that affects carbohydrate metabolism, including Percheron and Belgian draught horses.

### Metabolic

Hyperkalemic periodic paralysis occurs in certain pedigree lines of North American show Quarter horses.

### Degenerative Myopathy

Degenerative myopathy occurs in newborn calves, sheep, and goats infected by Akabane virus in utero.

### Inherited Myopathies

**Porcine stress syndrome**, which is discussed under that heading, now includes pale, soft, exudative pork encountered at slaughter and malignant hyperthermia following halothane anesthesia. Certain blood types in pigs have been used as predictors of stress susceptibility, and malignant hyperthermia in Pietrain pigs is genetically predetermined. Most of these myopathies of pigs thus have an inherited basis, and the stress of transportation, overcrowding, and handling at slaughter precipitates the lesion and rapid death.

**Congenital myopathy of Braunvieh–Brown Swiss calves** is thought to be inherited. Affected calves become progressively weak and recumbent within 2 weeks of birth.

**Doubling-muscling in cattle and splay-legs of newborn pigs** are also considered to be inherited. A **dystrophy-like myopathy** in a foal has been described and is similar to human muscular dystrophy. **Dystrophy of the diaphragmatic muscles** in adult Meuse–Rhine–Yessel cattle is thought to be inherited. **Xanthosis** occurs in the skeletal and cardiac muscles of cattle and is characterized grossly by a green iridescence.

### Toxic Agents

Certain myopathies are caused by poisonous plants, including *Cassia occidentalis*, *Karwinskia humboldtiana*, *Ixioloena* spp., *Geigeria* spp., and lupins. A special case is enzootic calcinosis of all tissues, especially muscle, and the principal signs are muscular. It is caused by poisoning by *Solanum malacoxylon*, *Tricetum* spp., and *Cestrum* spp. Another special case is equine atypical myopathy.

### Ischemia

Ischemic myonecrosis occurs in the thigh muscles of cattle recumbent for approximately 48 hours or more and is discussed in detail under the heading “Downer Cow Syndrome.” Iliac thrombosis in horses is an important cause of ischemic myopathy and has been reported in neonatal calves.

### Neurogenic

Neurogenic muscular atrophy occurs sporadically as a result of traumatic injury and subsequent degeneration or complete

severance of the nerve supply to skeletal muscle. The myopathy in arthrogryposis associated with the Akabane virus is thought to be a result of lesions of the lower motor neurons supplying the affected muscles. It has been suggested that cattle with muscular hypertrophy may be more susceptible to the effects of exercise and the occurrence of acute muscular dystrophy. Suprascapular nerve paralysis in the horse (sweeney) is a traumatic neuropathy resulting from compression of the nerve against the cranial edge of the scapula.

### Neoplasms

Neoplasms of striated muscle are uncommon in animals. Rhabdomyosarcomas are reported in the horse, affecting the diaphragm and causing loss of body weight, anorexia, and respiratory distress.

## PATHOGENESIS

### Primary Myopathy

The characteristic change in most cases of primary myopathy varies from hyaline degeneration to coagulative necrosis, affecting particularly the heavy thigh muscles and the muscles of the diaphragm. Myocardial lesions are also commonly associated with the degeneration of skeletal muscle and when severe will cause rapid death within a few hours or days. The visible effects of the lesions are varying degrees of muscle weakness, muscle pain, recumbency, stiff gait, inability to move the limbs, and the development of respiratory and circulatory insufficiency.

In primary nutritional muscular dystrophy associated with a deficiency of vitamin E and/or selenium there is lipoperoxidation of the cellular membranes of muscle fibers, resulting in degeneration and necrosis. The lesion is present only in muscle fibers, and the histologic and biochemical changes that occur in the muscle are remarkably similar irrespective of the cause. Variations in the histologic lesion occur but indicate variation in the severity and rapidity of onset of the change rather than different causes.

### Myoglobinuria

Because of the necrosis of muscle, myoglobin is excreted in the urine, and **myoglobinuric nephrosis** is an important complication, particularly of acute primary myopathy. The degree of myoglobinuria depends on the severity of the lesion, with acute cases resulting in marked myoglobinuria, and on the age and species of animal affected. Adult horses with myopathy may liberate large quantities of myoglobin, resulting in dark-brown urine. Yearling cattle with myopathy release moderate amounts, and the urine may or may not be colored; calves with severe enzootic nutritional muscular dystrophy may have grossly normal urine. In all species the renal threshold of myoglobin is so low that discoloration of the serum does not occur.

## Muscle Enzymes

An important biochemical manifestation of myopathy is the increased release of muscle cell enzymes that occurs during muscle cell destruction. Creatine kinase (CK) and serum glutamic oxaloacetate transaminase are both elevated in myopathy; CK, particularly, is a more specific and reliable indication of acute muscle damage. Increased amounts of creatinine are also released into the urine following myopathy.

## Exertional Rhabdomyolysis

In exertional rhabdomyolysis in horses there is enhanced glycolysis with depletion of muscle glycogen, the accumulation of large amounts of lactate in muscle and blood, and the development of hyaline degeneration of myofibers. Affected muscle fibers are richer in glycogen in the acute stage of “tying-up” than in the late stages, suggesting increased glycogen storage in the early phase of the disease compared with normal healthy horses. During enforced exercise there is local muscle hypoxia and anaerobic oxidation, resulting in the accumulation of lactate and myofibrillar degeneration. The pathogenesis of postanesthetic myositis in horses is uncertain. A significant postischemic hyperemia occurs in horses that develop postanesthetic myopathy. Postanesthetic recumbency can occur in the horse with polysaccharide storage myopathy.

## Types of Muscle Fiber Affected

In most animals, skeletal muscle is composed of a mixture of fibers with different contractile and metabolic characteristics. Fibers with slow contraction times have been called slow-twitch or type I fibers, and those with fast contraction time are fast-twitch or type II fibers. Histochemically, type I and II fibers can be differentiated by staining for myofibrillar ATPase. Type II fibers can be subgrouped into type IIA and IIB on the basis of acid preincubations. Several different characteristics of these muscle fibers have been studied in the horse. There are variations in the percentage of each type of fiber present and in composition of muscle fibers dependent on genetic background, age, and stage of training. There are also variations in the muscle fibers within one muscle and between different muscles. The histochemical characteristics of equine muscle fibers have been examined:

- Type I fibers are characterized by strong aerobic capacity, compared with type IIA.
- Type IIA fibers are more glycolytic and have strong aerobic and moderate to strong anaerobic capacities.
- Type IIB fibers are characterized by a relatively low aerobic and a relatively high anaerobic capacity and are glycolytic.

The histochemical staining characteristics of normal equine skeletal muscle have

been examined and serve as a standard for comparison with data obtained from skeletal muscles with lesions.

## Secondary Myopathy Resulting From Ischemia

In secondary myopathy resulting from ischemia there may be multiple focal areas of necrosis, which causes muscle weakness and results in an increase of muscle enzymes in the serum. The degree of regeneration with myofibers depends on the severity of the lesion. Some regeneration occurs, but there is considerable tissue replacement. In aortic and iliac thrombosis in calves under 6 months of age the thrombosis results in acute to chronic segmental necrosis of some skeletal muscles and coagulation necrosis in others.

## Neurogenic Atrophy of Muscle

In neurogenic atrophy there is flaccid paralysis, a marked decrease in total muscle mass, and degeneration of myofibers, with failure to regenerate unless the nerve supply is at least partially restored.

## CLINICAL FINDINGS

The nutritional myopathies associated with a deficiency of vitamin E and/or selenium occur most commonly in young, rapidly growing animals and may occur in outbreak form, particularly in calves and lambs. The details are presented under the heading “Vitamin E and Selenium Deficiency.”

## Primary Myopathy

In general terms, in acute primary myopathy there is a sudden onset of weakness and pseudoparalysis of the affected muscles, causing paresis and recumbency and, in many cases, accompanying respiratory and circulatory insufficiency. The affected animals will usually remain bright and alert but may appear to be in pain. The temperature is usually normal but may be slightly elevated in severe cases of primary myopathy. Cardiac irregularity and tachycardia may be evident, and myoglobinuria occurs in adult horses and yearling cattle. The affected skeletal muscles in acute cases may feel swollen, hard, and rubbery, but in most cases it is difficult to detect significant abnormality by palpation. Animals with acute cases of primary myopathy may die within 24 hours after the onset of signs.

## Acute Nutritional Myopathy

Although acute nutritional myopathy in horses occurs most commonly in foals from birth to 7 months of age, acute dystrophic myodegeneration also occurs in adult horses. There is muscle stiffness and pain, myoglobinuria, edema of the head and neck, recumbency, and death in a few days. A special occurrence of myopathy has been recorded in suckling Thoroughbred foals up to 5 months of age. The disease occurs in the

spring and summer in foals running at pasture with their dams and is unassociated with excessive exercise. In peracute cases there is a sudden onset of dejection, stiffness, disinclination to move, and prostration, with death occurring 3 to 7 days later. Lethargy and stiffness of gait are characteristic of less acute cases. There is also a pronounced swelling and firmness of the subcutaneous tissue at the base of the mane and over the gluteal muscles. There may be excessive salivation, desquamation of lingual epithelium, and board-like firmness of the masseter muscles. The foals are unable to suck because of inability to bend their necks. Spontaneous recovery occurs in mild cases, but most severely affected foals die.

Severe nutritional myopathy of the masseter muscles in a 6-year-old Quarter horse stallion has been reported. The masseter muscles were swollen and painful, and there was exophthalmos and severe chemosis with protrusion of the third eyelids. The mouth could be opened only slightly, and masticatory efforts were weak. Serum enzymology supported a diagnosis of nutritional muscular dystrophy, and the concentrations of vitamin E and selenium in the blood and feed were lower than normal.

## Tying-Up

In tying-up in horses there is a very sudden onset of muscle soreness 10 to 20 minutes following exercise. There is profuse sweating and the degree of soreness varies from mild, in which the horse moves with a short, shuffling gait, to acute, in which there is a great disinclination to move at all. In severe cases, horses are unable to move their hindlegs, and swelling and rigidity of the croup muscles develops. Myoglobinuria is common.

## Postanesthetic Myositis

Horses with postanesthetic myositis experience considerable difficulty during recovery from anesthesia. Recovery is prolonged, and when initial attempts are made to stand, there is lumbar rigidity, pain, and reluctance to bear weight. Some affected horses will be able to stand within several hours if supported in a sling. The limbs may be rigid and the muscles firm on palpation. In severe cases the temperature begins to rise—reminiscent of malignant hyperthermia. Other clinical findings include anxiety, tachycardia, profuse sweating, myoglobinuria, and tachypnea. Death may occur in 6 to 12 hours. Euthanasia is the only course for some horses. In the milder form of the syndrome, affected horses are able to stand but are stiff and in severe pain for a few days.

## Exertional Rhabdomyolysis

In horses, the clinical findings are **variable** and range from poor performance to recumbency and death. Signs may be mild and resolve spontaneously within 24 hours or severe and progressive.



The **usual presentation** is a young (2- to 5-year-old) female racehorse with recurrent episodes of stiff gait after exercise. The horse does not perform to expectation and displays a **short-stepping gait** that may be mistaken for lower leg lameness. The horse may be reluctant to move when placed in its stall, be apprehensive and anorexic, and frequently shift its weight. More severely affected horses may be unable to continue to exercise, have **hard and painful muscles** (usually gluteal muscles), sweat excessively, be apprehensive, refuse to walk, and be tachycardic and tachypneic. Affected horses may be hyperthermic. Signs consistent with abdominal pain are present in many severely affected horses. Deep-red urine (myoglobinuria) occurs but is not a consistent finding. Severely affected horses may be recumbent and unable to rise.

Many different manifestations of equine polysaccharide storage myopathy occur. All manifestations are related to dysfunction, which results in pain, weakness, segmental fiber necrosis, stiffness, spasm, atrophy, or any combination of these. The muscles most severely affected are the powerful rump, thigh, and back muscles, including the gluteals, semimembranosus, semitendinosus, and longissimus.

In exertional rhabdomyolysis in sheep chased by dogs, affected animals are recumbent, cannot stand, and appear exhausted, and myoglobinuria is common. Death usually follows. A similar clinical picture occurs in cattle that have run wildly for several minutes.

### Hyperkalemic Periodic Paralysis

Initially there is a brief period of myotonia with prolapse of the third eyelid. In severe cases, the horse becomes recumbent and the myotonia is replaced by flaccidity. Sweating occurs, and generalized muscle fasciculations are apparent, with large groups of muscle fibers contracting simultaneously at random. The animal remains bright and alert and responds to noise and painful stimuli. In milder cases, affected horses remain standing, and generalized muscle fasciculations are prominent over the neck, shoulder, and flank. There is a tendency to stand base-wide. When the horse is asked to move, the limbs may buckle, and the animal appears weak. The horse is unable to lift its head, usually will not eat, and may yawn repeatedly early in the course of an episode. The serum potassium levels are elevated above normal during the episodes.

### Secondary Myopathy Resulting From Ischemia

In secondary myopathy resulting from ischemia (e.g., downer cow syndrome), the affected animal is unable to rise, and the affected hindlegs are commonly directed behind the cow in the frogleg attitude. The appetite and mental attitude are usually normal. No abnormality of the muscles can

be palpated. With supportive therapy, good bedding, and the prevention of further ischemia by frequent rolling of the animal, most cows will recover in a few days.

In calves with aortic and iliac artery thrombosis there is an acute onset of paresis or flaccid paralysis of one or both pelvic limbs. Affected limbs are hypothermic and have diminished spinal reflexes and arterial pulse pressures. The diagnosis can be defined using angiography. Affected calves die or are euthanized because treatment is not undertaken.

### Neurogenic Atrophy

With neurogenic atrophy there is marked loss of total mass of muscle, flaccid paralysis, loss of tendon reflexes, and failure of regeneration. When large muscle masses are affected (e.g., quadriceps femoris in femoral nerve paralysis in calves at birth), the animal is unable to bear normal weight on the affected leg.

### Dystrophy of the Diaphragmatic Muscles

In dystrophy of the diaphragmatic muscles in adult Meuse–Rhine–Yessel cattle there is loss of appetite, decreased rumination, decreased eructation, and recurrent bloat. The respiratory rate is increased, with forced abdominal respirations, forced movement of the nostrils, and death from asphyxia in a few weeks.

Severe diaphragmatic necrosis in a horse with degenerative myopathy as a result of polysaccharide storage myopathy has been described. Affected horses may have severe respiratory distress and respiratory acidosis, and they do not respond to supportive therapy.

## DIAGNOSIS

### Muscle-Derived Serum Enzymes

The serum activity of the muscle enzymes is characteristically elevated following myopathy as a result of release of the enzymes from altered muscle cell membranes. CK is a highly specific indicator of both myocardial and skeletal muscle degeneration. Plasma CK activity is related to three factors: the amount and rate of CK released from an injured muscle into plasma, its volume of distribution, and its rate of elimination. CK has a half-life of about 4 to 6 hours; following an initial episode of acute myopathy, serum activity of the enzyme may return to normal within 3 to 4 days if no further muscle degeneration has occurred. Levels of AST are also increased following myopathy; however, because the enzyme is present in other tissues, such as the liver, it is not a reliable indicator of primary muscle tissue degeneration.

Because AST has a longer half-life than CK, the levels of AST may remain elevated for several days following acute myopathy. The daily monitoring of both CK and AST

levels should provide an indication of whether active muscle degeneration is occurring. A marked drop in serum CK activity and a slow decline in serum AST activity suggest that no further degeneration is occurring, whereas a constant elevation of CK suggests active degeneration.

In acute nutritional muscular dystrophy in calves, lambs, and foals the serum CK activity will increase from normal values of below 100 IU/L to levels ranging from 1,000 to 5,000 IU/L and even higher. The levels of CK in calves will increase from a normal of 50 IU/L to approximately 5,000 IU/L within a few days after being placed outdoors followed by unconditioned exercise. The amount of skeletal muscle damaged can be estimated based on the change in the amount of CK activity over time (specifically, the area under the serum CK activity–time relationship) and species-specific pharmacokinetic values related to CK clearance.<sup>1</sup>

The measurement of serum activity of glutathione peroxidase is a useful aid in the diagnosis of myopathy as a result of selenium deficiency.

In downer cows with ischemic necrosis of the thigh muscles, the serum CK and AST activities will be markedly elevated and will remain elevated if muscle necrosis is progressive in cows that are not well bedded and rolled from side to side several times daily to minimize the degree and extent of ischemic necrosis.

High serum activities of CK (1000 IU/L and greater) usually indicate acute primary myopathy. Levels from 500 to 1000 IU/L may be difficult to interpret in animals recumbent for reasons other than primary myopathy. This will necessitate a careful reassessment of the clinical findings, history, and epidemiology.

In horses with acute exertional rhabdomyolysis (paralytic myoglobinuria) the serum CK activity will range from 5000 to 10,000 IU/L. Following vigorous exercise in unconditioned horses, the serum CK and AST activity will rise as a result of increased cell membrane permeability associated with the hypoxia of muscles subjected to excessive exercise. Lactate dehydrogenase (LDH) activity has also been used as a biochemical measurement of the degree of physical work done by horses in training. With progressive training in previously unconditioned horses there is no significant change between rest and exercise in the serum CK, AST, and LDH activities. In horses with postanesthetic myositis the serum CK activity may exceed 100,000 IU/L, the serum calcium is decreased, and the serum inorganic phosphorus is increased. In naturally occurring cases of exertional rhabdomyolysis in horses the most consistent acid–base abnormality may be hypochloremia rather than metabolic acidosis as has been assumed.

## Muscle Biopsy

Investigation of the structural and biochemical alterations of muscle tissue in myopathy include biopsy techniques. Needle biopsies require specialized Bergstrom muscle biopsy needles, which are expensive, and most practitioners do not have them on hand. Open biopsy is recommended to obtain a strip of muscle. Biopsy of either the semi-membranosus or semitendinosus muscles, at a site between the base of the tail and the tuber ischium, provides an adequate sample. Muscle biopsy samples can be processed for either frozen section or routine formalin-fixed, paraffin-embedded sections. The frozen section is considered the gold standard.

Inclusions of periodic acid-Schiff (PAS)-positive, amylase-resistant complex polysaccharide are abnormal and characteristic findings in muscle of equine polysaccharide storage myopathy.

Histochemical techniques can be used on muscle biopsies of horses with muscular disease and animals with congenital and inherited myopathies.

## Myoglobinuria

Myoglobinuria is a common finding in adult horses with acute paralytic myoglobinuria but is not a common finding in acute nutritional muscular dystrophy in young farm animals, except perhaps in yearling cattle with acute muscular dystrophy. The myoglobinuria may be clinically detectable as a red-brown or chocolate-brown discoloration of the urine. This discoloration can be differentiated from that caused by hemoglobin by spectrographic examination or with the use of orthotolidine paper strips. Urine becomes dark when myoglobin levels exceed 40 mg/dL of urine. Discoloration of the plasma suggests hemoglobinuria. Both myoglobin and hemoglobin give positive results for the presence of protein in urine. Porphyrin causes a similar discoloration, although this may not be evident until the urine has been exposed to light for some minutes. The coloration is lighter, pink to red rather than brown, and the urine is negative to the guaiac test and fluoresces with ultraviolet light. Creatinuria accompanies acute myopathy but has not been used routinely as a diagnostic aid.

**Electromyography** is a special technique for the evaluation of the degree of neurogenic atrophy.

## NECROPSY FINDINGS

Affected areas of skeletal muscle have a white, waxy, swollen appearance like fish flesh. Commonly only linear strips of large muscle masses are affected, and the distribution of lesions is characteristically bilaterally symmetric. Histologically, the lesion varies from a hyaline degeneration to a severe myonecrosis, with subsequently the disappearance of large groups of muscle fibers and

replacement by connective tissue. Calcification of the affected tissue may be present to a mild degree in these cases.

The lesions in exertional rhabdomyolysis in the horse are of a focal distribution and consist of hyaline degeneration with insignificant inflammatory reaction and slight calcification. The degenerative changes affect primarily the fast-twitch fibers, which have a low oxidative capacity and are used when the horse runs at very close to its maximum speed.

## DIFFERENTIAL DIAGNOSIS

Most myopathies in farm animals occur in rapidly growing, young animals and are characterized clinically by a sudden onset of acute muscular weakness and pain, often precipitated by unaccustomed exercise. There may be evidence of a dietary deficiency of vitamin and selenium in the case of nutritional muscular dystrophy. A sudden onset of recumbency or stiffness in young farm animals that are bright and alert should arouse suspicion of acute muscular dystrophy. Primary myopathies are not common in adult cattle, sheep, or pigs, but myopathy secondary to recumbency for other reasons does occur.

Secondary myopathy as a result of aortic and iliac thrombosis in calves must be differentiated from other common causes of hindlimb paresis, including traumatic injury to the spinal cord, spinal cord compression as a result of vertebral body abscess, nutritional muscular dystrophy, myositis and nerve damage as a result of trauma of intramuscular injections, and clostridial myositis.

The exertional myopathies in the horse in training are usually readily obvious. Creatine kinase (CK) is a valuable aid to diagnosis. In special circumstances, such as neurogenic myopathy, muscle biopsy and electromyography may be useful additional diagnostic aids. The histologic and histochemical staining characteristics of equine muscle have been described and serve as a standard for comparison with abnormal muscle.

Myositis may present a similar syndrome but is usually present as a secondary lesion in a clinically distinguishable primary disease or is accompanied by obvious trauma or toxemia.

## TREATMENT

Vitamin E and selenium are indicated for the treatment of nutritional muscular dystrophy, and the details are provided under that heading. The treatment of exertional rhabdomyolysis in horses has not been well defined because of the uncertain etiology, but enforced rest and the relief of pain, if necessary, seem logical. Supportive therapy for any case of myopathy, particularly severe cases in which there is persistent recumbency, consists of the following:

- Liberal quantities of thick bedding, such as at least 6" (15 cm) of straw hay

- Removal from solid floors to softer ground
- Frequent turning from side to side to minimize secondary myopathy
- Provision of fluid therapy to prevent myoglobinuric nephrosis
- A palatable, nutritious diet

With the exception of the sporadically occurring congenital and inherited myopathies of farm animals, all the nutritional and exertional myopathies are amenable to treatment if it is begun early and if adequate supportive therapy is provided.

In myopathies associated with systemic acidosis, the use of a solution of sodium bicarbonate may be indicated. Dietary sodium bicarbonate at the rate of 2% of total dry matter intake has been used for the treatment of exertional rhabdomyolysis in a horse. Horses with postanesthetic myositis must be considered as critical care patients for 18 to 24 hours. Maintenance of adequate renal perfusion is vital. Large quantities of intravenous polyionic balanced electrolyte fluids (50 to 100 L) must be given over a 24-hour period. Dantrolene sodium at 4 mg/kg body weight (BW) given orally immediately upon recognition of clinical signs is efficacious.

## CONTROL

The nutritional myopathies in farm animals can be satisfactorily prevented by the provision of adequate quantities of dietary vitamin E and selenium in the maternal diet during pregnancy or at the strategic times in post-natal life. The prevention of exertional myopathy in the horse depends on a progressive training program and avoidance of sudden unaccustomed exercise in animals that are in good body condition and have been inactive. Similarly, in general terms, the prevention of porcine stress syndrome will depend on careful handling and transportation techniques combined with genetic selection of resistant pigs.

## FURTHER READING

- Naylor RJ. Polysaccharide storage myopathy—the story so far. *Equine Vet Educ.* 2015;27:414-419.
- Valberg SJ, McCue ME, Mickelson JR. The interplay of genetics, exercise, and nutrition in polysaccharide storage myopathy. *J Equine Vet Sci.* 2011;31:205-210.
- Votion DM. The story of equine atypical myopathy: a review from the beginning to a possible end. *ISRN Vet Sci.* 2012;article ID 281018.

## REFERENCE

1. Lefebvre HP, et al. *Vet Res.* 1996;27:343.

## MYOPATHY OF HORSES

Diseases of the muscles of horses include conditions that induce rhabdomyolysis (literally, dissolution or liquefaction of muscle) and, less commonly, conditions in which function of the muscle is impaired but there is not rhabdomyolysis. Rhabdomyolysis is characterized biochemically by marked

increases in the activity in serum of muscle-derived enzymes, such as creatine kinase (CK) and aspartate aminotransferase (AST). The diagnosis of rhabdomyolysis presents no great challenge, but determining the underlying disease condition usually requires a more sophisticated approach than just measuring CK and AST activity in serum.

### ETIOLOGY

Horses are affected by a number of diseases of muscle (Table 15-2), and diagnosis of the particular disease based solely on clinical signs might not be possible because of the limited range of manifestations of muscle disease. A useful differentiator is whether development of clinical signs is associated only with exercise or also occurs at rest. Classical exercise-induced rhabdomyolysis presents as signs of muscle disease during or soon after the completion of exercise, whereas signs of some inherited defects or intoxications are evident without the stimulus of exercise. Other muscle diseases can be apparent at rest and are exacerbated by exercise.

Myopathies of equids can be grouped according to their etiopathogenesis:

- **Genetic anomalies**—polysaccharide storage myopathy (type I), malignant hyperthermia, glycogen branching enzyme deficiency, hyperkalemic periodic paralysis, recurrent exertional rhabdomyolysis of Thoroughbreds (suspect), mitochondrial myopathy (specific genetic anomaly not identified), and myotonia in foals. More will be discovered with advent of access to the equine genome and ready access to advanced molecular technologies
- **Environmental or management**—unaccustomed exercise, heat stress or stroke, inconsistent exercise
- **Nutritional**—vitamin E/selenium deficiency (white-muscle disease, masseter myonecrosis), diet high in nonstructural (soluble) carbohydrates
- **Intoxications**—ingestion of hypoglycin A in *Acer negundo* or *Acer pseudoplatanus* seeds, inophores (monensin, salinomycin), tremetone (white snake root, rayless goldenrod [*Isocoma pluriflor*]), or *Cassia occidentalis*, or snake bite (*Notechis scutatus* and likely other elapid and crotalid snakes)
- **Infectious**—localized infections (clostridial myositis), *Streptococcus equi* myositis, *Salmonella* spp. myositis, associated with *Anaplasma phagocytophila* infection
- **Inflammatory or infarctive**—as part of purpura hemorrhagica (infarctive) or immune myositis (inflammatory)
- **Metabolic**—sarcopenia with pituitary pars intermedia dysfunction
- **Unknown**—sporadic exercise-induced rhabdomyolysis, recurrent

exercise-induced rhabdomyolysis, polysaccharide storage myopathy type II

### PATHOGENESIS

Exercise-induced rhabdomyolysis occurs because of abnormal responses of the muscle to contractions during exercise. Although the exact pathogenesis of exercise-induced muscle damage has not been demonstrated in horses, it likely involves accumulation of normal metabolites to excessive levels in all or part of the cell, formation of abnormal metabolites, or inadequate provision of energy to maintain homeostasis of myocytes during sustained or repetitive contractions. The critical common event is likely accumulation of calcium in the cytosol as a consequence of damage to the sarcolemma and sarcoplasmic reticulum and impaired function of calcium channels and pumps. Reduction of the cytosolic calcium concentration is achieved by the sarcoplasmic reticulum calcium-ATPase pump and calcium transport across the sarcolemma by the  $\text{Na}^+/\text{K}^+$  pump and the  $\text{Ca}^+/\text{Na}^+$  exchanger. Abnormal cytosolic calcium concentrations result in activation of intracellular proteases and other enzymes, leading to damage to cell constituents, including the cell membrane, with subsequent leakage of cell contents into interstitial fluid and blood. This is evident clinically as increases in activity in blood (serum, plasma) of muscle-derived enzymes (CK, AST, lactate dehydrogenase [LDH]) and concentration of myoglobin in blood and urine.

### DIAGNOSIS

Diagnosis of muscle diseases of horses is made using combinations of history and clinical signs, hematologic or biochemical examination of blood or urine, electromyography, exercise challenge tests, muscle biopsy, and genetic testing.

**Clinical signs** common to most muscle disease are varying degrees of exercise intolerance, gait abnormalities characterized by short strides or a stilted gait, pain on palpation of affected muscles, muscle fasciculation, myoglobinuria, and muscle atrophy. Not all signs are present in every disease of muscle, and horses can be clinically normal between episodes. Clinical signs of particular diseases are discussed under those topics elsewhere in this text.

There are no changes in routine hematology that are characteristic of all diseases of muscle or are discriminatory among muscle diseases. Most muscle diseases are associated with elevations in serum activity of **muscle-derived enzymes** (CK, AST, LDH). The most commonly measured enzymes are CK and AST. Serum concentrations of CK increase within minutes to hours of injury to the muscle and decline to baseline concentrations within 1 to 2 days of muscle cell membranes regaining their integrity. CK has an elimination half-life of approximately 2

hours in the plasma of horses, which accounts for the rapid reduction in activity in serum. Conversely, AST has a longer elimination half-life, and activity both increases and declines more slowly than that of CK. Horses with injury to muscle that resolved several days previously can therefore have normal activity of CK and elevated activity of AST in serum.

Plasma concentrations of **vitamin E** and **selenium**, or red cell glutathione peroxidase activity, are usually within the reference interval for healthy animals, with the exception of foals with white-muscle disease and adults with masseter myonecrosis.

Urinalysis of samples collected during the active phase of the disease can contain myoglobin. **Myoglobinuria** should be distinguished from hematuria (by centrifugation of the sample) or hemoglobinuria (by measurement of hemoglobin or myoglobin concentrations). Myoglobinuria kidney injury can cause the presence of granular casts in urine sediment. Urine and serum collected when the horse does not have clinical signs of muscle disease have been proposed to be useful in detecting abnormalities in body content of sodium, potassium, chloride, calcium, and phosphate. Calculation of **fractional excretion of electrolytes** have limited, if any, utility in the diagnosis of causes of exertional rhabdomyolysis.

**Muscle biopsy** is useful in providing a histologic diagnosis and is diagnostic in a number of diseases of muscle of horses. For muscle biopsy to be useful, the disease being considered must affect the muscle biopsied, the sample should be collected and transported to the laboratory in way that ensures that it is diagnostic, and the sample should be processed and examined in a laboratory accustomed to handling muscle biopsies. Open biopsies, as opposed to collection using a Bergstrom needle, are preferred for clinical samples.

**Genetic testing** is available for several diseases, and more tests will become available with advances in the field. Demonstration of mutations documented to cause muscle disease in a horse with compatible clinical signs can be considered diagnostic of the disease.

**Additional testing** can include imaging (ultrasonographic examination, scintigraphy), exercise testing, electromyography, analysis of targeted compounds in body fluids (e.g., methylenecyclopropyl acetic acid in horses with suspect hypoglycin A intoxication), and necropsy.

A rational diagnostic approach combining clinical signs, historical information, genetic testing, and muscle biopsy has been described (Fig. 15-1).<sup>1</sup>

### TREATMENT

Treatment should be directed at the underlying disease, and specifics are provided under each disease topic.



Table 15-2 Common or well-characterized myopathies of equids\*

Disease	Etiology	Risk factors	Clinical signs	Diagnosis	Treatment	Control
<b>Exertional myopathy</b>						
Sporadic exertional rhabdomyolysis	Unknown.	Unaccustomed exercise, heat stress or stroke, electrolyte imbalances.	Signs of acute rhabdomyolysis (see text).	Elevated serum activity of muscle-derived enzymes.	Supportive. Pain relief. Ensure adequate hydration.	Avoid known risk factors.
Recurrent exertional rhabdomyolysis (RER)	Idiopathic, presumed inherited in Thoroughbreds and Standardbreds.	Breed and diet in some instances.	Recurrent episodes of acute rhabdomyolysis.	Elevated serum activity of muscle-derived enzymes. Genetic testing. Muscle biopsy.	Supportive during acute episodes.	High-fat diet—for RER in Thoroughbreds and other light horse breeds. Dietary modification for PSSM (see following entry). Regular and consistent exercise. Turn out to pasture. Dantrolene (1–3 mg/kg PO q24h).
Polysaccharide storage myopathy type I (PSSM1)	Mutation in glycogen synthase gene (GYS1) leading to higher activity of glycogen synthase in muscle.	Quarter horse and related breeds, draft breeds (Belgians and Percherons), particularly in Europe, and Warmbloods. Many breeds affected. Intermittent exercise.	Exertional rhabdomyolysis (clinical or subclinical). Stiff gait, myalgia, and exercise intolerance. Some horses with histologic lesions are clinically normal. Homozygotes more severely affected than heterozygotes.	Genetic testing. Muscle biopsy.	Supportive.	Dietary control. High-fat, high-fiber diet with low content of soluble nonstructural carbohydrates. Regular, consistent exercise.
Polysaccharide storage myopathy type II (PSSM2)	No demonstrated abnormality in GYS1 gene or glycogen synthase activity. Unknown cause.	Disease documented in many breeds.	Exertional rhabdomyolysis (clinical or subclinical). Stiff gait, myalgia and exercise intolerance. Some horses with histologic lesions are clinically normal.	Examination of muscle biopsy. Rule out PSSM1 by genetic testing.	Supportive.	Dietary control. High fat, high fiber diet with low content of soluble nonstructural carbohydrates. Regular, consistent exercise.
Muscle sprains	Associated with exercise.	Exercise.	Localized muscle pain, stiff gait, ultrasonographic or scintigraphic abnormalities.	Clinical signs, response to treatment, results of imaging. Muscle-derived enzymes minimally elevated.	Rest. Nonsteroidal antiinflammatory drugs.	Prudent exercise and training schedules.
Mitochondrial myopathy	Deficiency of Complex I enzymes in respiratory chain of mitochondria. Other causes likely to be identified.	Exercise. Arabian breed.	No rhabdomyolysis. Severe exercise intolerance with signs of discomfort (sweating, short-strided gait).	Muscle-derived enzymes in serum not elevated. Accumulation of lactate out of proportion to exercise intensity or duration. Electron microscopy of muscle tissue.	Rest.	None. Consider wisdom of breeding affected horses.
<b>Nonexertional myopathy</b>						
Glycogen-branching enzyme deficiency	Fatal autosomal recessive mutation of glycogen branching enzyme (GBE1).	Foals of Quarter horse and related breeds.	Abortion and stillbirth. Neonates are hypoglycemic, weak, recumbent; die soon after birth.	Hypoglycemia. Minimal elevations in muscle derived enzymes. Accumulation of abnormal polysaccharide in muscle.	None.	Breeding programs.

Continued

Table 15-2 Common or well-characterized myopathies of equids\*—cont'd

Disease	Etiology	Risk factors	Clinical signs	Diagnosis	Treatment	Control
Malignant hyperthermia	Heterozygous, nonsynonymous polymorphism attributable to mutation in RyR1 gene (ryanodine receptor 1).	Quarter horse breed. Anesthesia.	Clinically normal until anesthetized, then hyperthermia, tachycardia, arrhythmias, rhabdomyolysis, and death.	Clinical signs. Elevated serum creatine kinase activity (but not in peracute cases). Detection of mutation by genetic analysis.	Supportive.	Detection of genetic abnormality before anesthesia.
Hyperkalemic periodic paralysis	Autosomal-dominant trait attributable to missense mutation in sodium channel gene (SCN4A).	Quarter horse or related breed. Familial and congenital.	Asymptomatic through episodic disease with occasional death. Muscle fasciculation and tremor. Episodic collapse with myotonia, prolapse of third eyelid, sweating, recumbency.	Measurement of serum potassium concentration (elevated) during episode. Genetic analysis.	Measure to reduce serum potassium concentration (dextrose, fluids, insulin).	Acetazolamide. Low-potassium diet. Prudent breeding program.
Myotonia	Hereditary. Genetic basis has not been identified.	Quarter horse, Thoroughbred, Anglo-Arabian foals.	Disease evident in foals. Generalized muscle stiffness. Dimpling of muscle on pressure (percussion). Weakness.	Classic electromyography of myotonic discharges (dive bomber).	None.	Prudent breeding programs.
Purpura hemorrhagica myopathy	Purpura hemorrhagica. Infarction of muscles.	As for purpura hemorrhagica.	Usually 2–4 weeks after respiratory infection. Acute-onset muscle pain, swelling, abnormal gait, plus signs of purpura hemorrhagica. High case-fatality rate.	Clinical signs. Increased serum activity of muscle-derived enzymes. Muscle biopsy.	Treatment of purpura hemorrhagica. Supportive. Pain relief.	Prevention of respiratory disease.
Immune myositis	Idiopathic.	More common in Quarter horses, but can affect any breed.	Severe muscle atrophy. No rhabdomyolysis at time of detection of atrophy.	Muscle biopsy—histiocytic lymphocytic myositis.	Administration of corticosteroids. Expect full recovery with or without treatment.	None.
Streptococcal myositis	Infection by <i>Streptococcus equi</i> .	Risk factors for infection by <i>S. equi</i> .	Acute- to peracute-onset myalgia, stiff gait, swelling and pitting edema of epaxial muscles.	Demonstration of muscle disease and rhabdomyolysis with <i>S. equi</i> infection.	Aggressive supportive care, antibiotic administration, NSAIDs.	Prevention of infection by <i>S. equi</i> .
Clostridia myositis	Infection by <i>Clostridium septicum</i> or other clostridia.	Trauma, intramuscular injections.	Acute-onset fever, tachycardia, localized pain over previous injection site or site of trauma.	Demonstration of clostridia in wound fluids.	Aggressive supportive care, administration of antimicrobials that block protein synthesis (tetracycline).	First aid of wounds, use of hygienic injection technique.
Massester myonecrosis	Likely selenium deficiency. Role for vitamin E unclear.	Horses on selenium-deficient diet.	Swelling and pain of masseter muscles, trismus; some horses have stilted gait and evidence of myocardial disease.	Clinical signs. Ultrasonographic examination of muscle and heart. Measurement of serum selenium concentration or red cell glutathione peroxidase activity.	Support. Administration of selenium with or without vitamin E.	Ensure diet contains adequate selenium.

Table 15-2 Common or well-characterized myopathies of equids\*—cont'd

Disease	Etiology	Risk factors	Clinical signs	Diagnosis	Treatment	Control
White-muscle disease	Selenium deficiency.	Foals in regions with low selenium in fodder.	Acute-onset weakness, stiff gait, recumbency, myoglobinuria.	Measurement of serum selenium concentration or red cell glutathione peroxidase activity. Increase serum activity of muscle-derived enzymes.	Supportive. Administration of selenium with or without vitamin E.	Ensure adequate selenium status of mares and foals.
Atypical pasture-associated myopathy	Ingestion of hypoglycin A in seeds of maple trees, <i>Acer negundo</i> (USA) or <i>Acer pseudoplatanus</i> (Europe).	Access to seeds of <i>A. negundo</i> or <i>A. pseudoplatanus</i> , usually by horses at pasture.	Acute onset of weakness, muscle fasciculations, myoglobinuria, recumbency, and death.	Increased concentrations of methylenecyclopropyl acetic acid in serum of affected horses.	Supportive.	Avoid exposure to seeds of <i>A. negundo</i> or <i>A. pseudoplatanus</i> .
Tremetone toxicosis	Rayless goldenrod ( <i>Isocoma pluriflora</i> ), white snakeroot.	Ingestion of plant.	Weakness, muscle fasciculation, tachycardia, arrhythmia, death over 5–7 days.	Increased serum CK and AST activity and troponin-I concentration. Necropsy with degeneration of myocardium and skeletal muscle.	Supportive.	Prevent access to the plants.
Envenomation by snakes	Documented as a consequence of envenomation by Australian tiger snake ( <i>Notechis scutatus</i> ).	Exposure to habitat of snakes.	Acute-onset anxiety, weakness, muscle fasciculations, myoglobinuria, death.	Demonstration of toxin in blood, body tissue, fluids, or urine. Elevated serum activity of muscle-derived enzymes.	Antivenom. Supportive care.	Avoid exposure to snakes.
Ionophore intoxication	Ingestion of ionophores such as salinomycin, monensin, lasalocid, maduramicin, or narasin.	None.	Anorexia, weakness, stiff gait, colic, recumbency, tachycardia, sudden death, myoglobinuria.	Historical exposure. Necropsy. Detection of ionophore in stomach contents.	Supportive. No specific antidote.	Ensure that horses do not have access to feed containing ionophores.
Fibrotic myopathy	Injury to hamstring muscles (semimembranosus and others).	Exercise. Congenital forms exist.	Foot-slapping gait. Firmness on palpation of hamstring region. Not painful. No response of gait to analgesics.	Differentiate from stringhalt. Palpation of affected muscles. Ultrasound examination.	Surgery.	None.

\*Not all myopathies are associated with rhabdomyolysis, and some are evident at rest. Details of each disease can be found under that topic. AST, aspartate aminotransferase; CK, creatine kinase; NSAIDs, nonsteroidal antiinflammatory drugs.



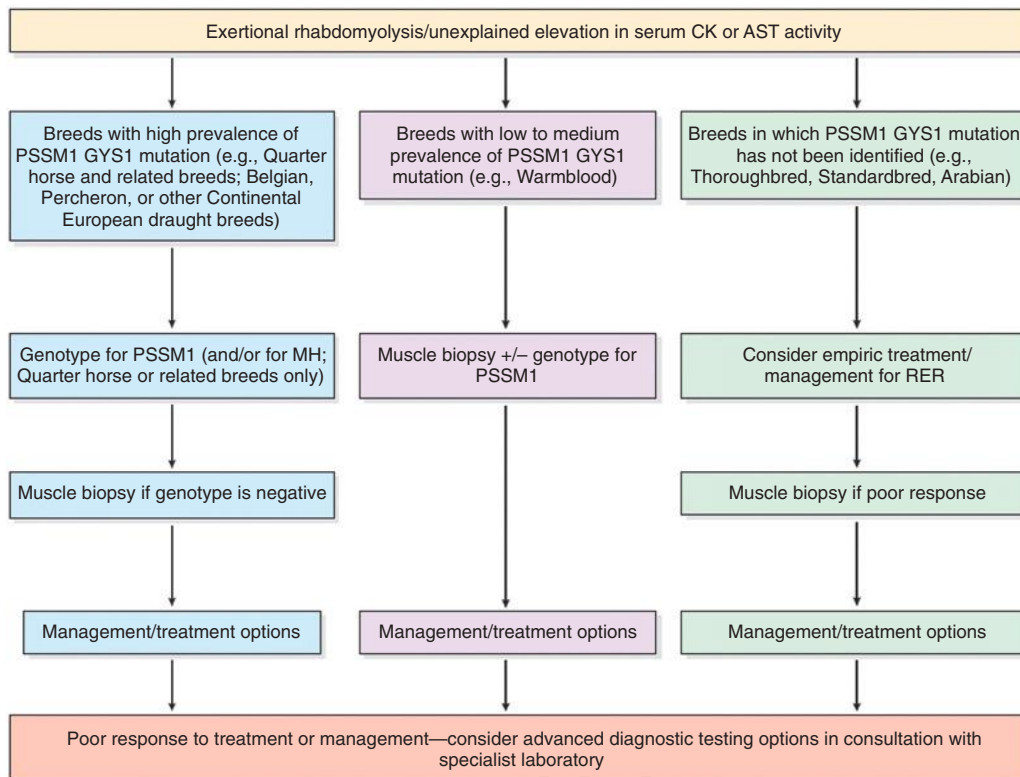

**Fig. 15-1** Diagnostic approach to horses with exertional myopathy or persistent increases in serum activity of creatine kinase and aspartate aminotransferase. The approach differs depending on the breed of horse (and hence pretest probability of disease and documented genetic abnormalities). MH, malignant hyperthermia; RER, recurrent exertional rhabdomyolysis (Reproduced with permission from Piercy RJ and Rivero J. Muscle disorders of equine athletes. In Hinchcliff KW, Kaneps AJ, and Geor RJ (eds): *Equine Sports Medicine and Surgery: Basic and clinical sciences of the equine athlete*, 2nd edition. W.B. Saunders. London. 2014:109.)

There are some general principles and treatments for management of acute rhabdomyolysis regardless of its underlying cause. The treatment chosen depends on the severity of the disease. The **general principles** are rest; correction of dehydration and electrolyte abnormalities; prevention of complications, including nephrosis and laminitis; and provision of analgesia.

**Mildly affected horses** (heart rate < 60 bpm, normal rectal temperature and respiratory rate, no dehydration) can be treated with rest and phenylbutazone (2.2 mg/kg, orally or intravenously [IV] every 12 hours for 2 to 4 days). Horses should be given mild exercise with incremental increases in workload as soon as they no longer have signs of muscle pain. Access to water should be unrestricted.

**Severely affected horses** (heart rate > 60 bpm, rectal temperature > 39° C [102° F], 8% to 10% dehydrated, reluctant or unable to walk) should not be exercised, including walking back to their stable, unless it is unavoidable. Isotonic, polyionic fluids, such as lactated Ringer's solution, should be administered IV to severely affected horses to correct any hypovolemia and to ensure a mild diuresis to prevent myoglobinuric nephropathy. Less severely affected horses can be treated by administration of fluids by nasogastric intubation (4 to 6 L every 2 to 3

hours). Although it has been recommended that urine should be alkalinized by administration of mannitol and sodium bicarbonate (1.3% solution IV, or 50 to 100 g of sodium bicarbonate orally every 12 hours) to minimize the nephrotoxicity of myoglobin, this therapy is not effective in humans at risk of myoglobinuric nephrosis. Affected horses should not be given diuretics (e.g., furosemide) unless they are anuric or oliguric after restoration of normal hydration.

**Phenylbutazone** (2.2 to 4.4 mg/kg, IV or orally, every 12 to 24 hours), **flunixin meglumine** (1 mg/kg IV every 8 hours), or **ketoprofen** (2.2 mg/kg IV every 12 hours) should be given to provide **analgesia**. **Mild sedation** (acepromazine 0.02 to 0.04 mg/kg IM, or xylazine 0.1 mg/kg IM, both with butorphanol, 0.01 to 0.02 mg/kg) can decrease muscle pain and anxiety. Tranquilizers with vasodilatory activity, such as acepromazine, should only be given to horses that are well hydrated. **Muscle relaxants**, such as methocarbamol, are often used but have no demonstrated efficacy. Dantrolene is used for prevention and does not have demonstrated efficacy in treatment of acute disease.

**Recumbent** horses should be deeply bedded and repositioned by rolling every 2 to 4 hours. Severely affected horses should not be forced to stand.

## CONTROL

Control measures should be specific for the particular disease wherever possible (see discussion of the specific diseases elsewhere in this text).

Prevention of the sporadic, idiopathic disease centers on ensuring that horses are fed a balanced ration with adequate levels of vitamin E, selenium, and electrolytes and have a regular and consistent program of exercise. Despite lack of clear evidence for a widespread role for **vitamin E or selenium deficiency** in exertional rhabdomyolysis, horses are often supplemented with 1 IU/kg vitamin E and 2.5 µg/kg selenium daily in the feed. Care should be taken not to induce selenium toxicosis.

**Sodium bicarbonate** (up to 0.5 to 1.0 g/kg body weight [BW] daily in the ration) and other electrolytes are often added to the feed of affected horses, but their efficacy is not documented. **Phenytoin** has proven useful in the treatment of recurrent rhabdomyolysis. It is administered at a dose rate of 6 to 8 mg/kg, orally, every 12 hours, and the dose is adjusted depending on the degree of sedation produced (a reduced dose should be used if the horse becomes sedated) or lack of effect on serum CK or AST activity. Phenytoin can be administered to horses for months. **Dimethylglycine, altrenogest, and progesterone** are all used on occasion in

horses with recurrent rhabdomyolysis, but again without demonstrated efficacy. **Dantrolene** might be effective in treatment of recurrent exertional rhabdomyolysis in Thoroughbred horses (see section on Recurrent Exertional Rhabdomyolysis later in this chapter).

The feeding of high-fat, low-soluble-carbohydrate diets is useful in the prevention of recurrent exertional rhabdomyolysis in Thoroughbred horses and polysaccharide storage myopathy in Quarter horses. The usefulness of this practice in preventing sporadic, idiopathic exertional rhabdomyolysis has not been demonstrated.

### FURTHER READING

Piercy RJ, Rivero J. Muscle disorders of equine athletes. In: *Equine Sports Medicine and Surgery: Basic and Clinical Sciences of the Equine Athlete*. 2nd ed. London: W.B. Saunders; 2014:109.

### REFERENCE

1. Piercy RJ, Rivero J. Muscle disorders of equine athletes. In: *Equine Sports Medicine and Surgery: Basic and Clinical Sciences of the Equine Athlete*. 2nd ed. London: W.B. Saunders; 2014:109.

## MYOSITIS

Myositis may arise from direct or indirect trauma to muscle and occurs as part of a syndrome in a number of specific diseases, including blackleg, foot-and-mouth disease, bluetongue, ephemeral fever, swine influenza, sarcosporidiosis, and trichinosis, although clinical signs of myositis are not usually evident in the latter. Sporadic cases of a localized infectious myositis of skeletal muscles, associated with *Escherichia coli*, may occur in calves. An asymptomatic eosinophilic myositis is not uncommon in beef cattle and may cause economic loss through carcass condemnation. The cause has not been determined.

### Acute Myositis of Limb Muscles

Acute myositis is accompanied by severe lameness, swelling, heat, and pain on palpation (Fig. 15-2). There may be accompanying toxemia and fever. In chronic myositis there is much wasting of the affected muscles, and this is difficult to differentiate clinically from atrophy as a result of other causes. Biopsy of the muscles may be necessary to confirm the diagnosis.

Injury to the gracilis muscle can cause acute, severe lameness in performance Quarter horses. Horses competing in barrel racing may be susceptible to gracilis muscle injury because the muscle functions to adduct the hindlimb. The prognosis is good for returning to athletic use after an adequate period of muscle healing and mild exercise. However, fibrotic myopathy or muscle atrophy can be a complication of the injury resulting in persistent gait deficits.

In horses, traumatic myositis of the posterior thigh muscles may be followed by

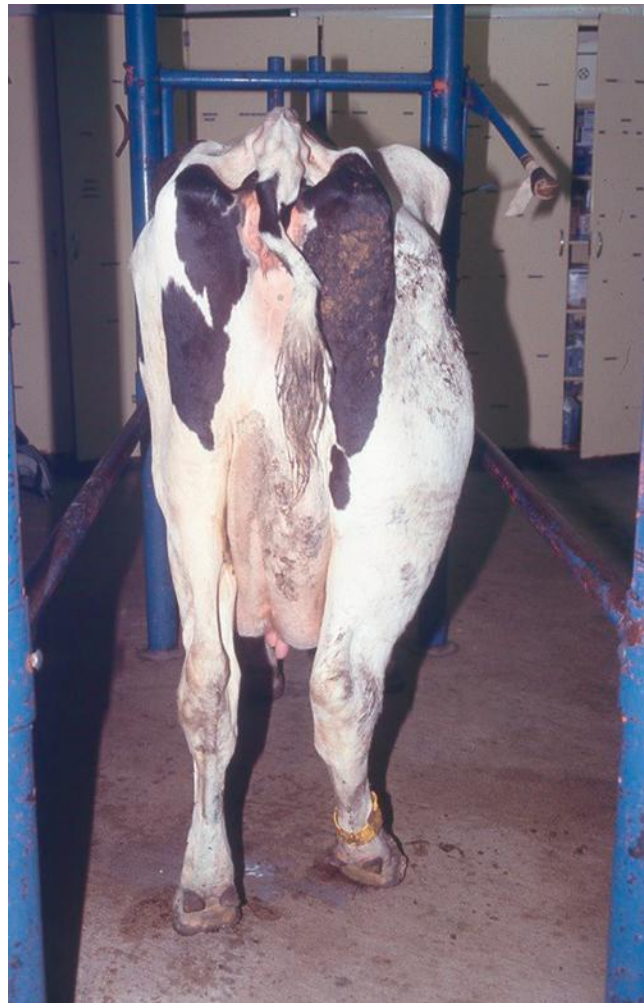

**Fig. 15-2** Myositis centered in the right lateral distal femur region of a lactating dairy cow as a result of a penetrating wound. The cow also has a fractured and shortened tail as a result of a traumatic injury when a calf.

the formation of fibrous adhesions between the muscles (fibrotic myopathy) and by subsequent calcification of the adhesions (ossifying myopathy). External trauma can result in fibrotic myopathy, but it may also be associated with excessive exercise or secondary to intramuscular injections. Occasionally similar lesions may be seen in the foreleg. The lesions cause a characteristic abnormality of the gait in that the stride is short in extension and the foot is suddenly withdrawn as it is about to reach the ground. The affected area is abnormal on palpation.

Generalized myositis ossificans, an inherited disease of pigs, is also characterized by deposition of bone in soft tissues. In traumatic injuries caused by penetration of foreign bodies into muscle masses, ultrasonography may be used to detect fistulous tracts and the foreign bodies.

Extensive damage to or loss of muscle occurs in screwworm and sometimes blowfly infestation, although the latter is more of a cutaneous lesion, and by the injection of necrotizing agents. For example, massive cavities can be induced in the cervical muscles of

horses by the intramuscular injection of escharotic iron preparations intended only for slow IV injection. Similarly, necrotic lesions can result from the IM injection of infected or irritant substances. Horses are particularly sensitive to tissue injury, or are at least most commonly affected. Some common causes are chloral hydrate, antimicrobials suspended in propylene glycol, and even antimicrobials alone in some horses.

### Injection-Site Lesions in Cattle

Muscle lesions associated with injection sites in the cattle industry are a source of major economic loss because of the amount of trim required at slaughter. The presence of injection-site lesions in whole muscle cuts, such as the top sirloin and outside round, limits their use and value. The occurrence of injection-site lesions in muscle remains among the top five quality challenges for both beef and dairy market cows and bulls. Because injection-site lesions are concealed in muscles and/or are under subcutaneous fat, they are seldom found during fabrication at the packing plant and appear instead

during wholesale/retail fabrication or at the consumer level.

Historically, most IM injections were given in the gluteals and the biceps femoris muscles, which are prime cuts of beef. Surveys of injection sites in beef cattle in North America have found lesions in a significant percentage of prime cuts of beef. Lesions consisting of clear scars and woody calluses are mature and probably originated in calfhood; scars with nodules or cysts are less mature, occurring later in the feeding period. It is now recommended that all IM injections be given in the cervical muscles (in front of the shoulder). Reducing the incidence of injection-site lesions requires that manufacturers of biological and antibiotic preparations develop less irritating formulations. Products should be formulated for subcutaneous use whenever possible and administered in the neck muscles, which are not prime cuts of beef.

The outcome of an IM injection depends on the nature of the lesion produced. Myodegeneration following IM injections of antibiotics in sheep results in full muscle regeneration within less than 3 weeks. Necrosis following the injection results in scar formation with encapsulated debris, which persists for more than a month and leaves persistent scar tissue.

An outbreak of myositis, lameness, and recumbency occurred following the injection of water-in adjuvanted vaccines into the muscles of the left and right hips of near-term pregnant beef cattle. Within 24 hours, some cattle were recumbent, some had non-weight-bearing lameness, and, within 10 days, 50% of the herd developed firm swellings up to 24 cm in vaccination sites. Histologically, granulomatous myositis with intralesional oil was present. The swellings resolved over a period of 6 months. The acute transient lameness was attributed to the use of two irritating biological vaccines in the hip muscles of cows near parturition.

### Injection-Site Clostridial Infections in Horses

Clostridial myositis, myonecrosis, cellulitis, and malignant edema are terms used to describe a syndrome of severe necrotizing soft tissue infection associated with *Clostridium* spp. Affected horses typically develop peracute emphysematous soft tissue swelling in the region of an injection or wound within hours of the inciting cause.

Myositis can occur following the IM or inadvertent perivascular administration of a wide variety of commonly administered drugs. In a series of 37 cases, the lesion occurred in most cases within 6 to 72 hours of a soft tissue injection, and most lesions were in the neck musculature.

Aggressive treatment of clostridial myositis can be associated with a survival rate of up to 81% for cases resulting from *Clostridium perfringens* alone; survival rates

for other *Clostridium* spp. are lower. A combination of a high dose of IV antibiotic therapy, surgical fenestration and aggressive debridement, antiinflammatory and analgesic therapy, and general supportive care is recommended.<sup>1</sup>

### REFERENCE

1. Adam EN, et al. *Vet Clin Equine*. 2006;22:335.

## Diseases of Bones

### OSTEODYSTROPHY

Osteodystrophy is a general term used to describe those diseases of bones in which there is a failure of normal bone development or abnormal metabolism of bone that is already mature. The major clinical manifestations include distortion and enlargement of the bones, susceptibility to fractures, and interference with gait and posture.

### ETIOLOGY

The common causes of osteodystrophy in farm animals include the following.

#### Nutritional Causes

##### Calcium, Phosphorus, and Vitamin D

Absolute deficiencies or imbalances in calcium–phosphorus ratios in diets cause the following conditions:

- Rickets in young animals (e.g., growing lambs fed a diet rich in wheat bran)
- Absolute deficiencies of calcium in beef calves on intensive rations with inadequate supplementation
- Osteomalacia in adult ruminants

**Osteodystrophia fibrosa in the horse** occurs most commonly in animals receiving a diet low in calcium and high in phosphorus.

**Osteodystrophia fibrosa in pigs** occurs as a sequela to rickets and osteomalacia, which may occur together in young, rapidly growing pigs that are placed on rations deficient in calcium, phosphorus, and vitamin D following weaning.

#### Copper Deficiency

- Osteoporosis in lambs
- Epiphysitis in young cattle

#### Other Nutritional Causes

- Inadequate dietary protein and general undernutrition of cattle and sheep can result in severe osteoporosis and a great increase in ease of fracture.
- Chronic parasitism can lead to osteodystrophy in young, rapidly growing ruminants.
- Hypovitaminosis A and hypervitaminosis A can cause osteodystrophic changes in cattle and pigs.
- Prolonged feeding of a diet high in calcium to bulls (such as high-quality alfalfa) can cause nutritional

hypercalcitoninism, replacement of trabecular bone in the vertebrae and long bones with compact bone, and neoplasms of the ultimobranchial gland.

- Multiple vitamin and mineral deficiencies are recorded as causing osteodystrophy in cattle. The mineral demands of lactation in cattle can result in a decrease in bone mineral content during lactation with a subsequent increase during the dry period.

#### Chemical Agents

- Chronic lead poisoning is reputed to cause osteoporosis in lambs and foals.
- Chronic fluorine poisoning causes the characteristic lesions of osteofluorosis, including osteoporosis and exostoses.
- Grazing the poisonous plants *Setaria sphacelata*, *Cenchrus ciliaris*, and *Panicum maximum* var. *trichoglume* causes osteodystrophia in horses.
- Enzootic calcinosis of muscles and other tissues is caused by the ingestion of *Solanum malacoxylon*, *Solanum torvum*, *Trisetum flavescens* (yellow oatgrass), and *Cestrum diurnum*, which exert a vitamin D–like activity.
- Bowie or bentleg, a disease caused by poisoning with *Trachymene glaucifolia*, is characterized by extreme outward bowing of the bones of the front limbs.

#### Inherited and Congenital Causes

There are many inherited and congenital defects of bones of newborn farm animals, which are described and discussed later in this chapter. In summary, these include:

- Achondroplasia and chondrodystrophy in dwarf calves and some cases of prolonged gestation
- Osteogenesis imperfecta in lambs and Charolais cattle. There is marked bone fragility and characteristic changes on radiologic examination.
- Osteopetrosis in Hereford and Angus calves
- Congenital chondrodystrophy of unknown origin (“acorn” calves)
- Inherited exostoses in horses; inherited thicklegs and inherited rickets of pigs, which are well-established entities

**Angular deformities** of joints of long bones as a result of asymmetric growth-plate activity are common in foals and are commonly repaired surgically. The distal radius and distal metacarpus are most often affected, the distal tibia and metatarsal less commonly. Physiologically immature foals subjected to exercise may develop compression-type fractures of the central or third tarsal bones. Some of these foals are born prematurely or are from a twin pregnancy. Retained cartilage in the distal radial physis of foals 3 to 70 days of age presents without apparent clinical signs.

**Phyinitis** is dysplasia of the growth plate, characterized by an irregular border between



the cartilage and the metaphyseal zone of ossification, an increase in the lateromedial diameter of the physis, and distoproximally oriented fissures at the medial aspect of the metaphysis, which originate at the physis. In some cases, these may result in bilateral tibial metaphyseal stress fractures in foals.

**Abnormal modeling** of trabecular bone has been recognized in prenatal and neonatal calves. Abnormalities included growth retardation lines and lattices, focal retention of primary spongiosa, and the persistence of secondary spongiosa. Intrauterine infection with viruses such as bovine virus diarrhoea (BVD) may be a causative factor.

### Physical and Environmental Causes

Moderate osteodystrophy and arthropathy may occur in rapidly growing pigs and cattle raised indoors and fed diets that contain adequate amounts of calcium, phosphorus, and vitamin D. Those animals raised on slatted floors or concrete floors are most commonly affected, and it is thought that traumatic injury of the epiphyses and condyles of long bones may be predisposing factors in osteochondrosis and arthrosis in the pig (leg weakness) and epiphysitis in cattle. Experimentally raising young calves on metal slatted floors may result in more severe and more numerous lesions of the epiphysis than occurs in calves raised on clay floors. Total confinement rearing of lambs can result in the development of epiphysiolysis and limb deformities. However, the importance of weight-bearing injury as a cause of osteodystrophy in farm animals is still uncertain. In most reports of such osteodystrophy, all other known causes have not been eliminated.

Chronic osteodystrophy and arthropathy have been associated with undesirable conformation in the horse.

**Vertebral exostoses** are not uncommon in old bulls and usually affect the thoracic vertebrae (T2 and T12) and the lumbar vertebrae (L2 to L3), which are subjected to increased pressure during the bending of the vertebral columns while copulating. The exostoses occur mainly on the ventral aspects of the vertebrae, fusing them to cause immobility of the region. Fracture of the ossification may occur, resulting in partial displacement of the vertebral column and spinal cord compression. The disease is commonly referred to as spondylitis or vertebral osteochondrosis and also occurs less commonly in adult cows and in pigs. It is suggested that the annulus fibrosus degenerates and that the resulting malfunctioning of the disk allows excessive mobility of the vertebral bodies, resulting in stimulation of new bone formation. A similar lesion occurs commonly in horses and may affect performance, particularly in hurdle races and cross-country events. The initial lesion may be a degeneration of the intervertebral disk.

**Some types of growth-plate defects** occur in young, rapidly growing foals, and

these are considered to be traumatic in origin. Failure of chondrogenesis of the growth plate may be the result of crush injuries in heavy, rapidly growing foals with interruption of the vascular supply to the germinal cells of the growth plate. Asymmetric pressures as a result of abnormal muscle pull or joint laxity may slow growth on the affected side and result in limb angulation.

**Femoral fractures** occur in newborn calves during the process of assisted traction during birth. Laboratory compression of isolated femurs from calves revealed that the fracture configurations and locations are similar to those found in clinical cases associated with forced extraction. The breaking strength of all femurs fell within the magnitude of forces calculated to be created when mechanical devices are used to assist delivery during dystocia. It is suggested that the wedging of the femur in the maternal pelvis and resulting compression during forced extraction accounts for the occurrence of supracondylar fractures of the femur of calves delivered in anterior presentation using mechanical devices in a manner commonly used by veterinarians and farmers.

### Tumors

**Osteosarcomas** are highly malignant tumors of skeletoblastic mesenchyme in which the tumor cells produce osteoid or bone. Osteosarcomas are the most common type of primary bone tumor in animals such as dogs and cats but are rare in horses and cattle. Most tumors of bone in large animals occur in the skull. A periosteal sarcoma on the scapula has been recorded in the horse and an osteosarcoma of the mandible in a cow.

### PATHOGENESIS

Osteodystrophy is a general term used to describe those diseases of bones in which there is a failure of normal bone development or abnormal metabolism of bone that is already mature. There are some species differences in the osteodystrophies that occur with dietary deficiencies of calcium, phosphorus, and vitamin D. Rickets and osteomalacia have a similar pathogenesis, with the end result being decreased or defective bone mineralization. In broad terms, rickets is the failure of endochondral ossification in growing bone, whereas osteomalacia is disrupted remodeling in mature bone. Rickets and osteomalacia occur primarily in ruminants fed a deficient diet, osteodystrophia fibrosa occurs in horses, and all three may occur in pigs.<sup>1</sup>

### Rickets

Rickets is a disease of young, rapidly growing animals in which there is a **failure of provisional calcification of the osteoid** plus a **failure of mineralization of the cartilaginous matrix of developing bone**. There is also failure of degeneration of growing cartilage and formation of osteoid on persistent

cartilage, with irregularity of osteochondral junctions and overgrowth of fibrous tissue in the osteochondral zone. Rickets is most commonly caused in ruminants by a deficiency of vitamin D or phosphorus.<sup>2</sup> Genetic causes of rickets exist, one of which is a simple autosomal-recessive inheritance in Corriedale sheep in New Zealand.<sup>3,4</sup>

Failure of provisional calcification of cartilage results in an increased depth and width of the epiphyseal plates, particularly of the long bones (humerus, radius, ulna and tibia) and the costal cartilages of the ribs. The uncalcified, and therefore soft, tissues of the metaphyses and epiphyses become distorted under the pressure of weight-bearing, which also causes medial or lateral deviation of the shafts of long bones. There is a decreased rate of longitudinal growth of long bones and enlargement of the ends of long bones as a result of the effects of weight, causing flaring of the diaphysis adjacent to the epiphyseal plate. Within the thickened and widened epiphyseal plate, there may be hemorrhages and minute fractures of adjacent trabecular bone of the metaphysis, and in chronic cases the hemorrhagic zone may be largely replaced by fibrous tissue. These changes can be seen radiographically as "epiphysitis" and clinically as enlargements of the ends of long bones and costochondral junctions of the ribs. These changes at the epiphyses may result in separation of the epiphysis, which commonly affects the femoral head. The articular cartilages may remain normal, or there may be subarticular collapse resulting in grooving and folding of the articular cartilage and ultimately degenerative arthropathy and osteochondrosis. Eruption of the teeth in rickets is irregular, and dental attrition is rapid. Growth of the mandibles is retarded and is combined with abnormal dentition. There may be marked malocclusion of the teeth.

### Osteomalacia

Osteomalacia is a **softening of mature bone as a result of extensive resorption of mineral deposits** in bone and failure of mineralization of newly formed matrix. There is no enlargement of the ends of long bones or distortions of long bones, but spontaneous fractures of any bone subjected to weight-bearing are common.

### Osteodystrophia Fibrosa

Osteodystrophia fibrosa may be superimposed on rickets or osteomalacia and occurs in secondary hyperparathyroidism. Diets low in calcium or that contain a relative excess of phosphorus cause secondary hyperparathyroidism. There is extensive resorption of bone and replacement by connective tissue. The disease is best known in the horse and results in swelling of the mandibles, maxillae, and frontal bones (the "bighead" syndrome). Spontaneous fracture of long bones and ribs occurs commonly.

Radiographically there is extreme porosity of the entire skeleton.

### Osteoporosis

Osteoporosis is defined as a systemic skeletal disease characterized by low bone mass and microarchitectural deterioration of bone tissue, with a consequent increase in bone fragility and increased susceptibility to fractures.<sup>5</sup> In osteoporosis, the bone becomes porous, light, and fragile, and it fractures easily. Osteoporosis is uncommon in farm animals and is usually associated with general undernutrition and intestinal parasitism rather than specifically a deficiency of calcium, phosphorus, or vitamin D.<sup>6</sup> Copper deficiency in lambs may result in osteoporosis as a result of impaired osteoblastic activity. Chronic lead poisoning in lambs also results in osteoporosis as a result of deficient production of osteoid. In a series of 19 lactating or recently weaned sows with a history of lameness, weakness, or paralysis, 10 had osteoporosis and pathologic fractures, and six had lumbar vertebral osteomyelitis. Bone ash, specific gravity of bone, and the ratio of cortical to total bone were significantly reduced in sows with osteoporosis and pathologic fractures.

Ovariectomized sheep that are fed an acidogenic (calcium-wasting) diet and administered corticosteroids develop osteoporosis, which is being used as a model to study the disease in humans.<sup>6,7</sup>

### Osteodystrophy of Chronic Fluorosis

Osteodystrophy of chronic fluorosis is characterized by the development of exostoses on the shafts of long bones as a result of periosteal hyperostosis. The articular surfaces remain essentially normal, but there is severe lameness because of the involvement of the periosteum and encroachment of the osteophytes on the tendons and ligaments.

### Congenital Defects of Bone

Congenital defects of bone include complete (**achondroplasia**) and partial (**chondrodys trophy**) failure of normal development of cartilage. Growth of the cartilage is restricted and disorganized, and mineralization is reduced. The affected bones fail to grow, leading to gross deformity, particularly of the bones of the head.

### CLINICAL FINDINGS

In general terms there is weakening of the bones as a result of defective mineralization and osteoporosis, which results in the **bending of bones**, which probably causes pain and shifting lameness—one of the earliest clinical signs of acquired osteodystrophy. The normal weight and tension stresses cause distortion of the normal axial relationships of the bones, which results in the bowing of long bones. The distortions occur most commonly in young, growing animals. The distal ends of the long bones

are commonly enlarged at the level of the epiphyseal plate, and circumscribed swellings of the soft tissue around the epiphyses may be prominent and painful on palpation.

The effects of osteodystrophy on appetite and body weight will depend on the severity of the lesions and their distribution. In the early stages of rickets in calves and pigs the appetite and growth rate may not be grossly affected until the disease is advanced and causes considerable pain. Persistent recumbency as a result of pain will indirectly affect feed intake unless animals are hand-fed.

**Spontaneous fractures** occur commonly and usually in mature animals. Common sites for fractures include the long bones of the limbs, pelvic girdle, femoral head, vertebrae, ribs, and transverse processes of the vertebrae. Ordinary hand pressure or moderate restraint of animals with osteomalacia and osteodystrophia fibrosa is often sufficient to cause a fracture. The rib cage tends to become flattened, and in the late stages affected animals have a slab-sided appearance of the thorax and abdomen. Separations of tendons from their bony insertions also occur more frequently and cause severe lameness. The osteoporotic state of the bone makes such separations easy. Any muscle group may be affected, but in young cattle in feedlots, separations of the gastrocnemius are the most common. Thickening of the bones may be detectable clinically if the deposition of osteoid or fibrous tissue is excessive or if exostoses develop, as in fluorosis. Compression of the spinal cord or spinal nerves may lead to paresthesia, paresis, or paralysis, which may be localized in distribution. Details of the clinical findings in the osteodystrophies caused by nutritional deficiencies are provided later in this chapter.

**Calcinosis of cattle** is characterized clinically by chronic wasting; lameness; ectopic calcifications of the cardiovascular system, lungs, and kidneys; ulceration of joint cartilage; and extensive calcification of bones.

### DIAGNOSIS

The **laboratory analyses** that are indicated include the following:

- Serum calcium and phosphorus concentration
- Serum alkaline phosphatase activity
- Feed analysis for calcium, phosphorus, vitamin D, and other minerals when indicated (such as copper, molybdenum, and fluorine)
- Bone ash chemical analysis
- Histopathology of bone biopsy
- Radiographic examination of the skeleton
- Single-photon absorptiometry, a safe and noninvasive method for the measurement of bone mineral content, is now available.

**Radiographic examination** of the affected bones and comparative radiographs

of normal bones are indicated when osteodystrophy is suspected. Radiographic examination of slab sections of bone is a sensitive method for detecting abnormalities of trabecular bone in aborted and young calves.

**Serum calcium and phosphorus** concentrations in nutritional osteodystrophies may remain within the normal range for long periods, and not until the lesions are well advanced will abnormal levels be found. Several successive samplings may be necessary to identify an abnormal trend.

**Serum alkaline phosphatase** activity may be increased in the presence of increased bone resorption, but this is not a reliable indicator of osteodystrophy. Increased serum levels of alkaline phosphatase may originate from osseous tissues, intestine, or the liver, but osseous tissue appears to be the major source of activity.

**Nutritional history and feed analysis** results will often provide the best circumstantial evidence of osteodystrophy. In vitamin D–dependent rickets, serum 25(OH)D<sub>3</sub> concentrations will be decreased. In phosphorus-dependent rickets, serum 25(OH)D<sub>3</sub> will be normal or increased with normal to decreased parathyroid (PTH) concentrations. Urine calcium-to-phosphorus ratios below 0.05 suggest a calcium or vitamin D deficiency, whereas ratios above 1 reflect phosphorus deficiency.<sup>1</sup>

The definitive diagnosis is best made by a combination of chemical analysis of bone, histopathologic examination of bone, and radiography. The details for each of the common osteodystrophies are discussed under the appropriate headings.

### NECROPSY FINDINGS

The pathologic findings vary with the cause, and the details are described under each of the osteodystrophies elsewhere in the book. In general terms, the nutritional osteodystrophies are characterized by bone deformities, bones that may be cut easily with a knife and that bend or break easily with hand pressure, and in prolonged cases the presence of degenerative joint disease. In young growing animals the ends of long bones may be enlarged, and the epiphyses may be prominent and circumscribed by periosteal and fibrous tissue thickening. On longitudinal cut sections the cortices may appear thinner than normal, and the trabecular bone might have been resorbed, leaving an enlarged marrow cavity. The epiphyseal plate may be increased in depth and width and appear grossly irregular, and small fractures involving the epiphyseal plate and adjacent metaphysis may be present. Separation of epiphyses is common, particularly of the femoral head. The calluses of healed fractures of long bones, ribs, vertebrae, and the pelvic girdle are common in pigs with osteodystrophy. On histologic examination there are varying degrees of severity of rickets in young, rapidly growing animals

and osteomalacia in adult animals, and osteodystrophia fibrosa is possible in both young and adult animals.

### DIFFERENTIAL DIAGNOSIS

In both congenital and acquired osteodystrophy the clinical findings are usually suggestive. There are varying degrees of lameness, stiff gait, long periods of recumbency and failure to perform physical work normally, and progressive loss of body weight in some cases, and there may be obvious contortions of long bones, ribs, head, and vertebral column. The most common cause of osteodystrophy in young, rapidly growing animals is a dietary deficiency or imbalance of calcium, phosphorus, and vitamin D. If the details of the nutritional history are available and if a representative sample of the feed given is analyzed, a clinical diagnosis can be made on the basis of clinical findings, nutritional history, and response to treatment. In some cases, osteodystrophy may be attributable to overfeeding, such as might occur in rapidly growing, large foals.

However, often the nutritional history may indicate that the animals have been receiving adequate quantities of calcium, phosphorus, and vitamin D, which necessitates that other, less common causes of osteodystrophy be considered. Often the first clue is an unfavorable response to treatment with calcium, phosphorus, and vitamin D. Examples include copper deficiency in cattle, leg weakness in swine of uncertain etiology—but perhaps there is weight-bearing trauma and a relative lack of exercise because of confinement—or chemical poisoning such as enzootic calcinosis or fluorosis. These will require laboratory evaluation of serum biochemistry, radiography of affected bones, and pathologic examination. The presence of bony deformities at birth suggests congenital chondrodystrophy, some cases of which appear to be inherited, whereas some are attributable to environmental influences.

### TREATMENT

The common nutritional osteodystrophies attributable to a dietary deficiency or imbalance of calcium, phosphorus, and vitamin D will usually respond favorably following the oral administration of a suitable source of calcium and phosphorus combined with parenteral injections of vitamin D. The oral administration of dicalcium phosphate, at the rate of 3 to 4 times the daily requirement, daily for 6 days, followed by a reduction to the daily requirement by the 10th day, combined with one injection of vitamin D at the rate of 10,000 IU/kg BW, is recommended. Affected animals are placed on a diet that contains the required levels and ratios of calcium, phosphorus, and vitamin D. The oral administration of the calcium and phosphorus will result in increased absorption of the minerals, which will restore depleted skeletal reserves. Calcium absorption is

increased in adult animals following a period of calcium deficiency; young animals with high growth requirements absorb and retain calcium in direct relation to intake. General supportive measures include adequate bedding for animals that are recumbent.

The treatment of the osteodystrophies resulting from causes other than calcium and phosphorus deficiencies depends on the cause. Copper deficiency will respond gradually to copper supplementation. There is no specific treatment for the osteodystrophy associated with leg weakness in pigs, and slaughter for salvage is often necessary. Overnutrition in young, rapidly growing foals may require a marked reduction in the total amount of feed made available daily.

Oxytetracycline has been used for the treatment of flexural deformities of the distal interphalangeal joints of young foals. It is postulated that oxytetracycline chelates calcium, rendering it unavailable for use for striated muscle contraction. It is considered effective for obtaining a short-term moderate decrease in metacarpophalangeal joint angle in newborn foals.

Hemicircumferential periosteal transection and elevation has gained wide acceptance for correction of angular limb deformities in young foals.

### REFERENCES

1. Madson DM, et al. *J Vet Diagn Invest.* 2012;24:1137.
2. Mearns R, et al. *Vet Rec.* 2008;162:98.
3. Dittmer KE, et al. *J Comp Path.* 2009;141:147.
4. Dittmer KE, et al. *Vet J.* 2011;187:369.
5. Klopfenstein Bregger MD, et al. *Vet Comp Orthop Traumatol.* 2007;20:18.
6. Braun U, et al. *Vet Rec.* 2009;164:211-217.
7. Kielbowicz Z, et al. *Pol J Vet Sci.* 2015;18:645.

### HYPERTROPHIC OSTEOPATHY (MARIE'S DISEASE)

Although hypertrophic osteopathy is more common in dogs than in the other domestic animals it has been observed in horses,<sup>1-4</sup> cattle,<sup>5</sup> sheep, New World camelids, and captive cervids.<sup>6</sup> The term *hypertrophic osteoarthropathy* is used in humans where there is joint involvement, but the term *hypertrophic osteopathy* is preferred in large animals because the joints are never affected.

Hypertrophic osteopathy is characterized by proliferation of the periosteum, leading to the formation of periosteal bone, and bilateral symmetric enlargement of bones, usually the long bones of limbs and in advanced cases in the horse, the ventral mandible.<sup>1,4</sup> The enlargement is quite obvious and in the early stages is usually painful and often accompanied by local edema. On radiographic examination there is a shaggy periostitis and evidence of periosteal exostosis. The pathogenesis is obscure, but the lesion appears to be neurogenic in origin associated with an increased blood flow to the limbs, with unilateral vagotomy causing regression of the bony changes. Stiffness of gait and

reluctance to move are usually present, and there may be clinical evidence of the pulmonary lesion with which the disease is frequently, but not always, associated (the condition was called *hypertrophic pulmonary osteopathy* for many years). Such pulmonary lesions are usually chronic, neoplastic, or suppurative processes such as tuberculosis. Cases of hypertrophic osteopathy have been diagnosed in horses without evidence of intrathoracic disease.<sup>1</sup> In one mare with a large granulosa thecal cell tumor, clinical signs of hypertrophic osteopathy decreased after surgical excision of the tumor.<sup>2</sup>

The majority of reports in large animals are in horses, where the lesions are found more commonly around but not involving the joints of distal limbs.<sup>1</sup> Radiographs of the distal limbs reveal periosteal new bone involving the metaphysis or diaphysis or both. The new bone appears smooth and speculated or has a palisade-like appearance perpendicular to the cortex, with chronic cases having other and less active bony changes.<sup>1</sup>

The disease is considered to be incurable, unless the thoracic lesion can be removed, but there are occasional reports of clinical improvement following prolonged administration of antiinflammatory agents<sup>1</sup> or antibiotics.<sup>3</sup> Affected animals are usually euthanized. At necropsy the periostitis and exostosis are evident, and most, but not all, have gross evidence of chronic intrathoracic disease.<sup>1,2</sup> There is no involvement of the joints.

### REFERENCES

1. Enright K, et al. *Equine Vet Educ.* 2011;23:224.
2. Packer M, McKane S. *Equine Vet Educ.* 2012;24:351.
3. Lewis NL, et al. *Equine Vet Educ.* 2011;23:217.
4. Bayless R, et al. *Israel J Vet Med.* 2014;69:151.
5. Guyot H, et al. *Can Vet J.* 2011;52:1308.
6. Ferguson NM, et al. *J Vet Diagn Invest.* 2008;20:849.

### OSTEOMYELITIS

#### ETIOLOGY AND PATHOGENESIS

Inflammation of bone (**osteitis**) or bone and bone marrow (**osteomyelitis**) is uncommon in large animals except when infection is introduced by traumatic injury or by the hematogenous route. **Bacteria can reach bone by any of three routes:**

- Hematogenously
- By extension from an adjacent focus of infection
- By direct inoculation through trauma or surgery

Focal metaphyseal osteomyelitis can occur following open fractures in the horse. Specific diseases that may be accompanied by osteomyelitis include actinomycosis of cattle and brucellosis, atrophic rhinitis, and necrotic rhinitis of pigs. Nonspecific, hematogenous infection with other bacteria occurs sporadically and is often associated with omphalitis, abscesses from tail-biting in



pigs, or infection of castration or docking wounds in lambs.

Foals and calves under 1 month of age and growing cattle 6 to 12 months of age may be affected by osteomyelitis in one or more bones. The majority of foals with suppurative polyarthritis have a polyosteomyelitis of the bones adjacent to the affected joints. In a series of cases of tarsal osteomyelitis in foals there was usually evidence of infectious arthritis. Osteomyelitis of the pubic symphysis associated with *Rhodococcus equi* in a 2-year-old horse has been described. The lameness was localized to the pelvis and was associated with a fever and an inflammatory leukogram.

The infections occur commonly in the metaphysis, physis, and epiphysis, which are sites of bony growth and thus susceptible to blood-borne infections. The metaphyseal blood vessels loop toward the physis and ramify into sinusoids that spread throughout the metaphyseal region. Blood flow through the sinusoids is sluggish and presents an ideal environment for propagation of bacteria. Lesions occur on both sides of the physis in both the metaphysis and the epiphysis. Multiple lesions are common and support the explanation that septic emboli are released from a central focus.

In a series of 445 cattle with bone infection of the appendicular skeleton, a distinction was made between hematogenous and posttraumatic origin (wound/fracture). Bone infection was classified into four types according to the site of infection: Type 1 is metaphyseal and/or epiphyseal osteomyelitis close to the growth plate; type 2 is primary subchondral osteomyelitis, mostly accompanied by septic arthritis; type 3 is infectious osteoarthritis with subchondral osteomyelitis, implying that infection in the subchondral bone originates from the infection. Type 4 includes bone infections that cannot be categorized in the other groups. Hematogenous osteomyelitis was 3.2 times more frequent than posttraumatic osteomyelitis. *Trueperella* (*Arcanobacterium* or *Corynebacterium*) *pyogenes* was the most common etiologic agent. Approximately 55% of the affected animals with osseous sequestration had physical evidence of lacerations, contusions, abrasions, or puncture wounds from a previous traumatic event.

**Hematogenous osteomyelitis** in cattle can be of two types:

- Physeal type, in which an infection generally of metaphyseal bone originates at or near the growth plate, usually affecting the distal metacarpus, metatarsus, radius, or tibia
- Epiphyseal type, in which an infection originates near the junction of the subchondral bone and the immature epiphyseal joint cartilage, most often affecting the distal femoral condyle epiphysis, the patellar, and the distal radius

Epiphyseal osteomyelitis is usually a result of infection with *Salmonella* spp. and is most common in calves under 12 weeks of age. The physeal infections are usually caused by *T. pyogenes* and occur most commonly in cattle over 6 months of age.

### Osseous Sequestration in Cattle

Osseous sequestration is a common orthopedic abnormality in cattle and horses. In most cases, the lesions develop in the bones of the distal portion of the limbs (Figs. 15-3 and 15-4). Sequestration is associated with trauma that results in localized cortical ischemia and bacterial invasion secondary to loss of adjacent periosteal and soft tissue integrity and viability. The soft tissues covering the bones that comprise the distal portions of the limbs fail to provide adequate protection and collateral blood supply to the bone.

### Osteomyelitis Secondary to Trauma

In horses, osteomyelitis is a frequent sequela to wounds of the metacarpal and metatarsal

bones and the calcaneus. These bones have limited soft tissue covering, which may predispose them to osteomyelitis following traumatic injury. Similarly, a portion of the lateral aspect of the proximal end of the radius has limited soft tissue covering. Penetrating and nonpenetrating wounds in this region therefore may result in serious consequences even though they may initially appear to be minor. Because lesions may be an extension of septic arthritis, a thorough examination of the wound area is necessary.

### Inflammation of Bone Marrow

Acute inflammation of the bone marrow commonly accompanies bacterial sepsis, resulting in either multifocal microabscesses or perivascular infiltrates of neutrophils, fibrin, edema, and hemorrhage. The most common abnormality associated with fibrinous inflammation is disseminated intravascular coagulopathy. Discrete granulomas may occur in the marrow of animals with systemic mycotic disease, idiopathic granulomatous disease, and serous atrophy of fat.



**Fig. 15-3** Holstein-Friesian heifer with a sequestrum of the left distal third metacarpal bone with draining tract associated with a hard swelling.



**Fig. 15-4** Palmar-dorsal radiograph of the limb of the heifer in Figure 15-3 showing involucrum laterally and medially (thick sheath of periosteal new bone surrounding a sequestrum) and marked bone proliferation on the cortical surface.

### CLINICAL FINDINGS

The common clinical findings of osteomyelitis include the following:

- Lameness
- Generalized soft tissue swelling and inflammation
- Pain on palpation of the affected area
- Chronic persistent drainage
- Secondary muscle atrophy of the affected limb

Erosion of bone occurs, and pus discharges into surrounding tissues, causing cellulitis or phlegmon, and to the exterior through sinuses, which persist for long periods. The affected bone is often swollen and may fracture easily because of weakening of its structure. When the bones of the jaw are involved, the teeth are often shed, and this, together with pain and the distortion of the jaw, interferes with prehension and mastication. Involvement of vertebral bodies may lead to the secondary involvement of the meninges and the development of

paralysis. Lameness and local swelling are the major manifestations of involvement of the limb bones.

Most osseous sequestra in cattle are associated with the bones of the extremities, most commonly the third metacarpal or metatarsal bone. Cattle 6 months to 2 years of age are most likely to have a sequestrum compared with animals less than 6 months of age.

The lesions are typically destructive of bone and cause severe pain and lameness. Those associated with *Salmonella* spp. are characteristic radiographically in foals and calves. *T. pyogenes*, *Corynebacterium* spp., and *E. coli* may also be causative agents. Affected animals are very lame, and the origin of the lameness may not be obvious. A painful, discrete soft tissue swelling over the ends of the long bones is often the first indication. The lameness characteristically persists in spite of medical therapy, and the animal may become lame in two or

more limbs and spend long periods recumbent.

Osteomyelitis affecting the cervical vertebrae, usually the fourth to sixth vertebra, causes a typical syndrome of abnormal posture and difficulty with ambulation. Initially there is a stumbling gait, which then becomes stiff and restricted and with a reluctance to bend the neck. Soon the animal has difficulty eating off the ground and must kneel to graze pasture. At this stage there is obvious atrophy of the cervical muscles, and pain can be elicited by deep, forceful compression of the vertebrae with the fists. There is no response to treatment, and at necropsy there is irreparable osteomyelitis of the vertebral body and compression of the cervical spinal cord. Radiologic examination is usually confirmatory.

**Cervicothoracic vertebral osteomyelitis** in calves between 2 and 9 weeks of age is characterized by difficulty in rising with a tendency to knuckle or kneel on the forelimbs, which are hypotonic and hyporeflexic. Pain can be elicited on manipulation of the neck. The lesion usually involves one or more of the vertebrae from C6 to T1. *Salmonella dublin* is commonly isolated from the vertebral lesion.

### DIAGNOSIS

Radiographs are an essential part of the diagnosis. **Radiographic changes** include the following:

- Necrotic sequestrum initially
- New bone formation
- Loss of bone density

Radiographic lesions are characteristically centered at the growth and extend into both metaphysis and epiphysis.

Nuclear scintigraphy, which is only available at large referral centers, can be useful in identifying osteomyelitis in areas of bone surrounded by a large amount of muscle, which minimizes the ability to detect subtle radiographic lesions.

Culture of the inflammatory exudate and necrotic sequestra removed surgically is necessary to determine the species of bacteria and their antimicrobial susceptibility. Samples of bone obtained at surgery provide the most accurate culture results compared with specimens obtained from the draining sinuses, which may yield a mixed flora. Specimens should consist of sequestra and soft tissues immediately adjacent to bone thought to be infected. Special transport media are desirable for optimum culture results. Anaerobic bacteria are frequently associated with osteomyelitis and should be considered when submitting samples for culture.

### NECROPSY FINDINGS

At necropsy the osteomyelitis may not be obvious unless the bones are opened longitudinally and the cut surfaces of the metaphysis and epiphysis are examined.

### DIFFERENTIAL DIAGNOSIS

A differential diagnosis for a destructive lesion in the end of a long bone of a foal or calf would include the following: a healing fracture, traumatic periostitis or osteitis, bone tumor, nutritional osteodystrophy and infection of the bone as a result of external trauma, fracture, extension from adjacent infection or hematogenous spread. The absence of equal pathologic involvement in the comparable parts of long bones and the young age of the animal will usually suggest infection of bone. The pathologic features of multiple-bone infection in foals are described.

### TREATMENT

Despite advances in antimicrobial therapy and refined diagnostic techniques, the clinical management of osteomyelitis is difficult. Medical therapy alone is rarely completely successful because of the poor vascularity of the affected solid bone, the inaccessibility of the infection, and the potential for development of a biofilm slime layer by bacteria. In cases of long-term infection or those with extensive bone necrosis, surgery is generally recommended to remove sequestra, devitalized tissue, and sinus tracts that are harboring large numbers of bacteria. Good results are obtained when the affected bone is removed and standard wound management practices are implemented.<sup>1</sup> A retrospective case series of 108 thoroughbred foals with septic osteomyelitis secondary to bacteremia indicated that 81% were discharged from the hospital, and 48% successfully raced.<sup>2</sup>

In septic physisitis, the implantation of homologous cancellous bone grafts following debridement of necrotic bone, the application of a walking cast for 4 to 5 weeks, and antimicrobial therapy for 2 weeks is usually a successful approach. Absolute asepsis is a fundamental requirement for successful application of a bone graft; after debridement of the necrotic bone, the cavity is flushed with saline and aqueous ampicillin or a combination of penicillin G potassium and ceftiofur.

Antimicrobials are an integral part of the treatment, and selection of the most appropriate drug should be based on identification and susceptibility testing of the organism. Initial treatment may be based on the most common isolates, and a combination of penicillin G and gentamicin or amikacin provides an excellent initial treatment in horses until culture and susceptibility results are available. Aminoglycosides such as gentamicin or amikacin do not provide an ideal initial treatment option in food-producing animals because of the extensive slaughter withdrawals associated with their use. Ideally, parenteral antimicrobial therapy should be continued for a minimum of 10 days and ideally 4 to 6 weeks following surgical curettage. However, in a series of osteomyelitis of

the calcaneus of adult horses, there was no difference in the survival rate of animals between those treated surgically and those treated medically. Likewise, a retrospective study of 108 Thoroughbred foals with osteomyelitis secondary to septicemia did not demonstrate an improved success rate with surgical debridement.<sup>2</sup>

Most anaerobic bacteria associated with osteomyelitis are sensitive to penicillin and the cephalosporins, but some species of *Bacteroides fragilis* and *Bacteroides asaccharolyticus* and other species of *Bacteroides* are known to produce beta-lactamases, which can inactivate penicillin and cephalosporin. Metronidazole and clindamycin will penetrate bone and can be considered for use in the horse, but metronidazole is not permitted to be used in food-producing animals in some countries.

Regional perfusion of the distal limb may be helpful as part of the initial treatment by providing higher antimicrobial concentrations at the site of infection. A tourniquet made of latex tubing is placed at a suitable location on the limb proximal to the site of infection. In regional intravenous perfusion, a large superficial vein is identified, and the overlying skin is disinfected. A butterfly catheter is inserted into the vein and a water-soluble antimicrobial agent that is minimally cytotoxic, such as penicillin G potassium or ceftiofur, is infused intravenously and the tourniquet left in place for 30 minutes to facilitate diffusion into infected tissues.

In regional osseous perfusion, an intraosseous infusion screw is inserted using aseptic technique into the medullary cavity, and appropriate water-soluble antimicrobial agents are periodically infused without the use of a tourniquet. The intraosseous screw is left in place under a sterile wrap in between infusions.

### FURTHER READING

- Goodrich LR. Osteomyelitis in horses. *Vet Clin Equine*. 2006;22:389-417.  
 Hardy J. Etiology, diagnosis, and treatment of septic arthritis, osteitis, and osteomyelitis in foals. *Clin Tech Equine Pract*. 2006;5:309-317.

### REFERENCES

1. Neil KM, et al. *Aust Vet J*. 2010;88:4.
2. Lischer CJ. *Equine Vet Educ*. 2009;21:76.

### TAIL-TIP NECROSIS IN BEEF CATTLE

Tail-tip necrosis occurs in cattle housed in confinement on slatted floors. The disease has occurred in steers, heifers, and bulls being fed for beef production, and less frequently in dairy cattle.

The lesion is most commonly caused by a traumatic injury of the tail caused by tramping of the tail by other animals.<sup>1</sup> The tail tip of a lying bull usually is away from the animal's body and therefore accessible for

tramping by herdmates. Focal damage is more severe when the tail tip is tramped on slatted floors. Tail-tip necrosis is rare in dairy cattle confined in free stalls because most cows lie down in free stalls and their tails are thereby relatively protected from being tramped. Less frequently, the lesion starts as a ball of manure on the tail switch of animals with loose feces; the manure accumulates until a large dry fecal mass (up to 15 cm in diameter) is present on the tip of the tail. The presence of the hard fecal mass increases the likelihood of damage to the tail tip, particularly when animals are confined.

The lesion begins at the tip of tail followed by varying degrees of extension proximally. Initially, the tip of the tail is swollen, followed by inflammation and infection with *Trueperella pyogenes*. Histopathologic changes are compatible with cutaneous ischemia as a pathogenic mechanism. Extension of the infection can result in metastases to other parts of the body, resulting in abscesses and osteomyelitis. Affected cattle do not grow normally, and deaths from pyemia may occur. The morbidity is about 5%. Approximately 10% of affected animals may be condemned for osteomyelitis and abscessation.

### Risk Factors

Risk factors include slatted concrete floors, close confinement, warm seasons, and a body weight above 200 kg. The risk increases as the space allotment, expressed as kg animal per m<sup>2</sup> pen, increases from approximately 165 kg/m<sup>2</sup>. Tail tramping is more frequent in slatted-floor pens with lower space allotment (1.5 m<sup>2</sup> per head) than in similar pens with higher space allotment (2.4 m<sup>2</sup> per pen head). In an Ontario study, no case of tail-tip necrosis was diagnosed in solid-floor barns, whereas 1.36% of cattle in slatted-floor barns were either treated or slaughtered for tail-tip necrosis. In a mail survey of feedlots in Ontario, 96% of 71 feedlots with slatted floors, but only 5% of 184 feedlots with solid floors, reported a problem with tail-tip necrosis from 1982 to 1986. Of 441 tails inspected at slaughter plants, 35% were affected, with 3% involving skin lacerations and infection, and 4% were amputated before slaughter. Most cases occur from May to September when the temperature is above 18° C (64 F). This may be associated with increased contamination as a result of increased humidity and temperature under confinement conditions.

In slatted-floor barns, abnormal locomotor patterns occur in 20% to 25% of the times when animals get up and lie down. When animals get up abnormally, they first rise from the front, then consequently assume a dog-like sitting posture. To obtain momentum to rise in the rear, they then start to sway back and forth. The tail may become pinched between the hock of the rocking animal and the floor, resulting in blunt trauma to the tip of the tail.



## TREATMENT

Treatment consists of early amputation combined with intensive antimicrobial therapy. Early detection is important. During warm months, cattle confined on slatted floors and weighing more than 200 kg should be closely inspected at least 2 or 3 times weekly. This includes palpation of all tail tips because early lesions are difficult to see.

## CONTROL

Control is dependent on providing sufficient space for housed cattle on slatted floors.

## REFERENCE

1. Ural K, et al. *Kafkas Univ Vet Fak Derg.* 2007;13:203.

## LAMINITIS OF HORSES

### SYNOPSIS

**Etiology** Degeneration of the sensitive lamellae of the hoof. Syndromes of endocrinopathic, sepsis-associated, supporting limb and concussive laminitis are recognized. Pasture-associated laminitis is considered a form of endocrinopathic laminitis.

**Epidemiology** Disease involving single animals. As a sequela to severe systemic disease induced by colic, enterocolitis, metritis, and grain engorgement. Horses worked on hard surfaces. Horses or ponies at pasture, and especially obese horses and ponies and those with hyperinsulinemia as a result of insulin resistance or equine metabolic syndrome. Horses with pituitary pars intermedia dysfunction. Horses with unilateral lameness often develop laminitis in the contralateral, supporting limb.

**Clinical signs** Lameness, ranging from mild to sufficiently severe to cause the horse to be recumbent, involving both front feet, and occasionally all four feet.

**Clinical pathology** None characteristic of the disease.

**Diagnostic confirmation** Physical examination. Radiography.

**Treatment** There is no single effective treatment. Control of pain by administration of nonsteroidal antiinflammatory drugs is important. Administration of vasodilatory agents, anticoagulants, frog and sole support, and corrective hoof trimming and shoeing are all used with variable success. Chilling of the limb (cryotherapy) in horses at high risk (e.g., diarrhea, metritis) during the prodromal or acute phase is promising but unproven as yet in prospective clinical trials.

**Control** Prophylaxis for acute, severe diseases. Aggressive treatment of systemic disease associated with metritis, colic, and enterocolitis, including digital cryotherapy. Prevent unrestricted access to feeds rich in

soluble carbohydrates. Maintain optimal body condition. Treat existing equine metabolic syndrome (insulin resistance) or pituitary pars intermedia dysfunction.

Laminitis refers to a spectrum of processes and clinical signs related to breakdown of the connection between of the basement membrane of the secondary dermal lamellae and the basal cells of the secondary epidermal lamellae, with subsequent disruption of the anatomic relationship between the hoof and the distal phalanx. Understanding of the condition is dependent on a specialized vocabulary and jargon, including the following:<sup>1,2</sup>

- **Hoof**—the layers of integument of the foot from the secondary epidermal lamella distally (outward, toward the hoof surface). The keratinized portion of the hoof is the hoof capsule.
  - **Distal phalanx**—the most distal of the bones in the limb of the horse (synonyms of pedal bone, P3, or third phalanx)
  - **Lamellae** (colloquially, “laminae”)—primary and secondary lamellae originate from the inside of the hoof and from the surface of the distal phalanx. Primary lamellae give rise to secondary lamellae. The basal cells of
- the primary and secondary epidermal lamellae attach the hoof to the basement membrane of the primary and secondary lamellae of the distal phalanx through numerous anchoring points, the hemidesmosomes (Fig. 15-5).<sup>3</sup> Hemidesmosomes are composed of multiple anchoring filaments that connect to laminin-5, a unique glycoprotein that attaches to type IV collagen in the lamina densa of the basement membrane. Type VII collagen connects the lamina densa to the distal phalanx. laminin-5 in the basement membrane is connected through the hemidesmosomes by integrin (which crosses the cell wall) and plectin to the cytoskeleton of the basal cell. Protein BP-180 is associated with the hemidesmosomes and might be involved in anchoring. Basal cells are connected to one another by desmosomes (containing cadherins, a group of compounds responsible for cell-cell adhesion).<sup>3</sup>
- **Parietal integument** (incorrectly, “lamellar integument”)—that part of the space between the hoof capsule and distal phalanx occupied by the lamellae, parts of the dermis, and all subcutaneous tissue.

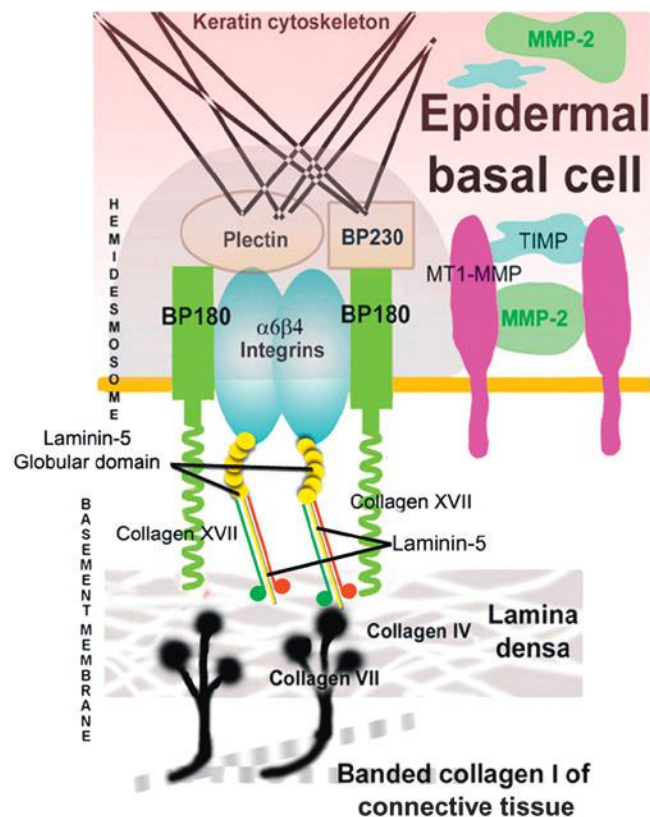

**Fig. 15-5** Depiction of the structure of a hemidesmosome and lamina densa, which provide the connection between the basal cell and basement membrane. Note the variety of proteins, including glycoproteins and collagen, that provide tight attachment of the distal phalanx to the hoof. (Reproduced with permission from Pollit C. The anatomy and physiology of the suspensory apparatus of the distal phalanx. *Vet Clin North Am Equine* 2010; 26:29-49.)

- **Laminitis**—the conventional definition is that of a clinical syndrome of foot pain, usually in an acute setting, in horses resulting from separation of the dermal and epidermal lamellae. Laminitis implies an inflammatory component or etiopathogenesis, which does not appear to always be present in all phases of the disease.
- **Prodromal laminitis** (developmental laminitis)—that phase between initiation of the disease process in the foot and appearance of clinical signs.
- **Acute laminitis**—that phase between first development of signs of foot pain and displacement of the distal phalanx (often 72 hours but variable and displacement does not occur in all cases).
- **Chronic laminitis**—phase of the disease after displacement has occurred. It can be further divided into early chronic laminitis, chronic active laminitis, and chronic stable laminitis.
- **Acute founder**—clinical signs of laminitis (strong digital pulses, toe relieving stance, and frequent weight shifting) plus signs of disruption of the normal gross anatomy of the foot evident as supracoronary depressions or radiographic evidence of rotation or distal displacement of the distal phalanx within the hoof (“sinking”).
- **Chronic founder**—clinical signs of concave dorsal hoof wall, abnormally wide dorsal white lines, and divergent growth rings in the hoof wall. Sometimes referred to as “chronic laminitis,” this syndrome is not characterized by continued disruption of the lamellae but rather represents the sequelae to laminitis or acute founder. If there is ongoing disruption of the epidermal-dermal connection, then this would be laminitis or acute founder.
- **Prolapse of the sole**—a consequence of distal displacement of the distal phalanx resulting in loss of concavity of the sole.
- **Penetration of the sole**—progression of prolapse of the sole to the point where the dermis or pedal bone protrudes through the sole.

## ETIOLOGY

The proximate cause of laminitis is acute degeneration of the connections between the basal cells of the primary and secondary epidermal lamellae and the basement membrane of the primary and secondary dermal lamellae. Loss of these connections can lead to microscopic and macroscopic disruption of the normal architecture of the foot and development of clinical signs of foot pain. The factors inciting or leading to breakdown of the epidermal-dermal connections within the hoof are uncertain and the subject of much active investigation.

Laminitis is recognized in a number of settings, which could have differing inciting causes:

- **Endocrinopathic laminitis**—laminitis associated with hormonal influences favoring hyperinsulinemia and often associated with insulin resistance as part of equine metabolic syndrome (EMS) or pasture associated laminitis.<sup>4</sup> Hyperinsulinemia is an experimental model for inducing laminitis.<sup>5,6</sup> Endocrinopathic laminitis, associated with either EMS or pituitary pars intermedia dysfunction, is responsible for most cases of laminitis, with estimates ranging from 71% to 89% of cases.<sup>4,7</sup>
- **Sepsis-related laminitis**—horses with septic illness characterized by signs of a systemic inflammatory response (fever, tachycardia, depression), such as horses with enterocolitis, pneumonia and/or pleuritis, and postpartum septic metritis, or after ingestion of large quantities of soluble carbohydrate, are at increased risk of laminitis.
- **Weight-bearing laminitis**—horses that chronically bear more weight on one limb, such as animals with severe persistent unilateral lameness, often develop laminitis in the weight-bearing limb.
- **Concussive laminitis**—associated with prolonged or unaccustomed exercise on a hard surface.
- **Toxic laminitis**—exposure to shavings of black walnut (*Juglans nigra*) causes laminitis. The mechanism involves a severe systemic inflammatory response, and this category of laminitis could share basic mechanisms with that caused by sepsis. Black walnut has been used as an experimental model of laminitis but is now considered less clinically relevant.<sup>8</sup>
- Sustained (lasting 48 hours) digital hyperthermia does not cause laminitis.<sup>9</sup>

## EPIDEMIOLOGY

For such a common and important disease, the epidemiology of laminitis is poorly documented.<sup>10</sup> Quantitative analysis and identification of putative risk factors is available from few studies, and in many instances such studies do not have clear case definitions or rely on lay reporting of the diagnosis and presence of potential risk factors, with the result that conclusions are unreliable and conflicting. There is a pressing need for well-designed, comprehensive studies that address the prevalence, risk factors, and outcome of spontaneously occurring laminitis in non-hospital settings.

A recent systematic review of the scientific literature reporting on risk factors for laminitis concluded that there is limited evidence to support a role for many of the putative risk factors for laminitis.<sup>10</sup> Based on the

reporting in the 6 highest-quality reports of 17 reviewed, the following conclusions were made:<sup>10</sup>

- Age—good evidence that increasing age is a risk factor for laminitis, although some studies did not find this association for acute laminitis
- Sex (gender)—inconsistent evidence; most studies did not find an association
- Breed—inconsistent evidence; most studies did not find an association
- Height—no evidence of an association
- Bodyweight—inconsistent evidence
- General obesity—no evidence
- Cresty neck—weak evidence
- Health variables—no evidence
- Exercise—weak evidence that reduced exercise level is a risk factor
- Endotoxemia—weak evidence, noting that experimental endotoxemia does not cause laminitis
- Pituitary pars intermedia dysfunction—no evidence
- Seasonality—inconsistent evidence
- Weather—weak evidence

Some of these results are surprising and likely will be revised as additional studies are conducted. As noted in the following discussion, there is consensus on several risk factors for development of laminitis that are not reflected in the results of the systematic review cited previously. In the absence of multiple high-quality epidemiologic studies, the results of the systematic review should be considered in light of other knowledge.

## Occurrence

Single sporadic cases are the rule for horses, in which the disease is usually related to individual risk factors such as obesity, systemic illness, or lameness. An estimated 13% of horse operations in the United States have a horse with laminitis at any one time, and laminitis accounts for 7.5% to 15.7% of all lameness in horses.<sup>11</sup> A study of 1000 horses on a single farm in East Anglia (UK) found annual that annual incidence rates for laminitis varied from 7.9% to 17.1%, that 33% of animals diagnosed once with laminitis has a repeat episode of the disease, and that 24% of animals with laminitis had a repeat episode in the same year.<sup>12</sup> Laminitis accounts for up to 40% of hoof problems in horses, depending on the use of the horse. Approximately 5% of horses with laminitis die or are euthanized. Among cases occurring in the field (as opposed to veterinary hospitals), approximately 74% recover and become sound, with 8% improving but continuing to be lame.<sup>11</sup> However, approximately 10% of horses that developed laminitis had a permanent change in their primary use as a result of having developed laminitis.

Within the United Kingdom, 30% of all cases of laminitis are speculated to be caused by grazing lush pasture, 21% as a result of pituitary pars intermedia dysfunction, 13% by obesity, and 9% attributable to equine

metabolic syndrome (cited in<sup>4</sup>). Laminitis accounts for approximately 4.4% of reported diseases in equids in the United Kingdom.<sup>13</sup>

## Risk Factors

### Animal Risk Factors

There are few studies that provide quantitative estimates of risk factors for equids developing laminitis.

### Phenotype

There is a consensus that ponies and horses at increased risk of developing pasture-associated laminitis have a particular phenotype characterized by regional and generalized obesity.<sup>14</sup> Although not borne out by the systematic review, there appears to be considerable diverse evidence that ponies, and especially obese ponies, are at high risk of developing pasture-associated laminitis.<sup>14,15</sup> This risk also applies to obese horses and especially those of “easy keeper” or “thrifty” breeds such as Andalusians, Quarter horses, Morgan, and Arabians. The risk of laminitis is associated with insulin resistance, and not all obese horses or ponies are insulin resistant. Ponies at increased risk might be identified by a variety of means, including measurement of plasma or serum insulin concentration 2 hours after ingestion of glucose (1 g/kg orally).<sup>16</sup> Ponies with exaggerated insulin response are at increased risk of developing laminitis.

### Hyperinsulinemia

Available evidence clearly indicates a propensity for ponies and horses at risk of insulin resistance (obesity, equine metabolic syndrome) to have a higher incidence of laminitis, especially if they are kept on pasture. These equids are considered to develop endocrinopathic laminitis.<sup>15-20</sup> A unifying feature of these horses and ponies is the presence, or presumed presence, of hyperinsulinemia.<sup>14</sup> Reports indicate that between 10% to 22% of obese horses and 28% of ponies in Australia have hyperinsulinemia. Insulin concentrations are higher (138 vs. 315  $\mu\text{mol/L}$ ) in ponies with a history of laminitis than in younger ponies of similar body condition that have never had laminitis,<sup>15,21</sup> and are higher in previously laminitic ponies that have a higher body-condition score than unaffected ponies.<sup>14</sup> The affected ponies are also insulin resistant based on a higher insulin:glucose ratio or the reciprocal of the square root of plasma insulin concentration (RISQI).<sup>15,21</sup> Similarly, hyperinsulinemia is common in horses presenting to veterinary hospitals with a complaint of laminitis—from 21 of 36 (58%) to 13 of 30 (43%).<sup>7,22</sup>

Horses or ponies with documented hyperinsulinemia or pituitary pars intermedia dysfunction (PPID) are at increased risk of having laminitis.<sup>7</sup> Horses of 15 years of age or older in Queensland with PPID diagnosed by seasonally adjusted plasma

adrenocorticotropic hormone (ACTH) concentrations were 4.7 times as likely to have laminitis compared with similarly aged horses without PPID.<sup>23</sup> Aged horses with hyperinsulinemia ( $>20 \mu\text{U/mL}$ ) were 10 times more likely to have laminitis than were horses without documented hyperinsulinemia.<sup>23</sup> Laminitis in horses with PPID is associated with hyperinsulinemia but not at a greater rate than for horses that do not have PPID,<sup>23</sup> suggesting that the hyperinsulinemia present in some horses with PPID might be coincidental in the horse has both EMS and PPID and that it is the EMS that predisposes to hyperinsulinemia and laminitis. Although not supported by the systematic review, clinical evidence clearly supports a link between insulin resistance (hyperinsulinemia) or PPID and risk of laminitis.

The disease is more common in the United States during spring and summer (1.3% in spring and 0.4% in winter in the central United States) and during May in the United Kingdom.<sup>12</sup> Increasing number of hours of sunlight has been linked to the risk of laminitis in horses at pasture—a reflection of the effect of sunlight to increase the content of nonstructural carbohydrate in pasture and not of a biological effect of sunlight on the horses.<sup>12</sup>

The disease is very uncommon in foals and horses less than 8 months of age, then increases in frequency with increasing age such that horses greater than 20 years of age have an incidence of the disease roughly 3 times that of horses between 5 and 20 years of age. This apparent age distribution could represent, among other factors, an increase in prevalence of PPID as horses and ponies age.

**Trauma and other physical factors** such as excessive work on hard surfaces, increased weight-bearing on one limb, and persistent pawing can contribute to the development of the disease in horses. Standing for periods of days during transport can predispose to laminitis.

Laminitis is associated with many **systemic illnesses** of horses. Horses with illness attributable to colic, diarrhea, pleuropneumonia, and metritis are prone to develop laminitis. **Potomac horse fever** (equine neorickettsiosis) is frequently a cause of laminitis in horses, and laminitis is the major cause of death from this disease. Approximately 28% of horses with **anterior enteritis** (duodenitis/proximal jejunitis) develop laminitis, usually within 2 days of developing enteritis. There are anecdotal reports that suggest that administration of **corticosteroids** (dexamethasone, triamcinolone) causes or exacerbates laminitis, but this association has not been proved.<sup>24-26</sup> Laminitis is common in horses that gorge on grain or similar feeds containing a high concentration of soluble carbohydrates. Ingestion of large quantities of lush pasture has been anecdotally associated with increased risk of

laminitis, especially among ponies. It is thought that the presence of a high concentration of soluble carbohydrates in the grass is responsible for the increased risk of laminitis.

### Supporting Limb Laminitis

Development of laminitis in a limb bearing a disproportionate amount of the horse's weight for prolonged periods of time is a frequent occurrence among horses treated for severe chronic unilateral lameness or subject to fracture repair requiring casting of the limb. Of 113 horses that received half-limb or full-limb casts, 14 (12%) developed confirmed supporting limb laminitis.<sup>27</sup> Risk factors significantly associated with development of laminitis included body weight of the horse and duration of casting in weeks, with horses requiring full-limb casts or transfixion pin casts more likely to develop this complication than horses requiring half-limb casts. Supporting hindlimbs (for the contralateral hindlimb) were as likely to be affected as supporting forelimbs.

Horses hospitalized for treatment of laminitis, or those that develop laminitis during hospitalization for other diseases, have risk factors that differ from those of horses with pasture-associated laminitis. Endotoxemia (defined clinically, not by measurement of blood endotoxin concentration, and therefore more appropriately referred to as toxemia) was the only factor associated with development of laminitis.<sup>28</sup> This study provides evidence that severe systemic inflammation increases the risk of laminitis, but it provides no evidence of the effect of endotoxemia.

### Importance

Death is unusual in horses with laminitis that do not have other severe systemic illness, but the severe lameness can cause a great deal of inconvenience, and affected horses can develop permanent deformities of the feet. Some have to be euthanized on humane grounds.

Of 107 horses with pasture-associated laminitis, 77 had a “good” outcome as assessed by a panel of veterinarians, and 47 of 79 animals used for riding before developing laminitis were being ridden 8 weeks later. Five of the initial 107 animals were euthanized by 8 weeks after development of the disease, and those that were more severely affected (based on Obel grade of lameness) were more likely to have been euthanized.<sup>29</sup>

Among 247 hospitalized horses that died or were euthanized because of laminitis and 344 horses that developed laminitis but did not die, factors increasing the risk of death because of laminitis were being Thoroughbred (odds ratio [OR] = 1.57) or a racehorse (OR = 1.76), treatment with flunixin meglumine (OR = 1.76), distal displacement of the third phalanx (OR = 2.68), pneumonia (OR



= 2.87), and lameness of Obel grade II (OR = 2.99), grade III (OR = 9.63), or grade IV (OR = 20.48) compared with Obel grade I.<sup>30</sup>

## **PATHOGENESIS**

The pathogenesis of laminitis is complex and in most cases involves systemic disease that is at least partially expressed in the foot. Evidence for laminitis being part of a systemic disease and not only a localized disease of the foot includes observations that analysis of a panel of tissue samples from horses with experimentally induced laminitis revealed that degradation of laminin-332 and collagen type IV, both proteins found in the basement membrane of the hoof, occurs in the skin and stomach in addition to the hoof lamellae.<sup>31</sup> Additionally, systemic inflammatory responses, including infiltration of neutrophils, are noted in lung, skin, liver, and gastrointestinal tract of horses with black walnut–induced laminitis.<sup>32–34</sup> These findings suggest that systemic inflammation and degradation of proteins common to a wide range of tissues, and including the basement membrane, are common to many epithelial tissues during equine laminitis, suggesting a systemic pathogenesis for at least some forms of this disease.

The local pathogenic process common to all forms of laminitis is disruption of the connective tissue (involving laminin-5 and collagen types IV and VII) providing connections between the lamellar basal cells and the basement membrane of the third phalanx.<sup>35</sup> Carbohydrate overload is associated with up-regulation of genes expressing MMP-13 (matrix metalloproteinase 13) and localized loss of collagen I, fibronectin, chondroitin, and keratin sulfate glycosaminoglycans in secondary lamellae.<sup>36</sup>

It is possible, indeed likely, that a more than one type of insult to basal cells or basement membrane can result in loss of adhesion between the basal cell and the basement membrane—sometimes referred to as dyshesion—or degeneration of the basement membrane. As a consequence of the loss of these connections, the weight of the horse is no longer transmitted through the numerous lamellae to the hoof wall but is instead transmitted toward the sole of the foot.

Loss of the connection between the third phalanx and hoof allows the third phalanx to **rotate** within the hoof capsule, likely in response to the torque applied by the deep digital flexor tendon, and/or to displace ventrally (**sink**) within the hoof as a result of weight transmitted through the third phalanx; or there can be a combination of these changes. Rotation of the third phalanx causes the sole to be pushed downward or “dropped,” and the point of the toe of the third phalanx may actually penetrate the sole. Serum accumulates in the space created by degeneration of the laminae and displacement of the third phalanx, and there is breakdown of the white line.

Exactly what the mechanism is that links the risk factors listed previously to the laminar degeneration, the basis of the separation, is unknown. There are differences in the microscopic lesions induced by either **hyperinsulinemia or models of sepsis-induced laminitis** (carbohydrate overload, oligofructose [OF] administration), suggesting that the inciting mechanisms in each form of laminitis could differ,<sup>37</sup> with subsequent common events resulting in the clinical signs of laminitis.<sup>38</sup> Calprotectin, a marker of the presence or activation of neutrophils, expression in lamellae was absent in control horses, moderate in hyperinsulinemic horses, and marked in OF-treated horses, indicating that hyperinsulinemia induces less leukocyte emigration than carbohydrate overload at 48 hours after initiation of the inciting cause.<sup>37</sup> Laminitis induced by administration of black walnut is characterized by early (1.5 hours) marked infiltration of neutrophils and expression of neutrophil adhesion molecules in lamellar endothelial cells and cytokines favoring extravasation of neutrophils into lamellae.<sup>39–42</sup> There are similar changes during carbohydrate overload laminitis but with a somewhat delayed time frame with some extravasation of leukocytes, which are predominantly monocytes and macrophages (compare with neutrophils in black walnut laminitis), during the prodromal phase but maximal accumulation in lamellar tissues at the onset of clinical signs.<sup>43–46</sup> Similarly, there is increased mRNA concentrations for IL-1 beta, IL-6, IL-12p35, COX-2, E-selectin, and ICAM-1 in laminae from horses with Obel grade I lameness but not during the prodromal phase in horses with carbohydrate-induced laminitis.<sup>43</sup>

The majority of laminar inflammatory events appear to occur at or near the onset of lameness in the carbohydrate-overload (CHO) model, whereas many of these events peak earlier in the prodromal (developmental) stages in the black walnut extract–model. This suggests that, in addition to circulating inflammatory molecules, there may be a local phenomenon in the CHO model resulting in the simultaneous onset of multiple laminar events, including endothelial activation, leukocyte emigration, and proinflammatory cytokine expression.<sup>43</sup> CHO laminitis is associated with increases in mRNA of various CXC and CC chemokines during either the prodromal or clinical phase, or both, and in the increase in expression of a wide range of proinflammatory genes.<sup>45,47</sup> CHO-induced laminitis is associated with marked changes in fecal microbiota, including overgrowth of gram-negative bacteria.<sup>48</sup> Inflammatory signaling is a consistent entity in the pathophysiology of laminitis, although there is evidence that leukocyte appearance in lamellar tissues is not the first event in the pathogenesis of laminitis but has a key early role in the development of lesions and progression of the disease.

**Hyperinsulinemia** (with euglycemia) induced by prolonged (up to 72 hours) infusion of insulin and glucose results in development of clinical and histologic signs of laminitis in insulin-sensitive horses and in ponies.<sup>5,49–51</sup> The concentrations of insulin required to induce laminitis in insulin-sensitive horses are very high (>1000 μU/mL), although lesions, but not clinical signs, have been detected in horses in which insulin concentrations approximated 200 μU/mL as a result of infusion of glucose.<sup>6</sup> Microscopic lesions induced by infusion of insulin during the prodromal (development) phase of laminitis have been well characterized and contrasted with those of carbohydrate overload.<sup>51–53</sup> There is no detectable calprotectin present before 48 hours (about the time of onset of clinical signs of laminitis), whereas secondary epidermal lamellar width decreases, and there is histomorphological evidence of epidermal basal (and suprabasal) cell death after 6 hours of hyperinsulinemia.<sup>50,53</sup> Increased cellular proliferation in the secondary epidermal lamellae, infiltration of the dermis with small numbers of leukocytes, and basement membrane (BM) damage occurred later at 24 and 48 hours. Narrowing of the secondary epidermal lamellae was progressive over the 6- to 48-hour period.<sup>50</sup> There were signs of apoptosis of basal cells. Cellular lesions preceded leukocyte infiltration and BM lesions, indicating that the latter changes may be secondary or downstream events in hyperinsulinemic laminitis to initial insults to basal cells.<sup>50</sup>

A role for insulin-like growth factor (IGF) has been proposed, with insulin acting as an agonist for the IGF receptor. Cell proliferation occurs in the lamellae during insulin-induced laminitis, and in other species high concentrations of insulin can activate receptors for the powerful cell mitogen IGF-1.<sup>54</sup> It is speculated that stimulation of the IGF-1 receptor by insulin could lead to inappropriate lamellar epidermal cell proliferation and lamellar weakening, a potential mechanism for hyperinsulinemic laminitis.<sup>54</sup>

Hyperinsulinemia causes increases in plasma concentrations of pentosidine, an advanced glycoxidation end product indicative of inflammation, which could indicate a role for glucose toxicity in the genesis of endocrinopathic laminitis.<sup>21</sup> However, the failure to detect advanced glycoxidation products in the lamellae of horses during the prodromal phase of laminitis induced by hyperinsulinemic–hyperglycemic clamp, although these products were detected when clinical signs of laminitis had developed, and the lack of evidence of oxidative stress do not lend support to oxidative stress and protein glycosylation playing a central role in the pathogenesis of acute, insulin-induced laminitis.<sup>55</sup> The insulin-independent glucose transporter GLUT-1 was increased in lamellar tissue in the developmental stages of

insulin-induced laminitis compared with control horses, although the importance of this observation is unclear.<sup>55</sup> There does not appear to be a role for toll-like receptor 4 (TLR4) in the development of hyperinsulinemic laminitis in otherwise healthy horses.<sup>56</sup>

Hyperinsulinemia in isolated (ex vivo) hooves of healthy horses increases vascular resistance and lamellar endothelin-1 expression and perfusion of isolated lamellar veins with cortisol and insulin.<sup>57</sup> Exposure of isolated lamellar veins to cortisol increases maximum contractility to the vasoconstrictors (noradrenaline and 5-hydroxytryptamine) and decreases the maximal contraction to endothelin-1, whereas exposure to insulin decreases contractility of vessels to phenylephrine and endothelin-1 (ET-1).<sup>58</sup> It is possible that short-term cortisol excess could enhance vasoconstrictor responses to 5-hydroxytryptamine and noradrenalin in lamellar veins in vivo, thereby predisposing to laminitis.<sup>58</sup> The authors conclude that a reduction in the ability of insulin to counteract alpha-adrenoreceptor and ET-1-mediated contraction, likely to occur in subjects with insulin resistance, could further exacerbate vasoconstriction in animals prone to laminitis. These mechanisms could also predispose horses with PPID or EMS to laminitis.<sup>58</sup> Others have demonstrated that insulin resistance, which is associated with hyperinsulinemia, increases vascular reactivity and response to various vasoconstrictors and has, in the absence of direct experimental evidence in horses or ponies, been speculated to contribute to excessive vasoconstriction in the dermis of susceptible horses.<sup>20</sup> Short-term hyperinsulinemia increases vascular resistance in the equine digit and increases expression of ET-1 in the lamellar tissue, providing a possible explanation for a role for insulin in perfusion of the digit.<sup>57</sup> Furthermore, laminitis induced by IV infusion of insulin is associated with warmth of the hoof, which is considered evidence of vasodilatation in the foot. It is plausible that there is a combination of these mechanisms, beginning with digital vasoconstriction and ending in arteriovenous shunting, that could lead to hypoxemia of lamella and loss of integrity of the basal cells or basement membrane.

Other theories for the etiopathogenesis of laminitis include the following:

- Ischemia of the laminae with subsequent dysfunction or death of basal cells or degeneration of the basement membrane—proposed causes of ischemia include vasoconstriction, development of arteriovenous shunts, interstitial edema, and presence of microthrombi in digital vessels. Ischemia as a result of microthrombus formation is no longer considered a potential cause of laminitis. However,

there is evidence from experimental laminitis, both black walnut and carbohydrate models, that there are changes to the microvasculature of the dermis, possibly secondary to changes in circulating concentrations of vasoactive amines or contractile activity of vessels in the hoof.<sup>57,59-63</sup> Alternatively, increases in capillary filtration pressure, resulting from venoconstriction, might cause edema and increased interstitial pressure with subsequent ischemia of the laminae.<sup>11</sup>

- Enzymatic digestion of connective tissues of the lamella by matrix metalloproteinases (MMPs) induced by circulating factors including products of *Streptococcus bovis* infection has been proposed as a cause of the loss of integrity of the basal cell–basement membrane junction. Recent evidence indicates that MMP-9 is not involved in this process because it remains in the inactive proenzyme form during the prodromal (developmental) phase of oligofructose-induced laminitis, although MMP-13 might be.<sup>36,64,65</sup> However, other proteinases, such as ADAMT-4, and metalloproteinases might be involved in affecting basal cell or basement membrane function. Interesting, ADAMT-4 is located primarily in the basal cells and not in the matrix, calling into question its role in basement membrane integrity or disruption of adhesion between basal cells and the basement membrane.<sup>66,67</sup> Alternatively, elevated ADAMT-4 expression and versican depletion could be associated with abnormal basal cell function and disruption of adhesion.<sup>68</sup>
- Infusion of endotoxin does not induce laminitis in healthy horses or ponies, nor does the systemic inflammatory response induced by administration of endotoxin manifest as expression of genes of proinflammatory cytokines in the lamellae.<sup>69</sup> Many of the inciting causes of laminitis are diseases that are associated with **endotoxemia** or, more generally, toxemia, and in experimental models endotoxin was detectable in the blood of horses that developed laminitis, suggesting that endotoxin could contribute to the development of the disease. However, infusions of endotoxin do not cause laminitis, although endotoxin does impair endothelium-dependent relaxation and augments adrenergic contraction of palmar digital arteries.
- Theories for development of laminitis in a supporting limb include loss of intermittent weight-bearing with a reduction in vascular perfusion of the hoof and ischemia of the lamellae.<sup>70</sup>
- There is no evidence that laminitis is an autoimmune disease.<sup>71</sup>

The disease occurs in three distinct phases: (1) a developmental stage in which lesions are detectable in the sensitive laminae but during which there are no clinical signs, (2) the acute phase from the development of the first clinical signs through to rapid resolution or to rotation or ventral displacement of the third phalanx, and (3) the chronic stage evidenced by rotation of the third phalanx with or without ventral displacement and characterized by variable but persistent pain.

## CLINICAL FINDINGS

The disease presents as both an acute disease and as a chronic disease. The severity of the acute disease varies considerably from very mild with rapid (5 to 7 days) recovery, to severe with progression to the chronic, refractory stage.

Severity of lameness attributable to laminitis can be graded according to a scale proposed by Obel in 1948:

**Grade 0**—normal

**Grade 1**—horse alternately and intermittently lifts its feet; lameness is not evident at a walk but the gait is short and stilted at a trot.

**Grade 2**—there is a stilted gait at the walk, but the horse moves willingly; a foot may be lifted by a handler without the horse resisting.

**Grade 3**—the horse moves reluctantly and resists attempts by a handler to lift a foot.

**Grade 4**—the horse refuses to move and does so only if forced.

The reliability of this system has been assessed, and it has reasonable intraobserver reliability (weighted kappa statistic of 0.54) when using all four (five) grades, which increases to 0.69 when reduced to three categories (sound, grades I and II combined, and grades III and IV combined).<sup>72</sup> Interobserver agreement (58 veterinarians in primary opinion equine practice) was 0.43 (moderate agreement) for the unweighted kappa statistic and 0.65 (substantial agreement) for the weighted kappa statistic when all four (five) grades were used. When grades were lumped into the three categories, the interobserver agreement increased to 0.52 and 0.54 for unweighted and weighted kappa statistics, respectively. Importantly, there was 83% agreement on detection of severely affected animals (of the three lumped grades).<sup>72</sup> These results are similar to those of a study comparing use of a visual analog scale, Obel grade, and clinical grading system. All methods of assessing severity of laminitis had acceptable intra- and interobserver agreement, with more experienced observers having greater reliability.<sup>73</sup> These studies demonstrate that the Obel grading system is useful for clinical description of laminitis and therefore assessment of the response to therapy.

The **acute disease** develops rapidly; apparently normal horses can founder within hours. Signs of the disease are entirely attributable to pain in the feet. All hooves can be affected, but more commonly the forefeet are affected and the hindfeet are spared. The disease is rarely unilateral except in cases in which the disease develops because of severe lameness in the contralateral limb or repeated pawing. Mild, or early, disease is apparent as a resistance to movement and repetitive and frequent shifting of weight from one foot to the other. There is a characteristic shuffling gait.

**More severe disease** is apparent as refusal to move or to lift a hoof. At this stage the horse has an anxious expression that can be accompanied by muscle fasciculation, sweating, a marked increase in heart rate to as high as 75/min, and rapid and shallow respiration. There is a characteristic posture with all four feet being placed forward of their normal position, the head held low, and the back arched. There is usually a great deal of difficulty in getting the animal to move, and when it does so the gait is shuffling and stumbling, and the animal evidences great pain when the foot is put to the ground. The act of lying down is accomplished only with difficulty, often after a number of preliminary attempts. There is also difficulty in getting the animals to rise, and some horses may be recumbent for long periods. It is not unusual for horses to lie flat on their sides. In occasional cases, the separation of the wall from the laminae is acute, and the hoof is shed. There may be exudation of serum at the coronet, and this is considered a sign of impending sloughing of the hoof and a poor prognosis.

**Clinical signs** in laminitis include pain on palpation around the coronet and a marked withdrawal response when hoof testers are applied to the hoof. The intensity of the pulse in the palmar digital artery, palpable over the abaxial aspects of the proximal sesamoid, of affected feet is markedly increased over normal. In horses in which the third phalanx is displaced distally (sinks), a concavity can be palpable at the coronary band. Infiltration of the palmar digital nerves at the level of the proximal sesamoid with local anesthetic agents provides marked, but not complete, relief.

In the **chronic stages** of the disease, there is separation of the wall from the sensitive laminae and a consequent dropping of the sole. The hoof wall spreads and develops marked horizontal ridges, and the slope of the anterior surface of the wall becomes accentuated and concave. Horses with chronic or refractory laminitis may continue to feel much pain, lose weight, and develop decubitus ulcers over pressure points because of prolonged recumbency. Loss of integrity of the sole and disruption of the white line can allow infection to develop in the degenerate lamellae. The infection can



**Fig. 15-6** Radiograph of a horse demonstrating rotation of the distal phalanx with likely penetration of the sole. The coronary band is indented, and there is no evidence of sinking. There is not osteolysis of the distal phalanx. (Reproduced with permission.<sup>75</sup>)

spread to involve the pedal bone, causing a septic pedal osteitis. The lameness might abate, but the animal becomes lame easily with exercise and can suffer repeated, mild attacks of laminitis.

**Radiographic examination** of the feet is an essential component in evaluation of horses with laminitis. The standard radiographic views that should be obtained to aid assessment of horses with laminitis are the lateromedial, horizontal dorsopalmar, and dorsal 45 degrees proximal palmarodistal oblique views.<sup>74</sup> A variety of objective measures have been developed to aid in the interpretation of radiographic examinations of the feet of laminitic horses (Figs. 15-6 and 15-7), and these are discussed in detail elsewhere.<sup>74</sup>

Initially and in mild cases, changes in the position of the distal phalanx are not evident. Radiographs of more severe or advanced cases will demonstrate rotation of the distal phalanx within the hoof, evident as a tilting of the most distal aspect of the third phalanx toward the sole. The space created by rotation of the pedal bone can fill with gas or serum and be evident as a radiolucent line between the pedal bone and the dorsal hoof wall. Displacement of the pedal bone toward the sole will be evident in approximately 25% of cases as a thickening of the dorsal hoof wall and reduction of the distance between

the sole and solar aspect of the distal phalanx. Chronic or refractory cases can have osteopenia of the pedal bone with proliferation of bone at the toe.

### Prognosis

The radiographic examination provides information of prognostic value, although because of differing radiographic techniques and interpretations the value of combining separate research studies to develop firm guidelines is difficult.<sup>74</sup> Horses that return to their previous level of athletic function after a bout of laminitis have pedal bone rotation of less than 5.5 degrees, whereas horses that can no longer perform as athletes usually have more than 11.5 degrees of rotation, although there are exceptions to this rule and the prognosis should be developed through a holistic assessment of the horse (level of pain, number of feet involved, sole penetration).<sup>74</sup> Therefore, these values should only be used as rough guidelines. The general rule is that the greater the degree of rotation or extent of displacement of the distal phalanx, the worse the prognosis for return to function and pain-free living.

Objective radiographic variables include the distance between the proximal aspect of the hoof wall (marked on the radiographic image by a piece of wire or strip of metal stuck to the dorsal hoof wall) and the



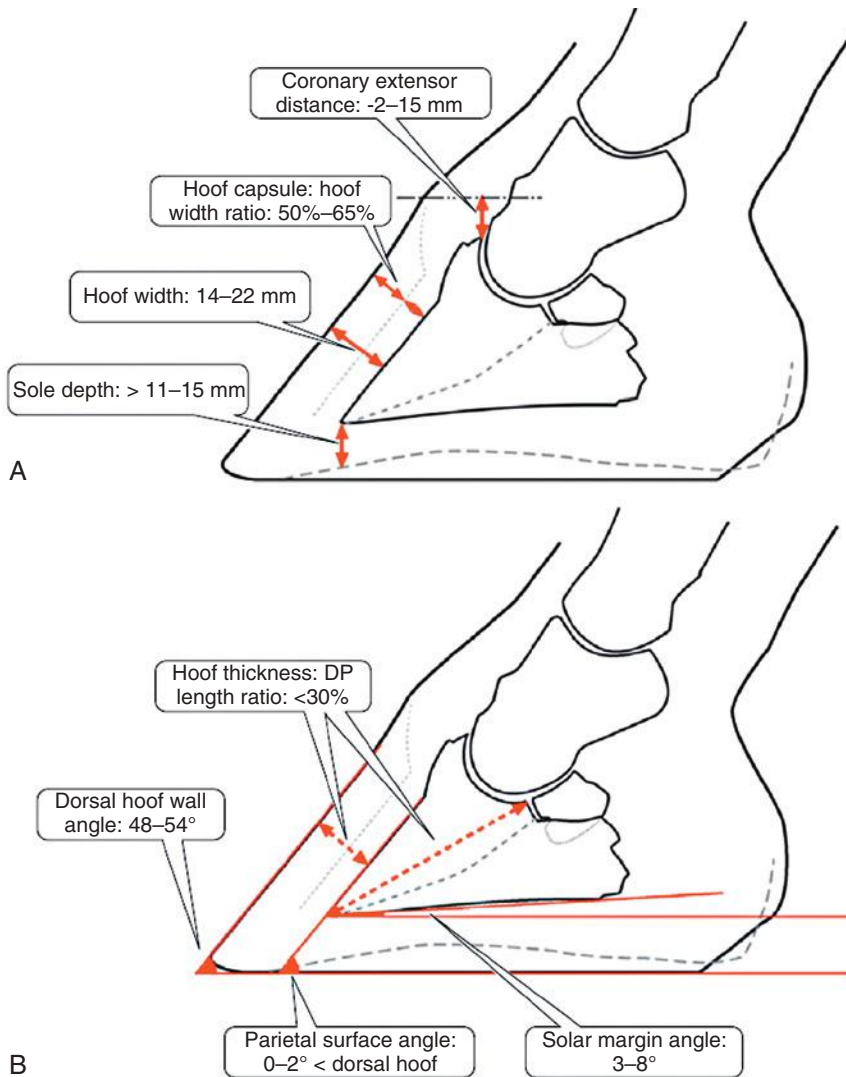

**Fig. 15-7** Diagrams showing the normal radiologic distances and proportions in the front feet of sound horses. Care must be taken in interpretation of these values because there is marked individual (breed and size) variability, and many can also be altered by farriery; the measurements in these diagrams do not represent the absolute minimum and maximum of normal values; rather, they are representative of the center of the range. (Reproduced with permission.<sup>74</sup>)

proximal limit of the extensor process of the distal phalanx (the “founder” distance), and the distance between the dorsal hoof wall and the dorsal cortex of the distal phalanx. Although values for these measures vary among breeds and with the size of the horse, most normal horses will have a “founder” distance of  $4.1 \pm 2.2$  (standard deviation) mm and a wall thickness of  $16.3 \pm 2.4$  mm. Intensively managed horses with signs of sinking (medial, lateral, or vertical) had an overall success rate of 18% (17/95), whereas nonsinkers (horses with or without apparent rotation) with laminitis had a 71% (107/150) success rate.<sup>75</sup>

### CLINICAL PATHOLOGY

There are no changes that are characteristic of the disease.

### NECROPSY FINDINGS

The disease is not usually fatal, but severely affected animals are often euthanized. In acute cases, there may be evidence of colitis, grain overload, or retained placenta and metritis in mares. No reliable gross findings are visible on the feet, but a midsagittal section of the hoof may reveal congestion, hemorrhage, and slight separation of the dorsal surface of P3 from the epidermal laminae of the inner surface of the horny hoof wall in severe cases. The separation of P3 becomes more obvious in subacute and chronic cases, leading to a ventral rotation of the phalanx. In some cases the degree of rotation of P3 results in perforation of the sole.

Histologic examination is required only in acute cases, and confirmation of the

diagnosis in such instances demands that the foot be cut into slab sections and fixed shortly after the death of the animal, before even moderate autolysis can ensue. Microscopically, the lesions are degeneration and necrosis of epithelial cells of the laminae, separation of epithelial cells from the basement membrane, and loss of the basement membrane.

### DIFFERENTIAL DIAGNOSIS

#### Horses

Rhabdomyolysis, tetanus, colic, and spinal ataxia may all mimic the immobility and pain of laminitis, but there is no pain in the feet in these diseases, and other distinguishing characteristics are apparent on careful clinical examination.

### TREATMENT

The adage “where facts are few experts are many” (Donald R. Gannon) applies well to the treatment of laminitis. There are few well-designed studies of the treatment of naturally occurring laminitis, and thus the choice of treatment is based on personal experience, extrapolation from our imperfect understanding of the pathogenesis of the disease, the availability of certain drugs, and current fashion. Indeed, the treatment of laminitis might one day be chronicled to demonstrate the power of “expert” opinion to determine treatments, many of which are now recognized as useless. A fascinating example is that of the application of nitroglycerin patches to the pasterns of horses with laminitis or at increased risk of laminitis. A multitude of horses were treated in this way, some to the extent that they were rendered hypotensive, at considerable direct cost and opportunity cost, and all for naught. Although not intended to discount the opinion of experts in the treatment of laminitis, it is a salutary tale demonstrating the strength of fashion and fad in promoting ineffective treatments of this important disease.

In general, the treatments can be grouped into several classes, based on the intended intervention. These are as follows:

- Removal of the causative agent or treatment of the inciting disease
- Pain relief and minimization of inflammation
- Prevention of further damage to lamellae and rotation or distal displacement of the pedal bone
- Promotion of keratinization and hoof growth

The efficacy of administration of analgesic, antiinflammatory, anticoagulant, and vasodilatory drugs and mechanical support of the hoof has never been demonstrated in appropriate clinical trials. There is evidence that local cryotherapy (cooling of the distal limb) is effective in reducing the clinical signs and severity of lesions of

oligofructose-induced experimental laminitis,<sup>76</sup> with limited although supportive clinical evidence.<sup>77</sup>

**Acute laminitis is an emergency,** and treatment should be started without delay because early and aggressive therapy might enhance the chances of recovery.

#### *Treatment of Inciting Process or Disease*

The inciting disease should be treated aggressively and every attempt made to remove any causative agent.

Horses with systemic inflammatory disease (colitis, metritis, etc.) should be treated aggressively to reduce the likelihood that they will develop laminitis. Treatment of colitis, metritis, pleuropneumonia, colic, and other diseases is dealt with under those topics.

Horses with laminitis should be rested and housed in stalls that are well bedded with sand or soft shavings. Horses suspected of having PPID, insulin resistance, or EMS<sup>17</sup> should have the diagnosis confirmed and appropriate therapy instituted.

#### *Cryotherapy or Digital Cooling*

There is experimental, and some clinical, evidence that chilling of the feet is effective in preventing development of laminitis and in attenuating the effects of established (acute) laminitis induced experimentally.<sup>77,78</sup>

Progression of experimental laminitis (CHO model) can be prevented by cooling (chilling) of the feet of horses during the prodromal and acute phases of the disease.<sup>76,78</sup> Cooling of the distal limbs of horses administered 10 g/kg body weight of oligofructose markedly reduced the clinical signs of laminitis and development of histologic lesions in the feet of treated horses. Cooling in the experimental model began at the time of administration of oligofructose and continued for 72 hours. Horses treated by immersion of the limbs in cold water (0.5 to 2.0° C; 33–36 F) had only mild signs of lameness (grade I or less) at all times up until euthanasia at 72 hours.<sup>76</sup> Furthermore, chilling of the limbs significantly reduced expression of a range of genes of proinflammatory proteins and increased expression of an antiinflammatory protein during both the prodromal and clinical phases of disease.<sup>79</sup>

Chilling of limbs after the onset of laminitis induced by oligofructose prevents lamellar structural failure and reduces the severity of damage to lamellae.<sup>80</sup> Chilling (cryotherapy) of feet was initiated as soon as Obel grade II lameness was detected (horses were examined every 4 hours) and continued until euthanasia 36 hours after onset of lameness. Horses were also administered phenylbutazone (8 mg/kg IV—a high dose) and had continuous peripheral nerve block to alleviate foot pain. The frequency of weight shifting was significantly reduced in chilled feet, as assessed by pedometer, which was inferred

as indicating less pain in chilled feet. It is important to consider that model was one of experimental laminitis, chilling was initiated less than 4 hours after onset of lameness, and chilling was maintained continuously for the duration of the study (36 hours). Whether the treatment would be as effective for other forms of laminitis or if initiated later in the development of lameness, and the optimal duration of chilling, are not known.

A **retrospective case-control study** identified that horses at risk of developing laminitis secondary to colitis were 0.14 (95% confidence interval [CI] 0.04 to 0.51) times less likely to develop laminitis if treated with digital cryotherapy.<sup>77</sup>

It has been practice for some time by both laypeople and veterinarians to cool the feet of acutely laminitic horses. With evidence that chilling reduces clinical and biochemical/genetic signs of inflammation in the feet of horses with induced laminitis, there is justification for clinical trials to determine the usefulness of this treatment in horses with acute or ongoing (chronic, active) laminitis. Prophylactic chilling of the feet of horses at high risk of developing laminitis, such as those with colitis, pleuropneumonia, metritis, and grain engorgement, could be considered, recognizing that there is a history of proposed treatments for laminitis that have not lived up to their promise. Protocols for chilling of limbs in a clinical setting have not been developed or demonstrated to be effective and without important adverse effects. It is important that any such protocols address issues such as the optimal time for starting cooling of limbs in horses with acute laminitis, duration of treatment, how to rewarm the limb, whether all limbs or only the forelimbs should be cooled, efficacy in differing forms of laminitis (endocrinopathic, sepsis-associated, supporting limb, concussive), and long-term outcome. Techniques have been developed to assist in monitoring the distal limb temperatures of horses during limb chilling.<sup>81</sup>

#### *Analgesics and Antiinflammatory Drugs*

A mainstay of the treatment of both acute and chronic laminitis is the use of nonsteroidal antiinflammatory drugs (NSAIDs). These are administered to provide pain relief, and there is no evidence that they delay progression of the disease.

**Phenylbutazone**, at doses of 2.2 to 4.4 mg/kg IV or orally every 12 to 24 hours, is an effective analgesic in cases of mild to moderate laminitis. Higher doses (6.6 mg/kg every 12 to 24 hours) can be required in severe cases. However, the potential for phenylbutazone toxicosis, evident as colic, gastrointestinal ulceration, nephrosis, hypoproteinemia, leukopenia, and hyponatremia, is dose related, and high doses of phenylbutazone should only be used for at most several days and only in horses experiencing

severe pain. **Flunixin meglumine** (1.1 mg/kg, IM or IV every 8 to 12 hours) or **keto-profen** (2.2 mg/kg, IM every 12 to 24 hours) are also effective analgesics. Their concurrent use with phenylbutazone can enhance pain relief but also increases the risk of NSAID toxicosis. A number of other NSAIDs are available for use in horses (meloxicam, firocoxib) and might be useful for management of pain in some horses. The use of aspirin is dealt with under “Anticoagulants.”

**Narcotic analgesics** such as butorphanol, morphine, and meperidine (pethidine) provide effective pain relief;  $\alpha$ -2 agonists such as **xylazine** and **detomidine** provide only brief respite from the pain.

Horses with severe lameness (Obel grade III or IV) might benefit from administration of drug cocktails including tramadol and subanesthetic doses of ketamine (0.6 mg/kg per hour IV)<sup>82</sup> or constant-rate infusions of a mixture of an  $\alpha$ -2 agonist, a narcotic, and ketamine.<sup>83</sup> The use of objective assessment tools to assess the severity of pain and response to administration of analgesics is preferred over unstructured assessment of pain.<sup>83</sup>

**Local analgesia** of the foot with agents such as lidocaine or bupivacaine provides marked pain relief. However, analgesia is usually only brief, depending on the agent used, and has the disadvantage of causing the horse to bear more weight on the affected limbs. Local analgesia can be useful in facilitating relocation of the horse, hoof trimming, corrective shoeing, or application of sole and frog support, but not as a routine treatment.

**Lidocaine**, administered intravenously as a constant-rate infusion, has been advocated as an antiinflammatory drug for the treatment of laminitis. However, evidence from the black-walnut model of laminitis does not indicate efficacy in reducing markers of inflammation.<sup>84</sup>

Because of suspicion that **corticosteroids** induce or exacerbate laminitis, at this time their use is contraindicated in the treatment of laminitis.<sup>24-26,85,86</sup>

#### *Vasodilatory Drugs*

Vasodilatory drugs are used on the premise that vasoconstriction is an important mechanism underlying the development or progression of acute laminitis. Several classes of drugs have been used, including  $\alpha$ -adrenergic antagonists such as phenoxybenzamine and phentolamine, drugs with multiple mechanisms of action such as acepromazine and isoxsuprine, and nitric oxide donors such as glyceryl trinitrate (nitroglycerine) and L-arginine. None of the vasodilatory drugs should be used in horses with compromised cardiovascular function or dehydration.

Phenoxybenzamine and phentolamine are not readily available and have limited use. Phenoxybenzamine causes sedation. **Acepromazine** is a potent vasodilator,

principally because of its  $\alpha$ -adrenergic antagonist activity, that is currently used occasionally in the treatment of acute laminitis.<sup>12</sup> Acepromazine increases blood flow to the digit, but its effect on nutritive flow to the lamellae is unknown, as is the case for all the vasodilators. The effect of Acepromazine persists for approximately 90 minutes after IV administration. Acepromazine can be administered at dose rates ranging from 0.01 to 0.05 mg/kg, IM, every 6 to 12 hours. Sedation may be considerable at the higher doses and/or with more frequent administration and might be a desired effect in reducing movement (and hence potential for further damage to lamellae) and anxiety. **Isoxsuprine** is a combined  $\alpha$ -antagonist and  $\beta$ -agonist that increases blood flow to the leg but not to the foot in normal horses. It has been used at doses of 1 to 1.5 mg/kg orally every 12 hours. Pentoxifylline (4.4 mg/kg orally q8h), which increases red blood cell deformability, does not increase digital blood flow in normal horses.

Application of **nitroglycerine** a nitric oxide donor, to the palmar digital arteries of affected horses has been reported to increase or not affect blood flow to the dorsal hoof wall. However, the effect of these substances on the course of the disease is unknown. In spontaneous cases of acute laminitis, nitroglycerine has been applied to the skin over both palmar digital arteries of affected feet at a dose of 15 to 30 mg per artery, once daily. However, because of lack of evidence of efficacy and the potential for systemic hypotension secondary to systemic absorption of the drug, its use is no longer recommended.

#### Anticoagulants

Anticoagulant drugs are administered to prevent the development of microthrombi within the hoof. Current evidence does not support an important role for microthrombi in the development of laminitis. However, activated platelets do accumulate in lamellar vessels and release vasoactive compounds.<sup>59</sup> Aspirin is a very poor analgesic in horses but is used because it reduces platelet aggregation in normal horses by blocking formation of thromboxane A<sub>2</sub>. However, thromboxane may not be an important cause of platelet aggregation in horses. Aspirin is administered at a dose of 10 mg/kg orally every 48 hours. The efficacy of aspirin in the treatment of laminitis has not been determined.

**Heparin** in sufficient doses prolongs blood clotting, provided that there is adequate antithrombin III in the patient's blood. Heparin has been reported to prevent or to have no effect on the development of laminitis in horses with anterior enteritis or colic, respectively. Heparin can be administered at 40 to 80 IU/kg IV or subcutaneously (SC) every 8 to 12 hours for 3 to 5 days. Anemia can develop during heparin administration but resolves rapidly when administration of the drug is stopped.

Administration of low-molecular-weight heparin is proposed as prophylaxis for laminitis in horses at high risk of the disease. A study of horses admitted for colic surgery included 304 horses treated with low-molecular-weight heparin between 1995 and 2007 and 56 horses, admitted before 1995, that were not treated with the compound found that the prevalence of horses developing laminitis in the treatment group (3.3%; 95% CI, 1.7% to 6.2%) was significantly lower than in the control group (10.7%; 95% CI, 4.4% to 22.6%).<sup>87</sup> However, horses in the control group were a historical control, and there might well be other factors that contributed to the reduction in incidence of laminitis, such as improved preoperative, intraoperative, and postoperative care. This one study cannot be considered to provide proof of efficacy.

#### Mechanical Support

Mechanical support to provide pain relief, minimize further damage to lamellae, and in an attempt to prevent rotation or distal displacement of the pedal bone is an important part of the care of horses with acute laminitis.

**Support of the frog** and/or sole can be achieved using packing material such as dental acrylic or firm plastic or silicone that is molded to conform to the shape of the sole. Some clinicians prefer to use **wedge pads** to elevate the heel and reduce tension in the deep digital flexor tendon, with the aim of preventing rotation of the distal phalanx by reducing "break-over" forces. Trimming of the toe could achieve the same effect.

Housing the horse on sand or other soft bedding is frequently recommended.

Corrective shoeing of horses with chronic laminitis is widely practiced, and there are proponents of a wide variety of shoe types (fullered egg-bar, heart-bar, glue-on shoes). Appropriate hoof care, which might include shoeing, is important in managing horses with chronic laminitis. Interestingly, there was not a difference among shoe types in efficacy for pain relief in horses with chronic laminitis.

#### Promotion of Healing

**Methionine** has been given to both acute and chronic laminitis cases on the known requirement for methionine in the chondroitin complex of collagen. There is some rationale for the treatment, but it seems more appropriate as a supportive than as a principal treatment. The oral dose rate is 10 g/day for 3 days followed by 5 g/day for 10 days.

**Antibiotics** might be indicated to treat secondary infection of the degenerate lamellae.

**Rest** is important in the convalescent phase. Horses with no rotation or sinking of the pedal bone should be rested after resolution of the clinical signs. Return to work should be gradual. Horses that develop

rotation or sinking of the pedal bone should be monitored both by physical examination and radiographic examination. It will be many months before horses with even mild rotation can be returned to work. Horses with severe rotation or sinking will likely never resume active work, although they may become pasture sound.

#### TREATMENT

##### Summary of treatment of acute laminitis

Depending on the cause, treatment of acute laminitis should include:

- Chilling of the limb (cryotherapy) (R-1)
- Administration of nonsteroidal antiinflammatory drugs (R-1)
- Administration of vasodilators (acepromazine) (R-2)
- Support of the frog and/or sole (R-1)
- Application of nitroglycerin (R-4)
- Aggressive treatment of the inciting disease (R-1)
- Trimming the hoof, distal phalanx realignment, and corrective shoeing (R-1)

#### Chronic Laminitis

The **prognosis** for return to normal of horses with chronic or refractory laminitis (laminitis of more than 1 week's duration) is poor (see previous discussion for the use of radiography to determine prognosis).

Treatment includes NSAIDs for pain relief, corrective shoeing (egg-bar or heart-bar shoes), trimming of the hoof (shortening the toe or complete removal of the dorsal hoof wall), and realignment of the distal phalanx.<sup>88</sup> Rehabilitating rotational displacement usually involves shoeing changes that move the center of pressure of the foot caudally from its normal position under the toes, decrease tension on the deep digital flexor tendon to reduce rotational forces on the distal phalanx that act to increase the distance between the distal phalanx and dorsal hoof wall, provide axial support of load structures within the perimeter of the wall (sole, frog, bars), and ease break-over in all directions (medial, lateral, and dorsally) in an effort to reduce distraction forces on the lamellae during movement.<sup>75</sup> Methods to move the center of pressure caudally and decrease tension on the deep digital flexor tendon using bar shoes and a heel elevation are recommended.<sup>75</sup> Use of a wedge to counteract rotational forces might be beneficial.<sup>75</sup>

**Tenotomy** of the deep digital flexor can provide relief, but the efficacy of this procedure in affecting long-term outcome has not been well demonstrated.<sup>11,75</sup>

#### CONTROL

The disease is not readily subject to control because of its sporadic nature, with the exception of management of diseases that increase risk of laminitis, such as PPID, insulin resistance, and EMS. Details of the



management of these conditions is provided elsewhere.

Moderate exercise by nonobese ponies previously affected with laminitis reduced serum amyloid A concentrations and haptoglobin concentrations and led to reductions in exercise-induced increases in postexercise serum insulin concentrations.<sup>89</sup> These results suggest a beneficial role for relatively low-intensity exercise (10 minutes enforced walking followed by 5 minutes of trotting) on inflammation in ponies at risk of laminitis.

## FURTHER READING

- Katz LM, Bailey SR. A review of recent advances and hypotheses on the pathogenesis of acute laminitis. *Equine Vet J*. 2012;44:752-761.
- Pollitt C. Advances in laminitis. Parts 1 and 2. *Vet Clin North Am-Equine*. 2010;26(1-2):1-466.

## REFERENCES

- Eustace RA. *Vet J*. 2010;183:245.
- Parks AH, et al. *Equine Vet Educ*. 2009;21:102.
- Pollitt CC. *Vet Clin Equine*. 2010;26:29.
- Wylie CE. *Vet J*. 2013;196:139.
- Asplin KE, et al. *Vet J*. 2007;174:530.
- de Laat MA, et al. *Vet J*. 2012;191:317.
- Karikoski NP, et al. *Dom Anim Endocrin*. 2011;41:111.
- Belknap J, et al. *Equine Vet J*. 2012;44:749.
- de Laat MA, et al. *Vet J*. 2012;192:435.
- Wylie CE, et al. *Vet J*. 2012;193:58.
- Radostits O, et al. *Laminitis of horses*. In: *Veterinary Medicine: A Textbook of the Diseases of Cattle, Horses, Sheep, Goats and Pigs*. 10th ed. London: Saunders; 2007:2030.
- Menzies-Gow NJ, et al. *Vet Rec*. 2010;167:690.
- Slater J. *Vet Rec*. 2014;175:271.
- Treiber KH, et al. *JAVMA*. 2006;228:1538.
- Carter RA, et al. *Equine Vet J*. 2009;41:171.
- Borer KE, et al. *J Anim Sci*. 2012;90:3003.
- Frank N, et al. *J Vet Int Med*. 2010;24:467.
- Geor RJ. *Vet Clin Equine*. 2009;25:39.
- McGowan C. *J Equine Vet Sci*. 2008;28:603.
- Badros EM, et al. *Equine Vet Educ*. 2013;25:152.
- Valle E, et al. *Vet J*. 2013;196:445.
- Knowles EJ, et al. *Equine Vet J*. 2012;44:226.
- McGowan TW, et al. *Equine Vet J*. 2013;45:74.
- Bailey SR. *Vet Clin Equine*. 2010;26:277.
- Bailey SR, et al. *Equine Vet J*. 2007;39:7.
- Bathe AP. *Equine Vet J*. 2007;39:12.
- Virgin JE, et al. *Equine Vet J*. 2011;43:7.
- Parsons CS, et al. *JAVMA*. 2007;230:885.
- Menzies-Gow NJ, et al. *Vet Rec*. 2010;167:364.
- Orsini JA, et al. *Can Vet J*. 2010;51:623.
- Visser MB, et al. *J Comp Pathol*. 2011;145:80.
- Chiavaccini L, et al. *Vet Immunol Immunopath*. 2011;144:366.
- de la Rebiere de Pouyade G, et al. *Vet Immunol Immunopath*. 2010;135:181.
- Stewart AJ, et al. *Vet Immunol Immunopath*. 2009;129:254.
- Pollitt CC. *Equine Laminitis: Current Concepts*. Canberra, Australia: Rural Industries Research and Development Corporation; 2008.
- Wang L, et al. *J Vet Int Med*. 2014;28:215.
- de Laat MA, et al. *J Comp Pathol*. 2011;145:399.
- Katz LM, et al. *Equine Vet J*. 2012;44:752.
- Belknap JK, et al. *Equine Vet J*. 2007;39:42.
- Black SJ. *Vet Immunol Immunopath*. 2009;129:161.
- Loftus JP, et al. *Am J Vet Res*. 2007;68:1205.
- Faleiros RR, et al. *J Vet Int Med*. 2009;23:174.
- Leise BS, et al. *Equine Vet J*. 2011;43:54.
- Faleiros RR, et al. *J Vet Int Med*. 2011;25:107.
- Faleiros RR, et al. *Vet Immunol Immunopath*. 2011;144:45.
- Visser MB, et al. *Vet Immunol Immunopath*. 2011;144:120.
- Budak MT, et al. *Vet Immunol Immunopath*. 2009;131:86.
- Moreau MM, et al. *Vet Microbiol*. 2014;168:436.
- Asplin KE, et al. *Equine Vet J*. 2010;42:700.
- de Laat MA, et al. *Vet J*. 2013;195:305.
- Nourian AR, et al. *Equine Vet J*. 2009;41:671.
- Nourian AR, et al. *Equine Vet J*. 2007;39:360.
- Karikoski NP, et al. *Am J Vet Res*. 2014;75:161.
- de Laat MA, et al. *Vet J*. 2013;197:302.
- de Laat MA, et al. *Vet Immunol Immunopath*. 2012;145:395.
- de Laat MA, et al. *Vet Immunol Immunopath*. 2014;157:78.
- Gauff F, et al. *Equine Vet J*. 2013;45:613.
- Keen JA, et al. *J Vet Pharmacol Ther*. 2013;36:382.
- Bailey SR, et al. *Vet Immunol Immunopath*. 2009;129:167.
- Eades SC, et al. *Am J Vet Res*. 2007;68:87.
- Eades SC, et al. *Am J Vet Res*. 2006;67:1204.
- Peroni JF, et al. *Equine Vet J*. 2005;37:546.
- Peroni JF, et al. *J Appl Phys*. 2006;100:759.
- de Laat MA, et al. *Vet Immunol Immunopath*. 2011;140:275.
- Loftus JP, et al. *Vet Immunol Immunopath*. 2009;129:221.
- Pawlak E, et al. *Am J Vet Res*. 2012;73:1035.
- Wang L, et al. *Am J Vet Res*. 2012;73:1047.
- Belknap JK, et al. *Equine Vet J*. 2012;44:738.
- Kwon S, et al. *Vet Immunol Immunopath*. 2013;155:1.
- Orsini JA. *Equine Vet J*. 2012;44:741.
- Steelman SM, et al. *Vet Immunol Immunopath*. 2013;153:217.
- Menzies-Gow NJ, et al. *Vet Rec*. 2010;167:52.
- Vinuela-Fernandez I, et al. *Vet J*. 2011;188:171.
- Sherlock C, et al. *Equine Vet Educ*. 2013;25:524.
- Morrison S. *J Equine Vet Sci*. 2011;31:89.
- van Eps AW, et al. *Equine Vet J*. 2009;41:741.
- Kullmann A, et al. *Equine Vet J*. 2014;46:554.
- van Eps AW, et al. *Equine Vet J*. 2014;46:625.
- van Eps AW, et al. *Equine Vet J*. 2012;44:230.
- van Eps A, et al. *Equine Vet J*. 2014;46:625-630.
- Reesink HL, et al. *Am J Vet Res*. 2012;73:860.
- Guedes AGP, et al. *Am J Vet Res*. 2012;73:610.
- Dutton DW, et al. *Equine Vet Educ*. 2009;21:37.
- Williams JM, et al. *Equine Vet J*. 2010;42:261.
- Cornelisse CJ, et al. *Equine Vet Educ*. 2013;25:39.
- Dutton H. *Equine Vet J*. 2007;39:5.
- de la Rebiere de Pouyade G, et al. *J Vet Emerg Crit Care*. 2009;19:113.
- O'Grady SE. *Equine Vet Educ*. 2006;18:214.
- Menzies-Gow NJ, et al. *Equine Vet J*. 2013;46:317-321.

## LAMINITIS IN RUMINANTS AND SWINE

### SYNOPSIS

**Etiology** Degeneration of the sensitive laminellae of the hoof.

### Epidemiology

**Cattle:** An endemic disease of some herds of high-producing dairy cattle, and in feedlots. Associated with ruminal acidosis, either clinical or subclinical.

### Clinical signs

**Cattle:** Inapparent to severe lameness, most common in the hindfeet. Predisposition to other infectious or traumatic diseases of the foot.

**Clinical pathology** None characteristic of the disease.

**Diagnostic confirmation** Physical examination. Radiography.

### Treatment

**Cattle:** Nonsteroidal antiinflammatory drugs. Corrective hoof care.

### Control

**Cattle:** Dietary control to prevent ruminal acidosis. Correction of housing and flooring problems.

## ETIOLOGY

Laminitis is caused by acute degeneration of the sensitive primary and secondary lamellae of the hoof. The cause of this degeneration is unknown, although the disease can be induced by administration of oligofructose (17 g/kg, orally) to dairy heifers.<sup>1,2</sup> The disease is less well characterized than that of horses, and several conditions are often classified as laminitis. Laminitis in dairy cattle occurs as part of a spectrum of foot diseases.<sup>3,4</sup> There is a detailed description of the radiographic (CT) anatomy of the digit of cattle.<sup>5</sup>

## EPIDEMIOLOGY

### Occurrence

In **cattle** the disease can occur as clusters in herds and on farms where a predisposition appears to be inherited or where access to large quantities of soluble carbohydrate are available, such as for high-producing dairy cows or feedlot cattle. On farms of high-producing dairy cattle the prevalence may be as high as 78%. The prevalence of laminitis-related hoof lesions in Norwegian dairy cattle is 18%,<sup>6</sup> although the prevalence is lower in Switzerland.<sup>7</sup> Among Swiss cattle, 5.4% had signs of subclinical laminitis, and 3.3% had signs of chronic laminitis.<sup>7</sup> A recent study of 1352 dairy cows in Israel detected lameness in 387 (28.6%).<sup>8</sup> Of these lame cows, 320 (82.7%) had 591 lesions that could be associated with subclinical laminitis.<sup>8</sup>

## Risk Factors

### Cattle and Sheep

**Subclinical laminitis** that predisposes to the development of other diseases of the hoof occurs in calves and first-calf heifers and is common in intensively fed feedlot cattle. Laminitis, conditioned by the inheritance of an autosomal-recessive gene, is recorded in Jersey heifers.<sup>9</sup> There may be an association between the disease in feedlot ruminants and **ruminal acidosis**. Administration of oligofructose to dairy heifers induced ruminal acidosis, with clinical signs of laminitis (hoof pain and abnormal gait) occurring by 30

hours after administration and being most severe at 3 to 5 days.<sup>1</sup>

Beef cattle being prepared for shows are often grossly overfed on high-grain rations and become affected with a chronic form of the disease that markedly affects their gait and may cause permanent foot deformity. The disease occurs in dairy cattle fed improper rations, especially first-calf heifers and cattle of herds attempting to increase milk production, and it is not uncommon for the disease to present as a herd problem.

Among **dairy cattle**, the heifers are usually the most affected, and the disease usually develops soon after calving, with more than 50% of cases occurring in the period 30 days before and 30 days after calving. There may be a relationship between being introduced to the herd, with the frequent harassment by dominant cows, when heavily pregnant, and when the surface of the yards is rough. Housing can be important, including standing in slurry or having to twist and turn in narrow passageways and races, and there is an association between the prevalence of the disease and rough concrete floors.

Diet is an important risk factor for development of laminitis in heifers. Diets of wet, fermented grass silage are associated with a greater risk of laminitis than are diets rich in dry unfermented straw and a concentrate. Furthermore, transition from a low-net-energy diet to a high-net-energy diet immediately after calving increases the risk of subclinical mastitis in Holstein dairy cows.

The disease is also reported to occur after metritis, retained placenta, mastitis, and mammary edema, but the incidence is not usually very high.

### Pigs

Laminitis has been recorded in pigs, but the disease is difficult to diagnose in this species, and many cases secondary to other diseases (e.g., postparturient fever) can be missed. The disease is also recorded when pigs are fed very heavy concentrate diets.

### Importance

Subclinical laminitis of dairy cattle predisposes to other hoof disease that decrease milk production.<sup>10</sup>

### PATHOGENESIS

The pathogenesis of laminitis in cattle, sheep, and pigs is unclear but likely has some similarity to that in horses (see “Laminitis in Horses”), with increased expression of genes coding inflammatory or proinflammatory products in corium of cattle with induced laminitis.<sup>11</sup> The links between nutrition and lameness in cattle have been reviewed.<sup>12</sup> Chronic laminitis leads to a low resistance of claw horn to mechanical insults in the dorsal wall, abaxial wall, and sole,<sup>13</sup> which could explain why laminitis predisposes cattle to other foot lesions.

## CLINICAL FINDINGS

### Cattle and Sheep

In cattle and sheep the clinical picture is similar to but less marked than that observed in the horse.

In **calves 4 to 6 months** of age, and in heifers, an acute syndrome similar to that seen in the horse has been described. Affected animals lie down much of the time and are reluctant to rise. When they attempt to rise, they remain kneeling for long periods. Their standing posture is with all four feet bunched together with the back arched; they shift their weight from foot to foot frequently and walk with a shuffling, painful gait. The feet are painful when squeezed and later become flattened and enlarged and look as though slippers are being worn. There is severe ventral rotation of the third phalanx.

In **adult cows** some cases have acute signs, whereas others show only local lesions. These include sole ulcers and patchy changes in the horn, including softening, waxy yellow discoloration, and red-brown patches suggestive of previous hemorrhage. The cow is chronically lame.

**Young bulls** are very susceptible to laminitis and may develop abnormalities of gait and posture, such as a stilted gait and frequent knuckling of the fetlocks, which may mislead the diagnostician.

**Chronic laminitis in adult cows** is characterized by a smaller anterior hoof wall-sole angle, down from 55 degrees to 35 degrees, a concave anterior wall, and the appearance of horizontal grooves (growth arrest lines) around the entire claw. The sole is usually dropped a little, and bruising and sole ulcers may be present. Overgrowth of the sole of the lateral claw may reach the point of creating a false or double sole. The white line is greatly widened and disrupted, and stones and other debris may be impacted in it.

Chronic, traumatic laminitis is most common in heifers when they are first introduced into the milking or dry herds. Housing them on concrete and exposing them to frequent confrontations with bossy cows lead to the development of sole hemorrhages and inflammation of the laminae.

**Radiographic signs** in cattle include rarefaction of the pedal bone, particularly the toe, and the development of osteophytes at the heel and on the pyramidal process.

### Pigs

In sows the clinical signs are similar and include arching of the back, bunching of the feet, awkwardness of movement, increased pulsation in the digital arteries, and pain when pressure is applied to the feet.

## CLINICAL PATHOLOGY

There are no changes that are characteristic of the disease.

## NECROPSY FINDINGS

Histologic examination of claws from heifers killed 72 hours after overload showed changes consistent with acute laminitis, including stretched lamellae, wider basal cells with low chromatin density, and a thick, wavy, and blurry appearance of the basement membrane.<sup>2,14</sup>

## DIFFERENTIAL DIAGNOSIS

### Cattle

- White-muscle disease, epiphysitis, other primary diseases of the foot

## TREATMENT

Although similar principles to those used to determine treatment of laminitis in horses are likely to apply to cattle, treatment in cattle is usually limited to administration of NSAIDs (aspirin 20 mg/kg, orally every 12 hours, phenylbutazone 4.4 mg/kg orally every 48 hours, or flunixin meglumine 1.0 mg/kg IV every 12 hours). The inciting cause (metritis, ruminal acidosis) should be treated aggressively.

## CONTROL

Cattle and lambs that are brought into feedlots should be gradually introduced to grain feeds and a higher forage:grain ratio provided in the feed. Calves should not be fed intensively on grain until they are 14 months old because of the high frequency of internal hoof lesions at the earlier ages. Some protection against laminitis in dairy cattle in intensive units is gained by careful planning of housing cubicles to make them more comfortable and less damaging to the feet and by providing more straw in the cubicles. Exercise should be provided around calving time. Vaccination with a gram-negative bacterin-endotoxin combination vaccine has provided some protection against laminitis induced by grain overload. Dietary supplementation of biotin (20 mg per head per day) improves hoof health of primiparous dairy cows and may be beneficial in reducing the incidence or severity of lameness in a herd. This treatment might not improve objective indicators of hoof health, but it does improve production.

Selection of traits for foot and leg conformation in Norwegian Red cattle is not associated with a reduced risk of disease of the claws.<sup>15</sup>

## REFERENCES

1. Danscher AM, et al. *J Dairy Sci.* 2009;92:607.
2. Danscher AM, et al. *J Dairy Sci.* 2010;93:53.
3. Capion N, et al. *Vet Rec.* 2008;163:80.
4. Capion N, et al. *Vet J.* 2009;182:50.
5. Tsuka T, et al. *J Dairy Sci.* 2014;97:6271.
6. Fjelddas T, et al. *Acta Vet Scand.* 2007;49.
7. Becker J, et al. *Schweiz Arch Tierheilkd.* 2014;156:71.
8. Sagliyan A, et al. *Israel J Vet Med.* 2010;65:27.
9. Radostits O, et al. Laminitis in ruminants and pigs. In: *Veterinary Medicine: A Textbook of the Diseases*

of Cattle, Horses, Sheep, Goats and Pigs. London: Saunders; 2006:2034.

10. Vatandoost M, et al. *J Anim Vet Adv.* 2009;8:880.
11. Osorio JS, et al. *J Dairy Sci.* 2012;95:6388.
12. Lean IJ, et al. *Livestock Sci.* 2013;156:71.
13. Hinterhofer C, et al. *Vet J.* 2007;174:605.
14. Mendes HMF, et al. *Pesquisa Veterinaria Brasileira.* 2013;33:613.
15. Odegard C, et al. *J Dairy Sci.* 2014;97:4522.

## Diseases of Joints

### DEGENERATIVE JOINT DISEASE (OSTEOARTHROPATHY) AND OSTEOCHONDROSIS

There are two common noninfectious conditions of the joint, degenerative joint disease and osteochondrosis. The terms *degenerative joint disease* and *osteoarthropathy* are used here to describe noninfectious lesions of the articular surfaces of joints characterized by the following:

- Degeneration and erosion of articular cartilage
  - Eburnation of subchondral bones
  - Hypertrophy of bone surrounding the articular cartilage, resulting in lipping and spur formation at the joint margins
- In contrast, a separate condition is **osteochondrosis** (dyschondroplasia), which is a degeneration of both the deep layers of the articular cartilage and the epiphyseal plate—a **defect in endochondral ossification**—that occurs most commonly in pigs and horses but also occurs in cattle. Osteochondrosis in horses is one of a number of conditions included in **developmental orthopedic disease**, which is a catch phrase that includes a number of skeletal conditions of the rapidly growing horse.<sup>1</sup>

#### ETIOLOGY AND EPIDEMIOLOGY

The etiology of degenerative joint disease and osteochondrosis is not clear in some cases. In most of the commonly occurring cases, the lesions are considered to have a genetic basis and to be multifactorial and perhaps secondary to conformational defects resulting in excessive joint laxity, acute traumatic injury of a joint, the normal aging process, and nutritional deficiencies. The etiologic information is primarily circumstantial, and some of the epidemiologic observations that have been associated with degenerative joint disease and osteochondrosis of farm animals are outlined here.

#### Nutritional Causes

- Secondary to, or associated with, rickets, osteomalacia, bowie, and osteodystrophia fibrosa
- Coxofemoral arthropathy in dairy cattle associated with aphosphorosis
- Experimental diets deficient in manganese or magnesium, causing arthropathy and joint deformity in some

calves—magnesium supplementation of foals decreased the prevalence of osteochondrosis.<sup>2</sup>

- Copper deficiency is thought to be related to osteochondrosis and enlargement of limb joints in foals on pasture and pigs fed experimental copper-deficient diets, and deficiency appears to impair the repair of damaged bone.<sup>1</sup>
- Experimental riboflavin deficiency in pigs

#### Toxic Causes

- As part of the enzootic calcinosis syndrome caused by poisoning with *Solanum malacoxylon* and others
- Fluorosis in cattle
- Chronic zinc poisoning in pigs and foals

#### Steroid Induced

The intraarticular injection or prolonged parenteral administration of corticosteroids in horses may lead to degenerative joint disease.

#### Biomechanical Trauma

- **Acute traumatic injury**—injury to, for example, joint surfaces, menisci, and ligaments, especially the cruciate ligaments of the stifle joints of breeding bulls, may lead to chronic progressive osteoarthritis. Injuries to the femorotibial ligaments of horses can predispose to osteoarthropathy of the stifle joint.
- **Repeated subacute trauma** to joint surfaces can lead to degenerative arthropathy. This is common in young racehorses in training, which may have their joint surfaces and surrounding tissues made susceptible to injury because of conformational defects and subtle deficiencies of calcium and phosphorus. Hard running surfaces may also contribute to the onset of degenerative joint disease.
- **Trauma caused by movement** is suspected of contributing to the erosive lesions on the articular surfaces of some horses affected by enzootic incoordination, the intervertebral joints of caudal thoracic and cranial lumbar vertebrae of old bulls with spondylitis, and the condition of bulls with inherited spasticity. Coxofemoral osteoarthritis may occur in aged horses with joint instability and in calves with hip dysplasia.

**Degenerative coxofemoral arthropathy** occurs in **young beef bulls** as early as 9 months of age. A congenital shallow acetabulum may predispose bulls to this condition. It may be secondary to hip dysplasia, but in some cases there is no evidence of this. The large, weight-bearing joints subjected to the greatest movement and concussion appear to be most susceptible. Rapidly

growing bull calves appear to be most susceptible, and some of them have an inherited susceptibility.

#### Aging Process

Degenerative arthropathy in aged dairy cows and bulls may be a manifestation of the normal aging process. Degenerative joint disease and vertebral osteophysis occur in middle-aged bulls.

Osteoarthrosis of the distal tarsal joints (hock), commonly known as **bone spavin**, is common in Icelandic horses and strongly related to age. In Icelandic horses aged 6 to 12 years and used for riding, the prevalence of radiographic signs of osteoarthrosis in the distal tarsus increased from 18% in horses 6 years of age up to 54% in 12-year-old horses. The age of onset of radiographic signs reflect a predisposition to bone spavin and indicates a trait with medium to high heritability. There is a high prevalence of chondronecrosis in young Icelandic horses, indicating an early onset and slow progression of disease. The disease is the most common cause of culling as a result of disease in riding horses in the age group of 7 to 17 years.

Osteoarthrosis of the antebrachial joint of riding horses has been described. Affected animals were aged mares that developed osteoarthrosis and ankylosis. The cause is unknown.

#### Osteochondrosis

Osteochondrosis occurs in rapidly growing **cattle** raised in confinement on hard, usually concrete, floors and with minimal exercise. Osteochondrosis has been reported in rapidly growing bull beef calves fed a diet lacking adequate calcium, sodium, copper, and vitamins A, D, and E and grazing on improved native pasture, in which a common ancestral sire and gender (all males) might have been contributing factors. Severe osteochondrosis of multiple joints but with remarkable changes in the humeral head and glenoid of both shoulder joints in 10-month-old beef calves has been described.

Osteochondrosis in feedlot cattle may be associated with a high-calorie diet and rapid growth rate. It is thought that weight-bearing trauma in these rapidly growing animals is sufficient to cause degenerative lesions of certain joints, especially in animals with a skeletal conformation that results in abnormal stress on certain weight-bearing condyles of long bones. In a series of 42 cases of stifle lameness in cattle, 18 had evidence of subchondral bone cyst and ranged in age from 6 to 18 months. Subchondral bone cyst is considered as a common clinical manifestation of osteochondrosis.

Osteochondrosis similar to that seen in pigs has been recorded in purebred **Suffolk lambs** raised in a system designed to produce rapidly growing, high-value **rams**. The disease has been recorded in a single pedigree Suffolk ram.



Osteochondrosis is an important cause of lameness in **horses**. It is usually seen in young rapidly growing animals, and it affects males more commonly than females. Mares that are fed concentrates during pregnancy are more likely to produce foals that will develop clinical signs associated with osteochondrosis. Moreover, foals kept entirely on pasture for their first year of life are less affected with osteochondrosis than foals housed in box stalls.<sup>3,4</sup> The predilection sites of osteochondrosis in the horse and their general order of incidence are hock, stifle, scapula-humeral joint, fetlock, and cervical spine. The stifle, hock, and scapula-humeral joints are more commonly affected, but many other joints may also be affected, including the metatarsal and metacarpal bones and, rarely, the acetabula of young foals. There is a nutritional component to osteochondrosis, with magnesium supplementation of foals decreasing the prevalence<sup>2</sup> and copper deficiency appearing to interfere with normal bone-repair processes.<sup>1</sup> There is also a genetic component to osteochondrosis, but the mechanism has not been identified.

The epidemiology, heritability, and body measurements and clinical findings of osteochondrosis of hock and fetlock joints in Standardbred trotters have been examined. The incidence of the disease is high in the Swedish Standardbred population and well developed by the age of 18 months. The incidence of osteochondrosis is higher in horses born later in the foaling season than earlier, and the incidence was related to body size: affected horses were taller at the withers and had a greater circumference of the carpus. This suggests that differences in body size at birth and the first few months of the foal's life are of major importance in the development of osteochondrosis. The heritability estimates of osteochondrosis in the hock and fetlock joints of 753 Standardbred trotters 6 to 21 months of age were 0.52 and 0.21, respectively.

**Osteochondrosis and arthrosis** are considered to be major causes of "leg weakness" in rapidly growing **pigs**. Restricting the energy intake appears to decrease the prevalence and severity of osteochondrosis when gilts are examined at 100 kg, and osteochondrosis is more common in pigs with faster growth rates from weaning to 3 months of age.<sup>5</sup> The prevalence and severity of osteochondrosis in growing pigs are probably not related to floor type. Recent work has shown a significant relationship between body conformation and the presence of joint lesions. Pigs with a narrow lumbar region, broad hams, and a large relative width between the stifle joints are highly susceptible to poor locomotor ability as a result of lesions in the elbow and stifle joints, the lumbar intervertebral joints, and the hip joint.

## PATHOGENESIS

A brief review of the structure and biochemistry of the normal articular joint will serve

as background for understanding the pathogenesis of osteoarthropathy.

Articular cartilage is a tissue consisting of chondrocytes scattered in a matrix of collagen fibers and an amorphous intercellular substance containing proteoglycans. Articular cartilage contains no nerves, is avascular, and has a high matrix-to-cell ratio. The chondrocytes are the only living matter in cartilage, produce the fine strands of collagen, and are engaged in protein and proteoglycan synthesis. The matrix of the cartilage consists of water-soluble proteoglycans interspersed with collagen fibers, which are arranged in parallel rows superficially and crisscross rows closer to the calcified layer. This enables the cartilage to withstand shearing stresses superficially and compression more deeply.

The proteoglycans are glycosaminoglycan-protein complexes, bound by a link glycoprotein to a linear hyaluronic acid molecule. The glycosaminoglycans in articular cartilage are chondroitin 4-sulfate, chondroitin 6-sulfate, and keratan sulfate. About 75% of the proteoglycans exist on aggregates that protect them from degradation, and because of their high water content, they form large polyanionic complexes that have considerable elastic resistance to compression.

Nutrition of the articular cartilage is provided via the synovial fluid and is dependent on the capillary flow to the synovial membrane. Nutrients flow through the synovial fluid and diffuse through the cartilage to the chondrocytes. Proteoglycans are synthesized by the chondrocytes and secreted to the cell exterior. Proteoglycans are also degraded intracellularly by lysosomes. The normal equilibrium between anabolism and catabolism is maintained by several different low-molecular-weight proteins. When the equilibrium is disturbed and shifts toward catabolism, degeneration occurs.

## Primary Osteoarthropathy

Primary osteoarthropathy is a result of normal aging processes and ordinary joint usage. The initial lesions occur in the superficial layers of the articular cartilages where, with increasing age, there is loss of the normal resilience of the cartilage, a lowering of the chondroitin sulfate content, and reduction in the permeability of the cartilaginous matrix, which results in progressive degeneration of the articular cartilage. There is grooving of the articular cartilage, eburnation of subchondral bone, and secondary hypertrophy of marginal cartilage and bone, with the formation of pearl-like osteophytes. In experimentally induced arthritis in the horse, the major changes include synovitis, increased synovial effusion, and superficial fibrillation with chondrocyte necrosis in the articular cartilage. These are comparable to the early changes in naturally occurring degenerative joint disease.

## Secondary Osteoarthropathy

Secondary osteoarthropathy appears to be initiated by injuries or congenital conformational defects that create greater shearing stresses on particular points, in contrast to the intermittent compressive stresses typical of ordinary weight-bearing. These irregular stresses result in cartilaginous erosion, increased density of subchondral bone at points of physical stress, and proliferation of bone and cartilage at the articular margins.

**Following acute trauma**, the initial changes are often characterized by acute synovitis and capsulitis. As a result of the inflammatory response, leukocytes, prostaglandins, lysosomal enzymes, and hyaluronidase enter the synovial fluid, which becomes less viscous, affecting the nutrition of the cartilage. There is some evidence of immune complexes associated with collagen-type-specific antibodies in horses with secondary osteoarthritis. Cytokines can be detected in the synovial fluid after racing in horses with degenerative joint disease. The cartilage matrix undergoes a variety of changes, possibly because of chondrocyte damage with lysosomal enzyme release or as result of collagen fiber injury. There is an increase in water content and loss of orientation of the collagen fibers. Proteoglycans are lost, and although increased chondrocyte activity synthesizes proteoglycans, they are of lower molecular weight and altered glycosaminoglycan composition. This leads to loss of elasticity and surface integrity of the cartilage, resulting in increased friction, blistering, and ulceration. There is additional lysosomal enzyme release from the chondrocytes, resulting in matrix destruction and further proteoglycan destruction. The degrading enzymes enter the altered matrix and cause further degradation.

The first stage of matrix degradation involves discoloration, softening, and blistering of the tangential layer of the cartilage surface, a process known as early fibrillation. As the fissuring extends to the radial layer, microfractures occur, with loss of cartilage fragments (debris) into the synovial fluid. As the cartilage is destroyed, the underlying bone is exposed and becomes sclerotic. Bony proliferation occurs in the floor of the cartilage lesions, whereas osteophyte formation occurs at the joint margins. The pathogenesis of degenerative joint disease indicates that the ideal treatment would be the use of a substance that would promote synthesis of matrix components and retard catabolic processes.

The major proteoglycan in cartilage is a high-molecular-weight aggrecan that contains chondroitin sulfate and keratan sulfate chains located on specific regions of the core protein. These macromolecules are continuously released into the synovial fluid during normal cartilage matrix metabolism. Cartilage proteoglycans are degraded early in the course of joint disease and released from the

cartilage into the synovial fluid, where they can be identified.

In horses with degenerative joint disease, proteoglycan fragments—glycosaminoglycans—have been determined in equine synovial fluid as indicators of cartilage metabolism in various types of arthritides. The intraarticular injection of corticosteroids depresses chondrocyte metabolism, alters the biochemical composition, and causes morphologic changes in the articular cartilage, which remains biochemically and metabolically impaired for several or more weeks.

In femoral-tibial osteoarthritis of bulls, the secondary degenerative joint lesions are a result of rupture of the attachments of the lateral meniscus resulting in mechanical instability in the joint, with unusual mechanical stresses on the articular cartilage leading to degeneration. The cranial cruciate ligament becomes progressively worn and eventually ruptures, resulting in loss of all joint stability and the development of gross arthrosis. In cattle with severe degenerative joint disease of the coxofemoral joints, an acetabular osseous bulla may develop at the cranial margin of the obturator foramen.

### Osteochondrosis

Osteochondrosis (dyschondroplasia) is characterized by a focal disturbance of the normal differentiation of the cells in the growing cartilage as a result of failure of the blood supply. The failure is associated with the process of incorporating blood vessels into the ossification front during growth,<sup>6</sup> but, experimentally, bacteremia can also result in vascular occlusion. The end result is a focal ischemic chondronecrosis, which can lead to formation of pseudocysts and true cysts in the subchondral bone.<sup>7</sup> **Osteochondrosis should therefore be considered as a disease that occurs multifocally at predilection sites.** Both the metaphyseal growth plate (the growth zone of the diaphysis) and immature joint cartilage (the growth zone of the epiphysis) are affected. The loss of normal differentiation of the cartilage cells results in failure of provisional calcification of the matrix and endochondral ossification ceases. Degeneration and necrosis of blood vessels in cartilage canals results in ischemia of an area of growing cartilage, followed by chondrocyte degeneration and death. The initial lesion occurs in growing cartilage, and *dyschondroplasia* is a more appropriate term. The primary lesion of osteochondrosis directly affects the differentiation and maturation of the cartilage cells and the surrounding matrix that are destined to become replaced by bone. This can occur at the two sites of endochondral ossification in long bones—the articular/epiphyseal cartilage complex and the metaphyseal growth plate. In osteochondrosis, the capillary buds fail to penetrate the distal region of the

hypertrophic zone, which leads to a failure of the final stages of cartilage maturation and modification of the surrounding matrix. These changes lead to retention and thickening of cartilage with subsequent weakening of the articular/epiphyseal cartilage complex.

**Typical lesions in the horse** involve extensive cartilaginous and subchondral bone degeneration with flap formation and, ultimately, loose pieces in the joint. This is usually referred to as osteochondritis dissecans and is associated with synovial effusion and varying degrees of synovitis. Osteochondral fracture associated with severe pathologic changes to the subchondral bone occurs most commonly on the trochlear ridges and the lateral or medial malleoli of the hock. It is likely that osteochondrosis lesions develop in foals within the first few months of extrauterine life, which is much earlier than originally thought.

In rapidly growing pigs raised in confinement with minimal exercise, **osteochondrosis and arthrosis** are seen as degeneration of the deep layer of the articular cartilage and adjacent subchondral bone with degenerative lesions of the epiphyseal plate. Lesions in the epiphyseal plate may result in epiphysiolysis, which occurs most commonly in the femoral head. The typical lesions are usually symmetric and commonly involve the elbow, tarsocrural, stifle, and hip joints and the distal epiphyseal plate of the ulna.<sup>5</sup> Lesions also occur in the intervertebral articulations. The lesions are common in pigs when they are examined at slaughter (90 to 100 kg BW), and there might have been no evidence of clinical abnormality, or a proportion of the pigs with severe lesions might have been affected with leg-weakness syndrome. Osteochondrosis and *Erysipelothrix rhusiopathiae* are the most common causes of nonsuppurative joint disease of pigs examined at the abattoir. Thus not all lesions are clinical.

### CLINICAL FINDINGS

The major clinical characteristic is a chronic lameness that becomes progressively worse over a long period of time and does not usually respond to treatment. The disease is insidious and generally not clinically apparent in the early stages. A common clinical history is that the affected animal becomes progressively more lame over a period of weeks and months and prefers long periods of recumbency. The lesion may develop slowly over a period of weeks and months during the convalescent stages of an acute traumatic injury to the joint when recovery is expected but the animal continues to be lame.

There is usually difficulty in flexing affected joints normally, which results in a stiff and stilted gait. In cattle confined to stanchions, one of the earliest and persistent signs is shifting of weight from limb to limb. In dairy cattle, as the lesions become more painful, there is a decline in appetite and

milk production, prolonged recumbency, and considerable difficulty in rising from the recumbent state. In the early stages, there may be an apparent remission of the lameness, but relapses are common. The bony prominences of the joint eventually appear more prominent than normal, which is a result of disuse muscle atrophy of the affected limbs. Acute and marked distension of the joint capsule is not as common as it is in an infectious or suppurative arthritis, but joints can slowly distend over weeks to months (Fig. 15-8). The joint capsule of palpable joints is usually not painful on palpation. Passive flexion of affected joints may be painful, and it may be possible to elicit crepitus as a result of detached pieces of cartilage and bone and osteophytes surrounding the articular cartilage. However, crepitus is most common in the large movable joints, such as the stifle, and commonly in osteoarthropathy secondary to acute traumatic injury of the meniscus and cranial cruciate ligament of the joint.

**Osteochondrosis in cattle** is characterized by chronic long-standing lameness, either with or without joint effusion. Joint fluid analysis is usually normal or indicates nonseptic inflammation. The stifle joint is most commonly affected, followed by the hock joint. In osteochondrosis in young, rapidly growing bulls there is reluctance to move, stiffness, enlargement of the ends of long bones, and a straightened joint. Although there may be clinical evidence of lameness in less than 40% of affected cattle, radiographically, 88% of the lesions are bilateral. Young breeding bulls in the early stages of coxofemoral arthropathy may be reluctant to perform the breeding act and yet appear to have sufficient libido.

**Osteochondrosis in the horse** is characterized by a wide range of clinical signs, and in some cases lesions are not accompanied by clinical signs. The most common sign of osteochondrosis is a nonpainful distension of an affected joint. In foals under 6 months of age, a tendency to spend more time lying down is common. This is accompanied by joint swelling, stiffness, and difficulty keeping up with the other animals in the group. An upright conformation of the limbs may also be present. In yearlings or older animals the common clinical signs are stiffness of joints, flexion responses, and varying degrees of lameness.

In the horse with osteochondrosis of the shoulder joint there is intermittent lameness, characterized by a swinging leg and shoulder lameness with pain elicited by extension, flexion, or abduction of the limb. Secondary joint disease is also a common finding. In a retrospective study of osteochondrosis dissecans in 21 horses, affected animals were 8 months to 5 years of age. The usual age of onset of clinical abnormalities was 18 to 24 months. The common presenting complaints included joint effusion and lameness of



**Fig. 15-8** Bilateral tarsitis in a lactating Holstein-Friesian cow. Note the marked joint effusion centered on both tarsal joints and the excessively straight hindlimbs.

**Table 15-3** Laboratory evaluation of synovial fluid in diseases of the joints

Synovial fluid analysis	Normal joint	Degenerative arthropathy	Infectious arthritis
Gross appearance	Colorless, clear	Pale yellow, may contain flocculent debris	Turbid, yellow
Total volume	—	Normal or slight increase	Usually marked increase
Clot formation	No clot	No clot	May clot within minutes after collection
Erythrocytes ( $\mu\text{L}$ )	<4,000	6,000–12,000	4,000–8,000
Leukocytes ( $\mu\text{L}$ )	<250	250–1,000	50,000–150,000
Neutrophils (%)	7	10–15	80–90
Lymphocytes (%)	35–40	45–50	4–8
Monocytes (%)	45–50	35–40	1–3
Microbiology	—	—	May be able to culture bacteria, mycoplasma, or virus, but not always
Total protein (g/dL)	1.2–1.8	1.6–1.8	3.2–4.5
Relative viscosity	—	Slightly reduced	Decreased
pH	—	—	Decreased

Other laboratory analyses of synovial fluid include the following: sugar content, alkaline phosphatase activity, lactic dehydrogenase activity, aldolase activity, glutamic oxaloacetic transaminase activity, glutamic pyruvic transaminase activity, mucinous precipitate quality.

either gradual or sudden onset. The prevalence was higher in males than in females.

Common clinical findings in **pigs with osteochondrosis** are hyperflexion of the carpus, limb bowing, adduction of both forelegs at the level of the carpus, hyperextension of the fore and hind phalanges, and anterior curvature of the tarsus. One of the first clinical abnormalities of osteochondrosis and epiphysiolysis in young breeding boars may be inability to mount the sow—impotentia coeundi. Locomotory dysfunction involves primarily the hindlegs. There is pronounced swaying of the hindquarters and crossing of the hindlegs with each step, which makes the pig appear uncoordinated. Epiphysiolysis of the head of the femur occurs in young pigs from 5 months to 1 year of age. There is usually a history of slight to moderate lameness, sudden in onset and affecting one or both hindlimbs. The onset of lameness may coincide with some physical activity such as breeding, farrowing, or transportation. The lameness is progressive, and in about 7 to 10 days the animal is unable to use its hindlegs. Crepitus may be audible on circumduction of the affected limb, and radiography may reveal the separation.

## DIAGNOSIS

### Joint Fluid

The changes in the synovial fluid of joints affected with degenerative arthropathy are usually unremarkable and can be readily distinguished from the changes in infectious arthritis. A summary of the laboratory evaluation of synovial fluid in diseases of the joints is set out in Table 15-3. The isolation of an infectious agent from the synovial fluid of a diseased joint suggests the presence of septic arthritis, but failure to isolate an organism must not be interpreted as the presence of a noninfectious arthritis. In well-advanced cases of septic arthritis the number of organisms may be small, or they might have been phagocytosed by neutrophils in the joint fluid.

**Total protein concentration and viscosity** of synovial fluid of horses can be determined. Normal values are available, and the concentration and molecular weight distribution of hyaluronate in synovial fluid from clinically normal horses and horses with diseased joints have been compared. Synovial fluid viscosity is reduced in horses with infectious and chronic arthritides and with radiographic evidence of cartilage degeneration. The synovial fluid hyaluronate concentration can be used as a diagnostic marker for chronic traumatic arthritis. However, high-molecular-weight proteoglycans or other markers in the synovial fluid cannot be used for diagnosing or monitoring degenerative joint disease.

**Infrared spectroscopy** measures the infrared absorption patterns of molecules in synovial fluid when exposed to infrared light. Infrared spectroscopy of synovial fluid



indicated that the infrared patterns from equine joints with traumatic arthritis differed from the pattern for corresponding healthy joints.<sup>8</sup> It remains to be determined whether this technology provides additional clinical information to that obtained by the routine analysis of synovial fluid. **Hematology and serum biochemistry** should be combined with appropriate hematology and serum biochemistry where indicated, although the results rarely change treatment protocols or prognosis. The concentration of hyaluronic acid in synovial fluid can be determined using an assay technique. The determination of serum calcium and phosphorus may reveal the existence of a dietary deficiency or imbalance of minerals.

### Radiography

Radiography of the hock joints in a craniomedial–caudolateral oblique view and of the fetlock joints in lateromedial view are standard techniques for the diagnosis of osteochondrosis in the horse. Those joints with abnormal radiographs may be radiographed from additional perspectives. Horses with bony fragments or defects at the cranial edge of the intermediate ridge of the distal aspect of the tibia or defects at the lateral trochlea of the talus can be classified as having osteochondrosis. The radiographic progression of femoropatellar osteochondrosis in horses under 1 year of age at the onset of clinical signs has been examined. The full extent of the radiographic lesions may take several weeks to develop.

### Arthroscopy

Arthroscopic examination and surgery of affected joints of horses with osteochondrosis can provide considerably more information than is possible from clinical and radiographic examination alone.

### NECROPSY FINDINGS

In **degenerative joint disease** the joint cartilage is thin or patchily absent, and polished subchondral bone is evident. The articular surfaces are irregular and sometimes folded. Exposed bone may be extensively eroded, and osteophytes (small bony excrescences, appearing like pearls) may be present on the nonarticular parts of the joint on the circumference of the articular cartilage. The synovial fluid is usually only slightly increased in volume and appears amber-colored. Menisci and intraarticular cartilages and ligaments may be entirely absent, and there may be areas of calcification in the joint capsule and cartilages free in the synovium. When the stifle is affected, fractures of the head of the tibia occur commonly, usually a chip of the lateral condyle having become separated. In such cases, fractures of the lateral condyle of the distal end of the femur may follow. With either of these fractures, lameness is extreme, and the animal may often refuse to rise. When the hip joint of bulls is affected,

the head of the femur becomes smaller and more flattened than normal, the acetabulum is shallower, and the round ligament is usually ruptured.

In **osteochondrosis** there is splitting and invagination of articular cartilage, loss of articular cartilage, chip fractures of condyles, exposed and collapsed subchondral bone, osteophyte formation around the circumference of the articular cartilage, and loose pieces of cartilage in the joint. In **equine osteochondrosis (dyschondroplasia)**, the histologic lesions can be divided into two groups. In one group, there are accumulations of small rounded chondrocytes, areas of necrosis, and chondrocyte clusters. In the second group, there are alterations in the appearance of the mineralized matrix, areas of necrosis, chondrocyte clusters, and an alteration in type VI collagen immunoreactivity within the chondrocyte clusters.

In the epiphyseal plates (e.g., the distal ulna in pigs with osteochondrosis), the cartilage is uneven and thickened, with hemorrhage, fibrous tissue, collapse of bone tissue in the metaphysis, and epiphyseal separation. Complete separation of the epiphysis occurs most commonly at the head of the femur. The ultrastructural appearance of normal epiphyseal cartilage of the articular–epiphyseal cartilage complex in growing swine has been examined and serves as a standard for comparison with the lesions in affected pigs. The lesions may be present in pigs at an early age as part of the usual growth pattern of cartilages.

### DIFFERENTIAL DIAGNOSIS

Osteoarthropathy is characterized clinically by a chronic lameness that becomes progressively worse and usually does not respond to treatment. The gait is stiff, there is disuse muscle atrophy, the bony prominences of the joint are more apparent, but usually there is no marked distension and pain of the joint capsule, as in infectious arthritis. Examination of synovial fluid may aid in differentiation from septic arthritis.

Radiographically, there is erosion of articular cartilage, sclerosis of subchondral bone, and periarticular accumulations of osteophytes. In the early stages of the disease in large animals, radiographic changes may not be visible, and repeated examinations may be necessary.

The radiographic changes of osteochondrosis in the shoulder joint of the horse consist of the following:

- Alteration in the contour of the humeral head and glenoid cavity
- Periarticular osteophyte formation
- Sclerosis of the subchondral bone
- Bone cyst formation

### TREATMENT

The treatment of arthropathy depends largely upon correction of the cause, but in most cases the lesions are progressive and

irreparable, and food-producing animals should be slaughtered for salvage. Tarsal degenerative joint disease in cattle has been treated with intraarticular injections of corticosteroids and has provided temporary relief from pain and discomfort. However, the corticosteroids do not promote healing of the joint, and their use in arthropathy may actually accelerate erosion of articular cartilage, loss of joint sensation, and the development of “steroid arthropathy.”

In the horse, there are many choices available for controlling inflammation in osteoarthritis. Treatment is symptomatic and largely nonspecific, but the long-term administration of antiinflammatory agents remains a central part of the treatment of equine joint disease.<sup>9</sup>

### Nonsteroidal Antiinflammatory Agents and Opioids

Several nonsteroidal antiinflammatory drugs (NSAIDs), such as **phenylbutazone**, **flunixin meglumine**, **ketoprofen**, **naproxen**, and **carprofen**, are available treatment options. Each has associated toxicities. They are now the most commonly used drugs because of their analgesic, antipyretic, and antiinflammatory properties. They inhibit some component of the enzyme system that converts arachidonic acid into prostaglandins and thromboxanes. All cells, including chondrocytes and synoviocytes, possess arachidonic acid as a fatty acid constituent of phospholipids. Once released, arachidonic acid is oxidized by either cyclooxygenase (COX) or 5-lipoxygenase. COX oxidation leads to prostaglandin production, whereas lipoxygenase oxidation leads to leukotriene formation. The effect of NSAIDs is primarily from inhibiting COX, which blocks arachidonic acid conversion to prostaglandin.

**Phenylbutazone** is the most commonly used NSAID around the world to treat arthritis in horses, but oral administration at 2 mg/kg every 12 hours did not appear to have a clinically relevant effect on joint tissue metabolism.<sup>10</sup> This suggests that the major clinical effect of phenylbutazone in horses with osteoarthritis is analgesia. Some countries, such as the United States, do not permit the use of phenylbutazone in food-producing animals. The oral administration of **meloxicam** (0.6 mg/kg BW once daily) altered joint tissue metabolism, as demonstrated by decreased synovial fluid concentrations of PGE<sub>2</sub>, substance P, bradykinin, and matrix metalloproteinase activity in horses with experimentally induced synovitis.<sup>9</sup> This suggests that meloxicam may have beneficial effects in limiting cartilage catabolism during acute synovitis.

Intraarticular morphine administration (0.05 mg/kg BW or 120 mg) is associated with substantial analgesic effects and beneficial antiinflammatory effects, resulting in less joint swelling and lower synovial fluid total protein concentration; leukocyte count;

and PGE<sub>2</sub>, bradykinin, and substance P concentrations in horses with experimentally induced acute synovitis.<sup>11,12</sup> The mechanism for the antiinflammatory effect of morphine is unknown.

### Intraarticular Steroids

Various steroidal formulations for intraarticular administration are available, and correct dosage, frequency of administration, indications, and toxicity are factors to consider for each drug. They include methylprednisolone acetate, betamethasone, and triamcinolone acetonide.

### Chondroprotective Agents

Various **chondroprotective** drugs, such as intraarticular **hyaluronic acid** and **polysulfated glycosaminoglycan**, and the oral nutraceutical agents **glucosamine-chondroitin sulfate** are also used to control inflammation and provide viscosupplementation. The allo-transplantation of synovial fluid into the joints of horses with arthropathies has been examined.

There is a notable lack of treatment information based on randomized, blinded, placebo-controlled clinical trials in the horse to identify the efficacy of therapeutic agents for both symptomatic and disease-modifying activity in degenerative joint disease. Until there are validated outcome measures that can be used practically in clinical trials, there will always be uncertainty about whether these therapeutic agents have any real disease-modifying action.

### Hyaluronic Acid

The beneficial effects of hyaluronic acid are claimed to be improved viscosity of the synovial fluid and thereby improved rheologic properties, lubrication of unloaded joints, and provision of an antiinflammatory and analgesic effect. The changes in the synovia following the intraarticular injection of **sodium hyaluronate** into normal equine joints and after arthroscopy and experimental cartilage damage have been examined, but in general the results are inconclusive.

### Polysulfated Glycosaminoglycan

Polysulfated glycosaminoglycan has been reported to induce articular cartilage matrix synthesis and to decrease matrix degradation. Experimentally, intraarticular injection of **polysulfated glycosaminoglycan** provides some protection against chemically induced articular cartilage damage but not against physical defects of articular cartilage in the horse. The polysulfated glycosaminoglycans inhibit lysosomal enzymes and neutral proteases. A survey of the use of polysulfated glycosaminoglycans by equine practitioners for the treatment of lameness in horses found that the drug is moderately effective overall and is considered most beneficial in the treatment of subacute degenerative joint disease. Its efficacy for incipient

and chronic forms of degenerative joint disease is considered comparable to that of sodium hyaluronate.

The prevention of further trauma should be ensured, and possible nutritional causes should be corrected. The treatment of active disease, particularly in soft tissues, that is contributing to articular degeneration includes rest, immobilization, physical therapy, intraarticular injections of corticosteroids, NSAIDs, joint lavage, and intraarticular injection of sodium hyaluronate, all of which have been used with variable success.

### Other Treatments

**Surgical therapy** includes curettage of articular cartilage, removal of osteophytes, and surgical arthrodesis. In a retrospective study of stifle lameness in 42 cattle admitted to two veterinary teaching hospitals over a period of 6 years, 18 had radiographic evidence of subchondral bone cyst without radiographic evidence of degenerative joint disease. The prognosis in those with a subchondral bone cyst was favorable, with 75% returning to their intended function, whereas in cases of septic arthritis only 22% returned to normal.

**Chemical arthrodesis** using the intraarticular injections of monoiodoacetate (MIA) has been described as an alternative to surgical arthrodesis for the treatment of degenerative joint disease of the distal tarsal joints. MIA causes an increase in intracellular concentration of adenosine triphosphate, resulting in inhibition of glycolysis and cell death. It causes dose-dependent cartilage degeneration characterized by cartilage fibrillations, chondrocyte death, and glycosaminoglycan and proteoglycan depletion. MIA produces reliable radiographic and histologic ankylosis of the distal tarsal joints. Resolution of the lameness required 12 months and occasionally longer. Soundness was achieved in 82% and 85% of horses at 12 and 24 months, respectively. Complications of the injections were uncommon and were probably related to periarticular injection or leakage of MIA, or to use of higher concentrations or volumes. Postinjection pain was marked in a small number of horses but was transient and managed effectively with analgesic drugs. The procedure is controversial. Some clinicians argue that arthrodesis should only be used where lameness is localized to the tarsometatarsal and centrodistal joints with objective means such as local analgesic techniques and when other more conservative treatments have failed.

### CONTROL AND PREVENTION

Prevention of osteoarthropathy will depend on recognition and elimination of the predisposing causes: provision of an adequate diet and the avoidance of overnutrition during the first 3 months of extrauterine life, regular exercise for confined animals, the provision of suitable flooring to minimize persistent concussion, and the use of breeding stock

that have a body conformation that does not predispose to joint lesions.

### FURTHER READING

- Lavery S, Girard C. Pathogenesis of epiphyseal osteochondrosis. *Vet J.* 2013;197:3-12.
- Lewczuk D, Korwin-Kossakowska A. Genetic background of osteochondrosis in the horse—a review. *Anim Sci Papers Rep.* 2012;30:205-218.
- Olstad K, Ekman S, Carlson CS. An update on the pathogenesis of osteochondrosis. *Vet Pathol.* 2015;52:785-802.
- Richardson DW, Loinaz R. An evidence-based approach to selected joint therapies in horses. *Vet Clin Equine.* 2007;23:443-460.
- Ytrehus B, Carlson CS, Ekman S. Etiology and pathogenesis of osteochondrosis. *Vet Pathol.* 2007;44:429-448.

### REFERENCES

- van Weeren PR, Jeffcott LB. *Vet J.* 2013;197:96.
- Counotte G, et al. *J Equine Vet Sci.* 2014;34:668.
- Robert C. *Vet Rec.* 2013;doi:10.1136/vr.f310.
- Vander Heyden J, et al. *Vet Rec.* 2012;doi:10.1136/vr.101034.
- van Grevenhof EM, et al. *Livestock Sci.* 2012;143:85.
- Lecocq M, et al. *Equine Vet J.* 2008;40:442.
- Olstad K, et al. *Vet Pathol.* 2015;52:862.
- Vijarnsorn M, et al. *Am J Vet Res.* 2006;67:1286.
- de Grauw JC, et al. *Equine Vet J.* 2009;41:693.
- de Grauw JC, et al. *Vet J.* 2014;201:51.
- Lindegaard C, et al. *Am J Vet Res.* 2010;71:69.
- van Loon JPAM, et al. *Equine Vet J.* 2010;42:412.

### SEPTIC ARTHRITIS SYNOVITIS

Inflammation of the synovial membrane and articular surfaces as a result of infection occurs commonly in farm animals. It is characterized by varying degrees of lameness and a warm, swollen, and painful joint. The synovial fluid is usually abnormal, containing an increased leukocyte count and the pathogens causing the arthritis. The arthritis may be severe enough to cause systemic illness, and in some cases a draining sinus tract may occur.

### ETIOLOGY AND EPIDEMIOLOGY

Specific bacterial infections of the joints are most common in newborn farm animals, in which localization of infection occurs in joints following bacteremia or septicemia. Surveys of Thoroughbred studs have shown that the incidence of infectious arthritis is higher in foals with other perinatal abnormalities and in which the ingestion of colostrum was delayed for more than 4 hours after birth. Calves with hypogammaglobulinemia are particularly susceptible to bacteremia and meningitis, ophthalmitis, and arthritis. Some of the important infectious causes of arthritis are as follows.

#### Calves

- Nonspecific joint-ill from omphalophlebitis associated with *Trueperella pyogenes*, *Fusobacterium necrophorum*, *Staphylococcus* spp.
- *Erysipelothrix rhusiopathiae* sporadically in older calves

- *Salmonella dublin*, *Salmonella typhimurium*, and *Mycoplasma bovis*

### Lambs

- *E. rhusiopathiae* in newborn and recently tail-docked lambs
- Sporadic cases associated with *F. necrophorum*, *Staphylococcus* spp., *Corynebacterium pseudotuberculosis*, *Histophilus somni*, *Mannheimia haemolytica*
- *Chlamydophila* spp. causes polyarthritis extensively in feedlot lambs
- Tick pyemia is associated with *Staphylococcus aureus*.

### Foals

- Part of neonatal septicemia, with gram-negative bacteria predominating<sup>1</sup>
- *Actinobacillus equuli*, *Rhodococcus equi*, *Salmonella abortusovae* in the newborn
- *Chlamydophila* spp. has caused polyarthritis in foals.

### Piglets

- Streptococci, Lancefield groups C, E, and L
- *Streptococcus suis*
- *E. rhusiopathiae* in pigs of any age—up to 65% of joints of pigs at slaughter are affected, and up to 80% of the farms from which the pigs come do not vaccinate for erysipelas. Mortality in preweaning groups of pigs may affect 18% of litters and 3.3% of the piglets, with a herd mortality of 1.5%
- In a 4-year period in a swine research station, 9411 piglets were born alive, and 9.8% were treated for lameness. About 75% of the cases were observed in piglets under 3 weeks of age. The incidence of lameness was much higher in piglets born from sows of parity 3 (11.4%) compared with piglets born to sows of parity 4 to 7 (8%).

### Cattle

- *Histophilus somni* is a cause of synovitis.
- *Mycoplasma agalactia* var. *bovis* is a common cause of synovitis, arthritis, and pneumonia in young feedlot cattle.
- *Mycoplasma bovigenitalium* may cause mastitis in cows, with some animals developing arthritis.
- *Mycoplasma mycoides* may cause arthritis in calves vaccinated with the organism against contagious bovine pleuropneumonia. Calves already sensitive to the organism develop an immediate-type allergic reaction of the synovial membrane.
- *Brucella abortus*—occasional cows with brucellosis develop arthrodial synovitis.
- Some cases of ephemeral fever have sterile arthritis.
- BVD virus in young bulls, rarely

- Idiopathic septic arthritis in dairy heifers—the etiology is unknown.
- Septic arthritis of the proximal interphalangeal (pastern) joint in cattle as a result of perforating wounds—*T. pyogenes* is the most common cause in cattle.

### Sheep and Goats

- As part of melioidosis
- *Mycoplasma* spp. of serositis—arthritis
- *Streptococcus dysgalactiae* in lambs and kids<sup>2,3</sup>

### Horses

- Septic arthritis after penetrating wounds, intraarticular injection of corticosteroids, and surgery; young foals under 6 months of age usually associated with septicemia; adult horses without a known etiology.
- In a series of 34 cases of monoarticular infectious arthritis in adult horses admitted to a veterinary teaching hospital over a period of 10 years, 16 had a penetrating wound over the joint, 4 had a puncture wound of the sole, and in 5 the infection was iatrogenic (3 had received intraarticular corticosteroids, 1 had received intraarticular anesthesia, and 1 had sepsis after a purulent thrombophlebitis); in 9 cases, no cause could be determined.
- Spread to the joints from generalized strangles.
- Rare cases of nonerosive polysynovitis in a horse, possibly immunologic and immune-mediated polysynovitis in foals.
- *Acedosporium prolificans*, a newly recognized opportunistic fungus, has been associated with an incurable arthritis and osteomyelitis in a mature horse.

### Pigs

- Glasser's disease
- *Mycoplasma* spp. in synovitis and arthritis of growing pigs, especially in housed pigs
- *Brucella suis* commonly infects bones, especially vertebrae, and joints.

### All Species

Sporadic cases are a result of the following:

- Traumatic perforation of the joint capsule
- Spread from surrounding tissues (e.g., footrot to interphalangeal joints in cattle and pigs, interdigital abscess in sheep)
- Hematogenous spread from suppurative lesions, commonly in udder, uterus, diaphragmatic abscess, infected navel or tail, castration wound

### PATHOGENESIS

In infectious arthritis that is hematogenous in origin there is usually a synovitis initially, followed by changes in the articular cartilages

and sometimes bone. With almost any systemic infection, there may be localization of the infectious agent in the synovial membrane and joint cavity. The synovial membrane is inflamed and edematous, and there are varying degrees of villous hypertrophy and deposition of fibrin. Bacteria colonize synovial membranes, which makes treatment difficult. The synovitis causes distension of the joint capsule with fluid, and the joint is painful and warm. Successful treatment and elimination of infection at this early stage of synovitis will minimize changes in articular cartilage and bone, and healing will result. A progressive infectious synovitis commonly results in pannus formation between articular surfaces, with erosion of articular cartilage, infection of subchondral bone, and osteomyelitis. In the chronic stages, there is extensive granulation tissue formation, chronic synovitis, and degenerative joint disease with osteophyte formation, and ankylosis is possible. Depending on the organism, the arthritis may be suppurative or serofibrinous. Suppurative arthritis is particularly destructive of cartilage and bone, and commonly there is rupture of the joint capsule. In foals with septic arthritis, there may be a concurrent polyosteomyelitis, usually in either the epiphysis and/or the metaphysis of the long bones.

### Calves With Experimentally Induced Infectious Arthritis

Septic arthritis induced by *E. coli* is a reliable and reproducible model of infectious arthritis in laboratory animals, including horses and calves. The inoculation of *E. coli* into the tarsal joint of newborn colostrum-fed calves resulted in septic arthritis in all calves. Clinic signs of septic arthritis appeared on day 2 after infection and persisted until day 9 for all calves. *E. coli* was cultured from synovial fluid on day 2 for one calf and until day 4 for five other calves. Polymerase chain reaction (PCR) for *E. coli* was positive in the synovial fluid of all calves. Synovial fluid neutrophil and white blood cell counts were increased on days 2 to 4. All bacterial cultures were negative on day 8, although clinicopathologic signs of inflammation persisted until day 20. Rapid recovery occurred within 1 week when an appropriate treatment was begun early in the course of the disease.

### Lambs With *Streptococcus dysgalactiae* Polyarthritis

*Streptococcus dysgalactiae* is the most common cause of septic arthritis in lambs under 4 weeks of age in the United Kingdom.<sup>3</sup> It appears that a small proportion of ewes carry *S. dysgalactiae* in vaginal secretions, milk, and other secretions, and *S. dysgalactiae* can survive on straw or hay for up to 5 to 6 weeks.<sup>2</sup> The route of entry of *S. dysgalactiae* into lambs is uncertain but appears to be either via the umbilicus or following ingestion.<sup>4</sup>



### Foals With Septicemia

Septicemic foals may develop infectious arthritis and a concurrent polyosteomyelitis because of the patency of transphyseal vessels in the newborn foal; this allows spread of infection across the physes with the development of lesions in the metaphysis, epiphysis, and adjacent to the articular cartilage. The syndrome is classified into four types according to the location of the lesions:

- A foal with **S-type** septic arthritis has synovitis without macroscopic evidence of osteomyelitis. This is most commonly seen in the first 2 weeks of life.
- Foals with **E-type** septic arthritis also have osteomyelitis of the epiphysis at the cartilage–subchondral bone junction. This is most commonly seen at 3 to 4 weeks of life.
- Those with **P-type** infections have osteomyelitis directly adjacent to the physis and do not have septic arthritis, although there may be a nonseptic effusion of the closest joint.
- Foals with **T-type** have an initial infection of the small cuboidal bones of the carpus and tarsus that spreads into the carpal or tarsal joints.

### Horses

Septic arthritis has been reproduced experimentally in horses and the sequential synovial fluid changes monitored. Following intraarticular inoculation of *S. aureus*, clinical signs are evident as early as 8 hours after infection. A high and persistent neutrophilia is one of the earliest and most accurate diagnostic abnormalities. The total white blood cell count rises within 12 to 24 hours to a mean value of  $100 \times 10^9/L$ . Total protein also increases. Synovial fluid acidosis also occurs in infectious arthritis, which may interfere with the antibacterial activity of some antimicrobials. In experimental arthritis, the synovial pH declined from a mean value of 7.43 to 7.12. Bacteria could be detected in 40% of the smears of infected synovial fluid samples, and primary cultures of the fluid were positive in 70%. The intraarticular inoculation of *E. coli* into horses induces a reliable, reproducible, and controlled model of infectious arthritis consistent with the naturally occurring disease and has been used to evaluate the efficacy of gentamicin for treatment. The injection of *E. coli* lipopolysaccharide into various joints of horses can cause clinical signs of endotoxemia, and the synovial fluid total nucleated cell count and total protein are linearly responsive in increases in endotoxin.

Endothelin (ET)-1, a 21-amino-acid polypeptide, is locally synthesized in the joints of horses with various forms types of joint disease. It induces a potent and sustained vasoconstriction. Synovial fluid concentrations of ET-1 varies among horses with joint disease, with higher concentrations in

animals with joint sepsis suggesting a pathogenic role in septic arthritis.

Synovial fluid in infectious arthritis in the horse may contain the proteolytic enzymes collagenase and caseinase, which may derive from both synovial cells and neutrophils. These enzymes are involved in the degradation of connective tissue and loss of cartilage matrix. Lavage of affective joints is intended to remove these enzymes.

Infectious arthritis may occur following traumatic injury to a joint, but the pathogenesis is obscure. Traumatic injury of the joint capsule resulting in edema and inflammation may allow latent organisms to localize, proliferate, and initiate a septic arthritis.

Septic arthritis occurs rarely in adult horses following injection of an intraarticular medication or elective equine arthroscopy without antimicrobial prophylaxis. In a retrospective and prospective case series involving 16,624 injected joints, the risk of septic arthritis was 1 case per 1,279 injections, with veterinarian and type of corticosteroid (triamcinolone and dexamethasone) being risk factors for infection.<sup>5</sup> The significant effect of the veterinarian suggests the presence of variable attention to strict aseptic technique. In 444 consecutive equine arthroscopies performed without prophylactic antimicrobial therapy, the incidence of septic arthritis in horses after surgery was 0.7%, which was similar to the infection rate (0.9%) in other studies where horses received antimicrobial prophylaxis.<sup>6</sup>

### CLINICAL FINDINGS

Inflammation of the synovial membrane causes pain and lameness in the affected limb, sometimes to the point that the animal will not put it to the ground. Pain and heat

are usually detectable on palpation, and passive movement of the joint is resented. The joint may be swollen, but the degree will depend on the type of infection. Pyogenic bacteria cause the greatest degree of swelling and may result in rupture of the joint capsule. Some enlargement of the epiphysis is usual, and this may be the only enlargement in nonpyogenic infections, particularly those associated with *E. insidiosa*.

Fever, inappetence to anorexia, endotoxemia, loss of body weight, and discomfort may occur in animals with only one severely affected joint or when several joints are less severely affected. In many of the neonatal infections, there will also be an accompanying omphalophlebitis (Fig. 15-9) and evidence of lesions in other organs and tissues, particularly the liver, endocardium, and meninges. Arthritis in older animals may also be accompanied by signs of inflammation of the serous membranes and endocardium when the infection is the result of hematogenous localization.

The joints most commonly involved are the hock, stifle, and knee, but infection of the fetlock, interphalangeal, and intervertebral joints is not uncommon. In chronic cases, there may be physical impairment of joint movement because of fibrous thickening of the joint capsule, periarticular ossification, and, rarely, ankylosis of the joints. Crepitus may be detectable in joints where much erosion has occurred.

In newborn and young animals, involvement of several joints is common. The joints may become inflamed simultaneously or serially. Lameness is often so severe that affected foals lie down in lateral recumbency most of the time and may have to be assisted to rise. Decubitus ulcerations as a result of



**Fig. 15-9** Very early signs of septic arthritis of the left hock joint in a 7-day-old Shorthorn calf. The calf did not suckle colostrum and had a slightly enlarged and painful umbilicus of 2 days in duration. Decreased weight-bearing on the left leg with palpable joint distention of the left hock has just become evident.

prolonged recumbency are common. The gait may be so impaired as to suggest ataxia of central origin.

The **prognosis** in cases of advanced septic arthritis is poor. Neglected animals may die or have to be destroyed because of open joints or pressure sores. The subsequent development of chronic arthritis and ankylosis may greatly impede locomotion and interfere with the usefulness of the animal.

## DIAGNOSIS

The diagnosis of septic arthritis requires aseptic arthrocentesis of infected joint(s) and synovial fluid analysis, including bacterial culture of the fluid. An important therapeutic question to be answered is whether infection is confined to the synovial structure of the joint or whether infection includes cartilage and subchondral bone (osteomyelitis). Imaging modalities are designed to identify extension of infection deeper to the synovial structures, of which radiography has been extensively used and is very helpful in chronic cases.

### Arthrocentesis

Aspiration of joint fluid for culture and analysis is necessary for a definitive diagnosis. Careful disinfection of the skin and the use of sterile equipment is essential to avoid the introduction of further infection. Intravenous diazepam (0.1 mg/kg BW) is helpful in sedating foals for arthrocentesis. Joint fluid should be collected using an 18-g or 16-g needle to facilitate removal of viscous or purulent fluid.

### Analysis of Joint Fluid

Total and differential cell count, total protein concentration, and specific gravity are determined. The classical changes in synovial fluid in large animals with septic arthritis are increased leukocyte count (particularly neutrophils), an increased protein concentration, and decreased fluid viscosity.

In infectious arthritis, the volume of joint fluid is increased, and the total leukocyte count is increased, with a high percentage (80% to 90%) of neutrophils. The severity of infectious arthritis may be manifested systemically by a leukocytosis with a marked regenerative left shift. In degenerative joint disease, the volume may be normal or only slightly increased, and the total and differential leukocyte count may be manifested within the normal range. In traumatic arthritis, there may be a marked increase in the number of erythrocytes. Special biochemical examinations of joint fluid are available that measure for viscosity, strength of the mucin clot, and concentrations of certain enzymes. The laboratory findings in examination of the joint fluid are summarized in [Table 15-3](#).

### Culture of Joint Fluid

Joint fluid must be cultured for aerobic and anaerobic bacteria and on specific media

when *Mycoplasma* spp. infection is suspected. It is often difficult to isolate bacteria from purulent synovial fluid. The rates of recovery of organisms vary from 40% to 75%. In one study of suspected infectious arthritis in 64 horses admitted to a veterinary teaching hospital over a period of 8.5 years, positive cultures were obtained from 55% of the joints sampled. The most common organisms were *S. aureus*, *E. coli*, and *Pseudomonas aeruginosa*, accounting for more than half the isolates obtained.

There is no single test that is reliable for the diagnosis of septic arthritis. Failure to isolate organisms on culture does not exclude a bacterial cause, and organisms are often not observed in synovial fluid smears. Poor collection, storage, and laboratory techniques; prior administration of antibiotics; or partial success of the immune system in containing the infection may explain the failure to detect organisms. Arthrocentesis should be done before antibiotics are given, and a blood culture bottle should be inoculated immediately, a Gram stain made, and culture for anaerobes included. Positive cultures from synovial fluid can be expected in only about 65% of cases.

A biopsy sample of synovial membrane may be more reliable than synovial fluid for culture, but there is little evidence based on comparative evaluations to support such a claim. PCR has been examined in in vitro studies to detect selected bacterial species in joint fluid compared with microbial culture. The benefits would include rapid and accurate diagnosis infectious arthritis, ability to detect bacteria in synovial fluid in the presence of antimicrobial drugs, and diagnosis of infectious arthritis when culture results are inconclusive. However, initial studies found no difference between microbial culture and PCR analyses.

### Serology of Joint Fluid

Serologic tests may be of value in determining the presence of specific infections with *Mycobacterium mycoides*, *Salmonella* spp., *Brucella* spp., and *E. insidiosus*. Radiographic examination may aid in the detection of joint lesions and can be used to differentiate between inflammatory and degenerative changes. In foals with arthritis and suspected osteomyelitis there may be radiographic evidence of osteolysis of the metaphysis or epiphysis.

### Radiography

Radiography of the affected joint will often reveal the nature and severity of the lesions. Typical radiographic findings of septic arthritis include osteolytic lesions of the articular cartilage, increased width of intra-articular joint space, and soft tissue swelling. Osteomyelitic changes are seen in some cases. Because radiographic changes usually appear after 2 to 3 weeks when destruction of subchondral bone has become extensive, it may be necessary to take a series of

radiographs several days apart before lesions are detectable.

## Ultrasonography

**Arthrosonography** is an effective, fast, and noninvasive complement to traditional diagnostic techniques (arthrocentesis and radiography) for comprehensive evaluation of the pathology of joints and associated tendons of cattle and horses.<sup>7</sup> Ultrasonography should be performed before arthrocentesis because joint distention facilitates imaging, and the introduction of air into the joint can interfere with interpretation of ultrasonographic images. Ultrasonography is particularly valuable in septic arthritis cases that are the result of trauma and to assist in the identification of foreign bodies.

Ultrasonographic changes are variable and primarily depend on the duration of infection.<sup>7</sup> Distension of the joint cavities can be imaged; assessment of the echogenicity, acoustic enhancement, and ultrasonographic character of the exudate correlates well with findings by arthrocentesis, arthrotomy, or at necropsy. Joint effusion, which is the earliest indication of septic arthritis, can usually be detected with ultrasound by an experienced operator in the early stages. The synovial membrane, synovial fluid, ligaments, tendons, and periarticular soft tissue, only inadequately imaged by radiography, can be imaged with ultrasonography. In advanced septic arthritis, ultrasonography provides accurate information on the location of the soft tissue swelling, the extent and character of the joint effusion, and the involvement of concurrent periarticular synovial cavities.

## Arthroscopy

Endoscopy is now used widely to define joint abnormalities more clearly and to gain access to the joint cavity as an aid in the treatment of septic arthritis.

## Nuclear Scintigraphy

Nuclear scintigraphy is considered much more sensitive than radiography for detecting the presence of subchondral (cortical) bone involvement and can be performed in the standing sedated horse. Scintigraphy is only found at large referral hospitals and usually cannot be scheduled on the same day as admission because the diagnostic agents need to be ordered and delivered. Consequently, the use of nuclear scintigraphy for identifying the extent of infection in acute cases of septic arthritis has declined. Scintigraphy remains a valuable diagnostic technique in adult horses with chronic septic arthritis, particularly of the proximal limbs and vertebral column.

## Magnetic Resonance Imaging and Computed Tomography

These imaging modalities are only found at large referral hospitals and require general anesthesia to prevent movement during

image acquisition. In general, the duration of anesthesia for imaging is shorter with magnetic resonance imaging (MRI) than computed tomography (CT). MRI and CT provide excellent anatomic information on articular structures, but imaging is usually confined to the distal limbs, including the carpus and hock, of adult horses and cattle because units are designed for human use.

MRI is regarded as the gold standard method for diagnosing subchondral osteomyelitis associated with septic arthritis in human medicine and is therefore likely to provide the best imaging modality for identifying the anatomic location of early cases of septic arthritis in large animals.<sup>8</sup> Magnetic resonance findings in adult horses with septic arthritis include diffuse hyperintensity within bone and extracapsular tissue on fat suppressed images, bone sclerosis, and cartilage and subchondral bone damage.<sup>9</sup> Intravenous gadolinium administration usually identifies synovial enhancement.<sup>9</sup> CT has the advantage of speed, permitting the evaluation of multiple joints, which is particularly advantageous in foals with septic arthritis.

## NECROPSY FINDINGS

The nature of the lesions varies with the causative organism. The synovial membrane is thickened and roughened, and there is inflammation and erosion of the articular cartilage. There is usually an increase in the amount of synovial fluid present, varying from a thin, clear, serous, brownish fluid through a thicker, serofibrinous fluid to pus. There may be some inflammation of the periarticular tissues in acute cases and proliferation of the synovial membrane in chronic cases. In the latter, plaques of inspissated necrotic material and fibrin may be floating free in the synovial fluid. Infectious arthritis caused by *T. pyogenes* is characterized by extensive erosion and destruction of articular cartilage and extensive suppuration. There may be a primary omphalophlebitis in newborn animals, and metastatic abscesses may be present in other organs.

## DIFFERENTIAL DIAGNOSIS

**Infectious arthritis** is characterized clinically by swollen joints that are painful and warm to touch, along with lameness of varying degrees of severity. The volume of joint fluid is usually markedly increased, and the leukocyte count is increased, with a high percentage of neutrophils. In the early stages of synovitis and in chronic nonsuppurative arthritis, the joint may not be visibly enlarged, and careful examination by palpation may be necessary to reveal abnormalities of the joint capsule. Lameness is common, however, even though only slight in some cases, and should arouse suspicion of the possibility of arthritis.

The diseases of the musculoskeletal system that cause lameness and stiffness of gait include the following:

- Degenerative joint disease
- Osteodystrophy and epiphysitis
- Osteomyelitis
- Degenerative myopathy
- Myositis
- Traumatic injuries of tendons and ligaments

Diseases of the nervous system, especially the peripheral nerves and spinal cord, may be confused with arthritis unless the joints are examined carefully.

Some severe cases of polyarthritis may cause recumbency that may be erroneously attributed to the nervous system.

**Degenerative joint disease** is characterized by an insidious onset of moderate lameness and stiffness of gait that becomes progressively worse over several weeks. The joint capsule is usually not grossly enlarged and not painful, and there is usually no systemic reaction. The total leukocyte count in the joint fluid is only slightly increased, and the differential count may be normal. Chronic arthritis is often difficult to differentiate clinically from degenerative joint disease. Chronic arthritis is more common in young animals than in older animals such as rapidly growing yearling bulls, adult bulls, and aged dairy cows and horses, in which degenerative arthropathy is most common. A sudden onset of acute lameness and marked swelling of a joint with severe pain suggests an infectious arthritis or traumatic injury to the joint. Marked swelling of several joints suggests infectious polyarthritis.

**Osteodystrophy** is characterized by the following:

- Lameness and stiffness of gait
- Usually, an absence of joint-capsule abnormalities
- Enlargements and deformities of the long bones in growing animals
- A number of animals being affected at about the same time

Radiography may reveal the abnormal bones, and the nutritional history may explain the cause.

**Degenerative myopathy** causes acute lameness and a stiff and trembling gait, often leading to recumbency and absence of joint or bone involvement.

**Traumatic sprains of tendons or ligaments** and fractures of the epiphyses may cause lameness and local pain; when they involve periarticular tissues, they may be difficult to differentiate from arthritis.

**Arthritis is never present at birth** and apparent fixation of the joints should arouse suspicion of a congenital anomaly. The differentiation between arthritis and diseases of the peripheral nerves or spinal cord, both of which can cause lameness or recumbency, may be difficult if the arthritis is not clinically obvious. Diseases of the peripheral nerves cause lameness as a result of flaccid paralysis and neurogenic atrophy. Lesions of the spinal cord usually result in weakness of the hindlimbs, weak or absent withdrawal reflexes, and loss of skin sensation.

## TREATMENT

### Parenteral Antimicrobials

Treatment should focus on **early diagnosis; removal of infected fluids and tissue** via joint lavage (tidal or though and through), arthroscopy, arthrotomy, or possibly closed suction drainage; **effective antimicrobial therapy**; and **controlling inflammation**. Acute septic arthritis should be treated as an emergency to avoid irreversible changes in the joint. The conservative approach is the use of antimicrobials given parenterally daily for several days and up to a few weeks in some cases, but this provides a lower success rate than when antimicrobial treatment is accompanied by removal of infected fluids and tissue. Antimicrobials that perfuse into septic joints in therapeutic concentrations when administered parenterally include the natural and synthetic penicillins, cephalosporins, tetracycline, trimethoprim-potentiated sulfonamides, neomycin, gentamicin, kanamycin, and amikacin, with species preferences regarding preferred antimicrobial protocols.

The relative efficacy of antimicrobials administered parenterally versus by intra-articular injections is uncertain. Trimethoprim-sulfadiazine, given to calves parenterally, results in therapeutic concentrations of the drug in the synovial fluid of calves, and penetrability was not enhanced or restricted by experimental joint inflammation. Oxytetracycline and penicillin given parenterally readily penetrate the synovial membrane of both normal neonatal calves and those with experimental arthritis. Because peak synovial joint fluid levels of oxytetracycline and penicillin exceeded the minimum inhibitory concentrations for organisms such as *T. pyogenes*, the use of parenteral antimicrobials for the treatment of infectious arthritis in calves is appropriate. Ceftiofur at 1 mg/kg BW intravenously every 12 hours for 20 days, along with joint lavage, was successful in treating experimental septic arthritis associated with *E. coli*. The duration of antibiotic therapy is empirical; 3 weeks is recommended. Cephapirin administered parenterally to normal calves or those with arthritis resulted in synovial fluid levels approximately 30% of serum levels. The use of ampicillin trihydrate in calves with suppurative arthritis, at a dose of 10 mg/kg BW intramuscularly, resulted in a peak serum concentration of 2.5 µg/mL, 2 hours after injection; the highest concentration in normal synovial fluid was 3.5 µg/mL at 4 hours, and the highest concentration in suppurative synovial fluid was 2.7 µg/mL at 2 hours. Marbofloxacin at 4 mg/kg BW intramuscularly daily for 10 days was effective for the treatment of infectious arthritis in calves.

In **foals and horses** with septic arthritis, the selection of the antimicrobial of choice will depend on the suspected cause of the arthritis. The antimicrobial susceptibilities of bacterial isolates from horses with septic



arthritis/synovitis or osteomyelitis after fracture repair vary widely. A combination of a cephalosporin and amikacin is recommended before culture and susceptibility results are available. Commonly used dosage protocols include penicillin G potassium (22,000 IU/kg BW IV every 6 hours) with aminoglycoside gentamicin (11 mg/kg BW IV every 24 hours) or amikacin (20 mg/kg BW IV every 24 hours) or the third-generation cephalosporin ceftiofur (2.2 mg/kg BW IM every 12 hours). In azotemic foals, care needs to be taken while administering aminoglycosides, and monitoring should be in place to detect nephrotoxicity. Amoxicillin at 40 mg/kg BW IV is effective for the treatment of infectious joint disease in horses. The administration of trimethoprim-sulfadiazine at 30 mg/kg BW orally once daily to horses with experimentally induced *S. aureus* arthritis was ineffective in maintaining adequate levels of both drugs in infected synovial fluid. In contrast, the use of the same drug at 30 mg/kg BW orally given every 12 hours was effective in maintaining therapeutic concentrations of both drugs in the serum and in the joint fluid. Amphotericin B given intravenously daily for up to 30 days combined with joint drainage has been used for the treatment of *Candida* sp. arthritis in the horse.

In piglets at 2 weeks of age, streptococcal arthritis is most likely, and it will respond quickly to penicillin given parenterally. Likewise, acute arthritis associated with erysipelas in pigs will respond beneficially if treated early before there is pannus formation.

Synovitis caused by *Histophilus somni* infection responds quickly to systemic treatment. However, in other specific types of infectious arthritis the response is poor, and recovery, if it does occur, requires several days or a week. Mycoplasma arthritis in cattle is relatively nonresponsive to treatment, and affected cattle may be lame for up to several weeks before improvement occurs; complete recovery may not occur. Chronic arthritis as a result of infection of pigs with *E. insidiosus* will commonly develop into a rheumatoid-like arthritis and be refractory to treatment.

Failure to respond to conservative therapy has been attributed to the following:

- Inadequate concentrations of antimicrobials achieved in the joint cavity
- Presence of excessive amounts of exudate and fibrin in the joint, making the infectious agent inaccessible to the antimicrobial
- Antimicrobial-resistant infections

It is often not possible to determine which situation is responsible.

If conservative treatment is not providing sufficient improvement and the value of the animal warrants extended therapy, a joint sample should be obtained for culture and

susceptibility testing. The most suitable antimicrobial may then be given parenterally and/or by intraarticular injection. Strict asepsis is necessary to avoid introduction of further infection.

### Intraarticular Antimicrobials

Antimicrobials infused into the joint should not be cytotoxic, and gentamicin (500 mg), amikacin (125 mg), soluble ceftiofur, and ceftazolin (500 mg) are commonly used with minimal to no apparent effects on developing cartilage. The combined intraarticular and intravenous administration of gentamicin to normal horses can result in concentrations 10 to 100 times greater than after intravenous administration alone. In addition, gentamicin concentration in synovial fluid remained above the minimum inhibitory concentration for many common equine bacterial pathogens for at least 24 hours after treatment. The intraarticular administration of gentamicin is advantageous for the treatment of infectious arthritis in animals in which the systemic administration of the drug may be contraindicated, especially in the presence of impaired renal function or endotoxemia. Continuous infusion of gentamicin into the tarsocrural joint of horses for 5 days is an acceptable method of treating septic arthritis.

Antimicrobial-impregnated polymethylmethacrylate beads and gentamicin-impregnated collagen sponges have been used for the treatment of orthopedic infections involving bone, synovial structures, and other soft tissues. The antimicrobials diffuse from the nonbiodegradable beads in a bimodal fashion. There is a rapid ("burst") release of 5% to 45% of the total amount of antimicrobial within the first 24 hours after implantation and then a sustained elution that persists for weeks to months, depending on the antimicrobial used. For effective diffusion, the antimicrobials must be water soluble, heat stable, and available in powder form. Aminoglycosides (gentamicin, amikacin) and third-generation cephalosporins (e.g., ceftiofur) have been incorporated most commonly into the beads, but to be successful the drug must retain its antimicrobial effect after heating. The major disadvantage with polymethylmethacrylate beads is that they must be removed because they act as a foreign body and also provide unknown slaughter withdrawal times in food-producing animals. Long-term placement of intraarticular catheters has also been used in horses with septic arthritis, but aseptic methods must be maintained at the catheter site and during continuous or intermittent antimicrobial infusion, which can be challenging in a mobile animal. Moreover, a catheter should always be considered a two-way street and a potential vehicle for bacterial contamination of the joint. Whether placement of intraarticular catheters, polymethylmethacrylate beads, or gentamicin-impregnated collagen sponges have any

substantive clinical advantages over intraarticular injections at approximately 3-day intervals has not been determined. Intraarticular ceftiofur injection every 3 days accompanied by wound management has become favored by some in the treatment of septic arthritis of the distal interphalangeal joint in cattle.

Regional limb perfusion with antimicrobials has been used for the treatment of experimentally induced septic arthritis. The antimicrobial is infused under pressure to a selected region of the limbs through the venous system. The concentration of the antimicrobial in the septic synovial fluid will usually exceed those obtained by intravenous administration. However, there are insufficient data available to evaluate the procedure in naturally occurring cases of septic arthritis. Therapeutic concentrations of ceftazolin are achieved in the synovial fluid of clinically normal cows when injected intravenously distal to a tourniquet, and the technique could be used as an alternative to systemic administration of antimicrobials to provide adequate concentrations in a joint cavity. Regional limb perfusion appears better suited to treatment of more extensive infections such as septic arthritis secondary to penetrating wounds or accompanied by infected tendons or osteomyelitis.

### Lavage of Joint

Drainage of the affected joint and through-and-through lavage of the joint is also desirable along with the systemic administration of antimicrobials. Aspiration and distension-irrigation of the joint cavity using polyionic electrolyte solutions buffered to a pH of 7.4 is recommended (Fig. 15-10). The irrigation removes exudates and lysozymes that destroy articular cartilage. A through-and-through lavage system may also be used with drainage tubes. General or local anesthesia should be provided. The distended joint is identified by palpation, the hair is clipped short, and the skin is prepared with appropriate surgical disinfection. A 2-cm 16-g needle is inserted into the joint cavity, avoiding direct contact with the bones of the joint. A second needle is inserted into the joint as far as possible from the first needle to cause any fluid perfused into the joint to pass through as much of the joint cavity as possible. Next, 0.5 to 1 L of a balanced crystalloid solution such as lactated Ringer's solution warmed to 37° C (99 F) is flushed through the joint using a hand-pumped pressure bag to keep a steady fluid flow into the joint. The only antimicrobial solution documented to be safe to be added to joint lavage solutions is 0.1% povidone-iodine solution, which produces minimal synovitis and no articular cartilage damage or joint irritation.

### Arthroscopy

Arthroscopy provides excellent visualization of most parts of an affected joint and can be



**Fig. 15-10** Through-and-through needle lavage of the left hock joint of the Shorthorn calf in Figure 15-9. Warmed lactated Ringer's solution is lavaged through the joint with periodic joint distention (present) to facilitate lavage of the entire joint. The calf made a complete recovery.

used to access the joint for the treatment of septic arthritis. The endoscope can be used to explore and debride the affected joint during the same intervention. Purulent exudate can be removed, and necrotic areas within the synovial membrane can be debrided.

### Surgical Drainage and Arthrotomy

Failure to respond to parenteral and intraarticular medication may require surgical opening of the joint capsule, careful debridement, and excision of synovium and infected cartilage and bone. This may be followed by daily irrigation of the joint cavity with antimicrobials and saline. A lavage system can be established and the joint cavity infused with an antimicrobial and saline daily for several days. Arthrotomy with lavage was more effective in eliminating joint infections by providing better drainage than arthroscopy, synovectomy, and lavage. However, with arthrotomy the risk of ascending bacterial contamination is greater, and the major difficulty is to eliminate the infection from the joint and incision site. Infected sequestra and osteomyelitis of subchondral bone will prevent proper healing. Curettage of septic phrease lesions in foals may be necessary.

Open drainage and intraarticular and parenteral antimicrobials have been used to treat persistent or severe septic arthritis/tenosynovitis. Although joint lavage through needles is still effective in many horses with acute infectious arthritis or tenosynovitis, in those with chronic or recurring septic arthritis, open drainage is indicated to remove the inflammatory exudate from the synovial space. Infected synovial structures are drained through a small (3-cm) arthrotomy incision left open and protected by a sterile bandage. Joint lavage using antimicrobials is

done daily, and parenteral antimicrobials are given intensively.

**Septic pedal arthritis in cattle** may be treated successfully by the creation of a drainage tract to promote adequate drainage. In cattle with septic arthritis of the digit, placement of a wooden block under the unaffected digit decreases weight-bearing on the affected digit and provides for earlier, less painful ambulation.

### Arthrodesis or Artificial Ankylosis

Surgical arthrodesis can be used for the treatment of chronic septic arthritis in horses and calves. Septic arthritis of the distal interphalangeal joint is a common complication of diseases of the feet of cattle. Facilitated ankylosis of the joint is a satisfactory alternative to amputation of the affected digit in valuable breeding animals. In a series of 12 cases of septic arthritis of the distal interphalangeal joint treated by use of facilitated ankylosis, the success rate was 100%.

### Physical Therapy

The local application of heat, by hot fomentations or other physical means, is laborious, but if practiced frequently and vigorously, it will reduce the pain and local swelling. Analgesics are recommended if there is prolonged recumbency. Persistent recumbency is one of the problems in the treatment of arthritis, particularly in foals. The animal spends little time feeding or sucking and loses much condition. Compression necrosis over bony prominences is a common complication and requires vigorous preventive measures.

Stall rest for at least 3 to 4 weeks is recommended to minimize excessive exercise because the joint cartilage appears to be more vulnerable to injury after an acute inflammatory episode.

### Antiinflammatory Agents and Adjunctive Therapy

NSAIDs are used routinely parenterally to decrease the inflammatory response and to provide analgesia. A common dose rate in foals with septic arthritis is 1.1 mg/kg BW IV every 24 hours for flunixin meglumine. In experimental synovitis in the horse, similar to septic arthritis, phenylbutazone was more effective than ketoprofen in reducing lameness, joint temperature, synovial fluid volume, and synovial fluid prostaglandin. Topical application of a fentanyl transdermal "patch" to the thorax or groin may provide additive analgesia, but scheduled drug requirements and reporting may make such treatment impractical.

Hyaluronic acid is protective for joint health because it is an important constitutive component of articular cartilage and synovial fluid. Horses with septic arthritis have depleted hyaluronic acid content, and consequently foals with septic arthritis benefit from the intraarticular administration of hyaluronic acid (10 mg) because this results in glycosaminoglycan loss from articular cartilage and has antiinflammatory properties.

### Prognosis for Survival and Athletic Use in Horses With Septic Arthritis

The factors affecting the prognosis for survival and athletic use in 93 foals treated for septic arthritis have been examined. The femoropatellar and tarsocrural joints were most commonly affected. Osteomyelitis or degenerative joint disease were detected in 59% of the foals. Failure of transfer of passive immunity, pneumonia, and enteritis were common. Treatment consisted of lavage, lavage and arthroscopic debridement with or without partial synovectomy, or lavage and arthrotomy to debride infected bone and parenteral antibiotics. Seventy-five foals survived and were discharged from hospital, and approximately one-third raced. Isolation of *Salmonella* from synovial fluid was associated with an unfavorable prognosis for survival, and multisystemic disease was associated with an unfavorable prognosis for survival and ability to race. The key to successful outcome for septic arthritis is rapid diagnosis and initiation of treatment. The presence of infection in multiple joints is associated with a poor outcome.<sup>1</sup>

In a series of 507 horses treated for joint disease at one equine hospital during a period of 7 years, the risk factors affecting discharge from the hospital were examined; 58% of foals, 78% of yearlings, and 94% of racing adults were discharged. Foals with a less severe lameness, duration of less than 1 day, and infectious arthritis had increased odds of discharge.

Factors associated with the short-term survival rate of 81 foals with septic arthritis were evaluated. Seventy-seven percent of the foals were discharged from the referral hospital, with nonsurvival being associated with

multiple joint involvement; detection of gram-negative, mixed bacterial intraarticular infection; and the presence of degenerate neutrophils in the joint fluid.<sup>10</sup> Initiation of treatment within 24 hours of first evidence of clinical abnormalities and the use of multiple treatment modalities were positively associated with survival.<sup>10</sup> In general, little information is available about athletic performance in horses following septic arthritis.

### CONTROL

The control of infectious arthritis is of major importance in newborn farm animals. The early ingestion of adequate quantities of good-quality colostrum and a clean environment for the neonate are necessary. The prophylactic use of antimicrobials may be considered to reduce incidence. Some of the infectious arthritides associated with specific diseases can be controlled through immunization programs. For example, vaccination of piglets at 6 to 8 weeks of age will provide protection against both the septicemic and arthritic forms of erysipelas.

### FURTHER READING

- Annear MJ, Furr MO, White NA 2nd. Septic arthritis in foals. *Equine Vet Educ*. 2011;23:422-431.
- Desrochers A, Francoz D. Clinical management of septic arthritis in cattle. *Vet Clin North Am Food A*. 2014;30:177-203.
- Haerdi-Landerer MC, Habermacher J, Wenger B, Suter MM, Steiner A. Slow release antibiotics for treatment of septic arthritis in large animals. *Vet J*. 2010;184:14-20.
- Hardy J. Etiology, diagnosis, and treatment of septic arthritis, osteitis, and osteomyelitis in foals. *Clin Tech Equine Pract*. 2006;5:309-317.
- Paradis MR. Septic arthritis in the foal: what is the best imaging modality? *Equine Vet Educ*. 2010;22:334-335.

### REFERENCES

- Hepworth-Warren KL, et al. *J Am Vet Med Assoc*. 2015;246:785.
- Rutherford SJ, et al. *Vet Rec*. 2014;10.1136/vr101753.
- Rutherford SJ, et al. *Vet Rec*. 2015;10.1136/vr.102781.
- Lacasta D, et al. *Small Ruminant Res*. 2008;78:202.
- Steel CM, et al. *Aust Vet J*. 2013;91:268.
- Borg H, et al. *Vet Surg*. 2013;42:262.
- Beccati F, et al. *Vet Radiol Ultrasound*. 2015;56:68.
- Gaschen L, et al. *Vet Radiol Ultrasound*. 2011;52:627.
- Easley JT, et al. *Vet Radiol Ultrasound*. 2011;52:402.
- Vos NJ, Ducharme NG. *Irish Vet J*. 2008;61:102.

## LAMENESS IN PIGS AND DEGENERATIVE JOINT DISEASE (OSTEOCHONDROSIS, OSTEOARTHROSIS, EPIPHYSIOLYSIS AND APOPHYSIOLYSIS, LEG WEAKNESS IN PIGS)

### LEG DISORDERS

Leg disorders are divided into three major groups<sup>1</sup>: (1) infectious arthritis, (2) physical injuries, and (3) osteochondrosis.

Leg weakness is a locomotory disability of pigs that is not associated with infectious disease. It is a combination of noninfectious arthropathy and osteopathy and is a significant cause of culling in pig herds. The causes are defects of conformation, osteochondrosis (including epiphysiolysis), arthrosis, lumbar intervertebral disk degeneration, and spondylosis. The clinical syndrome varies from lameness to difficulty in rising to recumbency. The characteristic signs are carrying a hindleg, sitting on the haunches for long periods of time, and a shuffling gait. All of the conditions affecting the limbs are related to the growth patterns in the respective limb bones. Rickets is seen from 8 weeks to physeal closure, osteomalacia from 8 weeks onward, osteochondrosis (OCD) from 0 to 30 weeks, epiphyseal separation from 15 weeks to physeal closure, and spondylosis in older sows or boars.

### LAMENESS

Lameness is deviation from normal gait. Joint kinetics have been described,<sup>2</sup> and lameness is closely associated with floor conditions.<sup>3</sup> One of the key decisions in examining pigs that are not showing signs of normal locomotion is to ascertain whether the pigs have abnormalities in the nervous, skeletal, muscular, or joint systems. In most cases lameness will involve the joints for a variety of reasons because these are the most stressed structures in the locomotory system. Patience in examination is essential, and noting the progression of signs is also very important. What the clinician will see and what the pathologist and laboratory diagnostician sees are usually two different things.

Lameness in pigs is associated with several etiologic disease groups: (1) trauma and bone fractures; (2) infections, such as arthritis, abscesses, tendonitis, and osteomyelitis; (3) overgrown feet, heels/claws, and wear conformation; and (4) osteochondrosis/osteoarthropathy, which is probably the most important group. The most common combination is trauma/infection/weak conformation.

### AGE-RELATED CHANGES IN PIGS

#### Young Pigs

Examination of young pigs for lameness is not easy. They are quick on their feet, bunch often, and need to be marked individually for further identification. You need to identify and mark those that are not walking or behaving normally or, if very young, not suckling properly. In young pigs purulent arthritis is common (usually *S. suis*, but may be others, including streptococci, *S. aureus*, *E. coli*).<sup>4-6</sup> In a Swedish study, 75% of lame piglets had polyarthritis (more than one joint affected).<sup>5</sup>

The risk factors<sup>7</sup> include the following:

- Poor mothering, poor milk supply, poor colostrum antibody protection, and agalactia

- Skin lesions, particularly at the carpal joints as piglets struggle to suckle
- Foot lesions associated with very poor flooring—rough edges, jagged metal (always worse than plastic), old plastic, poor concrete finish, and so forth—which causes damage to the tender feet of neonates, leading to bruised heels, erosion of heels, coronary band lesions, and subsequently septic arthritis
- Arthritis is ubiquitous, principally as a result of bad hygiene in the farrowing house; the importation of nonimmune gilts; poor management; no all-in/all-out system; improper cleaning, disinfection, and drying; lack of bedding; fully slatted floors; and lack of creep heating and feeding.

Most of the factors in the first two categories have disappeared by weaning because the piglet skin hardens and underfloor conditions generally improve.

The situation can be improved by proper management of sows and gilts; batch farrowing followed by cleaning, disinfection, and drying; proper building maintenance; bird and rodent control; treatment of sows for agalactia; use of cross-fostering if there are large litters; and use of vaccines if appropriate. It was shown that repairing floors and doubling the straw decreased the amount of abrasions,<sup>5</sup> and the level of lameness decreased from week 1 to week 3.

Osteodystrophy has been associated with hypervitaminosis A in growing pigs.

### Growers and Finishers

In growers and finishers all of the groupings of disease type are important. See how they react to walking. Usually lame pigs have an arched back, sit for longer periods, are reluctant to stand or move, are easily bullied, and tend to sit or lie down as soon as possible. If they are not lame they get up quickly and move quickly. In these animals the infectious causes involve *M. hyosynoviae*, *M. hyorhinis*, *S. aureus*, *Erysipelothrix* spp., and *H. parasuis*. In addition, OCD is important. In a survey of 1000 pigs,<sup>8</sup> 14% had OCD, and every pig with OCD gained 100 g/day less than the unaffected pigs.

The risk factors include low herd immunity (need to increase by exposure or vaccination); the importation of carriers onto the farm (e.g., *S. suis*, *Erysipelas* spp., *M. hyosynoviae*, and *H. parasuis* in particular); mixing of different ages of pigs (need all-in/all-out system by age); and stress as a result of excessive mixing, moving, and handling (reduce if possible).

A hereditary form of rickets has been described in which there is no enzyme to convert D2 to D3 in the kidney. Normally, rickets derived from dietary causes is normally seen in pigs of 2 to 6 months, and they have swollen joints, particularly the carpal, humeral, elbow, and stifle joints. Cases of rickets from dietary causes are very



uncommon and should not happen in this day and age, but cases do occur, particularly in the pigs of “back garden” and enthusiastic amateurs. The clinical signs include a stunted and unthrifty appearance, lameness, fractured long bones, and paresis. In young, weaned, growing pigs, there is a failure of mineralization of the osteoid and cartilage matrix, especially in the growth plates. At necropsy, the bones are pale and soft, particularly the ribs, which bend rather than snap under pressure and are radiolucent. Because the bones bend and don't fracture, there is often evidence of recent or healing fractures.

Rickets develop as a result of the following:

- Inadequate concentrations of calcium, phosphorus, and/or vitamin D in the ration
  - Improperly balanced calcium and phosphorus in the ration, resulting in a ratio greatly different from 1 to 2:1
  - Inadequate concentrations of the active vitamin D
  - No vitamin D synthesis in a dark environment
  - No proper ration analysis
  - Excess iron in the diet
- Kyphosis/lordosis (“kinky back” or lordosis/kyphosis) can be seen as a congenital abnormality, but it has also been seen in association with precocious behavior causing relaxation of the spinal ligaments and also by breeding for extra vertebrae in the spinal column, resulting in too much muscle weight for the skeleton.

### Older Animals

In older animals the disease is mainly of the infectious disease group, particularly polyarthritis and spondylitis. The risk factors are low herd immunity, the importation of carriers, mixing of pigs with different immunities, and episodes of stress. In these animals prevention is by isolation and quarantine of new imports, thorough mixing of pigs to ensure equal susceptibility and resistance, vaccination where possible (use the right strain, store vaccines correctly, and use them properly), and, importantly, reduction of adverse nutrition (look after P, Ca, and ratios, and make sure they are mixed at the right proportions).

A case-control study of factors associated with arthritis detected at slaughter in pigs from 49 farms in Finland showed that 93% to 96% of pigs had osteochondritic lesions in joints, both in the control group and the group with high incidence of arthritis at slaughter, and infection was found only rarely.<sup>9</sup> Bursitis is a common feature in this age group,<sup>10</sup> as are other foot lesions.<sup>11,12</sup> Osteomyelitis is an uncommon problem but may result in lameness or pathologic fractures of vertebrae with compression of the spinal cord. It may follow septicemia or a local progression, as in tail-biting abscessation.

### Adults

In a survey of cull sow bone and joint integrity in the Moorepark Research Farm herd in Ireland, it was found that there was no relationship between lameness and joint pathology in sows. Osteochondritic lesions were found in all the sows and were most common in the medial condyle of the humerus and the anconeal process of the ulna.<sup>13,14</sup> A study of lameness and fertility in sows and gilts in loose-housed herds in Finland<sup>15</sup> showed that 8.8% of the animals (646 in 21 herds) were lame. The most common clinical diagnoses were osteochondrosis, infected skin lesions, and claw lesions. Sows on slatted floors had twice the chance of being lame than those on solid floors. Yorkshire pigs were more likely to be lame than Landrace or crossbred pigs. Lameness was not a risk factor for nonpregnancy. With sows, fighting in loose-housing systems is an important factor, especially if there are limited numbers of feeders. Slipping on concrete-based flooring systems with badly drained, water-soaked floors is also a hazard. In these cases rubber mats may help. In sows there is commonly medial claw atrophy (hypoplasia) and an overgrown lateral claw. Quite often it is the younger animals that are affected, especially in loose-housed animals. Lesions at the coronary band are also not uncommon. Claw lesions may be primary, with secondary conditions to follow. In two commercial sow herds,<sup>16</sup> less than 4% of sows had lameness, with heel erosions being the most common cause and overgrowth of dewclaws second.

One of the most common lesions in this age group is cracked feet, either of the sole or wall or heels; affected animals are lame, but if treated, a proportion will always get better. OCD in sows will often cause an intermittent lameness, whereas animals with arthritis are persistently lame. In a survey of sows at casualty slaughter in 2005, 22% had fractures, 12% arthroses, and 15% osteomyelitis in the spine and other arthritides. All of the four groups are a problem in sows. Lameness is always on the list of culling for sows.<sup>17</sup>

Prevention is attention to all the items previously listed: inspect, trim, and treat feet regularly; check for wet floors, sharp edges, and newly laid concrete (treat with sodium carbonate); correct width of slats for age of animal; remove steps and steep slopes; check drainage angles; improve hygiene; perform regular cleaning, disinfection, and drying; reduce fighting; provide manipulable materials, particularly straw; have stable subgroups and provide good feeding and ad lib water; improve horn quality, possibly by increasing biotin and vitamin E in the diet; and, most important, improve genetic selection techniques.

Piglets often have fractures if laid on by sows, especially if they are hypoglycaemic or weak. Older piglets may fracture bones when they are stuck in fences or equipment. Finishing pigs may fracture bones during

transport. Fractures found in several animals at the same time may be a result of electrocution or sometimes outdoor lightning strike. Vertebrae, particularly in the thoracic area of the spine, humerus, neck of the scapula, pelvis, and neck of the femur are the usual sites. Sometimes the fractures are in the lumbosacral junction, resulting in separation of spinal cord and nerves. In these cases decomposition occurs quickly. Fractures have been described as part of lactational osteoporosis (downer sows) that occurred in first-litter sows when they were moved from the farrowing quarters and involved the pelvis, spine, femur, and other bones. It was caused by early mating, rapid growth rates, high milking yield of the sows, large litters, and insufficient nutrients in the diet to provide for both milk and sow growth, and thus calcium and phosphorus were drawn from the skeleton. Lactational osteoporosis is a result of an imbalance between bone formation (osteoblast activity) and bone resorption (osteoclast activity). There is often calcium deficiency. Sows bones decalcify to mobilize calcium for milk production. The specific gravity of bone in these animals will be 1.018, whereas the normal is 1.022. The ratio of cortex to total area is 0.2 or less compared with 0.3 in the normal cross section of the sixth rib. The bones are structurally normal but of lower mass. Complicating factors include long periods of restricted exercise (sow stalls, farrowing crates), and it is particularly a problem during the first litter when gilts are still growing and there is an even higher demand for calcium and phosphorus. At necropsy the most frequent sites for lesions are the proximal one-third of the humerus and the proximal one-third of the femur. Comminuted spiral fractures extend from the metaphysis down into the diaphysis.

Osteomalacia has been described as a result of deficiencies or imbalances of calcium, phosphorus, and vitamin D but may also be a result of the inability to consume sufficient food. Large quantities of unmineralized osteoids develop, thereby weakening the bones. This is attributable to a higher secretion of parathyroid hormone in the lactating sow.

Proliferative osteitis of the femoral greater trochanter and medial epicondyle of the humerus has been described, usually in gilts after the first weaning. Affected animals are seen dog-sitting, and they rise with pain and discomfort; the pathology is a hemolytic mass in the muscle.

**Ankylosing spondylitis** has been identified in culled sows and boars at abattoirs, but it is thought that the condition starts as early as the first year of life. Pigs have a painful lumbar region, may develop kyphosis, and waddle when walking or drag the hindfeet. The cause is probably multiple—wear and tear, spinal trauma, poor nutrition, genetics, arthritis of spinal joints, and so on.

Vertebrae may eventually fuse when alleviation occurs. Spondylosis results in bridging of the vertebrae, with possible trapping of the vertebrae.

**Arthrosis** is sometimes referred to as arthropathy, osteoarthritis, or osteoarthritis and is a nonspecific degenerating condition of cartilage that develops in chronic joint disease. The incidence increases with age (animals less than 18 months had 7% incidence, but those over 18 months had 82%). It is the result of instability resulting from osteochondrosis and the surface lesions in the joint that have filled with osseous repair tissue. Pathologically, the lesions include fibrillation of joint cartilage, ulceration of the articular surface, osteophyte production, and thickened synovial membranes and joint capsule.

Tumors are not common but include an osteosarcoma of the maxilla occluding the nasal cavity, secondary tumors from a malignant melanoma, congenital melanomas, and multiple myeloma<sup>18</sup> and a glioblastoma in the ventral cerebral cortex of a 6-month-old Yorkshire gilt.

## OSTEOCHONDROSIS

Leg weakness in pigs is a very loose term that includes a wide variety of conditions and is best discarded. Degenerative joint disease would be a much better general term to describe the lameness of young rapidly growing pigs affected with noninfectious joint diseases, which include osteochondrosis (OC), epiphyseolysis, and degenerative osteoarthritis (OA). Degenerative joint disease is characterized by varying degrees of intermittent but progressive lameness in rapidly growing pigs from 4 to 8 months of age, and pathologically it is characterized by the presence of OA and OC. The disease is of major economic importance because of the high culling rate of breeding-age swine.

Degenerative joint disease is, in fact, a dyschondroplasia that affects growth cartilage, both physeal and epiphyseal, in most breeds of rapidly growing pigs, which results in cartilage and bone lesions.

The term *dyschondroplasia* should be used to describe the majority of lesions affecting growth plates, especially physeal growth cartilage or physes and lesions involving the articular epiphyseal cartilage complex (AECC). Dyschondroplastic foci may undergo calcification and ossification; alternatively, the chondrocytes may die, and the necrotic chondrocytes and the denatured matrix are removed by fibrous connective tissue that ossifies. Occasionally, features develop at the chondro-osseous interface with the metaphysis or within the calcified portion of the zone of hypertrophying chondrocytes; cysts or clefts that contain blood persist and appear to stop the ossification front. Osteochondrosis is defined as a focal disturbance of endochondral ossification and is regarded as having a multifactorial

etiology, with no single factor accounting for all aspects of the disease. The most commonly cited factors are genetics, rapid growth, anatomic conformation, trauma, and dietary imbalances. Only heredity and anatomic conformation are confirmed by the scientific data. The term *osteochondrosis* should be used to describe a group of syndromes that cause limb deformities or degenerative joint disease in young, fast-growing pigs of either sex. Currently the consensus is that it is the effect of rapid growth (early excess weight) and lack of exercise on the developing cartilage that is at fault. The lesions appear to develop when pigs are less than 1 month old, when there is little muscle mass, indicating that heavy musculature is not the prime cause but helps in the exacerbation of the disorder. It has been observed in pigs as young as 1 day old. However, in these young pigs the AECC and growth plates are proportionately thicker and possibly susceptible to stress. This results in a thickening of part of the growth plate that causes interference with metaphyseal growth. This in turn results in deformation of bones, joints, and ultimately limbs. It is this distortion that may lead to incongruity of joints, with subsequent development of osteoarthritis and other degenerative joint diseases.

In the past, many of the lesions affecting the AECC were examined at a stage when degenerative joint disease (DJD) had already become established. In these cases, the articular surface was advanced, and subchondral bone was often exposed. However, examination of early lesions shows that the lesions are initiated as microscopic foci of chondrolysis at or near the interface of the articular cartilage and epiphyseal growth cartilage. The lesions may progress at this site, and lysed cartilage persists in the deeper layers of the AECC, at the chondro-osseous interface, and within the bone of the epiphysis. The recently replicated cells die, and there is either failure of matrix production or disruption of the formed matrix. Clusters of chondrocytes often develop at the periphery of the lesion in an attempt to repair the lesion. The soft denatured cartilage is probably subject to further damage during joint movement, so that flaps, fissures, and craters develop. When the AECC is breached and subchondral bone is in contact with the joint space, the joint becomes painful, and lameness develops.

There is a consensus view that vascular injury within cartilage canals is part of the pathogenesis, although there are opponents of this view. With no normal vascularization, there is no subsequent ossification. The position with regard to OCD has recently been summarized<sup>19</sup> and describes it as being a premature regression of the blood supply to the epiphyseal growth cartilage, leading to ischemic necrosis of the cartilage canals. Research suggests that there are three different manifestations of OCD: (1) *osteochondrosis latens* (OCL), where there are foci areas of cartilage

necrosis at the epiphyseal growth cartilage that are not visible grossly but are visible on microscopic examination; (2) *osteochondrosis manifesta* (OCM), where endochondral ossification becomes visible on microscopic and radiographic examination as thickened or uneven cartilage; and (3) *osteochondritis dissecans* (OCD), characterized by lesions of fissured articular cartilage protruding into the underlying bone.

There is still much confusion as to whether there is an association between OCD and lameness. Our considered opinion is that it is referable to the individual animal and depends entirely on the extent and severity of the lesion, the joints affected, the "meatiness" of the animal, and the age at which the animal is affected. In many cases, the situation is complicated by secondary processes such as osteomyelitis, fractures, and damage to greater trochanter and tubercle.

Epiphyseolysis and apophyseolysis are now considered to be part of the abnormalities of the AECC, with fractures occurring at the weakened epiphyseal sites in the femur and tuber ischiadicum, respectively.

Diagnosis of these conditions is achieved by ruling out other causes of lameness and then by confirming with a postmortem examination of cull sows.

### SYNOPSIS

**Etiology** The specific cause is unknown but is probably a failure of vascularization of cartilage.

**Epidemiology** Occurs in majority of breeds of rapidly growing pigs and young breeding females and males. Lesions are commonly present at slaughter. May be related to nutrition and rapid growth rate, genetic predisposition, and type of flooring, but there are no reliable correlations.

**Signs** There may be no clinical findings or possibly lameness and inability to breed.

**Clinical pathology** Radiographic evidence of osteochondrosis.

**Lesions** Osteochondritic lesions of varying degrees of development, severity, and healing.

**Diagnostic confirmation** Lesions at necropsy.

**Differential diagnosis list** As listed for the various ages.

Other causes of lameness include the following:

- Polyarthritis attributable to infectious causes
- Laminitis
- Nutritional osteodystrophy attributable to calcium, phosphorus, and vitamin D imbalance
- Hypovitaminosis A causing hindlimb paresis

**Treatment** None.

**Control** Uncertain. Select breeding stock with sound legs and gait.

## ETIOLOGY

The cause of the articular abnormalities is not known. The etiology and factors underlying these syndromes are poorly defined, partly because of the difficulty of definitive clinical examination of affected pigs and the frequent lack of apparent significant pathologic changes in necropsy examination of mild cases. There are no specific associations between degenerative joint disease and infectious diseases.

The growth plates that close last are the ones that are most susceptible (medial condyles of humerus and femur, ulna, costochondral junctions, and the 6th to 8th lumbar vertebrae). Many terms have been used to describe the condition, including osteochondritis, osteoarthritis, degenerative joint disease, arthropathy, arthritis, polyarthritis, and metaphyseal dysplasia, to name but a few. Most of these titles are inaccurate because the condition has its origin in the growth cartilage, and bones are affected secondarily.

## EPIDEMIOLOGY

### Occurrence

Recently, a study of 9,411 newborn piglets showed that 9.8% were treated for lameness. For parity 3 sows, the level had risen to 11.4%, but by parities 4 to 7, only 8% were treated. The treatments were in pigs of less than 3 weeks of age in 73% of the cases. Litters with 12 or more pigs had the highest incidences of lameness. Osteoarthritic changes are strongly associated with osteochondrotic changes in the humeral and femoral condyles. Osteochondrosis has been recorded as early as 1 day of age, so the lesions may be congenital. There may be some degree of change in up to 85% of pigs.

The osteochondrosis complex (OCD) is the most common cause of lameness in breeding pigs.<sup>20</sup>

However, a recent study<sup>14</sup> has shown no relationship between lameness and OCD, but all the sows studied had evidence of OCD (particularly in the medial condyle of the humerus and anconeal process of ulna).

We can say, in summary, that nearly all sows have some evidence of leg weakness, and in many circumstances leg weakness is a cause of culling. The reason for this is quite simple: the legs are the components of locomotion that are most influenced by genetics, nutrition, management, environment, and microorganisms and infection. Overfeeding is the cause that results in too much weight and not enough bone to support the weight.

There is a correlation between body conformation and the presence of joint lesions. Pigs with a narrow lumbar region, broad hams, and a large relative width between the stifle joints were highly susceptible to poor locomotory ability as a result of lesions in the elbow and stifle joints, the lumbar intervertebral joints, and the hip joint. It is postulated that inherited weakness of muscle,

ligaments, cartilage, and joint conformation results in local overloading of the joint and the development of OC and OA. Some breeds, such as the Duroc, have more problems of structure and movement in the front legs than the rear, but OC is not responsible for the leg weakness. OC has been recorded in wild boar–Swedish Yorkshire crossbred pigs, in which the growth rate was low. It is probably not related to floor type. It is not associated with adventitious bursitis.

The intensification of the swine industry has required that pigs grow rapidly and with high feed efficiency. Under such intensified conditions, rapidly growing pigs develop lesions of the bones and joints, especially the femur. Most pigs near market weight have varying degrees of OC. Except for severe lesions, which usually occur in a relatively small proportion of the total population examined, the lesions seen at slaughter often have no detrimental effect on the growth rate of pigs up to market weight. An advanced degree of OC, however, can result in severe degenerative joint disease and lameness in breeding stock. The disease occurs in both male and female pigs, and the incidence of lame pigs can be as high as 20% to 30%. It is a particular problem in gilt and boar testing stations, where it may necessitate slaughter of affected animals before the testing period is complete. The lesions develop most commonly in growing pigs, particularly boars from 20 to 30 weeks of age, raised in confinement. The onset occurs when pigs are between 4 and 8 months of age, which coincides with a period of maximal growth rate. The peak period of clinical manifestation is from the late grower stage until 18 months of age, although the effect of OA may carry through to the adult period. Extensive multicentric degenerative joint disease in adult sows and boars can cause severe lameness, which often warrants euthanasia. However, sows ranging in age from 1.5 to 3.0 years and culled for impaired reproductive performance, with no history of lameness, may have lesions of the femoral condylar surface.

### Risk Factors

Numerous risk factors contribute to the disease, including nutrition and rate of growth, genetic and breed predisposition, sex, type and quality of flooring, and exercise and confinement conditions. The pig carries 53% to 51% of its weight on the forelimbs and 47% to 49% on the hindlegs when young, but the weight supported on the hindlimbs is greater at 90-kg and 105-kg body weights. In a study of gilts and sows in Denmark, approximately 12% of gilts showed stiff locomotion, but 53% of gilts had at some time showed the same sign. Buck-kneed forelegs, upright pasterns, legs turned out wide, standing under position, and swinging hindquarters were associated with stiff locomotion or lameness. Weak pasterns on the hindfeet were associated

with stiff locomotion and lameness. Weak pasterns on hindlegs and splayed digits on forelegs were associated with brisk movement (freedom from locomotor problems). The following leg weakness signs at the gilt stage were found to have a significant effect on the longevity of the sows: buck-kneed forelegs, swinging hindquarters, and standing under position on the hindlegs.

### Nutrition and Rate of Growth

The disease is associated with rapid early growth, but it does not appear to be related to protein, vitamins A and D, or calcium and phosphorus imbalance in the ration. Maximal mineralization of bones is not necessary to prevent leg weakness. Only almost complete absence of calcium and phosphorus causes lameness. Disturbances of the Ca:P ratio below 0.5 or over 3.0 are necessary to produce lameness. Recently it has been suggested that long-term acidosis may be associated with the condition because bone is not formed as phosphorus is removed from the bone. In this context the acidification of pig diets has been suggested as a contributory cause. It has also been shown that the presence of deformed forelimbs is not associated with low levels of vitamin C in plasma. Rapid growth, especially during the early period, was thought to have a significant influence on the occurrence, and there is also some breed variation in susceptibility. However, in some feeding trials of pigs from weaning to slaughter weight, there was no direct effect of rapid growth rate on the incidence and severity of OC. In other feeding trials, average daily gain of gilts was an important factor in the severity of lesions of OC. Decreasing the rate of gain by restricting energy intake appeared to decrease the prevalence and severity of OC when gilts were slaughtered at 110 kg. However, it was shown that when pigs were fed waste food and grew more slowly, they had an increased prevalence and score for OC compared with pigs fed a commercial feed concentrate. Decreasing the concentration of protein in the diet of gilts from 16% to 12% resulted in less longitudinal bone growth but did not decrease the incidence of OC. A simple association between growth rate and the incidence or severity of joint lesions has not been consistently demonstrated, and a reduction in the growth rate of pigs does not control the disease.

A significant favorable association between leg action and daily gain has been noted. There has also been speculation that growth hormone could influence the development of lesions of OC by exerting a direct effect on differentiation and colonization of epiphyseal chondrocytes. There is no consistent relationship between the incidence of osteochondrosis and selection of pigs for lean tissue growth rate. It may be simply that more feed means more growth, which makes the stress on developing cartilage greater and therefore predisposes to OC.



### Genetic and Breed Predisposition

It has been proposed for many years that selection of pigs for increased growth rate resulted in a concomitant increase in the incidence and severity of musculoskeletal disease. Genetic studies indicate that the heritabilities of leg weakness are low to moderate (0.1 to 0.3). A more recent study suggested from 0.01 to 0.42 for leg weakness and OC and that both are associated with production traits (lean percentage and back-fat thickness). Genetic analysis of the incidence of OC and leg weakness in the Swedish pig progeny testing scheme revealed a low to moderate heritability. Genetic control of leg weakness has been achieved by various researchers, and thus inheritance is probably an important risk factor for this disease complex. The genetics of leg weakness have been described in Finnish Large White and Landrace populations. Meaty breeds are the most severely affected, including the Duroc and the Dutch and Swedish Landrace.

Inheritance may not be polygenic; it may be just one gene that controls OC, the MEP gene.

Osteochondrosis also occurs in crossbred Wild Boar–Yorkshire pigs with a genetically decreased growth rate, raised under the same conditions as finishing pigs. The distribution and extent of OC was similar to that of purebred Swedish Yorkshire pigs. This suggests that it is not limited to rapidly growing pigs. There are significant breed differences in the periarticular and meniscal ossifications seen on x-ray. Recently the quantitative trait loci for locomotion and osteochondrosis-related traits have been identified in Large White–Meishan crossbred pigs. Correlations between breeding values for longevity and for OC were low but significant, in a favorable direction. Higher OC scores were associated with a higher risk of being culled.

It has been seen in wild boar in Slovenia.

### Type of Flooring

Insecure footing because of unfavorable floor surfaces and the presence of foot lesions may change the posture of the animal and cause local overloading of certain joints. The effect of the quality of floor has been examined, and there is no clear evidence that the hardness of floor contributes to an increased incidence of leg weakness associated with joint disease. However, the incidence and severity of joint lesions may be related to the duration of confinement in pigs confined individually. Exercise will prevent abnormalities such as bow legs, flexion of the carpus, and sickle-legs from impairing the mobility of boars, but it does not influence the severity of joint lesions. The milder syndromes of poor movement and lameness associated with defects in leg conformation in the grower stage are not necessarily associated with bone or joint lesions and may regress spontaneously or improve if affected pigs are

placed on pasture. However, severe lameness at this age, and occurring in replacement stock and young adults, is frequently associated with severe bone and joint lesions, which may be irreversible. A recent study has looked at type of floor (solid floor plus straw, solid floor no straw, and fully slatted). The slatted floors were worst for leg weakness and the floors with straw best. The different types of floor affected leg weakness and claw disorders differently.

Trauma probably exacerbates the late lesions by damaging further the blood supply to the blood vessels of the cartilage.

### Exercise and Confinement

There is some limited evidence that a high lean growth rate may predispose toward leg weakness under confinement rearing. It may be that the growth rate at different ages is more important. Trauma during handling, penning, and transportation may be associated with a relatively high frequency of OC, but the evidence is very limited. A high stocking density had an adverse effect on four of the signs of leg weakness (knock knees, turned-out forelimbs or hindlimbs, standing with the legs under the body). A recent study of housing and treadmill training did not show any adverse effects on leg weakness. It has even been seen in pigs on grass and on deep litter and in wild boar.

### Economic Importance

In Scandinavia, breeding pigs culled because of lameness had a 100% frequency of OC or OA, and up to 40% of boars in a performance test station had osteochondrosis or osteoarthritis. A conservative estimate suggests that 3% of sows and 10% of boars are culled for unsoundness associated with OC and OA. The hidden costs include a reduced pool for selection of high-performance boars and gilts, the maintenance of pigs that cannot be used for breeding, increased mortality among piglets crushed by lame sows, reduced feed intake and growth rate in lame pigs, and transportation costs of replacement stock.

### PATHOGENESIS

The initial stage of pathogenesis is thought to consist of the formation of fragile cartilage, failure of chondrocyte differentiation, subchondral bone necrosis, and failure of blood supply to the growth cartilage. Some of the literature supports the idea that the failure of blood supply is the crucial lesion, either from the epiphyseal or metaphyseal side. In a summary, the primary lesion could be described as a focal ischemic necrosis of growth cartilage initiated by necrosis of cartilage canal blood vessels. The necrotic cartilage does not undergo mineralization or vascular penetration, and then focal failure of endochondral ossification occurs when the ossification front approaches the lesion.

The condition has been seen as early as 1 day of age, and the lesions develop with

age. The essential lesion is the necrosis of cartilage canals and surrounding cartilage. Lesions may be seen to be developing and healing at the same time. In growing animals, the superficial layer of joint cartilage is articular cartilage, and the deeper layer is epiphyseal cartilage that undergoes endochondral ossification as the animal matures. The articular cartilage persists in the mature animal, whereas the epiphyseal cartilage becomes a layer of calcified cartilage and underlying subchondral bone. The cartilage of the physis is known as the growth plate and is involved in metaphyseal growth. The normal growth plate cartilage has a well-ordered structure, with the chondrocytes of the proliferative and hypertrophic regions arranged into columns.

Osteochondrosis is a generalized disease in which there are focal areas of failure of endochondral ossification in the physeal (metaphyseal growth) and epiphyseal growth cartilage. The underlying defect may be an abnormality of the chondrocytes, which do not undergo normal hypertrophic ossification. They accumulate rough endoplasmic reticulum, lipid droplets, and mitochondria. The surrounding matrix contains deposits of electron-dense material that may prevent normal vascularization and therefore ossification. The hypertrophic region is disorganized and greatly extended compared with normal tissue. The matrix surrounding the clustered chondrocytes is altered compared with that in normal cartilage. The primary abnormality is an increased thickness of the joint cartilage combined with degenerative changes that result in infoldings and erosion of the articular cartilage. Defects of the growth plates (physes) result in short, deformed bones.

Pathologically, severe clinical cases are characterized by osteochondrosis and secondary degenerative joint disease, especially involving the medial aspects of the larger joints; epiphysiolysis; and lumbar intervertebral disc degeneration and spondylosis. Osteochondrosis has been used to encompass lesions involving the physes and the articular epiphyseal complexes. However, because of morphologic changes that have been observed in growing pigs, dyschondroplasia is now the preferred term to be used generically and then qualified by the location and nature of the morphologic description because the causes may be different.

Osteochondrosis occurs commonly in growing pigs at predilection sites of the medial condyle of the humerus and femur, the epiphyseal plates of the distal ulna, and the femoral head and the intervertebral joints. The 6th to 8th costochondral junctions may also be affected. It may heal spontaneously or it may progress to osteochondritis dissecans and OA. Its progression in either direction is influenced by local loading and by joint stability, which depends on joint shape and muscle

and ligamentous support. The age-related changes and OC in the articular and epiphyseal cartilage have been described. The cartilage increases with age up to 5 weeks and then begins to decrease in thickness. Deleterious influences such as defects in conformation; heavy musculature with skeletal immaturity; muscular weakness resulting from myofibrillar hypoplasia, myopathies, or lack of exercise; inadequate flooring; or even simple trauma may adversely affect this progression and lead to severe skeletal change.

Porcine synovial fluid contains both hyaluronic acid and chondroitin sulfate, and ratio of chondroitin sulfate to hyaluronic acid is not influenced by relatively advanced stages of osteochondrosis. Treatment of lame boars with glycosaminoglycan polysulfate improves leg soundness score and results in an increase in the hyaluronic acid concentration of the cubitus joint synovial fluid and in the proportion of aggregated proteoglycans in the articular cartilage of the medial femoral condyle. It is suggested that the hyaluronic acid accounts for most of the viscosity of synovial fluid and for efficient lubrication of the joint.

Well-established lesions typical of OC associated with the physes can be found in young pigs between 25 and 30 days of age. The earliest change associated with a dyschondroplasia of the physis is a focus of persistent hypertrophied chondrocytes that do progress but heal. Lesions associated with physes and articular epiphyseal complexes develop continuously and regress as pigs grow older. Changes in cartilage canal vessels appear to be important in the pathogenesis. There is no evidence that vascular damage is a factor in the pathogenesis of the lesions.

Because foci of dyschondroplastic lesions are associated with physes of pigs between birth and the stage of rapid growth, they could be regarded as part of the usual growth patterns in contemporary commercial swine. However, clinical signs of dyschondroplasias, or degenerative joint disease secondary to dyschondroplasias, usually do not appear until pigs are almost 6 months of age.

### Radiologic Monitoring of Lesions

Osteochondrosis can be diagnosed radiologically. Radiologically, the lesions were similar in Yorkshire pigs and Landrace but more severe in the Landrace and similar to the Danish Landrace.

The development of epiphyseal osteochondrosis in pigs from 42 to 147 days of age has been followed radiologically. Osteochondritic lesions were seen radiologically in the articular-epiphyseal (A-E) complexes of the humeral condyles of 42-day-old pigs and in the femoral condyles at 63 days of age, in contrast to earlier reports indicating that lesions were not visible radiologically until 100 days of age. The osteochondrosis lesions of the A-E complexes develop, become

progressive, and subsequently become either stable, regressive, or even more progressive as the pigs grow. This supports the observations that the lesions develop and become progressive and regress as the pigs grow. The humeral medial condyles have more pronounced lesions and are more frequent than the lateral ones.

Radiologic monitoring of the development and sequelae of physal osteochondrosis lesions of the growth plate cartilage and A-E complexes of the forelimbs and hindlimbs in young breeding swine found that the majority of distal ulnar lesions healed by 18 to 20 months, and some started fusing at 18 to 21 months. The distal ulna healed without complications in most animals, and the most severe lesions healed faster than the mild or moderate ones. In a recent study, periarticular ossifications at the elbow joint were found in the radiographs at a prevalence of 0.9%. Meniscal ossifications were seen as single or multiple foci at the cranial aspect of the joint at a prevalence of 2.6% and had a bilateral occurrence of 20%. Meniscal ossifications were associated with turned-out hindlegs and stiff locomotion in the hindlegs and negatively associated with growth rate.

### CLINICAL FINDINGS

Palpation is an important method of examination of lame pigs. Lame pigs are usually stiff on either front or back legs or both. The key is to send affected animals for slaughter quickly on diagnosis, provided they are fit to travel and inspected at the abattoir or rapidly placed in a quarantine area to prevent further injury and to supervise the effects of treatment.

OC and OA produce leg weakness that varies in severity from locomotor abnormality resulting from conformation and leg defects such as narrow lumbar area and broad hips, hyperflexion of the carpus, bowing of the forelimbs and "knock knees," hyperextension of the phalanges, and lateral angulation of the foot and sickle hocks, to more severe lameness and, in the extreme, inability to rise and paresis. Nine signs of leg weakness are described: buck-kneed forelegs, steep hock joints, turned-out forelimbs and hindlimbs, upright pasterns on the hindlegs, stiff locomotion, standing under on the hindlimbs, swaying hindquarters, goose-stepping hindlegs, and lameness and tendency to slip. The four most common signs are buck knees, small inner claws on forefeet, small inner claws on hindfeet, and upright pasterns on the hindlegs.

The clinical syndrome is a locomotor disorder usually involving the hindlimbs. Often the most rapidly growing pigs are lame. The lameness may be acute, intermittent, chronic, progressive, or a combination of these. An insidious onset is common, and pigs are unwilling to move, the stride is shortened, and the limbs are held in partial flexion. The

carpal joints may be underextended while the metacarpophalangeal joints are overextended, giving the limb an abnormal S-shaped profile. The pelvic limbs are commonly held straight, and the back is slightly arched. In some cases, affected animals will assume a kneeling position with flexed carpal joints and walk on those joints.

Mild cases show stiffness, especially immediately after a period of lying down, and lameness. Slowness to rise and a tendency to walk with short steps on tiptoes, frequently in association with a marked inward curve of hindlimb motion during forward progression and side-to-side motion of the buttocks, are frequently seen. More severely affected pigs sit on their hindquarters and are reluctant to stand. They carry one or both hindlimbs more forward under the body and walk with a short, goose-stepping gait. Wasting is not a feature except in severely affected animals, and the locomotor disorder may be minor unless exacerbated by physical exertion.

The syndrome is of particular importance in breeding animals because it may interfere with successful mating. Boars may show initial interest in mounting but subsequently slide off the sow or dummy before mating is complete, presumably as a result of the pain of the limb lesions.

There may be no meaningful association between visual scores for physical soundness in the live animal and the degree of joint damage. Some pigs with severe lesions are not lame; conversely, other pigs are severely lame with minor lesions.

### Epiphysiolysis

Separation of the epiphyses probably occurs when the process of endochondral ossification reaches or approaches the cartilage defect. The resulting fracture may extend in a jagged crack through primary and secondary spongiosa. It may be that the traumatic forces applied to the epiphyseal cartilage at the site of empty spaces near atrophic blood vessels or at eosinophilic streaks cause further separation and epiphysal lysis.

The defect involves the proximal femoral epiphysis. There is separation along the proximal femoral epiphysis and the metaphyseal bone. It is a traumatic occurrence at a site of a growth defect in the cartilage with a combination of excess tension in the hip joint across a weakened physal region in the femur, which then separates. It occurs from 5 months to 3 years of age (epiphyses fuse at 3 to 7.5 years of age). It may develop from an extended eosinophilic streak (area of matrix degeneration) or from areas of necrosis in the growth of cartilage rather than from areas of metaphyseal dysplasia.

Usually, it is a severe and sudden-onset lameness, occasionally insidious. Animals lie down, are unable to rise unless assisted, and usually eat and drink. It may be unilateral or bilateral, and manipulation reveals

crepitation. It can be confused with fractures of the femur, spinal canal abscesses, or lumbosacral fractures. It may become a center of necrosis if secondary bacterial infection occurs.

Epiphysiolysis contributes to the leg-weakness complex. In this case, repeated trauma and consequent microfractures significantly contribute to the retention of a thick and irregular epiphyseal cartilage and to fibrous tissue formation. Epiphysiolysis of the femoral head produces severe unilateral lameness, and if bilateral, it is usually manifest by marked reluctance to rise and severe locomotor disability. Initial signs are frequently deceptively mild and follow physical exertion, such as in mating, transport, farrowing, or fighting, but they progress to severe lameness over a 7- to 10-day period.

### Apophysiolysis

Epiphysiolysis of the tuber ischii is known as apophysiolysis. It may also occur following physical exertion but is more common in second- or third-parity sows and is manifest by “paralysis,” with the hindlimbs in forward extension under the body of the sow. These animals dog-sit and are unable to rise. In many instances, the injury occurs when the animals arrive on the farm or are first mated. In pigs the anconeal process does not arise from a separate ossification center, so apophysiolysis of the anconeal process is a better description than epiphysiolysis of the anconeal process.

Bilateral separation of the ischiatic tuberosities along their physes has been recognized in young sows. Most affected animals are heavily pregnant, most dog-sit with the hindlimbs forward, and palpation elicits crepitus. It is associated with slippery floors excessively pulling the biceps femoris tendons from the tuber ischiadicum. Unilateral lesions cause a moderate to severe lameness, but bilateral separation may prevent the sow from rising or walking. The pain and muscle contraction frequently make it difficult to determine the site and severity of the lesion by simple clinical examination, and palpation following general anesthesia or radiography may be required for proper clinical assessment. Physical examination should include complete palpation of all limbs for heat, swelling, and pain. The palpable parts of the pelvis should be examined, with particular emphasis on the ischial tuberosities. Passive flexion, extension, and rotation of each limb along with auscultation over the joint may reveal evidence of crepitus or a pain response.

Although the lesions of the physes and articular epiphyseal complexes are detectable in pigs under 14 days of age, they are not detectable radiographically in live animals until the pigs are over 100 days of age. Only 21% of the lesions associated with the physes and 22% of the lesions associated

with the articular epiphyseal complexes were detectable in radiographs of bones of live pigs.

Meniscal ossifications were observed as simple or multiple small, smooth, firm, and irregular swellings in the cranial horn of the lateral meniscus. The periarticular osseous foci were seen as focal firm swellings at the craniomedial aspect of the elbow joint.

### CLINICAL PATHOLOGY

The carpal, elbow, tarsal, and stifle joints can be radiographed for evidence of joint lesions, with the lesions then scored according to a system. It is also possible to use ultrasonics for diagnosis.

### NECROPSY FINDINGS

At necropsy, the cartilage is not normal, and cracks, fissures, and necrosis are seen below the cartilage. The pathology has been reviewed for osteochondrosis.<sup>19</sup>

The scapulohumeral, humeroradioulnar, carpal, coxofemoral, femorotibial, and tarsal joints should be examined. Typically, in osteochondrosis, the changes are feathery hypertrophy of villi, focal full-thickness cartilage buckles, ulcers or flaps of cartilage, and no changes in the draining lymph nodes. Joint mice and synovitis may also be seen. Deformation, or even fractures, may occur in the long bones.

Histologically, osseous trabeculae may be seen with clusters of chondrocytes; between the trabeculae, lined by flat osteoblasts, there are adipocytes. The osseous center is formed of mineralized cartilage that has blended into more or less fibrous cartilage, but toward the joint cavity the meniscal ossifications are covered by hyaline cartilage.

### DIFFERENTIAL DIAGNOSIS

The syndrome must be differentiated from other diseases that cause lameness and paralysis in growing and young adult pigs, including the following: infectious polyarthritis; laminitis; traumatic foot lesions; foot lesions produced by biotin deficiency and footrot; osteodystrophy resulting from calcium, phosphorus, and vitamin D imbalance in rations; vitamin A deficiency; and viral encephalomyelitis.

### TREATMENT

There is no effective treatment. Early cases may recover spontaneously after being placed outside on pasture or housed individually, inside, on deep straw litter. Recently it has been suggested that meloxicam at a dosage of 0.4 mg/kg is efficacious and safe for the treatment of noninfectious locomotor disorders in pigs. Treatment with 2.5-D vitamin D had no effect on the incidence and severity of OC/OA lesions. Animals that are affected with clinical signs should be removed from the herd quickly for casualty slaughter

and, if necessary, should be humanely destroyed as soon as possible.

### CONTROL

Because the etiology is unknown, it is not possible to provide specific control measures. The hereditary nature of the disease suggests that the selection of breeding stock with sound legs and a low incidence of lesions would be an effective long-term control measure. Genetic control of leg weakness has been documented by various researchers. Selection of boars for leg soundness has dramatic effects on the structural soundness of their crossbred progeny, and therefore selection of structurally sound replacements must be maintained if leg weakness in market or breeding pigs is to be avoided. Divergent selection for leg soundness in Duroc pigs has been dramatic. Progeny of leg-soundness sires had significantly better measures for all leg traits at 104 kg than did progeny of leg-weakness sires. Differences between the two progeny groups indicated that the realized heritability for front-leg soundness exceeded 0.50.

Selection of breeding stock will require careful genetic selection, examination of all pigs that are to be retained for breeding, and necropsy of siblings of affected pigs of the same gender, to identify genetic lines of pigs that have a low incidence of lesions. A recent study showed that the increase in wild boar alleles in crosses with Large White pigs reduced the prevalence of OC. It has been suggested that the selection of pigs based on the joint lesion score could lead to a better leg and joint condition both visually and pathologically. Reduction of growth rate and exercise may help, but they are not a real methods of control. Improvement of nutrition and housing may help to remove the traumatic component of cartilage damage. Increasing the calcium and phosphorus in the diet also does not help.

### REFERENCES

- Jensen TB, Toft N. *Pig News Info*. 2009;30:1.
- Thorup VM, et al. *J Anim Sci*. 2008;86:992.
- Kilbride AL, et al. *Animal Welfare*. 2009;18:215.
- Zoric M, et al. *Acta Vet Scand*. 2009;51:23.
- Zoric M, et al. *Acta Vet Scand*. 2008;50:37.
- Zoric M. *Pig J*. 2010;63:1.
- Holmgren N, et al. *Swedish, Vet J*. 2008;60:11.
- Busch ME, Wachmann H. *Vet J*. 2010;188:197.
- Heinonen M, et al. *Vet Rec*. 2007;160:573.
- Gillman CE, et al. *Prev Vet Med*. 2009;doi:10.1016/j.prevet-med.2009.05.023.
- Gillman CE, et al. *Prev Vet Med*. 2008;83:308.
- Kilbride AL, et al. *Prev Vet Med*. 2008;83:272.
- Kirk RK, et al. *Acta Vet Scand*. 2008;50:5.
- Ryan WF, et al. *Vet Rec*. 2010;166:268.
- Heinonen M, et al. *Vet Rec*. 2006;159:383.
- Sonderman J, et al. *Proc Am Assoc Swine Vet*. 2009;40:283.
- Engblom L, et al. *Livestock Sci*. 2009;106:76.
- Rintisch V, et al. *Berl Munch Tierarztl Wschr*. 2010;123:70.
- Ytrehus B, et al. *Vet Pathol*. 2007;44:429.
- Busch ME, et al. *Dansk Vet*. 2007;2:24.



## Infectious Diseases of the Musculoskeletal System

### BORRELIOSIS (LYME BORRELIOSIS, LYME DISEASE)

#### SYNOPSIS

**Etiology** Spirochete *Borrelia burgdorferi sensu lato* complex with different genospecies. In North America, genospecies *B. burgdorferi sensu stricto*; in Europe, *B. burgdorferi sensu stricto*, *B. afzelii*, and *B. barinii*. Other genospecies possibly associated with clinical disease are *B. spielmanii*, *B. bisentii*, *B. lusitaniae*, and *B. valaisiana*.

**Epidemiology** Occurs in North and South America, Europe, Asia, and Australia in cattle, sheep, horses, dogs, and humans. Transmitted by *Ixodes* spp. ticks from small wild animals, which are host reservoirs to domestic animals and humans. Larval ticks feed on small mammals; nymphal ticks feed on a broader range of hosts, including rodents, birds, sheep, and cattle; adult ticks feed on deer, horses, cattle, and dogs. All stages feed on humans.

**Signs** In horses: chronic weight loss, sporadic lameness, persistent fever, swollen joints, muscle stiffness, depression, anterior uveitis, neurologic signs, abortion, and weak foals. In cattle and sheep: polyarthritis, chronic weight loss, fever.

**Clinical pathology** Serology (indirect immunofluorescent antibody test [IFAT], enzyme-linked immunosorbent assay [ELISA]), culture, polymerase chain reaction (PCR), immunohistochemistry (IHC).

**Lesions** Polysynovitis, lymphadenopathy, interstitial myocarditis, nephritis, meningoencephalitis.

**Treatment** Tetracyclines and penicillin.

**Control** No specific control measures available; tick control.

#### ETIOLOGY

*Borrelia burgdorferi*, a gram-negative aerobic, microaerophilic, motile, spiral-shaped bacterium belonging to the family Spirochaetaceae, is the causative agent of Lyme borreliosis (Lyme disease). The *Borrelia burgdorferi sensu lato* complex comprises at least 12 genospecies, of which only a few have been associated with clinical disease. Of these different species, *B. burgdorferi sensu stricto*, *B. afzelii*, and *B. garinii* have been recognized as pathogens associated with clinical disease in mammals. The more recently identified species *B. spielmanii*, *B. bisentii*, *B. lusitaniae*, and *B. valaisiana* have also been incriminated as potentially pathogenic species in humans and mammals.<sup>1</sup>

#### EPIDEMIOLOGY

##### Occurrence and Prevalence of Infection

A disease complex consistent with Lyme borreliosis in humans with characteristic skin lesions was first described at the end of the nineteenth century, but the etiology of the condition remained unknown until 1982, when W. Burgdorfer identified the causative agent.<sup>2</sup> Currently, Lyme borreliosis is recognized as the most common vector-borne disease in the northern hemisphere.<sup>3</sup> The disease predominantly occurs in North America and Europe but has also been reported in parts of Asia and in Latin American countries, including Brazil, Mexico, and Colombia.<sup>1</sup>

In the United States the infection is primarily prevalent in three regions: the Northeast (from Massachusetts to Maryland), the Midwest (Wisconsin and Minnesota), and the Pacific region (California and Oregon). The disease occurs most commonly in areas with an appropriate density of the insect vector, intermediate hosts, and the environmental conditions favoring transmission.

The different genospecies of *B. burgdorferi sensu lato* differ in their geographic occurrence. Whereas in North America Lyme disease is most commonly associated with *B. burgdorferi sensu stricto*, in Europe, *B. afzelii* is most prevalent in the north, *B. burgdorferi sensu stricto* in the western part of the continent, and *B. lusitaniae* in the Mediterranean basin. *B. spielmanii* has been isolated in Germany, France, the Netherlands, Hungary and Slovenia, the Ukraine, and other countries. *B. valaisiana* was found to occur in central Europe, the United Kingdom, and Russia.<sup>1</sup>

The prevalence of vector ticks infected with *B. burgdorferi sensu lato* has been studied in different countries and occurs at rates of 22% to 35% in Germany, 10% to 35% in the Netherlands, 40% in Bulgaria, 38% in Slovakia, 5.4% in Poland, and 12.9% in Ontario, Canada.<sup>4-9</sup> The prevalence of infection with *B. burgdorferi* for different animal species has been studied for different geographic regions. These data must be interpreted cautiously because they reflect the degree of exposure of an animal population (seroprevalence) but are not associated with the prevalence of clinical disease (disease prevalence).

##### Cattle

Seroprevalence studies of cattle in the United Kingdom indicate that the seropositivity rate increased from 44% to 67% after the cattle were turned out to a pasture heavily infested with ticks. The seropositivity rate was found to be higher in cattle with digital dermatitis ("Morbus Mortellaro"; 71%) than in cattle without the lesions (7.3%). This observation nonetheless should be interpreted cautiously because there was a significant age difference between cows with digital dermatitis (adult

cows) and unaffected cows (1- to 3-year-old heifers), and an effect of age on the seroprevalence rate is well established in other animal species.<sup>4</sup>

In a study conducted during the grazing period of 2002 in Bavaria, Germany, including nearly 300 cattle, a seroprevalence of 45.6% was determined. Within-herd prevalence rates ranged from 20% to 100%. The antibody titer was associated with the number of ticks found on the animal but not with its age.<sup>10</sup>

In Japan, the seroprevalence of infection varied from 8% to 15% and was higher during the summer months; cows with arthritis had higher titers to the organism than healthy cows. Similar observations have been made in dairy cows in Minnesota and Wisconsin in areas with endemic *B. burgdorferi* infections. In Wisconsin, the peak seasonal incidence of clinical disease in horses and cattle occurs in May, June, and October, which correlates with emergence of *I. dammini* in the spring, usually March and April, and again in September.

##### Sheep

Seroprevalence studies in sheep infested with *Ixodes ricinus* in Scotland indicate an infection rate in lambs of 2.7%, with 24% to 40% in young sheep and 0% to 6% in ewes. There is also evidence for transmission of Lyme disease to sheep in Cumbria in the United Kingdom in grassland and heath communities where wild fauna are uncommon and sheep are thought to be the main host for all feeding stages of the tick. However, there was no evidence of clinical disease associated with the infection. Serologic surveys of infection in sheep in Norway indicate that 10% of animals tested are seropositive with the enzyme-linked immunosorbent assay (ELISA) test, with a range of 0% to 20% between counties. The geographic distribution of seropositive animals correlated with the known distribution of *I. Ricinus*, with the highest proportion of seropositive animals found in the southern coastal areas of Norway. The majority of animals appear to become infected during the first 2 years of life; the animals were all healthy at the time of sampling.

##### Horses

Geographic surveillance of horses in Europe and North America suggests that exposure of horses to *B. burgdorferi* is widespread. Seroprevalence rates for horses have been reported from several European countries, including France (31% to 48%),<sup>11</sup> Germany (16.1%), Sweden (16.8%), Denmark (29%), Italy (15.3% to 24.3%),<sup>12,13</sup> Poland (25.6%),<sup>14</sup> and Slovakia (47.8%).<sup>13</sup>

Serologic surveys of horse populations in the United States revealed that in the New Jersey-Pennsylvania area, approximately 10% of horses have significant serum antibody titers to the organism. Infection appears

to be uncommon in horses in Texas. In Cape Cod horses, the seroprevalence was 35%, which was found to be age-specific and considered to be a reflection of exposure because of the relative absence of disease. It was found that 7% to 13% of horses admitted to a veterinary teaching hospital were seropositive to the organism and the frequency of antibody response varied according to the geographic origin of the horses. A retrospective study on seroprevalence of infection with *B. burgdorferi* in Minnesota based on 1260 serum samples submitted to a diagnostic laboratory between 2001 and 2010 revealed an average seroprevalence of 58.7%.<sup>15</sup> Because of the selection bias in this study, which was based on blood samples obtained from horses with health issues, this value likely overestimates the overall prevalence in the equine population in the region.

Lyme disease in the horse is rare but it is clinically important in the United Kingdom. In areas where the disease occurs in humans, the seroprevalence of infection in horses was 49% compared with 3% to 4% in horses from other areas. Horses with unexplained lameness associated with fever and tick infestation had high levels of antibody to the organism. Within endemic areas, up to 60% of mares and yearlings on one farm were serologically positive. On such farms, there may be a clustering of clinical cases in foals after weaning. However, there is no evidence that abortion in mares is associated with infection.

### Wildlife

In Ontario, epidemiologic studies indicate a widespread but low level or scattered distribution of infection in wildlife reservoirs in the south, with occasional spillover into human and canine populations. Serologically, the organism was found to be circulating in populations of white-footed mice, field mice, and white-tailed deer.

A serologic survey including over 600 wild boars in the Czech Republic found seroprevalence rates between 8.9% and 25.0% depending on the region of the country, with the highest prevalence rates in the rural and forested regions. Seroprevalence rates increased in the spring months of March and April, with peak values in May.<sup>16</sup>

### Zoonotic Implications

Lyme borreliosis was first recognized when a cluster of suspected juvenile rheumatoid arthritis cases occurred among residents of Lyme, Connecticut. An arthropod-transmitted disease was suspected as the etiologic agent because, in addition to recurrent, short-lived joint pain, patients had an expanding, red, annular rash resembling erythema chronicum migrans similar to a lesion identified in Europe in the late nineteenth century associated with tick bites, and the rash was responsive to penicillin. An infectious cause was confirmed when spirochetal

bacteria isolated from *Ixodes* ticks and from blood, cerebrospinal fluid (CSF), and other tissues of patients were shown to be identical. Subsequently, *B. burgdorferi* was identified in ticks in numerous regions of the United States, and infection was associated with clinical disease in other animals, including dogs and horses.

The disease has been recognized in most areas of the United States and in at least 20 countries spanning every continent. In the United States, the northeastern states of Connecticut, Massachusetts, and New York; the midwestern states of Wisconsin, Minnesota, Michigan, Illinois, and Indiana; and the western states of California and Nevada are considered as the most endemic areas, especially in wooded and grassy parts of these regions.

Lyme borreliosis is the most common tick-transmitted disease of humans in the northern hemisphere. In the United States, roughly 20,000 clinical cases are reported to the Centers for Disease Control and Prevention every year. Depending on the region, this is equivalent to incidence rates of up to 10 per 100,000 population.<sup>1</sup> Incidence rates reported from European countries vary widely and range from 0.6 per 100,000 population in Ireland and the United Kingdom to 130 per 100,000 in Austria to 155 per 100,000 in Slovenia.<sup>17</sup>

The geographic prevalence of borreliosis in humans and animals is related to the distribution of the various *Ixodes* spp. and the location of herds of deer, which are preferred hosts for the ticks. Geographic areas with dense vegetation and high humidity promote the development of the tick. Risk of infection is correlated with the opportunity of being bitten by an infected tick and dependent on the density of vector ticks in an endemic area, the proportion of ticks infected, and the duration and extent of the susceptible host's activities in that area.

### Methods of Transmission

*B. burgdorferi* cycles between reservoir hosts and tick vectors. Reservoir hosts are defined as those animal species that can infect a significant number of ticks feeding on them but do not normally develop clinical disease. Reservoir hosts are critical for maintaining the agent in a geographic region. At present, 16 species of birds, 7 medium-sized mammals, and 9 small mammal species are considered to be able to transmit *B. burgdorferi* to vector ticks.<sup>4</sup> The white-footed mouse (*Peromyscus leucopus*) is considered to be the main reservoir for *B. burgdorferi* in the eastern United States. Rodents incriminated as reservoir hosts in the western part of the United States include the white-footed mouse, the brush mouse (*Peromyscus boylii*), the western gray squirrel (*Sciurus griseus*), the duskyfooted wood rat (*Neotoma fuscipes*), and the California kangaroo rat (*Dipodomys californicus*).<sup>1</sup> It is

suggested that migrating birds acting as carriers may account for the widespread nature of the infection. Pheasants and some passerine birds, including European blackbirds and song thrushes, are considered to be maintenance hosts.

Ungulates, including deer, sheep, cattle, and goats, feed large numbers of ticks, and seroprevalence rates in these species in tick-infested regions can be high. Nonetheless, an increasing body of evidence suggests that ungulates do not infect a high proportion of ticks—most of which are adult-stage ticks—that feed on them.<sup>17</sup>

The spirochete is transmitted by *Ixodes* ticks, including *I. scapularis*, the deer tick, in the northeastern and midwestern United States; *I. pacificus*, the black-legged tick, in the western United States; *I. ricinus*, the sheep tick, in Europe; and *I. persulcatus* in Asia. The life cycle of an ixodid tick is 2 to 3 years and includes the stages of egg, larvae, nymph, and adult. Ticks transmit spirochetes during feeding with their saliva. Spirochetes migrate from the midgut, where they are found in unfed ticks, to the tick's salivary glands, a migration that is thought to be activated by ingestion of blood. Because ixodid ticks only feed once at each developmental stage, infection is usually acquired by one stage and transmitted by the next (transstadial transmission). Ticks in the larval stage feed on small mammals and are not infected before their meal, suggesting that transovarial transmission does not occur. Both immature stages of the tick (larvae and nymphs) feed on the white-footed mouse, which makes the life cycle of the organism dependent on horizontal transmission from infected nymphs to mice in the early summer and from infected mice to the larvae in late summer. White-footed mice are susceptible to oral infection and transmit the infection to one another by direct contact. Infection with the spirochete does not cause clinical or pathologic changes or alter the biological features of the mouse. These combined factors indicate a long-standing relationship between the mouse and the spirochete. Nymphal ticks feed on a broader range of animal species, such as rodents, squirrels, birds, dogs, sheep, and cattle. Infected nymphs can transmit *B. burgdorferi* to their second host, and uninfected nymphs can contract infection from an infected host. The adult tick feeds primarily on larger animals such as deer, horses, cattle, sheep, and dogs. All three stages of the tick will feed on humans.

The white-tailed deer is the preferred host for the adult stage of the tick and often harbors large numbers of adult ticks. Adult ticks are likely to be responsible for transmission of infection to horses and cattle.

Transmission of Lyme disease requires prolonged attachment of the tick to its host of at least 18 hours.<sup>4</sup> This lag time between

attachment of the tick and infection of the host has been proposed to be caused by the delay between activation of *B. burgdorferi* in the tick's midgut at the onset of a blood meal and the appearance of the bacterium in the tick's salivary glands.<sup>17</sup>

The ticks *Dermacentor variabilis* and *Amblyomma americanum*, tabanid flies, and mosquitoes have also been shown to carry the organism.

The organism can be found in the urine of infected animals, and it is possible that transmission may occur through close contact without the bite of a tick. Infected cattle purchased from an endemic area could shed the organisms in the urine and transmit them to animals in a different herd.

Transplacental transmission of the organism from infected dams to their fetuses also occurs through in utero infection and can be a cause of mortality in foals and calves.

### PATHOGENESIS

Borrelia are highly motile and invasive, and they localize in selected tissues, thereby evading the host's immune response.<sup>4</sup> They spread through tissues and can directly transcytose endothelial layers. *B. burgdorferi* predominantly migrates within connective tissue, which may protect it from humoral antibodies. Following infection there is multisystemic inflammation, resulting in polyarthritis, generalized lymphadenitis, pleuritis, peritonitis, interstitial pneumonia, encephalitis, and in utero infection causing in fetal infection. In humans, the progression of Lyme borreliosis is divided into early localized, early disseminated, and late stages. In humans, the skin is the most frequently affected tissue. Erythema migrans, borrelial lymphocytoma, acrodermatitis chronica atrophicans, neuroborreliosis, myocarditis, arthritis, and ocular disease are possible outcomes of infection.

Borreliosis has been reproduced in ponies by exposure to *Ixodes* ticks infected with *B. burgdorferi*. Infection with *B. burgdorferi* was detected in skin biopsies and various tissues at necropsy by culture and PCR. Clinical signs were limited to skin lesions, all ponies seroconverted, and there were no significant other lesions.

### Immune Mechanisms

*B. burgdorferi* is able to persist in the mammalian host because of active immune suppression, induction of immune tolerance, phase and antigenic variation, intracellular seclusion, and incursion into immune privileged sites, all of which are survival strategies. Vaccination with outer surface protein A (OspA) from the organism prevented *B. burgdorferi* infection in animal and human studies. Vaccination of 1-year-old ponies with recombinant OspA (*osp. A* gene derived from *B. burgdorferi* B31) with adjuvant (aluminum hydroxide) followed by challenge with *B. burgdorferi*-infected adult ticks pro-

vided protection against skin infection compared with unvaccinated controls.

### CLINICAL FINDINGS

The symptoms of Lyme borreliosis in animals are poorly defined, and a broad spectrum of clinical manifestations have been attributed to *B. burgdorferi* infection. High seroprevalence rates in different animal species in endemic regions with low disease prevalence suggest that the large majority of infected animals remain asymptomatic.<sup>18</sup> On the other hand, the diagnosis of Lyme borreliosis is often based on clinical signs consistent with the disease (e.g., lameness or arthritis) in combination with positive serology, which can be considered as presumptive diagnosis at best. To complicate matters, many of the symptoms associated with Lyme disease have not been reproducible under experimental conditions.<sup>18</sup>

#### Horses

Infection with *B. burgdorferi* in horses in the majority of cases does not cause clinical disease, as is suggested by the large number of seroconverted animals without history of disease. Clinical signs attributed to *B. burgdorferi* infection in horses include chronic weight loss, persistent mild fever, intermittent or shifting lameness, laminitis, swollen joints, muscle stiffness, and anterior uveitis. Neurologic signs such as depression, behavioral changes, dysphagia, head tilting, and encephalitis have also been reported. Polyarthritis and swelling of tendon sheaths in horses of all ages are commonly reported. Infection of pregnant mares has been associated with abortion and the birth of weak foals that die soon after birth. An unexplained increase in early embryonic loss or failure of conception in mares has been associated with Lyme disease antibodies but not confirmed.

#### Cattle

In cattle, signs and symptoms attributed to infection with *B. burgdorferi* include persistent mild fever, chronic weight loss, decreased milk production, lameness, and polyarthritis.<sup>1</sup> Erythema of the udder or the skin between the digits and edematous lesions on the hairless skin of the udder have been described in cows with *B. burgdorferi* infection.

#### Sheep

In sheep, lameness, swollen joints, unthriftiness, and a persistent fever are commonly reported clinical signs.

### CLINICAL PATHOLOGY

#### Detection of Organism

*B. burgdorferi* is difficult to isolate because it is present in low numbers in blood or tissues. The microorganism is fastidious, is microaerophilic, and requires enriched bacteriologic media, making culture slow, difficult,

and expensive; special stains are required to visualize it. Aseptically collected blood, cerebrospinal fluid, urine, and colostrum can be examined under dark-field microscopy or in a culture.

Amplification of plasmid or chromosomal DNA of the microorganism by **polymerase chain reaction (PCR)** can be attempted, but because of the low number of microorganisms, lack of detection does not rule out infection.<sup>1</sup> On the other hand, positive PCR confirms the presence of bacterial DNA but does not prove the pathogen was alive, and it could be the result of leftover fragments from a previous infection.<sup>18</sup> **Immunohistochemistry** has been used to detect bacterial antigen in tissue.<sup>1</sup>

### Serology

Serologic testing is the most practical method of making at least a presumptive diagnosis of *B. burgdorferi* infection. Serum and synovial fluid samples may contain antibodies to the organism in horses. The indirect immunofluorescent antibody (IFA) test has been used with reliable results in horses and cattle. The ELISA is ideal for high-volume testing; the results are quantitative, and the test can detect total immunoglobulin or class-specific IgM and IgG antibodies to the organism. An ELISA and immunoblots using certain antigens of the spirochete are more specific for the diagnosis of Lyme borreliosis in horses. Western blotting techniques and the ELISA have been used for serologic surveys and for examination of synovial fluids of horses in the United Kingdom, where the incidence of infection is common in some areas. The positive results in horses are not as a result of cross-reactions with *Leptospira*, which has been suspected.

Subclinical infections are common in domestic animals, and the interpretation of serologic results must be done in conjunction with the clinical findings. Antibody titers higher than 1/64 or 1/100 are considered as positive. Positive antibody results are an aid to diagnosis but are not conclusive evidence of current infection or clinical disease. False-positive results may be a result of infection with other *Borrelia* species.

### NECROPSY FINDINGS

Polysynovitis, lymphadenopathy, and emaciation are present. Multifocal interstitial myocarditis, glomerulonephritis, interstitial pneumonitis, and polysynovitis have been described in cattle. In the horse, polysynovitis and meningoencephalitis have been reported. Using PCR amplification of DNA, necropsy tissues may be positive for *B. burgdorferi* DNA.

### Samples for Confirmation of Diagnosis

- **Bacteriology**—kidney, joint synovium, lung, choroid plexus (PCR)



- **Histology**—formalin-fixed kidney, joint synovium, heart, brain, lung, lymph node (LM, IHC)

### DIFFERENTIAL DIAGNOSIS

Diagnosis is dependent on recognition of clinical signs, a history of possible exposure to infection by the bites of ticks, and identification of the spirochete in the affected animal. Because clinically normal animals have antibodies to the organism, a positive antibody result is not conclusive of current infection or clinical disease. Other diseases causing muscle stiffness, lameness, polyarthritis, lymphadenopathy, and fever must be considered in the differential diagnosis.

### TREATMENT

Procaine penicillin, oxytetracycline, doxycycline (10 mg/kg PO q12h for 3 weeks) and ceftiofur (2.2 mg/kg IM q12h) have been used for treatment of Lyme disease in horses. Experimentally infected horses treated with oxytetracycline for 3 weeks were negative on culture and PCR following treatment.<sup>4</sup> Penicillin or oxytetracycline daily for 3 weeks has also been recommended for use in cattle.

Treatment recommendations are largely based on empirical evidence, and the efficacy of these treatments is difficult to assess. In many cases where the treatment was found to be effective, the diagnosis was presumptive; an unapparent coinfection with another pathogen cannot be ruled out. For example, horses with presumed Lyme disease that responded to oxytetracycline may actually have been infected with *Anaplasma phagocytophilum*, which is transmitted by the same vector, causes similar clinical signs, and is highly susceptible to tetracycline.<sup>4</sup>

### TREATMENT

- Procaine penicillin G (44,000 IU/kg q24 IM, for 3 weeks) (R-2)
- Oxytetracycline (6 to 12 mg/kg IV q24h for 3 weeks) (R-2)

### CONTROL

Prevention of Lyme borreliosis in domestic animals and humans is dependent on reduction of the risk of tick bites at the environmental or individual animal level. Knowledge of the ecologic requirements for the tick-borne diseases that are present in an area is necessary for selection and implementation of the most effective integrated prevention strategies. Protective measures may include the avoidance of tick-infested areas; the use of protective clothing, repellents, and acaricides; tick checks; and modifications of landscapes in or near residential areas. After a tick bite has occurred in humans, the body of the tick should be grasped with

medium-tipped tweezers as close to the skin as possible and removed by gently pulling the tick straight out, without twisting motions.

A commercial adjuvanted vaccine is available for use in dogs. An experimental vaccine composed of recombinant OspA protected ponies against *B. burgdorferi* infection, and further studies are necessary to determine duration of protection after vaccination, safety, and cross-protection against the possible heterogeneous OspA structures that may be present among new *B. burgdorferi* strains isolated in the United States.

A human vaccine was available in the United States but was withdrawn by the manufacturer in 2002. Problems included poor demand, high costs, the need for a series of three vaccinations and boosters to maintain adequate titers, failure to obtain adequate titers in a small subset of vaccines, and theoretical concerns with vaccine-induced autoimmune arthritis.<sup>1</sup>

### FURTHER READING

- Butler CM, Houwers DJ, Jongejan F, van der Kolk JH. *Borrelia burgdorferi* infections with special reference to horses: a review. *Vet Quart.* 2005;27:146-156.
- Divers TJ, Chang YF, Jacobson RH, McDonough SP. Lyme disease in horses. *Comp Cont Educ Pract Vet.* 2001;23:375-381.
- Embers ME, Ramamoorthy R, Phillip MT. Survival strategies of *Borrelia burgdorferi*, the etiologic agent of Lyme disease. *Microbes Infect.* 2004;6:312-318.
- Fritz CL, Kjemtrup AM. Lyme borreliosis. *J Am Vet Med Assoc.* 2003;223:1261-1270.
- Littman MP, Goldstein RE, Labato MA, Lappin MR, Moore GE. ACVIM small animal consensus statement on lyme disease in dogs: diagnosis, treatment, and prevention. *J Vet Intern Med.* 2006;20:422-434.
- Stanek G, Strle F. Lyme borreliosis. *Lancet.* 2003;362:1639-1647.

### REFERENCES

1. The Center for Food Security and Public Health. At <[http://www.cfsph.iastate.edu/Factsheets/pdfs/lyme\\_disease.pdf](http://www.cfsph.iastate.edu/Factsheets/pdfs/lyme_disease.pdf)>; 2011 Accessed 09.02.14.
2. Gern L, Falco RC. *Rev Sci Tech Off Int Epiz.* 2000;19:121-135.
3. Higgins R. *Rev Sci Tech Off Int Epiz.* 2004;23:569-581.
4. Butler CM, et al. *Vet Quart.* 2005;27:146-156.
5. Runge M, et al. *J Verbr Lebensm.* 2010;5:317-375.
6. Strube C, et al. *Berl Münch Tierärztl Wschr.* 2011;124:512-517.
7. Morshed MG, et al. *J Med Entomol.* 2006;43:762-773.
8. Cisak E, et al. *Ann Agric Environ Med.* 2006;13:301-306.
9. Gassner F, et al. *Appl Environ Microbiol.* 2008;74:7136-7144.
10. Lengauer H, et al. *Berlin Münch Tierärztl Wschr.* 2006;119:335-341.
11. Maurizi L, et al. *Vector-Borne Zoonot.* 2010;10:535-537.
12. Ebani VV, et al. *Ann Agric Environ Med.* 2012;19:237-240.
13. Veronesi F, et al. *Vet Microbiol.* 2012;160:535-538.
14. Stefancikova A, et al. *Ann Agric Environ Med.* 2008;15:37-43.
15. Durrani AZ, et al. *J Equine Vet Sci.* 2011;31:427-429.

16. Juricova Z, Hubalek Z. *Vector-Borne Zoonot.* 2009;9:479-482.
17. EUCALB. At <<http://www.eucalb.com>>; 2009 Accessed 10.02.14.
18. Littman MP, et al. *J Vet Intern Med.* 2006;20:422-434.

## MALIGNANT EDEMA, CLOSTRIDIAL MYONECROSIS (GAS GANGRENE)

### SYNOPSIS

**Etiology** Acute wound infection associated with organisms of the genus *Clostridium*.

**Epidemiology** All ages and species of animals are susceptible. Sporadic disease affecting individual animals following injections; outbreaks following contamination of wounds produced by management procedures.

**Clinical findings** Acute onset with fever and toxemia. Inflammation and swelling at site of a wound, with heat, edema, pain on palpation, and usually subcutaneous emphysema.

**Clinical pathology** No diagnostic change in hematology or serum biochemistry. Fluorescent antibody staining.

**Necropsy findings** Gangrene of the skin with edema of the subcutaneous and intermuscular connective tissue around the site of infection.

**Diagnostic confirmation** Demonstration of the causal organisms by fluorescent antibody staining.

**Treatment** Antibiotics, surgical debridement.

**Control** Vaccination. Prophylactic antibiotics.

### ETIOLOGY

*Clostridium septicum*, *C. chauvoei*, *C. perfringens*, *C. sordellii*, and *C. novyi* have all been isolated from lesions typical of malignant edema of animals. In some cases there can be mixed infections. The occurrence of malignant edema caused by *C. chauvoei* is discussed in the section on blackleg.

*C. sordellii* has been associated chiefly with malignant edema of cattle, but it has been found to be a cause of malignant edema and swelled head in sheep. However, swelled head of rams, in which the lesions of malignant edema are restricted to the head, is most commonly associated with *C. novyi* infection.

In a retrospective study of 37 horses with clostridial myonecrosis, *C. perfringens* was isolated from 68%, *C. septicum* from 16%, and the remainder were mixed infections with these two species. *C. chauvoei*, *C. novyi*, and *C. fallax* have been isolated incidentally.

### EPIDEMIOLOGY

All ages and species of animals are affected. The clostridia bacteria that cause malignant

edema are **common inhabitants** of the animal **environment** and intestinal tract, and although some of the causative species have a restricted distribution, the disease has a worldwide occurrence. The disease occurs sporadically, affecting individual animals, except in circumstances where a management procedure in a group of animals results in an outbreak.

### Source of Infection

The infection is usually **soil-borne**, and the resistance of spores of the causative clostridia to environmental influence leads to **persistence** of the infection for long periods in a local area. A dirty environment that permits contamination of wounds with soil is the common predisposing cause.

### Transmission

In most cases a wound is the **portal of entry**. Deep puncture wounds accompanied by trauma provide the most favorable conditions for anaerobic growth, and malignant edema occurs most frequently under such conditions. Infection may occur through surgical or accidental wounds following vaccination, intramuscular injection of drugs, venipuncture, or through the umbilical cord in the newborn. Dormant spores of *C. perfringens* and other clostridial species can be found in the normal muscle of horses, and it is possible in some cases that these may be activated by anaerobic conditions produced by the injected material.

### Animal and Management Risk Factors

In horses, intramuscular injection of drugs, commonly in association with the treatment of colic, is the common precipitating factor.<sup>1</sup> Certain drugs may have a greater propensity to initiate muscle necrosis and disease, but these drugs are also commonly used in the treatment of colic. Perivascular leaking of drugs is also a precipitating cause in horses. In all species there is risk with the intramuscular injection of drugs such as anthelmintics and nutritional supplements, some of which can cause significant tissue damage at the site, particularly if proper asepsis is not practiced.

Outbreaks can occur in sheep after management practices such as shearing and docking, or following lambing. Outbreaks have also been observed in cattle following **parturition**, sometimes associated with lacerations of the vulva. An unusual method of infection occurs when crows that have eaten infected carrion carry the infection to live, weak sheep and to lambs when they attack their eyes. Castration wounds in pigs and cattle may also become infected. Unless treatment is instituted in the early stages the death rate is extremely high.

The practice of **dipping** sheep immediately after they are shorn may cause a high incidence of malignant edema if the dip is

heavily contaminated. The disease “**swelled head**,” a form of malignant edema, occurs in young rams 6 months to 2 years old when they are run in bands and fight among themselves.

### Importance

Outbreaks of malignant edema are probably less common as a result of education of farmers and the availability of vaccines. In the wrong circumstances and with improper hygiene, severe disease can still occur.

### PATHOGENESIS

Potent necrotoxins are produced in the local lesion and cause death when absorbed into the bloodstream. Locally the exotoxins cause extensive edema and necrosis followed by gangrene.

### CLINICAL FINDINGS

Clinical signs appear within 6 to 48 hours of infection. There is always a local lesion at the **site of infection** consisting of a soft, doughy swelling with marked local erythema accompanied by severe pain on palpation. At a later stage the swelling becomes tense and the skin dark and taut. Emphysema may or may not be present, depending on the type of infection, and may be so marked as to cause extensive frothy exudation from the wound. With *C. novyi* infections, there is no emphysema. A high fever (41 to 42° C; 106 to 107° F) is always present; affected animals are depressed, are weak, and show muscle tremor and usually stiffness or lameness. The mucosae are dry and congested and have very poor capillary refill. The illness is of short duration, and affected animals die within 24 to 48 hours of the first appearance of signs. New cases continue to appear for 3 to 4 days after shearing or other precipitating cause.

When infection occurs at **parturition**, swelling of the vulva accompanied by the discharge of a reddish-brown fluid occurs within 2 to 3 days. The swelling extends to involve the pelvic tissues and perineal region. The local lesions are accompanied by a profound toxemia, and death occurs within 1 to 2 days.

In “**swelled head**” of rams, the edema is restricted initially to the head. It occurs first under the eyes and spreads to the subcutaneous tissues of the head and down the neck.

In **pigs**, the lesions are usually restricted to the axilla, limbs, and throat and are edematous, with very little evidence of emphysema. Local skin lesions consisting of raised, dull red plaques distended with clear serous fluid containing *C. septicum* and causing no systemic illness may be encountered in pigs at abattoirs.

In horses, emphysema, detected by palpation or ultrasound, is an early sign.<sup>1</sup>

### CLINICAL PATHOLOGY

Antemortem laboratory examination of affected farm animals is not usually

undertaken, usually because there are carcasses for postmortem examination.

Examination of a Gram-stained smear of aspirated fluid from edematous swellings or swabs from wounds will give an early diagnosis, allowing therapy early in the course of the disease. A PCR has been developed to allow the rapid identification and differentiation of the clostridia associated with malignant edema in livestock.

Hematologic examination in horses may reveal abnormal white blood cell counts, either leukocytosis or leukopenia with toxic degeneration of granulocytes and a regenerative left shift. Elevated activity of muscle enzymes such as CPK, AST, and LDH match the degree of muscle tissue involvement. Blood-gas analysis conducted in affected horses revealed severe acidemia and metabolic acidosis.<sup>1</sup>

### NECROPSY FINDINGS

Tissue changes occur rapidly after death, particularly in warm weather, and this must be kept in mind when evaluating postmortem findings. There is usually gangrene of the skin with edema of the subcutaneous and intermuscular connective tissue around the site of infection. There may be some involvement of underlying muscle, but this is not marked. The edema fluid varies from thin serum to a gelatinous deposit. It is usually bloodstained and contains bubbles of gas, except in *C. novyi* infections when the deposit is gelatinous, clear, and contains no gas. A foul, putrid odor is often present in infections with *C. perfringens* and *C. sordellii*.

Subserous hemorrhages and accumulations of serosanguineous fluid in body cavities are usual. In “swelled head” of rams, the edema of the head and neck may extend into the pleural cavity and also involve the lungs.

The **histologic** picture of malignant edema consists of abundant edema fluid, emphysema, and neutrophils within the connective tissues. Muscle is not spared, but the damage is focused along fascial planes.

### Samples for Confirmation of Diagnosis

- Bacteriology—fascial tissue, placed in an airtight container; four air-dried smears of fluid from lesion (anaerobic CULT, FAT)
- Histology—fixed sample of lesion

### DIFFERENTIAL DIAGNOSIS

The association of profound toxemia and local inflammation and emphysema at the site of a wound is characteristic.

- **Blackleg**—the disease is differentiated from blackleg by the absence of typical muscle involvement and the presence of wounds
- **Anthrax** in pigs and horses
- **Photosensitivity** in white-faced sheep with swelled head

## TREATMENT

Affected animals should be treated as emergency cases because of the acute nature of the disease. Specific treatment requires the administration of penicillin (high doses of crystalline penicillin intravenously, repeated at 4- to 6-hour intervals) or a broad-spectrum antibiotic. Antitoxin aids in controlling the toxemia but is expensive and must be given very early in the course of the disease. An NSAID and supportive therapy are recommended. Local treatment consists of surgical incision to provide drainage, along with irrigation with hydrogen peroxide. In horses, early and aggressive treatment with myotomy and fasciotomy, repeated if indicated, coupled with IV potassium penicillin is reported to allow recovery rates approaching 70%. The success rate in treating horses with infections with *C. perfringens* was higher than that with *C. septicum*.

### TREATMENT AND CONTROL

#### Treatment

Penicillin G sodium/potassium (40,000 IU/kg IV q6–8h) (R-2)

Surgical incisions to drain and flush with dilute H<sub>2</sub>O<sub>2</sub>

Flunixin meglumine (2.2 mg/kg IV q24h) (R-2)

Ketoprofen (3 mg/kg IM q24h) (R-2)

Carprofen (1.4 mg/kg IM as single dose) (R-2)

Meloxicam (0.5 mg/kg SC/IV as single dose) (R-2)

Diclofenac (2.5 mg/kg IM as single dose) (R-2)

#### Control

Penicillin (44,000 IU/kg IM q24 for 3 days for animals at risk) (R-2)

## CONTROL

Hygiene at lambing, shearing, castration, and docking is essential to the control of the infection in sheep. Vaccination with a specific or multivalent clostridial bacterin-toxoid will prevent the occurrence of the disease in enzootic areas. Penicillin can be given prophylactically to animals at risk for the disease.

## FURTHER READING

- Hatheway CL. Toxigenic clostridia. *Clin Microbiol Rev.* 1990;3:66-98.
- Lewis C. Aspects of clostridial disease in sheep. *In Pract.* 1998;20:494-500.
- Songer JG. Clostridial diseases of animals. In: Rood JJ, McClane BA, Songer JG, Titball RW, eds. *The Clostridia: Molecular Biology and Pathogenesis.* London: Academic Press; 1997:153-182.
- Songer JG. Clostridial diseases of small ruminants. *Vet Res.* 1998;29:219-232.

## REFERENCE

1. Recknagel S, et al. *Tierarztl Prax Grosstiere.* 2009;37:255-262.

## BLACKLEG

### SYNOPSIS

**Etiology** Infectious necrotizing myositis associated with *Clostridium chauvoei*. Common in cattle but occurs occasionally in other species.

**Epidemiology** Cattle 6 months to 2 years of age that are rapidly growing and on a high plane of nutrition. Seasonal occurrence in warm, wet months. There are often multiple cases in at-risk animals. Sheep of all ages—occurs as outbreaks predisposed by wounds from shearing, docking, castration, dystocia.

**Clinical findings** Lameness and pronounced swelling of upper limb. Myonecrosis of skeletal or cardiac muscles, severe toxemia, and a high case-fatality rate. May be found dead.

**Clinical pathology** Culture from needle biopsy. No diagnostic change in hematology or serum biochemistry.

**Necropsy findings** Myositis; dark, rancid odor, metallic sheen on the cut surface.

**Diagnostic confirmation** Fluorescent antibody identification of *C. chauvoei* in lesion.

**Treatment** High doses of penicillin in early stages. Surgical debridement.

**Control** Vaccination.

## ETIOLOGY

**Blackleg**, or clostridial myositis of skeletal and/or heart muscle tissue, is associated with *Clostridium chauvoei* (*feseri*), a gram-positive, spore-forming, rod-shaped bacterium. The spores are normally found in soil and are highly resistant to environmental changes and disinfectants and persist in soil for many years.

## EPIDEMIOLOGY

### Occurrence

Blackleg is an acute febrile disease primarily affecting cattle and sheep, with worldwide occurrence. The condition is characterized by severe necrotizing myositis of striated and occasionally cardiac muscle tissue and severe toxemia with high mortality. Although black leg is widely considered a disease of ruminants, available reports suggest that swine, mink, freshwater fish, wales, frogs, and ostriches are also susceptible to infection. In recent years at least two cases of fatal disease associated with *C. chauvoei* in humans have been reported.<sup>1,2</sup> Although sheep of any age can be affected, cattle between 6 months and 2 years of age most commonly develop clinical disease. The disease incidence shows a seasonal pattern, with peak incidences observed during the warmer period of the year. In general, several animals of a herd or flock are affected within a short period of

time. The disease is enzootic in particular areas, especially when they are subject to flooding. The **case-fatality rate** in blackleg approaches 100%.

## Source of Infection

Blackleg is a **soil-borne** infection. In sheep, infection with *C. chauvoei* is assumed to predominantly occur through penetrating lesions of the skin or mucosa, but the primary portal of entry for the organism in cattle is still in dispute. It is presumed that infection primarily occurs through the mucosa of the digestive tract after ingestion of contaminated feed or may be associated with erupting teeth. Spores of *C. chauvoei* have been found in the spleen, liver, and alimentary tract of healthy animals, and contamination of the soil and pasture may occur from infected feces or decomposition of carcasses of animals that died of the disease. Clinical disease develops when spores are caused to proliferate by yet undetermined mechanisms. Tissue trauma and anoxia have been incriminated as potential triggers.

## Transmission

Whereas in cattle the disease usually occurs without a history of trauma, in sheep, skin wounds from **shearing, docking, and vulvar or vaginal lacerations from parturition** or the fresh **navel** at birth are the most common routes through which *C. chauvoei* penetrates and infects muscle tissue to cause clinical disease. Infections of the vulva and vagina of the ewe at **lambing** may cause serious outbreaks, and the disease has occurred in groups of young ewes and rams up to a year old, usually as a result of infection of skin wounds caused by **fighting**. Occasional outbreaks have occurred in sheep **after vaccination** against enterotoxemia. Presumably the formalinized vaccine causes sufficient tissue damage to permit latent spores of the organism to proliferate.

A special occurrence is in **fetal lambs**. Ewes exposed to infection at shearing develop typical lesions, but ewes treated with penicillin are unaffected, except that the pregnant ewes in the latter group show distended abdomens, weakness, and recumbency as a result of edema and gas formation in the fetus, from which *C. chauvoei* can be isolated.

## Risk Factors

### Environment Risk Factors

Blackleg of cattle has a **seasonal incidence**, with most cases occurring in the warm months of the year. The highest incidence may vary from spring to autumn, likely depending on when calves reach the susceptible age group. There appears to be an increased disease incidence in years of high rainfall, which has been explained by increased anaerobiosis in water-saturated soils in combination



with enhanced pasture growth stimulating feed intake of pastured cattle.<sup>3</sup> Outbreaks of blackleg in cattle have occurred following excavation of soil, which suggests that disturbance of the soil may expose and activate latent spores.

An outbreak of blackleg has also been reported in housed cattle in a nonendemic blackleg area in Norway.<sup>4</sup>

#### Animal Risk Factors

Blackleg is usually a disease of cattle and to a lesser degree of sheep, but outbreaks of the disease have been recorded in deer and horses. In cattle, the disease is most commonly seen in young stock between the ages of 6 months and 2 years, although disease occurs occasionally in younger animals and cattle up to 3 years. In the field, **risk factors** include rapidly growing cattle and a high plane of nutrition. Elevation of the nutritional status of sheep by increased protein feeding increases their susceptibility to blackleg. In sheep, there is no restriction to age group. In calves and sheep, atypical outbreaks of sudden death occur in which the lethal lesion is a clostridial cardiac myositis.

In pigs, blackleg is not common, although a gas gangrene type of lesion may be associated with *C. chauvoei* or *C. septicum* infection.

#### Economic Importance

Blackleg is a cause of severe financial loss to cattle raisers in many parts of the world. For the most part, major outbreaks are prevented by vaccination, although outbreaks still occur occasionally in vaccinated herds or cattle incompletely vaccinated.

#### PATHOGENESIS

With spores of *Cl. chauvoei* normally found in soils, ingestion of such spores through contaminated pasture or silage is unavoidable. Spores of *C. chauvoei* have been found not only in the digestive tract but also the spleen and liver healthy animals. Because *C. chauvoei* appears to be present in tissue in a dormant state before disease occurs blackleg—at least in cattle—has also been termed as “endogenous” clostridial infection, in contrast to malignant edema that is considered an exogenous infection, because the pathogen gains access to the tissue through mucosal or skin breaks and directly causes clinical disease.<sup>5</sup>

Whereas in sheep the clinical disease in most cases has been related to tissue laceration and trauma, the stimulus that results in growth of the latent bacterial spores in cattle is unknown. There is usually no history of trauma. Once returned to its vegetative state, *C. chauvoei* produces a number of toxins, such as oxygen-stable and oxygen-labile hemolysins, DNase, hyaluronidase, and neuramidase, which cause severe **necrotizing myositis** locally in skeletal

muscles and a **systemic toxemia** that is usually fatal.

#### CLINICAL FINDINGS

##### Cattle

If the animal is observed before death there is severe lameness, usually with pronounced swelling of the upper part of the affected leg. On closer examination the animal will be found to be very depressed, have complete anorexia and ruminal stasis, and have a high temperature (41° C; 106° F) and pulse rate (100 to 120/min). Pyrexia is not present in all cases. In the early stages, the swelling is hot and painful to the touch but soon becomes cold and painless, and edema and emphysema can be felt. The skin is discolored and soon becomes dry and cracked.

Although the lesions are usually confined to the upper part of one limb, occasional cases are seen where the lesions are present in other locations, such as the base of the tongue, the heart muscle, the diaphragm and psoas muscles, the brisket, and the udder. Lesions are sometimes present in more than one of these locations in one animal. The condition develops rapidly, and the animal dies quietly 12 to 36 hours after the appearance of signs. Many animals die without signs having been observed.

##### Sheep

When blackleg lesions occur in the limb musculature in sheep, there is a stiff gait, and the sheep is disinclined to move because of severe lameness in one limb or, more commonly, in several limbs. The lameness may be severe enough to prevent walking in some animals but be only moderate in others. Subcutaneous edema is not common and gaseous crepitation cannot be felt before death. Discoloration of the skin may be evident, but skin necrosis and gangrene do not occur.

In those cases where infection occurs through **wounds** of the skin, vulva, or vagina, there is an extensive local lesion. Lesions of the head may be accompanied by severe local swelling as a result of edema, and there may be bleeding from the nose. In all instances, there is high fever, anorexia, and depression, and death occurs very quickly. Sheep and cattle with cardiac myositis associated with *C. chauvoei* are usually found dead.

##### Horses

The clinical syndrome in horses is not well defined. Pectoral edema, stiff gait, and incoordination are recorded.

#### CLINICAL PATHOLOGY

The disease is usually so acute that necropsy material is readily available but, failing this, it may be possible to obtain material suitable for cultural examination by needle puncture or swabs from wounds. There are no constant changes in hematologic parameters or serum biochemistry.

#### NECROPSY FINDINGS

**Cattle** found dead of blackleg are often in a characteristic position: lying on the side with the affected hindlimb stuck out stiffly. Bloating and putrefaction occur quickly, and bloodstained froth exudes from the nostrils and anus. Clotting of the blood occurs rapidly. Incision of the affected muscle mass reveals dark-red to black, swollen tissue with a rancid odor and thin, sanguineous fluid containing bubbles of gas. Freshly cut surfaces are often dry and may have a metallic sheen. The heart and all skeletal muscles, including those of the tongue, diaphragm, and lumbar region, must be checked because the lesion may be small and escape cursory examination. The thoracic cavity and the pericardial sac may contain excess blood-stained fluid with variable amounts of fibrin. This serositis is often overlooked or is misinterpreted as a component of pleuropneumonia. The lungs are usually congested and may be atelectatic as a result of abdominal tympany.

In **sheep**, the muscle lesions are more localized and deeper, and the **subcutaneous edema is not so marked, except around the head**. Gas is present in the affected muscles but not in such large amounts as in cattle. When the disease has resulted from infection of skin wounds, the lesions are more obvious superficially, with subcutaneous edema and swelling and involvement of the underlying musculature. When invasion of the genital tract occurs, typical lesions are found in the perineal tissues and in the walls of the vagina and occasionally the uterus. In the special case of pregnant ewes, typical lesions may involve the entire fetus and cause abdominal distension in the ewe.

**Histologically**, blackleg cases feature myonecrosis, edema, emphysema, and an unimpressive neutrophilic cellulitis. Organisms may be few in number but can usually be seen in tissue sections. Smears from the affected tissue should be made and material collected for bacteriologic examination. The isolation and identification of *C. chauvoei* and *C. novyi* is difficult because of the fastidiousness of these species in culture and rapid postmortem contamination of the tissues by clostridial species from the gastrointestinal tract. Thus it is essential that tissues be examined as soon after death as possible. Most laboratories use fluorescent antibody tests performed on tissue smears to complement (or substitute) anaerobic culture.

“**False blackleg**” may be associated with *C. septicum* and *C. novyi*, but this disease is more accurately classified as malignant edema. Mixed infections with *C. chauvoei* and *C. septicum* are not uncommon, but the significance of *C. septicum* as a cause of the disease is debated. However, in a study of 176 cases of clostridial myositis in cattle, *C. chauvoei* either alone or with *C. septicum* was demonstrated in 56%. In 36%, *C. novyi* was found alone or with *C. septicum*. This

indicates that maximum protection to cattle can be provided only by a multivalent vaccine that contains the antigens of *C. chauvoei*, *C. novyi*, and *C. septicum*. A multiplex PCR based on the flagellin gene sequence has been used to identify pathogenic clostridia in clinical specimens.

### Samples for Confirmation of Diagnosis

- Bacteriology—muscle, placed in air-tight container; four air-dried impression smears of surface of freshly cut lesion (anaerobic CULT, FAT, PCR)
- Histology—fixed samples of suspected muscle lesion

### DIFFERENTIAL DIAGNOSIS

In establishing a diagnosis when a number of animals are found dead in a group not kept under close observation and postmortem decomposition is so advanced that little information can be obtained, one must depend on one's knowledge of local disease incidence, season of the year, age group affected, and pasture conditions, and on a close inspection of the environment in which the animals have been maintained. More frequent observation should be established so that sick animals or fresh cadavers will be available for examination.

- **Malignant edema**—in typical cases of blackleg in cattle a definite diagnosis can be made on the clinical signs and the necropsy findings. Definitive identification of *Clostridium chauvoei* is by fluorescent antibody staining. Diagnosis on gross postmortem findings from other causes of clostridial myositides is hazardous and may result in improper recommendations for control
- **Anthrax**
- **Lightning strike**
- **Bacillary hemoglobinuria**
- Other causes of sudden unexpected death

### TREATMENT

Treatment of affected animals with **penicillin and surgical debridement** of the lesion, including fasciotomy, is indicated if the animal is not moribund. Recovery rates are low because of the extensive nature of the lesions. Large doses (44,000 IU/kg BW) should be administered, commencing with crystalline penicillin intravenously and followed by longer-acting preparations. Blackleg **antiserum** is unlikely to be of much value in treatment unless very large doses are given.

### TREATMENT AND CONTROL

#### Treatment

Penicillin G sodium/potassium (44,000 IU/kg IV q6–8h) (R-2)

*Clostridium chauvoei* antitoxin (only in early stages, but doubtful efficacy)

#### Control

Multivalent clostridial vaccine including at least *C. chauvoei*, *C. septicum*, and *C. novyi* (R-2)

Penicillin (44,000 IU/kg IM q24 for 3 days for animals at risk) (R-2)

### CONTROL Cattle

On farms where the disease is enzootic, annual vaccination of all cattle between 3 and 6 months with two vaccinations given 4 weeks apart followed by an annual booster vaccination is generally recommended. This should be done just before the anticipated danger period, usually spring and summer. Maternal immunity persists for at least 3 months and will interfere with active immunity in calves vaccinated before this age.

In an **outbreak**, all unaffected cattle should be vaccinated immediately and injected with penicillin intramuscularly. Movement of the cattle from the affected pasture is advisable. If antibiotics are not given, new cases of blackleg may occur for up to 14 days until immunity develops, and constant surveillance and the early treatment of cases will be necessary.

### Sheep

With sheep in areas where the disease is enzootic, the **maiden ewes** should be vaccinated twice, with the last vaccination given about 1 month before lambing and a subsequent yearly booster given at the same time before lambing. This will prevent infection of the ewes at lambing and will also protect lambs against umbilical infection at birth and infection of the tail wound at docking, provided the tail is docked at a young age. If an **outbreak** commences in a flock of ewes at lambing time, prophylactic injections of penicillin and antiserum to ewes requiring assistance are recommended.

A single vaccination of **wethers** can also be carried out 2 to 3 weeks before **shearing** if infection is anticipated. Because of the common occurrences of the disease in young sheep, vaccination before they go on to pasture and are exposed to infection of skin wounds from fighting is recommended in danger areas. The duration of the immunity in these young vaccinated animals is relatively short, and ewes in particular must be revaccinated before they lamb for the first time. Clostridial vaccines have **poorer antigenicity** in sheep and goats than in cattle.

In both sheep and cattle, it is advisable to use a **combined vaccine** containing at least *C. chauvoei*, *C. septicum*, and *C. novyi*, where these organisms occur in the area and cause clostridial myositis.

There is limited information on which to base the previous recommendations because

there is limited information on the **efficacy** of available individual manufacturers' vaccines.<sup>6</sup> There is variability in the immune response and its duration with different vaccines. **Vaccine failure** has been associated with an inadequate spectrum of the antigens in the vaccine, and in these circumstances a bacterin prepared from a local strain of *C. chauvoei* is preferred. Vaccines combined with anthelmintics or with trace elements are used in some areas to minimize the number of injections required when processing sheep.

It is important that **carcasses** of animals dying of blackleg are destroyed by burning or deep burial to limit soil contamination.

### FURTHER READING

- Hatheway CL. Toxigenic clostridia. *Clin Microbiol Rev.* 1990;3:66–98.
- Songer JG. Clostridial diseases of animals. In: Rood JI, McClane BA, Songer JG, Titball RW, eds. *The Clostridia: Molecular Biology and Pathogenesis*. London: Academic Press; 1997:153–182.
- Songer JG. Clostridial diseases of small ruminants. *Vet Res.* 1998;29:219–232.
- Useh NM, Nok AJ, Esievo KAN. Pathogenesis and pathology of blackleg in ruminants; the role of toxins and neuraminidase. A short review. *Vet Q.* 2003;25:155–158.

### REFERENCES

1. Nagano N, et al. *J Clin Microbiol.* 2008;46:1545–1547.
2. Wearherhead JE, Tweardy DJ. *J Infect.* 2012;64:225–227.
3. Useh NM, et al. *Vet Rec.* 2006;158:100–101.
4. Groseth PK, et al. *Vet Rec.* 2011;169:339.
5. Odani JSJ. *Vet Diagn Invest.* 2009;21:920–924.
6. Uzal F. *Vet Clin North Am Food A Pract.* 2012;28:71–77.

## BOVINE FOOTROT (INFECTIOUS BOVINE PODODERMATITIS, INTERDIGITAL PHLEGMON, INTERDIGITAL NECROBACILLOSIS, FOUL IN THE FOOT)

### SYNOPSIS

**Etiology** Biotypes A and AB of *Fusobacterium necrophorum*. Other organisms can facilitate infection.

**Epidemiology** All ages susceptible. Infected feet are source of infection. Transmission highest where conditions are wet underfoot and in wet, humid seasons.

**Clinical findings** Sudden onset of lameness and fever, drop in milk production with typical fissuring, necrotic lesion in the skin at the top of the interdigital cleft.

**Clinical pathology** Not routinely done.

**Diagnostic confirmation** Clinical findings. Culture may be done.

**Treatment** Antimicrobials.

**Control** Avoidance of abrasive underfoot conditions. Footbaths, antimicrobials, vaccination.

## ETIOLOGY

Footrot is usually described as a contagious disease as a result of localized infection by *F. necrophorum*, a gram-negative non-spore-forming anaerobe.<sup>1,2</sup> Other bacteria, primarily *Porphyromonas levii* (originally classified as *Prevotella melaninogenica* or *Bacteroides melaninogenicus*),<sup>3</sup> are present at variable rates in clinically infected cattle and may play a role in the development of clinical disease. Experimentally, the subcutaneous inoculation of only *F. necrophorum* into the interdigital skin of cattle will result in typical lesions of interdigital phlegmon.

*F. necrophorum* has traditionally been categorized into four biotypes: A (called *F. necrophorum* subsp. *necrophorum*), B (called *F. necrophorum* subsp. *funduliforme*), AB (taxonomic status is unresolved), and C (which is nonpathogenic). The majority of isolates of *F. necrophorum* obtained from the feet of cattle and sheep belong to biotypes A and AB; they produce a soluble exotoxin, a **leukotoxin**, that is produced by *F. necrophorum* strains carrying the *lktA* gene. Leukotoxin appears to play an important role in the pathogenesis of clinical disease. The isolates obtained from lesions that are not classified as interdigital necrobacillosis and from clinically normal feet are predominantly biotype B and cause few experimental lesions and produce little or no leukotoxin.

Strains of *Bacteroides nodosus* that are associated with the nonprogressive form of ovine footrot are occasionally isolated from the feet of cattle with footrot<sup>1,2</sup> and cause mild interdigital dermatitis. It is possible they may predispose to the much more severe dermatitis that characterizes bovine interdigital phlegmon.

## EPIDEMIOLOGY

### Occurrence

The disease is common in most countries and accounts for 5% to 15% of cases of lameness in dairy cattle.

Usually the disease is sporadic, but under favorable conditions, as many as 25% of a group may be affected at one time. An epidemiologic study of footrot in pastured cattle in Denmark over a 12-year period revealed that annual incidence ranged from 0.1% to 4.8%, but in most years it was below 1%. The incidence was higher in some breeds than others, higher in some geographic areas than others (usually where the fields were smaller and soil higher in pH), and higher 4 to 8 weeks after periods of high rainfall.

### Transmission

Discharges from the feet of **infected animals** are the probable source of infection. Duration of the infectivity of pasture or bedding is unknown. Infection gains entrance through **abrasions** or damage to the skin in the interdigital cleft. Introduction of the infection to a farm by transient cattle is often observed, but again the disease may not

develop on some farms in spite of the introduction of the infection. Contaminated footbaths can be a source of infection.

### Environmental Risk Factors

In many but not all regions, the incidence is much higher during **wet, humid weather** or when conditions are **wet underfoot**. Stony ground, lanes filled with sharp gravel and pasturing on coarse stubble also predispose to the condition. A high incidence can occur, with beef cattle at high stocking densities on irrigated pastures. The observation that the disease is common on some farms and does not occur at all on others suggests that there may be factors that limit the persistence of infectivity in certain soils or environments.

Abrasions to the skin of the feet are more likely to occur when the skin is swollen and soft as a result of continual wetting. The increased incidence in wet summer and autumn months may be so explained in part, although wet conditions may also favor persistence of the infection in pasture. In housed cattle, the incidence is higher in **loose-housed** cattle than tied cattle. Unhygienic cubicle passageways and poorly maintained straw beds may predispose to infection.

### Host Risk Factors

Cattle of all ages, including young calves, may be affected, but the disease is much more common in adults. The highest incidence occurs in cows in the **first month of lactation**. A field observation is that *Bos indicus* cattle are much more resistant to infectious footrot than *Bos taurus* breeds, and variations in prevalence have been observed among dairy breeds.

### Economic Importance

Footrot is of greatest economic importance in dairy cattle, in which it reaches the highest level of incidence because of the intensive conditions under which they are kept. A 2010 study estimated that each case of footrot costs dairy producers US\$121.<sup>4</sup> In beef cattle at range the incidence is usually low, but many cases may occur in purebred herds and in feedlot cattle. Lame cows will lie down for longer and eat less, have difficulty rising, and are at greater risk for teat trampling and mastitis. Loss of production occurs, and an occasional animal may suffer a serious involvement of the joint and other deep structures of the foot necessitating amputation of a digit. The disease is not fatal, but some cases may have to be slaughtered because of joint involvement.

### PATHOGENESIS

The pathogenesis is not completely understood, but with the experimental SC inoculation of the virulent biotype of *F. necrophorum* into the interdigital skin of cattle, the typical lesion of footrot develops in approximately 5 days. This suggests that any injury or constant wetting of the skin of the cleft that

interferes with its integrity will allow the organism to invade the tissues. There is acute swelling and necrosis of the skin and SC tissues, which may spread to adjacent tendon sheaths, joint capsules, and bone if treatment is delayed or ineffective.

## CLINICAL FINDINGS

Severe foot **lameness** appears suddenly, usually in one limb only, and may be accompanied by a moderate systemic reaction with a **fever** of 39 to 40° C (103 to 104° F). There is temporary depression of milk yield in cows, and affected bulls may show temporary infertility. The animal puts little weight on the leg, although the limb is carried only when severe joint involvement occurs. Swelling of the coronet and **spreading of the claws** are obvious.

The typical lesion occurs in the skin at the top of the **interdigital cleft** and takes the form of a **fissure** with swollen, protruding edges that may extend along the length of the cleft or be confined to the anterior part or that part between the heel bulbs. Pus is never present in large amounts, but the edges of the fissure are covered with **necrotic material**, and the lesion has a **characteristic odor**. Occasionally in early cases no external lesion may be visible, but there is lameness and swelling of the coronet. Such cases are usually designated “blind fouls” and respond well to parenteral treatment. A hand-held infrared thermographic unit may be helpful in identifying cattle with footrot, particularly when the difference in temperature between the plantar aspect is compared with the other hindfoot or front foot.<sup>5</sup>

A more severe form of the disease that is peracute in onset and refractory to conventional therapy has been termed “super foul” or “super footrot,” although there does not seem to be a persuasive reason to develop a descriptive term from separate footrot. With this type there is sudden onset of acute lameness, severe interdigital swelling, and rapid progression to necrosis and deep erosion of the interdigital space with swelling of soft tissue above the coronary band. The hindfeet or all four feet may be affected.

Spontaneous recovery is not uncommon, but if the disease is left untreated, the lameness usually persists for several weeks, with adverse effects on milk production and condition. The incidence of **complications** is also higher if treatment is delayed, and some animals may have to be destroyed because of local **involvement of joints and tendon sheaths**. In such cases the lameness is severe, the leg is usually carried, and the animal strongly resents handling of the foot. Swelling is usually more obvious and extends up the back of the leg. There is poor response to medical treatment, and surgical measures are necessary to permit drainage. **Radiologic examination** may be of value in determining the exact degree of involvement of bony tissue.



Long continued irritation may result in the development of a wart-like mass of fibrous tissue, the **interdigital fibroma**, in the anterior part of the cleft and chronic mild lameness. Interdigital fibroma occurs commonly without the intervention of footrot, the important cause being inherited defects in foot conformation in heavy animals.

### CLINICAL PATHOLOGY

Bacteriologic examination is not usually necessary for diagnosis, but direct smears of the lesion will usually reveal large numbers of a mixture of *Fusobacterium* and *Bacteroides* spp. Routine differentiation between virulent and nonvirulent bovine isolates of *F. necrophorum* can be done by assessment of the cultural characteristics of the colonies grown on blood agar. Proteomic analysis of plasma from cattle with footrot identified increased concentrations of innate immune recognition molecules, acute-phase proteins, and cell-adhesion and cytoskeletal proteins.<sup>6</sup>

#### DIFFERENTIAL DIAGNOSIS

The characteristic site, nature, and smell of the lesion; the pattern of the disease in the group; and the season and climate are usually sufficient to indicate the presence of true footrot.

### NECROPSY FINDINGS

Necropsy examinations are rarely carried out in cases of footrot. Dermatitis is followed by necrosis of the skin and subcutaneous tissues. In complicated cases there may be suppuration in joints and tendon sheaths.

### Interdigital Dermatitis/Stable Footrot

Interdigital dermatitis occurs commonly in cattle that are housed for long periods. Although the condition occurs most commonly when the cattle are kept under unsanitary conditions, it is also seen in well-managed herds. The causative agent has not been established, but *Bacteroides nodosus* can be isolated.

The initial lesion is an outpouring of sebaceous exudate at the skin-horn junction, particularly at the bulbs of the heel. There is a penetrating foul odor, the lesion is painful to touch, and there is little swelling and no systemic reaction. More than one foot is commonly affected. In long-standing cases there is separation of the horn at the heel bulb, and this is followed by secondary bacterial infection of the sensitive structures of the foot. Often there is a purulent dermatitis of the interdigital space. Stable footrot does not respond satisfactorily to the standard parenteral treatments used in footrot, but local treatments as set out as follows are effective.

### Verrucose Dermatitis

Verrucose dermatitis is a proliferative inflammatory lesion of the **skin of the**

**plantar surface** of the foot extending from the bulb of the heels to the fetlock joint. The condition is seen particularly in feedlot cattle that are overcrowded in wet muddy conditions and may occur in outbreaks. **All four feet** may be affected, there is considerable pain and lameness, and, on smear of the lesion, *F. necrophorum* is present in large numbers. The treatment of verrucose dermatitis consists of washing the affected skin with a disinfectant soap, followed by daily applications of 5% copper sulfate solution. When many animals are affected, a daily walk-through and soaking in a foot bath containing the copper sulfate solution is very effective.

### Traumatic Injury

Traumatic injury to bones and joints, puncture by foreign bodies, bruising of the heels, and gross overgrowth of the hoof can usually be distinguished by careful examination of the foot. **Laminitis** is the major cause of lameness in most herds, but with this condition there are no skin lesions present.

### TREATMENT

Parenteral administration of antibiotics or sulfonamides and local treatment of the foot lesion are necessary for best results. **Immediate treatment** as soon as possible after the onset of swelling and lameness will give excellent recovery in 2 to 4 days. In the experimental disease, when treatment was delayed for a few days after the onset of signs, severe lesions developed and recovery was extended. Under field conditions, the disease may be present in cattle at pasture for several days before being recognized, making it necessary to confine them for daily treatment until recovery is apparent.

### Antimicrobials

Long-acting antimicrobial formulations are preferred to decrease labor associated with daily treatment and hospital pen space requirements.<sup>7</sup> Oxytetracycline, 10 mg/kg BW IV daily, or long-acting tetracycline, 20 mg/kg BW IM, is preferred because of cost and excellent efficacy, but some prefer ceftiofur because of injection-site swelling and longer withdrawal period with oxytetracycline. Tulathromycin (2.5 mg/kg SC) and Florfenicol (40 mg/kg SC) are also effective as one-time treatments. Ceftiofur, 1 to 1.1 mg/kg BW IM, or procaine penicillin G, 22,000 IU/kg BW IM twice daily, or once daily for 3 consecutive days, are effective but need multiple treatments. Sodium sulfadimidine (150 to 200 mg/kg BW) solution given by IV injection is highly effective. Sulfabromomethazine at the rate of 30 g/kg grain was given for two consecutive days to calves weighing 150 kg, and results were excellent. Sulfonamides are not approved for use in lactating dairy cattle in many countries.

### Local Treatment

**Local treatment** necessitates restraint of the affected leg, and this procedure is greatly facilitated by a restraint table or the administration of a very small dose of xylazine. The foot is scrubbed, all necrotic tissue is curetted away, and a local dressing is applied under a pad or bandage. Any **antibacterial**, and preferably **astringent**, dressing appears to be satisfactory. A wet pack of 5% copper sulfate solution is cheap and effective. Any suitable antibacterial ointment preparation may be applied and secured with a bandage, which may be left on for several days. The main advantage of local treatment is that the foot is cleaned and kept clean. If conditions underfoot are wet, the animal should be kept stabled in a dry stall.

In cattle running at pasture, or in the case of large numbers of feedlot cattle, examination of the foot and local treatment are often omitted because of the time and inconvenience involved. However, identification of the animal with a marker is considered necessary in outbreaks to avoid unnecessary confusion in the days following, and examination of the foot is deemed necessary to ensure that foreign bodies are not involved. Local treatment may not be necessary in the early stages of the disease if the animal can be prevented from gaining access to wet, muddy areas.

### Surgical Drainage

Surgical drainage may be necessary in refractory cases or when complications with spread to deeper tissues have occurred.

### CONTROL

Prevention of foot injuries by filling in muddy and stony patches in barnyards and lanes will reduce the incidence of the disease. Lanes and bedding should be kept clean and dry. The incorporation of biotin in the diet, although reducing the incidence of lameness caused by white-line lesions, has no effect on the incidence of interdigital phlegmon.

### Footbaths

Provision of a footbath containing a 5% to 10% solution of formaldehyde or copper sulfate, in a doorway so that cattle have to walk through it twice daily, will practically eliminate the disease on dairy farms. A mixture of 10% copper sulfate in slaked lime is often used in the same manner. Similar measures can be adopted for small groups of beef animals; however, it is thought that providing dry footing and removing abrasive objects provides more effective control than footbaths.

### Antibacterials

Feeding chlortetracycline to feedlot cattle 500 mg/head per day for 28 days, followed by 75 mg/d throughout the finishing period, has been recommended, but controlled comparative trials have not been carried out. The

feeding of organic iodides (200 to 400 mg) of ethylene diamine dihydroiodide (EDDI) in the feed daily has been used for many years as a preventive against the disease in feedlot cattle. Feeding EDDI in an ad libitum salt mixture at a level of 0.156% EDDI (0.125% iodine) is also effective in reducing the incidence of footrot. Dosing cattle daily with zinc sulfate by including it in the feed has no prophylactic effect.

### Vaccination

Commercial vaccines against bovine interdigital phlegmon are available, but their efficacy has not been established in controlled comparative trials. A mineral-oil adjuvant vaccine containing whole cells or fractions of *F. necrophorum* provided about 60% protection from experimentally induced interdigital phlegmon. A similar vaccine containing *Bacteroides nodosus* appeared to reduce the severity of lesions but not the incidence compared with nonvaccinates.

### TREATMENT AND CONTROL

#### Treatment

- Oxytetracycline (20 mg/kg IM/SC of long-acting formulation) (R-1)
- Ceftiofur crystalline suspension (long-acting formulation, 6.6 mg/kg, once) (R-1)
- Tulathromycin (2.5 mg/kg SC, once) (R-1)
- Florfenicol (40 mg/kg SC, once) (R-1)
- Procaine penicillin 22,000 IU/kg IM daily for at least 3 days (R-2)
- Oxytetracycline (6.6 mg/kg IM daily for 3 days) (R-2)
- Ceftiofur sodium (1.1 or 2.2 mg/kg IM BW daily for 3 days) (R-2)
- Florfenicol (20 mg/kg IM, repeated at 48 hours) (R-2)

#### Control

- Decrease moisture on the ground by scraping and improving drainage (R-1)
- Minimize exposure to items that traumatize the interdigital cleft (R-1)
- Vaccination using a bacterin against *Fusobacterium necrophorum* and leukotoxin (R-3)

### FURTHER READING

- Apley MD. Clinical evidence for individual animal therapy for papillomatous digital dermatitis (hairly heel wart) and infectious bovine pododermatitis (footrot). *Vet Clin North Am Food A*. 2015;31:81-95.
- Nagaraja TG, Narayanan SK, Stewart GC, Chengappa MM. *Fusobacterium necrophorum* infections in animals: pathogenesis and pathogenic mechanisms. *Anaerobe*. 2005;11:239-246.

### REFERENCES

1. Bennett G, et al. *Res Vet Sci*. 2009;87(3):413.
2. Sun DB, et al. *African J Microbiol Res*. 2011;5:667.
3. Sweeney M, et al. *Vet Ther*. 2009;10:E1.
4. Cha E, et al. *Prev Vet Med*. 2010;97:1.
5. Main DCJ, et al. *Vet Rec*. 2012;doi:10.1136/vr100533.

6. Sun D, et al. *PLoS ONE*. 2013;8:e55973.
7. van Donkersgoed J, et al. *Vet Ther Res Applied Vet Med*. 2008;9:157.

## BOVINE DIGITAL DERMATITIS, PAPILOMATOUS DIGITAL DERMATITIS OF CATTLE (MORTELLARO'S DISEASE), FOOT WARTS, HAIRY FOOT WARTS, "HEEL WARTS"

### SYNOPSIS

**Etiology** Causative agent(s): primary causative agents are thought to be anaerobic spirochetes *Treponema medium*/*Treponema vincentii*-like, *Treponema phagedenis*-like, and *Treponema denticola*/*Treponema putidum*-like, and other foot-adapted *Treponema* strains. Other bacterial may play a role in establishing clinical disease.

**Epidemiology** Worldwide disease after first report in 1974; more common in dairy cattle housed in wet, unhygienic conditions.

**Clinical findings** Lesions located most commonly on caudal aspect of hindfeet; early lesions have a red, granular (strawberry-like) appearance and are very painful; mature lesions are less painful and more proliferative and may have long wart-like projections.

**Diagnostic confirmation** Clinical signs are sufficiently diagnostic; no additional diagnostic tests required.

**Treatment** Sustained topical treatment with topical bandage over gauze with 10 mL oxytetracycline in oil (100 mg/mL) is considered the gold standard treatment.

**Control** Footbaths—5% copper sulfate (not in European Union), 5% formaldehyde—new proprietary formulations are under active development; vaccination ineffective.

Digital dermatitis (DD) is a painful, erosive, papillomatous-like lesion of the skin of the feet of cattle. The region proximal and adjacent to the interdigital skin midway between the heel bulbs of the plantar surface of the foot is most frequently affected. Early lesions are circumscribed, with a red, granular appearance and variable degrees of proliferation of filiform papillae. Mature lesions tend to be more proliferative and may have long papillary fronds. Lameness is severe, particularly when evaluated against the size and location of the lesion, and economic losses result from decreased milk production and reproductive performance.

### ETIOLOGY

The etiology is uncertain, but it is very likely that anaerobic spirochetes in the genus *Treponema* play a primary role in infection. A mixed population of gram-negative bacteria, including anaerobes, microaerophilic

organisms, and spirochetes, has been demonstrated in or isolated from DD lesions, but spirochetes are consistently observed in superficial lesions and deeper layers of the epidermis in cattle with DD. At least 17 different spirochetal phylotypes within the genus *Treponema* have been identified in lesions,<sup>1</sup> and the most common isolates are *Treponema medium*/*Treponema vincentii*-like; *Treponema phagedenis*-like; and *Treponema denticola*/*Treponema putidum*-like, with the latter being recognized as a new species, *Treponema pedis*.<sup>2,3,4</sup> Other bacterial may play a role in establishing clinical disease. PCR measurement of a small subunit of ribosomal RNA or its gene (16S rDNA) has been used for phylogenetic analysis, with *T. phagedenis*-like or *T. denticola*/*T. putidum*-like in 51% of DD cases and *T. medium*/*T. vincentii*-like in 38% of DD cases.<sup>2,5</sup> The phylogenetic cluster distribution appears to vary from country to country, leading to the suggestion that the total amount of treponemes is an important determinant of disease outcome, with the presence of specific phylotypes being of lesser importance.<sup>6</sup> Quantitative 16S rRNA clonal analysis indicates that all DD isolates are more than 99% identical to *T. phagedenis*-like, which is an inhabitant of the human genital tract.<sup>7</sup> *Treponema* spp. have been isolated from the gingival tissue of 14% of dairy cattle, but only in the housing season and only in cattle with visible DD lesions, and from the rectal tissue of 15% of dairy cattle.<sup>8</sup> This finding suggests colonization of sites other than the foot in dairy cattle. Cow feces and environmental manure slurry have been shown to be potential reservoirs of treponemes that cause DS.<sup>9</sup>

A spirochete isolated from cases of severe virulent ovine footrot in Australia and the United Kingdom and Ireland is closely related to a treponeme isolated from human periodontitis and bovine digital dermatitis. This suggests the possibility of cross-species transmission, and that a number of spirochetes could be involved in the pathogenesis of either DD or severe virulent ovine footrot.

### EPIDEMIOLOGY

#### Occurrence and Prevalence of Infection

The disease was first described in Italy in 1974 as **Mortellaro's disease**. It occurs primarily in dairy cattle and has been reported as a cause of lameness in dairy cattle worldwide, although beef cattle can also be affected. Surveys of dairy farms in California in the United States found that 25% to 75% of farms have had the disease, and about 10% of cows have been affected, with a range from 1% to 99% of cows in affected herds.

Factors associated with high herd incidence of DD (>5%) include geographic location, herd size, type of land lactating cows accessed on a daily basis, flooring type where lactating cows walked, percent of cows born

off the farm, use of a primary hoof trimmer who trimmed cows' hooves on other farms, and lack of washing of hoof-trimming equipment between cows. It is likely that undisinfected hoof-trimming equipment plays a role in transmission of infection from farm to farm.<sup>10</sup> Seasonal differences occur and may be a result of a combination of weather, housing, and management. The incidence may be higher during the winter months, when the weather is cold and wet and cows are kept in confined housing, than during the summer months when cows are on pasture.

## Risk Factors

### Host Risk Factors

First-parity cows have the highest odds of DD, and the odds decrease, in a dose-effect manner, as parity increases. The odds of DD increase with increasing days in lactation.

Other risk factors include loose housing, slatted floors, housing under wet and unhygienic conditions, and the introduction of subclinically infected cows into susceptible populations. The plantar and palmar regions of the foot may be more conducive to the development of DD because these anatomic sites are exposed to more moisture. Exposure to slurry increases the permeability of the skin and therefore the susceptibility to DD.<sup>11</sup> Epidemiologic observations indicate that the risk of DD is associated with environmental conditions that cause moist feet in commercial dairy herds. Interdigital dermatitis and heel horn erosion predispose the foot to DD, and all three diseases appear to have similar causative mechanisms that focus on increased exposure of the foot to moisture.<sup>6</sup> Moreover, feet affected with clinical DD lesions have an increase prevalence in heel horn erosion, further supporting a common etiology for these foot conditions.<sup>12</sup> Nonhealing white-line disease and sole ulcers appear to be more common in herds endemically affected with DD,<sup>13</sup> and *T. medium*/*T. vincentii*-like is consistently isolated from these lesions.<sup>14</sup>

The greater incidence of the lesions in the hindfeet is considered to be associated with more exposure to deeper slurry during feeding times than the forelimbs. The plantar and palmar regions of the interdigital cleft are therefore more susceptible to being continually moist compared with the more open dorsal locations. The bovine gut and feces appear to be an important reservoir of infection,<sup>15</sup> but direct skin-to-skin contact could also be an important transmission route for DD treponemes.<sup>16</sup> The anatomic location of DD lesions also has an effect on the efficacy of topical treatment with antibiotics.

### Immune Mechanisms

*T. phagedenis*-like spirochetes isolated from active DD lesions in dairy cattle are associated with serum IgG<sub>2</sub> antibodies, and most react with lipopolysaccharide. Both the antibody and blastogenic responses were reduced in convalescent dairy cattle, suggesting the

immune response to the spirochetes has short duration. The presence of IgG<sub>2</sub> spirochete antibodies detected by ELISA does not necessarily describe an active immune protective response by affected cows but reflects prior infection and repeated exposures to treponemes.

Cattle and sheep with DD and severe virulent ovine footrot, respectively, and that may be infected by the same group of treponemes, have increased seropositivity rates to both treponeme isolates, with different patterns of reactivity between farms.

## Environmental and Management Risk Factors

Case-control studies in dairy farms indicate that the odds of having a higher proportion (>5%) of affected cows were about 20 times more likely in dairy farms with muddier corrals than in farms with drier ground surfaces in corrals. The disease appears to be more common in free-stall confined herds where feet are constantly exposed to moisture and manure conditions. The feet often become coated with a layer of dried feces, which may provide the anaerobic conditions necessary for bacterial growth.

Buying replacement heifers was associated with a 4.7-fold increase in the odds of a higher occurrence of disease than in herds that did not purchase heifers. There also may be a positive relationship between risk and the number of heifers purchased. Herd size was positively associated with the presence of the disease. Cows in dairy herds that used a footbath were less likely to have DD than those herds not using one. Animals housed in a straw yard were 3.2 times less likely to be affected compared with cattle on slatted floors. Feeding with a larger variety of dietary components (hay, milk, concentrates plus silage) was a protective measure.

### Pathogen Risk Factors

Molecular typing of DD-associated *Treponema* isolates has found some genetic relatedness to those of the related human-associated *Treponema* spp. associated with human periodontal disease. These *Treponema* strains have adhesion properties and produce high levels of chymotrypsin-like protease and high levels of proline iminopeptidase, which are major virulence factors.

### Economic Importance

The economic losses associated with the lameness accompanying DD in lactating cows include loss in milk production, the effects on reproductive performance, and the costs of treatment, including the time required to recognize the lesions, the costs of individual medication of affected cows if necessary, and the costs of construction and maintenance of a footbath. Lameness has an important effect on milk yield, with the total mean estimated reduction in milk yield per 305-day lactation being 360 kg. Lameness

has an important effect on reproductive performance. Dairy cows with claw lesions have a higher calving-to-conception interval and a greater number of services per conception.

## PATHOGENESIS

DD is an acute or chronic ulcerative lesion of the skin of the bulbs of the heel or interdigital cleft. In the early stages of the lesion, there is loss of superficial keratin, with a concurrent thickening of the epithelium by both hyperplasia and hypertrophy of epithelial cells. Superficial layers are eosinophilic and undergo necrotic change with the appearance of small holes. Large numbers of spirochetes are present around the holes. Loss of superficial layers of keratin stimulates epidermal proliferation and hyperplasia. In advanced cases, large numbers of spirochetes infiltrate the eroded dermis and may destroy the epidermis. DD is characterized by erosion of the superficial layers of the epidermis, epithelial hyperplasia and hypertrophy, pain, and mild swelling. Lesions usually occur on the hindfeet and are prone to bleeding. Early lesions are circumscribed with a red, granular (strawberry-like) appearance and variable degrees of proliferation of filiform papillae. Mature lesions are more proliferative and may have long wart-like projections, thus the term "hairy wart" disease.

## CLINICAL FINDINGS

DD typically occurs in dairy cattle as lameness episodes of variable severity. Affected cattle can be lame and reluctant to move. The affected limb is often held trembling in partial flexion as if the animal is in pain. Less severely affected limbs are rested on the toes and animals may walk on their toes, which become markedly worn and may even expose the sensitive laminae. Affected cattle lose weight and may not eat normally if they have to walk some distance to obtain feed. Milk production may decline if the lesions are severe enough.

Clinical inspection of the foot has been the most effective diagnostic procedure. Lesions are confined to the digits and do not occur above the dewclaws. The feet of the hindlimbs are most commonly affected. The plantar surface of the feet is most commonly affected, but the palmar aspects may also be involved. The majority of lesions are medium to large, measure 2 to 4 cm across at their largest dimension, and are **located on the skin at its junction with the soft perioplic horn of the heel and midway between the two claws**. Most lesions are situated proximal and adjacent to the plantar/palmar interdigital space and rarely involve the interdigital skin. The surface of the lesion is moist, prone to bleeding, and intensely painful to the touch. The lesions are circular to oval in shape, raised, and variable in color and in degree of papillary proliferation. The washed



surfaces are typically red and granular or a composite of white–yellow, gray, brown, or black papillary areas mixed with red granular areas (strawberry-like) (Fig. 15-11). Filiform papillae commonly protrude from the surface of the lesions. Most lesions are circumscribed or delineated by a discrete line of raised hyperkeratotic skin with long wart-like projections. The lesions are restricted to the skin and do not extend into the deeper soft tissues. If untreated, DD can persist for months associated with persistent lameness, reduced milk production, impaired reproductive performance, and premature culling.

More advanced lesions may lead to progressive separation of horn from the sensitive laminae, resulting in a typical underrun sole that may extend forward from the heel to reach halfway to the toe. Outbreaks of the disease may occur in dairy herds, in which up to 75% of all cows may be affected over a period of several months.

The presence and nature of any DD lesions on the plantar aspect of the foot are categorized using a scoring system.<sup>17</sup> The scoring system utilizes the size of the lesion, pain reaction, and clinical appearance and consists of five categories:

- M0, normal skin, no signs of disease
- M1, small (0.5 to 2 cm in diameter) DD lesion that is usually not painful
- M2, erosive hyperemic DD lesion greater than 2 cm in diameter that is usually painful on palpation (Fig. 15-11)
- M3, healing stage of M2 manifest as the presence of a scab with minimal pain
- M4, hyperkeratotic cutaneous DD lesion that is usually not painful on palpation (Fig. 15-11)

The consensus view is that lesion progression proceeds as follows: M0 → M1 → M2 → M3 → M4, although definitive experimental evidence is lacking. The duration of M3 appears to be very short. Lesion area (as measured by digital photography) appears to provide the most sensitive measure of treatment efficacy but has not been frequently applied.

A screening method for the detection of lesions of dairy cattle has been described. At the milking parlor and once the cows are in place for milking, a water hose is used to wash the cows' feet. Then, using a powerful flashlight, the digits are carefully inspected for DD lesions. A DD case is defined as a cow with a circular or oval-shaped, well-demarcated, alopecic, moist, erosive foot lesion, surrounded by a white hyperkeratotic ridge or hypertrophic hairs. Lesions bleed easily and are very painful. When struck by a concentrated jet of water from a hose, the animal frequently reacts by pulling the foot away and sometimes shaking it. The screening method has a sensitivity of 0.72 and a specificity of 0.99. This method can be approximated by turning a parlor hose fully on and using the following scoring system: (0) no movement of the foot after application of the water stream; (1) cow picks up foot and returns it to the floor within 2 seconds of application of the water stream; (2) cow picks up the foot and holds the foot up above the floor for more than 2 seconds. Use of a borescope (an extended rigid tube that provides a focused visual image of the foot at the end of the scope) in the milking parlor does not provide any additional diagnostic information to that provided by application of a water hose to wash the cows' feet.<sup>18</sup>

Infrared thermography does not appear to be of clinical value in detecting DD lesions and is of marginal clinical value in detecting other skin and claw lesions.<sup>18</sup> Improvement in clinical utility can be obtained by examining clean feet and comparing hindfeet to front feet,<sup>19</sup> but these requirements make the test impractical.

## CLINICAL PATHOLOGY

### Detection of Organism

Smears of the exudate and scrapings of the surface of the lesions are submitted for culture and for staining for spirochetes. Culture is extremely difficult, which has resulted in the increased application of PCR to identify the presence of spirochetes.

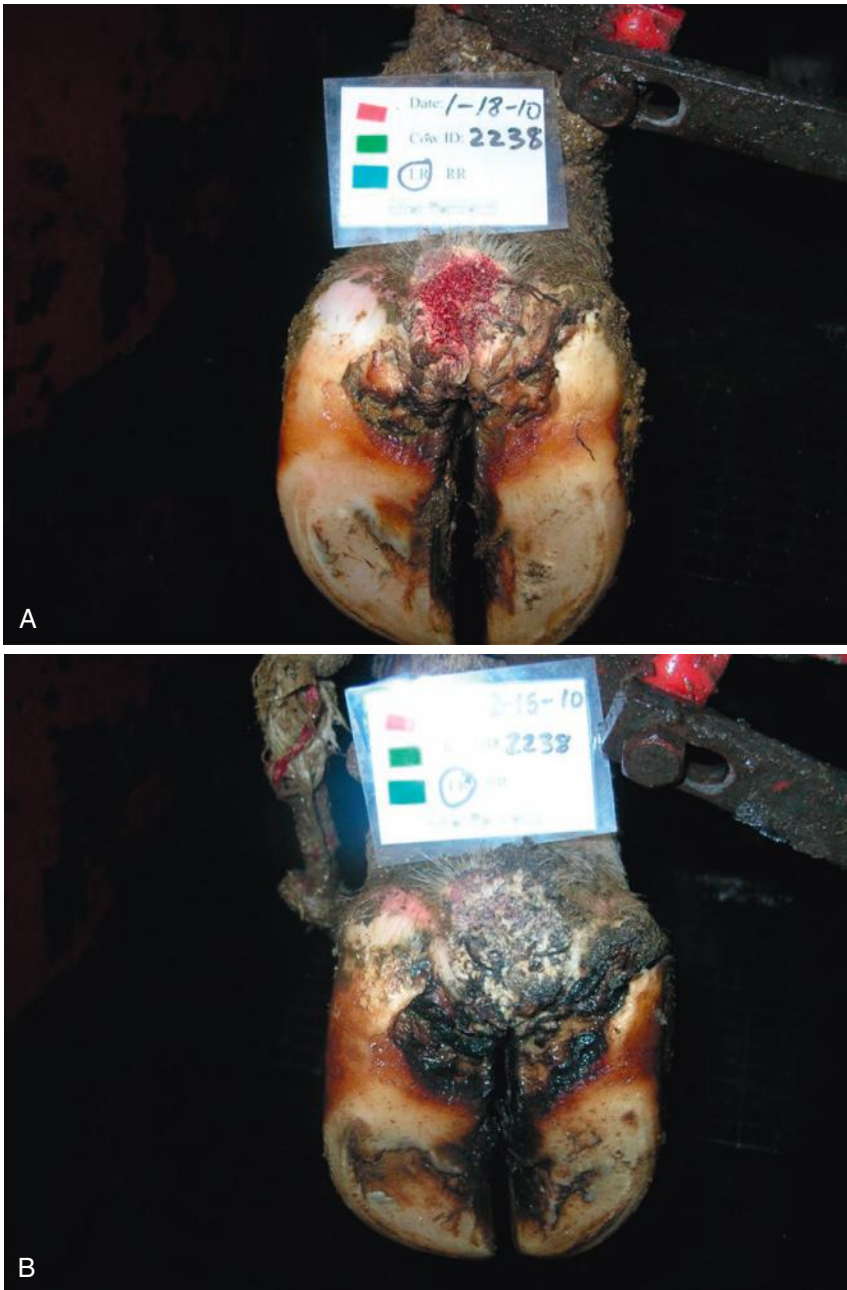

**Fig. 15-11** Progression of a painful M2 lesion (A) to a mature M4 lesion accompanied by heel horn erosion (B) 4 weeks later on the same foot of a 3-year-old Holstein–Friesian cow. Pictures generously provided by Dr. Tessa Marshall, United States.

Dark-field microscopy of the scrapings may reveal profuse motile spirochetes with vigorous rotational and flexing movements. Biopsy specimens of the lesions can be submitted for histologic examination and special silver staining to identify the spirochetes.

### Serology

Using an ELISA, in cattle with DD, there is a significant humoral response to certain strains of spirochetes isolated from lesions.<sup>20</sup> Animals without DD lesions show little or no response.

### PATHOLOGY

The majority of lesions are 2 to 4 cm across their largest dimension, circular to oval, raised, and variable in color. Washed surfaces are typically either extensively red and granular or a composite of white–yellow, gray, brown, and/or black papillary areas interspersed with red granular areas. The surface of the lesions is covered by filiform papillae, 0.5 to 1 mm in caliber and 1 to 3 mm in length. Most lesions are characteristically circumscribed or delineated by a discrete line of raised hyperkeratotic skin, often bearing erect hairs 2 to 3 times longer than normal. The surfaces are also partially to completely alopecic, moist, prone to bleed, and intensely painful to touch. Histologically active lesions are characterized by zones of acute degeneration, necrosis, and inflammatory cell infiltration within the stratum corneum, usually associated with focal thinning. Using immunocytochemical staining and PCR of lesion biopsies, *Treponema* spp. has consistently been identified.

### DIFFERENTIAL DIAGNOSIS

Digital dermatitis must be differentiated from the following:

**Interdigital dermatitis**—moist, gray thickening of the skin, with focal areas of shallow ulceration and hyperkeratosis. It is less painful and rarely has a granular, tufted, or papillomatous surface.

**Heel horn erosion (slurry heel)**—occurs commonly in dairy cows standing for long periods in slurry. The intact smooth horn of the heel develops deep, black fissures, which may become totally eroded. There is no liquefaction necrosis of keratin characteristic of digital dermatitis.

**Interdigital necrobacillosis (footrot)**—a necrotizing infection of the interdigital skin. There is marked painful, deep swelling of the tissues of the interdigital cleft; cracking of the skin may occur, with release of a foul-smelling discharge. Response to treatment with antimicrobials is good unless the lesion is advanced.

**Verrucose dermatitis**—occurs in cattle kept in deep muddy yards and is characterized by marked painful proliferative dermatitis of the plantar surface of pastern from the bulbs of the heels to the fetlocks. *Fusobacterium*

*necrophorum* is usually present in the lesions. Affected cattle are lame and respond to topical treatment and use of a footbath with a suitable antimicrobial.

**Interdigital fibroma (corn)**—develops from the fold of skin adjacent to the axial wall of the hoof in the interdigital space. The lesion consists of firm fibrous tissue and may extend the entire length of the interdigital cleft. Lameness is caused by the presence of the corn in the interdigital cleft; advanced corns must be removed surgically.

### TREATMENT

Treatment and control of DD have used two main approaches: (1) individual treatment of lesions by application of a topical antibiotic or disinfectant at the lesion site or, less frequently, parenteral antibiotic treatment, or (2) herd treatment using footbaths.<sup>21,22</sup> Evaluation of treatment efficacy is challenging because the M2 lesion appears to have a much higher level of infectivity than other lesion categories. Mathematically derived models of transition rates indicate that the speed in identifying acute M2 lesions and the efficacy of treatment of M2 lesions play important roles in determining whether lesions become more severe or heal.<sup>17</sup> The challenge is that accurate diagnosis requires clinical inspection of the foot, which is labor intensive.<sup>20</sup> Consequently, efficacy studies are frequently confounded by case definitions. Many treatments have not undergone rigorous evaluation and are likely to be ineffective. As an example, a survey of 65 French dairy farmers identified 30 different products that were used for individual treatment of DD and 31 products that were used for herd treatment of cows with DD.<sup>23</sup> The large number of treatments emphasizes the need for more randomized clinical trials related to treatment and control of DD.

#### Topical Antimicrobials

The consensus view is that the gold standard treatment is topical antimicrobial application with 10 mL of long-acting oxytetracycline (200 mg/mL in an oil base) in cotton ball or gauze, covered by a bandage, resulting in 2 g of tetracycline applied per treatment. The oil formulation is thought to help retain the antimicrobial in the gauze, resulting in sustained topical antimicrobial exposure. This treatment protocol does not result in detectable milk residues, and field efficacy is supported by in vitro susceptibility results; however, this treatment is not practical when large numbers of animals are affected. Moreover, there is one report that this treatment protocol resulted in a low healing rate in cows with a large lesion size in an endemic herd that had long-term application of tetracycline for treating DD.<sup>24</sup> An alternative equivalent treatment that does not require a bandage is application of a tetracycline paste consisting of 175 mL of propylene glycol,

175 mL of vinegar, and 150 g of tetracycline hydrochloride applied directly to the lesion with a paintbrush, resulting in 2 to 5 g of tetracycline applied per treatment.<sup>25</sup> This treatment protocol exposes more tetracycline to the environment than treatment involving application of a foot bandage. In general, application of a bandage over the lesion after application of a treatment should result in longer topical application times, and consequently it should be expected that a topical treatment followed by bandaging should be more effective than topical spray without bandaging.<sup>26</sup>

In vitro studies have identified the following minimum bactericidal concentrations for 90% of *Treponema* spp. isolated from DD lesions:<sup>2,7,16</sup> penicillin G (<0.06 to 0.19 µg/mL), erythromycin (<0.06 to 0.19 µg/mL), ampicillin (<0.06 to 4 µg/mL), oxytetracycline (0.5 to 6 µg/mL), ceftiofur (6 to 8 µg/mL), spectinomycin (48 µg/mL), lincomycin (8 to 48 µg/mL), enrofloxacin (8 to 192 µg/mL), rifampin (>128 µg/mL). These results support the routine use of topical oxytetracycline and suggest that topical lincomycin will be ineffective and that topical macrolides might provide an effective treatment.

Topical antimicrobial sprays or ointments are used on individual animals after the lesions have been cleaned. Direct spraying of the lesions with oxytetracycline at 25 mg/mL in 20% glycerine in deionized water once daily for 5 days using a garden-type spray applicator was effective. Only affected cows and individual lesions should be treated. The anatomic location of DD lesions has an effect on the efficacy of topical treatments. The use of oxytetracycline solution (25 mg/mL in distilled water) as a topical spray on cows with DD lesions was most effective on lesions located on the heels or dewclaws compared with those in the interdigital cleft; this result confirms the obvious conclusion that topical treatments need to be applied directly on the lesion and not near the lesion to be effective.

Oxytetracycline solution (100 mg/mL), acidified ionized copper solution, acidified sodium chlorite, or placebo given as a topical spray three times daily, after washing the lesions, for 3 weeks was effective in decreasing the lameness associated with the disease. In a Swedish dairy herd, topical oxytetracycline was more effective for the treatment of DD in cattle with heel-horn erosion than hoof trimming alone and more effective than glutaraldehyde. The use of an oxytetracycline solution topically at doses of 15 mL of a solution containing 100 mg oxytetracycline/mL sprayed twice daily for 7 days, or a one-time application of a bandage of cotton soaked with 20 mL of a solution containing 100 mg oxytetracycline/mL, has a low risk of causing volatile antibiotic residues in milk. Topical treatment with chlortetracycline cured painful digital dermatitis lesions at 79% per week (M2 to other categories).<sup>27</sup>

Lincomycin at a dose of 25 mL of a solution containing 0.6 mg lincomycin/mL or valnemulin at a dose of 25 mL of a solution containing 100 mg/mL valnemulin, given as an individual topical spray for two treatments 48 hours apart, resulted in significant improvement within 14 days after the first treatment.

### Nonantibiotic Topical Formulations

The efficacy of oxytetracycline has been compared with nonantibiotic solutions, a commercial preparation of soluble copper, peroxide compound and a cationic agent, 5% copper sulfate, acidified ionized copper solution, hydrogen peroxide–peroxyacetic acid solution, and tap water for the treatment of DD. The commercial formulation of soluble copper, peroxide compound, and a cationic agent appeared to be as effective as oxytetracycline. A nonantimicrobial cream containing soluble copper with peroxide and a cationic agent was compared with topical lincomycin. The efficacy of the treatments was not different for decreasing pain or lesion activity, but lincomycin was more effective in decreasing lesion size and preventing recurrence. Cows with 3 or more lactations were more likely to have a healed lesion at 29 days compared with first- and second-lactation cows.

The efficacy of a number of disinfectants, including proprietary formulations, has been evaluated *in vitro*. A 5% copper sulfate solution was extremely effective in killing *Trepone* spp., but its effectiveness was markedly affected by the presence of manure.<sup>28</sup> Organic chemicals such as glutaraldehyde and formaldehyde (formalin) were effective *in vitro* and have the benefit of being degraded in manure, but they are not as effective as 5% copper sulfate. Salicylic acid applied under a bandage is effective.<sup>26</sup> A nonantibiotic proprietary formulation based on a reduced soluble copper solution, peroxide compound, and a cationic agent was most effective for the treatment of DD, once daily for 5 days, compared with other similar formulations and oxytetracycline.

A nonantibiotic paste, Protexin Hoof-Care, containing formic acid (6.8%), acetic acid (3.74%), copper (3.29%), and zinc sulfate (0.40%), and essential oils (peppermint/eucalyptus, 0.16%) with a pH of 3.5 has been compared under controlled conditions with topical oxytetracycline and is considered an effective alternative to the antibiotic for the treatment of DD. Only one topical application is required after cleaning the lesion. Advantages include the following: no prescription is required, no withdrawal time is required, and it does not result in any concerns about antibiotic residue in meat or milk.

### Cleaning the Surface of the Lesion

It is very important to wash and clean the surface of the lesion with a disinfectant

soap before the topical administration of any medication. Topical treatment failures are commonly associated with failure to adequately wash and clean the surface of the lesion.

### Bandaging the Lesion

Whether or not the lesion should be bandaged after cleaning and medicating is controversial. Bandaging requires additional restraint to handle the leg and foot, is labor intensive, and is an additional cost. However, field observations indicate topical treatment under a bandage is particularly effective, with most cows showing remarkable improvement in 24 to 48 hours. Furthermore, when properly applied, the bandage and the topical medication have the potential of reaching lesions in the interdigital cleft.

### Antimicrobials Parenterally and Topically

Antimicrobial therapy is indicated and effective, and various methods of administration have been used, including parenteral and topical application in individual animals and footbaths for medication of large numbers of animals.

### Parenteral Antimicrobials

Although parenteral antibiotic treatment can be effective (depending on the antimicrobial class), milk withdrawal and cost are major concerns regarding this being a routine recommendation. Procaine penicillin, at 18,000 U/kg BW IM twice daily for 3 days, or intramuscular ceftiofur sodium at 2 mg/kg daily for 3 days, was highly successful for the treatment of DD in dairy cattle in California. IV regional administration of tetracycline hydrochloride into the lower lateral digital or median vein after application of a tourniquet proximally on the limb provides has been used<sup>29</sup> but appears to provide a much more complicated treatment protocol than topical tetracycline and bandage. However, the use of parenteral antimicrobials on an individual basis is labor intensive, costly, and not feasible when large numbers of animals are involved. In addition, drug residues in the milk are more likely when animals are treated parenterally. Recurrence after treatment may also occur. In one report, the lesions recurred in 18% of cows treated with antibiotics parenterally.

### Footbaths

Some veterinarians prefer to focus treatment protocols on footbaths. The benefits of footbaths include mass treatment and a potential decrease in the transmission of infection from carrier cows to noninfected animals. Footbaths containing antimicrobials and germicides have been used for treatment of groups of animals and for control of the disease. The most important benefit of using footbaths is that all animals are treated for DD at the same time. Types of footbaths

include walk-through and stand-in (stationary). The walk-through footbath, commonly located in milking-parlor exit lanes, is most popular in loose housing systems. Portable walk-through footbaths constructed of rubber, fiberglass, or hard plastic are also available and can be relocated as needed. The portable footbath is also the most convenient type for individual treatment situations that may involve bathing two, or possibly all four, feet for prolonged periods. Unfortunately, only a small number of randomized clinical trials have been published that document the efficacy of footbath solutions or topical antiseptic solutions in treating and preventing DD in lactating dairy cows. Copper sulfate is the most commonly used antiseptic footbath solution to treat and control DD because of its widespread availability, low cost, and ease of use. Repeated topical application of 8% copper sulfate solution has been shown to be effective in healing DD lesions, but is not as effective as daily application of a topical chlortetracycline spray to the lesion.<sup>30</sup> Copper sulfate footbaths have been shown to have some efficacy at reducing DD lesions, whereas other studies have shown little to no response. A 2015 systematic review<sup>31</sup> identified only one study that clearly demonstrated the efficacy of copper sulfate footbaths in decreasing the number of cattle with DD lesions; however, that one study provided unequivocal evidence of efficacy.<sup>32</sup> This study demonstrated that a 5% copper sulfate footbath solution applied at 4 consecutive milkings each week was effective in healing DD lesions but did not alter the new infection rate of cows with DD.<sup>32</sup> Copper sulfate footbaths also help to harden the horn on the foot,<sup>33</sup> but it is unclear what role this might play in preventing or treating DD. An acidified ionized copper sulfate footbath solution has been shown to be superior to a 4% formaldehyde (formalin) footbath in preventing new cases of DD.<sup>34</sup> Negative aspects of formaldehyde use include irritation to mucous membranes and carcinogenic effects in humans.<sup>33</sup>

After 150 to 300 cows pass through, the copper sulfate solution in the footbath is thought to become ineffective and is disposed of by land application. Government agencies have expressed concern that the frequent application of CuSO<sub>4</sub> solutions in footbaths will result in unacceptably high concentrations of copper in the soil; for example, the use of CuSO<sub>4</sub> solutions in footbaths has been restricted to low concentrations (0.5% CuSO<sub>4</sub>) in the Netherlands,<sup>27</sup> and 5% CuSO<sub>4</sub> footbath solutions are not permitted in the European Union. There is therefore widespread interest in developing alternative antiseptic solutions for the treatment and control of DD in dairy cattle. A well-controlled study in Denmark failed to document efficacy of commercially available hoof-care products containing glutaraldehyde, quaternary ammonium compounds,



or organic acids (acetic acid, peracetic acid, and hydrogen peroxide) in treating and preventing DD in dairy cattle.<sup>35</sup>

Optimal footbath dimensions are 3.0 to 3.7 m long, 0.5 to 0.6 m wide, and a 28-cm step-in height.<sup>36</sup> Proper construction includes systems for efficient drainage, cleaning, and refilling. Footbaths should be filled to a depth of at least 10 cm (4 in.) to ensure coverage of the typical lesion site for DD. The capacity of a rectangular footbath varies according to its dimensions, which can be calculated using the formula: width × length × depth × 7.46 = capacity in gallons. (Multiplying the number of gallons by 3.8 will provide capacity in liters.) The size of the footbath needed will depend on the number of feet that will be treated with the system. Footbaths must be carefully monitored for excessive contamination with dirt and feces.

Not only is the optimal footbath formulation unknown, but the optimal footbath frequency is also unknown. It has been suggested to use hygiene scoring to determine the frequency of foot bathing, whereby 20% of cows in the free-stall barn are scored; if more than 50% of the cows receive a score of “poor,” then the footbath frequency should be 5 days a week. The maximum number of cows that can be treated with a footbath varies according to the cleanliness of the cows, size of the bath, type and concentration of the medication used, housing system, weather conditions, and cow flow patterns. One recommendation suggests one footbath is sufficient for 150 to 200 cows and that DD may be controlled with a single monthly passage through a footbath containing 5 to 10 g/L of oxytetracycline or 1 to 3 g/L of lincomycin in 200 L of water or erythromycin at a rate of 50 g/150 L of water. A common recommendation is that a foot bath can treat 150 to 200 cows per change of solution, used three times per week in outbreaks, once every week or two for maintenance. Other observations, however, suggest that as few as 30 to 50 cows through a footbath may cause major shifts in pH and solids loading, and the largest increment of change in pH occurred with the passage of the first 32 cows through the bath.

Some footbaths are set up with a “pre-rinse” water bath to reduce contamination of the active ingredients by gross fecal matter on the feet of the cows. It is unclear whether this prerinse footbath provides any advantages. In summary, footbaths make biological sense for the treatment and control of DD. However, most of the recommendations regarding their use, footbath formulation, frequency of use, and optimum number of cows are based on uncontrolled field observations.

#### Antibiotics in Footbaths

Antibiotics are commonly used in footbaths for the treatment and control of DD, but their use should be discouraged. Use of footbath solutions containing antimicrobials,

such as tetracycline, chlortetracycline, lincomycin, or erythromycin, has decreased in popularity because of concerns over antimicrobial residues in the environment and the potential for increased antimicrobial resistance in bacteria. Most of the antibiotics require a veterinary prescription and must be used according to specific recommendations and compliance with withdrawal periods as necessary. Antibiotics in footbaths are rapidly neutralized in the presence of excessive contamination from mud and manure. This is a significant limitation in large herds or in housing situations in which muddy conditions are present.

Tetracycline in 6 to 8 g/L of water has been used in a footbath for treatment of DD. Tetracycline powder (324 g/lb) at 20 to 40 g per gallon (U.S.) to deliver 0.5% to 1% has been used. Lincomycin mix at 0.5 to 4 g/gallon (U.S.) is also used. A mixture of lincomycin and spectinomycin in 150 g/200 L of water for treatment and 125 g/200 L of water for control was also effective. Walking cows through a footbath containing erythromycin, at a concentration of 35 mg erythromycin/L, after two consecutive milkings is effective. Four days after treatment, four of the measured signs (exudation, reddening, creaminess, and pain) were all significantly improved.

#### Treatment Failure

The possible causes of treatment failure include inconsistent application of treatments or the failure to periodically retreat all feet of all cows in the herd every 2 to 3 months with a topical spray, improper formulation of the medication, the neutralization of the antibiotics by manure, and the inaccessibility of the medication when the lesion is in the interdigital cleft. In addition, ideally lesions should be washed and cleaned thoroughly before applying the medication.

#### CONTROL

Because the risk factors that predispose to the lesions are uncertain, specific environmental control strategies have not been examined using controlled field trials. Recurrence rates of DD vary from 40% to 52% after 7 to 12 months. Thus it makes biological sense to have an infectious disease control system in place in the herd to provide optimum control.

- **Housing, environment, and management.** The high incidence of the disease in dairy cattle in drylot and free-stall housing suggests that a high infection rate may be associated with high population density and contamination of bedding and the environment. Providing environmental conditions that promote clean and dry ground surfaces and bedding appears to be a logical strategy. Improving cow comfort by providing clean stalls, corrals, and alleys and dry and comfortable bedding, reducing the

stocking rate, and improving ventilation to allow drying of stalls and alleys may decrease the incidence and severity of clinical cases. Hoof trimming, mobile tilt tables, and livestock trailers should be thoroughly cleaned and disinfected to prevent potential transmission of the agent of DD. The optimal disinfectant has not been identified.

- **Biosecurity.** For herds that are free of DD, the most important control consideration is the purchase of herd replacements. According to the 1996 NAHMS survey in the United States, the odds of DD infection were 8 times greater in herds that purchased replacements from outside sources compared with those that did not. Herd replacements should be purchased from herds known to be free of DD. Quarantine procedures may be applicable but often impractical.
- **Footbath.** Successful control is possible by single passage of cattle through a footbath containing 5 to 6 g/L oxytetracycline or 150 g lincomycin/spectinomycin in 200 L water; however, use of antimicrobials in footbaths should be discouraged. For optimum results the heels of affected cows should be spray washed before entering the footbath. Repeating the footbath treatment in 4 to 6 weeks is recommended. Regular footbaths with 5% copper sulfate solution and formalin 3% to 5% solution once weekly, according to the incidence of the disease, may be necessary in certain circumstances. Regular inspection of the feet of cattle is recommended to monitor the occurrence of the lesions.
- **Vaccination.** There is no evidence that a vaccine is effective for the control of DD. An effective vaccine will be challenging to develop. Koch's postulates have not been fulfilled for DD, and natural immunity does not appear to be long lasting. Humoral immunity is elicited in cows with DD, and clinical disease is less common in older cows.

#### TREATMENT AND CONTROL

##### Treatment

Topical antimicrobial application with 10 ml of long-acting oxytetracycline (200 mg/ml) in cotton ball or gauze, covered by a foot bandage (R-1)

Application of a tetracycline paste consisting of 175 mL of propylene glycol, 175 mL of vinegar, and 150 g of tetracycline hydrochloride applied directly to the lesion with a paintbrush (R-2)

Direct spraying of lesions with oxytetracycline at 25 mg/mL in 20% glycerine in deionized water once daily for 5 days (R-2)

**Control**

Optimal footbath formulation and frequency of application is unknown; some evidence supporting use of weekly (or more frequent) footbaths with 5% copper sulfate solution (not permitted in the European Union) or formaldehyde 3% to 5% solution (R-2)

Footbath containing an antimicrobial (R-3)

Vaccination with *Treponema bacterin* (R-3)

**FURTHER READING**

- Apley MD. Clinical evidence for individual animal therapy for papillomatous digital dermatitis (hairy heel wart) and infectious bovine pododermatitis (footrot). *Vet Clin North Am Food A*. 2015;31:81-95.
- Rafaai W, Van Aert M, Abd El-Aal AM, Behery AE, Opsomer G. Infectious diseases causing lameness in cattle with a main emphasis on digital dermatitis (Mortellaro disease). *Livestock Sci*. 2013;156:53-63.

**REFERENCES**

- Rasmussen M, et al. *Vet Microbiol*. 2012;160:151.
- Evans NJ, et al. *J Clin Microbiol*. 2009;47:689.
- Sullivan LE, et al. *Vet Microbiol*. 2015;178:77-87.
- Klitgaard K, et al. *J Clin Microbiol*. 2013;51:2212.
- Evans NJ, et al. *Vet Microbiol*. 2008;130:141.
- Knappe-Poindecker M, et al. *J Dairy Sci*. 2013;96:7617.
- Yano T, et al. *J Clin Microbiol*. 2009;47:727.
- Evans NJ, et al. *Vet Microbiol*. 2012;156:102.
- Klitgaard K, et al. *Appl Environ Microbiol*. 2014;80:4427.
- Sullivan LE, et al. *Vet Rec*. 2014;doi:10.1136/vr.102269.
- Palmer MA, et al. *Animal*. 2013;7(10):1731.
- Gomez A, et al. *J Dairy Sci*. 2014;98:927.
- Kofler J, et al. *Vet J*. 2015;204:229.
- Sykora S, et al. *Vet J*. 2015;205:417.
- Zinicola M, et al. *PLoS ONE*. 2015;10(3):doi:10.1371/journal.pone.0120504.
- Evans NJ, et al. *Vet Microbiol*. 2012;156:102.
- Döpfer D, et al. *Vet J*. 2012;193:648.
- Stokes JE, et al. *Vet J*. 2012;193:679.
- Alsaad M, et al. *Vet J*. 2014;199:281.
- Gomez A, et al. *J Dairy Sci*. 2014;97:4864.
- Laven RA, Logue DV. *Vet J*. 2006;171:79.
- Nuss K. *Vet J*. 2006;171:11.
- Relun A, et al. *Animal*. 2013;7(9):1542.
- Nishikawa A, Taguchi K. *Vet Rec*. 2008;163:574.
- Cutler JHH, et al. *J Dairy Sci*. 2013;96:7550.
- Scultz N, Capion N. *Vet J*. 2013;198:518.
- Holzhauser M, et al. *Vet Rec*. 2008;162:41.
- Hartshorn RE, et al. *J Dairy Sci*. 2013;96:3034.
- Rodrigues CA, et al. *J Vet Pharmacol Ther*. 2010;33:363.
- Stevancevic M. *Acta Vet*. 2009;59:437.
- Thomsen PT. *J Dairy Sci*. 2015;98:2539.
- Speijers MHM, et al. *J Dairy Sci*. 2010;93:5782.
- Fjeldaas T, et al. *J Dairy Sci*. 2013;97:2835.
- Holzhauser M, et al. *Vet Rec*. 2012;193:659.
- Thomsen PT, et al. *J Dairy Sci*. 2008;91:1361.
- Cook NB, et al. *Vet J*. 2012;193:669.

**INFECTIOUS FOOTROT IN SHEEP****SYNOPSIS**

**Etiology** *Dichelobacter nodosus*. Strains vary in virulence to produce benign and virulent footrot.

**Epidemiology** Main source of infection is lesion discharge from other infected sheep. *D. nodosus* typically survives in the environment for only a few days. Highly contagious disease with high attack rate in warm, wet conditions. Lesions are present on both claws of the foot and commonly in more than one foot. Significant effect on productivity.

**Clinical findings** Inflammation of the skin at the skin-horn junction in the interdigital area with underrunning of the soft horn in benign (nonprogressive) footrot. Progresses to underrunning of the hard horn and inflammation of the sensitive laminae in virulent (progressive) footrot and severe lameness.

**Clinical pathology** Gram-stained smears and culture to confirm the presence of the organism; protease and polymerase chain reaction (PCR) tests for strain virulence.

**Diagnostic confirmation** Clinical.

**Treatment and control** Topical treatment with bactericides in footbaths at time of transmission to minimize new infections, parenteral antibiotics for treating virulent footrot, vaccination, culling. Goats and cattle can carry *D. nodosus* and so must be included in control programs.

**ETIOLOGY**

*Dichelobacter (Bacteroides) nodosus* is the essential causal pathogen. It is a highly specialized organism in the small taxonomic group, the Cardiobacteriaceae. *F. necrophorum* aids *D. nodosus* in the invasion of the foot and contributes in the inflammatory reaction. Two other bacteria, a treponeme originally known as *Spirochaeta (Treponema) penortha* and a motile fusiform bacillus, are commonly present in affected feet but are thought to have no primary etiologic importance.

The type IV fimbriae of *D. nodosus* are recognized as a major virulence factor, are highly immunogenic, and provide the basis for the classification of *D. nodosus* strains into two major classes based on the genetic organization of the fimbrial gene region, with class I containing strains of serogroups A, B, C, E, F, G, I, and M and class II consisting of serogroups D and H. The serologic diversity observed in the fimbriae is as a result of sequence variation in the fimbrial subunit protein and the fimbriae are the major immunoprotective antigens, although protection is serogroup-specific.

Within this typing scheme there are strains that have major and minor prevalence in the disease. For example, footrot introduced into Norwegian flocks around 2008 was predominantly serogroup A, with 96% of virulent isolates belonging to this serogroup.<sup>1</sup>

**EPIDEMIOLOGY****Geographic Occurrence**

Footrot of sheep is common in all countries where there are large numbers of sheep, except that it does not occur in arid and semiarid areas unless the sheep have access to wet areas such as subirrigated swales.

**Host Occurrence**

Sheep are the species principally affected, but goats are also susceptible. Infection has been identified in farmed red deer and in cattle and is considered the cause of overgrown and deformed claws in wild mouflon in Europe. With environmental conditions of moisture and warmth, the disease in sheep has a high attack rate, and a large proportion of a group of sheep can be affected within 1 to 2 weeks. Both claws of a foot and more than one foot (usually all) on the sheep will be affected. The disease is common, and in high-risk areas the prevalence of infected flocks is high.

**Source of Infection**

The source of infection of *D. nodosus* is discharge from the active or chronic infection in the feet of affected animals. The major reservoir of infection for virulent strains of sheep is other sheep because the isolates from cattle and deer generally produce the benign form of footrot in sheep. Culture has demonstrated that the organism does not usually survive in the environment for more than a few days, 2 weeks at the most, although PCR techniques suggest that maximum environmental survival could be up to 24 days.<sup>2</sup> It can survive virtually indefinitely in lesions on chronically infected feet.

Two classifications of footrot have been made based on the site of survival and perpetuation of the organism in a flock and the importance of this to control strategies:

- Virulent footrot (progressive footrot) and intermediate footrot**—strains survive between footrot transmission periods in pockets of infection in previously underrun ovine hoof
- Benign footrot (nonprogressive footrot)**—strains survive in the interdigital skin, and the organism can be demonstrated in the interdigital skin of a high proportion of asymptomatic sheep and cattle.

**Methods of Transmission**

Infection is usually introduced into a flock by the introduction of carrier sheep, although sheep can become infected from the environment when footrot-free sheep use yards, roads, or trucks that have been used by footrot-infected sheep in the immediate past. For example, transmission occurred when sheep were held for 1 hour in a yard that 4 hours previously had contained a flock of sheep in which less than 1% had footrot. Spread within a flock is facilitated by the flocking nature of sheep and heavy

environmental contamination around communal drinking and feeding areas. Spread from ewe to lamb in intensive systems can be rapid, within 5 to 13 hours.<sup>3,4</sup>

### Host Risk Factors

#### Age and Sex

Footrot occurs in sheep of all ages, with rams or ram lambs often more severely affected than ewes.<sup>4</sup> In a flock outbreak, the age-specific incidence and severity of lesions in ewes tends to increase with age, and older lambs have more severe lesions than younger lambs. Prior natural infection does not provide immunity at a subsequent challenge for sheep that have had the disease. However, sheep do vary in their resistance or susceptibility to footrot infection. This appears to be, in part, immunologically mediated, with the ability of some sheep to mount a strong T-cell response and to produce agglutinating antibodies to *D. nodosus* fimbriae being an important factor in conferring resistance to severe infection.

#### Breed

Merino sheep are the most susceptible to footrot. British breeds, particularly Romney Marsh, are less susceptible and suffer from a milder form of the disease; they respond better to vaccination by suffering fewer subsequent attacks of footrot but have worse reactions to a multivalent vaccine than Merinos. In the natural disease, some animals never become infected, a few become infected but recover, and most become infected and persist as chronic cases. There is evidence that this variation is genetically determined, and selection for resistance, based on exposure to the disease and rigorous culling of affected individuals, has been demonstrated in Merino, Corriedale, Romney, Perrendale, and Targhee breeds.<sup>4</sup> Substantial genetic variation in resistance to footrot has been demonstrated, both within flocks and between the progeny of different sires, among both Merino and Sottish Black-face breeds.<sup>5,6</sup>

### Environmental Risk Factors

#### Climate and Season

Moistness of the pasture and environmental temperature are major determinants for the transmission of footrot. Wetness and warmth favors persistence of the bacteria in pasture and increases the susceptibility of feet to injury and dermatitis, thus facilitating spread of the disease from carrier sheep. There must be continued moisture on the ground for transmission to occur. Thus in drier temperate climates, such as Australia, transmission tends to occur predominantly in the spring and, to a lesser degree, autumn. In cooler, wetter temperate climates, such as New Zealand and the United Kingdom, the transmission period can be much longer. The daily mean temperature must also be above 10° C (50° F) for transmission to occur, and

so in colder climates transmission is reduced or does not occur during the winter. There is a linear relationship between the prevalence of farms with footrot and yearly rainfall.

Transmission and outbreaks of footrot occur in winter in housed sheep when conditions underfoot are wet and in summer with sheep on irrigated pastures.

### Management

Any practice that concentrates sheep in small areas will favor spread of the disease when environmental conditions favor transmission. Routine foot trimming may increase risk of infection and clinical disease.

Failure to isolate introduced sheep until their footrot status has been determined, straying sheep, and the presence of at least one footrot-infected farm within a 1-km radius with severe footrot are confirmed risk factors for the introduction of footrot into a flock.<sup>7,8</sup>

### Pasture Type

Footrot is commonly associated with lush or improved, irrigated, and clover-dominant pastures. Long mature grass may result in interdigital abrasions as it is dragged through the interdigital space and facilitates infection, as may penetration of interdigital skin by barley grass seeds (*Hordeum murinum*). Skin penetration by larvae of the nematode *Strongyloides* spp. may also predispose to infection.

### Pathogen Factors

The major *D. nodosus*-encoded virulence factors that have been implicated in the disease are type IV fimbriae and extracellular proteases, and the fimbrial subunit gene, *fimA*, is essential for virulence.

There is considerable variation in the virulence of strains of *D. nodosus*. Some produce benign footrot, whereas others produce deep lesions that facilitate their survival and confound eradication programs. As a result, they have traditionally been subdivided into benign, intermediate, and virulent strains to conform with the types of clinical footrot they are associated with in the field. The virulence of each strain depends on its keratinolytic capacity; virulent strains produce more extracellular protease, and an earlier production of elastase, than benign strains. The separation of the hard horn of the claw from the germinal layer, which is a characteristic of virulent footrot, has been associated with infection with strains that produce a heat-stable protease with a single isoenzyme pattern, whereas benign strains have thermolabile protease. Infection associated with more than one strain is reported, and up to five serogroups including up to eight strains have been reported from a single foot.

The genome of *D. nodosus* has been fully sequenced,<sup>9</sup> and this has allowed further investigation of the factors that determine its

virulence. Acidic protease V2 (AprV2) is the main thermostable protease responsible for most elastase activity and differs from its benign counterpart, AprB2, by only a single amino acid.<sup>10</sup> It is one of three thermostable proteases that act synergistically, the others being AprV5 and a basic protease, BprV. AprV5 is needed to activate all three proteases, whereas BprV degrades hoof horn matrix more efficiently than its counterpart from benign strains, BprB.<sup>11</sup>

A molecular genetic analysis of *D. nodosus* isolates from four European countries, Switzerland, France, Germany, and Norway, found a perfect correlation between the clinical presentation of footrot and the presence of either AprV2 or AprB2.<sup>12</sup>

### Economic Importance

Benign footrot is generally considered to cause little if any economic effect, and its occurrence is confined to the warm, wet seasons. However, even benign footrot infections can depress body weight, wool growth, and wool quality in some countries, especially in Merinos.

In contrast, virulent footrot causes a severe loss of body condition, and this, combined with a moderate mortality rate, a reduction in wool production, the disruption of the general routine of the farm, and the expense of labor and materials to treat the disease adequately, makes footrot one of the most costly of sheep diseases. Estimates of the total annual cost to industry in Australia are estimated at \$32.3 m and \$12.1 m for virulent and benign footrot, respectively, and £24 m in Britain.<sup>13,14</sup> In addition, there are welfare concerns, societal pressures encountered by owners of footrot-infected flocks, and, in control areas, the community costs of statutory footrot control programs.

In controlled studies, virulent footrot causes an 11% depression in body weight and an 8% reduction in clean fleece weight of affected sheep. The magnitude of the loss can be related to the virulence of the infecting organism and the severity of disease.

The effects on body weight are most severe during the active transmission period of the organism and development of clinical disease, but there may be compensatory growth during the recovery period. Both greasy and clean fleece weight are significantly depressed by footrot, with a linear association between the extent of the depression and the severity of the disease. Wool fiber diameter is also decreased, which can partially compensate for decreased fleece weight in the final price for wool. Some sheep with severe disease may develop a break in the wool, which can then incur price discounts of up to 50%.

Feet of sheep affected with footrot are attractive to blowfly strike. Necrotic exudate with accompanying maggots from affected feet can be deposited on the fleece to result in a focus of body strike.



## PATHOGENESIS

**Maceration** of the interdigital skin from prolonged wet conditions underfoot allow for infection with *F. necrophorum*. This initial local dermatitis associated with infection with *F. necrophorum* at the skin and the skin–horn junction may progress no further, but the hyperkeratosis induced by this infection facilitates infection by *D. nodosus* if it is present. The preliminary dermatitis has been named “ovine interdigital dermatitis” and is also called “foot scald.”

### OVINE INTERDIGITAL DERMATITIS, FOOT SCALD

This disease is seasonal and occurs when moist conditions underfoot, or trauma from pastures or frost, produce maceration of the interdigital skin, allowing invasion by *Fusobacterium necrophorum*, a ubiquitous organism in feces and soil.

Lesions are in the interdigital space, where there is hyperemia, or swelling and blanching, and wetness of the interdigital skin. There is no, or only minimal, separation at the skin–horn junction (“underrun”). Lambs are more commonly affected, particularly in spring, but the disease can involve all ages of sheep. Most or all feet on a sheep are affected, and it is present in a large proportion of the age cohort of the flock.

In Australia and New Zealand, the disease is not usually associated with severe or chronic lameness and is often found incidentally when examining sheep for other reasons.

In Britain it is reported as a common cause of lameness, but this might reflect a lack of cultural differentiation from the less virulent forms of infectious footrot that can present with identical clinical findings. Examining Gram-stained air-dried smears of lesion material will reveal the absence of *Dichelobacter nodosus*.

Control is by avoiding grazing lambs on long grass or in muddy conditions. The disease will regress spontaneously when the pasture dries up or sheep are moved to drier paddocks, but it can be treated with topically applied oxytetracycline or by walking animals through a footbath containing 10% zinc sulfate (preferably standing in the solution for 1 to 3 minutes, then allowing the feet to dry on grating or in a woolshed) or 3% formalin.

Ovine interdigital dermatitis can predispose to infectious footrot or to foot abscess.

## Benign and Virulent Footrot

It is assumed that the pili of *D. nodosus* facilitate attachment of the organism to the epithelium of the foot. When the feet of sheep with interdigital dermatitis are colonized with a strain of *D. nodosus* that has little keratinolytic ability, there is underrunning of the soft horn but no further progression, and this infection has been given the name of benign or nonprogressive footrot. Benign

footrot cannot be easily distinguished on clinical examination from ovine interdigital dermatitis. Colonization with keratinolytic and virulent strains leads to the clinical disease of virulent footrot. The underrunning lesion is the result of keratolytic activity, and the associated inflammation is a consequence of a combined activity of *D. nodosus* and *F. necrophorum*. A designation of intermediate footrot is used to provide a midclassification of severity between benign and virulent footrot, with the classification of infected sheep into these categories based on a foot lesion scoring system (see following discussion). There is much difficulty in specifying exactly the characteristics of these clinical forms in natural outbreaks, partly because more than one strain is commonly involved, but also because the severity of the lesions is modulated by breed, previous treatments, and varying geographic and climatic conditions.

## CLINICAL FINDINGS

### Sheep

#### Virulent Footrot

In a flock, a sudden onset of lameness of several sheep is the usual presenting sign of footrot because the disease is not detected before this occurs. The pain associated with infection is severe, and affected sheep will limp or carry the affected leg. Usually more than one foot is affected, and affected sheep may graze on their knees.

On close examination the earliest sign of virulent footrot is swelling and moistness of the skin of the interdigital cleft and a parboiled and pitted appearance at the skin–horn junction in the cleft. This inflammation is accompanied by slight lameness, which increases as necrosis underruns the horn in the cleft. The underrunning starts as a separation of the skin–horn junction at the axial surface just anterior to the bulb of the heel and proceeds down the axial surface and forward and backward. There is destruction of the epidermal matrix beneath the hard horn, which is subsequently separated from the underlying tissues. In severe cases both the axial and the abaxial wall and the sole are underrun, and deep necrosis of tissue may lead to the shedding of the horn case. The separation may not be obvious on superficial visual examination but can be detected by trimming the feet with a knife or secateurs. There is a small amount of distinctive, gray, foul-smelling exudate, but abscessation does not occur.

Both claws of the one foot will be involved, and commonly more than one foot is involved. When extensive underrunning has occurred, lameness is severe. A systemic reaction, manifest by anorexia and fever, may occur in severe cases. Recumbent animals become emaciated and may die of starvation. Secondary bacterial invasion and/or fly strike may result in the spread of inflammation up the legs.

## Benign Footrot

Benign footrot is manifest with interdigital lesions, a break at the skin–horn junction, and separation of the soft horn, but the disease does not progress beyond this stage to severe underrunning of the hard horn of the foot. The interdigital skin becomes inflamed and covered by a thin film of moist necrotic material; the horn is pitted and blanching.

It is difficult to distinguish between an established infection with benign footrot and the early stages of virulent footrot. With virulent footrot, it is common to find all stages and severity levels of the disease in the same flock. A large number of sheep (e.g., 100 in large flocks or mobs) should be examined to differentiate benign from virulent footrot, and it may be necessary to reexamine the flock after a period of time to determine whether the disease has progressed to the virulent type.

## Scoring Systems

Several scoring systems, based on severity and persistence, have been devised to aid in epidemiologic and control programs and can be used to categorize the severity of disease, hence the virulence of associated strains of *D. nodosus*, within a flock. In the Australian system, a score of 0 (normal foot) to 4 (severe underrun) is allocated to each foot of each sheep, then the score is used to classify the severity of disease in that flock or a cohort.<sup>4</sup> Feet scored 0 have no evidence of necrosis or inflammation or cleavage of horn. Scores of 1 and 2 are confined to sheep with interdigital lesions, whereas a gradation of scores from 3 to 4 reflects progressive underrunning and separation of horn from the underlying lamina, with 3 representing underrunning of the soft horn. In this score system, most benign footrot cases score 1 or 2, with some allowance for scores of 3. Intermediate footrot in a cohort is defined when 1% to 10% of the cohort have a score of 4. Virulent footrot is defined by greater than 10% of the cohort with a score of 4. It has been suggested that the scoring system may not always be reliable because the severity of disease can be influenced by climate. However, a large field study in Australia found that a cohort of sheep with scores defining intermediate footrot maintained that clinical classification when moved to a climate that would have promoted the development of more severe disease. Evaluation of the repeatability of scoring systems has found that scoring is usually consistent within the same observer, but that differences can arise between observers through observer bias and different observer thresholds.<sup>15,16</sup>

## Symptomless Carriers

Symptomless carriers may be affected for periods of up to 3 years. Most such animals have a misshapen foot, and a pocket of infection beneath underrun horn can be found if

the foot is pared. A less common form of the chronic disease is an area of moist skin between the claws without obvious involvement of the claw.

### Goats

Footrot is associated with *D. nodosus* and is manifested by severe interdigital dermatitis. There may be some separation of the skin-horn junction at the axial surface, but the disease is less invasive, and there is much less underrunning of the horn of the sole or the abaxial surface of the foot compared with sheep.

### Cattle

Infection with *D. nodosus* is also associated primarily with a severe interdigital dermatitis, and there may be lameness. There is fissuring and hyperkeratosis of the interdigital skin, with pitting and erosion at the skin-horn junction in the cleft. There is also fissuring, pitting, and erosion on the horny bulbs of the heel. There may be underrunning at the heel, but it is usually minimal.

#### CONTAGIOUS OVINE DIGITAL DERMATITIS (CODD)

CODD is a relatively new disease described in the United Kingdom and is still poorly understood.<sup>17,18</sup>

It is manifest with severe, rapidly spreading lameness and is more common in adults than lambs. Commonly there is a history of poor response to conventional methods of footrot control. The initial lesion is a proliferative or ulcerative lesion at the coronet, with subsequent extensive underrunning of the hoof horn and, in some cases, complete separation of the hoof. Interdigital lesions are absent. It may affect only one claw on one foot. Spirochetes similar to the *Treponema* isolates from bovine digital dermatitis are associated with CODD lesions, but these are also recovered from heathy feet.<sup>19</sup>

*Fusobacterium necrophorum* and *Dichelobacter nodosus* may also be present in some flocks. Their contribution to CODD is unclear, although vaccination against *D. nodosus* had a mild protective effect against new CODD infections (32% compared with 62% against footrot).<sup>18</sup>

Response to formalin and zinc sulfate footbaths is poor, but the disease responds to long-acting parenteral amoxicillin.<sup>17,18</sup> Topical application of lincomycin and spectinomycin solutions has also been used.

#### CLINICAL PATHOLOGY AND NECROPSY FINDINGS

In countries that do not have a large sheep industry, identification of *D. nodosus* in most laboratories is made by examining an air-dried smear of exudate, taken from underneath some underrun horn at the advancing edge. Smears can be stained with Gram stain or a fluorescein-stained antibody.

In countries with larger sheep industries and where footrot is more common, culture of *D. nodosus*, examination of protease type, and the use of highly sensitive PCR tests are undertaken. PCR tests can be used to detect gene sequences and identify particular strains and are useful where eradication from flocks or areas is the aim.<sup>20,21</sup> Gene probes and nucleotide sequencing, to differentiate virulent from benign strains, are also used in regions with eradication programs and in epidemiologic studies.

The two most commonly used protease tests are the gelatin gel and elastase protease thermostability tests. A comparison of tests, using more than 2800 isolates collected from 12 flocks in southeastern Australia, found that 91%, 64%, and 41% were classed as virulent by the gelatin gel, elastase, and *intA* PCR tests, respectively.<sup>19</sup> The latter tests for an inserted genetic element that is unrelated to protease, and it was developed as a further test for cases where a gelatin gel test indicated a virulent *D. nodosus* isolate but this was inconsistent with a field assessment of benign footrot.<sup>22</sup>

Serum antibody develops as early as 2 weeks after natural infection, and the level obtained is proportional to the severity of the early clinical disease. The antibody response is not long lasting, falling to pre-infection levels within a few months after resolution of the foot lesions. An ELISA for serologic detection of infected sheep has some value for diagnosis of flock infection, but it lacks specificity and is inaccurate in older sheep and so is not routinely used.

**Necropsy** of sheep for diagnosis of footrot is not needed.

#### DIFFERENTIAL DIAGNOSIS

Diagnosis of virulent footrot is clinical, is based on a whole-flock approach, and postmortem examination is not necessary.

Because of the rigorous control measures required sometimes by law to control or eradicate infectious footrot of sheep, it is imperative that the diagnosis be made with great care. The greatest problem is in the identification of carrier sheep in the nontransmitting periods. A number of conditions may be confused with footrot, especially when they occur under the same environmental conditions (Table 15-4).

- **Foot abscess**—a major differential and can be present in several sheep in a flock at the same time. It usually affects only one foot, is not contagious, and is characterized by extensive suppuration. The abscess occurs in a single claw on the foot, and there is obvious local heat and pain on palpation.
- **Contagious ovine digital dermatitis**
- **Shelly toe**—the name given to a condition where there is separation of the wall of the foot in Merino sheep and occasionally in

other breeds on improved pasture. The abaxial wall of the hoof separates from the sole near the toe, and the crevice formed becomes packed with mud, gravel, and manure. The hoof in the region is dry and crumbly. The cause is not known but it is probably a form of laminitis.

- **Suppurative cellulitis**—associated with *Fusobacterium necrophorum*, commences as an ulcerative dermatitis of the pastern above the bulb of the heel and extends up the leg to the knee or the hock and more deeply into subcutaneous tissues.

Other diseases with foot lameness include:

- Contagious ecthyma
- Bluetongue
- Foot-and-mouth disease
- Ulcerative dermatosis
- Strawberry footrot
- Laminitis
- Lameness associated with *Erysipelothrix insidiosa*, and occurring after dipping

#### TREATMENT AND CONTROL

The time-honored method of treatment of footrot has been the application of topical bactericidal agents to the foot. These agents are most effective early in the transmission period, before any extensive underrunning of the horn. When there is underrunning of the horn, the underrun horn must be removed so as to expose the infection to the topical agent. This approach has been used successfully for treatment, control, and eradication purposes. However, it requires extensive paring of affected feet, which is labor intensive, time consuming, and distressing to both the operator and the sheep. Consequently, paring is now recommended mainly for diagnosis, and treatments usually minimize the need for extensive paring of the feet. These include the use of topical zinc sulfate, the use of parenteral antibiotics, and the recognition of vaccination as an adjunct to treatment and a strategy for control.

Where eradication of virulent or intermediate footrot from a flock is the aim, control measures are usually applied during the periods favorable for transmission. This reduces the number of infected sheep that have to be treated more intensively once transmission is reduced or negligible.

#### Topical Treatment

In general, parenteral treatment with antibiotics, without paring of the feet, has replaced topical antimicrobial treatment of individual or small numbers of sheep. To be reasonably effective most topical treatments require that all underrun horn be carefully removed so that the antibacterial agent can come into contact with infective material. This necessitates painstaking and careful examination and paring of all feet because as incomplete paring will leave pockets of infection. With severely underrun feet, it is impossible to expose all of the underrun areas without

**Table 15-4** Differential diagnosis of lameness accompanied by foot lesions in sheep

Disease	Epidemiology	Foot lesions	Other lesions	Other clinical signs	Response to treatment	Diagnostic microbiology
Infectious footrot	Serious outbreaks in wet, warm weather. High morbidity. Few chronic lame sheep in dry seasons.	Interdigital dermatitis, underrunning of horn medial aspect of claw. Strong smell of necrotic horn.	—	Very severe lameness. Walk on knees.	To penicillin and streptomycin, erythromycin excellent.	<i>Dichelobacter nodosus</i> on smear, or fluorescent antibody test
Benign footrot (scald)	High morbidity in wet, warm weather. Disappears with dry weather.	Interdigital dermatitis, no smell, almost no underrunning of horn.	—	Mild lameness.	Not treated.	<i>D. nodosus</i> avirulent strains not distinguishable microbiologically
Infectious bulbar necrosis	Adult sheep, usually less than 10% affected. Serious in wet seasons.	Toe abscess usually in front feet. Heel abscess in hindfeet. Swelling, pain, discharge of pus.	—	Very severe lameness.	Good to sulfonamides or penicillin-streptomycin.	<i>F. necrophorum</i> and <i>Actinomyces</i> ( <i>Corynebacterium pyogenes</i> )
Contagious ecthyma	Lambs mostly or nonimmune adults. Dry summer.	Raised proliferative lesions with tenacious scabs on coronet skin.	Lesions around mouth almost always.	Rarely lambs have septicemia. Lameness mild only.	—	—
Ulcerative dermatitis	Spread by physical contact at mating. Morbidity usually 20%.	Raw granulating ulcers in interdigital space and on coronet. No pus.	Around mouth and genitalia usually.	Moderate lameness.	—	—
Bluetongue	Insect-borne disease. Variable morbidity.	Coronitis, separation of horn. Are late in syndrome.	Severe erosions around mouth and nasal cavities.	High fever, salivation. Severe lameness and recumbency.	—	Virus isolation
Strawberry footrot	In summer, high morbidity; carrier sheep infect.	Proliferative dermatitis, piled up scabs. Heal in 5–6 weeks. Coronet to knee or hock.	—	No itching or lameness.	—	<i>Dermatophilus congolensis</i>
Foot-and-mouth disease	May present like outbreak of contagious footrot.	Vesicles at coronary band and skin of interdigital cleft.	Vesicles in mouth.	All ages.	—	Virus demonstration
Infestation with <i>Strongyloides</i> or trombiculid mites	Wet summer conditions. Local distribution only.	Nonspecific dermatitis of skin of lower legs.	—	—	Organophosphates for trombiculids.	Parasites in scrapings

causing hemorrhage because it may be necessary to remove all of the sole and the wall of the claw. Very sharp instruments, including a knife and hoof secateurs, are needed to do the job properly, and they should be disinfected after each use. The parings should be collected and buried or burned. Sheep restraint cradles make the task of paring safer, more accurate, and less arduous for the operator.

With small numbers of sheep, topical treatment may be applied by brush, spray, or aerosol. Topical treatments are likely to be washed off the feet, and thus their efficacy under wet conditions is inevitably reduced. Local applications include chloramphenicol (10% tincture in methylated spirits or propylene glycol), oxytetracycline (5% tincture in methylated spirits),

cetyltrimethyl ammonium bromide or cetrimide (20% alcoholic tincture), zinc sulfate (10% solution), copper sulfate (10% solution), and Dichlorophen as a 10% solution in either diacetone alcohol or ethyl alcohol.

Chloramphenicol is prohibited for use in food animals in many countries. It is also expensive, but it is reasonably effective under both wet and dry conditions. Oxytetracycline must be used as a 5% tincture for optimum results and is not as efficient as chloramphenicol under wet conditions, but it gives reasonable results when the weather is dry. Cetrimide is a relatively cheap product and appears to be as effective as chloramphenicol under all conditions. It is likely that in different countries, with different climates

and environmental conditions, the efficiency of particular treatments will vary. When only a few sheep are affected, bandaging may help maintain local concentrations of the topical preparation.

### Footbathing for Treatment and Control

Footbathing is a more practical approach to topical treatment and is used for control during transmission periods when dealing with large numbers of sheep. All sheep should be footbathed, but it is good practice to divide the flock into affected and unaffected mobs or groups by examination before the initial footbathing, then graze them separately following footbathing to minimize subsequent infection of uninfected sheep.



After several footbaths and inspections the majority of the flock should be free of infection, and the residual infected sheep are culled.

Preparations suitable for footbathing include 10% zinc sulfate, with or without a surfactant to aid wetting, 5% formalin, or 5% copper sulfate. Regardless of the agent used, it is recommended that the sheep be kept standing on concrete, wooden slats, or dry ground for 1 to 2 hours after treatment, although this may be logistically difficult with large flocks.

The relative merits and disadvantages of the various preparations used are as follows.

#### Zinc Sulfate Solution (10% to 20%)

Zinc sulfate solution is as effective as formalin, is more pleasant to use, and is generally the preferred topical chemical for the treatment of footrot. Its ability to penetrate the hoof horn is enhanced by the addition of the surfactant sodium lauryl sulfate to the footbath solution. Significant cure rates can be achieved without prior paring, which removes a significant labor cost from the treatment and control of the disease.

Cure rates, without paring, are higher in sheep that have moderate rather than severe lesions in their feet. Some paring of chronically affected, overgrown feet may be required to allow the treatment access to pockets of infection in the anterior aspects of the sole and also of feet that have underrunning that has progressed to the abaxial area of the digit. Sheep are stood for 1 hour in a footbath containing a 10% to 20% zinc sulfate solution with 2% sodium lauryl sulfate with sufficient depth to cover the coronet. The treatment is repeated in 5 days, then after a further 21 days the sheep are individually examined to determine their status and retreated or culled, depending on the strategy of treatment and control in the flock. Zinc sulfate footbathing can provide protection to the foot against reinfection for periods of at least 2 weeks and can be used effectively during periods of active spread of the disease. Repeated daily footbathing (10 min each day for 5 days) in a zinc sulfate solution with surfactant has eradicated (as opposed to controlled) virulent footrot in sheep associated with some strains but was ineffective against a strain that produced severe underrunning.

Thirsty sheep that drink from the footbath may die of acute zinc poisoning, and contamination with zinc can defoliate pasture at the exit of the footbath.

#### Formalin Solution (5%)

Formalin solution does not deteriorate with pollution but causes extreme discomfort to sheep that have heavily pared feet. Consequently, its use for sheep with severe lesions is discouraged on humane grounds. The feet of the sheep must be pared and all infected areas exposed before treatment. Formalin is

unpleasant to work with in enclosed areas and has toxicity for humans, and its use may be banned in some countries for this reason. Sheep should be passed through the footbath every 1 to 4 weeks during periods of high risk for transmission.

The use of solutions containing more than 5% formalin, footbathing at intervals of less than 1 week, or prolonged footbathing may cause irritation of the skin. Farmers can be neglectful in maintaining proper concentrations of formalin in footbaths, and frequent use of the bath combined with hot weather can result in a concentration of 30% formalin. Such concentrations cause extensive cellulitis around the coronets, and a high proportion of animals may be so badly affected that they need to be destroyed. The hoof horn also becomes hardened and deformed. The safest precaution is to empty the footbath and prepare a new mixture.

#### Copper Sulfate Solution (5%)

Copper sulfate solution colors the wool, deteriorates with pollution, corrodes metal, and may cause excessive contamination of the environment with copper. The feet of the sheep must be pared and all infected areas exposed before treatment. Copper sulfate footbathing appears to harden the horn, which can be an advantage but also a disadvantage if further paring is required at a later date. A patented copper salt preparation (not copper sulfate) has reasonable efficacy without the disadvantages of copper sulfate.

#### Antibiotic Treatment

Footrot can be treated with antibiotics without the necessity of paring of the feet. Treatment is considerably more effective if done during dry periods and when the sheep are kept on dry floors for 24 hours after treatment, because in wet conditions the concentration of antibiotic at the tissue level is much reduced. In conditions are unfavorable for eradication, such as in the United Kingdom, prompt treatment of lame sheep with parental antibiotics is associated with a significantly lower prevalence of lameness compared with farmers who treated by footparing and applying topical treatment (<2% compared with 9%).<sup>23,24</sup>

*D. nodosus* is susceptible in vitro to penicillin, cefamandole, clindamycin, tetracycline, chloramphenicol, erythromycin, sodium ceftioxin, tylosin tartrate, nitrofurazone, and tinidazole and has the least susceptibility to sulfonamides and the aminoglycosides. However, in vitro tests may have little relevance to field application because of differences in the penetrance of antibiotics to the affected part of the foot.

Antibiotics and their dosage shown to be effective against virulent footrot are presented in the accompanying box. Many of these treatments are "off label," and some are not approved for use on sheep in some countries. Choice of antibiotic will be influenced

by the withholding period required before sheep culled because they are not cured can be sent to market. Use of lincomycin/spectinomycin in sheep has precipitated severe outbreaks of salmonellosis in some flocks.

#### TREATMENT AND CONTROL

##### Treatment:

- Penicillin/streptomycin (single IM dose of 70,000 U/kg procaine penicillin and 70 mg/kg dihydrostreptomycin) (R-1)
- Erythromycin (single IM dose of 10 mg/kg) (R-1)
- Long-acting oxytetracycline (single IM dose of 20 mg/kg) (R-1)
- Lincomycin/spectinomycin (single SC dose of 5 mg/kg lincomycin and 10 mg/kg spectinomycin) (R-2)
- Gamithromycin (single SC dose of 6 mg/kg) (R-2)<sup>25</sup>
- Long-acting amoxicillin (single IM dose of 15 mg/kg) (R-2)<sup>18</sup>

##### Control:

- Multivalent or autogenous mono- or bivalent vaccination (R-1)

Australian studies with large numbers of sheep have demonstrated cure rates of approximately 90% using oxytetracycline, erythromycin, and lincomycin/spectinomycin, and slightly less for penicillin/streptomycin. Following treatment, sheep are kept in a dry environment for 24 hours, such as a wool shed, then moved to a "clean" dry pasture and inspected 3 to 4 weeks later. At this time sheep that are still clinically affected (i.e., not cured) are culled.

Reinfection will occur in footrot spread periods; thus, in general, the use of antibiotics for control of footrot should be confined to the summer period when there is reduced or no spread. Cure can occur even in severely affected sheep, and extensive paring before treatment does not improve cure rates. Cure rates fall to 60% if sheep are in a wet environment following treatment, although cure rates are improved slightly if sheep are footbathed at the time of antibiotic administration.

In naturally infected sheep on 10 farms in southern Germany, significantly higher cure rates were recorded 3 weeks after treatment with gamithromycin (94%) compared with oxytetracycline (79%), although this study involved only 20 sheep per farm.<sup>25</sup> Antimicrobial resistance has been reported in anaerobic bacteria isolated from ovine footrot,<sup>26</sup> and all farms had used oxytetracycline in topical applications for at least 3 years. Consequently, a decreased susceptibility to oxytetracycline may have contributed to this result.

Antibiotics are particularly valuable for the treatment of late-pregnant sheep that develop footrot, where more prolonged yarding for footbathing, paring, and topical treatment could lead to problems such as pregnancy toxemia. Antibiotics have no role in the prevention of footrot, but a combination of vaccination and antibiotic treatment can increase cure rates, especially in areas that have extended transmission periods and so are not well suited to eradication programs.<sup>18</sup>

### Vaccination

Vaccination against footrot can significantly increase short-term resistance to infection and is an important component of control strategies, especially in circumstances where climate and management practices make other control strategies difficult to apply. Vaccination also shortens the clinical course in infected sheep and can be used as a treatment strategy. In neither case is vaccination 100% effective.

Pilus antigens are the major host-protective immunogens and confer protection against challenge with homologous strains. Immunity is associated with circulating antibody, but high levels of pilus-specific circulating antibody are required for adequate diffusion into the epidermis and protection against the disease. There is a positive correlation between antibody titer and footrot resistance in the first few months following vaccination. Immunity can be passively transferred with gammaglobulins from immunized sheep to naive recipients and from vaccinated ewes to their lambs via colostrum to provide protection for the first 8 weeks of life.

Vaccines must contain adjuvants for an adequate antibody response, and vaccination with oil-adjuvant vaccines is accompanied by significant local reaction, including local swelling at the injection site and abscessation in a proportion of animals. This reaction is more severe in British breeds than in Merinos. In milk goats and sheep, vaccination can result in a significant drop in milk production. The potential gains from vaccination need to be weighed against this effect in a decision to use vaccination as a method of control rather than other control procedures.

### Multivalent Vaccines

Commercial multivalent vaccines have contained up to 10 strains of *D. nodosus* representative of the most common serogroups associated with footrot. The extent to which these vaccines will give protection or promote earlier cure depends on the relationship of the vaccine pilus types to those associated with the footrot problem. Vaccine failure is generally attributable to the occurrence of footrot associated with strains of the organism not present in the vaccine or for which there is no cross-protection, and to

individual animal variation in response. It is now recognized that there is a limitation to the number of strains that can be incorporated in current vaccines because of antigenic competition. Mixing different *D. nodosus* fimbriae in vaccines may lead to inadequate host responses to individual antigens, and an alternative approach is to identify *D. nodosus* strains present in a given geographic region, enabling the development of optimized and localized strain-specific vaccines.<sup>5,27-30</sup>

Field trials have shown a wide variation in the therapeutic effect of multivalent vaccination, with a reduction in footrot incidence varying from 27% to 54% in sheep in which there was no routine foot care to 69% to 91% in flocks in which vaccination was coupled with routine foot care such as trimming and footbathing. The effect is to reduce the incidence, severity, and duration of the infection. The improvement seems to be as a result of accelerated healing of the lesions with some protection against reinfection. For optimum effect, two vaccinations are required, and the duration of this effect depends on the adjuvant and the breed of sheep. Even so, the duration of the protection is limited to 4 to 12 weeks in most studies. It can be very effective in control when coupled with a culling policy of sheep that remain clinically infected.

Whereas vaccination is of value for control of an existing flock infection, it may not be economic to use vaccination as a strategy to prevent infection of a footrot-free flock. The use of footrot vaccines may be prohibited in areas where there are footrot eradication programs.

### Mono- and Bivalent Vaccines

The use of vaccines targeting only the strains of *D. nodosus* present was first tested in 40 flocks in Nepal with a recombinant fimbrial vaccine against two virulent serogroups. These were vaccinated annually for 4 years, with no virulent footrot detected after the first year of vaccination.<sup>5</sup> Subsequently, a monovalent whole-cell vaccine was used for 2 years in a chronically infected flock in Bhutan, and footrot was not detected after the first year of vaccination.<sup>27</sup> Further trials were conducted in two Australian flocks.<sup>28</sup> In the first, the prevalence of infection was reduced from 44% to 0.5% within 4 months of a monovalent vaccination, and no cases were detected 16 months later. In the second, a bivalent vaccine reduced the prevalence from 8.5% to 0.3% after 6 months, with no cases detected 18 months after vaccination. In both cases a few sheep that were not fully cured within 6 to 12 weeks of the second dose of vaccine ("nonresponders") had to be culled from each flock.

Where multiple virulent serotypes are present, sequential vaccination with specific mono- or bivalent vaccines has been demonstrated to be an effective strategy.<sup>29</sup> This was

undertaken after antigenic competition was demonstrated when bivalent vaccines were administered concurrently, but not when given 3 or more months apart.<sup>29</sup> Virulent footrot was eradicated from 5 of 12 commercial flocks that had 3 or less serogroups at the start of the study.<sup>5,29</sup> Where one or two serogroups were present, there was a rapid reduction in prevalence. However, where multiple serogroups were present, additional rounds of vaccination with different bivalent vaccines were given at 1-year intervals.<sup>29</sup> This controlled but did not eliminate all strains of virulent footrot in the remaining trial flocks, and so shortening the intervaccination interval was proposed as a means of accelerating this program.<sup>5,29,30</sup>

### Summary of Control Procedures in Infected Flocks

The objective of control programs in a footrot-infected flock is to maintain the lowest possible prevalence of disease by reducing the incidence of new infections and preventing the development of advanced lesions. This is achieved most cost-effectively through strategies that are based on whole-flock control, with minimal need for handling of individual animals. This less-labor-intensive approach is most likely to be adopted by sheep owners and includes routine footbathing, with or without vaccination, during transmission periods. Sheep that are affected with virulent footrot can also be treated with parenterally administered antibiotics or culled, depending on the relative proportion affected. The exact timing of these operations will vary by country and the prevailing climatic conditions.

### Genetic Selection

Whereas there are breed effects on susceptibility and an apparent high heritability for resistance, genetic selection for resistance has not been used in control programs on farms. Resistance can be determined by direct challenge of a candidate ram, which is undesirable in ram-breeding flocks, but antibody response to vaccination cannot be used as a surrogate.

### ERADICATION

Eradication of virulent footrot is a desirable but not always feasible objective. The simplest form of eradication is destocking (culling) the whole flock or just those mobs affected with virulent footrot. This assumes that it will be possible to restock with sheep that have a high degree of assurance of not being infected with virulent footrot, but this is not always the case. Eradication can also be achieved through treatment and control programs, especially in climates where the transmission periods are shorter. Conversely, eradication is more difficult where rainfall is heavy and pastures remain moist for most of the year.

Area eradication of virulent footrot is more challenging, task but has proceeded satisfactorily in several regions in Australia and in Norway.<sup>31,32</sup> In the Australian state of New South Wales, choice of eradication strategy was influenced by flock size, with destocking more often chosen for smaller flocks (those less than 500 sheep). Time spent in quarantine was considerably shorter when specialist contractors were used to inspect and treat sheep and longest when footbathing was the main eradication option chosen.<sup>31</sup> In Norway, virulent footrot has been eradicated from about 70% of the flocks in which this was attempted.<sup>32</sup>

Currently the eradication of benign footrot is not justified economically, nor is it possible with existing knowledge because benign footrot strains can be carried in the interdigital skin of asymptomatic sheep.

The principles for successful eradication from a flock have been described as follows:<sup>5</sup>

1. Correct diagnosis of the form of footrot present in the flock
  2. Knowledge of seasonal trends and patterns of transmission in that environment
  3. Ability of the operator (or contractor) to recognize footrot in its different forms
  4. Acceptance that eradication is a costly and time-consuming investment
  5. Understanding that in flocks with a high initial prevalence, it may take 2 or more years to eradicate the disease
  6. Acceptance that eradication should only be attempted if the flock can protect itself from reinfection, either from neighboring flocks or introduced sheep
- Further, eradication programs are based on the following facts:
1. *D. nodosus* persists in the flock in infected feet.
  2. Infection in the foot can be detected and the infected sheep cured or culled.
  3. The organism does not persist in pasture for long periods and does not transmit in dry periods.

Paddocks kept free of sheep for 14 days can be considered free of infection. If all infected animals are culled or cured and infection removed from the pasture, eradication is achieved. Eradication of the disease should be undertaken during a dry summer season, but active measures must be taken to reduce the incidence of infection and spread during the transmission period in the preceding spring. Regular footbathing, at intervals of 1 to 4 weeks, and possible vaccination are usually parts of this strategy.

In the eradication phase during the non-transmission period, all feet of sheep are examined, and affected or suspicious sheep are segregated. When examinations are carried out during dry weather, the feet are likely to be hard and the disease at a quiescent stage. In such circumstances minor lesions may be missed, necessitating careful “diagnostic” trimming and examination of

all feet. Clean sheep are run through a footbath (10% zinc sulfate or 5% formalin) and put into fresh fields, whereas the affected sheep are isolated and treated with antibiotics and/or footbathing. Sheep that do not respond may be treated intensively, for example, with an additional antibiotic treatment or two footbathings for 1 hour in 10% zinc sulfate, but preferably should be culled. The apparently clean mob should be reinspected at least twice more during the nontransmission period to ensure these sheep are in fact not infected. Eradication programs often fail because too much effort is invested in trying to cure the infected sheep rather than reinspecting the clean ones.

In areas where flocks are small and there are insufficient fields to carry out this program completely, it has been found to be sufficient to treat all affected sheep weekly but to put all affected sheep back in the flock and the flock back onto the infective pasture, provided conditions are dry.

Culling is an important strategy in footrot eradication, and if the number of infected sheep is small, immediate culling may be the most economic strategy. The use of autogenous mono- and bivalent vaccines can successfully eradicate virulent footrot, with a dramatic decrease in cases within 3 to 6 months of vaccinating.<sup>27-30</sup> Culling of persistent cases that do not respond to the vaccine is an important part of this strategy.

### Introduced Sheep

Most breakdowns in eradication occur because of inefficient examination and treatment or the introduction of affected sheep without first checking that they are free from the disease. Introduced sheep should be run as a separate group from the main flock until they have been proven to be footrot-free following a transmission period. Similar isolation of introduced sheep should also be practiced in flocks free of the disease. This is also an important management practice in flocks that have disease to minimize the risk of introduction of different strains of the organism.

### FURTHER READING

- Abbot KA, Lewis J. Current approaches to the management of ovine footrot. *Vet J*. 2005;169:28-41.
- Allworth B. Challenges in ovine footrot control. *Small Rum Res*. 2014;118:110.
- Bennett GN, Hickford JG. Ovine footrot: new approaches to an old disease. *Vet Microbiol*. 2011;148:1-7.
- Radostits O, et al. Infectious footrot in sheep. In: *Veterinary Medicine: A Textbook of the Diseases of Cattle, Horses, Sheep, Goats and Pigs*. 10th ed. London: W.B. Saunders; 2007:1070-1077.

### REFERENCES

1. Cederlöf SE, et al. *Acta Vet Scand*. 2013;55:4.
2. Gilhuus M, et al. *Vet Microbiol*. 2013;163:142.
3. Raadsma HW, Egerton JR. *Livestock Prod Sci*. 2013;156:106.

4. Muzafar M, et al. *Vet Microbiol*. 2015;179:53.
5. Raadsma HW, Dhungyel OP. *Livestock Prod Sci*. 2013;156:115.
6. Nieuwhof GJ, et al. *Animal*. 2008;2:1427.
7. Kaler J, Green LE. *Prev Vet Med*. 2009;92:52.
8. Gröneng GM, et al. *Prev Vet Med*. 2014;113:241.
9. Myers GS, et al. *Nat Biotechnol*. 2007;25:569.
10. Kennan RM, et al. *PLoS Pathog*. 2010;6:e1001210.
11. Wong W, et al. *J Biol Chem*. 2011;286:42180.
12. Strauble A, et al. *Vet Microbiol*. 2014;168:177.
13. Lane J, et al. MLA Report BAHE.0010, March 2015.
14. Nieuwhof GJ, Bishop SC. *Anim Sci*. 2005;81:57.
15. Conington J, et al. *Vet Res Commun*. 2008;32:583.
16. Fodda A, et al. *BMC Vet Res*. 2012;8:65.
17. Duncan JS, et al. *Vet Rec*. 2011;169:606.
18. Duncan JS, et al. *Vet J*. 2014;201:295.
19. Sayers G, et al. *J Clin Microbiol*. 2009;47:1199.
20. Dhungyel O, et al. *Vet Microbiol*. 2013;162:756.
21. Frosth S, et al. *Acta Vet Scand*. 2012;54:6.
22. Cheetham BF, et al. *Vet Microbiol*. 2006;116:166.
23. Wassink GJ, et al. *Prev Vet Med*. 2010;96:93.
24. Kaler J, et al. *J Vet Intern Med*. 2010;24:420.
25. Strobel H, et al. *Vet Rec*. 2014;174:46.
26. Lorenzo M, et al. *Vet Microbiol*. 2012;157:112.
27. Gurung RB, et al. *Vet J*. 2006;172:356.
28. Dhungyel OP, et al. *Vet Microbiol*. 2008;132:364.
29. Dhungyel OP, et al. *Vacc*. 2013;31:1701.
30. Dhungyel OP, Whittington RJ. *Vacc*. 2010;28:470.
31. Mills K, et al. *Aust Vet J*. 2012;90:14.
32. Vatn S, et al. *Small Rumin Res*. 2012;106:11.

## FOOT ABSCESS IN SHEEP

Foot abscess includes two diseases: heel abscess and toe abscess.

### HEEL ABSCESS/INFECTIOUS BULBAR NECROSIS

Heel abscess follows damage to the interdigital skin. This may be physical damage from sharp stones or stubble, or from friction produced by overgrown feet, but most commonly results as an extension from ovine interdigital dermatitis into the soft tissues of the heel associated with *Fusiformis necrophorum* and *Arcanobacterium (Actinomyces; Corynebacterium) pyogenes*. In interdigital dermatitis, the organisms can invade deep into the interdigital skin. The joint capsule of the distal interphalangeal joint is extremely vulnerable to invasion on the axial interdigital area, and this leads to abscessation.

Most flocks experience cases of heel abscess, but the yearly incidence is usually less than 1%. Heel abscess occurs mainly during very wet seasons, as does footrot, but the former is limited largely to adult sheep, especially ewes heavy in lamb, and rams. Interdigital dermatitis and heel abscess are frequently present in the flock at the same time. An increased prevalence in a flock of young rams may be a result of close flocking and increased muddying of pasture because of this high concentration of livestock. Usually only one foot and one claw will be involved, although in severe outbreaks all four feet may become affected. Most commonly, the medial claw of the hindfoot is affected.



In the initial stages the affected digit is hot and painful. There is an acute lameness—the affected sheep holds the foot off the ground while walking. There is swelling and inflammation of the interdigital skin and pain on pressure across the heel. Pressure in this area may result in the discharge of pus from sinuses in the interdigital space. When the phalangeal joints are involved, there is severe swelling at the back of the claw, and the infection may extend to break out at one or more points above the coronet, with a profuse discharge of pus.

### Treatment of Heel Abscess

The treatment of foot abscess is by surgical drainage, parenteral treatment with sulfonamides or a combination of penicillin and streptomycin, and the application of a local bandage. Therapy should be continued for several days. Recovery is not rapid. Because of the frequent involvement of the distal interphalangeal joints with heel abscess, treatment with antibiotics without surgical intervention is unlikely to be successful, but some cases heal spontaneously in 6 to 8 weeks.

### TOE ABSCESS

Toe abscess is a lamellar suppuration with purulent underrunning of the horn at the toe. It results from damage to the sole, white line, or wall of the foot and is a common sequela to overgrown feet. Most commonly, it involves a digit on the **front** feet. The affected digit is hot, and there is pain on pressure across the sole and toe. There is severe lameness, swelling of the coronet with pain and heat apparent, and usually rupture and purulent discharge at the coronet between the toes. Penetration to deeper structures may also occur.

### Treatment of Toe Abscess

The only treatment of toe abscess is by surgical drainage, and the response is rapid. Toe granuloma can be a sequela, but more commonly toe granuloma is a response to overzealous foot paring.

### FURTHER READING

Radostits O, et al. Foot abscess in sheep. In: *Veterinary Medicine: A Textbook of the Diseases of Cattle, Horses, Sheep, Goats and Pigs*. 10th ed. London: W.B. Saunders; 2007:1077-1079.

### LAMB ARTHRITIS

In the United Kingdom, *Streptococcus dysgalactiae* is a significant cause of outbreaks of arthritis in lambs, especially during the first 3 weeks of life. It occurs more commonly in lambs that are lambed indoors. Affected lambs are lame in one or more legs and are often found recumbent. There is minimal joint swelling in the initial stage of the disease, and for this reason differential diagnoses include nutritional myopathy,

swayback, and spinal abscess. Infection is present in any joint but most common in the tarsal and atlanto-occipital joints. Some die with systemic disease and myocarditis. Survivors may be chronically lame.

### CHLAMYDIAL POLYARTHRITIS

Virulent chlamydia, including *Chlamydia* (formerly *Chlamydophila*) *pecorum*, can be isolated from the joints and eyes of lambs with polyarthritis.<sup>1,2</sup> Intestinal infection with *C. pecorum* is also common in pastured lambs between 3 and 9 months of age, but it is not associated with clinical disease.

Chlamydial polyarthritis is a common disease of sheep in feedlots in the United States, but the mortality rate is low. The strain associated with arthritis is not common in the United Kingdom, and polyarthritis in the United Kingdom has been associated with a chlamydial strain distinct from *C. pecorum*. Outbreaks of polyarthritis caused by *C. pecorum* have also been reported with increased frequency in 3- to 6-month-old lambs Australia.<sup>2</sup> In sheep grazing pasture the morbidity may be as high as 80%, but deaths are usually less than 1%. PCR testing has demonstrated that mixed infections of *Chlamydophila* are often present in the conjunctivae of sheep, but there is no consistent association with the onset of disease.<sup>2</sup>

In calves, the disease is uncommon but often fatal, and response to treatment is poor; affected calves are often destroyed. The experimental disease in calves begins as chlamydiaemia, followed by localization in the joints.

The clinical signs in calves and lambs include gross swelling of most limb joints but especially the larger joints, lameness, stiffness, unwillingness to move, recumbency, depression, conjunctivitis, and fever of 39° to 42° C (102° to 108° F). The navel is unaffected, but there may be signs caused by localization of the infection in other organs (e.g., pneumonia, encephalomyelitis, and renal abscess). Clinically, the disease is indistinguishable from polyarthritis caused by other infections such as *Mycoplasma* and *Haemophilus* spp.

Response to treatment with oxytetracycline is variable, and residual effects of infection, such as poor growth and ill-thrift, commonly occur.

### FURTHER READING

Jelocnik M, Frenitiu FD, et al. Multilocus sequence analysis provides insights into molecular epidemiology of *Chlamydia pecorum* infections in Australian sheep, cattle and koalas. *J Vet Micro*. 2010;140:405-417.

Nietfeld JC. Chlamydial infections in small ruminants. *Vet Clin N Am Food A*. 2001;17:301.

### REFERENCES

1. Jelocnik M, et al. *J Vet Microbiol*. 2010;140:405.
2. Polkinghorne A, et al. *Vet Microbiol*. 2009;135:142.

### CHRONIC PECTORAL AND VENTRAL MIDLINE ABSCESS IN HORSES (PIGEON FEVER)

*C. pseudotuberculosis* biovar *equi* has been associated with a high regional prevalence of chronic abscessation in horses in California, Texas, and Colorado and can cause disease in horses in other states.<sup>1</sup> Six phenotypes are recognized on culture, but there is no association between phenotype and clinical form of the disease.<sup>2</sup>

The incidence of the disease is 9.2 per 10,000 horses and appears to be increasing, and this change might be related to climatic changes.<sup>1,3</sup> The disease is most prevalent in Texas (35 cases per 10,000 horses), Colorado (18 per 10,000), and Oregon (12 cases per 10,000), with California reporting 6 cases per 10,000 horses.<sup>1</sup> Within Texas, prevalence of the disease increased from 0.9 in 2005 to 10 cases per 100,000 horses at risk in 2011.<sup>4</sup> There is no apparent breed or sex predisposition and cases occur in horses of all ages, but the majority are adult horses and there are few cases under 1 year of age.<sup>1</sup> Usually, only a single horse on a farm is affected. A small proportion of farms have endemic infection, with a prevalence of disease of 5% to 10% and recurrent infections each year. In some years spread to naive horses results in epidemic disease.

Cases can occur in all months of the year but are most common in dry months in autumn, with a peak prevalence in November, December, and January; internal abscesses are more common in late autumn and January, with a smaller peak in June and July, and ulcerative lymphangitis is more common in March, April, and May.<sup>1,4</sup> There is a variation in the prevalence from year to year, and<sup>1,4</sup> in both Texas and California, years with high prevalence of the disease have been preceded by seasons with higher-than-normal rainfall and conditions that promote high insect populations. Insects, such as horn flies (*Habronema irritans*), that produce a ventral midline dermatitis during feeding may predispose to infection, and the organism has been detected by PCR populations of *H. irritans*, *Stomoxys calcitrans*, and *Musca domestica*. Feeding of infected house flies (*Musca domestica*) on experimentally induced wounds on the pectoral region caused disease in ponies, demonstrating that house flies are mechanical vectors of infection and can spread the disease to equids.<sup>5</sup> Flies are not the host of the organism, being mechanical vectors only, and the source appears to be soil. *C. pseudotuberculosis* persists and multiplies in a variety of soil types and under a range of environmental conditions.<sup>6</sup> Addition of feces to the soil enhances growth of the organism.<sup>6</sup>

Patterns of spatial and temporal clustering indicate that disease is transmitted directly or indirectly from horse to horse with an incubation period of 3 to 4 weeks.

The disease occurs in a region where caseous lymphadenitis is also common in sheep, although the disease in sheep is usually caused by *C. pseudotuberculosis biovar ovis*. Stable hygiene, insect control, and isolation of infected horses might aid in control.

Disease caused by *C. pseudotuberculosis* occurs in captive elk, although the biovar involved is not reported.<sup>7</sup>

### External Abscesses

The most common form of the disease is an external abscess (97% of reported cases), with internal abscess formation (2%) and ulcerative lymphangitis (1%) being much less common manifestations of infection.<sup>1</sup> However, the most common clinical manifestation of infection varies geographically, with California reporting 49% of cases as being internal abscesses and ulcerative lymphangitis being most common in Texas (96%).<sup>1</sup> These occur in a variety of areas on the body, but in the majority of cases they are in the pectoral, axillary, inguinal, or ventral midline regions.<sup>8</sup> Affected horses are usually markedly lame. The abscesses can reach a diameter of 10 to 20 cm, with a surrounding area of edema, before they rupture 1 to 4 weeks later. Clinical signs include local swelling, lameness, pain on palpation, ventral edema, reluctance to move, midline dermatitis, fever, and depression in the early stage, followed eventually by rupture of the abscesses.

Treatment of external abscesses is by hot packs to encourage opening and by surgical drainage and lavage. Ultrasound can aid in the detection of deeper abscesses. NSAIDs can be used to control swelling and pain. Recovery rates are excellent and are not improved by antimicrobial therapy.

### Internal Abscesses

Internal abscesses occur at a variety of sites but predominantly in the liver and can occur in horses with no external abscessation. The diagnosis should be suspected in horses, in the region and the season, with a clinical history of external abscess, fever, anemia, and colic and laboratory evidence of leukocytosis with neutrophilia, anemia, hyperglobulinemia, hyperfibrinogenemia, and elevated activity of hepatic-associated enzymes.<sup>8</sup> Abdominocentesis in most cases shows an elevated protein and nucleated cell count, and the organism can be cultured.

Treatment is with antimicrobial therapy, but the case-fatality rate is high if the abscess cannot be drained. *C. pseudotuberculosis* is sensitive to concentrations of most common antibiotics achieved in vivo with MIC90 values for chloramphenicol less than or equal to 4 µg/mL, enrofloxacin less than or equal to 0.25 µg/mL, gentamicin less than or equal to 1 µg/mL, penicillin at 0.25 µg/mL, rifampin less than or equal to µg/mL, tetracycline less than or equal to 2 µg/mL, trimethoprim-sulfamethoxazole (TMS) less

than or equal to 0.5 µg/mL, ceftiofur at 2 µg/mL, and doxycycline less than or equal to 2 µg/mL.<sup>9</sup>

The value of a **synergistic hemolysis inhibition serologic** test in diagnosis has been examined. The test was useful for detecting internal infection in horses that did not have external abscesses (likelihood ratio of 2.98 [95% CI 2.2 to 4.1] with a titer ≥ 512), but it was not useful when horses had external abscesses.<sup>10</sup>

An autogenous vaccine has given protection against experimental challenge, but in field trials, there has been no difference in the incidence of infection between vaccinated and control horses.

Otitis media interna, meningitis, and unilateral orchitis are documented forms of the disease.<sup>11,12</sup> *C. pseudotuberculosis* is also recorded as a cause of pericarditis and pleuritis in a horse and in association with suppurative facial dermatitis following trauma.

### REFERENCES

1. Kilcoyne I, et al. *JAVMA*. 2014;245:309.
2. Britz E, et al. *Vet J*. 2014;200:282.
3. Spier SJ. *Equine Vet Educ*. 2008;20:37.
4. Szonyi B, et al. *J Equine Vet Sci*. 2014;34:281.
5. Barba M, et al. *J Vet Int Med*. 2015;29:636.
6. Spier SJ, et al. *Vet Rec*. 2012;170.
7. Kelly EJ, et al. *J Wildlife Dis*. 2012;48:803.
8. Nogradi N, et al. *JAVMA*. 2012;241:771.
9. Rhodes DM, et al. *J Vet Int Med*. 2015;29:327.
10. Jeske JM, et al. *JAVMA*. 2013;242:86.
11. Gonzalez M, et al. *Equine Vet Educ*. 2008;20:30.
12. Rand CL, et al. *Equine Vet Educ*. 2012;24:271.

## INFECTIOUS POLYARTHRIITIS (GLÄSSER'S DISEASE, PORCINE POLYSEROITIS, AND ARTHRIITIS)

### SYNOPSIS

**Etiology** *Haemophilus parasuis* (HPS) rarely a primary pathogen in respiratory disease.

**Epidemiology** Common in pigs postweaning to 4 months of age. Sporadic outbreaks. Environmental stressors are risk factors. There may be significant losses.

**Signs** Sudden onset of anorexia, dyspnea, lameness, swollen joints, fever, nervous signs, and death. Three types: hyperacute (death), acute, and endemic. Glässer's disease not yet seen in wild boar.

**Clinical pathology** Culture organisms from serous membranes.

**Lesions** Peritonitis, pleuritis, synovitis, meningitis.

**Diagnostic confirmation** Culture organism and a variety of new techniques.

**Differential diagnosis** Erysipelas, mycoplasmal and streptococcal arthritis, other serositis; also *Actinobacillus pleuropneumoniae* infection, vitamin E

deficiency, *Escherichia coli*, and *Actinobacillus suis*.

**Treatment** Antimicrobials.

**Control** Minimize stressors at weaning and in nursery barns. Limited commercial vaccines.

Glässer's disease is a contagious disease of young pigs characterized by arthritis, pericarditis, pleurisy, peritonitis, and meningitis. In a study in the United Kingdom, it was found to be common in herds with a history of chronic respiratory disease.

### ETIOLOGY

Initially, the agent was thought to be *Haemophilus influenzae suis*, but it is now known to be *Haemophilus parasuis* (HPS). Now recognized as one species, it is, however, extremely pleomorphic. It is a gram-negative bacterium that requires V factor for its growth. A modified classification of 15 major serotypes has been achieved, although many are still untypeable. The current serotyping is based on reactions between antisera and surface antigens, which leads to a classification based on 15 serotypes. Serotyping originally used a GID test, but this has been replaced by indirect hemagglutination assay (IHA), which has increased the proportion of typeable strains from 60% to 80%. The study of these polysaccharides is under way.<sup>1-3</sup>

Most studies have shown that serotypes 4 and 5 are the most common strains involved in Glässer's disease. In many instances, the serotype is not an indicator of virulence because different strains within one serotype may have a different virulence. HPS, as with other *Haemophilus* spp., has an affinity for the mucosa of the oropharyngeal and upper respiratory tract. HPS can be isolated from the nasal cavity, tonsillar area, and trachea. Several strains may be found in the same nose, and there may be several types in the same herd.<sup>4</sup> HPS isolates are genetically heterogeneous within the same serovar and between serovars. The gene content and diversity of the loci encoding the biosynthesis of the capsular polysaccharides of the 15 serovars have recently been described.<sup>5</sup>

### EPIDEMIOLOGY

The colonization of the respiratory tract is rapid, with 50% of pig noses colonized by 7 days and 100% by 60 days,<sup>4</sup> and there is a turnover of the strains.

Most countries have different distributions of serotypes. In the United Kingdom, 5 is the most common, followed by 4 and 7 in equal numbers, and the rest are largely nontypeable. In Denmark, 5 is followed by 13 and 4 and then the nontypeable.

It may be a true commensal organism in the upper respiratory tract. It is responsible for severe polyserositis in young pigs, and it may also occasionally cause arthritis in older pigs and the individual sow. The organism,

like the others with a similar name, *Actinobacillus suis* and *Streptococcus suis*, has been called one of the “suis-cides” of pigs, which are responsible for considerable economic loss in high-health herds and herds that practice very early weaning. HPS is also commonly isolated from lungs with lesions of enzootic pneumonia.

Pigs infected with virulent isolates of HPS can remain healthy and serve as reservoirs for transmission to naïve pigs, and heterologous protection is possible.<sup>6</sup>

Although the disease occurs worldwide, reports used to be rare and mainly from Europe. However, since the onset of separate production and the occurrence of porcine reproductive and respiratory syndrome, virulent forms of swine influenza, and diseases associated with porcine circo virus type 2 (PCV-2), HPS has become one of the most common of the so-called secondary infections. It is a significant contributor to the porcine respiratory disease complex (PRDC). When it first appears in naïve or specific-pathogen-free herds, it may be a common cause of sudden death; such cases may be numerous, and these situations it also affects younger animals. When the disease becomes endemic, it may affect older animals, with fewer sudden deaths but more chronic polyserositis. The disease has also been observed in Australia, the United States, Canada, and the United Kingdom. The disease accounted for less than 1% of total mortalities of pigs submitted to veterinary diagnostic laboratories over an 11-year period in Ontario. However, the disease was the second most common cause of mortality in test station boars. In a survey of 19 excellent specific-pathogen-free pig herds, 16 were positive, and the average number of culture-positive pigs per herd was 6/10 for positive herds.

It is probably spread by aerosol and certainly by nose-to-nose contact. The disease occurs as sporadic outbreaks—usually in weanling to 4-month-old pigs that have been recently chilled, transported, weaned, or moved to different pens. The onset is sudden, with several pigs in the group affected, and occurs within 2 to 7 days of the initiating stress. Occasionally, it causes arthritis in older animals, or even sow herds. The case-fatality rate is high in untreated pigs. Acute myositis in primary specific-pathogen-free sows has been associated with HPS.

Little is known of the method of transmission of the disease. The causative organisms are facultative pathogens and can be frequently isolated from pig lungs diseased from other causes, even though they are generally not present in normal lungs. It is probable that a respiratory carrier state does exist and that invasion with subsequent septicemia and polyserositis is initiated by stress situations in young pigs that have lost maternal immunity but have not yet gained active immunity. Piglets probably acquire the

infection soon after birth, but maternal antibody protects them from clinical disease until they are 2 to 4 weeks of age. Animals that are weaned early are likely to have this infection, so the supposition is that most pigs acquire the infection at or immediately after birth. *H. parasuis* has been found in the tonsil using IHC and EM.

There are several pathogenic serovars of HPS. Serotypes 3, 6, 7, 8, 9, and 11 are considered to be avirulent; 15 more pathogenic; and 1, 4, 5, 10, 12, 13, and 14 virulent. However, this pattern cannot be considered permanent because genes can be shared, and in any case up to 50% of isolations are considered nontypeable. In the United States and Canada, 15.2% were classified as nontypeable, 26.2% in Germany, 29.3% in Spain, and 41.9% in Australia. In a particular pig herd, many strains can be isolated, but in most cases, one or two strains predominate. In many herds the nontypeable outnumber the typeable. Of seven reference strains examined, only serotypes 1 and 5 were pathogenic, and the seven strains have common antigenic determinants. Within specific-pathogen-free herds, many herds have common strains; no strains are common to both conventional and specific-pathogen-free herds, which is a reflection of little or no movement of pigs between these types of herd. Specific-pathogen-free pigs are often free of this organism and are highly susceptible to the infection, even at several months of age, if they are mixed with conventionally raised pigs that may be infected. Outbreaks with rapid spread and high mortality have been reported in specific-pathogen-free pigs. It has been suggested that the causative bacteria are common in most herds and that the disease arises only when pigs from uninfected herds are introduced to a contaminated environment, especially if they have been exposed to environmental stress during transport. When infection is introduced into a previously noninfected herd, the disease may act as a contagious disease until herd immunity is developed or the infection eliminated. Recently it has been suggested that the nasal cavity strains may be nonpathogenic and form a completely different population to the pathogenic strains. Serotypes from nasal and tracheal cultures were shown to be similar in one study. They found that there was a lower level of colonization in the litters of the young sows. The genetic diversity of the strains is not well understood. Several serotypes may be isolated from the same herd or even from the same pig. High-pathogenicity porcine respiratory and reproductive syndrome virus (PRRSV) has been shown to accelerate the colonization and load of HPS in conventional pigs.<sup>7</sup>

The organism probably does not survive outside the host, and therefore transmission is direct, with most of the transmission occurring during birth.

## PATHOGENESIS

One of the key factors may be that maternal antibody does not last a long time and may be gone by 2 to 4 weeks of age but will last until 6 to 8 weeks if sow antibody titers are high. It is the animals that become infected after their maternal protection has waned that have resulting clinical disease. Serovar 5 is highly virulent when inoculated into specific-pathogen-free piglets at 6 to 8 weeks of age. Bordetella bronchiseptica increases HPS colonization of the nasal cavity. However, it is also said that previous infection with PRRSV has no effect on the occurrence. The severity of the disease increases with the increase in the dose of the organisms.

The nonpathogenic isolates probably only colonize the upper respiratory tract. The pathogens colonize the upper respiratory tract and then descend to the lower respiratory tract by evading phagocytosis<sup>8,9</sup> and by using adhesion factors.<sup>10</sup> The pathogens escape from the respiratory tract,<sup>11</sup> enter the bloodstream, and attach to the endothelial cells;<sup>11,12</sup> they survive because the capsule prevents the killing of the organism.<sup>4</sup> Entrance to the bloodstream is more likely when the animal is stressed or immunity is suspect. The organism then establishes the pathology at the serosal surfaces using hemolysins, proteases, and neuraminidases. The outcome is determined by the innate and adaptive immunity (colostrum, previous exposure, concurrent infections, etc.). The blood cellular immune responses have been described, which suggests that there is an increased trafficking of inflammatory cells.<sup>13</sup> There is a response to iron restriction.<sup>14</sup> The pathogen enters the endothelial cells and induces apoptosis and produces IL-6 and IL-815.<sup>16</sup> The virulent strains survive against the phagocytes and complement system, and the nonvirulent are phagocytosed. HPS acquires iron for growth through the surface receptors.<sup>17</sup>

The precise relationship between protein patterns, serovars, and virulence potential remains to be defined. The major virulence factors and the protective antigens are still largely unknown. Only a small number of organisms in the region of 104 to 106 are sufficient to produce disease. The pathogenesis has recently been described.<sup>15</sup> A new technique called differential display reverse transcription PCR (RT-PCR) has been used to search for virulence factors. The pathogenic HPS may have an outer membrane protein, fimbriae, and lipopolysaccharides; a cytotoxin has yet to be described, but it may be a membrane neuraminidase. The outer membrane protein may be important, and it is iron regulated.<sup>18</sup> Fibrinous meningitis, polyserositis, and polyarthritis are typical. Fatal septicemia can occur spontaneously or following the intraperitoneal inoculation of pigs with HPS. The intranasal inoculation of HPS into cesarean-derived



colostrum-deprived pigs results in a suppurative rhinitis, which may represent an initial event in the pathogenesis of the systemic infection in pigs. After infection with HPS, there was a highly significant rise in radical formation, and monocyte proliferation was reduced. Neutrophils reacted inconsistently. In this experimental study, the CD25+ marker cells were markedly reduced. Experimental infections showed that not all field isolates are pathogenic, and it may be that route of infection and dosage are most important in determining the outcome of infections. In a new study, polyacramide gel electrophoresis (PAGE) typing of HPS and virulence potential based on site were looked at together. PAGE group I had 83.4% of the isolates from the upper respiratory tract (these were mostly of serotype 3 or nontypeable), but of the PAGE group II isolates, 90.7% of all the isolates were from the systemic sites (these are mostly serotypes 1, 2, 4, 5, 12, and 14). It may be that there is also a tropism for some sites because some strains are only found in the brain and others in the pericardium. This means that the systemic sites are the best sites for the identification of pathogenic HPS. Most practitioners have the opinion that the problem is more apparent when there is predisposing viral infection, particularly porcine respiratory and reproductive syndrome (PRRS), swine influenza, or porcine circo virus type 2 (PCV-2). Although most practitioners would say that the prevalence of PRRS-associated HPS infections has increased the natural occurrence of HPS, experimental confirmation is lacking. Only PRRS consistently increased the isolation of HPS from the lung.

On the other hand, both PRRS and *B. bronchiseptica* increase the colonization of the upper respiratory tract by HPS. There is no additive effect here. There is no doubt that the occurrence of the vasculitis plays a part in the pathogenesis.

## CLINICAL FINDINGS

**The incubation period depends on the strain.**<sup>11</sup> Clinical disease occurs because of a mismatch between immunity and colonization by virulent strains. This may be a result of early decline of colostrum immunity, later or slow HPS colonization, mixed pig flows, and the purchase of breeding stock that are carriers.

In the naive herd and where specific-pathogen-free animals have entered commercial herds, sudden death may be the only feature. Some people are of the opinion that there may be polyserositis, arthritic, and meningitic forms. A virulent type 10 outbreak has been described.<sup>19</sup> A wide variety of signs may be seen, including fever, depression, and reluctance to move, progressing to prostration, convulsions, and sudden death. The depression is a marked feature. The mortality rate may be high, and many pigs that survive become "poor doers."

The onset is sudden, with a fever, an unusual rapid and shallow dyspnea with noisy lung fields, an anxious expression, extension of the head, and mouth-breathing. There may be a serous nasal discharge, and coughing may occur. Depression and anorexia are observed. The animals are very lame, stand on their toes, and move with a short, shuffling gait. All the joints are swollen and painful on palpation, and fluid swelling of the tendon sheaths may also be clinically evident. In many animals there may be just a single joint affected, which is often the hock. A red to blue discoloration of the skin appears near death. Most cases die 2 to 5 days after the onset of illness. Animals that survive the acute stage of the disease may develop chronic arthritis, and some cases of intestinal obstruction caused by peritoneal adhesions occur. Meningitis occurs in some pigs, particularly when these are naive or where there is an acute onset, and is manifested by muscle tremor, paralysis, and convulsions. Although Glässer's disease can occur in pigs of any age, weaning pigs are most commonly and most seriously affected. In chronic cases, pigs may lose part of an ear as a result of ischemic necrosis. There may be also wasting piglets, which fade and die. In some instances in which there is a severe peritonitis, there may be scrotal swelling as the fluid drains down the tunica vaginalis.

Another type of syndrome of necrosis of the masseter muscles was described in which sows had swollen, cyanotic heads, with HPS isolated from the affected muscles. Purulent rhinitis has also been described.

## CLINICAL PATHOLOGY

The disease is essentially a polyserositis and arthritis, and as a result the organism is recoverable from joint fluid and pleural exudate. Material aspirated from joints may be serous, fibrinous, or purulent. It may just be a few fibrin tags that have organized from an initial fibrinous exudate. The disease can be diagnosed serologically on the presence of precipitins in the serum of recovered pigs, and complement-fixing antibody can be detected following infection. But these are not reliable methods. In an experiment in which 183 specific-pathogen-free pigs were given infections, the hemoglobin concentrations and hematocrit fell. Leukopenia developed 1 to 2 days after infection, with leukocytosis later. Any changes in the cerebrospinal fluid were not related to the clinical signs. One of the common findings in HPS infections is vitamin E deficiency, and this is most likely to be as a result of the toxic oxygen radical damage.

## NECROPSY FINDINGS

Glässer's disease generally is associated with three main lesions: fibrinous polyserositis and arthritis, signs of septicemia, and toxemia.

In some cases there are no gross lesions, and all that is seen is a small amount of peritoneal fluid or a very thin fibrin strand (tag).

Serofibrinous or fibrinous pleuritis, pericarditis, and peritonitis are usually present, but the exudate is scanty in some cases. Pneumonia may also be apparent. There is inflammation and edema of the periarticular tissues, and the joint cavities contain turbid fluid and discoid deposits of yellowish-green fibrin. A suppurative rhinitis is also possible. A fibrinopurulent meningitis is common. In specific-pathogen-free pigs, the lesions may be minimal, and only successful isolation of the organism permits the differentiation of Glässer's disease from other causes of sudden death. The distinction may be a difficult one because of the fastidious culture requirements of HPS. Eventually, all surfaces are covered with a thick mat of fibrin, and the individual organs may be difficult to recognize. This eventually becomes fibrotic. The spleen and liver may be enlarged.

Histologically, acutely affected serosal surfaces are thickened by neutrophils entrapped in a matrix of fibrin. As these lesions age, fibrous adhesions may develop and lead to chronic pleuritis, arthritis, and pericarditis. Such cases are often culture-negative, even when selective media are used. Most isolates are made from the lungs. Petechial hemorrhages may also be found on the kidney (the so-called "turkey egg," which is not pathognomonic for anything except septicemia in its widest sense, with over 30 agents known to cause it).

## Samples for Confirmation of Diagnosis

### Bacteriology

The collection of samples from animals that have been dead for several hours is not worth considering even at the best of times and certainly not when HPS is suspected. An acutely affected live pig, freshly autopsied, will give much better results, especially if there is no overheating of the carcass post-mortem or subsequent cooling because the organism is temperature-sensitive. Transport media to the laboratory will also be beneficial in recovery rates. It is said that culture of the nasal swabs will be as rewarding as collecting tracheal swabs, but it is likely that the larynx and below are normally sterile. What you isolate from the nasal cavity may then be a commensal population of largely nontypeable species, whereas the trachea harbors the pathogenic forms. Other authors say that they are the same serotypes. These authors have also found that a lower level of colonization was found in the litters of young sows, and a low level of colonization at weaning probably predisposed pigs to clinical disease in the nursery, assuming the presence of a virulent serotype.

Culture swabs from serosal surfaces, including joints and meninges. It is essential

to collect samples from areas that are not enclosed in fibrin. Nasal swabs are more easily collected than tracheal but may indicate a different population of HPS. It is usually said that it is difficult to isolate from fluids but is easier from the lesions. It is necessary to have a fresh pig with no antibiotic therapy. It may also be necessary to use Amies transport medium to preserve HPS on the way to the laboratory.

*H. parasuis* is a gram-negative rod existing as a coccobacillus to long filamentous chains. There is usually a capsule, but the expression of this is influenced by culture. NAD or V factor is required for growth (chocolate agar or staph streak, and then there is satellite growth). The availability of NAD may determine growth capabilities. After 24 to 48 hours the colonies are small, translucent, and nonhemolytic on chocolate agar.

### Histology

Histology includes formalin-fixed brain, synovial membranes, liver, lung (LM). Immunohistochemistry can be used to show the organisms in the cytoplasm of neutrophils and macrophages in the lungs and in the mononuclear cells in the subscapular and medullary sinuses of the lymph nodes. Immunofluorescence was observed on the bronchiolar epithelium in the alveoli and in the lung parenchyma.

Modern techniques have been applied. The results are better if you use both the Angen<sup>20</sup> and Olvera<sup>8</sup> PCR techniques, with few false positives.

### Serology

Recently, an indirect hemagglutination test has been described for the serotyping of field isolates. A new indirect hemagglutination technique has just been described, and it is rapid and effective. It is also much more sensitive than the immunodiffusion test.

### DIAGNOSIS

The best cases to examine are those that have received no antibiotics and are acute cases. The organism is very likely to die out if subjected to too much heat or cold.

There is a need to have the samples taken from the lesions as quickly as possible, transported to the laboratory quickly in transport media (Amies medium), preferably chilled if overnight transport, and plated as quickly as possible. It requires to be cultured on chocolate agar or blood agar with a staph streak.

Once cultured, strain typing can be achieved. There are 15 strains and many that are untypeable. The relative strain virulence is shown in Table 15-5.

Novel genotyping was first described in 2008, and an improved species specific PCR has been described since.<sup>15</sup> The complete genome of HPS was described.<sup>2,10</sup> Demonstration of HPS requires culture and PCR identification. There is a correlation between

**Table 15-5** Virulence of strains

HPS serotype	Virulence	Effects
1, 5, 10, 12, 13, 14	High	Death within 96 hours
2, 4, 15	Moderate	Severe polyarthritis
8	Low	Mild lesions
3, 6, 7, 9, 11	Nonpathogenic	No signs or lesions

clinicopathologic outcome and the typing of HPS field strains.<sup>21</sup>

A detailed analysis of diagnostic analyses and the occurrence of strains in the Netherlands is available,<sup>22</sup> in which strains 3 and 10 were not identified. In this study ERIC-PCR and *hsp60* gene typing were also employed because 145 of the strains could not be serotyped.

A multiplex nested PCR has been described<sup>23</sup> that works for *S. suis* and *M. hyorhinitis* and HPS. It is extremely useful when samples are negative after isolation and can be used on formalin-fixed and paraffin-embedded tissues as well.

Usually, HPS can be identified by either of two conventional PCR20 tests or by an RT-PCR,<sup>24</sup> but sometimes *A. indolicus* gives a false positive. A RT-PCR for HPS has been validated.<sup>25</sup> However, a recent paper has suggested that it may fail to recognize an HPS strain, so false negatives may be found.<sup>26</sup>

Researchers in China have described loop-mediated isothermal amplification for rapid detection of HPS and found it more sensitive than nested PCR. It appears to be best used for internal organs and tissues because there are many nonpathogenic types of HPS in the respiratory tract.

The first improvement in the diagnosis of HPS occurred with the development of an oligonucleotide-specific plate hybridization assay that could be used on the nasal swabs. The assay detects fewer than 100 cfu/mL in a pure culture and gives a positive result when HPS is present in the ratio of 1 : 103 to 1 : 104 in a mixed culture. The assay is more sensitive than culture for detection of HPS in nasal swabs.

In-situ hybridization will demonstrate a patchy to multifocal distribution of HPS in the lung. A repetitive-element-based PCR (rep-PCR) has been developed, which is a technique that compares very favorably with traditional microbiology. The rep-PCR uses repetitive sequences within the bacterial genome to produce strain-specific fingerprints, allowing comparison and differentiation between *H. parasuis* strains. This enables comparison of these strains and allows the source of virulent strains to be identified.

Another new technique is ERIC-PCR, and this is very successful compared with conventional microbiological techniques.

Identification and differentiation of *H. parasuis* using a species-specific PCR with subsequence DNA fingerprinting using the digestion of PCR products using Hind III endonuclease has been described. This restriction fragment length polymorphism (PCR-RFLP) enabled eight patterns to be determined for the nontypeable strains.

Recently, a technique for the computer-based analysis of HPS protein fingerprints has been described that is a considerable improvement on serotyping. It was shown that there is a high genetic diversity within the serovars. At least 12 different strains within the type 4 serovar, and genetic diversity in the other serotypes as well, were described. Nontypeable isolates were divided into 18 genotypes. The major advantage of this technique is that there is no need for isolation, culture, and biochemical identification of the isolates. In addition, all strains can be identified, not just those of certain serotypes. At the moment, there is no direct demonstration of a linkage between PCR-RFLP, OMP patterns, and serotyping and rep-PCR. In a recent study, 32 strains were grouped into six serovars and 11 genotypes. This led to the hypothesis that HPS strains with a similar distribution of repetitive sequences can express different antigens. A lot of work is still required to relate genome classification to the real virulence of the strain.

### DIFFERENTIAL DIAGNOSIS

The clinical signs and pathology are not pathognomic because similar pictures can be seen with *Escherichia coli*, *Mycoplasma hyosynoviae*, *Mycoplasma hyorhinitis*, *Erysipelothrix rhusiopathiae*, and *Streptococcus suis*.

The unusual combination of arthritis, fibrinous serositis, and meningitis is sufficient to make a diagnosis of Glässer's disease, but differentiation from the many similar disease entities apparently caused by other agents can only be confirmed by bacteriologic examination.

The disease may be confused with erysipelas, mycoplasma arthritis, and streptococcal arthritis on clinical examination. Mycoplasmosis is a much milder disease and is manifested principally by the presence of a few unthrifty or lame pigs in the litter just before weaning, rather than an acute outbreak with a high mortality. Differentiation between cases of Glässer's disease with meningitis and the other diseases of the nervous system in young pigs, especially streptococcal meningitis and Teschen disease, may not be possible without necropsy examination.

### TREATMENT

Pigs are usually ill with this disease, and thus parenteral treatment is required first. A high

**Table 15-6** Antimicrobial resistance in Spain and the UK.<sup>27</sup>

	Spain	UK
Florfenicol	0	0
Penicillin	60	0
Erythromycin	40	0
Tilmicosin	40	0
Enrofloxacin	20	0
Ceftiofur	7	0
Tiamulin	40	3
Ampicillin	57	7
Oxytetracycline	40	7
Trimet/sulpha	53	10
Spectinomycin	23	10
Gentamycin	27	10
Neomycin	33	20

proportion of HPS strains are resistant or multiresistant.<sup>27</sup> In China, over 70% of the strains were resistant to enrofloxacin.<sup>28</sup> Resistance has been reported for penicillin, and certain strains are resistant to tetracyclines, erythromycin, and other aminoglycosides (Table 15-6). This requires attention to the sensitivity patterns of the organism in different countries. If pigs are sick with HPS, then parenteral treatment is a must as the first step. This can be followed by water medication for at least 5 days. It has long been known that ill animals will not eat, but it is currently appreciated that sick pigs do not drink as much as when they are healthy, and therefore there is the tendency to underdose until they are well enough to drink their normal amounts.

Treatment with penicillin, trimethoprim-sulfadoxine, or oxytetracycline is effective in the early stages of the disease.

Tilmicosin can be used for effective treatment because it is concentrated in the macrophages and neutrophils. These can migrate to the site of infection, and therefore there may be higher levels of antibody in the tissue. Long-acting medication can also be useful (tulathromycin, ceftiofur).

## CONTROL

It is essential to protect high-herd-health units by not importing new stock into a unit also thought to be free, and vice versa, because both groups can be exposed. Never bring high-herd-health stock into a low-health unit. Multisourcing pigs into a grow-out unit is especially suicidal.

Control of PRRS and PCV-2 is important because HPS is associated with both of these.<sup>29,30</sup> Control is only possible if there is (1) diagnosis of infection, (2) identification of prevalent strains, (3) use of autogenous vaccines, and (4) management of new strains.

There are three main approaches:

1. Prophylactic medication
2. Optimization of pig immunity
3. Management techniques to maximize immunity

IgG antibodies kill HPS via the classical complement pathway.<sup>31,32</sup> It is therefore best to vaccinate piglets before weaning, or the sows to boost maternal antibody, but if you do, then delay vaccinating the piglets until maternal antibody has waned. Always vaccinate the replacement breeding stock.

Avoidance of undue exposure to adverse environmental conditions at weaning is recommended. Avoidance of undue fluctuations of temperature is absolutely essential. Prophylactic dosing at the time of shipping or medication of feed or drinking water on arrival with the previously mentioned drugs may be of value in preventing outbreaks. Feeding a mixture of 3% sulfamonomethoxine and 1% trimethoprim at 160 and 240 ppm for 5 days and challenging with *H. parasuis* at 3 days prevented clinical disease, and bacteria were not recovered. There are resistance genes for tetracyclines and beta-lactam antibiotics.<sup>33</sup> Maternal antibody does not interfere with vaccination of pigs at 1 to 3 weeks of age. Maternal immunity lasts about 20 days, but if the sows are vaccinated, then it may last 60 days.<sup>4</sup>

Humoral immunity is protective against experimental Glässer's disease.<sup>34</sup> A formalin-killed bacterin administered before weaning with two injections at 5 and 7 weeks of age has proved highly effective in preventing the disease. A formalin-killed whole-cell culture bacterin developed in Ontario is effective in protecting 4-week-old pigs against experimental challenge with the organism. A recent trial showed that vaccinating sows at 80 and 95 days of pregnancy with a commercial bacterin containing HPS 2, 3, and 5 was useful in reducing pneumonic lesions and arthritic joint changes in subsequently challenged piglets. Vaccination of piglets seemed to have no effect, and vaccination of the sows seemed to have no effect on the colonization of the nasal mucosa by HPS or on the timing of colonization.

Autogenous vaccines against homologous strains have been shown to work, but vaccination failures do occur. There may be little cross-protection between strains. A new serotype 5 vaccination was described, and the subsequent challenge with serotypes 1, 12, 13, and 14 produced different responses in control pigs.

The vaccines against this bacterium are whole-cell bacterins that are protective only against serotypes 1, 4, 5, and 6.<sup>35</sup> Vaccination has three important components. First, there is the decision of commercial or autogenous vaccination, and this depends on the strains in the field and whether they are in the commercial vaccine. Second, the timing of vaccination should take into account the length of persistence of maternal antibody and the peak of piglet mortality. If this peak is at 2 to 3 weeks, then the sows should be vaccinated. The piglets should then be vaccinated at weaning and 2 weeks later. Third, because sow and piglet vaccination together is not

recommended because the sow's vaccination can produce maternal antibody that interferes with the piglet's active immunity, you should make a choice of one or the other. A new departure is the production of a genetically inactivated vaccine, the ghost vaccine.<sup>36</sup>

Recently, the technique of introducing known populations of live HPS to the young piglet shortly after birth, thus allowing a slow rate of acquisition of organisms, has been advocated. All-in/all-out by age is absolutely essential to prevent carry-over of infection, and it is likely that nose-to-nose transmission is important, so solid partitions between different litters may help.

When it comes to disinfection, it has been suggested that chloramine may be useful<sup>37</sup> in deactivating HPS.

## FURTHER READING

- Kielstein P, Rapp-Gabriel V. Designation of the 15 serovars of *H. parasuis* on the basis of immunodiffusion using heat-stable antigen extracts. *J Clin Microbiol.* 1992;30:862-865.
- Olvera A, Segales J, Aragon V. Update on the diagnosis of HPS infections in pigs and novel genotyping methods. *Vet J.* 2007;174:523-529.

## REFERENCES

1. Perry MB, et al. *Carb Res.* 2013;doi:10.1016/J.carres.04.023.
2. Xu C, et al. *Vet J.* 2013;195:200.
3. Martinez-Moliner V, et al. *Microbiol.* 2012;158:2117.
4. Cerdd-Cuellar M, et al. *Vet Microbiol.* 2010;145:315.
5. Howell KJ, et al. *J Bacteriol.* 2013;195:e 4264.
6. Brockmeier SL, et al. *Clin Vacc Immunol.* 2013;20:1466.
7. Yu J, et al. *Vet Microbiol.* 2012;158:316.
8. Olvera AM, et al. *Vet Microbiol.* 2007;123:230.
9. Costa-Hurlado M, et al. *Vet Res.* 2012;43:57.
10. Olvera AM, et al. *Vet J.* 2007;174:522.
11. Aragon V, et al. *Vet Microbiol.* 2010;142:387.
12. Frandoloso R, et al. *Vet Microbiol.* 2012;154:347.
13. de la Fuente AJM, et al. *Res Vet Sci.* 2009;86:230.
14. Metcalf DS, MacInnes JL. *Can J Vet Res.* 2007;71:181.
15. Bouchet B, et al. *Microbial Pathogen.* 2009;46:108.
16. Vanier G, et al. *Microbiol.* 2006;152:135.
17. del Rio M, et al. *Vet Res.* 2006;37:49.
18. Mullins MA, et al. *J Bacteriol.* 2009;191:5988.
19. Strugnell BW, Woolfenden NJ. *Pig J.* 2011;65:43.
20. Angen V, et al. *Vet Microbiol.* 2007;119:266.
21. Yue M, et al. *J Bacteriol.* 2009;191:1359.
22. Dijkman R, et al. *Res Vet Sci.* 2012;93:585.
23. Kang I, et al. *Can J Vet Res.* 2012;76:195.
24. Turni C, et al. *Vet Microbiol.* 2009;108:1123.
25. Turni C, et al. *J Appl Microbiol.* 2010;108:1323.
26. Turni C, Blackall PJ. *J Vet Diag Invest.* 2011;23:355.
27. de la Fuente AJM, Tucker AW. *Vet Microbiol.* 2007;120:184.
28. Zhou M, et al. *Vaccine.* 2009;27:5271.
29. Li JK, et al. *Prev Vet Med.* 2009;91:274.
30. Palzer A, et al. *Vet Rec.* 2008;162:267.
31. Zhou SM, et al. *FEMS Microbiol Lett.* 2012;326:109.
32. Zhou SM, et al. *Vet J.* 2013;196:111.
33. De la Fuente AJM, et al. *J Com Path.* 2009;140:169.
34. san Millan A, et al. *Antimicrob Agents Chemother.* 2007;51:2260.
35. Dijkman R, et al. *Res Vet Sci.* 2012;93:589.
36. Hu M, et al. *Clin Vacc Immunol.* 2013;20:795.
37. Rodriguez-Ferri EF, et al. *Res Vet Sci.* 2010;88:385.



## ARTHRITIS RESULTING FROM ERYSIPELAS

### ERYSIPELAS IN SHEEP

Erysipelas in sheep is caused by infection with the soil-borne organism *Erysipelas rhusiopathiae* (formerly *Erysipelas insidiosus*). Pigs are the most important reservoir of infection, with up to 50% of healthy pigs carrying the bacterium in lymphoid tissues. The disease in sheep is manifested as arthritis in lambs, postdipping lameness, and rarely endocarditis. Sheep other than newly born lambs deprived of colostrum are generally quite resistant to infection with this organism.

### Arthritis in Lambs

Acute and chronic forms of arthritis are seen.<sup>1</sup> Acute nonsuppurative arthritis occurs most commonly after tail docking, especially when a cold knife is used, but can also follow umbilical infections at or soon after birth. The organism persists in the soil and gains entry via the umbilicus or tail-docking and/or mulesing wounds. The latter practice is used to make merino lambs less susceptible to flystrike, mainly in Australia, but is gradually being phased out. Up to 50% of lambs marked may be affected, especially if tail docking is performed in muddy or unhygienic conditions. The mortality rate is low, but some affected lambs lose weight and have permanently swollen joints, leading to trimming of meat or rejection of the whole carcass at abattoirs.

Clinical signs appear about 14 days after birth or tail docking. There is a sudden onset of lameness with some swelling of the affected joints, typically the carpus, tarsus, hock, or stifle. Recovery is slow, and a high proportion of affected lambs have chronic lameness and swollen joints.

Chronic fibrinous polyarthritis also occurs in 2- to 6-month-old lambs, affecting several joints, and lambs may be lame on all four legs.<sup>1</sup> Up to 20% of lambs may be affected, although severe outbreaks with a higher prevalence are associated with spreading pig slurry or running free-range pigs on areas grazed by sheep. Arthritis in mature ewes can also occur in these circumstances.<sup>2</sup>

At necropsy the joint capsule is thickened, and there may be erosions of articular cartilage and slightly increased amount of synovial fluid that has a turbid appearance. There is no obvious suppuration as occurs with septic arthritis caused by streptococcal infection. In chronic cases the organism is usually only isolated from joints, but PCR testing indicates that it is also a multisystemic disease.<sup>1</sup>

Improved hygiene at tail docking will usually reduce the prevalence of *Erysipelas* arthritis, but a formalin-killed bacterin is available in many countries and may be indicated where there is a persistently high prevalence of infection.

### Postdipping Lameness

The use of plunge dips to control ectoparasites in sheep can be followed by a high incidence of laminitis if the insecticide solution does not contain a suitable disinfectant. Dips that become grossly contaminated with organic matter are most likely to cause *Erysipelas* infection. The organism gains entry through skin abrasions and causes cellulitis, with extension to the laminae of the feet but without involving the joints. Up to 90% of a flock may be affected, although the incidence is usually about 25%. Similar outbreaks of lameness caused by *Erysipelas rhusiopathiae* have occurred without dipping, usually when sheep have to walk through wet, muddy areas likely to be contaminated with the organism.

Severe lameness begins 2 to 4 days after dipping, usually in one leg. The affected legs are hot and swollen from the coronet to halfway up the metacarpus or metatarsus, and the hair over the affected area usually falls out. Sheep rapidly lose body condition, but deaths are rare except in recently weaned lambs, in which septicemia may develop. Affected lambs show fever, malaise, and anorexia.

At necropsy there is subcutaneous edema of the area, sometimes with hemorrhage and inflammation extending to the coronet of the feet. Most cases recover spontaneously in 10 to 14 days, but long-acting penicillin will assist recovery. Wet dipping is now less common, but where dipping is still routinely practiced the use of fresh dipping solution each day and inclusion of a bacteriostatic agent into the solution will help prevent this condition.

Postdipping lameness can be differentiated from footrot by the history of recent dipping and lack of underrunning of the hoof tissue, from foot abscess by the lack of abscessation, and from strawberry footrot by the lack of any proliferative dermatitis.

### REFERENCES

1. Ersdal C, et al. *Vet Path.* 2015;52:635.
2. Scott P. *Livestock Health.* 2013;18:80.

## MYCOPLASMA HYOSYNOVIAE IN PIGS

Mycoplasma arthritis caused by *M. hyosynoviae* occurs in growing and finishing pigs from 35 kg upward and is characterized clinically by lameness, frequently in newly purchased stock.

### ETIOLOGY

*M. hyosynoviae* causes arthritis in growing pigs. *M. hyoarthrinosa* has been associated with a syndrome similar to that produced by *M. hyosynoviae*, but they may be the same species. Other mycoplasmas, including *M. flocculare* and *Acholeplasma* spp., have been isolated from pigs but appear to have no propensity to produce arthritis.

### EPIDEMIOLOGY

*M. hyosynoviae* is a causative organism with a very wide heterogeneity and is resident on the pharyngeal mucosa and tonsil. Shedding is less frequent than with *M. hyorhinis*, and the organism cannot usually be isolated from the pharynx of piglets before 7 weeks of age and is regarded as rare before 12 weeks. This is true even when most of the sows in a herd are tonsillar carriers. There is a very varied pattern of carriage. It appears that transference is fairly rare but can be the source of infection for the other littermates. There is some variation in virulence between strains. With virulent strains, bacteremia with subsequent arthritis follows within a few days of minor stress, such as vaccination, movement, regrouping, or a change in weather. The overall prevalence of clinical disease appears to be low, but it achieves significance in certain herds that experience a persistent problem. The reasons for this are still unclear. Infection profiles between herds vary considerably. In some herds in the United Kingdom, the incidence may be higher, with 21% of sows culled because of lameness primarily associated with *M. hyosynoviae*. It appears that there is a latent period between the tonsillar infection and the development of generalized infection and arthritis, which may be accounted for by the long persistence of maternal antibodies of 8 to 16 weeks. The active serologic response possibly indicating immunity only seems to occur when there is the onset of arthritis. It is more prevalent in heavily muscled pigs with straight-legged conformation, and there is variation in breed susceptibility. Morbidity in problem herds is generally 5% to 15% but may reach 50%. Mortality is rare, but 2% to 15% may become chronically affected.

Abattoir studies have suggested that 5% to 10% of pigs may be affected. Transmission of infection is by direct contact or possibly by aerosol infection.

*M. hyosynoviae* can survive drying for up to 4 weeks and may be capable of survival in the environment for longer periods than most mycoplasmas. A further consideration of the importance of these diseases must be given to their possible contribution to the occurrence of carcass condemnation from arthritis.

### PATHOGENESIS

The most important thing to remember about pathogenesis is that pigs can carry the infection in their tonsils and their synovial fluid without clinical signs of lameness and may therefore not be diagnosed as carriers and can act as a potential source of infection to others.

Systemic infection by mycoplasma may occur following stress. Clinical disease is manifest if localization occurs, but this is probably the exception rather than the rule. In the experimental disease, the incubation period varies from 4 to 10 days. After

experimental intranasal infection with *M. hyosynoviae*, septicemia usually takes about 2 to 4 days to manifest. *M. hyosynoviae* produces synovitis with some arthritis, especially in the larger joints of the hindlimbs.

### CLINICAL FINDINGS

Diagnosis is often difficult to make clinically. Often there is no fever and perhaps only a change in the gait of the pig. In these herds the sows are nearly always culled for lameness before the fourth parity, which constitutes a huge economic loss. Failure to treat leads to chronic lameness. Clinical disease occurs primarily in pigs over 3 months of age and in replacement stock brought into these problem herds.

With *M. hyosynoviae* infection, there is a sudden onset of acute lameness in one or more limbs, usually without fever. Lameness may be referable to one or more joints, and the stifle, hock, and elbow joints are most commonly affected. In many cases the pigs may lie in sternal recumbency. The lameness is severe, although clinical swelling of the affected joint may be minimal. In the majority of affected pigs, clinical recovery occurs after 3 to 10 days, but some may become permanently recumbent. In the United Kingdom, the condition is often associated with delivery of high-herd-health gilts to more conventional farms, with the condition occurring 2 days to 4 weeks after the delivery or with a change of housing. Other outbreaks have followed the introduction of pigs to straw yards, whereas contemporary animals kept in fully slatted accommodation have been unaffected. *M. hyosynoviae*-infected pigs may require humane slaughter.

### CLINICAL PATHOLOGY

Blood cell counts remain within the normal range, but there is an increase in leukocytes and protein in synovial fluid. The organisms may be detected by immunofluorescent techniques, and complement-fixing antibody develops following infection.

### PATHOLOGY

Synovial hypertrophy with an increased amount of serosanguinous synovial fluid occurs in affected joints with *hyosynoviae*. Sometimes the amount of fluid is considerable. Chronic cases show thickening of the joint capsule with a varying degree of articular erosion and pannus formation. Joint lesions are most likely to be found in the carpus, shoulder, stifle, and tarsus. Quite often with *M. hyosynoviae* infections, one joint—usually the hock—is affected.

Microscopically, there is usually edema, hyperemia, hyperplasia of synovial cells, and an increased density of subsynovial cells. Lymphocytes and plasma cells are present in the affected serosal and synovial membranes of subacute to chronic cases. There is often a significant villus hypertrophy of the synovial membrane. In the chronic phase, there may

be some fibrosis. A full description of the phases of infection has recently been described. The organism is more easily demonstrated during the acute stage of the disease.

### DIAGNOSIS

Clinical signs may help. Joint fluid may be helpful in that it is often clear or yellowish-brown and may contain flakes of fibrin. In streptococcal arthritis, the fluid is often hemorrhagic and turbid.

### Samples for Confirmation of Diagnosis

- Histology—synovial membrane, liver, lung, heart. Sometimes the mycoplasmas can be seen between the synoviocytes on the tips of the villi of the synovial membrane.
- Mycoplasmaology—culture swabs from serosal surfaces, joints. Selective media is usually required to suppress *M. hyorhinis*.
- *M. hyosynoviae* is best grown in anaerobic conditions, where it outgrows *M. hyorhinis*.
- Synovial fluid has been taken from the hock joint under general anesthesia and cultured. Isolation from the joints of lame pigs was twice as high as from littermates that were not lame. Approximately 8% to 9% of synovial fluid samples from nonpatent arthritis samples from Danish slaughterhouse pigs were positive. The same authors also showed that blood culture was also effective.
- Antigen detection. An in situ hybridization technique for the differentiation of *M. hyosynoviae*, *M. hyorhinis*, and *M. hyopneumoniae* has been described for use with formalin-fixed tissues.
- PCR can be used to amplify a p36 or p46 gene to differentiate *M. hyorhinis* and *M. hyosynoviae* infections for use in cultures and in blood samples.
- Serology—it has been shown that herds with *M. hyosynoviae* arthritis had higher serologic responses and more carriers among growers of 16-week-old pigs than did the unaffected herds, but by the end of the finishing period, the serologic response and carrier prevalence were as high in herds with arthritis as without.
- An indirect ELISA has been developed using membrane lipoprotein antigens and appears to be specific.

The differential diagnosis of mycoplasma infections must include *S. suis* and *H. parasuis*.

### TREATMENT

When gilts and sows are treated, they do not appear to have a reduced overall survival time, indicating that treatment is cost-effective.

Treatment with tylosin at 1 to 2 mg up to 15 mg/kg BW IM or Lincomycin at 2.5 mg/kg BW IM for 3 consecutive days has been recommended. Lincomycin was effective in one outbreak, but the outbreak flared up again as soon as it was removed. Oxytetracycline also can be used. Early treatment of *M. hyosynoviae* arthritis with 8 mg of betamethasone IM has been found to reduce the occurrence of chronic lameness. Tiamulin at both 10 and 15 mg/kg BW IM daily for 3 days is effective for treatment of pigs affected with arthritis associated with *M. hyosynoviae* and is as effective as Lincomycin. Recently, enrofloxacin has been used at 2.1 mg/kg IM or SC for 3 days. It is essential to treat the in-contacts and to isolate the treated animals until the clinical signs have disappeared. Valnemulin was highly active against *M. hyosynoviae*, whereas tiamulin and enrofloxacin were much less active.

### CONTROL

The control of mycoplasma joint disease rests largely in the avoidance of stress situations. The administration of tylosin or tetracyclines in the drinking water or feed during unavoidable stress such as weaning can reduce the incidence. The use of tiamulin as a single injection before moving pigs from one house to another was sufficient to prevent 50% of the cases of the disease. Early weaning at 3 to 5 weeks of age has been recommended as a method of preventing infection of pigs with *M. hyosynoviae* and thus of reducing the occurrence of the disease in growing pigs. However, in one study *M. hyosynoviae* was not eliminated in herds where the piglets were commingled after 4 weeks and reared in herds using all-in/all-out management. In fact, the herd had widespread infection when the herd was 4 months old. The authors concluded that elimination of *M. hyosynoviae* requires that the pigs are moved immediately from weaning at an age of no more than 4 weeks. If newly arrived gilts are under threat, usually 14 to 21 days after arrival, then a course of treatment such as Lincomycin in the water for 2 to 3 days may prevent the infection.

### FURTHER READING

Hagedorn-Olsen T Mycoplasma hyosynoviae arthritis in pigs. PhD thesis, Royal Veterinary and Agricultural University, Copenhagen, Denmark; 1997.

### FOOTROT IN PIGS (BUSH FOOT)

Footrot in pigs is similar clinically to footrot in other species. It is a term describing septic conditions of the claws of the foot, which burst at the coronet.

### ETIOLOGY

The majority of cases result from secondary infection of traumatic lesions. These are erosions of the sole and wall of the claw that occur in pigs reared on rough, abrasive

flooring. These lesions do not usually produce lameness, unless they are extensive, but when pigs are also reared in dirty conditions, infection and subsequent lameness may occur.

Foot lesions are common in pigs of all ages, and bruising of the sole-heel junction, one of the earliest lesions observed, can be seen in piglets less than 24 hours old. If the bruising is severe and further trauma is not prevented, necrosis will follow quickly. The cause may be a combination of factors, including trauma, contact dermatitis, and subsequent infection. Wet conditions underfoot may cause maceration of the horn and exacerbate the abrasive effect of the flooring. Foot abscess in neonatal pigs is associated with being reared on woven-wire floors. Dietary deficiency, especially biotin deficiency, may also result in foot lesions that predispose to secondary infection.<sup>1,2</sup>

*Fusiformis necrophorum*, *Trueperella pyogenes*, *Staphylococci* and an unidentified spirochete have been isolated from affected feet. In an outbreak of the disease on a semi-intensive pig farm, *Dichelobacter nodosus* and other anaerobic bacteria, including *Prevotella*, *Peptostreptococcus*, *Fusobacterium*, *Porphyromonas*, *Bacteroides*, and *Eubacterium*, have also been isolated from affected feet.

### EPIDEMIOLOGY

The disease is probably universal. A study of the prevalence and distribution of foot lesions in finishing pigs in England found that 94% of pigs had at least one foot lesion. The prevalence of the different lesions was as follows: toe erosion (33%), sole erosion (62%), heel erosion (13%), heel flaps (14%), white-line lesions (55%), false sand cracks (24%), and wall separation (11%). The hindfeet are more commonly affected than the front feet, and on each foot the lateral digits were significantly more frequently affected than the medial digits. Sole erosions, heel flaps, wall separation, and false sand cracks were observed more frequently on the lateral than the medial digit.

Erosive lesions on the foot are common and have been reported at an incidence as high as 65%. They have been reproduced experimentally, and the nature of the flooring has a marked influence on claw wear in pigs. Recently poured alkaline concrete and poorly laid concrete with constituents leading to a rough abrasive surface lead to a high incidence. A slope inadequate to allow proper drainage may also be an important predisposing factor. All ages of pigs are susceptible, but clinical lameness is uncommon. In individual herds where the unfavorable predisposing factors prevail, a high incidence of infection and clinical lameness can occur. The disease may cause reproductive inefficiency as a result of reluctance to stand or mount for mating.

### PATHOGENESIS

Perforation of the horn leads to infection of the sensitive laminae. The infection may track up the sensitive laminae to the coronary band and discharge to the exterior. Elastolytic activity is a virulence factor involved in the pathogenesis of footrot in pigs associated with *Dichelobacter nodosus* and *Prevotella melaninogenica*.

### CLINICAL FINDINGS

Where the disease is caused by abrasion of the horn by rough concrete surfaces, a number of characteristic lesions occur, including the following:

1. Erosion of the sole at either the toe or the heel
2. Bruising of the sole with hemorrhagic streaks in the horn
3. Separation of the hard horny wall from the heel or sole to produce a fissure at the white line
4. A false sand crack in the posterior third of the lateral wall of the claw

In the majority of cases these do not produce lameness, and they do not have any apparent effect on productivity. However, when they are extensive, where infection has occurred, and when more than one foot is affected, severe lameness is apparent. In most cases only the lateral digit of one foot is affected. Heat and obvious pain when moderate pressure is applied to the affected claw are constant findings. Necrosis extends up between the sole and sensitive laminae and may discharge at the coronet, causing the development of a granulomatous lesion, or it may extend to deeper structures of the foot with multiple sinuses discharging to the exterior. A minimal amount of purulent material is present. Productivity is affected with this type of lesion. With deeply infected feet, the recovery rate is only fair with treatment. A permanently deformed foot may result, and destruction of the pig may be necessary in severe cases. Secondary abscessation in other parts of the body is an occasional sequela and may result in partial carcass condemnation.

Foot abscesses in neonatal pigs are characterized by necrotic pododermatitis, severe osteomyelitis, arthritis, and tenosynovitis. The primary sites of injury are located at either the point of the toe at the white line, the bulb of the heel, or the haired skin around the coronet, including the interdigital area. The least severe lesions are superficial abrasions or ulcerations of the hoof wall, heel bulb, or interphalangeal skin, with only minimal inflammatory changes in deeper tissues. The most severely affected digits have focal superficial abscesses, or deep, diffuse, purulent inflammation and fibrosis around tendons, joints, and bones. The hindlimbs are more commonly affected than the forelimbs, and in the hindlimbs the medial claws are most likely to have lesions, whereas in the

forelimbs the lateral claws are more likely to be affected. Approximately 6% of piglets develop foot abscess before weaning. About one-third of litters may be affected, and most litters have only one or two affected pigs. Discharge of pus from the coronary band is common, and the horny claw may slough, leaving sensitive laminae of one or more claws or accessory digits exposed. Skin necrosis may be present over the carpi, fetlocks, hocks, coronary bands, and elbows in about 75% of pigs during the first week of life.

### CLINICAL PATHOLOGY

Bacteriologic examination of discharges from the lesions may aid in deciding the treatment to be used. In foot abscesses of neonatal pigs, bacteria isolated include the following:

- *Trueperella pyogenes*
- *Staphylococcus* spp.
- Beta-hemolytic *Streptococcus* spp.
- *Actinobacillus* spp.
- *Escherichia coli*

### NECROPSY FINDINGS

Necrosis of the laminar tissue with indications of progression from an infected sole are the usual findings. There may be progression to tenosynovitis.<sup>3</sup>

### DIFFERENTIAL DIAGNOSIS

Most other causes of lameness in pigs are not manifested by foot lesions. Bursitis, adventitious bursitis, and laminitis may occasionally be found. In young pigs they are not uncommon as a result of bad flooring (sharp metal and plastic and coarse concrete). These are seen as early as 24 hours, peak at 4 to 8 days, and are usually gone by 14 days. In adult pigs housed indoors, an overgrowth of the hoof may occur and be followed by underrunning of the sole, necrosis, and the protrusion of granulation tissue, causing severe lameness and often persistent recumbency. The general appearance of these feet is not unlike that of canker in horses. Swelling of the hoof is caused by an extensive fibrous tissue reaction. Vesicular exanthema and foot-and-mouth disease are characterized by the presence of vesicular lesions on the coronets and snout.

### TREATMENT

There are few published reports of treatment of footrot in pigs. Rubber mats in the farrowing house may prevent some of the worst effects for piglets. Use of a broad-spectrum antimicrobial or penicillin given parenterally seems rational, and the use of Nuflor was said to be a successful treatment.

### CONTROL

Prevention of excessive wear of the feet by the use of adequate bedding and less abrasive flooring in pig pens is suggested as a reasonable control measure. Slats should be round



edged and have a minimum width of at least 100 mm. Any existing dietary deficiency should be corrected. Of particular interest is the response to biotin supplementation of the diet of pigs in the prevention of foot lesions of various kinds. Regular foot care and paring of excessive growth is important. Formalin foot baths (5% to 10%, 2 to 3 times a week) may also reduce bacterial infection.

## REFERENCES

1. Fitzgerald RF, et al. *Livestock Sci.* 2012;145:230.
2. Knauer M, et al. *Prev Vet Med.* 2007;82:198.
3. Kilkbride AL, et al. *BMC Vet Res.* 2009;5:31.

## ROSS RIVER VIRUS

### ETIOLOGY

Ross River virus is an alphavirus within the Semliki Forest complex of togaviruses. These are small enveloped viruses with a single-stranded, positive sense RNA genome. There is considerable sequence homology between Getah and Ross River virus genomes.<sup>1</sup> Ross River virus causes disease in both humans and horses.

### EPIDEMIOLOGY

Ross River virus is found in most areas of continental Australia, Tasmania, West Papua and Papua New Guinea, New Caledonia, Fiji, Samoa, and the Cook Islands.<sup>2</sup> There is geographic genetic variability among isolates of Ross River virus. There is serologic evidence of lack of infection of cattle by RRV in the Coromandel region of New Zealand.<sup>3</sup>

The virus is arthropod borne, and infection is through the bite of an infected mosquito. The virus is maintained in the mosquito-vertebrate-mosquito host cycle typical of arboviruses. The vertebrate hosts of Ross River virus include a large number of eutherian, marsupial, and monotreme mammals and birds.<sup>2</sup> Macropod species, including kangaroos and wallabies, are assumed to be the most important amplifying hosts, although this is debated. There is a high prevalence of serologically positive Western Grey kangaroos (48%).<sup>4</sup>

There is a high incidence of Ross River virus infection of horses in endemic regions of Australia, and the prevalence was shown to be increased with year-round mosquito activity. The proportion of seropositive horses in Queensland, an area in with year-round mosquito activity, was approximately 80%, whereas that of horses around the Gippsland lakes in southern Australia, a region with seasonal mosquito activity, was 50%. Outbreaks of clinical disease attributed to Ross River virus infection of horses occurred in southeastern Australia in late 2010 and early 2011 and were also associated with serologic and virological evidence of infection by Murray Valley encephalitis virus and Kunjin virus (a lineage of West Nile virus).<sup>5</sup> During the outbreak, which was

associated with unusually wet summer conditions in an area characterized by hot, dry summers, 392 horses on 271 premises were suspected or confirmed to have been infected by one or more of these arboviruses.

### Zoonotic Implications

Disease associated with Ross River virus infection is common in humans in Australia, with an estimated 4800 cases per year, and much larger numbers during epidemics of the disease.<sup>2</sup> The horse is thought to be an amplifying host of the virus because experimentally infected horses can infect mosquitoes. Direct transmission from the horse, however, would be primarily occupational. The disease in humans is characterized by mild pyrexia and constitutional signs initially, with subsequent development of a rash on the skin and oral lesions. Arthritis or arthralgia is common and affects primarily the wrists, knees, ankles, and small joints of the extremities. These signs and symptoms can persist for 2 to 3 months, and the disease can relapse.

### CLINICAL SIGNS

The disease associated with Ross River virus infection of horses is typified by pyrexia; petechial hemorrhages; submandibular lymphadenopathy; lameness, including “stiffness”; swollen joints or distal limbs; inappetence; reluctance to move; and mild colic.<sup>5,6</sup> Horses are often described as being ataxic, although the neurologic basis of this sign is unclear. Any previous skepticism regarding the pathogenicity of Ross River virus in horses was addressed by the outbreak of disease caused by Ross River virus during 2010 and 2011 in southeastern Australia. Disease associated with confirmed Ross River virus infection was characterized by ataxia, stiff gait, depression, edema, listlessness, pyrexia, and reluctance to walk. Horses infected experimentally with Ross River virus have minimal clinical signs of disease. The duration of disease caused by Ross River virus in horses is uncertain, and some veterinarians consider that the disease can persist for weeks to months, and it can recur in horses.

There are insufficient reports of disease to determine whether characteristic or diagnostic abnormalities in serum biochemistry or hematology occur in affected horses. An elevated concentration of fibrinogen in plasma was reported in all of three horses with the presumptive disease that were tested.

### DIAGNOSIS

Diagnosis of infection by Ross River virus is confirmed by virus isolation from serum or heparinized blood samples collected during the acute phase of the disease or detection in serum of antibodies to the virus. Detection of IgM antibodies to Ross River virus is indicative of recent infection, whereas detection of IgG or neutralizing antibodies is indicative of

more distant infection. Seroconversion confirms exposure, and presumably infection, by the virus. Isolation of Ross River virus has been achieved from horses with IgM antibody to the virus but not with IgG antibody, likely because of the temporal pattern of antibody appearance in the blood of infected horses.<sup>6</sup> In addition to culture of the virus in mice or tissue culture, Ross River virus can be detected in blood and synovial fluid using an RT-PCR. It is important to remember that subclinical infection of horses in endemic regions is very common and that this high rate of subclinical infection increases the risk of incorrect diagnosis of infection by the virus. It is possible that clinical abnormalities in a horse with Ross River viremia or serum antibodies to the virus are actually not attributable to infection by Ross River virus. This is extremely significant in that there are no reports of postmortem examination of horses with disease confirmed to be caused by Ross River Virus. Thus case definition in terms of postmortem confirmatory diagnostics has not been established.

### TREATMENT

Treatment of affected horse is supportive. Affected horses might benefit from administration of analgesics and antipyretics such as phenylbutazone. Administration of antimicrobials is not indicated in uncomplicated cases.

### CONTROL

Control measures have not been evaluated, but minimizing the exposure of horses to infected mosquitoes is prudent, although the efficacy of this technique in preventing infection is unknown. There is no vaccine to prevent infection or disease of horses by Ross River Virus. There is an experimental vaccine for humans.<sup>7</sup>

### REFERENCES

1. Zhai Y-g, et al. *J Gen Virol.* 2008;89:1446.
2. Jacups SP, et al. *Vector-Borne Zoonot.* 2008;8:283.
3. McFadden AMJ, et al. *NZ Vet J.* 2009;57:116.
4. Potter A, et al. *Vector-Borne Zoonot.* 2014;14:740.
5. Roche SE, et al. *Aust Vet J.* 2013;91:5.
6. El-Hage CM, et al. *Aust Vet J.* 2008;86:367.
7. Wressnigg N, et al. *Clin Vac Immunol.* 2015;22:267.

## Nutritional Diseases Affecting the Musculoskeletal System

### SELENIUM AND/OR VITAMIN E DEFICIENCIES

Several diseases of farm animals are associated with a deficiency of either selenium (Se) or vitamin E (VE) alone or in combination, usually in association with predisposing factors such as dietary polyunsaturated fatty acids, unaccustomed exercise, and rapid

growth in young animals. All of these diseases are described under one heading because both Se and VE are important in the etiology, treatment, and control of the major diseases caused by their deficiencies.

There are also **selenium–vitamin E-responsive diseases** because, with some exceptions, they can be prevented by adequate supplementation of the diet with both nutrients. In some regions of the world, particularly New Zealand and in parts of Australia and North America, diseases such as ill-thrift in sheep and cattle and poor reproductive performance respond beneficially to Se. Although these cases usually occur in Se-deficient regions, they may not be attributable solely to Se deficiency. Thus there are some reasonably well-defined **selenium-deficiency diseases** and some ill-defined “**selenium-responsive**” diseases.

There is more concern with these diseases now because it is becoming increasingly important to make sure that milk and meat are not deficient in Se and VE from the human nutrition point of view. Deficient meat makes for deficient humans.

More and more oxidants, antioxidants, and oxidative stress disorders are featuring in human and animal diseases. At least theoretically, oxidative stress should be easily prevented with antioxidants, but such therapy is controversial.<sup>1</sup>

In addition, there is an increasing recognition of the importance of toxic oxygen radicals (free-oxygen radicals) produced in the body that are neutralized by antioxidants and that may or not be effective resulting in an oxidative stress.<sup>2,3</sup> This focus is particularly important in ruminant medicine<sup>4</sup> with respect to sepsis, mastitis, pneumonia, and retained placenta.

## ETIOLOGY

The Se- and VE-responsive or deficiency diseases of farm animals are caused by diets deficient in Se and/or VE, with or without the presence of conditioning factors such as an excessive quantity of polyunsaturated fatty acids in the diet. Almost all of the diseases that occur naturally have been reproduced experimentally using diets deficient in Se and/or VE. Conversely, the lesions can usually be prevented with Se and VE supplementation. In certain instances, such as, for example, in hand-fed dairy calves, the incorporation of excessive quantities of polyunsaturated fatty acids was a major factor in the experimental disease. The presence of polyunsaturated fatty acids in the diet may cause a conditioned VE deficiency because the vitamin acts as an antioxidant. In the case of naturally occurring muscular dystrophy in calves, lambs, and foals on pasture, the myopathic agent, if any, is unknown, and selenium is protective. However, Se is not protective against the muscular dystrophy associated with the feeding of cod liver oil to calves.

## SYNOPSIS

**Etiology** Dietary deficiencies of selenium and vitamin E and conditioning factors such as dietary polyunsaturated fatty acids.

### Epidemiology

- **Enzootic muscular dystrophy** occurs in young, rapidly growing calves, lambs, goat kids, and foals born to dams in selenium-deficient areas with unsupplemented diets. Occurs worldwide and common in Australasia, United Kingdom, and Great Plains of North America where soils are deficient in selenium. Vitamin E deficiency in animals fed poor-quality forage and diets high in polyunsaturated fatty acids. Outbreaks of muscular dystrophy precipitated by exercise.
- **Mulberry heart disease** in finishing pigs.
- **Selenium-responsive diseases** occur in Australasia and are not obvious clinically but respond to selenium supplementation. Selenium and vitamin E deficiency may be involved in reproductive performance, retained placenta in cattle, and resistance to infectious disease such as bovine mastitis. Controversial.

**Signs** Muscular dystrophy characterized by groups of animals with stiffness, weakness, and recumbency; severe in myocardial form. Mulberry heart disease characterized by outbreaks of sudden death in finishing pigs.

**Clinical pathology** Increased plasma levels of creatine kinase. Low serum levels of selenium and vitamin E. Glutathione peroxidase activity.

**Necropsy findings** Bilaterally symmetric pale skeletal muscle; pale streaks in myocardial muscle. Hyaline degeneration of affected muscle.

**Diagnostic confirmation** Low selenium and vitamin E in diet and tissues; increased creatine kinase and muscle degeneration.

Differential diagnosis list

Acute muscular dystrophy in calves and yearlings

- *Haemophilus somnus* septicemia
- Pneumonia

Subacute enzootic muscular dystrophy:

- **Musculoskeletal diseases**—polyarthritis, traumatic or infectious myopathies (blackleg), osteodystrophy, and fractures of long bones
- **Diseases of the nervous system**—spinal cord compression, *Haemophilus somnus* meningoencephalitis and myelitis, organophosphatic insecticide poisoning
- **Diseases of the digestive tract**—carbohydrate engorgement resulting in lactic acidosis, shock, dehydration, and weakness

- Muscular dystrophy in lambs and kids—enzootic ataxia and swayback
- Muscular dystrophy in foals—traumatic injury to the musculoskeletal system and polyarthritis; meningitis; traumatic injury to the spinal cord

**Treatment** Vitamin E selenium parenterally.

**Control** Selenium and vitamin E supplementation of diet; strategic oral and/or parenteral vitamin E and selenium to pregnant dams or young animals on pasture.

Se is an essential nutrient for animals, and diseases caused by Se inadequacy in livestock are of worldwide distribution.

## Biological Functions of Selenium and Vitamin E (VE)

### Selenium

Selenium is the component of over 30 selenoproteins<sup>5</sup> that protect cells from damage by free radicals, the cause of many chronic diseases.<sup>6</sup> The Se is present as selenocysteine in the selenoproteins. It is the 21st amino acid. The selenoproteins also participate in the metabolism of thyroid hormones, control reproductive functions, and exert neuroprotective effects. In addition to its antiproliferative and antiinflammatory effects, SE also stimulates the immune system via the macrophages, neutrophils, and lymphocytes. Se stimulates the T-helper cells, cytotoxic T cells, and natural killer (NK) cells. It is aided by VE and sulfur-containing amino acids. Se-containing proteins may have a role in muscle formation and repair.<sup>7</sup> Deficiencies can result in nutritional muscular dystrophy (white-muscle disease) in lambs, kids, calves, and poultry; exudative diatheses in poultry; and necrotic liver degeneration and mulberry heart disease in pigs. In cattle, it is also associated with parturition problems, placental retention, and metritis. Se deficiency also contributes to the formation of ovarian cysts and increased early embryonic mortality. VE and Se also facilitate leukocyte migration into the mammary glands and enhance neutrophil phagocytosis, which helps in the fight against mastitis.

One of these proteins is selenoprotein W, first identified in sheep suffering from Se deficiency; the majority of its functions are unknown, but it serves as an antioxidant, responds to stress, and is involved in cell immunity.<sup>8</sup> In sheep given sodium selenite and selenium nanoparticles, it was shown that expression of transferrin and its receptor genes was considerably increased during supplementation by both Se components for 10 to 20 days and then decreased significantly.<sup>9</sup> It is close to sulfur in terms of properties.<sup>10</sup> It is largely absorbed through the duodenum and the cecum by active transport through a sodium pump.

Long-term supplementation (0.3%) with organic Se modulates the gene-expression profiles in leukocytes of adult pigs; 28 genes

were up-regulated and 24 down-regulated by the Se supplementation, leading to improved expression of genes that are related to enhanced immunity of pigs.<sup>11</sup>

### Glutathione Peroxidases and Tissue Peroxidation

Se is a biochemical component of the enzyme glutathione peroxidase (GSH-PX).<sup>12</sup> The activity of the enzyme in erythrocytes is positively related to the blood concentration of Se in cattle, sheep, horses, and pigs and is a useful aid for the diagnosis of Se deficiency and to determine the Se status of the tissues of these animals. The enzyme from the erythrocytes of both cattle and sheep contains 4 g atoms of selenium per 1 mol of enzyme. Se is also a component of thyroid gland hormones and is very important in converting T4 to T3 (i.e., inactive to active).<sup>13</sup>

Plasma GSH-PX protects cellular membranes and lipid-containing organelles from peroxidative damage by inhibition and destruction of endogenous peroxides, acting in conjunction with VE to maintain the integrity of these membranes. Hydrogen peroxide and lipid peroxides are capable of causing irreversible denaturation of essential cellular proteins, which leads to degeneration and necrosis. GSH-PX catalyzes the breakdown of hydrogen peroxide and certain organic hydroperoxides produced by glutathione during the process of redox cycling. This dependence of GSH-PX activity on the presence of Se offers an explanation for the interrelationship of Se, VE, and sulfur-containing amino acids in animals. The sulfur-containing amino acids may be precursors of glutathione, which in turn acts as a substrate for GSH-PX and maintains sulfhydryl groups in the cell. Se is also a component of several other proteins, such as the selenoprotein of muscle (selenoflagellin), Se-transport proteins, and the bacterial enzymes formate dehydrogenase and glycine reductase. Se also facilitates significant changes in the metabolism of many drugs and xenobiotics. For example, Se functions to counteract the toxicity of several metals, such as arsenic, cadmium, mercury, copper, silver, and lead.

### Vitamin E

VE is important in the general immune response because it affects the blood cell populations and, in particular, the persistence of the immune response. Together with vitamins A and D and Se, it increases reproductive performance.<sup>14</sup>

The term "vitamin E" is a generic description encompassing two families of lipid-soluble compounds, the tocopherols and the tocotrienols, of which alpha-tocopherol is the most active.<sup>15</sup> VE is an antioxidant that prevents oxidative damage to sensitive membrane lipids by decreasing hydroperoxide formation. The vitamin has a central role in protection of cellular membranes from lipoperoxidation, especially membranes rich

in unsaturated lipids, such as mitochondria, endoplasmic reticulum, and plasma membranes.

Cows discriminate against the 2S isomers of the synthetic form, which contains all eight isomers (4 of 2R and 4 of 2S). This means that 1 g of all-rac is actually 0.5 g of the RRR form.<sup>15</sup>

It has been observed that low serum alpha-tocopherol levels are possibly indicative of a disposition to left-sided displaced abomasum in early-lactating dairy cows.<sup>16</sup> Organic farms have more VE than conventional ones, and grass clover silage is the best source of VE compared with hay, maize, or grain. Silage is a better source of tocopherols than hay as a result of high storage losses in the latter, and ensiled grasses and legumes have more VE than maize silage.<sup>17</sup>

### Interrelationships Between Selenium and Vitamin E

An important interrelationship exists between Se, VE, and the sulfur-containing amino acids in preventing some of the nutritional diseases caused by their deficiency. If VE prevents fatty acid hydroperoxide formation, and the sulfur amino acids (as precursors of GSH-PX) and Se are involved in peroxide destruction, these nutrients would produce a similar biochemical result, that is, lowering of the concentration of peroxides or peroxide-induced products in the tissues. Protection against oxidative damage to susceptible nonmembrane proteins by dietary Se, but not by VE, might explain why some nutritional diseases respond to Se but not to VE. On the other hand, certain tissues or subcellular components may not be adequately protected from oxidant damage because they are inherently low in GSH-PX even with adequate dietary Se. Damage to such tissues would be expected to be aggravated by diets high in unsaturated fatty acids and to respond adequately to VE but not to Se. The variations in GSH-PX activity between certain tissues, such as liver, heart, skeletal, and myocardial muscles, would explain the variations in the severity of lesions between species.

There are both selenium-dependent GSH-PX and nonselenium-dependent GSH-PX activities in the tissues and blood. The nonselenium-dependent enzyme does not contain Se and does not react with hydrogen peroxide but shows activity toward organic hydroperoxide substrates. The spleen, cardiac muscle, erythrocytes, brain, thymus, adipose tissue, and striated muscles of calves contain only the selenium-dependent enzyme. The liver, lungs, adrenal glands, testes, and kidney contain both enzymes. Hepatic tissue contains the highest level of nonselenium-dependent enzyme.

VE can prevent a toxic reaction to oral iron (ferrous sulfate) or iron dextran IM. When 0.1 ppm of Se and 50 IU VE/kg are

added during the gestation of sows, glutathione peroxidase activity increased in 2-day-old pigs, especially if the iron injection is given before colostrum ingestion.

### EPIDEMIOLOGY

#### Enzootic Nutritional Muscular Dystrophy

Enzootic nutritional muscular dystrophy (NMD) was the first disorder linked with Se and was associated with a high mortality, especially in ruminants, and impaired production in growing and adult animals.

#### Occurrence

This type of muscular dystrophy occurs in all farm animal species, but most commonly in young, rapidly growing calves, lambs, goat kids, and foals born from dams that have been fed for long periods, usually during the winter months, on diets low in Se and VE. It is an important cause of mortality in goat kids from birth to about 3 months of age. Goat kids may require more Se than lambs or calves, which may explain the higher incidence of the disease in kids. The disease in kids may also be associated with low  $\alpha$ -tocopherol levels and normal Se status.

NMD in horses occurs most commonly in foals to about 7 months of age. In reported cases, the concentration of Se in the blood of the mares was subnormal, the concentrations of Se and VE in the feedstuffs were subnormal, the level of unsaturated fatty acids in the feed was high, and VE and Se supplementation prevented the disease. The disease is not well recognized in adult horses, but sporadic cases of dystrophic myodegeneration are recorded in horses from 5 to 10 years of age. The disease also occurs in grain-fed yearling cattle. Stressors such as being turned outdoors after winter housing, walking long distances, the jostling and movement associated with vaccination, and dehorning procedures and similar management practices are often precipitating factors. The disease has occurred in steers and bulls 12 to 18 months of age under feedlot conditions. There may even be laboratory evidence of subclinical myopathy in normal animals in a group from which an index case occurred. Outbreaks of severe and fatal NMD have occurred in heifers, at the time of parturition, that were previously on a diet deficient in both Se and VE. The disease may also occur sporadically in adult horses that are deficient in Se. Muscular dystrophy has occurred in Bohemian Red Poll mature dairy cows in the Czech Republic moved from a stanchion barn into loose box housing that resulted in increased locomotor activity and stress associated with the change in housing conditions.

Myopathy and hepatic lipidosis in weaned lambs deficient in VE without concurrent Se deficiency has been described.

There are two major syndromes of myopathy:



- An acute form—myocardial dystrophy, which occurs most commonly in young calves and lambs and occasionally foals
- A subacute form—skeletal muscular dystrophy, which occurs in older calves and yearling cattle.

The two forms are not mutually exclusive.

### Geographic Distribution

NMD occurs in most countries of the world but is common in the United Kingdom, the United States, Scandinavia, Europe, Canada, Australia, and New Zealand. In North America, it is common in the Northeast and Northwest and uncommon on the relatively high-Se soils of the Great Plains, where Se toxicity has occurred. It is one of most common deficiency diseases of farm livestock in the United States. In the Czech Republic, the incidence of Se deficiency in cattle is high and most frequently diagnosed in heifers, feeder bulls, grazed beef cattle, and dairy cows in the dry period. Surveys of live cattle in the Czech Republic and in cattle tissues obtained at slaughter have found significant deficiency of Se. Poor-Se status, as assessed from blood, muscle, and liver Se concentrations, was found in 80%, 70%, and 73% of the tested animals, respectively. White-muscle disease has occurred in lambs in Turkey, where the levels of Se in the hay and soil are deficient. The mean values of Se in the soil and hay were 0.03 ppm and 0.07 ppm, respectively.

NMD is endemic in grazing goats on the Mexican plateau because of Se deficiency in the soil and forages. In two different locations of the plateau, the concentration of Se in the soil was 0.047 and 0.051 ppm; in the forages, 0.052 and 0.075 ppm; and in the serum of goats, 0.02 and 0.21 ppm, respectively. The pH of the soil was 6.1 and 5.9, respectively. The mean concentration of Se in the serum of kids with clinical signs of NMD was 36% lower compared with kids from the same farm that were normal.

Based on bulk-tank milk Se concentrations compared with serum Se concentrations in dairy herds in Prince Edward Island, Canada, 59% of the herds were at some point marginal or deficient in Se, which places them at risk of disease and suboptimal production. The periods of greatest risk were in the fall and winter, when 5% and 4%, respectively, of herds fell in the range of true deficiency. Herds in which Se supplementation was provided from a commercial dairy concentrate were over 4 times more likely to be selenium adequate than herds not using this method, and adjusted average daily milk yield was 7.6% greater in herds determined to be selenium adequate compared with selenium-marginal herds. In Chile, bulk-tank milk samples may show low levels of Se as a result of low-Se soil.<sup>18</sup>

Soils, and therefore the pastures they carry, vary widely in their Se content, depending largely on their geological origin.

In general, soils derived from rocks of recent origin (e.g., the granitic and pumice sands of New Zealand) are notably deficient in Se. Soils derived from igneous rocks are likely to be low in Se. Sedimentary rocks, which are the principal parent material of agricultural soils, are richer in Se. Forage crops, cereal grains, and corn grown in these areas are usually low in Se content (below 0.1 mg/kg dry matter [DM]) compared with the concentration in crops (above 0.1 mg/kg DM) grown in areas where the available soil Se is much higher and usually adequate. The disease occurs in pigs, usually in association with other more serious diseases, such as mulberry heart disease and hepatitis dietetica.

### Selenium in Soil, Plants, and Animals

#### *Selenium in Soils*

Soils containing less than 0.5 mg/kg of Se are likely to support crops and pastures with potentially inadequate Se concentrations (<0.05 mg/kg DM).

#### *Selenium in Plants*

Plants vary in their uptake of Se, but it is not a requirement for plant growth. The Se content of different pasture species on the same soil type does vary widely, but slow-growing and more deeply rooting species contain slightly higher concentrations. In New Zealand, the most deficient soils consist of rhyolitic pumice in the central volcanic plateau of the North Island. Peat soils in the Waikaito River Valley are also deficient. North Island coastal sands and stony soils in several locations are considered to be selenium responsive, whereas most of the South Island is at least marginally deficient.

Se deficiency occurs in most soils in the Balkan region; for example, the Se in wheat is so low that the daily requirement would not be met.<sup>19</sup> In the United States, the states of the Pacific Northwest and of the northeastern and southeastern seaboard are generally low in Se. In Canada, western prairie grains generally contain relatively high levels of Se, whereas in the eastern provinces, soils and feedstuffs usually have low Se concentrations. Most soils in the Atlantic provinces of Canada are acidic, and consequently, the forages are deficient in Se. Most forage samples contain less than 0.10 mg/kg DM of Se, and enzootic nutritional muscular dystrophy is common throughout the region.

Surveys in the United Kingdom found that the Se status may be low in sheep and cattle fed locally produced feedstuffs without any mineral supplementation. In some surveys, up to 50% of farms were low in Se, which places a large number of animals at risk. There are also differences in the Se concentrations of different feeds grown in the same area. For example, in some areas 75% of cattle fed primarily corn silage, or 50% of the cattle fed sedge hay, might be receiving diets inadequate in Se.

**Factors Influencing the Availability of Soil Selenium to Plants.** The Se concentration in soil varies with type, texture, and organic matter of the soil and with rainfall. In a study of various diets, it was found that the availability of Se increased when a 70% grain diet was fed, as a result of the high content of nonstructural carbohydrates.<sup>20</sup> Other influencing factors include the following:

- **Soil pH**—alkalinity encourages Se absorption by plants, and the presence of a high level of sulfur, which competes for absorption sites with Se in both plants and animals, with both factors reducing availability.
- The assimilation by plants is influenced by the physicochemical properties of the soil (redox status, pH, and microbial activity).
- Variation between plants in their ability to absorb selenium—“**selector**” and “**converter**” plants are listed under the heading of “Selenium Poisoning”; legumes take up much less Se than do grasses.
- **Seasonal conditions also influence the selenium content of pasture**, with the content being lowest in the spring and when rainfall is heavy. Blood Se levels in dairy cows in the United States were lower during the summer and fall than during the winter and spring. In this way, a marginally deficient soil may produce a grossly deficient pasture if it is heavily fertilized with superphosphate, thus increasing its sulfate content, if the rainfall is heavy and the sward is lush and dominated by clover as it is likely to be in the spring months.

**Environmental sulfur** from various anthropogenic activities has been suspected to be a significant factor in contributing to several health problems in livestock. Livestock producers near natural sour gas desulfurization plants have reported that sulfur emissions are responsible for an increased occurrence of nutritional muscular dystrophy, weak calves, and retarded growth. Experimentally, a moderate increase in dietary sulfur does not impair Se and copper status or cause related disease in cattle.

### *Selenium in Animals*

There may be wide variations in the serum Se concentrations and glutathione peroxidase activities in cattle grazing forages of various Se concentrations within the same geographic area. The Se status of beef cows can vary between geographic areas within a region of a country, which is likely attributable to variations in Se concentration of the soil and plants in these areas. Beef herds from areas with adequate soil levels of Se, herds provided with supplemental feed on pasture, and herds in which pregnancy diagnosis was done had higher average herd blood Se values than other herds. In growing cattle the recommended dose is 100 mu g/kg

DM, and for pregnant and lactating females it is 200  $\mu\text{g}$  per g/kg. In a study of Belgian Blue cattle, it was found that they have a higher requirement for Se as a result of the hypermusculature of the breed<sup>21</sup> and that yeast selenite provided the best response in the dams.

Some species have a greater ability to concentrate Se than other species. For example, Norwegian reindeer meat has more Se than beef, lamb, mutton, pork, or chicken.<sup>22</sup>

### Vitamin E

There may be an antioxidant interaction with proinflammatory cascades involving important signal transduction elements. There may be an antiinflammatory property of compounds that could shift the TH1–TH2 type of immune balance toward a TH2-type immunity.<sup>23</sup>

Cows supplemented with VE had a lower rate of culling and mastitis and a reduced level of retained fetal membranes, from 6.5% to 3.0%, compared with nonsupplemented diets. There was no effect on milk yield, reproductive performance, or uterine infections.<sup>24</sup> The relationship between plasma VE and milk VE is too poor for milk VE to be used as a primary test for VE deficiency.<sup>25</sup>

VE deficiency occurs most commonly when animals are fed inferior-quality hay or straw or root crops. Cereal grains, green pasture, and well-cured fresh hay contain adequate amounts of the vitamin.

Alpha-tocopherol levels are high in green grasses and clovers, but there are wide variations in the concentrations from one area to another. The serum  $\alpha$ -tocopherol levels are higher in calves born from cows fed grass silage than in those born from cows fed the same grass as hay. Many factors influence the  $\alpha$ -tocopherol content of pasture and hence the animals' intake. The level of  $\alpha$ -tocopherol in pasture declines by up to 90% as it matures. Levels as low as 0.7 mg/kg DM have been reported in dry summer pastures grazed by sheep. The  $\alpha$ -tocopherol content of ryegrass and clover pasture ranges from 22 to 350 mg/kg DM and 90 to 210 mg/kg DM, respectively. After harvesting and storage, the  $\alpha$ -tocopherol content of pasture and other crops may fall further, sometimes to 0. Preservation of grain with propionic acid does not prevent the decline. Thus the dietary intake of  $\alpha$ -tocopherol by cattle and sheep may be expected to vary widely and lead to wide variations in tissue levels. The plasma VE status of horses is highest from May to August in Canada when fresh grass is being grazed and lowest when the horses are being fed harvested or stored feed during the same period. Plasma VE levels in dairy cows in the United States were higher during the summer and fall than during the winter and spring.

Outbreaks of NMD may occur in yearling cattle fed on high-moisture grain treated with propionic acid as a method of inexpensive storage and protection from fungal growth.

There is a marked drop in the VE content of acid-treated grain and an increase in the levels of peroxides of fat, which is consistent with a loss of naturally occurring antioxidants such as the tocopherols (secondary VE deficiency). In these situations, the levels of Se in the feed were below 0.05 mg/kg DM, which is inadequate and emphasizes the interdependence of Se and VE. The  $\alpha$ -tocopherol content of moist grain (barley and maize) stored for 6 months, with or without propionic acid, falls to extremely low levels compared with conventionally stored grain, in which the  $\alpha$ -tocopherol levels usually persist over the same length of time. Selenium-deficient barley treated with sodium hydroxide to deplete it of vitamin E can be used to induce NMD when fed to yearling cattle. The disease may occur in sucking lambs with low plasma  $\alpha$ -tocopherol levels and an adequate Se status, which indicates that the sparing effect of each nutrient may not occur over the broad spectrum of clinical deficiencies.

### Polyunsaturated Fatty Acids in Diet

Diets rich in polyunsaturated fatty acids (PUFAs), such as cod liver oil, other fish oils, fishmeal used as a protein concentrate, lard, linseed oil, soybean, and corn oils, have been implicated in the production of NMD, particularly in calves fed milk replacers containing these ingredients. The disease can be reproduced experimentally in young ruminant cattle, 6 to 9 months of age, by feeding a diet low in VE and Se and adding linolenic acid. There are widespread lesions of myodegeneration of skeletal and myocardial muscles. Fresh spring grass containing a sufficient concentration of linolenic acid to equal the amount necessary to produce NMD in calves may explain the occurrence of the naturally occurring disease in the spring months. The oxidation during rancidification of the oils causes destruction of the vitamin, thus increasing the dietary requirements (a conditioned vitamin E deficiency), and the presence of myopathic agents in the oils may also contribute to the occurrence of the disease. The lack of specificity of VE in the prevention of muscular dystrophy in some circumstances is indicated by its failure and by the efficiency of Se as a preventive agent in lambs on lush legume pasture.

Supplementation with fish oil and barium selenite and its effects on carcass characteristics and muscle fatty acid of late-season lambs finished on grass or concentrate has been studied.<sup>26</sup> It was found that fish oil is of some help in concentrate diets but not in grass-based diets. Barium sulfate helps if there is no concentrate in the diet but is of little use if the lambs are fed on concentrate- or fish-oil-enriched diets.

### Other Myopathic Agents in Diet

Not all of the myopathic agents that may be important in the development of NMD in farm animals have been identified.

Unsaturated fatty acids in fish and vegetable oils may be myopathic agents in some outbreaks of NMD of calves and lambs. Lupinosis-associated myopathy in sheep is a substantial skeletal muscle myopathy encountered in weaner sheep grazing lupin stubbles infected with the fungus *Phomopsis* spp. Affected sheep have a stiff gait, walk reluctantly, stand with their back humped and their feet under the body, and have difficulty getting to their feet.

### Unaccustomed Exercise

Historically, NMD occurred most commonly in rapidly growing, well-nourished beef calves 2 to 4 months of age, shortly following unaccustomed exercise. This was commonplace in countries where calves were born and raised indoors until about 6 to 8 weeks of age, when they were turned out onto new pasture in the spring of the year. This has been a standard practice in small beef herds in the United Kingdom, Europe, and North America. A similar situation applies for ewes that lambed indoors and the lambs were let out to pasture from 1 to 3 weeks of age. Thus unaccustomed activity in calves and lambs, such as running and frolicking following their turn-out onto pasture, is an important risk factor but is not necessarily a prerequisite for the disease. In lambs, the vigorous exertion associated with running and sucking may account for the peracute form of myocardial dystrophy in young lambs on deficient pastures and from deficient ewes. In older lambs up to 3 months of age, outbreaks of acute NMD and stiff-lamb disease may be associated with the driving of flocks long distances. A similar situation applies for calves that are moved long distances from calving grounds and early-spring pastures to lush summer pastures. The wandering and bellying that occur in beef calves weaned at 6 to 8 months of age may precipitate outbreaks of subacute NMD. Degenerative myopathy of yearling cattle (feedlot cattle, housed yearling bulls, and heifer replacements) is now being recognized with increased frequency. The disease resembles subacute NMD of calves and in the United Kingdom is often seen when yearlings are turned outdoors in the spring of the year after being housed during the winter and fed poor-quality hay or straw or propionic-acid-treated grain. Unaccustomed exercise is a common precipitating factor. However, the disease has occurred in housed yearling bulls with no history of stress or unaccustomed exercise but whose diet was deficient in Se and VE.

In horses subjected to exercise, there is an increase in erythrocyte malondialdehyde, a product of peroxidation, but Se supplementation has no beneficial effect. There is inconclusive evidence that a selenium–vitamin E deficiency causes NMD in adult horses. There is no evidence that paralytic myoglobinuria and “tying-up” syndrome are a result of a deficiency of selenium and vitamin E.

### Congenital Nutritional Muscular Dystrophy

**Congenital NMD** is rare in farm animals. Isolated cases have been reported.

Similarly, NMD can occur in calves and lambs only a few days of age, but rarely. Se readily crosses the bovine placenta, and fetal Se is always higher than the maternal status. There is no evidence that weak-calf syndrome is associated with Se deficiency. Long-term parenteral supplementation with either Se alone or in combination with VE had no effect on the incidence of weak-calf syndrome.

An investigation of aborted bovine fetuses with lesions of heart failure, specifically cardiac dilatation or hypertrophy, along with a nodular liver and ascites compared with aborted fetuses without such lesions and nonaborted fetuses from the abattoir found myocardial necrosis and mean selenium levels of 5.5  $\mu\text{mol/kg}$  in the fetuses with heart lesions, 6.5  $\mu\text{mol/kg}$  in the fetuses without heart lesions, and 7.5  $\mu\text{mol/kg}$  selenium in the fetuses from the abattoir. This suggests that Se deficiency in bovine fetuses may cause myocardial necrosis and heart failure. Normal levels of selenium in the liver and kidney tissue of bovine fetuses derived from the abattoir were  $7.5 \pm 5.2 \mu\text{mol/kg}$  and  $4.4 \pm 1.1 \mu\text{mol/kg}$ , respectively.

In pigs, NMD has been produced experimentally on VE- and Se-deficient rations but is usually only a part of the more serious complex of mulberry heart disease and hepatitis dietetica.

### Vitamin E–Selenium Deficiency Syndrome

The combination of mulberry heart disease, hepatitis dietetica, exudative diathesis, and nutritional myopathy, also known as vitamin E–selenium deficiency (VESD) syndrome, occurs in pigs, usually as a serious disease. Nutritional muscular dystrophy may also occur in pigs. The occurrence of edema in various tissues has also been suggested as a possible result of Se or VE deficiency. Impaired spermatogenesis and increased susceptibility to the effects of swine dysentery have also been suggested as responses to reduced levels of these two substances. There is a suspicion that the problems become more common as the pig grows more quickly and the requirements and demands for antioxidants are increased at the same time that the provision of fat-soluble vitamins is increasingly difficult. In addition, there is a very small difference between the therapeutic and toxic levels of Se, and Se toxicosis has occurred in an attempt to prevent Se deficiency. A more recent complication is the realization that we have been using inorganic Se to provide Se in the diet, whereas in the plant, most of the Se is organic in the form of L-selenomethionine, an Se analog of the amino acid methionine. In the pig, as in other species, Se is thought to serve as an

antagonist to toxic free radicals and act in concert with other substances such as vitamin C. Little is known about Se metabolism in the pig. In the pig, there is very little transfer of fat-soluble products across the placenta, so there is very little reserve of VE in the new born pig. Immediately after birth, the young pig gets its VE from the colostrum and milk of the sow. If the sow has low body stores or is fed a ration low in VE, then the piglet will be very low in VE when it is weaned. SE and VE can substitute for each other in a limited way in the pig. In the pig, the diet has the most influence. Diets rich in polyunsaturated fatty acids, copper, vitamin A, or mycotoxins may reduce the availability of VE. As dietary vitamin A levels increase, serum and liver  $\alpha$ -tocopherol concentrations decline, suggesting a reduced absorption and retention of  $\alpha$ -tocopherol when weaned pigs were fed high dietary vitamin A levels. Se antagonists or crops from inherently low-soil-Se fields may also make the situation worse. In pigs, NMD has been produced experimentally on VE- and Se-deficient rations but is usually only a part of the more serious complex of mulberry heart disease and hepatitis dietetica. Microangiopathy is most common in weaned pigs and may be particularly related to VE deficiency.

There is conflicting evidence on the effect of the antioxidative vitamins C and E on the reproductive performance of sows. In some studies, increasing dietary VE in the diet during gestation may have increased the litter size and reduced the preweaning piglet mortality. A similar response has been seen following intramuscular injection of sows with VE and Se, but the injection of vitamin C has produced no improvement. A recent study has confirmed that there was no effect on the reproductive performance of sows and the growth performance of piglets when supplemented by both vitamin E and C. Vitamin E and Se given to immature gilts for flushing purposes led to the formation of fewer but larger corpora lutea after ovulation, probably as a result of the progression of a smaller number of follicles to the ovulatory stage. Vitamin E and Se increased the development of the uterus but did not influence the number of piglets at farrowing.

VESD occurs naturally in rapidly growing pigs, usually during the postweaning period (3 weeks to 4 months), particularly during the early finishing period. The lowest concentration of VE in piglets was at day 45 after farrowing, but it may be that the Se status of the newborn piglets may be more important for their health than their VE status. The first 3 to 4 weeks following the move to the finishing house is the most dangerous period for a low VE level, and it is important to remember that there is considerable individual variation. Serum VE declines after weaning, and even with VE supplementation it takes 2 to 3 days for levels to rise. There appears to be a temporarily decreased absorption of the vitamin in

the immediate postweaning period, and this in turn leads to the reduction of the stored vitamin E reserves. It is usually associated with diets deficient in both Se and vitamin E and those that may contain a high concentration of unsaturated fatty acids. Such diets include those containing mixtures of soybean, high-moisture corn, and cereal grains grown on soils with low levels of Se. The feeding of a basal ration of cull peas, low in Se and VE, to growing pigs can cause the typical syndrome, and low tissue levels of Se are present in pigs with spontaneously occurring hepatitis dietetica. It has been shown that feeding diets containing linseed oil reduced the VE levels in the diet but increased the skatole levels. However, there are reports of naturally occurring mulberry heart disease of pigs in Scandinavia in which the tissue levels of Se and VE are within normal ranges compared with normal pigs. In Ireland, in spite of supplementation of pig rations with VE and Se at levels higher than that necessary to prevent experimental disease, spontaneous mulberry heart disease may still occur. Affected pigs have lower tissue vitamin E levels than control pigs, which suggests an alteration in  $\alpha$ -tocopherol metabolism unrelated to dietary Se and PUFA contents.

Natural occurrence of the disease complex in pigs is not uncommonly associated with diets containing 50% coconut meal, fish-liver-oil emulsion, fish scraps with a high content of unsaturated fatty acids, or flaxseed, which produces yellow and brown discoloration of fat preventable by the incorporation of adequate amounts of  $\alpha$ -tocopherol or a suitable antioxidant. The quality of the dietary fat does not necessarily influence blood VE levels, but the presence of oxidized fat reduces the resistance of the red blood cells against peroxidation. The higher requirement for VE by pigs fed oxidized fat may be a result of the low VE content in such fat. It has recently been shown that the inclusion of 0.3 ppm Se to the diet of postweaning piglets resulted in better performance than non-Se-supplemented diets, irrespective of the level of VE in the ration (up to 200 ppm).

### Mulberry Heart Disease

Mulberry heart disease (MHD) is the most common form of Se and VE deficiency of pigs. It occurs most commonly in rapidly growing feeder pigs (60 to 90 kg) in excellent condition being fed on a high-energy diet low in VE and Se. The true causal mechanism is not known, but it can be prevented by supplementation with VE. It can also occur when it would appear that the level in the diet and in the serum or tissues appear to be satisfactory. The diets most commonly incriminated are soybean, corn, and barley. Mean liver concentrations of VE were lower in pigs with MHD than in pigs that died of causes other than MHD. The  $\alpha$ -tocopherol content of corn is usually low, and it is virtually absent from solvent-extracted soybean



meal. Both are low in Se. The use of high-moisture corn may further exacerbate the tocopherol deficiency. The level of PUFAs in the diet was thought to be an important etiologic factor, but this is now not considered to be a necessary prerequisite. Outbreaks of the disease may occur in which 25% of susceptible pigs are affected, and the case-mortality rate is about 90%. The disease has occurred in young piglets and in adult sows.

#### *Hepatitis Dietetica*

*Hepatitis dietetica* appears to be less common than mulberry heart disease, but the epidemiologic characteristics are similar. It appears to be less common because the Se levels in supplements were raised to 0.3 ppm. It affects young, rapidly growing pigs up to 3 to 4 months of age. NMD in pigs usually occurs in cases of mulberry heart disease and hepatitis dietetica, but it has occurred alone in gilts.

#### Selenium-Responsive Disorders

A variety of diseases have been known as selenium-responsive disorders because they respond beneficially to the strategic administration of Se. These include the following: **ill-thrift** in lambs and calves on pasture; **lowered milk production** in cows; **white-muscle disease** in lambs, calves, and kids; **lowered fertility** and **embryonic death** in sheep and cattle; **retained fetal membranes**, **metritis**, **poor uterine involution**, and **cystic ovaries** in cows; subclinical **mastitis** and **impaired immune function** in cattle; and **prematurity**, **perinatal death**, and **abortion** in cattle. Of these, only ill-thrift, lowered fertility, lowered milk production, and white-muscle disease have been reported in New Zealand.

The pathogenesis of these selenium-responsive diseases is not well understood, but it would appear that the Se deficiency is only marginal. Most investigations into selenium-responsive diseases have occurred in selenium-deficient areas in which diseases such as NMD of calves and lambs occur. The evidence that Se deficiency in breeding ewes can result in a decline in reproductive performance has not been substantiated experimentally. Reproductive performance was not affected in ewes on a selenium-depleted diet.

Selenium-responsive unthriftiness in sheep has received considerable attention in New Zealand, where the response to Se administration has been most dramatic, compared with Australia, where the syndrome has also been recognized but where the response is much smaller. The oral administration of Se to lambs in these areas results in greater body-weight gains from weaning to 1 year of age compared with lambs not receiving Se supplementation. The mean fleece weight of selenium-treated lambs is also greater.

The diagnosis of selenium-responsive unthriftiness depends on analyses of the soil, pasture, and animal tissues for Se and

response to trials of Se supplementation. A deficiency state might be encountered when the Se content of the soil is below 0.45 mg/kg, the pasture content is below 0.02 mg/kg DM, the liver content is below 21 µg/kg (0.27 µmol/kg wet weight [WW]), and wool concentrations are below 50 to 60 µg/kg (0.63 to 0.76 µmol/kg). For the blood in selenium-responsive unthriftiness of sheep, the following criteria are suggested for mean blood selenium status (µg/dL):

- Deficient = 1.0
- Doubtful = 1.1 to 1.9
- Normal = ~2.0

The GSH-PX activity is a good index of the Se status of sheep with a selenium-responsive disease. If measured on a regular basis, it can provide an indication of the Se status of grazing sheep in individual flocks. Single measurements of GSH-PX activity may fail to detect recent changes in grazing area, differences in pasture species and pasture composition, and alterations in the physiologic state of the animals.

#### Subclinical Selenium Insufficiency

Subclinical insufficiencies of Se in grazing ruminants are widespread over large areas of southern Australia. The plasma concentrations of affected sheep flocks are low, there are no obvious clinical signs of insufficiency in the ewes, and there are significant responses in wool production and fiber diameter to Se supplementation. The incidence of estrus and fertility is not affected by Se supplementation. Live weights at birth, in midlactation, and at weaning were increased in lambs born to selenium-supplemented and crossbred ewes and in lambs born as singletons. Clean fleece weight at 10 months of age was increased by 9.5% and fiber diameter by 0.3 µm in lambs born to ewes that had received supplementary Se. Differences in fleece weight and live weight were not detected at 22 months, suggesting that subclinical Se insufficiency in early life did not permanently impair productivity if Se status subsequently increased.

Temporal variations in glutathione peroxidase activity in sheep can be used to identify seasons of the year with the highest risk of Se deficiency. In the Mediterranean area, lambs born in the spring/summer are at higher risk of selenium-deficiency related diseases. Lambs born in autumn/winter are from ewes gestating during the summer, when supplementation with cereal grains is provided.

Se is a component of type I iodothyronine deiodinase, which catalyzes the extrathyroidal conversion of thyroxine (T4) to the more active tri-iodothyronine (T3). Sheep grazing pastures low in Se frequently have higher circulating T4 and lower circulating T3 concentrations than sheep receiving Se supplementations.

When ewes grazing pastures low in Se were supplemented with thiocyanate (to

cause iodine insufficiency), iodide, and Se, there was no evidence of clinical deficiencies. Growth rates of lambs were not affected by the thiocyanate of their dams during mid-pregnancy, but plasma T3 and T4 concentrations were depressed in ewes receiving thiocyanate. The iodide supplementation increased thyroid hormone concentrations in ewes but depressed plasma T3 concentrations in lambs. Supplementation of sheep grazing pastures low in Se with both Se and thyroid hormones improved wool characteristics, live-weight gain, and blood Se, but there was no evidence of an interaction between the Se and the hormones. Thus it seems unlikely that the decline in the quantity of T3 produced, or of T4 utilized for T3 production, in selenium-deficient sheep is responsible for the observed differences in the productivity of selenium-deficient and supplemented sheep. The thyroids have a major role in regulating thermogenesis, and lambs born to ewes supplemented with iodide tend to have higher rectal temperatures during cold stress. The thermoregulatory ability of the perinatal lamb is not adversely affected by subclinical Se deficiency.

In a survey of the status of VE and Se of the livers of cull ewes and market lambs raised in Ontario, Se was present at marginal levels in 3.3% of cull ewe samples and in 43% of market lamb samples. VE was low to deficient in 10% of cull ewe samples and in 90% of market lamb samples. In cull ewes, there was a strong relationship between Se and VE. A large percentage of samples with marginal Se values had adequate VE, which may indicate that the sheep had access to high levels of VE but received inadequate levels of supplement containing Se.

An evaluation of the trace mineral status of beef cows in Ontario found that 96% of cull cows were deficient in blood Se. Based on analysis of serum samples from cattle in Iowa and Wisconsin, subclinical Se deficiency is common in the cattle population. The serum levels may be adequate for reproductive performance but marginal for optimal resistance to mastitis or for adequate transfer of selenium to the calf.

In moose in northwestern Minnesota, declining numbers of moose have been associated with low trace elements, particularly copper and selenium.<sup>27</sup>

#### Reproductive Performance

The roles of reactive oxygen species in female reproduction have been reviewed,<sup>28</sup> and nutritional management is important.<sup>29</sup> The published information on the effects of VE and Se deficiency or of dietary supplementation with one or the other or both on reproductive performance in farm animals is conflicting and controversial. Reproductive performance is complex and dependent on the interaction of many factors. Reproductive inefficiency is likewise complex, and it is

difficult to isolate one factor, such as a deficiency of VE or Se, as a cause of reproductive inefficiency. Conversely, it is difficult to prove that supplementation with these nutrients will ensure optimum reproductive performance. The roles of cellular reactive oxygen species, oxidative stress, and antioxidants in the outcome of pregnancy have been reviewed.<sup>30</sup> Many vitamins and trace elements have a dual role in mammals in that they (a) control or are involved in the metabolic processes and/or gene expression and (b) spend most of their time in trapping radical oxygen species. Any deficiencies will produce high rates of radical oxygen species production.<sup>31</sup>

### Pigs

Selenium and vitamin E improve the *in vitro* maturation, fertilization, and growth to blastocysts of porcine oocytes.<sup>32</sup>

### Sheep

The evidence about the effect of Se and VE deficiency on reproductive performance in sheep is conflicting. Observations in the 1960s concluded that Se deficiency caused embryonic deaths 20 to 30 days after fertilization in ewes. But Se supplementation of ewes that were low or marginal in Se status did not improve reproductive performance. Experimental studies using selenium-deficient diets in ewes have been unable to find any adverse effects of Se depletion on ewe conception rates, embryonic mortality, or numbers of lambs born. The parenteral administration of Se to pregnant ewes between 15 and 35 days after mating resulted in a reduced embryonic survival rate and is not recommended during the first month of pregnancy.

### Cattle

VE supplementation can have significant effects on the health and some aspects of fertility in lactating dairy cows. VE supplementation of dairy cows has its most beneficial effect of reducing the incidence of mastitis when used at rates of at least 1000 IU per day during the dry period and early lactation. The primary effect of VE supplementation is on the immune system. The importance of Se and VE for the maintenance of optimum reproductive performance is not clear. The IM injection of dairy cattle at 3 weeks prepartum did not have any effect on average days to first estrus or first service, average days to conception, services per conception, or number of uterine infusions required. The prepartum IM injection of VE and Se at 3 weeks prepartum increased the percentage of cows pregnant to first service, reduced the number of services per conception, decreased the incidence of retained placenta, and reduced the interval from calving to conception. In a randomized field trial in a large dairy herd in the United States, oral supplementation of pregnant first-calf dairy heifers with Se using a commercially available

sustained-release intraruminal selenium bolus increased blood Se concentrations in treated animals at 30 days after treatment until after calving. However, based on data analyzed at midlactation and late lactation, there were no differences between treated and control groups in somatic cell count, days not pregnant, total milk production, or times bred. The use of an intraruminal pellet of Se at two different levels in dairy herds in New Zealand was evaluated in yearling heifers. The recommended dose was effective in elevating whole-blood GSH-PX activity and Se concentrations to over 10 times those of control animals. Milk production was increased, and there was a trend toward decreased somatic cell counts. There were no differences in calving-first-service or calving-conception intervals, or in the percentage of animals pregnant to first or all services. In other observations, there was an improvement in first-service conception rate and significantly higher blood levels of GSH-PX following the treatment of dairy cows with oral Se pellets. The inconsistent results obtained following the use of Se and VE in pregnant cows may be related to the Se status of the animals; in some herds the blood levels are marginal, and in others the levels are within the normal range.

Winter-fed lactating Norwegian dairy cows were found to have an adequate plasma levels of VE and marginal to adequate levels of blood Se. Silage was the most important source of VE, and selenium-supplemented commercial concentrates were the most important source of selenium. No significant differences in VE or Se status were found between cows with or without recorded treatments of mastitis, parturient paresis, or reproductive abnormalities.

### Retained Fetal Placenta

A high incidence (more than 10%) of retained fetal membranes has been associated with marginal levels of plasma Se compared with herds without a problem. In some cases, the incidence could be reduced to below 10% by the injection of pregnant cattle with Se and VE at approximately 3 weeks prepartum, whereas in other studies similar prepartum injections neither reduced the incidence nor improved reproductive performance. A single injection of Se 3 weeks prepartum can reduce the number of days postpartum required for the uterus to reach minimum size and reduce the incidence of metritis and cystic ovaries during the early postpartum period. The parenteral administration of a single injection of 3000 mg VE prepartum to dairy cows of all ages decreased the incidence of retained placenta and metritis to 6.4% and 3.9%, respectively, in the treated group, compared with 12.5% and 8.8% in the control group. The injection, 20 days prepartum, of 50 mg of Se and 680 IU of VE reduced the incidence of retained fetal membranes in one series, but it did not have this effect in another

series. The plasma Se concentration at parturition ranged from 0.02 to 0.05 ppm in control cows, in which there was an incidence of 51% retained membranes, and from 0.08 to 0.1 ppm in treated cows, in which the incidence was reduced to 9%. A dietary level of 0.1 mg/kg DM Se is recommended to minimize the incidence of the problem. The complex nature of the etiology of retained fetal membranes also requires a well-designed experimental trial to account for all of the possible factors involved. In a study in Croatia, where the soils are generally deficient, it was found that there is a high level of retained fetal membranes in cattle associated with low levels of Se and VE.<sup>33</sup> VE supplementation during the dry period has reduced the risk of retained fetal membranes, and it is said that the synthetic forms of VE are more effective in this regard.<sup>34</sup>

### Mammary Gland Function

One of the techniques for protection against mastitis is to increase the immunity of the bovine mammary gland. Se affects the innate and adaptive immune mechanisms of the mammary gland.<sup>35</sup> VE also reduces the incidence of mastitis.<sup>36</sup> VE supplementation was shown to have an adverse effect on the occurrence of clinical and subclinical mastitis in high doses. The level at dry-off of 14.5  $\mu\text{mol/L}$  was a risk factor for clinical mastitis. It is therefore necessary to assess the exact level at which VE affects udder health.

In buffaloes, Se helps to combat mastitis because it increases neutrophil phagocytosis and antioxidant levels during acute mastitis in riverine buffaloes.<sup>37</sup>

### Transport Stress

VE, Se, and vitamins A and D have been shown to prevent lipid peroxidation and oxidative stress associated with long-term transportation stress in cattle.<sup>38</sup>

### Resistance to Infectious Disease

Several trace elements, particularly copper, Se, and zinc, affect immune function, but the effects of supplementation are equivocal. However, adding VE may reduce bovine respiratory disease morbidity but have some effect on performance.<sup>39</sup>

Many studies have examined the role of Se and VE resistance to infectious disease. Most of the evidence is based on *in vitro* studies of the effects of deficiencies of Se or VE or supplementation with the nutrients on leukocyte responses to mitogens, or on the antibody responses of animals to a variety of pathogens. The status of Se and VE in an animal can alter antibody response, phagocytic function, lymphocyte response, and resistance to infectious disease. The deficiency of VE or Se reduces neutrophil function during the periparturient period. Se and iodine administration in prepartum cows may enhance the calf immune system.<sup>40</sup> The administration of VE and Se during the dry

period can influence mammary gland health and milk cell counts in dairy ewes. In general, a deficiency of Se results in immunosuppression, and supplementation with low doses of Se augments immunologic functions.

A deficiency of Se has been shown to inhibit the following:

- Resistance to microbial and viral infections
- Neutrophil function
- Antibody production
- Proliferation of T and B lymphocytes in response to mitogens
- Cytodestruction of T lymphocytes and natural killer lymphocytes

VE and Se have interactive effects on lymphocyte responses to experimental antigens.

VE supplementation of transport-stressed feedlot cattle is associated with reduced serum acute-phase protein concentrations compared with control animals. Supplementation of the diet of cattle arriving in the feedlot with VE had beneficial effects on humoral immune response and recovery from respiratory disease.

The parenteral administration of Se and VE during pregnancy in dairy cows has a positive effect on the increase of Se and VE concentrations in blood, increase of Se and immunoglobulin concentrations in colostrum, and increase of T3 concentration in blood on the day of parturition. In addition, there was a trend toward a decreased incidence of clinical mastitis.

### Neutrophil Function

Se deficiency can affect the function of polymorphonuclear neutrophils (PMNs), which are associated with physiologic changes in GSH-PX levels. In calves on an experimental selenium-deficient diet, the oxygen consumption and the activities of GSH-PX were lower than normal in neutrophils. The feeding of 80 to 120 mg of Se/kg of mineral mixture provided ad libitum was shown to be an effective method of increasing blood Se in a group of cattle and to optimize the humoral antibody response experimentally. It is suggested that blood Se levels over 100 µg/L are necessary to maintain optimum immunocompetence in growing beef cattle. In selenium-deficient goats, the production of leukotriene B<sub>4</sub>, a product of neutrophil arachidonic acid lipoygenation and a potent chemotactic and chemokinetic stimulus for neutrophils, is decreased, resulting in dysfunction of the neutrophils. A deficiency of Se in pregnant sows impairs neutrophil function, and VE deficiency impairs function of both neutrophils and lymphocytes, which may result in increased susceptibility of their piglets to infectious diseases. It is suggested that selenium supplementation be maintained at 0.3 mg/kg of the diet.

Neutrophils from postparturient dairy cows with higher levels of Se have greater potential to kill microbes, and cattle with

greater superoxide production may have higher milk production. VE is a fat-soluble membrane antioxidant that enhances the functional efficiency of neutrophils by protecting them from oxidative damage following intracellular killing of ingested bacteria. Peripartum immunosuppression in dairy cows is multifactorial but is associated with endocrine changes and decreased intake of critical nutrients. Decreased phagocytosis and intracellular killing by neutrophils occurs in parallel with decreased dry matter intake and decreased circulating VE. Because neutrophils are the primary mechanism of uterine defense and mammary health, the role of VE on the health of dairy cows during the transition period has been examined. Compared with control cows given a placebo, the parenteral administration of VE 1 week prepartum had no effect on the incidence of retained placenta, clinical mastitis, metritis, endometritis, ketosis, displaced abomasum, or lameness. However, there was a decreased incidence of retained placenta in cows with marginal pretreatment VE status. An increase in  $\alpha$ -tocopherol of 1 µg/mL in the last week prepartum reduced the risk of retained placenta by 20%. In addition, serum nonesterified fatty acid concentration greater than or equal to 0.5 mEq/L tended to increase the risk of retained placenta by 80%, and in the last week prepartum, a 100 ng/mL increase in serum retinol was associated with a 60% decrease in the risk of early-lactation clinical mastitis.

### Immune Response

The effects of Se deficiency and supplementation on the immune response of cattle to experimental infection with the infectious bovine rhinotracheitis virus and sheep to parainfluenza-3 virus indicate that a deficiency can affect the humoral response and that supplementation enhances the response. The administration of Se either alone or in combination with VE can improve the production of antibodies against *E. coli* in dairy cows. Pigs fed a deficient diet develop an impaired cell-mediated immunity as measured by lymphocyte response to mitogenic stimulations. Supplementation of the diets of young pigs with Se levels above those required for normal growth have increased the humoral response, but not in sows. The wide variations in antibody responses that occur in these experiments indicate that there is a complex relationship between the Se status of the host, humoral immune responses, and protective immunity. The concept of using selenium supplementation to enhance antibody responses in sheep to vaccines is probably unfounded. However, the administration of sodium selenite to sheep vaccinated against enzootic abortion (*Chlamydophila abortus*) increased the antibody response, but not when given with vitamin E. The Se sources provided to mares may influence the immune function of foals at 1 month of age.<sup>41</sup> In sheep

with footrot, an improved immune response is found after a higher blood serum Se response is found.<sup>42</sup>

Experimentally, VE can stimulate the immune defense mechanisms in laboratory animals and cattle. In most cases, the immunostimulatory effects of additional VE are associated with supplementation in excess of levels required for normal growth. The parenteral administration to calves of 1400 mg of VE weekly increases their serum VE concentrations and lymphocyte stimulation indices. Similarly, in growing pigs, a serum VE concentration above 3 mg/L is necessary to achieve a significant response of the lymphocytes to stimulation with mitogens.

The administration of a daily 2500 IU RRR- $\alpha$ -tocopherol to pregnant mares stimulated maternal IgG and IgM production in colostrum and enhanced VE and IgM status in foals.<sup>43</sup>

### General Resistance

These changes may render selenium-deficient animals more susceptible to infectious disease, but there is no available evidence to indicate that naturally occurring deficiencies are associated with an increase in the incidence or severity of infectious diseases. Neutrophils from selenium-deficient animals lose some ability to phagocytose certain organisms, but how relevant this observation is in naturally occurring infections is unclear. Field studies of the incidence and occurrence of pneumonia in housed calves found that Se status was not a risk factor.

### Transfer of Selenium and Vitamin E to the Fetus, Colostrum, and Milk

#### Selenium

In sheep, Se is transferred across the placenta to the fetus, and maternal Se status during gestation is positively associated with fetal and newborn lamb Se status. Supplementation of gestating ewes with Se will improve the Se status of the lambs at birth. Supplementing ewes with VE and Se during pregnancy increased the weight of lambs at weaning by about 2 kg above those on a marginal level of Se., and organic Se produced better lamb viability.<sup>44</sup> However, after birth, the Se of the lamb is depleted quickly, by about 18 days after birth. Thus continued intake of Se by the lamb is necessary to maintain normal Se status during the postnatal period. The colostrum of ewes contains higher levels of Se than ewe milk. The Se content of ewe's milk decreases rapidly after parturition, reaching a stable level by 1 week postpartum. Supplementation of ewes during lactation results in higher milk Se concentration and higher blood Se in lambs. Supplementation of ewes has been shown to prevent nutritional myodegeneration in nursing lambs in selenium-deficient flocks.

There is a highly significant relationship between blood Se of cattle and milk Se concentration. As in sheep, in cattle, Se is



transferred across the placenta to the fetus and across the mammary barrier into the colostrum and milk.

### Pigs

The maternal intake of Se affects fetal liver Se, and newborn piglets have lower liver Se concentrations compared with their dams, regardless of Se intake of sows during gestation. Thus compared with cattle and sheep, the relatively high concentration of Se needed in the diets of young rapidly growing piglets may be partially a function of limited placental transport or hepatic deposition of Se and may explain why the piglet is more susceptible to Se deficiency than the sow.

### Vitamin E

The transfer of VE across the placenta to the fetus in sheep and cattle is limited. Plasma levels of VE in the fetus and in newborn lambs (before ingestion of colostrum) are lower than in the ewe. VE supplementation of the ewe in late gestation results in insignificant increases of the serum VE in the lamb. However, supplementation of the ewe in the last month of pregnancy increases the VE content of colostrum and milk. Colostrum of the ewe is a rich source of VE for the neonatal lamb, containing 5 to 11 times more VE than milk at 1 week postpartum. The parenteral administration of sodium selenite to ewes at lambing increases the VE content of milk of ewes over the first 5 weeks of lactation, indicating a potential positive effect of Se repletion on VE transfer to milk.

### Neonatal Morbidity and Mortality

Based on some preliminary observations of the Se content of hair samples of young calves, higher Se levels in newborn calves may have some protective effect against morbidity as a result of neonatal disease. Similarly, neonatal piglets with high blood levels of GSH-PX activity may be more resistant to infectious diseases or other causes of neonatal mortality. Administration of VE and Se to dairy cows in late pregnancy resulted in the production of increased quantities of colostrum, and the calves had increased quantities of GSH-PX at birth and 28 days of age, but the improved Se status did not provide any improvement in passive immunity or growth.

Supplementing Se to beef cows grazing selenium-deficient pastures with a salt mineral mix containing 120 mg selenium/kg of mix increased the Se status of the cows and increased the serum IgG concentration, or enhanced transfer of IgG from serum to colostrum, and increased the Se status of the calves. The parenteral administration of 0.1 mg Se and 1 mg of vitamin E/kg BW at midgestation did not affect the production of systemic or colostrum antibodies. Supplementation of dairy cows at dry-off with Se at 3 mg/d as selenite via an intraruminal bolus resulted in sufficient transfer of Se to meet a target concentration of more than 2.2 µg of

selenium/g of liver DM in newborn calves. Milk Se is a useful indicator of animal and herd Se status.<sup>45</sup>

### Mastitis

There is some evidence that a dietary deficiency of VE may be associated with an increased incidence of mastitis in dairy cattle. An increased incidence of mastitis during the early stages of lactation coincides with the lowest plasma concentration of VE. Supplementation of the diet of dairy cows beginning 4 weeks before and continuing for up to 8 weeks after parturition with vitamin E at 3000 IU/cow per day, combined with an injection of 5000 IU 1 week before parturition, prevented the suppression of blood neutrophil and macrophage function during the early postpartum period compared with controls. The VE prevented the suppression of blood neutrophils during the postpartum period. Cows in both the treated and control groups were fed diets containing Se at 0.3 ppm of total dry matter. When Se status in dairy cows is marginal, plasma concentrations of  $\alpha$ -tocopherol should be at least 3 µg/mL. Cows receiving a dietary supplement of about 1000 IU/d of VE had 30% less clinical mastitis than did cows receiving a supplement of 100 IU/d of VE. The reduction was 88% when cows were fed 4000 IU/d of VE during the last 14 days of the dry period.

The Se status of dairy cows may also have an effect on the prevalence of mastitis and mammary gland health. Dairy herds with low somatic cell counts had significantly higher mean blood GSH-PX and higher whole-blood concentrations of Se than in herds with high somatic cell counts. The prevalence of infection caused by *Streptococcus agalactiae* and *Staphylococcus aureus* was higher in herds with the high somatic cell counts compared with those with the low somatic cell counts. This suggests that phagocytic function in the mammary gland may be decreased by a marginal Se deficiency. In a survey of cattle in herds in Switzerland, those with chronic mastitis had lower serum levels of Se than healthy control herds. Experimental coliform mastitis in cattle is much more severe in selenium-deficient animals than selenium-adequate animals. The severity was in part a result of the increased concentrations of eicosanoids.

Milk neutrophils from cows fed a selenium-deficient diet have significantly reduced capacity to kill ingested *E. coli* and *S. aureus*, compared with cells from cows fed a selenium-supplemented diet. However, other experimental results are not as convincing.

In pasture-based heifers injected with barium sulfate before calving and fed diets with 1.3 or 2.5 mg of Se/d precalving and during lactation, respectively, there was no clinical mastitis observed in the first month of lactation.<sup>46</sup> Se deficiency may predispose to mastitis in sheep, and examination of the

Se status may indicate which ewes may develop ovine mastitis.<sup>47</sup>

Lambs supplemented with Se were also able to deal with oxidative stress generated from *H. contortus* infections by the provision of higher GSH-Px levels.<sup>48</sup>

### Blood Abnormalities

In young cattle from areas where NMD is endemic, and particularly at the end of winter housing, the erythrocytes have an increased susceptibility to hemolysis following exposure to hypotonic saline. During clinical and subclinical white-muscle disease in calves, there is a significant increase in both the osmotic and the peroxidative hemolysis of the erythrocytes. This defect is thought to be the result of alterations in the integrity of cell membranes, of which tocopherols are an essential component. Abnormalities of the bone marrow associated with VE deficiency in sheep have been described, and abnormal hematologic responses have been described in young, rapidly growing pigs on an experimental SE- and VE-deficient diet. VE deficiency in sheep results in increased hemolytic susceptibility of erythrocytes, which may provide a basis for a single functional test for VE deficiency in sheep.

Anemia characterized by a decreased packed cell volume, decreased hemoglobin concentration, and Heinz-body formation has been observed in cattle grazing on grass grown on peaty muck soils in the Florida everglades. Se supplementation corrected the anemia, prevented Heinz-body formation, increased the body weight of cows and calves, and elevated blood Se. In a study of supplementation,<sup>49</sup> it was found that the Se levels stabilized in the liver and plasma by 56 to 112 days, whereas the whole-blood and red blood cell (RBC) concentrations were still increasing through 224 days of supplementation, regardless of the form of supplemental Se.

In lambs with WMD, there was a significant increase in serum total sialic acid (TSA) and lipid-bound sialic acid (LBSA), together with a significant decrease in serum Se and VE concentrations. Within 1 month of treatment, the changes were reversed.<sup>50</sup>

### Equine Nutritional Myopathy

In areas of severely Se-deficient soil, such as the Pacific Northwest of the United States, there is the possibility of Se deficiency myopathy; this can occur in horses of any age, but more usually it occurs in foals, most commonly up to 2 weeks of age. VE deficiency occurs in horses that eat marginal- or poor-quality grass hay with no access to pasture and no VE supplementation. Affected foals are born to deficient mares. They are weak at birth or shortly after. They may become recumbent but are generally bright and alert. The weakness of the tongue and pharyngeal muscles makes it difficult to suckle. The

affected horses are usually stabled, and the condition occurs mostly in late winter or early spring; in the very deficient Northwest, it can occur at any time of the year. The temporal or masseter muscles are often predisposed, with swelling and stiffness of these muscles and impaired mastication. There may be dysphagia and impaired prehension of food. There is often general weakness and a stiff, short-strided gait. The muscles may be pale, and the most severely affected muscles are those that do the most work. Often this means the neck muscles during attempts to suckle. The gross appearance depends on the duration of the condition and may involve the heart. In animals that die, there are often areas of severe necrosis. In the more subacute cases there are areas of repair and regeneration together with new areas of necrosis. In these animals diagnosis is based on the geographic area, history, clinical signs, increased levels of CK and AST, and gross and histologic lesions.

Fatal myocardial degeneration in an adult Quarter horse with Vitamin E deficiency but normal Se has been described.<sup>51</sup> There were pale and firm foci in the heart.

Congenital white-muscle disease also occurs in deer calves.<sup>52</sup>

### Equine Degenerative Myeloencephalopathy

Equine degenerative myeloencephalopathy, also sometimes called neuronal dystrophy, is seen pure and mixed breeds of horses. It has also been seen in zebras and in Morgan and Haflinger horses. Clinically, it is a symmetric spasticity with ataxia and paresis of the limbs.

Equine degenerative myeloencephalopathy, which may have an inherited basis, has been associated with VE deficiency. The VE status is low in some affected horses, and supplementation with the vitamin was associated with a marked reduction in the incidence of the disease. In some premises affected with the condition, the administration of VE reduced the incidence. On the other hand, however, serum VE and blood GSH-PX activities determined in horses with histologically confirmed diagnosis of the disease compared with age-matched controls failed to reveal any differences, and the findings did not support a possible role for VE deficiency as a cause. Foals sired by a stallion with degenerative myeloencephalopathy and with neurologic deficits consistent with the disease during their first year of life had lower plasma levels of  $\alpha$ -tocopherol when the levels were determined serially beginning at 6 weeks to 10 months of age than did age-matched controls. Absorption tests with VE revealed that the lower  $\alpha$ -tocopherol levels were not attributable to an absorption defect. The lesions are usually microscopic and are found as axonal degeneration in the spinal cord, with the dorsal spinocerebellar tracts in the lateral funiculi and some areas

of the ventral funiculi severely affected. Myelin loss is secondary to axonal loss. In the brain, there are eosinophilic spheroids in the brainstem nuclei.

### Equine Motor Neuron Disease

Equine motor neuron disease is a neurodegenerative disease of the somatic lower motor neurons resulting in a syndrome of diffuse neuromuscular disease in the adult horse. Case-control studies found the mean plasma VE concentrations in affected horses were lower than that of control horses. Adult horses are affected with the risk peaking at 16 years of age. In addition to the role of VE depletion, other individual and farm-level factors contribute to the risk of developing the disease.

### Generalized Steatitis

Steatitis in farm animals and other species may be associated with VE and/or Se deficiency. Most cases in horses have involved nursing or recently weaned foals. Generalized steatitis in the foal has been described as either generalized cachexia as a result of steatitis alone or as a primary myopathy or myositis, with steatitis of secondary importance. The terms used have included steatitis, generalized steatitis, fat necrosis, yellow-fat disease, polymyositis, and muscular dystrophy. The relationships between steatitis and VE and Se deficiency in the horse are not clear, and there may not be any. Many more clinical cases must be examined in detail before a cause-effect relationship can be considered.

### PATHOGENESIS

Dietary Se, sulfur-containing amino acids, and VE act synergistically to protect tissues from oxidative damage. GSH-PX, which is selenium dependent, functions by detoxifying lipid peroxides and reducing them to nontoxic hydroxy fatty acids. Vitamin E prevents fatty acid hydroperoxide formation. High levels of PUFAs in the diet increase the requirements for VE, and with an inadequate level of Se in the diet, tissue oxidation occurs, resulting in degeneration and necrosis of cells. VE protects cellular membranes from lipoperoxidation, especially membranes rich in unsaturated lipids, such as mitochondrial, endoplasmic reticulum, and plasma membranes. Thus dietary PUFAs are not a prerequisite for the disease. Diets low in Se and/or VE do not provide sufficient protection against the "physiological" lipoperoxidation that occurs normally at the cellular level.

The relative importance of Se, VE, and sulfur-containing amino acids in providing protection in each of the known diseases caused by their deficiency is not clearly understood. Se has a sparing effect on VE and is an efficient prophylactic against muscular dystrophy of calves and lambs at pasture, but it does not prevent muscular dystrophy in calves fed on a diet containing

cod liver oil. The current understanding of the biochemical function of Se and its relation to VE and the mechanisms of action of Se and VE in protection of biological membranes have been reviewed.

### Nutritional Muscular Dystrophy

A simplified integrated concept of the pathogenesis of the NMD would be as follows. Diets deficient in Se and/VE permit widespread tissue lipoperoxidation, leading to hyaline degeneration and calcification of muscle fibers. One of the earliest changes in experimental Se deficiency in lambs is the abnormal retention of calcium in muscle fibers undergoing dystrophy, and Se supplementation prevents the retention of calcium. Unaccustomed exercise can accelerate the oxidative process and precipitate clinical disease. Muscle degeneration allows the release of enzymes, such as lactate dehydrogenase, aldolase, and creatine phosphokinase, the last of which is of paramount importance in diagnosis. Degeneration of skeletal muscle is rapidly and successively followed by invasion of phagocytes and regeneration. In myocardial muscle, replacement fibrosis is the rule.

In calves, lambs, and foals, the major muscles involved are skeletal, myocardial, and diaphragmatic. The myocardial and diaphragmatic forms of the disease occur most commonly in young calves, lambs, and foals, resulting in acute heart failure, respiratory distress, and rapid death, often in spite of treatment. The skeletal form of the disease occurs more commonly in older calves, yearling cattle, and older foals and results in weakness and recumbency; it is usually less severe and responds to treatment. The biceps femoris muscle is particularly susceptible in calves, and muscle biopsy is a reliable diagnostic aid.

In foals with NMD, there is a higher proportion of type IIC fibers and a lower proportion of type I and IIA fibers than in healthy foals. The type IIC fibers are found in fetal muscle and are undifferentiated and still under development. During the recovery period, fibers of types I, IIA, and IIB increase and the proportion of type IIC fibers decreases. A normal fiber type composition is present in most surviving foals 1 to 2 months after the onset of the disease.

Acute NMD results in the liberation of myoglobin into the blood, which results in myoglobinuria. This is more common in horses, older calves, and yearling cattle than in young calves, whose muscles have a lower concentration of myoglobin. Hence, the tendency to myoglobinuria will vary depending on the species and age of animal involved.

### Subclinical Selenium Insufficiency

Se deficiency affects thyroid hormone metabolism and may explain the cause of ill-thrift. The conversion of the iodine-containing hormone thyroxine (T<sub>4</sub>) to the



more potent triiodothyronine (T3) is impaired in animals with low Se status, and iodothyronine deiodinase is a selenoprotein that mediates this conversion.

### VESD Syndrome and Others

The pathogenesis of mulberry heart disease, hepatitis dietetica, exudative diathesis, and muscular dystrophy of pigs is not yet clear. VE and Se are necessary to prevent widespread degeneration and necrosis of tissues, especially the liver, the heart, skeletal muscle, and blood vessels. Se and VE deficiency in pigs results in massive hepatic necrosis (hepatitis dietetica), degenerative myopathy of cardiac and skeletal muscles, edema, microangiopathy, and yellowish discoloration of adipose tissue. Myocardial and hepatic calcium concentrations are increased in pigs with mulberry heart disease. In addition, there may be esophagogastric ulceration, but it is uncertain whether or not this lesion is caused by a Se and/or VE deficiency. Anemia has also occurred and has been attributed to a block in bone-marrow maturation, resulting in inadequate erythropoiesis, hemolysis, or both. However, there is no firm evidence that anemia is a feature of Se and VE deficiency in pigs. The entire spectrum of lesions has been reproduced experimentally in pigs with natural or purified diets deficient in Se and VE or in which an antagonist was added to inactivate VE or Se. However, in some studies, the Se content of tissues of pigs that died from mulberry heart disease was similar to that of control pigs without the disease.

The extensive tissue destruction in pigs may account for the sudden-death nature of the complex (mulberry heart disease and hepatitis dietetica) and the muscle stiffness that occurs in some feeder pigs and sows of farrowing time with muscular dystrophy. The tissue degeneration is associated with marked increases in serum enzymes related to the tissue involved. An indirect correlation between VE intake and peroxide hemolysis in pigs on a deficient diet suggests that lipoperoxidation is the ultimate biochemical defect in pigs and that VE and Se are protective.

It is thought now that the disease is associated with the lack of balance between free-radical generation and scavenging of these radicals that is called oxidative stress. Scavengers include superoxide dismutase, glutathione peroxidase, vitamin C, and vitamin E. Se is included because it is a component of glutathione peroxidase. Deficiency of these scavengers can lead to cellular injury and death.

In these pigs, there are other complicating factors that may make the condition multifactorial. These include stress, increased iron tissue concentrations, increased calcium and decreased magnesium concentrations, and diets containing corn oil, PUFAs, aflatoxins, excess vitamin A, or dried distiller

grains. Individual animals may also have a genetic predisposition.

### CLINICAL FINDINGS

Nutritional muscular dystrophy is frequently diagnosed in cattle in Europe, but diagnosis based on samples is the only way to confirm the diagnosis because the clinical signs are rarely pathognomonic.<sup>53</sup>

### Acute Enzootic Muscular Dystrophy

Affected animals may collapse and die suddenly after exercise without any other premonitory signs. The excitement associated with the hand-feeding of dairy calves may precipitate peracute death. In calves under close observation, a sudden onset of dullness and severe respiratory distress, accompanied by a frothy or blood-stained nasal discharge, may be observed in some cases. Affected calves, lambs, and foals are usually in lateral recumbency and may be unable to assume sternal recumbency even when assisted. When picked up and assisted to stand, they feel and appear limp. However, their neurologic reflexes are normal. Their eyesight and mental attitude are normal, and they are usually thirsty and can swallow unless the tongue is affected. The heart rate is usually increased up to 150 to 200/min and often with arrhythmia, the respiratory rate is increased up to 60 to 72/min, and loud breath sounds are audible over the entire lung fields. The temperature is usually normal or slightly elevated. Affected animals commonly die 6 to 12 hours after the onset of signs, in spite of therapy. Outbreaks of the disease occur in calves and lambs in which up to 15% of susceptible animals may develop the acute form and the case-fatality approaches 100%.

### Subacute Enzootic Muscular Dystrophy

Subacute enzootic muscular dystrophy is the most common form in rapidly growing calves, often referred to as “white-muscle disease” and, in young lambs, “stiff-lamb disease.” Affected animals may be found in sternal recumbency and be unable to stand, but some make an attempt to stand (Fig. 15-12). If they are standing, the obvious signs are stiffness, trembling of the limbs, weakness, and, in most cases, an inability to stand for more than a few minutes. The gait in calves is accompanied by rotating movements of the hocks and in lambs by a stiff, goose-stepping gait. Muscle tremor is evident if the animal is forced to stand for more than a few minutes. On palpation the dorsolumbar, gluteal, and shoulder muscle masses may be symmetrically enlarged and firmer than normal (although this may be difficult to detect). Most affected animals retain their appetite and will suck if held up to the dam or eat if hand-fed. Major involvement of the diaphragm and intercostal muscles causes dyspnea with labored and abdominal-type respiration. The temperature is usually in the normal range, but there may be a transient fever (41° C; 105° F) as a result of the effects of myoglobinemia and pain. The heart rate may be elevated, but there are usually no rhythmic irregularities. Following treatment, affected animals usually respond in a few days, and within 3 to 5 days they are able to stand and walk unassisted. In sheep with stiff-lamb disease, there were heart arrhythmias resulting from myocardial degeneration. In these lambs with low VE and Se, there were seven different arrhythmias detected.<sup>54</sup>



**Fig. 15-12** Subacute enzootic muscular dystrophy in a recently weaned Merino lamb. The weanling is bright, alert, and responsive, with a good appetite, but it is unable to stand for more than a few seconds.



In alpacas grazing the same pastures as sheep, it was found that the sheep had higher blood Se levels but the alpacas had higher plasma Se levels.<sup>55</sup>

In some cases, the upper borders of the scapulae protrude above the vertebral column and are widely separated from the thorax. This has been called the “flying scapula” and has occurred in outbreaks in heifers from 18 to 24 months of age within a few days to 3 weeks after being turned out in the spring following loose-housing conditions throughout the winter.<sup>56</sup> The abnormality is a result of bilateral rupture of the serratus ventralis muscles and has also been reported in a red deer. Occasionally, the toes are spread, and there is relaxation of carpal and metacarpal joints or knuckling at the fetlocks and standing on tip-toe, inability to raise the head, difficulty in swallowing, inability to use the tongue, and relaxation of abdominal muscles. Choking may occur when the animals attempt to drink. In “paralytic myoglobinuria” of yearling cattle, there is usually a history of recent turning out on pasture following winter housing. Clinical signs occur within 1 week and consist of stiffness, recumbency, myoglobinuria, hyperpnea, and dyspnea. Severe cases may die within a few days, and some are found dead without premonitory signs. In rare cases, lethargy, anorexia, diarrhea, and weakness are the first clinical abnormalities recognized, followed by recumbency and myoglobinuria.

**Congenital muscular dystrophy** has been described in a newborn calf. The calf was still recumbent 13 hours after birth and had increased serum creatine kinase and decreased serum VE and Se levels. Recovery occurred following supportive therapy and VE and Se administration.

**Subcapsular liver rupture in lambs** has been associated with VE deficiency in lambs, usually those under 4 weeks of age. Affected lambs collapse suddenly, become limp, and die within a few minutes or several hours after the onset of weakness.

In **foals, muscular dystrophy** occurs most commonly during the first few months of life and is common in the first week. The usual clinical findings are failure to suck, recumbency, difficulty in rising, and unsteadiness and trembling when forced to stand. The temperature is usually normal, but commonly there is polypnea and tachycardia. The disease in foals may be characterized by an acute, fulminant syndrome, which is rapidly fatal, or a subacute syndrome characterized by profound muscular weakness. Failure of passive transfer, aspiration pneumonia, and stunting are frequent complications. In the subacute form, mortality rates may range from 30% to 45%.

In **adult horses with muscular dystrophy**, a stiff gait, myoglobinuria, depression, inability to eat, holding the head down low,

and edema of the head and neck are common. The horse may be presented initially with clinical signs of colic.

In **pigs, muscular dystrophy** is not commonly recognized clinically because it is part of the more serious disease complex of mulberry heart disease and hepatosis dietetica. However, in outbreaks of this complex, sucking piglets, feeder pigs, and sows after farrowing may exhibit an uncoordinated, staggering gait suggestive of muscular dystrophy.

**Subclinical nutritional muscular dystrophy** occurs in apparently normal animals in herds at the time clinical cases are present. The serum activity of creatine kinase may be elevated in susceptible animals for several days before the onset of clinical signs; following treatment with VE and Se the serum enzyme activity returns to normal. Grossly abnormal electrocardiograms occur in some animals and may be detectable before clinical signs are evident.

Juvenile mortality in captive lesser kudu was reported at Basle Zoo as a result primarily of WMD caused by a diet deficient in both VE and Se.<sup>57</sup>

### Vitamin E/Selenium Deficiency in Pigs

In pigs the total antioxidant pool is the important feature because Se and ascorbic acid are sparing for vitamin C and alpha-tocopherol.<sup>58</sup> Usually, they occur separately, but rarely MHD and HD occur together; even more rarely, you may find that there is NMD as well. There is a suspicion that the occurrence of two or more together has recently become more common, but this in fact may be a result of the greater awareness of both conditions. Two or more conditions require supplementation with both VE and Se.

### Mulberry Heart Disease

MHD is usually seen in pigs from a few weeks to 4 months of age. The incidence of the disease is generally low. These pigs are nearly always the best of the group, and it may be that this rate of growth increases the demand for VE and Se. Nearly always the animals are found dead, so clinical signs are not often seen. Death usually results from arrhythmias associated with the myocardial necrosis.

More than one pig may be found dead. When seen alive, animals show severe dyspnea, cyanosis, and recumbency, and forced walking can cause immediate death. In some outbreaks, about 25% of pigs will show a slight inappetence and inactivity; these are probably in the subclinical stages of the disease. The stress of movement, inclement weather, or transportation will precipitate further acute deaths. The temperature is usually normal, the heart rate is rapid, and irregularities may be detectable. The feces are usually normal.

### Hepatositis Dietetica

In hepatosis dietetica, most pigs are found dead. Very few cases show other signs. In occasional cases, before death there will be dyspnea, severe depression, vomiting, staggering, diarrhea, and a state of collapse. Some pigs are icteric. Outbreaks also occur similar to the pattern in mulberry heart disease. Muscular dystrophy is an almost consistent necropsy finding in both mulberry heart disease and hepatosis dietetica but is usually not recognized clinically because of the seriousness of the two latter diseases. Clinical muscular dystrophy has been described in gilts at 11 months of age. About 48 hours after farrowing, there was muscular weakness, muscular tremors, and shaking. This was followed by collapse, dyspnea, and cyanosis. There were no liver or heart lesions. In experimental Se and VE deficiency in young, rapidly growing pigs, a subtle stiffness occurred along with a significant increase in the creatinine phosphatase (CPK) and serum glutamic-oxaloacetic transaminase (SGOT) values.

## CLINICAL PATHOLOGY

### Myopathy

#### Plasma Creatine Kinase

Plasma creatine kinase (CK) is the most commonly used laboratory aid in the diagnosis of NMD. The enzyme is highly specific for cardiac and skeletal muscle and is released into the blood following unaccustomed exercise and myodegeneration. In cattle and sheep, its half-life is 2 to 4 hours, and plasma levels characteristically decline quickly unless there is continued myodegeneration but remain a good guide to the previous occurrence of muscle damage for a period of about 3 days. The normal plasma levels of CK (IU/L) are as follows: sheep,  $52 \pm 10$ ; cattle,  $26 \pm 5$ ; horses,  $58 \pm 6$ ; and pigs,  $226 \pm 43$ . In cattle and sheep with NMD, the CK levels will be increased, usually above 1000 IU/L and commonly to 5000 to 10,000 IU/L, and not uncommonly even higher. Following turn-out of housed cattle onto pasture, the CK levels will increase up to 5000 IU/L within a few days. The CK levels will usually return to normal levels within a few days following successful treatment. Persistent high levels suggest that muscle degeneration is still progressive or has occurred within the last 2 days. Measurement of plasma CK activity could be used to monitor recovery of animals treated for nutritional myopathy.

#### Aspartate Aminotransferase

**Aspartate aminotransferase (AST) activity** is also an indicator of muscle damage, but it is not as reliable as the CK because increased AST levels may also indicate liver damage. The AST activity remains elevated for 3 to 10 days because of a much longer half-life than CK. In acute cases, levels of 300 to 900 IU/L in calves and 2000 to 3000 IU/L in lambs have been observed. In normal animals of

these species, serum levels are usually less than 100 IU/L.

The magnitude of the increase in AST and CK is directly proportional to the extent of muscle damage. Both are elevated initially; an elevated AST and declining CK would suggest that muscle degeneration is no longer active. The levels of both enzymes will be increased slightly in animals that have just been turned out and subjected to unaccustomed exercise, horses in training, and in animals with ischemic necrosis of muscle as a result of recumbency caused by diseases other than muscular dystrophy. However, in acute muscular dystrophy, the levels are usually markedly elevated.

### Selenium Status

Although information on the critical levels of Se in soil and plants is accumulating gradually, the estimations are difficult and expensive. Most field diagnoses are made on the basis of clinicopathologic findings, the response to treatment, and control procedures using selenium. The existence of NMD is accepted as presumptive evidence of Se deficiency, which can now be confirmed by analyses of GSH-PX and the concentrations of Se in soil, feed samples, and animal tissues. Tentative critical levels of the element are as follows:

- **Forages and grains:** A content of 0.1 mg/kg DM is considered adequate.
- **Soil:** Soils containing less than 0.5 mg/kg are likely to yield crops inadequate in selenium concentration.
- **Animal tissues, blood, and milk:** The concentrations of Se in various tissues are reliable indicators of the Se status of the animal. There is a positive correlation between the Se content of feed and the Se content of the tissues and blood of animals ingesting that feed, and the values fluctuate with the dietary intake of the element.

Three tests can be used to assess Se status in cattle and sheep: serum and whole-blood Se and glutathione peroxidase activity. Serum Se responds more rapidly to the administration of Se than whole-blood Se. There is a similar delay in glutathione peroxidase activity to Se supplementation. Blood or serum Se status is most consistently measured at the herd level. Interlaboratory differences in thresholds for deficiency exist, and results should be considered based on laboratory-specific guidelines.

The recommended blood Se reference ranges for New Zealand livestock have been used in several publications.

Reference ranges for Se and VE in serum, blood, and liver of sheep and goats in the United States are available.

### Selenium Status in Horses

In New Zealand, the reference ranges for blood used for Se status in horses are as follows: adequate, greater than 1,600 nmol/L

(128 ng/mL); marginal, 450 to 1,600 nmol/L (36 to 128 ng/mL); and deficient, less than 450 nmol/L (36 ng/mL).

### Kidney Cortex and Liver

Normal liver Se concentrations range from 1.2 to 2.0  $\mu\text{g/g}$  DM, regardless of species or age. Levels of 3.5 to 5.3  $\mu\text{g/g}$  (44 to 67 nmol/g) DM in the kidney cortex and 0.90 to 1.75  $\mu\text{g/g}$  (11 to 22 nmol/g) DM in the liver of cattle are indicative of adequate Se. Levels of 0.6 to 1.4  $\mu\text{g/g}$  (8 to 18 nmol/g) in the kidney cortex and 0.07 to 0.60  $\mu\text{g/g}$  (0.9 to 8 nmol/g) in the liver represent a deficient state.

The Se content of bovine fetal liver samples collected at an abattoir contained 0.77  $\mu\text{g/mL}$  WW and 0.13  $\mu\text{g/mL}$  WW, from dairy breeds and beef breeds of cattle, respectively. Mean liver Se levels from aborted bovine fetuses with myocardial lesions were 5.5  $\mu\text{mol/kg}$ , 6.5  $\mu\text{mol/kg}$  in fetuses without myocardial lesions, and 7.5  $\mu\text{mol/kg}$  in fetuses from the abattoir, which suggests that Se deficiency may be the cause of abortion.

### Blood and Milk

Blood and milk levels of Se are used as indicators of Se status in cattle and the effect of dietary supplementation. Serum Se values increase gradually with age from starting ranges for neonates of 50 to 80 ng/mL for calves and sheep and 70 to 90 for foals and pigs. Expected or normal values for adults are in the ranges of 70 to 100 for cattle, 120 to 150 for sheep, 130 to 160 for horses, and 180 to 220 for pigs.

Dams of affected calves have levels of 1.7 ng/mL (22 nmol/L) in blood and 4.9 ng/mL (62 nmol/L) in milk; their calves have blood levels of 5 to 8 ng/mL (63 to 102 nmol/L). Normal selenium-supplemented cows have 19 to 48 ng/mL (241 to 609 nmol/L) in blood and 10 to 20 ng/mL (127 to 253 nmol/L) in milk, and their calves have blood levels of 33 to 61 ng/mL (419 to 774 nmol/L). Mean Se concentrations in the blood of normal mares are 26 to 27 ng/mL (329 to 342 nmol/L). In Thoroughbred horses, Se concentrations in serum range from 39.5 to 118.5 mg/mL (40 to 160 ng/mL; 0.5 to 2.0  $\mu\text{mol/L}$ ), and there are significant differences between various stables of horses.

### Bulk-Tank Milk

The bulk-tank milk Se levels are closely related to the mean herd blood and milk levels and have the potential to be a low-cost, noninvasive means of evaluating herd Se levels to determine Se deficiency in the dairy herd. Bulk-tank Se concentrations are an accurate reflection of the herd Se status over the range of Se intakes typical of dairy herds in an area.

### Glutathione Peroxidase

There is a direct relationship between the GSH-PX activity of the blood and the Se levels of the blood and tissues of cattle, sheep,

horses, and pigs. The normal Se status of cattle is represented by whole-blood Se concentration of 100 ng/mL (1270 nmol/L) and blood GSH-PX activity of approximately 30 mU/mg hemoglobin.

There is a high positive relationship ( $r = 0.87$  to  $0.958$ ) between blood GSH-PX activity and blood Se concentrations in cattle. Blood Se levels less than 50 ng/mL are considered as selenium-deficient, levels between 50 and 100 ng/mL (126.6 nmol/L) are marginal, and those greater than 100 ng/mL are adequate. Comparable whole-blood levels of GSH-PX are deficient if less than 30 mU/mg hemoglobin, marginal if 30 to 60 mU/mg, and adequate if greater than 60 mU/mg hemoglobin. There is some evidence of variation in GSH-PX activities between breeds of sheep; levels may also decrease with increasing age. Low levels in some breeds of sheep may also be a reflection of adaptation to low Se intake because of low levels of Se in the soil and forages.

The GSH-PX activity is a sensitive indicator of the level of dietary Se intake and the response to the oral or parenteral administration of Se. Because Se is incorporated into erythrocyte GSH-PX only during erythropoiesis, an increase in enzyme activity of the blood will not occur for 4 to 6 weeks following administration of Se. Plasma GSH-PX will rise more quickly and will continue to increase curvilinearly with increasing dietary Se levels because it is not dependent on incorporation of the Se into the erythrocytes. The liver and Se concentration and serum GSH-PX activity may respond to changes in dietary Se more rapidly than either whole-blood Se or erythrocyte GSH-PX activity. The response in GSH-PX activity may depend on the Se status of the animals at the time when Se administered. Larger increases in the enzyme activity occur in selenium-deficient animals. The GSH-PX activity in foals reflects the amount of Se given to the mare during pregnancy.

The sandwich ELISA is a simplified method for the estimation of GSH-PX activity and Se concentration in bovine blood and can be used for rapid screening of the Se status of a large number of cattle. The GSH-PX activity of whole-blood samples has been used to assess the Se status of cattle in the Czech Republic.

The GSH-PX activity can be determined rapidly using a spot test, which is semiquantitative and can place a group of samples from the same herd or flock into one of three blood Se categories: deficient, low marginal, and marginal adequate. A commercial testing kit known as the Ransel Kit is now available. Because of the instability of GSH-PX plasma, GSH-PX activity in sheep, cattle, and pigs should be measured in fresh plasma or stored at  $-20^{\circ}\text{C}$  ( $-4^{\circ}\text{F}$ ). For absolute measurements, it is suggested that pig plasma GSH-PX activity be measured

immediately after separation from the blood cells or be assayed within 24 hours under specified laboratory conditions.

### Vitamin E Status

VE occurs in nature as a mixture of tocopherols in varying proportions. They vary widely in their biological activity so that chemical determination of total tocopherols is of much less value than biological assay. Tocopherol levels in blood and liver provide good information on the VE status of the animal. However, because of the difficulty of the laboratory assays of tocopherols, they are not commonly done, and insufficient reliable data are available. Analysis of liver from clinically normal animals on pasture reveals a mean  $\alpha$ -tocopherol level of 20 mg/kg WW for cattle and 6 mg/kg WW for sheep. The corresponding ranges were 6.0 to 53 mg/kg WW for cattle and 1.8 to 17 mg/kg WW in sheep. The critical level below which signs of deficiency may be expected are 5 mg/kg WW for cattle and 2 mg/kg WW for sheep. Tocopherol levels in the serum of less than 2 mg/L in cattle and sheep are considered to be critical levels below which deficiency diseases may occur. However, if the diet contains adequate quantities of Se, but not an excessive quantity of PUFAs, animals may thrive on low levels of serum tocopherols. In growing pigs, the serum VE levels are between 2 and 3 mg/L. In summary, there are insufficient reliable data available on the VE status on animals with NMD to be of diagnostic value.

The mean plasma VE level in clinically normal horses of various ages and breeds was 2.8  $\mu$ g/mL. The optimal method for storing equine blood before  $\alpha$ -tocopherol analysis is in an upright position in the refrigerator for up to 72 hours. If a longer period is needed, the serum or plasma should be separated, blanketed with nitrogen gas, and frozen in the smallest possible vial; the  $\alpha$ -tocopherol in these samples will be stable at  $-16^{\circ}$  C ( $3^{\circ}$  F) for at least 3 months.

A summary of the GSH-PX activity, tocopherol levels, and Se levels in blood and body tissues of animals deficient in Se appears in Table 15-7. Normal values are also tabulated for comparison. Both the abnormal and normal values should be considered as guidelines for diagnosis because of the wide variations in levels between groups of animals. The level of dietary Se may fluctuate considerably, which may account for variations in GSH-PX. Se reference ranges to determine Se status of sheep and cattle in New Zealand are shown in Table 15-8.

In the early stages of the subclinical form of NMD in lambs, there may be a decrease in serum Se and glutathione peroxidase activity and an increase in the activity of aspartate aminotransferase (AST), creatine kinase (CK), and lactate dehydrogenase (LDH) compared with healthy lambs. The LDH-isoenzyme activity is useful for

**Table 15-7** Glutathione peroxidase (GSH-PX) activity and selenium concentration in blood and body tissues of animals deficient in selenium

Species	Clinical state or degree of deficiency	Erythrocyte GSH-PX activity $\mu$ mol/min at $37^{\circ}$ C/g hemoglobin	Serum selenium ( $\mu$ g/mL)	Liver selenium ( $\mu$ g/g DM)
Cattle	Normal or adequate	19.0–36.0	0.08–0.30	0.90–1.75
	Marginal	10.0–19.0	0.03–0.077	0.45–0.90
	Deficient	0.2–10.0	0.002–0.025	0.07–0.60
Sheep	Normal or adequate	60–180	0.08–0.50	0.90–3.50
	Marginal	8–30	0.03–0.05	0.52–0.90
	Deficient	2–7	0.006–0.03	0.02–0.35
Horse	Adequate	30–150	0.14–0.25	1.05–3.50
	Deficient	8–30	0.008–0.55	0.14–0.70
Pigs	Adequate	100–200	0.12–0.30	1.40–2.80
	Deficient	<50	0.005–0.60	0.10–0.35

**Table 15-8** Selenium reference range to determine selenium status of sheep and cattle in New Zealand

	Deficient	Marginal	Adequate
<b>Sheep</b>			
Blood selenium (nmol/L)	<130	130–250	>250
Liver selenium (nmol/kg fresh tissue)	<250	250–450	>450
<b>Cattle</b>			
Blood selenium (nmol/L)	<130	130–250	>250
Liver selenium (nmol/kg fresh tissue)	<600	600–850	>850
Serum selenium (nmol/L)	<85	85–140	>250
Blood glutathione peroxidase (Ku/L $-25^{\circ}$ C)	<0.5	0.5–2.0	>2.0

detection of subclinical forms of NMD because of significant increases in the activity of the LDH<sub>5</sub>-muscle fraction.

### Farmed Red Deer

Reference range data for liver and blood selenium in red deer are limited. White-muscle disease has occurred in young deer with blood and liver Se concentrations of 84 to 140 nmol/L and 240 to 500 nmol/kg fresh tissue, respectively. No growth-rate response to Se supplementation occurred in 1-year-old deer when blood Se concentrations were less than 130 nmol/L, the range in which a growth rate response would be expected in sheep.

### Pigs

An increase in the activity of several plasma enzymes occurs in Se and VE deficiencies of pigs. The measurement of AST, CPK, LDH, and isocitrate dehydrogenase can be used to detect the onset of degeneration of skeletal and myocardial muscles and liver. However, these are not commonly used for diagnostic purposes because of the acuteness of the illness. The determination of the levels of Se in feed supplies, tissues, and blood of affected pigs is much more useful as an aid to diagnosis and for guidelines for supplementation of the diet.

In Se–VE deficiency in pigs, serum Se values of less than 2.5 ng/mL (3.2 nmol/L), hepatic Se of less than 0.10 mg/kg (1.3  $\mu$ mol/kg), plasma  $\alpha$ -tocopherol values of less than 0.40  $\mu$ g/mL, and hepatic  $\alpha$ -tocopherol concentrations of less than 0.75  $\mu$ g/g of tissue are common. In a recent study, the VE level was less than 2 ppm in 25% of pigs with gross and microscopic lesions of MHD. In a recent study, results suggested that supplementation with a surfeit level of VE reduced the response to endotoxin (i.e., a reduced response to the peak levels of IL-6).

The diagnostic criteria for the VESD complex in pigs in New Zealand indicate that liver VE concentrations greater than 10  $\mu$ mol/kg are adequate, with less than 2.5  $\mu$ mol/kg associated with deficiency. Corresponding estimates for serum VE are greater than 2.5  $\mu$ mol/L and less than 0.8  $\mu$ mol/L, respectively. Liver Se concentrations of greater than 2200 nmol/kg are adequate, with 1100 to 2200 nmol/kg being in the marginal range and less than 1100 nmol/kg being deficient. Deficiency levels for blood are in the range of 400 to 1500 nmol/L. These values must be interpreted along with the concentration of PUFAs in the diet.

There is a close relationship between blood VE and resistance of erythrocytes against lipid peroxidation. The



supplementation of the diet of pigs with VE will increase both the serum levels of VE and the resistance of the erythrocytes to lipid peroxidation.

### NECROPSY FINDINGS

The gross appearance of the muscle lesions is quite constant, but the distribution of affected muscles varies widely in different animals. Affected groups of skeletal muscle are bilaterally symmetric and contain localized white or gray areas of degeneration and necrosis. These areas may be in streaks, involving a large group of muscle fibers that run through the center of the apparently normal muscle or as a peripheral boundary around a core of normal muscle. In the diaphragm, the distribution of damaged bundles gives the tissue a radially striated appearance. The affected muscle is friable and edematous and may be mineralized. Secondary pneumonia often occurs in cases where the muscles of the throat and chest are affected. In cases with myocardial involvement, white areas of degeneration are visible, particularly under the endocardium of the left ventricle in calves and of both ventricles in lambs. The lesions may extend to involve the interventricular septum and papillary muscles and have a gritty character consistent with mineralization. Pulmonary congestion and edema is common.

Histologically, the muscle lesions in all species are **noninflammatory**. Hyaline degeneration is followed by coagulation necrosis and variable degrees of mineralization.

Other than a variable degree of muscular atrophy, gross lesions are not seen in horses with **equine motor neuron disease**. Confirmation of the diagnosis relies on histologic identification of characteristic degeneration and loss of motor neurons of the spinal cord ventral horns. However, a very strong presumptive diagnosis can be achieved by microscopic confirmation of neurogenic atrophy in the sacrocaudalis dorsalis muscle or axonal degeneration in the spinal accessory nerve.

A generalized **steatitis** has been described in newborn foals less than 2 months of age. The microscopic appearance of this yellow-brown fat consists of necrotic fat infiltrated by neutrophils, macrophages, and giant cells. Steatitis and nodular panniculitis have also been reported in a 3-year-old VE-Se-deficient mare.

In **mulberry heart disease**, the carcass is in good condition. All body cavities contain excessive amounts of fluid and shreds of fibrin. In the peritoneal cavity, the fibrin is often in the form of a lacy net covering all the viscera. The liver is enlarged, appears mottled, and has a characteristic nutmeg appearance on the cut surface. The lungs are edematous, and excessive fluid in the pleural cavities is accompanied by collapse of the ventral lung field. The pericardial sac is filled with gelatinous fluid interlaced with

bands of fibrin. Beneath the epicardium and endocardium are multiple hemorrhages of various sizes. Usually, this hemorrhage is more severe on the right side of the heart. This gives the heart the typical mottled appearance, which is caused by areas of necrosis and areas of hemorrhage.

Histologically, the characteristic lesion is widespread myocardial congestion, hemorrhage, and myofiber degeneration. Multiple fibrinous microthrombi are within the myocardial capillaries, and occasionally degenerative changes are visible in the walls of small arterioles in many organs, including the heart. Malacia of cerebral white matter or, more rarely, the molecular layer of the cerebellum may occur and is attributable to microvascular damage. Microscopic lesions consistent with dietary microangiopathy may also be found in arterioles and capillaries of the heart, kidneys, liver, stomach, intestine, mesentery, skeletal muscle, and skin. It should be stressed that in some cases, the disease course is so rapid that morphologic changes are not discernible in the myocardial cells. Because it can be extremely difficult to distinguish mulberry heart disease from *S. suis* septicemia histologically, it is prudent to also attempt bacteriologic culture when attempting to confirm the diagnosis.

In **hepatosis dietetica**, the liver is swollen and turgid and has a mottled to mosaic-like appearance throughout its lobes. Many of the lobules are distended and reddish in color. There is in fact an irregular distribution of hepatic necrosis and hemorrhage. The gall bladder may be edematous, and there may also be myocardial necrosis and pulmonary edema. Typically, the disease course is so rapid that jaundice does not develop. Histologically, there is a distinct lobular distribution of hemorrhage, degeneration, and necrosis.

In NMD of pigs, the lesions are often only visible at the microscopic level and consist of areas of bilaterally distributed areas of muscular degeneration. The changes include hyalinization, loss of striations, and fragmentation of myofibers. The sections are difficult to cut because of the presence of calcium in the myocytes. A mild degree of NMD may accompany some cases of hepatosis dietetica.

### Samples for Confirmation of Diagnosis

- **Toxicology**—50 g liver (ASSAY [Se] [VE])
- **Histology**—formalin-fixed skeletal muscle (multiple sites), heart (both left and right ventricular walls), and brain (including cerebral hemisphere) (LM). It may require special stains to show the presence of calcium in the sections. In biopsies from medial gluteal muscles using a Bergstrom needle, there were ragged red fibers of type I and IIA. Muscle fiber atrophy and

subsarcolemmal aggregates in type I and IIA fibers were also found. More severely affected horses had inflammatory infiltrate, collagen proliferation, phagocytosis, necrosis, and calcification.<sup>59</sup>

- **Bacteriology** (for mulberry heart disease only)—heart, liver, swab from pericardial sac (CULT)

### DIFFERENTIAL DIAGNOSIS

#### Nutritional muscular dystrophy (NMD)

NMD is most common in young rapidly growing animals fed a ration deficient in selenium and vitamin E or whose dams were on a deficient, unsupplemented ration throughout the winter months.

Characteristically, the disease is sudden in onset, and several animals are affected initially or within a few days, particularly following unaccustomed exercise. In the acute form, generalized weakness and a state of collapse are common. In the subacute form, the major clinical findings are stiffness in walking, long periods of recumbency or total recumbency, inability to stand, a normal mental attitude and appetite, and no abnormal neurologic findings to account for the recumbency. The creatine phosphokinase (CPK) levels are markedly elevated.

#### Calves and yearlings

Acute enzootic muscular dystrophy in calves with myocardial involvement must be differentiated from other diseases causing generalized weakness, toxemia, and shock.

These include the following:

- **Septicemias:** *Haemophilus* septicemia resulting in weakness, recumbency, and fever
- **Pneumonia:** Pneumonic pasteurellosis causing dyspnea, toxemia, fever, and weakness

#### Subacute enzootic muscular dystrophy,

in which skeletal muscle lesions predominate, must be differentiated from other diseases of young calves and yearlings characterized clinically by paresis and paralysis. The subacute form is more common in yearlings and young cattle and is characterized by recumbency, with other body systems being within relatively normal ranges. The other diseases include the following:

- **Musculoskeletal diseases**—polyarthritis, traumatic or infectious myopathies (blackleg), osteodystrophy and fractures of long bones
- **Diseases of the nervous system**—spinal cord compression, *Hemophilus* meningoencephalitis and myelitis, organophosphatic insecticide poisoning
- **Diseases of the digestive tract**—carbohydrate engorgement resulting in lactic acidosis, shock, dehydration, and weakness

#### Lambs and kids

In lambs with “stiff-lamb” disease, there is stiffness and a stilted gait, affected animals

Continued

prefer recumbency, and they are bright and alert and will suck the ewe if assisted. The serum levels of CPK and serum glutamic-oxaloacetic transaminase (SGOT) are also markedly elevated. Differentiation may be necessary from enzootic ataxia and swayback, but in these two diseases, stiffness is not characteristic, but rather, weakness and paresis.

#### Foals

In foals, NMD must be differentiated from acute diseases of the musculoskeletal and nervous system causing abnormal gait, weakness, and recumbency. They include the following:

- Polyarthritis
- Meningitis
- Traumatic injury to the spinal cord

#### Mulberry heart disease

Mulberry heart disease must be differentiated from other common causes of sudden death in pigs in which the diagnosis is made at necropsy:

- Acute septicemias attributable to salmonellosis, erysipelas, pasteurellosis, and anthrax
- Porcine stress syndrome
- Gut edema
- Intestinal volvulus, heat exhaustion, suffocation during transportation

## TREATMENT

Because of the overlapping functions of Se and VE and because it is not always possible to know the relative etiologic importance of one nutrient or the other in causing some of the acute conditions already described, it is recommended that a combined mixture of selenium and  $\alpha$ -tocopherol be used in treatment.  $\alpha$ -Tocopherol is the most potent form of the tocopherols and is available in a number of pharmaceutical forms, which also vary in their biological activity. It has become necessary to express the unitage of VE in terms of international units of biological activity (1 IU:1 mg synthetic racemic  $\alpha$ -tocopherol acetate; natural D- $\alpha$ -tocopherol acetate 1 mg; 1 IU and natural D- $\alpha$ -tocopherol 1 mg: 0.92 IU). It is also obvious that we need to know how to use organic Se (Se-enriched yeast) because this is likely to be much more valuable as a supplement than sodium selenite as a component of the 30+ selenoproteins.

In cattle, a blend of ammonium chloride, VE, and Se is recommended for the treatment of retained fetal membranes.<sup>60</sup>

Organic selenium (Se-enriched yeast) is a strategy to increase the benefits of the replacement of sodium selenite.<sup>61</sup> Se-enriched yeast increases milk selenium at parturition and weaning.<sup>62</sup>

### Nutritional Muscular Dystrophy

For treatment of NMD in calves, lambs, and foals, a mixture containing 3 mg Se

(as sodium or potassium selenite) and 150 IU/mL of dL- $\alpha$ -tocopherol acetate, given IM at 2 mL/45 kg BW, is recommended. One treatment is usually sufficient. Animals with severe myocardial involvement will usually not respond to treatment, and the case-mortality rate is about 90%. However, all in-contact animals in the herd (calves, lambs, and foals) should be treated prophylactically with the same dose of Se and VE. They should be handled carefully during treatment to avoid precipitating acute muscular dystrophy. Animals with subacute skeletal muscular dystrophy will usually begin to improve by 3 days following treatment and may be able to stand and walk unassisted within 1 week.

Animals sometimes do not respond to either VE or Se or treatment with both.

Supplementation of lambs with Se had no significant effect on performance and blood hematology, but it increased blood G-Th-P and serum T3 but decreased serum T4 compared with nonsupplemented lambs. Se-enriched yeast significantly improved the digestibility.<sup>63</sup> In outbreaks of mulberry heart disease, hepatosis dietetica, and related Se- and VE-deficiency diseases in pigs, all clinically affected pigs and all pigs at risk should be treated individually with a combination of Se/VE parenterally, at first to prevent any further sudden deaths. It can then be followed by oral administration.

## CONTROL

It is necessary to adapt production systems to take into account changes in climatic systems, which can alter the feeding constituents and increase vitamin and mineral requirements and alter the balance between gestation and sources of stress.<sup>31</sup>

Se status is now associated with improved immune function, arthropathy, and cardiomyopathy. Most important, it protects against oxidative stress and aids in regulation of thyroid hormone metabolism.<sup>64</sup>

The control and prevention of the major diseases caused by Se and VE deficiencies can generally be accomplished by the provision of both nutrients to susceptible animals fed on deficient rations.

### Provide Selenium and Vitamin E

Over the years, both the VE levels and Se levels in the diets have increased but particularly the former. This is in response to the more rapid growth rates of pigs but also the realization that pigs are coping with many more oxidative disease states. Outdoor pigs usually have sufficient levels of both unless the soil is Se deficient. A recent study from China has suggested that dietary zinc at 85 mg/kg, Se at 0.40 mg/kg, and vitamin E at 45 IU/kg is appropriate for crossbred sows.

Although Se alone is protective against a greater spectrum of diseases than is VE, there are situations in which VE is more protective. Both Se and VE should be provided

when the diets are deficient in both nutrients, but this may not apply in every situation. Most of the emphasis has been on Se supplementation at the expense of VE, which is more expensive and less stable. Most injectable VE and Se preparations are adequate in Se but insufficient in VE.

There have been several attempts to supplement weaner pigs with a VE preparation. Besides individual injections, it is possible to supplement weaner pigs with water supplementation. Pigs will usually drink even if they are not eating. A recent study showed that the supplementation of drinking water with high doses of VE (150 mg of dL- $\alpha$ -tocopherol acetate) was effective in maintaining serum VE levels over the weaning period. This was even true when the intake of food over the weaning period was very low (it can be as low as 0.2 to 0.3 kg) and there was a temporary malabsorption in the intestine. It takes about 100 IU/L of water to provide a good VE blood serum value.

### Maternal Transfer to Newborn

Treatment with organic and inorganic Se improves the growth rate, humoral immune response, and antioxidant status of the lambs.<sup>65</sup> Se supplementation in cattle and ewes is associated with increased embryo production, higher fetal mass, and reduced levels of retained placenta. There is a complex relationship between supplementation (source of Se, time, length of time, presence of interfering elements, and the diet feeding regime). A 79-mg Se pill to dairy cows 3 weeks before expected calving date significantly elevated blood Se levels in cows after calving.<sup>66</sup> Nearly always, calf VE levels are lower than cow VE levels.<sup>67</sup>

Diseases caused by Se deficiency are preventable by the administration of Se to the dam during pregnancy or directly to the young, rapidly growing animal. Se is transported across the placenta and provides protection for the neonate. Oral supplementation with Se in beef cattle will provide enough to maintain blood levels in the dam and for adequate transfer to the fetus, which can sequester Se when the levels are low in the dam. The colostrum of selenium-supplemented cattle also contains an adequate amount of Se to prevent severe selenium-deficiency diseases. However, by 7 days after parturition, the levels in milk may be inadequate to maintain adequate serum levels in calves. The strategic administration of Se and VE before the expected occurrence of the disease is also a reliable method of preventing the disease.

### Selenium Is Potentially Toxic

Selenium toxicosis is seen as a chronic problem (alkali disease) or as an acute selenosis (blind staggers). In a study of Se toxicity in lambs, it was found that sodium selenite administration led to decreased VE

levels in the liver, but selenomethionine (organic Se) did not.<sup>68</sup> This study suggests that the chemical form of the ingested Se must be known to interpret tissue, blood, and serum concentrations. It can be associated with severe depression, dyspnea, congested mucous membranes, watery diarrhea, and colic spasms,<sup>69</sup> and high levels of Se can be found in heart muscle, liver, and kidney. Chronic selenosis has also been described in camels.<sup>70</sup>

Because Se is toxic, any treatment and control program using it must be carefully monitored. Se injected into or fed to animals concentrates in liver, skeletal muscle, kidney, and other tissues, and withdrawal periods before slaughter must be allowed. There is some concern that Se may be a carcinogen for humans. The only tissues that appear likely to consistently accumulate more than 3 to 4 mg/kg of Se are the kidney and liver, and these are very unlikely to constitute more than a very small part of the human diet. There have been no reports of untoward effects of Se on human health when it has been used at nutritional levels in food-producing animals. The incorporation of Se into commercially prepared feeds for some classes of cattle and pigs has been approved in some countries. A recent case in Norway showed the hazards of Se contamination in the case of an iron supplement. Se toxicosis has been fairly regularly reported. Se toxicosis in pigs seen as progressive apathy, paralysis, and sudden death has been described.<sup>71</sup>

Pigs that are deficient may be more susceptible to other diseases. Pigs with NMD often have the appearance of pneumonic pigs because the diaphragm is weak and the pigs are dyspneic.

Deficient and small pigs may be more susceptible to the effects of iron, and when this is given by injection there may be large numbers of dead piglets as a result of iron toxicity. In these cases, the heart lesions resemble those of MHD.

In a recent case of Se toxicosis in sheep associated with excessive sodium selenite in commercial supplement,<sup>72</sup> there were hemorrhages throughout the lung lobes and edema. Toxicity is greater than 250  $\mu\text{mol/kg}$  DM, and in these sheep the levels were 325 to 400  $\mu\text{mol/kg}$  DM. Se-accumulating plants are thought not to occur in the United Kingdom, and these sheep were thought to have been given free-access minerals from bags with 7628 to 8771 ppm of selenium.

### Selenium in Milk Supplies

The use of Se in the diet of lactating dairy cows has caused concern about possible adulteration of milk supplies. However, the addition of Se to the diets of lactating dairy cows at levels that are protective against the deficiency diseases does not result in levels in the milk that are hazardous for human consumption. The feeding of excessive quantities of Se to dairy cattle would cause toxicity

before levels became toxic for humans. Se supplementation to colostrum increased the IgG amounts and Se concentration in blood plasma in newborn calves.<sup>73</sup>

### Dietary Requirement of Selenium

The dietary requirement of Se for both ruminants and nonruminants is 0.1 mg/kg DM of the element in the diet. There may be Nutritionally important differences in the Se status between the same feeds grown in different regions and between different feeds within a region. Even within a region featuring high Se concentrations, some feeds may contain levels of Se below the 0.1 mg/kg minimum requirement for livestock. Thus an Se analysis of feeds appears necessary to supplement livestock appropriately. Some geographic areas are known to be deficient in Se, and the feeds grown in these areas must be supplemented with Se and VE on a continuous basis. Some reports indicate that surveys have found that dairy producers are providing insufficient supplementary Se in the ration to meet the recommended Se intake for lactating dairy cows. Long-term administration of organic Se in the form of Se yeast provides higher blood and tissue concentrations than repeated parenteral administration of recommended therapeutic doses of inorganic Se.

Grass-based diets elevate precursors of VE and vitamin A. Argentinian beef contains more  $\alpha$ -tocopherols, beta carotene, ascorbic acid, and glutathione than feedlot beef.<sup>74</sup>

There is an improvement in the preventative antioxidant systems of cows fed Se-enriched yeast.<sup>75</sup>

Avoidance of high-sulfate diets is desirable, but provision of adequate Se overcomes the sulfate effect.

### Glutathione Peroxidase Activity

Whole-blood GSH-PX activity is a way of monitoring Se status but is not as reliable in pigs as in sheep and cattle. Levels of the enzyme increased significantly over a 12-week period when beef cattle were receiving organic or inorganic Se. Levels were higher in the group receiving organic Se. It was shown that combinations of Se injections and supplementation could help maintain Se and GSH-Px blood status in beef cattle heifers.<sup>76</sup>

### Pigs

In growing pigs, both Se and vitamin E at 30 IU/kg DM of feed are necessary for the prevention of the diseases caused by diets deficient in vitamin E and Se. Supplementation of the diet of the sow will result in an adequate transfer to the piglets. Satisfactory protection of the diseases of pigs caused by VE/Se deficiency depends on the correct balance between Se,  $\alpha$ -tocopherol, and PUFAs in the diet and the presence of a suitable antioxidant to conserve the  $\alpha$ -tocopherol.

### Different Methods of Supplementation

The prevention of the major diseases caused by Se and VE deficiencies can be achieved by different methods, including the following:

- Dietary supplementation in the feed or water supplies
- Individual parenteral injections
- Oral administration
- Pasture top dressing

The method used will depend on the circumstances of the farm, the ease of administration, the cost, the labor available, the severity of the deficiency that exists, and whether or not the animals are being dosed regularly for other diseases, such as parasitism. The subcutaneous injection of barium selenate, the administration of an intraruminal pellet, and the addition of Se to the water supply were compared in cattle; each method was effective for periods ranging from 4 to 12 months.

### Dietary Supplementation

The inclusion of Se and VE in the feed supplies or salt and mineral mixes has been generally successful in preventing the major diseases caused by deficiencies of these two nutrients. The currently available data do not support the use of supplemental injections of VE for beef cattle because the benefits are greater when VE is fed.<sup>77</sup>

### Selenium Dose

#### Individual Injections

Injections of Se and VE have been used successfully for prevention, particularly in circumstances where the diet cannot be easily supplemented. Following the IM injections of sodium selenite into calves, lambs, and piglets, the Se concentration of the tissues, particularly the liver, increases and then declines to reach preinjection levels in 23 days in calves and 14 days in lambs and piglets. Adequate sources of vitamin E also must be provided. Injectable preparations of Se and VE are usually adequate in Se and deficient in VE, and it may not be possible to correct a marginal deficiency of VE in pregnant beef cattle, for example, by IM injection of a Se and VE preparation that contains an inadequate concentration of VE. The current label dose of injectable Se, 0.055 mg Se/kg BW, which is therapeutically adequate for NMD, is not sufficient for long-term Se supplementation of cattle on a Se-deficient diet. Copper and Se supplementation by parenteral administration can be combined when both deficiencies are present.

#### Subcutaneous Injections

**Cattle and Sheep.** A slow-release preparation of barium selenate for SC injection is now available for use in cattle and sheep. An SC injection of 1 mg selenium/kg BW to ewes 3 weeks before breeding elevated the Se level in milk during lactation and increased the Se concentration and GSH-PX activity



in the blood of the lambs during the period when they are at greatest risk from selenium-deficiency diseases. At a dose of 1 mg selenium/kg BW to pregnant ewes, the GSH-PX activity is increased and maintained at adequate levels for up to 5 months. There is adequate transfer of Se to the lambs, providing protection for up to 12 weeks of age, which covers the period when lambs are at greatest risk. A dose of 1.2 mg selenium/kg BW provided adequate Se status for as long as two consecutive lambing seasons. Barium selenate at 1 mg selenium/kg BW SC provides protection in young sheep for at least 3 months and is not associated with risk of Se toxicity or unacceptable residues of Se in tissues other than the site of injection. A dose of 1 mg selenium/kg BW (barium selenate) to cattle SC increased the GSH-PX activity within 4 weeks and was maintained at high levels for up to 5 months.

**Pigs.** The SC injection of barium selenate of pregnant sows at 0.5 to 1.0 mg selenium/kg BW resulted in a significant difference in GSH-PX activity in the piglets from treated sows compared with untreated controls. The SC injection of barium selenate at 2.5 mg selenium/kg BW into pigs weighing 20 kg also maintained blood levels of selenium and GSH-PX activity during the most rapid growing period. The relative safety of barium selenate is a result of its slow rate of release from the site of injection. By comparison, when Se is administered as a soluble salt, such as sodium selenite, acute toxicity may occur at doses of 0.45 mg selenium/kg BW. Treatment with barium selenate increases the concentration of Se in blood, liver, and muscle and persists for at least 4 months. One disadvantage of barium selenate is that a large residue persists at the site of injection for long periods. The use of sodium selenite also increases tissue and blood concentrations of Se, but they begin to decline by 23 days. The bovine liver rapidly removes approximately 40% of injected Se salts (soluble) from the systemic plasma, binds it to a plasma component, and releases it back into circulation within 1 hour of injection.

**Farmed Red Deer.** A long-acting barium selenate given subcutaneously to red deer on pasture, at 0.5, 1.0, or 2.0 mg Se/kg BW, elevated blood Se concentrations from 105 nmol/L preinjection for at least 377 days, with peak levels of 1894, 1395, and 818 nmol/L for high, medium, and low doses, respectively. Pastures contained 10 to 30 mg Se/kg DM. There was no significant difference in growth rate between treated and control deer. The preparation produced fewer and less severe SC tissue reactions than previous preparations. Young, rapidly growing deer seem less sensitive to Se deficiency, as measured by weight gain, than sheep and cattle, suggesting that reference

ranges for those species are not appropriate for deer.

### Oral Selenium and Anthelmintics

Oral dosing using sodium selenite is sometimes combined with the administration of anthelmintics and vaccinations. The dose should approximate 0.044 mg/kg BW. A routine program in a severely deficient area comprises three doses of 5 mg of selenium (11 mg sodium selenite) each to ewes, one before mating, one at midpregnancy, and one 3 weeks before lambing, along with four doses to the lambs. The first dose to lambs (of 1 mg) is given at docking and the others (2 mg each) at weaning and then at 3-month intervals. A 100-day controlled release anthelmintic capsule containing 13.9 mg of selenium will protect lambs from Se deficiency for at least 180 days.

Both Se and cobalt can be incorporated into an anthelmintic program. The levels of GSH-PX activity may be monitored on a regular basis following the drenching with Se and provide a good indication of Se availability and the Se status of grazing sheep.

### Pasture Top Dressing

The application of sodium selenate as a top dressing to pasture is now practiced and permitted in some countries. Top dressing at the approved rate of 10 g selenium/ha is effective for 12 months and has a toxicity margin of safety of about 20 times. Sodium selenate is now used in preference to sodium selenite because only about one-fifth is required to raise the pasture level of Se to the same concentrations provided by sodium selenite. Top dressing of severely deficient pumice soils in New Zealand prevented deficiency for at least 12 months, sheep were protected against white-muscle disease in sheep, and reproduction performance and weight gains were improved. It is recommended that sodium selenate be applied annually to all selenium-deficient soils at the rate of 10 g selenium/ha added to the superphosphate fertilizer or as prills of sodium selenate alone. Top dressing is an economical alternative to individual animal dosing, particularly in severely deficient areas with a high stocking rate. At the approved rate, no adverse effects are anticipated for human or animal health or for the environment. Se-enriched fertilizer increases the Se level of hay to a level that is recommended for horses (0.1 mg/kg DM).<sup>78</sup>

### Muscular Dystrophy

Under most conditions, NMD of calves and lambs can be prevented by providing Se and VE in the diets of the cow or ewe during pregnancy at 0.1 mg/kg DM of actual Se and  $\alpha$ -tocopherol at 1 g/d per cow and 75 mg/d per ewe. If possible, the supplementation should be continued during lactation to provide a continuous source of Se to the calves and lambs. Under some conditions the level of 0.1 mg/kg DM may be inadequate. In

some circumstances, the optimal Se concentration in the feed is considerably higher than 0.1 mg/kg DM, and levels up to 1.0 mg/kg DM in the feed result in increases in GSH-PX activity, which may be beneficial; however, the cost-effectiveness has not been determined. Pregnant ewes being fed on alfalfa hay may require selenium at a level of up to 0.2 mg/kg DM to prevent white-muscle disease in their lambs. Young, rapidly growing cattle, particularly beef cattle, likely to receive hay and straw deficient in Se and those that are fed high-moisture grain should receive a supplement of Se at the rate of 0.1 mg/kg DM and  $\alpha$ -tocopherol at 150 mg/d per head. If selenium-supplemented concentrates are used as part of a feeding program for dairy cows, it is not necessary to provide additional Se by parenteral injection.

Lambs are born with a low serum level of VE, but the concentration increases rapidly after the ingestion of colostrum. Supplementation of pregnant ewes with  $\alpha$ -tocopherol, either as a single IM dose (500 mg 2 weeks before lambing) or orally (150 mg daily during 3 to 4 weeks before lambing) results in a marked increase in the levels of the vitamin in the serum and colostrum. The VE concentration in colostrum was 5 to 11 times higher than in milk 1 week after lambing.

VE supplementation of the feed of weaner sheep by oral drench or feed additive is effective in increasing plasma  $\alpha$ -tocopherol concentrations. This is the most practical method for housed sheep and prevents subclinical myopathy. The IM oily injection was slow to increase plasma levels of tocopherols and did not prevent myopathy in grazing experiments. VE supplements have no beneficial effects on wool quality or quantity in grazing sheep, and unless certain flocks are susceptible to VE deficiency myopathy, it is not recommended.

### Beef Cattle and Sheep

#### Salt-Mineral Mixture

NMD can be prevented in unweaned beef calves and lambs by the inclusion of Se (14.8 mg/kg) and VE (2700 IU/kg) in the mineral supplement provided ad libitum to the pregnant cows and ewes on a selenium-deficient ration during the latter two-thirds of gestation and for the first month of lactation. Under most conditions this will provide Se at 0.1 mg/kg DM in the diet.

The provision of **sodium selenite in a salt-mineral mixture** to provide 90 mg of selenium/kg salt-mineral mixture on a year-round basis, even under range conditions, increased GSH-PX activity levels into normal ranges in beef cows for 3 months when fed to extremely deficient animals. Calves of these cows had increased weaning weights and decreased incidence of infectious diseases, but the trial was uncontrolled. The provision of 30 mg selenium/kg salt-mineral mixture was insufficient to raise the GSH-PX activity levels to normal ranges. Peak blood

selenium levels were achieved in weaned beef calves supplemented with 80 and 160 mg selenium/kg in free-choice salt-mineral mixtures for a period of 108 days. In some jurisdictions, it may be necessary for the veterinarian to prescribe a supplement containing higher levels than those permitted by legislation. A level of 25 mg/kg selenium of a salt-mineral mixture provided ad libitum for sheep will result in sufficient levels of Se in the dam's blood and milk to prevent Se deficiency diseases. Each ewe must consume from 8 to 12 g of the salt-mineral mixture per day.

Se deficiency in grazing and forage-fed cattle is widespread in the United States and other countries. Calves may be severely depleted of Se and selenium-dependent glutathione peroxidase but exhibit no clinical signs of deficiency unless they are subjected to an oxidant or other types of stress. Nursing beef calves may be at risk of Se deficiency if their dams are not supplemented with Se. Even when sodium selenite is used in a free-choice mineral supplement designed to deliver 2 mg of Se daily, calves are still at risk for Se deficiency for up to 90 days. Se supplementation of pregnant beef cows with seleno-yeast in a free-choice mineral mixture increased the whole-blood Se and GSH-PX activity of both cows and calves and was much superior to sodium selenite.

In some parts of the world, it is recommended that animals be allowed to graze saltbrush, which produces a higher quality of sheep and goat meat with less fat, more lean meat, and higher VE levels.<sup>79</sup>

The supplementation of beef cattle in late gestation with oral VE, 1000 IU/head per day, influenced the VE status of cows that calved in late winter to a greater extent than that of cows calving in late summer because of the high VE content in the pasture-based summer diet. Calves from supplemented cows had higher serum VE levels than calves from unsupplemented cows. Winter-born calves from supplemented Hereford cows had heavier 205-day adjusted weaning weights than did winter-born calves from unsupplemented cows. Supplementation did not affect vitamin E or IgG concentrations in cows that calved in late summer, and it did not affect calf growth.

## Dairy Cattle

### Selenium

The legal commercial Se supplementation of complete rations for dairy cattle in the United States has been increased from 0.1 to 0.3 mg/kg DM of complete feed. At this rate, a lactating cow consuming 20 kg of DM/d would consume about 6 mg supplemental selenium in addition to that naturally present in the feedstuffs. Current recommendations indicate that Se intake for lactating and gestating dairy cattle should range from 5 to 7 mg/d for adequate concentrations in serum or plasma that would range from 70 to

100 ng of selenium/mL serum. Such supplementation should result in improved Se status of the newborn, improved concentration of Se in colostrum, and improved health of the calves. The effects of Se supplementation in dairy cattle on reproductive performance is equivocal. Some studies over a period of two lactations revealed no effect on reproductive performance, whereas others report an improvement in dairy cattle in a district considered to be marginally deficient in selenium. Intakes of inorganic Se as sodium selenite in amounts of 50 mg/d for 90 days or 100 mg/d for 28 days by adult dairy cows (10 to 30 times the nutritional requirement) did not cause any health problems. The toxic dose for cattle ranges from 0.25 to 0.5 mg/kg BW.

Milk replacers for dairy calves should contain a suitable antioxidant and be supplemented with 300 IU/kg DM of  $\alpha$ -tocopherol acetate at the rate of 0.1 mg/kg DM of the milk replacer.

### Vitamin E

Dietary or parenteral supplementation of VE to dairy cows during the peripartum period has consistently improved the function of neutrophils and macrophages. However, the effects of supplementation of dry dairy cows with VE in the feed or parenteral administration of VE before parturition on the incidence of disease have been variable. The amount of supplemental VE fed per day during the prepartum period has ranged from 1000 to 3000 IU/day. Feeding 1000 IU/day of supplemental VE to dry cows when adequate Se was supplemented reduced the incidence of retained placenta. The prepartum subcutaneous injection of dairy cows with 3000 IU of VE, 1 week before expected calving, had no significant effect on the incidence of retained placenta, clinical mastitis, metritis, endometritis, ketosis, displaced abomasum, or lameness. VE administered to cows with marginal pretreatment VE status had a reduced risk of retained placenta. In cows with adequate serum VE, there was no reduction in the incidence of any disease.

Based on health and immune function in cows, plasma concentrations of  $\alpha$ -tocopherol in peripartum cows should be approximately 3  $\mu$ g/mL. To maintain these blood values, dry cows and heifers fed stored forages during the last 60 days of gestation require approximately 1.6 IU of supplemental vitamin E/kg BW (approximately 80 IU/kg DMI). Increased intake of VE of cows and heifers during the prepartum period also increases the VE in colostrum. Milk is not a major source of VE, but colostrum contains high concentrations of  $\alpha$ -tocopherol (3 to 6  $\mu$ g/mL). To reduce the incidence of mastitis in lactating cows being fed stored forages, the recommendation for VE is 0.8 IU/kg BW (approximately 20 IU/kg DMI). When fresh forage is fed, there is less need for supplemental VE. The intake of polyunsaturated

fatty acids increases the VE requirement, and additional VE may be required when protected unsaturated fats are fed. VE supplementation increases the response to vaccination,<sup>80</sup> and supplementation to pregnant and lactating ewes blunts the immune suppression that make take place over the parturition period. High levels of copper given to sheep during the final 3 weeks of pregnancy has a negative effect on the serum VE concentrations at 72 hours postpartum.<sup>81</sup> High levels of iodine in late pregnancy also seem to preprogram ewes to low VE levels from colostrum,<sup>82</sup> and therefore the presence of NMD in the neonate should be checked.

Although Se alone is protective against a greater spectrum of diseases than is VE, there are situations in which VE is more protective. Both Se and VE should be provided when the diets are deficient in both nutrients, but this may not apply in every situation. NMD can occur in ruminants with VE deficiency and an adequate Se status. Most of the emphasis has been on Se supplementation at the expense of VE, which is more costly and less stable. Most injectable VE and Se preparations are adequate in Se but insufficient in VE.

## Selenium-Responsive Reproductive Performance and Growth Sheep

In situations of Se deficiency, reproductive performance of ewes may be improved by Se or Se/VE supplementation. Survival of lambs and live weights at birth and at weaning may be increased by Se supplementation. Single injections of Se before mating and lambing had no significant effects on estrus, fertility, prolificacy, and the number of lambs born and reared to 28 days in 2-year-old ewes. Two consecutive injections of Se (before mating and lambing) significantly increased the incidence of estrus, fertility, and lamb body weight at 28 days and daily weight gains for 28 days in 3-year-old ewes compared with controls. The injection of Se/VE did not significantly improve reproductive performance in 2- or 3-year-old ewes in the flock not considered Se deficient. Injected VE and Se can improve semen characteristics and reproductive performance of rams during the hot season.<sup>83</sup>

## Weak-Calf Syndrome

The parenteral injection of Se and iodine to pregnant cattle in Ireland did not significantly reduce the incidence of the weak-calf syndrome, which is often attributed to a Se deficiency.

## Pigs

The injection of Se (0.06 mg/kg BW) into piglets under 1 week of age, repeated at weaning time and into the sow 3 weeks before farrowing, will be effective. The minimum lethal dose of Se for piglets is 0.9 mg/kg BW, which provides a reasonably

wide range of safety. A high concentration of Se in the diet of pregnant sows in the last half of gestation has been associated with hemorrhagic lesions on the claws of newborn piglets.

### Horses

Little information is available on the need of horses for Se, but the optimum intake is 6 mg/week or 2.4 µg/kg BW daily. The oral supplementation of 1 mg selenium/d increases blood Se concentrations above levels associated with myodegeneration in horses and foals. In New Zealand, for horses on pasture, the injection of barium selenate, at a dose of 0.5 mg Se/kg BW, aseptically at a deep intramuscular site was efficacious in correcting the Se status of mares grazing pasture with a Se content of 0.01 to 0.07 mg/kg DM. Some local swelling will occur.

To ensure nutritional adequacy and to have an adequate safety margin, adult Standardbred horses should receive 600 to 1800 mg dL- $\alpha$ -tocopherol daily in their feed. The parenteral administration of VE and Se to mares in late pregnancy and to their foals beginning at birth will increase blood Se to adequate levels. In selenium-deficient areas or when mares are fed selenium-deficient hay, parturient injections of Se/VE are indicated, followed by intermittent injection of the foals or supplementation of the diet with Se at 0.1 mg/kg DM.

### Intraruminal Selenium Pellets

#### Sheep

Intraruminal Se pellets, similar to those used in cobalt deficiency, have produced satisfactory blood levels of Se for up to 4 years in ewes at pasture. A satisfactory pellet is composed of 0.5 g elemental Se and finely divided metallic iron. The technique is efficient, but not completely, because of wide variations between animals in the absorption rate of the Se. The average delivery of Se is 1 mg/d, and there is no danger of toxicity. In sheep grazing selenium-deficient pastures, the ruminal pellets increase the Se status and weight gains compared with controls. About 15% of treated sheep reject the pellets within 12 months, and in varying degrees the pellets acquire deposits of calcium phosphate. Sheep fed pellets recovered from sheep have low selenium levels, which suggests a low release of Se from pellets that have been in the rumen of other sheep for several months. The peak levels of Se occur 3 months after administration; there is a rapid decline in activity between 5 and 13 months. Sustained-released boluses containing sodium selenite, cobalt sulfate, potassium iodide, manganese sulfate, zinc oxide, sulfate, and vitamins A, D, and E have also been formulated to provide long-term maintenance of Se levels.

A soluble glass bolus containing zinc, cobalt, and Se administered to ram lambs increased the Se status of the animals and increased sperm motility, percentage of live

sperm, and sperm responding to hypo-osmotic swelling test (an assay to determine plasma membrane permeability).

High-density compressed pellets containing both sodium selenite and cobalt carbonate have been developed for cattle and sheep. The sheep pellet weighs 6 g and contains 276 mg Se and 765 mg Co. A 6-g bolus given to ewes before mating resulted in improved lambing performance, an increase in the percentage of twin lambs.

#### Cattle

A Se pellet containing 10% selenium and 90% iron grit is available for cattle and will maintain plasma Se and GSH-PX activity above the critical level for up to 2 years. When given to beef cows in the last 3 months of pregnancy, the Se levels in milk were found to be higher than in controls, and the Se status of the calves was sufficient to prevent NMD. The use of these pellets at 2, 3, and 4 times the recommended dose in growing cattle weighing 300 to 350 kg did not cause toxicosis, and the Se levels in the tissues at slaughter were not a risk for humans.

Use of the intraruminal Se pellets in dairy cattle in New Zealand resulted in improved growth and milk production in herds where the Se status was below the adequate range, but there was no effect on udder health and reproductive performance.

High-density compressed pellets containing both sodium selenite and cobalt carbonate have been developed for cattle and sheep. For cattle, the pellets weigh 18 g and contain 4.6% selenium and 12.75% cobalt (828 mg Se and 2295 mg Co). In both beef cows and growing cattle, the boluses increased blood glutathione peroxidase activity for at least 1 year.

A sustained-release intrarecticular bolus is an osmotic pump designed to release 3 mg selenium into the reticulo-rumen. It is intended to provide Se supplementation for 120 days in grown heifers and pregnant beef cattle.

A soluble glass bolus containing zinc, copper, and Se resulted in an increased antibody response.<sup>84</sup>

### Selenium Toxicity and Residues

Selenium intoxication can occur following the administration of toxic amounts of an Se salt. The use of selenium selenite instead of sodium selenate and giving a dose of 5 times the intended dose resulted in a high mortality within several hours after administration. Animals deficient in Se are more susceptible to Se toxicosis than those that are selenium-adequate. The pharmacokinetics of Se toxicity in sheep given selenium selenite parenterally has been examined. When oral preparations of Se and monensin are given concurrently as part of a routine dietary management practice, there is greater risk of Se intoxication than if the Se is given alone.

Administration of monensin sodium at a constant, safe dosage enhanced the toxicity of Se, as demonstrated by increased severity of the signs of intoxication, fatalities, and tissue Se concentrations and intensified gross, histopathologic, and biochemical changes. There is some concern about Se supplementation of beef cattle being a potential source of contamination for nearby aquatic systems, but there is no evidence that this has occurred.

### Selenium Responsiveness

The response to Se supplementation is proportional to the degree of deficiency, and supplementation of animals that have adequate Se intakes is unlikely to significantly improve growth rate. In New Zealand, for selenium-deficient lambs, the potential for a growth response to Se supplementation is strongly related to blood Se concentration. Economically significant live-weight gains of greater than 10 g/d can occur when initial blood Se concentrations are less than 130 nmol/L. This is the basis for the development of reference curves using blood Se concentration to diagnose Se deficiency and predict growth responses to lambs.

Although many methods of supplementation of Se are efficacious, they can differ widely in their cost and convenience of administration. The objective of any micronutrient supplementation program should be to optimize the return on investment. The least-cost option that provides adequate supplementation for the required period should be recommended initially.

Veterinarians are the professionals in the best position to offer advice on cost-effectiveness supplementation. To retain this position, they must provide sound recommendations based on micronutrient analysis of animal tissue and defensible reference ranges that are supported by production response data. Monitoring micronutrient status in animal tissue should be encouraged to ensure that regulatory requirements are met and that deficiency and excessive use are avoided. Circumvention of veterinary involvement in the diagnosis and treatment of micronutrient supplementation can lead to greater use of supplements when not indicated, higher costs to farmers, and low cost-to-benefit ratios for the industry.

Depot and bolus preparations have revolutionized the treatment of deficiencies of cattle and sheep that are grazed extensively where there is little opportunity for frequent administration. The relatively short duration of a single drench or injection of Se salts such as sodium selenite should be noted. The use of fertilizer applications is gaining widespread acceptance on farms with high stocking rates.

### FURTHER READING

Baldi A, et al. Influence of antioxidants on ruminant health. *Feed Comp.* 2006;26:19-25.



Faye B, Seboussi R. Selenium in camels—a review. *Nutrients*. 2009;1:30.

Guyot H, Rollin F. Diagnosis of selenium and iodine deficiencies in bovines. *Ann Med Vet*. 2007;151:166.

Lykkesfeldt J, Svendsen O. Oxidants and antioxidants in disease: oxidative stress in farm animals. *Vet J*. 2007;173:502.

Lyons MP, et al. Selenium in food chain and animal nutrition: lessons from nature—review. *Asian-Australasian J Anim Sci*. 2007;20:1136.

Mehdi Y, et al. Selenium in the environment, metabolism and involvement in body functions. *Molecules*. 2013;18:3292.

Willshire JA, Payne JH. Selenium and vitamin E in dairy cows—a review. *Cattle Practice*. 2011;19:22.

Zarczynska K, et al. Effects of selenium on animal health. *J Elem*. 2013;18:329.

## REFERENCES

- Lykkesfeldt J, Svendsen O. *Vet J*. 2007;173:502.
- Spears JW, Weiss WP. *Vet J*. 2008;176:70.
- Sordillo LM, Aitken SL. *Vet Immunol Immunopathol*. 2009;128:104.
- Celi P, et al. *Immunopathol Immunotoxicol*. 2011;33:233.
- Lyons MP, et al. *J Anim Sci*. 2007;16:435.
- Zarczynska KP, et al. *J Elem*. 2013;18:329.
- Rederstorff M, et al. *Cellular Molec Life Sci*. 2006;63:52.
- Whanger PD, et al. *Biochim Biophys Acta-General*. 2009;1790:1448.
- Kojouri GA, et al. *Res Vet Sci*. 2012;93:275.
- Mehdi Y, et al. *Molecules*. 2013;18:3292.
- Song K-D, et al. *Anim Sci J*. 2013;84:238.
- Elijah MRH, et al. *Jap J, Vet Res*. 2007;54:163.
- El Ghany Hefnawy A, Tortora-Perez JL. *Small Rumin Res*. 2010;89:185.
- Ahmed WM, et al. *Global Vet*. 2012;8:172.
- Politis I, et al. *Animal*. 2012;6:1427.
- Qu Y, et al. *J Dairy Sci*. 2007;96:3012.
- Kalac P. *Fd Chem*. 2011;125:307.
- Ceballos A, et al. *Archiv Med Vet*. 2013;45:33.
- Manojlovic M, Singh BR. *Acta Agric Scand B*. 2012;62:673.
- Del Razo-Rodriguez OE, et al. *Czech, J Anim Sci*. 2013;58:253.
- Guyot H, et al. *Livestock Sci*. 2007;111:259.
- Hassan AA, et al. *Nutrients*. 2012;4:724.
- Zaknun D, et al. *Int Arch Allergy Immunol*. 2012;157:1130.
- Bourne N, et al. *Vet J*. 2008;177:381.
- Bourne N, et al. *Livestock Sci*. 2007;106:57.
- Annett RW, et al. *Animal*. 2011;5:1923.
- Murray DL, et al. *Wildl Monog*. 2006;166:1.
- Rizzo A, et al. *Reprod Dom Anim*. 2012;47:344.
- Roche JF. *Anim Reprod Sci*. 2006;96:282.
- Al-Gubory KHY, et al. *Int J Biochem Cell Biol*. 2010;42:1634.
- Aurorusseau B, et al. *Reprod Nutr Develop*. 2006;46:601.
- Tareq KMA, et al. *J Reprod Develop*. 2012;58:621.
- Asic K, et al. *Acta Agric Sloven*. 2008;92(Supp2):155.
- Bourne N, et al. *Theriogenol*. 2007;67:494.
- Salman S, et al. *Anim Hlth Res Rev/Conf Res Work Anim Dis*. 2009;10.
- Heinrichs AJ, et al. *Vet Microbiol*. 2009;134:172.
- Muicheljee R. *Vet Res Commun*. 2008;32:305.
- Aktas MS, et al. *Livestock Sci*. 2011;141:76.
- Duff CC, et al. *J Anim Sci*. 2007;85:823.
- Giles A, et al. *Rev Med Vet*. 2009;160:10.
- Montgomery JB, et al. *J Eq Vet Sci*. 2012;32:352.
- Hall JA, et al. *Vet Res*. 2011;42:99.
- Bondo T, Jensen SK. *J Anim Physiol Anim Nutr*. 2011;95:214.
- Munoz C, et al. *Animal*. 2008;2:64.
- Bertoni G, et al. *Italian J Anim Sci*. 2009;8:491.
- Ceballos-Marquez A, et al. *J Dairy Sci*. 2010;93:4602.
- Giadinis ND, et al. *Small Rum Res*. 2011;95:193.
- do Reo Leal ML, et al. *Vet Res Commun*. 2010;34:549.
- Brennan KM, et al. *Biol Trace Element Res*. 2011;144:504.
- Deger Y, et al. *Biol Trace Element Res*. 2008;121:39.
- Bargiye R, et al. *J Eq Vet Sci*. 2007;27:405.
- Pourliotis K, et al. *NZ Vet J*. 2009;57:44.
- Guyot H, Rollin F. *Ann Med Vet*. 2007;151:166.
- Kojouri GA, et al. *Small Rum Res*. 2009;84:65.
- Judson GJ, et al. *Anim Product Sci*. 2011;51:873.
- Jobse KW, et al. *Tijd Diergeneesk*. 2008;133:704.
- Besselmann D, et al. *J Zoo Wildl Med*. 2008;39:86.
- Bertinato J, et al. *Nutrition J*. 2007;6:7.
- Amorim RM, et al. *Pesq Vet Brasil*. 2011;31:579.
- Brozos CN, et al. *Livestock Sci*. 2009;124:210.
- Cozzi G. *Animal*. 2011;5:1531.
- Davis PA, et al. *Prof Anim Scient*. 2008;24:52.
- Alimohamady R, et al. *Biol Trace Elem Res*. 2013;154:45.
- Palmieri C, Szarek J. *J Elementology*. 2011;16:143.
- Kumar N. *Anim Fd Sci Technol*. 2009;153:77.
- Geishauser T, et al. *Pract Tierarzt*. 2012;93:938.
- Maas J, et al. *J Vet Diag Invest*. 2008;20:86.
- Tiway AK, et al. *J Vet Diag Invest*. 2006;18:61.
- Schiavon E, et al. *Large Anim Rev*. 2007;13:3.
- Seboussi R, et al. *J Camel Pract Res*. 2009;16:25.
- Nathues H, et al. *Can Vet J*. 2010;51:515.
- Strugnell BW, et al. *Vet Rec*. 2010;167:707.
- Kamada H, et al. *J Dairy Sci*. 2007;90:5665.
- Descalzo AM, Sancho AM. *Meat Sci*. 2008;79:423.
- Calamari L, et al. *Livestock Sci*. 2011;142:128.
- Chorf Y, et al. *Can Vet J*. 2011;52:1089.
- Cusack P, et al. *Prev Vet Med*. 2009;88:229.
- Montgomery JB, et al. *Anim Fd Sci Tech*. 2011;170:63.
- Pearce KL, et al. *Small Rum Res*. 2010;91:29.
- Anugu S, et al. *Small Rum Res*. 2013;111:83.
- Boland TM, et al. *Animal*. 2008;2:197.
- Boland TM, et al. *Anim Sci*. 2008;82:310.
- Ali ABT, et al. *Italian J Anim Sci*. 2009;8:743.
- Kendall NR, et al. *Livestock Sci*. 2012;148:81.

## MASSETER MYONECROSIS

Degeneration of the masseter muscles causes dysphagia and trismus in adult horses and Miniature horses.<sup>1</sup> The disease is associated with abnormally low serum or blood concentrations of vitamin E or selenium in some affected horses, and ingestion of tetrachlorvinphos, an organophosphate, was associated with the disease in Miniature horses.<sup>1,2</sup> Muscles of locomotion and cardiac muscle can be affected in addition to disease of the masseter muscle. Clinical signs include acute onset of dysphagia, trismus, salivation, and swelling of the masseter muscles. These can progress to weight loss, gait abnormalities, atrophy of the masseter muscle, teeth grinding or quidding of feed, and unexpected death. Ultrasonography of the masseter muscles reveals hyperechoic lesions with patchy blurring of the fascia, indicative of inflammation and edema.<sup>3</sup> There is electrocardiographic and echocardiographic evidence of myocardial disease in some horses.

These signs include tachycardia (after resolution of hypovolemia and pain) with supra-ventricular and ventricular extrasystole and diminished left ventricular systolic (decreased ejection fraction and fractional shortening) and diastolic function (increased isovolumic relaxation time).<sup>3</sup>

Horses with extensive involvement of other muscles can have myoglobinuria. Signs of dysphagia and trismus are related to dysfunction of the masseter muscle.<sup>4</sup> Gait abnormalities are related to disease in muscles of locomotion, and unexpected death is probably a result of the cardiac lesions. Serum activity of creatine kinase and aspartate aminotransferase is elevated in acute cases. Serum concentrations of troponin are elevated in horses with involvement of the myocardium.<sup>3</sup> Necropsy examination reveals diffuse swelling, muscle pallor, and white streaking of masseter muscle in acutely affected animals. Lesions are also detected in muscles of locomotion and myocardium in some horses. Chronic cases have atrophy of affected muscle. Histologic changes include swelling, fragmentation and loss of striations of myocytes in acute cases, and degenerating fibers replaced by fibrosis in chronic cases. Treatment is symptomatic, and affected horses can require enteral or parenteral delivery of nutrients. Vitamin E and selenium status should be determined and supplements administered if indicated. Prevention should focus on ensuring that horses in geographic regions in which vitamin E or selenium are deficient in feeds are supplemented with these micronutrients.

## REFERENCES

- Myers CJ, et al. *Equine Vet J*. 2006;38:272.
- Radostits O, et al. *Masseter myonecrosis*. In: *Veterinary Medicine: A Textbook of the Diseases of Cattle, Horses, Sheep, Goats and Pigs*. 10th ed. London: W.B. Saunders; 2006:1686.
- Schefer KD, et al. *J Vet Int Med*. 2011;25:1171.
- Aharonson-Raz K, et al. *Vet Rec*. 2009;164:597.

## SPORADIC EXERTIONAL RHABDOMYOLYSIS IN HORSES (AZOTURIA, TYING-UP)

The disease discussed here is that of sporadic acute exertional rhabdomyolysis that occurs as a single event in a horse and does not have a tendency to recur. The recurrent disease is discussed toward the end of this chapter under “Congenital/Inherited Musculoskeletal Disease.”

## ETIOLOGY

The etiology of most cases of *sporadic* acute exertional rhabdomyolysis is unknown, although suggested causes include hypothyroidism, sodium or potassium deficiency, viral infection, high-carbohydrate diets, and abnormalities in metabolic function. The most common cause is performing exercise

of unaccustomed intensity or duration, which can result in metabolic exhaustion and hyperthermia. However, the disease is not always associated with severe exertion or hyperthermia, and it can occur with as little exercise as slow draft work or turn-out to pasture after stabling. An important contributing factor is a prolonged period (days to weeks) of rest in a horse previously accustomed to regular exercise. The disease occurs in young horses as a result of vitamin E/selenium deficiency, although this is an uncommon cause in adult horses.

Rhabdomyolysis not associated with exercise occurs during general anesthesia maintained by inhalation of halothane in horses of a specific genotype or in horses at pasture in Europe. Rhabdomyolysis also occurs in horses with *S. equi* infection (strangles).

Recurrent exertional rhabdomyolysis is a recognized syndrome in Thoroughbred horses and is dealt with separately.

It is likely that most cases of sporadic exertional rhabdomyolysis are a result of a combination of predisposing factors, with the disease precipitated by a bout of exercise. The difficulty in detecting the presence of predisposing factors contributes to the sporadic nature of the disease.

## EPIDEMIOLOGY

The sporadic disease is almost always associated with exercise that is either enforced, as with horses in training or competition, or spontaneous, as with young horses turned out to pasture after a prolonged period of stabling.<sup>1</sup> Clinical signs occur in horses within minutes to hours of the cessation of exercise, although signs can be apparent in horses during prolonged exercise. The epidemiology of the sporadic disease has not been well defined, in contrast to that of recurrent exertional rhabdomyolysis, and the subsequent discussion includes some of the epidemiology of each because it is not always possible to determine whether one episode of exertional rhabdomyolysis is the only occurrence in that animal or will reoccur.

Interpretation of reports of prevalence and risk factors for exertional rhabdomyolysis is difficult because studies to date have mostly not differentiated between the recurrent exertional rhabdomyolysis of Thoroughbreds, polysaccharide storage myopathy of Quarter horses and related breeds, and the sporadic disease in other breeds. The **incidence** or 1-year period prevalence of exertional rhabdomyolysis is as follows: 1.5% in ponies in Australia; 4.9% in Thoroughbred racehorses in the United States, Australia, and Great Britain; 6.1% in National Hunt Thoroughbreds in Great Britain; 4% to 5% in 2- to 3-year-old Thoroughbreds in the United Kingdom;<sup>2</sup> and up to 13.5% in polo ponies in the United States and Great Britain. Polo, racing, rodeo, Western, and show jumping are all associated with a high period

prevalence (>5% per annum) of exertional rhabdomyolysis.

**Risk factors** for exertional rhabdomyolysis include exercise, breed and use, and sex. Overall, horses that exercise are approximately 10 times more likely to develop the disease than are sedentary horses, and among breed/use groups, polo horses are approximately 3 times more likely to develop the disease than are horses used for racing. Horses used for racing are more likely to have episodes of the disease than are horses used for pleasure riding or “other” uses, although racing and breed (Thoroughbred or Standardbred) are confounding factors. Female racehorses are three times more likely to have episodes of exertional rhabdomyolysis than are male (intact or castrated) racehorses, and young female Thoroughbreds are at greatest risk. Among National Hunt horses in Great Britain, females are 24 times as likely to have an episode of the disease as are males. Female polo ponies are not more likely to develop the disease. Thoroughbred racehorses and polo ponies, but not National Hunt horses, with a nervous or “flighty” temperament are more likely to experience episodes of the disease. Other apparent risk factors include a rest day before hard exercise, feeding greater than 4.5 kg of grain per day, lameness, playing polo at a level for which the horse is not fit, and playing early in the season.

The disease occurs repeatedly in 74% of affected Thoroughbred racehorses in Great Britain and in 20% of affected polo ponies.

The disease is of considerable **economic impact** because of its frequent occurrence in athletic horses, recurrent nature, and need to rest affected horses. On average, affected Thoroughbred racehorses cannot train for 6 days after an episode, and approximately two-thirds of affected horses are unable to race because of the disease. Polo ponies lose an average of 7 days of training after an episode of exertional rhabdomyolysis. The effect of the loss of training days for each episode is magnified because of the recurrent nature of the disease in a large proportion of affected horses. Approximately 6% of the wastage of Thoroughbred racehorses in Australia is attributable to exertional rhabdomyolysis.

## PATHOGENESIS

The disease is a result of dysfunction and death of myocytes with subsequent release of cellular constituents, including the enzymes creatine kinase, aspartate aminotransferase and carbonic anhydrase, and myoglobin. The proximate cause of myocyte death is uncertain, but it is not related to accumulation of lactic acid, as previously supposed. Proposed mechanisms include oxidant injury to cells as a result of increased oxidant formation during exercise or inadequate antioxidant activity. Apart from horses deficient in vitamin E and/or selenium, which are rare, there is no indication that oxidant

injury is a common cause of rhabdomyolysis in horses.

Cell death is likely linked to abnormal accumulation of calcium in intracellular fluids secondary to deranged energy and/or membrane function. Necrosis of myocytes causes pain and inflammation in the muscle, with infiltration of inflammatory cells. Healing and regeneration of myocytes occurs over a period of weeks in the absence of further episodes of myonecrosis.

Release of cellular constituents results in electrolyte abnormalities, primarily hypochloremic metabolic alkalosis, a systemic inflammatory response, and pigmenturia. Severely affected horses can have metabolic acidosis. Myoglobin and possibly other cell constituents are nephrotoxic, and acute renal failure can develop as a result of myoglobinuric nephrosis. Pain and loss of muscle function cause a stilted, short-stepping gait.

## CLINICAL FINDINGS

The clinical findings are variable and range from poor performance to recumbency and death. Signs can be mild and resolve spontaneously within 24 hours or be severe and progressive.

Clinical findings are very similar to those observed in horses with sporadic acute exertional rhabdomyolysis that occurs as a single event in a horse (see earlier section in this chapter), except that clinical signs recur. The most common presentation of recurrent exertional rhabdomyolysis is a horse that does not perform to expectation and displays a stiff or short-stepping gait that can be mistaken for lower leg lameness. The horse might be reluctant to move when placed in its stall, be apprehensive and anorexic, paw, and frequently shift its weight. More severely affected horses can be unable to continue to exercise, have **hard and painful muscles** (usually gluteal muscles), sweat excessively, tremble or have widespread muscle fasciculations, be apprehensive, refuse to walk, and have elevated heart and respiratory rates. Affected horses can be hyperthermic, especially soon after exercise. Signs consistent with abdominal pain are present in many severely affected horses. Deep-red urine (myoglobinuria) occurs but is not a consistent finding. Severely affected horses are often recumbent.

## CLINICAL PATHOLOGY

Mildly affected or apparently nonaffected horses have moderate increases in **serum creatine kinase (CK)** (20,000 to 50,000 IU/L), **aspartate aminotransferase (AST)**, and **lactate dehydrogenase (LDH)** activity. Severely affected horses have large increases in CK (>100,000 IU/L) and other muscle-derived enzymes. Serum CK and AST activities peak approximately 5 to 6 and 24 hours after exercise, respectively, and in the absence of further muscle damage, serum AST might not return to normal levels for 7 to 10 days. The half-life of CK activity in serum is

approximately 12 hours, and serum CK declines rapidly in the absence of continuing muscle damage. The persistence of increased AST activity, compared with CK, is useful in identifying affected horses days or weeks after the episode.

**Serum myoglobin** concentrations increase markedly during exercise in affected horses and decline within 24 to 48 hours. Serum carbonic anhydrase III activity is increased in horses with exertional rhabdomyolysis.

Severely affected horses are often **hyponatremic** (<130 mEq/L), **hyperkalemic** (>5.5 mEq/L), **hypochloremic** (<90 mEq/L), azotemic (increased serum urea nitrogen and creatinine concentrations), and **acidotic** or **alkalotic**. Hemoconcentration (hematocrit > 50%, 0.5 L/L) and increased serum total protein concentration (>80 g/L) indicative of dehydration are common. Serum bicarbonate concentration can be falsely markedly elevated in animals with severe rhabdomyolysis because of cellular constituents released from damaged muscle that interfere with the analytical method when automated clinical chemistry analyzers are used. **Myoglobinuria** is detectable either grossly or on chemical analysis and should be differentiated from hemoglobinuria or hematuria. Measurement of **urinary excretion of electrolytes**, although popular in the past, is of no use in diagnosing, treating, or preventing exertional rhabdomyolysis.

**Muscle biopsy** during the acute or convalescent stages reveals myonecrosis of type II (fast-twitch, oxidative) fibers, mild myositis, and fibrosis.

### NECROPSY FINDINGS

Horses dying of exertional rhabdomyolysis have widespread degeneration of striated muscle, principally the muscles of exertion, but often involving the diaphragm and heart. Affected muscles tend to be dark and swollen but may have a pale, streaked appearance. The kidneys are swollen and have dark-brown medullary streaks. Dark-brown urine is present in the bladder. Histologic examination reveals widespread necrosis and hyaline degeneration of predominantly type II (fast-twitch, oxidative) fibers. In horses with recurrent disease, there may be evidence of myofiber regeneration. Myoglobinuric nephrosis is present in severely affected horses.

### Samples for Postmortem Confirmation of Diagnosis

- Formalin-fixed kidney and affected muscle for light microscopic examination

### DIAGNOSTIC CONFIRMATION

Biochemical confirmation of muscle damage by demonstration of increased serum CK or AST activity, in conjunction with appropriate clinical signs, provides the diagnosis.

### DIFFERENTIAL DIAGNOSIS

- Muscle cramping induced by ear tick (*Otobius megnini*)
- Polysaccharide storage myopathy of Quarter horses and related breeds
- Emerging or newly recognized myopathies, such as vacuolar myopathy in Warmbloods<sup>3</sup>
- Ionophore intoxication (monensin, lasalocid, salinomycin, narasin, maduramicin)
- Infection by *Anaplasma phagocytophilum*<sup>4</sup>
- Equine lower motor neurone disease (acute form)
- White snake root (*Eupatorium rugosum*) or rayless goldenrod (*Isocoma pluriflora*)
- Hyperkalemic periodic paralysis
- Laminitis
- Colic
- Pleuritis
- Aorto-iliac thrombosis

### TREATMENT

The treatment chosen depends on the severity of the disease. The **general principles** are rest; correction of dehydration and electrolyte abnormalities; prevention of complications, including nephrosis and laminitis; and provision of analgesia.

**Mildly affected horses** (heart rate < 60 bpm, normal rectal temperature and respiratory rate, no dehydration) may be treated with rest and phenylbutazone (2.2 mg/kg, orally or IV every 12 hours for 2 to 4 days). Horses should be given mild exercise with incremental increases in workload as soon as they no longer have signs of muscle pain. Access to water should be unrestricted.

**Severely affected horses** (heart rate > 60 bpm, rectal temperature > 39° C [102° F], 8% to 10% dehydrated, reluctant or unable to walk) should not be exercised, including walking back to the stable, unless it is unavoidable. Isotonic, polyionic fluids, such as lactated Ringer's solution, should be administered IV to severely affected horses to correct any hypovolemia and to ensure a mild diuresis to prevent myoglobinuric nephropathy. Less severely affected horses can be treated by administration of fluids by nasogastric intubation (4 to 6 L every 2 to 3 hours). Although it has been recommended that urine should be alkalized by administration of mannitol and sodium bicarbonate (1.3% solution IV, or 50 to 100 g of sodium bicarbonate orally every 12 hours) to minimize the nephrotoxicity of myoglobin, this therapy is not effective in humans at risk of myoglobinuric nephrosis. Affected horses should not be given diuretics (e.g., furosemide) except if they are anuric or oliguric after correction of hypovolemia.

**Phenylbutazone** (2.2 to 4.4 mg/kg, IV or orally, every 12 to 24 hours), **flunixin meglumine** (1 mg/kg IV every 8 hours), or **keto profen** (2.2 mg/kg IV every 12 hours) should be given to provide **analgesia**. **Mild sedation**

(acepromazine 0.02 to 0.04 mg/kg IM, or xylazine, 0.1 mg/kg IM, both with butorphanol, 0.01 to 0.02 mg/kg) may decrease muscle pain and anxiety. Tranquilizers with vasodilatory activity, such as acepromazine, should only be given to horses that are well hydrated. **Muscle relaxants**, such as methocarbamol, are often used but have no demonstrated efficacy.

**Recumbent** horses should be deeply bedded and repositioned by rolling every 2 to 4 hours. Severely affected horses should not be forced to stand.

### CONTROL

Prevention of the sporadic, idiopathic disease centers on ensuring that horses are fed a balanced ration with adequate levels of vitamin E, selenium, and electrolytes and have a regular and consistent program of exercise. Despite lack of clear evidence for a widespread role for **vitamin E or selenium deficiency** in exertional rhabdomyolysis, horses are often supplemented with 1 IU/kg vitamin E and 2.5 µg/kg selenium daily in the feed. Care should be taken not to induce selenium toxicosis.

**Sodium bicarbonate** (up to 0.5 to 1.0 g/kg BW daily in the ration) and other electrolytes are often added to the feed of affected horses, but their efficacy is not documented. **Phenytoin** has proven useful in the treatment of recurrent rhabdomyolysis. It is administered at a dose rate of 6 to 8 mg/kg, orally, every 12 hours, and the dose is adjusted depending on the degree of sedation produced (a reduced dose should be used if the horse becomes sedated) or lack of effect on serum CK or AST activity. Phenytoin can be administered to horses for months. **Dimethylglycine, altrenogest, and progesterone** are all used on occasion in horses with recurrent rhabdomyolysis, but again, without demonstrated efficacy.

The feeding of high-fat, low-soluble-carbohydrate diets is useful in the prevention of recurrent exertional rhabdomyolysis in Thoroughbred horses and polysaccharide storage myopathy in Quarter horses. The usefulness of this practice in preventing sporadic, idiopathic exertional rhabdomyolysis has not been demonstrated.

### FURTHER READING

Piercy RJ, Rivero J. Muscle disorders of equine athletes. In: *Equine Sports Medicine and Surgery: Basic and Clinical Sciences of the Equine Athlete*. 2nd ed. London: W.B. Saunders; 2014:109.

### REFERENCES

- Radostits O, et al. Sporadic exertional rhabdomyolysis of horses. In: *Veterinary Medicine: A Textbook of the Disease of Cattle, Horses, Sheep, Goats and Pigs*. 10th ed. London: W.B. Saunders; 2007:1683.
- Wilsher S, et al. *Equine Vet J*. 2006;38:113.
- Massey CA, et al. *Neuromusc Dis*. 2013;23:473.
- Hilton H, et al. *J Vet Int Med*. 2008;22:1061.



## DIETARY DEFICIENCY OF PHOSPHORUS, CALCIUM, AND VITAMIN D AND IMBALANCE OF THE CALCIUM:PHOSPHORUS RATIO

A dietary deficiency or disturbance in the metabolism of calcium, phosphorus, or vitamin D, including imbalance of the calcium:phosphorus ratio, is the principal cause of the **osteodystrophies**, which can occur in a number of forms:

- **Osteomalacia**—a reduction in the strength of bones secondary to defective bone mineralization typically caused by inadequate or imbalanced levels of available phosphate and calcium, vitamin D deficiency, or because of excessive resorption of calcium from the bone, such as is caused by hyperparathyroidism. There is a reduction in the mineral:matrix ratio in bone in that there is less mineral than expected for the bone mass. The disease is histologically evident as increased osteoid (unmineralized matrix).
- **Osteoporosis**—a reduction in bone mass, with associated increased risk of fracture, in which there is a proportionate reduction in both the mineral and the matrix (protein, osteoid) content of bone. The remaining bone is essentially normal but is insufficient in quantity. The disease is typically evident as thin bone cortices on sectioning or radiographic examination.
- **Rickets**—a disease caused by vitamin D deficiency, resulting in aberrant calcium and phosphorus metabolism, that affects young animals and is characterized osteomalacia. Affected animals are described as “rachitic.”

**Osteodystrophia fibrosa**—also referred to osteitis fibrosa (incorrectly, because this is not an inflammatory condition) or fibrous osteodystrophy. A form of osteomalacia in which mineralized bone is replaced by unmineralized fibrotic tissue under the influence of prolonged hyperparathyroidism, secondary to a high phosphorus:low calcium ratio in feed in horses, calcium deficiency in pigs, or chronic renal disease in some species.

The etiology and pathogenesis of these disorders is discussed in more detail in the sections of this text dealing with those diseases. It is important to note that the interrelations of calcium, phosphorus, and vitamin D metabolism are complex, and the importance of these and related factors (age, overall nutritional status, other mineral deficiencies or excesses) in clinical disease is often very difficult to define.

In an attempt to simplify this situation, the diseases in this section are covered in the following order:

### Calcium deficiency (*hypocalcemicosis*)

- Primary: an absolute deficiency in the diet
- Secondary: when the deficiency is conditioned by some other factor, principally an excess intake of phosphorus

### Phosphorus deficiency (*hypophosphatosis*)

- Primary: an absolute deficiency in the diet
- Secondary: when the deficiency is conditioned by some other factor; although in general terms an excessive intake of calcium could be such a factor, specific instances of this situation are lacking

### Vitamin D deficiency (*hypovitaminosis-D*)

- Primary: an absolute deficiency intake of the vitamin
- Secondary: when the deficiency is conditioned by other factors of which excess carotene intake is the best known.

In different countries with varying climates, soil types, and methods of husbandry, these individual deficiencies are of varying importance. For instance, in South Africa, northern Australia, and North America, the most common of the deficiencies just listed is that of phosphorus deficiency; vitamin D deficiency is uncommon. In Great Britain, Europe, and parts of North America, a deficiency of vitamin D can also be of major importance.<sup>1,2</sup> Animals are housed indoors for much of the year, they are exposed to little ultraviolet irradiation, and their forage may contain little vitamin D. Under such conditions, the absolute and relative amounts of calcium and phosphorus in the diet need to be greater than in other areas if vitamin D deficiency is to be avoided. In New Zealand, where much lush pasture and cereal grazing are used for feed, the vitamin D status is reduced not only by poor solar irradiation of the animal and plant sterols, but in addition, an antivitamin D factor is present in the diet, possibly in the form of carotene.

Now that the gross errors of management with respect to calcium and phosphorus and vitamin D are largely avoided, more interest is devoted to the marginal errors; in these, diagnosis is not nearly so easy, and the deficiency can be evident only at particular times of the year. The conduct of a response trial in which part of the herd is treated is difficult unless they are hand-fed daily; there are no suitable reticular retention pellets or long-term injections of calcium or phosphorus because the daily requirement is so high. Two methods suggest themselves:

1. Analysis of ash content of samples of spongy bone from the tuber coxae
  2. The metabolic profile method
- The latter program may have some value as a monitoring and diagnostic weapon in the fields of metabolic disease, nutritional deficiency, and nutritional excesses.

## Absorption and Metabolism of Calcium and Phosphorus

In ruminants, dietary calcium is absorbed by the small intestine according to body needs, whereas in equids there is greater obligatory absorption of calcium, and it is less dependent on vitamin D (and its metabolites) than in ruminants.<sup>3,4</sup> Whereas young animals with high growth requirements absorb and retain calcium in direct relation to intake over a wide range of intakes, adult male ruminants, irrespective of intake, absorb only enough calcium to replace that lost by excretion into urine and intestine, retaining none of it. Calcium absorption is increased in adult animals during periods of high demand, such as pregnancy and lactation, or after a period of calcium deficiency, but a substantial loss of body stores of calcium appears to be necessary before this increase occurs. The dietary factors influencing the efficiency of absorption of calcium include the nature of the diet, the absolute and relative amounts of calcium and phosphorus present in the diet, and the presence of interfering substances. The calcium in milk is virtually all available for absorption, but the calcium in forage-containing diets has an availability of only about 50%. The addition of grain to an all-forage diet markedly improves the availability of the calcium.

Phosphorus is absorbed by young animals from both milk and forage-containing diets with a high availability (80% to 100%), but the availability is much lower (50% to 60%) in adult animals. Horses fed diets containing adequate amounts of calcium and phosphorus absorb 50% to 65% of the calcium and slightly less than 50% of the phosphorus present in a variety of feedstuffs. In grains, 50% to 65% of the phosphorus is in the phytate form, which is utilizable by ruminants, but not as efficiently by nonruminants such as the horse and pig. An average availability of 70% has been assumed for phosphorus in early-weaning diets for young pigs, and a value of 50% is assumed for practical cereal-based feeds as supplied to growing pigs, sows, and boars.

The metabolism of calcium and phosphorus is influenced by the parathyroid hormone, calcitonin, and vitamin D (Fig. 15-13), although there are important differences in calcium homeostasis between ruminants and equids.<sup>5-8</sup> For instance, equids have much lower serum vitamin D concentrations, greater absorption of calcium by the small intestine (duodenum), and greater renal excretion of calcium than do ruminants.<sup>4,8,9</sup> In all mammalian species, parathyroid hormone is secreted in response to hypocalcemia and stimulates the conversion of 25-dihydroxycholecalciferol to 1,25-dihydroxycholecalciferol (1,25-DHCC). Parathyroid hormone and 1,25-DHCC together stimulate bone resorption, and 1,25-DHCC alone stimulates active intestinal absorption of calcium.<sup>10</sup> Calcium enters the blood from bone and intestine, and when the

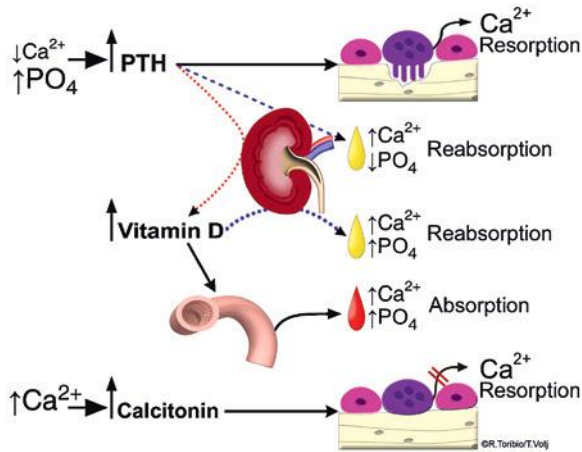

**Fig. 15-13** Calcium and phosphate homeostasis. A decrease in extracellular  $\text{Ca}^{2+}$  concentrations or an increase in phosphate ( $\text{PO}_4$ ) concentrations leads to a parathyroid hormone (PTH) release from the parathyroid gland, which in turn increases renal reabsorption of  $\text{Ca}^{2+}$ , renal activation of vitamin D, urinary  $\text{PO}_4$  excretion, and bone resorption. In turn, vitamin D increases intestinal absorption and renal reabsorption of  $\text{Ca}^{2+}$  and  $\text{PO}_4$ . An increase in  $\text{Ca}^{2+}$  concentration stimulates the thyroid gland to secrete calcitonin to inhibit osteoclastic bone resorption. (Courtesy of Ramiro E. Toribio, DVM, MS, PhD, and Tim Vojt, Columbus, OH; Reproduced with permission.<sup>8</sup>)

serum calcium level increases above normal, parathyroid hormone is inhibited and calcitonin secretion stimulated. The increased calcitonin concentration blocks bone resorption, and the decreased parathyroid hormone concentration depresses calcium absorption. Most calcium absorption occurs in the small intestine, with equids absorbing a greater proportion of dietary calcium than ruminants.<sup>5</sup> Detailed descriptions of the physiology of calcium metabolism are available in the section “Milk Fever (Hypocalcemia)” and in reviews.<sup>5</sup>

## REFERENCES

- Hymoller L, et al. *J Dairy Sci.* 2010;93:2025.
- Hymoller L, et al. *Brit J Nutr.* 2012;108:666.
- Breidenbach A, et al. *Vet Res.* 1998;29:173.
- Rourke KM, et al. *Gen Comp Endocrin.* 2010;167:6.
- Cihak A, et al. *Comp Biochem Physiol.* 2012;161:259.
- Goff JP. *Vet Clin North Am Food A.* 2014;30:359.
- Hymoller L, et al. *J Equine Vet Sci.* 2015;35:785.
- Toribio RE. *Vet Clin Equine.* 2011;27:129.
- Pozza ME, et al. *Vet J.* 2014;199:451.
- Christakos S. *Arch Biochem Biophys.* 2012;523:73.

## CALCIUM DEFICIENCY

Calcium deficiency can be primary or secondary, but in both cases, the end result is a type of osteodystrophy, with the specific disease depending largely on the species and age of the animals affected.

### SYNOPSIS

**Etiology** Primary dietary deficiency of calcium is uncommon. Secondary calcium deficiency can be induced by marginal calcium intake and high phosphorus intake.

**Epidemiology** Sporadic. Not common if diets adequate.

**Signs** Poor growth and dentition. Tetany can occur in lactating ewes. Inappetence, stiffness, fracture of long bones. Specific diseases include rickets, osteomalacia, and osteodystrophia fibrosa.

**Clinical pathology** Serum calcium and phosphorus. Radiography.

**Necropsy findings** Osteoporosis; low ash content of bone.

**Diagnostic confirmation** Histology of bone and bone ash analyses.

**Differential diagnosis list** See differential diagnosis of each specific disease.

**Treatment** Calcium salts parenterally (for tetany) and orally (for prolonged correction of deficiency).

**Control** Adequate calcium and phosphorus levels in diet.

## ETIOLOGY

A primary deficiency attributable to a lack of calcium in the diet is uncommon, although a secondary deficiency attributable to a marginal calcium intake aggravated by a high phosphorus intake is not uncommon. In ponies, such a diet depresses intestinal absorption and retention of calcium in the body, and the resorption of calcium from bones is increased as a result of hyperparathyroidism (secondary nutritional hyperparathyroidism—see discussion of osteodystrophia fibrosa later in this section). Hypoparathyroidism, either primary or secondary to renal disease, reduces intestinal and renal reabsorption of calcium and causes seizures and muscle fasciculation.<sup>1-3</sup>

## EPIDEMIOLOGY

Calcium deficiency is a sporadic disease occurring in particular groups of animals rather than in geographically limited areas. Although death does not usually occur, there can be considerable loss of function and disabling lesions of bones or joints.

Horses in training, cattle being fitted for shows, and valuable stud sheep are often fed artificial diets containing cereal or grass hays that contain little calcium and grains that have a high content of phosphorus. The secondary calcium deficiency that occurs in these circumstances is often accompanied by a vitamin D deficiency because of the tendency to keep animals confined indoors. Pigs are often fed heavy concentrate rations with insufficient calcium supplement. Dairy cattle can occasionally be fed similarly imbalanced diets, the effects of which are exaggerated by high milk production.

There are no well-established records of calcium deficiency in grazing cattle, but there are records of low calcium intake in feedlots accompanied by clinical osteodystrophy. There is also a well-recognized field occurrence of calcium deficiency in young sheep in southeast Australia. Outbreaks can affect many sheep and are usually seen in winter and spring, following exercise or temporary starvation. In most outbreaks, the characteristic osteoporosis results from a long-term deprivation of food as a result of poor pasture growth. Occasional outbreaks occur on green oats used for grazing. The calcium intake in some cases is as low as 3 to 5 g/week in contrast to the requirement of 3 to 5 g/d. Sheep in the Kalahari Desert develop osteoporosis as a result of low calcium intake and low-grade fluorosis.<sup>4</sup> Goats deficient in calcium, phosphorus, and vitamin D develop osteoporosis.<sup>5</sup> Copper deficiency is associated with osteoporosis in young sheep.

High protein intake and rapid growth have been suggested as contributory factors in the development of skeletal problems in young horses (developmental orthopedic disease [DOD]). The cause of DOD in young horses is multifactorial and related to mineral imbalances in the diet, genetic predisposition,<sup>6</sup> trauma, and maternal<sup>7</sup> and foal nutritional status. For instance, wither height at 30 days of age, age of the mare, breed, regularity of exercise, Ca/P level in the mare and foal rations, group size in pasture, and the type and frequency of handling were identified as risk factors for DOD in foals in France.<sup>8</sup> Although excessive energy intake is sometimes blamed, a concentration of dietary protein of 20%, which is significantly above the National Research Council (NRC) recommended level of 14%, is neither helpful nor harmful to growing horses. The high protein intake did not affect the rate of growth, height, and circumference of cannon bones compared with horses receiving the lower 14% diet. The high-protein diet did not

result in hypercalciuria and did not affect calcium absorption or calcium retention.

In females there is likely to be a cycle of changes in calcium balance, with a negative balance occurring in late pregnancy and early lactation and a positive balance in late lactation and early pregnancy and when lactation has ceased. The negative balance in late pregnancy is in spite of a naturally occurring increased absorption of calcium from the intestine at that time, at least in ewes.

### PATHOGENESIS

The main physiologic functions of calcium are the formation of bone and milk, participation in the clotting of blood, and the maintenance of neuromuscular excitability. In the development of osteodystrophies, dental defects, and tetany, the role of calcium is well understood; however, the relation between deficiency of the element and lack of appetite, poor growth, loss of condition, infertility, and reduced milk flow is not readily apparent. The disinclination of the animals to move about and graze and poor dental development may contribute to these effects.

Experimentally, feeding young lambs a diet low in calcium and phosphorus for 12 weeks results in soft and pliable ribs with thickening of the costochondral junctions, reduction in feed intake by about 34%, significant changes in plasma calcium and phosphorus concentrations, and changes in dry matter digestibility. Feeding repletion diets results in complete remineralization of rib bones but only partial remineralization of the metatarsal bones.

Nutritional factors other than calcium, phosphorus, and vitamin D can be important in the production of osteodystrophies, which also occur in copper deficiency, fluorosis,<sup>4</sup> and chronic lead poisoning. Vitamin A is also essential for the development of bones, particularly those of the cranium.

### CLINICAL FINDINGS

The clinical findings, apart from the specific syndromes described later, are less marked in adults than in young animals, in which there is decreased rate or cessation of growth and dental maldevelopment. The latter is characterized by deformity of the gums, poor development of the incisors, failure of permanent teeth to erupt for periods of up to 27 months, and abnormal wear of the permanent teeth as a result of defective development of dentine and enamel, occurring principally in sheep.

A calcium deficiency can occur in lactating ewes and sucking lambs, whose metabolic requirements for calcium are higher than in dry and pregnant sheep. There is a profound fall in serum calcium. Tetany and hyperirritability do not usually accompany hypocalcemia in these circumstances, probably because it develops slowly. However, exercise and fasting often precipitate tetanic seizures and parturient paresis in such sheep.

This is typical of the disease as it occurs in young sheep in southeast Australia. Attention is drawn to the presence of the disease by the occurrence of tetany, convulsions, and paresis, but the important signs are ill-thrift and failure to respond to anthelmintics. Serum calcium levels will be as low as 5.6 mg/dL (1.4 mmol/L). There is lameness, but fractures are not common even though the bones are soft. A simple method for assessing this softness is compression of the frontal bones of the skull with the thumbs. In affected sheep, the bones can be felt to fluctuate.

Pigs fed on heavy concentrate rations may develop a hypocalcemic tetany, which responds to treatment with calcium salts. Tetany may also occur in young, rapidly growing cattle in the same circumstances.

Inappetence, stiffness, tendency of bones to fracture, disinclination to stand, difficult parturition, reduced milk flow, loss of condition, and reduced fertility are all nonspecific signs recorded in adults.

### SPECIFIC SYNDROMES

#### Primary Calcium Deficiency

No specific syndromes are recorded, although the complex relationship between overall nutrition, including concentration or amount of calcium in the diet, and bone development should be noted.

#### Secondary Calcium Deficiency

Rickets, osteomalacia, osteoporosis, osteodystrophia fibrosa of the horse, goat, and pig and degenerative arthropathy of cattle are the common syndromes in which secondary calcium deficiency is one of the specific causative factors.<sup>5</sup> In sheep, rickets is seldom recognized, but there are marked dental abnormalities. Rickets has been produced experimentally in lambs by feeding a diet low in calcium. There is an inherited form of rickets in Corriedale sheep.<sup>9-11</sup>

### CLINICAL PATHOLOGY

Because of the effect of the other factors listed previously on body constituents, examination of specimens from living animals may give little indication of the primary cause of the disturbance. For example, hypocalcemia need not indicate a low dietary intake of calcium. Data on serum calcium and phosphorus concentrations and plasma alkaline phosphatase activity, radiographical examination of bones, and balance studies of calcium and phosphorus retention are all of value in determining the presence of osteodystrophic disease, but determination of the initial causative factor will still depend on analysis of feedstuffs and comparison with known standard requirements. Serum calcium concentration can be within the normal range in most cases, although calcium deficiency is followed, at least in sheep, by a marked fall in serum calcium levels to as low as 3.5 mg/dL (0.87 mmol/L).

In an uncomplicated nutritional deficiency of calcium in sheep, there is only a slight reduction in the radiopacity of bone, in contrast to sheep with a low phosphorus and vitamin D status, which show marked osteoporosis. The response to dietary supplementation with calcium is also of diagnostic value.

### NECROPSY FINDINGS

True primary calcium deficiency is extremely rare, but when it does occur, severe osteoporosis and parathyroid gland hypertrophy are the significant findings. The cortical bone is thinned, and the metaphyseal trabeculae appear reduced in size and number. The ash content of the bone is low because the bone is resorbed before it is properly mineralized.

Calcium deficiency secondary to other nutritional factors is common and typically induces the form of osteodystrophy known as osteodystrophia fibrosa (see subsequent description). In most instances, the confirmation of a diagnosis of hypocalcemia at necropsy includes an analysis of the diet for calcium, phosphorus, and vitamin D content.

### Samples for Confirmation of Diagnosis

- **Toxicology**—long bone (ASSAY [ash]); feed (ASSAY [Ca] [P] [Vit D])
- **Histology**—formalin-fixed section of long bone (including metaphysis), parathyroid (LM)

### DIFFERENTIAL DIAGNOSIS

A diagnosis of calcium deficiency depends on proof that the diet is, either absolutely or relatively, insufficient in calcium, that the lesions and signs observed are characteristic, and that the provision of calcium in the diet alleviates the condition. The diseases that may be confused with calcium deficiency are described under the diagnosis of each of the specific disease entities.

The close similarity between the dental defects in severe calcium deficiency of sheep and those occurring in chronic fluorosis may necessitate quantitative estimates of fluorine in the teeth or bone to determine the cause.

### TREATMENT

The response to treatment is rapid, and the preparations and doses recommended here are effective as treatment. Parenteral injections of calcium salts are advisable when tetany is present. When animals have been exposed to dietary depletion of calcium and phosphorus over a period of time, it is necessary to supplement the diet with calcium and phosphorus during dietary mineral repletion.

### CONTROL

The provision of adequate calcium in the diet, the reduction of phosphorus intake where it



is excessive, and the provision of adequate vitamin D are the essentials of both treatment and prevention. Some examples of estimated minimum daily requirements for calcium, phosphorus, and vitamin D are set out in Table 15-9. These are estimated minimum requirements and may need to be increased by a safety factor of 10% to allow for variation in individual animal requirements, the biological availability of nutrients in the feed-stuffs, and the effect which total amount of feed intake has on absolute intake of minerals. For example, the use of a complete pig ration on a restricted basis may require that the concentration of both calcium and phosphorus be increased for that ration to deliver the actual total quantity of calcium and phosphorus necessary to meet a particular requirement for growth, pregnancy, or lactation. The information in Table 15-9 is presented as a guideline. When investigating a nutritional problem of formulating rations, it is recommended that the most recently available publications on the nutrient requirements of domestic animals be consulted.

Ground limestone is most commonly used to supplement the calcium in the ration, but it should be prepared from calcite and not from dolomite. Variations in availability of the calcium in this product occur with variations in particle size, with a finely ground preparation being superior in this respect. Bone meal and dicalcium phosphate are more expensive, and the additional phosphorus may be a disadvantage if the calcium:phosphorus ratio is very wide. Alfalfa, clover, and molasses are also good sources of calcium but vary in their content. The optimum calcium:phosphorus ratio is within the range of 2:1 to 1:1. In cattle, absorption of both elements is better at the 2:1 ratio. For optimum protection against the development of urolithiasis in sheep, a ratio of 2 to 2.5 calcium to 1 phosphorus is recommended.

The dustiness of powdered limestone can be overcome by dampening the feed or adding the powder mixed in molasses. Addition to salt or a mineral mixture is subject to the usual disadvantage that not all animals partake of it readily when it is provided in a free-choice manner, but this method of supplementation is often necessary in pastured animals. High-producing dairy cows should receive the mineral mixture in their ration and have access to it in boxes or in blocks.

## REFERENCES

1. Durie I, et al. *J Vet Int Med.* 2010;24:439.
2. Schwarz B, et al. *Equine Vet Educ.* 2012;24:225.
3. Toribio RE. *Vet Clin Equine.* 2011;27:129.
4. Simon MJK, et al. *Osteoporosis Int.* 2014;25:1891.
5. Braun U, et al. *Vet Rec.* 2009;164:211.
6. Corbin LJ, et al. *Mamm Genome.* 2012;23:294.
7. Vander Heyden L, et al. *Vet Rec.* 2013;172:68.
8. Lepeule J, et al. *Prev Vet Med.* 2011;101:96.
9. Thompson KG, et al. *NZ Vet J.* 2007;55:137.
10. Dittmer KE, et al. *J Comp Pathol.* 2009;141:147.
11. Zhao X, et al. *PLoS ONE.* 2011;6.

## PHOSPHORUS DEFICIENCY

### SYNOPSIS

**Etiology** Usually a primary deficiency in the diet; may be conditioned by vitamin D deficiency.

**Epidemiology** Primary phosphorus (P) deficiency occurs in arid regions with low phosphorus content in soil. Most commonly chronic, but transient and acute P deficiency thought to occur in lactating dairy cattle in early lactation. Occurs under range conditions in beef cattle and sheep. Occurs in pigs not supplemented with sufficient phosphorus.

**Signs** Feed intake depression and anorexia are most commonly encountered sign with chronic P deficiency. Young animals grow slowly and develop rickets. Adults develop osteomalacia, unthriftiness, weight loss, reduced feed consumption, reluctance to move, leggy appearance, and fractures. Impaired milk production, growth rate, and fertility, presumably from energy and nutrient deficiency as a result of feed-intake depression. Recumbency and acute intravascular hemolysis (postparturient hemoglobinuria) in high-producing cows in early lactation have empirically been associated with hypophosphatemia and P depletion.

**Clinical pathology** Serum inorganic phosphorus. Phosphorus content of diet.

**Necropsy findings** Rickets and osteomalacia; lack of mineralization of bones.

**Diagnostic confirmation** Radiography of long bones, histology of bone lesions; bone ash analyses.

**Differential diagnosis** Those diseases resembling rickets and osteomalacia. Milk fever and downer cow syndrome in periparturient recumbent cattle. Other disorders associated with intravascular hemolysis in cases of periparturient hemoglobinuria.

**Treatment** Phosphate salts orally or intravenously, vitamin D.

**Control** Supplement diets with adequate phosphorus, calcium, and vitamin D.

## ETIOLOGY

Phosphorus (P) deficiency occurs predominantly in arid regions of the world with low P content in soil. Phosphorus deficiency is encountered whenever the daily dietary P intake is insufficient to cover the requirements for maintenance and production and the organism has to recur to the mobilization of bone P. Under most circumstances P deficiency is chronic, and signs and symptoms associated with it occur after dietary P deprivation over months to years.

In dairy cattle, a rather acute and transient period of P deficiency is thought to occur in the first days to weeks of lactation

and has been associated with recumbency and acute intravascular hemolysis in early-lactating cows. Rations with marginal P content in combination with low feed intake around calving are thought to result in inadequate P intake to cover for the suddenly increasing P requirements for milk production at the onset of lactation. The assumption that the commonly observed periparturient hypophosphatemia is an indicator for P depletion is, however, under contentious debate, and the clinical relevance of subnormal plasma inorganic phosphorus (Pi) levels in affected cows is uncertain.<sup>1</sup> Pronounced hypophosphatemia is also seen around parturition in mastectomized cattle, which don't produce any milk. Furthermore, even severe hypophosphatemia is often seen in healthy fresh cows not showing any clinical signs or symptoms.<sup>1</sup>

## EPIDEMIOLOGY

### Geographic Occurrence

Chronic P deficiency has a distinct geographic distribution depending largely upon the P content of the parent rock from which the soils of the area are derived, but also upon the influence of other factors, such as excessive calcium, aluminum, or iron, which reduce the availability of P to plants. Large areas of grazing land in many countries are of little value for livestock production without P supplementation. In New Zealand, for example, where fertilization of pasture with superphosphate has been practiced for many years, P deficiency may still occur in dairy herds because of inadequate maintenance of application over several years. Animals in affected areas mature slowly and are inefficient breeders, and additional losses as a result of botulism and defects and injuries of bones may occur. Apart from areas in which frank P deficiency is seen, it is probable that in many other areas a mild degree of deficiency is a limiting factor in the production of meat, milk, and wool.

Heavy leaching by rain and constant removal by cropping contribute to P deficiency in the soil, and the low P levels of the plant cover may be further diminished by drought conditions. Pastures deficient in P are classically also deficient in protein.

## Cattle

The earliest report of naturally occurring P deficiency in grazing cattle was at Armoedsvlakte in the Northern Cape of South Africa. The disease was called **aphosphorosis**, and animals with the disease demonstrated a depraved appetite characterized by the desire to eat wood, bones, rocks, and other such materials, a behavior known as **pica**. In severely affected regions, cattle often died from botulism from eating bones from old carcasses contaminated with *Clostridium botulinum* toxin. In advanced states of aphosphorosis, animals developed bone malformations that were associated with stiffness in

**Table 15-9** Examples of estimated daily requirements of calcium, phosphorus, and vitamin D

Species, kg body weight, and function	Calcium	Phosphorus	Vitamin D
	(G/ANIMAL)		
<b>Dairy cattle</b>			
Growing heifers (large breeds)			300 IU/kg dry matter (DM) intake
159	15	12	
300	24	18	
400	26	20	
Growing heifers (small breeds)			
100	9	7	
200	15	11	
300	19	14	
Growing bulls (large breeds)			
300	27	20	
400	30	23	
500	30	23	
Maintenance of mature lactating cows			
400	17	13	
500	20	15	
600	22	17	
Maintenance and pregnancy			
400	23	18	
500	29	22	
600	34	26	
Milk production	Add 2–3 g calcium and 1.7–2.4 g phosphorus to the maintenance requirements for each kg of milk produced.		
	(% OF RATION)		
<b>Beef cattle</b>			
Dry mature pregnant cows	0.16	0.16	300 IU/kg DM intake
Cows nursing calves	0.30	0.25	
Bulls, growth and maintenance	0.26	0.20	
Growing heifers (200-kg live weight gaining 0.8 kg/d)	0.33	0.26	
Growing steers (200-kg live weight gaining 0.8 kg/d)	0.36	0.28	
<b>Sheep</b>			
<b>Ewes</b>			
Maintenance	0.30	0.28	250–300 IU/kg DM intake
Pregnant (early)	0.27	0.25	
Pregnant (late)	0.24	0.23	
Lactating	0.52	0.37	200 IU/kg DM intake
<b>Rams</b>			
(40- to 120-kg live weight)	0.35	0.19	200 IU/kg DM intake
<b>Lambs</b>			
Early weaned (10- to 30-kg live weight)	0.40	0.27	150 IU/kg DM intake
Finishing (30- to 55-kg live weight)	0.30	0.20	
<b>Horses</b>			
Mature horses (400- to 600-kg live weight)	0.30	0.20	6–8 IU/kg body weight
Mares (400- to 600-kg live weight)			
Last 90 days of pregnancy	0.38	0.30	
Peak of lactation	0.50	0.40	
Growing horses (400-kg mature weight)			
3 months old	0.68	0.43	
6 months old	0.68	0.48	
12 months old	0.45	0.30	
Growing horses (500-kg mature weight)			
3 months old	0.69	0.44	
6 months old	0.82	0.51	
12 months old	0.43	0.28	
<b>Pig</b>			
Growing pigs (10- to 100-kg live weight)	0.65	0.50	200 IU/kg ration
Breeding pigs (gilts, sows, boars)	0.75	0.50	275 IU/kg ration

the forelegs, with a characteristic lameness referred to as “styfsiekte” in South Africa, “creeps” in Texas, and “pegleg” in Australia.

A survey of the mineral status of bones of cattle at abattoirs in western New South Wales, Australia, found evidence of osteodystrophy based on ash density. They represented cattle attempting to grow in a poor season, often female, in poor body-fat condition, light in body weight, and mostly from red soils known to be deficient in P.

Cattle constantly grazing pasture in the southern hemisphere appear to require somewhat less P in the diet (0.20% is probably adequate) than do higher-producing, partly housed livestock. The dietary requirements of P recommended by the NRC for beef cows weighing 450 kg may exceed the basic requirements. Over a period of several gestations, a daily allowance of 12 g of P per day per animal was deemed to be adequate for beef cows. Cattle given a P-deficient diet did not develop detectable signs of P deficiency until after 6 months of deprivation of this mineral.<sup>2</sup>

Hypophosphatemia in periparturient dairy cows is widespread, affecting at least 10% of fresh dairy cows, and it is often interpreted as a sign of dietary P deficiency in the periparturient period.<sup>1,3,4</sup> Hypophosphatemia in early lactation has been associated with syndromes such as postparturient hemoglobinuria, a form of intravascular hemolysis that is thought to be caused by increased fragility of red blood cell in P-deficient states and postparturient recumbency that is not responsive to intravenous treatment with calcium salts.<sup>1,5</sup>

### Sheep and Horses

Sheep and horses at pasture are much less susceptible to the osteodystrophy of P deficiency than are cattle, and their failure to thrive on P-deficient pasture is probably attributable in part to the low protein content of the pasture. In fact, there has been no clear demonstration of a naturally occurring P deficiency in sheep.

There is some limited evidence that the plasma inorganic phosphorus (Pi) levels in Thoroughbred racehorses may be related to certain feeding regimens and to racing performance. Horses fed cubed or pelleted dietary supplement have plasma Pi concentrations consistently below an accepted mean of 1.03 mmol/L (3.2 mg/dL). It is suggested that a rapid rate of passage of the ingesta may affect P absorption. Other observations indicate that some of the best track performers had significantly lower plasma Pi concentrations compared with some of the worst performers.

### Pigs

A primary deficiency can occur in pigs kept in confinement and not provided with sufficient dietary P. Lactating sows are more commonly affected than growing pigs. In some

situations, in the cereal grains, the phytate levels are so high and phytase levels so low that rickets and osteomalacia are common in the pig population.

### Secondary Phosphorus Deficiency

Secondary P deficiency is the result of hyperparathyroidism or vitamin D deficiency. This is of minor importance compared with the primary P deficiency. A deficiency of vitamin D is not necessary for the development of osteodystrophy, although with suboptimal P intakes deficiency of this vitamin becomes critical. Excessive intake of calcium does not necessarily result in secondary P deficiency, although it may cause a reduction in weight gains, probably as a result of interference with digestion, and may contribute to the development of P deficiency when the intake is marginal. The presence of phytic acid in plant tissues, which renders phytate-P unavailable to nonruminant species, is a major consideration in pigs but of only minor importance in ruminants, except that increasing intakes of calcium may reduce the availability of phytate-P even for ruminants. Rock phosphates containing large amounts of iron and aluminum have been shown to be of no value to sheep as a source of P. A high intake of magnesium, such as that likely to occur when magnesite is fed to prevent lactation tetany, may cause hypophosphatemia if the P intake of dairy cows is already low.

### PATHOGENESIS

Of the body P, 80% to 85% is located in the skeleton, where it is deposited in a metabolically inert form together with calcium as hydroxyapatite. Hydroxyapatite is the compound that provides bone with its characteristic structural rigidity and stability. Bone P also functions as an important P reservoir that can be mobilized when body requirements temporarily exceed dietary intake. The remainder of the body P is available as dissolved P that is either encountered as inorganic phosphate (Pi) or forming part of organic molecules such as phospholipids, phosphocreatine, different adenosine molecules, or various carbohydrate metabolites. Phosphorus is a predominantly intracellular mineral, of which only small amounts are located in the extracellular space. Phosphorus bound in phospholipid molecules is essential for the structural stability of cell membranes that are composed of these phospholipids. The availability of soluble Pi in the intracellular space is essential for a plethora of biochemical reactions, especially those concerned with energy metabolism and transfer. Phosphorus furthermore functions as a buffer in rumen fluid, urine, and the intracellular space. Rumen microbes that are of critical importance for ruminant nutrition are inherently dependent of adequate P supply, which is not only provided by feed but also by the salivary glands, which produce large amounts of saliva rich in P.

Inadequate dietary P supply will result in the mobilization of hydroxyapatite, from which will release P together with calcium. Prolonged P deficiency is therefore associated with abnormal development of bone tissue, known as osteodystrophy.

Experimentally, female beef cattle fed diets containing less than 6 g of P/day developed an insidious complex syndrome characterized by weight loss, rough hair coat, abnormal stance, and lameness. Spontaneous fractures occurred in the vertebrae, pelvis, and ribs. Some affected bones were severely demineralized, and the cortical surfaces were porous, chalky white, soft, and fragile. The osteoid tissue was not properly mineralized.

Experimental dietary P depletion in cattle results in a rapid and marked decline in serum Pi. When markedly P deficient diets are fed over months, affected animals develop an avid appetite for old bones. The long-term signs include decreased weight gain in growing animals or loss of body condition in adult animals, feed-intake depression, reduced bone density as determined by radiography, and reduced bone weight, which are consistent with osteodystrophy. Serum Pi concentrations tend to increase despite of ongoing dietary P deprivation with activation of counterregulatory mechanisms that are reflected in increased plasma 1,25-dihydroxyvitamin D, reduced plasma concentrations of parathyroid hormone, and increased renal calcium excretion.

Muscle weakness to the point of recumbency is thought to be another symptom of P depletion, particularly in early-lactating dairy cows. The proposed underlying mechanism is a deficiency of Pi that may result in decreased concentration of phosphorylated molecules such as phosphocreatine and adenosine triphosphate (ATP) that are essential for energy storage on a cellular level. It has been proposed that it is through a depletion of these energy-storing molecules that P deficiency may result in muscle weakness and recumbency in periparturient cattle.<sup>6</sup> Nevertheless, it should be noted that disturbed muscle function has only been associated with hypophosphatemia in fresh cows but is not a common feature of chronic P deprivation in cattle. Doubts about the causative association between P deficiency and recumbency in cattle have furthermore been raised because of the impossibility of experimentally inducing recumbency through dietary P depletion in cattle and because of the variable response to treatment with P salts in recumbent hypophosphatemic cows.<sup>1</sup>

A decline of the intracellular ATP concentration, this time of red blood cells, is the presumed mechanism behind intravascular hemolysis observed in fresh cows with postparturient hemoglobinuria (see also the discussion of postparturient hemoglobinuria). Red blood cells (RBCs) require ATP to maintain their osmotic stability. A



decrease of the ATP concentration in P depleted human RBCs to 15% of normal values resulted in increased osmotic fragility of erythrocytes that was associated with intravascular hemolysis. In cattle, hypophosphatemia has been reported in many but not all cases of postparturient hemoglobinuria, and response to treatment with phosphate salts is variable.<sup>5,7</sup> In a recently published study in which dairy cows were fed a ration over 40% deficient for several weeks, the plasma Pi concentration dropped by over 60% within days, whereas the Pi concentration of RBCs and their osmotic resistance remained unchanged.<sup>7</sup> The authors concluded that dietary P depletion causing pronounced hypophosphatemia is not generally associated with intracellular P depletion of RBCs or increased osmotic fragility, and that the plasma Pi concentration is an unsuitable indicator for the intracellular P content of RBCs.<sup>7</sup>

Decreased fertility was historically one of the predominant symptoms associated with P deficiency in cattle. Because there is no known mechanism through which P deficiency would directly affect fertility and because P depletion is commonly associated with feed-intake depression, weight loss, and decreased milk production along with reproductive failure, it is more likely that poor fertility is a result of a negative energy and nutrient balance rather than a specific effect of P on a (yet undetermined) reproductive function.

The pathophysiologic effects of low dietary P in pigs have been examined. Determination of the serum concentrations of parathyroid hormone, 1,25-(OH)<sub>2</sub>D, and osteocalcin were monitored in Romanian Landrace pigs originating from herds with dietary P deficiency. Serum Pi concentrations were negatively correlated with those of 1,25-(OH)<sub>2</sub>D. In lactating animals and sucklings, the linear relationships were not present. Serum Pi concentrations positively correlated with those of PTH, and 1,25-(OH)<sub>2</sub>D concentrations were negatively correlated. The serum concentrations of 1,25-(OH)<sub>2</sub>D and osteocalcin were positively correlated. Milk P concentrations ranging from 3.1 to 7.5 mmol/L were correlated positively with urinary Pi concentrations ranging from 0.3 to 11.4 mmol/L. In conclusion, similar to other species, P homeostasis is achieved in pigs by feedback mechanisms between P, PTH, and 1,25-(OH)<sub>2</sub>D, and osteocalcin production is induced by 1,25-(OH)<sub>2</sub>D.

### CLINICAL FINDINGS

A plethora of clinical signs and conditions, such as unthriftiness, anorexia, pica, impaired growth and fertility, muscle weakness, lameness, recumbency, intravascular hemolysis, osteomalacia, and many more, have been associated with P deficiency in ruminants and other species.

Primary P deficiency is common only in cattle and is associated with chronic dietary P deprivation. In the experimental production of P deficiency in beef or dairy cattle, several months to years on a P-deficient diet are necessary before clinical signs develop.

Young animals grow slowly and develop rickets. In adults there is an initial subclinical stage followed by osteomalacia. In ruminants of all ages, a reduction in voluntary feed intake is a first sign of P deficiency and is the basis of most of the general systemic symptoms to follow, which are retarded growth, weight loss, low milk yield, and reduced fertility. For example, in severe P deficiency in range beef cattle, the calving percentage has been known to drop from 70% to 20%. The development and wear of teeth are not greatly affected, in contrast with the severe dental abnormalities that occur in a nutritional deficiency of calcium. However, malocclusion may result from poor mineralization and resulting weakness of the mandible. More advanced stages of P deficiency occurring in severely P-deficient regions are associated with reluctance to move, abnormal stance, and increased incidence of bone fractures. The animals have a leggy appearance with a narrow chest and small girth, the pelvis is small, and the bones are fine and break easily. The chest is slab-sided as a result of weakness of the ribs, and the hair coat is rough and lacking in pigment. In areas of severe deficiency, the mortality rate may be high as a result of starvation, especially during periods of drought when deficiencies of P, protein, and vitamin A are severe. Osteophagia is common and may be accompanied by a high incidence of botulism.

Cows in late pregnancy often become recumbent, and although they continue to eat, they are unable to rise. Such animals present a real problem in drought seasons because many animals in the area may be affected at the same time. Parenteral injections of P salts are ineffective, and the only treatment that may be of benefit is to terminate the pregnancy by the administration of corticosteroids or by cesarean section.

A more acute form of P deficiency is thought to occur in the first days to weeks of lactation in mature, high-yielding dairy cows. Hypophosphatemia in these animals has been associated with periparturient recumbency that is unresponsive to IV treatment with calcium salts. Affected animals are recumbent but mentally alert, with normal or only slightly decreased feed intake. They continue making attempts to stand and tend to creep around.

Another condition associated with P depletion and hypophosphatemia in dairy cattle in early lactation is postparturient hemoglobinuria. The disorder affects individual mature animals in the first days to weeks of lactation and is characterized by massive intravascular hemolysis, resulting in

the excretion of large amounts of hemoglobin in urine (see also the discussion of postparturient hemoglobinuria).<sup>7</sup>

Although sheep and horses in P-deficient areas do not develop clinically apparent osteodystrophy, they are often of poor stature and unthrifty and may develop perverted appetites. An association between low serum or plasma Pi and infertility in mares has been suggested, but the evidence is not conclusive. The principal sign in affected sows is posterior paralysis.

### CLINICAL PATHOLOGY

#### Serum Phosphorus

The concentration of serum or plasma Pi is the most commonly used parameter to assess the P status of an individual animal independent of the species. Although the serum Pi concentration reflects the short-term dietary P supply and the body's P pool size reasonably well, it is less suited to diagnose chronic P deficiency because compensatory mobilization of P reserves from bone tend to increase the Pi concentration in serum or plasma, thereby masking P depletion at least partially. Marked individual and diurnal fluctuations of the serum Pi concentration further complicate the interpretation of this parameter on an individual animal basis.<sup>1</sup>

Serum Pi levels are affected by such factors as age, milk yield, stage of pregnancy, breed, dietary P content, time of sample collection relative to feeding, and the blood vessel from which the blood sample is collected. Rapid and pronounced changes of the serum Pi level in the range of 10% to 30% can occur as a result of sudden shifts of P from the extracellular to the intracellular space, for instance, after strenuous physical exercise or oral or parenteral administration of carbohydrates.<sup>1</sup> Hypophosphatemia diagnosed in one single sample collected from one animal is therefore an unreliable indicator for the P status of that individual or a group of animals. The diagnostic value of the serum P concentration is complicated by the fact that clinical signs are not consistently observed with a certain degree of hypophosphatemia. For instance, serum Pi levels below 0.6 mmol/L (1.9 mg/dL) in cattle have been associated with intravascular hemolysis and recumbency, whereas even lower concentrations are often measured in healthy dairy cows.<sup>1</sup> To obtain comparable results it is advisable to collect blood from the same blood vessel at standardized times relative to feeding.

Reference ranges for cattle given in the literature are 1.4 to 2.6 mmol/L (4.0 to 8.0 mg/dL) and 1.9 to 2.6 mmol/L (6.0 to 8.0 mg/dL) for adult and growing animals, respectively. The reference ranges for sheep and goats are 1.6 to 2.4 mmol/L (5.0 to 7.3 mg/dL) and 1.3 to 3.0 mmol/L (4.2 to 9.1 mg/dL), respectively. Juvenile and growing individuals have higher serum Pi because of enhanced intestinal Pi uptake,

presumably to provide sufficient Pi for adequate bone mineralization. The reference ranges for serum Pi for horses and swine are 1.0 to 1.8 mmol/L (3.1 to 5.6 mg/dL) and 2.1 to 3.3 mmol/L (6.5 to 10.2 mg/dL) respectively.

### Dietary Phosphorus Content

Estimating the dietary P content is among the most reliable methods to estimate the P status of one or several animals, provided the feed intake can also be quantified. For pastured cattle, estimation of the dietary P content based on the P content in soil has been proposed. A P content in soil above 8 ppm was not associated with any signs of P deficiency, whereas negative effects on feed intake, growth, and fertility became apparent in cattle pastured for prolonged periods on soils with a P content between 7 and 8 ppm. Signs became more prominent in animals kept on soils with a P content between 4 and 6 ppm and were most severe on soils with a P content below 4 ppm.

The association between dietary P intake and the concentrations of P in feces has been explored in several studies. Although the effect of the dietary P content on the intestinal absorption rate of P is well established, neither rumen fluid samples nor fecal grab samples were found to reliably identify P depleted animals. Specifically, when P-depleted animals show feed-intake depression, a clinical sign often associated with P deficiency, fecal output decreases. This can translate into unchanged or even increased fecal P, although the total fecal P output is decreased.<sup>1</sup>

### Bone Ash Concentrations

Determination of total bone ash concentrations and bone calcium and P concentrations from a sample of rib can provide useful diagnostic information and comparison to normal values. Nonetheless the bone P content is slow to respond to changes in dietary P supply, which means that the nutritional history has a strong impact on the mineral content of fresh bone. The P content in fresh bone is considered an excellent indicator for the body P reserves, but not for the current dietary P supply or the P pool size. Because obtaining bone biopsies is impractical under field conditions, determination of bone P content is largely restricted to post-mortem examination or research.<sup>1</sup>

### NECROPSY FINDINGS

The necropsy findings are those of the specific diseases, rickets, and osteomalacia.

#### DIFFERENTIAL DIAGNOSIS

A diagnosis of phosphorus (P) deficiency depends on evidence that the diet is lacking in P and that the lesions and signs are typical of those caused by P deficiency and can be

arrested or reverted by the administration of P. Differentiation from those diseases that may resemble rickets and osteomalacia is dealt with under those headings.

Milk fever and downer cow syndrome in periparturient recumbent cattle.

Other disorders associated with intravascular hemolysis in cases of periparturient hemoglobinuria.

### TREATMENT

For P supplementation in ruminants, either oral or parenteral treatment has been proposed. For metabolism and cell function, the organism requires P as inorganic phosphate ( $\text{PO}_4$ ). Accordingly, P must be supplemented in a form that either contains phosphate or as a compound that can be hydrolysed to phosphate. Most pharmaceutical products containing P and labeled for parenteral administration in animals contain phosphite ( $\text{PO}_2$ ), hypophosphite ( $\text{PO}_3$ ), or organic P compounds such as toldimfos (dimethylamino-methylphenyl-phosphinate) or butafosfan (butylamino-methylethyl-phosphoric acid), which the body does not appear to convert to phosphate. These compounds must thus be considered to be unsuitable for P supplementation.

The preparation of a custom-made solution either with 300 mL of distilled water containing 30 g of  $\text{NaH}_2\text{PO}_4$  or 500 mL of deionized water containing 90 g of  $\text{Na}_2\text{HPO}_4 \times 12\text{H}_2\text{O}$ , which are to be administered intravenously as a single dose to an adult cow, have been proposed in the literature (both equivalent to approximately 8 g of P) but are extra-label treatments. Both solutions are only suitable for IV administration, and their effect on the plasma Pi concentration is short lived, lasting for less than 2 hours when administered as an IV bolus.

Because of the rapid and sustained effect of orally administered P salts, this treatment route is preferred over the parenteral treatment. Oral administration of monosodium dihydrogen phosphate (300 g) or monopotassium dihydrogen phosphate (250 g), both providing approximately 60 g of P, were found to increase the plasma Pi concentration in hypophosphatemic dairy cows within 3 to 4 hours of treatment and for at least 12 hours.<sup>8</sup> Monocalcium phosphate (250 g, also equivalent to approximately 60 g P) was less effective than monosodium phosphate and monopotassium phosphate, but more effective than dicalcium phosphate.<sup>8,9</sup>

#### TREATMENT AND CONTROL

##### Treatment

Cattle:  
Monosodium dihydrogen phosphate (36 g  $\text{NaH}_2\text{PO}_4$  dihydrate in 300 mL distilled water IV as single dose) (R-2)

Disodium monohydrogen phosphate (90 g  $\text{Na}_2\text{HPO}_4 \times 12 \text{H}_2\text{O}$  in 500 distilled water IV as single dose) (R-2)

Monosodium dihydrogen phosphate (300 g  $\text{NaH}_2\text{PO}_4$  PO q12h for 1 to 3 days) (R-1)

Monopotassium dihydrogen phosphate (250 g  $\text{KH}_2\text{PO}_4$  PO q12h for 1 to 3 days) (R-2)

Monocalcium dihydrogen phosphate (250 g  $\text{Ca} [\text{HPO}_4]_2$  PO q12h for 1 to 3 days) (R-2)

Dicalcium monohydrogen phosphate (300 g  $\text{CaHPO}_4 \times 2\text{H}_2\text{O}$  PO q12h for 1 to 3 days) (R-3)

Monosodium dihydrogen phosphate IM or SC (R-3)

Disodium monohydrogen phosphate IM or SC (R-3)

Butafosfan (butylamino-methylethyl-phosphoric acid) (R-3)

Toldimfos (dimethylamino-methylphenyl-phosphinate) (R-3)

##### Control

Bone meal, calcium-phosphate salts, sodium-phosphate salts, and sodium-pyrophosphate may be provided in supplementary feed or by allowing free access to their mixtures with salt.

Fertilization of P-deficient pastures with phosphate.

### CONTROL

Phosphorus deficiencies in grazing livestock can be prevented by direct treatment of the animal through supplementing the diet or the water supply, or indirectly by approximate fertilizer treatment of the soils. Hand-fed animals are supplemented with P in their diets.

### Phosphorus Requirements Cattle

The P requirements for cattle in various stages of the production cycle have varied widely worldwide. Estimates of daily P requirements for cattle have been adjusted over the past decades based on evidence indicating that the digestibility of dietary P has been underestimated in the past, particularly in ruminants.<sup>10</sup> Apparent P requirements can vary for a variety of reasons: differences among breeds of cattle, P availability in the feed, whether animals are pen fed or free grazing, possible interactions between nutrients, and the effects of disease and parasitism.

### Dairy Cattle

There is widespread belief among producers and consultants that reproductive performance in dairy cows can be improved by feeding P above recommended levels. The current NRC recommendations for early-lactation (90 days in milk) diets are 0.36% P (DM basis) for cows milking 45 kg/d and 0.35% P for cows milking 35 kg/d. The NRC

recommends up to 0.42% dietary P for the highest-producing cows during the first few weeks of lactation.<sup>10</sup>

Several studies indicate that dietary P at 0.38 to 0.40% is sufficient for high producing dairy cows. Depending on feed ingredients, this concentration of P can be obtained with no or minimum supplementation with P of a standard North American or European dairy cow ration. Negative effects on milk yield and feed intake were observed in dairy cows fed ration with a dietary P content below 0.31% of feed dry matter over several months.<sup>1</sup> Cows conserve P when fed diets low in P by reducing P excretion in feces.

The transition period from late gestation to lactation presents a particular challenge for the mechanisms regulating the P homeostasis. In the last weeks of gestation, the dietary P content is often limited to reduce the risk of periparturient paresis.<sup>10</sup> With the onset of lactation, daily P requirements increase suddenly while daily feed intake is at a nadir. This situation may indeed result in a transiently negative P balance during the first days of lactation, which is likely to contribute to the commonly encountered hypophosphatemia in fresh cows. However, the mechanisms driving this periparturient hypophosphatemia are not well understood, and the degree of P depletion in affected cows has never been examined in detail, but has rather just been extrapolated from the observed declines in plasma Pi levels.<sup>1</sup> Hypophosphatemia shortly after calving is an unreliable indicator for P depletion because this decline in plasma Pi levels has not only been attributed to P losses through the mammary gland but also to hormone-induced compartmental shifts of P from the extracellular to the intracellular space.<sup>1</sup>

It is deemed unlikely that increasing the amount of dietary P in late pregnancy and early lactation will be able to prevent periparturient hypophosphatemia because this imbalance seems to occur secondary to hypocalcemia.<sup>10</sup>

#### *Environmental Implications of Phosphorus Feeding of Livestock*

In the European Union and the United States, environmental pollution with P from cattle manure has received increased attention over the past decades, and incentives with the objective to reduce the P content in ruminant fecal material have been implemented in many countries.

Ideally, P is recycled into the soil/plant/animal system, from which only the P incorporated into the animal system escapes. In a sustainable dairy farming system, the amount of P expelled in the form of manure must be limited to the amount that crops need for maximum growth. However, because of high livestock intensities and excessive amounts of P in feed, overapplication of P from manure occurs, leading to P accumulation in the soil and finally leaching, thus causing

eutrophication of surface waters. Reducing the dietary P intake of cattle has been identified as an effective way to reduce the amount of P in manure and thereby contain environmental pollution with P.

The current recommendations for dairy cattle from the NRC are to provide phosphorus at 0.32% to 0.42% of dry matter intake.<sup>10</sup> These are lower than the previous recommendation of 0.5% of dry matter intake. Based on calculation of P losses and the true absorption coefficient using data on saliva production, saliva P content, and the efficiency of P absorption, the P requirement recommended for dairy cows in the Netherlands are as follows: P requirement (g/d per 600-kg cow) =  $19 + 1.43 \times 1$  kg milk. This recommendation is up to 22% lower than the current recommendation for high-yielding dairy cows used in the United Kingdom.

Surveys in the United States revealed that dairy diets contain approximately 0.45% to 0.50% P (DM basis), an amount that is about 20% in excess of estimated requirements. A reduction of the dietary P content by 20% was estimated to result in a 25% to 30% reduction in the P content of manure and a similar reduction in the amount of land required to accommodate the manure. Phosphorus is the most expensive nutrient in typical mineral-vitamin formulations for dairy cattle. Feeding a diet containing 0.45% P versus one containing 0.55% would save about \$0.05/cow daily; for a 100 cows over 1 year, this would save about \$1825.00.

Simulation models of the long-term effects of changes in feeding, cropping, and other production strategies on P loading and the economics of 100-cow and 800-cow dairy farms in southeastern New York found that the most easily implemented change was to reduce the supplemented mineral P fed to that required to meet the current NRC recommended amounts, which would provide an annual increase in farm profit of about \$22.00 per cow.

The overfeeding of P has important environmental implications. Phosphorus excretion increases linearly as P intake is increased above the requirement. Once P requirements are met, all of the excess dietary P is excreted in the feces. This excess P accumulates in the environment, primarily by the recycling of manure to land as fertilizer for crop production. The surface runoff of this excess P promotes the eutrophication of surface waters (eutrophication is the accidental or deliberate promotion of excessive growth of one kind of organism to the disadvantage of other organisms in the ecosystem). Therefore, close monitoring of P inputs in the livestock industry is important to reduce the risk of eutrophication of lakes and streams. Reducing dietary intake closer to the requirement will require frequent and accurate feed analysis, quantification of dry matter intake, and ration management to ensure that formulated diets are mixed and delivered to the

cows properly. Phosphorus reduction will be achieved by precision of feeding of dairy cattle. Portable and rapid tests are now available to determine the level of P in dairy cattle manure. These hand-held tools can yield real-time measurements of dissolved P and total P in manure.

The effects of feeding low amounts of P to high-yielding dairy cows have been examined extensively in numerous studies.<sup>10</sup> Lactating dairy cows were fed diets containing 67%, 80%, and 100%, respectively, of the P requirements recommended by the Dutch Committee on Mineral Nutrition for a period of 21 months. Nearly 5 months after the beginning of the feeding trial, the milk yield and milk lactose content of the 67% group decreased significantly. It was concluded that rations for high-yielding dairy cows should not have a P content lower than 3.0 g/kg (or 0.3%) DM. The P supply with the 80% ration was considered to be just sufficient.

The supplementation of dietary P above levels recommended by the NRC (0.38% considered adequate or 0.48% excessive) did not improve duration or intensity of estrus in dairy cows. Large lactation studies have shown that feeding P in excess of 0.37% of diet DM, which corresponds closely to the NRC P requirements, did not affect milk production, milk composition, or animal health. Digestion studies and P retention data also support the NRC recommendations.<sup>10</sup>

#### **Beef Cattle**

There has been a notable lack of research into the P requirements of grazing beef cattle of various age groups and under varying soil and forage conditions, which has created considerable confusion and disagreement about the P requirements. The effects of P fertilizer on forage P levels and seasonal changes in P concentration are well understood, but the availability of P in different forage species, at different stages of maturity, and grown under different management schemes and environmental conditions is not well understood.

The details of the phosphorus requirements for beef cattle of various age groups are available in the NRC publication *Nutrient Requirements of Beef Cattle*, which was updated in 2000.<sup>2</sup>

#### **Feedlot Cattle**

The P requirement of finishing feedlot calves is less than 0.16% of diet DM or 14.2 g/d. Typical grain-based feedlot cattle diets do not require supplementation of inorganic mineral P to meet P requirements. Plasma P, performance, and bone characteristics indicate that P requirements are less than the predicted requirements and should be modified. Supplementation of mineral P in finishing diets is an unnecessary economic and environmental cost for beef feedlot producers and should be discontinued.



## Pigs

The estimated dietary P requirements for maximum growth and feed efficiency of pigs at 3 to 5, 5 to 10, 10 to 20, 20 to 50, 50 to 80, and 80 to 120 kg, as a percentage of diet (90% DM) are 0.70%, 0.65%, 0.60%, 0.50%, 0.45%, and 0.40%, respectively. The form in which P exists in natural feedstuffs influences the efficiency of its utilization. In cereal grains, grain byproducts, and oilseed meals, about 60% to 75% of the P is organically bound in the form of phytate, which is poorly available to nonruminant species. The biological availability of P in cereal grains is variable, ranging from less than 15% in corn to approximately 50% in wheat, which has naturally occurring phytase enzyme. The P in inorganic phosphorus supplements also varies in bioavailability. The P in ammonia, calcium, and sodium phosphates is highly available.

## Phosphorus Supplementation

Bone meal, calcium-phosphate salts, sodium-phosphate salts, and sodium-pyrophosphate may be provided in supplementary feed or by allowing free access to their mixtures with salt or more complicated mineral mixtures. The availability of the phosphorus in feed supplements varies, and this needs to be taken into consideration when compounding rations. For cattle, mineral sources with the highest absorption coefficients for P are monosodium dihydrogen phosphate (absorption coefficient 0.9), ammonium phosphates and monocalcium phosphate (absorption coefficient 0.80), followed by dicalcium phosphate (absorption coefficient 0.75).<sup>10</sup> The relative biological values for young pigs in terms of phosphorus are as follows: dicalcium phosphate or rock phosphate, 83%; steamed bone meal, 56%; and colloidal clay or soft phosphate, 34%. It is suggested that in deficient areas adult dry cattle and calves up to 150 kg BW should receive 225 g bone meal/week, growing stock over 150 kg BW 350 g/week, and lactating cows 1 kg weekly, but experience in particular areas may indicate the need for varying these amounts. The top dressing of pasture with superphosphate is an adequate method of correcting the deficiency and has the advantage of increasing the bulk and protein yield of the pasture, but it is often impractical under the conditions in which the disease occurs.

The addition of phosphate to drinking water is a much more satisfactory method, provided the chemical can be added by an automatic dispenser to water piped into troughs. Adding chemicals to fixed tanks introduces errors in concentration, excessive stimulation of algal growth, and precipitation in hard waters. Monosodium dihydrogen phosphate (monosodium orthophosphate) is the favorite additive and is usually added at the rate of 10 to 20 g/20 L of water. Superphosphate may be used instead but is not

suitable for dispensers, must be added in larger quantities (50 g/20 L), and may contain excess fluorine. A reasonably effective and practical method favored by Australian dairy farmers is the provision of a supplement referred to as “super juice.” Plain superphosphate at a rate of 2.5 kg in 40 L of water is mixed and stirred vigorously in a barrel. When it has settled for a day, the “super juice” is ready for use and is administered by skimming off the supernatant and sprinkling 100 to 200 mL on the feed of each cow.

## FURTHER READING

- Grünberg W. Treatment of phosphorus balance disorders. *Vet Clin North Am Food A.* 2014;30:383-408.
- Karn JF. Phosphorus nutrition of grazing cattle: a review. *Anim Feed Sci Technol.* 2001;89:133-153.
- National Research Council. Minerals. In: *Nutrient Requirements of Beef Cattle.* 7th rev. ed., updated 2000. Washington, DC: National Academy of Sciences; 2000 [Ch. 5].
- National Research Council. Minerals. In: *Nutrient Requirements of Dairy Cattle.* 7th rev. ed. Washington, DC: National Academy of Sciences; 2001 [Ch. 7].
- National Research Council. Minerals. In: *Nutrient Requirements of Swine.* 10th rev. ed. Washington, DC: National Academy of Sciences; 1998 [Ch. 4].
- Valk H, Beyen AC. Proposal for the assessment of phosphorus requirements of dairy cows. *Livestock Prod Sci.* 2003;79:267-272.

## REFERENCES

1. Grünberg W. *Vet Clin North Am Food A.* 2014;30:383-408.
2. National Research Council. Minerals. In: *Nutrient Requirements of Beef Cattle.* 7th rev. ed., updated 2000. Washington, DC: National Academy of Sciences; 2000 [Ch. 5].
3. Macrae AI, et al. *Cattle Practice.* 2012;20:120-127.
4. Macrae AI, et al. *Vet Rec.* 2006;159:655-661.
5. Stockdale C, et al. *Aust Vet J.* 2005;83:362-366.
6. Goff JP. *Vet Clin North Am Food A.* 2014;30:359-381.
7. Grünberg W, et al. *J Vet Intern Med.* 2014;doi:10.1111/jvim.12497.
8. Idink MJ, Grünberg W. *Vet Rec.* 2015.
9. Grünberg W, et al. *Br J Nutr.* 2013;110:1012-1023.
10. National Research Council. Minerals. In: *Nutrient Requirements of Dairy Cattle.* 7th rev. ed. Washington, DC: National Academy of Sciences; 2001 [Ch. 7].

## VITAMIN D DEFICIENCY

### SYNOPSIS

**Etiology** Deficiency of preformed vitamin D and, less commonly, insufficient exposure to ultraviolet solar irradiation.

**Epidemiology** Uncommon because diets are supplemented. Occurs in animals in countries with relative lack of UV irradiation, especially in winter months; animals raised indoors for long periods. Can occur in young grazing animals in winter months. The is marked species variation in susceptibility to effects of vitamin D deficiency.

**Signs** Reduced productivity; poor weight gain; reduced reproductive performance. Rickets in young animals (see that topic); osteomalacia in adults.

**Clinical pathology** Serum calcium and phosphorus. Plasma vitamin D.

**Necropsy findings** Lack of mineralization of bone.

**Diagnostic confirmation** Histology of bone lesions.

**Differential diagnosis list** See rickets and osteomalacia.

**Treatment** Administer vitamin D parenterally and oral calcium and phosphates.

**Control** Supplement diets with vitamin D. Injections of vitamin D when oral supplementation not possible.

Vitamin D deficiency is usually caused by insufficient solar irradiation of animals or their feed, or inadequate concentrations of vitamin D in rations of housed animals, and is manifested by poor appetite and growth and in advanced cases by osteodystrophy (rickets or osteomalacia).

## ETIOLOGY

A lack of ultraviolet solar irradiation of the skin, coupled with a deficiency of preformed vitamin D complex in the diet, leads to a deficiency of vitamin D in tissues.

## EPIDEMIOLOGY

Although the effects of clinically apparent vitamin D deficiency have been largely eliminated by improved nutrition, the subclinical effects have received little attention. For example, retarded growth in young sheep in New Zealand and southern Australia during winter months is corrected or prevented by vitamin D administration.

However, general realization of the importance of this subclinical vitamin D deficiency in limiting productivity of livestock has come only in recent years. This is partly a result of the complexity of the relations between calcium, phosphorus, and vitamin D and their common association with protein and other deficiencies in the diet. Much work remains to be done before these individual dietary essentials can be assessed in their correct economic perspective.

Vitamin D is available to animals from either or both of isomerization of 7-dehydrocholesterol (7-DHC) in the skin to vitamin D<sub>3</sub> during exposure to ultraviolet light or ingestion of vitamin D<sub>2</sub> or D<sub>3</sub> in the diet.<sup>1</sup>

## Ultraviolet Irradiation

The intensity of ultraviolet light that reaches the skin of the animal depends on latitude and altitude. The lack of ultraviolet irradiation becomes important as distance from the

equator increases and the sun's rays are filtered and refracted by an increasing depth of the earth's atmosphere. Cloudy, overcast skies, smoke-laden atmospheres, and winter months exacerbate the lack of irradiation. When the incidence angle of sun striking the skin is less than 35 degrees, as occurs during winter at latitudes of 31 degrees or higher, there is insufficient penetration of ultraviolet light to convert 7-DHC to previtamin D<sub>3</sub>.<sup>1</sup> Reduced grazing time of cattle during summer at higher latitudes (56 degrees) is linearly associated with serum vitamin D concentrations.<sup>2</sup> The production of vitamin D<sub>3</sub> by dairy cows is directly correlated with the amount of skin exposed to ultraviolet radiation, and blanketing cows reduces vitamin D<sub>3</sub> production.<sup>3</sup>

The effects of poor irradiation are felt first by animals with dark skin (particularly pigs and some breeds of cattle) or heavy coats (particularly sheep), by rapidly growing animals, and by those that are housed indoors for long periods. The concentration of plasma vitamin D<sub>3</sub> recorded in grazing sheep varies widely throughout the year. During the winter months in the United Kingdom, the levels in sheep fall below what is considered optimal, whereas in the summer months, the levels are more than adequate. There is a marked difference in vitamin D status between sheep with a long fleece and those that have been recently shorn, especially in periods of maximum sunlight. The higher blood levels of vitamin D in the latter group are probably a result of their greater exposure to sunlight. Pigs reared under intensive farming conditions and animals being prepared for shows are susceptible especially if the diet is marginal or deficient in vitamin D.<sup>4</sup>

### Dietary Vitamin D

The importance of dietary sources of preformed vitamin D must not be underestimated. Irradiated plant sterols with antirachitic potency occur in the dead leaves of growing plants. Variation in the vitamin D content of hay can occur with different methods of curing. Exposure to irradiation by sunlight for long periods causes a marked increase in antirachitic potency of the cut fodder, whereas modern hay-making technique with its emphasis on rapid curing tends to keep vitamin D levels at a minimum. Grass ensilage also contains very little vitamin D.

Based on a survey of the concentrations of vitamin D in the serum of horses in the United Kingdom, the levels may be low. In the absence of a dietary supplement containing vitamin D, the concentrations of 25-OH D<sub>2</sub> and 25-OH D<sub>3</sub> are, respectively, a reflection of the absorption of vitamin D<sub>2</sub> from the diet and of biosynthesis of vitamin D<sub>3</sub>.

Information on the vitamin D requirements of housed dairy cattle is incomplete and contradictory. It appears, however, that

in some instances natural feedstuffs provide less-than-adequate amounts of the vitamin for optimum reproductive performance in high-producing cows.

### Grazing Animals

The grazing of animals, especially in winter and on lush green feed including cereal crops, leads to a high incidence of rickets in the young. An antivitamin D factor is suspected because calcium, phosphorus, and vitamin D intakes are usually normal, but the condition can be prevented by the administration of calciferol. Carotene, which is present in large quantities in this type of feed, has been shown to have antivitamin D potency, but the existence of a further rachitogenic substance seems probable. The rachitogenic potency of this green feed varies widely according to the stage of growth and virtually disappears when flowering commences. Experimental overdosing with vitamin A causes a marked retardation of bone growth in calves. Such overdosing can occur when diets are supplemented with the vitamin and may produce clinical effects.

Exposure of animals to solar radiation is important in metabolism of vitamin D, with previtamin D<sub>3</sub> formed in the skin. Skin pigmentation—specifically, melanin—influences the amount of ultraviolet exposure needed to produce vitamin D<sub>3</sub>. A longer time in sunlight is required for maximum previtamin D<sub>3</sub> formation in dark-skinned animals.<sup>1</sup>

The importance of vitamin D to animals is now well recognized, and supplementation of the diet where necessary is usually performed by the livestock owner. Occasional outbreaks of vitamin D deficiency are experienced in intensive systems where animals are housed and in areas where specific local problems are encountered (e.g., rickets in sheep on green cereal pasture in New Zealand).

### Animal Risk Factors

Most herbivores efficiently produce vitamin D<sub>3</sub> in the skin, and shorn sheep have higher concentrations of vitamin D<sub>3</sub> than do unshorn sheep.<sup>1</sup> However, New World camelids are particularly susceptible to vitamin D deficiency, likely as a result of their heavy fleece and evolution in the Andes and attendant exposure to high levels of solar radiation. Movement to lower altitudes, higher latitudes, or housing denies them access to the required amount of sunlight.<sup>1,5-7</sup> Inherited rickets in Corriedale sheep is caused by excessive vitamin D catabolism as a result of overexpression of the gene for 25-hydroxyvitamin D3-24-hydroxylase, the enzyme responsible for catabolism of vitamin D.<sup>8,9</sup> The disease occurs in housed fattening pigs, likely as a result of errors in feed formulation resulting in vitamin D deficiency.<sup>4</sup>

Foals have lower serum vitamin D concentrations than do adult horses.<sup>10</sup>

## PATHOGENESIS

Vitamin D is a complex of substances with antirachitogenic activity. Increasingly in human medicine, vitamin D is recognized as also having important roles in immune function and resistance to neoplasia and cardiovascular disease.<sup>11,12</sup> The important components are as follows:

- Vitamin D<sub>3</sub> (cholecalciferol) is produced from its precursor 7-dehydrocholesterol in mammalian skin by natural irradiation with ultraviolet light (270 to 315 nm) over the course of 3 days.<sup>1</sup>
- Vitamin D<sub>2</sub> is present in certain plants, such as sun-cured hay, as a result of conversion of ergosterol to vitamin D<sub>2</sub> by ultraviolet light. Vitamin D<sub>2</sub> is present in and is produced by ultraviolet irradiation of plant sterols.
- Vitamin D<sub>4</sub> and D<sub>5</sub> occur naturally in the oils of some fish.

Vitamin D produced in the skin or ingested with the diet and absorbed by the small intestine is transported to the liver. In the liver, 25-hydroxycholecalciferol is produced, which is then transported to the kidney, where at least two additional derivatives are formed by 1- $\alpha$ -hydroxylase. One is 1,25-dihydroxycholecalciferol (DHCC), and the other is 24,25-DHCC. Under conditions of calcium need or calcium deprivation, the form predominantly produced by the kidney is 1,25-DHCC. At present, it seems likely that 1,25-DHCC is the metabolic form of vitamin D most active in eliciting intestinal calcium transport and absorption and is at least the closest known metabolite to the form of vitamin D functioning in bone mineralization. The metabolite also functions in regulating the absorption and metabolism of the phosphate ion and especially its loss from the kidney. A deficiency of the metabolite may occur in animals with renal disease, resulting in decreased absorption of calcium and phosphorus, decreased mineralization of bone, and excessive losses of the minerals through the kidney. A deficiency of vitamin D per se is governed in its importance by the calcium and phosphorus status of the animal.

Because of the necessity for the conversion of vitamin D to the active metabolites, there is a lag period of 2 to 4 days following the administration of the vitamin parenterally before a significant effect on calcium and phosphorus absorption can occur. The use of synthetic analogs of the active metabolites such as 1- $\alpha$ -hydroxycholecalciferol (an analog of 1,25-DHCC) can increase the plasma concentration of calcium and phosphorus within 12 hours following administration and has been recommended for the control of parturient paresis in cattle.

### Maternal Status

Maternal vitamin D status is important in determining neonatal plasma calcium concentration. There is a significant correlation between maternal and neonatal calf plasma

concentrations of 25-OH D<sub>2</sub>, 25-OH D<sub>3</sub>, 24,25-(OH)<sub>2</sub> D<sub>2</sub>, 24,25-(OH)<sub>2</sub> D<sub>3</sub>, and 25,26-(OH)<sub>2</sub> D<sub>3</sub>. This indicates that the vitamin D metabolite status of the neonate is primarily dependent on the 25-OH D status of the dam. The maternal serum concentrations of calcium, phosphorus, and magnesium do not determine concentrations of these minerals found in the newborn calf. The ability of the placenta to maintain elevated plasma calcium or phosphorus in the fetus is partially dependent on maternal 1,25-(OH)<sub>2</sub> D status. Parenteral cholecalciferol treatment of sows before parturition is an effective method of supplementing neonatal piglets with cholecalciferol via the sow's milk and its metabolite via placenta transport.

### Calcium:Phosphorus Ratio

When the calcium:phosphorus ratio is wider than the optimum (1:1 to 2:1), vitamin D requirements for good calcium and phosphorus retention and bone mineralization are increased. A minor degree of vitamin D deficiency in an environment supplying an imbalance of calcium and phosphorus might well lead to disease, whereas the same degree of vitamin deficiency with a normal calcium and phosphorus intake could go unsuspected. For example, in growing pigs, vitamin D supplementation is not essential provided calcium and phosphorus intakes are rigidly controlled, but under practical circumstances, this may not be possible.

The minor functions of the vitamin include maintenance of efficiency of food utilization and a calorogenic action, with the metabolic rate being depressed when the vitamin is deficient. These actions are probably the basis for the reduced growth rate and productivity in vitamin D deficiency. Some evidence suggests that vitamin D may have a role in the immune system. Local production of 1,25-(OH)<sub>2</sub> D by monocytes may be important in immune function, particularly in the parturient dairy cow.

### Other Roles for Vitamin D

Vitamin D is now recognized in humans to have important roles in immune function, cancer, and cardiovascular disease as a result of a diverse range of biological actions, including induction of cell differentiation, inhibition of cell growth, immunomodulation, and control of hormonal systems. In addition, 1,25-dihydroxyvitamin D (calcitriol), through the vitamin D receptor, has an immunoregulatory role in both the innate and adaptive immune systems and exerts pleiotropic effects on numerous tissues.<sup>12</sup>

### CLINICAL FINDINGS

The most important effect of lack of vitamin D in farm animals is reduced productivity. A decrease in appetite and efficiency of food utilization cause poor weight gains in growing stock and poor productivity in adults. Reproductive efficiency is also

reduced, and the overall effect on the animal economy can be severe. The underlying mechanisms are unclear but could be related to the recently recognized pleiotropic effects of vitamin D (calcitriol).

In the late stages, lameness, which is most noticeable in the forelegs, is accompanied in young animals by bending of the long bones and enlargement of the joints. This latter stage of clinical rickets may occur simultaneously with cases of osteomalacia in adults. An adequate intake of vitamin D appears to be necessary for the maintenance of fertility in cattle, particularly if the phosphorus intake is low. In one study in dairy cattle, the first ovulation after parturition was advanced significantly in vitamin D-supplemented cows.

### CLINICAL PATHOLOGY

#### Serum Calcium and Phosphorus

A pronounced hypophosphatemia occurs in the early stages and is followed some months later by a fall in serum calcium. Plasma alkaline phosphatase levels are usually elevated. The blood picture quickly returns to normal with treatment, often several months before the animal is clinically normal. Typical figures for beef cattle kept indoors are serum calcium 8.7 mg/dL (10.8 normal), 2.2 mmol/L (2.7 normal); serum inorganic phosphate 4.3 mg/dL (6.3 normal), 1.1 mmol/L (1.6 normal); and alkaline phosphatase 5.7 units (2.75 normal).

#### Plasma Vitamin D

The normal ranges of plasma concentrations of vitamin D and its metabolites in the farm animal species are now available and can be used to monitor the response of the administration of vitamin D parenterally or orally in sheep. The serum concentrations of vitamin D in the horse have been determined.<sup>10</sup>

### NECROPSY FINDINGS

The pathologic changes in young animals are those of rickets, whereas in older animals there is osteomalacia. In all ages, a variable amount of osteodystrophia fibrosa may develop, and distinction of the origin of these osteodystrophies based on only gross and microscopic examination is impractical. A review of management factors and a nutritional analysis of the feed are essential. The samples for confirmation of the diagnosis at necropsy are as per calcium deficiency.

### DIFFERENTIAL DIAGNOSIS

A diagnosis of vitamin D deficiency depends on evidence of the probable occurrence of the deficiency and response of the animal when vitamin D is provided. Differentiation from clinically similar syndromes is discussed under the specific osteodystrophies.

### TREATMENT

It is usual to administer vitamin D in the dose rates set out under "Control." Affected animals should also receive adequate calcium and phosphorus in the diet.

### CONTROL

#### Supplementation

The administration of supplementary vitamin D to animals by adding it to the diet or by injection is necessary only when exposure to sunlight or the provision of a natural ration containing adequate amounts of vitamin D is impractical.

A total daily intake of 7 to 12 IU/kg BW is optimal. Sun-dried hay is a good source, but green fodders are generally deficient in vitamin D. Fish liver oils are high in vitamin D, but they are subject to deterioration on storage, particularly with regard to vitamin A. They have the added disadvantages of losing their vitamin A and D content in pre-mixed feed, of destroying vitamin E in these feeds when they become rancid, and of seriously reducing the butterfat content of milk. Stable water-soluble vitamin A and D preparations do not suffer from these disadvantages. Irradiated dry yeast is probably a simpler and cheaper method of supplying vitamin D in mixed grain feeds.

Stable water-soluble preparations of vitamin D are now available and are commonly added to the rations of animals being fed concentrate rations. The classes of livestock that usually need dietary supplementation include the following:

- Calves raised indoors on milk replacers
- Pigs raised indoors on grain rations
- Beef cattle receiving poor-quality roughage during the winter months
- Cattle raised indoors for prolonged periods and not receiving sun-cured forage containing adequate levels of vitamin D—these include calves raised as herd replacements, yearling cattle fed concentrate rations, bulls in artificial insemination centers, and purebred bulls maintained indoors on farms.
- Feedlot lambs fed grain rations during the winter months or under totally covered confinement
- Young, rapidly growing horses raised indoors or outdoors on rations that may not contain adequate concentrations of calcium and phosphorus—this may be a problem in rapidly growing, well-muscled horses receiving a high level of grain.

Because there is limited storage of vitamin D in the body, compared with the storage of vitamin A, it is recommended that daily dietary supplementation be provided when possible for optimum effect.

#### Injection

In situations where dietary supplementation is not possible, the use of single IM injections of vitamin D<sub>2</sub> (calciferol) in oil will protect



ruminants for 3 to 6 months. A dose of 11,000 units/kg BW is recommended and should maintain an adequate vitamin D status for 3 to 6 months.

In mature nonpregnant sheep weighing about 50 kg, a single IM injection of 6000 IU/kg body weight produced concentrations of 25-hydroxyvitamin D<sub>3</sub> at adequate levels for 3 months. The parenteral administration of vitamin D<sub>3</sub> results in both higher tissue and plasma levels of vitamin D<sub>3</sub> than does oral administration, and IV administration produces higher plasma levels than does IM injection. The timing of the injection should be selected so that the vitamin D status of the ewe is adequate at the time of lambing. The vitamin D<sub>3</sub> status of lambs can be increased by the parenteral administration of the vitamin to the pregnant ewe. Dosing pregnant ewes with 300,000 IU of vitamin D<sub>3</sub> in a rapidly available form, approximately 2 months before lambing, provides a safe means of increasing the vitamin D status of the ewe and the newborn lambs by preventing seasonally low concentrations of 25-hydroxyvitamin D<sub>3</sub>. In adult sheep, there is a wide margin of safety between the recommended requirement and the toxic oral dose, which provides ample scope for safe supplementation if such is desirable. In adult sheep given 20 times the recommended requirements for 16 weeks, there was no evidence of pathologic calcification. Oral dosing with 30 to 45 units/kg BW is adequate, provided treatment can be given daily. Massive oral doses can also be used to give long-term effects (e.g., a single dose of 2 million units is an effective preventive for 2 months in lambs). Excessive doses may cause toxicity, with signs of drowsiness, muscle weakness, fragility of bones, and calcification in the walls of blood vessels. The latter finding has been recorded in cattle receiving 10 million units/d and in unthrifty lambs receiving a single dose of 1 million units, although larger doses are tolerated by healthy lambs.

#### FURTHER READING

- Dittmer KE, Thompson KG. Vitamin D metabolism and rickets in domestic animals: a review. *Vet Pathol.* 2011;48:389-407.
- O'Brien MA, et al. Vitamin D and the immune system: beyond rickets. *Vet J.* 2012;194:27.

#### REFERENCES

- Dittmer KE, et al. *Vet Pathol.* 2011;48:389.
- Hymoller L, et al. *Brit J Nutr.* 2012;108:666.
- Hymoller L, et al. *J Dairy Sci.* 2010;93:2025.
- Madson DM, et al. *J Vet Diagn Invest.* 2012;24:1137.
- Stieger-Vanegas SM, et al. *Aust Vet J.* 2013;91:437.
- Van Saun RJ. *Small Rumin Res.* 2006;61:153.
- Van Saun RJ. *Vet Clin North Am Food A.* 2009;25:797.
- Dittmer KE, et al. *Res Vet Sci.* 2011;91:362.
- Zhao X, et al. *PLoS ONE.* 2011;6.
- Pozza ME, et al. *Vet J.* 2014;199:451.
- Dittmer K. *Vet J.* 2012;194:5.
- O'Brien MA, et al. *Vet J.* 2012;194:27.

## VITAMIN D INTOXICATION

Vitamin D intoxication has occurred in cattle, horses, alpacas and llamas, and pigs after the parenteral or oral administration of excessive quantities of the vitamin. It also occurs in horses, cattle, and sheep after ingestion of hay or silage containing large amounts of *Trisetum flavescens* (yellow oat grass).<sup>1,2</sup>

In cattle, large parenteral doses of vitamin D<sub>3</sub> (15 to 17 million IU) result in prolonged hypercalcemia, hyperphosphatemia, and large increases in plasma concentrations of vitamin D<sub>3</sub> and its metabolites. Clinical signs of toxicosis occur within 2 to 3 weeks and include marked anorexia, loss of body weight, dyspnea, tachycardia, loud heart sounds, weakness, recumbency, torticollis, fever, and a high case-fatality rate. Pregnant cows 1 month before parturition are more susceptible than nonpregnant cows.

Hypercalcemia and hypervitaminosis D occurred in 17-day-old lambs being fed a milk replacer. The vitamin D content of the milk replacer was not excessive; there was no explanation for the abnormalities in the lamb, which recovered when the milk replacer was changed. Serum concentrations of calcium were high at 23.61 mg/dL and 23.09, respectively, in the two lambs.

Accidental vitamin D<sub>3</sub> toxicosis has occurred in horses fed a grain diet that supplied 12,000 to 13,000 IU/kg BW of vitamin D<sub>3</sub> daily for 30 days, equivalent to about 1 million IU vitamin D<sub>3</sub>/kg of feed. Clinical findings included anorexia, stiffness, loss of body weight, polyuria, and polydipsia. There was also evidence of hyposthenuria, aciduria, soft tissue mineralization, and fractures of the ribs. Calcification of the endocardium and the walls of large blood vessels are characteristic.

Vitamin D intoxication occurs in pigs, usually as a result of errors in mixing of rations, and can result in polydipsia, polyuria, and weight loss.<sup>3</sup> Severe toxicosis in pigs occurs at a daily oral dose of 50,000 to 70,000 IU/kg BW. Signs include a sudden onset of anorexia, vomiting, diarrhea, dyspnea, apathy, aphonia, emaciation, and death. Clinical signs are commonly observed within 2 days after consumption of the feed containing excessive vitamin D. At necropsy, hemorrhagic gastritis and mild interstitial pneumonia are commonly present. Arteriosclerosis with calcification of the heart base vessels may also be visible macroscopically in poisoned cattle. Osteoporosis with multiple fractures has been observed in subacute to chronic hypervitaminosis D in pigs. Histologically, there is widespread soft tissue mineralization, with a predilection for the lung and gastric mucosa, and elastin-rich tissue, such as blood vessels. Changes in bone vary with the duration of exposure to toxic levels of the vitamin.

Research notes development of vitamin D intoxication in New World camelid cria

supplemented with vitamin supplements that provided doses of 4000 to 13,000 IU/kg per day over several days.<sup>4</sup> The recommended dose of vitamin D to crias is a single parenteral dose of 1000 to 2000 IU/kg BW every 7 to 11 weeks.<sup>4</sup> Clinical signs of intoxication in the supplemented crias included weakness and inappetence. There was azotemia, hypercalcemia, and hyperphosphatemia.<sup>4</sup> Treatment was for acute renal failure.

Assay of the various metabolites of vitamin D in tissues is difficult. The diagnosis is therefore usually confirmed by correlating microscopic changes with a history of exposure to toxic levels of vitamin D.

#### Samples for Confirmation of Diagnosis

- Toxicology**—500 g of suspect feed (ASSAY [Vit D])
- Histology**—formalin-fixed lung, stomach/abomasum, proximal aorta, lung, bone (LM)

#### REFERENCES

- Bockisch F, et al. *Tieraerztliche Praxis Ausgabe Grosstiere Nutztiere.* 2015;43:296.
- Franz S, et al. *Vet Rec.* 2007;161:751.
- Anon. *Vet Rec.* 2014;175:452.
- Gerspach C, et al. *J Vet Intern Med.* 2010;24:443.

## RICKETS

### SYNOPSIS

**Etiology** Deficiencies of any or combination of phosphorus and vitamin D, and less commonly calcium. Inherited forms are recognized in sheep and pigs.

**Epidemiology** Young, rapidly growing animals. No longer common. In calves on phosphorus-deficient diets (range or housed). In grazing lambs as a result of lack of solar irradiation. Rare in foals and pigs.

**Signs** Stiff gait and lameness, enlargement of ends of long bones, curvature of long bones, prolonged periods of recumbency. Delayed dentition.

**Clinical pathology** Elevated alkaline phosphatase; low serum calcium and phosphorus. Lack of density of bone radiographically.

**Necropsy findings** Abnormal bones and teeth. Bone shafts are soft, epiphyses enlarged. Ratio of bone ash to organic matter is decreased.

**Diagnostic confirmation** Histology of bone, especially epiphyses.

#### Differential diagnosis list

- Epiphysitis
- Congenital and acquired abnormalities
- Infectious synovitis

**Treatment** Vitamin D injections; calcium and phosphate orally.

**Control** Supplement deficient diets with calcium, phosphorus, and vitamin D.

Rickets is a disease of young growing animals caused by impaired mineralization of physal and epiphyseal cartilage during endochondral ossification and of newly formed osteoid.<sup>1</sup> Osteomalacia is the failure of calcification of osteoid in adult animals (i.e., after closure of the growth plate). The essential lesion is a failure of provisional calcification with persistence of hypertrophic cartilage and enlargement of the epiphyses of long bones and the costochondral junctions (so-called “rachitic rosary” of humans). The poorly mineralized bones are susceptible to fracture, compression, or both.

### ETIOLOGY

Rickets is caused by an absolute or relative deficiency of any or a combination of calcium, phosphorus, or vitamin D in young growing animals. The effects of the deficiency are also exacerbated by a rapid growth rate.

An inherited form of rickets has been described in pigs. It is indistinguishable from rickets caused by nutritional inadequacy. The inherited form of the disease in Corriedale sheep is associated with increased expression of the gene for 25-hydroxyvitamin D<sub>3</sub>-24-hydroxylase, the enzyme responsible for catabolism of vitamin D.<sup>2,3</sup>

### EPIDEMIOLOGY

Clinical rickets is not as important economically as the subclinical stages of the various dietary deficiencies that produce it. The provision of diets adequate and properly balanced with respect to calcium and phosphorus and sufficient exposure to sunlight are mandatory in good livestock production. Rickets is no longer a common disease because these requirements are widely recognized, but the incidence can be high in extreme environments, including purely exploitative range grazing, intensive feeding in fattening units, and heavy dependence on lush grazing, especially in winter months.

Rickets is a disease of young, rapidly growing animals and occurs naturally under the following conditions.

#### Calves

Primary phosphorus deficiency in phosphorus-deficient range areas and vitamin D deficiency in calves housed for long periods are the common circumstances. Vitamin D deficiency is the most common form of rickets in cattle raised indoors for prolonged periods in Europe and North America. Grazing animals may also develop vitamin D deficiency rickets at latitudes where solar irradiation during winter is insufficient to promote adequate dermal photobiosynthesis of vitamin D<sub>3</sub> from 7-dihydrocholesterol. Rickets has occurred in yearling steers in New Zealand wintered on swede (*Brassica napus*) crop deficient in phosphorus.

In young, rapidly growing cattle raised intensively indoors, a combined deficiency of calcium, phosphorus, and vitamin D can result in leg weakness characterized by stiffness, reluctance to move, and retarded growth. In some cases, rupture of the Achilles tendon and spontaneous fracture can occur. The Achilles tendon may rupture at the insertion of, or proximal to, the calcaneus.

#### Lambs

Lambs are less susceptible to primary phosphorus deficiency than cattle, but rickets does occur under the same conditions. Green cereal grazing and, to a lesser extent, pasturing on lush ryegrass during winter months may cause a high incidence of rickets in lambs; this is considered to be a secondary vitamin D deficiency. An outbreak of vitamin D-deficiency rickets involving 50% of lambs aged 6 to 12 months grazing new grass and rape occurred during the early winter months in Scotland. In the South Island of New Zealand, where winter levels of solar irradiation are low, rickets occurs in hoggets grazing green oats, or other green crops, which have been shown to contain high levels of rachitogenic carotenes. The disease occurs in sheep flocks in northern England, likely for similar reasons to the disease occurring in New Zealand.<sup>4</sup> A vitamin D-responsive rickets has occurred in twin lambs at 3 to 4 weeks of age.

#### Pigs

Rickets in young pigs occurs in intensive fattening units.<sup>5</sup> The cause is assumed to be imbalances or mixing errors resulting in feed that contains excessive phosphate (high-cereal diets), or vitamin D and calcium deficiencies.

#### Foals

Rickets is uncommon in foals under natural conditions, although it has been produced experimentally.

#### New World Camelids

Llamas and alpacas are particularly susceptible to rickets secondary to vitamin D deficiency,<sup>6-9</sup> a consequence of them evolving at high altitudes with consequent high exposure to solar radiation. Movement to lower altitudes, where the increased atmospheric depth reduces solar radiation, or indoor housing, reduces the opportunity for dermal production of vitamin D.

### PATHOGENESIS

Dietary deficiencies of calcium, phosphorus, and vitamin D result in defective mineralization of the osteoid and cartilaginous matrix of developing bone. There is persistence and continued growth of hypertrophic epiphyseal cartilage, increasing the width of the epiphyseal plate. Poorly calcified spicules of diaphyseal bone and epiphyseal cartilage

yield to normal stresses, resulting in bowing of long bones and broadening of the epiphyses, with apparent enlargement of the joints. Rapidly growing animals on an otherwise good diet will be first affected because of their higher requirement of the specific nutrients.

### CLINICAL FINDINGS

The subclinical effects of the particular deficiency disease will be apparent in the group of animals affected and have been described in the earlier general section. Clinical rickets is characterized by the following:

- Stiffness in the gait
- Enlargement of the limb joints, especially in the forelegs
- Enlargement of the costochondral junctions
- Long bones showing abnormal curvature, usually forward and outward at the carpus, in sheep and cattle
- Lameness and a tendency to lie down for long periods

Outbreaks affecting 50% of a group of lambs have been described. Arching of the back and contraction, often to the point of virtual collapse, of the pelvis occur, and there is an increased tendency for bones to fracture.

**Eruption of the teeth is delayed** and irregular, and the teeth are poorly calcified, with pitting, grooving, and pigmentation. They are often badly aligned and wear rapidly and unevenly. These dental abnormalities, together with thickening and softness of the jaw bones, may make it impossible for severely affected calves and lambs to close their mouths. As a consequence, the tongue protrudes, and there is drooling of saliva and difficulty in feeding. In less severely affected animals, dental malocclusion may be a significant occurrence. Severe deformity of the chest may result in dyspnea and chronic ruminal tympany. In the final stages, the animal shows hypersensitivity, tetany, and recumbency and eventually dies of inanition.

### CLINICAL PATHOLOGY

The plasma alkaline phosphatase activity is commonly elevated, but serum calcium and phosphorus levels depend on the causative factor. If phosphorus or vitamin D deficiencies are the cause, the serum phosphorus level will usually be below the normal lower limit of 3 mg/dL. The serum concentrations of 25-hydroxyvitamin D<sub>3</sub> and 25-hydroxyvitamin D<sub>2</sub> are markedly decreased in vitamin D-deficient rickets compared with the normal values of greater than 5 ng/mL. Serum vitamin D concentrations as low as 0.4 ng/mL have been reported in lambs with vitamin D-responsive rickets. Serum calcium levels will be low only in the final stages. In leg weakness of young, rapidly growing cattle, the serum concentration of 25-hydroxyvitamin D may be nondetectable,

and the serum levels of calcium and inorganic phosphorus may be low.

**Radiographic examination of bones and joints** is one of the most valuable aids in the detection of rickets. Rachitic bones have a characteristic lack of density compared with normal bones. The ends of long bones have a “woolly” or “moth-eaten” appearance and have a concave or flat, instead of the normal convex, contour. Surgical removal of a small piece of costochondral junction for histologic examination has been used extensively in experimental work and should be applicable in field diagnosis.

### NECROPSY FINDINGS

Apart from general poorness of condition, the necropsy findings are restricted to abnormal bones and teeth. The bone shafts are softer and larger in diameter, in part because of the subperiosteal deposition of osteoid tissue. The joints are enlarged, and on cutting, the epiphyseal cartilage can be seen to be thicker than usual. Histologic examination of the epiphysis is desirable for final diagnosis. In sheep, the best results are obtained from an examination of the distal cartilages of the metacarpal and metatarsal bones.

A valuable diagnostic aid is the ratio of ash to organic matter in the bones. Normally the ratio is 3 parts of ash to 2 of organic matter, but in rachitic bone this may be depressed to 1:2, or to 1:3 in extreme cases. A reduction below 45% of the bone weight as ash also suggests osteodystrophy. Because of the difficulty encountered in repeating the results of bone ash determinations, a standardized method has been devised in which the ash content of green bone is determined, using either the metacarpus or metatarsus and the ash content related to the age of the animal, as expressed by the length of the bone. Although normal standards are available only for pigs, the method suggests itself as being highly suitable for all species.

### Samples for Confirmation of Diagnosis

- **Toxicology**—long bone (ASSAY [ash]); 500 g feed (ASSAY [Ca] [P] [Vit D])
- **Histology**—formalin-fixed long bone (including growth plate) (LM)

### DIFFERENTIAL DIAGNOSIS

Rickets occurs in young, rapidly growing animals and is characterized by stiffness of the gait and enlargement of the distal physes of the long bones, particularly noticeable on the metacarpus and metatarsus as circumscribed painful swellings. A history of a dietary deficiency of any of calcium, phosphorus, or vitamin D will support the clinical diagnosis. Radiographic evidence of widened and irregular physes suggests rickets. Copper deficiency in young cattle under 1 year of age

can also result in clinical, radiographic, and pathologic findings similar to rickets. Clinically, there is an arched back, severe stiffness of gait, reluctance to move, and loss of weight. There are marked swellings of the distal aspects of metacarpus and metatarsus, and radiographically there is a widened zone of cartilage and lipping of the medial and lateral areas of the physal plate. Copper concentration in plasma and liver are low, and there is usually dietary evidence of copper deficiency.

**Epiphysitis** occurs in rapidly growing yearling cattle raised and fed intensively under confinement. There is severe lameness, swelling of the distal physes, and radiographic and pathologic evidence of a necrotizing epiphysitis. The etiology is uncertain but thought to be related to the type of housing.

**Congenital and acquired abnormalities** of the bony skeletal system are frequent in newborn and rapidly growing foals. Rickets occurs, but only occasionally. “Epiphysitis” in young foals resembles rickets and is characterized by enlargements and abnormalities of the distal physes of the radius, tibia, third metacarpal, and metatarsal bones and the proximal extremity of the proximal phalanx. There may or may not be deviation of the limbs caused by uneven growth rates in various growth plates. The suggested causes include improper nutrition, faulty conformation and hoof growth, muscle imbalance, overweight, and compression of the growth plate. Recovery may occur spontaneously or require surgical correction.

**Rickets in pigs** is uncommon and the diagnosis can be difficult. The disease is usually suspected in young, rapidly growing pigs in which there is stiffness in the gait, walking on tip-toes, enlargements of the distal ends of long bones, and dietary evidence of a marginal deficiency of calcium or phosphorus. The radiographic and pathologic findings may suggest a rickets-like lesion.

**Mycoplasmal synovitis and arthritis** clinically resemble rickets of pigs. There is a sudden onset of stiffness of gait, habitual recumbency, a decrease in feed consumption, and enlargements of the distal aspects of the long bones, which may or may not be painful; spontaneous recovery usually occurs in 10 to 14 days. The locomotor problems in young, growing pigs raised in confinement and with limited exercise must be considered in the differential diagnosis. In performance testing stations, up to 20% of boars may be affected with leg weakness.

Rickets in lambs must be differentiated from chlamydial and erysipelas arthritis, which are readily diagnosed at necropsy.

### TREATMENT AND CONTROL

Recommendations for the treatment of the individual dietary deficiencies (calcium, phosphorus, and vitamin D) are presented

under their respective headings. Lesser deformities recover with suitable treatment, but gross deformities usually persist. A general improvement in appetite and condition occurs quickly and is accompanied by a return to normal blood levels of phosphorus and alkaline phosphatase. The treatment of rickets in lambs with a vitamin A, vitamin D<sub>3</sub>, calcium borogluconate solution containing magnesium and phosphorus parenterally and supplementation of the diet with bone meal and protein resulted in a dramatic response. Recumbent animals were walking within a few days.

### FURTHER READING

Dittmer KE, Thompson KG. Vitamin d metabolism and rickets in domestic animals: a review. *Vet Pathol.* 2011;48:389-407.

### REFERENCES

1. Dittmer KE, et al. *Vet Pathol.* 2011;48:389.
2. Dittmer KE, et al. *Res Vet Sci.* 2011;91:362.
3. Zhao X, et al. *PLoS ONE.* 2011;6.
4. Mearns R, et al. *Vet Rec.* 2008;162:98.
5. Madson DM, et al. *J Vet Diagn Invest.* 2012;24:1137.
6. Schroeder C, et al. *Tierärztliche Praxis Ausgabe Grosstiere Nutztiere.* 2008;36:343.
7. Stieger-Vanegas SM, et al. *Aust Vet J.* 2013;91:437.
8. Van Saun RJ. *Small Rumin Res.* 2006;61:153.
9. Van Saun RJ. *Vet Clin North Am Food A.* 2009;25:797.

### OSTEOMALACIA

#### SYNOPSIS

**Etiology** Absolute or relative deficiency of any one or combination of calcium, phosphorus, and vitamin D in adult animals.

**Epidemiology** Primarily in cattle and sheep on phosphorus-deficient diets. In feedlot animals as a result of excessive phosphorus without complementary calcium and vitamin D.

**Signs** Reduced productivity, licking and chewing inanimate objects, stiff gait, moderate nonspecific lameness, shifting from leg to leg, crackling sounds while walking, arched back, lying down for long periods. “Milk lameness” in high-producing dairy cows on deficient diet.

**Clinical pathology** Increased alkaline phosphatase, decreased serum phosphorus levels. Decreased density of long bones radiographically.

**Necropsy findings** Decreased density of bones; erosions of articular cartilages.

**Diagnostic confirmation** Histology of bones.

#### Differential diagnosis list

- Chronic fluorosis
- Polysynovitis and arthritis
- Spinal cord compression

**Treatment** As for calcium, phosphorus, and vitamin D deficiency.

**Control** Adequate supplementation of diet.



Osteomalacia is a disease of mature animals affecting bones in which endochondral ossification has been completed. The characteristic lesion is osteoporosis and the formation of excessive uncalcified matrix (osteoid). Lameness and pathologic fractures are the common clinical findings.

## ETIOLOGY

In general, the etiology and occurrence of osteomalacia are the same as for rickets, except that the predisposing cause is not the increased requirement of growth but the drain of lactation, pregnancy, or both.

## EPIDEMIOLOGY

Osteomalacia occurs in mature animals under the same conditions and in the same areas as rickets in young animals, but it is recorded less commonly. Its main occurrence is in cattle in areas seriously deficient in phosphorus. It occurs in goats.<sup>1</sup> It is also recorded in sheep, again in association with hypophosphatemia. In pastured animals, osteomalacia is most common in cattle, and sheep raised in the same area are less severely affected. In feedlot animals, excessive phosphorus intake without complementary calcium and vitamin D is likely as a cause, especially if the animals are kept indoors. It also occurs in sows that have recently weaned their pigs after a long lactation period (6 to 8 weeks) while on a diet deficient in calcium. A marginal deficiency of both phosphorus and vitamin D will exaggerate the condition. Intensively fed yearling cattle with inadequate mineral supplementation may be affected with spontaneous fractures of the vertebral bodies, pelvic bones, and long bones, leading to recumbency.<sup>1</sup> Simply handling the animals through a chute for routine activities such as tuberculin testing may precipitate the fractures.

## PATHOGENESIS

Increased resorption of bone mineral to supply the needs of pregnancy, lactation, and endogenous metabolism leads to osteoporosis and weakness and deformity of the bones. Large amounts of uncalcified osteoid are deposited around the diaphyses. Pathologic fractures are commonly precipitated by sudden exercise or handling of the animal during transportation. There is evolving understanding of the role of fibroblast growth factor 23 in this disease and other diseases (rickets) associated with abnormalities in calcium, phosphorus, or vitamin D metabolism.<sup>2</sup>

## CLINICAL FINDINGS

### Ruminants

In the early stages, the signs are those of phosphorus deficiency, including lowered productivity and fertility and loss of condition. Licking and chewing of inanimate objects begins at this stage and may bring their attendant ills of oral, pharyngeal,

and esophageal obstruction; traumatic reticuloperitonitis; lead poisoning; and botulism.

The signs specific to osteomalacia are those of a painful condition of the bones and joints and include a stiff gait; moderate lameness, often shifting from leg to leg; crackling sounds while walking; and an arched back. The hindlegs are most severely affected, and the hocks may be rotated inward. The animals are disinclined to move, lie down for long periods, and are unwilling to get up. The colloquial names “pegle,” “creeps,” “stiffs,” “cripples,” and “bog lame” describe the syndrome aptly. The names “milkleg” and “milk lameness” are commonly applied to the condition when it occurs in heavily milking cows. Fractures of bones and separation of tendon attachments occur frequently, often without apparent precipitating stress. In extreme cases, deformities of bones occur; when the pelvis is affected, dystocia may result. Finally, weakness leads to permanent recumbency and death from starvation.

### Pigs

Affected sows are usually found recumbent and unable to rise from lateral recumbency or from the dog-sitting position. The shaft of one femur or the neck of the femur is commonly fractured. The fracture usually occurs within a few days following weaning of the pigs. The placing of the sow with other adult pigs usually results in some fighting and increased exercise, which commonly precipitates the pathologic fractures.

## CLINICAL PATHOLOGY

In general, the findings are the same as those for rickets, including increased serum alkaline phosphatase and decreased serum phosphorus levels. Radiographic examination of long bones shows decreased density of bone shadow.

## NECROPSY FINDINGS

It can be difficult to discern any gross changes as the epiphyses are seldom enlarged, and the altered character of cancellous bone may not be macroscopically visible. Cortical bone may be somewhat thinned, and erosions of the articular cartilages have been recorded in cattle suffering from primary phosphorus deficiency. The parathyroid glands may be enlarged. Histologically, abnormal osteoid covers trabeculae, and a degree of fibrous tissue proliferation is often evident. Analysis reveals the bones to be lighter than normal with a low ratio of ash to organic matter.

## Samples for Confirmation of Diagnosis

- **Toxicology**—long bone (ASSAY [ash]); 500 g feed (ASSAY [Ca] [P] [Vit D])
- **Histology**—formalin-fixed bone, parathyroid (LM)

## DIFFERENTIAL DIAGNOSIS

The occurrence of nonspecific lameness with pathologic fractures in mature animals should arouse suspicion of osteomalacia. There may be additional evidence of subnormal productivity and reproductive performance and dietary evidence of a recent deficiency of calcium, phosphorus, or vitamin D.

A similar osteoporotic disease of cattle in Japan has been ascribed to a dietary deficiency of magnesium. The cattle are on high-concentrate, low-roughage diets and have high serum calcium and alkaline phosphatase levels but a low serum magnesium level. The osteoporosis is observable at slaughter, and clinical signs observed are those of intercurrent disease, especially ketosis, milk fever, and hypomagnesemia. Reproductive and renal disorders occur concurrently.

In **cattle** it must be differentiated from **chronic fluorosis** in mature animals, but the typical mottling and pitting of the teeth and the enlargements on the shafts of the long bones are characteristic. In some areas (e.g., northern Australia) where the water supply is obtained from deep subartesian wells, the two diseases may occur concurrently. Analysis of water supplies and foodstuffs for fluorine may be necessary in doubtful cases.

In sows, **osteomalacia** with or without pathologic fractures must be differentiated from **spinal cord compression** as a result of a vertebral body abscess and chronic arthritis resulting from erysipelas.

## TREATMENT AND CONTROL

Recommendations for the treatment and control of the specific nutritional deficiencies have been described under their respective headings. Some weeks will elapse before improvement occurs, and deformities of the bones are likely to be permanent.

## REFERENCES

1. Braun U, et al. *Vet Rec.* 2009;164:211.
2. Hardcastle MR, et al. *Vet Pathol.* 2015;52:770.

## OSTEODYSTROPHIA FIBROSA

Osteodystrophia fibrosa is similar in its pathogenesis to osteomalacia, but it differs in that soft, cellular, fibrous tissue is laid down as a result of the weakness of the bones instead of the specialized uncalcified osteoid tissue of osteomalacia.<sup>1</sup> It occurs in horses, goats, and pigs.<sup>2-4</sup> The disease occurs in large animals, principally equids, as a result of secondary nutritional hyperparathyroidism.<sup>4</sup> Renal hyperparathyroidism, as is widely recognized in dogs, is rare to nonexistent in equids.<sup>1</sup>

## ETIOLOGY

A **secondary calcium deficiency resulting from excessive phosphorus feeding is the**

**common cause in horses** and probably also in pigs. The disease also occurs in horses grazing tropical or subtropical pastures containing buffel, pangola, setaria, kikuyu, green panic, guinea, signal, and purple pigeon grasses. These tropical grasses contain oxalate, which interferes with mineral utilization by horses by forming calcium oxalate, which renders the calcium unavailable for intestinal absorption.<sup>4</sup> Grasses with more than 0.5% oxalate or calcium:oxalate ratios of less than 0.5 result in a negative calcium balance and are capable of inducing hypocalcemia in horses.<sup>4</sup> The disease can be readily produced in horses on diets with a ratio of calcium:phosphorus of 1:2.9 or greater, irrespective of the total calcium intake. Calcium:phosphorus ratios of 1:0.9 to 1:1.4 have been shown to be preventive and curative. With a very low calcium intake of 2 to 3 g/d and a calcium:phosphorus ratio of 1:13, the disease may occur within 5 months. With a normal calcium intake of 26 g/d and a calcium:phosphorus ratio of 1:5, obvious signs appear in about 1 year, but shifting lameness may appear as early as 3 months.

The disease is reproducible in pigs on similar diets to those just described and also on diets low in both calcium and phosphorus. The optimum calcium:phosphorus ratio is 1.2:1, and the intake for pigs should be within the range of 0.6% to 1.2% of the diet.

### EPIDEMIOLOGY

Osteodystrophia fibrosa is principally a disease of horses and other Equidae and to a lesser extent of pigs. It occurs in goats. Previously, among horses, those engaged in heavy city work and in racing were more likely to be affected because of the tendency to maintain these animals on unbalanced diets. Widespread adoption of use of commercial diets and recognition of the importance of correct mineral nutrition has likely decreased the importance of this disease in these animals. The disease in developed countries is now restricted to equids fed inadequate or imbalanced diets. The major occurrence is in horses fed a diet high in phosphorus and low in calcium. Such diets include cereal hays combined with heavy grain or bran feeding. Legume hays, because of their high calcium content, are preventive.

The disease may reach endemic proportions in army horses moved into new territories, whereas local horses, more used to the diet, suffer little. Although horses may be affected at any age after weaning, it is the 2-to-7-year age group that suffers most, probably because they are the group most likely to be exposed to the rations that predispose to the disease.

A novel occurrence has been recorded of an endemic form of the disease affecting large numbers of horses at pasture.<sup>4</sup> The dietary intake of calcium and phosphorus and their proportions were normal. The

occurrence was thought to be caused by the continuous ingestion of oxalate in specific grasses: *Cenchrus ciliaris*, *Panicum maximum* var. *trichoglume*, *Setaria anceps*, *Brachiaria mutica*, and *Pennisetum clandestinum*.

### PATHOGENESIS

Defective mineralization of bones follows the imbalance of calcium and phosphorus in the diet, and a fibrous dysplasia occurs. This may be in response to the weakness of the bones, or it may be more precisely a response to hyperparathyroidism stimulated by the excessive intake of phosphorus. The weakness of the bones predisposes to fractures and separation of muscular and tendinous attachments. Articular erosions occur commonly, and displacement of the bone marrow may cause the development of anemia.

### CLINICAL FINDINGS

#### Horse

As in most osteodystrophies, the major losses are probably in the early stages before clinical signs appear or on diets where the aberration is marginal. In horses, a shifting lameness is characteristic of this stage of the disease, and arching of the back may sometimes occur. The horse is lame, but only mildly so, and in many cases, no physical deformity can be found by which the seat of lameness can be localized. These signs probably result from relaxation of tendon and ligaments and appear in different limbs at different times. Articular erosions may contribute to the lameness. In more advanced cases, severe injuries, including fracture and visible sprains of tendons, may occur, but these are not specific to osteodystrophia fibrosa, although their incidence is higher in affected than in normal horses. Fracture of the lumbar vertebrae while racing has been known to occur in affected horses.

The more classical picture of the disease has largely disappeared because cases are seldom permitted to progress to this advanced stage. Local swelling of the lower and alveolar margins of the mandible is followed by soft, symmetric enlargement of the facial bones, which may become swollen so that they interfere with respiration. Initially these bony swellings are firm and pyramidal and commence just above and anterior to the facial crests. The lesions are bilaterally symmetric and prevent full occlusion of the incisors. Flattening of the ribs may be apparent, and fractures and rupture or avulsion of ligaments might occur if the horse is worked. There may be obvious swelling of joints and curvature of long bones. Severe emaciation and anemia occur in the final stages.

#### Pigs

In pigs, the lesions and signs are similar to those in the horse, and in severe cases, pigs may be unable to rise and walk and show

gross distortion of limbs and enlargement of joints and the face. In less severe cases, there is lameness, reluctance to rise, pain on standing, and bending of the limb bones, but normal facial bones and joints. With suitable treatment, the lameness disappears, but affected pigs may never attain their full size. The relationship of this disease to atrophic rhinitis is discussed under the latter heading.

#### Goats

An outbreak of the disease has been recorded in goats receiving a diet of wheat straw (60%) and 40% barley for 89 months. The ratio of calcium to phosphorus in the diet was 1:1.8. Affected goats were 9 to 10 months of age, with a history of stunted growth, lameness, diarrhea, and tongue protrusion. Clinically, there was symmetric enlargement of the face and jaws, tongue protrusion, prominent eyeballs, and tremor. The enlarged bones were firm and painful on palpation. The hindlimbs were bent outward symmetrically from the tarsal joints.

### CLINICAL PATHOLOGY

There are no significant changes in blood chemistry in horses affected with severe osteodystrophia fibrosa. However, the serum calcium level will tend to be lower than normal, the serum inorganic phosphorus higher than normal, and the alkaline phosphatase activity higher than normal. The levels of diagnostic alkaline phosphatase have not been determined. Affected horses may be unable to return their serum calcium levels to normal following the infusion of a calcium salt. Radiographic examination reveals increased translucency of bones, especially of the mandibles.

### NECROPSY FINDINGS

The entire skeleton is abnormal in this severe form of metabolic bone disease, but the change is most notable in the mandibular, maxillary, and nasal bones, which may appear thickened and distorted. The fleshy tissue that replaces normal cancellous bone in these sites is also present in the metaphyses of the long bones. Microscopically, there is proliferation of fibrous tissue and markedly increased osteoclast activity along thinned and abnormally oriented bony trabeculae. The parathyroid glands are enlarged. It must be remembered that osteodystrophia fibrosa is a lesion, not a disease. The pathway to this lesion usually involves a dietary imbalance in calcium and phosphorus, but the kidneys should also be examined to rule out the possibility of renal secondary hyperparathyroidism.

### Samples for Confirmation of Diagnosis

- **Toxicology**—bone (ASSAY [ash]); 500 g feed (ASSAY [Ca] [P] [Vit D])
- **Histology**—formalin-fixed bone, parathyroid gland, kidney (LM)

## DIFFERENTIAL DIAGNOSIS

In the early stages, the diagnosis may be difficult because of the common occurrence of traumatic injuries to horses' legs. A high incidence of lameness in a group of horses warrants examination of the ration and determination of their calcium and phosphorus status. An identical clinical picture has been described in a mare with an adenoma of the parathyroid gland. Inherited multiple exostosis has been described in the horse.

In pigs, osteodystrophia can be the result of hypovitaminosis A and experimentally as a result of manganese deficiency.

## TREATMENT AND CONTROL

A ration adequately balanced with regard to calcium and phosphorus (calcium:phosphorus should be in the vicinity of 1:1 and not wider than 1:1.4) is preventive in horses, and affected animals can only be treated by correcting the existing imbalance. Even severe lesions may disappear in time with proper treatment. Cereal hay may be supplemented with alfalfa or clover hay, or finely ground limestone (30 g daily) should be fed. Dicalcium phosphate and bone meal are not as efficient because of their additional content of phosphorus.

## FURTHER READING

Stewart J, et al. Bighead in horses—not an ancient disease. *Aust Equine Vet.* 2010;29:55-62.

## REFERENCES

1. Toribio RE. *Vet Clin Equine.* 2011;27:129.
2. Braun U, et al. *Vet Rec.* 2009;164:211.
3. John E, et al. *Intas Polivet.* 2007;8:458.
4. Stewart J, et al. *Aust Equine Vet.* 2010;29:55.

## "BOWIE" OR "BENTLEG" IN LAMBS

Bowie is a disease of lambs of unknown etiology characterized by carpus valgus, and less commonly carpus varus, resulting in a lateral displacement of the carpus and medial displacement of the hooves. The lesions differ from those of rickets. It has been observed only on unimproved range pasture in New Zealand and in South Africa. The cause is unknown, although phosphorus deficiency has been suggested. A similar syndrome has been produced by the feeding of wild parsnip (*Trachemene glaucifolia*) and, experimentally, by the feeding of a diet low in both calcium and phosphorus. There is no clear genetic component to the disease in South Africa.

Improvement of the pasture by top dressing with superphosphate and sowing-improved grasses is usually followed by disappearance of the disease. Only sucking lambs are affected, and cases occur only in the spring at a time when rickets does not occur. Up to 40% of a group of lambs can be affected without breed differences in

incidence. Signs of the disease can be evident at 3 to 4 weeks of age.

The disease has also been reported from South Africa, where it occurs primarily in ram lambs and develops from as early as 3 months up to 1 year of age. There is gradual bending of the forelimbs, with the hooves turned inward and the carpal joints turned outward. Animals of the South African Mutton Merino breed had significantly higher plasma phosphorus concentrations than those of the Merino and Dohne Merino breeds. The plasma calcium:phosphorus ratio was lower in affected lambs and their ewes, and this converse ratio is thought to result in an induced plasma ionized calcium deficiency leading to improper calcification of bone.

Some tenderness of the feet and lateral curvature at the knees can be seen as early as 2 to 3 weeks of age, and marked deformity is present at 6 to 8 weeks, with maximum severity at weaning. The forelimbs are more commonly affected than the hindlimbs. Carpus varus occurs in rare cases. The sides of the feet become badly worn, and the lateral aspects of the lower parts of the limbs can be injured and be accompanied by lameness. The lambs grow well at first, but by the time of weaning, affected lambs are in poor condition because of their inability to move about and feed properly. A rather similar syndrome has been observed in young Saanen bucks, but the condition showed a tendency to recover spontaneously.

At necropsy lesions are restricted to the radius and metacarpus with medial collapse of the distal radial epiphysis and consequent carpus valgus. There is often excessive synovial fluid in the carpal joints; in the later stages, there are articular erosions. Increased deposition of osteoid is not observed.

Supplementation of the diet with phosphorus or improvement of the pasture seems to reduce the incidence of the disease. Dosing with vitamin D or providing mineral mixtures containing all trace elements is ineffective.

## DEGENERATIVE JOINT DISEASE AND OSTEOARTHRITIS

Degenerative joint disease in food animals describes severe, progressive, nonseptic arthropathy in growing animals that is the result of one or more processes that lead to damage to articular cartilage and consequent osteoarthritis. The insult can be to cartilage or underlying bone as a result of metabolic, nutritional, congenital, or traumatic causes but can be difficult to identify because the insult to tissues causing the disease usually occurs weeks to months before clinical signs of disease. Degenerative joint disease can affect almost any diarthrodial joint. The most severe disease occurs when affected joints are loaded with weight.<sup>1</sup> The disease is well documented and researched in racehorses in

which it is the end result of damage to articular cartilage.<sup>2,3</sup>

According to some studies, greater than 90% of steers are affected by osteoarthritis, and it is an important cause of infertility in beef bulls.<sup>4</sup> The disease is most often seen in the stifle joint, where the predilection sites are the medial and lateral condyles and the patellar groove. Most lesions are bilateral.<sup>1,4,5</sup>

Degenerative arthropathy occurs in cattle of all breeds but reaches its highest incidence as a sporadic disease of young beef bulls. The disease has been identified as hip dysplasia because of the preexisting shallow contour of the acetabulum. It is considered to be inherited as a recessive characteristic and exacerbated by rapid weight gain in young animals. The occurrence of the condition in these animals is usually associated with rearing on nurse cows, housing for long periods, provision of a ration high in cereal grains and byproducts (i.e., a high phosphorus:calcium ratio), and possibly with an inherited straight conformation of the hindlegs. Although the disease occurs in all beef breeds, there is a strong familial tendency that appears to be directly related to the rate of body-weight gain and the straightness of the hindleg. If the potential for rapid weight gain is being realized in animals being force fed, the rate of occurrence appears to be dependent on their breeding, and animals in the same herd that are allowed to run at pasture under natural conditions are either not affected or are affected at a much later age. Thus animals in a susceptible herd can show signs as early as 6 months of age if they are heavily handled and raised on dairy cow foster mothers. In the same herd, signs do not appear until 1 to 2 years of age if supplementary feeding is not introduced until weaning and not until 4 years if there is no significant additional feeding.

Clinically there is a gradual onset of lameness in one or both hindlegs. The disease progresses, with the lameness becoming more severe over a period of 6 to 12 months. In some animals, there is a marked sudden change for the worse, usually related to violent muscular movements, as in breeding or fighting. In severely affected animals, the affected limb is virtually useless; on movement, distinct crepitus can often be felt and heard over the affected joints. This can be accomplished by rocking the animal from side to side or having it walk while holding the hands over the hip joints.

An additional method of examination is to place the hand in the rectum close to the hip joint while the animal is moved. Passive movement of the limb may also elicit crepitus or louder clinking or clicking sounds. The hip joints are always most severely affected, but in advanced cases, there may be moderate involvement of the stifles and minimal lesions in other joints. Affected animals lie down most of the time and are reluctant to



rise and to walk. The joints are not swollen, but in advanced cases, local atrophy of muscles may be so marked that the joints appear to be enlarged. There is a recorded occurrence in which the lesions were confined mainly to the front fetlocks.

Radiographic examination can provide confirmatory or diagnostic evidence but is restricted to facilities with equipment suited to these examinations.

At **necropsy**, the most obvious finding is extensive erosion of the articular surfaces, often penetrating to the cancellous bone, and disappearance of the normal contours of the head of the femur or the epiphyses in the stifle joint. The synovial cavity is distended, with an increased volume of brownish, turbid fluid; the joint capsule is much thickened and often contains calcified plaques. Multiple small exostoses are present on the periarticular surfaces. When the stifle is involved, the cartilaginous menisci, particularly the medial one, are very much reduced in size and may be completely absent. In cattle with severe degenerative changes in the coxofemoral joint, an acetabular osseous bulla may be present at the cranial margin of the obturator foramen.<sup>1</sup>

Adequate calcium, phosphorus, and vitamin D intake and a correct calcium:phosphorus ratio in the ration should be ensured. Supplementation of the ration with copper at the rate of 15 mg/kg has also been recommended for the control of a similar disease.

Degenerative joint disease of cattle is recorded on an enzootic scale in Chile and is thought to be attributable to gross nutritional deficiency. The hip and tarsal joints are the only ones affected, and clinical signs appear when animals are 8 to 12 months old. There is gross lameness and progressive emaciation. An inherited osteoarthritis is described under that heading. Sporadic cases of degenerative arthropathy, with similar signs and lesions, occur in heavy-producing, aged dairy cows and are thought to be caused by long-continued negative calcium balance. Rare cases also occur in aged beef cows but are thought to be associated with an inherited predisposition. In both instances the lesions are commonly restricted to the stifle joints.

Degenerative arthropathy of the distal interphalangeal joints and sesamoid bones occurs in calves (Fig. 15-14). Affected animals have moderate to severe lameness of one or both forelimbs but no discernible distension of the joint. Treatment is palliative, involving administration of NSAIDs (meloxicam or phenylbutazone, where permitted by regulatory authorities) or surgery.<sup>6</sup>

Osteoarthritis occurs in the stifle joint of dairy breed bulls. Seventy-two percent (39/54) of stifle joints and 85% (23/27) of dairy bulls 31 to 60 months of age had at least one gross lesion, and 94% of the lesions were localized to the distal end of the femur, with the patellar groove and the lateral trochlear ridge being predilection sites.



**Fig. 15-14** Degenerative joint disease (arrow) affecting P2 to P3 of a calf. (Reproduced with permission.<sup>6</sup>)

Osteoarthritis of one or both temporomandibular joints occurs in ~1.3% of Soay sheep on the island of St. Kilda, being more common in older ewes.<sup>7</sup> Osteoarthritis also occurs in the elbows of sheep.<sup>8</sup> It can be bilateral, in which case the sheep have a characteristic stance with both hindfeet placed more cranially, under the abdomen, apparently in an effort to reduce weight-bearing by the forelegs. There is no definitive treatment.<sup>8</sup>

#### FURTHER READING

Nichols S, Larde H. Noninfectious joint disease in cattle. *Vet Clin North Am Food A.* 2014;30:205-220.

#### REFERENCES

1. Heinola T, et al. *J Comp Pathol.* 2013;148:335.
2. McCoy AM. *Vet Pathol.* 2015;52:803.
3. Nichols S, et al. *Vet Clin North Am Food A.* 2014;30:205.
4. Persson Y, et al. *Acta Vet Scand.* 2007;49.
5. Heinola T, et al. *Vet J.* 2014;200:88.
6. Mulon P-Y, et al. *JAVMA.* 2009;234:794.
7. Arthur C, et al. *Vet J.* 2015;203:120.
8. Scott PR. *Vet Rec.* 2001;149:652.

#### MANGANESE DEFICIENCY

A dietary deficiency of manganese (Mn) can cause skeletal deformities, both congenitally and after birth, and infertility.

#### ETIOLOGY

A primary deficiency occurs endemically in some areas because of a geological deficiency of manganese in the local rock formations. Apart from a primary dietary deficiency of manganese, the existence of factors depressing the availability of ingested manganese is suspected. An excess of calcium and/or phosphorus in the diet increases the requirements of manganese in the diet of calves and is considered to reduce the availability of dietary manganese to cattle generally.

Congenital chondrodystrophy in calves has been associated with a manganese deficiency, and there are outbreaks of congenital skeletal defects in calves suspected to be attributable to manganese deficiency.<sup>1-3</sup>

#### EPIDEMIOLOGY

Soils containing less than 3 mg/kg of manganese are unlikely to be able to support normal fertility in cattle. In areas where manganese-responsive infertility occurs, soils on farms with infertility problems have contained less than 3 mg/kg of manganese, whereas soils on neighboring farms with no infertility problems have had levels of more than 9 mg/kg. A secondary soil deficiency is thought to occur, and one of the factors suspected of reducing the availability of manganese in the soil to plants is high alkalinity. Thus

heavy liming is associated with manganese-responsive infertility. There are three main soil types on which the disease occurs:

- Soils low in manganese, which have low output even when pH is less than 5.5
- Sandy soils, where availability starts to fall
- Heavy soils, where availability starts to fall at a pH of 7.0

Many other factors are suggested as reducing the availability of soil manganese, but the evidence is not conclusive. For example, heavy liming of soils to neutralize sulfur dioxide emissions from a neighboring smelter is thought to have reduced the manganese intake of grazing animals.

Herbage on low-manganese soils, or on marginal soils where availability is decreased (possibly even soils with normal manganese content), is low in manganese. A number of figures are given for critical levels. It is suggested that pasture containing less than 80 mg/kg of manganese is incapable of supporting normal bovine fertility, and that herbage containing less than 50 mg/kg is often associated with infertility and anestrus. The Agricultural Research Council believes that although definite figures are not available, levels of 40 mg/kg DM in the diet should be adequate. Other authors state that rations containing less than 20 mg/kg DM may cause anestrus and reduction in conception rates in cows and the production of poor-quality semen by bulls. Most pasture contains 50 to 100 mg/kg DM. Skeletal deformities in calves occur when the deficiency is much greater than that just noted; for example, a diet containing more than 200 mg/kg DM is considered to be sufficient to prevent them.

Rations fed to pigs usually contain more than 20 mg/kg DM of manganese, and deficiency is unlikely unless there is interference with manganese metabolism by other substances.

There are important variations in the manganese content of seeds, an important matter in poultry nutrition. Maize and barley have the lowest content. Wheat or oats have 3 to 5 times as much, and bran and pollard are the richest natural sources, with 10 to 20 times the content of maize or wheat. Cows' milk is exceptionally low in manganese.

Diets high in iron reduce duodenal activity of manganese transporters in calves, although the clinical importance of this finding is unclear.<sup>4</sup>

### PATHOGENESIS

Manganese plays an active role in bone-matrix formation and in the synthesis of chondroitin sulfate, which is responsible for maintaining the rigidity of connective tissue. In manganese deficiency, these are affected deleteriously, and skeletal abnormalities result. Only 1% of manganese is absorbed from the diet, and the liver removes most of it, leaving very low blood levels of the element.

### CLINICAL FINDINGS

In cattle, the common syndromes in confirmed or suspected manganese deficiency are infertility, stillbirth, perinatal loss, calves with congenital limb deformities, and calves that manifest poor growth, dry coat, and loss of coat color.<sup>2,3</sup> The deformities include knuckling over at the fetlocks, enlarged joints, and, possibly, twisting of the legs. The bones of affected lambs are shorter and weaker than normal, and there are signs of joint pain, hopping gait, and reluctance to move.

Heifers fed a low-manganese diet (16 mg Mn per kg DM of diet) during pregnancy had impaired fetal growth and development evident as lower birth weight than calves from heifers fed 50 mg of Mn per kg DM, superior brachygnathism, unsteadiness, disproportionate dwarfism, and swollen joints.<sup>5</sup> A severe congenital chondrodystrophy in Charolais calves occurred on one farm. The limbs were shortened and the joints enlarged. The pregnant cows were fed on apple pulp and corn silage, both of which were low in manganese.

An outbreak of congenital skeletal malformations in Holstein calves was characterized clinically by small birth weights (average 15 kg). Abnormalities included joint laxity, doming of the foreheads, superior brachygnathia, and a dwarflike appearance as a result of the short length of the long bones. The features of the head were similar to those of the wildebeest. The majority of affected calves were dyspneic at birth, and snorting and grunting respiratory sounds were common. Affected calves failed to thrive, and most were culled because of poor performance.

A manganese-responsive infertility has been described in ewes and is well known in cattle. In cattle, it is manifested by slowness to exhibit estrus and failure to conceive, often accompanied by subnormal size of one or both ovaries. Subestrus and weak estrus have also been observed.

Functional infertility was once thought to occur in cattle on diets with calcium-to-phosphorus ratios outside the range of 1:2 to 2:1. This was not upheld on investigation but might have been correct if high calcium-to-phosphorus intakes directly reduced manganese (or copper or iodine) availability in diets marginally deficient in one or other of these elements.

In pigs, experimental diets low in manganese cause reduction in skeletal growth; muscle weakness; obesity; irregular, diminished, or absent estrus; agalactia; and resorption of fetuses or the birth of stillborn pigs. Leg weakness, bowing of the front legs, and shortening of bones also occur.

### CLINICAL PATHOLOGY

The blood of normal cattle contains 18 to 19 µg/dL (3.3 to 3.5 µmol/L) of Mn, although considerably lower levels are sometimes

quoted. The livers of normal cattle contain 12 mg/kg (0.21 mmol/kg) of Mn and down to 8 mg/kg (0.15 mmol/kg) in newborn calves, which also have a lower content in hair. The Mn content of hair varies with intake. The normal level is about 12 mg/kg (0.21 mmol/kg), and infertility is observed in association with levels of less than 8 mg/kg (0.15 mmol/kg). In normal cows, the Mn content of hair falls during pregnancy from normal levels of 12 mg/kg (0.21 mmol/kg) in the first month of pregnancy to 4.5 mg/kg (0.08 mmol/kg) at calving. All of these figures require much more critical evaluation than they have received before they can be used as diagnostic tests.

Although tissue manganese levels in normal animals have been described as being between 2 and 4 mg/kg (0.04 and 0.07 mmol/kg), in most tissue there appears to be more variation between tissues than this. However, tissue levels of manganese do not appear to be depressed in deficient animals, except for in the ovaries, in which levels of 0.6 mg/kg (0.01 mmol/kg) and 0.85 mg/kg (0.02 mmol/kg) are recorded in contrast to a normal level of 2 mg/kg (0.04 mmol/kg).

Thus, there is no simple, single diagnostic test permitting detection of manganese deficiency in animals. Reproductive functions, male and female, are most sensitive to manganese deficiency and are affected before possible biochemical criteria (e.g., blood and bone alkaline phosphatase, and liver arginase levels) are significantly changed. The only certain way of detecting moderate deficiency states is by measuring response to supplementation. Clinical findings in response to treatment that may provide contributory evidence of manganese deficiency are set out in the following discussion.

### NECROPSY FINDINGS

In congenital chondrodystrophy in calves, the limbs are shortened, and all the joints are enlarged. Histologically, there is poor cartilage maturation with excessive amounts of rarefied cartilage matrix. The major histologic abnormality in the physes is disorderly development of the zones of cartilage hypertrophy, with reduced number and irregular arrangement of hypertrophic chondrocytes; similar but less severe changes are present in the zones of cartilage proliferation.<sup>3</sup> There are degenerative changes in the chondrocytes and severe reduction in the mucopolysaccharide content of all body hyaline cartilage.

### TREATMENT AND CONTROL

The NRC estimated the maintenance requirement (0.002 of available Mn/kg BW) of dairy cows from dietary concentrations of Mn reported to cause Mn deficiency in cattle. Based on NRC of 2001 equations, the maintenance requirement for Mn

represents 82% of the total Mn requirement for a nonlactating, late-gestation cow and 53% for a cow producing 40 kg/d of milk. Fecal loss of endogenous Mn is assumed to comprise the entire maintenance requirement. Assuming typical dry matter intake (DMI), a diet with approximately 14 mg Mn/kg DM will meet the requirement for a 700-kg nonlactating cow during the last month of lactation. Recent research has determined that Mn intake had to equal 580 mg/d to meet the metabolic fecal Mn requirement. The corresponding dietary concentrations, assuming DMIs of 21 and 12 kg/d for lactating and dry cows, respectively, were 28 and 49 mg/kg DM. These concentrations are approximately 1.6 and 2.7 times higher than those needed to meet the Mn requirements for lactating and dry cows, respectively, as calculated using the 2001 NRC dairy nutrient requirements model. Supplementation of 50 mg of Mn/kg of DM to the control diet of heifers was sufficient to overcome any signs of Mn deficiency in calves; the control diet contained ~17 mg Mn per kg DM.<sup>5</sup>

For pigs, the recommended dietary intakes are 24 to 57 mg manganese per 45 kg BW. Expressed as a proportion of food intake, the recommended dietary level is 40 mg/kg DM in feed. The manganese requirements for gestation and lactation are 20 ppm of the diet.

Supplementation with high levels of manganese to cattle fed a copper-deficient diet can further impair copper absorption, with consequent reductions in the growth and health of cattle.<sup>6</sup>

## REFERENCES

1. Anon. *Vet Rec.* 2013;172:389.
2. Cave JG, et al. *Aust Vet J.* 2008;86:130.
3. McLaren PJ, et al. *Vet Pathol.* 2007;44:342.
4. Hansen SL, et al. *J Dairy Sci.* 2010;93:656.
5. Hansen SL, et al. *J Dairy Sci.* 2006;89:4305.
6. Hansen SL, et al. *Brit J Nutr.* 2009;101:1068.

## BIOTIN (VITAMIN H) DEFICIENCY (HYPOBIOTINOSIS)

Biotin, or vitamin H, has several important biochemical functions. It is a cofactor in several enzyme systems involved in carboxylation and transcarboxylation reactions and consequently has a significant effect on carbohydrate metabolism, fatty acid synthesis, amino acid deamination, purine synthesis, and nucleic acid metabolism. Biotin is found in almost all plant and animal materials and, being required in very small quantities, is unlikely to be deficient in diets under natural conditions, especially because microbial synthesis occurs in the alimentary tract.

### Cattle

Biotin is now considered a significant factor in lameness of cattle.<sup>1-5</sup> Biotin is important

for the differentiation of epidermal cells, which are required for normal production of keratin and hoof horn tissue. Biotin also acts as a cofactor in carboxylase enzymes and is an important factor in both gluconeogenesis and fatty acid synthesis. Significant differences in the fatty acid profile of horn tissue of cattle with claw lesions have been observed. Biotin supplementation reduces clinical white-line disease, reduces horn lesions, and improves horn quality by strengthening the intercellular cementing material between keratinocytes. Improved hoof integrity in intensively managed dairy cows has occurred following biotin supplementation. However, a long period of supplementation is required before the effect of the vitamin on hoof health care is expressed. In addition, there can be improved milk production, milk composition, and cow fertility with biotin supplementation, although this finding is not consistent across studies.<sup>6</sup>

Biotin is synthesized in the rumen, and absolute biotin deficiency has not been recognized. However, ruminal synthesis of biotin may be compromised by acidic conditions in the rumen, which may increase the need for supplementation of biotin in the diet of high-producing dairy cows. In the dairy cow in the periparturient period and early lactation, the levels of biotin may decrease. A decrease in plasma biotin levels of dairy cows at 25 days in milk (DIM) has been noted, returning to constant levels from 100 DIM until the end of lactation. Feeding supplemental biotin at 20 g/d during the last 16 days postpartum and at 30 g/d from calving through to 70 days postpartum elevated concentrations of plasma and milk compared with cows unsupplemented with biotin. Supplemental biotin also elevated plasma glucose and lowered nonesterified fatty acids, which indicates that supplemental biotin is involved in hepatic gluconeogenesis. The triacylglycerol concentration in liver tended to decrease at a faster rate within 2 days after parturition.

Supplementation of young, extensively managed cattle with 12.5 mg of diluted powdered biotin, or a control treatment, for 40 consecutive days revealed an effect of biotin to increase average hoof growth of 11.3 +/- 0.72 mm in supplemented cattle versus 7.2 +/- 0.78 mm over the 40 days.<sup>2</sup> There was a positive effect of biotin supplementation on the growth of the angle and length of the dorsal hoof wall and the hoof sole length, and on resistance to wearing, in young, extensively managed cattle.<sup>2</sup> The supplementation of Holstein cows in the Atherton Tablelands in Australia with biotin at 20 mg/head per day resulted in improved locomotion scores compared with unsupplemented cows. In the wet summer period, the number of lame cows observed by the farmer was significantly fewer during the rainy period for the biotin-supplemented herds, and animals in the herd required

fewer antibiotic treatments than unsupplemented herds. Most hoof lesions were most commonly observed in the outer claws of the hindlimb.

In a randomized control field trial on five commercial dairy farms in Gloucestershire, southwest United Kingdom, the effect of parity and duration of supplementation with oral biotin at 20 mg/d on white-line disease was studied over a period of 18 months. The incidence of white-line disease increased with increasing parity independent of biotin supplementation from 2 cases per 100 cow-years in primiparous cows to 15.5 cases per 100 cow-years in all multiparous cows, but up to 47.7 cases per 100 cow-years for cows in parities = 5. Supplementation with biotin reduced white-line disease lameness by 45% in multiparous cows down to 8.5 cases per 100 cow-years, whereas the effect of biotin supplementation in primiparous cows was not significant. A supplementation of length of at least 6 months was required to reduce the risk of white-line lameness in multiparous cows. The overall incidence rate of lameness (per 100 cows per year) was 68.9, with a range of 31.6 to 111.5 per farm. The incidence rates of the four most frequently reported causes of lameness were sole ulcer, 13.8; white-line separation, 12.7; digital dermatitis, 12.0; and interdigital necrobacillosis, 7.1 per 100 cows per year. The incidence of lameness was highly variable between farms. However, when the data from all farms were pooled, the risk of lameness caused by white-line separation in cattle supplemented with biotin was approximately 50%. Approximately 130 days of biotin supplementation is required before a significant difference in white-line lesion lameness occurs.

A controlled 14-month field trial evaluated the effect of biotin supplementation on hoof lesions, milk production, and reproductive performance of dairy cows housed in the same free-stall facility with the same environment, base diet, and management. Supplemented cows received 20 mg/d by computer feeder. The feet of a select number of cows were trimmed three times at 6-month intervals, and hoof health was evaluated. At the final hoof trimming, the incidence of sole hemorrhages was significantly higher in the control group (50%) compared with the supplemented group (24%). No cases of lameness occurred. Milk production and fat yield increased in all parities, and fertility was improved in first-calf heifers.

It is possible that biotin improves the quality of claw horn, which encourages the replacement of defective horn, improves healing, and makes it less likely for sole lesions to develop from laminitis in its early stages. The administration of biotin at 40 mg per day for 50 days to dairy cows with uncomplicated sole ulcers resulted in significant improvement in histologic horn quality of the newly formed epidermis covering the sole ulcer. Biotin supplementation at 20 mg/d



did not affect the tensile strength of the white line.

Vertical fissures, or sand cracks, are vertical cracks of the hoof that may extend across the coronary band and continue to the bearing surface of the dorsal wall of the claw. Sand cracks are common in beef cattle in western Canada. One survey, 37.5% of beef cows were affected with one or more cracks. Supplementary dietary biotin at 10 mg/head per day significantly increased serum levels of biotin and increased claw hardness compared with unsupplemented cows. After 18 months, 15% of the biotin-supplemented cows had vertical fissures compared with 35% in the unsupplemented cows.

### Sheep

There is evidence from a small number of studies that biotin supplementation of the diets of sheep improves hoof health.<sup>7</sup>

### Pigs

The principal source of biotin for the pig is the feed it receives, and feeds vary greatly in their biotin content and in the biological availability of that biotin. Diets based on cereals with a low available biotin content may provide insufficient dietary biotin for the maintenance of hoof horn integrity in pigs. The biotin content in basal diets fed to pigs has varied from 29 to 15 µg/kg available biotin, and supplementation of these diets has resulted in improvements in litter size. Continuous feeding of sulfonamides or antibiotics may induce a deficiency. An antivitamin to biotin (avidin) occurs in egg white, and biotin deficiency can be produced experimentally by feeding large quantities of uncooked egg white.

In pigs, experimental biotin deficiency is manifested by alopecia, dermatitis, and painful cracking of the soles and the walls of the hooves.

Naturally occurring outbreaks of lameness in gilts and sows associated with lesions of the soles and the walls of the hooves, which responded to biotin supplementation, have now been well described. The severe lameness and long course of convalescence have been responsible for a high rate of culling in breeding animals. In gilts fed a basal diet with a low level of biotin (32 µg available biotin/kg) from 25 kg live weight to 170 days of age, there were no significant differences in the number of lesions and claws affected compared with gilts fed a biotin-supplemented diet (350 µg available biotin/kg). However, between 170 days of age and the first weaning, the incidence of hoof lesions increased markedly. Over the next four litters, the incidence of lesions increased with the age of the sow. The predominant lesions in the foot were cracks, which occurred mainly in two associated regions: the heel/toe junction and the heel and the sidewall and adjacent white-line region of the toe. Supplementation of the diet of

breeding sows with biotin at an early stage of development makes a significant contribution to the maintenance of horn integrity.<sup>8</sup>

Affected animals become progressively lame after being on a biotin-deficient ration for several months. Arching of the back and a haunched stance with the hindlegs positioned forward occurs initially. This posture has been described as a “kangaroo-sitting” posture. The foot pads become softer and the hoof horn less resilient. The feet are painful, and some sows will not stand for breeding. Deep fissures at the wall-sole junction may extend upward beneath the wall horn, and gaping cracks may separate the toe and heel volar surfaces. The foot pads initially show excessive wear; later, longitudinal painful cracks develop. In well-developed cases, the foot pads appear enlarged, and the cracks are obvious and covered by necrotic debris. The foot pads of the hindfeet are usually more severely affected than those of the forefeet, and the lateral digit is more frequently affected. The dewclaws also are affected by cracks and the accumulation of necrotic tissue.

Skin lesions also develop in affected gilts and sows. There is gradual alopecia, particularly over the back, the base of the tail, and the hindquarters. The hairs are more bristly than normal and break easily. The alopecia is accompanied by a dryness of the skin.

As the lesions of the feet and skin develop there is a marked drop in the serum biotin concentrations, which is considered as a sensitive index of biotin deficiency. Adequate biotin status may be indicated by serum biotin levels (ng/L) greater than 700; marginal, 600 to 700; inadequate, 400 to 600; and deficient, below 400. Compression and hardness tests made on external hoof have also been used as an indirect measure of biotin adequacy in pigs. The tests indicate that significant improvements in the strength and hardness of pig hoof horn are produced by biotin. Supplementation of the diet with biotin does not affect either horn growth or wear rates. Biotin supplementation does affect the structure of the coronary epidermis; there is an increase in the density of the horn tubules in the stratum medium, the horny squames in the stratum medium are more tightly packed, and the tubules are more clearly defined.

Reproductive performance of sows is also influenced by their biotin status. Supplementation of the diet with biotin may increase litter size, increase the number of pigs weaned, decrease the mean interval in days from weaning to service, and improve conception rate. Over a period of four parities, piglet production increased by 1.42 pigs/sow year.

### Biotin Requirements

#### Pigs

The daily requirements of biotin for pigs have not been well defined, but certain

amounts have been associated with an absence of lameness and improved reproductive performance. Basic diets for gilts contain 35 to 50 µg/kg, and the addition of 350 to 500 µg/kg is recommended. This provides a daily intake of 4.0 to 5.0 mg/sow per day. The response to dietary supplementation may take several months; therefore, supplementation should begin at weaning. The details of biotin studies in pigs, including experimental deficiency, the absorption and synthesis of biotin, biotin availability in feedstuffs, and the biotin requirements of the growing pig, are available.

Supplementation of a basal diet, calculated to contain 56 µg/kg available biotin with daily allowances of biotin at 1160 µg/sow per day in pregnancy and 2320 µg/sow per day in lactation, produced significant improvements in litter size in second- and fourth-parity sows. It is suggested that the requirement is in excess of 175 µg available biotin per 1 kg of diet. In a swine herd with a lameness problem, the supplementation of the sow's ration during pregnancy and lactation with daily intakes of biotin of 400 and 800 µg/sow per day, respectively, and the rations of the weaners and growers to 150 and 250 was effective.

### Horses

The dietary supplementation of horses with 10 to 30 mg biotin/d for 6 to 9 months is considered to be effective as an aid in the treatment of weak horn hoof in horses. The hoof horn quality of more than two-thirds of the Lippizaner horses had moderate to severe changes: microcracks visible in the transition from the middle to the inner zone of the coronary horn; separation of the sole from the coronary horn in the region within the white zone. Biotin supplementation for 19 months improved horn quality. Continuous dietary supplementation with biotin at a daily dose of 20 mg is necessary to improve and maintain hoof horn quality in horses with less-than-optimum-quality hooves.

### REFERENCES

1. Barker ZE, et al. *Animal Welfare*. 2012;21:563.
2. Franco da Silva LA, et al. *Can Vet J*. 2010;51:607.
3. Lean IJ, et al. *Livestock Sci*. 2013;156:71.
4. Osorio JS, et al. *J Dairy Sci*. 2012;95:6388.
5. Randhawa SS, et al. *Vet Res Comm*. 2008;32:599.
6. Ferreira G, et al. *J Dairy Sci*. 2007;90:1452.
7. Bampidis VA, et al. *Anim Feed Sci Tech*. 2007;134:162.
8. van Riet MMJ, et al. *Livestock Sci*. 2013;156:24.

## Toxic Agents Affecting the Musculoskeletal System

### HYENA DISEASE OF CATTLE

Hyena disease of cattle occurs worldwide and is characterized clinically by a lateral body appearance similar to the hyena. The

cause is unknown for some cases, but sustained excessive intake of vitamin A and vitamin D<sub>3</sub> in young calves appears to be the most likely cause of hyena disease by suppressing differentiation and proliferation in chondrocytes and osteoblasts. This effect is clinically detectable because of **premature closure of the physis of long bones**. A small number of cases may be a result of systemic viral disease of young calves.

In some naturally occurring cases in yearlings from one large dairy herd, approximately 1% of calves were affected annually. Affected calves had received vitamins A and D<sub>3</sub> immediately after birth, and from birth to weaning they received the same vitamins from fresh milk, whole corn, a customized feed mix, and a milk supplement. The mean daily intake of vitamin A from birth to 6 weeks of age was approximately 80,000 IU and 6,300 IU of vitamin D<sub>3</sub>, and progressively less vitamin A and D<sub>3</sub> was fed from 6 weeks until weaning at 3 months. The NRC recommendations for daily vitamin intake are 2100 IU of vitamin A at birth, increasing to 6360 IU at 2 months, and 330 IU of D<sub>3</sub>, increasing to 990 IU over the same period. Experimentally, the IM injection of vitamins A and D (2,000,000 IU and 300,000 IU, respectively) on the first day after birth followed by 30,000 IU/kg BW added to the milk replacer daily resulted in gross lesions in the proximal tibial growth plates in 3 weeks. Excessive amounts of vitamin D<sub>3</sub> appear to promote the primary effect of vitamin A on premature closure of the physis. For example, daily administration of vitamin A (30,000 IU/kg BW) in milk replacer fed to lambs resulted in premature closure of the distal growth plate in the femur and proximal growth plate in the tibia, but clinical signs of hyena disease were not detected.<sup>1</sup>

The premature closure of the growth plates of the long bones results in a marked dissimilarity in growth and development between the forequarters and the hindquarters, the latter being comparatively underdeveloped. This gives the animal the classic contours of the hyena, and this resemblance is heightened by a crest of thick, stiff bristles along the back in the midline. An aggressive attitude also develops. Affected calves are normal at birth and only develop the abnormality at 5 to 6 months of age. The femur and tibia are shorter in affected than in normal animals. There are accompanying difficulties of locomotion, with a tendency to fall sideways, and to frequently adopt a position of lateral recumbency. The gait is described as “bunny-hopping.”

German Simmental, Charolais, Black Pied, German Holstein–Friesian, and German Red Pied cattle have been involved. Genetic analysis appears to indicate that the disease is inherited as a simple recessive trait with incomplete penetrance, but this is obviously not so in some herds.

The lesion is a chondrodystrophy affecting particularly the long bones and the lumbar vertebrae. Gross examination and radiography of the longitudinal slabs of the humeri, tibiae, and femurs reveal focal to almost complete closure of the physes, with physes subjected to compression being more severely affected more than those subjected to tension.

#### FURTHER READING

- Espinasse J, Parodi AL, Constantin A, Viso M, Laval A. Hyena disease in cattle: a review. *Vet Rec*. 1986;118:328-330.
- Rothenberg AB, Berdon WE, Woodard JC, Cowles RA. Hypervitaminosis A-induced premature closure of the epiphyses (physeal obliteration) in humans and calves (hyena disease): a historical review of the human and veterinary literature. *Pediatr Radiol*. 2007;37:1264.

#### REFERENCE

1. Azimpour S, Mortazavi P. *Comp Clin Pathol*. 2013;22:941.

### CALCINOGENIC GLYCOSIDE POISONING (ENZOOTIC CALCINOSIS)

#### SYNOPSIS

**Etiology** Ingestion of calcinogenic glycosides in a few specific poisonous plants.

**Epidemiology** Enzoootic disease in all species in regions where toxic plants occur.

**Clinical pathology** Elevated blood calcium and phosphorus concentration; tissue calcification visible on x-ray.

**Lesions** Calcification of all tissues; degenerative arthritis in all limb joints.

**Diagnostic confirmation** Identification of specific plant.

**Treatment** None.

**Control** Remove and keep animals away from toxic plants.

#### ETIOLOGY

Calcinogenic glycosides occur in very small quantities in plant leaves. The aglycone (non-sugar) radical is a vitamin D<sub>3</sub> sterol, a 1,25-(OH)<sub>2</sub>D<sub>3</sub>-like compound. Hydrolysis of the glycoside releases the vitamin D<sub>3</sub> analog, causing the development of calcification of soft tissues, similar to hypervitaminosis D. The plants in which these glycosides have been identified are *Solanum malacoxylon* (i.e., *S. glaucophyllum*, *S. glaucum*, *S. glaucescens*, *S. glaucumfrutescens*), *Nierembergia veitchii*, and *Cestrum diurnum* (wild jessamine).<sup>1</sup>

Other plants in which the presence of calcinogenic glycosides is suspected are *Stenotaphrum secundatum* (crab grass) in Jamaica, *S. linnaeanum* (= *S. hermannii*, *S. sodomaeum*; apple of Sodom), *S. torvum* (devil's fig), and *Trisetum flavescens* (yellow or golden oat grass) in Europe.<sup>1,2</sup>

The plants are weeds of pasture and are readily eaten by livestock, especially in drought years when other forage is scarce.<sup>2</sup> The glycosides are very stable and resist drying and storage for periods of longer than a year. Heating reduces the toxicity of *Solanum malacoxylon* significantly but has little effect on that of *Trisetum flavescens*.

#### EPIDEMIOLOGY

##### Occurrence

Enzoootic calcinosis and its causative plants occur in most countries. The disease associated with *Solanum* spp. occurs in tropical and subtropical regions, including Africa, Argentina, Brazil, Cuba, Papua New Guinea, the West Indies, and Hawaii. *Cestrum diurnum* poisoning occurs in the far southern United States, especially Florida, Texas, and California. Tentative diagnoses have been made in India and Israel. In Jamaica the disease is known as “Manchester wasting disease,” in Hawaii as “naalehu,” and in South America as “espichamento” or “enteque seco.”

In Austria and Germany, *T. flavescens* is a common component of alpine pasture and is associated with the onset of signs about 18 months after cattle are put onto the infested pasture. Resident cattle show clinical signs at about 3 years of age. The grass is most toxic when it is young, and the clinical signs are worse when the cattle are at pasture.

##### Risk Factors

##### Animal Risk Factors

Both sexes and all ages of all animal species are affected—ruminants most commonly, horses less so. Pigs and sucking lambs are least susceptible.

#### PATHOGENESIS

The glycoside ingested in the plant is hydrolyzed by rumen microbes, intestinal mucosal enzymes, and bone cells to form the vitamin D<sub>3</sub> analog.<sup>2</sup> Absorption of the active substance results in a dramatic increase in the uptake of calcium from the diet. Blood levels of calcium are markedly increased, and this is followed by deposition of calcium in soft tissues. The mode of action of the glycoside is similar to that of 1,25-dihydroxycholecalciferol.

#### CLINICAL FINDINGS

The disease is chronic and may persist for several years. It is characterized by wasting, reluctance to walk, a stiff gait, constant shifting of the weight from foot to foot, and a disinclination to get up or to lie down.<sup>1,2</sup> Forced exercise is associated with severe distress; some animals may become aggressive. Affected animals stand for long periods with the back arched and the legs stiffly extended. Calcification of blood vessels may be palpable, for example, during rectal examination. Cardiac murmurs are audible. Clinical signs subside if the animals are removed from the causative feed, but resorption of calcium

deposits in tissues is minimal even years after removal from the affected pastures. Animals left on the toxic pasture eventually become recumbent and die. Fetuses may be affected.

### CLINICAL PATHOLOGY

Serum concentrations of calcium and phosphorus increase by 20% to 25%, with increases of up to 3.4 mmol/L of calcium and 4 mmol/L of phosphorus.<sup>2</sup> Tissue calcification should be detectable radiologically. Anemia is common in animals poisoned by *Solanum malacoxylon*.

### NECROPSY FINDINGS

Nonspecific emaciation, anasarca, and ascites are common. Calcification of all blood vessels, including the aorta and coronary arteries, and of the endocardium, is the most readily visible, characteristic lesion. Calcification is also present in the pleura; the lung parenchyma, which is usually emphysematous; in most other viscera; and in tendons and ligaments.<sup>3</sup> Degenerative arthritis occurs in the limb joints.

### DIFFERENTIAL DIAGNOSIS

The history, clinical findings, and discovery of specific toxic plants will provide diagnostic confirmation. Repeated overdosing with vitamin D, by injection or administration in compounded feeds, replicates the clinical and necropsy findings.

### TREATMENT AND CONTROL

No practicable treatment is available. Careful management of affected pasture in Europe has been shown to significantly reduce the losses as a result of the disease.

### FURTHER READING

- Haussler MR, Wasserman RH, McCain TA, et al. 1, 25-dihydroxyvitamin D<sub>3</sub>-glycoside: identification of a calcinogenic principle of *Solanum malacoxylon*. *Life Sci*. 1976;15:1049-1056.
- Hughes MR, McCain TA, Chang SY, et al. Presence of 1, 25-dihydroxyvitamin D<sub>3</sub>-glycoside in the calcinogenic plant *Cestrum diurnum*. *Nature*. 1977;268:347-349.
- Mello JRB. Calcinosis—calcinogenic plants. *Toxicol*. 2003;41(1):1-12.

### REFERENCES

1. Y Santos C, Capelli A, Sosa S, et al. Enzootic calcinosis of sheep in Uruguay. In: Riet-Correa, Pfister J, Schild AL, Wierenga TL, eds. *Poisoning by Plants, Mycotoxins, and Other Toxins*. Oxfordshire: CAB International; 2011:448.
2. Santos C, et al. *J Vet Diag Invest*. 2012;24:423.
3. Barros SS, et al. *Vet Pathol*. 2006;43:494.

## HYPOGLYICIN A INTOXICATION OF HORSES (ATYPICAL MYOPATHY [MYOGLOBINURIA] IN GRAZING HORSES)

Hypoglycin A intoxication of horses is a syndrome of acute myoglobinuria occurring in

horses at pasture in Great Britain, Ireland, Europe, North America, and, possibly, Australia and New Zealand.<sup>1-6</sup> The disease is caused by ingestion of seeds of the maple trees *Acer negundo* (box elder) in the United States and *Acer pseudoplatanus* in Europe.<sup>6-8</sup> The toxic compound is hypoglycin A (L-amino-methylenecyclopropylpropionic acid), which is metabolized to methylenecyclopropylacetic acid (MCPA). MCPA can be detected in the blood of affected horses<sup>9</sup> and is a potent inhibitor of multiple acyl-CoA dehydrogenases causing a specific abnormal pattern of accumulation of blood acylcarnitines and urine organic acids.<sup>7</sup> This pattern was recognized in affected horses before the causative agent was identified.<sup>5</sup>

The potential of other maple trees (*Acer palmatum* [Japanese maple], *A. saccharum* [sugar maple], *A. spicatum* [mountain maple], and possibly others) to cause this disease is unknown, although these species contain, or likely contain, hypoglycin A.<sup>10</sup>

The disease has a strong seasonal distribution, with most, but not all, cases occurring in autumn.<sup>1,4,11,12</sup> Occurrence of the disease is sporadic but usually affects more than one animal in a band of equids. Horses, ponies, and zebras have been affected.<sup>11</sup> Localized outbreaks involving large numbers of horses are reported.<sup>11</sup> Risk of the disease in Europe increases with increasing time at pasture, presence of wood or dead leaves in the pasture, lack of supplemental feeding, and presence of trees.<sup>11,12</sup> Wind speed and speed of wind gusts is greater immediately preceding outbreaks of the disease than at other times.<sup>7</sup>

There does not appear to be a breed or sex predilection to development of the disease. Younger horses might be at greater risk of the disease, but this could simply reflect the age distribution of horses at pasture in areas in which the disease occurs. Atypical myopathy occurs almost exclusively in horses at pasture and is not associated with enforced exercise.

The case-fatality rate is usually 60% to 70% but can be much higher.<sup>11</sup> Prognosis is directly related to the severity of clinical signs, such as tachycardia, tachypnea, recumbency, sweating, anorexia, and dyspnea.<sup>13</sup>

Clinical signs are those characteristic of acute rhabdomyolysis and include an abrupt onset of stiffness and reluctance to move. Affected horses might be noticed to be depressed or have reduced activity for 1 to 2 days before onset of clinical signs.<sup>11</sup> Horses can be affected up to 4 days after being removed from pasture.<sup>11</sup> Progression to lateral recumbency is rapid, occurring within hours of the initial onset of signs. Recumbency is often the first indication of this disease observed in horses at pasture. Horses forced to stand have tremors and difficulty walking. Lumbar and gluteal muscles can be firm. Affected horses are tachycardic and tachypneic. Respiratory distress, presumably secondary to degeneration of intercostal

muscle and the diaphragm, is common in recumbent horses in the terminal stages of the disease. There is discolored urine (pigmenturia). There are abnormal ventricular arrhythmias and impaired myocardial function, which can persist for at least 10 weeks in affected horses.<sup>14</sup> Affected horses usually die or are euthanized within 24 to 72 hours of onset of clinical signs.<sup>11</sup>

Serum biochemical abnormalities include massively increased serum activities of creatine kinase, lactate dehydrogenase, and aspartate aminotransferase. Serum concentrations of troponin T, a marker of myocardial damage, are above normal in most affected horses. Serum concentrations of vitamin E and/or selenium and red cell activity of glutathione peroxidase are not consistently abnormally low. Serum concentrations of acylcarnitines are abnormal, with elevations of concentrations of short-, medium-, and long-chain compounds.<sup>6,7</sup> Urine concentrations of ethylmalonic acid, methylsuccinic acid, lactic acid, adipic acid, butyrylglycine, isovalerylglycine, and hexanoglycine are increased in affected horses.<sup>7</sup>

The acid–base status of affected horses is a mixture of respiratory alkalosis, lactic acidosis, and strong iron difference (SIDm) alkalosis.<sup>15</sup> Abnormalities in serum sodium, potassium, and chloride concentrations are usually small.<sup>15</sup>

Necropsy examination does not reliably reveal gross evidence of muscle disease, although there can be swelling, edema, and localized hemorrhage into muscles. There are hemorrhagic or pale areas in the ventricular myocardium of some horses. Histologic examination reveals the presence of widespread degeneration of myocytes, without inflammation, in muscles of locomotion and respiration. Within a muscle group, some fibers are severely affected, whereas other neighboring fibers are apparently normal. The ventricular myocardium has lesions of muscle degeneration in some horses. Myoglobinuric nephrosis is a consistent finding in horses that die spontaneously or are euthanized in the terminal stages of the disease.

Definitive diagnosis is based on the presence of clinical signs of muscle disease, large elevations in serum activity of muscle-derived enzymes, and necropsy examination.

Treatment is supportive because there is no definitive antidote for hypoglycin A.<sup>16,17</sup> Affected and at-risk horses should be removed from the pasture and prevented from eating more seeds of *A. negundo* or *A. pseudoplatanus*. Consideration should be given to administering activated charcoal to reduce absorption of further toxin from the gastrointestinal tract (500 g per 500-kg horse, orally). Some affected horses are in pain and should be administered analgesics. Hydration and electrolyte and acid–base balance should be maintained.



Administration of antioxidants and muscle relaxants is recommended but is without objective evidence of efficacy.<sup>16,17</sup>

Control centers around preventing horses and ponies from eating the seeds (samaras) of *Acer negundo* or *A. pseudoplatanus*. The seeds can be blown into pastures from trees bordering the pasture—consistent with wind speeds being higher immediately preceding outbreaks than at times when the disease did not occur.<sup>7</sup>

## REFERENCES

- Hollyer J, et al. *Irish Vet J*. 2010;63:612.
- McKenzie RK, et al. *NZ Vet J*. 2013;61:367.
- Quist EM, et al. *Vet Pathol*. 2011;48:E52.
- Sponseller BT, et al. *J Vet Int Med*. 2012;26:1012.
- van der Kolk JH, et al. *Mol Gen Metab*. 2010;101:289.
- Votion DM, et al. *Equine Vet J*. 2013;n/a.
- Valberg SJ, et al. *Equine Vet J*. 2013;45:419.
- Unger L, et al. *J Vet Int Med*. 2014;28:1289.
- Votion DM, et al. *Equine Vet J*. 2014;46:146.
- Gillman JH, et al. *Equine Vet J*. 2014;46:135.
- van Galen G, et al. *Equine Vet J*. 2012;44:614.
- van Galen G, et al. *J Vet Emerg Crit Care*. 2010;20:528.
- van Galen G, et al. *Equine Vet J*. 2012;44:621.
- Verheyen T, et al. *J Vet Int Med*. 2012;26:1019.
- van Galen G, et al. *J Vet Int Med*. 2013;27:186.
- van Galen G, et al. *Equine Vet Educ*. 2013;25:264.
- van Galen G, et al. *Equine Vet Educ*. 2013;25:308.

## PLANT POISONINGS WITH KNOWN TOXINS

### AMINOPROPIONITRILE

3-Aminopropionitrile is a poisonous substance found in *Lathyrus* spp. (wild peas), for example, *Lathyrus hirsutus* (wild winter pea), sometimes sown with grasses to provide early-spring grazing. Signs of toxicity in cattle grazing mature plants bearing seed pods consist of salivation, sawhorse stance, head held low, continuous head and ear movements, trance-like gaze, diminished responsiveness, reluctance to move, pain in the feet causing lameness, sitting with the feet under the body, and a marked disinclination to rise. Other signs include lameness, stumbling gait, recumbency, and paddling convulsions. The signs are exacerbated by driving or other stimulation. Necropsy findings are limited to nonspecific lesions such as pulmonary congestion.

## PLANT POISONINGS WITH SUSPECTED OR UNIDENTIFIED TOXINS

### JUGLONE

Juglone, a poisonous resinoid found in the shavings of *Juglans nigra* (black walnut tree), has been suspected as being associated with lameness and edema of the lower limbs in horses bedded on the shavings, but juglone is present in the bark and leaves, not the heartwood from which the shavings are

made. The lesions are produced by an increase in local capillary blood pressure.

A similar syndrome is associated with *Berberoa incana* (hoary alyssum). Swelling of the distal limbs and fever are consistent signs associated with ingestion of this plant. Signs appear 18 to 36 hours after ingestion of the plant and disappear 2 to 4 days after the plant is removed. Abortions have been reported but may be secondary to the high fever. An alternative syndrome of severe gastroenteritis plus intravascular hemolysis is also recorded in horses fed hay contaminated by *Berberoa incana*.

## MYOPATHY—WITH GAIT INCOORDINATION, RECUMBENCY, ELEVATED CPK

- Karwinskia humboldtiana*—coyotillo
- Small amounts of *Senna* (= *Cassia*) spp. ingested over a long period are associated with skeletal muscle myopathy and/or paralysis. In *Senna occidentalis* poisoning in horses and goats, the early signs are anorexia and diarrhea followed by hyperpnea, tachycardia, ataxia, staggering, and recumbency. At autopsy there is a fatal cardiomyopathy. The muscle lesion is accompanied by marked elevations of SGOT and CPK levels. Similarly, in pigs, early diarrhea may be followed by lateral recumbency and skeletal muscle myopathy.

## FURTHER READING

Radostits O, et al. *Veterinary Medicine: A Textbook of the Disease of Cattle, Horses, Sheep, Goats and Pigs*. 10th ed. London: W.B. Saunders; 2007:1883.

## ALUMINUM TOXICOSIS

Aluminum is one of the potentially toxic elements introduced into the diets of animals by the deposition of soluble salts in acid rain, powder particles in factory effluent, accidental dosing, or absorption by plants.

Case reports in large animals are rare, and most of the toxicologic information comes from human data or investigational studies using rats, mice, and rabbits. Frank et al. reported polioencephalomalacia associated with elevated aluminum levels in Simmental calves,<sup>1</sup> and Easterwood et al. reported phosphine gas generation in horses accidentally receiving aluminum phosphide in their feed.<sup>2</sup> It should be pointed out that the toxin associated with aluminum phosphide intoxication is the toxic gas phosphine and not aluminum.

Absorption of aluminum is poor following oral, dermal, and inhalation exposure. Following absorption, it is distributed to other tissues, with the highest concentration in the bone.<sup>3</sup> Chronic exposure to aluminum results in sequestration in the bone, from which it is slowly released. Aluminum

readily crosses the blood–brain barrier and placental barrier, resulting in neurotoxicity and developmental toxicity.<sup>4,5</sup> Excretion is through the urine, with very little bile and fecal excretion.<sup>3</sup>

Clinical signs depend on specific organs, but deposition in the bone is associated with osteoarthritis and anemia. Other organs affected include the heart (myocardial infarction), brain (cognitive dysfunction and other neurotoxic effects), liver, and kidney.

There is no treatment, and diagnosis depends on finding aluminum in the liver and kidney. Aluminum levels of 6 to 11 ppm in the liver and 4 to 5 ppm in the kidney of sheep and cattle are considered toxic amounts.

## FURTHER READING

- Allen VG, Robinson DL, Hembry FG. Aluminum in the etiology of grass tetany in cattle. *J Anim Sci*. 1980;50:44.
- Allen VG. Influence of dietary aluminum on nutrient utilization in ruminants. *J Anim Sci*. 1984;59:836-844.
- Frank AA, Hedstrom OR, Braselton WE, et al. Multifocal polioencephalomyelomalacia in Simmental calves with elevated tissue aluminum and decreased tissue copper and manganese. *J Vet Diagn Invest*. 1992;4:353-355.

## REFERENCES

- Frank AA, et al. *J Vet Diagn Invest*. 1992;4:353-355.
- Easterwood L. *J Am Vet Med Assoc*. 2010;236:446.
- Krewski D, et al. *J Toxicol Environ Health B*. 2007;10:1.
- Domingo JL, Aluminum, Gupta RC, eds. *Reproductive and Developmental Toxicology*. Elsevier; 2011:407.
- Kumar V, Gill KD. *Arch Toxicol*. 2009;83:965.

## FLUORIDE TOXICOSIS

### SYNOPSIS

**Etiology** Toxic amounts of fluoride are found in water (naturally or contaminated), soil, and plants contaminated by industry pollution, mineral mixes with excessive fluoride, and older insecticides, anthelmintics, and rodenticides containing sodium fluoride, sodium fluorosilicate, and sodium fluoroacetate. Fluoroacetate may also be found in several plant species, such as *Dichapetalum* spp., *Gastrolobium* spp., *Oxylobium* spp., and others.

**Epidemiology** Most often associated with continuous ingestion of small but toxic amounts of fluoride in the diet or drinking water.

**Clinical pathology** Elevated serum and urine levels of fluoride; elevated serum levels of Ca, BUN, and ALP in some cases.

### Lesions

**Live animals:** Dental fluorosis—mottling and erosion of permanent teeth. Osteofluorosis with lameness and unthriftiness.

**Postmortem:** Osteoporosis; widespread exostoses. Dental enamel and dentin hypoplasia.

**Diagnostic confirmation** Fluoride assay of forage, soil, or water; blood and urine of affected animals; bones and teeth at necropsy.

**Treatment** Primarily supportive; activated charcoal is not recommended; oral calcium, magnesium, or aluminum to bind fluoride in gastrointestinal tract.

**Control** Good nutritional plane; keep young animals off and rotate stock if water or forage contaminated; keep fluoride in feed less than 2%; use of aluminum salts in feed of questionable efficacy.

## ETIOLOGY

Fluoride is present in some concentration in almost all animal feed and water sources, so exposure not only occurs but continues throughout the lifetime. Both acute and chronic poisoning occur. Acute toxicosis in large animals is very rare and generally occurs after exposure to an older commercial product, such as sodium fluoride, sodium fluorosilicate, or sodium fluoroacetate, or to volcanic ash.<sup>1,2</sup> Chronic toxicosis is associated with the ingestion of high-fluoride-containing rock salt phosphate supplements, fluoride-contaminated forage or soil, and water either naturally containing excess fluoride or that has been contaminated with fluoride.<sup>3-6</sup> The severity of the poisoning depends on the amount ingested, the solubility of the fluoride compound, the species, diet, and the animal's age.<sup>1,7</sup> Death losses are rare and restricted largely to acute poisoning, with the major losses taking the form of unthriftiness associated with chronic fluorosis.

## EPIDEMIOLOGY Occurrence

Fluoride intoxication has been observed in most countries, usually in association with specific natural or industrial hazards. In Europe and Great Britain, losses are greatest on summer grazing of pastures contaminated by industrial fumes, including dust from factories converting rock phosphate to superphosphate and effluent from aluminum smelters. Iceland and parts of the southern Andes Mountains are extensively affected by contamination from volcanic ash. Drinking water from deep wells, industrial contamination of pasture, and the feeding of fluoride-bearing phosphatic supplements are the common associations in North America. Deep wells also are an important source in Australia and South America. In Africa the important association is the feeding of phosphatic rock supplements.

In experimentally induced fluorosis in cattle, mottling of the tooth enamel occurs at

intakes of 27 mg/kg in the diet, but there is no pitting until levels of 49 mg/kg are fed. Bony lesions are slight at intakes of 27 mg/kg, moderate at 49 mg/kg, and marked at 93 mg/kg, and milk production in dairy cows is thought not to be affected by intakes of 50 mg/kg of fluoride in the diet until about the fourth lactation. A more recent view is that the existing tolerance level for dairy cows of 40 mg/kg is too high and will lead to serious loss of production and some dental fluorosis in high-producing cows.<sup>1</sup>

## Risk Factors

### Animal Risk Factors

Host factors are age and species. Daily intakes of 0.5 to 1.7 mg/kg BW of fluoride as sodium fluoride produce dental lesions in growing animals without affecting general well-being. Intakes equal to twice these amounts are consumed by adult animals without ill effect. In heifers a continuous intake of 1.5 mg/kg BW per day is sufficient to be associated with severe dental fluorosis without affecting growth rate or reproductive function. However, extensive osteofluorosis and periods of severe lameness will occur. The fluoride content of the bones of newborn calves depends on the dam's intake of fluoride in the last 3 to 4 months of pregnancy and not on her own bone composition.

Most recorded occurrences of fluorosis are in cattle. Sheep are less susceptible than cattle, and it is rarely reported in horses. A continuous intake of 1 mg/kg BW is the maximum safe limit for ruminants; an intake of 2 mg/kg BW produces clinical signs. In pigs an intake of 1 mg/kg BW added fluoride for long periods has no deleterious effect.

Fetal effects are small. The current view is that placental passage is infinitesimal in amount, but historically, cases of neonatal dental fluorosis have been identified in cattle.<sup>3</sup> Fluoride does not occur in significant quantities in the milk or colostrum of poisoned cows.<sup>1</sup>

### Environmental Risk Factors

Fluoride occurs naturally in rocks, particularly in association with phosphate, and these rocks, the soils derived from them, and the surface water leaching through the soils may contain toxic quantities of fluoride. In such areas the soil content of fluoride may be as high as 2000 to 4000 mg/kg, even up to 12,000 mg/kg, and the levels in water up to 8.7 mg/kg; soil fluoride varies in its solubility from 10% to 20%. Levels of fluoride likely to be toxic to animals are not usually encountered in natural circumstances; interference by humans is necessary in most instances to increase fluoride ingestion above the critical level.

Contamination from industrial factories by smoke, vapor, or dust may produce pasture containing 20 to 50 mg/kg of fluoride. Factories producing aluminum by the electrolytic process, iron and steel with

fluoride-containing fluxes, superphosphate, glazed bricks, copper, glass, and enamels are likely to be potent sources and may be associated with toxic levels of contamination as far as 14 km downwind from the factory. Dust from factories manufacturing superphosphate from rock phosphate may contain as much as 3.3% fluoride. Industrial plants engaged in the calcining of ironstone have also been incriminated as sources of fluoride.

Contamination by effluent is a complex problem because of variation in the form of the contaminating compound. Grass can absorb and retain gaseous fluoride from the ambient air, but physical deposit of liquids and dust is the critical form of contamination.<sup>5,6</sup> Two of the common effluent substances are hydrofluoric acid and silicon tetrafluoride, both of which are as toxic as sodium fluoride, and dental lesions occur in 100% of young ruminants on an intake of 14 to 16 mg/kg DM of these substances. Severe cases occur on pasture or hay containing more than 25 mg/kg DM, and similar lesions develop much more rapidly on pasture containing 98 mg/kg DMr. Fluoracetamide is also known to be a toxic factory effluent.

Dust and gases from volcanic eruptions may also be associated with acute fatal fluoride intoxication in the period immediately after the eruption, and contamination of pasture may be sufficient to be associated with subsequent chronic intoxication in animals eating the herbage, although the fluoride content of the contaminated materials decreases very rapidly if rain falls. Iceland is particularly afflicted with fluoride intoxication deriving from this source.

Top dressing of pasture with phosphatic limestone is commonly associated with fluorosis. Most phosphatic limestones, particularly those from North Africa, are rich in fluoride (0.9% to 1.4%). Nonphosphatic limestones contain insignificant amounts.

## Supplementary Feeding of Phosphates

The common occurrence of phosphorus deficiency in animals has led to the search for cheap phosphatic materials suitable for animal feeding. Rock phosphates are commonly used, and many deposits contain dangerous amounts of fluoride (3% to 4%).<sup>8</sup> The fluoride content of the mineral can be reduced, but the cost encourages the use of marginally safe material.

The major occurrence of water-borne fluoride intoxication is from water obtained from deep wells or artesian bores. The available data suggest that although minor tooth lesions occur at 5 mg/kg of fluoride, it is not until levels of 10 mg/kg are exceeded that excessive tooth wear occurs and the nutrition of the animal is impaired. More serious systemic effects do not occur until the water contains 30 mg/kg.

Miscellaneous sources of fluoride include the ingestion of superphosphate itself, but a

supernatant liquid of a suspension of the fertilizer will contain no fluoride. Some wood preservatives may contain large quantities of fluoride, which may be associated with acute poisoning in some circumstances.

#### Farm Risk Factors

Animals that are housed in the winter and grazed only during the summer and fall on pasture contaminated by factory effluent may show considerable clinical improvement in clinical signs during the winter and an annual recrudescence of signs when the animals are outside.<sup>9</sup>

#### Human Risk Factors

Although it is possible for animal tissues to contain amounts of fluoride in excess of permissible amounts, this is not usually so in chronic fluorosis. The fluoride content of milk in these circumstances is below that permitted in fluoridated drinking water (1 mg/L).

### PATHOGENESIS

Absorption from the gastrointestinal (GI) tract depends on the form ingested, with soluble forms such as sodium fluoride being more bioavailable than fluoride found in contaminated feed, soil, or water. Once absorbed, fluoride is distributed throughout the body, primarily to bone and teeth. Excretion is renal.<sup>10</sup>

Acute intoxication, as a result of the ingestion of large amounts of soluble fluorides (e.g., sodium fluoride), occurs rapidly, with signs appearing 30 to 60 minutes after ingestion. The mechanism of action is unknown but may be attributable to the development of hydrofluoric acid in the GI tract, onset of systemic hypocalcemia, decreased Na/K ATPase activity, or the inhibition of glycolysis.<sup>10</sup>

Chronic ingestion results in the deposition of fluoride in the bones and/or teeth of affected animals.<sup>7</sup> Deposition in bone occurs throughout life but in teeth only in the formative stages.<sup>1,7</sup> In bones, fluorides alter mineralization, crystal structure, and remodeling of bone by replacing hydroxyl groups in the hydroxyapatite of the bone crystalline structure. The degree of deposition varies, being greatest on the periosteal surface of the long bones where exostoses commonly develop. These bony changes are often referred to as skeletal fluorosis or osteofluorosis.

During tooth formation, fluorides inhibit the action of ameloblasts and odontoblasts, resulting in failure of the developing tooth to accept minerals. Thus tooth lesions occur only if the intake is high before the teeth have erupted, but bone lesions occur at any stage.

When the tissue levels of fluoride are moderate, characteristic lesions as a result of hypoplasia of enamel appear in the teeth. During this time the fluoride levels in bone can increase slowly without appreciable bone

changes. The facility of storage in bone explains the long latent period that occurs in animals subjected to chronic intoxication. Lesions generally begin on the medial side of the proximal metatarsal bones and expand to include the mandibles, metacarpal bones, and ribs. Abnormalities, once they occur, result in lameness and are generally symmetric and bilateral.<sup>1</sup> At very high levels the storage capacity of bone and teeth is exceeded, and blood and urine levels rise. The bone lesions of osteomalacia and osteoporosis, with accompanying pathologic fractures, are associated with excessive mobilization of calcium and phosphorus to compensate for their increased urinary excretion in conjunction with fluoride.

The kidney is the primary tissue affected, but other tissues in which degenerative changes may occur are the bone marrow, adrenal glands, heart muscle, and central nervous system.<sup>2,10,11</sup> A severe anemia may rarely occur as a result of toxic depression of bone-marrow activity, although this is not a constant or expected sign.

### CLINICAL FINDINGS

#### Acute Intoxication

The syndrome includes dyspnea, complete anorexia, vomiting, and diarrhea in pigs and ruminal stasis with constipation or diarrhea in ruminants.<sup>1,2</sup> Vomiting acts as a protective mechanism, and toxic doses in pigs may be eliminated in this way without the development of other signs. Nervous signs are characteristic and include ataxia, muscle tremors and weakness, a startled expression, pupillary dilatation, hyperesthesia, and constant chewing. Tetany, convulsions, and collapse and death follow within a few hours.

#### Chronic Intoxication

Because of the distinct clinical separation between animals with dental lesions and those that have, in addition, signs of lameness and general ill-health, it is customary to refer to two forms of the disease: dental fluorosis and osteofluorosis. Lesions of the teeth and bones are characteristic, and the signs are largely referable to these lesions. Tooth changes are the earliest and most diagnostic sign but may not produce clinical effects until other signs have developed.<sup>12</sup> Consequently, they are often missed until other clinical findings suggest that the teeth be examined.

#### Dental Fluorosis

The permanent teeth exposed to intoxication before eruption will be affected and perhaps those of animals exposed in utero. The earliest and mildest sign is mottling with the appearance of pigmented (very light yellow, green, brown, or black) spots or bands arranged horizontally across the teeth. Occasional vertical bands may be seen where pigment is deposited along enamel fissures. Mottling and staining occur on incisors and

cheek teeth and are not evident when the affected tooth erupts, and in fact they may not appear until some months later. The cheek teeth are usually more dramatically affected than the incisors but are very difficult to examine clinically. If the period of exposure to intoxication has been limited only some of the teeth may be affected, but the defects will always be bilateral.

Mottling may not progress any further, but if the intoxication has been sufficiently severe, defective calcification of the enamel leads to accelerated attrition or erosion of the teeth, usually in the same teeth as the mottling. The mottled areas become pits, and the teeth are brittle and break and wear easily and unevenly. Patterns of accelerated attrition are dependent on the chronologic occurrence of the intoxication and the eruption time of the teeth. Uneven and rapid wear of the cheek teeth makes proper mastication impossible. Infection of the dental alveoli and shedding of teeth commonly follow. The painful condition of the teeth and inability to prehend and masticate seriously reduce the food intake and are associated with poor growth in the young and unthriftiness and acetonemia in adults. Affected cattle may lap cold drinking water to avoid the discomfort occasioned by normal drinking. Eruption of the teeth may be abnormal, resulting in irregular alignment.

A standard for the classification of fluorosis has been proposed based on the degree of mottling, pitting, and rate of wear of the teeth. The effects of dental mottling, pitting, and excessive wear of incisors can be used to estimate the exposure periods of cattle during odontogenesis. The additional clinically apparent abnormalities include delayed eruption of permanent incisor teeth, necrosis of alveolar bone resulting in recession of bone and gingiva, oblique eruption of permanent teeth, hypoplasia of teeth, wide spaces between teeth, and rapid development of any dental lesions.

#### Osteofluorosis

Lameness most marked in the loins, hip joints, and hindlimbs and unthriftiness in animals of any age are the signs usually observed first.<sup>11,12</sup> The occurrence of hip lameness or fractures of the third phalanx on a herd scale in cattle is thought to be diagnostic of fluorosis. Pain is evinced on pressure over limb bones and particularly over the bulbs of the heels. The bones may be palpably and visibly enlarged. This is most readily observed in the mandible, sternum, metacarpal, and metatarsal bones and the phalanges. This overall thickness may be subsequently replaced by well-defined exostoses. The bones are subject to easy fracture. These well-defined lesions occur only in advanced cases and are often accompanied by extensive tooth lesions in young animals. In addition to the cases affected by



generalized lameness, there are cases that show a sudden onset of very severe lameness, usually in a forelimb, associated with transverse fracture of the third phalanx.

### Other Effects

Reproduction, milk yield, and wool growth are not usually considered to be adversely affected except indirectly by the reduced food intake. Severely lame animals may have lowered reproductive performance indirectly as a result of physical dysfunction that interferes with mating.

Additional signs, including diarrhea and anestrus and other forms of infertility in cattle, diarrhea in sheep, and polydipsia and polyuria in pigs, are recorded in the naturally occurring disease but cannot be considered as constant or pathognomonic. Horses with chronic fluorosis have lameness; dental lesions, including excessive molar abrasion; and hyperostotic lesions of the metatarsus, metacarpus, mandible, and ribs.

### CLINICAL PATHOLOGY

Normal cattle have blood levels of up to 0.2 mg fluoride per mg/dL of blood and 2 to 6 mg/kg in urine. Cattle on fluoride intakes sufficient to cause intoxication may have blood levels of 0.6 mg/dL and urine levels of 16 to 68 mg/kg, although blood levels are often normal. Such high levels may not be an indication of high intakes immediately preceding the examination because heavy deposits in bones may be associated with abnormally high blood and urine fluoride levels for some months after the intake has been reduced to normal. Urine levels should be corrected to a specific gravity of 1.040. Serum calcium may be low or normal, phosphorus levels are usually normal, and there is a significant correlation between the amount of fluoride fed and the concentration of alkaline phosphatase in the serum.<sup>2,12</sup> The increase in phosphatase activity is probably related to the abnormal formation of bone and may be 3 to 7 times the normal level.

Radiographic changes of bones containing more than 4000 mg/kg of fluoride include increased density or abnormal porosity, periosteal feathering and thickening, increased trabeculation, thickening of the compact bone, and narrowing of the marrow cavity. Spontaneous rib fractures show incomplete union. Good data are available for fluoride concentrations in rib bones, and estimations of fluoride content in biopsy samples of ribs have been used in the clinicopathologic study of the disease. Samples of tail bone and the spongiosa of the tuber coxae have also been used for these purposes.

### NECROPSY FINDINGS

Severe gastroenteritis is present in acute poisoning, and there may be degenerative changes in the renal tubular epithelium. In chronic fluorosis the bones have a chalky, white appearance; are brittle; and have either

local or disseminated exostoses, particularly along the diaphyses. Intraarticular structures are not primarily affected, although there may be some spurring and bridging of the joints. Histologically, there is defective and irregular calcification of newly formed trabecular bone and active periosteal bone formation. Hypoplasia of the enamel and dentin are consistent physical and histologic defects in the teeth of affected young animals. Young animals may also develop thickened growth plates and widened metaphyses that are grossly similar to rachitic changes. Degenerative changes in kidney, liver, heart muscle, adrenal glands, and central nervous system have been reported in severe cases. Degeneration of the bone marrow and consequent aplastic anemia also occur.

Chemical examination of necropsy specimens is valuable in the diagnosis because the fluoride content of bones from poisoned animals is greatly increased. Levels of up to 1200 mg/kg of bone on a dry, fat-free basis are observed in normal animals but may be increased up to 3000 mg/kg in animals exposed to fluoride and showing only mottling of the teeth. Animals showing severe clinical signs have levels greater than 4000 mg/kg of bone on a dry, fat-free basis; after prolonged heavy feeding, levels may be as high as 1.04%. Care must be taken in selecting the bone samples because of the great variation in the concentration of fluoride that occurs between different bones. Good data are available for comparison between metacarpal, metatarsal, rib, pelvic, and mandibular bones and antlers of deer. Mandibles usually show the greatest concentrations; in the long bones, the distal and proximal quarters are more sensitive indicators than the center half.

Diagnostic confirmation depends on fluoride assay of forage, soil, or water; blood and urine of affected animals; and bones and teeth at necropsy.

### Samples for Confirmation of Diagnosis

- **Toxicology**—mandible/metacarpal/metatarsal, rib, vertebrae for evidence of osteofluorosis; urine from affected animals for evidence of recent exposure (ASSAY [F])
- **Histology**—formalin-fixed metacarpal/metatarsal/mandible (LM)

### DIFFERENTIAL DIAGNOSIS

#### ACUTE:

- Heavy metal toxicosis
- Nephrotoxic mycotoxicosis
- Oak (*Quercus* spp.) toxicosis
- Plant toxins (*Amaranthus* spp., *Isotropis* spp., *Lantana* spp.)

#### Chronic:

- Chronic selenium toxicosis
- Degenerative joint disease/osteoarthritis

- Enzootic calcinosis
- Ephemeral fever in cattle
- Nutritional deficiency of phosphorus
- Nutritional deficiency of vitamin D
- Osteodystrophia fibrosa in horses
- White-muscle disease

### TREATMENT

Treatment, apart from removing the animals from the source of fluoride, is largely impractical and supportive in nature. In acute ingestions, most animals die before there is time for treatment. With chronic ingestions, no improvement in dental or osseous lesions can be anticipated, but there may be amelioration of the other clinical signs. Activated charcoal is not recommended because fluoride does not bind well to it. Calcium, magnesium, or aluminum may be used to bind hydrofluoric acid produced in the stomach, and because of their insolubility they are safe even in large quantities.<sup>13,14</sup> Intravenous calcium should be used if hypocalcemia or tetany are present.

### CONTROL

- Where fluoride levels are marginal, careful husbandry, including the watering of young growing stock on fluoride-free supplies, permitting only adults to be watered on the dangerous supplies, and rotating the animals between safe and dangerous waters at 3-month intervals, may make it possible to utilize land areas otherwise unsuitable for stock raising. In some areas, dairy herds may have to be maintained by the purchase of replacements rather than by the rearing of young stock. In areas where long-term ingestion of fluoride is likely to occur, the aim should be to provide a diet of less than 50 mg/kg of the total diet of dairy cows. Adequate calcium and defluorinated phosphorus intakes should be ensured because these reduce bone storage of fluoride.
- Phosphate feed supplements should contain no more than 0.2% fluoride for milking or breeding cattle or 0.3% for slaughter cattle, and they should not comprise more than 2% of the grain ration if the fluoride content is of this order. Some deposits of rock phosphate have much higher contents of fluoride than others, and commercial defluorination makes these toxic deposits safe for animal feeding.
- Bone meal in some areas may contain excessive quantities of fluoride and should be checked for its fluoride content.
- Water from deep wells and artesian bores should be assayed for fluoride content before use. The fluoride content of drinking water can be reduced (from 10 to 0.95 mg/kg) by adding freshly

slaked lime to the water; 500 to 1000 mg/kg should be added, and the water must be allowed to settle for 6 days. The method requires the use of large storage tanks.

- Aluminum salts are the principal substances used to detoxicate food and water. They are unpalatable and relatively ineffective, reducing the accumulation of fluoride in bone by only 20% to 30%, and are thus referred to as “alleviators.” Extensive field trials of aluminum as an alleviator have not justified its use as a practicable control measure in average circumstances.

### FURTHER READING

- Clark RG, Hunter AC, Steward DJ. Deaths in cattle suggestive of subacute fluoride poisoning following ingestion of superphosphate. *NZ Vet J.* 1976;24:193.
- Radostits O, et al. Fluorine poisoning. In: *Veterinary Medicine: A Textbook of the Disease of Cattle, Horses, Sheep, Goats and Pigs.* 10th ed. London: W.B. Saunders; 2007:1816.
- Wheeler SM, Fell LR. Fluorides in cattle nutrition. *Nutr Abst Rev.* 1983;53:741-766.

### REFERENCES

1. Poppenga RH. *Vet Clin North Am Food A.* 2011;27:373.
2. DeBey BM, et al. *J Vet Diagn Invest.* 2007;19:305.
3. Begum A, et al. *Rasayan J Chem.* 2008;4:774.
4. Bombik E, et al. *Bull Vet Inst Pulawy.* 2010;54:63.
5. Skinner G, et al. *Bios.* 2008;79:61.
6. McGrath D, et al. *J Plant Nutr Soil Sci.* 2010;173:548.
7. Mishra PC, et al. *Bioscan.* 2007;2:31.
8. Zanetti MC, et al. Fluoride availability from rock phosphate in sheep. In: Schlegel P, Durosy A, Jongbloed A, eds. *Trace Elements in Animal Production Systems.* Netherlands: Wageningen Academic Pub; 2008:303.
9. Grace ND, et al. *NZ Vet J.* 2007;55:77.
10. Barbier O, et al. *Chem Biol Interact.* 2010;188:319.
11. Ulemale AH, et al. *Vet World.* 2010;3:526.
12. Ranjan RD, et al. *Indian J Anim Sci.* 2009;79:546.
13. Lohakare J, et al. *Revista Brasileira de Zootecnia.* 2013;42:751.
14. Whitford AM. *Monogr Oral Sci.* 2011;22:66.

## Congenital Defects of Muscles, Bones, and Joints

Defects of the musculoskeletal system are among the most common congenital abnormalities in farm animals. In cattle, 476 such defects are listed. Many of them are lethal, and most of the remainder are life-threatening because of interference with grazing or the prehension of food. Many of them occur in combinations, and thus single defects are uncommon. For example, most axial skeletal defects and cleft palates occur in calves that already have arthrogryposis.

Because of the very large volume of literature involved it is not possible to deal with all the recorded defects here, and the text is limited to those defects that are thought to be of general importance. Whether or not

they are inherited or have an environmental cause is often not known, and thus an etiologic classification is not very effective—nor is an anatomic or pathologic classification, so we are reduced to a classification based on abnormal function.

### WEAKNESS OF SKELETAL MUSCLES

A number of sporadic myopathies are recorded in cattle and sheep. Causes have not been determined in most of them. Splayleg in pigs has been well described and occurs in most countries.

### CONGENITAL HYPERPLASIA OF MYOFIBER

There is only one identified state of congenital hyperplasia; it is the inherited form of doppelender, double muscling, or culard of cattle, described under “Myofiber hyperplasia.” The principal cause of the bulging muscles is an increase in the number of myofibers in the muscle.

### OBVIOUS ABSENCE OR DEFORMITY OF SPECIFIC PARTS OF THE MUSCULOSKELETAL SYSTEM

Some of these defects are inherited and include the following:

- Achondroplastic dwarfism, inherited miniature calves, bulldog calves
- Umbilical or scrotal hernia, cryptorchidism
- Tail deformity (kinking), taillessness
- Reduced phalanges, including hemimelia (individual bones missing), amputates (entire limbs missing), vestigial limbs (all parts present but limbs miniaturized)—amputates in outbreak form are recorded in cattle and produced experimentally by irradiation injury of sows, cows, and ewes during early pregnancy
- Inherited arachnomyelia (spidery limbs) of calves
- Congenital thickleg of pigs, osteopetrosis of calves, muscular hypertrophy of calves
- Cyclopean deformity—the inherited form is associated with prolonged gestation. The toxic form associated with ingestion of *Veratrum californicum*.
- Displaced molar teeth, mandibular prognathism—agnathia in lambs takes a variety of forms, including complete absence of the lower jaw and tongue.

### FIXATION OF JOINTS

Because arthrogryposis, which has been used to convey the description of joint fixation, strictly means fixation in flexion, the term **congenital articular rigidity** has been

introduced. The immobilization of the joint may be attributable to lack of extensibility of muscles, tendons, ligaments, or other tissues around the joint; to deformity of articular surfaces; or, theoretically, to fusion between the bones at the articular surface. Muscle contracture, which is the principal cause of joint fixation, has been produced experimentally and occurs naturally as a result of primary muscle atrophy or of atrophy resulting from denervation. Articular surface deformity is usually associated with gross deformity of the limb bones and is usually identifiable, but the principal problem in the diagnosis of congenital articular rigidity is to determine what the pathogenesis might have been and, beyond that, what was the specific cause.

Congenital fixation of joints can be caused by some well-known entities, as follows.

#### Cattle

- Hereditary congenital articular rigidity (HCAR) with cleft palate in Charolais
- HCAR with normal palates in Friesians, Danish Reds, Swedish, Shorthorns
- Inherited arthrogryposis
- Inherited multiple-tendon contracture
- Sporadic cases of congenital joint deformity as described for foals
- Inherited multiple ankylosis of Holstein-Friesian cattle
- Environmentally induced congenital articular rigidity caused by the following:
  - Intrauterine infection with Akabane virus
  - Ingestion of lupins
  - Ingestion of *Astragalus* and *Oxytropis* spp. (locoweeds)
  - Sorghum, Johnson grass, Sudan grass
  - Dietary deficiency of manganese

#### Sheep and Goats

- Inherited congenital articular rigidity in Merino sheep
- Infection with Akabane virus
- Infection with Schmallenberg virus
- Poisonous plants as for cattle
- Poisoning with parabendazole and cambendazole.

#### Foals

- “Contracted” foals having congenital axial and appendicular contractures of joints have been reported in the United States; the cause unknown, but it is not thought to be inherited. Deformities include torticollis, scoliosis, and thinning of ventral abdominal wall, sometimes accompanied by eventration, asymmetry of the skull, and flexion contracture in distal limb joints.
- **Congenital articular rigidity** also occurs in foals from mares fed on hybrid Sudan grass pastures.

- **Sporadic cases of congenital joint deformity** occur in foals and calves. They are manifested usually by excessive flexion of the metacarpophalangeal joints, causing affected animals to “knuckle” at the fetlocks and sometimes walk on the anterior aspect of the pastern. A similar defect occurs in the hindlegs. Many mild cases recover spontaneously, but surgical treatment may be required in badly affected animals. The cause in these sporadic cases is unknown, and necropsy examination fails to reveal lesions other than excessive flexion of the joints caused by shortening of the flexor tendons. Rarely such fixations are associated with spina bifida or absence of ventral horn cells of the spinal cord.

### Piglets

- Inherited congenital articular rigidity
- Nutritional deficiency of vitamin A
- Poisonous plants, hemlock (*Conium maculatum*), *Prunus serotina*, Jimson weed (*Datura stramonium*), tobacco wastes

## CONGENITAL ARTHROGRYPOSIS AND HYDRANENCEPHALY, AKABANE DISEASE, CACHE VALLEY VIRUS DISEASE, SCHMALLENBERG VIRUS

### SYNOPSIS

**Etiology** Akabane virus in the Simbu serogroup of *Orthobunyavirus*, Cache Valley virus in the Bunyamwera serogroup of *Orthobunyavirus*, Schmallenberg virus in the Simbu serogroup of *Orthobunyavirus*.

**Epidemiology** Transmission by hematophagous insects. Outbreaks occur when cattle or sheep are infected in early pregnancy.

**Clinical findings** Teratogenic pathogen that results in abortions, stillbirths, and birth of calves (Akabane virus, Schmallenberg virus) and lambs or kids (Cache Valley virus, Schmallenberg virus) with skeletal deformities and neurologic disorders (arthrogryposis-hydranencephaly syndrome).

**Necropsy findings** Necrotizing nonsuppurative encephalomyelitis and polymyositis. Arthrogryposis and hydranencephaly.

**Control** Vaccination or exposure of breeding females to natural infection before pregnancy.

### ETIOLOGY

Akabane virus and Cache Valley viruses are both members of the genus *Orthobunyavirus* in the family *Bunyaviridae*, with Akabane virus and Schmallenberg virus being

members of the Simbu serogroup of the genus *Orthobunyavirus* and Cache Valley virus being a member of the Bunyamwera serogroup of the genus *Orthobunyavirus*. There are a large number of members of the *Orthobunyavirus* genus, and several can produce clinically inapparent infections in ruminants, but Akabane virus and Cache Valley virus produce fetal disease when they infect the dam in early pregnancy. There are subtypes of these viruses.

Other *Bunyavirus* that have been associated with natural or experimentally produced fetal disease in ruminants include the following:

- Simbu serogroup—Aino and Peaton viruses
- Bunyamwera serogroup—Main Drain viruses
- California serogroup—LaCrosse and San Angelo viruses

Antibodies to the related, but as far as is known nonpathogenic, Australian Douglas virus and Tinaroo virus have been detected in cattle, sheep, goat, buffalo and deer.

### EPIDEMIOLOGY

#### Occurrence

##### Akabane

Serologic studies suggest that infection occurs in cattle, sheep, goats, horses, donkeys, camels, pigs, and buffaloes, but disease occurs only in calves, lambs, and goat kids.

The disease is most common in calves and has been recorded as the cause of epizootics of abortion, stillbirths, and congenital malformation in calves, with high attack rates in affected herds in two north-south geographic bands. The first band extends from Japan/Korea through Taiwan to Australia.<sup>1,2</sup> The second band extends from the Middle East to South Africa. Congenital disease in lambs is less common but is recorded in Israel and Australia. The virus has also been isolated from insect vectors in Africa and is the probable cause of the “rigid lamb syndrome” in Zimbabwe.

Serologic surveys suggest widespread distribution of the virus in the Middle East, Asia and South East Asia, and in parts of Africa. Whereas infection in adult cattle is common in endemic areas, reports of clinical disease are rare, but neurologic disease associated with infection in cattle 2 to 7 years of age has been observed. Akabane viruses have been divided genetically into four groups (I to IV), with group I being further divided into two subgroups (Ia, Ib).<sup>1,3,4</sup> Genogroup Ia strains are found primarily in Japan and Taiwan and appear to have a stronger neurovirulence than genogroup II strains that have been isolated from Japan and Korea. Genogroup Ib strains have been isolated in Japan and Israel. Genogroup III strains have been isolated from Queensland in Australia, whereas a strain isolated in Kenya represents genogroup IV.<sup>1,3,4</sup>

##### Cache Valley

There is serologic evidence that infection occurs in sheep, goats, horses, cattle, pigs, and several wildlife species but clinical disease is recorded only in sheep. The disease in sheep is recorded as an occasional epizootic in flocks in North America. Cache Valley virus is one of the more common *Orthobunyaviruses* in North America and has been isolated from mosquito pools collected in 22 states and several provinces in Canada and Mexico and also in Central and South America. Cache Valley is an agricultural valley in northern Utah and southeast Idaho in the United States.

##### Schmallenberg

A new disease in dairy cattle was identified in autumn 2011 in northwest Germany and the Netherlands. Viral genome sequences were identified in pooled blood from three affected sick dairy cows from a farm near Schmallenberg in northwest Germany, hence the name Schmallenberg virus (SBV). Serologic studies indicate that SBV was not present in domestic ruminants in northern Europe before 2011, and that the epizootics constituted introduction of the new virus into a susceptible population. Genomic studies indicate that SBV belongs to the species *Sathuperi* and may represent the ancestor of the reassortant Shamonda virus.

Antibodies against SBV have been identified in roe deer, red deer, European fallow deer, mouflons, bison, New World camelids, and wild boar in northern and west-central Europe.<sup>5</sup>

##### Aino and Shamonda

Aino virus is present and thought to be a cause of disease in Australia, Japan, and Israel. Serologic studies in Australia show a similar distribution in cattle to Akabane but at a lower prevalence, and clinical disease is much less common than with Akabane virus. Aino virus and Shamonda virus can induce congenital malformations in sheep and goats.

##### Source of Infection

The viruses are maintained through a cycle involving vectors, in which there is probably transovarial transmission, and a susceptible vertebrate population. Replication occurs in both vertebrate and insect populations.

##### Akabane

Viremia in cattle is short-lived, lasting 1 to 9 days, and long-term carriers are not thought to occur. Herbivores appear essential to the vector-virus-host cycle, and there is serologic evidence of infection in cattle, sheep, goats, camels, horses, and buffaloes. In endemic areas, breeding females are infected before their first pregnancy, and therefore clinical signs are not observed in their offspring. Clinical signs occur at the north and south end of the two bands, where weather



effects determine expansion of vectors out of the endemic region. This accounts for intermittent “outbreaks” of congenitally affected calves in southern Australia, Japan, and Korea.

In Australia, transmission is by the bites of midges *Culicoides brevitarsis* and *C. nebulosus*. The virus has been isolated from *C. brevitarsis*, and this is probably the major vector; serologic data in Australia show that most identified infections are within the known habitat of *C. brevitarsis*. Vertical infection occurs, but introduction of the virus into the bovine uterus in semen causes no developmental defects. Ruminants do not become persistently infected.

The vectors for Akabane disease in Japan and Korea are *C. brevitarsis*, *Culicoides oxystoma*, *Aedes vexans*, and *Culex tritaeniorhynchus*.

### Cache Valley

The Cache Valley virus has been isolated predominantly from mosquitoes. The primary amplifying vertebrate hosts are unknown, but white-tailed deer are suspected to play a role as a disease reservoir.<sup>6</sup>

### Schmallenberg

Biting midges, including *C. dewulfi*, *C. chiopterus*, and *C. obsoletus* complex are thought to be important vectors for SBV transmission in Belgium and Denmark and presumably contiguous countries.

### Aino

Aino virus has been isolated from mosquitoes and midges, including *C. brevitarsis*. Serologic studies show antibody in cattle, sheep, goats, and buffalo but not camels, dogs, or horses.

### Host and Environmental Risk Factors

The seasonal and geographic pattern of epizootics of abortions and premature births are determined by the distribution of vectors and the availability of susceptible ruminant populations in early pregnancy. Global warming is thought to be contributing to extension of vectors into geographic regions north and south of the typical infection belts and therefore disease epidemics.<sup>1,3,7</sup>

### Akabane

In the north of Australia, *C. brevitarsis* is active throughout the year, cattle are infected with Akabane virus before their first pregnancy, and disease does not occur. Epizootics occur in southern Australia when *C. brevitarsis* extends its range of distribution, probably by wind-borne spread from the north, to infect immunologically naive herds. Abortions and premature births commence in the autumn, with clinical cases of arthrogryposis and hydranencephaly occurring in midwinter.

Wind-borne introduction of *Culicoides* spp. is also postulated as the means

of introduction of infection in Israel. The movement of immunologically naive pregnant cattle into an enzootic area can be the result in severe outbreaks in those herds.

The disease is likely to disappear for intervals of 5 to 10 years, until there is combination of a susceptible population and a heavy vector population. Occurrences of the disease are also dependent on the presence of susceptible early-pregnant females at the time that the vectors are plentiful. These conditions are provided by a series of years of drought in an enzootic area, so that there are no insect vectors, no infection, and no immunization activity of prepubescent females, followed by a wet season when the vectors are plentiful.

### Cache Valley

Outbreaks occur after a long period of drought and winter frosts reducing the population of mosquito vectors and resulting in populations of seronegative ewes. Mating in the summer appears to be a major risk factor, allowing sheep to be in the susceptible stage of pregnancy during the vector season. Many outbreaks are in areas that interface between suburban and rural environments.

### Schmallenberg

Retrospective analysis of stored serum samples indicates that SBV was introduced into Europe in spring or early summer of 2011, probably first along the border of the Netherlands with northwest Germany. It is interesting to note that SBV emerged in the same region of Europe in 2011 as did blue-tongue strain 8 in 2006.

### Experimental Reproduction

Disease has been reproduced by inoculation into early-pregnant cattle, sheep, and goats.

### Zoonotic Implications

*Bunyavirus* infections occur in humans from bites from infected insect vectors.

### PATHOGENESIS

#### Akabane

Viremia occurs in the dam for 2 to 4 days, with an antibody peak 4 to 5 days after the viremia and a subsequent secondary rise. The dam is unaffected, but there is a focal viral persistence in cotyledons and subsequent viremia in the fetus.

Inflammatory and degenerative lesions occur in the central nervous system, but tissue tropism and damage are determined by the age of the fetus and its ability to mount an immune response. Three forms, or principal manifestations, of the disease in an affected herd are described. The first is arthrogryposis occurring in calves infected at an older age than others (fetus infected at 105 to 174 days of pregnancy). The second is arthrogryposis accompanied by hydranencephaly. The third is hydranencephaly

only (infected between days 76 and 104 of pregnancy).

With arthrogryposis, there is almost complete absence of ventral horn cells in the spinal cord and an accompanying neurotropic failure of muscle development. Contracture of the joints results. The hydranencephaly is manifested by a partial or complete failure of development of the cerebral cortex. The brainstem and cerebellum are usually normal.

Several other manifestations have been described. They include prearthrogryposis groups of calves with incoordination and a mild to moderate nonsuppurative encephalitis, along with other calves with flaccid paralysis and active secondary demyelination in motor areas of the spinal cord. Some calves are unable to stand and have thickened dorsal cranial bones, hydranencephaly involving anterior and midbrainstem, and a diminutive cerebellum. The infection with Akabane virus is also credited with causing abortion, stillbirth, and premature birth. There are reports from Japan and South Korea where encephalomyelitis as a result of Akabane virus is thought to have been acquired after birth,<sup>2,8</sup> and experimental inoculation of young calves with the Iriki variant of Akabane virus has induced encephalitis.

Lesions produced in lambs by experimental inoculation of the ewes during early pregnancy (days 32 to 36) include skeletal muscle atrophy and degeneration, and inflammatory and degenerative lesions in the cerebrum; the lesions in the central nervous system vary from porencephaly to hydranencephaly. There are also brachygnathism, scoliosis, hypoplasia of the lungs, agenesis or hypoplasia of the spinal cord, and arthrogryposis. Lesions are also present in fetuses of ewes inoculated between 29 and 45 days of gestation.

### Cache Valley

Ovine fetuses are susceptible to the teratogenic effects between 28 and 48 days of gestation.<sup>9</sup> Destructive lesions occur in the central nervous system, but infection of fetal membranes with a reduction in the volume of amniotic fluid and constriction by membranes around the fetus are thought to contribute to the occurrence of arthrogryposis.

### Schmallenberg

The acute phase of infection in adult ruminants produces a viremia of 5 to 6 days in duration.<sup>10</sup> In utero infection of the lamb appears to be determined by the absence or presence of a functional blood-brain barrier, explaining the window for experiment infection of 28 to 50 days (placentomes are initially present on day 28; the blood-brain barrier becomes functional on day 50 of gestation).

Arthrogryposis is secondary to transplacental infection resulting in abnormal development of motor neurons of the ventral horn

of the fetal spinal cord. This results in hypoplasia of the limb musculature, neurogenic muscle atrophy, and subsequent fixation (ankyloses) of the joints.

## CLINICAL FINDINGS

### Akabane

Infection in adult cattle is most commonly clinically inapparent, unless there is dystocia, but neurologic disease manifests with hypersensitivity, tremor, and ataxia has been recorded. In calves, the two syndromes, arthrogryposis and hydranencephaly, occur separately—arthrogryposis in the early stages of the outbreak and hydranencephaly at the end. Cases of calves with both defects occur in the middle of the outbreak. In some outbreaks, only one of the manifestations of the disease is seen.

Calves with arthrogryposis almost always are the subjects of difficult birth requiring physical assistance. They are small and significantly underweight, but they are fully mature in terms of teeth eruption and hair coat and hoof development. They are unable to rise, stand, or walk. One or more limbs is fixed at the joints; there is a congenital articular rigidity. The limb is usually fixed in flexion, but it may be in extension. The joint becomes freely movable if the tendons around it are severed; that is, there is no abnormality of the articular surface. The muscles of affected limbs are severely wasted. Kyphosis or scoliosis are common.

Calves with hydranencephaly have no difficulty rising and walking. The major defects are a lack of intelligence and blindness. They will suck if put onto the teat, but if this is not done, they stand and vocalize and have no apparent dam-seeking reflex. A few calves have microencephaly and are more severely affected. They are dummies, very uncoordinated in gait, and unable to stand properly, and they move erratically when stimulated. These cases appear at the very end of the outbreak.

In addition to the skeletal and neurologic diseases, cases of abortion, stillbirth, and premature birth are also regarded as being associated with Akabane virus infection in cows. They are usually recorded at the beginning of the outbreak before the neurologic defects occur.

### Cache Valley

Affected flocks have a higher rate of stillbirth and mummified fetuses. Congenital malformations in liveborn lambs include arthrogryposis of one or more limbs, scoliosis, and torticollis, and neurologic signs are similar to those seen in calves with Akabane disease.

### Schmallenberg

Adult cattle exhibit clinical signs of decreased milk production and fever, and some have diarrhea, with the duration of illness ranging from 1 to 6 days. Clinical disease has not been reported in sheep or goats.

Embryonic deaths, abortions, stillbirths, and arthrogryposis–hydranencephalopathy syndrome in newborn lambs and kids are the most common clinical abnormalities observed following infection of pregnant ewes and does. These abnormalities in lambs and kids are almost identical to those produced by Akabane virus in calves. Teratogenic effects were also observed in cattle, but at a much lower rate than in sheep and goats. A presumptive diagnosis of SBV teratogenicity is made in lambs, kids, and calves in Europe if stillbirth, premature or mummified fetuses, or abnormal neonates present with two or more of the following abnormalities: arthrogryposis, hydranencephaly, torticollis, scoliosis, kyphosis, brachygnathia inferior, muscle atrophy, joint malformations, ataxia, paresis, behavioral abnormalities, or blindness.

## CLINICAL PATHOLOGY

The presence of specific antibody in fetal sera or the precolostral sera of neonates is diagnostic, but its absence does not exclude the diagnosis if infection precedes the development of immunologic competence. Precolostral sera from several animals should be tested, and most cases are positive at high titer. A rising titer with paired samples from the dam, or a high titer in the serum of surviving neonates, is suggestive of recent infection but not confirmatory for disease. Serologic tests include microneutralization, hemagglutination inhibition, agar gel immunodiffusion (AGID), and an ELISA test.

Virus can be detected using real-time RT-PCR and culture in specific cell lines. RT-qPCR testing of blood is of reduced value because the period of viremia is short, but brainstem material provides the best tissue for testing teratogenic fetuses.<sup>11</sup> A humoral immune response mounted by the fetus can clear SBV from the fetus during gestation; consequently, SBV antibody testing of fetal heart blood or dam blood should be combined with RT-PCR testing of brainstem tissue for confirmation of SBV infection.<sup>11,12</sup>

## NECROPSY FINDINGS

The primary lesions with Akabane, Cache Valley, and Schmallenberg infections in the fetus are a **necrotizing nonsuppurative encephalomyelitis and polymyositis**.

In calves and lambs with arthrogryposis, there is severe muscle atrophy, fixation of joints by tendon contracture, and normal articular surfaces. The joints are easily released by cutting the surrounding tendons. Histologically, there may be almost complete absence of ventral horn cells in the spinal cord. This lesion may be localized to one segment of the cord, and viral antigen may be demonstrated via immunohistochemistry.

In calves and lambs with hydranencephaly, the cerebral hemispheres are completely absent, and the vacant space is filled with

fluid enclosed by the normal meninges. In a few cases the lesions will be limited to porencephaly. In most, the brainstem and cerebellum lack cavitations, but diminution of their size may be recorded.

## Samples for Confirmation of Diagnosis

- **Virology**—2 mL fetal heart blood and maternal serum for serology performed using ELISA<sup>13</sup>
- **Histology**—brain, spinal cord, muscle (LM, IHC)

## DIFFERENTIAL DIAGNOSIS

Akabane virus disease in calves, Cache Valley virus disease in lambs and kids, and Schmallenberg virus disease in calves, lambs, and kids, because they are manifest epidemiologically and are well-defined and easily recognizable entities. Differentials include the following:

- Lupine-induced arthrogryposis in calves
- Manganese deficiency in calves
- Heritable forms of arthrogryposis and/or micrencephaly

- Fetal infection with bluetongue virus, Rift Valley fever virus, or pestivirus

Cattle in Japan may also produce hydranencephalic calves, which are recumbent, opisthotonic, and unable to suckle at birth, when infected during pregnancy by the Chuzan virus. The virus, a member of the Polyam subgroup of orbiviruses, is transmitted by *Culicoides oxystoma*.

In Africa, infection with flaviviruses, including West Nile, Banyi, and AR5189, also causes abortion, stillbirth, and congenital brain malformations.

## TREATMENT AND CONTROL

No treatment is contemplated because affected calves, lambs, and kids are not viable and cannot be humanely kept alive.

Vector control is not possible with current knowledge, and vaccination provides the most effective method of control.

Killed vaccines for Akabane virus have proved very effective against natural exposure and are available in Japan and Australia. Japanese data suggest vaccines should include genogroup Ia strains because these strains have a stronger neurovirulence,<sup>14</sup> and vaccine failures has been attributed to antigenic variation among Akabane virus strains.<sup>15</sup> Vaccination requires two inoculations before pregnancy and an annual booster. Maternally derived antibodies against Akabane virus appear to last 4 to 5 months in colostrum-fed calves, and they last slightly longer in beef calves than dairy calves,<sup>16</sup> possibly as a result of a higher colostrum titer in beef calf colostrum as a result of smaller colostrum volumes. The economics of annual vaccination against Akabane virus is dictated by the risk of disease in regions subject to periodic outbreaks of disease.

Vaccines are not commercially available for Cache Valley virus.

Killed vaccines are commercially available for Schmallenberg virus in the United Kingdom and France, but they have not been widely used. Vaccination of calves with a commercially available Japanese vaccine against Akabane virus, Aino virus, and Chuzan virus did not provide cross-protection against SBV.<sup>17</sup> Preliminary data on a small number of vaccinated sheep suggest that protection against detectable viremia is provided after one injection of a SBV vaccine.<sup>18</sup> Early lambing flocks and pedigree flocks have been more likely to employ vaccination in the United Kingdom.<sup>19</sup> The seroprevalence in ranges widely from herd to herd, and determination of seroprevalence within a herd could be used to guide the decision regarding the need to vaccinate. Individual blood testing is not practical in this regard, and for cattle, determining the titer of a bulk-tank milk sample does not provide a sufficiently accurate test of herd seroprevalence.<sup>20</sup> Maternally derived antibodies against SBV last at least 2 years in adult cattle after natural infection and 5 months in their colostrum-fed calves;<sup>21</sup> on this basis, an initial vaccination series could start at 6 months of age if indicated.

Spread of SBV infection from farm to farm appears to be primarily a result of vector movements on the wind, and thus application of animal movement restrictions, including a total animal movement ban, is likely to have little impact on farm-to-farm transmission of infection.<sup>22</sup> In the Schmallenberg virus outbreak in Europe, cattle that had access to pasture for grazing in 2011 were 2.6 times more likely to delivered malformed calves than cattle that were housed inside.<sup>23</sup> Specific control measures may not be economically indicated in cattle because the decrease in milk production is mild and transient, non-SBV-associated mortality in adult cattle has been reported, and the incidence of fetal abnormalities is low.<sup>24</sup> Housing sheep to minimize contact with midges has been shown to decrease seroprevalence within a flock. The seroprevalence in the endemic area is lower in goat herds than sheep flocks; this has been attributed to differences in housing, with goats being more likely to be kept indoors with decreased exposure to midges. The use of insecticides or repellants on pregnant ewes and does is not likely to be efficacious, but experimental data are lacking. Changing the timing of lambing and kidding so that the second month of gestation occurs during cold ambient temperatures when midges are not active will theoretically decrease the incidence of teratogenic effects resulting from SBV. This recommendation has been supported by epidemiologically studies indicating lower odds of SBV-induced fetal malformations in sheep flocks that started breeding in October versus August.<sup>25</sup>

A number of European countries, including Germany, France, and the Netherlands, made it mandatory to report the birth of malformed lambs, kids, and calves on farms seropositive for SBV. The numbers of abnormal lambs, kids, and calves born decreased in 2013 and 2014, most likely because of the development of herd immunity and high seroprevalence. Reemergence and spread of SBV within Europe is considered likely.

#### FURTHER READING

- Beer M, Conraths FJ, van der Poel WHM. Schmallenberg virus—a novel orthobunyavirus emerging in Europe. *Epidemiol Infect.* 2013;141:1-8.
- Ganter M, Eibach R, Helmer C. Update on Schmallenberg virus infections in small ruminants. *Small Rumin Res.* 2014;118:63-68.
- Lievaert-Peterson K, Luttkholt SJM, van den Brom R, Velleme P. Schmallenberg virus infection in small ruminants—first review of the situation and prospects in northern Europe. *Small Ruminant Res.* 2012;106:71-76.
- Tarlington R, Daly J, Dunham S, Kydd J. The challenge of Schmallenberg virus emergence in Europe. *Vet J.* 2012;194:10-18.

#### REFERENCES

- Oem JK, et al. *Vet Microbiol.* 2012;158:250.
- Kamata H, et al. *J Comp Path.* 2009;140:187.
- Kobayashi T, et al. *Virus Res.* 2007;130:162.
- An DJ, et al. *Vet Microbiol.* 2010;140:49.
- Mouchantat S, et al. *Vet Res.* 2015;46:99.
- Andreadis TG, et al. *Vector-Borne Zoonot.* 2014;14:763.
- Oem JK, et al. *J Comp Path.* 2012;147:101.
- Lee JK, et al. *Vet Rec.* 2007;161:236.
- Hoffmann AR, et al. *J Virol.* 2012;86:4793.
- Wernike K, et al. *Vet Microbiol.* 2013;166:461.
- de Regge N, et al. *Vet Microbiol.* 2013;162:595.
- Bouwstra RJ, et al. *Vet Microbiol.* 2013;165:102.
- Oem JK, et al. *Trop Anim Health Prod.* 2014;46:261.
- Kono R, et al. *BMC Vet Res.* 2008;4:20.
- Bangphoomi N, et al. *J Vet Med Sci.* 2014;76:1471.
- Tsutsui T, et al. *J Vet Med Sci.* 2009;71:913.
- Hechinger S, et al. *Vet Res.* 2013;44:114.
- Hechinger S, et al. *Vet Res.* 2014;45:79.
- Roger P. *In Pract.* 2015;37:33.
- Daly JM, et al. *BMC Vet Res.* 2015;11:56.
- Elbers ARW, et al. *BMC Vet Res.* 2014;10:103.
- Gubbins S, et al. *Prev Vet Med.* 2014;116:380.
- Veldhuis AMB, et al. *Prev Vet Med.* 2014;116:412.
- Veldhuis AMB, et al. *Vet Microbiol.* 2014a;168:281.
- Luttkholt S, et al. *PLoS ONE.* 2014;9(6):e100135.

#### HYPERMOBILITY OF JOINTS

- This is recorded as an inherited defect in Jersey cattle. Affected animals are unable to rise or stand because of the lack of fixation of limb joints. The joints and limbs are usually all affected simultaneously and are so flexible that the limbs can be tied in knots. Causes include the following:
  - Inherited joint hypermobility in Jersey cattle
  - Heredity in Holstein-Friesian cattle, which also have pink teeth as a result of absence of enamel
  - In inherited congenital defects of collagen formation, including

dermatosparaxis, hyperelastosis cutis, and Ehlers-Danlos syndrome in cattle

- Sporadically in newborn animals

## Inherited Diseases of Muscles

### GLYCOGEN STORAGE DISEASES

A number of glycogen storage diseases have been detected in large animal species. The glycogen storage diseases discussed here are those that result in accumulation of abnormal concentrations of glycogen in muscle, either within lysosomes or within myocytes. These diseases include polysaccharide storage myopathy (glycogen storage disease type I) in various breeds of horses and as a result of a mutation in the gene encoding the enzyme glycogen synthase (addressed in detail later in the discussion of other inherited myopathies of the horse), glucosidase deficiency (glycogen storage disease type II) in sheep and cattle, and glycogen phosphorylase deficiency (glycogen storage disease type V) in sheep and cattle. Glycogen storage disease types II and V are discussed in the following sections.

### GENERALIZED GLYCOGENOSIS (GLYCOGEN STORAGE DISEASE TYPE II)

Generalized glycogenosis is a glycogen storage disease. Glycogen storage disease type II (GSD II; generalized glycogenosis), which resembles Pompe's disease in humans, occurs in Corriedale sheep, Shorthorn, and Brahman beef cattle, and it is caused by mutant alleles of the glucosidase alpha acid (GAA), creating a loss of function. Glucosidase is a lysosomal enzyme catabolizing glycogen to glucose. The heredity is autosomal recessive. In Brahman cattle, the glycogenosis is caused by two mutations; the mutation in exon 7 is a dinucleotide deletion (c.1057\_1058delTA) causing frameshift, and the mutation in exon 13 is the cytosine-to-thymine transition (c.1783C>T) coding for stop codons in exons 8 and 13, respectively.<sup>1</sup> The mutation in exon 9 (c.1351C>T) reduces glucosidase activity, and MspI polymorphism is a silent mutation in exon 16 (c.2223G>A). In Shorthorn cattle, glycogenosis type II is caused by a single mutation that is a deletion (c.2454\_2455delCA). The genetic abnormality was not detected in a survey of Charolais, Czech Spotted (Czech Simmental), Belgian Blue, Limousine, Blonde d'Aquitaine, Aberdeen Angus, and Beef Simmental sires reared in the Czech Republic, although the number of animals tested was small for some breeds (Czech Simmental, 62; Charolais, 34; Belgian Blue, 6; Limousine, 4; Blonde d'Aquitaine, 4; Beef Simmental, 2; and Aberdeen Angus, 1).<sup>1</sup>



In Brahman cattle, there is a common mutation affecting many Australian Brahmans and a less common one affecting descendants of one imported bull. In addition, a third mutation is associated with significantly reduced  $\alpha$ -glucosidase activity, but not sufficient to cause clinical disease in the homozygous state.

Clinical signs include poor growth, muscle weakness, incoordination of gait, and difficulty in rising. The animals become permanently recumbent. The disease is identified as a lysosomal storage disease, with lesions present in skeletal and cardiac muscle and central nervous tissue. During the course of the disease there is progressive muscular damage and acute degeneration of muscle fibers in the terminal stage. Affected Brahman calves die at 8 to 9 months of age and British breed cattle at over 1 year. Only histopathologic lesions are evident and include extensive vacuolation and accumulations of granular material in affected tissues. Among the biochemical lesions are greatly diminished  $\alpha$ -glucosidase activity in liver and muscle and a correspondingly high level of glycogen. Animals in affected herds are divisible into normal heterozygotes and homozygotes on the basis of  $\alpha$ -1,4-glucosidase activity in lymphocytes or in muscle, especially the semitendinosus muscle.

Genotyping methods using hair root and blood samples to test Shorthorn cattle for generalized glycogenosis are available, and PCR assays have been developed to genotype Brahman cattle for loss-of-function alleles within the acidic  $\alpha$ -glucosidase gene.

#### FURTHER READING

Jolly RD, Blair HT, Johnstone AC. Genetic disorders in sheep in New Zealand: a review and perspective. *NZ Vet J*. 2004;52:52-64.

#### REFERENCE

1. Citek J, et al. *J Vet Med A*. 2007;54:257.

### GLYCOGEN STORAGE DISEASE TYPE V (MUSCLE GLYCOGEN PHOSPHORYLASE DEFICIENCY)

Glycogen storage disease Type V (akin to McArdle's disease in humans) has been recorded in Charolais cattle in North America and Merino sheep in Australia.<sup>1</sup> Type V is inherited as an autosomal-recessive trait, and the mutation in sheep has been identified as an adenine-for-guanine substitution at the intron 19 3' splice site, with subsequent lack of myophosphorylase activity.<sup>2</sup> There is mildly elevated muscle glycogen concentration and elevated serum creatine and aspartate aminotransferase activity. Severely affected animals can develop rhabdomyolysis, which may be accompanied by myoglobinuria.

In Charolais cattle, glycogen storage disease type V is usually seen in calves at several weeks or months of age and is associated with exercise intolerance or reduced

capacity for exercise. Calves lag behind their dam or herd and may become temporarily recumbent for several minutes; with continuous exercise there are further periods of collapse and recumbency, which can become prolonged. Not all homozygous animals are clinically affected if they are allowed to "pace their exercise," and some animals have been known to breed despite muscle weakness.

The disease in Merino sheep is associated with exercise intolerance and increased concentrations of glycogen in muscle.<sup>1,2</sup>

A PCR restriction fragment length polymorphism test has been used to identify heterozygous individuals in a Charolais herd in New Zealand that were otherwise normal. Using a similar test, a Blonde d'Aquitaine crossbred calf with a double-musled phenotype and suspected of having myophosphorylase deficiency based on clinical findings of brown-colored transparent urine after exercise, pain, and elevated creatine kinase was considered negative. The gene maps to chromosome 29.<sup>3</sup>

#### REFERENCES

- Howell JM, et al. *Neuromusc Dis*. 2014;24:167.
- Tan P, et al. *Neuromusc Dis*. 1997;7:336.
- Citek J, et al. *J Vet Med A*. 2007;54:257.

### INHERITED DIAPHRAGMATIC MUSCLE DYSTROPHY

Inherited diaphragmatic muscle dystrophy is an inherited defect in diaphragmatic muscle of Meuse-Rhine-Yssel and Holstein-Friesian cattle appearing in adults and characterized by anorexia, decreased rumination, and eructation leading to recurrent bloat, dyspnea, abdominal respiration, nostril dilatation, and death from asphyxia after a course of several weeks. The disease is a result of a mutation involving one of the genes for heat shock protein 70 (HSP70), resulting in markedly reduced HSP70 concentrations in muscle of affected animals.<sup>1</sup> Loss of HSP70 function causes accumulation of glycogen phosphorylase enzyme protein in muscle. Necropsy lesions comprise degenerative changes in diaphragmatic and thoracic muscles.

#### REFERENCE

1. Sugimoto M, et al. *Anim Genet*. 2003;34:191.

### CONGENITAL MYASTHENIA GRAVIS

Congenital myasthenic syndrome occurs in Brahman cattle in South Africa and is reported in a Hereford heifer in the United States. Affected Brahman calves develop progressive muscular weakness, beginning at birth and up to 3 to 4 weeks of age. Within 1 week they are unable to stand without assistance. Some calves are able to stand and walk for 30 to 45 minutes before collapsing, but they are still able to suck their dams. The

calves remain alert and continue sucking but may collapse after 20 to 60 seconds. The weakness becomes progressively worse, and affected calves are usually euthanized. Hematology and serum biochemistry are normal, and muscle biopsies do not reveal any abnormalities.

The disease was traced to two founder animals as the most likely original carriers. Pedigree analysis revealed no ancestors common to all known carriers, but rather that the mutation had been introduced at least twice into the South African Brahman population, probably via animals imported from the United States.<sup>1</sup>

The underlying defect is a homozygous 20-base-pair (bp) deletion in the gene, muscular acetylcholine receptor (bov $CHRNE$ ), coding for the subunit of the nAChR at the neuromuscular junction. A PCR-based DNA test, using blood or semen, has been developed and validated. The test makes it possible to differentiate rapidly and accurately between homozygous wild-type, heterozygous, and homozygous affected animals. Overall prevalence of carriers among 1453 animals tested in South Africa was 0.97% (0.50% to 1.68%, 95% confidence interval). Heterozygosity for the  $CHRNE$  470del20 mutation is associated with a 13.3-kg increase in adjusted 600-day body weight, providing evidence of a selective advantage for carrier animals and an explanation of the relatively high prevalence of the disease.<sup>1</sup>

The disease in a Hereford heifer was characterized as recurrent recumbency and upper eyelid ptosis. Both recumbency and ptosis resolved within 1 minute of IV administration of edrophonium (0.1 mg/kg) and persisted for up to 48 hours.<sup>2</sup> The heifer was first examined at 7 months of age and was slaughtered at 11 months of age.

#### REFERENCES

- Thompson PN, et al. *J Anim Sci*. 2007;85:604.
- Wise LN, et al. *J Vet Int Med*. 2008;22:231.

### BOVINE FAMILIAL DEGENERATIVE NEUROMUSCULAR DISEASE

Bovine familial degenerative neuromuscular disease has been reported as occurring in Gelbveih cattle in several separate beef herds in the United States. Affected animals are 4 to 20 months of age, and the case-fatality rate is 100%. Clinical findings include ataxia, weakness, and terminal recumbency. Gross and histologic muscle lesions were indicative of nutritional muscular dystrophy with no myocardial lesions. Acute to chronic lesions in most large skeletal muscle groups consist of degeneration, necrosis, regeneration, fibrosis, and atrophy. Fibrinoid necrosis of arterioles is a common feature in multiple tissues. Lesions in the spinal cord white matter and peripheral nerves consisted of degeneration of the dorsal columns and axons, respectively. Chronic

interstitial nephritis with fibrosis, hyaline droplet change, and tubular epithelial vacuolar change were most severe in older calves. Vitamin E levels were abnormally low in most affected calves. Pedigree analysis found a common ancestry for all but one of the affected calves. It is hypothesized that a hereditary metabolic defect, possibly involving antioxidant metabolism, may be the causative factor.

### INHERITED UMBILICAL HERNIA

Umbilical hernias in cattle have been considered to be inherited defects for many years, but the evidence is uncertain.

Umbilical hernias are commonly identified in dairy heifers. In 18 commercial dairy herds in New York, 15% of heifer calves had umbilical hernias during the first 3 months of age. The economic costs of umbilical hernias include the cost of medical and surgical treatment and the loss in value for breeding animals.

It has been generally accepted that umbilical hernias may be inherited in a dominant or recessive mode. Some studies have found the risk of hernias was higher in some breeds, with the incidence being much higher in Holstein cattle than other breeds such as Angus, Ayrshire, Brown Swiss, Charolais, Guernsey, Hereford, Jersey, and Shorthorn. However, aspects other than genetic factors may be important. For example, many veterinarians have observed that umbilical infections commonly lead to umbilical hernia by slowing closure of the umbilicus. It is unlikely that the responsible genes are sex-linked, in spite of the apparent greater incidence in females. Umbilical hernias in Holstein-Friesian cattle can also be conditioned by a dominant character with incomplete penetrance or be caused by environmental factors. In a case-control study to determine risk factors associated with identification of an umbilical hernia during the first 2 months after birth in Holstein heifers, the sire and umbilical infection were associated with risk of a hernia. Heifers born to sires with = 3 progeny with an umbilical hernia were 2.31 times as likely to develop a hernia as were heifers born to sires with = 2 progeny with an umbilical hernia. Heifers with umbilical infection were 5.65 times as likely to develop a hernia as were heifers without umbilical infection. Attributable proportion analysis found that the frequency of umbilical hernias in Holstein heifers with umbilical infection would have been reduced by 82% if umbilical infection had been prevented.

The risk factors for congenital umbilical hernias in German Fleckvieh calves offered for sale at livestock markets were examined. An umbilical hernia was defined as a palpable opening in the abdominal wall of the umbilical region greater than 1.5 cm, even if no hernia had developed. Inflammation, abscesses, or fistulae were excluded. Data

from 53,105 calves were collected from 77 livestock markets over a 2-year period. The overall incidence of congenital hernia was 1.8%. The analyses found significant effects for sex of calf, birth type, age of calf at examination, market place and date, sire line, sire, and frequency of affected herdmate calves in male calves. The incidence was 2.2% in males and 1.5% in females. The calves varied from 3 to 8 weeks of age. The diameter of hernial openings was between 1.5 and 9 cm, with 47% of affected calves with a hernia measuring greater than 3 cm. A significantly higher incidence occurred in twin or triplet calves. Shorter gestation periods increased the risk of hernias linearly by a factor of 1.3% for 10 days. There were differences in the incidence of hernias according to sire lines, but the heritability estimates were low, varying from  $h = 0.04$  (>100 progeny) or  $h = 0.05$  (>25 or 50 progeny). However, analysis of the data found no evidence for a monogenic autosomal-recessive inheritance. The analyses indicated that the incidence of congenital umbilical hernia observed could not be explained by one autosomal-recessive gene locus; it seems much more likely that more than one gene locus is involved, or a mixed multifactorial monogenic mode of inheritance may be the underlying genetic mechanism. It is suggested that the incidence of congenital umbilical hernias could be reduced if all breeding bulls are examined as calves and a veterinary certificate confirms a closed umbilical ring.

Breeders should be aware of the implications of congenital hernias, and, thus, congenital hernia should get more attention in the selection process of young sires.

Breeding studies and genotyping using the Canadian Holstein bull Glenhaption

Enhancer have provided evidence that Enhancer is the carrier of a major dominant or codominant gene with partial penetrance for umbilical hernia. Five sons of Enhancer produced progeny with greater than 10% frequency of umbilical hernia, whereas the progeny of three sons had less than 3% frequency umbilical hernia. Genotyping of grand-progeny found significant differences in paternal allele frequencies between the affected and unaffected progeny groups for a marker BMS1591 on bovine chromosome 8(BTA8). The umbilical hernia-associated paternal allele originated from Enhancer.

### MYOFIBER HYPERPLASIA (DOUBLE MUSCLING, DOPPELENDER, CULARD)

#### EPIDEMIOLOGY

Myofiber hyperplasia is an inherited condition characterized by an increased bulk of skeletal muscles as a result of the presence of a greater-than-normal number of muscle fibers that occurs in Charolais, Belgian Blue (Fig. 15-15), Piedmont, and South Devon breeds. The condition is recorded only rarely in sheep (Texel breed).<sup>1</sup> Pietrain pigs (see following discussion) exhibit many of the characteristics of double-muscling cattle, including large muscle mass and susceptibility to stress.

The condition in Belgian Blue cattle is attributable to a mutation in the MSTN gene that regulates myostatin production.<sup>1-3</sup> Inhibition of myostatin, through a loss-of-function mutation, results in increases in muscle fiber number and muscle mass. The disease in Belgian Blue cattle, and presumably in other breeds of cattle and sheep,



Fig. 15-15 Myofiber hyperplasia in a Belgian Blue cow.

is transmitted as an autosomal-recessive characteristic. A similar mutation in Thoroughbred horses is associated with superior sprint (<1600 m) racing performance.<sup>4,5</sup> The mutation has been induced experimentally in Meishan pigs.<sup>6</sup>

The mutation of *MSTN* was “fixed” in the Belgian Blue breed in the 1990s as a result of strong selection pressure for the double-muscle phenotype.<sup>2</sup> Subsequent continued selection pressure has resulted in increases in frequency of other haplotypes favoring increased lean muscle mass, resulting in a polygenic basis for the current phenotype. Selection of the phenotype is currently limited because of the occurrence of crooked-tail syndrome (see section on Inherited Taillessness and Tail Deformity later in this chapter) in animals homozygous for the *MRC2* gene, which encodes protein Endo180. Animals heterozygous for the *MRC2* mutation do not have crooked-tail syndrome and have enhanced muscularity.<sup>7</sup>

### CLINICAL FINDINGS

Severely affected cattle show a marked increase in muscle mass most readily observed in the hindquarters, loin, and shoulder; an increase in the muscle:bone ratio; and a decrease in body fat.<sup>8</sup> Affected calves demonstrate above-average weight gains during the first year of life if well fed and managed, although mature size is somewhat reduced. Well-marked grooves along the intramuscular septa in the hindquarters are a distinguishing feature, as is an apparent forward positioning of the tail head. Macroglossia, prognathism, and a tendency toward muscular dystrophy and rickets have been observed in affected calves. Electrocardiographic abnormalities have been reported. The condition often gives rise to dystocia and the need for frequent caesarian section to deliver viable calves.<sup>9</sup> There is also a very high incidence of Elso heel in affected cattle, and this interferes greatly with their economic value. Other associated defects are brachygnathia, deviation of the incisor arch, and, in Belgian Blue and White cattle, greater susceptibility than normal to laryngitis and bronchopneumonia.

### CLINICAL PATHOLOGY

Blood lactate is increased, as is susceptibility to stress. These findings are interpreted as being indicators of cell-membrane fragility, which is also manifested by fragility of the erythrocytes.

### NECROPSY FINDINGS

The skin is thinner than normal, and the muscle mass is characterized by a disproportionate number of glycolytic anaerobic fibers.

### REFERENCES

1. Clop A, et al. *Nat Genet.* 2006;38:813.
2. Druet T, et al. *BMC Genet.* 2014;15.
3. Grobet L, et al. *Nat Genet.* 1997;17:71.
4. McGivney BA, et al. *Anim Genet.* 2012;43:810.

5. Petersen JL, et al. *Anim Genet.* 2014;45:827.
6. Qian L, et al. *Sci Rep.* 2015;5.
7. Sartelet A, et al. *Anim Genet.* 2012;43:604.
8. Kolkman I, et al. *Animal.* 2010;4:661.
9. Kolkman I, et al. *Reprod Dom Anim.* 2012;47:365.

### INHERITED SPLAYED DIGITS

Recorded only in Jersey cattle, this defect appears to be conditioned by an inherited gene, most likely a monogenic autosomal-recessive gene. Lameness becomes apparent at 2 to 4 months of age, with the toes becoming increasingly widely spread and the toes themselves misshapen. Walking and standing are painful, especially on the front feet, so that some animals graze and walk on their knees. Affected animals either lie down increasingly or stay standing for very long periods. The apparent abnormality is a defect of the muscles and ligaments holding the phalanges together.

### INHERITED PROGRESSIVE MUSCULAR DYSTROPHY

Inherited progressive muscular dystrophy is a primary skeletal muscle disease of sheep with a strong probability of having a genetic mode of transmission. It is recorded in Merino flocks in Australia and is characterized by a gradually progressive failure to flex the joints of the hindlimbs commencing at 3 to 4 weeks of age. Eventually the limbs are rigid at all times, and running becomes impossible. The forelimbs and the head and neck are normal. Affected sheep are easily detected when they are 1 year old and will have mobility problems by the time they are 2 to 3 years old. At necropsy there are pale areas in skeletal muscle and sometimes the muscles of the diaphragm in those sheep that have a tendency to bloat. The histopathology and histochemistry of the muscle lesions are comparable with those of inherited muscle atrophies in humans.

### PSEUDOMYOTONIA OF CATTLE, CONGENITAL MUSCULAR DYSTONIA-1

#### SYNOPSIS

**Etiology** Pseudomyotonia (PMT) and congenital muscular dystonia-1 (CMD1) are caused by dysfunctional sarcoplasmic reticulum  $\text{Ca}^{2+}$ -ATPase (SERCA1) that is caused by a mutation in the *ATP2A1* gene that encodes SERCA1.

**Epidemiology** PMT is predominantly observed in Italian beef cattle breeds; CMD1 has only been reported in Belgian Blue cattle.

**Clinical findings** Increased resting muscle tone; exercise-induced, transient muscle stiffness that resolves within seconds to

minutes and may result in adaptation of a sawhorse-type posture or flipping over. Congenital, nonprogressive. Animals with PMT can reach adult age; calves with CMD1 die in the first weeks of life.

**Diagnostic confirmation** Genome analysis to identify gene mutation.

**Treatment** None available.

**Control** Check parents of confirmed cases for presence of gene defect and exclude from future breeding. In population with high prevalence of gene defect, test breeding bulls for gene defect.

### ETIOLOGY

Pseudomyotonia (PMT) of cattle is a congenital muscular condition similar to Brody's disease in humans that is clinically indistinguishable from myotonia.<sup>1,2</sup> Congenital muscular dystonia-1 (CMD1) is a condition thus far only reported in Belgian Blue calves that is clinically distinct from PMT.<sup>3</sup> The underlying cause for both conditions was determined to be a malfunction of the **sarcoplasmic reticulum  $\text{Ca}^{2+}$ -ATPase isoform 1 (SERCA1)** as a result of a **missense mutation in the *ATP2A1* gene** that encodes SERCA1.<sup>1,2</sup> It is inherited in an autosomal-recessive manner.<sup>4</sup>

### EPIDEMIOLOGY

Bovine congenital pseudomyotonia has been described in Italian Chianina and Romagnola cattle and as a single case in a Dutch Improved Red and White crossbred calf.<sup>1,5</sup> Congenital muscular dystonia in contrast has only been described in Belgian Blue cattle.<sup>3</sup> Two distinct point mutations in the *ATP2A1* gene have been identified, with one consistently occurring in Italian cattle breeds and one identified in Belgian Blue and in one Dutch Improved Red and White crossbred calf.<sup>4</sup> Although the mutation described in Italian breeds has only be associated with PMT, the mutation observed in Belgian Blue calves, and thus generally associated with CMD1, was also found in the single animal, where it presented clinically as PMT.<sup>1,5</sup>

The incidence of CMD in Belgian Blue calves, which comprises CMD1 but also the clinically similar but etiologically different condition CMD2, has been given as 0.1% to 0.2%.<sup>3</sup> The prevalence of the PMT gene defect in the Italian Chianina sire population used for artificial insemination was 13.6% for the period between 2007 and 2011, and the prevalence in the male progeny selected for a performance testing program was 13.4%.<sup>6</sup>

### PATHOGENESIS

PMT and CMD1 are both caused by a malfunction of the **sarcoplasmic reticulum  $\text{Ca}^{2+}$ -ATPase isoform 1 (SERCA1)**.<sup>1,5</sup> In normal skeletal muscle fibers, contraction



and relaxation are determined by  $\text{Ca}^{2+}$  interaction with contractile proteins.  $\text{Ca}^{2+}$  is normally stored in the lumen of the sarcoplasmic reticulum, and its release into the cellular cytoplasm induces muscle contraction. At the end of a contraction cycle, SERCA1 proteins pump excessive  $\text{Ca}^{2+}$  ions back from the cytoplasm into the sarcoplasmic reticulum to initiate relaxation. Impaired function of SERCA1 delays the removal of  $\text{Ca}^{2+}$  from the cytosol of muscle fibers, thereby prolonging the contractile phase.<sup>5</sup>

### CLINICAL FINDINGS

Although PMT and CMD1 are caused by the same gene defect, the clinical presentation of both conditions differs markedly.

#### Congenital Muscular Dystonia Type 1 (CMD1)

CMD1 is a fatal congenital and nonprogressive condition of Belgian Blue calves.<sup>3</sup> The disease is characterized by exercise-induced pronounced episodes of generalized muscle contractures. During such episodes the affected calf has stiffened limbs and is unable to move or may even flip over with the extremities extended. Impaired swallowing has also been reported, and affected calves usually die in the first weeks of life as a result of respiratory complications.<sup>3</sup>

#### Pseudomyotonia (PMT)

PMT in cattle is a congenital and nonprogressive disease characterized by a generally increased muscle tone and exercise induced episodes of generalized muscle stiffness. Affected animals are reported to have a stiff or clumsy gait from birth on, and forcing them to move faster than at their own pace will trigger an episode of transient muscle contracture lasting from 20 seconds to over 1 minute. During this episode the animal is unable to move as a result of rigidity of the limbs. It either adopts a saw-horse type posture or may even flip over with all of the limbs extended. After a variable time period lasting from a few seconds to over a minute, the muscle contracture resolves progressively and the animal returns to its normal behavior. Although affected animals are often thought to have a neurologic affliction, the condition is purely a muscular disorder and is not associated with any neurologic deficiencies. In contrast to CMD1, animals with PMT can reach adult age.<sup>5</sup>

### CLINICAL PATHOLOGY

Clinically, the condition is indistinguishable from myotonia, a chloride channel disorder, occurring incidentally in cattle as consequence of a spontaneous mutation in the *ClCN1* gene (see also "Myotonia of Goats"). Percussing large muscle bellies either with the fingers or a percussion hammer will fail to produce local muscle fasciculation (**percussion myotonia**) in calves with PMT or CMD1, which would be characteristic for

myotonia. **Electromyographic examination** is unremarkable, which also allows for differentiation of the condition from myotonia.<sup>1,5</sup>

Genome analysis to confirm the presence of a mutation in the **ATP2A1 gene** is required to make the definitive diagnosis. DNA analysis is also required to rule out congenital myotonia type 2 (CMD2) in Belgian Blue cattle, which is caused by a nonsense mutation in the gene encoding the inhibitory glycine receptor.<sup>3</sup>

### TREATMENT

There is currently no specific treatment available.

### NECROPSY FINDINGS

Necropsy examination has been not reported to yield remarkable findings.

### CONTROL

With the condition being inherited in an autosomal-recessive manner, it has been recommended to test parents of a calf confirmed with PMT or CMD1 for the presence of the gene defect. Parent animals recessively carrying the gene defect are clinically healthy but should not be used for breeding. For populations with high prevalence of the gene defect, it is advisable to systematically check breeding bulls for the presence of the mutations before using their semen for breeding.<sup>6</sup>

### REFERENCES

1. Testoni S, Boni P, Gentile A. *Vet Rec.* 2008;163:252.
2. Drögemüller C, et al. *Genomics.* 2008;92:474-477.
3. Charlier C, et al. *Nat Genet.* 2008;40:449-454.
4. Murgiano L, et al. *BMC Vet Res.* 2012;8:186.
5. Grunberg W, et al. *Neuromuscular Disord.* 2010;20:467-470.
6. Murgiano L, et al. *Vet J.* 2013;195:238-240.

### OVINE HUMPYBACK

Ovine humpyback is probably a form of heat stroke that affects Merino wethers in western Queensland (Australia). It is characterized by a stiff, short gait when sheep are forced to walk for about a kilometer. The sheep stops walking and adopts an arched-back posture, and the body temperature is significantly elevated. Blood samples reveal a low number of lymphocytes. The condition occurs predominantly in summer, when sheep are in full wool, and the hyperthermia and ataxia disappear when sheep are shorn. Environmental temperatures at the time of the greatest prevalence of the disease are commonly 40° C (104 F).

### FURTHER READING

- Radostits O, et al. Focal symmetrical encephalomalacia. In: *Veterinary Medicine: A Textbook of the Diseases of Cattle, Horses, Sheep, Goats and Pigs*. 10th ed. London: W.B. Saunders; 2007:2015.

## MYOTONIA OF GOATS (FAINTING GOATS)

### SYNOPSIS

**Etiology** Chloride channel disorder caused by a gene mutation affecting the *ClCN-1* gene.

**Epidemiology** Myotonia of goats is the characteristic trait of an uncommon American goat breed, the fainting goat.

**Clinical findings** Increased resting muscle tone; transient muscle stiffness after startling the animal that resolves within seconds to minutes and may result in adaptation of a sawhorse-type position or flipping over. Congenital, nonprogressive.

**Diagnostic confirmation** Muscle percussion, electromyography, genetic analysis to identify gene mutation.

**Treatment** Not treated.

**Control** Not applicable.

### ETIOLOGY

Myotonia of goats describes an inherited condition that is characterized by an abnormal delay in muscle relaxation following voluntary forceful muscle contraction.<sup>1</sup> The underlying cause is a structural and functional defect of the **skeletal muscle chloride channel 1 (ClCN1)** that is essential to restore and maintain the membrane potential of muscle cells at the resting level. A missense mutation of the *ClCN1* gene encoding the skeletal muscle *ClCN1* in so-called fainting goats has been identified and has been associated with decreased muscle chloride conductance resulting from a decreased number of functional chloride channels on muscle cell membranes.<sup>2</sup>

Anecdotal evidence suggests that the myotonic goat phenotype is transmitted as an autosomal-dominant trait, although many herds have been inbred, resulting in clinical presentation reminiscent of human recessive generalized myotonia (or Becker myotonia) with recessive inheritance.<sup>1</sup>

Historically the fainting goats played an important role in the process of unraveling the etiology and pathophysiology of congenital myotonia, a condition also affecting humans and other species.<sup>2</sup>

### EPIDEMIOLOGY

#### Occurrence

Myotonia in goats was first reported in the 1880s in Tennessee, United States, where several does and one buck with signs of nervousness and stiffness appear to have been introduced by a transient farm worker.<sup>3</sup> Since then, the progeny of these animals have become established in the area. These goats, which are now a recognized breed, the **fainting goat**, became popular in the region as shepherds used them to protect their flocks from predators. During a predator attack, the

fainting goat would become startled and develop a characteristic episode of muscle stiffness, making it an easy prey, while the rest of the flock would be able to make an escape.

Currently there are two strains of this breed, which is indigenous to the United States. The original strain in Tennessee and the eastern part of the United States consists of smaller animals, whereas fainting goats found in and around Texas have been selectively bred for the meat market and are larger and heavy rumped, with a deep chest. The Livestock Breed Conservancy has this goat breed listed as a conservation priority livestock breed, with an estimated world population below 10,000 head.<sup>4</sup>

### Economic Importance

Myotonic goats are considered a rare breed. Although historically their main purpose appears to have been to serve as prey animals to protect flocks from predators, this use has fallen out of practice. Today the main purposes are meat production and amusement. Myotonia is generally accompanied by muscle fiber hypertrophy, yielding greater muscle mass, less body fat, and higher bone-to-meat ratio than other breeds. Frequently this breed is kept as pet for its fainting spells for the owners' amusement, which has led to ethical concerns about breeding animals with this gene defect.

### PATHOGENESIS

The missense mutation in the CLCN1 gene results in the transcription into a faulty chloride channel 1 protein that reduces the sarcolemmal chloride conductance. With normal chloride conductance across muscular cell membranes, chloride moves in and out of the cell until the intracellular concentration is adjusted to set the chloride equilibrium potential equal to the resting potential. The function of chloride is to rapidly return the membrane potential of the contracted and thus depolarized cell to the resting membrane potential, thereby allowing muscle relaxation. A reduced number of functional chloride channels on the sarcolemmal membrane reduces the velocity with which the membrane potential can be returned to the resting level, which has two important consequences: (1) a lower electrical stimulus is required to trigger an action potential, resulting in increased excitability of the muscle cell; and (2) after initial depolarization, the membrane potential very slowly returns to a normal resting membrane potential. Until the resting membrane potential is reached, the actual membrane potential is closer to the threshold voltage needed to trigger a new action potential, which can result in spontaneous action potentials that are not triggered by neuromuscular transmission. Such autonomous action potentials will cause persistent muscle contraction and delayed muscle relaxation after an initial vol-

untary muscle activity, which are characteristic for myotonia.<sup>1,5</sup>

### CLINICAL FINDINGS

The congenital condition that is characterized by a delay in muscle relaxation following an initial voluntary contraction is present from birth and is nonprogressive. Although affected goats are referred to as fainting goats, the condition is a purely muscular disorder and not associated with any neurologic deficits. The severity can vary from very mild to severe, and it appears that goats are able to adjust to the condition with age. Myotonia is not associated with pain.

A typical presentation is a slightly to moderately increased resting muscle tone that may result in a clumsy or stiff gait in animals with severe myotonia. Myotonic episodes and muscular stiffness can be triggered by startling the animal and thereby inducing a forceful initial movement. Because of delayed muscle relaxation, initially contracted muscles remain tensed for a period of between 10 seconds and 1 minute or longer and relax progressively thereafter. During this prolonged phase of muscle contraction, animals may either remain in a sawhorse-type position or may flip over with extended, stiffened limbs. Once muscle contraction resolves, the animal returns to normal attitude and behavior.

### CLINICAL PATHOLOGY

The presentation is characteristic, with animals being affected from birth by inducible myotonic episodes. Clinically the diagnosis can be supported by percussing large muscle bellies either with the fingers or a percussion hammer. In myotonic animals, muscle percussion triggers local muscle fasciculation (**percussion myotonia**) that lingers for several seconds. **Electromyographic examination** reveals increased insertional activity when inserting myography needles into muscle tissue and continued high-frequency discharges that outlast normal motor unit responses by several seconds.

To confirm the diagnosis, DNA analysis to confirm the presence of mutation in the CLCN1 gene is required.<sup>6</sup>

### NECROPSY FINDINGS

Necropsy examination is not usually undertaken for diagnostic purposes.

### FURTHER READING

- Lossin C, George AL. Myotonia congénita. *Adv Genet.* 2008;63:25-55.  
Tang CY, Chen TY. Physiology and pathophysiology of CLCN-1: mechanisms of a chloride channel disease, myotonia. *J Biomed Biotech.* 2011;article ID 685328.

### REFERENCES

1. Lossin C, George AL. *Adv Genet.* 2008;63:25-55.
2. Beck CL, et al. *Proc Nat Acad Sci.* 1996;93:11248-11252.
3. Clark SL, et al. *J Nerv Ment Dis.* 1939;90:297-309.

4. American Livestock Conservancy. At <<http://albc-usa.etapwss.com/images/uploads/docs/PriorityLivestock2013.pdf>>; 2013 Accessed 10.01.13.
5. Tang CY, Chen TY. *J Biomed Biotech.* 2011;article ID 685328.
6. Wijnberg ID, et al. *Neuromuscular Dis.* 2012;22:361-367.

## MYOTONIA CONGENITA AND MYOTONIC DYSTROPHY

Myotonia is the prolonged contraction of muscle as a result of delayed relaxation. It can be present soon after birth or develop as a progressive disease.

The **congenital** form in horses (New Forest ponies),<sup>1</sup> goats, and Murrah buffalo is an inherited disorder of muscle membrane hyperexcitability caused by mutations in the voltage-gated chloride channel gene CLCN1. The mutation reduces sarcolemmal chloride conductance and delays relaxation of the muscle.<sup>1,2</sup> It is transmitted as an autosomal-recessive trait in ponies.<sup>1</sup> The disease is evident as generalised myotonia evident soon after birth. The disease is not progressive, but there is not treatment. Control is based on breeding programs.

The disease in horses **myotonia dystrophia** is evident as increased muscle tone, increased muscle bulk or muscle atrophy, stilted gait, and weakness.<sup>3</sup> Electromyographic examination reveals the classic myotonic discharges. Affected horses can have testicular atrophy and cataracts. The disease is progressive. There are no characteristic changes in blood or serum. Muscle biopsy demonstrates dystrophic changes, with variations in fiber size and fiber-type grouping. There is no effective treatment, and control is through avoidance of breeding of affected animals.

### REFERENCES

1. Wijnberg ID, et al. *Neuromusc Dis.* 2012;22:361.
2. Borges AS, et al. *Neuromusc Dis.* 2013;23:206.
3. Ludvikova E, et al. *Vet Quart.* 2012;32:187.

## RECURRENT EXERTIONAL RHABDOMYOLYSIS IN THOROUGHBRED AND STANDARDBRED HORSES

### ETIOLOGY

Recurrent exertional rhabdomyolysis is a recognized syndrome in Thoroughbred, Standardbred, and Arabian racehorses. A genetic basis is considered likely, with heritability of 0.42,<sup>1</sup> but has not been demonstrated. Genome-wide scans and linkage analyses map candidate genes to the genomic region between UCDEQ41 and TKY499 on ECA12 (*Equus caballus* chromosome 12) or regions on ECA16 or ECA 20.<sup>1,2</sup> The differences between the two studies, with one mapping to ECA16<sup>2</sup> and the other to ECA12 and ECA20,<sup>1</sup> might be attributable to the

study of different populations of horses (North America vs. Japan), phenotyping (disease classification), or laboratory techniques. The RYR1, CACNA1S, and ATP2A1 genes are not linked to recurrent exertional rhabdomyolysis in Thoroughbreds,<sup>3</sup> nor do affected Standardbred horses have the GSY1 mutation identified as a cause of polysaccharide storage myopathy in Quarter horses, draft horses, and other breeds.<sup>4</sup> Mutations in genes expressing monocarboxylate transporter 1 and CD147 are not associated with the disease.<sup>5</sup>

Recurrent exertional rhabdomyolysis in Thoroughbreds is likely to be a complex genetic disease resulting from one or more genes having a major effect, with expression affected by modifying genes, environment, or sex.<sup>2,6</sup>

## EPIDEMIOLOGY

Interpretation of reports of prevalence and risk factors for exertional rhabdomyolysis are imprecise because of difficulties in distinguishing the disease from other causes of rhabdomyolysis, including the sporadic disease. The **incidence** or 1-year period prevalence of exertional rhabdomyolysis is as follows: 4.9% in Thoroughbred racehorses in the United States, Australia, and Great Britain; 6.1% in National Hunt Thoroughbreds in Great Britain; and 4% to 5% in 2- to 3-year-old Thoroughbreds in the United Kingdom.<sup>7</sup> The annual incidence in Standardbred racehorses in Sweden is 6.4 (95% CI 4.6% to 8.2%) per 100 horses.<sup>4</sup> Annual incidence in 22 Standardbred training yards in Sweden ranged from 1.7 to 20 cases per 100 horses.<sup>4</sup>

**Risk factors** for recurrent exertional rhabdomyolysis include exercise and sex. Female racehorses are 3 times more likely to have episodes of exertional rhabdomyolysis than are male (intact or castrated) racehorses, and young female Thoroughbreds are at greatest risk. Among 2- to 4-year-old Thoroughbreds in the United Kingdom, 76% to 78% of occurrences of “tying-up” are in females, and female Standardbreds in Sweden are 7 times more likely (95% CI 2.1 to 23.4) to be affected by the disease than are males.<sup>4</sup> Among National Hunt horses in Great Britain, females are 24 times as likely to have an episode of the disease as are males. Thoroughbred racehorses and Standardbred horses (odds ratio [OR] 7.9, 95% CI 2.3 to 27)<sup>4</sup>, but not National Hunt horses, with a nervous or “flighty” temperament are more likely to experience episodes of the disease.<sup>8</sup>

The disease occurs repeatedly in 74% of affected Thoroughbred racehorses in Great Britain and in 20% of affected polo ponies.

The disease is of considerable **economic impact** because of its frequent occurrence in athletic horses, its recurrent nature, and the need to rest affected horses.<sup>8</sup> On average, affected Thoroughbred racehorses cannot train for 6 days, and Standardbreds for 7

days, after an episode,<sup>4,8</sup> and approximately two-thirds of affected horses are unable to race because of the disease. The effect of the loss of training days for each episode is magnified because of the recurrent nature of the disease in a large proportion of affected horses. Approximately 6% of the wastage of Thoroughbred racehorses in Australia is attributable to exertional rhabdomyolysis.

Interestingly, Standardbred horses in the United Kingdom with recurrent exertional rhabdomyolysis have enhanced performance.<sup>4</sup>

## PATHOGENESIS

The cellular defect has not been identified and fully explicated. Muscle from affected horses has abnormal contraction and relaxation kinetics and is hypersensitive to exposure to caffeine *in vitro*, but connection with development of the disease is unclear. Affected French Trotters have a characteristic micro-RNA profile in muscle, although this might represent a response to muscle damage rather than the mi-RNAs involvement in development of the disease.<sup>9</sup>

The disease is attributable to dysfunction and death of myocytes with subsequent release of cellular constituents, including the enzymes creatine kinase, aspartate aminotransferase, and carbonic anhydrase, and myoglobin. The proximate cause of myocyte death is uncertain, but it is not related to accumulation of lactic acid.

Cell death is likely linked to abnormal accumulation of calcium in intracellular fluids secondary to deranged energy and/or membrane function. Necrosis of myocytes causes pain and inflammation in the muscle, with infiltration of inflammatory cells. Healing and regeneration of myocytes occurs over a period of weeks in the absence of further episodes of myonecrosis.

Release of cellular constituents results in electrolyte abnormalities, primarily a hypochloremic metabolic alkalosis, a systemic inflammatory response, and pigmenturia. Severely affected horses can have a metabolic acidosis. Myoglobin, and possibly other cell constituents, is nephrotoxic, and acute renal failure can develop as a result of myoglobinuric nephrosis. Pain and loss of muscle function cause a stilted, short-stepping gait.

## CLINICAL FINDINGS

The clinical findings are variable and range from poor performance through classic signs of muscle pain, stiffness, and reluctance to move, to recumbency and death, although the latter are rare with recurrent exertional rhabdomyolysis. Most affected horses have more than one episode of the disease each year while in training, and some can have numerous episodes (up to 20).<sup>4,8</sup>

The most common presentation is of a horse that does not perform to expectation and displays a stiff or **short-stepping gait** that can be mistaken for lower leg lameness.

The horse might be reluctant to move when placed in its stall, be apprehensive and anorexic, paw, and frequently shift its weight. More severely affected horses can be unable to continue to exercise, have **hard and painful muscles** (usually gluteal muscles), sweat excessively, tremble or have widespread muscle fasciculations, be apprehensive, refuse to walk, and have elevated heart and respiratory rates. Affected horses can be hyperthermic, especially soon after exercise. Signs consistent with abdominal pain are present in many severely affected horses. Deep-red urine (myoglobinuria) occurs but is not a consistent finding. Severely affected horses are often recumbent.

Among affected Standardbred horses, clinical signs are evident in 98% of horses within 1 hour of exercise. Clinical signs include stiffness in all cases (44), sweating (86%), pain or evident distress (43%), swollen or firm gluteal muscles (23%), and recumbency (2%).<sup>4</sup>

## CLINICAL PATHOLOGY

Mildly affected or apparently nonaffected horses have moderate increases in **serum creatine kinase** (CK) (20,000 to 50,000 IU/L), **aspartate aminotransferase** (AST), and **lactate dehydrogenase** (LDH) activity. Severely affected horses have large increases in CK (>100,000 IU/L) and other muscle-derived enzymes. Serum CK and AST activities peak approximately 5 to 6 and 24 hours after exercise, respectively, and in the absence of further muscle damage, serum AST might not return to normal levels for 7 to 10 days. The half-life of CK activity in serum is approximately 2 hours, and in the absence of continuing muscle damage, serum CK declines rapidly. The persistence of increased AST activity, compared with CK, is useful in identifying affected horses days or weeks after the episode.<sup>8</sup>

**Serum myoglobin** concentrations increase markedly during exercise in affected horses and decline within 24 to 48 hours. Serum carbonic anhydrase III activity is increased in horses with exertional rhabdomyolysis.<sup>8</sup>

Severely affected horses are often **hypotremic** (<130 mEq/L), **hyperkalemic** (>5.5 mEq/L), **hypochloremic** (<90 mEq/L), azotemic (increased serum urea nitrogen and creatinine concentrations), and **acidotic** or **alkalotic**. Hemoconcentration (hematocrit > 50%, 0.5 L/L) and increased serum total protein concentration (>80 g/L) indicative of dehydration are common. Serum bicarbonate concentration can be falsely markedly elevated in animals with severe rhabdomyolysis because of cellular constituents released from damaged muscle that interfere with the analytical method when automated clinical chemistry analyzers are used. **Myoglobinuria** is detectable either grossly or on chemical analysis and should be differentiated from hemoglobinuria or hematuria.



Measurement of **urinary excretion of electrolytes**, although popular in the past, is of no use in diagnosing, treating, or preventing exertional rhabdomyolysis.

**Muscle biopsy** during the acute or convalescent stages reveals myonecrosis of type II (fast-twitch, oxidative) fibers, mild myositis, and fibrosis.

### NECROPSY FINDINGS

Horses dying of exertional rhabdomyolysis have widespread degeneration of striated muscle, principally the muscles of exertion, but often involving the diaphragm and heart. Affected muscles tend to be dark and swollen but may have a pale, streaked appearance. The kidneys are swollen and have dark-brown medullary streaks. Dark-brown urine is present in the bladder. Histologic examination reveals widespread necrosis and hyaline degeneration of predominantly type II (fast-twitch, oxidative) fibers. In horses with recurrent disease, there may be evidence of myofiber regeneration. Myoglobinuric nephrosis is present in severely affected horses.

### Samples for Postmortem Confirmation of Diagnosis

- Formalin-fixed kidney and affected muscle for light microscopic examination (LM)

### DIAGNOSTIC CONFIRMATION

Biochemical confirmation of muscle damage by demonstration of increased serum CK or AST activity, in conjunction with appropriate clinical signs, provides the diagnosis.

#### DIFFERENTIAL DIAGNOSIS (See Table 15.4)

- Muscle cramping induced by ear tick (*Otobius megnini*)
- Ionophore intoxication (monensin, lasalocid, salinomycin, narasin, maduramicin)
- Infection by *Anaplasma phagocytophilum*<sup>10</sup>
- White snake root (*Eupatorium rugosum*) or rayless goldenrod (*Isocoma Pluriflora*),
- Laminitis
- Colic
- Pleuritis
- Aorto-iliac thrombosis

### TREATMENT AND CONTROL

#### TREATMENT OF RECURRENT EXERTIONAL RHABDOMYOLYSIS IN THOROUGHBRED AND STANDARD BRED HORSES

##### Treatment of Acute disease

- Nonsteroidal antiinflammatory drugs—phenylbutazone (2.2 to 4.4 mg/kg IV or PO q12–24h) or **ketoprofen** (2.2 mg/kg IV every 12 h) (R-1)
- Rest (R-1)
- Fluid therapy—as needed (R-1)

- Acepromazine or similar sedatives (R-2)
- Furosemide (R-3)

##### Control

- Consistent exercise schedule (R-1)
- Dietary modifications (R-1)
- Dantrolene sodium (R-2)
- Phenytoin (R-3)

The treatment chosen depends on the severity of the disease. The **general principles** are rest; correction of dehydration and electrolyte abnormalities; prevention of complications, including nephrosis and laminitis; and provision of analgesia, and are the same as for all acute myopathies with rhabdomyolysis.

**Mildly affected horses** (heart rate < 60 bpm, normal rectal temperature and respiratory rate, no dehydration) may be treated with rest and phenylbutazone (2.2 mg/kg, orally or IV every 12 hours for 2 to 4 days). Horses should be given mild exercise with incremental increases in workload as soon as they no longer have signs of muscle pain. Access to water should be unrestricted.

**Severely affected horses** (heart rate > 60 bpm, rectal temperature > 39° C [102° F], 8% to 10% dehydrated, reluctant or unable to walk) should not be exercised, including walking back to the stable, unless it is unavoidable. Isotonic, polyionic **fluids**, such as lactated Ringer's solution, should be administered IV to severely affected horses to correct any hypovolemia and to ensure a mild diuresis to prevent myoglobinuric nephropathy. Less severely affected horses can be treated by administration of fluids by nasogastric intubation (4 to 6 L every 2 to 3 hours). Although it has been recommended that urine should be alkalized by administration of mannitol and sodium bicarbonate (1.3% solution IV, or 50 to 100 g of sodium bicarbonate orally every 12 hours) to minimize the nephrotoxicity of myoglobin, this therapy is not effective in humans at risk of myoglobinuric nephrosis. Affected horses should not be given diuretics (e.g., furosemide) except if they are anuric or oliguric after correction of hypovolemia.

**Phenylbutazone** (2.2 to 4.4 mg/kg, IV or orally, every 12 to 24 hours), **flunixin meglumine** (1 mg/kg IV every 8 hours), or **ketoprofen** (2.2 mg/kg IV every 12 hours) should be given to provide **analgesia**. **Mild sedation** (acepromazine 0.02 to 0.04 mg/kg IM, or xylazine, 0.1 mg/kg IM, both with butorphanol, 0.01 to 0.02 mg/kg) might decrease muscle pain and anxiety. Tranquilizers with vasodilatory activity, such as acepromazine (acepromazine), should only be given to horses that are well hydrated. **Muscle relaxants**, such as methocarbamol, are often used but have no demonstrated efficacy.

**Recumbent** horses should be deeply bedded and repositioned by rolling every 2 to 4 hours. Severely affected horses should not be forced to stand.

### CONTROL

Although the cause has not been identified, a number of preventive measures are used, including the following: ensuring consistency of exercise (i.e., every day); dietary interventions to provide a high-fat, low-soluble-carbohydrate diet, with reduction of the amount of soluble carbohydrate in the diet on days when the horse will not exercise; and administration of dantrolene sodium.

Despite lack of clear evidence for a role for **vitamin E or selenium** deficiency in recurrent exertional rhabdomyolysis, horses are often supplemented with 1 IU/kg vitamin E and 2.5 µg/kg selenium daily in the feed. Care should be taken not to induce selenium toxicosis.

**Sodium bicarbonate** (up to 0.5 to 1.0 g/kg BW daily in the ration) and other electrolytes are often added to the feed of affected horses, but their efficacy is not documented.

**Phenytoin** is administered at a dose rate of 6 to 8 mg/kg, orally, every 12 hours, and the dose is adjusted depending on the degree of sedation produced (a reduced dose should be used if the horse becomes sedated) or lack of effect on serum CK or AST activity. Phenytoin can be administered to horses for months, although its efficacy has not been demonstrated. **Dimethylglycine, altrenogest, and progesterone** are all used on occasion in horses with recurrent rhabdomyolysis, but again without demonstrated efficacy.

The feeding of high-fat, low-soluble-carbohydrate diets is useful in the prevention of recurrent exertional rhabdomyolysis in Thoroughbred horses,<sup>4</sup> and dietary modifications that reduce feeding of grain (oats) are common in Standardbred horses in Sweden (and likely elsewhere).<sup>4</sup>

Administration of **dantrolene sodium** (1 to 3 mg/kg, PO q24 h) has been advocated for prevention or amelioration of recurrent exertional rhabdomyolysis, and the pharmacokinetics of dantrolene in horses have been determined.<sup>11,12</sup> Dantrolene reduces calcium efflux from the sarcoplasmic reticulum and is a muscle relaxant. Plasma concentrations are greatest when it is administered with feeding, and feed restriction for more than 4 hours before oral administration decreases gastrointestinal absorption of dantrolene.<sup>11</sup> There is only relatively weak laboratory or field trial evidence of the efficacy of dantrolene in prevention of the disease.<sup>13</sup>

### FURTHER READING

Piercy RJ, Rivero J. Muscle disorders of equine athletes. In: *Equine Sports Medicine and Surgery: Basic and Clinical Sciences of the Equine Athlete*. 2nd ed. London: W.B. Saunders; 2014:109.

### REFERENCES

- Tozaki T, et al. *Anim Genet*. 2010;41:80.
- Fritz KL, et al. *Anim Genet*. 2012;43:730.
- Dranchak PK, et al. *Am J Vet Res*. 2006;67:1395.
- Isgren CM, et al. *PLoS ONE*. 2010;5.

5. Mykkanen AK, et al. *Res Vet Sci*. 2011;91:473.
6. Barrey E, et al. *Anim Genet*. 2012;43:271.
7. Wilsher S, et al. *Equine Vet J*. 2006;38:113.
8. Radostits O, et al. Sporadic acute exertional rhabdomyolysis in horses. In: *Veterinary Medicine: A Textbook of the Diseases of Cattle, Horses, Sheep, Goats and Pigs*. 10th ed. London: W.B. Saunders; 2007:1683.
9. Barrey E, et al. *Equine Vet J*. 2010;(suppl):303.
10. Hilton H, et al. *J Vet Int Med*. 2008;22:1061.
11. McKenzie EC, et al. *Equine Vet J*. 2010;42:613.
12. Knych HKD, et al. *J Vet Pharmacol Ther*. 2011;34:238.
13. Holmes MA. *Equine Vet Educ*. 2007;19:97.

## POLYSACCHARIDE STORAGE MYOPATHY OF HORSES

Polysaccharide storage myopathy, a myopathy of principally Quarter horses and related breeds, but also occurring with high frequency in draft breeds, is characterized by excessive accumulations of amylase-resistant glycogen (evident as amylase-resistant polysaccharide on periodic acid–Schiff [PAS] staining) in muscle and signs of exertional rhabdomyolysis. One form of the disease is associated with a specific mutation in the GYS1 gene (polysaccharide storage myopathy 1 [PSSM1]) and another with an identical phenotype but without the same genetic abnormality (PSSM2).<sup>1</sup>

### ETIOLOGY

PSSM1 is the result of a single missense G-to-A gain-of-function mutation in the skeletal muscle glycogen synthase (GYS1) gene that results in a histidine (H) substitution for arginine (R) in the enzyme.<sup>1,2</sup> The mutation is dominant, with both homozygotic (AA, both H alleles) and heterozygotic (GA, one H allele, one R allele) animals affected. Homozygotes for the H allele are more severely affected than are heterozygotes, as indicated by accumulation of amylase-resistant polysaccharide in muscle and elevated resting serum CK and AST activities.<sup>3</sup> The mutation is conserved in the haplotype of many affected horse breeds, has been present in horses for over 1200 years, and is widely distributed among breeds of horses, with the mutation identified in over 30 breeds.<sup>2</sup> The gene is well characterized in equids.<sup>4</sup>

The etiology of PSSM2 is not known, but it is not associated with the same mutation as PSSM1.

### EPIDEMIOLOGY

A polysaccharide storage myopathy characterized by accumulation of polysaccharide in muscle was described in Quarter horses and other breeds and subsequently recognized as being either of amylase-resistant polysaccharide or amylase-sensitive polysaccharide. Approximately 48% of 831 muscle samples from horses with PSSM tested positive for the GYS1 mutation, with 16% of horses with

amylase-sensitive polysaccharide accumulation having the H allele and 70% of horses with amylase-resistant having the allele. Of the 831 horses, 31 (3.7%) were homozygous for the H allele (gene AA), 379 (45.6%) were heterozygous (HR for enzyme, GA for gene), and 430 were homozygous normal (RR for enzyme, GG for gene). The presence of the mutated gene (heterozygous form) increases the risk of clinical exertional rhabdomyolysis by 7 times in Warmblood horses.<sup>5</sup>

The disease and mutation are recognized in many breeds, with the greatest frequency in Quarter horses and related breeds and draft breeds worldwide.<sup>1,6-14</sup> Allele frequencies are available for PSSM in horses in the United States (Percheron, 0.346; Belgian, 0.242; Paint, 0.041; Quarter horse, 0.034; Appaloosa, 0.030; Morgan, 0.005; Shire, 0.003; Thoroughbred, 0.000) and Europe (South German Coldblood, 0.117; Saxon-Thuringian Coldblood, 0.068; Shire, 0.000; Hanoverian, 0.000).<sup>14</sup> The GYS1 mutation was detected in 11 breeds, with a prevalence of genetic susceptibility to type 1 PSSM from 0.5% to 62.4%. The GYS1 mutation was not found in the sampled Thoroughbreds, Akhal-Teke, Connemaras, Clydesdales, Norwegian Fjords, Welsh Ponies, Icelandics, Schleswig Coldbloods, or Hanoverians, but failure to detect the mutation does not guarantee its absence from the breed, although it does imply a low prevalence.<sup>14</sup>

PSSM, based on examination of muscle biopsy from a convenience sample of 164 Quarter horses, occurs in 6% to 12% of overtly healthy Quarter horses in the United States.<sup>6</sup> Allele frequencies for type 1 PSSM among Quarter horses in the United States range from 0.055 to 0.155, depending on the population sampled.<sup>15</sup>

The mutation, and disease, are common in Percheron and Belgian draft horses in Europe, and the disease is reported in Normandy Cob draft horses.<sup>11,16</sup> Of a nonrandom selection of continental European draught horses belonging to 13 breeds, 62% (250 of 403) tested were found to carry the mutant allele.<sup>9</sup> The highest percentages of GYS1-positive horses were found in the Belgian trekpaard (92%, 35 of 38 horses tested), Comtois (80%, 70 of 88), Netherlands trekpaard (74%, 17 of 23), Rheinisch-Deutsches kaltblut (68%, 30 of 44), and Breton (64%, 32 of 51).<sup>9</sup> There is genetic evidence of historical selection pressure in favor of the mutated genotype in Belgium draft horses, but not in American Quarter horses.<sup>17</sup>

The mutation has not been detected in purebred Thoroughbred, Standardbred, and Arabian horses.<sup>1,18</sup>

It appears that the GYS1 mutation arose in heavy (draft) breeds of horses in Europe over 1200 years ago, as indicated by its high frequency in European draft breeds, but not English draft breeds, and the

lower prevalence of the mutation in lighter breeds.<sup>9</sup> Light breeds with closely kept stud books that have prevented ingress of genes over centuries, such as Thoroughbreds and Standardbreds, do not carry the mutant gene.

Animal risk factors for exertional rhabdomyolysis include breed (as discussed previously) but not sex or age.<sup>6,19</sup> Quarter horses that carry a mutation of the RYR1 (ryanodine) gene and the mutated GYS1 gene have more severe expression of the disease.<sup>20</sup>

Prolonged periods of rest or irregular exercise schedules are risk factors for development of exertional rhabdomyolysis associated with the disease.

### PATHOGENESIS

Mutation of the GYS1 gene causes increased activity in muscle glycogen synthase activity without an increase in activity of glycogen branching enzyme.<sup>2</sup> There is subsequent accumulation of amylase (diastase)-resistant polysaccharide (polyglucosan)—proglycogen and macroglycogen with fewer branching points and more straight chains—in skeletal muscle.<sup>2,21</sup> The reason that accumulation of polysaccharide causes myopathy and exertional rhabdomyolysis is unclear. It does not appear to be related to availability of energy within the cell, although this is uncertain, and it could be related to physical damage caused by accumulation of polysaccharide in vacuoles within predominantly type 2A fibers of homozygous horses.<sup>3</sup>

### CLINICAL FINDINGS

The clinical findings are variable and range from sporadic to episodic exertional rhabdomyolysis of varying severity. Notably, 6% to 12% of overtly healthy (asymptomatic) Quarter horses in the United States have histologic evidence of the disease.<sup>6</sup> The acute clinical syndrome does not vary importantly from that of other exertional rhabdomyolysis syndromes. Horses with PSSM1 do not have important cardiac abnormalities as part of their disease syndrome.<sup>22</sup>

**Muscle biopsy** reveals accumulation of amylase (diastase)-resistant polysaccharide (PAS-positive) inclusions in vacuoles in predominantly, but not exclusively, type 2A and type 2X fibers.<sup>3</sup> Examination of muscle biopsies from candidate horses should be done with consideration of the risk of false-positive findings, especially if the amylase-resistant nature of the polysaccharide is not determined. Horses with PSSM2 will have excess accumulation of amylase-resistant polysaccharide but will not have the mutation in the GYS1 gene. PSSM is most accurately diagnosed in muscle biopsy specimens on the basis of appearance of amylase-resistant, abnormal polysaccharide, not amylase-sensitive glycogen, regardless of fixation technique.<sup>23</sup>

## CLINICAL PATHOLOGY

Most Quarter horses and related breeds, but not draft breeds, with the GYS1 mutation have elevations in serum CK and AST at rest.<sup>3</sup> Mildly affected or apparently nonaffected horses have moderate increases in serum CK, AST, and LDH activity after moderate exercise. Severely affected horses have large increases in CK and other muscle-derived enzymes. Serum CK and AST activities peak approximately 5 to 6 and 24 hours after exercise, respectively, and in the absence of further muscle damage, serum AST might not return to normal levels for 7 to 10 days.

## NECROPSY FINDINGS

Gross lesions may vary depending on whether or not the horse died from severe rhabdomyolysis or was euthanized after being recumbent. Affected muscles may be pale pink or diffusely red-tinged, which can be mistaken for autolysis. Any of the large power muscle groups and the diaphragm can be affected. The kidneys may be swollen and dark red as a result of myoglobinuria. In chronic cases with repeated episodes, muscle atrophy may be marked, or the muscles may be of normal size but contain pale streaks where myofibers have been replaced by fat.

Microscopically, the presence of amylase-resistant, abnormal polysaccharide inclusions in the cytoplasm of type 2 myocytes is the most sensitive and specific diagnostic indicator for polysaccharide storage myopathy.<sup>23</sup> Other lesions, such as fiber atrophy, internal nuclei, and fatty infiltration, may be present. Muscles most often affected include the semimembranosus, semitendinosus, gluteal, longissimus, and pectoral muscles and the diaphragm.<sup>24</sup>

## Samples for Postmortem Confirmation of Diagnosis

Samples of semimembranosus, semitendinosus, gluteal, and diaphragmatic muscles for H & E and PAS stains are used for confirmation of the diagnosis. Frozen sections of biopsies are better suited for studying myopathies because many histopathologic features of skeletal muscle are obscured by formalin fixation.<sup>23</sup>

## DIAGNOSTIC CONFIRMATION

Biochemical confirmation of muscle damage is achieved by demonstration of increased serum CK or AST activity in horses with compatible clinical signs. In breeds with known or strongly suspected genetic basis for PSSM1, gene testing for the GYS1 mutation provides evidence of the PSSM1. Confirmation is achieved by examination of a muscle biopsy (see Diagnostic Algorithm in Fig. 15-1). If the muscle biopsy demonstrates the presence of amylase-resistant polysaccharide and the horse is negative for the AA or AG mutation in the GYS1 gene, then the horse has PSSM2.

## DIFFERENTIAL DIAGNOSIS (See Table 15-1)

- Muscle cramping induced by ear (*Otobius megnini*)
- Laminitis
- Colic
- Pleuritis
- Aorto-iliac thrombosis
- Other myopathies

## TREATMENT

The treatment chosen depends on the severity of the disease. The **general principles** are rest; correction of dehydration and electrolyte abnormalities; prevention of complications, including nephrosis and laminitis; and provision of analgesia, and are the same as for all acute myopathies with rhabdomyolysis (see “Myopathies of Horses”).

## CONTROL

The feeding of high-fat, low-soluble-carbohydrate diets is useful in the prevention of clinical signs in affected horses with either PSSM1 or PSSM2 and is reported to be useful in controlling the disease.<sup>19</sup> Horses should have a regular exercise program, preferably with frequent turn-out to pasture, and be fed a diet rich in long-chain fatty acids with low starch content (<10%) and high in fat (10% of digestible energy).<sup>25-27</sup>

## FURTHER READING

Piercy RJ, Rivero J. Muscle disorders of equine athletes. In: *Equine Sports Medicine and Surgery: Basic and Clinical Sciences of the Equine Athlete*. 2nd ed. London: W.B. Saunders; 2014:109.

## REFERENCES

1. McCue ME, et al. *J Vet Int Med*. 2008;22:1228.
2. McCue ME, et al. *Genomics*. 2008;91:458.
3. Naylor RJ, et al. *PLoS ONE*. 2012;7.
4. Echigoya Y, et al. *Molecular Bio Rep*. 2011;38:461.
5. Johl L, et al. *Equine Vet J*. 2011;43:240.
6. McCue ME, et al. *JAVMA*. 2007;231:746.
7. McGowan CM, et al. *Vet J*. 2009;180:330.
8. Stanley RL, et al. *Equine Vet J*. 2009;41:597.
9. Baird JD, et al. *Vet Rec*. 2010;167:781.
10. Schwarz B, et al. *Vet Rec*. 2011;169:583.
11. Herszberg B, et al. *Anim Genet*. 2009;40:94.
12. Colgan S, et al. *Aust Vet J*. 2006;84:436.
13. Stanley R, et al. *Equine Vet Educ*. 2007;19:143.
14. McCue ME, et al. *Anim Genet*. 2010;41:145.
15. Tryon RC, et al. *JAVMA*. 2009;234:120.
16. Larcher T, et al. *Vet Pathol*. 2008;45:154.
17. McCoy AM, et al. *J Heredity*. 2014;105:163.
18. Isgren CM, et al. *PLoS ONE*. 2010;5.
19. Hunt LM, et al. *Equine Vet J*. 2008;40:171.
20. McCue ME, et al. *Neuromusc Dis*. 2009;19:37.
21. Brojer JT, et al. *Am J Vet Res*. 2006;67:1589.
22. Naylor RJ, et al. *J Vet Int Med*. 2012;26:1464.
23. Firshman AM, et al. *Vet Pathol*. 2006;43:257.
24. van Vleet J, et al. Maxie M, ed. *Jubb, Kennedy and Palmers' Pathology of Domestic Animals*. 5th ed. Edinburgh: W.B. Saunders; 2007:185.
25. Aleman M. *Neuromusc Dis*. 2008;18:277.
26. Borgia LA, et al. *Am J Vet Res*. 2010;71:326.
27. Finno CJ, et al. *Equine Vet J*. 2010;42:323.

## EQUINE HYPERKALEMIC PERIODIC PARALYSIS

### SYNOPSIS

**Etiology** Defect in sodium channel of skeletal muscle.

**Epidemiology** Disease of Quarter horses and crossbreds. Inherited as an autosomal-dominant trait with variable penetrance.

**Clinical signs** Episodes of muscle fasciculation, stridor, muscle weakness, and flaccid paralysis.

**Clinical pathology** Hyperkalemia during episodes. Gene probe to detect mutated gene.

**Lesions** None.

**Treatment** Palliative. Potassium-free intravenous fluids. Acetazolamide.

**Control** Selective breeding. Low-potassium diet.

## ETIOLOGY

Hyperkalemic periodic paralysis (HYPP) is caused by a heritable defect in the sodium channel of skeletal muscle. The mutation, of which only one form has been identified, results in substitution of a cytosine for guanine, with consequent replacement of phenylalanine by leucine in a transmembrane protein regulating sodium flux across the cell membrane and T-tubule.<sup>1</sup> The disease is transmitted as an autosomal-codominant trait, with the result that homozygotes are more severely affected than heterozygotes, and phenotypic expression (disease severity) differs among heterozygotes.

## EPIDEMIOLOGY

The disease is familial and affects Quarter horse and crossbred descendants of a single Quarter horse sire, Impressive. More than 50,000 registered Quarter horses are related to known carriers of the disease. Quarter horses with the disease are presumably selected because they outperform unaffected animals in the Halter classes in which they compete at horse shows, although recent rule changes have changed this practice. The disease occurs in breeds derived from or crossed with Quarter horses, including Appaloosas, American Paint horses, and crossbreds. Of 651 elite performance American Quarter horses, 200 control American Quarter horses, and 180 control American Paint horses (APHs), allele frequency for HYPP in all animals was 0.008, APHs had high prevalence of HYPP of 0.025, and Halter horses had significantly greater allele frequency for HYPP of 0.299,<sup>2</sup> consistent with the alleles associated with the desired phenotype. Approximately 14% of 51 Quarter horses in Mexico have the N/H genotype, with 2% having the H/H genotype. Allele frequencies were 0.157 N and 0.843 normal.<sup>3</sup>



The disease is inherited in an **autosomal-codominant** manner. Therefore 50% of the offspring of the breeding of a heterozygote and a normal animal will carry the trait, as will 75% of the offspring of the breeding of two heterozygotes. Of the breeding of two heterozygotes, 50% of progeny will be heterozygotes, 25% homozygotes for the mutated gene, and 25% homozygotes for the normal gene. Animals homozygous for the abnormal gene are uncommon, representing only 0.9% of animals tested for the disease. The low prevalence of the homozygote genotype is likely a reflection of severity of disease and the reduced likelihood that homozygotic animals will reach sexual maturity.

The risk of a **heterozygous** animal being affected with periodic paralysis is variable. Most heterozygous horses appear normal and never experience an attack, whereas others have severe episodes starting at a young age. **Homozygous** horses are much more likely to have severe manifestations of the disease at a young age.

### PATHOGENESIS

The abnormality in the sodium channel coded for by the mutated gene predisposes the horse to episodes of complete depolarization of the muscle membrane and flaccid paralysis. The mutation in the sodium channel increases the probability that any one channel is open, with the result that the resting membrane potential in affected horses is higher (less negative and closer to the depolarization threshold) than that of normal horses. This results in frequent depolarizations of individual muscle fibers, causing muscle fasciculations. The weakness associated with severe episodes of the disease results from failure of sodium channels to close after depolarizations. Opening of potassium channels when the muscle is depolarized results in movement of potassium out of the muscle cell and the development of hyperkalemia.

### CLINICAL SIGNS

The disease in **heterozygous** animals is characterized by periods of muscle fasciculation and tremor that progress to weakness, paralysis, and recumbency. Such episodes may last minutes to hours, and most resolve spontaneously. Horses often sweat, have prolapse of the third eyelid, and have contractions of facial and locomotor muscles during episodes. Episodes may be mistaken for colic. Inspiratory stertor commonly noted during episodes is probably attributable to laryngeal and pharyngeal dysfunction.

Episodes are more frequent and severe in **homozygous** animals, and signs of **laryngeal and pharyngeal dysfunction**, such as stridor and dysphagia, occur in almost all of these animals. Endoscopic examination of homozygotes reveals pharyngeal collapse,

laryngopalatal dislocation, and laryngeal paralysis. The disease can manifest in foals as young as 7 days of age. The severity of signs in some homozygotes diminishes with age.

**Electromyographic** demonstration of myotonic discharges, prolonged insertional activity, and doublets and triplets is a sensitive and specific indicator of the disease.

Horses with HYPP have reduced exercise tolerance compared with normal horses. Homozygotic horses have laryngospasm, airway obstruction, hypoxia, hypercapnia, and ventricular depolarizations during intense exercise, which is not recommended for these horses.

### CLINICAL PATHOLOGY

**Hyperkalemia** (>5.5 mEq/L) during or immediately after episodes is characteristic of the disease, although the existence of a normokalemic variant has been suggested.

**Diagnostic confirmation** has in the past been achieved by provocative testing by administering potassium chloride (88 to 166 mg/kg, orally) to suspect horses. However, the development of genotyping has rendered provocative testing obsolete and, for humane reasons and because of the risk of death, its use is not recommended. The **test of choice** for demonstrating the presence of the mutated gene is a specific **gene probe**. The probe can be applied to various tissues, but blood or hair, with attached root (a plucked hair), are preferred for diagnostic testing of live animals. This test classifies horses as normal, heterozygous, or homozygous but does not indicate the propensity of heterozygotes to exhibit the disease. Samples can be analyzed in the United States at the Veterinary Genetics Laboratory of the University of California ([www.vgl.ucdavis.edu](http://www.vgl.ucdavis.edu)).

#### DIFFERENTIAL DIAGNOSIS

- Colic
- Laminitis
- Hypocalcemia
- Botulism
- Exertional rhabdomyolysis
- Upper airway obstruction

### NECROPSY FINDINGS

There are no characteristic findings on necropsy examination.

### TREATMENT

#### Acute Episodes

Most acute episodes resolve spontaneously or with only minor treatment. The aim in treating more severe or prolonged episodes is to **reduce the plasma potassium concentration** by intravenous infusion of isotonic potassium-free fluids such as sodium chloride, sodium bicarbonate, or dextrose.<sup>4</sup> Some authors recommend infusion of calcium gluconate, but others caution against its use. A

practical approach is the slow IV administration of 0.25 to 0.5 mL of 23% calcium gluconate per 1 kg of body weight (125 to 250 mL for a 500-kg horse) diluted in isotonic sodium chloride or, preferably, 5% dextrose. Administration of NaHCO<sub>3</sub> at 1 mL/kg IV has been suggested.

### Prevention of Episodes

Maintaining affected horses on a **low-potassium diet** reduces the frequency with which episodes occur. Alfalfa (lucerne); some oils, including soyabean; molasses; lite salt (a mixture of KCl and NaCl); and many sweet feeds are potassium rich and should be avoided. Grass hay (timothy) and straw and oats, corn, and barley are low in potassium. There are commercial feeds that have a guaranteed low concentration of potassium. Alternatively, diets can be formulated using feed of known potassium concentration, as determined by feed analysis. Care should be taken that diets are nutritious and contain appropriate concentrations and ratios of calcium and phosphorus.

Acetazolamide (2 to 4 mg/kg, every 12 hours) reduces the severity and frequency of episodes and is widely used to control the disease. The drug is poorly absorbed in horses, but the concentration required in plasma of horses to achieve a pharmacodynamic effect is lower than that of humans.

### CONTROL

The disease is heritable, and carriers are readily identified; thus, a breeding program to eliminate the disease is feasible.

### REFERENCES

1. Radostits O, et al. Equine hyperkalemic periodic paralysis. In: *Veterinary Medicine: A Textbook of the Diseases of Cattle, Horses, Sheep, Goats and Pigs*. 10th ed. London: W. B. Saunders; 2007:1965.
2. Tryon RC, et al. *JAVMA*. 2009;234:120.
3. Riojas-Valdes V, et al. *African J Biotech*. 2014;13:1323.
4. Pang DSJ, et al. *Vet Anaesth Analg*. 2011;38:113.

## MALIGNANT HYPERTHERMIA IN HORSES

Malignant hyperthermia is a disease of Quarter horses and other breeds induced by exposure to halothane, succinylcholine, or similar depolarizing agents and various other stressors. It also occurs in pigs, dogs, and humans.<sup>1</sup> The disease in Quarter horses is caused by a mutation in the RyR1 gene, with subsequent dysfunction of calcium handling within the cell.<sup>2</sup> There is excessive release of calcium from the sarcoplasmic reticulum on exposure to halothane, with development of hyperthermia, hypercapnia, and lactic acidosis, and often death.<sup>2</sup> There is no apparent breed, age, or sex predilection for the sporadic disease. Breed is clearly a predilection for affected Quarter horses. The mutation in Quarter horses can be detected by analysis of the genome.<sup>3</sup>

The clinical signs are rapid onset of hyperthermia, sweating, muscle fasciculation, tachycardia, tachypnea, and muscle rigidity in anesthetized horses. There is acidosis, hypercapnea, and, in acute cases, increases in serum activity of CK. Elevations in CK might not be evident in horses that die peracutely. Treatment is supportive and includes prompt removal of the inciting agent (halothane), cooling, correction of acid:base and electrolyte abnormalities, and prevention of myoglobinuric nephrosis.

## REFERENCES

1. Aleman M. *Neuromusc Dis.* 2008;18:277.
2. Aleman M, et al. *J Vet Int Med.* 2009;23:329.
3. Nieto JE, et al. *J Vet Int Med.* 2009;23:619.

## PORCINE STRESS SYNDROME (MALIGNANT HYPERTHERMIA)

### SYNOPSIS

**Etiology** Inherited defect caused by an autosomal-recessive gene at a single locus with incomplete penetrance. Also known as the halothane-sensitivity gene, or porcine stress syndrome (PSS) mutation, which is a single-point mutation of nucleotide 1843 in the skeletal muscle gene for the calcium-release channel of the sarcoplasmic reticulum.

**Epidemiology** Worldwide in major breeds of swine: Landrace, Yorkshire, Duroc, Pietrain, and Poland China. Market-weight pigs and adult sows and boars. Prevalence of defective gene varies between breeds and countries. Syndromes precipitated by stress of transportation, high environmental temperatures and humidity, exhaustive exercise, and halothane anesthesia. Major economic importance because of deaths and poor-quality pork.

### Signs

- Porcine stress syndrome: death during transportation
- Malignant hyperthermia: induced by halothane anesthesia; results in muscular rigidity and death
- Pale, soft, exudative pork: rapid rigor mortis after slaughter followed by excessive dripping of carcass and pale, watery pork; dark, firm, and dry pork is a variation
- Back-muscle necrosis: reluctance to move, acute swelling and pain over back; some may die; subacute form also possible

**Clinical pathology** Halothane test. Blood creatine kinase test. Blood typing. DNA-based test for PSS mutation gene.

**Lesions** Pale skeletal muscles in PSS deaths. Pale muscles in back-muscle necrosis.

Diagnostic confirmation—necropsy findings. Identification of homozygous animals with tests.

### Differential diagnosis list

- Mulberry heart disease
- Acute septicemias attributable to salmonellosis, erysipelas, pasteurellosis, and anthrax
- Intestinal volvulus
- Heat exhaustion
- Suffocation during transportation.

Treatment None.

Control Genetic selection. Reduction of environmental and management stressors.

## ETIOLOGY

Considerable attention from breeders has greatly reduced the occurrence of this condition in recent years.

Three closely related stress syndromes occur in pigs. Porcine stress syndrome (PSS) is characterized by acute death induced by stressors such as transport, high ambient temperature, exercise, and fighting, which results in progressive dyspnea, hyperthermia, disseminated vasoconstriction, and the rapid onset of rigor mortis. Pale, soft, and exudative pork (PSE) occurs postmortem in some pigs slaughtered by conventional methods. Malignant hyperthermia (MH) is a drug-induced stress syndrome characterized by muscle rigidity and hyperthermia occurring in susceptible pigs following the use of halothane or the muscle relaxant suxamethonium. Back-muscle necrosis of pigs is a special manifestation of PSS.

**Malignant hyperthermia also occurs in humans.** PSS is caused by an inherited defect as a result of an autosomal-recessive gene at a single locus with incomplete penetrance. It is also known as the halothane sensitivity gene, or PSS mutation, which is single-point mutation of nucleotide 1843 in the skeletal muscle gene for the calcium-release channel of the sarcoplasmic reticulum. The PSS defect renders muscle hypersensitive to stimulation by various stressors. In stress-susceptible pigs there is a rapid onset of anaerobic glycolysis and loss of control of skeletal muscle metabolism in response to stress and anoxia.

The gene is commonly known as the halothane-sensitivity gene (HAL gene) because pigs with the homozygous genotype can be identified with the halothane test, which results in malignant hyperthermia. The halothane gene is located within a group of blood-type genes on the same chromosome, allowing identification of affected pigs by blood typing. A single-point mutation in the porcine gene for the skeletal muscle ryanodine receptor channel is associated with malignant hyperthermia in five major breeds of heavily muscled swine. There is then massive muscle contraction and release of heat. Comparison of the sequences of the HAL genes of PSS and normal pigs revealed a single mutation at nucleotide 1843 in the cDNA derived from the HAL gene.

## EPIDEMIOLOGY

### Prevalence and Occurrence

This subject needs to be kept in perspective. It has recently been suggested that only 4% of inferior-quality meat is a result of genetics (halothane positive), with the remainder being caused by preslaughter and post-slaughter treatment.

PSS occurs worldwide, but there is considerable breed and area variation in its prevalence. In some European countries the prevalence is a major problem in pig production because of the inadvertent selection for this trait in genetic improvement programs. This underlies the problems of selection based purely on performance and production characteristics.

The prevalence of PSS in the swine population can be determined by the use of screening tests applied on the farm or when pigs enter swine performance test stations. The halothane test and the CK test are useful for this purpose. A DNA-based test with 99% accuracy is also available. In European breeds, the prevalence varies from 0% to 88%, with up to 100% in the Pietrain breed. The prevalence of halothane susceptibility is low in the Danish Landrace breed in Denmark. Based on the halothane test, 1.5% of young boars entering a Record of Performance Test Station in Canada were positive reactors. The reactors originated from 7.5% of 107 herds. The halothane succinylcholine test was a more sensitive test because 18% of the same pigs were identified as reactors.

Using a DNA-based test, in a survey of 10,245 breeding swine of various breeds from 129 farms in the United States, Canada, and England, approximately 1 of 5 pigs was a heterozygous carrier of the PSS mutation, and 1% were homozygous. The prevalence of the PSS mutation was 97% for 58 Pietrain, 35% for 1962 Landrace, 15% for 718 Duroc, 19% for 720 Large White, 14% for 496 Hampshire, 19% for 1727 Yorkshire, and 16% for 3446 crossbred swine. The PSS gene frequencies for these breeds were 0.72, 0.19, 0.08, 0.10, 0.07, 0.10, and 0.09, respectively. The PSS mutation has also been identified in Poland China and Berkshire breeds. These gene frequencies were 30% to 75% lower in Canadian swine than in U.S. swine, with the exception of Yorkshires, for which the gene frequency is threefold in Canadian swine.

### Risk Factors

#### Animal Risk Factors

Susceptibility to the PSS is inherited, and the biochemical events leading to PSE, transport death, or malignant hyperthermia are triggered by several external influences or stressors in the living animal. PSS probably occurs in all breeds of pigs, but the incidence is highest in pigs selected for heavy muscling, and stress-susceptible pigs are leaner and more meaty. These include the Pietrain and Poland China breeds and also some European strains of Landrace, where a score for

muscling and growth rate, feed conversion, and back fat has been included in the selection index. A recent study has shown that there are considerable breed differences, in that halothane-stress-susceptible pigs and Hampshires suffer more severely from heat stress than Yorkshires, Danish Landrace, and Duroc boars.

There is a correlation between halothane susceptibility and carcass traits. Halothane status is the most important factor influencing pork quality, although preslaughter handling and stunning method also influence the carcass quality.

Halothane-positive animals usually score higher for visual conformation of the loin and ham than halothane-negative pigs. The progeny of reactor boars are also more susceptible than the progeny of nonreactors. Until recently it was thought that the major limitation of the halothane test was that it identified only those pigs that are stress-susceptible to the syndrome. It is now known that the halothane-sensitivity gene is expressed in heterozygous pigs, where it is likely to cause poor carcass quality.

Landrace pigs can be divided into those that are sensitive to halothane and develop PSE pork postmortem, those that are resistant to halothane but develop PSE pork, and those resistant to halothane and PSE pork (the normal pig). Muscle from pigs susceptible to malignant hyperthermia and PSE pork has significantly higher glucose-6-phosphate levels and lower phosphocreatine under thiopentone anesthesia than muscle from pigs susceptible to PSE and normal pigs. Altered muscle fiber type is not the primary basis of the disease complex.

### Environmental and Management Risk Factors

The most important precipitating factors are transportation at high environmental temperatures and humidity, exhaustive exercise, and, under experimental conditions, the more specific reaction toward the anesthetic halothane. Response of pigs to transport is dependent on genotype, particularly at high temperatures such as 36° C (97 F). Experimentally, psychological mechanisms can precipitate the PSS. The effects of mixing, transportation, and duration of lairage can have profound effects on the carcass characteristics of susceptible pigs. Death during transportation and PSE are associated with fear, defensive or aggressive reactions in unfamiliar social environments, and conflict with other unfamiliar pigs or people. Other activities that may trigger malignant hyperthermia include restraint, mating, farrowing, fighting, and vigorous exercising.

### Economic Importance

The economic losses associated with PSS are attributable to mortality from transport death and inferior meat quality as a result of PSE pork. As a result of the excessive rates of

production of lactic acid and heat, sarcoplasmic proteins denature, thereby causing a deterioration of the water-binding capacity of muscle. The increased osmotic activity resulting from end products of hypermetabolism causes an influx of water from the extracellular space, resulting in hemoconcentration and increased intramyofiber water content. The muscle becomes pale, soft, and exudative, sour-smelling, and loose textured. The shrinkage resulting from water loss during storage, transport, and processing of the carcass is the major cause of wholesale losses at pork-packing plants. PSE carcasses yield less bacon, and the drip loss from fresh PSE meat is more than doubled compared with normal carcasses. Another cause of lost revenue with MH-susceptible swine is their decreased average daily weight gains, conception rates, litter sizes, and boar breeding performance.

### PATHOGENESIS

The molecular basis for susceptibility to the PSS is a hypersensitive triggering mechanism of the calcium-release channel of skeletal muscle sarcoplasmic reticulum. The calcium channel, also known as the ryanodine receptor, plays a critical role in the initiation of muscle contraction. The PSS defect renders muscle hypersensitive to stimulation by various stressors. Stress-susceptible pigs cannot tolerate stress and lose control of skeletal muscle metabolism. The stress may be from external influences such as transportation, fear and excitement, or halothane anesthesia. There is excessive catecholamine release and the sudden onset of anaerobic glycolysis of skeletal muscle, excessive production of lactate, and excessive heat production, which, in conjunction with peripheral vasoconstriction, leads to hyperthermia. Following exertional or thermal stress, susceptible pigs undergo more extensive physiologic change than do resistant pigs. Halothane-sensitive pigs are more susceptible to becoming nonambulatory when subjected to multiple stressors and may be more prone to producing inferior pork products. The blood glucose concentrations are dependent on the MH genotype, with the homozygous-positive animals having the highest levels and the homozygous-negative animals having the lowest. The changes in carbohydrate metabolism at rest in MH-positive animals are caused by latent increases of intracellular  $Ca^{2+}$  concentrations. Under physical load conditions there is higher lipolysis, which may be the result of an indirect activation of the lipolytic system via catecholamine-induced cAMP turnover.

Depending on the nature, severity, and duration of the stress, the syndrome may manifest in different ways:

- The porcine stress syndrome causes rapid death following severe stress.
- The PSE pork and dark, firm, dry (DFD) pork are seen after slaughter, which

might have been preceded by mild stressors during lairage.

- The malignant hyperthermia is drug-induced.

PSE pork is attributed to increased glycolysis after slaughter. In muscles that develop DFD pork, the muscle glycogen is already depleted before slaughter. When PSE develops in a muscle, pH drops to values lower than 5.8 at 45 minutes after death. In normal muscles, the pH decreases from approximately 7 in living muscles to 5.3 to 5.8 at 24 hours after death. The lower pH in PSE muscles, combined with a high carcass temperature within the first hour after death, causes the proteins in the muscles to denature. This contributes to the pale color of PSE meat and to its reduced water-holding capacity. Development of muscles with PSE characteristics seems to be initiated by a combination of lower muscle pH already at exsanguination and a faster pH decrease.

Malignant hyperthermia is the drug-induced and often fatal stress syndrome occurring in susceptible pigs within 3 minutes following the inhalation of a mixture of halothane and oxygen. Susceptible pigs develop limb rigidity and a hyperthermia, which are not easily reversed and may result in death. There is an increased rate of intracellular ATP hydrolysis leading to a progressive failure of ATP-dependent  $Ca^{2+}$  accumulation by the sarcoplasmic reticulum and/or the mitochondria, with a rise in myoplasmic concentration of  $Ca^{2+}$  and consequent contraction of muscle. The same molecular defect occurs in lymphocytes from affected susceptible pigs. There is no histomorphometric evidence of cardiac abnormalities in MH-susceptible pigs. The mitochondria from predominantly red muscle fibers have a greater calcium-binding capacity than those from predominantly white-muscle-fiber areas. There is extreme rigidity of skeletal muscles, hyperthermia, tachycardia, cardiac arrhythmia, an increase in oxygen consumption, lactate formation and high-energy phosphate hydrolysis in muscle, respiratory and metabolic acidosis, and a rise in the CK activity and concentrations of potassium, lactate, glucose, free fatty acids, and catecholamines in blood. There is a large release of glucose and potassium from the liver, which contributes to the hyperglycemia and hyperkalemia. There is a marked  $\alpha$ -adrenergic stimulation, which is responsible for the heat production in MH-susceptible pigs. However, the  $\beta$ -adrenergic response in stress-sensitive and stress-resistant pigs is inconsistent. The lactic acidemia is severe because of the overproduction of lactate peripherally and failure of normal lactate uptake.

Malignant hyperthermia can also be induced using methoxyflurane, isoflurane and enflurane, and succinylcholine.

Exposing stress-susceptible pigs to halothane or exercise induces glycolysis, but the



mechanisms are different. There are no histochemical differences between muscles of susceptible and normal swine. There is some indication that halothane causes a transient but significant vasoconstrictive action, which could be a contributing factor in initiating the severe reactions in malignant hyperthermia. Electron microscopy of platelets from stress-susceptible pigs reveals a defect characterized by dilatation of the open canalicular system.

## CLINICAL FINDINGS

### Porcine Stress Syndrome (Transport Death)

Death during or following transport to market may be significant and is more prevalent when overcrowding occurs and during the hot summer period. If seen alive, affected pigs initially show a rapid tremor of the tail, general stiffness associated with increased muscular rigidity, and dyspnea to the extent of mouth-breathing. The body temperature is elevated, often beyond the limits of the clinical thermometer, and there are irregularly shaped areas of skin blanching and erythema. At this stage the affected pig is frequently attacked by other pigs within the group. The pig collapses and dies shortly afterward, and the total time course of the syndrome is generally of the order of 4 to 6 minutes.

### Malignant Hyperthermia

Malignant hyperthermia is also a manifestation of the PSS. It may be induced in stress-susceptible pigs by stress and injectable (succinyl choline, acepromazine, ketamine) or inhalation anesthesia with potent volatile anesthetics such as halothane or isoflurane. It is characterized by the development during anesthesia of increased muscle metabolism with muscular rigidity, lactic acidosis, a marked increase in basal metabolic rate, increased oxygen consumption and carbon dioxide production, severe hyperthermia and tachycardia, tachyarrhythmia, and death. Death is a result of the peripheral circulatory changes that are produced by severe acidosis, vasoconstriction, hyperkalemia, reduced cardiac output, and hypotension. Once fully developed, the syndrome is irreversible. The syndrome poses a hazard in swine anesthesia, which can be averted by prior medication with dantrolene and has received considerable study as a model for an analogous syndrome in humans. It has also been used as a method for determining stress susceptibility for genetic selection programs.

### Pale, Soft, and Exudative Pork

In stress-susceptible pigs, after slaughter, the inferior quality of the meat, with its pale, soft, exudative (PSE) characteristics, is obvious. This is caused by excessive post-mortem glycolysis with lactic acid production and a rapid fall in muscle pH, with depigmentation and reduced water binding

as a consequence. In affected muscle, rigor mortis occurs rapidly after slaughter but then decreases, so that affected carcasses have been "set" and postmortem drip is excessive. Affected pork has a pH of less than 6 and generally a temperature of 41° C (106° F) or greater 45 minutes after slaughter, compared with the normal pork with a pH above 6 and a temperature less than 40° C (104° F). This causes denaturation of muscle proteins, leading to affected meat that has inferior taste, cooking, and processing qualities and does not accept curing as readily. The occurrence of this syndrome is considerably influenced by the stress of transport and handling before and during slaughter, and this aspect of the syndrome is of major economic importance. Rapid chilling helps prevent PSE, but chill type has no effect.

### Dark, Firm, and Dry Pork

Dark, firm, and dry (DFD) pork has darker color and higher ultimate pH than normal meat. In muscles that develop DFD, the muscle glycogen is already depleted before slaughter, which may be related to prolonged transport with fasting.

### Back-Muscle Necrosis

Acute necrosis of the longissimus dorsi occurs in German Landrace pigs and other breeds. The acute syndrome lasts approximately 2 weeks and is characterized by swelling and pain over the back muscles, with arching or lateral flexion of the spine and reluctance to move. The swelling and pain then subside, but there is atrophy of the affected muscle and development of a prominent spinal ridge. Some regeneration may occur after several months. Acute cases may die. The syndrome occurs in young adults weighing from 75 to 100 kg. The mild form may be undetectable except for pigs lying down near the feed trough. In the severe form, affected pigs may assume the dog-sitting position with a hunched-up back.

## CLINICAL PATHOLOGY

Several testing methods are available for predicting susceptibility.

### Halothane Test

The halothane test is highly reliable for the identification of pigs that are homozygous for the single recessive gene responsible for susceptibility to PSS. However, the test is not 100% accurate because of the incomplete penetrance of the halothane sensitivity trait (not all homozygous MH-susceptible pigs react by developing limb rigidity). Penetrance of the halothane sensitivity trait is estimated to vary from 50% to 100% depending on the breed, herd, and investigators. The test detects the worst clinical outcomes, and it will not identify all the pigs that will develop PSE. There is now evidence that it will detect the heterozygote. Stress-susceptible pigs are sensitive to halothane at 8 weeks of age, and if

the anesthetic challenge is removed immediately after obvious signs of limb rigidity develop and before the development of fulminant hyperthermia, the mortality from the procedure is negligible. Pigs that remain unreactive for a challenge period of 5 minutes are considered normal.

A halothane-sensitive muscle defect can be present in certain individuals that do not develop rigid malignant hyperthermic episodes on brief exposure to halothane. A longer halothane exposure combined with succinylcholine is required if these false negatives are to be identified. The halothane test has good predictive value for the occurrence of PSE. However, there may be breed variations, as mentioned previously.

A decrease in the amplitude of the phosphocreatine (PCr) signal in the in vivo <sup>31</sup>P nuclear magnetic resonance spectrum of skeletal pigs is an early and 100% predictive measurement for the detection of malignant hyperthermia in anesthetized piglets. Nuclear magnetic resonance techniques such as magnetic resonance imaging and magnetic resonance spectroscopy are sensitive diagnostic aids for detecting the onset of PSS in young animals and for following the metabolic changes in muscle tissue during the syndrome.

Halothane concentration markedly affects the outcome of halothane testing, and either higher halothane concentrations or longer exposure might be required to identify positive reactors in a heterogeneous population. The ionophore A23187, a lipophilic carboxylic antibiotic that binds and transports divalent cations across both natural and artificial membrane bilayers, allows clear differentiation between the muscles of normal and pathologic animals and may be a useful adjunct to the halothane test.

### Blood Creatine Kinase Levels

The blood creatine kinase (CK) levels are higher in stress-susceptible pigs. Pigs are subjected to a standard exertion test, and blood samples are taken 8 to 24 hours later and analyzed for CK. The original research indicated a good correlation between CK levels and the halothane test. There is also an increase in CK levels in pigs as they are transported from the farm to the abattoir. However, not all pigs that develop PSE have increased serum levels of CK. Increased CK activity is highest in stress-susceptible pigs of a certain phenotype Phi-B, and their total plasma CK levels are higher than those of nonreactors. The initial test was modified so that blood could be collected as drops on a filter paper and sent to a laboratory for identification by a bioluminescent technique. A recent evaluation of a commercial CK screening test using the method of bioluminescence compared with the halothane challenge test on young boars entering a Record of Performance Test Station revealed that it was an inadequate indicator of susceptibility

to PSS or MH. In a different study the CK levels of piglets 8 to 10 weeks of age predicted halothane-induced stress syndrome with an accuracy of 87% to 91%.

Plasma pyruvate kinase activity has been compared with CK activity as an indicator of PSS. Both enzymes are increased significantly in homozygous halothane-reacting pigs compared with nonreacting pigs. Pyruvate kinase activity was less variable within groups than CK activity, which may allow more effective discrimination between the two different genotypes. However, age-related effects and the failure to identify heterozygotes may restrict the use of plasma pyruvate activity as a diagnostic test.

### Blood Typing

Blood typing is also used as a method for the identification of susceptible pigs. On one of the chromosomes of the pig, a region with four known loci has been identified. These loci contain the genes responsible for variants of the enzymes 6-phosphogluconate dehydrogenase and phosphofructose isomerase (PHI). The H-blood group system is determined by one of the loci, and halothane sensitivity is also determined by genes at a locus in this region. This region is of special interest because a close connection has been found between this and important carcass traits such as the PSE condition. Thus blood grouping may be used to detect halothane-sensitive pigs and heterozygote carriers.

A DNA-based blood test can now be used to detect the HAL gene status. It can be adapted for rapid batch analysis of many samples simultaneously, is less invasive, and can be applied to as little as 50  $\mu\text{L}$  of blood. The test is more than 99% accurate, is cost-effective, and can be used to determine the prevalence of the PSS mutation in various breeds of swine in various countries. A recent study showed that 23% of pigs classified as Hal-1843-free based on a DNA test responded abnormally to halothane anesthesia.

### Pale, Soft, and Exudative Pork

Pale, soft, and exudative pork (PSE) is evaluated by a meat quality index that combines meat color, pH at 24 hours postmortem, and water-binding capacity. Susceptible lines can be identified by carcass inspection and the results applied to sibling or progeny selection. A recent approach is the measurement of mitochondrial calcium efflux. Mitochondria isolated from Mm longissimus dorsi muscle exhibit a rate of  $\text{Ca}^{2+}$  efflux twice that of normal pigs. Most of the tests readily predict the worst examples of the syndrome but are not sufficiently precise to be able to identify tendencies toward it, which restricts their value in breeding programs.

### Erythrocyte Osmotic Fragility

Erythrocyte osmotic fragility may be correlated with malignant hyperthermia and is

being examined as a possible aid in the determination of susceptibility.

### Other Tests

Any reliable test that can identify stress-susceptible pigs without using halothane testing is attractive. Increased peroxidation of the erythrocytes may be an improved diagnostic test for PSS. Differences in the levels of cortisol, creatinine, aspartate aminotransferase, and lactate dehydrogenase are highly significant between halothane-sensitive and halothane-negative lines of pigs.

An allele-specific PCR (AS-PCR) technique has been developed. A PCR followed by reduction endonuclease assay has been developed and used on plucked hair as a source of genomic DNA. In a test with this method, 9 of 12 Pietrains tested were homozygous or heterozygous. A one-step procedure has been developed called mutagenically separated PCR (MS-PCR).

### NECROPSY FINDINGS

In PSS, rigor mortis is present immediately following death, and carcass putrefaction occurs more rapidly than normal. The viscera are congested, and there is usually an increased quantity of pericardial fluid and pulmonary congestion and edema. The muscles—especially the gluteus medius, biceps femoris, and longissimus dorsi—are pale, wet, and soft. In back-muscle necrosis, these changes appear grossly to be confined to the epaxial musculature. Histologically, the lesions in skeletal muscle may be minimal and are easily obscured by autolysis. In some instances only interstitial edema is visible, whereas in animals that have survived repeated episodes there is obvious phagocytosis of degenerate myofibers, with ongoing regeneration and fibrosis. The most typical microscopic finding is hypercontraction of myofibers, characterized by division of the cell into irregularly sized segments by transverse and sometimes branching bands. Degenerate sarcoplasm of a floccular or sometimes hyaline character may be present. Degenerative changes may also be detected in myocardial cells.

### Samples for Confirmation of Diagnosis

- Genetic analysis—50 g frozen muscle (DNA ANALYSIS) and hair for PCR tests
- Histology—formalin-fixed skeletal muscle (several sections, including longissimus dorsi), heart (LM)
- Biochemistry—it has been reported that pigs with PSS develop metabolic acidosis in association with respiratory acidosis, which is manifested as lower values of acid-base excess and  $\text{HCO}_3^-$ —with higher  $\text{H}^+$  concentrations and  $\text{PCO}_2$  compared with resistant pigs.

### DIFFERENTIAL DIAGNOSIS

The acute nature of porcine stress syndrome (PSS) and its relation to stress serve to differentiate it from most other syndromes causing sudden death in market- and adult-sized pigs. The sudden death syndrome must be differentiated from:

- Mulberry heart disease
- Acute septicemias attributable to salmonellosis, erysipelas, pasteurellosis, and anthrax
- Other causes of sudden death, including intestinal volvulus, heat exhaustion, and suffocation during transportation
- Hypocalcemic tetany resulting from severe vitamin D deficiency, which can produce a similar clinical syndrome
- Porcine viral encephalomyelitis, which can also result in a similar clinical syndrome in post-weaned pigs; pathologic and biochemical examinations differentiate these from the PSS

### TREATMENT

Early recognition enables successful treatment. Any drug administration should cease. Aggressive cooling using icepacks and alcohol baths should be instituted. The acute syndromes are usually not treated. Several drugs are available for the protection of pigs against drug-induced malignant hyperthermia. A combination of acepromazine and droperidol will delay the onset or prevent the occurrence of halothane-induced malignant hyperthermia. Dantrolene is also effective for treatment and prevention. The therapeutic dose is 1 to 3 mg/kg BW IV and 5 mg/kg orally as a preventative. Carazolol is effective for the prevention of transport death when given 3 to 8 hours before transportation and improves meat quality compared with untreated susceptible animals. Acute back necrosis has been treated successfully with isopyrin and phenylbutazone. Experimentally, the supplementation of the diets of stress-susceptible pigs with vitamin E and C will provide some protective effect on cell-membrane integrity.

### CONTROL

The control of this syndrome depends on genetic selection and possible eradication of the PSS mutation and reduction of the severity of stress imposed on pigs.

### Genetic Selection

The best strategy for control of this complex is not clear. Several factors must be considered. Swine homozygous for the PSS mutation are at very high risk for developing PSS and severe PSE to make them useful for market pigs. They are used primarily as a source of the PSS mutation for breeding programs and research purposes. Using swine that are heterozygous for the PSS mutation as market pigs may be advantageous. They benefit from the positive effects of the

mutation, have minimal risk of developing PSS, and may have acceptable prevalence and severity of PSE, if the environmental and management risk factors that precipitate PSE are minimized during marketing and slaughter. The mutation is not a prerequisite for leanness and muscularity, and it is possible for breeders to eradicate the gene from their breeding stock. The negative effects of the halothane gene on fresh pork quality are well known. However, such a policy may result in the loss of an easily accessible and cost-effective selection criterion for favorable carcass characteristics. The PSS mutation has been used successfully in most swine breeds for increasing leanness and muscling. With the development of the DNA-based test for the PSS mutation, the mutation can be selected for with high precision and accuracy, and its expression can be finely controlled in a breeding program.

The various testing methods described under "Clinical Pathology" are used to identify pigs with the halothane gene. The tests can be applied to breeding stock entering swine performance test stations or on a herd basis. A reliable diagnostic test such as a DNA-based blood test to identify the gene will provide the basis for elimination of the gene or its controlled inclusion in swine breeding programs.

### Management of Stressors

Control through reduction of stress is not easily applied because frequently the syndrome is induced by routine minor procedures within the piggery. The incidence of transport deaths or the necessity for immediate slaughter salvage of severely stressed pigs on arrival at the abattoir and the occurrence of PSE meat characteristics are a significant economic problem in some countries. The necessity to climb an upper deck in the transport poses a significant stress, and the use of single-deck transports or mechanical lifts for multiple-deck transports, and the shipment of pigs in containers, has resulted in a decreased incidence. The provision of spacious, well-ventilated transport vehicles and spray-cooling of pigs on arrival at the holding pens is also beneficial. Pigs should not be slaughtered directly after arrival at the abattoir and should be rested for at least 1 to 2 hours if they have been stressed only by transportation. In cases of severe physical exertion, even more time should be allowed for recovery. Where possible transport distance should be kept to a minimum, and transport should be avoided on excessively hot days.

### PIETRAIN CREEPER PIGS

A progressive muscular weakness is found in stress-susceptible Pietrain pigs. A similar condition might have been seen in Landrace. It was originally described in one to three herds in the United Kingdom. It is probably

an autosomal-recessive gene and is a progressive familial myopathy. In each litter one-quarter to one-third of piglets may be affected. The syndrome commences with muscle tremor at 2 to 4 weeks of age, in the hindlimbs progressing to the forelimbs, followed by reluctance to stand, limbs being flexed, and standing on tip-toe, with walking on flexed carpal joints leading to complete recumbency by 12 weeks of age. At this stage the pigs move with a creeping gait with the limbs flexed. The pigs remain alert and feed and grow normally. There are no neuropathologic lesions, but there are myopathic changes, especially in the forelimbs. In these muscles there are very variable muscle cells with internal nuclei.

### FURTHER READING

Wells GAH, et al. A progressive familial atrophy of the Pietrain pig: the clinical syndrome. *Vet Rec.* 1980;106:556.

### ASYMMETRIC HINDQUARTER SYNDROME OF PIGS

Asymmetric hindquarter syndrome of pigs was first reported in Germany and Belgium and was recognized in the United Kingdom in 1968. In these cases perineurial fibrosis was a feature, and it was thought that the condition resulted from either a neurogenic atrophy or a periarticular fibrosis extending to the peripheral nerves.

In this syndrome variable asymmetry of the hindquarters is evident during early growth of the animal and obvious by 80 kg live weight. An asymmetric distribution of subcutaneous fat is also noted, and possibly skin dimpling. The muscle most frequently affected is the semimembranosus, followed by the semitendinosus, biceps femoris, adductor femoris, and gracilis. The muscles show changes that can be described as myofibril degeneration, interstitial fibrosis, and dystrophic changes.

Several breeds, including Landrace, Large White, and Hampshire, have been found affected, but the problem is generally restricted to certain herds and to certain families within these herds, suggesting that a genetic liability exists for this condition. The mechanism of inheritance studied from test matings is not simple. Whatever the cause, there is a marked reduction in the number of muscle fibers. Both sexes may be involved, and the condition may involve either hindlimb.

Despite a marked reduction in muscle mass, there is no detectable abnormality in gait. The cause is unknown, although it appears to result from suboptimal muscle growth rather than degenerative loss. In the only cases recorded from outside Europe, a group of seven Australian pigs were examined in detail; in one of these pigs the affected semitendinosus weighed only 41% of the normal, unaffected one. Perineurial fibrosis

and myopathy have been observed in some cases.

### FURTHER READING

Done JT, et al. Asymmetric hindquarter syndrome (AHQS) in the pig. *Vet Rec.* 1975;96:482.

### PORCINE CONGENITAL SPLAYLEG (SPLAYLEG SYNDROME IN NEWBORN PIGS)

Porcine congenital splayleg (PCS) is also called spraddle leg, but more usually myofibrillar hypoplasia. This may be an erroneous term because this hypoplasia occurs in many normal pigs and may be a normal feature of postnatal muscle growth. This clinical condition of splayleg occurs in newborn piglets in most countries and is characterized by a temporary inability to stand with the hindlimbs.

### ETIOLOGY

The etiology is unknown, but based on epidemiologic evidence, it is multifactorial. The current hypothesis is that the disease is caused by an interaction of genetic and non-genetic factors, a polygenic mode, or expression of many genes without dominance.

Splayleg is not characterized by general muscular atrophy in the affected hindlimbs.<sup>1</sup>

The studies of Czech workers have suggested that the patho-morphology of the condition resembles that of glucocorticoid-induced myopathy in humans and animals. Dexamethasone given to minisows from the first to the last days of pregnancy produced a disorder characterized by splayleg syndrome with retardation of both muscle growth and myofibrillogenesis in their newborn piglets. It has also been experimentally produced following the administration of pyrimethamine.

There may be pathways indicated in gene expression for the further investigation of congenital splayleg.<sup>2</sup> It may be that the combined differential expression of MAFbx (a major atrophy marker) and P311 (a novel protein down regulated in all PCS muscles) is of potential in the diagnosis of subclinical PCS.<sup>3</sup>

### EPIDEMIOLOGY

The prevalence of the disease in the United Kingdom is 0% to 4%, and the morbidity in affected herds varies from 2% to 27%. The case-fatality rate is approximately 50% and is attributable to crushing, chilling, and starvation because affected piglets are not able to move around normally. The disease is more common in the Pietrain, Welsh, Landrace, and Large White breeds of swine; Landrace pigs may be especially susceptible. This suggests a genetic basis, but test-matings, with the exception of a few, have not been successful in reproducing the disease. On most farms the disease affects both male and female piglets. In a recent



retrospective analysis of the incidence of the disease in a swine herd over a period of 5 years, the overall frequency was 1.74 times greater in males than females, and the birth weight of splayleg piglets tended to be subnormal. The environmental factors that have been associated with some outbreaks include slippery floors, a dietary choline deficiency, and the ingestion of *Fusarium toxin* by pregnant sows. Choline deficiency is unlikely to be a factor, and no other factors have been substantiated as etiologic factors or epidemiologic determinants.

### PATHOGENESIS

The pathogenesis of the disease is unclear. In affected pigs there is myofibrillar hypoplasia, but this is also a feature of many muscles in normal pigs. There are simply too few maturing type I fibrils in the muscles, particularly of the foreleg, lumbar epaxial group, and the hindlimb, to carry weight. The semitendinosus appears to be the most significantly affected muscle. However, because myofibrillar hypoplasia may also be present in normal unaffected littermates, it has been difficult to explain the pathogenesis of the muscular weakness. The use of morphometrics has enabled the detailed determination of the myofibrillar hypoplasia. In addition to myofibrillar hypoplasia, in splayleg pigs there is a higher content of sarcoplasmic RNA, reflected ultrastructurally by the presence of numerous ribosomes. The extramyofibrillar space was also filled with glycogen in splayleg pigs. In myofibrillar hypoplasia induced with glucocorticoids given to the pregnant sow, none of the pigs had splaylegs, but the extramyofibrillar space contained little glycogen. There were also many glycogen-filled phagosomes and residual bodies, indicating a difference in the metabolism of glycogen in the first 2 or 3 days after birth. In a study of natural cases there was hypoplasia, but there was an increased accumulation of glycogen, especially within the large extramyofibrillar spaces, in comparison with the normal pigs. These authors also found an anomalous distribution of glucose-6-phosphatase in splayleg-affected muscles, in that the activity was concentrated at the periphery of the extremely dilated cisternae of the sarcoplasmic reticulum. In the normal muscles this enzyme activity was normal. This distribution could account for the slower utilization of glycogen in affected muscles and therefore would account for the build-up. Quantitative image analysis of skeletal muscle revealed that the arrangement of the myofibrils within the fascicles of affected and unaffected pigs was different.

Some studies have found both quantitative (hypoplastic type) and qualitative (dystrophic type) insufficiencies in affected pigs that represent a temporary perinatal developmental disturbance. This could explain the muscular weakness and the recovery that occurs.

### CLINICAL FINDINGS

There is a temporarily impaired functionality of the hindleg muscles immediately after birth. Essentially, the adductors are not as powerful as the abductors.

Larger litters may be more affected, possibly because these tend to be born earlier. The clinical signs are usually obvious in 2 to 3 hours after birth when the litter should be standing and walking around the creep area. Affected piglets are unable to stand, their hindlimbs are splayed sideways or forward, and the animals rest in sternal recumbency. Sometimes the forelimbs are also splayed. Most severely affected piglets are unable to move; less severely affected animals are able to move slightly. Many pigs have soiled hindlimbs and perineum as a result of being unable to stand. As a result, the piglets are likely to be crushed or have difficulty gaining access to their source of nourishment. Affected piglets are normal in other respects, have a normal appetite, and will suck the sow if placed near a teat. In the experimental induction there was hypoplasia but no clinical signs, which is further evidence for suggestions that the condition has a threshold for clinical signs and has strong maternal influences.

### TREATMENT

Treatment can be successful. If the pigs are able to suck or if they are fed artificially for 2 to 4 days, recovery will occur within 1 week in about 50% of cases. The ambulatory capacity of affected pigs can be improved, and mortality reduced, by taping or loosely tying together the hindlimbs for a period of up to 1 week. The method of loose tying of the hindlimbs consists of a figure-of-eight bandage (2.5-cm-wide adhesive tape) being fixed around the metatarsal bones, leaving a space between the legs of up to 7 cm depending on the size of the piglet. The legs should be tied together within a few hours after the syndrome is obvious; a delay of several hours will decrease the prognosis. The provision of a nonslip floor surface such as a carpet or sack may also be helpful. Many farmers will tell you that repeated massaging of the limbs will also improve the survival rate.

### CONTROL

Whether or not to cull the boar depends on the pedigree value of the animal, the incidence of the disease, and the probability that the boar is responsible. There is no evidence that the disease is monogenic. However, the incidence is highest in the Landrace breed, which suggests a hereditary predisposition. In deciding whether to use a suspected carrier animal, there is a need to distinguish between different situations. The consequences of disease are felt differently at the different levels of organization of the pig industry. A boar of high merit for performance traits may be more economical to retain as breeding stock even though some

progeny are affected with the disease than a less superior boar whose progeny are unaffected. If stress of the pregnant sow is a factor, control of the disease may be dependent on the selection of stress-resistant boars and sows.

Concurrent disease should be controlled; producers report a higher percentage of splayleg piglets after a period of porcine respiratory and reproductive syndrome (PRRS) infection. There are also suggestions that induced early farrowing and zearalenone poisoning may also be complicating factors to prevent.

### FURTHER READING

Papatsiros VG, et al. The splay leg syndrome in piglets: a review. *Am J Anim Vet Sci*. 2012;7:80-83.

### REFERENCES

- Boettcher D, et al. *Dev Biol*. 2008;132:301.
- Maack S, et al. *Int J Biol Sci*. 2009;5:331.
- Ooi P, et al. *BMC Vet Res*. 2006;2:23.

## Inherited Diseases of Bones

Congenital skeletal abnormalities are relatively common in large animals and can be genetic, teratogenic, or nutritional in origin.<sup>1-3</sup> Exposure of developing fetuses to a wide variety of toxic compounds, maternal mineral deficiencies or imbalances, or exposure to one of a number of infectious agents at certain stages of gestation can create skeletal lesions indistinguishable from those caused by a genetic abnormality. In some cases, teratogenic or nutritional causes of skeletal abnormalities can appear very similar to genetic causes, and distinguishing among them can be challenging.<sup>3</sup> For example, chondrodysplasia associated with intrauterine zinc or manganese deficiency have similar clinical features and histologic lesions to mild forms of hereditary chondrodysplasia.<sup>3</sup> Therefore, historical data are essential in any attempt to distinguish genetic and acquired causes of skeletal lesions; as many animals as possible should be examined, and samples should be collected for future analysis, such as genetic testing.

### ETIOLOGY

Over 350 defects in cartilage and bone development are identified in humans.<sup>4</sup> Although substantially fewer are identified in large animals, this large number in humans underscores the many potential diseases in animals. The situation in many production animal industries is compounded by the “founder effect” and widespread use of elite sires by means of artificial insemination that leads to the frequent emergence of recessive genetic defects, which cause important economic and animal welfare concerns.<sup>2,5</sup> Table 15-10, modified from Dittmer and Thompson,

**Table 15-10** Inherited skeletal diseases of livestock with known mutations and proposed mechanisms.

Disease	Breed/mutation/OMIA no.	Proposed mechanism
Bulldog chondrodysplasia	Dexter cattle, other miniature cattle breeds Mutated gene, Aggrecan ( <i>ACAM</i> ), OMIA: 001271-9913	ACAN is the main proteoglycan expressed by chondrocytes during cartilage formation in the primordial limb bud.
Angus dolichocephalic long-nosed dwarfism	Angus cattle Mutated gene; cGMP-dependent type II protein kinase ( <i>PRKG2</i> ); OMIA: 001485-9913	<i>PRKG2</i> is required for growth-plate development because it regulates <i>SOX9</i> , a critical transcription factor involved in endochondral ossification and the control of growth-plate collagens type II and X.
Ellis van Creveld syndrome 2	Japanese Brown cattle, Gray Alpine cattle	Part of the primary cilia, thought to have a role in regulating sonic hedgehog, a key regulator of skeletal development.
Arachnomelia	Italian Brown, Simmental, German Fleckvieh, and Brown Swiss cattle Mutated gene; molybdenum cofactor synthesis step 1 ( <i>MOC51</i> ), sulfite oxidase ( <i>SUOX</i> ); OMIA: 001541-9913, 000059-9913	Increased sulfite levels result in atypical bone development.
Osteopetrosis with gingival hamartomas	Belgian Blue cattle Mutated gene; chloride/proton exchanger, lysosomal anion transporter ( <i>CLCN7</i> ); OMIA: 001887-9913	<i>CLCN7</i> and associated subunit osteopetrosis associated transmembrane protein ( <i>Ostm1</i> ) are on lysosome membranes and the ruffled border of osteoclasts. Mutations in <i>CLCN7</i> and <i>Ostm1</i> impair acidification of resorption lacunae.
Osteopetrosis	Red Angus cattle Mutated gene; anion exchange transporter ( <i>SLC4A2</i> ); OMIA: 000755-9913	The <i>SLC4A2</i> transporter exchanges bicarbonate ions for chloride ions. As a result of proton secretion during acidification of resorption lacunae, mutations in this transporter result in accumulation of bicarbonate ions, leading to toxic osteoclast alkalization.
Marfan syndrome	Japanese Black cattle Mutated gene; fibrillin 1 ( <i>FBN1</i> ); OMIA: 000628-9913	Fibrillin is a component of the extracellular microfibrils present in connective tissues. Fibrillins regulate TGF- $\beta$ and BMP availability, and the decreased bone mineral density and decreased mechanical strength seen in Marfan syndrome are thought to be attributable to increased activation of TGF- $\beta$ signaling.
Autosomal-recessive hypophosphatemic rickets, type I	Corriedale sheep Mutated gene; dentin matrix protein 1 ( <i>DMP1</i> ); OMIA: 001542-9940	Dentin matrix protein 1 ( <i>DMP1</i> ) is a noncollagenous bone protein involved in bone mineralization. In addition, decreased <i>DMP1</i> results in increased <i>FGF23</i> and subsequent phosphaturia.
Spider lamb syndrome	Suffolk sheep, Hampshire sheep Mutated gene; fibroblast growth factor receptor 3; OMIA: 001703-9940	Mutation removes <i>FGFR3</i> inhibition of chondrocytes entering the hypertrophic chondrocyte phase, resulting in increased length of long bones.
Texel chondrodysplasia	Texel sheep Mutated gene; sodium-sulfate transporter ( <i>SLC13A1</i> ); OMIA: 001400-9940	In addition to changes in the cartilage matrix, undersulfation of cartilage proteoglycans leads to altered Indian hedgehog signaling, resulting in decreased chondrocyte proliferation. <sup>2,5</sup>
Schmid metaphyseal chondrodysplasia	Yorkshire pig Mutated gene; collagen, type X, alpha 1 chain ( <i>COL10A1</i> ); OMIA: 001718-9825	Type X collagen is expressed by hypertrophic chondrocytes, and this mutation prevents trimerization of the collagen X chains.
Vitamin D–dependent rickets type I	Hannover pig Mutated gene, 25-hydroxyvitamin D 1- $\alpha$ -hydroxylase ( <i>CYP27B1</i> ); OMIA: 000837-9825	<i>CYP27B1</i> is required for the formation of active vitamin D (1,25-dihydroxyvitamin D). Decreased active vitamin D leads to hypocalcemia and hypophosphatemia, impaired cartilage and bone mineralization, and decreased chondrocyte apoptosis.

Modified from Dittmer and Thompson.<sup>3</sup>

provides a listing of currently recognized inherited skeletal diseases of livestock, the associated mutations, and mechanisms underlying the disease.<sup>3</sup>

### PATHOGENESIS

Bone development and remodeling is a complex process involving timely expression and control of numerous genes and epigenetics factors, and there is increasing understanding of the role of these factors in creation of bone and cartilage.<sup>4,6</sup> The large number of genes involved in osteogenesis and cartilage formation and development,

and the crucial and nonredundant role of many of these genes, means that a wide range of skeletal defects occur in humans and domestic animals. A variety of transcription and growth factors are identified as being involved in the pathogenesis of skeletal defects. This allows etiologic, rather than morphologic, classification of diseases and abnormalities. **Osteochondrodysplasia** (or skeletal dysplasia) includes generalized abnormalities in chondro-osseous tissues, whereas *dysostosis* refers to a localized malformation of an individual bone or group of bones.<sup>2</sup> Osteochondrodysplasias are now

mostly classified according to the underlying defect, rather than the morphologic presentation.<sup>7</sup> Most of the skeleton develops through processes involving endochondral ossification, and abnormalities in cartilage formation or structure can have widespread effects on the skeleton. Defects in cartilage formation that result in skeletal abnormalities are called **chondrodysplasia**. **Achondroplasia**, referring to an absence of cartilage, should be reserved for diseases characterized by a lack of cartilage, rather than abnormalities in its composition or structure.<sup>2</sup>

## CLINICAL FINDINGS

Animals with acquired defects often have substantial variation in clinical signs and lesions and can improve over time, whereas animals with disease caused by genetic defects usually have a consistent clinical presentation and pathology. Clinical signs of the various diseases are described under those headings.

## Diagnosis

If a disease is determined to be of genetic origin, a number of approaches can be used to detect mutations, include sequencing candidate genes, single-nucleotide polymorphism array with genome-wide association studies, and exome or whole-genome sequencing.<sup>3</sup> Use of genome-wide, high-density single-nucleotide polymorphism (SNP) panels, or next-generation genomic analysis, combined with an understanding of livestock populations, allows for rapid positional identification of genes and mutations that cause inherited defects.<sup>5</sup> However, a thorough understanding of the history of the animal's disease, its clinical presentation, and its lesions is essential for establishing a reliable diagnosis.

Differential diagnoses for inherited skeletal diseases of animals are shown in Table 15-11 (modified from Dittmer and Thompson).<sup>3</sup>

## TREATMENT AND CONTROL

There is no effective treatment for genetic diseases, and affected animals are usually euthanized. Control is based on an understanding of the mode of inheritance, identification of carrier animals (for diseases with recessive inheritance), and selective breeding or testing and removal of heterozygotes from the breeding pool.

## FURTHER READING

Thompson KG, et al. Inherited disorders of skeletal development in sheep. *Vet J*. 2008;177:324-333.  
Online Mendelian Inheritance of Animals. University of Sydney. (Accessed June 30, 2016 at <<http://omia.angis.org.au/home/>>.)

## REFERENCES

1. Thompson KG. *Small Rumin Res*. 2008;76:112.
2. Thompson KG, et al. *Vet J*. 2008;177:324.
3. Dittmer KE, et al. *Vet Pathol*. 2015;52:851.
4. Krakow D, et al. *Genet Med*. 2010;12:327.
5. Charlier C, et al. *Nat Genet*. 2008;40:449.
6. Pitsillides AA, et al. *Nat Rev Rheum*. 2011;7:654.
7. Rimoin DL, et al. *Am J Med Genet*. 1998;79:376.

## INHERITED OSTEOGENESIS IMPERFECTA

The term *osteogenesis imperfecta* covers a heterogeneous group of connective tissue diseases caused by quantitative or qualitative defects in type I collagen.

The disease is recorded as being inherited in Holstein–Friesian cattle and New Zealand Romney sheep.

## Cattle

It is transmitted as an autosomal-dominant trait. Calves are clinically abnormal at birth, with the main presenting signs being bright-pink teeth and slackness of the flexor tendons on all four feet so that the animals are unable to stand. The calves become progressively worse, to the point where they cannot walk. The full list of abnormalities in this syndrome includes smaller-than-normal body size at birth, a dome-shaped cranial vault, and fragility of bones, manifested by multiple fractures occurring during birth. The defect is one of connective tissue cells in which there is a faulty production of collagen and intercellular cement. Radiologic examination demonstrates growth-arrest lines and multiple fractures in the long bones and thin dentine and enamel layers on the teeth, which are pink because of the exposed condition of the enlarged pulp. The excessive mobility of the joints results from the small bulk of the ligaments and tendons.

A syndrome of simple bone fragility occurs in Charolais cattle and is called *osteogenesis imperfecta*.

## Sheep

The disease in New Zealand Romney sheep<sup>1</sup> is similar to that in Holstein–Friesian cattle with additional lesions of thickness of the diaphyses and reduction in size of the medullary cavity, moderate brachygnathia inferior, subcutaneous edema, skin fragility, and a dark blue color of the sclera. It is inherited as an autosomal dominant trait, and was thought to have developed as a new mutation in the testicular cell line of the parent ram.

## REFERENCE

1. Thompson KG, et al. *Vet J*. 2008;177:324.

## INHERITED DWARFISM

Most inherited food animal dwarfs are chondrodysplastic, and the disease occurs in cattle and sheep.

## Sheep

Brazilian hair sheep of the Cabugi breed, which are typically shorter and more compact than other breeds, have a form of skeletal dysplasia characterized by lambs born with craniofacial abnormalities and dwarfism that die at 2 to 6 months of age.<sup>1</sup> Dwarf lambs are much smaller than normal, with short legs, a domed head with superior brachygnathism, sternal deformities, and exophthalmic eyes situated more laterally in the head than normal. There is disproportionate shortening of the appendicular bones. The disease is inherited as an incomplete dominant trait, with the shortened face, a feature of the Cabugi breed, representing the heterozygous state and the more severe, often lethal, dwarfism occurring in homozygotes.

A syndrome of **dwarfism, brachygnathia, cardiomegaly, and renal hypoplasia syndrome** occurs in Poll Merino/Merino sheep in Australia.<sup>2</sup> The disease is a lethal genetic disorder associated with homozygosity in genetic material located toward the distal end of chromosome OAR2, from 220,932,050 to 221,939,408, which includes approximately 25 genes.<sup>3</sup> Segregation analysis suggests the disorder is transmitted as an autosomal trait with a recessive mode of inheritance. Affected lambs are dwarfs with multiple defects in the skeleton, heart, liver, and kidneys.

## Cattle

### Snorter Dwarfs

Snorter dwarfs are no longer important because of successful efforts in eliminating carriers of the gene. These calves are short-legged with short, wide heads and protruding lower jaws. The mandibular teeth may protrude 2 to 4 cm beyond the dental pad, preventing effective grazing and necessitating hand-feeding if the animal is to survive. There is protrusion of the forehead and distortion of the maxillae, and obstruction of the respiratory passages results in stertorous respiration and dyspnea. The tip of the tongue usually protrudes from the mouth, and the eyes bulge. There is some variation between affected animals in their appearance at birth. In most cases the defects are as just described, but they become more exaggerated as the calf grows. In addition, abdominal enlargement and persistent bloat develop. The head is disproportionately large. The calves fail to grow normally and are about half the weight of normal calves of the same age.

The predominant form of the condition appears to be inherited as a simple recessive character, although the relationship of the “compresst” types to the total syndrome is more complex. Heterozygotes vary widely in conformation, but some of them show minor defects that may be attractive to cattle breeders who were seeking a chunkier, short-legged type of animal. For this reason, indiscriminate selection toward the heterozygote undoubtedly occurred, resulting in widespread dissemination of the character. Herefords and Aberdeen Angus are the breeds most commonly affected, but similar dwarfs occur also in Holstein and Shorthorn cattle, and typical dwarf animals have been produced by mating heterozygous Aberdeen Angus and Herefords. Besides the shortness of limbs, there is also a looseness of attachment of limbs and abnormal mobility of joints. The disorder of dolichocephalic long-nosed dwarfism in American Angus cattle is attributable to a nonsense mutation in exon 15 of cGMP-dependent type II protein kinase (PRKG2).<sup>4</sup>

**Ellis van Creveld syndrome** (bovine chondrodysplastic dwarfism) occurs Grey Alpine cattle, Japanese Brown cattle, and



**Table 15-11** Differential diagnoses for inherited skeletal diseases of animals

Disease	Clinical signs and lesions
<b>Abnormal head shape</b>	
Genetic	Usually has recessive inheritance, so only small numbers of animals affected. Breeds: Angus, Dexter, Japanese Brown, Tyrolean Grey, and Holstein–Friesian cattle; Texel, Merino, and Cabugi sheep; Danish Landrace pigs. Clinical signs have a consistent presentation, typically with minimal variation. Normal liver zinc and manganese concentrations. Shortened long bones (mild to severe depending on the gene affected), epiphyses potentially mushroomed, domed head, + brachygnathia inferior. Decreased thickness of physes, particularly hypertrophic zone; histologic lesions present in severe forms but mild or nonexistent in other forms.
Chondroplasia—nutritional	Prevalence generally higher than expected for inherited forms of chondrodysplasia. History of drought or adverse weather events during pregnancy and exposure of pregnant animals to unusual supplementary feeding or toxic plants. Variation in severity of dwarfism and twisted limbs; animals with mild cases improve after birth. Shortened long bones, epiphyses can be mushroomed. Decreased thickness of physes, particularly hypertrophic zone; histologically, lesions may be mild or nonexistent. Low liver zinc or manganese concentrations; if deficiency occurred for a finite period during gestation, zinc or manganese concentrations can return to normal.
Plant toxins	<i>Veratrum californicum</i> toxicity in sheep: shortening metacarpal/metatarsal + other bones, fusion of metacarpal bones, arthrogryposis, hypermobility of hock joints. Wild lupins ( <i>Lupinus</i> spp.): cattle; shortening and rotation of limb bones, flexion contracture, arthrogryposis.
Vitamin A intoxication	Pigs: shortening of long bones, abnormally shaped long bones and carpal/tarsal bones, osteoporosis. Calves: possibly associated with “hyena disease”; premature closure of hindlimb growth plates, segmental narrowing of physes.
<b>Vertebral abnormalities</b>	
Brachyspina	Cattle; smaller-than-normal size, shortened vertebral column as a result of fusion of vertebrae, and long thin limbs. Irregular areas of ossification separated by cartilage, fusion of epiphyses, and diaphysis of adjacent vertebrae.
Complex vertebral malformation	Cattle; smaller-than-normal size, consistent arthrogryposis of forelimbs + hindlimbs, shortening of cervical and thoracic vertebral column, hemivertebrae, fused vertebrae, scoliosis. Cardiac abnormalities in ~50% of cases.
Shortened spine	<i>Veratrum californicum</i> : cattle; decreased coccygeal vertebrae, arthrogryposis. Parabendazole toxicosis: compression/fusion vertebrae, absence of various limb bones, curvature of long bones.
Scoliosis, kyphosis, torticollis	Wild lupins: see also craniofacial defects and shortened limbs. Conium maculatum: cattle, sheep, pigs; + arthrogryposis, carpal flexure, cleft palate <i>Nicotiana tabacum</i> , <i>N. glauca</i> : cattle/pigs; + arthrogryposis, brachygnathia. Locoweed ( <i>Astragalus</i> spp., <i>Oxytropis</i> spp.): cattle/sheep; also brachygnathia. <i>Lathyrus</i> spp., <i>Vicia</i> spp.: cattle/sheep; + arthrogryposis, rotation of forelimbs.
Manganese deficiency	Cattle; congenital spinal stenosis and premature closure of growth plates associated with Mn deficiency but not proven.
<b>Limb abnormalities</b>	
Syndactyly	Autosomal recessive with incomplete penetrance and variable expression in Holstein–Friesian, Angus, Chianina, Hereford, Simmental, German Red Pied, Indian Haryana, and Japanese native cattle. Right forelimb most commonly involved, but all limbs may be affected. <i>Veratrum californicum</i> toxicosis in cattle.
Angular limb deformity	<i>Trachymene</i> spp.: sheep; outward bowing, particularly of forelimbs. Locoweed ( <i>Astragalus</i> spp., <i>Oxytropis</i> spp.): cattle/sheep; also limb contractures, osteoporosis.
Congenital hyperostosis	Severe edema: soft tissues of limbs (particularly antebrachium). Radiating trabeculae of new periosteal bone.
Tibial hemimelia	Bilateral tibial hemimelia, cryptorchidism, ventral abdominal hernia, + meningocele.
<b>Abnormalities in multiple axial and appendicular bones</b>	
Spider lamb syndrome	Excessively long limbs and neck leading to angular limb deformities, scoliosis/kyphosis, sternal deformities, Roman nose, degenerative joint disease. Multiple irregular islands of ossification in epiphyseal cartilage.
Schmallenberg virus, Akabane virus, bunyaviruses	Arthrogryposis (Schmallenberg, Akabane); torticollis, kyphosis, scoliosis, lordosis (Schmallenberg); brachygnathia inferior (Schmallenberg); and central nervous system abnormalities (Schmallenberg, Akabane, bluetongue virus).
Plant toxins	Wild lupins, <i>Conium maculatum</i> , <i>Nicotiana</i> spp.

Modified from Dittmer KE, Thompson KG. Approach to investigating congenital skeletal abnormalities in livestock. *Veterinary pathology*. 2015; 52:851.

Tyrolean Grey cattle, in which it is an autosomal-recessive defect with the phenotype of short limbs, joint abnormality, and ateliosis.<sup>5,6</sup> Long bones of affected animals have insufficient endochondral ossification with irregularly arranged chondrocyte, abnormal formation of cartilaginous matrix, and partial disappearance of the epiphyseal growth plates. The mutated gene is Ellis van Creveld syndrome 2 gene (EVC2),<sup>5,6</sup> also known as LIMBIN; OMIA: 000187-9913, causing a defect in the primary cilia, which is thought to have a role in regulating sonic hedgehog, a key regulator of skeletal development.

These disorders should not be mistaken for chondrodysplasia caused by nutritional deficiencies, which characteristically occur with a much higher incidence in affected herds after periods of drought or nutritional stress.<sup>7-9</sup>

### Inherited Congenital Achondroplasia With Hydrocephalus

First recorded as **bulldog calves** in Dexter cattle, this inherited defect has since been observed in a variety of forms in other breeds, including Jerseys, Guernseys, Holsteins, and Japanese Brown cattle. Chondrodysplasia in the Holstein-Friesian breed sharing morphologic features with the Dexter bulldog calves have been reported from the United States, the Netherlands, Great Britain, and recently in Denmark. Dexter bulldog-type calves have occurred in French and Danish Holstein calves in a familial pattern related to the sire Igale Masc, and it is likely that the genetic disorder is present in the Holstein breed worldwide.

Characteristic features of lethal chondrodysplasia (Dexter bulldog) calves in Australian Dexter cattle include abortion, disproportionate dwarfism, a short vertebral column, marked micromelia, a relatively large head with retruded muzzle, cleft palate and protruding tongue, and a large abdominal hernia.<sup>5</sup> Histologic changes in limb bones are consistent with failure of endochondral ossification. Dexter chondrodysplasia is considered to be inherited in an incompletely dominant manner, with the homozygous form producing the congenital lethal condition. Based on analysis of the contribution of three obligate heterozygotes whose semen has been widely used in artificial insemination in Australia, it is estimated that the heterozygote frequency is 19% within the registered Australian Dexter herd.

Affected calves are often aborted, but some reach full term and cause fetal dystocia because of the extreme hydrocephalus. The forehead bulges over a foreshortened face with a depressed, short nose. The tongue protrudes, the palate is cleft or absent, the neck is short and thick, and the limbs are shortened. Accompanying defects are fetal anasarca and hydrups amnii in the dam.

The defect is primarily chondrodystrophy rather than achondroplasia; the nasal bones and maxillae do not grow. Hydrocephalus develops because of the deformed cranium. In most breeds the condition is inherited as a simple recessive character, but a dominant form has occurred in Jerseys. The heterozygous form in Dexters is easily recognized by the shortness of the limbs. The heterozygote in other breeds is normal in appearance.

### Miscellaneous Dwarfs

Other types of dwarfs have been described and include “**comprest**” and “**compact**” cattle in Herefords and Shorthorns and various other forms of **proportional dwarfs**. For example, in Charolais, miniature calves have been recorded that are exact replicas of normal calves but weigh only 5 to 16 kg at birth and are born 2 or more weeks prematurely. Most are dead at birth or die soon after so that the condition is effectively lethal. Proportional dwarfs occur also in Simmentals.

Other forms of chondrodystrophy, including “bulldog calves” and a form that causes fatal nasal obstruction in the German Black Spotted breed of cattle, have also been recorded. In the latter there are multiple deformities of limb bones, and the condition appears to be inherited as a result of the influence of a single recessive gene.

### REFERENCES

1. Dantas FPM, et al. *J Comp Pathol*. 2014;150:245.
2. Shariflou MR, et al. *Aust Vet J*. 2011;89:254.
3. Shariflou MR, et al. *Anim Genet*. 2013;44:231.
4. Koltes JE, et al. *Proc Nat Acad Sci*. 2009;106:19250.
5. Murgiano L, et al. *PLoS ONE*. 2014;9.
6. Muscatello LV, et al. *Vet Pathol*. 2015;52:957.
7. Dittmer KE, et al. *NZ Vet J*. 2015;63:174.
8. White PJ, et al. *Prev Vet Med*. 2010;94:178.
9. White PJ, et al. *Vet J*. 2012;193:336.

### CONGENITAL OSTEOPETROSIS

Osteopetrosis is a skeletal disorder of humans and animals characterized by the formation of overly dense bones. The disease is reported in Angus, Red Angus, Hereford, Simmental, and Holstein cattle.<sup>1</sup> The inherited defect is recorded in Aberdeen Angus calves, which are stillborn and undersized. The major manifestations are shortening of the mandible with protrusion of the tongue, impaction of the lower molars, a patent fontanelle, and the characteristic lesion of shortness of the long bones and absence of a marrow cavity in them. The absence of the marrow cavity, caused by defective remodeling of the bone, gives it a homogeneous shaft, leading to the colloquial name of “marble bone.” Genetically affected calves are typically aborted late in gestation, display skull deformities, and exhibit a marked reduction of osteoclasts. The disease is caused by a deletion mutation within bovine SLC4A2,<sup>1</sup> encoding an anion exchanger protein, causing loss of SLC4A2 function that induces premature cell death

and likely results in cytoplasmic alkalinization of osteoclasts, which, in turn, may disrupt acidification of resorption lacunae.

### REFERENCE

1. Meyers SN, et al. *BMC Genet*. 2010;11.

### INHERITED PROBATOCEPHALY (SHEEPSHEAD)

This defect is inherited in Limousin cattle. The cranial bones are deformed so that the head resembles that of a sheep. The accompanying defects in the heart, buccal cavity, tongue, and abomasum increase the chances of an early death.

### INHERITED ATLANTO-OCCIPITAL DEFORMITY

(See “Congenital Defects of the Nervous System.”)

### INHERITED AGNATHIA

Partial or complete absence of the mandibles with ventral displacement of the ears occurs in sheep and is categorized as a lethal recessive because the sheep are unable to graze properly.

### INHERITED DISPLACED MOLAR TEETH

Inherited as a simple recessive character, the defect of displaced molar teeth usually results in the death of affected calves within the first week of life. The six premolars of the lower jaw are impacted or erupted in abnormal positions, often at grotesque angles. The mandible is shorter and narrower than normal. There is no abnormality of the incisors or upper jaw.

### INHERITED JAW MALAPPOSITION

Defective apposition of upper and lower incisors, or lower incisors and dental pad, in ruminants may result in inefficient grazing and malnutrition. Abnormal protrusion of the mandible (mandibular **prognathism**) is of most importance in ruminants, and there is good evidence that abnormal length of the mandible is inherited. Among British breeds of **cattle** the defect is more common in beef than in dairy breeds. In Herefords and Angus the inheritance is thought to be conditioned by a single recessive gene.

**Brachygnathia**, underdevelopment of the mandible, has also been recorded in Dairy Shorthorn, Jersey, Holstein, Ayrshire, and Simmental cattle, with the defect so severe in some cases that the animals are unable to suck. In Angus cattle, brachygnathia can occur linked to a generalized degenerative joint disease, in which all joint surfaces are involved. Affected animals,

detected at a few days to 4 months of age, are not viable. Inheritance of the defect is probably conditioned by a recessive gene.

A less severe degree of **brachygnathia** has been recorded in Merino and Rambouillet **sheep**. The mode of inheritance is suggested to be by the interaction of several pairs of genes. Brachygnathia occurs in Poll Merinos in Australia as part of the lethal brachygnathia, cardiomegaly, and renal hypoplasia syndrome.<sup>1</sup> The disorder is also caused by intrauterine infection by the Schmallenburg virus.<sup>2</sup>

**Mandibular prognathism** occurs as a part of other, more general defects, including achondroplastic dwarfism and inherited displaced molar teeth. It is associated with mutations in the *MATN1* gene in donkeys.<sup>3</sup>

**Brachygnathia** is also seen in **horses** but is not recognized as inherited. Maxillary prognathism is associated with two SNPs within a region on the distal end of chromosome ECA 13 in horses.<sup>4</sup>

## REFERENCES

1. Shariflou MR, et al. *Anim Genet*. 2013;44:231.
2. Wagner H, et al. *Berliner Munchener Tierarztliche Wochenschrift*. 2014;127:115.
3. Rodrigues JB, et al. *Gene*. 2013;522:70.
4. Signer-Hasler H, et al. *PLoS ONE*. 2014;9.

## INHERITED CRANIOSCHISIS (CRANIUM BIFIDUM)

The disease occurs in a number of pig breeds, but has been shown to be inherited only in Poland China pigs and their cross-breeds. There is a deficit in the cranial bones, and meningoceles or encephaloceles may result. The pigs are not viable. Genetic experiments have shown the inheritance to be of a recessive character with varying penetrance.

Many single cases of cranial and spinal deformity in farm animals have been likened to the human Arnold-Chiari malformation, but a specific syndrome of protrusion of the medulla oblongata and the cerebellum through the foramen magnum into the spinal canal has not been identified in a hereditary context in these species. Cases of cranium bifidum are reported on lambs and calves, but the inherited basis, if any, is unclear.<sup>1-3</sup>

## REFERENCES

1. Lopez MJ, et al. *Large Anim Pract*. 2000;21:16.
2. Mirshahi A, et al. *Iran J, Vet Surg*. 2012;7:85.
3. Yadegari M, et al. *Res Op Anim Vet Sci*. 2013;3:387.

## INHERITED CRANIOFACIAL DEFORMITY

The defect is incompatible with life. One form in Border Leicester lambs is characterized by a variable degree of nasomaxillary hypoplasia, often associated with incomplete cerebral development with less pronounced

sulci and gyri than normal. It appears to be inherited in a simple autosomal-recessive mode. A similar lethal defect is recorded in Angus cattle (as brachygnathia superior) in association with generalized degenerative joint disease.

**Cyclopia (cyclops anomaly)** is commonly associated with ingestion of plants, such as *Veratrum californicum*, containing cyclopamine, which is an inhibitor of the sonic hedgehog pathway.<sup>1-3</sup> Cyclopia of other cause, or unknown cause, occurs sporadically.<sup>4</sup>

## REFERENCES

1. Lee ST, et al. *J Agric Food Chem*. 2014;62:7355.
2. Welch KD, et al. *J Appl Toxicol*. 2009;29:414.
3. Welch KD, et al. *Int J Poison Plant Res*. 2012;2:54.
4. Zeiss CJ, et al. *Vet Ophthalmol*. 2008;11:30.

## INHERITED ARACHNOMELIA (INHERITED CHONDRODYSPLASIA)

### Cattle

Arachnomelia, a suspected inherited disease of Simmental, Brown Swiss, Italian Brown calves, Fleckvieh,<sup>1</sup> and other European breeds of cattle, is manifested by excessively long, thin distal extremities, which give the calves a spidery look—hence the term *arachnomelia*. The bones are fragile, and there is curvature of the spine, foreshortening of the mandible, and associated cardiac and vascular defects. In Swiss Braunvieh cattle it is combined with arthrogryposis. The mutation is a 2-bp deletion mutation c.1224\_1225delCA in exon 11 of the molybdenum cofactor biosynthesis protein 1 (*MOCS1*) gene in Simmental and Fleckvieh cattle<sup>1,2</sup> and a 1-bp insertion c.363–364insG in the sulfite oxidase (*SUOX*) gene of Brown Swiss cattle.<sup>3</sup> It is inherited as a simple recessive trait.

### Sheep

#### Spider Lamb Syndrome

A hereditary chondrodysplasia is recorded in Suffolk and Hampshire lambs in which the limbs are thin and disproportionately long and have abnormal positions of the bones near the joints, causing abnormalities of posture. The disease is caused by a nonsynonymous T > A transversion in the highly conserved tyrosine kinase II domain of a positional candidate gene, fibroblast growth factor receptor 3 (*FGFR3*).<sup>4</sup> The mutant *FGFR3* allele has an additive effect on long-bone length, suggesting that the disease is not inherited as a strict monogenic, mendelian recessive trait but is determined primarily by the presence of the mutant *FGFR3* allele and influenced by an animal's genetic background. In contrast to *FGFR3* mutations causing dwarfism in humans, this single-base change results in a skeletal overgrowth. There is also less muscle than normal. In severe cases the deformities are obvious at

birth and may be lethal. In less severe cases the deformities do not become apparent until the lambs are several weeks old. The defects are readily visible in x-rays before clinical signs develop, and affected lambs can be detected in this way. The diagnostic lesion is multiple irregular islands of ossification in the upper limb joints. Spinal deformities, especially kyphoscoliosis, and cranial deformities, including a roman nose, deviation of the nose poll axis, and shortening of the mandible, are observed in some lambs (Fig. 15-16).

Inheritance by an autosomal-recessive gene with complete penetrance and variable expressivity has been established as the cause in Suffolks. The defect is thought to be one of deficiency of an insulin-like growth factor (IGF) and IGF-binding proteins. Differentiation from arthrogryposis-hydranencephaly is important because of the superficial similarity of the two diseases.

### Inherited Chondrodysplasia in Texel Sheep

A chondrodysplasia resulting in a dwarfing phenotype has occurred in a Texel sheep flock as a newly recognized recessively inherited genetic disease of the Texel breed. The disorder in this breed is attributable to a 1-bp deletion of T (g.25513delT) at the 107bp position of exon 3 in the *SLC13A1* gene (solute carrier family 13 [sodium/sulfate symporters], member 1). The mutation g.25513delT shifts the open reading frame of *SLC13A1* to introduce a stop codon and truncate C-terminal amino acids.<sup>5</sup> Heterozygotes appear clinically normal. Affected lambs appear normal at birth but show evidence of dwarfism, wide-based stance, and exercise intolerance as early as 1 week of age. Death usually occurs within 3 months, often after developing bilateral varus deformity of the forelimbs. Some severely affected lambs die with respiratory distress, probably as a result of tracheal collapse. Gross and microscopic lesions of variable severity were present in the tracheal, articular, epiphyseal, and physal cartilage. In severe cases, articular cartilage in major joints was eroded from weight-bearing surfaces. The trachea was flaccid, was abnormally kinked, and had thickened cartilaginous rings and a narrow lumen. Affected sheep that survived to breeding age commonly developed severe degenerative joint disease. Histologically, chondrocytes were disorganized and surrounded by concentric rings of abnormal fibrillar material, and the matrix often contained focal to coalescing areas of chondrolysis. The disease has considerable potential as a suitable model for studying various forms of therapy for human chondrodysplasia.

## REFERENCES

1. Seichter D, et al. *Anim Genet*. 2011;42:544.
2. Jiao S, et al. *PLoS ONE*. 2013;8.
3. Chu Q, et al. *Yichuan*. 2013;35:623.





**Fig. 15-16** Spider lamb syndrome in two yearling Suffolk lambs. **A**, A wether with marked angular limb abnormalities and disproportionately long, thin legs. **B**, A wether with a roman nose, shortening of the mandible, and kyphoscoliosis.

4. Beever JE, et al. *Anim Genet.* 2006;37:66.
5. Zhao X, et al. *Anim Genet.* 2012;43:9.

### COMPLEX VERTEBRAL MALFORMATION IN HOLSTEIN CALVES

A lethal congenital defect of the axial skeleton of purebred Holstein calves has been

reported in Denmark, the United States, and the United Kingdom. It is caused by a mutation in the gene *SLC35A3* coding a uridine-diphosphate-*N*-acetylglucosamine transporter.<sup>1</sup> A single-base transversion of guanine to thymine has been located in the abnormal allele at position 559. It is present in both copies of the allele, and the mutation is lethal. It is a simple recessive genetic defect

that requires that both the sire and the dam of an affected calf are carriers.

Most affected calves are born between day 250 and 285 of gestation. Approximately 80% of homozygous affected fetuses are aborted before gestation day 260. Birth weights are reduced. Most affected calves are stillborn, but affected calves occasionally are born alive. Euthanasia must be performed for humanitarian reasons.

In premature, stillborn, and neonatal affected calves, the defect is characterized by congenital growth retardation, malformed vertebrae, and tetramelic arthrogryposis. There is shortening of the cervical and thoracic parts of the vertebral column as a result of multiple hemivertebrae, fused and misshaped vertebrae, and scoliosis. Growth retardation and vertebral malformation are typical lesions. Malformation of the head, primarily in the form of dysplasia or palatoschisis, also occurs.

Symmetric flexures of the carpal and joints and the metacarpophalangeal joint in combination with a slight lateral rotation of the phalanges are also present. Similar low-grade arthrogryposis is present in the pelvic limbs. Heart defects were present in 50% of affected calves (interventricular septal defects, dextroposition of the aorta, and eccentric hypertrophy of the right ventricle).

Retrospective genotyping of affected calves according to the mutation in the *SLC35A3* gene determined that there were homozygous affected, heterozygote, and homozygous normal genotypes. The morphologic expression of the malformation is wide, but certain aspects such as growth retardation, vertebral malformation, and symmetric arthrogryposis are nearly constant findings. A presumptive diagnosis of the malformation can be made in most cases based on necropsy findings combined with pedigree analysis and genotyping. Breeding studies were carried out in Denmark using selected cows that were progeny of sires with a heterozygous genotype for the malformation and were pregnant after insemination with semen from another sire with heterozygous malformation genotype. The number of calves born with the malformation was less than expected, suggesting increased intrauterine mortality. Fertility traits in Holsteins are severely affected by the malformation phenotype of the fetus. If the fetus is homozygous for the malformation, 29% of the cows will abort before gestation day 100, increasing to 45% at day 150 and 77% at day 260. Rates of nonreturn to service, frequency of calvings after the first insemination, and interval from insemination to next calving were significantly reduced by a fetal malformation phenotype.

Pedigree analysis and DNA analyses of semen from sires used for insemination have found a widely branched familial occurrence of the malformation in the Holstein breed.

The mutation in the *SCL35A3* gene has been traced to the U.S. sire Penstate Ivanhoe Star, born in 1963, and his widely used son Carlin-M Ivanhoe Bell, born in 1974. Descendants of this bull in China have a heterozygote carrier frequency of 9.54% and 16.7% in Poland.<sup>2,3</sup> The frequency of carriers in Girolando dairy cattle in Brazil is less than 2%.<sup>4</sup> The malformation mutation is not restricted to descendants of the American Holstein-Friesian bull Carlin-M Ivanhoe Bell. Through these sires and elite sires genetically related to them, the defect has been disseminated in the Holstein breed worldwide. PCR testing is available to detect heterozygotes.<sup>2</sup> Testing is available on registered or registerable Holstein animals only through the Holstein Association (Holstein USA), through one of the National Association of Animal Breeders' member AI organizations, or at the Van Haeringen Laboratorium, Wageningen, the Netherlands.

#### REFERENCES

1. Thomsen B, et al. *Genome Res.* 2006;16:97.
2. Zhang Y, et al. *J Anim Sci, Biotech.* 2012;3.
3. Rusc A, et al. *Pol J Vet Sci.* 2013;16:579.
4. Paiva DS, et al. *Gen Mol Res.* 2013;12:3186.

### INHERITED REDUCED PHALANGES (AMPUTATES, ACROTERIASIS, ECTROMELIA)

The defect of inherited reduced phalanges has been recorded in cattle and appears to be inherited as a single recessive character.<sup>1,2</sup> The limbs are normal down to the metacarpal and metatarsal bones, which are shorter than usual, but the first two phalanges are missing, and the normal hooves and third phalanges are connected to the rest of the limb by soft tissues only. The calves are unable to stand but can crawl about on their knees and hocks.

#### *Hereditary Hemimelia*

The bilateral absence of the distal half of the limb (e.g., the patella) and shortening or absence of the tibia, often accompanied by hydrocephalus, meningoceles, ventral abdominal hernia, and cryptorchidism, comprise the syndrome known as tibial hemimelia. It is inherited in the Galloway breed of cattle. An autosomal-recessive mode of inheritance is assumed. A concerted program of eradicating the defect has been undertaken, based on test matings and examination for defects of 90-day fetuses obtained by terminating pregnancy with prostaglandin. Hemimelia and amelia also occur in sheep.<sup>3</sup>

#### *Hereditary Peromelia of Mohair Goats*

The syndrome of hereditary peromelia of mohair goats includes agenesis of the phalanges and parts of the metacarpus and metatarsus affecting one or more limbs; it follows an autosomal-recessive mode of inheritance.

#### *Amputates*

An even more serious defect, in which the mandible and all the bones below the humerus and stifle are vestigial or absent, has been reported in British, French, and German Friesians. It appears to be conditioned by the inheritance of a single recessive gene. Similar "amputates" have been shown not to be inherited. The disease occurs in Italian buffalo, in which it is associated with chromosomal instability.<sup>4,5</sup>

#### REFERENCES

1. Droege Mueller C, et al. *BMC Genet.* 2007;8.
2. Duchesne A, et al. *Genomics.* 2006;88:610.
3. Scholes SFE, et al. *Vet Rec.* 2008;163:96.
4. Albarella S, et al. *Mutagenesis.* 2009;24:471.
5. Szczerbal I, et al. *Vet Pathol.* 2006;43:789.

### INHERITED CLAW DEFORMITY

Extra claws (**polydactylism**) and fusion of the claws (**syndactylism**) are known hereditary defects of cattle, the former in the Normandy breed and the latter in Holsteins, Angus, Hereford, and Chianina.<sup>1,2</sup> Polydactyly in pigs appears to be inherited, in some forms, as an autosomal-recessive trait with incomplete penetrance, although the genetic abnormality is unclear.<sup>3</sup>

**Dactylomegaly** (enlarged dewclaws), often associated with syndactyly or deviation of the adjacent major digit and creating a clubfooted appearance, may be inherited in Shorthorn cattle. In most cases they cause no more than inconvenience but an association of syndactyly with susceptibility to hyperthermia is recorded, and some of these animals die of hyperthermia when subjected to high environmental temperatures.

**Adactyly** is a recorded but less-well-defined defect in cattle and sheep in which the hooves are absent at birth.

There is good field evidence that **corkscrew claw** or **curled toe** is an inherited defect in cattle, especially in beef breeds, but also in Holstein-Friesians. It is almost always the lateral claw that is affected. In some breeds it is more common in the hindfeet; in others it is more common in the front feet. In the affected digit the third phalanx is much smaller than normal and is narrower and longer. The soft tissue and the horn are correspondingly deformed so that the horn grows much longer and narrower and tends to curl over the sole so that the cow walks on the wall of the hoof. The claw also curls over the front of the other digit of the limb. There are often cracks in the front of the claw, originating at the coronet and causing serious lameness. All affected animals suffer gait abnormalities as they get older and heavier. Much of this is attributable to distortion and wear of the articular surfaces in the companion claw, which has to carry much more weight than is usual. Marked changes in the affected digit are detectable by anteroposterior radiography.

#### REFERENCES

1. Droege Mueller C, et al. *BMC Genet.* 2007;8.
2. Duchesne A, et al. *Genomics.* 2006;88:610.
3. Gorbach D, et al. *J Hered.* 2010;101:469.

### INHERITED MULTIPLE EXOSTOSIS

Multiple exostosis affecting both cortical and medullary bone of the limbs and ribs has been described in Quarter horses and Thoroughbreds in the United States. The lesions are visible externally but cause little apparent inconvenience. It is inherited as a single autosomal-dominant gene. Restriction nuclease analysis is used to diagnose the disease.

### INHERITED CONGENITAL HYPEROSTOSIS (THICK FORELIMBS OF PIGS)

This defect is thought to be caused by the inheritance of a simple recessive character. Affected piglets show obvious lesions at birth, and although many of them die or are destroyed immediately, a proportion of them may survive. The forelimbs are markedly enlarged below the elbows, and the skin is tense and may be discolored. There is difficulty in standing and moving about, and starvation and crushing contribute to the mortality rate. There is extensive edema of the subcutaneous tissues, thickening of the bones, and roughness of the periosteum. It is thought that the primary lesion is a separation of the periosteum from the bone.

### INHERITED RICKETS

An inherited form of rickets occurs in purebred Corriedale sheep in New Zealand, with an incidence of up to 20 lambs out of 1600 over a 2-year period. Affected sheep have decreased growth rate, thoracic lordosis, and angular limb deformities, with low serum calcium and phosphate concentrations and normal 25 hydroxyvitamin D and 1,25 dihydroxyvitamin D<sub>3</sub> concentrations.<sup>1-3</sup> The disease is inherited as a simple autosomal-recessive disorder caused by a nonsense 250C/T mutation on exon 6 in the dentin matrix protein 1 gene (*DMP1*).<sup>4</sup> This mutation introduces a stop codon (R145X) and could truncate C-terminal amino acids. Affected sheep are "T T" genotypes, carriers are "C T," phenotypically normal related sheep are either "C T" or "C C," and unrelated normal sheep from other breeds are "C C." A simple diagnostic test can identify carriers with the defective "T" allele. Necropsy examination reveals segmental thickening of physes, growth-arrest lines, collapse of subchondral bone of the humeral head, thickened cortices, and enthesophytes around distal limb joints.<sup>5</sup> Other features include hypertrophic chondrocytes at sites of

endochondral ossification; inappropriate and excessive osteoclastic resorption; microfractures; and wide, unmineralized osteoid seams lining trabeculae and filling secondary osteons.<sup>5</sup>

The disease of pigs is indistinguishable from rickets as a result of nutritional inadequacy.<sup>6</sup> The pigs are healthy at birth. Subsequently there is hypocalcemia, hyperphosphatemia, and increased serum alkaline phosphatase activity. The defect is a failure of active transport of calcium through the wall of the small intestine.

## REFERENCES

1. Dittmer KE, et al. *Vet J*. 2011;187:369.
2. Dittmer KE, et al. *Res Vet Sci*. 2011;91:362.
3. Thompson KG, et al. *NZ Vet J*. 2007;55:137.
4. Zhao X, et al. *PLoS ONE*. 2011;6.
5. Dittmer KE, et al. *J Comp Pathol*. 2009;141:147.
6. Dittmer KE, et al. *Vet Pathol*. 2011;48:389.

## INHERITED TAILLESSNESS AND TAIL DEFORMITY

Complete absence of the tail or deformity of the appendage occur relatively commonly as a congenital defect. The disease “crooked-tail syndrome” in Belgian Blue cattle is attributable to a loss-of-function mutation of the bovine *MRC2* gene that impairs production of Endo18 protein. Affected cattle have signs of impaired endochondral ossification and skeletal and muscular malformations. The mutation is also associated with muscular attributes in heterozygotes, including double muscling (as a result of a defect in the myostatin gene), that are desirable traits and result in 25% of Belgian Blue cattle being carriers for the condition.<sup>1</sup>

A syndrome of **vertebral and spinal dysplasia** occurs in Holstein cattle. There are tail malformations and neurologic dysfunction, with gait abnormalities of the hindlimbs. The deformities and neurologic dysfunctions vary from subtle or mild (limited to tail deformities) to paraparesis. The syndrome is inherited in a dominant mode with incomplete penetrance.<sup>2</sup>

## REFERENCES

1. Fasquelle C, et al. *PLoS Genet*. 2009;5.
2. Kromik A, et al. *Vet J*. 2015;204:287.

## CONGENITAL CHONDRODYSTROPHY OF UNKNOWN ORIGIN (CCUO, “ACORN” CALVES, CONGENITAL JOINT LAXITY AND DWARFISM, CONGENITAL SPINAL STENOSIS)

A noninherited condition has been described in the United States, Europe, Africa, Australia, and New Zealand that resembles inherited dwarfism.<sup>1</sup> The disease occurs in poor-range areas and is thought to be attributable to a maternal nutritional deficiency

during the middle trimester of pregnancy.<sup>2</sup> The specific dietary factors involved have not been determined.

Cases are characterized by damage to physal growth plates with subsequent failure of growth of long bones. Abnormal osseous development of the head causes superior brachygnathia. Shortening of the shafts of the long bones of the limbs is accompanied by rotated limbs and bending at the joints, and calves nurse and stand with difficulty. Deformities of the nasal turbinates and trachea are often present and frequently lead to breathing difficulties. Incoordination, arching of the back, and a tendency to bloat, which may cause death, also occur. The dentition is normal. Muscle spasticity, wry neck, circling, falling backward, and goose-stepping occur rarely. Serologic results for Akabane virus, Aino virus, bovine virus diarrhea virus, and Bluetongue are typically negative.<sup>3</sup>

Most of the calves are born alive; in badly affected herds, as many as 15% of calves may be affected. The original name for the condition (Acorn calves) was derived from the common occurrence of acorns in the diet of affected herds, although the acorns are not thought to have any etiologic significance. Currently, an unknown nutritional deficiency or deficiencies, possibly including manganese,<sup>3</sup> during the second trimester is thought to be the cause.

## REFERENCES

1. White PJ, et al. *Prev Vet Med*. 2010;94:178.
2. White PJ, et al. *Prev Vet Med*. 2010;96:36.
3. Cave JG, et al. *Aust Vet J*. 2008;86:130.

## Inherited Diseases of Joints

### INHERITED ARTHROGRYPOSIS (INHERITED MULTIPLE TENDON CONTRACTURE)

Inherited fixation of limb joints present at birth is recorded in many breeds of cattle, especially in Belgian Blue, Shorthorn, Charolais, Piedmont, and Swedish Dole. It is inherited as a single recessive mutation in the *PIGH* gene in Belgian Blue cattle.<sup>1</sup> The disease occurs in Swiss Large White pigs as part of the **arthrogryposis multiplex congenita** complex of clinical abnormalities that includes inferior brachygnathism and spinal curvature.<sup>2</sup>

There are many environmental causes of the disease, the most well recognized of which are Schmallenberg and Akabane virus infection of early pregnancy (discussed under that heading).<sup>3</sup>

#### Simple Arthrogryposis

The limbs of affected calves are fixed in flexion or extension and cause dystocia as a result of abnormal positioning and lack of

flexibility. There is no involvement of joint surfaces, and the joints can be freed by cutting the surrounding tendons or muscles. There is atrophy of limb muscles, and those calves that are born alive are unable to stand and usually die or are destroyed within a few days.

#### Arthrogryposis With Dental Dysplasia

Arthrogryposis with dental dysplasia in cattle appears to be inherited in a dominant manner. The teeth are soft, fleshy, and easy to bend. There is no defect of bones or joints other than marked softness and the presence of excess cartilage at the epiphyses. There is abnormal ossification of the cartilage. The calves are of normal size, do not cause dystocia, and, although they are unable to stand because of the excessive flexibility of the limbs, they can suck. Hypostatic pneumonia usually develops and causes death of the calf.

#### Arthrogryposis With Palatoschisis

Arthrogryposis with palatoschisis (SAP) is inherited as a simple recessive trait with low penetrance in pure French Charolais in France and high penetrance in 7/8 Charolais cattle in Canada, where the gene frequency is high in purebred and crossbred Charolais. Among crossbred Charolais cattle the homozygous condition is almost always markedly expressed and lethal, but a high percentage of purebred homozygous cattle show slight to no visible effect of the gene and survive. Because of the low rate of prevalence in France, attempted eradication does not appear to be economical.

In this syndrome all limbs are usually affected but the front limbs more than the hindlimbs, and the more distal joints are more rigidly fixed than proximal ones. The muscles of affected limbs are atrophic and pale in color. Histologic changes in the spinal cord suggest that the muscle atrophy is neurogenic. In affected calves the gestation period may be longer than normal by an average of 2 weeks.

#### Arthrogryposis With Multiple Defects

In Simmentals a combined set of defects includes arthrogryposis, often with the limbs in a wraparound position around the body, underdevelopment of the mandible, curvature of the spine, and defects of the heart and main vessels.

#### Arthrogryposis in Species Other Than Cattle

Inherited arthrogryposis has also been recorded in Merino and Corriedale **sheep** and in Norwegian Landrace **pigs**, in which it is thought to be inherited as a simple recessive trait. The Corriedale defect is associated with other lesions, including brachygnathia inferior, hydranencephaly, and thoracic scoliosis. Inherited arthrogryposis in pedigree Suffolk lambs has been described.<sup>1</sup> Breeding studies using superovulation and embryo transfer were used to increase the numbers



of offspring from females that were carrying the gene or genes responsible for the defect, which is inherited as an autosomal-recessive trait.

**Ovine heritable arthrogryposis multiplex congenita** is a congenital syndrome in lambs characterized by curvature, hunching, and twisting of the thoracic spine, with associated abnormalities of the ribs and sternum, distal arthrogryposis of the carpal and tarsal joints, and cleft hard and soft palate or palatoschisis (a median fissure of the palate) and is an autosomal-recessive inherited disease.<sup>4</sup> Affected lambs are born full term but die shortly after birth. Affected lambs have slightly reduced body weight (as a result of low muscle mass) compared with normal newborn lambs of the same flock. The syndrome is similar to **bovine heritable arthrogryposis multiplex congenita** in Angus cattle and **porcine heritable arthrogryposis multiplex congenita**.<sup>2</sup>

An inherited arthrogryposis also occurs in Norwegian Fjord horses. The arthrogryposis affects the hindlimbs, and there are accompanying defects of polydactyly, palatoschisis, and brachygnathia in some. Most foals are unable to stand, and the defect must be considered to be a lethal one.

### **INHERITED MULTIPLE ANKYLOSES**

Multiple ankylosis affecting all limb joints has been recorded as an inherited congenital defect of Holstein calves. The abdomen of the dam shows marked enlargement at month 6 to 7 of pregnancy, and this may occasion some respiratory distress. Excessive fetal

fluids are present, and insertion of the hand per rectum is impeded by the distended uterus. Abortion during the last month of pregnancy is a common occurrence. Affected fetuses have a very short neck, ankylosed intervertebral joints, and varying degrees of ankylosis of all limb joints. The limbs are fixed in flexion, and there is some curvature of the spine. Fetal dystocia always occurs, and embryotomy or cesarean section is necessary to deliver the calf.

Ankylosis of limb joints combined with **cleft palate** occurs occasionally in Charolais cattle and is suspected of being inherited. **Ankylosis of the coffin joint**, developing at several weeks of age, has been reported in Simmental calves. The etiology of the condition is not clear.

### **REFERENCES**

1. Sartélet A, et al. *BMC Genet.* 2015;16:316.
2. Haubitz M, et al. *Mol Cell Prob.* 2012;26:248.
3. Agerholm JS, et al. *Acta Vet Scand.* 2015;57.
4. Tejedor MT, et al. *J Comp Pathol.* 2010;143:14.

### **INHERITED PATELLAR SUBLUXATION**

Unilateral or bilateral subluxation occurs as an inherited defect in *Bos indicus* cattle and in water buffalo (*Bubalus bubalis*). Shetland ponies also have a predisposition, and a monogenic autosomal-recessive transmission is suspected. There is periodic lameness, with the affected limb held in rigid extension; the patella is displaced medially.<sup>1</sup>

### **REFERENCE**

1. Busschers E. *Equine Vet Educ.* 2009;21:464.

### **INHERITED HYPERMOBILITY (LAXITY) OF JOINTS**

Inherited hypermobility of joints is recorded only in Jersey cattle. It has assumed great importance because of the great popularity of a sire that carried the gene. There is abnormal flexure and extension of all joints but especially the hock, stifle, hip, knee, elbow, and shoulder joints. The muscles are much atrophied, and the joints look very enlarged as a result. It is impossible for the calves to stand, but they are bright, alert, and eat well. The limbs are so flexible that they can be bent into extraordinary positions and almost tied in knots. A drawer sign, a displacement of the articular surfaces laterally, produced by manual pressure, can be elicited easily and with a displacement of up to 2 cm. There are no detectable lesions in the nervous or musculoskeletal systems. Although the disease is known to be inherited as a simple autosomal-recessive trait, it has also been seen in circumstances that preclude inheritance being the cause.

### **INHERITED HIP DYSPLASIA**

An inherited defective development of the acetabulum occurs in Dole horses. There is no clinical evidence of the disease at birth, but osteoarthritis of the joint and disruption of the round ligament develop subsequently. Hip dysplasia occurs in Belgian Blue cattle.<sup>1</sup>

### **REFERENCE**

1. Van Vlierbergen B, et al. *Vet Rec.* 2007;160:910.

**INTRODUCTION 1541****PRINCIPLES OF TREATMENT OF DISEASES OF THE SKIN 1543**

Primary Treatment 1543

Supportive Treatment 1543

**DISEASES OF THE EPIDERMIS AND DERMIS 1543**

Pityriasis 1543

Hyperkeratosis 1544

Parakeratosis 1544

Pachyderma 1544

Impetigo 1545

Urticaria 1545

Dermatitis and Dermatoses 1546

Photosensitization 1549

**DISEASES OF THE HAIR, WOOL, FOLLICLES, AND SKIN GLANDS 1552**

Alopecia and Hypotrichosis 1552

Achromotrichia 1553

Leukoderma and Leukotrichia 1553

Vitiligo 1553

Seborrhea 1554

Folliculitis 1554

**DISEASES OF THE SUBCUTIS 1555**

Subcutaneous Edema (Anasarca) 1555

Angioedema (Angioneurotic Edema) 1555

Subcutaneous Emphysema 1556

Lymphangitis 1556

Panniculitis 1557

Hematoma 1557

Necrosis and Gangrene 1557

Subcutaneous Abscess 1558

Cutaneous Cysts 1558

Granulomatous Lesions of the Skin 1558

**NON-INFECTIOUS DISEASES OF THE SKIN 1559**

Insect Bite Hypersensitivity in Horses (Equine Seasonal Allergic Dermatitis) 1559

Seasonal Allergic Dermatitis of Sheep 1560

Anhidrosis (Nonsweating Syndrome, Puff Disease, Dry Coat) 1561

Wetness (Maceration) 1562

Cockle 1562

Wool Slip, Wool Loss 1563

Wool Eating 1563

Idiopathic Nasal/Perioral Hyperkeratotic Dermatitis of Camelids (Mouth Munge) 1563

**BACTERIAL DISEASES OF THE SKIN 1564**Methicillin-Resistant *Staphylococcus aureus* 1564

Dermatophilosis (Mycotic Dermatitis Cutaneous Streptotrichosis, Senkobo Disease of Cattle, Lumpy Wool of Sheep) 1570

Skin Tuberculosis 1573

*Mycobacterium ulcerans* Infection (Buruli or Bairnsdale Ulcer) 1574

Fleece Rot in Sheep 1574

Bolo Disease 1575

Strawberry Footrot of Sheep (Proliferative Dermatitis) 1575

Contagious Acne of Horses (Canadian Horsepox, Contagious Pustular Dermatitis) 1576

Exudative Epidermitis (Greasy Pig Disease) 1576

Ulcerative Dermatitis (Granulomatous Dermatitis) of Pigs 1579

**VIRAL DISEASES OF THE SKIN 1580**

Papillomavirus Infection (Papillomatosis, Warts) 1580

Saroid 1585

Cowpox and Buffalopox 1587

Pseudocowpox (Milkers' Nodule) 1588

Lumpy Skin Disease (Knopvelsiekte) 1589

Sheepox and Goatpox 1591

Contagious Ecthyma (Contagious Pustular Dermatitis, Orf, Scabby Mouth, Soremouth) 1593

Ulcerative Dermatitis of Sheep 1596

Poxvirus Infections in Horses (Horsepox, Uasin Gishu, Viral Popular Dermatitis, Equine Molluscum Contagiosum) 1596

Swinepox 1597

**DERMATOMYCOSES 1600**

Ringworm 1600

Mucormycosis 1603

*Malassezia* spp. Dermatitis 1603

Sporotrichosis 1604

Epizootic Lymphangitis (Pseudoglanders, Equine Blastomycosis, Equine Histoplasmosis) 1604

Equine Phycomycosis (Swamp Cancer, Pithyosis, Hyphomycosis Destruens, Florida Horse Leech, Bursattee) 1605

Maduromycosis 1607

**PROTOZOAL DISEASES OF THE SKIN 1607**

Besnoitiosis (Elephant Skin Disease) 1607

**NEMATODE INFECTIONS OF THE SKIN 1608**

Summer Sores in Horses (Habronemosis) 1608

Rhabditic Dermatitis 1609

Onchocerciasis (Worm Nodule Disease) 1609

Parafilariosis 1610

Stephanofilariosis 1611

**CUTANEOUS MYIASIS 1611**

Blow-Fly Strike of Sheep 1611

Screwworm (*Cochliomyia hominivorax* and *Chrysomya bezziana*) 1615Wohlfahrtiosis (Flesh Fly, *Wohlfahrtia magnifica*) 1617**MITE INFESTATIONS 1618**

Harvest Mites (Chigger Mites) 1618

Itchmites (*Psorergates ovis*, *Psorergates bos*) 1618

Demodectic Mange (Follicular Mange) 1619

Sarcoptic Mange (Barn Itch) 1619

Psoroptic Mange (Sheep Scab, Body Mange, Ear Mange) 1621

Chorioptic Mange (Tail Mange, Leg Mange, Scrotal Mange) 1622

**KED AND LOUSE INFESTATIONS 1623**Sheep Ked (*Melophagus ovinus*) 1623

Louse Infestations (Pediculosis) 1624

**MISCELLANEOUS SKIN DISEASES CAUSED BY FLIES, MIDGES, AND MOSQUITOES 1625**Stable Flies (*Stomoxys calcitrans*) 1625Horse Flies, March Flies or Breeze Flies (*Tabanus* spp.), and Deer Flies (*Chrysops*, *Hematopota*, and *Pangonia* spp.) 1626*Hypoderma* spp. Infestation (Warble Flies) 1626Horn Flies and Buffalo Flies (*Hematobia* spp.) 1628Black Flies, Buffalo Gnats (*Simuliidae*) 1629Housefly (*Muscidae*—*Musca domestica*) 1630Bush Flies (*Musca vetustissima*) 1630Face Fly (*Musca autumnalis*) 1630Head Fly (*Hydrotoea irritans*) 1630Biting Midges (*Ceratopogonidae*) 1631Mosquitoes (*Culicidae*) 1631**TICK INFESTATIONS 1631****DEFICIENCIES AND TOXICITIES AFFECTING THE SKIN 1634**

Zinc Deficiency (Parakeratosis) 1634

Plant Poisoning Associated With Known Toxins 1637  
 Plant Poisonings Associated With Unidentified Toxins 1637  
 Selenium Toxicosis 1638  
 Iodine Toxicosis 1640

### CUTANEOUS NEOPLASMS 1640

Papilloma and Sarcoid 1640  
 Squamous-Cell Carcinoma 1640  
 Melanoma 1641  
 Lipoma 1641  
 Mast Cell Tumors 1642  
 Lymphomatosis 1642  
 Neurofibromatosis 1642  
 Histiocytoma 1642  
 Cutaneous Angiomatosis 1642  
 Hemangioma and Hemangiosarcoma 1642  
 Congenital Skin Tumors 1642

### CONGENITAL AND INHERITED DEFECTS OF THE SKIN 1643

Inherited Albinism 1643  
 Disorders of Coat Color, Pseudoalbinism, and Lethal Whites 1643  
 Inherited Symmetric Alopecia 1644  
 Inherited Congenital Hypotrichosis 1644

Inherited Hair-Coat-Color-Linked Follicle Dysplasia 1645  
 Inherited Birthcoat Retention 1645  
 Inherited Leukoderma 1645  
 Inherited Epidermal Dysplasia (Baldy Calves) 1645  
 Inherited Parakeratosis of Calves (Lethal Trait A46, Adema Disease) 1645  
 Inherited Dyserythropoiesis–Dyskeratosis 1645  
 Inherited Congenital Absence of the Skin 1645  
 Inherited Hyperbilirubinemia and Photosensitization 1646  
 Inherited Congenital Ichthyosis (Fish-Scale Diseases) 1646  
 Inherited Dermatitis Vegetans of Pigs 1646  
 Dermatosparaxis (Hyperelastosis Cutis) 1646  
 Inherited Melanoma 1647  
 Inherited Hyperhidrosis 1647  
 Lavender Foal Syndrome 1647  
 Hereditary Equine Regional Dermal Asthenia (Hyperelastosis Cutis) 1647  
 Dermatitis Vegetans 1647  
 Pustular Psoriaform Dermatitis (Pityriasis Rosea) 1648

### EYE AND CONJUNCTIVAL DISEASES 1648

Conjunctivitis and Keratoconjunctivitis 1648  
 Listerial Keratoconjunctivitis and Uveitis (Silage Eye, Bovine Iritis) 1649  
 Infectious Bovine Keratoconjunctivitis of Cattle (Pinkeye, Blight) 1650  
 Ovine and Caprine Contagious Ophthalmia (Ovine and Caprine Infectious Keratoconjunctivitis, Contagious Conjunctivo-Keratitis, Pinkeye in Sheep and Goats) 1653  
 Diseases of the Eyes Associated With *Mycoplasma* Spp. 1654  
*Thelaziasis* (Eye Worm) 1655  
 “Bright Blindness” of Sheep Caused by Bracken Ingestion 1655  
 Bovine Ocular Squamous-Cell Carcinoma 1655  
 Equine Ocular Squamous-Cell Carcinoma 1658  
 Inherited Eye Defects 1658

### EXTERNAL EAR DISEASES 1660

Otitis Externa 1660  
 Ear-Tip Necrosis 1661  
 Inherited Crop Ears 1661

## Introduction

### The major functions of the skin are:

- To maintain a normal body temperature
- To maintain a normal fluid and electrolyte balance within the animal
- To create a mechanical barrier to protect the body from noxious agents and organisms
- To act as a sensory organ perceiving those features of the environment that are important to the subject's survival

In general, these functions are not greatly impeded by most diseases of the skin of large animals, with the exceptions of failure of the sweating mechanism, which does seriously interfere with body temperature regulation, and severe burns or other skin trauma, which may cause fatal fluid and electrolyte loss.

The major effects of skin diseases in large animals are esthetic and economic but can also present a considerable animal welfare concern. Discomfort and scratching interfere with normal rest and feeding, and when the lips are affected, there may be interference with prehension. The unsightly appearance of the animal distresses the owner. There is loss of the economic coat, and the sales value and acceptability of animals for transport and appearance in exhibitions is greatly reduced.

### Primary/Secondary Lesions

Diseases of the skin may be primary or secondary in origin. In primary skin disease

the lesions are restricted initially to the skin, although they may subsequently spread from the skin to involve other organs. Conversely, cutaneous lesions may be secondary to disease originating in other organs. Differentiation between primary and secondary skin diseases should be attempted by seeking evidence that organs other than the skin are affected. If there is no such evidence produced during a thorough clinical examination of the patient, it is reasonable to assume that the disease is primary. Even if involvement of other organs is diagnosed, it is still necessary to determine whether the involvement constitutes the primary state or whether it has developed secondarily to the skin disease. This decision can be based on the chronology of the signs, elicited by careful history taking, and a detailed knowledge of the individual diseases likely to be encountered.

Taking an accurate anamnesis and doing a complete clinical examination must precede the careful examination of the skin itself, using the proper technique of examination. The veterinarian may need to employ advanced diagnostic procedures such as histopathological examination of a biopsy specimen to define the type of lesion present.

The purpose of this chapter is to describe the basic skin lesions so that the differential diagnosis, up to the point of defining the type and nature of the lesion, the pathoanatomical diagnosis, can be accomplished. A definitive etiologic diagnosis requires further examination and is included in the discussion of the specific diseases.

### Clinical Signs and Special Examination

A general clinical examination is followed by a special examination of the skin and must include inspection and, in most cases, palpation. Additional information can be obtained by taking swabs for bacteriologic examinations, scrapings for examination for dermatophytes and metazoan parasites, and biopsy for histopathological examination.

Biopsy material should include abnormal, marginal, and normal skin. Artifacts are common in biopsy specimens, including nonrepresentative sampling, crushing the specimen by forceps or hemostat, and inadequate fixation.

A Wood's lamp finds a special use in the examination of the skin for dermatophytes.

Descriptions of lesions should include size, depth to which they penetrate topographic distribution on the body, and size of the area affected. Abnormalities of sebaceous and sweat secretion, changes in the hair or wool coat, and alterations in color and temperature of the skin should be noted, as should the presence or absence of pain or pruritus.

### Lesions

An accurate definition of the lesions, summarized in Table 16-1, is an essential part of a dermatologic patient's clinical record. The table makes a primary differentiation into discrete and diffuse lesions, and these categories need to be further categorized in terms



Table 16-1 Terms used to identify skin lesions

Name of lesion	Nature of lesion	Relation to skin surface	Skin surface
Scales	Dry, flaky exfoliations	On surface only, no penetration of skin	Unbroken
Excoriations	Traumatic abrasions and scratches	Penetration below surface	Variable skin surface damage—depends on severity
Fissures	Deep cracks	Penetrate into subcutis	Disrupted
Dry gangrene	Dry, horny, black, avascular, shield-like	Above skin, usually all layers affected	Removed
Early, moist gangrene	Blue-black, cold, oozing serum	In plane of skin or below	Complete depth of subcutis
Keratosis	Overgrowth of dry, horny, keratinized epithelium	Above skin	Undamaged stratum corneum is retained
Acanthosis	Like keratosis but moist, soft	Above skin	Prickle cell layer swollen; is really part of skin
Hyperkeratosis	Excessive overgrowth of keratinized, epithelium-like scab	Above skin	Skin surface unbroken
Parakeratosis	Adherent to skin	Above skin	Cells of stratum corneum nucleated and retained; really part of skin
Eczema	Erythematous, itching dermatitis	Superficial layer of epidermis affected	Weeping, scabby disruption of surface
Hypermelanosis	Increased deposits of melanin (e.g., melanosis, meloderma)	In epidermis or dermis	Unbroken
Hypomelanosis	Decreased deposits of melanin	In epidermis or dermis	Unbroken
<b>Discrete lesions</b>			
Vesicle, bleb, bulla, blister	Fluid (serum or lymph)-filled blister 1–2 cm diameter	Above skin surface, superficial	Unbroken but will slough
Pustule	Pus-filled blister, 1–5 mm	Above, superficial	Will rupture
Wheal	Edematous, erythematous, swellings, transitory	Above, all layers affected	Undamaged
Papules (pimples)	Elevated, inflamed, necrotic center, up to 1 cm diameter	Above surface, all layers affected	Points and ruptures
Nodules, nodes	Elevated, solid, up to 1 cm diameter Acute or chronic inflammation. No necrotic center	Above surface, all layers	Surface unbroken
Plaque	Larger nodule, up to 3–4 cm diameter	All layers affected; raised above surface	Surface unbroken
Acne	Used synonymously with <i>pimple</i> but strict meaning is infection of sebaceous gland	Above surface of skin; all layers affected	May point and rupture
Comedo	Plugged (sebum, keratin) hair follicle	Raised above skin	May rupture
Impetigo	Flaccid vesicle, then pustule, then scab, up to 1 cm diameter	Raised above skin; very superficial	Upper layers destroyed
Scab (or crust)	Crust of coagulated, blood, pus, and skin debris	Raised above skin	Disrupted, depth varying with original lesion
Macule (patch)	Small area of color change; patch is larger	Within superficial layers	Unbroken

of size (e.g., they may be limited diffuse lesions or extensive localized ones).

### Abnormal Coloration

The parameter of abnormal coloration includes jaundice, pallor, and erythema. In animals these conditions are rarely visible in light-colored skins. Red–purple discoloration of the skin of septicemic, white pigs may be dramatic, but no diagnostic significance can be attached to its degree. Early erythema is a common finding where more definite skin lesions are to develop, as in early photosensitization. The blue coloration of early gangrene (e.g., of the udder and teat skin in the early stages of peracute bovine mastitis asso-

ciated with *Staphylococcus aureus*) is characterized by coldness and loss of elasticity.

Hypopigmentation of the skin may be general, as in albino, pseudoalbino, and lethal white animals. Local patches of hypopigmentation are characteristic of vitiligo and leukoderma.

### Pruritus

- **Pruritus or itching** is the sensation that gives rise to scratching.
- **Hyperesthesia** is increased sensitivity to normal stimuli.
- **Paresthesia** is perverted sensation, a subjective sensation, and not diagnosed in animals.

All sensations that give rise to rubbing or scratching are therefore included with pruritus, more properly defined as scratching. Pruritus can arise from peripheral or central stimulation. When it is peripheral in origin, it is a primary cutaneous sensation, similar to heat, cold, pain, and touch; it differs from pain because it is purely epidermal, whereas pain can still be felt in areas of skin denuded of epidermis. Thus itching does not occur in the center of deep ulcerations or in very superficial lesions, such as those of ringworm, where only the hair fibers and keratinized epithelium are involved. Itching can be elicited over the entire skin surface but is most severe at the mucocutaneous

junctions. Common causes include the following.

#### Cattle

- Sarcoptic and chorioptic mange
- Lice infestation
- Nervous acetonemia
- Aujesky's disease

#### Sheep

- Lice, mange, ked, blow-fly, and itch-mite infestations
- Scrapie

#### Horses

- Chorioptic mange on the legs
- Queensland (sweet) itch along the dorsum of the body
- Lice infestation
- Perianal pruritus from *Oxyuris equi* infestation

#### Pigs

- Sarcoptic and chorioptic mange
- Lice infestation

#### All Species

- Early stages of photosensitive dermatitis
- Urticarial wheals in an allergic reaction
- **"Licking syndromes,"** such as those that occur in cattle on copper-deficient diets, are accompanied by pica and the licking of others as well as themselves. They are examples of depraved appetites developed in response to nutritional deficiency and are not a response to pruritus.
- **Itching of central origin** derives mainly from the scratch center below the acoustic nucleus in the medulla. It may have a structural basis, as in scrapie and pseudorabies, or it may be functional in origin, as in the nervous form of acetonemia. The only lesions observed are those of a traumatic dermatitis with removal of the superficial layers to a variable depth, breakage or removal of the hairs, and a distribution of lesions in places where the animal can bite or rub easily.

#### Secretion Abnormalities of Skin Glands

The activity of the **sweat glands** is controlled by the sympathetic nervous system and is for the most part a reflection of body temperature. Excitement and pain may cause sweating as a result of cerebral cortical activity. A generalized form of hyperhidrosis, apparently inherited, has been recorded in Short-horn calves. Local areas of increased or decreased sweating may arise from peripheral nerve lesions or obstruction of sweat gland ducts. A generalized anhidrosis is recorded in horses and occasionally in cattle.

Excess secretion of sebum by **sebaceous glands** causes oiliness of the skin or

seborrhea, but its pathogenesis is poorly understood.

#### Abnormalities of Wool and Hair Fibers

Deficiency of hair or wool in comparison to the normal pilosity of the skin area is **alopecia** or **hypotrichosis**.

**Hirsutism**, abnormal hairiness, manifested by a long, shaggy, and usually curly coat, is most common in aged ponies with adenomas of the pars intermedia of the pituitary gland.

The character of the fiber may also vary with variations in the internal environment. For example, in copper deficiency the crimp of fine wool fibers is lost, and the wool becomes straight and "steely." Alternation in coat color, achromotrichia, may be generalized or segmental along the fiber.

#### FURTHER READING

- Knotterbelt DC. The approach to the equine dermatology case in practice. *Vet Clin Equine*. 2012;25:131-153.
- Metz M, et al. Pruritus: an overview of current concepts. *Vet Dermatol*. 2011;22:121-131.
- Outerbridge CA. Cutaneous manifestations of internal diseases. *Vet Clin North Am Small*. 2013;43:135-152.
- Paterson S, Ball C. A practical approach to equine dermatology. *In Pract*. 2013;35:190-196.

## Principles of Treatment of Diseases of the Skin

### PRIMARY TREATMENT

For a specific treatment, accurate diagnosis of the condition and the identification of underlying cause must precede the selection of any topical or systemic treatment. Hair coat and debris on and around the affected area must be removed to enable topical applications to come into direct contact with the affected skin. In bacterial diseases susceptibility tests on cultures of the organism are advisable. Bacterial resistance to antimicrobials used in veterinary dermatologic practice is a concern. The uncritical use of antimicrobials either locally or systemically should be avoided to contain the development of bacterial resistance to microbials. Specific skin diseases caused by bacteria, fungi, and metazoan parasites are reasonably amenable to treatment with the appropriate specific remedy. Identification of the fungal or parasitic organism presumably causing the disease allows for selection of a pharmacologic substance and route of administration with documented efficacy against the agent in question and can prevent frustrating treatment failures.

Removal of the causative agent in allergic diseases and photosensitization may be impossible, and symptomatic treatment may be the only practicable solution. Symptomatic treatment may also be indicated for

welfare reasons in cases where the underlying cause of the disorder could not (yet) be identified. The veterinarian must be aware that in these cases antiinflammatory treatment, although indicated, may complicate further diagnostic workup. In some instances the primary disease may be confounded by the presence of a secondary agent, which can lead to confusion in diagnosis.

### SUPPORTIVE TREATMENT

Supportive treatment may include prevention of secondary infection by the use of bacteriostatic ointments or dressings and the prevention of further damage from scratching.

- Effective treatment of pruritus depends on the reduction of central perception of itch sensations by the use of ataractic, sedative, or narcotic drugs administered systemically or on successful restraint of the mediator between the lesion and the sensory end organ. In the absence of accurate knowledge of the pathogenesis of pain, it is usual to resort to local anesthetic agents, which are short-lived in their activity, and corticosteroids, which are longer-acting and effective, provided that vascular engorgement is part of the pruritus-stimulating mechanism.
- When large areas of skin are involved, it is important to prevent the absorption of toxic products by continuous irrigation or the application of absorptive dressings. Losses of fluid and electrolytes should be compensated by oral or parenteral administration of fluids containing the necessary electrolytes.
- Ensure an adequate dietary intake of protein, particularly sulfur-containing amino acids, to facilitate the repair of skin tissues.
- Boredom contributes significantly to an animal's response to itch stimuli, and close confinement of affected animals is best avoided.

#### FURTHER READING

- Matousek JL, Campbell KL. A comparative review of cutaneous pH. *Vet Dermatol*. 2002;13:293-300.
- Schwarz S, Noble WC. Aspects of bacterial resistance to antimicrobials used in veterinary dermatological practice. *Vet Dermatol*. 1999;10:163-176.
- Scott DW. *Large Animal Dermatology*. Philadelphia: WB Saunders; 1988.

## Diseases of the Epidermis and Dermis

### PITYRIASIS

**Primary pityriasis** is characterized by excessive bran-like scales on the skin and is caused

by overproduction of keratinized epithelial cells. The etiology is uncertain. The diagnosis is based on clinical presentation and can be supported by further diagnostic testing ruling out other differential diagnoses. Proposed causative or predisposing factors are as follows:

- Hypovitaminosis A
- Nutritional deficiency of B vitamins, especially of riboflavin and nicotinic acid, in pigs, or linolenic acid, and probably other essential unsaturated fatty acids
- Poisoning by iodine

**Secondary pityriasis** is characterized by excessive desquamation of epithelial cells and usually associated with the following:

- Scratching in flea, louse, and mange infestations
- Keratolytic infection (e.g., with ringworm fungus)

Pityriasis scales are accumulations of keratinized epithelial cells, sometimes softened and made greasy by the exudation of serum or sebum. Overproduction, when it occurs, begins around the orifices of the hair follicles and spreads to the surrounding stratum corneum.

Primary pityriasis scales are superficial, accumulate where the coat is long, and are usually associated with a dry, lusterless coat. Itching or other skin lesions are not features. Secondary pityriasis is usually accompanied by the lesions of the primary disease.

**Pityriasis rosea or pustular psoriaform dermatitis** is a skin condition of piglets that is clinically and histopathologically distinct from human pityriasis rosea (see also “**Pityriasis rosea**”).

Pityriasis is identified by the absence of parasites and fungi in skin scrapings.

#### DIFFERENTIAL DIAGNOSIS

Hyperkeratosis (see following discussion)  
 Parakeratosis (see following discussion)  
 Swine erysipelas (for pityriasis rosea in pigs)  
 Porcine dermatitis and nephropathy syndrome (for pityriasis rosea in pigs)  
 Ringworm (for pityriasis rosea in pigs)

#### TREATMENT

**Primary treatment** requires correction of the primary cause.

**Supportive treatment** commences with a thorough washing, followed by alternating applications of a bland emollient ointment and an alcoholic lotion. Salicylic acid is frequently incorporated into a lotion or ointment with a lanolin base.

#### HYPERKERATOSIS

Epithelial cells accumulate on the skin as a result of excessive keratinization of epithelial cells and intercellular bridges, interference

with normal cell division in the granular layer of the epidermis, and hypertrophy of the stratum corneum.

**Local hyperkeratosis** may be caused by the following:

- Mechanical stress on pressure points (e.g., elbows, hocks, or brisket) when animals lie habitually on hard surfaces
- Mechanical and/or chemical stress (e.g., **teat-end keratosis** of dairy cows that can be caused by improper milking machine settings, overmilking, improper use of teat sanitizers or cold weather)
- Parasitism (e.g., hyperkeratotic form of sarcoptes mange of pigs and small ruminants)

**Generalized hyperkeratosis** may be caused by the following:

- Poisoning with highly chlorinated naphthalene compounds
- Chronic arsenic poisoning
- Inherited congenital ichthyosis
- Inherited dyserythropoiesis–dyskeratosis
- Infection with *Scopulariopsis brevicaulis*, a fungus, was recently associated with generalized hyperkeratosis in a calf and a goat kid.<sup>1,2</sup>

The skin is dry, scaly, thicker than normal, usually corrugated, hairless, and fissured in a gridlike pattern. Secondary infection of deep fissures may occur if the area is continually wet. However, the lesion is usually dry, and the plugs of hyperkeratotic material can be removed, leaving the underlying skin intact.

Confirmation of the diagnosis is by the demonstration of the characteristically thickened stratum corneum in a biopsy section, which also serves to differentiate the condition from parakeratosis (see also “**Parakeratosis**”) and inherited ichthyosis (see also “**Congenital and Inherited Skin Defects**”).

Primary treatment depends on correction of the cause. Supportive treatment is by the application of a keratolytic agent (e.g., salicylic acid ointment).

#### REFERENCES

1. Ogawa S, et al. *J Comp Pathol*. 2008;138:145-150.
2. Ozturk D, et al. *Bull Vet Pullawy*. 2009;53:361-363.

#### PARAKERATOSIS

Parakeratosis, a skin condition characterized by incomplete keratinization of epithelial cells, can have various causes:

- Caused by nonspecific chronic inflammation of cellular epidermis
- Associated with dietary deficiency of zinc
- Part of an inherited disease (described later in the chapter)

The initial lesion comprises edema of the prickle cell layer, dilatation of the intercellular lymphatics, and leukocyte infiltration. Imperfect keratinization of epithelial cells at the granular layer of the epidermis follows, and the horn cells produced are sticky and soft, retain their nuclei, and stick together to

form large masses, which stay fixed to the underlying tissues or are shed as thick scales.

The lesions may be extensive and diffuse but are often confined to the flexor aspects of joints (referred to historically in horses as **mallenders** and **sallenders**). Initially the skin is reddened, followed by thickening and gray discoloration. Large, soft scales accumulate, are often held in place by hairs, and usually crack and fissure; their removal leaves a raw, red surface. Hyperkeratosis scales are thin and dry and accompany an intact, normal skin.

Parakeratosis in pigs is most commonly seen in swine 2 to 4 months of age and responds to dietary supplementation of zinc. Zinc deficiency in affected animals can be absolute or relative. The latter can be caused by excessive dietary calcium or phytic acid content or by a deficiency in essential fatty acids, which all interfere with the intestinal absorption of zinc.

The diagnosis is made based on the clinical presentation and can be confirmed by the identification of imperfect keratinization in a histopathological examination of a biopsy or a skin section at necropsy.

#### DIFFERENTIAL DIAGNOSIS

Hyperkeratosis  
 Pachyderma  
 Ringworm  
 Sarcoptic mange  
 Greasy pig disease (*Staphylococcus hyicus* infection)  
 Inherited ichthyosis  
 Inherited parakeratosis of calves  
 Inherited dermatosis vegetans in pigs  
 Inherited epidermal dysplasia

#### TREATMENT

**Primary treatment** requires correction of any nutritional deficiency (specifically, correcting zinc and preventing excessive dietary calcium content).

**Supportive treatment** includes removal of the crusts by the use of keratolytic agent (e.g., salicylic acid ointment) or by vigorous scrubbing with soapy water, followed by application of an astringent (e.g., white lotion paste), which must be applied frequently and for some time after the lesions have disappeared.

#### PACHYDERMA

Pachyderma, including scleroderma, is thickening of the skin affecting all layers, often including subcutaneous tissue, and usually localized but often extensive, as in lymphangitis and greasy heel in horses. There are no specific causes, with most cases being a result of a nonspecific chronic or recurrent inflammation.



In affected areas the hair coat is thin or absent, and the skin is thicker and tougher than usual. It appears tight and, because of its thickness and reduced volume of subcutaneous tissue, cannot be picked into folds or moved easily over underlying tissue. The skin surface is unbroken, and there are no lesions and no crusts or scabs as in parakeratosis and hyperkeratosis.

Confirmation of the diagnosis depends on histopathological examination of a biopsy. The cells in all layers are usually normal, but the individual layers are increased in thickness. There is hypertrophy of the prickle cell layer of the epidermis and enlargement of the interpapillary processes.

#### DIFFERENTIAL DIAGNOSIS

Parakeratosis  
Cutaneous neoplasia  
Papillomatosis

#### TREATMENT

**Primary treatment** requires removal of the causal irritation, but in well-established cases little improvement can be anticipated, and surgical removal may be a practical solution when the area is small. In early cases local or systemic corticosteroids may effect a recovery.

#### IMPETIGO

Impetigo is a superficial eruption of thin-walled, small vesicles, surrounded by a zone of erythema, that develop into pustules, then rupture to form scabs.

In humans, impetigo is specifically a streptococcal infection, but lesions are often invaded secondarily by *staphylococci*. In animals the main organism found is usually a staphylococcus. The causative organism appears to gain entry through minor abrasions, with spread resulting from rupture of lesions causing contamination of surrounding skin and the development of secondary lesions. Spread from animal to animal occurs readily.

Two specific examples of impetigo in large animals are as follows:

- **Udder impetigo** (udder acne) of cows
- **Contagious impetigo**, also known as **exudative epidermitis** (see also “Udder Impetigo”) or “**greasy pig disease**,” caused by *Staphylococcus hyicus* (see also “Exudative Epidermitis/Greasy Pig Disease”)

Confirmation of the diagnosis is by isolation of *staphylococci* from vesicular fluid.

#### DIFFERENTIAL DIAGNOSIS

Cowpox/buffalopox, in which the lesions occur almost exclusively on the teats and

pass through the characteristic stages of pox

Pseudocowpox, in which lesions are characteristic and also restricted in occurrence to the teats

Pityriasis rosea (for greasy pig disease)

Sarcoptic mange (for greasy pig disease)

Ringworm

#### TREATMENT

**Primary treatment** with antibiotic topically is usually all that is required because individual lesions heal so rapidly (see also under “Greasy Pig Disease”).

**Supportive treatment** is aimed at preventing the occurrence of secondary lesions and spread of the disease to other animals. Twice-daily bathing with an efficient germicidal skin wash is usually adequate.

#### URTICARIA

Urticaria (hives) is a skin condition characterized by development of topical dermal edema becoming apparent as cutaneous wheals. Horses are the most commonly affected species. In acute cases hives appear suddenly and regress within hours. Longer-lasting or even chronic cases are characterized by the continuous recurrence of new wheals on the skin for days or even months. Urticaria can occur as localized allergic reaction only affecting parts of the skin or as part of a more severe systemic allergic reaction.

#### ETIOLOGY

Although urticaria in many cases is of allergic origin, nonallergic causes such as physical stress on the skin (e.g., through squeezing [pressure urticaria or dermatographism] or exposure to low ambient temperature [cold urticaria]) can result in the development of urticaria.

In horses chronic urticaria is most commonly associated with feed allergies. Specifically, in some of the chronic and recurrent cases a causative allergen cannot be found and the underlying etiology remains obscure. In humans the presence of serum immunoglobulin G (IgG) autoantibodies targeting immunoglobulin E (IgE) or the IgE receptor has been documented in a subset of patients with chronic urticaria of unknown etiology. An autoimmune basis for chronic urticaria has therefore been proposed.<sup>1,2</sup>

**Primary urticaria** can be caused by the following:

- Insect stings
- Contact with stinging plants
- Ingestion of unusual food, with the allergen, usually a protein
- Occasionally an unusual feed item (e.g., garlic to a horse)

- Administration of a particular drug (e.g., penicillin, streptomycin, possibly guaifenesin or other anesthetic agent)
- Allergic reaction in cattle following vaccination for foot-and-mouth disease
- Death of warble fly larvae in tissue
- Milk allergy when Jersey cows are dried off
- Transfusion reaction
- Cutaneous vasculitis (purpura hemorrhagica)
- Local skin trauma (dermatographism)
- Temperature induced (heat, cold, sunlight)
- Infection—parasitic, bacterial, fungal, viral

**Secondary urticaria** occurs as part of a syndrome, such as the following:

- Respiratory tract infections in horses, including strangles and the upper respiratory tract viral infections
- Erysipelas in pigs

#### PATHOGENESIS

Degranulation of mast cells liberating chemical mediators of inflammation that result in the subsequent development of dermal edema is the presumed cause for the development of urticaria. A primary dilatation of capillaries causes cutaneous erythema. Exudation from the damaged capillary walls causes local edema in the dermis, and a wheal develops. Only the dermis, and sometimes the epidermis, is involved. In extreme cases the wheals may expand to become seromas, when they may ulcerate and discharge. The lesions of urticaria usually resolve in 12 to 24 hours, but in recurrent urticaria an affected horse may have persistent and chronic eruption of lesions over a period of days or months.

#### CLINICAL FINDINGS

Wheals, mostly circular, well-delineated, steep-sided, easily visible elevations in the skin, appear very rapidly and often in large numbers, commencing usually on the neck but being most numerous on the body. They vary from 0.5 to 5 cm in diameter, with a flat top, and are tense to the touch. There is often no itching, except with plant or insect stings, and no discontinuity of the epithelial surface, exudation, or weeping. Pallor of the skin in wheals can be observed only in unpigmented skin. Other allergic phenomena, including diarrhea and slight fever, may accompany the eruption. The onset of the lesions is acute to peracute, with the wheals developing within minutes to hours after exposure to the triggering agent. When associated with severe adverse systemic responses, including apnea, respiratory arrest, atrial fibrillation, cardiac arrest, or sudden death, the case qualifies as one of anaphylaxis.

Subsidence of the wheals within 24 to 48 hours is usual, but they may persist for 3 to 4 days because of the appearance of fresh lesions. In some very sensitive horses,

dermatographism, the production of a continuous wheal following the pattern of a blunt-pointed instrument drawn across the skin, can be demonstrated about 30 minutes later.

Urticaria lasting 8 weeks or longer is classified as chronic or recurrent urticaria, which may require testing for atopic disease using intradermal skin testing and serum testing for antigen-specific IgE.

Adverse reactions in dairy cattle following annual vaccination for foot-and-mouth disease are characterized by wheals (3 to 20 mm in diameter) covering most of the body, followed by exudative and necrotic dermatitis. The affected areas become hairless, and the wheals exude serum and become scabbed over. Edema of the legs is common, and vesicles occur on the teats. The lesions appear 8 to 12 weeks postvaccination and may persist for 3 to 5 weeks. Loss of body weight and lymphadenopathy also occur. Pruritus, depression, and a drop in milk yield are common. Adverse effects of parenteral administration of penicillin streptomycin in the form of a type I hypersensitivity reaction that was associated with rapid development of urticaria have been reported.<sup>3</sup>

### CLINICAL PATHOLOGY

The diagnosis in most cases is based on the clinical presentation, possibly in combination with a history of local or systemic exposure to a potential allergen. Biopsies show that tissue histamine levels are increased, and there is a local accumulation of eosinophils. Blood histamine levels and eosinophil counts may also show transient elevation.

Opinions over the usefulness of intradermal skin tests in horses are strongly divided. Although intradermal testing may be of use in some cases, results are often difficult to interpret, and the panel of available allergens may not be the most appropriate for horses.<sup>4</sup> Intradermal tests in horses without atopy and horses with atopic dermatitis or recurrent urticaria using environmental allergens indicate a greater number of positive reactions for intradermal tests in horses with atopic dermatitis or recurrent urticaria compared with horses without atopy. This provides evidence of type I IgE-mediated hypersensitivity for these diseases.

### DIFFERENTIAL DIAGNOSIS

Urticaria is manifested by a sudden appearance of a crop of cutaneous wheals, sometimes accompanied by restlessness, mostly in horses, occasionally in cattle. Identification of the etiology is also helpful in diagnosis but is often difficult, depending on a carefully taken history and examination of the environment.

The **differential diagnosis list** is limited to angioedema, but in urticaria the lesions can be palpated in the skin itself. Angioedema

involves the subcutaneous tissue rather than the skin, and the lesions are much larger and more diffuse. The two conditions may appear in the same animal at the same time.

### TREATMENT

#### Primary Treatment

Spontaneous recovery is common in acute cases with incidental exposure to an allergen. In chronic or recurrent cases identification and removal of the allergen must be a priority. A change of diet and environment, especially exposure to the presumably causal insects or plants, is standard practice.

#### Supportive Treatment

Corticosteroids, antihistamines, or epinephrine by parenteral injection provides the best and most rational treatment, especially in the relief of the pruritus. One treatment is usually sufficient, but lesions may recur. The local application of cooling astringent lotions such as calamine or white lotion or a dilute solution of sodium bicarbonate is favored. In large animal practice parenteral injections of calcium salts are used, with apparently good results.

Long-term medical management of persistent/chronic urticaria involves the administration of corticosteroids and/or antihistamines. Oral administration of prednisone or prednisolone at the lowest possible dose on alternate days is the method of choice. The antihistamine of choice is oral hydroxyzine hydrochloride, initially at 1 to 2 mg/kg administered twice daily or three times daily, followed by gradual reduction to a minimum maintenance dose required to keep the horse free of lesions.

### TREATMENT

Acute anaphylaxis with urticaria in horses:  
Epinephrine: 3 to 5 mL/450 kg of a 1:1000 solution IM or SC (can be combined with steroids) (R-1)

Acute urticaria in horses:  
Dexamethasone soluble 0.01 to 0.1 mg/kg IV or IM q24 h for 3 to 7 days (R-1)

Chronic or recurrent urticaria:  
Prednisolone 0.25 to 1.0 mg/kg IV or PO q24 h. Reduce to 0.2 to 0.5 mg/kg q48 h (R-1)

Dexamethasone 0.01 to 0.02 mg/kg PO q48-72 h (R-1). Further reduce dose until the lowest dose keeping the animal free of signs is determined.

Hydroxyzine hydrochloride 0.5 to 1.0 mg/kg IM or PO q8 h (R-2)

Diphenhydramine hydrochloride 0.7 to 1 mg/kg q12 h (R-2)

Chlorpheniramine 0.25 to 0.5 mg/kg q12 h (R-2)

### FURTHER READING

- Evans AG. Urticaria in horses. *Compend Contin Educ Pract Vet.* 1997;15:626-632.
- Knottenbelt DC. The approach to the equine dermatology case. *Vet Clin Equine.* 2012;28:131-153.
- Stannard AA. Immunologic diseases. *Vet Dermatol.* 2000;11:163-178.

### REFERENCES

- Caplan AP, Greaves M. *Clin Exp Allerg.* 2009;39:777-787.
- Vonakis BM, Saini SS. *Curr Opin Immunol.* 2008;20:709-716.
- Omidi A. *Can Vet J.* 2009;50:741-744.
- Knottenbelt DC. *Vet Clin Equine.* 2012;28:131-153.

## DERMATITIS AND DERMATOSIS

### SYNOPSIS

**Etiology** Any disease of skin, including those characterized by inflammation. All pathogens, infectious, chemical, physical, allergic, autoimmune.

**Epidemiology** Sporadic or outbreak; acute or chronic course; cosmetic to lethal; of most importance because of constraints on movement, sale, or exhibition; may affect animal welfare.

**Clinical signs** Primarily localized to skin, including lesions varying from parakeratosis and pachyderma to weeping, through necrosis, vesicles, and edema. Secondarily signs of shock, toxemia, anaphylaxis.

**Clinical pathology** Positive findings in the area of skin swabs or scrapings.

**Necropsy lesions** Inflammatory, degenerative, or vascular lesions in skin biopsy.

**Diagnostic confirmation** Positive finding in skin biopsy.

**Treatment** Primary treatment is removal of the (presumed) causative agent; supportive treatment includes treatment for pruritus, secondary infection, shock, toxemia, or fluid and electrolyte loss.

### ETIOLOGY

Some of the identifiable occurrences of dermatitis in food animals and horses are as follows.

#### All Species

- Mycotic dermatitis as a result of *Dermatophilus congolensis*, in horses, cattle, and sheep
- S. aureus*, a common finding in cases in all species, either as a sole pathogen or combined with other agents
- Ringworm
- Photosensitive dermatitis
- Chemical irritation (contact dermatitis) topically
- Arsenic—systemic poisoning
- Mange mite infestation—sarcoptic, psoroptic, chorioptic, demodectic mange

- Trombidiform mite infestation (tyroglyphosis)
- Biting flies, especially *Culicoides* spp.; observed most commonly in horses, but also in other species
- *Stephanofilaria* spp. dermatitis
- *Strongyloides (Pelodera)* spp. dermatitis
- Besnoitiosis (*Besnoitia* spp.)

### Cattle

- Udder impetigo (udder acne)—*Staphylococcus* spp.
- Udder cleft dermatitis of cattle
- Dermatitis interdigitalis (see following discussion)
- Ulcerative mammillitis—udder and teats only
- Cutaneous botryomycosis of the udder caused by a combination of trauma and infection by *Pseudomonas aeruginosa*
- Cowpox/buffalopox
- Flexural seborrhea
- Lumpy skin disease of cattle—painful nodules (2 to 5 cm) develop over the entire body, caused by pox virus, serotype *lumpy skin disease virus* (LSDV)
- Foot-and-mouth disease—vesicles around natural orifices; vesicular stomatitis with lesions on teats and coronet
- Bovine virus diarrhea, bovine malignant catarrh, bluetongue—erosive lesions around natural orifices, eyes, coronets
- Potato dermatitis in cattle, horses, and swine associated with prolonged feeding of potato distillery wastes; erythematous skin disease of distal limbs suspected to be of allergic origin
- Dermatitis as a result of the ingestion of *Vicia villosa* and *Vicia dasycarpa*
- Bovine exfoliative dermatitis

### Sheep and Goats

- Strawberry footrot—proliferative pustular dermatosis linked to spirochete-like organisms and *Dermatophilus* and *Rhizobium*
- Dermatophilosis (lumpy wool disease, rain scald)—*Dermatophilus congolensis*
- Fleece rot—constant wetting and associated with *Pseudomonas aeruginosa*
- Staphylococcal dermatitis—exudative dermatitis around eyes, ears, and base of horns in sheep; vesicles possibly present on teats and udder in goats
- Sheeppox
- Contagious ecthyma—*Parapoxvirus* (Orf)
- Ulcerative dermatosis—caused by similar but antigenically distinct virus to Orf
- Rinderpest, peste de petits ruminants, bluetongue—as for cattle
- Foot-and-mouth disease and vesicular stomatitis
- Itch-mite (*Psorergates ovis*) infestation
- Blow-fly infestation (cutaneous myiasis)

- Elaeophoriosis (*Elaeophora* spp. infestation)
- Caprine idiopathic dermatitis
- Postdipping necrotic dermatitis (see following discussion).

### Horses

- Staphylococcal pyoderma caused by *S. aureus/Staphylococcus intermedius*
- *Staphylococcus hyicus* in a syndrome reminiscent of greasy heel
- Dermatophytes, including ringworm, follicular dermatitis, hyphomycosis (pythiosis), tinea versicolor dermatitis
- Summer eczema (also Queensland or sweet itch)—sensitivity to *Culicoides* spp. sandflies
- Dermatophilosis/rain scald—*D. congolensis*
- *Actinomyces viscosum* causing skin pustules and nodules
- Horsepox
- Canadian horsepox
- Viral papular dermatitis (see following discussion)
- Vesicular stomatitis—vesicles around natural orifices
- Vesicular dermatitis around nasal area, eyes, and ears in horses stabled on shavings of a tree of the *Quassia* spp.
- Spongiotic vesicular dermatitis of unknown etiology
- Sporotrichosis
- Atopic dermatitis (IgE-mediated hypersensitivity)
- Chronic eosinophilic dermatitis (see following discussion)
- Pemphigus, lupus erythematosus, erythema multiforme, eosinophilic dermatitis and stomatitis (described separately in following discussion)
- Molluscum contagiosum (see following discussion)
- Linear hyperkeratosis (see following discussion)
- Nodular necrobiosis
- Equine aural plaque (see following discussion)
- Uasin Gishu disease
- Cutaneous habronemiasis
- Equine tropical lichen (see following discussion)
- Midline ventral dermatitis as a result of infestation with *Hydrotaea irritans* (horn fly and buffalo fly)
- Trombidiform mites, e.g., *Pyemotes tritici* and *Acarus (Tyroglyphus) farinae*
- Ulcerative dermatitis, thrombocytopenia and neutropenia in neonatal foals (see Alloimmune hemolytic anemia of the newborn (neonatal isoerythrolysis, isoimmune hemolytic anemia of the newborn).

### Pigs

- Ulcerative granuloma—*Borrelia suilla*
- Contagious epidermitis—*Staphylococcus hyicus* (“greasy pig disease”)

- Pig pox
- Swine vesicular disease, vesicular exanthema of swine, foot-and-mouth disease—vesicles around natural orifices
- Contact with fresh parsnip tops, celery
- Sunburn
- Porcine necrotic ear syndrome (see following discussion)
- Nonspecific nutritional dermatitis—experimental nutritional deficiency of nicotinic acid, riboflavin, pantothenic acid, biotin
- Pityriasis rosea
- Idiopathic chronic recurrent dermatoses

### Special Local Dermatitides

Special local dermatitides include dermatitis of the teats and udder, the bovine muzzle and coronet, and flexural seborrhea, and are dealt with under their respective headings.

### PATHOGENESIS

Dermatitis is an inflammation of the deeper layers of the skin involving the blood vessels and lymphatics. The purely cellular layers of the epidermis are involved only secondarily. The noxious agent causes cellular damage, often to the point of necrosis, and, depending on the type of agent responsible, the resulting dermatitis varies in its manifestations. It may be acute or chronic, suppurative, weeping, seborrheic, ulcerative, or gangrenous. In all cases there is increased thickness and increased temperature of the part. Pain or pruritus is present, and erythema is evident in unpigmented skin. Histologically there is vasodilatation and infiltration with leukocytes and cellular necrosis. These changes are much less marked in chronic dermatitis.

### CLINICAL FINDINGS

Affected skin areas first show erythema and increased warmth. The subsequent stages vary according to the type and severity of the causative agent. There may be development of discrete vesicular lesions or diffuse weeping. Edema of the skin and subcutaneous tissues may occur in severe cases. The next stage may be the healing stage of scab formation; if the injury is more severe, there may be necrosis or even gangrene of the affected skin area. Spread of infection to subcutaneous tissues may result in a diffuse cellulitis or phlegmonous lesion. A distinctive suppurative lesion is usually classified as pyoderma. Deep lesions that cause damage to dermal collagen may cause focal scarring and idiopathic fibrosing dermatitis (see following discussion).

A systemic reaction is likely to occur when the affected skin area is extensive. Shock, with peripheral circulatory failure, may be present in the early stages. Toxemia as a result of absorption of tissue breakdown products, or septicemia as a result of invasion



via unprotected tissues, may occur in the later stages.

Individual dermatitides are as follows:

- **Interdigital dermatitis** is a low-grade exudative inflammation of the interdigital skin of cattle housed indoors and standing continuously in slurry. This condition has been linked to *Dichelobacter nodosus*.
- **Ovine postdipping necrotic dermatitis** is associated with *P. aeruginosa* and related to dipping in solutions containing no bacteriostatic agent. Necrotic lesions (1 to 3 cm in diameter), with cellulitis down to the underlying muscle, occur only along the backline and may be related to trauma during dipping. It may be accompanied by an outbreak of fatal otitis media with *P. aeruginosa* present in the lesion.
- **Ovine atopic dermatitis:** Only the wool-less parts of the skin are affected by symmetric erythema, alopecia, lichenification, and excoriation. Only occasional sheep in the flock are affected, and these are affected each summer, with remission during the winter months.
- **Caprine idiopathic dermatitis:** Alopecic, exudative dermatitis of all ages and both sexes of pygmy goats is characterized by hair loss and scaling and crusting around the eyes, lips and chin, ears, poll, perineum, and ventral abdomen. Histologically the lesions have a psoriasis-like form.
- **Chronic equine eosinophilic dermatitis** is characterized by marked acanthosis and hyperkeratosis, and eosinophilic granulomas in the pancreas, salivary glands, and other epithelial organs. The systemic involvement is accompanied by severe weight loss. The disease is chronic, and the cause unknown.
- **Spongiotic vesicular dermatitis** has been described in horses. Lesions are characterized by a multifocal, exudative, oozing dermatitis characterized histologically by epidermal spongiotic vesicles and perivascular eosinophilic, neutrophilic, and mixed mononuclear inflammation. Some horses are pruritic.
- **Equine nodular necrobiosis (eosinophilic granuloma):** Firm, small (up to 1 cm in diameter) nodules, usually a number of them, occur on the sides of the trunk and neck. A hypersensitivity reaction to insect bites has been proposed as the underlying cause. The lesions consist largely of an accumulation of eosinophils.
- **Molluscum contagiosum** is a chronic, progressive dermatitis characterized by raised, hairless lesions 0.5 to 2 cm in diameter, covered by soft keratin, that bleed profusely when the horse is groomed. The lesions are on the face,

shoulders, trunk, lateral aspects of limbs, fetlocks, and pasterns. Histologic examination identifies the disease because of the presence of characteristic inclusions in cells. These are thought to be poxvirus virions, but the virus cannot be cultivated from the lesions. There is no specific treatment

- **Systemic lupus erythematosus (SLE)** is an extensive dermatitis, manifested as a scaly, crusty dermatitis of the face, neck, and trunk, with loss of hair over the lesions, edema of the limbs, and mild to moderate lymph node enlargement. Multiple ulcers 11 cm in diameter are present on the oral mucosa, especially the mucocutaneous junctions of the lips and nares, and on the tongue. There is a severe systemic reaction, including a marked loss of body weight, a temperature up to 39.5°C (103.1 F), heart rate of 80/min, respiratory rate up to 60/min, painful swollen joints containing sterile serous fluid, stiff gait, reluctance to move, and persistent lateral recumbency. SLE is an immune-mediated disease with a characteristic histopathology including a necrotizing lymphocytic dermatitis and focal accumulations of lymphocytes in the liver, membranous glomerulonephritis, and synovocyte hyperplasia. An antinuclear antibody test is diagnostic. No treatment is effective, and the disease runs a chronic progressive course marked by remissions and exacerbations.
  - **Discoïd lupus erythematosus** is an uncommon, benign variant of the systemic disease, with cutaneous lesions similar to those in the major disease but with no involvement of other tissues.
  - **Erythema multiforme** is a self-limiting skin disease of horses and cattle characterized by macular, papular, urticarial, or bullous skin lesions but without any abnormality of the epidermis or loss of hair, and with no apparent itching or pain. The lesions occur symmetrically on most parts of the body, persist for long periods, and increase in size up to 5 cm to form annular or crescent-shaped wheals. Spontaneous disappearance of the lesions after about 3 months is usual. Symptomatic treatment may be effective but is not usually necessary.
  - **Equine aural plaque:** Multiple white plaques, resembling papilloma and about 1 cm in diameter, develop on the inner surface of the ear pinna of horses. This condition has been associated with the papillomavirus that is thought to be transmitted by biting insects.
  - **Equine tropical lichen** is an intensely irritating, papular eruption in the skin on the side of the neck, under the mane, on the shoulders, and at the tailhead,
- occurring in summer and recurring annually. The disease closely resembles the cutaneous sensitivity to *Culicoides* spp. but responds dramatically to treatment with ivermectin. Microfilariae, thought to be *Onchocerca* spp., can be found in histologic sections.
- **Linear hyperkeratosis** is most common in horses, especially Quarter horses. One case has been recorded in cattle. Lesions appear spontaneously in horses 1 to 5 years old and persist, usually for life. They appear first as isolated scaly lumps, which then coalesce to form a ridge, usually vertical, 3 to 4 cm wide and up to 70 cm long, of hyperkeratotic, hairless skin. There may be one or more lesions, commonly on the sides of the neck and chest. Symptomatic treatment appears to have no effect on the lesions.
  - **Idiopathic fibrosing dermatitis:** As the end stage of several severe dermatoses, this causes damage to dermal collagen. Manifested by multiple fibrous plaques in the skin caused by sclerosis of the skin or subcutis, it resembles human morphea and the skin granulomas of animals.
  - **Porcine dermatitis–nephropathy syndrome**, an idiopathic low-morbidity but highly fatal disease of feeder pigs, is characterized by papular vascular dermatopathy, systemic necrotizing vasculitis, and exudative and proliferative glomerulonephritis. Skin lesions are full-depth necrosis appearing as multiple flat red–blue papules up to 2 cm in diameter (which may coalesce to form large plaques) on any part of the body. Some pigs die of glomerulonephritis without skin lesions having been apparent. Many cases that show only skin lesions recover spontaneously in several weeks. The disease may disappear if the commercial grain ration used is ground more coarsely.
  - **Porcine necrotic ear syndrome** is an extensive necrosis of the edges of the ears. The cause is unknown, but the possibility that a combination of *S. hyicus* infection and trauma by biting by pen mates is the cause seems high.
  - **Porcine idiopathic chronic, recurrent dermatitis** has been recorded in sows in specific farrowing houses. Boars and piglets were not affected, and lesions disappeared as soon as the sows left the houses. Annular macules 11 cm in diameter and patches of erythema 11 cm in diameter occur only on white skin. There are no systemic signs.
  - **Equine staphylococcal pyoderma** is a serious disease because the lesions are intractable to treatment and are so painful to touch that the horse is hard to handle, and the presence of the lesions under the harness, where they

commonly are, prevents the horse from working kindly. Harness horses are at a particular disadvantage. Individual lesions are raised nodules, 3 to 5 mm in diameter, covered by a small, easily removed scab. When these lift, they take a tuft of hair with them, and a small crater is left. A little pus exudes, and only a red serous fluid can be expressed. Individual lesions last a long time, at least several weeks, and fresh crops occur, causing the disease to spread slowly on the animal.

### Pemphigus

Pemphigus is an autoimmune disease of the skin occurring in mature horses, usually 5 years of age or older, as well as in foals. Vesicles and pustules are usually very difficult to find because they progress rapidly to crusts, exfoliation, alopecia, and scaling.<sup>1</sup> There are a number of manifestations, of which pemphigus foliaceus is the most common. Pemphigus vulgaris and bullous pemphigoid, in contrast, are rare. Pemphigus is a chronic autoimmune disease often accompanied by severe weight loss.

**Pemphigus foliaceus** is not only the predominant form of pemphigus but also the most common autoimmune disease of the horse. The classic, but rarely seen, primary lesion is a vesicle or pustule. Usually, the earliest lesions visible are crusted papules best seen in lightly or nonhaired skin adjacent to mucocutaneous junctions—the nostrils, eyelids, or lips. Lesions rapidly coalesce to form multifocal or diffuse areas of crusting. Pemphigus foliaceus occurs as a generalized scabby, weeping dermatitis, but it may be localized as circumscribed, circular lesions in the mouth and vulva and on the skin at mucocutaneous junctions. The lesions are subepidermal bullae, from which the top layer can be pulled away, and are sore to the touch. In some cases the lesions are around the coronary bands on all limbs. Edema, urticaria, pruritus, and pain of the extremities, especially the hindlimbs, and the ventral abdominal region may result in pronounced lameness.

The differential diagnoses include all skin diseases caused by scaling and crusting. These include dermatophytosis, dermatophilosis, staphylococcal dermatitis and folliculitis, systemic granulomatous disease, and primary or idiopathic abnormalities of keratinization.

The diagnosis is based on history, clinical presentation, skin cytology, and histopathology. Immunohistochemical staining and direct immunofluorescence examination, consisting of a fluorescein-antihorse IgG applied to the lesion, can confirm the diagnosis. Corticosteroid or gold (aurothioglucose) therapy has been reported to result in improvement, but an inexorable deterioration is usual. Pemphigus foliaceus is recorded in goats as a widespread disease character-

ized by the presence of scales, sometimes in heavy crusts, and involvement of the coronets.

### CLINICAL PATHOLOGY

Examination of skin scrapings or swabs for parasitic, bacterial, or other agents is essential. Culture and sensitivity tests for bacteria are advisable to enable the best treatment to be selected. Skin biopsy may be of value in confirming the diagnosis and determining the causal agent. In allergic or parasitic states there is usually an accumulation of eosinophils in the inflamed area. In mycotic dermatitis organisms are usually detectable in the deep skin layers, although they may not be cultivable from superficial specimens.

### DIAGNOSIS

The clinical features of dermatitis are apparent. The characteristic features of the etiologic types of dermatitis are described under each specific disease. **Diagnostic confirmation** is by histopathological demonstration in a biopsy specimen.

#### DIFFERENTIAL DIAGNOSIS

**Hyperhidrosis** and **anhidrosis** are dysfunctions of sweating and have no cutaneous lesion.

**Cutaneous neoplasm** is differentiable on histopathological examination.

**Epitheliogenesis imperfecta** is a congenital absence of all layers of skin.

**Vascular nevus** is a congenital lesion commonly referred to as a "birthmark."

### TREATMENT

**Primary treatment** must be to remove the noxious physical or chemical agent from the environment or to supplement the diet to repair a nutritional deficiency. The choice of a suitable treatment for infectious skin disease will depend on the accurate identification of the etiologic agent.

**Supportive treatment** includes both local and systemic therapy. Local applications may need to be astringent, either as powders or lotions in the weeping stage or as greasy salves in the scabby stage. The inclusion of corticosteroids or antihistamine preparation is recommended in allergic states, and it is desirable to prescribe sedative or anesthetic agents when pain or pruritus is severe.

If shock is present, parenteral fluids should be administered. If the lesions are extensive or secondary bacterial invasion is likely to occur, parenterally administered antibiotics or antifungal agents may be preferred to topical applications. To facilitate skin repair, a high-protein diet or the administration of protein hydrolysates or amino acid combinations may find a place in the treatment of valuable animals. Nonspecific remedies such as gold-containing remedies

(e.g., aurothioglucose) are commonly used in autoimmune diseases such as pemphigus.

The use of vaccines as prophylaxis in viral and bacterial dermatitides must not be neglected. Autogenous vaccines may be most satisfactory in bacterial infections. An autogenous vaccine is particularly recommended in the treatment of staphylococcal dermatitis in horses and bovine udder impetigo, in which long and repeated courses of treatment with penicillin produce only temporary remission. An autogenous vaccine produces a cure in many cases.

### REFERENCE

1. Yu A. *Proc Am Assoc Eq Pract.* 2006;52:492-497.

### PHOTOSENSITIZATION

#### SYNOPSIS

**Etiology** Caused by the accumulation of photosensitizing substances (PSs) in the skin, resulting in the local irritation of unprotected, unpigmented skin after exposure to sunlight. Four types of photosensitization are differentiated based on the underlying etiology. Type I, or primary, caused by intake of primary PS. Type II, as a result of inherited defects of porphyrin metabolism. Type III, or hepatogenous, as a result of liver damage and ensuing faulty excretion of phylloerythrin. Type IV, or idiopathic, as a result of undetermined etiology.

**Epidemiology** Exposure to PSs and sunlight of specific wavelength. Similar incidence of sporadic cases and outbreaks. Always life-threatening condition unless exposure to sunlight can be avoided.

**Clinical signs** Primary cases have cutaneous signs only (erythema, edema, necrosis, gangrene of light-colored skin or mucosae exposed to sunlight). Secondary cases have also signs of hepatic dysfunction (jaundice, prostration, short course, death) or porphyrin metabolism.

**Clinical pathology** Nil for evidence of photosensitivity. In secondary cases there is evidence of the primary disease.

**Necropsy lesions** Only skin lesions in primary cases. Secondary cases show liver lesions or evidence of porphyrin accumulation.

**Differential diagnosis** Clinical evidence of restriction of damage to white, wool-less skin on body dorsum and lateral aspects of limbs, teats, corneas, and tongue and lips.

**Treatment** Primary: remove from exposure to sunlight and PS. Supportive: treat for infection, shock, toxemia.

### ETIOLOGY AND EPIDEMIOLOGY

Photosensitization is caused by exposure of tissue containing certain photoactive

substances to light of specific wavelength. Substances with the potential to accumulate in skin and get activated by solar irradiation are termed **photosensitizing substances (PSs)**. Skin containing an excess of PSs that is exposed to sunlight while unprotected by hair, wool, or pigmentation is most affected. PSs release unstable high-energy molecules when exposed to a wavelength of light above 320 nm that reacts with substrate molecules in the skin. The result is the formation of free radicals causing cell damage in outer cells and becoming clinically apparent as inflammation, edema, ulceration, and even necrosis of the skin.

Photosensitization differs from sunburn in that it requires the presence of a photosensitizing agent, it is triggered by exposure to a wavelength of light between 320 and 400 nm (in contrast to sunburn, which in most cases is the result of exposure to light with lower wavelength), its onset is rapid (in contrast to the more delayed onset with sunburn), and skin lesions are considerably more severe than with sunburn.

Based on the origin of the photosensitizing agent, photosensitization has been classified into four classes, as follows:

- **Type I**, primary photosensitization caused by PSs of exogenous origin (no underlying primary pathology of the organism)
- **Type II**, photosensitization caused by aberrant pigment metabolism
- **Type III**, hepatogenous photosensitization caused by disturbed liver function
- **Type IV**, idiopathic photosensitization that is of undetermined etiology

Another form of photosensitization that is of little importance in livestock is the **photoallergic photosensitization** related to an immunologic response involving T-cell-mediated delayed hypersensitivity.

### Type I, Primary Photosensitization

Exogenous PSs can enter the organism through oral ingestion (e.g., PSs contained in feed), parenteral administration (e.g., certain drugs), or direct absorption through skin. In livestock oral ingestion is the most common route of exposure, with PSs being either contained in the diet or, less commonly, an orally administered drug. Photosensitization as a result of the ingestion of exogenous photodynamic agents usually occurs when the plant is in the lush green stage and is growing rapidly. Livestock are affected within 4 to 5 days of going to pasture, and new cases cease soon after the animals are removed. In most cases the plant responsible must be eaten in large amounts and will therefore usually be found to be a dominant inhabitant of the pasture. All species of animals are affected by photodynamic agents, although susceptibility may vary between species and between animals

of the same species. PSs that occur naturally in plants include the following:

- Dianthrone derivatives—hypericin in *Hypericum perforatum* (St. John's wort) and other *Hypericum* spp. and fagopyrin in seeds and dried plants of *Fagopyrum esculentum* (buckwheat)
- Furocoumarins in *Cymopterus* spp. (wild carrot), *Ammi majus*, and *Thamnosma texana*
- Perlolone from perennial ryegrass (*Lolium perenne*)
- Cocoa shells in feedlot rations causing photosensitization in feedlot calves
- Gluten metabolites in dairy cattle concentrates being fed to horses
- *Erodium moschatum*, an exotic weed in South Africa, causing photosensitization in sheep
- Unidentified photodynamic agents in *Medicago denticulata* (burr trefoil) and the aphids that infest it, and in *Brassica* spp., *Erodium* spp., and *Trifolium* spp.

Drug-related photosensitization has been reported after oral treatment with phenothiazine, an antiparasitic drug, and anecdotally after treatment of cows with corticosteroids to induce parturition (photosensitive dermatitis of the teats, escutcheon, and udder).

### Type II, Photosensitization as a Result of Aberrant Pigment Metabolism

The PSs associated with type II photosensitization are porphyrins that may accumulate in an organism with disturbed heme synthesis. The only known examples in domestic animals are the two rare inherited conditions of **congenital porphyria erythropoietica** (pink tooth) and **congenital protoporphyria erythropoietica** described in Limousin cattle.

### Type III, Hepatogenous Photosensitization

Hepatogenous photosensitization is the most common form of the disorder in livestock. The PS is invariably **phylloerythrin**, a normal end product of chlorophyll metabolism excreted in the bile. When biliary secretion is obstructed by hepatitis or biliary duct obstruction, phylloerythrin accumulates in the body and may reach levels in the skin that make it sensitive to light. Although hepatogenous photosensitization is more common in animals grazing green pasture, it can occur in animals fed entirely on hay or other stored feeds and in animals exposed to hepatotoxic chemicals (e.g., carbon tetrachloride). There appears to be sufficient chlorophyll, or breakdown products of it, in stored feed to produce critical tissue levels of phylloerythrin in affected animals. The following list includes those substances or plants that are common causes of hepatogenous photosensitization. The individual

plants are discussed in more detail in the section on poisonous plants.

### Plants Containing Hepatotoxins

- *Pithomyces chartarum* fungus on perennial ryegrass, causing **facial eczema of sheep**
- *Periconia* spp. fungus on Bermuda grass
- Cyanobacteria associated with blue-green algae (water bloom) on drinking water in ponds, dams, and dugouts—*Microcystis flosaquae*
- Lupins—*Lupinus angustifolius* plus the accompanying fungus, *Phomopsis leptostromiformis*
- Signal grass (*Brachiaria decumbens* and *Brachiaria brizantha*), a common component of established pastures in Brazil
- Alligator weed (*Alternanthera philoxeroides*), a South American aquatic plant causing photosensitization in dairy cattle in Australia and New Zealand
- Weeds, including lantana (*Lantana camara*), *Lippia rehmanni*, sacahuiste (*Nolina texana*), coal oil bush (*Tetradymia* spp.), alecrim (*Holocalyx glaziovii*), ngaio (*Myoporum laetum*), *Crotalaria retusa*, ragwort (*Senecio jacobea*), *Sphenosciadium* spp.

### Plants Containing Steroidal Saponins

The following plants containing steroidal saponins cause crystal-related cholangiohepatopathy:

- *Agave lecheguilla*, *Nartheceum ossifragum*, *Panicum* spp. (panic and millet grasses), and *Tribulus terrestris* (caltrop, geeldikkop), plants that are grazed particularly by sheep
- *Nartheceum ossifragum* (bog asphodel)—Sheep (lambs) grazing on pastures containing *N. ossifragum* on the west coast of Norway and in Scotland, northern England, Ireland, and the Faroe Islands have been affected by alveld, a hepatogenous photosensitivity disease. The disease is known as alveld (literally, “elf fire”) in Norway; plochteach, saut, or yellowises in the British Isles; and ormajuka (“worm disease”) in the Faroe Islands. Pastures containing *N. ossifragum* in these countries are commonly used for grazing sheep. Photosensitization of sheep grazing this plant usually occurs in 2- to 6-month-old lambs and is rarely seen in adult sheep. It produces similar clinical signs to those resulting from facial eczema, a disease most commonly seen in New Zealand and associated with the fungal toxin sporidesmin.

### Congenitally Defective Hepatic Function

Inherited congenital photosensitivity in Corriedale and Southdown lambs is an inherited defect in the excretion of bile pigment.



### Type IV, Photosensitization of Uncertain Etiology

In the following diseases it has not been possible to ascertain whether the photosensitization is primary or as a result of hepatic insufficiency:

- Feeding on rape or canola (*Brassica rapa*), kale, lucerne or alfalfa (*Medicago sativa*), burr medic or burr trefoil (*Medicago denticulata*), *Medicago minima*, *Trifolium hybridum* (alsike or Swedish clover), and *Erodium cicutarium* and *Erodium moschatum* (lamb's tongue, plantain)
- Cattle feeding on water-damaged or moldy alfalfa hay or alfalfa silage; extensive outbreaks usually with no signs suggestive of hepatic disease
- Cattle, sheep, and horses grazing lush pasture; many clinical cases occur sporadically
- Corticosteroids used systemically to terminate parturition in cows
- Phenanthridium used in the treatment of trypanosomiasis

### PATHOGENESIS

Penetration of light rays to sensitized tissues causes local cell death and tissue edema. Irritation is intense because of the edema of the lower skin level, and loss of skin by necrosis or gangrene and sloughing is common in the terminal stages. Nervous signs may occur and are caused either by the photodynamic agent, as in buckwheat poisoning, or by liver dysfunction.

Hepatogenous photosensitization involves production of a toxin, by a higher plant, fungus, or cyanobacterium (algae), that causes liver damage or dysfunction, resulting in the retention of the photosensitizing agent phylloerythrin.

### CLINICAL FINDINGS

#### General Signs

Skin lesions are limited to lightly or unpigmented skin directly exposed to light; pigmented parts of the integument remain unaffected. Early signs include erythema and swelling of the muzzle, nasal and ocular discharge, and photophobia. Local edema is often severe and may cause drooping of the ears; closure of the eyelids and nostrils, causing dyspnea; and dysphagia as a result of swelling of the lips. As the disease progresses, fissuring followed by sloughing of the thick skin is observed. Keratitis may be present and become severe enough to cause blindness. Behavioral changes are a result of intense irritation and include restlessness and scratching and rubbing of affected skin parts. When the teats are affected, the cow may kick at them and walk into ponds to immerse the teats in water, sometimes rocking backward and forward as if to cool the affected parts. In nursing ewes there may be resentment toward the lambs sucking, and heavy lamb mortalities as a result of starvation may result.

General depression, anorexia, and even recumbency may occur but are related to liver injury and disturbed liver function.

### Skin Lesions

Skin lesions are initially erythema, followed by edema and subsequent weeping with matting and then shedding of clumps of hair, and finally gangrene. The lesions have a characteristic distribution, restricted to the unpigmented areas of the skin and to those parts that are exposed to solar rays. They are most pronounced on the dorsum of the body, diminishing in degree down the sides, and are absent from the ventral surface. The demarcation between lesions and normal skin is very clear-cut, particularly in animals with broken-colored coats.

Predilection sites for lesions are the ears; conjunctiva, causing opacity of the lateral aspect of the cornea; eyelids; muzzle; face; lateral aspects of the teats; and, to a lesser extent, the vulva and perineum. In solid black cattle dermatitis will be seen at the lips of the vulva, on the edges of the eyelids, and on the cornea. Linear erosions often occur on the tip and sides of the tongue in animals with unpigmented oral mucosa. In severe cases the exudation and matting of the hair and local edema cause closure of the eyelids and nostrils. In the late stages necrosis or dry gangrene of affected areas leads to sloughing of large areas of skin.

### Systemic Signs

Systemic signs include shock in the early stages, as a result of extensive tissue damage. There is an increase in the pulse rate, with ataxia and weakness. Subsequently a considerable elevation of temperature (41° to 42° C, 106° to 107° F) may occur.

### Nervous Signs

Nervous signs, including ataxia, posterior paralysis and blindness, and depression or excitement, are often observed. A peculiar sensitivity to water is sometimes seen in sheep with facial eczema: when driven through water, they may lie down in it and have a convulsion.

### CLINICAL PATHOLOGY

In most cases a presumptive diagnosis can be made based on clinical presentation in combination with the history of the patient (recently pastured, access to certain plants, etc.). There are no specific diagnostic tests to confirm photosensitization.

Hepatogenous photosensitization can be diagnosed by analysis of plasma phylloerythrin concentration using a spectroscopic method. Plasma or serum fluorescence can be used to measure the elevation of phylloerythrin above normal levels before hepatogenous photosensitization. The levels of phylloerythrin in plasma of lambs grazing *N. ossifragum* are increased from a normal of less than 0.05 µg/mL to more than 0.3 µg/

mL when clinical signs of photosensitization are observed. Levels in skin are also increased.

In lambs in which facial eczema was experimentally induced by dosing with the mycotoxin sporidesmin, the plasma concentrations of phylloerythrin were increased from a normal of less than 0.1 µmol/L to 0.3 µmol/L when clinical signs were evident. The concentration of phylloerythrin in the skin began increasing 2 to 3 days later than that in the blood.

Determining the presence of liver damage or disturbed liver function is indicated. Icterus is highly suggestive of hepatogenous hypersensitization but should be confirmed by measuring the serum activity of specific liver enzymes and the serum bilirubin concentration.

### NECROPSY FINDINGS

In primary photosensitization, lesions are restricted to white-haired or pale-skinned areas of skin or mucosa that have been exposed to sunlight, and they vary from necrosis to gangrene. Lesions characteristic of hepatic injury or metabolic defects of porphyrin metabolism are described elsewhere.

Diffuse hepatocellular hydropic degeneration and hyperplasia of the smooth endoplasmic reticulum associated with marked multifocal cholangitis in the portal triads with bile duct proliferation are characteristic of the hepatic lesions of sheep grazing *Brachiaria decumbens*. Foam cells are present in the liver and mesenteric and hepatic lymph nodes of cattle grazing *Brachiaria* spp. Hepatocellular degeneration is the primary event in alveled photosensitization in sheep. High concentrations of conjugated episapogenins are present in both the liver and bile in alveled-affected lambs.

### DIFFERENTIAL DIAGNOSIS

The diagnosis of photosensitivity depends almost entirely on the distribution of the lesions. It can be readily confused with other dermatitides if this restriction to unpigmented and hairless parts is not kept in mind.

Mycotic dermatitis is often mistaken for photosensitization because of its tendency to commence along the back line and over the rump, but it occurs on colored and white parts alike.

Frequent wetting, as in periods of heavy rainfall, along the back in horses or cattle with a dense hair coat.

Bighead of rams associated with *Clostridium novyi* infection may also be confused with photosensitization, but the local swelling is an acute inflammatory edema, and many clostridia are present in the lesion.

Keratitis sometimes seen in photosensitization can be confused with those of pinkeye, but that disease is not accompanied by extensive dermatitis.

*Continued*

Sunburn is a very rare differential that has been reported in white swine, closely shorn sheep, and white-faced horses only.

### Treatment

**Primary treatment** includes immediate removal from direct sunlight, prevention of ingestion of further toxic material, and the administration of laxatives to eliminate toxic materials already eaten. In areas where the disease is enzootic the use of dark-skinned breeds may make it possible to utilize pastures that would otherwise be too dangerous.

**Local treatment** is governed by the stage of the lesions. Nonsteroidal antiinflammatory drugs (NSAIDs), corticosteroids, or antihistamines can be administered parenterally and adequate doses maintained. To avoid septicemia, the prophylactic administration of antibiotics may be worthwhile in some instances.

### FURTHER READING

House JK, et al. Primary photosensitization in cattle ingesting silage. *J Am Vet Med Assoc.* 1996;209:1604.  
Plumlee KH. Photosensitization in ruminants. *Vet Med.* 1995;90:605-612.

## Diseases of the Hair, Wool, Follicles, and Skin Glands

### ALOPECIA AND HYPOTRICHOSIS

#### ETIOLOGY

Alopecia and hypotrichosis are defined as lack of hair in any quantity on a normally haired body surface.<sup>1</sup> In contrast to alopecia, which describes hair loss of a skin surface with previously normal hair growth, hypotrichosis refers to a condition where there was no hair growth or abnormally low hair growth in the first place. Some texts define alopecia simply as hair loss and subdivide alopecia into a congenital and an acquired form, the former also being referred to as hypotrichosis. Acquired alopecias are further subdivided into cicatricial and noncicatricial alopecia.

Both may be caused by the following conditions.

#### Failure of Follicles to Develop

- Congenital hypotrichosis
- Hypotrichosis in piglets without dental dysplasia

#### Loss of Follicles

- Cicatricial alopecia as a result of scarring after deep skin wounds that destroy follicles—Cicatricial alopecia occurs following permanent destruction of the hair follicles, and regrowth of hair

will not occur. Examples include physical, chemical, or thermal injury; severe furunculosis; neoplasia; and certain infections, such as cutaneous onchocerciasis.

#### Failure of the Follicle to Produce a Fiber

##### Congenital

- Inherited symmetric alopecia
- Congenital hypotrichosis/hypotrichosis and anodontia defect (alopecia of variable degree associated with incomplete dentation, mainly occurring in male calves)
- Hypotrichosis in Polled Hereford calves
- Lethal hypotrichosis in Holstein–Friesian calves (generalized alopecia, with sparse hair on muzzle, eyelids, and ears—affected calves die within hours of life)
- Viable hypotrichosis in different cattle breeds (Guernsey, Jersey, Holstein–Friesian: generalized alopecia with sparse hair growth on legs, tail, eyelids, and ear pinnae)
- Hair-coat-color-linked follicle dysplasia
- Inherited dyserythropoiesis and dyskeratosis
- In baldy calves combined with adeno-hypophyseal hypoplasia
- Congenital hypothyroidism (goiter) as a result of iodine deficiency in the dam

##### Acquired

- Neurogenic alopecia as a result of peripheral nerve damage
- Infection in the follicle
- Epidermolysis bullosa in calves<sup>2</sup>
- Alopecia areata of horses and, less commonly, cows characterized by one or more round lesions of nonpruritic, nonscarring alopecia over the face, neck, shoulders, and brisket<sup>3</sup>
- Bovine besnoitiosis<sup>4</sup>

##### Loss of Preformed Fibers

- Dermatomycoses—ringworm
- Mycotic dermatitis in all species as a result of *D. congolensis*
- Metabolic alopecia subsequent to a period of malnutrition or severe illness (e.g., calves having suffered severe diarrhea or calves with incomplete function of the reticular groove reflex [rumen drinker calves])<sup>5</sup>
- Alopecia of calves fed milk replacer containing fats of nonanimal origin (whale, palm, or soya oil); fibers grown during the period of nutritional or metabolic stress have a zone of weakness and are easily broken
- Traumatic alopecia as a result of excessive scratching or rubbing associated with louse, tick, or itch-mite infestations; rubbing against narrow doors, feed troughs, or tethers in

confined housing; rubbing against harness in working animals

- Poisoning by thallium, selenium, arsenic, mercury, or the tree *Leucaena leucocephala*
- Idiopathic hair loss from the tail-switch of well-fed beef bulls
- Sterile eosinophilic folliculitis of cattle
- Wool slip
- In many primary skin diseases (e.g., parakeratosis, hyperkeratosis, dermatitis, cutaneous neoplasia, sarcoid, pythiosis), hair loss at the site of local lesions

### PATHOGENESIS

In inherited hair defects the underlying cause can be disturbed hair follicle formation resulting in a reduced hair follicle quantity or disturbed functionality of hair follicles that are present in adequate numbers. Noncicatricial alopecia is caused by reversible trauma to previously functional hair follicles by inflammation or mechanical trauma, which results in disturbed or interrupted synthesis in the hair bulb and ensuing shedding or fracture of hairs. Cicatricial alopecia is characterized by an irreversible destruction of hair follicles most commonly caused by physical, chemical, or thermal injury or severe inflammation.

Chemical depilation produced by cytotoxic agents, such as cyclophosphamide, occurs as a result of induced cytoplasmic degeneration in some of the germinative cells of the bulb of the wool follicle. The alteration in cell function is temporary, so that regrowth of the fiber should follow.

The pathogenesis of alopecia areata, primarily occurring in horses but also in cattle, has been associated with damage to growing hair mediated by T lymphocytes presumably specific for antigens of the hair matrix (auto-immune disease).<sup>3</sup> A genetic predisposition for alopecia areata has been discussed for humans.

### CLINICAL FINDINGS

When alopecia is a result of breakage of the fiber, the stumps of old fibers or developing new ones may be seen. When fibers fail to grow, the skin is shiny and in most cases is thinner than normal. In cases of congenital follicular aplasia, the ordinary covering hairs are absent, but the coarser tactile hairs around the eyes, lips, and extremities are often present. Absence of the hair coat makes the animal more susceptible to the effects of sudden changes of environmental temperature. There may be manifestations of a primary disease and evidence of scratching or rubbing.

Alopecia areata in horses primarily affects the mane, head, and tail, whereas in cattle extensive alopecia affecting large parts of the body has been reported.<sup>3,6</sup> Cases reported in the literature are primarily from animals showing first signs at adult age.<sup>3,6</sup> In cattle a predisposition of black-haired breeds (Black

Angus, Aberdeen Angus, Eringer) has been proposed.<sup>3</sup>

Congenital hypotrichosis results in alopecia that is apparent at birth or develops within the neonatal period.

### CLINICAL PATHOLOGY

If the cause of the alopecia is not apparent after the examination of skin scrapings or swabs, a skin biopsy will reveal the status of the follicular epithelium. Alopecia areata is characterized by bulbar and peribulbar lymphocyte infiltration, primary targeting anagen hair follicles.<sup>3</sup> In early stages several biopsies may be required to identify this pattern of infiltration. More advanced stages show dysplastic follicles with mild to moderate concentric fibrosis surrounding rudiments of hair bulbs.<sup>5</sup>

#### DIFFERENTIAL DIAGNOSIS

Diagnostic confirmation of alopecia is by visual recognition, the diagnostic problem being to determine the primary cause of the hair or fiber loss.

### TREATMENT

Primary treatment consists of removing the causes of trauma or other damage to fibers. In cases of faulty follicle or fiber development treatment is not usually attempted.

### FURTHER READING

- Anonymous. Alopecia in the horse—an overview. *Vet Dermatol.* 2000;11:191-203.
- Mecklenburg L. An overview on congenital alopecia in domestic animals. *Vet Dermatol.* 2006;17:393-410.
- Pascoe RR. Alopecia, diagnosis and treatment. *Equine Pract.* 1993;15:8-16.

### REFERENCES

1. Mecklenburg L. *Vet Dermatol.* 2006;17:393-410.
2. Foster AP, et al. *J Comp Pathol.* 2010;142:336-340.
3. Valentine B, et al. *J Vet Diagn Invest.* 2012;24:405-407.
4. Rostaher A, et al. *Vet Dermatol.* 2010;21:329-334.
5. Lorenz I, et al. *Dtsch Tierarztl Wochenschr.* 2007;114:231-235.
6. Hoolahan DE, et al. *Vet Dermatol.* 2013;24:282-285.

### ACHROMOTRICHIA

Achromotrichia is a deficient pigmentation in hair or wool fiber, which may manifest as follows:

- Bands of depigmentation in an otherwise black wool fleece are the result of a transitory deficiency of copper in the diet.
- Cattle on diets containing excess molybdenum and deficient copper show a peculiar speckling of the coat caused by an absence of pigment in a proportion of hair fibers. The speckling is often most marked around the eyes, giving the animal the appearance of wearing spectacles.

- General loss of density of pigmentation in all coat colors (e.g., Hereford cattle shade off from their normal deep red to a washed-out orange)

### LEUKODERMA AND LEUKOTRICHIA

Several skin diseases of the horse are characterized by an acquired loss of melanin pigment in the epidermis or hair. Melanocytes in the epidermis and those in the hair bulbs are frequently affected independently. Leukotrichia occurs when the melanocytes in the hair bulbs lose their normal amount of melanin pigment. When the melanocytes in the epidermis are affected and the skin loses normal pigmentation, the abnormality is leukoderma. Whereas leukotrichia can be observed as a single entity, leukoderma is most commonly associated with leukotrichia.

### ETIOLOGY

The etiology and pathogenesis of leukoderma are unknown, but trauma, inflammation, autoimmune reactions against melanocytes, local injections with epinephrine-containing local anesthetics, and defects of the autonomous nervous system have been discussed. Specific forms of leukoderma have been linked to hereditary gene defects (see following discussion).

### PATHOPHYSIOLOGY

The unknown underlying cause appears to result in acquired loss of functional melanocytes.

### CLINICAL FINDINGS

The forms of leukotrichia/leukoderma have been reported in horses:

- **Reticulated leukotrichia:** Alopecia and ensuing leukotrichia in a characteristic cross-hatched or reticulated pattern. Yearlings and occasionally older animals are affected, and Quarters horses appear to be predisposed.
- **Spotted leukotrichia:** Multiple, sharply demarcated area of leukotrichia of 1 to 3 cm in diameter.
- **Juvenile Arabian leukoderma:** Most common form of leukoderma in horses, reported in young Arabian and occasionally in Quarter horses. One- to 2-year-old animals develop leukoderma on eyelids, periocular skin, muzzle, nares, genitalia, anus perineum, and inguinal region.
- **Hyperesthetic leukotrichia:** Condition of unknown etiology that is characterized by the development of single or multiple very painful crusts on the dorsal midline from withers to tail. Crusts disappear and pain resolves after 2 to 3 months, while leukotrichia persists.

- **Albinism and lethal white foal syndrome:** Albinism refers to a congenital lack of melanin pigment in skin, hair, and other normally pigmented tissues. Albinism can occur as partial or complete albinism, the latter being inherited as autosomal-dominant trait that is only viable in the heterozygous state. The homozygous state results in a nonviable embryo that is resorbed in early gestation. A different form of lethal white foal syndrome results in homozygous expression of the associated trait and affects a subset of American Paint horses with the so-called frame overo color pattern.

### CLINICAL PATHOLOGY

A reduced number of melanocytes within epidermis and follicular epithelium in combination with complete loss of melanin pigment from the epidermis are typical findings.

### TREATMENT

No specific treatment is currently available

### FURTHER READING

Pigmentary disorders. *Vet Dermatol.* 2000;11:205-210.

### VITILIGO

Vitiligo is a presumably acquired autoimmune disorder characterized by patchy depigmentation of the skin described in horses, cattle, and other species.

### ETIOLOGY

Although the etiology of vitiligo is still unknown, evidence corroborating the hypothesis that vitiligo is an acquired autoimmune disease associated with the production of antimelanocyte antibodies has accumulated over the last decades.<sup>1</sup> Other etiologies discussed in the literature are an increased susceptibility of melanocytes to certain melanin precursor molecules or local nerve injuries. A genetic etiology is suspected in Arabian horses and Holstein-Friesian cattle.

### PATHOPHYSIOLOGY

The underlying cause results in a complete, although sometimes reversible, loss of functional melanocytes in a small area of the dermis.

### CLINICAL FINDINGS

Vitiligo has been reported in different breeds, without apparent gender predisposition. Although the condition can develop at any age, it most commonly is observed in young animals. Typical presentation is a patchy depigmentation of the skin of the muzzle, eyelids, and occasionally anus and other body regions. The degree of depigmentation can vary over time, and the condition may even completely resolve, making the



interpretation of anecdotal treatment successes difficult. The defect is esthetic only.

### CLINICAL PATHOLOGY

Histopathological examination reveals a complete absence of melanocytes from affected areas. Increased numbers of Langerhans cells and epidermal vacuolization have been reported in some cases.<sup>1</sup>

### TREATMENT

No specific treatment with confirmed efficacy is currently available. Anecdotal reports of improvement after supplementation of vitamins and minerals (vitamin A and copper) are available.<sup>1</sup> Because of the possible genetic predisposition, the use of affected animals for breeding has been discouraged.

### FURTHER READING

Montes LF, et al. Value of histopathology in vitiligo.

*J Dermatol.* 2003;42:57-61.

Sandoval-Cruz M, et al. Immunopathogenesis of vitiligo.

*Autoimmun Rev.* 2011;10:762-765.

### REFERENCE

1. Montes LF, et al. *J Eq Vet Sci.* 2008;28:171-175.

## SEBORRHEA

### ETIOLOGY

The etiology of seborrhea is still not understood. Historically seborrhea was considered to be the result of excessive secretion of sebum onto the skin surface. More recently seborrhea was classified as disease of abnormal cornification and keratinization of the skin rather than of excessive sebum production because there is little evidence for abnormal function of the sebaceous glands. In large animals it is always secondary to dermatitis or other skin irritations that result in excessive crusting, scaling, or oiliness, such as the following:

- Exudative epidermitis of pigs associated with *S. hyicus*
- Greasy heel of horses, including infection with *S. hyicus*
- Greasy heel of cattle
- Flexural seborrhea of cattle
- Besnoitiosis of cattle associated with *Besnoitia besnoiti*

### CLINICAL FINDINGS

In primary seborrhea there are no lesions, only excessive greasiness of the skin. The sebum may be spread over the body surface like a film of oil or be dried into crusts, which can be removed easily. Sebaceous glands may be hypertrophied.

### Flexural Seborrhea

Flexural seborrhea is most common in young periparturient dairy cows. Severe inflammation and a profuse outpouring of sebum appear in the groin between the udder and the medial surface of the thigh or in the median fissure between the two halves of the udder. Extensive skin necrosis follows,

causing a pronounced odor of decay, which may be the first sign observed by the owner (see also under “Udder Cleft Dermatitis”). Irritation may cause lameness, and the cow may attempt to lick the part. Shedding of the oily, malodorous skin leaves a raw surface beneath; healing follows in 3 to 4 weeks.

### Greasy Heel of Cows

Cows grazing constantly irrigated, wet pastures or in very muddy conditions in tropical areas may develop local swelling, with deep fissuring of the skin and an outpouring of vile-smelling exudate on the back of the pastern of all four feet but most severely in the hindlimbs. Affected animals are badly lame, and their milk yield declines sharply. Moving the cows to dry land and treating systemically with a broad-spectrum antibiotic effects a rapid recovery.

### Greasy Heel of Horses (Scratches)

Greasy heel occurs mostly on the hind pasterns of horses that stand continuously in wet, unsanitary stables. Some cases do occur in well-managed stables. It has been suggested that secondary infections associated with either *S. aureus* and *D. congolensis* may be causative factors. Dermatophytosis, choriocytic mange, and photosensitization are also possible causative factors.

Lameness and soreness to touch are a result of excoriations called scratches on the back of the pastern that extend down to the coronary band. The skin is thick and greasy; if neglected, the condition spreads around to the front and up the back of the leg. This involvement can be severe enough to interfere with normal movement of the limb.

### CLINICAL PATHOLOGY

The diagnosis is based on the clinical presentation and on ruling out other skin conditions resulting in abnormal cornification and keratinization. The primary cause of the seborrhea may be diagnosed by a suitable examination for the presence of parasitic or bacterial pathogens. Histopathology may be supportive to rule out other causes.

### DIFFERENTIAL DIAGNOSIS

The lesion is characteristic, and diagnostic confirmation is by histopathological examination of a biopsy specimen; the principal difficulty is to determine the primary cause. All the types listed may be mistaken for:

Injury, commonly wire cuts or rope burn

Flexural seborrhea for injury, usually a result of straddling a gate or wire fence

Greasy heel of horses for choriocytic mange

### TREATMENT

With secondary seborrhea the primary objective of treatment must be to resolve the underlying cause. Topical and symptomatic

treatment of the affected skin is indicated for relief and to assist in control of the disease. Seborrheic shampoos and lotions can either be keratolytic or keratoplastic. Keratolytic products may initially worsen the scale production by chemically debriding the stratum corneum but will eventually result in reduced scale formation. Particularly during the initial phase, frequent washing of the affected skin to remove debrided cells is important. Keratoplastic ointments slow the mitotic rate of the epidermis, thereby reducing scale formation. Emollients are useful after washing the skin to rehydrate, lubricate, and soften the skin. In severe cases associated with pyoderma or even skin necrosis, the use of local and systemic broad-spectrum antibiotics may be indicated.

## FOLLICULITIS

### ETIOLOGY

Etiology includes inflammation and possibly infection of hair follicles that can be caused by suppurative organisms (often *staphylococci*), secondary to follicular trauma, obstruction of sebaceous gland ducts, or more rarely as result of an autoimmune reaction. Identifiable forms of folliculitis as individual diseases include the following:

- Staphylococcal dermatitis of horses
- Contagious acne of horses
- Benign facial folliculitis of sucking lambs
- Staphylococcal folliculitis of goats
- Bovine sterile eosinophilic folliculitis

### PATHOGENESIS

Depending on the underlying etiology, inflammatory cells infiltrate the walls and lumen of hair follicles. With more extensive inflammation, neutrophils may also infiltrate perifollicular tissue, resulting in formation of larger abscesses (**furunculosis**). Increased pressure and tissue lysis will result in a rupture of the hair follicle with an ensuing granulomatous dermal reaction.

### CLINICAL FINDINGS

Folliculitis may present with skin lesions in almost any location of the skin. Early stages present as papules or pustules with hairs emerging through the lesions. Involvement of the hair follicle allows one to differentiate this condition from impetigo, where the hair follicle is not involved.<sup>1</sup> Later focal crusting and alopecia and pruritus may develop. Pustule rupture leads to contamination of the surrounding skin and development of further lesions, such as ulcerations and draining tracts. Severe cases can be associated with pain, pyrexia, and feed-intake depression. Chronic folliculitis can affect skin pigmentation and cause permanent destruction of hair follicles, which results in cicatricial alopecia.

In **bovine sterile eosinophilic folliculitis**, the multiple lesions are crusted, alopecic,

3- to 5-cm-diameter nodules on all parts of the body except the limbs. They are composed largely of eosinophilic cells and are negative on culture.

**Staphylococcal folliculitis in goats** can be generalized, with pustules developing in the periocular and periauricular area, ventral abdomen, medial thighs, and distal limbs.<sup>1</sup> Involvement of the udder skin can occasionally occur.

**Benign folliculitis of suckling lambs** can develop from the first week of life and consists of small pustules and crusts on the lips, nostrils, ventral tail, and perineum. The condition resolves spontaneously over several weeks.

### CLINICAL PATHOLOGY

Swabs should be taken for bacteriologic and parasitologic examination. Histopathological findings include microabscesses associated with hair follicles, along with abscessation and necrosis of the epidermis, dermis, and subcutaneous tissue. Cellular infiltration with mononuclear cells and granulocytes is another common finding.

#### DIFFERENTIAL DIAGNOSIS

Diagnostic confirmation is by demonstration of infection of hair follicles in a biopsy specimen.

Udder impetigo of cattle; lesions do not involve hair follicles in the first place.

Dermatophytosis

Dermatophilosis

Besnoitiosis of cattle

Viral infections caused by BHV (types 1, 2, and 4), BVD, bovine *parapox virus*, cowpox, buffalopox, bluetongue virus, vesicular stomatitis, foot-and-mouth disease

Exudative epidermitis of pigs (greasy pig disease) as a result of *S. hyicus*, with extensive seborrheic dermatitis

Ulcerative dermatitis of face in adult sheep

Ecthyma (orf)

Facial eczema of sheep; caused by hepatogenous photosensitization

Leg dermatitis down to coronet of sheep

Chronic pectoral and ventral midline abscesses in horses as a result of *Corynebacterium pseudotuberculosis*; not a skin lesion but it resembles furunculosis.

### TREATMENT

**Primary treatment** consists of identifying and eliminating possible primary causes. Topical treatment commences with clipping and cleaning the skin by washing followed by a disinfectant rinse, for instance, with chlorhexidine-based products. Affected areas should be treated with antibacterial ointments or lotions. If the lesions are extensive, the parenteral administration of antibiotics is recommended. The course

of treatment should last 1 week; in chronic cases this may need to be at least 1 month; a broad-spectrum preparation is recommended.

For **supportive treatment**, infected animals should be isolated and grooming tools and blankets disinfected.

### REFERENCE

1. Foster AP. *Vet Dermatol.* 2012;23:e42-e63.

## Diseases of the Subcutis

### SUBCUTANEOUS EDEMA (ANASARCA)

#### ETIOLOGY

Extensive accumulation of edema fluid in the subcutaneous tissue is part of general edema and is caused by the same diseases, as follows.

#### Increased Hydrostatic Pressure

- Congestive heart failure
- Vascular compression by a mass (e.g., anterior mediastinal lymphosarcoma, large hematoma)
- Vascular obstruction of blood vessels or lymphatic vessels (e.g., thrombophlebitis or thrombosis)

#### Hypoproteinemic (Hypooncotic) Edema

- Reduced albumin production in the liver associated with chronic inflammation or liver insufficiency (e.g., fascioliasis or liver cirrhosis)
- Nephrotic syndrome with protein loss into urine (e.g., renal amyloidosis in cattle)
- Protein-losing enteropathy (e.g., intestinal nematodiasis or paratuberculosis in cattle)

#### Increased Blood Vessel Permeability

- Inflammation (e.g., **dourine** of horses or equine infectious anemia, bacterial infections by *Clostridium* spp. or *Anthrax*)
- Allergic reaction (e.g., purpura hemorrhagica of horses, insect stings)

#### Fetal Anasarca

- Some pigs with congenital goiter also have myxedema, especially of the neck.
- Sporadic cases resulting from unknown causes are sometimes associated with deformities (e.g., in Awassi sheep).
- Congenital absence of lymph nodes and some lymph channels causes edema to be present at birth.

#### DIFFERENTIAL DIAGNOSIS

Diagnostic confirmation is by clinical detection of serous fluid in a subcutaneous site.

In male ruminants, **extravasation of urine** as a result of urethral obstruction and rupture.

**Subcutaneous hemorrhage, hematoma or seroma**, which is not necessarily dependent, nor bilaterally symmetric.

**Ventral hernia**, usually unilateral and does not pit on pressure.

**Cellulitis**, usually asymmetric, hot, often painful, does not pit on pressure and can be sampled by needle puncture.

### PATHOGENESIS

Alteration in the balance between the hydrostatic pressure of intravascular fluids, the blood and lymph, and the osmotic pressure of those fluids or changes in the integrity of the filtering mechanism of the capillary endothelium (leaky vessels) leads to a positive advantage by the hydrostatic pressure of the system and causes a flow of fluid out of the vessels into the tissues.

### CLINICAL FINDINGS

There is visible swelling, either local or diffuse. The skin is puffy and pits on pressure; there is no pain unless inflammation is also present. In large animals the edema is usually confined to the ventral aspects of the head, neck, and trunk and is seldom seen on the limbs.

### CLINICAL PATHOLOGY

Anasarca is a clinical diagnosis, but many estimates (e.g., arterial blood pressure, serum and urine protein levels) provide contributory evidence. Normal total protein concentrations in serum or plasma allow one to rule out hypooncotic edema. Differentiation between obstructive and inflammatory edema can be made by cytologic and bacteriologic examination of the fluid.

### TREATMENT

Primary treatment requires correction of the primary causal abnormality. Supportive treatment will also depend on the underlying cause but can consist of transfusing plasma or whole blood in cases of hypooncotic edema, or antiinflammatory or diuretic therapy in cases of inflammatory or allergic edema.

### ANGIOEDEMA (ANGIONEUROTIC EDEMA)

#### ETIOLOGY

Transient, localized subcutaneous edema as a result of an allergic reaction and caused by endogenous and exogenous allergens provokes either local or diffuse lesions. Angioedema occurs most frequently in cattle and horses on pasture, especially during the period when the pasture is in flower. This suggests that the allergen is a plant protein. Fish meal may also provoke an attack.

Recurrence in individual animals is common. Angioedema can also occur as adverse reaction to parenteral administration of certain antibiotics, vaccines, blood, plasma, or other IV fluids.

### PATHOGENESIS

The precise type of hypersensitivity reaction has not yet been determined, but most cases appear to be associated with a type I or type III hypersensitivity reaction. After an initial erythema, local vascular dilatation is followed by leakage of plasma through damaged vessels.

### CLINICAL FINDINGS

**Local lesions** most commonly affect the head, with diffuse edema of the muzzle, eyelids, conjunctiva, and cheeks. Occasionally only the conjunctiva is affected, so that the eyelids are puffy, the nictitating membrane is swollen and protruding, and lacrimation is profuse. Affected parts are not painful to touch, but shaking the head and rubbing against objects suggest irritation. Salivation and nasal discharge may be accompanying signs.

**Perineal involvement** includes vulvar swelling, often asymmetric, and the perianal skin, and sometimes the skin of the udder, is swollen and edematous. When the **udder** is affected, the teats and base of the udder are edematous and cows may paddle with the hind limbs, suggesting irritation in the teats. Edema of the lower limbs, usually from the knees or hocks down to the coronets, is a rare sign.

**Systemic signs** are absent, except in those rare cases where angioedema is part of a wider allergic response, when bloat, diarrhea, and dyspnea may occur, often with sufficient severity to require urgent treatment.

### CLINICAL PATHOLOGY

The blood eosinophil count is often within the normal range, but may be elevated from a normal level of 4% to 5% up to 12% to 15%.

#### DIFFERENTIAL DIAGNOSIS

Diagnostic confirmation is found with sudden onset and disappearance of edema at the typical sites.

**Subcutaneous edema as a result of vascular pressure** occurs mostly in dependent parts and is not irritating.

In horses, and rarely in cattle, angioedema may be simulated by **purpura hemorrhagica**, but hemorrhages are usually visible in the mucosae in purpura.

### TREATMENT

**Primary treatment** to remove the specific cause is usually impossible, but affected animals should be removed from the suspected source of allergens. Cattle running at

pasture should be confined and fed on dry feed for at least a week.

**Supportive treatment** to relieve the vascular lesion is always administered even though spontaneous recovery is the rule. In acute cases with suspected anaphylaxis, epinephrine should be administered parenterally. For subacute cases, corticosteroids or other antiinflammatories are preferred over antihistamines or epinephrine; usually only one injection is required.

#### TREATMENT

Acute anaphylaxis with angioedema:  
Epinephrine: 3 to 5 mL/450 kg of a 1:1000 solution IM or SC (can be combined with steroids) (R-1)

Acute angioedema in horses:  
Dexamethasone soluble 0.01 to 0.1 mg/kg IV or IM q24 h for 3 to 7 days (R-1)  
Hydroxyzine hydrochloride 0.5 to 1.0 mg/kg IM or PO q8 h (R-2)  
Diphenhydramine hydrochloride 0.7 to 1 mg/kg q12 h (R-2)  
Chlorpheniramine 0.25 to 0.5 mg/kg q12 h (R-2)

## SUBCUTANEOUS EMPHYSEMA

### ETIOLOGY

Emphysema, free gas in the subcutaneous tissue, occurs when air or gas accumulates in the subcutaneous tissue as a result of the following:

- Air entering through a cutaneous wound made surgically or accidentally, particularly in the axilla or inguinal region
- Extension from pulmonary emphysema
- Air entering tissues through a discontinuity in the respiratory tract lining (e.g., in fracture of nasal bones; trauma to pharyngeal, laryngeal, and tracheal mucosa caused by external or internal trauma, as in lung puncture by a fractured rib; trauma to the trachea during an attempt to pass a nasoesophageal tube; following a tracheal wash procedure to assist in the diagnosis of respiratory disease where the trachea does not seal quickly to air movement after removal of the trocar)
- Extension from vaginal lacerations in cattle, particularly in cattle with vaginal prolapse and following dystocia, or cattle with puerperal metritis and gas accumulation in the uterus
- Gases migrating from abdominal surgery because the abdominal cavity is usually at a negative pressure relative to atmospheric pressure
- Gas gangrene infection

### PATHOGENESIS

Air moves very quickly in a dorsal manner through fascial planes, especially when there

is local muscular movement. For example, when a lung is punctured, or in cases of severe interstitial pulmonary edema, air escapes under the visceral pleura and passes to the hilus of the lung, and hence to beneath the parietal pleura, between the muscles, and into the subcutis, particularly between the dorsal aspects of the scapulae.

### CLINICAL FINDINGS

Visible subcutaneous swellings are soft, painless, fluctuating, and grossly crepitant to the touch, but there is no external skin lesion. In gas gangrene, discoloration, coldness, and oozing of serum may be evident. Affected areas of skin are moderately painful to touch. Emphysema may be sufficiently severe and widespread to cause stiffness of the gait and interference with feeding and respiration. The source of the subcutaneous emphysema is usually directly ventral to the most severely affected area, which is usually along the back.

### CLINICAL PATHOLOGY

Clinical pathology is not necessary except in cases of gas gangrene, when a bacteriologic examination of fluid from the swelling should be carried out to identify the organism present.

#### DIFFERENTIAL DIAGNOSIS

Diagnostic confirmation is based on the observation of crepitus and the extreme mobility of the swelling; these distinguish emphysema from other superficial swellings.

**Anasarca**, dependent and pits on pressure (see previous discussion).

**Hematoma, seroma at injury sites**, confirmed by needle puncture (see following discussion).

**Cellulitis** is accompanied by toxemia, confirmed by needle puncture.

### TREATMENT

**Primary treatment** is to address the source of the air, but this may be impossible to locate or to close. **Supportive treatment** is only necessary in the extremely rare case where emphysema is extensive and incapacitating, in which case multiple skin incisions may be necessary. Gas gangrene requires immediate and drastic treatment with antibiotics.

## LYMPHANGITIS

Lymphangitis is characterized by inflammation and enlargement of the lymph vessels and is usually associated with lymphadenitis.

### ETIOLOGY

Lymphangitis in most cases is a result of local skin infection with subsequent spread to the lymphatic system. Common causes are as follows.



## Cattle

- Bovine farcy caused by *Mycobacterium farcinogenes* and *Mycobacterium senegalense*
- Cutaneous tuberculosis associated with atypical mycobacteria, rarely *Mycobacterium bovis*

## Horse

- Epizootic lymphangitis (equine histoplasmosis) as a result of *Histoplasma capsulatum* var. *farciminosum*
- Ulcerative lymphangitis as a result of *Corynebacterium pseudotuberculosis*
- Glanders (farcy) caused by *Burkholderia mallei*
- Sporotrichosis
- Sporadic lymphangitis
- Strangles in cases where bizarre location sites occur
- In foals, ulcerative lymphangitis associated with *Streptococcus zooepidemicus*

## PATHOGENESIS

Spread of infection along the lymphatic vessels causes chronic inflammation and thickening of the vessel walls. Abscesses often develop, with discharge to the skin surface through sinuses.

## CLINICAL FINDINGS

An indolent ulcer usually exists at the original site of infection. The lymph vessels leaving this ulcer are enlarged, thickened, and tortuous and often have secondary ulcers or sinuses along their course. Local edema may result from lymphatic obstruction. In chronic cases much fibrous tissue may be laid down in the subcutis, and chronic thickening of the skin may follow. The medial surface of the hindlimb is the most frequent site, particularly in horses.

## CLINICAL PATHOLOGY

Bacteriologic examination of discharge for the presence of the specific bacteria or fungi is common practice.

## TREATMENT

**Primary treatment** requires vigorous, early surgical excision or specific antibiotic therapy.

**Supportive treatment** is directed toward removal of fluid and inflammatory exudate and relief of pain.

## PANNICULITIS

Panniculitis is diffuse inflammation of subcutaneous fat that has been associated with a number of causes, such as trauma, infection, postinjection site inflammation, insect bite, neoplasia, drug eruption, and dietary factors (excessive intake of polyunsaturated fatty acids or vitamin E deficiency). Deep-seated, firm, and painful nodules or plaques that can

reach a diameter of 15 cm or more, often in large numbers, anywhere over the body but especially on the neck and sides, most commonly occur in young horses and rarely in cattle. The lesions may fluctuate greatly in size and number, or even disappear spontaneously. In a few cases there is transient fever, reduced feed intake, and weight loss. Lameness may be evident in horses with extensive lesions.

Diagnosis is by histologic examination of a biopsy specimen. At necropsy examination there are no other lesions. The lesions reduce in size and number after the administration of dexamethasone but recur when treatment stops.

## HEMATOMA

Hematoma refers to extravasation of whole blood into the subcutaneous tissues.

## ETIOLOGY

Accumulation of blood in the subcutaneous tissues beyond the limit of that normally caused by trauma may be a result of defects in the coagulation mechanism or a result of increased permeability of the vessel wall.

Common causes include the following:

- Traumatic rupture of large blood vessel
- Dicoumarol poisoning from moldy sweet clover hay
- Purpura hemorrhagica in horses
- Bracken poisoning in cattle; other granulocytopenic diseases manifested principally by petechiation, with lesions observed only in mucosae
- Systemic disease associated with disseminated intravascular coagulopathy (DIC)
- Hemangiosarcoma in subcutaneous sites
- Neonatal bovine pancytopenia
- Inherited hemophilia

## PATHOGENESIS

Leakage of blood from the vascular system can cause local swellings, which interfere with normal bodily functions but are rarely sufficiently extensive to cause signs of anemia.

## CLINICAL FINDINGS

Subcutaneous swellings resulting from hemorrhage are diffuse and soft, with no visible effect on the skin surface. There may be no evidence of trauma. Specific locations of subcutaneous hemorrhages in horses include the frontal aspect of the chest—as a result of fracture of the first rib in collisions at full gallop, and often fatal through internal hemorrhage—and perivaginal at foaling, causing massive swelling of the perineum and medial aspect of the thigh.

## CLINICAL PATHOLOGY

Visual examination of a needle aspirate confirms the existence of subcutaneous hemorrhage. Diagnosis of the primary cause is

greatly assisted by platelet counts and prothrombin, clotting, and bleeding times.

## TREATMENT

### Primary Treatment

Primary treatment targets removal or correction of the cause.

### Supportive Treatment

The hematoma should not be opened until clotting is completed, except in the case of a massive hemorrhage that is interfering with respiration, defecation, or urination. If blood loss is severe, blood transfusions may be required. Parenteral injection of coagulants can be justified if the hemorrhages are recent and severe.

## DIFFERENTIAL DIAGNOSIS

Hematomas as a result of coagulopathies are usually associated with hemorrhages into other tissues, both manifestations being a result of defects in clotting or capillary wall continuity. Single hematomas (e.g., from trauma) must be differentiated from abscesses, seromas, and neoplasias.

Diagnostic confirmation is by needle puncture of the swelling, avoiding excessive blood loss (that would decrease pressure on the leaking vessel) and contamination of a possibly sterile fluid pocket.

## NECROSIS AND GANGRENE

Necrosis is tissue death; gangrene is sloughing of dead tissue. When either change occurs in the skin, it involves the dermis, epidermis, and subcutaneous tissue.

Different types of gangrene are recognized:

- **Dry gangrene** is primarily caused by arterial occlusion resulting in tissue ischemia. Affected tissue appears dry and shrunken, with dark discoloration and a clear demarcation line from healthy tissue. There is no bacterial infection or putrefaction because bacteria fail to survive in the desiccated tissue.
- **Wet gangrene** is most common after sudden blockage of venous blood flow resulting in ischemia while the affected tissue is saturated with stagnant blood. Tissue trauma (e.g., from mechanical trauma or burns) and ischemia result in release of tissue water and give the affected area a moist and swollen appearance. Because the moist and protein-rich tissue facilitates bacterial growth, infection with saprogenic microorganisms is common. This infection results in the putrid and rotten aspect and odor of the tissue and may cause septicemia.
- **Gas gangrene** is caused by *C. perfringens* (see also “Malignant Edema”).

## ETIOLOGY

Severe **damage to the skin** in the following categories causes gangrene:

- Severe or continued trauma (e.g., pressure sores, saddle and harness galls, carpal or tarsal necrosis in recumbent animals)
- Strong caustic chemicals (e.g., creosote)
- Severe cold or heat, with bushfires and stable fires being the worst offenders. Frostbite is an unusual occurrence in animals unless the patient has a circulatory deficit (e.g., in the neonate, in severe shock or toxemia).
- Beta-irradiation
- **Infections**, especially:
  - Erysipelas and salmonellosis in pigs
  - Clostridial infections in cattle, affecting subcutis and muscle
  - Staphylococcal mastitis in cattle; pasteurella mastitis in sheep
  - Bovine ulcerative mammillitis of the udder and teats
- **Local vascular obstruction**—obstruction by thrombi or arterial spasm causes skin gangrene but includes deeper structures, also from poisoning by:
  - *Claviceps purpurea*
  - *Festuca arundinacea* (probably as a result of an accompanying fungus)
  - *Aspergillus terreus*
  - Mushrooms
- Intradermal injection of local anesthetics containing epinephrine have been associated with dry gangrene of injected skin in cattle.

Similar cutaneous and deeper-structure involvement occurs in systemic infections in which bacterial emboli block local vessels (e.g., in salmonellosis in calves, and after tail vaccination of calves with *Mycoplasma mycoides*).

### Other Causes

- Final stages of photosensitive dermatitis and flexural seborrhea
- Screw-worm infestation

## PATHOGENESIS

The basic cause of gangrene is interference with local blood supply by external pressure; by severe swelling of the skin, as in photosensitization; or by arteriolar spasm or damage to vessels by bacterial toxins.

## CLINICAL FINDINGS

With **dry gangrene** the lesion is dry from the beginning, and the area is cold and sunken, with red-brown discoloration and without offensive odor, resembling mummified tissue. Bacterial infection is commonly not present. Sloughing of dry tissue may take a long time, and the underlying surface usually consists of granulation tissue.

With **wet gangrene** the initial lesion is moist and oozing, and the affected area is swollen, raised, discolored, and cold.

Separation occurs at the margin, and the affected skin may slough before it dries; the underlying surface is raw and weeping. Because wet gangrene is in most cases accompanied by infection with saprophytic pathogens, affected tissue often has a putrid and rotten aspect and odor. Systemic disease may result from absorption of toxic products from tissue breakdown and bacteria, resulting in septicemia.

The presentation of **gas gangrene** is discussed under “Malignant Edema.”

## DIFFERENTIAL DIAGNOSIS

Confirmation of the diagnosis is by visual recognition.

Gangrenous mastitis in cows or ewes.

Photosensitive dermatitis.

*Claviceps purpurea* poisoning.

## TREATMENT

**Primary treatment** requires removal of the etiologic insult.

**Supportive treatment** comprising the application of astringent and antibacterial ointments may be required in cases of wet gangrene to facilitate separation of the gangrenous tissue and to prevent bacterial infection. Aggressive tissue debridement of necrotic tissue and in severe cases amputation of affected body parts may be required. Systemic antibiotics do not reach gangrenous tissue but are indicated whenever septicemia is suspected.

## SUBCUTANEOUS ABSCESS

Most subcutaneous abscesses are matters of purely local and esthetic concern, but if they are sufficiently extensive and present with active **localized infection**, they may cause mild toxemia. Their origins include the following.

### Trauma

Most subcutaneous abscesses are the result of traumatic skin penetration with resulting infection. For example, **facial subcutaneous abscesses** are common in cattle eating roughage containing foxtail grass (*Hordeum jubatum*). Several animals in a herd may be affected at one time. The awns of these plants migrate into the cheek mucosa, causing subcutaneous abscesses containing *Trueperella* (formerly *Arcanobacterium*) *pyogenes* and *Actinobacillus* spp. The abscesses contain purulent material, are well encapsulated, and must be surgically drained and treated as an open wound. Medical therapy with parenteral antimicrobials and iodine is ineffective.

### Hematogenous

Rarely the infection reaches the site via the bloodstream (e.g., chronic pectoral abscesses of horses, infections in foals with *R. equi*,

infections in all species with *Corynebacterium pseudotuberculosis*, infections in lambs with *Histophilus somni* or *Pseudomonas pseudomallei*).

### Extension

Abscesses may originate by **extension** from lesions of furunculosis, pyoderma, or impetigo or by **contiguous spread** by contact from an internal organ (e.g., from traumatic reticuloperitonitis).

## CUTANEOUS CYSTS

Cysts contained by an epithelial wall enclosing amorphous contents or living tissue may be congenital, inherited defects or acquired as a result of inappropriate healing of accidental wounds. They are smooth, painless, about 1.5 to 2.5 cm in diameter, round, and usually fluctuating, although inspissated contents may make them feel quite hard. The skin and hair coat over them are usually normal, although some may leak mucoid contents onto the skin. Epidermoid cysts are lined with skin; dermoid cysts usually contain differentiated tissue such as sebaceous glands and hair follicles; dentigerous cysts contain teeth or parts of them. Acquired cysts include apocrine, sebaceous, and keratin varieties.

Developmental cysts, which are present from birth, are usually located at specific anatomic sites, and include the following:

- **Branchial cysts** in the neck, formed from an incompletely closed branchial cleft
- **False nostril cysts** in horses
- **Wattle cysts** in goats

Cysts may occur anywhere on the body, but most commonly they are found near the dorsal midline. In horses a common site is the base of the ear.

Other diseases that cause cutaneous nodules in horses include collagenolytic granuloma, mastocytosis, amyloidosis, lymphoma, sarcoidosis, and infestation with *Hypoderma* spp.

Surgical excision for cosmetic reasons is common practice.

## GRANULOMATOUS LESIONS OF THE SKIN

Granulomatous lesions are chronic inflammatory nodules, plaques, and ulcers; they are cold, hard, and progress slowly, often accompanied by lymphangitis and lymphadenitis. In many cases there is no cutaneous discontinuity or alopecia. Some of the common causes in animals are as follows.

### Cattle

- Bovine farcy caused by *M. farcinogenes* and *M. senegalense*
- Actinobacillosis (botryomycosis) caused by *Actinobacillus lignieresii*

- Infestation with *Onchocerca* spp.
- Infestation with larvae of *Hypoderma* spp.
- Infection with *Mucor* spp. fungi in thick-walled nodules in the skin on the posteroventral aspect of the udder
- Lechiguana associated with the sequential infection with *Dermatobia hominis* and *Mannheimia granulomatosa*. The condition has been reported in Brazilian cattle, which develop very large granulomata consisting of fibrous tissue that develop in subcutaneous sites in any part of the body.<sup>1</sup>

### Sheep

- Strawberry footrot—*D. congolensis*
- Ecthyma
- Ulcerative lesions of lower jaw and dewlap associated with *A. lignieresii*

### Horses

- Tumorous calcinosis, which causes hard, painless, spherical granulomata, up to 12 cm in diameter, near joints and tendon sheaths, especially the stifle joint
- Cutaneous amyloidosis
- Collagenolytic granuloma (nodular necrobiosis)—the most common nodular skin disease of the horse. The etiology is unknown. There are multiple firm nodules located in the dermis, ranging in size from 0.5 to 5 cm in diameter. The overlying skin surface and hair are usually normal. Biopsy reveals collagenolysis. Treatment consists of surgical removal and possibly the administration of corticosteroids.
- Botryomycosis, or bacterial pseudomycosis, results from bacterial infection at many sites, often accompanied by a foreign body. Lesions on the limbs, brisket, ventral abdomen, and scrotum vary in size from nodules to enormous fungating growths composed of firm inflammatory tissue riddled by necrotic tracts, leading to discharging sinuses, often containing small yellow-white granules or “grains.” Surgical excision is the only practicable solution.
- Equine eosinophilic granuloma—nonalopecic, painless, nonpruritic, firm nodules, 2 to 10 cm in diameter and covered by normal skin, develop on the neck, withers, and back of horses, especially in the summer. The cause is unknown, and palliative treatment, surgical excision, or corticosteroid administration is usually provided.
- Systemic granulomatous disease (equine sarcoidosis)—a rare disease of horses characterized by skin lesions and widespread involvement of the lungs, lymph nodes, liver, gastrointestinal tract, spleen, kidney, bones, and central nervous system

- *Burkholderia mallei*—cutaneous farcy or glanders
- *Actinomadura* spp. and *Nocardia brasiliensis*—painless mycetomas
- *Histoplasma farciminosum*—epizootic lymphangitis
- *Corynebacterium pseudotuberculosis*—ulcerative lymphangitis
- *Habronema megastoma* and *Hyphomyces destruens* as causes of swamp cancer, bursattee, Florida horse leech, and blackgrain mycetoma
- Infestation with *Onchocerca* spp.
- Chronic urticaria

### Pigs

- *Actinomyces* spp. and *B. suilla* cause lesions on the udder.

### REFERENCE

1. Andrade GB, et al. *Vet Res Comm.* 2008;32:65-74.

## Non-Infectious Diseases of the Skin

### INSECT BITE HYPERSENSITIVITY IN HORSES (EQUINE SEASONAL ALLERGIC DERMATITIS)

Insect bite hypersensitivity (IBH) is an intensely pruritic dermatitis of horses caused by hypersensitivity to insect bites, especially *Culicoides* spp. and, less frequently, *Simulium* spp.

#### ETIOLOGY

The disease is caused by type I (immediate) hypersensitivity to salivary antigens introduced into the skin by the bites of sandflies and other insects. There may be a lesser role for type IV (cell-mediated) hypersensitivity in the disease. *Culicoides brevitarsus* is the cause in Australia, *Culicoides pulicaris* in the United Kingdom and Europe, and *Culicoides obsoletus* in Canada. *Stomoxys calcitrans*, the stable fly, and *Simulium* spp. cause the disease. The distribution of the skin lesions and seasonal nature of the disease are related to the feeding habits of the inciting insect. For instance, *C. pulicaris* has a predilection for landing at the mane and tail, and this is where the lesion is most commonly seen.

#### EPIDEMIOLOGY

The prevalence of the disease varies depending on environmental factors, and possibly characteristics of the local horse population. Up to 60% of horses are reported to be affected in areas of Queensland, Australia; 22% in Israel; and 18% of Icelandic horses in Norway. The prevalence in Switzerland is very low in regions above 1000 m and 1.6% in lower areas. The prevalence of the disease in Dutch Shetland Ponies (>7000) assessed over 3 years was 8.8%.<sup>1</sup>

The disease is quite common worldwide in areas where **hot and humid summer**

**weather** favors the causative insects: Sweden, the United Kingdom, Japan, Israel, Hong Kong, North America, Australia, the Philippines, India, and France. Most cases occur during **summer**, and lesions disappear during cooler weather. Lesions disappear when the horses have been stabled in insect-proof barns for several weeks or are moved outside the geographic range of the inciting insect.

The disease is characteristically sporadic and affects only a few of a group of horses. However, because the predilection to the disease is inherited, there may be multiple cases among related animals on a farm. The prevalence of the disease increases with age; 3.4% of Icelandic horses 1 to 7 years of age compared with 32% of horses older than 14 years were affected.

The disease has a demonstrated genetic basis in some breeds, including heritability of 0.08 (standard error [SE] = 0.02) on the observed binary scale and 0.24 (SE = 0.06) on the underlying continuous scale in Dutch Shetland ponies.<sup>1</sup> Variants in the major histocompatibility complex (MHC) class II region are associated with disease susceptibility, with the same allele (COR112:274) associated with the disease in Icelandic ponies and Exmor ponies. In addition, homozygosity across the entire MHC class II region is associated with a higher risk of developing the disease ( $p = 0.0013$ ).<sup>2</sup> Genes not encoding MHC and associated with IBH in Old Kaldruby horses include interferon gamma (IFNG), transforming growth factor beta 1 (TGEB1), Janus kinase 2 (JAK2), thymic stromal lymphopoietin (TSLP), and involucrin (IVL).<sup>3</sup> Expression of genes associated with allergy and immunity in the skin of affected horses indicates a role for these pathways in the disease.

#### PATHOGENESIS

Reaginic antibodies (IgE) produced in response to exposure to proteins in insect saliva bind to mast cells in the skin; when exposed to the antigen, they are associated with degranulation of the mast cell. Horses with IBH have IgE antibodies that react with constituents of the salivary gland of *Culicoides* spp., whereas horses that do not have the disease have IgG, but not IgE, antibodies against *Culicoides* spp. salivary gland antigens. Horses that have not been exposed to *Culicoides* spp. do not have either antibody to the insect salivary gland antigen. IgE antibodies against *Culicoides* spp. are present on a seasonal basis in horses that do not have evidence of the disease, indicating that the presence of these antibodies, although necessary for development of the diseases, is not sufficient and that other factors are involved.<sup>4</sup>

The antigen in saliva of *Culicoides* sp. and *Simulium* spp. has identical IgE epitopes, demonstrating that the disease in some horses is caused by IgE-mediated cross-reactivity to homologous allergens in the



saliva of both species.<sup>5</sup> A specific antigen in midge (*Culicoides sonorensis*) saliva associated with IgE reagenic antibodies and causing both in vivo and in vitro activity mimicking IBH is a 66 kDa protein referred to as Cul s 1.<sup>6</sup>

**Degranulating mast cells** and intradermal or subcutaneous lymphocytes release various vasoactive substances and cytokines that cause inflammation and accumulation of eosinophils in the skin of affected areas and eosinophilia. The distribution of the lesions on patients reflects the insects' preferred feeding sites. Ponies with seasonal allergic dermatitis have greater numbers of circulating CD5+ and CD4+ T lymphocytes than do normal animals. Increased numbers of CD3+ T lymphocytes, most of which are CD4+, and eosinophils are present in the skin of affected ponies after injection of *Culicoides* antigen. Furthermore, in eotaxin and monocyte chemoattractant protein (MCP) 1, but not MCP-2 or MCP-4, mRNA expression is upregulated in skin biopsies of sweet itch lesions, demonstrating a mechanism for accumulation of eosinophils and T-2 lymphocytes in the lesions.

### CLINICAL FINDINGS

**Lesions** are usually confined to the base of the tail, rump, along the back, withers, crest, poll, ears, and, less commonly, ventral midline. In severe cases the lesions may extend down the sides of the body and neck and onto the face and legs.

**Pruritus** is intense, especially at night, and the horse scratches against any fixed object for hours at a time. In the early stages, slight, discrete papules, with the hair standing erect, are observed. Constant scratching may cause self-mutilation, severe inflammatory lesions, and loss of hair. Scaliness and loss of hair on the ears and tail base may be the only lesions in mildly affected horses.

### CLINICAL PATHOLOGY

Affected animals have **eosinophilia** and thrombocytosis.

**Diagnosis** is facilitated by skin biopsy, fungal culture, parasitologic examination of skin scrapings, and intradermal sensitivity testing. **Skin biopsy** of early lesions, before trauma masks the true picture, reveals edema, capillary engorgement, and eosinophilic and mononuclear perivascular infiltration. Fungal culture and parasitologic examination of **skin scrapings** are useful only in that they rule out dermatophytosis, onchocerciasis, and strongyloidosis. **Intradermal skin testing** demonstrates immediate and delayed sensitivity reactions to extracts of *Culicoides* spp. and *Stomoxys* spp. Recommended concentrations of insect antigen in the testing solution are 60 to 250 PNU per mL,<sup>7</sup> or 1:1000 w/v concentration of *Culicoides* spp. extracts relevant to the locality, providing useful support for a clinical diagnosis of equine insect hypersensitivity.<sup>8</sup>

Testing of serum for specific IgE antibodies holds potential for enhancing diagnostic strategies, but because of the detection of IgE antibodies against *Culicoides* spp. and *Simulium* spp. antigens in healthy horses,<sup>4</sup> the poor concordance between results of skin hypersensitivity testing and serum IgE concentration,<sup>9</sup> and the poor performance of serologic testing with enzyme-linked immunosorbent assay (ELISA) that uses the high-affinity IgE receptor (Fc epsilon R1 alpha),<sup>10</sup> serologic testing is currently not recommended.

### DIFFERENTIAL DIAGNOSIS

Infection with larvae of *Onchocerca* spp., *Strongyloides* spp., or *Dermatophilus congolensis* can produce similar lesions. Alopecia of the tailhead may be caused by *Oxyuris equi*.

### TREATMENT

The principles of treatment are removal of the inciting cause and suppression of the hypersensitivity reaction.

**Removal of the inciting cause** is achieved by preventing horses from being exposed to the inciting insects. This can be achieved by relocating the horse to a geographic region where the insects do not occur, stabling of the horse in an insect-proof stable during the periods of the day (early evening) when the insects are most active, or applying agents that kill the insects or otherwise prevent them from alighting on and biting the horse.

**Suppression of the immediate hypersensitivity reaction** or its sequelae can be achieved by administration of corticosteroids (prednisolone, 1 mg/kg orally every 24 hours initially, then reducing to as low of a maintenance dose as possible).

Hyposensitization (allergen-specific immunotherapy) has received attention for its potential efficacy in desensitizing affected horses. Two controlled clinical trials did not demonstrate a beneficial effect (although the placebo effect on the owners was impressive) in a representative sample of horses. These trials were blinded and used objective measures of efficacy.<sup>11</sup> A retrospective study using owner-reported responses (reduction in antipruritic therapy) found a response in 57% of horses.<sup>12</sup> There is insufficient high-quality evidence to support use of allergen-specific immunotherapy as routine treatment for IBH.

### CONTROL

#### Reduce Exposure to Biting Midges

Horses should be housed in insect-proof buildings or, at a minimum, buildings that limit exposure of horses to midges by closure of doors and covering of windows with gauze. Impregnation of gauze with an insecticide further reduces biting rates. Stables should be situated in areas that have minimal

midge populations, such as on hilltops or well-drained sites. Midge numbers on individual farms should be reduced by habitat alteration, so that areas of damp, organically enriched soils are eliminated.<sup>13</sup> Widespread use of insecticides is unlikely to be environmentally acceptable.

The feeding pattern of midges is such that housing of horses during the crepuscular periods and at night will significantly reduce biting rates and likelihood of infection. Horses kept at pasture should have insect repellents applied regularly and especially to provide protection during periods of high insect-biting activity. Diethyltoluamide, or DEET (*N,N*-diethyl-*meta*-toluamide), is the only commercially available repellent with documented activity against *Culicoides* spp. Application of deltamethrin (10 mL of 1% solution) to the skin of horses did not reduce the frequency of midge feeding in an experimental trial in the United Kingdom.<sup>14</sup> Installation of alphacypermethrin-impregnated mesh in jet stalls reduced the attach rate of *Culicoides* spp. by 6- to 14-fold and markedly reduced the number of *Culicoides* spp. insects collected from horses housed in the stalls compared with sentinel horses, suggesting that this might be a useful means of reducing exposure of housed horses to midges.<sup>15</sup>

### REFERENCES

- Schurink A, et al. *J Anim Sci*. 2009;87:484.
- Andersson LS, et al. *Immunogenetics*. 2012;64:201.
- Vychodilova L, et al. *Vet Immunol Immunopath*. 2013;152:260.
- Wilkolek PM, et al. *Polish J Vet Sci*. 2014;17:331.
- Schaffartzik A, et al. *Vet Immunol Immunopath*. 2010;137:76.
- Langner KFA, et al. *Int J Parasit*. 2009;39:243.
- Baxter CG, et al. *Vet Dermatol*. 2008;19:305.
- van Oldruitenborgh-Oosterbaan MMS, et al. *Vet Dermatol*. 2009;20:607.
- Morgan EE, et al. *Vet Immunol Immunopath*. 2007;120:160.
- Frey R, et al. *Vet Immunol Immunopath*. 2008;126:102.
- Ginel PJ, et al. *Vet Dermatol*. 2014;25:29.
- Stepnik CT, et al. *Vet Dermatol*. 2012;23:29.
- Carpenter S, et al. *Med Vet Ent*. 2008;22:175.
- Robin M, et al. *Vet Rec*. 2015;176.
- Page PC, et al. *Vet Parasitol*. 2015;210:84.

### SEASONAL ALLERGIC DERMATITIS OF SHEEP

A disease similar to seasonal dermatitis (insect bite hypersensitivity) of horses (see "Equine Seasonal Allergic Dermatitis," in this chapter) occurs in sheep in the United Kingdom, Brazil, Israel, and likely elsewhere.<sup>1-3</sup> The disease is also reported in goats in Brazil and suspected in New World camelids (alpaca) in New York State.<sup>4,5</sup> Up to one-third of a sheep flock can be affected, with the disease remitting and affected sheep appearing to fully or almost fully recover during the dry season in Brazil, or during winter in higher latitudes.<sup>1</sup> Because of the seasonal appearance of the disease during periods



**Fig. 16-1** Lesions of seasonal allergic dermatitis in a Hampshire Down sheep. (Reproduced with permission from Correa TG et al. *Vet Parasitol* 2007; 145:181.)

when midges are present or most active, a cutaneous sensitivity to *Culicoides* spp., especially *C. obsoletus* in the United Kingdom or *Culicoides insignis* in Brazil, is suspected.<sup>6</sup> Cutaneous sensitivity to ground-up *Culicoides* spp. is present in affected sheep, and observed bites by *C. insignis* in sheep in Brazil caused pruritus.<sup>6</sup> Allergic dermatitis occurs in sheep infested with fleas (*Ctenocephalides* spp.), although rarely are sheep infested by fleas.<sup>7</sup> Similar skin lesions can occur in sheep infested with lice (*Bovicola ovis*) or scabies (*Psoroptes ovis*).<sup>8</sup> The equivalent disease in horses has a genetic basis, and this should be considered in sheep.<sup>2,9</sup>

The lesions are similar to those in horses and are located principally on the teats, udder, and ventral midline, but also on the tips of the ears, around the eyes, and on the nose and the lips (Fig. 16-1). Initially there is erythema and small red papules followed by development of alopecia and crust formation. The skin of the affected sheep is whitish and irregularly thickened, with alopecia, crusts, and intense pruritus. Histologically the lesions represent the changes characteristic of immediate (type I) hypersensitivity, evident as perivascular eosinophilic dermatitis.<sup>6</sup> Histologic lesions of the epidermis are hyperkeratosis, acanthosis, hypergranulosis, and moderate spongiosis with infiltration of the dermis by eosinophils, macrophages, and plasma cells. There are no diagnostic changes in the differential blood count. Treatment, if provided, should include topical or systemic administration of antihistamines or corticosteroids, although both might be restricted for use in food animals, and there is no formal evidence of efficacy. Affected animals recover when they are not exposed to midges.<sup>1</sup> Control is based on preventing or minimizing exposure to midges.

A very similar disease occurs in cattle in Japan. It is thought to be a result of an allergy to the bite of an external parasite.

## REFERENCES

1. Portela RA, et al. *Pes Vet Brasil*. 2012;32:471.
2. Shrestha M, et al. *J Heredity*. 2015;106:366.
3. Yeruham I, et al. *Vet Rec*. 2000;147:360.

4. Macedo JTSA, et al. *Pes Vet Brasil*. 2008;28:633.
5. Scott DW, et al. *Vet Dermatol*. 2011;22:2.
6. Correa TG, et al. *Vet Parasitol*. 2007;145:181.
7. Yeruham I, et al. *Vet Dermatol*. 2004;15:377.
8. Shu D, et al. *Vet Immunol Immunopath*. 2009;129:82.
9. Schurink A, et al. *J Anim Sci*. 2009;87:484.

## ANHIDROSIS (NSWEATING SYNDROME, PUFF DISEASE, DRY COAT)

Anhidrosis refers to the reduced or absent capacity to produce sweat. It affects horses and cattle. Reduced ability to sweat affects horses in hot and humid climates. Affected horses are unable to maintain their body temperature within safe limits, especially during or after exercise, and suffer heat stress and a reduction in athletic performance. The only effective treatment is to move the horses to a cooler environment.

## ETIOLOGY

The etiology of anhidrosis is unknown, but it involves a reduction in the sensitivity of the sweat gland to  $\beta$ -2 adrenergic stimulation, the normal stimulus for sweating in the horse. Hypothyroidism does not contribute to anhidrosis, although anhidrotic horses have an exaggerated thyroid-stimulating-hormone response to administration of thyroid-releasing hormone.<sup>1</sup> The etiologic or pathogenic importance of this observation is unclear.

## EPIDEMIOLOGY

The disease occurs in horses, and rarely in cattle, in countries with hot, humid climates, including tropical and semitropical regions.

The overall prevalence in horses is approximately 2% to 6% in Florida, with the highest prevalence in southern Florida (4.3%) and lowest in northern Florida (0.08%).<sup>2</sup> The prevalence of affected farms is 11%. There is no reported sex or color predilection. Thoroughbred horses and Warmblood horses in Florida are 4.4 (95% confidence interval [CI] 1.2 to 15.5) times and 13.9 (2.5 to 77.5) times as likely to have the disease as are Quarter horses.<sup>2</sup> None of 190 Arabian horses were affected.<sup>2</sup> Horses with a family history of the disease are approximately 6 times more likely to be affected.<sup>2</sup>

Both native and imported horses are affected, although horses born in the western and midwestern United States are at 2.5 times the risk of developing the disease as are native-born horses.<sup>2</sup> Among native horses, the age of onset of the condition ranges from 1 year to 10 years. Foals, especially of draft breeds, can be affected. Horses imported to endemic areas usually do not develop the disease within 1 year. The incidence and severity of the disease are highest in the hotter season, with most affected horses first exhibiting signs of the disease in the summer.<sup>2</sup>

The disease is rarely fatal unless severely affected horses are exercised in the heat, in

which case death from heat stroke can occur. The major importance of the disease is the inability of affected horses to exercise and compete in athletic events.

## PATHOGENESIS

Sweat is produced in horses by apocrine sweat glands that have a single type of secretory cell. The sweat glands are epitrichial (associated with a hair follicle) and have a density of about 800 per square centimeter, with a greater volume density of sweat glands in the summer compared with winter, in skin of healthy Thoroughbreds.<sup>3</sup> Evaporation of sweating is responsible for elimination of approximately 70% of the heat load of exercising horses (with a further ~20% attributable to evaporation from the respiratory tract).<sup>4</sup> Evaporation is essential for heat transfer because the latent energy of evaporation of 1 mL of water is 2.2 kJ (2260 kJ/kg of water). High heat transfer from the horse to the environment is possible because of the **high sweating rate** of strenuously exercising horses of up to 3300 g per meter square of skin surface area per hour or 10 to 12 liters per horse per hour.<sup>4</sup> The sweat of horses during exercise is alkaline (pH 8.0 to 8.9), is slightly hyperosmolar compared with plasma (290 to 340 mm Osmol), and has sodium concentrations that approximate those of plasma, potassium concentrations approximately 10 times those of plasma, and chloride concentrations double those of plasma.

The sweat glands are well innervated, and sweating is controlled by a combination of hormonal ( $\beta$ -2 adrenergic) and neural factors.<sup>4</sup> The apocrine sweat glands respond in vitro to both purinergic stimuli, including adenosine triphosphate (ATP), adenosine diphosphate (ADP), and uridine triphosphate (UTP), and application of isoprenaline, a  $\beta$ -agonist.<sup>5,6</sup> Both  $\beta$ -adrenoreceptor and purinergic receptors are present on the basolateral aspects of the sweat glands, but not the apical aspect.<sup>6</sup> Responses to isoprenaline or purinergic stimulants by sweat glands of anhidrotic horses are much reduced compared with those of sweat glands from unaffected horses.<sup>6</sup> The defect in sweating of anhidrotic horses is a consequence of failure of the gland to respond to either of the agonists for sweat production. This breakdown of cellular secretory function is thought to be the prime cause of lack of sweating, as opposed to earlier suggestions of obstruction of the sweat gland duct.<sup>6</sup>

Sweat production increases with increasing concentrations of epinephrine in blood up to a peak value, after which sweating rates decline. Anhidrotic horses have lower initial and peak rates of sweat production and lower overall sweat production than do normal horses during intravenous (IV) infusion of epinephrine.<sup>7</sup> Suggested, but unproved, mechanisms for decreased sweat production by anhidrotic horses includes diminished glandular sensitivity to epinephrine, failure

of secretory function, blocking of sweat gland ducts, fatigue of the gland, and gland atrophy.

Sweating is the predominant means by which horses dissipate heat. Reduction in the capacity to produce sweat results in an inability to effectively control body temperature during exercise and when temperature and humidity are high. The elevation in body temperature results in tachypnea in an attempt to dissipate heat through the respiratory tract. Hyperthermia impairs performance and, if severe, can result in heat shock, a systemic inflammatory response syndrome, and death.

### CLINICAL FINDINGS

The most apparent clinical sign is lack of sweating in response to an appropriate stimulus, such as exercise. In severely affected horses, sweating is limited to the perineum, brisket, and areas under the mane and saddle. Less severely affected horses have a diminished sweat response and do not lather during exercise. The skin becomes dry and scurfy and loses its elasticity, and there may be alopecia, especially of the face.

Affected animals become extremely tachypneic when heat stressed, leading to the colloquial term for the disease, “dry puffer.”<sup>1</sup> Affected horses have abnormally high respiratory rates after exercise that persist for at least 30 minutes after 30 minutes of lunging exercise. Affected horses have a respiratory rate twice that of healthy horses after exercise (60 bpm vs. 120 bpm).<sup>1</sup> The animal's appetite declines, and it loses weight. Athletic performance is severely compromised. Affected horses have higher body temperatures during exercise than unaffected horses, and this difference can persist for at least 30 minutes.<sup>1</sup>

**Diagnostic confirmation** is achieved by demonstrating reduced sweating in response to intradermal injection of epinephrine or the  $\beta$ -2 adrenergic agonists terbutaline and salbutamol. A crude test involves the intradermal injection of 0.1 mL of a 1:1000 dilution of epinephrine. If the horse sweats, then it is not considered to be completely anhidrotic. A semiquantitative test using epinephrine, terbutaline, or salbutamol may be useful in identifying partially anhidrotic horses. Normal horses sweat when 0.1 mL of 1:1,000,000 epinephrine is injected, whereas partially anhidrotic horses sweat only with higher concentrations (1:10,000 or 1:1000). Injections are usually made using small-gauge needles (25 g) into the skin over the lateral aspects of the neck. Terbutaline (0.1 mg/mL) injected intradermally induces sweating in approximately 4 minutes (+/- 1.7 min) in healthy horses and 10.5 minutes (+/- 7 min) in anhidrotic horses.<sup>1</sup>

A further refinement is the **quantitative intradermal terbutaline** sweat test in which 0.1 mL of solutions of terbutaline of 0.001, 0.01, 0.1, 1, 10, 100, and 1000 mg/mL are injected into the skin of the horse.<sup>8</sup>

Preweighed absorbent pads are then taped over each site, removed after 30 minutes, and weighed. The amount of sweat produced is quantified as the change in weight of the pad. This technique, although not described in anhidrotic horses, provides a means of quantifying the sweat test.

The **prognosis** is poor for athletic function for affected animals that remain in hot and humid environments, but the condition may resolve if the horse is moved to a cool climate.

### CLINICAL PATHOLOGY

Plasma epinephrine concentrations are reported to be higher in affected horses than in unaffected horses, but this has not been a consistent finding among studies.

### NECROPSY FINDINGS

There are no characteristic gross lesions at necropsy. Histologic examination of the skin of affected horses reveals abnormalities in sweat gland morphology, including flattening of cells, loss of luminal microvilli, and a reduction in the number of secretory vesicles.<sup>7</sup> These findings are thought to be a consequence, rather than a cause, of the disease.

### TREATMENT AND CONTROL

There is **no specific treatment** that restores the horse's ability to sweat, other than movement to a cooler climate. Affected horses for which translocation to a cooler environment is not feasible benefit from housing in air-conditioned stables so that exposure to high ambient temperatures is minimized. Exercise of affected horses during the coolest periods of the day is sensible. Affected horses are frequently administered **electrolyte supplements**, but these are without demonstrated benefit. However, as with all working horses, an adequate intake of sodium, potassium, and chloride should be ensured.

Administration of **thyroid hormone supplements** is not warranted and might be dangerous because they cause an increase the metabolic rate, and therefore heat production, of affected horses. **Vitamin E** administration has no demonstrated efficacy.

Removal of affected animals to cooler climates is often necessary, although air-conditioning of stables and maintenance of horses in higher country where they can be returned after a day's racing may enable susceptible horses to be kept locally.

### FURTHER READING

- Jenkinson DM, Elder HY, Bovell DL. Equine sweating and anhidrosis part 1: equine sweating. *Vet Derm.* 2006;17:361-392.
- Jenkinson DM, Elder HY, Bovell DL. Equine sweating and anhidrosis part 2: anhidrosis. *Vet Derm.* 2007;18:2-11.

### REFERENCES

- Breuhaus BA. *J Vet Int Med.* 2009;23:168.
- Johnson EB, et al. *J Am Vet Med Assoc.* 2010;236:1091.

- Sneddon JC, et al. *Vet Dermatol.* 2008;19:163.
- Jenkinson DM, et al. *Vet Dermatol.* 2006;17:361.
- Bovell DL, et al. *Vet Dermatol.* 2013;24:398.
- Wilson DCS, et al. *Vet Dermatol.* 2007;18:152.
- Jenkinson DM, et al. *Vet Dermatol.* 2007;18:2.
- MacKay RJ. *Equine Vet J.* 2008;40:518.

### WETNESS (MACERATION)

Frequent exposure to wetting, sufficient to keep the skin permanently wet for long periods, results in maceration with loss of dermal integrity and predisposes to fleece rot in sheep and mycotic or bacterial dermatitis in all species. In horses it leads to a superficial dermatitis along the dorsum, especially over the croup, and is known as scald. Frequent immersion of the lower limbs of cattle on irrigated pasture causes dermatitis on the backs of the pasterns, leading to mycotic dermatitis. Digital dermatitis of cattle can be induced by prolonged wetness of the skin, resulting in maceration, and inoculation with *Treponema* spp.<sup>1</sup> Wetting also predisposes to hypothermia in the young.

Standing in cold water for a period of more than 3 days causes the immersed parts to become edematous and congested and slough their skin in the form of a cuff around the limb. Recovery is slow and incomplete.

### REFERENCE

- Gomez A, et al. *J Dairy Sci.* 2012;95:1821.

### COCKLE

Cockle is a superficial nodular dermatitis of sheep recorded only in New Zealand that results in nodules in the skin that are of economic importance to the leather industry. The presence of cockle downgrades the value of the pelt, which is rendered unsuitable for suede and clothing.

Cockle is not usually diagnosed clinically, but examination by close inspection of the skin over the upper shoulder region after close shearing has high specificity for detection. The lesions are the result of an immune response in some sheep to infestation with the biting louse *B. ovis*. The occurrence of cockle and its severity are positively correlated with the severity of the louse infestation, and sheep that develop lesions have *B. ovis*-specific homocytotropic antibody. Serum histamine concentrations are significantly higher in louse-infested lambs than louse-naïve lambs.

Lesions commence on the neck and shoulders and may extend over the entire pelt. Widely distributed lesions, termed scatter cockle, are attributed to infestation with *B. ovis*, and this is the most common cause, but rib cockle may be a hypersensitivity to infestation with the sheep ked *Melophagus ovinus*. Pelt lesions in the dorsal midline region are usually a result of infection with *D. congolensis*.



## CONTROL

Control rests with the control of *B. ovis*. For cockle control, sheep should be treated off-shears with pour-on or spray-on insecticide and, as soon as practical after shearing, treated by saturation dipping. Saturation dipping is required to significantly reduce louse populations. Prelambing dipping is also recommended to reduce the risk of lambs acquiring louse infestations.

## FURTHER READING

Radostits O, et al. Cockle. In: *Veterinary Medicine: A Textbook of the Disease of Cattle, Horses, Sheep, Goats and Pigs*. 10th ed. London: W.B. Saunders; 2007:2041.

## WOOL SLIP, WOOL LOSS

Wool slip is a condition in which housed ewes, shorn in winter, lose part of their fleece and develop bald patches over a large area of the rear half of the back. This commonly starts at the base of the tail and progresses to the rump and back and less commonly the neck. There is no systemic disease; the skin is normal. Histologic examination of skin biopsies shows that in affected sheep the wool follicles are in the active anagen stage rather than the inactive telogen phase of unaffected cohort sheep, and the wool regrows immediately following loss. The loss of wool starts 2 to 3 weeks after shearing. All breeds are equally susceptible, and there is no effect of age or whether the sheep are carrying single or twin lambs; up to 40% of a flock may be affected. The wool loss occurs because of a premature and synchronized shedding of wool fibers and not because of a pathologic process that damages the wool fiber. Wool shedding can be induced experimentally by prolonged treatments with corticosteroids, and the current explanation for the wool shedding that occurs with the wool-slip syndrome is that blood corticosteroid levels rise after the stress of shearing and are maintained for a long period because of the trauma of being housed and shorn and kept in the cold. Blood zinc concentrations in sheep affected with wool slip are within the normal range, and there is no epidermal change as occurs in zinc deficiency.

The prevention of the condition is aimed at reducing the severity and length of the stress period by shearing the sheep at the time of entry to winter housing and ensuring a good nutritional plane in the postshearing period. This hypothesis as to cause may not be correct because the syndrome has also been seen in the summer in Wiltshire shorn sheep that had little history of stress in the period immediately preceding the wool slip.

Wool slip should not be confused with the normal shedding of wool that occurs in breeds such as the Wiltshire or Shetland in the spring period. Loss of wool along the

backline also occurs in older longwool sheep and may be exacerbated by lambs playing or sleeping on the ewe.

Impairment of wool growth and a thinning of fiber diameter can occur during the course of any severe disease, such as blue-tongue, pregnancy toxemia, or footrot, temporarily affecting the growth of the fleece. This results in a segment of the wool fiber that has decreased tensile strength, and the condition has the name *tender wool*. Following recovery from the inciting disease the wool growth is normal, but there is a line of wool with poor tensile strength in the staple. This can be observed in the intact fleece as a line of decreased fiber diameter, often with a change in crimp character and discoloration as a result of entrapment of dust. The wool may break if the staple on either side of this break is sharply snapped between the fingers. The fleece may subsequently be shed in part or in whole at the level of the defect, a condition known as wool break. Tender wool downgrades the value of a fleece and has economic significance in wool-producing sheep.

Zinc deficiency can reduce keratinization, reduce wool growth, and occasionally result in fleece loss in sheep. Wool loss associated with pruritus occurs in association with external parasite infestations and with scrapie and pseudorabies in ruminants.

*Pelodera* dermatitis, characterized by thickening of the skin and complete wool loss in affected skin areas, has been recorded in winter-housed sheep where there was poor bedding management. The condition affected the majority of the ewes at risk. The parasite *Pelodera (Rhabditis) strongyloides* is a free-living nematode commonly present in decaying organic material but can invade hair follicles to produce an inflammatory response. Histologic examination of the skin showed the presence of the parasite in wool follicles and infiltration of eosinophils and mast cells in connective tissue. Affected skin areas were those that had contact with the bedding when the sheep were lying down, and large numbers of the nematode were found in the bedding. Clinical signs regressed with the more frequent provision of new bedding and disinfection of the stable.

## WOOL EATING

Wool eating can occur as a result pica associated with micronutrient deficiency. A condition called *shimao zheng*, occurring in a region of the Gansu province of China, has wool eating as its primary manifestation. The disease has a seasonal occurrence, with the peak incidence in January through April. Both goats and sheep are affected, but the incidence and severity are much higher in goats, where 90% may show signs. Affected animals bite the wool or hair off their own or other animals' bodies, particularly in the

hip, belly, and shoulder areas. Histology on biopsies shows heavily keratinized epithelial cells, a decreased number of hair follicles, and aggregated foci of lymphocytes in the dermis. Controlled trials have shown that the condition can be corrected by supplementation with sulfur, copper, and iron. Wool eating is also recorded in Israel, possibly associated with trace-element copper and zinc deficiency, and in housed superfine Merino sheep in Australia fed grain-based supplements, where it is corrected by the provision of roughage in the form of hay. Wool and hair loss in individual sheep and cattle in association with excessive licking have been recorded and are postulated as psychogenic dermatoses.

## FURTHER READING

Radostits O, et al. Wool slip, wool loss. In: *Veterinary Medicine: A Textbook of the Disease of Cattle, Horses, Sheep, Goats and Pigs*. 10th ed. London: W.B. Saunders; 2007:2041-2042.

## IDIOPATHIC NASAL/PERIORAL HYPERKERATOTIC DERMATOSIS OF CAMELIDS (MOUTH MUNGE)

Idiopathic nasal/perioral hyperkeratotic dermatosis is a common skin condition of llamas and has anecdotally been reported in alpacas. The ailment is characterized by a thickening of the stratum corneum of the epidermis resulting in hyperkeratotic plaques and crusts in the perinasal and perioral region. Similar skin lesions may occur on the perineum, ventral abdomen, medial hind- and forelegs, axillae, and inguinal region, in which case the condition is more globally referred to as idiopathic hyperkeratosis.<sup>1</sup> The etiology of this condition is poorly understood but has been categorized as zinc-responsive dermatosis because cases responsive to high oral doses of zinc have been reported.

## CLINICAL FINDINGS

Individual animals of either sex between 6 and 24 months of age are commonly affected. Animals present with thick papular crusts and plaques covering the periocular and perioral area, occasionally obstructing the nostrils. Secondary dermatitis that waxes and wanes is common, but pruritus is usually mild or absent.<sup>2</sup>

## CLINICAL PATHOLOGY

The diagnosis is based on clinical presentation and by ruling out other differentials. Histologic examination of skin biopsies shows epidermal and follicular orthokeratotic hyperkeratosis that can be associated with dermal infiltration with lymphocytes, macrophages, and occasionally eosinophiles.<sup>1</sup> The degree of infiltration is dependent on the extent of secondary inflammation.<sup>3</sup> The treatment outcome of diagnostic therapy consisting of oral zinc supplementation will

contribute to confirming or refuting the diagnosis.<sup>3</sup>

The usefulness of measuring the serum zinc concentration in affected animals is doubtful because the condition could not be linked to subnormal plasma zinc concentrations in affected animals.<sup>4</sup>

#### DIFFERENTIAL DIAGNOSIS

Choriocytic mange  
Dermatophilosis  
Dermatophytosis  
Viral contagious pustular dermatitis  
Bacterial dermatitis

#### TREATMENT

Supplementing the diet with zinc, either by offering zinc-enriched feed or by supplementing organic or inorganic zinc, for a minimum of 2 months has been suggested. Current recommendations are to supplement either zinc sulfate (2 g/d and animal) or zinc methionine (4 g/d and animal) for a period of 2 to 3 months before reassessing the patient to determine the treatment effect.

Treatments targeting at resolving secondary dermatitis consist of local and/or systemic administration of antibiotics. The topical use of a 7% iodine tincture to control secondary dermatitis and of chlorhexidine-based shampoos to loosen hyperkeratotic crusts has been recommended. The use of topical or systemic glucocorticoids has been proposed in cases not responsive to antibiotic therapy.

#### TREATMENT

##### Oral treatment:

Zinc sulfate (2 g/d and animal q24 PO for 2 to 3 months) (Q2)  
Zinc methionine (4 g/d and animal q24 PO for 2 to 3 months) (Q2)

##### Topical treatment:

Chlorhexidine-based shampoo (3%, once to twice a week locally) (Q1)  
Topical treatment for secondary dermatitis:  
Iodine tincture (7%, once to twice a week locally) (Q2)  
Topical antibiotic skin ointments (based on culture and sensitivity testing to control secondary dermatitis) (Q2)  
Topical skin ointments containing glucocorticoids in cases unresponsive to antibiotics (Q2)

##### Systemic treatment:

Systemic antibiotics (based on culture and sensitivity testing to control secondary dermatitis) (Q2)  
Systemic glucocorticoids in cases unresponsive to oral zinc supplementation and antibiotic therapy (Cave: pregnant animals) (Q2)

#### REFERENCES

1. Foster A, et al. *In Pract*. 2007;29:216-223.
2. Scott DW, et al. *Vet Dermatol*. 2010;22:2-16.
3. Zanolari P, et al. *Tierarztl Prax*. 2008;36:421-427.
4. Clauss M, et al. *Vet J*. 2004;167:302-305.

## Bacterial Diseases of the Skin

### METHICILLIN-RESISTANT STAPHYLOCOCCUS AUREUS

Staphylococcal skin disease in animals<sup>1</sup> is not uncommon and includes udder dermatitis in cattle; secondary infections to choriocytic mange or orf in goats (may also be *S. chromogenes* and occasionally *S. hyicus*); dermatitis of the head in sheep; and in pigs, usually *S. hyicus* but also possibly *S. sciuri*, *S. rostri*, *S. pasteurii*, *S. hominis*, *S. warneri*, *S. hemolyticus*, *S. epidermidis* (may be methicillin resistant), and *S. chromogenes*.<sup>2</sup>

#### INTRODUCTION

Methicillin (formerly meticillin in the United Kingdom) was introduced into human medicine in the 1950s to treat penicillinase-resistant *S. aureus* (SA).

Methicillin-resistant *S. aureus* (MRSA) strains have an altered protein-penicillin binding protein (PBP2a) that has a low affinity for all beta-lactam antibiotics (i.e., penicillins and cephalosporins). The protein is encoded by the *mecA* gene.

The MRSA strains may also have or not have a penicillinase enzyme (a beta-lactamase). *Spa*-typing is a method of typing *S. aureus* based on repeats located on several housekeeping genes.

Multilocus sequence typing (MLST) is a method of typing based on the sequence of several housekeeping genes. Similar sequence types may be grouped together in clonal complexes (CCs).

This protein is encoded by the gene *mecA*, which resides on a mobile genetic element called a staphylococcal chromosomal cassette (SCC*mec*). The detection of this gene is the best detection for MRSA.<sup>3</sup>

Methicillin is no longer used in human medicine, but oxacillin, nafcillin, and cloxacillin, which are very similar, are still used, although the resistance to these is usually lower than it is to methicillin.

The serious problem is that MRSA organisms are also often resistant to other antimicrobials, in particular aminoglycosides, macrolides, tetracyclines, and fluoroquinolones.<sup>4</sup>

#### Human Public Health

MRSA organisms cause infections, can be carried both persistently or intermittently, can colonize, and can also cause contamination. The infection can be mild or severe and sometimes fatal. There is a wide range of

human prevalence in many countries. In some countries, a certain lineage may be most common.

Over the years, the types found in humans will change as new clones arise and they introduce new toxins.<sup>5</sup> The type CC398 is the most common animal type isolated from humans and is associated with increased mortality and morbidity. It also carries endotoxin genes but has only once been associated with food poisoning.

These bacteria have been an important cause of nosocomial infections for over 40 years.<sup>6</sup>

Type CC398 is a poor persistent colonizer of humans.<sup>7</sup> It is also less transmissible than non-ST398 in humans and in Dutch animals.<sup>8</sup>

Very rarely are these large animal-associated MRSA organisms responsible for serious infections in humans, although they have been found in deep-seated infections in skin and soft tissue and in pneumonia and septicemia. However, in most cases these infections with hospital-acquired MRSA (HA-MRSA) are inapparent, except when there is stress, such as in surgical situations or in immunocompromised patients.

A new strain has arisen in the Netherlands with no link to existing established Dutch risk factors for acquisition. In one study, a quarter of the 5545 MRSA isolates were from defined risk groups; 26% were CC398, and 74% were non-CC398.<sup>9</sup> Increases in CC398 have occurred in patients with or without contact with livestock and have led to an increase in carriers and infections.<sup>10</sup> Over the period from 2002 to 2008, there was a 925% increase in the number of cases in the laboratory database. Most cases involved CC398, with *spa* type *t567* particularly overrepresented in sepsis and post-trauma osteomyelitis. CC398 was also more likely to be multiresistant than other types of MRSA. Simply put, the increase in CC398 has led to more carriers and infections.

MRSA accounts for approximately 20% of all bloodstream infections in U.S. hospitals and approximately 65% of the *S. aureus* infections in intensive care units, and it killed approximately 18,000 Americans in 2005.

#### Veterinarians

The carriage of MRSA by veterinarians in Australia attending a conference in 2009 has been investigated.<sup>11</sup> Industry and government veterinarians had the lowest levels of MRSA carriage at 0.9% prevalence. Those with horses as a major workload had 11.8% prevalence, and those on horse work only had 21.4% prevalence. Veterinarians with a dog and cat practice had 4.9% prevalence. The conclusion was that MRSA was an occupational hazard for those working in clinical practice in Australia.

A study of veterinarians showed that MRSA and livestock-associated MRSA (LA-MRSA) infection levels were 9.5% and 7.5%,

respectively, in Belgium and Denmark (all Danish MRSA are LA-MRSA). A strong association was found with live pigs.<sup>12</sup> At the 2008 meeting of the American College of Veterinary Surgeons, a survey sampled 341 people; 17% of the veterinarians and 18% of the technicians were positive for MRSA. Contact with small ruminants in the previous 30 days, living with a person with MRSA diagnosed in the previous year, and working where there is a person specifically in charge of an infection control program were associated with colonization.<sup>13</sup>

Veterinary students conducting diagnostic investigations were also sampled.<sup>14</sup> Thirty students visited 40 pork farms and found MRSA on 30% of the farms; 22% of the students picked up the infection following exposure, but all were clear within 24 hours of the visit.

### Pig Farmers

Thirty-five persons were screened for MRSA and sent on holiday; 27 of the farmers (77%) carried MRSA at least transiently. For 59% of the farmers, the infection was not cleared after the holiday away from pigs.<sup>15</sup>

### Butchers

Colonization of butchers with LA-MRSA has been documented in markets in Hong Kong;<sup>16</sup> 300 pork butchers were sampled, and 17 were positive. Although five strains were health-care associated, the high incidence of *t899* (CC9) suggests that cross-contamination from pork products occurs quite frequently.

### Animal MRSA

Animal MRSA strains are found in farm animals, and it is likely that people in contact with these animals and their families, such as veterinarians, farmers, farm workers, and abattoir workers, may acquire these organisms. In the European Union, there are many animal MRSA types, but the most common type in farm animals is CC398. It is found commonly in pigs, veal calves, and broiler chickens. This type does not appear to be a risk to abattoir workers. There is also no evidence, as yet, that this strain can cause infection or generate carriers in humans when found in food. Where workers work full time, the incidence of MRSA is higher, and less if part time.

In general, the presence of multiple virulence profiles within a MRSA genotype in an animal species suggests possible reverse zoonosis and the potential for new MRSA clones by gaining or losing additional genes.<sup>16</sup>

If the *staphylococci* are resistant, then treatment with antibiotics to which the *staphylococci* are resistant can increase the proportion of infected pigs and increase the numbers of bacteria present. Generally, MRSA organisms are poor responders to treatment, and infected patients have a high death rate.

For years, the problem was restricted to hospitals (HA-MRSA). These strains were the main group for over 40 years, and they are resistant to many antibiotics. Since then, the incidence of HA-MRSA has decreased and now only accounts for about 20% of all infections, particularly those occurring in intensive care units.

Community-associated MRSA (CA-MRSA) developed in the 1960s, and strains were found outside of hospitals. In particular, these strains were isolated from cats, dogs, and horses and consisted of *S. intermedius* and *S. pseudointermedius*. It is now estimated that CA-MRSA may account for about 13,000 infections annually that require hospitalization, with a resultant 1400 deaths.

In 2003, large-animal-associated MRSA (LA-MRSA) strains were discovered. These were largely CC398, as determined by MLST. In different countries various types are found. For example, in Germany CC5, CC9, and CC97 are often found. In a German study of 14,036 MRSA samples, there were 578 *spa* types.<sup>17</sup> Where there are large numbers of these, such as in pigs, the possibility of colonization and infection rises.<sup>18</sup> LA-MRSA strains share some virulence factors with human strains, but they also have distinct virulence factors.<sup>19</sup> Exchange of these genes encoding virulence factors may extend the host range and thereby threaten public health.

### ETIOLOGY

Three types of MRSA are currently recognized, as described in the previous sections: HA-MRSA, CA-MRSA, and LA-MRSA. Originally, the HA-MRSA strains were most common, then the CA-MRSA strains became problematic as the incidence of HA-MRSA decreased, and currently LA-MRSA strains are receiving increased attention.<sup>20</sup>

The CC398 (ST 398) type is 12 times more likely to be carried by pig farmers than nonfarmers, and cattle farmers are more than 20 times more likely to be carriers. LA-MRSA strains, which do not spread rapidly in the human population, emerged in the 1960s following poor response to treatment. It is now thought that half of the swine herds in Iowa carry LA-MRSA CC398. Pig farmers in Switzerland were found to be carriers of CC398.<sup>21</sup>

LA-MRSA strains were first described in a pig in 2003 and in other species in 2005 and 2007,<sup>22,23</sup> and since then cases have occurred in several countries.<sup>24-28</sup> LA-MRSA strains are an important source of infection in humans. It is thought that people spending a lot of time with pigs are at a higher risk of testing positive.<sup>29</sup> LA-MRSA strains were first noticed as spreading to humans in 2008 after cases reached hospitals in the Netherlands<sup>30</sup> and Denmark. Pig exposure has been cited as an important factor in LA-MRSA colonization in humans.<sup>31,32</sup> There is apparent transmission between pigs, pig farmers,

and their families.<sup>33</sup> Pig farmers are 760 times more likely to be colonized by LA-MRSA than the general population.<sup>22</sup> LA-MRSA strains are not typable by pulsed field gel electrophoresis (PFGE) because of the presence of a novel DNA methylation enzyme. For this reason, *spa* types have been isolated from pigs and their human contacts; however, the majority are classified as sequence type (ST) 398 by MLST, suggesting that ST398 strains are adept at colonizing pigs and can be transmitted between pigs and their human contacts.

MRSA infections spreading from dogs and horses to humans are not usually important causes of infection; they tend to be sporadic and involve human skin infection.

In one study, 4 out of 13 workers at a teaching and research farm had MRSA, but a variety of animals (dairy cattle, beef cattle, sheep, horses, pigs, and goats) did not.<sup>34</sup> A unique sequence was found in pigs in Europe, and it was found that the new MRSA clone ST398 belonged mainly to random *spa* types *t034*, *t011*, and *t108*. ST398 is considered the main reservoir of LA-MRSA infection, and it is the main type that subclinically affects pigs. The transmission of ST398 to humans is dependent on the intensity of the animal contact,<sup>35</sup> but spread to the local community is not very frequent.<sup>36</sup>

CC398 is the predominant clone in animals.<sup>37</sup> Genes confirming metal resistance are commonly found in CC398, and only a few non-CC398 types carry these genes. This suggests that the use of metal-containing compounds in pig production may aid in the selection for LA-CC398.

### EPIDEMIOLOGY

#### Distribution

MRSA can be found in nearly any location. It has been found in Korea<sup>38</sup> in a variety of forms in pigs (ST398, ST541, and HA-ST72). It has been found in Italy in a slaughterhouse study, suggesting a high risk from pork products. It was found in Sweden in cattle.<sup>39</sup> In the United States, United Kingdom, and Denmark, it has been found in pigs and pig workers.<sup>40</sup> At the equine hospital in Turkey,<sup>41</sup> 48% of the horses, 92.3% of the clinical staff, and 71.4% of the environmental samples were positive for MRSA. In France, three MRSA strains belonging to *t034 spa* were identified.<sup>42</sup> *S. aureus* was identified in 59/60 necropsies where *staphylococci* were implicated, and the organism was associated with 1.7% of the total equine deaths. The other case was associated with *S. pseudointermedius*.

In a study of veterinary hospital environments, MRSA was found in 12% of the environments. In the small-animal hospital, it was 16%; equine hospital, 4%; and large-animal hospital, 0%. The strain was usually type *spa* 100, which is commonly found in the United States.<sup>43</sup> MRSA was found in fattening pigs in Germany (152/290), all of



which were ST398 cases. In Belgium, pigs were found to be already colonized in the farrowing house.<sup>44</sup> Various strains were found in Japan, including ST398 and ST9, but also ST5, ST97, and ST705.<sup>45</sup> In Belgium, 94% of the open farms and 56% of the closed farms were found to be infected,<sup>46</sup> and management and age-related trends were found to be important. There is a low level of MRSA incidence in Switzerland.<sup>21</sup> In Ireland, MRSA has been found in horses and dogs, but not cats,<sup>47</sup> and in three distinct clones (CC5, CC8, and CC22).<sup>47</sup>

### Colonization

Colonization commences at birth, and piglets born to positive sows rapidly become infected; thus, by weaning, all the offspring are positive.

Subclinical nasal infection is common in pigs.<sup>25,48</sup> In other studies, the prevalence was found to increase rapidly after weaning but then fall during the finishing period,<sup>44</sup> and the strains were found to circulate from the nursery unit to the finishing unit. Where there is a doubling of veal calf, cattle, and pig populations in a municipality, there appears to be an increase of MRSA over the other types of *S. aureus* in the population.<sup>18</sup>

Pigs in slaughterhouses were found to be colonized by MRSA in different EU countries.<sup>24,29,40,49</sup>

### Transmission

Air inlets and outlets have been found to be contaminated, contributing to MRSA transmission. Regular airborne transmission of LA-MRSA and deposition, strongly influenced by wind direction and season, up to 300 m was found in MRSA-positive pig farms.<sup>50,51</sup> LA-MRSA is regularly found downwind of pig and poultry barns (73% and 44%, respectively) but at low concentrations, suggesting that colonization is unlikely.

In a study in Denmark, MRSA was found in the dust and in five different age groups of pigs.<sup>52,53</sup> Inside pig and poultry barns, the levels were much higher. MRSA has also been found in the exhaust air from piggeries. In one study, 85% of all barns had MRSA in the air, and boot swabs and feces were also positive.<sup>51</sup>

In one study, nine fomites were investigated, and all transmitted MRSA to pig skin, except soap.<sup>54</sup> The nonporous fomites were able to transmit to the pig skin many weeks after contamination. In one study it was found that use of mobile phones by healthy workers in the health-care industry raised the possibility of transferring infection to workers, patients, and people outside the hospital.<sup>55</sup>

MRSA can be considered a contaminant of the environment<sup>51</sup> and has been detected on field surfaces.<sup>56</sup> There is a highly significant positive association between nasal carriage of MRSA in animals and the ability to isolate MRSA from dry surfaces.<sup>57</sup>

Pig workers have a significant risk of transmission.<sup>58</sup> Transmission to humans is associated with contact time, which is why workers are more likely to be carriers than the other members of the family. People who visit farms regularly to buy eggs or milk, or even for private farm visits, are more likely to be colonized.

Shower units on conventional swine farms have been shown to be infected.<sup>59</sup> MRSA can be isolated at postmortem examinations.<sup>60</sup> In a recent study, it was found that pharyngeal tissues had a high level of MRSA and thus may be more important in transmission than was previously thought because nose-to-nose contact with infected pharyngeal tissues is possible.<sup>61</sup>

In an experimentally induced infection with two sequence types (ST398 and ST9) and four commonly found *spa* types (*t011*, *t08*, *t034*, and *t899*), it was found to be difficult to produce carriage after nasal/gastrointestinal infection of piglets. Vaginal inoculation of the sow resulted in persistent carriage of *t011*-ST398 and *t899*-ST9 in all newborn piglets.<sup>62</sup> A low-dose inoculation was shown to be capable of horizontal transmission between pigs.<sup>63</sup> The major risk of transmission of ST398 is probably through trading of piglets.<sup>64</sup>

In a U.S. study in Ohio, 3% of the pigs were found to be positive for MRSA before slaughter, 11% in the lairage, and 2% in the carcasses, along with 4% of the retail pork.<sup>65</sup> The most common type was ST5, followed by ST398.

### RISK FACTORS

Management is an important factor, although direct transmission is probably the most important. Animal carriers and human carriers present a hazard.

Risk factors also include herd size. The larger the herd, the more likely it is that MRSA is present.

Low incidence at birth is common, which slowly increases and stays positive for weeks, and then the prevalence slowly declines. In one study, 33% of sows were infected before farrowing, but the level had risen to 77% before weaning. Transmission rates were higher in preweaning pigs than in postweaning pigs<sup>66</sup> and spread rapidly in weaned piglets.<sup>67</sup>

There are usually up to three *spa* types per herd. The sow herd determines the production-chain levels of infection. The level of infection in piglets depends on the sow's colonization.

In all systems, the prevalence decreases with age.<sup>68,69</sup> If a pig herd is positive, people can be positive. If the pigs are positive, then farm dust certainly will be. Environmental contamination is therefore a risk. In one study, MRSA was found in dust, boots, socks, feces, air, and the shower units.<sup>59</sup>

In dairy herds the use of antibiotics is a risk factor, as are dairy hygiene and the age

of the cow population. In pigs, LA-MRSA may persist without the use of antibiotics.<sup>70</sup>

If there are no positive pigs, then usually there are no positive people.<sup>71</sup> Farm visits are associated with the acquisition of MRSA, but most of these cases are only temporary.<sup>27</sup> At the 2006 International Pig Veterinary Society (IPVS) conference, 276 pig vets from a large number of countries were sampled, and 12.5% tested positive for MRSA.

On Swiss pig farms, it was shown that SA (including MRSA), endotoxin, and fungi levels were higher in the winter, so there may be a seasonal effect.<sup>72</sup> The incidence of MRSA is higher in zinc-treated and antibiotic-treated pigs.<sup>73</sup>

### Pigs

It is generally acknowledged that the pig is the main reservoir for MRSA in large animals. *S. hyicus* is usually present in pigs but differs from *S. aureus* in that it does not have the *mecA* gene. Other species in pigs may include *S. chromogenes*, *S. epidermidis*, *S. sciuri*, *S. warneri*, and *S. xylosum*. A new species (*S. rostri*) has been found in the nasal cavity of pigs in Switzerland.<sup>74</sup>

There is known transfer between pigs and humans,<sup>23,33,75,76</sup> but it rarely spreads to the community.<sup>77</sup> Under some circumstances, MRSA strains can also produce enterotoxin. MRSA strains have been implicated in swollen ears, umbilical abscesses, vegetative endocarditis, subcutaneous abscesses, foot lesions, arthritis, osteomyelitis, mastitis, metritis, and enteritis.

There is a low incidence of MRSA in the United States compared with Europe. MRSA has been found in pigs in France, the Netherlands, Denmark, and Singapore.<sup>24,40,78</sup> In one study of Irish pigs, no cases of MRSA were found, and only two workers tested positive.<sup>79</sup> In finishing units in Italy, 11 different *spa* types were found, and this report identified ST9 for the first time in Europe and ST1 and ST97 for the first time in pigs.<sup>80</sup> In Spain, slaughter pigs are commonly affected with CC398 and CC97.<sup>81</sup> Free-range pigs in Spain are also infected (CC398 and *t1011*).<sup>82</sup> In Belgium, 94% of pigs on open farms were infected, compared with 56% of pigs on closed farms.<sup>67</sup> Thus far, in pigs in Europe, ST398 does not seem to be highly resistant to most antibiotics, with the exception of tetracyclines and perhaps macrolides.

The existence of lineages in species has been shown; for example, cattle often have CC133 and CC151, CC5 is common in poultry, and CC8 is common in horses. In pigs, the most common clonal complex is CC398,<sup>83</sup> which is different from the HA-MRSA and CA-MRSA in strains in humans,<sup>48,84</sup> but CC30, CC9, and CC49 have all been found. There are differences in colonization patterns of the different MRSA types in pigs.<sup>85</sup> CC9 is most common in Asia; ST8 has been found on a Norwegian pig

farm, and the low occurrence suggests that this strain may be less able to colonize and persist on pig holdings.<sup>86</sup> There is considerable heterogeneity of the resistance genes in the complex, so CC398 may acquire multiple antimicrobial antiresistance genes.<sup>87</sup> It easily acquires genetic material, and therefore strains with increased resistance will develop.

ST398 seems to prefer pigs but has no host specificity.<sup>88</sup> The same authors suggested that ST398 has an apparent lack of virulence genes in a unique genetic background. It does not, for example, usually produce Pantón-Valentin E leukocidin.

In a study in the Netherlands, it was found that the MRSA strains were usually resistant to at least three but sometimes five out of six antibacterials.<sup>89</sup>

There may be a link with cephalosporin usage in pigs.<sup>90</sup>

In Switzerland, there is a low level of MRSA in pigs, although transfer to humans may happen frequently. This low level is a result of the very low level of antibiotic use for pigs in Switzerland.<sup>21</sup> MRSA ST49 was found in Switzerland, and it has been suggested that it has been selected in the Swiss pig husbandry because a nearly threefold increase was noted over a 3-year period.<sup>91</sup>

MRSA is commonly present in pigs in Denmark as a reservoir, but not in other species.<sup>92</sup> In pigs, it has been shown that 74% of the CC398 strains from Denmark had a reduced susceptibility to zinc chloride,<sup>93</sup> which is important as a reflection of the use of zinc oxide to prevent *Escherichia coli* scours.

In a study of slaughterhouse pigs in Switzerland, it was found that 89% of farms screened<sup>54</sup> were positive for SA. Although no MRSA strains were found, there was widespread antimicrobial resistance, particularly to penicillin (62.5%) and tetracycline (33.3%). The *S. aureus* isolates belonged to Ridon *spa* types *t034*, *t208*, and *t899*.<sup>94</sup>

In a large study of herds in the Netherlands (202 pig farms), MRSA was present in 67% of the breeding herds and 71% of the finishing herds. MRSA was found in 40% of small herds and 80% of the larger herds.

A study in pigs and people in Canada in 2008 showed that 45% of the farms were affected, but only 24.9% of the pigs<sup>29</sup> and 20% of the farmers. The most common type was the same as that found in Europe, CC398 of *spa* type 539 (Ridon *t034*). The same strains were found in the pigs and personnel on the five farms where human colonization was present.

A pig can be colonized with several strains at any one time.

### Cattle

MRSA has been associated with mastitis in cattle.<sup>95,96</sup> In a Belgian study, the presence of *mecA* was investigated in 118 MRSA strains from 118 different farms with *S. aureus* mastitis, and MRSA was found in 11 samples; all

were CC398 (*t011* or *t567*).<sup>97</sup> Non *S. aureus* MRSA strains have also been studied in veal calves, dairy cows, and beef cattle, and most of the organisms were *S. sciuri*, *S. lentus*, *S. fleurette*, and occasionally *S. epidermidis*.<sup>98</sup> In a long-term study of MRSA ST1, *t127* mastitis in a dairy cow was reported.<sup>99</sup>

The first isolations from bulk-tank milk in the United Kingdom were described in 2012,<sup>100</sup> and in these strains a *mecC* homologue was described. In a subsequent study of UK cattle veterinarians, only 8/307 delegates were positive for MRSA, and none had the *mecC* homologue.<sup>101,102</sup>

MRSA has been found in milk from the udder in Switzerland and at high levels in milk in Africa. It was found to be present at quite high levels in Iran (28%), but at low levels in India and Japan. It can invariably be found on the skin of the udder and the inside of the thigh. Generally, in Europe, the United States, and Canada, the level of MRSA in cattle is quite low. In a study of U.S. bulk-tank milk samples, only 4% had MRSA (6/150).<sup>103</sup>

The most common MRSA strain is generally CC398, but there may be more than one strain of different types on the same farm, which suggests that subtypes may have been imported onto the farms or that a strain of CC398 has undergone diversification.<sup>104</sup>

In one study, 88% of dairy farms had MRSA (90/102), 458/2151 (28%) of the cattle were positive, 32% of the farmers were positive, and only 8% of the family members were positive; the prevalence in the humans decreased in the vacation periods.

A novel *mecA* homologue has been found in humans and cattle in Denmark. In a study in Denmark, a new *mecC* gene was discovered. In a study of 411 cows, it was found that 3.9% had MRSA, and all were positive for *mecA*, negative for *mecC*, and negative for Pantón-Valentine-leukocidin (PVL).<sup>105</sup> The MRSA-positive level was much lower than in Dutch pigs and veal calves.

In a study of 36 German dairy herds, CC398 strains were found in all 36; no PVL genes were detected, but a hemolysin gene was found.<sup>106</sup> In another German study, it was found that where dairy cattle were kept in an area with a large number of pigs, the MRSA level was approximately 2%; where there were no pigs, the level was less than 1%.<sup>107</sup>

In the Netherlands, in a study during 2008 to 2009, over 50,000 milk samples were examined from 14 different dairy herds, and only 14 MRSA strains were found. All were CC398 and the usual *spa* types (*t011*, *t108*, and *t889*) commonly found in pigs. Not all of the strains possessed PVL genes, and all were resistant to two or more antibiotics.

In the United Kingdom, a study of *S. aureus* in milk samples showed that 31/940 were resistant to cefoxitin and/or oxacillin, and 3/24 tested positive for the novel *mecA* variant. This variant is 70% homologous to

the *mecA* gene, and it is located on a newly recognized SCC *mecA* element designated SCC *mecXI*. Most isolates were MLST 1245, CC130, and *spa* type *t843*.<sup>100</sup>

A study showed the correlation between MRSA in humans and the percentage of positive cows in a herd; 36% of human nasal swabs and 61% of bovine nasal swabs were positive. In addition, 44% of bulk milk tests were also positive.

A new type showing resistance to cefoxitin and/or oxacillin has been detected in bulk milk and mastitis cases in England and Wales and also in humans from England and Denmark. The isolates are negative for the *mecA* gene and in latex agglutination tests for PBP2, encoded by *mecA* in standard tests. This new variant *mecA* gene was found in 13/940 samples examined. Most of these isolates were MLST 1245, CC130, and *spa* type *t843*.

In a study of beef cattle in the United States, MRSA was not isolated from 491 nasal swabs and 488 fecal samples.<sup>108</sup>

### Veal Calves

In a study in veal calf farms, it was found that 38% of farmers had MRSA, and 16% of family members also had MRSA. Carriage was related to contact, and a family member was more likely to be positive when the farmer was positive. Only a small percentage consisted of persistent carriers, and only 7.5% were not CC398.<sup>109</sup>

In a study of rose and white veal calves, it was found that rose veal calves had less MRSA than white veal calves, and the conclusion was that care had to be taken in the use of antibiotics.<sup>110</sup> Conversely, it has been suggested that MRSA increased in calves with the length of the production cycle but was not related to antibiotic use.<sup>109</sup>

A high carriage rate of LA-MRSA was found in Belgian veal calves compared with other farm types, and they were significantly more resistant to antibiotics than the pig strains. Most were CC398 in the multispecies survey, but MRSA CC130 and CC599 carrying the *mecC* gene were detected in the beef and dairy cattle.<sup>111</sup>

### Sheep and Goats

*S. aureus* is widely carried in sheep and goats and shows considerable diversity.<sup>112,113</sup> It has been isolated from goats with mastitis.<sup>114</sup> In a study of 179 sheep, 41% were positive; in a small sample of goats, 11/17 were positive. Twelve ST types were found and 26 *spa* types. Most commonly these were ST133. Only three MRSA strains were found in all of the positive strains, and two were ST130 and 1 ST398.<sup>115</sup>

### Small Animals

MRSA was first recognized in dogs and cats in the United States. In pets, the MRSA strains can include a number of species, including *S. epidermidis*, *S.*

*pseudoepidermidis*, *S. hemolyticus*, *S. hominis*, *S. capitis*, *S. cohnii*, and *S. warneri*.<sup>116,117</sup> It usually passes from humans to pets and then back again. Usually, the strains in pets are the same as those found in the local hospitals.

A strain harboring the *mecA* gene has been isolated from humans, dogs, cats, and a guinea pig in Germany.<sup>118</sup>

In a study in the United States of dogs, cats, horses, pigs, and other species, 24 isolates were resolved into four PFGE clones (USA100, USA300, USA500, and USA800) and into sequence types (ST5, ST8, ST105, ST830, and ST956; or two clonal complexes, CC5 and CC8).<sup>119</sup>

A study of companion animals in the London area found that 26/1692 samples were positive for MRSA. Animals presented for treatment were more likely to be positive than healthy animals. MRSA carriage was rare, and it is likely that companion animals were contaminated vectors rather than true reservoirs.<sup>120,121</sup> A case-control study in the United Kingdom showed that significant risk factors for MRSA were the number of antimicrobial courses, the number of days admitted to veterinary clinics, and the presence of surgical implants. A risk study in the United States and Canada in dogs showed that both MRSA and methicillin-sensitive *S. aureus* (MSSA) were common on the ears of pets and that the risk factors were antibiotic treatments (beta-lactams and fluoroquinolones) and intravenous catheterization. MRSA did not transmit readily from apparently healthy dog to healthy dog in a study carried out in a rescue center.<sup>122</sup>

### Horses

Humans who work with horses are sometimes affected by MRSA. MRSA can cause serious skin disease and soft tissue infections in horses. It is most easily cultured from the nostril, with carriage from 55 to 771 days.<sup>123</sup> The most vulnerable horse appears to be the long-term hospitalized horse.<sup>124</sup> Exposure to veterinary care may predispose both healthy horses and horse handlers to MRSA.<sup>125</sup>

MRSA was first recognized in horses in 1996 and since then has become a problem in horse clinics in Europe and North America. Originally, the strain was CC8 (t8 and t254), but this strain has been replaced by CC398, and recent evidence suggests that human strains may appear in horses. The horse is likely a low-level contributor to LA-MRSA in Belgium, where CA-MRSA is at a low level.<sup>126</sup>

MRSA was recognized in horses in the United States in 2005. In one study in the United States, it was not found on a pleasure horse farm but was found on a racehorse farm, where 61% of nasal samples and 71% of environmental samples tested positive.<sup>127</sup>

In the United States, the most common strain is CC500, whereas in Europe it is CC398, which is highly prevalent in horses and veterinary personnel at equine clinics.

In the Netherlands, there were no cases of MRSA in 2002, but by 2008 MRSA was found to be present in 375 of the SA samples. The CC398 strain currently predominates (t1011, t2123, and t064).

During an outbreak in a teaching hospital, some of the personnel tested positive, in addition to 57% of the environmental samples, including samples from the students' and staff members' rooms. In another study, 81 swabs from 42 horses on four farms were examined, and 11 species of *staphylococci* were found; 17/42 were untypable.<sup>128</sup>

MRSA was reported in Sweden in 2012, where 8/10 horses were infected in a veterinary hospital and two other infected horses were found close by. In another hospital study, 12/84 horses and 16/139 staff at a veterinary teaching hospital had MRSA. ST5 was the culprit. The risk was greater in the veterinarians and in the full-time rather than the part-time staff.<sup>129</sup>

The first strain of MRSA isolated in horses in the United Kingdom was ST398 from two horses and reported in 2009.<sup>130</sup>

A survey of horses admitted to the Berne University Clinic showed that 2.2% of the horses had MRSA.<sup>131</sup>

It has been found in Lusitano horses at the Lisbon teaching hospital.<sup>132</sup>

In a large study of 209 racehorses, 13 veterinarians, and 14 environmental surfaces, it was found that 48.3% of the equines, 92.3% of the vets, and 71% of the environmental samples were positive for a variety of staphylococcal species.<sup>41</sup>

In another study of nasal swabs from horses, 42 strains of MRSA were found,<sup>133</sup> again from a variety of staphylococcal species (*S. sciuri*, *S. xylosus*, *S. lentus*, *S. aureus*, and *S. capitis*). All the species contained the *mecA* gene.

### Other Species

#### Poultry

People working with broilers have higher levels of MRSA than the general population (5.5% compared with < 0.1%) in the Netherlands. However, the level is lower than in those working with pigs and veal calves.<sup>134</sup> In another Dutch study of broiler flocks, slaughterhouses, and personnel, it was found that the risk was greater when dealing with live animals. Over 36% of the flocks were positive and 6% of the broilers. During the production day the level of MRSA infection increased from 8% to 35%. Most strains were ST398, but there were also large numbers of ST9.

In a study of mixed pig and poultry farms,<sup>135</sup> MRSA was most frequently isolated from the cloaca, nose, pharynx, and skin under the wings. There was a low prevalence in the broilers (0% to 28%) on the farm, but 82% to 92% of the pigs had MRSA. The broilers may be less sensitive to the ST398 strain than pigs. The farmer may have been part of the cause of the spread of the MRSA from

the pigs to the poultry on the same mixed farm.

### Turkeys

A study showed that 18/120 turkey farms had MRSA, as did 22/59 people on the farms. Those with frequent access were most likely to test positive.<sup>136</sup>

### Donkeys

In a study of donkeys in Sicily, 40/46 donkeys were found to be positive for *staphylococci*. Of the 80 isolates examined, 52/80 were *S. aureus*. Nine genera were found; most of these were MSSA, and only 14 were MRSA. The *mecA* gene was found in 6/52 SA cases.

Donkeys could be a reservoir for the CC133 lineage.

### Wild Boar

So far no important MRSA cases have been found in wild boar.<sup>137</sup>

### Backyard Pigs

A study in the United States of backyard pigs suggested that there were no major differences from domestic commercial pigs,<sup>138</sup> and that in all probability there was no greater risk for human infection from these pigs.

In a study of farms in Connecticut (considered noncommercial) and their pig handlers (263 pigs and 9 humans on 35 farms), it was found that 51% of farms, 30% of pigs, and 22% of the handlers were positive for MRSA. The swine had HA-MRSA, CA-MRSA, and LA-MRSA, but the humans only had HA -strains of MRSA. The PVL gene was found in 7/8 of MRSA isolates, and this was the first time this gene had been found in pigs in the United States.<sup>139</sup>

### Camels

MRSA has been described in an alpaca, which was infected with a human epidemic clone.<sup>140</sup>

### Fish

MRSA have been isolated from Tilapia. In one study, 559 isolates of *staphylococci* were obtained; 198 (35%) were *S. aureus*, and 98 (50%) of these were MRSA.<sup>141</sup>

### Zoo Animals

There are few reports of MRSA in zoo animals (skin in an elephant, rumen in a Moufflon, digit of a rhinoceros).<sup>142</sup>

### Other Sources

#### Holding Areas

The abattoir holding area may act as a reservoir for MRSA, but this area does not appear to disseminate MRSA into the processing lines.<sup>143</sup>

Working in a lairage area or in a dehairing area was the major risk factor for MRSA carriage in pig slaughterhouse workers. The overall prevalence is low and decreases along the slaughterhouse line.<sup>144</sup>



The high prevalence of nasal carriage in slaughterhouse workers is largely associated with working with pigs.<sup>144,145</sup>

### State Fairs

A study at two state fairs in the United States showed that only 25/157 pigs (15.9%) were positive for *S. aureus*, and only two MRSA cases were found.<sup>146</sup>

### Food

There is no doubt that MRSA acquired on the farm can be transferred through to processing, but there is no significant evidence of cross-contamination between carcasses.<sup>147</sup>

In a German study the contamination rate was highest in nasal swabs at stunning (64.7%) and was low in carcasses (6%), meat at processing (4.2%), and final products (2.8%). MRSA can be identified at all points in the food chain.<sup>148,149</sup>

Food may be contaminated by MRSA, but there is no evidence that this leads to increased carriage rates in humans, either in food handlers or the public. It has been found in meat,<sup>150,151</sup> and its incidence in meat was not uncommon.<sup>152</sup> MRSA can enter the slaughterhouse on or in animals and therefore does occur in raw meat emanating from the abattoir. ST398 has been found in up to 11.9% of retail meat samples in several studies in different parts of the world.<sup>153</sup>

In a study of retail meat samples (raw pork, chicken, beef, and turkey) from stores in Iowa, there was an overall presence of 16% positivity for MRSA, but only two isolates from pork were positive, although one had the PVL gene. The study suggested that MRSA rates in retail meat supplies, especially pork, were low.<sup>154</sup>

In Denmark, imported broiler meat had the highest levels of MRSA (18%), followed by imported pork (7.5%) and Danish pork (4.6%). In the same study, CC398 was found in Danish beef (1.4%). In addition to ST398, CC30 was also found for the first time.<sup>155</sup>

The transfer of MRSA from retail pork products to food-contact surfaces and the potential for consumer exposure has been described.<sup>156</sup> Pork loins, bacon, and fresh pork sausage were inoculated with mixed MRSA, vacuum packed, and stored for 2 weeks at 5 degrees C (41 F); the products were then placed on knives, cutting boards, and a human skin model for 5 minutes. Transfer to the cutting board occurred in 39% to 49%, to the knives in 17% to 42%, and to the human skin model in 26% to 36%. The transfer ranged from 2.2% to 5.2% across all products and contact surfaces.

### PATHOGENESIS

*S. aureus* can produce many virulence factors, including protein A, teichoic acid, coagulase, staphylokinase, deoxyribonuclease (DNase), lipase, hyaluronic acid, leucocidin, enterotoxins, and exfoliative toxins.

### PATHOLOGY

MRSA has been detected in less than 1% of all pig postmortems. It is found both as a primary pathogen and as mixed infections, mainly in suckling and weaned pigs. Joints are more often affected than tissues. MRSA organisms live in clusters between the cilia or as singletons on the cilia in the respiratory tract. There are no morphologic changes when pig tracheal explants are experimentally infected. In an experimental infection,<sup>157</sup> there was colonization of lymph nodes (ileocecocolic).

### DIAGNOSIS

MRSA organisms can be identified by phenotypic methods or genotyping. Samples are taken directly from lesions, biopsies, or blood culture onto selective and nonselective media. Contamination can be detected by swabbing noses (individuals), sampling dust (in herds and flocks), and food sampling. Increased sensitivity is obtained when using selective liquid enrichment media. *Spa* typing is available for lineage studies.<sup>158</sup>

Diagnosis of MRSA is based on culture, colony morphology, MLST on the protein A gene sequencing (*spa* typing), coagulase testing, antimicrobial sensitivity testing, and confirmation with Ceftiofur resistance and polymerase chain reaction (PCR) for the *mecA* gene.

### CONTROL

Control should focus on the careful use of antimicrobials and consistent application of hygiene measures to reduce the spread of infection.<sup>159</sup> The reduction of access and exposure to pigs is most important. This means that movement restrictions and farm-level hygiene measures are the only possibilities.

There should be methods for harmonizing the sampling, detecting, and quantifying of MRSA in humans and animals and for detecting MRSA as a contaminant in food and the environment. Professionals connected with animals should also be tested on entry to the hospital. Transfer from animals to humans is difficult to control. Hand washing before and after contact is essential, as is avoiding direct contact with nasal secretions, saliva, and wounds. MRSA organisms can be killed with photodynamics.<sup>160</sup>

There is a clear difference between colonization and infection with MRSA.<sup>161</sup> Disinfection programs may temporarily reduce MRSA strains for the sow and piglets, but they do not result in a complete removal.<sup>162</sup> These programs are more effective in farrowing units than in finishing units.<sup>163</sup> Control programs in abattoirs should involve reduction in carcass contamination.<sup>164</sup>

### FURTHER READING

Fitzgerald JR. Livestock associated *Staphylococcus aureus*; origin, evolution, and public health threat. *Trends Microbiol.* 2012;20:192-198.

Heller J, Hughes K. MRSA in horses. *In Pract.* 2013;35(1):30-35.

Voss A, et al. MRSA in pig farming. *Emerg Infect Dis.* 2005;11:1965-1966.

### REFERENCES

- Foster AP. *Vet Derm.* 2012;23:342.
- Vanderhaeghen W, et al. *Vet Microbiol.* 2012;158:123.
- Vanni M, et al. *Veterinaria.* 2012;26:19.
- Deurenberger RH, et al. *Clin Microbiol Infect.* 2007;13:222.
- Graveland H, et al. *Prev Vet Med.* 2012;107:180.
- de Lencastre H, et al. *Curr Opin Microbiol.* 2007;10:428.
- Graveland H, et al. *Int J Med Microbiol.* 2011;301:630.
- Bootsma MCJ, et al. *J Roy Soc Interface.* 2011;8:578.
- Lekkerkerk WSH, et al. *Clin Microbiol Infect.* 2012;18:656.
- Wulf MWH, et al. *Europ J Clin Microbiol Inf Dis.* 2012;31:61.
- Jordan D, et al. *Aust Vet J.* 2011;89:152.
- Garcia-Graells C, et al. *Epid Infect.* 2012;140:388.
- Burstiner L, et al. *Vet Surg.* 2010;39:150.
- Frana TS, et al. *PLoS ONE.* 2013;8:1.
- Koeck R, et al. *J Hosp Infect.* 2011;79:292.
- Lin Y, et al. *Clin Med Res.* 2011;9:7.
- Koeck R, et al. *PLoS ONE.* 2013;8:2.
- Feingold BJ, et al. *Emerg Infect Dis.* 2012;18:1841.
- Fluit AC, et al. *Clin Microbiol Infect.* 2012;18:735.
- Koeck R, et al. *Deutsch Arz Int.* 2011;108:761.
- Opplinger A, et al. *Appl Env Microbiol.* 2012;78:8010.
- Voss A, et al. *Emerg Infect Dis.* 2005;11:1965.
- Van Loo I, et al. *Emerg Infect Dis.* 2007;13:1834.
- de Neeling AJ, et al. *Vet Microbiol.* 2007;122:366.
- Smith TC, et al. *PLoS ONE.* 2009;4:e4258.
- Huber H, et al. *Euro Surveill.* 2010;15:19542.
- van Cleef BA, et al. *Epidemiol Infect.* 2010;138:756.
- Horgan M, et al. *Vet J.* 2011;190:255.
- Khanna T, et al. *Vet Microbiol.* 2008;128:298.
- Van Rijen MM, et al. *Clin Infect Dis.* 2008;46:261.
- Vandenbroucke-Grauls CMJE, Beaujen DJMA. *Ned Tijds Gen.* 2006;150:1710.
- Rijen MV, et al. *Clin Microbiol Infect.* 2007;13:S446.
- Huijsdens XW, et al. *Ann Clin Microbiol Antimicrob.* 2006;5:26.
- Aquino GDV, et al. *Zoonoses Public Health.* 2012;59:1.
- Graveland H, et al. *PLoS ONE.* 2011;6:e16830.
- Cuny C, et al. *PLoS ONE.* 2009;2:e6800.
- Otter JA, French GL. *Lancet Infect Dis.* 2010;10:227.
- Lim S-K, et al. *Vet Microbiol.* 2012;155:88.
- Unnerstad HE, et al. *Svensk Vet.* 2012;64:35.
- Guardabassi L, et al. *Vet Microbiol.* 2007;122:384.
- Asiantas O, et al. *J Vet Med Sci.* 2012;74:1583.
- Haenni M, et al. *J Vet Diagn Invest.* 2010;22:953.
- Hoet AE, et al. *Vector Zoo Dis.* 2011;11:609.
- Dewaele I, et al. *Vet Sci Dev.* 2011;1:e1.
- Asai T, et al. *Jpn J Infect Dis.* 2012;65:551.
- Crombe F, et al. *Microb Drug Resist.* 2012;18:125.
- Abbott Y, et al. *Epidem Infect.* 2010;138:764.
- Smith TC, Pearson N. *Vector Zoo Dis.* 2009;11:327.
- Schwarz S, et al. *J Antimicrob Chemother.* 2008;61:282.
- Schulz J, et al. *Appl Environ Microbiol.* 2012;78:5666.
- Friese A, et al. *Vet Microbiol.* 2012;158:129.
- Espinosa-Gongora C, et al. *Vet Rec.* 2012;170:564.
- Espinosa-Gongora C, et al. *Epidem Infect.* 2012;140:1794.
- Desai R, et al. *Am J Infect Control.* 2011;39:219.
- Ustun C, Cihanoglu M. *J Occup Environ Hyg.* 2012;9:538.

56. Friese A, et al. *Berl Munch Tierarztl Wschr.* 2013;126:175.
57. Peterson AE, et al. *Vet Microbiol.* 2012;160:539.
58. Comland O, Hoffmann L. *Ann Agric Evol Med.* 2012;19:637.
59. Larson KRL, et al. *J Ag Safety Health.* 2012;18:5.
60. Wolf PJ, et al. *Vet Microbiol.* 2012;158:136.
61. Gibbons JF, et al. *Vet Microbiol.* 2013;162:771.
62. Moodley W, et al. *Epidem Infect.* 2011;139:1594.
63. Jovy E, et al. *Lett Appl Microbiol.* 2012;54:518.
64. Espinosa-Gongora C, et al. *Vet Rec.* 2012;doi:10.1136/vr.100704.
65. Molla B, et al. *J Clin Microbiol.* 2012;50:3687.
66. Broens EM, et al. *Vet Microbiol.* 2012;155:381.
67. Crombe F, et al. *Appl Environ Microbiol.* 2012;78:1631.
68. Verheghe M, et al. *Vet Microbiol.* 2013;162:679.
69. Weese JS, et al. *Zoonoses Public Health.* 2011;58:238.
70. Broens EM, et al. *BMC Vet Res.* 2012;8:58.
71. Overesch G, et al. *Schweiz Arch Tierheilk.* 2013;155:339.
72. Masclaux FG, et al. *Annl Occup Hyg.* 2013;57:550.
73. Moodley A, et al. *Vet Microbiol.* 2011;152:420.
74. Stegman R, Perreten V. *Vet Microbiol.* 2010;145:165.
75. Denis O, et al. *Emerg Infect Dis.* 2009;15:98.
76. Graveland H, et al. *PLoS ONE.* 2011;6:e16830.
77. Cuny C, et al. *PLoS ONE.* 2009;4:e6800.
78. Sergio DMB, et al. *J Med Microbiol.* 2007;56:1107.
79. Horgan M, et al. *Vet J.* 2012;190:255.
80. Battisti A, et al. *Vet Microbiol.* 2010;142:361.
81. Gomez-Sanz E, et al. *Food Pathog Dis.* 2010;7:1269.
82. Porrero MC, et al. *Vet Microbiol.* 2012;156:157.
83. Vanderhaeghen W, et al. *Vet Microbiol.* 2012;158:123.
84. Smith TC, Pearson N. *Vector Zoo Dis.* 2010;11:327.
85. Szabo I, et al. *Appl Environ Microbiol.* 2012;78:541.
86. Sunde M, et al. *J Vet Diagn Invest.* 2011;23:348.
87. Argudin MA, et al. *Appl Environ Microbiol.* 2011;77:3052.
88. Jamroz DM, et al. *PLoS ONE.* 2012;7:e40458.
89. Van Der Wolf PJ, et al. *Vet Microbiol.* 2012;158:136.
90. Burch DGH. *Pig Progress.* 2010;26:14.
91. Overesch G, et al. *BMC Vet Res.* 2011;7:30.
92. Hasman H, et al. *Vet Microbiol.* 2012;141:326.
93. Aarestrup FM, et al. *Vet Microbiol.* 2010;142:455.
94. Riesen A, Perreten V. *Schweiz Arch Tierheilk.* 2009;151:425.
95. Frey Y, et al. *J Dairy Sci.* 2013;96:2247.
96. Pilla RVV, et al. *Vet Rec.* 2012;170:312.
97. Vanderhaeghen W, et al. *Vet Microbiol.* 2010;144:166.
98. Vanderhaeghen W, et al. *J Anim Chemother.* 2013;68:300.
99. Pilla R, et al. *Vet Rec Case Rep.* 2013;doi:10.1136/vetreccr.100510rep.
100. Paterson GK, et al. *Eurosurveillance.* 2012;17:20327.
101. Paterson GK, et al. *J Antimicrob Chemother.* 2012;67:2809.
102. Paterson GK, et al. *PLoS ONE.* 2013;8:e68463.
103. Haran KP, et al. *J Clin Microbiol.* 2012;50:688.
104. Fessler AT, et al. *Vet Microbiol.* 2012;160:77.
105. Van Duijkeren E, et al. *Vet Microbiol.* 2010;141:96.
106. Kreauskon K, et al. *J Dairy Sci.* 2012;95:4382.
107. Friedrich A, et al. *Ther Umsch.* 2012;66:195.
108. Weese JS, et al. *Zoonoses Public Health.* 2012;59:144.
109. Graveland H, et al. *PLoS ONE.* 2012;6:2.
110. Bos MEH, et al. *Prev Vet Med.* 2012;105:155.
111. Vandendriessche S, et al. *J Anim Chemother.* 2013;68:1510.
112. Porrero MC, et al. *Lett Appl Microbiol.* 2012;54:280.
113. Gharsa H, et al. *Vet Microbiol.* 2012;156:367.
114. Aras Z, et al. *Small Rum Res.* 2012;102:68.
115. Eriksson J, et al. *Vet Microbiol.* 2013;163:110.
116. Cooper KS. *Vet Med.* 2012;107:516.
117. Kern A, Perrenden VD. *J Ant Chemother.* 2013;68:1266.
118. Walther B, et al. *Emerg Inf Dis.* 2012;18:2017.
119. Lin Y, et al. *Clin Med Res.* 2011;9:17.
120. Loeffler A, Lloyd DH. *Epidem Infect.* 2010;138:595.
121. Loeffler A, et al. *Epidem Infect.* 2011;139:1019.
122. Loeffler A, et al. *Vet Microbiol.* 2010;141:178.
123. Bergstrom K, et al. *Vet Microbiol.* 2013;163:388.
124. Van den Eede A, et al. *Vet J.* 2012;193:408.
125. Van den Eede A, et al. *Vet Microbiol.* 2013;163:313.
126. Maddox TW, et al. *Eq Vet J.* 2012;44:289.
127. Peterson AE, et al. *Vet Microbiol.* 2012;160:539.
128. Van Meurs MLJGM, et al. *Infection.* 2013;41:339.
129. Schwabe MJ, et al. *Vet Microbiol.* 2013;162:907.
130. Loeffler A, et al. *J Hosp Infect.* 2009;72:1.
131. Panchaud Y, et al. *Schweiz Arch Tierheilk.* 2010;152:176.
132. Couto N, et al. *J Equine Vet Sci.* 2012;32:300.
133. Mallardo K, et al. *Irpologia.* 2010;21:23.
134. Geenen P, et al. *Epidem Infect.* 2013;141:1099.
135. Pletinckx LJ, et al. *Inf Gen Evol.* 2011;11:2133.
136. Richter A, et al. *Epidem Infect.* 2012;140:2223.
137. Meemken D, et al. *Appl Environ Microbiol.* 2013;79:1739.
138. Gordoncillo MJ, et al. *Zoonoses Public Health.* 2012;59:212.
139. Osadebe LU, et al. *Zoonoses Public Health.* 2013;60:234.
140. Still JW, et al. *Canad Vet J.* 2012;53:670.
141. Atyaih MAS, et al. *Vet Microbiol.* 2010;144:502.
142. Vercammen F, et al. *J Zoo Wildl Med.* 2012;43:159.
143. Hawken P, et al. *Food Control.* 2013;31:473.
144. Gilbert MJ, et al. *Occup Environ Med.* 2012;69:472.
145. Van Cleef BAGL, et al. *Epidem Infect.* 2012;138:706.
146. Driessler AE, et al. *Vet Rec.* 2012;170:495.
147. Hawken P, et al. *J Food Protect.* 2013;76:624.
148. Beneke B, et al. *J Food Prot.* 2011;74:126.
149. Tenhagen B-A, et al. *Vet Rec.* 2009;165:589.
150. Lozano C, et al. *J Antimicrob Chemother.* 2009;64:1325.
151. de Jonge R, et al. *Eurosurveillance.* 2010;15:19712.
152. Weese JS, et al. *Lett Appl Microbiol.* 2010;51:338.
153. Kluytermans JA. *Clin Microbiol Infect.* 2010;16:11.
154. Hanson BM, et al. *J Infect Public Health.* 2011;4:169.
155. Agero Y, et al. *Vet Microbiol.* 2012;157:246.
156. Snyder HL, et al. *J Food Protect.* 2013;76:2087.
157. Szabo I, et al. *Appl Environ Microbiol.* 2012;78:541.
158. Graveland HJ, et al. *Vet Microbiol.* 2009;139:121.
159. Nes A, Wolf MWH. *Wien Tierarztl Mschr.* 2012;99:315.
160. Eichner A, et al. *Photochem Photoderm Sources.* 2013;12:135.
161. Brasse K, et al. *Tier Umschau.* 2012;67:260.
162. Pletinckx LJ, et al. *J Appl Microbiol.* 2013;114:1634.
163. Meriadi G, et al. *Res Vet Sci.* 2013;94:425.
164. Lassok B, Tenhagen BA. *J Food Protect.* 2013;76:1095.

## DERMATOPHILOSIS (MYCOTIC DERMATITIS CUTANEOUS STREPTOTRICHOSIS, SENKOB DISEASE OF CATTLE, LUMPY WOOL OF SHEEP)

The disease is commonly called mycotic dermatitis in sheep and cutaneous streptotrichosis in cattle, although other local names

exist including Senkobo skin disease in central Africa, Kirchi in Nigeria, and Saria in Malawi. Dermatophilosis is a name common to the disease in all species.

### SYNOPSIS

#### Etiology *Dermatophilus congolensis*

**Epidemiology** Organism present in minor carriage lesions on face and feet. Serious disease occurs when body skin is broken by shearing or insect bites, or macerated by prolonged wetting, coupled with management practices that promote transmission. The disease has significant importance in cattle in tropical areas, whereas in high-rainfall temperate climates it occurs mainly in sheep and horses. In tropical areas ticks promote severe infection in cattle by suppression of immune function.

**Clinical findings** Sheep: hard crusts distributed over backline palpable in fleece. Cattle and horses: nonpruritic crusting dermatitis, initially with paintbrush tufts of hair. In cattle in tropical areas, extensive skin lesions.

**Clinical pathology** Branching filaments containing cocci in pairs.

**Diagnostic confirmation** Clinical. Organisms in scrapings or biopsy sections, culture, polymerase chain reaction (PCR).

**Treatment** Antibiotics. Topical antibacterial in horses.

**Control** Avoidance of skin trauma and of management practices that promote transmission. Use of topical bactericides to prevent infection of shear cuts, and of skin in risk periods. Acaricides in cattle.

### ETIOLOGY

*D. congolensis* is the infective agent but requires damage to the skin from other causes to establish infection. The organism is dimorphic and grows as branched filamentous mycelia containing dormant zoospores that are transformed by moisture to the infective stage of motile isolated cocci. There is considerable genetic diversity between isolates. Isolates from the same geographic region are not necessarily closely genetically related, although genotypic variation between isolates is correlated with the host species.

### EPIDEMIOLOGY

#### Occurrence

##### Geographic Occurrence

The disease occurs in all areas of the world but can be epizootic in tropical and subtropical areas of the world, where it can result in considerable economic loss. Surveys of large numbers of cattle in Africa report prevalence rates approaching 15%, with a 100% infection rate in some herds at the time of peak seasonal prevalence. In temperate climates the disease is usually sporadic but can still be

of considerable economic importance where predisposing factors pertain. For example, an incidence ranging from 10% to 66% was recorded in nine dairy herds, where shower cooling was the predisposing factor to disease.

High prevalence in sheep flocks occurs in the high- and medium-rainfall areas of Australia. Significant clinical disease has been reported as far north as Canada, the northern United States, and Scotland, and as far south as New Zealand.

### Host Occurrence

Disease occurs in cattle, sheep, goats, horses, and donkeys, and occasionally in deer, pigs, camels, and wildlife species. Animals of all ages are susceptible, including sucklings a few weeks old.

### Source of Infection

The major source of infection for outbreaks of clinical disease exists with minor active lesions on the face and feet in otherwise healthy carrier animals, and with infection in scabs still carried in the hair and wool from healed lesions.

*D. congolensis* is not highly invasive and does not normally breach the barriers of healthy skin. These barriers include the stratum corneum, the superficial wax layer produced by the sebaceous glands, and, on the body of sheep, the physical barrier of the wool. On the feet and face, these barriers are easily and commonly broken by abrasive terrain or thorny and spiny forage and feedstuffs.

*Dermatophilus* may infect these lesions and may be transmitted mechanically by feeding flies to result in minor infection on the face and feet. This subclinical carriage form of the disease is common in most herds and flocks, and the minor lesions are most evident at the junction of the haired and non-haired areas of the nares and of the claws and dewclaws. Minor lesions may also be present in the haired areas of the face and feet and on the scrotum and, in lambs, on the skin along the dorsal midline of the back. They are of no clinical significance to the animal except that they provide a source of more serious infection when other areas of the skin surface are predisposed to infection.

### Transmission

Transmission occurs from the carriage lesions by contact from the face of one animal to the fleece or skin of another, and from the feet to the skin during mounting. Infection can be transmitted mechanically by flies and ticks and mediate infection by contaminated dips.

### Environmental and Management Risk Factors

#### Sheep

Prolonged wetting of the fleece is the major risk factor and leads to emulsification of the

wax barrier and maceration of the skin surface with disruption of the stratum corneum. A prolonged and heavy rain is sufficient to do this, especially if followed by warm and humid weather that retards drying of the fleece. Increased environmental humidity and temperature, as distinct from wetting of the skin, does not appear to promote the development of lesions. Moisture releases infective zoospores from carriage lesions, and these may be carried mechanically by flies that are attracted to the wet wool. The motile zoospores are aided in their movement to the skin surface by the moisture of the fleece and their positive chemotactic response to carbon dioxide at the skin surface.

A protracted wetting period of the fleece can also occur following dipping, jetting, or spraying of sheep for external parasites when these procedures are conducted at periods greater than 1 to 2 months after shearing; the incidence of mycotic dermatitis in sheep has been shown to increase with the time period between shearing and dipping. The infection onto the fleece comes primarily from the lesions on the face and feet and is promoted by tightly yarding sheep following these procedures.

Shearing cuts also destroy the barriers of the skin, and cuts may become infected mechanically by flies, physically by tight yarding after shearing, and by mediate infection in **dips** when sheep are dipped immediately following shearing. The resultant lesions do not spread over the body but provide a significant source of infection for other sheep in the flock when management or climatic circumstances lead to a high degree of flock skin susceptibility. Skin infection can also occur following infection with contagious ecthyma.

### Cattle

#### Temperate Zones

Outbreaks in herds and severe disease in individuals are uncommon but can occur associated with high rainfall, with attack rates of 50%. There is a particular tendency for lesions to occur on the rump and back in females and males, probably as a result of the introduction of infection through minor skin abrasions caused by mounting. Lesions down the flanks of cattle may also result from abrasions and direct infection from the dewclaws during mounting. Other penetrating lesions caused by eartags or biting flies can also result in minor lesions.

The use of periodic showers or continual misting to cool cattle during hot periods is a risk factor for infection in dairy herds. Intercurrent disease and stress are also risk factors, and in infected dairy herds a higher incidence has been observed during the first weeks of parturition in first-calf heifers that also had endometritis or mastitis.

### Tropical Zones

Climate is the most important risk factor and in tropical and subtropical regions; the disease has its highest incidence and severity during the humid, high-rainfall season. Animals in which the disease regresses are usually reinfected repeatedly in successive wet seasons. As in sheep, the disease in cattle requires disruption of natural skin barriers. However, prolonged wetting of the skin of cattle does not appear to be a major predisposing factor by itself, and the seasonal occurrence is associated with a concomitant increase in tick and insect infestation.<sup>1</sup> For example, a study in Ethiopia found that although prevalence was higher in cattle in the wet season, in both seasons, infestation with *Amblyomma variegatum* significantly affected the occurrence of disease, with infested cattle having a risk 7 times higher.

Tick infestation, particularly with *A. variegatum*, *Hyalomma asticum*, and *Boophilus microplus*, is strongly associated with the occurrence of extensive lesions of dermatophilosis, which can be minimized by the use of acaricides.

The lesions of dermatophilosis on the body do not occur at the predilection sites for ticks, and it is thought that the importance of tick infestation relates to a tick-produced immune suppression in the host rather than mechanical or biological transmission.

Lesions do occur at predilection sites for biting insects, mainly *Stomoxys* spp., *Lyperosia* spp., *Glossinia* spp., *Calliphoria* spp., and mosquitoes. In Africa the disease is often combined with demodicosis to produce Senkobo disease, a more severe and often fatal combination.

Trauma to the skin produced by thorny bushes and the ox-pecker bird (*Buphagus africanus africanus*) can also initiate lesions.

### Horses

Biting flies (*Stomoxys calcitrans*) are thought to act as mechanical vectors of the infection, and the housefly (*Musca domestica*) can carry infection. Skin damage from trauma or from ectoparasites can predispose for disease, as does wetting from rainfall or from **frequent washing**.

### HOST RISK FACTORS

There are breed differences in susceptibility in cattle and sheep. In Africa, the N'dama and Muturu cattle breeds and native sheep are resistant, whereas Zebu, White Fulani, Renditelo,<sup>2</sup> and European breeds are susceptible. Within-breed differences in susceptibility are also apparent, and genetic markers have been identified in Zebu cattle and Merino sheep. Susceptibility in cattle can be influenced by genetic selection. For example, selection against susceptibility to dermatophilosis, based on a BoLA-DRB3/DQB class II haplotype, reduced the prevalence of disease in



Brahman cattle in Martinique from 76% to 2% over 5 years.

In the Merino, sheep of the strong- or medium-wool strains are more susceptible. Open-fleeced sheep and sheep with a low-wax and high-suint content in their fleece are more prone to infection.

### **PATHOGEN RISK FACTORS**

*D. congolensis* does not live well off the body and in the normal environment, and it is susceptible to the external influences of pH and moisture fluctuations. In the laboratory it can survive for 4 years in otherwise sterile broth culture and for at least 13 years in dry scab material kept at room temperature.

### **EXPERIMENTAL DISEASE**

Local lesions, but not with spread to extensive disease, can be readily reproduced in sheep and cattle by removal of the skin wax followed by local challenge. Genetic differences modulate the severity of the lesion that occurs.

### **ECONOMIC IMPORTANCE**

#### **Sheep**

Damage to the fleece causes severe losses, up to 30% loss of value of wool and 40% loss of skin value, and may be so extensive in lambs that spring lambing has to be abandoned. Other losses in sheep are caused by interference with shearing and a very great increase in susceptibility to blow-fly infestation.

#### **Cattle**

In Africa the disease in cattle causes great losses and many deaths, and it ranks as one of the four major bacteriologic diseases with equivalent importance to contagious bovine pleuropneumonia and brucellosis. Goats in the same area also suffer a high incidence. Losses are from direct animal loss, decreased work ability of affected oxen, reproductive failure from vulval infection or infection on the limbs of males preventing mounting, death from starvation of calves of dams with udder infection, loss of animal meat and milk production, and downgrading of hides. In temperate climates deaths are uncommon, but cows that fail to respond to treatment and have to be culled are not infrequent. In a study in nine herds in Israel, death or culling rates from this disease ranged from 2% to 17%, and there was an average 23% fall in milk production in affected cattle. Reproductive inefficiency is a common accompaniment in severe cases.

### **Zoonotic Implications**

Human infection is reported, such as on the hand of a veterinarian working with infected sheep, but contagion from livestock is rare in spite of ample opportunity.

### **PATHOGENESIS**

The natural skin and wool waxes act as effective barriers to infection. Minor trauma, or

maceration by prolonged wetting, allows establishment of infection and multiplication of the organism in the epidermis. The formation of the typical pyramid-shaped crusts is caused by repeated cycles of invasion into the epidermis by hyphae, bacterial multiplication in the epidermis, rapid infiltration of neutrophils, and regeneration of the epidermis. The organism in the scab is the source for the repeated and expanding invasion, which occurs until immunity develops and the lesion heals. The scab then separates from the healed lesion but is still held loosely in place by hair or wool fibers. In sheep, the extensive maceration of skin that can occur with prolonged fleece wetting can result in extensive skin lesions under the fleece. In cattle, tick infestation suppresses immune function and promotes the spread of the lesion. Secondary bacterial invasion may occur and gives rise to extensive suppuration and severe toxemia.

### **CLINICAL FINDINGS**

#### **Sheep**

Lesions are commonly not visible in sheep because they are obscured by the fleece, but the crusts can be palpated as hard masses at the surface of the skin (**lumpy wool disease**) and typically are distributed irregularly over the dorsal midline, with “ribs” spreading laterally and ventrally. The crusts are roughly circular, thick, up to 3cm, often distinctly **pyramidal** with a concave base, and often pigmented, and the underlying skin is moist and reddened. The muzzle, face, and ears, and the scrotum of rams, may also be involved. The health of the animal is unaffected unless the lesions are widespread.

Heavy mortalities can occur in very young **lambs**, where there can be extensive lesions over the body. Many develop cutaneous blow-fly myiasis, and in occasional cases a secondary pneumonia resulting from the organism may cause the death of the animal.

#### **Cattle**

The early lesion is a pustule, and the hair over the infected site is erect and matted in tufts (paintbrush lesions) with greasy exudate forming crumbly crusts that are hard to remove. These develop into scabs that are greasy and fissures at flexion points, and finally to scabs that are hard, horny, and confluent. The scabs vary in color from cream to brown, are 2 to 5 cm in diameter, and are often in such close apposition that they give the appearance of a mosaic. In the early stages the crusts are very tenacious, and attempts to lift them cause pain. Beneath the crusts there is granulation tissue and some pus. In the later stages, the dermatitis heals and the crusts separate from the skin and are held in place by penetrating hairs, but they are easily removed.

Lesions occur on the neck, body, and back of the udder and may extend over the

sides and down the legs and the ventral surface of the body. Commonly they commence along the back from the withers to the rump and extend halfway down the ribcage. In some animals the only site affected is the flexor aspect of the limb joints, the inguinal area, or between the forelimbs.

In young calves, infection commences on the muzzle, probably from contact with the infected udder or because of scalding by milk in bucket-fed calves, and may spread over the head and neck.

### **Horses**

Lesions in horses are similar to those in cattle. The hairs are matted together over the lesion, and an exudative dermatitis produces a firm mat of hairs and debris just above the skin surface. If this hair is plucked, the entire structure may lift off, leaving a characteristic ovoid, slightly bleeding skin area. No pruritus or irritation is apparent, although the sores are tender to the touch.

Infection can appear on the head, beginning at the muzzle and spreading up the face to the eyes, and if sufficiently extensive may be accompanied by lacrimation and a profuse, mucopurulent nasal discharge. In some horses the lesions are confined to the lower limbs, with a few on the belly. In very bad environmental conditions the lesions may be widespread and cover virtually the whole of the back and sides. The lesions on lower limbs are most common behind the pastern, around the coronet, and on the anterior aspect of the hind cannon bones. If the underlying skin cracks, the horse can become very lame. This variable distribution of lesions may depend on the inciting skin trauma.

### **Goats**

Lesions appear first on the lips and muzzle and then spread, possibly by biting, to the feet and scrotum. They may extend to all parts of the body, especially the dorsal midline and inside the thighs. In some cases lesions commence on the external ear. Heavy crust formations may block the ear canal and the external nares.

### **CLINICAL PATHOLOGY**

The causative organism may be isolated from scrapings or a biopsy section and is much easier to isolate from an acute case than a chronic one. Polymyxin B sulfate can be used to suppress contaminants. Typical branching organisms with double rows of zoospores can be seen in a stained impression smear made directly from the ventral surface of a thick scab pressed firmly onto a slide. The organism can also be demonstrated by fluorescent antibody. ELISA and counterimmunoelectrophoresis have been used to detect serologic evidence of infection, and a real-time PCR test for rapid detection of *D. congolensis* has been developed in Spain.<sup>3</sup>

## NECROPSY FINDINGS

In animals that die, there is extensive dermatitis, sometimes a secondary pneumonia, and often evidence of intercurrent disease.

## Samples for Confirmation of Diagnosis

- **Bacteriology**—affected skin and draining lymph node (CYTO FUNGAL CULT)
- **Histology**—formalin-fixed samples of these tissues (LM)

## DIFFERENTIAL DIAGNOSIS

Ringworm  
Staphylococcal dermatitis/folliculitis  
Scabies  
Pediculosis  
Fleece rot—sheep  
Other causes of dermatitis are listed in [Tables 16.3 and 16.4](#).

## TREATMENT

### Sheep

Bactericidal dips are used but have limited efficacy because topical treatments do not penetrate the scab to the active lesion; they are more appropriate for control.

Antibiotic treatment at high dose for a single treatment is effective in reducing the proportion of active lesions in an affected flock. Antibiotics that are effective include procaine penicillin combined with streptomycin at a dose of 70,000 units/kg and 70 mg/kg, respectively; erythromycin at 10 mg/kg; long-acting tetracycline at 20 mg/kg; and combination of lincomycin and spectinomycin at a dose of 5 mg/kg and 10 mg/kg, respectively; all treatments are given intramuscularly. Treatments appear effective in wet weather. The usual strategy is to treat 8 weeks before shearing so that there is time for the lesions to heal and shearing to occur without interference from active lesions. Sheep may be dipped in a bactericidal dip after shearing, as detailed under “Control.” An alternate approach is to cull affected sheep.

### Cattle

With the disease that occurs in temperate areas, tetracycline (5 mg/kg body weight [BW]) repeated weekly as required is recommended, and long-acting tetracycline (20 mg/kg BW) in one injection is reported to give excellent results in cattle. Parenteral procaine penicillin G (22,000 IU/kg IM) daily for 3 days is also reported as efficacious.

With the disease that occurs in tropical areas and associated with tick infestation, there is no completely satisfactory treatment in herds with extensive involvement or those being constantly reinfected or exposed to predisposing causes. In general terms, better results are obtained during dry weather and in dry climates. In tropical Africa, treatments

that are reasonably effective elsewhere are of little or no value.

Parenteral treatment with antibiotics, as described previously, can be used and should be used in conjunction with acaricides when ticks are present.

### Horses

Topical therapy is most commonly used in horses, coupled with removal from whatever is causing prolonged wetness of the skin. Although horses generally respond well, in bad weather even they can be recalcitrant to treatment. Scabs can be removed by grooming under sedation and the lesions treated topically daily with povidone-iodine or chlorhexidine until the lesions heal. Benzoyl peroxide has keratolytic, antibacterial, and follicular flushing properties and is reported to be effective in therapy when applied topically at a concentration of 2.5%.

Severe cases can be treated daily for 3 days with procaine penicillin G at 20,000 units/kg intramuscularly alone or in combination with streptomycin at 10 mg/kg IM.

## CONTROL

The principal approach, where possible, is the avoidance of predisposing factors. The disease usually disappears in dry weather. Isolation of infected animals and avoidance of contact by clean animals with infected materials such as grooming tools is desirable. Affected sheep should be shorn and/or dipped last.

Close yarding of sheep or factors that promote face-to-skin contact immediately after shearing or after dipping should be avoided. Insecticidal dips should contain a bactericide. Where dipping immediately after shearing is a risk factor, the severity of infection can be reduced by delaying dipping, for example, from the 1st to the 10th day after shearing, or by dipping in zinc sulfate immediately following shearing with later dipping in an insecticide. Alternatively, pour-on insecticides can be used.

Bactericidal dips will give some protection to sheep. Spraying or dipping of sheep in a 0.5% to 1.0% solution of zinc sulfate immediately after shearing is used to prevent infection of shear cuts. Spraying or dipping sheep in a 1% solution of alum (potassium aluminum sulfate) provides protection against infection for up to 70 days, with alum rendering the organism nonmotile, and can be used to provide protection during the rainy season in woolled sheep. Alum strips from the dip, and the dip requires frequent replenishment, with the amount depending on wool length. An alternate treatment is to dust alum along the back of the sheep.

With cattle in tropical areas, **tick control** (see Tick Infestations in this chapter) is most important in control of dermatophilosis. Attempts at prophylaxis by vaccination in both sheep and cattle have been unsuccessful; immunity appears to be isolate-specific.

## FURTHER READING

- Norris BJ, Colditz IG, Dixon TJ. Fleece rot and dermatophilosis in sheep. *Vet Microbiol.* 2008;128:217-230.
- Radostits O, et al. Dermatophilosis (mycotic dermatitis, cutaneous streptotrichosis, Senkobo disease of cattle, lumpy wool of sheep). In: *Veterinary Medicine: A Textbook of the Diseases of Cattle, Horses, Sheep, Goats and Pigs*. 10th ed. London: W.B. Saunders; 2007:1048-1051.

## REFERENCES

1. Chatikobo P, et al. *Trop Anim Health Prod.* 2009;41:1289.
2. Razafindrala H, et al. *Ann NY Acad Sci.* 2006;1081:489.
3. Garcia A, et al. *J Vet Sci.* 2013;14:491.

## SKIN TUBERCULOSIS

Chronic indurative lesions of the skin in cattle, occurring usually on the lower limbs, are called “skin tuberculosis” because they frequently sensitize affected animals to tuberculin.

## ETIOLOGY

Acid-fast organisms can often be found in the lesions in small numbers. They have not been identified and are probably not true pathogens. Iatrogenic lesions may be caused by aluminum adsorbed vaccines that produce subcutaneous granulomas, which are colonized by acid-fast bacteria.

## EPIDEMIOLOGY

The disease occurs in most countries of the world, particularly where animals are housed and incur minor abrasions and pressure sores. The frequent occurrence of lesions on the lower extremities suggests **cutaneous abrasions** as the probable portal of entry of the causative organism.

The lesions cause little inconvenience but are unsightly, and affected animals may give a suspicious or positive reaction to the tuberculin test when they are in fact free of tuberculosis. This becomes important when herds and areas are undergoing eradication and attention is focused on any condition that complicates the tuberculin test.

## PATHOGENESIS

Tubercloid granulomas occur at the site of infection, with spread along local lymphatic vessels but without involvement of lymph nodes.

## CLINICAL FINDINGS

Small lumps 1 to 2 cm in diameter appear under the skin. The **lower limbs** are the most common site, particularly the forelimbs, and spread to the thighs and forearms, and even to the shoulder and abdomen, may occur. The lesions may be single or multiple and often occur in **chains** connected by thin cords of tissue. The nodules are attached to the skin; they may rupture and discharge thick cream-to-yellow pus. Ulcers do not

persist. Individual lesions may disappear, but complete recovery to the point of disappearance of all lesions is unlikely if the lesions are large and multiple.

### CLINICAL PATHOLOGY

Affected animals may react to the tuberculin test. Bacteriologic examination of smears of pus may reveal the presence of acid-fast bacteria.

### NECROPSY FINDINGS

The lesions comprise much fibrous tissue, usually containing foci of pasty or inspissated pus, and are sometimes calcified.

#### DIFFERENTIAL DIAGNOSIS

In herds with tuberculosis, reactors that have lesions of skin tuberculosis are disposed of in the usual way. In herds free of tuberculosis, a positive reaction to the tuberculin test in animals with skin tuberculosis is usually taken to be nonspecific; the affected animal is retained, provided it is negative on retest.

**Bovine farcy** (see also "Bovine Farcy")

**Ulcerative lymphangitis** (see also "Ulcerative Lymphangitis").

### TREATMENT AND CONTROL

Treatment and control measures are not usually instituted, although surgical removal may be undertaken for cosmetic reasons.

## MYCOBACTERIUM ULCERANS INFECTION (BURULI OR BAIRNSDALE ULCER)

*Mycobacterium ulcerans* causes progressive ulcers in the skin of humans, dogs, cats, alpacas, horses and wildlife.<sup>1-5</sup> Pigs can be infected experimentally.<sup>6</sup> The disease in humans occurs in at least 30 countries,<sup>5</sup> often as geographic clusters associated with water bodies. Wildlife, such as the common brush-tailed possum (*Trichosurus vulpecula*) and ring-tailed possum (*Pseudocheirus peregrinus*) in southeastern Australia, are proposed as important components of the disease infection cycle, with *M. ulcerans* detected in the feces of 41% of possums in areas in which the disease is endemic and less than 1% in nonendemic areas.<sup>5</sup> Clusters of the disease in people are spatially associated with the presence of possums.<sup>7</sup> A relationship between wildlife and domestic animal disease has not been investigated or reported. The organism can be detected in a number of species of mosquitoes, although the importance of these species in spread of the infection and causation of disease is unclear.<sup>7</sup>

Infection by the organism causes extensive and progressive necrosis of the skin and underlying soft tissue, usually of the limbs or extremities. The disease is reported in the thigh of one horse and the withers and fetlock of another,<sup>1</sup> and the distal limb and

face, respectively, of two alpacas.<sup>4</sup> Infection causes both ulcerating and nonulcerating granulomatous lesions in dogs and cats.<sup>2</sup> One of two horses affected died as a result of the disease, as did both alpacas.<sup>1,4</sup>

Diagnosis is by the demonstration of the organisms by Ziehl–Neelson staining of biopsies of lesions with confirmation by culture or, more conveniently and presumably with greater sensitivity, by PCR detection of *M. ulcerans* genome.<sup>1,2,4</sup>

Treatment is by surgical excision of the lesion. Therapy with antimycobacterial drugs such as rifampin, clarithromycin, or fluoroquinolones can be considered but is limited because of drug-induced toxicoses, including diarrhea, difficulty in long-term administration, and expense.

There are no accepted control measures. The disease has zoonotic potential, and affected animals and samples should be handled accordingly.

### REFERENCES

1. van Zyl A, et al. *Aust Vet J.* 2010;88:101.
2. O'Brien CR, et al. *Aust Vet J.* 2011;89:506.
3. Malik R, et al. *Vet Dermatol.* 2013;24:146.
4. O'Brien C, et al. *Aust Vet J.* 2013;91:296.
5. Fyfe JAM, et al. *PLoS Neglect Trop Dis.* 2010;4.
6. Bolz M, et al. *PLoS Neglect Trop Dis.* 2014;8.
7. Carson C, et al. *PLoS Neglect Trop Dis.* 2014;8.

## FLEECE ROT IN SHEEP

### SYNOPSIS

**Etiology** Dermatitis associated with growth of chromogenic *Pseudomonas aeruginosa* following prolonged wetting of the skin of sheep.

**Epidemiology** Occurs with high incidence in sheep with susceptible fleece characters in wet seasons. Major risk factor for body flystrike.

**Clinical findings** Dermatitis with fleece coloration over the backline.

**Diagnostic confirmation** Clinical.

**Control** Selection of sheep with resistant fleece characters.

### ETIOLOGY

Fleece rot develops as an exudative dermatitis following wetting of the fleece by rain. The growth of toxigenic strains of *Pseudomonas aeruginosa* is thought to be the major cause of the dermatitis, and the fleece coloration that usually accompanies it, but other *Pseudomonas* spp., including *P. maltophilia*, have been incriminated in the genesis of the condition. The enzyme phospholipase C in *P. aeruginosa* is a virulence determinant for this disease.

### EPIDEMIOLOGY

#### Occurrence

The disease is common in most parts of Australia and occurs in South Africa and also in

areas of New Zealand. Its occurrence is associated with wet years, and in these circumstances the incidence in affected flocks varies from 40% to 100%.<sup>1,2</sup>

### Environmental and Host Risk Factors

Fleece rot occurs in sheep only in wet seasons and when the fleece is predisposed to wetting by its physical characters.

Prolonged rainfall, sufficient to wet sheep to the skin for a week, is required for this condition to occur. Young sheep (those < 10 months) are more susceptible than old, and heritable differences in fleece characters affect the susceptibility of individual sheep. These characters are probably related to the ease with which the skin can be wetted.

### Fleece Characteristics

The degree of "grip" and body skin wrinkling are unimportant as factors affecting susceptibility, but fleece weight, fiber diameter and variability, staple density, and neck wrinkle are positively correlated with susceptibility. These characteristics produce visible differences between fleeces. Resistant sheep have closely packed elliptical wool staples with blocky tips and even crimp. Susceptible fleeces have thin staples of unevenly crimped wool and with a fringe-tipped appearance as a result of the protrusion of thicker wool fibers above the top of the staple. This fringed appearance is visible along the back and sides. Susceptible flocks are characterized by fleeces with longer, heavier, thicker staples with lower crimp frequency and higher fiber diameter and variability.

Fleeces with a high wax content are less susceptible, probably because of the waterproofing effect of the wax. This view is supported by the observation that disruption of the sebaceous layer on the skin increases its susceptibility to wetting.

Greasy fleece color has been found to be a good predictor of susceptibility to fleece rot in some studies but not others. Wool with a high suint content is highly susceptible.

### Experimental Production

The disease can be reproduced experimentally by inoculating *P. aeruginosa* epicutaneously and wetting the fleece.

### Economic Importance

Fleece rot causes considerable financial loss because of the depreciation in the value of the damaged fleeces and the increased need for chemical applications to treat or prevent body flystrike, for which it is a major risk factor.

### PATHOGENESIS

With prolonged wetting, conditions of high humidity in the fleece microenvironment and the availability of rich nutrients from serous exudates and indigenous suint allow the proliferation of opportunistic skin and fleece bacteria, including *P. aeruginosa*, and



result in dermatitis. The predominant bacterium is usually *P. aeruginosa*, which inhibits the growth of other bacteria, and its pyocyanin produces a green color. Its rapid growth is accompanied by the production of the dermonecrotic toxin phospholipase C, which exacerbates the dermatitis and initiates the inflammatory cascade that draws neutrophils and lymphocytes into the skin.

In the experimental disease there is outpouring of serous exudate and infiltration of leukocytes into dermis, but *P. aeruginosa* is localized as aggregates at the leading front of the seropurulent exudate and never penetrates the dermis.

Other discolorations may occur depending on the predominance of a particular chromogenic bacterium, many of which belong to *Pseudomonas* spp. *P. maltophilia* can result in yellow–brown coloration, and *P. indigofera* results in blue coloration.

The odor produced by the bacteria and the serum protein on the skin surface is very attractive to blow flies, and most body strikes are a result of preexisting fleece-rot lesions. To add a further complication, *P. aeruginosa* also proliferates in the presence of organophosphorus insecticides and facilitates its biodegradation.

Sequencing of 16SrRNA genes to identify bacteria present before and after the onset of disease in an experimental flock at Trangie in Australia identified several new bacteria associated with fleece rot, and the bacterial populations differed between susceptible and resistant sheep.<sup>3</sup> It was concluded that although *P. aeruginosa* may be associated with severe fleece-rot lesions, there may be other bacteria associated with susceptibility or resistance to this condition. Subsequently, investigation of single-nucleotide polymorphisms between susceptible and resistant sheep identified 155 genes that were differentially expressed.<sup>4</sup> Fibulin (FBLN1) and fatty acid binding protein 4 (FAB4) were identified as key factors in resistance to fleece rot. If validated in larger populations, these could enable marker-assisted selection to increase the resistance of Merino sheep to fleece rot.<sup>4</sup>

## CLINICAL FINDINGS

Lesions occur most commonly over the withers and along the back. In active cases, the wool over the affected part is always saturated, and the tip is more open than over unaffected areas. The wool is leached and dingy and in severe cases can be plucked easily. The skin is inflamed, and serous exudate produces bands of matted and colored fibers across the staple. The coloration of the fibers is commonly green, but may be yellow, yellow–brown, or red–brown and occurs in fibers at skin level or extending the full length of the staple.

The general health of the sheep is unaffected in typical fleece rot, but severe ulcerative dermatitis with mortality associated

with *P. aeruginosa* can occur. For example, chronic ulcerative and necrotic dermatitis associated with *P. aeruginosa*, occurring on the tail, udder, and legs of sheep and accompanied by green coloration of the surrounding fleece, was recorded following excessive rain in the Mediterranean climate zone of Israel.

## CLINICAL PATHOLOGY AND NECROPSY FINDINGS

Autopsy examinations are not carried out, and laboratory examination of the living animal is not usually necessary.

There are differences in the inflammatory response and in peripheral blood lymphocyte subsets between fleece-rot-resistant and susceptible sheep, with several different mechanisms likely to occur in resistant sheep.<sup>2</sup>

## DIAGNOSIS

Fleece rot resembles mycotic dermatitis in body distribution and predisposing factors, but the typical scab is not present in fleece rot.

## CONTROL

Treatment is unlikely to be of value, but some degree of control may be effected by selection of fleece-rot-resistant sheep for use in susceptible localities. In these same localities, shearing before the wet season should facilitate drying of the fleece and lessen susceptibility, although the variable and unpredictable timing of rainfall means that no shearing time will reliably prevent fleece rot. The heritability of resistance to fleece rot has been estimated to be between 0.35 and 0.4; thus, selective breeding programs have been advocated, with genetically selected lines showing increased resistance in high-risk environments.<sup>2</sup>

Considerable effort was invested into the investigation of vaccines against fleece rot in the 1980s and 1990s.<sup>2</sup> These reduced the severity of fleece rot in pen experiments, often by up to 60%, but when the infecting serotype of *P. aeruginosa* differed from the vaccine strain there was little cross protection.

## REFERENCES

1. Radostits O, et al. Fleece rot in sheep. In: *Veterinary Medicine: A Textbook of the Diseases of Cattle, Horses, Sheep, Goats and Pigs*. 10th ed. London: W.B. Saunders; 2007:1081–1082.
2. Norris BJ, et al. *Vet Microbiol*. 2008;128:217.
3. Dixon TJ, et al. *Aust J Agric Res*. 2007;58:739.
4. Smith WJM, et al. *BMC Vet Res*. 2010;6:27.

## BOLO DISEASE

This disease of the fleece of predominantly merino and Döhne merino sheep appears confined to the Eastern Cape province of South Africa and gets its name from the region where it was first described. An unclassified *Corynebacterium* spp. closely

resembling *Corynebacterium pseudodiphtheriticum* and *Corynebacterium urealyticum* can be isolated from the skin of affected sheep. This organism is rarely isolated from the skin of sheep with normal fleeces. The disease can be experimentally reproduced by the topical application of the organism onto the intact skin of newly shorn sheep and sheep in 5-month wool, and the organism persists in the produced lesions for at least 169 days.

Bolo disease is a disease of medium- and medium–strong-wool Merino sheep having dense fleeces with a high yolk content. It occurs in sheep on natural grazing. There is no sex predilection, but older and poor-conditioned sheep are more severely affected. It can occur in semiarid climates, and there is no apparent seasonal or climatic influence or influence of external parasites. The attack rate in a flock can be as high as 90%, and the disease has considerable economic impact because as the wool is of inferior quality and low economic value.

Lesions occur most commonly on the sides of neck and the shoulders and are more easily seen in unshorn sheep as well-defined, dark gray to black patches and bands that vary in number and in size (20 mm to 30 cm in diameter) and are sunk below the surface of the tips of the surrounding staple. The underlying skin is red–purple in color, is tender to the touch, and breaks easily. There is a yellow sticky exudate on the surface of the skin and in between the wool fibers, resulting in a spiky staple. On freshly shorn sheep, the affected areas are chalky white.

Histologically there is acanthosis, superficial and follicular hyperkeratosis and hyperpigmentation, and sebaceous gland hypertrophy.

Treatment regimens are not defined, but high-dose parenteral penicillin as used in mycotic dermatitis might be effective.

Bolo disease can be differentiated from fleece rot and mycotic dermatitis by its clinical presentation and the epidemiologic circumstances in which it occurs.

## FURTHER READING

Radostits O, et al. Bolo disease. In: *Veterinary Medicine: A Textbook of the Disease of Cattle, Horses, Sheep, Goats and Pigs*. 10th ed. London: W.B. Saunders; 2007:798.

## STRAWBERRY FOOTROT OF SHEEP (PROLIFERATIVE DERMATITIS)

Strawberry footrot of sheep is a proliferative dermatitis of the lower limbs of sheep.

## ETIOLOGY

The causative agent is thought to be *D. congolensis* (*Dermatophilus pedis*).<sup>1</sup>

## EPIDEMIOLOGY

The disease is recorded in the United Kingdom and occurs extensively in some

parts of Scotland and in Australia. It is not fatal, but severely affected animals do not make normal weight gains. Up to 100% of animals in affected flocks may show the clinical disease.

All ages and breeds appear susceptible, but under natural conditions lambs are more commonly affected. Most outbreaks occur during the summer months, and lesions tend to disappear in cold weather. Although the disease is recorded naturally only in sheep, it can be transmitted experimentally to man, goats, guinea pigs, and rabbits. Complete immunity does not develop after an attack, although sheep recently recovered from contagious ecthyma may show a transient resistance.

The natural method of transmission is unknown, but the frequency of occurrence of lesions at the knee and coronet suggests infection from the ground through cutaneous injuries. Dried crusts containing the causative agent are infective for long periods, and ground contamination by infected animals, or infection from carrier animals, is the probable source of infection.

### PATHOGENESIS

Histologically, the lesions are those of a superficial epidermitis similar to that of contagious ecthyma.

### CLINICAL FINDINGS

Most cases appear 2 to 4 weeks after sheep have been moved onto affected, pasture but incubation periods of 3 to 4 months have been observed. Small heaped-up scabs appear on the leg from the coronet to the knee or hock. These enlarge to 3 to 5 cm in diameter and become thick and wart-like. The hair is lost, and the lesions may coalesce. Removal of the scabs reveals a bleeding, fleshy mass resembling a fresh strawberry, surrounded by a shallow ulcer. In later stages the **ulcer** is deep and pus is present. There is no pruritus or lameness unless lesions occur in the interdigital space. Most lesions heal in 5 to 6 weeks, but chronic cases may persist for 6 months.

### CLINICAL PATHOLOGY

Swabs and scrapings should be examined for the causative organism.

#### DIFFERENTIAL DIAGNOSIS

Lesions of strawberry footrot closely resemble those of contagious ecthyma but are restricted in their distribution to the lower limbs, whereas lesions of contagious ecthyma occur mostly on the face and less often on the legs. On careful examination, often both leg and face lesions are present. The absence of a systemic reaction and the proliferative character of the lesions differentiate it from sheeppox.

### TREATMENT

There is little information on treatment. Antibiotics as used in dermatophilosis should be effective. In an unusual outbreak of lameness affecting 40% of a flock, with lesions resembling strawberry footrot but from which no organisms were isolated, the response to topical antibiotic and preparations was poor, although lesions did become less painful after bathing affected areas in a solution of lincomycin/spectinomycin.<sup>2</sup> Systemic treatment with tilmicosin and long-acting amoxicillin did assist healing.<sup>2</sup>

### CONTROL

In the light of present knowledge, isolation of infected sheep and the resting of infected fields are the only measures that can be recommended.

### REFERENCES

1. Radostits O, et al. Strawberry footrot. In: *Veterinary Medicine: A Textbook of the Disease of Cattle, Horses, Sheep, Goats and Pigs*. 10th ed. London: W.B. Saunders; 2007:1051.
2. van Burgt GM, et al. *Vet Rec*. 2011;168:569.

## CONTAGIOUS ACNE OF HORSES (CANADIAN HORSEPOX, CONTAGIOUS PUSTULAR DERMATITIS)

Contagious acne of horses is characterized by the development of pustules, particularly where the skin comes in contact with the harness.

### ETIOLOGY

*Corynebacterium pseudotuberculosis* is the specific cause of this disease.

### EPIDEMIOLOGY

The disease is spread from animal to animal by means of contaminated grooming utensils or harnesses. An existing seborrhea or folliculitis as a result of blockage of sebaceous gland ducts by pressure from the harness probably predisposes to infection. Inefficient grooming may also be a contributing cause.

Contagious acne is of limited occurrence and causes temporary inconvenience when affected horses are unable to work.

### PATHOGENESIS

Infection of the hair follicle leads to local suppuration and the formation of pustules, which rupture and contaminate surrounding skin areas. Occasional lesions penetrate deeply and develop into indolent ulcers.

### CLINICAL FINDINGS

The skin lesions usually develop in groups in areas that come into contact with the harness. The lesions take the form of papules that develop into pustules varying in diameter from 1 to 2.5 cm. There is no pruritus, but the lesions may be painful to touch. Rupture of the pustules leads to crust formation over

an accumulation of greenish-tinged pus. Healing of lesions occurs in about 1 week, but the disease may persist for 4 or more weeks if successive crops of lesions develop.

### CLINICAL PATHOLOGY

Swabs of the lesions can be taken to determine the presence of *C. pseudotuberculosis*.

#### DIFFERENTIAL DIAGNOSIS

Ringworm

Staphylococcal pyoderma

Nodular necrobiosis

#### Diagnostic confirmation

Isolation of *C. pseudotuberculosis* from lesions

### TREATMENT

Affected animals should be rested until all lesions are healed. Frequent washing with a mild skin disinfectant solution followed by the application of antibacterial ointments to the lesions should facilitate healing and prevent the development of further lesions. Parenteral administration of antibiotics may be advisable in severe cases.

### CONTROL

Infected horses should be rigidly isolated, and all grooming equipment, harnesses, and blankets must be disinfected. Grooming tools must be disinfected before each use. Vaccination is not likely to be effective because of the poor antigenicity of the organism.

## EXUDATIVE EPIDERMITIS (GREASY PIG DISEASE)

### ETIOLOGY

The condition of exudative dermatitis (marmite disease) is similar to staphylococcal scalded skin syndrome in humans associated with *S. aureus*. It is a skin condition of pigs of all ages. One human case of *S. hyicus* septicemia has been recorded.

*S. hyicus* is the cause of exudative epidermitis (EE) in suckling and weaned piglets. It also causes several other diseases sporadically in different animal species, bacteriuria in pigs, polyarthritis in pigs, abortion in pigs, flank biting and necrotic ear lesions, and pneumonia. It is a normal inhabitant of the skin of adults. Virulence is associated with toxins.<sup>1,2</sup>

In other species it has been associated with skin infections in horses, donkeys, and cattle; subclinical mastitis in cows; and osteomyelitis in heifers.

A second species, *Staphylococcus chromogenes*, is part of the normal skin flora of pigs, cattle, and poultry. It had been considered nonpathogenic until EE was associated with it in 2005. These strains produced exfoliative

toxin type B (ExLB), which was identified by PCR. A third species, *Staphylococcus sciuri*, has also caused EE.<sup>3</sup>

## SYNOPSIS

**Etiology** *Staphylococcus hyicus* of at least six serotypes and many phage types.

**Epidemiology** Affects suckling and weanling piglets under 6 weeks of age; peak incidence under 1 week of age. Morbidity 20% to 100%; case fatality 50% to 75%. Organism carried by sow. Introduced by carriers.

**Signs** Marked cutaneous erythema and pain, dehydration, extensive greasy exudate; peracute cases die; less severe cases may survive. May cause ear necrosis syndrome.

**Clinical pathology** Bacterial culture of skin.

**Necropsy findings** Exudative epidermitis; degenerative changes in kidney.

**Diagnostic confirmation** Culture of organism.

**Differential diagnosis** See Table 16-2.

**Treatment** Penicillin parenterally.

**Control** Sanitation and hygiene of pens. In outbreaks, isolate affected piglets and sows.

## EPIDEMIOLOGY

### Occurrence

The disease occurs in all pig-producing countries. Most cases of exudative epidermitis occur in suckling and weaned piglets under 6 weeks of age, with a peak incidence in piglets under 1 week. Occasionally groups of pigs up to 3 months of age may be affected. Within litters the incidence is high; often all piglets are affected. The morbidity will vary from 20% to 100% and the case fatality rate from 50% to 75%. The organism has been isolated from the joint fluid of lame pigs affected with arthritis.<sup>3</sup> In 28% and 26% of studies of cases of exudative epidermitis, no cases of toxigenic *S. hyicus* could be detected. In a recent study of 314 cases in Denmark, it was shown that 20% had exfoliatum toxin A, 33% had B, 18% had C, and 22% had D in 60% of cases of EE investigated.

### Method of Transmission

The source of the organism is unknown, but the gilt or sow is probably an inapparent carrier. It can be isolated from the skin of healthy in-contact piglets and healthy sows. It can be frequently isolated from the vagina of prepubertal gilts, and the majority of the litters from the same gilts may be colonized by the organism within 24 hours after farrowing. The maternal strains of *S. hyicus* persisted on the skin of the offspring piglets for the first 3 weeks of the piglets' lives—the critical period for outbreaks of exudative epidermitis. The organism has also been

isolated from the atmosphere of buildings housing affected pigs. Bacteriophage typing of *S. hyicus* subsp. *hyicus* isolated from pigs with or without exudative epidermitis revealed two or more phage patterns in the isolates from each pig with the disease and a single-phage pattern in isolates from healthy pigs. It may also spread by aerosol.

## Risk Factors

### Animal Risk Factors

Field evidence suggests that environmental stress of various kinds, including agalactia in the sow and intercurrent infection, predisposes to the disease. Lesions commonly develop first over the head, apparently in association with bite wounds, which occur when the needle teeth have not been cut or have been cut badly. Other factors include fighting following mixing of litters, excessive humidity over 70%, and following sarcoptic mange. The presence of the disease in a swine herd can account for a 35% reduction in the margin of output over feed and veterinary costs over a 2-month period. It may also occur as a result of floor injuries.

### Pathogen Risk Factors

Strains of *S. hyicus* can be divided into virulent and avirulent strains with regard to ability to produce exudative epidermitis in experimental piglets; both types of strain can be isolated simultaneously from diseased piglets. It has been shown that different types of *S. hyicus* expressing different types of toxin may be present in the same diseased pig.

*S. hyicus* produces an exfoliative toxin that can be used to reproduce the disease. There are several toxins, including ExLA, ExLB, ExLC, ExLD, SHETa, and SHETb.<sup>4</sup> Toxigenic *S. hyicus* is isolated more freely from diseased than healthy pigs.<sup>5</sup> Strains of the organism isolated from a large number of Danish pig herds indicated different electrophoretic motility and plasma-mediated antibiotic resistance patterns. The antibiotic and plasmid profiles of strains isolated from pig herds may be a reflection of the use of antibiotics in those herds. Different types of toxin are produced.

Recently the genes encoding for the exfoliative toxins SHETb, ExLA, ExLB, ExLC, and ExLD have been identified and sequenced.

The condition has been seen more frequently in cases of PRRS and PCV-2 infections. It is very resistant to drying and can persist in the environment.

The organism has been found as a frequent inhabitant of the skin of cattle and has been isolated from cattle with skin lesions. Naturally occurring lesions of dermatitis of the lower limbs of horses and similar lesions over the neck and back of donkeys have been recorded. Experimentally, the organism can cause lesions in horses similar to those of exudative epidermitis. A concurrent

infection with *D. congolensis* has also been reported.

## PATHOGENESIS

*S. hyicus* has cytotoxic activity for porcine keratinocyte cells in culture, particularly the cells of the stratum granulosum. At least six toxins have been found. There is also a virulence factor that helps resist phagocytosis by binding IgG.<sup>6</sup> The organism also produces a coagulase, streptokinase lipase, and has a fibronectin-like substance that aids attachment to skin cells.

The exfoliative toxins are actually epidermolysins that are active against desmoglein-1, which is a desmosomal cadherin-like molecule involved in cell-to-cell adhesion. The ExLs can cause blister formation in the porcine skin by digesting porcine desmoglein-1 in a similar way to exfoliative toxins of *S. aureus*.

The earliest lesion is a subcorneal pustular dermatitis involving the interfollicular epidermis. Exfoliation follows with sebaceous exudation and formation of a crust. In the well-developed case there is a thick surface crust composed of orthokeratotic and parakeratotic hyperkeratosis and neutrophilic microabscesses with numerous colonies of gram-positive cocci.

Although the principal lesion is an inflammatory-exudative reaction in the corium and upper layers of the epidermis, the disease is probably a systemic rather than a local one. Experimental infection of gnotobiotic pigs leads to dermatitis of the snout and ears, then the medial aspect of the thighs, the abdominal wall, and the coronets. The lesions can be produced experimentally by using crude extracellular products and a partially purified exfoliative toxin.

## CLINICAL FINDINGS

The morbidity varies from 10% to 100% and the mortality from 5% to 90%, with an average of 25%. It is usually self-limiting, and as immunity rises, it may well disappear.

In the peracute form, which occurs most commonly in piglets only a few days of age, there is a sudden onset of marked cutaneous erythema, with severe pain on palpation, evidenced by squealing. Anorexia, severe dehydration, and weakness are present, and death occurs in 24 to 48 hours. The entire skin coat appears wrinkled and reddened and is covered with a greasy, gray-brown exudate that accumulates in thick clumps around the eyes, behind the ears, and over the abdominal wall. In the less acute form, seen in older pigs 3 to 10 weeks of age, the greasy exudate becomes thickened and brown and peels off in scabs, leaving a deep-pink-colored to normal skin surface. There is no irritation or pruritus. In the subacute form, the exudate dries into brown scales that are most prominent on the face, around the eyes, and behind the ears. In a small percentage of pigs, the chronic form occurs and the course is much



Table 16-2 Differential diagnosis of diseases of swine with skin lesions

Disease	Epidemiology	Clinical and laboratory findings	Response to treatment
Swinepox	Mainly suckling piglets. High morbidity but low mortality except in very young piglets. Usually associated with swine louse infestation.	Papules, vesicles, and circular red-brown scabs on ventral belly wall and over the sides and back. Pox characteristics.	None required except for insect and louse control. Spontaneous recovery in 3 weeks.
Skin necrosis	Suckling piglets. High morbidity with abrasive flooring.	Abrasion and necrosis starting shortly after birth and reaching maximum severity at about 1 week. Anterior aspect of carpus more common site but also fetlock, hock, elbow, and coronet. Bilateral. Necrosis and erosion of anterior two or three pairs of teats.	Usually none required. Recovery in 3–5 weeks. Protect area with tape if severe, plus topical antiseptics. Teat necrosis will render animal unsuitable for selection and breeding. Correction of flooring.
Exudative epidermitis (greasy pig disease)	Entire litters of sucklings pigs, most severe under 1 week of age, occurs up to 10 weeks, high case fatality in younger pigs.	Marked cutaneous erythema with seborrhea, severe dehydration, and death in piglets under 10 days. Older piglets covered with greasy exudate and recover. <i>S. hyicus</i> on culture.	Piglets under 10 days of age die in spite of therapy. Older pigs may survive with penicillin treatment topically and parenterally.
Dermatitis vegetans	Inherited and congenital, high morbidity. High case fatality by 8 weeks.	Erythema and edema of coronets, uneven brittle hooves, dry brown crusts on belly wall, giant-cell pneumonia. Club foot.	None indicated. Genetic control.
Pityriasis rosea	One or more piglets in litter after weaning. High morbidity, nil mortality.	Lesions begin as small, red, flat plaques that enlarge from 1–2 cm diameter with a prominent ring of erythematous skin covered in center by thin, dry, brown, loose scales. Lesions usually coalesce, forming a mosaic pattern, especially on belly. Scraping negative. No growth depression.	None required. Emollient to soothe the lesion. Recovery occurs in 4–8 weeks.
Parakeratosis (zinc deficiency)	Weaners and feeder pigs on diet low in zinc and high in calcium. Herd problem, high morbidity, no mortality.	Erythematous areas on ventral abdomen and symmetrically over back and legs develop into thick crusts and fissures. No pruritus. Skin scrapings negative. Growth rate depression.	Add zinc to diet 100 ppm. Adjust calcium. Recovery in 2–6 weeks.
Ringworm	Feeder and mature pigs. Usually several pigs within pen or shed. High morbidity with <i>M. nanum</i> in sows.	Centrifugally progressing ring of inflammation surrounding an area with scabs, crusts, and brown or black exudate. May reach large size. Bristles usually intact. No pruritus. Positive skin scrapings and hair. No ground depression.	Fungicides. In growers, spontaneous recovery in 8–10 weeks if well nourished. <i>M. nanum</i> in sows is persistent and responds poorly.
Facial dermatitis	Suckling piglets. High incidence in litters associated with fighting. Low mortality.	Lesions on cheeks—usually bilateral abrasions which become infected. Scabs hard and brown and difficult to remove. Overlie a raw shallow bleeding ulcer. Occasional extension to other areas.	Usually none indicated. Topical antibacterials. Clip teeth at birth.
Ulcerative granuloma	Young pigs but all ages. Sporadic. Infection following abrasion. Poor hygiene.	Large swollen tumorous mass with several discharging sinuses. Central slough and ulcer.	Fair, depending on site. Surgical removal and/or sulfadimidine and streptomycin.
Sarcoptic mange	All ages of pigs. Herd problem. Reservoir of infection in sows. High morbidity. Nil mortality.	Intense pruritus. Mites on scraping. Erythematous spots with scale and minor brown exudation. Especially evident in thin skin areas. Secondary trauma to skin and bristles from rubbing. If severe, intense erythema. Chronic infections, thickening and wrinkling of skin. Depression or weight gain.	Good response to vigorous therapy with ascaricides. Treat on herd basis.
Allergic dermatoses to <i>Tyroglyphus</i> spp. (harvest mites)	Weaner and feeder pigs few weeks after eating dry ground feed from automatic feeders.	Pinpoint erythematous spots and fragile scales. Intense pruritus. Skin scraping positive for mites.	Spontaneous recovery common. Insecticide effective.
Erysipelas	Feeder and adult pigs, occasionally weaners. Variable morbidity. Low mortality if treated early.	Small red spots developing to characteristic rhomboidal lesion, raised and red in color. Lesions may become joined and lose their characteristic shape. Progress to necrosis and desquamation. Fever and other signs of septicemia.	Penicillin.

longer; there is thickening with wrinkling of the skin and thick scabs that crack along flexion lines, forming deep fissures. Most peracute cases die, whereas piglets with the less severe forms will survive if treated. Some pigs are affected with ulcerative glossitis and stomatitis.

In older pigs lesions may be very limited. Sometimes just the ears are affected. Abortion in a sow has been attributed to the organism. In some cases pigs are dehydrated and emaciated. Surface lymph nodes may be enlarged or edematous. The condition is much more common when there are the immunosuppressive disorders (Porcine reproductive and respiratory syndrome virus, Porcine circovirus 2, Swine Influenza Virus).

### CLINICAL PATHOLOGY

Bacterial examination of skin swabs may reveal the presence of *S. hyicus*. A phage typing system can be used to determine the presence of virulent strains and to distinguish them from less virulent strains.

### NECROPSY FINDINGS

Necropsy of these dehydrated, unthrifty piglets often reveals a white precipitate in the renal papillae and pelvis. Occasionally this cellular debris causes ureteral blockage. Some piglets also have a mild ulcerative glossitis and stomatitis. Microscopically, there is separation of the cells of the epidermis in the upper stratum spinosum, exfoliation of the skin, erythema, and serous exudation. The crusting dermatitis features a superficial folliculitis and a hyperkeratotic perivascular dermatitis with intracorneal pustules and prominent bacterial colonies. Degenerative changes are visible in the renal tubular epithelium.

### DIAGNOSIS

Diagnosis is usually made on the basis of clinical signs and lesions.

Samples for confirmation of diagnosis include the following:

- Bacteriology—samples of acute skin lesions for culture are best if the skin underneath the crusts is sampled or the local lymph nodes. The organism forms 3- to 4-mm white, nonhemolytic colonies on blood agar. It is catalase- and mannitol-negative but hyaluronidase-positive. Selective media can be used (potassium thiocyanate),
- Histology—formalin-fixed skin (multiple sites), kidney (LM)
- A PCR is available but requires a pure culture and large numbers of organisms to be successful. An ELISA has been developed for the toxins.<sup>7</sup>

### DIFFERENTIAL DIAGNOSIS

Exudative epidermitis may resemble several skin diseases of pigs of all age groups (Table

16-2). However, in exudative epidermitis there is no pruritus or fever. In mange there is pruritus, and the lesions can be scraped. Ringworm can be cultured or skin scrapings made for microscopy. Pityriasis rosea is erythematous and self-limiting. Zinc deficiency in 2- to 4-month-old pigs is particularly found in Landrace, and the lesions are dry. Swinepox is usually local and rarely fatal. Careful gross examination of the lesions, particularly their distribution, the state of the hair shaft, the character of the exudate, and the presence or absence of pruritus, must be considered, along with skin scrapings and biopsies.

### TREATMENT

In severely affected animals, injection is best followed by water and feed medication. Experimentally infected piglets respond favorably to a topical application of cloxacillin 10,000 IU/g of lanolin base and 1% hydrocortisone combined with parenteral cloxacillin. Treatment must be administered as soon as the lesions are visible. Procaine penicillin G at a dose of 20,000 IU/kg BW intramuscularly daily for 3 days is also recommended. The antimicrobial sensitivities determined in one field investigation revealed that all isolates were sensitive to novobiocin, neomycin, and cloxacillin. Novobiocin may be the antimicrobial of choice because *staphylococci* are universally sensitive to this antibiotic. However, there is no available information on the efficacy of antimicrobials for naturally occurring cases of exudative epidermitis. A study has suggested that lincomycin, amoxicillin, and cetaloxin (off-label use) seem to work well in the United Kingdom. Erythromycin, sulfathiazole, and trimethoprim may be the most useful drugs, whereas penicillin and tetracyclines may not be very useful. Resistance to penicillin, erythromycin, streptomycin, sulphonamides, and tetracycline is fairly common. There is, however, no correlation between genes and resistance patterns.<sup>2</sup> Naturally occurring cases in piglets under 10 days of age respond poorly, whereas older pigs recover with a skin wash using a suitable disinfectant soap. The most successful treatment is antibiotics and skin washing for a period of at least 5 to 7 days. It is also essential to make sure that there is sufficient dietary provision of zinc, biotin, fat, selenium, and vitamin E in the diet. Because there is dehydration, electrolyte therapy may help.

### CONTROL

Improved hygiene, lower humidity, and dimmed lighting all help, as will control of concurrent infectious disease. Teeth clipping also reduces skin damage. Soft bedding also reduces skin damage (e.g., chopped straw is better than straw).

The infected accommodation should be cleaned, disinfected, and left vacant before another farrowing sow is placed in the pen. Strict isolation of the affected piglets and their dam is necessary to prevent spread throughout the herd. Dead piglets should be removed promptly from the premises, and in-contact sows should be washed with a suitable disinfectant soap. Maternal antibodies will protect piglets in the first few weeks of life. Prophylactic medication in feed or water has also helped.

Autogenous vaccines have been used, with varying degrees of success. It is important to use a strain that produces the exfoliative toxin, so the recent development of PCRs that identify the genes for toxin development will ensure that the right isolate is used for the autogenous vaccine. It will also facilitate the development of a commercial vaccine.

A novel approach to the control is bacterial interference. Experimentally, the pre-colonization of the skin of gnotobiotic piglets with an avirulent strain of *S. hyicus* will prevent the experimental reproduction of the disease with the virulent strain of the organism.

### REFERENCES

1. Futagawa-Saito F, et al. *Vet Microbiol.* 2007;124:370.
2. Futagawa-Saito F, et al. *J Vet Med Sci.* 2009;71:681.
3. Chen S, et al. *PLoS ONE.* 2007;2:e147.
4. Nishifuji K, et al. *J Derm Sci.* 2008;49:21.
5. Kanbar T, et al. *J Vet Sci.* 2008;9:327.
6. Rosander A, et al. *Vet Microbiol.* 2011;149:273.
7. Voytenko AV, et al. *Vet Microbiol.* 2006;116:211.

## ULCERATIVE DERMATITIS (GRANULOMATOUS DERMATITIS) OF PIGS

Ulcerative granuloma is an infectious disease of pigs originally associated with the spirochete *Borrelia suilla* (formerly *B. suis*) and more recently *T. pedis*.<sup>1</sup> In some cases it has become more common where there is PCV2 infection. It is characterized by the development of chronic ulcers of the skin and subcutaneous tissues. It can be confused with necrotic ear syndrome and, more importantly, with swine vesicular disease when there are granulating lesions at the coronary groove.

For sows, it occurs most commonly under conditions of poor hygiene. Lesions occur on the central abdomen of sows and on the mammary glands. The lesions expand, often to 20 to 30 cm in diameter, on the belly of the sow. They are usually single or in small numbers. In adult animals there is considerable inconvenience if the lesions are permitted to develop. Necrotic ulcers on the udders of sows may continue to develop and extend deeper into areas with fistulae, and sloughing may result.

The faces of sucking piglets are affected, suggesting infection of cutaneous or mucosal

abrasions as the portal of entry. In some instances, these outbreaks have followed episodes of severe fighting. Initially the lesions are small, hard, fibrous swellings that ulcerate in 2 to 3 weeks to form a persistent ulcer with raised edges and a center of excessive granulation tissue covered with sticky, gray pus. All you may see is a grayish, crusty, weeping lesion that may spread. There is often coinfection with *S. hyicus* or beta-hemolytic streptococci, and the lesions may be contaminated by *Trueperella* (*Arcanobacterium*) *pyogenes*. The lesions commence about the lips and erode the cheeks, and sometimes the jawbone, and often cause shedding of the teeth.

In young pigs, usually at 5 to 7 weeks of age, the whole litter may be affected. Here the lower margin of both ears close to the junction with the neck, with extensive tissue destruction and sloughing, is affected. The major diagnostic problem is that the initial spirochetal lesions may be secondarily infected with environmental organisms such as *Fusobacterium* spp. or *T. pyogenes*, and the underlying spirochetes may be missed unless smears are viewed. The pathology usually involves edema, erythema, necrosis, ulceration, and purulent lesions. In young pigs there may be heavy losses as a result of severe damage to the face.

Differential diagnosis may include abscesses, foreign bodies, granulomas, and pressure necrosis. In growing pigs, the lesions need to be differentiated from necrotic lesions resulting from snout rubbing and ear biting, and those resulting from excessive self-trauma with mange infestation. It may be mistaken for lesions of *Actinomyces* and *Nocardia* in sows, and swabs should be taken from the ulcers for bacteriologic examination. A fresh smear of the exudates usually shows the spirochetes, and if necessary they can be stained by silver stains or viewed in histologic sections. A course of potassium iodide given orally (1 g/35 kg up to 3 g) or a 5-day period of injections of penicillin are the methods of treatment. Topical tetracycline spray has been used effectively with early lesions followed by tetracycline injection in the deeper-seated and more chronic cases. Dusting with sulphanyl-amide, arsenic trioxide, or tartar emetic has also been recommended. Removal of large granulomas surgically has also been tried. Fly repellents should be used to prevent flystrike.

The injection of 0.2 mL of a 5% solution of sodium arsenite into the substance of the lesion is reported to give good results. Improvement in hygiene, particularly at the times of routine treatments, and disinfection of skin wounds should reduce the incidence in affected piggeries.

## REFERENCE

1. Pringle M, Fellstrom C. *Vet Microbiol.* 2010;142:461.

## Viral Diseases of the Skin

### PAPILLOMAVIRUS INFECTION (PAPILLOMATOSIS, WARTS)

#### SYNOPSIS

**Etiology** Papillomaviruses (PVs), including bovine papillomaviruses 1 through 13, equine papillomaviruses 1 through 7, and various other host-specific papillomaviruses.

**Epidemiology** Occur in all countries in all species but most common in young cattle and horses. Transmission is by direct contact and fomites. Risk factors for PV-associated diseases include ingestion of bracken fern (enzootic hematuria, alimentary squamous-cell carcinoma in cattle) and increasing age (penile squamous-cell carcinoma in equids).

**Clinical findings** Solid outgrowths of epidermis, may be sessile or pedunculated. Most common type in cattle occurs on head and neck and has cauliflower-like appearance, but lesion site and appearance vary with papilloma type. Alimentary (squamous epithelium) warts and squamous-cell carcinoma in cattle. Enzootic hematuria (bladder carcinoma) in cattle. In the horse, lesions are on the face and lips. Penile and prepuccial papillomatosis and squamous-cell carcinoma in horses. Aural plaques in horses. Sarcoids in horses.

**Clinical pathology** None specific.

**Lesions** Papilloma or fibropapilloma.

**Diagnostic confirmation** Histology and DNA identification by polymerase chain reaction (PCR) in biopsy or tissue scraping.

**Treatment** Removal by surgery or cryosurgery. Vaccination with autogenous vaccine. Application of imiquimod 5% cream to aural plaques.

Papillomaviruses appear to infect all groups of amniotes, having been isolated from 54 species, including mammals, birds, and reptiles.<sup>1</sup> Study of this group of viruses is historically important in the context of demonstration of the possibility of a viral etiology for some neoplastic diseases.<sup>2</sup> Diseases associated with infection by papillomaviruses range from nonneoplastic lesions on epithelial surfaces (skin, urogenital tract, gastrointestinal tract) through to neoplasms, including in humans (human papillomavirus and cervical cancer).<sup>3</sup> Cutaneous warts in cattle, horses, sheep, and goats are benign tumors induced by host-specific papillomaviruses. These infect epithelial cells, causing hyperproliferative lesions that are benign and self-limiting and that, in most cases, spontaneously regress. The virus is also associated with neoplastic diseases, including

bladder cancer in cattle ingesting bracken fern, carcinoma of the upper alimentary tract of cattle (usually associated with ingestion of bracken fern), and squamous-cell carcinoma of the penis and prepuce in horses. Papillomaviruses are usually quite host specific, with the exception of some bovine papillomaviruses, and require close contact for spread of infection.

#### ETIOLOGY

Papillomaviruses (PVs) are members of the Papillomaviridae family, which have a characteristic circular double-stranded DNA genome of around eight kilobase pairs (kbp) that usually contains at least six relatively conserved open reading frames (ORFs) in an early (E1, E2, E6, E7) and a late (L1, L2) region.<sup>4</sup> Papillomaviruses are characterized genetically by the L1 ORF.<sup>4</sup> To date, at least 112 nonhuman papillomaviruses have been identified, and there is the anticipation that more will be detected.<sup>1</sup> It appears that each species carries a suite of papillomaviruses—for example, 13 bovine papillomavirus (BPV) types have been identified in cattle (BPV-1 through BPV-13), 15 canine papillomavirus (CPV) types in dogs (CPV-1 through CPV-15), and 7 equine caballus papillomavirus (EcPV) types in horses (EcPV-1 through EcPV-7). The feline sarcoïd-associated virus has been proposed as BPV-14; it can infect cattle but has not been demonstrated in horses.<sup>5</sup>

Unusually, horses are also infected by BPV-1 and/or BPV-2, and possibly BPV-13,<sup>6</sup> which are associated with development of sarcoids (see “Sarcoids” for further discussion).<sup>7</sup> Papillomaviruses have been isolated from camels, goats, deer, sheep, and pigs, usually from papillomas or similar epithelial lesions.<sup>1</sup> BPV-1 and BPV-2 are associated with papillomas in yaks and sarcoids in zebra, giraffes, and sable antelope.<sup>8–10</sup> New papillomaviruses continue to be identified.<sup>11</sup>

Cattle types show some site predilection or site specificity, as exemplified by the following partial listing:

- **BPV-1**—frond fibropapillomas of teat and skin and penile fibropapilloma
- **BPV-1 and BPV-2**—fibropapilloma of the skin of the anteroventral part of the body, including the forehead, neck, and back;<sup>12</sup> the common cutaneous wart
- **BPV-2**—cauliflower-like fibropapillomas of the anogenital and ventral abdominal skin
- **BPV-2**—associated with bladder cancer in cattle in association with the ingestion of bracken fern (*Pteridium* spp.) (see “Enzootic Hematuria”)<sup>13</sup>
- **BPV-3**—cutaneous papilloma
- **BPV-4**—papilloma of the esophagus, esophageal groove, forestomachs, and small intestine; capable of becoming malignant, particularly in animals fed bracken fern; has site specificity to the upper alimentary tract



- **BPV-5**, and to a lesser extent BPV-1 and BPV-2, in fibropapilloma/papilloma of the mouth, esophagus, rumen, and reticulum of cattle and water buffalo<sup>14</sup>
- **BPV-5**—rice grain fibropapilloma on the udder; has also been demonstrated in cutaneous skin warts
- **BPV-6**—frond epithelial papillomas of the bovine udder and teats
- **BPV-7, BPV-9, and BPV-10**—lesions of the teats and udder<sup>15,16</sup>
- **BPV-10**—lingual papilloma<sup>17</sup>
- **BPV-12**—associated with papillomas<sup>18</sup>

Although a single BPV type is detected in an individual papilloma, a single animal can have papillomas at different sites associated with different BPV types.

Other papilloma of cattle that have regional distribution and may have separate antigenic identity are as follows:

- Oral papillomas, mostly in adult cattle and apparently reaching a high incidence, up to 16% in some areas; these are probably BPV-4
  - Papilloma of the larynx in steers
  - Papillomavirus has been observed in squamous-cell carcinoma of bovine eyes, although its etiologic role is unclear.
- Other skin lesions in which papillomavirus plays an etiologic role are:
- Equine sarcoid, which is associated with BPV-1 and BPV-2, and possibly BPV-13 (see “Sarcoid,” in this chapter)
  - Squamous-cell carcinoma of sheep (likely OaPV-3, although this can be isolated from the skin of healthy sheep)<sup>19</sup>
  - Epithelial tumors in goats (although the causal relationship is not clear)<sup>20</sup>
  - Cauliflower-like tumor of the external nares in a chamois<sup>21</sup>

## Equids

Papillomas, aural plaques, and squamous-cell carcinoma in horses are associated with infection by one of the seven equine papillomaviruses.<sup>1</sup> Cutaneous papilloma, including of the penis, and aural or genital plaques are associated with infection by EcPV-1 through EcPV-6.<sup>1</sup> EcPV-7 was isolated from a penile mass that was not histologically classified.<sup>4</sup> Penile papillomas are associated with infection by EcPV-2.<sup>22</sup> EcPV-2 DNA was detected in abnormal tissue in 15 of 16 cases of penile squamous-cell carcinoma, 8 of 8 cases of penile intraepithelial neoplasia, 4 of 4 cases of penile papilloma, and 1 of 2 lymph nodes containing metastatic tumor cells. EcPV-2 DNA was detected in 4 of 39 of penile swabs of healthy horses and in 0 of 20 vulvovaginal swabs.<sup>23</sup> Coinfection by more than one EcPV appears to be common.<sup>4</sup> Infection by equine papillomavirus EcPV-2, as demonstrated by detection of EcPV-2 DNA in lesions,<sup>24</sup> is associated with squamous-cell carcinoma of the genitalia of horses,<sup>25</sup> being transcriptionally active in tumor but not semen or swabs of healthy

horses,<sup>26</sup> and detected in 91 of 103 tissue samples of horses with penile or preputial carcinoma and in 1 of 12 samples from horses free of the disease.<sup>27</sup> There is no evidence to date that EcPV-3 is associated with carcinoma of the penis or prepuce. Papillomavirus DNA is not detected in periocular squamous-cell carcinoma of horses.<sup>28</sup>

Sarcoids in equids are discussed under that topic.

## Pigs

Papillomavirus specific to pigs has been isolated from skin of healthy pigs, but has not been associated with disease.<sup>29</sup>

## EPIDEMIOLOGY

### Occurrence

Papillomatosis has an international occurrence in all animal species, and sarcoids and urogenital tumors occur in almost all populations of horses. There are few studies of the seroprevalence of papillomaviruses in healthy animals. Five of 50 horses without evidence of skin disease or urogenital tumors in Switzerland had EcPV-2-specific DNA amplified but not EcPV-2-specific antibodies detected, 14 of 50 horses had antibodies against EcPV2 but no DNA detected, and both antibodies and viral DNA were detected in 4 of 50 horses. Neither specific antibodies nor viral DNA were found in 27 of 50 horses (54%).<sup>30</sup>

BPV-1 or BPV-2 infection is common in horses and cattle, being detectable by PCR and/or reverse transcription PCR (RT-PCR) in 14 of 70 blood samples (20%) and in 11 of 31 semen samples (35%) from healthy horses,<sup>31</sup> and in 8/12 blood samples of healthy cattle and in 8/9 samples from cattle with papillomatosis. Six of 8 papilloma-free cattle that were positive for BPV also had evidence of expression of BPV in blood.<sup>32</sup>

Papillomaviruses were detected in 28/45 of samples of horses with aural plaques, of which 4/45 were solely EcPV-3 and 17/45 were solely EcPV-4, with 7/45 being coinfecting. Viral DNA was not detected in 17/45 of samples. Neither EcPV-3 nor EcPV-4 was detected in samples from 10 horses that did not have aural skin lesions.<sup>33</sup> Similar results demonstrating presence of papillomavirus antigen or EcPV DNA in papillomas, aural plaques, and sarcoids supports the etiologic associated between the virus and these diseases.<sup>34</sup>

### Origin of Infection and Transmission

The method of spread is by **direct contact** with infected animals, with infection gaining entry through **cutaneous abrasions**. Viruses can also persist on inanimate objects in livestock buildings and infect animals rubbing against them. BPV-1 DNA is present in flies (*Musca domestica*, *Fannia carnicularis*, and *Stomoxys calcitrans*) trapped in stables of donkeys with sarcoids, suggesting the possibility that flies, and especially biting flies (S.

*calcitrans*), are potential vectors.<sup>35</sup> The presence of BPV-1 and BPV-2 in blood of both horses and cattle raises the possibility of spread by biting flies independent of them feeding on actual lesions.

The means of transmission of the virus causing penile and preputial papillomas and squamous-cell carcinoma is unclear. Venereal transmission is possible, but lesions occur in animals that are not and have not been sexually active (e.g., geldings).

Crops of warts sometimes occur around eartags, at branding sites, or along scratches made by barbed wire, and they can be spread by tattooing implements, by dehorning shears, and by procedures such as tuberculin testing.

An extensive outbreak of perianal warts is recorded in beef heifers, the infection having been spread by rectal examination for pregnancy. A high prevalence of papillomas on the larynx of feedlot steers is ascribed to implantation of the virus in contact ulcers, which are also entry sites for *Fusobacterium nodosus* (a cause of calf diphtheria), so that the two diseases may occur in the one animal. An outbreak of periorbital papillomatosis in cattle is recorded in association with a heavy periorbital infestation with *Haematopinus quadripertusus*.

### Animal Risk Factors

All species may be affected by papillomas or fibropapilloma, but it is most commonly reported in cattle and horses. With cattle, usually several animals in an age group are affected. Alimentary papillomas occur in up to 20% of cattle ingesting bracken fern, but in less than 4% of other cattle.<sup>3</sup>

Outbreaks have been recorded in sheep and goats, but the disease is uncommon in sheep. It is also uncommon in pigs, usually affecting the genitalia.

Papillomavirus infection is widespread in nondomestic species, including birds and reptiles, and is associated with disease in many of these species (see previous discussion).<sup>1</sup>

## Age

Cutaneous papillomas of the head and neck occur predominantly in young animals, the lack of susceptibility of adults to natural infection being ascribed to immunity acquired by apparent or inapparent infection when young. The occurrence of cutaneous warts and their severity can be influenced by factors that induce immunosuppression, and latent infection has converted to clinical disease with the administration of immunosuppressive agents. Congenital infection is recorded in the foal and calf, but it is rare.

Alimentary papillomas in cattle, teat papillomas in cattle, and papillomas on the mammary glands of goats occur, or persist, at all production ages.

Squamous-cell carcinoma of the penis or prepuce occurs mostly in older horses (mean

age 20 y) and without apparent breed predilection.<sup>36</sup>

### Experimental Production

The supernatant from a suspension of wart tissue, injected intradermally (ID) or applied to skin scarifications, is an effective means of experimental production of the disease. Lesions are restricted to the site of inoculation. Cutaneous and oral papillomas have been transmitted in cattle, and cutaneous papillomas have been transmitted in sheep and horses. The incubation period after experimental inoculation in cattle is 3 to 8 weeks but is usually somewhat longer after natural exposure.

### Economic Importance

Cutaneous warts are quite common in young cattle, especially when they are housed, but ordinarily they cause little harm and regress spontaneously. In purebred animals they may interfere with sales and shows because of their unsightly appearance. Animals with extensive lesions may lose condition, and secondary bacterial invasion of traumatized warts can occur. Warts on the teats of dairy cows often cause interference with milking. In horses, the lesions are usually small and cause little inconvenience, but they are esthetically unattractive.

Urogenital lesions in equids, predominantly penile and preputial papillomas, can progress to squamous-cell carcinoma, which carries a poor prognosis unless treated early in the disease.<sup>36</sup>

### PATHOGENESIS

The virus infects the basal keratinocytes, replicating its genome in the differentiating spinous and granular layers and causing the excessive growth that is characteristic of wart formation.<sup>2</sup> Expression of the late structural proteins of the virus is limited to the differentiated cells of the squamous layer where the new virus particles are encapsulated and shed into the environment as the cells die. The tumor contains epithelial and connective tissues and can be a papilloma or a fibropapilloma, depending on the relative proportions of epithelial and connective tissue present; papillomas contain little connective tissue, and fibropapillomas are mostly fibrous tissue, with very little epithelial tissue. Papillomas are the result of basal-cell hyperplasia without viral antigen production. Fibropapillomas are uncommon in horses but are the common lesion in cattle, sheep, and wild ruminants. Latent infection in the skin and lymphocytes has been demonstrated in cattle.

### CLINICAL FINDINGS

Warts are solid outgrowths of epidermis that are sessile or pedunculated. Other papillomavirus-associated diseases include penile or prepuccial lesions in horses, alimentary lesions in ruminants, enzootic hematuria in

cattle ingesting bracken fern, and squamous-cell carcinoma of the urogenital or alimentary tracts.

### Cattle

In cattle, warts occur on almost any part of the body, but when numerous animals in a group are affected it is common to find them all affected in the same part of the body. The most common papillomas occur in the skin of cattle under 2 years of age, most commonly on the head (Fig. 16-2), especially around the eyes, and on the neck and shoulders (Fig. 16-3), but they may spread to other parts of the body. They vary in size from 1 cm upward, and a dry, horny, cauliflower-like appearance is characteristic. In most animals they regress spontaneously, but the warts may persist for 5 to 6 months, and in some cases for as long as 36 months, with serious loss of body condition.

Warts on the **teats** manifest with different forms depending on the papillomavirus type and may show an increasing frequency with age. The **frond forms** have filiform projections on them and appear to have been drawn out into an elongated shape of about 1 cm in length by milking machine action. If sharp traction is used, they can often be pulled out by the roots.

The second form is the flat, round type, which is usually multiple, always sessile, and up to 2 cm in diameter. The third form has an elongated structure appearing like a **rice grain**. Teat warts may regress during the dry period and recur with the next lactation.

**Perianal** warts are esthetically unattractive, but they do not appear to reduce activity or productivity. **Genital warts** on the vulva and penis make mating impracticable because the lesions are of large size, are friable, and bleed easily. They commonly become infected and flyblown. They occur on the shaft or on the glans of the penis in young bulls, may be single or multiple, are pedunculated, and frequently regress spontaneously.

**Alimentary tract** papillomas can occur anywhere from the mouth to the rumen. They often appear as lines of warts, suggesting a predisposing effect of trauma as a result of ingestion of roughage. Papillomas occur on the lateral and dorsal aspects of the tongue, soft palate, oropharynx, esophagus, esophageal groove, and rumen. Papillomas occurring in the esophageal groove and in the reticulum are a cause of chronic ruminal tympany. Papillomas also can progress to squamous-cell carcinoma in cattle, with an inevitable fatal outcome.<sup>3</sup>

Less common manifestations of papillomatosis in cattle include lesions in the **urinary bladder**, which cause no clinical signs but may predispose to enzootic hematuria. BPV-4 papillomas in the upper alimentary tract of cattle being fed bracken fern are the focus for transformation to squamous-cell carcinomas. Cattle fed bracken fern are immunosuppressed, which promotes the persistence and spread of the papillomavirus, and mutagens in bracken fern cause neoplastic transformation of papilloma cells.



Fig. 16-2 Warts on the face of a yearling Belgian Blue bull.





**Fig. 16-3** A, Warts (papillomas) on the neck and shoulders of a Holstein–Friesian heifer. B, Extensive warts (papillomas) on the face, neck, and shoulder of a yearling Hereford bull.

### Goats

Papillomas most commonly occur on the face and ears but may occur on the skin generally, especially on unpigmented skin. Most completely regress, others regress and recur, and occasional lesions progress to carcinomas. Papillomas that occur on the teats are persistent and may spread through the herd.

### Horses

Warts are confined to the lower face, the muzzle, nose, and lips, and are usually sessile and quite small, rarely exceeding 1 cm in diameter. Papillomas also occur on the penis and prepuce of both geldings and stallions,<sup>36</sup> and much less commonly on the vulva. All ages can be affected. Spontaneous recovery of papillomas on the head is usual, but the warts may persist for 5 to 6 months.

**Aural plaques** in horses are well-delineated lesions that affect the concave aspect of the pinna with a flat surface of whitish keratinous crust covering a shiny and erythematous skin surface. Lesions are single or multiple and coalescing and, in some cases, can cover almost the entire surface of one or both pinnae (Fig. 16-4).<sup>37</sup> The lesions are usually not pruritic, but some horses with aural plaques resist bridling or handling of the ears. A common concern is cosmetic in show horses.

**Squamous-cell carcinoma** of the penis and prepuce is usually evident as ulcerations or mass lesions and can be complicated



**Fig. 16-4** Coalescing plaques covered with a keratinous crust occupying most of the concave aspect of the horse's left ear, as viewed from the front. (Reproduced from Torres SMF et al. *Vet Dermatol* 2010; 21:503.)



by secondary bacterial infection.<sup>36</sup> Approximately 40% of affected horses have purulent or blood-stained preputial discharge. Preputial edema or the inability to prolapse the penis occurs in approximately 10% of horses.<sup>36</sup> Lesions are most commonly (~80%) located on the glans of the penis and can have papillomas neighboring the neoplastic tumor. Metastasis to inguinal lymph nodes is common as the disease progresses and is more likely in horses with poorly differentiated tumor.<sup>27</sup> Intrathoracic (lung) metastases are rare. Survival is related to the degree of differentiation of the tumor (log rank  $P < 0.001$ ), with a greater proportion of horses with less differentiated tumors dying of the disease (papilloma, 8.3%; G1, 26.1%; G2, 26.3%; G3, 63.3%; where G1 = well differentiated, G2 = moderately differentiated, and G3 = poorly differentiated) (Fig. 16-5).<sup>27</sup>

### CLINICAL PATHOLOGY

There are no specific changes in the hemogram or blood chemistry of affected cattle. As noted previously, papillomavirus can be detected in blood and semen of healthy and affected animals, varying with the species of animal and papillomavirus.

Biopsy of a lesion can be used to differentiate papillomas from squamous-cell carcinoma. Biopsy of classic “warts” is unnecessary. However, it may be advisable when large growths are found on horses to determine whether the lesion is a verrucous form of sarcoid. Microscopically, true papillomas consist of a hyperplastic epidermis with scant dermal tissue, whereas in fibropapillomas the dermal component tends

to predominate. The need to identify the specific virus in a crop of warts creates a requirement for serologic and histologic examinations.

Detection of viral DNA is achieved by RT-PCR or PCR, and serologic tests are available to determine exposure to some papillomaviruses.<sup>16,18,27,38-40</sup> As with all PCR assays, care must be taken to ensure that the appropriate primers are used.<sup>40</sup>

### DIFFERENTIAL DIAGNOSIS

Clinically, there is little difficulty in making a diagnosis of dermal papillomatosis, with the possible exception of atypical papillomas of cattle, probably associated with an unidentified type of the papillomavirus. These lesions are characterized by an absence of dermal fibroplasia and are true papillomas rather than fibropapillomas. All ages of animals can be affected, and the lesions persist for long periods. They are characteristically discrete, low, flat, and circular, and they often coalesce to form large masses. They do not protrude like regular warts, and the external fronds are much finer and more delicate.

#### Horses:

Sarcoid  
Melanoma

### TREATMENT

Warts can be removed by surgery or cryosurgery. Crushing of a proportion of small warts, or the surgical removal of a few warts, has been advocated as a method of hastening regression, but the tendency for spontaneous

recovery makes assessment of the results of these treatments very difficult. Partial resection of a wart(s) in a horse does not always promote resolution of the residue. Surgical removal can be followed by vaccination with an autogenous vaccine, although the efficacy of this approach is unclear. There is anecdotal concern that surgical intervention, and even vaccination, in the early stages of wart development may increase the size of residual warts and prolong the course of the disease.

Aural plaques in horses can be treated by application of imiquimod, an immunomodulator, and antiviral agents, as 5% cream applied three times a week, every other week, for 6 weeks to 8 months. Crusts were removed before each application of the cream and required sedation in most horses. Complete resolution of lesions was noted in all horses at the cessation of treatment, and the long-term resolution rate was 88%.<sup>37</sup> Imiquimod is used for treatment of penile papillomas and squamous-cell carcinoma in humans, but its use in horses for this purpose is not reported. Imiquimod is used for treatment of sarcoids in horses.<sup>41</sup>

### Vaccination

For cattle, autogenous vaccines prepared from wart tissues of the affected animal are effective in many cases. Commercially available vaccines are available for cattle but may be less efficacious; an autogenous vaccine prepared for a specific problem has the advantage of including the local virus types. The vaccine is prepared from homogenized wart tissue that is filtered and inactivated with formalin. Because of the different BPV types, care is required in the selection of the tissues. In general terms they can be selected based on tumor type, location, and histologic composition. The alternative is to use many types of tissue in the vaccine. Animal-to-animal variation in regression following vaccination of a group of calves with a vaccine prepared from a single calf in the group has been attributed to more than one BPV type producing disease in the group. The stage of development is also important, and the virus is present in much greater concentration in the epithelial tissue of older warts than young ones. The vaccine can be administered subcutaneously, but better results are claimed for ID injection. Dosing regimens vary, but 2 to 4 injections 1 to 2 weeks apart are commonly recommended. Recovery in 3 to 6 weeks is recorded in 80% to 85% of cases where the warts are on the body surface or penis of cattle, but in only 33% when the warts are on the teats. The response of low, flat, sessile warts to vaccination is poor. Development of DNA vaccines for prophylaxis or therapy (which will likely use different genes) is active but experimental at this time.<sup>42</sup>

Other treatments no longer commonly used include the injection into the wart of

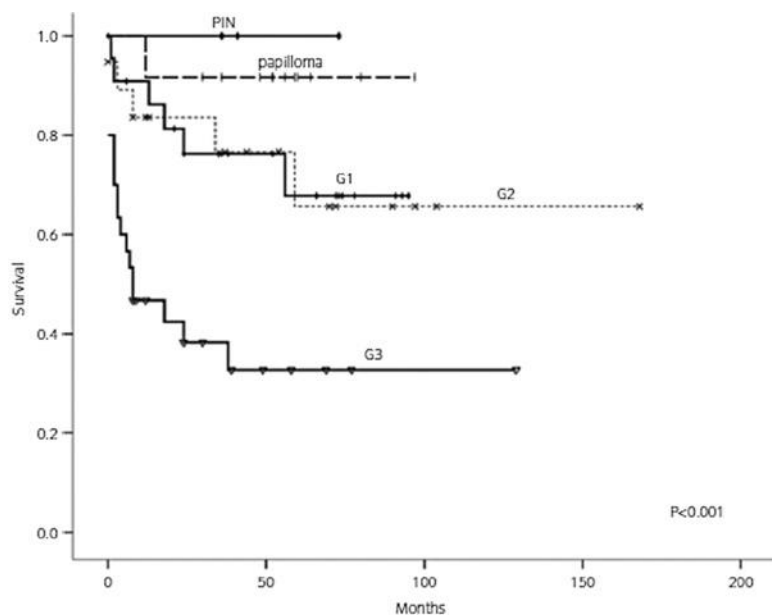

**Fig. 16-5** Survival of horses with penile or preputial papilloma, or squamous-cell carcinoma (G1, well differentiated; G2, moderately differentiated; and G3, poorly differentiated. PIN, penile intraepithelial neoplasia). (Reproduced from van den Top JGB et al. *Equine Vet J* 2015; 47:188.)

proprietary preparations containing anti-mony and bismuth or the intralesional injection of bacille Calmette–Guérin (BCG).

## CONTROL

Specific control procedures are usually not instituted or warranted because of the unpredictable nature of the disease and its minor economic importance.

Vaccination has been shown experimentally to be an effective prevention method and gives complete protection in cattle against stiff experimental challenge. The vaccine must contain all serotypes of the papillomavirus because they are very type-specific.

Avoidance of close contact between infected and uninfected animals should be encouraged, and the use of communal equipment between affected and unaffected animals should be avoided.

## FURTHER READING

- Munday JS. Bovine and human papillomaviruses: a comparative review. *Vet Pathol.* 2014;51:1063-1075.  
 Rector A, van Ranst M. Animal papillomaviruses. *Virology.* 2013;445:213-223.

## REFERENCES

- Rector A, et al. *Viol.* 2013;445:213.
- Cheville NF. *Vet Pathol.* 2014;51:1049.
- Munday JS. *Vet Pathol.* 2014;51:1063.
- Lange CE, et al. *J Gen Virol.* 2013;94:1365.
- Munday JS, et al. *Vet Microbiol.* 2015;177:289.
- Lunardi M, et al. *J Clin Micro.* 2013;51:2167.
- Nasir L, et al. *Vet Microbiol.* 2013;167:159.
- Bam J, et al. *Transbound Emerg Dis.* 2013;60:475.
- van Dyk E, et al. *J S Afr Vet Assoc.* 2011;82:80.
- Williams JH, et al. *J S Afr Vet Assoc.* 2011;82:97.
- Melo TC, et al. *Gen Mol Res.* 2014;13:2458.
- Pangty K, et al. *Transbound Emerg Dis.* 2010;57:185.
- Cota JB, et al. *Vet Microbiol.* 2015;178:138.
- Kumar P, et al. *Transbound Emerg Dis.* 2015;62:264.
- Hatama S, et al. *Vet Microbiol.* 2009;136:347.
- Tozato CC, et al. *Brazil J Micro.* 2013;44:905.
- Zhu W, et al. *Vet J.* 2014;199:303.
- Araldi RP, et al. *Gen Mol Res.* 2014;13:5644.
- Alberti A, et al. *Viol.* 2010;407:352.
- Simeone P, et al. *Open Vet J.* 2008;2:33.
- Mengual-Chulia B, et al. *Vet Microbiol.* 2014;172:108.
- Knight CG, et al. *Vet Dermatol.* 2011;22:570.
- Bogaert L, et al. *Vet Microbiol.* 2012;158:33.
- Lange CE, et al. *Vet Pathol.* 2013;50:686.
- Scase T, et al. *Equine Vet J.* 2010;42:738.
- Sykora S, et al. *Vet Microbiol.* 2012;158:194.
- van den Top JGB, et al. *Equine Vet J.* 2015;47:188.
- Newkirk KM, et al. *J Vet Diagn Invest.* 2014;26:131.
- Stevens H, et al. *J Gen Virol.* 2008;89:2475.
- Fischer NM, et al. *Vet Dermatol.* 2014;25:210.
- Silva MAR, et al. *Transbound Emerg Dis.* 2014;61:329.
- Silva MAR, et al. *Gen Mol Res.* 2013;12:3150.
- Gorino AC, et al. *Vet J.* 2013;197:903.
- Postey RC, et al. *Canad J Vet Res.* 2007;71:28.
- Finlay M, et al. *Virus Res.* 2009;144:315.
- van den Top JGB, et al. *Equine Vet J.* 2008;40:528.
- Torres SMF, et al. *Vet Dermatol.* 2010;21:503.
- Bogaert L, et al. *BMC Biotechnol.* 2006;6.
- Kawauchi K, et al. *J Virol Meth.* 2015;218:23.
- Silva MAR, et al. *J Virol Meth.* 2013;192:55.
- Nogueira SAF, et al. *Vet Dermatol.* 2006;17:259.
- Lima EG, et al. *Gen Mol Res.* 2014;13:1121.

## SARCOID

### SYNOPSIS

**Etiology** Locally aggressive benign fibroblastic tumors of the skin associated with bovine papillomavirus (BPV) types 1 and 2 (BPV-1 and BPV-2).

**Epidemiology** Common tumor of equids, including horses, donkeys, mules, and zebras. Breed differences in prevalence. Transmission by close contact and infection of wounds.

**Clinical findings** Single or multiple lesions in the skin of limbs, lips, eyelids, eye, penile sheath, and base of the ears. Can present as warty growth or have the appearance of granulation tissue or as nodules beneath the skin. Spontaneous regression is rare.

**Diagnostic confirmation** Histopathology.

**Treatment** No single treatment modality has an advantage. Surgical excision, cryosurgery, immunotherapy, radiation, and local chemicals (intralesional cisplatin, acyclovir) are used.

**Control** None recognized.

## ETIOLOGY

The cause of sarcoid in horses, mules, and donkeys is associated with infection by bovine papillomavirus (BPV) types 1 or 2, and possibly BPV-13.<sup>1-6</sup> Infection of young horses with BPV-1 virions induces nodular skin lesions 11 to 32 days after inoculation.<sup>7</sup> DNA of both types can be demonstrated in sarcoid tumors by PCR, as can the major transforming gene of BPV, E5, although papillomavirus has not been isolated from these tumors, nor have papillomavirus particles been demonstrated.<sup>8</sup> Variants of BPV-1 associated with sarcoids in horses have greater activity in equine cells than in bovine cells, indicating some adaptation or predilection of this variant for equine tissues.<sup>9</sup> The causative virus (BPV-1 or BPV-2) appears to vary geographically, with ~80% of cases in western Canada associated with BPV-2, as opposed to reports from other countries in which BPV-1 predominates.<sup>10</sup>

Genomic studies reveal that BPV-1 associated with sarcoids in horses likely diverged on multiple occasions from that in cattle at least 50,000 years before the present, and possibly much earlier, and well before domestication of either horses or cattle.<sup>11</sup>

It is speculated that this is a nonproductive infection in which viral DNA exists episomally, and a “hit-and-run” mechanism for pathogenesis has been proposed, in which infection by the virus, which resolves, induces changes that then lead to neoplastic transformation of tissue.<sup>6</sup>

However, given the demonstration of genetic susceptibility to sarcoid,<sup>12</sup> the cause is almost certainly multifactorial, with virus infection being an inciting event in

susceptible animals. There does not appear to be a role for mutation in the tumor suppressor gene, *p53*, in the development of sarcoid in horses.

## EPIDEMIOLOGY

### Occurrence and Prevalence

Horses, donkeys, mules and zebras are affected, as are giraffes and sable antelope.<sup>13-16</sup> Skin lesions histologically similar to those in equids also occur in felids.<sup>17</sup> Equine sarcoid is the **commonest neoplasm** in horses, representing about 20% of all equine tumors diagnosed at necropsy, ~46% of all neoplastic skin lesions in horses at two sites in North America, and lesions in 21 of 68 horses examined in a first-opinion practice in the United Kingdom.<sup>18,19</sup> Sarcoids were the histologic diagnosis in 42% of skin samples submitted to veterinary diagnostic laboratories in Canada.<sup>10</sup>

Sarcoid tumors occur in 0.7% to ~11% of 3-year-old Swiss warmbloods<sup>20</sup> and 0.4% of Freiburger horses in Switzerland. Sarcoids made up 53% of all tumors located on the head and body.<sup>18</sup> Sarcoids occurred as solitary tumors in more than 99% of horses.<sup>18</sup>

### Methods of Transmission

Transmission can be by infection of wounds, and castration is thought to be a risk factor, with flies as possible vectors. Close contact may facilitate transmission. BPV DNA has been detected in flies (*M. autumnalis*, *M. domestica*) and biting stable flies (*S. calcitrans*) associated with horses and donkeys with sarcoids.<sup>21</sup>

### Experimental Reproduction

The disease has been transmitted with sarcoid tissue and cell free supernatant from minced sarcoid tumors. The disease has also been reproduced with bovine papillomavirus, although the experimentally produced tumors subsequently regressed, which seldom occurs with natural sarcoid.<sup>5</sup>

### Animal Risk Factors

Horses with sarcoids had a mean age of 7 years (95% CI, 7.9 to 8.5 years). Horses with fibroblastic sarcoids are younger (median age of 5 years, range 0.6 to 25 years) than those with nodular (median 7, range 1.0 to 23), occult (median 7, range 1.1 to 21), verrucose (median 6, range 0.5 to 19), or mixed (median 6, range 0.5 to 31) sarcoids.<sup>10</sup> This wide age range highlights that sarcoids occur in young horses in addition to more aged animals. Risk of sarcoids was not associated with age or breed in two studies,<sup>10,18</sup> but other studies report that Appaloosa, Arabian, and Quarter horses are at greater risk than are Standardbreds or Thoroughbreds. Donkeys were overrepresented in one study,<sup>10</sup> and prevalence of disease was greater in populations of inbred zebra populations than in outbred populations (53% vs. 2%).<sup>13</sup>

There is a **genetically based susceptibility** to the disease, and the predisposition of horses to sarcoid is associated with the type of **major histocompatibility complex**, although this association is not universally accepted.<sup>12</sup> There are quantitative trait loci on equine chromosome (ECA) 20, 23, and 25 associated with genes that regulate virus replication and host immune responses.<sup>22</sup> Approximately 40% of the susceptibility to the disease in Swedish Halfbred horses is attributable to an autosomal-dominant equine leukocyte antigen (ELA)-linked gene. However, Swiss Warmbloods are no more likely to have the disease if their parent is diagnosed with sarcoids than if the sire is free of the disease.<sup>20</sup>

### Environmental Risk Factors

Lesions commonly occur on traumatized areas.

### PATHOGENESIS

The virus infects fibroblasts, and the infection is nonproductive. Viral DNA can be detected in lesional tissue, although viral load varies only slightly with clinical type of sarcoid.<sup>2,23</sup> However, intralesional viral load is directly associated with the severity of the disease.<sup>24</sup> It is thought that virus capsids of BPV are not found in equine sarcoids because papillomaviruses are usually host specific and the expression of virus capsids of the bovine papillomavirus requires the cellular environment of keratinocytes of the host species. Fibroblasts isolated from sarcoids are highly invasive, an attribute related to the high level of viral gene expression,<sup>2,24</sup> matrix metalloproteinase upregulation,<sup>25</sup> and production of viral oncoproteins.<sup>26-28</sup> Protein products of E5 and E6 enhance cell proliferation and, in vitro, increased invasion in EqS02a cells, and E7 enhances independence of cell anchorage independence, all attributes of neoplastic cells.<sup>29</sup> Elevated expression of phosphorylated p38 occurs in fibroblasts infected with BPV-1 as a result of the expression of BPV-1 E5 and E6 with enhancement of phosphorylation of the MK2 kinase, a substrate of p38, suggesting cellular mechanisms for the neoplastic transformation of infected cells.<sup>30</sup> Expression levels of FOXP3, interleukin-10, and interferon gamma mRNA (markers of regulatory T cells) and BPV-1 E5 copy numbers are significantly increased in lesional compared with tumor-distant skin samples from horses with sarcoids, suggesting local, regulatory, T-cell-induced immune suppression.<sup>27</sup>

Sarcoids do not regress, in contrast to the majority of papillomavirus infections, probably because expression of BPV in equine cells elicits immune evasion mechanisms.

### CLINICAL FINDINGS

Sarcoids are localized proliferations of epidermal and dermal tissue that may remain small and dormant for many years and then undergo a stage of rapid, cancer-like growth. The lesions show moderate malignancy but

do not metastasize to other sites, although there are sometimes (~2% of horses or 20% 30% of horses with sarcoids) multiple lesions.<sup>10,20</sup> Sarcoids occur as single or, more commonly, multiple lesions or clusters in the skin. The lesions occur anywhere on the body, but are more common on the head. Tumors on the head are 2.3 (95% CI, 2.0 to 2.7) times as likely to be sarcoids, compared with any other tumor type. Of 746 horses with sarcoids, 41% were on the head, 20% on the limbs, 16% on the neck or shoulder, 11% on the abdomen, 8% on the axilla or chest, and 5% in paragenital regions.<sup>10</sup>

Several forms of sarcoid are described:

- Verrucous (wart) sarcoid is a dry, horny, cauliflower-like surface that is usually partially or completely hairless. It may be broad based (sessile) or pedunculated. Verrucous sarcoids occur most commonly on the face, body, groin, and sheath area.
- Fibroblastic sarcoid has a similar appearance to that of proud flesh or excessive granulation tissue. It is often a firm, fibrous nodule in the dermis, although the surface may be ulcerated. It is found most commonly at sites of previous wounds and also the eyelid and limbs.
- A combination of both of the forms just described (“mixed”)
- Occult sarcoid is typically an area of slightly thickened skin that has a roughened surface. It is usually partially hairless. Interference with these slow-growing sarcoids, including attempts at treatment, should be avoided; such interference can cause the tumor to proliferate. They occur most commonly around the mouth and eyes and on the neck.

### CLINICAL PATHOLOGY

Confirmation of the diagnosis requires a **biopsy specimen** for histologic examination. Because sarcoids are usually associated with excessive granulation tissue and pyogranulomatous debris, the preferred specimen is a **transverse section of the excised tumor**. If punch biopsies are to be collected, then care should be taken that they include a representative section of the tumor, not just peripheral granulation tissue and edematous nontumor material. Examination by a pathologist accustomed to examining equine skin sections is important because the tumor has some features in common with papillomas and sarcomas and can be easily misdiagnosed.

PCR has been used to detect and quantify BPV DNA.<sup>31,32</sup>

### DIFFERENTIAL DIAGNOSIS

Cutaneous habronemiasis  
Phycomycosis

Fibromas

Granulation tissue

Squamous-cell carcinoma, especially of the penis and eyelid

Other skin tumors, including melanoma, by examination of a biopsy of the lesion

Papillomatosis

### TREATMENT

**Surgical excision** results in the return of the tumor in a significant proportion of animals within 6 months, often with overproliferation. BPV DNA can be detected in normal skin immediately surrounding sarcoids, and the recurrence has been speculated to reflect activation of latent BPV in normal tissue surrounding the tumor, although this interpretation is not supported by objective measurement of viral load in skin margins of the excised lesions.<sup>33</sup>

Intralesional administration of **cisplatin**, an oncolytic agent with in vitro activity against sarcoids cells,<sup>34</sup> by injection into the sarcoids or by electrochemotherapy, results in cure rates of 96% and 98%, respectively.<sup>35,36</sup> The protocol for intralesional injection of cisplatin in sesame seed oil is as follows:<sup>36</sup>

1. Crystalline lyophilized cisplatin powder is reconstituted with sterile water at a concentration of 10 mg/mL and mixed with medical-grade sesame seed oil (60%) and sorbitan monooleate (7%) by use of the pumping method just before administration (3.3 mg of cisplatin/mL of mixture).
2. Dosing objective is to deliver 1 mg of cisplatin per cubic centimeter of tumor. Tumor volume is calculated from the formula  $V = \pi \times D1 \times D2 \times D3/6$ , where D1 through D3 are tumor diameters measured with Vernier calipers.
3. Four intratumoral administrations of cisplatin are given at 2-week intervals of a series of intratumoral and peritumoral injections in 1 or 2 parallel planes, depending on the tumor size. The cisplatin emulsion is injected through narrow-bore needles (22 or 25 gauge). The spacing between injection rows is uniform, with a separation of 6 to 8 mm. The spacing between planes of injection is approximately 1 cm.

The largest dose of cisplatin to an adult horse should be not greater than 85 mg. Adverse reactions include moderate skin irritation. The treatment can be combined with surgical debulking of the lesion, with cisplatin administration begun when the surgical site has healed.<sup>36</sup>

Administration of **imiquimod** 5% cream to sarcoids three times weekly resulted in a cure rate of 60% in a study involving 15 horses.<sup>37</sup> Topical application of acyclovir (5%



cream) daily for 2 months to 47 sarcoids in 22 horses resulted in cure of 68%, with regression of tumor size in the remaining horses.<sup>38</sup>

**Cryotherapy** is associated with a much lower recurrence rate, but its use is limited by the anatomic location of the tumor. For instance, cryotherapy is not recommended for periocular lesions because of the risk of damaging nearby ocular tissues. The efficacy of cryotherapy may be enhanced by the use of thermocouples to monitor the temperature of the lesion to ensure adequate freezing. At least two or three freeze-thaw cycles are necessary.

**Radiation therapy** using radon-222, gold-198, radium-226, cobalt-60, or iridium-192 has been used and is indicated for recurrent or surgically inaccessible sarcoids such as periocular sarcoid. Radiation therapy is also useful for treating sarcoids of the body and legs. Local hyperthermia induced by a radiofrequency current of 2 MHz is also reported to be effective.

**Immunotherapy**, by injection of live organisms, killed bacilli, or cell-wall extract of the bacillus of Calmette and Guérin (BCG) have been successful on occasion, but their efficacy depends on the size of the lesion, its anatomic location, and possibly its type. Immunotherapy may work by inducing tumor-specific immunity. Adverse effects include local reactions characterized by edema and systemic anaphylactoid reactions after the second or third injections if commercial, whole-cell vaccines are used. Vaccines composed of cell-wall fractions in oil are free of such reactions and have given good results in periocular lesions, but sarcoids of the axilla did not react favorably. Large sarcoids or cases with multiple lesions may also respond poorly. Immunotherapy using mycobacterial cell-wall skeleton combined with trehalose dimycolate has resulted in total tumor regression.

Autogenous vaccines might result in the regression of existing sarcoids but have the risk of inducing new tumors and are not recommended for routine therapy. Use of acupuncture to treat sarcoids is reported, but there is little scientific justification for using this procedure.<sup>39</sup>

As yet, no single treatment modality is universally successful in the treatment of sarcoid. In a study in 92 horses comparing outcome, a successful outcome was obtained in 79% of horses treated with cryosurgery, 67% of those treated with BCG vaccination, 82% of those treated with conventional excision, and 71% of those treated using carbon dioxide laser. Greater success rates are reported for intralesional administration of cisplatin, and possibly for imiquimod and acyclovir.<sup>35-38</sup>

## FURTHER READING

Taylor S, Halderson G. A review of equine sarcoid. *Equine Vet Educ*. 2013;25:210-216.

## REFERENCES

- Lunardi M, et al. *J Clin Micro*. 2013;51:2167.
- Bogaert L, et al. *J Gen Virol*. 2007;88:2155.
- Nasir L, et al. *Vet Microbiol*. 2013;167:159.
- Rector A, et al. *Vet Microbiol*. 2013;445:213.
- Torres SMF, et al. *Vet Clin Equine*. 2013;29:643.
- Munday JS. *Vet Pathol*. 2014;51:1063.
- Hartl B, et al. *J Gen Virol*. 2011;92:2437.
- Wilson AD, et al. *Vet Microbiol*. 2013;162:369.
- Nasir L, et al. *Vet Microbiol*. 2007;364:355.
- Wobeser BK, et al. *Can Vet J*. 2010;51:1103.
- Trewby H, et al. *J Gen Virol*. 2014;95:2748.
- Christen G, et al. *Vet J*. 2014;199:68.
- Marais HJ, et al. *J S Afr Vet Assoc*. 2007;78:145.
- Marais HJ, et al. *J Wildl Dis*. 2011;47:917.
- van Dyk E, et al. *J S Afr Vet Assoc*. 2011;82:80.
- Semięka MA, et al. *J Adv Vet Res*. 2012;2:276.
- Orbell GMB, et al. *Vet Pathol*. 2011;48:1176.
- Schaffer PA, et al. *J Am Vet Med Assoc*. 2013;242:99.
- van Dyk E, et al. *Pferdeheilkunde*. 2012;28:697.
- Studer S, et al. *Schweiz Arch Tierheilkd*. 2007;149:161.
- Finlay M, et al. *Virus Res*. 2009;144:315.
- Jandova V, et al. *Schweiz Arch Tierheilkd*. 2012;154:19.
- Bogaert L, et al. *Vet Microbiol*. 2010;146:269.
- Haralambus R, et al. *Equine Vet J*. 2010;42:327.
- Yuan Z, et al. *Vet Microbiol*. 2010;396:143.
- Corteggio A, et al. *J Gen Virol*. 2011;92:378.
- Maehlmann K, et al. *Vet J*. 2014;202:516.
- Mosseri S, et al. *Vet J*. 2014;202:279.
- Yuan Z, et al. *J Gen Virol*. 2011;92:773.
- Yuan Z, et al. *J Gen Virol*. 2011;92:1778.
- Bogaert L, et al. *Vet Pathol*. 2011;48:737.
- Wobeser BK, et al. *J Vet Diagn Invest*. 2012;24:32.
- Taylor SD, et al. *J Equine Vet Sci*. 2014;34:722.
- Finlay M, et al. *Vet Res*. 2012;43.
- Tamzali Y, et al. *Equine Vet J*. 2012;44:214.
- Theon AP, et al. *J Am Vet Med Assoc*. 2007;230:1506.
- Nogueira SAE, et al. *Vet Dermatol*. 2006;17:259.
- Stadler S, et al. *Vet Rec*. 2011;168:187.
- Thoresen AS. *Am J Trad Chin Vet Med*. 2011;6:29.

## COWPOX AND BUFFALOPOX

### SYNOPSIS

**Etiology** Cowpox and buffalopox virus are members of the genus *Orthopoxvirus* in the family Poxviridae. Buffalopox is a close variant of vaccinia virus.

**Epidemiology** Cowpox is endemic in the population of certain rodents in Europe and East Asia. Cattle are a rare and incidental host. Buffalopox is a (re) emergent disease occurring in buffaloes, cattle, and humans in India and neighboring countries. The natural host of buffalopox virus has not yet been identified. Spread of both viruses is by contact.

**Clinical findings** Typical pox lesions on the teats and udder. Erythema, papules with a zone of hyperemia around the base, vesiculation, pustular stage, and scab.

**Clinical pathology** Electron microscopy, polymerase chain reaction (PCR).

**Diagnostic confirmation** Electron microscopy, PCR, and virus isolation.

**Treatment** Palliative.

**Control** Sanitation to prevent spread between cows.

## ETIOLOGY

Cowpox virus (CPXV) and buffalopox virus (BPXV) are members of the genus *Orthopoxvirus* in the family Poxviridae. Other orthopoxviruses infecting agricultural animals include horsepox, Uasin Gishu, and camel-pox. All orthopoxviruses are antigenically extremely similar, but they can be identified by a combination of phenotypic and genetic tests.

CPXV received its name as a result of the association of this agent with skin lesions on the teat and udder skin of dairy cattle. Notwithstanding, it is probably a misnomer because infection of cattle is rare, whereas infection is widespread among rodents in Europe and western Asia.

## EPIDEMIOLOGY Occurrence

Infection with CPXV is **endemic in wild rodents** such as voles (*Microtus* spp.) in **Great Britain, Europe, and western Asia**, with infection in different rodent species acting as the reservoir host in different geographic areas. Domestic cats are commonly infected from hunting rodents, but CPXV infection can occur in a number of different mammalian species, one of which is cattle. The clinical syndrome of cowpox in cattle is now extremely rare, but it occurs sporadically in Europe. In recent decades, reemergence of CPXV infections in cats, zoo animals, and humans has been reported.<sup>1</sup>

BPXV was first isolated in India in the early 1930s, and disease outbreaks affecting buffaloes, cattle, and humans have been reported in India, Nepal, Pakistan, Egypt, and Indonesia since then.<sup>2</sup> BPXV is considered an important emerging or reemerging zoonotic viral infection in regions with a large buffalo population.<sup>3</sup> A similar but **distinct vaccinia-like virus** has been associated with disease outbreaks among cattle and humans in **Brazil**.<sup>2</sup>

## Origin of Infection and Transmission

The origin of CPXV infection is most probably from infected farm cats or humans. **Transmission** from cow to cow within a herd is effected by milkers' hands or teat cups. Spread from herd to herd is probably effected by the introduction of infected animals, by carriage on milkers' hands, and in the absence of either of these methods, transport by biting insects is possible. In a herd in which the disease is enzootic, only heifers and new introductions develop lesions. Milkers recently vaccinated against smallpox may serve as a source of infection for cattle, although the **vaccinia virus**, the smallpox vaccine virus, is a different virus.

BPXV is most commonly isolated from buffaloes, cattle, and people having direct and frequent contact with these animals. Although a primary host species functioning as virus reservoir has not yet been identified for BPXV, peridomestic rodents have been incriminated as potential vectors.<sup>4</sup> Because disease outbreaks in buffalo herds are often associated with high disease occurrence among animal handlers and caretakers, transmission from animal to animal by means of people as vectors is considered to play an important role.<sup>3</sup>

It is generally assumed that the virus gains access to tissues through injuries to teat skin, and extensive outbreaks are likely to occur when the environment is conducive to teat injuries. Spread is rapid within a herd and immunity is solid, so that the disease tends to occur in sharp outbreaks of several months in duration, with subsequent immunity protecting the cattle for at least several years.

### Economic Importance

Losses are a result of inconvenience at milking time because of the soreness of the teats and from occasional cases of mastitis, which develop when lesions involve teat sphincters and decreased milk production.

### Zoonotic Implications

Human cowpox is not common, although the disease incidence has increased over the past decades, an observation that has been explained by increasing susceptibility of the human population to poxvirus infection following discontinuation of smallpox vaccination in most parts of the world.<sup>5</sup> Clinical cases in humans usually consist of one or a few lesions on the hand and face with minimal systemic reaction and are most commonly traced back to infected cats or occasionally rats rather than cattle.<sup>1</sup>

An increasing incidence of clinical cases of BPXV and Brazilian vaccinia-like virus infection has been reported in humans, particularly among animal caretakers and animal handlers in India but also in Brazil, and has become a serious public health concern in some countries.<sup>2,3</sup> Consumption of unpasteurized milk of affected animals has been incriminated as potential route of virus transmission from animal to human.

### PATHOGENESIS

Five stages of a **typical pox eruption** can be observed. After an incubation period of 3 to 6 days, a roseolar erythema is followed by firm, raised papules light in color but with a zone of hyperemia around the base. Vesiculation, a yellow blister with a pitted center, follows. The subsequent pustular stage is followed by the development of a thick, red, tenacious scab.

In experimentally produced **vaccinia virus** mammillitis (produced by inoculation of smallpox vaccine), the lesions have three zones: a central brown crusty area of

necrosis, surrounded by a gray–white zone of microvesicle formation, again surrounded by a red border as a result of congestion. The lesions are essentially hyperplastic.

### CLINICAL FINDINGS

Typical **lesions** are similar for CPXV and BPXV infection and may be seen at any stage of development, but they are mostly observed during the scab stage, with the vesicle commonly having been ruptured during milking. True cowpox scabs are 1 to 2 cm in diameter and are thick, tenacious, and yellow–brown to red in color. In cows being milked, scab formation is uncommon, with the scab being replaced by a deep ulceration.

**Distribution** of the lesions is usually confined to the teats and lower part of the udder. Soreness of the teats develops, and milk letdown may be interfered with; the cow usually resents being milked. Secondary mastitis occurs in a few cases. Individual lesions heal within 2 weeks, but in some animals fresh crops of lesions may cause the disease to persist for a month or more. In severe cases, lesions may spread to the insides of the thighs, and rarely to the perineum, vulva, and mouth. Sucking calves may develop lesions around the mouth. In bulls, lesions usually appear on the scrotum.

Ulcerative skin lesions with raised edges frequently affected by secondary bacterial or fungal infection are commonly observed on the ears of nonlactating cattle and buffaloes infected with BPXV.<sup>3</sup>

### CLINICAL PATHOLOGY

The virus can be propagated in tissue culture, and differentiation is possible by electron microscopy. The presence of virus-related DNA sequences can be identified by means of PCR.

### DIFFERENTIAL DIAGNOSIS

A number of skin diseases may be accompanied by lesions on the udder and can easily be confused with cowpox if the lesions are advanced in age. Most outbreaks of teat skin disease that clinically resemble classical cowpox are associated with vaccinia virus from contact with a recently vaccinated person.

Pseudocowpox

Bovine ulcerative mammillitis associated with bovine herpesvirus-2 and bovine herpesvirus-4

Vesicular stomatitis and foot-and-mouth disease

Udder impetigo

Teat chaps and frostbite

Black spot

### CONTROL

Prevention of spread is difficult because the virus responsible for the disease is readily

transmitted by direct or indirect contact. Udder cloths, milking machines, and hands should be disinfected after contact with infected animals. Dipping of the teats in an alcoholic tincture of a suitable disinfectant, such as quaternary ammonium compounds, is usually satisfactory in preventing immediate spread. Although the prevalence and significance of CPXV infection in cattle is too low to warrant the development of vaccines, the emergence of buffalopox in buffalo and cattle herds and the ensuing zoonotic risk in some parts of the world may warrant considering the development of vaccines against BPXV for certain regions of the world.<sup>3</sup>

### REFERENCES

- Kurth A, Nitsche A. The challenge of highly pathogenic microorganisms. In: Schafferman A, et al., eds. *Berlin: Springer Science+Business Media BV*. 2010:157-164.
- Singh RK, et al. *Indian J Virol*. 2012;23:1-11.
- Venkatesan G, et al. *Vet Ital*. 2010;46:439-448.
- Abraham JS, et al. *PLoS ONE*. 2009;10:e7428.
- Bray M. *Am J Trop Med Hyg*. 2009;80:499-500.

## PSEUDOCOWPOX (MILKERS' NODULE)

### SYNOPSIS

**Etiology** Parapoxvirus.

**Epidemiology** Primarily affects cows in early lactation. Low, but progressive, morbidity in herd. Spread during milking.

**Clinical findings** Vesicles, pustules, formation of a thick scab elevated by granulating tissue. Key distinguishing feature is horseshoe-shaped ring of small scabs surrounding granulating tissue on the teat.

**Clinical pathology** Vesicle fluid for electron microscopy.

**Diagnostic confirmation** Electron microscopy.

**Treatment** Antiseptics and emollient ointment.

**Control** Milking hygiene.

### ETIOLOGY

Pseudocowpox virus is a member of the genus *Parapoxvirus*, with close similarity to the viruses of infectious papular stomatitis of cattle and contagious ecthyma of sheep and goats. It is possible that pseudocowpox virus (PCPV) might be identical to bovine papular stomatitis virus (BPSV).<sup>1,2</sup> The pseudocowpox virus was previously known as parapoxvirus bovis 2.

### EPIDEMIOLOGY

#### Occurrence

Pseudocowpox is reported in **most countries**. In an affected herd the rate of spread is relatively slow and may result in the disease being present in the herd for up to a year. The **morbidity** rate approximates 100%, but at

any given time it varies between 5% and 10%, and occasionally up to 50%.

### Origin of Infection and Transmission

The source of infection is **infected cattle**. The method of **transmission** includes physical transport by means of contaminated milkers' hands, washcloths, and teat cups. The virus cannot penetrate mucosa, and a preexisting discontinuity of it is necessary for the virus to gain entry. Transmission by biting insects seems likely. The virus can be isolated from the mouths of calves sucking affected calves, and from the semen of bulls.

### Animal Risk Factors

**Freshly calved and recently introduced cattle** are most susceptible, but **all adult cattle** in a herd, including dry cows, are likely to be affected. The disease does not appear to occur in animals less than 2 years of age unless they have calved. There is no seasonal variation in incidence. Little immunity develops, and the disease is likely to recur in the herd within a short time.

### Economic Importance

Pseudocowpox is relatively benign, with most losses occurring as a result of difficulty in milking and an increase in the incidence of mastitis.

### Zoonotic Implications

The disease is transmissible to humans, with infection usually resulting in the development of milkers' nodule on the hand.

### PATHOGENESIS

Transmission most commonly occurs at milking time and is mechanical, with the potential for transmission from cow to calf by suckling. The disease can be reproduced by the introduction of the virus onto scarified areas of skin. The lesions are characterized by hyperplasia of squamous epithelium.

### CLINICAL FINDINGS

Acute and chronic lesions occur, and there may be up to 10 lesions on one teat (the udder is very rarely infected). **Acute lesions** commence as erythema followed by the development of a vesicle or pustule, which ruptures after about 48 hours, resulting in the formation of a thick scab. Pain is moderate and present only in the prescab stage. The scab, varying in size from 0.5 to 25 mm in diameter, becomes markedly elevated by developing granulating tissue beneath it; the scabs drop off 7 to 10 days after lesions appear, leaving a **horseshoe-shaped ring** of small scabs surrounding a small, wart-like granuloma, which may persist for months. The disease tends to disappear from a herd after 18 to 21 days but may recur cyclically about 1 month later. There are reports of lesions occurring occasionally in cows' mouths.

**Chronic lesions** also commence as erythema, but progress to a stage in which yellow-gray, soft, scurfy scabs develop. The scabs are readily rubbed off at milking, leaving the skin corrugated and prone to chapping. There is no pain, and the lesions may persist for months.

**Milkers' nodules** are clinically indistinguishable from human lesions associated with ecthyma virus. The lesions vary from multiple vesicles to a single, indurated nodule.

An outbreak of pseudocowpox infection occurred in Brazil, characterized by the presence of severe vesicular, papulopustular, and proliferative scabby lesions on the muzzle of 14 crossbred calves that did not have contact with dairy cattle.<sup>2</sup> The lesions started as macules and papules on the muzzle that progressed to vesicles, pustules, and scabs with a clinical course of 10 to 15 days, at which time the lesions spontaneously resolved. Nucleotide sequencing of the virus isolated from the lesions revealed 97% homology with pseudocowpox virus and only 84% homology with bovine popular stomatitis virus.<sup>2</sup>

### CLINICAL PATHOLOGY AND NECROPSY FINDINGS

Material for examination by tissue culture or electron microscopic examination, the latter being highly recommended as a diagnostic procedure, should include fluid from a vesicle.

#### DIFFERENTIAL DIAGNOSIS

Differentiation of those diseases in which lesions of the teat are prominent is dealt with in the preceding section on cowpox.

### TREATMENT

Locally applied ointments of various kinds appear to have little effect on the lesions. The recommended treatment includes the removal of the scabs, which should be burned to avoid contaminating the environment, application of an astringent preparation, such as triple dye, after milking and an emollient ointment just before.

### CONTROL

Recommended measures, such as treatment and isolation of affected cows or milking them last, the use of disposable paper towels for udder washing, and disinfection of teat cups, appear to have little effect on the spread of the disease. An iodophor teat dip is recommended as the most effective control measure because it appears to exert some antiviral effect. An effort should be made to reduce teat trauma because infection is facilitated by discontinuity of the skin.

### REFERENCES

1. Yaegashi G, et al. *J Vet Med Sci.* 2013;75:1399.
2. Cargnelutti JF, et al. *J Vet Diagn Invest.* 2012;24:437.

## LUMPY SKIN DISEASE (KNOPVELSIEKTE)

### SYNOPSIS

**Etiology** Lumpy skin disease virus, of the genus *Capripoxvirus* (closely related to sheep and goatpox viruses).

**Epidemiology** Previously enzootic in sub-Saharan Africa, but expanded into most of Africa in the 1970s. The disease is now actively spreading in the Middle East, with outbreaks in Israel, Lebanon, Turkey, Syria, Iran, Azerbaijan, and North Cyprus. Epizootics interspersed with periods of sporadic occurrence. Transmission by contact and a range of sucking/biting arthropod vectors.

**Clinical findings** Fever, nodular lesions on the skin and mucous membranes and lymphadenopathy. A proportion of cattle develop generalized infection, with high mortality. Losses accrue from damage to hides, decreased milk yield and growth, abortion, deaths, and disruption of international trade. Necrotic plugs of tissue highly susceptible to secondary infection and flystrike.

**Clinical pathology** Intracellular, eosinophilic inclusion bodies in biopsy material. Virus isolation. Fluorescent antibody, serum neutralization, and polymerase chain reaction (PCR) tests.

**Necropsy findings** Nodules in skin, upper alimentary tract, respiratory tract.

**Diagnostic confirmation** Biopsy and histology. Virus isolation to differentiate from pseudo lumpy skin disease caused by bovine herpesvirus-2.

**Treatment** Supportive.

**Control** Vaccination, control of movement of cattle from affected areas.

### ETIOLOGY

Lumpy skin disease (LSD) is a severe systemic disease of cattle associated with the Neethling poxvirus, a *Capripoxvirus*. It has close antigenic relationship to sheeppox and goatpox viruses, which are in the same genus. There appears to be a difference in virulence between strains.

### EPIDEMIOLOGY

#### Occurrence

The disease used to be confined to sub-Saharan Africa, but spread to many other African countries in the 1970s, then Egypt (outbreaks occurred in 1988 and 2006; the disease is now enzootic) and Israel (outbreaks in 1989, 2006-2007, and 2012). In Israel it was initially eradicated by slaughter of infected and in-contact animals, but vaccination using Sheeppox, and more recently Neethling strain vaccine, has since been used. The virus is actively spreading within and from the Middle East, with cases



confirmed in Kuwait (1991), Lebanon (1993), the United Arab Emirates (2000), Bahrain (2003), Oman (2010), Turkey and Syria (2013), Jordan (2013), Iran and Iraq (2013), Azerbaijan and North Cyprus.<sup>1-3</sup> There is a risk it could be introduced into European countries, mainly through the illegal movement of animals but also within vectors.<sup>2,3</sup>

Some outbreaks are associated with severe and generalized infections and a high mortality rate, whereas others have few obviously affected animals and no deaths. In general, outbreaks are more severe following introduction of the infection into a region and then abate, probably associated with the development of widespread immunity. Morbidity rates can reach 80% during epizootics, but typically range from 10% to 30% in enzootic areas. In Kenya, the disease is milder, with a lower morbidity rate and an average case fatality of 2%. Outbreaks in Israel produced no direct mortality from the disease. A resurgence of the disease in South Africa was associated with higher rainfall and a decrease in the use of vaccination.

### Origin of Infection and Transmission

The virus is present in the nasal and lacrimal secretions, semen, and milk of infected animals. However, direct contact is not thought to be the major source of transmission, with most cases associated with transmission by an arthropod vector. LSD virus has been isolated from *S. calcitrans* and *M. confiscata* and transmitted experimentally using *S. calcitrans* and *Abyomma* and *Rhipicephalus* ticks, with evidence that the virus may be transmitted vertically and overwinter in these tick species.<sup>4,5</sup> Other vectors are suspected, including *Biomyia*, *Culicoides*, *Glossina*, and *Musca* spp. However, although the virus was detected in mosquitoes (*Anopheles stephensi*, *Culex quinquefasciatus*), stable flies, and biting midges (*Culicoides nebeculosis*) after feeding on cattle with lumpy skin disease, infection did not transmit to susceptible cattle when these arthropods were subsequently allowed to feed on them.

Transmission via infected semen used in artificial breeding has been demonstrated experimentally.<sup>6</sup>

### Risk Factors

#### Animal Risk Factors

All ages and types of cattle are susceptible, although very young calves and lactating and malnourished cattle develop more severe clinical disease. Recently recovered animals are immune for about 3 months.

British breeds, particularly Channel Island breeds, are much more susceptible than zebu types, both in numbers affected and the severity of the disease. Wildlife species are not affected in natural outbreaks, although there is concern that they might be reservoir hosts in interepidemic periods, such as African buffalo (*Syncerus caffer*) in the Kruger National Park in South Africa.<sup>7</sup>

Typical skin lesions, without systemic disease, have been produced experimentally with Neethling virus in sheep, goats, giraffes, impalas, and Grant's gazelles, but wildebeests were resistant. Natural cases of lumpy skin disease were recorded in water buffalo (*Bubalis bubalis*) during an outbreak in Egypt in 1988, but morbidity was much lower than for cattle (1.6% vs. 30.8%).

### Environmental Risk Factors

Outbreaks tend to follow waterways. Extensive epizootics are associated with high rainfall and high levels of insect activity, with peaks in the late summer and early autumn. Introduction of new animals and communal grazing have been identified as risk factors for LSD infection in Ethiopia.<sup>8</sup>

### Pathogen Risk Factors

Capripoxviruses are resistant to drying and able to survive freezing and thawing, but most are inactivated by temperatures above 60°C (140°F).

### Experimental Transmission

Experimental transmission can be achieved with ground-up nodular tissue, blood, or virus grown in tissue culture given by intranasal, ID, or IV routes. Although lumpy skin disease is characterized by generalized nodular skin lesions, less than 50% of natural or experimental infections develop generalized skin nodules. The length of viremia is not correlated with the severity of clinical disease.

### Economic Importance

The mortality rate is usually low (although it can be 10% or more), but economic losses are high. There is reduced feed intake, a reduction in milk production, and occurrence of secondary mastitis associated with lesions on the teats. Losses also accrue from hide damage, reduced body condition, decreased fertility in bulls, and abortion in cows. There has always been a high risk of LSD spreading out of Africa, and it is now actively spreading in the Middle East. It is also a potential agent for agricultural bioterrorism.

### PATHOGENESIS

In the generalized disease there is viremia and fever, followed by localization in the skin and development of inflammatory nodules. Following ID inoculation, local lesions develop at the challenge site but without viremia and systemic infection.

### CLINICAL FINDINGS

The incubation period is typically 2 to 4 weeks in field outbreaks and 7 to 14 days following experimental challenge. In severe cases there is an initial rise of temperature, which lasts for over a week, occasionally accompanied by lacrimation, nasal discharge, salivation, and lameness. Multiple intradermal nodules appear suddenly about

a week later, often initially on the perineum. They are round and firm, 1 to 4 cm in diameter, and flattened, and the hair on them stands on end. They vary from a few to hundreds and, in most cases, are confined to the skin. However, lesions can occur elsewhere, such as in the nostrils and on the turbinates, causing mucopurulent nasal discharge, respiratory obstruction, and snoring; in the mouth, as plaques and then ulcers, causing salivation; on the conjunctiva, causing severe lacrimation; and on the prepuce or vulva, spreading to nearby mucosal surfaces. In most cases the nodules disappear rapidly, but they may persist as hard lumps or become moist and necrotic, then slough.

Lymph nodes draining the affected area become enlarged, and local edema can occur, particularly of the limbs. When the yellow center of nodules slough, this can expose underlying tissues, including testicles or tendons. Lesions where skin is lost may remain visible for long periods. When lesions coalesce, large areas of raw tissue can be exposed, and these are susceptible to invasion with screwworm fly larvae. Lesions in the respiratory tract are often followed by pneumonia.

Convalescence usually takes 4 to 12 weeks, and pregnant cows may abort.

### CLINICAL PATHOLOGY

The virus can be cultivated from lesions, and the viral antigen can be detected by a variety of PCR tests. Viral DNA can be detected in the skin up to 90 days after infection using PCR, which is much longer than the virus can be isolated. An antigen ELISA has also been used with samples collected early in the course of the disease, before the development of neutralizing antibodies. Electron microscopy will identify capripox virions in skin biopsies or scabs. This must be used in combination with the history of generalized nodular skin disease; capripox can be distinguished from parapoxvirus (the agent of bovine papular stomatitis) and pseudocowpox, but it is morphologically similar to cowpox and vaccinia viruses. Histopathology of lesions reveals a granulomatous reaction in the dermis and hypodermis, with intracellular, eosinophilic inclusion bodies in early lesions.

Virus neutralization is the most specific serologic test, but immunity is predominantly cell mediated, and thus it may fail to detect low concentrations of antibodies in many exposed cattle. The agar gel immunodiffusion (AGID) and indirect fluorescent antibody tests are less specific, producing false positives as a result of cross-reaction with bovine papular stomatitis and pseudocowpox viruses.

### NECROPSY FINDINGS

The skin lesions are described under "Clinical Findings." Similar lesions are present in the mouth, pharynx, trachea, skeletal muscle,

bronchi, and stomachs, and there may be accompanying pneumonia. The superficial lymph nodes are usually enlarged. Respiratory distress and death are often the result of respiratory obstruction by the necrotic ulcers and surrounding inflammation in the upper respiratory tract, often with concurrent aspiration pneumonia. Histologically, a widespread vasculitis reflects the viral tropism for endothelial cells. Intracytoplasmic viral inclusion bodies may be seen in a variety of cells types.

### Samples for Confirmation of Diagnosis

- **Histology**—formalin-fixed lesions from skin, alimentary and respiratory tissue, lymph node (LM)
- **Virology**—lymph node, skin lesion (ISO, EM)
- **Antigen detection**—affected tissue, blood, semen (PCR, antigen ELISA).

### DIFFERENTIAL DIAGNOSIS

The rapid spread of the disease and the sudden appearance of lumps in the skin after an initial fever make this disease quite unlike any other disease of cattle.

Pseudolumphy skin disease (also known as Allerton virus infection and general infection of cattle with bovine herpesvirus-2), is associated with bovine herpesvirus-2, the agent of bovine mammillitis. It occurs primarily in southern Africa, although occasional cases occur in the United States, Australia, and the United Kingdom. Multifocal lesions are distributed over the body, are circular and up to 2 cm in diameter, and have an intact central area and raised edges, accompanied by loss of hair. Some lesions show a circular ring of necrosis around a central scab. The scabs fall off, leaving discrete hairless lesions that may be depigmented. The disease runs a course of approximately 2 weeks, and there is no mortality. Only the superficial layers of skin are involved. This is in contrast to the lesions of lumpy skin disease, which are often deep enough to expose underlying tissues. Herpesvirus can be isolated from the periphery of the lesions. Diagnosis can be made by polymerase chain reaction (PCR) on full-thickness skin biopsy.

### TREATMENT

No specific treatment is available, but prevention of secondary infection with antibiotics or sulfonamides is recommended.

### CONTROL

Lumpy skin disease moves into new territory principally by movement of infected cattle, and possibly by wind-borne vectors. Once in a new area, further spread probably occurs via insect vectors, and ticks have been implicated in maintaining the virus in between epidemics.<sup>4,5</sup> Control of cattle movement

from uninfected to infected areas is an important measure to prevent the introduction of the virus. Once in an area, control is by vaccination.

### Vaccination

Freeze-dried, live attenuated vaccines are commercially available and the most commonly used. There is antigenic homology between the *Capripoxviruses*, and thus vaccination of cattle with attenuated sheeppox virus has been used to protect against infection with LSD virus. This was used in countries previously free of LSD virus because it eliminated any risk of escape of attenuated live vaccine virus from vaccinated herds. However, incomplete protection with a vaccine based upon what was thought to be a Kenyan sheep and goatpox occurred during a 2006 outbreak of LSD in Egypt, and following the use of a sheeppox vaccine in Israel in 2006-2007 in which 11% of vaccinated cattle developed skin lesions.<sup>3</sup> Consequently, the attenuated Neethling strain vaccine of LSD virus was used in response to a serious outbreak of the disease in Israel during 2012. A battery of three molecular tests was able to differentiate infection with the vaccine strain, and a virulent virus was developed; no spread from vaccinated to nonvaccinated cattle was recorded.<sup>9</sup>

A small percentage of cattle vaccinated with the sheeppox virus do develop local granulomatous reactions, but there is no spread of the virus to sheep running with the cattle. However, the commonly used Kenyan sheeppox and goatpox vaccine virus (designated O-240) has been identified as an LSD virus; the low attenuation of this virus probably makes it unsafe for cattle because of its potential to cause clinical disease in vaccinated animals.<sup>10</sup> Other viruses capable of infecting sheep, goats, and cattle have been identified as potential candidates for vaccines against all capripox diseases.<sup>10</sup>

Vaccination of a herd at the start of an outbreak is of limited use. Most animals will already be incubating the disease, and poor needle hygiene in these circumstances may spread the disease. Slaughter of affected and in-contact animals, destruction of contaminated hides, and vaccination of at-risk animals is a common approach when the disease is introduced to a previously free country.

### FURTHER READING

OIE *Terrestrial Manual*, Chapter 2.4.14. Lumpy skin disease. Accessed at: <[http://www.oie.int/fileadmin/Home/eng/Animal\\_Health\\_in\\_the\\_World/docs/pdf/Disease\\_cards/LUMPY\\_SKIN\\_DISEASE\\_FINAL.pdf](http://www.oie.int/fileadmin/Home/eng/Animal_Health_in_the_World/docs/pdf/Disease_cards/LUMPY_SKIN_DISEASE_FINAL.pdf)> Accessed July 16, 2016.

Tuppurainen ESM, Oura CAL. Review: lumpy skin disease: an emerging threat to Europe, the Middle East and Asia. *Transbound Emerg Dis.* 2012;59:40-48.

### REFERENCES

1. Fernandez P, et al. *Atlas of Transboundary Animal Diseases*. OIE; 2010.

2. EFSA Panel on Animal Health & Welfare. *EFSA J.* 2015;13:3986.
3. Tuppurainen ESM, Oura CAL. *Transbound Emerg Dis.* 2012;59:40.
4. Lubinga JC, et al. *Ticks Tick Borne Dis.* 2014;5:113.
5. Lubinga JC, et al. *Transbound Emerg Dis.* 2015;65:174.
6. Annadale CH, et al. *Transbound Emerg Dis.* 2015;61:443.
7. Shamsudeen F, et al. *J S Afr Vet Assoc.* 2014;85:1075.
8. Hailu B, et al. *Prev Vet Med.* 2014;115:64.
9. Menasherov S, et al. *J Virol Methods.* 2014;199:95.
10. Tuppurainen ESM, et al. *Antiviral Res.* 2014;109:1.

## SHEEPOX AND GOATPOX

### SYNOPSIS

**Etiology** *Capripoxvirus*. Strains vary in virulence and host specificity.

**Epidemiology** Highly contagious, spread by aerosol, contact, and flies. Young and nonindigenous animals more susceptible. Morbidity and case-fatality rates are high.

**Clinical findings** Fever, generalized skin and internal pox lesions, lymphadenopathy, mucopurulent nasal discharge, high mortality.

**Clinical pathology** Fluorescent antibody and electron microscopy of biopsy material, serology, virus isolation.

**Necropsy findings** Pox nodular lesions in alimentary tract and respiratory tract.

**Diagnostic confirmation** Fluorescent antibody staining, virus isolation.

**Control** Vaccination.

### ETIOLOGY

Sheeppox, goatpox and lumpy skin disease of cattle are members of the genus *Capripoxvirus*, one of six genera of poxviruses. The diseases produced by sheeppox and goatpox viruses are collectively called capripox infections. They are named on the basis of their host specificity in natural outbreaks and are usually highly host specific in natural infections, although exceptions exist. For example, Kenya sheeppox and goatpox viruses, and Yemen and Oman sheep isolates, infect both sheep and goats, although the disease caused by the same isolate can vary dramatically between the two hosts.<sup>1</sup> The viruses are closely related genetically, and hence they cross-react in serologic tests, and many can cross species barriers in experimental infections. Recombination may also occur naturally between isolates from different host species.

### EPIDEMIOLOGY

#### Prevalence of Infection

Sheeppox and goatpox are prevalent in North and Central Africa north of the equator, the Indian subcontinent, the Middle East, China, Southwest Asia, and the former Soviet Union. Sporadic outbreaks occur in

southern Europe, including Turkey, Greece, and Bulgaria, and elsewhere.<sup>2</sup> The *Capripoxvirus* infections of small ruminants are the most serious of all the pox diseases in animals, characterized by fever and skin lesions.<sup>3</sup> In susceptible flocks and herds morbidity is 75% to 100%, with outbreaks often causing death in 10% to 85% of affected animals depending on the virulence of the infecting strain.

### Methods of Transmission

Sheeppox and goatpox are highly contagious. The virus enters via the respiratory tract, and transmission commonly is by aerosol infection associated with close contact with infected animals. The virus is present in nasal and oral secretions for several weeks after infection and can live in scabs that have fallen off the animal for several months. Spread can also occur from contact with contaminated materials and through skin abrasions produced iatrogenically or by insects. Capripox has been shown to spread via the bites of *S. calcitrans* and the tsetse fly.

### Experimental Reproduction

The disease can be transmitted by intradermal, intravenous, and subcutaneous inoculation and by virus aerosols. Capripox antigen is detected 6 and 8 days postinfection in skin and lungs, respectively.<sup>4</sup>

### Risk Factors

#### Animal Risk Factors

Both sheeppox and goatpox affect sheep and goats of all ages, all breeds, and both sexes, but young and old animals and lactating females are more severely affected. In areas where sheeppox is enzootic, imported breeds such as Merinos or some European breeds may show greater susceptibility than the native stock. Young animals are more susceptible.

#### Pathogen Risk Factors

The virus is resistant to drying and survives freezing and thawing. It is sensitive to extremes of pH and 1% formalin. Sensitivity to heat varies between strains, but most are inactivated at 60°C (140°F) for 60 minutes. Isolates from most regions are host specific, but isolates from Kenya and Oman naturally infect both goats and sheep. Scabs shed by infected animals remain infective for several months.

### Economic Importance

Loss is from mortality, abortions, mastitis, loss of wool, skin condemnation, and loss of exports. In ewes and does, severe losses may occur if the udder is invaded because of the secondary occurrence of acute mastitis. In some outbreaks, adult sheep are affected with the more severe form of the disease. Sheeppox is a potent threat to countries that have large sheep populations, and

where the disease does not occur, because it is difficult to eradicate and has a high mortality rate.

In a natural outbreak in an intensive sheep dairy in Israel, losses accrued from acute illness, deaths, reduced milk production, and reduced fertility. Milk production declined for 8 weeks after the index cases and was accompanied by an increased somatic cell count.<sup>5</sup>

### Zoonotic Implications

Human infections in people handling infected animals are not a consideration.

### PATHOGENESIS

During an initial viremia, the virus is carried by infected monocytes/macrophages to many tissues, particularly the skin, respiratory tract, and gastrointestinal tract.<sup>4</sup> Syncytial cells are seen in skin, and these probably facilitate local spread of the virus. The development of typical pox lesions, as in vaccinia, is characteristic of the disease. The virus is present in greatest quantities from 7 to 14 days after inoculation. Passive protection by serum will protect against challenge. Circulating antibody limits spread of infection, but does not prevent replication of the virus at the site of inoculation.

### CLINICAL FINDINGS

In sheep, sheeppox has an incubation period of 12 to 14 days, with the malignant form being the most common type in lambs. There is marked depression and prostration, a very high fever, and discharge from the eyes and nose. Affected lambs may die during this stage before typical pox lesions develop. When pox lesions develop, they appear on unwooled skin and on the buccal, respiratory, digestive, and urogenital tract mucosae. They commence as papules, then become nodular, occasionally vesicular, and pustular, then finally scab. Some progress from nodules to tumor-like masses. The mortality rate in this form of the disease may reach 50%. In the benign form, more common in adults, only skin lesions occur, particularly under the tail; there is no systemic reaction, and animals recover in 3 to 4 weeks. Abortion and secondary pneumonia are complications. In sheep, infection with goatpox is more severe than with sheeppox, with lesions on the lips and oral mucosa, teats, and udder.

Goatpox in goats is very similar clinically to sheeppox in sheep. Young kids suffer a systemic disease, with lesions spread generally over the skin and on the respiratory and alimentary mucosae. Adult goats may have systemic disease and extensive lesions, but in adult goats the disease is usually mild, and lesions are as described previously for the benign form in sheep. A flat hemorrhagic form of capripox is seen in some European goats, and this form has a high case-fatality rate.

## CLINICAL PATHOLOGY

### Antigen Detection

Diagnosis is based on typical clinical signs combined with laboratory confirmation of the presence of the virus or antigen. Using electron microscopy, large numbers of characteristic “sheeppox cells” containing inclusion bodies and typical capripox virions can be seen in biopsies of the skin. The virus can be cultured in tissue culture, but virus isolation as a method of rapid diagnosis is limited by the extended time it takes for virus cytopathic effects to develop and the need, with some strains, for several blind passages before this occurs. Direct fluorescent antibody testing is used to detect the presence of poxvirus in the edema fluid, and the antigen can be detected in biopsies of lymph glands by AGID using specific immune sera. An antigen detection ELISA is also available.

### Serology

Serologic testing can be by virus neutralization, which is 100% specific, or by an indirect fluorescent antibody or an agar gel precipitation test (AGPT), both of which cross-react with antibody to orf virus. An indirect ELISA has a similar diagnostic sensitivity and slightly lower specificity than the virus neutralization assay.<sup>6</sup> Virus-specific analysis of antibody response by Western blot can differentiate the infections.

PCR and melt-point analyses for the detection of capripox antigen have been developed, some as duplex or multiplex assays to differentiate capripox infections from orf virus.<sup>7</sup> These are suitable for use in countries that do not have the disease and do not hold live capripox virus. Loop-mediated isothermal amplification (LAMP) assays are potentially a cost-effective test to rapidly differentiate sheeppox and goatpox during outbreaks.<sup>8</sup>

### NECROPSY FINDINGS

In the malignant form, pox lesions extend into the mouth, pharynx, larynx, and vagina, with lymphadenopathy and a hemorrhagic spleen. Lesions may also appear in the trachea. Lesions in the lung are severe, manifesting as lentil-sized white pox nodules to a consolidating and necrotizing pneumonia. Lesions occasionally reach the abomasum and are accompanied by hemorrhagic enteritis.

Histologically, cells infected with capripox virus have a characteristic appearance with vacuolated cytoplasm and nuclei, marginated chromatin, and multiple inclusion bodies (“sheeppox cells”). With the use of double immunohistochemical labeling, the viral antigen appears in cells of the monocyte/macrophage lineage within 6 to 8 days of infection, and later in pneumocytes.<sup>4</sup>

### DIFFERENTIAL DIAGNOSIS

Contagious ecthyma (orf)  
Bluetongue



## TREATMENT

No specific treatment is advised, but palliative treatment may be necessary in severely affected animals.

## CONTROL

Control in countries or regions that are free of this disease centers around prohibiting the importation of live animals and unprocessed produce from infected areas and, if the infection is introduced, ring vaccination, the destruction of affected flocks, and the quarantine of infected premises.

Vaccination with natural lymph has been used in some affected areas, but it can spread the disease. Natural infection with one capripox strain imparts immunity to all capripox infections, and vaccination with a single capripox vaccine will give protection across all species and against all capripox infections.

A variety of commercial vaccines are available, and there is no easy basis for comparison. Killed virus vaccines elicit only temporary protection, but live attenuated vaccines protect against infection for more than 1 year. Colostral antibody can interfere with vaccination until 6 months of age. Vaccination programs in endemic areas recommend vaccination of lambs at 2 and 10 weeks, followed by an annual booster.<sup>5</sup> A subunit capripox virus vaccine has been developed.

Vaccination in the face of outbreak is unlikely to prevent deaths during the subsequent 2 weeks and, if needle hygiene is poor, may facilitate the spread of the disease.

## FURTHER READING

Embury-Hyatt C, Babiuk S, et al. Pathology and viral antigen distribution following experimental infection of sheep and goats with *Capripoxvirus*. *J Comp Pathol*. 2012;146:106-115.

Radostits O, et al. Sheeppox and goatpox. In: *Veterinary Medicine: A Textbook of the Diseases of Cattle, Horses, Sheep, Goats and Pigs*. 10th ed. London: W.B. Saunders; 2007:1430-1431.

## REFERENCES

1. Babiuk S, et al. *Transbound Emerg Dis*. 2008;55:263.
2. Bowden TR, et al. *Virology*. 2008;371:380.
3. Babiuk S, et al. *J General Virology*. 2009;90:105.
4. Embury-Hyatt C, et al. *J Comp Pathol*. 2012;146:106.
5. Yeruham I, et al. *Vet Rec*. 2007;160:236.
6. Babiuk S, et al. *Transbound Emerg Dis*. 2009;56:132.
7. Venkatesan G, et al. *J Virol Methods*. 2014;195:1.
8. Zhao Z, et al. *BMC Microbiol*. 2014;14:10.

## CONTAGIOUS ECTHYMA (CONTAGIOUS PUSTULAR DERMATITIS, ORF, SCABBY MOUTH, SORE MOUTH)

### SYNOPSIS

**Etiology** Orf virus. Genus *Parapoxvirus*. Family Poxviridae.

**Epidemiology** Primarily young lambs and kids. Morbidity may reach 100% and case-fatality rate 5% to 15%. Rapid spread in flock by contact or via inanimate objects such as feed troughs, ear-tag equipment, and emasculators. Scabs from lesions remain infective in the environment for a long time. Orf infections can cause considerable setback in young lambs and has economic importance as a result of restriction of movement and trade of affected sheep. May infect humans.

**Signs** Papules, pustules, scabs covering ulceration, granulation, proliferation, and inflammation. Lesions begin at oral mucocutaneous junction and oral commissures and spread to muzzle and oral cavity. Lambs cannot suck or graze. Malignant form occurs with invasion of alimentary tract. Severe systemic reaction can occur and lesions on coronets, ears, anus, and vulva. Lesions can be multifocal in goats.

**Clinical pathology** Electron microscopy, polymerase chain reaction (PCR)

**Lesions** Scabs, pustules, granulation tissue, and secondary lesions. Eosinophilic cytoplasmic inclusion bodies.

**Diagnostic confirmation** Clinical signs, differentiate virus by PCR.

### Differential diagnosis list:

Ulcerative dermatosis  
Proliferative dermatitis (strawberry footrot)  
Blue tongue  
Foot-and-mouth disease  
Sheeppox and capripox

**Treatment.** Nothing specific; general care of lesions.

**Control.** Isolation of affected animals. Vaccination.

## ETIOLOGY

Orf is associated with the orf virus, a type species of the genus *Parapoxvirus* (family Poxviridae). In addition to the orf virus (parapox ovis), the genus includes the viruses of bovine papular stomatitis (parapox bovis 1), pseudocowpox (parapoxvirus bovis 2), and a parapox virus of deer. The orf virus withstands drying and is capable of surviving at room temperature for at least 15 years. Restriction endonuclease digests of DNA shows considerable heterogeneity between different field isolates.

## EPIDEMIOLOGY

### Occurrence

The disease occurs worldwide in sheep and goats.<sup>1</sup> It causes unthriftiness, varying degrees of pain, and some economic loss. It occurs most commonly in 3- to 6-month-old lambs at pasture, although lambs 10 to 12 days of age and adult animals can be severely affected. Outbreaks involving the lips and face of young lambs and the udders of the

ewes are common. This disease can occur at any time, but outbreaks are most common in grazing sheep during dry conditions, lambs in feedlots, and penned sheep being fed from troughs. The disease has occurred in musk ox, in which it causes heavy losses, and in reindeer, mountain goats and bighorn sheep, chamois, caribou, Dall sheep, buffalo, wild goats, and camels. The virus can be passaged in rabbits if large doses are placed on scarified skin or injected ID. Mild lesions develop on the chorioallantois of the 9- to 12-day-old chick embryo. Guinea pigs and mice are not susceptible.

The disease also occurs in humans working among infected sheep. In abattoir workers it is most common in those handling wool and skins.

## Morbidity and Case Fatality

Outbreaks may occur in sheep and goats, with morbidity rates approaching 100% and case-fatality rates from 5% to 15%. The deaths that occur are a result of the extension of lesions in the respiratory tract, but the case fatality rate may reach 15% if severely affected lambs are not provided with adequate care and support, or if secondary infection and cutaneous myiasis (flystrike) are allowed to occur. In the rare outbreaks where systemic invasion occurs, the case-fatality rate averages 25% and may be as high as 75%. Under field conditions, recovered animals are immune for 2 to 3 years, but no antibodies appear to be passed in the colostrum, and newborn lambs of immune ewes are susceptible.

## Methods of Transmission

Scabs that fall off from healing lesions contain the virus and remain highly infective for long periods in dry conditions, but survival of the disease in a flock may be the result of chronic lesions that exist for long periods on individual animals. Infection can be from environmental persistence of the virus or from infected sheep. Spread in a flock is very rapid and occurs by contact with other affected animals or by contact with contaminated inanimate objects, such as feed troughs or ear-tagging pliers. An outbreak of lesions on the tail has been recorded in association with the use of docking instruments.

It has been assumed that natural infections on pasture are the result of invasion of the virus after skin damage induced by prickly plants or stubble; application of a viral suspension to scarified skin is the established method of inducing orf. However, an outbreak has occurred in groups of lambs collected from several farms and transported in a vehicle over a period of 23 hours when there was no evidence of injury to their mouths.

## Experimental Reproduction

The disease is readily reproduced by introduction of the virus onto scarified areas of

skin. Immunity to reinfection is relatively solid at the site of initial infection, but shorter-duration lesions can be reproduced by rechallenge of these sheep at other sites.

### Risk Factors

The primary risk factors are the presence of the virus and the immune status of the sheep. Mixing of sheep, such as occurs in a feedlot with sheep originating from several sources, allows transmission of the infection. Inter-current infections may exacerbate the occurrence of disease on rare occasions. For example, the disease has spread from clinically normal ewes to susceptible 2- to 4-year-old ewes that were persistently infected with border disease virus. Lambs experimentally infected with *Ehrlichia phagocytophilia* and subsequently challenged with orf virus developed more severe lesions with a longer course than those in control lambs.

### Economic Importance

The disease produces only a minor setback, except when it affects young sucking lambs with associated lesions on the teats and udders of their ewes. Loss from lamb mortality and secondary mastitis in these circumstances can be significant.

The disease assumed economic importance for Australia when shipments of sheep exported from Australia in 1989 to 1990 were rejected at some ports in the Middle East because of scabby mouth. Litigation is also a potential concern when zoonotic infections occur at petting zoos or fairs.

### Zoonotic Implications

Orf virus is readily transmitted to humans and historically has been a risk for industrial workers handling raw wool.

Lesions occur at the site of infection, usually an abrasion infected while handling diseased sheep for shearing, crutching, or drenching, or by accidental inoculation with live scabby mouth vaccine. Lesions progress from macular to papular stages, are usually single, and are localized on the hands, arm, or face. The lesions are self-limiting and heal without scarring after 6 to 7 weeks. They are pruritic and respond poorly to local treatment. Orf is also a zoonotic consideration in petting zoos and fairs where children allow lambs to suck their fingers or otherwise become infected from handling sheep in interactive exhibits.

### PATHOGENESIS

Damage to the skin is essential for the establishment of orf infection and the development of typical lesions. Following viral challenge of mildly abraded skin, the virus does not establish in the damaged epidermis, but instead replicates in the cells of an underlying replacement epidermal layer derived from the walls of the wool follicles. Following scarification of ovine skin and topical application of the orf virus, antigen cannot be

detected in the skin during the period when the epidermis is being renewed. The virus can first be detected in the center of the newly differentiated epidermis immediately below the stratum corneum, 72 hours after infection. The location of the virus during the eclipse stage is unknown. The infection spreads laterally and uniformly from the new epidermis, initially in the outer stratum spinosum and subsequently throughout the entire depth of the epidermis. The skin reaction consists of a cellular response with necrosis and sloughing of the affected epidermis and underlying stratum papillare of the dermis. The cutaneous response to infection includes a delayed-type hypersensitivity reaction and an influx of inflammatory cells involving neutrophils, basophils, and possibly mast cells. Class II dendritic cells are also involved and appear to form the basis of a highly integrated local dermal defense mechanism. The lesions evolve through the stages of macule, papule, vesicle, pustule, scab formation, and resolution. The pustules develop within a few days and then rupture, resulting in ulcers and subsequently the formation of a thick overlying crust or scab that is shed within 3 to 4 weeks, leaving no scar. Immunity is solid but will last only about 8 months. Although there is an antibody immune response to the virus, recovery is the result of cell-mediated immune mechanisms. Experimentally, a secondary infection, following recovery from a primary infection, is milder and accelerated. During the secondary challenge, pustules and scabs develop earlier, the lesions resolve more rapidly, and no vesicular stage may occur.

### CLINICAL FINDINGS

#### Sheep

Lesions develop initially as papules and then pustules, stages that are not usually initially seen, and progress to a raised and moderately proliferative area of granulation and inflammation covered with a thick, tenacious scab. Time from the initial lesions to the formation of scabs is approximately 6 to 7 days. New lesions will develop during the first 10 days of infection. The first lesions develop at the oral mucocutaneous junction, usually at the oral commissures, and are accompanied by swelling of the lips. From here they spread to the muzzle and nostrils, the surrounding haired skin, and, to a lesser extent, to the buccal mucosa. They may appear as discrete, thick scabs 0.5 cm in diameter, or coalesce and be packed close together as a continuous plaque. Fissuring occurs, and the scabs are sore to the touch. They crumble easily but are difficult to remove from the underlying granulation. Affected lambs suffer a severe setback because of restricted sucking and grazing. In benign cases the scabs dry and fall off, and recovery is complete in about 3 weeks.

Affected lambs sucking ewes may cause spread of the disease to the udder, where a similar lesion progression is seen on the teats



**Fig. 16-6** Contagious ecthyma on the teat of an ewe. The ewe contracted the infection by being suckled by a lamb with orf lesions on the commissures of its mouth.

(Fig. 16-6). Lesions on the teats predispose to mastitis, and secondary infection of the skin lesions by bacteria or fly larvae occurs in some cases. In rams, lesions on the scrotum may be accompanied by fluid accumulation in the scrotal sac and associated temporary infertility. A high incidence of infection can also occur where the dominant lesions are on the feet, occurring around the coronary band, the dew claws, and on the volar areas of the intervening skin.

Occasionally severe edema of the face can occur in association with oral lesions. In a severe case, over 50% of 4-month-old Texel lambs grazing good-quality pastures in Ireland were affected.<sup>2</sup> The edema resolved after 10 days but appeared quite similar to that seen with experimental bluetongue infections.

Rarely, systemic invasion occurs and lesions appear on the coronets and ears, around the anus and vulva or prepuce, and on the nasal and buccal mucosae. There is a severe systemic reaction, and extension down the alimentary tract may lead to a severe gastroenteritis; extension down the trachea may be followed by bronchopneumonia. Lesions may also occur in the mouth, involving the tongue, gums, dental pad, or a combination of those sites. These are more commonly seen in outbreaks affecting lambs less than 2 months of age. In the mucosa of the mouth these lesions do not scab but are papular erosive and surrounded by an elevated zone of hyperemia. Extensive painful and proliferative lesions occur on the gingival margins of the incisor teeth.

In some outbreaks the lesions on the skin are highly proliferative and present as raw, raised, granulating lesions without an overlying scab. This manifestation appears more common in Suffolk sheep, and lesions are present on the lips, bridge of the nose, and around the eyes (Fig. 16-7). Cases of this proliferative form involving the feet are also recorded.

A malignant form of the disease has also been observed in sheep. It begins with an acute episode manifested by oral vesicles, followed by extension of these lesions down the gastrointestinal tract, followed later by granulomatous lesions and shedding of hooves.

An atypical case of the disease in sheep after extensive cutaneous thermal injury has been described. The virus was present in proliferative verrucous tissue lesions at the periphery of the original thermal injury. The lesions consisted of tightly packed 0.5-mm-diameter papillary projections.

### Goats

An unusual case in a group of female goats has been described, with multifocal lesions over the head, neck, thorax, and flanks of each animal. The lesions developed approximately 2 weeks after the animals returned from a show at which the does were housed for 3 days in pens previously occupied by sheep. The lesions began as plaques, followed by epidermal proliferation and severe encrustation. Affected areas were discrete and approximately 2 to 7 cm in diameter. There were no lesions of the muzzle, lips, udders, or teats. Recovery occurred uneventfully within 3 to 6 weeks without treatment. The skin crusts gradually dried and fell off, leaving areas of alopecia and depigmented skin. Regrowth of hair followed.



**Fig. 16-7** Extensive chronic lesions as a result of chronic orf infection in a Suffolk ewe lamb. These facial lesions are often accompanied by similar lesions on the distal limbs.

Persistent orf occurred in a proportion of Boer goats following an outbreak. In most animals the disease ran a typical clinical course of 3 to 4 weeks, but in 2% of animals it persisted for several months, with lesions disseminated over the body. There were no particular distinguishing differences of the virus genome compared with those of other orf viruses, and the persistence was possibly a result of individual host-susceptibility factors.

### CLINICAL PATHOLOGY

Electron microscopic identification of the virus is quick and generally reliable with multiple samples from an affected herd or flock. Viral DNA can also be detected by a number of PCR assays, including real-time PCR and a multiplex PCR to differentiate orf, sheeppox, and capripox viruses.<sup>3</sup> LAMP assays have also been developed.<sup>4</sup> These are comparable to a real-time PCR but require less sophisticated equipment and thus may be a suitable test where resources are limited but rapid differentiation of orf virus and poxviruses is necessary.

Recovered animals have elevated neutralizing antibodies in their serum that are detectable by a gel diffusion test. Other serologic tests have been developed but are not widely available and probably of little clinical value.

### NECROPSY FINDINGS

In malignant cases there are irregularly shaped lesions with a hyperemic border in the oral cavity and the upper respiratory tract, with rare involvement of the mucosae of the esophagus, abomasum, and small intestine. Typical lesions are actually proliferative, with subsequent loss of centrally located cells creating an ulcer-like

appearance. Microscopically, the hyperplastic epithelium contains swollen degenerate cells, some of which may house eosinophilic cytoplasmic inclusion bodies.

### Samples for Confirmation of Diagnosis

- **Histology**—formalin-fixed lesions (LM)
- **Virology**—vesicle fluid, scraping from lesion (EM)

### DIFFERENTIAL DIAGNOSIS

In most outbreaks of ecthyma, the cases are sufficiently mild to cause no real concern about losses or about diagnosis.

Dramatic outbreaks of a very severe form of the disease may occur and may be confused with bluetongue. Very severe cases are also commonly seen in housed experimental sheep, especially colostrum-free lambs.

**Ulcerative dermatosis** is sufficiently similar to cause confusion in diagnosis, but this disease has not been reported for many years.

**Mycotic dermatitis** usually occurs on woolled skin, but lesions can occur on the lips and feet (strawberry footrot), have a thick dry asbestos-like scab, and are easily differentiated by laboratory culture.

**Facial eczema** is distinguished by diffuse dermatitis and severe edema and damage to the ears.

**Papillomatosis (warts)** need also to be considered in the differential diagnosis for the proliferative manifestations of contagious ecthyma, although warts are extremely uncommon in sheep.

**Bluetongue** is always accompanied by a high mortality rate and a severe systemic reaction, and lesions occur on the muzzle, the coronets, and extensively on the buccal mucosa. It is more common in adults than sucking lambs. Because it is transmitted by insect vectors, the morbidity rate is usually much less than the 90% commonly seen in contagious ecthyma.

**Sheeppox** may present a rather similar clinical picture, but the lesions are typical and there is a severe systemic reaction and heavy mortality rate.

**Foot-and-mouth disease.** The classic developed lesions of orf are easily differentiated from foot-and-mouth disease, but the papular and vesicular stages seen early in the course of orf, particularly lesions in the mouth, can be difficult to differentiate, especially when a prompt on-farm differentiation is required. The raised, firm, papular erosive nature of the lesion with the surrounding zone of hyperemia is a crucial differentiating feature in the field.



## TREATMENT

Removal of the scabs and the application of ointments or astringent lotions are practiced but delay healing in most cases. Antiviral drugs have been combined with emollients in gels and sprays (e.g., cidofovir and sucralfate).<sup>5</sup> These formulations can decrease the time to healing and amount of virus shed in scabs, but will be impractical and not cost-effective in most flocks. Supportive treatment, such as providing soft, palatable food, may be helpful.

## CONTROL

In the early stages of an outbreak, the affected animals should be isolated and the remainder vaccinated. Vaccination is of little value when a large number of animals are already affected. Persistence of the disease from year to year is common. If lesions are severe and consistently provide a setback, lambs should be vaccinated at 6 to 8 weeks of age. Vaccination when a few days old evokes a protective response. However, prelambling vaccination of the ewe is of no benefit for the lamb and so is not recommended. Vaccination of housed lambs should be given before the time that lesions have been observed in previous years.

Commercially available vaccines are typically a suspension of live tissue culture virus, often with a blue dye. An autogenous vaccine can also be prepared from a suspension of scabs in glycerol saline. The vaccine is scratched in a 5-cm line onto bare skin, usually the inside of the foreleg, brisket, or inner thigh. Alternative methods are to apply autogenous vaccine to a small area of scarified skin or to prick the ear with a needle dipped in the vaccine. Vaccination is effective for at least 2 years, but the lambs should be inspected 1 week after vaccination to check that a local reaction has occurred. A small proportion of vaccinated lambs may develop mild lesions around the mouth because of nibbling at the vaccination site. Absence of a local reaction signifies either a lack of viability of the vaccine or the existence of prior immunity. Immunity is not complete until 3 weeks after vaccination. As a further protective measure, removal of abrasive material from the environment is recommended but is not usually practicable. For the live-sheep export trade from Australia to the Middle East, sheep should be vaccinated at least 3 weeks before shipment to allow immunity to develop.

Because the vaccines are live virus vaccines and the shed scabs contain live virus, routine vaccination against orf in flocks that have not experienced the disease is not recommended. Outbreaks have occurred from vaccine virus.

## FURTHER READING

Fleming SB, Wise LM, et al. Molecular genetic analysis of orf virus: a *parapox virus* that has adapted to skin. *Viruses*. 2015;7:1505-1539.

Radostits O, et al. Contagious ecthyma (contagious pustular dermatitis, orf, scabby mouth, soremouth). In: *Veterinary Medicine: A Textbook of the Diseases of Cattle, Horses, Sheep, Goats and Pigs*. 10th ed. London: W.B. Saunders; 2007:1418-1421.

## REFERENCES

1. Nandi S, et al. *Small Rumin Res*. 2011;96:73.
2. Casey MJ, et al. *Vet Rec*. 2007;161:600.
3. Venkatesan G, et al. *J Virol Methods*. 2014;195:1-8.
4. Venkatesan G, et al. *Mol Cell Probes*. 2015;29:93.
5. Sonvinco F, et al. *AAPS J*. 2009;11:242.

## ULCERATIVE DERMATOSIS OF SHEEP

Ulcerative dermatosis of sheep is an infectious disease characterized by the destruction of epidermal and subcutaneous tissues and the development of raw, granulating ulcers on the skin of the lips, nares, feet, legs, and external genital organs. The lesions on the lips occur between the lip and the nostril, those on the feet occur in the interdigital space and above the coronet, and the genital lesions occur on the glans and the external opening of the prepuce of rams and the vulva of ewes.

A virus, very similar to but antigenically different from the ecthyma virus, is the cause of the disease, which is likely to be confused with contagious ecthyma. However, the lesions are ulcerative and destructive, rather than proliferative as in ecthyma, and bleed easily. It is not highly infectious like bluetongue or sheepox, and the “lip-and-leg” distribution of the lesions differentiates it from balanoposthitis of wethers, strawberry footrot (dermatophilosis), footrot, and interdigital abscess. The presence of lesions on the glans penis and their absence from mucosae, the typical ulcerative form of the lesion; the absence of pus; and the susceptibility of recovered animals to infection with ecthyma virus are diagnostic features of ulcerative dermatosis.

The typical morbidity rate is 15% to 20%, but up to 60% of a flock may be affected. Mortality is low if the sheep are in good condition and the lesions don't get secondary bacterial infection or flystrike. Physical contact at breeding time seems to be the most probable method of spread.

The lip cutaneous form of this disease is very rare and possibly has disappeared since its original description, or is very uncommon. A clinically similar disease to the genital infection of ulcerative dermatosis, with balanoposthitis and vulvovaginitis, is associated with *Mycoplasma mycoides*.

## FURTHER READING

Radostits O, et al. Ulcerative dermatosis of sheep. In: *Veterinary Medicine: A Textbook of the Diseases of Cattle, Horses, Sheep, Goats and Pigs*. 10th ed. London: W.B. Saunders; 2007:1432.

## POXVIRUS INFECTIONS IN HORSES (HORSEPOX, UASIN GISHU, VIRAL POPULAR DERMATITIS, EQUINE MOLLUSCUM CONTAGIOSUM)

Equids can be infected by horsepox virus or vaccinia virus. Infection is associated with classical horsepox, equine molluscum contagiosum, viral papular dermatitis, or Uasin Gishu disease and possibly a form of “greasy heel” in horses and donkeys. Classical horsepox, caused by infection of horses by a specific poxvirus (horsepox virus, HSPV), was common before the twentieth century and was considered a rare, if not extinct, disease of horses until it was again identified in Brazil in 2010.<sup>1</sup> The genome of HSPV has been determined and demonstrates that although it is closely related to vaccinia viruses, it contains additional genetic material that appears to confer some host specificity and pathogenicity.<sup>2</sup> HSPV, with cowpox virus, was used for vaccination of humans against smallpox before introduction of use of vaccinia virus.<sup>3</sup> Whereas most poxviruses are highly host adapted and do not cross species lines (e.g., variola virus causing smallpox in humans does not naturally infect animals), this is not the case with cowpox, horsepox, and vaccinia viruses, which can be zoonoses or anthroponoses. Widespread use of vaccinia virus live vaccines in humans was associated with a pox-like disease in horses.<sup>3</sup> This disease has largely not occurred since the cessation of the smallpox vaccination program, but other poxvirus diseases in animals are reported, and infection appears to have the potential to be zoonotic for horsepox and cowpox viruses, or anthroponotic (reverse zoonosis) for vaccinia viruses.<sup>3-5</sup>

The eradication of smallpox and the discontinuation of human vaccination in most countries were accompanied by a gradual reduction of the number of horse cases,<sup>1-3</sup> although the disease is not eradicated, and infections involving cattle, horses and humans occur in Brazil.<sup>4</sup> The virus isolated from horses (Pelotas 1 virus [P1V] and Pelotas 2 virus [P2V]) in Brazil is highly pathogenic in rabbits.<sup>6,7</sup> The source of the vaccinia virus in these outbreaks has not been determined (e.g., wildlife, rodents).<sup>4</sup>

Horses infected with the **vaccinia virus** used in human vaccine programs develop a transient and self-limiting disease characterized by pox-like lesions (papulopustular) in the mucous membranes of the mouth and in the skin of the lips and nose. Infection by particular strains of the vaccinia virus (P1V and P2V) in Brazil causes papules and vesicles progressing to proliferative and exudative lesions on the muzzle, external nares, and external and internal lips (Fig. 16-8).<sup>1</sup> The vesicles erode, and the proliferative lesions progress to moist crusts and scars.



**Fig. 16-8** Muzzle of an affected mare during acute disease associated with infection by vaccinia-like virus. Multiple, confluent papules and proliferative lesions in the muzzle, between and surrounding the nares, and extending aborally. (Reproduced with permission, Brum MCS et al. *J Vet Diagn Invest* 2010; 22:143.)

Clinical signs last approximately 6 to 12 days. The overall duration of the outbreak is 90 days.

Infection by classical HSPV causes either a relatively benign disease or a more severe, sometimes fatal, disease.<sup>1,2</sup> The benign or localized form (contagious pustular stomatitis) causes lesions in the muzzle and buccal cavity. The more severe form (equine papular stomatitis) is a generalized, highly contagious disease causing fever, skin lesions that can involve the udder, and death in some animals. Both adults and foals are susceptible.<sup>2</sup> Immunity after an attack is solid.

Typical pox lesions develop in a **leg form** or in a **buccal form**. In the **leg-form** nodules, vesicles, pustules, and scabs develop, in that order, on the back of the pastern and cause pain and lameness. There may be a slight systemic reaction, with elevation of temperature. In the **buccal form**, similar lesions appear first on the insides of the lips and then spread over the entire buccal mucosa, sometimes to the pharynx and larynx and occasionally into the nostrils. In very severe cases, lesions may appear on the conjunctiva, the vulva, and sometimes over the entire body. The buccal lesions cause a painful stomatitis, with salivation and anorexia as prominent signs. Most cases recover, with lesions healing in 2 to 4 weeks.

**Uasin Gishu** is a skin disease of nonindigenous horses of the Uasin Gishu plateau of Kenya and neighboring areas associated with a poorly documented poxvirus. The source of the virus, and its method of transmission, are unknown, although a wildlife host is presumed. Concerns have been raised of the potential for zoonotic spread or anthroponosis (reverse zoonosis) of horsepox viruses or vaccinia virus, respectively.<sup>4,5</sup> Lesions of Uasin Gishu occur on the head, neck, and flanks and resemble papillomas. Various stages of the lesions can be present in the same horse, and lesions can develop and regress intermittently for years. There is no specific treatment, and no control methods are reported.

**Viral papular dermatitis** is a disease of horses in the United States, the United Kingdom, and Australia. It is a contagious disease characterized by cutaneous lesions in the form of firm papules 0.5 to 2 cm in diameter. No vesicles or pustules are formed, but after 7 to 10 days a dry crust is detached, leaving small circumscribed areas of alopecia. The lesions are not itchy, there is no systemic disease, and the distribution of the lesions, and the way in which they can develop simultaneously in large numbers in introduced horses, is suggestive of an insect-borne disease.

The course of the disease varies between 10 days and 6 weeks. The disease is strongly suspected to be caused by a poxvirus.<sup>1,2</sup> A febrile reaction, up to 40.2°C (104.5°F), precedes the appearance of skin lesions by about 24 hours. There is no histologic description. Recovery is usually complete and uncomplicated. The disease is clinically similar to **molluscum contagiosum** in horses associated with poxvirus. This disease has similar papular lesions, which are hypopigmented and covered by tufts of raised hair, but the disease has a long clinical course. Histologically, these lesions show proliferation of keratinocytes containing large intracytoplasmic inclusions, known as molluscum bodies, which are composed of numerous pox virions.

Differential diagnoses include greasy heel, vesicular stomatitis, viral papular dermatitis, molluscum contagiosum, and Uasin Gishu. See [Tables 16-3](#) and [16-4](#).

There is **no specific treatment**. Local wound care is indicated. Because of the contagious nature of the disease, rigid isolation and hygiene in the handling of infected horses is essential. No vaccine is available.

## REFERENCES

1. Brum MCS, et al. *J Vet Diagn Invest*. 2010;22:143.
2. Tulman ER, et al. *J Virol*. 2006;80:9244.
3. Sanchez-Sampedro L, et al. *Viruses*. 2015;7:1726.
4. Campos RK, et al. *Arch Virol*. 2011;156:275.
5. Osadebe LU, et al. *Clin Infect Dis*. 2015;60:195.
6. Cargnelutti JF, et al. *Microb Pathogen*. 2012;52:192.
7. Cargnelutti JF, et al. *Res Vet Sci*. 2012;93:1070.

## SWINEPOX

### SYNOPSIS

**Etiology** Swinepox virus.

**Epidemiology** Widespread sporadic disease that is generally benign with low morbidity and low **mortality** in older pigs. High case fatality in congenitally infected and very young sucking piglets. Transmitted mechanically and by the hog louse.

**Clinical findings** Characteristic pox lesions mainly on skin of head, legs, and belly.

**Clinical pathology** Demonstration of typical lesions by histology and virus by electron microscopy.

**Lesions** Typical pox lesions.

**Diagnostic confirmation** Demonstration of typical lesions by histology and virus by electron microscopy.

**Treatment** None.

**Control** Control of hog louse.

Swinepox virus causes a mild, acute disease of swine characterized by typical poxvirus lesions of the skin. There are no public health concerns.

**Table 16-3** Differential diagnosis of diseases of horses characterized by discrete lesions of the skin only

Disease	EPIDEMIOLOGY			Clinical pathology
	Method of spread	Behavior in herd	Lesions	
Horsepox	Extremely rare, usually benign. Can be severe. Spread by contact, rugs, grooming tools.	Solid immunity after attack. No recurrence. Lesions heal 2–4 weeks.	Typical pox lesions in mouth or behind pasterns. Rare cases have lesions in mouth, nostrils, vulva.	Electron microscopy of swab from lesion. Poxvirus present—horsepox virus or vaccinia virus. Polymerase chain reaction (PCR).
Vesicular stomatitis	Occurs in horses, cattle, and pigs. Spread by insect or contact. Clustered outbreaks summer and autumn.	Lesions last only 3–4 days. Solid immunity for 6 months.	On tongue and lips. Uncommon on udder or prepuce. Vesicles up to 2 cm rupture, leaving raw area; profuse ropey saliva. Heal quickly.	Virus isolation, PCR. Many serologic tests available.
Viral papular dermatitis	Insect vector. May affect many horses at one time. Local horses immune. Summer and autumn.	Recovered in 10 days to 6 weeks. Benign, disappears without trace.	Generalized cutaneous papules 0.5–2 cm in diameter, dry crust at 7–10 days, then spot of alopecia.	Assumed poxvirus.
Staphylococcal dermatitis	Sporadic. Lesions under harness suggest pressure or spread by contact. A common disease.	No information, does not spread much. Very difficult to cure in individual. Horse will not work under harness.	5-mm nodules then pustules. Slough, taking small scab and hair. Very painful to touch.	<i>Staphylococcus aureus</i> culture from swab of lesion.
Deep ringworm	Diffuse ringworm more common. Spread easily by direct contact or harness or tools.	Sporadic usually. Difficult to cure.	3-mm-diameter follicular nodule, hair loss leaving bald patch. No extensive lesions. Sore to touch, itchy. Spreads from axilla.	<i>Trichophyton</i> or <i>Microsporum</i> spp. on swab.
Demodectic mange	Spread via grooming tools and rugs. Rare.	Slow spread.	Lesions around face and eyes initially.	<i>Demodex</i> spp. in scraping.
Mycotic dermatitis	Wet, humid weather predisposes. Prolonged wetness. Mud leads to foot lesions. Biting flies may spread other forms.	May be number affected if weather conditions suitable.	Lesions commence on head at muzzle and around eyes, with laceration and mucopurulent nasal discharge, on lower legs or generalized. Not itchy; may be sore. Matted hair and scab can be lifted off an ovoid, slightly bleeding area.	Branching filamentous <i>Dermatophilus congolensis</i> on smear of lesion.
Tyroglyphosis	In horses fed recently harvested, infested grain, or at pasture.	Transient, self-limiting disease.	Dermatitis, itchy, scaly; with rubbing get alopecia and scab formation on muzzle and face, lower limbs at flexures.	Larvae of chigger mites <i>Pediculoides</i> and <i>Trombicula</i> spp. in scraping.
Photosensitization	Rare in horses. Feeding on St. John's wort or hepatotoxic plants; secondary to cholangiohepatitis or cholelithiasis.	Occurs only in sunlight. Disappears on removal from damaging feed and sun.	Extensive edema, weeping dermatitis, or skin sloughing on white parts. May also be signs of hepatic insufficiency.	Nil.
Queensland itch	Sporadic. During insect season. Only in horses outdoors.	Only hypersensitive horses affected. Disease persists as long as insects present. Interferes with work and grazing.	Intensely itchy. Lesions at tail butt, along back, withers, crest, poll, ears, down sides. Papules, hair rubs off. Pachydermia, no weeping.	Hypersensitivity indicated by eosinophilia in skin biopsy.
Ringworm	Ready transmission by contact and with equipment and premises. Most serious in winter.	Spontaneous recovery in about 3 months. Spread in herd can be very rapid.	Thick, dry, crumbly scab, 2–3 cm diameter, or diffuse alopecia with scaliness begin at girth or under head stall.	<i>Trichophyton</i> and <i>Microsporum</i> spp. on scraping.

Note: See also discussions of cutaneous globulidiosis, multiple abscess caused by *Corynebacterium pseudotuberculosis*, anhidrosis, congenital absence of skin.



**Table 16-4** Differential diagnosis of diseases of horses characterized by lesions of the skin of the lower limbs only

Disease	EPIDEMIOLOGY			Clinical pathology
	Method of spread	Behavior in herd	Lesions	
Glanders	Contact with infected horses. Ingestion from contaminated environment.	This is chronic form. Other cases of classical glanders with pulmonary and nasal mucosal involvement.	Nodules and ulcers on nasal mucosa, purulent discharge. Stellate scars on septum. Limb lesions mostly at hock (medial aspect): nodules 1–2 cm, discharge honey-like pus.	Mallein test. Complement fixation tests on serum. Transmission to guinea-pigs. <i>Burkholderia mallei</i> in smears.
Epizootic lymphangitis (equine blastomycosis)	Occurs in outbreaks. Spread by spores on contaminated bedding. May survive in soil. Entry through skin abrasions.	Horses cannot be worked. Common in large groups (e.g., military horses).	Ulcers at hocks, lymph nodes at hocks swell and discharge creamy pus. Lymphangitis. Some cases generalized with pulmonary abscesses.	<i>Histoplasma farciminosum</i> in smears of pus. Skin sensitivity test.
Sporotrichosis	Slow spread. Sporadic cases. Spread by contact and contamination.	Lesions heal 3–4 weeks, but new crops keep disease going.	Painless nodules at fetlocks ulcerate then heal. Lymphangitis in some animals.	<i>Sporotrichum schenckii</i> on smear.
Swamp cancer (pythiosis)	Sporadic. Infection or invasion of wound.	Does not spread.	On lower limbs, ventral abdomen, or below medial canthus of eye, lips. Papules to plaques 1 cm thick, connective tissue with ulcers up to 20 cm, with inspissated pus in pockets.	Biopsy and scrapings for hyphae of <i>Pythium insidiosum</i> , <i>Entomophthora coronata</i> , larvae of <i>Habronema megastoma</i> .
Greasy heel	Sporadic cases only. Horses standing in manure and urine.	Not contagious, but can be chronic and incapacitating.	Horizontal cracks and fissures behind pastern, very lame. Much sebaceous exudate. May develop cellulitis.	Nil.
Ulcerative lymphangitis	Infection of skin wounds in dirty stable.	Lesions heal in 1–2 weeks. New lesions develop for up to 12 months.	Painful nodules around pastern rupture; creamy green pus. Lame. Lymphangitis with ulcers.	No lymph node involvement. <i>Corynebacterium pseudotuberculosis</i> in pus. Other organism can cause similar disease.
Chorioptic mange	Widespread. Mostly draft and other working horses.	Most horses in group affected.	Violent stamping; rubs back of pasterns; swollen, scabby, cracked, greasy, painful to touch; lame.	Scrapings reveal mites, <i>Chorioptes equi</i> .

Note: See also horsepox (Table 16-3).

## ETIOLOGY

The cause is swinepox virus, the sole member of the genus *Suipoxvirus* in the family Poxviridae.

## EPIDEMIOLOGY

### Occurrence

Swinepox (pigpox) occurs worldwide where swine are raised and is more common in swine units where there is poor sanitation.

### Methods of Transmission

Transmission is not well understood. It is by contact transmission and mechanically by the pig louse (*Haematopinus suis*), and because these cannot always be found, it is suspected that possibly flies and other insects may also be involved. Young sucking pigs may have lesions on the face, with similar lesions on the udder of the sow, so there is evidence of spread by direct contact. Vertical transmission is also possible; there are reported cases of congenital infection. The virus can survive in scab material for several months and in dust and dried secretions.

### Animal Risk Factors

The virus infects only swine and can infect all ages, but clinical disease is most commonly seen in young piglets. It is usually a sporadic disease, with occasional outbreaks affecting a cluster of litters within a herd, and of short duration. Some or all pigs in a litter may show clinical signs. The disease may appear apparently spontaneously or may occur only in pigs brought into the contaminated environment of a herd in which the indigenous pigs are immune.

The incidence in individual herds may be high. Mortality is usually low except in very young piglets and congenitally affected piglets, where mortality rates can be high. Congenital infection presents with low morbidity but high case fatality. Older animals seem to suffer few ill-effects.

### PATHOGENESIS

The virus may enter the skin through preexisting skin lesions and then replicates in the keratinocytes of the stratum spinosum. It rarely affects other tissues. It can be isolated

from the skin as soon as 3 days following intradermal inoculation. In field cases, the lesions progress through the classical phases of poxvirus infections but do not usually proceed past the pustular or vesicle stage. At this time there is rupture and the formation of scabs, which heal and drop off. Congenital infection is thought to occur when naïve pregnant sows become infected and develop viremia with infection of the fetal membranes. Not all fetuses are born affected, and compartmentalization of placentas may restrict further uterine spread as occurs with parvovirus infections.

### CLINICAL FINDINGS

The morbidity may be high in individual herds where young pigs are affected, but the mortality is usually very low. The incubation period may be from 4 to 14 days. Small 1- to 1.5-cm-diameter papules develop first and may pass through the pustular and vesicular stage very quickly with the formation of red-brown, round scabs. In neonatal pigs, the rupture of many vesicles at one time may

cause wetting and scab formation over the cheeks, and conjunctivitis and keratitis are present in many affected animals. In most cases the lesions are restricted to the belly and inside the upper limbs, but they may involve the back and sides and sometimes spread to the face. Lesions may coalesce. A slight febrile reaction may occur in the early stages in young animals, and in sucking pigs, deaths are observed. In adult pigs, detectable skin lesions are less well defined, restricted to the nonhaired softer skin areas, and frequently do not progress through the developmental stages to form scabs. Congenital swinepox is characterized by striking lesions present in piglets at birth, involving the skin and also commonly the tongue and hard palate. Affected piglets are born from healthy sows. Affected piglets may be stillborn or die within a few days after birth.

### CLINICAL PATHOLOGY

The diagnosis is confirmed by examination of skin biopsies, which show hydropic degeneration of the stratum spinosum keratinocytes. Focal superficial erosions, marked epidermal hyperplasia with acanthosis, ballooning of epidermal cells, and occasional large eosinophilic intracellular inclusion bodies are present on histologic examination. Hydropic degeneration can also be seen in the outer sheaths of the hair follicles. There is no fluid accumulation between the keratinocytes. Necrosis may occur later. Inflammatory cells invade the underlying dermis. Electron microscopy can be used to detect the viral particles, and the virus can be cultivated in primary pig kidney cell tissue culture with at least seven passages. Crusts, papules, or pustules are best for this. Pigs will develop virus-neutralizing and virus-precipitating antibodies but not at high enough levels to make antibody tests reliable. There is strong immunity in recovered animals.

### DIFFERENTIAL DIAGNOSIS

The distribution of the pox-like lesions and the association of the disease with louse infestations suggest the diagnosis. Swinepox may resemble swine vesicular disease, which is characterized by vesicles on the coronary bands, lips, tongue, and snout.

Lesions associated with *Tyroglyphus* spp. mites are usually larger, occur anywhere on the body, and, like those of sarcoptic mange, are usually accompanied by itching. The causative mites are detectable in skin scrapings. Ringworm and pityriasis rosea have characteristic lesions that do not itch, occur in older pigs than typically does swinepox, and fungal spores are present in scrapings in the former disease.

A vesicular disease with necrosis resembling swinepox has been attributed to infection with parvovirus, but there is little evidence that parvovirus is a primary skin pathogen.

### TREATMENT

No specific treatment is available, and lesions cause so little concern to the pig, and heal so rapidly, that none is attempted.

### CONTROL

Vaccination is not usually practiced, and control of the pig lice is the principal prophylactic measure attempted in most outbreaks.

## Dermatomycoses

### RINGWORM

#### SYNOPSIS

Invasion of cutaneous keratinized epithelial cells and hair fibers by dermatophytes.

**Etiology** *Trichophyton*, *Microsporium* spp. fungi.

**Epidemiology** Carrier animals are the source; spread is via direct contact or contact with infected inanimate objects. Housed animals most susceptible.

**Clinical signs** Circumscribed areas of hairless skin; thick gray crumbly crusts (cattle) or shiny, bald areas (horses); heavy pityriasis; common locations where infection likely to contact (e.g., neck, sides).

**Clinical pathology** Spores and mycelia in skin scraping, or in culture.

**Necropsy lesions** Mycelia identifiable in skin sections.

**Diagnostic confirmation** Laboratory typing of fungus in scraping or tissue.

**Treatment** Spontaneous recovery usual. Topical ointments such as Whitfield's ointment, systemic griseofulvin. Vaccination widely used in European countries and supportive treatment.

### ETIOLOGY

The associated fungi that grow on the hair, skin, or both are as follows:

- **Cattle:** *Trichophyton verrucosum* (most commonly), *T. mentagrophytes*, *T. megninii*, *T. rubrum*, *T. simii*, *T. verrucosum* var. *album*, *T. verrucosum* var. *discooides*, *Microsporium gypseum*
- **Sheep:** *T. verrucosum* var. *ochraceum*, *T. quinckeanum*, *T. mentagrophytes*, *M. gypseum* ("club lamb fungus" in show lambs in the United States), *Microsporium canis*
- **Goat:** *T. verrucosum*
- **Horse:** *T. equinum*, including a dark variant able to perforate hair in vitro (*T. equinum* var. *equinum*), *T. quinckeanum*, *T. mentagrophytes*, *T. verrucosum*, *Microsporium equinum* (syn. *M. canis*), *M. gypseum*, *Equicapillimycetes hongkongensis*
- **Donkey:** *T. mentagrophytes*, *T. verrucosum*

- **Pig:** *T. mentagrophytes*, *T. rubrum*, *T. verrucosum* var. *discooides*, *M. canis*, *Microsporium nanum*

Uncommon dermatophytes also found in skin lesions in farm animals and horses include the following: *M. gypseum* and *Keratinomyces allejoi* in horses; *Malaessezia* spp. yeasts causing superficial mycoses in immunocompromised horses; *Scopulariopsis brevicaulis* in cattle; *M. nanum* in adult pigs, in which it is most common and in which the lesions are often so mild as to go unnoticed by the farmer; and *Alternaria alternata* in horses, goats, pigs, sheep and cattle.

A rare but similar disease is tinea versicolor, a fungal dermatomycosis associated with *Malassezia furfur* (syn. *Pityrosporum orbiculare*) on the teats of goats. The lesions are circular, discrete, slightly thickened, and scaly at the edges, but not painful. They are characterized by an alteration in the color of the surrounding skin, either darker or lighter. The infection persists on a patient for at least a year and in a flock for a longer period. Hyphae are distinguishable in sections of the lesions.

### EPIDEMIOLOGY

#### Occurrence, Source of Infection, and Transmission

Ringworm occurs in all animal species in all countries but more commonly where animals are accommodated in dense groups, especially indoors.

Direct contact with infected animals is the common method of spread of ringworm, but indirect contact with inanimate objects, particularly bedding, harnesses, grooming kits, and horse blankets, is probably more important. Spores can exist on the skin without causing lesions, and up to 20% of normal animals in an infected group will act as carrier animals. Premises and harnesses may remain infective for long periods because fungal spores remain viable for years if they are kept dry and cool. Moderate heat and desiccation destroy them.

A dermatophytosis in lambs in the United States, called **club lamb fungus**, affects lambs during lamb show season. Approximately one-third of families reported that children or owners involved in showing these lambs developed skin lesions consistent with dermatophytosis.

Ringworm in yearling horses can interfere with training, causing economic losses because of the isolation required to prevent spread of infection to other horses and humans and to decrease environmental contamination.

### Risk Factors

#### Pathogen Factors

*M. gypseum*, *K. allejoi*, and *M. nanum* are soil saprophytes, and the reasons for their assumption of pathogenicity are not understood.

### Environment and Host Factors

A high incidence of clinical cases in the winter and of spontaneous recovery in the spring is common, but outbreaks also occur during the summer months, so that close confinement and possibly nutrition seem to be more important in the spread of the disease than other environmental factors such as temperature and sunlight. Humidity is known to be important, with high humidity being conducive to multiplication of the fungus. In calf-rearing and vealing units the prevalence is greater in units that continuously add or remove calves from the stock; an "all-in-all-out" program is less conducive to spread of the disease.

Animal susceptibility is determined largely by immunologic status, and thus young animals are most susceptible.

### Zoonotic Considerations and Economic Importance

Spread between species occurs readily, and in rural areas 80% of human ringworm may derive from animals. *Trichophyton* spp. infections are commonly contracted from horses and cattle<sup>1</sup> and *M. canis* infections from dogs. Ringworm of animal origin affects adult humans and children, and diagnosis and treatment are often very difficult.<sup>2</sup>

Injury to affected animals is of a minor nature, but sufficient damage to hides occurs to warrant some attempt at control of the disease.

### PATHOGENESIS

Ringworm fungi chiefly attack keratinized tissues, particularly the stratum corneum and hair fibers, resulting in autolysis of the fiber structure, breaking off of the hair, and alopecia. Exudation from invaded epithelial layers, epithelial debris, and fungal hyphae produce the dry crusts that are characteristic of the disease. The lesions progress if suitable environmental conditions for mycelial growth exist, including a warm and humid atmosphere and a slightly alkaline pH of the skin. Ringworm fungi are all strict aerobes, and the fungi die out under the crust in the center of most lesions, leaving only the periphery active. It is this mode of growth that produces the centrifugal progression and the characteristic ring form of the lesions.

The significance of skin pH in the development of ringworm is widely known. The susceptibility of humans to ringworm infection is much greater before puberty than afterward, when the skin pH falls from about 6.5 to about 4.0. This change is largely attributable to excretion of fatty acids in the sebum, and these fatty acids are often highly fungistatic. Calves are more commonly infected than adult cattle, but whether this is a result of increased susceptibility in calves or the development of immunity in adults has not been determined.

There is some experimental evidence that traumatic injury of the skin is an important factor for the development of ringworm lesions in calves. Different numbers of microconidia of *T. verrucosum* are required to induce ringworm depending on the degree of shearing of the hair and scarification of the skin. *T. mentagrophytes* secretes a small peptide (hemolysin) that is suspected to result in cell-membrane damage and facilitate infection of the skin.<sup>3</sup>

Secondary bacterial invasion of hair follicles is common. The period after experimental infection before distinct lesions appear is about 4 weeks in calves, but considerably less in horses. Spontaneous recovery occurs in calves in 2 to 4 months, with the duration and severity of the disease often depending on the nutritional status of the host. A resistance to reinfection occurs after recovery from experimental or natural infection even though a local mycotic dermatitis may occur at the reinfection site. The immunity is specific to the fungal species concerned, and in horses immunity lasts up to 2 years.

### CLINICAL FINDINGS

#### Cattle

The typical lesion is a heavy, gray-white crust raised perceptibly above the skin. The lesions are roughly circular and about 3 cm in diameter. In the early stages the surface below the crust is moist; in older lesions the scab becomes detached, and pityriasis and alopecia may be the only obvious abnormalities. Lesions are most commonly found on the neck, head, and perineum, but a general distribution over the entire body may occur, particularly in calves, and in severe cases the lesions may coalesce. Itching does not occur, and secondary acne is unusual.

#### Sheep

In sheep the lesions occur on the head and rarely in the fleeced areas, and although lesions usually disappear in 4 to 5 weeks, the disease may persist in the flock for some months. The lesions are discrete, round, nearly bald patches covered with a grayish crust. Similar lesions occur in goats, but they are distributed generally over all parts of the body. The exception to this description is a new ringworm associated with an unidentified *Trichophyton* that has appeared in sheep in the western U.S. states, plus Georgia and Kentucky, since 1989. Lesions occur extensively in fleeced areas and are characterized by shedding of the wool staple and exudation from the skin surface. Serious spread of the infection to human attendants occurs.

Outbreaks of ringworm in sheep flocks associated with *T. verrucosum* have been reported in Scotland. The outbreaks have been unusual because of the high morbidity rates and persistence of active lesions for up to 6 months. The presence of ringworm

lesions precluded the sale of rams in affected flocks.

In club lamb fungus in show lambs in the United States, gross lesions typical of ovine dermatophytosis were located on all parts of the body and consisted of circular areas of matted wool, crusts, and discoloration.

### Horses

The lesions may be superficial or deep. Superficial infections are more common. Lesions resulting from *T. equinum* commence as round patches of raised hair and soreness of the lesions to touch. This stage is followed about 7 days later by matting of the hair, which becomes detached, leaving a bald, gray, shining area about 3 cm in diameter. Fine scabs appear, and recovery with regrowth of hair commences in 25 to 30 days. Heavier scabs and larger lesions are usually a result of rubbing by the harness. Lesions associated with *M. gypseum* are smaller, about 10 mm in diameter, and are manifested either by the development of thick crusts or, more generally, a diffuse moth-eaten appearance with desquamation and alopecia. Less commonly, deeper structures are infected through the hair follicles, causing small foci of inflammation and supuration. A small scab forms over the follicle and the hair is lost, but extensive alopecia and crust formation do not occur. Some irritation and itching may be caused by this type. The distribution of lesions in the horse differs from that in cows, with lesions usually appearing first on the axillary girth area and spreading generally over the trunk and over the rump; lesions may spread to the neck, head, and limbs. Some cases are clinically impossible to differentiate from dermatophilosis.

Chromoblastomycosis is a sporadic, slow-developing chronic granulomatous fungal infection of skin following traumatic injury that has been reported occasionally in horses. Nodular granuloma-like nodules gradually appear that are clinically indistinguishable from habronemiasis.

**Brittle-tail syndrome** of horses is a newly reported disease of horses in Hong Kong caused by a keratinolytic fungus, *Equicapillomyces hongkongensis*. Affected horses develop short, stumpy tails as a result of breakage of hairs in the dorsal layers of the tail.<sup>4</sup> The disease is contagious, and environmental or animal reservoirs (apart from horses) are unknown.

### Pigs

Ringworm is not common in pigs. Regular ringworm lesions in pigs develop as a centrifugally progressing ring of inflammation surrounding a scabby, alopecic center. The lesion produced by *M. nanum* is different—there is no pruritus or alopecia and cutaneous reaction is minimal, but the centrifugal enlargement of each lesion may cause it to reach an enormous size.<sup>5</sup> Superficial, dry,



brown crusts cover the affected area but are not obviously raised, except at the edges in some cases. The crusts are formed of flakes or dust composed of epithelial debris. Most lesions occur on the back and sides. Spontaneous recovery does not occur in adult pigs.

### CLINICAL PATHOLOGY

Laboratory diagnosis depends on the demonstration of spores and mycelia in skin scrapings from the edge of the lesion and in culture. Skin scrapings should be made after decontaminating the skin with 70% ethyl alcohol, placing the scraping in a 10% solution of potassium hydroxide, and potentially adding lactophenol cotton blue before microscopic examination is performed. Spores are the diagnostic feature and appear as round or polyhedral, highly refractive bodies in chains (*Trichophyton* spp.) or mosaics (*Microsporum* spp.) in hair follicles, in epithelial scales, and in or on the surface of hair fibers. A hair perforation test, which measures the capacity of a fungal isolate to perforate human hair fibers in the laboratory, is used in the differentiation of dermatophytic species. Culture can take 2 to 6 weeks to provide a diagnosis; consequently, a PCR test using the primer pair for chitin synthase 1 (CHS1) gene has been developed for use in horses.<sup>6</sup> An ELISA for serodiagnosis has been developed for cattle, but it appears it will be most successful in monitoring response to vaccination and epidemiologic studies.<sup>7</sup>

The most useful technique for the early diagnosis of ringworm in cattle uses a small sterilized hairbrush. The skin lesion is first swabbed with a cotton swab containing 70% to 90% ethyl alcohol to remove environmental contaminants and allowed to dry. The lesion is then brushed; the brush is placed in a sterile plastic bag for immediate transportation to the laboratory<sup>8</sup> and subsequent culture within a few hours.

Examination of the skin of infected animals to detect the fluorescence associated with some fungal infections can also be a useful clinical aid, but many trichophyton fungi do not fluoresce, whereas petroleum jelly and other oily skin dressings may do so. Fungal hyphae in tissues can be identified, even down to the genus, by the use of immunofluorescent staining. The technique was devised for use on necropsy material but should have application for biopsy material and scrapings. Specimens to be sent for laboratory examination should be packed in envelopes because airtight jars and cans favor the growth of nonpathogenic fungi during transportation.

### DIFFERENTIAL DIAGNOSIS

The diagnosis of ringworm depends on evidence of infectivity, the appearance of characteristic lesions, and the presence of

fungal mycelia and spores. Diagnostic confirmation is by demonstration of fungal elements in a scraping or biopsy.

The differential diagnosis list of ringworm, which may be confused with diseases with similar clinical profiles, follows.

#### Cattle

Mycotic dermatitis, which has tenacious scabs that cover a raw area of skin.

Inherited parakeratosis, characterized by tenacious thick crusts that respond quickly and completely to dietary supplementation with zinc.

Sarcoptic mange, in which mites can be demonstrated in scrapings; there is intense pruritus and a quick response to standard insecticides.

Psoroptic mange, identifiable by the presence of mites in scrapings, pruritus, occurrence in housed cattle, and the location of the lesions over the hindquarter.

#### Horses

Mycotic dermatitis, which is limited in its distribution to the back of the horse, and *Dermatonomus congolensis* can be cultured.

Queensland itch diagnosable on its occurrence only in summer, only along the back, and the associated intense pruritus.

Other equine dermatitides.

#### Pigs

Pityriasis rosea, in which no mites can be demonstrated, and the disease is limited to a particular age group.

Exudative epidermitis has extensive lesions with a characteristic greasy covering.

Tyroglyphosis is self-limiting, associated with a new source of grain, and characterized by pruritus.

Sarcoptic mange, identifiable by the mites in scrapings, the intense pruritus, and the prompt response to treatment with insecticide.

### TREATMENT

Many recorded cures are no doubt a result of strategic treatment just before spontaneous recovery, but treatment is widely practiced and recommended because it greatly reduces contamination of the environment by infected animals. Local or systemic treatments are used, the latter when lesions are widespread. Gloves and protective clothing should be worn when treating affected animals because of the potential for zoonotic spread.<sup>2</sup> Administration of a live attenuated *T. verrucosum* vaccine to cattle with ringworm is effective in hastening the resolution of lesions.<sup>9</sup> Vaccination with an inactivated lyophilized *T. verrucosum* vaccine twice at a 14-day interval has been reported to be an effective treatment in horses with multiple ringworm lesions.<sup>10</sup>

### Local Application

The crusts should be removed by scraping or brushing with a soft wire brush and burned; the selected medicament should be brushed on or rubbed in vigorously. Clipping of the hair may facilitate treatment application. Suitable topical applications include Whitfield's ointment (a mixture containing 6% benzoic acid and 3% salicylic acid);<sup>11,12</sup> propionic and undecylenic acid ointments; povidone-iodine, thiabendazole 1% to 5%, and captan ointments; ointments containing one of theazole compounds, such as imidazole, miconazole, or tioconazole (1%),<sup>13</sup> or enilconazole (0.2%),<sup>5</sup> and a 10% ammoniated mercury ointment; propolis (a resinous substance collected by honeybees from plants<sup>11</sup>); homeopathic remedies;<sup>13</sup> burnt motor oil;<sup>14</sup> a 10% solution of povidone-iodine; 5% to 10% copper sulfate solution;<sup>14,15</sup> solutions of quaternary ammonium compounds (1:200 to 1:1000); solutions of 0.25% hexadecamethylene-1, 16-bis-isoquinolinium chloride (Tinevet), and Hexetidine (bis-1,3 beta-ethylhexyl-5 methyl-5-amino-hexahydroprymidine) borotannic complex; and ivermectin (SC, 200 µg/kg BW).<sup>16</sup> The long list of potential treatments indicates the lack of a definitive, large-population, randomized clinical trial using objective measures of treatment efficacy and a negative control group. Whitfield's ointment appears to have the strongest evidence of efficacy and is considered to have keratolytic, antimicrobial, and antifungal effects. Topical treatments are probably of greater value in the early stages of an outbreak when the lesions are small and few in number, and spontaneous resolution is likely in younger animals.

### Sprays, Washes

When infection in a group is widespread, washes or sprays that can be applied over the entire body surface of all animals are used, although the efficacy of the preparations is less than that of ointments, and daily application for at least 5 days is required. Sprays have a big advantage if prophylactic treatment of all in-contact animals is recommended. Examples are agricultural Bordeaux mixture, 5% lime sulfur (20% w/v polysulfides diluted 1:20), captan (N-(trichloromethylthio)-cyclohex-4-ene-1, 2-dicarboxamide) 3%, N-trichloromethylthio-tetrahydrophthalimide, iodofors, 0.5% sodium hypochlorite, and natamycin (100 ppm). These treatments may not be available or permitted in every country.

### Systemic Treatment

Systemic treatments recommended for use in farm animals include the IV injection of sodium iodide (1 g/14 kg body weight) as a 10% solution repeated on several occasions, and, if the high cost of the treatment can be overlooked, the oral administration of griseofulvin has been empirically recommended at 7.5 to 10 mg/kg BW once daily, with no

strong evidence to support or refute this dosage protocol.

Spontaneous recovery is common in individual animals within 90 days, and careful appraisal of results in clinical trials is necessary. Many farmers overtreat their animals with irritant preparations administered daily for long periods. A crusty dermatitis, or even a neoplastic acanthosis, may result.

## CONTROL

### Hygiene

Failure to control an outbreak of ringworm is usually a result of the widespread contamination of the environment before treatment is attempted. Isolation and treatment of infected animals; the provision of separate grooming tools, horse blankets, and feeding utensils; and disinfection of these items after use on affected animals are necessary if the disease is to be controlled. All grooming equipment should be carefully washed and treated with a solution of enilconazole or 1:10 dilution of household bleach. Cleaning and disinfection of stables with a commercial detergent or a strong solution (2.5% to 5%) of phenolic disinfectant, 5% lime sulfur, 5% formalin, 3% captan, or 5% sodium hypochlorite is advisable where practicable. Good results are also claimed for the disinfection of buildings with a spray containing 2.0% formaldehyde and 1.0% caustic soda. Sunlight and a low stocking rate provide very effective control measures, which is why ringworm occurs at a much lower incidence in suckling beef calves in pasture than dairy calves raised in group housing with no direct sunlight.

### Vaccination

A vaccine developed in the former Soviet Union has achieved a great deal of success in preventing infection in cattle and horses in most countries of Europe and Scandinavia. The nonadjuvanted vaccine includes lyophilized microconidia and hyphal elements of a highly immunogenic, nonvirulent strain of *T. verrucosum*. Small injection-site skin lesions are present for a few weeks in vaccinated calves.<sup>17</sup> Vaccination of all animals in the group is recommended, and isolation and treatment of infected animals and disinfection of premises and gear must be carried out at the same time.

The vaccine is almost totally without side effects except for very rare deaths as a result of anaphylaxis, apparently related to keeping reconstituted vaccine for too long a period. National vaccination campaigns have been successful in eradicating *T. verrucosum* from cattle herds.<sup>17</sup>

### Nutrition

Although ringworm occurs in well-nourished and poorly fed animals, there does seem to be a tendency for the latter to become infected more readily and to develop

more extensive lesions. Supplementation of the diet, particularly with vitamin A to young housed animals, should be encouraged as a preventive measure. The adequacy of dietary selenium and zinc intake should be determined.<sup>18</sup>

## TREATMENT AND CONTROL

### Treatment

#### Discrete lesions in calves or horses

Whitfield's ointment (6% benzoic acid, 3% salicylic acid) applied topically daily (R-2)

5% to 10% copper sulfate solution, daily for 15 days or 4 times at 5-day intervals (R-2)

1% tioconazole ointment, 2% miconazole ointment, 0.2% enilconazole solution (R-2)

Ivermectin (200 µg/kg BW, SC) (R-2)

#### Widespread multiple lesions

Topical 2% ketoconazole shampoo twice a week for 4 weeks in horses (R-2)

Consider oral griseofulvin (7.5 to 10 mg/kg BW once daily) in all species, but excessive cost and may not be permitted in many countries (R-2)

### Control

#### Calves

Vaccinate with modified live *Trichophyton verrucosum*. (R-1)

#### All animals

Don't share grooming equipment between animals (R-1).

Ensure adequate sunlight and house on pasture with low stocking density. (R-2)

Ensure adequate vitamin A, selenium, and zinc status. (R-2)

## FURTHER READING

- Cafarchia C, Figueredo LA, Otranto D. Fungal diseases of horses. *Vet Microbiol*. 2013;167:215-234.
- Chermette R, Ferreiro L, Guillot J. Dermatophytoses in animals. *Mycopathologia*. 2008;166:385-405.
- Lund A, DeBoer DJ. Immunoprophylaxis of dermatophytosis in animals. *Mycopathologia*. 2008;166:407-424.

## REFERENCES

1. Aghamirian MR, Ghiasian SA. *Mycoses*. 2009;54:e52-e56.
2. Agnetti F, et al. *Mycoses*. 2014;57:400.
3. Schaufuss P, et al. *Vet Microbiol*. 2007;122:342.
4. Wong SSY, et al. *Vet Microbiol*. 2012;155:399.
5. Garcia-Sánchez A, et al. *Mycoses*. 2009;54:179.
6. Chung TH, et al. *Equine Vet J*. 2010;42:73.
7. Bağut ET, et al. *Clin Vaccine Immunol*. 2013;20:1150.
8. Papini R, et al. *Zoonoses Public Health*. 2009;56:59.
9. Arslan HH, et al. *Revue Med Vet*. 2007;10:509.
10. Ural K, et al. *J Equine Vet Sci*. 2008;10:590.
11. Cam Y, et al. *Vet Rec*. 2009;165:57.
12. Gupta VK, et al. *Intas Polivet*. 2013;14:333.
13. Kirmizigül AH, et al. *Kafkas Univ Vet Fak Derg*. 2013;19(suppl-A):A191.
14. Ghodasara SN, et al. *Intas Polivet*. 2013;14:336.
15. Kachhawaha S, et al. *Vet Practitioner*. 2011;12:106.
16. Kirmizigül AH, et al. *Kafkas Univ Vet Fak Derg*. 2012;18(3):523.

17. Lund A, et al. *Vet Immunol Immunopathol*. 2014;158:37.

18. Kojouri GA, et al. *Comp Clin Pathol*. 2009;18:283.

## MUCORMYCOSIS

Mucormycosis is a rare disease of humans, horses, cattle, and pigs caused by coenocytic fungi of the order Mucorales. *Lichtheimia corymbifera* (formerly *Absidia corymbifera*, *Mycocladius corymbiferus*) causes severe disease and death of horses, abscessation of lymph nodes in pigs, and mastitis and abortion in cattle.<sup>1,2</sup> The disease is usually acute and progressive, and antemortem diagnosis is difficult. Clinical signs include fever, diarrhea, circling, convulsions, and acute death. Horses can have ulcerating skin lesions of the muzzle, nostrils, knees, and hocks, which can develop in animals that survive the acute disease. Necropsy examination reveals demarcated necrotic or hemorrhagic lesions in the respiratory and gastrointestinal mucosa, lungs, spleen, and brain. Thin-walled hyphae are visible in routine sections of tissue examined microscopically. There is no effective treatment or control. Zygomycotic lymphadenitis attributable to *Rhizomucor pusillus* or *Lichtheimia corymbifera* (formerly *Absidia corymbifera*) was detected in 0.04% of feedlot steers slaughtered in California. Lesions most commonly affected the mesenteric lymph nodes.<sup>3</sup>

## REFERENCES

1. Piancastelli C, et al. *Repro Biol Endo*. 2009;7.
2. Zeeh F, et al. *Schweiz Arch Tierheilkd*. 2010;152:523.
3. Ortega J, et al. *Vet Pathol*. 2010;47:108.

## MALASSEZIA SPP. DERMATITIS

*Malassezia* spp., formerly known as *Pityrosporum*, is a genus of fungi. Dermatitis associated with *Malassezia* spp. is described in goats and horses. A number of species of *Malassezia*, including *M. furfur*, *M. obtusa*, *M. globosa*, *M. pachydermatis*, *M. restricta*, *M. slooffiae*, *M. sympodialis*, and *M. equina*, are present on normal and abnormal skin of horses.<sup>1,2</sup> *Malassezia* spp. were cultured from 5 of 44 swabs and detected on microscopic examination in 40 of 44 swabs of preputial or mammary skin from 11 healthy horses, indicating the need for caution when ascribing etiologic importance to detection of this organism in samples of skin of horses with dermatitis.<sup>1</sup>

Lesions in a horse with alopecia areata included scaling and crusting dermatitis characterized histologically by mild to moderate hyperplasia, mild lymphocytic exocytosis, mild eosinophilic dermatitis, and diffuse parakeratosis with numerous budding yeasts. Alopecia areata might have predisposed the horse to infection, and disease caused by *Malassezia* spp., or the organism might have been an incidental finding.<sup>2</sup> The putative disease in goats is not well characterized.<sup>3</sup>

## REFERENCES

- White SD, et al. *J Vet Int Med.* 2006;20:395.
- Kim DY, et al. *Vet Pathol.* 2011;48:1216.
- Eguchi-Coe Y, et al. *Vet Dermatol.* 2011;22:497.

## SPOROTRICHOSIS

Sporotrichosis is a contagious disease of horses, dogs, cats, cattle, and humans characterized by the development of **cutaneous nodules and ulcers** on the limbs that may be accompanied by lymphangitis.

## ETIOLOGY

*Sporotrichum schenckii* (*Sporothrix beurmannii*, *S. schenckii*, *S. equi*) is a gram-positive dimorphic fungus that forms single-walled spores. The organism survives in a mycelial phase on living or decaying plant material but changes to a yeast phase when it enters a mammalian body through a puncture wound or bite.

## EPIDEMIOLOGY

The disease is reported to occur in Europe, India, Africa, and the United States and likely occurs throughout the world.<sup>1</sup> The host range includes humans, horses, cattle, cats, camels, mice, rats, and chimpanzees. Economic loss caused by sporotrichosis is not great because the disease spreads slowly, the case fatality rate is low, and treatment is effective. Outbreaks of sporotrichosis in dairy cattle causes reduced milk production.

The causative agent persists in organic matter, and contamination of cutaneous wounds can occur either by contact with discharges from infected animals or from contaminated surroundings. The disease is readily spread from affected cats to humans. Transmission from horses to humans has not been reported.

## Pathogenesis, Clinical Findings and Clinical Pathology

Local invasion through wounds results in the development of abscesses and discharging ulcers. Multiple, small, cutaneous nodules develop on the lower parts of the legs, usually near the fetlock. The nodules may follow lymphatics and extend to the proximal limb. The nodules are painless, develop a scab on the summit, discharge a small amount of pus, and heal in 3 to 4 weeks. Succeeding crops of lesions may cause the disease to persist in the animal for months. Lymphangitis, causing cording of the lymphatics, occurs.

Demonstration of gram-positive spores in discharges is diagnostic, but it is difficult because of their low number in horses and cattle, as opposed to the high number of spores present in lesions in cats. The organism can be demonstrated in air-dried smears of exudate stained with Wright stain or Romanowsky stain. The hyphal stage is rare in tissues. Injection of pus into rats or hamsters produces a local lesion containing large

numbers of the yeast-like cells. The organism can be **cultured** on Sabourard agar.

## DIFFERENTIAL DIAGNOSIS

Glanders  
Epizootic lymphangitis  
Ulcerative lymphangitis

## TREATMENT AND CONTROL

Systemic treatment with **iodides** (potassium iodide orally or sodium iodide IV) is the most effective treatment. Local application of tincture of iodine daily to ulcers may suffice in mild cases. **Itraconazole** might be effective.

Prophylactic treatment of all cuts and abrasions, isolation and treatment of clinical cases, and disinfection of bedding, harnesses, and gear will prevent spread of the disease in enzootic areas. Thorough washing of hands and arms with povidone iodine or chlorhexidine is recommended for humans handling infected animals or plant material.

## REFERENCE

- Dalis JS, et al. *Vet Microbiol.* 2014;172:475.

## EPIZOOTIC LYMPHANGITIS (PSEUDOGLANDERS, EQUINE BLASTOMYCOSIS, EQUINE HISTOPLASMOSIS)

### SYNOPSIS

**Etiology** *Histoplasma capsulatum* var. *farciminosum*, a fungus.

**Epidemiology** Epizootic disease of low mortality of horses in Asia, Africa, and the Mediterranean. The disease has important adverse effects on the horse, the owner, and wider society in communities that rely on horses as draft animals.

**Clinical signs** Nodules, lymphadenopathy, and lymphangitis, usually of the hindlimbs. Nodules discharge creamy pus. Conjunctivitis and pneumonia may occur. Spontaneous resolution after a long course is usual.

**Clinical pathology** Organism in pus, fluorescent antibody test. Histofarcin skin test.

**Lesions** Lymphangitis, lymphadenitis.

**Differential diagnosis** Glanders (farcy), ulcerative lymphangitis, sporotrichosis.

**Diagnostic confirmation** Demonstration of organism in pus. Clinical characteristics of the disease.

**Treatment** Parenteral iodides. Amphotericin.

**Control** Hygiene, slaughter, vaccination.

The disease is important in developing countries, such as Ethiopia, that have a dependence on use of equids as draft animals. In these communities, the disease has an

adverse impact on affected equids beyond that caused by the lesions, because affected equids continue to be used as draft animals, because of lost utility of affected animals to owners, and because of the wider societal impact of the loss of availability of large numbers of draft animals.<sup>1</sup> Income generated from providing a cart-horse service is often the sole source of income for families in developing countries, and the presence of the disease reduces the utility of the equid and therefore the income of the family.<sup>1,2</sup>

## ETIOLOGY

The cause is a fungus, *Histoplasma capsulatum* var. *farciminosum*, a dimorphic fungal soil saprophyte. The organism has also been classified by the genus name *Zymonema*, *Cryptococcus*, *Saccharomyces*, or *Blastomyces*.

The disease is listed by the OIE as a notifiable disease.

## EPIDEMIOLOGY

The disease occurs as outbreaks in horses, donkeys, and mules in parts of Iran, Asia, India, northern Africa, and the Mediterranean littoral. Most outbreaks occur in autumn and winter or when large numbers of horses are gathered together for military or other purposes. The disease was detected 19% of cart horses in Ethiopia over an 18-month period, with the prevalence of the disease varying by geographic region from 0% to 39%.<sup>3</sup> The disease was more prevalent in areas with higher mean temperature.<sup>3</sup> The case-fatality rate is 10% to 15%, but the course is prolonged. Cattle and camels are rarely affected.

Fungal spores are carried from infected animals by direct contact or on bedding, grooming utensils, horse blankets, or harnesses, and gain entry through abrasions, usually on the lower limbs. A saprophytic stage in the soil has been suggested to account for the difficulty experienced in eradicating the disease. The organism has been isolated from the alimentary tract of biting flies, and they may play a role in the transmission of the disease.

## Zoonotic Potential

Infection is reported in humans.

## PATHOGENESIS

After gaining entry through wounds, the fungus invades subcutaneous tissue, sets up a local granuloma or ulcer, and spreads along the lymphatic vessels. The ocular form of the disease results from inoculation of the organism into the eye, likely by biting flies.

## CLINICAL FINDINGS

The disease is primarily an ulcerating, suppurative, pyogranulomatous dermatitis, and, in most cases, lymphangitis. An ocular form of the disease is characterized by ulcerating conjunctivitis. Of 65 cases in cart mules in



Ethiopia, 92% had cutaneous lesions, 5% lung lesions, and 3% ocular lesions.<sup>4</sup> The incubation period in two horses experimentally infected varied from 4 weeks to 3 months.<sup>5</sup>

In the **cutaneous form** of the disease an indolent ulcer develops at the portal of entry, making its appearance several weeks to 3 months after infection occurs. The affected skin and subcutaneous tissues are thickened and firm.<sup>4</sup> Nodules that do not rupture are hairless. A spreading dermatitis and lymphangitis, evident as corded lymphatics with intermittent nodules, develops. Nodules rupture, discharging a thick, creamy pus. Local lymph nodes also enlarge and can rupture. Thickening of the skin in the area and general swelling of the whole limb are common. The lesions are painless.

The lesions usually develop on the limbs, particularly around the hocks, but may also be present on the back, sides, neck, vulva, and scrotum. Occasionally lesions appear on the nasal mucosa just inside the nostrils and do not involve the nasal septum. Ocular involvement is manifested by keratitis and conjunctivitis. Sinusitis and pneumonia occur in other forms of the disease.

The disease is chronic, persisting for 3 to 12 months. Spontaneous recovery occurs, and immunity is solid after an attack, but many animals are destroyed because of the chronic nature of the disease.

### CLINICAL PATHOLOGY

Gram-positive, yeast-like cells, with a characteristic double-walled capsule, are easily found in discharges. The organisms are located both extracellularly and intracellularly in giant cells and macrophages. The agent can be cultured on special media, but the fungus dies quickly in specimens unless these are collected in antibiotic solutions, refrigerated, and cultured promptly. The specimen should be collected into a solution containing 500 units/mL penicillin.

The mallein test is negative, but a sterile filtrate of a culture of *H. capsulatum* var. *farciminosum* has been used in a cutaneous sensitivity test, and several serologic tests, including a fluorescent antibody test, are available. Antibodies to *H. capsulatum* var. *farciminosum* are detectable in serum before or at the time of development of lesions.

### NECROPSY FINDINGS

Lesions are usually confined to the skin, subcutaneous tissues, and lymph vessels and nodes. In some cases, granulomatous lesions may be found in the lungs, liver, and spleen. Histologically, the lesion is quite characteristic and consists of pyogranulomatous inflammation with fibroplasia. Langerhans giant cells are common. The presence of numerous organisms, some of which show budding, in both intra- and extracellular

tissue sections stained with H&E, Periodic acid–Schiff reaction, and Gomori methenamine–silver stain is of diagnostic value.

### DIFFERENTIAL DIAGNOSIS

See Table 16-4.

Glanders (*Burkholderia mallei*)

Ulcerative lymphangitis (*Corynebacterium pseudotuberculosis*)

Sporotrichosis (*Sporothrix schenckii*)

Histoplasmosis (*Histoplasma capsulatum*)

### TREATMENT AND CONTROL

Many treatments have been tried, largely without success. Parenteral iodides have been reported as effective in some cases, as has amphotericin. Sodium iodide is administered as a 10% solution at a dose of 1 mL per 5 kg IV once weekly for 4 weeks. Amphotericin is administered at a dose of 0.2 mg/kg body weight every 48 hours for three treatments, but it might not be economically feasible for use in developing countries.

Outbreaks in uninfected areas are probably best controlled by **slaughter of affected animals**. In enzootic areas, severe cases should be destroyed and less severe cases kept in strict quarantine while undergoing treatment; however, the high prevalence of the disease in some areas (39%) and economic importance to the horse owner of the animal continuing to work make this a difficult recommendation to enforce. All infected bedding, harnesses, and utensils should be destroyed or vigorously disinfected. Formalinized aluminum hydroxide adsorbed and heat-attenuated vaccines have been widely used, apparently with success.

### FURTHER READING

Cafarchia C, et al. Fungal diseases of horses.

*Vet Microbiol.* 2013;167:215-234.

Stringer AP. Infectious diseases of working equids.

*Vet Clin Equine.* 2014;30:695.

### REFERENCES

1. Scantlebury CE, et al. *Prev Vet Med.* 2015;120:265.
2. Nigatu A, et al. *6th Inter Coll Working Equines.* 2010:83.
3. Ameni G. *Vet J.* 2006;172:160.
4. Gobena A, et al. *J Equine Sci.* 2007;18:1.
5. Ameni G. *Vet J.* 2006;172:553.

## EQUINE PHYCOMYCOSIS (SWAMP CANCER, PITHYOSIS, HYPHOMYCOSIS DESTRUENS, FLORIDA HORSE LEECH, BURSATTEE)

### SYNOPSIS

**Etiology** *Pityium insidiosum*, *Basidiobolus haptosporus*, or *Conidiobolus coronatus*

**Epidemiology** Tropical and subtropical areas of the world. Pithyosis occurs during the wet time of the year, but there is no seasonal distribution for *B. haptosporus* or *C. coronatus*.

**Clinical signs** All cause ulcerative granulomas. *P. insidiosum* causes lesions on the legs and ventral abdomen; *B. haptosporus* causes lesions on the side of the body, neck, and head; *C. coronatus* causes lesions in the oral, nasal, pharyngeal, and tracheal mucosae.

**Clinical pathology** Agar gel double diffusion test and histologic examination and immunohistochemical staining of tissue sections.

**Lesions** Ulcerative granulomas with sinus tracts containing yellow coagulated material.

**Diagnostic confirmation** Histologic examination of tissue.

**Treatment** Surgical excision. Sodium or potassium iodide. Vaccination.

**Control** None.

### ETIOLOGY

The causes are fungi, including *Pythium insidiosum* (syn. *Hyphomyces destruens*), *Basidiobolus haptosporus* (syn. *B. haptosporus* var. *minor*), *Conidiobolus coronatus* (syn. *Entomophthora coronata*), and *Rhinosporidium* spp. *Pseudoallescheria boydii* causes granulomatous lesions of the nasal cavity. *Alternaria alternata* causes small granulomatous lesions on the head of horses, especially young horses.<sup>1</sup> *Scedosporium prolificans* has been associated with conjunctival lesions, arthritis, and osteomyelitis in horses.<sup>2</sup> Unidentified fungi also cause lesions containing black-colored granules or grains, the so-called “black-grain mycetomas.”

Skin lesions in horses have been associated with infection by wide variety of fungi, including:<sup>3</sup> *Madurella mycetomatis*, *Curvularia erruculosa*, *Bipolaris speciferum*, *Cladosporium* spp., and *Exserohilum rostratum*. Nonpigmented fungi that cause localized fungal infections in horses include *P. boydii*, *Aspergillus versicolor*, *Alternaria tenuis*, and *Scedosporium apiospermum*.<sup>3</sup> *B. haptosporus* is a terrestrial fungus that lives in decaying vegetation.

### EPIDEMIOLOGY

#### Occurrence

The disease occurs most commonly in **tropical and semitropical climates** but can occur in animals housed in temperate climates. Although the disease is recorded most commonly in horses, it does occur in young cattle, dogs, and humans.<sup>4</sup> Fungal disease, excluding that caused by the dermatophytes, accounted for 2.5% of nonneoplastic diagnoses of nodule skin lesions examined in Colorado and the prairie provinces of Canada.<sup>5</sup>

Pythiosis occurs mostly during the monsoon season in tropical areas, whereas infection by *B. haptosporus* and *C. coronatus* occurs year round. A survey in tropical northern Australia showed that granulomas of horses were caused by *P. insidiosum* in 77%, *B. haptosporus* in 18%, and *C. coronatus* in 5% of cases.

### Animal Risk Factors

The fungi gain access to the subcutaneous tissues through wounds or other disruptions of the integrity of the skin or mucosa. A strong correlation between the occurrence of the lesions and frequent wetting and exposure to water is reported and is consistent with the concept of an aquatic life cycle and **motile zoospores** of *P. insidiosum*. There is no breed, age, or sex predilection. Multiple cases can occur in horses maintained in the same enclosure.

### Zoonotic Potential

Many of these fungi cause disease in humans, for instance, *P. boydii* infection causes granulomas of the lower extremities of people in tropical regions and is referred to colloquially as Madura foot. However, there is no evidence of spread of infection from horses or other infected animals to humans, although appropriate caution should be exercised when handling infected tissues, especially by individuals with compromised immune function.

## PATHOGENESIS AND CLINICAL FINDINGS

The **life cycle** of *P. insidiosum* involves colonization of leaves of aquatic plants where the organism undergoes sexual reproduction and produces sporangia. Motile zoospores, released from the sporangia, are attracted to plant and animal tissue, to which they adhere. Zoospores are attracted to damaged tissue, on which they encyst and develop germ tubes. The hyphae invade tissue and produce the granulomatous reaction and ulceration. Ejected kunkers (necrotic material infected with hyphae) may produce sporangia.

The large (20-cm), rapidly growing, circular, fibrotic, ulcerative granulomas caused by *P. insidiosum* usually develop on the lower limbs, ventral abdomen, or thorax and contain yellow concretions in sinus tracts (leeches or kunkers).<sup>4,6,7</sup> The lesions are pruritic and grow rapidly, often becoming greater 20 cm in diameter in 1 month. *P. insidiosum* lesions may involve underlying bone, and **osteomyelitis** may be a common feature of chronic pythiosis of the lower limbs. *Pithium* spp. infection of the small intestine causes **eosinophilic enteritis** and granuloma formation, resulting in colic and the need for surgical resection. Dissemination of infection from subcutaneous sites to the liver, lung, and spleen occurs and results in a progressive weight loss and eventual death.

*C. coronatus* causes lesions similar to, but smaller than, those of pythiosis.<sup>8</sup> However,

lesions are only on the nares, nasal passages, oral cavity, pharynx, or trachea. The lesions can be very slow growing and take 1 to 2 years to become invasive, whereas others grow rapidly. *P. boydii* causes granulomatous lesions of the nasal cavity in horses. *B. haptosporus* causes ulcerative, granulating lesions that have a hemorrhagic, edematous surface, in contrast to the fibrotic lesions caused by *Pithium* spp., on the sides of the **trunk, thorax, neck, and head**. Lesions caused by *B. haptosporus* are pruritic.

*A. alternata* causes cutaneous nodules that are not painful or pruritic on the head of horses. The nodules may be solitary but are usually multiple and slowly progressive.<sup>1</sup>

*S. proliferans* causes infection of musculoskeletal structures, including joints and bone, usually secondary to puncture wounds or surgery. This organism causes disseminated lesions and a fatal disease in immunosuppressed humans.

### CLINICAL PATHOLOGY

Culture of the causative fungus is a laborious task but is necessary to demonstrate presence of the organism, although PCR detection is becoming available and could replace culture as the definitive diagnostic test. A PCR test has been developed for the identification of *Pythium* spp., and this test also is useful for the detection of *C. coronatus*. Horses infected with *P. insidiosum* have a positive reaction to an **agar gel double-diffusion test**, and complement fixation and intradermal hypersensitivity tests are also of diagnostic value.

Examination of a biopsy specimen is also of value, but care is needed to include a portion of necrotic tissue in which hyphae are most likely to be found. *P. boydii* is indistinguishable from *Aspergillus* spp. on microscopic examination of tissue. **Immunohistochemical** staining methods, using indirect peroxidase techniques, are of value in distinguishing *Pythium* spp. from other fungi in swamp cancer lesions.

Necropsy examination of horses with disseminated pythiosis reveals small, firm, irregularly branched, yellow–white masses in the regional lymph nodes draining cutaneous lesions and in the liver, lungs and spleen. Histologically the masses are eosinophilic granulomas containing hyphal elements of *Pythium* spp.

### DIFFERENTIAL DIAGNOSIS

Habronemiasis
Granulation tissue
Sarcoid
Fibrosarcoma
Amyloidosis of the nasal septum
Squamous cell carcinoma
Aspergillosis of the nasal septum
Osteomyelitis

### TREATMENT

The most **efficacious treatment** for pythiosis and conidiobolomycosis is excision, although recurrence is common (30%) with larger lesions. Laser ablation of the bed of the granuloma may reduce the rate of recurrence. Larger lesions are usually treated medically. Fungal lesions respond to treatment of **sodium iodide** (20 to 40 mg/kg BW IV, q 24 h, as a 20% solution), followed by oral administration of **potassium iodide** (10 to 40 mg/kg po q 24h for 7 to 120 days). Potassium iodide can also be administered at a dose of 10 g/425 kg once daily, with the dose increasing by 2 g/day until the horse exhibits feed refusal or a dose of 20 g/day is achieved. Treatment should continue until signs of mycotic disease have resolved, which is often weeks to months. An alternative to potassium iodide is ethylenediamine dihydroiodide (1.3 mg/kg, oral q 12 hours for up to 4 months and q 24 hours for up to 1 year). Iodism is a potential adverse effect of administration of sodium or potassium iodide, although this is rarely observed.

**Amphotericin** also gives good results as a systemic treatment (intravenously 0.4 mg/kg BW increasing to 1.5 mg/kg per day for 10 to 40 days) combined with local infiltration and after surgical excision in extensive lesions. Administration of amphotericin can be limited by its nephrotoxicity, which should be monitored during treatment. **Itraconazole** (3 mg/kg orally every 12 hours for 3 to 4 months) is effective in the treatment of *C. coronatus* infections of the nasal septum. **Fluconazole** (14 mg/kg oral loading dose followed by 5 mg/kg q 12 hours orally for 6 weeks) is effective in the treatment of nasal conidiobolomycosis in horses. The pharmacokinetics of fluconazole in horses have been determined, permitting rational dosing of this drug. Ketoconazole is not effective for the treatment of *C. coronatus* in horses.

**Miconazole** (5 grams of 2% solution) infused for 4 weeks into lesions in the nasal cavity, in combination with systemic administration of iodides, was effective in treatment of nasal lesions caused by *P. boydii*.

*S. proliferans* is resistant to commonly used antifungal drugs.

A **vaccine** composed of elements of *P. insidiosum* causes recovery or improvement in most cases. It also causes a severe reaction, sometimes a cold abscess, at the injection site. Other complications include osteitis and laminitis, which necessitate euthanasia.

### REFERENCES

- Dicken M, et al. *NZ Vet J.* 2010;58:319.
- Berzina I, et al. *Vet Clin Pathol.* 2011;40:84.
- Valentine BA, et al. *Vet Dermatol.* 2006;17:266.
- Martins TB, et al. *J Comp Pathol.* 2012;146:122.
- Schaffer PA, et al. *Can Vet J.* 2013;54:262.
- Mosbah E, et al. *J Equine Vet Sci.* 2012;32:164.
- Salas Y, et al. *Mycopathologia.* 2012;174:511.
- Schumacher J, et al. *Equine Vet Educ.* 2007;19:405.

## MADUROMYCOSIS

Maduromycosis is a skin disease of horses characterized by cutaneous granuloma caused by a variety of fungi, including *Helminthosporium spiciferum*, *Brachycladium spiciferum*, *Curvularia geniculata*, and *Monosporium apiospermum*. One or more lesions 1 to 2.5 cm in diameter appear anywhere on the skin but with a special frequency at the coronet. The incised lesion has a mottled appearance and drains pus containing the fungus.

## Protozoal Diseases of the Skin

### BESNOITIOSIS (ELEPHANT SKIN DISEASE)

#### SYNOPSIS

**Etiology** Intermediate host-specific tissue cysts of *Besnoitia besnoiti*, *B. caprae*, and *B. bennetti*.

**Epidemiology** Endemic disease in some tropical and subtropical areas, with high morbidity and low mortality. Rare disease elsewhere. Definitive host not known. Disease occurs in donkeys in the United States. Possible insect transmission of disease to cattle and goats.

**Clinical findings** Anasarca, alopecia, hyperpigmentation and scleroderma, and infertility.

**Inspiratory dyspnea and loss of condition** Pin-point nodules (cysts) on the scleral conjunctiva and nasal, pharyngeal, and/or laryngeal mucosa.

**Lesions** Parasitic cysts in dermis, subcutaneous, and other fascia.

**Diagnostic confirmation** Demonstration of bradyzoites in skin biopsy or scleral conjunctival scrapings.

**Treatment and control** Little information available.

Besnoitiosis is a parasitic disease of cattle, goats, horses, and certain wild animals. Infections in the chronic cystic stage can result in severe disease and/or production loss.<sup>1-5</sup>

#### ETIOLOGY

*Besnoitia* are cyst-forming coccidian (apicomplexan) parasites. The life cycle involves a definitive host and an intermediate host. There are seven classified species, of which three occur in domestic livestock. These are *B. besnoiti* in cattle, *B. caprae* in goats, and *B. bennetti* in horses, donkeys, and mules. The other four known *Besnoitia* species infect wildlife species. Cats are the definitive host for some *Besnoitia* infecting wildlife, but the definitive host(s) for the three domestic

livestock species are unknown. Recent evidence suggests that *B. besnoiti* and *B. capri* are the same genetically, that they also have the same bradyzoite ultrastructure, and that they may not be separate species.<sup>2,3</sup>

#### EPIDEMIOLOGY

##### Occurrence

Besnoitiosis of livestock animals occurs as outbreaks in some tropical and subtropical regions, and sporadically in other areas. In endemic areas, the disease can affect a large proportion of the herd and cause significant economic loss.<sup>1-3</sup> **Bovine** besnoitiosis is recorded in the African continent, southern Europe,<sup>1</sup> South America, Israel, Asia, and the Russian Federation; **caprine** besnoitiosis in Kenya, Uganda, Iran, and Kazakhstan; and besnoitiosis is found in equids in Africa and has recently emerged in donkeys in the United States.<sup>4,5</sup>

##### Risk Factors

*Besnoitia* are relatively host specific. *B. besnoiti* infects cattle and in Africa also infects goats and wild ruminants. The Kenyan species of *B. caprae* does not infect cattle or sheep. The natural means of transmission is not known, but is presumed to be by ingestion of oocysts from the definitive host(s). Infection with *B. besnoiti* and *B. caprae* can be transmitted experimentally with endozoites and bradyzoites, and mechanically by infections or biting flies. Outbreaks of disease in cattle or goats occur in fly seasons, and it is postulated that biting insects may be important vectors. Transmission via semen from infected males is also suggested.

##### Economic Importance

*B. besnoitia* is an economically important parasite of cattle in Africa and Israel.<sup>2,3</sup> Although mortality is generally low, morbidity can approach 10% in the chronic stages. There is a loss of condition, and the fertility of male cattle and goats can be significantly impaired from chronic scrotal skin lesions. Skins have no value for tanning. Besnoitiosis in equids appears to have a rare occurrence, but there is evidence of an emergence in donkeys in the United States.<sup>4,5</sup>

#### PATHOGENESIS

Following infection of the intermediate host, the endozoites (tachyzoites) proliferate in macrophages, fibroblasts, and endothelial cells, causing **vasculitis** and thrombosis, particularly in capillaries and small veins of the dermis, subcutis, and testes. They then mature to form bradyzoite cysts (cystozoites) within fibroblasts. Replication is accompanied by cellular destruction and the release of inflammatory mediators, resulting in anorexia, lethargy, testicular degeneration, generalized edema of the skin, alopecia, and scleroderma.<sup>2-5</sup> *Besnoitia* cysts form in high numbers in the dermis and subcutaneous

tissue. Inspiratory dyspnea is associated with infection in the upper respiratory tract.

#### CLINICAL FINDINGS

##### Bovine Besnoitiosis

Typical signs occur in two stages: the acute anasarca stage associated with the proliferation of endozoites and the chronic scleroderma stage associated with cyst formation.<sup>2,3</sup>

##### Acute Stage

In the acute stage there is fever and an increase in pulse and respiratory rates; warm, painful swellings appear on the ventral aspects of the body, interfering with movement. There is also generalized edema of the skin. The superficial lymph nodes are swollen, diarrhea may occur, and pregnant cows may abort. Lacrimation and an increased nasal discharge are evident; small, whitish, and elevated macules may be observed on the conjunctiva and nasal mucosa. The nasal discharge is serous initially, but it becomes mucopurulent later and may contain blood.

##### Chronic Stage

As the disease becomes chronic, the skin becomes grossly thickened and corrugated, and there is alopecia. A **severe dermatitis** is present over most of the body surface. Affected bulls often become sterile for long periods, particularly if the scrotal skin is affected. Cystic stages of the *Besnoitia* have been found in vascular lesions in the testes of affected animals and may be a major contributor to the sterility. **Cysts on the scleral conjunctiva** are considered to be of particular diagnostic importance.<sup>3</sup>

In endemic areas, the signs that attract clinical attention are alopecia and severely thickened and wrinkled skin, which is often thrown into folds around the neck, shoulder, and rump region and the carpal and tarsal areas. Small, subcutaneous, seed-like lumps can be palpated. In cattle, infections of the teat skin may result in lesions around the mouth in suckled calves. The case fatality rate can be ~10%, and the convalescence in survivors is protracted over a period of months.

##### Caprine Besnoitiosis

The acute stage is not commonly seen in goats; the disease presents like the chronic stage in cattle,<sup>3</sup> with dyspnea and cutaneous lesions. The cutaneous lesion is a chronic dermatitis of the legs, particularly the carpal and tarsal regions, and the ventral surface of the abdomen. It varies from mild thickening with superficial scaling, to marked thickening with hyperpigmentation and a serous discharge. The hair is sparse.

##### Equid Besnoitiosis

The clinical signs are similar for different species of equids (horses and donkeys).<sup>4,5</sup> Animals may show exercise intolerance, nasal discharge, and inspiratory dyspnea.



Skin lesions, like those in cattle and goats, are present on the ventral abdomen and legs or the whole body surface. Pin-point white nodules can be seen on the nares and sclera, and by endoscopy on the soft palate, pharynx, and/or larynx.<sup>4,5</sup>

### CLINICAL PATHOLOGY

There is little information on hematology and blood chemistry. Hypergammaglobulinemia has been reported in one horse. Cysts containing a number of banana- or spindle-shaped zoites can be detected in scrapings or sections of skin or scleral conjunctival scrapings. Ear-tip biopsies are commonly used in surveys of goats, and many infected animals show no clinical signs of infection. Serum antibodies to *Besnoitia* spp. can be detected using an indirect immunofluorescence technique or ELISA, but such tests likely have inadequate sensitivity and specificity.

### NECROPSY FINDINGS

At necropsy, apart from any lesions detected upon clinical examination, animals that die in the acute stage of disease usually have widespread petechiae and ecchymoses in the subcutis and edema in the lymph nodes and in the testis in males. In the chronic stage, small white granules (the size of sugar granules) may be found in multiple muscles, intermuscular fascia, and tendons, particularly in the limbs, neck, and nasal mucosa. Parasite stages are evident in lesions upon histologic examination, and they are found in endothelial cells and the intima of blood vessels, often associated with necrosis and a mild inflammatory reaction.

### DIAGNOSTIC CONFIRMATION

The most efficient and cost-effective method of diagnosis of clinical disease is the demonstration of *Besnoitia* bradyzoites in skin biopsy smears or scleral conjunctival scrapings. PCR-based techniques might also be used.<sup>5,6</sup>

### TREATMENT AND CONTROL

There is little information on treatment. Clinical cure of a donkey with a 9-month history of chronic skin disease is reported following prolonged oral administration of trimethoprim-sulfamethoxazole.<sup>1</sup> Animals should receive supportive therapy and be treated symptomatically for enteritis or dermatitis. A vaccine containing *Besnoitia besnoiti*, grown on tissue culture and originally isolated from blue wildebeest, has been used to vaccinate cattle. A durable immunity to the clinical form of the disease was reported, but low-level subclinical infection did occur.<sup>1</sup>

### FURTHER READING

Bigalke RD, Prozesky L. Besnoitiosis. In: Coetzer JAW, Tustin RC, eds. *Infectious Diseases of Livestock*. Vol. 1. 2nd ed. Oxford: Oxford University Press; 2005:351.

### REFERENCES

1. Radostits O, et al. *Veterinary Medicine: A Textbook of the Disease of Cattle, Horses, Sheep, Goats and Pigs*. 10th ed. London: W.B. Saunders; 2007:1517.
2. Olias P, et al. *Infect Genet Evol*. 2011;11:1564.
3. Jacquet P, et al. *Vet Parasitol*. 2010;174:30.
4. Elsheikha HA. *Vet Parasitol*. 2007;145:390.
5. Ness SL, et al. *J Am Vet Med Assoc*. 2012;240:1329.
6. Schares G, et al. *Vet Parasitol*. 2011;178:208.

## Nematode Infections of the Skin

### SUMMER SORES IN HORSES (HABRONEMOSIS)

#### SYNOPSIS

**Etiology** Three nematode species, *Habronema muscae*, *H. majus* (syn. *H. microstoma*), and *Draschia megastoma*, infect the horse.

**Epidemiology** Larvae from eggs in the feces are ingested by fly larvae; adult flies deposit infective larvae on skin.

**Signs** Larvae deposited in wounds or in eye cause local inflammation and the development of extensive granulation tissue.

**Clinical pathology** Larvae may be found in skin scrapings, biopsies, or discharge; marked local eosinophilia.

**Lesions** Adult *D. megastoma* cause tumorlike lesions in stomach; other species cause a catarrhal enteritis.

**Diagnostic confirmation** *Gastric form*: eggs difficult to find in feces; *cutaneous form*: demonstration of larvae, eosinophils in biopsy or scraping.

**Treatment** Ivermectin.

**Control** Protect horses from flies; treat all skin wounds promptly.

### ETIOLOGY

The various forms of cutaneous habronemosis, with local names such as “summer sores,” “swamp cancer,” and “bursattee,” involve three nematode species, *Habronema muscae*, *Habronema majus* (syn. *microstoma*), and *Draschia megastoma*, the adults of which infest the stomach of horses.

### LIFE CYCLE

*Habronema* spp. adults are larger (1 to 2.5 cm long) than those of *D. megastoma* (1.25 cm). The life cycles are indirect; all species use flies as their intermediate hosts. *H. muscae* and *D. megastoma* mainly use the housefly (*Musca domestica*)<sup>1</sup> but can use other muscid species, whereas *H. majus* usually passes through the stable fly (*Stomoxys calcitrans*),<sup>2</sup> although *Haematobia irritans exigua*, *Sarcophaga melanura*, and the housefly can also be used. The thin-walled larvated eggs hatch in the manure and are ingested by maggots,

in which they develop. The infective form is reached at about the time the adult fly emerges from the puparium. Horses become infected by swallowing dead flies with feed or water, or, alternatively, infective larvae may pass through the proboscis of the fly when it is feeding on the lips or on wounds.<sup>3</sup> Larvae that are swallowed reach maturity in the stomach, whereas those deposited in wounds cause cutaneous habronemosis. Stray larvae may be found anywhere throughout the body but occasionally massive invasion of the lungs is seen.

### EPIDEMIOLOGY

*Habronema* and *Draschia* have a worldwide distribution. They are of importance only in warmer climates, where they are commonly found, especially in wetter areas where the intermediate hosts are common.<sup>4-6</sup> Elsewhere they tend to be a sporadic nuisance. Gastric granulomas and most cutaneous lesions appear to be associated with *D. megastoma*, although typical cutaneous lesions do occur naturally and have been produced experimentally by the cutaneous implantation of *H. majus* or *H. muscae* larvae. The latter, however, only cause a transitory reaction. Horses of all ages are susceptible, but the disease is most common in adults.

### PATHOGENESIS

Two types of gastric habronemosis occur. The more serious is associated with *D. megastoma*. Larvae invade the gastric mucosa and cause the development of large granulomatous masses that later fibrose. These tumors contain adult worms and have a central orifice through which eggs and larvae escape into the lumen. In many horses, the lesions cause only a mild chronic gastritis. In rare cases perforation occurs and is followed by a local peritonitis, which may involve the intestine, causing constriction, or the spleen, causing abscesses. *H. majus* and *H. muscae* do not cause tumors but penetrate the stomach glands and cause a catarrhal gastritis with the production of a thick tenacious mucus. Heavy burdens may cause ulceration. In donkeys, hyperoxemia, edema, erosions, and ulcers in addition to parasitic lesions have been observed.<sup>7</sup>

**In cutaneous and conjunctival habronemosis**, *Habronema* spp. larvae deposited in wounds cause local inflammation and the development of extensive granulation tissue.<sup>5</sup> Secondary bacterial or mycotic invasions may occur. In the eye, similar lesions form on the inner canthus, the nictitating membrane, or the eyelid. These can cause profuse lacrimation and other signs of local irritation.

### CLINICAL FINDINGS

**Gastric habronemosis** does not usually provoke clinical signs, but affected animals may, on occasion, have a poor coat and a

variable appetite. Large tumors may cause pyloric obstruction and gastric distension. When perforation occurs, there is depression, a fever of 39.5° to 40.5° C (103° to 105° F), and pain and heat on the left side just behind the costal arch. Mild to moderate colic may be evidenced when intestinal stenosis is present. If the spleen is involved, there is marked anemia and a gross increase in the total leukocyte count with a shift to the left.

**Cutaneous habronemosis** is manifested by the appearance of lesions on those parts of the body where skin wounds or excoriations are most likely to occur and where the horse cannot easily displace the vector flies. Thus they are most common on the face below the medial canthus of the eye and on the midline of the abdomen, extending in males onto the prepuce and penis. Less commonly, lesions may be found on the legs and withers, but those occurring in the region of the fetlocks and coronary band are especially serious. The cutaneous lesions commence as small papules with eroded, scab-covered centers. Development is rapid, and individual lesions may increase to 30 cm in diameter in a few months. The center is depressed and composed of coarse, red granulation tissue covered with a grayish necrotic membrane, and the edges are raised and thickened. Although the lesions do not usually heal spontaneously, they may regress in colder weather and recur the following summer. There is little discharge. The sores are unsightly, are inconvenient, and cause some irritation.

In **conjunctival habronemosis**, lesions on the nictitating membrane may be as large as 5 mm in diameter. The conjunctivitis is manifested by small, yellow, necrotic masses about 1 mm in diameter, accompanied by soreness and lacrimation, which do not respond to standard treatments for bacterial conjunctivitis.

### CLINICAL PATHOLOGY

Diagnosis is difficult in the gastric form of the disease because the eggs and larvae are not easy to find in the feces. Biopsy of a cutaneous lesion reveals connective tissue containing small, yellow caseous areas up to 5 mm in diameter. Larvae may be found in skin scrapings or biopsies, and ocular lesions can be found in the conjunctival sac or discharge. A marked local eosinophilia occurs.

### NECROPSY FINDINGS

Tumor-like lesions of *D. megastoma* bulge into the lumen of the stomach and may reach the size of a golf ball. Adult *Habronema* are stout worms, but their presence is often masked by a thick, tenacious layer of mucus. This is on the glandular part of the stomach and often close to the margo plicatus.

**Granulomatous lesions** may be found in all the sites mentioned in the description of clinical signs, and although varying in size, they are of essentially the same composition

as described earlier under "Biopsy." Horses that have had the cutaneous form of the disease may have small nodules in the parenchyma of the lung. These are hard and yellowish and contain inspissated pus and larvae.

### DIAGNOSTIC CONFIRMATION

A biopsy will confirm clinical diagnosis of the cutaneous and conjunctival forms of the condition. Experimentally, PCR assays targeting the application of the Internal transcribed spacer 2 (ITS2) of ribosomal DNA for specific identification of *Habronema* spp. in feces and biopsies have been developed.<sup>8,9</sup>

#### DIFFERENTIAL DIAGNOSIS

The gastric form of habronemosis is difficult to differentiate from infestation with stomach bot (*Gasterophilus*) larvae or *Trichostrongylus axei*. These parasites often coexist in the same animal. Cutaneous habronemosis must be distinguished from:

Fungal granulomata associated with *Hyphomyces destruens*

Overgrowth of granulation tissue following a wound

Equine sarcoids

### TREATMENT

#### TREATMENT

Ivermectin (0.2 mg/kg SQ) (R-1)

Moxidectin (0.4 mg/kg) (R-1)

Fenbendazole (10 mg/kg, q.1d. for 5d) (R-2)

Few anthelmintics have been adequately tested against *Habronema* spp. and *D. megastoma*. Ivermectin 0.2 mg/kg will remove these species from the stomach with a single SC treatment,<sup>10</sup> but a second dose is sometimes necessary to promote healing in cutaneous lesions. Moxidectin (0.4 mg/kg) is active against adult *Habronema muscae*. Fenbendazole used at 10 mg/kg PO once daily for 5 days is reported to have high efficiency against *D. megastoma* and possibly *Habronema* spp.

### CONTROL

Interruption of the life cycle by careful disposal of horse manure and control of the fly population are obvious measures. In enzootic areas all skin wounds and excoriations should be treated promptly to promote healing and protect them against flies.

### FURTHER READING

Hodgkinson JE. Molecular diagnosis and equine parasitology. *Vet Parasitol.* 2006;136:109.

### REFERENCES

1. Traversa D, et al. *Vet Parasitol.* 2007;150:116.
2. Traversa D, et al. *Vet Parasitol.* 2006;141:285.
3. Traversa D, et al. *Med Vet Entomol.* 2008;22:283.

4. Naem S. *Parasitol Res.* 2007;101:1303.
5. Yarmut Y, et al. *Isr J Vet Med.* 2008;63:87.
6. Schuster RK, et al. *Vet Parasitol.* 2010;174:170.
7. Teixeira WF, et al. *Rev Bras Parasitol Vet.* 2014;23:534.
8. Buzzell GR, et al. *Parasitol Res.* 2011;108:629.
9. Al-Mkaddem AK, et al. *Equine Vet J.* 2014;10(1111):doi.
10. Cutolo AA, et al. *Rev Bras Parasitol Vet.* 2011;20:171.

### RHABDITID DERMATITIS

*Pelodera* is a subgenus of the soil nematode *Rhabditis*. Dermatitis associated with the larvae of *P. strongyloides* is rare. It is recorded most commonly in the dog,<sup>1</sup> but outbreaks have been observed in cattle, sheep, and horses. It has also been an incidental finding in other skin diseases associated with poor husbandry practices. Alopecia is marked, particularly on the neck and flanks. In moderate cases the skin on affected areas is thickened, wrinkled, and scurfy, and some pustules are present on the ventral abdomen and udder. Pustules are up to 1 cm in diameter and contain thick, yellow caseous material and worms. There is marked irritation and, in severe cases, affected areas are swollen and raw and exude serum.

*Pelodera strongyloides* is a free-living soil nematode found particularly in decaying leaf mold and similar material. When warm-blooded animals lie on its habitat for prolonged periods, it takes the opportunity to invade the skin. Thus infestation is encouraged by housing animals on warm, wet bedding. Under favorable conditions, the disease may spread rapidly. In these circumstances the lesions occur most commonly where the skin contacts the bedding. The nematodes are easily detected in skin scrapings or biopsy specimens and in samples of the bedding, preferably taken from the top few centimeters in the pen.

**Control measures** include the regular removal of soiled bedding and steps to ensure that the litter is kept dry. Spontaneous recovery usually occurs if these precautions are taken, but local application of a parasiticide and symptomatic therapy will speed recovery.

### REFERENCE

1. Saari SA, Nikander SE. *Acta Vet Scand.* 2006;48:18.

### ONCHOCERCIASIS (WORM NODULE DISEASE)

*Onchocerca* spp. are filamentous, thread-like nematodes found mostly as convoluted masses in fibrous tissues. They vary in length; those of the horse are 15 to 18 cm long, whereas bovine species may be as long as 75 cm. They are filarial worms, and the females produce motile embryos (microfilariae). These congregate in the skin and subcutaneous tissues at the favored feeding site of their intermediate host. Each *Onchocerca*

species uses a particular biting fly, usually a species of *Culicoides* (midge) or *Simulium* (blackfly). Transmission takes place when infective larvae that develop in the fly are deposited on the skin of their host at a subsequent feed.

Infestation by adult worms is often symptomless, and prevalence tends to increase with age. Relatively nonpathogenic species of widespread occurrence in cattle include *O. gutturosa* in the ligamentum nuchae and *O. lienalis* in the gastrosplenic ligament, whereas horses often harbor *O. cervicalis* in the ligamentum nuchae and *O. reticulata* around the flexor tendons. In horses *O. cervicalis* can cause recurrent fluid-filled masses over the withers that lead to mild bone lysis of the dorsal spinous processes and mineralization within the soft tissue swelling.<sup>1,2</sup> Some cause rejection of meat for human consumption. *O. gibsoni* in Australian cattle, for example, provokes nodules up to 3 cm across in subcutaneous tissues, especially in the brisket. *O. ochengi* produces subcutaneous nodules in African cattle,<sup>3,4</sup> most commonly on the scrotum and udder. Other species may be more pathogenic, such as *O. armillata*, which lives in the aorta of cattle, buffalo, and goats in India and Iran.

**Losses caused by adult worms** are slight, although *O. gibsoni* in cattle causes unsightly lesions and rejection of beef carcasses from the high-class meat trade. The characteristic nodules of *O. gibsoni* are usually freely movable and consist of fibrous tissue canalized by the long body of the worms. With *O. armillata*, the inner wall of the aorta may be corrugated and swollen. In horses, new infections with *O. reticulata* may cause swelling of the suspensory ligament and a hot edematous swelling of the posterior part of the cannon that persists for 3 to 4 weeks. After the swelling subsides, the suspensory ligament remains thickened, and small caseated or calcified nodules may be palpated. Affected animals are lame while the area is edematous and swollen, but many recover when the swelling disappears. *O. cervicalis* causes fibrotic, caseous, and calcified lesions in the ligamentum nuchae, but clinical signs are not seen. The conditions known as “poll evil” and “fistulous withers” are no longer thought to be associated with this parasite.

**Microfilariae** may sometimes be damaging. Those of *O. cervicalis*, for example, are occasionally observed in the cornea of horses, but the proposed causal relationship with periodic ophthalmitis is no longer thought to be valid. They can, however, induce hypersensitivity reactions in the skin of some individuals. Lesions are characterized by alopecia, scaliness, and pruritus, particularly along the ventral abdomen. They may extend between the forelegs and backlegs to include the thigh, and in severe cases they may extend up the lower abdominal wall. Some horses have lesions on the face, neck, or thorax. The lesions may be confused

with those associated with horn-fly feeding, but these are more likely to include crusting and ulcerating dermatitis. In onchocercosis, microfilariae are not detectable in the bloodstream but may be found in skin biopsies. *O. ochengi* in African cattle has been associated with a dermatitis resembling demodectic mange and pox, and in Turkey microfilariae of *O. gutturosa*, *O. lienalis*, and an unidentified species have recently been reported in association with teat lesions, including sores, chaps, and nodules.<sup>5</sup> In cattle, sheep, and horses common pathologic lesions that have been observed in muscle fasciae and connective tissues include greenish-gray coloration, edema, and small (3 to 10 mm) pale granulomatous nodules on fasciae. In the liver there are multifocal, small (2 to 6 mm), clustered pale or yellowish nodules. Histopathological examination of the nodules shows mild to intense infiltration with eosinophilic granulocytes and multifocal nodular lymphoplasmacytic aggregations.<sup>5</sup>

#### TREATMENT

Ivermectin (0.2 mg/kg, PO) (R2)  
Moxidectin (0.4 mg/kg, PO) (R2)

**Control** of the intermediate hosts is virtually impossible, but valuable horses prone to hypersensitivity to *O. cervicalis* microfilariae can be partially protected by housing at night because most *Culicoides* species feed during twilight hours and/or at night. The use of insect repellents and avoidance, if possible, of grazing areas where the insects are likely to be in large numbers will also be beneficial. There is no specific treatment for the adult worms. A novel approach has been the experimental use of tetracycline to eliminate *O. ochengi* by killing the symbiotic bacterium *Wolbachia*, which is found in many, but not all, filarial species.<sup>6,7</sup> An experimental multivalent subunit vaccine based on recombinant proteins of *O. volvulus* has shown partial protection against patent *O. ochengi* infection in cattle.<sup>8,9</sup> Experimental treatment with three doses of 4 mg/kg melarsomine hydrochloride in aqueous solution by slow IV injection on alternate days has been shown to be macrofilaricidal in cattle with *O. ochengi* infection.<sup>10</sup> Oral ivermectin 0.2 mg/kg or moxidectin 0.4 mg/kg can be used to eliminate microfilariae in horses, but recurrence of microfilariae and lesions has been observed even after repeated treatment with ivermectin.<sup>1,11</sup> About 10% of treated horses develop an edematous reaction within 24 hours. This is usually restricted to the area of the lesion, but some may develop a pruritic ventral edema.

#### REFERENCES

1. Metry CA, et al. *J Am Vet Med Assoc.* 2007;231:39.
2. Hestvik G, et al. *J Vet Diagn Invest.* 2006;18:307.
3. Hildebrandt JC, et al. *Parasitol Res.* 2012;111:2217.
4. Eisenbarth A, et al. *Acta Trop.* 2013;127:261.
5. Solismaa M, et al. *Acta Vet Scand.* 2008;50:20.

6. Bah GS, et al. *Antimicrob Agents Chemother.* 2014;58:801.
7. Hoerauf A, et al. *Med Microbiol Immunol.* 2008;197:295.
8. Makepeace BL, et al. *PLoS Negl Trop Dis.* 2009;3:10.
9. Achukwi MD, et al. *Parasite Immunol.* 2007;29:113.
10. Tchakoute VL, et al. *Proc Natl Acad Sci USA.* 2006;103:5971.
11. Katarbwa MN, et al. *J Parasitol Res.* 2013;2013:420928.

## PARAFILARIOSIS

Horses in Europe, particularly eastern Europe, China, South America, and North Africa, are sometimes infected with *Parafilaria multipapillosa*, a 3- to 6-cm-long nematode. The female lives in a nodule in the skin, which it pierces to lay eggs on the surface. The subcutaneous nodules ulcerate, bleed, heal, and disappear spontaneously. The hemorrhagic exudate from the lesion attracts bloodsucking flies such as *Haematobia*, which ingest the eggs and act as the intermediate host. The condition is relatively benign, occurring in the spring, summer, and autumn. Many nodules may occur on a horse, but although unsightly, they do little harm unless they interfere with harness straps.

Similar lesions in cattle are associated with *P. bovicola*, which is endemic in eastern and some western European countries,<sup>1,4</sup> India, the Philippines, Japan, and South Africa. It has recently become established in Canada, Ireland, and Sweden, where it spread at a rate of 50 km/year. Muscid flies, for example, *Musca autumnalis* in Sweden and Belgium,<sup>1</sup> act as the intermediate host, and the prepatent period in cattle is 7 to 9 months.<sup>1</sup> The condition is seen mostly in late winter, spring, and summer and causes widespread economic losses as a result of carcass trimming and hide damage. The majority of lesions are superficial and localized, but sometimes they cover the whole carcass. In such cases intermuscular lesions will be found within the fascia of adjacent muscles. Subperitoneal, abdominal, subpleural, and thoracic lesions may also occur and cause condemnation of the whole carcass. *Suifilaria suis* causes similar lesions in the pig in South Africa.

Clinical signs are restricted to the presence of bleeding points, and a diagnosis may be made by examining a smear of the exudate microscopically for larvated eggs.<sup>1</sup>

#### DIFFERENTIAL DIAGNOSIS

- Insects bites (mainly tabanids)<sup>1</sup>
- Injuries<sup>1</sup>
- Warbles, bacterial or fungal granulomas<sup>1</sup>

#### TREATMENT

Ivermectin (0.2 mg/kg IM) (R-1)  
Nitroxylin (20 mg/kg SQ q72 twice) (R-2)



Ivermectin markedly reduces the area of the lesions and the mass of affected tissue.<sup>1</sup> A control program for *P. bovicola* using ivermectin has been evaluated. Blood spots were dramatically reduced, but transmission was not stopped. Nitroxylin 20 mg/kg twice at 72-hour intervals is effective in reducing the number and area of lesions, but care must be taken to ensure accuracy of dosing or toxic signs of drug overdose may be seen.<sup>5</sup> Topical levamisole may also be effective.

## REFERENCES

1. Caron Y, et al. *Vet Rec.* 2013;172:129.
2. Losson B, et al. *Vet Rec.* 2009;164:623.
3. Galuppi R, et al. *Vet Parasitol.* 2012;184:88.
4. Hamel D, et al. *Res Vet Sci.* 2010;89:209.
5. Borgsteede FH, et al. *Vet Parasitol.* 2009;161:146.

## STEPHANOFILARIASIS

*Stephanofilaria* spp. are very small (up to 8 mm) filarial nematodes living in cysts at the base of hair follicles. They are associated with subcutaneous tissue lesions in cattle and buffalo. There are a number of species, including *S. dedoisi* (synonyms *S. assamensis*, *S. kaeli*, and *S. okinawaensis*), which provokes a dermatitis (“cascado”) affecting the eyes, neck, withers, shoulders, and dewlap in cattle in parts of Asia, in addition to “humpsores” in India, leg sores on cattle in Malaysia, and muzzle and teat lesions in Japan. *S. zahaeri* causes “earsore” in India, and *S. stilesi* is responsible for dermatitis of the ventral abdomen in parts of the United States and Russia. A similar species in Queensland, Australia, affects the head, neck, dewlap, and sternum. *S. boomkeri* has recently been described in pigs in Africa. The adult worms release microfilariae that later develop into flies that feed on the sores. The vector for *S. dedoisi* is *Musca conducens*, whereas the horn fly *Haematobia irritans* is the intermediate host for *S. stilesi* in the United States. The Australian species is probably spread by the buffalo fly, *Haematobia irritans exigua*.

**Cutaneous stephanofilariosis** starts with small papules that later coalesce to produce lesions varying from 3 to 15 cm in diameter. They are an extreme irritant, and evidence of rubbing is present. Part but not all of the hair is lost, and dried exudate forms a thick, crumbly scab that may crack to expose blood-stained fluid. Skin scrapings taken from beneath the scab may reveal worm fragments. If healing occurs, the scab disappears, leaving a scar. Infection does not affect growth rate, and treatment and control are required only in stud cattle in which lesions are esthetically undesirable.

### TREATMENT

Levamisole (7.5 mg/kg PO) (R-2)

Ivermectin is an effective microfilaricide in buffaloes and reduces the number of adult

worms. Oral levamisole 7.5 mg/kg once or twice at 3- to 4-week intervals is reported to be effective. Ointments containing insecticides may aid control. The Asian species require a preexisting wound for infection to take place. Simple wound prevention and treatment would therefore reduce the risk of disease in this region.

## Cutaneous Myiasis

Cutaneous infestation by fly larvae or maggots (known as myiasis) causes serious loss to the livestock industries across the world. Losses include mortality, increased morbidity, and reduced production of meat, milk, and fiber. The disease is associated with larvae of flies in two major dipteran families, Calliphoridae and Sarcophagidae.

Two types of cutaneous myiasis can be distinguished: primary, in which the fly larvae are obligate parasites feeding on living tissues, and secondary, in which the larvae feed primarily on necrotic tissues and only secondarily invade uninjured tissue. Clearly, primary myiasis is most significant to animal health and therefore the most costly, not only in terms of mortality, morbidity, and reduced productivity, but also in terms of cost of control. However, it may be difficult to differentiate primary from secondary myiasis because the larvae are superficially similar.

Three primary fly-strike disease states, resulting from the activities of different species, are well known and described. Blow-fly strike by calliphorids such as *Lucillia cuprina* and *Lucillia sericata* is a major problem, particularly for sheep producers, in Australia, New Zealand, and Great Britain. The second group are the screwworms, *Cochliomyia hominivorax* (in the New World) and *Chrysomya bezziana* (in southern Europe, Africa, and Asia), which are of importance across the livestock species and result in great costs for control. The sarcophagid (flesh fly) *Wohlfahrtia magnifica* causes traumatic myiasis in a wide range of livestock species, but has the greatest effect on goat and sheep production. This species occurs in southern Europe, particularly the Mediterranean and the steppe regions of the continent. Because of differences in the nature of the disease state and control practices for each of these three groups, they will be dealt with as separate entities.

## BLOW-FLY STRIKE OF SHEEP

Blow-fly strike (“strike”) is a very important cause of production and economic loss in most countries where large numbers of sheep are kept. In bad years many sheep may die (up to 30% of a flock), and the expense of controlling the flies and failure of wool to grow after recovery may be a serious cost, both for individual farmers and the overall industry. For example, in Australia the annual cost

of blow-fly control and production losses in 2014 was estimated at around A\$170 million.<sup>1</sup> Merino sheep, especially those with heavy skin wrinkles and fecal soiling, are by far the most susceptible breed.

### SYNOPSIS

**Etiology** *Lucillia cuprina* and *L. sericata* are the most important primary flies; other calliphorids act as secondary invaders.

**Epidemiology** Fly numbers depend on temperature and moisture. Flies are attracted to wool that has been wetted or to areas affected by fleece rot, mycotic dermatitis, diarrhea, or urine staining. Incidence of strike is positively correlated with fly numbers, rainfall, humidity, cloud cover, and pasture growth. Covert (unnoticed) strikes provide larvae for future generations.

**Clinical signs** Sheep are restless, bite at the affected area, and wriggle their tails. Affected area is moist and malodorous, body temperatures may reach 42°C (107.6°F), pulse and respiratory rates increase.

**Clinical pathology** A clinical examination is all that is necessary. The larvae of the primary and secondary flies can be differentiated, but this is of little use and rarely done.

**Lesions** Moist, malodorous areas containing active larvae. Predisposing diseases such as dermatophilosis, fleece rot, parasitic gastroenteritis, and footrot are easily identified.

**Diagnostic confirmation** Clinical signs are diagnostic.

**Differential diagnosis** Lice, sheep scab, screwworm fly infestations.

**Treatment** Insect growth regulators (principally cyromazine and dicyclanil), macrocyclic lactone endectocides, spinosad, or organophosphates (although the latter are restricted or no longer registered in many countries because of environmental and occupational health and safety concerns).

**Control** Dicyclanil protects from flystrike for up to 18 weeks, depending on the formulation; cyromazine and ivermectin for 10 to 12 weeks. Spinosad is an option for organic treatment and has short or no withholding period, but protects for only 2 to 3 weeks. The insect growth regulators do not kill existing larvae until they molt to the next stage; thus, ivermectin, spinosad, or an organophosphate (if permitted) need to be used if a rapid kill is desirable. Breeding and managing sheep to be less susceptible to strike, including the strategic or timely application of insecticide, form an integrated control program. For breech strike this is predominantly by genetic selection for decreased breech wrinkle and

Continued

reduced susceptibility to diarrhea, and control of predisposing diseases, especially gastrointestinal nematodes. The Mules operation reduces susceptibility by dramatically reducing breech wrinkle, but it remains controversial because of the pain and initial lost production associated with the procedure. Docking tails to the correct length and strategic timing of crutching and shearing are other important management factors. For body strike, reducing susceptibility of sheep to fleece rot by genetic selection and controlling mycotic dermatitis by appropriate management, such as not mustering or crowding wet sheep, are important.

## ETIOLOGY

Despite there being a large number of species capable of causing the disease, there are two species that initiate most strikes and are of primary concern: *Lucilia cuprina* and *Lucilia sericata*. Locations of typical species are as follows:

- Australia: *L. cuprina*, *L. sericata* (secondary flies include *Calliphora stygia*, *Calliphora novica*, *Calliphora augur*, *Calliphora hilli*, *Calliphora albifrontalis*, *Chrysomya rufifacies*, and *Chrysomya varipes*)
- New Zealand: *L. sericata*, *L. cuprina* (*C. stygia*)
- Great Britain and northern Europe: *L. sericata* (secondary flies include *Calliphora erythrocephala*, *Calliphora vomitoria*, and *Phormia terra-novae*)
- North America: *Phormia regina*, *P. terra-novae*

## LIFE CYCLE AND EPIDEMIOLOGY

The primary agents of flystrike are obligate parasites. *L. cuprina* is overwhelmingly important in the initiation of strike in sheep from Australia and South Africa. *L. cuprina* was confirmed to be present in New Zealand in 1988, and flystrike from this species is now a major disease in that country. In northern Europe the primary agent of flystrike is *L. sericata*, although there are some other minor species that have been reared from struck sheep.

The incidence varies widely, depending largely on the climate, with warm, humid weather being most conducive to a high incidence. In summer-rainfall areas flystrike may be seen most of the year, being limited only by dry winter conditions. In winter-rainfall areas it is usually too cold in the winter and too dry in the summer for outbreaks to occur.<sup>2</sup> Under these conditions abnormally heavy summer or autumn rains may be necessary before an outbreak will occur.

### The Fly Population

Primary flies are of particular importance because they initiate the strike and provide

suitable conditions for subsequent invasion by secondary flies. These latter flies are not of economic importance but may infest wool matted with dried exudate or feed on necrotic tissue surrounding a healing strike. In warm areas, pupal development may continue throughout the year, but as soil temperatures fall an increasing number of larvae fail to pupate, and larvae may overwinter until the following spring. Adult flies emerge in the spring, and after one to two breeding cycles, numbers increase to a peak in summer.<sup>3</sup> Numbers may remain high if climatic conditions are suitable, with adequate moisture being of prime importance, but fall dramatically in hot and dry conditions during the summer. An increase in numbers may occur again in the autumn.

All adult flies require carbohydrate and water, but females require protein for ovarian development. The flies are attracted to sheep that have undergone prolonged wetting such that bacterial growth and decomposition of the skin occurs. The association of breech strike with diarrhea and urine staining, and body strike with fleece rot, mycotic dermatitis, and footrot, is related to the excessive moisture deposited on the skin or to the production of serous exudates. Fleece-rot-affected wool with *Pseudomonas aeruginosa* has been shown to stimulate oviposition.

*L. cuprina* deposit eggs in batches of up to 300, the actual number depending on the fly's size and its ability to locate sufficient protein for egg development. Similarly, *L. sericata* deposit eggs in batches of approximately 200.

The average female longevity in the field in Australia is about 2 weeks, and females rarely live long enough to mature more than two or three batches of eggs. In the United Kingdom, mean female longevity is shorter at 5 days.

The eggs hatch in 12 to 24 hours, and the first instars feed on protein-rich serous exudate that has been provoked by bacterial damage or some other irritation. Larval mouth hooks and enzymes present in the saliva and excreta will further digestion of the skin. Large groups of larvae, particularly second and third instars, further damage of the skin, which extends the lesion and ensures a continuing supply of food. The second and third instars are 6 to 12 mm long, thick, and yellow and white in color, and they move actively. Larvae reach maturity after approximately 72 hours. They leave the feeding lesion, fall to the ground, wander briefly, and then burrow into the earth to pupate. The length of the life cycle is highly temperature dependent; it can be completed in as little as 8 days but may require up to 6 weeks in temperate regions such as the United Kingdom. Egg and larval stages are highly susceptible to desiccation, and mortality will be high if the relative humidity in the fleece falls below 60%. In temperate

climates when the temperature declines in autumn, wandering larvae that have left the sheep will burrow into the ground but cease development, thereby overwintering as arrested mature larvae.

A few generations of primary flies are necessary before numbers are high enough to cause severe outbreaks, and so warm, humid weather must persist for a reasonable time before severe outbreaks occur. The incidence of body strike increases with the increase in the number of gravid flies and is positively correlated with rainfall, cloud cover, and rate of pasture growth. Other primary flies are not as effective as *L. cuprina* in initiating a strike, and in Australia and South Africa 85% to 90% of all primary strikes are a result of *L. cuprina*. Larvae of primary flies, other than *L. cuprina*, and secondary flies develop in carrion or in rotting vegetation, and their main role is to invade and extend the primary strike. *Ch. rufifacies* is the most important secondary fly in Australia. It requires higher temperatures than the other flies, is found later in the season, and is the first to disappear as temperatures fall.

Detailed population models have been developed for the strike by *Lucilia* spp. in Australia and northern Europe, and both have been used to predict onset of flystrike in sheep populations.<sup>4,5</sup> The latter model has been extensively validated and is sufficiently accurate to establish an early warning system for alerting producers of the impending onset of flystrike, and hence the optimum time for prophylactic treatment.

Distribution of flystrike in flocks is highly aggregated, with a small number of sheep having high numbers of larvae in lesions, a moderate number of sheep with low numbers of larvae, and the majority of sheep being unstruck. In part this is a result of the attractiveness of already-struck sheep to ovipositing flies, although other factors, such as innate attractiveness to flies, shown by the propensity of some sheep to be restruct within the same fly season, also play a role.

### Susceptibility of Sheep

By far the most common site for flystrike is the breech, resulting from soiling and excoriation by soft feces and the urine of ewes. Lush pasture, parasitic gastroenteritis, and fleece length are predisposing factors, but individual sheep are predisposed because of their breech conformation. Excessive wrinkling of the skin on the back of the thighs and perineum, a narrow perineum and crutch, and an excessively long or short tail favor continuous soiling of the area and encourage "breech strike" or "tail strike."

"Body strike" occurs along the dorsum of the body, especially in young sheep in wet seasons when fleece rot or dermatophilosis is common. Less common sites for infestation are around the prepuce ("pizzle strike") and

on the dorsum of the head when there is excessive folding of the skin (“poll strike”). Sheep grazing on tall, dense pasture are commonly affected by body strike because wet plants keep the fleece on the lower part of the body wet. Footrot lesions and wounds, especially castration incisions, docking wounds, and head wounds on rams caused by fighting, are also likely to provide good sites for blow-fly strike. Young sheep are more susceptible.

### PATHOGENESIS

The first instars feed on the exudate produced by the bacterial infection on the skin, but the larvae also produce excretory/secretory enzymes that may cause some skin degradation after egg hatch and provide soluble molecules on which the first instars can feed. Later instars can cause severe skin damage when feeding. Larvae may also migrate from the original area of strike, along the surface of skin, to establish additional focal lesions.

Many primary strikes remain small and are unnoticed by the farmer. Such “covert” strikes may outnumber obvious strikes and are important as a source of future generations of flies. Once the initial strike is made, the site becomes suitable for the secondary flies, which invade and extend the lesion. The effects of strike include toxemia as a result of absorption of toxic products of tissue decomposition, loss of skin and subsequent fluid loss, and secondary bacterial invasion.

### CLINICAL FINDINGS

Individual sheep may be struck at any time provided they are in a susceptible condition. Massive outbreaks tend to be confined to periods of humid, warm weather and are therefore in temperate areas usually limited in length to relatively short periods of 2 to 3 weeks, but in subtropical areas characterized by summer rainfall, severe strikes may occur over many months.

The clinical effects of blow-fly strike vary with the site affected, but all struck sheep have a basic pattern of behavior caused by the irritation of the larvae. The sheep are restless, moving about from place to place with their heads held close to the ground, and they become anorexic. They tend to bite or kick at the struck area and continually wriggle their tails.

If the area is large, there is an obvious odor, and the wool can be seen to be slightly lifted above the normal surrounding wool. The affected wool is moist and usually brown in color, although in wet seasons (when fleece rot is prevalent) other colors may be evident. In very early cases, the maggots may still be in pockets in the wool and not yet in contact with the skin. When they have reached the skin, it is inflamed and then ulcerated, and the maggots begin burrowing into the subcutaneous tissue.



**Fig. 16-9** A, Body strike on a wether as viewed from above. The wether is depressed, and maggots (white) are visible on the surface of the struck area (blackened area of wool). B, Body strike on a weaned sheep as viewed from above. The wool has been clipped away from the edges of the lesion before application of treatment.

Three days after the primary oviposition feed intake is reduced, rectal temperature rises to about 42°C (108°F), and pulse and respiratory rates increase. There is a reduction of feed intake and loss of body weight, and some sheep may die.<sup>6</sup> The wool may be too hot to handle as a result of the inflammation caused by the mass of maggots that can be seen when the wool over the strike is opened. When primary strikes are invaded by secondary flies, particularly *C. rufifacies*, the affected area is extended, and the maggots may burrow deeply into the tissues. Affected sheep may lose their fleece over the affected area (Fig. 16-9) and may suffer a break in the remaining fleece. Tracts of discolored wool may lead to other affected areas of skin. As the struck area extends, a scab forms over the center, the wool falls out, and the maggots are active only at the periphery.

### CLINICAL PATHOLOGY AND NECROPSY FINDINGS

A clinical examination is all that is necessary to make the diagnosis, but identification of the flies responsible may be important if epidemiology is being considered. Identification of larvae should be carried out by a specialist. Molecular techniques for accurate identification are available but are a specialized research technique rather than routine diagnostic tool. Preservation of the larval stages is critical to these techniques, and larvae should be rapidly frozen or preserved in 70% ethanol. Fly trapping may not correlate with larval findings because not all flies are attracted equally by the commonly used baits.

### DIFFERENTIAL DIAGNOSIS

Attention will be drawn to affected sheep by their foot stamping, tail twitching, and biting at the affected part. Affected sheep can easily be diagnosed by finding the moist, malodorous, maggot-infested area. Many covert strikes may be present without producing clinical signs. Predisposing diseases such as footrot, wound infections, dermatophilosis, and diarrhea resulting from parasitic gastroenteritis are usually easily detected, and fleece rot is indicated by matting of the wool and discoloration.

### TREATMENT

Removal of wool from the surrounding area removes most of the maggots, and applying a dressing prevents reinfestation of the wound. Dressings containing cyromazine, spinosad, ivermectin, or an organophosphate such as diazinon, tetrachlorfenvinphos, or propetamphos (if permitted), are the most commonly used. Cyromazine is an insect growth regulator, and thus live larvae will be seen in the fleece for some days after treatment. Thus other chemicals need to be included in a dressing if immediate killing of larvae is desirable. Ivermectin at 0.3 mg/kg is highly effective in killing all larval stages, and no resistance has yet been reported. However, resistance to organophosphates is widespread in Australia; many products do not kill all the resistant larvae, with some performing poorly even against susceptible larvae. Preventing reinfestations is important, and thus application of the larvicide to the wool surrounding the treated area is essential.



## CONTROL

In Australia, practical control of breech strike of Merino sheep in extensive farming areas has relied on the use of the Mules operation, which removes breech wrinkle and extends the bare areas around the perineum and tail. This has been integrated with other strategies to reduce the susceptibility of Merino sheep to strike, such as effective worm control to reduce diarrhea, and hence contamination of the perineal region with feces (“breech soiling”), correct tail length, strategic timing of crutching and shearing, and timely application of insecticides (an integrated pest management approach).<sup>2,7</sup> Control of strike in other situations is based on insecticidal treatment and treatment of wounds as they occur.

Under conditions of extensive sheep rearing, such as occur in Australia, New Zealand, and South Africa, and where climatic conditions are conducive to the development of the disease, the control of blow-fly strike is a major challenge. An extensive literature on the subject is available, so only a summary is given here.

Control programs can be thought of as having three components: reduction in fly numbers (mainly by strategic application of insecticide and fly trapping), prediction of risk periods (to most appropriately time activities such as crutching, shearing, or the application of insecticide), and reduction in susceptibility of sheep (mulesing of Merinos, genetic selection for plain breeches and/or reduced breech cover; control of predisposing factors, particularly diarrhea and fleece rot).

### Reduction of Fly Numbers

Reducing the fly population has been of limited value because there are usually enough flies present to strike all susceptible sheep if suitable conditions are present. Nevertheless, if the primary fly responsible for initiating strikes can be controlled, the buildup of primary flies and involvement and importance of secondary flies is greatly reduced. Measures include early insecticide treatment, just before or after the first generation of primary flies emerge in areas that have a seasonal pattern of fly emergence; trapping of flies; early treatment of clinical cases; and the proper disposal of carcasses and wool waste. Biological control by the use of insects parasitizing blow flies has been proposed but has yet to be exploited.

A weather-driven model of flystrike risk in southeastern Australia predicted that strategic early treatment would reduce the number of treatments and have a positive cost-benefit outcome in high-risk areas where preventive treatments were routinely given, but there was less benefit for low-risk areas because treatments were not needed every year.<sup>8</sup> A large-scale field study comparing early strategic treatment of unmulesed Merino sheep with mulesed ones not given

an insecticide found a similar prevalence of strike in both groups and concluded that this was a potential medium-term strategy for the control of strike in unmulesed Merinos in this area.<sup>2,9</sup>

Trapping, provided the traps are carefully tended and satisfactory baits are used, can reduce the number of blow flies. However, the benefits in reducing the prevalence of strike are mixed. The use of a trap designed specifically for *L. sericata*, the primary fly in the United Kingdom, reduced strikes by 55%.<sup>10</sup> However, despite reducing the numbers of *L. cuprina* by 60% to 80%, the use of a trap specific for this species (LuciTrap™) has not consistently reduced the prevalence of strikes in Australia or South Africa.<sup>7,11</sup> In addition, it is expensive and logistically difficult to use these traps in large flocks at the suggested distribution of 1 trap per 100 sheep. Nevertheless, trapping can still be useful to indicate the presence and abundance of blow flies and the most appropriate time to apply a strategic early treatment.<sup>11</sup>

It is also important to identify clinically affected sheep, particularly those affected early in the season, and to treat these infestations. If early-season strikes are not treated, they can propagate a larger second and third generation of flies on a farm, given that *L. cuprina* doesn't travel large distances. Thus large farms breed most of their own flies, and so outbreaks of strike will be potentially more problematic later in the season. When affected areas are clipped, the clippings should be treated with a suitable dressing to kill the larvae, then burned or buried.

Control by genetic manipulation of the fly offers some promise for long-term control, but this strategy has yet to be exploited with either *L. cuprina* or *L. sericata*. For example, reduced fertility in male flies and lethal mutants, such as flies that will be blind under field conditions and die, have been reported. The sequencing of the draft genome of *L. cuprina* may facilitate these and other developments, such as exploring genetic mechanisms of insecticide resistance, the design of novel insecticides, and other strategies.<sup>12</sup>

### Prediction of Risk Periods

Flystrike results from a complex interaction between fly abundance and sheep susceptibility, both of which are directly related to weather, geography, and animal husbandry. Predictive models incorporating climatic and production components have been developed in the United Kingdom and are used to give producers warning of impending flystrike.<sup>5</sup> In Australia, models have been incorporated into tools on an advisory website for farmers and advisers (Flyboss), enabling them to compare management systems for flystrike risk.

Outbreaks of breech strike will occur if sheep have diarrhea or if ewes have urine wetting of the breech area because their tails are docked too short or too long. If an

outbreak is routinely expected, such as during spring in a winter- or uniform-rain-fall area, removal of breech wool by crutching or shearing, and/or the prophylactic application of insecticides, will largely eliminate or reduce the severity of strike. Crutching is routinely carried out before lambing or an expected increase in fly numbers and provides protection from strike for around 6 weeks in crossbreeds and mulesed Merinos but for a shorter period in unmulesed Merinos. It has a significant cost as a result of the labor and loss of wool involved, and thus many sheep farmers use prophylactic treatment with an insecticide.

Sporadic cases of body strike may occur in sheep at any time and cannot always be prevented, but if environmental circumstances conducive to high fly populations and high susceptibility of sheep are recognized, then short-term prophylactic measures can be taken. Warm, showery weather extending over several weeks allows several generations to be completed and sufficient flies to be available to cause an outbreak of strike. Once sufficient flies are present, an outbreak of flystrike may occur whenever the sheep become susceptible. Warm, humid weather, rain over 2 to 3 days, or grazing in long and wet grass may provide suitable conditions for the sheep to become susceptible to body strike. Sheep with poor physical conformation (e.g., high shoulder blades), fleece that is yellow with high suint and low wax content, and a wool staple structure more prone to wetting (pointed, thin staples that are less tightly packed) are most susceptible. The time of year when shearing is carried out also exerts a strong influence on the frequency and severity of outbreaks of body strike because the staple length when sheep are wetted determines the degree of wetting and rapidity of drying. It also influences susceptibility to breech strike, with a longer staple length usually facilitating a greater accumulation of feces (“dag”).

### Treatment and Prevention

Prophylactic treatment with insecticide has been a major part of blow-fly control for many years, and surveys in countries with significant sheep populations show that up to 90% of farmers in high-risk areas routinely treat their sheep. Currently available chemicals include the insect growth regulators (dicyclanil and cyromazine), macrocyclic lactones (ivermectin), and spinocyn (spinosad). Organophosphate chemicals have also been heavily used, but resistance is widespread, and thus the period of protection is reduced to as little as 3 to 5 weeks. There is also increasing concern over their environmental effects and occupational health and safety, and thus their use is restricted or prohibited in many jurisdictions. Resistance by *L. cuprina* to cyromazine has been detected in Australia, but application of this chemical at the recommended

concentration is still effective in preventing reinfestations.<sup>13</sup>

Depending on the formulation used, the insect growth regulators can provide 10 to 12 (cyromazine) and 18 to 24 (dicyclanil) weeks of protection, and can be applied by high-volume jetting (cyromazine) or a low-dose spray (both). Their action is specific to dipteran larvae, although they inhibit chitin synthesis and thus larvae do not die until they molt.

The methods of application include dipping, jetting, and tip spraying. However, dipping requires specialized equipment, has higher labor costs, and is much slower and thus is not recommended unless lice are also present. Jetting is recommended for breech strike, and if the jetting piece is combed through the wool from the poll to the rump with the solution at high pressure (500 to 900 kPa), this method will also prevent body strike.

### Reducing the Susceptibility of Sheep

The primary method for reducing the susceptibility of Merino sheep to breech strike has been the modified Mules and tail-strip operation.<sup>14</sup> Mulesing, originally developed to remove the wrinkled region of the breech, has been modified by incorporating pain relief to address concerns regarding animal welfare, which must be balanced against the effects of strike. Although still permitted by codes of practice in Australia, the technique remains controversial because of ongoing opposition from animal welfare activists and concern over production losses. The latter accrue following a significant growth setback when lambs are mulesed at a young age (6 to 10 weeks old), often leading to reduced weaning weights and higher mortality rates after weaning. The protection gained by mulesing surpasses that afforded by breeding and is immediate and permanent.

The Mules operation is often supplemented by a tail-strip operation, whereby a thin strip of woolled skin is removed from each side of the tail. This stretches the bare skin over much of the tail, reducing fecal and urinary contamination. Unfortunately, some contractors dock tails too short, leaving a "butted" tail that the sheep is unable to elevate when defecating, thereby increasing the degree of breech soiling (dag). When butted tails are combined with mulesing, there is often a high prevalence of squamous-cell carcinoma of the vulva. Consequently, docking tails to the correct length (tip of the vulva in ewes) and leaving a V-shaped flap of wool bearing skin on the tip of the tail is important.

Alternatives to mulesing have been developed and investigated in an ongoing research program funded by Australian woolgrowers.<sup>15</sup> These methods include plastic breech clips, applied to the breech of lambs at a similar age to mulesing, and the intradermal injection of compounds, such as sodium

lauryl sulfate, into the breech area.<sup>16</sup> Unfortunately, to date no alternative has produced the degree of breech modification achieved by mulesing, nor have they significantly reduced the prevalence or risk of breech strike compared with unmulesed sheep. For example, in a field study involving over 6000 sheep there was a significant reduction in the breech wrinkle scores of hoggets and ewes that had clips applied as lambs, but these changes were only a fraction of the reduction seen in mulesed sheep. Compared with mulesed sheep, the clipped ones had from 3 to 27 times the risk of breech strike as hoggets, and 2 to 8 times the risk of strike as maiden ewes.<sup>3,9</sup>

Consequently, selective breeding to reduce the susceptibility of Merino sheep to breech strike is being recommended. This possibility was first noted in the 1930s, when sheep with certain breech characteristics were found to have a far higher risk of breech strike, whereas others were relatively immune.<sup>14</sup> However, these investigations were discontinued as a result of the effectiveness and widespread adoption of mulesing, plus the development of highly effective insecticides. Genetic selection offers cumulative and permanent changes, although not total reduction in risk. Several risk factors for breech strike were identified in a large-scale study in western Australia involving over 2800 unmulesed lambs sired by 49 rams.<sup>17</sup> The most important of these were breech soiling (dag), urine staining, and breech "cover" (the reverse of bare area), which had genetic correlations with breech strike of 0.64 to 0.81, 0.54, and 0.32, respectively. Breech wrinkle was not identified as a risk factor because these were a plain-bodied genotype of sheep. However, a similar study of typical wrinkly fine-woolled Merinos in a summer-rainfall area confirmed a strong relationship between breech strike and breech wrinkle.<sup>18</sup> This research has been summarized and published on an open-access website called Flyboss.<sup>19</sup> A similar genetic and phenotypic relationship of breech soiling with breech strike has been demonstrated for New Zealand Romney sheep and in the United Kingdom.<sup>20</sup>

Other good management practices are essential to prevention of flystrike. These include management of gastrointestinal nematodes to prevent diarrhea ("scouring"), docking of tails to the correct length, and crutching before a risk period (typically before lambing with ewes) to reduce breech soiling that predisposes animals to breech strike.

Pizzle strike can be dramatically reduced or eliminated by the use of testosterone implants to prevent posthitis ("pizzle rot"), and "ringing" (shearing of the pizzle area) provides 6 to 8 weeks of protection from strike. Pizzle dropping (the surgical separation of the preputial sheath from the belly) also provides good protection. However, treated sheep can be more difficult to shear,

and it will no longer be an approved practice when draft Australian animal welfare standards are endorsed.<sup>21</sup> Fleece rot occurs most commonly on the withers of sheep, and the conformation that allows accumulation of moisture and the development of fleece rot and flystrike is heritable, so sheep with these faults should be culled. Although control is mainly centered on management, the application of an insecticide may be needed when weather conditions are particularly suitable for body strike, such as summer storms.

### FURTHER READING

- James PJ. Genetic alternatives to mulesing and tail docking in sheep: a review. *Aust J Exper Agric.* 2006;46:1-18.
- Radostits O, et al. Blow fly strike. In: *Veterinary Medicine: A Textbook of the Diseases of Cattle, Horses, Sheep, Goats and Pigs*. 10th ed. London: W.B. Saunders; 2007:1590-1593.
- Wall R. Ovine cutaneous myiasis: effects on production and control. *Vet Parasitol.* 2012;189:44-51.

### REFERENCES

- Report B. AHE.0010. *Meat and Livestock Australia*. Sydney: 2015.
- Tyrell L, et al. *Aust Vet J.* 2014;92:348.
- De Cat S, et al. *Aust J Entomol.* 2012;51:11.
- Wardhaugh K, et al. *Med Vet Entomol.* 2007;21:153.
- Wall R, et al. *Med Vet Entomol.* 2002;16:335.
- Colditz I, et al. *Aust Vet J.* 2005;83:695.
- Scholtz AJ, et al. *J S Afr Vet Assoc.* 2011;82:107.
- Horton BJ. *Anim Prod Sci.* 2015;55:1131.
- Larsen JWA, et al. *Aust Vet J.* 2012;90:158.
- Broughan JM, Wall R. *Vet Para.* 2006;135:57.
- Urech R, et al. *Aust J Entomol.* 2009;48:182.
- Anstead CA, et al. *Nature Comms.* 2015;6:7344.
- Levot GW. *Aust Vet J.* 2012;90:433.
- James PJ. *Aust J Exper Agric.* 2006;46:1.
- <<http://www.wool.com/on-farm-research-and-development/sheep-health-welfare-and-productivity/sheep-health/breech-flystrike/>>; Accessed 07.12.2015.
- Colditz IG, et al. *Aust Vet J.* 2010;88:483.
- Greef JC, et al. *Anim Prod Sci.* 2014;54:125.
- Smith J, et al. *Proc Assoc Advanc Anim Breed Genet.* 2009;18:334.
- <<http://www.flyboss.com.au/breeding-and-selection.php>>; Accessed 07.12.2015.
- Pickering NK, et al. *New Zeal Vet J.* 2015;63:98.
- <<http://www.animalwelfarestandards.net.au/files/2011/02/Sheep-Standards-and-Guidelines-for-Endorsement-May-2014-080714.pdf>>; Accessed 07.12.2015.

### SCREWORM (COCHLIOMYIA HOMINIVORAX AND CHRYSOMYIA BEZZIANA)

Cutaneous myiasis associated with the screwworm maggots has been a cause of great financial loss in livestock in the western hemisphere, Africa, and Asia. Deaths may be heavy in groups of livestock that are at range and seen infrequently.

#### SYNOPSIS

**Etiology** *Cochliomyia hominivorax* in the New World (New World screwworm) and

*Continued*

*Chrysomya bezziana* (Old World screwworm) in Africa and Asia.

**Epidemiology** Eggs laid in fresh wounds. Flies most active at 20° to 30°C (68 to 86°F). Disease spread by dispersal of flies or transport of infested animals.

**Clinical signs** Larvae invade the tissue, producing characteristic large lesions containing mature larvae and foul-smelling brown exudate.

**Clinical pathology** Not applicable.

**Lesions** Deep wound containing foul-smelling brown material and third instars.

**Diagnostic confirmation** Rows of spines are present on the anterior part of each segment of the third instar.

**Differential diagnosis** No other disease causes such lesions.

**Treatment** Ivermectin 0.2 mg/kg subcutaneously kills many larvae and provides protection for 16 to 20 days. Other insecticides used as gels or ointments twice weekly are also effective. Doramectin subcutaneously.

**Control** Eradication has been achieved in North and Central America by the mass release of sterile males. Chemical attractant baits will reduce the prevalence of flies and strikes. Breeding and management procedures such as castration and shearing should be carried out in the cold weather.

## ETIOLOGY

Larvae of the flies *C. hominivorax* and *C. bezziana* cause myiasis or “screwworm disease” of animals. The flies are typically blowflies, *C. hominivorax* (New World screwworm), which is blue–green with an orange head, or *C. bezziana* (Old World screwworm), which is of similar coloring. *C. hominivorax* occurs in the Americas, and *C. bezziana* occurs in the Persian Gulf, Africa, and Asia. The occurrence of *C. bezziana* in Papua New Guinea provides a constant threat to livestock on the Australian mainland. A similar fly is *Callitroga (Cochliomyia) macellaria*, which is not a true “screw-fly” in that the larvae feed only on carrion or necrotic tissues.

## EPIDEMIOLOGY

The screwworm maggots are obligatory parasites with no host specificity. Thus all domestic and wild mammals, marsupials, and birds are potential hosts. Females are attracted to fresh wounds, where they will oviposit. The navel of a newborn animal is a favored site, but fresh accidental or surgical wounds, such as those produced by castration, docking, and dehorning, are readily infested. Wounds that have already been infested are markedly attractive to the flies because of their odor. In bad seasons the flies will lay eggs on minor wounds such as areas

of excoriation, tick bites, running eyes, peeling brands, and on the perineum soiled by vaginal and uterine discharges in animals that have recently given birth. Injury is not necessarily a prerequisite for screwworm strike in sheep, which can be struck in the intact infraorbital fossa and vulva. Wool loss and tenderness may occur, and the remaining fleece may be stained.

The development of the fly is favored by hot, humid weather. The optimum temperature range for *C. bezziana* is 20° to 30°C (68° to 86°F). Below this temperature, the flies become sluggish, and at 10°C (50°F) and below the flies will not move. Temperatures above 30°C (86°F) can be tolerated, provided shade is available. *C. hominivorax* is active all year in areas where temperatures exceed 16°C (61°F) and disperses rapidly from these areas as the temperature increases in the neighboring colder areas. The disease can be spread either by migration of flies or their carriage in livestock ships or commercial aircraft, by shipment of infested cattle or other livestock, and by movement of affected wildlife. The mean distance that *C. bezziana* can travel and deposit eggs is 11 km. The maximum distance is 100 km, but long distances are probably wind assisted. In the new environment the flies may die out if the climate is unsuitable or persist to set up a new enzootic area. Persistence of the fly in an area may depend on persistence in wildlife or in neglected domestic animals, although the latter do not usually survive unattended for more than about 2 weeks.

In many enzootic areas it is common for the fly to persist in neighboring warmer areas during winter, returning to its normal summer habitat as the temperature rises. This pattern is exemplified by the introduction of screwworms into the southeastern United States in 1933 where they had not previously occurred. The flies died out in most areas in winter but persisted in southern Florida. In succeeding summers migrations of flies northward caused outbreaks. The disease has since been eradicated from the area.

The disease is of importance in tropical and subtropical areas of Africa, Asia, North and South America, the Caribbean islands, Mexico, American states bordering on Mexico, and especially Central America. The prevalence of the fly in enzootic areas places severe restriction on the times when prophylactic surgical operations can be carried out.

The potential worldwide geographic distribution and abundance of *C. bezziana* has been assessed using a computer program. The differences in the observed global distribution and the potential predicted distribution indicate the areas at risk of colonization.

## LIFE CYCLE

The screwworm flies have a typical fly life cycle with eggs, three larval instars, and a

pupal stage. Females lay 150 to 500 white eggs in shingle-like clusters at the edges of fresh wounds. Larvae hatch in about 12 hours and penetrate the tissues surrounding the wound. The larvae preferentially feed on fresh, living tissue, which is digested by regurgitation of a wide variety of salivary enzymes. Oviposition by other screwworm flies is encouraged by the presence of larvae already in the wound. The larvae feed as a group and at their time of maturation will have created a deep lesion 10 to 12 cm in diameter. Larval development is complete in 5 to 7 days, after which they leave the wound and fall to the ground. These mature third instars burrow into the upper soil layers and pupate. On the ground, pupal development is highly temperature dependent, requiring from 3 to 60 days. Emerging flies commence egg-laying in about 1 week, having completed the life cycle, under optimum environmental conditions, in less than 3 weeks. There may be 15 or more generations per year.

The temperature sensitivity of the pupal stage, which is unable to survive freezing for more than short periods, limits the distribution of this parasite. As with all flies, pupal development is highly temperature regulated. The screwworm pupal development is inhibited at soil temperatures below 15°C (60°F). Temperatures below this point for more than 2 months cause death of the pupa. Thus the occurrence of the disease is limited to warm climates. Pupae are also affected by the moisture content of the soil. The emergence of adults is reduced when the moisture content is more than 50%, whereas temporary floods can drown pupae.

## PATHOGENESIS

Following invasion of the wound a cavernous lesion is formed, characterized by progressive liquefaction, necrosis, and hemorrhage. Anemia and decreased total serum protein result from hemorrhage into the wound. Secondary bacterial infection, toxemia, and fluid loss contribute to the death of the animal. Surviving calves frequently develop infectious polyarthritis.

## CLINICAL FINDINGS

The young larvae invade the nearby healthy tissues vigorously and do not feed on necrotic superficial tissue. A profuse brownish exudate, composed of larval excreta and host fluids, pours from the wound, and an objectionable odor is apparent. This is highly attractive to other flies, and multiple infestations of a single wound may occur within a few days. The resulting tissue damage may be so extensive that the animal is virtually eaten alive. Affected animals show irritation in the early phase of the infestation and by day 3 show pyrexia. Animals do not feed but wander about restlessly, seeking shade and shelter.



## CLINICAL PATHOLOGY

It is imperative to differentiate screwworm infestation from infestation with other fly larvae. The appearance and smell of the wound are significant, but careful examination of the larvae is necessary to confirm the diagnosis. Mature larvae are 1 to 2 cm long and pink in color; they are pointed anteriorly and blunt posteriorly; two dark lines are visible reaching from the blunt posterior to the middle of the body, and they have rows of dark fine spines on the anterior part of each segment. Specimens forwarded to a laboratory for identification should be preserved in 70% alcohol.

## NECROPSY FINDINGS

Superficial examination of infested wounds is usually sufficient to indicate the cause of death.

### DIFFERENTIAL DIAGNOSIS

The presence of maggots in the wound is usually apparent. It is important to differentiate them from blow-fly larvae as described previously.

## TREATMENT

Affected wounds should be treated with a dressing containing an efficient larvicide and preferably an antiseptic. The larvicide should be capable of persisting in the wound for some time to prevent reinfestation. An ointment or gel base is preferred so that as much of the active ingredient as possible is left in the site. It should be liberally and vigorously applied with a paint brush to ensure that larvae in the depths of the wound are destroyed. To avoid reinfestation in extensive lesions or in bad seasons, the treatment should be repeated twice weekly.

Thirteen acaricides, commonly used for *Boophilus microplus* control, have been tested against *C. bezziana* larvae. Although they are not sufficiently active to use as a primary treatment, their continued use for tick control would reduce screwworm populations.

Ivermectin 200 mcg/kg given subcutaneously kills all *C. bezziana* larvae up to 2 days old and many older larvae. It provides residual protection for 16 to 20 days. Bull calves treated with ivermectin at the time of castration were completely protected against strike. A preliminary study showed that closantel at 15 mg/kg body weight was effective, with a residual protection of 8 to 15 days. Doramectin 200 mcg/kg subcutaneously caused complete expulsion of *C. hominivorax* larvae within 8 days. Prophylactic use of ivermectin and doramectin significantly reduced occurrence of screwworm strike in cattle. Fipronil had a prophylactic effect, reducing occurrence of screwworm infestations in cattle and providing efficacious treatment in those that did become infested.<sup>1</sup>

## CONTROL

In an enzootic area the incidence of the disease can be kept at a low level by the general institution of measures designed to break the life cycle of the fly. Surgical procedures should be postponed where possible until cold weather. In the warm months all wounds, including shearing cuts, must be immediately dressed with one of the preparations described under "Treatment." All range animals should be inspected twice weekly and affected animals treated promptly. Infestation of fresh navels is common, and newborn animals should be treated prophylactically. If possible, the breeding program should be arranged so that parturition occurs in the cool months. The routine use of ivermectin for internal parasite control provides protection for about 2 weeks.

In the United States, the Caribbean, and Central America, an eradication program has been successfully carried out against *C. hominivorax* using the sterile insect technique (SIT).<sup>2</sup> Huge numbers of pupae are mass reared on semiartificial media and exposed to the sterilizing effects of cobalt 60. The resulting sterile male flies are released over large areas, primarily by aerial drops, where they compete with wild males for available females, which mate only once. *C. hominivorax* has now been eliminated from the United States, the Caribbean, and all of Central America, up to the Darien Gap in Panama. *C. hominivorax* appeared in Libya in 1988, apparently with a load of sheep transported from South America, but has been eradicated using sterile male flies from the United States.<sup>3</sup>

Attractants may also be used to reduce the fly population. A chemical bait has been developed that, when combined with an insecticide, forms a screwworm adult suppression system (SWASS) that reduces the fly population and the incidence of strikes. An examination of the efficacy of various methods of baiting showed that polythene sachets containing swarm-lure 2, a pungent mixture of 11 chemicals, attracted flies (not *C. bezziana*) for at least 2 weeks and was as efficient as jar bait. This result needs confirming in a screwworm-endemic country.

## REFERENCES

1. Lima WS, et al. *Vet Parasitol.* 2004;125:373.
2. Spradbery JP, Evans K. *Agric Zool Rev.* 1994;6:1.
3. Chaudhury MF. *Vet Parasitol.* 2004;125:99.

## WOHLFAHRTIOSIS (FLESH FLY, WOHLFAHRTIA MAGNIFICA)

Cutaneous infestation by larvae of the sarcophagid fly, *Wohlfahrtia magnifica*, has become a major disease of domestic livestock, including birds managed extensively (e.g., geese) in the Mediterranean basin, eastern Europe, and western regions of China. The disease is particularly significant for sheep in these regions, where it is more

prevalent than strike by the calliphorid fly, *L. sericata*.

Other species of this genus are known from North America, but they do not infest domestic species. They are predominantly reported in very young rodents and birds, although there are occasional reports in infants.<sup>1</sup> Mortality of infested hosts tends to be very high.

## LIFE CYCLE AND EPIDEMIOLOGY

Larvae of this species are obligatory parasites developing only in the living flesh of warm-blooded vertebrates. They are not host specific. Adults are typical for this group of flies, being dark gray in color with three distinct black stripes on the thorax where the wings are attached.

Female flesh flies, which are active during the warm parts of the day, deposit first instars on the host, usually in small groups of 15 to 20. Each female may produce up to 170 larvae. Completion of the three larval stages takes from 5 to 7 days, after which the mature third instars leave the lesion and fall to the ground, where they pupate. Development of the fly within the pupa is regulated by temperature and may require between 7 and 21 days.

Larvae are usually deposited near small wounds (bites of blood-feeding arthropods are sufficient to attract the larvae), but the favored sites appear to be the genitalia.<sup>2</sup> Irritation of the vulva associated with the use of vaginal sponges for estrus synchronization may be a predisposing factor in sheep.

Flies are active between April and October, with several generations being produced. Little information is available on overwintering. Wildlife are suspected as being reservoir hosts, but little information is available on which are the most important.

## PATHOGENESIS

Larvae have well-developed mouthhooks that are used to abrade the skin surface, and with the aid of a wide variety of salivary enzymes, they quickly produce a dramatic lesion. Lesions increase in size as the larvae grow and require additional fresh tissue. Each animal may have one or more focal lesions, each packed with larvae. In severe cases several lesions may coalesce into one larger site.

Animals are often struck multiple times during a season, suggesting the absence of protective immunity. This adds to the impact of this disease because animals must be constantly monitored.

## CLINICAL PATHOLOGY AND NECROPSY FINDINGS

A clinical examination is all that is necessary to make the diagnosis. Larvae can be distinguished from those of the screwworm or strike flies by the presence of a large posterior cavity surrounded by a number

of prominent tubercles. However, specific identification should be done by a specialist. Larvae should be preserved in 70% ethanol.

Affected animals are clearly stressed, showing restlessness and anorexia. Lesions formed at the vulva or prepuce are the most significant, causing great discomfort and dysfunction. Lightly infested animals shown no impairment of productivity.<sup>2</sup> Infested animals develop strong antibody responses to salivary secretions, particularly of the third instars.<sup>3</sup>

### TREATMENT

There are currently no products specifically registered for management of this disease. Evaluations of several drugs and treatment approaches have been made. Of particular interest is the equivocal results of trials with macrocyclic lactones. In sheep, ivermectin and moxidectin had no effect on existing infestations and no prophylactic effect or only short protection against early instars. In contrast, doramectin provided complete prophylactic protection for 21 days and significant reductions for 40 days.

The insect growth regulator dicyclanil has also been evaluated and shown to reduce prevalence of infestation in sheep. The reduction not only occurred in treated animals, but was seen in untreated herd mates, possibly as a result of the overall reduction in fly numbers.

### RECOMMENDATION

Animals likely to be attractive to these flies should be checked weekly, and appropriate treatment should be applied as soon as fly larvae are detected.

### REFERENCES

1. Colwell DD, O'Connor M. *J Med Ent.* 2000;37:854.
2. Sotiraki S, et al. *Vet Parasitol.* 2005;131:107.
3. Sotiraki S, et al. *Vet Parasitol.* 2003;116:327.

## Mite Infestations

### HARVEST MITES (CHIGGER MITES)

Infestations with trombidiform mites cause dermatitis in all species. Except for *Psorergates ovis*, *P. bos*, and *Demodex* spp., they are referred to as harvest or grain mites. These mites are primarily predatory on other arthropods associated with harvested grain and infesting animals only secondarily and usually transiently. It is usually the larval stages that are found feeding on animals, whereas the nymphs and adults are free-living. Hair loss and patchiness in cattle that are extremely well bedded often results from these mites but can be confused with louse infestations.

The larvae of *Pyemotes ventricosus*, *Neotrombicula autumnalis*, *Neotrombicula*

*heptneri*, *Eutrombicula alfreddugesi*, *Eutrombicula splendens*, *Eutrombicula batatas*, *Trombicula* spp., and some species of *Leprotrombidium* and *Schoengastia* are parasitic on humans and most animals, causing dermatitis and, in humans, transmitting rickettsial diseases. Nymphs and adults are free-living predators feeding mainly on arthropods in grain and hay. The larvae are most active in the autumn at harvest time and may cause dermatitis in animals grazing at pasture or those confined in barns and being fed newly harvested grain.

Horses, cattle, and goats<sup>1</sup> are usually affected on the face and lips, which, in white-faced horses, may suggest a diagnosis of photosensitization, and around the feet and lower limbs, especially in the flexures. Affected areas are itchy and scaly, but with rubbing, small fragile scabs and absence of hair may become apparent. Infestation of horses with *Trombicula sarcina* causes a severe pruritus, and yearlings show irritation by lip-biting their legs and rubbing against stable walls. Stamping is uncommon and usually occurs when yearlings are stabled on fresh, contaminated bedding. Sheep, when first affected, stamp their feet repeatedly and bite their legs. The skin at the heels, coronet, and pasterns, and sometimes the shank, becomes erythematous and weeps fluid. The mites detach after 3 to 5 days and leave a small ulcerated area. In light infestations the mites may be confined to the area between the accessory digits, but in heavy infestations the skin over the whole of the lower limbs may be swollen and thickened. The infestation is self-limiting, and treatment is not usually necessary.

Infestation with *Tyroglyphus* spp. in pigs appears to be manifested by itchiness and the development of fragile scabs about 3 cm in diameter scattered over the body. Unlike the thick scabs of sarcoptic mange, the skin beneath appears normal. The infestations occur in pigs eating dry ground grain from automatic feeders, with lesions appearing several weeks after the dry feeding is begun and disappearing spontaneously about 3 weeks later. No treatment is necessary. Affected pigs show no ill-effects, but the lesions may be mistaken for those of swinepox or sarcoptic mange. The ingestion of large numbers of mites appears to have no ill-effects.

Recent work on the role of *N. autumnalis* has suggested that these mites are capable of acting as reservoirs of *Borrelia burgdorferi*,<sup>2</sup> but this remains to be established.

### RECOMMENDATIONS

No treatment is usually recommended, but a macrocyclic lactone will be effective if a treatment is required.

### REFERENCES

1. Stelnikov AA, Kar S. *Acarologica.* 2015;55:355-359.
2. Kampen H, et al. *Exp App Acarol.* 2004;33:93-102.

### ITCHMITES (*PSORERGATES OVIS*, *PSORERGATES BOS*)

The "itchmite," *Psorergates ovis*, has been recorded as a parasite of sheep in Australia, New Zealand, South Africa, the United States, Argentina, and Chile. *Psorergates bos* has also been recorded in cattle in the United Kingdom.

### LIFE CYCLE AND EPIDEMIOLOGY

The entire life cycle of this mite—egg, larvae, two nymphal stages, and adult—takes place entirely on the host. In sheep the cycle takes 4 to 5 weeks. All stages occur in the superficial layers of the skin. The adults are extremely small and can be seen only with the aid of a microscope. Only the adults are mobile on the skin surface, and they spread infection by direct contact. In sheep this often occurs between recently shorn animals when contact is close and prolonged, such as when shorn sheep are packed in yards after shearing, or from ewe to lamb while suckling. Mite feeding activity, in addition to excreta, causes skin irritation, leading to rubbing and biting of the affected parts (principally the sides, flanks, and thighs) and raggedness, and sometimes shedding of the fleece. Wool over these areas becomes thready and tufted and contains dry scales.

### PATHOGENESIS

The skin shows no gross abnormality other than an increase in scurf. Histologically there is hyperkeratosis, desquamation, and increased numbers of mast cells. Irritation appears to be caused by hypersensitivity and results in biting and chewing of the fleece on the flanks and rump behind a line approximately from the elbow to the hips. In the individual sheep and in flocks, the disease spreads slowly, and thus it may be several years before clinical cases are observed and appreciable numbers are visibly affected. The incidence of clinical cases in a neglected flock may be as high as 15%. Sheep on poor nutrition have significantly higher mite populations, more scurf, and greater fleece derangement. Affected sheep may become tolerant after 1 to 2 years and show no signs, even though they remain infested.

Among sheep, Merinos are most commonly affected. The highest incidence is observed in this breed, particularly in areas where the winter is cold and wet. There is a marked seasonal fluctuation in the numbers of mites; the numbers are very low in summer, begin to rise in the autumn, and peak numbers are found in the spring. Spring or summer shearing exacerbates the decline in numbers. Clinically, the disease resembles louse infestation, but may be distinguished by the smaller proportion of the flock affected (10% to 15%), the less severe irritation, and the tendency of the sheep to bite those areas they can reach. Hence lesions are confined to

parts of the flank and the hindquarters, and the wool tufts have a chewed appearance.

### CLINICAL FINDINGS

Diagnosis depends on finding the mites in a skin scraping. The selection of sheep with excess scurf and fleece derangement increases the chance of finding mites, and in the absence of lice, ked, and grass seed infestation, about 75% of such sheep prove positive for *P. ovis*. The wool should be clipped as close as possible, the skin smeared lightly with oil, and then scraped over an area of about 25 cm<sup>2</sup>. The mites have a seasonal incidence and may be very difficult to find in summer and autumn. For best results the scraping should be made on the ribs or shoulder in winter or spring. Scrapings are usually teased out in oil and examined microscopically without digestion. A number of scrapings may be needed from each sheep before mites can be demonstrated. Because of the difficulty of finding mites in summer and autumn, sheep dipped at that time cannot be said to be free of infestation until they prove negative on skin scraping in the following spring, when mite numbers should be at the highest levels.

### TREATMENT AND CONTROL

There is no compound available that will eradicate itchmite after a single treatment. Arsenic, lime sulfur, and finely divided sulfur have been used and markedly reduce the number of mites. Because the mites are slow to build up, dipping every second year will mask the signs of infestation. However, arsenic is no longer used in most countries. Finely divided rotenone by itself or mixed with the synergist piperonyl butoxide reduces the mite population. It is usually combined with an organophosphate to include lice and ked control in the one product. Phoxim, an organophosphorous compound, has good activity, but two dippings 1 month apart are necessary to eradicate infestations. Amitraz causes a marked reduction in mites that will be maintained for some months.

A single subcutaneous injection of 0.2 mg/kg ivermectin freed sheep of mites for up to 56 days posttreatment. However, these sheep would have to be examined over a longer period to ensure eradication. Other macrocyclic lactone products, in various formulations, have been shown to have good efficacy. The absence of reports of itchmites over the last 15 years would suggest that the widespread use of macrocyclic lactone products has decreased the prevalence of infection.

### DEMODECTIC MANGE (FOLLICULAR MANGE)

Mites of *Demodex* spp. infest hair follicles of all species of domestic animals. The disease causes little concern, but in cattle and goats there may be significant damage to the hide,

and, rarely, death may result from a secondary bacterial invasion.

### ETIOLOGY

Mites infesting the different host species are considered to be specific and are designated as *Demodex bovis* for cattle, *Demodex ovis* for sheep, *Demodex caprae* for goats, *Demodex equi* for horses, and *Demodex phylloides* for pigs.

Demodicosis may occur in farm animals of any age, especially those in poor condition, but most cases in cattle occur in adult dairy cattle in late winter and early spring. This differs from the well-known condition in the dog, which occurs in young, immunodeficient animals.

### LIFE CYCLE AND EPIDEMIOLOGY

The entire life cycle is spent on the host. Adult mites invade the hair follicles and sebaceous glands, which become distended with mites and inflammatory material. The life cycle passes through the egg, larval, and two nymphal stages. The disease spreads slowly, and transfer of mites is thought to take place by contact, probably early in life. Calves can acquire mites from an infected dam in half a day. However, in horses, grooming instruments and rugs may transmit infection.

### PATHOGENESIS

Invasion of hair follicles and sebaceous glands leads to chronic inflammation, loss of the hair fiber, and, in many instances, the development of secondary staphylococcal pustules or small abscesses. It is these foci of infection that cause the small pinholes in the hide that interfere with its industrial processing and limit its use. In most farm animals, the lesions are difficult to see externally, and only the advanced ones will be diagnosed.

### CLINICAL FINDINGS

The important sign is the appearance of small (3-mm-diameter) nodules and pustules, which may develop into larger abscesses, especially in pigs and goats. The small lesions can be seen quite readily in short-coated animals and on palpation feel like particles of bird-shot in the hide. In severe cases there may be a general hair loss and thickening of the skin in the area, but usually there is no pruritus, and hair loss is insufficient to attract attention. The contents of the pustules are usually white in color and cheesy in consistency. In large abscesses the pus is more fluid. In cattle and goats the lesions occur most commonly on the brisket, lower neck, forearm, and shoulder, but also occur on the dorsal half of the body, particularly behind the withers. Larger lesions are easily visible, but very small lesions may only be detected by rolling a fold of skin through the fingers. In horses the face and around the eyes are predilection areas. Demodicosis in pigs usually commences on the face and

spreads down the ventral surface of the neck and chest to the belly. There is little irritation, and the disease is observed mainly when the skin is scraped at slaughter. The disease may be especially severe in goats, spreading extensively before it is suspected and in some instances causing death. Severe cases in goats commonly involve several skin diseases, such as mycotic dermatitis, ringworm, besnoitiosis, and myiasis. Demodicosis is rare in sheep. In this species pustules and scabs appear on the coronets, nose, and tips of the ears, and around the eyes, but clinical signs are not usually seen, and mites may be found in scrapings from areas of the body not showing lesions.

### CLINICAL PATHOLOGY

The characteristically elongated mites are usually easy to find in large numbers in the waxy material that can be expressed from the pustular lesions. They are much more difficult to isolate from squamous lesions. Lesions in hides can be detected as dark spots when a fresh hide is viewed against a strong light source. However, lesions may not be readily seen until the hair has been removed and the skin has been soaking for some time.

### DIFFERENTIAL DIAGNOSIS

- The commonest error is to diagnose the disease as a nonspecific staphylococcal infection.
- In cattle and goats the disease often passes unnoticed unless the nodules are palpated.
- Deep-seated ringworm in horses has much in common with demodicosis.
- A satisfactory diagnosis can only be made by demonstration of the mite.

### TREATMENT AND CONTROL

Repeated dipping or spraying with the acaricides recommended for other manges is usually carried out but is more to prevent spread than to cure existing lesions. Ivermectin, which does not eradicate the infection in dogs, possibly because of the difficulty in getting the acaricide to the mite, has been reported to cure 98% of beef bulls when used at 0.3 mg/kg. Recent developments in the development of diagnostics may allow newer techniques that will effectively detect infestations.<sup>1</sup>

### REFERENCE

1. Wells B, et al. *Mol Cell Probes*. 2012;26:47-53.

### SARCOPTIC MANGE (BARN ITCH)

Sarcoptic mange occurs in a wide variety of host species and causes a severe pruritic dermatitis. Although in most countries it has been a major problem and was a reportable



disease, the advent of macrocyclic lactone endectocides has reduced the incidence of disease dramatically.

### ETIOLOGY

The causative mite, *Sarcoptes scabiei*, is usually considered to have a number of varieties, each generally specific to a particular host species. Morphologic, immunologic, and molecular research confirms the close relationship among the varieties, but it does not explain the biological differences, particularly with respect to host specificity. Because host specificity is not strict and transference from one host species to another can occur, there is some concern when attempting to control the disease.

Animals in poor condition appear to be most susceptible, but conditions, especially overcrowding, in which sarcoptic mange occurs often go hand in hand with poor feeding and general poor husbandry. The disease is most active in cold, wet weather and spreads slowly during the summer months.

### LIFE CYCLE AND EPIDEMIOLOGY

Female mites form shallow burrows in the lower stratum corneum of the skin, in which they deposit eggs. Development for both sexes includes a larval stage and two nymphal stages before molting to the adult. All life-cycle stages, except the eggs, can be found moving on the skin surface and are thus easily transferred to other hosts. The normal exfoliation of the skin eventually exposes the tunnels, exposing eggs as well. The life cycle, from egg to adult, takes 10 to 13 days.

Although direct contact between hosts is the most effective method of transmission, inert materials such as bedding, blankets, grooming tools, and clothing may act as carriers. Adult mites do not usually survive for more than a few days away from the host, but in optimum laboratory conditions they may remain alive for up to 3 weeks. In pigs, adult sows are often the source of infestation for young pigs even though they show no signs of the disease. Large numbers of mites can often be found in the ears of normal sows, and the mites are transmitted soon after farrowing. Significant scratching does not occur until a hypersensitivity develops some 8 to 10 weeks later and may continue until slaughter. A small proportion of young pigs do not develop a hypersensitivity, and these become chronically affected.

Among domestic species, pigs are most commonly affected, but it is an important disease in cattle and camels and occurs in sheep. It has been a notifiable disease in most countries, because of its severity, but a decline in prevalence accompanying the advent of new therapeutics has resulted in the removal of this requirement in some countries. People handling infested animals may become infected, but lesions will disappear if further contact is prevented.

Infested animals develop protective immunity and are able to clear challenge infestations rapidly. A proportion of infested hosts do, however, remain chronically infested, and mite populations may show a postpartum recrudescence, thereby facilitating transfer to the susceptible offspring.

### PATHOGENESIS

Young animals, in particular piglets, become infected in the first few weeks of life and develop a hypersensitivity within 8 to 10 weeks. This allergic phase lasts for 8 to 9 months, and during this time affected animals are constantly itchy. The disease, if untreated, progresses to a localized crust formation characteristic of a chronic hyperkeratotic state.

Many infestations in pigs have little or no effect on weight gain, although there is some controversy, and treatments improve productivity (see following discussion). There are suggestions in other hosts of reduced feed efficiency. In some pigs, the loss of condition, production, and vitality may be severe, and the appearance of affected animals is esthetically displeasing. Erythema, papules, and intense pruritus may be seen. Few mites may be necessary to cause a reaction in a previously sensitized animal. A chronic condition is uncommon but is seen in pigs with an immunodeficiency.

In cattle and camels, severe hypersensitivity lesions occur and often lead to death. Sheep initially show an intense pruritus and rub the affected part against fences or bite at the skin. Later papules and vesicles occur and the skin becomes thickened, covered with pale scabs, and the hair is lost.

### CLINICAL FINDINGS

Early lesions are characterized by the presence of small red papules and general erythema of the skin. The affected area is intensely itchy and frequently excoriated by scratching and biting. Loss of hair, thick brown scabs overlying a raw surface, and thickening and wrinkling of surrounding skin soon follow. In pigs the lesions commence on the trunk; in sheep and goats on the face; in cattle on the inner surface of the thighs, the underside of the neck and brisket, and around the root of the tail; and in horses and camels on the head and neck. Except in sheep, where the lesions do not spread to the woolled skin, lesions become widespread if neglected, and such animals may show systemic effects, including emaciation, anorexia, and weakness. In neglected cases, death may occur.

The course of sarcoptic mange is rather more acute than in the other forms of mange and may involve the entire body surface of cattle in a period as short as 6 weeks.

### CLINICAL PATHOLOGY

Necropsy examinations are not usually undertaken. Deep scrapings that draw blood

are required for accurate diagnosis and must be taken from the edges of any evident lesions (scrapings taken from the central portions of lesions are very often negative). Examination of scrapings either directly or after digestion in 10% potassium hydroxide will reveal mites and/or eggs. When practical, multiple scrapings from affected animals should be taken. Examination of the ear wax of pigs often shows mites when none can be seen in scrapings.

Change in behavior, a result of the intense pruritus, have been used in swine as an initial diagnostic tool. An increase in the rubbing index is indicative of infestation, but other clinical confirmation is required.

An ELISA for detection of antibodies to *Sarcoptes scabiei* has been developed. The test has high specificity and moderate sensitivity, being more sensitive in young animals undergoing their first infestation. It has been shown to work well in herd-level eradication programs and functions afterward as an effective surveillance tool.

Recent description of the genome of a canine variety has elucidated several aspects of the host response and biology of the mite.<sup>1</sup>

### DIFFERENTIAL DIAGNOSIS

- Sarcoptic mange is the only mange that occurs in pigs. It can be confused with infestation with *Tyroglyphus* spp. mites or lice, or with swinepox, parakeratosis, infectious dermatitis, pityriasis rosea, and ringworm. In most of these diseases there are clinical features that are characteristic, and final diagnosis can be made on the presence or absence of the mite.
- The same comments apply to the differentiation in cattle of sarcoptic mange from chorioptic and psoroptic mange and from chlorinated naphthalene poisoning and ringworm.
- Horses may be affected by psoroptic or chorioptic mange, but the lesions are most common at the base of the mane and tail and at the back of the pastern, respectively.
- Infestation with the trombidiform mites and photosensitization may resemble sarcoptic mange.
- The disease is uncommon in sheep.

### TREATMENT AND CONTROL

Macrocyclic lactone endectocides (including ivermectin, eprinomectin, moxidectin, and doramectin) are the preferred products for treatment of sarcoptic mange. Use of these products in pour-on or injectable formulations is highly efficacious when used at the label-recommended dose. Because of the residual activity of these compounds, retreatment is not usually necessary, although moxidectin given subcutaneously at 0.2 mg/kg to infested sheep resulted in a rapid clinical improvement but did not eliminate the mites. Two doses 10 days apart resulted in negative skin scrapings by 14 days

posttreatment. A single injection to cattle eliminated the mites by day 14. The resolution of the lesions may take considerable time, but should not be misconstrued as product failure.

Prefarrowing treatment of sows with ivermectin to prevent transmission to the newborn piglets improves weight gain and early feed conversion.

If other treatments are used, they must be thoroughly applied so that all parts of the skin, especially under the tail, in the ears, and between the legs, are wetted by the acaricide. Although buildings, bedding, and other inert materials do not support the mite for more than a few days, they should also be treated unless they can be left in a dry state for 3 weeks.

## RECOMMENDATION

Always treat affected animals. To control spread, animals should be isolated or quarantined.

## REFERENCE

- Rider SD, et al. *Parasites Vectors*. 2015;8:585.

## PSOROPTIC MANGE (SHEEP SCAB, BODY MANGE, EAR MANGE)

Psoroptic mange is of greatest importance in sheep, in which it causes sheep scab, but it is also responsible for body mange in cattle and horses and ear mange in horses, sheep, goats, and rabbits. The disease is a major animal welfare concern.

## ETIOLOGY

The various species of *Psoroptes* have now been reduced to two or three species. Based on molecular evidence, *Psoroptes ovis*, *Psoroptes cuniculi* and *Psoroptes cervinus* are identical despite differences in morphology and biology. It is clear that *P. ovis* from cattle and sheep are identical, although cross-transmission is not always successful. *P. equi* occurs on horses, donkeys, and mules in Great Britain and *P. natalensis* on cattle and the water buffalo. The ear mites are all *P. cuniculi*, and recent work has suggested this is a variant of *P. ovis* adapted to the aural environment. *P. cervinus* assumes a dual role, being an ear mite of the American bighorn and a body mite of the wapiti.

## LIFE CYCLE AND EPIDEMIOLOGY

Psoroptic mange is a major disease in sheep that was once virtually eliminated in most progressive countries where wool production is an important industry. With the cessation of organophosphate dips in the United Kingdom there has been a resurgence of the problem. The disease in cattle was widespread in the United States but has now largely been brought under control. It can spread rapidly and cause serious losses in cattle if neglected, as shown by the serious

losses that can occur in feedlots. The ear manges cause irritation and, in horses, a touchiness around the head.

Psoroptic mites abrade the surface and feed on lipid exudate, bacteria, and skin debris. Erythrocytes are not normally a constituent of the diet and may be accidentally ingested when host scratching results in skin breakage. They cause the formation of scabs, under which they live. The eggs are laid on the skin at the edge of a scab and hatch in 1 to 3 days, although this is prolonged if eggs are not in contact with the skin. There are the usual larval and nymphal stages, and the whole life cycle is complete in 10 to 11 days. All stages are capable of survival away from the host for up to 10 days, and under optimum conditions adult females may survive for 3 weeks.

Optimum conditions for development include high humidity and cool temperatures. Thus the disease is most active in autumn and winter months. This is a result of not only the increased activity of the mites but also the more rapid development in housed animals and the tendency for the disease to be most severe in animals in poor condition. When conditions are adverse, as in summer, mites survive in sheep in protected parts in the perineum, in the inguinal and interdigital regions, in the infraorbital fossae, and inside the ear and the scrotum. Spread occurs from sheep to sheep, but transmission from infected premises and by passive spread of pieces of wool also occurs.

The life cycle of the other species is thought to be similar. Spread of ear mite in horses can occur by grooming or by the use of infected harness.

## PATHOGENESIS

The mite migrates to all parts of the skin and prefers areas covered with hair or wool. Salivary secretions and mite excreta contain proteinases that result in a severe allergic pruritus. The exudation of serum accumulates to form a crust. In cattle the mites are most active at the edge of the crust, and the lesion spreads peripherally. Infested calves have lower weight gains, lower feed conversion, and lower energy retention than non-infested calves. In sheep the mites are more generally distributed, and bacterial invasions of the skin are more common.

## CLINICAL FINDINGS

### Sheep

Cutaneous lesions may occur on any part of the body, but characteristically in badly affected sheep they are most obvious on the sides.<sup>1</sup> Very early lesions are small (6-mm-diameter) papules that ooze serum. Attention may be attracted to the area by raggedness of the wool caused by biting and scratching. In older lesions thin yellow crusts are present, and the wool commences to shed. The wool may contain large masses of scab material that binds the fibers together

in a mat. Under suitable conditions the infestation spreads rapidly, and in 6 to 8 weeks three-quarters of the body may be affected.

In a typical outbreak of sheep scab many animals are affected and show itchiness and shedding of the fleece. Some become markedly emaciated and weak, and deaths may occur. However, it is possible to have the disease in a flock at a very low level of incidence and with minimal lesions. This usually occurs when the sheep are highly resistant because of good nutrition, climatic conditions are adverse for mite development, or treatment has been carried out but has been incomplete. In such cases there may be little or no clinical evidence of the disease, and a careful search for latent cases may be necessary. This is facilitated by packing the animals into a confined space, so that the mites become active, and watching for signs of itchiness.

Behavioral changes in infested sheep are dramatic, with sheep biting at the affected areas and rubbing or scratching. In addition, infested sheep exhibit stereotypic behaviors typical of animals under stress. These changes combine to reduce productivity. Animals exhibiting these changes should be carefully examined by palpating the surface of the skin in search of papules and scabs. Special attention should be paid to the ears, the base of the horns, the infraorbital fossa, and the perineal and scrotal areas in rams.

### Goats

Lesions can vary from a dry crusty scab on the external ear canal with no clinical signs to severe lesions covering much of the body and causing death. However, it is commonly an ear mite, feeding on whole blood and causing the production of scabs that vary from a single layer lining the large sulcus at the base of the concha to abundant laminated scab formation occluding the meatus. In severe cases the poll may be affected, and scabs may also be found on the pasterns. Female goats serve as the source of infection for the kid; mites may be found by 5 days, and clinical signs are seen by the 3rd week of life. *Railletia* may also be found in the ear of goats, but *Railletia caprae* is easily differentiated microscopically because all legs are on the anterior part of the body.

### Horses

*P. equi* causes the production of large, thick crusts on those parts of the body carrying long hair, such as the base of the mane and the root of the tail, and hairless areas such as the udder, prepuce, and axilla. Affected parts are itchy, the hair is lost, and with constant rubbing the surrounding skin becomes thickened. *P. cuniculi* infestations in horses cause severe irritation in the ear accompanied by discharge, shaking of the head, rubbing of the head, and tenderness of the poll.

## Cattle

Typical lesions appear first on the withers, neck, and around the root of the tail. In severe cases they may spread to the rest of the body. The lesions are intensely itchy. They commence as papules but soon are covered with a scab, which enlarges peripherally and coalesces with other lesions so that very large areas of skin may become involved. The hair is lost and the skin becomes thickened, wrinkled, and covered with scabs. Badly affected animals become weak and emaciated and may die.

## CLINICAL PATHOLOGY

The mites can be easily demonstrated in scrapings taken from the edges of the lesions. Examination is facilitated by prior digestion of the scraping in warm 10% potassium hydroxide solution.

An ELISA has been developed for diagnosis of *Psoroptes* infestation in sheep.<sup>2</sup> It has been applied to monitoring of infestations as part of efficient control programs.

### DIFFERENTIAL DIAGNOSIS

- Severe cases of psoroptic mange in sheep are similar to mycotic dermatitis except that there is no itching in the latter. Diseases causing itchiness, such as scrapie, ked, and louse infestations and infestations with *Psorergates ovis* and harvest mites, do not have typical cutaneous lesions, and the latter group can usually be detected by examination for the causative parasites.
- In horses, attention is drawn to the condition because of the horse rubbing its head, by swelling around the base of the ear, or by resentment to the bridle passing over the ears. In some horses, the affected ear may droop.

## TREATMENT AND CONTROL

Macrocytic lactone endectocides are used most frequently for control of psoroptic scabies. Cattle treated with ivermectin must be separated from noninfested cattle for between 9 and 14 days; otherwise, spread and reinfection may occur. In sheep two treatments of ivermectin 0.2 mg/kg subcutaneously are necessary to eliminate infestations.

Moxidectin applied as a 0.5% pour-on at 0.5 mg/kg to cattle is effective against *P. ovis* lice, and *Chorioptes bovis*, and it was equally effective against *P. ovis* as 0.2 mg/kg by subcutaneous injection. In sheep, although a single subcutaneous dose of 0.2 mg/kg moxidectin gave a rapid clinical improvement, two doses 7 days apart were necessary to eliminate mites. In large-scale field use, sheep receiving a single injection in the autumn remained free of the infestation throughout the winter, and two injections 10 days apart were effective in treating outbreaks.

Doramectin injectable at 0.2 mg/kg SC was highly effective in eliminating mites in

scrapings of infested cattle. The same treatment was found to protect cattle from infestation for up to 3 weeks.

If sheep are to be dipped, it is important to wet the skin thoroughly and pay special attention to severe cases where mites are likely to be present in inaccessible sites on the body. Thus a plunge dip is almost essential, and the sheep must be kept immersed in the dipping fluid for at least 1 minute. Prior shearing may be advisable but may lead to further spread of the infestation. Care must be taken to ensure that the concentration of the acaricide in the dip is maintained, especially when large numbers of sheep are being treated. Badly affected animals should be set aside, and inaccessible sites, including ears, horn bases, and perineum, should be treated manually with the dipping fluid. Dipped sheep should not be returned to their pastures or to the barn unless the latter has been thoroughly cleaned and sprayed with the dipping fluid.

The synthetic pyrethroids are variable in their efficacy. Flumethrin, used as a non-stripping dipping compound, eradicated *P. ovis* from sheep when used at 55 ppm and gave at least 7 weeks of protection.

In horses, affected ears should be cleaned of all wax, and ear preparations containing benzene hexachloride should be used at weekly intervals. Benzyl benzoate is a safe and effective treatment when given every 5 days for three treatments. Ivermectin is highly effective against *P. equi*.

Eradication of sheep scab on an area basis is usually undertaken by quarantine and compulsory treatment of all susceptible animals in the area at the same time. Now that there are effective treatments that do not require dipping, eradication of scab from areas should be more easily accomplished. The necessity to dip all animals in the area during a short period presents difficulties, and the cost of construction of dips and lack of desire to dip in cold climates are other obstructing factors. The use of pour-ons or injections is an attractive alternative to autumn dipping and has the added advantage of providing helminth control in late-season lambs and in ewes.<sup>3</sup> Further, even pregnant animals can be yarded and treated by subcutaneous injection or pour-on as long as care is taken in the yards. Where it is desired to keep the disease at a low level short of eradication, the disease is made notifiable, movement of stock is restricted, and infested farms are quarantined.

## RECOMMENDATION

Treatment is absolutely necessary to keep this from becoming an animal welfare issue.

## REFERENCES

1. Nunn FG, et al. *Mol Cell Probes*. 2011;25:212-218.
2. Losson BJ. *Vet Parasit*. 2012;189:24-43.
3. Wells B, et al. *Mol Cell Probes*. 2012;26:47-53.

## CHORIOPTIC MANGE (TAIL MANGE, LEG MANGE, SCROTAL MANGE)

Chorioptic mange is the commonest form of mange in cattle and horses. Although the primary effect on cattle is esthetic damage, there are production effects in dairy animals. In horses, leg mange is a source of annoyance and inefficiency at work. In sheep, it affects the scrotum and may cause a decrease in fertility.

## ETIOLOGY

Chorioptic mites were formerly named according to the host species, but those on cattle, horses, goats, and sheep are now considered to be one species, *Chorioptes bovis*. Another species, *Chorioptes texanus*, has been reported on goats, cattle, and Canadian reindeer.<sup>1</sup> In cattle, the mites are much more active in the latter part of the winter and tend to disappear in cattle at pasture. This diminution in activity is not noted in cattle kept housed in the summer.

## LIFE CYCLE AND EPIDEMIOLOGY

*C. bovis* feed on the skin surface, abrading the upper layers with their mouthparts and contaminating the area with salivary secretions and excreta. Developmental stages are similar to that of *Psoroptes*, and a complete cycle, from egg to adult, requires approximately 3 weeks. The number of parasites is influenced by temperature and humidity, with the mite populations beginning to increase on sheep in early autumn and numbers reaching a peak in late autumn or early winter and declining in spring. In cattle the cycle is longer, with peak numbers occurring in late winter and early spring and declining in summer. Transmission is probably effected by direct contact in most instances, although in animals housed in barns, grooming tools may be an additional method of spreading the disease. Infestation of bedding is not a common method of transmission.

In horses, the parasites occur almost entirely in the long hair on the lower parts of the legs and are rarely found on other parts of the body. In cattle the disease is most evident in the winter, with lesions occurring most commonly on the perineum and back of the udder, extending in severe cases to the backs of the legs and over the rump. In the summer months, the mites persist in the area above the hooves, particularly the pasterns of the hind leg. In sheep, lesions are confined to the wool-less areas, chiefly the lower parts of the hindlegs and scrotum. Rams are more heavily infested than ewes and probably infect ewes while copulating. Lactating ewes probably act as the source of infection for lambs.

## PATHOGENESIS

The mites cause an allergic exudative dermatitis; the yellowish serous exudate coagulates



and breaks as the hair grows so that small scabby lesions are seen on the hair. In horses the mites cause severe irritation and itchiness. The initial lesion in cattle is a small nodule that exudes serum, causing matting of the hair. In severe cases these coalesce to form heavy scabs and cause thickening and wrinkling of the skin. Mites can be isolated from many animals that show no clinical evidence of the disease. Although most cases do not cause any symptoms, a rapidly spreading syndrome characterized by coronitis, intense irritation, and a marked fall in milk production has been reported.<sup>2</sup> *C. bovis* is a common parasite of sheep in the United States, New Zealand, and Australia, and causes an allergic exudative dermatitis on the scrotum of rams. This may cause a rise in temperature of the scrotal contents and severe testicular degeneration if the lesion has an area greater than 10 cm<sup>2</sup>.

### CLINICAL FINDINGS

The first sign in horses is usually violent stamping of the feet and rubbing of the back of the hind pasterns on wire, rails, or stumps. This is most evident during periods of rest and at night. Examination of the area is difficult because of the long hair present, and the horses may resent manipulation. In cases of long duration, the skin is seen to be swollen, scabby, cracked, and usually greasy; small amounts of serous exudate may be attached to most hair in the affected area.

Cattle show little evidence of cutaneous irritation, but the small crusty scabs (3 mm in diameter) on the escutcheon, udder, and thighs are unsightly. Although the mites appear to cause little trouble in the summer, occasional animals are seen that have thick, crusty scabs on the skin, just above the coronets and around the muzzle.

The main lesion in sheep is seen on the scrotum of rams, where an allergic dermatitis results in the production of a yellowish serous exudate over areas from a few millimeters to several centimeters.

### CLINICAL PATHOLOGY

Scrapings from the affected areas usually contain large numbers of mites.

### DIFFERENTIAL DIAGNOSIS

Greasy heel in horses resembles chorioptic mange except that pain is more evident in the former and itchiness in the latter. It has been suggested that the two diseases are etiologically related.

The lesions in cattle may go unnoticed but are not likely to be mistaken for those of any other disease, with the possible exception of other manges. The presence of chorioptic mites in footrot and mucosal disease lesions may be purely coincidental, but cases of chorioptic mange that have lesions around the coronet and muzzle may

be mistaken for one of the erosive diseases.

Sheep with itchy, scabby legs may be infested with other forms of mange or have contagious ecthyma or strawberry footrot.

### TREATMENT AND CONTROL

The macrocyclic lactone endectocides have shown efficacy against *Chorioptes* spp., but eradication of the parasites from a herd is difficult. Moxidectin 0.5 mg/kg applied as a pour-on eliminated *C. bovis* as well as sucking lice and *P. ovis*. When given as a single injection of 0.2 mg/kg, there was a marked decline in the number of mites, but few cattle were cleared of infection. Doramectin has high efficacy at the label rate in cattle, but a single treatment did not clear mites from all of the trial animals. Treatment with eprinomectin at recommended rates was completely effective, but mites persisted for at least 14 days.

Amitraz 0.05% removed 98% and phoxim 0.05% and 0.1% used twice at 10-day intervals has also eradicated the infection from cattle. Other compounds if used repeatedly will reduce mite numbers, but recrudescence may occur. Ivermectin 0.2 mg/kg given subcutaneously on two occasions reduced but did not eliminate the infestation on cattle. A single treatment of infested horses with ivermectin paste also did not remove all mites, but when combined with hair removal, washing encrusted areas with oil of salicylic acid, and the later removal of crusts with a stiff brush, eradication was achieved.

### REFERENCES

1. Lusat J, et al. *Med Vet Entomol.* 2011;25:370.
2. Villarreal A, Halliburton MK. *Vet J.* 2013;197:233-237.

## Ked and Louse Infestations

Ked and louse infestations cause irritation resulting in skin or wool damage. Blood loss may occur with some species.

### SHEEP KED (*MELOPHAGUS OVINUS*)

Keds are flat, brown, wingless flies, about 6 to 7 mm in length, found on sheep throughout the world. Keds are now rarely reported in many countries because of good management and control. For example, it wasn't mentioned in a review of livestock ectoparasites of Europe and the Mediterranean,<sup>1</sup> although anecdotal evidence suggests it may be present in isolated pockets associated with organic production.<sup>2</sup> The ked can transmit *Trypanosoma melophagium* and *Rickettsia melophagi*, harmless blood parasites of sheep. Recent studies suggest that it may have more

importance than otherwise indicated.<sup>3</sup> Staining of the wool by the feces of the ked reduces its value and gives it a peculiar musty odor. Heavy infestations cause skin blemishes, which are costly to the leather industry. Sheep in poor condition suffer most from infestations. Goats may also be infested.

### LIFE CYCLE

Keds live their entire life cycle on the host. Adults of both sexes are blood feeders, and although the degrees of infestation usually encountered cause only irritation with resulting scratching, biting, and damage to the fleece, very heavy infestations may cause severe anemia. Spread is generally the result of direct contact between hosts. A recent review<sup>2</sup> suggests that this exchange is primarily between dams and their offspring and that it is predominantly the newly emerged adults that migrate to new hosts. Larvae develop within the female one at a time and are deposited on the host as mature third instars that pupate within a few hours. The female ked lives for 4 to 5 months and may lay up to 10 to 15 larvae, so buildup of infection is slow. The larvae are attached to the wool fiber some distance above, the skin and many larvae and pupae are removed at shearing. The young ked usually emerges in 20 to 22 days, but this period may be prolonged for up to 35 days in winter. The complete life cycle takes 5 to 6 weeks under optimal conditions. Heavy infestations usually occur in winter months, and they decline in the summer. The parasite is mainly seen in colder, wetter areas, and infestations may disappear when sheep are moved to hot, dry districts. Resistance is acquired in time, and resistant sheep grow better and produce more wool.

A seasonal pattern of infestation occurs. Keds are sensitive to hot, dry weather and numbers decrease markedly over the summer. Populations increase slowly over the autumn and winter. Although keds that have been dislodged from the host can live for up to 2 weeks if in mild moist conditions, most die in 3 to 4 days and probably do not play a part in reinfesting sheep.

Keds have recently been implicated in the transmission of *Anaplasma ovis* from infected sheep.<sup>3</sup> This potentially zoonotic disease can infect people, with important implications.

### CONTROL

At shearing a large proportion of adults and pupae will be removed. This can provide effective control on adult sheep, particularly where a combination of hot conditions and a short fleece will kill most of the remaining keds. However, some may remain alive in protected places such as the ventral neck and breech regions and on younger stock. If treatment is carried out within the next 2 to 4 weeks, eradication will be achieved as long as all sheep are included and the insecticide

used has a residual protection longer than the time taken for the last pupae to hatch.

Ivermectin and its analogs given at the standard anthelmintic dose will act to eliminate the ked populations. Closantel is also effective against keds.

## REFERENCES

1. Wall R. *Vet Parasitol.* 2007;148:62-74.
2. Small RW. *Vet Parasitol.* 2005;130:141.
3. Hornock S, et al. *Vector Borne Zoonotic Dis.* 2011;11:1319-1321.

## LOUSE INFESTATIONS (PEDICULOSIS)

Louse infestations are common throughout the world. The species are host specific and are divided into biting and sucking lice.

### SYNOPSIS

**Etiology** Species-specific sucking and chewing lice affecting all animals.

**Epidemiology** Transmission from host to host. Lice show a marked seasonal periodicity, rising from low numbers after summer to a peak in the following late spring. Foot lice infested from pasture.

**Clinical signs** Irritation that causes rubbing, damage to the fleece or skin, and loss of milk production. Some species cause anemia. Foot lice cause stamping.

**Clinical pathology** Hair loss may result from hypersensitivity.

**Lesions** Skin lesions as a result of rubbing; fleeces have tufts protruding and lose their brightness.

**Diagnostic confirmation** Lice can be seen on careful inspection. Preferred site varies with host and species of louse.

**Differential diagnosis** In sheep, must be differentiated from *Psorergates*, ked, and *Psoroptes* infections. In other animals, separate from allergic dermatitis.

**Treatment** Macrocytic lactones and synthetic pyrethroids (where available).

**Control** Pour-on and injectable treatments control lice on cattle, horses, sheep, and pigs. Good husbandry practices will reduce infestations. Plunge or shower dips used on sheep; all sheep should be treated, and sheep must be thoroughly wetted. Treatment should follow shearing, which removes many lice; sheep in short wool are also easier to wet.

## ETIOLOGY

The important species are as follows:

- Cattle:
  - Sucking lice—*Linognathus vituli* (long-nosed sucking louse), *Solenopotes capillatus* (small blue sucking louse), *Haematopinus eurysternus* (short-nosed sucking louse), *Haematopinus quadripertusus*

(tail louse), *Haematopinus tuberculatus* (buffalo louse)

Chewing lice—*Damalinea* (= *Bovicola*) *bovis*

- Sheep:
  - Sucking lice—*Linognathus ovillus* (sucking face louse), *Linognathus africanus*, *Linognathus stenopsis* (goat sucking louse), *Linognathus pedalis* (sucking foot louse)
  - Chewing lice—*Damalinea ovis*
- Goats:
  - Sucking lice—*L.* (blue louse), *L. africanus*
  - Chewing lice—*Damalinea caprae*, *Damalinea limbata*, *Damalinea crassiceps*
- Pigs:
  - Sucking lice—*Haematopinus suis*
- Horses:
  - Sucking lice—*Haematopinus asini*
  - Chewing lice—*Damalinea equi*
- Donkeys:
  - Chewing lice—*Werneckiella* (= *Bovicola*) *ocellatus*

## LIFE CYCLE AND EPIDEMIOLOGY

### Sucking Lice

All life-cycle stages of sucking lice are found on the host. Both sexes are obligate blood feeders, taking small meals from capillaries in the upper skin.<sup>1</sup> Survival off the host is limited, although some species, such as the foot lice of sheep, may survive away from the host for up to 2 weeks. Females lay 2 to 6 eggs per day, which are attached to individual hair shafts. Eggs complete embryo development and hatch within 5 to 11 days of deposition. Lice have three nymphal stages, which bear a morphologic similarity to the sexually mature adult stage. Each nymphal stage will take 2 to 4 days to complete. Louse development rate, at all stages, is highly temperature dependent and requires a narrow temperature range. Temperatures above 41°C (106°F) and 46°C (115°F) are lethal for eggs and adults, respectively, of *L. vituli*.<sup>2</sup> Optimal development takes place between 33°C and 37°C (91°F and 99°F). Lice therefore show a seasonal periodicity, with very low numbers in the summer when conditions are hot. Populations begin to increase with cooler fall temperatures, reaching maximum levels in late winter.<sup>3</sup>

### Chewing Lice

All life-cycle stages of chewing lice are found on the host. Lice feed on dead skin cells, hair, and oil secretions, which they abrade from the surface using their chewing mouthparts. There may be some abrasion of the upper skin layers, and there has been demonstration that sheep develop antibodies to salivary sections of *Damalinea* (= *Bovicola*) *bovis*. Sex ratios are highly female biased, and there are suggestions that parthenogenesis occurs in some species. Females deposit less than 1 egg per day. Embryo development is completed

in 7 to 10 days, producing nymphs that molt three times before reaching sexual maturity. As with the sucking lice, there is a strong temperature/development relationship that is highly regulated, with a narrow range for optimal development and survival. Chewing lice can survive off the host for up to 2 weeks.

Transmission of both types of lice occurs by direct contact, but inert objects such as blankets, grooming tools, and harnesses may remain infective for several days. Sheep may become infested with foot lice from the pasture. Young pigs may become infected some 10 hours after birth. Newborn calves rapidly acquire infestations from their dams.

## CLINICAL FINDINGS AND DIAGNOSIS

### Sucking Lice

All species cause irritation of the skin and stimulate scratching, rubbing, and licking, leading to restlessness, damage to hair coat or fleece and hides, and loss of milk production. These behavioral changes result in reduced efficiency, particularly in feedlot cattle.

Lice appear to be present on a large proportion of cattle, but measurement of their impact on productivity has produced equivocal results. It is often thought that infestation has little or no effect on weight gain and hematological values. However, there appears to be a synergistic effect between louse infestations and the presence of gastrointestinal nematodes that does have an influence on weight gain. Anemia is rare but has been described for heavy infestations of *L. vituli* and *H. eurysternus*. Treatment, however, may be warranted to reduce the damage to hides and prevent damage to fences and other fixtures. Hairballs may occasionally occur in calves as a result of continual licking. Cattle and pig lice have been reported as vectors of several rickettsial diseases, but this remains to be verified.<sup>4</sup>

The pig louse spreads swinepox, and although weight loss may not occur, even with heavy burdens, some pigs develop an allergic dermatitis, and the consequent rubbing leads to skin lesions.

Foot lice of sheep are thought to live on blood. Light infestations may not cause clinical signs, but moderate to severe infestations cause stamping and biting of the affected parts. Lice cause goats to rub or to bite their coats, which become matted and damaged. Angora goats can damage the hair shaft and lose their coats. Signs of infestation are restlessness, hair loss, and decreased milk production. In horses, *H. asini* is the more serious species because it removes blood and may cause some anemia.

### Chewing Lice

Chewing lice cause irritation and rubbing. In sheep, the wool loses its brightness and may become matted and more yellow. There is evidence that a pelt defect called cockle is

associated with infestation with body lice. The quantity and quality of the fleece is reduced, and losses up to AUS\$3.20 per infested sheep have been measured.

Chewing lice on cattle also cause an increase in rubbing and licking, which contributes to reduction of efficiency and damage to facilities. Hair loss has been attributed to this infestation, but it is a controversial association because many other causes are likely. Lice have been implicated in the transmission of several bacterial pathogens, but this finding requires verification.<sup>5</sup>

Diagnosis of lice on cattle and horses requires close visual inspection, with particular attention being paid to known predilection sites. These include the head, the sides of the neck, the dewlap, the escutcheon, and tail switch. Effective diagnosis requires that hair be parted and skin examined at several locations at each of the predilection sites. Use of a supplementary light source and restraint of the animal are very helpful.

Chewing lice of cattle, sheep, and horses are recognized by their rounded heads and light brown color. These lice are highly mobile and will move away from inspection sites. Their eggs are difficult to see unless on dark-haired cattle or horses. Sucking lice are recognized by their gray or blue-gray color and their pointed heads. They tend to remain fixed to the skin.

Chewing lice may congregate on the dorsal surface and flanks, whereas sucking lice are found on the head and in the long hair of the mane and tail; in heavy winter infestations, however, lice may be found on any part of the body. In sheep with long wool, the greatest numbers of *D. ovis* may be seen on the midside, particularly the shoulders, from where they spread to the back and rump. After shearing, small residual infestations may be found on the ventral neck. Foot lice are usually found in clusters on those parts covered with hair, mainly on the lower limbs, but in heavy infestations they can be found in clusters above the hock, on the scrotum, in the belly wool, and, more rarely, on the face.

### TREATMENT AND CONTROL

Self-grooming and grooming by herdmates effectively regulates louse populations on most hosts, but the effectiveness is limited when hair coat or fleece become too long for the tongue surface to effectively remove lice and eggs. Similarly, shearing is an important factor in reducing body lice populations on sheep. Between 30% and 50% of the population is removed with the fleece, and those remaining are subjected to a more variable microclimate. Populations are at their lowest 30 to 60 days after shearing. Reversing temperature gradients as sheep move in and out of shade, and very wet conditions, will also reduce lice numbers.

Body lice of sheep are relatively easy to eradicate if a clean muster is achieved, the

sheep are thoroughly treated, and reinfestation is avoided. However, in practice, failure to eradicate commonly occurs as a result of the inability to thoroughly wet the fleece because of poor formulation of products or because the lice are resistant to the chemical used. The most difficult problem when attempting to eradicate lice from flocks over a large area is the diagnosis of lice in lightly infested flocks. Methods of detection of louse antibodies in fleece have been developed for use on the farm that give good results. Adoption has been limited, and in many cases the methods have been withdrawn from practice because the delay between testing and results has been too long. Similarly, techniques have been devised to test for lice by digesting the wool and examining the residue for lice, but the delays inherent in such a system often mean that by the time the farmer obtains the results, the optimum time to treat sheep has passed.

Affected sheep can be effectively treated with macrocyclic lactone or chitin synthesis inhibitors. An ivermectin 0.03% jetting fluid was reported to have high efficacy in treating lice in sheep with 3 to 9 months of wool, but failed to eradicate the lice. No treatment is known that can eradicate lice from long-wooled sheep under field conditions. Following treatment of foot lice, sheep should be moved to a paddock that has been free of sheep for a month.

Treatment of goats has not been studied extensively, and the treatments used on sheep and cattle are thought to be effective in goats. Lactating goats should not be treated.

Macrocyclic lactone-based products (ivermectin, moxidectin, doramectin, and eprinomectin) are available as pour-on or injectable formulations for cattle and have shown excellent efficacy against both sucking and chewing lice. Persistence of activity is one of the exceptional benefits of these products.

Essential oil treatments using a variety of products have been evaluated against *W. ocellatus* in donkeys and have been proven an effective alternative to synthetic chemicals.<sup>4</sup>

Sheep lice have been shown to quickly develop insecticide resistance, and strains of *D. ovis* that are resistant to the insecticides are common in the United Kingdom and Australia.<sup>6</sup> Tolerance has been reported in other species as well.<sup>7</sup> Resistance management strategies that use combination treatments are now considered the best approach to management of the problem.

Treatments should be timed to coincide with the beginning of louse population growth (i.e., autumn or early winter). Extremely early treatments often result in spring outbreaks that are caused by very small residual populations on a few animals.<sup>8</sup> Products with persistent activity, in excess of 21 days (e.g., macrocyclic lactones), do not require a second application.

Effective management of lice in a herd requires that new animals be isolated for a period of time sufficient for all lice to be eliminated by treatment. The introduction of one or two infested individuals, such as occurs when strays are allowed into a herd, leads to a slow buildup of infestation. In Australia, modeling approaches have been developed for the treatment of sheep.<sup>9</sup>

### RECOMMENDATION

All animals in a herd should be treated for louse control to prevent the buildup of the louse population to a point that is damaging.

### REFERENCES

1. Colwell DD. *Vet Parasitol.* 2002;104:319-322.
2. Colwell DD. *Vet Parasitol.* 2014;194:144-149.
3. Otter A, et al. *Vet Record.* 2003;153:176-179.
4. Ellse L, Wall RL. *Med Vet Entomol.* 2014;28:233-243.
5. Hornok S, et al. *Vet Parasitol.* 2010;174:355-358.
6. Sands B, et al. *Vet Rec.* 2014;doi:10.1136/vr.102777.
7. Ellse L, et al. *Vet Parasitol.* 2012;188:134-139.
8. James PJ, et al. *An Prod Sci.* 2011;51:753-762.
9. Lucas PG, Horton BJ. *Aust Vet J.* 2014;92:8-14.

## Miscellaneous Skin Diseases Caused by Flies, Midges, and Mosquitoes

Although these insects differ quite markedly, they are dealt with together because they exert similar deleterious effects. Their activity causes stress and induces behavioral changes, and in many cases they are important vectors for a variety of parasites and infectious diseases.

### STABLE FLIES (*STOMOXYS CALCITRANS*)

#### ETIOLOGY

The stable fly, *Stomoxys calcitrans*, has a cosmopolitan distribution. Other species, including *Stomoxys nigra*, occur in South Africa. *S. calcitrans* is a moderate-sized, gray to black fly about the size of a housefly. These are the most economically important species of fly affecting confined livestock in North America.

#### LIFE CYCLE AND EPIDEMIOLOGY

These insects have a typical fly life cycle, with eggs being deposited in high-organic-matter areas with an elevated moisture content, such as spilled feed and the edge of silage pits. The larvae grow in a temperature-dependent manner in the same high-organic-matter area through three larval stages. Pupae form in dry material at the edges of the areas where the larvae develop. Flies rest on fences and structural surfaces in a characteristic head-upward position and can readily be recognized by the prominent, forward-directed, pointed proboscis between short palps.



Stable flies of both sexes are blood feeders, attacking particularly cattle and horses, people, and, to a lesser extent, pigs. Bites are painful and often bleed freely when fresh. The flies are intermittent feeders, spending only short periods on the host; most of their time is spent resting on fences and building sides. Eggs are laid in high-moisture areas of rotting hay or straw, along the edge of silage pits, and on the edges of manure pack of feedlots and compost piles. Mature larvae leave the high-moisture sites to pupate in drier sites nearby. Development times are regulated by temperature, with higher temperatures resulting in more rapid development. A complete life cycle will require 3 to 4 weeks in summer. In temperate climates flies exhibit a distinct seasonality, with peak populations in middle to late summer. Larvae will overwinter in warmer areas of silage piles. The flies are highly mobile, traveling up to 20 km in search of suitable hosts. These flies have now moved onto pasture, where they can affect cattle that are fed from round bales left as a food source.<sup>1</sup>

Feeding activity by the flies results in stress to the animals and reduced efficiency through reductions in feeding time. When large numbers of flies are present, the animals will bunch to reduce biting rates. At high temperatures the bunching may result in cattle overheating.

### PATHOGENESIS

*S. calcitrans* organisms are mechanical vectors for anthrax, infectious equine anemia, bovine virus, diarrhea virus, and surra. They are intermediate hosts for the nematode *Habronema majus*,<sup>3</sup> which is reputed to be a cause of allergic dermatitis in horses in Japan.

### CLINICAL FINDINGS

A localized sensitivity of the forelimbs of cattle may develop and result in the formation of intradermal blisters that coalesce to form bleeding sores. With very heavy infestations some deaths may occur. Populations can be assessed by counting the number of flies on the front legs of cattle. When the average number exceeds 2 per leg, significant losses occur, and population management is required.

### TREATMENT AND CONTROL

Effective management of stable flies requires removal of high-moisture, rotting organic matter from the environment.<sup>2</sup> Edges of silage pits, manure packs, and compost piles should be kept dry, and manure-contaminated bedding should be removed regularly. Insecticide treatments must be applied to all exterior surfaces (e.g., barn sides, fences, and exterior of feed bunks). Spraying of fixtures and walls, particularly sunlit walls where the flies often remain unnoticed, with long-acting compounds reduces infestations for 2 weeks or longer.

Application of insecticides or repellants directly on animals is generally impractical because of the short duration of efficacy. Low frequency of insecticidal application, when necessary, slows the development of insecticide resistance. Permethrin applied as a microencapsulated formulation gave longer protection than an emulsifiable concentrate. Affected horses can be treated locally with an analgesic cream, and if the irritation is severe they can be tranquilized with acetylpromazine.

### RECOMMENDATION

Treatment is absolutely necessary to keep these flies from reaching population levels that are in excess of the economic threshold and from reaching levels where they are an animal welfare issue. Populations are also an issue for humans.

### REFERENCES

1. Taylor DB, Berkebile DR. *Environ Entomol.* 2011;40:184.
2. Kneeland KM, et al. *USDA ARS.* Washington: 2012:173.
3. Amado S, et al. *Exp Parasitol.* 2014;136:35.

## HORSE FLIES, MARCH FLIES OR BREEZE FLIES (*TABANUS* SPP.), AND DEER FLIES (*CHRYSOPS*, *HAEMATOPOTA*, AND *PANGONIA* SPP.)

Horse flies, march flies or breeze flies, and deer flies are large, robust, blood-feeding flies that are widespread in both temperate and tropical regions. Only the females take blood meals, but the bites are savage and cause significant distress to large animals, particularly horses and cattle. These flies can act as mechanical vectors of diseases caused by viruses (equine infectious anemia, bovine leukosis, vesicular stomatitis, hog cholera), bacteria (anthrax, tularemia), and trypanosomes (surra). Eggs are laid on the leaves of plants growing in or near standing water. The larval and pupal stages occur in the water or mud, and the life cycle takes 4 to 5 months to complete. The flies are active in summer and attack animals principally on the legs and ventral abdomen. Duration of activity can be relative short (i.e., 3 to 4 weeks), but stress on the animals can be very high during that time. Fly attacks lead to bunching of animals with the attendant likelihood of overheating and in some cases resulting in animals stampeding through fences. Adult flies are attracted to host volatiles, including components of host urine.<sup>1</sup> Control is difficult unless wet areas can be drained or livestock kept away from those areas where the flies are most active. Repellents have been used and are reasonably effective in horses subject to fly worry. The use of DEET affords protection for only a few days and is costly, but its use in milking cattle gives increased milk yield and butterfat.

Synthetic pyrethroid-impregnated eartags give very little protection against these flies.

### RECOMMENDATION

Control is extremely difficult for both larvae and adults but should be attempted for the purpose of reducing effects of adult flies on animal welfare.

### REFERENCE

1. Mihok S, Mulye H. *Med Vet Entomol.* 2010;24:266-272.

## HYPODERMA SPP. INFESTATION (WARBLE FLIES)

Infestations of cattle with the larvae of *Hypoderma* spp. cause serious damage to hides and carcasses, in addition to production losses. Occasional deaths result from anaphylactic shock or toxemia and damage to the central nervous system or esophagus. Several other flies with very similar life histories affect goats (*Przhevalskiana silenus*) and semidomestic reindeer (*Hypoderma tarandi*) in addition to affecting the well-being of wild ruminants. *Dermatobia hominis* larvae affect all species of ruminants and humans (tropical bot fly) in South America.

### SYNOPSIS

**Etiology** *Hypoderma bovis* and *H. lineatum* in cattle, *H. sinense* in cattle and yaks, *H. diana* in deer, *H. tarandi* in reindeer and caribou, *Przhevalskiana silenus* in goats. Horses are occasionally affected.

**Epidemiology** Eggs attached to hair in spring to late summer, larvae penetrate skin and migrate to esophagus (*H. lineatum* and *H. sinense*) or spine (*H. bovis*), where they stay for 2 to 3 months; they then move to subdermal tissue along the back and after 2 to 3 months emerge from the breathing hole, fall to the ground, pupate, and emerge as adult flies 3 to 5 weeks later. Larvae of *P.* and *H. tarandi* do not undergo migration within deep tissues of their host.

**Clinical signs** Reduced growth and production. Larvae in the back cause obvious swellings; larvae in the spinal cord may cause posterior paralysis. Treatment of larvae while they are in the esophagus may cause serious edema, and edema and paraplegia may occur if animals are treated when larvae are in the spinal canal.

**Clinical pathology** An enzyme-linked immunosorbent assay (ELISA) is available.

**Lesions** Larvae are found in discolored tissue.

**Diagnostic confirmation** Swellings along back characteristic.

**Differential diagnosis** Traumatic injury to the spine; aberrant *S. vulgaris* larvae in the horse.

**Treatment** Macrocytic lactone endectocides.

**Control** Treatments are given so as to avoid treating when larvae are in the esophagus or spinal canal. (Usually treated in autumn and spring, but varies with location.)

## ETIOLOGY

There are two species that specifically parasitize cattle: *Hypoderma bovis* and *H. lineatum*. A third species, *H. sinense*, affects cattle and yaks in central Asia.<sup>1,2</sup> The adult flies are robust and hairy, are about the size of a bee (12 to 18 mm long), are yellow-orange in color, and have two wings. They are not easily seen because of the rapidity of their flight. Repeated infestation results in an acquired immunity that results in older animals being less severely affected than younger animals.

Horses are occasionally infected with *Hypoderma* species of cattle. The larvae are found in subcutaneous cysts on the back, but they have not been reported to complete development. This location causes problems if they are in the saddle region.

Losses to the cattle industry caused by warble fly have not been estimated recently, but in 1965 the loss was estimated to be US\$192 million per annum in the United States, and in 1976 approximately \$100 million. In 1982 the cost of warble fly was estimated as £35 million for Great Britain, but the parasite has now been eradicated from the United Kingdom and Ireland. Advent of the macrocyclic lactone endectocides has greatly reduced the prevalence of the cattle species in North America, but they persist in localized areas.<sup>2</sup>

*Hypoderma tarandi*, *H. acteon*, and *H. diana* infect reindeer/caribou and deer. *H. diana* is found throughout Europe in several deer species but may also occur in sheep. *H. actaeon*, also found throughout Europe, is known only from the red deer. These species do not undergo deep tissue migrations that characterize the life cycle of the cattle species.

*Przhevalskiana silenus* is similar to the previously described species and is a parasite of goats in the Mediterranean basin, parts of eastern Europe, Pakistan, and India. This species also does not have a deep tissue migration, and larvae tend to develop subcutaneously very near the site of initial skin penetration. The losses resulting from this parasite are significant and result from reductions in carcass quality and reduced animal health.

The larvae of *Dermatobia hominis*, a small (12 mm long) related fly, parasitize a wide variety of hosts and cause major economic losses to cattle production in South America. They also affect humans and are a major zoonosis for travelers in the region. Mature larvae are about 2.5 cm long and develop in a subcutaneous cyst that can be quite painful. Female *Dermatobia* oviposit on zoophilous, "porter" flies such as mosquitoes and stable flies, which they catch on the

wing.<sup>2</sup> The eggs are transported to the mammalian host, and they hatch in response to increased temperature as the fly lands. Larvae penetrate the skin, but do not migrate. Treatment and control measures are the same as for *Hypoderma* spp. of cattle.

## LIFE CYCLE AND EPIDEMIOLOGY

Warble flies historically were common parasites of cattle in the northern hemisphere, including North America and Europe, and are common in parts of Asia. The distribution of these parasites has been changing recently with the widespread use of macrocyclic lactone endectocides and the adoption of eradication programs in many European countries. Infestations south of the equator are rare and are the result of imported cattle, although endemic cases have occurred in Chile.

Adult flies are active in the spring to late summer, with *H. lineatum* usually appearing 3 to 4 weeks before *H. bovis*. *H. lineatum* attaches up to 600 eggs, in strings of 5 to 25, to hairs on the legs or lower parts of the body, whereas *H. bovis* attaches eggs, one at a time, to hairs on the rump and upper parts of the hindleg. The oviposition flight of *H. bovis*, darting in to lay each egg, will terrorize cattle. Eggs hatch in 4 to 6 days. The larvae penetrate the skin using protease enzymes and migrate through connective tissues to reach the esophagus (*H. lineatum*) or the epidural fat in the spine (*H. bovis*), where they stay, feeding and growing, for 2 to 4 months. They subsequently continue their migration to reach the subdermal tissue of the back in the early spring. Here they make a breathing hole and become encased in a granulomatous cyst. They complete development in 1 to 2 months, passing through second and third instars, and emerge through the hole, fall to the ground, and pupate. Adult flies emerge some 3 to 5 weeks later. The fully developed larvae are thick and long (25 to 30 mm), light cream in color, but darkening to almost black as mature third instars. A single animal may have up to 300 larvae, each developing with granulomatous cysts, with breathing holes, under the skin of the back.

*Hypoderma tarandi* females deposit eggs on the hair of reindeer or caribou, and larvae hatch in approximately 7 to 10 days. Larvae penetrate the skin close to where the eggs are deposited and do not migrate into deep tissues. Flies are active during arctic summer, and larvae remain in the back until early spring.

*Przhevalskiana silenus* eggs are attached to host hairs, and the larvae hatch after 7 to 8 days. Larvae penetrate the skin in the area where they were deposited, where they remain throughout their development period. Flies are known to be active from May through June in southern Italy and can be found in host tissues from May through the following February.

The timing of the life cycle, that is, the period when grubs are present in the animals and the time at which the flies are present in large numbers, varies with the climate and is of importance in a control program. *H. lineatum* generally is 1 to 2 months ahead of *H. bovis*, and where the two flies are present, both "grub" and "fly" seasons may be very long. In the southern United States the fly season is February and March; in Canada it is June to August. The period when grubs are present in the back is December in the south and February to May in Canada. In Europe the larvae begin to move to the back from January to July.

## PATHOGENESIS

Migrating first instars cause little damage as they use their proteolytic enzymes to migrate through connective tissue. The enzymes, however, have an antiinflammatory effect, partially through cleavage of complement components. Larvae maturing under the skin of the back form holes in the skin, and the reaction of the host encloses each grub within a granulomatous cyst. On rare occasions an anaphylactic reaction may occur in a sensitized animal as the result of death of migrating larvae; chance migration into the brain may also occur. Intracranial myiasis as a result of *H. bovis* has also been recorded in the horse. Treatment of animals when the first instars are in the esophagus may cause a massive inflammatory edema that may prevent feeding and swallowing of saliva; eructation may stop and bloating may occur. Treatment of *H. bovis* while it is in the spinal canal may also cause edema and mild to severe paraplegia.

## CLINICAL FINDINGS

Cattle at pasture may be worried by adult fly attacks that disrupt grazing and breeding behavior, which are exacerbated when fly populations are large. Avoidance behavior, called gadding, may result in injury as cattle run into fences and other natural obstructions. Heavy infestations with larvae are commonly associated with poor growth, poor body condition, and production losses, but such heavy infestations are often complicated by other forms of mismanagement, including malnutrition and parasitic gastroenteritis. Immunosuppression results from the effect of larval secretions. Infected cattle milk poorly, and a considerable increase in milk production and milk fat occurs after treatment.

The presence of the subcutaneous larvae causes obvious swelling, with pain on touch. The swellings are usually soft and with an opening that is usually evident. There may be as many as 200 to 300 such lesions on the back of one animal.

With involvement of the spinal cord there is a sudden onset of posterior paralysis without fever and without other systemic

signs. The suddenness of onset and the failure of the disease to progress usually suggest traumatic injury. A similar disease can occur in horses and is reputed to be more common in horses than in cattle.

### CLINICAL PATHOLOGY

An ELISA that detects antibodies to the secreted enzymes of *H. lineatum* and *H. bovis* has been developed. It has been used in monitoring the eradication program in Great Britain and in France.<sup>3</sup> In addition, an antigen-capture ELISA, used to detect the presence of circulating quantities of the predominant larval enzyme, has been developed. This will be useful in differentiating active from cleared infestations and will be useful in detailed surveillance programs if used at the correct time in the life cycle.

### NECROPSY FINDINGS

The first instars, migrating within connective tissue, are usually surrounded by a zone of yellow-green discoloration. Later larval stages lie in a subcutaneous, granulomatous cyst that may contain a pale fluid. Rarely the cyst will contain a large amount of purulent discharge. Other characteristic findings include the following:

- No other disease causes the characteristic swellings on the back.
- The differential diagnoses of posterior paralysis and anaphylaxis are discussed in detail under the respective headings of “Disease of the Spinal Cord” and “Anaphylaxis.”
- The clinical signs of macrocyclic lactone poisoning have not been reported to cause these symptoms.
- Posterior paralysis as a result of destruction of the larvae in the epidural space usually occurs, but macrocyclic lactone products have not been reported to cause these symptoms.

### TREATMENT

#### Macrocyclic Lactone Compounds

All larval stages of cattle grubs and other oestrid flies are very sensitive to macrocyclic lactone endectocides. Their widespread use in nematode control programs plays a major role in controlling warble flies. Their residual activity will persist for about 4 weeks.<sup>4,5</sup>

#### Treatment Recommendations

Treatment with a macrocyclic lactone-based product is strongly advised, both to increase productivity and to maintain population control.

#### Manual Removal

When small numbers of cattle are affected with relatively few warble grubs, manual removal of the larvae can be practiced. Incomplete removal or breaking the larvae during removal may cause a severe systemic reaction. This reaction and the one that sometimes occurs after systemic treatment of

cattle infected with cattle grubs has been ascribed to anaphylaxis. However, there is evidence that it is a direct result of toxins liberated from dead maggots and that phenylbutazone may control this toxin. The clinical signs include dullness, salivation, lacrimation, dyspnea, wrinkling of skin on the side of the neck, and edema under the jaw.

### CONTROL

With the macrocyclic lactone endectocides, in general, systemic treatments are given at the end of fly activity and in the spring after first instars have left sensitive tissues. In those species that do not undergo deep tissue migration, treatment can be instituted anytime after the cessation of fly activity.

Cattle grub has been eradicated in Norway, Sweden, Denmark, Malta, Ireland, and Great Britain. Eradication programs were initiated in France.<sup>3</sup> Surveillance has decreased in most countries as a result of the excellent efficacy of the macrocyclic lactone products. However, evidence from Canada suggests that residual populations remain.<sup>4</sup> A joint Canadian–U.S. study using sterile male *Hypoderma* species eradicated these species from the test area, but the difficulty of mass producing flies, in the absence of an in vitro rearing system, makes this technique impractical for large-scale warble fly control.<sup>6</sup>

Vaccination of cattle using crude larval extracts has reduced both the number of warbles in the back and the number of larvae that could pupate.<sup>7</sup> Results of vaccination studies with recombinant antigens have been variable, and commercial development has ceased. Use of antigens derived from “hidden” sites such as the fatbody have produced excellent results,<sup>5</sup> and potential components have been identified, but further work has not been followed up.<sup>8</sup> Sequencing of the mitochondrial genome of *H. lineatum* has been completed.<sup>9</sup>

### REFERENCES

1. Otranto D, et al. *J Parasitol*. 2004;90:958.
2. Colwell DD, et al, eds. *CABI Publishing*. 2006.
3. Boulard C, et al. *Vet Parasitol*. 2008;158:1-10.
4. Colwell DD. *Vet Parasitol*. 2013;197:297-303.
5. Rehbein S. *Vet Parasitol*. 2013;192:353-358.
6. Colwell DD. *Vet Parasitol*. 2011;175:313-319.
7. Dacal V, et al. *J Comp Path*. 2011;145(2-3):282-288.
8. Sandeman RM. *Parasite Immunol*. 2014;111:214-222.
9. Weigl S, et al. *Med Vet Entomol*. 2010;24:329-335.

## HORN FLIES AND BUFFALO FLIES (*HAEMATOBIA* SPP.)

### ETIOLOGY

The small (6-mm) grayish flies of the *Haematobia* species, known as horn flies and buffalo flies, have distinct geographic distributions, *H. irritans exigua* in Australia and South East Asia, *H. irritans irritans* throughout North and South America and Hawaii, and *H. minuta* in Africa. *H. irritans irritans*

is common in Europe, where it causes few problems. This species was transported to North America in the late 1800s, where it rapidly established and spread. It has subsequently moved into South America, where it has also become a major problem. *Haematobia* species are known as vectors for the nematodes *Stephanofilaria stilesi*, but their impact is thought to be of little importance.

### LIFE CYCLE AND EPIDEMIOLOGY

These insects have a typical fly life cycle and habits. Eggs are deposited away from the animal onto freshly deposited dung, where the larval stages develop in a highly temperature-regulated manner. The onset of diapause in the pupal stage is regulated at this stage and requires that the larvae be exposed to increased hours of low temperatures for the pupae to become diapause driven. Three larval stages are spent in the dung, with larvae feeding largely on bacteria. Pupae form in the dry regions outside of the dung pat. Both sexes of these flies are obligate blood feeders, primarily attacking pastured cattle and water buffalo. They do not survive off the host, other than for short periods. They are not known as vectors for any disease agents other than the nematodes *Stephanofilaria* spp. They cause significant reductions in productivity of pastured cattle through induction of stress, changes in grazing patterns, and, in extreme cases, blood loss. Burdens of 200 to 500 flies will reduce weight gains of beef cattle (up to 14% reduction) and milk yield of dairy cows. Heavy infestations (over 1000 flies) can cause serious loss of condition and, rarely, deaths. Control results in higher feed efficiency, increased growth rate, and increased calf-weaning weights.

The flies are easily recognized by the way in which the wings are held at rest, slightly divergent and angled upward, away from the body. Adult flies stay on the host most of the time, unless disturbed. Females leave the host, as feces are passed, to deposit eggs around edges of the freshly deposited dung. Larvae develop within the dung pat, feeding primarily on bacteria. Development is regulated by environmental temperatures, and the larvae are stimulated to enter diapause (arrested development) if temperatures become too low. Mature larvae exit the dung to pupate in the dry soil below and around the pat. A complete life cycle may require up to 3 weeks under optimal environmental conditions. Thus at higher temperatures in excess of 15 generations may be produced in a single season; in more temperate climates such as Canada and the upper United States, only 5 generations may occur.

### PATHOGENESIS

The flies congregate chiefly on the withers, shoulders, and flanks and around the horns and eyes. Flies take numerous (15 to 20) small blood meals per day. In North America



feeding often takes place on the ventral midline and several 2- to 5-cm-diameter feeding lesions are often observed. Zebu cattle are less affected by the flies than British breeds, and although they may carry large populations of flies, they show fewer feeding lesions.

### CLINICAL FINDINGS

Whereas adults rarely leave the host except for oviposition, the newly emerged flies of *H. irritans irritans* will travel up to 20 km in search of new hosts. They may be dispersed also by prevailing strong winds, and they are carried long distances by the movement of cattle to new pastures. The distribution of *H. irritans exigua* is controlled by environmental factors, particularly temperature and humidity. At temperatures below 21° C (70° F), the flies become sluggish, and at 5° C (41° F) they become comatose.

### TREATMENT AND CONTROL

Infestations have been controlled by traps, insecticide sprays, back rubbers, dust bags, or eartags impregnated with insecticides. Traps have been designed for use with dairy cattle that walk through them on their way to and from the dairy. The flies are dislodged by gauze strips and are retained in the trap and killed when they rest on the insecticide-coated walls. Traps are rarely used today, but recent work with modified traps has given 80% to 90% control.

Back rubbers consist of absorbent material, impregnated with insecticide or oil, wrapped around a cable or chain suspended from a central pole and attached to ground-level supports or as a cable suspended a little over a meter above the ground between two posts 4 to 5 m apart. Cattle quickly learn to use rubbers to dislodge flies, and their coats become smeared with insecticide. Insecticidal-impregnated eartags attached to back rubbers and dust bags controlled horn fly for about 6 weeks, whereas fenvalerate tags were still effective 18 weeks after application.

Eartags impregnated with a mixture of organophosphorous compounds and synthetic pyrethroids have been widely used, but resistance has built up to levels that make this technique ineffective. Discontinuing the use of pyrethroid-impregnated eartags for one season does not allow substantial reduction in resistance to occur. Eartags impregnated with compounds of both classes have been effective in managing increases in pyrethroid resistance. Current recommendations for use of impregnated eartags note that tags should be applied to the cows (because they harbor the most flies and present the largest surface area for exposure to the insecticide) at the maximum recommended rate. Although this is less convenient, it helps to avoid one of the leading causes of insecticide resistance, which is the dilution of the insecticide as it spreads from calves to cows. Flies

can also be controlled by dipping, but this technique is rarely used solely for flies. Current products are combined with synthetic pyrethroids to extend the protective period. In areas where cattle ticks require regular treatment, adequate control of flies may be gained incidentally, but if treatments are not effective cattle can be oversprayed with pyrethroids. Some research on control in North America<sup>1</sup> using essential oils has been conducted, and the microbiome<sup>2</sup> has been sequenced.

Macrocytic lactone endectocides are highly effective against larval horn flies and the larvae of face flies, stable flies, and houseflies, often killing larvae for periods in excess of 8 weeks. However, in terms of practical control, where flies immigrate from surrounding herds, the duration of efficacy is not more than 2 weeks. In addition, the macrocytic lactones generally cause significant reductions of nontarget insects in the dung community,<sup>3</sup> many of which are beneficial because they are natural enemies of the horn fly and buffalo fly. The various macrocytic lactone products have differential effects on flies and other dung insects, and it appears that moxidectin has the least impact.<sup>3</sup> Virtually all of the cattle on pasture in North America are affected by horn flies, with the exception of those kept at higher elevations.<sup>1</sup> The effect will be altered by various factors, including both physical and biological characteristics of the flies and their hosts.

Pour-on formulations of pyrethroids are highly effective, as evidenced by application of 1% cyfluthrin. Insect growth regulators (e.g., Diflubenzuron) applied as a bolus gave 80% control of the immature stages of the face fly and horn fly in the manure for at least 20 weeks and reduced the number of dung beetles for 7 weeks. A 3% methoprene bolus was also active against flies but had no apparent effect on the dung beetles. The use of essential oils has been shown to have good fly control, but their use requires further testing.<sup>1</sup>

### RECOMMENDATION

Treatment is necessary to keep populations below the economic threshold and to prevent this from becoming an animal welfare issue.

### REFERENCES

1. Scasta JD. *J Int Pest Manage.* 2015;6:8.
2. LaChance S, Grange G. *Med Vet Entomol.* 2013;28:193-200.
3. Floate KD, et al. *Bull Entomol Res.* 2002;92:471-481.

## BLACK FLIES, BUFFALO GNATS (SIMULIIDAE)

These small gray to black flies (5 mm) are members of the family Simuliidae and include a number of species and genera. The important flies appear to be *Cnephia pecuarum*, which is common in the southern states of the United States; *Simulium arcti-*

*cum* and *Simulium luggeri* in Canada; *Austrosimulium pestilens* and *Austrosimulium bancrofti* in Australia; and *Simulium ornatum* in Great Britain. These very small flies occur in most parts of the world. With the exception of *S. arcticum* and two or three other species common in northern regions of North America, black flies are primarily a concern in tropical regions.

Female flies are voracious blood feeders. They are active in the summer months, when large numbers emerge from the streams and rivers where they have spent their larval and pupal stages.

*A. pestilens* has adapted to reach large numbers, mate, and oviposit within a very short time to utilize the flood situations that occur in northern Australia. The flies congregate in swarms and attack all animals, causing much worry and annoyance. They tend to bite animals around the legs, on the belly, and around the head, causing wheals and papules. The annoyance may be so intense that animals stampede or mill about, and young animals may be injured or even trampled to death and are frequently separated from their dams. Cattle may spend much of their time wallowing in mud or kicking up dust to keep the flies away. Herding of cattle onto bare areas reduces fly attacks because the flies commonly rest in tall grass, but this reduces feeding. The cause of death is unknown, although swelling of the throat causing suffocation, anaphylaxis, and direct toxicity are suspected. Filarid worms of *Onchocerca* spp. are transmitted by these flies, and their role as an intermediate host of nematodes has been discussed.

A similar situation occurs in northern Canada, where large numbers of *S. arcticum* have caused severe stress and occasional deaths of cattle introduced into the area of the Athabasca River and similar regions in the province of Saskatchewan. When black fly populations are extreme, previously unexposed cattle develop symptoms of shock resulting from blood loss and cumulative effects of the fly salivary secretions. In northern Saskatchewan, *S. luggeri* causes similar problems along major waterways.

Because the larval stages of these flies are passed in flowing streams where mouthparts are developed into fan-like structures for filtering out particles from water currents, large-scale control measures must be directed at killing the larvae at this stage. In the past, annual injection of methoxychlor upstream from major larval sites proved effective in reducing black fly populations, but off-target effects were undesirable. Repellents are of some use; alcoholic or aqueous solutions and dusts of permethrin, cypermethrin, and resmethrin can be applied to the whole body and will repel black flies for some days. Recently, toxins of *Bacillus thuringiensis* var. *israelensis* have been used in river injections in northern Saskatchewan, which has kept

several species under control. An electrostatic sprayer that allows efficient application of repellents or insecticides to cattle under pasture conditions can be used. The insecticide or repellent solution is dispersed as charged droplets that are attracted to the hair of the animals.

### HOUSEFLY (MUSCIDAE—*MUSCA DOMESTICA*)

The common housefly has a worldwide distribution and is of veterinary importance because it is capable of transmitting, in a mechanical manner, the causative bacteria of many infectious diseases. It is often cited as a means whereby anthrax, erysipelas, and brucellosis are spread, but its importance in this regard is largely unproven. Houseflies are intermediate hosts for the larvae of *Habronema muscae* and *Draschia megastoma*.

The eggs are laid in decaying organic matter of any kind. Larval development is temperature dependent, and a life cycle may be completed in 12 to 14 days so that in warm, wet summers the fly population may increase very rapidly, causing annoyance to livestock and farm workers.

Housefly population management requires frequent and thorough removal of manure and other rich organic matter. In dry weather the manure can be spread thinly on fields, but a more dependable method is to place it in a special fly trap (e.g., Baber's fly traps), from which larvae and adult flies cannot escape. Chemical treatments to control flies require application to resting sites on buildings and other facilities or the placement of baits containing methomyl, propoxur, naled, or dichlorvos at appropriate locations. Development of insecticide resistance can occur rapidly, and there are numerous examples of resistance to multiple classes of insecticide at a single location. Rotational use of insecticide classes is absolutely essential in the management of resistance.

Management of housefly populations can be augmented through release of parasitic wasps (family Pteromalidae) that kill pupae. These tiny wasps (1 to 2 mm long) actively search for the fly pupae and lay one or more eggs inside. The developing wasps devour the fly within the pupa. They have been found to be useful adjuncts to other fly control measures when used in confined facilities such as hog barns. Inundative releases at feedlots, where thousands of wasps are released at regular intervals throughout the fly season, have shown some efficacy but require an integrated approach with good manure management and selective application of insecticides.

Reducing the fly population in buildings is an important procedure in public health work, and many measures are recommended. It is not possible to give details of them here because so many factors have to be taken into consideration, including toxicity of the

products used for humans and animals, development of resistance to the insecticides, and contamination of food products such as milk by the insecticides.

### RECOMMENDATION

Fly control should always be attempted in an integrated manner with rational use of pesticides and other approaches.

### BUSH FLIES (*MUSCA VETUSTISSIMA*)

Bush flies occur commonly in Australia in drier areas and are a cause of stress to livestock in the summer months. Bush flies die out in southern Australia each winter, but breeding continues in the north, and the regular northern winds that commence about September each year blow flies southward, which then repopulate the areas that are now suitable for reproduction. Larvae usually develop in fecal matter from several source animals. Adult *Musca vetustissima* occur in very large numbers and during the day congregate around the eyes, on the lips, on any visible mucous membrane, and on wounds to obtain moisture. They are thought to carry contagious ophthalmia of sheep, infectious keratoconjunctivitis of cattle, and contagious ecthyma of sheep; to delay the healing of wounds; to contribute to the lesions produced by buffalo flies (*Haematobia irritans exigua*); and to act as intermediate hosts for the larvae of *Draschia megastoma*, *Habronema muscae*, and *Thelazia* spp. Control of the fly population is virtually impossible in the areas where it occurs, but individual animals may be protected by repellents such as dimethyl phthalate or DEET. Sprays containing 1% of dichlorvos are effective but must be applied daily. Dung beetles, introduced from Africa, break up dung pats, which aids in control of larval stages and in reducing fly numbers. The bush fly has been implicated in the dissemination of several food-borne pathogens that can have serious concerns.<sup>1</sup>

### RECOMMENDATION

Control of adults is recommended to alleviate animal welfare concerns.

### REFERENCE

1. Vriesekoop F, Shaw R. *Foodborne Pathol Dis.* 2010;7:275-729.

### FACE FLY (*MUSCA AUTUMNALIS*)

This medium-sized fly, indigenous to Europe and Asia, first appeared in North America in 1952 and is now present over large areas of Canada and the northeastern and north-central United States. The flies resemble the housefly but are slightly larger. They congregate on the face of cattle, feeding on nasal and lacrimal secretions and saliva. Very

large numbers cause a certain amount of stress, cause petechiation in the eye, and are instrumental in transmitting infectious keratoconjunctivitis (pinkeye) of cattle. Face flies are vectors for the eyeworms, *Thelazia* spp., which infest the conjunctival sacs and lacrimal ducts of domestic animals.

Flies oviposit on fresh cattle manure, where larval development takes place. As with all flies, development is temperature dependent. In temperate latitudes the flies will overwinter as adults, resting inside homes and other farm structures.

Fly numbers are greatest in summer, and cattle are particularly troubled when outdoors. Repellents have been extensively used but are not highly successful. Self-applied or hand-applied dusts containing insecticides are extensively used. Reduction of face-fly populations on cattle can be achieved through use of synthetic pyrethroid-impregnated eartags, but their use is complicated by the presence of insecticide-resistant horn flies. Diflubenzuron boluses give 80% control of the immature stages of *M. autumnalis* in the manure for up to 20 weeks.

### RECOMMENDATION

Control should be attempted but may be difficult in areas where resistance is a problem.

### HEAD FLY (*HYDROTOEA IRRITANS*)

This medium-sized fly, similar in appearance to the housefly but having an olive abdomen and yellow wing bases, is found in the United Kingdom and Europe. It is a nonbiting muscid fly that swarms around animals and humans from late June to September. Larval development is in soil and litter, and generally there is only one life cycle per year. The lesions on sheep are self-inflicted trauma in attempts to alleviate fly irritation. Sores are often large and open, and they may be made more severe by bacterial invasion.<sup>1</sup> The wounds may predispose to blowfly strike by *Lucilia sericata*. The pathogens of summer mastitis of cattle can be spread mechanically by this fly as well as a number of related muscid flies, and *Trueperella* (*Actinomyces* or *Corynebacterium*) *pyogenes* has been shown to persist in *H. irritans* for up to 4 days.

Control is difficult and is similar to that used for the other nonbiting muscid fly, *M. autumnalis*. Eartags impregnated with 8.5% cypermethrin or 10% permethrin reduce the severity of fly damage in sheep, and tagged ewes give protection to their lambs. However, it is likely that resistance will quickly occur in the same manner as in the face fly. Head caps are most effective but are tedious to apply.

### REFERENCE

1. Milne CE, et al. *Livestock Sci.* 2008;118:20-33.

## BITING MIDGES (CERATOPOGONIDAE)

These tiny flies (1-3 mm long) are members of the family Ceratopogonidae, of which the most important genus is *Culicoides*. These flies are blood feeders and induce stress in hosts, and they can transmit infectious diseases such as bluetongue in sheep, horse sickness, and ephemeral fever in cattle.<sup>1</sup> They are also intermediate hosts for nematodes of the genus *Onchocerca*. Because of their importance as vectors of arboviruses, studies have been done on their feeding habits. Cattle and sheep are the most common hosts attacked, but some species also feed on birds or dogs. Hypersensitivity to the bites of *Culicoides* spp. results in an allergic dermatitis (sweet itch) in horses in Australia and North America and is discussed elsewhere. Cattle also show considerable irritation during attacks by large numbers of midges. They react with vigorous stamping of the feet, switching of the tail, and continuous movement.

The flies are plentiful in the warmer months and are most active at dawn and dusk. Because of their small size they are capable of being carried long distances by wind. Larvae develop in rich, high-organic-matter sites with high moisture content. Control of the larvae and of flies is virtually impossible, and most measures to reduce their importance are based on preventing access of the flies to the animals. Repellents, especially dimethyl phthalate or DEET, are effective on a short-term basis. Antihistamines can be used regularly but are too expensive for general use. Keeping horses away from areas where the flies are present in large numbers is advisable. Backline pour-on treatment of horses with 4.0 mL of a 4% high-CIS permethrin 3 times weekly gave a good response in 86% of horses. Ivermectin at the recommended dose of 0.2 mg/kg would not produce the serum concentration that would have noticeable effects on blood-feeding *C. variipennis*. Recently, modeling of changing weather patterns indicates that such patterns may alter the distribution of important vectors and thus alter the influence of diseases.<sup>2</sup>

### REFERENCES

1. Ruder MG, et al. *Vector Borne Zoonotic Dis.* 2015;15(6):348-363.
2. Zuliani A, et al. *PLoS ONE.* 2015;10(8):e0130294.

## MOSQUITOES (CULICIDAE)

A number of mosquitoes, including *Psoorophora*, *Aedes*, *Mansonia*, *Culex*, and *Anopheles* spp. are important parasites of domestic animals. When the blood-feeding females are present in large numbers, they cause stress to animals and have been known to kill young pigs and puppies by the severe anemia they produce. Although such occurrences

are rarely recorded, the blood loss that can occur in severe infestations is surprising. The stress associated with mosquito attack is sufficient to cause reductions in efficiency, even in mature large animals.

Their most important role is as vectors of disease. *Culex tarsalis*, *Aedes dorsalis*, and *Aedes nigromaculis* transmit equine encephalomyelitis. *Culex tritaeniorhynchus* is the principal vector of Japanese B encephalitis in Japan. Various *Culex* species vector western equine encephalitis, eastern equine encephalitis, and West Nile virus. These viruses can have serious effects on unprotected horses and are transmissible to humans via mosquito bites. Vaccines are available to protect against all of these arboviruses. *Psorophora confinnis* is instrumental in spreading the eggs of *Dermatobia hominis*, the tropical warble fly; and *Mansonia* spp. transmit Rift Valley fever. The filarid worm *Setaria digitata* is also spread by mosquitoes.

Control over a large area must include drainage of collections of still surface water or destruction of the larvae by the addition of any one of a number of insecticides. For small groups of animals, protection from the attacks of mosquitoes can only be satisfactorily effected by mosquito-proof screens. Temporary protection by repellents such as dimethyl phthalate is only partial. Permethrin, 100 mL of a 0.5% emulsion, applied with an electrostatic sprayer provided greater than 70% protection for at least 72 hours.

## Tick Infestations

### SYNOPSIS

**Etiology** Many species of ticks act as vectors of disease or cause death from anemia; others cause paralysis. Heavy burdens cause loss of production.

**Epidemiology** Life cycles vary widely both in the number of hosts required and the host specificity. Animals are infested by larval or nymphal stages on the ground.

**Clinical signs** Anemia, paralysis, tick fever, and tick worry.

**Clinical pathology** Ticks obvious on clinical examination. Blood smears for tick fevers (*Babesia*, *Theileria*, and *Anaplasma*).

**Lesions** Skin damage as a result of biting and rubbing; anemia. See other chapters for lesions as a result of diseases transmitted by ticks.

**Diagnostic confirmation** Ticks easily found, should be identified as to species.

**Treatment** Dipping, spraying, application of pour-ons and injectable acaricides.

**Control** Regular treatment at intervals dependent on the life cycle of the tick, pasture spelling to destroy free-living stages, the use of resistant cattle, and vaccination all play a part.

Tick infestations are of great importance in the production of animal diseases, particularly in livestock housed in tropical and subtropical areas. In addition to their role as vectors of infectious diseases, as outlined in the following discussion, heavy infestations can cause direct losses. Many ticks are active blood feeders and may cause death from anemia. Some species cause tick paralysis, and it is possible that other ticks may elaborate toxins other than those causing paralysis. Heavy tick burdens cause sufficient irritation and stress such that affected animals become anorexic, which may lead to reduced productivity. One tick, *Boophilus microplus*, is reported to affect in excess of 75% of the world cattle population. The economic impact has been estimated at US\$7 per animal per year, and in Brazil, which has the fifth largest cattle herd, the losses are estimated at US\$2 billion per year.

Ticks are divided into two groups: Argasidae (soft-body ticks) and Ixodidae (hard-body ticks). The life cycles of the ticks vary widely. Some species pass their entire lives on one host, others pass different stages of the cycle on successive hosts, and others are parasitic only at certain stages. The eggs are laid in the soil, and larvae attach themselves to a passing host, on which they may develop through one or more nymphal stages before becoming adults. Adult females engorge on blood or lymph and drop to the ground to lay their eggs. One-host ticks are more easily controlled than those that pass part of their life cycles away from the host. A list of the single- and multiple-host ticks is shown in Table 16-5.

Although many ticks favor a particular host, they are usually not completely host-specific, and many parasitize a wide variety

**TABLE 16-5** Single- and multiple-host ticks

### One-host ticks

*Boophilus* spp.  
*Margaropus winthemi*  
*Otobius megnini* (adults are not parasitic)  
*Dermacentor albipictus*

### Two-host ticks

*Rhipicephalus evertsi*  
*Rhipicephalus bursa*  
*Hyalomma* spp. (most have two or three hosts)

### Three-host ticks

*Ixodes* spp.  
*Rhipicephalus* spp. (except *R. evertsi* and *R. bursa*)  
*Haemaphysalis* spp.  
*Amblyomma* spp.  
*Hyalomma* spp. (most have two or three hosts)  
*Ornithodoros* spp.—many hosts  
*Dermacentor* spp.



of animals. In the limited space available here, the species are listed according to whether they transmit bacterial, viral, or rickettsial diseases of livestock or only cause worry. Ticks that transmit economically important protozoan diseases of livestock, such as babesiosis and theileriosis, are discussed in Chapter 11 (Table 11-7). Ticks that cause paralysis and other neurologic signs are discussed in Chapter 15.

### Bacterial, Viral, and Rickettsial Diseases Transmitted by Ticks

The transmission of diseases associated with these agents may be effected by means other than ticks. *Anaplasma marginale* can be spread by biting flies if large numbers are present when the animals are experiencing a heavy parasitemia. Outbreaks of anaplasmosis can also occur following the use of unclean instruments for dehorning, vaccination, castration, or blood sampling, and anaplasmosis is easily caused by blood transfusions. The ticks involved more commonly in transmitting bacteria, viruses, and rickettsia are listed in Table 16-6. Transmission of *Anaplasma* may be transovarially, with one stage becoming infected and a subsequent stage passing the infection to a new host,

or ticks may transmit infection within the one stage if they detach and feed on a new host.

### Ticks That Cause Direct Losses

Ticks cause damage to hides and loss of production, anemia, and death when they are present in large numbers. They also cause greater morbidity and mortality during periods of drought, in addition to delays in fattening, resulting in animals held longer before they can be sold. Ticks that have this effect on production but are not known to cause paralysis or transmit infectious diseases in farm animals are as follows:

- *Otobius megnini*—the “spinose ear tick” of the United States and Canada
- *Amblyomma americanum*—the “Lone Star tick” of the United States
- *A. maculatum*—the “Gulf Coast tick” of the United States
- *Margaropus winthemi*—of South America and Africa
- *Ornithodoros moubata*—of Africa and Southeast Asia
- *O. savignyi*—of Africa and Southeast Asia
- *Haemaphysalis longicornis*—of Australia and New Zealand.

### TREATMENT AND CONTROL OF TICK INFESTATIONS

Four methods are now available to treat and control tick infestations, with the primary role continuing to be played by chemical acaricides:

- Administration of acaricidal agents
- Pasture management
- Use of resistant cattle
- Vaccination

### Acaricidal Agents

Individual animals can be effectively treated by the application of any one of a number of acaricides applied either as a spray or by dipping. The choice of acaricide for treatment depends largely on three factors:

- The persistence of the compound on the skin and hair coat
- The likelihood of residues toxic to humans appearing in the milk or meat
- Whether or not the ticks in the area have developed resistance to the particular acaricide

Arsenicals, in the form of water-soluble arsenic salts, have been widely used to treat tick infestations but are no longer used in many parts of the world because of resistance, toxicity, and environmental concerns.

**Table 16-6** Diseases associated with bacteria, viruses, and rickettsia and reported to be transmitted by ticks

Disease	Causative agent	Vector ticks	Country
Tick pyemia (lambs)	<i>Staphylococcus aureus</i>	<i>Ixodes ricinus</i>	Great Britain
Tularemia (sheep)	<i>Francisella tularensis</i>	<i>Haemaphysalis leporispalustris</i> , <i>H. otophila</i> ; <i>Dermacentor andersoni</i> , <i>D. variabilis</i> , <i>D. pictus</i> , <i>D. marginatus</i> ; <i>Ixodes luguri</i>	United States Norway, Europe, Russia, and states of the former USSR
<b>Anaplasmosis</b>			
Cattle	<i>Anaplasma marginale</i>	<i>Boophilus annulatus</i> ; <i>Argas persicus</i> ; <i>Dermacentor albipictus</i> , <i>D. andersoni</i> , <i>D. occidentalis</i> , <i>D. variabilis</i> ; <i>Ixodes scapularis</i> ; <i>Rhipicephalus sanguineus</i> ; <i>Boophilus microplus</i> , <i>B. decoloratus</i> ; <i>Hyalomma excavatum</i> ; <i>Rhipicephalus bursa</i> , <i>R. simus</i> ; <i>Haemaphysalis punctata</i> ; <i>Ixodes ricinus</i> ; <i>Boophilus (annulatus) calcaratus</i>	North America  Australia and South America Africa  Europe Russia, and states of the former USSR
Sheep and goats	<i>Anaplasma ovis</i>	<i>Dermacentor silvarum</i> , <i>Rhipicephalus bursa</i> , <i>Ornithodoros lahorensis</i>	Russia, and states of the former USSR
Brucellosis	<i>Brucella abortus</i> and <i>Br. melitensis</i>	Many ticks may be infected, but infection of host appears to occur only if ticks or their feces are eaten	Russia, and states of the former USSR
Heartwater	<i>Ehrlichia ruminantium</i>	<i>Amblyomma</i> spp.	Africa and Caribbean
African swine fever	Virus	<i>Ornithodoros</i> spp.	Africa, Spain, Portugal
Louping-ill	Virus	<i>Rhipicephalus appendiculatus</i> (laboratory only) <i>Ixodes ricinus</i>	Africa England
Tick-borne fever	<i>Anaplasma phagocytophila</i>	<i>Ixodes ricinus</i> <i>Rhipicephalus haemaphysaloides</i>	Great Britain, Norway India
Caseous lymphadenitis of sheep	<i>Corynebacterium pseudotuberculosis</i>	<i>Dermacentor albipictus</i>	North America
Epizootic bovine abortion	<i>Spirochete</i>	<i>Ornithodoros coriaceus</i>	United States
Nairobi sheep disease	Virus	<i>Rhipicephalus appendiculatus</i>	Africa
Lyme disease	<i>Borrelia burgdorferi</i>	<i>Ixodes dammini</i> , <i>I. pacificus</i> , <i>I. ricini</i>	United States, Europe, Australia

Chlorinated hydrocarbons replaced the use of arsenicals but have been withdrawn from most markets because of high toxicity and long duration of effect. Resistance to chemical acaricides, including macrocyclic lactones, has become a major issue for the effective management of one cattle tick, *Boophilus microplus*. In many cases cross-resistance between chemical families occurs, further complicating the use of rotational schemes aimed at managing the development and degree of resistance.

The same criteria apply in control as in treatment except that cost becomes a limiting factor when large numbers of animals require frequent treatments, and it is obvious in some circumstances that the effect of tick infestation on Brahman-cross steers is insufficiently great to warrant treatment. It is impossible to make specific recommendations on methods of application and the most efficient insecticide to use because these vary widely between species of ticks. However, whenever possible, treatment should be given systematically in a program based on the life cycle and epidemiology of the tick. A number of treatments may be used early in the tick season to prevent the increase in tick numbers. Care must be taken in areas where tick fevers also occur, so as not to disrupt the transmission of the tick-fever organisms and leave the cattle susceptible to later infection. Other special cases include *Otobius megnini*, the nymphs of which drop off to molt and lay eggs in protected spots, necessitating the spraying of buildings, fence posts, feed troughs, and tree trunks in feedlots where heavy infestations are most common. *Ornithodoros* spp. ticks are difficult to control because the nymphs and adults attach to feed for brief periods only. Where ticks that cause paralysis are common, it may be necessary to apply an insecticide as a dust and dip at short intervals.

### Organophosphates

The organophosphates as a group are effective, but tick strains resistant to many of them have appeared. Other drugs in current use include dioxathion, diazinon, carbophenothion, coumaphos, ethion, bromophosethyl, chlorpyrifos, and phosmet. Pour-on applications of chlorpyrifos and phosmet have been tested but were not as effective as spray applications. Addition of acaricides to the feed has also been tried but has not been successful, whereas eartags impregnated with tetrachlorvinphos did not give satisfactory control and increased the risk of development of resistance to the drug.

Preparations vary in the duration of the protection they afford, and local conditions of rainfall and tick population must be taken into account when determining the time intervals between sprayings or dippings. A special case is that of young lambs that are exposed to tick pyemia. Sprays, dips, and

ointments are too toxic, and the most effective procedure is the application of a liquid emulsion cream containing the insecticide to the wool-less parts of the body. Chlorpyrifos 0.48 kg/ha markedly reduces the number of ticks on the pasture, but it is too expensive for routine use.

### Pyrethroids

Amitraz, a formamidine, and the synthetic pyrethroids have been used widely in Australia and have proved to be efficient, active against organophosphate-resistant strains, and safe. In a study in the United States, 0.025% amitraz applied as a whole-body spray or by dipping gave 86.0% or 99.8% control, respectively. Ticks resistant to DDT are also resistant to the synthetic pyrethroids, and to overcome resistance pyrethroids can be combined with an organophosphate. Successful combinations in Australia are cypermethrin plus chlorfenvinphos and deltamethrin plus ethion. A synthetic pyrethroid, flumethrin, has been marketed by itself at higher use concentrations for both plunge dipping and as a pour-on treatment. As a 1% pour-on, 1 mL per 10 kg body weight gave 97% efficacy, and 0.0033% as a spray gave 99% efficacy and acted more quickly. The efficacy of synthetic pyrethroid-impregnated eartags has been reported, but these are likely to lead to resistance. Cyhalothrin also controls multiresistant strains and is used in plunge dips.

Bioassay results show lambda-dacyhalothrin to be as effective as cyhalothrin as a whole-body spray, although the 1% pour-on was less than 50% effective. Resistance to all pyrethroids has been reported. Three pyrethroid acaricides have been shown to markedly reduce the hatching of eggs. Permethrin 0.1% or cypermethrin and cyfluthrin 0.05% could be useful in cleansing and disinfecting premises.

### Macrocyclic Lactones

Ivermectin given subcutaneously gives satisfactory control of *Boophilus microplus* for 21 days following an initial lag period of 2 days. As little as 0.015 mg/kg per day gives complete control and raises the possibility of a slow-release subcutaneous implant. Two treatments of 0.2 mg/kg at 4-day intervals is considered satisfactory in cleansing cattle under field conditions. However, ivermectin may not be effective against *Ixodes ricinus*, but a slow-release bolus active for 90 days did give good control of a variety of ticks. If given topically, 0.5 mg/kg was required to reach the efficiency achieved by 0.2 mg/kg subcutaneously.

Moxidectin 0.2 mg/kg subcutaneously at 4-week intervals or 0.5 mg/kg as a pour-on along the back gives good protection against *B. microplus* resistant to organophosphorous insecticides and DDT, and each treatment has a rapid knockdown effect on populations of buffalo fly after treatment. Doramectin

0.2 mg/kg SC is highly efficacious in removing *B. microplus* and preventing reestablishment. Closantel 22.2 mg/kg orally to cattle (greater than the typical oral dose) was shown to disrupt the life cycle of *Rhipicephalus appendiculatus*; those that oviposited laid few eggs, and most of these did not hatch. Few larvae or nymphs molted.

Ticks in the ears of horses should be treated by the insertion of a few drops of an oily acaricidal preparation.

### Use of Resistant Cattle

It is possible to reduce the impact of ticks and tick-borne diseases by the introduction of Brahman and Brahman-cross cattle, which are more resistant than British breeds and African cattle.<sup>1</sup> The resistance has been shown to be largely acquired, and it is mainly expressed against the larvae in the first 24 hours after attachment. In Australia the possibility that *B. microplus* might escape from its control area because of increased resistance to acaricides has been realized. For this reason a great deal of attention is being paid to the possibility of selecting cattle for tick resistance. In most tick-infested areas, cattle should have up to 50% *Bovis indicus* breeding because this allows for a reduction in the frequency of treatments. Penalties such as reduced live-weight gains, late maturity, and poor temperament become evident when cattle have more than 50% *B. indicus*. With successive infestations cattle differ in their response to *B. microplus*. Thus there is increased irritation and more licking and a decrease in the number of ticks carried. Resistance to ticks has been shown to be related to skin thickness and other factors and is heritable.<sup>2</sup> Selection for tick resistance does not affect milk production.

### Pasture Management

Measures other than the application of acaricides used in the control of tick infestation include burning of pasture, removal of native fauna, and plowing of fields. So little is known of the bionomics of specific ticks in specific areas that these measures have been largely unsuccessful, and it is impossible to provide details for their proper implementation.

In contrast, pasture spelling and rotational grazing are capable of greatly reducing the tick population on farms in some areas. If cattle are placed on spelled pastures early in winter when the ticks are producing few or no progeny and then alternated at 4-month intervals, the tick population can be controlled with a markedly lower number of treatments. The practicability of the procedure depends on a full-scale financial assessment of the increased weight gains relative to the costs of management. Duration of the spelling period varies between 2 and 3 months in summer to 3 to 4 months in the winter, but these intervals need to be

determined for each district. In practice, pasture spelling is rarely used.

In those areas where the epidemiology is known, it has been shown that in regions with a cold winter the females stop laying eggs, and the development of eggs is prolonged. This results in few larvae being available in the spring, and if repeated treatments are given at this time, pasture contamination will remain low for some months. In hot tropical areas where the required temperatures for tick breeding are always present, the dry period may cause mortality by desiccation.

Certain *Stylosanthes* spp., tropical legumes, can kill or immobilize larval ticks, and the use of these plants may simultaneously improve pasture quality and reduce the pasture contamination of larval ticks if high legume-to-grass ratios are achieved. *Brachiaria brizantha* has also been shown to be lethal to *Boophilus* larvae.

### Vaccination

Crude vaccines made from extracts of semiengorged adult female *B. microplus* give effective immunity. The antibody destroys the cells lining the tick's midgut and allows blood to escape into the hemocoel; some ticks die, and the fertility of those remaining is reduced by up to 70%. The fertility of males is also reduced. A recombinant vaccine based on a membrane-bound glycoprotein Bm86 from the tick's midgut has been isolated and was shown to be as effective as the native antigen in studies conducted between 1993 and 1997,<sup>2</sup> and to be effective against acaricidal-resistant ticks. Its major effect is a progressive control in tick numbers in successive generations through a decrease in their reproductive capacity.<sup>2</sup> Because the vaccine acts against an antigen in the tick's gut to which cattle are never exposed, they must be given booster injections at regular intervals. This was the first recombinant parasite vaccine sold commercially (Tick-GARD) and was initially marketed in 1994 in Australia.<sup>3</sup> A second antigen that significantly enhances efficacy and does not impair the response to Bm86 has now been added to the vaccine,<sup>4,5</sup> which is currently available in one commercial formulation (Gavac) in North and South America.<sup>3</sup> Although vaccines offer long-term control, they need to be used with application of acaricides, use of tick-resistant cattle, and pasture management as part of an integrated pest management control system.

Integrated management of tick infestations requires the use of several complementary approaches to reduce populations below acceptable thresholds. One component of these strategies is the development of acaricidal pathogens that may augment other approaches such as vaccination and selective acaricide application. Fungal pathogens are under evaluation for use in this type of program, in particular *Metarhizium anisopliae* and *Beauveria bassiana*.

### ERADICATION

In most countries all that is attempted is reduction of the tick population by periodic dipping or spraying. Complete eradication is extremely difficult because of the persistence of ticks, especially multihost ticks, on wild fauna and the ability of adult ticks to live for very long periods away from a host. On the other hand, continuous treatment to restrain the tick population is highly conducive to the development of resistance, a problem that has become apparent in many tick areas.

*Boophilus annulatus* was eradicated from the southeastern United States by a program of continuous dipping at short intervals of all livestock in the area. *B. microplus* was also eradicated from Florida by a similar procedure, but 20,000 deer, the important alternate host in the area, had to be slaughtered. Concern has been expressed that deer and other wildlife species may threaten efforts to prevent *B. microplus* and *B. annulatus* from becoming reestablished in the southern United States after they are introduced from Mexico. Attempts to eradicate other single-host ticks in other countries generally have not been successful.

Although both dipping and spraying are recommended for the control of ticks, complete wetting of the animals, which can only be effected by dipping, is essential if eradication is to be undertaken. This adds another impediment to eradication plans because of the cost of constructing proper dips and yards. When one considers that dipping may have to be carried out every 14 days for 15 months, that every animal in the eradication area must be dipped, and that a strict quarantine of the area must be maintained, it is obvious that eradication cannot be undertaken lightly.

### FURTHER READING

Ghosh S, Azhahianambi P, Yadav MP. Upcoming and future strategies of tick control: a review. *J Vector Borne Dis.* 2007;44:79-89.

### REFERENCES

- Shyma KP, et al. *J Parasit Dis.* 2015;39:1.
- Canales M, et al. *BMC Biotechnol.* 2009;9:29.
- Guerrero FD, et al. *Intern J Parasitol.* 2012;42:421.
- de la Fuente J, et al. *Anim Health Res Rev.* 2007;8:23.
- Domingos A, et al. *Rev Soc Bras Med Trop.* 2013;46:265.

## Deficiencies and Toxicities Affecting the Skin

### ZINC DEFICIENCY (PARAKERATOSIS)

#### SYNOPSIS

**Etiology** Dietary deficiency of zinc and factors that interfere with zinc absorption or utilization.

**Epidemiology** Growing pigs, cattle, and sheep. Excess of calcium favors disease in pigs.

#### Signs

**Pigs** Loss of body weight gain. Symmetric, crusty skin lesions (parakeratosis) over dorsum and ears, tail; become thick and fissured. No pruritus.

**Ruminants** Alopecia over muzzle, ears, tail head, hindlegs, flank, and neck. Stiff gait and swelling over coronets. Loss of wool and thickened skin in sheep. Infertility in rams. Poor growth in goats and skin lesions.

**Clinical pathology** Serum zinc concentrations lower than normal.

**Necropsy findings** Parakeratosis.

**Diagnostic confirmation** Histology of skin lesions and serum zinc levels.

#### Differential diagnosis list

Sarcoptic mange in cattle and pigs.  
Exudative epidermitis in piglets.

**Treatment** Add zinc to diet.

**Control** Supplement zinc in diet.

### ETIOLOGY

#### Pigs

A zinc deficiency in young, growing pigs can cause parakeratosis, but it is sometimes not a result of a simple zinc deficiency. Rapidly growing pigs have a high requirement for zinc in the diet.<sup>1</sup> The availability of zinc in the diet is adversely affected by the presence of phytic acid, a constituent of plant protein sources such as soybean meal. Much of the zinc in plant protein is in the bound form and unavailable to the monogastric animal such as the pig. The use of meat meal or meat scraps in the diet will prevent the disease because of the high availability of the zinc. Another unique feature of the etiology of parakeratosis in swine is that an excess of dietary calcium (0.5% to 1.5%) can favor the development of the disease, and the addition of zinc to such diets at levels much higher (0.02% zinc carbonate or 100 mg/kg zinc) than those normally required by growing swine prevents the occurrence of the disease. The level of copper in the diet may also be of some significance, with increasing copper levels decreasing the requirement for zinc. A concurrent enteric infection with diarrhea exacerbates the damage done by a zinc deficiency in pigs.

Weaning can induce transient declines in the serum zinc concentration of piglets, and this can be prevented by oral supplementation with zinc oxide.<sup>2</sup> The clinical importance of this decline is unclear.

#### Ruminants

A primary zinc deficiency resulting from low dietary zinc in ruminants is rare but does occur. Many factors influence the availability of zinc from soils, including the degree of compaction of the soil and the nitrogen and



phosphorus concentration. The risk of zinc deficiency increases when soil pH rises above 6.5 and as fertilization with nitrogen and phosphorus increases. Some legumes contain less zinc than grasses grown on the same soil, and zinc concentration decreases with aging of the plant. Several factors may deleteriously affect the availability of zinc to ruminants and cause a secondary zinc deficiency. These include the consumption of immature grass, which affects digestibility; the feeding of late-cut hay, which may be poorly digestible; and the presence of excessive dietary sulfur. The contamination of silage with soil at harvesting can also affect the digestibility of zinc.

## EPIDEMIOLOGY

### Pigs

Parakeratosis in pigs was first recorded in North America in rapidly growing pigs, particularly those fed on diets containing growth promoters. The disease occurs most commonly during the period of rapid growth, after weaning and between 7 and 10 weeks of age. From 20% to 80% of pigs in affected herds may have lesions, and the main economic loss is a result of a decrease in growth rate. In general, the incidence is greater in pigs fed in dry lots on self-feeders of dry feed than in pigs with access to some pasture, which is preventive and curative.

A low level of dietary zinc intake during pregnancy and lactation of gilts can result in skin lesions, stressful parturition, and an increased incidence of intrapartum mortality of piglets and deleterious effects on neonatal growth.

It has been suggested that parakeratosis occurs because very rapidly growing pigs outstrip their biosynthesis of essential fatty acids, and when the diet is high in calcium the digestibility of fat in the diet is reduced at the same time. The net effect in rapidly growing pigs could be a relative deficiency of essential fatty acids.

### Ruminants

There are naturally occurring cases in cattle, sheep, and goats. The disease is well recognized in Europe, especially in calves. It is common in some families of cattle, and an inherited increased dietary requirement for zinc is suspected. The inherited disease occurs in Friesian and Black Pied cattle and is known as lethal trait A46. Signs of deficiency appear at 4 to 8 weeks of age. The main defect is an almost complete inability to absorb zinc from the intestine; zinc administration is curative.

The disease in **cattle** has been produced experimentally on diets low in zinc, and naturally occurring cases have responded to supplementation of the diet with zinc. Calves remain healthy on experimental diets containing 40 mg/kg zinc, but parakeratosis has occurred in cattle grazing pastures with a zinc content of 20 to 80 mg/kg (normal

93 mg/kg) and a calcium content of 0.6%. There is also an apparently improved response in cattle to zinc administration if copper is given simultaneously. Parakeratosis has also been produced experimentally in goats and sheep.

Zinc nutrition may be involved in the immune responses of feedlot calves. When calves are stressed by transportation or challenged with the infectious bovine rhinotracheitis virus, they tend to have reduced fevers, higher dry matter intake, and less body weight loss when fed organic zinc and manganese sources than the corresponding oxide forms.

Outbreaks of the disease have occurred in **Sudanese Desert ewes** and their lambs fed on a zinc-deficient diet of Rhodes grass containing less than 10 mg/kg of zinc. The disease has also been diagnosed in **mature sheep and goats**, and the cause of the deficiency could not be determined. A marginal zinc deficiency, characterized by subnormal growth and fertility and low concentration of zinc in serum, but without other clinical signs, can occur in sheep grazing pastures containing less than 10 mg/kg zinc.

In Germany, skin lesions have occurred in alpacas and llamas with low-zinc and low-copper status. In the affected herd, the average serum zinc and copper levels were 0.17 and 0.49  $\mu\text{g}/\text{mL}$  for alpacas and 0.22 and 0.38  $\mu\text{g}/\text{mL}$  for llamas, respectively. The levels considered normal in llamas are 0.30  $\mu\text{g}$  for zinc and 0.40 to 0.70  $\mu\text{g}$  copper per mL.

## PATHOGENESIS

The pathogenesis of zinc deficiency is not well understood. Zinc is a component of the enzyme carbonic anhydrase, which is located in the red blood cells and parietal cells of the stomach, and is related to the transport of respiratory carbon dioxide and the secretion of hydrochloric acid by the gastric mucosa. Zinc is also associated with RNA function and related to insulin, glucagon, and other hormones. It also has a role in keratinization, calcification, wound healing, and somatic and sexual development. Because it has a critical role in nucleic acid and protein metabolism, a deficiency may adversely affect the cell-mediated immune system.

Zinc and vitamin A deficiency can occur together, with complex interactions between the compounds affecting liver metabolism of vitamin A.<sup>3</sup> Zinc deficiency impairs vitamin A mobilization from the liver.

A zinc deficiency results in a decreased feed intake in all species and is probably the reason for the depression of growth rate in growing animals and body weight in mature animals. Failure of keratinization resulting in parakeratosis, loss and failure of growth of wool and hair, and lesions of the coronary bands probably reflects the importance of zinc in protein synthesis. There are lesions of

the arteriolar walls of the dermis. The bones of zinc-deficient ruminants reveal abnormal mineralization and a reduction of zinc concentration in bones and cartilage and should be considered in animals with evidence of chondrodysplasia.<sup>4</sup> Retarded testicular development occurs in ram lambs, and complete cessation of spermatogenesis suggests impairment of protein synthesis.

## CLINICAL FINDINGS

### Pigs

A reduced rate and efficiency of body weight gain is characteristic. Circumscribed areas of erythema appear in the skin on the ventral abdomen and inside the thigh. These areas develop into papules 3 to 5 mm in diameter, which are soon covered with scales, followed by thick crusts. These crusts are most visible in areas about the limb joints, ears, and tail and are distributed symmetrically in all cases. The crusts develop fissures and cracks, become quite thick (5 to 7 mm), and are easily detached from the skin. They are crumbly and not flaky or scaly. No greasiness is present except in the depths of fissures. Little scratching or rubbing occurs. Diarrhea of moderate degree is common. Secondary subcutaneous abscesses occur frequently, but in uncomplicated cases, the skin lesions disappear spontaneously in 10 to 45 days if the ration is corrected. Affected boars have testicular abnormalities that impair fertility.<sup>5</sup>

### Ruminants

In the naturally occurring disease in cattle, in severe cases, parakeratosis and alopecia may affect about 40% of the skin area. The lesions are most marked on the muzzle, vulva, anus, tailhead, ears, backs of the hind-legs, kneefolds, flank, and neck. Most animals have below-average body condition and are stunted in growth. After treatment with zinc, improvement is apparent in 1 week and complete in 3 weeks. Experimentally produced cases exhibit the following signs:

- Poor growth
- A stiff gait
- Swelling of the coronets, hocks, and knees
- Soft swelling containing fluid on the anterior aspect of the hind fetlocks
- Alopecia
- Wrinkling of the skin of the legs, scrotum, and neck and head, especially around the nostrils
- Hemorrhages around the teeth
- Ulcers on the dental pad

The experimental disease in cattle is manifested by parakeratotic skin, mainly on the hindlimbs and udder, and similar lesions on teats, which tend to become eroded during milking. The fetlocks and pasterns are covered with scabby scales. There is exudation first with matting of hair, then drying and cracking. The skin becomes thickened and inelastic. Histologically, there is

parakeratosis. Clinical signs develop about 2 weeks after calves and lambs go onto a deficient diet so that there is no evidence of storage of zinc in tissues in these animals. In goats, hair growth, testicular size, and spermatogenesis are reduced, and growth rate is less than normal. Return to a normal diet does not necessarily reverse these signs, and the case-fatality rate is high. There is a marked delay in wound healing.

Zinc deficiency increases the risk of mastitis in dairy cows, potentially because of adverse alterations in mammary duct epithelium.<sup>6</sup> Deficiency is associated with increased somatic-cell numbers in milk, decreased thickness of stratum corneum in ductus papillaris, and increased leukocyte infiltration of udder parenchyma.<sup>6</sup>

Inherited zinc deficiency in cattle (lethal trait A46), which is caused in Holstein-Friesian cattle by a splice-site variant in SLC39A4, is described under the heading “Inherited Parakeratosis of Calves” later in this chapter.<sup>7</sup> An inherited syndrome in Fleckvieh cattle with similar phenotype is not a result of zinc deficiency, and it does not have the same genetic abnormality.<sup>8</sup>

### Sheep

The natural disease in sheep is characterized by loss of wool and the development of thick, wrinkled skin. Wool-eating also occurs in sheep and may be one of the earliest signs noticed in lambs after being on a zinc-deficient diet for 4 weeks. Induced cases in lambs have exhibited reduced growth rate, salivation, swollen hocks, wrinkled skin, and open skin lesions around the hoof and eyes. The experimental disease in goats is similar to that in lambs.

One of the most striking effects of zinc deficiency in **ram lambs** is impaired testicular growth and complete cessation of spermatogenesis. Diets containing 2.44 mg/kg dry matter (DM) caused poor growth, impaired testicular growth, cessation of spermatogenesis, and other signs of zinc deficiency within 20 to 24 weeks. A diet containing 17.4 mg/kg DM of zinc is adequate for growth, but a content of 32.4 mg/kg DM is necessary for normal testicular development and spermatogenesis. On severely deficient experimental diets, other clinical signs in young rams are as follows:

- Drooling copious amounts of saliva when ruminating
- Parakeratosis around eyes and on nose, feet, and scrotum
- Shedding of the hooves
- Dystrophy and shedding of wool, which showed severe staining
- Development of a pungent odor

In naturally occurring cases in rams, the animals stood with their backs arched and feet close together.

A marginal zinc deficiency in ewes may be characterized by only a reduction in feed intake and a slightly reduced

body weight, and no other external signs of disease. This is important because, in grazing ruminants, the lack of external signs indicates that zinc deficiency could easily pass undetected.

### Infertility in Ewes

Infertility in ewes and a dietary deficiency of zinc have not been officially linked, but a zinc-responsive infertility has been described in ewes. Again, attention is drawn to the need for response trials when soil and pasture levels of an element are marginal.

An **experimental zinc deficiency in pregnant ewes** results in a decrease in the birth weight of the lambs and a reduced concentration of zinc in the tissues of the lambs; these effects are a result of the reduced feed intake characteristic of zinc deficiency. The zinc content of the diet did not significantly influence the ability of the ewes to become pregnant or maintain pregnancy. The combination of pregnancy and zinc deficiency in the ewe leads to highly efficient utilization of ingested zinc, and the developing fetus will accumulate about 35% of the total dietary intake of zinc of the ewe during the last trimester of pregnancy. The disease is correctable by the supplementary feeding of zinc.

### Goats

Experimentally induced zinc deficiency in goats results in poor growth, low food intake, testicular hypoplasia, rough dull coat with loss of hair, and the accumulation of hard, dry, keratinized skin on the hindlimbs, scrotum, head, and neck. On the lower limbs the scabs fissure, crack, and produce some exudate. In naturally occurring cases in pygmy goats there was extensive alopecia, a kyphotic stance, extensive areas of parakeratosis, abnormal hoof growth, and flaky, painful coronary bands. A zinc-responsive alopecia and hyperkeratosis occurs in Angora goats. Affected animals had recurrent pruritus; hyperemia; exfoliation, fleece loss over the hindquarters, face, and ears; and a decline in reproductive performance. Zinc supplementation (40 or 80 mg/d) increases rate of fleece growth, plasma testosterone concentrations, and serum alkaline phosphatase activity in Cashmere goats.<sup>9</sup>

Immediately before parturition in cows, there is a precipitate fall in plasma zinc concentration, which returns to normal slowly after calving. The depression of zinc levels is greater in cows that experience dystocia. This has led to the hypothesis that dystocia in beef heifers may be caused in some circumstances by a nutritional deficiency of zinc and that preparturient supplementation of the diet with zinc may reduce the occurrence of difficult births. This phenomenon does not appear to occur in sheep. The level of serum zinc increases in cattle during the season of facial eczema when sporidesmin intoxication causes depletion of liver zinc.

## CLINICAL PATHOLOGY

### Skin Scraping

Laboratory examination of skin scrapings yields negative results, but skin biopsy will confirm the diagnosis of parakeratosis.

### Zinc in Serum and Hair

Serum zinc levels may have good diagnostic value. Normal levels are 80 to 120  $\mu\text{g/dL}$  (12.2 to 18.2  $\mu\text{mol/L}$ ) in sheep and cattle. Calves and lambs on deficient diets may have levels as low as 18  $\mu\text{g/dL}$  (3.0  $\mu\text{mol/L}$ ). Dairy cattle with serum zinc less than 9.7  $\mu\text{mol/L}$  are at increased risk of changes that predispose to mastitis.<sup>6</sup>

Normal serum zinc levels in sheep are above 78  $\mu\text{g/dL}$  (12  $\mu\text{mol/L}$ ), and values below 39  $\mu\text{g/dL}$  (6  $\mu\text{mol/L}$ ) or less are considered as evidence of deficiency. There is a general relationship between the zinc content of the hair and the level of zinc in the diet, but the analysis of hair is not considered to be a sufficiently accurate indicator of an animal's zinc status. In experimental disease in piglets, there is a reduction in serum levels of zinc, calcium, and alkaline phosphatase, and it is suggested that the disease could be detected by measuring the serum alkaline phosphate and serum zinc levels. Levels of zinc in the blood are very labile, and simple estimations of levels alone are likely to be misleading. For example, other intercurrent diseases commonly depress serum calcium and copper levels. In addition, zinc levels in plasma fall precipitately at parturition in cows; they are also depressed by hyperthermal stress. After 1 week on a highly deficient diet, serum zinc levels fall to about 50% of normal, or pretreatment, levels.

### NECROPSY FINDINGS

Necropsy examinations are not usually performed, but histologic examination of skin biopsy sections reveals a marked increase in thickness of all the elements of the epidermis. Tissue levels of zinc differ between deficient and normal animals, but the differences are statistical rather than diagnostic.

### DIFFERENTIAL DIAGNOSIS

Sarcoptic mange may resemble parakeratosis, but is accompanied by much itching and rubbing. The parasites may be found in skin scrapings. Treatment with appropriate parasiticides relieves the condition.

Exudative epidermitis is quite similar in appearance, but occurs chiefly in unweaned pigs. The lesions have a greasy character that is quite different from the dry, crumbly lesions of parakeratosis. The mortality rate is higher.

### TREATMENT

In outbreaks of parakeratosis in swine, zinc should be added to diet immediately at the rate of 50 mg/kg DM (200 mg of zinc sulfate or carbonate per kg of feed). The calcium

level of the diet should be maintained at between 0.65% and 0.75%. The injection of zinc at a rate of 2 to 4 mg/kg BW daily for 10 days is also effective.

Zinc oxide suspended in olive oil and given IM at a dose of 200 mg of zinc for adult sheep and 50 mg of zinc for lambs will result in a clinical cure within 2 months. The oral administration of zinc at the rate of 250 mg zinc sulfate daily for 4 weeks resulted in a clinical cure of zinc deficiency in goats in 12 to 14 weeks.

## CONTROL

### Pigs

The calcium content of diets for growing pigs should be restricted to 0.5% to 0.6%. However, rations containing as little as 0.5% calcium and with normal zinc content (30 mg/kg DM) may produce the disease. Supplementation with zinc (to 50 mg/kg DM) as sulfate or carbonate has been found to be highly effective as a preventive, and there appears to be a wide margin of safety in its use, with diets containing 1000 mg/kg DM added zinc having no apparent toxic effect. Organic and inorganic zinc supplements are handled differently by pigs, with organic forms of zinc being more bioavailable.<sup>1</sup> Rapidly growing pigs require 75 mg/kg of organic zinc in a complex nursery diet to maximize growth, health, and well-being.<sup>1</sup> The standard recommendation is to add 200 g of zinc carbonate or sulfate to each ton of feed. Weight gains in affected groups are appreciably increased by the addition of zinc to the diet. The addition of oils containing unsaturated fatty acids is also an effective preventive. Access to green pasture, reduction in food intake, and the deletion of growth stimulants from rations will lessen the incidence of the disease but are not usually practicable.

### Ruminants

For cattle, the feeding of zinc sulfate (2 to 4 g daily) is recommended as an emergency measure followed by the application of a zinc-containing fertilizer. As an alternative to dietary supplementation for ruminants, an intraruminal pellet has been demonstrated in sheep. It was effective for 7 weeks only and would not be satisfactory for long-term use. The creation of subcutaneous depots of zinc by the injection of zinc oxide or zinc metal dust has been demonstrated. The zinc dust offered a greater delayed effect. A soluble glass bolus containing zinc, cobalt, and selenium was able to correct experimentally induced zinc deficiency in sheep. The bolus supplied the daily requirement of the sheep for zinc with no detrimental effect on their copper status, although high-dose zinc supplementation does impair copper absorption in cattle that are provided additional copper in the diet.<sup>10</sup>

Zinc-methionine, an organic zinc supplement for dairy goats, improved udder health,

an enhanced the absorption of nitrogen, and increased nitrogen retention. Recommended dietary intake of zinc for Cashmere goats is 86 mg/kg DM during the breeding season and cashmere-fiber growing period.<sup>9</sup>

## REFERENCES

- Hill GM, et al. *J Anim Sci*. 2014;92:1582.
- Davin R, et al. *J Anim Physiol Nutr*. 2013;97:6.
- Khakzad P, et al. *J Vet Res*. 2014;69:173.
- Dittmer KE, et al. *Vet Pathol*. 2015;52:851.
- Cigankova V, et al. *Acta Veterinaria Beograd*. 2008;58:89.
- Davidov I, et al. *Rev Med Vet*. 2013;164:183.
- Yuzbasiyan-Gurkan V, et al. *Genomics*. 2006;88:521.
- Jung S, et al. *BMC Genomics*. 2014;15.
- Liu HY, et al. *J Anim Physiol Nutr*. 2015;99:880.
- Smith SL, et al. *New Zeal Vet J*. 2010;58:142.

## PLANT POISONING ASSOCIATED WITH KNOWN TOXINS

### DIANTHRONE DERIVATIVES

Hypericin, a complex derivative of dianthron, is found in *Hypericum perforatum* (St. John's wort or Klamath weed) and *Hypericum triquetrifolium* and is the prototypical primary photosensitizing agent.<sup>1</sup> All parts of these plants are associated with photosensitive dermatitis when ingested by sheep and cattle, but they have to be eaten in large quantities. They are not very palatable, and most outbreaks occur when they are in the young stage and dominate the pasture. Narrow-leaf varieties contain 2 or 3 times as much hypericin as broadleaf varieties, and the flowering tops are 6 to 9 times as toxic as other parts. Clinical signs may appear within a few days of livestock going onto affected fields and usually disappear within 1 to 2 weeks after removal from them. Experimental production of poisoning with *H. perforatum* has shown that the plant contains a primary photodynamic agent. There is neither liver damage nor loss of hepatic function.

### FAGOPYRIN

Fagopyrin, a red helianthron pigment found in *Fagopyrum sagittatum* (buckwheat), is associated with primary photosensitization in all species.

### FUROCOUMARIN

Plants containing furocoumarins (including psoralens) include the following:

- Ammi majus*—bishop's weed, meadow sweet
- Ammi visnaga*—visnaga
- Cooperia pedunculata*—thunder lily
- Cymopterus longipes*
- Cymopterus watsonii*—wild or spring parsley
- Heracleum mantegazzianum*—giant hogweed
- Petroselinum* spp.—parsley
- Thamnosma texana*—Dutchman's breeches, blister weed

Similar furocoumarins, identified as 4,5,8-trimethylpsoralen, 5-methoxypsoralen, and 8-methoxypsoralen, are also present in *Pastinaca sativa* (parsnip root) infested with the fungus *Ceratocystis fimbriata*, and *Apium graveolens* (celery) infested with *Sclerotinia* spp. (pink-rot fungus). These toxins have the particular characteristic of being photosensitizing by contact, without the need for ingestion, and are associated with serious lesions in humans. *A. majus* is most poisonous to livestock when there are ripe seeds in the seedheads. Its most serious occurrence is as a contaminant in hay. *C. pedunculata*, a perennial forb of western range country in the United States, occurs at times of high humidity or after rain has wet the foliage, and the live as well as dead leaves are toxic.

The clinical syndrome associated with plants containing furocoumarins is one of photosensitizing dermatitis. It includes severe cutaneous gangrene, on the white parts of the skin on the dorsal and lateral sides of the body and edema of the head and ears, the lateral aspects of the teats, the unpigmented conjunctivae, the muzzle and the oral mucosa inside the lower lip, and the undersurface of the tip of the tongue. Photosensitive dermatitis in pigs may be associated with distinctive vesicles on the snout and raise a false alarm of viral vesicular disease. One serious international incident arose out of a feeding of moldy parsnips.

## PLANT POISONINGS ASSOCIATED WITH UNIDENTIFIED TOXINS

### DERMATITIS

- Entandrophragma cylindricum*—redwood; shavings as bedding associated with balanoposthitis in rams
- Excoecaria* spp.
- Heracleum mantegazzianum*—cow parsnip
- Vicia benghalensis*—popany vetch; associated with dermatitis, conjunctivitis, rhinitis, fever, and multiple eosinophilic granulomas in many organs<sup>1</sup>
- Vicia dasycarpa*—woolly pod vetch; same symptoms as *V. benghalensis*
- Vicia villosa*—hairy vetch; same signs as *V. benghalensis*.

### PHOTOSENSITIZATION—PRIMARY; WITHOUT HEPATIC LESIONS

- Echinochloa utilis*—Japanese millet
- Erodium cicutarium*—storksbill
- Froelichia humboldtiana*<sup>2</sup>
- Holocalyx glaziovii*
- Lachnanthes tinctoria*
- Mentha satureioides*
- Sphenosciadium capitellatum*
- Medicago polymorpha*—burr trefoil
- Verbena* spp.



Photodermatitis associated with *M. polymorpha* and *F. humboldtiana* occurs in all animal species on pasture dominated by the plant, usually in the spring. Lesions on the unpigmented parts of the skin disappear quickly when animals are taken off the pasture; there is no liver damage or permanent after-effects.<sup>2</sup> Aphids, which commonly infest the plant in very large numbers, contain large amounts of a photodynamic agent and may be important in some outbreaks of the disease.

## REFERENCES

1. Soliva CR, et al. *J Anim Feed Sci.* 2008;17:352.
2. Souza PEC, et al. *Res Vet Sci.* 2012;93:1337.

## SELENIUM TOXICOSIS

### SYNOPSIS

**Etiology** Ingestion of plants or feed supplements or injection of pharmaceutical agents with excessive amounts of selenium.

**Epidemiology** Enzootic disease where soils and pasture contain toxic amounts of selenium; outbreaks after errors in feed supplementation or oral or injection doses.

**Clinical pathology:** Elevated concentration of selenium in body tissues and fluids.

#### Lesions:

##### Living Animals:

Acute: dyspnea, diarrhea, prostration, short course, death.

Chronic: emaciation, rough coat, stiff gait, lame, hoof deformity.

##### Postmortem:

Acute: evidence of cardiovascular compromise, hemorrhages.

Chronic: skeletal and cardiac myopathies.

**Diagnostic confirmation:** Elevated selenium levels in body fluids and tissues.

**Treatment:** None; avoid pastures with selenium-containing plants; take care with medication and feed additives containing selenium.

## ETIOLOGY

Selenium toxicosis in animals is a worldwide problem, either as an acute or chronic poisoning. It is associated with the ingestion or injection of organic or inorganic selenium compounds as follows:

- Inorganic selenium compounds administered as feed supplements
- Organic selenocompounds (selenomethionine and methylselenocysteine) occurring in pasture plants<sup>1,2</sup>
- Pharmaceutical preparations administered orally or by injection, frequently combined with vitamin E<sup>3</sup>

Discrepancies exist in the toxic doses quoted in the literature, and the reasons for this are not fully understood. Identified

animal factors include species, age, health, reproductive status, and nutritional status.<sup>4</sup> Other factors include dose, route of administration, and interactions with other dietary substrates.<sup>3</sup> The daily intake of a diet containing 2 mg/kg BW of selenium can be marginally toxic for sheep, yet pregnant and lactating ewes tolerated doses as high as 12 mg dietary selenium (as sodium selenite) per kilogram of BW for 72 weeks without developing any clinical or pathologic signs of selenium toxicosis.<sup>5</sup> Oral ingestion of 1 to 2.2 mg of Se/kg BW as sodium selenite caused mortality in lambs, but other lambs have survived doses of 4 mg/kg BW.<sup>6,7</sup> Feed containing 44 mg/kg selenium for horses and 11 mg/kg for pigs is associated with poisoning. Toxic single acute oral doses (as mg/kg BW) are 2.2 for sheep, 1.49 for horses,<sup>3</sup> 9 for cattle, and 15 for pigs.

## EPIDEMIOLOGY

### Occurrence

#### Pastoral

Selenium poisoning occurs in restricted areas in North America, Ireland, Israel, Canada, Australia, and South Africa where the soils are derived from particular rock formations containing a high content of selenium. The high level in these plants occurs from the high levels of selenium found naturally in the environment.

High levels of selenium in plants can also be found in areas where the soil is not naturally high in selenium. This is associated with industrial or commercial release of selenium into the water and soil.

### Dosing Errors

Substantial losses as a result of selenium poisoning also occur because of misunderstanding about the dose rates of selenium compounds used therapeutically or prophylactically.

## Risk Factors

### Animal Risk Factors

Cattle are more tolerant than sheep. Pigs are unlikely to be exposed but can develop the disease in the field. Young animals are less tolerant than adults.

Dietary supplementation is used in the prevention of known deficiency syndromes such as white muscle disease in lambs, as a nonspecific growth stimulant, and as a prophylactic for a large number of other vague syndromes. The concurrent administration of monensin and selenium increases the toxicity of the selenium being fed. There are many case reports of unexpected illness and mortality in animals dosed with selenium preparations, and it is apparent that not all of the factors affecting selenium toxicity are known.

Organic selenium compounds, especially those occurring naturally in plants, may be more toxic than inorganic compounds, but this difference may not be apparent in ruminants because of alterations in ingested

compounds produced by digestive processes in the rumen.<sup>4</sup> Selenite is more toxic than selenate, and both are more damaging than selenium dioxide.

## Environmental Risk Factors

Industrial deposition (e.g., fly ash from soft coal deposited in fields) has been shown to be associated with increased selenium levels in tissues from sheep grazing there.

## Farm Risk Factors

Selenium poisoning in animals grazing plants growing on seleniferous soils may be restricted to very distinct areas as small as individual fields. A low rainfall predisposes to selenium poisoning because soluble, available selenium compounds are not leached out of the topsoil, and lack of competing forage may force animals to eat large quantities of selenium-containing plants.

The effective selenium is contained in the top 60 to 90 cm of the soil profile, selenium at lower levels than this not being within reach of most plants. Selenium poisoning may occur on soils containing as little selenium as 0.01 mg/kg, but some soils may contain as much as 1200 mg/kg. Most pasture plants seldom contain selenium in excess of 100 ppm, but a number of species, the so-called converter or indicator plants, take up the element in such large quantities that selenium levels may reach as high as 10,000 ppm. Included in this category are *Acacia cana*; *Artemisia canescens*; *Aster* spp.; some of the *Astragalus*, *Atriplex*, and *Castilleja* spp.; *Comandra pallida*; *Descurainia pinnata*; *Grindelia* spp.; *Machaeranthera ramosa*; *Morinda reticulata*; *Neptunia amplexicaulis*; *Oenopsis*, *Penstemon*, and *Sideranthus* spp.; *Stanleya pinnata*; and *Xylorrhiza* spp.

These plants tend to grow preferentially on selenium-rich soils and are thus “indicator” plants. They are in general unpalatable because of a strong odor, and thus an acute syndrome is unlikely, but heavy losses have been attributed in the past to a chronic form of the disease known as alkali disease.

## PATHOGENESIS

Ingested selenium compounds are absorbed primarily in the duodenum, with some absorption in the remainder of the small intestine. Little, if any, absorption occurs in the rumen. The mechanism of absorption varies depending on the specific form of selenium, with selenite absorption by passive transfer and selenomethionine and selenocysteine by active transport.<sup>1,2</sup> Tissue distribution also depends on the form of selenium, with the kidney and liver ultimately having the highest concentration of selenium. Placental transfer occurs, especially in the last trimester; little is excreted in the milk.<sup>5</sup> Metabolism occurs in the red blood cells and liver; excretion is primarily through urine, with a small amount of

metabolized selenium excreted in the bile and feces.<sup>1</sup>

The mechanism of action is not well understood, and several different theories have been proposed.<sup>3</sup> Selenium occurs in plants in analogs of the sulfur-containing amino acids (e.g., selenocysteine), and a possible mechanism of intoxication is by interference with enzyme systems that contain these amino acids. Other proposed mechanisms include generation of free radicals, causing oxidative tissue damage, and incorporation into proteins, causing disruption of normal cell function.<sup>3,4</sup>

## CLINICAL FINDINGS

### Acute Poisoning

In naturally occurring and experimental poisoning there is severe respiratory distress, restlessness, complete anorexia, salivation, watery diarrhea, fever, tachycardia, abnormal posture and gait, prostration, and death after a short illness. Acutely poisoned horses showed marked central nervous system (CNS) signs, with ataxia and excitation, sweating, pyrexia, tachycardia, dyspnea, and death within 6 hours.<sup>3</sup> Mildly affected pigs show posterior ataxia, walking on tiptoe, difficulty in rising, sternal recumbency, tremor, and vomiting in some. Extreme cases assume a posture of lateral recumbency.

### Chronic Poisoning

Chronic poisoning is manifested by dullness, emaciation, rough coat, lack of vitality, stiffness, and lameness. In cattle, horses, and mules the hair at the base of the tail and switch is lost, and in pigs, goats, and horses there may be general alopecia. There are hoof abnormalities, including swelling of the coronary band and deformity or separation and sloughing of the hooves, in all species. Lameness is severe. Congenital hoof deformities may occur in newborn animals. Hemorrhagic lesions on the proximal wall and soles of claws on all four feet may accompany these deformities. Chronic poisoning in pigs on rations containing 20 to 27 mg/kg is also associated with a syndrome of reduced feed intake and paraplegia and quadriplegia as a result of poliomyelomalacia. Pigs on marginal levels of intake of selenium (10 mg/kg) develop necrosis of the coronary band, low conception rates, and increased neonatal mortality.

## CLINICAL PATHOLOGY

A moderate anemia occurs in acute and chronic poisoning, and a depression of hemoglobin levels to about 7 g/dL is one of the early indications of selenium poisoning. Selenium can be detected in the urine, milk, and hair of affected animals. Clinical illness is evident at blood levels of 3 mg/kg and at urine levels of more than 4 mg/kg of selenium. Normal serum levels of 140 to 190 ng/mL are elevated to the level of 1500 ng/mL.

Critical levels of selenium in hair include the following:

- Less than 5.0 mg/kg suggests that chronic selenosis is unlikely.
- From 5.0 to 10.0 mg/kg suggests borderline problems.
- More than 10 mg/kg is diagnostic of chronic selenosis.

## NECROPSY FINDINGS

### Acute

In confirmed cases of natural or experimentally produced acute selenium poisoning, most of the macroscopic findings can be attributed to cardiovascular compromise. There is pulmonary edema and congestion, petechiation of the thoracic viscera, and congestion of the liver, kidneys, and gastrointestinal tract. In parenterally overdosed lambs and piglets there is usually hydrothorax, hydropericardium, and ascites.

Histologic lesions may be minimal if the clinical course is brief. Changes that may be observed in animals surviving more than 24 hours include a serous effusion within pulmonary alveoli, mild hyaline or granular degeneration of skeletal muscle fibers, hydropic degeneration in renal tubular epithelial cells, and periacinar degeneration and necrosis of hepatocytes. Cardiac myocytes may appear swollen and contain areas of cytoplasmic granularity and lysis.

### Chronic

In animals suffering from subacute to chronic selenium poisoning there is a skeletal and cardiac myopathy. Deformities of the feet and skin are usually apparent. Atrophy and dilatation of the heart and pulmonary edema, cirrhosis and atrophy of the liver, glomerulonephritis, mild gastroenteritis, and erosion of articular surfaces have also been recorded.

Symmetric poliomyelomalacia has been identified in both natural and experimental settings in pigs fed excessive selenium. The areas primarily affected are the ventral horns of the cervical and lumbar enlargements, with lesser damage in brainstem nuclei. The microscopic appearance of affected spinal cord includes vacuolation of the neuropil and sometimes of the cytoplasm of neurons. Neuronal chromatolysis, axonal swelling, and endothelial cell swelling and proliferation are consistently present.

## Samples for Confirmation of Diagnosis

- **Toxicology**—50 g liver, kidney; 500 g of suspect feed (ASSAY [Se])
- **Histology**—formalin-fixed skeletal muscle, heart, liver, kidney, +/- spinal cord from cervical and lumbar enlargements (LM)

**Selenium Levels in Tissue.** In chronic selenosis in sheep, hepatic and renal levels of selenium are about 20 to 30 mg/kg, and

levels in wool are in the range of 0.6 to 2.3 mg/kg. In horses, hair levels of more than 5 mg/kg are recorded.

The diagnosis of selenium poisoning rests largely on the recognition of the typical syndromes in animals in areas where the soil content of selenium is high or when there has been administration of selenium as medication or as a feed additive. The clinical and necropsy lesions associated with the poisoning cover a wide range of signs, and lesions are not easily summarized. Diagnostic confirmation depends on an assay of toxic levels of selenium in body tissues or fluids.

## DIFFERENTIAL DIAGNOSIS

Differential diagnostic list:

### Acute poisoning

- Acute arsenic toxicosis
- Anaphylaxis
- Ionophores/tiamulin in swine
- Septicemia
- Toxemia

### Chronic poisoning

- Hypovitaminosis A
- Laminitis
- Sodium chloride toxicosis

## TREATMENT

A number of substances have been tried in the treatment of selenium poisoning, including potassium iodide, ascorbic acid, and beet pectin, but without apparent effect. The use of BAL is contraindicated.

## CONTROL

Selenium in feeds should not exceed 5 mg/kg dry matter if danger is to be avoided, and feeding on pasture containing 25 mg/kg dry matter for several weeks can be expected to be associated with chronic selenium poisoning. Pasture may contain as much as 2000 to 6000 mg/kg of selenium and is associated with the acute form of the disease when fed for a few days.

Protection against the toxic effects of selenium in amounts up to 10 mg/kg in the diet has been obtained by the inclusion in the ration fed to pigs of 0.01% to 0.02% of arsenic acid or 0.005% of 3-nitro-4-hydroxyphenyl arsonic acid. In cattle, 0.01% arsenic acid in the ration or 550 mg/day to grazing steers gives only slight protection. The addition of linseed oil to the ration improves the efficiency of this protection. A high-protein diet also has a general protective effect.

When using selenium as a pharmaceutical agent, strict attention should be paid to the recommended dose and route of administration.

## FURTHER READING

- Blodgett DJ, Beville RF. Acute selenium toxicosis in sheep. *Vet Hum Tox.* 1987;29:233-236.
- Casteel SW, Osweiler GD, Cook WO, et al. Selenium toxicosis in swine. *J Am Vet Med Assoc.* 1985;186:1084-1085.

- O'Toole T, Raisbeck MF. Pathology of experimentally induced chronic selenosis (alkali disease) in yearling cattle. *J Vet Diagn Invest.* 1995;7:364-373.
- Perry TW, Beeson WM, Smith WH, et al. Effect of supplemental Se on performance and deposit of Se in blood and hair of finishing beef cattle. *J Anim Sci.* 1976;42:192-195.
- Radostits O, et al. Selenium poisoning. In: *Veterinary Medicine: A Textbook of the Disease of Cattle, Horses, Sheep, Goats and Pigs.* 10th ed. London: WB. Saunders; 2007:1811.
- Raisbeck MF, Dahl ER, Sanchez DA, et al. Naturally occurring selenosis in Wyoming. *J Vet Diagn Invest.* 1993;5:84-87.

## REFERENCES

- Herdt TH. *Vet Clin North Am Food A.* 2011;27:255.
- Nogueira CW, et al. *Arch Toxicol.* 2011;85:1313-1359.
- Desta B, et al. *J Vet Diagn Invest.* 2011;23:623.
- Kienzle E, et al. *Eur Eq Nutr Health Con.* 2006;3:1.
- Davis PA, et al. *J Anim Sci.* 2006;84:660.
- Faye B, et al. *Nutrients.* 2009;1:30.
- Tiwary AK, et al. *J Vet Diagn Invest.* 2006;18:61.

## IODINE TOXICOSIS

### ETIOLOGY

Iodine is found in low concentrations in nature both as inorganic and organic forms. Common sources of iodine include iodized salt (100 ppm iodine), ethylenediamine dihydroiodide (EDDI), and iodine containing feed additives such as calcium iodate, potassium iodide, and sodium iodine.<sup>1</sup> Potassium iodide, the most water-soluble and chemically unstable form, is the least commonly used product in cattle feed; calcium iodate is the most stable product. Ethylenediamine dihydroiodide is often used to prevent or treat footrot in cattle but has been used in other countries to treat pythiosis in horses.<sup>2</sup>

Poisoning with inorganic iodine products is rarely associated with illness in animals. Excretion in milk and eggs is linear, and the toxic dose is large. As the amount of inorganic iodine ingested increases, so does the amount excreted in milk, with a fairly constant excretion ratio of 8% to 12% iodine.<sup>3</sup> Doses of 10 mg/kg BW daily are usually required to produce fatal illness in calves. There is a special occurrence of goiter in foals when the foal and the dam are fed excessive amounts of iodine, especially when kelp is fed as a dietary supplement. Intakes of 35 to 40 mg iodine/day in a mare can be associated with the development of goiter in her foal.

Toxicity with organic iodides has also occurred at much lower levels of intake (e.g., 160 mg/day per cow) and appears to be a practical risk when cows or calves are fed EDDI constantly as a prophylactic against footrot.

### CLINICAL FINDINGS

Clinical signs vary depending on the species and form of iodine. Horses appear to be the most sensitive to iodine toxicosis, followed by ruminants and then pigs.<sup>1,2</sup> In cattle and

sheep, signs include heavy dusting of the hair coat with large-sized dandruff scales, hair loss, dryness of the coat, coughing, and profuse nasal discharge.<sup>1</sup> Feed intake and milk production are often decreased. Other common signs in ruminants include lacrimation, hyperthermia, and hypersalivation. Exophthalmos occurs in some cases, and severely affected animals may die of bronchopneumonia. In horses, alopecia and heavy dandruff are characteristic. Anhidrosis, rhabdomyolysis, and exercise intolerance have also been reported.<sup>2</sup>

### CLINICAL PATHOLOGY/NECROPSY

Serum iodine levels are elevated above the normal level<sup>3</sup> of 5 µg/100 mL up to 20 to 130 µg/mL.

Most of the postmortem lesions are associated with changes in the respiratory tract, with tracheitis, bronchopneumonia, and pleurisy reported in cattle. Lung tissue shows exudative inflammation, hypertrophy of the bronchial mucous membranes, bronchiole necrosis, and fibrinous exudate in the alveoli. Sheep with iodine toxicosis showed suppurative bronchopneumonia and fibrinous pneumonia.

### FURTHER READING

- Baker DH. Iodine toxicity and its amelioration. *Exp Biol Med.* 2004;229:473-478.
- Paulikova I, Kovac G, Bires J, et al. Iodine toxicity in ruminants. *Vet Med Czech.* 2002;12:343-350.
- Thompson LJ, Hall JO, Meerdink GL. Toxic effects of trace mineral excess. *Vet Clin North Am Food A.* 1991;7:277-306.

### REFERENCES

- Schone F, Rajendram R. Iodine in farm animals. In: Preedy VR, Burrow GN, Watson RR, Burlingham MA, eds. *Comprehensive Handbook of Iodine: Nutritional, Biochemical Pathologic and Therapeutic Aspects.* Academic Press; 2009:151.
- Doria RGS, et al. *Arq Bras Vet Med Zootec.* 2008;60:521.
- Norouzian MA, et al. *J Anim Vet Adv.* 2009;8:1111.

## Cutaneous Neoplasms

### PAPILLOMA AND SARCOID

Sarcoid of horses and cutaneous papillomatosis of horses, goats, and cattle are specific diseases (see also “Sarcoid” and “Papillomatosis”). The lesions are characteristically nodular growths of viable tissue and, if there is no traumatic injury, with no discontinuity of the covering epidermis.

**Aural flat warts (aural plaques)** occur commonly in the horse and are caused by papillomavirus. Blackflies may serve as a vector. Lesions consist of one to several gray or white plaques involving the inner surface of the pinna. Similar lesions may occur around the anus, vulva, and inguinal regions. The lesions are usually asymptomatic, may persist indefinitely, may regress spontaneously, and are refractory to treatment.

## SQUAMOUS-CELL CARCINOMA

Squamous-cell carcinoma can occur anywhere on the skin, and also in the mouth and maxillary sinus. Squamous-cell carcinoma in cattle and horses may develop as an uncommon complication of an infection with bovine papillomavirus type 1 and 2.<sup>1</sup> Common types are as follows:

- **Ocular squamous-cell carcinoma (cancer—eye)** is the commonest lesion, on the eyelids and the eyeball in horses and cattle (see also “Bovine Ocular Squamous-Cell Carcinoma” and “Equine Ocular Squamous-Cell Carcinoma”).
- **Squamous-cell carcinomas in horses** are the second most common cutaneous neoplasia (after the equine sarcoid) in this species and primarily affect the glans penis and prepuce and the perianal region of aged horses.<sup>2</sup> Squamous-cell carcinoma can cause fatal metastases unless the primary tumor is resected in the early stages. Grossly similar lesions are caused by epithelial hyperplasia, habronemiasis, and squamous papillomata.
- **Vulvar squamous-cell carcinoma** appears frequently in Merino ewes as a result of excessive exposure of vulvar skin to sunlight after radical perineal surgery to help control blow-fly strike. Squamous-cell carcinomas also occur on the vulva of cattle, and a greater incidence has been observed on unpigmented than on pigmented vulvas.
- **Horn cancer** in cattle and rarely in sheep, goats, and buffaloes is a squamous-cell carcinoma arising from the pseudostratified columnar epithelium of the horn core mucosa; it is most prevalent in *Bos indicus* breeds. This tumor affects approximately 1% of the Indian cattle population and accounts for over 80% of reported tumors in Indian cattle. Steers have been reported to be affected more frequently than female animals. In the early stages, affected animals may rub the horns against a fixed object or shake the head frequently. A bloody discharge begins from the nostril on the affected side, or from the base of the horn, and the animal holds its head down and toward one side. The horn becomes loosened and falls off, leaving the tumor exposed to infection and fly infestation. Secondary metastases are common. The high prevalence of metastases in regional lymph nodes and internal organs discourages treatment, but a phenol extract of horn core tissue is immunogenic, and immunotherapy may be a successful treatment technique. Other forms of therapy are also practiced for squamous-cell carcinoma generally, including surgical excision,



preferably by cryotherapy, and radiofrequency hyperthermia.

- **Ear cancer** in sheep is in most cases a squamous-cell carcinoma. The lesion commences around the free edge of the ear and then invades the entire ear, which becomes a large, cauliflower-shaped mass. A high incidence may occur in some flocks, but the cause is not known; the presence of papillomavirus in many aural precancerous lesions suggests that the virus may participate in the etiology.
- **Ovine skin cancer:** A high incidence of epitheliomas has been recorded in some families of merino sheep in Australia. The lesions occur on the woolled skin and are accompanied by many cutaneous cysts. It has been suggested that predisposition to the neoplasm is inherited. Metastasis is common with both epitheliomas and squamous-cell carcinomas.
- **“Brand cancer,”** which occurs as a granulomatous mass at the site of a skin fire or freeze brand, is usually considered to be of chronic inflammatory rather than neoplastic origin, but squamous-cell carcinomas are recorded at branding sites in sheep and cattle.
- **In goats,** the perineum is a common site for squamous-cell carcinoma. The udder, ears, and base of the horns may also be affected. Ulceration, flystrike, and matting of hair are unattractive sequelae. A bilaterally symmetric vulvar swelling as a result of ectopic mammary tissue that enlarges at parturition is likely to be confused with squamous-cell carcinoma. Milk can be aspirated from the swellings.

## REFERENCES

1. Nasir L, Campo MS. *Vet Dermatol.* 2008;19:243-254.
2. Schaffer PA, et al. *J Am Vet Med Assoc.* 2013;242:99-104.

## MELANOMA

Melanomas are skin neoplasias commonly occurring in pigs, horses, cattle, small ruminants, and camelids.<sup>1</sup> In horses, between 4% and 15% and in cattle approximately 6% of all tumors were reported to be melanomas.<sup>1-3</sup> In horses, melanomas primarily occur in mature gray- and white-coated horses, reaching a prevalence of over 80% in this subgroup of animals.<sup>4</sup> Although historically melanomas were considered to be benign skin proliferations, more recently the concept of melanoma as a neoplasia with malignant potential has become more accepted. Some sources claim that at least 66% of melanocytic tumors in horses eventually become malignant.<sup>4</sup>

Four types of melanocytic abnormalities are recognized in horses:<sup>2,4</sup>

- **Melanocytic nevi** are seen in younger horses independent of the coat color and are discrete and benign discolorations of the skin. Presence of several nevi is considered a predisposing factor for the development of dermal melanoma.<sup>1</sup>
- **Discrete dermal melanomas** present as single masses, most commonly in typical locations such as the tail, anal, perianal, perineal, and genital region. They are most common in mature gray horses with an average age of 13 years. Although dermal melanomas frequently are benign, malignant forms occur. Surgical excision at early stages is recommended and is curative in most cases.<sup>1,4</sup>
- **Dermal melanomatosis** refers to the occurrence of several dermal melanomas, and it has a high incidence of metastasis. Melanomatosis in general affects horses that are older than 15 years and is not amenable to surgical resection. Visceral metastasis is a not uncommon complication; this type of melanoma is considered to be potentially fatal.<sup>4</sup>
- **Anaplastic malignant melanomas** occur in older nongray horses, with a high incidence of metastasis. The presentation of discrete dermal melanoma and dermal melanomatosis is referred to as **dermal melanoma**.

## PATHOPHYSIOLOGY

Although the initiation of most animal melanomas is still poorly understood, the development of melanomas is epidemiologically linked to mutations generated by both UV-A and UV-B solar radiation. Malignant cells can infiltrate surrounding tissue and metastasize via lymphatic or blood vessels, with regional lymph nodes being the usual first target.<sup>1</sup> A genetic predisposition to the development of melanomas is recognized in Sinclair miniature pigs, Duroc pigs, and Angora goats, which have been proposed as potential models for human melanoma.<sup>1</sup> In horses, the well-recognized connection between gray coat color and the increased risk of melanoma has led to the assumption that specific genetic mutations in gray-coated horses may either predispose to or facilitate the development of melanoma. Presence of multiple melanocytic nevi is considered to increase the risk of melanoma. Melanocytic tumors can also be congenital (see also “**Inherited Melanoma**”).

## CLINICAL FINDINGS

Melanomas initially present as single, small, firm, raised nodule with a slow growth rate. They are frequently found incidentally during grooming or routine physical examination. Melanomas may be of any color, ranging from gray or brown to black, red, or even dark blue.<sup>1</sup> Typical locations for

melanomas are the perineum, tail base, sheath, commissures of the lips, jugular furrow, and subauricular lymph nodes.<sup>4</sup> Although in many cases tumors may exist for many years without causing any clinical signs, the skin may ulcerate in rapidly growing tumors, leading to secondary bacterial infection. Large masses in the perianal region may impair defecation and result in fecal impaction. Similarly, large tumors in the neck area may impair head movement and the ability to eat, drink, and swallow. Visceral metastatic masses may occur in more advanced cases.<sup>4</sup>

## CLINICAL PATHOLOGY

Although the location, appearance, and color of a mass can be highly suggestive, an excisional biopsy, which involves surgically removing small tumors integrally and submitting them to a diagnostic laboratory for histologic confirmation of the diagnosis, has been recommended whenever possible.<sup>4</sup>

## TREATMENT

Single noninvasive tumors of small to moderate size have been surgically excised with good success and good prognosis. Surgical excision is unrewarding in cases with multiple tumors, infiltrating masses, or masses located around the parotid salivary gland, which complicate the surgical approach considerably.<sup>4</sup>

In horses, treatment with oral cimetidine, a histamine type 2 receptor antagonist, either at a dose of 2.5 mg/kg BW q8h or 7.5 mg/kg BW q24h p.o., for at least 60 days has yielded variable results.<sup>3</sup> Promising results were reported with the use of cisplatin, either as repeated intratumoral injection or as biodegradable beads in horses.<sup>4</sup>

## FURTHER READING

- Moore JS, Shaw C, Shaw E, et al. Melanoma in horses: current perspectives. *Equine Vet J.* 2013;25:144-151.
- Smith SH, Goldschmidt MH, McManus MP. A comparative review of melanocytic neoplasms. *Vet Pathol.* 2002;39:651-678.

## REFERENCES

1. Smith SH, et al. *Vet Pathol.* 2002;39:651-678.
2. Schaffer PA, et al. *J Am Vet Med Assoc.* 2013;242:99-104.
3. MacGillivray KC, et al. *J Vet Intern Med.* 2002;16:452-456.
4. Moore JS, et al. *Equine Vet J.* 2013;25:144-151.

## LIPOMA

Lipomas are benign subcutaneous or submucosal tumors that can be locally extensive and consist of well-differentiated adipocytes. Lipomas are occasionally seen in horses but are rare in cattle. In horses, lipomas occur either as mesenteric or cutaneous lipomas. Mesenteric lipomas predominantly develop in older horses, presenting as pedunculated lipomas that may cause secondary complications such as intestinal strangulation.

Subcutaneous lipomas are the predominant form in young horses less than 2 years of age. The large majority of cutaneous lipomas are encapsulated and well demarcated from surrounding tissue, making them easily resectable, with minimal risk for recurrence. Occasionally lipomas may grow invasively, infiltrating surrounding tissue such as muscles, tendons, joints, and even bone. Despite their invasive growth, infiltrative lipomas are benign because they do not metastasize.<sup>1</sup> The invasive growth pattern makes integral resection of tumorous tissue impossible and results in high recurrence rates after surgical intervention.<sup>1</sup> Differentiating between lipomas and infiltrative lipomas is important to determine the eligibility for surgical resection and the prognosis but can be challenging under field conditions.<sup>1</sup>

In foals and calves, congenital external infiltrating lipomas have been reported.<sup>2,3</sup>

## REFERENCES

1. Pease A. *Equine Vet Educ.* 2010;22:608-609.
2. Rebsamen E, et al. *Equine Vet Educ.* 2010;22:602-607.
3. Sickinger M, et al. *J Vet Diagn Invest.* 2009;21:719-721.

## MAST CELL TUMORS

A mast cell tumor (mastocytoma) is a rare neoplasia primarily affecting the skin in cattle, horses, swine, and New World camelids. The large majority of mast cell tumors in cattle and horses are benign, but malignant forms have been described. Less than 6% of all equine and less than 1% of all bovine neoplasias have been identified as mastocytomas.<sup>1-3</sup> Incidental case of mast cell tumors have been reported in pigs, small ruminants, and New World camelids. Mast cell tumors in the species just mentioned are most frequently located in the skin, with no apparent site of predilection. Other than on the skin, mastocytomas in horses have also been identified in the gastrointestinal tract, salivary glands, eyes, testes, and spleen.<sup>1</sup> In cattle, apart from the cutaneous form, mast cell tumors have been found in spleen, lung, liver, lymph nodes, muscle tissue, omentum, abomasum, tongue, and uterus.

## CLINICAL FINDINGS

Animals of all ages can be affected, and neither a gender nor a breed predilection has been reported.<sup>2</sup> Single lesions are the most common presentation, but cases of multicentric mastocytoma have been reported in different species.<sup>1,4,5</sup> In most instances a mastocytoma presents as slow-growing, indolent cutaneous or subcutaneous mass. Lesions typically are well demarcated and vary from 0.5 to 20 cm in diameter and feel firm or fluctuating on palpation. Masses located on the limbs are often firm and immovable.<sup>1</sup> The overlying skin is usually intact, although alopecia, hyperpigmentation, or ulceration may be present.<sup>1</sup>

## CLINICAL PATHOLOGY

Diagnosis of cutaneous mastocytoma is either by fine-needle aspiration or excisional biopsy, removing the mass integrally. Histologically mast cell tumors are characterized by the predominance of well-differentiated mast cells. Mitotic figures are few in number, and eosinophilic infiltration of the mass is a consistent finding.<sup>1</sup> Older lesions may contain considerable amount of fibrosis, mineralization, and necrosis.<sup>1</sup>

## TREATMENT

Cutaneous mastocytomas in cattle and horses in general are benign and indolent, but they rarely resolve spontaneously. Surgical excision may therefore be indicated for cosmetic reasons or when masses cause discomfort, and surgery is usually curative.

Other reported treatments include cryosurgery and the intra- or sublesional injection of corticosteroids (e.g., 10 to 20 mg methylprednisolone acetate).<sup>1</sup>

## REFERENCES

1. Mair TS, Krudewig C. *Equine Vet J.* 2008;20:177-182.
2. Schaffer PA, et al. *J Am Vet Med Assoc.* 2013;242:99-104.
3. Tzu-Yin L, et al. *J Vet Diagn Invest.* 2010;22:808-811.
4. Martinez J, et al. *J Vet Diagn Invest.* 2011;23:1222-1225.
5. Millward LM, et al. *Vet Clin Pathol.* 2010;39:365-370.

## LYMPHOMATOSIS

In cattle and horses, skin lesions occur as nodules in the subcutaneous tissue, most commonly in the paralumbar fossae and the perineum. In cattle, the lesions are associated with the virus of enzootic bovine leukosis (EBL) and are only one manifestation of the disease, usually being accompanied by lesions in other organs. In horses, there are no leukemic lesions in lymph nodes or visceral organs.

## NEUROFIBROMATOSIS

This common lesion of nerves in cattle usually attracts attention only in abattoir specimens but can occur in a cutaneous form resembling a similar disease of humans; a particularly high prevalence of this benign disease is recorded in breeds of European pied cattle. Clinical cases are usually recorded in calves, in which there are cutaneous lesions that appear as tumor-like lumps between the eyes and on the cheeks. They are flat, round tumors up to 8 cm in diameter and of a lumpy, elastic consistency.

## HISTIOCYTOMA

Histiocytomas originate from epidermal Langerhans cells of antigen-presenting lineage. This is a very rare benign neoplasm in farm animals but is recorded as cutaneous nodules or plaques, which bleed easily, in

goats and cattle. The lesions regress spontaneously.

## CUTANEOUS ANGIOMATOSIS

Angiomatosis is vasoproliferation originating from endothelial cells from blood vessels. The etiology of this condition that is rarely observed in horses, cattle, swine, small ruminants, and New World camelids is not yet understood. Causes discussed in the literature are inflammatory reactions, bacterial or viral infection, congenital abnormalities, and hyper- or neoplastic transformations.

In cattle, cutaneous angiomatosis most commonly presents as single or multiple cutaneous lesions situated most commonly along the dorsum of the neck characterized by recurrent profuse hemorrhage. The lesions consist of what appears to be protruding granulation tissue and are benign. Histologically angiomas are characterized by the nonencapsulated proliferation of vascular tissue that may or may not be infiltrated with inflammatory cells.

A juvenile version of angiomatosis in calves is characterized by similar lesions but in many organs, sometimes including the skin.

Surgical excision is effective.

## HEMANGIOMA AND HEMANGIOSARCOMA

Benign vascular proliferations are occasionally encountered in most animal species. Cutaneous hemangiomas of young horses are morphologically the same as bovine cutaneous angiomatosis lesions. Young horses usually present with solitary lesions between 1 and up to 30 cm in diameter on distal parts of the limbs. The lesions can consist of nodules or plaques with firm to fluctuating consistency that bleed easily. The skin overlying the proliferation tends to be dark colored, hyperkeratotic, and associated with local alopecia.

Hemangiosarcomas (hemangioepithelioma) are malignant tumors recorded relatively frequently in older horses. They are large, highly vascular, subcutaneous masses, usually associated with one or more internal lesions. The primary lesion may be internal, commonly in the spleen, or cutaneous. Recurrence after excision, extensive local infiltration, and death as a result of anemia are common sequelae.

## CONGENITAL SKIN TUMORS

Congenital tumors are defined as those existing at birth. A broader definition is that congenital tumors can be detected in fetuses and in newborns until 2 months of age. Embryonic tumors are those that arise during embryonic, fetal, or early postnatal development from a particular organ rudiment or tissue while it is still immature. Hamartomas are benign, tumor-like nodules composed of

overgrowth of mature cells, which normally occur in the affected part but often with one element predominating. Hamartomas include hemangiomas, ameloblastomas, and rhabdomyomas. Teratomas are true neoplasms consisting of different types of tissue not native to the area in which they occur.

### Cattle

Congenital skin neoplasms of cattle described include mast cell tumors, lymphosarcoma, myxoma, and vascular hamartoma. Benign melanomas, mastocytomas, hemangiomas and lymphangiomas, fibrosarcomas, neurofibromatosis, subcutaneous lipomas, multiple lipomas, and retroperitoneal lipomas have also been recorded in calves. The comparative aspects of tumors in calves have been described.

### Pigs

The literature on congenital and hereditary tumors in piglets has been reviewed. Spindle-cell sarcoma, malignant melanoma, and papillomatosis are common congenital tumors of the skin of piglets. Congenital cutaneous papillomatosis of the head and neck of a newborn piglet has been described on a pig-breeding farm where sporadic cutaneous papillomatosis of the prepuce and scrotum had previously occurred in several boars.

### Foals

Congenital tumors in foals are rare. Congenital skin tumors are of the papillomatous, vascular, and melanocytic types. The vascular tumors are capillary hemangiomas, cavernous hemangiomas, and hemangiosarcomas.

### FURTHER READING

Misdorp W. Congenital tumours and tumour-like lesions in domestic animals. 1. Cattle: a review. *Vet Q.* 2002;24:1-11.

Misdorp W. Congenital tumours and tumour-like lesions in domestic animals. 2. Pigs: a review. *Vet Q.* 2003;25:17-30.

Misdorp W. Congenital tumours and tumour-like lesions in domestic animals. 3. Horses: a review. *Vet Q.* 2003;25:61-71.

## Congenital and Inherited Defects of the Skin

Examples of common inherited skin defects that are present at birth are as follows:

- **Inherited parakeratosis** (lethal trait A46, adema disease, inherited nutritional zinc deficiency) occurs in cattle.
- **Dermatosis vegetans** of Landrace breed pigs is a hereditary skin disease characterized by well-demarcated, raised, roughened skin lesions; enlarged, ridged, discolored hooves; and characteristic giant-cell pneumonia.
- **Inherited congenital ichthyosis** (fish-scale disease) of calves is

characterized by diffuse cutaneous hyperkeratosis, giving the skin an appearance of fish scale. Two forms, the more severe and lethal **ichthyosis fetalis** (bovine harlequin fetus) and the milder **ichthyosis congenitalis**, are recognized.<sup>1</sup>

- **Inherited hypotrichoses and alopecias** have been described in numerous cattle breeds. Inherited hypotrichosis is often associated with other congenital defects, such as dental anomalies, absent horn development, abnormal coat coloration, and others.
- **Epitheliogenesis imperfecta**, a rare congenital defect reported in calves, pigs, lambs, and foals, is characterized by a discontinuity of the squamous epithelium. There are sharply demarcated areas in which there is absence of epidermis. The condition is inherited as a single autosomal-recessive trait and is fatal if skin lesions are extensive.
- **Epitheliogenesis imperfect (aplasia cutis)** occurs in piglets as a result of ingestion of *Fusarium* spp. toxin.
- **Epidermolysis bullosa syndrome** is observed in calves, lambs, and foals (especially the Belgian breed) and is characterized by separation of the dermal-epidermal junction beneath the basal epithelium. Lesions involve the skin, mucocutaneous junctions, and oral mucosa. The defect is present at birth, but it may be several months before the disease is clinically apparent.
- **Hereditary equine regional dermal asthenia (hyperelastosis cutis)** is an inherited connective tissue disorder primarily seen in Quarter horses. The condition is characterized by sharply demarcated areas of loose skin, which is hyperfragile, tears easily, and exhibits impaired healing. The underlying cause is a faulty collagen fiber production.
- **Congenital dyserythropoiesis and dyskeratosis** of Polled Hereford calves is a congenital syndrome of alopecia and anemia. The condition is characterized by nonregenerative anemia that is accompanied by progressively worsening cutaneous lesions in the form of generalized alopecia and hyperkeratotic dermatitis.
- **Hair-coat-color-linked follicular dysplasia**
- **Familial acantholysis** in New Zealand Angus calves is characterized by defective cell-to-cell adhesion in the epidermis. The skin is normal at birth, but erosions and crusts develop on exposed skin. Partial separation of the hooves and skin shedding over the carpus may occur.
- **Cutaneous asthenia, dermatosparaxis**, and the **Ehlers-Danlos syndrome** are reported in cattle sheep, pigs, and horses and are characterized by faulty collagen

production. Skin is fragile and hyperextensible from birth on, with disturbed wound healing.

- **Nevus** is an irregularly shaped, cutaneous defect, present at birth and originally covered with hair, but subsequently hairless. Depending on which cells are involved, a nevus is referred to as vascular, epidermal, connective tissue, or melanotic nevus. Individual lesions are 3 to 4 cm in diameter, bright pink, ulcerated, and inflamed. Vascular nevi consist of densely packed convoluted blood vessels, which bleed easily. Most lesions are on the lower limbs, especially at the coronet.
- **Dermoid cysts** are cystic structures occasionally observed in horses and other species containing hair, exfoliated skin, and glandular debris. Dermoid cysts are present at birth but may become apparent later in life as they grow in size.
- **Inherited epidermal dysplasia (baldy calf syndrome)** of Holstein-Friesian calves is an autosomal-recessive inherited lethal condition. Calves appear normal at birth but progressively loose hair and condition; they have elongated and narrow hooves and scaly skin. Secondary skin ulceration and failure of horn development occur.<sup>2</sup>

### REFERENCES

1. Gentile A, Testoni S. *Slov Vet Res.* 2006;43:17-29.
2. Windsor PA, Agerholm JS. *Aust Vet J.* 2009;87:193-199.

### INHERITED ALBINISM

Albinism is a congenital lack of melanin pigment in the skin, hair, and other normally pigmented structures such as the uveal tract. Albinism is classified as generalized or localized and as complete, partial, or incomplete. The affected skin in albinism is characterized microscopically as melanopenic rather than melanocytopenic, which distinguishes partial albinism from piebaldism. Most of the normal, inherited white markings that occur on horses are localized forms of piebaldism. Generalized and complete albino animals (oculocutaneous albinism) have white hair, white skin, and pink irides, and they usually exhibit photophobia. Generalized albinism in the horse is inherited as an autosomal-dominant trait that is only viable in the heterozygous states. These horses have incomplete albinism because there is some coloration to the iris.

### DISORDERS OF COAT COLOR, PSEUDOALBINISM, AND LETHAL WHITES

There are a number of forms of pseudoalbinism and disorders of coat color in domestic animals that involve congenital systemic



disease.<sup>1-5</sup> There is a nonlethal form in cattle and a lethal dominant form in horses in which 25% of conceptions produced by mating dominant white horses die in utero in early gestation. The only pigment in the affected foals is in the eyes.

The disease in **cattle** occurs in Angus, Brown Swiss, Holstein, and Hereford cattle. The Angus cattle have a brown coat and two-tone irises with an outer pale brown ring and an inner blue one. There appears to be no defect in digestion or metabolism. Hereford incomplete albinos have the Chediak-Higashi syndrome. The other breeds do not appear to have defects other than in pigmentation, and the defect in Angus is probably more accurately called “oculocutaneous hypopigmentation.” They do have one problem; they are photophobic and prefer to be out of the sun.

A complete albinism in Icelandic **sheep** is manifested by white skin color, pink eyes, and impaired vision in bright light. It is an autosomal recessive. Albinism occurs in Karakul sheep. White lambs of an inbred flock of the Cameroon breed born with light blue eyes died within hours to days of birth, with signs of intestinal obstruction. Affected lambs had deletion of both copies of the gene for endothelin type-B receptor and deletion of a single copy of the gene in the phenotypically normal dams and several other unaffected sheep from the same flock.<sup>6,7</sup>

True albino **horses** rarely if ever occur in nature, but white horses with pigmented eyes do. They are more accurately called pseudo-albinos. See “Lethal White” for discussion of colonic aganglionosis caused by a mutation in the endothelin type-B receptor gene in overo white Paint horses.<sup>5</sup>

## REFERENCES

1. Bettley CD, et al. *Anim Welfare*. 2012;21:59.
2. Charon KM, et al. *Annals Anim Welfare*. 2015;15:3.
3. Webb AA, et al. *Can Vet J*. 2010;51:653.
4. Bellone RR. *Anim Genet*. 2010;41:100.
5. Finno CJ, et al. *Vet J*. 2009;179:336.
6. Luehken G, et al. *PLoS ONE*. 2012;7.
7. Pauciuillo A, et al. *Cytogen Genom Res*. 2013;140:46.

## INHERITED SYMMETRIC ALOPECIA

Inherited symmetric alopecia is an inherited skin defect of cattle in which animals born with a normal hair coat lose hair from areas distributed symmetrically over the body. It has been observed in Holstein cattle as a rare disease, but its appearance among valuable purebred cattle has economic importance. It appears to be inherited as a single autosomal-recessive character. Loss of hair commences at 6 weeks to 6 months of age. The alopecia is symmetric and commences on the head, neck, back, and hindquarters, and progresses to the root of the tail, down the legs, and over the forelimbs. Affected skin areas become completely bald. Pigmented and unpigmented skin is equally affected;

there is no irritation, and the animals are normal in other respects. Failure of hair fibers to develop in apparently normal follicles can be detected by skin biopsy.

## INHERITED CONGENITAL HYPOTRICHOSIS

In inherited congenital hypotrichosis there is partial or complete absence of the hair coat with or without other defects of development. The main importance of the disease is in cattle, in which there are six syndromes, but it is also inherited in **pigs**, in which it is associated with low birth weight, weakness, and high mortality, and in Poll Dorset **sheep**, in which the face, ears, and lower legs are bald; there are no eyelashes; and the patient lacrimates excessively. The skin is thick, wrinkled, greasy, scaly, and erythematous. Hair fibers are completely absent from the follicles, but wool fibers and follicles are normal.

### Viable Hypotrichosis

Viable hypotrichosis is recorded in North America in Guernsey and Jersey cattle. Calves are viable provided they are sheltered. They grow normally but are unable to withstand exposure to cold weather or hot sun. In most instances hair is completely absent from most of the body at birth, but eyelashes are present in addition to tactile hair around the feet and head. Occasionally hair may be present in varying amounts at birth but is lost soon afterward. There is no defect of horn or hoof growth. The skin is normal but has a shiny, tanned appearance and on sections no hair follicles are present in the skin. The condition is inherited as a single recessive character.

Congenital hypotrichosis has been reported in a Perheron draught horse. At birth there were circumscribed patchy areas of alopecia that was progressive, becoming almost complete by 1 year of age. Skin biopsy at 7 months of age revealed severe follicular hypoplasia, and the animal was still alive at 6 years of age.

### Nonviable Hypotrichosis

Nonviable hypotrichosis is a complete hypotrichosis in which the thyroid is abnormally small and hypofunctional and the calves die shortly after birth.

### Congenital Hypotrichosis and Anodontia (Anhidrotic Ectodermal Dysplasia)

Congenital X-linked hypotrichosis with missing teeth in bull calves is characterized by abnormal morphogenesis of the teeth, hair follicles, and eccrine sweat glands.<sup>1-4</sup> The disease has also been recognized in a cross-bred calf in Canada.<sup>5</sup> Two different forms can be distinguished according to the severity of the tooth defects: (1) congenital hypotrichosis with complete or almost complete anodontia, and (2) congenital

hypotrichosis with completely missing incisors or defective incisors. Impaired body condition and growth of the affected animals result from missing teeth. In addition, animals with sparse hair are more susceptible to cold and more prone to skin lesions.

The phenotype and inheritance of hypotrichosis with nearly complete anodontia has been recorded in pedigreed Canadian and German Holstein calves. The phenotype is inherited as a monogenic X-linked recessive trait. An RT-PCR assay was used to identify the causative large genomic deletion in the bovine *EDA* gene. The bovine *EDA* gene encodes ectodysplasin A, a membrane protein expressed in keratinocytes, hair follicles, and sweat glands, which is involved in the interactions between cell and cell and/or cell and matrix.<sup>1</sup> A single-nucleotide polymorphism (SNP) at the 9(th) base of exon 8 in the *EDA* gene is located in the exonic splicing enhancers (ESEs) recognized by SRp40 protein. Consequently, the spliceosome machinery is no longer able to recognize the sequence as exonic and causes exon skipping.<sup>1</sup> The mutation determines the deletion of the entire exon (131 bp) in the RNA processing, causing a severe alteration of the protein structure and thus the disease. Analysis of the SNP allows the identification of carriers that can transmit the disease to the offspring.<sup>1</sup>

## REFERENCES

1. Gargani M, et al. *BMC Vet Res*. 2011;7.
2. Karliskov-Mortensen P, et al. *Anim Genet*. 2011;42:578.
3. Ogino A, et al. *Hereditas*. 2011;148:46.
4. Ogino A, et al. *Anim Genet*. 2012;43:646.
5. Barlund CS, et al. *Can Vet J*. 2007;48:612.

### Streaked Hairlessness

A sex-linked semidominant gene causes development of a streaked hairlessness in which irregular narrow streaks of hypotrichosis occur in female Holsteins.

### Partial Hypotrichosis

Partial hypotrichosis has been recorded in polled and horned Hereford cattle. At birth there is a fine coat of short, curly hair that later is added to by the appearance of some very coarse, wiry hair. The calves survive but do not grow well. It is inherited as a simple recessive character. The disease in Poll Herefords results in the same short curly coat, but there is also a deficiency of hair in the switch and over the poll, brisket, neck, and legs in some cattle. Some have a much lighter hair-coat color. Histologically, there is a characteristic accumulation of large trichohyalin granules in the hair follicles.

### Hypotrichosis and Coat-Color Dilution—“Rat-Tail Syndrome” in Calves

The abnormality is characterized by short, curly, malformed, sometimes sparse hair and lack of normal tail-switch development. Coat-color dilution and hypotrichosis occur

when red animals, particularly of the Simmental breed and carrying the mutation responsible, are crossed with black or black-pied cattle.<sup>1</sup> Inherited as a dominant trait, 50% of progeny of such matings have black diluted to a charcoal- or chocolate-colored coat and variable degrees of hypotrichosis. This condition also occurs in offspring of Hereford–Friesian crosses and is evident as dilution of the dark coat color and hypotrichosis affecting particularly the tail switch when the hair of the tail is colored (hence “rat tail”). White hair is not affected.

The abnormality is in the premelanosome protein 17 gene (PMel17), and affected animals are heterozygous. Cattle that express the syndrome must have at least one dominant gene for black color and be heterozygous at the other locus.

A study of the inheritance of the abnormality found that all rat-tail calves were sired by Simmental bulls and were from cows with various percentages of Angus breeding. The abnormality had no effect on birth weight, weaning weight, or gain from birth to weaning. However, rat-tail calves had significantly lower rates of gain during the winter months from weaning to yearling than non-rat-tail calves. Histologically, there are enlarged, irregularly distributed, and clumped melanin granules in the hair shafts, which are asymmetric, short, curled, and small. The scale surface is rough and pitted, and scale fails to form in some areas.

## REFERENCE

1. Jolly RD, et al. *New Zeal Vet J.* 2008;56:74.

## INHERITED HAIR-COAT-COLOR-LINKED FOLLICLE DYSPLASIA

Some “buckskin”-colored follicular dysplasia occurs in so-called “Portuguese” Holstein cattle, a grade variant of Red Holsteins with a tan color instead of the red. This defect consists of a coat-color-linked hair follicle dysplasia, in which the colored hairs are shorter and less lustrous than the white hair, making the coat much finer and smoother. Test matings seem to confirm an autosomal-dominant inheritance.

A **black-hair-colored follicular dysplasia** is also recorded in Holstein cattle. Patches of hair loss varying from hypotrichosis to complete alopecia occur in a random fashion but only on black areas. Follicular dysplasia is evident in biopsy samples. The abnormality persists for the life of the animal and is of cosmetic importance only. An inherited etiology is assumed.

A follicular dysplasia in a mature Brangus-cross cow and a mature Angus cow has been described. Adult-onset alopecia occurred, and skin biopsy revealed follicular distortion and atrophy, with melanin clumping in follicular epithelium, hair bulb matrix cells, hair shafts, and infundibular keratin.

## INHERITED BIRTHCOAT RETENTION

Inherited birthcoat retention is recorded in Merino and Welsh mountain sheep and characterized by a coat of hairy medullated fibers in contrast with the nonmedullated wool fibers of the normal sheep fleece.

## INHERITED LEUKODERMA

The **Arab fading syndrome** commences in young horses, in particular families of Arab horses, as round, unpigmented patches of skin around the lips, eyes, perineum, and preputial orifice. Some cases recover spontaneously, but the blemish is usually permanent.

## INHERITED EPIDERMAL DYSPLASIA (BALDY CALVES)

This is a lethal defect of Holstein–Friesian calves inherited as an autosomal-recessive character. The calves, most commonly heifers, are normal at birth but at 1 to 2 months of age begin to lose condition in spite of good appetites. The skin over most of the body is slightly thickened, scaly, and relatively hairless. There are also patches of scaly, thickened, and folded skin, especially over the neck and shoulders, and hairless, scaly, and often raw areas in the axillae and flanks and over the knees, hocks, and elbow joints. The skin over the joints is immovable. There is usually alopecia around the base of the ears and eyes. The tips of the ears are curled backward. The horns fail to develop, and there is persistent slobbering, although there are no mouth lesions. The hooves are long, narrow, and pointed because of gross overgrowth of the walls; these and stiffness of joints cause a shuffling, restricted gait. Calves assume a recumbent posture most of the time. Severe emaciation leads to destruction at about 6 months of age.

Histologic changes in the skin include acanthosis, hyperkeratosis, and patchy neutrophil invasion. The similarity of this condition to inherited parakeratosis and to experimental zinc deficiency suggests an error in zinc metabolism, but treatment with zinc had no effect on the course of the disease.

## INHERITED PARAKERATOSIS OF CALVES (LETHAL TRAIT A46, ADEMA DISEASE)

See “Inherited deficiency of lymphocyte maturation in Chapter 11.”

## INHERITED DYSERYTHROPOIESIS–DYSKERATOSIS

See “Inherited Blood Diseases.”

## INHERITED CONGENITAL ABSENCE OF THE SKIN

### Epitheliogenesis Imperfecta (Aplasia Cutis)

Absence of mucous membrane or, more commonly, absence of skin over an area of the body surface has been recorded at birth in pigs, calves, lambs, and foals. There is complete absence of all layers of the skin in patches of varying size and distribution. In **cattle** the defect is usually on the lower parts of the limbs and sometimes on the muzzle and extending onto the buccal mucosa. The disease is best known in Holstein–Friesians, but is also recorded in Japanese Black, Short-horn, Sahiwal, and Angus cattle. In **pigs** the skinless areas are seen on the flanks, sides, back, and other parts of the body, and these areas develop into ulcers and are often secondarily infected, necessitating casualty slaughter.<sup>1</sup> The defect is usually incompatible with life, and most affected animals die within a few days. Inheritance of the defect in cattle is conditioned by a single autosomal-recessive gene, and pigs are thought to have the same genetic cause. Tissue-cultured fibroblasts from affected animals produce subnormal amounts of collagen and lipids.

## REFERENCE

1. Benoit-Biancamano MO, et al. *J Vet Diagn Invest.* 2006;18:573.

### Familial Acantholysis

Suspected of being an inherited disease, familial acantholysis in Angus calves is characterized by defective collagen bridges in the basal and prickle layers of the epidermis so that skin, normal at birth, is subsequently shed at the carpal and metacarpophalangeal joints and coronet, and there is separation of the horn at the coronet.

### Epidermolysis Bullosa

Epidermolysis bullosa is a congenital disease of Suffolk and South Dorset Down sheep and Simmental and Brangus calves and is characterized by the formation of epidermal bullae in the mouth and on exposed areas of skin, such as the extremities of the limbs, muzzle, and ears, leading to shedding of the covering surface and separation of the horn from the coronet. Lesions may be present at birth. Simmental calves grow poorly, have hypotrichosis, and suffer repeated breaks in the skin, apparently as a result of an abnormal susceptibility to trauma. Most calves die, but some survive and the lesions subside. In Simmentals the disease is inherited as an autosomal-dominant trait. The disease in Brangus calves is very similar to familial acantholysis in Angus cattle.

The severe form of Herlitz junctional epidermolysis bullosa, which occurs in humans, has been recorded in foals of the French draft horse breeds. A mutation in the *LAMC2* gene is responsible for the defect. Affected foals were born with skin blistering and skin and

buccal ulceration, followed by loss of hooves. In the affected skin, there was disjunction of the epidermis from the underlying dermis at the dermal-epidermal junction. Genomic DNA testing is used to determine the presence of the mutation in carrier animals.

### Junctional Epidermolysis Bullosa (Hereditary Junctional Mechanobullous Disease)

Junctional epidermolysis bullosa (JEB) is inherited in Belgian foals; Danish Hereford, Belgian Blue, Charolais, Angus, and Simmental calves; and Suffolk, Churra, and South Dorset Down lambs.<sup>1,4</sup> The disease is inherited in an autosomal-recessive pattern.

JEB in horses is an autosomal-recessive trait affecting Belgians, other draft breeds, and American Saddlebred horses.<sup>5,6</sup> The heterozygous haplotype is common in draft breeds, with 17% of Belgian horses being carriers in North America and 8% to 27% of horses of the Breton, Comtois, Vlaams Paard, and Belgische Koudbloed Flander draft horse breeds being carriers in Europe.

The genetic defect responsible for JEB in the Belgian and European draft breeds is a cytosine insertion (1368insC) creating a premature stop codon in the *Lamc2* gene, which encodes the laminin  $\gamma 2$  subunit chain. The truncated laminin  $\gamma 2$  subunit chains lacks the C-terminal domain so it cannot interact with the other two subunits, thereby preventing the formation of laminin 5. The defect in Belgian Blue cattle is in the *LAMA3* gene, which encodes the alpha 3 subunit of the heterotrimeric laminin-332.<sup>4</sup> Laminin is widely distributed in the basement membrane of epithelial tissues, and lack of this family of proteins results in loss of cell adhesion between the dermis and epidermis.<sup>4</sup> The disease in Charolais calves is a result of a mutation in the integrin beta 4 gene (as for the disease in humans) and loss of function of this protein.<sup>2</sup> The disease in Hereford cattle is a result of a mutation in the *LAMC2* gene, encoding for laminin gamma 2 protein, which results in loss of function of the gene and lack of laminin gamma 2 protein.<sup>3</sup>

Foals are typically born alive, but irregular, reddened erosions and ulcerations develop in the skin and mouth over pressure points or after mild trauma. There are often extensive erosions along the coronary bands, with sloughing of hooves, and at mucocutaneous junctions of the mouth, rectum, and vulva. Dystrophic teeth that are visible at birth are white with irregular serrated edges and pitted enamel. Definitive diagnosis in draft horses requires DNA testing for JEB.

There is no treatment for affected foals, lambs, or calves, and they will eventually succumb to secondary infections or complete sloughing of the hooves.

### Red Foot Disease of Sheep

Red foot disease of sheep is similar to junctional epidermolysis bullosa and occurs in

Scottish Blackface and Welsh mountain sheep. The lesions are not present at birth but become apparent at 2 to 4 days of age when there is sloughing of skin of the limbs, the accessory digits, the ear pinna, and the epidermal layers of the cornea and buccal mucosa, especially the dorsum of the tongue. There is also an absence of head horn and a separation of hoof horn from the coronet. Pieces of horn become completely detached, exposing the red corium below, hence the term “red foot.” The cutaneous and mucosal lesions often commence as blood-filled or fluid-filled blisters. The corneal lesions are similarly the result of sloughing of epidermal layers. Although the cause is unknown, there are indications that it is inherited.

### FURTHER READING

Jolly RD, Blair HT, Johnstone AC. Genetic disorders of sheep in New Zealand: a review and perspective. *New Zeal Vet J.* 2004;52:52-64.

### REFERENCES

1. Benavides J, et al. *Vet Dermatol.* 2015;26:367.
2. Michot P, et al. *Genet Select Evol.* 2015;47.
3. Murgiano L, et al. *BMC Vet Res.* 2015;11:334.
4. Sartellet A, et al. *Anim Gen.* 2015;46:566.
5. Finno CJ, et al. *Vet J.* 2009;179:336.
6. Cappelli K, et al. *BMC Vet Res.* 2015;11:374.

### INHERITED HYPERBILIRUBINEMIA AND PHOTOSENSITIZATION

An inherited photosensitization with hyperbilirubinemia has been observed in Southdown sheep in New Zealand and the United States, and in Corriedales in California. It is inherited as an autosomal-recessive trait.

Liver insufficiency is present, but the liver is histologically normal. Phylloerythrin and bilirubin excretion by the liver is impeded, and the accumulation of phylloerythrin in the bloodstream causes the photosensitization. There is also a significant deficiency in renal function. Symptomatic treatment of photosensitization and confining the animals indoors may enable the lambs to fatten to market weight. The persistent hyperbilirubinemia is accompanied by an inability of the kidneys of these sheep to concentrate urine and the eventual death of the sheep from renal insufficiency.

Affected sheep live for several years if they are protected from sunlight and tend to die of renal failure associated with progressive fibrosis of the kidney.

A similar disease in Corriedale sheep in California is inherited as an autosomal-recessive trait. The functional defect is not in the uptake of unconjugated bilirubin and phylloerythrin, but rather its excretion from liver into bile. It affects lambs as they begin to eat pasture. Lambs live until 6 months of age if provided with some shade. There is also marked melanin-like pigmentation of the liver.

These two diseases are examples of the involvement of external environmental

disease factors with a genetic disease: a diet of green forage (chlorophyll) and sunlight working in concert with the inborn error of metabolism to induce photosensitization.

### INHERITED CONGENITAL ICHTHYOSIS (FISH-SCALE DISEASES)

Congenital ichthyosis is a disease characterized by alopecia and the presence of plates of horny epidermis covering the entire skin surface. It has been recorded only in Holstein and Norwegian Red Poll and probably in Brown Swiss calves among the domestic animals, although it occurs also in humans.

The newborn calf appears to be either partly or completely hairless, and the skin is covered with thick, horny scales separated by fissures that follow the wrinkle lines of the skin. These may penetrate deeply and become ulcerated. There are plenty of normal hair follicles and normal hairs, but these are lost in the areas covered by the growth of scales. A skin biopsy section will show a thick, tightly adherent layer of keratinized cells. The disease is incurable, and although it may be compatible with life, most affected animals are disposed of for esthetic reasons. The defect has been shown to be hereditary and to result from the influence of a single recessive gene.

### INHERITED DERMATOSIS VEGETANS OF PIGS

Inherited dermatosis vegetans of pigs appears to be conditioned by the inheritance of a recessive, semilethal factor. Affected pigs may show defects at birth but in most instances lesions appear after birth and up to 3 weeks of age. The lesions occur at the coronets and on the skin. Those on the coronets consist of erythema and edema with a thickened, brittle, uneven hoof wall. Lesions on the belly and inner surface of the thigh commence as areas of erythema and become wart-like and covered with gray-brown crusts.

Many affected pigs die, but some appear to recover completely. Many of the deaths appear to be a result of the giant-cell pneumonitis that is an essential part of the disease. The pathology of the disease indicates that it is the result of a genetic defect that selectively affects mesodermal tissue. It is known to have originated in the Danish Landrace breed.

### DERMATOSPARAXIS (HYPERELASTOSIS CUTIS)

Dermatosparaxis is an extraordinary fragility of skin and connective tissue in general, with or without edema. It is probably inherited as a recessive character. It occurs in cattle, in horses (see “Hereditary Equine Regional Dermal Asthenia”), in Finnish and White Dorper sheep, and in a mild form in Merino sheep. The latter is inherited as a



simple autosomal-recessive trait. The skin is hyperelastic, as are the articular ligaments; marked cutaneous fragility, delayed healing of skin wounds, and the development of papyraceous scars are also characteristic. Pieces of skin may be ripped off when affected sheep are being handled. In horses the skin in some parts of the body is thinner than elsewhere (e.g., the skin of the ventral abdomen) and the collagen bundles in the area are more loosely packed and are curved rather than straight. The proportion of acid-soluble collagen is also much higher in this abnormal skin. The disease involves a molecular defect of a collagen-binding protein and is related to a recognized problem in dogs and cats identified as “dominant collagen packing defect.”

Hereditary equine regional dermal asthenia is discussed under that heading in the following section.<sup>1</sup> Ehlers–Danlos syndrome, recorded in Charolais and Simmental cattle, Quarter horses (cyclophilin-B gene independent),<sup>2</sup> Warmblood foals (cyclophilin-B gene independent),<sup>3,4</sup> and Ripposela sheep, is also characterized by extreme fragility of the skin and laxness of joints in the newborn. There is a defect in collagen synthesis, and histopathological findings include fragmentation and disorganization of collagen fibers. The disease in Warmblood foals is well recognized and is caused by a defect in the equine procollagen-lysine, 2-oxoglutarate 5-dioxygenase 1 (PLOD1, or lysyl hydroxylase 1) gene.<sup>5</sup> Affected foals born at term have thin and friable skin, skin lesions on the legs and the head, and an open abdomen.<sup>5</sup> Histologic examination reveals abnormally thin dermis and markedly reduced amounts of dermal collagen bundles, with loose orientation and abnormally large spaces between deep dermal fibers. A genetic test is available and should be considered for Warmblood mares that abort, have stillborn foals, or have foals with characteristic lesions.<sup>5</sup> A case of dermal asthenia reported in a Warmblood in Australia was in a 6-week-old foal. Confirmatory genetic testing was not undertaken.<sup>3</sup>

The syndrome has also been recorded in lambs. The skin was loose and present in excessive amounts, with folds over the carpal joints and lower regions of the legs. In some lambs, there may be separation of the epidermis from the dermis with blood-filled cavitations and intact skin that can be easily torn.

## REFERENCES

1. Rashmir-Raven AM, et al. *Equine Vet Educ.* 2015;27:604.
2. Steelman SM, et al. *J Equine Vet Sci.* 2014;34:565.
3. Marshall VL, et al. *Aust Vet J.* 2011;89:77.
4. Ruefenacht S, et al. *Schweiz Arch Tierheilkd.* 2010;152:188.
5. Monthoux C, et al. *BMC Vet Res.* 2015;11.

## INHERITED MELANOMA

Inherited cutaneous malignant melanoma is found in National Institute for Health (NIH

miniature) and Sinclair miniature swine. Its expression is associated with two genetic loci, one of which is associated with the swine major histocompatibility complex. Familial melanomas have also been recorded in members of successive litters from an individual Duroc × Slovak White sow.

## INHERITED HYPERHIDROSIS

Inherited hyperhidrosis, a condition characterized by excessive sweating and thought to be inherited, is recorded in beef Shorthorn calves. The syndrome includes conjunctivitis, with some cases progressing to complete opacity of the cornea, heavy dandruff, and persistent wetness of the hair coat.

## LAVENDER FOAL SYNDROME

Lavender foal syndrome is a congenital, inherited, autosomal-recessive disease of Egyptian Arab foals characterized by an unusual dilute coat color and signs of neurologic disease evident at birth. Additional details provided in [Chapter 14](#) (“Diseases of the Nervous System”).

## HEREDITARY EQUINE REGIONAL DERMAL ASTHENIA (HYPERELASTOSIS CUTIS)

Hereditary equine regional dermal asthenia (HERDA) is a degenerative skin disease caused by an autosomal-recessive trait of Quarter horses and related breeds attributable to a mutation in *Equus caballus* chromosome 1 (ECA1).<sup>1</sup> The abnormality is a c.115G>A mutation in the peptidyl-propyl isomerase cis-trans B (PPIB) gene.<sup>2</sup> Resultant abnormalities in cyclophilin B cause a two- to threefold reduction in the tensile strength and elastic modulus of skin of affected horses.<sup>3,4</sup> The allele frequency in 651 elite performance American Quarter horses, 200 control (nonelite) American Quarter horses, and 180 control American Paint horses was 0.021, with cutting horses having a frequency of 0.142 and 28% of cutting horses being carriers.<sup>5</sup> The frequency of carriers is estimated to be 3.5% of Quarter horses in the United States and 1.6% in France.<sup>1,6</sup> Allele frequency is estimated at 2.9%, and carrier frequency at 5.8%, in American Quarter horses in Brazil.<sup>2</sup> A similar inherited disease of Warmbloods is reported, although the genetic basis has not been determined.<sup>7,8</sup> The disease can occur in Quarter horses without the PPIB mutation.<sup>9</sup>

Clinical signs typically appear at 1 to 2 years of age, at about the time of breaking for riding, and are evident as open wounds, sloughing of skin, hematomas, and seromas. Clinical signs can develop in foals. The skin of affected animals is “stretchy” and remains deformed for considerable periods of time when stretched. The lesions are most severe over the dorsum, although the mechanical

abnormalities are present at all sites.<sup>4</sup> Horses with HERDA have a greater incidence of corneal ulcers than do unaffected horses.<sup>10</sup> The cornea of horses with HERDA is thinner than that of normal horses.<sup>10</sup>

Diagnosis is based on clinical signs, histologic examination of skin, and genetic testing. Histologic examination of skin of animals before the development of clinical signs is not conclusive in detecting the disease, although affected horses have thinner skin, on histologic examination, than do unaffected horses.<sup>11,12</sup> Measurement of skin thickness has sensitivity of 73% to 88% and specificity of 35% to 75%.<sup>12</sup> Skin thickness is not regionally distributed in affected horses. The genetic test is definitive.

There is no definitive treatment. Affected mares can carry foals to term and deliver safely.<sup>11</sup> Control involves the selective breeding of unaffected animals and those not carrying the disease, bearing in mind that it is an autosomal-recessive disease. However, the high prevalence of the disease in some uses of horses (cutting horses) suggests selection for the trait, perhaps because it is closely associated with a desired phenotype.

## REFERENCES

1. Tryon RC, et al. *Genomics.* 2007;90:93.
2. Badial PR, et al. *Vet J.* 2014;199:306.
3. Bowser JE, et al. *Equine Vet J.* 2014;46:216.
4. Grady JG, et al. *Vet Dermatol.* 2009;20:591.
5. Tryon RC, et al. *J Am Vet Med Assoc.* 2009;234:120.
6. White SD, et al. *Vet Dermatol.* 2011;22:206.
7. Ruefenacht S, et al. *Schweiz Arch Tierheilkd.* 2010;152:188.
8. Marshall VL, et al. *Aust Vet J.* 2011;89:77.
9. Steelman SM, et al. *J Equine Vet Sci.* 2014;34:565.
10. Mochal CA, et al. *J Am Vet Med Assoc.* 2010;237:304.
11. White SD, et al. *Vet Dermatol.* 2007;18:36.
12. Badial PR, et al. *Vet Dermatol.* 2014;25:547.

## DERMATOSIS VEGETANS

Dermatosis vegetans is a rare condition of pigs first described in 1967 and originating in the Swedish Landrace import to the United Kingdom. It is governed by a semilethal factor with autosomal-recessive inheritance. Often only two to three pigs per litter are affected. Pigs will often first show a decline in growth and then die after 7 to 8 weeks, but some occasionally recover. It is seen as three clinical conditions:

- There is an erythematous maculopapular dermatitis often present at birth or around 2 to 3 weeks of age. Lesions are found on the abdomen or inside of the thighs and may spread and pass through a Pityriasis-like phase. After 5 to 8 weeks the lesions become thickened and covered with crusts.
- The second group of lesions, usually present at birth, occur in the form of “clubfeet,” with swelling and erythema and defective horn on the walls, sole, and bulb of the foot.

- The third major clinical condition is respiratory dysfunction, which is caused by a giant-cell pneumonitis. It is characteristic of the condition in pigs older than 1 week of age. There are granules present throughout the lung, and these heal by fibrosis. The differential diagnoses include pityriasis rosea, chronic exudative dermatitis, and vitamin deficiencies.

There is no treatment, and control is through culling of breeding stock that have been affected.

#### FURTHER READING

Done JT, et al. Dermatitis vegetans in the pig. *Vet Rec.* 1967;80:292.

### PUSTULAR PSORIAFORM DERMATITIS (PITYRIASIS ROSEA)

The condition of pityriasis rosea in humans is not like the condition in pigs; thus, pustular psoriaform dermatitis (PPD) is a much better term for what is in fact a ring or rings of keratinized cells that are erythematous initially and raised surrounding a central crater. The condition occurs in young pigs, 3 to 14 weeks of age, is self-limiting, and is usually gone by 4 to 6 weeks following appearance.

The etiology is thought to be an autosomal-dominant gene with incomplete penetrance. It is definitely familial and may be more common in Landrace.

Clinically, there is a superficial accumulation of scales in a dry, lusterless coat.

Pityriasis scales are accumulations of keratinized epithelial cells, sometimes softened and made greasy by the exudation of serum or sebum. Overproduction, when it occurs, begins around the orifices of the hair follicles and spreads to the surrounding stratum corneum. The lesions are not itchy.

Diagnosis is based on age, clinical appearance, lack of itching and failure to demonstrate mites or ringworm on skin scrapings. Skin biopsy also helps in that there is an epidermal hyperplasia and superficial perivascular dermatitis.

Pityriasis is identified by the absence of parasites and fungi on skin scrapings.

#### DIFFERENTIAL DIAGNOSIS

Differential diagnosis of excessive bran-like scales on the skin, characterized by overproduction of keratinized epithelial cells, can be caused by deficiency of B vitamins, especially riboflavin and nicotinic acid, or linoleic acid and possibly other essential fatty acids, and poisoning by iodine. It can also be secondary to flea, louse, and mange infestations and ringworm infections. Also, hyperkeratosis and parakeratosis conditions should be considered.

#### TREATMENT

Treatment does not appear to have any effect, and self-cure is the norm. If there is secondary infection under conditions of bad hygiene, supportive therapy may help. Culling of the breeding stock producing the affected stock is advisable.

### Eye and Conjunctival Diseases

#### CONJUNCTIVITIS AND KERATOCONJUNCTIVITIS

Conjunctivitis refers to inflammation of the covering membrane of the eye, including the orbit and the inner surface of the eyelids. The inflammation commonly extends to layers below the conjunctiva, referred to as keratoconjunctivitis.

#### ETIOLOGY

Causes of inflammation of the conjunctiva can be various and include bacterial, viral, parasitic, or mycotic infections; allergic and immune reactions; conjunctival foreign bodies; and trauma.

#### Specific Conjunctivitis

##### Cattle

- **Infectious bovine keratoconjunctivitis (IBK, pinkeye)** a common and highly contagious form of keratoconjunctivitis that is associated with *Moraxella bovis* (see also “[Infectious Bovine Keratoconjunctivitis](#)”)
- **Listerial keratoconjunctivitis and uveitis (silage eye)** is associated with *Listeria monocytogenes*<sup>1</sup> (see also “[Listerial Keratoconjunctivitis](#)”)
- **Ulcerative blepharitis and conjunctivitis** associated with *Moraxella bovoculi* in cattle<sup>2,3</sup>

##### Sheep and Goats

- **Infectious keratoconjunctivitis (pinkeye) of sheep and goats** associated with *Mycoplasma conjunctivae* and *Chlamydia psittaci*.

##### Pigs

- Chlamydial-associated conjunctivitis in pigs associated with *Chlamydia spp*<sup>4</sup>

##### Horses

- Eosinophilic keratoconjunctivitis of unknown etiology<sup>5</sup>
- Conjunctival habronemiasis caused by larval invasion of *Habronema spp.*
- Ocular onchocerciasis associated with microfilaria of *Oncocerca spp.* The causative association between these microfilaria and equine ocular disease is under debate.

- Fungal keratomycosis in foals and adult horses; *Aspergillus flavus* has been identified in some cases.

*A. fumigatus* is listed among the causes of mycotic keratitis in animals. Most cases begin as traumatic injuries with secondary infections or begin in eyes treated for long periods with broad-spectrum antibiotics.

#### Secondary Diseases in Which Conjunctivitis Is a Significant but Secondary Part of the Syndrome

##### Cattle

- Bovine viral diarrhea
- Malignant catarrhal fever
- Rinderpest
- Infectious bovine rhinotracheitis
- Viral pneumonia as a result of various viruses
- Bluetongue (specifically BTV-8)
- Besnoitiosis

##### Sheep

- Bluetongue

##### Pigs

- Swine influenza
- Inclusion-body rhinitis

##### Horses

- Equine viral arteritis
- Equine viral rhinopneumonitis

#### Nonspecific Conjunctivitis

Nonspecific conjunctivitis refers to inflammation caused by foreign bodies or chemicals, or secondarily as exposure keratitis, and conjunctivitis/keratitis in paralysis of eyelids as in listeriosis. Ant-bite conjunctivitis occurs in similar circumstances.

#### CLINICAL FINDINGS

Blepharospasm and weeping from the affected eye are the initial signs. Watery tears are followed by mucopurulent, then purulent ocular discharge if the lesion extends below the conjunctiva. Varying degrees of opacity of the conjunctiva may develop, depending on the severity of the inflammation. In the severest lesions there is underrunning of the conjunctiva with pus accompanied by vascularization of the cornea. During the recovery stage there is often long-lasting, diffuse opacity of the eye and terminally a chronic white scar in some cases.

#### CLINICAL PATHOLOGY

In herd or flock outbreaks, conjunctival swabs and/or scrapings should be taken for culture and examination of cells using special stains and histologic techniques.

#### REFERENCES

1. Erdogan HM. *Vet Clin North Am Food A.* 2010;26:505-510.
2. Angelos JA, et al. *Int J Syst Evol Microbiol.* 2007;57:789-795.
3. Galvao KN, Angelos JA. *Can Vet J.* 2010;51:400-402.

4. Becker A, et al. *J Vet Med A Physiol Pathol Clin Med.* 2007;54:307-313.  
 5. Wolfe JE, et al. *Equine Vet J.* 2010;22:375-381.

## LISTERIAL KERATOCONJUNCTIVITIS AND UVEITIS (SILAGE EYE, BOVINE IRITIS)

### SYNOPSIS

**Etiology** *Listeria monocytogenes* is the causative pathogen, presumably reaching the eye with contaminated feed particles. The condition is the result of a local listerial infection specifically affecting the eye and is not associated with systemic infection with *L. monocytogenes*. Cattle, sheep, and horses are affected.

**Epidemiology** Cattle fed poor-quality silage from round bales or ring feeders are at risk of developing the condition; allowing feed to fall on the cows' heads increases risk. In most cases individual animals are affected, but outbreaks have occurred. Incidence is highest in winter and early spring when animals are housed inside and fed silage.

**Clinical findings** Epiphora, conjunctivitis, blepharospasm, photophobia, corneal edema, uveitis. The condition is usually not associated with systemic disease.

**Diagnostic confirmation** Culture, polymerase chain reaction (PCR).

**Treatment** Self-limiting disease. Topical and systemic antibiotics.

**Control** Avoid feeding poor-quality silage, avoid feeding systems providing feed at or above the height of the animals' eyes.

### ETIOLOGY

*Listeria monocytogenes* is the only causative agent associated with listerial conjunctivitis, which is a condition specifically affecting the eye.<sup>1</sup> It is unrelated to systemic infection with *L. monocytogenes* causing the classic forms of listeriosis (see also "Listeriosis"). Local uveitis associated with *L. monocytogenes* has been reported to occur in cattle, sheep, horses, fallow deer, and humans.<sup>2</sup>

*Listeria* is a ubiquitously occurring gram-positive, asporogenic bacterium easily surviving in organic material at temperatures between 3° and 45°C (37° to 113°F) and at pH as low as 3.8 in an aerobic environment. Silage of poor quality that is either not conserved anaerobically or not sufficiently acidic facilitates growth of *Listeria*. Listerial conjunctivitis is almost invariably associated with feeding poor-quality silage either directly as big bale or from ring feeders. With these feeding systems animals tend to burrow their heads into the bales, which not only exposes the eyes to the pathogen but also has the potential to mechanically damage

the conjunctiva, thereby creating a portal of entry.<sup>1</sup>

### EPIDEMIOLOGY

#### Occurrence

The disease has been reported to occur in different parts of the world, although most cases are recorded in the United Kingdom, probably because of greater awareness of the existence of this condition. The disease incidence is highest in **late fall, winter, and early spring** when animals are kept inside and fed silage. Frequently only individual cases occur, but outbreaks with morbidity rates far above 25% have been reported.<sup>1,2</sup> In the United Kingdom an overall animal incidence of 3.4% and an average incidence in affected herds of 66.5% was reported.<sup>1</sup>

#### Source of Infection

Because most cases of listerial keratoconjunctivitis have been linked to silage feeding, grass silage of poor quality contaminated with *L. monocytogenes* is widely accepted as the primary source of infection.

#### Environmental Risk Factors

Feeding grass silage from big bales or ring feeders is considered a major predisposing factor. With cows starting to feed on the lower part of the bale, feed particles from the upper part continuously fall onto the head of the feeding animal, thereby increasing the risk of ocular contact with the pathogen.

### CLINICAL FINDINGS

Although in most cases only one eye is affected, bilateral lesions can occur. Systemic disease is usually absent. First clinical signs include increased lacrimation and catarrhal conjunctivitis with photophobia and blepharospasm. Inflammation of the cornea, starting at the limbic border and spreading centripetally, results in a bluish-white opacity of the cornea. Corneal ulcers are uncommon.<sup>1</sup> In advanced cases focal aggregation of fibrin accumulating in the anterior eye chamber may become visible as white foci beneath the corneal surface. The course of the disease, which is considered to be self-limiting, is between 1 and 3 weeks when left untreated.<sup>2</sup>

### CLINICAL PATHOLOGY

The tentative diagnosis can be made based on the clinical presentation in combination of the history (season and silage feeding) but should be confirmed by identifying *L. monocytogenes* from swab obtained from affected eyes. Cultures or PCR are used to identify the pathogen.

### DIFFERENTIAL DIAGNOSIS

**Infectious bovine keratoconjunctivitis (IBK)** has a different seasonality (peaks occurring in the warm season of the year). Evaluation of housing and feeding system may provide

further clues to differentiate between these conditions. Corneal ulceration is a common finding with IBK but not with listerial conjunctivitis.

#### *Pasteurella multocida* (capsular type A)

has been isolated from the eyes of housed heifers that experienced outbreaks of severe keratitis with severe loss of corneal stroma within 72 hours of onset.

*Mycoplasma bovis* has been isolated from the eyes of steers with an outbreak of severe conjunctivitis with corneal opacity and ulceration, with disease being followed by serologic conversion in affected animals. Involvement of the eyelids with marked swelling was prominent. Conjunctivitis is prominent in other mycoplasmal infections that produce keratoconjunctivitis.

**Chlamydial keratoconjunctivitis** presents with identical clinical findings but has a protracted course despite treatment and a higher morbidity. *Chlamydia* DNA can be detected by polymerase chain reaction (PCR) in conjunctival swabs. This disease is a possible zoonosis.

#### Infectious bovine rhinotracheitis

#### Bovine malignant catarrhal fever

#### Bovine viral diarrhea

#### Bluetongue (BTV-8)

#### Thelaziasis

#### Squamous-cell carcinoma

### TREATMENT

A number of empirical treatment approaches have been reported, with variable outcome. Listerial keratoconjunctivitis is considered to be a self-limiting disease, and it is difficult to determine whether reported treatments were effective or if recovery was primarily a result of removing access to the primary cause.<sup>3</sup>

Proposed treatments include the topical use of eye ointments containing oxytetracycline or cloxacillin as well as the parenteral administration of repeated doses of oxytetracycline, procaine-penicillin, or ampicillin. The use of topical or subconjunctival dexamethasone application has been proposed, with variable outcome.<sup>1-3</sup>

### TREATMENT

#### Topical treatment:

Benzathine cloxacillin eye ointment (250 mg q48) (R-2)  
 Oxytetracycline eye ointment (q24h) (R-2)

#### Systemic treatment:

Procaine-penicillin-G (40,000 IU/kg q24 IM) (R-3)  
 Oxytetracycline (10 mg/kg q24h IM) (R-3)  
 Ampicillin (10 mg/kg q24 SC) (R-3)

### CONTROL

The most important control measures are to avoid feeding poor-quality silage and to use



feeding systems that provide feed at a height that is below the animals' heads.

## REFERENCES

1. Laven RA, Lawrence KR. *New Zeal Vet J*. 2006;54:151-152.
2. Staric J, et al. *Bull Vet Inst Pulawy*. 2008;52:353-355.
3. Erdogan HM. *Vet Clin North Am Food A*. 2010;26:505-510.

## INFECTIOUS BOVINE KERATOCONJUNCTIVITIS OF CATTLE (PINKEYE, BLIGHT)

### SYNOPSIS

**Etiology** *Moraxella bovis* is the primary infectious agent. Pili and hemolysin are the main virulence factors. Solar radiation, flies, and dust are contributing factors.

**Epidemiology** Cattle of all ages are susceptible. Source is asymptomatic carrier cattle, with transmission by mediate contagion and by flies. More common in summer months. Usually multiple cases in a herd.

**Clinical findings** Conjunctivitis, lacrimation, blepharospasm, photophobia, corneal edema, corneal ulceration.

**Diagnostic confirmation** Culture.

**Treatment** Self-limiting disease. Topical antibiotics, subconjunctival penicillin G, parenteral oxytetracyclines, florfenicol, tulathromycin. Protection of eye from sunlight.

**Control** Current vaccines have limited efficacy. Fly control.

## ETIOLOGY

Hemolytic *Moraxella bovis* is the only infectious agent for which Koch's postulates have been established for infectious bovine keratoconjunctivitis (IBK), although other organisms, such as *Moraxella ovis*, *Moraxella bovoculi*, *Neisseria* spp., *Mycoplasma* spp., and *Chlamydia* spp. have been implicated.<sup>1</sup> Experimental infections in calves and studies on corneal tissue culture show a great variation in virulence between strains. Two virulence factors are determinants of cause in clinical disease. These are the **presence of fimbriae, so-called pili**, on the bacterial surface and the **production of  $\beta$ -hemolysin**. Other contributing virulence factors include phospholipases, iron acquisition systems, and hydrolytic and proteolytic enzymes.<sup>1</sup> *M. bovis* has serologically distinct shared and variable pilus epitopes, and strains can be distinguished by their pilus antigens into seven distinct **serogroups**. There are two distinct types of **pilus**, I and Q (formerly  $\alpha$  and  $\beta$ ). **Q pili mediate bacterial adhesion** to the cornea and the establishment of infection by preventing removal of the pathogen by the continual flushing effect of ocular secretions and the mechanical action of

blinking. Beta-hemolysin is **cytotoxic** and produces corneal damage. In some outbreaks of pinkeye more than one serotype can be isolated from affected eyes.

In addition to *M. bovis*, other pathogens, such as *M. bovoculi*, *M. ovis*, *Chlamydia* spp., *Neisseria* spp., *Mycoplasma* spp., *Acholeplasma* spp., and viruses have been identified as common participants and are likely to contribute to the development of clinical disease. Infectious bovine rhinotracheitis virus causes ocular disease in its own right, but it may also be involved with *M. bovis* in causing the more severe disease. Clinical disease in experimentally induced IBK has been shown to be more severe when the calves are concurrently given a modified live infectious bovine rhinotracheitis virus vaccine.

Conjunctival infection with *M. bovoculi* has been proposed to play a role in the pathophysiology of IBK by some authors.<sup>2-3</sup> The evidence in support of this assumption is inconsistent. A clinical study consistently demonstrated the development of corneal ulcers after inoculation with hemolytic *M. bovis* but not with *M. bovoculi*.<sup>3</sup> *Branhamella ovis* causes a severe conjunctivitis in sheep and goats and is also recorded from outbreaks of keratoconjunctivitis in cattle in Israel; it may be a cause of vaccine breakdown in other countries.

Because the naturally occurring disease is usually much more severe than that produced experimentally, factors other than infectious agents have been examined. **Solar radiation, flies, and dust** have been shown to have an enhancing effect. Cultural characteristics of the organisms isolated from the conjunctiva can change with the level of solar ultraviolet radiation.

## EPIDEMIOLOGY Occurrence

The disease occurs in most countries of the world. Although it can occur in all seasons, it is most common in **summer and autumn**. The prevalence and severity of the disease vary greatly from year to year, and it may reach epizootic proportions in feedlots and in cattle running at pasture. There is no mortality, and cases in which there is permanent blindness or loss of an eye are rare. However, the morbidity rate can be as high as 80%, with the peak infection rate at weeks 3 to 4 of the outbreak. Severe outbreaks can be experienced in winter, especially if the cattle are confined in close quarters, such as barns or intensive feedlots.

## Source of Infection

Cattle are the only known reservoir, and the organism is carried on the conjunctiva and also in the nares and vagina of cattle. Persistence of the disease from year to year is by means of infected but asymptomatic animals, which can act as carriers for periods exceeding 1 year. Receptors for I-pili may be found

on tissues other than the cornea and facilitate colonization of noncorneal tissue and inapparent infection, and the organism can switch from expression of one pilus type to the other.

## Environmental Risk Factors

The disease incidence shows a **clear seasonality**, with the highest incidence in the warmer months of the year. This seasonal expression has been associated with prolonged exposure of the eye to **UV radiation**, the increased **fly population**, and **long grass**.<sup>1</sup> The exposure of the eye to UV radiation increases the susceptibility to the disease and the severity of signs resulting from it. The face fly (*Musca autumnalis*) and Asian face fly (*Musca bezzii*), because of feeding preference for the area around the eyes, are important vectors.

Other environmental factors, such as dust, wind, and tall grass, can increase the disease incidence by causing mechanical irritation of the cornea.

## Transmission

Transmission is thought to be by means of flies contaminated by the ocular and nasal discharge of infected cattle. Under experimental conditions, transmission is unusual in the absence of flies and occurs generally in their presence. *M. autumnalis* is known to remain infected for periods of up to 3 days. *M. bovis* can be isolated from the crops of *M. autumnalis* that have fed on the eyes of infected cattle.

## Animal Risk Factors

Only cattle are affected, the young being most susceptible, but in a susceptible population, cattle of all ages are likely to be affected.

It is commonly observed that there is a much higher prevalence of the disease in *B. taurus* cattle as distinct from *B. indicus* cattle, and the severity and proportion of bilateral infections is much greater in *B. taurus* cattle than in crossbreeds. Hereford and Hereford crossbreed cattle have a significantly higher risk of developing IBK than other breeds or crossbreeds not containing Hereford.<sup>1</sup> This higher predisposition is thought to be based on a relationship between rate and severity of infection and the degree of **eyelid pigmentation**; eyes with complete pigmentation are less affected.

## Immune Mechanisms

Previous infection appears to confer a significant immunity that lasts through to the next season, when further reinfection, usually with minimal clinical disease, confers further immunity. Lacrimal secretions contain antibody, and antibody directed against the **pilus antigens** of *M. bovis* will prevent adherence of the organism to the cornea. In experimental infections, significant protection against challenge can be

achieved by prior vaccination with pilus antigens of the homologous strain.

However, there is antigenic diversity in pili from different strains of *M. bovis*, and vaccines composed of pili from one strain only confer protection to challenge with organisms of the same serogroup. Further, *M. bovis* in the eye can **switch** their pilus antigenicity in response to antibody presence and render monovalent vaccines ineffective. A polyvalent vaccine might provide protection, but polyvalent vaccines are less immunogenic than monovalent vaccines because of antigenic competition.

### Economic Importance

Infectious bovine keratoconjunctivitis is a prominent disease in surveys of the predominant diseases in cattle and is considered the economically most important ocular disease of cattle. Losses result from reduced weight gain or loss of body condition; loss of milk production; costs of drugs, labor, and veterinary care; and loss of value of show animals. The conditions under which calves are reared can affect the importance of the disease. In veal calves, the disease may have no measurable effect on growth, but in calves running at pasture it can result in a significant reduction of weaning weight. Occasionally, animals become completely blind, and those at pasture may die of starvation. Animal welfare presents an increasing concern.

### PATHOGENESIS

As mentioned, only piliated and hemolytic strains of *M. bovis* are pathogenic to cattle (determinant virulence factors). Attachment of *M. bovis* to the corneal epithelium requires the presence of pili and Q-piliated organisms that are more infectious than I-piliated strains. Hemolysins produced by these virulent strains are cytotoxic and cause the development of corneal ulcers by destroying corneal epithelial cells.

Microscopic corneal erosions are present within 12 hours of infection and occur at this time in the absence of a significant inflammatory response, indicating that the initial production of the corneal ulceration is a result of the direct cytotoxic activity of the organism. This is followed by focal loss of corneal epithelium, degeneration of keratocytes, and invasion of the corneal stroma with fibrillar destruction. An inflammatory reaction occurs several days postinfection and results in enlargement of the corneal ulcers with deeper stromal involvement, corneal edema, and corneal neovascularization. The lesions are localized in the eye, and there is no systemic infection.

### CLINICAL FINDINGS

An incubation period of 2 to 3 days is usual, although longer intervals, up to 3 weeks, have been observed after experimental introduction of the bacteria. Injection of the



**Fig. 16-10** Infectious bovine keratoconjunctivitis (IBK) in a beef steer. Note the extensive lacrimation and blepharospasm and the centrally located corneal ulcer with keratitis and conjunctivitis.

corneal vessels and edema of the conjunctiva are the early signs and are accompanied by a copious watery lacrimation, blepharospasm, photophobia, and, in some cases, a slight to moderate fever with fall in milk yield and depression of appetite.

In 1 to 2 days, corneal edema presenting as a small opacity appears in the center of the cornea, and this may become elevated and ulcerated during the next 2 days, although spontaneous recovery at this stage is quite common. With progressive disease the opacity becomes quite extensive, and at the peak of the inflammation, about 6 days after signs first appear, it may cover the entire cornea. The color of the opacity varies from white to deep yellow (Fig. 16-10). As the acute inflammation subsides, the ocular discharge becomes purulent and the opacity begins to shrink, complete recovery occurring after a total course of 3 to 5 weeks.

One or both eyes may be affected. The degree of ulceration in the early stages can be readily determined by the infusion of a 2% fluorescein solution into the conjunctival sac, the ulcerated area retaining the stain.

About 2% of eyes have complete **residual opacity**, but most heal completely with a small, white scar persisting in some. In severe cases the cornea becomes conical in shape, there is marked vascularization of the cornea, and ulceration at the tip of the swelling leads to underrunning of the cornea with bright yellow pus surrounded by a zone of erythema. These eyes may rupture and result in complete blindness.

A proportion of cases will develop minimal clinical lesions and heal spontaneously, and the severity of clinical disease can also vary between outbreaks.

### CLINICAL PATHOLOGY

The organism can be identified by culture or fluorescent antibody. The hemolytic form of the bacterium is noticeably more pathogenic than the nonhemolytic form. Serum agglutinins (1:80 to 1:640) are present 2 to 3 weeks after clinical signs commence, and a modified gel diffusion precipitin test is capable of detecting *M. bovis* antibodies. An ELISA test is also used for antibody detection in experimental studies; however, neither agglutinating antibody nor antibody detected by ELISA correlates well with individual animal resistance to infection. There is little indication for serologic examinations in clinical practice. Necropsy examinations are not usually necessary.

### DIFFERENTIAL DIAGNOSIS

**Traumatic conjunctivitis** is usually easily differentiated because of the presence of foreign matter in the eye or the conjunctival sac or evidence of a physical injury.

***Pasteurella multocida* (capsular type A)** has been isolated from the eyes of housed heifers that experienced outbreaks of severe keratitis with severe loss of corneal stroma within 72 hours of onset.

***Mycoplasma bovis*** has been isolated from the eyes of steers with an outbreak of severe conjunctivitis with corneal opacity and ulceration, with disease being followed by serologic conversion in affected animals. Involvement of the eyelids with marked swelling was prominent. Conjunctivitis is prominent in other mycoplasmal infections that produce keratoconjunctivitis.

*Continued*

**Listerial keratoconjunctivitis and uveitis**

(silage eye) has a different seasonality and is associated with the use of specific feeding systems. Corneal ulcers are uncommon with listerial keratoconjunctivitis.

**Chlamydial keratoconjunctivitis** presents with identical clinical findings but has a protracted course despite treatment and a higher morbidity. *Chlamydomphila* DNA can be detected by polymerase chain reaction (PCR) in conjunctival swabs. This disease is a possible zoonosis.

**Infectious bovine rhinotracheitis****Bovine malignant catarrhal fever****Bovine viral diarrhoea****Bluetongue (BTV-8)****Thelaziasis****Squamous-cell carcinoma****TREATMENT**

Infectious bovine keratoconjunctivitis is frequently a **self-limiting disease**. Recovery commonly occurs without treatment, although early treatment will reduce the incidence of scarring of the eyes. Antibacterial treatment is commonly used, and mass treatment of the herd as opposed to just affected individuals may halt the occurrence of further cases. The route of administration is often determined by efficiency of the available treatment options, ease of access to the animals, availability of facilities to restrain animals for treatment, labor intensity of treatment, cost of the drug, and withhold times.

**Topical Therapy**

Early, acute cases respond to treatment with ophthalmic ointments and solutions containing antibiotics, but they need to be instilled in the conjunctival sacs at frequent intervals, which may be impractical under field conditions. The organism is **sensitive** to most antibiotics and sulfonamides but is resistant to erythromycin, lincomycin, and tylosin. The administration of an oil-based formulation of benzathine cloxacillin (250 to 375 mg per treatment dose) was found to be effective in therapy in controlled trials. Two doses, 72 hours apart, treating both eyes, even if only one eye is affected, is recommended. The use of the same ointment tube in affected and unaffected eyes is likely to present a risk for transmission of the pathogen.

**Subconjunctival Therapy**

The objective of subconjunctival treatment is to reduce the treatment dose and number of treatments while achieving higher antimicrobial tissue concentrations.<sup>4</sup> Although subconjunctival therapy with antibiotic was found to be effective in treating IBK in several studies, it is under contentious debate if the treatment effect is obtained through direct diffusion of the drug to the

surrounding tissue or rather through continuous leakage of the antibiotic onto the conjunctiva from the injection site.<sup>4</sup> A small volume (1 to 2 mL) of procaine-penicillin G (300,000 IU/mL) is commonly injected under the scleral conjunctiva. Two treatments 48 to 72 hours apart were found to be equally effective as a single parenteral treatment with long-acting formulation of oxytetracycline (20 mg/kg).<sup>4</sup> Therapy must be administered under the bulbar conjunctiva but was found to be ineffective if given in the superior palpebral conjunctiva. A controlled trial found that subconjunctival penicillin was effective in treatment, but recurrence was higher than with treatment with parenteral oxytetracycline, and mass treatment of calves with subconjunctival penicillin does not eliminate infection.

The intrapalpebral injection of 2 mL of a 10% oxytetracycline formulation was found equally effective as the systemic treatment with oxytetracycline (20 mg/kg).<sup>5</sup> Transient swelling of the eyelids, leading to complete closure of the palpebral fissure, was observed in some cases after intrapalpebral injection of oxytetracycline. It was suggested that this transient closure of the eye may favor healing by protecting the cornea and conjunctiva.<sup>5</sup>

Another technique for prolonging the maintenance of high levels of antibiotic in the conjunctival sac is the use of collagen inserts impregnated with an antibiotic.

**Parenteral Therapy**

Parenteral treatment with two doses of long-acting oxytetracycline (20 mg/kg) 72 hours apart has been shown to ameliorate clinical signs of naturally occurring IBK.<sup>4,5</sup>

Recent studies have documented that florfenicol when administered either as a single subcutaneous dose of 40 mg/kg or two doses of 20 mg/kg administered 48 hours apart is effective for treatment of clinical IBK in calves. Healing times were shorter and relapses were fewer when using florfenicol instead of long-acting oxytetracycline for treatment of IBK in calves.

The use of tulathromycin, a macrolide antibiotic, was found to be effective to treat experimentally induced IBK in calves in one study.<sup>6</sup> A single dose of 2.5 mg/kg resulted in faster healing and higher bacteriologic cure compared with untreated control animals.

Tilmicosin administered at a dose of 5 or 10 mg/kg SC was found effective to treat IBK in one field study.<sup>4</sup>

The efficacy of a long-acting formulation of ceftiofur crystalline-free acid (CCFA) administered as a single subcutaneous dose at the base of the ear to treat naturally occurring IBK has been examined in one study. A dose of 6.6 mg of ceftiofur equivalents/kg was found to result in higher healing rates and faster healing times of naturally occurring IBK compared with untreated control animals.<sup>7</sup>

**Ancillary Therapy**

Severe cases should be placed in a dark shelter out of direct sunlight. If housing is not possible, **eye flap patches** are available and effective. They are glued on above the eye and can be flipped up for medication of the eye.

When corneal ulceration has occurred, recovery is always protracted. The use of topical ophthalmic anesthetics combined with atropine administration may be indicated to minimize ciliary spasm and pain. Severe cases may require that the third eyelid be temporarily sutured across the globe of the eye for several days to promote healing. The use of NSAIDs should be considered in more advanced and severe cases.

**TREATMENT AND TREATMENT****Treatment****Topical treatment:**

Benzathine cloxacillin ointment (250 to 375 mg topical q72h, 2 treatments) (R-1)

**Subconjunctival injection:**

Procaine-penicillin G (300,000 to 600,000 IU subconjunctival q48-72 h, 2 treatments) (R-1)

**Intrapalpebral injection:**

Oxytetracycline (treatment 1 to 2 mL of 10% solution intrapalpebral, single treatment) (R-2)

**Systemic treatment:**

Oxytetracycline long-acting formulation (20 mg/kg q48h IM, two treatments) (R-1)

Florfenicol (20 mg/kg q48 SC, 2 treatments or 40 mg/kg SC, single treatment) (R-1)

Tulathromycin (2.5 mg/kg SC, single treatment) (R-2)

Tilmicosin (5 mg/kg SC, single treatment) (R-3)

**Treatment**

Decrease exposure to dust and implement fly control, particularly against face flies (R-2)

Vaccination with commercially available or autogenous bacterins (R-3)

**CONTROL**

Eradication or prevention of the disease does not seem possible under extensive range conditions because of the method of spread, but if **fly control** can be fitted into the farm's management program this should significantly reduce the infection rate. Insecticide-impregnated eartags may help in the control of the disease but do not prevent it. In many herds the best that can be done is to keep animals under close surveillance and isolate and treat any cattle that show excessive lacrimation and blepharospasm. Cattle that have had the disease should not be mixed with those that have not until after the fly season.



## Vaccination

There has been considerable effort to develop methods of immunoprophylaxis; however, the commercial bacterins, although available for over 30 years, have given inconsistent results, providing at best limited protection from subsequent infection and clinical disease. Killed, whole-cell vaccines require repeat injections, may be associated with anaphylactic reactions, and have not proven effective in the field. To avoid the need for repeated injections an adjuvant vaccine has been tested, but without apparent benefit.

Vaccines containing pilus antigens, with or without cornea-degrading enzyme antigens, protect against challenge with homologous strains of *M. bovis*, and some field trials report efficacy in naturally occurring outbreaks. However, others do not, and the results of field studies that have shown a beneficial effect from vaccination have been criticized on the basis of bias in the selection of controls. It is probable that currently available vaccines do not contain the diversity of antigens required to protect against the variety of strains that occur in natural outbreaks. Autogenous vaccines are a consideration in individual herds, but a recent controlled trial of an autogenous vaccine administered by subcutaneous or subconjunctival injection found no significant effect of either route or the vaccine on the incidence of disease.

Weekly treatment of both eyes of calves, but not the cows, with a furazolidone eye spray has been shown to be a more effective prophylaxis than vaccination with a commercial bacterin in some areas.

Total eyelid pigmentation may reduce the incidence of this disease, but the recorded differences are unlikely to arouse enthusiasm for a genetic approach to the problem.

## FURTHER READING

- Angelos JA. Infectious bovine keratoconjunctivitis (pinkeye). *Vet Clin North Am Food A*. 2015;31(1):61-79.
- McConnel CS, Shum L, House JK. Infectious bovine keratoconjunctivitis antimicrobial therapy. *Aust Vet J*. 2007;85:65-69.
- O'Connor AM, Brace S, Gould S, Dewell R, Engelken T. A randomized clinical trial evaluating a farm-of-origin autogenous *Moraxella bovis* vaccine to control infectious bovine keratoconjunctivitis (pinkeye) in beef cattle. *J Vet Intern Med*. 2011;25:1447-1453.
- Postma GC, Carfagnini JC, Minatel L. *Moraxella bovis* pathogenicity: an update. *Comp Immunol Microbiol Infect Dis*. 2008;31:449-458.

## REFERENCES

- Postma GC, et al. *Comp Immunol Microbiol Infect Dis*. 2008;31:449-458.
- Angelos JA. *Vet Clin North Am Food A*. 2010;29:73-78.
- Gould S, et al. *Vet Microbiol*. 2013;164:108-115.
- McConnel CS, et al. *Aust Vet J*. 2007;85:65-69.
- Starke A, et al. *Dtsch Tierarztl Wochenschr*. 2007;114:219-224.
- Lane VM, et al. *J Am Vet Med Assoc*. 2006;229:557-561.
- Dueger EL, et al. *Am J Vet Res*. 2004;65:1185-1188.

## OVINE AND CAPRINE CONTAGIOUS OPHTHALMIA (OVINE AND CAPRINE INFECTIOUS KERATOCONJUNCTIVITIS, CONTAGIOUS CONJUNCTIVO-KERATITIS, PINKEYE IN SHEEP AND GOATS)

### SYNOPSIS

**Etiology** *Mycoplasma conjunctivae* is a significant cause, but other agents, in particular *Chlamydia pecorum*, *Moraxella ovis*, and other *Mycoplasma* spp., can produce clinically identical disease.

**Epidemiology** Rapid spread by contact with carrier animals. Usually occurs as outbreak in summer and when conditions are dry and dusty. Disease is most severe in weaned lambs.

**Clinical findings** Lacrimation, conjunctival hyperemia, pannus, neovascularization, iritis, keratitis in one or both eyes.

**Diagnostic confirmation** Clinical examination of the flock, exfoliative cytology, culture and polymerase chain reaction (PCR).

**Treatment** Topical or preferably parenteral tetracycline.

**Control** Avoid confinement and movement in dusty conditions. Fly control.

## ETIOLOGY

A variety of organisms have been isolated from the eyes of sheep and goats with keratoconjunctivitis. Some are primary pathogens and others secondary invaders. It is difficult to attribute a primary etiological cause to a single agent because all the putative causal organisms have also been isolated from the eyes of normal sheep. Mixed infections occur during an outbreak, with potential synergism between *Mycoplasma* spp. and other infectious agents. The management circumstances that lead to outbreaks of disease with each agent, and the clinical syndromes that result, are not sufficiently distinct to allow the differentiation of the various etiologies on clinical or epidemiological grounds. There have been limited studies on the relative prevalence of flock outbreaks of disease associated with the various putative causes, but there is a strong evidence to incriminate *Mycoplasma* spp., particularly *M. conjunctivae*, as the major cause in domesticated sheep and goats, and wild ruminants such as chamois, Alpine ibex, European mouflon, and Bighorn sheep.

### *Mycoplasma conjunctivae*

*Mycoplasma conjunctivae* is a common isolate in outbreaks of the disease. However, it is not present in all affected sheep and can also be isolated, with lesser frequency, from

the eyes of clinically normal sheep. Disease can be reproduced with the inoculation of pure cultures of this organism into the eye of sheep and is then spread to other sheep by contact transmission. Consequently, it is thought to be a principal cause of pinkeye in sheep and goats.

### Other Mycoplasmas

Other *Mycoplasma* spp. are frequently identified in the eyes of sheep and goats with pinkeye. *M. agalactiae* was considered a primary cause of an outbreak in Spain, whereas *M. arginini* and *Acholeplasma oculi* have been isolated from clinical cases of contagious ophthalmia. Infection with other mycoplasmas, such as *M. capricolum* subsp. *capricolum* and *M. mycoides* subsp. *capri*, can be accompanied by conjunctivitis, but other clinical signs, such as pneumonia, predominate.

### *Chlamydophila pecorum*

*Chlamydophila pecorum* (*Coletsiota conjunctivae*) was initially incriminated as a cause of contagious ophthalmia in sheep and goats in South Africa and Australia. It has been isolated from outbreaks of keratoconjunctivitis in sheep in the United States and the United Kingdom, and the disease has been reproduced experimentally. The strains are related to those associated with polyarthritis in sheep rather than abortion. A rickettsial agent, *Rupricapra rupricapae*, has been isolated from keratoconjunctivitis in chamois (*R. tragis*) and ibex (*Capra ibex*) in the French Alps. In Egypt, *Chlamydophila psittaci* was isolated at a higher rate from diseased eyes, compared with asymptomatic eyes, in both sheep (80% and 68%, respectively) and goats (92% and 76%, respectively).<sup>1</sup>

A number of bacteria, including *Branhamella* (*Neisseria*) *ovis*, *S. aureus* and *E. coli*, can be isolated from the eyes of animals with contagious ophthalmia, with rates of isolation from affected eyes higher than those from normal sheep. They have not always produced disease following experimental challenge. Consequently, they are considered to be secondary infections rather than having a primary causal role, exacerbating the lesions produced by the primary agent. *B. ovis* is considered a cause of follicular conjunctivitis. Similarly, *Moraxella bovis*, which is associated with contagious keratoconjunctivitis in cattle, has no apparent causal association with the disease in sheep, although it was isolated from clinical cases in goats in Nigeria.<sup>2</sup> *Listeria monocytogenes* may be a primary cause of keratoconjunctivitis and iritis in sheep.

## EPIDEMIOLOGY

### Occurrence

The disease is widespread in sheep of all breeds in most countries. Recently weaned animals are often the most severely affected.

### Source of Infection and Transmission

The source of infection is infected or carrier animals. The disease is spread indirectly by flies, long grass, and dust contaminated by the tears of infected sheep, or directly by means of exhaled droplets or immediate contact. *M. conjunctivae* infects many wild small ruminant species and can be transmitted between domestic and wild animals.<sup>3,4</sup>

### Risk Factors

The prevalence is highest during the warm, summer months and when conditions are dry and dusty and flies are abundant. The morbidity rate varies widely depending on seasonal conditions; it is usually about 10% to 15% but may be as high as 80%. Resistance to infection is reduced by other disease, poor nutrition, and adverse weather. Widespread outbreaks occur in some years where the disease contributes to poor growth and ill-thrift, presumably from reduce foraging ability, especially in young stock. Outbreaks during mating can reduce conception and lambing rates.

In many flocks at pasture the disease causes little disruption to grazing, and so only minor inconvenience. However, in other flocks, and in some years, higher morbidity, severe lesions, and detrimental effects on production occur. Clinical experience suggests that the incidence and the severity of the disease in an affected flock are increased by the stress, dust, and close contact associated with gathering and yarding of the flock. Thus a decision to treat during an outbreak can be associated with an apparent exacerbation of clinical disease.

### PATHOGENESIS

Rapid onset of acute inflammation of the conjunctiva is followed by hyperemia of the sclera and pannus and opacity of the cornea.

### CLINICAL FINDINGS

Clinical findings are similar with all agents associated with the disease. There is conjunctivitis, lacrimation, and blepharospasm, followed by keratitis with cloudiness of the cornea and some increase in vascularity. There is profuse lacrimation, and thus initial signs in the flock may be a brown discoloration below the eye associated with dust accumulating on lacrimal discharges.

Corneal opacity is initially most pronounced at the dorsal corneal-scleral junction. This is followed by vascularization, to produce a horizontal zone of opacity associated with an area of vertical-oriented vascularization in the upper area of the eye. In severe cases, the whole cornea is affected, and there may be corneal ulceration.

In flocks experiencing an outbreak, the disease in most sheep is mild if there are no complicating circumstances; the initial watery discharge from the eye becomes purulent, but recovery commences in 3 to 4 days and is complete at about 20 days. In

some animals the cloudiness of the cornea may persist for several weeks or even permanently. Local ulceration of the cornea may cause collapse of the eyeball. One or both eyes may be affected, but many sheep have both eyes affected in outbreaks, and spread through the flock is rapid.

Conjunctivitis is followed by the development of granular lesions of follicular conjunctivitis on the palpebral conjunctiva and third eyelid, which are thought by some to be specific for infections involving *B. ovis*.

In goats, the disease is milder with little apparent ophthalmia or keratitis. A more severe keratoconjunctivitis than that associated with *M. conjunctivae*, and manifest with corneal edema, occurs in some outbreaks in goats, but its cause has not been established. All age groups are affected, and although the morbidity is usually 12% to 20%, it may reach 50%. Direct contact between animals appears to be necessary for spread of the infection, but the disease has not been transmitted experimentally. Conjunctivitis, opacity, vascularization, and sometimes ulceration of the cornea are accompanied by an ocular discharge and blepharospasm. In some goats there is severe corneal edema with intracorneal edema accumulating to a degree to produce corneal vesicles. In mildly affected goats, recovery begins in 4 to 7 days, but in severe cases, healing may not be complete for 2 to 4 weeks or longer.

### CLINICAL PATHOLOGY

Scrapings can be taken for exfoliative cytology from the palpebral conjunctiva, preferably from early clinical cases. *Mycoplasma*, *Branhamella*, and *Chlamydomphila* have characteristic morphology and can be demonstrated in Giemsa- or immunofluorescent-stained smears. Samples can also be submitted for culture identification, and paired serum samples can be submitted for examination for antibodies to *Chlamydomphila*.

The determination of the etiologic agent currently has limited significance to the subsequent approach to the control and treatment of the disease, and so is largely academic. However, conventional and real-time PCR can be used to detect *M. conjunctivae* and *Moraxella* spp., and PCR is a more sensitive way of detecting of infection than culture.<sup>5,6</sup>

### TREATMENT

A decision for treatment needs to be taken with consideration of the adverse effects on the disease of the associated movement and close yarding of the flock. Repeated treatments of sheep pastured under extensive grazing are impractical, and spontaneous recovery will occur within 3 weeks. Consequently, in extensive grazing conditions a decision for no treatment is often made.

A single intramuscular injection of long-acting tetracycline at 20 mg/kg halts further development of clinical conjunctivitis when given as clinical signs develop and results in rapid clinical cure in animals affected with keratoconjunctivitis produced by *M. conjunctivae*. Florfenicol readily penetrates tear fluid, with doses greater than 20 mg/kg needed to provide minimum inhibitory concentrations against most *Mycoplasma* spp.<sup>7</sup> However, neither parenteral or topical antibiotic treatment eliminates infection; thus, repeated infections in individual animals and recurrence of outbreaks in flocks are common. Where the etiology is not known and treatment is deemed desirable, tetracyclines administered either topically or parenterally, or topical treatment with cloxacillin or erythromycin ophthalmic ointments, have been shown to be of benefit.

### CONTROL

Complete eradication of the disease is not attempted, but isolation of affected sheep and removal to grassier, less dusty pasture may reduce the rate of spread. Confinement of affected sheep should also be avoided.

### FURTHER READING

Radostits O, et al. Ovine and caprine contagious ophthalmia (ovine and caprine infectious keratoconjunctivitis, contagious conjunctivokeratitis, pinkeye in sheep and goats). In: *Veterinary Medicine: A Textbook of the Diseases of Cattle, Horses, Sheep, Goats and Pigs*. 10th ed. London: W.B. Saunders; 2007:1142-1143.

### REFERENCES

- Osman KM, et al. *Transbound Emerg Dis*. 2013;60:245.
- Ojo OE, et al. *Niger Vet J*. 2009;30:56.
- Jansen BD, et al. *J Wildl Dis*. 2006;42:407.
- Fernandez-Aguilar X, et al. *BMC Vet Res*. 2013;9:253.
- Vilei EM, et al. *J Microbiol Meth*. 2007;70:384.
- Shen HG, et al. *J Appl Microbiol*. 2011;111:1037.
- Regnier A, et al. *J Am Vet Med Assoc*. 2013;74:268.

## DISEASES OF THE EYES ASSOCIATED WITH MYCOPLASMA SPP.

*Mycoplasma conjunctivae* is the etiologic agent causing **infectious keratoconjunctivitis of small and wild ruminants** (see also “Ovine and Caprine Infectious Keratoconjunctivitis”).

In cattle *M. bovoculi* is frequently isolated from conjunctival swabs without necessarily being associated with clinical disease. The recovery rate of *M. bovoculi* from eye swabs obtained from clinically healthy cattle and animals with conjunctivitis was approximately 40% in both instances. *M. bovoculi* was isolated more frequently from animals younger than 2 years of age than from older animals, whereas the disease incidence of infectious keratoconjunctivitis was similar in both age groups. The higher recovery rate of *M. bovoculi* in younger animals was explained

by the development of immunity after initial infection.

Other *Mycoplasma* spp. that have been isolated from cattle with keratoconjunctivitis are *M. bovis*, *M. bovis genitalium*, *M. bovirhinis*, *M. verecundum*, *Ureaplasma diversum*, *Acholeplasma laidlawii*, and *Acholeplasma oculi*, some of which have been incriminated as contributing to the development of **infectious bovine keratoconjunctivitis**.

### THELAZIASIS (EYEWORM)

A number of species of the nematode genus *Thelazia* occur in the conjunctival sac and tear ducts of mammals throughout the world. *T. gulosa* and *T. skrjabini* are the main species in cattle in the New World, *T. rhodesi* is the commonest in the Old World, and *T. lacrymalis* is common in horses. They are thin worms up to 2 cm long. Infestation is often inapparent, but they may cause excessive lacrimation, photophobia, conjunctivitis,<sup>1</sup> corneal opacity,<sup>2</sup> keratitis, corneal ulceration, and abscess formation on the eyelids. In horses, this condition mainly occurs in young animals.<sup>3</sup> One U.S. survey in Kentucky found 43% of horses up to 4 years old to be infected. In those species that have been studied, the life cycles are indirect, with muscid flies, particularly the face fly *M. autumnalis*, being the intermediate hosts. These flies deposit larvae on the conjunctiva when feeding on fluid around the eye. The disease is mainly seen in summer and autumn when the flies are active. It is usually more common in cattle<sup>1</sup> and African buffalo<sup>2</sup> than horses, and worms may be more abundant in beef than in dairy cattle. Eyeworm in cattle is differentiated from infectious keratitis by observing the adult worm in the conjunctival sac or demonstrating first-stage larvae in eye washings. Ivermectin (0.2 mg/kg, repeated three times at 1-month intervals) is active against worms in African buffalo.<sup>2</sup> Ivermectin and doramectin are active against the adult worm in cattle, but anecdotal reports suggest that it may be less effective in horses.<sup>3</sup>

### REFERENCES

1. Djungu DF, et al. *Trop Biomed*. 2014;31:844.
2. Munangandu HM, et al. *Korean J Parasitol*. 2011;49:91.
3. Lyons ET, et al. *Parasitol Res*. 2006;99:114.

### "BRIGHT BLINDNESS" OF SHEEP CAUSED BY BRACKEN INGESTION

A progressive retinal degeneration associated with ptaquiloside was observed in sheep kept for more than 3 years on pastures heavily infested with bracken in the United Kingdom, and the disease has been produced experimentally in sheep fed bracken. Affected sheep are blind, reluctant to move, but bright and alert. The pupils are dilated and show poor

light and menace reflexes, and on ophthalmoscopic examination there is retinal degeneration. This degeneration may be observable in many more sheep than the clinically blind ones. Leukopenia is a characteristic.

### BOVINE OCULAR SQUAMOUS-CELL CARCINOMA

Bovine ocular squamous-cell carcinoma (BOSCC), often referred to as "cancer eye," is one of the most common neoplasms of cattle.

#### SYNOPSIS

**Etiology** Genetic–environmental interaction. Lack of pigmentation around the eye and solar radiation.

**Epidemiology** One of most common neoplasms of cattle; mostly in beef cattle breeds with white on their heads (Hereford, Simmental) and lacking pigment around the eye; animals over 5 years of age. Solar radiation is a major risk factor.

**Signs** Precursor lesions; single or multiple plaques on eyelid or conjunctiva, except the cornea or pigmented lid; may regress or lead to carcinomas of sclera resembling papillomas with crumbly, necrotic ulcerated mass attached to the eyelid, causing irritation to eye and conjunctiva and excessive lacrimation and pus. Invasion of surrounding tissues of eye and possibly to nearby lymph nodes.

**Clinical pathology** Histology of lesion.

**Lesions** Squamous-cell carcinoma.

**Diagnostic confirmation** Biopsy and histology.

#### Differential diagnosis list

Pinkeye  
Lymphoma of periorbital tissues

**Treatment** Excision by cryosurgery. Radical surgery may be necessary. Immunotherapy with vaccines has been attempted.

**Control** Breeding program to increase degree of periocular pigmentation in white-faced beef cattle and remove genetically susceptible cattle from the breeding herd.

### ETIOLOGY

A genetic–environmental interaction has been proposed as the cause. A relative **lack of circumocular and corneoscleral pigmentation**, both of which are highly heritable, increases the probability of lesion development when the animal is exposed to a carcinogenic agent such as the **ultraviolet component of sunlight**.<sup>1</sup> The carcinoma has been regarded as a papilloma-associated tumor because papillomavirus can be found in the precursor lesions, and papillomavirus DNA in the carcinomas. It is possible the papillomavirus infection predisposes to BOSCC by induction of precursor lesions, but papillomavirus does not appear to be

needed for maintenance of the tumor. Moreover, advanced virological techniques have failed to reveal any association between the virus and the tumor.<sup>2</sup>

The *p53* gene product is highly expressed in bovine BOSCC, which provides support for its role in BOSCC tumor development.

### EPIDEMIOLOGY

#### Occurrence

Bovine ocular squamous-cell carcinoma is a very common neoplasm of the eyelids and the eyeball of cattle and one of the most common neoplasms of cattle. The disease is most common in beef cattle, which are exposed to more sunlight than dairy cattle. Breeds affected most commonly are Hereford and Simmental, but BOSCC has also been recorded in Shorthorn, Holstein–Friesian, Guernsey, Jersey, Ayrshire, Brown Swiss, Normandy, Hollandensa, Javanese–Mongolian, and Brahman cattle.

The tumors are uncommon in cattle younger than 5 years and are almost never seen in cattle younger than 3 years. The condemnation rate at slaughter of cattle with ocular squamous-cell carcinoma in Canada is about 30% of cases. A squamous-cell carcinoma of the anal and perianal area of a 15-year-old bull has been recorded.

#### Risk Factors

The heritabilities and phenotypic and genetic correlations of eyelid and corneoscleral pigment and eye lesions associated with eye cancer were investigated in 2831 Herefords from 34 herds in 21 U.S. states and one Canadian province. The results indicated that periocular pigmentation and eyelid and corneoscleral pigment were highly heritable and genetically correlated. These findings lead to the general conclusion that the genetic effect on pigment determines to a large extent the degree to which the eye is susceptible to an environmental carcinogenic agent such as ultraviolet light. A very high heritability estimate ( $h^2 = 0.79$ ) was reported for circumocular pigmentation in 3579 Simmental cattle in Germany.<sup>1</sup>

In Zimbabwe, ocular squamous-cell carcinoma was frequently observed in five breeding herds of Simmental cattle. In these herds, initial signs of the disease were evident in cattle of about 3 years of age, and gradually the prevalence increased to over 50% in animals over 7 years of age. It is suggested that because most cattle in Zimbabwe are slaughtered by 10 years of age, that more than 67% of cattle without periorbital skin pigmentation would develop the tumor. The tumors were multiple and commonly bilateral. Simmental cattle have a complete or partly white face, and the lack of facial pigmentation risks exposure to intense solar radiation when they are kept at a high altitude (1500 m) in a sunny and warm climate. The prevalence was much lower in white-faced Friesian cattle in the same



environment, which indicates a genetic predisposition for the tumors in Simmental cattle, separate from periocular pigmentation. In Zimbabwe, the tumor is not recorded in fully pigmented cattle breeds.

The positive association between prevalence of BOSCC and various measures of solar radiation indicate a significant association between increasing risks of developing eye cancer and increasing levels of radiation. Ultraviolet light is generally regarded as an important risk factor. Most tumors are located only in the sun-exposed mucocutaneous areas not protected by hair. Tumors are predominantly localized in the third eyelid and the lateral limbus, and tumor growth usually starts at the outer edge, which receives the most sunlight. Cattle exposed to higher levels of ultraviolet radiation develop the disease at younger ages.

### Economic Importance

The disease results in serious economic consequences through lessened productivity and carcass condemnations. Commercial cattle can be culled early without much loss, because only the head is condemned. Purebred cattle are more of a problem because of the difficulty of deciding when euthanasia must be the humane decision, rather than another attempted extirpation of the eye. An additional issue in purebred cattle is whether the bloodline of affected cattle should be preserved.

### PATHOGENESIS

The initial lesion may be on the eyelid or any structure in the conjunctival sac, except the avascular cornea or pigmented eyelid. Lesions can encroach on these tissues from others nearby, carrying a blood supply with them.

The lesions develop through four stages. The first three, plaque, keratoma, and papilloma, are nonmalignant and have relatively high spontaneous regression rates. The fourth stage is the squamous-cell carcinoma, which does not regress. The tumor is located in the sclera adjacent to the lateral limbus, in the membrana nictitans (third eyelid), or in the lower eyelid (Fig. 16-11A-C). It is an invasive tumor, metastasizing along the draining lymphatics into cervical lymph nodes. Primary lesions of the lids are most likely to metastasize to these nodes.

Animals do not appear to develop resistance to the cancer; only a few cows with the disease develop measurable antibodies in their sera. It is one of the characteristics of this disease that the carcinomas appear to produce immunosuppressive substances, and removal of tumor mass reduces their blood concentrations.

In countries and in herds where ocular carcinoma is common, it is not unusual to encounter lesions on the labia of the vulva, especially if there are patches of unpigmented skin.

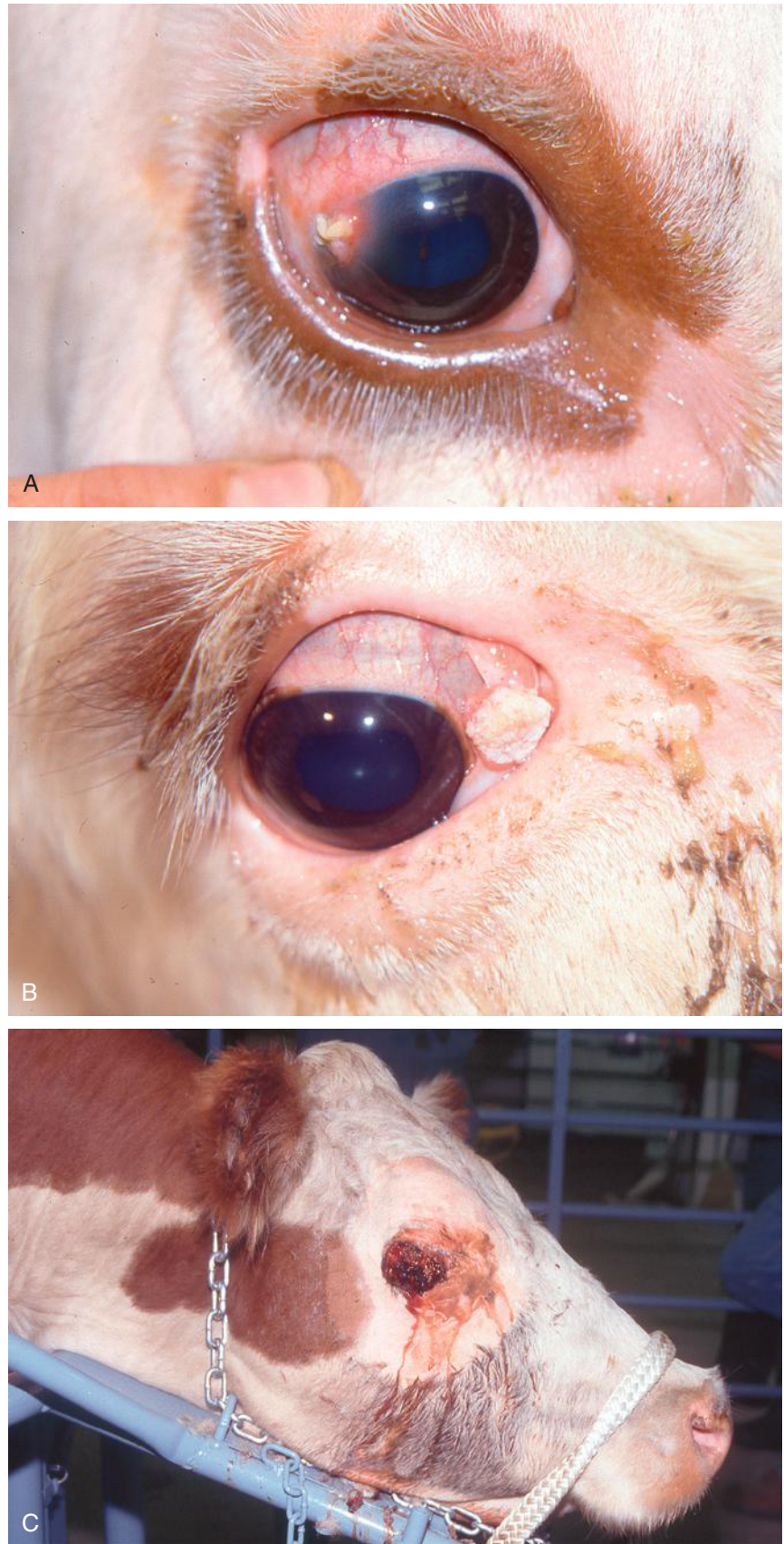

**Fig. 16-11** A, Advanced plaque on the lateral limbus of the right eye from a Simmental cow. This is a precursor to ocular squamous-cell carcinoma. B, Advanced papilloma on the third eyelid of the right eye from a Simmental cow. This is a precursor to squamous-cell carcinoma. Note the small amount of periocular eyelid pigmentation. C, Advanced squamous-cell carcinoma of the right lower eyelid of a Simmental cow. The tumor mass is large enough that metastasis to the regional lymph node was likely.

## CLINICAL FINDINGS

**Typical precursor lesions** are single or multiple plaques of gray–white, smooth or rough, hyperplastic to hyperkeratinized tissue anywhere in the conjunctiva (stage 1). Plaques may develop into keratoma or keratoacanthomas (stage 2) and papillomas (stage 3), which are also regarded as precursor lesions. Squamous-cell carcinomas (stage 4) may develop from any of these precursor stages, which may also regress spontaneously. **Classic ocular squamous-cell carcinoma lesions** resemble papillomas, with a fleshy, sometimes crumbly, often necrotic and ulcerated mass attached to the lid or the orbit by a wide base. They are visible even when the eyelids are closed, and they cause obvious irritation to the surrounding conjunctiva, resulting in increased lacrimation and sometimes in the discharge of pus. Invasion of surrounding tissues is common, but metastases to nearby lymph nodes and to viscera occur in only a few cases and then only late in the course of the disease. In general, all lesions with a dimension greater than 2 cm are cancerous (stage 4). The proportion of small precursor lesions that regress without specific treatment is up to 88%, which complicates evaluation of treatment efficacy.

The most common location for tumor development is the lateral corneoscleral junction (limbus), which usually accounts for three-fourths of all lesions. Other predilection sites are the nictating membrane (third eyelid) and middle to medial aspect of the lower eyelid. Tumors on the nictating membrane appear to grow more quickly than tumors located elsewhere.<sup>3</sup> Tumors in the eyelids have a higher frequency of metastasis than tumors of the cornea or limbus; this most likely reflects total tumor volume at diagnosis, with eyelid lesions typically being more extensive when the animal is first examined for treatment.

## CLINICAL PATHOLOGY

Differentiation between carcinomas and precursor lesions is difficult clinically, and cytologic examination or biopsy is recommended for definitive diagnoses. The cytology of squamous-cell carcinomas in domestic animals has been described.

### DIFFERENTIAL DIAGNOSIS

One of the difficulties encountered in the field is the clinical differentiation of benign precursor lesions from the malignant carcinomas; failure to do so may account for the high rates of spontaneous regression recorded, especially in Hereford cattle, where a spontaneous recovery rate of 88% has been recorded. To avoid this inaccuracy, exfoliative cytology by the examination of smears of lesions is helpful. Combined with a clinical assessment, this is the recommended method

of confirming the diagnosis. Differentiation from similar lesions that are not BOSCC can only be achieved by proper laboratory examination of tissues.

BOSCC must be differentiated clinically from:

Pinkeye and its complications, which result in excessive lacrimation and purulent material

Lymphoma of the periorbital tissues, which usually manifests as exophthalmos

## TREATMENT

Surgical excision of small lesions with a margin of 2 to 3 mm, accompanied by cryonecrosis (two freeze–thaw cycles) of the tumor site using appropriately sized copper probes placed in liquid nitrogen, is widely practiced in cattle. Results are good to excellent in cattle with small lesions (<2 cm in dimension). Enucleation (removal of the eye) and extirpation or exenteration (removal of the eye and para-orbital tissue) is commonly performed in animals with larger lesions (>2 cm in dimension) that indicate presence of carcinoma in situ that are locally invasive. The major challenges with enucleation are intraoperative hemorrhage and postoperative infection, which occurred in 19% of 53 cattle.<sup>4</sup> Radical surgery, including removal of the local lymph nodes and parts of the salivary gland, may be desirable in advanced cases of BOSCC.

Recurrence, or the development of new lesions at the same site, is common. Treatment can also be combined with immunotherapy, for example, with **bacillus Calmette–Guérin** (BCG) vaccine injected systemically or into the lesion, or with vaccination with BOSCC tumor material. There is a significant cell-mediated immune response in cattle with BOSCC, and it is thought that this immune process plays an important role in the rejection of the tumors. One controlled trial in cattle showed that intralesional injection of BCG vaccine can interrupt neoplastic progression and prevent malignant disease. A permanent regression after BCG vaccination can be expected in 37% of cases, recurrence at the same site in 26%, and continued growth in 37%.

A favorable response to a single injection of a saline phenol extract of fresh tumor tissue can induce a high rate of regression of ocular tumors, with a higher recovery rate after the use of 200 mg of lyophilized tumor extract compared with an injection of 100 mg. The injection may need to be repeated. Occasional tumors show enhancement of growth after vaccination, especially if it is repeated. The vaccine does not need to be autologous, and only one injection is required. A freeze-dried preparation of tumor antigen has been used successfully. In general, the use of a vaccine seems likely to provide a satisfactory method for controlling an esthetically distressing and financially important disease.

Reports on the effect of vaccination with a tumor vaccine on the vulvar form of squamous-cell carcinoma vary.

Daily peritumoral injections of BOSCC lesions up to 2.8 cm<sup>2</sup> in area with interleukin-2 for 10 days at 5000 to 1,000,000 U was effective in inducing complete tumor regression in 50% to 69% of tumors at 20 months, compared with 14% regression in control cattle injected with solvent.<sup>3</sup> Lower daily IL-2 doses (<200,000 U) were similarly effective as higher doses in inducing tumor regression at 9 months, but their effectiveness was not maintained at 20 months. Interleukin-2 is thought to induce tumor regression by initially inducing edema, then angiogenesis, recruitment of monocytes, and macrophage and lymphocyte activation. However, the tumor response rate to IL-2 treatment is lower than that achieved by surgery, which remains the preferred treatment for BOSCC.

Treatment by the use of radioactive implants or topically applied radiation has also been successful, but reduced availability and concerns about the use of radioactivity in a meat-producing animal has markedly decreased the application of localized radiation therapy. Other treatments that have received favorable comment, but need to be evaluated in the light of the known natural recovery rate of the benign precursor lesions, include radiofrequency hyperthermia and combinations of the previously described procedures.

## TREATMENT AND CONTROL

### Treatment

Surgical excision of lesions > 2 cm in dimension (stage 4) (R-1)

Surgical excision of lesions < 2 cm in dimension (stages 1, 2, 3, or 4) (R-1)

Cryonecrosis (2 freeze–thaw cycles) (R-2)

Intralesional BCG injection(s) (R-2)

Intralesional IL-2 injections (200,000 to 2,000,000 U daily for 10 days) (R-2)

Local radiofrequency hyperthermia (2 heating cycles) (R-2)

Local radiation therapy (if available and permitted) (R-2)

### Prophylaxis

Decrease exposure to ultraviolet light (usually not practical) (R-1)

Implement breeding program based on increasing periocular pigmentation (R-1)

Remove direct descendants and sires and dams of cattle diagnosed with BOSCC (R-2)

## CONTROL

Because of the strong correlation between absence of pigmentation of the eyelids and the occurrence of the disease, and because of the high heritability of this pigmentation in Hereford and Simmental cattle, it is



suggested that a breeding program aimed at increasing the degree of pigmentation of eyelids could quickly reduce the incidence of the disease in this breed. A positive approach to the problem would be to crossbreed susceptible *B. taurus* cattle with *B. indicus* cattle, which always have pigmented eyelids and have much lower rates of eye cancer. In Ayrshires there is a corresponding predilection for squamous-cell carcinomata of the vulva, but the neoplasm does not occur on both sites in the same cow. Selection on the basis of the occurrence of lesions alone results in only limited reduction in incidence.

### FURTHER READING

Tsujita H, Plummer CE. Bovine ocular squamous cell carcinoma. *Vet Clin North Am Food A.* 2010;26:511-529.

### REFERENCES

1. Pausch H, et al. *PLoS ONE.* 2012;7:e36346.
2. Nasir L, Campo MS. *Vet Dermatology.* 2008;19:243.
3. Stewart RJE, et al. *Vet Rec.* 2006;159:668.
4. Schulz KL, Anderson DE. *Can Vet J.* 2010;51:611.

## EQUINE OCULAR SQUAMOUS-CELL CARCINOMA

Squamous-cell carcinoma is one of the most common neoplasms of the horse and is the most common neoplastic tumor of the eye and orbit.

Equine ocular squamous-cell carcinoma (EOSC) is associated with a number of factors, including lack of pigmentation around the eye, exposure to solar radiation, mutations in the *p53* gene, and presence of equine caballus papillomavirus type 2 (EcPV-2) and bovine papillomavirus type 1 (BPV-1) DNA.<sup>1,2</sup> EcPV-2 is also found in squamous carcinoma of the penis of horses, but not in clinically normal nictitating membrane tissue (75 horses).<sup>3</sup> Although DNA of BPV-1 can be found in normal equine skin, there is increasing evidence of an etiologic link between mucocutaneous squamous-cell carcinoma (SCC) in horses and EcPV-2 infection. Approximately 25% of these tumors express cyclooxygenase-2 activity.<sup>4,6</sup>

The reported frequency has been highest in animals lacking periocular pigmentation and is more common in Appaloosa, albino, and color-dilute horses. An increased prevalence for ocular and adnexal SCC has been reported in Belgian draft horse breeds, Appaloosas, Paint horses, Thoroughbreds, and Quarter horses. A predisposition for the development of ocular and adnexal SCC has also been reported in geldings. The risk has been higher in draft breeds than in other pigmented breeds, probably related to the large expanses of white skin on the face and around the eye of the heavy draft breeds. The overall mean age range of affected animals is 8 to 10 years. In a series of limbal neoplasms in horses admitted to the Veterinary Teaching Hospital in the Netherlands, SCC was the most predominant tumor type, and Haflinger

horses accounted for 69%, whereas their occurrence in the hospital population was 5%.

In a retrospective study of 50 cases submitted to the University of Florida Veterinary Medical Teaching Hospital, the Appaloosa accounted for the majority of cases, which may be a reflection of the high level of solar radiation in southeastern United States. The average age at which the tumor was diagnosed initially was 11.8 years; males accounted for 64% and females 36% of the cases. The rate of metastasis was 18%.

In the Florida study, higher cure rates were associated with surgical excision followed by radiation therapy for a cure rate of 75%, whereas with only surgical excision the cure rate was 55%. Best results with treatment are seen when surgical intervention is early. In horses, treatment is largely surgical, but all of the immunologic techniques developed for cattle have been used, including local irradiation therapy.

The most frequent site for ocular involvement is the nictitating membrane and conjunctiva, but the eyelids and cornea are also involved.

Treatment of ocular and adnexal SCC has included various types of therapy, with and without adjuvant radiation therapy. Types of treatment without adjuvant radiation therapy include excision, cryotherapy, radiofrequency hyperthermia, immunotherapy, chemotherapy with cisplatin, and carbon dioxide laser ablation. Treatment with adjuvant radiation therapy includes use of strontium 90 (Sr), cobalt 60 (Co), gold 198, iridium 192 (Ir), cesium 137, iodine 125 (I), and radon 222 (Rn). In a series of 157 cases of ocular and adnexa SCC, those treated with adjuvant radiation therapy had a significantly lower recurrence rate compared with those treated without adjuvant radiation therapy, independent of anatomic location.

Superficial keratectomy followed by cryosurgery is a simple and effective procedure for the treatment of small-sized limbal tumors (less than 2 cm) in horses. Sophisticated equipment is not required, and the legal restrictions associated with the use of radioactive substances in many countries are not a consideration.

Prevention is through reduction of exposure to sunlight through use of fly masks and tattooing of ocular tissue.

Ocular pseudotumors have been described in horses. They are proliferative inflammatory lesions involving the eye, adnexa, or orbit, which clinically mimic true neoplasms. Cases are characterized by a unicellular, pink, proliferative limbal or perilimbal lesion. Affected horses may be from 5 to 9 years of age. Most cases occurred during the summer months and none of the affected animals had a history of trauma or recent deworming. The dorsal bulbar conjunctiva was most commonly affected, followed by the third eyelid. Lesions were relatively

flat with indistinct margins or discrete and nodular. Histologically, the lesion is inflammatory and characterized by predominantly lymphocytic infiltrates. The cause is unknown, but an immune-mediated pathogenesis is suspected based on the preponderance of immunocytes consisting primarily of lymphocytes. Treatment consists of surgical excision alone, partial resection with antiinflammatory therapy, or antiinflammatory therapy alone.

### FURTHER READING

Dugan SJ, et al. Epidemiological study of ocular/adnexal squamous cell carcinoma in horses. *J Am Vet Med Assoc.* 1991;198:251-256.

Giuliano EA. Equine periocular neoplasia: current concepts and aetiopathogenesis and emerging treatment modalities. *Equine Vet J.* 2010;42:9-18.

### REFERENCES

1. Kaiznbauer C, et al. *Equine Vet J.* 2012;44:112.
2. Sykora S, et al. *Vet Microbiol.* 2012;158:194.
3. Knight CG, et al. *Vet Microbiol.* 2013;166:257.
4. McInnis CL, et al. *Am J Vet Res.* 2007;68:165.
5. Rassnick KM, et al. *J Vet Diagn Invest.* 2007;19:436.
6. Smith KM, et al. *Vet Ophthalmol.* 2008;11:8.

## INHERITED EYE DEFECTS

Inherited eye defects of farm animals and horses are not uncommon and typically occur in breeds that originate from a small founder base, such as, for example, with the complex ocular abnormalities of "Rocky Mountain horses" (which actually originated in the Ohio Valley of the United States) or Texel sheep.<sup>1,2</sup> Abnormalities of the eyes include strabismus; microphthalmia; single, multiple, or complex intraocular abnormalities; cataracts; retinal abnormalities (night blindness); corneal lesions, including abnormal tissue on the surface of the cornea (dermoids) or corneal opacity; abnormal eyelid conformation (entropion); distichiasis; and absence of the nasolacrimal duct. The genetic basis for some of the more common lesions has been determined.<sup>3-7</sup>

Inherited convergent **medial strabismus with exophthalmos** occurs in German Brown, Jersey, Shorthorn, Ayrshire, Bulgarian Grey, Irish Friesian, German Fleckvieh, German Black and White, and Dutch Black Pied breeds.<sup>7</sup> The incidence of BCSE in German Brown cattle is 0.9% in adult cows and 0.1% in young animals. The disease appears to be inherited in an autosomal-dominant manner with incomplete penetrance, with a relative decrease in neurons in the nuclear region of the abducens nerve. This decrease in neurons induces paresis of the lateral rectus muscles and the lateral part of the retractor bulbi muscles, resulting in the clinical signs of exophthalmos and strabismus. Candidate genes for the defect are thought to be on bovine chromosomes 5 and 18.<sup>8,9</sup>

The disease is characterized by late onset (>1 year of age) of clinical signs that are





**Fig. 16-12** Advanced case of bilateral convergent strabismus with exophthalmos in a German Brown cow. (Reproduced, with permission, from Mömke S, Distl O. Bilateral convergent strabismus with exophthalmos [BCSE] in cattle. An overview of clinical signs and genetic traits. *Vet J* 2007; 173:272-277.)

progressive, including bilateral, symmetric, permanent rotation of the eyeballs in an anterior-medial direction and slight to severe laterodorsal exophthalmos (Fig. 16-12).<sup>7</sup> Parts of the lateral rectus muscle or retrobulbar fat pad can become visible in severely affected animals. Epiphora is common in cattle with advanced BCSE. The sclera becomes darkly dark pigmented. Mildly affected animals compensate well and can be difficult to detect without close examination of the eyes, whereas more severely affected animals clearly have visual impairment up to and including blindness. There is no effective treatment.

An inherited, congenital **corneal opacity** occurs in Holstein cattle. The cornea is a cloudy blue color at birth, and both eyes are equally affected. Although the sight of affected animals is restricted they are not completely blind, and there are no other abnormalities of the orbit or the eyelids. Histologically there is edema and disruption of the corneal lamellae.

**Lens dystrophy** occurs in Brown Swiss cattle that are affected by an inherited congenital blindness. Japanese Black cattle also suffer from an inherited blindness caused by defects in the pupil, retina, and optic disk.

**Congenital cataracts** occur in a variety of breeds of cattle, and some have a suspected genetic component.<sup>10</sup> Multiple cataracts in a herd of Ayrshire cattle in Ireland were not clearly inherited, but the cause was not determined.<sup>10</sup> The condition of bilateral cataracts has been observed to be an inherited defect in Romney sheep. It is inherited as an autosomal-dominant trait and can be eradicated easily by culling. Congenital cataracts in Exmoor ponies in Canada are

inherited in a sex-linked fashion, with the disease being significantly more common in females.<sup>11</sup>

Complete **absence of the iris** (aniridia) in both eyes is also recorded as an inherited defect in Belgian horses. Affected foals develop secondary cataracts at about 2 months of age. Total **absence of the retina** in foals has also been recorded as being inherited in a recessive manner.

Congenital stationary night blindness (CSNB) in Appaloosa horses is associated with homozygosity for the gene conferring the coat spotting pattern in horses, which itself is caused by a single incomplete dominant gene (LP).<sup>5,12</sup> LP maps to a 6-cM region on ECAL. Expression of transient receptor potential cation channel, subfamily m, member 1 (TRPM1) in the retina of homozygous Appaloosa horses is 0.05% the level found in non-Appaloosa horses. Decreased expression of TRPM1 in the eye and the skin may alter bipolar cell signaling and melanocyte function, thus causing both CSNB and LP in horses.<sup>5</sup>

**Microphthalmia** is reported to be an inherited defect in Texel sheep, but the incidence is low. It is a well-recognized genetic defect of Texel sheep in Europe. Following importation and "breeding up" of the breed in New Zealand in the 1990s, animals were released from quarantine for further expansion of the breed. The abnormality has occurred in a number of flocks in New Zealand, and an experimental breeding flock is maintained to study the molecular genetics. It is inherited as an autosomal-recessive trait. An outbreak in Texel sheep in New Zealand has been recorded. The optic globes are approximately one-half normal size, and the optic nerves at the chiasma are approximately one-half normal size. No other lesions are present in any organs. The retina is composed of an irregular mass attached to and continuous with the ciliary apparatus at one pole and connected to the optic nerve posteriorly by a short stalk. The morphology and morphogenesis of the defect has been followed in embryos at different ages from ewes known to be carriers of the microphthalmia factor. The primary event was abnormal development of the lens vesicle, with disintegration of the lens and subsequent overgrowth of mesenchymal tissue. The mesenchymal tissue later differentiated in various directions, whereas the epithelial structures found in the microphthalmic eyes at days 56 and 132 of gestation and in newborn lambs appeared to be remnants of the epithelial lens vesicle.

**Typical colobomata**, ophthalmoscopically visible defects of one or more structures of the eye, caused by an absence of tissue, have assumed a more prominent position than previously because of their high level of occurrence in Charolais cattle. The lesions are present at birth and do not progress beyond that stage. They affect vision very

little, if at all. However, because they are defects they should be named in certificates of health, but they are not usually considered as being a reason for disqualification from breeding programs. In Charolais cattle the inheritance of the defect is via an autosomal-dominant gene with complete penetrance in males and partial (52%) penetrance in females. The prevalence may be as high as 6%, and in most cases both eyes are affected. The defect is a result of incomplete closure of one of the ocular structures at or near the line of the embryonic choroidal fissure. Failure of the fissure to close represents the beginnings of the coloboma. The retina, choroid, and sclera are usually all involved.

**Entropion** is inherited in a number of sheep breeds, including Oxfords, Hampshires, and Suffolks. Affected lambs are not observed until about 3 weeks of age when attention is drawn to the eyelids of the apparent conjunctivitis. A temporary blindness results, but even without treatment there is a marked improvement in the eyelids. Congenital entropion occurs in related Boer goat kids, but the mode of inheritance, if any, is unknown.<sup>13</sup>

Distichiasis, in which aberrant cilia are present at the eyelid margin, appears to occur with greater frequency in Friesian horses, in which rigid cilia cause corneal irritation or corneal ulceration. Although an inherited cause is suspected, the etiology is unclear.<sup>14</sup>

**Ocular dermoids** are recorded as genetically transmitted in Hereford cattle. They occur as multiple small masses of dystrophic skin complete with hair on the conjunctiva of both eyes of affected cattle. They can be anywhere on the cornea, on the third eyelid, or the eyelid, and they may completely replace the cornea; there may be a resulting marked dysplasia of the internal ocular structures.

**Ocular dermoid cysts** are single, solid, skin-like masses of tissue, adherent usually to the anterior surface of the eye, causing irritation and interfering with vision (Fig. 16-13). The eyelid, the third eyelid, and the canthus may also be involved, and the lesions may be unilateral or bilateral. When they occur at a high frequency in a population, it is likely they are inherited, as they can be in Hereford cattle. It is also recorded in foals. The defect is sometimes associated with microphthalmos. Surgical ablation is recommended.

**Nasolacrimal duct fistulae**, either unilateral or bilateral, occur in Brown Swiss cattle. The defect, evidenced by persistent epiphora and presence of a nasolacrimal fistula medial to the medial canthus of the eye, is inherited, although the mode of inheritance is unclear.<sup>15,16</sup>

### Combined Ocular Defects

Although the vision appears unaffected, a large number of congenital defects of the eye



**Fig. 16-13** Ocular dermoid cyst on the ventral corneal and limbus of the left eye of a Simmental calf.

have been observed in cattle, including Herefords, affected by partial albinism. The defects include iridal heterochromia, tapetum fibrosum, and colobomas. Congenital blindness is also seen in cattle with white coat color, especially Shorthorns. The lesions are multiple and include retinal detachment, cataract, microphthalmia, persistent pupillary membrane, and vitreous hemorrhage. Internal hydrocephalus is present in some, and hypoplasia of optic nerves also occurs.

A combination of **iridal hypoplasia, limbic dermoids, and cataracts** occurred in the progeny of a Quarter horse stallion, presumably as a result of a mutation in the stallion and transmission to the foals via an autosomal-dominant gene. The inheritance is simple autosomal recessive.

**Irideremia** (total or partial absence of iris), **microphakia** (smallness of the lens), ectopia lentis, and cataract have been reported to occur together in Jersey calves. The mode of inheritance of the characters is as a simple recessive trait. The calves are almost completely blind but are normal in other respects and can be reared satisfactorily if they are hand-fed. Although the condition has been recorded only in Jerseys, similar defects, possibly inherited, have also been seen in Holsteins and Shorthorns.

**Multiple congenital ocular abnormalities** occur with high frequency in Rocky Mountain horses and the closely related breeds Kentucky Mountain Saddle horse and Mountain Pleasure horse.<sup>1,12,17,18</sup> The cause is a missense mutation in the PMEL gene that has pleiotropic effects on the eye and coat color, causing a dilute or “silver” coat.<sup>17</sup> Similar to the silver mutation, MCOA is controlled by a dominant gene, with some

reports demonstrating a codominant mode of inheritance and incomplete penetrance.<sup>3,18</sup> Homozygotes are thought to be more severely affected, having multiple abnormalities, whereas heterozygotes have cysts only, although this may not always be the case. Incomplete penetrance of this disorder has made studying the molecular mechanism behind these eye phenotypes difficult. Individuals carrying the causative mutation that are phenotyped as normal may either have cysts that were too small to detect or be true cases of nonpenetrance.<sup>18</sup> Equine MCOA is characterized by a diverse set of ocular phenotypes.<sup>18</sup> The predominant phenotype consists of large cysts, which are often bilateral, originating from the temporal ciliary body or peripheral retina, and additional phenotypes include abnormalities of the cornea, iris, lens, and iridocorneal angle.<sup>18</sup>

### INHERITED NYSTAGMUS

#### Familial Undulatory Nystagmus

Familial undulatory nystagmus is an inherited defect of Finnish Ayrshire cattle characterized by a tremor-like, synchronous movement of the eyeballs. The tremor has small amplitude (1 to 2 mm) and fast (200/min) rate and is usually vertical. Nystagmus is present at all times, there is no sign of impaired vision, and the eye reflexes are normal. The condition is a blemish rather than a disease because there is no functional deficiency.

#### Pendular Nystagmus

Pendular nystagmus is an inherited defect of Holstein–Friesian cattle observed primarily in North America. A report from 1981 utilizing a convenience sample in New York state reported a prevalence of 0.51% in 2932 cattle from 62 herds. Affected cattle have a

high-frequency (approximately 100 to 200 horizontal oscillations/minute) nystagmus of both eyes, with the eyes moving approximately 1 mm. Nystagmus has been observed shortly after birth in some calves, but the age of onset is not accurately known. Adult animals appear to be unaffected by the nystagmus and appear to have normal vision and balance and ocular reflexes. Pendular nystagmus is not thought to affect production and should not be mistaken as indicating the presence of a serious neurologic disease.

### REFERENCES

1. Kaps S, et al. *Pferdeheilkunde*. 2010;26:536.
2. Tetens J, et al. *Tierarztl Prax Ausg G Grosstiere Nutztiere*. 2007;35:211.
3. Andersson LS, et al. *BMC Genet*. 2008;9.
4. Andersson LS, et al. *Mamm Genome*. 2011;22:353.
5. Bellone RR, et al. *Genetics*. 2008;179:1861.
6. Brunberg E, et al. *BMC Genet*. 2006;7.
7. Moemke S, et al. *Vet J*. 2007;173:272.
8. Fink S, et al. *Mol Vision*. 2012;18:2229.
9. Momke S, et al. *Anim Gen*. 2008;39:544.
10. Krump L, et al. *Irish Vet J*. 2014;67.
11. Pinard CL, et al. *Vet Ophthalmol*. 2011;14:100.
12. Bellone RR. *Anim Gen*. 2010;41:100.
13. Donnelly KS, et al. *Vet Ophthalmol*. 2014;17:443.
14. Hermans H, et al. *Equine Vet J*. 2014;46:458.
15. Braun U, et al. *BMC Vet Res*. 2014;10.
16. Braun U, et al. *Schweiz Arch Tierheilkd*. 2012;154:121.
17. Andersson LS, et al. *PLoS ONE*. 2013;8.
18. Grahn BH, et al. *Can Vet J*. 2008;49:675.

## External Ear Diseases

### OTITIS EXTERNA

Otitis externa, inflammation of the skin and external auditory canal, can affect cattle of all ages, in isolated cases, an entire herd, or in entire regions.

Arthropod parasites, foreign bodies, and sporadic miscellaneous infections may cause irritation in the ear, accompanied by rubbing of the head against objects and frequent head-shaking.

In tropical and subtropical regions, parasitic otitis is more important than in other more temperate regions. The mites *Raillietia auris* and *Dermmanyssus avium*, the tick *Otobius magnini*, larvae (*Stephanofilaria zahaeri*), free-living nematodes (*Rhabditis bovis*), and the blue fly (*Chrysomia bezziano*) are of importance in Europe, Africa, India, and America. *Malassezia* spp., *Candida* spp., *Rhodotorula mucilaginosa*, *Aspergillus* spp., and *Micelia sterilia* are common causes of otitis externa in cattle in Brazil.

When the syndrome occurs in a large number of animals in a herd, as it does in tropical countries, it is necessary to identify the specific causative agent. *R. bovis* is a common cause. Affected animals are depressed, eat little, and appear to experience

pain when they swallow, and they shake their heads frequently. Both ears are affected in most cases, and there is a stinky, blood-stained discharge that creates a patch of alopecia below the ear. The area is painful when touched, the external meatus of the aural canal is obviously inflamed, and the parotid lymph nodes are enlarged. Extension to the middle ear is an unusual sequel. Topical treatment with ivermectin and a broad-spectrum antibiotic is effective.

Circumscribed ulcerative lesions on the ears with raised edges frequently associated with secondary bacterial or fungal infection are a common finding in cattle and buffaloes affected by buffalopox virus infection (see also “Coxpox and Bufallopox”).

#### FURTHER READING

Duarte ER, Hamdan JS. Otitis in cattle, an aetiological review. *J Vet Med B Infect Dis Vet Public Health.* 2004;51:1-7.

### EAR-TIP NECROSIS

Currently, ear-tip necrosis of pigs appears to be a more common condition.

#### ETIOLOGY

The condition may be associated with the presence of *Treponema pedis*. It can be cultured from the lesions and from the gingivae of pigs. It is anaerobic, fastidious, 4 mm to 6 mm in length, and 0.25 microns in diameter. There may be a sequence of infections when *Staphylococcus hyicus* is followed by the spirochetes and then infected with streptococci. In a recent study of putative agents, no single cause could be found,

and it was suggested that the condition is multifactorial.<sup>1</sup>

#### EPIDEMIOLOGY

Ear-tip necrosis is usually seen in pigs at 1 to 16 weeks of age with a peak around 8 to 10 weeks. It may also occur in older pigs, when it is usually seen at the base of the ear. Typically it may occur in only one litter of pigs, and 80% may be affected. It may be associated with mixing and moving when a lot of pigs show ear biting.

Contributing factors are thought to include poor hygiene, high humidity, low air changes, overstocking, abrasions on feeders and pen divisions, and fighting associated with moving and mixing.

#### CLINICAL SIGNS

The affected pigs appear to show little evidence of distress and often recover spontaneously, and in these cases the only evidence of the condition is a crinkled edge to the ears. When it first appears, if the grease on the ear is removed you can see a crack in the skin, which obviously then allows bacterial penetration. Some persistent lesions may enlarge and spread. Occasionally, pigs show inappetence, unthriftiness, fever, or even death, often as a result of secondary infections.

#### PATHOLOGY

The lesions are black areas of necrosis with ulcers on the tips of the ears and the caudal edge of the ears. The lesions are dry and crusty, and in some cases there may be loss of the whole ear or part of the ear. This is caused by progressive thrombi formation

leading to ischemia because there is a poor collateral circulation in the ear. In cases reported in Sweden, spirochetes were observed in silver-stained histologic sections, and a spirochete isolate was obtained and identified as a yet unnamed species of the genus *Treponema* closely resembling those found in digital dermatitis in cattle. The same organism was isolated from oral samples, along with *T. socranskii*.<sup>2</sup>

#### DIFFERENTIAL DIAGNOSIS

Simple ear biting is the main differential, but this usually starts at the base of the ear. Other septicemic causes of ear tissue loss, such as *H. parasuis*, *Salmonella*, or *S. suis*, may be suspected when ears are discolored, congested, or necrotic.

#### TREATMENT

Antibiotic sprays may or may not help.<sup>2,3</sup> A recent study has suggested that vaccination for PCV-2 infections may reduce the incidence of ear-tip necrosis.<sup>4</sup>

#### REFERENCES

1. Weissenbacher-Lang C, et al. *Vet J.* 2012;194:392.
2. Pringle M, et al. *Vet Micro.* 2010;139:279.
3. Pringle M, et al. *Vet Micro.* 2010;142:461.
4. Pejsak Z, et al. *Res Vet Sci.* 2011;91:125.

### INHERITED CROP EARS

Inherited as a single autosomal-dominant incomplete character in Bavarian Highland cattle, the crop ear anomaly affects both ears, appears at birth, and varies from a minor trimming up to a complete deformity and reduction in size.



**INTRODUCTION 1662****METABOLIC DISEASES OF RUMINANTS 1662**

- Periparturient Period in Cattle and Sheep 1662
- Metabolic Profile Testing 1667
- Parturient Paresis (Milk Fever) 1675
- Acute Hypokalemia in Cattle 1690
- Downer-Cow Syndrome 1693
- Hypomagnesemic Tetanies 1699
- Hypomagnesemic Tetany (Lactation Tetany, Grass Tetany, Grass Staggers, Wheat Pasture Poisoning) 1699
- Hypomagnesemic Tetany of Calves 1706
- Transport Recumbency of Ruminants 1707
- Ketosis and Subclinical Ketosis (Hyperketonemia) in Cattle 1708
- Fatty Liver in Cattle (Fat-Mobilization Syndrome, Fat-Cow Syndrome, Hepatic Lipidosis, Pregnancy Toxemia in Cattle) 1716
- Pregnancy Toxemia (Twin Lamb Disease) in Sheep 1722
- Steatitis, Panniculitis, and Fat Necrosis 1726

**INHERITED METABOLIC DISEASES OF RUMINANTS 1727**

- Deficiency of UMP Synthase (Dumps) 1727
- Hepatic Lipodystrophy in Galloway Calves 1727

**METABOLIC DISEASES OF HORSES 1727**

- Equine Pituitary Pars Intermedia Dysfunction (Formerly Equine Cushing's Disease) 1727
- Equine Metabolic Syndrome 1731
- Pheochromocytoma (Paraganglioma) 1736
- Glycogen Branching Enzyme Deficiency in Horses 1736
- Lactation Tetany of Mares (Eclampsia, Transport Tetany) 1736
- Equine Hyperlipemia 1737

**DISORDERS OF THYROID FUNCTION (HYPOTHYROIDISM, HYPERTHYROIDISM, CONGENITAL HYPOTHYROIDISM, THYROID ADENOMA) 1739**

- Iodine Deficiency 1742
- Inherited Goiter 1747

**DISEASES CAUSED BY NUTRITIONAL DEFICIENCIES 1747**

- Introduction 1747
- Evidence of a Deficiency as the Cause of the Disease 1747
- Evidence of a Deficiency Associated With the Disease 1748
- Evidence Based on Cure or Prevention by Correction of the Deficiency 1748

**DEFICIENCIES OF ENERGY AND PROTEIN 1753**

- Deficiency of Energy 1753
- Deficiency of Protein 1753
- Low-Milk-Fat Syndrome 1754

**DISEASES ASSOCIATED WITH DEFICIENCIES OF MINERAL NUTRIENTS 1754**

- Prevalence and Economic Importance 1754
- Diagnostic Strategies 1754
- Deficiencies in Developing Countries 1755
- Pathophysiology of Trace-Element Deficiency 1755
- Laboratory Diagnosis of Mineral Deficiencies 1756

**Introduction**

Metabolic diseases are very important in dairy cows and pregnant ewes. In the other livestock species, metabolic diseases occur only sporadically. The high-producing dairy cow always verges on abnormal homeostasis, and the breeding and feeding of dairy cattle for high milk yields is etiologically related to metabolic disease so common in these animals. The salient features of the common metabolic diseases of farm animals are summarized in Table 17-1.

The term *production disease* includes those diseases previously known as *metabolic diseases*, such as parturient paresis (milk fever), hypokalemia, hypomagnesemia, hyperketonemia and ketosis, hyperlipemia, and other conditions that are attributable to an imbalance between the rates of **input** of dietary nutrients and the **output** of production. When the imbalance is maintained, it may lead to a change in the amount of the body's reserves of certain metabolites and their "throughput." This generalization applies principally to energy balance (such as ketosis and hypoglycemia), in addition to hypomagnesemia, and to a lesser extent hypocalcemia. In these diseases output is greater than input, either because of the

selection of cattle that produce so heavily that no naturally occurring diet can maintain the cow in nutritional balance or because the diet is insufficient in nutrient density or unevenly balanced. For example, a ration may contain sufficient protein for milk production but contains insufficient precursors of glucose to replace the energy excreted in the milk. Although we agree with the generalization on which the term *production disease* is based, we prefer to continue to use the expression *metabolic disease* because of common usage and the clinical focus that metabolism must match the level of production.

**Metabolic Diseases of Ruminants****PERIPARTURIENT PERIOD IN CATTLE AND SHEEP**

The incidence of metabolic disease in dairy cattle increases as milk production increases and, in particular, as the rate of increase in milk production increases (called **milk yield acceleration**). In dairy cows, the total disease incidence rapidly increases in the very late periparturient period, peaks on the day of parturition, and then rapidly declines until day 7 of lactation (Fig. 17-1). This critical

7-day window starting with parturition has a tremendous influence on morbidity, lactation production, reproductive performance, and mortality.

The susceptibility of dairy cows to metabolic disease appears to be related to the extremely high turnover of water, electrolytes, and soluble organic materials during the early part of lactation. With this rapid rate of exchange of water, sodium, calcium, magnesium, chloride, and phosphate, a sudden variation in their excretion or secretion in milk or by other routes, or a sudden variation in their intake because of changes in ingestion, digestion, or absorption, may cause abrupt, damaging changes in the internal environment of the animal. It is the volume of the changes in intake and secretion and the rapidity with which they can occur that affect the metabolic stability of the cow. In addition, if the continued nutritional demands of pregnancy are exacerbated by an inadequate diet in the dry period, the incidence of metabolic disease will increase. The effect of pregnancy is particularly important in ewes, especially those carrying more than one lamb.

**Transition Period in Dairy Cows**

The transition period is a crucial stage in the production cycle of the dairy cow; no other

**Table 17-1** Salient features of metabolic diseases of farm animals

Disease	Etiology and epidemiology	Diagnosis	Treatment	Control
Milk fever of cattle	Hypocalcemia Occurs primarily in dairy cows after third lactation Also in beef cows 48 hours before or after calving and in midlactation	Low serum calcium concentration	Calcium salts IV, SC	Dietary management of anions-cations
Downer cow	Complication of milk fever; recumbent too long before treatment	Clinical findings Serum CK activity	Supportive therapy	Early treatment of milk-fever cases
Acute hypokalemia of cattle	In lactating dairy cows treated with corticosteroids for recurrent ketosis, and mastitis	Low serum potassium concentration	Potassium chloride IV	Avoid excessive use of isoflupredone for recurrent ketosis
Lactation tetany of mares	High-producing lactating mares being nursed by vigorous well-nourished foal a few weeks of age	Low serum calcium concentration	Calcium borogluconate	No reliable method available
Hypomagnesemic tetany (lactation tetany)	Lactating dairy cows on lush fertilized pastures Also in beef cows before and after calving	Low serum magnesium concentration	Magnesium salts IV	Supplementation of diets at strategic times with magnesium salts
Ketosis of cattle	Before and after parturition in cattle	Blood, urine, and milk levels of ketone bodies during the transition period 3 weeks before and after parturition	Glucose IV Propylene glycol and electrolyte solutions orally	Prepartum dietary management of energy intake
Pregnancy toxemia of sheep	Declining plane of nutrition in ewes in late pregnancy	Urinary ketones Hypoglycemia Metabolic acidosis and terminal uremia	Cesarean section or induction of parturition	Nutritional management of pregnant ewes to ensure a rising plane of nutrition in the second half of pregnancy
Fatty liver of cattle	High-producing dairy cows overfed during the dry period In well-conditioned beef cattle in late pregnancy when energy intake suddenly decreased	Ketonemia, ketonuria, hypoglycemia	Poor prognosis in severe cases Fluid and electrolyte therapy, glucose IV, propylene glycol orally and insulin	Nutritional management of pregnant cows to avoid excessive weight gain Avoid situations that reduce feed intake at time of parturition
Equine hyperlipidemia	Deranged fat metabolism Pregnant or lactating middle-aged ponies, donkeys, and American miniature horses worldwide Sporadic	Hyperlipidemia	Enteral or parenteral feeding, insulin, heparin Treat underlying disease	Maintain optimal body condition Prevent disease and nutritional stress in pregnancy
Postparturient hemoglobinuria	Dietary deficiency in high-producing dairy cows 2–4 weeks after calving Copper-deficient area Cruciferous crops	Low serum inorganic phosphorus concentration Low PCV Hemoglobinuria	Whole blood transfusion Sodium acid phosphate IV Dicalcium phosphate orally	Ensure adequate dietary phosphorous intake

period can affect subsequent production, health, and reproductive performance so greatly. The success of the transition period effectively determines the profitability of the cow during that lactation. Nutritional or management limitations during this time may impede the ability of the cow to reach maximal milk production. The primary challenge faced by cows is a sudden and marked increase of nutrient requirements for milk production, at a time when dry matter intake, and thus nutrient supply, lags far behind. Dry matter intake typically declines during the final week before parturition. This decline and changes in endocrine profiles contribute to elevated plasma nonesterified fatty acid (NEFA) concentrations, which have been

related to the occurrence of fat-mobilization-related metabolic diseases such as fatty liver and ketosis. The magnitude of the decline in feed intake as parturition approaches may be a better indicator of metabolic health of postpartum cows than the actual level of feed intake. Diet, body-condition score, and parity influence dry matter intake and energy balance. The occurrence of diseases during the transition period results in lost milk production during the time of illness and often for the entire lactation.

A key area of the biology of transition cows is lipid metabolism. Excessive lipid metabolism from adipose tissue is linked with a higher incidence of periparturient diseases. Fatty livers were described in ketotic

cows in the 1950s. Hepatic fat accumulation was then noted in normal cows during early lactation. This was followed by a description of a **fat-mobilization syndrome** in early lactation, in which cows mobilized body lipids from adipose tissue and deposited lipids in the liver, muscle, and other tissues. This was followed by descriptions of elevated non-esterified fatty acid concentrations during the last 7 days before calving being associated with a higher incidence of ketosis, displaced abomasum, and retained fetal membranes, but not associated with the incidence of milk fever. Understanding the metabolism of NEFA by the liver is a critical component of understanding the biology of the transition cow. Extreme rates of lipid

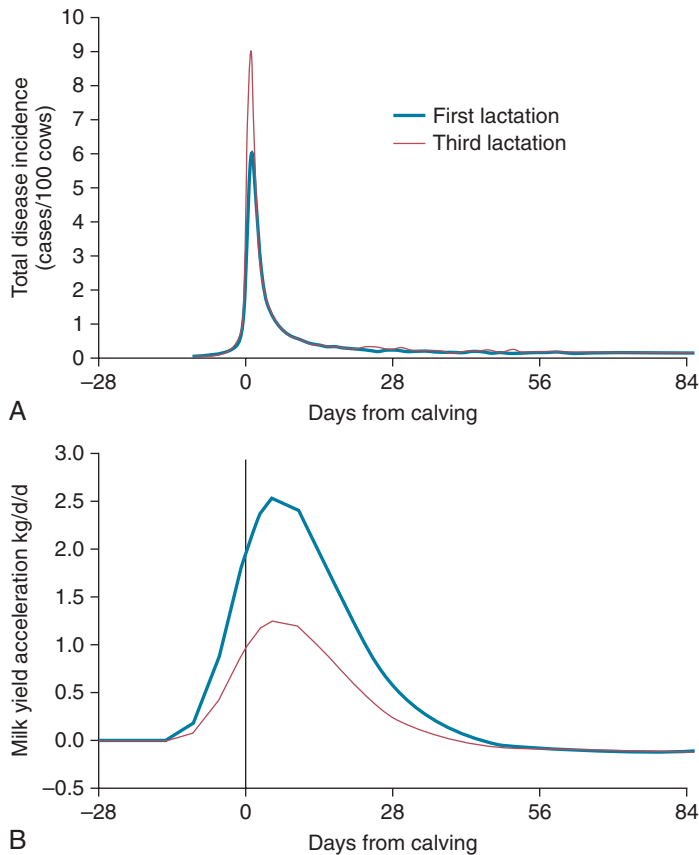

**Fig. 17-1** **A**, Total disease incidence (sum of mastitis, ketosis, digestive disorders, and laminitis) relative to days from calving for first- and third-lactation cows in Danish dairy herds that calved in 1998. **B**, Acceleration in milk yield through lactation for cows peaking at 30 kg or 60 kg (bold line) of milk daily. (Reproduced with permission from Ingvarsten KL. *Anim Feed Sci Technol* 2006; 126:175-213.)

mobilization lead to increased uptake of NEFA by the liver and an increased rate of triglyceride accumulation in the liver. If this lipid infiltration becomes severe, the syndrome of hepatic lipidosis or fatty liver may result, which can then result in prolonged recovery from other diseases, increased incidence of other diseases, and increased susceptibility to induction of ketosis.

During the transition period, dairy cows undergo large metabolic adaptations in glucose, fatty acid, and mineral metabolism. The practical goal of nutritional management during this period is to support these metabolic adaptations. There are two different philosophic approaches for feeding transition cows in animals fed a total mixed ration. The first approach increases the energy density of the diet to “correct” for the anticipated decrease in dry matter intake in late gestation. Increasing the amount of energy supplied through dietary carbohydrate during the prepartum period results in generally positive effects on metabolism and performance of transition cows. In contrast, the second approach focuses on decreasing the energy density and increasing forage (by

the daily provision of 2 to 4 kg of straw) in far-off cattle in an attempt to promote dry matter intake. Attempts to increase energy supply by feeding dietary fat sources or decrease energy expenditure by supplying specific fatty acids such as *trans*-10, *cis*-12conjugated linoleic acid to decrease milk-fat output during early lactation do not decrease the release of NEFAs from adipose tissue.

In addition to nutritional management strategies to optimize the health of the transition cow, certain feed additives are in use to reduce subclinical ketosis and reduce the incidence of displaced abomasum. **Monensin** is a carboxylic polyether ionophore produced by a naturally occurring strain of *Streptomyces cinnamonensis*. Monensin exerts its many effects by shifting the microbial populations in the rumen; this results in changes in the proportions of short-chain volatile fatty acids in the rumen, specifically increasing propionic acid and reducing the molar percentages of butyric acid and acetic acid. Increased rumen propionic acid concentrations directly lead to increased gluconeogenesis and should therefore decrease the

incidence of ketosis and hyperketonemia in early lactation and improve energy balance. In Canada, monensin is approved to be administered as a controlled-release capsule (CRC) as an aid in the prevention of subclinical ketosis in lactating dairy cattle. The monensin CRC delivers 335 mg of monensin daily for 95 days, improves energy balance, and decreases the incidence of all three energy-associated diseases of lactating dairy cows: retained placenta, displaced abomasum, and clinical ketosis. Cows treated with the monensin CRC at 3 weeks before the anticipated calving date had decreased serum NEFA and  $\beta$ -hydroxybutyrate (BHB) concentrations and increased serum cholesterol and urea concentrations in the week immediately preceding precalving. Monensin has no effect on serum calcium, phosphorus, or glucose concentration in the precalving period. After calving, serum concentrations of BHB and phosphorus concentrations were lower and serum concentrations of cholesterol and urea higher in monensin-treated cows. The lower NEFA values indicate less fat mobilization, and the higher cholesterol suggests greater lipoprotein export from the liver. The higher urea levels are thought to result from a protein-sparing effect in the rumen, resulting in an increased supply of amino acids in the small intestine. There was no effect of treatment on serum NEFA, glucose, or calcium concentrations in the first week postcalving. Daily monensin ingestion starting before calving therefore improves indicators of energy balance in both the immediate precalving and postcalving periods.

### Voluntary Dry Matter Intake in Periparturient Dairy Cattle

The factors affecting voluntary dry matter intake (DMI) of lactating cattle are extremely important and have received much attention for many decades. A substantial decrease in DMI is initiated in late pregnancy and continues into early lactation, with the lowest DMI occurring on the day of calving. Postpartum DMI is considerably higher in multiparous cows compared with primiparous cows and increases after lactation in both groups, but the rate of increases varies widely. In cows given diets of constant composition, the milk yield typically peaks at 5 to 7 weeks postpartum, and the maximum intake is reached between 8 and 22 weeks after calving. The increase in DMI from week 1 postpartum to time of peak intake is affected by the diet fed during lactation and also by prepartum feeding; the latter influences the amount of fat stored and therefore the body-condition score of the animal. The normal pattern of feed intake may be severely influenced by disease states because both clinical and subclinical infections are known to substantially reduce appetite and performance.

The decrease in DMI has traditionally been attributed to physical constraints such



as the enlarging uterus, but this role may be overemphasized. The decrease in DMI coincides with changes in reproductive status, changes in fat mass, and metabolic changes in support of lactation. A number of metabolic signals may have a role in intake regulation. These signals include nutrients, metabolites, reproductive hormones, stress hormones, leptin, insulin, gut peptides, cytokines and neuropeptides such as neuropeptide Y, galanin, and corticotrophin-releasing factor.

### Immunosuppression During the Transition Period

In addition to the adaptations in classical metabolism, cows during the transition period also undergo a period of reduced immunologic capacity during the periparturient period. The immune dysfunction is broad in scope, affects multiple functions of various cell types, and lasts from approximately 3 weeks before calving until approximately 3 weeks after calving. Cows during this period are more susceptible to mastitis. The etiology of periparturient immunosuppression is multifactorial and not well understood, but it seems to be related to physiologic changes associated with parturition and the initiation of lactation and to metabolic factors related to these events. Glucocorticoids are immunosuppressants, plasma cortisol concentration is increased at parturition, and endogenous glucocorticoids have been postulated to play a role in periparturient immunosuppression. Periparturient cattle have impaired expression of adhesion molecules and decreased migration capacity of blood neutrophils. Because the rapid recruitment of neutrophils into newly infected mammary tissue is the key immunologic defense against mastitis-causing pathogens in ruminants, periparturient neutrophil dysfunction may contribute to the increased susceptibility to mastitis at this time. Metabolic challenges around calving may also play a role in increased susceptibility, as non-esterified fatty acids significantly reduce the *in vitro* immunosuppressiveness of mononuclear cells of ewes, potentially resulting in impairment of cell-mediated and humoral immunity in sheep and cattle with ketosis.

Vitamin E is a fat-soluble membrane antioxidant that enhances the functional efficiency of neutrophils by protecting them from oxidative damage following intracellular killing of ingested bacteria. The parenteral administration of vitamin E has been investigated for the prevention of peripartum diseases such as retained placenta, metritis, and clinical mastitis. Only cows with marginal vitamin E status (serum  $\alpha$ -tocopherol  $< 2.5 \times 10^{-3}$ ) 1 week before calving will have a reduction in the risk of retained placenta following a subcutaneous injection of 3000 IU of vitamin E. In cows with an adequate serum vitamin E concentration there was no reduction, and primiparous animals were most

likely to benefit from vitamin E 1 week before parturition. The associations between peripartum serum vitamin E, retinol, and  $\beta$ -carotene concentrations in dairy cattle and disease risk indicated that an increase in  $\alpha$ -tocopherol of 1  $\mu\text{g}/\text{ML}$  in the last week prepartum reduced the risk of retained placenta by 20%, whereas serum NEFA concentrations  $\geq 0.5$  mEq/L tended to increase the risk of retained placenta by 80%. In the last week prepartum, a 100-ng/mL increase in serum retinol was associated with a 60% decrease in the risk of early-lactation clinical mastitis.

### Diseases of Lactation

Parturition is followed by the sudden onset of a profuse lactation, which, if the nutrient reserves have already been seriously depleted, may result in clinical metabolic disease. The essential metabolite that is reduced below the critical level determines the clinical syndrome that will occur. Most attention has been paid to variations in balances of calcium and inorganic phosphates relative to parturient paresis, magnesium relative to lactation tetany, and plasma glucose and ketone concentration and hepatic lipidosis relative to ketosis, but it is probable that other imbalances are important in the production of as yet unidentified syndromes.

The vast majority of production diseases of dairy cows occur very early in lactation. At this time, the cow is producing milk at a rate that is substantially less than her maximum. In terms of rate, high- and low-milk-yielding cows are producing rather similar amounts at this time. However, in terms of acceleration, the change in milk yield per day, it is highest immediately after calving. During the succeeding period of lactation, particularly in cows on test schedules and under the strain of producing large quantities of milk, there is often variable food intake, especially when pasture is the sole source of food, and instability of the internal environment inevitably follows. The period of early lactation is an unstable one in all species. Hormonal stimulation at this stage is so strong that nutritional deficiency often does not limit milk production, and a serious drain on reserves of metabolites may occur.

**Recombinant bovine somatotrophin** (rBST, sometribove zinc) is a synthetically derived hormone that may be identical to naturally occurring bovine growth hormone, or slightly modified by the addition of extra amino acids. The product was approved in the United States in 1993, and its use began commercially in 1994 in dairy herds to increase milk production. The product is a sterile, prolonged-release injectable formulation of rBST in single-dose syringes that each contain 500 mg of sometribove zinc. The recommended dosage protocol is one syringe injected subcutaneously (SC) in the postscapular region (behind the shoulders)

or in the ischioanal fossa (depression on either side of the tailhead) every 14 days beginning during the 9th week after calving and continuing until the end of lactation.<sup>2</sup> Approximately 15% of dairy herds in the United States used rBST in 2013. The product has been licensed for use in at least 20 other countries, including Argentina, Brazil, Chile, Colombia, Costa Rica, Ecuador, Egypt, Guatemala, Honduras, Jamaica, Lebanon, Mexico, Panama, Pakistan, Paraguay, Peru, Salvador, South Africa, South Korea, Uruguay, and Venezuela. In comparison, a number of countries, including Australia, Canada, Israel, Japan, New Zealand, and all European Union countries, have not approved its use.

A meta-analysis of the effects of rBST on milk production, animal health, reproductive performance, and culling was undertaken. Recombinant bovine somatotrophin was found to increase milk production by 11% in primiparous cows and 15% in multiparous cows, although there was considerable variation in the magnitude of the milk production increase between studies. Some statistically significant effects on milk composition (percentage of butterfat, protein, and lactose) were found; however, they were all very small. Treatment increased dry matter intake by an average of 1.5 kg/d during the treatment period, and dry matter intake remained elevated for the first 60 days of the subsequent lactation. Despite the increase in dry matter intake, treated animals had lower body-condition scores at the end of the treatment period, and the reduced scores persisted until the start of the subsequent lactation. Recombinant bovine somatotrophin increased the risk of clinical mastitis by approximately 25% during the treatment period, but there were insufficient data to draw firm conclusions about the effects of the drug on the prevalence of subclinical intramammary infections as assessed by somatic cell count. The increase in the incidence of clinical mastitis in cattle administered rBST appears similar to that expected from an increase in milk production alone using genetic selection and improved nutrition, milking frequency, and management practices. Use of rBST increased the risk of a cow failing to conceive by approximately 40%. For cows that did conceive, there was no effect on services per conception and only a small increase in average days open. Use of the drug had no effect on gestation length, but the information about a possible effect on twinning was equivocal. Cows treated with rBST had an estimated 55% increase in the risk of developing clinical signs of lameness. There appeared to be an increased risk of culling in multiparous cows. Use of the drug in one lactation period appeared to reduce the risk of metabolic diseases (particularly ketosis) in the early period of the subsequent lactation. It was found that the reproductive effects of the drug could be

controlled by delaying its use until the cows were confirmed pregnant.

In 1998, an expert panel appointed by the Canadian Veterinary Medical Association at the request of Health Canada found a number of legitimate animal welfare concerns associated with the use of rBST. In 1999 Health Canada announced that it would not approve the use of rBST for sale in Canada on the basis of the health and welfare of cattle. The Royal College of Physicians and Surgeons of Canada's Expert Panel on Human Safety of rBST found no biologically plausible reason for concern about human safety if rBST were to be approved for sale in Canada. In 1999 a working group from within the Scientific Committee on Animal Health and Animal Welfare of the European Commission presented a more extensive report on rBST that summarized similar results and engaged substantive discussion of animal welfare issues. It concluded that rBST should not be used in dairy cattle in Europe. In October 1999, the European Commission banned the use and marketing of rBST in the European Union as of January 1, 2000.

### Relationship Between Lactational Performance and Health of Dairy Cattle

There is little evidence that high-yielding cows have increased risk of dystocia, retained placenta, metritis, and left-side displacement of the abomasum. The association between high levels of production and periparturient diseases is inconsistent; in general, high levels of management (including nutrition and housing) are usually associated with high levels of production. Although no phenotypical relationship between milk yield and the risk of ketosis and lameness has been found, selection for higher milk yield will probably increase the lactational incidence risk for both diseases. Mastitis is the only disease for which a clear relationship between increased milk yield and increased risk of infection has been found. Continued selection for high milk yield should therefore be expected to increase the incidence of clinical mastitis in dairy cattle.

However, some authors have stated that "Reviewing existing literature, even with structured literature selection, is inadequate to the task of elucidating the relationship between the lactational performance and risk of production diseases."<sup>3</sup> The most notable feature of the literature evaluation is the large variability that exists between studies. This strongly suggests that there are important factors that need to be considered before meaningful conclusions concerning the relationship between lactational performance and risk of disease can be drawn.

### Breed Susceptibility

The fact that some dams are affected much more by these variations than others is probably explainable on the basis of variations in

internal metabolism and degree of milk production among species and among individuals. Among groups of cows, variations in susceptibility appear to depend on either genetic or management factors. Certainly, Jersey cows are more susceptible to parturient paresis than cows of other breeds. Even within breeds, considerable variation is evident in susceptibility between families. Under these circumstances, it seems necessary to invoke genetic factors as predisposing causes for metabolic diseases.

### Management Practices

The management practices of most importance are nutrition and housing. In those sections of North America where cattle are housed during the winter and in poor pasture areas, ketosis is prevalent. In the Channel Islands, local cattle are unaffected by lactation tetany, whereas the disease is prevalent in the United Kingdom. In New Zealand, metabolic diseases are complex and the incidence is high, both of which are probably related to the practice of having the cows calve in late winter when feed is poor, the practice of depending entirely on pasture for feed, and the high proportion of Jerseys in the cattle population.

Detailed knowledge of the nutrition and housing factors is essential before any reasonable scheme of prevention can be undertaken. For example, knowledge of the complex behavioral needs of the dairy cow is essential to provide adequate housing during the transition period. In North American dairy herds, the flow of cows through the transition period often necessitates many changes of pens, which are disruptive to the social organization of cow groups. Stocking rates that exceed stall and feed bunk capacity place even greater challenges on the dairy cow at this time. Current free-stall recommendations include providing 75 cm (30 in.) of bunk space for close-up and fresh cows to ensure that overcrowding does not occur, moving preparturient cows to a new pen at least 8 to 10 days ahead of the anticipated calving date or when calving is imminent, adding cows to groups on a minimum of a weekly basis (it takes up to 1.5 days for a new social order to be determined after the addition of a new animal), and keeping a clean and comfortable environment.

The diagnosis and treatment of dairy cows with periparturient diseases requires a program suited to the particular herd. Particularly in large herds, there is a need for collaboration between the veterinarian, nutritionist, manager of the herd, and animal attendants. Specific procedures should be developed for each herd based on past experience with the problems of recently calved cows, the facilities, the skills of the workers, the priorities of management, and the flow patterns of the cows in the herd. Every effort must be made to prevent periparturient diseases in the cows. In general, diseases in the

early postpartum period originate in the feeding and management of the dry cow. Important principles include a protocol of grouping parturient cows according to the feeding program and handling facilities on the farm. Groups of cows can be screened for mastitis, visual evidence of illness, daily milk yield, body temperature, and urine pH, and they can be palpated for evidence of metritis. Individual cows that have been identified by a screening method must be examined individually to make a diagnosis and decide on a treatment protocol based on the particular diagnosis.

Management and environmental factors can be manipulated to ease the transition into lactation. For example, the photoperiod, defined as the duration of light exposure an animal receives within a day, can be adjusted to produce clinically significant effects on periparturient health and subsequent lactational efficiency. Increasing the frequency of milking in the immediate postpartum period also produces persistent increases in milk yield and improvements in mammary health. In both techniques, evidence is emerging to support the concept that alteration of prolactin sensitivity is the mechanism underlying health and production responses. The reader is directed to publications related to production for more information on these and related topics.

### Occurrence and Incidence of Metabolic Diseases

Knowledge of the etiologic and epidemiologic factors involved will help in understanding the occurrence and incidence of the various metabolic diseases. Largely because of variations in climate, the occurrence of metabolic disease varies from season to season and from year to year. In the same manner, variations in the types of disease occur. For example, in some seasons, most cases of parturient paresis will be tetanic; in others, most cases of ketosis will be complicated by hypocalcemia. Further, the incidence of metabolic disease and the incidence of the different syndromes will vary from region to region. Ketosis may be common in areas of low rainfall and on poor pasture. Lactation tetany may be common in colder areas and where natural shelter is poor. Recognition of these factors can make it possible to devise a means whereby the incidence of the diseases can be reduced.

The metabolic diseases, because of high prevalence and high mortality rate, are of major importance in some countries, so much so that predictive systems are being set up. Rapid analysis of stored feed samples, pasture, and soil is commonly used in Europe and North America, but the interesting development has been the recognition of "production diseases" and the consequent development of metabolic profile tests, particularly in the United Kingdom and Europe.

## Record Keeping

The use of reliable records to monitor the health and production of dairy cows during the transition period is essential to evaluate the efficacy of programs at the farm level. Transition cow management programs will assist in determining how well cows are prepared for milk production and good health in the coming lactation. Appropriate monitoring should focus on three areas: **cows that die or are culled in early lactation, the productivity of the surviving cows in early lactation, and the rates of disease in the periparturient period.**

Cows that leave the herd in the first 60 days of lactation are usually culled because of disease or injury. Removal rates and their causes can be a critical monitor of the efficacy of transition cow management programs. Measuring productivity and health of cows in early lactation involves monitoring daily milk yields, first-test mature-equivalent 305-day projected milk, milk components at first Dairy Herd Improvement Association (DHIA) test day, milk-fat percentage, ratios of test-day components, somatic cell count at first DHIA test day, and peak milk (also called summit milk). DHIA records also allow comparison of the performance of each cow in early lactation to her performance in the prior lactation. Comparisons can be made of the changes in somatic cell count between the last test of the prior lactation and the first test of the current lactation and mature-equivalent 305-day difference from the prior lactation to the first test of the current lactation.

Health and production records in dairy herds have traditionally emphasized reproductive events and administered treatments for specific diseases. The records should capture the information about the common diseases that occur in most dairy herds. The record system should be set up to do the following:

- Monitor rates of well-defined disease events as a measure of the effectiveness of health and production programs and to aid in problem solving.
- Determine the clinical efficacy of treatments by monitoring retreatment rates for specific diseases.
- Maintain an individual cow history record for cow-side use to enhance treatment decisions.
- Measure compliance and consistency of implementation of the health program being used.
- Reconcile pharmaceutical purchases with treatment protocol entries and to meet regulatory requirements on the use of pharmaceuticals in food animals.
- Determine the costs of certain disease rates over achievable targets. The costs of specific diseases are compelling to most dairy herd producers. Good records can generate an incidence rate of common diseases. These costs include the

immediate cost of treatment, the cost of the veterinarian's and herdsman's time, and the cost of milk withheld from the market. For the majority of diseases of recently calved cows, the cost per disease in the United States was estimated in 2001 at approximately US\$320, with a range from \$150 to \$450.

An adequate record system will allow producers and veterinarians to determine the differences between actual performance and benchmark performance and then determine the causes of the shortfall. The most important determinants of profitability on dairy farms are milk income and feed cost, and the difference between milk income and feed costs is the **return-over-feed index (ROF)**. Many factors affect the ROF index. These include three-times-daily milking, component percentages in the herd milk test, milk-fat and protein percentages, use of a core lipopolysaccharide antigen mastitis vaccine, and use of monensin in the lactating-cow diet (if permitted). One of the most important factors associated with profitability is milk production. From 80% to 95% of the income on dairy farms is derived from milk sales. Thus it is critical that the producer, the veterinarian, and other advisors collaborate to plan an animal health and production program that will result in the optimum ROF.

## METABOLIC PROFILE TESTING

Methods are needed to monitor the nutritional and metabolic status of dairy herds. The most valuable methods will be those that are sensitive enough to detect change before clinical or economic consequences are manifested. A major challenge in the application of metabolic profile testing is dealing with extraneous sources of variation. Successful management of extraneous variation requires sampling strategies based on animal grouping and testing of multiple animals. Larger herds are more suitable for monitoring because they allow for better design sampling strategies and spread the costs of testing across more animals. Statistical process control methods offer a unique approach to interpretation that may increase the usefulness of metabolic profiles.

The traditional approach to herd-based assessment of metabolic status (also called the **Compton metabolic profile test**) is based on the concept that the laboratory measurement of certain components of plasma or serum of 7 to 10 cows per subgroup will reflect the nutritional status of the subgroup, with or without the presence of clinical abnormalities.<sup>1</sup> For example, a lower-than-normal mean plasma glucose concentration in a group of dairy cows in early lactation may indicate an insufficient intake of energy, which may or may not be detectable clinically. On a theoretical basis, the ability of the laboratory to make an objective

assessment of the input-output (nutrient-productivity) relationships is an attractive tool for the veterinarian engaged in providing a complete health management service to a herd. The test would theoretically be able to detect the qualitative and quantitative adequacy of the diet of cows expected to produce a certain quantity of milk or return to estrus within a desirable length of time following parturition. A reliable test for the early diagnosis of nutritional deficiency or metabolic disease would therefore be a major step forward in attempting to optimize livestock production and obtain maximum yields at minimum costs.

There was considerable interest in metabolic profile testing following its earlier descriptions, which stimulated considerable field research. The results of the research have thus far indicated that the test may be useful only as an aid in the diagnosis of nutritional imbalance and production diseases. The results of metabolic profile testing are usually difficult to interpret without a careful conventional assessment of the nutritional status and reproductive performance of the herd, and it appears doubtful that such testing would reveal significant abnormalities that could not be detected using conventional clinical methods. Because of the cost of the test, the profile testing must be carefully planned with specific objectives. A regional diagnostic laboratory with automated analytical equipment should be available, and this is often a major limiting factor. The test should not be undertaken unless reference values for each laboratory measurement are available from the population within the area. The results from the groups within the herd are compared with local population means. Metabolic profiles have also been suggested as an aid in the selection of superior individuals.

The prediction of whether an individual cow is metabolically prepared to undergo a stressful lactation at a high level of production would seem to be a useful undertaking. This could be particularly important under management conditions of heavy concentrate feeding, lead feeding, zero grazing, or even indoor housing. There are no well-established, low-cost, practical protocols for conducting such profile tests.

## Usefulness of Metabolic Profile Testing

Metabolic profiles in dairy cows were used initially in the United Kingdom in the 1960s. Success was limited primarily by the unjustified expectation that all biochemical concentrations in the blood of cows would reflect nutritional intake and status at all times. However, the practical value was found in the approach as an aid to nutritional management. In the 1970s the approach was reassessed and revised, culminating in a program for farmers evaluating health and productivity using metabolic profile testing as an



integral part of a health management program involving a multidisciplinary approach. The UK Dairy Herd Health and Productivity Service (DHHPS) provides the opportunity for veterinarians to lead a multidisciplinary team that can monitor health, fertility, and production and can plan, when necessary, corrective action. Effectively the approach has been to “ask the cows” what they think of their nutrition by following a set of guidelines on timing, cow selection, and the use of background information. Metabolic profiling and body-condition scoring found that at least a third of the cows sampled were mobilizing excessive fat during the transition from the dry period to early lactation. Improving both health and nutrition, before and after calving, would improve reproductive performance in many herds. The DHHPS method now utilizes a team approach involving farmer, veterinarian, and agricultural advisor. If useful information is to be obtained, the blood-testing aspect depends critically on following a set of firm criteria for selection of small groups of typical cows within each herd; the timing of testing in relation to concentrate feeds, feed changes, and stage of lactation; and the collection of other data about the cows, such as body weight and condition, productivity, and feeding. The successful approach has been to look, following specific times of nutritional change, at metabolite levels in strictly defined small representative groups of cows within each herd in conjunction with information on body condition and weight, milk performance, and feeding. Comparison with optimum values, the degree of variation from them, and comparisons between groups within herds have allowed information about nutritional constraints on productivity to be made available to farmers more quickly and more specifically than by other means.

### Biological and Statistical Basis for Herd Testing

The interpretation of herd-based tests for metabolic diseases is different from interpreting laboratory tests for metabolites from individual cows. Test results from individual cows are interpreted by comparing the value to a normal reference range established by the laboratory that did the testing. Normal ranges are often derived by calculating a 95% confidence interval (or a similar statistic) of test results from 100 or more clinically normal animals.

Herd test results for metabolic diseases can be interpreted as either the **mean test result of the subgroup** sampled or as the **proportion of animals above or below a certain cut-point within the subgroup**. There is a major philosophic difference and marked cost difference between the two approaches. At the moment, there does not appear to be a clear preference for either approach, and this area should be a focus of future investigation. An important difference

in the approaches is that the cost of determining the mean value of a subgroup is very low if the samples from the subgroup are pooled and then analyzed. The only advantage of analyzing individual samples instead of pooled samples is that individual samples provide an estimate of the proportion of abnormal values. Whether knowing the proportion is worth the marked increase in analytical cost remains to be determined.

If a metabolite is associated with disease when it is above or below a biologic threshold (cut-point), then it should be evaluated as a proportional outcome. For example, hyperketonemia (subclinical ketosis) in dairy herds can be monitored by testing for  $\beta$ -hydroxybutyrate (BHB) or other ketone bodies in blood, plasma, serum, urine, or milk. Subclinical ketosis is a threshold disease, and cows are affected only when ketone concentrations are elevated. Plasma BHB concentrations above 1.0, 1.2, or 1.4 mmol/L (equivalent to 9.7, 11.7, or 14.4 mg/dL, respectively) are the most commonly used cut-points for detecting hyperketonemia (subclinical ketosis) in lactating dairy cattle. Early-lactation cows with plasma BHB concentrations above the selected cut-point have a four- to eightfold greater risk of developing displaced abomasum, a threefold greater risk of developing clinical ketosis, decreased 305-day milk production, increased severity of mastitis, a 50% increase in anestrus at 60 days in milk, and a 50% decrease in pregnancy at first insemination. NEFA concentrations in plasma are an indicator of negative energy balance in prepartum cows. Elevated plasma NEFA concentration before calving ( $>0.4$  mEq/L for cows between 2 and 14 days before the anticipated calving date) is associated with a 4-fold increased risk for displaced abomasum, a 2- to 3-fold increase in the risk of subclinical ketosis, and 1.5-fold increased risk of retained placenta after calving.

It is also necessary to determine the alarm level for the proportion of animals above or below the described cut-point. The alarm level is determined from research results or clinical experience. The suggested alarm-level proportion for plasma BHB concentration with a cut-point of 1.4 mmol/L is greater than 10%; the proportion for plasma NEFA concentration with a cut-point of 0.4 mmol/L is greater than 10%.

Herd-based testing is useful only when a sufficient number of cows within the herd are tested, which gives reasonable confidence that the results truly represent the entire population of eligible cows in the herd. In the United States, the minimum sample size for herd-based tests with proportional outcomes has been estimated as 12 cows, based on 75% confidence intervals and a general detection cut-point of greater than 10%. Cows to be sampled need to be selected from the appropriate eligible or at-risk group. Obviously, measurement of a homogeneous group

requires a large herd size; to sample 12 cows consistently between day 4 and day 14 of lactation requires a milking herd of at least 428 cows, assuming equal monthly calving rates. The subgroup size recommendation of 12 cows in the United States contrasts with the subgroup size recommendation of 7 to 10 cows in the United Kingdom. The difference in recommendations has not been reconciled.

The proper use of metabolic profiles depends on the timing of blood tests, the selection of cows to be included, and the collection and use of background information about the farm, feeding and feeding system, and physical state and performance of the cows.

### Variables in Dairy-Herd Metabolic Profile Testing

There are five main areas of interest for metabolic profile testing:

1. Energy balance
2. Protein evaluation
3. Liver function
4. Macromineral evaluation
5. Urine evaluation

In general terms, measurement of analytes in urine has been greatly underutilized in metabolic profile testing, and it is clear that current testing protocols are not economically optimized.

### Energy Balance

Strategic use of metabolic testing to monitor transition dairy cows should focus on measuring plasma NEFA concentration in the last week prepartum and plasma/serum BHB and urine acetoacetate concentration in the first and second weeks postpartum.

### Nonesterified Fatty Acids

Plasma NEFA concentration provides the most sensitive indicator of energy balance, particularly in the last 2 weeks of gestation. Plasma NEFA concentration is useful for monitoring the energy status of dry cows in the last month of gestation, when rapid changes in energy-balance status may not be detectable from changes in body-condition score. Plasma NEFA concentrations start to increase 3 days before parturition and remain elevated for the first 9 days of lactation<sup>7</sup> (Fig. 17-2). High plasma concentrations of NEFAs indicate negative energy balance, which occurs in animals that are inappetent as a result of illness.

The serum concentrations of NEFAs have been monitored in dairy cows as predictors of displaced abomasum. In cows with left-displaced abomasum (LDA), mean NEFA concentration began to diverge from the mean in cows without LDA 14 days before calving, whereas mean serum BHB concentrations did not diverge until the day of calving. Prepartum, only NEFA concentration was associated with risk of LDA. Between day 0 and 6 days after calving, cows

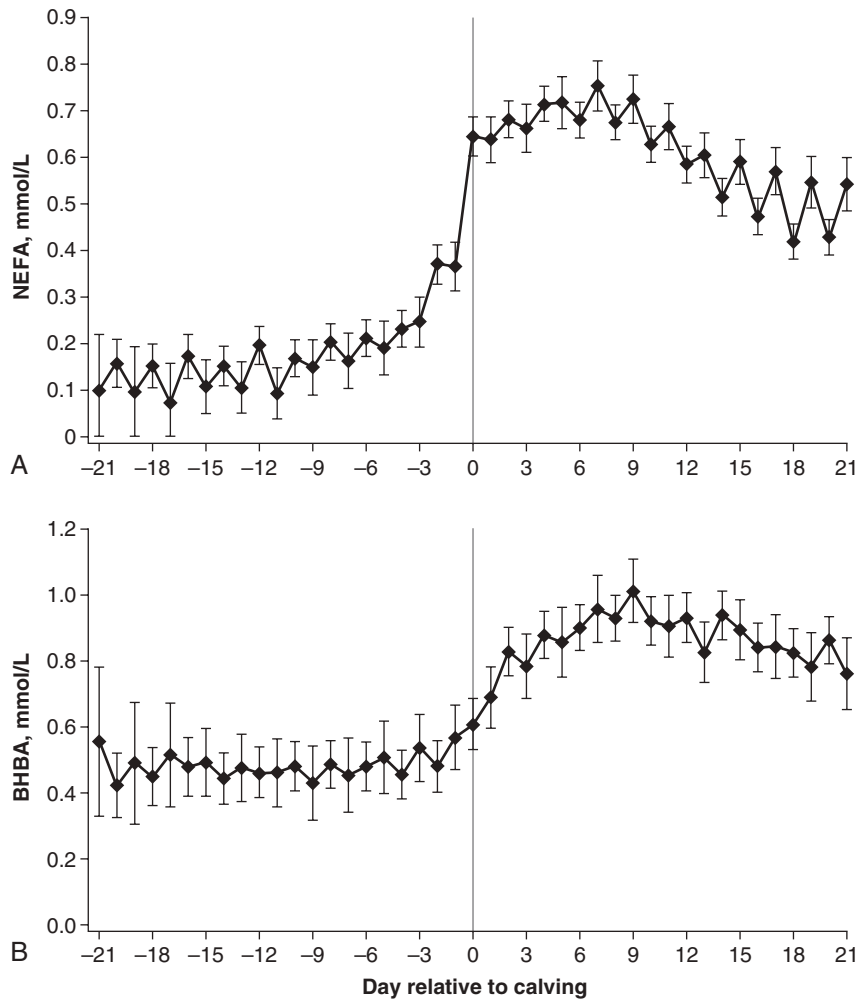

**Fig. 17-2** Least-squares means and 95% confidence interval (error bars) for plasma nonesterified fatty acid concentration and  $\beta$ -hydroxybutyrate concentration in 269 multiparous Holstein-Friesian cows from 21 days prepartum to 21 days postpartum. (Reproduced with permission from McCarthy MM, Mann S, Nydam DV, Overton TR, McArt JAA. *J Dairy Sci* 2015; 98:6284-6290.)

with serum NEFA concentration of 0.5 mEq/L or greater were 3.6 times more likely to develop LDA after calving. In another study, cows with plasma NEFA greater than 0.3 mEq/L between 3 and 35 days before calving were twice as likely to subsequently have LDA. Strategic use of metabolic tests to monitor energy balance in prepartum dairy cows should therefore focus on measurement of plasma/serum NEFA concentration. There are three major drawbacks with this approach: the high cost of testing (US\$8/test), the need to centrifuge blood to harvest serum or plasma, and the lack of a cow-side test. Until all three issues are satisfactorily resolved, plasma/serum NEFA testing will remain a research tool with minimal practical application.

#### *$\beta$ -Hydroxybutyrate*

Plasma/serum BHB concentrations are affected by energy and glucose balance and

are a less sensitive indicator of energy balance than plasma NEFA. High plasma BHB concentrations are associated with reduced milk production, increased incidence of clinical ketosis and LDA, and reduced fertility. The gold-standard test for hyperketonemia (subclinical ketosis) is plasma/serum BHB concentration, which is more stable after collection than plasma/serum acetone or acetoacetate concentrations. Prepartum BHB concentrations are relatively stable before parturition, but increase rapidly after parturition to peak at around 9 days in milk, after which time BHB concentration gradually declines (Fig. 17-2).

Subclinical ketosis may start at serum concentrations above 1.0 mmol/L. The alarm level for the proportion of cows above the cut-point of 1.0, 1.2, or 1.4 mmol/L has not been validated, but it is suggested that no more than 10% of early-lactation cows should have hyperketonemia (subclinical

ketosis). In cows with serum BHB concentrations of 1.2 mmol/L or greater or 1.4 mmol/L or greater in the first week postpartum, the odds of LDA were three and four times greater, respectively, than in cows with BHB below the cut-points.<sup>7</sup>

#### *Glucose*

Plasma/serum glucose concentrations are usually lower in early lactation<sup>4</sup> and during the winter months; in early lactation, there is a heavy demand for glucose, and during the winter the energy intake is likely to be lower than necessary to meet requirements. One major cause of variation in blood glucose may be the major fluctuations in daily feed intake. Investigations of feed intake of dairy cows on commercial farms have shown that concentrate dispensers are commonly incorrectly adjusted, and errors of more than 50% in feed intake are sometimes found. In situations of marginal energy imbalance, glucose concentrations may be unreliable as an index of the adequacy of energy intake. Several factors may cause short-term changes in glucose concentration. Blood glucose may be influenced by the chemical nature of the carbohydrate and physical form of the feed and the roughage content of the feed. In addition, elevation of plasma glucose concentration has been associated with excitement and low environmental temperature.

There is some conflicting evidence about the relationship between the mean plasma glucose concentrations of a lactational group and insufficient energy intake and reproductive inefficiency. In some work, there is an expected relationship between low plasma glucose concentration and an increased incidence of ketosis. In others, the relationship is not clear; however, there was a more consistent relationship between the actual energy intake as a percentage of requirement and the plasma NEFA concentration, but this finding was not sufficiently reliable to be useful. The mean plasma glucose concentrations within 3 days before or after first service of cows that conceived on first service was higher than that of cows that returned, but the difference was only approaching significance at the 5% level, and it is doubtful whether this could be of practical value. Although plasma NEFA concentration is more sensitive than plasma glucose concentration as an indicator of energy status of the lactating cow, the excessive variability of this relationship during early lactation limits its usefulness. Plasma NEFA concentration begins to increase several weeks prepartum, peaks at parturition, and decreases gradually to normal concentrations after several weeks of lactation. Plasma glucose concentrations follow a similar pattern. The main disadvantage of using plasma glucose concentration as an index of metabolic balance is that glucose concentration is a tightly regulated variable, and marked metabolic imbalances need to be present before plasma glucose

concentration is altered. However, this means that decreased plasma/serum glucose concentrations provide an unequivocal and specific indicator of negative energy balance.

### Protein Evaluation

Currently, there is not a single biochemical factor that accurately reflects the protein status of dairy cattle. A number of indices have therefore been monitored, including milk urea nitrogen and plasma/serum urea nitrogen, creatinine, albumin, and total protein concentrations. Of these indices, milk urea nitrogen concentration in the bulk tank provides the best global picture of protein balance in a dairy herd.

### Urea Nitrogen

Plasma urea nitrogen and milk urea nitrogen (MUN) concentration are useful indicators of protein status, particularly when the diet contains adequate energy.

Increases in plasma urea nitrogen concentration and ammonia occur primarily as a result of inefficient nitrogen utilization. An excess of rumen degradable protein results in an increase in the concentration of rumen ammonia, which is absorbed through the rumen wall and transported to the liver, where it is converted to urea. The catabolism of body protein for gluconeogenesis can also result in the production of ammonia, which is also converted to urea in the liver. Plasma urea nitrogen concentration has therefore been the most commonly used blood constituent for monitoring protein status and intake. Values greater than 19 mg/dL suggest excessive protein intake in the diet, whereas values less than 10 mg/dL suggest inadequate protein intake in the diet.

MUN concentration can be used as a management aid to improve dairy-herd nutrition and monitor the nutritional status of lactating dairy cows. Elevated MUN concentration indicates that excess protein has been fed to the dairy cow for a given level of production. Milk samples should be submitted to an accredited diagnostic laboratory for MUN analysis. The Azotest Strip, an on-farm dipstick test, lacks accuracy and is not recommended. The MUN target concentrations for lactating dairy cows fed according to National Research Council recommendations have been evaluated. The target MUN concentrations are 8.5 to 11.5 mg/dL for most dairy herds compared with the previous target concentrations of 12 to 16 mg/dL. MUN, together with percentage milk protein, is being used increasingly as an indicator of the dietary protein–energy balance. The time of sampling can have a significant effect on MUN concentrations; the highest concentration was found to occur in the morning, and the diurnal pattern was not influenced by intrinsic factors such as parity, days postpartum or daily milk yield. MUN concentration was significantly increased after refrigeration for 1 week.

Several reviews of the literature have examined the effect of protein nutrition on reproduction in dairy cows. The reported effect of high nitrogen intake on fertility is inconsistent. Experimentally, the ingestion of a high level of degradable protein commencing 10 days before insemination in lactating dairy cows had no effect on the reproductive performance of the lactating high-yielding dairy cow. The relationship between MUN concentration and the fertility of dairy cows from 250 herds in the United Kingdom found no relationship between bulk-tank MUN concentration and fertility, or between changes in bulk-tank MUN concentrations and fertility.

A meta-analysis of the literature evaluated the associations between dietary requirements for protein for dairy cattle, the metabolism of protein in cattle, factors influencing the degradability of protein in ruminant feeds, and factors influencing MUN concentrations. There are good correlations between dietary protein intake and rumen ammonia, blood urea, and milk urea concentrations. Ryegrass clover pastures provide feed in many of the temperate dairy regions of the world, and for much of the year pasture crude protein may exceed 30%, of which a high proportion is rapidly degradable. High dietary protein intakes may have a negative effect on reproductive performance in lactating dairy cows, but the role of milk urea as a predictor of fertility needs further definition given the high conception rates in many Australasian dairy herds. High intakes of dietary protein may induce adaptations in urea metabolism, and the negative relationship identified between high intakes of dietary protein and fertility for northern hemisphere dairy herds may not necessarily apply in Australasian dairy herds. Because of the potential for cows to adapt to high-protein diets, the use of a single MUN determination on a herd will have limited value as an indicator of nutritional status and little value as a predictor of fertility. The differing observations between various production systems indicate the need for careful consideration in applying recommendations for dietary protein management based on milk urea concentrations. MUN determinations may, however, have value, particularly when used in conjunction with other herd and nutritional data to assess the protein nutrition of dairy herds. It is unlikely that single or even serial determinations of MUN concentration in single cows or bulk-tank milk will have a high predictive value for determining the risk of conception in the cow or herd.

### Albumin

Plasma/serum albumin concentration is related to the protein status of the animal and whether an acute-phase reaction has been induced. Lactation stage has a substantial effect on serum albumin concentration. Animals should be grouped into dry cows,

early lactation (1 to 10 weeks), and later lactation. Minimal values for dry-cow means are from 2.9 to 3.1 g/dL, from 2.7 to 2.9 g/dL for recently calved cows, and from 3.0 to 3.2 g/dL for cows in later lactation.

### Liver Function and Injury

The presence of liver injury can be evaluated by measuring plasma/serum aspartate amino-transferase (AST), sorbitol dehydrogenase (SDH), alkaline phosphatase, and gamma-glutamyl-transferase (GGT) activities. Of these enzyme activities, the plasma/serum AST activity is the most clinically useful, with plasma AST greater than 162 U/L being indicative of hepatic lipidosis. Because increased AST activity also reflects damaged skeletal muscle, AST activity is not a specific test for liver injury in cattle at calving or for a few days after calving because of the potential for parturition-related muscle damage.

Liver function can be assessed by measuring the plasma/serum total bilirubin, cholesterol, and albumin concentrations. Serum bile acid concentration is not a useful index of liver function in cattle. Calculation of the ratio of plasma NEFA to cholesterol on a molar basis appears to provide a clinically useful index to evaluate the degree of hepatic lipidosis and the liver's ability to export mobilized peripheral fat reserves, and has been able to predict the incidence of postpartum disease. The major drawback with measuring the NEFA:cholesterol concentration is the cost, in that each analysis costs approximately US\$8/test, for a total test cost of US\$16. Plasma/serum albumin concentrations are decreased for the first month after calving as a result of plasma volume expansion to accommodate the nutrient flow for milk production, loss into the uterine lumen associated with uterine involution, catabolism of body protein resulting from negative energy balance, and decreased hepatic function as a result of hepatic lipidosis. The major clinical utility of plasma/serum albumin concentration is therefore in the first 4 weeks of lactation.

### Macromineral Evaluation

Abnormalities of the blood levels of the four macrominerals, calcium, phosphorus, magnesium, and potassium, in the cow during the transition period are involved in subclinical hypocalcemia, clinical milk fever, hypomagnesemia, and acute hypokalemia.

### Calcium

Serum calcium concentrations are tightly regulated and are not sensitive indicators of input–output balance. Measurement of plasma/serum calcium concentrations during the first 24 hours after calving, particularly in multiparous dairy cows, can provide useful insight into the effectiveness of control programs for periparturient hypocalcemia.



### Phosphorus

Serum inorganic phosphate concentrations tend to fall following long-term insufficient dietary intake.

### Magnesium

Serum magnesium concentrations are usually low during the winter months, and subclinical hypomagnesemia exists in many herds, especially pregnant beef cattle. This can be converted into clinical hypomagnesemia with a sudden deprivation of feed or a sudden fall in environmental temperature. Supplementation of the diet with magnesium salts is protective.

### Sodium

Low serum sodium concentrations occur in early lactation in cows grazing on summer pastures without supplementation with salt. Levels down to 135 mmol/L may be associated with depraved appetite and polydipsia and polyuria.

### Potassium

Serum potassium concentrations have been difficult to interpret because the levels of the electrolyte in serum are not necessarily indicative of potassium deficiency. The normal serum potassium concentration is much more variable than that of sodium, and its average concentration in roughages of all kinds is nearly always in excess of requirements; any abnormalities are usually in the direction of excess.

### Hematology

#### *Hematocrit (Packed Cell Volume)*

The hematocrit can be used as a general reflection of health. In most dairy herds, a low hematocrit may be a reflection of suboptimal energy and protein nutrition. Mean values of packed cell volume (PCV), hemoglobin, and serum iron are consistently higher in nonlactating cows than in lactating cows. Parasitism causing blood loss will result in a low hematocrit. The hematocrit varies with lactation stage, being highest in dry cows and lowest at peak (summit) milk. Cows should be grouped by lactation stage when evaluating hematocrit.

### Urine Evaluation

Urine samples are easier to obtain than blood samples, although stimulation of the perineal area to induce urination is usually only 75% to 90% successful. Higher success rates in obtaining a urine sample are obtained in cattle that have been sitting down and that are encouraged to stand.

Urine appears to be the optimal fluid to monitor acid-base and calcium status in dairy cattle. The most accurate insight into acid-base homeostasis in healthy cattle is obtained by measuring urine net acid excretion (NAE) or net base excretion (NBE) (see Chapter 5). However, when urine pH is between 6.3 and 7.6, urine pH measured by

urine dipsticks or pH papers provides an inexpensive and clinically useful insight into acid-base homeostasis in cattle.<sup>5</sup> This is because the change in urine pH over this pH range accurately reflects the change in NAE or NBE. Optimum target values for urine pH to decrease the incidence of milk fever in dairy herds have not been identified, and recommendations for optimal urine pH values vary widely.<sup>5</sup>

Feeding rations with low dietary cation-anion difference (DCAD) to dairy cows for at least 2 weeks before calving decreases the incidence of periparturient hypocalcemia. The most likely reason for this effect is that ingestion of a low-DCAD diet increases calcium (Ca) flux, which in nonlactating cows is most readily detected as an increase in urinary calcium excretion. Low urine pH decreases calcium uptake from the tubular lumen into the renal epithelial cell and therefore decreases calcium absorption in the distal convoluted tubule and connecting tubule, thereby directly resulting in hypercalciuria. It remains to be determined whether laboratory measurement of urinary calcium concentration is more accurate and cost-effective than cow-side measurement of urine pH or laboratory determination of urinary strong ion difference and NBE when evaluating the effectiveness of milk-fever control programs.

### Timing of Blood Tests

#### *In Relation to Feed Changes*

Because changes in the diet of ruminants cause changes in the character of rumen activity, blood samples for metabolic profile testing should not be done until 2 weeks after a major dietary change. Minor changes such as an increase in the quantity of an existing component or in access to the same ration do not require a wait of more than 7 to 10 days. Changes in forage type, such as turnout to pasture, housing, or the introduction of silage, require the full 2 weeks. The same applies for introduction of concentrates or of a new type of concentrate.

#### *In Relation to Feeding*

There can be changes in biochemical values in blood associated with feeding. These are most marked in cows receiving their entire concentrate ration at milking time. In such cases, 2 hours should be allowed to elapse after milking before blood sampling. In circumstances where the major part of the concentrate input is mixed with the forages and is available for most of each 24 hours, the timing of tests in relation to feeding is less critical. If lower-yielding midlactation cows are included (see later discussion), their results can be used as a check to see if there is an effect of feeding on the biochemical values in the blood samples. Cows should not be separated at milking time and confined for hours without access to food

while waiting for blood sampling because this can also affect the results.

The available recommendations regarding the timing of blood collection relative to feeding are somewhat confusing. A common recommendation is that blood samples should be obtained 5 hours after feeding if animals are fed a fresh total mixed ration once daily. This recommendation does not seem logical in that plasma BHB concentration is increased at this time in cattle fed rations based on corn (maize) silage because of the metabolism of absorbed butyrate by ruminal epithelial cells. In most nutritional studies, blood samples are collected in a preprandial state because this is most consistent, but this will give the highest plasma NEFA concentrations over a 24-hour period. On this basis, sampling should be done in the morning immediately before or at the time of feeding of a fresh total mixed ration.

#### *In Relation to Calving Pattern and Seasonal Feeding Changes*

The cow in early lactation is the most important because what happens to her in the first few weeks after calving has the major influence on her subsequent productivity, including her future fertility efficiency. Therefore blood sampling for metabolic profiles should be carried out at the beginning of each new calving season, with the first cows checked so that the majority can benefit from the information derived. Of equal importance is the need to test as soon as possible after the introduction of a new ration, so that evaluation of the cows' biochemistry can be made available as quickly as possible to determine **what the cows, the end users, think of the ration**. Therefore planning of metabolic profile tests needs to be done in advance and should take into account both expected calving pattern and feed changes. Without planning along these lines, time may be lost, and productivity with it.

### Selection of Cows

Picking appropriate cows for blood sampling is very important. This is because some of the metabolites looked at, particularly those relating to energy balance, can quickly return to the optimum range as cows adapt themselves, including their productivity, to a nutritional constraint. It is possible for cows to experience a significant energy deficit in the first 2 to 3 weeks of lactation because of intake problems, lose excessive body condition, perhaps have their milk yield modified, and have their subsequent fertility efficiency suppressed, but yet still arrive at 4 weeks calved with all biochemical measurements within the optimum ranges. If blood is sampled at 4 weeks after calving or longer, a producer could see thin, underproducing cows with poor fertility but with nothing abnormal about their biochemistry. Thus the farmer would be entitled to feel the

metabolic profile test was of no value. However, if those cows had been blood sampled at 14 days calved instead of 28 days, the blood results would have been quite different and would have identified the nutritional constraint on productivity.

The guidelines for metabolic profiling of dairy cattle recommend sampling from the following groups:

- Dry period (D): between 7 and 10 days before anticipated date of calving
- Early lactation (EL): between 3 and 14 days of lactation
- Midlactation (ML): between 50 and 120 days of lactation.

Individual variations in biochemical values are such that single cows should not be tested. **Groups of no less than five should be sampled.** They should not be picked at random, but rather should be typical, average cows of their stage of lactation. Cows with extremes of performance—either very high or very low—should not be selected. Cows with problems should also not be included because the type of analysis carried out is not designed to clarify individual problems. It is important to make all this clear to farmers in advance because they cannot be expected to appreciate the limitations of the analyses made. Experience in the Dairy Herd Health and Productivity Service in the United Kingdom suggests that selecting cows for metabolic profiles may be best done by the veterinarian in advance of the test after looking at the calving and production records. If there is a specific concern of poor conception rate, for example, farmers may expect only cows that failed to conceive to be sampled. This tactic hardly ever delivers helpful information because any nutritional constraints have by then been compensated for, and blood biochemical values are usually within optimum ranges. The best approach may be to include such cows as the midlactation group.

#### Dry-Cow Group

Because the dry period is so important to the success of the following lactation, blood sampling to make sure nutrition is adequate is essential. However, the nature of the measurements that can be made means that primarily **cows in the last 7 to 10 days of gestation should be sampled.** Blood sampling a group of dry cows with 1 month or longer to go to calving at the same time can sometimes provide a useful within-herd comparison with respect to energy balance. Such sampling may also identify the presence of dietary protein inadequacy—specifically, rumen degradable—in the early part of the dry period.

#### Early-Lactation Group

The definition used for the early-lactation group is most critical for the reasons given in the previous paragraph. Since the original

Compton metabolic profile, in which a high-yielding cow was used as the definition, the importance of this group has become increasingly apparent. The definition also has had to be changed to take into account changes in farm practice. The way cows are fed now—total mixed rations, increased out-of-parlor concentrate feeding—has reduced the time after calving by when they can adapt themselves to an unsatisfactory diet. **To be sure of detecting the presence of an energy constraint in particular, blood sampling should be carried out between 3 and 14 days calved**—at less than 3 days, the metabolic impact of hypercortisolemia associated with parturition is still present; at more than 14 days, some cows will be thin, unproductive, and subfertile but may have compensated for their nutrition and thus have normal blood metabolite values.

#### Midlactation Group

Some cows that have past the period of peak yield and so past the greatest period of potential nutritional stress should always be included. **They should be between 50 and 120 days calved** so that they are still relatively high yielding. This group provides a within-herd comparison with the early-lactation cows. Without this it is very difficult to distinguish between problems caused by constraints on intake of food or protein and energy content; to identify changes in biochemical values caused by mistiming of tests in relation to feeding or by oddities in the diet, such as silage with a high butyric acid content; and to make judgments on concentrate/forage usage within the herd.

In the DHHPS program, a majority of farms do metabolic profiles three to four times a year at critical times as a check, or “ask-the-cows-what-they-think” exercise. Thus metabolic profiles are used as part of a proactive preventive health and productivity program. Some of the larger farms may do more than 10 tests a year to cover feed changes and to check on the success of any corrective action.

In the DHHPS program, a standard DHHPS metabolic profile includes analysis of plasma for NEFA, BHB, glucose, urea nitrogen (urea N), albumin, globulin, magnesium, and inorganic phosphate. Analyses for copper and glutathione peroxidase (GSHPx) are done on approximately one-third of samples received and thyroxine T4 on even fewer. Biochemical analysis is performed using two biochemical auto-analyzers, with standard internal controls. It also employs an independent, external quality control system. Derivation of optimum metabolite values are summarized in Table 17-2. They are BHB less than 0.6 mmol/L in dry cows and less than 1.0 mmol/L in cows in milk; glucose greater than 3.0 mmol/L; NEFA less than 0.5 mmol/L in dry cows and less than 0.7 mmol/L in cows

**Table 17-2** Metabolic profile parameters in cattle—optimum values

Parameter	SI units
BHB	
Milkers	Below 1.0 mmol/L
Dry cows	Below 0.6 mmol/L
Plasma glucose	Over 3.0 mmol/L
NEFA	
Milkers	Below 0.7 mmol/L
Dry cows	Below 0.4 mmol/L
Urea nitrogen	1.7–5.0 mmol/L
Albumin	Over 30 g/L
Globulin	Under 50 g/L
Magnesium	0.8–1.3 mmol/L
Phosphate (inorganic)	1.4–2.5 mmol/L
Copper	9.4–19.0 μmol/L
Thyroxine T4 (iodine)	Over 20 nmol/L
GSHPx (selenium)	Over 50 units/g Hb

in milk; urea N greater than 1.7 mmol/L; albumin greater than 30 g/L; globulin less than 50 g/L; magnesium greater than 0.7 mmol/L; phosphate greater than 1.3 mmol/L; copper greater than 9.2 μmol/L; glutathione peroxidase (GSHPx) greater than 50U/g HB; and thyroxine T4 greater than 20 nmol/L.

**Energy.** The data in Table 17-3 use only the cows fitting precisely the definitions of D, EL, and ML. The table shows that, overall, an average of 30% EL cows had metabolite results reflecting satisfactory energy status, as did 61% of ML cows and 43% of D cows. In both EL and ML groups, glucose is the metabolite most commonly outside its optimum range, followed by BHB and NEFA. The percentage of NEFA values above optimum is low in ML cows. The most common finding is high BHB and low glucose in the same cow. In tests showing most cows in an EL group having these results, there is usually one or two with high NEFAs as well. Some EL cows show only low glucose or only high NEFA. Where low glucose only predominates in EL cows, ML cows often show the same picture.

**Protein.** The plasma urea concentration results in Table 17-3 show that the EL stage is more vulnerable to low values than later in lactation, even though the cows would have been on the same diets in virtually every case. In fact, an even greater average percentage of the blood of 1361 cows sampled between 0 and 9 days after calving over the 5 years showed low urea concentration.

The proportion of low-urea-concentration results in D cows is high (Table 17-3). In addition to the category shown of 10 days or less before calving, 4335 cows were sampled at more than 10 days

**Table 17-3** Annual (April–March) percentages outside optimum ranges of metabolite results in blood plasma in adult dairy cows<sup>a</sup>

	EARLY LACTATION (EL) (10–20 DAYS CALVED)					MID LACTATION (ML) (50–120 DAYS CALVED)					DRY (D) (7–10 DAYS PREPARTUM)				
	1999	2000	2001	2002	2003	1999	2000	2001	2002	2003	1999	2000	2001	2002	2003
	/00	/01	/02	/03	/04	/00	/01	/02	/03	/04	/00	/01	/02	/03	/04
β-hydroxybutyrate (BHB)	19.5	16.6	22.3	22.9	17.5	11.2	10.5	14.3	10.6	9.6	34.5	24.7	38.5	28.5	22.7
Glucose	46.0	48.7	43.1	49.0	59.3	21.8	25.9	14.5	22.5	25.4	23.9	27.3	21.7	27.3	33.8
Non-esterified fatty acid (NEFA)	19.1	22.2	24.9	27.4	28.0	0.6	2.1	1.8	2.7	3.1	10.8	15.0	14.2	13.0	14.8
One or more energy metabolite per cow	65	70	67	72	78	34	39	32	40	44	59	57	63	46	63
Urea-nitrogen (UreaN)	0.8	17.3	18.3	16.7	16.7	4.4	6.4	6.0	5.3	5.6	18.4	20.4	20.2	20.8	22.3
Number of cows	1295	1421	1248	1285	1530	914	1066	849	1179	1494	1160	1379	1253	1358	1543

prepartum, and 22% of them had low plasma urea concentrations.

Results outside the optimum ranges for albumin (0.6%), magnesium (2.5%), phosphate (1.0%), copper (10%), and GSHPx (3%) are relatively uncommon. Thyroxine T4 analysis was carried out in 836 samples on specific request, and only 3% were below optimum.

### Background Information

So that full value can be obtained by the farmer from the metabolic-profile approach, information about the cows and the farm should accompany the blood samples to the laboratory. This should include cow identification; last calving date for milkers/expected for dry cows; body weight (calculation from heart-girth measurement with a weighband pulled to a constant 5-kg tension is the best because it is not affected by gutfill and usually most practical because no mechanical weighing device/crush is required); body-condition score by a palpation method; current daily milk yield; expected current daily milk yield; lactation number; daily supplementary feed intakes; daily estimated forage intakes; analytical description of feeds; and current herd milk solids percentages. It is useful to have information on herd size, breed, feeding systems, and health and fertility. A note of what concerns the farmer has, if any, should also be made.

### Interpretation of Results at the Farm

Circumstances where the diagnosis of a nutritional constraint from blood samples is clearly correct, but the cause(s) are unclear from a distance and could be many, are common. Therefore it is very important that a final interpretation of what is not working and what are the best and most economic solutions ought to be made at the farm with the information from the laboratory in hand. Farm advisory visits should be made

as soon as the results are available and discussions made, including farm staff and any other advisors involved. Experience in the DHHPS suggests that such a team approach produces a more balanced strategy and is more beneficial than each party working in isolation.

### Written Advice

Any advice given should be recorded concisely in writing and copies given to all participants on the farm. This ensures that the agreed path is followed, creates a record, and ensures that the fee is for something tangible.

### Milk Production, Activity Meters, and Ruminant Monitors

The application of real-time monitoring of dairy cattle has great potential to provide low-cost and immediate insight into health and production. Of all potential indices, daily milk production (relative to previous production during the lactation or the previous lactation, or to peers) appears to provide the most sensitive and specific measure of dry matter intake and health. Milk production can be measured noninvasively and at very low cost using automated procedures at milking time. As diagnostic algorithms are refined, it is likely that monitoring of daily milk production will provide the most practical and low-cost method for evaluating health and production and for early disease detection.

Activity meters can detect standing and lying periods in cattle and from that information can infer time spent feeding in cows housed in free stalls or tie stalls. Ruminant monitors detect the time spent ruminating each day, which is strongly associated with dry matter intake and health.

### Body-Condition Score

Managing body reserves is critical for successful cow management and requires an

accurate assessment of the cow's "condition." Body-condition scoring is an important aspect of metabolic diseases of farm animals. Body weight alone is not a valid indicator of body reserves because cows of a specific weight may be tall and thin or short and fat. The energy stores may vary by as much as 40% in cows of similar body weight, which emphasizes the futility and inaccuracy of relying on body weight alone as an index of cow condition. In addition, because tissue mobilization in early lactation occurs as feed intake is increasing, decreases in body-tissue weight can be masked by enhanced fill of the gastrointestinal tract, so that body-weight changes do not reflect changes in adipose tissue and lean-tissue weight.

There is a strong positive relationship ( $R^2 = 0.86$ ) between BCS and the proportion of physically dissected fat in Friesian cows. Therefore the visual or tactile (palpation) appraisal of the cow's BCS provides a good assessment of body-fat reserves, ignoring—or minimizing the effect of—frame size and intestinal contents. Most animal and dairy scientists acknowledge the successful manipulation of BCS as an important management factor that influences or has a relationship to animal health, milk production, and reproduction in the modern dairy cow. For example, cows that lost 0.5 to 1.0 point in BCS between parturition and first service achieved a pregnancy-to-first-service rate of 53%, whereas those losing more than 1.0 point achieved a rate of 17%. In a seasonal pasture-based system for Holstein–Friesian cows, it is necessary to maintain the BCS at 2.75 or greater during the breeding season. BCS is important in achieving good reproductive performance. Loss of body condition between calving and first service should be restricted to 0.5 BCS to avoid a detrimental effect on reproductive performance.

BCS is a subjective method of assessing the amount of metabolizable energy stored



	SCORE	1	2	3	4	5	6	7	8
		Spinous processes SP (anatomy varies)	Spinous to Transverse processes	Transverse processes	Overhanging shelf (care-rumen fill)	Tuber coxae (hooks) & Tuber ischii (pins)	Between pins and hooks	Between the hooks	Tailhead to pins (anatomy varies)
SEVERE UNDERCONDITIONING (emaciated)	1.00	individual processes distinct, giving a saw-tooth appearance	deep depression	very prominent, >1/2 length visible	definite shelf, gaunt, tucked	extremely sharp, no tissue cover	severe depression, devoid of flesh	severely depressed	bones very prominent with deep "V" shaped cavity under tail
	1.25								
	1.50								
FRAME OBVIOUS	1.75			1/2 length of process visible					
	2.00	individual processes evident	obvious depression		prominent shelf	prominent	very sunken		bones prominent "U" shaped cavity formed under tail
	2.25			between 1/2 to 1/3 of process visible					
FRAME & COVERING WELL BALANCED	2.50	sharp, prominent ridge		1/3 - 1/4 visible	moderate shelf		thin flesh covering	definite depression	first evidence of fat
	2.75								
	3.00		smooth concave curve	<1/4 visible	slight shelf	smooth	depression	moderate depression	bones smooth, cavity under tail shallow & fatty tissue lined
	3.25			appears smooth, TP's just discernible					
	3.50	smooth ridge, the SP's not evident	smooth slope	distinct ridge, no individual processes discernible		covered	slight depression	slight depression	
FRAME NOT AS VISIBLE AS COVERING	3.75						sloping		
	4.00	flat, no processes discernible	nearly flat	smooth, rounded edge	none	rounded with fat	flat	flat	bones rounded with fat and slight fat-filled depression under tail
	4.25								
SEVERE OVERCONDITIONING	4.50			edge barely discernible		buried in fat			bones buried in fat, cavity filled with fat forming tissue folds
	4.75								
	5.00	buried in fat	rounded (convex)	buried in fat	bulging		rounded	rounded	

**Fig. 17-3 Body-condition scoring chart.** (Adapted from Edmonson AJ, Lean JJ, Weaver LD, Farver T, Webster G. A body condition scoring chart for Holstein dairy cows. *J Dairy Sci.* 1989; 72:68–78.)

in fat and muscle (body reserves) in a live animal. BCS in dairy cows is done using a variety of scales and systems. This method involves palpating the cow to assess the amount of tissue under the skin. Scoring body condition and assessing changes in the body condition of dairy cattle have become strategic tools in both farm management and research. BCS is being researched worldwide. But international sharing, comparing, and use of generated data are limited because different BCS systems are used. There is difficulty in interpreting the literature because of variability in the way authors apply scoring methods. In the United States, Canada, and

Ireland, a 5-point BCS system is used for dairy cows, whereas Australia and New Zealand use 8- and 10-point scales, respectively. The following scoring method is recommended for the 0-to-5 scale. A BCS chart<sup>6</sup> appears in Fig. 17-3.

#### Score: 1

- Condition: Poor.
- Tailhead area: Cavity present around tailhead. No fatty tissue felt between skin and pelvis, but skin is supple.
- Loin area: Ends of transverse processes sharp to touch and dorsal surfaces can be easily felt. Deep depression in loin.

#### Score: 2

- Condition: Moderate.
- Tailhead area: Shallow cavity lined with fatty tissue apparent at tailhead. Some fatty tissue felt under the skin. Pelvis easily felt.
- Loin area: Ends of transverse processes feel rounded, but dorsal surfaces felt only with pressure. Depression visible in loin.

#### Score: 3

- Condition: Good.
- Tailhead area: Fatty tissue easily felt over the whole area. Skin appears smooth, but pelvis can be felt.

- Loin area: Ends of transverse processes can be felt with pressure, but thick layer of tissue dorsum. Slight depression visible in loin.

**Score: 4**

- Condition: Fat.
- Tailhead area: Folds of soft fatty tissue present.
- Patches of fat apparent under skin. Pelvis felt only with firm pressure.
- Loin area: Transverse processes cannot be felt even with firm pressure. No depression visible in loin between backbone and hip bones.

**Score: 5**

- Condition: Grossly fat.
- Tailhead area: Tailhead buried in fatty tissue. Skin distended. No part of pelvis felt even with firm pressure.
- Loin area: Folds of fatty tissue over transverse processes. Bone structure cannot be felt.

### Relationships Among International Body-Condition Scoring Systems

The New Zealand 10-point scale was compared with the scoring systems in the United States, Ireland, and Australia by trained assessors. Cows were assessed visually in the United States and Australia; in Ireland, cows were assessed by palpating key areas of the cow's body. Significant positive linear relationships were found between the New Zealand 10-point scale and the other scoring systems. The relationships between the 10-point BCS scale used in New Zealand and the scales used in Ireland and the United States are summarized in [Table 17-4](#).

**Table 17-4** Relationship between the 10-point BCS scale used in New Zealand and the 5-point BCS scale used in Ireland and the United States, and the 8-point scale used in Australia

New Zealand	USA	Ireland	Australia
1.0	1.83	1.21	2.74
1.5	1.98	1.41	3.01
2.0	2.14	1.61	3.28
2.5	2.30	1.81	3.55
3.0	2.46	2.01	3.82
3.5	2.62	2.21	4.09
4.0	2.78	2.41	4.36
4.5	2.94	2.61	4.63
5.0	3.10	2.81	4.90
5.5	3.26	3.01	5.17
6.0	3.42	3.21	5.44
6.5	3.58	3.41	5.71
7.0	3.74	3.61	5.98
7.5	3.90	3.81	6.25
8.0	4.06	4.01	6.52
8.5	4.22	4.21	6.79
9.0	4.38	4.41	7.06
9.5	4.54	4.61	7.33
10.0	4.70	4.81	7.60

### FURTHER READING

- Grummer RR. Nutritional and management strategies for the prevention of fatty liver in dairy cattle. *Vet J*. 2008;176:10-20.
- LeBlanc S. Monitoring metabolic health of dairy cattle in the transition period. *J Reprod Dev*. 2010;56:S29.
- Macrae AI, Whitaker DA, Burrough E, Dowell A, Kelly JM. Use of metabolic profiles for the assessment of dietary adequacy in UK dairy herds. *Vet Rec*. 2006;159:655.

### REFERENCES

1. Borchardt S, Staufienbiel R. *J Am Vet Med Assoc*. 2012;240:1003.
2. <<http://www.fda.gov/downloads/AnimalVeterinary/Products/ApprovedAnimalDrugProducts/FOIADrugSummaries/UCM050022.pdf>>. Accessed June 18, 2016.
3. Ingvarsen KL, et al. *Prev Vet Med*. 2003;83:277.
4. Garverick HA, et al. *J Dairy Sci*. 2013;96:181.
5. Constable PD, et al. *Am J Vet Res*. 2009;70:915.
6. National Research Council. *Nutrient Requirements of Dairy Cattle*. 7th rev. ed. Washington DC: National Academy Press; 2001:13-27.
7. McCarthy MMM, et al. *J Dairy Sci*. 2015;98:6284.
8. Whitaker DA. *Cattle Pract*. 2005;13:27.

## PARTURIENT PARESIS (MILK FEVER)

### SYNOPSIS

**Etiology** Hypocalcemia just before, around, or after parturition.

**Epidemiology** Adult dairy cows in third parity and older; clinical case incidence of 4% to 9%, with low case fatality, but up to 50% of multiparous periparturient dairy cows affected subclinically. Most commonly occurs within 48 hours after calving, but also occurs several weeks before or after. Occurs in beef cattle in epidemics. Occurs in sheep and goats in epidemics, usually following stressors. Parturient diets high in calcium.

**Signs** Three progressively worse stages including early signs such as restlessness, muscle fasciculation over shoulder and neck, cool skin, anorexia, rumen atony with mild bloat, and insecure gait. More advanced stages with general muscle weakness leading to sternal recumbency with head resting on the chest, mental depression, dilated pupils, weak heartbeat and pulse, increased heart rate, dry muzzle, dry feces, and hypothermia. Last stage characterized by lateral recumbency, severe obtundation, severe rumen bloat, barely audible heart, tachycardia, circulatory collapse, coma, and death.

**Diagnostic confirmation** Hypocalcemia and response to treatment with calcium borogluconate.

**Treatment** Calcium borogluconate IV, oral calcium salts.

**Control** Dietary management to reduce dietary potassium intake prepartum, while

increasing the content of anions in the ration (low dietary cation-anion difference rations). Reducing dietary calcium content below requirements prepartum to prepare the organism for a negative calcium balance. Oral administration of calcium salts immediately before, at, and after calving. Oral or parenteral vitamin D and analogs before calving.

### ETIOLOGY

A depression in the levels of ionized calcium in the extracellular space, including plasma, is the basic biochemical disturbance in milk fever. A transient period of subclinical hypocalcemia (total plasma calcium [Ca] < 2.0 mmol/L or 8 mg/dL) occurs at the onset of lactation caused by an imbalance between calcium influx to the extracellular pool from gut and bone and output in colostrum and milk. The sudden increase of Ca losses through the mammary gland at the onset of lactation presents a considerable challenge for the circuits regulating Ca homeostasis. With milk containing approximately 2 g of Ca per kg and colostrum approximately 2.3 g of Ca per kg, the production of 10 kg of milk or colostrum requires the equivalent of the entire amount of Ca available in the extracellular space of an adult cow. Calcium lost from the extracellular pool must be replaced by increasing intestinal absorption and bone resorption of calcium. Whereas the calcium requirements of a cow in late gestation are minimal at about 30 g/d, a dairy cow must mobilize an additional 30 g or more of calcium per day for milk production from parturition on. A certain degree of hypocalcemia around parturition is unavoidable and is a result of the lag time of counter-regulatory mechanisms reacting to the sudden imbalance of Ca homeostasis at the onset of lactation. Most cows adapt within 48 hours after calving by increases in plasma concentrations of parathyroid hormone (PTH) and 1,25-(OH)<sub>2</sub>D, the biologically active form of vitamin D<sub>3</sub>. The incidence of subclinical hypocalcemia, with serum Ca concentrations between 1.4 and 2.0 mmol/L (5.5 to 8.0 mg/dL) in multiparous periparturient cows has been estimated at 50%.<sup>1</sup> Clinical milk fever is estimated to occur in 5% of periparturient dairy cows in the United States.<sup>2</sup>

### EPIDEMIOLOGY

#### Occurrence

#### Cattle

The disease occurs most commonly in high-producing multiparous lactating dairy cattle. Lactating beef cows also are affected, but less commonly.

**Age.** Hypocalcemia at calving is age related and most marked in cows at their third to seventh parturition, although rare cases have been observed at the first and second calvings.

**Breed.** Field observations have for many years suggested that Jersey, Swedish Red and White, and Norwegian Red breeds develop clinical milk fever more frequently than Holstein–Friesian cows.<sup>3</sup> The higher Ca concentration in milk from Jersey compared with Holstein cows has been proposed as possible explanation, although the absolute differences in Ca excreted through the mammary gland per day between breeds are negligible when considering the higher milk yield of Holstein–Friesian cows.<sup>3</sup> Differences in the number of intestinal vitamin D receptors regulating the intestinal Ca uptake have been reported in some studies.<sup>3</sup> The disease in beef cattle breeds occurs either in individual cows or in herd outbreaks.

**Individual Cows.** Individual cows, and to some extent families of cows, are more susceptible than others; the disease tends to recur at successive parturitions. The heritability of susceptibility to milk fever and hypocalcemia has been assessed as insignificant; different studies reported heritabilities of 0%, 4%, and 12.8%.<sup>4</sup> Complete milking in the first 48 hours after calving, as opposed to normal sucking by a calf, appears to be a precipitating factor. Several studies have reported that the incidence of milk fever is positively associated with the level of milk production.

**Time of Occurrence.** In cattle, milk fever occurs at three main stages in the lactation cycle. Most prepartum cases occur in the last few days of pregnancy and during parturition, but rare cases occur several weeks before calving. Some cases will occur a few hours before parturition or at the time of parturition when the attendant expects the cow to calve and the second stage of parturition does not occur because of uterine inertia resulting from hypocalcemia. Most cases occur within the first 48 hours after calving, and the danger period extends up to about the 10th postpartum day. Up to 20% of cases can occur subsequent to the 8th day after calving. In such cases the declines in serum Ca levels are smaller than in parturient cows. The clinical signs are also less severe, and there are fewer relapses after treatment. Occasional cases occur during mid- or even late lactation. Such cases are often recurrences of the disease in highly susceptible cows that were affected at calving. Undue fatigue and excitement may precipitate such attacks, and there is a special susceptibility at estrus. In the latter case, the depression of appetite by the elevation of blood estrogen levels may be a contributing factor.

Hypocalcemic episodes lasting 1 to 2 days may occur two or three times with a periodicity of about 9 days. Fluctuations in the intestinal absorption of Ca during this period may be the cause of Ca cycling. Subclinical hypocalcemia is of major significance because it inhibits reticulorumen motility,

which affects appetite, delays intestinal absorption of nutrients, and exacerbates the negative energy balance already existing in the cow in the first month of lactation.

**Stressors.** Feed intake depression for 48 hours contributes to the depression of serum Ca levels, and this may be of importance in the production of hypocalcemic paresis in this species at times other than in the postparturient period. Pregnant beef cattle may develop hypocalcemic paresis during the winter months when they are fed on poor-quality roughage; within a group of such cows, lower-ranked individuals of the herd may suffer selective malnutrition. The disease has also occurred in beef cows affected with diarrhea of undetermined etiology. As another explanation of the heightened susceptibility of cows at estrus, a possible depression of the degree of ionization of calcium under the influence of estrogens has been proposed. Differences in total serum Ca or plasma ionized Ca values in cows during estrus, however, are not documented.

The intravenous administration of certain aminoglycosides, especially neomycin, elihydrostreptomycin, and gentamicin, may cause a reduction in the degree of ionization of serum calcium and a syndrome similar to milk fever. Oral dosing with zinc oxide (40 or 120 mg Zn/kg body weight [BW]) as a prophylaxis against facial eczema in ewes causes a serious drop in serum calcium levels 24 hours after treatment. Caution is recommended with the use of these drugs in parturient cows.

### Sheep and Goats

In sheep, the disease commonly occurs in outbreaks in groups of ewes exposed to forced exercise, long-distance transport, sudden feed deprivation, and grazing on oxalate-containing plants or green cereal crops. These circumstances commonly precipitate outbreaks of hypocalcemic paresis in sheep; mature ewes are the most susceptible, particularly in the period from 6 weeks before to 10 weeks after lambing. Up to 25% of the flock may be affected at one time. The disease also occurs in young sheep up to about 1 year of age, especially when they graze green oats, but also when pasture is short in winter and spring, as in southeast Australia. The disease is manifested by paresis, but poor growth, lameness, and bone fragility can be detected in the rest of the flock. A sudden deprivation of feed or forced exercise of ewes can cause marked depression of the serum Ca levels. However, ewes are in a susceptible state in early lactation because they are in negative Ca balance. In late lactation a state of positive balance is a result of a low rate of bone resorption. There is an unexplained occurrence of hypocalcemia in sheep fed on hay when they are supplemented with an energy-rich concentrate, which increases their calcium intake. Another

occurrence in ewes is at the end of a drought when the pasture growth is lush and very low in Ca content. The incidence may be as high as 10% and the case-fatality rate 20% in ewe flocks in late pregnancy or early lactation.

Hypocalcemia in sheep depresses endogenous glucose production and insulin release, and in late pregnancy in combination with hyperketonemia, it facilitates the development of pregnancy toxemia.

In does, a depression in serum levels of Ca and phosphorus occurs similar to that in cows, but in ewes no such depression occurs at lambing, and the intervention of a precipitating factor appears to be necessary to reduce the serum Ca level below a critical point.

Milking goats become affected mostly during the 4- to 6-year-old age group. Cases occur before and after kidding, some later than 3 weeks after parturition. Clinical syndromes are identical to those in cows, including the two stages of ataxia and recumbency. Serum Ca levels are reduced from normal levels for parturient does.

### Morbidity and Case Fatality Clinical Hypocalcemia

Several epidemiologic studies of milk fever have reported incidence rates between 5% and 10% for clinical milk fever in cattle, calculated either as the lactational incidence or incidence per cow year.<sup>2,5</sup> Overall clinical disease is sporadic, but on individual farms the incidence may occasionally reach 25% to 30% of high-risk cows. With early treatment mortality is low in uncomplicated cases, but incidental losses as a result of aspiration pneumonia, mastitis, and limb injuries may occur. From 75% to 85% of uncomplicated cases respond to parenteral Ca therapy alone. A proportion of these animals require more than one treatment, either because complete recovery is delayed or because relapse occurs. The remaining 15% to 25% are either complicated by other conditions or incorrectly diagnosed.

### Subclinical Hypocalcemia

Subclinical hypocalcemia, defined as total plasma Ca between 1.4 and 2.0 mmol/L (5.5 and 8.0 mg/dL), is common in dairy cattle during the first few weeks of lactation. The incidence rates of subclinical postparturient hypocalcemia reported in the literature are in the range of 33% and may even increase to 50% in older cows.<sup>1,5</sup>

### Risk Factors

#### Animal Risk Factors

Serum Ca levels decline in all adult cows at calving as a result of the Ca loss through the mammary gland at the onset of lactation. This decline is more pronounced in some cows than in others, and it is this difference that results in the varying susceptibility of animals to parturient paresis. First-calf heifers rarely develop milk fever because



they are able to adapt more effectively to the high Ca demand at the onset of lactation. With increasing age, this adaptation process is hampered and results in moderate to severe hypocalcemia in older cows. The adaptation mechanism is directly related to the efficiency of intestinal absorption of Ca, which decreases with increasing age.

**Calcium Homeostasis.** The following three factors affect Ca homeostasis, and variations in one or more of them may contribute to the development of clinical disease in any individual:

1. Excessive loss of calcium in colostrum beyond the capacity of absorption from the intestines and mobilization from the bones to replace it. Variations in susceptibility between cows could be the result of variations in the Ca concentration in colostrum or milk and the volume of milk produced.
2. Impairment of absorption of Ca from the intestine at parturition.
3. Mobilization of Ca from storage in the skeleton may not be sufficiently rapid or efficient to maintain normal plasma Ca levels. The Ca mobilization rate is markedly reduced in cows in later pregnancy in response to the low requirements in the weeks before parturition. The lag time in reinitiating bone resorption at the moment Ca losses through the mammary gland suddenly begin contributes to the transient depression of the plasma Ca concentration. Bone resorption makes only a minor contribution to the total rate of Ca mobilization at parturition and is therefore of minor importance for the prevention of periparturient hypocalcemia. Osteoblasts are the only type of bone cell to express the  $1,25\text{-(OH)}_2\text{D}$  receptor protein, and the decrease in the numbers of osteoblasts with increasing age could delay the ability of bone to contribute Ca to the plasma Ca pool. Bone resorption shortly before and around calving can furthermore be hampered in states of metabolic alkalosis as it occurs in cows fed a ration with high potassium content. Animals with mild to moderate forms of compensated metabolic acidosis, in contrast, have enhanced bone-resorption activity, releasing additional Ca to the extracellular pool. Preventing alkalization by avoiding excessive dietary potassium and inducing mild to moderate acidosis by adding so-called anionic salts to the diet in late gestation are common strategies for prevention of milk fever in cattle (see also the discussion under “Control” in this chapter).

Historically it was proposed that failure to secrete sufficient levels of PTH or insufficient availability of  $1,25\text{-(OH)}_2\text{D}$  was the

primary defect in cows that developed milk fever. More recent research has shown that the secretion of PTH and the production of  $1,25\text{-(OH)}_2\text{D}$  are similar in most cows with or without milk fever. However, about 20% of cows treated for parturient paresis experience relapsing episodes of hypocalcemia that require further treatment. These cows appear to be less efficient in producing adequate amounts of  $1,25\text{-(OH)}_2\text{D}$  at the onset of lactation. Both relapsing and nonrelapsing cows develop the same degree of hypocalcemia and secondary hyperparathyroidism, but production of  $1,25\text{-(OH)}_2\text{D}$  is about twofold greater in nonrelapsing cows than relapsing cows. Following treatment of parturient hypocalcemia with intravenous Ca salts and restoration of ruminal and intestinal motility, nonrelapsing cows establish Ca homeostasis over the next 3 to 4 days by increasing intestinal absorption of Ca, which is activated by a sufficient level of  $1,25\text{-(OH)}_2\text{D}$ . In relapsing cows, even when rumen and intestinal motility are restored after treatment, hypocalcemia and paresis are likely to occur because of insufficient plasma  $1,25\text{-(OH)}_2\text{D}$ . These cows may remain in this stage of prolonged hypocalcemia for several days, and only after a few days and several repeated treatments with Ca will the plasma levels of  $1,25\text{-(OH)}_2\text{D}$  increase to an adequate level to maintain Ca homeostasis. Tissue  $1,25\text{-(OH)}_2\text{D}$  receptor concentrations decline with age, which renders older cows less able to respond to the hormone; thus it will take longer for older cows to adapt intestinal Ca absorption mechanisms to meet lactational demands for Ca.

**Body-Condition Score.** A high BCS increases the risk of milk fever. The odds ratio of milk fever with a BCS greater than 4/5 on the first milk recording day after calving was 4.3, and cows with milk fever had a postpartum predisease body weight 12 kg higher compared with healthy cows, indicating an increased risk of milk fever as a result of higher body weight. Cows with subclinical hypocalcemia in the winter period had significantly higher mean body weight over the 60 days postpartum than normocalcemic cows, but the effect was not significant in cows calving during the summer months.

### Dietary and Environmental Risk Factors

Several dietary factors of the pregnant cow during the prepartum period (last 4 weeks of gestation) can influence the incidence of milk fever in cattle.

**Dietary Calcium.** Feeding more than 100 g of calcium daily during the dry period is associated with an increased incidence of milk fever. The daily dietary Ca requirements of an adult cow in late gestation are in the range of 30 g Ca/d. When supplying Ca far in excess of the daily requirements (>100 g

Ca/d), the active absorption of Ca from the digestive tract and mobilization from bone are homeostatically depressed and become quiescent. As a consequence, at calving when sudden changes of the Ca balance occur, the cow is unable to rapidly return to bone Ca stores or intestinal Ca absorption mechanisms and is susceptible to severe hypocalcemia until these mechanisms can be activated, which may take several days.

Feeding prepartum diets with a Ca concentration low enough to induce a negative Ca balance already before calving prevents milk fever by activating Ca transport mechanisms in the intestine and bone before parturition, thus allowing the animal to adapt more rapidly to the lactational drain of Ca. The challenge of this approach is to formulate a balanced dry-cow ration with a sufficiently low Ca concentration providing less than 20 g/d of absorbable Ca (see also the discussion under “Control” in this chapter).

Supplementing dietary Ca immediately before and around parturition may also lower the incidence of milk fever by providing additional dietary Ca at the moment intestinal Ca absorption is upregulated (see also the discussion under “Control” in this chapter).

**Dietary Potassium.** The dietary potassium content of the ration fed in late gestation is a major contributing factor to the risk of periparturient hypocalcemia. Positively charged electrolytes (cations) contained in the diet and absorbed from the digestive tract tend to alkalize the organism, whereas electrolytes with a negative charge (anions) are acidifying.<sup>6</sup> Studies of the 1970s furthermore demonstrated that alkalization of the organism by increasing the amount of dietary cations increased the incidence of milk fever, whereas acidification by increasing the dietary anion content reduced the milk-fever incidence, which is the basis of the so-called dietary cation–anion difference (DCAD) concept (see also the discussion under “Control” in this chapter). With potassium being the quantitatively most important cation in a standard ruminant diet, it follows that high potassium concentrations (>2% of the ingested dry matter) in the ration fed to cows in their last weeks of gestation can considerably increase the incidence of periparturient hypocalcemia.

**Dietary Magnesium.** Magnesium deficiency during late gestation is a major risk factor for periparturient hypocalcemia, and hypomagnesemia is considered to be the most common cause of milk fever occurring in midlactating dairy cows.<sup>3</sup> Because magnesium is required for the release PTH from the parathyroid glands and furthermore influences the tissue sensitivity to PTH, the efficacy of PTH for the correction of hypocalcemia greatly depends on an adequate supply of magnesium.

**Dietary Phosphorus.** Parturient diets high in phosphorus (P; > 80 g P/d) greatly increase the incidence of milk fever and the severity of hypocalcemia. High dietary levels of P increase the serum level of P, which is inhibitory to the renal enzymes that catalyze the conversion of vitamin D to its active form 1,25-(OH)<sub>2</sub>D. Decreased amounts of 1,25-(OH)<sub>2</sub>D will not only reduce the intestinal absorption of P, but also of Ca, and thereby predispose to periparturient hypocalcemia.<sup>7</sup>

**Dietary Cation–Anion Difference.** Studies in the 1960s and 1970s showed that experimentally increasing the dietary cation concentration or decreasing the dietary anion concentration had an alkalinizing effect on the organisms, whereas feeding diets with a higher anion or lower cation concentration resulted in acidification. It was furthermore demonstrated that alkalization achieved through feeding high-cation/low-anion diets increased the incidence of milk fever, whereas acidification by increasing the ration of anions to cations caused the milk-fever incidence to decline.<sup>6</sup> Accordingly the basis of the DCAD concept is to modulate the ratio of cations to anions in the diet to reduce the risk of milk fever in cattle. The cation–anion difference of a diet is commonly given in milliequivalents (mEq) per kilogram of feed dry matter (DM; mEq/kg DM) or sometimes in mEq/100 g DM. Although several different equations have been proposed for the calculation of the DCAD, the most commonly used only considers the four quantitatively most important dietary ions: sodium (Na<sup>+</sup>), potassium (K<sup>+</sup>), chloride (Cl<sup>-</sup>), and sulfur (S<sup>2-</sup>). Other electrolytes, such as Ca, P, and magnesium, also affect the actual DCAD and thereby the effect on the acid–base status of the animal consuming the diet, and these compounds are included in some of the equations proposed in the literature to calculate the DCAD. However, because these minerals are present in relatively low amounts in the ruminant diet, their effect is considered to be minor. They are therefore commonly disregarded for practicability reasons.

The DCAD exerts a strong linear effect on the incidence of milk fever and is more important than the level of dietary Ca as a risk factor for milk fever. Parturient diets high in cations such as potassium are associated with an increased incidence of milk fever, whereas diets high in anions, especially chloride and sulfur, result in a decrease in the incidence of the disease. Most forages, such as legumes and grasses, are high in potassium and are alkaline. The addition of anions, specifically chloride and sulfur, to the diet of dairy cows before parturition can effectively reduce the incidence of milk fever (see also the discussion under “Control” in this chapter).

Systemic acidification induced by anionic supplementation affects the function of PTH hormone, the major effect being an increased

tissue response to PTH, which results in increased retention of Ca and enhanced mobilization of Ca from bone. A meta-analysis of 75 feeding trials designed to study the nutritional risk factors for milk fever in dairy cattle found that the parturient dietary concentrations of S and dietary anion–cation balance ([Na + K]—[Cl + S]) were the two nutritional factors most strongly correlated to the incidence of milk fever. Dietary S acts as a strong anion and reduces the risk of milk fever, and increasing the dietary S concentrations lowers the odds ratio of developing milk fever.

### ECONOMIC IMPORTANCE

Although economic losses from milk fever have decreased considerably since the introduction of intravenous treatment with Ca salts many years ago, the disease incidences reported in recent years remain similar to values reported decades ago.<sup>2,5</sup> The most obvious costs are associated with drugs, veterinary intervention, and losses resulting from complications in clinical cases. Costs associated with subclinical hypocalcemia are, however, considered to be far more important. Incidence rates between 3.5% and 7% for clinical disease and over 30% for subclinical hypocalcemia have been reported, and hypocalcemia is considered to be a so-called “gateway disease” that predisposes to a number of common fresh-cow disorders, such as dystocia, uterine prolapse, retained fetal membranes, mastitis, ketosis, abomasal displacement, ketosis, and immune suppression.<sup>5</sup> The costs per clinical case of milk fever have been estimated at US\$300, whereas subclinical cases may cost around US\$125 per case, based on estimates accounting for reduced milk production and increased risk of developing periparturient disorders such as ketosis or abomasal displacement.<sup>8</sup>

The literature on the effects of clinical and subclinical hypocalcemia is difficult to interpret because of the complex relationships between milk production, parity of lactation, breed of cattle, epidemiologic methods used, and management systems used, in addition to the reproducibility of the clinical observations and the accuracy of the recording systems used. In general, there is insufficient information available to document the consequences of milk fever and subclinical hypocalcemia. A summary of several consequences that have been examined follows here.

**Milk Fever Relapses.** Milk fever cases that need repeat treatment because of relapses increase the costs.

**Downer-Cow Complications.** The downer-cow syndrome associated with those milk fever cases that fail to respond to intravenous (IV) Ca treatment and remain recumbent for days before subsequently standing, those that die, or those that require destruction represents an important cause of economic

loss. The literature reports incidence rates for the downer-cow syndrome ranging from 3.8% to 28.2% of milk-fever cows, with a case fatality rate of 20% to 67%.<sup>9</sup>

**Dystocia and Reproductive Disease.** Hypocalcemia at the time of parturition can result in uterine inertia, which may cause dystocia and uterine prolapse. In general, there is an increased risk of dystocia associated with milk fever, whether the farmer or the veterinarian attends to the dystocia.<sup>5</sup>

**Retained Placenta.** Several studies have found an increased risk of retained placenta following milk fever.

**Metritis.** A few studies have found an indirect relationship between milk fever and subsequent metritis.

**Milk Production.** There is no reliable evidence that the occurrence of milk fever or subclinical hypocalcemia in cows that recover following treatment affects milk production in the subsequent lactation. Some studies have found a limited effect, no effect, or even positive effect of milk fever on milk production.

**Mastitis.** Hypocalcemia not only impairs immune function but furthermore may weaken the tone of the teat sphincter, which has been proposed to facilitate intramammary infection, particularly in recumbent cows that are not milked or milked less frequently.<sup>3</sup> An odds ratio of 8.1 for mastitis has been estimated, for coliform mastitis the odds ratio is estimated at 9.0, and for acute clinical mastitis a relative risk of 1.5 following milk fever has been found.

**Displacement of Abomasum.** Odds ratios ranging from 2.3 to 3.4 for left-side displacement of the abomasum occurring in dairy cows with hypocalcemia at parturition have been estimated.

**Ketosis.** Studies on the occurrence of ketosis following milk fever have found relative risks or odds ratios ranging from 1.3 to 8.9; using all the confidence intervals, the relative risks/odds ratios range from 1.1 to 15.3.

**Body Weight.** A temporary drop in body weight occurs in cows with milk fever, but there is no long-term effect. In cows with subclinical hypocalcemia in early lactation, there may be some weight loss compared with cows with normal levels of calcium.

**Culling.** There may be an increased probability of culling cows that have had milk fever because of the complications or direct or indirect consequences associated with the disease. There is some evidence of culling cows in early lactation because of milk fever, but not in late lactation.

## PATHOGENESIS

### Hypocalcemia

Calcium has several functions relevant for the pathophysiology of periparturient hypocalcemia, which include the following:

- Cell membrane stability: Calcium bound to cell membranes contributes to the maintenance of adequate membrane stability. In excitable cells the decreased availability of ionized Ca results in higher cell membrane permeability, thereby altering the resting membrane potential and making nerve cells more excitable.
- Muscle contractility: Calcium is required to clear the binding site for myosin on the actin molecule inside the muscle fibers. The cross-bridging between actin and myosin is the basis for the contraction of muscle fibers. Decreased availability of Ca can therefore affect muscle contractility.
- Release of acetylcholine: Calcium is required for the neuronal release of the neurotransmitter acetylcholine into the synaptic cleft of the neuromuscular junctions. Calcium depletion can thus hamper the signal transmission at the level of the neuromuscular endplate.

Whereas decreased membrane stability and ensuing increased excitability are the probable underlying cause of hypocalcemic tetany of monogastric species and the muscle twitching observed in the early stages of milk fever in cattle, disturbed muscle fiber contractility and neurotransmitter release are considered the basis of the flaccid paresis observed in advanced stages of milk fever in ruminants.

The plasma Ca concentration is normally maintained between 2.1 and 2.6 mmol/L (8.4 to 10.4 mg/dL). Almost all multiparous dairy cows will experience at least transient and subclinical hypocalcemia, less than 1.8 mmol/L (7.5 mg/dL), within 24 hours after calving. In some cows, hypocalcemia is more pronounced, causing neuromuscular dysfunction resulting in clinical milk fever. Without treatment, levels may continue to decline to values as low as or even below 0.5 mmol/L (2 mg/dL), which is usually incompatible with life.

Hypocalcemia is the cause of the signs of typical milk fever. Atony of skeletal muscle and plain muscle are well-known physiologic effects of hypocalcemia in ruminants.

### Experimental Hypocalcemia

Hypocalcemia can be induced experimentally by administering  $\text{Na}_2\text{-EDTA}$  intravenously, which results in the complex binding or chelation of ionized Ca. The IV infusion of  $\text{Na}_2\text{-EDTA}$  into cows over a period of 4 to 8 hours results in severe hypocalcemia and paresis and has been used extensively as a model for the reproduction of the disease. A standardized flow rate of 1.2 mL/kg per hour of a 5% solution of  $\text{Na}_2\text{-EDTA}$  until

recumbency results in changes in plasma ionized Ca, total Ca, inorganic phosphate (Pi), and magnesium comparable to what is observed in spontaneous cases of milk fever. Induced hypocalcemia results in depression of the frequency and amplitude of rumen contractions as early as 1.0 mmol/L of ionized serum Ca, well before any clinical signs of hypocalcemia are detectable and while feeding behavior and rumination are still normal. The induction of subclinical hypocalcemia in cows results in a linear decrease in feed intake and chewing activity as the plasma ionized calcium decreases. Feed intake depression was observed with ionized Ca concentrations below 0.9 mmol/L and before other signs commonly associated with hypocalcemia were recorded. Feed intake approached zero when ionized Ca concentrations declined to 0.6 mmol/L. This suggests that hypocalcemia may contribute to the reduction in feed intake prepartum and depresses the rumination process, ultimately leading to anorexia. Experimental hypocalcemia in cattle furthermore resulted in a marked reduction in cardiac stroke volume, a 50% reduction in arterial blood pressure, and a significant reduction in ruminal and abomasal tone and motility.

In experimental hypocalcemia in sheep, blood flow is reduced by about 60% to all tissues except the kidney, heart, lung, and bladder, in which the reduction is not as high. During periods of prolonged hypocalcemia in cows and ewes, blood flow to skeletal muscles and the alimentary tract may be reduced to 60% to 70% of normal for a long period, which may present a predisposing factor for the downer-cow syndrome. Serum Ca and Pi levels are significantly lower in clinical cases than in comparable normal cows, and there is some relationship between the severity of the signs and the degree of biochemical change.

Signs of hypocalcemic tetany, presumably attributable the increased membrane instability, commonly recognized in nonruminant species are observed in the initial stages of milk fever in cattle:

- Nervousness and early excitement
- Muscle twitching
- Tetany, particularly of the hindlimbs
- Hypersensitivity and convulsive movements of the head and limbs

There are additional signs in the experimental disease, such as excessive salivation, excessive lip and tongue actions, and tail lifting. The serum muscle enzyme levels of creatine phosphokinase (CPK) and aspartate aminotransferase (AST) increase as a result of muscle injury associated with prolonged recumbency. Blood glucose levels increase, and serum Pi and potassium levels decrease.

The prolonged infusion of  $\text{Na}_2\text{-EDTA}$  in sheep over 18 hours at a rate to induce hypocalcemia and maintain recumbency resulted in prolonged periods of recumbency ranging from 36 to 64 hours before the animals were

able to stand. There are also decreases in plasma sodium, plasma potassium, and erythrocyte potassium and prolonged increases in PCVs, suggesting that fluid replacement therapy may be indicated in cattle with prolonged recumbency associated with hypocalcemia. The activity of AST and CPK, the PCVs, and white blood cell (WBC) counts were elevated 24 hours later.

### Hypomagnesemia

Hypomagnesemia is recognized as an importing contributing factor to periparturient hypocalcemia and has been proposed to be the major risk factor for milk fever occurring in cattle in mid- to late lactation.<sup>3</sup> The two mechanisms through which Mg deficiency may predispose to hypocalcemia are an impaired release of PTH in response to hypocalcemia and decreased tissue sensitivity to PTH in hypomagnesemic states.<sup>3</sup> Hypomagnesemia can therefore predispose to clinical or subclinical milk fever by blunting the main counter-regulatory mechanism of hypocalcemia.

### Hypophosphatemia

Low serum Pi concentrations are commonly observed in milk-fever cows, but also in healthy dairy cows, around parturition.<sup>7</sup> Although the clinical relevance of hypophosphatemia in recumbent cattle remains uncertain, empirical associations between hypophosphatemia and recumbency have been established.<sup>9</sup> Anecdotal reports from field veterinarians suggest that the numbers of recumbent periparturient dairy cows not responding to standard therapy with intravenous Ca salts and showing pronounced hypophosphatemia have increased in recent years. To date, however, there is no unequivocal evidence corroborating the hypothesis that hypophosphatemia plays a role in periparturient recumbency or confirming the treatment efficacy of oral or parenteral Pi supplementation to recumbent cattle.<sup>7</sup>

## CLINICAL FINDINGS

### Cattle

Three stages of milk fever in cattle are commonly recognized and described.

#### Stage 1

In the first stage, the cow is still standing. This is also the brief stage of nervousness, excitement, and tetany with hypersensitivity and muscle tremor of the head and limbs. The animal is disinclined to move and often has a decreased or no feed intake. There may be a slight shaking of the head, protrusion of the tongue, and grinding of the teeth. The rectal temperature is usually normal to slightly above normal; the skin may feel cool to the touch. The animal appears ataxic, with a stiff and insecure gait, and falls easily. Close examination reveals agalactia, rumen stasis, and scant feces. Heart rate and respirations may be within normal limits or slightly elevated.



## Stage 2

The second stage is characterized by sternal recumbency with depressed consciousness; the cow has a drowsy appearance in sternal recumbency, usually with a lateral kink in the neck or the head turned into the flank (Fig. 17-4). When approached, some of these cows will open their mouths, extend the head and neck, and protrude their tongues, which may be an expression of apprehension and fear in an animal unable to stand. The tetany of the limbs present in the first stage is not present, and the cow is unable to stand. The muzzle is dry, the skin and extremities cool, and the rectal temperature subnormal (36 to 38°C, 97 to 101°F). There is a marked decrease in the absolute intensity of the heart sounds, whereas the heart rate is increased (about 80 bpm). The arterial pulse is weak and the venous pressure is also low, making it difficult to raise the jugular veins. The respirations are not markedly affected, although a mild forced expiratory grunt or groan is sometimes audible. Ruminal stasis and secondary bloat are common, and constipation is characteristic. There is also relaxation of the anus and loss of the anal reflex.

The eyes are usually dry and staring. The pupillary light reflex is incomplete or absent, and the diameter of the pupil varies from normal to maximum dilatation. A detailed examination of the pupils of cows with parturient paresis, nonparetic disorders, and nonparturient paresis found that the mean sizes of the pupils were not significantly different from one another. Rather, disparity of the size of the pupils was common. In cows that develop hypocalcemia a few hours before or at the time of parturition, the second stage of parturition may be delayed. Vaginal examination usually reveals a fully dilated cervix and normal presentation of the

fetus. The cow may be in any stage of milk fever, and administration of Ca-salts IV will usually result in a rapid beneficial response and normal parturition.

Prolapse of the uterus is a common complication of milk fever, and often the Ca levels are lower than in parturient cows without uterine prolapse. Thus it is standard practice to treat cases of uterine prolapse with IV calcium salts.

## Stage 3

The third stage is characterized by a severely obtunded or even comatose cow in lateral recumbency. There is complete flaccidity on passive movement, and the cow cannot assume sternal recumbency on its own. In general, the depression of temperature and the cardiovascular system are more marked. The heart sounds are almost inaudible, and the rate is increased up to 120 bpm; the pulse is almost impalpable, and it may be impossible to raise the jugular veins. Bloat is common because of prolonged rumen stasis and lateral recumbency. Without treatment, a few animals remain unchanged for several hours, but most become progressively worse during a period of several hours and die quietly from shock in a state of complete collapse.

**Concurrent Hypomagnesemia.** Mild to moderate tetany and hyperesthesia persisting beyond the first stage suggests a concurrent hypomagnesemia. There is excitement and fibrillary twitching of the eyelids, and tetanic convulsions are readily precipitated by sound or touch. Trismus may be present. The heart and respiratory rates are increased, and the heart sounds are much louder than normal. Without treatment, death occurs during a convulsion.

## Sheep and Goats

The disease in pastured ewes is similar to that in cattle. The early signs include a stilty, proppy gait and tremor of the shoulder muscles. Recumbency follows, sometimes with tetany of the limbs, but the proportion of ewes with hypocalcemia that are recumbent in the early stages is much less than in cattle. A similar generalization applies to female goats. The characteristic posture is sternal recumbency, with the legs under the body or stretched out behind. The head is rested on the ground, and there may be an accumulation of mucus exudate in the nostrils. The venous blood pressure is low and the pulse impalpable. Mental depression is evidenced by a drowsy appearance and depression of the corneal reflex. There is loss of the anal reflex, constipation, tachycardia, hyposensitivity, ruminal stasis and tympany, salivation, and tachypnea. Response to parenteral treatment with Ca salts is rapid; the ewe is normal 30 minutes after an SC injection. Death often occurs within 6 to 12 hours if treatment is not administered. The syndrome is usually more severe in pregnant than in lactating ewes, possibly because of the simultaneous occurrence of pregnancy toxemia or hypomagnesemia. Fat late-pregnant ewes on high-grain diets indoors or in feedlots show a similar syndrome accompanied by prolapses of the vagina and intestine.

## CLINICAL PATHOLOGY

Total serum Ca levels are reduced to below 2.0 mmol/L (8 mg/dL), usually to below 1.2 mmol/L (5 mg/dL), and sometimes to as low as 0.5 mmol/L (2 mg/dL). The reduction is usually, but not always, proportional to the severity of the clinical syndrome. Average figures for total serum Ca levels in the three species are as follows: cows,  $1.30 \pm 0.30$  mmol/L ( $5.2 \pm 1.2$  mg/dL); ewes,  $1.15 \pm 0.37$  mmol/L ( $4.6 \pm 1.5$  mg/dL); goat does,  $0.94 \pm 0.15$  mmol/L ( $3.8 \pm 0.6$  mg/dL).

Although the concentration of ionized Ca, which is the biologically active fraction of the total Ca pool, is the factor determining the presence and severity of clinical signs in hypocalcemic animals, the total serum Ca concentration is commonly used for convenience. Measurement of ionized Ca concentration requires the use of ion-selective electrodes, which have become much more accessible in recent decades. Nonetheless, the association between ionized and total Ca in serum is tight, with excellent correlation between the two, which is why total Ca concentration in serum is considered clinically useful and sufficiently accurate in practice.<sup>3</sup> Between 42% and 48% of the total Ca content in the extracellular space is available as biologically active ionized Ca. A decrease in serum albumin or acidemia tends to increase the ionized Ca fraction, whereas alkalemia or an increase in serum albumin tends to decrease the proportion of ionized Ca.<sup>3</sup> Equine, bovine, and ovine blood may be



**Fig. 17-4** Friesian cow with stage 2 periparturient hypocalcemia. The cow is unable to stand without assistance.

stored for up to 48 hours without any clinically relevant alteration of blood Ca ion concentration.

Levels of ionized Ca in the venous whole blood of cows are as follows: normal, 1.06 to 1.26 mmol/L (4.3 to 5.1 mg/dL); slight hypocalcemia, 1.05 to 0.80 mmol/L (4.2 to 3.2 mg/dL); moderate, 0.79 to 0.50 mmol/L (3.2 to 2.0 mg/dL); severe hypocalcemia, less than 0.50 mmol/L (<2.0 mg/dL). Total serum Ca levels are reduced below normal in all cows at calving, whether they have milk fever or not, but not in ewes.

Serum **magnesium** levels are usually moderately elevated to 1.65 to 2.06 mmol/L (4 to 5 mg/dL), but in some areas low levels may be encountered, especially in cows at pasture.

Serum **inorganic phosphorus (Pi)** levels are usually depressed to 0.48 to 0.97 mmol/L (1.5 to 3.0 mg/dL).

**Blood glucose** levels are usually normal, although they may be depressed if ketosis occurs concurrently. Higher-than-normal blood glucose levels are likely to occur in cases of long duration and are presumable because Ca is required for the release of insulin from the pancreas.

#### Serum Muscle Enzyme Activity

Prolonged recumbency results in ischemic muscle trauma and necrosis and increases in the serum muscle enzyme activity of creatine kinase (CK) and aspartate aminotransferase (AST). During prolonged recumbency following treatment for milk fever, the levels of CK will remain elevated if muscle trauma is progressive in animals that are not rolled from side to side every few hours to reduce the effects of compression on the large muscle groups of the pelvic limbs (see also the discussion under “**Downer-Cow Syndrome**” in this chapter).

#### Hemogram

Changes in the leukocyte count include eosinopenia, neutrophilia, and lymphopenia suggestive of adrenal cortical hyperactivity, but similar changes occur at calving in cows that do not develop parturient paresis. High plasma cortisol levels and PCVs occur in cows with milk fever and are higher still in cows that do not respond to treatment. They are expressions of stress and dehydration. Clinicopathological findings in the other species are not described in detail except with regard to depression of total serum calcium levels.

#### NECROPSY FINDINGS

There are no gross or histologic changes unless concurrent disease is present.

#### DIFFERENTIAL DIAGNOSIS

A diagnosis of milk fever is based on the occurrence of paresis and depression of consciousness in animals following parturition. The diagnosis is supported by a favorable

response to treatment with parenteral injections of calcium solutions and by biochemical examination of the blood. In ewes, the history usually contains some reference to recent physical stress, and the disease is more common in the period preceding lambing.

There are several diseases that cause recumbency in cows in the immediate postpartum period, and their differentiation is summarized in [Table 17-5](#).

Several diseases that occur at the time of parturition must be differentiated from milk fever in cattle. These are grouped here according to the following categories:

- Other metabolic diseases
- Diseases associated with toxemia and shock
- Injuries to the pelvis and pelvic limbs
- Degenerative myopathy
- Downer-cow syndrome

#### Metabolic Diseases

**Hypomagnesemia** may occur as the sole cause of recumbency; it may accompany a primary hypocalcemia or result in secondary hypocalcemia so that the case presented is one of parturient paresis complicated by lactation tetany. Hyperesthesia, tetany, tachycardia, and convulsions are common instead of the typical findings of depression and paresis in milk fever.

**Hypophosphatemia**, which commonly accompanies milk fever, is suggested as a cause of continued recumbency in cows after partial response to Ca therapy; serum Pi levels are low and return to normal if the cow stands or following treatment with calcium salts. The role of hypophosphatemia in the etiology of periparturient recumbency in cattle is under contentious debate. Although there is no unequivocal evidence available supporting the role of P in the etiology of recumbency in cattle, cows not responding to IV Ca were found to have lower serum Pi levels.<sup>7,9</sup>

**Severe hypokalemia (<2.5 mmol/L)** in dairy cows is characterized by extreme weakness or recumbency, especially after treatment for ketosis with isoflupredone.<sup>10</sup> Clinical signs tend to resemble botulism rather than hypocalcemia, with flaccid paralysis of the tongue and masticatory muscles and the head resting on the ground rather than on the chest of the cow. The case-fatality rate is high in spite of therapy with potassium. Hypokalemic myopathy is present at necropsy.

**Ketosis** may complicate milk fever, in which case the animal responds to Ca therapy by standing but continues to manifest the clinical signs of ketosis, including in some cases the nervous signs of licking, circling, and abnormal voice.

#### Diseases Associated With Toxemia and Shock

During the immediate postparturient period, several diseases occur commonly and are characterized by toxemia.

**Acute or peracute coliform mastitis** is characterized by one or several obviously enlarged and inflamed mammary glands with watery and serouslike secretions that may be overlooked if the cow is recumbent. Other signs include fever in early stages that may be followed by hypothermia in advanced stages of toxemia or septicemia, tachycardia, dehydration, depression and weakness up to the point of recumbency, ruminal stasis, and frequently also watery diarrhea.

**Aspiration pneumonia** secondary to regurgitation and aspiration of rumen contents is a complication of third-stage milk fever, or accidental aspiration or fluid administration into the trachea of periparturient cattle that were meant to be drenched. Fever, dyspnea, expiratory grunt, severe depression, and anxiety are common. Auscultation of the lungs reveals the presence of abnormal lung sounds. Aspiration pneumonia should be suspected if the animal has been lying on its side, especially if there is evidence of regurgitation of ruminal contents from the nostrils, no matter how small the amount, or if there is a history of the animal having been drenched. Abnormal auscultatory findings may not be detectable until the second day. Early diagnosis is imperative if the animal is to be saved, and the mortality rate is always high.

**Acute diffuse peritonitis** resulting from traumatic perforation of the abomasum or uterus is characterized by severe depression, tachycardia, dehydration, rumen stasis, fever, weakness and recumbency, grunting or groaning with respiration, and possibly splashing sounds on ballottement of the abdomen.

**Carbohydrate engorgement (grain overload)** results in depression, dehydration, tachycardia, hypothermia, diarrhea, and weakness up to the point of recumbency. The rumen is atonic and mildly to moderately bloated. The rumen content is watery, and the fiber mat is absent. A positive steelband sound and splashing sounds may be audible over the rumen on auscultation and percussion of the left flank. Examination of the rumen fluid will reveal a sour smell with low pH (<5.0). Microscopic examination of a smear will reveal absence of living protozoa and a predominance of gram-positive microorganisms if a stain is performed.

**Toxemic septic metritis** occurs most commonly within a few days after parturition and is characterized by depression, anorexia, fever, tachycardia (100 to 120 bpm), ruminal stasis, and presence of foul-smelling uterine discharge found on vaginal examination. The fetal placenta may be retained. Some affected cows are weak and prefer recumbency, which resembles milk fever.

Prolapse and rupture of the uterus cause varying degrees of shock, with tachycardia, hypothermia and cool extremities, weakness and recumbency, and rapid death. A history of difficult parturition or assisted dystocia

**Table 17-5** Parturient paresis: Differential diagnosis of common causes of recumbency in parturient adult cattle

Disease	Epidemiology	Clinical signs	Clinical pathology	Response to treatment
Milk fever (parturient paresis)	Mature cows, within 48 hours of calving, some in midlactation	Early excitement and tetany, then depression, coma, hypothermia, flaccidity, pupil dilatation, weak heart sounds No rumen movements HR increases as state worsens	Hypocalcemia, with total Ca < 5 mg/dL (1.25 mmol/L) calcium frequently combined with hypophosphatemia with low inorganic phosphate, < 3 mg/dL (0.9 mmol/L)	Rapid, characteristic response (muscle tremor, sweating on muzzle, defecation, urination, pulse amplitude and heart rate decrease and heart sound intensity improves after IV administration of Ca salt solutions)
Downer cows following milk fever	Most common in situation where milk fever and lactation tetany are common and intensity of treatment is lax; cows are left down too long before treatment	Moderately bright, active, eating Temp. slightly raised, HR 80–100 Unable to stand but tries—creepers or alert downer cows When dull and depressed—nonalert downers Long course, 1–2 weeks	Variable May be low inorganic phosphate, or potassium, or glucose Ketonuria, plasma CPK, and AST elevated	Variable response to calcium, phosphorus, and potassium salts Fluid therapy and provision of deep bedding and hourly rolling from side to side are necessary
Carbohydrate engorgement	Access to large amount readily fermentable carbohydrate when not accustomed Enzootic in high-grain rations in feedlots Intensive IV fluid and electrolyte therapy necessary for survival	Severe gastrointestinal atony with complete cessation of ruminal activity Fluid splashing sounds in rumen Severe dehydration, circulatory failure Apparent blindness, then recumbency and too weak to rise Soft, odoriferous feces	Hemoconcentration with severe acidosis, pH of rumen fluid below 5, serum calcium may be depressed No living protozoa in rumen	Rumenotomy or rumen lavage may be necessary Oral antibiotics, alkalinizing agents per os and IV
Hypomagnesemia (lactation, grass tetany)	All classes and ages of cattle, but most recently calved cows May occur in pregnant beef cattle	Excitement, hypersensitivity, muscle tremor, tetany Recumbent with tetanic convulsions, loud heart sounds, rapid rate Subacute cases remain standing	Low serum magnesium, < 1.2 mg/dL (0.5 mmol/L), low (undetectable) urine magnesium	Even after IV injection, response in a severe case may take 30 min, much slower than response to calcium in milk fever
Severe toxemia (acute diffuse peritonitis, coliform mastitis)	Sporadic only Mastitis most common where hygiene poor Peritonitis as a result of foreign body perforation of reticulum, perforation of abomasal ulcer, rupture of uterus or vagina	Recumbency, depression to coma, sleepy, dry nose, hypothermia, gut stasis, heart rate > 100 beats/min, may be grunting Examine mammary gland Examine abdomen for abdominal disease	Profound leukopenia Serum calcium may be as low as 7–8 mg/dL (1.75–2.0 mmol/L) Examine milk	Require supportive response for toxemia and shock Response is poor and temporary Prognosis very bad May die if treated IV with calcium or magnesium salts
Fat-cow syndrome	Fat dairy or beef cows in late gestation or at parturition Some predisposing cause precipitates illness in fat animals	Excessive body condition, anorexia, apathy, depression, recumbency that looks like milk fever, scant soft feces, ketonuria	Evidence of hepatic disease	Will recover if begin to eat Treat with fluids, glucose, insulin Provide good-quality palatable roughage
Physical injuries	Ruptured gastrocnemius, dislocation of hip, etc. Sporadic sequelae to milk fever, may be contributed to by osteoporosis, slippery ground surface, stimulating to rise too early	As for Maternal obstetric paresis with ruptured gastrocnemius, hock remains on ground when standing Excessive lateral mobility of limb with hip dislocation	Increase serum CK and AST activity	Supportive therapy, deep bedding, and frequent rolling
Acute hypokalemia	Dairy cattle treated for ketosis with isoflupredone acetate Calved within previous 30 days	Recumbent, very weak, appear flaccid, in sternal or lateral recumbency, unable to support head off ground, hold head in flank, anorexia; cardiac arrhythmia may present Most die or are euthanized	Serum potassium below 2.5 mEq/L Muscle necrosis at necropsy	Potassium chloride orally or very carefully IV (drip infusion)

AST, aspartate aminotransferase; CK, creatine kinase; IV, intravenous.

with fetotomy may be associated with rupture of the uterus. The administration of calcium salts may cause ventricular fibrillation and sudden death.

Although some elevation of the temperature may be observed in these severe

toxemic states, it is more usual to find a subnormal temperature. The response to Ca therapy is usually a marked increase in heart rate, and death during the injection is common. Every case of recumbency must be carefully examined because these

conditions may occur either independently or as complications of parturient paresis. In our experience, about 25% of cases of postparturient recumbency in cows are attributable primarily to toxemia or injury rather than to hypocalcemia.



## Injuries to the Pelvis and Pelvic Limbs

Injuries to the pelvis and pelvic limbs are common at parturition because of the marked relaxation of the ligaments of the pelvic girdle. Seven types of leg abnormalities have been described in this group at an incidence level of 8.5% in 400 consecutive cases of parturient paresis. The described abnormalities include radial paralysis, hip dislocation, and rupture of gastrocnemius muscle. In most instances the affected animals are down and unable to stand, but they mentally alert; eat, drink, urinate, and defecate normally; have a normal temperature and heart rate; and make strong efforts to stand, particularly with the forelimbs.

Maternal obstetric paralysis is the most common injury. Although this occurs most frequently in heifers after a difficult parturition, it may also occur in adult animals following an easy birth and occasionally before parturition, especially in cows in poor body condition. The mildest form is evidenced by a frequent kicking movement of a hindleg, as though something was stuck between the claws. All degrees of severity—from the mild kicking through knuckling and weakness of one or both hindlegs, to complete inability to rise—may occur, but sensation in the affected limb is usually normal. There is traumatic injury to the pelvic nerves during passage of the calf. There are often gross hemorrhages, both deep and superficial, and histopathological degeneration of the sciatic nerves. In individual animals, injury to the obturator nerves is common and results in defective adduction of the hindlimbs. The position of the hindlimbs may be normal, but in severe cases, especially those with extensive hematoma along the sciatic nerve trunk, the leg may be held extended with the toe reaching the elbow as in a dislocation of the hip; however, in the latter case there is exaggerated lateral mobility of the limb. Additional injuries causing recumbency near parturition include those associated with degenerative myopathy, dislocation of the hip, and ventral hernia.

Dislocation of the coxofemoral joint can cause recumbency and inability to stand in some cows, whereas others can stand and move around. Recumbent cows are usually in sternal recumbency, and the affected limb is abducted excessively. In standing cows, the affected limb is usually extended, often difficult to flex, and often rotated about its long axis. The diagnostic criteria are as follows:

- Sudden onset of lameness with the affected limb extended and possibly rotated
- Displacement of the greater trochanter of the femur from its normal position relative to the ischiatic tuber and coxal tuber of the pelvis (compare left and right rear limb)
- Ability to abduct the limb manually beyond its normal range

- Crepitus in the hip on abduction and rotation of the limb
- Ability to palpate the femoral head per rectum or per vaginam against the cranial border of the ilium or pubis in cases of cranioventral dislocation, or in the obturator foramen in cases of caudoventral dislocation

Manual replacement by closed reduction is successful in 80% of cases of craniodorsal dislocation and in 65% of cases of caudodorsal dislocation; relapses are, however, common. The ability to stand before reduction is the most useful prognostic aid.

## Degenerative Myopathy (Ischemic Muscle Necrosis)

Degenerative myopathy, affecting primarily the large muscles of the thighs, occurs commonly in cattle that have been recumbent for more than several hours. At necropsy, large masses of pale muscle are present, surrounded by muscle of normal color. Clinically it is indistinguishable from sciatic nerve paralysis. Markedly increased serum activities of CK occur in cows recumbent for several hours following the initial episode of milk fever as a result of ischemic necrosis. Persistent elevation of CK activity indicates progressive ischemic muscle necrosis as a result of continued compression of the large muscle masses of the pelvic limbs. Rupture of the gastrocnemius muscle or separation of its tendon from either the muscle or the tuber calcis may also cause myopathy.

## Downer-Cow Syndrome

Downer-cow syndrome is a common sequel to milk fever in which postparturient cows that may initially have been hypocalcemic remain recumbent for unknown reason after repeated intravenous treatment with Ca salts. Following treatment, most of the clinical findings associated with milk fever resolve, but the animal remains unable to stand. Clinically, the animal may be alert with normal or slightly decreased appetite and will commonly recover and stand normally within several hours or a few days. The animal's vital signs are within the normal range, and its alimentary tract function is normal. However, some affected animals are anorexic, may not drink, exhibit bizarre movements of lying in lateral recumbency, dorsally extend the head and neck frequently, moan and groan frequently, assume a frog-legged posture with the pelvic limbs, and crawl or creep around the stall; these animals may die or are euthanized for humane reasons within a few days. The diagnostic dilemma with these cows is that, at least initially, they resemble cows with milk fever, and whether or not to treat them with additional amounts of calcium salts is questionable.

## Nonparturient Hypocalcemia

Paresis with mental depression and associated with low total serum Ca levels can occur

in cows at times other than at parturition. The cause is largely unexplained, but hypomagnesemia has been proposed as a major risk factor for this atypical form of clinical milk fever in cattle.<sup>3</sup> Hypocalcemia may also occur after gorging on grain and may be a significant factor in particular cases. Sudden rumen stasis as a result of traumatic reticulitis may rarely cause hypocalcemic paresis. Diarrhea, particularly when cattle or sheep are placed on new lush pasture, may also precipitate an attack. Access to plants rich in oxalates may have a similar effect, particularly if the animals are unaccustomed to the plants. Affected animals respond well to Ca therapy, but relapse is likely unless the primary cause is corrected. The differential diagnosis of diseases of nonparturient cows manifested principally by recumbency is also summarized in Table 17-5.

## Hypocalcemic Paresis in Sheep and Goats

Hypocalcemia in sheep must be differentiated from pregnancy toxemia, in which the course is much longer, the signs indicate cerebral involvement, and the disease is restricted to pregnant ewes. There is no response to Ca therapy, and a positive test for ketonuria is almost diagnostic of pregnancy toxemia. At parturition, goats are susceptible to enterotoxemia and hypoglycemia (rarely), both of which present clinical signs similar to parturient paresis.

## Hypocalcemia in Sows

Hypocalcemia is rare in sows. The disease must be differentiated from the mastitis, metritis, and agalactia complex, which is characterized by fever, agalactia, anorexia, toxemia, and enlarged and inflamed mammary glands.

## Treatment

Every effort must be made to treat affected cows as soon as possible after clinical signs are obvious. Treatment during the first stage of the disease, before the cow is recumbent, is the ideal situation. The longer the interval between the time the cow first becomes recumbent and treatment, the greater the incidence of downer-cow syndrome as a result of ischemic muscle necrosis from prolonged recumbency. Complications of milk fever occur when cows have been in sternal recumbency for more than 4 hours. Farmers must be educated to appreciate the importance of early treatment. Cows found in lateral recumbency (third stage) should be placed in sternal recumbency until treatment is available. This will facilitate eructation and reduce the risk of aspiration if the cow regurgitates. Cows that have difficulty finding solid, nonslip footing beneath them will often not try to stand and may develop ischemic myonecrosis. Avoidance of this complication necessitates the placement of rubber or other mats under the cow or

transportation of the cow to a piece of pasture with a dense sward on it.

### Standard Treatment

IV with solutions containing Ca as Ca-gluconate, Ca-borogluconate, and—nowadays less commonly—as Ca-chloride is the treatment of choice. Most cows with milk fever can be treated successfully with Ca salt solutions providing 8 to 10 g of Ca (Ca-borogluconate is 8.3% Ca). The dose rate of Ca is frequently under discussion. A typical treatment for an adult lactating dairy cow with periparturient hypocalcemia is 500 mL of 23% Ca-borogluconate by slow IV injection with cardiac auscultation; this provides 10.7 g of Ca. Although the calculated Ca deficit in a recumbent periparturient dairy cow is 4 g Ca, additional Ca should be provided to overcome the ongoing losses in milk.<sup>6</sup> Underdosing increases the chances of incomplete response, with inability of the cow to rise, or of relapse, whereas considerable overdosing may result in potentially fatal cardiac toxicity. Additional subcutaneous administration of Ca-borogluconate (500 mL) markedly decreased the relapse rate in cattle receiving 500 mL of Ca-borogluconate IV for the treatment of hypocalcemia.<sup>6</sup>

The standard rate of administration is a rapid IV administration of the calculated dose of Ca-borogluconate over a period of 15 minutes. The maximum safe rate of Ca administration in cattle was determined to be 0.07 mEq of ionized Ca per kg body weight per minute, which is equivalent to 0.065 mL of a 23% Ca-borogluconate per kg body weight per minute.<sup>6</sup> An average nonhypocalcemic 600-kg cow could therefore safely be treated with intravenous Ca-borogluconate (23%) at an infusion rate of 39 mL/min. Immediately following IV administration of Ca-borogluconate over a period of 12 to 15 minutes, treated animals are commonly markedly hypercalcemic (up to 6 mmol/L or 24 mg/dL). The plasma Ca concentration will then gradually decline over a period of several hours. Although the direct effect of intravenously administered Ca does not last for more than 6 to 8 hours, this transient correction of hypocalcemia in most cases is not only associated with clinical recovery of recumbent animals, but also with improved feed intake and enhanced gastrointestinal motility, which will result in improved intestinal Ca absorption. This latter effect, which relies on the availability of adequate amounts of Ca for absorption in the digestive tract, is responsible for the sustained correction of hypocalcemia observed in most cases. However, in some cows, mechanisms regulating the Ca homeostasis are less effective or the oral Ca supply is insufficient, and subclinical or clinical hypocalcemia may recur. For this reason, it is astute to follow up on intravenously treated animals with oral supplementation of Ca salts for 1 to 2 days.

Because of concerns with these rapid and short-lived peaks in plasma Ca after rapid infusion of Ca salt solutions, it has been suggested that slower IV infusion might be safer and more effective. The slow infusion of a Ca solution via an IV indwelling catheter over 6 hours was compared with the conventional single IV administration of 600 mL of a 40% Ca-borogluconate and 6% Mg-hypophosphite solution over 15 minutes in cows recumbent with milk fever. Cows receiving the rapid infusion responded more quickly, stood sooner, and returned to normal demeanor more quickly. The slow infusion consisted of 200 mL IV over a 10-minute period, with the remaining 400 mL added to 10 L of a solution of 90 g sodium chloride and 500 g glucose and given via IV drip over a 6-hour period at a rate of 1.7 L/h. In cows treated rapidly, the serum Ca and magnesium levels increased rapidly compared with the infused cows. In sheep and goats, the recommended amount is 15 to 20 g IV with an optional 5 to 10 g SC. Sows should receive 100 to 150 mL of a similar solution IV or SC.

### Routes of Administration

#### IV Route

The IV route is preferred because the response is rapid and obvious. The heart should be auscultated throughout the IV administration for evidence of gross arrhythmia, bradycardia, and tachycardia. Although bradycardia is a normal response to Ca administration in hypocalcemic animals and is of no concern, the IV administration should be interrupted in case arrhythmia or pronounced tachycardia is noticed. If the cardiac irregularity continues, the remainder of the solution can be given subcutaneously. The best recommendation is to give as much of the solution as possible intravenously and the remainder subcutaneously. The common practice of giving half the dose intravenously and half subcutaneously is a reasonable compromise because with this method there are fewer relapses. If a cow has been previously treated subcutaneously by the farmer, additional Ca given intravenously may cause toxicity if the improved circulation enhances the absorption of the subcutaneous Ca.

Toxemic cows are very susceptible to the IV administration of Ca-borogluconate, and death may occur. In such cases the heart rate increases markedly (up to 160 bpm); there is respiratory distress, trembling, and collapse; and the cow dies within a few minutes. SC or IV administration is preferred in cows with severe toxemia as a result of aspiration pneumonia, metritis, and mastitis.

### Typical Response to Intravenous Ca-Borogluconate

Cows with milk fever exhibit a typical pattern of response to Ca-borogluconate IV if the response is favorable, including:

- Belching
- Muscle tremor, particularly of the flanks and often extending to the whole body
- Slowing and improvement in the amplitude and pressures of the pulse
- Decrease of the heart rate
- Increase in the intensity of the heart sounds
- Sweating of the muzzle
- Defecation

The feces are in the form of a firm fecal ball with a firm crust and covered with mucus. Urination usually does not follow until the cow stands. A slight transitory tetany of the limbs may also be observed. Many cows will eat and drink within minutes following successful treatment if offered feed and water.

In general, recovery can be expected in 75% of cases within 2 hours; in 10% recovery is complicated by one of the diseases discussed earlier, and 15% can be expected either to die or to require disposal. Of those that recover after one treatment, 25% to 30% can be expected to relapse and require further treatment.

### Unfavorable Response to Intravenous Ca-Borogluconate

An unfavorable response is characterized by a marked increase in heart rate in cows affected with toxemia and bradyarrhythmia in animals developing an atrial block as a result of Ca overdosage. Overdosage may occur when a standard dose is administered to quickly, when an excessive dose is administered, when repeated doses are administered in excess of requirements, or when an individual with increased sensitivity to Ca is treated. Toxicity can, for instance, occur when farmers treat cases unsuccessfully by multiple SC injections and these are followed by an IV dose. When the peripheral circulation is poor, it is probable that the calcium administered subcutaneously is not absorbed until the circulation improves following the IV injection, and the large doses of Ca then absorbed cause acute toxicity.

Increased sensitivity to Ca has been reported in toxic animals with coliform mastitis or toxic metritis and in cows with severe ketosis or hepatic lipidosis. Hypokalemia that is common in anorectic animals may present a further factor predisposing to increased sensitivity of the heart muscle to excessive Ca doses. Sudden death may also occur after calcium injections if the cow is excited or frightened, which may be the result of an increased sensitivity to epinephrine. When affected cows are exposed to the sun or a hot, humid atmosphere, heatstroke may be a complicating factor. In such cases an attempt should be made to reduce the temperature to below 39.5°C (103°F) before the calcium is administered.

In all cases of IV treatment with Ca salts, the circulation must be monitored closely. If there is gross arrhythmia or a sudden increase in heart rate, the injection should be

discontinued. In normal circumstances at least 15 minutes should be taken to administer the standard dose. The acute toxic effect of calcium salts seems to be exerted specifically on heart muscle, with a great variety of defects occurring in cardiac action; the defect type depends on the specific Ca salt used and the speed of injection. Electrocardiogram (ECG) changes after induced hypercalcemia show increased ventricular activity and reduced atrial activity. Atropine is capable of abolishing the resulting arrhythmia.

### SC Route

The SC route is commonly used by farmers who treat affected cows at the first sign of hypocalcemia, preferably during the first stage when the cow is still standing. The SC route has also been used by veterinarians when the effects of IV administration of Ca are uncertain or if an unusual response occurs during IV administration. The main inconvenience of the SC route of administration is that the absorption is difficult to predict because of the often comprised blood flow to the periphery in affected animals.<sup>11</sup> Subcutaneous treatment with Ca solutions is inappropriate with severe hypocalcemia or dehydration because absorption in these animals is impaired, which may result in a markedly delayed treatment effect.<sup>8</sup> The amount of Ca administered per injection site should be limited to 1 to 1.5 g, which is equivalent to 50 to 75 mL of most commercial Ca infusion solutions.<sup>11</sup> Although most solutions containing Ca-gluconate or Ca-borogluconate are suitable for SC administration, the SC administration of salt solutions containing Ca-chloride should be avoided because these formulations are highly caustic. The SC administration of Ca solutions also containing glucose, particularly at higher concentrations, is discouraged because concentrated glucose can result in pronounced tissue irritation.<sup>8</sup> Administration of 500 mL of a 23% Ca-borogluconate solution over 10 injection sites was associated with an increase of the plasma Ca concentration of over 15% within 30 minutes; the plasma Ca concentration returned to baseline concentrations within 6 hours of treatment.<sup>8</sup>

### Oral Route

Or administration of different Ca salts has been practiced for decades. Oral formulations are commonly based on Ca-chloride (CaCl<sub>2</sub>) and Ca-propionate. Calcium chloride formulations have the advantage of low cost and a small volume required to administer an appropriate dose of 50 g Ca, but they are highly caustic and may cause severe damage of the digestive tract mucosa exposed to the concentrated formulation. Repeated treatment with CaCl<sub>2</sub> may furthermore result in uncompensated metabolic acidosis in treated animals.<sup>11</sup> In contrast, Ca-propionate formulations require a higher volume to provide the same amount of Ca and are absorbed at a slower rate but are less

injurious to tissue and do not alter the acid-base equilibrium. In these formulations, the availability of propionate, which is a glucose precursor, has been marketed as a further potential advantage, but studies investigating the effect of the gluconate contained in these products failed to identify any positive effects on plasma glucose, insulin, or NEFA concentration in cows treated with Ca-gluconate.<sup>12</sup> Oral CaCl<sub>2</sub> formulations typically contain 50 g of Ca and increase the plasma Ca concentration within 30 minutes and for at least 6 hours.<sup>6,8</sup> Oral Ca formulations should only be administered to cattle with undisturbed swallowing ability, which precludes their use as first-line treatment in animals in an advanced stage of clinical hypocalcemia.

### Failure to Respond to Treatment

A failure to respond favorably to treatment may be the result of an incorrect or incomplete diagnosis, or inadequate treatment. A poor response to treatment includes: (1) no observable changes in the clinical findings immediately following the calcium administration, or (2) the animal may respond to the calcium in all respects with the exception of being unable to stand for varying periods of time following treatment. An inadequate response also includes relapse after successful recovery, which usually occurs within 48 hours of the previous treatment. The needs of individual animals for Ca replacement vary widely depending on many factors, such as the body weight, milk yield, age, and degree of hypocalcemia. Incomplete responses may be more common in older cows and in cases of inability of the normal mechanisms to maintain serum Ca levels during the period of sudden changes in the equilibrium input and output of the extracellular Ca pool. The duration of the illness and the severity of clinical signs at the time of first treatment also affect the treatment response. In an extensive field study, there were no downer cows or deaths in cows still standing when first treated, 13% of downers and 2% of deaths occurred in cows in sternal recumbency when first treated, and 37% of downers and 12% of deaths occurred in cows in lateral recumbency when first treated. Therefore, in general, the longer the period from onset of milk fever to treatment, the longer the period of posttreatment recumbency and the higher the case-fatality rate. The best procedure to follow if response does not occur is to revisit the animal at 6- to 12-hour intervals and check the diagnosis. If no other cause of the recumbency can be determined, the initial treatment can be repeated on a maximum of three occasions. Beyond this point, further calcium therapy is seldom effective.

### GENERAL MANAGEMENT AND CLINICAL CARE PROCEDURES

The care of the cow and the calf following milk fever is important. If the cow is recumbent for any length of time, she must be kept propped up in sternal recumbency and not

left in lateral recumbency, which may result in tympany, regurgitation, and aspiration pneumonia. The cow should be rolled from side to side every few hours and provided with adequate bedding or moved to a suitable nonslip ground surface. In extreme climatic conditions, erection of a shelter over the cow is advisable if she cannot be moved to permanent shelter. If a cow is recumbent for more than 48 hours, occasional assisted lifting using appropriate cow lifters should be considered. However, heroic measures to get cows to stand should be avoided. Gentle nudging in the ribs or the use of an electric prod are the maximum stimulants advised. The best assistance that can be given to a cow attempting to stand is a good heave at the base of the tail when she is halfway up.

### TREATMENT AND CONTROL

#### Treatment

- Calcium gluconate (equivalent to 8 to 12 g Ca/cow IV or SC as single dose) (R-1)
- Calcium borogluconate (equivalent to 8 to 12 g Ca/cow IV or SC as single dose) (R-1)
- Calcium chloride (equivalent to 8 to 12 g Ca/cow IV as single dose) (R-2)
- Calcium chloride (equivalent to 50 g Ca/cow) PO q12 for 48h (R-1)
- Calcium propionate (equivalent to 50 g Ca/cow) PO q12 for 48h (R-2)

#### Control

- Reduce dietary calcium intake 2 to 3 weeks before calving to less than 20 g Ca/cow/day (R-1)
- Reduce dietary potassium content as much as possible in late gestation (in any case, below 2% in feed dry matter) (R-1)
- Provide adequate dietary magnesium in late gestation (≈0.4% of feed dry matter) (R-1)
- Anionic salts mixed into feed to obtain a dietary cation-anion difference of -100 to -150 mEq/kg of feed dry matter for at least 2 weeks before calving (R-1)
- Zeolite A (250 to 500 g/cow/day) PO q24h for at least 2 weeks before calving (R-2)
- Supplement diet in late gestation with vitamin D (R-1)
- Vitamin D<sub>3</sub> (10 million IU/cow IM as single dose 3 to 7 days before expected calving) (R-2)
- Vitamin D<sub>2</sub> (10 to 20 million IU/cow PO for at least 7 days before expected calving) (R-2)
- Calcium chloride (equivalent to 50 g Ca/cow) PO q12h for 48 hours from the time of parturition) (R-1)
- Calcium propionate (equivalent to 50 g Ca/cow) PO q12h for 48 hours from the time of parturition) (R-2)
- Partial milking during the first days of lactation (R-3)
- Udder insufflation in the first days of lactation (R-3)



## CONTROL

When the incidence of milk fever increases to above 10% of high-risk cows (third or later lactations), a specific control program is necessary. When the incidence is low, a specific control program may not be economical, and the alternative is to monitor cows carefully at the time of parturition and for 48 hours after parturition and treat affected animals during the first stage of the disease if possible.

Strategies for prevention of periparturient hypocalcemia in general are based on one of following approaches:

- Reduction of dietary Ca available for intestinal absorption during the dry period
- Induction of mild to moderate acidosis during the last weeks of gestation
- Supplementation of vitamin D during the dry period
- Oral Ca supplementation around parturition
- Parenteral Ca administration around parturition
- Partial milking

For purposes of optimal nutritional management of dairy cows that are fed prepared feeds (not pasture based), the dry period is frequently divided into two distinct portions: cows in the early and middle part of the dry period (*far-off* or *regular* dry-cow group) and cows in the final 2 to 3 weeks before their calving date (*prefresh*, *transition*, *close-up*, *near*, *lead-feeding*, or *steam-up* group). Large herds may have additional subgroups of dry cows depending on management circumstances and facilities available. Special attention must be given to the mineral nutrition of the close-up group. Minerals should be provided to close-up cows in known quantities, either as part of a grain mixture or a total mixed ration (TMR).

### Reduction of Dietary Calcium Available for Intestinal Absorption

#### Dietary Calcium Concentration in Late Gestation

Diets high in Ca during the prepartum period can result in a high incidence of milk fever, and diets low in Ca will reduce the incidence of milk fever in dairy cows. Feeding more than 100 g of Ca per cow per day during the dry period is associated with an increased incidence of milk fever. An adult cow requires only around 30 g/daily of Ca to meet maintenance and fetal demands in the last 2 months of late gestation. Low-Ca diets (<20 g [Ca/cow]/d) fed during the last 2 weeks before parturition are effective in reducing the occurrence of clinical milk fever. The low levels of dietary Ca push the organism into a negative Ca balance before calving, which activates the homeostatic mechanisms before the Ca losses through the mammary gland begin. These mechanisms include the secretion of PTH, which increases renal reabsorption of Ca within minutes, stimulates Ca resorption from bone within

hours to days, and stimulates renal vitamin D metabolism to toward production of 1,25-(OH)<sub>2</sub>D within hours or days. The 1,25-(OH)<sub>2</sub>D stimulates the active transport of Ca across the intestinal epithelial cells. At the time of calving, the cow is more efficient in absorbing Ca from the digestive tract and mobilizing Ca from bone reserves. At least 14 days of a low-Ca diet are required to be effective in minimizing the incidence of milk fever.

#### Practicality of Feeding Diets Low in Calcium

There are practical problems with the implementation of the recommendation to feed diets low in Ca. Most farms utilizing home-grown forages, especially alfalfa, find it difficult to obtain forages that are low in Ca. A low-Ca diet can be achieved by replacing some or all alfalfa hay in the dry-cow diet with grass hay and using additional corn silage and concentrates. When feeding grass hay to dry cows, attention must be paid to the dietary potassium content of the dry-cow ration because high potassium intake tends to alkalize the organism and thereby impair the efficacy of bone mobilization.

#### Binding Dietary Calcium

If formulating a diet low enough in Ca to induce a negative Ca balance is a problem, it is possible to reduce the digestibility of dietary Ca by adding a substance to the feed capable of binding dietary Ca and making it less available for intestinal absorption. The oral administration of sodium aluminum silicate or zinc oxide to cows in late lactation binds dietary Ca, thereby inducing a negative Ca balance. Supplementing the dry-cow ration with sodium aluminium silicate (zeolite A) at the rate of 1.4 kg of zeolite pellets per day (700 g of pure zeolite A) for the last 2 weeks of pregnancy results in a significant increase in plasma Ca and 1,25-(OH)<sub>2</sub>D around calving. It should, however, be noted that this amount of pellets is equivalent to over 10% of the dry matter feed intake of a dairy cow in the last days before calving. Plasma magnesium and inorganic phosphate levels also decrease, which has raised concerns with the use of these salts. Feed intake was decreased by over 20% in zeolite-treated cows compared with control cows, which was associated with significantly increased betahydroxybutyrate concentrations after calving.<sup>13</sup> Lower doses of zeolite A in the range of 250 g of pure zeolite A resulted in a less pronounced feed intake depression while significantly increasing the plasma Ca concentration around calving in cattle in third or higher lactation. This lower dose of zeolite A still was associated with decreased plasma inorganic phosphate concentrations, whereas plasma magnesium was unaffected.<sup>13</sup>

Feeding a vegetable oil supplement (soya bean oil) to pregnant pastured dairy cattle

during the last 2 to 3 weeks of pregnancy is effective in preventing milk fever and increases milk solids production in early lactation. The same supplement has been used to stimulate Ca absorption and reduction in susceptibility to fasting-induced hypocalcemia in pregnant ewes. Following supplementation, the ewes are fasted overnight to challenge calcium homeostasis. Following fasting, there is a greatly increased capacity to absorb calcium.

#### Level of Phosphorus in Diet

Increased levels of dietary phosphorus, greater than 0.5% kg dry matter, can increase the incidence of milk fever. The increased intake increases the serum level of phosphorus, which has an inhibitory effect on renal enzymes catalyzing the activation of vitamin D<sub>3</sub>. Decreased availability of bioactive vitamin D<sub>3</sub> results not only in reduced intestinal phosphate, but also reduced Ca absorption.

#### Calcium-to-Phosphorus Ratio in Diet

Although the ratio of Ca to phosphorus in the diet is of relevance in monogastric species, it is now recognized that this ratio is of little importance in ruminants, provided that the minimum requirements for both minerals are met. The presumable explanation for this difference from monogastric species is the high concentration of phosphorus in saliva in combination with the large volumes of saliva produced per day that are entering the rumen. The salivary P content will thus greatly distort the ratio of calcium to phosphate of the ingested diet.

#### Induction of Mild to Moderate Acidosis During Late Gestation: Cation-Anion Difference

A more reliable method of controlling milk fever in dairy cows is to manipulate the dietary cation-anion difference (DCAD) during the prepartum period. Diets high in cations, especially potassium and sodium, tend to induce milk fever compared with those high in anions, primarily chloride and sulfur, which can reduce the milk-fever incidence. When the dietary cation concentration is increased and these cations are absorbed from the digestive tract, they tend to increase the plasma strong ion difference (SID), thereby creating a metabolic (or strong ion) alkalosis. Conversely, dietary anions absorbed from the gut decrease the SID, which causes metabolic acidosis.<sup>6</sup> The feeding of diets containing an excess of anions relative to cations, thus with a low DCAD, will result in metabolic acidosis. Two PTH-dependent functions, bone resorption and renal production of 1,25-(OH)<sub>2</sub>D, are enhanced in cows fed diets with added anions, and thus a low DCAD, which increases their resistance to milk fever and hypocalcemia.

The DCAD is expressed in milliequivalents per kilogram of dry matter (mEq/kg DM) or in some instances in mEq/100 g DM. Several different equations have been proposed for the calculation of the DCAD; for convenience, the most commonly used is  $DCAD_4 = (Na^+ + K^+) - (Cl^- + S^{2-})$ , which only considers the four (thus  $DCAD_4$ ) quantitatively most important dietary ions. Other electrolytes, such as calcium, magnesium, and phosphorus, also affect the acid-base status and are included in some of the DCAD equations proposed in the literature. The impact of these minerals on the actual DCAD value is, however, considered to be minor because of the relatively low content of these elements in the ruminant diet.

The equation assigns the same acidification potency to each milliequivalent of Cl and S, although Cl is absorbed to a greater extent than S and thus has a higher potential of acidification. Such effects are considered in more developed DCAD equations that include a corrective factor for each element accounting for these differences in digestibility.

Calculation of the DCAD requires converting the dietary content of each mineral from g/kg or mg/kg to into charges per kg (equivalents/kg). The mass expressed in mmol/kg DM is equal to mEq/kg for all monovalent elements, with only one charge per molecule, such as  $Na^+$ ,  $K^+$ , and  $Cl^-$ . Divalent elements, such as  $Mg^{+2}$ ,  $Ca^{2+}$ , and  $S^{2-}$ , have two valences per molecule; thus 1 mmol is equivalent to 2 mEq. Table 17-6 provides reference values for determining the mEq of important electrolytes and converting from g/kg or percent diet dry matter (DM) to mEq/kg. Once milliequivalents are calculated, the DCAD can then be determined by subtracting the anions from the cations. The following equation can be used to calculate the DCAD from the percent element in the diet dry matter:  $mEq/100\text{ g DM} = [(\%Na \div 0.023) + (\%K \div 0.039)] - [(\%Cl \div 0.0355) + (\%S \div 0.016)]$ .

Based on current evidence, the range that achieves the lowest incidence of milk fever is a DCAD of  $-10$  to  $-15$  mEq/100 g DM ( $-100$  to  $150$  mEq/kg DM). Such a diet should be fed for 2 to 3 weeks before calving. This rate of supplementation is reported not to affect DM intake or energy balance before or after calving. A more moderate rate of supplementation to reduce the DCAD to 0 mEq/100 g dietary DM also did not decrease feed intake or energy status, but was less effective in preventing parturient hypocalcemia.

Most typical diets fed to dry cows have a DCAD of about  $+100$  to  $+250$  mEq/kg DM. Addition of a cationic salt such as sodium bicarbonate to the dry-cow diets increases the DCAD and thereby increases the incidence rate of milk fever. Decreasing the dietary potassium content, by choosing ration ingredients low in potassium or adding an anion source or a mixture of

**Table 17-6** Parturient paresis: Molecular weights, equivalent weights, and conversions from percent to milliequivalents (%-mEq) of anions and cations used in calculating dietary cation-anion difference

Element	Molecular weight (g/mol)	Valence	Equivalent weight (g/Eq)	To convert from % diet DM to mEq. Multiply by: (mEq/kg)
Sodium	23.0	1	23.0	434.98
Potassium	39.1	1	39.1	255.74
Chloride	35.5	1	35.5	282.06
Sulfur	32.1	2	16.0	623.75
Calcium	40.1	2	20.0	499.00
Magnesium	24.3	2	12.2	822.64
Phosphorus	31.0	1.8	17.2	581.14

anionic salts containing Cl and S to the diet, lowers the DCAD and reduces the incidence of milk fever. Commonly used sources of anion salts include the Cl and  $SO_4$  salts of calcium, ammonium, and magnesium. The phosphate salts have not been used because they are only weakly acidifying.

The addition of anions to the diet to reduce dietary DCAD is limited in quantity because of problems with the palatability of the anionic salt sources commonly used. If the DCAD is greater than 250 mEq/kg, for instance, because of excessive amounts of dietary potassium, it is difficult to add enough anionic salts to lower the DCAD to the recommended  $-100$  mEq/kg of the diet without affecting palatability. In these cases the first objective should be to reduce the dietary cation content as much as possible and only then determine the amount of anions required to achieve the proposed DCAD.

In one study, the incidence of milk fever was 47% when prepartum cows were fed a ration with a DCAD of  $+330.5$  mEq/kg dietary DM and 0% when the prepartum ration had a balance of  $-128.5$  mEq/kg dietary DM. The incidence of milk fever was reduced by the addition of chloride and sulfur in excess relative to sodium and potassium in the diet.

Although it has been proposed that dry cows on low-DCAD diets to control milk fever need to be supplemented with dietary Ca to compensate for increased renal Ca losses resulting from acidification, this recommendation is not undisputed. Several studies showed that the dietary Ca content of dry cows on a high-chloride diet had no effect on the occurrence rate of clinical hypocalcemia. Feeding rations with a dietary Ca between 0.5% and 1.5% did not alter the efficacy of low-DCAD diets, but high-Ca diets fed to dry cows were associated with slightly decreased feed intakes compared with control cows.<sup>3</sup> In any case, DCAD diets should not be combined with low-Ca diets or the use of Ca binding compounds in the feed before calving.

Monitoring the urine pH can be a useful aid to find the effective dose of anionic salts in the close-up ration. Adequate activation of

mechanisms increasing Ca absorption from the gut and release from bone through mild to moderate acidification of the organism is associated with a decline of the urine pH below 7.0. Urine pH values of dry cows on a low-DCAD diet above 7.0 suggest that the degree of acidification may not be sufficient to effectively mobilize Ca through the mechanisms previously described. It is suggested that a urine pH between 6.0 and 7.0 is ideal.<sup>3</sup>

#### *Anionic Salts for Acidification of Prepartum Diets for Dairy Cows*

Several anionic salts are available for addition to the ration of prepartum dairy cows to prevent milk fever. Generally, acidification of the cows occurs within approximately 36 hours following addition of the anionic salts to the ration; it also takes less than 36 hours for the cow to return to an alkaline state following removal of the salts from the diet. The relative acidifying activity of anionic salts commonly used to prevent milk fever has been evaluated. Salts of chloride have about 1.6 times the acidifying activity of sulfate. Calcium and magnesium, which are usually not included in the DCAD equation, have a small but significant alkalizing effect when accompanied by chloride or sulfate. The ranking of the anion sources tested at a dose of 2 Eq/day, from most to least potent urine acidifier, was **hydrochloric acid, ammonium chloride, calcium chloride, calcium sulfate, magnesium sulfate, and sulfur**. Magnesium sulfate is the most palatable of the anionic salts commonly supplemented, and calcium chloride is the least palatable. It is best to add the anionic salts to a total mixed ration. Because of the low incidence of milk fever in heifers, there is no need to feed anionic salts to heifers.

Anionic salts can reduce dry matter intake when more than 300 mEq of anions/kg diet DM are supplemented in the diet. The reductions in dry matter intake are commonly ascribed to decreased palatability, but they may represent a response to the metabolic acidosis induced by the salts. The duration of feeding anion salts ranges from 21 to 45 days before expected parturition. At least

5 days of consumption are necessary for maximal benefit.

**Ammonium Chloride.** Ammonium chloride is more effective than most other salts as an acidifier. The addition of ammonium chloride salts to prepartum diets offers considerable promise as a practical and reliable method of control of milk fever. Within the European Union, ammonium chloride is currently permitted as a pharmacologically active substance in veterinary medicinal products, but not as a zootechnical or feed additive in cattle.<sup>14</sup> Experimentally, the addition of ammonium chloride and ammonium sulfate, each at 100 g/head per day, to the prepartum diets 21 days before parturition decreased the incidence of milk fever from 17% in the unsupplemented group to 4% in the supplemented group.

#### *Strategies for Supplementing Anion Sources*

A systematic protocol for the addition of anions to a prepartum diet and monitoring of its effects is as follows:

1. perform macromineral analysis of all available forages for prepartum cows.
2. Select feed ingredients with a low DCAD, especially those low in potassium.
3. Calculate the DCAD of the diet without any supplemental anion sources. If the DCAD is more than +250 mEq/kg, then priority must be given to reduce this value by replacing some of the forage with a lower-DCAD forage.
4. Balance dietary magnesium at 0.40% DM by adding additional magnesium chloride or magnesium sulfate. Magnesium chloride is preferred.
5. Evaluate the feeding management of the prepartum cows. Ensure adequate feeding space and quality of feed.
6. Add supplemental chloride and/or sulfur to the prepartum cow diet to lower DCAD to about -150 mEq/kg DM.
7. Evaluate the dietary nonprotein nitrogen (NPN) and degradable intake protein (DIP) of the diet. If NPN is more than 0.50% of the diet DM or DIP is more than 70% of crude protein, then reduce the amount of ammonium salts or other NPN or DIP sources in the diet.
8. Monitor dry matter intake of the prepartum-cow group.
9. Consider more palatable anion sources or a reduced dose of anion sources if dry matter intake is depressed.
10. After 1 week of feeding anionic salts, monitor the pH of close-up dry cows. Urinary pH is an accurate indication of optimal dietary acidification. Collect urine from at least six cows at one time and average the urinary results. Adjust

the dose of supplemental anions to achieve an average urinary pH of between 6.0 and 7.0.

#### *DCAD and Acid-Base Balance of Dairy Cows on Pasture-Based Diets*

The dairy industries of southern Australia and New Zealand are based largely on fresh pasture and pasture silage, and grazed pasture is the key determinant of the DCAD. The concentration of potassium is often in excess of 4%, and the DCAD greater than 500 mEq/kg DM, in pasture-based diets, yet the incidence risk of milk fever is not higher than those in other countries where dietary potassium is much lower. For a considerable part of spring and early summer, the DCAD of pasture in those countries may be in excess of +500 to +700 mEq/kg DM. The variation in the DCAD of pasture and the difficulty in accurately assessing dry matter intake make an accurate reduction in DCAD difficult to achieve practically. Pasture cation-anion difference in those conditions is not greatly influenced by stocking rate or associated management practices. The urine pH of grazing dairy cows in south eastern Australia remains relatively constant throughout the year despite changes in stage of lactation, management practices, season, weather, and large changes in DCAD. The DCAD of pasture throughout the year in south eastern Australia ranges from 0 to 800 mEq/kg DM and is often outside the levels previously recommended for optimal performance of lactating cows. For spring-calving herds on pasture, a high DCAD at the time of parturition presents practical problems in administering the large amounts of anionic salts required to lower urine pH and to decrease the incidence of hypocalcemia.

In these pasture-based systems, sulfur (S) is considered a more important dietary constituent in determining the risk of hypocalcemia than either chloride or potassium. The absorption efficiency of S is less than either Cl or K and would not be expected to incur the same change in systemic pH. Thus its importance in hypocalcemia prevention does not fit with the current understanding of how manipulation of DCAD influences calcium homeostasis. Studies indicate that precalving dietary S is more important in the control of hypocalcemia than either K or Cl concentration. Although the effects of a systemic acidosis on Ca absorption is accepted, the effect of S on periparturient Ca homeostasis when absorption of S is low in comparison to Cl, Na, or K suggest that there are mechanisms involved that are not related to acid-base balance. An increased incidence of milk fever may occur in pastured-based dairy when the diet is supplemented with Cl and S, even though calcium absorption, as indicated by urine calcium concentration, increases. The increased incidence may be a result of a greater demand for dietary calcium after calving following a reduction in the pH of

body fluids precalving and the fact that pasture-based diets, as opposed to total mixed rations, are generally low in calcium. Supplementation of cows with calcium after calving increased plasma calcium concentration on the day of calving and during the subsequent 14 days. Milk production was not affected by pre- or postcalving treatments.

Experimentally, the application of potassium fertilizer on pasture resulted in a DCAD ranging from 350 to 535 mEq/kg DM, but calcium homeostasis in pasture-based dairy cows was not changed. Plasma concentrations were increased, and the risk of clinical periparturient hypocalcemia was reduced, by MgCl<sub>2</sub> and MgSO<sub>4</sub> delivered by 150 g MgCl<sub>2</sub>, 200 g MgSO<sub>4</sub>, and 35 g MgO/head daily for 21 days prepartum. After calving, cows were supplemented with 150 g CaCO<sub>3</sub>/head per day for 4 days. Improvements in calcium homeostasis were not the result of an altered systemic pH.

The optimum DCAD for lactating cows grazing fresh pasture and the effect of deviating from the optimum on milk production have been examined under experimental manipulation of the dietary DCAD using a drench in early-lactation dairy cows in New Zealand. Dietary cation-anion differences ranged from +23 to +88 mEq/100 g of DM. As DCAD increased, there was a linear increase in blood pH and HCO<sub>3</sub> concentration and blood base excess. Plasma concentrations of Mg, K, and Cl declined as DCAD increased and Na increased. Urinary excretion of Ca decreased as DCAD increased. Increasing DCAD did not significantly affect milk yield or milk protein, but the concentration and yield of milk fat increased linearly. Milk production results suggest that DCAD for optimal production on pasture diets may be higher than the +20 mEq/100 g DM previously identified for total mixed rations.

*Summary of Macromineral Nutritional Strategies for the Prevention of Hypocalcemia in the Soon-to-Calve or Transition Dairy Cow in Pasture-Based Systems*  
Circumstances and principles can be summarized as follows:

- When dairy cows are dried off, they are commonly moved onto nonirrigated pastures until calving. In the summer, dry cows would be put onto actively growing tropical pasture, whereas in autumn, winter, and spring, the pasture is most likely to be tropical pasture carried over from the previous summer. This carryover pasture is likely to be supplemented with medium-quality hay, silage, and grain or molasses 2 to 3 weeks before calving. Anionic salts have been added to these diets.
- The DCAD on a yearly basis ranges from 0 to 80 mEq/100 g DM.
- The incidence of milk fever in Australia ranges from 1.6% to 5.4%, but in some



years the incidence in individual herds may reach 20%. The incidence of subclinical hypocalcemia can range widely; up to 40% of apparently normal cows had subclinical hypocalcemia (total plasma calcium < 1.9 mmol/L during the first 12 days of lactation).

- In temperate climates, reducing dietary calcium to recommended low levels can be difficult to achieve, but in tropical pastures the levels are already low.
- Excessive levels of potassium may be the most important dietary risk factor for milk fever in Australian feeding systems. Potassium contents of pastures may be as high as 4% to 5% of DM. The use of potassium fertilizers exacerbates the problem. Potassium and consequently dietary DCAD peak in winter and are lowest in autumn. The majority of cows in Victoria, Australia, calve in winter to early spring when the potassium levels are high.
- Hypomagnesemia influences calcium homeostasis, and diets high in potassium reduce the concentration of plasma magnesium. Magnesium supplementation of the transition diet should be done to ensure that magnesium requirements are met (0.4% of DM).
- Excessive dietary phosphorus increases the concentration of phosphorus in plasma, which can induce hypocalcemia and increase the incidence of milk fever at calving. Supplements likely to increase the dietary intake of phosphorus above 40 g/day should not be fed to cows in the weeks before calving.

### Supplementation of Vitamin D During the Dry Period

#### *Parenteral Vitamin D<sub>3</sub> Application*

In an attempt to reverse the negative Ca balance of susceptible cows at the onset of lactation, the administration of vitamin D<sub>3</sub> and its analogs has been used to increase intestinal Ca absorption. Vitamin D<sub>3</sub> is hydroxylated in the liver, and the resulting metabolite is 25-hydroxycholecalciferol. This is metabolized in the kidney to 1,25-dihydroxycholecalciferol, which has an active hypercalcemic effect but is difficult to synthesize. One of its analogs, 1- $\alpha$ -hydroxycholecalciferol, is as active, is easy to prepare, and is used pharmacologically. A single parenteral dose of 10 million IU per cow of intramuscular (IM) vitamin D<sub>3</sub> given 2 to 8 days before parturition is often recommended, although the dose recommendation based on body weight (1 million units per 45 kg BW) has given consistently better results. Two important inconveniences of the parenteral treatment with vitamin D<sub>3</sub> are the narrow time frame before calving during which vitamin D<sub>3</sub> must be administered to be effective and the narrow therapeutic range of the drug. If the cow fails to calve within

10 days of treatment, another 10 million units may need to be administered because cows treated more than 10 days before calving are at increased risk of developing clinical milk fever. Repeated treatment is associated with soft tissue calcification, particularly after repeated injections. Pregnant cows are more susceptible to calcification than nonpregnant animals. Whereas single doses below 10 million units to an adult cow were found to be considerably less effective in preventing clinical milk fever, a dose of 17 million units was lethal for 75% of treated animals.

Another disadvantage of using injectable vitamin D<sub>3</sub> is that although it is effective in preventing clinical milk fever, it tends to result in significantly lower plasma Ca concentrations between 3 and 14 days postpartum compared with untreated control cows. Cows treated with injectable vitamin D<sub>3</sub> therefore are at decreased risk of developing clinical milk fever around parturition but may be at increased risk of subclinical hypocalcemia during the first weeks of lactation. The problem appears to be that the effect of the exogenous metabolite on intestinal Ca absorption declines, whereas its inhibiting effect on the renal enzymes activating endogenous vitamin D<sub>3</sub> is more sustained. Treated cows therefore appear to be impaired in their ability to produce sufficient 1,25-(OH)<sub>2</sub>D to maintain enhanced intestinal absorption of calcium in the first weeks of lactation.

#### *Oral Vitamin D Administration*

Oral dosing with 20 million IU of vitamin D<sub>2</sub>/d for 5 days to cows immediately before calving can markedly reduce the expected incidence of milk fever. Because the onset of action after oral treatment is more delayed than after injection, a cow must be treated for at least 5 days before calving for the treatment to be effective. The exact date of calving is often difficult to determine, and if the administration is discontinued for up to 4 days before calving, an unusually high incidence of the disease may follow, probably because of the depression of parathyroid activity that follows the administration. Toxicity of the oral treatment is considerably lower compared with injection. A dose of 30 million IU of vitamin D administered over 7 days was without obvious signs of toxicity. The danger of causing metastatic calcification, however, also exists; this has been produced with smaller doses (20 million IU daily for 10 days).

#### *Oral Calcium Supplementation Around Parturition*

The oral administration of easily absorbed Ca salts such as calcium chloride or calcium propionate providing the equivalent of 40 to 50 g calcium per dose as a bolus, gel, paste, or liquid, given in a single dose or repeated doses beginning 12 to 24 hours before calving and continuing to 24 hours after

calving, is a common practice that will effectively increase the plasma Ca concentrations for at least 6 hours. Based on clinical studies, a treatment interval of 6 to 12 hours for the period around calving has been suggested. Depending on the type of formulation, its palatability, and the required treatment frequency, oral treatment can be more or less labor intensive, demanding, and invasive. Calcium chloride is highly soluble, resulting in a rapid increase of the plasma Ca concentration within 30 minutes, but it is also caustic and may result in epithelial lesions of the mucosa of the oropharyngeal region, esophagus, forestomachs, or abomasum. In contrast, Ca-propionate requires a larger volume to provide a similar amount of Ca and has a more delayed effect on the plasma Ca concentration, but it is less injurious and thus safer to administer. The combined administration of Ca together with propionate, which is a glucose precursor in the form of calcium propionate, has been used as a further supporting argument for the use of this compound around calving. However, studies investigating the effect of Ca-propionate on feed consumption, milk yield, plasma glucose, insulin, and NEFA concentration in periparturient cows failed to identify a beneficial effect.<sup>12</sup>

Prophylactic treatment with oral Ca formulations in contrast to parenteral Ca administration bears the advantage that it does not disturb mechanisms regulating the Ca homeostasis, but rather supports them by providing oral Ca while intestinal Ca absorption has been upregulated.<sup>15</sup>

#### *Parenteral Calcium Supplementation Around Parturition*

Intravenous or subcutaneous administration of Ca-gluconate or Ca-borogluconate solutions to cattle around parturition is sometimes practiced because this approach may be perceived as a convenient and inexpensive method to control milk fever.<sup>15</sup> However, increasing the plasma Ca concentration to supraphysiological levels, as often occurs after parenteral administration of therapeutic doses of Ca solutions, disturbs the endocrine circuits regulating calcium homeostasis by abruptly interrupting the PTH secretion that is essential to prevent excessive declines of the plasma Ca concentration around parturition. This disruption will result in a delay of the correction of the periparturient disequilibrium of the Ca balance, which has been documented in several studies. Cows treated prophylactically with Ca solutions parenterally have pronounced but transient hypercalcemia that is followed by decline of the plasma Ca concentration below pretreatment Ca concentrations within 12 hours. A recent study comparing IV Ca administration with oral Ca administration and no treatment in periparturient cows not showing clinical signs of milk fever revealed that plasma Ca concentrations were significantly

higher than those in orally treated and control cows only for the first 4 hours post-treatment, but they were below the Ca concentrations of orally treated cows from 24 hours until at least 48 hours posttreatment and below the values of untreated cows from 36 hours until at least 48 hours post-treatment.<sup>16</sup> **Parenteral administration of Ca solutions should therefore be a tool reserved to rapidly correct clinical hypocalcemia and should never be a standard procedure at calving.**<sup>8,15</sup>

### Partial Milking

Partial milking after calving has been proposed for decades as a strategy to decrease Ca losses through the mammary gland in early lactation. Although this practice evidently reduces the amount of Ca excreted through the mammary gland, studies investigating the effect of partial milk-out on the plasma Ca concentration in the first days of lactation failed to identify a beneficial effect.<sup>6</sup>

### FURTHER READING

- Block E. Manipulation of dietary cation–anion difference on nutritionally related production diseases, productivity and metabolic responses of dairy cows. *J Dairy Sci.* 1994;77:1437-1450.
- Goff JP, Horst RL. Role of acid-base physiology on the pathogenesis of parturient hypocalcemia (milk fever)—the DCAD theory in principle and practice. *Acta Vet Scand.* 2003;97:51-56.
- Houe H, et al. Milk fever and subclinical hypocalcemia—An evaluation of parameters on incidence risk, diagnosis, risk factors and biological effects as input for a decision support system for disease control. *Acta Vet Scand.* 2001;42:1-29.
- Horst RL, Goff JP, Reinhardt TA. Role of vitamin D in calcium homeostasis and its use in prevention of bovine periparturient paresis. *Acta Vet Scand.* 2003;97:35-50.
- Thilising-Hansen T, Jørgensen RJ, Østergaard S. Milk fever control principles: a review. *Acta Vet Scand.* 2002;43:1-19.

### REFERENCES

- Reinhardt TA, et al. *Vet J.* 2011;188:122-124.
- USDA. Dairy 2007, part I. Accessed February 15, 2014, at <[http://www.aphis.usda.gov/animal\\_health/nahms/dairy/downloads/dairy07/Dairy07\\_dr\\_PartI.pdf](http://www.aphis.usda.gov/animal_health/nahms/dairy/downloads/dairy07/Dairy07_dr_PartI.pdf)>; 2007.
- Goff JP. *Vet Clin North Am Food Anim Pract.* 2014;30:359-381.
- DeGaris PJ, Lean IJ. *Vet J.* 2009;176:58-69.
- Mulligan FJ, Doherty ML. *Vet J.* 2008;176:3-9.
- Constable PD. *Proc XXVIII World Buiatrics Congress.* Cairns: 2014:59-63.
- Grünberg W. *Vet Clin North Am Food Anim Pract.* 2014;30:383-408.
- Oetzel GR. *Vet Clin North Am Food Anim Pract.* 2013;29:447-455.
- Menard L, Thompson A. *Can Vet J.* 2007;48:487-491.
- Constable PD, et al. *J Am Vet Med Assoc.* 2013;246:826-835.
- Goff JP. *Vet J.* 2008;176:50-57.
- Kara C. *J Biol Environ Sci.* 2013;7:9-17.
- Grabherr H, et al. *J Anim Physiol Anim Nutr.* 2009;93:221-236.
- EFSA. *EFSA J.* 2012;10:2738.
- Martin-Tereso JM, Martens H. *Vet Clin North Am Food Anim Pract.* 2014;30:643-670.
- Blanc CD. *J Dairy Sci.* 2014;97:6901-6906.

## ACUTE HYPOKALEMIA IN CATTLE

### SYNOPSIS

**Etiology** Sustained decrease in dry matter intake in lactating dairy cattle, abomasal disorder, alkalemia, two or more injections of isoflupredone acetate (corticosteroid/mineralocorticoid).

**Epidemiology** Most common in lactating dairy cattle with decreased appetite and high-milk-production potential and low muscle mass.

**Clinical findings** Generalized muscle weakness; depression; cardiac arrhythmias, particularly atrial fibrillation.

**Clinical pathology** Low serum/plasma potassium concentrations; alkalemia and hyperglycemia may be present.

**Necropsy findings** Multifocal myonecrosis with microphage infiltration and myofiber vacuolation, characteristic for hypokalemia myopathy.

**Diagnostic confirmation** Response to treatment, serum potassium concentration less than 2.5 mEq/L.

**Treatment** Potassium chloride administered orally, increased feed intake.

**Control** Maintain adequate dry matter intake, early detection and correction of abomasal disorders, no more than one treatment of isoflupredone acetate.

### ETIOLOGY

Hypokalemia is most common in lactating dairy cattle and is secondary to the following:

- Anorexia resulting from clinical mastitis and retained placenta
  - Upper gastrointestinal obstruction, particularly left-displaced abomasum, right-displaced abomasum, abomasal volvulus, and abomasal impaction
  - Obligatory loss of potassium in milk (1.4 g potassium/L of milk)
  - Hyperinsulinemia secondary to hyperglycemia and transcellular shift of extracellular potassium
  - Sympathetic nervous system activation
  - Aldosterone release in response to hypovolemia and the need for sodium retention
  - Decreased whole-body potassium stores as a result of the relatively low muscle mass in dairy cows
- In most cases, the hypokalemia is not severe enough to cause weakness and recumbency.

### EPIDEMIOLOGY

Hypokalemia occurs commonly in lactating dairy cattle with prolonged inappetence (>2 days), but it is rare in adult ruminants with

adequate dry matter intake and neonatal calves, lambs, and kids. Hypokalemia occurs more commonly in lactating dairy cows than beef cows or feedlot animals because of the additional loss of potassium in the milk, the lower muscle mass in dairy cows that results in decreased whole-body potassium stores, and the use of glycogen and skeletal muscle protein for energy in early lactation.

Milk typically has a potassium concentration of 36 mmol/L.<sup>1</sup> High-producing dairy cows are therefore at increased risk for hypokalemia, and the incidence of hypokalemia in the postparturient period increases as milk production increases. Early-lactation dairy cows are in a marked state of negative energy balance; catabolism of intracellular glycogen and protein leads to increased potassium excretion in urine and therefore whole-body potassium depletion because potassium is bound to glycogen.

Potassium excretion by the kidneys is via secretion by the distal tubular cells. Aldosterone or other steroids with mineralocorticoid activity enhance distal tubular secretion of potassium by increasing permeability of the tubular luminal membranes to potassium and increasing losses of potassium in the urine. Hypokalemia and whole-body potassium depletion is common in lactating dairy cattle receiving one or more injections of corticosteroids for ketosis that have mineralocorticoid activity, particularly isoflupredone acetate.<sup>2,3</sup> The hypokalemic effect occurs because the mineralocorticoid activity of isoflupredone enhances renal and gastrointestinal (saliva and colon) losses of potassium. Hypokalemia reaches its nadir of approximately 60% to 70% of the normal value by 72 hours after the first of two 10-mg injections. Exogenous or endogenous insulin release secondary to hyperglycemia following IV dextrose administration or corticosteroid administration can lead to hypokalemia associated with the intracellular movement of potassium accompanying glucose; this is a shift in potassium and not whole-body depletion.<sup>4,5</sup>

In general, alkalemia decreases serum potassium concentration, and acidemia increases serum potassium concentration. Hypokalemia therefore occurs commonly in ruminants with metabolic alkalosis. Experimental induction of metabolic alkalosis by oral administration of sodium bicarbonate in three Jersey cows caused marked metabolic (strong ion) alkalosis (base excess, 14 to 19 mEq/L), hypokalemia (2.6 to 3.1 mEq/L), and an increase in muscle potassium concentration of 6% to 10%, indicating an intracellular shift of potassium from the extracellular space to the intracellular space.

Whole-body depletion of potassium may be present in healthy dairy cattle immediately after calving, based on the results of potassium balance studies and studies documenting decreased skeletal muscle potassium content at calving and decreased

urinary potassium concentrations immediately after calving.<sup>2,6</sup>

### PATHOGENESIS

Potassium homeostasis in adult cattle is determined by the balance between absorption of potassium from the gastrointestinal (GI) tract and subsequent excretion by the kidneys and salivary glands. Transport of potassium is passive in the small intestine and active in the colon under the influence of aldosterone. The most important hormone affecting renal and salivary potassium excretion is aldosterone, which is released from the zona glomerulosa of the adrenal gland in response to hyperkalemia and other factors. At least 95% of whole-body potassium is intracellular, with skeletal muscle containing 60% to 75% of the total intracellular potassium. Total potassium losses in lactating cattle are 75% in urine, 13% in feces (mainly endogenous loss), and 12% milk, with urine, fecal, and milk losses being obligatory. Marked changes in serum or plasma potassium concentrations alter the resting membrane potential of cells because the potassium gradient generated by Na-K ATPase is the main cause for the negative electric potential across cell membranes. Hypokalemia therefore alters the resting membrane potential and leads to clinically significant changes in cellular and organ function. Hypokalemia indicates whole-body depletion of potassium unless induced by hyperglycemia and hyperinsulinemia.<sup>4,5</sup>

The potassium content of cattle has been estimated at approximately 2.2 g/kg BW. Lactating dairy cattle should be fed a diet containing at least 0.7% potassium on a dry-weight basis, although high-producing dairy cattle need a higher dietary potassium concentration, and potassium is frequently fed at 1.3% to 1.4% on a dry-weight basis. The absorption efficiency of potassium on a typical lactating dairy cow diet ranges from 74% to 88%, with potassium being absorbed in the small intestine and forestomach, with the former predominating. Rumen fluid in cattle usually has a potassium concentration of 24 to 85 mEq/L, and rumen fluid potassium concentration and potassium absorption are strongly dependent on intake. This indicates that increasing potassium intake (specifically, increasing rumen potassium concentration) will directly lead to increased potassium absorption. Studies in fed sheep have indicated a strong linear relationship between potassium absorbed from the rumen and rumen potassium concentration; however, it should be noted that the rate of potassium absorption depends also on whether the animal is fed or fasted. Fasting in sheep for 26 hours decreased rumen potassium concentration from 50 mmol/L to 24 mmol/L and decreased plasma potassium concentration from 4.2 to 3.7 mmol/L.

Potassium homeostasis is not considered to be under direct hormonal control in

sodium-replete healthy lactating cattle because there is no association between plasma aldosterone concentrations and whole-blood or urine potassium concentrations.<sup>3</sup> Anorexia is thought to play an important role in the development of hypokalemia in cattle because 24 to 48 hours are needed for the mammalian kidney to adjust to a reduction in dietary potassium intake.<sup>3</sup> Dehydration also plays an important role in hypokalemia via aldosterone activation. There appears to be a gut or hepatoportal sensor that detects potassium intake and sends a signal to the kidney to increase potassium excretion in response to increased potassium ingestion, but the anatomic location of the sensor and the molecular pathway for signal transduction remain unknown.<sup>7</sup> Nevertheless, activation of the gut/hepatoportal sensor means that there is increased potassium excretion by the kidneys even before there is a detectable increase in serum potassium concentration following increased potassium intake.

Relative to an in vitro potassium concentration of 5 mmol/L, decreases in tissue bath potassium concentration decrease the amplitude of contraction of the circular muscle of the cow abomasal corpus; this smooth muscle is responsible for the propulsion of abomasal chyme.<sup>8</sup> Small, but nonsignificant, decreases in the force developed by abomasal smooth muscle from bulls is observed when in vitro potassium concentration is decreased from 5.4 to 2.0 to 3.0 mmol/L.<sup>9</sup> Hypokalemia may therefore result in decreased abomasal emptying rate and consequently an increased risk of developing left-displaced abomasum, abomasal volvulus, and potentially retained placenta and metritis in dairy cattle. The relationship between potassium concentration and skeletal muscle tone has not been determined for cattle, but studies in humans suggest hypokalemia must be marked (<2.0 to 2.5 mEq/L) to decrease skeletal muscle tone.

### CLINICAL FINDINGS

Affected animals have generalized muscle weakness, decreased gastrointestinal motility, and depression. Severely affected animals are unable to stand or lift their heads from the ground. Cows with severe hypokalemia (<2.0 mEq/L) are usually recumbent and profoundly weak, appear flaccid, and lie in sternal or lateral recumbency. They are unable to support the weight of their heads off the ground and commonly hold their heads in their flanks. Profound weakness of the lateral cervical muscles may occur. Anorexia is common. Cardiac arrhythmias are often detectable on auscultation, and atrial fibrillation may be present on electrocardiography.

Cardiac arrhythmias are associated with abnormal serum potassium concentrations, both hypokalemia and hyperkalemia. In an unpublished study of 110 adult cattle with atrial fibrillation, hypokalemia was

commonly present before the induction of atrial fibrillation. Although there do not appear to be any large-scale studies examining the association between hypokalemia and cardiac arrhythmias in adult cattle, hypokalemia, hypocalcemia, and alkalemia are commonly present in lactating dairy cattle with left-displaced abomasum and atrial fibrillation. In a recent study, 2/15 lactating dairy cows with experimentally induced hypokalemia and alkalemia developed atrial fibrillation that resolved within 24 hours of administration of KCl, accompanied by an increase in plasma potassium concentration and a decrease in blood pH.<sup>6</sup> Atrial fibrillation in other studies was diagnosed in 4/10, 2/14, and 5/17 cows with naturally acquired hypokalemia, and in 1/7 lactating dairy cows with experimentally induced hypokalemia following IM administration of two 20-mg doses of isoflupredone acetate at a 48-hour interval. Taken together, these findings suggest that hypokalemia plays an important role in the development of atrial fibrillation in adult cattle.

Signs of chronic potassium depletion in cattle include anorexia; pica characterized by hair licking, floor licking, and chewing of wooden partitions; rough hair coat; muscular weakness; irritability; paralysis; and tetany.

### CLINICAL PATHOLOGY

The order of sensitivity/specificity in determining whole-body potassium depletion is as follows: skeletal muscle > serum/plasma > milk > erythrocyte/whole blood > urine > saliva.

#### Skeletal Muscle Potassium Content

Skeletal muscle potassium concentration is considered the most sensitive and specific method for assessing whole-body potassium status and therefore provides the gold-standard test. Skeletal muscle is considered the best tissue to sample because it contains approximately 75% of the whole-body stores of potassium. A standardized muscle should be evaluated in cattle because differences in potassium content of greater than 15% are present in individual animals, and this muscle-to-muscle variation is greater than that produced by breed.

#### Plasma Potassium Concentration

Determination of serum/plasma potassium concentration is required to confirm a suspected diagnosis of hypokalemia. A serum potassium concentration less than 2.5 mEq/L reflects severe hypokalemia, and most animals will be weak or recumbent. A serum potassium concentration of 2.5 to 3.5 mEq/L reflects moderate hypokalemia, and some cattle will be recumbent or appear weak, with depressed gastrointestinal motility. In addition to measurement of serum potassium concentration, determination of the serum concentrations of sodium, chloride,



calcium, and phosphorus and the serum activities of creatine kinase and aspartate aminotransferase can be very helpful in guiding treatment of cattle with hypokalemia. Serum potassium concentration is usually a little higher than plasma potassium concentration because platelet activation releases potassium. In summary, a serum/plasma potassium concentration below the normal range provides unequivocal evidence of hypokalemia unless there is concurrent hyperinsulinemia or alkalemia.<sup>4,5</sup> However, because more than 95% to 98% of whole-body potassium stores are intracellular, it is likely that serum/plasma potassium concentration is not as sensitive as skeletal muscle potassium content in indicating whole-body potassium depletion.

### Milk Potassium Concentration

Milk potassium concentration is theoretically more sensitive than serum/plasma potassium concentration in detecting whole-body potassium depletion in individual cows because the milk concentration of potassium is constant for an individual cow. Potassium depletion in lactating dairy cows caused milk potassium concentration to decrease from 1.45 g/L to 1.28 g/L; this was a greater percentage decrease than that in the plasma or whole blood of cattle with whole-body potassium depletion. However, there is marked individual variation in the milk concentration of potassium in healthy cattle, with variations of up to 50% occurring between cows. This variability appears to be a result of changes in milk fat, protein, and lactose percentage, with the highest correlation of milk potassium concentration being with milk lactose concentration ( $R = -0.53$  or  $-0.74$ ). The relationship between potassium and lactose is attributable to the fact that these are important contributors to milk osmolality, which is constant and isotonic. Milk potassium concentration also changes during lactation, being 42 mmol/L in early lactation, 40 mmol/L in midlactation, and 27 mmol/L in late lactation, with a mean bulk milk potassium concentration of 37 mmol/L. The large cow-to-cow variability in milk potassium concentration and dependence on milk lactose concentration make it difficult to produce a suitable cut-point for identifying whole-body potassium depletion in sick lactating dairy cows. However, milk potassium concentration has clinical utility in monitoring potassium homeostasis over time in an individual cow.

### Erythrocyte Potassium Concentration

Erythrocyte potassium concentration is determined by measuring plasma potassium concentration and hematocrit, and then adding sufficient distilled water to hemolyze the erythrocytes followed by potassium measurement of the hemolyzed fluid and mathematical calculation. There is marked cow-to-cow variability in the erythrocyte

potassium concentration (7 to 70 mmol/L) and sodium concentration (15 to 87 mmol/L) of healthy cattle that has a genetic basis with no breed influence. There are two main peaks of cellular potassium concentration, one at 20 mmol/L and a second at 50 mmol/L. In lactating dairy cattle with induced whole-body potassium deficiency, whole-blood potassium concentration changed similarly to plasma potassium concentration. However, in 180 cows, no relationship between plasma potassium concentration and erythrocyte potassium concentration was found. Measurement of erythrocyte or whole-blood potassium concentration is not currently recommended in evaluating whole-body potassium status.

### Urine Potassium Concentration

Urine potassium concentrations are normally high ( $454 \pm 112$  mEq/L) but variable, with a mean fractional clearance of 82% and a coefficient of variation of 61%. The large variability in urine potassium concentration makes it difficult to produce a suitable cut-point for identifying whole-body potassium depletion. However, determination of urine potassium concentration has clinical utility in an individual cow ingesting a constant diet over time because it reflects potassium homeostasis. Urine pH may provide some value as a better screening test because aciduria may be present in response to a marked decrease in urine potassium concentration.<sup>10</sup>

### Salivary Potassium Concentration

Salivary potassium concentrations are more influenced by aldosterone in the response to changes in serum sodium concentration, and salivary potassium concentration must therefore be compared with the salivary sodium concentration (one-for-one exchange), sodium homeostasis, and the ratio of serum sodium to potassium to have clinical utility. The normal saliva potassium concentration shows a large range of 4 to 70 mEq/L, with sodium homeostasis having the greatest effect. A study in cattle with left-displaced abomasum, right-displaced abomasum, or abomasal volvulus indicated no association between salivary potassium concentration and serum potassium concentration. Taken together, it appears that measurement of salivary potassium concentration provides minimal insight into whole-body potassium status.

### NECROPSY FINDINGS

Necropsy of cattle with hypokalemia-induced recumbency reveals the presence of muscle necrosis in the pelvic limbs. Histologic examination of non-weight-bearing muscles reveals multifocal myonecrosis with microphage infiltration and myofiber vacuolation, which is characteristic of hypokalemic myopathy in humans and dogs. It is important to note that hypokalemic

myopathy is also present in muscles not subject to ischemia of recumbency.

### TREATMENT

Treatment of hypokalemia in lactating dairy cows should focus on surgical correction of abomasal displacement, increasing the potassium intake by increasing dry matter intake or the oral administration of KCl, and correction of hypochloremia, alkalemia, metabolic alkalosis, and dehydration.<sup>2</sup> Oral potassium administration is the method of choice for treating hypokalemia. Inappetent adult cattle should initially be treated with 120 g of KCl PO, followed by an additional oral treatment of 120 g KCl 12 hours later, for a total 24-hour treatment of 240 g KCl (0.4 g/kg BW).<sup>6</sup> Higher oral doses of KCl are not recommended because they can lead to diarrhea, excessive salivation, muscular tremors of the legs, and excitability.

Potassium is rarely administered intravenously; the IV route is used only for the initial treatment of recumbent ruminants with severe hypokalemia and rumen atony because it is much more dangerous and expensive than oral treatment. The most aggressive IV treatment protocol is an isotonic solution of KCl (1.15% KCl), which should be administered at less than 3.2 mL/kg/hr, equivalent to a maximal delivery rate of 0.5 mEq of potassium/kg BW per hour. Higher rates of potassium administration run the risk of inducing hemodynamically important arrhythmias, including ventricular premature complexes that can lead to ventricular fibrillation and death.

Palatable hay and propylene glycol orally are recommended. In a series of 14 cases, treatment consisted of potassium chloride given intravenously and orally at an average total daily dose of 0.42 g/kg BW (26 g orally and 16 g IV) for an average of 5 days, resulting in recovery in 11 cases after an average of 3 days. During recumbency, affected cattle require special attention to minimize ischemic necrosis of muscles of the pelvic limbs.

Glucocorticoids are often used to treat ketosis, and the most commonly used glucocorticoids are dexamethasone and isoflupredone acetate. Dexamethasone has little mineralocorticoid activity compared with prednisone and prednisolone, which are related chemically to isoflupredone. Dexamethasone is recommended for the treatment of ketosis in dairy cattle at a single dose of 10 to 20 mg IM, and repeated, if necessary, 12 to 24 hours later. Field observations indicate that repeated doses of isoflupredone acetate decrease plasma concentrations of potassium by 70% to 80%, which suggests a strong mineralocorticoid activity. It is recommended that isoflupredone acetate be used judiciously and animals be monitored for plasma potassium and any evidence of weakness and recumbency. Treatment with oral potassium chloride may be required, but treatment may be ineffective.

## CONTROL

Oral administration of potassium is a mandatory component of fluid and electrolyte administration to inappetent lactating dairy cattle. Ensuring an adequate dry matter intake is the best method for preventing hypokalemia in lactating dairy cattle.

### TREATMENT AND CONTROL

#### Treatment

KCl 120 g PO, followed by an additional oral treatment of 120 g KCl 12 hours later, for a total 24-hour treatment of 240 g KCl (0.4 g/kg BW) (R-1)

KCl 1.15% IV, less than 3.2 (mL/kg BW)/hour, equivalent to a maximal delivery rate of 0.5 mEq of potassium/kg BW per hour (R-2)

Isoflupredone acetate (R-4)

#### Control

Maintain adequate dry matter intake (R-1)

## FURTHER READING

- Constable PD. Fluids and electrolytes. *Vet Clin North Am Food Anim Pract.* 2003;19(3):1-40.
- Sattler N, Fecteau G. Hypokalemia syndrome in cattle. *Vet Clin North Am Food Anim Pract.* 2014;30:351-357.

## REFERENCES

- Constable PD, et al. *J Dairy Sci.* 2009;92(1):296.
- Constable PD, et al. *J Am Vet Med Assoc.* 2013;242:826.
- Coffer NJ, et al. *Am J Vet Res.* 2006;67:1244.
- Grünberg W, et al. *J Am Vet Med Assoc.* 2006;229:413.
- Grünberg W, et al. *J Vet Intern Med.* 2006;20:1471.
- Constable PD, et al. *J Dairy Sci.* 2014;97(3):1413.
- Greenlee M, et al. *Ann Intern Med.* 2009;150:619.
- Türk G, Leonhard-Marek S. *J Dairy Sci.* 2010;93(8):3561.
- Zurr L, Leonhard-Marek S. *J Dairy Sci.* 2012;95:5750.
- Constable PD, et al. *Am J Vet Res.* 2009;70(7):915.

## DOWNER-COW SYNDROME

### SYNOPSIS

**Etiology** Ischemic myopathy of large muscles of pelvic limbs and ischemic neuropathies of obturator or sciatic nerve or its branches secondary to prolonged recumbency associated with milk fever or dystocia; injury of bones, joints, and muscles; undetermined etiologies.

**Epidemiology** Most common in dairy cows with previous episodes of milk fever; in beef cows after prolonged or difficult calving. Delay of more than 4 hours in treatment for recumbent milk-fever cows. Hypophosphatemia and/or hypokalemia have been discussed as potential risk factors.

**Signs** Alert downer cows: Unable to stand following treatment for milk fever. Sternal recumbency; normal mental status, vital signs, and alimentary tract. Appetite and thirst normal or mildly decreased. Most will

stand in few days if provided good clinical care and secondary muscle necrosis is minimized.

**Nonalert downer cows:** Persistent recumbency with altered mentation and vital signs; frequently unable to maintain sternal recumbency; abnormal position of legs; groaning; anorexia; die in several days.

**Clinical pathology** Increased serum activity of creatine kinase (CK) and aspartate aminotransferase (AST); serum phosphorus and potassium concentrations may be subnormal or elevated; proteinuria, myoglobinuria.

**Necropsy findings** Ischemic necrosis, edema and hemorrhage of large medial thigh muscles.

**Diagnostic confirmation** Increased serum activities of CK, AST, proteinuria; myoglobinuria necropsy lesions in cow unable to rise with no other lesions.

**Treatment** Provide excellent bedding or ground surface such as sand or dirt pack. Roll animal from side to side every few hours. Antiinflammatory therapy/pain management. Fluid and electrolyte therapy as necessary. Hoist cows making attempts to stand.

**Control** All recently calved dairy cows that are at high risk for milk fever must be observed closely 12 to 24 hours before and after calving for evidence of milk fever and while still standing; if recumbent, do not delay treatment for more than 1 hour. Can treat all high-risk cows with calcium salts orally to prevent clinical milk fever.

The term *downer cow* first appeared in the veterinary literature in the 1950s and referred to cattle that were too injured, weak, or sick to stand or walk without assistance.<sup>1</sup> In most of the early publications using this terminology a case definition was not provided or was imprecise, such as “cattle unable to rise” or “unable to stand without assistance,” and did not make reference to possible etiologies, duration of recumbency, or outcome.<sup>2</sup> More recently the term *downer cow* was used to denote nonambulatory cattle recumbent for at least 24 hours without obvious reason.<sup>1</sup> A further classification of downer cows into mentally alert, nonambulatory cattle that are able to maintain themselves in sternal recumbency, so-called alert downer cows, and cows with moderate to severe mental obtundation and abnormal vital signs that frequently are unable to maintain sternal recumbency, the so-called nonalert downer cows, was proposed.<sup>3</sup> The term *creeper cows* is sometimes used to denote alert recumbent cows that are unable to bear weight on their hindlimbs but that use the forelegs to propel themselves over short distances.

## ETIOLOGY

Alert downer cows are in most cases recumbent because of musculoskeletal or neuro-

logic injuries such as lesions of the sciatic or obturator nerve secondary to dystocia (calving paralysis), fractures of long bones or the pelvis, hip luxation, or muscle injury as a result of primary trauma or secondary to prolonged recumbency. Nonalert downer cows comprise animals with systemic disease affecting mental status and general attitude, such as periparturient hypocalcemia, septicemia, hypovolemia, diffuse peritonitis, and severe hepatic lipidosis, or neurologic diseases affecting the brainstem or cortex.<sup>3</sup>

In most cases, the downer-cow syndrome is a complication of milk fever. Myopathies and neuropathies develop in nonambulatory cows secondary to prolonged periods of recumbency. Ischemic myopathy affecting the large muscles of the pelvic limbs and injuries to the tissues around the hip joint and of the obturator muscles are common in cows that do not fully recover and stand. Injuries to the musculoskeletal system are also common as a result of cows “spread-eagling” their hindlimbs if they are unsteady during parturition or forced to stand or walk on a slippery floor immediately before or following parturition.

A survey conducted among dairy operations in 21 U.S. states determined that the three most common causes for persistent recumbency were periparturient hypocalcemia (19%), calving-related injuries (22%), and injuries from slipping or falling (15%). Beef cattle operations reported calving paralysis as the single most common cause for downer-cow syndrome.<sup>1</sup>

## EPIDEMIOLOGY

### Occurrence

The disease is most common in dairy cows and typically occurs within the first 2 or 3 days after calving, often immediately following an episode of milk fever. Other debilitating conditions of periparturient cows that can be associated with persistent recumbency include acute coliform mastitis, septic metritis, and acute rumen acidosis (grain overload).

In the United States an estimated 270,000 cattle became nonambulatory on-farm in 2004, of which 57.4% were dairy and 31.5% beef cattle, corresponding to 1.2% of dairy cattle and 0.2% of beef cattle becoming persistently recumbent in 1 year.<sup>4</sup> An older survey conducted in 1986 in Minnesota that included data from 738 dairy operations and 34,656 cow years at risk reported incidences per herd and year between 0.4% and 2.1% (case definition in this study: “sternal recumbency for at least 24 h for no obvious reason”). The overall outcome was that 33% of downer cows recovered, 23% were slaughtered, and 44% died. The owners perceived that downer cows were high producers (48%) or average producers (46%), with only 6% being low producers. Approximately 58% of cases occurred within 1 day of parturition, and 37% occurred during the first 100 days

of lactation. The incidence was highest (39%) during the three coldest months: December to February. A clinical survey conducted in New Zealand and including 433 periparturient recumbent cows reported a recovery rate of 39%, whereas 30% died, and 32% had to be destroyed. The case-fatality rate in this study was 11% higher in precalving recumbent cows than postcalving cows. A 2006 survey including dairy operations from 21 U.S. states reported that 78.6% of participating operations had at least one downer cow in 2006.<sup>2</sup> The case definition of a downer cow in this study was “nonambulatory cattle that were unable to stand for any length of time, including those that recovered.”<sup>2</sup>

Because it is a syndrome lacking in clinical definition and includes all those “other cases” that cannot be otherwise classified, downer-cow incidence varies depending on the clinical acuity of the individual veterinarian and various environmental factors in different areas. In any case, the incidence seems to be increasing, particularly in intensive dairy farming areas, although this impression could arise from the increased necessity to effect a cure in valuable animals.

## Risk Factors

### Animal Risk Factors

**Complication of Milk Fever.** Prolonged recumbency after an episode of clinical milk fever either because of a delay in administration of proper treatment or delayed response to treatment is considered the most common primary cause of downer-cow syndrome. The incidences for downer-cow syndrome that is associated with milk fever reported in the literature range from 3.8% to 28.2% of all milk-fever cases.<sup>5</sup>

Prolonged recumbency, regardless of the primary cause, results in increased tissue pressure over a confined anatomic area, causing local ischemia and neuromuscular dysfunction. An insecure gait of a hypocalcemic periparturient cow presents an increased risk of injury from slipping or falling, such as muscle rupture, bone fractures, or hip luxation, that can result in downer-cow syndrome.

**Traumatic Injuries to Pelvis and Pelvic Limbs.** Traumatic injuries to bones, muscles, and nerves can be directly related to parturition (e.g. calving paralysis), be associated with muscle weakness and an insecure gait (e.g. in hypocalcemic cattle), or be the result of an inadvertent accident. **Calving paralysis** refers to a paresis or paralysis of one or both hindlimbs caused by a lesion of the obturator nerve and/or the lumbar root of the sciatic nerve inflicted during the calving process. Both nerves are vulnerable to compression between the bony birth canal and the calf at parturition; accordingly, nerve damage is most commonly diagnosed after dystocias, deliveries of large calves, or prolonged calvings. Calving paralysis is con-

sidered the most common cause for persistent recumbency in beef cattle.

Pressure injuries of the superficial nerves of the extremities may occur as secondary lesions in cows that are recumbent for an unrelated reason.

**Serum Electrolyte Imbalances.** Apart from hypocalcemia, hypophosphatemia, hypokalemia, and hypomagnesemia have been incriminated as potential factors contributing to downer-cow syndrome. **Hypophosphatemia** is a common finding in recumbent but also in healthy periparturient cows;<sup>6</sup> it is the mineral imbalance most commonly quoted as risk factor, especially in the so-called creper cows, which are bright and alert and crawl about, but are unable to rise. The clinical relevance of hypophosphatemia in persistently recumbent animals has been debated contentiously, but an undisputed empirical observation is that hypophosphatemia is more common or more pronounced in recumbent periparturient cows that are unresponsive to intravenous calcium administration at least in very early stages of recumbency.<sup>5,6</sup> However, the mechanisms through which phosphate depletion may cause persistent recumbency are not well understood, and treatment response to oral or parenteral administration of phosphate salts is inconsistent.<sup>6</sup> Studies including cattle that were nonambulatory for longer than just a few hours, in contrast, found that low serum phosphorus levels are suggestive of a good prognosis, whereas nonsurvivors tend to have higher serum phosphorus concentrations.<sup>3</sup> A likely explanation for this finding is that cows recumbent for longer time periods may have developed more severe muscle damage that is associated with release of intracellular phosphorus into the circulation and thus an increase of the serum phosphorus concentration.

A long-term low-level **hypomagnesemia** has been associated with downer-cow syndrome, especially when it accompanies hypocalcemia. But it is usually manifested by a tetanic hyperesthetic state, which is not part of downer-cow syndrome.

Severe **hypokalemia** in cattle is associated with signs of depression and profound skeletal muscle weakness leading to recumbency.<sup>7</sup> Reports of pronounced hypokalemia in individual animals that were associated with persistent recumbency, with serum potassium concentrations below 2.0 mmol/L, have accumulated over the past decades. These cases have in most instances been traced back to the repeated use of isoflupredone, a mineral corticoid with strong kaliuretic effect that was commonly used for the treatment of ketosis in the United States.<sup>7</sup> Mild to moderate hypokalemia is known to occur in early lactating and anorectic cows, but the role of this mild form in the pathogenesis of downer-cow syndrome needs to be determined.<sup>8</sup>

The **age and stage of lactation** of a recumbent cow were found to be risk factors for nonrecovery. Recovery rates of nonambulatory cows were 10.1% for first-lactation cows, 17.7% for cows in their second to fourth lactation, and 22.2% for fifth-lactation cows.<sup>2</sup> Cows less than 15 days in milk had a recovery rate of 28.4%, whereas cows in later lactation had a 6.2% chance of making a full recovery.<sup>2</sup> Higher recovery rates in older cows and cows that were earlier in lactation have been attributed to an association between persistent recumbency and hypocalcemia. Cows that are older and earlier in lactation are more likely to be recumbent because of hypocalcemia as primary or contributing cause, which has a better prognosis than persistent recumbency for other reasons.

**Duration of recumbency** was also found to be associated with the likelihood of making a full recovery. Cows that were down for less than 24 hours recovered in 32% of the cases, whereas cows recumbent for longer periods had an 8.2% chance of recovery.<sup>2</sup>

A high **body-condition score** is a recognized risk factor for milk fever and therefore must also be considered as predisposing for downer-cow syndrome. Cows with a BCS above 4.0/5 around calving were found to be at 4.3 times higher risk to become nonambulatory than thinner cows. In contrast, cows in poor body condition, with a BCS below 2.5/5, recovered in 8.1% of all cases, whereas 16.6% of cows with a BCS of 2.75 or higher made a full recovery.<sup>2</sup>

## Environmental and Management Risk Factors

A slippery ground surface is a major risk factor. Cattle that must walk across slippery floors, especially at the time of calving, may slip and fall and injure the large muscles of the pelvic limbs, resulting in an inability to stand.

## PATHOGENESIS

In most cases downer-cow syndrome is a complication of an unrelated primary problem causing muscle weakness or persistent recumbency. Primary conditions that can lead to downer-cow syndrome have been grouped into four major categories: metabolic disorders (e.g., hypocalcemia, hypokalemia), acute systemic illness (e.g., coliform mastitis, toxic metritis), musculoskeletal disorders (e.g., fractures, joint luxation), and undetermined causes.<sup>9</sup>

Prolonged recumbency will result in secondary damage from excessive pressure on limbs squeezed between the body and the ground or from struggling to get up. If severe enough, these secondary lesions may prevent the affected cow from getting up, even though the primary cause of recumbency may in the meantime be resolved. Secondary damage can affect muscles, nerves, or other structural components such as bones or joints. Regardless of the initial cause,



prolonged recumbency results in varying degrees of pressure damage predominantly affecting the hindlimbs. Based on the results of experimental studies, it has been suggested that 6 hours of recumbency is the time threshold, beyond which tissue damage as a result of excessive weight bearing must be expected. This underscores the importance of handling any persistently recumbent cow as a medical emergency.

Pressure damage in recumbent cattle primarily occurs in the major muscles of the hindlimbs, particularly the semitendinous muscle, muscles caudal to the stifle, and the peripheral sciatic nerve and its branches. The local tissue damage is referred to as **compartment syndrome**; systemic effects resulting from local tissue damage are summarized in the so-called **crush syndrome**.

### Compartment Syndrome

A compartment of the body is composed of muscle and nerves within an anatomically defined area that is surrounded by a rigid muscle fascia layer. In a recumbent cow, the compartments of interest are the ones of the upper part and to a lesser extent the lower part of each hindlimb. The initial pressure acting on the hindlimb located underneath the body of a recumbent cow depends on the body weight resting on this limb and the rigidity of the ground on which the cow is lying. This pressure on the limb directly translates into increased pressure within the affected compartment and will result in partial or complete occlusion of venous blood flow before the arterial blood flow of the affected region is decreased. The mismatch between blood flow into and out of the compartment leads to a further pressure increase within the compartment. Impaired blood supply to muscles and nerves and ensuing tissue hypoxia will add to the direct damage from mechanical compression. The thick muscle-fascial boundaries surrounding the compartment prevent tissue expansion that would relieve the structures within the compartment from the excessive pressure. Cell damage and inflammation are associated with swelling, causing a further increase in pressure and contributing to a detrimental cascade of events.

Experimental external compression of the pelvic limb in goats, to simulate limb compression in recumbent cows, resulted in a marked reduction in the nerve conduction velocity of the peroneal nerve, which was associated with clinically evident limb dysfunction.

### Crush Syndrome

Crush syndrome refers to the sum of the systemic effects of extensive muscle tissue injury and is attributed to the massive release of muscle-tissue breakdown products into the blood circulation. Notably, a large increase in the serum activity of muscle enzymes, such as aspartate aminotransferase (AST) or

creatinase kinase (CK); increases in serum concentration of predominantly intracellular electrolytes, such as potassium and phosphorus; and ultimately the appearance of myoglobin in urine are indicative of crush syndrome. Myoglobinuria is a potentially life-threatening complication of downer-cow syndrome that can lead to acute renal failure.

### Experimental Sternal Recumbency

Experimentally induced sternal recumbency with one hindlimb positioned under the body to simulate prolonged recumbency will result in a swollen rigid limb within 6 to 9 hours. Following injury to the muscle cells, the serum activity of CK is markedly elevated at about 12 hours after the onset of recumbency. Proteinuria and in some severe cases myoglobinuria occur between 12 and 36 hours after the onset of prolonged recumbency, as a result the release of myoglobin from damaged muscles. In cows that make efforts to stand but cannot do so, continued struggling may result in rupture of muscle fibers and hemorrhage.

Acute focal myocarditis occurs in about 10% of cases, resulting in tachycardia, arrhythmia, and the unfavorable response to IV calcium salts observed in some cases. The cause of the myocardial lesion is unknown, but repeated administration of calcium salts has been suggested. The prolonged recumbency can result in additional complications, such as acute mastitis, decubitus ulcers, and traumatic injuries of the limbs.

The pathogenesis of the nonalert downer cow is not understood. Most such cows have had an initial episode of milk fever and did not respond satisfactorily. Within 1 or 2 days, affected cows have a preference for lateral recumbency and exhibit expiratory moaning and groaning. They represent about 2% of all cases of milk fever.

### CLINICAL FINDINGS

Downer-cow syndrome may occur independently or follow apparent recovery after treatment for milk fever, except for the prolonged recumbency. In the typical case, affected cows either make no effort or are unable to stand following treatment for parturient paresis. About 30% of cows treated for milk fever will not stand for up to 24 hours following treatment. Affected cows are usually bright and alert with good or only mildly depressed feed intake and are thus classified as alert downer cows. The temperature is normal and the heart rate may be normal or elevated to 80 to 100 bpm. Tachycardia and arrhythmia occur in some cows, especially immediately following the administration of IV calcium, and sudden death has occurred. Respirations are usually unaffected. Defecation and urination are normal, but proteinuria is common and may indicate extensive muscle damage if marked.

Some affected cows may make no effort to stand. Others will make frequent attempts

to stand but are unable to fully extend their pelvic limbs and lift their hindquarters more than 20 to 30 cm from the ground. On a nonslippery surface (bare ground, sand pack, or deep bedding) some cows are able to stand with some assistance by lifting on the tailhead or with the use of hip slings. Those cows that do not make an effort to stand usually cannot stand even with assistance, and if supported with cow slings, they will usually make no effort to bear weight with either the hindlimbs or the forelimbs. Their limbs appear stiff, painful, or numb, and they are unable or reluctant to bear weight. Damage to the peroneal nerve is usually present when there is hyperflexion of the fetlock joints, which is evident if and when the cow is able to stand and bear weight on the hindlimbs.

In some cases, the hindlimbs are extended on each side of the cow and reach up to the elbows on each side. In this position, the cow is bearing considerable weight on the medial thigh musculature and causing ischemic myopathy. This abnormal position of the legs may also result from dislocation of one or both hip joints or be associated with traumatic injuries surrounding the hip joints with or without rupture of the ligamentum teres. Regardless of the cause, the cow prefers this leg position and invariably will shift the legs back to the abnormal position if they are placed in their normal position.

In some cows, the signs may be more marked and bizarre, including a tendency to lie in lateral recumbency with the head drawn back. When placed and propped up in sternal recumbency, these cows appear almost normal, but when they are left alone, they revert to the position of lateral recumbency within a short period of time. Still more severe cases are hyperesthetic, and the limbs may be slightly stiff, but only when the cow is lying in lateral recumbency. These severe cases do not usually eat or drink and have been described as nonalert downers.

Complications in downer-cow syndrome are common and often result in death or the need for euthanasia. Coliform mastitis, decubitus ulceration, especially over the prominences of the hock and elbow joint, and traumatic injuries around the tuber coxae caused by the hip slings are common. When these complications occur in the early stages of the disease, they commonly interfere with any progress being made and become the focus of clinical attention.

The course of the disease is variable and dependent on the nature and extent of the lesions and the quality of the care and comfort that is provided for the cow during the first few days. About 50% of downer cows will stand within 4 days or less if cared for properly. The prognosis is poor for those that are still recumbent after 7 days, although some affected cows have been down for 10 to 14 days and subsequently stood up and recovered. Death may occur in 48 to 72

hours following the onset and is usually associated with myocarditis.

### Clinical Examination of the Downer Cow

Clinical examination of the downer cow can be very difficult and challenging depending on the environmental circumstances and the physical size of the animal.<sup>9</sup> Causes of persistent recumbency in cattle include metabolic, musculoskeletal, neurologic, neoplastic, and inflammatory disease; accordingly, obtaining an adequate history and conducting a thorough physical examination are indispensable.<sup>10</sup> Key aspects of the history include age and stage of lactation of the animal, duration of recumbency, any previous clinical abnormalities before the recumbent stage, any previous treatments, diet and accidental access to new feeds, sudden unaccustomed exercise, and assessment of the management provided.

The environment and the ground surface surrounding the recumbent animal may provide clues about the possibility that the animal slipped, fell, and was injured.

A systematic physical examination of all accessible body systems is necessary. The animal should be examined visually from a distance for evidence of abnormalities of the carriage of the head and neck, to observe the position of the limbs, and to observe any attempts of the animal to stand or creep along the ground surface.

The details of the clinical examination are presented elsewhere in this book. The standard close clinical examination is necessary to determine body temperature, heart rate and pulse, respiratory rate, and the state of the major body systems, such as the respiratory tract, cardiovascular system, central nervous system for mental state, gastrointestinal tract, mammary gland, and reproductive tract, any of which may indicate the presence of abnormalities associated with shock that results in recumbency.

In the recently calved cow, particular emphasis must be given to adequate examination of the udder for mastitis, the uterus for metritis, and the gastrointestinal tract for diseases associated with toxemia, dehydration, and shock (abomasal volvulus, acute diffuse peritonitis, carbohydrate engorgement) that result in recumbency. A urine sample must always be obtained and tested for ketones and the presence of myoglobinuria. Careful systematic examination of the musculoskeletal system includes palpating the muscles, bones, joints, and feet of each limb, including passive flexion and extension of each limb. The coxofemoral joints are examined for evidence of dislocation. The vertebral column is examined for evidence of fracture or dislocation of vertebrae. It is important to examine both sides of the animal, which means rolling the cow over from side to side; often the animal may have to be rolled over more than once to repeat a particular examination.

A neurologic examination includes examination of the withdrawal reflexes, patellar reflexes, and sensation of all four limbs and the reflex arcs of the spinal cord; careful examination of lumbar and sacral areas, including sensation and tone in the tail; and examination of the cranial nerves.

The examination can be extended by lifting the downer cow with appropriate lifters and observing if the animal extends its limbs and attempts to bear weight. While the animal is being assisted to stand, additional examinations of other parts of the body can be made.

### CLINICAL PATHOLOGY

The serum calcium and glucose concentrations are frequently within the normal range, whereas phosphorus and potassium concentrations may be decreased in cows with depressed feed intake or increased in animals with more pronounced muscle damage and/or dehydration. Results of hematologic examinations are usually unremarkable in early stages of the recumbency. The serum activity of CK and AST are usually markedly elevated by 18 to 24 hours after the onset of recumbency. Very high levels of serum CK activity shortly after the onset of recumbency that decline markedly within the following 24 to 48 hours are indicative of an acute muscle trauma (e.g., muscle rupture) that may be the cause of recumbency. More moderate elevation of the serum activity of CK with a tendency to slightly increase or remain constant over the following days is suggestive of continuous and ongoing muscle trauma resulting from prolonged muscle-tissue compression. Muscle tissue is rich in CK, and the plasma half-life of this enzyme in cattle is only about 8 to 9 hours; this parameter is therefore a sensitive but short-lived marker of muscle damage. When interpreting the serum CK activity of a recumbent cow, it is critical to consider the time of sample collection relative to onset of recumbency.

AST, in contrast, has a considerably longer half-life and remains elevated for several days after initial trauma. In a series of 262 recumbent dairy cows, serum samples were analyzed for CK, lactate dehydrogenase (LDH), and AST to evaluate the value of serum enzyme activities for predicting a failure to recover. The optimal cutoff points maximizing the sensitivity and specificity of the tests were 2330, 2225, and 171 U/L for CK, LDH, and AST, respectively. The predictive value of AST was significantly better, with optimal cutoff points of 128 and 189 U/L, respectively. AST provided the best predictive indicator of whether a recumbent cow would not recover, the best results being obtained with serum samples taken on the first day of recumbency.

In experimentally induced recumbency in cows, the CK activity remained within normal limits for the first 6 hours. However, by 12 hours there was a marked increase to mean

values of 12,000 U/L rising to 40,000 U/L by 24 hours. There may be moderate ketonuria. A marked proteinuria is usually evident by 18 to 24 hours after the onset of recumbency. The proteinuria may persist for several days or be absent within a few days. In severe cases, the urine may be brown and turbid because of severe myoglobinuria.

Elevations of serum urea, muscle enzymes, and laboratory evidence of inflammation are considered the best prognostic indicators of an unfavorable recovery. The recovery rate was lower in cows with a total protein:fibrinogen ratio less than 10:1, and evidence of neutropenia and/or left shift. Cows with a serum urea level above 25 mmol/L and serum creatinine levels above 130 mmol/L had a poor prognosis.

### NECROPSY FINDINGS

Hemorrhages and edema of the skin of traumatic origin are common. The major pathologic changes consist of hemorrhages and degeneration of the medial thigh muscles. Hemorrhages around the hip joint with or without rupture of the ligamentum teres are also common. Local areas of ischemic necrosis of the musculature (gracilis, pectineus, and adductor muscles) occur at the anterior edge of the pelvic symphysis. Eosinophilic infiltration of ruptured necrotic thigh muscles of downer cows has been described. Hemorrhages and edema of the nerves of the limbs (obturator, sciatic, peroneal, radial) are also common and usually associated with severe muscle damage. The heart is dilated and flabby; histologically, there is focal myocarditis. There is fatty degeneration of the liver, and the adrenal glands are enlarged. Histologically, there are also degenerative changes in the glomerular and tubular epithelium of the kidneys.

### DIFFERENTIAL DIAGNOSIS

The diagnosis of downer-cow syndrome is typically made by exclusion of all other known causes of recumbency in a cow persistently recumbent for at least 24 hours while having received two courses of parenteral calcium treatment.

#### Differential diagnoses for alert downer cows:

- Hypocalcemia
- Calving paralysis
- Fractures of bone or pelvis
- Hip luxation
- Hypokalemia
- Botulism
- Spinal lymphosarcoma (BLV)

#### Differential diagnoses for nonalert downer cows:

- Hypocalcemia
- Hepatic lipidosis/puerperal liver coma
- Coliform mastitis
- Toxic metritis

- Hypomagnesemia
- Hypovolemic shock
- Septic shock
- Generalized peritonitis
- Acute rumen acidosis
- Right-displaced abomasum/abomasal volvulus
- Hypokalemia
- Botulism
- Meningoencephalitis
- Polioencephalomalacia

## TREATMENT

Treatment of a nonambulatory cow evidently must focus on the primary cause of recumbency whenever it has been identified, but must also address secondary damage resulting from prolonged recumbency. The reader is referred to the corresponding chapter of this book for the treatment of primary cause of recumbency whenever it is known. Intensive supportive care is required for the treatment of secondary damage and prevention of further damage. The prognosis of a downer cow not only depends on the initial cause of the recumbency but to a large part also on the quality of the care provided during the recumbent period.

### Antiinflammatory Therapy

Antiinflammatory therapy as part of pain management in ruminant production medicine has received increased attention over the past years because this is increasingly recognized as an essential aspect of animal welfare by veterinarians and owners alike.<sup>11</sup>

Although currently not much data are available to support the use of steroidal and nonsteroidal antiinflammatory drugs in downer cows, their use seems indicated not only to alleviate pain and discomfort of the sick, nonambulatory cow, but also to contain and control inflammation secondary to recumbency that is likely to exacerbate myopathy and neuropathy. Pain in cattle, as in other species, can occur as result of tissue damage, nerve damage, and inflammation, all factors considered to greatly contribute to downer-cow syndrome.<sup>12</sup> Repeated doses of nonsteroidal antiinflammatory drugs (NSAIDs) may be required for adequate control of pain and inflammation, which may put the treated animal at increased risk for adverse gastrointestinal effects, such as abomasal ulceration.<sup>12</sup> It is therefore advisable to instruct the patient owner to regularly check the produced feces for signs of melena.

A single but high dose of dexamethasone (0.2 to 0.3 mg/kg IV) early in the recumbent period has been advocated by some clinicians, based on clinical experience, to control and contain inflammatory neuropathy resulting from trauma or pressure. Because of the abortive effect of the treatment, this therapy in pregnant cows must be discussed with the animal owner.

### Fluid and Electrolyte Therapy

Fluid and electrolyte therapy orally and if necessary parenterally is indicated in patients with inadequate water and feed intake. Multiple electrolytes can be added to the drinking water if the cow is drinking normally. The supplementation of minerals such as phosphates, magnesium, or potassium has been advocated, but they have been used without consistent success.

Oral fluid therapy by drenching is an effective way to maintain hydration in an alert animal. For a recumbent cow, drenching should only be considered in alert cows with a good swallowing reflex. Because the pressure on visceral organs is increased with recumbency, the amount of fluid administered per treatment should not exceed 40 L to prevent the risk of reflux as a result of increased intraruminal pressure.

### Bedding and Clinical Care

The most important aspect of treatment is to provide the most comfortable bedding possible and to roll the cow from side to side several times daily to minimize the extent of ischemic damage and para-analgesia that results from prolonged recumbency. With conscientious care and the provision of good bedding, palatable feed, and liberal quantities of water, most cows will attempt to stand with some difficulty and assistance within 24 hours, and most will stand unassisted and normally 1 or 2 days later. A sand or dirt pack is the ideal ground surface to facilitate standing when downer cows attempt to stand. If affected cows are left on a slippery ground surface, they will not make an effort to stand and will become progressively worse. Cows should be milked normally and the udder kept clean by washing with germicide soap before milking, and postmilking teat dips should be applied.

### Assisted Lifting to Aid Standing

The clinician and farmer are commonly faced with the questions of whether or not to lift a recumbent cow that has not attempted to stand within a few hours after treatment for milk fever. The guiding principle should be the behavior of the cow. If the cow makes an effort to stand on her own or by some coaxing such as a gentle nudge in the ribs, she should be assisted to stand by ensuring a good nonslip ground surface, providing deep bedding, and lifting up on the tailhead when she attempts to stand. The cow should be rolled from side to side every few hours and encouraged to stand a few times daily.

Several different kinds of **cow-lifting devices** have been used to assist downer cows to stand. Hip lifters, which fit and tighten over the tuber coxae, and body slings such as harnesses are designed to fit around the abdomen and thorax of the animal. These devices can assist a downer cow to stand if she makes some effort on her own. For those cows that make some effort to stand, the

hip lifters or slings can be applied and the animal lifted to the standing position. If the animal bears weight on all four legs, she should be allowed to stand with the aid of the device for 20 to 30 minutes and then lowered down. This procedure can be repeated once or twice a day, provided the cow is able to support her own weight while standing. In most cases, such downer cows will stand on their own within a few days. While the cow is in the standing position, she can be milked, and other clinical examinations can be carried out.

The hip lifters can result in traumatic injuries to the tissues surrounding the tuber coxae if not used judiciously. Cows carrying their own weight after being lifted must not under any circumstances be left unattended while hoisted with the hip lifter because they could lose strength and hang in the device, which could result in severe trauma. Animals that make no effort to stand and bear weight on their own must not be left suspended in the lifter for more than a few minutes but lowered immediately. If the hip lifters are not applied carefully, the animal may slip out of the device while it is being lifted, which commonly results in tissue injury around the tuber coxae; fractures of the coxae have even occurred. These injuries are often unnoticed clinically, but contribute to persistent recumbency. Lifting devices must be used carefully by experienced personnel.

Body slings that fit around the abdomen and thorax of the animal are more suitable to lift down cows that will not readily bear weight after being hoisted, because they distribute the weight over several sites in contrast to the hip lifters, which concentrate the weight over the tuber coxae. However, the body slings are cumbersome to apply to a recumbent animal, and they require more time and experienced personnel to ensure proper application. When the slings are applied properly, they do appear to allow the lifted animal to stand comfortably for 30 minutes or more and promote recovery.

Lifting cows that make no effort to stand on their own is usually unsuccessful. When lifted, they usually do not bear any significant weight.

More recently, water flotation tanks have been used for the management of nonambulatory cows.<sup>3</sup> Proposed devices consist of a watertight metal tub with inside dimensions of approximately 234 cm long, 109 cm wide, and 130 cm high. The system can be mobile, and although the use is labor intensive, it can give good results when selecting suitable patients judiciously.<sup>3</sup> Depending on the system used the downer cow is either pulled into the tub on a mat and the ends of the tub closed to make a water-tight container with an open top like a bathtub or is fitted with a harness and lifted into the tub already filled with warm water. With the cow's head held up by a halter, the tub is filled with water at 37°C to 38°C (100°F to 102°F) as quickly as



possible. Cows in lateral recumbency will roll into sternal recumbency when 40 to 50 cm of water are in the tub and will usually attempt to stand when the tub is one-half to two-thirds full. Cows are allowed to stand in the water for 6 to 8 hours, in some cases up to 24 hours. If the water temperature falls below 35°C (95°F), more hot water is added. When the decision is made to remove the cow, the water is drained and the end of the tub opened, or the cow is hoisted out of the tub on a sling. A recent retrospective study including 51 recumbent patients of a veterinary teaching hospital treated with flotation tank reported a success rate of this therapy of 37%.<sup>3</sup> The success rate could be higher if the selection of cases for flotation is more rigorous. Cows with ruptured tendons, fractures, luxated coxofemoral joints, septic polyarthritis, and other physical injuries of the musculoskeletal system are not good candidates for flotation. The most suitable case for flotation would appear to be the downer cow as a sequel to milk fever.

### Handling, Transportation, and Disposition of Nonambulatory Cattle

There has been considerable controversy and disparity among veterinarians and livestock producers about the handling, transportation, and disposition of nonambulatory cattle. Economics has a major influence on decision making in these cases. There has been no common understanding of whether or not they are fit for transportation and which ones are fit for slaughter for salvage. When the owner and veterinarian are faced with a downer cow that is valuable and the cause of the recumbency is uncertain, the tendency is to either attempt to provide treatment for several days and assess the progress or consider slaughter for salvage. In the case of valuable breeding animals that are recumbent as a complication of milk fever, or a disease such as acute carbohydrate engorgement or peracute mastitis, supportive and specific therapies are commonly selected. In the case of downer cattle of commercial value, slaughter for salvage has been a common option. Cattle producers would like to obtain as much financial return as possible by slaughter for salvage. Cattle affected with complications of milk fever, traumatic injuries of the musculoskeletal system, and other diseases not associated with toxemia or septicemia are commonly submitted to slaughter for salvage. Transportation of these compromised animals has always been an animal welfare issue because of the difficulty of loading them humanely because of their size. The mere act of lifting, pulling, dragging, or by other means forcefully loading an animal weighing 500 to 800 kg onto a truck cannot be done without considerable pain and discomfort to the animal. However, beginning in the 1990s, worldwide concern emerged from the public about the handling and disposition of

nonambulatory animals, particularly downer cows, regardless of the cause of their recumbency. Government animal health regulatory agencies, livestock associations, and veterinary associations began drafting regulations on the care and handling of nonambulatory recumbent animals such as the downer cow.

Downer-cow syndrome is an animal welfare issue, and the veterinarian should be proactive about the problem. Society is concerned about how downer animals are cared for and handled and the methods used for their disposition. If recovery does not occur within a few days, the prognosis is uncertain; the owner and veterinarian must decide whether to continue providing clinical care to the downer cow or whether the animal should be euthanized.

### Euthanasia

The quality of care provided to a recumbent cow can easily become an issue of animal welfare, and humane euthanasia should always be considered, particularly in cases with poor prognosis or when the attending veterinarian can foresee that adequate supportive care cannot or will not be provided for whatever reason. Suggested “trigger points” for euthanasia suggested in the literature include the following:<sup>10</sup>

- Conditions with poor prognosis
- Pain and suffering that is unresponsive to treatment
- Anorexia over several days
- Nonalert downer cows not responding to treatment in due time
- Cows unable to maintain sternal recumbency
- Owner unable or unwilling to provide adequate care
- Complications such as pressure sore, mastitis, or other condition
- Deterioration despite adequate patient care
- Unresponsive to treatment for over 10 days

### TREATMENT AND CONTROL

Treatment of primary cause as indicated

#### Supportive care

Move cow off concrete floor onto soft bedding (R-1)

Oral fluid therapy in dehydrated or anorectic cows (R-1)

Roll recumbent cow from one side to the other q4-8h (R-1)

NSAIDs (at label dose with label treatment interval) (R-2)

Dexamethasone (0.2 to 0.3 mg/kg IV as a single dose) (R-2)

Hoist cows that make attempts to stand (R-2)

#### Control

Close monitoring of periparturient cows for signs of milk fever (R-1)

Immediate and adequate treatment of cows with milk fever (R-1)

Provide comfortable calving area with soft bedding and nonslippery flooring (R-1)

Avoid moving pregnant cows too late to calving area (R-2)

Avoid moving fresh cows too early out of calving pen (R-2)

### CONTROL

The early detection and treatment of milk fever will reduce the incidence and severity of downer-cow syndrome. Under ideal conditions, cows should be treated during the first stage of milk fever before they become recumbent. Once recumbent, cows should be treated as soon as possible and not delayed for more than 1 hour. Cows with milk fever should be well bedded with liberal quantities of straw or moved to a soft-ground surface. Recumbent cows should be coaxed and assisted to stand if possible after treatment for milk fever. If they are unable to stand, they should be rolled from one side to the other every few hours if possible. It is usually difficult to get owners to comply with this recommendation, but frequent rolling from side to side is necessary to minimize the ischemic necrosis. Dairy cows should be placed in a comfortable, well bedded box stall before calving and should be left in that box stall until at least 48 hours after partition in the event that milk fever develops.

### FURTHER READING

- Cox VS. Nonsystemic causes of the downer cow syndrome. *Vet Clin North Am Food Anim Pract.* 1988;4:413-433.
- Grandin T. Welfare of cattle during slaughter and the prevention of non-ambulatory (downer) cattle. *J Am Vet Med Assoc.* 2001;219:1377-1382.
- Green AI, et al. Factors associated with occurrence and recovery of nonambulatory dairy cows in the United States. *J Dairy Sci.* 2008;91:2275-2283.
- Poulton PJ. *Musculo-Skeletal Examination and Diagnosis of the Downer Cow.* Proc XXVIII World Buiatrics Congress. Cairns, Australia; 2014:212-218.
- Poulton PJ. *Management of the Downer Cow.* Proc XXVIII World Buiatrics Congress. Cairns, Australia; 2014:219-222.

### REFERENCES

1. Stull CL, et al. *J Am Vet Med Assoc.* 2007;231:227-234.
2. Green AL, et al. *J Dairy Sci.* 2008;91:2275-2283.
3. Burton AJ, et al. *J Am Vet Med Assoc.* 2009;234:1177-1192.
4. NASS. Accessed July 12, 2015, at <<http://usda.mannlib.cornell.edu/usda/current/nacac/nacac-05-05-2005.pdf>>; 2005.
5. Ménard L, Thompson A. *Can Vet J.* 2007;48:487-4919.
6. Grünberg W. *Vet Clin North Am Food Anim Pract.* 2014;30:383-408.
7. Sattler N, Fecteau G. *Vet Clin North Am Food Anim Pract.* 2014;30:351-357.
8. Constable PD, et al. *J Am Vet Med Assoc.* 2013;242:826-835.

9. Poulton PJ. Proc. XXVIII World Buiatrics Congress. 2014:212-218.
10. Poulton PJ. Proc XXVIII World Buiatrics Congress. 2014: 219-222.
11. Thomsen PT, et al. *Vet J.* 2012;194:94-97.
12. Coetzee JF. *Vet Clin North Am Food Anim Pract.* 2013;29:11-28.

## HYPOMAGNESEMIC TETANIES

Tetany associated with a marked decrease in serum magnesium concentration is a common occurrence in ruminants. The syndrome associated with hypomagnesemia is relatively constant, irrespective of the cause, but the group of diseases in which it occurs has been divided into three groups:

- hypomagnesemic tetany of calves, which appears to result specifically from a deficiency of magnesium in the diet transport tetany
- a group of hypomagnesemias in ruminants characterized by lactation tetany, in which there may be a partial dietary deficiency of magnesium but in which nutritional or metabolic factors reduce the availability, or increase the body's loss, of the element so that serum magnesium levels fall below a critical point.

In general, the occurrence of hypomagnesemic tetany is related to three sets of circumstances. Most common is the occurrence in lactating cows turned out onto lush, grass-dominant pasture in the spring after wintering in closed housing—the classic lactation or grass tetany of Holland. Wheat pasture poisoning may occur when cattle or sheep are grazed on young, green cereal crops. The third occurrence is in beef or dry dairy cattle running at pasture in the winter, usually when nutrition is inadequate and where no shelter is provided in changeable weather rather than in severe, prolonged cold. Less common forms occur in housed animals on poor feed. Hypomagnesemia of sheep, although less common, occurs in the same general groups of circumstances as the disease in cattle. A chronic hypomagnesemia, without manifestations of tetany, can be a cause of suboptimal production efficiency and may predispose to hypocalcemia.

## HYPOMAGNESEMIC TETANY (LACTATION TETANY, GRASS TETANY, GRASS STAGGERS, WHEAT PASTURE POISONING)

### SYNOPSIS

**Etiology** The etiology is multifactorial, related to magnesium concentration in the diet and the presence of competing cations such as potassium and sodium that affect either herbage magnesium status or magnesium absorption.

**Epidemiology** Disease of all classes of ruminants, but reaches its highest incidence in older lactating cows exposed to bad weather or grazing green cereal crops or lush grass-dominant pasture.

**Clinical findings** Incoordination, hyperesthesia and tetany, tonic-clonic muscular spasms and convulsions. High case fatality without treatment.

**Clinical pathology** Serum, urine, vitreous humor, or cerebrospinal fluid (CSF) magnesium concentrations. Hypomagnesemia, and in some circumstances hypocalcemia.

**Necropsy findings** None specific.

**Diagnostic confirmation** Response to treatment, serum or urinary magnesium concentrations.

**Treatment** Magnesium or combined calcium/magnesium solutions administered IV or SC.

**Control** Magnesium supplementation, but a palatable and practical delivery method is a problem. Magnesium applied to pastures. Avoidance of movement and food deprivation at risk periods.

## ETIOLOGY

Magnesium is the major **intracellular divalent cation** and is an essential element in a large number of enzymatic activities in the body. For this reason, it might be expected that hypomagnesemia would be rare. However, because of the peculiarities of absorption of magnesium in the ruminant forestomach, and the use of animal and pasture management systems that can lead to marginal magnesium uptake, ruminants are at risk of hypomagnesemia.

## Magnesium Homeostasis

There is **no feedback regulatory mechanism** to control concentrations of magnesium in the body of ruminants. As a consequence, magnesium concentrations in blood and extracellular fluid are essentially determined by the balance between dietary intake of magnesium, loss in feces and milk, and the modulating effect of magnesium **homeostasis by the kidney**.

### Dietary Intake

In normal circumstances, magnesium absorbed from the diet is sufficient to meet the requirements of the body, and excess amounts are excreted in the urine.

### Renal Excretion

The kidney is the major organ of homeostasis and can act to conserve magnesium. Magnesium is freely filtered across the renal glomerulus and is reabsorbed within the renal tubules, the degree of reabsorption acting in homeostasis. The endogenous daily urinary loss is typically 3 mg/kg BW, equivalent to 1.8 g/day for a 600-kg cow. When the dietary intake of magnesium is decreased, blood and

interstitial fluid magnesium concentrations fall; excretion of magnesium in the urine will cease when **serum concentrations fall below 1.8 mg/dL**. The renal threshold for magnesium excretion is partially under the control of parathyroid hormone, and increased plasma concentrations of parathyroid hormone will act to conserve magnesium.

## Magnesium Reserves

There are large stores of magnesium in the body, especially in bone. These are available to the young calf, but mobilization rate decreases with age, and in the adult ruminant there is little mobilization in response to short-term deficits of magnesium. In ruminants, this control mechanism for magnesium can maintain adequate concentrations of magnesium in bodily fluids in most production circumstances, but it can fail where there is a high requirement for magnesium coupled with a decreased intake. This combination leads to hypomagnesemia, and hypomagnesemic tetany is a possible outcome.

## Lactation

Increased requirement for magnesium is almost always associated with the loss of magnesium in the milk during lactation. Whereas the amount of magnesium in milk is not high (14 mg/kg BW), the loss of magnesium to milk in high-producing animals (4.2 g of magnesium in 30 L of milk) represents a significant proportion of the dietary intake of magnesium. As a consequence of this drain, most instances of hypomagnesemia occur in lactating animals around the period of peak milk production, although in some circumstances the demands of late pregnancy are the cause of the increased requirement. The decreased intake of magnesium can result from an absolute deficiency of magnesium in the diet or because the availability or absorption of magnesium from the diet is impaired. These factors determine the circumstances of occurrence of the disease and are the **factors that can be manipulated for control**.

## Factors Influencing Absorption of Magnesium

In the adult ruminant, magnesium absorption occurs in the forestomach with little absorption in the abomasum and small intestine. Some absorption occurs in the large intestine, particularly in sheep; however, it cannot compensate for malabsorption in the forestomach. Magnesium is absorbed from the small intestine of calves, lambs, and kids, but this ability appears to be lost when these animals become ruminants.

## Na:K Ratio in Rumen

Magnesium is transported across the epithelium of the forestomach by an active sodium-linked ATPase-dependent transport system. Absorption, and the serum magnesium concentration, is influenced by the

Na:K ratio in the rumen, which is determined by the dietary and salivary concentrations of sodium and potassium. Absorption of magnesium increases with an increasing Na:K ratio to plateau at a ratio of 5:1. Absorption is significantly impaired if the Na:K ratio is less than 3:1.

Young, rapidly growing grass that is low in sodium and high in potassium can result in **sodium deficiency** in grazing ruminants and can significantly depress the Na:K ratio in the rumen fluid, causing impaired magnesium absorption. Depression is observed at dietary potassium concentrations of greater than 22 g/kg dry matter.

**Saliva** normally has a high Na:K ratio, but where there is a deficit of sodium in the diet, a proportion of sodium in saliva may be replaced with potassium under the influence of aldosterone, which further negatively influences the uptake of magnesium.

Approximately 40% of the total magnesium available in extracellular fluid is secreted daily in saliva, and 20% of this is reabsorbed in the forestomach. When animals are on tetany-prone grass, forestomach absorption is impaired, which accounts for the susceptibility of ruminants to hypomagnesemia compared with monogastric animals.

#### Other Factors Influencing Absorption

Young grass fertilized with nitrogenous fertilizers has an increased crude protein content, which is readily fermentable and leads to increased ammonia concentrations. A sudden rise in ruminal concentrations of ammonia impairs magnesium absorption in the rumen. The uptake of magnesium is also influenced by the carbohydrate content of the diet; magnesium absorption is improved with increasing amounts of readily degradable carbohydrates. The mechanism of this action is not known, but low concentrations of readily degradable carbohydrate in tetany-prone pastures in combination with high concentrations of protein may be important to the occurrence of the syndrome. Volatile fatty acids provide the energy for the active transport of magnesium across the rumen wall and increase magnesium absorption.

Ruminal pH is thought to affect absorption efficiency by influencing magnesium solubility, which decreases markedly as ruminal pH increases above 6.5. Magnesium binders, such as fats, can form insoluble magnesium salts. Other dietary substances have been proposed to influence the absorption of magnesium, including calcium and phosphorus, organic acids such as citric acid and transaconitate, fatty acids, and aluminum, but the significance of their role is controversial.

#### Magnesium in Pastures and Tetany Hazard

The dietary intake of magnesium in grazing animals is directly related to the magnesium

concentration in pastures, but other elements in pastures also influence magnesium absorption by the ruminant, as detailed earlier.

#### Required Magnesium Concentrations

Hypomagnesemia can result from the ingestion of pastures that have insufficient magnesium to meet dietary requirements. The estimated magnesium concentration in pasture required to meet the dietary requirement for pregnant or lactating cattle varies from 1.0 to 1.3 g/kg dry matter (DM) for pregnant cattle, depending on the stage of pregnancy, and from 1.8 to 2.2 g/kg DM for lactating cattle, with both estimates assuming minimal interference of absorption by other elements in the pasture.

The recommended minimal “safe” concentration of magnesium in pastures is 2 g/kg DM for lactating and pregnant cattle, with a preference for a concentration of 2.5 g/kg DM.

#### Magnesium Availability in Pastures and Hazard

Hypomagnesemia can also occur in animals grazing pastures with adequate concentrations of magnesium but that contain high concentrations of potassium and nitrogen, which, as detailed earlier, impair absorption of magnesium in the rumen. Pastures with concentrations of **potassium** of greater than 30 g K/kg DM and **nitrogen** greater than 40 g N/kg dry matter are considered hazardous.

An alternate method for estimating the potential **hazard of a pasture** is to calculate the **K/(Ca + Mg) ratio** using milliequivalent (mEq) values for this estimate. Pastures with ratios above 2.2 are considered a risk.

#### Winter Hypomagnesemia

The occurrence of hypomagnesemia is not restricted to cattle grazing lush pastures; it can also occur during winter. In **housed lactating dairy** cattle being fed conserved feeds, hypomagnesemia probably has the same genesis as that in grazing cattle, being associated with a high lactational drain of magnesium in combination with the feeding of conserved feeds prepared from pastures with marginal magnesium concentrations. Hypomagnesemia also occurs in **cattle outwintered** on poor-quality feed.

#### Hypomagnesemia and Hypocalcemia

In some outbreaks of hypomagnesemic tetany, there is also hypocalcemia, and although it is of less severe degree than in parturient paresis, there is increasing evidence that the actual onset of clinical tetany may be associated with a rapid fall in serum calcium levels superimposed on a preexisting hypomagnesemia. This is particularly true for wheat pasture poisoning but can also apply to outbreaks with different predisposing factors.

Chronic hypomagnesemia can have a profound effect on calcium homeostasis. Hypomagnesemia reduces the production

and secretion of parathyroid hormone, reduces hydroxylation of vitamin D in the liver, and also causes target-organ insensitivity to the physiologic effects of parathyroid hormone and 1,25-dihydroxyvitamin D<sub>3</sub>. Chronic subclinical hypomagnesemia can increase susceptibility to milk fever and can predispose to episodes of **milk fever and downer cows in lactating dairy cows** during the period of peak lactation.

#### Summary of Etiology

In summary, it appears that a number of factors are capable of causing hypomagnesemia in ruminants and that under particular circumstances one or other of them may be of major importance.

**In lactation tetany of cows and ewes** turned out onto lush pasture in the spring, a primary dietary deficiency of magnesium or the presence of high relative concentrations of potassium and nitrogen in the diet reduces the absorption of magnesium and possibly calcium.

**In wheat (cereal) pasture poisoning**, the ingestion of abnormally large amounts of potassium and low levels of calcium in the diet leads to hypomagnesemia and also hypocalcemia.

**Hypomagnesemic tetany in cattle wintered at pasture** and exposed to inclement weather is associated with low magnesium intake and inadequate caloric intake, and possibly to the resultant hyperactivity of the thyroid gland.

Although the suggestions as to the most important etiologic factors in each set of circumstances in which lactation tetany occurs may be valid, undoubtedly **combinations** of these and other factors have etiologic significance in individual outbreaks of the disease. The **worst combination** of causative factors, and the most common circumstances in which the disease occurs, is inadequate energy intake with a low dietary content of magnesium (grass pasture) in recently calved cows during a spell of cold, wet, and especially windy weather.

One other important factor is the **variation between individual animals in susceptibility** to hypomagnesemia and to the clinical disease. These variations are quite marked in cattle, and in intensively managed, high-producing herds it is probably worthwhile to identify susceptible animals and give them special treatment.

#### EPIDEMIOLOGY

##### Occurrence and Risk Factors for Lactation Tetany

Lactation tetany in dairy and beef cattle turned out to graze on lush, grass-dominant pasture after winter housing is common in northern Europe, the United Kingdom, and the northern parts of North America. Grass tetany also occurs in Australia and New Zealand, where the cows are not housed in winter but have access to a phenomenal flush



of pasture growth in the spring. This also commonly occurs in beef cattle in all countries.

With housed cattle, or cattle fed conserved feed during the winter, most cases occur during the first 2 weeks after the cattle are turned out to **spring pasture**. Pasture that has been heavily top dressed with fertilizers rich in nitrogen and potash is potentially the most dangerous. The disease may also occur on this type of pasture even when the cattle have wintered on pasture in temperate regions. In regions where there is an autumn flush of pasture, a high incidence of hypomagnesemic tetany may occur in the **autumn** or early winter.

Cattle in the **first 2 months of lactation** and **4 to 7 years of age** are most susceptible, which probably reflects an increased risk because of a higher loss of magnesium in milk. **Friesian** cows have lower magnesium concentrations than Jerseys grazed under the same conditions.

In the northern parts of the United States, outbreaks commonly occur during periods of **low barometric pressure** when the **ambient temperature** ranges between 7°C (45°F) and 16°C (60°F) and **soil temperatures** are below 7°C (45°F). Outbreaks may be precipitated by inclement weather. In beef cattle there is commonly a history of poor nutrition and falling body condition in the past few weeks as a result of diminishing hay supplies.

### Occurrence and Risk Factors for Wheat (Cereal) Pasture Poisoning

Wheat pasture poisoning is a misnomer because it can occur with grazing of any small-grain cereal pasture. It has been recorded in many countries, but it is most prevalent where **young cereal crops** are utilized for winter grazing. The southwestern United States has experienced heavy losses of cattle caused by this disease. This pasture can induce hypomagnesemia in **pregnant and lactating cattle and sheep**. The risk is with young, rapidly growing pasture, either in the **spring** or in the **autumn and winter** with pastures planted in late summer. The pasture is usually dangerous for only a few weeks, but heavy losses may occur in all classes of sheep and cattle. *Bos taurus* breeds are more susceptible to the development of hypomagnesemia than *Bos indicus*.

### Occurrence and Risk Factors for Winter Hypomagnesemia

Hypomagnesemic tetany in cattle wintered in the open causes some losses in the United Kingdom, New Zealand, southern Australia, and the east-central states and Pacific slope of the United States. It occurs in cattle grazed on pasture in the winter with **minimal supplemental hay** and in cattle grazed on **aftermath crops** and corn stover. The disease occurs in regions with temperate climates, and risk is increased by **exposure to bad**

**weather**, which is exacerbated by absence of trees or other **shelter** in fields and by failure to supply supplementary feed during these cold spells. The disease does not seem to occur in cattle kept outside in prolonged winters where environmental temperature is consistently very low and there is adequate feed. Hypomagnesemia, commonly presenting as chronic hypomagnesemia and sudden death, has been recognized as occurring in housed cattle in the winter in Europe for many years and recently has also been reported in the United States.

### Morbidity and Mortality

In all of these forms of the disease, the morbidity rate is highly variable, reaching as high as 12% in individual herds and up to 2% in particular areas. The incidence varies from year to year depending largely on climatic conditions and management practices, and the disease is often limited in its occurrence to particular farms and even to individual fields.

Although an effective treatment is available, the **case-fatality rate is high** because of the short course. Because animals die before they are observed to be ill, there are not accurate figures on case fatality, but it is probably of the order of 30% in dairy cattle and considerably higher in beef cattle.

There have been few epidemiologic studies specifically addressing the importance of the syndrome. In Finland, a **lactational incidence** varying between 0.1% and 0.3% has been recorded, with an **increase in parity** to at least six for lactation tetany occurring on pasture but not for indoor tetany. No association with other diseases was found other than for milk fever. In Northern Ireland, approximately 10% of dairy cows and 30% of beef cows have subnormal or deficient blood magnesium concentrations during the grazing season, and hypomagnesemia is considered the cause of 20% of the sudden-death mortality in beef cattle. Surveys of beef cattle owners of the relative importance of different diseases invariably rate hypomagnesemia high in importance.

### Pasture Risk Factors

In most areas of the world, there is a strong association between risk for hypomagnesemia and systems of pasture improvement and pasture fertilization to increase forage yield. There are a number of influences on the concentration of magnesium and other elements in pasture.

### Pasture Species

Hypomagnesemia is a problem on grass-dominant pastures. Concentrations of calcium and magnesium are higher in legumes and forbs than in grasses. Within the grasses, different genotypes of the same species can differ markedly in calcium and magnesium concentrations, and most **cool-season grasses** have the potential to produce hypomagnesemia. However, there are some

differences, and grasses with a high ratio of potassium to calcium and magnesium (e.g., *Dactylis glomerata*, *Lolium perenne*, *Phalaris arundinacea*) are more likely to cause grass tetany than those with low ratios (e.g., *Bromus inermis*, *Poa pratensis*, *Agrostis* spp.). On soil types where the disease is common, cool-season grass pastures top dressed with **nitrogenous fertilizers** are dangerous, and their toxicity may be increased by the **application of potash**. **Warm-season grasses** do not have the same risk, and grass tetany is not a problem in cattle grazing tropical grasses.

### Cereal Pastures

The greater tendency of cereal grazing to cause hypomagnesemia is related to a high content of potassium and a low content of magnesium. The tetany hazard, in order of decreasing hazard, is wheat, oats, barley, rye.

### Season

High concentrations of potassium and nitrogen and low concentrations of sodium and soluble carbohydrates occur in pastures during the early growing season and during rapid growth following cold, wet periods. Pasture magnesium concentrations may not be depressed, but the K/(Ca + Mg) ratio is increased.

### Fertilization

Application of potash and nitrogenous fertilizers to pastures will decrease the concentration of calcium and magnesium in plants and will also increase the concentration of potassium and nitrogen. There is some evidence that nitrate sources of nitrogen depress magnesium less than ammonium sources of nitrogen.

### Soil Type

The availability of magnesium to the plant is influenced by soil type, and some deficiencies in plant magnesium can be corrected by soil fertilization with magnesium. There is no strong association with any one soil type, but high potassium concentrations are consistently associated with increased risk for tetany.

Highly leached, acid, sandy soils are particularly magnesium deficient and the most likely to respond to liming and magnesium fertilization. In very acidic soils, high aluminum concentrations may depress magnesium uptake by plants.

A local knowledge of soil type and its influence on magnesium, potassium, calcium, and nitrogen uptake by pastures can allow the judicious selection or avoidance of the use of pastures for at-risk groups during periods of risk for hypomagnesemia.

### Animal and Management Risk Factors

#### Dry Matter Intake

The dry matter and energy intake of ruminants can influence susceptibility to

hypomagnesemia. A reduction in dry matter intake must reduce the magnesium intake; in situations where hypomagnesemia is already present, a further depression of serum magnesium levels can be anticipated when complete or partial starvation occurs. An insufficient intake of **fiber** in the winter months can precipitate hypomagnesemia in pastured cows and ewes, and lipolysis is accompanied by a fall in serum magnesium.

#### Period of Food Deprivation

Many outbreaks of hypomagnesemia are preceded by an episode of stress or temporary starvation. Whether chronic hypomagnesemia preexists or not, a period of starvation in lactating cows and ewes is sufficient to produce a marked hypomagnesemia, and the fall may be sufficiently great to cause clinical tetany. A period of **bad weather, yarding, transport, or movement** to new pastures or the introduction to **unpalatable pastures** may provide such a period of partial starvation.

#### Alimentary Sojourn

Diarrhea is commonly associated with lactation tetany on spring pasture and, by decreasing the alimentary sojourn, may also reduce magnesium absorption.

#### Climate

A close association between climatic conditions and serum magnesium levels has also been observed. Reduced levels occur in adult cattle and sheep exposed to cold, wet, windy weather with little sunshine and no access to shelter or supplementary feed. Supplementary feeding appears to reduce the effect of inclement weather on serum magnesium levels, and it is possible that failure to eat, or depression of appetite, and a negative energy balance during bad weather may be a basic contributing cause to hypomagnesemia in these circumstances.

#### Animal Movement

Epinephrine release will result in a precipitous fall in serum magnesium, and this may explain the common observation that clinical cases are often precipitated by excitement or movement of the herd.

#### Intensive Dairies

Intensive dairies that apply effluent on a limited land base can build soil potassium to high concentrations. Silage from these grounds can have a high risk for inducing hypomagnesemia.

#### Hypomagnesemia in Sheep

Hypomagnesemia occurs in sheep, particularly in Australia and the United Kingdom. The disease is not common, but it appears to be increasingly associated with pasture improvement practices, and it can cause heavy losses in individual flocks. It is more

common in ewes bred for milk and lamb production. In outbreaks, **ewes with twins** are more liable to develop clinical disease than those with singles, and the main occurrence is in ewes **1 to 4 weeks after lambing**, with cases up to 8 weeks after lambing.

Disease is often precipitated by a **management procedure** involving movement and temporary food deprivation, and cases will occur within the first 24 hours following this and for a few days afterward. As in cattle, disease occurs when ewes are placed on lush grass pastures, but it is especially common where ewes in early lactation are placed on young cereal pastures. Losses usually cease when the flock is moved onto rough, unimproved pasture.

Cases also occur in sheep that are exposed to inclement weather when on low nutritive intake. Simultaneous hypomagnesemia and ketosis can occur in ewes after lambing if they are exposed to low feed availability. These cases do not respond well to treatment. Hypomagnesemia in ewes is predisposed by **prior pregnancy toxemia** in the flock.

#### PATHOGENESIS

Most evidence points to hypomagnesemia as the cause of the tetanic signs observed, but the concurrent hypocalcemia may have a contributory effect and in many instances may even be the dominant factor. Most clinical cases of the disease have serum magnesium concentrations below 1 mg/dL (0.4 mmol/L) compared with the reference range in cattle of 1.7 to 3.0 mg/dL (0.7 to 1.2 mmol/L), and there is a striking relationship between the incidence of the clinical disease and the occurrence of a seasonal hypomagnesemia.

The reduction in serum concentrations of magnesium is concurrent with a marked fall in the excretion of magnesium in the urine. In affected herds and flocks, many clinically normal cows and sheep have low serum magnesium concentrations. In some of these circumstances a concurrent hypocalcemia may be the precipitating cause.

Magnesium has many influences on impulse transmission in the neuromuscular system, including effects on the release of acetylcholine, on the sensitivity of the motor end plate, on the threshold of the muscle membrane, and on activation of the cholinesterase system. These offer an attractive hypothesis for the muscular irritability seen with the disease. However, it has also been established that magnesium concentrations in the cerebrospinal fluid (CSF) are more predictive of clinical disease than those in serum, which would indicate that alterations in central nervous system (CNS) function are more important than alterations in peripheral nerve function. It is also evident that CSF concentrations of magnesium in hypomagnesemic animals rise significantly after treatment with a magnesium salt. The need for this to happen would explain the

delay of about 30 minutes after an IV injection before recovery occurs, because CSF volume turns over at approximately 1% per minute.

#### CLINICAL FINDINGS

For convenience, lactation tetany is described in acute, subacute, and chronic forms.

#### Acute Lactation Tetany

In acute lactation tetany, the animal may be grazing at the time and suddenly cease to graze, adopt a posture of **unusual alertness**, and appear uncomfortable; twitching of the muscles and ears is also evident. There is severe **hyperesthesia**, and slight disturbances precipitate attacks of continuous belching, frenzied galloping, and occasionally aggression. The gait becomes **staggering**, and the animal falls, with obvious tetany of the limbs, which is rapidly followed by **clonic convulsions** lasting for about a minute. During the convulsive episodes the following characteristics are common:

- Opisthotonos
- Nystagmus
- Champing of the jaws
- Frothing at the mouth
- Pricking of the ears
- Retraction of the eyelids

Between episodes, the animal lies quietly, but a sudden noise or touch may precipitate another attack.

The temperature rises to 40.0 to 40.5°C (104 to 105°F) after severe muscle exertion; the pulse and respiratory rates are also high. The absolute intensity of the heart sounds is increased so that they can be heard some distance away from the cow. Death usually occurs within 5 to 60 minutes, and the mortality rate is high because many die before treatment can be provided. The response to treatment is generally good if the animal is treated early.

#### Subacute Lactation Tetany

In subacute lactation tetany, the onset is more gradual. Over a period of 3 to 4 days, there is slight inappetence, **wildness of the facial expression**, and **exaggerated limb movements**. The cow often resists being driven and throws her head about as though expecting a blow. **Spasmodic urination** and frequent defecation are characteristic. The appetite and milk yield are diminished, and ruminal movements decrease. **Muscle tremor** and mild tetany of the hindlegs and tail with an unsteady, straddling gait may be accompanied by retraction of the head and trismus. Sudden movement or noise, the application of restraint, or the insertion of a needle may precipitate a violent convulsion.

Animals with this form of the disease may recover spontaneously within a few days or progress to a stage of recumbency with a similar but rather milder syndrome than in the acute form. Treatment is usually effective, but there is a marked tendency to relapse.

### Chronic Hypomagnesemia

Many animals in affected herds have low serum magnesium levels but do not show clinical signs. There may be sudden death. A few animals exhibit a rather vague syndrome that includes dullness, unthriftiness, and indifferent appetite and may subsequently develop one of the more obvious syndromes. In lactating cows, this may be the development of paresis and a milk-fever-like syndrome that is poorly responsive to calcium treatment. Depressed milk production has also been attributed to chronic hypomagnesemia in dairy herds in New Zealand. The chronic type may also occur in animals that recover from the subacute form of the disease.

### Parturient Paresis With Hypomagnesemia

This syndrome is described in the discussion of parturient paresis and consists of paresis and circulatory collapse in an adult cow that has calved within the preceding 48 hours but in which dullness and flaccidity are replaced by hyperesthesia and tetany.

### CLINICAL PATHOLOGY

Serum or urinary magnesium concentrations can be used for clinical cases. Where an animal is dead and hypomagnesemia is suspect, a presumptive diagnosis can be made from samples taken from other at-risk animals in the group or from the **vitreous humor** of the dead animal. An acute-phase inflammatory response with leukocytosis and increased numbers of neutrophils and monocytes has been recorded in ruminants and laboratory animals fed magnesium-deficient diets.

### Serum Magnesium Concentrations

Normal serum magnesium concentrations are 1.7 to 3.0 mg/dL (0.70 to 1.23 mmol/L). These levels in cattle are often reduced in seasonal subclinical hypomagnesemia to between 1 and 2 mg/dL (0.41 and 0.82 mmol/L), but risk for tetany is not present until the level falls to below 1.2 mg/dL (0.49 mmol/L).

The average concentration at which signs occur is approximately 0.5 mg/dL (0.21 mmol/L), and in sheep it is suggested that clinical tetany does not occur until the serum magnesium concentration is below 0.5 mg/dL (0.21 mmol/L).

Serum magnesium concentration in some animals may fall to as low as 0.4 mg/dL (0.16 mmol/L) without clinical illness. This may be a result of individual animal variation in the degree of ionization of the serum magnesium and in the difference between serum and CSF concentrations. A transitory elevation of serum magnesium concentration occurs after violent muscular exercise in cattle with clinical signs of hypomagnesemia.

Total serum calcium concentrations are often reduced to 5 to 8 mg/dL (1.25 to 2.00 mmol/L), and this may have an

important bearing on the development of clinical signs. Serum inorganic phosphate concentrations may or may not be low.

In wheat pasture poisoning of cattle there is hypomagnesemia, hypocalcemia, and hyperkalemia. In acute tetany, serum potassium concentrations are usually dangerously high and may contribute to the high death rate.

### Magnesium Concentrations in Cerebrospinal Fluid

Magnesium concentrations in CSF can be used as a diagnostic procedure, but CSF is not easily or safely collected in tetany cases. CSF collected up to 12 hours after death can be used diagnostically.

Magnesium concentrations in CSF of 1.25 mg/dL (0.51 mmol/L) were found in tetanic cows with hypomagnesemia (serum magnesium concentrations of  $0.54 \pm 0.41$  mg/dL;  $0.22 \pm 0.17$  mmol/L). In clinically normal cows with hypomagnesemia, comparable concentrations in CSF were 1.84 mg/dL (0.74 mmol/L) and 0.4 mg/dL (0.16 mmol/L) in serum. In normal animals CSF concentrations are the same as in plasma, that is, 2.0 mg/dL (0.82 mmol/L) and up. The magnesium content of ventricular CSF may be quite different from that of lumbar CSF. Ventricular CSF is also more responsive to changes in serum magnesium concentrations and is preferred for diagnosis at necropsy.

### Vitreous Humor

Magnesium concentrations in vitreous humor (but not aqueous humor) can be measured because vitreous humor magnesium concentration remains stable for a longer period of time than magnesium concentrations in serum or CSF. In general, vitreous humor magnesium concentrations less than 0.55 mmol/L for cattle and less than 0.65 mmol/L for sheep up to 48 hours after death indicate the presence of hypomagnesemia, particularly at ambient temperatures of 4° C or 20° C.<sup>1</sup>

Vitreous humor is viscous and must be collected using a 14-gauge (preferably) or 16-gauge needle attached to a syringe. With the deceased animal placed in sternal recumbency, the needle is introduced vertically from a position caudal to the dorsal limbus of the eye parallel and caudal to the lens before aspiration (Fig. 17-5). The needle position should be altered to facilitate aspiration.<sup>1</sup> The aspirated sample should be placed in a plain tube and centrifuged, and the supernatant should be submitted for determination of the magnesium concentration. Aqueous humor should not be collected for analysis because it is readily contaminated by degenerating iris tissue and evaporation of free water across the cornea.

### Urine Magnesium Concentrations

The occurrence of low urine magnesium levels is good presumptive evidence of

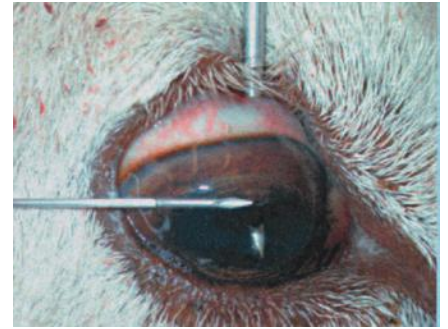

**Fig. 17-5** Vitreous humor is sampled from a recently deceased animal by inserting a 14-gauge needle perpendicular and caudal to the limbus. The needle tip can be observed through the pupil. Aqueous humor is obtained by inserting a 21-gauge needle horizontally rostral to the limbus and into the anterior chamber. Vitreous humor is required to evaluate magnesium concentrations. (Reproduced, with permission, from Edwards G, Foster A, and Livesey C. *In Practice* 2009; 31:22-25.)

hypomagnesemia; however, it is not the most sensitive test. Normalization of urine magnesium to simultaneously determine urine creatinine concentration will adjust urine magnesium concentration for animal-to-animal variability in urine concentration.<sup>2</sup> Further adjustment by calculating the fraction clearance of magnesium (requiring simultaneous determination of plasma/serum magnesium and creatinine concentrations) has not been shown to provide additional information beyond that provided by the concentration of urinary magnesium to creatinine alone.

### Herd Diagnosis

The kidney is the major organ of homeostasis, and it has been argued that analysis of urine magnesium status is a more accurate method of assessing herd magnesium status than serum magnesium concentrations. The magnesium status of a herd, and the need to supplement the diet to prevent lactation tetany, can be established from the following values:

- serum magnesium concentrations
- urine magnesium concentrations
- urinary magnesium fractional clearance<sup>2</sup>
- creatinine-corrected urinary magnesium concentrations

Laboratory charges for urinary magnesium fractional clearance ratios are expensive. The determination of the **creatinine-corrected urinary magnesium concentration** from 10 cows in a herd has been found to be a more sensitive indicator of magnesium status of the herd than estimates from serum, and it is a better predictor of response to supplementation. Values of less than 1.0 mmol/L indicate that a positive response to supplementation is likely. **Urine**



**magnesium concentrations** below 1.0 mg/dL (0.4 mmol/L) indicate a danger for tetany.

### NECROPSY FINDINGS

There are **no specific necropsy findings**. Extravasations of blood may be observed in subcutaneous tissues and under the pericardium, endocardium, pleura, peritoneum, and intestinal mucosa. Agonal emphysema may also be present.

The magnesium content of the bovine vitreous humor is considered to be an accurate estimate of magnesium status for 72 hours after death, provided the environmental temperature does not exceed 23°C (73°F) and there is not growth of bacterial contamination after sampling, which can result in a false low magnesium concentration. The addition of a small amount of 4% formaldehyde (3% of the vitreous humor volume) will allow accurate analysis for periods up to 72 hours after sampling.

Concentrations in the aqueous humor are not stable after death.

### DIFFERENTIAL DIAGNOSIS

#### Cattle

- Acute lead poisoning
- Rabies
- Nervous ketosis
- Bovine spongiform encephalopathy

#### Sheep

- Hypocalcemia
- Phalaris poisoning
- "Stagger" syndromes

### TREATMENT

IV administration of preparations containing magnesium or, more commonly, magnesium and calcium are used. The efficiency of the various treatments appears to vary from area to area, and even within areas under different conditions of management and climate. Response rates and recovery rates are much higher in cases treated early in the clinical course. IV chloral hydrate may be administered to reduce the severity of convulsions during treatment with magnesium. Case fatality, even with therapy, can be high, especially in advanced cases.

### Combined Calcium/Magnesium Therapy

The safest general recommendation is to use a combined calcium–magnesium preparation (e.g., 500 mL of a solution containing 25% calcium borogluconate and 5% magnesium hypophosphate for cattle, 50 mL for sheep and goats) IV followed by an SC injection of a concentrated solution of a magnesium salt. The details and risks of administration of the type of solution are described in the section on parturient paresis. A combination of 12% magnesium

adipate and 5% calcium gluconate at a dose rate of 500 mL is also used.

### Magnesium Therapy

When magnesium solutions are used, 200 to 300 mL of a 20% solution of magnesium sulfate may be injected **IV**; this is followed by a very rapid rise in serum magnesium concentration, which returns to preinjection levels within 3 to 6 hours. A much slower rise and fall occurs after **SC injection**, and for optimum results the SC injection of 200 mL of a 50% solution of magnesium sulfate has been recommended. A rise in serum magnesium of 0.5 mg/dL (0.21 mmol/L) occurs within a few minutes, and subsequent serum concentrations do not go above 5 mg/dL (2.06 mmol/L). In cases where serum magnesium concentrations are low because of seasonal hypomagnesemia, the injection of magnesium salts is followed by a rise and then a return to the subnormal preinjection levels.

The IV injection of magnesium salts is not without danger. It may induce cardiac dysrhythmia, or medullary depression may be severe enough to cause respiratory failure. If signs of respiratory distress or excessive slowing or increase in heart rate are noticed, the injection should be stopped immediately and, if necessary, a calcium solution injected.

The substitution of magnesium lactate for magnesium sulfate has been recommended to provide a more prolonged elevation of serum magnesium levels. A dilute solution (3.3%) causes minimal tissue injury and can be administered IV or SC. Magnesium gluconate has also been used as a 15% solution at dose rates of 200 to 400 mL. High serum magnesium concentrations are obtained more slowly and are maintained longer with magnesium gluconate than with magnesium sulfate. The feeding of magnesium-rich supplements, as described in the following section on control, is recommended after parenteral treatment.

### Provision for Further Cases

The predisposing factors that lead to a case of hypomagnesemia apply to the herd as a whole, and it is probable that further clinical cases will occur before the effects of corrective strategies are observed. In extensive range situations, it is advisable to instruct the owner on how to treat cases because a delay in treatment can markedly increase the rate of treatment failures. SC treatment is within the realm of most, but successful therapy is also recorded by the rectal infusion of 30 g of magnesium chloride in a 100-mL solution; serum concentrations of magnesium return to normal levels within 10 minutes of administration.

### CONTROL

Where possible, animals at high risk should be moved to low-risk pastures during the grass tetany season. High-risk pastures can

be grazed by low-risk animals, steers, or yearling heifers, for example, during this period.

The occurrence of hypomagnesemia can be corrected by the provision of adequate or increased amounts of magnesium in the diet. A requirement as high as 3.0 g/kg DM diet may be required for lactating cows on spring pasture. The problem is in determining an **adequate delivery system**, and this will vary according to the management system. Thus blocked minerals containing magnesium or foliar dressing of magnesium may be adequate delivery systems where there is a high stocking density of cattle, but they are totally inadequate or economically unfeasible on range with one cow per 20 acres.

Magnesium oxide is commonly used for supplementation, but other magnesium salts can be used, and they have an approximate equivalent availability. The biological **availability** of magnesium from magnesium carbonate, magnesium oxide, and magnesium sulfate for sheep is influenced by particle size, but it has been determined as 43.8%, 50.9%, and 57.6%, respectively.

### Feeding of Magnesium Supplements

The preventive measure that is now universally adopted is the feeding of magnesium supplements to cows during the danger period. The feeding of magnesite (containing not less than 87% magnesium oxide), or other sources of **magnesium oxide**, prevents the seasonal fall in serum magnesium concentrations. Daily administration by drenching, or in the feed, of at least 60 g of magnesium oxide per day is recommended to prevent the disease. This is not always completely effective, and in some circumstances large doses may be necessary. Daily feeding of 120 g is safe and effective, but 180 g daily may cause diarrhea. The dose for sheep and goats is 7 g daily or 14 g every second day. Magnesium phosphate (53 g/d) is also a safe and effective way of ensuring a good intake of magnesium. The protection afforded develops within several days of commencing administration and terminates abruptly after administration ceases.

### Problems With Palatability

The problem with magnesium supplements is getting the stock to eat the required amount because they are unpalatable. This can be partially countered by mixing the supplement with molasses in equal parts and allowing free access to the mixture or feeding it in ball feeders, but uniform intake by all animals does not occur, and at-risk animals may still develop hypomagnesemic tetany. Similarly, magnesium blocks may have limited efficacy in preventing hypomagnesemia. **Salt blocks** can help repair the sodium deficiency associated with young spring grasses and improve the Na:K ratio in the rumen. If they also contain Mg they can be

an aid in prevention, but usually, by themselves, they do not guarantee freedom from risk for tetany.

### Spraying on Hay

One method of attempting to ensure an adequate intake of magnesium is to spray it on hay and to feed this hay as a supplement during periods of grass tetany risk. The common practice is as follows:

1. Mix magnesite with molasses.
2. Dilute mixture with water.
3. Spray mixture onto hay in the windrows when it is being made.
4. Inject mixture into the bales before feeding or spray onto the hay at feeding.
5. Tip bale of hay so that the cut side is uppermost and pour the mixture evenly over the entire surface area.
6. Determine the level of application by the amount of hay intended to be fed.

Depending on local circumstances, this method may or may not be effective because cattle and sheep will frequently not eat hay when on spring pasture unless they are confined for that purpose.

### Pellets

Magnesium-rich pellets suggest themselves as a means of supplementation when the additional cost can be borne. Palatability is again a problem, and care needs to be taken to include palatable material in the pellets; alternatively, they may be mixed with other grain or molasses for feeding. Calves should be restricted from access because magnesium oxide at high levels of intake (2% and 4% of the ration) is toxic to calves and causes diarrhea with much mucus in the feces.

In some high-risk situations it may be advisable to provide magnesium in several forms to ensure adequate intake.

### Routine Daily Drenching

A once-daily oral administration of magnesium oxide or magnesium chloride to lactating dairy cows (to provide 10 g magnesium per cow), administered with a drenching gun just before the cows leave the milking parlor, is used in New Zealand to ensure adequate supplemental magnesium during periods of high risk. The cows become used to the procedure (and the farmers adept at carrying it out), and it causes minimal disruption of management.

### Heavy Magnesium "Bullets"

The use of heavy "bullets" of magnesium to prevent hypomagnesemia has been effective in laboratory trials, and they are available commercially in some countries. The objective is to place a heavy bullet of magnesium in the reticulum, from which it constantly liberates small amounts of magnesium—about 1 g/d. This objective is achieved, and the occurrence of the clinical disease is

usually greatly reduced but not eliminated. In dangerous situations, it is customary to administer up to four bullets at a time. As with all bullets, there is a proportion lost by regurgitation and by passage through the gut. A special sheep-sized bullet is used in ewes, with similar results.

### Top Dressing of Pasture

Top dressing of pasture, together with magnesium-rich fertilizers, raises the level of magnesium in the pasture and decreases the susceptibility of cattle to hypomagnesemia. For top dressing, calcined magnesite (1125 kg/ha) or magnesian limestone (5600 kg/ha) are satisfactory, with the former resulting in a greater increase in pasture magnesium.

Other magnesium-containing fertilizers can be used depending on cost. The duration of the improved magnesium status varies with the type of soil: it is greatest on light sandy loams, on which a dressing of 560 kg/ha of calcined magnesium can provide protection for 3 years. On heavy soils protection for only 1 year is to be expected. To avoid unnecessary expense, it may be possible to top dress one field with the magnesium fertilizer and keep this field in reserve for spring grazing. Fertilization with magnesium is expensive, and the response of pastures varies markedly with the soil type. It is advisable to seek agronomic advice.

### Foliar Dusting and Spraying

The magnesium content of pastures can be raised much more quickly by spraying with a 2% solution of magnesium sulfate at fortnightly intervals or by application of very finely ground magnesium oxide to the pasture (30 kg/ha) before grazing commences. The technique is referred to as foliar dusting or spraying and has the advantage over feed supplementation that the intake is standard. It is very effective in cattle in maintaining serum magnesium concentrations and preventing the occurrence of the clinical disease.

Dusting with 20 to 50 kg MgO/ha can provide protection for up to 3 weeks, but the duration is adversely influenced by wind and rain. A MgO-bentonite-water slurry sprayed onto pastures (26 kg MgO and 2.6 kg bentonite/ha) is effective in providing protection in high-rainfall periods.

### Provision in Drinking Water

The problem with water medication is that the water intake of the group to be treated is not known and may be minimal on rapidly growing pastures. However, water medication may provide a delivery system for magnesium on management systems such as extensive range pastures where other methods may have limited success. Water sources other than the medicated supply need to be fenced off or otherwise restricted. The addition of magnesium sulfate (500 g/100 L) or magnesium chloride

hexahydrate (420 g/100 L) to the water supply during the risk period for hypomagnesemia has proved effective.

### Management of Pasture Fields

The economics of dairy farming make it necessary to produce maximum pasture growth, and the development of tetany-prone pastures is unavoidable in many circumstances. In some areas it may be possible to reduce the danger of such pastures by encouraging the development of legumes. In other areas the period of legume growth does not coincide with the period of maximum risk for grass tetany.

Restricting the amount of potash added to pastures, especially in the period immediately preceding the risk period for tetany, or using potash fertilizers in the autumn or late spring after the period of risk can reduce risk of the disease. The grazing of low-risk animals on high-risk pastures is another strategy. Ensuring that ample salt is available during the danger period to counteract the high intake of potassium can also reduce risk of the disease.

Plant geneticists are developing cultivars of cool-season grasses with high magnesium content that could be used for grazing during the tetany season. Lactating sheep grazing a **high-magnesium cultivar** of perennial rye grass (*Lolium perenne* cv *Radmore*) in the spring have shown higher serum magnesium concentrations than sheep grazing control cultivar, and cultivars of tall fescue (*Festuca arundinacea*) with high magnesium and calcium concentrations and low tetany potential are also available.

### Provision of Shelter

In areas where winter pasturing is practiced, the observation that serum magnesium levels fall during the winter and in association with inclement weather suggests that cattle and sheep should be provided with shelter at such times. If complete housing is impractical, it may be advisable to erect open-access shelters in those fields that have no tree cover or protection from prevailing winds. Fields in which lactating cows are kept should receive special attention in this regard. Unfortunately, the disease is most common on highly improved farms, where most natural shelter has been removed, and it is desired to keep the cows on the highly improved pasture to maintain milk production or fatten calves rapidly.

### Time of Calving

In areas where the incidence of the disease is high, it may be advisable to avoid having the cows calve during the cold winter months when seasonal hypomagnesemia is most likely to develop. Unfortunately, it is often important to have cows calve in late winter to take advantage of the flush of spring growth when the cows are at the peak of their lactation.

## Feeding on Hay and Unimproved Pasture

Because of the probable importance of lush, improved, grass pasture in producing the disease, the provision of some grain, hay, or rough grazing may reduce its incidence. It is most important that the periods of fasting, such as occur when cattle or sheep are yarded or moved or during bad weather, should be avoided, especially in lactating animals and when seasonal hypomagnesemia is likely to be present.

### TREATMENT AND CONTROL

#### Treatment

IV administration of a solution containing 25% calcium borogluconate and 5% magnesium hypophosphite (500 mL for cattle, 50 mL for sheep and goats) (R-1)

SC administration of a 50% solution of magnesium sulfate (200 mL for cattle) (R-1)

IV administration of a 15% solution of magnesium gluconate (200 to 400 mL for cattle) or a 20% solution of magnesium sulfate (200 to 300 mL for cattle) (R-2)

#### Control

Magnesium oxide—daily administration by drenching or in the feed of 60 g (cattle) or 7 g (sheep and goats) (R-1)

Increase dietary magnesium intake at times of increased risk for hypomagnesemia (R-2)

Monitor urine magnesium-to-creatinine ratio of animals at increased for hypomagnesemia (R-2)

### FURTHER READING

- Brozos C, Mavrogianni VS, Fthenakis GC. Treatment and control of periparturient metabolic diseases: pregnancy toxemia, hypocalcemia, hypomagnesemia. *Vet Clin North Am Food Anim Pract.* 2011;27:105-113.
- Foster A, Livesey C, Edwards G. Magnesium disorders in ruminants. *In Pract.* 2007;29:534-539.
- Goff JP. Calcium and magnesium disorders. *Vet Clin North Am Food Anim Pract.* 2014;30:359-381.
- Martin-Tereso J, Martens H. Calcium and magnesium physiology and nutrition in relation to the prevention of milk fever and tetany (dietary management of macrominerals in preventing disease). *Vet Clin North Am Food Anim Pract.* 2014;30:643-670.
- Schonewille JT. Magnesium in dairy cow nutrition: an overview. *Plant Soil.* 2013;368:167-178.

### REFERENCES

- Edwards G, Foster A, Livesey C. *In Pract.* 2009;31:22-25.
- Schweigel M, et al. *J Anim Physiol Anim Nutr.* 2009;93:105-112.

## HYPOMAGNESEMIC TETANY OF CALVES

### SYNOPSIS

**Etiology** Hypomagnesemia, resulting from inadequate magnesium in the diet.

**Epidemiology** Most commonly calves 2 to 4 months of age, on whole milk or milk-replacer diets and poor or no roughage. Diarrhea and chewing of bedding or other coarse fiber may exacerbate the deficiency.

**Clinical findings** Apprehension, agitation, hypersensitivity to all external stimuli, fine muscle tremors progressing to spasticity and violent convulsions. Rapid course and high case-fatality rate.

**Clinical pathology** Serum magnesium concentrations below 0.8 mg/dL, bone calcium:magnesium ratio above 90:1.

**Necropsy findings** Calcification of the spleen, diaphragm, and endothelium of the aorta and endocardium. Enzootic muscular dystrophy is often concurrent.

**Diagnostic confirmation** Blood magnesium and response to treatment. Bone calcium:magnesium ratios.

**Treatment and control** Magnesium injection and dietary supplementation with magnesium compounds.

### ETIOLOGY

The disease results when the dietary intake of magnesium is inadequate for the requirements of the calf. Affected animals may have concurrent hypocalcemia.

### Magnesium Homeostasis in the Calf

Milk has low concentrations of magnesium. A milk diet provides adequate magnesium for the requirements of a growing calf up to a body weight of approximately 50 kg, but if milk is the sole diet, the intake of magnesium will be inadequate for requirements once this body weight is reached. The deficit will perpetuate if the other feeds that are fed are also low in magnesium.

In the young calf, magnesium is absorbed in the intestine; however, the efficiency of magnesium absorption decreases from 87% to approximately 30% at 3 months of age, when maximum susceptibility to the disease occurs. The efficiency of absorption is also decreased by a reduction in intestinal transit time caused by diarrhea.

In contrast to adult cattle, young calves can mobilize body stores of magnesium, which are principally located in the skeleton. Approximately 40% of the magnesium stored in the skeleton can be mobilized, which will protect against a short-term deficit.

Hypomagnesemic tetany in calves is often complicated in field cases by the coexistence of other diseases, especially enzootic muscular dystrophy.

### EPIDEMIOLOGY

#### Occurrence

The disease is not common. Cases may occur sporadically, or a number of deaths may occur on one farm within a short period of time.

### Risk Factors

The disease can occur under a number of different circumstances. Most commonly, hypomagnesemic tetany occurs in calves 2 to 4 months of age or older that are fed solely on a diet of whole milk, and calves receiving the greatest quantity of milk and growing most rapidly are more likely to be affected because of their greater need for magnesium for incorporation into developing soft tissues. It is most likely to occur in calves being fattened for veal. Those cases that occur in calves on milk replacer appear to be related to chronic scours and the low magnesium content of the replacer. This problem is less common than it once was because most modern commercial milk replacers have added adequate magnesium.

A significant loss of magnesium in the feces also occurs in calves allowed to chew fibrous material, such as bedding; the chewing stimulates profuse salivation and creates greater loss of endogenous magnesium. Peat and wood shavings are bedding materials known to have this effect.

Cases have also been reported in calves fed milk-replacer diets or milk, concentrates, and hay, and in calves running at pasture with their dams. Deaths resulting from hypomagnesemic tetany have also occurred in 3- to 4-month-old calves whose hay and silage rations were low in magnesium content.

Hypomagnesemia also occurs in young cattle, about 6 months of age, that are being fattened intensively indoors for the baby beef market. The phosphorus content of their diet is high, and a lack of vitamin D is probable. The situation is exacerbated by a shortage of roughage. The hypomagnesemia is accompanied by hypocalcemia.

### Experimental Reproduction

A condition closely resembling the field syndrome has been produced experimentally by feeding an artificial diet with a very low content of magnesium and a high calcium content, and biochemical hypomagnesemia is readily produced in calves with a diet based on skim milk and barley straw. Hypomagnesemia has also been produced experimentally in very young foals by feeding a diet with a very low magnesium content. The clinical signs are similar to those in calves, and the calcification found in the walls of vessels of calves also occurs in foals.

### PATHOGENESIS

On affected farms, calves are born with normal serum magnesium concentrations of 2 to 2.5 mg/dL (0.82 to 1.03 mmol/L), but the concentrations fall gradually in the succeeding 2 to 3 months, often to below 0.8 mg/dL (0.33 mmol/L). Tetany does not occur until the serum magnesium falls below this concentration and is most severe at concentrations below 0.6 mg/dL (0.25 mmol/L), although some calves in a group may have



concentrations even lower than this and show few clinical signs.

Magnesium deficiency inhibits the release and action of parathyroid hormone, and this is thought to be the genesis of the concurrent hypocalcemia. It is probable that depression of the serum calcium level precipitates tetany in animals rendered tetany prone by low serum magnesium levels. Tetanic convulsions can occur in hypocalcemic calves in the absence of hypomagnesemia.

Hypomagnesemic tetany is not related in any way to enzootic muscular dystrophy, although the diseases may occur concurrently.

### CLINICAL FINDINGS

The first sign in the experimental disease is constant movement of the ears. The temperature is normal and the pulse rate accelerated. Hyperesthesia to touch and grossly exaggerated tendon reflexes with clonus are present. Shaking of the head, opisthotonos, ataxia without circling, and a droopy, backward carriage of the ears are constant. There is difficulty in drinking because of the animal's inability to get to the bucket.

Initially, the calves are apprehensive, show agitation and retraction of the eyelids when approached, and are hypersensitive to all external stimuli, but they show no tetany. Later, fine muscle tremors appear, followed by kicking at the belly, frothing at the mouth, and spasticity of the limbs. Convulsions follow, beginning with stamping of the feet, head retraction, chomping of the jaws, and falling.

During the convulsions the following signs are present:

- Jaws are clenched.
- Respiratory movements cease.
- There are tonic and clonic movements of the limbs.
- There is involuntary passage of urine and feces.
- There are cycles of protrusion and retraction of the eyeballs.

The pulse rate rises to 200 to 250/min, and the convulsions disappear terminally. The pulse becomes impalpable, and cyanosis appears before death.

In field cases the signs are almost identical, but they are rarely observed until the terminal tetanic stage. Older calves usually die within 20 to 30 minutes of the onset of convulsions, but young calves may recover temporarily only to succumb to subsequent attacks. Cases that occur in young calves with scours, usually at about 2 to 4 weeks of age, show ataxia, hyperesthesia, opisthotonos, and convulsions as the presenting signs. The convulsions are usually continuous, and the calves die within 1 hour.

### CLINICAL PATHOLOGY

Serum magnesium concentrations below 0.8 mg/dL (0.33 mmol/L) indicate severe hypomagnesemia, and clinical signs occur

with levels of 0.3 to 0.7 mg/dL (0.12 to 0.29 mmol/L). Normal values are 2.2 to 2.7 mg/dL (0.9 to 1.11 mmol/L). Erythrocyte magnesium concentrations are also low, indicating a chronic deficiency. Serum calcium concentrations tend to fall when serum magnesium levels become very low and are below normal in most clinical cases.

The estimation of the magnesium in bone (particularly ribs and vertebrae) is a reliable confirmatory test at necropsy. Values below a ratio of 70:1 for calcium:magnesium may be regarded as normal, and those above 90:1 are indicative of severe magnesium depletion. In the normal calf the ratio is about 55:1.<sup>1</sup> Absolute bone calcium values are not decreased and are often slightly elevated. An incidental change is the marked increase in serum creatinine kinase activity in calves after an acute attack of hypomagnesemic tetany.

### NECROPSY FINDINGS

There is a marked difference between the necropsy lesions of some natural cases and those in the experimental disease. In field cases, there is often calcification of the spleen and diaphragm, and calcified plaques are present in the aorta and endocardium, together with hyaline degeneration and musculature. In other cases necropsy lesions similar to those in enzootic muscular dystrophy occur.

In experimentally produced cases these lesions are not evident, but there is extensive congestion in all organs, and hemorrhages are present in unsupported organs, including the following:

- Gallbladder
- Ventricular epicardium
- Pericardial fat
- Aorta
- Mesentery wall
- Intestinal wall

The lesions are obviously terminal and are associated with a terminal venous necrosis. Some field cases present a picture identical to this.

### DIFFERENTIAL DIAGNOSIS

- Acute lead poisoning
- Enterotoxemia caused by *Clostridium perfringens* type D
- Polioencephalomalacia
- Tetanus
- Vitamin A deficiency
- Meningitis

### TREATMENT

Response to magnesium injections (100 mL of a 10% solution of magnesium sulfate) is only transitory because of the severe depletion of bone reserves of magnesium. This dose provides only a single day's requirements. A magnesium sulfate enema in warm water (containing 15 g of magnesium sulfate) was associated with a rapid response in hypomagnesemic 3-month-old calves.<sup>2</sup>

Follow-up supplementation of the diet with magnesium oxide or carbonate as described later is advisable. Chloral narcosis or tranquilization with an ataractic drug may be essential to avoid death as a result of respiratory paralysis during convulsions.

### CONTROL

The provision of hay that is high in magnesium, such as alfalfa, helps to prevent the disease, as will well-formulated concentrates.

### Supplementary Feeding of Magnesium

If begun during the first 10 days of life, supplementary magnesium feeding will prevent excessive drops in serum magnesium, but if begun after the calf is 7 weeks old, it may not prevent further depression of the levels. Supplementation should continue until at least 10 weeks of age. Daily feeding of the magnesium compound and fairly accurate dosing are necessary to avoid scouring or inefficient protection. For calves of average growth rate, appropriate dose rates are 1 g/d for calves to 5 weeks of age, 2 g/d for calves 5 to 10 weeks of age, and 3 g/d for calves 10 to 15 weeks of age of magnesium oxide or twice this dose of carbonate. Supplementation of the diet with magnesium restores serum calcium levels to normal and corrects the hypomagnesemia.

### Magnesium Alloy Bullets

Two bullets of the sheep size (together releasing approximately 1 g/d of magnesium) per calf have shown high efficiency in preventing the clinical disease and also the hypomagnesemia that precedes it. Calves kept indoors and fed largely on milk should get adequate mineral supplement and vitamin D (70,000 IU vitamin D<sub>3</sub>/d). Magnesium utilization will not be affected, but calcium absorption, which is often sufficiently reduced to cause a concurrent hypocalcemia, will be improved.

### REFERENCES

1. Foster A, et al. *In Pract.* 2007;29:534.
2. Soni AK, Shukla PC. *Environ Ecol.* 2012;30:1601.

### TRANSPORT RECUMBENCY OF RUMINANTS

Transport recumbency (tetany) occurs after prolonged transport, usually in cows and ewes in late pregnancy. It is also recorded in lambs transported to feedlots and in cows and sheep delivered to abattoirs. It is characterized by recumbency, alimentary tract stasis, and coma, and it is highly fatal. It occurs in most countries. Large losses can be encountered when cows and ewes in late pregnancy are moved long distances by rail, by truck, or on foot.

Although cows of any age in late pregnancy are most commonly affected, the disease has also been recorded in cows

recently calved, bullocks, steers, dry cows, and lambs. Risk factors include the following:

- Heavy feeding before shipment
- Deprivation of feed and water for more than 24 hours during transit
- Unrestricted access to water
- Exercise immediately after unloading

There is an increased incidence of the disease during hot weather. The cause is unknown, although physical stress is an obvious factor. Lambs show the following characteristics:

- Restlessness
- Staggering
- Partial paralysis of hindlegs
- Early assumption of lateral recumbency

Death may occur quickly, or after 2 to 3 days of recumbency. There is mild hypocalcemia (7 to 7.5 mg/dL; 1.75 to 1.87 mmol/L). The recovery rate even with treatment is only fair.

Clinical signs may occur while the cattle are still on the transportation vehicle or up to 48 hours after unloading. In the early stages, animals may exhibit excitement and restlessness, trismus, and grinding of the teeth. A staggering gait with paddling of the hindlegs and recumbency occur, accompanied by stasis of the alimentary tract and complete anorexia. Animals that do not recover gradually become comatose and die in 3 to 4 days. There may be moderate hypocalcemia and hypophosphatemia in cattle. In sheep of various ages, some are hypocalcemic and hypomagnesemic, some are hypoglycemic, and some have no detectable biochemical abnormality. There are no lesions at necropsy other than those related to prolonged recumbency. Ischemic muscle necrosis is the most obvious of these lesions. The relationship of the disease to transport or forced exercise is diagnostic.

Some cases respond to treatment with combined calcium, magnesium, and glucose injections. Repeated parenteral injections of large volumes of electrolyte solutions are recommended. In lambs, the SC injection of a solution of calcium and magnesium salts is recommended, but the response is usually only 50%, due probably because of an intercurrent myonecrosis.

If prolonged transport of cows or ewes in advanced pregnancy is unavoidable, they should be provided with adequate food, water, and rest periods during the trip. The incidence of this condition after transportation appears to have been markedly reduced with increased monitoring and awareness of transportation-related morbidity and mortality.

## KETOSIS AND SUBCLINICAL KETOSIS (HYPERKETONEMIA) IN CATTLE

### SYNOPSIS

**Etiology** A multifactorial disorder of energy metabolism. Negative energy balance

results in hypoglycemia, ketonemia (the accumulation in blood of acetoacetate,  $\beta$ -hydroxybutyrate [BHB] and their decarboxylation products acetone and isopropanol), and ketonuria.

**Epidemiology** Primary ketosis and subclinical ketosis occurs predominantly in well-conditioned cows with high lactation potential, principally in the first month of lactation, with a higher prevalence in cows with a higher lactation number. Loss of body condition in the dry period and immediately postpartum. Secondary ketosis occurs where other disease reduces feed intake.

**Clinical findings** Cattle show wasting with decrease in appetite, body condition, and milk production. Some have short periods of bizarre neurologic and behavioral abnormality (nervous ketosis). Response to treatment is good. Subclinical ketosis (hyperketonemia) is detected by tests for ketones, usually BHB in blood, plasma, or serum, and acetoacetate in urine.

**Clinical pathology** Hypoglycemia, ketonemia, ketonuria, or elevated ketones in milk.

**Necropsy findings** None specific. Varying degrees of hepatic lipidosis.

**Diagnostic confirmation** Ketonemia, ketonuria, or, less commonly, elevated ketone concentration in milk.

**Treatment** Intravenous glucose, parenteral corticosteroid, and oral glucose precursors such as propylene glycol. The disease responds readily to treatment in cattle with mild hepatic lipidosis and is self-limiting.

**Control** Correction of energy imbalance. Herd biochemical monitoring coupled with condition scoring. Daily monensin administration to late-gestation and early-lactation dairy cows.

## ETIOLOGY

### Glucose Metabolism in Cattle

The maintenance of adequate concentrations of glucose in the plasma is critical to the regulation of energy metabolism. The ruminant absorbs very little dietary carbohydrate as hexose sugar because dietary carbohydrates are fermented in the rumen to short-chain fatty acids, principally acetate (70%), propionate (20%), and butyrate (10%). Consequently, glucose needs in cattle must largely be met by gluconeogenesis. **Propionate and amino acids are the major precursors** for gluconeogenesis, with glycerol and lactate being of lesser importance.

**Propionate** is produced in the rumen from starch, fiber, and proteins. It enters the portal circulation and is efficiently removed by the liver, which is the primary glucose-producing organ. Propionate is the **most important glucose precursor**; an increased availability of propionate can spare the hepatic utilization of other glucose precursors, and production of propionate is favored by a high grain inclusion in the diet. The

gluconeogenic effect of propionate should be contrasted to **acetate**, which is transported to peripheral tissues and to the mammary gland and metabolized to long-chain fatty acids for storage as lipids or secretion as milk fat.

**Amino acids.** The majority of amino acids are gluconeogenic and are also important precursors for gluconeogenesis. Dietary protein is the most important quantitative source, but the labile pool of body protein (particularly skeletal muscle) is also an important source; together they contribute to energy synthesis, milk lactose synthesis, and milk protein synthesis.

## Energy Balance

In high-producing dairy cows there is always a negative energy balance in the first few weeks of lactation. The highest dry matter intake does not occur until 8 to 10 weeks after calving, but peak milk production is at 4 to 6 weeks, and energy intake may not keep up with demand. In response to a negative energy balance and low serum concentrations of glucose (and consequently low serum concentrations of insulin), cows will mobilize adipose tissue, with consequent increases in serum concentrations of **nonesterified fatty acids (NEFA)** and subsequent increases in serum concentrations of  **$\beta$ -hydroxybutyrate (BHB)**, **acetoacetate**, and **acetone**. The hepatic mitochondrial metabolism of fatty acids promotes both gluconeogenesis and ketogenesis. Cows partition nutrients during pregnancy and lactation and are in a lipolytic stage in early lactation and at risk for ketosis during this period.

## Hepatic Insufficiency in Ketosis

Hepatic insufficiency has been shown to occur in bovine ketosis, but it does not occur in all cases. Ketosis is defined as an increased plasma or serum concentration of ketoacids and is divided into three types. In **type I**, or “spontaneous” ketosis, the gluconeogenic pathways are maximally stimulated, and ketosis occurs when the demand for glucose outstrips the capacity of the liver for gluconeogenesis because of an insufficient supply of glucose precursors. Rapid entry of NEFAs into hepatic mitochondria occurs and results in high rates of ketogenesis and high plasma/serum ketone concentration. There is little conversion of NEFAs to triglycerides, resulting in little fat accumulation in the liver. In **type II** ketosis, manifest with **fatty liver**, gluconeogenic pathways are not maximally stimulated, and consequently mitochondrial uptake of NEFAs is not as active, and NEFAs become esterified in the cytosol, forming triglyceride. The capacity of cattle to transport triglyceride from the liver is low, resulting in accumulation and fatty liver. The occurrence of a fatty liver can further suppress hepatic gluconeogenic capacity. Hepatic insufficiency may occur more commonly in those cows predisposed to ketosis by overfeeding in the dry period. In **type III** ketosis, cattle

are fed a diet (typically a high-maize ration) that results in a higher ruminal production of butyrate, which is directly metabolized by ruminal epithelial cells to butyrate.

### Ketone Formation

Ketones arise from two major sources: butyrate in the rumen and mobilization of fat. A large proportion of butyrate produced by rumen fermentation of the diet is converted to BHB in the rumen epithelium and is absorbed as such. Free fatty acids produced from the mobilization of fat are transported to the liver and oxidized to produce acetyl-CoA and NADH.

Acetyl-CoA may be oxidized via the tricarboxylic acid (TCA) cycle or metabolized to acetoacetyl-CoA. Complete oxidation of acetyl-CoA via the TCA cycle depends on an adequate supply of oxaloacetate from the precursor propionate. If propionate, and consequently oxaloacetate, is deficient, oxidation of acetyl-CoA via the TCA cycle is limited, and acetyl-CoA is metabolized to acetoacetyl CoA and subsequently to acetoacetate and BHB.

The ketones BHB and acetoacetate can be utilized as energy sources. They are normally present in the plasma/serum of cattle, and their concentration is a result of the balance between production in the liver and utilization by the peripheral tissues. Acetoacetate can spontaneously convert to **acetone**, which is volatile and therefore exhaled in the breath; diffusion of acetone across the rumen epithelium into the rumen means that some acetone is eructated. Ruminal flora (most likely bacteria) can metabolize acetone to isopropanol, which can then be absorbed to increase plasma concentrations of **isopropanol**, a 3-carbon alcohol.<sup>1</sup>

### Role of Insulin and Glucagon

The regulation of energy metabolism in ruminants is primarily governed by insulin and glucagon. Insulin acts as a glucoregulatory hormone stimulating glucose use by tissues and decreasing hepatic gluconeogenesis. Plasma insulin concentrations decrease with decreasing plasma concentrations of glucose and propionate. Insulin also acts as a liporegulatory hormone stimulating lipogenesis and inhibiting lipolysis. Glucagon is the primary counterregulatory hormone to insulin. The counteracting effects of insulin and glucagon therefore play a central role in the homeostatic control of glucose. A low **insulin:glucagon ratio** stimulates lipolysis in adipose tissue and ketogenesis in the liver. Cows in early lactation have low insulin:glucagon ratios because of low plasma glucose concentrations and are in a catabolic state. Regulation is also indirectly governed by **somatotropin**, which is the most important determinant of milk yield in cattle and is also lipolytic. Factors that decrease the energy supply, increase the demand for glucose, or increase the utilization of peripheral fat

reserves as an energy source are likely to increase ketone production and ketonemia. There is, however, considerable cow-to-cow variation in the risk for developing clinical ketosis.

### ETIOLOGY OF BOVINE KETOSIS

It is not unreasonable to view clinical ketosis as one end of a spectrum of a metabolic state that is **common in heavily producing cows** in the **postcalving period**. This is because high-yielding cows in early lactation are in negative energy balance and are subclinically ketotic as a result.

Cattle are particularly vulnerable to ketosis because, although very little carbohydrate is absorbed as such, a direct supply of glucose is essential for tissue metabolism, particularly the formation of lactose associated with milk production. The utilization of volatile fatty acids for energy purposes is also dependent on a supply of available glucose. This vulnerability is further exacerbated in the lactating dairy cow by the tremendous rate of turnover of glucose.

In the period between calving and peak lactation, the demand for glucose is increased and cannot be completely restrained. Cows will reduce milk production in response to a reduction of energy intake, but this does not follow automatically nor proportionately in early lactation because hormonal stimuli for milk production overcome the effects of reduced food intake. Under these circumstances, lowered plasma glucose concentrations result in lowered plasma insulin concentrations. Long-chain fatty acids are released from fat stores under the influence of both a low plasma insulin:glucagon ratio and the influence of high somatotropin concentration, and this leads to increased ketogenesis.

### Individual Cow Variation

The rate of occurrence of negative energy status, and therefore the frequency of clinical ketosis cases, has increased markedly over the last 4 decades because of the increase in the lactation potential of the modern dairy cow. Because of the mammary gland's metabolic precedence in the partitioning of nutrients, especially glucose, milk production continues at a high rate, causing an energy drain. In many individual cows, the need for energy is beyond their capacity for dry matter intake, but there is between-cow variation in risk under similar nutritional stress. Clinical ketosis is easily produced in early-lactation dairy cows by reducing the daily feed intake.<sup>2</sup> Subclinical ketosis (hyperketonemia) in early-lactation dairy cows is associated with decreased dry matter intake and feeding time during the week before calving.<sup>6</sup>

### Types of Bovine Ketosis

There are many theories on the cause and biochemical and hormonal pathogenesis of

ketosis, in addition to the importance of predisposing factors. Reviews of these studies are cited at the end of this disease section. In general, it can be stated that clinical ketosis occurs in cattle when they are subjected to demands on their resources of glucose and glycogen that cannot be met by their digestive and metabolic activity.

A common classification of the disease based on its natural presentation in intensively and extensively managed dairy herds, and one that accounts for the early lactational demand for glucose, a limited supply of propionate precursors, and preformed ketones or mobilized lipids in the pathogenesis, has been developed. Such a classification scheme includes the following mechanisms for ketosis, which will be discussed in turn:

- Primary ketosis (production ketosis)
- Secondary ketosis
- Alimentary ketosis
- Starvation ketosis
- Ketosis resulting from a specific nutritional deficiency

#### Primary Ketosis (Production Ketosis)

This is the ketosis of most herds, the so-called estate acetonemia. Primary ketosis occurs in cows in good to excessive body condition that have high lactation potential and are being fed good-quality rations but that are in a negative energy balance. There is a tendency for the disease to recur in individual animals, which is probably a reflection of variation between cows in digestive capacity or metabolic efficiency. A proportion of primary ketosis cases appear as **clinical ketosis**, but a much greater proportion occurs as cases of **subclinical ketosis** in which there are increased concentrations of circulating ketone bodies but no overt clinical signs. Affected cattle recover with correct feeding and ancillary treatment.

#### Secondary Ketosis

Secondary ketosis occurs where the presence of **other disease** results in a **decreased food intake**. The cause of the reduction in food intake is commonly the result of abomasal displacement, traumatic reticulitis, metritis, mastitis, or other diseases common to the postparturient period. A high incidence of ketosis has also been observed in herds affected with fluorosis. An unusual occurrence reported was an outbreak of acetonemia in a dairy herd fed on a ration contaminated by a low level (9.5 ppm) of lincomycin, which caused ruminal microbial dysfunction. The proportion of cases of ketosis that are secondary and their diagnosis as such are both matters of great interest because a significant proportion of all cases of ketosis in lactating dairy cattle are secondary to other disease.

#### Alimentary Ketosis

Alimentary ketosis (also called type III in some classification systems) is a result of



excessive amounts of **butyrate in silage** and possibly also a result of decreased food intake resulting from the poor palatability of high-butyrate silage. Silage made from succulent material may be more highly ketogenic than other types of ensilage because of its higher content of preformed butyric acid. Spoiled silage is also a cause, and toxic biogenic amines in silage, such as putrescine, may also contribute. This type of ketosis is commonly subclinical, but it may predispose to the development of production or primary ketosis.

### Starvation Ketosis

Starvation ketosis occurs in cattle that are in poor body condition and that are fed poor-quality feedstuffs. There is a deficiency of propionate and protein from the diet and a limited capacity of gluconeogenesis from body reserves. Affected cattle recover with correct feeding.

### Ketosis Resulting From Specific Nutritional Deficiency

Specific dietary deficiencies of **cobalt** and possibly phosphorus may also lead to a high incidence of ketosis. This may be in part a result of a reduction in the intake of total digestible nutrients, but in cobalt deficiency, the essential defect is a failure to metabolize propionic acid in the TCA cycle. The problem is restricted to the cobalt-deficient areas of the world, although the occurrence of cobalt deficiency in high-producing dairy cows in nondeficient areas has been described.

There is a marked nadir in food intake around calving, followed by a gradual increase. This increase is quite variable between cows, but in the great majority of cases does not keep pace with milk yield. The net result is that high-yielding dairy cows are almost certain to be in negative energy balance for the first 2 months of lactation.

## EPIDEMIOLOGY

### Occurrence

Ketosis is a very common disease of lactating dairy cattle and is prevalent in most countries where intensive farming is practiced. Ketosis occurs mainly in animals housed during the winter and spring months and is rare in cows that calve on pasture. In housed or free-stalled cattle, ketosis occurs year around. The occurrence of the disease is very much dependent on management and nutrition and varies between herds. As might be expected, **lactational incidence rates** vary between herds, and a review of 11 epidemiologic studies showed a lactation incidence rate for ketosis that varied from 0.2% to 10.0%.

The incidence of **subclinical ketosis** (more correctly called hyperketonemia) is influenced by the cut-point of plasma BHB used for definition, but it is much higher than the incidence of clinical ketosis, especially in undernourished herds, and can

approach 40%. Incidence can be challenging and expensive to estimate because prevalence information is usually measured. In general, the incidence of subclinical ketosis is 1.8 times the prevalence.

### Animal and Management Risk Factors

There are conflicting reports on the significance of risk factors for ketosis and subclinical ketosis, which probably reflect that the disease can be a cause or effect of a number of interacting factors. The disease occurs in the immediate postparturient period, with 90% of cases occurring in the first 60 days of lactation. Regardless of the specific etiology, ketosis occurs most commonly during the **first month** of lactation, less commonly in the second month, and only occasionally in late pregnancy. In different studies, the median **time to onset following calving** has varied from 10 to 28 days, with some recent studies showing a peak prevalence of subclinical ketosis in the first 2 weeks post-calving. A prolonged previous intercalving interval increases risk.

**Age.** Cows of any age may be affected, but the disease increases from a low prevalence at the first calving to a peak at the fourth calving, associated with the level of milk production. Lactational incidence rates of clinical ketosis of 1.5% and 9%, respectively, were found in a study of 2415 primiparous and 4360 multiparous cows. Clinical ketosis can also recur in the same lactation.

**Herd differences** in prevalence are very evident in clinical practice and in the literature, with some herds having negligible occurrence. Although apparent differences in breed incidence are reported, evidence for a heritable predisposition within breeds is minimal. Feeding frequency has an effect, with the prevalence of ketosis being much lower in herds that feed a **total mixed ration (TMR)** ad libitum compared with herds that feed roughage and concentrate separately fed twice a day (**component fed**).

**Body-Condition Score.** There are conflicting reports on the relation between BCS at calving and ketosis, but it is very likely that studies that have found no relationship have not had many fat cows in the herds examined. Fat body condition postpartum was observed to be associated with a higher first-test-day milk yield, milk-fat-to-protein ratio of greater than 1.5, increased body-condition loss, and a higher risk for ketosis. In another study, cows with a BCS greater than 3.25 at parturition and that lost 0.75 points in BCS in the first 2 months of lactation developed subclinical ketosis. Body-condition loss during the dry period also increases risk for ketosis in the following lactation.

**Season.** There is no clear association with season. In some but not all summer grazing

areas, a higher risk is generally observed in cattle during the winter housing period. Higher prevalence has been observed in the late summer and early winter in Scandinavian countries.

**Other Interactions.** There is a **greater risk** for the development of ketosis in cows that have an extended long dry period;<sup>3</sup> those that develop milk fever, retained placenta, lameness, or hypomagnesemia; or those that have high milk production and high first milking colostrum volume.<sup>3</sup> Cows with twins are also at risk for ketosis in the terminal stages of pregnancy. There is a bidirectional relation between risk for displaced abomasum and risk for ketosis, but in a field study of 1000 cows in 25 herds, cows that had a serum BHB concentration greater than 1.4 mmol/L in the first 2 weeks of lactation had odds of 4:1 that a displaced abomasum would be diagnosed 1 to 3 weeks later. In another study of 1010 cows, a serum BHB concentration of 1.5 mmol/L or greater in the first 2 weeks of lactation was found to be associated with a threefold increase in ketosis or displaced abomasum. Interestingly, cows with increased blood BHB concentration immediately before surgical correction of left-displaced abomasum have increased longevity within the herd, compared with cattle with BHB concentrations within the reference interval.<sup>7,8</sup>

### Economic Significance

Clinical and subclinical ketosis are major causes of loss to the dairy farmer. In rare instances the disease is irreversible and the affected animal dies, but the main economic loss results from the loss of production while the disease is present, the possible failure to return to full production after recovery, and the increased occurrence of periparturient disease. Both clinical and subclinical ketosis are accompanied by **decreased milk yields**; lower milk protein and milk lactose; **increased risk** for delayed estrus and lower first-service conception rates; lower pregnancy rates; increased intercalving intervals; increased risk of cystic ovarian disease, metritis, and mastitis; and increased involuntary culling.<sup>4</sup> The estimated economic loss from a single case of subclinical ketosis was US\$117 in 2015, and the estimated average total cost per case of subclinical ketosis was \$289 after considering the costs of displaced abomasum and metritis attributed to hyperketonemia.<sup>5</sup>

## PATHOGENESIS

### Bovine Ketosis

The principal metabolic disturbances observed, hypoglycemia and ketonemia, may both exert an effect on the clinical syndrome. However, in the experimental disease in cattle, it is not always clear what determines the development of the clinical signs in cases that convert from subclinical to clinical

ketosis. In many cases, the severity of the clinical syndrome is proportional to the degree of hypoglycemia, and this, together with the rapid response to parenterally administered glucose in cattle, suggests **hypoglycemia as the predominant factor**. This hypothesis is supported by the development of prolonged hypoglycemia and a similar clinical syndrome to that of ketosis, after the experimental IV or SC injection of insulin (2 U/kg BW).

However, in most field cases the severity of the clinical syndrome is also roughly proportional to the degree of ketonemia. This is an understandable relationship because ketone bodies are produced in larger quantities as the deficiency of glucose increases. However, the ketone bodies are thought to exert an additional influence on the clinical signs observed; for instance, acetoacetic acid is known to be toxic and probably contributes to the terminal coma in diabetes mellitus in humans.

The **nervous signs** that occur in some cases of bovine ketosis are thought to be caused by the production of isopropanol, a breakdown product of acetone in the rumen,<sup>1</sup> although the requirement of nervous tissue for glucose to maintain normal function may also be a factor in these cases. A reasonable explanation for the development of nervous ketosis is that a rapid increase in plasma acetone concentration in an animal that has an active rumen flora leads to a rapid increase in ruminal acetone concentration. The acetone is metabolized by rumen microflora to isopropanol, which is then absorbed into the bloodstream, potentially leading to neurologic abnormalities. This mechanism is consistent with observations that nervous signs of ketosis are more common in cattle with severe ketosis that is rapidly induced.

Spontaneous ketosis in cattle is usually **readily reversible** by treatment; incomplete or temporary response is usually a result of the existence of a primary disease, with ketosis present only as a secondary development, although fatty degeneration of the liver in protracted cases may prolong the recovery period. Changes in ruminal flora after a long period of anorexia may also cause continued impairment of digestion.

**Immunosuppression** has been demonstrated with energy deficiency and ketosis. The higher susceptibility of ketotic postpartum cows to local and systemic infections may be related to impairment of the respiratory burst of neutrophils that occurs with elevated plasma concentrations of BHB.

### CLINICAL FINDINGS

Two major clinical forms of bovine ketosis are described—wasting and nervous—but these are the two extremes of a range of syndromes in which wasting and nervous signs are present in varying degrees of prominence.

The **wasting form** is the most common of the two and is manifest with a gradual but moderate decrease in appetite and milk yield over 2 to 4 days. In component-fed herds, the pattern of appetite loss is often very specific in that the cow first refuses to eat grain, then ensilage, but may continue to eat hay. The appetite may also be depraved.

Body weight is lost rapidly, usually at a greater rate than one would expect from the decrease in appetite. Farmers usually describe affected cows as having a “woody” appearance because of the apparent wasting and loss of cutaneous elasticity presumably resulting from disappearance of subcutaneous fat. The feces are firm and dry, but serious constipation does not occur. The cow is moderately depressed and is quieter than usual. The disinclination to move and to eat may suggest the presence of mild abdominal pain, but localized pain cannot be detected via abdominal palpation.

The temperature and the pulse and respiratory rates are normal, and although the ruminal movements may be decreased in amplitude and number, they are within the normal range unless the course is of long duration, in which case they may virtually disappear. The characteristic sweet odor of ketones is detectable on the breath and often in the milk, but people vary in their ability to detect ketones on the breath (specifically the volatile ketone, acetone).

Very few affected animals die, but without treatment the milk yield falls; although spontaneous recovery usually occurs over about a month, as equilibrium between the drain of lactation and food intake is established, the milk yield is never fully regained. The fall in milk yield in the wasting form may be as much as 25%, and there is an accompanying sharp drop in the solids-not-fat content of

the milk. In the wasting form, nervous signs may occur in a few cases, but they rarely comprise more than transient bouts of staggering and partial blindness.

In the **nervous form (nervous ketosis)**, signs are usually bizarre and begin quite suddenly. The syndrome is suggestive of delirium rather than of frenzy, and the characteristic signs include the following:

- Walking in circles
- Straddling or crossing of the legs
- Head pushing or leaning into the stanchion
- Apparent blindness
- Aimless movements and wandering
- Vigorous licking of the skin and inanimate objects (Fig. 17-6)
- Depraved appetite
- Chewing movements with salivation

Hyperesthesia may be evident, with the animal bellowing on being pinched or stroked. Moderate tremor and tetany may be present, and there is usually an incoordinate gait. The nervous signs usually occur in **short episodes** that last for 1 or 2 hours and may recur at intervals of about 8 to 12 hours. Affected cows may injure themselves during the nervous episodes. Surgical correction of displaced abomasum in cows exhibiting some signs consistent with nervous ketosis should be delayed until their energy status has been evaluated and treatment instituted, if indicated.

### Subclinical Ketosis (Hyperketonemia)

Subclinical ketosis is defined as an increase in blood/plasma/serum BHB above the normal reference range or ketonuria in a cow without detectable clinical signs of disease. Many cows that are in negative energy balance in early pregnancy will have ketonuria without showing clinical signs, but they



**Fig. 17-6** Holstein–Friesian cow with nervous ketosis, manifest as excessive and sustained licking behavior.

will have diminished productivity, including depression of milk yield and a reduction in fertility. Clinical diagnosis is not effective, and in one study, diagnosis by routine urine testing at 5 to 12 days postpartum was considerably more efficient (15.6% detected) than diagnosis by the herdsman (4.4% detected). In a British study of 219 herds the annual mean rate of reported clinical ketosis was 0.5 per 100 adult cows, but the rate of subclinical ketosis, as defined by increased plasma concentrations of BHB and nonesterified fatty acids, was substantially higher. There is debate about whether subclinical ketosis is the correct term, with some support for replacing the term with *hyperketonemia*.

**Potential milk production** in cows with subclinical ketosis is reduced by 1% to 9%. Surveys of large populations show a declining prevalence of ketosis-positive cows after a peak in the period immediately after calving and a positive relationship between hyperketonemia and high milk yield. **Infertility** may appear as an ovarian abnormality, delayed onset of estrus, or endometritis resulting in an increase in the calving-to-conception interval and reduced conception rate at first insemination.<sup>4</sup>

## CLINICAL PATHOLOGY

Hypoglycemia, ketonemia, and ketonuria are characteristic of the disease.

### Glucose

Plasma glucose concentrations are reduced from the normal of approximately 50 to 65 mg/dL to 20 to 40 mg/dL. Ketosis secondary to other diseases is usually accompanied by plasma glucose concentrations above 50 mg/dL, and many cattle have much higher concentrations. Conversion factors are shown in [Table 17-7](#).

### Ketones

Most commonly, plasma or serum  $\beta$ -hydroxybutyrate (BHB) measured in SI units (mmol/L) is used for analysis of ketonemia. BHB is the quantitatively highest circulating ketone body in cattle. Plasma concentrations of BHB significantly correlate with plasma concentrations of acetoacetate, but acetoacetate is unstable in blood samples, whereas BHB is stable, particularly when samples are refrigerated or frozen. Normal cows have plasma BHB concentrations less

than 1.0 mmol/L; cows with subclinical ketosis have blood or plasma/serum concentrations greater than 1.0, 1.2, or 1.4 mmol/L (the cut-point varies depending on the study, analytical method, and whether blood or plasma is analyzed).<sup>9,10</sup> Different cut-points have been proposed for serum BHB concentration in the first week postpartum (1.0 mmol/L) and the second week postpartum (1.4 mmol/L);<sup>11</sup> this may be attributable to blood BHB concentrations being highest at 8 days in milk.<sup>12</sup> In general, because the cut-point for the diagnosis of subclinical ketosis should be based on a detectable effect on decreasing milk production or an increased risk of adverse health events,<sup>10</sup> a consensus is developing around the use of serum/plasma BHB concentration greater than 1.0 mmol/L as the cut-point for subclinical ketosis based on the association with impaired reproductive performance<sup>11</sup> and increased risk of developing a displaced abomasum, puerperal metritis, or clinical ketosis.<sup>13</sup>

Cows with clinical ketosis usually have serum/plasma BHB concentrations in excess of 2.5 mmol/L, with values rarely reaching 10.0 mmol/L. Plasma BHB shows some diurnal variation in cows fed twice daily, with peak concentrations occurring approximately 4 hours after feeding and higher concentrations in the morning than in the afternoon. This diurnal variation is not as prominent in cows fed a total mixed ration *ad libitum*.

Measurement of blood or plasma/serum BHB concentration has recently become a cost-effective and convenient method for routine analysis and cow-side monitoring, with the introduction of low-cost point-of-care devices for measurement (US\$2/test). The concentration of acetoacetate or BHB in urine and milk is also used for diagnostic purposes.<sup>14</sup> Concentrations of BHB and acetoacetate in urine and milk are less than those in plasma/serum, but the correlation coefficients for plasma/serum and milk BHB and plasma/serum and milk acetoacetate are 0.66 and 0.62, respectively. For cow-side use, urine acetoacetate concentration using the nitroprusside test and blood BHB concentration using a point-of-care device are currently the preferred tests for detecting subclinical or clinical ketosis in cattle.

## Milk and Urine Cow-Side Tests

Cow-side tests have the advantage of being inexpensive and giving immediate results, and they can be used as frequently as necessary. A minor source of error is that the concentration of ketone bodies in these fluids will depend not only on the ketone concentration of the plasma, but also on the amount of urine excreted or on the milk yield. Milk concentration of ketones is less variable, easier to collect, and may give fewer false negatives in cows with subclinical ketosis.

Milk and urine ketone concentrations have been traditionally detected by the reaction of acetoacetate with **sodium nitroprusside** and can be interpreted in a semi-quantitative manner based on the intensity of the reaction. The nitroprusside reaction detects both acetoacetate and acetone, but it is much more sensitive to acetoacetate than acetone; the latter is only detected when acetone concentrations are greater than 600 mmol/L, which represents a supraphysiologic concentration.<sup>15</sup> As a consequence, the nitroprusside test functions as a semi-quantitative test of acetoacetate concentration and should be clinically regarded as a test of acetoacetate and not acetone. Several products are available commercially as strips or test powders and are commonly accompanied by a color chart that allows a classification of acetoacetate concentration in grades such as negative, trace (5 mg/dL; 0.5 mmol/L), small (15 mg/dL; 1.0 mmol/L), moderate (40 mg/dL; 2.0 mmol/L), or large (>80 mg/dL; 5 mmol/L), based on the intensity of the color of the reaction.<sup>15</sup> Milk powder tests are not sufficiently sensitive for detection of subclinical ketosis (report too many false negatives), and urine tests are not sufficiently specific (report too many false positives).

**Milk Testing.** The sensitivity and specificity of the nitroprusside powder test with milk in various studies is reported as 28% to 90% and 96% to 100%, respectively. Currently, a milk strip test detecting the concentration of BHB in milk is available and is graded on the concentration of BHB. In different studies, milk BHB has a reported sensitivity and specificity of 58% to 96% and 69% to 99%, respectively. These variations are in part a result of the use of different plasma BHB reference values (1.2 and 1.4 mmol/L) for designation of subclinical ketosis and different statistical methods for analysis. Somatic cell counts in milk greater than 1 million cells/mL will cause an elevation in reading of both the BHBA strip test and the nitroprusside tests.

**Urine Testing.** A nitroprusside tablet has a reported sensitivity and specificity of 100% and 59%, respectively, compared with serum BHB concentrations above 1.4 mmol/L; a nitroprusside strip test has a reported

**Table 17-7** To convert from the SI unit to the conventional unit, divide by the conversion factor; to convert from the conventional unit to the SI unit, multiply by the conversion factor

Substrate	Conventional unit	Conversion factor	SI unit
$\beta$ -hydroxybutyrate	mg/dL	0.0961	mmol/L
Acetoacetate	mg/dL	0.0980	mmol/L
Acetone	mg/dL	0.1722	mmol/L



sensitivity and specificity of 78% and 96%, respectively, with a urine cut-point corresponding to “small” on the color chart or 49% and 99%, respectively, with a urine cut-point corresponding to “moderate” on the color chart. BHB test strips when used with urine have a reported sensitivity and specificity of 73% and 96%, respectively, at a urine cut-point of 0.1 mmol/L BHB and 27% and 99%, respectively, at a urine cut-point of 0.2 mmol/L BHB. Urinary ketone concentrations are more closely related to plasma ketone concentrations than are milk BHB and acetoacetate concentrations.<sup>16,17</sup> Moreover, urine acetoacetate concentration appears superior to milk BHB concentration in diagnosing ketosis.<sup>17</sup>

**Milk-Fat-to-Protein Ratio.** Milk-fat concentration tends to increase, and milk protein concentration tends to decrease, during postpartum negative energy balance. A **fat-to-protein ratio greater than 1.5** in first-day test milk is indicative of a lack of energy supply in the feed and of risk for ketosis and provides a similar test sensitivity ( $Se = 0.63$ ) for detecting subclinical ketosis as does milk BHB concentration ( $Se = 0.58$ ).<sup>17</sup> Milk production in multiparous animals is also separately associated with postpartum negative energy balance.<sup>18</sup>

**Clinical Chemistry and Hematology.** White and differential cell counts are variable and not of diagnostic value for ketosis. There are usually elevations of liver enzyme activity in plasma/serum, but liver function tests are within the normal range. Liver biopsy is the only accurate method to determine the degree of liver damage.

Plasma concentrations of NEFAs and total bilirubin are elevated in ketosis, with mean NEFA concentrations increasing above 0.3 mmol/L from 3 days before parturition to approximately 0.7 mmol/L from 0 to 9 days in milk, after which time plasma NEFA concentration gradually decreases.<sup>12</sup> The increase in bilirubin is attributed, in part, to hepatic dysfunction; however, bilirubin is not a sufficiently sensitive indicator to assess the extent of fat mobilization and liver function in cows with ketosis. Plasma cholesterol concentration is typically decreased for the stage of lactation; the decrease in cholesterol is a result of decreased hepatocyte secretion of very-low-density lipoproteins (VLDLs), which are cholesterol rich, or increased mammary uptake of cholesterol relative to cholesterol availability. After secretion, VLDLs are processed in plasma to intermediate-density lipoproteins by hydrolysis of triglycerides.<sup>19</sup> Intermediate-density lipoproteins are then metabolized in plasma to cholesterol-rich low-density lipoproteins that carry cholesterol to peripheral tissues, including the mammary gland.<sup>19,20</sup> A clinically significant proportion of lactating dairy cattle with ketosis have low plasma cortisol

concentrations;<sup>21</sup> although the mechanism has not been determined, it is possible that decreased cholesterol availability negatively affects cortisol synthesis.

Liver glycogen levels are low, and the glucose tolerance curve may be normal. Volatile fatty acid levels in the rumen are much higher in ketotic than in normal cows, and the ruminal concentrations of butyrate are markedly increased relative to acetate and propionate acids. There is a small but significant drop in serum calcium concentrations (down to about 9 mg/dL [2.25 mmol/L]), probably as a result of decreased dry matter intake in lactating dairy cattle relative to the level of milk production.

Plasma and urine metabolic profiling shows promise as a means of differentiating cattle with clinical ketosis and subclinical ketosis from healthy cattle at the same stage of lactation. Twenty-five plasma metabolites<sup>22,23</sup> and 11 urine proteins<sup>24</sup> have been identified to differ between these three groups. Differences include changes in plasma amino acid concentrations that may reflect differences in feed intake relative to milk production or altered metabolic pathways and changes in urine polypeptide concentrations that may reflect decreased immune responsiveness.

## NECROPSY FINDINGS

The disease is not usually fatal in cattle, but fatty degeneration of the liver and secondary changes in the anterior pituitary gland and adrenal cortex may be present.

## DIFFERENTIAL DIAGNOSIS

### Cattle

The clinical picture is usually too indefinite, especially in cattle, to enable a diagnosis to be made solely on clinical grounds. General consideration of the history, with particular reference to the time of calving, and the feeding program, and biochemical examination to detect the presence of hypoglycemia, ketonemia, and ketonuria are necessary to establish a diagnosis.

### Wasting form:

- Abomasal displacement
- Traumatic reticulitis
- Primary indigestion
- Cystitis and pyelonephritis

### Nervous form:

- Rabies
- Hypomagnesemia
- Bovine spongiform encephalopathy

## TREATMENT

In cattle, a number of effective treatments are available for ketosis, but in some affected animals, the response is only transient; in rare cases, the disease may persist and cause death or necessitate slaughter of the animals. Most of these cases are secondary, and failure to respond satisfactorily to treatment is a result of the primary disease. Specific

treatment for subclinical ketosis is usually not applied on an individual basis, but nutrition and management issues should be investigated whenever a large proportion of early-lactation cows are diagnosed with subclinical ketosis.

The rational treatment in ketosis is to relieve the need for glucose formation from tissues and allow ketone-body utilization to continue normally. Theoretically, the simplest means of doing this is by the administration of glucose replacement therapy. The effect of the administration of glucose is complex, but it allows the reversal of ketogenesis and the establishment of normal patterns of energy metabolism. Ideally, treatment should be at an early stage of the disease to minimize loss, and with subclinical ketosis this requires biochemical testing.

## Replacement Therapy Glucose (Dextrose)

The IV injection of 500 mL of a 50% solution of glucose results in transient hyperglycemia, increased insulin and decreased glucagon secretion, and reduced plasma concentration of NEFAs. Glucose administration effects a marked improvement in most cows, but relapses occur commonly unless repeated treatments are used. This is probably a result of the transience of the hyperglycemia (3 to 4 hours) or insufficient dosing—the dose required varies directly with the amount of lactose being lost in the milk. Contrary to widespread belief, **very little of the administered glucose is lost to urinary excretion** (<10%).<sup>25,26</sup> SC injections of hypertonic glucose prolong the response, but they are not recommended because they cause discomfort, and large unsightly swellings, which often become infected, may result. Intraperitoneal injections of 20% solution of dextrose have also been used, but they are not recommended because of the risk of infection.

## Other Sugars

Other sugars, especially fructose, either alone or as a mixture of glucose and fructose (invert sugar), and xylitol, have been used in an effort to prolong the response, but idiosyncratic responses to some preparations, in the form of polypnea, muscle tremor, weakness, and collapse, can occur while the injection is being given.

## Propylene Glycol and Glycerine/Glycerol

To overcome the necessity for repeated injections, propylene glycol can be administered as a drench. The traditional dose is 225 ml twice daily for 2 days, followed by 110 ml daily for 2 days to cattle, but higher volumes are also used for larger cattle (a typical treatment protocol in North America is 300 ml PO daily for 5 days). Some of the administered propylene glycol is metabolized to propionate in the rumen and absorbed, whereas some of the propylene glycol is absorbed

directly across ruminal epithelium and metabolized by the liver. Propylene glycol (200 to 700 g daily), or **salts of propionate**, can be administered in the feed and give good results. Administration in feed is preferred by some because this method avoids dangers of aspiration with drenching; however, cows not used to its inclusion in the feed may show feed refusal. Studies also suggest that drenching of propylene glycol provides a more beneficial response than including the same amount in a total mixed ration; the bolus effect of propionate production appears to be more beneficial than a steady-state increase as a result of a bolus increase in plasma insulin concentration. It is recommended that for best results, dosing with propylene glycol should be preceded by an IV injection of glucose.

Parenteral infusions of glucose solutions and the feeding of glycerol depress the fat content of milk, and the net saving in energy may favorably influence response to these drugs. Glycerol and propylene glycol are not as efficient as glucose because conversion to glucose utilizes oxaloacetate. Propylene glycol is absorbed directly from the rumen and acts to reduce ketogenesis by increasing mitochondrial citrate concentrations; its metabolism to glucose occurs via conversion to pyruvate, with subsequent production of oxaloacetate via pyruvate carboxylase.

#### Other Glucose Precursors

Because of its glucogenic effect, sodium propionate is theoretically a suitable treatment, but when administered in 110- to 225-g doses daily, the response in cattle is often very slow. Lactates are also highly glucogenic, but both calcium and sodium lactate (1 kg initially, followed by 0.5 kg for 7 days) and sodium acetate (110 to 500 g/d) have given less satisfactory results than those obtained with sodium propionate. Ammonium lactate (200 g for 5 days) has, however, been used extensively, with reported good results. Lactose, in whey or in granular form in the diet, can increase dry matter intake, but it also increases ruminal butyrate concentration and plasma BHB concentrations.

#### Hormonal Therapy

**Glucocorticoids.** The efficiency of glucocorticoids in the treatment of bovine ketosis has been demonstrated in both experimental and field cases. The observation that a clinically significant proportion of lactating dairy cattle with ketosis have low plasma cortisol concentrations<sup>21</sup> provides support for glucocorticoid administration. Hyperglycemia occurs within 24 hours of glucocorticoid administration and appears to result from a repartitioning of glucose in the body rather than from gluconeogenesis.

Historically, many glucocorticoid preparations have been used successfully, but current drugs are more potent, require lower dosage, and have fewer side effects. A hyper-

glycemic state is produced for 4 to 6 days in ketotic cows given 10 mg of dexamethasone 21-isonicotinate, and other preparations that have a shorter duration of action, such as dexamethasone sodium phosphate (40 mg) and flumethasone (5 mg), are also used. Dexamethasone 21-isonicotinate (20 to 25 mg IM) decreases whole-body insulin sensitivity and affects glucose and lipid metabolism; it decreases liver fat content in early-lactating dairy cows with surgically corrected left-displaced abomasum.<sup>27</sup> Label regulations vary between countries; in general, the recommendations of the manufacturer with regard to glucocorticoid use and dosage should be followed. Profound hypokalemia with high case fatality is a potential sequel to prolonged repeated therapy of ketosis with isoflupredone acetate, which has both glucocorticoid and mineralocorticoid activity. For this reason, only one treatment of isoflupredone acetate is recommended for cows with ketosis. Response of cows with primary ketosis to treatment with **corticosteroids and IV glucose is superior** to therapy with corticosteroids or IV glucose alone, with fewer relapses.

**Insulin** facilitates cellular uptake of glucose, suppresses fatty acid metabolism, and stimulates hepatic gluconeogenesis. Insulin is administered in conjunction with either glucose or a glucocorticoid and may be of particular value in early-onset cases of ketosis that are unresponsive to glucose or corticosteroid therapy, but it is not commonly used. The dose of protamine zinc insulin is 200 to 300 IU per animal (depending on body weight) administered SC every 24 to 48 hours as required. It should be recognized that endogenous insulin is released in all lactating dairy cattle administered 500 mL of 50% dextrose, although to a lower extent in ketotic cattle because they have a lower peak plasma glucose concentration following IV infusion of glucose or propionate;<sup>28</sup> consequently, IV dextrose administration should always be considered as a dual treatment of glucose and insulin.

**Anabolic steroids** have also been used for treatment of lactational ketosis and ketosis in late pregnant cows that are overfat, stressed, or have twin fetuses. Experimentally, 60 mg and 120 mg of trenbolone acetate are effective as single injections, but no extensive field trials are recorded, and the drug is banned for use in food animals in most countries.

**Miscellaneous Treatments.** Vitamin B<sub>12</sub> and cobalt are indicated in regions where cobalt deficiency is a risk factor for ketosis. Cobalt is sometimes administered to cattle with ketosis in regions where cobalt deficiency does not occur, but the therapeutic value is not proven. Cyanocobalamin (vitamin B<sub>12</sub>, 1 to 4 mg daily IV) in a combined formulation with butaphosphan has strong evidence supporting its role in

normalizing energy status in early-lactation dairy cows when administered to dairy cattle before or around parturition.<sup>29,30</sup> Cyanocobalamin is essential for gluconeogenesis from propionate, and a theoretical argument can be made for the administration of cyanocobalamin for ketotic dairy cattle being treated for ketosis. It is also thought that high-producing dairy cows in early lactation have a relative or actual deficiency of cyanocobalamin.<sup>30</sup> Cysteamine (a biological precursor of coenzyme A) and also sodium fumarate have been used to treat cases of the disease. Reported results were initially good, but the treatment has not been generally adopted. The recommended dose rate of cysteamine is 750 mg IV for three doses at 1- to 3-day intervals.

**Glucagon**, although ketogenic, is strongly gluconeogenic and glycogenolytic, and glucagon concentrations are decreased in the plasma of fat cows at calving and cows with ketonemia. Glucagon could be of value in prevention and therapy, but it would require a prolonged delivery system because it has a very short physiologic half-life and its effects following a single injection are short-lived.

#### TREATMENT AND CONTROL

##### Treatment

- Propylene glycol (300 to 500 mL daily for 5 days, PO) (R-1)
- Dextrose (500 mL of 50% dextrose once, IV) (R-1)
- Dexamethasone, dexamethasone-21-isonicotinate or flumethasone, IM (R-1)
- Cyanocobalamin (vitamin B<sub>12</sub>, 1 to 4 mg IV, daily for 2 to 6 treatments) (R-2)
- Isoflupredone (20 mg, IM, multiple injections) (R-3)
- Insulin (lente formulation, 200 IU SC daily for 3 days) (R-3)

##### Control

- Monensin (11 to 22 g/ton of total mixed ration on a 100% dry matter basis; oral administration of a controlled-release capsule delivers 335 mg/day for 95 days) (R-1)
- Propylene glycol (300 to 500 mL daily, PO) (R-1)
- Rumen-protected choline (15g daily, PO, from 25 days precalving to 80 days postcalving) (R-2)
- Cyanocobalamin (vitamin B<sub>12</sub>, 1 to 4 mg IV, daily for 2 to 6 treatments before or at calving) (R-2)
- Isoflupredone (20 mg, IM, once), with or without insulin (100 U, SC) (R-3)

#### CONTROL

The control of clinical ketosis is integrally related to the adequate nutrition of the cow in the dry and lactating periods. This encompasses details such as the following:

- Dry matter intake
- Fiber digestibility
- Particle size distribution
- Energy density
- Fat incorporation in early lactation rations
- Protein content
- Feeding systems
- Rumen size
- Other factors better covered in texts on nutrition

It is difficult to make general recommendations for the control of the ketosis because of the many conditions under which it occurs, its probable multiple etiology, and feeding systems that vary from those that feed components separately to those that feed total mixed rations. Cows neither should have been starved nor be overfat at calving. Careful estimation of diets by reference to feed value tables is recommended, and detailed recommendations on diet and management are available, with the caveat that planned rations can deviate from feed bunk rations, and feed bunk dry matter and actual dry matter intake may not be the same. Too low a feeding frequency and the feeding of concentrates separate from roughage rather than as a total mixed ration can lead to an increase in rates of ketosis.

In the United States, dry cows are typically divided into two groups: far-off and close-up cows. Far off cows are generally fed to National Research Council (NRC) dry-cow feeding guidelines, and close-up cows are given an acidogenic ration that decreases the incidence of clinical milk fever (periparturient hypocalcemia) starting 3 weeks before the estimated calving date. Practical recommendations based on British feeding standards and units are also available.

In high-producing cows being fed stored feeds, poor-quality roughage commonly leads to ketosis. Wet ensilage containing much butyrate, and moldy or old and dusty hay, are the main offenders. In concentrates, it is the change of source that creates off-feed effects and precipitates attacks of ketosis.

Cows that are housed should get some exercise each day, and in herds where the disease is a particular problem during the stabling period, the cattle should be turned out to pasture as soon as possible in the spring.

The ration should contain adequate amounts of cobalt, phosphorus, and iodine.

If there is a high incidence of ketosis in a herd receiving large quantities of ensilage, reduction of the amount fed for a trial period is indicated.

### Energy Supplements

Propylene glycol is used for the prevention of clinical and subclinical ketosis. Traditionally, propylene glycol has been drenched to cattle in early lactation at doses varying from 350 to 1000 mL daily for 10 days after calving. There is a linear effect of dose on

plasma glucose. Propylene glycol can also be added to feed and is frequently present in commercial feed products, but a bolus dose of propylene glycol is more effective in raising blood glucose than incorporation in feed. A dose of 1 L per day given as an oral drench for 9 days before parturition has also been shown efficacious; however, it is important to note that at doses above 500 mL administered by drench or present in feed, some cows may develop rapid and shallow respiration, ataxia, salivation, and somnolence. For this reason, a maximum daily dose of 500 mL as a drench should be considered.

Glycerol can be substituted for propylene glycol at equivalent dose rates, although most studies indicate that glycerol is inferior to propylene glycol. A preliminary report of a small experimental study with larger doses of glycerol showed that glycerol given orally at a dose of 1 L, 2 L, or 3 L elevated blood glucose concentrations to 16%, 20%, and 25%, respectively, of pretreatment values at 0.5 hours after treatment and that these concentrations remained elevated for 8 hours. Staggering, depression, and diuresis were observed in some cows given the 2-L or 3-L dose, but this could be prevented by administering the glycerol in a large (37-L) volume of water. It concluded that a dose of 1 L was effective in increasing milk production and reducing urinary ketones. Glycerol fed as a constant component in the transition dairy cow diet is not effective and possibly may be ketogenic when fed continually. Glycerol should only be used as drench in hypoglycemic cows and not fed as a component of the diet.

### Propionic Acid and Its Salts

Propionic acid absorbed across the rumen wall is transported to the liver, where it is converted to glucose via gluconeogenesis to result in an increase in serum blood glucose levels. Older literature reports that 110 g/d fed daily for 6 weeks, commencing at calving, has given good results in reducing the incidence of clinical bovine ketosis and improving production, but is not palatable and has the risk of reducing feed intake. In controlled trials, feeding energy supplements containing propionic acid and/or its salts for 3 weeks prepartum and 3 weeks postpartum had a beneficial effect on milk production, but a variable effect on reducing subclinical ketosis.

### Ionophores

Ionophores alter bacterial flora of the rumen, leading to decreases in gram-positive bacteria, protozoa, and fungi and increases in gram-negative bacteria. The net effect of these changes in bacterial flora is increased propionate production and a decrease in acetate and butyrate production providing increased gluconeogenic precursors. Field trials with monensin have consistently demonstrated a reduction in serum or blood BHB, acetoacetate, and HEFA concentrations. In addition,

monensin increased serum or blood glucose, urea, and cholesterol concentrations, and decreased the prevalence of clinical ketosis, clinical mastitis, and displaced abomasum in dairy cattle.<sup>31-33</sup> Monensin also decreases methane production by cattle; methane production by ruminants has been considered as contributing to global warming. Although approved for administration to lactating dairy cows in more than 20 countries, ionophores are not labeled for inclusion in lactating-cow rations in a number of countries.

Monensin is approved for continuous administration (>14 days) to dairy cattle in the United States at 185 to 660 (mg/head)/day monensin to lactating cows or 115 to 410 (mg/head)/day monensin to dry cows. To accomplish this, monensin is approved to be fed at 11 to 22 g/ton of total mixed ration on a 100% dry matter basis, at a daily per-cow cost of about 2 to 4 cents. Monensin is also approved for use in the United States as part of a component feeding system at 11 to 400 g/ton (as is basis); this includes application as a "top dress," where a small amount of feed is added to a ration.

In some countries, monensin can be administered orally as a controlled-release capsule to cattle 2 to 4 weeks before calving. The capsule contains 32 g of monensin and releases approximately 335 mg monensin a day for 95 days. This product is effective and practical for a variety of feeding systems, and approximately 18% of dairy herds in Canada are administering monensin by controlled-release capsule.

### Corticosteroids

Isoflupredone acetate (20 mg, IM, once) was not effective in preventing subclinical ketosis in early-lactation dairy cows, and it actually increased the likelihood of subclinical ketosis.<sup>34</sup>

### Ancillary Agents

A commercially available injectable product containing **cyanocobalamin** (vitamin B<sub>12</sub>, 1 to 4 mg daily IV) in a combined formulation with **butaphosphan** is effective in normalizing energy status when administered to dairy cattle 2 to 6 times before or around parturition.<sup>29,30</sup> The administration of cyanocobalamin and butaphosphan may be most beneficial in cows at increased risk of developing ketosis, such as older cows, over-conditioned cows, or those experiencing dystocia or metritis.<sup>29</sup> Phosphorus may be limiting in early lactation, based on low liver phosphorus content in dairy cattle.<sup>35</sup> It is not clear whether additional phosphorus mitigates the reduction in hepatic phosphorus content.

Rumen protected choline (15 g/day) fed daily starting 25 days before calving and continuing to 80 days after calving decreased the incidence of clinical ketosis and improved the health of lactating dairy cows.<sup>36</sup> Choline



is a precursor for phosphatidylcholine, which is thought to be rate limiting in early lactation; phosphatidylcholine deficiency is associated with impaired lipid metabolism.

Niacin is antilipolytic and induces increases in blood glucose and insulin, but there is conflicting evidence that niacin given in the feed has a beneficial effect on subclinical ketosis in cattle. It has been suggested that niacin should be supplemented from 2 weeks before parturition to 12 weeks postpartum.

### General Control

**Herd Monitoring.** There is currently no consensus as to the optimal monitoring program for ketosis and subclinical ketosis in lactating dairy cattle, and consequently a variety of monitoring programs have been proposed. Challenges with developing optimal monitoring programs are the herd size (through the influence on the eligible numbers of animals available to be tested), ease of testing, cost of the test, and test sensitivity and specificity. In addition, the goals of the monitoring program need to be defined; typically they are either to monitor the adequacy of the diet relative to the level of milk production (i.e., the magnitude of negative energy balance in early lactation) or to identify animals to receive a standard treatment protocol, such as daily oral propylene glycol drenching. The optimal time for testing appears to be cows 3 to 9 days in milk because cows that are hyperketonemic at this stage of lactation are at highest risk for subsequent negative production and health effects, with the incidence and prevalence of subclinical ketosis occurring on day 5 of lactation.<sup>37</sup> A recent modeling approach utilizing 13,000 cows from 833 dairy farms in North America and Europe suggested that testing cows twice weekly from 3 to 9 days in milk was the most cost effective strategy when the subclinical ketosis incidence was between 15% and 50%; below an incidence of 15% it was not economical to test, and above 50% all cows should be treated without testing.<sup>38</sup> In addition, whenever the subclinical ketosis incidence increased to above 15%, a variety of testing and treatment protocols are economically beneficial.<sup>38</sup>

The six most valuable and practical indices for monitoring negative energy balance are urine acetoacetate concentration, blood BHB concentration, blood glucose concentration, body-condition score, back-fat thickness determined ultrasonographically, and milk-fat-to-protein ratio. The first five indices can be obtained cow side and at no cost or relatively low cost, although determining the blood BHB concentration costs approximately 5 to 10 times that of the first two tests and requires a blood sample. The milk-fat-to-protein ratio is readily obtained from individual monthly test data and is more highly correlated with energy balance than plasma BHB or glucose concentration.<sup>39</sup>

This should be coupled with body-condition scoring or back-fat thickness to monitor the efficacy of the nutritional program. Plasma NEFA concentration is an excellent monitoring test of negative energy balance, but it is currently too expensive for routine herd monitoring, and an easy-to-use cow-side test is not available.

Urine testing using the nitroprusside test for acetoacetate is the simplest of the cow-side tests, and despite some reports that urine samples are difficult to obtain from all cattle, urine is easily obtained from more than 90% of cattle using the following standardized technique. First, stimulation of the perineum to obtain a urine sample must be the first part of the examination of the cow and ideally should be performed without the cow being aware that the veterinarian is present. Second, never hold the tail while stimulating the perineum because tail holding alerts the cow to the presence of the veterinarian, and it is not needed because cattle never urinate on their tails when posturing to urinate. Third, obtain urine samples in the normal environment of the animal; because cattle urinate on average five times per day, urine samples are easily obtained on recumbent cattle that are gently encouraged to stand.

Blood BHB testing has become very popular because of the availability of low-cost point-of-care meters. Despite this, it must be recognized that obtaining a blood sample is more complicated than obtaining a urine sample, and that the cost, although low, is much higher than that for urine acetoacetate or blood glucose testing. Moreover, serum BHB concentration is correlated with energy balance in a similar manner to plasma glucose concentration.<sup>40</sup> Automated monitoring by in-line measurements of ketone bodies in milk has been studied and may be of particular value in large dairies. BHB is proposed as the candidate because it is the more robust in milk, and where cows are fed a total mixed ration, it is not subject to significant diurnal variation. Milk BHB concentration can be measured in real-time with a fluorometric method that requires no pretreatment of the milk.

Biochemical monitoring of herds for subclinical ketosis and adequacy of periparturient feeding can be conducted using blood glucose estimations on a sample of cows in their second week of lactation. Plasma glucose concentrations below 45 mg/dL (2.4 mmol/L) suggest subclinical ketosis. For individual cows, blood glucose estimations should be done at about 14 days after calving. This method of monitoring is inexpensive using widely available point-of-care devices.

### FURTHER READING

- Gordon JL, LeBlanc SJ, Duffield TF. Ketosis treatment in lactating dairy cattle. *Vet Clin North Am Food Anim Pract.* 2013;29:433-445.
- Ingvarsen KL. Feeding- and management-related diseases in the transition cow. *Physiological*

adaptations around calving and strategies to reduce feeding-related diseases. *Anim Feed Sci Technol.* 2006;126:175-213.

- McArt JAA, Nydam DV, Oetzel GR, Overton TR, Opsina PA. Elevated non-esterified fatty acids and  $\beta$ -hydroxybutyrate and their association with transition dairy cow performance. *Vet J.* 2013;198:560-570.
- Opsina PA, McArt JA, Overton TR, Stokol T, Nydam DV. Using nonesterified fatty acids and  $\beta$ -hydroxybutyrate concentrations during the transition period for herd-level monitoring of increased risk of disease and decreased reproductive and milking performance. *Vet Clin North Am Food Anim Pract.* 2013;29:387-412.
- Zhang Z, Liu G, Wang H, Li X, Wang Z. Detection of subclinical ketosis in dairy cows. *Pakistan Vet J.* 2012;32:156-160.

### REFERENCES

- Sato H. *Anim Sci J.* 2009;80:381.
- Loor JJ, et al. *Physiol Genomics.* 2007;32:105.
- Vanholder T, et al. *J Dairy Sci.* 2015;98:880.
- Shin EK, et al. *Theriogenology.* 2015;84:252.
- McArt JAA, et al. *J Dairy Sci.* 2015;98:2043.
- Goldhawk C, et al. *J Dairy Sci.* 2009;92:4971.
- Croushore WS, et al. *J Am Vet Med Assoc.* 2013;243:1329.
- Reynen JL, et al. *J Dairy Sci.* 2015;98:3806.
- Kessel S, et al. *J Anim Sci.* 2008;86:2903.
- Borchardt S, et al. *J Am Vet Med Assoc.* 2012;240:1003.
- Walsh RB, et al. *J Dairy Sci.* 2007;90:2788.
- McCarthy MM, et al. *J Dairy Sci.* 2015;98:6284.
- Opsina PA, et al. *J Dairy Sci.* 2010;93:546.
- Denis-Robichaud J, et al. *Bovine Pract.* 2011;45:97.
- Smith SW, et al. *Acad Emerg Med.* 2008;15:751.
- Larsen M, Kristensen NB. *Acta Agric Scand Sect A.* 2010;60:239.
- Krogh MA, et al. *J Dairy Sci.* 2011;94:2360.
- Kayano M, Kataoka T. *J Vet Med Sci.* 2015;in press.
- Kessler EC, et al. *J Dairy Sci.* 2014;97:5481.
- Gross JJ, et al. *PLoS ONE.* 2015;10(6):doi:10.1371.
- Forslund KB, et al. *Acta Vet Scand.* 2010;52:31.
- Sun LW, et al. *J Dairy Sci.* 2014;97:1552.
- Li Y, et al. *Vet Quart.* 2014;54:152.
- Xu C, et al. *Vet Quart.* 2015;35:133.
- Grunberg W, et al. *J Vet Intern Med.* 2006;20:1471.
- Grunberg W, et al. *J Dairy Sci.* 2011;94:727.
- Kusenda M, et al. *J Vet Intern Med.* 2013;27:200.
- Djokovic R, et al. *Acta Vet Brno.* 2007;76:533.
- Rollin E, et al. *J Dairy Sci.* 2010;93:978.
- Furll M, et al. *J Dairy Sci.* 2010;93:4155.
- Duffield TF, et al. *J Dairy Sci.* 2008;91:1334.
- Duffield TF, et al. *J Dairy Sci.* 2008;91:1347.
- Duffield TF, et al. *J Dairy Sci.* 2008;91:2328.
- Seifi H, et al. *J Dairy Sci.* 2007;90:4181.
- Grunberg W, et al. *J Dairy Sci.* 2009;92:2106.
- Lima FS, et al. *Vet J.* 2012;193:140.
- McArt JAA, et al. *J Dairy Sci.* 2012;95:5056.
- McArt JAA, et al. *Prev Vet Med.* 2014;117:170.
- Reist M, et al. *J Dairy Sci.* 2002;85:3314.

### FATTY LIVER IN CATTLE (FAT-MOBILIZATION SYNDROME, FAT-COW SYNDROME, HEPATIC LIPIDOSIS, PREGNANCY TOXEMIA IN CATTLE)

Fatty liver (hepatic lipidosis) is an important metabolic disease of dairy cows in early lactation and is associated with decreased health status and reproductive performance.

## SYNOPSIS

**Etiology** Mobilization of excessive body fat to liver during periods of negative energy balance at time of parturition or in early lactation of dairy cows and late pregnancy of beef cows.

**Epidemiology** High-producing dairy cows overfed during dry period may develop fatty liver syndrome just before or after calving precipitated by any factor or disease that interferes with feed intake. Occurs in well-conditioned beef cattle in late pregnancy when energy intake is suddenly decreased. Moderate and subclinical degrees of fatty infiltration may adversely affect reproductive performance of dairy cows.

**Signs** Inappetence to anorexia, ruminal atony, lethargic, inactivity, ketonuria, fat body condition, weakness and recumbency if worsens. Recover if continue to eat and appetite improves.

**Clinical pathology** Increase in plasma/serum nonesterified fatty acid, acetoacetate,  $\beta$ -hydroxybutyrate, and total bilirubin concentrations; increase in plasma/serum hepatic enzyme activity (particularly aspartate aminotransferase and ornithine carbamoyl transferase activity); increased fat content in liver biopsy.

**Necropsy findings** Fatty infiltration of liver, liver may appear yellow.

**Diagnostic confirmation** Liver biopsy.

**Differential diagnosis list**

- Left-sided or right-sided displacement of abomasum
- Milk fever
- Abomasal impaction
- Vagus indigestion
- Peritonitis

**Treatment** Fluid and electrolyte therapy including glucose IV (bolus infusion). Propylene glycol orally. Dexamethasone IM. Provision of palatable feed.

**Control** Avoid overfeeding during late lactation and dry period. Avoid situations that reduce feed intake at time of parturition.

## ETIOLOGY

Fatty liver is caused by the mobilization of excessive quantities of fat from body deposits to the liver. It develops when the hepatic uptake of lipids exceeds the oxidation and secretion of lipids by the liver. Excess lipids are stored as triacylglycerol in the liver, and excessive lipid in hepatocytes is associated with decreased metabolic function of the liver. Fatty liver occurs because of a sudden demand of energy in the immediate postpartum period in well-conditioned lactating dairy cows. Fatty liver also occurs because of a sudden deprivation of feed in fat pregnant beef cattle, and is especially severe in those bearing twins. The disease is an exaggeration

of what is a common occurrence in high-producing dairy cows that are in a state of negative energy balance in early lactation. A substantial drop in voluntary dry matter intake is initiated in late pregnancy and continues into early lactation. This decrease has traditionally been interpreted as caused by physical constraints in the abdomen as a result of the enlarging gravid uterus, but this purported mechanism appears to have been overemphasized. The decline in dry matter intake coincides with changes in reproduction status, changes in fat mass, and metabolic changes in support of lactation, and the associated metabolic signals are likely to play an important role in intake regulation. These signals include nutrients, metabolites, reproductive hormones, stress hormones, leptin, insulin, gut peptides, cytokines, and neuropeptides. Body fat, especially subcutaneous fat, is mobilized and deposited primarily in liver but also in muscle and the kidneys. Whether or not the cow is truly fat at parturition may not be important in determining the degree of fat mobilization, but the degree of negative energy balance in early lactation is critical.

### EPIDEMIOLOGY

#### Occurrence and Incidence

Fatty infiltration of the liver is common in high-producing dairy cattle from a few weeks before and after parturition<sup>1</sup> and is associated with several periparturient diseases and an increase in the calving-to-conception interval. In dairy cows, fatty liver occurs primarily in the first 4 weeks after calving when up to 50% of all cows have some accumulation of triacylglycerol in the liver. A severe form of fatty infiltration of the liver immediately before or after parturition is known as the **fat-mobilization syndrome, fat-cow syndrome, or pregnancy toxemia** of cattle, and it can be highly fatal. In beef cattle, the disease occurs most commonly in late pregnancy when the nutrient intake is decreased in cattle that were previously well fed and in good body condition. In a field study, the percentage of cattle dying or being culled because of disease was affected by the amount of hepatic triglyceride: 15%, 31%, and 42% for cattle with mild, moderate, and severe hepatic lipidosis, respectively. **Outbreaks of the disease have occurred in dairy herds** in which up to 25% of all cows were affected, with a case-fatality rate of 90%.

Cattle have been classified into three groups on the basis of liver fat content determined histologically 1 week after parturition. Less than 20% lipid corresponds to less than 50 mg/g liver by weight; 20% to 40% lipid, 50 to 100 mg/g liver; and greater than 40% represents more than 100 mg/g liver. These concentrations correspond to mild, moderate, and severe cases of fatty infiltration, respectively. Cows with less than 20% lipid in the liver at 1 week after calving are considered normal, and those with more than 20% are

considered to have a fatty liver. About 30% of high-yielding dairy cows in the United Kingdom are considered to have a fatty liver 1 week after calving. Clinical evidence of hepatic disease may not occur consistently until liver lipid concentrations are in the range of 35% to 45% or more.

**Risk Factors****Host Factors**

Fatty infiltration of the liver is part of a generalized fat-mobilization syndrome that occurs in early lactation, particularly in high-yielding dairy cows, as milk production outstrips appetite and body reserves are used to meet the energy deficit. In about 30% of high-producing cows, fatty infiltration in the liver is severe and is associated with reversible but significant effects on liver structure and function. In some populations of cows, the incidence of fatty liver is much lower and insignificant.

Diseases that occur commonly in early lactation predispose to fatty liver include **ketosis, left-side displacement of the abomasum, mastitis, retained fetal membranes, milk fever, and downer-cow syndrome**. Any disease of early lactation that affects appetite and voluntary intake can contribute to fatty liver.

The deficit occurs because dietary intake cannot meet the energy requirements for the high yield. Peak yields of milk are reached 4 to 7 weeks after calving, but the highest levels of voluntary feed intake are not reached until 8 to 10 weeks after calving. As a result of the energy deficit, the cow mobilizes body reserves for milk production and may lose a large amount of body weight.

The BCS at calving can have a direct effect on the health, milk yield, and fertility of cows. It represents the cumulative effects of the dry period, the BCS at drying off, and the loss of body condition during the dry period. The risk of retained placenta may be greater for cows underconditioned at drying, whereas cows that lost more body condition during the dry period may be more affected by both retained placenta and metritis; the two effects are independent of each other. The risk of ketosis is increased in cows overconditioned at calving, which may be a result of a long dry period. Cows calving at a higher BCS produced more milk, fat, and protein in the first 90 days of lactation, and the effect was most pronounced for milk-fat content. Cows with a higher BCS at calving were less prone to anestrus, but they did not conceive more successfully to first service. A reduction of 6 open days in primiparous cows was estimated for each additional unit of BCS at calving. Multiparous cows that lose more body condition during the dry period are more prone to inactive ovaries and are more likely to be open 150 days after calving in the next lactation.

Dairy cows with abnormally long dry periods also have a tendency to become

obese and develop the fatty liver syndrome of parturition. The feeding of dairy cows in large groups, as in loose housing systems, has been associated with an increase in the incidence of the disease. The disease has occurred in pregnant heifers within 31 days after being turned out onto grass.

The disease can occur in **nonlactating dairy cows** by the imposition of a partial-starvation diet in late pregnancy in an attempt to reduce the body weight of cows that are considered to be too fat. Changing the diet of pregnant beef cows from silage to straw in an attempt to reduce their body weight and the incidence of dystocia has resulted in outbreaks of the disease.

In beef cattle in North America, the severe form of the disease, pregnancy toxemia, is seen most commonly in the last 6 weeks of pregnancy in cows that are fat and pregnant with twins. The affected cows are usually well fed until late pregnancy, when an unexpected shortage of feed occurs, or the cows are too fat and cannot consume sufficient low-energy feed to meet the demands of pregnancy. Under usual circumstances, the disease in beef cattle occurs sporadically: the morbidity is about 1%, but the mortality is usually 100%.

**Pregnancy toxemia** of cattle has occurred in pregnant beef cattle in Australia and the United Kingdom. First-calf heifers were more commonly affected than older cows, and most were in late pregnancy (7 to 9 months) or had just recently calved. Cows pregnant with twins are particularly susceptible.

#### *Genetics of Lipid Mobilization*

Cows generally mobilize body lipid reserves in early lactation and regain these reserves during subsequent pregnancy. Lipid mobilized from body reserves makes a substantial contribution to the energetic cost of milk production in early lactation. It is usually assumed that this mobilization of body energy reserves is entirely a response to a deficit in feed energy intake relative to milk energy output. This implies that increasing the energy content of the feed being offered would decrease body energy mobilization in early lactation. A number of studies indicate that this is not always the case. It has been proposed that mobilization of body reserves in early lactation and the subsequent gain in body reserves during pregnancy are to a large extent genetically driven. Genetically driven body-lipid change is defined as that which would occur in cows kept in an environment that was in no way constraining. It then follows that environmentally driven body-lipid change is defined as that which occurs in response to an environment that is constraining. The rationale and evidence for genetically driven body-lipid change have their basis in evolutionary considerations and in the changes in lipid metabolism throughout the reproductive cycle.

#### *Environmental and Dietary Factors*

In North America, the introduction of the system of **challenge feeding** of dairy cows was associated with an increased incidence of fatty liver. The overall effect of the system is to provide excess energy in the diet during late pregnancy or during the dry period generally. The diets fed may contain a high percentage of the cereal grains, corn ensilage, or brewer's grains. In this system, high-energy rations are fed beginning a few weeks before parturition. The total daily amount of feed is increased by regular increments to reach a high level at parturition and peak levels to coincide with the peak in the lactation curve several weeks after parturition. This resulted in some excessively fat cows at the time of parturition, when energy demands are high. The disease has also occurred in dairy cows that were fed excessive amounts of high-energy rations throughout the dry period. In dairy herds, fatty liver syndrome has also been associated with an increase in the incidence of milk fever, ketosis, and left-sided displacement of the abomasum, all of which are much more difficult to treat successfully because of the fatty liver.

Overfeeding during the dry period predisposes cows to accumulate fat in adipose tissue during the prepartum period. Before parturition, adipose tissue from overfed cows has higher rates of esterification than the adipose tissue of cows fed a restricted energy intake. In the fatty livers of these overfed cows, the rate of gluconeogenesis is not optimal, which results in prolongation of lipolysis, particularly during the first few weeks after parturition. The increased lipolysis after parturition leads to a major increase in the hepatic triacylglycerol concentration and to a shift in hepatic fatty acid composition. Unrestricted feed intake during the dry period impairs postpartum oxidation and synthesis of fatty acids in the liver of dairy cows.

In Australia, only beef cattle have been involved in pregnancy toxemia; the fat and the obese are most commonly affected. The disease occurred most notably when there was a shift to autumn calving (February to April) when feed supplies were low because of low late-summer rainfall. The cows were in good to fat body condition because of lush pastures in the spring and early summer, but by autumn when the calving season approached, the feed supplies were low and the nutritive value of the pasture inadequate. The lack of feed combined with the expensive nature of supplementary feeding resulted in an inadequate level of nutrition during late pregnancy. The morbidity is usually from 1% to 3%, but may be as high as 10%, and the disease is usually fatal.

#### **PATHOGENESIS**

Fatty liver is associated with a negative energy balance that is essentially universal in dairy cows in the first few weeks of lactation.

Most cows adapt to the negative energy balance through an intricate mechanism of metabolic adaptation. Fatty liver develops because of failure of these adaptive mechanisms. Under normal physiologic conditions, the total amount of fat increases in the liver beginning a few weeks before calving, rises to an average of about 20% (of wet-weight basis) 1 week after calving, and declines slowly to the normal level of less than 5% by 26 weeks after calving. However, the fat content varies from almost none to 70% among cows 1 week after calving. Fat mobilization begins about 2 to 3 weeks before calving and is probably induced by a changing hormonal environment before calving rather than an energy deficit. After calving, there is a larger increase in fat accumulation. The changes in the liver in dairy cows are functional and reversible and related to the metabolic demands of late pregnancy and early lactation.

The heavy demands for energy in the high-producing dairy cow immediately after parturition, or in the pregnant beef cow that may be bearing twins, result in an increased rate of mobilization of fat from body reserves, usually subcutaneous fat, to the blood that transports it to body tissues, particularly the liver but also muscle and the kidneys. Any decrease in energy intake caused by a shortage of feed or an inability of the cow to consume an adequate amount of feed during the critical periods of late pregnancy or early lactation results in the mobilization of an excessive amount of **nonesterified fatty acids (NEFAs)**. This results in increased hepatic lipogenesis with accumulation of lipid in enlarged hepatocytes, depletion of liver glycogen, and inadequate transport of lipoprotein from the liver. Most of the lipid infiltration of the liver in dairy cows after calving is in the form of triacylglycerols because of the increased uptake of NEFAs and a simultaneous increase in diacylglycerol acyltransferase; the activity of this enzyme is activated by fatty acids. The gradual increase in plasma NEFA concentration during the final prepartum days may explain the gradual depression in dry matter intake and a contributing factor to triglyceride accumulation in the liver. During this period there is also an elevated concentration of plasma glucose and a lowered plasma BHB concentration. The serum lecithin:cholesterol acyltransferase activity in spontaneous cases of fatty liver in cows is also decreased, which may be associated with reproductive performance because cholesteryl esters are utilized for the synthesis of steroid hormones.

Cattle are prone to fatty liver because their hepatocytes have limited capacity to export VLDLs and therefore a limited ability to export accumulated fat in the hepatocytes. NEFAs transported to the liver are usually oxidized in the mitochondria and peroxisomes or secreted as VLDL particles into the blood. Fatty liver develops when the



uptake of NEFAs by the liver exceeds the oxidation of NEFAs by the liver to CO<sub>2</sub>, partial oxidation of NEFAs to form ketones, and export of phospholipids, cholesterol, and apoproteins from the liver as lipoproteins. For unknown reasons, the capacity for VLDL formation is low in cattle and further impaired in early-lactating cows a result of very low apolipoprotein B100 (apoB100) availability, the main apolipoprotein of VLDL particles. Production of ketones in moderate levels is beneficial in that energy is exported from the liver to other tissues that can utilize ketones as an energy source. Excess lipids that cannot be exported are stored as triacylglycerol in the liver and are associated with decreased metabolic functions of the liver. Also, a prepartum surge of estrogen may contribute to the development of fatty liver in ruminants by increased fatty acid esterification along with limited export of triglyceride.

During fat mobilization, there is a concurrent loss of body condition and adipose tissue. The degree of mobilization will be dependent on the fatness of the cow and extent of the energy deficit. Fat and thin cows respond differently to the metabolic demands of early lactation. Fat cows appear less able to utilize mobilized fatty acids, and as a result they accumulate esterified fat in tissues. This can adversely influence susceptibility to disease, and the response of the cow to that disease imposes further metabolic demands, particularly on muscle and protein metabolism. Both fat and skeletal muscle mass are decreased after calving, and fat cows lose 2.5 times more muscle fiber area than thin cows. Thus the loss of body condition is a result of total tissue mobilization (protein and fat) rather than fat alone. There appears to be a higher rate of protein mobilization in fat cows than in thin cows.

Cows that are not fat initially do not develop fatty liver syndrome. Pregnant beef cows in thin body condition on pasture can become extremely emaciated and eventually recumbent and die of starvation, but they do not develop pregnancy toxemia.

### CLINICAL FINDINGS

In dairy cattle, fat-cow syndrome occurs usually within the first few days following parturition and is commonly precipitated by any condition that interferes with the animal's appetite temporarily, such as the following:

- Parturient hypocalcemia
- Left-sided displacement of the abomasum
- Indigestion
- Retained fetal membranes
- Dystocia

Affected cows are usually excessively fat, with a BCS of 4/5 or higher. Excessive quantities of subcutaneous fat are palpable over the flanks, the shoulder areas, and around the tailhead. The affected cow usually does

not respond to treatment for some of these diseases and becomes anorexic. The temperature, heart rate, and respiration are within normal ranges. Rumen contractions are weak or absent, and the feces are usually scant. Periods of prolonged recumbency are common, and affected cows may have difficulty in standing when they are coaxed to stand. A severe ketosis that does not respond to the usual treatment may occur. There is marked ketonuria. Affected cows will not eat and gradually become weaker and progress to totally recumbent, and they die in 7 to 10 days. Some cattle exhibit nervous signs consisting of a staring gaze, holding the head high, and muscular tremors of the head and neck. Some severe cases appear to develop hepatic failure, do not respond to therapy, and become weak and recumbent and die. Terminally there is coma, tachycardia, and marked hyperglycemia. The case-fatality rate in severe cases may reach 50% or more.

In fat beef cattle shortly before calving, affected cows are aggressive, restless, excited, and uncoordinated with a stumbling gait; sometimes have difficulty in rising; and they fall easily. The feces are scant and firm, and there is tachycardia. When the disease occurs 2 months before calving, the cows are depressed for 10 to 14 days and do not eat. Eventually they become sternally recumbent. The respirations are rapid, there may be an expiratory grunt, and the nasal discharge is clear, but there may be flaking of the epithelium of the muzzle. The feces are usually scant; terminally, there is often a fetid yellow diarrhea. The disease is highly fatal; the course is 10 to 14 days, and terminally there may be coma, with cows dying quietly.

In dairy cattle with moderately severe fatty liver, the clinical findings are much less severe, and most will recover within several days if they continue to eat even small amounts of hay. In dairy cattle, there is a relationship between the occurrence of a subclinical fatty liver within the first few weeks after parturition and inferior reproductive performance as a result of a delay in the onset of normal estrus cycles and a reduction in the conception rate that results in an increase in the average days between calving and conception. There may be differences in reproductive performance between cows with mild and moderate fatty livers early after calving. However, an examination of the postpartum hormone profiles of cows with fatty liver did not reveal the pathogenic mechanism of the reduced fertility. Fat-cow syndrome may also be associated with an increased incidence of parturient paresis and unresponsive treatment for ketosis in early lactation.

### CLINICAL PATHOLOGY

#### Serum Biochemistry

The biochemical changes associated with fatty liver syndrome in cows depend on the severity of the fatty liver. There is a

significant association between increasing serum biochemical abnormalities with increasing amounts of liver fat, although there may be considerable overlap in the distribution of individual test values in a population of animals with suspected fatty liver.

Increased plasma/serum nonesterified fatty acid, acetoacetate, BHB, and total bilirubin concentrations, and decreased serum fructosamine concentration,<sup>2</sup> are associated with increased liver fat percentage. Likewise, increased plasma/serum hepatic enzyme activity (particularly aspartate aminotransferase and ornithine carbamoyl transferase activity) is also associated with increased liver fat percentage. Other hepatic enzyme activities in plasma, such as alanine aminotransferase, sorbitol dehydrogenase, glutamate dehydrogenase, alkaline phosphatase, and gamma-glutamyl transferase activities, are poorly associated with liver fat percentage.<sup>1</sup> Possibly the most relevant biochemical index of the liver fat percentage is the **plasma NEFA:cholesterol** ratio. The rationale for using this ratio is that the plasma NEFA concentration reflects a metabolite that has not been cleared by the liver, whereas the plasma cholesterol concentration reflects the rate of hepatic reesterification and export as a VLDL. A high plasma NEFA:cholesterol concentration therefore is thought to indicate a high liver fat percentage. An increased concentration of plasma total bilirubin is also associated with increased liver fat percentage; competition between bilirubin and NEFA for the same binding site on hepatocytes decreases the hepatic uptake of bilirubin and therefore results in hyperbilirubinemia.<sup>2</sup> Serum fructosamine concentration provides a retrospective record of serum/plasma glucose concentrations over the previous 1 to 3 weeks and therefore provides a useful longer-term index of glucose availability. Serum fructosamine concentrations less than 213 μmol/L are predictive of hepatic lipidosis in dairy cattle.<sup>2</sup>

The plasma ammonia concentration in arterial or venous samples is poorly associated with liver fat percentage, but it is an excellent indicator of hepatic failure in severely affected cattle with hepatic lipidosis.<sup>3</sup> In cattle, ammonia in plasma is derived mainly from bacterial activity in the rumen and metabolism of tissue amino acids and is converted to urea by the liver or glutamine by the liver and other tissues. Consequently, severe liver dysfunction results in elevated plasma ammonia concentrations (>29 μmol/L), with higher ammonia concentrations in arterial samples than venous samples because of nonhepatic metabolism of ammonia.

Several cow-side blood, urine, and milk ketone tests are available for the detection of subclinical ketosis in postpartum dairy cows (see previous section on ketosis and subclinical ketosis). Metabolomic biomarkers show promise in identifying a typically pattern

of changes in cattle with hepatic lipidosis; for example, plasma fibrinogen decreases inversely with the severity of hepatic lipidosis, presumably because of intracellular lipid accumulation interferes with fibrinogen synthesis.<sup>4</sup>

### Hemogram

In cattle with subclinical fatty liver, there may be a leukopenia, neutropenia, and lymphopenia. Leukopenia has been observed in dairy cows with more than 20% liver fat in the second week after calving. This may be related to the increased incidence of postparturient diseases, such as mastitis and endometritis, observed in cows with subclinical fatty liver. In cows with fatty liver, there is decreased functional capacity of the polymorphonuclear cells. However, this is not necessarily a cause-and-effect relationship.

### Liver Biopsy and Analysis

The severity of fatty liver has been arbitrarily classified into severe, moderate, and mild, based on the amount of triglyceride present in the hepatocytes.<sup>1</sup> In severe hepatic lipidosis, the accumulation of triglyceride in the cytoplasm is accompanied by disturbances in hepatic structure and function that may result in hypoglycemia and ketonemia; these signs are manifested as anorexia and depression, and there may be clinical evidence of nervous signs. A liver biopsy can be used to determine the severity of the fatty liver and the concentration of triglyceride and is the most reliable method of accurately estimating the degree of fatty infiltration of the liver.

The triglyceride concentration of liver in normal cows ranges from 10% to 15% on a wet-weight basis. Estimation of the lipid content of bovine liver samples obtained by biopsy may be made by biochemical or histologic methods. Both methods provide reasonable estimates of liver fat content over a wide range of values. The lipid content of bovine liver is highly correlated with its specific gravity and the submersion of needle biopsy specimens into water, and copper sulfate solutions with specific gravities of 1.025 and 1.055 can be used as a test to estimate lipid content. For routine clinical diagnosis, three solutions of specific gravities of 1, 1.025, and 1.055 can be used. Liver samples that float in all three solutions contain greater than 34% lipid, those that sink in water but float in solutions of 1.025 and 1.055 specific gravity contain less than 34% but greater than 25% lipid, whereas those that float only in solutions of 1.055 specific gravity contain less than 25% but greater than 13% lipid. Samples that sink in all three solutions contain less than 13% lipid. Some limited evidence indicates that cows with liver lipid concentrations above 34% are severely affected and can be expected to have clinical manifestations of hepatic insufficiency. Those with liver lipid levels between 34% and 25% are moderately

affected and might have some clinical evidence of hepatic insufficiency. Those between 25% and 13% are mildly affected, which is the range of most postpartum dairy cows without any evidence of disease. Liver lipid concentrations below 13% are inconsequential.

### Ultrasonography of the Liver

Ultrasonography of the liver has been used to evaluate fatty infiltration in dairy cattle with mixed results.<sup>5,6</sup> Two strategies have been employed: identification of hepatic enlargement by comparing liver position with published reference range relative to the ribs, and the echogenicity or brightness of the liver. In the normal cow, the hepatic ultrasonogram consists of numerous weak echoes distributed homogeneously over the entire area of the liver. The echo beam gradually attenuates as it passes through the normal liver tissue. The portal and hepatic veins can be seen within the normal echotexture, and the parenchymal edges are normally visible. In the fatty liver, there is a diffuse nature and echogenicity that are roughly proportional to the volume of fat vacuoles and the amount of triglyceride in the liver. Assessment of echogenicity is subjective and varies with equipment and settings on the ultrasonographic unit. Consequently, objective ultrasonographic indices of hepatic lipidosis are under investigation, such as spectral analysis and analysis of brightness (B)-mode image statistics and texture characteristics.<sup>6</sup> Technological challenges associated with digital processing of ultrasonographic images of the liver need to be resolved before the noninvasive measurement of liver fat percentage becomes a widely available diagnostic tool.

### NECROPSY FINDINGS

In severe fatal cases, the liver is grossly enlarged, pale yellow, friable, and greasy. Mild and moderate cases are usually not fatal unless accompanied by another fatal disease, such as peracute mastitis. The degree of fatty infiltration in these instances is much less obvious. The histologic changes include the occurrence of fatty cysts or lipogranulomas, enlarged hepatocytes, compression of hepatic sinusoids, a decreased volume of rough endoplasmic reticulum, and evidence of mitochondrial damage. The latter two changes are reflected in reduced albumin levels and increased activities of liver enzymes in the blood. The proportions of the various fatty acids in the liver are altered considerably. Palmitic and oleic acid proportions are higher in fatty-liver cows than in normal cows, whereas stearic acid is lower.

### DIFFERENTIAL DIAGNOSIS

In **dairy cows, fatty liver** must be differentiated from those diseases that occur commonly immediately following parturition. **Left-sided displacement of the abomasum**

results in a secondary ketosis, inappetence, and pings over the left abdomen.

**Retained placenta** and **metritis** may be accompanied by fever, inappetence to anorexia, ruminal atony, and a foul-smelling vaginal discharge. A degree of fatty liver may occur in these cows, making it indistinguishable from the effects of the retained placenta and metritis.

**Primary ketosis** may occur immediately after parturition or within several days rather than at the most common time, at 6 to 8 weeks of lactation. Inappetence, ruminal hypotonicity, marked ketonuria, and a good response to glucose and propylene glycol are characteristic.

In **beef cattle, pregnancy toxemia** before parturition must be differentiated from abomasal impaction, vagus indigestion, and chronic peritonitis.

### TREATMENT

The prognosis for severe fatty liver is unfavorable. In general, cows with the severe fat-cow syndrome that are totally anorexic for 3 days or more usually die in spite of intensive therapy. The prognosis for cases with nervous signs is very poor. Liberal quantities of highly palatable good-quality hay and an ample supply of water should be provided. Cattle that continue to eat in increasing daily amounts will recover with supportive therapy and palatable feeds. The major prognostic factor is whether the cow will eat; failure of the appetite to return is usually a very poor prognostic sign.

Three treatment strategies for fatty liver are available. The most effective strategy is to decrease the rate of fat mobilization and therefore the plasma NEFA concentration; propylene glycol appears to act partly by this mechanism. The second strategy is to facilitate the complete oxidation of NEFAs in the liver. The third strategy is to increase the rate of export of VLDLs from the liver; choline is thought to act by this method. Because they address different mechanisms, combined treatment using propylene glycol and rumen-protected choline offers theoretical advantages. Several different therapeutic approaches have been tried and are discussed in detail in the previous section on ketosis and subclinical ketosis.

Additional treatments that have been tried in cattle with fatty liver include intravenous fluids, ruminal transfaunation, and glucagon.

**Fluid and Electrolyte Therapy.** Intensive therapy directed at correcting the effects of the ketosis and the fatty liver is required. The recommended treatment includes continuous IV infusion of 5% **glucose and multiple electrolyte solutions** and the intraruminal administration of rumen juice (5 to 10 L) from normal cows in an attempt to stimulate

the appetite of affected cows. Water and multiple electrolytes (10 to 30 L) can be administered intraruminally.

**Glucagon.** The subcutaneous injection of 15 mg/d of glucagon for 14 days beginning at day 8 postpartum decreases liver triglyceride concentrations in cows older than 3.5 years. Glucagon, containing 29 amino acids, is a pancreatic hormone that improves the carbohydrate status of cows by stimulating hepatic gluconeogenesis, glycogenolysis, amino acid uptake, and ureagenesis. The effect of glucagon on lipid metabolism is both direct and indirect because it directly increases lipolysis in adipose tissue but indirectly decreases lipolysis by increasing concentrations of plasma glucose and insulin. IV infusions of glucagon are not practical for on-farm use.

**Glucocorticoids.** Dexamethasone-21-isonicotinate (20 to 25 mg, IM) decreases hepatic total lipid and triglyceride content in cattle after surgical correction of left-displaced abomasum, which is a beneficial effect.<sup>7</sup>

**Propylene glycol** given orally at 300 mL/day for 5 days promotes gluconeogenesis and is used for the treatment of ketosis.

**Insulin** as zinc protamine at 200 to 300 SC twice daily promotes the peripheral utilization of glucose, but clinical results have been mixed. It is important to recognize that IV administration of glucose is always accompanied by insulin release, no matter the metabolic state of the cow. Consequently, IV glucose administration should be considered as a combined treatment with glucose and insulin.

**Outbreaks in a Herd.** When outbreaks of fat-cow syndrome occur in pregnant beef cattle, all remaining cows should be sorted into groups according to body condition and fed accordingly. Excessively fat cows should be fed the best-quality hay that is available along with a supplement. Fat cows should be exercised by feeding them on the ground and forcing them to walk.

#### TREATMENT AND CONTROL

##### Treatment

Propylene glycol (300 mL daily for 5 days, PO) (R-1)

Dextrose (500 mL of 50% dextrose once, IV) (R-1)

Dexamethasone, dexamethasone-21-isonicotinate, or flumethasone, IM (R-1)

Cyanocobalamin (vitamin B<sub>12</sub>, 1 to 4 mg IV, daily for 2 to 3 treatments) (R-2)

Isoflupredone (20 mg, IM, multiple injections) (R-3)

##### Control

Monensin (controlled-release capsule, 335 mg/day) (R-1)

Propylene glycol (300 to 500 mL daily for 5 days, PO) (R-1)

Cyanocobalamin (vitamin B<sub>12</sub>, 1 to 4 mg IV, daily for 2 to 6 treatments before or at calving) (R-2)

#### CONTROL

Control and prevention of fatty liver in cattle will depend on decreasing or eliminating most of the potential risk factors for the disease. Early recognition and treatment of diseases that affect the voluntary dietary intake in late pregnancy and immediately after parturition are necessary to minimize the mobilization of body-fat stores to meet the overall energetic requirements of the cow during the period of negative energy balance and to maintain or increase hepatic gluconeogenesis. Diseases such as ketosis, displaced abomasum, retained placenta, acute mastitis, milk fever, and downer-cow syndrome must be treated as early as possible to avoid varying degrees of hepatic lipidosis.

#### Dry Matter Intake and Energy Balance in the Transition Period

The literature on dry matter intake and energy balance in the transition period of the dairy cow has been reviewed.

The transition from late gestation to early lactation in the dairy cow is a critical period in the lactation–gestation cycle. During this period, feed intake is at the lowest level in the production cycle. In addition to the drop in feed intake, there is a concurrent transition from late gestation to lactation, with huge increases in energy demands. This leads to a negative energy balance that can result in ketosis or fatty liver. Voluntary dry matter intake (DMI) may decrease 25% and 52% during the final 14 days of gestation for first- and second-parity animals and aged (third and fourth or greater) cows, respectively. A negative energy balance can occur before parturition and is more likely to occur in heifers than cows because heifers have a lower DMI and an additional need for energy requirement for growth. The fall in DMI is the usual cause of a negative energy balance rather than an increase in energy requirements for fetal growth.

#### Metabolic Adaptations During the Transition Period

The primary goal of nutritional management strategies of dairy cows during the transition period should be to support the metabolic adaptations that occur. The hallmark of the transition period of dairy cattle is the dramatic change in nutrient demands that necessitates exquisite coordination of

metabolism to meet requirements for energy, amino acids, and calcium by the mammary gland after calving. Estimates of the demand for glucose, amino acids, fatty acids, and net energy by the gravid uterus at 250 days of gestation and the lactating mammary gland at 4 days postpartum indicate approximately a tripling of demand for glucose, a doubling of demand for amino acids, and approximately a fivefold increase in demand for fatty acids during this period. In addition, the requirement for calcium increases approximately fourfold on the day of parturition. The literature on the integration of metabolism and intake regulation in periparturient animals has been reviewed.

#### Glucose Metabolism

The primary homeorhetic adaptation of glucose metabolism to lactation is the concurrent increase in hepatic gluconeogenesis and decrease in oxidation of glucose by peripheral tissues to direct glucose to the mammary gland for lactose synthesis. The major substrates for hepatic gluconeogenesis are propionate from ruminal fermentation, lactate from Cori cycling, amino acids from protein catabolism or net portal-drained visceral absorption, and glycerol released during lipolysis in adipose tissue.

#### Lipid Metabolism

The primary homeorhetic adaptation of lipid metabolism to lactation is the mobilization of body fat stores to meet the overall energetic requirements of the cow during a period of negative energy balance in early lactation. Body fat is mobilized into the bloodstream in the form of NEFAs that are used to make upward of 40% of milk fat during the first days of lactation. Skeletal muscle uses some NEFA for fuel, particularly as it decreases its reliance on glucose as a fuel during early lactation. Given that NEFA concentrations increase in response to increased energy needs accompanied by inadequate feed intake, and plasma NEFA concentrations usually are inversely related. The liver takes up NEFAs in proportion to their supply, but the liver typically does not have sufficient capacity to completely dispose of NEFAs through export into blood or catabolism for energy. Therefore cows are predisposed to accumulate NEFAs as triglycerides within liver when large amounts of NEFA are released from adipose tissue into the circulation.

#### Nutritional Management to Support Metabolic Adaptations During the Transition Period Grouping Strategies

The primary goal of nutritional management strategies of dairy cows during the transition period should be to support the metabolic adaptations just described. Industry-standard nutritional management of dairy cows during the dry period consists of a two-group nutritional scheme. The National



Research Council (NRC) Nutrient Requirements of Dairy Cattle recommends that a diet containing approximately 1.25 Mcal/kg of NE<sub>L</sub> should be fed from dry-off until approximately 21 days before calving, and that a diet containing 1.54 to 1.62 Mcal/kg of NE<sub>L</sub> should be fed during the last 3 weeks before calving. The primary rationale for feeding a lower-energy diet during the early part of the dry period is to minimize BCS gain during the dry period. During the last 3 to 4 weeks prepartum, a diet higher in energy and protein concentration than current NRC recommendations should be fed so that adequate nutrient intake occurs within the limits of the reduced voluntary dry matter intake. Supplying excessive energy to dairy cows during the early dry period may have detrimental carryover effects during the subsequent early lactation. Managing cows to achieve a BCS of approximately 3.0 at drying off rather than the traditional 3.5 is now recommended.

### Strategies to Meet Glucose Demands and Decrease NEFA Supply During the Transition Period

**Carbohydrate Formulation of the Prepartum Diet.** Feeding diets containing higher proportions of nonfiber carbohydrate (NFC) promotes ruminal microbial adaptation to NFC levels typical of diets fed during lactation and provides increased amounts of propionate to support hepatic gluconeogenesis and microbial protein (providing the diet contains sufficient ruminally degradable protein) to support protein requirements for maintenance, pregnancy, and mammogenesis.

**Direct Supplementation With Glucogenic Precursors.** Propylene glycol is a glucogenic precursor that has been used as an oral drench in the treatment of ketosis. Decreased concentrations of plasma NEFA and BHB follow oral administration of propylene glycol. The administration of an oral drench of propylene glycol for 2 days beginning at calving decreased concentrations of NEFA in plasma and increased milk yield during early lactation. However, in general, the lack of consistent production responses does not support a recommendation for routine use. Propionate supplements added to the diet to supply substrate for hepatic gluconeogenesis have also been used, but with inconsistent results.

Glycerol given orally is an effective treatment for lactational ketosis in dairy cattle. Feeding glycerol to dairy cows from 14 days prepartum to 21 days in milk did not have the glucogenic effect attributed to it when given orally as a drench to individual cows.

Monensin provided in controlled-release capsules (CRCs) administered 2 to 4 weeks prepartum has been shown to decrease the incidence of energy-associated diseases, subclinical ketosis, and left-side displaced abomasum by 40%, and a 25% reduction in

retained placenta was found. The capsule delivers 335 mg/d of monensin for 95 days. The common mechanism for reduction of the incidences of these energy-associated diseases is likely to be improved energy metabolism during the transition period. The net effect of monensin within the rumen is to increase ruminal propionate production at the expense of ruminal acetate and methane production so that propionate supply is increased and the overall energetic efficiency of ruminal fermentation is increased.

**Added Fat in Transition Diets.** It has been proposed that dietary fat may partially decrease concentrations of NEFA and prevent the occurrence of ketosis. Dietary long-chain fatty acids are absorbed into the lymphatic system and do not pass first through the liver. The fat can provide energy for peripheral tissues and the mammary gland, and the increased energy availability would in turn decrease mobilization of body fat and decrease plasma NEFA concentrations. However, available evidence indicates that added fat fed to cows during the prepartum period does not decrease plasma NEFA concentrations.

**Effects of Specific Fatty Acids on NEFA Supply.** A substantial amount of research has examined the metabolic roles of individual fatty acids in transition-cow nutrition and metabolism. Feeding *trans*-10, *cis*-12 conjugated linoleic acid or transoctadecanoic acid experimentally may decrease the negative energy balance, but the ultimate metabolic effects in transition cows are as yet uncertain.

Because of the large economic losses associated with pregnancy toxemia in cattle, every economic effort must be made to prevent the disease. The principal method of control is to prevent pregnant cattle from becoming fat during the last trimester of pregnancy, particularly during the dry period in dairy cattle. During pregnancy, mature cattle should receive sufficient feed to meet the needs for maintenance and pregnancy, and the total daily nutrient intake must increase throughout the last trimester to meet the needs of the fetus. However, this increase is usually difficult to control without some cows getting fat and others losing weight. Sorting cows into groups on the basis of size and condition and feeding accordingly is recommended. Metabolic profiles may be used as a means of assessing energy status and, correspondingly, the likelihood of occurrence hyperketonemia or pregnancy toxemia. Both plasma glucose and BHB concentrations can be used.

**Body-condition scoring of dairy cows** at strategic times can be used to monitor the nutritional status of the herd and minimize the incidence and severity of fatty liver syndrome. The scoring should be done throughout the production cycle as part of a herd

health program. Scoring done at calving, at 21 to 40 days, and 90 to 110 days postpartum can be used to monitor the nutritional status of the herd. Scoring done at 100 to 60 days before drying off provides an opportunity for management to make appropriate adjustments in the feeding program so that optimal body-condition goals are achieved. The optimum BCS of a cow at calving that will result in the most economical amount of milk has not yet been determined. On a scale of 5, the suggested optimum score at calving has ranged from 3 to 4. The optimum score will probably depend on the characteristics of the individual herd, which include type of cow, type of feedstuffs available, season of the year, environmental temperature, and the people doing the actual body-condition scoring.

### FURTHER READING

- Gordon JL, LeBlanc SJ, Duffield TF. Ketosis treatment in lactating dairy cattle. *Vet Clin North Am Food Anim Pract.* 2013;29:433-445.
- Grummer RR. Nutritional and management strategies for the prevention of fatty liver in dairy cattle. *Vet J.* 2008;176:10-20.
- Ingvarsten KL. Feeding and management related diseases in the transition cow. Physiological adaptations around calving and strategies to reduce feeding-related diseases. *Anim Feed Sci Technol.* 2006;126:175-213.
- Ringseis R, Gessner CK, Eder K. Molecular insights into the mechanisms of liver-associated diseases in early-lactating dairy cows: hypothetical role of endoplasmic reticulum stress. *J Anim Physiol Anim Nutr.* 2015;99:626-645.

### REFERENCES

- Kalaitzakis E, et al. *J Vet Intern Med.* 2007;21:835.
- Mostafavi M, et al. *Anim Prod Sci.* 2015;55:1005.
- Mudron P, et al. *Vet Med Czech.* 2004;49:187.
- Imhasly S, et al. *BMC Vet Res.* 2014;10:122.
- Rafia S, et al. *Am J Vet Res.* 2012;73:830.
- Starke A, et al. *J Dairy Sci.* 2010;93:2952.
- Kusenda M, et al. *J Vet Intern Med.* 2013;27:200.

## PREGNANCY TOXEMIA (TWIN LAMB DISEASE) IN SHEEP

### SYNOPSIS

**Etiology** A multifactorial disorder of energy metabolism, with hypoglycemia and ketonemia (the accumulation in blood of acetoacetate,  $\beta$ -hydroxybutyrate, and their decarboxylation products acetone and isopropanol).

**Epidemiology** The disease in sheep is associated with a falling plane of nutrition, principally in the last month of pregnancy in ewes bearing twins and triplets, but can be induced by other stress at this time.

**Clinical findings** Encephalopathy with blindness, muscle tremor, convulsions, metabolic acidosis, and a clinical course of 2 to 8 days, usually terminating fatally unless treated early.

**Clinical pathology** Hypoglycemia, ketonemia, ketonuria.

**Necropsy findings** None specific. Twin lambs and fatty liver.

**Diagnostic confirmation** Ketonemia, ketonuria, or elevated ketones in milk. Elevated  $\beta$ -hydroxybutyrate (BHBA) in aqueous humor of dead sheep.

**Treatment** Parenteral glucose with corticosteroid and oral glucose precursors such as propylene glycol, occasionally insulin, or oral glucose and electrolyte therapy. Cesarean section or induction of parturition. Case fatality high.

**Control** Monitoring of condition score, pasture availability, feeding, and biochemical indicators of ketosis. Correction of energy imbalance if detected.

## ETIOLOGY

Hypoglycemia and hyperketonemia are the primary metabolic disturbances in pregnancy toxemia. The precipitating cause is the energy demand of the conceptus in the latter part of pregnancy. However, there is a great deal of variation between sheep flocks in the prevalence of the naturally occurring disease under conditions that appear conducive to its development. The most important factor in pregnancy toxemia is a decline in the plane of nutrition during the last 4 to 6 weeks of pregnancy. This is the period when fetal growth is rapid and the demands for energy are markedly increased, particularly in ewes carrying twins or triplets. For example, the energy requirement for a 70-kg ewe carrying twins increases 36% in the last weeks of pregnancy, from 13.5 MJ (3.2 Mcal)/d midgestation to 18.3 MJ (4.4 Mcal)/d at term. The disease in goats during late pregnancy has the same initiating causes.

Pregnancy toxemia can be classified according to the underlying management cause that is critical to its control and prevention:

- Primary pregnancy toxemia
- Fat-ewe pregnancy toxemia
- Starvation pregnancy toxemia
- Secondary pregnancy toxemia
- Stress-induced pregnancy toxemia

## EPIDEMIOLOGY

### Primary Pregnancy Toxemia

Primary pregnancy toxemia is the most common. In most flocks it is a result of a declining plane of nutrition in the latter half of pregnancy, often exacerbated by a short period of food deprivation associated with a management procedure in late pregnancy, such as crutching, shearing, a change of environment, or drenching. In sheep grazing pastures the decreased plane of nutrition is often associated with inadequate pasture availability and/or overstocking. In sheep at pasture it occurs more frequently in

early-lambing flocks, where there is insufficient supplement provided during autumn or winter. In some outbreaks ewes have been moved onto better pasture during late pregnancy specifically to prevent the occurrence of ketosis, but if ewes are unaccustomed to the new feed, their intake of metabolizable energy will be reduced.

For sheep that are housed in late pregnancy, the provision of poor-quality hay may predispose pregnancy toxemia. A change in feed type, feeding of moldy feed, or feed contaminated with manure can also lead to decreased intake, especially with goats. Competition for inadequate trough space can also be important. Goats exhibit greater dominant/submissive behavior than sheep, and this can result in lower food intake in submissive goats in groups that are being fed a partial supplement or total ration.

In all management systems, failing to identify and separate ewes bearing twins and triplets, and to feed them accordingly, or failing to increase the nutritional plane of mixed mobs of pregnant sheep during the last 6 weeks of pregnancy are important predisposing factors.

### Fat-Ewe Pregnancy Toxemia

Fat-ewe pregnancy toxemia occurs without a specific stressor in ewes that are very well fed and are in an overfat condition in late pregnancy (a condition score of 4 or 5 on a scale of 1 [emaciated] to 5 [fat]). Fat ewes have a decreased food intake in late pregnancy when the volume of the rumen is reduced by the pressure of intraabdominal fat and the developing fetus. This can occur especially when feeds with high water content are being fed, such as silage or root crops. A lack of exercise is thought to predispose this type of pregnancy toxemia, and there is often concurrent hypocalcemia.

### Starvation Pregnancy Toxemia

Starvation pregnancy toxemia occurs in ewes that are excessively thin. It is relatively uncommon, but it occurs in extensive grazing systems where there is prolonged drought and an inadequate alternative feed supply. It can occur in any production system where there is mismanagement and undernutrition.

### Secondary Pregnancy Toxemia

Secondary pregnancy toxemia usually occurs as a sporadic disease as the result of the effect of an intercurrent disease, such as foot rot or foot abscess, that affects food intake. Heavy worm infestation, such as mixed infections of *Teladorsagia*, *Haemonchus*, or *Trichostrongylus* species, would add a similar drain on glucose metabolism and increase the chances of development of this condition.

### Stress-Induced Pregnancy Toxemia

Stress-induced pregnancy toxemia is the least common variant of this condition, in

which stress is the initiator. Examples are the close shepherding or housing of late-pregnant sheep of breeds not used to being housed, the transport of late pregnant sheep, and outbreaks following attack by dogs.

## Occurrence

Pregnancy toxemia is seen primarily in ewes carrying triplet or twin lambs in the last 6 weeks of pregnancy, with the peak incidence in the last 2 weeks of pregnancy. It occurs wherever sheep are raised, but it is primarily a disease of sheep raised in intensive farming systems, either grazing or when housed during the winter. In part this is because the breeds of sheep used in intensive farming are more likely to bear twins or triplets. In contrast, sheep breeds in extensive grazing systems commonly bear single lambs, and significant outbreaks of pregnancy toxemia are uncommon except where there is drought or insufficient pasture as a result of poor management. The attack rate in a flock varies with the nature and severity of the nutritional deprivation and the proportion of the flock at risk. It can be very high in starvation pregnancy toxemia, whereas fat-ewe pregnancy toxemia is generally sporadic. In outbreaks that follow management procedures or other stressors, clinical disease is not seen until 48 hours afterward, and new cases will develop over several days. Intercurrent disease in late-pregnant ewes, such as foot rot or foot abscess, may predispose pregnancy toxemia.

The natural incidence in intensively farmed sheep is approximately 2% of pregnant ewes, but where there are severe management deficiencies it may affect the majority of late-pregnant ewes. The proportion of flocks with cases varies by year, but in a study of sheep diseases in Canada, 19% of flocks reported cases of pregnancy toxemia. The case fatality is high unless treatment is initiated early in the clinical course, but even with early treatment many ewes will die.

## Experimental Reproduction

Hypoglycemia and ketosis can be experimentally produced in pregnant sheep by undernourishment, but the resultant syndrome has biochemical and clinical differences from spontaneously occurring pregnancy toxemia. For example, loss of appetite is an early sign in the spontaneous disease, whereas starved experimental animals, even though hypoglycemic and ketotic, will eat feed when offered. Consequently, there is debate about whether hypoglycemia is the primary precipitating cause of the clinical signs in the naturally occurring disease.

There is a great deal of variation between sheep in the ease with which the hypoglycemia and ketosis can be produced experimentally and in the variation in incidence of the naturally occurring disease in conditions that appear to be conducive to it developing. It is likely that the difference between sheep

depends on the metabolic efficiency of the liver.

### Animal Risk Factors

#### Pregnancy

The disease occurs only in ewes in the last 6 weeks of pregnancy, with the peak incidence in the last 2 weeks. It occurs primarily in ewes carrying triplet or twin lambs, although ewes bearing a single, large lamb may also be affected.

#### Parity

The disease is uncommon in maiden ewes because of their lower fecundity, and then increases in prevalence up until 5 to 6 years of age.

#### Breed

Breed differences largely reflect differences in fecundity and differences in management systems. Thus the disease is more common in British lowland breeds and their crosses than the Merino. British hill-breeds are traditionally thought to be more resistant to the development of pregnancy toxemia in the face of nutritional deprivation of the ewe, but resistance is achieved at the expense of lamb birth weight and has the penalty of higher neonatal mortality. Differences in the susceptibility of individual sheep appear to be related to differences in rates of hepatic gluconeogenesis.

### Economic Significance

The disease has considerable effect. Without treatment, the case-fatality rate can approach 100%, and in individual flocks the prevalence can be high enough to be classed as an outbreak. Treated ewes that recover may have dystocia and die during parturition or develop retained placenta and metritis. Flocks that experience pregnancy toxemia also have a significantly higher-than-normal mortality in neonatal lambs and often a severe decrease in wool quality. Often these flocks are also predisposed to hypomagnesemia during lactation.

### PATHOGENESIS

Approximately 60% of fetal growth takes place in the last 6 weeks of pregnancy, and pregnancy toxemia results from inadequate energy intake during this time, usually in ewes with more than one fetus. Ewes that are predisposed to the disease have an ineffective gluconeogenic response to the continued preferential demands for glucose by the growing fetuses, resulting in hypoglycemia, lipid mobilization, and the accumulation of ketone bodies and cortisol. The reason for this predisposition is not precisely known, but the subsequent disease and metabolic changes are associated with excessive lipid mobilization. Elevated concentrations of BHB further suppress endogenous glucose production and exaggerate the development of ketosis. Thus the negative feedback of

hyperketonemia on glucose production produces a self-perpetuating cycle.

An encephalopathy develops, thought to be a hypoglycemic encephalopathy from hypoglycemia in the early stages of the disease. The encephalopathy and the disease are frequently not reversible unless treated in the early stages. The onset of clinical signs is always preceded by hypoglycemia and hyperketonemia, although it is not related to the minimum blood glucose or maximum ketone levels, and thus hypoglycemia may not be the initial or precipitating cause of the syndrome. In affected ewes, there is an abnormally high level of cortisol in plasma, and adrenal steroid diabetes ("insulin resistance") may either contribute to or be a predisposing factor. For example, a comparison of ewes with a high risk of pregnancy toxemia (German Blackheaded Mutton) with a breed of lower risk (Finnish Landrace) found that the glucose elimination rate and glucose stimulated first-phase insulin secretion was lower and the basal rate of lipolysis significantly higher in the high-risk ewes. However, further investigation of insulin resistance and impaired insulin sensitivity, and the underlying cause of pregnancy toxemia, is needed.<sup>1</sup>

The increase in plasma concentrations of nonesterified fatty acids depresses cellular and humoral immune responses in the experimentally produced disease, but the clinical significance of this to naturally occurring disease is not clear.<sup>2</sup> Renal dysfunction is also apparent in the terminal stages of ovine ketosis and contributes to the development of clinical signs and the fatal outcome.

Those ewes that are carrying only one lamb and have been well fed before a short period of undernutrition may develop a subacute syndrome, both clinically and biochemically. In lines of ewe selected for increased fecundity, ewes bearing more than three fetuses have an increased susceptibility to pregnancy toxemia.<sup>3</sup>

### CLINICAL FINDINGS

The earliest signs of ovine ketosis are separation from the group, altered mental state, and apparent blindness, manifested by an alert bearing but a disinclination to move. Sheep at pasture may fail to come up for supplementary feeding, and housed sheep may stand near the feed trough with other sheep but not eat. The ewe will stand still when approached by attendants or dogs and will turn and face them, but it will make no attempt to escape. If it is forced to move, it blunders into objects; when an obstacle is encountered, it presses against it with its head. Many affected ewes stand in water troughs all day and lap the water. Constipation with dry, scanty feces is common, and there is grinding of the teeth.

In later stages, marked drowsiness develops, and episodes of more severe nervous signs occur, but they may be infrequent and easily missed. In these episodes, tremors of

the muscles of the head cause twitching of the lips, champing of the jaws, and salivation, and these are accompanied by a cog-wheel type of clonic contraction of the cervical muscles causing dorsiflexion or lateral deviation of the head, followed by circling. The muscle tremor usually spreads to involve the whole body, and the ewe falls with tonic-clonic convulsions. The ewe lies quietly after each convulsion and rises normally afterward, but is still blind.

Between the convulsions there is marked drowsiness that may be accompanied by head pressing; assumption of abnormal postures, including unusual positions of the limbs and elevation of the chin (the "stargazing" posture); and incoordination and falling when attempting to walk. A smell of ketones may be detectable on the breath.

Affected ewes usually become recumbent in 3 to 4 days and remain in a state of profound depression or coma for a further 3 to 4 days, although the clinical course is shorter in fat ewes. Terminally there may be a fetid diarrhea.

Fetal death often occurs and is followed by transient recovery of the ewe, but the toxemia caused by the decomposing fetus soon causes a relapse.

Affected ewes commonly have difficulty in lambing. Recovery may occur after the ewe lambs or if the lambs are removed by cesarean section in the early stages of the disease. In an affected flock, the disease usually takes the form of a slow, prolonged outbreak, with a few ewes affected each day over a period of several weeks. Recovered ewes may subsequently show a break in the wool.

### CLINICAL PATHOLOGY

Hypoglycemia, ketonemia, and ketonuria are characteristic of the disease. The initial changes are similar to ketosis in cattle but the sequel is not. Hypoglycemia can be used as a diagnostic aid in the early stages of the disease, but is of limited value later on when the ewe becomes recumbent, when blood glucose levels may be normal or grossly elevated. This may follow fetal death, which has been shown to remove the suppressing effect of the fetus on hepatic gluconeogenesis.

Ketonemia and ketonuria are constant, with serum BHB concentrations greater than 3.0 mmol/L. Sheep develop a severe metabolic acidosis, develop renal failure with a terminal uremia, and become dehydrated. Liver function tests show liver dysfunction. Elevated plasma cortisol concentrations occur, with greater than 10 ng/mL indicative of pregnancy toxemia. However, elevated plasma cortisol can occur with other conditions, such as hypocalcemia.

### NECROPSY FINDINGS

Without treatment, pregnancy toxemia in ewes is almost always fatal. At necropsy, there is severe fatty degeneration of the liver and usually constipation, although some



cases have fetid, light-colored diarrhea. A large single or, more commonly, twin or greater number of fetuses are present. These may have died before the ewe and be in varying stages of decomposition.

Histopathologically there is hepatic lipodosis and a poorly defined renal lesion, and there may be evidence of neuronal necrosis. Hepatic glycogen concentrations are usually very low. Concentrations of BHB in the aqueous humor or the CSF greater than 2.5 mmol/L or 5.0 mmol/L respectively, are supportive of a diagnosis of pregnancy toxemia.

### DIFFERENTIAL DIAGNOSIS

Pregnancy toxemia is usually suspected in late-pregnant ewes that show nervous signs and die within 2 to 7 days. There may be a history of exertion, stress, or sudden deprivation of food. **Hypocalcemia** can occur under similar circumstances, but the following help in differentiation:

1. The onset is within 12 hours of the stress.
2. A considerable proportion of the flock will be affected at the same time.
3. There is obvious myasthenia.
4. It has a much shorter course, 12 to 24 hours.
5. Affected animals respond well to treatment with solutions of calcium salts.

Differential diagnoses include

- Listeriosis
- Cerebral abscess
- Acidosis
- Uterine torsion or impending abortion
- Rabies

### TREATMENT

Sheep treated very early in the course of the disease generally respond favorably,<sup>4</sup> but response to therapy is poor once sheep have become recumbent, and the IV administration of 50% dextrose at this time may hasten death. Optimum therapy requires the correction of fluid, electrolyte, and acid-base disturbances in addition to treating with glucose.

### Parenteral Therapy

Ideally, individual sheep should be examined biochemically and the corrective therapy based on these results, with fluids, electrolytes, and glucose (dextrose) given over a prolonged period. A recommendation for glucose therapy is the administration of 5 to 7 g of glucose IV 6 to 8 times a day in conjunction with 20 to 40 units of zinc protamine insulin given IM every other day for 3 days. However, in many sheep-raising areas intensive laboratory monitoring and such intensive therapy is not possible because of lack of access, expense, or the number of sheep involved in an outbreak. In the absence of biochemical monitoring, therapy with glucose should be accompanied by the IV injection of isotonic sodium bicarbonate or

lactated Ringer's solution, with additional fluids given by a stomach tube.

Standard doses of corticosteroids have little therapeutic effect in sheep, and thus treatment with these drugs is not recommended, although they are often used. Very large doses are effective in ewes still able to stand, but the success probably rests in the removal of the glucose drain by the induction of premature parturition.

### Oral Therapy

Oral propylene glycol or glycerin (100 mL once daily) can be used to support parenteral glucose therapy. Less intensive therapy with propylene glycol or glycerin alone can give excellent results, especially with early treatment,<sup>4</sup> but is less successful with longer-standing cases. Oral drenching every 4 to 8 hours with 160 mL of a commercial calf scours concentrate (containing 28% glucose, 3.9% glycine, 5.3% sodium chloride, and other electrolytes) induces higher blood concentrations of glucose compared with drenching with glycerol or propylene glycol. Reported recovery rates are 90% in early and 55% in advanced cases. For the more intensive treatment of valuable ewes, insulin ([0.4 IU/kg]/d SC), combined with oral glucose precursors and electrolytes, may improve survival compared with treatment with oral glucose precursors and electrolytes alone.

Induction of parturition is an option, but it should only be used if the ewe is in the early stage of the disease because there is a delay in the delivery of the lambs (24 hours or more). If the ewe is unlikely to survive this period, cesarean section may be a better option. Induction can be achieved with dexamethasone 21-isonicotinate or the sodium phosphate form, at a dose rate of 16 to 25 mg per ewe, but dexamethasone trimethylacetate appears to be ineffective. Lambs will be born 24 to 72 hours after injection, with most born within 36 hours. Induction of parturition in normal sheep can be achieved with 10 mg of betamethasone or 2.5 mg of flumethasone, but there are no reports of their efficacy in sheep with pregnancy toxemia.

### Cesarean Section

Cesarean section can be used as an alternate to glucose replacement, and provided that ewes are in the early stages of the disease, removal of the lambs by cesarean section probably has the greatest success. The demand for glucose by the lambs is immediately removed, and both the ewe and the lambs have a high chance of survival, provided that the cesarean section is conducted before there is irreversible brain damage in the ewe and the lambs are close to term. If the ewe is recumbent, then chances of survival, for both the ewe and the lamb, are reduced. The lamb may already be dead, and thus ultrasound examination will inform

fetal age and condition and hence whether to undertake a cesarean section.

### TREATMENT AND CONTROL

#### Treatment

Oral electrolyte and glucose (calf scours) concentrate solution (160 mL qid) (R-1)

OR Oral propylene glycol (60 mL bid or 100 mL/d for 3 days) (R-1)

For more intensive treatment, include: oral calcium (calcium lactate 12.5 g/d for 3 days); oral potassium (7.5 g KCl/d for 3 days); insulin 0.4 ([IU/kg]/d SC for 3 days) (R-2)

If hypoglycemia: Dextrose (60 to 100 mL IV) (R-2)

#### Abort fetus

Ewe: Dexamethasone (20 mg IV or IM) (R-2)

Doe: Dexamethasone plus prostaglandin F<sub>2α</sub> (10 mg IM) or synthetic analog (cloprostenol; 75 g/45 kg IM) (R-2)

Cesarean section if late-term fetus and valuable ewe/doe (R-2)

#### Control

Correct the contributing factors (e.g., insufficient feed or inadequate trough space, intercurrent disease such as foot rot or foot abscess) (R-1)

### CONTROL

When clinical cases occur, the rest of the flock should be examined daily for evidence of ketosis, and affected animals should be treated immediately with oral glucose/glycine/electrolyte or propylene glycol/glycerol. Supplementary feeding of the flock should immediately be increased or started, with particular attention given to increasing in the intake of energy (carbohydrate). However, care is needed with cereal grains because rapid introduction can cause ruminal acidosis, and ewes may need from 0.25 to 1 kg/head per day (0.5 to 2.0 lb/head per day). Consequently, good-quality lucerne hay or legume grains, such as lupins or field peas, may be a safer option if ewes are not currently being fed a grain-based supplement, even though ewes do not need the higher protein content of these feeds.

### Prevention

Ensure that the plane of nutrition is rising in the second half of pregnancy, even if it means restricting the diet in the early stages. An ideal condition score for ewes at 90 days of gestation is 2.75 to 3.0 on a scale of 1 to 5. If necessary, ewes with higher condition scores at the end of the first month of pregnancy can be fed to slowly lose 0.5 in condition score during the period to the third month of pregnancy without any detrimental effect on the ewe or the size or viability of the lamb. In many smaller flocks ewes tend to be in

excessively high condition score early in pregnancy.

The last 2 months are important in the prevention of pregnancy toxemia because 70% of the lamb's birth weight is gained during the last 6 weeks of pregnancy. In intensively managed flocks the provision of cereal grain or a concentrate containing 10% protein during this period, at the rate of 0.25 kg/d, increasing to 1 kg/d in the last 2 weeks, provides adequate energy. During this period, there should be an increase in body weight of 10% for ewes with single lambs and 18% in those carrying twins, but the average condition score should remain around 3.0. Higher body-condition scores can result in higher birth weight of lambs, but this is usually not a financially viable strategy, and it increases the risk of fat-ewe pregnancy toxemia and dystocia. At the beginning of the fourth month of pregnancy, the flock can be divided into three groups by condition score, suboptimal, acceptable, and excess (overfat), and the groups are then fed accordingly. These can be monitored by condition scoring every 2 to 3 weeks during the fourth and fifth months of pregnancy. Maiden ewes should be fed as a separate group to provide for their growth in addition to pregnancy. Attention should also be given to broken-mouthed or older ewes to ensure that they maintain adequate body condition.

There are too many variations in flock structure and husbandry systems to discuss nutritional management in great detail here; readers should consult specialist texts appropriate to the system they work in.<sup>5</sup> However, in more intensive systems, especially prime lamb production, ewes can be pregnancy tested by ultrasound and divided into groups depending on whether they are barren or are carrying single or multiple fetuses. Account needs to be taken of those ewes (and does) that are timid and are thus, or for other reasons, slow feeders. If there is insufficient trough space or if the supplement is fed in small amounts and highly edible, a proportion may get little or no feed. The cost-effectiveness of a feeding program should be evaluated. In breeds with low twinning rates that are well managed, it is often more profitable to simply observe the flock and treat the occasional case.

Flock monitoring for latent pregnancy toxemia during the last 6 weeks of pregnancy can be conducted using serum BHB; concentrations of 0.8 mmol/L indicate adequate energy intake, 0.8 to 1.6 mmol/L indicate inadequate energy intake, and greater than 1.6 mmol/L indicate severe undernourishment. Pooled samples can reduce the cost of analysis, but serum glucose and BHB concentrations do vary significantly between flocks.

Ionophores are used in transition rations for dairy cows to prevent subclinical ketosis. There is some evidence that feeding monensin may have benefits for the energy metabolism of late pregnant ewes. Lower serum BHB,

lowered feed intake, and improved feed efficiency have been observed, and thus further investigation of this strategy is warranted.<sup>6</sup>

### FURTHER READING

- Freer M, Dove H, Nolan JV. *Nutrient Requirements of Domesticated Ruminants*. Collingwood, Australia: CSIRO Publishing; 2007.
- Radostits O, et al. Pregnancy toxemia in sheep. In: *Veterinary Medicine: a Textbook of the Diseases of Cattle, Horses, Sheep, Goats and Pigs*. 10th ed. London: W.B. Saunders; 2007:1668-1671.

### REFERENCES

1. Duellmeier R, et al. *J Anim Physiol Anim Nutr*. 2013;97:971.
2. Yarim GF, et al. *Vet Res Commun*. 2007;31:565.
3. Moallem U, et al. *J Anim Sci*. 2012;90:318.
4. Cal-Pereyra L, et al. *Ir Vet J*. 2015;68:25.
5. Freer M, Dove H. *Sheep Nutrition*. Collingwood, Australia: CABI and CSIRO; 2002.
6. Taghipoor B, et al. *Livestock Sci*. 2011;135:231.

## STEATITIS, PANNICULITIS, AND FAT NECROSIS

Steatitis is inflammation of adipose tissue and can affect any fatty tissue. Clinical expression is usually because of inflammation of intraabdominal or subcutaneous fat (panniculitis). The disease can be relatively innocuous or fulminant and is reported for cattle, in which it is referred to as fat necrosis or bovine lipomatosis, and horses. The colloquial name is "yellow-fat disease" because of the color of affected tissues—a result of accumulation of lipofuscin and products of fat oxidation.<sup>1-4</sup> The disease is not neoplastic.

The **disease in cattle** is characterized by inflammation and necrosis of fat in the abdominal cavity. It can be clinically silent with lesions detected during rectal examination for pregnancy diagnosis or other reason. Clinical signs of the disease in cattle are usually attributable to space-occupying lesions (such as compression of the rectum) or intestinal obstruction as a result of constriction of the intestine by mesenteric accumulations of fat or fibrotic constriction of the lumen.<sup>3</sup> The lesions are firm masses present in any portion of the omental, mesenteric, or retroperitoneal fat or as mobile, free-floating structures in the abdomen.<sup>2</sup> The free-floating masses do not appear to originate from necrosis of fat.<sup>2</sup> The masses range from small nodules to large, solid, and irregularly shaped tumors. Unlike in horses, in which intraabdominal lipomas are often pedunculated (see Chapter 7) and cause acute intestinal obstruction when the peduncular stalk wraps and constricts the small intestine, the lesions in cattle are seldom pedunculated.<sup>2</sup>

The clinical disease in cattle can be variable and range from silent through inappetence, decreased milk production, persistent diarrhea, mild recurrent colic, acute colic, dystocia, urinary retention of feces, and decreased passage of feces. Masses can be detected on rectal examination or laparotomy. Ultrasonography (transcutaneous or

transrectal) can be useful in detecting and characterizing the lesions.<sup>3</sup> The lesions are present as heterogeneous hyperechoic masses in the retroperitoneal, omental, or mesenteric fat. A hyperechoic ring around the kidney is common.<sup>3</sup> Affected tissues can be biopsied with ultrasonographic guidance.

Abnormalities in the hemogram and serum biochemistry are confined to indicators of inflammation (neutrophilia), hypergammaglobulinemia, decreased concentrations of phospholipids and cholesterol, and an increase in concentration of free fatty acids.<sup>3</sup>

The disease must be differentiated from lymphosarcoma, adenocarcinoma, intraabdominal abscess, or dry fecal balls in the descending colon. The lesions are composed of necrotic fat embedded in normal adipose tissue with mild inflammatory infiltrates of neutrophils, lymphocytes, plasma cells, macrophages and giant cells, and fibrosis.<sup>2</sup> There is rarely evidence of pancreatitis in the disease in cattle.<sup>2</sup>

The cause of the disease is unknown, although a prevalence of 67% is reported in steers grazing tall fescue, in which serum cholesterol concentrations were abnormally low.

The **disease in horses** affects mostly foals and young animals and ponies. Older animals are less frequently affected.<sup>1</sup> Generalized steatitis can be a fulminant disease in horses, ponies, and foals.<sup>1,4</sup> Panniculitis, an unusual form of steatitis limited to the subcutaneous tissues, has been reported in an aged pony mare<sup>5</sup> and in perivaginal tissues after dystocia.<sup>6</sup> Perivaginal steatitis included involvement of the bladder ligament and subsequent rupture of the bladder.<sup>6</sup>

The clinical signs of generalized steatitis consist of anorexia and depression, fever, tachycardia, and subcutaneous edema.<sup>1,4</sup> Painful subcutaneous swellings can occur in the nuchal crest and inguinal and axillary regions. Affected horses often have mild to moderate colic and signs of abdominal tenderness. Rectal examination reveals painful masses in the mesentery of some horses.

Hematology and serum biochemical examination reveal mild to moderate leukocytosis, with occasional horses having leukopenia, hypoproteinemia, hypoalbuminemia, and increases in activity in serum of lactate dehydrogenase (LDH), aspartate aminotransferase (AST), GGT, and lipase and amylase.<sup>1,4</sup> Serum vitamin E concentrations are sometimes abnormally low.

Biopsy of some of the SC swelling reveals histopathological evidence of fat necrosis with mineralization. At necropsy, the fat is hard, dry, and yellow-white, with areas of necrosis forming abscess-like lesions up to 3 cm deep and 10 cm in diameter. The fat lining the abdominal wall may contain firm yellow-white and red tissue nodules up to 3 cm in diameter. Pancreatitis is evident in equids with systemic disease, and there is necrosis and inflammation in most fatty

tissues (subcutaneous, retroperitoneal, mesenteric, and omental).<sup>1</sup>

Generalized steatitis with fat necrosis (“yellow-fat disease”) has been recognized in many species at various ages and is thought to be related to a dietary deficiency of vitamin E and selenium and intake of unsaturated fatty acids.<sup>1,5</sup>

## REFERENCES

1. de Bruijn CM, et al. *Equine Vet Educ.* 2006;18:38.
2. Herzog K, et al. *J Comp Pathol.* 2010;143:309.
3. Tharwat M, et al. *Can Vet J.* 2012;53:41.
4. Waitt LH, et al. *J Vet Diagn Invest.* 2006;18:405.
5. Radostits O, et al. Steatitis. In: *Veterinary Medicine: a Textbook of the Diseases of Cattle, Horses, Sheep, Goats and Pigs.* 10th ed. London: W.B. Saunders; 2006:1680.
6. Claes E, et al. *Vlaams Diergeneeskundig Tijdschrift.* 2014;83:36.

## Inherited Metabolic Diseases of Ruminants

### DEFICIENCY OF UMP SYNTHASE (DUMPS)

This is a partial deficiency of an enzyme that is involved in the conversion of orotate to uridine 5'-monophosphate (UMP) as a step in the synthesis of pyrimidine nucleotides. It is recorded at a high prevalence in Holstein-Friesian cattle in the United States and Japanese Black cattle and is characterized by an autosomal-recessive form of inheritance and the secretion of high levels of orotate in the milk.<sup>1</sup> Heterozygous animals have a partial deficiency of UMP synthase, but they have no individual or herd clinical abnormalities. Heterozygous animals can be detected biochemically by their half-normal levels of erythrocyte UMP synthase or by nested polymerase chain reaction (PCR) testing.<sup>2,3</sup> Bovine homozygotes die at about the 40th day of pregnancy. Embryonic mortality is the only form of loss.

## REFERENCES

1. Ohba Y, et al. *J Vet Med Sci.* 2007;69:313.
2. Dai Y, et al. *China Anim Health Inspection.* 2014;31:76.
3. Paiva DS, et al. *Genet Mol Res.* 2013;12:3186.

### HEPATIC LIPODYSTROPHY IN GALLOWAY CALVES

Hepatic lipodystrophy has been reported in Galloway calves on five farms in the United Kingdom over a 10-year period. Calves appear normal after birth but die by 5 months of age. Clinically there is tremor, opisthotonus, and dyspnea before affected calves become recumbent and die. At necropsy the liver is enlarged, pale, and mottled. Histologically there is evidence of hepatic encephalopathy. The cause is unknown, but limited evidence suggests a storage disease is possible.

## Metabolic Diseases of Horses

### EQUINE PITUITARY PARS INTERMEDIA DYSFUNCTION (FORMERLY EQUINE CUSHING DISEASE)

Equine pituitary pars intermedia dysfunction (PPID) is a slowly progressive neurodegenerative disease of older equids caused by nonmalignant hypertrophy and hyperplasia of melanotropes of the pars intermedia of the pituitary gland. It is characterized in its most severe form by hirsutism, laminitis, polyuria, and polydipsia.

## ETIOLOGY

The pars intermedia of equids is composed of a single cell type—melanotropes—which are innervated by dopaminergic neurons of the periventricular nucleus. Innervation by these neurons is inhibitory on secretion by the melanotropes of proopiomelanocortin (POMC)-derived peptides. Thyrotropin-releasing hormone stimulates melanotropes.<sup>1</sup> The pars distalis of the pituitary of healthy horses releases adrenocorticotropic hormone (ACTH) in response to, among other stimuli, declines in plasma cortisol concentration. Cortisol exerts negative feedback on secretion of ACTH by the pars distalis, but not by the pars intermedia.<sup>2</sup>

The disease is attributable to degeneration of the periventricular hypophyseal dopaminergic neurons with subsequent development of a nonmalignant functional tumor comprised of melanotropes of the pars intermedia of the pituitary gland.

Cushing syndrome caused by adrenocortical tumors is exceedingly rare in equids.

## EPIDEMIOLOGY

The disease is being diagnosed with increasing frequency.<sup>3</sup> The prevalence of the disease is not well documented, but surveys of owners indicate hair-coat abnormalities consistent with the disease in 15% to 39% of aged equids. Of 200 randomly selected equids 15 years of age or older in the United Kingdom, 22% had hair-coat abnormalities suggestive of PPID detected on clinical examination,<sup>4</sup> and owners of 12% of approximately ~980 aged equids in the United Kingdom reported hair-coat abnormalities and abnormal moulting.<sup>5</sup> Similarly, owners of 17% of 974 horses 15 years of age or older in Queensland, Australia, reported hirsutism.<sup>6</sup> Given that changes in hair coat are specific (95%) but of unknown sensitivity for the diagnosis of PPID,<sup>7</sup> these estimates likely provide the lower range for prevalence of the disease. Accordingly, 21% of 325 randomly selected horses 15 years of age or older in Queensland had PPID diagnosed based on measurement of plasma ACTH concentrations and using

seasonally adjusted cutoff values.<sup>8</sup> This likely provides the best current estimate of the prevalence of PPID in mature and aged horses. Reports of prevalence of the disease provided in early studies likely were unreliable as indicators of disease frequency in the overall population of horses because of selective or nonrandom sampling of horses.

The disease occurs worldwide in all breeds of horses and ponies. Differences in geographic distribution are not reported.

The only well-recognized animal risk factor for the disease is increasing age (adjusted OR of 1.18 [95% CI, 1.1 to 1.25]) per year of age, and there is no apparent sex or breed predisposition.<sup>8</sup>

## PATHOGENESIS

PPID is a neurodegenerative disease in which there is a loss of the inhibitory effect of dopamine with subsequent hypertrophy and hyperplasia of melanotropes of the pars intermedia of the pituitary gland with unchecked secretion of proopiomelanocortin and compression of the neurohypophysis, hypothalamus, and optic chiasma.<sup>9</sup> Production of proopiomelanocortin by melanotropes in the pars intermedia is not under the negative feedback control of glucocorticoids, and as a result, affected equids produce large quantities of POMC, melanocyte-stimulating hormone ( $\alpha$ -MSH),  $\beta$ -endorphin, and smaller but still excessive quantities of ACTH. Production of ACTH results in loss of the normal circadian rhythm in serum cortisol concentration.<sup>10</sup> The space-occupying effects of the tumor can cause blindness because of compression of the optic chiasm. Polyuria and polydipsia are common and are probably related to neurohypophyseal dysfunction and compression of the pars nervosa, the source of antidiuretic hormone.<sup>11</sup>

Not all equids with PPID have impaired glucose metabolism.<sup>12,13</sup> A proportion of horses, estimated as ~40%, with PPID have evidence of abnormal glucose metabolism, including hyperinsulinemia, hyperglycemia, or both, although only 20% have evidence based on results of an IV glucose and insulin test.<sup>12</sup> Furthermore, horses with PPID do not have abnormalities in glucose metabolism detected during an isoglycemic clamp procedure.<sup>13</sup> It is unclear if the abnormal glucose metabolism and hyperinsulinemia are attributable to PPID or concurrent equine metabolic syndrome, but it is apparent that there should not be an assumption of abnormalities in glucose metabolism in all equids with PPID.

## CLINICAL FINDINGS

Affected equids exhibit one or more findings of hirsutism, hyperhidrosis, polyuria, polydipsia, polyphagia, muscle atrophy (sarcoopenia), laminitis, and docile demeanor.

Hirsutism is a clinical sign with high specificity (95%) for the disease,<sup>7</sup> meaning that aged equids with hirsutism are likely to



have the disease and that there will be few false-positive diagnoses when hirsute aged equids are considered to have PPID. Equids with an owner-reported history of hirsutism are 7.8 times (95% CI, 3.7 to 16.6) more likely to have PPID than are nonhirsute equids of similar age.<sup>8</sup> Hirsutism is characterized by delayed or absent seasonal moulting resulting in a long, shaggy hair coat. There can be some lightening of the coat color. The changes in hair coat are a result of equids with PPID having a greater proportion of hair follicles in the anagen phase (95% of hair follicles on the neck) than healthy equids (15%).<sup>14</sup> Abnormalities of hair follicles resolve and resumption of moulting occurs with administration of pergolide.<sup>14</sup>

Polyuria and polydipsia are common clinical signs in equids with PPID and are likely secondary to diabetes insipidus and not to hyperglycemia.<sup>11</sup> Administration of desmopressin reduces polyuria and polydipsia.<sup>11</sup>

Hyperhidrosis is reported in affected equids, although it does not appear to have been quantified. Equids with PPID in hot environments can be anhidrotic, and this resolves with treatment of the PPID.<sup>15</sup>

Myopathy associated with PPID is characterized by atrophy of type 2 (slow-twitch) fiber types consistent with sarcopenia.<sup>16</sup> Plasma activity of muscle-derived enzymes is not greater in equids with PPID than in healthy aged-matched equids.<sup>16</sup> The molecular basis for muscle atrophy in equids with PPID has been investigated, but the mechanism remains unclear.<sup>17</sup>

There is often central obesity, characterized by excessive fat deposition in the crest of the neck and in the supraorbital fossae, but this is likely a reflection of comorbidity with equine metabolic syndrome rather than a characteristic of PPID. One report demonstrates insulin resistance in equids with PPID using the euglycemic-hyperinsulinemic clamp technique, but this is not a consistent finding.<sup>13,18</sup> However, equids were not screened for hyperinsulinemia before admission to the study and were selected from a population of equids referred for treatment of laminitis, among other diseases. These equids might well have had both equine metabolic syndrome (EMS) and PPID. Further evidence to support this comorbidity is that plasma fructosamine concentrations are not different between nonlaminitic equids with PPID and healthy controls (reference interval of 195.5 to 301.9).<sup>19</sup> Equids with PPID and laminitis have plasma fructosamine concentrations that are higher than those of animals with PPID but not laminitis.<sup>19</sup> Fructosamine is a reflection of average blood glucose concentrations over a period of weeks, and higher values are indicative of hyperglycemia.

Laminitis is common in equids with PPID (see “Laminitis of Horses,” Chapter 15).<sup>8</sup> However, it is unclear if this is a result of PPID or comorbidity with EMS.

Rarely, affected equids are blind or have seizures. Affected equids are often infertile and heal poorly. Equids with PPID are considered immunosuppressed and susceptible to development of opportunistic infections and parasitism.<sup>20,21</sup>

Computed tomography allows measurement of the size of the pituitary gland of equids that correlates well with that measured postmortem.<sup>22</sup> The size of the pituitary gland can be evaluated antemortem.

The outcome is favorable in that 50% of equids are alive 4.6 years after diagnosis, most owners are satisfied with the equid's quality of life, and most (28/29; 97%) would treat a second equid with the disease.<sup>3</sup> In a study of cases diagnosed between 1993 and 2002, the cause of death among equids (15/20; 85%) was euthanasia, and 11/15 (73%) were euthanized because of conditions associated with PPID.<sup>3</sup>

### CLINICAL PATHOLOGY

There are no characteristic findings on serum biochemical testing or hematology.<sup>8</sup> Resting serum cortisol concentrations of affected and healthy equids are similar and not useful in diagnosis.

### DIAGNOSTIC CONFIRMATION

**Antemortem diagnosis** of PPID is not simple and is achieved on the basis of clinical signs and results of one or more of several diagnostic tests. It is important that testing be based on the presence of clinical signs compatible with the disease to minimize the frequency of false-positive diagnoses. Laboratory tests for the disease are not infallible, and the results of these tests should be viewed only in the context of the equid's clinical signs. Further complicating diagnosis of equine pars intermedia dysfunction is the slow and progressive onset of the disorder. It is therefore likely that attempting a definitive dichotomous answer (disease present or disease absent) based on laboratory testing is unreasonable—some mildly affected equids will test normal, and, less commonly, some apparently healthy equids with histologically normal pituitary glands will test positive. Repeated testing is warranted when test results are ambiguous or not consistent with clinical signs (primarily hirsutism).

Assessment of the utility of the various diagnostic tests is prevented by the lack of a gold-standard diagnosis, except for postmortem examination. Determination of sensitivity and specificity of laboratory tests, or clinical signs, is therefore difficult. Furthermore, antemortem testing is complicated by the seasonal and circadian variations in pituitary function with consequent changes in “resting” or basal serum or plasma concentrations of many analytes. Furthermore, plasma concentrations of some analytes, including ACTH, are affected by feeding.<sup>23</sup> The changes in pituitary function with season are a recognized physiologic

phenomenon related to preparing or adapting physiologic functions to colder conditions and shorter days.<sup>10,24-30</sup> This phenomenon was not generally recognized before about 2005, and reports of the characteristics of diagnostics tests before that date should be interpreted with caution.

**Laboratory tests** used to diagnose pars intermedia dysfunction include measurement of serum or plasma cortisol, ACTH, glucose, or insulin concentrations; the ACTH stimulation test; the thyrotropin-releasing hormone stimulation test; administration of domperidone with subsequent measurement of plasma ACTH; measurement of urinary and salivary corticoid concentrations; and combinations of these tests (Table 17-8). The most widely accepted laboratory tests are the overnight dexamethasone suppression test and measurement of serum ACTH concentration. Other tests have been suggested, but either their sensitivity and specificity have not been determined or they involve measurement of multiple variables or of hormones for which assays are not readily commercially available. Measurement of basal serum insulin concentration is not a useful diagnostic test for equine pars intermedia dysfunction. Measurement of urine or salivary cortisol concentrations has been suggested as a means of diagnosing equine pars intermedia dysfunction, but neither has been validated in a sufficient number of equids to permit assessment of their clinical utility.<sup>31</sup>

One of the first diagnostic tests developed was the **overnight dexamethasone suppression test**.<sup>31</sup> After collection of a serum sample for measurement of cortisol, dexamethasone (40 µg/kg IM) is administered at about 5 p.m. A second blood sample is collected 15 hours later, with the option to collect a third sample 19 hours after dexamethasone administration. Normal horses will have a serum cortisol concentration of less than 1 µg/dL (28 nmol/L) in the second and third blood samples, whereas affected horses will not show a significant reduction in serum cortisol concentration from that of the initial sample. The sensitivity and specificity of this test are apparently high, with both reported in earlier studies to be approximately 100%.<sup>31</sup> However, recent studies of healthy horses demonstrate that there is considerable seasonal variation in the dexamethasone suppression test, with all of 39 healthy aged ponies and horses having normal tests in January (winter) but 10 of the same 39 (26%) having abnormal tests in September (autumn),<sup>31</sup> and that the test is specific but not sensitive.<sup>32</sup> These results suggest that these diagnostic tests should be interpreted with caution when conducted in the autumn.

Measurement of **plasma adrenocorticotropic (ACTH)** concentration has been widely accepted as a useful laboratory indicator of equine pars intermedia dysfunction. The plasma ACTH concentration varies with the age of the horse and with the season

**Table 17-8** Diagnostic Testing Methods for Equine pituitary pars intermedia dysfunction (PPID)

Diagnostic test	Procedure	Sample	Interpretation	Comments (also see text)
Overnight DEX suppression	Collect serum between 4 and 6 p.m. Administer DEX at 40 µg/kg BW IM. Collect serum 19–20 hours later.	2 serum samples, 1 mL each; 1 pre-DEX administration and 1 post-DEX administration	Serum control of > µg/dL at 19 hours post-DEX administration suggests PPID.	A mildly decreased resting cortisol (pre-DEX administration) is typical of a PPID-affected horse. A resting cortisol of < 1.8 µg/dL is suggestive of iatrogenic adrenal insufficiency.
Endogenous plasma ACTH concentration	Collect EDTA plasma, preferably in plastic blood-collection tube. Separate plasma by centrifugation, and freeze for submission to laboratory. Avoid hemolysis and heat. Process sample within 8 hours of collection.	EDTA plasma sample, 1 mL	Normal reference range depends on methodology and laboratory. Typically an ACTH concentration < 35 pg/mL (chemiluminescent immunoassay) or < 45–50 pg/mL (radioimmunoassay) is considered normal.	ACTH is likely affected by many biologic events, all of which are not well documented at present. Seasons can have a profound effect, with higher concentrations seen in autumn.
Endogenous plasma α-MSH concentration	Collect EDTA plasma, preferably in plastic blood-collection tube. Separate plasma by centrifugation, and free for submission to laboratory. Avoid hemolysis and heat. Process sample within 8 hours of collection.	1 EDTA plasma sample, 1 mL	Nonautumn reference range: > 35 pmol/L suggests PPID.	Plasma α-MSH concentration is extremely seasonal. High concentrations are observed in autumn.
TRH stimulation assay	Collect serum. Administer TRH, 1 mg IV. Collect serum 30–60 minutes after TRH.	2 serum samples, 1 mL each: pre-TRH administration, 30 minutes post-TRH administration, and 24 hours post-DEX administration	30%–50% increase in serum cortisol 30 minutes after TRH administration suggests PPID.	Pharmaceutical TRH is expensive; TRH compounded for this use may be difficult to obtain. False-positive results may be common.
Combined DEX suppression/TRH stimulation test	Collect plasma between 8 and 10 a.m. Administer DEX at 40 µg/kg BW IM. Administer TRH, 1 mg IV, 3 hours after DEX administration. Collect serum 30 minutes after TRH and 24 hours after DEX administration.	3 plasma samples, 1 mL each: pre-DEX administration, 30 minutes post-TRH administration, and 24 hours post-DEX administration	Plasma cortisol > 1 µg/dL at 24 hours post-DEX administration or ≥ 66% increase in cortisol levels 3 hours after TRH administration suggests PPID.	Some diagnostic laboratories prefer to use serum for measurement of cortisol levels. The effect of season on the combined test has not been assessed but would likely result in false-positive results as each of the component tests do.
Domperidone response test	Collect EDTA plasma at 8 a.m. Administer domperidone at 3.3 mg/kg BW po. Collect EDTA plasma at 2 and 4 hours after domperidone administration.	3 EDTA plasma samples, 1 mL each	A twofold increase in plasma ACTH concentration suggests PPID.	Higher doses (5 mg/kg po) may improve response. The 2-hour sample is more diagnostic in the summer and autumn, and the 4-hour sample is best in the winter and spring.

Abbreviations: ACTH, adrenocorticotropic hormone; BW, bodyweight; DEX, dexamethasone; IM, intramuscularly; IV, intravenously; TRH, thyroid-releasing hormone. (Reproduced, with permission, from McFarlane, D. *Vet Clin Equine* 2011; 27:93-113. McFarlane D. *Vet Clin North Am Equine Pract.* 2011;27:93.)

of the year in both the northern and southern hemispheres, but not between ponies and horses.<sup>33</sup> The upper reference intervals of plasma ACTH for healthy horses in the United Kingdom in one report were 29 pg/mL between November and July and 47 pg/mL between August and October.<sup>25</sup> The reference intervals were obtained by sampling a convenience sample of hospitalised horses. A similar pattern is detected in the eastern and southern United States, with the autumnal peak in ACTH occurring earlier in horses in more northern locations.<sup>1,24,29,30</sup> This circannual variation in plasma ACTH occurs in

both non-PPID and PPID horses, with PPID horses having higher concentrations than non-PPID horses at all times.<sup>10,23,25,26,33,34</sup> Furthermore, the increase in plasma ACTH concentrations stimulated by administration of thyrotropin-releasing hormone (1 mg, IV) to healthy horses is greater in autumn and summer than in late winter.<sup>23,27</sup> These results demonstrate the need for including consideration of season (photoperiod) and latitude when assessing the diagnostic importance of plasma ACTH concentrations in aged horses. It is prudent to use reference intervals developed in local laboratories or in distant

laboratories with knowledge of the reference interval for the particular geographic location (latitude) and season of the horse.<sup>30</sup>

There is no circadian rhythm to ACTH concentrations in horses with PPID, but there is conflicting evidence of a circadian rhythm in healthy horses.<sup>10,35,36</sup> It appears that ACTH concentrations of horses are highest at 0800 hours and then decline over the day, although the changes are small and not likely to affect clinical interpretation of plasma ACTH concentrations.<sup>35</sup> There is not an ultradian rhythm (periodic changes during a 24-hour period) in plasma ACTH

concentration, although measured concentrations do vary over brief periods of time (minutes) and to a greater extent in horses with PPID.<sup>35</sup>

Fasting and feeding affect plasma ACTH concentrations in healthy horses, with higher concentrations found 2 hours after feeding than after a 12-hour fast (46 vs. 17 pg/mL, respectively).<sup>23</sup>

Measurement of **plasma ACTH** combined with use of seasonally adjusted cutoffs provides good **sensitivity and specificity** for diagnosis of PPID, defined using the presence of hirsutism plus three or more clinical signs as the gold standard.<sup>33</sup> The referenced study was of 325 randomly selected horses 15 years of age or older in Queensland, Australia (approximate latitude 27.5°S). Cutoff values for diagnosis of PPID were 30 pg/mL (sensitivity and specificity of 80% and 82%, respectively) for nonautumn months and 77 pg/mL (sensitivity and specificity of 100% and 95%, respectively) during the autumn. It is important to note that the gold standard for determining the characteristics of the test was a clinical examination. Therefore the sensitivity and specificity reported for measurement of plasma ACTH concentration apply only for horses with characteristic clinical signs of the disease. The usefulness of measuring plasma ACTH concentration in horses that have milder, or nonexistent, clinical signs is unknown. Similarly, the clinical importance of elevated ACTH concentrations in younger horses is unclear, and such results should be considered cautiously and carefully before decisions regarding treatment are made.

Plasma concentrations of  $\alpha$ -melanocyte-stimulating hormone ( $\alpha$ -MSH) correlate well with plasma ACTH concentrations, and comments about seasonal and horse-related factors affecting ACTH concentrations also apply for  $\alpha$ -MSH.<sup>1,10,24,27,33,37</sup>

Plasma ACTH concentrations can be measured before and after administration of **thyrotropin-releasing hormone** or **domperidone**.<sup>37,38</sup> The thyrotropin-releasing hormone test appears to have greater utility than administration of domperidone, with the latter having greater variation. These tests have not been adequately evaluated to recommend at this time.

The combined **dexamethasone suppression/thyroid-releasing hormone (TRH) stimulation** test has reported sensitivity and specificity of 88% and 76%, respectively.<sup>7</sup> The test is performed by administering 40  $\mu$ g/kg of dexamethasone phosphate (or similar dexamethasone salt) intravenously between 8 a.m. and 10 a.m. Cortisol concentration in serum is then measured 3 hours later, and TRH (1 mg) is administered intravenously. Serum cortisol concentration is measured 30 minutes after TRH administration. Serum cortisol concentrations of healthy horses 30 minutes after TRH administration are unchanged from those at the time of TRH

administration, whereas serum cortisol concentrations in horses with equine pars intermedia dysfunction increase by more than 66% of the baseline value.

Plasma **fructosamine** concentrations do not differ between healthy horses (range 195.5 to 301.9  $\mu$ mol/L) and horses with PPID.<sup>39</sup> **Plasma insulin** concentrations are increased in a proportion of horses with PPID and are suggested to be indicative of the risk of laminitis in these horses (see discussion of equine laminitis, Chapter 15).<sup>40,41</sup>

## NECROPSY FINDINGS

The pituitary gland is usually enlarged as a result of the increased numbers of melanocortin cells comprising an adenoma of the pars intermedia. The adrenal cortices are usually of normal width, but they may be thickened in some cases. With the appropriate clinical history, the observation of a well-defined nodule within the pituitary gland is usually sufficient for confirmation of the diagnosis, but histology and immunohistochemical testing of the mass can be performed. There is only fair ( $\kappa = 34\%$ ) agreement among pathologists for histologic diagnosis of the disease.

### DIFFERENTIAL DIAGNOSIS

- Insulin resistance
- Diabetes insipidus (nephrogenic)
- Both of these diseases are exceedingly rare in horses
- Obesity
- Psychogenic polydipsia or salt eating
- Chronic renal failure

## TREATMENT

Treatment is palliative and not curative in that clinical signs can be controlled by administration of pergolide, but the underlying neurodegenerative disease is not cured. The aim of treatment is to reduce secretion of the products of the melanotropes through the use of dopamine agonists or serotonin antagonists. Treatment must be continued for the life of the horse or pony.

The **treatment of choice** is administration of **pergolide mesylate**, a dopamine agonist, at 1.7 to 5.5  $\mu$ g/kg orally every 24 hours. The recommended starting dose is 2.0 to 3.0  $\mu$ g/kg once daily for 2 months, at which time clinical (hirsutism) and laboratory (plasma ACTH concentration) signs of the disease should be evaluated. The dose can be escalated by 1- $\mu$ g/kg increments until control of clinical signs is achieved.

Pergolide mesylate is rapidly absorbed after oral administration to fasted mares with a time to maximum drug concentration in plasma of 0.4 hours, maximum concentration of  $4 \pm 2$  ng/mL, and terminal elimination half-life estimated to be  $5.9 \pm 3.4$  hours.<sup>43</sup>

Care should be exercised in the storage of pergolide mesylate compounded in an

aqueous vehicle because it is susceptible to degradation if exposed to heat, light, or both.<sup>44</sup> Compounded pergolide formulations in aqueous vehicles should be stored in a dark container, protected from light, and refrigerated, and it should not be used more than 30 days after production. Formulations that have undergone a color change should be considered degraded and discarded.<sup>44</sup> A commercial form of pergolide mesylate formulated for use with horses and ponies (Prascend®, Boehringer Ingelheim) is available in some countries.

Cyproheptadine, a serotonin antagonist, is administered at 0.25 mg/kg orally every 24 hours for 1 month. If an acceptable response is achieved, then this dose is continued; if not, then the dose is increased to 0.25 mg/kg every 12 hours. This drug is now rarely used in the treatment of PPID.

Symptomatic treatment should include clipping of the hair coat in spring, treatment of laminitis and wounds, prevention of injuries and infection, and dietary management to reduce hyperglycemia in those animals with this abnormality documented (see “**Equine Metabolic Syndrome**”), in addition to maintenance of optimal body weight. Some equids with PPID lose weight and require careful nutritional management.

## CONTROL

None.

## FURTHER READING

- Durham AE, McGowan CM, Fey K, Tamzali Y, van der Kolk JH. Pituitary pars intermedia dysfunction: diagnosis and treatment. *Equine Vet Educ.* 2014;26:216-223.
- McFarlane D. Equine pars intermedia dysfunction. *Vet Clin North Am Equine Pract.* 2011;27:93-113.
- McFarlane D. Pathophysiology and clinical features of pituitary pars intermedia dysfunction. *Equine Vet Educ.* 2014;26:592-598.

## REFERENCES

1. McFarlane D, et al. *Dom Anim Endocrin.* 2006;30:276.
2. McFarlane D. *Equine Vet Educ.* 2014;26:592.
3. Rohrbach BW, et al. *J Vet Int Med.* 2012;26:1027.
4. Ireland JL, et al. *Equine Vet J.* 2012;44:101.
5. Ireland JL, et al. *Equine Vet J.* 2011;43:37.
6. McGowan TW, et al. *Aust Vet J.* 2010;88:465.
7. Frank N, et al. *J Vet Int Med.* 2006;20:987.
8. McGowan TW, et al. *Equine Vet J.* 2013;45:74.
9. McFarlane D. *Ageing Res Rev.* 2007;6:54.
10. Cordero M, et al. *Dom Anim Endocrin.* 2012;43:317.
11. Moses ME, et al. *Equine Vet Educ.* 2013;25:111.
12. Gehlen H, et al. *J Equine Vet Sci.* 2014;34:508.
13. Mastro LM, et al. *Dom Anim Endocrin.* 2015;50:14.
14. Innera M, et al. *Vet Dermatol.* 2013;24:212.
15. Spelta CW, et al. *Aust Vet J.* 2012;90:451.
16. Aleman M, et al. *Neuromuscul Disord.* 2006;16:737.
17. Aleman M, et al. *Am J Vet Res.* 2010;71:664.
18. Klinkhamer K, et al. *Vet Quart.* 2011;31:19.
19. Knowles EJ, et al. *Equine Vet J.* 2013;n/a.
20. McFarlane D, et al. *J Vet Int Med.* 2008;22:436.
21. McFarlane D, et al. *JAVMA.* 2010;236:330.
22. Pease AP, et al. *J Vet Int Med.* 2011;25:1144.
23. Diez de Castro E, et al. *Dom Anim Endocrin.* 2014;48:77.
24. Beech J, et al. *JAVMA.* 2009;235:715.



25. Copas VEN, et al. *Equine Vet J*. 2012;44:440.
26. Frank N, et al. *J Vet Int Med*. 2010;24:1167.
27. Funk RA, et al. *J Vet Int Med*. 2011;25:579.
28. Haritou SJA, et al. *J Neuroendocrin*. 2008;20:988.
29. McFarlane D, et al. *J Vet Int Med*. 2011;25:872.
30. Schreiber CM, et al. *JAVMA*. 2012;241:241.
31. Radostits O, et al. *Veterinary Medicine: a Textbook of the Diseases of Cattle, Horses, Sheep, Goats and Pigs*. London: Saunders; 2006:1686.
32. Beech J, et al. *JAVMA*. 2007;231:417.
33. McGowan TW, et al. *Equine Vet J*. 2013;45:66.
34. Lee Z-Y, et al. *Vet J*. 2010;185:58.
35. Rendle DI, et al. *Equine Vet J*. 2013;n/a.
36. Rendle DI, et al. *Equine Vet J*. 2014;46:113.
37. Beech J, et al. *JAVMA*. 2011;238:1305.
38. Beech J, et al. *J Vet Int Med*. 2011;25:1431.
39. Knowles EJ, et al. *Equine Vet J*. 2014;46:249.
40. Walsh D, et al. *J Equine Vet Sci*. 2009;29:87.
41. Durham AE, et al. *Equine Vet Educ*. 2014;26:216.
42. McFarlane D. *Vet Clin North Am Equine Pract*. 2011;27:93.
43. Wright A, et al. *J Vet Int Med*. 2008;22:710.
44. Davis JL, et al. *JAVMA*. 2009;234:385.

## EQUINE METABOLIC SYNDROME

### SYNOPSIS

**Etiology** Unknown, but likely involves genetic predisposition for insulin resistance with phenotypic expression permitted or induced by environmental factors that favor obesity.

**Epidemiology** Associated with obesity and particular breeds, especially ponies. Standardbreds appear to be at reduced risk. No sex predilection. Increasing incidence with age.

**Clinical signs** Obesity, regional adiposity including cresty neck, predisposition to laminitis.

**Clinical pathology** Hyperinsulinemia, hypertriglyceridemia, normal blood glucose concentration.

**Diagnostic confirmation** Demonstration of insulin resistance in presence of clinical signs of equine metabolic syndrome. Measurement of serum insulin and plasma or blood glucose concentrations. Requires validated insulin assay.

**Treatment** Weight loss, which can be difficult to achieve. Exercise. Potentially administration of insulin sensitizing drugs (metformin).

**Control** Maintenance of optimal body condition and prevention of obesity.

Equine metabolic syndrome (EMS) is a recently recognized condition of equids characterized by increased regional adiposity (localized deposition of fat) or generalized obesity, hyperinsulinemia, hypertriglyceridemia, insulin resistance, and a predisposition to laminitis that develops in the absence of other known inciting factors (such as colic, metritis, or acute carbohydrate overload).<sup>1</sup> Insulin resistance is defined as abnormally depressed insulin-mediated glucose

transport into insulin-sensitive cells (adipose tissue, skeletal muscle). EMS is the clinical syndrome, whereas insulin resistance is an underlying metabolic abnormality.

### ETIOLOGY

EMS likely has important genetic determinants, with manifestation of the syndrome when susceptible animals, by virtue of their genetic composition, are exposed to environmental conditions that favor or enable development of the disease. This is thought to be similar to the situation with human metabolic syndrome or type 2 diabetes. It is speculated that breeds of equids that evolved under conditions of frequent restriction of energy intake, such as during long winters, are genetically predisposed to have efficient energy metabolism that under modern management systems can result in obesity and development of insulin resistance.<sup>1,2</sup>

### EPIDEMIOLOGY

The epidemiology of EMS is not well described, and there are few studies that have identified the frequency of the condition, using established case definitions, in large numbers of horses or ponies. Consequently, there is little evidence on outcome (morbidity, case-fatality rates, all-cause morbidity, specific-cause mortality) in horses and only anecdotal information on breed, age, and sex as risk factors. Twenty seven percent (51/188) of ponies of various breeds examined in Australia were hyperinsulinemic (>20 µu/mL) after ponies with documented PPID (see previous section) were excluded.<sup>3</sup> There is somewhat more information regarding the epidemiology of obesity in horses, but it should be recognized that not all obese horses are insulin resistant (and therefore do not fit the definition of EMS).<sup>4,5</sup> Similarly, there is information on the epidemiology of pasture-associated (endocrinopathic) laminitis (see “Laminitis of Horses,” Chapter 15), and from this one can infer risk factors for insulin resistance and EMS.

Horses or ponies of different breeds but similar body weight differ in their insulin resistance, and there is consensus that particular breeds are at increased risk of EMS; these include ponies (of any of the common breeds), Morgan Horses, Paso Fino, Andalusian, Arabian, Saddlebred, Quarter Horses, Tennessee Walking Horses, and Warmblood Horses.<sup>1,2</sup> It appears that some light breeds such as Standardbreds and perhaps Thoroughbreds are at reduced risk. The frequency of the condition increases with age in ponies,<sup>3</sup> and sex does not appear to be a risk factor.

There is a **seasonality** to the occurrence of pasture-associated laminitis,<sup>6</sup> and this might represent seasonal changes in energy intake (from pasture) of susceptible animals rather than seasonal variations in severity of insulin resistance. However, there is evidence that measures of insulin resistance in horses and/or ponies vary depending on season,

with declines in insulin sensitivity of ponies in summer.<sup>7</sup> Insulin sensitivity, defined using the combined insulin and glucose intravenous test, and serum insulin concentrations are not related to season in healthy, mature horses.<sup>8,9</sup>

Obesity is common in domestic horses, with studies in Scotland and the eastern United States finding that 45% and 19%, respectively, of horses were considered obese.<sup>10,11</sup> Although interpretation of both studies is limited by the localized nature of the sampling and restrictions on the types of horses included, these studies do support a wider consensus that obesity is common in horses. Chronic intake of energy in excess of maintenance needs (overeating) and insufficient exercise are thought to be risk factors, or inciting factors, for obesity.

### PATHOGENESIS

EMS is primarily a manifestation of insulin resistance, and insulin resistance is often, but not always, associated with obesity. The syndrome likely includes abnormalities in energy metabolism, adipocyte function, hemostasis (thrombosis), inflammation, response to lipopolysaccharide (endotoxin) exposure, and oxidant stress.<sup>1,12</sup> The pathogenesis of laminitis associated with EMS (“endocrinopathic laminitis”) is discussed elsewhere.

Insulin resistance is the decreased rate of transport of glucose into cells of glucose-sensitive tissues in response to exposure to insulin. Horses with insulin resistance have lesser reductions in blood glucose concentration in response to administration of insulin than do insulin-sensitive horses.<sup>13,14</sup> Insulin-stimulated glucose transport is achieved by GLUT-4 (glucose transporter protein 4, which is one of at least 12 glucose transporter proteins) when it is present on the surface of adipose or muscle tissue. Insulin causes the relocation of GLUT-4 within the cell to the cell plasma membrane and subsequent increases in rate of glucose transport into the cell. Horses with insulin resistance have abnormal glycemic and insulinemic responses to oral or IV administration of glucose or oral administration of sugar (see following discussion) and have reduced concentrations of GLUT-4 on the surface of skeletal muscle and adipose tissue.<sup>15-17</sup> Insulin resistance in horses is associated with an exaggerated response in plasma/serum insulin concentration after administration of glucose. This exaggerated response allows maintenance of resting blood glucose concentrations in the reference range in affected horses—so-called compensated insulin resistance.<sup>1</sup>

Insulin resistance in humans is currently thought linked to inflammation induced by macrophage activation in adipose tissue, and there is increasing evidence of a similar mechanism in equids.<sup>18</sup> The BCS of horses is also correlated with both plasma insulin concentration and serum amyloid A

concentration (an acute-phase protein indicative of inflammation).<sup>19</sup> There are only minimal effects of insulin infusion (6-hour duration) on tumor necrosis factor alpha and interleukin(IL)-6 concentrations in the plasma of healthy horses,<sup>20</sup> and no association has been found between BCS or insulin concentration and plasma concentrations of tumor necrosis factor and IL-6.<sup>19</sup> Horses with EMS have prolonged inflammatory responses (evidenced by plasma IL-8, IL-10 and tumor necrosis factor concentrations) to infusion of endotoxin compared with healthy horses,<sup>12</sup> although the clinical importance of this observation is unclear. Horses with EMS have a marked increase in neutrophil reactive oxygen species production induced by phagocytosis that is strongly correlated to the blood insulin concentration.<sup>21</sup> In contrast, peripheral blood cells of obese hyperinsulinemic horses showed decreased endogenous proinflammatory cytokine gene expression (IL-1 and IL-6) and similar cytokine response following immune stimulation compared with that of control horses. The authors conclude that this could suggest that, unlike in people, cytokine-mediated inflammation does not increase in direct response to obesity or insulin resistance in horses.<sup>21</sup>

Mechanisms underlying obesity and regional adiposity are unclear, but at the most fundamental level involve an excess of energy intake over energy expenditure, with deposition of the net excess energy as fat. As discussed previously, some horses and ponies appear to be much more efficient at converting feed into energy, or at regulating energy use, with the result that it is challenging to achieve a reduction in the weight of these animals even with strict control of food intake.<sup>22</sup> The genetic or hormonal causes of this resistance to weight loss are unclear, although it is apparent that some horses and ponies have an exaggerated insulinemic response to ingestion of soluble carbohydrate.<sup>2,17,23</sup> This exaggerated response could be the underlying mechanism for hyperinsulinemia, obesity or regional adiposity, and endocrinopathic laminitis.<sup>24</sup>

Adipose tissue is an important source of hormones regulating energy metabolism and of inflammatory cytokines. Obesity, or “over-conditioning,” in horses (as assessed by BCS) is associated with higher plasma insulin and leptin concentrations than in optimally conditioned horses.<sup>25,26</sup> Obese horses also have higher triglyceride concentrations and lower red blood cell glutathione peroxidase activities (an indication of antioxidant capacity) than optimally conditioned horses.<sup>27</sup>

Regional obesity is an important risk factor in humans for metabolic syndrome and might be similarly so in horses and ponies. Visceral fat is important in humans, but it appears to be less so in horses, with nuchal ligament fat (which contributes to the cresty neck characteristic of affected horses and ponies) having greater proinflammatory

gene expression (IL-1 $\beta$  and IL-6) in affected horses,<sup>28</sup> although others, using measurement of other markers of inflammation, find that the omental and retroperitoneal (visceral) fat of insulin-resistant horses have greater expression of markers of inflammation (Toll-like receptor 4 and suppressor of cytokine signaling 3 [SOCS-3]) than do insulin-sensitive horses.<sup>18</sup> Finally, there is evidence of regional differences in glucose transport by adipose tissue, with omental adipose tissue having the highest total GLUT content compared with subcutaneous and nuchal ligament fat in healthy horses, but having a reduced total GLUT4 content and cell surface expression in insulin-resistant horses.<sup>16</sup>

### CLINICAL SIGNS

Equine metabolic syndrome is defined by obesity (with or without regional adiposity), insulin resistance, and increased susceptibility to laminitis. As such, only obesity and regional adiposity and clinical signs of active or past laminitis are physical evidence of the presence of metabolic syndrome. Affected ponies can be hypertensive.<sup>5,7</sup>

Clinical assessment of obesity/adiposity is achieved by use of body-condition scoring, measurement of subcutaneous or retroperitoneal fat by ultrasound, and grading of regional adiposity. Methods used for research studies include slaughter and dissection with proximate analysis of body constituents or measurement of the deuterium dilution space (volume of distribution) in living animals.<sup>29,30</sup> Bioelectrical impedance can be used to measure body-water content, but it has not achieved widespread clinical acceptance.<sup>31</sup> Measurement of body weight is not useful for assessment of obesity or adiposity because body weight is highly correlated with height and girth and does not provide an accurate indication of body fat.<sup>32</sup>

A number of body-condition scoring systems have been developed, and the two most commonly used are those of Henneke (later modified by various authors), which uses a 1-to-9 grading system (Table 17-9 and Fig. 17-7), and Carroll and Huntington, which uses a 1-to-5 grading system.<sup>33,34</sup> These grading systems were not developed to assess the fat content (proportion) of horses, but rather to assess “flesh” or the general body condition. Both systems have limitations, including their subjective nature and the fact that they have not been validated in all breeds and body types of horses (validation determines the relationship between BCS and a gold-standard measure of body fat, such as deuterium dilution space or carcass analysis), nor has their reliability (intrarater and interrater agreement/repeatability expressed as an intraclass correlation coefficient or, less optimally, a kappa or weighted-kappa statistic) been demonstrated over large numbers of raters. There are reports of an intraclass correlation coefficient (ICC) of 0.74 for four

raters of 21 mares and 75 ponies, but details are not provided.<sup>35</sup> Another reports an ICC of 0.92, but without details to allow assessment of the methodology.<sup>25</sup> Additionally, body-condition scoring systems do not provide an assessment of regional adiposity, which might have greater clinical relevance.

BCS (1-to-9 scale) correlates well with percent body fat (TBF) when both are log transformed ( $e^{TBF} = 0.006 + e^{1.56 \cdot BCS}$ ).<sup>32</sup> In practical terms, this means that the accuracy of this body-condition scoring system to predict the proportion of body fat declines as BCS increases—for example, the proportion of body fat varies from ~13% to 36% in horses with a BCS of 7 to 8/9.<sup>32</sup> The log-log BCS model correctly predicted body fat greater than 20% (BCS = 6.83) in 76% of horses and with sensitivity of 83% and specificity of 71%.<sup>32</sup> However, the need to use log-log transforms decreases the general utility of this technique.

Body-condition scoring is a demonstrably insensitive measure of changes in body fat—ponies subject to 11% reduction in body weight and a 45% reduction in body fat did not have a change in BCS.<sup>36,37</sup> This indicates that the BCS system (1-to-9 scale) has some utility in assessment of body-fat proportion in horses and ponies, but it should be used with a full awareness of its limitations.

The BCS correlates well with plasma concentrations of glucose tolerance, insulin sensitivity, and insulin, leptin, and triglyceride concentrations in horses or ponies,<sup>5,19,35</sup> all of which could be clinically important.

A grading system for assessment of regional adiposity evident as a “cresty neck” has been developed for use with ponies and horses.<sup>35</sup> The ICC (a measure of reliability between raters) is 0.70 for four raters of 21 mares and 75 ponies.<sup>35</sup> The “cresty neck score” correlates well with plasma insulin and glucose concentrations in pooled horse and pony data, and with insulin, leptin, glucose, and triglyceride concentrations when horses and ponies are considered separately. Additionally, ponies with a cresty neck score of 4 or greater are at increased risk of developing pasture-associated laminitis.<sup>39</sup> This scoring system therefore appears to be both reliable (good interrater agreement) and indicative of clinically meaningful variables and outcomes (Table 17-10).

Acute laminitis and residual signs of laminitis (sometimes call chronic laminitis) are common in animals with insulin resistance and provide the physical confirmation of EMS in these animals. Clinical signs of laminitis are described under that topic (Chapter 15).

### Diagnosis

Definitive diagnosis of EMS of horses in the field is achieved by demonstration of insulin resistance in equids with appropriate clinical signs (obesity, regional adiposity, laminitis) and is confirmed by measurement of plasma concentrations of glucose and insulin.<sup>1</sup>

**Table 17-9** Criteria for estimating body condition in light-breed horses

Score	Condition	Description
1	Poor	Animal is extremely emaciated. Spinous processes (parts of vertebrae that project upward), ribs, tailhead, hooks (tuber coxae; hip joints), and pins (tuber ischia; lower pelvic bones) projecting prominently. Bone structure of withers, shoulders, and neck easily noticeable. No fatty tissue can be felt.
2	Very thin	Animal is emaciated. Slight fat covering over base of the spinous processes, transverse processes (portions of vertebrae that project outward) of lumbar (loin area) vertebrae feel rounded. Spinous processes, ribs, tailhead, hooks, and pins are prominent. Withers, shoulders, and neck structures are faintly discernible.
3	Thin	Fat is built up about halfway on spinous processes; transverse processes cannot be felt. Slight fat cover over ribs. Spinous processes and ribs are easily discernible. Tailhead is prominent, but individual vertebrae cannot be visually identified. Hook bones appear rounded, but are easily discernible. Fat can be felt around tailhead (prominence depends on conformation). Hook bones are not discernible. Withers, shoulders, and neck are not obviously thin.
4	Moderately thin	Negative crease along back (spinous processes of vertebrae protrude slightly above surrounding tissue). Faint outline of ribs is discernible. Fat can be felt around tailhead (prominence depends on conformation). Hook bones are not discernible. Withers, shoulders, and neck are not obviously thin.
5	Moderate	Back is level. Ribs cannot be visually distinguished, but can be easily felt. Fat around tailhead begins to feel spongy. Withers appear rounded over spinous processes. Shoulders and neck blend smoothly into body.
6	Moderately fleshy	May have slight crease down back. Fat over ribs feels spongy. Fat around tailhead feels soft. Fat begins to be deposited along at sides of the withers, behind shoulders, and along neck.
7	Fleshy	May have crease down back. Individual ribs can be felt, but with noticeable filling of fat between ribs. Fat around tailhead is soft. Fat is deposited along withers, behind shoulders, and along neck.
8	Fat	Crease down back. Difficult to feel ribs. Fat around tailhead is very soft. Area along withers is filled with fat. Area behind shoulder is filled with fat and flush with rest of the body. Noticeable thickening of neck. Fat is deposited along inner thighs.
9	Extremely fat	Obvious crease down back. Patchy fat appears over ribs. Bulging fat around tailhead, along withers, behind shoulders, and along neck. Fat along inner thighs may rub together. Flank is filled with fat and flush with rest of the body.

Based on Henneke et al. (1983) Henneke DR, et al. *Equine Vet J.* 1983;15:371 and reproduced with permission. Carter RA, et al. In: Geor RJ, et al., eds. *Equine Applied and Clinical Nutrition.* W.B. Saunders; 2013:393.

Insulin resistance can be detected by use of measurement of insulin and glucose concentrations in a single blood sample (point testing) or by more sophisticated testing using measurement of these analytes on multiple occasions after administration of glucose and insulin to equids (dynamic testing)—either as the euglycemic clamp technique or the frequently sampled intravenous glucose and insulin test (minimal model).<sup>40-42</sup> The former has greater utility in clinical and field settings, although with the potential for reduced sensitivity and/or specificity, whereas the latter is useful for research or referral settings and is regarded as the gold standard for diagnosis.

**Hyperglycemia** is rarely detected in equids with insulin resistance, and

measurement of blood glucose concentrations alone is not a useful test for detection of insulin resistance.<sup>1</sup> Detection of persistent, inappropriate hyperglycemia (i.e., that not associated with stress or ingestion of food) should prompt consideration of diabetes mellitus.<sup>43</sup>

**Hyperinsulinemia** in the absence of conditions that increase insulin secretion (stress, pain, feeding) is strong evidence of the presence of insulin resistance.<sup>1</sup> Interpretation of plasma or serum insulin concentration must include consideration of a number of factors that could affect the actual concentration reported by the laboratory. Physiologic factors that can increase serum insulin concentration include feeding, stress and pain, and administration of alpha-2

**Table 17-10** Grading system for assessing regional adiposity in the neck of ponies and horses

Score	Description
0	No visual appearance of a crest (tissue apparent above the ligamentum nuchae). No palpable crest.
1	No visual appearance of a crest, but slight filling felt with palpation.
2	Noticeable appearance of a crest, but fat deposited fairly evenly from poll to withers. Crest easily cupped in one hand and bent from side to side.
3	Crest enlarged and thickened, so fat is deposited more heavily in middle of the neck than toward poll and withers, giving a mounded appearance. Crest fills cupped hand and begins losing side-to-side flexibility.
4	Crest grossly enlarged and thickened and can no longer be cupped in one hand or easily bent from side to side. Crest may have wrinkles/creases perpendicular to topline.
5	Crest is so large it permanently droops to one side.

adrenergic agonists (xylazine, detomidine, romifidine, etc.). Feeding increases plasma insulin concentration in both healthy and insulin-resistant horses and confounds interpretation of the results of testing. Pain and stress increase both plasma glucose and insulin concentrations through increases in cortisol and epinephrine concentrations in blood, which decrease insulin sensitivity.<sup>44</sup> This could be important when testing equids with active laminitis or other causes of pain—evaluation should be delayed until the pain is resolved.<sup>1</sup>

**Point testing** of plasma glucose and insulin concentrations should be performed under controlled conditions and ideally after 6 hours of feed withholding and preferably with sampling between 8 and 10 a.m.<sup>1</sup> Horses can be fed a small amount of hay with a low content of nonstructural carbohydrates the night before testing (approximately 2 kg of hay per 500-kg horse) and then nothing immediately before testing.<sup>1</sup>

**Laboratory factors** can influence the insulin concentration reported for a blood sample. This is primarily a result of differences in testing methodology returning different concentrations for the same blood sample.<sup>45</sup> Until recently, most testing for equine insulin involved use of kits or testing methodology designed for use with human samples, taking advantage of the



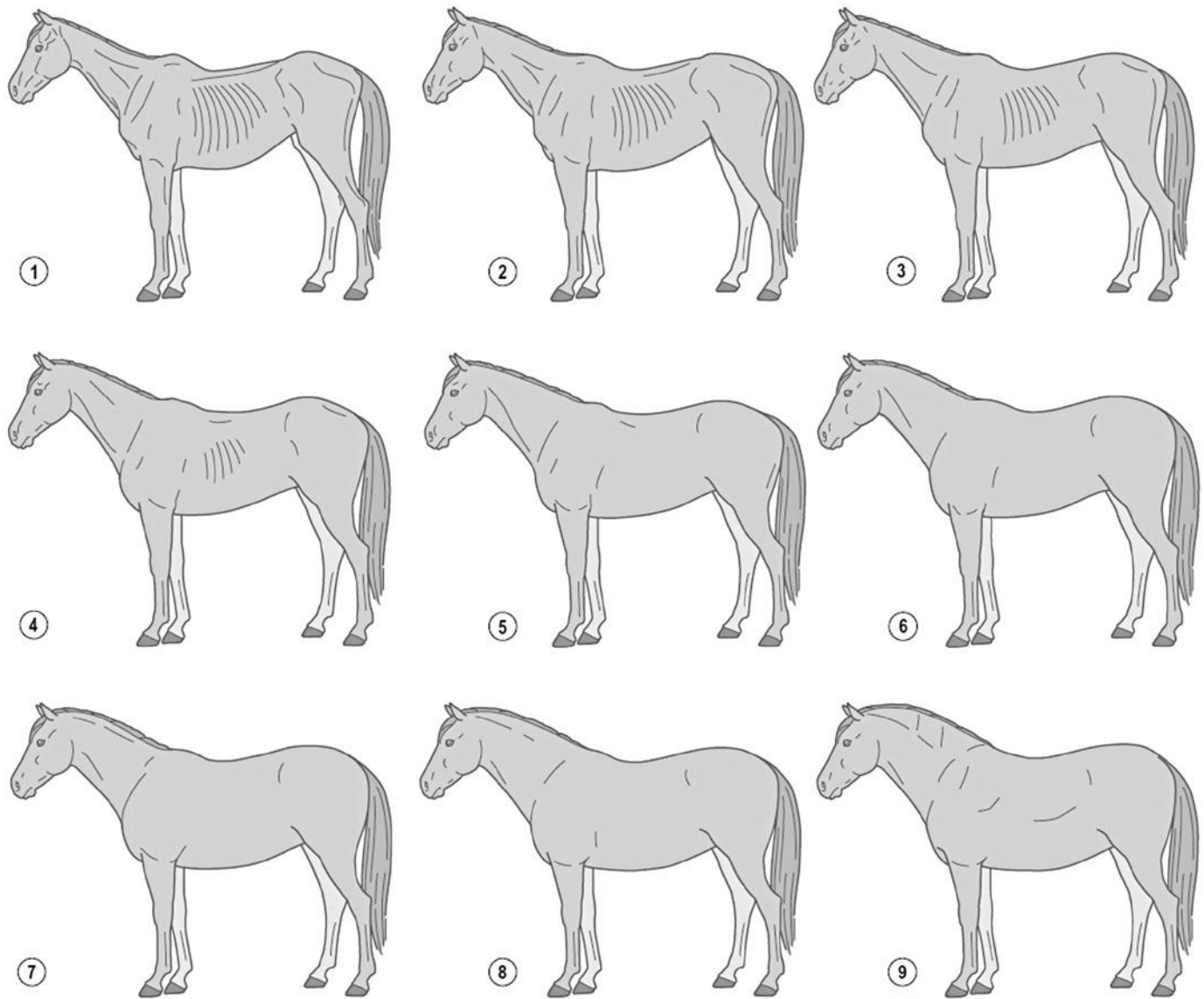

**Fig. 17-7** Appearance of light-breed horses at each of the body-condition scores described by Henneke et al. (1983). Henneke DR, et al. *Equine Vet J.* 1983;15:371. (Reproduced with permission from Carter RA, et al. In: Geor RJ, et al., eds. *Equine Applied and Clinical Nutrition*. W.B. Saunders; 2013:393.)

considerable cross-reactivity between human and equine insulin. Equine-specific tests are now available, and their precision, accuracy, and specificity have been reported.<sup>45</sup> The gold-standard methodology is liquid chromatography-mass spectrometry (LC-MX), but this is expensive and has limited accessibility in laboratories processing large numbers of clinical samples. Analysis of six commonly used or available test kits for measuring plasma or serum concentrations of insulin demonstrated that none reflected concentrations measured by LC-MS and that only one provided reliable (valid) results—the Siemens Coat-a-Count Insulin Radioimmunoassay (RIA)—and only if samples with concentrations exceeding the highest standard were diluted with charcoal-stripped plasma and not the provided diluents.<sup>45</sup>

The effect of use of differing methods of measuring serum insulin concentration is that use of “cutoff” values for detecting insulin resistance provided by different laboratories is problematic. A value of 20  $\mu\text{U}/\text{mL}$  is recommended as a cutoff, measured using the Siemens Coat-a-Count Insulin RIA, for defining insulin resistance.<sup>1</sup> However, this value should be interpreted with caution because the sensitivity (proportion of false negatives) and specificity (proportion of false positives) are not reported, and the test as a way of defining insulin resistance has not been well validated. It can be a useful screening test.<sup>1</sup> Local laboratories should be contacted before testing to determine the test used and whether the laboratory has determined reference ranges for its testing methodology.

Proxy indicators of insulin resistance, derived from measurement of plasma glucose and insulin concentrations, have been proposed and used to define insulin resistance and predict predisposition to laminitis in ponies.<sup>7,40,41,46</sup> A commonly used proxy is the RISQI:

$$\text{RISQI} = \text{insulin concentration}^{-0.5}$$

where lower values of the RISQI indicate lower insulin sensitivity.

**Dynamic testing** is usually achieved using combined glucose and insulin challenge tests of varying complexity.<sup>1,41</sup> One of these tests measures the insulin and glucose responses to IVs administration of glucose (150 mg/kg BW) and insulin (0.10 U/kg) with frequent sampling of blood (immediately before and at 1, 5, 15, 25, 35, 45, 60, 75,

90, 105, 120, 135, and 150 minutes after infusion).<sup>15</sup> Blood glucose concentrations of insulin-sensitive horses return to baseline values within 45 minutes of infusion of glucose. Insulin-resistant horses have a delayed decline of blood glucose concentrations and an exaggerated increase in plasma/serum insulin concentrations.<sup>1,5</sup> A more complex test, involving the frequent sampling of blood and delayed administration of insulin, is analyzed using the “minimal model” and yields four measures of insulin sensitivity, glucose disposal, and insulin secretion (pancreatic response).<sup>41</sup>

Dynamic testing can also involve the administration of insulin and monitoring of blood (plasma) glucose concentrations.<sup>13,14</sup> More complex testing involves the IV administration of increasing doses of insulin (either bovine or human recombinant) and measurement of blood glucose concentrations at defined times. The dose of insulin required to achieve a 50% reduction in blood glucose concentration is then used as the diagnostic index. This test is cumbersome and has a high risk of inducing hypoglycemia and is therefore of limited clinical utility.<sup>13</sup> A modified test involves administration of 0.1 U/kg IV of recombinant human insulin and measurement of blood glucose concentrations immediately before and 30 minutes after.<sup>14</sup> Insulin-sensitive horses ( $n = 6$  in the study) all had a 50% or greater reduction in blood glucose concentrations 30 minutes after insulin administration, whereas none of the insulin-resistant horses ( $n = 6$ ) had this response. The sensitivity and specificity of this test need to be determined in larger numbers of healthy and insulin-resistant horses for it to be clinically useful.

An oral sugar test (OST) provides results as reliable as the IV glucose tolerance test for detection of insulin resistance and hyperinsulinemia. The test involves oral administration of 0.15 mL/kg of corn syrup (approximately 150 mg/kg BW of dextrose-derived digestible sugars) to equids after an overnight fast. Plasma insulin and glucose concentrations are measured immediately before and 30, 60, and 90 minutes after administration of corn syrup. Equids with EMS have higher glucose and insulin concentrations than do unaffected horses.<sup>17</sup>

### CLINICAL PATHOLOGY

Clinical pathology includes detection of hyperinsulinemia (as noted in the previous discussion), hyperleptinemia, hypertriglyceridemia, and normoglycemia. Plasma ACTH concentrations of horses with EMS are within the reference range for healthy horses, noting that horses with EMS might also have PPID.

### NECROPSY

Affected horses are usually examined post-mortem because of laminitis. Other than signs of laminitis and obesity/regional

adiposity, there are no other characteristic lesions. The pancreas is normal.

### DIFFERENTIAL DIAGNOSIS

- Obesity without insulin resistance
- Pituitary pars intermedia dysfunction
- Laminitis of cause other than EMS (systemic septic disease such as colitis or metritis)

### TREATMENT

The objective of treatment is to improve the insulin sensitivity of affected equids. This can be achieved by reducing the proportion of the body made up of fat through careful dietary control. Administration of insulin-sensitizing drugs is attracting interest, but has yet to be of clearly demonstrated clinical utility.

#### Dietary Management

The fundamental aims of dietary management are as follows:

- Achieve and maintain an ideal BCS (body weight, noting earlier comments that body weight does not indicate body composition).
- Minimize intake of nonstructural carbohydrates because these induce an insulinemic and hyperglycemic response in EMS-affected equids and at-risk animals.<sup>1</sup>
- Ensure an adequate and balanced intake of essential nutrients.

The ideal BCS of ponies has been much mentioned, but little or seldom defined. The ideal body condition for a pony or horse would be one at which it has insulin sensitivity within the reference range (i.e., is not insulin resistant), has plasma triglyceride concentrations within the reference range, and is not at increased risk of laminitis. There is likely no one BCS that meets all of these criteria for all equids, and each animal must be considered in light of its own circumstances and physiology. Monitoring of measures of insulin resistance and plasma triglyceride concentration would provide guidance in achieving the animal's ideal, or acceptable, body weight.

Achieving and maintaining an acceptable BCS (as a proxy for proportion of body fat) is not easy.<sup>47</sup> Animals at most risk of obesity and regional adiposity are often metabolically equipped to maintain this body condition, and reducing body weight or BCS might not be as simple as just reducing feed intake.<sup>22</sup>

Recommendations for reduction in feed intake suggest that feeding 1.25% of body weight daily as hay is adequate to achieve a gradual reduction in body weight. However, planning a diet to provide a reduction in body weight while ensuring an adequate intake of essential nutrients and providing for the digestive and psychological health of the horse or pony can be challenging.

An initial step must be to eliminate or severely reduce access to pasture. Pasture provides unregulated access to fodder, and ponies can consume 2% to 5% of their body weight in pasture each day. This will result in weight gain. Additionally, pasture, and especially green pasture, has a high content of nonstructural carbohydrates (glucose, starch) that induces a glycemic and hyperinsulinemia response in ponies and susceptible horses. Access to pasture can be eliminated by housing animals on a dry lot or by fitting a grazing muzzle.

Hay can be fed as 1.25% to 1.5% of body mass as dry matter per day. The nonstructural carbohydrate content of the hay should be reduced by soaking it in cold water for 12 to 16 hours before feeding. The water used to soak the hay should not be provided to the horse or pony. Feeding this diet will induce a reduction in body weight and improvement in indices of insulin sensitivity.<sup>22,37,48,49</sup>

Individual horses and ponies can be resistant to weight loss, and a reduction in daily dry matter intake to 1% of body weight might be needed to achieve loss of body weight. However, restriction of intake to this level can cause behavioral changes, such as eating bedding, chewing tails of companions, and other allotriphagia. An early example of dietary restriction inducing allotriphagia was that of Robert Falcon Scott's use of ponies in an expedition to reach the South Pole. The ponies displayed profound appetite for roughage as a consequence of their highly concentrated ration.

Supplements including chromium have been promoted as improving insulin sensitivity in horses. There is evidence that they are not effective, and there is no evidence of efficacy.<sup>50</sup>

#### Exercise

Exercise increases the insulin sensitivity of horses,<sup>51</sup> and it appears sensible to recommend an increase in the amount of exercise of obese ponies and horses.<sup>1</sup> However, moderate exercise training does not improve the insulin sensitivity of horses.<sup>52</sup> Moderate exercise by nonobese ponies previously affected with laminitis reduced serum amyloid A concentrations, heptoglobin concentrations, and postexercise serum insulin concentrations.<sup>53</sup> These results suggest a beneficial role for relatively low-intensity exercise (10 minutes enforced walking followed by 5 minutes of trotting) in reducing inflammation in ponies at risk of laminitis.

#### Medications

Administration of levothyroxine or metformin has been advocated for treatment of EMS.<sup>1,54,55</sup> Levothyroxine (0.1 mg/kg orally q24 h) causes weight loss and improves insulin sensitivity in obese horses and is recommended as an adjunct to dietary management.<sup>55</sup>

Metformin, which is used for treatment of type 2 diabetes in people, has been administered to horses in an attempt to improve insulin sensitivity. Although initial reports were favorable,<sup>56</sup> more recent pharmacologic investigation has not demonstrated its efficacy at a dosage of 15 mg/kg orally q12h in improving insulin sensitivity.<sup>54,57-59</sup> However, administration of metformin at 30 mg/kg q12h reduced glycemic and insulinemic responses of healthy horses and horses with dexamethasone-induced insulin resistance to administration of dextrose.<sup>60</sup> Whether this dosage will be effective in horses or ponies with naturally occurring insulin resistance remains to be determined.

Pioglitazone has been investigated in healthy horses, in which it does not improve insulin sensitivity (at 1 mg/kg q24h for 12 days) or attenuate the effects of endotoxin infusion on indicators of systemic inflammation.<sup>61,62</sup> The pharmacokinetics of pioglitazone in horses have been reported.<sup>63</sup>

### FURTHER READING

- Frank N, Tadros EM. Insulin dysregulation. *Equine Vet J*. 2014;46:103-112.  
 Frank N, et al. Equine metabolic syndrome. *J Vet Int Med*. 2010;24:467-475.

### REFERENCES

- Frank N, et al. *J Vet Int Med*. 2010;24:467.
- Bamford NJ, et al. *Dom Anim Endocrin*. 2014;47:101.
- Morgan RA, et al. *Aust Vet J*. 2014;92:101.
- Treiber KH, et al. *JAVMA*. 2006;228:1538.
- Frank N, et al. *JAVMA*. 2006;228:1383.
- Menzies-Gow NJ, et al. *Vet Rec*. 2010;167:690.
- Bailey SR, et al. *Am J Vet Res*. 2008;69:122.
- Funk RA, et al. *J Vet Int Med*. 2012;26:1035.
- Place NJ, et al. *J Vet Int Med*. 2010;24:650.
- Thatcher CD, et al. *J Vet Int Med*. 2012;26:1413.
- Wyse CA, et al. *Vet Rec*. 2008;162:590.
- Tadros EM, et al. *Am J Vet Res*. 2013;74:1010.
- Caltabilla TJ, et al. *J Anim Sci*. 2010;88:2940.
- Bertin FR, et al. *Dom Anim Endocrin*. 2013;44:19.
- Waller AP, et al. *J Vet Int Med*. 2011;25:315.
- Waller AP, et al. *Biochim Biophys Acta*. 2011;1812:1098.
- Schuber A, et al. *J Equine Vet Sci*. 2014;34:465.
- Waller AP, et al. *Vet Immunol Immunopathol*. 2012;149:208.
- Suagge JK, et al. *J Vet Int Med*. 2013;27:157.
- Suagge JK, et al. *Vet Immunol Immunopathol*. 2011;142:141.
- Holbrook TC, et al. *Vet Immunol Immunopathol*. 2012;145:283.
- Argo CM, et al. *Vet J*. 2012;194:179.
- Borer KE, et al. *J Anim Sci*. 2012;90:3003.
- Bailey SR, et al. *Anim Prod Sci*. 2013;53:1182.
- Carter RA, et al. *Am J Vet Res*. 2009;70:1250.
- Ungru J, et al. *Vet Rec*. 2012;171:528.
- Pleasant RS, et al. *J Vet Int Med*. 2013;27:576.
- Burns TA, et al. *J Vet Int Med*. 2010;24:932.
- Dugdale AHA, et al. *Equine Vet J*. 2011;43:552.
- Dugdale AHA, et al. *Equine Vet J*. 2011;43:562.
- Latman NS, et al. *Res Vet Sci*. 2011;90:516.
- Dugdale AHA, et al. *Vet J*. 2012;194:173.
- Carroll CL, et al. *Equine Vet J*. 1988;20:41.
- Henneke DR, et al. *Equine Vet J*. 1983;15:371.
- Carter RA, et al. *Vet J*. 2009;179:204.
- Dugdale AHA. *Equine Vet J*. 2011;43:121.
- Dugdale AHA, et al. *Equine Vet J*. 2010;42:600.

- Carter RA, et al. In: Geor RJ, et al., eds. *Equine Applied and Clinical Nutrition*. W.B. Saunders; 2013:393.
- Carter RA, et al. *Equine Vet J*. 2009;41:171.
- Kronfeld D. *J Equine Vet Sci*. 2006;26:281.
- Kronfeld DS, et al. *JAVMA*. 2005;226:712.
- Frishman AM, et al. *Equine Vet J*. 2007;39:567.
- Durham AE, et al. *Equine Vet J*. 2009;41:924.
- Tiley HA, et al. *Am J Vet Res*. 2007;68:753.
- Tinworth KD, et al. *Dom Anim Endocrin*. 2011;41:81.
- Borer KE, et al. *Equine Vet J*. 2012;44:444.
- Frank N, et al. *Equine Vet J*. 2014;46:103.
- McGowan CM, et al. *Vet J*. 2013;196:153.
- Schmengler U, et al. *Livestock Sci*. 2013;155:301.
- Chameroy KA, et al. *Equine Vet J*. 2011;43:494.
- Stewart-Hunt L, et al. *Equine Vet J*. 2010;42:355.
- Carter RA, et al. *Am J Vet Res*. 2010;71:314.
- Menzies-Gow NJ, et al. *Equine Vet J*. 2013;n/a.
- Durham AE. *Vet J*. 2012;191:17.
- Frank N, et al. *Am J Vet Res*. 2005;66:1032.
- Durham AE, et al. *Equine Vet J*. 2008;40:493.
- Tinworth KD, et al. *Vet J*. 2012;191:79.
- Tinworth KD, et al. *Vet J*. 2010;186:282.
- Tinworth KD, et al. *Am J Vet Res*. 2010;71:1201.
- Rendle DI, et al. *Equine Vet J*. 2013;45:751.
- Wearn JG, et al. *Vet Immunol Immunopathol*. 2012;145:42.
- Suagge JK, et al. *J Vet Int Med*. 2011;25:356.
- Wearn JMG, et al. *J Vet Pharmacol Ther*. 2011;34:252.

### PHEOCHROMOCYTOMA (PARAGANGLIOMA)

Pheochromocytomas are unusual tumors of domestic animals and occur in cattle, sheep, and horses.<sup>1-5</sup> A pheochromocytoma is a neuroendocrine tumor of chromaffin cells of the adrenal medulla or extraadrenal chromaffin tissue. The tumor secretes catecholamines; in humans, clinical signs are related to elevated concentrations of circulating epinephrine or norepinephrine. The clinical presentation in horses usually involves intermittent or acute colic or hemoabdomen. Horses can die acutely of exsanguination into the abdomen from ruptured tumor.<sup>2</sup> Affected horses can be persistently or intermittently tachycardic with excessive or untimely sweating. The mass can be palpable near the left kidney or imaged by transrectal ultrasonography.<sup>2,6</sup> The normal right adrenal gland cannot be imaged transrectally in a horse.<sup>6</sup> The disease in cattle and sheep is usually detected at postmortem examination and has no real economic impact, with the exception of the rare valuable bull affected.<sup>5</sup> The disease can occur as part of multiple endocrine neoplasia, but is usually solitary, although gangliomas can metastasize.<sup>7</sup> Antemortem diagnosis can be confirmed by measuring high concentrations of metanephrine and vanillylmandelic acid, both of which are metabolites of catecholamines, in blood or urine. There is no effective treatment, nor are there control measures.

### REFERENCES

- Aydogan A, et al. *Rev Med Vet*. 2012;163:536.
- Elsar N, et al. *Israel J Vet Med*. 2007;62:53.

- Germann SE, et al. *Vet Rec*. 2006;159:530.
- Nielsen AB, et al. *J Comp Pathol*. 2012;146:58.
- Seimiya YM, et al. *J Vet Med Sci*. 2009;71:225.
- Durie I, et al. *Vet Radiol Ultrasound*. 2010;51:540.
- Herbach N, et al. *J Comp Pathol*. 2010;143:199.

### GLYCOGEN BRANCHING ENZYME DEFICIENCY IN HORSES

Glycogen branching enzyme deficiency (GBED) is a fatal condition of fetuses and neonatal foals of the Quarter Horse, Paint Horse, and associated breeds.<sup>1</sup> The disease is caused by a nonsense mutation in codon 34 of the *GBE1* gene, which prevents the synthesis of a functional GBE protein and severely disrupts glycogen metabolism.<sup>1</sup> The mutant *GBE1* allele frequency in registered Quarter Horse, Paint Horse, and Thoroughbred horses is reported as 0.041, 0.036, and 0.000, respectively.<sup>2</sup> Among 651 elite-performance American Quarter Horses, 200 control American Quarter Horses, and 180 control American Paint Horses, the GBED allele was detected with an overall frequency of 0.054.<sup>3</sup> GBED is inherited as a simple recessive trait from a single founder.<sup>2</sup> The disease is reported in North America and Germany.<sup>4</sup>

Affected foals are aborted, born dead, or affected at birth. It is estimated that up to 2.5% of fetal and early neonatal deaths in Quarter Horses and related breeds are associated with this defect.<sup>3</sup> Foals that are born alive are weak and hypothermic, some have flexural limb deformities, and all die usually within hours to days of birth.<sup>5</sup> Affected foals have refractory hypoglycaemia and minor elevations in serum activity of creatine kinase.

The disease is confirmed by detection of periodic acid-Schiff (PAS)-positive inclusions in the cardiac or skeletal muscle and genotype analysis. There is no effective treatment, and control is by selective and prudent breeding.

### REFERENCES

- Ward TL, et al. *Mamm Genome*. 2004;15:570.
- Wagner ML, et al. *J Vet Int Med*. 2006;20:1207.
- Tryon RC, et al. *JAVMA*. 2009;234:120.
- Winter J, et al. *Pferdeheilkunde*. 2013;29:165.
- Finno CJ, et al. *Vet J*. 2009;179:336.

### LACTATION TETANY OF MARES (ECLAMPSIA, TRANSPORT TETANY)

Lactation tetany of mares is caused by hypocalcemia and is characterized by abnormal behavior progressing to incoordination and tetany. The precise cause of the hypocalcemia has not been determined, but the cause of the clinical signs is a marked reduction in serum concentration of ionized calcium. The effect of feeding diets high in calcium, such as alfalfa hay, during late pregnancy, and of abrupt changes in diet after parturition, have not been investigated in horses



as they have in cattle (see discussion of milk fever).

The disease was most common when draft-horse breeding was widely practiced, but it is uncommon now.<sup>1</sup> The case fatality rate is high in untreated animals. Most cases occur in lactating mares, either at about the 10th day after foaling or 1 to 2 days after weaning. High-producing mares grazing on lush pasture are most susceptible and in many instances are engaged in hard physical work. The housing of wild ponies or prolonged transport can precipitate an episode. The latter has been a particularly important factor in the etiology of the disease in Britain and has been credited with precipitating it even in stallions and dry mares. Occasional cases occur without there being any apparent cause. The disease has occurred in a 20-year-old gelding pony. Hypocalcemia with clinical signs also occurs in horses used for prolonged exercise, such as endurance racing or 3-day events.

Hypocalcemia occurs in other diseases of horses, including colic and colitis, and as a result of hypoparathyroidism.<sup>2,3</sup>

Many mild cases of lactation tetany that recover spontaneously occur after transport, but the case fatality rate in some shipments can be greater than 60%. Mares that develop the disease at the foal heat or at weaning are usually more seriously affected, and the case fatality rate is high if mares are not treated in a timely fashion.

Severely affected animals sweat profusely and have difficulty moving because of tetany of the limbs and incoordination. The gait is stiff, and the tail is slightly raised. Rapid, labored respirations and wide dilatation of the nostrils are often accompanied by synchronous diaphragmatic flutter (“thumps”) evident as a distinct thumping sound from the thorax. Muscular fibrillation, particularly of the masseter and shoulder region, and trismus are evident, but there is no prolapse of the membrana nictitans. Affected animals are not hypersensitive to sound, but handling can precipitate increased tetany. The temperature is normal or slightly elevated, and although the pulse is normal in the early stages, it later becomes rapid and irregular. The mare might make many attempts to eat and drink but appears to be unable to swallow, and passage of a stomach tube can be difficult. Urination and defecation are in abeyance, and peristalsis is reduced.

Within about 24 hours the untreated mare becomes recumbent; tetanic convulsions develop and become more or less continuous. The mare dies about 48 hours after the onset of illness. The tetany and excitement in the early stages suggest tetanus, but there is no prolapse of the third eyelid, and there is the usual relationship to recent foaling or weaning and physical exertion. The anxiety and muscle tremor of laminitis can be confused with those of lactation tetany, especially when it

occurs in mares that have foaled and retained the placenta. Pain in the feet and bounding digital pulses are diagnostic features of this latter disease.

Hypocalcemia occurs with serum concentrations in the range of 4 to 6 mg/dL (1 to 1.50 mmol/L), and the degree of hypocalcemia has been related to the clinical signs. When serum calcium levels are higher than 8 mg/dL (2 mmol/L), the only sign is increased excitability. At levels of 5 to 8 mg/dL (1.25 to 2 mmol/L), there are tetanic spasms and slight incoordination. At levels of less than 5 mg/dL (1.25 mmol/L), there is recumbency and stupor. It is the concentration of ionized calcium that is important, and some animals, such as horses used for 3-day events, can have normal total calcium concentrations but abnormally low ionized calcium concentrations as a result of changes in acid:base status. If possible, serum concentrations of ionized calcium should be measured in horses with clinical signs suggestive of hypocalcemia. Hypomagnesemia with serum magnesium levels of 0.9 mg/dL (0.37 mmol/L) has been observed in some cases, but only in association with recent transport. Hypermagnesemia has been reported in other cases.

Treatment by IV administration of calcium borogluconate as recommended in the treatment of parturient paresis in cattle results in rapid, complete recovery. The dose for a 500-kg mare is 300 to 500 mL of a 25% solution of calcium borogluconate or gluconate administered slowly (over 15 to 30 min) intravenously. One of the earliest signs of recovery is the voiding of a large volume of urine. Occasional cases that persist for some days have been recorded.

## REFERENCES

1. Radoszits O, et al. Lactation tetany of mares. In: *Veterinary Medicine: a Textbook of the Diseases of Cattle, Horses, Sheep, Goats and Pigs*. 10th ed. London: W.B. Saunders; 2006:1651.
2. Borer KE, et al. *Equine Vet Educ*. 2006;18:320.
3. Durie I, et al. *J Vet Int Med*. 2010;24:439.

## EQUINE HYPERLIPEMIA

### SYNOPSIS

**Etiology** Abnormal energy metabolism secondary to inadequate caloric intake.

**Epidemiology** Pregnant or lactating middle-aged, overweight ponies, donkeys, and American miniature horses. Worldwide. Sporadic.

**Clinical signs** Depression, anorexia, weight loss, ventral edema, muscle fasciculation, mania, recumbency.

**Clinical pathology** Hypertriglyceridemia (triglyceride > 500 mg/dL, 5 mmol/L).

**Necropsy findings** Widespread lipidosis, swollen liver, hepatic rupture.

**Treatment** Increase energy intake through enteral or parenteral feeding. Treat underlying disease.

**Control** Maintain optimal body condition. Prevent disease and nutritional stress, including changes in diet and prolonged transportation.

## ETIOLOGY

The potentially life-threatening disease hyperlipemia is associated with hyperlipidemia (an abnormal concentration of lipids in blood) in equids. The disease is a result of a derangement in fat metabolism secondary to nutritional stress and, in particular, inadequate energy intake.<sup>1</sup>

Hyperlipemia is the clinical syndrome of depression, weakness, and ventral edema with high blood concentrations of triglycerides and hepatic lipidosis. It carries a high case-fatality rate. A related condition is the detection of hypertriglyceridemia associated with an overt, severe, primary disease (colic, neoplasia, endocrine disease) in which the triglyceridemia likely has minimal clinical importance. Hyperlipemia has its greatest importance as a disease of ponies and donkeys in field situations and related to relatively minor inciting causes.

## EPIDEMIOLOGY

### Occurrence

Hyperlipemia occurs worldwide. Although its occurrence is sporadic, multiple cases can occur on a farm when there are a number of at-risk animals exposed to the same inciting factor, such as lack of adequate grazing or supplementary feeding. The annual incidence of the disease in ponies in southeastern Australia is 5%, and it is 2% to 10% in donkeys in the United Kingdom.<sup>2</sup> The case-fatality rate is 40% to 80%, although it appears to be less in hospitalized equids provided more focused care.<sup>2,3</sup> Incidence varies with season and locality; the disease in ponies in Europe occurs most commonly during late gestation (January–March), whereas in southern Australia, the disease is more common in ponies during early lactation (November–January).

### Animal Risk Factors

Hyperlipemia can occur in any breed of horse or pony and in donkeys, but it is more common in ponies and donkeys.<sup>2,3</sup> Any breed of equid can develop hypertriglyceridemia as a result of a primary disease, but development to the clinical condition lipemia is most common in ponies, miniature horses, miniature donkeys, and donkeys. The disease is considered most common in females, uncommon in pony stallions and geldings, and rare in foals. Most affected ponies are more than 4 years old, and the peak incidence occurs in 9-year-olds. Hypertriglyceridemia occurs in foals secondary to other diseases.<sup>3-5</sup>

Risk factors for hyperlipemia (triglyceride concentration  $\geq 4.4$  mmol/L) in 449 donkeys with the disease from a population of 3829 donkeys included concurrent disease (odds ratio [OR] 77, 95% confidence interval [CI], 45 to 129), weight loss in previous month (OR = 6.4, 3.6 to 11.3), relocation to a new site (farm) (OR = 3.9, 1.3 to 12), dental disease (OR = 1.7, 1.1 to 2.8), history of inappetence (OR = 3.2, 1.3 to 7.9), and increasing age (OR = 1.26, 1.1 to 1.45).<sup>2</sup>

Horses and ponies with primary endocrine disease, including pituitary pars intermedia dysfunction (PPID) or suspected diabetes mellitus and conditions associated with insulin resistance, can have marked elevations in serum triglyceride concentrations (10.5 to 60.3 mmol/l) without evident clinical signs attributable to hypertriglyceridemia. The hypertriglyceridemia resolves with successful treatment of the underlying endocrine disease.<sup>6</sup>

Pregnancy and lactation increase the risk of the disease in ponies, but not in donkeys. The disease in miniature horses is always associated with underlying disease, such as colic, which is apparently an important risk factor. Underlying disease is identified in 50% of cases in ponies and 72% of affected donkeys;<sup>2</sup> however, many cases occur in pregnant or lactating pony mares without evidence of other disease.

Overweight ponies and donkeys are at increased risk, and insulin resistance is likely a risk factor for the disease.<sup>7</sup> Onset of disease is often preceded by some sort of stress, typically transport, lactation, food deprivation, or a combination of these factors. Characteristically the disease occurs in fat, middle-aged, pregnant, or lactating ponies that experience a decrease in feed intake. However, the disease is not restricted to this demographic, and horses or thin ponies can develop the disease.

**Hypertriglyceridemia** is detected in horses with evidence of systemic inflammatory response syndrome (severe illness associated with decreased feed intake). There is no opacity of the plasma or serum, and the hypertriglyceridemia has not been demonstrated to worsen the outcome of the underlying disease.

### **PATHOGENESIS**

The combination of the innate insulin resistance of ponies and a nutritional stressor, such as disease, pregnancy, lactation, or food deprivation, results in excessive mobilization of fatty acids from adipose tissue at a rate that exceeds the gluconeogenic and ketogenic capacity of the liver.<sup>1</sup> Adipocytes of ponies, in response to norepinephrine, release fatty acids at a rate 6.5 times greater than those of horses, possibly providing at least a partial explanation for the difference in likelihood of differing breeds developing the disease. Lipolysis is mediated by  $\beta_2$ -adrenergic receptors in ponies and horses.

The induction of excessive fat mobilization in ponies is likely associated with the well-characterized insulin resistance of this breed, especially in obese individuals. There is no difference between ponies and horses in the extent to which lipolysis is inhibited by insulin. The effect of insulin resistance on glucose uptake from the blood might be exacerbated in sick ponies by the increase in serum cortisol concentrations associated with stress or disease.

Equids have little propensity to produce ketones, and thus the excess fatty acids are reesterified in the liver to triglycerides and released into the circulation as very low-density lipoproteins (VLDLs). The **fundamental defect** in the disease is in the regulation of free fatty acid release from fat stores as a result of a defect in control of hormone-sensitive lipase, the enzyme responsible for hydrolysis of triglycerides to free fatty acids and glycerol in adipose tissue. Unchecked activity of this enzyme results in mobilization of fatty acids in hyperlipemic ponies that is 40 times the rate in normal ponies. There is no dysfunction of lipoprotein lipase, the enzyme mediating uptake of plasma free fatty acids by extrahepatic tissues, and its activity can be 300% of that of unaffected ponies.

Hyperlipidemia causes widespread lipodosis and organ dysfunction. Hepatic lipodosis compromises liver function, resulting in accumulation of toxic metabolites and derangement in coagulation.

### **CLINICAL FINDINGS**

The clinical course varies between 3 and 22 days but is generally 6 to 8 days. The unchecked disease progresses from mild depression and inappetence; through profound depression, weakness, and jaundice; to convulsions or acute death in 4 to 7 days. Depression, weight loss, and inappetence are the initial signs in 90% of cases. Approximately 50% of cases have fasciculation of muscles of the limb, trunk, or neck. Ventral edema unrelated to parturition occurs in approximately 50% of cases. Inappetence progresses to anorexia and depression, which is followed by somnolence and hepatic coma. Compulsive walking or mania develops in 30% of cases. Signs of mild colic, including flank watching, stretching, and rolling, are evident in 60% of cases. The incidence of jaundice is variable. Many animals show a willingness to drink, but they are unable to draw water into the mouth and swallow. Others continually lap at water. The temperature is normal or moderately elevated, and heart rate and respiratory rates are increased above normal. Diarrhea is an almost constant feature in the terminal stages.

Visual examination of the plasma or serum phase of a blood sample collected from an affected animal reveals cloudy, milky, mildly opalescent plasma.

### **CLINICAL PATHOLOGY**

There is usually leukocytosis with neutrophilia. Hyperlipidemia is a consistent feature of the disease. Serum triglyceride concentrations will be at least 5 mmol/L (500 mg/dL) and can be much higher. Serum cholesterol and free fatty acid concentrations are also increased, although less so than triglycerides. The plasma triglyceride concentration is of minimal prognostic use in ponies, but most American miniature horses with triglyceride concentrations above 1200 mg/dL (12 mmol/L) die.

Plasma glucose concentration is usually low. Ketonemia and ketonuria do not occur. Biochemical evidence of liver disease is characteristic of the advanced disease. Serum activity of gamma-glutamyltransferase (GGT) can be elevated before clinical signs of disease are apparent. Serum creatinine and urea nitrogen concentrations increase as renal function declines. Blood clotting time increases. Metabolic acidosis develops terminally. Hematologic and biochemical variables can also be affected by any underlying disease.

Diagnostic confirmation of hyperlipemia is achieved by demonstration of hyperlipidemia (plasma triglyceride concentrations above 5 mmol/L [500 mg/dL]) in a horse with appropriate clinical signs.

The utility of point-of-care (stall-side) analyzers has been investigated, and both units performed adequately, although not perfectly.<sup>8,9</sup> The upper operating range of both units (~6.0 mmol/L) was lower than values for triglycerides in severely affected animals, which limits their usefulness, although it does allow identification of equids with very high concentrations. The instruments have coefficients of variation for measurement of the same sample of 10% to 16%, which limits their usefulness in monitoring responses to treatment. These analyzers are useful for field measurement of triglyceride concentrations in equids, but care should be taken in evaluating values that exceed the range of the instrument.

### **NECROPSY FINDINGS**

Extensive fatty change is present in most internal organs, but especially in the liver, which is yellow to orange, swollen, and friable. Liver rupture with intraabdominal hemorrhage may be present. Tissue pallor as a result of lipid accumulation is also prominent in the kidney, heart, skeletal muscle, and adrenal cortex. Serosal hemorrhages of the viscera reflect disseminated intravascular coagulation. The necropsy should also include an examination for lesions that might predispose the animal to hyperlipidemia, such as pancreatic damage or laminitis. Histologically, widespread microvascular thrombosis and intracellular lipid in various tissues are evident.

### Samples for Postmortem Confirmation of Diagnosis

Samples for postmortem diagnosis include formalin-fixed liver, kidney, heart, adrenal, skeletal muscle, and pancreas for light microscopic examination.

#### DIFFERENTIAL DIAGNOSIS

- Parasitism
- Anemia
- Liver disease, including pyrrolizidine toxicosis
- Serum hepatitis
- Aflatoxicosis

Hyperlipemia should be considered in any pony with a history of weight loss, inappetence, and progressive somnolence, especially in late pregnancy or early lactation.

#### TREATMENT

- The principles of treatment are as follows:
- Treatment of the underlying or inciting disease
- Restoration and maintenance of a positive energy balance
- Correction of any defects in hydration, acid–base, and electrolyte status
- Reduction of the hyperlipidemia

Every effort should be made to determine whether there is an underlying disease, and if so, it should be treated aggressively. Parasitism is a common inciting disease, as are equine Cushing's disease and neoplasia (lymphosarcoma, gastric squamous cell carcinoma) in older ponies.

The negative energy balance must be corrected. A mature, nonpregnant, and nonlactating 200-kg (440-lb) pony has energy requirements (digestible energy intake) of 9.3 Mcal/d (38 MJ/d), whereas a lactating pony has energy requirements of 13.7 Mcal/d (57.2 MJ/d). Affected animals should be encouraged to eat and must be supplemented either orally or intravenously if they will not eat a sufficient quantity. Supplements, either oral or IV, are unlikely to meet all the animal's energy requirements, but normalization and stabilization of blood glucose concentrations, and the apparent consequent changes in hormonal milieu, inhibit lipolysis and enhance clearance of triglycerides from plasma and hepatic and renal tissues.

Oral supplementation using commercial equine or human enteral nutrition preparations has been successful for treatment of the disease in American miniature horses and donkeys. If these products are not available, a homemade gruel consisting of alfalfa pellets and cottage cheese can be used. These preparations are administered every 6 hours through a nasogastric tube. Alternatively, glucose can be given orally (1 g/kg, as 5% solution every 6 hours, about 5 L to a 250-kg pony) or intravenously (5% solution,

100 mL/kg per day as a continuous IV infusion). As noted earlier, this dose of glucose will not meet the energy needs of the pony, but it might be sufficient, along with treatment of the underlying disease and supportive care, to restore normal fat metabolism. Provision of parenteral nutrition is feasible and apparently effective, but expensive and technically demanding, thereby restricting its use to veterinary hospitals.<sup>10,11</sup>

Mares in late pregnancy can be aborted, and lactating mares should have the foal removed.

Dehydration and abnormalities in electrolyte and acid–base status should be corrected by oral or IV administration of isotonic fluids (lactated Ringer's solution) and, if necessary, sodium bicarbonate.

Encephalopathy associated with liver failure should be treated with oral neomycin (20 mg/kg, every 6 hours) or lactulose (1 mL/kg, every 6 hours).

Hyperlipidemia should be reduced by minimizing free fatty acid production by adipose tissue and enhancing triglyceride removal from plasma. Free fatty acid production is minimized by ensuring adequate energy intake and normal plasma glucose concentrations. Use of insulin and heparin has been recommended for reduction of plasma free fatty acid concentration. However, the efficacy of these treatments is not clear, and the emphasis should be placed on provision of adequate energy intake rather than administration of these hormones. Insulin (protamine zinc insulin) is administered at 0.1 to 0.3 IU/kg SC every 12 to 24 hours. Blood glucose concentrations should be monitored, and the insulin dose may need to be adjusted. Heparin (40 to 100 IU/kg SC every 6 to 12 hours) can be given to increase lipoprotein lipase activity and promote the clearance of triglycerides from plasma. It should be noted that lipoprotein lipase activity is not deficient in affected ponies, and therefore the administration of heparin to ponies with hyperlipemia is not recommended. Severely affected ponies may have an increase in clotting time that could be exacerbated by heparin.

Corticosteroids and adrenocorticotropic hormone are contraindicated in treatment of this disease.

#### CONTROL

A mature, nonpregnant, and nonlactating 200-kg (440-lb) pony has energy requirements of 9.3 Mcal/d (38 MJ/d), whereas a lactating pony has energy requirements of 13.7 Mcal/d (57.2 MJ/d), and every effort should be made to meet these requirements. This might require dietary supplementation during periods of nutritional stress, such as drought, late pregnancy, peak lactation, or transportation. Ponies should be maintained in optimal body condition, and nutritional stress should be avoided. A parasite and disease control program should be instituted.

Transport of pregnant and lactating ponies should be avoided.

#### FURTHER READING

- Hughes KJ, et al. Equine hyperlipemia: a review. *Aust Vet J.* 2004;82:136.
- McKenzie HA. Equine hyperlipidemias. *Vet Clin North Am Equine Pract.* 2011;27:59.

#### REFERENCES

1. Radostits O, et al. Equine hyperlipemia. In: *Veterinary Medicine: a Textbook of the Disease of Cattle, Horses, Sheep, Goats and Pigs.* 10th ed. London: W.B. Saunders; 2006:1678.
2. Burden FA, et al. *J Vet Int Med.* 2011;25:1420.
3. Waitt LH, et al. *JAVMA.* 2009;234:915.
4. Armengou L, et al. *J Vet Int Med.* 2013;27:567.
5. Ollivett TL, et al. *Equine Vet J.* 2012;(suppl):96.
6. Dunkel B, et al. *Equine Vet J.* 2014;46:118.
7. Oikawa S, et al. *J Vet Med Sci.* 2006;68:353.
8. Naylor RJ, et al. *Vet Rec.* 2012;170:228B.
9. Williams A, et al. *Equine Vet Educ.* 2012;24:520.
10. Durham AE. *Vet Rec.* 2006;158:159.
11. Magdesian KG. *Equine Vet Educ.* 2010;22:364.

## Disorders of Thyroid Function (Hypothyroidism, Hyperthyroidism, Congenital Hypothyroidism, Thyroid Adenoma)

Disorders of thyroid function as a result of abnormalities in the thyroid gland, pituitary gland, or hypothalamus are uncommon in the domestic species and are best documented for the horse. Thyroid disorders secondary to excessive or inadequate intake of iodine or selenium deficiency are discussed under those headings. Animals with low concentrations of thyroid hormones, usually total T3 and total T4, in blood could have nonthyroidal illness syndrome, which is well described in humans and dogs.<sup>1</sup> Furthermore, neonates have lower concentrations of thyroid hormones in blood than do adults, and premature neonates have even lower concentrations.<sup>2</sup>

#### ETIOLOGY

Disorders of thyroid function result in hypothyroidism or hyperthyroidism.<sup>3</sup> Hypothyroidism can result from diseases of the thyroid gland (primary hypothyroidism), pituitary gland (secondary hypothyroidism as a result of reduced secretion of thyroid-stimulating hormone), or hypothalamus (tertiary hypothyroidism, decreased thyrotropin [thyroid-releasing hormone] secretion). Autoimmune thyroiditis has not been described in horses. Lymphocytic thyroiditis occurs in goats. Consumption of propylthiouracil (4 mg/kg body weight orally once daily for 4 to 6 weeks) induces hypothyroidism in adult horses. Administration of trimethoprim-sulfadiazine (30 mg/kg orally q24 h for 8 weeks), which can induce



hypothyroidism in humans and dogs, does not impair thyroid function of most horses. Systemic illness, such as sepsis, or starvation can alter function of the hypothalamic–pituitary–thyroid axis, resulting in euthyroid sick syndrome, more recently termed nonthyroidal illness syndrome. The syndrome has been documented in adult horses<sup>1</sup> and in foals with septic and nonseptic illnesses.<sup>2,4,5</sup>

**Hereditary congenital hypothyroidism** secondary to defects in thyroglobulin production occurs in sheep, goats, and Afrikaner cattle. The disease is inherited as an autosomal-recessive trait. The cause of congenital hypothyroidism in foals is uncertain, although ingestion of nitrates by the pregnant dam is strongly suspected. Partial thyroidectomy of equine fetuses results in birth of foals with clinical and pathologic characteristics similar to those in the spontaneous disease.

Hyperthyroidism in horses is attributable to functional adenocarcinoma or adenoma of the thyroid gland, but most thyroid tumors are not functional.<sup>6-8</sup>

## EPIDEMIOLOGY

The frequency with which hypothyroidism occurs in adult horses is unknown. It is relatively common practice to administer thyroid hormone or iodinated casein to fat horses; to those with laminitis, rhabdomyolysis, or anhidrosis; or to enhance fertility, but documentation of abnormal thyroid function in these animals is rare. None of 79 clinically normal brood mares had an abnormal response to thyroid-stimulating hormone administration, indicating that hypothyroidism is uncommon in this type of animal. Importantly, horses with nonthyroid-related illness often have low concentrations of thyroid hormones in the blood without evidence of thyroid dysfunction—this is referred to as the euthyroid sick or nonthyroidal illness syndrome and is not indicative of thyroid disease.

Abnormalities of the thyroid gland were detected in 12% of 1972 **goats** examined in India. Of thyroid glands examined from 1000 goats in India, 2.4% had colloid goiter, 39% had parenchymatous goiter, 1.8% had lymphocytic thyroiditis, and 2.1% were fibrotic.

**Congenital hypothyroidism** in foals occurs in western Canada and the western and northern United States. One survey of necropsy records of almost 3000 equine fetuses and neonatal foals in western Canada found that 2.7% had histologic evidence of thyroid and musculoskeletal abnormalities consistent with congenital hypothyroidism. Congenital hypothyroidism occurs in Dutch goats, Merino sheep, and Afrikaner cattle. Hypothyroidism is reported in an East Friesian ram.

Hyperthyroidism is a sporadic disease of older horses for which other risk factors are not identified.

Exercise and participation in endurance racing or competitive show jumping usually, but not always, influences serum concentrations of thyroid hormones, but is not considered a pathologic process.<sup>9,10</sup> The response depends on the type and intensity of exercise—endurance exercise (40 to 420 km) reduces plasma concentrations of T3 and T4 at the end of the race, with return to basal concentrations by 24 hours.<sup>11</sup> Serum T4 concentrations are lower in overtrained or malconditioned young Standardbred horses.<sup>12</sup>

Thyroid tumors are common in older horses, with ~50% having adenomas evident on histologic examination of the thyroid gland. The clinical course of such tumors is benign, although their size can be quite impressive. Thyroid adenocarcinoma is much less common but has a malignant course.<sup>6-8</sup>

Fetal undernutrition of lambs during late gestation adversely affects postnatal thyroid function and causes hyperthyroidism as adult sheep.<sup>13</sup>

## CLINICAL FINDINGS

Clinical characteristics of hypothyroidism in adult horses are poorly defined, largely because of the difficulty of confirming the diagnosis and the pharmacologic effect of exogenous thyroid hormones. Clinical abnormalities anecdotally attributed to hypothyroidism include exercise intolerance, infertility, weight gain, maldistribution of body fat, agalactia, anhidrosis, and laminitis, among others. Peripheral neuropathy and keratitis sicca (secondary to facial nerve dysfunction) responsive to levothyroxine administration has been reported in a horse.<sup>14</sup> Definitive association of these clinical syndromes with abnormalities of thyroid function is lacking.

Thyroidectomy of horses causes a reduction in resting heart rate and body temperature, docility, decreased food intake, increased cold sensitivity, dull hair coat, and delayed shedding of hair. Blood and plasma volumes of horses increased after removal of the thyroid glands. Effects of thyroidectomy were reversed by administration of thyroxine, with the exception of blood and plasma volume that did not return to euthyroid values. Thyroidectomized horses did not become obese or develop laminitis.

Induced hypothyroidism in goats is evident as a loss of body weight, facial edema, weakness, profound depression, and loss of libido.

**Congenitally hypothyroid** foals have a prolonged gestation but are born with a short and silky hair coat, soft and pliable ears, difficulty in standing, lax joints, and poorly ossified bones. The foals are referred to as dysmature. Characteristic musculoskeletal abnormalities include inferior (mandibular) prognathism, flexural deformities, ruptured common and lateral extensor tendons, and poorly ossified cuboidal bones.

Horses with **hyperthyroidism** are tachycardic, display cachexia, and have hyperactive behavior. There is usually detectable enlargement of the thyroid gland both on physical examination and on scintigraphic imaging.

Thyroid adenomas are evident as a unilateral nonpainful enlargement of the thyroid gland of older (>15 years) horses and are detectable on scintigraphic examination.<sup>15</sup> Ultrasonographic and scintigraphic imaging of the thyroid gland of healthy horses is described.<sup>16</sup> Thyroid adenocarcinoma presents as metastatic disease with both local and distant spread. Some affected horses have signs of hyperthyroidism, although this is unusual.<sup>6</sup>

Anhidrosis in horses is not associated with abnormal thyroid function.<sup>17</sup>

## CLINICAL PATHOLOGY

Hematologic abnormalities in hypothyroid horses are not well documented. Induced hypothyroidism in horses causes increases in serum concentrations of VLDLs, triglycerides, and cholesterol, and decreased concentrations of NEFAs. Induced hypothyroidism in goats caused hypoglycemia, hypercholesterolemia, and anemia. Hypothyroidism in a ram caused hypercholesterolemia.

## Thyroid Hormone Assays

Assays are available for measurement of serum concentrations of T3, T4, free T4 (fT4), free T3 (fT3; radioimmunoassay or equilibrium dialysis), and/or TSH in various species.<sup>18-20</sup> Values of each of these analytes vary depending on the method of analysis, physiologic status of the animal, and administration of other compounds (Table 17-11). Serum concentrations of thyroid hormones are high at birth and decline with age in ruminants and nonruminants.<sup>5,21,22</sup> For example, serum T3 concentrations of weaned Thoroughbred foals declined from 2.89 to 0.29 nmol/L at 7 and 9 months of age, serum T4 concentrations from 100.17 to 21.77 nmol/L at 1 month and at 10 months, serum fT3 concentrations were 6.96 and 1.50 pmol/L at 1 month and 4 months of age, and serum fT4 concentrations were 31.40 and 4.93 pmol/L at 1 month and 9 months of age.<sup>22</sup>

There are statistically significant **diurnal variations** in serum concentrations of T3 and T4 in adult horses, with the lowest concentrations observed during the early morning hours, likely coincident with the time at which metabolic rate is lowest (Table 17-8). There is not a seasonal variation in thyroid hormone concentrations in horses.<sup>23</sup>

**Feed restriction** for 3 to 5 days lowers serum concentrations of T3, T4, and fT4 in horses by 24% to 42%. Administration of **phenylbutazone** decreases concentrations of fT4 (measured by equilibrium dialysis) and T4 by 4 days of treatment, which can persist for up to 10 days after discontinuation of phenylbutazone. The decrease in T4 is suggested

**Table 17-11** Serum or plasma concentrations of thyroid hormones and thyroid-stimulating hormone in foals, horses, donkeys, and cattle

Physiologic status	Serum or plasma tT3	Serum or plasma tT4	fT4	TSH
<b>Age</b>				
Birth (<10 hours)	991 ng/dL 12.8 ± 7.4 mmol	28.8 µg/dL 493 ± 58 nmol/L	12.1 ng/dL	
1–3 days	366 ± 222 ng/L 940 ng/dL	13.3 ± 5.1 µg/dL 28.0 µg/dL	12.1 ng/dL	
4 days	935 µg/dL 7.8 ± 4.2 mmol	11.2 µg/dL 232 ± 61 nmol/L	5.9 ng/dL	
5–11 days	631 µg/dL	7.45 µg/dL	3.30 ng/dL	
20 days	4.2 ± 0.9 mmol	36.7 ± 17.4 nmol/L		
22–90 days	192 µg/dL	2.57 µg/dL	1.76 µg/dL	
28 days	3.1 ± 0.4 mmol	30.6 ± 17.4 nmol/L		
1.5–4 months	193 ± 9 ng/dL	4.02 ± 0.19 µg/dL		
2–5 years	120 ± 8 ng/dL	2.9 ± 0.1 µg/dL		
6–10 years	86 ± 7.5 ng/dL	1.7 ± 0.1 µg/dL		
11–25 years	84 ± 9 ng/dL	1.6 ± 0.1 µg/dL		
Adult mares and geldings	0.99 ± 0.51 nmol/L	12.9 ± 5.6 nmol/L	12.2 ± 3.5 pmol/L (RIA)	0.39 ± 0.30 ng/mL
Adult mares and geldings		19 (17.6–22.1) nmol/L	11 (10.5–11.8) pmol/L (RIA)	
Adult mares and geldings		19 (17.6–22.1) nmol/L	22 (20.9–25.1) pmol/L (ED)	
Adult geldings, 16.00 hours	53.2 ± 12.4 ng/dL	2.43 ± 0.81 µg/dL		
Adult geldings, 04.00 hours	42.0 ± 11.5 ng/dL	1.79 ± 0.63 µg/dL		
Adult horses	1.02 ± 0.16 nmol/L	19.9 ± 1.7 nmol/L	11.6 ± 0.7 pmol/L	
Adult horses <sup>25</sup>	47.7 (32.7–62.8) pg/mL (mean, range)	1.64 (0.37–3.2) ug/dL (mean, range)	0.23 (0.12–0.34) ng/dL (mean, range)	
<b>Sex</b>				
Mare	89.9 ± 7.9 ng/dL	1.7 ± 0.1 µg/dL		
Gelding	92.9 ± 9.7 ng/dL	1.69 ± 0.1 µg/dL		
Stallion	123 ± 9.7 ng/dL	1.97 ± 0.2 µg/dL		
Broodmare (not pregnant)	62 ± 2.7 ng/dL	1.47 ± 0.47 µg/dL		
Donkeys <sup>25</sup>	67 (40–130) pg/mL (mean, range)	3.5 (.057–8.1) ug/mL (mean, range)	0.44 (0.14–0.85) ng/dL (mean, range)	
Adult cattle		64 (31–97) nmol/L		
Beef cattle <sup>18</sup>		Mean ± 2 SD		1.3–15.5 µU/mL (2.5%–97.5% range)
Dairy cattle <sup>18</sup>		56 (25–91) nmol/L Mean ± 2 SD		1.3–9.2 µU/mL (2.5%–97.5% range)
Calves <sup>18</sup>	5.06 (2.02–16.1) nmol/L Mean ± 2 SD	241 (84–283) nmol/L Mean ± 2 SD		7.3 (1.3–19.7) µU/mL (2.5–97.5% range)
<b>Disease</b>				
<b>Calves</b>				
Goiter	0.43 (0.65–17.3) nmol/L (2.5%–97.5% range)	13 (13–348) nmol/L (2.5%–97.5% range)		47.4 (25.3–80.0) nmol/L (2.5%–97.5% range)
<b>Horses</b>				
Induced hypothyroidism (PTU)		4 (1–10) nmol/L	4.5 (1.5–13) pmol/L (RIA)	
Induced hypothyroidism (PTU)			8 (1–20) pmol/L (ED)	
Euthyroid sick horses		2 (2–24) nmol/L	5 (2–13) pmol/L (RIA)	
Euthyroid sick horses			19 (4–48) pmol/L (ED)	

ED, equilibrium dialysis; fT4, free T4; RIA, radioimmunoassay; SD, standard deviation; TSH, thyroid-stimulating hormone; tT3, total T3; tT4, total T4. Mean ± SD or median (95% confidence interval).

To convert µg/dL to nmol/L for T4 or fT4, multiply by 12.87.

To convert ng/dL to nmol/L for fT3 or T3, multiply by 0.0154.

fT4 determined by RIA or ED. PTU, propylthiouracil

to be attributable to displacement of T4 from protein binding sites by phenylbutazone, but this does not explain the decrease in fT4. Topical application twice daily of 50 g of an ointment containing 17 mg/100g of **dexamethasone-21-acetate** (daily application of 17 mg dexamethasone) suppressed serum T3 and T4 concentrations during 10

days of treatment and for at least 20 days after cessation of treatment.<sup>24</sup> The clinical significance of phenylbutazone-induced decreases in thyroid hormones is uncertain, but should be considered when assessing thyroid function in horses.

Plasma concentrations of fT3, tT3, rT3, fT4, and tT4 of **donkeys** differs with the age

of the donkey and from that of adult horses (Table 17-11).<sup>25</sup> Donkeys less than 5 years of age have higher serum fT3, tT3, rT3, fT4, and tT4 than older donkeys.<sup>25</sup>

Because of the number of analytical and physiologic factors that affect serum thyroid hormone concentrations, values considered normal vary considerably, as illustrated by

the finding that 44 of 79 clinically normal nonpregnant broodmares had serum T4 concentrations below the reference range, although responses to TRH were normal. This example illustrates the need to determine reference ranges based on the methodology used and with well-defined definition of the physiologic state of the animals being tested.

Diagnosis of hypothyroidism is aided by demonstration of inappropriate responses of the thyroid gland to administration of TSH or TRH,<sup>17,26</sup> although the use of these tests depends on determining the increase in serum T3 and/or T4 that is expected in normal horses and in horses with thyroid disease. Of 79 clinically normal mares, all had some increase in T3, and 77 had an increase in T4, 2 hours after IV administration of 1 mg of TRH intravenously. The mean increase in serum T3 concentration was 4.5 times that of resting values (from 0.62 ng/mL to 2.44 ng/mL), whereas serum T4 concentration increased to a mean of 2.1 times that of resting value (from 14.7 ng/mL to 28.6 ng/mL). Although responses to administration of TSH have been reported, responses indicative of abnormal thyroid function—other than complete lack of response—have not been determined, and the utility of the test has been questioned.

The TSH response test involves administration of 5 IU of TSH intravenously. Blood samples are collected before administration and 30 minutes after, 2 hours after, and 4 hours after administration. Serum concentrations of T3 and T4 in healthy horses double after administration of TSH. An alternative involves administration of 5 IU IM and collection of blood before and 3 and 6 hours after TSH administration. TSH is often unavailable.

The TRH response test requires administration of 0.5 to 1 mg of TRH IV. Serum concentrations of T3 and T4 at 2 and 4 hours are double those before TRH administration in horses with normal thyroid function.

Measurement of fT4 in serum is useful for assessment of thyroid function. fT4 concentrations can be normal in horses with low concentrations of T3 and T4, and in this situation are likely indicative of normal thyroid function.

Measurement of serum concentrations of TSH is useful in determining thyroid responsiveness to endogenous TSH. Elevated TSH concentrations in horses with low serum concentrations of T3, T4, or fT4 is indicative of thyroid dysfunction.

**Diagnosis of hypothyroidism** in horses should be based on the presence of compatible clinical signs, low serum concentrations of thyroid hormones (T3, T4, fT4), elevated concentrations of TSH, lack of an increase in serum concentrations of thyroid hormones in response to administration of TRH, and increased TSH concentration in serum in response to TRH administration. Diagnosis

of hypothyroidism should not be based solely on clinical signs or on the measurement of resting (unstimulated) serum T3 or T4 concentrations. At a minimum, appropriate clinical signs and documentation of an abnormal response to stimulation testing (TSH or TRH) are essential for diagnosis of hypothyroidism in horses. Measurements of fT4 concentrations determined by equilibrium dialysis are useful in determining thyroid function in sick horses in which T3 and T4 concentrations are low because fT4 concentrations will be normal in horses without thyroid disease.

Foals with congenital hypothyroidism have abnormally low concentrations of T3 and T4 and less-than-expected increases in serum concentrations of these hormones in response to TSH administration.

Horses with hyperthyroidism have markedly elevated concentrations of T3 and T4. Concentrations of T4 do not decline in response to administration of T3. T3 (2.5 mg) is administered intramuscularly twice daily for 3 days and serum concentrations of T3 and T4 measured. T4 concentrations in the serum of healthy horses decline by approximately 80%, whereas those of horses with hyperthyroidism do not decline.

### NECROPSY FINDINGS

Findings on necropsy examination of hypothyroid horses have not been reported. Foals with congenital hypothyroidism have histologic evidence of thyroid hyperplasia, but no gross signs of goiter.

### TREATMENT

Treatment of confirmed hypothyroidism in horses is achieved by administration of levothyroxine (20 µg/kg PO q24h). Serum T3 concentrations peak in 1 hour and then decline, whereas concentrations of T4 peak in 2 hours and persist for 24 hours. Administration of levothyroxine to healthy (euthyroid) horses resulted in 3.7- to 5.4-fold increases in pretreatment total T4 concentrations in serum.<sup>27</sup> The clinical status of horses treated for hypothyroidism should be monitored during treatment and serum concentrations of T3 and T4 measured every several months. Iodinated casein, which is no longer readily available in the United States, is administered at 5 g/450 kg body weight orally once daily. Administration of thyroxine or iodinated casein for treatment of low serum thyroid hormone concentrations in horses with nonthyroidal illness syndrome (euthyroid sick syndrome) should be done judiciously, if at all.

A response to thyroxine administration is not necessarily confirmation of hypothyroidism because thyroxine can have marked effects in horses with normal thyroid function.<sup>27</sup> Administration of thyroxine (up to 96 mg/470-kg horse, orally once daily) increases serum concentrations of T4 and, to a lesser extent, fT4, and decreases concentrations of TSH. The increases in T4 are

associated with a loss of body weight; decreases in serum concentrations of triglycerides, cholesterol, and VLDLs; and an increase in whole-body insulin sensitivity. Thyroxine should be administered with caution to horses with normal thyroid function.

### CONTROL

There are no recognized control measures for hypothyroidism in adult horses. Minimizing intake of nitrates by pregnant mares appears warranted, but definitive proof of the efficacy of this practice is lacking. Pregnant mares should not be fed fodder or supplements that interfere with thyroid function.

The inherited disorder in sheep, cattle, and goats can be prevented by selective breeding.

### FURTHER READING

Breuhaus BA. Disorders of the equine thyroid gland. *Vet Clin North Am Equine Pract.* 2011;27:115.

### REFERENCES

- Hilderbran AC, et al. *J Vet Int Med.* 2014;28:609.
- Breuhaus BA. *J Vet Int Med.* 2014;28:1301.
- Radostits O, et al. *Veterinary Medicine: a Textbook of the Diseases of Cattle, Horses, Sheep, Goats and Pigs.* 10th ed. London: W.B. Saunders; 2006:1688.
- Himler M, et al. *Equine Vet J.* 2012;44:43.
- Pirrone A, et al. *Theriogenology.* 2013;80:624.
- Tan RHH, et al. *J Vet Int Med.* 2008;22:1253.
- Tucker RL, et al. *Equine Vet Educ.* 2013;25:126.
- Ueki H, et al. *J Comp Pathol.* 2004;131:157.
- Fazio E, et al. *Vet Rec.* 2008;163:713.
- Ferlazzo A, et al. *Equine Vet J.* 2010;42:110.
- Graves EA, et al. *Equine Vet J.* 2006;(suppl):32.
- Leleu C, et al. *Equine Vet J.* 2010;42:171.
- Johnsen L, et al. *J Endocrinol.* 2013;216:389.
- Schwarz BC, et al. *JAVMA.* 2008;233:1761.
- Saulez MN, et al. *Equine Vet Educ.* 2013;25:118.
- Davies S, et al. *Vet Radiol Ultrasound.* 2010;51:674.
- Breuhaus BA. *J Vet Int Med.* 2009;23:168.
- Guyot H, et al. *J Vet Diagn Invest.* 2007;19:643.
- Breuhaus BA, et al. *J Vet Int Med.* 2006;20:371.
- Kasagic D, et al. *Acta Veterinaria (Beograd).* 2011;61:555.
- Paulikova I, et al. *Acta Veterinaria (Beograd).* 2011;61:489.
- Fazio E, et al. *Livestock Sci.* 2007;110:207.
- Place NJ, et al. *J Vet Int Med.* 2010;24:650.
- Abraham G, et al. *Vet J.* 2011;188:307.
- Mendoza FJ, et al. *Equine Vet J.* 2013;45:214.
- Breuhaus BA. *Vet Clin North Am Equine Pract.* 2011;27:115.
- Frank N, et al. *Am J Vet Res.* 2008;69:68.

### IODINE DEFICIENCY

#### SYNOPSIS

**Etiology** Primary dietary deficiency of iodine or secondary to conditioning factors such as calcium, Brassica plants, or bacterial pollution of water.

**Epidemiology** In all species, most common in continental landmasses. Neonatal animals. Diets of dams deficient in iodine as a result



of abundant pasture growth or leaching of iodine from soil in years of unusually high rainfall, or diets containing conditioning factors such as certain plants.

**Signs** Goiter as palpable enlargement of thyroid gland. Neonatal mortality as a result of stillbirths or weak neonates not able to suck that die in few days, alopecia at birth, myxedema.

**Clinical pathology** Serum total iodine concentration.

**Necropsy findings** Thyroid enlargement, alopecia, myxedema.

**Diagnostic confirmation** Goiter and iodine deficiency.

**Differential diagnosis list**

- Weak-calf syndrome
- Abortion
- Congenital defects
- Hypothyroidism

**Treatment** During an outbreak, oral administration of 280 mg/head potassium iodide to pregnant ewes and provision of iodized salt licks. Lambs with goiter can be administered 20 mg potassium iodide per os, once.

**Control** Ensure adequate dietary intake of iodine in pregnant animals.

Iodine metabolism is influenced by physiologic and environmental factors, making assessment of thyroid status, and the need for supplementation, challenging. See previous section for a discussion of hypothyroidism.

## ETIOLOGY

Iodine deficiency can be a result of deficient iodine intake or secondarily conditioned by a high intake of calcium, diets consisting largely of *Brassica* spp., or gross bacterial pollution of feedstuffs or drinking water. A continued intake of a low level of cyanogenetic glycosides (e.g., in white clover) is commonly associated with a high incidence of goitrous offspring. Linamarin, a glycoside in linseed meal, is the agent producing goiter in newborn lambs born from ewes fed the meal during pregnancy. A continued intake of the grass *Cynodon aethiopicus*, which has low-iodine and high-cyanogenetic glucoside content, can cause goiter in lambs. Rapeseed and rapeseed meal are also goitrogenic. Presence of abundant pasture after unusually high rainfall and a “seasonal break” (marked increase in pasture growth in the weeks after end of summer) is associated with clinical iodine deficiency in newborn lambs.<sup>1</sup>

Goiter or hypothyroidism in newborn lambs occurs when pregnant ewes have a low iodine intake or ingest goitrogens.

## EPIDEMIOLOGY

### Occurrence

Goiter caused by iodine deficiency occurs in all of the continental landmasses. It is not of

major economic importance because of the ease of recognition and correction, but if neglected it can cause heavy mortalities in newborn animals. Stillbirth or death of newborns reduced a pregnancy rate at midterm (number of fetuses detected by ultrasonographic examination/number of ewes) of 130% to a marking rate at ~2 weeks of age to 70%.<sup>1</sup> The most common cause of iodine deficiency in farm animals is the failure to provide iodine in the diet. The sporadic occurrence of the disease in marginal areas attracts most attention. An epidemiologic survey in Germany found that up to 10% of cattle and sheep farms and 15% of swine herds were affected with iodine deficiency, which included both primary and secondary conditions as a result of the presence of nitrates, thiocyanates, or glucosinolates in the diet.

The importance of subclinical iodine deficiency as a cause of neonatal mortality could be much greater than that of clinical disease. For example, in southern Australia, ewes supplemented with iodine by a single injection of iodine in oil have shown lower mortality in the lambs, have grown larger lambs, or performed the same as controls. In New Zealand, subclinical iodine deficiency has been recognized in a sheep flock in which fertility and lamb perinatal mortality occurred and was corrected by supplementation of the ewes with iodine. The annual cost associated with iodine deficiency in one Manawata Romney flock was conservatively estimated at \$6.00 per ewe. Iodine supplementation reduces perinatal mortality and increases lambing percentage by 14% to 21% in pasture-fed ewes. Thus subclinical iodine deficiency can affect reproductive performance and perinatal lamb mortality.

Young animals are more likely to bear goitrous offspring than older ones, and this may account for the apparent breed susceptibility of Dorset Horn sheep, which mate at an earlier age than other breeds.

A survey of crossbred cows in the Punjab of India found that 36% of cows were iodine deficient, with considerable geographic variation from 0% to 86% within Punjab. The cardinal clinical signs of iodine deficiency were absent, and basal plasma T3 (triiodothyronine) and T4 (plasma thyroxine) concentrations and their ratios did not differ between deficient and control cows. The response to injection of 1 mL of 78% ethiodized oil can prevent the deficiency for more than 70 days.

## Risk Factors

### Dietary and Environmental Factors

A simple deficiency of iodine in the diet and drinking water can occur and is related to geographic circumstances. Areas where the soil iodine is not replenished by cyclical accessions of oceanic iodine include large continental landmasses and coastal areas where prevailing winds are offshore. In such

areas, iodine deficiency is most likely to occur where rainfall is heavy and soil iodine is continually depleted by leaching. Iodine ingested in the diet comes largely from ingestion of soil, either directly or on pasture. Consequently, abundant pasture growth can reduce intake of soil and lead to iodine deficiency in sheep.<sup>1</sup>

Soil formations rich in calcium or lacking in humus are also likely to be relatively deficient in iodine. The ability of soils to retain iodine under conditions of heavy rainfall is directly related to their humus content, and limestone soils are, in general, low in organic matter. A high dietary intake of calcium also decreases intestinal absorption of iodine, and in some areas, heavy applications of lime to pasture are followed by the development of goiter in lambs. This factor can also be important in areas where drinking water is heavily mineralized.

There are several situations in which the relationship between iodine intake and the occurrence of goiter is not readily apparent. Goiter may occur on pastures containing adequate iodine; it is then usually ascribed to a secondary or conditioned iodine deficiency. A diet rich in plants of the *Brassica* spp., including cabbages and brussels sprouts, may cause simple goiter and hypothyroidism in rabbits, which is preventable by administered iodine. Severe iodine deficiency can occur when ewes are fed *Brassica* crops for long periods. Brassicas such as swedes, turnips, and kale have low iodine content and contain goitrogens, and they may result in weak newborn lambs with enlarged thyroid glands. Goiter occurred in 85% of lambs examined at necropsy that born from ewes fed on the *Brassica* crop and not supplemented with iodine.

Diffuse hyperplastic goiter has occurred in calves in beef cows in Japan that were on pasture or being fed feed containing *Rorippa indica*, Hiern, genus *Brassica*, family Crucifera, Inugarash, which contains thiocyanate. The iodine content of the waters on affected farms was low at 0.361 µg/L and 0.811 µg/L and that of the pastures, 87 µg/kg and 121 µg/kg, on two different farms.

Hypothyroidism has also been produced in rats by feeding rapeseed and in mice by feeding rapeseed oil meal. Feeding large quantities of kale to pregnant ewes causes a high incidence of goiter and hypothyroidism, also preventable by administering iodine in the newborn lambs. The goitrogenic substance in these plants is probably a glucosinolate capable of producing thiocyanate in the rumen. The thiocyanate content, or potential content, varies between varieties of kale, being much less in rape-kale, which also does not show the twofold increase in thiocyanate content other varieties show in autumn. Small young leaves contain up to five times as much thiocyanate as large, fully formed leaves. Some of these plants are excellent sources of feed, and in some areas, it is

probably economical to continue feeding them, provided suitable measures are taken to prevent goiter in the newborn. Although kale also causes mild goiter in weaned lambs, this does not appear to reduce their rate of gain.

**A diet high in linseed meal** (20% of ration) given to **pregnant ewes** may result in a high incidence of goitrous lambs, which is preventable with iodine or thyroxine. Under experimental conditions, groundnuts are goitrogenic for rats, the goitrogenic substance being a glycoside-arachidic acid. The goitrogenic effect is inhibited by supplementation of the diet with small amounts of iodine. **Soybean by-products** are also considered to be goitrogenic. **Gross bacterial contamination of drinking water** by sewage is a cause of goiter in humans in countries where hygiene is poor. There is a record of a severe outbreak of goitrous calves from cattle running on pasture heavily dressed with crude sewage. Prophylactic dosing of the cows with potassium iodide prevented further cases. Feeding sewage sludge is also linked to the occurrence of goiter.

**Goiter in lambs** may occur when permanent pasture is plowed and re-sown. This may be a result of the sudden loss of decomposition and leaching of iodine-binding humus in soils of marginal iodine content. In subsequent years the disease may not appear. There may be some relation between this occurrence of goiter and the known variation in the iodine content of particular plant species, especially if new pasture species are sown when the pasture is plowed. The maximum iodine content of some plants is controlled by a strongly inherited factor and is independent of soil type or season. Thus in the same pasture, perennial rye grass may contain 146 µg iodine per 100 g dry matter (DM) and Yorkshire grass only 7 µg/100 g DM. Because goiter has occurred in lambs when the ewes are on a diet containing less than 30 µg iodine per 100 g DM, the importance of particular plant species becomes apparent. A high incidence of goiter associated with heavy mortality has been observed in the newborn lambs of ewes grazing on pasture dominated by white clover and by subterranean clover and perennial rye-grass.

Thyroid-weight:birth-weight ratios greater than 0.8 g/kg in lambs are indicative of iodine deficiency and should be considered a risk factor for iodine deficiency in lambs. Ratios less than 0.4 g/kg rarely occur among deficient flocks.<sup>2</sup>

**Congenital goiter has been observed in foals** born to mares on low iodine intake, but also to mares fed an excessive amount of iodine during pregnancy.

### PATHOGENESIS

Iodine deficiency results in a decreased production of thyroxine and stimulation of the secretion of thyrotropic hormone by the pituitary gland. This commonly results in

hyperplasia of thyroid tissue and a considerable enlargement of the gland. Most cases of goiter of the newborn are of this type. The primary deficiency of thyroxine is responsible for the severe weakness and hair abnormality of the affected animals. Although the defect is described as hairlessness, it is truly hypoplasia of the hairs, with many very slender hairs present and a concurrent absence and diminution in the size of hair follicles. A hyperplastic goiter is highly vascular, and the gland can be felt to pulsate with the arterial pulse; a loud murmur may be audible over the gland. Colloid goiter is less common in animals and probably represents an involutional stage after primary hyperplasia.

Other factors, particularly the ingestion of low levels of cyanide, exert their effects by inhibiting the metabolic activity of the thyroid epithelium and restricting the uptake of iodine. Thiocyanates and sulfocyanates are formed during the process of detoxication of cyanide in the liver, and these substances have a pronounced depressing effect on iodine uptake by the thyroid. Some pasture and fodder plants, including white clover, rape, and kale, are known to have a moderate content of cyanogenetic glucosides. These goitrogenic substances may appear in the milk and provide a toxic hazard to both animals and humans. The inherited form in cattle is a result of the increased activity of an enzyme that deiodinates iodotyrosines so rapidly that the formation of thyroxine is inhibited.

Iodine is an essential element for normal fetal brain and physical development in sheep. A severe iodine deficiency in pregnant ewes causes reduction in fetal brain and body weight from 70 days of gestation to parturition. The effects are mediated by a combination of maternal and fetal hypothyroidism, the effect of maternal hypothyroidism being earlier than the onset of fetal thyroid secretion. There is also evidence of fetal hypothyroidisms and absence of wool growth and delayed skeletal maturation near parturition.

### CLINICAL FINDINGS

Goiter is an unambiguous indicator of iodine deficiency in lambs and calves,<sup>2</sup> but clinically important increases in thyroid size might be easily missed unless careful attention is paid to assessment of the thyroid gland in newborns.<sup>3</sup> Thyroid volume can be estimated in calves by ultrasonographic examination.<sup>4</sup> It is important to recognize that ingestion of excessive iodine also can result in goiter in neonates and adults.<sup>5</sup>

A high incidence of **stillbirths and weak, newborn animals** is the most common manifestation of iodine deficiency.<sup>3</sup> Partial or complete **alopecia** and palpable enlargement of the thyroid gland are other signs that occur with varying frequency in the different species. Affected foals have a normal hair

coat and little thyroid enlargement, but they are very weak at birth. In most cases, they are unable to stand without support, and many are too weak to suck. Excessive flexion of the lower forelegs and extension of lower parts of the hindlegs has also been observed in affected foals. Defective ossification occurs in foals and lambs (Fig. 17-8), and in foals the manifestation is collapse of the central and third tarsal bones, leading to lameness and deformity of the hock. Enlargement of the thyroid also occurs commonly in adult horses in affected areas, with Thoroughbreds and light horses being more susceptible than draft animals.

In **cattle**, the incidence of thyroid enlargement in adults is much lower than in horses, and the cardinal manifestations are gross **enlargement of the thyroid gland and weakness in newborn calves**. If they are assisted to suck for a few days, recovery is usual, but if they are born on the range during inclement weather, many will die. In some instances, the thyroid gland is sufficiently large to cause obstruction to respiration. Affected calves have a thick neck and appear to be suffocating. Lethargy, weakness, and difficulty in consuming colostrum are common. Partial alopecia is a rare accompaniment.

In **pigs**, the characteristic findings are birth of **hairless, stillborn, or weak piglets, often with myxedema** of the skin of the neck. The hairlessness is most marked on the limbs. Most affected piglets die within a few hours of birth. Thyroid enlargement may be present, but it is never sufficiently great to cause visible swelling in the live pig. Survivors are lethargic, do not grow well, and have a waddling gait and leg weaknesses as a result of weakness of ligaments and joints.

Adult **sheep** in iodine-deficient areas can show a high incidence of thyroid enlargement, but are clinically normal in other respects. Newborn lambs manifest weakness, extensive alopecia, and palpable, if not visible, enlargement of the thyroid glands (Fig. 17-9). The gestation length of ewes may be increased, and there is increased perinatal mortality, especially in inclement weather. Marginal iodine deficiency can result in non-specific production losses from embryonic mortality or high perinatal lamb death and reduced lamb growth rates and is difficult to diagnose.<sup>3</sup>

**Goats** present a similar clinical picture, except that all abnormalities are more severe than in lambs. Goat kids are goitrous and alopecic. The degree of alopecia varies from complete absence of hair, through very fine hair, to hair that is almost normal.

Animals surviving the initial danger period after birth may recover, except for partial persistence of the goiter. The glands may pulsate with the normal arterial pulse and may extend down a greater part of the neck and cause some local edema. Auscultation and palpation of the jugular furrow may reveal the presence of a murmur and thrill,

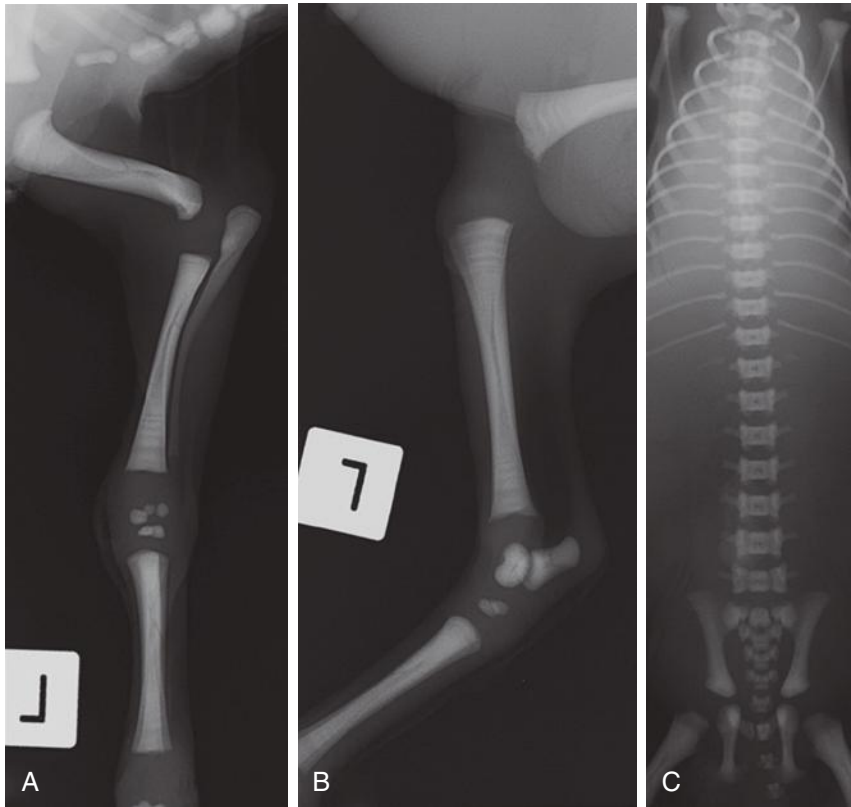

**Fig. 17-8** Radiographs of a stillborn lamb from a flock with severe iodine deficiency revealing lack of mineralization of the epiphyses of long bones and vertebral bodies and presence of incompletely ossified cuboidal bones of the carpus and tarsus. (Reproduced with permission from Campbell AJD, et al. *Aust Vet J.* 2012;90:235.)



**Fig. 17-9** Marked goiter in a neonatal lamb as a result of in utero iodine deficiency. A palpable thrill was present in the ventral cervical region.

the “thyroid thrill,” as a result of the increased arterial blood supply of the glands. Calves that had larger goiter and were hairless ( $n = 8$ ) died within the first day of life, whereas four others with moderate goiter and normal hair lived.<sup>6</sup>

Although loss of condition, decreased milk production, and weakness might be anticipated, these signs are not usually observed in adults. Loss of libido in the bull, failure to express estrus in the cow, and a high incidence of aborted, stillborn, or weak calves have been suggested as manifestations of hypothyroidism in cattle, whereas prolonged gestation is reported in mares,

ewes, and sows. As noted previously, pathognomonic changes in production indices are not available for diagnosis of iodine deficiency.<sup>2</sup>

Goiter has occurred in newborn foals whose mares were supplemented with excess iodine during the last 24 hours of pregnancy.

#### CLINICAL PATHOLOGY

There are no wholly satisfactory indices of the severity of iodine deficiency, and biochemical markers of iodine metabolism, such as serum iodine or thyroxine (T<sub>4</sub>) and triiodothyronine (T<sub>3</sub>) concentrations, have not been shown to accurately and reliably reflect an animal's iodine status, identify marginal deficiency, or predict the production response of a flock to iodine supplementation.<sup>2</sup> Thyroid-related hormones often do not discriminate between adequate and marginal iodine status in pasture-fed livestock during supplementation trials, probably a result of the complex, adaptive systems maintaining homeostasis of these important regulators of cell growth and metabolic rate.<sup>7</sup> Knowles and Grace (2007) think that data are inadequate to quantify the relationship between iodine status and an economically relevant measure of animal performance, and this has hindered the setting of laboratory reference ranges for biomarkers.<sup>2</sup>

However, measurement of serum total iodine concentration, which is an elemental determination that comprises the iodinated hormones plus various chemical forms of serum inorganic iodine, might be more effective in diagnosing iodine deficiency than measurement of serum iodine concentration or biochemical markers (see following “Control” section).<sup>7</sup>

Several criteria have been used for the laboratory diagnosis of iodine deficiency in sheep, including T<sub>3</sub> and T<sub>4</sub> and related hormones. They include thyroid weight, lamb thyroid-to-body-weight ratio, and comparison of serum T<sub>4</sub> (serum thyroxine) concentrations in lamb and dam. However, concentrations of biochemical and hormonal markers are variable and difficult to compare among reports because of, among other factors, differing assay methodologies.<sup>8</sup>

Measurement of thyroid-stimulating hormone concentrations (TSH, thyrotropin) appears to be useful in detection of hypothyroidism attributed to iodine deficiency in calves.<sup>6</sup> TSH is significantly higher in goitrous calves compared with healthy calves, whereas plasma iodine concentrations do not differ. Concentrations, and ratios, of T<sub>4</sub>, T<sub>4</sub>/T<sub>3</sub> ratio, T<sub>4</sub>/TSH ratio, rT<sub>3</sub>, and T<sub>3</sub> are higher in healthy calves than in calves with goiter. Calves with goiter that die have higher TSH values; lower T<sub>4</sub>, T<sub>3</sub>, T<sub>4</sub>/TSH, and rT<sub>3</sub>; but similar T<sub>4</sub>/T<sub>3</sub> ratio ( $P > 0.1$ ) than calves with goiter that live. In the absence of TSH assay, the T<sub>4</sub>/T<sub>3</sub> ratio can be used to diagnose hypothyroidism in newborn calves.<sup>6</sup> Feed iodine concentration was 175 mg/kg DM (reference range  $> 1200$  mg/kg DM) in a herd of cattle with 10% incidence of stillbirth and death of newborns as a result of iodine deficiency.<sup>9</sup>

Thyroid-weight:birth-weight ratios greater than 0.8 g/kg in newborn lambs are indicative of iodine deficiency. Ratios less than 0.4 g/kg rarely occur in lambs of flocks deficient in iodine. Intermediate ratios are ambiguous.<sup>2</sup> The relationship between thyroid and body weight is not linear and is best defined by a probit plot (Fig. 17-10), and this nonlinear relationship should be considered when interpreting these ratios for diagnosis of iodine deficiency and need for supplementation.<sup>2</sup>

Other tests are concentrations of iodine in plasma, milk, and urine, all of which reflect current iodine status rather than revealing a profile or providing indications of previous iodine status.

Estimations of iodine levels in the blood and milk are reliable indicators of the iodine status of the animal. There may be between-breed differences in blood iodine levels, but levels of 2.4 to 14  $\mu\text{g}$  of protein-bound iodine per 100 mL of plasma appear to be in the normal range. In ewes, an iodine concentration in milk of below 8  $\mu\text{g}/\text{L}$  indicates a state of iodine deficiency. Bulk-tank milk iodine content should be greater than 300  $\mu\text{g}/\text{L}$ .



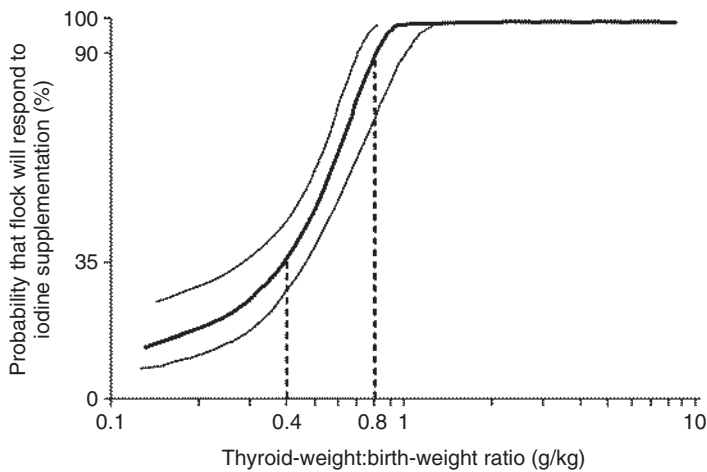

**Fig. 17-10** Plot of probability that a flock of ewes will respond to iodine supplementation based on lamb thyroid-weight:body-weight ratios. A ratio of 0.40 g/kg (95% confidence interval [CI] = 0.29 to 0.47) predicted with 35% probability, and a ratio of 0.80 g/kg (95% CI = 0.70 to 0.99) predicted with 90% probability, that a lamb came from an unsupplemented (i.e., iodine-deficient) flock. (Reproduced with permission from Knowles SO, et al. *N Z Vet J.* 2007;55:314.)

Changes in serum thyroid hormone levels in newborn calves have been used as a diagnostic index in endemic goiter, but their high variation has been unreliable. The T<sub>4</sub>/T<sub>3</sub> ratio of calves with goiter was lower than in healthy calves and adult cows, and it may be a useful diagnostic aid.

In determining the iodine status of an area, iodine levels in soil and pasture should be obtained, but the relationship between these levels, and between them and the status of the grazing animal, may be complicated by conditioning factors.

### NECROPSY FINDINGS

Macroscopic thyroid enlargement, alopecia, and myxedema may be evident. The weights of thyroid glands have diagnostic value. In full-term normal calves the average fresh weight is 6.5 g; in lambs 2 g is average. Newborn lambs from ewes unsupplemented with iodine had a mean ratio of thyroid weight (g) to body weight (kg) of 0.40 g/kg or greater. In calves with severe thyroid hypertrophy, the gland may be heavier than 20 g.

The iodine content of the thyroid will also give some indication of the iodine status of the animal. At birth, a level of 0.03% of iodine on a wet-weight basis (0.1% on dry weight) can be considered to be the critical level in cattle and sheep. On histologic examination, hyperplasia of the glandular epithelium may be seen. Follicles depleted of colloid, infolded, and lined by columnar epithelium are indicative of hypothyroidism in lambs born from ewes unsupplemented with iodine.

The hair follicles will be found to be hypoplastic. Delayed osseous maturation, manifested by absence of centers of ossification, is also apparent in goitrous newborn lambs.

### Samples for Confirmation of Diagnosis

- **Toxicology**—1 thyroid gland (assay [iodine])
- **Histology**—skin, thyroid (LM)

### DIFFERENTIAL DIAGNOSIS

Iodine deficiency is easily diagnosed if goiter is present, but the occurrence of stillbirths without obvious goiter may be confusing. Abortion as a result of infectious agents in cattle and sheep must be considered in these circumstances. In stillbirths resulting from iodine deficiency, gestation is usually prolonged beyond the normal period, although this may be difficult to determine in animals bred at pasture. Inherited defects of thyroid hormone synthesis are listed under the heading of inherited diseases. Hyperplastic goiter without gland enlargement has been observed in newborn foals in which rupture of the common digital extensor tendons, forelimb contracture, and mandibular prognathism also occur. The cause of the combination of defects is unknown.

### TREATMENT

When outbreaks of iodine deficiency occur in neonates, the emphasis is usually on providing additional iodine to the pregnant dams. The recommendations for control can be adapted to the treatment of affected animals. During an outbreak, oral administration of 280 mg/head potassium iodide to pregnant ewes and provision of iodized salt licks is advisable.<sup>1</sup> Lambs with goiter can be administered 20 mg potassium iodide per os, once.<sup>1</sup>

### CONTROL

The recommended dietary intake of iodine for cattle is 0.8 to 1.2 mg/kg DM of feed for lactating and pregnant cows and 0.1 to 0.3 mg/kg DM of feed for nonpregnant cows and calves. Monitoring of lamb thyroid:body-weight ratios in areas at risk for iodine deficiency can be useful in determining the need for supplementation before and/or during pregnancy.<sup>2</sup> Thyroid-weight:birth-weight ratios greater than 0.8 g/kg are indicative of iodine deficiency, and ewes should be supplemented preparturition or during pregnancy to prevent goiter the following year. Ratios less than 0.4 g/kg rarely occurred among deficient flocks, so the probability of benefit from supplementation is low. Intermediate ratios are ambiguous, and individual-farm supplementation trials might be required to detect and manage the risks of marginal deficiency.

Pastures in New Zealand that contain 0.24 mg iodine/kg DM provide an adequate intake for dairy cows. The injection of iodine (iodized oil) IM three times at a dose of 2370 mg iodine/dose at the start of lactation and at 100-day intervals increased iodine concentrations in milk to 58 µg/L for at least 98 days after each treatment. Two iodine injections at 100-day intervals increased milk iodine concentrations to 160 µg/L and 211 µg/L at least 55 days after each treatment, but had no effect on serum thyroid hormone concentrations. Iodine supplementation had no effect on milk, milk fat, or milk protein yield. Increasing iodine concentration in milk by IM injection of iodine could provide a method for increasing iodine intakes of humans, especially children.

Iodine can be provided in salt or a mineral mixture. The loss of iodine from salt blocks may be appreciable, and an iodine preparation that is stable but contains sufficient available iodine is required. Potassium iodate satisfies these requirements and should be provided as 200 mg of potassium iodate per kilogram of salt. Potassium iodide alone is unsuitable, but when mixed with calcium stearate (8% of the stearate in potassium iodide) it is suitable for addition to salt—200 mg/kg of salt.

Individual dosing of pregnant ewes, on two occasions during the fourth and fifth months of pregnancy, with 280 mg potassium iodide or 370 mg potassium iodate has been found to be effective in the prevention of goiter in lambs when the ewes are on a heavy diet of kale. For individual animals, weekly application of tincture of iodine (4 mL for cattle; 2 mL for pigs and sheep) to the inside of the flank is also an effective preventive. The iodine can also be administered as an injection in poppy seed oil (containing 40% bound iodine): 1 mL given IM 7 to 9 weeks before lambing is sufficient to prevent severe goiter and neonatal mortality in the lambs. Control of goiter can be achieved for up to 2 years. The gestation period is also

reduced to normal. A similar injection 3 to 5 weeks before lambing is less efficient.

The administration of long-acting injectable iodine (iodized oil) at a dose of 390 mg iodine to ewes, 5 weeks prelambling, prevented goiter in newborn lambs from ewes fed swedes or swedes/turnips/kale as winter supplement. Administration of ~400 mg iodine per ewe increased serum iodine concentrations from 41 (standard deviation [SD] 12.2)  $\mu\text{g}$  iodine/L ( $n = 54$ ) to 109 (SD 18.5)  $\mu\text{g}$ /L ( $n = 20$ ;  $p < 0.001$ ) at lambing ~99 days later, regardless of forage fed. High serum iodine concentrations persisted for 127 to 206 days after supplementation.<sup>2</sup> Diet did not affect iodine concentrations in ewe serum or milk. Responses of serum total iodine concentration (an elemental determination that comprises the iodinated hormones plus various chemical forms of serum inorganic iodine<sup>7</sup>) to injection of iodized oil to sheep are proportional to dose level increasing from 42  $\mu\text{g}$ /L to approximately 150 and 240  $\mu\text{g}$ /L for sheep administered either 300 mg or 400 mg of iodine, remaining elevated for 161 days.<sup>2</sup> Milk concentrations of iodine were 26, 271, and 425  $\mu\text{g}$ /L for sheep administered no supplemental iodine or 300 mg or 400 mg, respectively. Mean serum iodine concentrations of lambs from supplemented ewes with 300 mg or 400 mg iodine were 237 and 287  $\mu\text{g}$  g l/L at birth, and by weaning were similar ( $62 \pm 3$   $\mu\text{g}$ /L). Concentrations in lambs born of ewes that were not supplemented were less than ~140  $\mu\text{g}$ /L and were markedly affected by the diet of the ewe.<sup>7</sup>

Administration of 0.45 mg or 0.90 mg of potassium iodide orally daily to crossbred dairy goats increased mean milk iodine concentrations from  $60.1 \pm 50.5$  (unsupplemented goats) to  $78.8 \pm 55.4$  and  $130.2 \pm 62.0$   $\mu\text{g}$ /L (mean  $\pm$  SD), respectively. Milk production was not affected.<sup>10</sup>

A device to release iodine slowly into the forestomachs, while still retaining its position there, has given good results in preventing congenital goiter in lambs when fed to ewes during late pregnancy.

A recommended approach for iodine supplementation in sheep is as follows:<sup>2</sup>

1. If feeding *Brassica* crops, then supplement ewes.
2. If any lamb thyroid-weight:birth-weight ratio is greater than 0.8 g/kg, then supplement ewes. The relationship between thyroid weight and body weight is not linear and is best defined by a probit plot (Fig. 17-10), and this nonlinear relationship should be considered when interpreting these ratios for diagnosis of iodine deficiency and need for supplementation.<sup>2</sup>
3. If all or most thyroid-weight:birth-weight ratios are less than 0.4 g/kg, there is probably no need to supplement ewes because the probability of benefit is low.

4. If many thyroid-weight:birth-weight ratios fall between 0.4 and 0.8 g/kg, then the iodine status of the flock is unclear and can be impossible to determine from biomarkers.

Supplement the ewes if other evidence is persuasive, such as occurrence of iodine deficiency in the district. An on-farm supplementation trial might be required to detect marginal deficiency on these properties.

## REFERENCES

1. Campbell AJD, et al. *Aust Vet J.* 2012;90:235.
2. Knowles SO, et al. *N Z Vet J.* 2007;55:314.
3. Robertson SM, et al. *Aust J Exp Agr.* 2008;48:995.
4. Metzner M, et al. *Vet Radiol Ultrasound.* 2015;56:301.
5. Ong CB, et al. *J Vet Diagn Invest.* 2014;26:810.
6. Guyot H, et al. *Cattle Pract.* 2007;15:271.
7. Knowles SO, et al. *J Anim Sci.* 2015;93:425.
8. Todini L. *Animal.* 2007;1:997.
9. Annon. *Vet Rec.* 2011;169:461.
10. Nudda A, et al. *J Dairy Sci.* 2009;92:5133.

## INHERITED GOITER

Inherited goiter is recorded in Merino sheep, Afrikaner cattle, crossbred Saanen dwarf goats, Boer goats, possibly Poll Dorset sheep, and pigs, and it appears to be inherited as a recessive character. The essential defect is in the synthesis of abnormal thyroid hormone, leading to increased production of thyrotropic factor in the pituitary gland, causing in turn a hyperplasia of the thyroid gland. In Afrikaner cattle the defect stems from an abnormality of the basic RNA, and heterozygotes can be identified by blot hybridization analysis.

Clinically in **sheep**, there is a high level of mortality, enlargement of the thyroid above the normal 2.8 g (but varying greatly up to 222 g), and the appearance of lustrous or silky wool in the fleeces of some lambs. Other defects that occur concurrently are edema and floppiness of ears, enlargement and outward or inward bowing of the front legs at the knees, and dorsoventral flattening of the nasal area. The thyroglobulin deficiency in the neonatal lamb may result in defective fetal lung development and the appearance of neonatal respiratory distress syndrome; there is dyspnea at birth.

The clinical picture in **goats** is the same as for lambs. It includes retardation of growth, sluggish behavior, rough and sparse hair coat that worsens as the goats get older, and thick and scaly skin.

In Afrikaner **cattle**, most of the losses are from stillbirths or from early neonatal deaths. Some are caused by tracheal compression from the enlarged gland. It is the calves with the largest glands that have the greatest mortality. In these cattle there may be a concurrent inherited gray coat color, a defect in a red breed.

In **pigs**, hairless and swollen piglets with enlarged thyroid glands occur, in the

proportions with normal piglets consistent with an autosomal-recessive mode of inheritance.

## Diseases Caused by Nutritional Deficiencies

### INTRODUCTION

Three criteria are suggested for the assessment of the importance of nutrition in the etiology of a disease state in a single animal or in a group of animals:

- Is there evidence from an examination of the diet that a deficiency of a specific nutrient or nutrients may be occurring?
- Is there evidence from an examination of the animals that a deficiency of the suspected essential nutrient or nutrients could cause the observed disease?
- Does supplementation of the diet with the essential nutrient or nutrients prevent or cure the condition?

The difficulties encountered in satisfying these criteria, and making an accurate and reliable diagnosis of a nutritional deficiency, increase as investigations progress into the area of trace element and vitamin nutrition. The concentration of these micronutrients in feedstuffs and body tissues are exceedingly small, and assays are often difficult and expensive. Because of these difficulties it is becoming more acceptable to describe individual syndromes as “responsive diseases”—that is, the investigation satisfies only the third of the previously listed three criteria. This practice is not ideal, but has advantages in that it is more a more cost-effective approach, and relevant control measures are directly assessed.

### EVIDENCE OF A DEFICIENCY AS THE CAUSE OF THE DISEASE

Evidence of a deficiency as the cause of the disease will include evidence of a deficiency in the diet or an abnormal absorption, utilization, or requirement of the nutrient under consideration. Additional evidence may be obtained by chemical or biological examination of the feed.

### Diet

The diet for a considerable period before the occurrence of the disease must be considered because body stores of most dietary factors may delay the appearance of clinical signs. Specific deficiencies are likely to be associated with particular soil types, and in many instances national or local soil and geological maps may predict the likely occurrence of a nutritional disease. Diseases of plants may also indicate specific soil deficiencies, such as “reclamation disease” of oats, which indicates copper deficiency. The predominant

plant species in the pasture sward may also be important; subterranean clover selectively absorbs copper, legumes selectively absorb molybdenum, and *Astragalus* spp. accumulate selenium.

Farming practices can have a strong influence on the concentration of specific nutrients in livestock feed. For example, heavy applications of nitrogen fertilizer can reduce the copper, cobalt, molybdenum, and manganese content of pasture. On the other hand, many applications of lime will reduce the concentration of copper, cobalt, zinc, and manganese in plants, but increase molybdenum. These effects are significant enough to influence the trace-element nutrition of grazing livestock. Modern hay-making methods, with their emphasis on the artificial drying of immature forage, tend to conserve vitamin A, but may result in a gross deficiency of vitamin D. Improved pasture species and increased applications of fertilizer can exaggerate the depletion of trace elements from marginally deficient soil, giving rise to overt deficiency disease in previously marginal or unaffected areas. Thus local knowledge of farming and feeding practices in a particular area is of primary importance in the diagnosis of nutritional deficiency states.

### Abnormal Absorption

Although a diet may contain adequate amounts of a particular nutrient, some other factor, by decreasing its absorption, may induce a deficiency. For example, excess phosphate reduces calcium absorption, excess calcium reduces the absorption of iodine, and the absence of bile salts prevents proper absorption of the fat-soluble vitamins. Chronic enteritis reduces the absorption of most essential nutrients. The list of antagonisms that exist between elements continues to grow, most being an interference with absorption. For example, excess calcium in the diet interferes with the absorption of fluorine, lead, zinc, and cadmium, such that it may cause nutritional deficiencies of these elements, but it also reduces their toxic effects when they are present in the diet in excessive amounts.

### Abnormal Utilization of Ingested Nutrients

Abnormal utilization of ingested nutrients may also have an effect on the development of conditioned deficiency diseases. For example, molybdenum and sulfate reduce copper storage, vitamin E has a sparing effect on vitamin A, and thiamine reduces the dietary requirement for essential fatty acids.

### Abnormal Requirement

An enhanced growth rate of animals, either by improved nutrition or genetic selection, may increase their requirement for specific nutrients to the point where deficiency disease occurs. There seems to be little doubt that there is a genetic variation in mineral

metabolism, and it has been suggested that it may be possible to breed sheep to “fit” deficiency conditions. The significance of the inherited component of an animal’s nutritional requirement is unknown, but should not be overlooked when policies to upgrade livestock in deficient areas are being planned.

## EVIDENCE OF A DEFICIENCY ASSOCIATED WITH THE DISEASE

Evidence of a deficiency associated with the disease is usually available from experimental work that demonstrates the clinical signs and necropsy findings produced by each deficiency. Several modifying factors may confuse the issue. Under natural circumstances, nutritional deficiencies may not be a single entity, and thus clinical and necropsy findings will often be complicated by deficiencies of other factors and intercurrent infections. Most syndromes are variable and insidious in their onset, and clinical signs and gross necropsy lesions in many nutritional deficiency diseases are either minimal or nonspecific. This increases the challenge of making a definitive diagnosis.

Consequently, laboratory examination of blood and animal tissues is an essential diagnostic aid in many instances. However, the normal range of blood or tissue concentrations of minerals and vitamins, or their biochemical markers, and those values that indicate deficiency, are often not well established. Experimentally induced and naturally occurring nutritional deficiencies provide an indication of the changes that occur in the concentrations of a particular nutrient, but variations resulting from age, genotype, production cycle, length of time on the inadequate diet, previous body stores of the element, and intercurrent disease and stressors can complicate the results, making them difficult to interpret.

In most cases, nutritional deficiencies affect a proportion of the herd or the flock at the same time. The clinicopathological examination should include a selection of both normal and clinically affected animals because the comparison of results from these groups allows a more accurate and reliable interpretation of laboratory tests, facilitating a diagnosis.

## EVIDENCE BASED ON CURE OR PREVENTION BY CORRECTION OF THE DEFICIENCY

The best test of the diagnosis of a suspected nutritional deficiency is to observe the effect of supplementing that nutrient, either directly to the animal or via the ration. Confounding factors can occur, such as spontaneous recovery; hence, adequate controls and a sufficient sample size are essential. Curative responses may be poor because of an inadequate dose or advanced tissue damage. Alternatively, the abnormality may

have only been a predisposing or secondary factor to another factor that is still present. A common cause of confounding in therapeutic trials is the impurity or bioactivity of the preparations used, particularly with trace elements and vitamins. The preparations used may also have some intrinsic pharmacologic activity and hence partially or temporarily ameliorate the condition without a deficiency actually having been present.

### Monitoring of Nutritional Status

On breeding farms, there are several different age groups of animals at different levels of growth and production. This requires close surveillance to avoid either a deficiency or overnutrition in each class of animal. Scoring of the body condition of dairy and beef cattle, sheep, and pigs is commonly used as an indicator of the adequacy of the diet leading to the present time (termed *prior nutrition*).

The feeds and feeding program have a major influence on reproductive performance, and hence growth and milk production and must be monitored regularly. The veterinarian must be aware of any changes in the feeding program that have occurred since the last farm visit or that are intended in the near future. Veterinary clinical nutrition is now a specialty that should provide new and useful information for the practitioner working with a particular species or class of food animals. An experienced and competent nutritionist should be consulted to assist with complex nutritional problems.

### Nutritional Management in Dairy Herds

Advising farms about nutrition is a key activity for dairy cattle practitioners. Feed costs are approximately 60% of the total cost of producing milk, so even minor improvements in feeding efficiency can be profitable.

Some dairy practitioners function as the nutritional specialist for the dairy farms they serve, collecting feed samples for nutrient analysis, formulating rations, and advising on crop and harvesting conditions. These veterinarians often devote a considerable amount of their professional time to nutritional management. Nevertheless, it is common for farms to employ a professional nutritionist or to use a nutritionist employed by a feed company or local cooperative. These professionals generally formulate the rations and submit feed samples for nutrient analysis. For these herds, the veterinarian can have an important role in ensuring that the diet described on paper is adequately formulated and delivered to the cows. Routine scheduled activities, such as measuring the dry matter of forages, hand-mixing of total mixed ration (TMR) for one cow and comparing it with the machine-mixed TMR (termed the TMR test mix), and scoring the feed bunk to assess feed sorting and dry matter intake are important procedures that



help to ensure the successful delivery of a nutritional program. Assessing pasture conditions by periodic inspection of pasture is an important component of managing the nutritional program of herds that use management-intensive grazing. These quality control activities should be conducted routinely as part of the health and production management program.

There is probably no aspect of a dairy enterprise that has a wider impact than the feeding program, which has direct effects on production and growth. Many health problems on a dairy farm relate in some way to the feeding program, and a significant portion of the farm's labor is spent planting, growing, harvesting, mixing, and feeding rations. Investment in equipment used in feeding programs is also an important capital cost. Small changes in feeding programs may bring about large changes in productivity, health, income, feed costs, labor allocation, cash flow, and debt. Thus the total savings from these small changes can be substantial, with one study showing that routine nutritional consultation by a veterinarian can save 14% of total feed costs even without accounting for improved production or health effects.

For these reasons, veterinarians who wish to serve their dairy clients on a whole-farm basis must become actively involved in the herd's feeding program. Dairy herds are often fed unbalanced, expensive rations, but as a consultant independent from the feed company, a veterinarian can provide unbiased advice about the feed program. For example, a recumbent, hypocalcemic cow raises questions about dry-cow feeding, whereas an anestrous, thin cow with smooth ovaries raises questions about energy and dry matter intake (DMI) during early lactation. If the average mature equivalent milk production for the herd falls by 220 kg (500 lb), this generates the same sense of urgency as a cow with a prolapsed uterus. A dairy veterinarian cannot truly serve a client's needs by practicing therapeutic medicine in isolation from the nutrition of the herd and thus must acquire skills to directly deal with nutrition problems.

As the average size of dairy herds increases, many dairy farmers now rely on a team of advisors rather than just one or two. Consequently, a nutritional consultant, local veterinarian, and remote specialist consultant may all be providing advice to a dairy farm, and thus awareness of and communication about the feeding program, and the indicators of performance of the farm, are critical. It is imperative that, as part of the advisory team, the dairy veterinarian knows about dairy nutrition and is aware of, but preferably involved in, the ration formulation.

### Levels of Nutritional Service

Having decided to be involved in a dairy's feeding program, a first step is for the client and veterinarian to discuss and agree on

the level of nutritional advice that is to be provided. This varies from herd to herd, depending on the veterinarian's expertise, the client's ability and interest, and the role of other consultants. There are essentially four levels of service that might be provided, as described next.

#### Level 1: Problem Identification and Analysis

At level 1, the veterinarian takes on the task of monitoring the dairy herd for indicators of nutrition-related problems. Many areas need to be monitored: production, milk composition, DMI, body scores, disease rates, heifer management and growth, and feed costs. Based on these measures, the veterinarian can identify problems as they arise, form and test hypotheses about likely causes, and interact with the client and other advisors as the problems are prioritized and addressed.

#### Level 2: Ration Analysis

Level 2 requires assessment of the adequacy of diets that are actually being fed to the cows. Problems of balance or economics are referred to the appropriate person, for example, if reformulation of a specific diet is needed. This involvement may be difficult to sustain if the person formulating the ration resents being "second-guessed," but it can work well if a functional team approach is in place.

#### Level 3: Ration Formulation

If a dairy veterinarian takes responsibility for ration formulation, the veterinarian will need considerably enhanced skills in dairy nutrition, far beyond those traditionally taught at veterinary colleges. Typically, this involves using a computer program to formulate a balanced, least-cost ration for each class of animal. It requires expertise in the mechanics of how feeds are handled and fed to cows on a daily basis, and hence an intimate knowledge of the farm and its personnel and daily trends in the price and availability of feed components.

If not well managed, this level of service has several pitfalls because it lacks the on-farm follow-up, supervision of implementation, and monitoring of results that are included in level 4. There is a truism about feeding dairy cows that every cow has three rations: the one formulated, the one delivered, and the one actually eaten. The best feeding programs minimize the difference among these three rations. If the veterinary consultant's role stops at formulation, then mistakes can occur in delivery and feed-bunk management that can doom the program to failure. However, if the program fails, it is the ration formulation that is most likely to be blamed.

#### Level 4: Total Program Consulting

Level 4 service includes the critical aspects missing from level 3 because the veterinarian

plays an active role in implementing the feeding recommendations. Attention is paid to areas such as bunk management, cow comfort, feeding frequency and scheduling, quality control, and consistency of feeding management. Working closely with the producer, plans for future forage production can be generated, including attention to factors such as timing the harvest for maximum feed value. The monitoring described in level 1 is sustained, and timely adjustments and feedback are provided to ensure that the rations are accomplishing the desired ends. In the long term, this is the level of service that is most desirable for both the specialist dairy veterinarian and client. The producer benefits from the added supervision and support, and the veterinarian can assure the client that the program is implemented as it is intended. If it is not working, the total program can be modified, often with the veterinarian as a part of a team that includes a nutritionist. When multiple consultants are used in larger herds, this team approach provides the owner with the best opportunity for expert advice, and the specialist dairy veterinarian is often best suited to be the "team leader."

### Nutritional Management of the Beef Breeding Herd

Good nutrition provides the essential basis for optimum productivity in cattle-breeding operations. Despite this, nutritional expertise has not been a traditional strength of many food-animal veterinarians.

Throughout the world, beef-breeding operations are generally range or pasture based. These operations are conducted in diverse environments, with great variation in nutritional management. In many countries, the area of pasture or rangeland required to maintain a cow-calf unit may vary from 0.5 to 1 ha (1 or 2 acres) in intensive high-rainfall regions to many square kilometers in remote dryland areas. However, in general, the land area or amount of pasture necessary for production is related to local economic realities. This, in turn, is related to levels of managerial and resource inputs that differ markedly between regions, markets, and enterprises. Notwithstanding this variation, there are a number of principles of good nutritional management that can be universally applied to cattle-breeding operations. Regardless of region, an important consideration is that of maintaining or improving production (increasing income) while reducing costs per unit of production. In simple terms, financial return from a beef-breeding operation is a function of number of calves, their weaning weight, and price. On the cost side is the cost of maintaining the breeding females. This varies considerably between farms, both within and between regions. Although it can be influenced, the price received is generally not significantly controlled by the farm business. However, both

the number of calves born and their weaning weights are strongly influenced by an appropriate management calendar that matches nutritional demand with the supply of pasture. For example, good nutritional management helps to ensure that as many females as possible are cycling at the start of the breeding season. This, combined with good bull management, helps to ensure that calves are born early and that they are older and heavier at weaning than later-born calves.

In general, nutrition is the most important limiting factor of beef-breeding performance, and thus an understanding of the principles underlying the nutritional management of breeding females is essential. Effective monitoring does not necessarily require a higher degree in nutrition, although it should include sufficient knowledge and wisdom to know when additional expertise is needed. A starting point is to have a working knowledge of the different energy measuring systems (total digestible nutrients [TDN], metabolizable energy [ME], and net energy, NE) that are commonly used and their applications for different classes of animals, activities, and feedstuffs, and to identify one with which the veterinarian can work best. The Nutrient Requirements of Beef Cattle from the National Research Council (NRC) in the United States is a useful document, with the 7th edition published in 2000. This is packaged with a computer program that includes ration formulators and a library of feeds and feedstuffs. A number of programs for least-cost-ration formulation in beef herds are also available from Departments of Agriculture or commercial suppliers.

### Nutritional Advice for Beef Feedlots

Beef feedlots frequently consult a qualified nutritionist to assist in the formulation of cost-effective rations. In this case the veterinarian should communicate regularly with the nutritionist to be aware of the composition of the diets and any changes that are planned. Because feed is the major portion of the cost per unit of body weight gain, it is imperative that the diet be the lowest-cost diet possible while providing nutrients that allow optimum growth and finishing. Most of the emphasis in feedlot nutrition has been on the development of cost-effective diets that support a maximum growth rate without any deleterious effects. Considerable information is available on the nutrient requirements for feedlot cattle and on the feeds and feeding systems used.

The precise specifications of the diets are the responsibility of the nutritionist, but the feedlot veterinarian is often able to evaluate the quality of the feed delivery system. This includes whether cattle are fed on time, whether the feed delivered to troughs is properly mixed, and whether feed intake is intermittent as a result of insufficient trough space, poor trough and pen design,

inclement weather, and muddy or slippery ground. Any deviations should be discussed with feedlot managers and the consulting nutritionist, similar to the team approach suggested for large dairy herds.

Nutritional deficiency diseases are uncommon in feedlot cattle because cattle usually receive a diet that contains the nutrients required for maintenance and promotion of rapid growth. Diets prepared according to the Nutrient Requirements of Beef Cattle should meet all the requirements under most conditions.

Specific nutrient deficiencies are extremely rare because diets are prepared every few days or daily, and it would be highly unusual for a feedlot to use a feedstuff deficient in a specific nutrient for a prolonged period. However, such a situation may occur on a small farm or opportunistic feedlot that prepares its own diet with little or no attention to the need to supplement homegrown feeds. Thus there are only a few nutrition-related diseases that may affect a well-managed feedlot, but these diseases may cause large economic losses when they occur. They include the following:

- Carbohydrate engorgement (grain overload or lactic acidosis)
- Feedlot bloat or ruminal tympany
- Feeding errors, including accidental incorporation of an excessive amount of feed additives, such as monensin or urea; sudden unintended changes in the composition of the diet; and accidental feeding of the wrong dietary mix

### Nutritional Advice for Swine-Herds

Veterinarians involved in health management of swine-herds must be well informed about the nutrient requirements of the different age groups of pigs. Feed constitutes 60% to 80% of the cost of producing a market pig, so every effort is needed to increase the efficiency of feed use. Surveys of well-managed pig farms in Alberta, Canada, found a 20% difference in feed costs, and it is estimated that in the industry the range in feed costs is likely to be near 50%. Reduction of the feed cost of the highest-costing farm to that of the lowest-costing farm would save that farm more than US\$23,000 annually, a reduction in the cost of production of \$6.80/pig. The trend is to use complete feeds formulated by feed company nutritionists familiar with the nutrient composition of local feedstuffs. With complete diets, specific nutrient deficiencies are uncommon.

The major problem is the efficiency of utilization of the different feeds throughout the life cycle of the pig. The nutrient requirements of the pig at various phases of growth, from birth to market weight and of breeding stock, are well established. The remaining questions relate to the amount of feed provided during the different growth phases of the pig to achieve optimum production and yield the best carcass. The following are some

recommended practices for increasing efficiency of feed utilization:

- Provide well-balanced diets with adequate levels of amino acids, energy, vitamins, and minerals necessary to meet the particular demands of the pig at each stage of its life cycle. The diet depends on the demands, usually characterized as the growth rate or lean deposition, with feed intake being the supply function. Feed intake is limited by appetite, and thus other nutrients are matched to expected energy intake and subsequent growth.
- Use least-cost formulation to the extent that it is feasible. The least-cost energy source in most of the pig-rearing areas is corn, and the most common protein source is soybean meal.
- Restrict the level of a properly balanced diet for sows during gestation to avoid overfeeding. Sows that have lost excessive body weight in the previous lactation need supplemental feed during the dry period to avoid thin-sow syndrome.
- Ad-lib feeding for growing pigs is usually optimal unless the genotype deposits excess fat during the latter stages of growth.
- Market pigs as close to optimum slaughter weight as possible to maximize margin over feed costs.
- Avoid feed wastage by using well-designed feeding systems and proper adjustment of feeders.
- Use pelleting of diets to increase digestibility, especially of small grains, and to decrease feed wastage. However, pelleting does predispose pigs to gastroesophageal ulcers.

The feed efficiency of the pigs from weaning to market should be monitored regularly. It is often difficult to obtain accurate data for a specific group of pigs because a common feeding system for multiple groups is often used. However, the total amount of feed used and the total weight of pigs marketed will give an estimate of feed efficiency.

Although the nutrient requirements of pigs are well known, they do continue to change because of changes in growth and production characteristics. Pigs with high lean-growth rates require higher levels of amino acids to support their increased rate of body protein deposition. Similarly, high-milk-producing sows nursing large litters have increased amino acid requirements. The NRC in the United States provides an important service in establishing the nutrient requirements of swine and other species. The 10th edition of the Nutrient Requirements of Swine was published in 1998, and it includes areas such as modeling nutrient requirements and reducing nutrient excretion, particularly nitrogen and phosphorus, which can contribute to environmental pollution.

The approach used to produce estimates of nutrient requirements account for the

pig's body weight and the accretion of lean (protein) tissue, gender, health status, and various environmental factors. To accurately estimate nutrient needs of gestating and lactating sows, there is a need to account for body weight, weight gain during gestation, weight loss during lactation, number of pigs in the litter, weight gain of the litter (a reflection of milk yield), and certain environmental factors. A series of integrated equations is used to account for the many factors known to influence nutrient requirements. These provide the framework for modeling the biological basis of predicting requirements. The NRC models predict the levels of nutrients (outputs) needed to achieve a certain level of production under a given set of environmental conditions (inputs).

Five principles were used to develop the models: (1) ease of use by people with varying levels of nutritional expertise; (2) continued relevance; (3) structural simplicity; (4) transparency, so that all equations are available to the user; and (5) empirical data at the whole-animal level was used rather than data based on theoretical values. Three independent models were developed for growth, gestation, and lactation. The growth model estimates amino acid requirements of pigs from weaning to market weight, and the gestation and lactation models estimate energy and amino acid requirements of gestating and lactating sows.

Few revisions were needed from the previously published mineral requirements; higher dietary requirements for sodium and chloride in the young pig were established, and manganese requirements were increased from 10 to 20 ppm for gestating and lactating sows.

Feed composition tables are built from multiple databases on the nutrient composition of feeds, including the feed industry and datasets outside the United States and Canada.

The information on water was expanded, with more detailed information on the factors that influence water intake. Information on nonnutritive feed additives, such as antimicrobial agents, anthelmintics, microbial supplements, oligosaccharides, enzymes, acidifiers, flavors, odor-control agents, antioxidant pellet binders, flow agents, high-mineral supplements, and carcass modifiers, is also included.

### Nutritional Advice for Sheep Flocks

The influence of nutrition on the reproductive performance of ewes has been a matter of concern for many years. Clearly, the relationship between the provision of nutrients and requirements for optimum reproductive performance is seldom ideal because of the wide range of environmental conditions and the seasonal breeding patterns of most sheep breeds. Prolonged periods of undernutrition often occur during midpregnancy, partly the result of the decline in feed availability and

quality over that stage of the reproductive cycle and partly from the seasonal variability in pasture growth.

Prolonged moderate to severe undernutrition of ewes bearing twins in midpregnancy reduces placental development and can cause a significant reduction in lamb birth weight and increased lamb mortalities. Considerable progress has been made in understanding the principles of nutrition of sheep and in defining their nutrient requirements for maintenance, pregnancy, and lactation. It has been established that mortality rates are high in lambs with birth weights below the breed norm, and that after birth the absolute growth rates are lower in surviving light lambs than in heavier lambs of the same breed. The plane of nutrition and the size of the placenta have been recognized as major determinants of the fetal growth rate. Fetal growth retardation in undernourished ewes has a placental component, and thus factors that affect placental growth are highly relevant.

The 21-week gestation can be divided into a number of periods to consider the effects of nutrition on reproduction within each period. In the first 4 weeks of gestation, embryonic loss is the main sequelae of inadequate nutrition. During this period, it is generally recommended that the body-condition score (BCS) of the ewe be maintained at an average of 3.0, on a scale of 1 (emaciated) to 5 (very fat), to minimize embryonic and early fetal loss. This is followed by a period of 2 months in which there is rapid growth of the placenta, but during which growth of the fetus in absolute terms is still small. Over this period, losses in body weight should not exceed 5%, and BCS should be maintained at 2.7 to 3.0. Finally, there is the phase from 90 days to parturition, in which gain in the mass of the fetus amounts to 85% of its birth weight, during which time nutrient intake must be increased if excessive weight loss in the ewe and light-birth-weight lambs are to be avoided.

### Placental and Fetal Growth

Placental development in the pregnant ewe begins about 30 days after conception. The number of placentomes associated with each fetus is fixed at this time, but the total weight of the placentomes increases until about 90 days of gestation, after which there is little change. The factors that influence the ultimate size of the placenta and its weight include hormonal and nutritional factors, prolonged environmental heating of pregnant ewes, parity, and possibly genotype. However, by far the most important determinant is nutrition of the ewe. Moderately severe undernutrition during early and midpregnancy significantly reduces placental weight at term and causes chronic intrauterine growth retardation.

The size of the placenta is a major determinant of fetal growth. In well-fed ewes, the

fetal growth rate until 120 days (17 weeks) of gestation is not positively correlated with placental weight, but fetal growth rate is limited by the size of the placenta during the last 3 to 4 weeks of pregnancy. However, when ewes are underfed, the influences of a lighter placenta on fetal growth rate are evident sooner, with placental weight and fetal growth positively correlated from as early as 90 days (13 weeks) of gestation. During the first 90 days of pregnancy, placental growth is reduced when ewes are moderately underfed. Light fetuses in ewes with placenta weights near the bottom of the normal range suffer chronic and progressive hypoxemia and hypoglycemia. This affects fetal metabolism, causing fetal death during late pregnancy, fetal hypoxemia during parturition, premature birth, and a high perinatal mortality rate from hypoglycemia and hypothermia, the latter being more severe in lighter lambs.

The extent to which ewes maintained on a fixed ration draw on their own body reserves in an attempt to meet the energy costs of pregnancy is determined by fetal weight. In well-fed ewes, fetal growth rate remains constant until at least 120 days of gestation and then decreases. However, the absolute growth rate increases markedly during the last 8 weeks of gestation, when fetal growth is most rapid, exceeding 100 g/day near birth. The growth rate among fetuses is highly variable, which accounts for birth weights ranging from 2 kg to over 7 kg. When ewes that have previously been well fed are severely underfed at any stage during the last 40 to 50 days of pregnancy, fetal growth rate decreases by 30% to 70% within 3 days. This demonstrates that mobilization of maternal reserves is substantially less than fetal requirements, emphasizing the importance of a continuous supply of good-quality feed during late pregnancy. The larger the fetal burden, the more susceptible an ewe is to hypoglycemia during underfeeding.

Refeeding after severe underfeeding can reverse the reduced growth rate of fetuses, but the response depends on the duration of the underfeeding. If the period of underfeeding is 16 days or less, the growth rate increases when ewes are refed, but there is no change when refeeding occurs after 21 days of severe underfeeding. Moderate underfeeding of pregnant ewes for 85 days reduces the fetal growth rate irreversibly. Refeeding them in late pregnancy does not cause fetal growth rate to increase, but it does prevent further decreases after 120 days.

### Lamb Losses

The major consequences of prenatal growth retardation are on lamb survival. Neonatal mortality increases markedly in many environments when the birth weight falls below 3 to 3.5 kg. Compared with normal lambs, low-birth-weight animals have reduced insulation because of the smaller number of wool



fibers, greater relative heat loss because of their larger surface area per unit of body weight, and a reduced capability to maintain heat production because of their lower fat and energy reserves. All of these factors increase their susceptibility to environmental stress and reduce their ability to compete with normal-sized siblings.

Underfeeding during pregnancy reduces available body lipids in lambs by about 47%, and it also decreases the lactose, lipid, and protein available in colostrum during the first 18 hours after birth by about 50%. Newborn lambs have to draw on body reserves of glycogen to maintain heat production during the first 18 hours after birth. Consequently, they depend heavily on colostrum and supplements, when these are provided, to avoid hypoglycemia and hypothermia.

The effects of maternal nutrition on udder development and on the production and yield of colostrum and milk in ewes have also been examined. In the 30 days before birth, there is a marked increase in the rate of mammary tissue growth in the ewe. In well-fed ewes with one or two lambs, large volumes of colostrum accumulate in the mammary glands during the last few days of pregnancy, and copious milk secretion begins soon after birth, with averages of 1800 to 2800 mL of colostrum and milk being produced during the first 18 hours. Udder growth rates show a similar pattern to fetal growth rates, such that the greatest increase in udder weight occurs in the last 30 days of gestation, and the weight of udder tissue is 30% to 40% of the total weight of the litter. Colostrum production is proportional to udder weight, but refeeding ewes a few days before lambing fills the udder tissue present rather than increasing udder tissue weight. In underfed ewes, accumulation of colostrum before birth is reduced markedly, lactogenesis is delayed, and the total production of colostrum and milk during the first 18 h averages only 1000 mL. Subsequently, for ewes on both planes of nutrition, milk production increases, reaching a peak about 1 to 2 weeks after birth. Underfeeding ewes from 105 days (15 weeks) of gestation can reduce the total yield of colostrum during the first 18 hours after birth by decreasing mammary tissue growth. Thus the prepartum accumulation of colostrum and its subsequent rates of secretion are reduced. Improving the ewe's nutrition from 1 hour after birth can increase the secretion rates of colostrum between 10 and 18 hours.

The growth rate of lambs during the first few weeks of life is positively correlated with birth weight. Low planes of maternal nutrition during late pregnancy and early lactation are generally associated with low birth weights, milk yields, and postnatal growth rates, and high planes of nutrition are associated with the opposite effects. A marked increase in the plane of maternal nutrition at birth can overcome the inhibitory effects on

lactation and lamb growth rate of underfed ewes in late pregnancy.

### Ewe Body-Condition Score

Target condition scores for ewes at different stages of their reproductive cycle have been developed by research groups and departments of agriculture in many countries. These vary according to the predominant breeds and production systems in each country, and they can be quite different for a Merino, Dorset, or Friesian ewe used for wool, meat, or dairy production versus a dual-purpose enterprise producing both meat and wool. Consequently, readers should directly access information appropriate to the production systems of their clients. However, in general, the aim at breeding time is to have ewes with a BCS of 3.0 to 3.5, which ensures maximum ovulation rate. Ewes with a BCS of 3.5 at breeding can be allowed to lose no more than 5% of their body weight, steadily, during the second and third months of pregnancy, equivalent to approximately 0.5 to 1 BCS units. This mild degree of undernutrition enables good placental growth, establishing the basis for maximum fetal growth in the fourth and fifth months of pregnancy, during which the fetus achieves over 80% of its growth. During these final 2 months of pregnancy, there is a limit to the extent to which body-fat reserves can be used because excessive mobilization of fat deposits as a consequence of inadequate dietary energy supply leads to pregnancy toxemia. Ewes with a BCS below 3.0 should be managed to maintain that score.

In late gestation, the optimum BCS ranges from 2.75 to 3.0. In contrast, early lactation is a period in which body fat can be safely used to meet some of the high-energy demands of lactation. During this period, a loss of BCS of from 0.5 to 1.0 (equivalent to 5 kg of fat for a 70-kg ewe at mating) may occur. However, replacement of body fat, to increase the BCS to 3.0 to 3.5 before the next mating, is important to maximize ovulation rate and achieve optimum reproductive performance.

Winter shearing of pregnant ewes during the final 10 weeks of pregnancy can cause a significant increase in lamb birth weight by stimulating ewe appetite. However, this also increases the base energy requirements of the ewe at a feed-limiting time of the year in many production systems (e.g., winter for a spring-lambing flock). Thus it is not always an optimum or profitable system, but this will vary between production systems and different countries.

The nutrient requirements for maintenance, breeding, pregnancy, and lactation of ewes have been cataloged, and optimum feeding strategies for the breeding ewe can be formulated. The evaluation of the ewes' ration during late gestation by monitoring plasma concentrations of the BHB has been described, and these evaluations have been

used to provide nutritional advice in intensively managed flocks during late gestation.

In more intensively managed flocks, achieving optimum reproductive performance requires adjusting feeding strategies and the nutrient value of the diet to meet the needs of each stage of the reproductive cycle. Requirement for metabolizable energy increases above maintenance levels from 8 to 12 weeks of pregnancy, increasing further in late pregnancy and lactation. During early lactation, when the energy requirements of prolific ewes exceed the voluntary intake from all but the highest-quality diets, body-fat reserves are used and then replenished toward the end of lactation, when milk yield declines, and in the period leading up to rebreeding.

The rapid growth of the fetus after 90 days of pregnancy and increased energy demand may require the feeding of cereal or legume concentrates, rather than hay, which has far lower metabolizable energy content. This is particularly true for ewes carrying twins or triplets.

In contrast to the ability of the ewe to use body reserves when the intake of energy fails to meet her needs, particularly in early lactation, there is little scope for sustaining production by drawing on body protein. For example, lactating ewes can lose up to 7 kg of body fat during a 4-week period in early lactation, when energy intake is below requirements. For ewes on a low-protein intake, the maximum daily loss of protein is around 26 g. Therefore it is important to meet the protein needs of the ewe during pregnancy, but especially during late pregnancy, to ensure adequate fetal growth, udder development, and colostrum production.

The estimates for the minimum protein requirements of the animal are based on distinguishing between the needs of the rumen microflora for rumen-degradable protein and of the host animal for additional undegraded dietary protein when rumen-degradable protein fails to meet those requirements. In practice, the dietary allowances for late pregnancy and early lactation are higher than the sum of the rumen-degradable protein and undegradable protein.

### FURTHER READING

- Freer M, ed. *Nutrient Requirements of Domesticated Ruminants* [eBook]. Melbourne: CSIRO Publishing; 2007.
- Freer M, Dove H, eds. *Sheep Nutrition*. Wallingford, Oxon, UK: CSIRO and CABI Publishing; 2002.
- Hayton A, Husband J, Vecqueray R. Nutritional management of herd health. In: Green M, ed. [eBook]. *Dairy Herd Health*. Wallingford, Oxon, UK: CAB International; 2012.
- Herring AD. *Beef Cattle Production Systems*. Wallingford, Oxon, UK: CAB International; 2014.
- Subcommittee on Dairy Cattle Nutrition, Committee on Animal Nutrition, Board on Agriculture, National Research Council Subcommittee on Dairy Cattle Nutrition. *Nutrient Requirements of Dairy Cattle*. 7th ed. Washington, DC: National Academy Press; 2000.

Subcommittee on Beef Cattle Nutrition, Committee on Animal Nutrition, Board on Agriculture, National Research Council. *Nutrient Requirements of Beef Cattle*. 7th rev. ed. Washington, DC: National Academy Press; 2000.

Subcommittee on Horse Nutrition, Committee on Animal Nutrition, Board on Agriculture, National Research Council. *Nutrient Requirements of Horses*. 6th rev. ed. Washington, DC: National Academy Press; 2007.

Subcommittee on Sheep Nutrition, Committee on Animal Nutrition, Board on Agriculture, National Research Council. *Nutrient Requirements of Sheep*. 6th rev. ed. Washington, DC: National Academy Press; 1985.

Subcommittee on Swine Nutrition, Committee on Animal Nutrition, Board on Agriculture, National Research Council. *Nutrient Requirements of Swine*. 10th rev. ed. Washington, DC: National Academy Press; 1998.

## Deficiencies of Energy and Protein

### DEFICIENCY OF ENERGY

#### ETIOLOGY

Insufficient quantity or quality of feed is a common nutritional deficiency and practical problem of feeding livestock. The term *protein-energy malnutrition* is used to describe a form of incomplete starvation in which a suboptimal amount of energy and protein is present in the diet. Such deficiencies typically occur when livestock are underfed, and often the two scenarios cannot be separated.

#### EPIDEMIOLOGY

A deficiency of energy is the most common production-limiting nutrient deficiency of farm animals. There may be inadequate amounts of feed available, or the feed may be of low quality (low digestibility). The availability of pasture may be inadequate because of overgrazing, drought, or snow covering. Alternatively, it may be too expensive to provide enough supplementary feed of the required quality, or the available feed may be of such low quality and poor digestibility that animals cannot consume enough to meet energy requirements. In some cases, forage may contain a high concentration of water, which limits total energy intake.

#### CLINICAL FINDINGS

The clinical findings of an energy deficiency depend on the age of the animal, whether or not it is pregnant or lactating, concurrent deficiencies of other nutrients, and environmental factors. In general, an insufficient supply of energy in young livestock causes decreased growth and delayed onset of puberty. In mature animals, there is reduced milk production and a shortened lactation. A prolonged energy deficiency in pregnant beef heifers will result in a failure to produce adequate quantities of colostrum at parturition.

In mature animals, there is also a marked loss of body weight, especially when demand for energy increases in late pregnancy and early lactation. There are prolonged periods of anestrus, which reduces the reproductive performance of the herd. Primigravid females are particularly susceptible to protein-energy malnutrition because of their requirements for growth and maintenance. A deficiency of energy during late gestation can produce undersized, weak neonates with a high mortality rate, whereas abomasal impaction is associated with energy deficiency during prolonged cold weather, especially in pregnant beef cattle and ewes being wintered on poor-quality roughage. Heat loss from the animal to the environment increases considerably during cold weather, and when ambient temperatures are below the critical temperatures, the animal responds by increasing metabolic rate to maintain normal body core temperature.<sup>1</sup> If sufficient feed is available when temperatures are below the lower critical temperature, ruminants will increase their voluntary feed intake to maintain body temperature. If sufficient feed is not available, the animal will mobilize energy stored as fat or muscle to maintain body temperature and thus lose body weight. In the case of ruminants and horses, if the feed is of poor quality, for example, poor-quality roughage, the increased feed intake may result in impaction of the abomasum and forestomachs in cattle and of the large intestine in the horse.

Cold, windy, and wet weather will increase the needs for energy, and the effects of a deficiency are exaggerated, often resulting in weakness, recumbency, and death. A sudden dietary deficiency of energy in fat, pregnant beef cattle and ewes can result in starvation ketosis and pregnancy toxemia. Hyperlipemia occurs in fat, pregnant or lactating ponies that are on a falling plane of nutrition.

Protein-energy malnutrition occurs in neonatal calves fed inferior-quality milk replacers that may contain insufficient energy or added nonmilk proteins, which may be indigestible by the newborn calf. A major portion of the body fat present at birth can be depleted in diarrheic calves deprived of milk and fed only fluids and electrolytes for 4 to 7 days. Feeding only fluids and electrolytes to normal, healthy newborn calves for 7 days can result in a significant loss of perirenal and bone-marrow fat and depletion of visible omental, mesenteric, and subcutaneous fat stores. The amount of body fat present in a calf at birth is an important determinant of the length of time an apparently healthy calf can survive in the face of malnutrition. Calves born from dams on an adequate diet usually have sufficient body fat to provide energy for at least 7 days of severe malnutrition. The absence of perirenal fat in a calf at 2 to 4 days of age suggests inadequate reserves of fat at birth and chronic fetal malnutrition.

### DEFICIENCY OF PROTEIN

A deficiency of protein commonly accompanies a deficiency of energy. However, the effects of the protein deficiency, at least in the early stages, are usually not as severe as those of energy deficiency. Insufficient protein intake in young animals results in reduced appetite, lowered feed intake, inferior growth rate, lack of muscle development, and a prolonged time to reach maturity. In mature animals, there is loss of weight and decreased milk production. In both young and mature animals, there is a drop in hemoglobin concentration, packed cell volume, total serum protein, and serum albumin. In the late stages, there is edema associated with the hypoproteinemia. Ruminants do not normally need a dietary supply of essential amino acids, in contrast to pigs, which need a natural protein supplement in addition to the major portion of total protein supplied by the cereal grains. The amino acid composition of the dietary protein for ruminants is not critical because the ruminal flora synthesize the necessary amino acids from lower-quality proteins and nonprotein sources of nitrogen.

#### CLINICAL FINDINGS

The clinical findings of a protein deficiency are similar to those of an energy deficiency, and the clinical findings of both resemble those of many other specific nutrient deficiencies and subclinical diseases. Protein-energy malnutrition in beef cattle occurs most commonly in late gestation and is characterized clinically by weakness, clinical recumbency, marked loss of body weight, a normal mental attitude, and a desire to eat. Cows with concurrent hypocalcemia will be anorexic. If the condition occurs at the time of parturition, there will be an obvious lack of colostrum. Calves of these cows may attempt to vigorously suck their dams, attempt to eat dry feed, drink surface water or urine, and bellow continuously. Affected cows and their calves may die within 7 to 10 days.

Protein-energy malnutrition is less common in dairy cattle because they are usually fed to meet the requirements of maintenance and milk production. Dairy calves fed inferior-quality milk replacers during periods of cold weather will lose weight, become inactive and lethargic, and may die within 2 to 4 weeks. Affected calves may maintain their appetites until just before death. Diarrhea may occur concurrently and be confused with acute undifferentiated diarrhea as a result of the enteropathogenic viruses or cryptosporidiosis. Affected calves recover quickly when fed cow's whole milk.

Protein-energy malnutrition also occurs in sheep and, less commonly, in goats. Excessive dental attrition is a common cause in grazing sheep, which is exacerbated by the excessive ingestion of soil.

## DIFFERENTIAL DIAGNOSIS

The diagnosis will depend on an estimation of the concentration of energy and protein in the feed, or a feed analysis, and comparing the results with the estimated nutrient requirements of the class of affected animals. In some cases, a sample of feed used several weeks earlier may no longer be available, or the daily feed intake may not be known. Marginal deficiencies of energy and protein may be detectable with the aid of a metabolic profile test. Specific treatment of livestock affected with protein-energy malnutrition is usually not undertaken because of the high cost and prolonged recovery period. Oral and parenteral fluid and electrolyte therapy can be given as indicated. The provision of high-quality feeds appropriate to the species is the most cost-effective strategy.

## PREVENTION

The prevention of protein-energy malnutrition requires the provision of the nutrient requirements of the animals according to age, stage of pregnancy and production, the environmental temperature, and the cost of the feeds. Body-condition scoring of cattle and sheep can be used as a guide to monitor body condition and nutritional status. Regular analysis of feed supplies will assist in the overall nutritional management program. The published nutrient requirements of domestic animals are only guidelines to estimated requirements because they were determined in experimental animals selected for uniform size and other characteristics. Under practical conditions, all of the common factors that affect requirements must be considered.

## FURTHER READING

- Freer M, ed. *Nutrient Requirements of Domesticated Ruminants* [eBook]. Melbourne: CSIRO Publishing; 2007.
- Freer M, Dove H, eds. *Sheep Nutrition*. Wallingford, Oxon, UK: CSIRO and CABI Publishing; 2002.
- Hayton A, Husband J, Vecqueray R. Nutritional management of herd health. In: Green M, ed. [eBook]. *Dairy Herd Health*. Wallingford, Oxon, UK: CAB International; 2012.
- Herring AD. *Beef Cattle Production Systems*. Wallingford, Oxon, UK: CAB International; 2014.

## REFERENCE

1. Grazfeed v 5.04, CSIRO. Accessed at <<http://www.hzn.com.au/grazfeed.php>>; June 18, 2016.

## LOW-MILK-FAT SYNDROME

In low-milk-fat syndrome, the concentration of fat in milk is reduced, often to less than 50% of normal, while milk volume is maintained. This syndrome is a significant cause of wastage in high-producing cows. Low concentration of fat in milk occurs with ruminal acidosis in cattle.<sup>1</sup> The cause appears to be an increase in concentrations

of conjugated linoleic acid in the diet, with subsequent reduction in lipogenesis in the udder.<sup>2</sup> A supply of polyunsaturated fatty acids in the cows' ration and alteration in fermentation in the rumen results in biohydrogenation of linoleic acid (abundant in oils and seeds) and formation of intermediate hydrogenated fatty acids are absorbed into the blood and have an inhibitory effect on lipogenesis.<sup>3</sup> This syndrome occurs most commonly in cows on low-fiber diets, for example, lush, irrigated pasture or grain rations that are ground very finely or fed as pellets. Treatment is achieved by administration of sodium bicarbonate or magnesium oxide, which increase fiber digestibility and hence the propionate:acetate ratio. Magnesium oxide also increases the activity of lipoprotein lipase in the mammary gland and increases uptake of triglycerides by the mammary gland from the plasma.<sup>4</sup>

## REFERENCES

1. Atkinson O. *Cattle Pract*. 2014;22:1.
2. Gulati SK, et al. *Can J Anim Sci*. 2006;86:63.
3. Dubuc J, et al. *Point Veterinaire*. 2009;40:45.
4. Radostits O, et al. *Veterinary Medicine: a Textbook of the Diseases of Cattle, Horses, Sheep, Goats, and Pigs*. 10th ed. London: W.B. Saunders; 2006: 1686.

## Diseases Associated With Deficiencies of Mineral Nutrients

There is an enormous literature about mineral nutrient deficiencies in livestock, and thus it is not possible to comprehensively review it here, but some general comments are appropriate. In developed countries, severe deficiencies of single elements affecting very large numbers of animals now seldom occur. The diagnostic research work has been done, the guidelines for preventive programs have been outlined, and these have been applied in the field. Thus the major contributions to knowledge have already been made, and what remains is essentially applying and extending that knowledge. Some loose ends remain, including preventing the overzealous or unnecessary application of minerals, which can produce toxicoses or is simply not cost-effective; sorting out the relative importance of the constituent elements in combined deficiencies, characterized by incomplete response to single elements; and devising better ways of detecting marginal deficiencies.

At least 15 mineral elements are essential nutrients for ruminants. The macrominerals, required daily in gram amounts, are calcium, phosphorous, potassium, sodium, chlorine, magnesium, and sulfur. The trace elements, or microminerals, are copper, selenium, zinc, cobalt, iron, iodine, manganese, and

molybdenum. Improving trace-element nutrition of grazing livestock, in a way that is cost-effective and that meets consumer perceptions and preferences, is a continuing challenge.<sup>1</sup>

## PREVALENCE AND ECONOMIC IMPORTANCE

Despite experimental evidence that deficiencies or excesses of trace elements can influence growth, reproductive performance, or immunocompetence of livestock, there is often a lack of information on the prevalence and economic significance of such problems. Most published reports of trace-element-related diseases are case reports and thus provide insufficient information to assess prevalence and economic impact on a regional or national scale. Many reports are also compromised by commercial bias. Despite this, Food and Agriculture Organization/World Health Organization (FAO/WHO) Animal Health Yearbooks show that of the countries providing information on animal diseases, 80% report nutritional diseases of moderate or high incidence, and trace-element deficiencies or toxicities are involved in more than half of those whose causes were identified. As a specific example, in the United Kingdom it has been estimated that despite the activities of its nutritional and veterinary advisory services, and extensive supplementation, clinical signs of copper deficiency occur annually in approximately 1% of the cattle population. Copper deficiency can also predispose to increased mortality as a result of infectious diseases in lambs, and so it is likely that the economic losses from copper deficiency may be considerably underestimated even in developed agricultural economies.

## DIAGNOSTIC STRATEGIES

In developed countries with more advanced livestock industries, the emphasis is on disease prevention rather than therapy, and the cost-effective control of trace-element deficiencies is a matter of ongoing farmer education rather than research. Copper, cobalt, selenium, and iodine deficiencies can affect reproductive performance, appetite, early postnatal growth, and immunocompetence on a herd or flock basis, and thus emphasis is placed on identifying the risk of deficiency before clinical signs appear.

Monitoring the trace-element status of livestock is typically done by blood, saliva, or tissue analysis, or less commonly by measuring the concentration of the trace element in the diet. An alternative way of monitoring preclinical stages of a trace element deficiency is to identify and measure a biochemical indicator that reflects changes in the activity of an enzyme involved in a key metabolic pathway, such as vitamin B<sub>12</sub> or glutathione peroxidase, which are indirect



measures of cobalt and selenium nutrition in sheep, respectively. To be useful, techniques should be able to predict the likely pathologic outcome of different suboptimal concentrations of a particular measure, and hence when it is clinically and economically justifiable to apply treatments or interventions. For example, a high proportion of grazing cattle become hypocupremic if maintained on pasture forage, but they don't develop clinical signs of deficiency, and only a small percentage exhibit any physiologic response to the administration of copper. This illustrates the variation in the development of clinical signs of copper deficiency, which can be induced by a simple dietary deficiency or by interactions between copper and other elements in the diet, such as molybdenum, sulfur, and iron. There is also evidence that genetic variation influences the utilization of trace elements by livestock. For example, there are differences in dietary requirements for copper between some breeds of sheep. Sheep can also be selected for a high or low concentration of plasma copper, which can have profound physiologic consequences in the low-copper group.

Thus although it is known from soil maps and local knowledge where trace-element deficiencies occur, their prevalence and importance may be underestimated because subclinical deficiency may go unnoticed for prolonged periods.

## DEFICIENCIES IN DEVELOPING COUNTRIES

In developing countries, deficiencies of trace elements are often hidden or confounded by gross nutritional deficiencies of energy, protein, phosphorus, and water, which affect postnatal growth and reproductive performance. Undernutrition is the most important limitation to herbivore livestock production in tropical countries, but mineral deficiencies or imbalances in soils and pasture forages, particularly of phosphorus, cobalt, or copper, are also responsible for poor reproductive performance and low growth rates.

## PATHOPHYSIOLOGY OF TRACE-ELEMENT DEFICIENCY

The physiologic basis of trace-element deficiency is complex.<sup>1</sup> Some trace elements are essential for the function of a single enzyme, whereas others are involved in multiple metabolic pathways. Consequently, a deficiency of a specific element may affect one or more metabolic processes and produce a variety of clinical signs in different classes of livestock. Furthermore, there is a wide variation in the clinical response to decreased blood or tissue concentrations of a trace element between individuals. For example, two animals in a herd or flock with the same concentration of copper in their blood may be in different body condition. Their susceptibility to

clinical disease will also be influenced by their age, physiologic status (pregnant, lactating, or dry), genetic differences, and interactions with other trace elements. For example, there is good evidence that whereas dietary copper may be adequate for some breeds of sheep, such concentrations may be deficient, or even toxic, for others.

Dietary deficiency does not inevitably lead to clinical disease, but several factors interact and predispose the animal to clinical disease, including the following:

- Age—for example, late-term fetal lambs are highly susceptible to demyelination as a result of copper deficiency, which produces “swayback.”
- Genetic differences and individual variation in response to deficiency.
- Fluctuating demand for trace elements because of changes in growth, physiologic status (especially lactation), and diet.
- Substitution—the use of alternative metabolic pathways in response to a deficiency, such as selenium, which may incompletely protect sheep from white-muscle disease when the diet is deficient in vitamin E.
- Size of the functional reserves.

The trace elements are component parts of many tissues and are often involved in metabolic pathways, either as a single key enzyme or in many interacting components. Consequently, their deficiency leads to a variety of pathologic consequences, metabolic defects, and clinical signs. These are summarized in Table 17-12.

The soil and its parent materials are the primary sources of trace elements from which soil–plant–animal relationships are built. Soil maps created from geochemical surveys can help identify areas in which livestock are exposed to excessive ingestion or deficiencies of trace elements. Variations in the concentration of most trace elements in soils are quite wide, ranging from soils that are grossly deficient to those that are potentially toxic. The availability of trace elements to plants is controlled by their total concentration in the soil and their chemical form. Certain species of plants take up more trace elements than others, and the ingestion of soil can also have a profound effect on the nutrition and metabolism of some trace elements.

It is often difficult to determine the role of individual trace elements in deficiency states because many trace-element

**Table 17-12** Principal pathologic and metabolic defects in essential trace-element deficiencies

Deficiency	Pathologic consequence	Associated metabolic defect
Copper	Defective melanin production	Tyrosine/DOPA oxidation
	Defective keratinization; hair, wool	–SH oxidation to S–S
	Defective cross linkages in connective tissue, osteoporosis	Lysyl oxidase
Cobalt	Ataxia, myelin aplasia	Cytochrome c oxidase
	Growth failure	Decreased biogenic molecules such as gastrin
	Anemia	Ceruloplasmin (ferroxidase)
Selenium	Uricemia	Urate oxidase
	Anorexia	Methyl malonyl CoA mutase
	Impaired oxidation of propionate	Tetrahydrofolate methyl transferase
Zinc	Anemia	
	Myopathy; cardiac/skeletal	Peroxide/hydroperoxide destruction
	Liver necrosis	Decreased glutathione peroxidase
Iodine	Defective neutrophil function	OH; O <sub>2</sub> generation
	Anorexia, growth failure	Multifactorial; increased expression of leptin (satiety signal) and cholecystokinin (appetite regulation), reduced pyruvate kinase
	Parakeratosis	Polynucleotide synthesis, transcription, translation?
Manganese	Perinatal mortality	
	Thymic involution	
	Defective cell-mediated immunity	
Manganese	Thyroid hyperplasia	Decreased thyroid hormone synthesis
	Reproductive failure	
	Hair, wool loss	
Manganese	Skeletal/cartilage defects	Chondroitin sulfate synthesis
	Reproductive failure	

deficiencies produce nonspecific and specific clinical signs, especially when complex interactions occur. Consequently, the dose–response trial still has a significant role to investigate complex or marginal deficiencies and whether a cost-effective response will occur on a particular farm.<sup>2</sup> A properly conducted dose–response trial requires comparison of the response to treatment, typically a biochemical indicator and a measure of production, such as body weight, in a supplemented and control group. Ideally, animals should be randomly selected and allocated to groups, and the groups should be of sufficient size to reliably detect an economically significant difference (e.g., have a 95% chance of detecting a 1-kg difference in body weight). Where appropriate, the control (unsupplemented) group should be treated with the vehicle or inactive portion of the substance given to the supplemented group (a placebo). Additional requirements for a reliable dose–response trial include a careful appraisal of the reasons for conducting the trial, a suitable form of treatment, and a reliable biochemical method for monitoring the response to the trace element. Dose–response trials establish a link between a trace element and certain clinical signs. They can also identify factors that modify the response to a trace element and, importantly, provide some indication of the economic response to supplementation.

The ad hoc field observations made by veterinarians who make a diagnosis of a trace-element deficiency, followed by treatment or dietary changes, are subjective and usually lack controls. Nevertheless, they are useful in that they indicate the magnitude and variability of response that might be expected in future studies.

There are major challenges in predicting and diagnosing trace-element deficiencies in grazing livestock, including complex interactions between dietary constituents and the homeostatic mechanisms of the animal. Thus it is usually impossible to predict from the composition or analysis of the diet whether clinical signs of deficiency will occur. Consequently, assessment of the absorbable, rather than the total, concentration of elements in the diet is now considered to be more important in understanding the nutritional basis for the deficiencies, but tests of the livestock are a more definitive assessment of deficiency.

### LABORATORY DIAGNOSIS OF MINERAL DEFICIENCIES

The diagnosis of mineral deficiencies, particularly trace-element deficiencies, relies heavily on the interpretation of the biochemical tests. This is because deficiencies of any one or more of several trace elements can result in nonspecific clinical abnormalities, such as loss of weight, growth retardation, anorexia, and inferior reproductive performance.

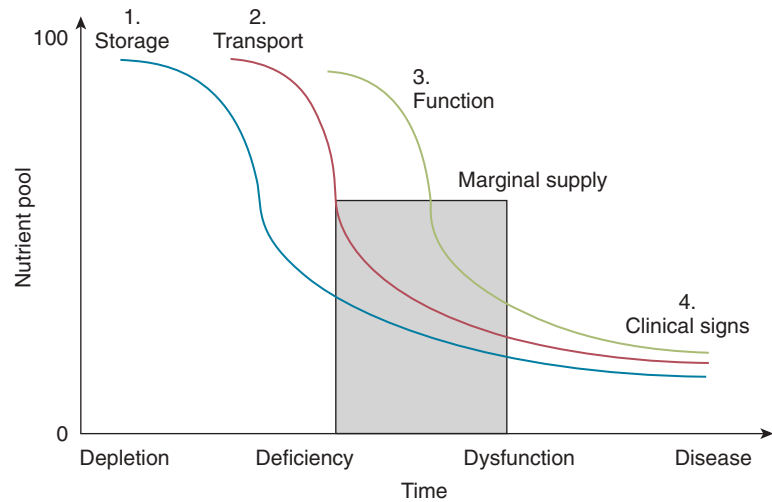

**Fig. 17-11** The sequence of pathophysiological changes that can occur in mineral-depleted livestock, commencing with depletion and ending with clinical disease, and their relation to the body pools of that nutrient. (Reproduced with permission from Suttle NF. *Mineral Nutrition of Livestock*. 4th ed. Wallingford, Oxon, UK: CAB International; 2010 [Chapter 1].)

The interpretation of biochemical criteria of trace-element status is governed by three important principles: **relationship with intake, time, and function**. These are further explained as follows:

1. Relationship between the tissue concentrations of a direct marker and the dietary intake of the element will generally be sigmoid in shape (a dose–response curve). The important point on the curve is the intake at which the requirement of the animal is passed, which is the intake of the nutrient needed to maintain normal physiologic concentrations of the element and/or avoid impairment of essential functions. For several markers of trace-element status, the position on the x-axis at which the requirement is passed coincides with the end of the lower plateau of the response in marker concentration. Under these conditions, the marker is an excellent index of sufficiency and body reserves, but an insensitive index of a deficiency. If requirement is passed at the beginning of the upper plateau, the marker is a poor index of sufficiency, but a good index of deficiency. This principle allows direct markers to be divided into storage and nonstorage types corresponding to the former and latter positions on the x-axis.
2. Nonstorage criteria can be divided into indicators of acute and chronic deficiency, and two types of relationships can be distinguished: a rapid, early decline in marker concentration followed by a plateau; and a slow, linear rate of decline. Markers with a slow, linear response will be good indices of a chronic deficiency, but unreliable indices of acute deficiency, because they cannot respond quickly

enough. Conversely, the marker with a rapid, early decline will be a good index of acute deficiency, but an unreliable indicator for chronic deficiency if the low plateau is reached before functions are impaired. Those biochemical criteria that are based on metalloenzyme or metalloprotein concentrations in erythrocytes are of the slow type because the marker is incorporated into the erythrocyte before its release into the bloodstream, and thereafter its half-life is determined by that of the erythrocyte, which is 150 days or more. Metalloenzymes or metalloproteins in the plasma with short half-lives provide markers of the rapid type.

3. A deficiency can be divided into four phases: depletion, deficiency (marginal), dysfunction, and clinical disease. During these phases there are progressive changes in the body pools of mineral that serve as storage (e.g., liver for copper, bone for Ca and P), transport (e.g., plasma), and function (e.g., muscle enzymes) (Fig. 17-11).<sup>3</sup>

Depletion is a relative term describing the failure of the diet to maintain the trace-element status of the body, and it may continue for weeks or months without observable clinical effects when substantial body reserves exist. When the net requirement for an essential element exceeds the net flow of the absorbed element across the intestine, then depletion occurs. The body processes may respond by improving intestinal absorption or decreasing endogenous losses. During the depletion phase, there is a loss of trace element from any storage sites, such as the liver, during which time the plasma concentrations of the trace element may remain constant. The liver is a common store for copper, iron, and vitamins A and B<sub>12</sub>.

If the dietary deficiency persists, eventually there is a transition from a state of depletion to one of deficiency, which is marked by biochemical indications that the homeostatic mechanisms are no longer maintaining a constant level of trace elements necessary for normal physiologic function. After variable periods of time, the concentrations or activities of trace-element-containing enzymes will begin to decline, leading to the phase of dysfunction. There may be a further lag period, the subclinical phase, before the changes in cellular function are manifested as clinical disease. The biochemical criteria can be divided, according to the phase during which they change, into indicators of marginal deficiency and dysfunction. The rate of onset of clinical disease will depend on the intensity of the dietary deficiency, the duration of the deficit, and the size of the initial

reserve. If reserves are nonexistent, as with zinc metabolism, the effects may be acute, and the separate phases become superimposed. The application of these principles to the interpretation of biochemical criteria of trace-element status is presented elsewhere where applicable, in the discussion of each mineral nutrient.

The definitive etiologic diagnosis of a trace-element deficiency will depend on the response in growth and health obtained following treatment or supplementation of the diet. The concurrent measurement of biochemical markers will aid in the interpretation and validation of those markers for future diagnosis. The strategies for anticipating and preventing trace-element deficiencies include regular analysis of the feed and soil, which is not highly reliable, and monitoring samples from herds and flocks to

prevent animals from entering the zone of marginal trace-element deficiencies that precedes the onset of functional deficiency. The decision to intervene can be safely based on the conventional criteria of marginal trace-element status.

#### FURTHER READING

- Lee J, Masters DG, White CL, Grace ND, Judson GJ. Current issues in trace element nutrition of grazing livestock in Australia and New Zealand. *Aust J Agric Res.* 1999;50:1341-1364.
- Suttle NF. *Mineral Nutrition of Livestock*. 4th ed. Wallingford, Oxon, UK: CAB International; 2010.

#### REFERENCES

1. Suttle NF. *Mineral Nutrition of Livestock*. 4th ed. Wallingford, Oxon, UK: CAB International; 2010 [Chapter 1].
2. Ibid., [Chapter 19].
3. Ibid., [Chapter 3].



**INFECTIOUS DISEASES PRIMARILY AFFECTING THE REPRODUCTIVE SYSTEM 1758**

Induction of Parturition 1758

Freemartinism in Calves 1760

Buller Steer Syndrome 1760

**INFECTIOUS DISEASES PRIMARILY AFFECTING THE REPRODUCTIVE SYSTEM 1761**Brucellosis Associated With *Brucella abortus* (Bang's Disease) 1761Brucellosis Associated With *Brucella ovis* 1774Brucellosis Associated With *Brucella suis* in Pigs 1778Brucellosis Associated With *Brucella melitensis* 1781Abortion in Ewes Associated With *Salmonella abortusovis* 1784Abortion in Mares and Septicemia in Foals Associated With *Salmonella**abortusequi* (*abortivoequina*) (Equine Paratyphoid) 1785

Chlamydial Abortion (Enzootic Abortion of Ewes, Ovine Enzootic Abortion) 1786

Coxiellosis (Q-Fever) 1791

Diseases of the Genital Tract Associated With *Mycoplasma* spp. 1793

Equine Coital Exanthema 1794

Porcine Reproductive and Respiratory Syndrome (PRRS) 1794

Menangle 1816

Japanese Encephalitis (JE; Japanese B Encephalitis) 1817

Neosporosis 1817

Dourine (*Maladie du coit*) 1819**TOXIC AGENTS PRIMARILY AFFECTING THE REPRODUCTIVE SYSTEM 1821**

Estrogenic Substances 1821

Phytoestrogen Toxicosis 1822

Zearalenone Toxicosis 1824

Mare Reproductive Loss Syndrome (Early Fetal Loss, Late Fetal Loss, Fibrinous Pericarditis, and Unilateral Uveitis) 1825

Equine Amnionitis and Fetal Loss 1827

Plants and Fungi (Unknown Toxins) Affecting the Reproductive System 1827

**CONGENITAL AND INHERITED DISEASES PRIMARILY AFFECTING THE REPRODUCTIVE SYSTEM 1828**

Chromosomal Translocations in Cattle 1828

Inherited Prolonged Gestation (Adenohypophyseal Hypoplasia) 1828

Inherited Inguinal Hernia and Cryptorchidism 1829

**Infectious Diseases Primarily Affecting the Reproductive System**

This chapter presents information related to important and selected livestock pathogens that affect not only the fertility but also the health of animals, and in some cases, such as bovine brucellosis, the health of humans. It is worth noting that national control and eradication campaigns against *Brucella abortus* infection in cattle played, and continue to play, an important global role in expanding the veterinary profession. More recently, the worldwide spread of porcine reproductive and respiratory syndrome (PRRS) virus during the last 20 years has had a marked economic impact on the swine industry. As a consequence, PRRS is currently one of the most intensively researched diseases of livestock.

Readers seeking detailed information related to reproductive performance, the estrous cycle, conception, pregnancy, and parturition are directed to the many excellent textbooks that address these subjects.

**INDUCTION OF PARTURITION****CALVES**

The induction of parturition in pregnant cows during the last 6 weeks of gestation by

the parenteral injection of corticosteroid with or without prostaglandin F<sub>2α</sub> (PGF<sub>2α</sub>) has raised the question of animal welfare and of the possible effects of prematurity on the disease resistance of the newborn calf. The induction of premature parturition in cattle has found application in the following areas:

- With pastoral-based dairy production, synchronization of the calving period has allowed maximal utilization of seasonally available pastures by the synchronization of peak demand for dry matter intake with spring flush in pasture growth. In pastoral-based herds with breeding for seasonal calving, late-calving cows will be induced and these average approximately 8% of the herd.
- Ensuring that calving coincides with the availability of labor to facilitate observations and management of calving and to overcome the inconvenience caused by late-calving cows.
- Minimizing dystocia in small heifers and animals with exceedingly long gestation periods (past due).
- The therapeutic termination of pregnancy for various clinical reasons.
- As an aid in the control of milk fever in combination with parenteral administration of vitamin D analogs.

A variety of short-acting and long-acting corticosteroids have been used. A single injection of a short-acting formulation is

used when it is desirable to induce calving within the last 2 weeks of gestation. Earlier in pregnancy short-acting corticosteroids were found to be insufficiently reliable to induce parturition, which has led to the common use of long-acting corticosteroid formulations. A variety of protocols to induce premature parturition (3–6 weeks before due date) are used in practice; the main issue is the poor predictability of the time of calving relative to treatment when using long-acting corticosteroids. Common protocols use a second treatment with short-acting corticosteroids or the administration of PGF<sub>2α</sub> 50 to 10 days after the initial treatment. The use of PGF<sub>2α</sub> at least 9 days after treatment with long-acting corticosteroids was found to reliably narrow down the calving time, with the great majority of all cows calving within 72 hours of PGF<sub>2α</sub> treatment.<sup>1</sup> The use of PGF<sub>2α</sub> did not improve the viability of the premature neonates or their survival rate.

For cattle near term (within 2 weeks of due date) the use of short-acting corticosteroid formulation is more appropriate with parturition generally occurring within 2 to 4 days posttreatment.<sup>2</sup>

The **mortality rate** of induced calves is considerable and can exceed 30%, particularly when dams are induced at or before the eighth month of gestation.<sup>2</sup> Mortality in calves born as a result of induced parturition is primarily a result of prematurity, and

calf mortality is generally low when calving is induced within 12 days of parturition, although there are welfare concerns. The calves born earlier in pregnancy after using long-acting corticosteroid are usually lighter in weight, lethargic, and slow to stand and to suck properly. The serum immunoglobulin concentration was found to be lower in calves born from dams induced with long-acting corticosteroids because of interference with intestinal absorption by the corticosteroid. Up to 60% of calves born following induction with long-acting corticosteroids are at risk for failure of transfer of passive immunity. The colostrum available to such calves also has a reduced immunoglobulin content, and there may also be a reduction in the total volume of colostrum available from the induced-calving cows. Immunoglobulin absorption rates were not impaired when short-acting corticosteroids are used to induce calving close to term.

Artificial induction of parturition is an important risk factor for retention of the placenta, and the incidence is reported to vary from 20% to 100%. Subsequent reproductive performance of induced cows can be impaired. A risk for acute gram-negative bacterial infections is reported in a low (0.3%) proportion of cows following induction with dexamethasone. The use of long-acting corticosteroids was also associated with a higher incidence of photosensitization in treated heifers.<sup>2</sup>

In a study where partus induction was systematically used in cows that exceeded a gestation length of 282 days, no detrimental effects on calf viability, cow health, and productive and reproductive performance during lactation were found compared with untreated control animals. The incidence of retained fetal membranes in untreated animals was not recorded in this study and could thus not be compared with treated animals.<sup>2</sup>

When parturition is induced in large herds of beef cattle, particularly with a high percentage of heifers, increased surveillance will be necessary after the calves are born to avoid mismothering. Every attempt must be made to establish the cow-calf pair (neonatal bond) and move them out of the main calving area. Heifers that disown their calves must be confined in a small pen and be encouraged to accept the calf and let it suck, which is sometimes a very unrewarding chore. Calf mortality can be very high where calving is induced earlier than 35 weeks of pregnancy.

## LAMBS

The induction of parturition in sheep is not a common practice, but it can be used to synchronize lambing in flocks where there are accurate dates of mating for individual ewes. Unless accurate dates are available, there is risk of prematurity. Also, ewes that are more than 10 days from their normal parturition date are unlikely to respond.

Induction of parturition is also used as a therapeutic ploy to terminate pregnancies in sheep with pregnancy toxemia. Induction is usually performed with dexamethasone and less commonly with betamethasone or flumethasone, which is more expensive. Lambing occurs 36 to 48 hours later, and there may be breed differences in response. Variability in lambing time can be reduced by the use of clenbuterol and oxytocin.

## FOALS

The induction of parturition in mares for reasons of economy, management convenience, concern for prolonged gestation, or clinical conditions such as prepubic tendon rupture or research and teaching is now being practiced.

Foaling can be induced with oxytocin, ideally administered as an intravenous (IV) drip over 15 to 30 minutes, and occurs within 15 to 90 minutes of its administration. High doses of oxytocin are potentially dangerous to the foal and low doses (10–20 IU) are preferred. Glucocorticoids, and antiprogestagens that are effective in inducing pregnancy in other species, are either ineffective in the mare or capricious in their efficacy and can also be associated with adverse effects on the foal.

Prostaglandin F<sub>2α</sub> and its analogs have been used for partus induction in the mare and low doses (5–12 mg intramuscularly [IM]) may be effective at term, but repeated treatments may be required. The time interval between treatment and delivery is difficult to predict and can range from 1 to 48 hours. The use of PGF<sub>2α</sub> for partus induction in mares has been discouraged because considerable risks such as premature placental separation and foal death that have been associated with this treatment.<sup>3</sup>

Induction of parturition in the mare is not without risk and has been associated with the birth of foals that are weak, injured, or susceptible to perinatal infections. The period of fetal maturation is relatively short in the horse and is considered to be the last 2 to 3 days' gestation. Because spontaneous parturition in healthy mares can occur between 320 and 360 days, there is the risk of delivering a foal that is premature and nonviable. Fetal maturity is the major prerequisite for successful induced parturition, and the three essential criteria are

- A gestational length of more than 330 days
  - Substantial mammary development and the presence of colostrum in the mammary gland with a calcium concentration greater than 10 mmol/L
  - Softening of the cervix
- The rise in calcium concentration is the most reliable predictor of fetal maturity and milk calcium concentrations above 10 mmol/L, in combination with a concentration of potassium that is greater than sodium, are indicative of fetal maturity. Commercial milk test strips are available for estimating mammary

secretion electrolyte concentrations; however, it is recommended that testing be done in an accredited laboratory.

In mature foals, head lifting, sternal recumbency, and evidence of suck reflex occurs within 5 minutes of spontaneous full-term deliveries. The foal can stand within 1 hour and suck the mare within 2 hours. The behavior and viability of the premature foal after induced parturition have been described. The overall survival rate of foals delivered from induced parturition before 320 days' gestation was 5%. Four patterns of neonatal adaptation were observed on the basis of righting, sucking, and standing ability. If the suck reflex was weak or absent and the foals were unable to establish righting reflexes, the prognosis of survival was poor. Foals born before 300 days' gestation did not survive for more than 90 minutes; foals born closer to 320 days' gestation had a better chance of survival and exhibited behavioral patterns of adaptation.

In addition to the potential delivery of a premature or weak foal, other adverse effects of induction can be dystocia, premature placental separation, and retained placenta.

## PIGLETS

The induction of parturition of gilts and sows on days 112, 113, or 114 of gestation is highly reliable and can be achieved by a single IM injection of 175 µg of cloprostenol or 5 to 10 mg of PGF<sub>2α</sub>. The sows farrow approximately 20 to 36 hours later. Synchronization of farrowing can be improved by administration of oxytocin (5–30 IU) 20 to 24 hours after injection of PGF<sub>2</sub>.

Induction of parturition has been used on large-scale farms to allow a concentration of labor, to improve supervision and care at the time of farrowing, to reduce the incidence of the mastitis/metritis/agalactia syndrome, and to reduce the percentage of stillborn piglets. The end day of a batch farrowing system can be fixed and weekend farrowing avoided. The subsequent fertility of the sows is not impaired. Induction on day 110 may be associated with a slight increase in perinatal mortality.

### TREATMENT

#### Premature partus induction cattle (>2 weeks before due date):

Dexamethasone trimethyl-acetate (or other long-acting formulation) (25–30 mg/animal IM as single dose) (R-1)

Dinoprost (or other PGF<sub>2α</sub>-analogon) (25 mg/animal IM as a single dose 5–10 days after dexamethasone treatment) (R-2)

#### Partus induction cattle (<2 weeks before due date):

Dexamethasone sodium-phosphate (or other short-acting formulation) (40 mg/animal IM as a single dose) (R-1)

*Continued*

Cloprostenol (500 µg/animal IM 36–48 h after dexamethasone treatment) (R-1)

Dinoprost (25 mg/animal IM as a single dose 36–48 h after dexamethasone treatment) (R-2)

**Partus induction mare:**

Oxytocin (10–20 IU/animal as IV drip over 15–30 min, several repetitions possible) (R-1)

Prostaglandin F<sub>2α</sub> (or analogon) (R-3)

**Partus induction sow:**

Prostaglandin F<sub>2α</sub> (or analogon) (10–25 mg/animal IM) (R-1)

Cloprostenol (175 µg/animal IM) (R-1)

Oxytocin (5–30 IU/animal IM 20–24 h after treatment with PGF<sub>2α</sub>) (R-1)

**Partus induction ewe:**

Dexamethasone (15–20 mg/animal IM) (R-1)

IM, intramuscularly; IV, intravenously.

## FURTHER READING

- Ingoldby L, Jackson P. Induction of parturition in sheep. *In Pract.* 2001;23:228231.
- MacDiarmid SC. Induction of parturition in cattle using corticosteroid: a review. Part 1. Reasons for induction, mechanisms of induction and preparations used. *Anim Breed Abstr.* 1983;51:40319.
- MacDiarmid SC. Induction of parturition in cattle using corticosteroid: a review. Part 2. Effects of induced calving on the calf and cow. *Anim Breed Abstr.* 1983;51:499508.
- Pressing AL. Pharmacologic control of swine reproduction. *Vet Clin North Am Food Anim Pract.* 1992;8:70723.

## REFERENCES

- Mansell PD, et al. *Aust Vet J.* 2006;84:312.
- Villarreal A, Lane VM. *Can J Vet Res.* 2010;74:136.
- Olsey J. *Equine Vet Educ.* 2003;15:164.

## FREEMARTINISM IN CALVES

A freemartin is defined as a sterile female partner of a pair of heterosexual twins. In cattle, 92% of females born cotwins to males are freemartins.

In normal calves, the chromosomal identification of females is 60,XX (60 chromosomes, both X chromosomes) and of males is 60,XY (the Y being smaller and not readily paired with its opposite X chromosome).

The freemartin is the classical example of the chimera in cytogenetics. They are the individuals that contain two or more cell types that originated in separate individuals. The only way in which a chimera can develop is via the fusion of circulations or zygotes in utero. Sex chromosome chimerism is also reported in goats, sheep, and pigs, and, although the male partners of female twins are usually anatomically normal, they often have reduced fertility. Bulls born cotwin with freemartin females may also be chimeric and have low reproductive efficiency.

The diagnosis of freemartinism has been based on physical examination, karyotyping, or blood typing, and each has its limitations. There is variation in the degree of reproductive tract abnormalities in freemartins. The external genitalia may appear normal, the vulval hair may be coarser than usual, or the clitoris may be enlarged. The vagina is generally expected to be shorter than normal. The cervix, uterus, uterine tubes, and ovaries may be absent, present in underdeveloped form, or may appear normal on rectal palpation.

Special cytogenetic techniques are also available that facilitate the diagnosis of freemartinism in a female calf of a male–female twinning. In freemartins (phenotypically female, but also carrying male cells) there is a mixture of mostly 60,XX chromosomes to a cell and a small proportion of 60,XY cells. A large number of cells need to be analyzed if only the freemartin calf is available, because the proportion of abnormal cells present may be as low as 2%. It is, however, possible to make a diagnosis on the examination of 10 to 20 cells, provided the male twin is also analyzed; the female may have very few XY chromosomes, but the male will have a very high proportion of XX chromosomes. This technique is much more accurate than blood group analysis or clinical observations of a short vagina, enlarged clitoris, and the presence of a vulval tuft of hair. Karyotyping is a definitive method of freemartin diagnosis, but it is tedious, time-consuming, and expensive. Blood typing analysis may be performed on both the male and female cotwins to demonstrate two blood group populations, but it is expensive and requires blood samples from both cotwins.

The **polymerase chain reaction (PCR)** method of freemartin diagnosis using sex-specific DNA sequences is rapid, accurate, relatively simple, and inexpensive to perform, and a blood sample is required only from the female cotwins. It allows for the accurate decision of freemartinism down to a level of 0.05% of male chimeric cells present.

## FURTHER READING

- Padula AM. The freemartin syndrome: An update. *Anim Reprod Sci.* 2005;87:93-109.

## BULLER STEER SYNDROME

### SYNOPSIS

**Etiology** Unknown. Behavioral problem of steers in feedlots.

**Epidemiology** Prevalence varies and increases with increasing age and weight at entry.

**Clinical findings and lesions** Areas of denuded hair, subcutaneous hematomas, and other traumatic injuries.

**Treatment** Symptomatic.

**Control** Removal from pen.

## ETIOLOGY

The buller steer syndrome is a **behavioral** problem in cattle confined in feedlots<sup>1</sup> of unknown etiology. Within a pen of cattle, one or more cattle persistently ride a particular individual or individuals of the group. The ridden animals are referred to as bullers. There have been several suspect etiologies. Improper placement of hormonal growth implants has been suspected as being associated with this behavioral problem.

## EPIDEMIOLOGY

### Occurrence

The syndrome occurs only in cattle in feedlots. A recent survey conducted among U.S. feedlots revealed a feedlot prevalence of 68.8% of all surveyed feedlots and an animal level prevalence of 2.8%.<sup>1</sup> The prevalence increases with increasing weight and age. The case fatality has been estimated at 1%. The incidence of occurrence is higher in the summer and the fall and during the first 30 days of the feeding period.

Epidemiologic studies indicate that bullers occur as a point source epidemic with the cause occurring soon after cattle arrive in the feedlot and mingle into pen groups. The peak incidence of bullers occurs much sooner after arrival and declines much quicker in older cattle. Bullers occur significantly sooner after mixing in older cattle than in younger cattle. The pen prevalence also increases as cattle become older on arrival at the feedlot and are more aggressive. As the prevalence of intact bulls increases in pens of cattle, so does the prevalence of bullers, presumably caused by more aggressiveness in the bulls.

### Risk Factors

Postulated causative and risk factors include the incorrect timing and administration of hormonal growth implants, reimplantation and double dosing, estrogenic substances in feeds, pheromones in the urine of certain cattle, improper or late castration of young cattle, daily feedlot management, weather and seasonal factors, disease, group size, and dominance behavior. However, these factors have not been well substantiated, and controlled studies have found little influence of implant type and implant timing on buller incidence.

The mixing and confinement of **unfamiliar cattle** into pen groups, with subsequent agonistic interactions because these cattle established a social hierarchy, are considered as important risk factors. Both riding behavior and antagonistic behavior cease once cattle establish a stable social hierarchy. This suggests that riding behavior and subsequent identification of bullers is associated with this dominance behavior. It is possible that when a dominant animal becomes ill in a pen, other more subordinate animals in the pen that were previously subdued in



dominance contests may want to fight the sick animal to achieve higher social status.

### Economic Importance

The syndrome has been ranked along with acute undifferentiated bovine respiratory disease and foot rot as **one of the three most important disease syndromes** in beef feedlots in North America. In addition to the economic loss from decreased weight gain, injury, treatment, death, and carcass condemnation, there are economic losses associated with extra handling necessary to accommodate affected cattle, the disruption of uniform marketing of cattle, especially in custom feedlots, and the need for extra pens in which to house the bullers. The importance of the syndrome includes animal welfare aspects.

Bullers may be at significantly greater risk of illness and mortality (from bacterial pleuropneumonia) than other steers. The association between illness, mortality, and bullers among individuals was greatest among the oldest yearling steers.

### CLINICAL FINDINGS

Two types of bullers are identified. **Type 1 or true bullers** stand as if they were a heifer in estrus and do not move away or show agonistic behavior when being mounted by rider cattle. There can be several rider cattle in a pen and type 1 bullers are rapidly damaged. **Type 2 bullers** are animals that appear low in social dominance. They use aggression to discourage riders and will lie down to avoid being ridden.

Affected animals show areas of denuded hair and have extensive subcutaneous hemorrhage. The hematomas may become infected and develop to subcutaneous pockets of pus and gas. Other traumatic injuries, such as limb fractures, also occur.

### CONTROL

Management of the syndrome has usually involved identification and removal from the pen to prevent injury and even death from riding-related injuries. The high rate of risk of illness and mortality in bullers relative to other feedlot steers suggests that bullers should always be checked for evidence of illness in addition to their removal from their designated pen to prevent severe riding-related injuries. Treating sick bullers may improve the chance of settling them back into their designated pen by allowing them to resume their original position in the social hierarchy.

### FURTHER READING

Blackshaw JK, Blackshaw AW, McGlone JJ. Buller steer syndrome review. *Appl Anim Behav Sci.* 1997;54:97.

### REFERENCE

1. USDA-APHIS. Feedlot 2011, Part IV. 2014. <[http://www.aphis.usda.gov/animal\\_health/nahms/feedlot/downloads/feedlot2011/Feed11\\_dr\\_PartIV.pdf](http://www.aphis.usda.gov/animal_health/nahms/feedlot/downloads/feedlot2011/Feed11_dr_PartIV.pdf)>; Accessed 20.01.2014.

## Infectious Diseases Primarily Affecting the Reproductive System

### BRUCELLOSIS ASSOCIATED WITH *BRUCELLA ABORTUS* (BANG'S DISEASE)

#### SYNOPSIS

**Etiology** *Brucella abortus*

**Epidemiology** Major cause of abortion in cattle in countries without a national control program. Undulant fever in humans; is an important zoonosis. Sexually mature animals susceptible; outbreaks occur in first-calf heifers, older cows are infected but do not abort. Transmitted directly from the infected animal to the susceptible animal by uterine discharges. Congenital infection occurs. Infection in wildlife species but significance to domestic animals unknown. Infection introduced into herd by unknown infected carrier animal. Natural infection and vaccination result in immunity to abortion but not infection, and infected animals remain serologically positive for a long time.

**Signs** Abortion epidemics in first-calf unvaccinated heifers after fifth month of pregnancy. Subsequent pregnancies carried to term. Orchitis and epididymitis in bulls. Synovitis (hygroma) occurs. Fistulous withers in horses.

**Clinical pathology** Serology. Serum agglutination test is standard test. Rose Bengal test (rapid screening test). Complement fixation test. ELISA test. Milk ring test. False-positive reactors are a major problem.

**Lesions** Necrotizing placentitis, inflammatory changes in fetus.

**Diagnostic confirmation** Culture organism from fetus. Positive serologic test in unvaccinated animal.

**Treatment** No treatment.

**Control** Test and reduce reservoir of infection. Quarantine. Depopulation. Vaccination to reduce incidence of abortion and percentage of infected animals. Eradication on herd and area basis by test and cull.

ELISA, enzyme-linked immunosorbent assay.

### ETIOLOGY

*Brucella abortus*, a gram-negative, facultative intracellular coccobacillus of the family Brucellaceae, is the organism responsible for **bovine brucellosis**. *B. abortus* is one of 10 species with validly published names, including *B. melitensis*, *B. abortus*, *B. suis*, *B. ovis*, *B. neotomae*, *B. canis*, *B. ceti*, *B. pinnipedialis*, *B. microti*, and *B. inopinata*, each of which has specific host preferences.<sup>1</sup> *B. abortus* is

responsible for bovine brucellosis, *B. melitensis* is the main causative agent of brucellosis in small ruminants and men, *B. suis* for brucellosis in swine, and *B. ovis* in sheep. *B. abortus* has eight recognized biovars (1–7, 9) of which the most prevalent are 1–4, and 9.<sup>2</sup> Approximately 5% of infections are from biovar 1. Biovar 2 was isolated in an outbreak of brucellosis in cattle in Canada in 1986. In the United States, biovars 1 to 4 are found.

### EPIDEMIOLOGY

#### Occurrence and Prevalence of Infection

Bovine brucellosis has a worldwide occurrence and, according to the Food and Agriculture Organization (FAO), the World Health Organization (WHO), and the World Organization for Animal Health (OIE), is still one of the most important and widespread bacterial zoonoses in the world. The prevalence of infection varies considerably among herds, areas, and countries. Many countries have made considerable progress with their eradication programs, and some have eradicated the disease. However, in other countries brucellosis is still a serious disease facing the veterinary and medical professions. Currently, Australia, New Zealand, Canada, Japan, and 16 member states of the European Union (EU) have a status as officially brucellosis free.<sup>2,3</sup> Bovine brucellosis remains prevalent in several southern European countries and the Mediterranean basin. The seroprevalence of bovine brucellosis in the Kars district of Turkey between 2004 and 2006 was determined to be around 34%.<sup>4</sup> In Greece 0.97%, in Italy 0.51%, in Portugal 0.19%, in Spain 0.07%, and in the UK 0.09% of all cattle herds were positive for brucellosis in 2012.<sup>3</sup> Although bovine brucellosis has been reported from Egypt (biovar 1), Iran (biovar 2), and Sudan (biovar 6), little is known about the infection prevalence in the region.<sup>5</sup>

In the United States, the entire country is classified as class free for bovine brucellosis. Notwithstanding, infection remains highly prevalent in the wildlife population in the Greater Yellowstone area, with occasional spread to cattle. Repeated incidents of brucellosis-infected cattle in Montana, Idaho, and Wyoming have been reported in recent years.<sup>2</sup> Bovine brucellosis remains an important bacterial disease in Mexico, with biovars 1–6 the most prevalent. Although limited epidemiologic data are available for Central America, the disease seems to prevail widely, with an estimated animal prevalence of between 4% and 8% and a (dairy) herd prevalence between 10% and 25%.<sup>5</sup> In South America Chile made great progress toward eradicating the disease, but it remains prevalent in Venezuela (animal seroprevalence 3%–4%), Argentina (animal seroprevalence 2%–3%), and Brazil.<sup>5</sup>

The livestock prevalence was estimated at 8.2% in East Africa, 15.5% in West Africa,

14.2% in South Africa, and 13.8% in North Africa.<sup>6</sup>

### Cattle

Infection occurs in cattle of all ages but is most common in sexually mature animals, particularly dairy cattle. **Abortions are most common during outbreaks and primarily occur in unvaccinated heifers over 5 months pregnant.** Bulls are affected with orchitis, epididymitis, and seminal vesiculitis.

### Camelids

Brucellosis has been reported in the one-humped (*Camelus dromedarius*) and two-humped camel (*C. bactrianus*) and New World camelids such as llama (*Lama glama*), alpaca (*Lama pacos*), guanaco (*Lama guanicoe*), and vicuña (*Vicugna vicugna*) and was related to contact with small and large ruminants infected with either *B. abortus* or *B. melitensis*.<sup>7</sup>

### Wildlife Species

The infection has been observed in American and European bison (*Bison bison*, *B. bonasus*); domestic buffalo (*Bubalus bubalus*); elk (*Cervus elaphus canadensis*); deer; coyotes; wild opossums; and raccoons, moose, and other wild and domesticated ruminants. Infection of moose with *B. abortus* biovar 1 is highly fatal, and it is likely that the moose is a dead-end host for brucellosis. Experimental inoculation of the organism into badgers results in the development of antibodies and elimination of the organism, which indicates that the badger is relatively resistant to infection and unlikely to be a reservoir of the organism.

Bison and elk are potential reservoirs of bovine brucellosis and have been associated with recurrence of bovine brucellosis in the Greater Yellowstone area in the United States. Brucellosis associated with *B. abortus* was first detected in bison (*B. bison*) in Yellowstone National Park in 1917 and has been present ever since. Bison can remain latently infected with virulent *B. abortus* until attainment of reproductive age despite extensive use of vaccination and serologic testing.

Cattle and bison appear to maintain *B. abortus* at higher seroprevalence than other ungulate species. The seroprevalence in the Yellowstone bison and elk population is estimated with 40% to 60% and 22%, respectively.<sup>8,9</sup> This has been associated with physiologic and immunologic characteristics common to bovine species but is probably also caused by typical behavioral patterns of large social groups and the periparturient behavior of bison dams that tend to calve within groups that facilitate disease transmission through direct contact around parturition.<sup>10</sup> In contrast elk dams segregate themselves during the periparturient period and meticulously clean the birthing site, considerably reducing the risk of disease

transmission through direct contact.<sup>11</sup> Disease transmission may, however, be common during the abortion period in the last trimester of pregnancy from February to April, when many elk congregate in large groups on lower elevation winter habitat that overlaps with cattle-grazing areas.<sup>11</sup> From 2009 to 2011 eight infected cattle or captive bison herds were detected in Wyoming and Montana and all episodes were genetically or epidemiologically linked to elk, suggesting that spillover transmission from elk to cattle is epidemiologically more important than transmission from bison to cattle.<sup>11</sup> This has been explained with the continuously increasing elk population, which is currently above management target values in many areas of the Greater Yellowstone area and the greater mobility of free-ranging elk.<sup>10</sup>

### Horses

In horses the organism is often found in chronic bursal enlargements as a secondary invader rather than a primary pathogen. It is commonly present with *Actinomyces bovis* in fistulous withers and poll evil. It has also been identified as a cause of abortion in mares. A serologic survey of horses over a period of 8 years revealed that 8% to 16% of serum samples were positive. However, experimentally infected horses do not excrete the organism in sufficient numbers to infect susceptible in-contact cattle.

### Pigs and Sheep

The organism can be recovered from naturally infected pigs and, although not normally pathogenic in this species, may occasionally cause abortion. The disease occurs naturally in sheep exposed to infected cattle, which has significant implications for brucellosis eradication.

### Dogs

Naturally acquired *B. abortus* infection can occur in dogs associated with infected cattle. Although farm dogs are not generally considered to be a major reservoir of *B. abortus*, the organism has been isolated from dogs on a farm in which several cattle were serologically positive for brucellosis, and dogs should be included in any investigation and eradication of the disease.

### Methods of Transmission Parturition/Abortion

The **risk posed to susceptible animals** following parturition or abortion of infected cattle depends on three factors:

- Number of organisms excreted
- Survival of these organisms under the existing environmental conditions
- Probability of susceptible animals being exposed to enough organisms to establish infection

The organism achieves its greatest numbers in the contents of the pregnant uterus, the fetus, and the fetal membranes,

all of which must be considered as major sources of infection. The numbers of organisms in the tissues of two naturally infected cows and their fetuses were as follows: umbilicus  $2.4 \times 10^8 - 4.3 \times 10^9/g - 1.4 \times 10^{13}/g$ . This illustrates the potentially large numbers of organisms that can be shed and to which other animals and humans are potentially exposed. However, the numbers of organisms decrease when uterine discharges are cultured at sequential parturitions, and a substantial number of uterine samples from infected cows are culture negative at the second and third parturition following challenge.

### Transmission

The disease is transmitted by ingestion, penetration of the intact skin and conjunctiva, and contamination of the udder during milking. The organism does not multiply in the environment but merely persists, and the viability of the organism outside the host is influenced by the existing environmental conditions. Grazing on infected pasture, or consuming feedstuffs or water supplies contaminated by discharges and fetal membranes from infected cows, and contact with aborted fetuses as well as infected newborn calves are the most common methods of spreading the disease.

Intra-herd spread occurs by both vertical and horizontal transmission. **Horizontal transmission is usually by direct contamination** and, although the possibility of introduction of infection by flies, dogs, rats, ticks, infected boots, fodder, and other inanimate objects exists, it is not significant relative to control measures. The organism is ingested by the face fly but is rapidly eliminated, and there is no evidence for a role in natural transmission. Evidence exists for horizontal, dog-to-dog, cattle-to-dog, dog-to-cattle, and dog-to-human transfer of infection. The most likely and effective means of cattle-to-dog transfer is exposure to aborted fetuses or infected placental membranes, because dogs commonly ingest the products of parturition.

### Spread Between Herds

Movement of an infected animal from an infected herd to a susceptible noninfected herd is a common method of transmission. The rate of spread will depend on the level of surveillance testing. In Great Britain, which is officially brucellosis free, 20% or more of both beef and dairy cattle more than 24 months old are tested routinely. A simulation model indicates that reducing the level of testing would have a major effect on the rate of spread of infection, should it be imported.

### Spread Between Countries (Breach of Biosecurity)

A quantitative risk assessment model to determine the annual risk of importing brucellosis-infected breeding cattle into Great

Britain from Northern Ireland and the Republic of Ireland, which are not brucellosis free, was developed. Predictions estimated that brucellosis could be imported from Northern Ireland every 2.63 years and from the Republic of Ireland every 3.23 years. Following this assessment, the Department of Environment, Food, and Rural Affairs introduced postcalving testing for all imported breeding cattle. Under this system, all imported animals are issued a passport that records their age and pregnancy status. This information enables identification of animals that require testing and provides an additional safeguard in maintaining official brucellosis status.

### Congenital Infection

Congenital infection may occur in calves born from infected dams but its frequency is low. The infection occurs in utero and may remain latent in the calf during its early life; the animal may remain serologically negative until its first parturition, when it then begins to shed the organism. Calves born from reactor dams are serologically positive for up to 4 to 6 months because of colostral antibodies and later become serologically negative even though a latent infection may exist in a small proportion of these calves. The **frequency of latent infections** is unknown, but may range from 2.5% to 9%. Latent infections in serologically negative animals are of some concern because they remain unnoticed and can potentially serve as a source of infection later. However, latent infections in calves born from infected cows are infrequent. The organism could not be isolated from any of 150 calves born to infected cows, 135 of which were experiencing their first pregnancy after infection. In one report, a heifer from a herd affected with widespread infection with *B. abortus* biotype 2 was moved to a brucellosis-free herd and remained apparently free from brucellosis until 9 years later, when the same animal produced a strongly positive serologic reaction and the same biotype was isolated from its milk. Such observations have resulted in the recommendation that calves from seropositive dams should not be used for breeding. Even vaccinated heifers from seropositive dams can harbor a latent infection. There is a risk that 2.5% of heifer calves born from serologically positive dams will react in early adulthood and constitute a threat to a reestablished herd.

### Survival of Organism

The organism can survive on grass for variable periods depending on environmental conditions. In temperate climates, infectivity may persist for 100 days in winter and 30 days in summer. The organism is susceptible to heat, sunlight, and standard disinfectants, but freezing permits almost indefinite survival. The activity of several disinfectants against *B. abortus* has been examined, and representatives of the

phenolic, halogen, quaternary ammonium, and aldehyde groups of disinfectants at 0.5% or 1.0% concentrations in the absence of serum generally inhibited a high concentration of the organism.

### Uterine Discharges and Milk

A cow's tail heavily contaminated with infected uterine discharges may be a source of infection if it comes in contact with the conjunctiva or the intact skin of other animals. In the same way that the more common forms of mastitis can be spread during milking, *B. abortus* infection can be spread from a cow whose milk contains the organism to an uninfected cow. This may have little significance in terms of causing abortion, but it is of particular importance in its effects on agglutination tests on milk and the presence of the organism in milk used for human consumption.

### Bulls and Semen

Bulls do not usually transmit infection from infected to noninfected cows mechanically. Infected bulls may discharge semen containing organisms but are unlikely to transmit the infection. The risk of spread from the bull is much higher, however, if the semen is used for artificial insemination. Some infected bulls are negative on serum agglutination tests and their carrier status can only be detected by the isolation of organisms from the semen or agglutination tests on seminal plasma.

### Carrier Cows

Few infected cows ever recover from infection completely and should be considered as permanent carriers whether or not abortion occurs. Excretion of the organism in the milk is usually intermittent, is more common during late lactation, and can persist for several years. In cattle vaccinated before infection, the degree of excretion of *B. abortus* in the milk is less than in nonvaccinated animals. Embryo transfer from infected donors may be achieved without transfer of infection, and superovulation is unlikely to reactivate the release of *Brucella* into the uterus during the period when embryos are normally collected. Thus embryo transfer is a safe procedure for salvaging genetic material from infected animals.

The herd characteristics and the results of the first herd test may be used as predictors of the potential presence or absence of *B. abortus* in herds with reactors to the tube agglutination test. The presence of only single suspicious reactors on the first test is a reliable predictor of lack of infection. The presence of one or more positive reactors on the first herd test is a reliable predictor of the presence of infection.

### Risk Factors

The risk factors that influence the initiation, spread, maintenance, and/or control of

bovine brucellosis are related to the animal population, management, and the biology of disease. The variables that contribute significantly to seropositive animals are

- Size of farm premises
- Percentage of animals on a premises that are inseminated artificially
- Size of investment in livestock
- Number of cows that aborted in the previous year, whether or not dairying is the major agricultural activity of the premises
- Policy of the owner regarding disposal of reactor animals

The longer infected animals are in contact with the remainder of the herd, the greater will be the ultimate number of seropositive animals. In a defined geographic area in northern Mexico where a brucellosis control program did not exist, the greatest percentage of seropositive animals was related to larger farms, poor artificial insemination technique, and small financial investment in the farm.

From a practical viewpoint, the factors influencing the transmission of brucellosis in any given geographic region can be classified into two fundamental categories: those associated with the transmission of disease between herds and those influencing the maintenance and spread of infection within herds. Factors influencing interherd transmission include the purchase of infected replacement animals, which is influenced by frequency of purchase, source of purchase, and brucellosis test history of purchased animals. The proximity of infected herds to clean herds is an important risk factor. Cattle contacts at fence lines, sharing of pastures, and strays of infected animals into clean herds are common methods by which transmission occurs to adjacent herds.

The risk factors associated with spread of the disease within a herd include unvaccinated animals in infected herds, herd size, population density, method of housing, and use of maternity pens. Large herd sizes are often maintained by the purchase of replacement cattle, which may be infected. It is also more difficult to manage large herds, which may lead to managerial mistakes that allow the disease to spread. There is a positive association between population density (number of cattle to land area) and disease prevalence, which is attributed to increased contact between susceptible and infected animals. The use of maternity pens at calving is associated with a decrease in the prevalence of infection, presumably from decreasing the exposure of infected and susceptible animals.

### Animal Risk Factors

Susceptibility of cattle to *B. abortus* infection is influenced by the age, sex, and reproductive status of the individual animal. **Sexually mature, pregnant cattle are more susceptible to infection with the organism than sexually immature cattle of either sex.** Natural exposure to field strains occurs



primarily at the time of parturition of infected cows. The greater the number of infected cows that abort or calve, the greater the exposure risk to the other cattle in the herd. An important application of this observation is that infected cows need to be removed from the herd before parturition. Young cattle are less susceptible to *B. abortus* than older, sexually mature cattle. Susceptibility appears to be more commonly associated with sexual maturity than age. Young, sexually immature cattle generally do not become infected following exposure, or recover quickly. Susceptibility increases with pregnancy and as the stage of gestation increases. The probability of isolation of the organism at parturition increased from 0.22 to 0.90 as fetal age at exposure of nonvaccinated heifers increased from 60 to 150 gestation days.

### Management Risk Factors

The spread of the disease from one herd to another and from one area to another is almost always caused by the movement of an infected animal from an infected herd into a noninfected susceptible herd. The unregulated movement of cattle from infected herds or areas to brucellosis-free herds or areas is the major cause of breakdowns in brucellosis eradication programs. A case-control study of brucellosis in Canada indicated that herds located close to other infected herds and those herds whose owners made frequent purchases of cattle had an increased risk of acquiring brucellosis. Once infected, the time required to become free of brucellosis was increased by large herd size, by active abortion, and by loose housing.

### Pathogen Risk Factors

*Brucella* spp., in contrast to other pathogens, do not possess typical virulence factors such as a capsule, flagella, exotoxins, or inducers or host cell apoptosis. They express a **lipopolysaccharide (LPS)** that, in contrast to LPS from other gram-negative pathogens, is nonendotoxic but is important for the protection from complement-mediated bacterial killing and the resistance against antimicrobial peptides such as defensins and lactoferrin.<sup>12</sup>

*Brucella* spp. possess a number of **outer membrane proteins (OMPs)**, some of which are required for full virulence, and that are recognized as antigen by immunity receptors such as Toll-like receptors (TLRs), triggering proinflammatory cytokine release.<sup>13</sup> Certain mutants of *B. abortus* lack a major 25-kDa OMP (Omp25), which renders them unable to replicate efficiently in bovine phagocytes and chorionic trophoblasts. Expression of OMPs is regulated through the **BvrR/BvrS two-component regulatory system**, which also modulates the host cell cytoskeleton on invasion, contributing to pathogen virulence.<sup>12</sup> The BvrR/BvrS two-component regulatory system furthermore regulates the

expression of the **type IV secretion system (T4SS)**, which is crucial for intracellular survival in host cells and virulence in vivo. T4SS is required for *Brucella* spp. to reach their intracellular replication niche.<sup>12</sup>

### Immune Mechanisms

Brucellas are able to survive within host leukocytes and may use both neutrophils and macrophages for protection from humoral and cellular bactericidal mechanisms during the periods of hematogenous spread.

Immunity against brucellosis is principally mediated by cellular immune responses because it is an intracellular pathogen. *B. abortus* is an efficient inducer of type 1 cellular immune responses, and interferon gamma (IFN- $\gamma$ ) is crucial for control of brucellosis. Infections are chronic and often lifelong. The bovine T lymphocyte in brucellosis is a critical component of host defense based on mononuclear phagocyte activation by IFN- $\gamma$ . The killing of *Brucella*-infected mononuclear phagocytes and IFN- $\gamma$ -mediated activation of mononuclear phagocytes are the major mechanisms of host defenses against brucellosis in cattle.

The antibody response to *B. abortus* in cattle consists of an early IgM isotype response, the timing of which depends on the route of exposure, the dose of the bacteria, and the health status of the animal. The IgM response is followed almost immediately by production of IgG<sub>1</sub> antibody and later by small amounts of IgG<sub>2</sub> and IgA. Most cross-reacting antibody from exposure to bacteria other than *Brucella* spp. or environmental antigens consists mainly of IgM. Serologic tests that measure IgM are therefore not desirable, because false-positive results occur. Because IgG<sub>2</sub> and IgA antibodies accumulate later after exposure and are usually present in small and inconsistent amounts, the main isotype for serologic testing is IgG<sub>1</sub>.

Naturally infected animals and those vaccinated as adults with strain 19 remain positive to the serum and other agglutination tests for long periods. The serum of infected cattle contains high levels of IgM, IgG<sub>1</sub>, IgG<sub>2</sub>, and IgA isotypes of antibody. Most animals vaccinated between 4 and 8 months of age return to a negative status to the test within a year. All are considered to have a relative immunity to infection. Calves from cows that are positive reactors to the test are passively immunized via the colostrum. The half-life of colostrum antibodies to *B. abortus* in calves that have received colostrum from either vaccinated noninfected or infected dams is about 22 days. It is possible that some calves remain immune sufficiently long to interfere with vaccination. After vaccination of cattle with strain 19 of the organism, IgM antibodies appear after about 5 days, reaching peak values after 13 days. IgG<sub>1</sub> antibodies appear a little later or simultaneously with IgM, and peak values are reached at 28 to 42 days, after which they decline. The

same general pattern follows experimental infection with virulent strains and also in chronic field cases, except that IgM antibody declines to low levels and residual activity resides in IgG<sub>1</sub> and IgG<sub>2</sub> as well as in IgA, which remain at higher levels.

### Economic Importance

Losses in animal production caused by this disease can be of major importance, primarily because of decreased milk production in aborting cows. The common sequel of infertility increases the period between lactations, and in an infected herd the average intercalving period may be prolonged by several months. In addition to the loss of milk production, there is the loss of calves and interference with the breeding program. This is of greatest importance in beef herds where the calves represent the sole source of income. A high incidence of temporary and permanent infertility results in heavy culling of valuable cows, and some deaths occur as a result of acute metritis following retention of the placenta.

### Zoonotic Implications

According to the Food FAO, the WHO, and OIE, brucellosis is still one of the most important and widespread zoonoses in the world. Of the six *Brucella* spp. known to cause human disease (*B. melitensis*, *B. abortus*, *B. suis*, *B. canis*, *B. ceti*, and *B. pinnipedialis*), *B. melitensis* is the one with the largest public health impact because it is the most virulent species and has the highest prevalence in small ruminant populations in many areas of the world. *B. abortus* and *B. suis* serovars 1, 3, and 4 are also important human pathogens; *B. suis* serovar 2 and *B. canis* are uncommon human pathogens. Most cases in humans are occupational and occur in farmers, veterinarians, and slaughterhouse personnel after direct contact with infected animals or animal material contaminated with the pathogen. The organism can be isolated from many organs other than the udder and uterus, and the handling of a carcass of an infected animal may represent severe exposure. Brucellosis is also one of the most easily acquired laboratory infections.<sup>15</sup> Infection can also occur after ingestion of raw milk or raw milk products. Officially approved methods of commercial pasteurization render naturally *Brucella*-contaminated raw milk safe for consumption.

In endemic regions, the reported incidences of human brucellosis range from less than 0.01 per 100,000 population to more than 200 per 100,000 population.<sup>15</sup> In the United States, where approximately 100 cases of human brucellosis are reported annually, the incidence rate is less than 0.05 per 100,000 population.<sup>15</sup> In Europe the highest incidences were reported from Greece (1.09 per 100,000 population), Portugal (0.36 per 100,000 population), and Spain (0.13 per 100,000 population), which together

accounted for 67.7% of all confirmed cases of human brucellosis in member states of the EU in 2012.<sup>14</sup> Of the human cases reported within the EU in 2012 where species information was available 83.9% were caused by *B. melitensis*, 10.1% *B. abortus*, 3.0% *B. suis*, and 3.0% by other *Brucella* spp.<sup>14</sup> The importance of the disease in humans is an important justification for its eradication. The cost-effectiveness to human health and the potential net economic benefits of a nationwide mass vaccination program for livestock over a period of 10 years has been evaluated using Mongolia as the model. If the costs of vaccination of livestock against brucellosis were allocated to all sectors in proportion to the benefits, the intervention would be cost-effective and would result in net economic benefits.

### PATHOGENESIS

The successful coexistence of *Brucella* spp. with its preferred host is the outcome of coevolutionary relationships and selection pressures, which result in a stalemate where the pathogen has evolved to survive within the biologic system of the host, and the host has evolved innate and acquired immune systems that allow controlled survival of infection by the pathogen, ultimately supporting the survival of the host–pathogen system.

Following ingestion most commonly through the digestive or respiratory tract *Brucella* spp. can invade epithelial cells of the host, allowing infection though intact mucosal surfaces. Once invasion successfully occurs the organism may be phagocytized by host immune cells and may also invade non-phagocytic host cells through a mechanism that is not entirely understood. Following cell invasion the organism is contained in a membrane-bound modified phagosome, the *Brucella*-containing vacuole (BCV), and interferes with intracellular trafficking, preventing fusion of the BCV with lysosome markers and directing the BCV to the rough endoplasmic reticulum, which is highly permissive for intracellular replication of *Brucella*.<sup>12</sup> Invaded polymorphonuclear leukocytes then transport the pathogen to regional lymph nodes, other sites such as the reticuloendothelial system, and organs such as the udder and when present the fetal placenta. In the draining lymph node, *Brucella* infection causes cell lysis and eventual lymph node hemorrhage 2 to 3 weeks following exposure. Because of vascular injury, some of the bacteria enter the bloodstream and subsequent bacteremia occurs, which disseminates the pathogen throughout the body.

*B. abortus* has a predilection for the placenta; udder; testicle; and accessory male sex glands, lymph nodes, joint capsules, and bursae. Erythritol, a substance produced by the fetus and capable of stimulating the growth of *B. abortus*, occurs naturally in greatest concentration in the placental and

fetal fluids and is responsible for localization of the infection in these tissues. Invasion of the gravid uterus results in a severe ulcerative endometritis of the intercotyledonary spaces. The allantochorion, fetal fluids, and placental cotyledons are invaded, and the villi are destroyed. The organism has a marked predilection for the ruminant placenta. In acute infections of pregnant cows, up to 85% of the bacteria are in cotyledons, placental membranes, and allantoic fluid. The resulting tissue necrosis of the fetal membranes allows transmission of the bacteria to the fetus. The net effect of chorionic and fetal colonization is abortion during the last trimester of pregnancy. The characteristic pneumonia in aborted fetuses is caused by localization of perivascular foci in the interlobular septa of the lung, indicative of hematogenous spread in the fetus rather than aspiration of contaminated fetal fluids. Fetuses inoculated with sufficient numbers of *B. abortus* will abort 7 to 19 days postinoculation. With experimental conjunctival exposure of pregnant heifers with the organism, the numbers of infected animals and the number of tissue samples positive for the organism are increased as fetal age at exposure increases from gestation days less than 127 to more than 157. **Abortion occurs principally in the last 3 months of pregnancy**, and the incubation period is inversely proportional to the stage of development of the fetus at the time of infection.

Congenital infection can occur in newborn calves as a result of in utero infection, and the infection may persist in a small proportion of calves, which may also be serologically negative until after their first parturition or abortion.

In the adult, nonpregnant cow, localization occurs in the udder, and the uterus, if it becomes gravid, is infected from periodic bacteremic phases originating in the udder. Infected udders are clinically normal, but they are important as a source of reinfection of the uterus, as a source of infection for calves or humans drinking the milk, and because they are the basis for the agglutination tests on milk and whey. Variable disease expression may occur in the male reproductive tract and musculoskeletal system, particularly affecting large joints, of either sex.

### CLINICAL FINDINGS

#### Abortion

The clinical findings are dependent on the immune status of the herd. In highly susceptible nonvaccinated pregnant cattle, abortion after the 5th month of pregnancy is a typical feature of the disease in cattle. In subsequent pregnancies, the fetus is usually carried to full term, although second or even third abortions may occur in the same cow. Retention of the placenta and metritis are common sequelae to abortion. Mixed infections are usually the cause of the metritis, which may

be acute, with septicemia and death following, or chronic, leading to sterility.

The history of the disease in a susceptible herd can usually be traced to the introduction of an infected cow. Less common sources are infected bulls, or horses with fistulous withers. In a susceptible herd, it is common for the infection to spread rapidly and for an abortion “storm” to occur. The storm might last for a year or more, at the end of which time most of the susceptible cows are infected and have aborted and then carry their calves to full term. Retained placenta and metritis could be expected to be common at this time. As the abortion rate subsides, the abortions are largely restricted to first-calf heifers and new additions, because other animals of the herd acquire partial resistance.

In recent years, particularly in areas where vaccination is extensively practiced, an insidious form of the disease may develop, which spreads much more slowly and in which abortion is much less common.

#### Orchitis and Epididymitis

In the bull, orchitis and epididymitis occur occasionally. One or both scrotal sacs may be affected, with acute, painful swelling to twice normal size, although the testes may not be grossly enlarged. The swelling persists for a considerable time, and the testis undergoes liquefaction necrosis and is eventually destroyed. The seminal vesicles may be affected and their enlargement can be detected on rectal palpation. Affected bulls are usually sterile when the orchitis is acute but may regain normal fertility if one testicle is undamaged. Such bulls are potential spreaders of the disease if they are used for artificial insemination.

#### Synovitis

*B. abortus* can often be isolated from the tissues of nonsuppurative synovitis in cattle. Hygromatous swellings, especially of the knees, should be considered with suspicion. Progressive and erosive nonsuppurative arthritis of the stifle joints has occurred in young cattle from brucellosis-free herds that had been vaccinated with strain 19 vaccine. The calves may or may not be serologically positive, but synovial fluid and joint tissue samples contain immunologic evidence of strain 19 *B. abortus* antigenic material. The synovitis has been reproduced by intra-articular injection of the vaccine.

#### Fistulous Withers

In horses, the common association of *B. abortus* is with chronic bursal enlargements of the neck and withers, or with the navicular bursa, causing intermittent lameness, and the organism has been isolated from mares that have aborted. When horses are mixed with infected cattle, a relatively high proportion can become infected and develop a positive reaction to the serum agglutination test

without showing clinical illness. Some horses appear to suffer a generalized infection with clinical signs including general stiffness, fluctuating temperature, and lethargy.

### CLINICAL PATHOLOGY

The major objective in the laboratory diagnosis of brucellosis is to identify animals that are infected and potentially shedding the organism and spreading the disease. Most infected animals are identifiable using the standard serologic tests, but latent infection occurs in some animals that are serologically negative. Furthermore, vaccinated animals may be serologically positive and uninfected, and transitory titers occur sporadically in a small percentage of animals, for which there is no clear explanation. These diagnostic problems make control and eradication programs difficult to administer and difficult to explain to animal owners.

The collection and submission of samples to the laboratory must be done with care, and careful attention must be given to recording the identity of the animal and the corresponding sample, which should be uniquely identified. For blood samples, it is recommended that silicone-coated evacuated glass tubes without additives be used to collect the blood sample, because they ensure effective clotting and clot retraction, to provide an easy source of serum without the need for centrifugation. Clotting is also aided by maintaining the sample at 25°C to 37°C for 1 to 2 hours.

Laboratory tests used in the diagnosis of brucellosis include isolation of the organism and serologic tests for the presence of antibodies in blood, milk, whey, vaginal mucus, and seminal plasma. The organism may be present in the cervical mucus, uterine flushings, and udder secretions of experimentally infected cows for up to 36 days after abortion.

### Identification of *Brucella* spp.

#### Staining

The appearance of specifically stained smears and the colonial morphology can lead to a presumptive diagnosis of brucellosis. *Brucella* bacteria are not really acid-fast but are resistant to decolonization by weak acids, and the presence of a weakly acid-fast intracellular organism, stained with the Stamp-modified Ziehl-Neelsen method may be suggestive for the presence of *Brucella* spp. in the smear. However, staining has a very limited sensitivity because of the low number of organisms present that may be present in some tissues and body fluids of infected animals. Positive results must be interpreted carefully because of the morphologic similarities of *Brucella* organisms with other pathogens associated with abortion, such as *Coxiella burnetii* or *Chlamydia abortus*.<sup>7</sup> Results, positive or negative, should only be considered presumptive and always need to be confirmed ideally by culture.

### Culture

The gold standard diagnostic test continues to be based on isolation and characterization of the organism from the organs and lymph nodes of the fetus, the placenta, milk, vaginal mucus, or uterine exudate. Bacteriologic methods detect the organism directly and thus limit the possibility of false-positive results. Isolation of the organism from the udder secretion of a cow is conclusive evidence of infection. Culture methods are reliable and usually definitive. A range of specific culture media are commercially available. A disadvantage is the long time required for definitive identification. Most culture results are positive between the 7th and 21st day and rarely become positive before the 4th day of culture.<sup>16</sup> Incubation for at least 45 days has been advised before declaring a blood sample negative for *Brucella* spp.<sup>16</sup> Furthermore *Brucella* organisms are among the most dangerous bacteria with which to work in terms of the risk of producing laboratory-acquired infections.<sup>7</sup>

### Detection by Polymerase Chain Reaction (PCR)

The PCR-based assays for *Brucella* spp. have been developed and are simple. PCR has been applied to tissues such as aborted fetuses and associated maternal tissues, blood nasal secretions, semen, and food products such as milk and soft cheeses. *Brucella* spp. can be detected in the milk of naturally infected cattle, sheep, goats, and camels using a PCR assay that is more sensitive than the culture method. A further diagnostic advancement of recent years is the Bruce-ladder PCR, which is a multiplex PCR assay that helps to identify and differentiate several *Brucella* spp., including vaccine strains, in a single step.<sup>17</sup>

### Serologic Tests

In the absence of a positive culture of *B. abortus*, a presumptive diagnosis is usually made based on the presence of antibodies in serum, milk, whey, vaginal mucus, or seminal plasma.

The antibody response following infection depends on whether or not the animal is pregnant and on the stage of gestation. On average, the agglutinins and complement fixation antibodies become positive 4 weeks following experimental infection during the fourth to sixth months of gestation and not until about 10 weeks if experimental infection occurs 2 months before or after insemination. The serologic diagnosis is considered to be unreliable when applied 2 to 3 weeks before and after abortion or calving.

Any of the currently available serologic tests or combination of tests measures the response of a single animal at one point in time and does not describe the status of the herd. When the tests are used in the recommended sequence and in combination, along with a consideration of accurate

epidemiologic data, the limitations of each test can be minimized. None of the tests is absolutely accurate, and there are varying degrees of sensitivity. The result has been the development of a very extensive range of tests, each of which has its own special applicability. The salient features are as follows.

### Agglutination Tests

#### Serum Agglutination Test

The serum (tube) agglutination test (SAT) or microtiter plate variants of it are some of the traditional standard tests, which are widely used, but are not recognized as prescribed or alternative tests. The main limitations are

- Detect nonspecific antibodies as well as specific antibodies from *B. abortus* infection and vaccination
- During the incubation stage of the disease these tests are often the last to reach diagnostically significant levels
- After abortion caused by *B. abortus* they are often the last tests to reach diagnostically significant levels
- In the chronic stage of the disease, the serum agglutinins tend to wane, often becoming negative when the results of some other tests may be positive.

#### Rose Bengal Test (Buffered Plate Antigen or Card Test)

The rose Bengal test (RBT) is a simple, rapid spot-agglutination test using antigen stained with rose Bengal and buffered to low pH. The test detects early infection and can be used as an initial screening test. False-positive reactions are caused by residual antibody activity from vaccination, colostral antibody in calves, cross-reaction with certain bacteria such as *Yersinia enterocolitica*, and laboratory error. False-negative reactions are observed during early incubation of disease and immediately after abortion. However, the RBT is an excellent test for the large-scale screening of sera. The application of the RBT as a screening test, followed by a confirmatory or complementary test, can markedly increase the proportion of infected cattle that test positive.

For **beef cattle**, screening of herds can be achieved by collecting blood at abattoirs and submitting it to the RBT or tube agglutination test. Reactors are traced back to the herd of origin, and the herd is tested. In heavily infected herds, it is best to remove all cows positive to the RBT even though it is highly sensitive and there will be a small percentage of false-positive cows. In herds where the prevalence of infection is low and where vaccination has been used, this procedure will eliminate too many false-positive cows. In this situation the sera positive to the RBT are submitted to a more definite confirmatory test such as the complement fixation test (CFT), and only those animals reacting to the test are discarded.



### Complement Fixation Test

The CFT is one of the prescribed tests for international trade and is widely accepted as a confirmatory test. It rarely exhibits nonspecific reactions and is useful in differentiating titers of calffood vaccination from those caused by infection. The reactions to the CFT recede sooner than those to the serum agglutination test after calffood vaccination with the strain 19 vaccine. The CFT titers do not wane because the disease becomes chronic and often the CFT reaches diagnostic levels sooner than the serum tube agglutination test following natural infection. In addition, recent technical laboratory advances have allowed much greater speed and accuracy in doing the CFT and it is now considered to be the nearest approach to a definitive test for infection. Nonetheless, because of its complexity the CFT requires good laboratory facilities and skilled laboratory personnel.

### Enzyme-Linked Immunosorbent Assays

Two main types of immunosorbent assay have been used: the indirect and competitive formats.

#### Indirect Enzyme-Linked Immunosorbent Assay

The indirect enzyme-linked immunosorbent assay (iELISA) has been a useful test during an eradication program, after vaccination has ceased; for screening; or as a supplementary test to the CFT. Several variations of the assay using either whole-cell, smooth lipopolysaccharide (sLPS), or O-polysaccharide (OPS) as an antigen have been validated.<sup>7</sup> The iELISA has gained wide acceptance for serologic diagnosis of bovine brucellosis because of its ability to detect antibody of all isotopes, unlike the conventional tests. The iELISA can be useful in conjunction with the CFT during the later stages of an eradication program, when it is important to reduce the number of false-negative serologic reactions that contribute to the persistence of problem herds. The iELISA has an excellent sensitivity and specificity but cannot distinguish between the antibody response induced by vaccination with *B. abortus* strain 19 and natural infection.

The iELISA has also been developed and validated for milk, and several different variations of this assay are currently commercially available.

#### Competitive Enzyme-Linked Immunosorbent Assay

The competitive ELISA (C-ELISA) uses monoclonal antibody specific for one of the epitopes of the *Brucella* spp., which makes it more specific than assays using cross-reacting antibody. The C-ELISA is thus more specific but less sensitive than the iELISA. It eliminates most but not all reactions caused by cross-reacting organisms and in most but not all cases, eliminates reactions with

residual antibody in animals vaccinated with strain 19.<sup>7</sup> The OIE therefore recommends the further investigation of positive reactors with the C-ELISA using appropriate complementary or confirmatory diagnostic tests.<sup>7</sup>

### Fluorescence Polarization Assay

This test can be done outside the diagnostic laboratory, allowing for rapid and accurate diagnosis. The fluorescence polarization assay (FPA) can be done almost anywhere using a portable analyzer, which receives power from a laptop computer, using serum, milk, or ethylenediaminetetraacetic acid (EDTA) anticoagulated blood. The FPA technology has been developed and validated for the serologic diagnosis of brucellosis in cattle, pigs, sheep, goats, bison, and cervids. Sufficient cross-reactivity of the common epitopes of *B. abortus*, *B. melitensis*, and *B. suis* OPS has allowed for the use of a single antigen for all species of smooth *Brucella* and animals. The FPA was initially developed for testing serum; however, the technology has been extended to testing whole blood and milk from individual animals or bulk tank samples pooled from 2000 or fewer animals. The accuracy results of the FPA equals or exceeds those obtained using other serologic tests such as the buffered antigen plate agglutination test, the milk ring test, the CFT, the iELISA, and the C-ELISA. Validation of studies of the FPA and the C-ELISA for the detection of antibodies to *B. abortus* in cattle sera and comparison to the standard agglutination test, the CFT, and the iELISA, found that the FPA is highly superior. It offers a clear advantage because it is easy to use. Full implementation and acceptance of FPA methods for the diagnosis of brucellosis will necessitate the use of an International Standard Serum panel containing at least a low titer-positive sample and a negative sample.

### Brucellin Skin Test

The brucellin skin test presents an alternative immunologic test that can be used to test unvaccinated animals. Tested animals are injected intradermally with 0.1 mL of a standardized brucellin preparation consisting of purified, sLPS-free *Brucella* antigen. The skin thickness at the injection site is measured with Vernier calipers before and 48 to 72 hours after injection. Skin thickening of at least 1.5 to 2 mm at the injection site are considered a positive reaction. This test is among the most specific brucellosis tests available, provided it is conducted with a purified, standardized antigen preparation; serologically negative unvaccinated animals with a positive reaction to the skin test are therefore considered as infected.<sup>7</sup> Because not all infected animals show a positive reaction the test is not recommended as a stand-alone test for the purpose of international trade.

### Sensitivity and Specificity of Serologic Tests

Serologic tests must have high sensitivity to ensure that all true serologic reactors are detected. However, with a high sensitivity, a high rate of false-positive reactions may be expected and hence the need for the use of a confirmatory test to identify false-positive reactors. Confirmatory tests must therefore demonstrate a high level of diagnostic specificity and yet maintain an effective diagnostic sensitivity.

It has been recommended to use a buffered *Brucella* antigen test, such as the buffered plate antigen test or the RBT as a screening test. Either the CFT or the indirect enzyme immunoassay is appropriate for use as a confirmatory test in situations requiring a high specificity. The relationships between the quantitative serology and infection status of brucellosis in bison in Yellowstone National Park have been evaluated and found to be similar to those in chronically infected cattle.

### Antibodies in Milk

The **milk ring test** is a satisfactory inexpensive test for the surveillance of dairy herds for brucellosis. A small sample of pooled fresh milk or cream, from no more than 25 cows, is tested and the herd is classified only as suspicious or negative. Final determination of the status of a suspicious herd and each animal in it is accomplished by blood testing. The more frequently a herd is tested with the milk ring test, the more effective the test becomes as a method to detect early infections, preventing serious outbreaks in susceptible herds. At least three tests done annually are now required by some regulatory agencies. The major limitation of the test is the dilution factor, which occurs in large dairy herds where large quantities of milk are stored in bulk tanks. To adjust for this dilution effect, larger sample volumes are used with increasing herd size. Although 1 mL of bulk milk is required for herds with up to 150 head, the use of 2 mL for herds between 150 and 450 head and 3 mL for herds with 450 to 700 head has been advised.<sup>7</sup> False-positive reactions have been observed with cattle vaccinated less than 4 months before testing and in samples containing colostrum or mastitic milk.

The milk iELISA test is a sensitive, specific, and inexpensive method for screening large numbers of individual or bulk milk samples for the antibody to *B. abortus*. An ELISA using potassium chloride extract of the organism used on bulk tank milk samples of dairy herds was highly specific and is considered as a highly reliable test for monitoring brucellosis control programs. The combined use of an ELISA and PCR on milk samples gives a sensitivity of 100%.

### False-Positive Reactors

A major problem in brucellosis eradication programs has been the false-positive animals

or singleton reactor, which may remain persistently suspicious or positive in a herd that is otherwise considered to be free of brucellosis. It is of some concern because of the unnecessary slaughter of uninfected animals.

Cross-reacting antibodies usually result from exposure to antigen(s) that share antigenic determinants with *Brucella* spp., which are found in a large number of bacteria. The most prominent cross-reaction is with *Yersinia enterocolitica* O:9, which shares the major OPS almost completely with *B. abortus*. Serologic cross-reactions have also been demonstrated between smooth *Brucella* spp. and *Escherichia coli* O116:H21 and *E. coli* O157:H7, *Francisella tularensis*, *Salmonella* serotypes of Kauffman–White group N, *Pseudomonas maltophilia*, *Vibrio cholerae*, and *Y. enterocolitica* serotype O:9. Only rarely will naturally occurring *E. coli* O157:H7 infections cause false-positive reactions with standard serologic tests for bovine brucellosis. The standard serologic tests are unreliable in differentiating between *Y. enterocolitica* and *Brucella*-infected cows, but both the lymphocyte transformation and brucellin skin tests could be used to differentiate them.

Other causes of false positives include a *B. abortus*-infected animal, strain 19 residual vaccination titer, and naturally occurring nonspecific agglutinins, which may occur in some cattle populations. These agglutinins are EDTA labile and can be differentiated from agglutinating antibodies by the addition of EDTA to the diluent used in the standard serum agglutination test. The serologic cross-reactions are of major significance when the prevalence of infection has decreased to a very low level. At this stage it becomes much more important to correctly identify the status of animals reacting to the serologic tests for brucellosis.

The incorrect attribution of such reactions to factors other than *Brucella* infection is likely to result in herd breakdowns and failure to control the disease. On the other hand, the misinterpretation of cross-reactions as evidence of brucellosis results in the imposition of unnecessary restrictions and waste of resources. The problem of serologic cross-reactions has resulted in considerable research and an investigation to find laboratory tests, which will accurately distinguish positive, infected animals from positive, noninfected animals. Differentiation of cross-reacting antibodies can be difficult to achieve, especially in the case of *Y. enterocolitica* O:9 antigen, but immunodiffusion, immunoelectrophoresis, and primary binding tests and cross-absorption procedures are useful. The DNA homology of *B. abortus* strains 19 and 2308 has been examined using restriction enzyme analysis. Strain 19 is the official U.S. Department of Agriculture (USDA)-attenuated *Brucella* vaccinal strain for cattle, and strain 2038 is a virulent laboratory-adapted strain that is

pathogenic to cattle. The DNA differences between the two strains are small and will require analysis at the DNA sequence level.

The serologic assay of choice for screening samples for antibody to *B. abortus* is the FPA. It is robust, very rapid, and field-adaptable, without subjective results. The C-ELISA is a useful confirmatory assay. The sera from cattle naturally infected with *B. abortus*, vaccinated with *B. abortus* S19, or immunized with *Y. enterocolitica* O:9 or *E. coli* O157:H7, were compared for antibody content to the same bacteria by iELISA, FPA, and C-ELISA. The serologic assay of choice for screening samples for antibody to *B. abortus* is the FPA. Between the two tests, nearly all reactivity to *E. coli* O157:H7 and more than one-half of the sera with antibody to *Y. enterocolitica* O:9 could be eliminated as *Brucella* reactors. These assays, perhaps in combination with a brucellin skin test, may be capable of distinguishing virtually all reactions caused by *Y. enterocolitica* O:9.

### NECROPSY FINDINGS

The host responses at the organ and tissue levels have been described and are summarized here. Lymph nodes draining the sites of the early stages of infection have marked germinal center hyperplasia and hypertrophy, accompanied by acute neutrophilic and eosinophilic lymphadenitis. In the later stages of the infection, lymph nodes draining mammary gland, head, and reproductive tract develop chronic granulomatous lymphadenitis, which is usually associated with cortical and paracortical T-cell-dependent lymphoid depletion, germinal center expansion, and deep histiocytic expansion. The spleen may develop lymphoid hyperplasia and histiocytic and plasmacytic expansion in the germinal centers, and the mammary gland usually has a pronounced interstitial lymphoplasmacytic mastitis. In the uterus, there is usually an endometritis, fibrosing mural lymphocytic metritis, and caruncular necrotizing vasculitis, whereas the placenta is colonized with *B. abortus* and has extensive desquamation of fetal chorioallantoic trophoblasts with subsequent hematogenous spread to villous trophoblastic epithelium, and **necrotizing fibrinopurulent cotyledonary placentitis of the placental arcades** accompanied by granulation and intercotyledonary inflammation exudation. The placenta is usually edematous. There may be leathery plaques on the external surface of the chorion, and there is necrosis of the cotyledons. The key microscopic feature of this inflamed chorioallantoic is the presence of **intracytoplasmic coccobacilli within chorionic trophoblasts**. The use of modified Ziehl–Neelsen stains on impression smears from fresh placentas can provide a rapid presumptive diagnosis. The fetal lesions consist of marked fibrinopurulent necrotizing bronchopneumonia; monocytic and neutrophilic

alveolitis; thromboembolic necrotizing arteritis and lymphangitis; fibrinopurulent pleuritis; and granulomata of the liver, spleen, kidney, and lymph nodes. In **fetuses naturally and experimentally infected** with *B. abortus*, the tissue changes include lymphoid hyperplasia in multiple lymph nodes, lymphoid depletion in the thymic cortex, adrenal cortical hyperplasia, and disseminated inflammatory foci composed mainly of large mononuclear leukocytes.

The affected joints usually develop a fibrinous and granulomatous synovitis with proliferative villous projection formation, proliferative tendovaginitis with lymphoplasmacytic nodule formation, and arthritis with articular erosions, which may be associated with suppurative, granulomatous bursitis. In the testes there are unilateral or bilateral visceral to parietal tunica adhesions, interstitial lymphocyte orchitis with seminiferous tubular degeneration, necrotizing intratubular orchitis, and acute fibrinopurulent periorchitis with infarction. The ampulla may have a unilateral or bilateral granulomatous epididymitis with focally necrotic purulent and calcified sperm granulomata, and the seminal vesicles have unilateral or bilateral necrotizing fibrinopurulent seminal vesiculitis and interstitial lymphocytic, plasmacytic seminal vesiculitis with necrosis.

The distribution of *B. abortus* in experimentally and naturally infected cattle has been examined. In experimentally infected pregnant cows, the most frequently infected specimen was the mammary lymph node; the organism could also be found in other lymph nodes, uterine caruncles, cotyledons, or fetal tissues. In naturally infected heifers, the most frequently infected specimen was the mandibular lymph node. In bulls, the most frequently infected tissues were the mandibular, caudal superficial cervical, subiliac, and scrotal lymph nodes.

The lesions in *Brucella*-positive aborted fetuses and placentas in bison are similar to those in experimental infections of *B. abortus* in bison and cattle. Both *B. abortus* biovar 1 and *B. abortus* biovar 2 were isolated from specimens collected from aborted bison fetuses or stillborn calves and their placentas. The infection can also be associated with death in calves at least 2 weeks of age.

### Samples for Confirmation of Diagnosis

- Bacteriology: maternal caruncle; placenta, fetal stomach content, lung (culture, has special growth requirements; cytology, Stamp's or Koster's stain on placental smears)
- Histology: fixed placenta, lung, spleen, brain, liver, kidney; maternal caruncle (light microscopy, immunohistochemistry)

Note the zoonotic potential of this organism when handling carcasses and submitting specimens.

## DIFFERENTIAL DIAGNOSIS

The diagnosis of the cause of abortion in a single animal or in a group of cattle is difficult because of the multiplicity of causes that may be involved. When an abortion problem is under investigation, a systematic approach should be used. This includes a complete laboratory evaluation and follow-up inquiries into each herd.

The following procedure is recommended:

- Ascertain the age of the fetus by inspection and from the breeding records.
- Take blood samples for serologic tests for brucellosis and leptospirosis.
- Examine uterine fluids and the contents of the fetal abomasum at the earliest opportunity for trichomonads, and subsequently by cultural methods for *B. abortus*, *Campylobacter fetus*, trichomonads, *Listeria* spp., and fungi.
- Supplement these tests by examination of urine for leptospire, and of the placenta or uterine fluid for bacteria and fungi, especially if the fetus is not available.
- Examine placenta fixed in formalin for evidence of placentitis.

It is most important that all examinations are done in all cases because coincident infections with more than one agent are not uncommon.

In the early stages of the investigation, the herd history may be of value in suggesting the possible etiologic agent. For example, in brucellosis, abortion at 6 months or later is the major complaint, whereas in trichomoniasis and vibriosis, failure to conceive and prolongation of the diestrus period is the usual history.

Of special interest is epizootic bovine abortion, which is a major disease of rangeland cattle in the western United States. A spirochete has been isolated from the soft tick *Ornithodoros coriaceus* and from the blood of fetuses with lesions of epizootic bovine abortion. The disease occurs at a very high level of incidence but only in cattle introduced to a certain area; resident cattle are usually unaffected. Cattle returned to the area each winter are unaffected after the first abortion. The cows are unaffected systemically. Aborted fetuses show characteristic multiple petechiae in the skin, conjunctiva, and mucosae; enlargement of lymph nodes; anasarca; and nodular involvement of the liver.

In most countries where brucellosis is well under control and artificial insemination limits the spread of vibriosis and trichomoniasis, leptospirosis may be the most common cause of abortion in cattle.

However, surveys in such countries reveal that in about two-thirds of the abortions that occur no causative agent is detectable with routine laboratory techniques. In only 35% of cases was the cause determined, and brucellosis accounted for less than 1% of the total. In an Australian experience, the cause of abortion was determined in only 37% of cases in spite of the submission of the fetus,

placenta, and maternal serum. The general procedures for submission of specimens to the laboratory and laboratory methods are available.

### Bulls

Infected bulls may be serologically positive or negative, and their semen may be culturally positive or negative, but the organism may be isolated at slaughter. Clinical examination may reveal the presence of epididymitis, orchitis, seminal vesiculitis, and ampullitis. All bulls from known infected herds should therefore be considered as suspicious, regardless of their serologic status, and not be used for artificial insemination.

## TREATMENT

Treatment is unsuccessful because of the intracellular sequestration of the organisms in lymph nodes, the mammary gland, and reproductive organs. *Brucella* spp. are facultative intracellular bacteria that can survive and multiply within the cells of the macrophage system. Treatment failures are considered to be caused by the inability of the drug to penetrate the cell membrane barrier instead of the development of antimicrobial resistance.

## CONTROL AND ERADICATION

Most countries with brucellosis have programs designed to control and ultimately eradicate the infection in cattle to reduce economic losses and protect the public from the disease. These programs usually have several components, and to ensure effectiveness each component needs to be scientifically sound and accepted by all concerned. The major components of a control and eradication program are as follows.

### Test and Reduction of Reservoir of Infection

All breeding cattle in the herd are tested, and those that are positive are culled and sent for slaughter. This removes infected cows from the herd and reduces exposure and transmission within the herd. Of particular importance is the detection and removal of infected cows before parturition.

### Quarantine

This is a period of time during which cattle movement is restricted and the cattle are tested. This will prevent interherd transmission by infected cattle, especially those that are test negative and incubating the disease. The quarantine period should be sufficiently long that all cattle have had sufficient time to develop brucellosis and ensure that the remaining cattle will not be a source for interherd transmission. The time will usually range from 120 days to 1 year, or until all breeding animals have completed a gestation without test evidence of infection.

## Depopulation

Depopulation is slaughter of all cattle in a herd when all animals have been exposed and are capable of becoming infected and acting as a source of new infection.

## Vaccination

Properly vaccinated cattle are less likely to be infected and, therefore, are less likely to shed field strains of the organism. Vaccination strategies will be discussed in more detail below.

## Education

All participants in a program must understand and adopt the scientific basis for the program. This includes livestock producers, veterinarians, and regulatory officials.

## Guidelines

To be successful, any program needs guidelines and policies, which must be followed and modified to meet the needs of certain areas or herds.

Apart from the question of human exposure to infection, the cost and economic benefits of an eradication program must be assessed against the costs and benefits from a vaccination control program. Certain basic considerations apply to all programs aimed at the eradication of brucellosis.

- The control programs indigenous to any given area must receive primary recognition, and any plan or plans must be adapted to that area
  - Cooperation at all levels of government from local to the national is essential for the success of a program. This is attained only after an intensive program of education has been performed. The individual owner of an infected herd must recognize the problem of brucellosis and express a willingness to cooperate. Experience has shown that the owner must be impressed with the hazards of the disease for human health and with the economic losses in the herd
  - A reliable and uniform diagnostic procedure must be generally available.
  - If disease is detected in a herd, established procedures should be available for handling the disease. If immunization is to be used, a standardized and effective vaccine must be readily available. The disposal of infected animals may create a serious economic threat for the owner and the possibilities of financial compensation must be explored
  - Finally, and of major importance, the movement of animals from one area to another must be controlled at a high level, because a rigid eradication program in one area may be nullified by neglect in a neighboring area.
- Sufficient information exists about bovine brucellosis that it can be eradicated. The



disease was considered to have been eradicated from Great Britain in 1981; in 1985, having met certain European Community criteria for national surveillance and with over 99.8% of the cattle herds free from brucellosis, all herds within the country not under restrictions were designated as being officially brucellosis free for trade purposes. However, small foci of infection persisted, and following the prohibition of the use of *Brucella* vaccines the national herd was becoming fully susceptible to brucellosis. This was followed by outbreaks of brucellosis in southwest England from 1984 to 1986. The movement of cattle through premises owned by dealers who specialized in the purchase and sale of newly calved cattle was a significant epidemiologic feature of these herd breakdowns.

### Control by Vaccination

Because of the serious economic and medical consequences of brucellosis, efforts have been made to prevent the infection through the use of vaccines. Historically brucellosis vaccines were composed of attenuated strains of *B. abortus* and *B. melitensis*. These vaccines were shown to be effective in reducing pathogen transmission and production loss, but were less effective in preventing infection. Another inconvenience of these whole-cell vaccines was that they interfere with diagnostic assays detecting antibody against the O-side chain of the *Brucella* LPS.<sup>18</sup> Currently vaccines used to protect livestock against infection with *B. abortus* contain one of three attenuated live strains of *B. abortus*: strain 19, RB51, and strain 82.

#### *Brucella abortus* Strain 19 Vaccine

Vaccines containing the live *B. abortus* strain 19 are the most widely used vaccines to prevent bovine brucellosis and are considered the reference vaccines to which any other vaccine is compared.<sup>7</sup> The vaccine protects uninfected animals living in a contaminated environment, enabling infected animals to be disposed of gradually. This overcomes the main disadvantage of the test and disposal method of eradication, in which infected animals must be discarded immediately to avoid spread of infection. *B. abortus* strain 19 has a low virulence and is incapable of causing abortion except in a proportion of cows vaccinated in late pregnancy. Strain 19 is a smooth *B. abortus* strain expressing the O-antigen on its LPS. Antibody produced in response to vaccination will interfere with diagnostic assays identifying this antigen, which is a major problem with the use of these vaccines. Another weakness of the vaccines is that it cannot completely prevent infection.<sup>18</sup>

Strain 19 vaccines are normally administered to female calves between 3 and 8 months old as a single subcutaneous dose of  $5$  to  $8 \times 10^{10}$  organisms (**calfhoo** vaccination). There is no significant difference

between the immunity conferred at 4 and at 8 months of age. Calves vaccinated with strain 19 at 2 months of age have resistance comparable to those vaccinated at 4 to 8 months of age. However, generally, calves under 75 days of age are immunologically immature in response to strain 19 vaccine. Vaccination of calves with a single dose at 3 to 5 weeks of age does not provide protection compared with vaccination at 5 months of age.

In calves vaccinated between the recommended ages, the serum agglutination test returns to negative by the time the animals are of breeding age, except in a small percentage (6%) of cases. The LPS with an O-chain on *B. abortus* strain 19 explains the appearance and persistence of antibodies in serum following vaccination. These antibodies are detectable in the serologic assays used for the diagnosis of brucellosis and are the major problem with strain 19 vaccination, because they prevent easy differentiation of vaccinated from infected cattle. The appearance and persistence of these antibodies depends on age, dose, and route of vaccination. This situation makes the continued use of the vaccine incompatible with simultaneous application of test and slaughter procedures for the control of brucellosis.

In brucellosis-free herds where heifers are vaccinated between 4 and 9.5 months of age, positive titers may persist for up to 18 months if they are tested with screening tests such as the RBT. This supports the official policy in some countries not to test vaccinated heifers before 18 months of age and to retest positive cases with the CFT.

In most control programs, vaccination is usually permitted up to 12 months of age, but the proportion of persistent postvaccinal serum and whey reactions increases with increasing age of the vaccinates. Such persistent reactors may have to be culled in an eradication program unless the reaction can be proved to be the result of vaccination and not due to virulent infection.

Vaccination of adult cattle is usually not permitted if an eradication program is contemplated, but it may be of value in reducing the effects of an abortion storm. Under specific circumstances vaccination of adult cattle with a reduced single subcutaneous dose of  $3 \times 10^8$  to  $3 \times 10^9$  viable organisms can be used but will result in persistent antibody titers in some animals. Furthermore, the risk of abortion when vaccinating pregnant animals and the risk of excretion of the vaccine strain in milk has been reported.<sup>7</sup> An alternative vaccination protocol for adult cattle consists in the single or repeated subconjunctival administration of a dose of  $5 \times 10^9$  living organisms. This latter protocol was reported to reduce the risk of abortion and shedding in milk while providing similar protection.<sup>7</sup>

Vaccination of bulls is of no value in protecting them against infection and has

resulted in the development of orchitis and the presence of *B. abortus* strain 19 in the semen. For these reasons the vaccination of bulls is discouraged.

#### Efficiency of *Brucella abortus* Strain 19 Vaccine

**Calfhoo Vaccination.** This can be assessed by its effect on both the incidence of abortion and the prevalence of infection as determined by testing. Field tests show a marked reduction in the number of abortions that occur, although the increased resistance to infection, as indicated by the presence of *B. abortus* in milk, may be less marked. Vaccinated animals have a high degree of protection against abortion and 65% to 75% are resistant to most kinds of exposure. The remaining 25% to 35% of vaccinated animals may become infected but usually do not abort. Experimentally, 25% of cattle vaccinated with strain 19 will become infected following challenge. Vaccinated animals continually exposed to virulent infection may eventually become infected and act as carriers without showing clinical evidence of the disease.

In summary, vaccination with a single dose of *B. abortus* strain 19 vaccine given subcutaneously at 3 to 8 months of age confers adequate immunity against abortion for five or more subsequent lactations under conditions of field exposure. Multiple or late vaccinations have no appreciable advantage and increase the incidence of postvaccinal positive agglutination reactions. When breakdowns occur, they are caused by excessive exposure to infection and not by enhanced virulence of the organism. In herds quarantined for brucellosis, calfhoo vaccination reduces reactor rates, duration of quarantine, and the number of herd tests.

**Adult Vaccination.** Vaccination of adult cows with strain 19 vaccine is highly successful in reducing the number of infected cows in large dairy herds in which it is impossible to institute management procedures for the ideal control of brucellosis.

The vaccination of adult cattle with a reduced dose of vaccine is efficacious and results in an agglutinin response that declines more rapidly after vaccination than when the full dose is used. The reduced dose also provides protection comparable to the standard dose. Vaccination eliminates clinical disease and reduces exposure of infection to susceptible cattle. The reduction of infected adult cattle may vary from 60% to 80% in 6 to 9 months following vaccination. The CFT becomes negative sooner than the standard tube agglutination test following vaccination and can be used to distinguish postvaccine titers from culture-positive cows. The use of reduced doses of strain 19 vaccine in adult cows will also help to eliminate the problem of postvaccine titers.

The protection provided by **subcutaneous and conjunctival routes of vaccination** is the same but the subcutaneous route may result in a persistent serologic response, which requires complement fixation testing and milk culture to identify infected animals.

The principal advantages of adult vaccination include the following:

- An effective method of control of abortion
- Reduction in the reactor losses in herds
- Reduction of the number of tests required to eliminate brucellosis from infected herds

The major disadvantages of adult vaccination are

- Residual vaccine titers
- Persistent positive milk ring test
- Persistent strain 19 infection in a small percentage of adult vaccinates
- The stigma attached to adult vaccinates, which identifies them with infected herds, even though brucellosis has been eliminated and the herd released from quarantine

*B. abortus* strain 19 has been recovered from the supramammary lymph nodes of cattle at slaughter that were vaccinated with a low dose of the vaccine 9 to 12 months previously and had persistent titers to the CFT. The stage of gestation affects the immune responses of cattle to strain 19 vaccination. Cattle that are late in the first or early in the second trimester of gestation (84 to 135 days) at the time of administration of a low dose of strain 19 are at greater risk of being positive by official tests for brucellosis. Vaccination of cattle during the third trimester with a low dose of the vaccine is not as efficacious as when performed earlier. Although reduced-dose strain 19 vaccination is a possible alternative to the total depopulation of problem herds, its use during pregnancy should be avoided because of the risk of abortion and positive serologic titers and positive bulk milk ring tests.

The results expected following adult vaccination depend on the disease situation. In herds vaccinated in the acute phase of the disease, abortion may continue for 60 to 90 days but the incidence begins to decline by 45 to 60 days. A large number of serologic reactors will be present for the first 120 days following vaccination, and testing is usually not done for the first 60 days. The rate of reactors declines rapidly after 120 days and with good infected herd management most adult vaccinated herds can be free of brucellosis 18 to 24 months following vaccination.

The prevalence of *B. abortus* strain 19 infection in adult vaccinated cattle is low and is often not permanent. The prevalence is lower among cattle given the reduced dose of the vaccine subcutaneously. Bacteriologic examination of the milk and serologic examination of the infected cattle are necessary to

identify strain 19 infected cattle, which can be retained for milk production because the infections are temporary.

**Adult vaccination**, even with a low dose, should **not be used in uninfected herds** because of persistent titers, which may last for more than 12 months in up to 15% of vaccinated animals, and because of the potential for abortion. The illegal or unintentional use of the standard dose of strain 19 vaccine in adult cattle will result in a sudden steep antibody titer response in the CFT, which declines in 6 to 11 months. In herds where adult vaccination with a reduced dose of vaccine is used, blood samples should be collected about 4 months after vaccination and subsequently at intervals of 2 months. Those positive to the CFT should be culled. In one study of three large dairy herds in California, the CFT at 2 and 4 months after vaccination was used to identify and cull pregnant reactor cows that were at risk of aborting or calving. The prevention of parturition of infected cows is an effective management technique.

#### *Systemic Reactions to Vaccination With Strain 19*

These occur rarely in both calves and adults, and may be more severe in Jersey calves than in other breeds. A local swelling occurs, particularly in adult cattle, and there may be a severe systemic reaction manifested by high fever (40.5–42°C; 105–108°F) lasting for 2 to 3 days, anorexia, listlessness, and a temporary drop in milk production. An occasional animal goes completely dry. The swellings are sterile and do not rupture, but a solid, fibrous mass may persist for many months.

Deaths within 48 hours of vaccination have been recorded in calves after the use of lyophilized vaccine.

*B. abortus* strain 19 vaccine has been associated with lameness in young cattle with synovitis following vaccination. Experimentally, the intraarticular injection of the vaccine strain can produce synovitis similar to that which occurs following vaccination.

Septicemia due to *B. abortus* may cause some deaths but in most cases the reaction is anaphylactic, and vaccinated calves should be kept under close observation. Immediate treatment with epinephrine hydrochloride (1 mL of 1:1000 solution subcutaneously) or antihistamine drugs is recommended and is effective provided it can be administered in time.

Cows in advanced pregnancy may abort if vaccinated, but the abortion rate is only about 1%; although *B. abortus* strain 19 organisms can be recovered from the fetus and placenta, their virulence is unchanged and they do not cause further spread of infection. Vaccination with strain 19 does not have a deleterious effect on the subsequent conception rate.

***Brucella abortus* Strain RB51 Vaccine**  
*Brucella abortus* strain RB51 (SRB51) is a live, stable, rough mutant of *B. abortus* strain 2308 that lacks much of the LPS O-side chain, therefore, it does not interfere with serologic surveillance tests. Since 1996 vaccines containing SRB51 have become the official vaccines for prevention of brucellosis in several countries.<sup>7</sup> The results of studies comparing the efficacy of SRB51 and strain 19 vaccines in the literature are inconsistent. Generally, SRB51 vaccines are administered subcutaneously to female calves between 4 and 12 months old with a dose of  $1$  to  $3.4 \times 10^{10}$  living organisms.<sup>7</sup> Heifer calves vaccinated at 3 months, 5 months, or 7 months of age with the SRB51 vaccine were protected when challenged against infection and abortion during their first pregnancy. None of the heifers developed antibodies that reacted in the standard agglutination test. A reduced dose of  $1 \times 10^9$  viable organisms administered as calfhod vaccine does not protect against *B. abortus* infection.

Vaccination of cattle over 12 months of age may be permitted under some circumstances and is performed by subcutaneous administration of a single dose of  $1$  to  $3 \times 10^9$  viable organisms. The use of SRB51 vaccines in pregnant cows is discouraged. The strain RB51 has a tropism for the bovine placental trophoblast and has been associated with placentitis and abortion under field conditions.<sup>7</sup> A reduced dose of an SRB51 vaccine containing  $1 \times 10^9$  viable organisms given to pregnant cattle was protective against infection with *Brucella abortus* without causing placentitis or abortion but resulted in shedding of the vaccine strain in a significant proportion of vaccinated animals.<sup>7</sup> Vaccination of mature sexually intact bulls and heifers with a standard calfhod dose of SRB51 is not associated with shedding or colonization in tissues, and does not appear to cause any reproductive problems when administered to sexually mature cattle. Use of the vaccine in cattle already vaccinated with strain 19 vaccine will not cause positive responses on confirmation tests and does not interfere with brucellosis surveillance.

Studies with strain RB51 vaccine indicate that it is as efficacious as *B. abortus* strain 19 vaccine but is much less abortigenic in cattle. It does not produce any clinical signs of disease after vaccination and does not produce a local vaccination reaction at the injection site. The organism is cleared from the bloodstream within 3 days and is not present in nasal secretions, saliva, or urine. Immunosuppression does not cause recrudescence, and the organism is not spread from vaccinated to nonvaccinated cattle. The vaccine is safe in all cattle over 3 months of age.

In the United States, strain RB51 vaccine was licensed by the USDA's Animal and Plant Health Inspection Service (APHIS) in 1996 for use in cattle and was approved for use in

the Cooperative State–Federal Brucellosis Eradication Program. Strain RB51 vaccine must be administered by an accredited veterinarian or by a state or federal animal health official. Calves must be vaccinated with the calf dose ( $1\text{--}3.4 \times 10^{10}$  organisms) between 4 and 12 months of age. Only animals in high-risk areas should be vaccinated over 12 months of age.

Vaccinates must be identified with the standard metal vaccination eartag and a vaccination tattoo. The tattoo will be the same as the tattoo for *B. abortus* strain 19 vaccination except the first digit for the quarter of the year will be replaced with an R to distinguish animals vaccinated with RB51 from those vaccinated with strain 19. Recording and reporting are the same as with strain 19 vaccine. The diagnosis requires special diagnostic tests that are not routinely available in most hospitals. Both strains are sensitive to a range of antimicrobials. Physicians deciding to initiate a metaphylactic treatment in a human patient exposed to the RB51 vaccine strain must be advised that this strain is resistant to rifampin, one of the antimicrobials of choice for the treatment of human brucellosis.

#### **Brucella Vaccines in Wildlife**

A reservoir of *B. abortus*-infected bison in the Greater Yellowstone area in the United States is an obstacle in the effort to eradicate brucellosis from the United States and a source of potential reinfection for livestock in the states of Wyoming, Idaho, and Montana. The free-ranging and infected bison in the area migrate from public land on to private lands and may come into contact with cattle. *Brucella*-induced abortions in bison have occurred under experimental and field conditions, and infected bison can transmit brucellosis under range conditions. Wild and free-ranging bison in parts of western Canada have also been shown to be infected with bovine brucellosis. Therefore a safe and effective vaccine suitable for delivery to free-ranging bison in the Greater Yellowstone area and in Canada is considered useful in reducing the risk of transmission and an aid in the prevention and control of the disease.

#### **Brucella abortus Strain 19 in Bison**

The use of strain 19 vaccine has been evaluated in pregnant bison and 10-month-old calves, and the results have been unsatisfactory. In adult bison, strain 19 was found to be highly abortigenic, and animals vaccinated as calves were not protected from infection after experimental inoculation in later life.<sup>18</sup>

#### **Brucella abortus Strain RB51 in Bison**

The vaccine is safe for vaccination in herds of naive and previously exposed bison calves, young growing bison, adult males, and adult pregnant and nonpregnant females. Fetal lesions do not appear to be significant with

bison cows vaccinated with RB51 in early gestation, but placentitis and abortion have occurred incidentally in advanced stages of pregnancy. Limited data from efficacy studies indicate that booster vaccination with strain RB51 vaccines may increase the protection after experimental challenge.<sup>18</sup>

Calfhood vaccination of bison with SRB51 vaccines is efficacious in protecting against intramammary, intrauterine, and fetal infection following exposure to a virulent strain of *B. abortus* during pregnancy. However, these vaccines appear to be less effective in bison than in cattle in protecting from experimental infection. Limited data from efficacy studies indicate that booster vaccination with strain RB51 vaccines may increase the protection after experimental challenge.<sup>18</sup> Calfhood vaccination with SRB51 would be beneficial in a program to reduce the prevalence of *B. abortus* field stains in American bison. As with cattle, SRB51 calfhood vaccination provides a method to prevent transmission and reduce the numbers of susceptible individuals in a bison herd without interfering with serologic identification of *Brucella*-infected animals. Brucellosis management programs in bison and elk are unlikely to be successful if capture and hand vaccination is necessary. The effect of hand vaccination versus ballistic vaccination for vaccination of bison and elk on the immunologic responses to SRB51 has been evaluated. Ballistic delivery may require a greater dose of SRB51 to induce cell-mediated immune responses in bison that are comparable to those induced by hand injection.

#### **Brucella abortus Strain RB51 in Elk (*Cervus elaphus canadensis*)**

Several studies conducted in elk using strain 19 and SRB51 vaccines have yielded disappointing results with poor or no protection against experimental infection. Neither single nor repeated doses provided significant protection against *B. abortus*-induced abortion. Following vaccination, elk remain bacteremic for a prolonged period of time, rapidly develop high antibody titers while the cellular immune response is poor or lacking.<sup>18</sup>

#### **Control Programs on a Herd Basis**

The following recommendations are based on the need for flexibility depending on the level of infection that exists and the susceptibility of the herd and the disease regulations in effect at the time.

#### **During an Abortion Storm**

Test and disposal of reactors may be unsatisfactory during an outbreak because spread occurs faster than eradication is possible. Vaccination of all nonreactors is recommended in some countries or, if testing is impracticable, vaccination of all cattle. It is preferable to retest the herd before the

second vaccination and to cull cows with a threefold rise in agglutination titer.

#### **Heavily Infected Herds in Which Few Abortions Are Occurring**

These do not present an urgent problem because a degree of herd resistance has been reached. All calves should be vaccinated immediately, and positive reactors among the remainder should be culled as soon as possible. Periodic milk ring tests (preferably at 2-month, and no more than 3-month, intervals) on individual cows are supplemented by complement fixation and culture tests.

#### **Lightly Infected Herds**

These present a special problem. If they are situated in an area where infection is likely to be introduced, calfhood vaccination should be implemented and positive reactors immediately culled. If eradication is the goal in the area, culling of reactors will suffice, but special market demands for vaccinated cattle may require a calfhood vaccination policy. When a herd is declared free of brucellosis on the basis of serum agglutination tests, its status can be maintained by introducing only negative-reacting animals from brucellosis-free herds and annual blood testing. In areas where dairying predominates, semiannual testing of milk may be substituted for blood testing.

In all of the previously mentioned programs, the careful laboratory examination of all aborted fetuses is an important and necessary corollary to routine testing. There are many difficulties achieving control and eventual eradication on a herd basis. These relate mainly to the failure of owners to realize the highly infectious nature of the disease and to cooperate fully in the details of the program. Particularly, they may fail to recognize the recently calved cow as the principal source of infection. In a herd control program, such cows should be isolated at calving and blood tested at 14 days, because false-negative reactions are not uncommon before that time.

#### **Hygienic Measures**

These include the isolation or disposal of infected animals; disposal of aborted fetuses, placentas, and uterine discharges; and disinfection of contaminated areas. It is particularly important that infected cows be isolated at parturition. All cattle, horses, and pigs brought on to the farm should be tested, isolated for 30 days, and retested. Introduced cows that are in advanced pregnancy should be kept in isolation until after parturition, because occasional infected cows may not show a positive serum reaction until after calving or abortion. Chlorhexidine gluconate is an effective antiseptic against *B. abortus* and is recommended for washing the arms and hands of animal attendants and veterinarians who come into contact with contaminated tissues and materials.



### Eradication on an Area Basis by Test and Slaughter and Cessation of Calfhood Vaccination

Following a successful calfhood vaccination program, eradication on an area basis can be considered when the level of infection is below about 4% of the cattle population. Brucellosis control areas must be established and testing and disposal of reactors and their calves at foot is performed. Financial compensation is paid for disposal of reactors. Infected herds are quarantined and retested at intervals until negative; in heavily infected herds complete depopulation is often necessary. Brucellosis-free areas are established when the level of infection is sufficiently low, and the movement of cattle between areas is controlled to avoid the spread of infection.

Farms with a low incidence may find it possible to engage in an eradication program immediately provided the incidence on surrounding farms is low. Breakdowns may occur if there are accidental introductions from nearby farms, and in these circumstances it is hazardous to have a herd that is not completely vaccinated. When the area incidence is low enough (about 5%) that replacements can be found within the area or adjoining free areas, and immediate culling of reactors can be performed without crippling financial loss, compulsory eradication by testing and disposal of reactors for meat purposes can be instituted. Compensation for culled animals should be provided to encourage full participation in the program.

The work of testing can be reduced by using screening tests to select herds for more intensive epidemiologic and laboratory investigation. In dairy herds, the milk ring test conducted on bulk milk samples is useful. In beef herds, the favored procedure is the collection of blood from drafts of cattle at the abattoir and use of the RBT. The same technique has also been used to screen shipments of beef destined for countries with an aversion to meat infected with *B. abortus*. An additional means of reducing labor costs in an eradication program is the use of automated laboratory systems such as the one available for the RBT and the one based on agglutination and CFT. An educational program to promote herd owners to voluntarily submit all aborted fetuses to a laboratory for bacteriologic examination is also deemed necessary in any eradication scheme. When an area or country is declared free, testing of all or part of the population needs to be performed only at intervals of 2 to 3 years, although regular testing of bulk milk samples (milk ring test) and of culled beef cows in abattoirs and examination of fetuses should be maintained as checks on the eradication status. In all eradication programs, some problem herds will be encountered in which testing and disposal do not eliminate the infection. Usually about 5% of such herds are encountered and are best handled by a "problem herd" program. Fifty percent of

these herds have difficulty because of failure to follow directions. The other half usually contain infected animals that do not respond to standard tests. Supplementary bacteriologic and serologic tests as set out previously may occasionally help these spreader animals to be identified and the disease to be eradicated.

#### United States

Efforts to eradicate brucellosis associated with *B. abortus* in the United States began in 1934 as an economic recovery program to reduce the cattle population because of the Great Depression. Brucellosis was considered the most significant livestock disease at that time, with a reactor rate of 11.5%. In 1954, a cooperative federal and state program was launched based on calfhood vaccination and test and slaughter with compensation. Two very effective surveillance programs for detecting brucellosis were the market cattle testing and milk ring testing of dairy herds. On July 10, 2009, all 50 states, Puerto Rico, and the U.S. Virgin Islands were officially classified as class free for bovine brucellosis.<sup>19</sup> The number of human cases of brucellosis declined with the decline in number of cases in animals. As of 2013, about 100 human cases per year are reported of which most cases are associated with consumption of unpasteurized milk and milk products of goat origin infected with *B. melitensis*.

Bison and elk in the Greater Yellowstone area are the last known remaining reservoir of *B. abortus* in the United States. Control of brucellosis in these species on public lands requires special consideration to preserve the largest wild, free-ranging population of bison in the United States. Vaccination trials are under way.

The primary surveillance methods for testing eligible cattle in the United States have been the **market cattle testing** program in the beef industry and the **milk ring testing** in the dairy industry. In 2009, the National Surveillance Unit USDA-APHIS identified considerable redundancies in bovine brucellosis surveillance in regions classified as class free for bovine brucellosis for at least 5 years.<sup>19</sup> Consequently, slaughter surveillance was reduced, and brucellosis milk surveillance was eliminated in 2011.

#### Market Cattle Testing

Surveillance by this method is part of the marketing process. Testing is done at livestock markets, slaughterhouses, livestock buying stations, or dealer premises. This type of testing is very effective, especially if required at the first point of assembly of cattle after leaving the farm of origin. Until 2011 95% or more of cows and bulls 2 years of age or older were required to be tested for brucellosis at slaughter in the United States. As of 2011 the number of slaughter plants participating in slaughter surveillance testing was reduced to 13 of the 40 top

establishments and two bison slaughter plants. These slaughter plants are located in 13 states, representing all regions of the country.

#### Milk Ring Testing

Surveillance by this method involves the regular, periodic testing of milk or cream from commercial dairy herds. Milk ring testing is required twice annually in commercial dairy herds in states officially declared free of brucellosis, and four times annually in states not officially free of brucellosis. This test is very sensitive and is done on a small sample of milk from the entire herd. The milk ring test itself is simple and inexpensive. A well-managed testing program is important to public health and can reduce the exposure potential of contaminated dairy products to humans by quickly identifying affected herds. Routine brucellosis ring testing was discontinued in the United States in 2011, following the recommendation of the National Surveillance Unit of the USDA-APHIS that had identified redundancies in the diagnostic surveillance of bovine brucellosis in regions free of brucellosis for over 5 years.<sup>19</sup>

#### Australia

In Australia, under range conditions, considerable progress toward eradication of brucellosis in large beef herds has been possible. Management must be motivated and confident that the disease can be permanently eradicated. All cattle should be permanently identified, security between subherds must be good, vaccination histories must be accurate, and accurate round-up (mustering) of cattle must be possible. Quarantine facilities for infected subherds must be strict and absolutely reliable, and fence lines must be impenetrable. The development of a two-herd system, based on segregation of weaned heifer calves from adult cows and maintenance of testing pressure on the adults, will reduce the chance of infection of heifers. All calves from reactor dams are discarded, which necessitates positive identification. Only bulls or semen from brucellosis-free herds should be used in clean herds. In some situations, a laboratory is established on the ranch and equipped to do RBT and CFT. This increases the efficiency of the testing program and creates an excellent team effort between management, laboratory personnel, and the field veterinarian.

#### New Zealand

In New Zealand, the brucellosis status of accredited herds is monitored by a triennial CFT with a sensitivity of greater than 95%. Slaughterhouse surveillance, as performed in Australia, has a low probability of identifying infected herds. A skin test for brucellosis is attractive because it could be used at the same time as routine tuberculin testing.

## Canada

In Canada, the bovine brucellosis eradication program is a success story that began in 1950 when the national prevalence of infection was about 9%. With the cooperative Federal-Provincial Calfhood Vaccination Program, the prevalence of infection was reduced to 4.5% by 1956. In 1957, a test and slaughter program was begun in which brucellosis control areas were established and mandatory testing of all cattle was done using the tube agglutination test. Reactors were identified and ordered to be slaughtered, and compensation was paid. Infected herds were quarantined and retested until negative or in some cases completely depopulated. When the infection rate was reduced to below 1% of the cattle population and 5% of the herds, the area was certified for a period of 3 years. When the infection rate was reduced to below 0.2% of the cattle in the area and 1% of the herds, the area was designated brucellosis free and certified for a period of 5 years. In the 1960s, the milk ring test and the market cattle testing programs were introduced as surveillance procedures. These are done on a continuing basis, are effective in locating infected herds, and have reduced the volume of on-farm testing required to recertify areas.

When the national level of infection was reduced to below 0.2%, calfhood vaccination was deemphasized to overcome the problem of distinguishing between persistent vaccination titers and titers caused by natural infection. Thus all seropositive animals could be disposed of and no vaccination privileges allowed. In 1973, an increase in the incidence of brucellosis occurred, which necessitated some modifications in the eradication program. The intensity of milk ring testing was increased, herds adjacent to infected herds were tested, the length of quarantine of infected herds was increased, and calves from reactor dams were ordered to be slaughtered. In heavily infected herds and in those in which it is not possible to maintain effective quarantine, it was preferable to completely depopulate a herd rather than conduct tests and successive retests. In the Canadian experience, brucellosis-free herds usually became infected when the owner unknowingly purchased an infected animal. The uncontrolled movement of infected animals from infected herds to brucellosis-free herds was a major obstacle in the final stages of the eradication.

The rate of progress in an eradication program is determined mainly by the rate at which herds that are accredited free of the infection become reinfected. The severity of reinfection (or **breakdown**) is dependent on the proportion of the herd that has been vaccinated as calves. The cessation of compulsory calfhood vaccination results in a large proportion of cattle that are fully susceptible to *B. abortus* infection. The prevention of

reinfection requires a constant surveillance system.

Canada was declared free of bovine brucellosis in 1985. In 1997, a comprehensive review of Canada's bovine brucellosis surveillance program was undertaken. As a result of the findings of this review, a number of modifications to the surveillance program were introduced in 1999. The routine serologic testing of market and slaughter cattle and the routine milk ring testing of all dairy cattle were discontinued in 1999. However, auction market testing of cattle 24 months and older continues in the five markets in northern Alberta and British Columbia in response to the disease risk associated with the infected free-roaming bison herds in and around Wood Buffalo National Park.

In April 2000, the vaccination of calves with reduced dosage strain 19 *B. abortus* vaccine was discontinued. Strain RB51 *B. abortus* vaccine is not licensed for use in Canada.

Bovine brucellosis in wildlife is restricted to free-roaming bison in and around Wood Buffalo National Park in northern Canada. Information on this occurrence is found in Canada's report to the OIE Wildlife Diseases Working Group.

## FURTHER READING

- DelVecchio VG, Wagner MA, Eshenbrenner M, et al. *Brucella* proteomes: a review. *Vet Microbiol*. 2002;90:593-603.
- Ragan VE. The Animal and Plant Health Inspection Service (APHIS) brucellosis eradication program in the USA. *Vet Microbiol*. 2002;90:11-18.
- Lapaque N, Moriyon I, Moreno E, Gorvel J-P. *Brucella* lipopolysaccharide acts as a virulence factor. *Curr Opin Microbiol*. 2005;8:60-66.
- OIE. Bovine brucellosis. OIE Terrestrial Manual. At: <[http://www.oie.int/fileadmin/Home/eng/Health\\_standards/tahm/2.04.03\\_BOVINE\\_BRUCCELL.pdf](http://www.oie.int/fileadmin/Home/eng/Health_standards/tahm/2.04.03_BOVINE_BRUCCELL.pdf)>; 2009 Accessed 25.01.14.
- WHO. Brucellosis in humans and animals. At: <<http://www.who.int/csr/resources/publications/Brucellosis.pdf>>; 2006 Accessed 27.01.14.

## REFERENCES

- Scholz HC, Vergnaud G. *Rev Sci Tech*. 2013;32:149.
- Díaz-Apparicio E. *Rev Sci Tech*. 2013;32:53.
- EFSA. *EFSA J*. 2014;12(3547):175.
- Otl S, et al. *Acta Vet Brno*. 2008;77:117.
- Lopez LB, et al. *Open Vet Sci J*. 2010;4:72.
- McDermott J, et al. *Rev Sci Tech*. 2013;32:249.
- OIE 2009. At: <[http://www.oie.int/fileadmin/Home/eng/Health\\_standards/tahm/2.04.03\\_BOVINE\\_BRUCCELL.pdf](http://www.oie.int/fileadmin/Home/eng/Health_standards/tahm/2.04.03_BOVINE_BRUCCELL.pdf)>; 2014 Accessed 25.02.14.
- White PJ, et al. *Biol Conserv*. 2011;144:1322.
- Scurlock BM, Edwards WH. *J Wildl Dis*. 2010;46:442.
- Cross PC, et al. *Rev Sci Tech*. 2013;32:79.
- Schumaker B. *Rev Sci Tech*. 2013;32:71.
- Poester FP, et al. *Rev Sci Tech*. 2013;32:105.
- Baldi PC, Giambartolomei GH. *Rev Sci Tech*. 2013;32:117.
- EFSA. *EFSA J*. 2014;12:3547.
- The Center for Food Security and Public Health 2007. At: <<http://www.cfsph.iastate.edu/Factsheets/pdfs/brucellosis.pdf>>; 2014 Accessed 27.01.14.

- WHO 2006. At: <<http://www.who.int/csr/resources/publications/Brucellosis.pdf>>; 2014 Accessed 27.01.14.
- McGiven JA. *Rev Sci Tech*. 2013;32:163.
- Olsen SC. *Rev Sci Tech*. 2013;32:207.
- USDA. At: <[http://www.aphis.usda.gov/animal\\_health/animal\\_diseases/brucellosis/downloads/natl\\_bruc\\_surv\\_strategy.pdf](http://www.aphis.usda.gov/animal_health/animal_diseases/brucellosis/downloads/natl_bruc_surv_strategy.pdf)>; 2010 Accessed 27.01.14.

## BRUCELLOSIS ASSOCIATED WITH *BRUCELLA OVIS*

### SYNOPSIS

**Etiology** *Brucella ovis*.

**Epidemiology** Organism carried by sexually mature rams with spread by direct contact or passive venereal infection. Predominantly a disease of sheep, but red deer stags can be naturally infected.

**Clinical findings** Complete or partial infertility in rams caused by epididymitis. Epididymal abnormality can be detected by palpation in some affected rams. Occasionally abortion in ewes and neonatal mortality in lambs.

**Clinical pathology** Serology of most value including complement fixation, gel diffusion, and ELISA; semen examination.

**Diagnostic confirmation** Physical palpation of scrotal contents; serology; culture or PCR of semen, testes, and seminal vesicles, aborted material.

**Treatment** Oxytetracycline in valuable rams.

**Control** Total segregation of normal and young rams. Initial culling of rams with palpable scrotal abnormality and subsequent repeated serologic testing and culling of seropositive rams. Where permitted, vaccination with live *B. melitensis* strain Rev. 1 is an alternative.

## ETIOLOGY

*Brucella ovis* has significant DNA homology with other members of the *Brucella* genus and shares antigenic and other characteristics. However, it has a permanently rough phenotype, whereas *B. melitensis* and *B. abortus* colonies are smooth.<sup>1</sup>

## EPIDEMIOLOGY

### Geographic Occurrence

Brucellosis of sheep associated with *B. ovis* has been reported in most of the major sheep-producing regions of the world, including Australia, New Zealand, North and South America, Central Asia, Russia, South Africa, and Europe, but is not a major cause of ram wastage in Great Britain. When the disease is first diagnosed in a country, and before control procedures are established, the flock prevalence of infection can be as high as 75% and as many as 60% of rams may be infected. The prevalence of infection is generally much lower in

countries and in flocks that have established control programs.

### Host Occurrence

In nature mainly sheep are affected, with the ram more susceptible than the ewe. A small number of natural cases occur in farmed red deer (*Cervus elaphus*) in New Zealand, but most infections resolve after 340 days and it is regarded as a self-limiting disease.<sup>2</sup> It is difficult to establish infection in laboratory animals. However, white-tailed deer and goats can be infected experimentally and develop epididymitis. There is no evidence of natural infection in goats, even in those that graze with infected sheep.

The Merino breed and Merino-derived crossbreeds show a much lower incidence of the disease than do British breeds. The disease is most important in large flocks where there is multisire breeding.

### Source of Infection

The infected ram is the source of infection and perpetuates the disease in a flock. The majority of infected rams excrete the organism in semen, and in most rams the active excretion in semen probably persists indefinitely. Ewes are more resistant to infection, but the organism can be isolated from them in infected flocks. After being bred by an infected ram, the majority will not carry infection for more than one or two heat cycles. Infection may result in early embryonic death and occasionally abortion or the birth of weak and poorly viable lambs. In ewes where the infection does persist to produce abortion, the organism is present in the placenta, vaginal discharges, and milk.

### Transmission

Transmission between rams occurs via passive venereal infection and by direct ram-to-ram transfer. Passive venereal infection occurs from ewes that have been bred by an infected ram in the same heat cycle. Under natural conditions, this may be the major form of transmission from ram to ram during the breeding season. Infection can also be transmitted between rams in the non-breeding season when housed or grouped together on pasture. This occurs as they sniff and lick each other's prepuce and by homosexual activity. Submissive rams may lick the prepuce of dominant rams as a trait in the dominance hierarchy. Spread of infection in a group of virgin rams is recorded. Lambs born from infected ewes and drinking infected milk do not become persistently infected.

The organism can survive on pasture for several months, but transmission by fomites appears to have no practical significance. However, transmission from infected rams to infection-free red deer stags grazed on the same pasture can occur, and it is not known if this results from direct contact between the

animals or indirectly via environmental and pasture contamination.

### Host Risk Factors

All postpubertal rams are susceptible to infection, but disease is more common in adult rams and disease prevalence increases with age, probably because of greater exposure to infection. Differences between flocks in the prevalence of disease suggest that environmental factors and stress may modulate susceptibility, but the risk factors are poorly defined. When the number of affected rams in a flock is greater than about 10%, the fertility of the flock is appreciably decreased.

### Experimental Reproduction

Experimentally, rams can be infected by the IV, subcutaneous, intratesticular, oral, conjunctival, and preputial routes, but the latter two are the most effective. The first observable abnormality is the presence of inflammatory cells in the semen, which appear at 2 to 8 weeks. *B. ovis* appears in the ejaculate at approximately 3 weeks, but it is not always present in an infected ram after that.<sup>3</sup> Testicular and epididymal lesions can be palpated at about 9 weeks after infection but may occur earlier in some rams. A significant proportion of infected rams have no palpable lesions but still excrete the organism.

Ewes in early pregnancy can also be infected by the oral and IV routes, but many of these infections are transient and do not result in abortion. Abortion caused by placentitis has been produced experimentally. Intrauterine infection produced experimentally also causes lesions in and death of the fetus, but the significance of this to natural cases is undetermined.

### Economic Importance

The economic effects of the disease are subtle but significant. The effect of the disease on ram fertility can influence the number of rams that are required in a flock, with the required ram to ewe ratio significantly reduced in *B. ovis*-free flocks. The percentage of lambs born early and within the first 3 weeks of the lambing period is also markedly increased. Lambing percentage may be reduced by 30% in recently infected flocks and by 15% to 20% in those where the infection is endemic. The loss of rams of high genetic potential and the need for repeat serologic testing are additional costs. In the United States, the advantage in a control program has been calculated as an additional return of \$12 per ewe mated.

### Zoonotic Implications

*B. ovis* is not a zoonosis, but live *Brucella* vaccines used for prevention of this infection in some countries, such as Rev. 1 *B. melitensis* vaccine, are pathogenic to humans and should be handled and used with care.

## PATHOGENESIS

There is an initial bacteremia, often with a mild systemic reaction, and the organism can be isolated from the internal organs of animals slaughtered after experimental infection. However, systemic disease is not a feature of the natural disease, and clinical disease results from localization and inflammation in the epididymides, typically in the tail. Inflammation in this area results in sperm stasis and extravasation with a subsequent immunologic reaction that is often unilateral, causing a spermatocele and reduced fertility. Not all infected rams have palpable lesions in the epididymis, and infection can also establish in the seminal vesicles and ampullae. In either case the organism is shed in the ejaculate.

Generally, *B. ovis* has low pathogenicity for ewes. The primary effect is a placentitis, which interferes with fetal nutrition, sometimes to the point of causing fetal death, but more commonly producing lambs of low birth weight and poor viability.

Analysis of the immune response by microarray hybridization and reverse transcription (RT)-PCR found that infection with *B. ovis* causes upregulation of genes involved in phagocytosis and downregulation of host defense mechanisms, both of which probably contribute to the chronic nature of the infection.<sup>4</sup>

## CLINICAL FINDINGS

The first reaction in rams is a marked deterioration in the quality of the semen together with the presence of leukocytes and *Brucella*. Acute edema and inflammation of the scrotum may follow. A systemic reaction, including fever, depression, and increased respiratory rate, accompanies the local reaction.

Regression of the acute syndrome is followed, after a long latent period, by the development of palpable lesions in the epididymis and tunicae of one or both testicles.

The palpation of both testicles simultaneously is the best method of examination. The epididymis is enlarged and hard, more commonly at the tail; the scrotal tunics are thickened and hardened; and the testicles are usually atrophic. The groove between the testis and epididymis may be obliterated.

The abnormalities are often detectable by palpation, but many affected rams show no acute inflammatory stage and others may be actively secreting *Brucella* and poor-quality semen in the chronic stage in the absence of palpable abnormalities. Palpable abnormality of the scrotal contents may be present in less than 50% of serologically positive rams. Affected rams have normal libido.

There are usually no clinical signs in the ewe but in some flocks infection causes abortion or the birth of weak or stillborn lambs, associated with a macroscopic placentitis.



In red deer, only a small proportion of stags infected with *B. ovis* develop epididymitis detectable by scrotal palpation.<sup>5</sup> In contrast to rams, in most stags the infection resolves within 12 months following infection.<sup>2</sup>

### CLINICAL PATHOLOGY

Semen examination, including culture of the ejaculate, and serologic tests are used in suspect individuals and in groups of rams. The complement fixation and ELISA tests are by far the most useful; many infected rams have palpably normal scrotal contents and microbiologically negative semen. Ultrasound examination of the scrotal contents can reveal anechoic areas that correspond to foci of fibrosis, but these appear no earlier and are nonspecific, offering no real advantage over scrotal palpation.

Multiplex PCRs to differentiate *B. ovis* from *Actinobacillus seminis* and *Histophilus ovis* have been described for use on semen or urine.<sup>6,7</sup> Real-time PCR has also been used to type *Brucella* from field material, such as ovine placenta, without the need for culture.<sup>8</sup>

### Semen Examination

A combination of semen examination and palpation of the testicles for abnormalities will identify approximately 80% of infected rams. In affected animals the findings are a general reduction in semen quality, a reduced total sperm output, poor motility, and a high proportion of spermatozoa with secondary morphologic abnormalities.

### Culture

*B. ovis* is fastidious in its growth and requires special cultural techniques. The examination of the semen for the presence of leukocytes has been used to determine those sheep that should be cultured for *B. ovis*, but it is not a highly sensitive screening test. PCR for detection of *B. ovis* in semen has an equivalent sensitivity to culture.

### Serology

The CFT, the standard test in many countries, is the prescribed test for international trade, and when used in conjunction with genital palpation has allowed the eradication of *B. ovis* from flocks. However, a small proportion of infected rams are negative to CFT, which can compromise or delay eradication programs. The sensitivity and specificity of the various serologic tests depend mainly on the antigens used and the serologic cut points, which may vary between countries and laboratories. A UK study reported the sensitivity of an ELISA, gel diffusion, and CFT as 97.6, 96.4, and 92.7%, respectively, with all tests 100% specific. Studies in other countries support this ranking, but others suggest that the ELISA has no advantage over the classic complement and gel diffusion tests. A combination of serologic tests may increase the sensitivity closer to 100%,

but will obviously increase testing costs. Seroconversion occurs slightly earlier with the ELISA, compared with the complement fixation and gel diffusion tests, so it may be useful in situations where infection is rapidly spreading within a group of rams.<sup>9</sup>

Serologic tests will not differentiate vaccinated from infected sheep or sheep infected with *B. melitensis*.

### NECROPSY FINDINGS

In the acute stage, there is inflammatory edema in the loose scrotal fascia, exudate in the tunica vaginalis, and formation of granulation tissue. In the chronic stage, the tunics of the testes become thickened and fibrous and develop adhesions. There are circumscribed indurations in the epididymis and these granulomata may also be present in the testicle. In advanced stages, they undergo caseation necrosis. As the epididymis enlarges the testicle becomes atrophied. *B. ovis* can usually be isolated from the genital organs, especially the tail of the epididymis, and rarely from internal organs and lymph nodes. Similar lesions are described in red deer stags.<sup>5</sup>

The abortus is characterized by thickening and edema, sometimes restricted to only a part of the placenta, with firm, elevated yellow-white plaques in the intercotyledonary areas and varying degrees of cotyledonary necrosis. Microscopically, organisms are visible within the cytoplasm of trophoblasts of the inflamed placenta. A vasculitis is often present. The organism can be isolated from the placenta and the stomach and lungs of the lamb.

### Samples for Confirmation of Diagnosis

- Bacteriology and PCR: epididymal granuloma, seminal vesicle, inguinal lymph node/fetal lung, stomach content, placenta (culture, has special growth requirements; cytology, Stamp's or Koster's stain on placental smear; PCR)
- Histology: formalin-fixed epididymis, testicle, seminal vesicle, inguinal lymph node from rams; in abortions placenta, fetal lung, liver, spleen, kidney, heart, brain

### DIFFERENTIAL DIAGNOSIS

Infection with *Actinobacillus seminis* and *Histophilus ovis* can cause similar scrotal lesions, although many rams with abnormalities of intrascrotal tissues do not have brucellosis or infectious epididymitis.

Abortion in ewes may be associated with a number of infectious diseases, which are summarized in Table 18-1.

### TREATMENT

Treatment of naturally occurring cases is rarely undertaken. IM administration of

long-acting oxytetracycline at 20 mg/kg body weight (BW), given every 3 days for 24 days, along with the daily IM administration of 20 mg/kg of dihydrostreptomycin sulfate, resulted in bacteriologic cure of 90% of experimentally infected rams. Oxytetracycline alone is less effective, but the use of dihydrostreptomycin is prohibited in food-producing animals in many countries. Treatment is economically feasible only in valuable rams and must be instituted before irreparable damage to the epididymis has occurred. The treatment of rams that are infected but without palpable lesions results in a significant improvement in breeding soundness classification on examinations subsequent to treatment.

### CONTROL

Control is by preventing the spread of infection between rams and detecting and culling infected rams. In small flocks, culling of all rams and replacement with *B. ovis*-free rams may be the most cost-effective approach. Some control can be achieved using scrotal palpation to detect infected rams, but this must be combined with repeated serologic testing if eradication is the goal. Vaccination may be the most economical and practical means of controlling the disease in areas with a high incidence of infection and in regions of the world where eradication by test and slaughter is impractical.

### Eradication

In a flock where the diagnosis has been confirmed all rams are palpated and those with scrotal abnormalities are culled. The remaining rams are tested serologically and reactors culled. Serologic tests are repeated at monthly intervals, with culling of reactors, until all rams are serologically negative. Further tests, 6 and 18 months later, are used to confirm eradication.

Infection spreads rapidly during the mating season, so eradication should be delayed until after the breeding season. During breeding it may be wise to run two breeding flocks, with virgin rams and rams known to be free of infection separated from older or suspicious rams (seropositive and/or those with scrotal lesions). Strict separation of the two ram flocks must be maintained at all times, and the clean group must not mate ewe flocks that have been mated to the suspect rams.

Several countries have voluntary accreditation schemes based on inspection of boundary fencing, restricting the introduction of new rams to those from accredited flocks and serologic testing.

### Vaccination

A number of vaccines have been used, but none is fully effective. In some countries, vaccination is not permitted and eradication by test and slaughter is the only method of control.

Table 18-1 Diagnostic summary of infectious abortion in ewes

Disease	Transmission	Epidemiology and diagnosis			Laboratory findings	
		Time of abortion	Clinical data	Fetus	Serology	Vaccination
Brucellosis ( <i>Brucella ovis</i> )	Passive venereal, ram to ram	Late or stillbirth, weak lambs	Abortion in ewes, epididymitis in rams	Organisms in fetal stomach and placenta	CFT or ELISA	In some countries simultaneous <i>B. abortus</i> strain 19 and killed <i>B. ovis</i> vaccine, or <i>B. melitensis</i> Rev. 1 vaccine
<i>Campylobacter fetus</i> or <i>C. jejuni</i>	Ingestion High stocking rate, intensive grazing, and supplementary feeding on the ground increases risk	Mainly young ewes; last 6 weeks of pregnancy, stillbirths, weak lambs	Metritis in ewes after abortion	<i>Campylobacter</i> in stomach, large necrotic foci in liver	Agglutination test, flock only	Formalin-inactivated bivalent vaccine can increase live lambs by around 10%; variable efficacy depending on which strains are present
Enzootic abortion of ewes ( <i>Chlamydomphila abortus</i> )	Ingestion	Last 2–3 weeks. Stillbirths, weak lambs	No sickness in ewes, neonatal mortality	<i>Chlamydomphila</i> in fetal cotyledons Degenerative changes in placenta	ELISA, CFT, PCR	Killed vaccine gives moderate immunity. Live attenuated vaccine
Listeriosis ( <i>Listeria monocytogenes</i> )	Probably ingestion	After 3 months	Retained placenta and metritis Septicemia in some ewes	Organisms in fetal stomach Autolysis, necrotic foci in liver	Agglutination and complement fixation of doubtful value	In some countries killed or live attenuated vaccines
Salmonellosis ( <i>Salmonella abortusovis</i> )	Probably ingestion Carrier sheep	Last 6 weeks	Metritis after abortion	Organisms in fetal stomach Not in the United States	Agglutination test	Doubtful efficacy
Salmonellosis ( <i>S. dublin</i> , <i>S. montevideo</i> , <i>S. typhimurium</i> )	Ingestion	Last month	Abortion: fetal metritis, neonatal mortality	Organisms in stomach	Agglutination test	—
Toxoplasmosis	Ingestion	Late or stillbirths Live-born weak lambs	Abortion, stillbirths, and neonatal mortality; no illness in ewe	Multiple small necrotic foci in fetal cotyledons Toxoplasma in cells of trophoblast epithelium	Modified agglutination test, ELISA of limited value in adult; test pleural fluid of fetus PCR	Live S48 tachyzoite in some countries (e.g., UK, New Zealand); single dose 3 weeks before mating
Rift Valley fever	Insects	—	Important cause of abortion in all species in Central Africa Heavy mortality in young animals	Acidophilic inclusions hepatic cells	Hemagglutination inhibition and ELISA Fluorescent antibody for tissues	Available in endemic countries
Coxiellosis (Q-Fever)	Inhalation, ingestion	Later term and weak lambs	No illness in ewe, neonatal mortality	Fetus fresh, Intercotyledonary necrotizing placentitis	Fluorescent and PCR; serology of limited value	Vaccine available in Europe but not in most other countries
Tick-borne fever	Ticks	Late, following systemic disease	Fever and abortion	None specific	Giemsa smear of blood, PCR Counterimmunoelectrophoresis	None
Border disease	Ingestion	All stages, stillbirth	Infertility in ewes, hairy shaker lambs	Virus isolation	See text description	None that are specific for sheep strains

CFT, complement fixation test; ELISA, enzyme-linked immunosorbent assay; PCR, polymerase chain reaction.

**Killed *B. ovis* vaccines**, even with adjuvants, have poor efficacy. The use of a killed vaccine may be inadvisable in flocks where eradication is being attempted, because it may protect against clinical disease but allow a carrier state in some rams in which there is excretion of the organism in animals that become seronegative. An experimental vaccine prepared from enriched OMPs and rough LPS of *B. ovis* gave equivalent protection in challenge studies to that given by *B. melitensis* Rev. 1 vaccine.

A **combined vaccine** containing killed *B. ovis* in an adjuvant and *B. abortus* strain 19 also provided durable immunity but had several disadvantages. Vaccinated animals become seropositive, which compromises the subsequent use of serologic tests for eradication. Strain 19 also can cause epididymitis, and vaccinated rams may excrete strain 19 in their semen.

Live *B. melitensis* strain Rev. 1 has been found to be most effective and is the most widely used vaccine, where permitted. This strain was developed in the 1950s from a virulent isolate that had become streptomycin dependent. It is avirulent for rams, and subcutaneous or conjunctival vaccination provides protection against experimental and field challenge. Vaccinated animals become positive to the complement fixation and ELISA tests, but titers are low and can be minimized by using the conjunctival route for vaccination. However, vaccinated animals can excrete *B. melitensis* strain Rev. 1, and it can cause abortions, so alternative vaccine candidates are being evaluated. These include an OMP extracted from *B. melitensis* (Omp31) and an attenuated strain of *B. ovis* (Delta abcBA). The latter protects against experimental challenge with virulent *B. ovis* and is considered a potential vaccine strain for rams.<sup>10</sup>

If vaccination is used there should also be a program of culling clinically abnormal rams, and ram replacements should be yearlings vaccinated at 4 to 5 months.

## FURTHER READING

Ridler AL, West DM. Control of *Brucella ovis* infection in sheep. *Vet Clin North Am Food Anim Pract.* 2011;27:61-66.

## REFERENCES

1. Whatmore AM. *Infect Genet Evol.* 2009;9:1168.
2. Ridler AL, et al. *New Zeal Vet J.* 2006;54:85.
3. Carvalho Júnior CA, et al. *Small Rumin Res.* 2012;102:213.
4. Galindo RC, et al. *Vet Immunol Immunopathol.* 2009;127:295.
5. Ridler AL, et al. *New Zeal Vet J.* 2012;60:146.
6. Saunders VF, et al. *Aust Vet J.* 2007;85:72.
7. Moustakas VS, et al. *BMC Vet Res.* 2013;9:51.
8. Gopaul KK, et al. *Vet Rec.* 2014;175:282.
9. Ridler AL, et al. *New Zeal Vet J.* 2014;62:47.
10. Silva AP, et al. *PLoS ONE.* 2015;10:e0136865.

## BRUCELLOSIS ASSOCIATED WITH *BRUCELLA SUIIS* IN PIGS

*Brucella suis* infection may be inapparent or may result in stillbirths, abortion, and infertility in both sexes. In boars it causes infection of the testicles and accessory sex glands. It will cause disease in man<sup>1</sup>.

### SYNOPSIS

**Etiology** Disease in pigs is caused by *Brucella suis* biovars 1–3. Biovars 1–4 cause rare disease in cattle.

**Epidemiology** Disease in pigs is transmitted by contact, ingestion, and venereally.

#### Clinical findings

**Sows:** Infertility, irregular estrus, small litters, and abortion.

**Boars:** Orchitis, lameness, incoordination, and posterior paralysis.

**Piglets:** Mortality.

**Clinical pathology** Isolation of organism. Several serologic tests available but none with good sensitivity.

**Necropsy** Metritis, orchitis, osteomyelitis. Granulomatous inflammation and foci of caseous necrosis.

**Diagnostic confirmation** Isolation of *B. suis* and herd serology tests.

**Treatment** None satisfactory.

**Control** Serologic testing and disposal of reactors. No effective vaccine. Humans, and occasionally cattle. Transmission congenital or by ingestion or contact with infected placenta, vaginal discharge, or milk.

**Clinical findings** Abortion storms, abortions often in last 2 months of pregnancy. Weak-born lambs.

**Clinical pathology** Culture of organism. Serologic tests and skin hypersensitivity testing for herd diagnosis.

**Necropsy findings** Placentitis.

**Diagnostic confirmation** Only by isolation of the organism.

**Control** Slaughter eradication. Vaccination with Rev. 1 vaccine, which will produce abortion in pregnant animals.

## ETIOLOGY

It is a small, aerobic, gram-negative *Bacillus*. Remember that *B. abortus* and *B. melitensis* will also occasionally infect the pig, however, only *B. suis* will cause systemic and generalized infections in pigs. The other species will infect pigs, but the infection is self-limiting and the infection is usually restricted to the local lymph nodes. There are five biovars.

## EPIDEMIOLOGY

### Geographic Occurrence

#### Biovar 1

Biovar 1 is important in pigs and occurs worldwide, but the disease has not been recorded in the UK, Canada is disease free,

and the prevalence is very low in the United States. It is particularly important in the Philippines and the Pacific islands and Africa.

#### Biovar 2

Biovar 2 occurs in pigs in west central Europe, particularly Croatia and Czechoslovakia, and also in hares. There appears to be a close relationship between pigs and wildlife in this strain and wild boar in particular.<sup>2</sup> Occasionally it appears in cattle, dogs, and horses.

#### Biovar 3

Biovar 3 has a close similarity to *B. melitensis* biovar 2 and requires phage typing, oxidative metabolic testing, or PCR for differentiation. It also occurs in pigs in the United States, South America, and southeast Asia. It is a problem in wild boar where it may reach 8% to 32% prevalence,<sup>3,4</sup> and particularly in Italy<sup>5</sup> and Spain<sup>6</sup> the spill over from wild boar to domestic pigs is a particular problem.<sup>7</sup>

#### Biovar 4

Biovar 4 is a cause of rangiferine brucellosis (reindeers, caribou, bison, moose, etc.) and can transmit to cattle but does not appear to be a disease of pigs. It will transmit to humans.

#### Biovar 5

Biovar 5 is murine brucellosis. It may also include *B. microti*, which has been isolated from voles and wild rodents in Russia.<sup>8</sup>

## Host Occurrence

Domestic, wild, or feral pigs are the host for biotypes 1 and 3, and widespread infection in feral pigs is recorded in Queensland, Australia, and the southern states of the United States. Bison may remain reservoirs. Incursion to domestic pigs from wild boar is an increasing problem.

Cattle and horses may be infected, especially if they share a range with feral pigs, and this association adversely affects the status of cattle herds undergoing brucellosis eradication programs. Cattle are noncontagious hosts, but an outbreak in Switzerland where the disease had not appeared since 1946 has been attributed to a spread of infection from horses.

#### Biovar 1

Biovar 1 has been isolated from the semen of a ram. Infection in dogs, usually symptomless but occasionally producing orchitis or epididymitis, or granulomas can result from eating raw pig meat.

#### Biovar 2

In addition to the pig, the European hare (*Lepus capensis*) is also a major host for biovar 2, and this biovar is common in central Europe. Some studies have suggested that the type found in hares in Europe is a different strain from the wild boar.<sup>9</sup>



#### Biovar 4

Biovar 4 can transmit to cattle in contact with infected reindeer. Wild canids can also be naturally infected with biovar 4, presumably by ingestion.

#### Source of Infection

Infected boars can shed  $10^4$  to  $10^7$  colony-forming units (CFU) of *B. suis* per milliliter of semen. The bacterium is also shed in the milk.

The introduction of infected pigs, usually a boar or the communal use of an infected boar, is the common means of introduction of the bacterium into a pig unit. Artificial insemination using noncertified or untreated semen can also spread the disease as can ova. Transmission usually requires direct or close contact and is usually oral. Discharges in milk and uterine secretions are infectious. Sows may be carriers and piglets can spread the disease horizontally. It is thought that infection through the conjunctiva is also a possibility. It probably does not survive in the environment unless contained in organic matter under cold conditions. Within a piggery the disease is spread by ingestion and by coitus. The ingestion of food contaminated by infected semen and urine and discharges from infected sows are also important methods of spread. Dried secretions, if frozen, may remain infective. Most disinfectants and sunshine kill the virus.

The feeding of kitchen waste containing raw pig meat also presents a risk. Domestic herds are also at risk when they are kept under extensive husbandry methods in areas where there is a high prevalence of infection in feral pigs. Cattle infected with biovar 1 are noncontagious to other livestock and can have normal pregnancies and give birth to uninfected calves.

Wild animals, including hares and rats, may provide a source of infection with biovar 2, and ticks are also suspected of transmitting the disease.

#### Host and Pathogen Risk Factors

The fact that *B. suis* survives so well in raw meat, e.g., 128 days in sausage meat, means that prepared pork products are always a source of infection. They can survive freezing for over 2 years. Environments and pastures can be infected for a long period of time.

*B. suis* is more resistant to adverse environmental conditions than *B. abortus*, although its longevity outside the body has not been fully examined. It is known to survive in feces, urine, and water for 4 to 6 weeks. As the environmental temperature rises, the survival in the environment decreases. It is also deactivated by bright sunlight. It has also been known to survive desiccation.

Among pigs, susceptibility may vary with age. The prevalence of infection is much higher in adults than in young pigs, although

this may represent an exposure risk rather than an age-related risk. Susceptibility is much greater in the postweaning periods and is the same for both sexes, but there may also be genetically determined differences in susceptibility. Some piglets acquire infection from the sow, either from the ingestion of infected milk or by congenital infection.

Lateral spread through a herd is rapid because of the conditions under which pigs are kept. No durable herd immunity develops and, although a stage of herd resistance is apparent after an acute outbreak, the herd is again susceptible within a short time and the bacteria can spread rapidly on entry to a herd. Within a few months 50% may be infected and 70% to 80% may be involved at the start of the outbreak. Further outbreaks may occur if infection is reintroduced.

In an enzootic area, the proportion of herds infected is usually high (30%–60%). The prevalence of seropositivity in an infected herd varies but can be as high as 66%. Seroprevalence in feral pigs is also high, is higher in adult pigs than pigs under 6 months of age, and varies between populations of feral pigs.

#### Economic Importance

The disease is economically important because of infertility and reduction in numbers of pigs weaned per litter. Mortality in live-born piglets, which occurs during the first month of life, may be as high as 80%. The mortality rate is negligible in mature animals, but sows and boars may have to be culled because of sterility, and occasionally pigs are culled because of posterior paralysis. In addition, eradication involves a great deal of financial loss if complete disposal of a registered herd is undertaken.

#### Zoonotic Implications

Biovar 2 is not a zoonosis, but biovars 1, 3 (as pathogenic as *B. melitensis*), and 4 have considerable significance for public health and are very pathogenic to humans. In countries where pigs are a significant part of animal farming and the human diet, *B. suis* is the major cause of human brucellosis (e.g., South America).<sup>10,11</sup>

*B. suis* presents an occupational hazard, particularly to abattoir workers, and to a lesser extent to farmers and veterinarians and hunters.<sup>12</sup> *B. abortus* and *B. melitensis* may also be found in pig carcasses and present similar hazards. *B. suis* can be widespread in the carcass of infected pigs, and undercooked meat can be a source of human infection. This is particularly true for wild boar and feral pig meat. A recent experiment described infection with biovar type 1 and its transmission to negative pigs after 4 to 6 weeks. Antibody was detected in blood samples from farmers and abattoir workers.

In infected cattle, *B. suis* localizes in the mammary gland without causing clinical abnormality and, where cattle and pigs are

run together, the hazard to humans drinking unpasteurized milk may be significant. Biovar 4 causes human disease associated with consumption of caribou.

Human brucellosis at a pig slaughterhouse in Argentina has been described.<sup>13</sup> The median age of the slaughterhouse workers was 40 (23–65) and they had worked for 1 to 9 years in the slaughtering or butchery part of the plant. A systemic or localized disease with recurrent episodes was described. The chronic disease may be progressive. The patients' serum antibody titers (SAT) titers ranged from 1:25 to 1:12,800 and CFT from 1:10 to 1:1280. Of the pigs tested, 11% of the males (7/62) and 18% of the females (25/138) were positive. It is suggested that the swine keepers did not send infected animals for incineration but sent them to slaughter. Diagnoses are rarely made on farms that breed pigs. Such pigs arriving at packing plants have high levels of organisms but rarely have lesions and genital infections that may be a major source of infection. Protective clothing, such as gloves, protective clothing, eye protection, and protection of any bare skin, is essential.

#### PATHOGENESIS

Infection is followed by multiplication in the local lymph nodes. Only  $10^{4-7}$  organisms will produce an experimental infection, but the severity of the infection is not correlated with either the dose or the route of infection. As for the other species, *B. suis* requires the *virB* operon-encoded T455 for intracellular invasion and multiplication within host cells. The T455 mutants are not able to survive and multiply in macrophages or epithelial cells.

As in brucellosis associated with *B. abortus*, there is initial systemic invasion possibly through the M cells of the lymphoid tissue in the gut, but also possibly the oral, nasopharyngeal, conjunctival, or vaginal mucosa. There is generally a long period of incubation before clinical signs appear. In young animals these are not necessarily visible and will depend mainly on the age, sex, and physiologic state of the animals at the time they are infected. The organism then appears in the bloodstream, usually within 1 to 7 weeks, and often lasts for 5 weeks but can persist for up to 34 weeks. However, infection with *B. suis* differs from that associated with *B. abortus* in that localization occurs in several organs in addition to the uterus and udder, and the organism is found in all body tissues and produces a disease similar to undulant fever in humans. The organisms persist in lymph nodes, joints, bone marrow, and the genital tract. The more common manifestations of localization are abortion and infertility caused by localization in the uterus; lymphadenitis, especially of the cervical lymph nodes; arthritis and lameness caused by bone and joint localization; and posterior paralysis caused by osteomyelitis. In boars, involvement of the testicles

often leads to clinical orchitis, and the boars are probably infected for life. Widespread infection makes handling of the freshly killed carcass hazardous and creates a risk for brucellosis in humans eating improperly cooked pork.

### CLINICAL FINDINGS

Do not forget that clinical signs in pigs may also be produced by *B. abortus* and *B. melitensis*. Porcine brucellosis is usually a more generalized and chronic disease than bovine brucellosis.<sup>14</sup>

The clinical findings in swine brucellosis vary widely, depending on the site of localization. The signs are not diagnostic, and in many herds a high incidence of reactors is observed with little clinical evidence of disease. Reproductive inefficiency is the common manifestation.

### Sows

Infection at service usually results in early abortion, sometimes as early as 17 days after natural service with infected boars, with return to estrus at 5 to 8 weeks after service, which may be the only sign that infection has taken place.

Infertility, irregular estrus, small litters, and abortion occur. Later infection will give rise to mummification and stillbirths. The incidence of abortion varies widely between herds but is usually low and is usually early. Infection of the fetus may lead to abortion. As a rule, sows abort only once in a lifetime, and this is most common during the third month of pregnancy. Affected sows usually breed normally thereafter. Sows may remain carriers and may shed organisms in milk and uterine discharges, which may be extremely bloody and may be accompanied by endometritis and retained fetal membranes.

### Boars

Orchitis with testicular swelling, epididymitis, and necrosis of one or both testicles is followed by sterility usually within 7 weeks of infection. Lameness, incoordination, and posterior paralysis are fairly common. The onset is gradual, and signs may be caused by arthritis or, more commonly, osteomyelitis of lumbar and sacral vertebral bodies. Testicular atrophy may result at around 19 weeks. Boars have a low rate of recovery (less than 50%). After infection, enough animals remain infected to perpetuate the disease.

In both sows and boars, the bones and joints may be involved, and in these cases there may be posterior paralysis and lameness. Nodules may be seen in the spleen and liver and abscesses may be seen in boars.

### Piglets

A heavy mortality in piglets during the first month of life is sometimes encountered, but most piglet loss results from stillbirths and the death of weak piglets within a few hours

of birth. Up to 10% may contract infection when they are young and retain the infection until adulthood.

## CLINICAL PATHOLOGY

### Culture

Laboratory identification of the disease is difficult. It should be routine to use more than one culture method.<sup>15</sup> Isolation of the organism should be attempted if suitable material is available. Such material for culture includes aborted fetuses, testicular lesions, abscesses, blood and lymph nodes (particularly the submandibular, gastrohepatic, and external iliac nodes).<sup>16</sup> The organism is a small, slender, aerobic gram-negative organism that produces 1- to 2-mm colonies on blood agar after 2 to 4 days. A new method of culture has been described for *B. suis* called LNIV-M.<sup>17</sup> Interestingly, in a study of wild boar the organism was isolated from 93% of males but only 61% of females.<sup>18</sup>

PCRs using the *omp* 2b gene or RT-PCR may be more reliable.<sup>19</sup> *B. suis* can be differentiated from the other species by PCR,<sup>20-22</sup> although it may be less successful than culture.<sup>23</sup>

A fingerprinting technique based on a PCR method for multilocus variable number tandem repeat analysis (MLVA) has been developed.<sup>24</sup>

There is no PCR test for differentiating the five biovars from each other.<sup>25</sup>

### Serology

Antibodies are usually developed 6 to 8 weeks after infection. These tests are only useful on a herd basis. There is no satisfactory serologic test. Some animals remain seronegative to all tests. Recently indirect or competitive ELISAs have been developed and may be 98% and 100% specific.<sup>26</sup>

An ELISA compared with complement fixation was found to be just as sensitive and as specific a test for both pigs and hares for *B. suis* infections. A meat juice ELISA has also been shown to be a valuable method for testing both hares and wild boars. There is considerable individual variation in the antibody response of pigs following infection, and some may be culture positive but have negative or indefinite titers to the common tests. Pigs under 3 months of age have a poor antibody response to infection.

Serologic tests in common use include the rose Bengal plate agglutination test, Rivanol test, rose Bengal card test, complement fixation, agar gel immunodiffusion, and tube agglutination. The preferred test varies between countries but most use the rose Bengal plate or card test. *B. abortus* antigens are used for diagnosis because *B. suis* has the same surface LPS antigens. Estimates of the sensitivities of the complement fixation and tube agglutination tests range from 40% to 51%, and they range from 62% to 79% for the rose Bengal plate test. The immunodiffusion test has poorer sensitivity

than the standard serologic tests. The sensitivity and specificity of all the tests have been shown to vary with the stage of infection in the experimental disease, and it has been recommended that more than one test should be used for diagnosis. A recent study showed a range of sensitivity from 84% to 100% with the CFT low at 84% and the serum agglutination test high at 100%. The sensitivities ranged from 79.7% to 100%, with the serum agglutination test low at 79.7% and iELISA and C-ELISA high at 100%. A recent validation of the polarization assay as a serologic test for the presumptive diagnosis of porcine brucellosis has shown promise. Tests have been reviewed,<sup>26,27</sup> and both authors say that the problem is cross-reaction with *Yersinia* O9.

## NECROPSY FINDINGS

On necropsy, there may be arthritis, posterior paralysis, spondylitis, and abscess formation in both sexes. The lesions are usually granulomatous as a result of persistent cytokine release, and these may be in the liver, kidney, spleen, and reproductive tracts.

Many organs may be involved in chronic cases. Chronic metritis manifested by nodular, white, inflammatory thickening, 2 to 5 mm in diameter, and abscessation of the uterine wall is characteristic with or without hemorrhage and necrosis. Arthritis may be purulent, and necrosis of vertebral bodies in the lumbar region may be found in lame and paralyzed pigs. The clinical orchitis of boars is revealed as testicular enlargement or atrophy and testicular necrosis, often accompanied by lesions in the epididymis and seminal vesicles. Splenic enlargement and pronounced lymphadenopathy, caused by hyperplasia of mononuclear phagocytes, occur in some cases. Typical histologic changes consist of granulomatous inflammation with neutrophils, macrophages, and giant cells and hyperplasia of reticular tissues and foci of caseous necrosis in the liver, kidney, spleen, and reproductive tract.

## DIAGNOSIS

Diagnosis is suggested by the clinical signs, the necropsy findings, clinical pathology, and epidemiologically by the presence of wild boar locally. None of the tests is capable of diagnosing disease in the individual animal. The real problem of diagnosis is the cross-reactions with *Y. enterocolitica* O:9 infection.<sup>28</sup> In a survey of slaughter pigs in the UK 10% were found to have *Y. enterocolitica* in their gut.<sup>29</sup> There are false positives caused by this organism in initial screenings as the antibody lasts 2 to 9 weeks following *Y. enterocolitica* infection. They can be eliminated by testing for cellular immunity by measuring the IFN- $\gamma$  generation by leukocytes.

Internationally accepted tests for swine brucellosis include ELISAs, FPA, RBT, buffered plate agglutination test, and the CFT.

## Samples for Confirmation of Diagnosis

- Bacteriology: *adults*, culture swab from joint, lymph nodes, spleen, uterus, epididymis, or other site of localization; *fetus*, lung, stomach content, placenta (has special growth requirements)
- Histology: formalin-fixed samples of above tissues (light microscopy)

Note the zoonotic potential of this organism when handling carcasses or submitting specimens.

### DIFFERENTIAL DIAGNOSIS

The protean character of this disease makes it difficult to differentiate. Syndromes that need differentiation include:

- Abortion and infertility in sows
- Posterior paresis diseases of spinal cord
- Mortality in young pigs is also caused by many agents, and the important entities are listed in [Chapter 19](#) in the section on Perinatal Disease—General Epidemiology.

## TREATMENT

Treatment with a combination of streptomycin parenterally and sulfadiazine orally, or with tetracycline, is ineffective, although combinations of oxytetracycline, streptomycin, and possibly gentamicin have been used.<sup>30</sup> It is unlikely that treatment will ever be attempted on a commercial scale.

## CONTROL

### Vaccination

No suitable vaccine is available.<sup>31</sup> Strain 19 *B. abortus*, *B. abortus* “M” vaccine, living attenuated *B. suis* vaccines, and phenol and other extracts of *B. suis* are all ineffective. In a recent study, a natural rough mutant of *B. suis* that does not induce adverse clinical effects or tissue localization but does induce significant humoral and cellular immune responses after vaccination in swine has been observed.<sup>32</sup> The antibody responses to infection in any case are often not powerful enough to eliminate infection.

### Test and Disposal

In herds where the incidence of reactors is high, complete disposal of all stock as they reach marketing age is by far the best procedure because of the difficulty in detecting individual infected animals. This is most practicable in commercial pork-producing herds. Restocking the farm should be delayed for 6 months after thorough disinfection is complete. The existing serologic tests can be used for certifying herds free of infection that can then provide replacement stock. Repopulation programs can also use specific pathogen-free pigs.

The alternative is to commence a two-herd segregation program, and this is recommended for purebred herds that supply pigs for breeding purposes. Total disposal is not usually economical in these herds. Once a

herd diagnosis has been established, all the breeding animals must be considered to be infected; all piglets at weaning are submitted to the serum agglutination, Rivanol, or other test and, if negative, go into new quarters to start the nucleus of a free herd. It is probably safer to wean the pigs as young as possible and test again before mating. If complete protection is desired, these gilts should be allowed to farrow only in isolation, should then be retested, and their piglets used to start the clean herd. A modified scheme based on the previously mentioned method of weaning and isolating the young pigs as soon as possible but without submitting them to the serum agglutination test has been proposed, but its weakness is that infections may occur and persist in young pigs.

After eradication is completed, breakdowns are most likely to occur when infected animals are introduced. All introductions should be from accredited free herds, should be clinically healthy, and be negative to the serum agglutination test twice at intervals of 3 weeks before introduction.

Eradication of swine brucellosis from an area can only be achieved by developing a nucleus of accredited free herds and using these as a source of replacements for herds that eradicate by total disposal. Sale of pigs for breeding purposes from infected herds must be prevented.

With the advent of infection in wild boar and feral pigs, it is essential to maintain an effective separation from them when there are domestic pigs, and this is especially true where there are outdoor pig units. Recently contaminated wood has been shown to be a problem.<sup>33</sup>

## REFERENCES

1. Meirelles-Bartolli RB, et al. *Trop Anim Health Prod.* 2012;44:1575.
2. Wu N, et al. *J Wildl Dis.* 2011;47:868.
3. Koppel C, et al. *Eur J Wildl Dis.* 2007;53:212.
4. Munoz PM, et al. *BMC Infect Dis.* 2010;10:46.
5. Bergagna S, et al. *J Wildl Dis.* 2009;45:1178.
6. Closa-Sebastia F, et al. *Vet Rec.* 2010;167:826.
7. Cvetnic Z, et al. *Rev Sci Tech.* 2009;28:1057.
8. Audic S, et al. *BMC Genomics.* 2009;10:352.
9. Lavin S, et al. *Informacion Veterinaria.* 2006;10:18.
10. Lucero N, et al. *Epidem Infect.* 2008;136:496.
11. Ariza J, et al. *PLoS Med.* 2007;4:e317.
12. Irwin MJ, et al. *N S W Public Health Bull.* 2009;20:192.
13. Escobar GL, et al. *Comp Immunol Microbiol Infect Dis.* 2013;36:575.
14. Megid J, et al. *Open Vet Sci.* 2010;4:119.
15. De Miguel MJ, et al. *J Clin Microbiol.* 2011;49:1458.
16. Abril C, et al. *Vet Microbiol.* 2011;150:405.
17. Ferreira AC, et al. *Res Vet Sci.* 2012;93:565.
18. Stoffregen WC, et al. *J Vet Diagn Invest.* 2007;19:227.
19. Hinic V, et al. *BMC Vet Res.* 2009;5:22.
20. Garin-Bastuji B, et al. *J Clin Microbiol.* 2008;46:3484.
21. Lopez-Goni I, et al. *J Clin Microbiol.* 2008;46:3484.
22. Mayer-Scholl A, et al. *J Microbiol Methods.* 2010;80:112.
23. Bounaadja L, et al. *Vet Microbiol.* 2009;137:156.
24. Garcia-Yoldi D, et al. *J Clin Microbiol.* 2007;45:4070.
25. Ferrao-Beck L, et al. *Vet Microbiol.* 2006;115:269.
26. McGiven JA, et al. *Vet Microbiol.* 2012;160:378.
27. Praud A, et al. *Prev Vet Med.* 2010;104:94.
28. Jungersen G, et al. *Epidemiol Infect.* 2006;134:347.
29. Milnes A, et al. *Epidemiol Infect.* 2008;136:739.
30. Grillo MJ, et al. *J Anim Chemother.* 2006;58:622.
31. Stoffregen WC, et al. *Am J Vet Res.* 2006;67:1802.
32. Stoffregen WC, et al. *Res Vet Sci.* 2013;95:451.
33. Calfee MW, Wendling M. *Lett Appl Microbiol.* 2012;54:504.

## BRUCELLOSIS ASSOCIATED WITH *BRUCELLA MELITENSIS*

### SYNOPSIS

**Etiology** *Brucella melitensis*.

**Epidemiology** Disease of goats, sheep, humans, and occasionally cattle. Transmission congenital or by ingestion or contact with infected placenta, vaginal discharge, or milk.

**Clinical findings** Abortion storms, abortions often in last 2 months of pregnancy. Weak-born lambs. Important zoonotic disease in humans.

**Clinical pathology** Polymerase chain reaction (PCR) and culture of organism. Serologic tests and skin hypersensitivity testing for herd diagnosis.

**Necropsy findings** Placentitis.

**Diagnostic confirmation** Isolation of the organism, PCR.

**Control** Slaughter eradication. Vaccination with *B. melitensis* Rev. 1 vaccine, but this can cause abortion in pregnant animals.

## ETIOLOGY

*B. melitensis* causes brucellosis in goats and sheep, is capable of infecting most domestic animal species, and is the primary cause of brucellosis of humans (Malta fever) in many countries. There are three biovars of the organism that have differing geographic distribution, but no difference in pathogenicity or animal species affected. There is a close relationship to other members of the genus, which currently has 10 species but is expanding with the advent of molecular typing.<sup>1</sup>

## EPIDEMIOLOGY

### Geographic Occurrence

The distribution of *B. melitensis* is more restricted than that of *B. abortus* and its primary area of occurrence is in the Mediterranean region, including southern Europe. Infection is also present in west and central Asia, Mexico, countries in Central and South America, and in Africa. Northern Europe is free of infection, except for periodic incursions from the south, as are Canada, the United States, southeast Asia, Australia, and New Zealand.

The prevalence of infection varies between countries and regions, but in many



countries the prevalence has declined in the past 20 years in association with mandatory vaccination policies. However, in many others it is not effectively controlled because of the low incomes or nomadic nature of those who farm small ruminants. Hence it is regarded as a neglected but very important disease of livestock and humans in developing countries.<sup>2,3</sup>

### Host Occurrence

Goats and sheep are highly susceptible. Susceptibility in sheep varies with the breed, with Maltese sheep showing considerable resistance. The organism is capable of causing disease in cattle and has been isolated from buffalo, yaks, camels, and pigs.

### Source of Infection

The source of infection is the infected carrier animal. Introduction to a naive herd or flock occurs with the introduction of an infected animal, and persistence results from sheep or goats that are prolonged excretors. Excretion is from the reproductive tract and in milk.

### Reproductive Tract

Infected does and ewes, whether they abort or give birth normally, discharge many brucellas in their uterine exudates and placenta. The organism can be present in uterine discharge for at least 2 months following parturition in infected goats. The vaginal exudate of infected virgin or open animals may also contain the bacteria, but transmission between animals is most likely from the massive exposure provided by an infected placenta.

### Milk

The majority of goats infected during pregnancy will excrete the organism in milk in the subsequent lactation and many will excrete it in all future lactations. In sheep, the period of excretion of the organism from the uterus and in milk is usually less than in goats, but the organism can be present in milk throughout lactation. The duration of excretion in cattle is not known.

### Transmission

Routes of infection for both adults and young are via ingestion, by nasal or conjunctival infection, and through skin abrasions, with infected placenta and uterine discharge as a major source.

### In Utero Infection

Infection of the fetus during pregnancy does not necessarily result in abortion: infected kids and lambs may be born alive but weak, or they may be quite viable. In some cases the infection persists in a latent form until sexual maturity, when pregnant animals may abort the first pregnancy. However, others, if weaned early from their dams and from the infected environment, become free from the infection as adults.

### Colostrum and Milk

Latent infection can also be acquired from the ingestion of infected colostrum and milk. This is a major route of transmission and perpetuation of infection in a herd or flock.

### Host and Pathogen Risk Factors

The organism is reasonably resistant to environmental influences and under suitable conditions can survive for over 1 year in the environment. *B. melitensis* is susceptible to disinfectants in common use at recommended concentrations.

In goats and sheep, the infection of a naive herd or flock will produce an abortion storm, following which most animals are infected but immune, and further abortions are usually limited to young or introduced animals. Because of the limited periods of excretion in sheep the disease tends to be self-limiting in small flocks that have few new introductions. It can be a continuing problem in large flocks because of massive environmental contamination of areas used for pregnant and lambing ewes. In some areas the prevalence of brucellosis associated with *B. melitensis* is linked to the practice of animal movement to summer and mountain pastures in which there is commingling of sheep and goats from a variety of sources on the same pasture.<sup>3</sup>

Spread in beef cattle is slow, presumably because they are usually farmed at lower stocking rates, whereas spread in dairy herds can be more rapid and extensive.

### Economic Importance

Brucellosis has major veterinary and human importance in affected countries. Costs include production loss associated with infection in animals, the considerable cost of preventive programs, and human disease. There is further loss from restriction in international trade in animals and their products.

The occurrence of *B. melitensis* in the sheep and goat population of countries that have eradicated *B. abortus* poses a threat for the continuing occurrence of brucellosis in cattle herds.

### Zoonotic Implications

*B. melitensis* is the most invasive and pathogenic for humans of the three classical species of the genus, and is the cause of Malta or Mediterranean fever in humans, which is an extremely debilitating disease. It is an important zoonosis in areas of the world in which *B. melitensis* is enzootic in goats and sheep. The disease in humans is severe and long-lasting and often occurs in communities with limited access to antimicrobial therapy. Control and eradication of the infection in animal populations has high priority in all countries.

Large numbers of organisms are excreted at and following parturition, providing a source of infection for humans managing the

herd or flock and also for people in the immediate vicinity from aerosol infection with contaminated dust. The risk of infection is high in cultures that cohabit with their animals or when weak, infected newborn animals are brought into the house for warmth and intensive care. Milking of sheep and goats is usually manual, often with poor sanitation and milking-time hygiene. Raw milk and cheese products from infected goats, sheep, or cattle also provide a risk and were the mechanism for the occurrence of Malta fever that initiated the definition of the disease.

Abattoir workers, shearers, and people preparing goat and sheep skins are also at risk. The risk for veterinarians is primarily from assisting birthing in infected animals and herds, but is also the examination of any animal that is subclinically infected. There is also the risk of accidental self-inoculation with live vaccine.

Vaccination of small ruminants with *B. melitensis* Rev. 1 vaccine is a primary method in controlling the human disease. In Greece, a 15-year period of vaccination was associated with a drop in the incidence of human brucellosis, but when this program was stopped the prevalence of abortions in animals and the incidence of brucellosis in humans increased dramatically, only to be controlled by the reinstatement of vaccination of animals as an emergency mass vaccination program. However, although the Rev. 1 vaccine is attenuated compared with field strains, it retains some virulence and incorrect selection from the seed stock can result in vaccines with considerable virulence for both vaccinated animals and in-contact humans.

Because of its pathogenicity to humans and animals, *B. melitensis* is listed as an agent of bioterrorism and agroterrorism. It is thought that fewer than 10 CFU are capable of infecting humans via aerosols. This would require mass therapy of human populations and destruction of animal populations.

### PATHOGENESIS

The organism is a facultative intracellular parasite. As in other forms of brucellosis, the pathogenesis depends on localization in lymph nodes, udder, and uterus after an initial bacteremia. In goats, this bacteremia may be sufficiently severe to produce a systemic reaction, and blood culture may remain positive for a month. Localization in the placenta leads to the development of placentitis, with subsequent abortion. After abortion, uterine infection persists for up to 5 months, and the mammary gland and associated lymph nodes may remain infected for years. Spontaneous recovery may occur, particularly in goats that become infected when they are not pregnant. In sheep, the development of the disease is very similar to that in goats. In cattle, *B. melitensis* has a similar pathogenesis and produces a persistent

infection in the mammary gland and the supramammary lymph node, with obvious significance for public health.

## CLINICAL FINDINGS

Abortion during late pregnancy is the most obvious sign in goats and sheep, but as in other species there may be a storm of abortions when the disease is introduced, followed by a period of flock resistance during which abortions do not occur. Abortion is most common in the last 2 months of pregnancy. The excretion of the organism in milk is not accompanied by obvious signs of mastitis. Infection in males may be followed by orchitis, which is frequently unilateral.

In experimental infections, a systemic reaction occurs with fever, depression, loss of weight, and sometimes diarrhea. These signs may also occur in acute, natural outbreaks in goats and may be accompanied by mastitis, lameness, and hygroma; however, they are uncommon in the natural disease and their occurrence in the experimental disease reflects a massive challenge dose. Osteoarthritis, synovitis, and nervous signs may occur in sheep.

In pigs, the disease is indistinguishable clinically from brucellosis associated with *B. suis*.

In many instances, *B. melitensis* infection reaches a high incidence in a group of animals without signs of obvious illness, and its presence may be first indicated by the occurrence of disease in humans infected from the herd or flock. This is so in cattle where the infection is subclinical and does not produce abortion, but the organism is shed in milk.

## CLINICAL PATHOLOGY

### Culture and Molecular Tests

Positive blood culture soon after the infection occurs and isolation of the organism from the aborted fetus, vaginal mucus, or milk are the common laboratory procedures used in diagnosis. The organism is moderately acid fast, and staining smears from the placenta and fetus with a modified Ziehl-Neelsen method may give a tentative diagnosis; however, this does not distinguish this infection from *B. ovis* or the agent of enzootic abortion (*Chlamydia abortus*), and culture is required.

The organism can be detected by PCR in the abomasal fluid of aborted fetuses and, compared with culture, PCR has a sensitivity and specificity of 97.4% and 100%, respectively. PCR can also be used to detect the organism in tissues, semen, and milk. A real time RT-PCR has been used to type *Brucella* from field samples, such as ovine placenta, without the need for culture.<sup>4</sup>

Multilocus variable-number tandem repeats analysis (MVLTA) is an alternative to classical biotyping and may be useful in analyzing the epidemiology and source of outbreaks. For example, in 2011 a strain of *B.*

*melitensis* in a single infected flock in Sardinia, a region of Italy free from this disease since 1998, was confirmed as being a rare America lineage and probably originating from Spain.<sup>5</sup> Multiplex PCR and high-resolution melt point analysis has also been used to differentiate *Brucella* spp.

## Serology

The conventional serologic tests for the diagnosis of *B. melitensis*—agglutination, CFT, and the rose Bengal or card test—use the same antigens that are used for the diagnosis of *B. abortus* infections (either whole cells or sLPS).

The RBT and CFT are the most widely used. These, plus iELISA and FPA are prescribed tests for international trade.<sup>6</sup> The RBT is not 100% specific, but is typically used as a screening test with the CFT applied in series or parallel. RBT or CFT is not sufficiently sensitive to accurately detect infection in an individual animal. Nevertheless, they can be used to detect infected herds for slaughter eradication of the disease. They can be used for test and slaughter programs within an infected herd, but their reduced sensitivity makes this strategy less effective in sheep and goats compared with cattle. A combination of these tests and tests performed on several occasions may increase the accuracy of detection of infected animals. If only one test is possible, the CFT is recommended, but it suffers from the requirement for a sophisticated laboratory, which is not always available in affected areas.

Conventional serologic tests will not differentiate infection with different species of *Brucella* and will not differentiate infection associated with *Y. enterocolitica* type O:9.

Several ELISA tests have been evaluated for use in small ruminants, some using recombinant antigens such as Omp31 and others using whole-cell antigens. These include indirect, competitive, and blocking ELISAs. A C-ELISA had a diagnostic sensitivity ranging from 74% to 89%, depending on cutoff values, and a specificity from 93% to 97%.<sup>7</sup> Comparisons of the FPA and commercial ELISA tests with the RBT and CFT have shown no great advantages over the older tests, with the iELISA often having a slightly greater sensitivity. Overall testing sensitivity may be improved if these tests are used in parallel.<sup>7,8</sup>

*Brucella*-free animals are serologically positive for long periods following vaccination with *B. melitensis* Rev. 1, with varying persistence in different serologic tests. The period of seropositivity is shorter in animals vaccinated conjunctively.

## Milk Tests

The milk ring test used for testing pooled (bulk) milk in cattle is not useful in small ruminants. Other tests include whey CFTs, whey Coombs or antiglobulin test, whey agglutination tests, and a milk ELISA. They

have no apparent advantage over serologic tests, and in many cases they are less sensitive, hence, they are not suitable as screening tests using pooled milk samples.

## Allergic Tests

An intradermal allergic test using 50 mg of brucellin INRA (purified and free from LPS) can be used for diagnosis. The injection sites in goats are the neck or caudal fold and in sheep the lower eyelid, with reactions read in 48 hours. The test has high specificity in flocks that are free of infection and not vaccinated. However, it has little advantage over conventional serologic tests in infected herds, and Rev.-1-vaccinated animals can react for at least 2 years. It has particular value in identifying some animals that are false-positive reactors, differentiating infections with *Y. enterocolitica* but not *B. ovis*. Anergy occurs between 6 and 24 days after injection.

## NECROPSY FINDINGS

There are no lesions that are characteristic of this form of brucellosis. The causative organism can often be isolated from all tissues but the spleen, lymph nodes, and udder are the most common sites for attempted isolation in chronic infection.

## Samples for Confirmation of Diagnosis

- Bacteriology: *adults*, spleen, lymph node, udder, testicle, epididymis; *fetus*, lung, spleen, placenta (culture: has special growth requirements; cytology: Stamp's or Koster's stain on placental smear; PCR); *fetus*, PCR of fetal abomasal fluid
- Histology: formalin-fixed samples of the previously listed tissues

The zoonotic potential of this organism means care needs to be taken when handling potentially infected material, and specimens should be properly packaged when submitted to a laboratory.

## DIFFERENTIAL DIAGNOSIS

The primary differential is from other forms of brucellosis (seen in this chapter) and other causes of abortion in small ruminants.

## TREATMENT

Treatment is unlikely to be undertaken in most animals because it is unlikely to be economically feasible or therapeutically effective. For example, a dose of 1000 mg per animal of long-acting tetracycline given every 3 days for 6 weeks achieved a cure rate of 75%.

## CONTROL Hygiene

Control measures must include hygiene at kidding or lambing and the disposal of infected or reactor animals. Separate pens for kidding does that can be cleaned and

disinfected, early weaning of kids from their does and their environment, and vaccination are recommended. In endemic areas, all placentas and dead fetuses should be routinely buried.

### Eradication

Where a group is infected for the first time it may be most economical to dispose of the entire herd or flock, because eradication by test and slaughter is prolonged by the lack of sensitivity of the serologic tests.

Many countries that have this disease have statutory control measures and the disease can be eradicated, such as from Cyprus. *B. melitensis* also can be eradicated, with difficulty, from dairy cattle. However, vaccination may be the only practical method of control in areas in which there is a high prevalence of the disease, extensive management systems, communal and nomadic grazing, and a low socioeconomic level.

### Rev. 1 Vaccination

Rev. 1 vaccine is a live, attenuated *B. melitensis* strain derived from a virulent *B. melitensis* isolate that is resistant to dihydrostreptomycin. It is the reference vaccine strain that provides protection against infection with *B. melitensis* in sheep and goats and against infection with *B. ovis* in rams. However, this vaccine has significant disadvantages, including persistent serologic response and, although attenuated compared with field strains, it retains some virulence. Incorrect selection from the seed stock can result in vaccines with considerable virulence for both vaccinated animals and in-contact humans.

Vaccination with Rev. 1 produces a bacteremia that is cleared by 14 weeks in goats and a shorter time in sheep. Vaccination at 3 to 8 months of age confers a high degree of immunity that lasts for more than 4 years in goats and 2½ years in sheep. The initial recommendations were to vaccinate replacement animals with the expectation that herd/flock immunity would develop over time. However, this has proved ineffective in some regions, and whole-flock/herd vaccination is now recommended in certain countries.

Vaccination of pregnant goats and sheep, especially in the second and third month of pregnancy, will result in abortion and the excretion of the living *B. melitensis* vaccine organism in the vaginal discharge and the milk. Consequently, the vaccine should not be used in pregnant animals or for 1 month before breeding. Vaccination of lactating animals may be followed by excretion of the organism in the milk for a short time. Reduced dose vaccination or conjunctival vaccination does not significantly reduce the risk of vaccine-induced abortions in pregnant animals, although reduced-dose Rev. 1

vaccination has been shown to provide protection for at least 5 years in endemically infected areas.

Conjunctival vaccination does decrease the period of seropositivity following vaccination. Vaccine efficacy and safety can vary with the manufacturer. National policies promoting widespread vaccination of sheep and goats with Rev. 1 vaccine have resulted in a significant reduction in the prevalence of small ruminant brucellosis and in the incidence rates of human brucellosis. However, Rev. 1 vaccine is also pathogenic to humans and its excretion, and persistence in milk following vaccination can result in human infection.

The general approach in endemically infected countries is to institute a whole-flock vaccination scheme followed by a young-stock vaccination until the prevalence of the disease is reduced, at which time test and slaughter can be implemented to eradicate the disease. This ignores the risk of adverse disease in the vaccinated animals and the risk for human infection from the vaccine strain. There is an urgent need for a nonvirulent vaccine that induces seropositivity that can be differentiated from the seropositivity resulting from natural infection.

### Other Vaccines

To circumvent the problem of persistent serologic response, ongoing efforts have been made to develop defined rough mutant vaccine strains that would be more effective against *B. melitensis*. Various studies have examined cell-free native and recombinant proteins as candidate protective antigens, with or without adjuvants. However, limited success has been obtained in experimental models with these, or with DNA vaccines encoding known protective antigens.<sup>9</sup>

*B. abortus* strain 19 has been used for vaccination and appears to give protection that is as good as that achieved with the attenuated *B. melitensis* vaccine.

### FURTHER READING

- Blasco JM, et al. Control and eradication of *Brucella melitensis* in sheep and goats. *Vet Clin North Am Food Anim Pract.* 2011;27:95-104.
- Whatmore AM. Current understanding of the genetic diversity of *Brucella*, an expanding genus of zoonotic pathogens. *Inf Genet Evol.* 2009;9:1168-1184.

### REFERENCES

1. Whatmore AM. *Inf Genet Evol.* 2009;9:1168.
2. Ducrotot MJ, et al. *PLoS Negl Trop Dis.* 2014;8(7):e3008.
3. Kasymbekov J, et al. *PLoS Negl Trop Dis.* 2013;7(2):e2047.
4. Gopaul KK, et al. *Vet Rec.* 2014;175:282.
5. De Massi F, et al. *Transbound Emerg Dis.* 2015;62:463.
6. OIE. *Terrestrial Manual.* 2012 Ch 2.7.2; 968.
7. Minas A, et al. *Vet J.* 2008;177:411.
8. Fiasconaro M, et al. *Small Rumin Res.* 2015;130:252.
9. Da Costa Martins R, et al. *Expert Rev Vaccines.* 2012;11:87.

## ABORTION IN EWES ASSOCIATED WITH *SALMONELLA ABORTUSOVIS*

*Salmonella abortusovis* (*S. enterica* serovar Abortusovis) is a gram-negative rod-shaped aerobic bacterium of the family Enterobacteriaceae. The pathogen is highly adapted to sheep and is considered to be host specific for this species in which it can cause abortion. *S. Abortusovis* infection has a worldwide occurrence with a generally low prevalence. The infection appears to be more common in some European and Western Asian countries.

Transmission and spread of the infection occurs through infected animals that are introduced to flocks naive to the pathogen. The reservoir of infection is infected animals that do not abort. The organisms persist in internal organs of the **asymptomatic carriers** for up to 6 months and are excreted in the feces and vaginal mucus for periods up to 4 months. Infection can occur through the oral, conjunctival, or respiratory route, but oral ingestion is thought to be the main mode of infection. Venereal spread has been postulated, and rams certainly become infected, but all the evidence is against spread at coitus. Intrapreputal inoculation results in infection of rams and the passage of infected semen for up to 15 days.

The only significant clinical sign of *S. Abortusovis* infection is abortion, which is common during the second half to last third of gestation. Lambs may also be stillborn or die within the first day of life. Mortality in lambs is common from either weakness and ensuing hypothermia and hypoglycemia or to the development of acute pneumonia in previously healthy lambs up to 2 weeks old.

In flocks naive to the infection, introduction of the pathogen can cause abortion storms, with up to 60% of ewes aborting generally in the last trimester of gestation. Ewes rarely develop clinical signs, although some may transiently have a fever or develop post-abortive endometritis with vaginal discharge. Septic metritis and peritonitis in dams has been associated with deaths among ewes. Spread of the disease is strongly associated with the presence of aborting ewes and subsequent heavy environmental contamination. In flocks where the pathogen is endemic, abortion occurs sporadically, mainly affecting primiparous and newly introduced ewes. The infection appears to induce a strong immune response preventing abortion during the following pregnancies.<sup>1</sup>

Identification of the disease depends on isolation of the organism, which is present in large numbers in the fetus, placenta, and uterine discharges. Use of PCR to identify *S. Abortusovis* is feasible because the organism has an IS200 element in a distinct chromosomal location. The resulting PCR assay has high specificity for *S. Abortusovis*, effectively



discriminating it from other *S. enterica* serovars. The disease can be diagnosed in fetuses by using a coagulation test on fetal stomach contents. The test had a sensitivity and specificity of 100% and 90% in a small number of samples.

Serologic tests to detect antibody to *S. abortusovis* include the SAT, hemagglutination inhibition, complement fixation, indirect immunofluorescence, gel immunodiffusion, and ELISA.

A strong immunity develops after an attack, and an autogenous vaccine has shown good results in the control of the disease.<sup>1</sup> The results of vaccination need to be very carefully appraised because flock immunity develops readily and the disease tends to subside naturally in the second year.

The clinical findings in *S. Dublin* infections in ewes are very similar, and infection has become more important as a cause of abortion in ewes in the UK than *S. Abortusovis*. *S. Ruiru* has also been recorded as a cause of abortion in ewes, and ewes with salmonellosis associated with *S. typhimurium* may also lose their lambs. *S. Brandenburg* is a cause of illness and abortion in sheep, horses, calves, goats, and humans in New Zealand. Other **differential diagnoses** for abortion in ewes include chlamydiosis, brucellosis, campylobacteriosis, listeriosis, coxiellosis (Q-fever), and toxoplasmosis.

The administration of broad-spectrum antibiotics might aid in controlling an outbreak, but available reports are not generally encouraging. Chloramphenicol and the trimethoprim and sulfadiazine combination are considered effective for treatment, but use of chloramphenicol in animals intended for human food production is not permitted in many countries. A live *S. typhimurium* vaccine with optimal level of attenuation for sheep constructed by means of “metabolic drift” mutations was highly effective in preventing *S. Abortusovis*-induced abortions under field trial conditions. Subcutaneous and conjunctival vaccination with a live attenuated strain of *S. Abortusovis* confers immunity for at least three lambing periods. More recent vaccines, including those containing plasmid-cured strains of *S. Abortusovis*, are effective in preventing pregnancy loss in response to experimental challenge with wild-type *S. Abortusovis*.

To contain the spread of the infection during an outbreak aborted ewes should be isolated and abortion products that contain large amounts of bacteria must be destroyed. Disinfection of stalls and fomites with an agent with proven efficacy against *Salmonella* spp. is important.

#### FURTHER READING

Jack EJ. *Salmonella* abortion in sheep. *Vet Annu.* 1971;12:57.

#### REFERENCE

1. Cagiola M, et al. *Vet Microbiol.* 2007;121:330.

### ABORTION IN MARES AND SEPTICEMIA IN FOALS ASSOCIATED WITH *SALMONELLA ABORTUSEQUI* (*ABORTIVOEQUINA*) (EQUINE PARATYPHOID)

This is a specific disease of Equidae characterized by abortion in females, testicular lesions in males, and septicemia in the newborn.

#### ETIOLOGY

*Salmonella abortusequi* (*abortivoequina*) (also known as *Salmonella enterica* serovar Abortusequi) is a host-adapted serovar causing abortion in mares and donkeys. *S. Abortusequi* strains vary in virulence, with more virulent strains having greater in vitro cytotoxicity. It is possible to determine the origin and progression of outbreaks of the disease by determining pulsed-field gel electrophoretic patterns of *S. Abortusequi*.

#### EPIDEMIOLOGY

The infection appears to be limited to horses and donkeys. Although widely reported in the early 1900s, this disease is rarely encountered and is one of the less common causes of either abortion or septicemia in horses. Recent reports of the disease are from Austria, Brazil, Croatia, Japan, and India, although the disease occurs in other countries. However, in the early 1990s, an outbreak of abortion occurred in a herd of 38 horses, in which 21 mares aborted between 5 and 10 months of gestation.

Natural infection may be caused by the ingestion of foodstuffs contaminated by uterine discharges from carriers or mares that have recently aborted. Transmission from the stallion at the time of service is also thought to occur. The infection may persist in the uterus and cause repeated abortion or infection of subsequent foals. Transmission from a female donkey to mares is reported with abortion a result in both species.

#### PATHOGENESIS

When infection occurs by ingestion, a transient bacteremia without marked systemic signs is followed by localization in the placenta, resulting in placentitis and abortion. Foals that are carried to term probably become infected in utero or soon after birth by ingestion from the contaminated teat surface or through the umbilicus.

#### CLINICAL FINDINGS

Abortion usually occurs at about the seventh or eighth month of pregnancy. The mare can show signs of impending abortion followed by difficult parturition, but other evidence of illness is usually lacking. Retention of the placenta and metritis are common sequels and may cause serious illness, but subsequent sterility is unusual. A foal that is

carried to term by an infected mare may develop an acute septicemia during the first few days of life or survive to develop polyarthritis 7 to 14 days later. Polyarthritis has also been observed in foals from vaccinated mares that showed no signs of the disease.

Infection in the stallion has also been reported with clinical signs including fever, edematous swelling of the prepuce and scrotum, and arthritis. Hydrocele, epididymitis, and inflammation of the tunica vaginalis are followed by orchitis and testicular atrophy.

#### CLINICAL PATHOLOGY

The organism can be isolated from the placenta, the uterine discharge, the aborted foal, and the joints of foals with polyarthritis. A high titer of *Salmonella* agglutinins in the mare develops about 2 weeks after abortion. Vaccinated mares will give a positive reaction for up to a year.

#### NECROPSY FINDINGS

The placenta of the aborted foal is edematous and hemorrhagic and may have areas of necrosis. The nonspecific changes of acute septicemia will be manifested in foals dying soon after birth; polyarthritis is found in those dying at a later stage.

#### Samples for Confirmation of Diagnosis

- Bacteriology: placenta, fetal stomach content, lung, culture swabs of joints (culture)
- Histology: formalin-fixed placenta, various fetal tissues including lung, liver (light microscopy)

#### TREATMENT

The antimicrobials recommended in the treatment of salmonellosis should also be effective in this disease.

#### CONTROL

Careful hygiene, including isolation of infected mares and disposal of aborted material, should be practiced to avoid spread of the infection. Infected stallions should not be used for breeding. In the past, when this disease was much more common than it is now, great reliance was placed on vaccination as a control measure. An autogenous or commercial bacterin, composed of killed *S. Abortusequi* organisms, was injected on three occasions at weekly intervals into all mares on farms in which the disease was enzootic, commencing 2 to 3 months after the close of the breeding season. A smaller dose (5 mL) of vaccine of higher concentration is as effective as a larger dose (20 mL) of vaccine of lower concentration. A formal-killed, alum-precipitated vaccine is considered to be superior to a heat-killed, phenolized vaccine. In China, a virulent strain vaccine is credited with effective protection after two injections 6 months apart.

The widespread use of vaccines and hyper-immune sera is credited with the almost complete eradication of the disease in developed countries.

## CHLAMYDIAL ABORTION (ENZOOTIC ABORTION OF EWES, OVINE ENZOOTIC ABORTION)

### SYNOPSIS

**Etiology** *Chlamydia abortus*.

**Epidemiology** Prevalence varies within regions and between countries. Oral route of infection, with the placenta and uterine discharge of aborting ewes the major source of infection. Pregnant sheep infected by contact with aborting ewes usually do not abort until the next lambing season. Zoonotic.

**Clinical findings** Abortion, stillborn and weak-born lambs.

**Necropsy findings** Necrotic and hemorrhagic placental cotyledons, intercotyledonary areas thickened, edematous, and leathery.

**Diagnostic confirmation** Demonstration of the organism in the placenta by polymerase chain reaction, rising titer in paired serum samples.

**Control** Isolation of aborting ewes. Killed vaccine with adjuvant gives short-term protection and can be used in pregnant ewes during an outbreak in an attempt to reduce the number of abortions. Live attenuated vaccines may be more effective but cannot be used during pregnancy.

### ETIOLOGY

*Chlamydia abortus* (previously known as *Chlamydophila abortus* and *Chlamydia psittaci* biotype 1/serotype 1) has a tropism for ruminant placenta and causes the disease commonly referred to as ovine enzootic abortion (OEA). The organism causes a similar disease in goats, and although this organism also can produce abortion in cattle, pigs, and horses, abortion associated with this organism is not common in these species. There is considerable genetic diversity among strains that cause abortion.

### EPIDEMIOLOGY

#### Occurrence

The disease is one of the most common causes of diagnosed abortion in sheep and goats in the UK, Europe, Asia, the United States, and other countries. In the UK, it accounts for approximately 45% of abortions, and it is particularly common in lowland flocks that are intensively managed at lambing. However, its importance varies from country to country. It is an uncommon cause of abortion in Northern Ireland, and the disease does not occur in Norway, Australia, or New Zealand.

There have been several studies of seroprevalence in Europe that show a high seroprevalence in both domestic and wild ruminants but, until recently, most surveys have used the complement fixation test (CFT), which is not specific for *C. abortus*; therefore, the true seroprevalence of *C. abortus* in many countries is not well established.

### Source of Infection and Transmission

Infection is introduced into a flock by the purchase of latently infected replacements that usually abort at the end of their first pregnancy. Within a flock, the major source of infection is the placenta and the uterine discharge of aborting ewes. The main routes of transmission of *C. abortus* are oral or nasal: either ingestion of organisms shed in vaginal fluids and placental membranes at the time of abortion or lambing, or the inhalation of aerosols from contaminated areas. Pasture and the environment are contaminated by vaginal discharges, placenta, and aborted fetuses, and infected ewes shed the organism for a week before aborting and 2 weeks afterward. The elementary body of *C. abortus* is resistant to both physical and chemical influences, because it is metabolically inactive and the rigid cell envelope is osmotically stable and poorly permeable. Consequently, the organism is thought to survive for several days on pasture and longer in cold weather.

Infection of the ewe lamb may occur at birth, shortly following, or at subsequent lambing periods. Infection of pregnant ewes in early or midgestation results in either abortion in the final 2 to 3 weeks of gestation or the birth of stillborn or weak lambs that frequently die in the first few days of their life. Abortion always appears in the last weeks of gestation regardless of the time of infection. Infection of ewes in the last 5 to 6 weeks of pregnancy usually leads to the development of a latent infection, in which ewes appear to be uninfected until the next lambing season, when they abort. Thus late pregnant sheep may be infected by contact with aborting ewes, but usually do not abort until the next lambing season.

The common pattern of infection and disease is the small number of abortions in year 1 following the introduction of infected replacement ewes and then an epidemic abortion storm, in which up to 35% of ewes abort in the last 3 weeks of gestation or give premature birth to weak or dead lambs. After aborting, ewes develop a protective immunity and, in endemically infected flocks, 5% to 10% of the ewes abort annually. Surviving lambs born to infected mothers may be affected by enzootic abortion in ewes (EAE) in their first pregnancy.

Sheep that have aborted, subsequently rebreed successfully, do not have further abortions, and the organism is not present in the placenta or vaginal discharge of

subsequent pregnancies. However, levels of immunity vary and some may excrete organisms at estrus or seasonally for up to 3 years.

In chronically infected sheep, persistent infection can be demonstrated in the endometrial cells of the reproductive tract, and the organism is excreted in vaginal fluids during estrus.

Vaginal challenge of ewes at breeding time will result in infection and subsequent abortion. Thus venereal or passive venereal transmission is a possible route of infection but is not common. Chronic infection of the male genital tissues has been recorded, and infection may impair fertility in both rams and bulls.

The epidemiology of abortion with this agent in cattle is unknown, but it may transmit to cattle from infected sheep on the same farm.

### Experimental Reproduction

The disease is readily reproduced experimentally. Following subcutaneous injection there are no signs of clinical disease other than a modest increase in rectal temperature for 2 days after infection. There is a systemic antibody response that peaks 2 weeks after infection and then decreases until just before abortion or parturition, during which there is a second increase in antibodies to *C. abortus*. Experimental infection at 70 to 75 days pregnancy can cause abortion in the last 2 to 3 weeks of pregnancy or the birth of stillborn or live lambs. There is variation in the severity of the placental lesions in experimental infections. Abortion is associated with severe placental lesions, but the reason for the variation in severity and fetal manifestations is not known.

### Economic Importance

In the UK, enzootic abortion is the most common infectious cause of abortion in lowland flocks that are intensively managed at lambing time and has a major economic impact on agricultural industries worldwide. There are no recent estimates, but losses in the UK were estimated in the early 1990s at £15 to £20 million per annum.

### Zoonotic Implications

There is some risk for people working with livestock, such as shepherds and abattoir workers, for respiratory infection with this organism. However, the major zoonotic risk is to pregnant women because of the ability of *C. abortus* to colonize the human placenta. Human infection in early pregnancy results in abortion, whereas later infection can result in stillbirth or preterm labor. Infection is probably oral, from infected hands or food following handling of infected sheep or goats, or contaminated fomites such as clothing. Practices at lambing, such as mouth to mouth resuscitation of weak lambs or bringing weak lambs into the house to be warmed, promote zoonotic spread. Consequently,

infected placentas and dead lambs should be handled using gloved hands and disposed of by burning or burial. The organism can be detected in the milk of both sheep and cattle, so consuming raw milk also poses a risk for zoonotic infection.

### PATHOGENESIS

Following infection, it is thought that the organism resides first in the tonsil and is then disseminated by blood and lymph to other organs, although the site of latent infection is not definitely known. Release from the latent state during pregnancy is thought to be caused by immune modulation and leads to bacteremia and infection of the placenta. Despite being a key feature of infection with *C. abortus*, little is understood about the underlying mechanisms that result in latent infections. However, experimental intranasal infection of nonpregnant ewes with a low or moderate dose of organisms induced latent infection and subsequent abortion, whereas a higher dose stimulated protective immunity.<sup>1</sup>

The organisms invade the trophoblast cells of the fetal cotyledon then spread to the intercotyledonary regions of the chorion, producing a necrotic suppurative placentitis and impairment of the maternal–fetal exchange of nutrients and oxygen, hence, fetal death and abortion. An inflammatory response in the fetus may also contribute to fetal death.

It is not known why, regardless of the time of infection, pathologic changes in the placenta do not commence before 90 days' gestation, or even as late as 120 days, although this coincides with the commencement of rapid fetal growth.

### CLINICAL FINDINGS

There are generally no premonitory indications of the impending abortions, which occur in late pregnancy. Ewes suffer no obvious systemic effects, but retained placenta and metritis can occur in goats. A vaginal discharge, lasting up to 3 weeks following the abortion, is common. Additional losses are caused by stillbirths and weak-born lambs and kids that die soon after birth.

In cattle, the infection causes abortion in the last third of pregnancy. Infected calves born alive may show lethargy, depression, and may be stunted. Mixed infections with *C. abortus*, *C. suis* and Chlamydia-like organisms (*Parachlamydia* and *Waddlia* spp.) are recorded in cattle and associated with abortions featuring necrotic placentitis, but the true prevalence and significance of these infections is not clear.<sup>2,3</sup>

### CLINICAL PATHOLOGY

If the flock history and placental lesions suggest OEA, smears from affected and adjacent chorionic villi of the placenta can be appropriately stained (e.g., Giemsa or modified Ziehl–Neelsen) and examined under

high magnification. Single or clumps of small, coccoid elementary bodies (300 nm) will stain red compared with blue cellular debris. Vaginal swabs from recently aborted ewes and smears of the fleece of uncleaned lambs or fetal abomasal contents can also be examined but contain fewer organisms. The organisms appear similar to *Coxiella burnetii*, the agent of coxiellosis (Q fever), so this is not a definitive test.

Commercial antigen detection kits (fluorescent antibody test [FAT] and ELISA) are available but do not discriminate between Chlamydial species.

Chlamydial DNA can be amplified by conventional or real time RT-PCR. These are highly sensitive, but can result in false positives if samples are cross-contaminated or false negatives if samples contain PCR-inhibitory substances. RT-PCR is rapid and relatively easily standardized and can demonstrate the DNA of *C. abortus* in tissues and swabs, such as of vaginal fluid, conjunctivae, and fetal membranes.<sup>4,5</sup> A number of multiplex PCR tests are described and can differentiate between Chlamydial species and other agents of infectious abortion, such as *Toxoplasma gondii* and *C. burnetii*.<sup>6</sup>

*C. abortus* can be isolated in embryonated chicken eggs or cell culture, but most diagnostic laboratories do not do this because of the zoonotic risk and requirement for level 2 biocontainment.

Infection in aborting animals can be demonstrated by rising serologic titers in paired serum samples collected 3 weeks apart. The CFT is commonly used but has only moderate sensitivity and is not specific because of common antigens shared with other Chlamydiae and some gram-negative bacteria. It will also be positive in vaccinated animals. Ambiguous results, such as suspected false-positive tests in flock accreditation programs or export testing, can be analyzed further by a Western blot using specific antigens.

A number of research and commercial ELISA tests have been developed. Those based on whole-cell or extracts of chlamydial elementary bodies have better specificity than the CFT but are less sensitive. Those based on segments of the outer membrane protein (OMP) or synthetic peptide antigens have greater sensitivity and specificity and are now more frequently used in diagnostic, epidemiologic, and seroprevalence studies.<sup>7</sup>

Vaccinated animals will react to the currently used serologic tests, but wild-type and vaccine strains of *C. abortus* can be differentiated by PCR-restriction fragment length polymorphism (RFLP).<sup>8</sup> This has provided evidence that the temperature sensitive mutant strain 1B used in vaccines is associated with ovine abortions in Scotland.<sup>9,10</sup>

### NECROPSY FINDINGS

Aborted fetuses typically have no gross abnormalities. Fetal fluid may contain

chlamydial antibody and, although less sensitive than either isolation in McCoy cells or detection of chlamydial LPS antigen, can be useful when placenta is not available. Histologically, there may be mononuclear cell infiltration of hepatic portal areas and multifocal areas of hepatitis. The placenta is critical for diagnosis of chlamydial abortion in both cattle and sheep.

Placental cotyledons are necrotic and hemorrhagic, and the intercotyledonary areas are thickened, edematous, and leathery. This is in direct contrast to the targeting of cotyledons seen with toxoplasmosis. Chlamydial organisms can be seen in tightly packed sheets within the cytoplasm of swollen trophoblasts in formalin-fixed tissues or in direct placental smears using modified Gimenez, Koster's, or other appropriate stains. Well-preserved, fresh placenta should be examined because the organisms are difficult to demonstrate in the fetus. Immunohistochemical stains perform well on formalin-fixed specimens. Most laboratories are reluctant to culture *Chlamydia* spp. because of their zoonotic potential.

### Samples for Confirmation of Diagnosis

- **Bacteriology:** chilled liver, lung, placenta (cytology, PCR, ELISA)
- **Histology:** fixed placenta, liver (light microscopy, IHC)

The zoonotic potential of this organism means care needs to be taken when handling potentially infected material, and specimens should be properly packaged when submitted to a laboratory.

### DIFFERENTIAL DIAGNOSIS

Other causes of abortion in cattle and ewes are given in Tables 18-1 and 18-2.

### CONTROL

Ewes that have aborted should be isolated from the rest of the flock. There should be proper hygiene of the lambing areas, including disposal of bedding and aborted materials, and disinfection of pens with intensive lambing systems. Long-acting oxy tetracycline has been used at 20 mg/kg IM in early pregnant sheep within an aborting flock to reduce subsequent abortions. However, treated ewes still shed the organism in vaginal discharges, and treatment at 10-day intervals may be needed.

### Vaccines

Killed and live attenuated vaccines are available, but none are fully protective. **Killed vaccines**, composed of egg-derived or tissue culture organisms of one or two strains have been used for several decades. They are variably effective, but can reduce the frequency of abortion and shedding of the organism. However, outbreaks have occurred in vaccinated sheep, with strain variation a possible



**Table 18-2** Diagnostic summary of causes of abortion in cattle

Epidemiology disease	Field examination				Laboratory diagnosis		
	Clinical features	Abortion rate	Time of abortion	Placenta	Fetus	Isolation of agent	Serology
Brucellosis ( <i>Brucella abortus</i> )	Zoonotic disease, chronic infection, abortion, retained placenta, and metritis	High, up to 90% in susceptible herds	5 months +	Severe placentitis, thickened placenta with surface exudate	Possibly pneumonia	Culture of fetal stomach, placenta, uterine fluid, milk, and semen	Serum and blood agglutination test, milk ring test, whole milk plate agglutination test; whey plasma, and vaginal mucous agglutination test
Trichomoniasis ( <i>Trichomonas foetus</i> )	Venerally transmitted disease resulting in early embryonic loss with occasional abortion and pyometra	Moderate, 5%–30%	Primarily first 5 months	Flocculent material and clear, serous fluid in uterine exudate	Usually no gross lesions, histologically fetal giant cell pneumonia may occur	Hanging drop or culture examination of fetal stomach and uterine exudate within 24 hours of abortion; isolation, best source in female pyometra fluid if pyometra exists; best method is InPouch; in male bulls' preputial smegma with InPouch	Cervical mucous agglutination test; serology rarely performed, mucus agglutination or complement fixation hemolytic assay
Neosporosis ( <i>Neospora caninum</i> )	Worldwide distribution of infection in both dairy and beef cattle, most abortions reported in dairy cattle. In addition to abortion, mummification and birth of full-term infected calves can occur with or without clinical signs. Chronic infection in which congenital transmission commonly occurs during pregnancy, acquired postnatal infection may also occur	Sporadic or outbreaks common (20%–40%) Repeat abortions from same cows can occur	3–8 months of gestation (mean 5.5 months)	No characteristic gross lesions in placenta Parasite may be present	Autolyzed midgestation fetus, widespread histologic inflammatory lesions in fetus including nonsuppurative necrotizing encephalitis and myocarditis	Identify parasite in fetal tissues by immunohistochemistry stain or PCR	Antibodies in fetus and cow IFAT and ELISA antibodies used for serologic detection Positive result supports infection in cow and/or fetus but is not causal proof; negative result in dam strong evidence that neosporosis not involved in abortion; serologic comparison of groups of aborting and nonaborting herdmates useful in establishing the role in herd outbreaks of abortion
Vibriosis ( <i>Campylobacter fetus</i> subsp. <i>veneralis</i> )	Venerally transmitted, resulting in infertility, irregular, moderately prolonged diestrus with occasional abortion. Epidemiology similar to trichomoniasis except for a longer vaginal carrier state (up to 4 months after uterus has cleared organism). Significance: fertility returns but is still a threat to any uninfected bull	Low, up to 5%, may be up to 20%	46 months	Semiopaque, little thickening Petechiae, localized avascularity and edema	Flakes of pus on visceral peritoneum Fibrin may be present in serosal cavities Usually associated with suppurative pneumonia in fetus	Culture of fetal stomach, placenta, and uterine exudate Sporadic abortion, not venerally transmitted, can be associated with <i>C. fetus</i> subsp. <i>fetus</i> and <i>C. jejuni</i> , which need to be differentiated from <i>C. fetus</i> subsp. <i>veneralis</i>	Blood agglutination after abortion (at 3 weeks) Cervical mucous agglutination test at 40 days after infected service

**Table 18-2** Diagnostic summary of causes of abortion in cattle—cont'd

Epidemiology disease	Field examination				Laboratory diagnosis		
	Clinical features	Abortion rate	Time of abortion	Placenta	Fetus	Isolation of agent	Serology
Leptospirosis ( <i>Leptospira interrogans</i> serovar pomona and <i>Leptospira hardjo</i> ) <i>L. borgpetersenii</i> serovar hardjo (formerly serovar hardjo-bovis) occurs worldwide; <i>L. interrogans</i> serovar hardjo (formerly hardjo-prajitno) primarily in the UK	Abortion may occur at acute febrile stage, later, or unassociated with illness	25%–30%	Abortions may occur throughout gestation; Late, 6 months +	Avascular placenta, atonic yellow-brown cotyledons, brown gelatinous edema between allantois and amnion	Fetus usually autolyzed, occasional icterus Fetal death common	Fluorescent antibody stain of smears of fetal kidney or PCR Direct examination of urine of cow by dark-field or fluorescent antibody stain	Positive serum agglutination test 14–21 days after febrile illness Titers usually at or near maximum at time of abortion Chronically infected <i>L. hardjo</i> dams may have low or negative titers
Infectious bovine rhinotracheitis (IBR)	Abortion storms in inadequately vaccinated animals. May be associated with upper airway disease in one or several animals	Variable	Most in second half of gestation	No significant gross lesions	Autolyzed fetus, rarely may have pale foci of hepatic necrosis Histopathology characteristic with multifocal necrosis	Virus isolation or PCR on placenta or fetal tissues Immunohistochemistry or fluorescent antibody stain on fetal tissues	Acute and convalescent sera
Mycoses ( <i>Aspergillus</i> , <i>Abidia</i> )	Variable incidence, more common in cooler moist climates, retained placenta may occur	Unknown. 6%–7% of all abortions encountered	3–7 months	Necrosis of maternal cotyledon, adherence of necrotic material to chorionic cotyledon causes soft, yellow, cushion-like structure Small, yellow, raised, leathery lesions on intercotyledonary areas	Minority of fetuses have skin lesions May be small, raised, gray-buff, soft lesions, or diffuse white areas on skin Resemble ringworm	Direct examination of cotyledon and fetal stomach for hyphae, suitable cultural examination Histopathology on placenta	

Continued

**Table 18-2** Diagnostic summary of abortion in cattle—cont'd

Epidemiology disease	Clinical features	Abortion rate	Time of abortion	Field examination			Laboratory diagnosis	
				Placenta	Fetus	Isolation of agent	Serology	
Listeriosis ( <i>Listeria monocytogenes</i> )	May be an associated septicemia (Cows that abort may die of septicemia near term.) Retained placentas and metritis may also occur	Low, rare abortion storms related with poorly fermented silage	About 7 months	—	Autolysis Foci of necrosis in liver and other organs	Organisms in fetal stomach, liver, and throughout fetus placenta and uterine fluid	Agglutination titers higher than 1:400 in contact animals classed as positive	
Epizootic bovine abortion	Tick-transmitted bacterial infection, occurs in dry foothill pastures in the western United States in which tick vector resides No clinical signs in aborting cattle Herd immunity develops Incubation period ≈3 months after exposure to agent	Abortion storms may occur, usually in heifers and newly introduced cattle High, 30%–40%	Third trimester abortion or birth of premature weak calves	Negative	Fresh fetus with petechiae in mucosa, enlarged lymph nodes and spleen, subcutis edema, ascites, nodular swollen liver	Diagnosis based on typical histologic lesions, etiologic bacterial agent has been identified by DNA analysis but is not culturable on artificial media Bacterial rod can be detected with special stains (Steiner silver stain and immunohistochemistry)	No serology test, elevated fetal IgG levels	
Bovine viral diarrhea (BVD)	Variable outcome of fetal infection depending on timing of infection and other factors. Persistent bovine viral diarrhea virus infection in full-term live calves a significant problem for exposure of other animals	Less than 10%	Any time during gestation Most common in first trimester	No obvious gross lesions	Mummification, variable fetal lesions possible including deformities (cerebellar, pulmonary, or renal hypoplasia), myocardial lesions with congestive heart failure, thymic depletion or no lesions	Immunohistochemical or fluorescent antibody examination of tissues to detect virus Virus isolation or PCR also available Animals affected early with congenital lesions may no longer be positive for virus at time of abortion	Fetal antibody, evidence of seroconversion in dam and/or herd	

**Nutritional:** Ingestion of excessive amounts of performed estrogens in the diet may cause abortion. There are usually accompanying signs due to increased vascularity of the udder and vulva. Possible dietary factor in so-called lowlands abortion.

**Isoimmunization:** Has not been observed to occur naturally in cattle. It has been produced experimentally by repeated IV injections of blood from the one bull of pregnancy. Intravascular hemolysis occurs in the calves.

**Unknown:** 30%–75% of most abortions examined are undiagnosed. The ingestion of large quantities of pine needles is suspected as a cause of abortion in range cattle in the United States. Infection with *Ureaplasma* and *Mycoplasma* spp. are other causes of undetermined relative importance.

ELISA, enzyme-linked immunosorbent assay; IFAT, indirect fluorescent antibody test; PCR, polymerase chain reaction.



explanation when using monovalent vaccines. The addition of Freund's incomplete adjuvant provides better protection, and some other adjuvants may improve the efficiency of killed vaccines against naturally occurring enzootic abortion. Killed vaccines can be used in pregnant ewes and have been used in the face of an outbreak in an attempt to reduce the prevalence of abortion.

A live vaccine containing a temperature-sensitive attenuated strain of *C. abortus* (strain 1B) provides reasonable, but not complete, protection against *C. abortus*. It is registered for use in sheep (not goats). Live attenuated vaccines should not be used in pregnant ewes because they may pose a risk of zoonotic infection and have been associated with abortions.<sup>8-10</sup>

Recombinant and DNA vaccines have shown little protection against experimental challenge with *C. abortus*.

### FURTHER READING

- Radostits O, et al. Chlamydophila abortion (enzootic abortion of ewes, ovine enzootic abortion). In: *Veterinary Medicine: A Textbook of the Diseases of Cattle, Horses, Sheep, Goats and Pigs*. 10th ed. London: W.B. Saunders; 2007:1435-1437.
- Stuen S, Longbottom D. Treatment and control of *Chlamydial* and *Rickettsial* infections in sheep and goats. *Vet Clin North Am Food Anim Pract*. 2011;27:213-233.

### REFERENCES

- Longbottom D, et al. *PLoS ONE*. 2013;8(2):e5790.
- Ruhl S, et al. *Vet Microbiol*. 2009;135:169.
- Reinhold P, et al. *Vet J*. 2011;189:257.
- Sachse K, et al. *Vet Microbiol*. 2009;135:2.
- Gutierrez J, et al. *Vet Microbiol*. 2011;147:119.
- Gutierrez J, et al. *J Vet Diagn Invest*. 2012;24:846.
- Wilson K, et al. *Vet Microbiol*. 2009;135:38.
- Laroucau K, et al. *Vaccine*. 2010;28:5653.
- Wheelhouse N, et al. *Vaccine*. 2010;28:5657.
- Sarginson N, et al. *New Zeal Vet J*. 2015;63:284.

## COXIELLOSIS (Q-FEVER)

### SYNOPSIS

**Etiology** *Coxiella burnetii*.

**Epidemiology** High seroprevalence in ruminants. Latent infection with recrudescence and excretion at parturition. Infection by direct contact and inhalation. Persists in the environment. Important zoonotic disease.

**Clinical findings** Infection in ruminants is common. Clinical disease is less common and presents mainly as abortion in sheep and goats.

**Necropsy findings** Placentitis. Organisms demonstrable in placental trophoblast cells by fluorescent antibody.

**Diagnostic confirmation** Fluorescent antibody staining and PCR of aborted material and vaginal discharge. Acid-fast rodlike organisms in stained impression smear of placenta. Serology (ELISA, CFT,

immunofluorescent antibody) or bulk tank milk test to establish herd infection status.

**Control** Vaccination possible in many countries. Isolation of aborting ruminants. Destruction of bedding and straw contaminated with birth fluids.

**Zoonotic aspects** Infection of humans can vary from asymptomatic to severe and even fatal. Presents mainly as a mild influenza-like illness with pneumonia, but chronic infections can have serious outcomes, including endocarditis and osteoarticular disease. Mainly follows contact with sheep and goats around parturition rather than cattle.

CFT, complement fixation test; ELISA, enzyme-linked immunosorbent assay; PCR, polymerase chain reaction.

### ETIOLOGY

Coxiellosis (Q) fever is a zoonosis associated with *C. burnetii*, which is an obligate intracellular parasite classified within the family Coxiellaceae (formerly Rickettsiaceae). It can be divided into six genotype clusters on the basis of RFLP, although different methods can be used such as multispacer sequence typing (MST) or MLVA, which can identify up to 17 different microsatellite markers.<sup>1</sup> The presence or absence of specific genotypes could explain inconsistencies in reports on the effects of coxiellosis, particularly on reproduction in cattle. Coinfection with multiple genotypes can occur, although a large study of milk samples in the United States identified predominantly genotype ST20 in bovine milk and mainly ST8 in caprine milk,<sup>2</sup> whereas ST20 was associated with an abortion storm in a goat dairy in the UK<sup>3</sup> and ST33 with the large outbreak in the Netherlands.<sup>4</sup> Unlike other rickettsiae, *C. burnetii* is quite resistant to environmental influences and is not dependent on arthropod vectors for transmission. It displays two antigenic phases or phenotypes: Phase 1 is more infectious and able to replicate in the host, and Phase 2, which is unable to replicate (these phases correspond to the smooth and rough phases of other gram-negative bacteria, respectively).

### EPIDEMIOLOGY

#### Occurrence

The organism has worldwide distribution, although serologic surveys have found no evidence of infection in New Zealand.

*C. burnetii* cycles in a wide variety of wildlife species and their ectoparasites. The infection also cycles in domestic animals; cattle, sheep, and goats are the main livestock reservoirs of infection for humans. Rates of infection in farm animals vary considerably between locations, between countries, and with time, because there appears to be cycles of infection within regions.<sup>5</sup>

There can be a wide range in the seroprevalence of Q fever within regions and

within individual herds or flocks. In cattle, from 4% to 100% of herds have been reported as positive (either seropositive or bulk milk test), and the within-herd prevalence varies from 0% to 49%.<sup>6</sup> The flock and within-flock prevalence in sheep and goats shows similar ranges and, as for cattle, varies according to year and region.<sup>5,6</sup> There is little information on management or other factors that might influence this variation in prevalence, but one study found a significantly higher prevalence in housed cattle compared with cattle kept on pasture. Analysis of data from 69 publications found the overall mean prevalence to be slightly higher in cattle (estimate of 20% and 38% for herd and within-herd prevalence, respectively) than for small ruminants (sheep and goat; 15% and 25% for flock and within-flock prevalence, respectively).<sup>6</sup> The prevalence in flocks of dairy goats and dairy sheep is much higher than in nondairy flocks.

### Source of Infection and Transmission

Infection and transmission is by direct contact and by inhalation. Infection of non-pregnant animals is clinically silent and is followed by latent infection until pregnancy, at which time there is recrudescence with infection in the intestine, uterus, placenta, and udder and excretion from these sites at parturition. The organism is present in high concentration in the placenta and fetal fluids and subsequent vaginal fluids, is also excreted in urine, and is present in the feces of sheep from 11 to 18 days postpartum. In a longitudinal study in a naturally infected sheep flock in France, the number of *C. burnetii* was higher in vaginal mucus and feces compared with milk, peaked 3 weeks after abortion or birth, and was highest in primiparous and aborting ewes.<sup>7</sup> Shedding of *C. burnetii* in the feces can be persistent, so this can contribute significantly to environmental contamination with the organism. Infection can result in abortion, stillbirths, or poorly viable lambs, but the neonates of infected, excreting ewes are often born clinically normal.

Abortion usually does not occur at successive pregnancies. However, there can be recrudescence of infection and excretion at these pregnancies, especially the one immediately following, and reproductive failure at a second consecutive pregnancy is recorded in goats.<sup>8</sup> Goats excrete the organism in vaginal discharges for up to 2 weeks, it is present in milk for up to 52 days after kidding, and is also found in the feces. It also strongly adheres to the zona pellucida not removed by standard washing procedures. Thus the possibility of transfer of *C. burnetii* by embryo transfer cannot be ruled out.<sup>9</sup>

In cattle, maximum shedding also occurs at and 2 weeks following parturition, the organism is excreted in milk for at least

several months and can be detected for up to 2 years in bulk tank milk. Abortion in cattle is less common than in goats and sheep and is sporadic rather than occurring as abortion storms like occur with sheep and goats. The organism is present in the semen of seropositive bulls, and venereal transmission is suspected.

There is a significant contamination of the environment of infected animals at the time of parturition and abortion. This is a major risk period for transmission of the disease within herds and flocks and presents a significant zoonotic risk. The organism is still present in large concentrations in soil 12 months after outbreaks of coxiellosis on goat farms.<sup>10</sup>

### Pathogen Risk Factors

*C. burnetii* is very resistant to physical and chemical influences and can survive in the environment, manure, and soil for several months. It can resist common chemical disinfectants but is susceptible to sodium hypochlorite, 1:100 Lysol solution, and formalin fumigation provided a high humidity is maintained.

There is strain variation in the organism, and differences in genotypes and DNA sequences have been correlated with differences in the type of disease occurring in humans and domestic ruminants. The organism is highly infectious, with the infective dose for humans estimated to be one organism.

### Zoonotic Implications

In humans infection is primarily by inhalation. Sources of infection include such diverse materials as soil; airborne dust; wool, bedding; and other materials contaminated by urine, feces, or birth products of animals. The potential for human infection from these sources is substantial (e.g., ovine manure used as a garden fertilizer has been incriminated).

Sheep and goats have traditionally been identified as the major reservoir of infection for humans, and the location of urban populations in proximity to large dairy goat herds was a significant reservoir in the Dutch outbreak from 2007 to 2010.<sup>1</sup>

The organism is present in the milk of infected cattle, sheep, and goats. A significant proportion of seropositive cattle excrete the organism in milk, and periods and duration of excretion are variable but may persist at least 2 years. *C. burnetii* is destroyed by pasteurization but there is a risk for people who consume raw milk, particularly unpasteurized milk from sheep and goat.

Rates of seropositivity in humans vary markedly between surveys, but there is a higher rate of seropositivity in people that are associated with domestic animals and their products and with farm environments (such as farm workers, veterinarians,

livestock dealers, dairy plant and slaughterhouse workers, and shearers).<sup>5</sup>

Many instances of infection in humans have been linked to exposure to parturient sheep and goats. A spectacular example is the 2007 to 2010 epidemic in the Netherlands, in which over 3000 notifications of human disease were analyzed and only 3.7% of people had worked in agriculture or slaughterhouses.<sup>11</sup> This outbreak was attributed to airborne transmission of contaminated dust originating from dairy goat farms located in densely populated areas. The number of human cases abruptly declined after control measures were implemented on the goat and sheep farms, including vaccination, the mass culling of more than 50,000 pregnant does and ewes on infected farms to reduce shedding of the organism, and mandatory PCR testing of bulk tank milk for *C. burnetii*.<sup>11</sup> Living close (<2 km) to a large dairy goat farm that had an abortion storm caused by *Coxiella burnetii* was identified as the major risk factor for human cases during the Netherlands epidemic.<sup>12</sup>

Coxiellosis in humans is referred to as Q-fever and is often asymptomatic, but can result in acute disease characterized by fever, general malaise, headache, and less commonly, pneumonitis, hepatitis, and meningoencephalitis. Endocarditis, hepatitis, and osteoarticular diseases are manifestations of chronic disease in around 2% of human infections.<sup>11</sup> Those at most risk of chronic disease are immunocompromised individuals and pregnant women. There is a concern that the prevalence of infection in farm animals is increasing and spreading geographically, so that there is a greater risk for human infection, particularly when dairy farms are located near urban populations. Epidemics of human infection have been documented in several countries including Australia, France, Germany, the United States, Bulgaria, the UK, and the Netherlands.<sup>11</sup>

*C. burnetii* is considered a potential agent for bioterrorism because of its survival in the environment, the ease with which it can be transmitted by aerosol and wind, and the very low infectious dose.

### CLINICAL FINDINGS

Infection of ruminants can occur at any age and is usually clinically inapparent. In the experimental disease in cattle, anorexia is the only consistent clinical finding. *C. burnetii* is a cause of abortion storms and sporadic abortion in sheep and goats but only rarely associated with sporadic abortion in cattle.<sup>13</sup> Abortion occurs during the latter part of pregnancy in individual does or ewes, usually with no sign of impending abortion.

In the 2007 to 2010 epidemic in the Netherlands, abortion storms were reported on 28 dairy goat and 2 sheep dairy farms, with up to 60% of goats aborting compared

with an average of 5% abortions on the sheep farms.<sup>11</sup>

### CLINICAL PATHOLOGY

There are a number of serologic tests, including complement fixation, microagglutination, ELISA and indirect immunofluorescence, and PCR (both conventional and quantitative real-time PCR). A comparison of these tests concluded a combination tests was preferable, such as ELISA for serology and PCR for detection of DNA of the organism.<sup>14</sup>

The immunofluorescence assay is used as the seroreference test for the serodiagnosis of coxiellosis. It can detect antibody to phase variants and can provide epidemiologic information because Phase 1 antibody is associated with recent and acute infections and Phase 2 antibody with chronic infections.

Conventional and quantitative real-time PCR tests can be conducted on bulk tank milk and are a useful means of monitoring herd or flock prevalence within regions and outbreaks within herds or flocks.<sup>15,16</sup>

### NECROPSY FINDINGS

There are seldom gross lesions in aborted fetuses, but foci of necrosis and inflammation are occasionally seen in the liver, lung, and kidney microscopically.<sup>13</sup> The placenta from aborting animals is usually thickened and a purulent exudate or large, red-brown foci of necrosis is typically seen in the thickened intercotyledonary areas. Microscopically, large numbers of necrotic neutrophils are usually visible on the chorionic surface, and swollen trophoblasts filled with the organisms can also be found in well-preserved specimens. This is consistent with bacterial replication occurring only in the trophoblasts of placenta, and not in other organs, of experimentally infected pregnant does and their kids.<sup>17</sup> Examination of placental impression smears stained with Gimenez, Koster's, or other appropriate techniques provides a means of rapid diagnosis. However, care must be taken to avoid confusing *Coxiella*-infected trophoblasts with cells containing *Chlamydochloa* organisms. Coxiellosis can be confirmed by PCR, fluorescent antibody staining of fresh tissue, or immunohistochemical staining of formalin-fixed samples. In most laboratories, culture is not attempted because of the zoonotic potential of this agent.

### Samples for Confirmation of Diagnosis

- **Bacteriology and detect DNA:** chilled placenta (fetal liver and spleen) (cytology, FAT, PCR)
- **Histology:** fixed placenta and fetal lung, liver, kidney (light microscopy, immunohistochemistry)

Note the zoonotic potential of this agent when handling aborted material and packaging and submitting specimens.

## DIFFERENTIAL DIAGNOSIS

- Other causes of abortion in sheep and goats (*Campylobacter*, *Chlamydomphila*, and *Toxoplasma*, Table 18-1).
- The diagnosis of the disease in farm animals, other than abortion, suspected as associated with this agent is difficult and relies on the detection of the organism.
- A positive serologic test in an animal or herd is indicative of infection at some time but does not indicate an association with the problem at hand.
- PCR or PCR-ELISA has been used for detection of the organism in milk.

ELISA, enzyme-linked immunosorbent assay; PCR, polymerase chain reaction.

## CONTROL

Aborting animals should be isolated for 3 weeks and aborted and placenta-contaminated material burnt. Ideally, manure should be composted for 6 months before application to fields to inactivate the organism, and closed composting with CaO or CaCN<sub>2</sub> has been practiced following outbreaks in the Netherlands, France, and Germany.<sup>5</sup> Feed areas should be raised to keep them free from contamination with feces and urine.

Although Q fever has significant implications for human health, until recently it has not been regarded as important enough to justify national or regional control strategies based on control in the animal population. In the Netherlands, a seasonal epidemic of animal and human *C. burnetii* infections occurred in 2007, but was no different from several previous isolated outbreaks in Europe. Subsequently, the unexpected scale of the outbreak in 2008 meant that national and regional public health authorities were largely unprepared for the expanding epidemic.<sup>5,18</sup>

The response in the Netherlands was to cull all pregnant dairy goats on affected farms before the 2010 kidding season, without reference to individual testing, and to vaccinate dairy goats and dairy sheep.<sup>18,19</sup> A retrospective analysis identified that testing pregnant goats by PCR or ELISA, followed by culling only the positive goats, would not have effectively reduced the massive bacterial shedding on these farms because many infected goats would not have been detected.<sup>20</sup>

Inactivated Phase 1 vaccines show a good and persistent antibody response, suggesting that vaccination should limit the excretion of the organism. However, there is little economic incentive for vaccination of livestock when an outbreak of coxiellosis is not occurring, and a vaccine for livestock is not available in many countries. A systematic review and meta-analysis of investigations into the use of inactivated Phase 1 vaccines, such as used in the Dutch outbreak, found a

significantly reduced risk of shedding in vaginal mucus, uterine fluids, milk, and feces of vaccinated goats exposed to infection compared with controls. However, it was concluded that there was no reduction in the risk or amount of shedding in vaccinated ewes compared with unvaccinated ones.<sup>21</sup>

Vaccination of humans has reduced infection rates in high-risk groups and is used in the appropriate circumstances in Australia, such as workers on goat and sheep dairy farms, abattoir workers, veterinarians, and veterinary students.

During a natural outbreak of coxiellosis in a dairy flock, two treatments with oxytetracycline at days 100 and 120 of pregnancy failed to reduce shedding of the organism in vaginal fluids, milk, or feces compared with untreated ewes.<sup>22</sup> In this flock, vaccination for three consecutive seasons reduced the proportion of ewes shedding the organism to around 4%.

Pasteurization of milk that is consumed fresh is preferable, but veterinarians dealing with herds that provide raw milk should ensure that these herds are seronegative or bulk tank milk is PCR negative for *C. burnetii*. In a study of manufactured dairy products in France (mainly cheese, but also yogurt, cream, and butter), the DNA of *C. burnetii* was detected in 64%, but no viable organisms were recovered. A greater proportion of food products from large-scale manufacturers were positive compared with artisan food.<sup>23</sup>

## FURTHER READING

- Agerholm JS. *Coxiella burnetii* associated reproductive disorders in domestic animals—a critical review. *Acta Vet Scand.* 2013;55:13.
- Georgiev M, et al. Q fever in humans and animals in four European countries, 1982 to 2010. *Euro Surveill.* 2013;18:pii 20407.
- Hogerwerf L, et al. Reduction of *Coxiella burnetii* prevalence by vaccination of goats and sheep, the Netherlands. *Emerg Infect Dis.* 2011;17:379-386.
- O'Neil TJ, et al. A systematic review and meta-analysis of phase I inactivated vaccines to reduce shedding of *Coxiella burnetii* from sheep and goats from routes of public health importance. *Zoonoses Public Health.* 2014;61:519-533.
- Roest HIJ, et al. The Q fever epidemic in the Netherlands: history, onset, response and reflection. *Epidemiol Infect.* 2011;139:1-12.

## REFERENCES

1. Roest HIJ, et al. *Emerg Infect Dis.* 2011;17:668.
2. Pearson T, et al. *BMC Microbiol.* 2014;14:41.
3. Reichel R, et al. *Res Vet Sci.* 2012;93:1217.
4. Tilburg JJHC, et al. *Emerg Infect Dis.* 2012;18:887.
5. Georgiev M, et al. *Euro Surveill.* 2013;18:pii 20407.
6. Guatteo R, et al. *Vet Microbiol.* 2011;149:1.
7. Joulié A, et al. *Appl Environ Microbiol.* 2015;81:7253.
8. Berri M, et al. *Res Vet Sci.* 2007;83:47.
9. Alsaleh A, et al. *Theriogenology.* 2013;80:571.
10. Kersh GJ, et al. *Appl Environ Microbiol.* 2013;79:1697.
11. Dijkstra F, et al. *FEMS Immunol Med Microbiol.* 2012;64:3.

12. Schimmer B, et al. *BMC Infect Dis.* 2010;10:69.
13. Agerholm JS. *Acta Vet Scand.* 2013;55:13.
14. Niemczuk K, et al. *Vet Microbiol.* 2014;171:147.
15. Garcia-Pérez AL, et al. *J Dairy Sci.* 2009;92:1581.
16. Bauer AE, et al. *BMC Vet Res.* 2015;11:186.
17. Roest H-J, et al. *PLoS ONE.* 2012;7:e48949.
18. Roest HIJ, et al. *Epidemiol Infect.* 2011;139:1.
19. Hogerwerf L, et al. *Emerg Infect Dis.* 2011;17:379.
20. Hogerwerf L, et al. *Vet J.* 2014;200:343.
21. O'Neill TJ, et al. *Zoonoses Public Health.* 2014;61:519.
22. Astobiza I, et al. *Vet J.* 2013;196:81.
23. Eldin C, et al. *Am J Trop Med Hyg.* 2013;88:765.

## DISEASES OF THE GENITAL TRACT ASSOCIATED WITH MYCOPLASMA SPP.

Vulvovaginitis in cattle, sheep, and goats may be associated with *Mycoplasma agalactiae* var. *bovis*. The same infection, when introduced with semen into the uterus, can cause endometritis and salpingitis, resulting in temporary infertility and failure to conceive. Persistent infection of the genital tract of bulls has also been produced experimentally.

Although ureaplasmas and *M. bovis genitalium* are considered to pertain to the normal flora of the lower urogenital tract of ruminants, these organisms have also been associated with reproductive disease.<sup>1</sup> In healthy individuals *Ureaplasma diversum* is usually limited in its distribution to the vestibule and vulva. Both microorganisms have been isolated from the vulva of animals with granular vulvovaginitis, and the disease could be transmitted experimentally. *M. bovis genitalium* infection has further been associated with infertility, abortion, and birth of weak calves.<sup>1</sup> These infections adversely affect reproduction when they are either acute or chronic; along with producing granular vulvovaginitis, some strains can, if introduced to the upper reproductive tract, cause transitory endometritis and salpingitis. Because *U. diversum* is a normal inhabitant of the upper respiratory tract and the lower urogenital tract of ruminants, contamination of fetal membranes or fetal tissue submitted to the diagnostic laboratory should be considered.<sup>2</sup> The diagnosis of *U. diversum* as a causative agent for abortion should therefore ideally be based on isolation of the pathogen from fetal lung tissue, stomach content, or placenta, coupled with the presence of compatible lesions in the lung and placenta.<sup>2</sup>

Ureaplasmas, *M. bovis*, and *M. bovis genitalium* have been found in the reproductive tract of bulls and their semen. Using PCR for the detection of mycoplasma in semen, *M. mycoides* subsp. *mycoides* SC (the causative agent of the contagious bovine pleuropneumonia) has been found in semen of yearling bulls with seminal vesiculitis. Mycoplasmas in semen can be transmitted through in vitro fertilization (IVF) and infect embryos, and



supplementation of culture media with standard antibiotics and washing embryos as recommended by the International Embryo Transfer Society are not effective in making IVF embryos free from *M. bovis* and *M. bovinegenitalium*. *M. bovis* in frozen semen can survive the antibiotic combination of gentamicin, tylosin, and lincomycin and spectinomycin.

In horses, *M. equigenitalium*, *M. subdolium*, and *Acholeplasma* spp. have been associated with infertility, endometritis, vulvitis, and abortion as well as with reduced fertility and balanoposthitis in stallions.<sup>3</sup> Notwithstanding, these microorganisms are also commonly isolated from clinically healthy horses, which has raised questions about their direct association with genital disease. Two microorganisms frequently isolated from the upper respiratory tract of horses, *M. equirhinis* and *M. felis*, have also been isolated from the genital tract of stallions but have not been associated with any clinical disease.<sup>3</sup>

In pigs infection with *M. suis*, the causative agent of eperythrozoonosis, has also been associated with infertility, abortion, stillbirth, and birth of weak piglets.<sup>1</sup>

## REFERENCES

1. Given MD, Marley MSD. *Theriogenology*. 2008;70:270.
2. Anderson ML. *Theriogenology*. 2007;68:474.
3. Spengler J, et al. *Vet Microbiol*. 2002;87:119.

## EQUINE COITAL EXANTHEMA

Equine coital exanthema is a **venereal disease** associated with infection of equids by equine herpesvirus-3 (EHV-3). The genome of EHV-3 has been sequenced.<sup>1</sup> The disease is highly contagious and has economic importance because of disruptions to breeding programs on stud farms when stallions have clinical signs or there is an outbreak of disease among mares. The economic impact is greatest in those breeds or studbooks, such as Thoroughbreds, that do not permit artificial insemination of mares.<sup>2</sup>

**Transmission** is usually venereal from affected or clinically normal carrier animals in which the infection is thought to be latent in sciatic ganglion.<sup>3</sup> The virus is highly contagious, and outbreaks among mares in an embryo transfer facility in which both donor and recipient mares were affected is strongly suggestive of iatrogenic spread by personnel or on equipment such as ultrasound probes.<sup>2</sup> Inapparent or latent infection is apparently common, with 14% of 220 Thoroughbred mares on a stud farm having EHV-3 genome detectable by PCR in swabs of the perineum and vagina and 48% having serum antibodies to the virus.<sup>3</sup> The virus can be excreted intermittently by infected mares, although the factors determining reactivation have not been determined.<sup>3</sup> Efforts to demonstrate that administration of corticosteroids

induces reactivation of EHV-3 shedding are inconclusive.<sup>4</sup>

The disease can be reproduced experimentally with more severe disease and longer shedding of the virus in mares that are seronegative at the time of infection than in seropositive mares.<sup>5</sup>

The disease is relatively mild and causes only local signs manifested by papular, then pustular, and finally **ulcerative lesions** of the vaginal mucosa, which is generally reddened. The ulcers can be as large as 2 cm in diameter and 0.5 cm deep and are surrounded by a zone of hyperemia. In severe cases the lesions extend onto the vulva and the perineal skin to surround the anus. There can be pain on passage of feces, and the anorectal lymph nodes are enlarged.<sup>2</sup> In the male, similar lesions to those on the perineum of the mare are found on the penis and prepuce. Many mild cases are unobserved because there is no systemic disease and affected horses eat well and behave normally. The effect on fertility is equivocal although there might be a loss of libido during the active stage of the disease in stallions. The **incubation period** is 2 to 10 days and the course up to complete healing of ulcers is about 14 days, although depigmented lesions on the perineum can persist for months.<sup>3</sup>

EHV-3 has been associated with **unilateral rhinitis** in adult horses examined with the same endoscope. All horses were affected unilaterally and in the nostril through which the endoscope was passed.<sup>6</sup>

Diagnosis can be achieved by use of virus isolation or demonstration of viral DNA in skin lesions or swabs of the vaginal or perineal regions.<sup>3</sup> Secondary bacterial infection can lead to suppurative discharge and a longer course. In some outbreaks lesions occur on the skin of the lips, around the nostrils, and on the conjunctiva and can also be present on the muzzle of the foal. Ulcerative lesions of the pharyngeal mucosa also occur in infections with EHV-2 and with equine adenovirus. Ulcerative lesions of the oral mucosa are of great importance because of the necessity to diagnose vesicular stomatitis early.

Treatment is symptomatic and can include cleaning of lesions, although this might not be necessary in uncomplicated disease. Mares with severe inflammation of the perianal tissues with or without enlargement of the anorectal lymph nodes and signs of pain on defecation might benefit from administration of fecal softening agents (mineral oil) or diets.

Control can be achieved by use of artificial insemination, but careful attention must be paid to biosecurity measures that minimize the opportunity for iatrogenic spread on stud farms or embryo transfer facilities. Recommendations for control in embryo transfer facilities and stud farms include the following<sup>2,7</sup>:

- Strict adherence to hygiene procedures designed to prevent both the direct and indirect transmission of the virus.
- Personnel with direct contact with mares should wear long, disposable examination sleeves and short latex gloves, which should be changed between subsequent inspections.
- Ultrasonography probe should be covered with a disposable glove or be carefully disinfected before the inspection of each mare.
- All instruments and other devices used during the inspection procedure, artificial insemination, and embryo collection must be either disposable or washed and sterilized between uses.

## FURTHER READING

Barrandeguy M, Thiry E. Equine coital exanthema and its potential economic implications for the equine industry. *Vet J*. 2012;191(1):35-40.

## REFERENCES

1. Sijmons S, et al. *Genome Announc*. 2014;2:e00797.
2. Barrandeguy M, et al. *J Equine Vet Sci*. 2010;30:145.
3. Barrandeguy M, et al. *Theriogenology*. 2010;74:576.
4. Barrandeguy M, et al. *Equine Vet J*. 2008;40:593.
5. Barrandeguy M, et al. *Vet Microbiol*. 2012;160:319.
6. Barrandeguy M, et al. *Vet Rec*. 2010;166:178.
7. Barrandeguy M, et al. *Vet J*. 2012;191:35.

## PORCINE REPRODUCTIVE AND RESPIRATORY SYNDROME (PRRS)

### SYNOPSIS

**Etiology** Porcine reproductive and respiratory syndrome virus belonging to the Arteriviridae family.

**Epidemiology** Highly contagious disease of swine manifested by reproductive failure, and respiratory disease in young pigs. Worldwide occurrence; spreads rapidly in swine-raising areas during the last 20 years. Subclinical infection endemic in most swine herds; incidence of clinical disease lower but causes severe economic losses. Pigs become infected in nursery from older infected pigs; persistent infection for several months is common. Different antigenic strains with variable virulence. Natural infection or vaccination results in immunity, but viremia still common. Infection with virus may predispose to secondary infections of respiratory tract. Transmitted by direct contact, feces and discharges, importation of infected pigs into herds, aerosol infection, and semen.

**Signs** Highly variable clinical syndrome.

**Reproductive failure** Outbreaks of late gestation abortions, stillbirths, mummified fetuses, weak neonates, and high rate of return to estrus. Problem may persist and recur for many months.

**Respiratory form** Anorexia, fever, dyspnea, polypnea, coughing, unthriftiness, high mortality in young pigs and low in older pigs and breeding stock. Deaths occur in acute phase.

**Lesions** Interstitial pneumonia with reduction in alveolar macrophages. Aborted and mummified fetuses, stillbirths, and weak neonates with pulmonary lesions.

**Diagnostic confirmation** Serologic testing for viral antibody titers. Detection of virus in tissues and alveolar macrophages using immunofluorescent microscopy and other techniques.

**Differential diagnosis list** Major differential is porcine circovirus infections

#### Respiratory disease:

##### Pneumonia caused by

- *Mycoplasma hyopneumoniae*
- *Actinobacillus pleuropneumoniae*
- *Pasteurella multocida*
- Glasser's disease (*Haemophilus parasuis*)
- *Streptococcus suis*

##### Reproductive failure

- Leptospirosis
- Parvovirus
- Brucellosis
- Aujeszky's disease
- Hog cholera virus

**Treatment** Must clinically manage outbreak to minimize mortality in young pigs.

**Control** Segregation and off-site rearing of recently weaned pigs. Nursery depopulation and clean up protocol. Import only virus-free breeding stock into breeding herds. Both live attenuated and dead vaccines available for sows and piglets.

## INTRODUCTION

PRRS is a significant cause of respiratory disease in its own right but is also a significant contributor to the porcine respiratory disease complex (PRDC).<sup>1</sup> The ever-expanding diversity of porcine reproductive and respiratory syndrome virus (PRRSV) infections has been emphasized.<sup>2</sup> This agent is one of the three major contributors to the continuing evolution of respiratory disease in pigs (swine influenza virus [SIV], PRRS, and porcine circovirus type 2 [PCV2]).

## ETIOLOGY

PRRS is caused by an RNA virus morphologically, structurally, and genomically similar to members of the genus *Arterivirus* of the family *Arteriviridae* belonging to the Order *Nidovirales*<sup>3</sup> including equine arteritis virus. The virus was first isolated in Lelystad in the Netherlands in 1991 (it was initially called the "Lelystad virus"). The mystery swine disease in North America was then shown to be a similar virus. These two strains are considered to be one virus but differ genetically and antigenically. The North American and European strains are only 60% identical at the nucleotide level.<sup>4</sup>

In terms of evolution, it is possible that lactic dehydrogenase virus of mice infected wild boar in Central Europe and became adapted. It then went to North Carolina in the United States possibly in wild boar. It is thought that the most likely date for a common isolate of the European strains is before 1981. The two species of PRRSV then developed separately on the two continents. Some evidence of this comes from a study of the number of nucleotides in open reading frame 7 (ORF7) of the virus from the United States (372 nucleotides), and the European virus (Lelystad types) had 387 nucleotides, but the Lithuanian strains that were collected had 378 nucleotides.

The European viruses (Lelystad type) have become known as type 1, and the North American viruses as type 2 viruses (ATC-2332 was the first).

There is the implied existence of two distinct genotypes derived from a common ancestor.<sup>5</sup> New clinical cases may occur because of other microbes interacting with the virus but also because new viral variants escape the neutralizing responses of pigs to the previous pig strains of PRRSV.<sup>6</sup>

## Genome

The virus has a genome of approximately 15.4 kb consisting of 10 ORFs. ORF1a and ORF1b comprise 80% of the genome and encode polyproteins that are processed to 14 nonstructural proteins (nsps)<sup>7</sup> by viral proteases. ORF 2a, ORF2b, ORF3, ORF4, ORF5a, and ORF5-7 encode eight structural proteins: GP2a, GP2b, GP3, GP4, ORF5a, GP5, matrix protein (M), and nucleocapsid (N).<sup>8,9</sup>

All of these structural proteins have been shown to be important for virus infectivity because of their critical roles in virion assembly and/or interaction with cell-surface receptors.<sup>8</sup> N-linked glycosylation of GP5 is critically important for virus replication.<sup>10</sup> The heterodimer consisting of the GP5 and M proteins is required for infectivity of arteriviruses. GP5 plays a key role in viral entry by interacting with the host cell receptor.<sup>11</sup> ORF2b is also essential for virus infectivity and is likely to function as an ion channel to facilitate uncoating of the virus.<sup>12,13</sup> GP3 is found in type 1 and 2 viruses.<sup>14</sup>

One other protein, (N) or nucleocapsid, synthesized by ORF7 is highly immunogenic and has been used for most antibody studies. It is found in the cytoplasm and the nucleus in which it has an important role in antagonizing cellular gene function. The more recent type 2 strains still exhibit variability in sequence and pathogenicity.<sup>15</sup>

A novel structural protein in PRRSV has been discovered to be encoded by an alternative ORF5, and this protein is referred to as ORF5a and is expressed in infected cells. Pigs infected also express ORF5a antibodies. It is found in all PRRSV subgenomic RNA5 genes as an alternative reading frame and in all

other arteriviruses, which suggests that it may play an important role.<sup>16</sup>

There is evidence of recombination between vaccine and wild-type PRRSV strains.<sup>17</sup> There is an exceptional diversity in PRRSV strains in Eastern Europe,<sup>18</sup> which is developed from European viruses and the use of attenuated virus vaccines (containing North American viruses) and these are associated with new genetic subtypes.

GP4-specific neutralizing antibodies might be a driving force in PRRSV evolution.<sup>19</sup> Amino acid substitutions in the GP4 neutralizing epitope may abrogate antibody recognition and favor the development of neutralizing antibody-resistant variants.

The genetic and antigenic characterization of the complete genomes of type 1 PRRSV isolated in Denmark over a period of 10 years have been described. In Denmark, more than 50% of the herds are affected<sup>20</sup> by type 1 and/or type 2.<sup>20</sup> The study showed that there were two major clusters within the type 1 genotype. The differences from the original Lelystad virus varied from 84.9% to 98.8% for ORF5 and 90.7% to 100% for ORF7 for the nucleotide identities. The results strongly suggest that there have been at least two independent introductions of type 1 PRRSV into Denmark with significant drift in several regions of the virus. The genetic dissection of complete genomes of type 2 PRRS viruses isolated in Denmark over 15 years has been described.<sup>21</sup> The virus arrived at the same time as Ingelvac PRRS-MLV, and since then the viruses were found to be 94.0% to 99.8% identical to the vaccine strain. The nucleotide identity was 90.9% to 100% for ORF5 and 93.0% to 100% for ORF7. There was wide diversity in the nsp2 with some deletions in the NSP2 region. The analysis showed that all Danish isolates belonged to a single cluster (sublineage 5.1) resembling the type 2 prototype isolate VR-2332.

## North American Viruses (Type 2 Porcine Reproductive and Respiratory Syndrome Virus)

The North American genotype PRRSVs in China have evolved independently from those in other countries, suggesting that geographic separation might be one factor influencing the molecular evolution of PRRSV.<sup>22</sup>

There is an exceptional diversity of North American type 1 PRRSV<sup>4,5</sup> in China.<sup>23</sup>

Korean strains have evolved from North American strains imported some years earlier and have evolved separately from other Asian countries, suggesting that geographic separation may influence the molecular evolution.<sup>24</sup>

## European Viruses (Type 1 Porcine Reproductive and Respiratory Syndrome Virus)

In a study of over 100 new PRRSV UK isolates, all type 1, in the period from 2003 to 2007, it was found that some strains were

similar to those found in the early 1990s.<sup>25</sup> It was also found that the diversity is greater now than it was then.<sup>26</sup>

The evolution of Spanish strains of PRRSV from 1991 to 2005 has been studied from 1991 to 2005 using the ORF5 of the virus.<sup>27,28</sup>

The emergence of PRRSV in Sweden was described in 2007 when it was detected through a national surveillance program.<sup>29</sup>

In a study in Thailand, European isolates seem to have evolved from the Lelystad virus, whereas the Thai U.S. isolate may have come from vaccine strains that were not available in Thailand so they may have been imported in pigs or semen and later spread.<sup>30</sup>

### High Pathogenicity Viruses

In June 2006, an unknown disease characterized by high fever, high morbidity, and high mortality was seen in many areas of China. It was highly pathogenic and characterized by a unique discontinuous deletion of 30 amino acids in the nsp2 protein with extensive substitutions in the GP5 sequence from the ORF5 gene. This epidemic has affected over 2 million pigs in China, with over 400,000 deaths.<sup>31</sup> A further 140,000+ pigs with 40,000 deaths occurred between January and July 2007.<sup>32</sup> A similar outbreak in Vietnam caused huge losses in 2007.<sup>33,34</sup> The genetic variation and pathogenicity of a highly virulent PRRSV has been described.<sup>35</sup> The genomic diversity of Chinese PRRSV isolates from 1996 to 2009 has been described.<sup>36</sup> They are divided into four highly diverse groups, and it is suggested that they developed from the domestic Chinese viruses by gradual variation and evolution. A new variant has since been described.<sup>37</sup> The complete genome sequences of two other variant PRRSVs isolated from vaccinated pigs have been described.<sup>38</sup> The high pathogenicity (HP)-PRRSV strain has become the predominant strain in China.<sup>39</sup> This virus has undergone rapid evolution and can circumvent immune responses induced by currently used vaccines.

A 1-year study of dynamics and evolution of type 1 and 2 PRRSV in a swine farm in Korea<sup>40</sup> showed the farm was first infected with a type 2 virus and then with a type 1 virus of unknown etiology. The type 1 virus has undergone further change.<sup>41</sup>

The magnitude of differentially expressed gene profiles in HP-PRRSV-infected pigs compared with the original VR-2332-infected pigs is consistent with the increased pathogenicity of HP-PRRSV in vivo.<sup>42</sup>

### Spread of High Pathogenicity Porcine Reproductive and Respiratory Syndrome

Highly pathogenic strains of PRRSV have been identified within both genotypes<sup>43-45</sup> and have been isolated in China and Southeast Asia.<sup>31,34,45</sup> A 59 amino acid discontinuous deletion has been found in an

HP-PRRSV Chinese virus,<sup>46</sup> whereas most of the previous HP-PRRSVs have had a 30 amino acid deletion.<sup>47</sup> Six different subgenotypic isolates have been found in pigs in China from 2006 to 2008.<sup>48</sup> New genomic characteristics of HP-PRRSV do not lead to significant changes in pathogenicity.<sup>49</sup> High pathogenicity strains have been described in Vietnam.<sup>50</sup> These have been found to be different from the Chinese strains and cause different pathogenic outcomes in American high-health swine.<sup>51</sup>

A highly pathogenic PRRSV virus isolated from a piglet stool in North America was sequenced.<sup>52</sup>

### Experimental Infections With High Pathogenicity Porcine Reproductive and Respiratory Syndrome

Experimental infection with a Chinese HP-PRRSV in American swine showed that it replicated in swine with at least a 100-fold increased kinetic activity over VR-2332, which is the American reference strain. It caused significant weight loss, exacerbated disease because of bacterial sepsis, and had more severe histologic lesions. It rapidly transmitted between animals. It also greatly increased serum cytokine levels associated with innate (IFN- $\alpha$  and IFN- $\beta$ ; TNF- $\alpha$ ; and IL-1 $\beta$ , IL-6, and IL-8) and adaptive immunity (IL-2, IL-4, IL-10, IL-12, and IFN- $\gamma$ ) in bronchoalveolar lavage fluid and most of them in serum and tracheobronchial lymph node homogenates.<sup>53</sup> These included IFN- $\alpha$ , IL-1 $\beta$ , IL-2, IL-10, and IFN- $\gamma$ . In addition, IL-12 was also elevated 11 days postexposure. None of the pigs inoculated with VR-2332 had significant elevations in the serum levels of the 10 cytokines. It may be that this represents a severe cytokine release syndrome or cytokine storm, as has been suggested for humans.<sup>54-56</sup> These conditions share many features including massive inflammatory responses, elevated serum cytokine levels, and multiorgan disease often with death.<sup>57</sup>

### ECONOMIC LOSS

A recent study of economic loss caused by PRRSV was made in the Netherlands, and it was found that the loss varied between €59 and €379 per sow per 18-week period of the outbreak. The mean loss was €126. The costs after the outbreak varied from €3 to €160 per sow.<sup>58</sup>

### EPIDEMIOLOGY Occurrence

PRRSV was first reported as a new disease in swine-raising areas in North America in 1986 to 1987, and in 1991 it was recognized in, and spread rapidly across, Western Europe. The disease was first recognized in Germany in 1990 and in the Netherlands in 1991 and then spread rapidly. Based on serologic surveys, there is no evidence of infection in swine herds in Switzerland<sup>59</sup> and Australia.

The introduction of legislation in some countries to restrict the movement of pigs from affected farms slowed the spread of the disease, but the rapid spread of the disease initially to the southwest of Europe and then to the north, paralleled the direction of the wind. Airborne spread was also suspected because even well-managed and isolated herds became infected, but airborne spread over distances of a few kilometers continued to occur, particularly in areas with high pig population density.

The terms *mystery pig disease* and *blue-eared pig disease* were used because the etiology was unknown and the skin of the ears of affected pigs commonly appeared blue. The disease affects pregnant gilts and sows, unweaned and recently weaned pigs, and growing-finishing pigs. Outbreaks of late-term abortions, high numbers of stillbirths and mummified or weak newborn piglets, and respiratory disease in young unweaned and weaned pigs are common. After 10 or more years of acceptance and relief that the European virus was not as pathogenic as the North American virus, it is now accepted in Europe that the recent evolution of the virus may now be causing as many problems as the North American virus always has done.

A high seroprevalence of PRRSV and SIV on Spanish farms was found to be over 85% for sows, around 80% for finishers, and around 50% for boar studs.<sup>60</sup>

It has also been studied in wild boars in Germany and 15.9% of 531 examined were found to be positive.<sup>61</sup> The genetic diversity of PRRSV in selected herds in the pig-dense region of northwestern Germany showed that of 65 samples tested 5 were the North American type and 60 were the European type 1.<sup>62</sup> Of the original 18 herds visited only 2 reported clinical signs 2 years later.

Both the European genotype (type 1) and the North American (type 2) genotype now circulate globally.<sup>63</sup>

Strains within the genotype may differ by as much as 20% with the GP5 protein showing the widest heterogeneity with 50% to 55% difference between types 1 and 2.<sup>5</sup>

The distribution of genotypes of PRRSV in Ontario from 2004 to 2007 and the association between genotype and clinical signs of disease have been described,<sup>64</sup> and four RFLP types were recognized. In a further study, it was suggested that the diversity in Canada is not described adequately by RFLP typing.<sup>65</sup>

### Prevalence of Infection

In endemic herds 30% to 70% of pigs may be seropositive to the virus and about 60% of herds have some seropositive pigs. Although the seroprevalence may be high in herds in some regions, the incidence of clinical disease is lower and variable. Although the number of herds with the acute form of the disease has been decreasing, the infection is now **endemic** in many herds, characterized



by increased mortality and suboptimal performance in nursery pigs, with active spreading of the virus mainly in nurseries. In endemically infected herds, **subpopulations of infected animals** may exist consisting of a low prevalence (<10%) of seropositive animals in the breeding animals and a high prevalence (>50%) of seropositive nursery piglets. The elimination of these susceptible subpopulations, by exposing all members of a population to the virus, is used as a control strategy in large herds in which there may be subpopulations of highly susceptible breeding females. The virus can persist in non-pregnant sows and be transmitted to naive in-contact sows. A PRRSV strain may persist in a herd for up to 3.5 years displaying as little as 2% variation in ORF5 during this period. In 78% of herds with multiple submissions, genetically different strains were identified within 1 year of the original identification. Virulent PRRSV isolates exhibit longer viremias but not more elevated levels; they induce higher death rates and cause more severe clinical signs in a respiratory disease model. More virulent strains grew to significantly higher levels in pigs than did cell culture-adapted isolates. Pathogenic consequences and immunologic responses of pigs to PRRSV are closely related to viral load in acute infections as reflected in viral titers in blood.

On some farms in Great Britain, PRRSV fails to persist indefinitely on some infected farms, with fade-out more likely in smaller herds with little or no reintroduction of infectious stock. Persistence of infection may be associated with large herds in pig-dense regions with repeated introductions.<sup>66</sup>

In a study of 33 sites established as PRRSV free, it was found that 40% became positive within 1 year of establishment.<sup>67</sup>

### Morbidity and Mortality

The morbidity rate in young pigs may be up to 50%, and mortality in nursery piglets can reach 25%. Death is usually associated with secondary bacterial infections such as *Salmonella Choleraesuis*, *Streptococcus suis*, *Actinobacillus pleuropneumoniae*, and *Haemophilus parasuis*. Major losses occur in reproductive failure, but figures for the magnitude of reproductive losses during an outbreak are not readily available. Generally, the reproductive performance of positive herds is significantly lower than negative herds.

### Risk Factors

The severity and duration of outbreaks following infection are variable. Some herds may be devastated by high production losses, whereas other herds may have almost no losses. Differences in morbidity and mortality may be caused by dose of virus at exposure, differences in host susceptibility, differences in strain virulence, environmental or housing differences, or the production practices in the herd.

A study of risk factors in Quebec<sup>68</sup> suggested that the transmission of PRRSV is likely to occur through the sites belonging to the same owner or through a 5-km area.

In a study of risk factors for PRRSV infection, it was found that there was a higher proportion of infected farms in areas of high pig density (more than 15,000 pigs within a 10-km radius from the farm), if they used live virus vaccines, if they were located in a high-density pig area, or if dead pigs had been collected. Farms weaning at 28 days or more had lower odds of being PRRSV positive compared with those weaning at 21 to 27 days.<sup>69</sup>

### Animal Risk Factors

Nursing piglets lacking maternal immunity, young growing and finishing pigs, and sows lacking acquired immunity from natural infection or vaccination are highly susceptible to infection and clinical disease. Severe disease appears to be more likely in large herds that have a large turnover of pigs, purchase replacements from other herds, and do not use a quarantine system. Introduction of the virus to previously virus-naive herds may cause severe economic losses. In the recent outbreaks in Denmark, the study of 107 herds showed that a variety of hazards were identified including close neighboring herds, increasing herd size, and purchase of semen from infected studs used for artificial insemination.

There is a within-breed genetic variation for commercially relevant traits that could be exploited in future breeding programs.<sup>70</sup> A significant line difference in growth in two genetically diverse commercial pig lines was seen during infection with PRRSV.<sup>71</sup>

One study has shown that the number of piglets per litter infected by PRRSV was lower for the Landrace breed than for Large White, Duroc, and Pietrain breeds.<sup>72</sup>

In a study of 316 herds in Canada, it was found that the three most important factors for the spread of PRRSV RFLP 1-18-4 were sharing the same herd ownership, gilt source, and market trucks.<sup>73</sup> Spatial proximity could not be identified as a contributor to the spread.

### Environmental and Management Risk Factors

Housing of all age groups in one building, introduction of new animals, housing on slatted floors, storage of slurry under floors, exposure to transport vehicles, and lack of disinfection procedures have been suggested as factors that increase the probability of herd infection. Lack of quarantine facilities for recently imported pigs is a major risk factor. There appears to be infrequent spread during warm weather compared with cold weather.

### Pathogen Risk Factors

PRRS virus strains have many identical properties with some antigenic differences.

Strains of the virus from the United States and Canada are antigenically similar but different from the European Lelystad virus isolate. All the strains appear to be highly infectious. There are serologic differences between the European and American strains, and the antigenic and genomic differences between the North American and European isolates suggest the existence of two genotypes. There are different genotypes and at least three minor genotypes within the major U.S. genotype. The simultaneous coexistence of the strains has been shown, but the significance of the observation is not understood. Genetic variations exist not only between European and U.S. strains but also among the U.S. isolates, indicating the heterogeneous nature of the virus. Antigenic variation may affect the accuracy of diagnostic tests and the efficacy of vaccines. The North American strains have been called type 2 virus, and they are continually varying. The European type 1 virus was thought to be less virulent and less likely to change, but this may not be so because recent isolations show that it is also continuing to change.

Infection with the virus does not always result in clinical disease, and the detection of high levels of serum antibody in many herds without history of clinical disease suggests that the consequences of natural and experimental infection depend on a complex of factors associated with host susceptibility and virus virulence. From 2000 to 2001, there were severe outbreaks in the United States associated with new isolates. There are now both European and U.S. strains originating from viral vaccines in Poland. The effects of the virus on reproductive performance are strain dependent. Strains of the virus cross the placenta when given to pregnant sows, and most sows will remain clinically normal and farrow normally. However, depending on the strain used, the number of late-term dead fetuses from gilts infected experimentally at 90 days' gestation may vary widely, and all gilts become viremic and develop antibodies. There are also marked differences in pathogenicity for the respiratory tract between U.S. strains of the virus compared with the Lelystad virus when inoculated experimentally into 4-week-old cesarean-derived colostrum-deprived pigs. Some strains cause severe lesions of the lymphoid and respiratory systems, which appear to be the major sites of viral replication. The difference in pathogenicity may explain the variation in severity of clinical disease observed in field outbreaks.

Field observations have suggested that the presence of the virus in a herd may increase the susceptibility of animals to other infections. However, studies with sequential infection of the virus followed by experimental inoculation with *H. parasuis*, *Pasteurella multocida*, or *A. pleuropneumoniae* have failed to demonstrate increased severity of disease. There is, however, strong evidence to

say that PRRSV predisposes to *S. suis*. It may also predispose to *Salmonella* Choleraesuis, *Bordetella bronchiseptica*, or *M. hyopneumoniae*. This view is not universal in that infection with the virus did not increase the severity of experimental *M. hyopneumoniae* (MH) infection in young piglets. However, in the laboratory investigation of PRDC the most potent combination of agents is PRRSV and MH. A model of the dual infection has recently been described in which MH was shown to predispose to PRRSV infection. Based on diagnostic submissions, however, concurrent pulmonary bacterial infections may occur in up to 58% of cases in which the virus was also isolated.

There is also the possibility that many strains may be found in the same herd, e.g., three strains were found in one herd. Several viruses have been found in the same pig, and one great authority has expressed the view that each virus in each pig may be different from every other virus.

A syndrome was described in neonatal pigs marked by neurovirulence. Replication in the brain was verified by IHC in brain sections. Meningoencephalitis induced by the virus was unusually severe.

### Methods of Transmission

Virus is produced rapidly after infection, probably within 12 hours. The virus was shown to evolve continuously in infected pigs with different genes of the viral genome undergoing various degrees of change.

There are unlikely to be any wildlife reservoirs (except for feral and wild pigs), although infected mallard can still excrete the virus 39 days later. Most pigs clear PRRSV within 3 to 4 months but some may remain persistently infected for several months. The antibody response does not reflect the carrier status. It is possible that cytokines can switch the balance from a sub-clinical infection to disease manifestation. There is no evidence that PRRSV is found in the tonsils as a representative tissue.

The virus spreads rapidly within herds when infected pigs are housed in confinement. Up to 90% of sows may seroconvert within 3 months of the virus being introduced into a closed breeding herd. The mode of spread is presumed to be by direct contact, probably nose to nose. The virus generally requires close pig-to-pig contact to achieve an exposure dose.

### Presence Within the Herd

The virus is present in a variety of biologic fluids; nasal discharge (positive 21 days later); oropharyngeal scrapings (158 days later); possibly mammary secretions, although this is probably uncommon as previous vaccination does appear to prevent shedding; urine (28 days) and feces (28 days); and intranasal inoculation has been used to reproduce the disease experimentally. The feces may be an intermittent source,

a usual source, or not a source. The virus is present in saliva and, considered in the context of the **social behavior** of pigs, may play an important role in transmission.

The virus may persist in, and circulate between, different age groups and locations in a herd for several months despite the absence of clinical disease and may be transmitted by contact to replacement animals or to uninfected farms. Infected pigs may remain carriers of the virus for up to 15 weeks. Persistent and contact infection can be maintained in a nursery if uninfected pigs are continuously exposed to infected pigs. Pigs in the nursery become infected through contact with older infected pigs and not by in utero or postpartum exposure to infected sows. Long-term surveys of farrow-finish herds reveal that isolation rates of the virus reach highest level of 70% to 100% of pigs, 6 to 8 weeks of age, which coincided with the lowest level of maternal immunity. If you rely on infected nursery pigs to transmit infection to incoming gilts in acclimatization studies, then nursery pigs may only be viremic for a maximum of 60 days. There is no association between lymphadenopathy and PRRSV viremia in nursery pigs 4 and 6 weeks postweaning. Viremia cannot be predicted solely on the basis of clinical signs. Large finishing enterprises purchasing pigs of variable infection and immune status provide ideal conditions for persistent virus circulation. Breeding herd subpopulations of infected pigs may exist and perpetuate and enhance the infection in a herd. The inability to control such subpopulations may reduce opportunities for successfully controlling the disease.

Infection may **persist** for an extended period of time because of the following:

- Incomplete infection of the susceptible population during the acute phase
- Introduction of susceptible breeding stock
- A persistent viral infection in individual pigs with the potential of shedding virus under certain conditions, such as grouping for weaning or farrowing
- A rapid decline in passive immunity in young pigs and variable periods of active immunity

Genetic randomness of isolates does not correlate with geographic distance. Movement on to the farm of PRRSV does not generally occur by distance-limited processes, such as the usual wildlife vectors, but more typically occurs because of long-distance transport of animals or semen.

It is likely that piglets born with infection from in utero exposure probably may remain viremic for life, even in the face of antibody formation. Neonatal infection is probably cleared slowly, but infection in the older animal may be cleared much more quickly.

Experimental infection suggests that PRRSV infection is eventually cleared from

the host and persistent infection rarely lasts more than 200 days.

In a study in France, a semiquantitative real time RT-PCR was developed to assess the evolution of the viral genome in blood and nasal swabs from inoculated and contact pigs with time. Viral genome was detected from 7 to 77 days postinfection (DPI), whereas viral genome shedding was detectable from nasal swabs from 2 to 48 DPI. The infections increased from 7 to 14 days and then decreased slowly to 42 DPI. The evolution of infectiousness was mainly correlated with the time course of viral genome in the blood, whereas the decrease of infectiousness was strongly related to the increase in total antibodies.<sup>74</sup>

A mathematical model of within-herd transmission dynamics of PRRSV, fade-out and persistence, has been described.<sup>75</sup> It was found that fade-out was likely to occur when breeding females failed to pass the virus on to the piglets. Persistence was more likely to occur once infection was present in piglets, which in turn infected rearing pigs. The probability of persistence was higher in large herds, increased contact between different age groups, and increased reintroduction of infectious gilts.

Possible routes of transmission include introduction of vaccinated animals, use of semen from vaccinated artificial insemination boars, and aerosol spread.

### Introduction of Vaccinated Animals

The disease has occurred in PRRSV-seropositive herds in Denmark with no previous clinical evidence of PRRSV. These herds were then vaccinated with a modified live virus vaccine licensed for use in pigs 3 to 18 weeks of age. Boars entering artificial insemination units were also vaccinated. Following vaccination, a large number of herds experienced an increased number of abortions and stillborn piglets and an increasing mortality in the nursing period. The problems occurred mainly in herds without clinical signs among sows and with sows with low antibody titers in the period immediately before vaccination. The PRRSV was isolated from fetuses and identified as the vaccine virus. The evidence suggested that the vaccine virus had spread to nonvaccinated sows followed by transplacental infection of the fetuses. Spread of the vaccine virus was also demonstrated in a nonvaccinated and previously virus-free breeding herd. There are three main methods of spread:

1. Introduction of infected animals: Spread between herds is associated with the introduction of infected carrier pigs.
2. Use of semen from vaccinated or infected boars: Infected boars may shed the virus in their semen for up to 40 days after experimental infection. In boars, the virus can be found in semen by PCR for much longer periods than

can be found in the blood by virus isolation or antigen detection, and the likelihood is that monocytes enter the bulbourethral glands, which then contaminate the semen. Following experimental infection of sexually mature boars the virus was present in the semen 3 to 5 days after infection and on days 13, 25, 27, and 43. Using a PCR assay the virus can be detected in semen for up to 92 days after experimental infection. The insemination of gilts with semen from experimentally infected boars resulted in clinical signs of disease and failure to conceive. Following artificial insemination of gilts with semen from experimentally infected boars, the gilts will seroconvert. The use of the modified-live PRRS virus vaccine in boars is controversial because some boars may still shed wild-type virus in semen after challenge exposure 50 days after vaccination. The inoculation of PRRSV-negative replacement gilts with serum from nursery pigs presumed to be viremic resulted in seroconversion of all 50 gilts tested.

Exposure of pregnant gilts to either attenuated (vaccine) or virulent (field) strains of the virus can result in congenital infection. Congenitally infected pigs can support virus replication for a long period of time during which the viral replication is confined to the tonsils and lymph nodes. After 260 days there were no serum antibodies, and between 63 and 132 days there was no evidence of virus in the lung. Vaccine and field strains can be transmitted postnatally from infected to noninfected littermates. Pigs infected with field strains have an inferior rate of survival and growth than do noninfected pigs. This suggests that use of attenuated virus vaccine during gestation is questionable.

- Aerosol spread: Airborne spread across regions and between countries was suspected in Europe during the winter of 1990 to 1991. The infection appeared to spread by the airborne route from Germany, across the Netherlands, and into Belgium. Low temperatures, low sunlight, and high humidity may have facilitated airborne spread. Airborne spread up to 20 km has been suggested, but most airborne spread is probably limited to less than 2 km. Usually it is difficult to transmit the agent 1 m. Although an experiment failed to transmit infection from pig to pig in a trailer parked 30 m away, there is a suggestion that it is transmitted for a short distance, but this possibly only occurs intermittently. Aerosol infection might be responsible in the absence of

any other means of spread.<sup>76,77</sup> The effect of temperature and relative humidity on an aerosol of PRRSV has been calculated, and it is more stable at lower temperature and/or lower humidity.<sup>78</sup>

In a study of aerial transmission,<sup>79</sup> it was found that 21/21 aerial samples were positive from exhaust gases from an experimentally infected pig group. Five of 114 long-distance samples were positive and were collected 2.3, 4.6, 6.6, and 9.1 km from the experimentally infected herd. Interestingly, only PRRSV variant 1-8-4 was detected, whereas 1-18-2 and 1-26-4, the other two strains given to the source pigs, were not detected. A production region model to assess the airborne spread of PRRSV has been produced by the same team.<sup>80</sup> Animal age, MH coinfection, and PRRSV isolate pathogenicity did not significantly influence the concentration of aerosol shedding. The shedding of PRRSV in aerosols may be isolate dependent.<sup>81</sup>

A production region model has been used to assess the airborne spread of PRRSV.<sup>82</sup>

The median infectious dose of PRRSV via aerosol exposure has been described.<sup>83</sup> The MN-184 isolate was far more infectious than the VR-2332 isolate.

Long-distance transmission of PRRSV was confirmed in a study where 1.3% of 306 samples were positive. These samples were positive 4.7 km away from the source population.<sup>84</sup>

### Other Sources Fomites

Fomites and infected personnel were shown to be capable of transmitting the virus following contact with infected material. Infected hands, boots, and protective clothing can transmit it.<sup>85</sup> Needles will transmit the virus. People do not usually act as vectors.

### Meat

Pig meat does not retain detectable amounts of the virus, and it is unlikely that the transmission through meat occurs. PRRSV can survive in fresh pork at refrigerator temperatures, and the moving of meat juice may increase the risk of viral spread from personnel to pigs.<sup>86</sup> In a study of PRRSV in muscle it was found that 13/89 samples between 28 and 202 days after inoculation were found to be positive by quantitative RT-PCR, but if fed to pigs there was no evidence of infection, suggesting that the test detected noninfectious PRRSV in pig meat.<sup>87</sup>

### Insects

Mosquitoes were not seen in one study to be a likely vector for PRRSV. Houseflies may pose some level of risk for the transport and transmission of PRRSV between pig populations under field conditions.<sup>88</sup> The intestinal tract of houseflies will support infectious

PRRSV for up to 12 hours following feeding on an infected pig but only for a short period of time on the surface of the fly.

### Virus Survival

The PRRS virus is fairly labile and does not survive for more than 1 day on solid fomites, but does survive for several days in well and city water. It may survive for several years in deep frozen tissues, but only 1 month at 4°C (39°F), 48 hours at 37°C (99°F), and less than 45 minutes at 56°C (133°F). There appears to be a low risk from contaminated lagoon water, and the viability of PRRSV in swine effluent is relatively short (18 days), although this is very temperature dependent.

### Economic Importance

The export market for pork from a country can be seriously affected when a disease such as PRRSV occurs. When the disease was recognized in the United States, countries such as Mexico, Japan, Canada, and South Korea banned the importation of pork from the United States or required certification that the swine originated from premises where, within the 30 days before the issuance of the health certificate, no swine were introduced from a municipality in which a premises infected with the virus is located.

The economic losses may be very high because of stillbirths, abortions, small litter sizes, and birth of weak pigs, which increases preweaning mortality and increased nonproductive days. In weaned pigs, losses are associated with respiratory disease. In addition, there are the costs of control, which may be high, dependent on the control strategies undertaken. Typically, about 20% loss in annual production can be expected from a severe outbreak.

Negative weaned pigs had an increased margin per pig of \$2.12 over the pigs minimally affected by PRRSV in the nursery but which seroconverted in the finishing herd and \$7.07 over the pigs with persistently circulating PRRSV in the nursery.

### PATHOGENESIS Effects on Macrophages and Dendritic Cells

PRRSV has a very restricted tropism for porcine alveolar macrophages (PAMs) and some peripheral blood monocytes.<sup>63</sup>

Replication of PRRS in the PAMs directly impairs their basic functions including phagocytosis, antigen presentation, and production of cytokines.<sup>89,90</sup> The virus undergoes a productive replication in these cells leading to cell death via both apoptosis and necrosis mechanisms. In addition, there is also a reduced expression of major histocompatibility complex (MHC) class I and MHC class II, CD14, and CD11 cells.

PRRSV also induces necrosis or apoptosis of macrophages and lymphocytes in the lung and lymphoid organs, impairing the host response.<sup>91</sup>



In eukaryocytes, autophagy is a widely found mechanism that transports damaged cell organelles and long-lived proteins to lysosomes for degradation.<sup>92</sup> The autophagy induced by PRRSV infection plays a part in sustaining replication in host cells.<sup>93</sup>

PRRSV causes a massive increase in the number of B cells, resulting in lymphoid hyperplasia, hypergammaglobulinemia, and autoimmunity in neonatal piglets. There is a preferential expansion of certain clones bearing certain H chain third complementary lengths. The same dominant B-cell type clones occur throughout the body. The authors believed that hypergammaglobulinemia results from the products of these cells.<sup>94</sup>

Many piglets are probably infected in utero. PRRSV infection modulates the leukocyte subpopulations in peripheral blood and bronchoalveolar fluids. Following infection the number of CD8+ cells increased in systemic lymphoid tissue, whereas numbers of B cells increased in mucosal associated lymphoid tissue. Virus infection induces a simultaneous polyclonal activation of B cells mainly in the tonsils and an exaggerated and prolonged specific humoral immune response caused by persistent viral infection in lymphoid organs. Piglets surviving in utero infections have a high count of CD8+, CD2+, CD4+, and SLA-class II cells in the peripheral blood.

Persistent infection occurs in these pigs. Virus appears to persist in the lymphatic organs and particularly the tonsils and the lungs. Lymphoid tissue tropism occurs during persistent infection when the piglets have been exposed in utero.

Neonatal or nursery infection is probably through the virus reaching the nasopharyngeal epithelium following inhalation from the nose-to-nose contact with other pigs. It is then probably removed to the tonsils in which they are internalized into cells of the macrophage/monocyte series.

Initially, a viremia occurs, with subsequent distribution and multiplication of the virus in multiple body systems and organs causing interstitial pneumonia, vasculitis, lymphadenopathy, myocarditis, and encephalitis. Alveolar macrophages are primary targets for virus multiplication, but this does not fully explain the pathogenesis. Multiple glycoproteins appear to be involved in infection of pulmonary alveolar macrophages. Possibly up to 40% of alveolar macrophages are destroyed. Whether it is a particular group that is damaged or all the alveolar macrophages are damaged is not known, but after about 28 days there is a resumption of normal alveolar macrophage function. PRRSV causes the apoptosis of alveolar macrophages and pulmonary intravascular macrophages. The increase in IFN- $\gamma$ -positive cells correlated well with the severity of the lung lesions, which may be because of the presence of PRRSV in the lung. IFN- $\gamma$

markedly inhibits the replication of PRRSV in macrophages.

## RECEPTORS

As few as 10 or even fewer virus particles inoculated into the nose or given IM will infect a pig. The virus may enter the cell through an endocytic pathway or through a virus receptor. A third possibility is that the virus may enter the cell through an antibody-dependent enhancement with virus-antibody complexes entering the cell through Fc receptors on the cell surface.

There may be a PRRSV ligand for a cell-surface heparin-like receptor on pulmonary alveolar macrophages.

Several receptors have been described including heparin sulfate, sialoadhesin,<sup>95</sup> and vimentin.<sup>96</sup> The interaction of PRRSV with sialoadhesin inhibits alveolar macrophage phagocytosis.<sup>97</sup> Recently, CD163, a molecule that is expressed solely on the monocytic lineage,<sup>98</sup> has been identified as a possible cellular receptor for PRRSV.<sup>99</sup> This is a receptor that allows previously nonpermissible cells to become susceptible to PRRSV. It is a hapten/hemoglobin scavenger in the scavenger receptor cysteine-rich superfamily. Other factors also appear to be necessary for PRRSV permissiveness.<sup>100</sup> The initial step in infection involves heparin sulfate glycosaminoglycans as an initial attachment receptor and subsequent engagement of the Siglec sialoadhesin resulting in a virus internalization via clathrin-mediated endocytosis. The viral membrane M and the M/GP5 complex were identified as ligands for the initial attachment receptor. Sialic acids present on the surface of the PRRSV virions have been shown to play an essential role in PRRSV infection. Recently CD163 was identified as a key receptor and involved in the entry into macrophages.<sup>101</sup> In a recent study,<sup>102</sup> it was suggested that expression of CD163 on macrophages in different microenvironments in vivo possibly may determine the replication levels of PRRSV and the virus pathogenicity.

## VIRUS ENTRY

For productive infection, viruses need to enter the target cell and release their genome.<sup>103,104</sup> It has been shown that PRRSV entry into the alveolar macrophage involves attachment to a specific virus receptor followed by a process of endocytosis by which virions are taken into the cell within vesicles by a clathrin-dependent pathway.

It has recently been shown that PRRSV enters early endosomes after internalization but does not continue through the endocytic pathway to late endosomes. It colocalizes with its internalization receptor sialoadhesin on the cell surface and beneath the plasma membrane.<sup>105</sup> Sialoadhesin downregulates phagocytosis in PAMs (not CD163).<sup>97</sup>

There is a significant role for IL-10 in the CD163 and PRRSV susceptibility during the

differentiation of macrophages. Possibly the internalization of PRRSV via CD163 in the target cells may induce the expression of IL-10, which in turn induces the expression of CD163 on neighboring cells.

Virus entry into the porcine macrophage has been reviewed<sup>106</sup> as has the virus structural and nonstructural proteins in viral pathogenesis.<sup>107</sup>

## REPLICATION

The primary targets for replication are alveolar macrophages of the lung and other cells of the monocyte/macrophage lineage including pulmonary intravascular macrophages, subsets of macrophages in lymph nodes, and spleen and intravascular macrophages of the placenta and umbilical cord. A highly pathogenic strain may possess an expanded tropism to include epithelial cells.

The virus can persist in the pig for up to 132 days after birth in tonsil and lymph nodes infected in utero and from 105 to 157 days from pigs infected in postnatal infection. Over time the initial levels of viral load may decrease 10,000-fold in the tonsil or lymph nodes. The wild-type virus is capable of inducing a higher level of viral load than the mutations.<sup>108-111</sup>

The high pathogenicity strains from China in 2006 contain a unique 30 amino acid deletion in the nsp2 coding region, but this is not associated with virulence of these strains but nsp2 can attenuate replication and virulence.<sup>112</sup> The virus can cross the placenta at about 90 days' gestation and infect the fetus and can use the thymus as the principal site of replication and induce antiviral cytokines.<sup>113</sup>

Macrophages are activated by endogenous danger signals.<sup>114</sup>

There are mitogen-activated protein kinase cascade pathways, which are essential building blocks in the intracellular signaling systems. There are four of these pathways that have been identified, and one of these is the extracellular signal-regulated kinase (ERK) signaling pathway. This has been shown to play an important role in the postentry steps of PRRSV replication cycle and contributes to viral infection.<sup>115</sup>

PRRSV E protein is likely to be an ion-channel protein embedded in the viral envelope and facilitates uncoating of the virus and release of the genome in the cytoplasm.<sup>116</sup> This E protein is probably nonessential for virus infectivity but promotes growth of the virus.<sup>117</sup>

PRRSV can infect and replicate in monocyte and bone marrow-derived dendritic cells.<sup>90,118,119</sup> The exposure of bone marrow-derived immature dendritic cells to PRRSV produced a downregulated expression of MHC class I.

The monocytes and macrophages are the main cellular target for PRRSV replication, particularly the alveolar macrophages. It also replicates in vitro in dendritic cells and bone

marrow-derived monocytes.<sup>118-121</sup> It has a higher predilection for PAMs than septal macrophages.<sup>122</sup> PAMs phagocytose whereas septal cells may modulate immune responses. There is a complex viral replication mechanism in immune cells such as alveolar macrophages for PRRSV.<sup>123</sup>

### General Effects of Porcine Reproductive and Respiratory Syndrome Virus on the Immune System

Generally, both innate and adaptive immune responses to PRRSV are suppressed. It produces modest levels of IFN- $\alpha$  and proinflammatory cytokines.<sup>120</sup> In addition, the response is weak and slow. Neutralizing antibodies are slow to be produced. Cell-mediated responses in the form of IFN- $\gamma$  producing cells can take 4 to 8 weeks to develop. The virus produces an increase in IL-10, which is possibly immunosuppressive because it suppresses antigen-presenting cell activities such as processing and presenting antigen and expression of IL-1, IL-12, IL-18, TNF- $\alpha$ , and type I IFN expression.<sup>119</sup>

### Macrophage Damage

The PRRSV nucleocapsid protein regulates alveolar macrophages and, in a study of infected macrophages, 23 protein spots were found that were differentially expressed. Of these, 15 had a statistically significant alteration including 4 upregulated and 11 downregulated<sup>124</sup> spots. Individual mature nsp5 are found in virus-infected cells.<sup>125</sup>

The alveolar macrophages when infected round up, show bleb formation, and eventually rupture. TNF- $\alpha$  released from damaged macrophages after PRRSV infection may induce apoptosis in uninfected lymphoid cells. In a study of cells in the lungs, it was found in both noninfected and infected cells. The majority of the apoptotic cells were noninfected. The peak of apoptosis was at 14 days and was preceded by a peak of IL-1 and IL-10 production at 9 DPI. The PRRSV infection directly interferes with type I IFN transcriptional activation.

### Toll-Like Receptors

PRRSV inhibits TLR expressions in PAMs at 6 hours postinfection and it is then restored at 24 DPI when the cells showed upregulated IL-12.<sup>126</sup>

The possibility of increased expression of TLR mRNA and cytokines in pigs with PRRSV has been shown.<sup>127</sup> In these experiments there was an upregulation of TLR 2, 3, 4, 7, and 8 in at least one of the lymphoid tissues and cells.

### Modulation of Immune Responses Cellular Changes (Natural Killer, T-Regulatory, etc.)

The original VR-2332 prototype North American strain of the virus induces immune modulatory changes at mucosal tissues. Peak

antibody response and cytokine IFN- $\gamma$  were detected at PID30 with increased TGF- $\beta$  until PID60. Populations of CD4+, CD8+, CD4+ CD8+ T cells, natural killer (NK) cells, and  $\gamma\delta$  T cells in the lungs and lymphoid tissues were significantly modulated favoring PRRSV persistence. The NK-cell-mediated cytotoxicity was significantly reduced in infected pigs. In addition, increased populations of immunosuppressive T-regulatory cells (T-regs) and associated cytokines were also observed in infected pigs.<sup>128</sup> These results suggest that both innate ( $\gamma\delta$  T cells and NK cells) and adaptive immune cell subsets were modulated in mucosal tissues in which the virus persists for a long time. IL-10 and TGF- $\beta$  are immunosuppressive in nature produced by T-regs and are upregulated in PRRSV-infected pigs.<sup>129</sup> Although wild-type parenteral strain VR-2332 is avirulent it dampens the most essential immune components at the site of replication, which are the lung parenchyma and lymphoid tissue, resulting in weak and delayed anti-PRRSV immunity.

NK cells are only a small fraction of circulating lymphocytes that are not B or T cells. Cytokines IL-2 and IFN- $\alpha$  are activators of T cells.<sup>130</sup> PRRSV is a poor inducer of IFN- $\alpha$ . These cells early in infections kill infected cells and produce cytokines.<sup>131</sup> PRRSV-infected macrophages are less susceptible to NK cells. This reduced activity begins at 6 hours postinfection and coincides with the detection of observable PRRSV structural proteins.<sup>132</sup> It is likely that the transcription of viral genes and proteins also contributes to the resistance of PRRSV-infected macrophages toward NK cells. PRRSV infection inhibits both NK and cytotoxic T-cell activity via a common mechanism.<sup>133</sup> It might be that during PRRSV infection the virus may modulate the ligands for the NK receptors on the surface of pulmonary alveolar macrophages, leading to insufficient NK cytotoxicity.

The PRRSV has a suppressive effect on the NK cells, which are part of the innate immune response. They are usually activated by IL-2, IL-12, IL-15, IL-18, and IFN- $\alpha$  and by the interaction between NK activating receptors and their ligands on target cells.<sup>134</sup> One of the components of reduced NK cell activity is the possibility that there is incomplete activation of NK cells by a lower level of activating cytokines.<sup>135</sup> PRRSV-infected pulmonary alveolar macrophages showed a reduced susceptibility toward NK cytotoxicity, and this may represent one of the multiple evasion strategies of PRRSV.<sup>133</sup>

Replicating PRRSV in both infected and contact pigs was responsible for rapid modulation in NK cell-mediated cytotoxicity and alteration in the production of important immune cytokines. These changes produce a delay in adaptive immunity. At 2 DPI 50% of viremic pigs had a greater than 50% reduction in NK cell-mediated cytotoxicity, and

nearly a onefold increase in IFN- $\alpha$  was found in the blood of some pigs. Enhanced secretion of IL-4 was found in 90% of pigs and IL-10 and IL-12 in a few pigs. IFN- $\gamma$  was not enhanced. There was a reduced frequency of myeloid cells, CD4+ CD8+ T cells, and CD4- CD8+ T cells, and upregulated frequency of lymphocytes bearing natural T-reg cell phenotype were detected in viremic pigs.<sup>136</sup>

This is associated with a decrease in cytotoxicity but not the number of NK cells (increased IL-4, IL-10, and IL-12).<sup>136</sup> Regulatory T cells (induced by type 2 but not type 1 PRRS) also impair the host.<sup>137-140</sup>

There is a decrease in the number of antigen-presenting cells and T cells in the tonsil and lymph nodes of PRRSV-infected pigs, suggesting a modulation of the host immune response.<sup>141</sup>

CD14+ monocytes may also infiltrate the interstitial tissue in the lung and develop into interstitial macrophages. The early development of subneutralizing or nonneutralizing antibody may have a significant effect on the development of PRRS by antibody-dependent enhancement, which can facilitate the attachment and internalization of the virus onto host cells through Fc receptor-mediated endocytosis.<sup>142</sup>

A higher expression of proinflammatory cytokines is also expressed in septal macrophages in pigs.<sup>122,143</sup> T-regs<sup>143</sup> control the immune response and maintain homeostasis and are natural or induced. Induction of T-regs during the early stage of PRRSV infection is one of the ways pathogens escape the immune response.<sup>138,139,144-147</sup>

### Cytokines

Many cytokines influence the immune response to PRRSV infection (Table 18-3). TNF- $\alpha$  may act as an antiviral cytokine protecting cells from infection by an IFN-independent mechanism, and several strains of PRRSV have a low ability to induce the expression.

The cytokines IL-10 and IL-12 are expressed in inflammatory lesions in the lung and play an important role in the defense against PRRSV. In some PRRSV infections, there was no change in the levels of IL-10, IL-12, and IFN- $\gamma$  in PRRSV infections. It also induces minimal levels of T-helper-1 (Th1) cytokines (IL-12 and IFN- $\gamma$ ).<sup>90</sup>

In utero-infected pigs showed significantly increased IL-6, IL-10, and IFN- $\gamma$  mRNA expression (IL-2, IL-4, and IL-12 remained the same) and this was concurrent with a significant decrease in the number of CD4+ CD8+ T cells. The cell-mediated and cytokine message profiles returned to normal.

The increased expression of IL-10, IL-6, and TNF- $\alpha$  in the lungs of pigs with PRRSV is correlated with the development of interstitial pneumonia.<sup>122</sup> Different isolates induce

**Table 18-3** Cytokines and porcine reproductive and respiratory syndrome<sup>159</sup>

Cytokine	Function
IL-1	Attracts macrophages, monocytes, polymorphs
IL-6	Induces acute phase proteins Upregulates CD163 receptor
IL-10	Upregulates CD163 receptor Upregulates in the lung
TNF- $\alpha$	Inhibits replication of PRRSV Induces acute phase proteins Downregulated in PRRSV-infected macrophages Downregulates CD163 receptor
IFN- $\alpha$	Interferes with replication of PRRSV Downregulated in PRRSV-infected macrophages
IFN- $\gamma$	Inhibits replication of PRRSV Enhanced by vaccination with IL-12/IFN- $\alpha$ Downregulates CD163 receptor
IL-10	Correlates with expression in the lung Inhibits IFN- $\gamma$ in the lung
TGF- $\beta$	Induces T-regs after PRRSV infection Correlates with expression in the lung Downregulates CD163 receptor

IFN, interferon; PRRSV, porcine reproductive and respiratory syndrome virus.

different patterns of IL-10 and TNF- $\alpha$ . Four possible phenotypes were identified, but different cells had different capabilities. In addition, cytokine-release profiles on antigen-presenting cells could induce different expressions of cell markers.<sup>121</sup>

Certain regions of nsp2 also downregulate IL-1 $\beta$  and TNF- $\alpha$ .<sup>148</sup> The inhibition of early cytokine production contributes to the weak innate immune response, delayed neutralizing antibody, slow IFN- $\gamma$  response, and a depressed cytotoxic T-cell response.<sup>149</sup>

In PRRSV infections, the production of proinflammatory cytokines is limited.<sup>150</sup> The nsp5 may downregulate TNF- $\alpha$ .<sup>151,152</sup>

IL-10 inhibits the synthesis of proinflammatory cytokines as well as inhibiting the production of IFN- $\alpha$ , and may also suppress the proinflammatory response to PRRSV-infected pigs. There is a significant correlation between the response to PRRSV antigen expression and the expression of regulatory cytokines, such as IL-10 and TGF- $\beta$  in the lungs but not in the lymph nodes.<sup>153,154</sup>

There may be, as a result of the cytokine expression, a reduction of the infiltration and proliferation of inflammatory cells.<sup>155</sup> IL-10 is expressed mainly by septal macrophages

and TGF- $\beta$  mainly by PAMs. There may be different expressions of different cytokines by different subsets of the lung cells. TGF- $\beta$  production may be dependent on the PRRSV strain.<sup>156</sup> CD163 is one component of a complex of receptors required for entry of PRRSV entry into the cell including heparin sulfate and sialoadhesin. It is upregulated by IL-10 and IL-6 promoting PRRSV entry into the cell and replication but downregulated by TNF- $\alpha$ , TGF- $\beta$ , and IFN- $\gamma$ .<sup>102,157</sup>

The induction of the IL-10 response may be one of the strategies used by PRRSV to modulate the host immune responses.<sup>158</sup> Increases in IL-4, IFN- $\gamma$ , and TNF- $\alpha$  were found in the lymphocytes of infected piglets, but IL-8 showed a decrease. Other authors have the opposite view, which suggests that T cells showed an increase in CD8+ CD4+ and CD4- CD8+ subsets within activated cells, whereas CD4+ CD8- cells decreased with time. T cells responding to the virus showed a Th1 type cytokine production pattern. These authors<sup>158</sup> also reported a decrease in TNF- $\alpha$  and a decrease of IL-1 $\alpha$  and macrophage inflammatory protein.

Perhaps this is the key to PRRSV infections in that all pigs may respond differently. There may be either depressive or stimulatory effects. The imbalance of IL-12 and IL-10 produced in PRRSV-infected pigs may favor the humoral responses and suppress cell-mediated immune responses for the first 2 weeks of life.

PRRSV was detected in the cytoplasm of macrophages at two peaks, 3 to 7 DPI and second at 14 DPI. IFN- $\alpha$  increased at 3 DPI, and IFN- $\gamma$  and IL-12 were increased at 3 to 7 DPI and 14 to 17 DPI, but IL-10 was lower than the others suggesting that other factors also play a part.<sup>153</sup>

### Interferons

PRRSV is able to downregulate the production of inflammatory cytokines such as type I interferons (IFN- $\alpha$ , IFN- $\beta$ , TNF- $\alpha$ , and IL-1). Pigs that can clear PRRSV early have early expression of these cytokines.<sup>160</sup> Five of the 13 nsp5 were found to inhibit IFN- $\beta$  promoter activation, particularly nsp1 $\beta$ <sup>161</sup> as well as TNF- $\alpha$  promoter activity.<sup>162</sup> One of the mechanisms to suppress the immune response would be to suppress several key immune regulatory cytokines, such as type IFN, IL-1, TNF- $\alpha$ , IL-12, and IL-6, and upregulate to aberrant levels the antiinflammatory cytokines IL-10.<sup>162</sup>

IFN- $\alpha$  is an early response to PRRSV, but the virus circumvents the host innate response with an inadequate production of type I IFNs, resulting in a delayed IFN- $\gamma$  production, cellular immunity, and neutralizing antibodies and a delayed viral clearance.<sup>163</sup>

PRRSV is able to suppress the transcription of key antiviral genes, TNF- $\alpha$  and IFN- $\beta$ , when infection was antibody-dependent enhanced. This pathway of infection allows PRRSV to specifically target antiviral genes

and alters the innate intracellular immune responses in macrophages.<sup>164</sup>

The proposed model of how PRRSV nsp1 negatively regulates IFN- $\beta$  has been shown.<sup>165</sup> Plasmacytoid dendritic cells are not present in large numbers in blood but, when exposed to viruses, usually morph into dendritic cells but not when exposed to PRRSV and may help in the persistence of the virus.<sup>166</sup>

In the bone marrow-derived monocyte cells, there was also a significantly increased secretion of IL-1, IL-6, IL-8, IL-10, and IFN- $\gamma$  but not IL-12 or TNF- $\alpha$ .<sup>167</sup>

Infection with PRRSV increased serum levels of IL-1 $\beta$ , IL-6, TNF- $\alpha$  and IFN- $\gamma$ . It also increased mRNA for the proinflammatory cytokines as well as the mRNA for TLR3, LR4, and TLR7 in the tracheobronchial tree. Most of the proinflammatory genes were also upregulated in the discrete brain areas.<sup>168</sup>

PRRSV does not elicit a specific IFN- $\gamma$  response in nonadult animals, and IFN- $\gamma$  cells may be present in similar numbers in both infected and control animals.<sup>169</sup> PRRSV suppresses T-cell recognition of infected macrophages.<sup>170</sup>

The ORF1a and ORF1b are translated to generate polyproteins, which are processed by viral proteases to form 14 different nsp5.<sup>7</sup> Several of the nsp5 have been identified as integral members of viral replication and transcription machinery, whereas others might be involved in these processes through their interaction with host cell factors.<sup>7,171</sup>

The nsp5 are also likely to regulate viral pathogenesis through their involvement in modulation of host innate immune responses. The nsp1 $\beta$ -mediated subversion of the host innate response plays an important role in PRRSV pathogenesis.<sup>172</sup>

The type I IFNs constitute a major player of the host innate immune system. Viral replication intermediates like double-stranded RNA (dsRNA) are sensed by cytoplasmic (RIG-1-like helicases) as well as endosomal (TLR3) sensors, which trigger a complex signaling cascade.<sup>173,174</sup> These signaling events result in an activation of several transcription factors including interferon regulatory factor 3 (IRF3), nuclear factor kappa B (NF- $\kappa$ B) and activating transcription factor-2. These factors drive expression of type I IFN genes. Once secreted, they bind to receptors on the cell surface, which ultimately leads to the synthesis of IFN-stimulated genes.<sup>175</sup> Viruses have produced several measures to counteract the IFN production,<sup>176</sup> and PRRSV infection results in poor type I IFN production. The nsp5 of PRRSV inhibit IFN-dependent transcription. The nsp1 $\alpha$  and nsp1 $\beta$  proteins suppress both IRF3 and NF- $\kappa$ B-mediated IFN gene induction.<sup>148,177,178</sup> The nsp1 $\beta$  also interferes with IFN signaling.<sup>148,179</sup> The nsp2 is likely to play an important role in the subversion of innate antiviral defenses and provides a basis for elucidating the mechanisms underlying



PRRSV pathogenesis.<sup>180</sup> The PRRSV nsp2 has a cysteine protease domain at its N terminal, which belongs to the ovarian tumor protease family and which appears to antagonize the type I IFN induction.<sup>181</sup>

It also interferes with the activation and signaling pathway of type I IFNs by blocking nuclear translocation.<sup>179</sup> Certain regions of nsp2 are nonessential for PRRSV replication but may play an important part in modulation of the host immunity.<sup>148</sup> PRRSV nsp2 interferes with NF- $\kappa$ B signaling, which is important for its activation.<sup>181</sup> The virus lasts up to 5 months after infection in some lymphoid tissues. The levels of proinflammatory cytokines are also low, and the development of other effector components is slow (neutralizing antibodies and antigen-specific T cells). Therefore there is an inappropriate suboptimal initial innate response to PRRSV.<sup>182</sup> A nonsuppressive PRRSV virus could therefore be expected to stimulate a strong adaptive immune response.<sup>183</sup> The IFN inhibitory nature of PRRSV nsp1 in the context of virus infection was confirmed.<sup>175,184,185</sup> The nsp1 is cleaved into nsp1 $\alpha$  and nsp1 $\beta$ , and the nsp1 $\beta$  has the ability to inhibit IFN synthesis and signaling.<sup>186</sup>

Type I IFNs (IFN- $\alpha$  and IFN- $\beta$ ) promote production of antiviral mediators and elicit NK-cell activity for killing viral-infected cells. They also induce the maturation of dendritic cells into antigen presenting cells, macrophage development, and maturation and together with IL-6 convert B cells into plasma cells.<sup>187</sup> How this might be achieved by the PRRSV has been suggested.<sup>178,181,188</sup> Increased levels of IFN- $\alpha$  at the time of challenge delays PRRSV viremia<sup>189</sup> and lessens the severity of the disease. That the presence of IFN- $\alpha$  at the time of infection can alter the innate and adaptive immune responses was confirmed.<sup>190</sup>

PRRSV encodes viral products that are able to suppress type I IFN production in different ways by interfering with the various transcription factors in the regulation of IFN expression.<sup>172,180,181,190-192</sup> The impairment of type I IFN induction seems to be linked to a weak adaptive immunity, which includes a delayed or slow development of humoral and cellular immunity responses leading to viral persistence in infected pigs.<sup>193,194</sup> Pigs infected with PRRSV had moderate interstitial pneumonia, and the virus was found in all tested tissues. Peak antibody response and IFN- $\gamma$  occurred at 30 DPI with increased TGF- $\beta$  until 60 DPI.<sup>128</sup>

The nsp2 inhibits the antiviral function of IFN-stimulated gene (ISG) 15.<sup>195</sup> IFN-stimulated genes are the ISGs of which ISG15 is one of the most highly expressed proteins that functions as an effector molecule in the host cell response to viral infection.

The induction of the IL-10 response may be one of the strategies used by PRRSV to modulate the host immune responses.<sup>158</sup> Increases in IL-4, IFN- $\gamma$ , and TNF- $\alpha$  were

found in the lymphocytes of infected piglets, but IL-8 showed a decrease. It has been shown that T cells show an increase in CD8+ CD4+ and CD4- CD8+ subsets within activated cells, whereas CD4+ CD8- cells decreased with time. T cells responding to the virus showed a Th1-type cytokine production pattern. There is also a reported decrease in TNF- $\alpha$  and a decrease of IL-1 $\alpha$  and macrophage inflammatory protein. Perhaps this is the key to PRRSV infections in that all pigs may respond differently. There may be either depressive or stimulatory effects. The imbalance of IL-12 and IL-10 produced in PRRSV-infected pigs may favor the humoral responses and suppress cell-mediated immune responses for the first 2 weeks of life.

### DIFFERENTIAL EFFECTS IN DIFFERENT PARTS OF THE BODY

The differential expression of proinflammatory cytokines in the lymphoid organs of PRRSV-infected pigs has been described.<sup>196</sup> The expression was different in the different body compartments. IL-1 $\alpha$  and TNF- $\alpha$  were the most highly expressed in the mediastinal lymph nodes. IL-6 was most expressed in the retropharyngeal lymph nodes, but none was expressed in the tonsil. Proinflammatory cytokines are able to modulate the expression of CD163, a hemoglobin scavenger receptor that also acts as a PRRSV receptor and is involved in viral uncoating.<sup>197</sup> Whereas IL-6 can upregulate this receptor expression, TNF- $\alpha$  can downregulate it, inhibiting PRRSV replication. The imbalance in cytokines may play a role in the susceptibility to PRRSV replication.

Recombinant porcine IFN- $\alpha$  given to cells before infection reduced the cytopathogenicity of PRRSV, and viral propagation and antibody responses were delayed. It might be that the IFN alleviated damage to the immune system or enhanced the propagation of host cytotoxic T lymphocytes.<sup>198</sup>

Cytokine expression by macrophages in the lungs of pigs infected with PRRSV has been described.<sup>122</sup> Expression of IL-1 $\alpha$ , IL6, and TNF- $\alpha$  correlated with the severity of pulmonary pathology and the numbers of pulmonary macrophages. Significant correlations were found between PRRSV infection and the expression of IL-12p40 and IFN- $\gamma$  and between the expression of TNF- $\alpha$  and IFN- $\gamma$ . These findings suggest that PRRSV modulates the immune response by the upregulation of IL-10, which may in turn reduce the expression of cytokines involved in viral clearance (IFN- $\alpha$ , IFN- $\gamma$ , IL-12p40, and TNF- $\alpha$ ). The results also suggest that expression of IFN- $\gamma$  is stimulated by IL-12p40 and TNF- $\alpha$  but not IFN- $\alpha$ . All of these cytokines were expressed mainly by septal macrophages with weaker expression by alveolar macrophages, lymphocytes, and neutrophils. There appears to be a differential activation of septal and alveolar macrophages in PRRSV

infection, with septal macrophages as the major source of cytokines.

There is probably a regulatory role of PRRSV ORF1A on porcine alveolar gene expression.<sup>199</sup>

The expression of PRRSV antigens is correlated with the expression of regulatory cytokines such as IL-10 and TGF- $\beta$  in the lungs of pigs.<sup>122,154</sup> There are no substantial changes in the level of serum proinflammatory cytokines. Expression of proinflammatory cytokines were increased in mediastinal lymph nodes, but there was little increase in the tonsils and retroperitoneal lymph node.<sup>196</sup>

### DIFFERENTIAL EFFECTS OF DIFFERENT STRAINS

There is a differential expression of cytokines by different PRRSV isolates<sup>121</sup> and within different lymphoid organs.<sup>196</sup>

The virulence of these strains may be caused by the impairment of TNF- $\alpha$  by inhibiting the ERK signaling pathway.<sup>200</sup> The limited expression of TNF- $\alpha$  with some strains of PRRSV may be a mechanism in which some are able to impair the host immune response and prevent viral clearance. These downregulations have been associated with nsp1 $\alpha$  and 1 $\beta$  and 2.<sup>148</sup>

TGF- $\beta$  and IL-10 are immunomodulatory cytokines that are able to downregulate the host response. An increased mRNA and protein expression of TGF- $\beta$  has been observed in PRRSV infection with the North American type II PRRSV.<sup>122,138,201</sup> There is an enhanced expression of TGF- $\beta$  protein in lymphoid organs and the lung following PRRSV, and this may be important because it is an immunomodulatory cytokine.<sup>202</sup>

In some cases new strains can induce a preferential cytokine profile,<sup>203</sup> and the experimental results show a defective pattern of both innate and adaptive immunity that underlies the long-term persistence of PRRS-infected pigs. Both serum-neutralizing antibody and IFN- $\gamma$  secreting cells were defective in experimental infections.<sup>204</sup>

On the other hand, in the field, there are complex interactions of virus/host further complicated by interactions with bacterial agonists such as LPS. Under field conditions there was poor or no development of a specific IFN- $\gamma$  response rather than a delayed one.<sup>170,205</sup> Type 2 isolates are more pneumovirulent than type 1 isolates as seen by clinical signs and macroscopic and microscopic lesions.<sup>206</sup>

Genotype 2 strains of PRRS are more efficient at escaping the intrinsic antiviral activity induced by type I and type II IFNs. Monocyte-derived macrophages can be used by the virus instead of alveolar macrophages.<sup>207</sup>

In a study comparing 39 isolates, there were different effects depending on the strain and the host cell infected.<sup>121</sup> All strains produced high levels of IL-1 and IL-8 in

macrophage cultures but could be differentiated in their responses with IL-10 and TNF- $\alpha$ .

### STRAIN VARIATIONS

A comparative analysis of the immune response in experimental infections with three strains of PRRSV showed that although the outcome of infection was similar with clearance at 33 DPI, there were differences in the immune response to the viruses. The “Lena” strain produced fever and clinical signs, whereas the Lelystad virus and Belgium strain A did not. It also resulted in high virus titers in serum, low numbers of IFN- $\gamma$  secreting cells, a change in leukocyte populations, and a delayed antibody response to immunization with Aujeszky’s disease virus. Levels of IL-1 $\beta$ , IFN- $\alpha$ , IL-10, IL-12, TNF- $\alpha$ , and IFN- $\gamma$  mRNA of the Lena-infected pigs were also increased but not in the other two infections.<sup>208</sup>

The phenotypic modulation and cytokine profiles of antigen presenting cells infected with European type subtype 1 and 3 PRRSV strains *in vitro* and *in vivo* was described.<sup>209</sup> The subtype 3 strains (largely Eastern European, e.g., the Lena strain) are more virulent than the type 1 strains. Bone marrow-derived dendritic cells and alveolar macrophages were infected. The Lena strain caused more apoptosis and a higher level of infectivity and some downregulation of the cell-surface molecules. These facts may have explained the increased pathogenicity of the Lena strain and have dampened the specific immune responses. This could explain the delayed and decreased adaptive immune responses observed after infections with this strain.

The effect of genotypic and biotypic differences among PRRS viruses on the serologic assessment of pigs for virus infection has shown that<sup>210</sup> all of the pigs inoculated with field virus became seropositive (indirect fluorescent antibody [IFA] and ELISA). There was a great deal of variation in the onset and level of serum virus neutralization antibody in individual pigs and with each virus. The authors concluded that biotype differences may affect the kinetics of humoral immune response.

Recent studies have suggested that the new strain (Lena) replicates more efficiently than the old Lelystad virus in nasal mucosal explants. This is probably caused by the use of a broader population of entry receptor cells.<sup>211</sup>

### HIGH PATHOGENICITY PORCINE REPRODUCTIVE AND RESPIRATORY SYNDROME PATHOGENESIS

Classical PRRS produces apoptosis in a variety of organs including lungs, testes, lymph nodes, and thymus. Apoptotic changes in peripheral immune organs and lungs, following experimental infection of piglets with highly pathogenic and classical PRRS, have

been described.<sup>212</sup> Previous reports have suggested that HP-PRRS induces thymic atrophy with related thymocyte apoptosis, but there have been no reports in other tissues. The HP-PRRS exhibited much greater cell tropism than the usual PRRS and led to serious injury in tonsil, spleen, and lymph nodes. There were large numbers of apoptotic cells in the organs examined. In HP-PRRS alone, in comparison with vaccinated pigs receiving HP-PRRS, piglets showed thymus atrophy, decreased serum levels of IL-4, and increased serum levels of IL-10 and IFN- $\gamma$ . The results suggested that elevated IL-10 levels at the early stage of infection may enhance viral survival and delay the onset of protective immunity.<sup>213</sup> The HP-PRRSV affects all stages of production. Pregnant sows manifest abortion and give birth to weak and stillborn piglets, and there are morbidity and mortality rates of 50% to 100%.

### DEVELOPMENT OF LESIONS

There was also a temporary immunosuppression in piglets at about 4 weeks postinfection. Vascular lesions associated with PRRSV infection are analogous to those observed in horses with equine arteritis virus, which is also a member of the Arteriviridae family, and the renal lesions of equine viral arteritis infection correspond to those of PRRSV. Inflammatory infiltrates are seen at the junction of the renal cortex and medulla, with vascular changes associated with the muscular tunics of small arterioles.

The characteristic lesions can be reproduced in conventional pigs at 1 week, 4 weeks, or 10 weeks of age, and the variation in severity of clinical disease can be attributed to differences in strain virulence. The effects of the virus on reproductive performance are also strain dependent. There is no evidence that virus will grow in the ovarian tissues but may be taken into them by circulating macrophages. PRRSV can replicate in the testicular germ cells, but there is no evidence that there is any PRRSV in ova, indicating that the female gonad is resistant to persistent infection. Some strains are of low pathogenicity, whereas others are highly pathogenic. The reproductive disease has been reproduced experimentally, and the effects on the fetus are dependent on the stage of gestation. Aerosol exposure of non-immune pregnant gilts to the Lelystad virus in late gestations (84 days) results in clinical disease. After an incubation period of 4 to 7 days, all sows are inappetent and listless for 6 to 9 days. Some sows develop blue-colored ears accompanied by abdominal respirations. Sows may farrow at days 116 and 117 of gestation, giving birth to dead, mummified, and live piglets. Many of the live-born piglets are pale, listless, and weak, and some are in respiratory distress and exhibit varying degrees of splayleg or muscular tremors. The virus may be isolated from stillborn piglets or those born alive. Antibody is present in

precolostral serum samples or ascitic fluids of piglets, which demonstrates transplacental passage of the virus.

The gross and microscopic lesions in the fetuses from sows experimentally infected oronasally with the virus at 90 days’ gestation consist of hemorrhage of the umbilicus and necrotizing umbilical arteritis with periarterial hemorrhage. Severe pulmonary lesions are present in fetuses inoculated in utero with the virus between 45 and 49 days’ gestation. Even the lowest PRRSV exposure dose caused reproductive failure in naive, unvaccinated animals. When sows are inoculated oronasally with the virus in midgestation, the virus does not readily cross the placenta but replicates in fetuses that are inoculated directly in midgestation. It is suggested in prenatal piglets that PRRS replicates primarily in lymphoid tissues, having gained access to them from the placenta via the bloodstream. Thus the fetuses are more susceptible in late gestation than earlier in midgestation, or there is greater likelihood of transplacental infection during late gestation. Experimentally, the intrauterine inoculation of the virus into gilts on the day after natural breeding may have little or no effect on their reproductive performance. There appears to be no direct or indirect effect on luteal function contributing to PRRSV-induced abortion. The virus may cause cell death directly, such as the alveolar macrophages, or in lymphoid tissues. PRRSV affects Marc 145 cells, which undergo necrosis at a much higher rate than apoptosis, and increases with virus levels used to infect the cells. Apoptosis does occur in PRRSV-infected cells, but it is a late event during PRRSV replication and rapidly results in a necrotic-like death. Lesions have been seen in the placenta and in the vessels of the umbilical cord, but these are rarely reported with European strains, although they may be more common with the North American strains.

The original descriptions of porcine necrotizing pneumonia (PNP) were associated with swine influenza, but more recent research has shown that PRRSV is consistently and predominantly associated with PNP and should be considered the key etiologic agent for PNP together with PCV2.

The pathogenesis of a Korean type 1 PRRSV in experimentally infected pigs has been described.<sup>214</sup> Infected pigs developed multifocal, tan-mottled areas of lung. Microscopic lesions were multifocal, mild to moderate, and generally most extensive at 5 to 7 DPI and were nearly resolved by 28 DPI. PRRSV nucleic acid was detected in cytoplasm of macrophages and type 1 and II pneumonocytes.

### HIGH PATHOGENICITY PORCINE REPRODUCTIVE AND RESPIRATORY SYNDROME RESPONSES

HP-PRRSV infection could impair TNF- $\alpha$  production by inhibiting the ERK signaling pathway.<sup>215</sup>

In HP-PRRS the marked inappetence and severe respiratory signs are related to the severe interstitial pneumonia and high levels of expression of IL-1 $\alpha$  in the lungs compared with other PRRSV strains.<sup>215</sup>

High pathogenicity PRRSV displays an expanded tissue tropism *in vivo* suggesting that this may contribute to its high pathogenicity. Positivity was recorded in macrophages in lymphoid organs but also in the epithelium including gastric mucous membrane and mucous glands.<sup>216</sup>

The HP-PRRS epidemic in China, the so-called high fever disease with nervous signs, has been on the increase in China since 2009. There was a nonsuppurative encephalitis with lymphohistiocytic perivascular cuffing and infiltration of leukocytes into the neuropil. The electron microscope showed that the virus that infected the endothelial cells crossed the blood-brain barrier into the central nervous system (CNS) and then induced cellular damage to the neurons and neuroglial cells.<sup>217</sup>

An HP-PRRSV strain (HuN4) was shown to produce a loss of appetite, decrease in BW, raised body temperature, and respiratory signs. Lesions were of multifocal interstitial pneumonia with macrophage infiltration. The lesions in the lymph nodes were characterized by collapsed follicles, depletion of germinal centers, and reduction in lymphocytes. Perivascular cuffing and glial nodules were observed in some brains. PRRSV was detected in macrophages, alveolar epithelial cells, and vascular endothelial cells in the tonsil and lymph nodes. It is more pathogenic than some strains because of its higher replication rate.<sup>218</sup>

Chinese and Vietnamese strains of HP-PRRSV cause different outcomes in U.S. swine.<sup>53,218</sup> The Vietnamese virus replicated in an approximately 10-fold lower level in serum than did the Chinese virus. It also produced a lower temperature response and resulted in a lower mortality. The cytokine responses in a 9-plex panel varied between the strains, between the tissues examined, and by the inoculum dose. In this study, also using the U.S. prototype strain VR-2332, all three produced detectable levels of TNF- $\alpha$ , IL-1 $\beta$ , IFN- $\gamma$ , IL-10, and IL-12p70, but the levels and the kinetics also differed. There was also a high sustained level of IL-10 and IFN- $\gamma$ , and these might impair effective immune clearance.<sup>53,219,220</sup> Polyclonal B-cell activation can result in IL-10 producing B cells.<sup>221</sup> PRRSV produces a polyclonal activation of B cells accompanied by a hypergammaglobulinemia.<sup>222-224</sup> This leads to deregulated cytokine production.

## IMMUNOLOGY

The immune responses generated by PRRSV and control of the disease by immune mechanisms are not yet completely understood.

There are highly conserved T-cell epitopes on nsp9 and 10 of type 2 PRRSV,<sup>225</sup> and

these may be important in the formulation of immunogens to provide broad cross-protection against diverse strains of PRRSV.

Inoculation with different PRRSV strains results in different virologic and immunologic outcomes and in different degrees of homologous and heterologous protection.<sup>156</sup> The core effect of the virus is to infect and cause abnormalities in the macrophages. Disturbed macrophages may fail to present antigen successfully. More important, whatever cytokines are present in the pig or are induced by the PRRSV in that particular host may determine the outcome. It was shown that PRRSV is slow to produce both neutralizing antibodies and cell-mediated immunity, but it does produce an IFN response in PRRSV-infected lymphoid tissue.

Following natural infection, most pigs are resistant to subsequent infection, but the mechanisms of protective immunity are not understood. It has been suggested that the immune response to PRRSV has some degree of strain specificity. Indeed, it has also been suggested that the ability to cross the placenta is also strain specific and that although maternal immunity may not prevent transplacental infection, it may exert additional selection pressure. Circulating antibodies to the virus are detectable within 14 and 21 DPI based on indirect immunofluorescence test or ELISA, and 15-kDa protein is the most immunogenic of the viral proteins and may provide the antigenic basis for the development of improved diagnostic tests. However, this response is not of neutralizing antibodies. These may take a long time to develop. At the same time the occurrence of IFN- $\gamma$ -producing cells is initially weak, but this becomes much stronger from 3 to 6 months after infection. This response may be enhanced by the use of IL-12. Several structural, functionally distinct, and specific antibodies to the virus are generated following infection or vaccination. Cell-mediated immune responses specific to the virus also occur. The relative role of humoral and cell-mediated immunity in providing protection against disease is unknown.

A unique feature of infection is that viremia and circulating antibodies may exist together; the antibodies protect pigs from reinfection and reduce or eliminate shedding of the virus in the semen of boars. Sows are immune to further disease associated with the virus following recovery from acute infection. Following an outbreak of reproductive disease the level of performance will return to normal, suggesting that immunity develops following natural exposure. Protection against subsequent reproductive losses is of long duration in individual animals. However, cross-protection to different strains may not occur. Experimentally infected sows are protected against reproductive losses when challenged with homologous virus over 300 days after initial exposure. Extended

studies against homologous infection found that the duration of protection was at least 604 days, which is essentially lifelong protection. Protective immunity was based on two criteria: the absence of transplacental transfer of challenge virus and the apparent lack of virus replication in the dam 21 days following inoculation.

Piglets born from seropositive sows acquire **colostral antibodies** that decline at highly variable rates from 3 to 8 weeks after birth. Passive immunity provides effective immunity for the piglets, but loss of passive immunity at various ages results in susceptible pigs and infection that results in persistence of the virus in pigs 6 to 9 weeks of age, which are considered as the major reservoir of the virus in farrow-finish herds. In the absence of natural infection, maternal antibodies become undetectable between 6 and 10 weeks of age. Some litters do not have detectable antibodies until 4 weeks of age, and clinical disease may occur at 2 weeks of age. By 8 weeks of age, antibodies are usually detectable in all pigs and they persist for several months. However, there may be a large variation in the levels of antibodies in piglets at 10 to 12 weeks of age when they are moved to the finishing units. In longitudinal surveys, the seroprevalence of the virus in the 4- to 5-week-old pigs was higher than in the 8- to 9-week-old pigs, and most pigs were negative when they entered the finishing units. In herds where the virus persists, sows did not suffer repeated reproductive losses, indicating that some form of protective immunity develops.

The virus has a predilection for immune cells, and disease manifestations can be linked directly to changes in the immune system. The replication of the virus in the cells of the immune lineage, especially macrophages, may lead to immunosuppression and predispose to secondary infections. Thus immunity to the virus may be a double-edged sword; the virus attacks the immune system, which may cause immunosuppression, while inducing protective antibodies.

Antibody-dependent enhancement of infection may also occur, because low levels of antibody enhance the ability of the virus to enter the pulmonary alveolar macrophage cells and replicate and destroy the cells. This may be important in suckling and nursery pigs exposed to the virus during a period of declining maternal antibody.

PRRSV complicates the ability of the host to respond to infection through several immune evasion mechanisms.<sup>63,226</sup> PRRSV infection is characterized by a delayed appearance of neutralizing antibodies (3–4 months) and a slow development of virus-specific IFN responses. PRRSV nsp2 is increasingly emerging as a multifunctional protein possibly with a profound impact on PRRSV replication and viral pathogenesis.<sup>227</sup> Acquired immunity has been reviewed.<sup>63,184,204,226</sup> After



infection, most antibodies are nonneutralizing and are principally targeted to N and nsp2 proteins. Neutralizing antibodies appear from 2 to 4 weeks but do not peak until several weeks to months later. Virus persists in the presence of neutralizing antibody. It is possible that PRRSV produces “decoy” epitopes that produce nonneutralizing antibodies.<sup>228</sup>

The T-cell responses to PRRSV are induced 2 to 8 weeks postinfection and are detected against all structural proteins encoded by ORFs 2 to 7 but are considered to be weak, transient, and highly variable.

GP5 and M are the major proteins of the envelope of PRRSV, and the GP5/M ectodomain peptide epitopes are available for host antibody recognition but are not associated with antibody-mediated virus neutralization.<sup>229</sup>

### CLINICAL FINDINGS

The main feature of clinical disease associated with this virus was the extreme variability of the clinical signs. Generally, signs associated with PRRSV appear to result from a combination of genetic factors and herd management characteristics. The relative influences of these two factors differ depending on the specific clinical signs in question. These may vary from inapparent infection to sudden death and abortion storms (the sow abortion and mortality syndrome).

The condition continues to evolve from the first descriptions of mystery swine disease in the United States and Canada and blue-eared pig disease in Europe. The swine mortality and abortion syndrome was then described in the United States. Then, there have been the high pathogenicity cases in China (“high fever disease”) characterized with greater than 20% mortality<sup>230-232</sup> and the highly virulent 1-18-2 strain that occurred in the north central United States in 2007.<sup>233</sup>

### Concurrent Infections

The increased secondary bacterial infection has been linked to an upregulation of CD14 and LPS-binding protein in PAMs.<sup>234</sup> The effects of the virus on the immune system may explain the suspected immunosuppression and secondary infections, which are recognized clinically but have not been reproduced experimentally.

Its synergism with PCV2 is in doubt. It does not seem to be potentiated by the other great pig pathogen PCV2 virus, but it has been proposed that it may increase the severity of PRRSV-induced interstitial pneumonia. PRRSV infection may enhance PCV2 replication. It is predisposed by MH, and this can be reduced by vaccination for MH. In turn, PRRSV predisposes to *B. bronchiseptica*. Both may interact to reduce the efficiency of lung defense mechanisms and facilitate infection with *P. multocida*. There is little effect on *H. parasuis* secondary infection with a slight increase in macrophage

uptake of *H. parasuis* during the early infection, which is reduced after 7 days. There is evidence that concurrent infection with transmissible gastroenteritis virus and PRRSV is likely to have little or no effect on subsequent shedding or persistence of infection. Infection with PRRSV is common in pigs with postweaning multisystemic wasting syndrome (PMWS), but there is no evidence that PRRSV is necessary for the development of it. PRRSV has been seen in a swine herd with porcine cytomegalovirus. Synergism between PRRSV and *S. Choleraesuis* has been described with unthriftiness, rough hair coats, dyspnea, and diarrhea. Pigs that received dexamethasone were the most severely affected and half died, but they also shed significantly more organisms in feces and also had significantly higher PRRSV titers. Simultaneous infection between PRRSV and *S. suis* is much more severe than with either agent on its own. PRRSV-induced suppression of pulmonary intravascular macrophage function may in part explain PRRSV associated susceptibility to *S. suis* infection.

There is also a clear synergism between PRRSV and LPS in the exhibition of respiratory signs in conventional pigs. In these infections with the virus and bacteria, the rise in TNF- $\alpha$ , IL-1, and IL-6 was 10 to 100 times higher than in the single infections. Reproductive failure and respiratory disease are the major clinical findings that are also highly variable between herds. All age groups in a herd may be affected within a short period of time.

Pigs infected with both PRRSV and MH had a greater percentage of pneumonic lung, increased clinical disease, and lower viral clearance than pigs with single infections. There were also increased levels of IL- $\beta$ , IL-8, IL-10, and TNF- $\alpha$  in lung lavage fluid, and this may be the way that the combined infection increases the pulmonary response.

Clinical disease is often more severe when accompanied by infection with PCV2<sup>1</sup> and is associated with other conditions in the field that often appear as indicators of the underlying PRRSV infection.<sup>135,235</sup> These are mainly caused by the pneumovirulence of the virus and its persistence in lymphoid organs. There is a decrease in NK cell cell-mediated activity caused by a decreased expression of IFN. The adaptive immune response is also impaired, leading to an increased apoptosis of PAMs caused by increased IL-6 and IL-10.<sup>135,236</sup>

Pigs with PRRSV and subsequently exposed to porcine respiratory coronavirus (PRCV) had reduced weight gains, higher incidence of fever, and more severe pneumonia compared with either single infection.<sup>236</sup> This was caused by reduced IFN- $\alpha$  in the lungs and reduced NK cells, and it coincided with the pneumonia. The subsequent PRCV enhanced the level of PRRSV replication in the lung and a tendency to increased

serum Th1 activity (IFN- $\gamma$ ) but decreased type II activity (IL-4) responses, further exacerbating the PRRSV pneumonia. More severe alveolar macrophage apoptosis then occurred.

Pulmonary function has been studied in PRRSV-affected pigs.<sup>237</sup> Infected pigs developed fever, reduced appetite, respiratory distress, and dullness within 9 DPI. The non-invasive pulmonary tests revealed airway obstruction, reduced lung compliance, and reduced lung gas transfer. The effects were worst at 9 to 18 DPI in which they were accompanied by an increased respiratory rate and decreased tidal volume. Expiration was affected more than inspiration, and this is caused by airflow limitation predominantly in the peripheral airways. Pigs have both obstructive and restrictive disorders and have shorter breathing cycles and shallower respiration. The energy requirement for breathing increases because of the increased effort.

Infection with the European PRRSV causes CNS disorders in the suckling pig.<sup>238</sup> PRRSV was detected in the macrophages in the cerebrum by IHC.

### Reproductive Failure

If 90-day gestational gilts are given vaccine or field strains of PRRSV then some pigs are born dead, most pigs survive, and some pigs are infected in utero. Vaccine strains did not affect postnatal growth, but field strains reduced growth. It may be that the virus entered the reproductive tract through the viremia and then the seeded tissues may release the virus back into the serum at low levels.

The infection of fetuses with an attenuated virus shows the same immune dysfunction as in wild-type infections in piglets kept in isolators.<sup>224</sup>

All sows given IM injections of a mild strain of PRRSV at 90 days' gestation showed transmission of the virus in utero. The proportion of virus-positive pigs and their level of viremia were higher at 4 days of age than at birth or weaning. The findings suggest that monitoring piglets in late lactation will enable assessment of the shedding of the virus from sows.<sup>239</sup>

Landrace gilts when given PRRSV had a significantly reduced number of fetuses but a similar effect in crossbred pigs was not found. The Landrace had less weight loss during pregnancy, suggesting greater tolerance of PRRSV infection. Breeds do differ in phenotypic impacts of PRRSV.<sup>240</sup>

Anorexia, lethargy, depression, and mild fever in pregnant gilts and sows are common initial clinical findings affecting 5% to 50% of animals. This is commonly followed by a sudden increase in early farrowings at 108 to 112 days' gestation, late-term abortions, still-born and mummified fetuses, partially autolyzed fetuses, weak neonates with high mortality within a few hours or days after

birth, late returns to estrus, and repeat breeders. This is generally followed by midgestation abortions and marked increases in the percentage of mummified fetuses, early embryonic death, and infertility. In large herds, successive groups of 10% to 20% of gilts and sows may become anorexic over a period of 2 to 3 weeks. Cyanosis of ears, tails, vulvas, abdomens, and snouts may occur in a small number of sows, which is more common in European outbreaks and uncommon in North America. Following the initial outbreak, a storm of reproductive failure may occur consisting of premature farrowings, late-term abortions, an increase in stillbirths, mummified fetuses, and weak neonates. This second phase of reproductive failure may last 8 to 12 weeks. Stillbirths may reach 35% to 40%. Weak-born piglets die within 1 week and contribute to a high preweaning mortality.

The interaction between PRRSV and the late gestation pig fetus has been described.<sup>113</sup> The major site of replication was the thymus. There were elevated IFN- $\gamma$  and TNF- $\alpha$  in tissues from infected piglets. The hyperplastic fetal lymph nodes had large numbers of B cells. Fetal infection can alter the selection of PRRSV variants and may represent a source of PRRSV genetic diversity.

The pathogenesis of PRRSV in experimentally infected pregnant gilts has been described.<sup>241</sup> There was a significant increase in apoptotic cells in lung, heart, thymus, liver, adrenal gland, and spleen of stillborn fetuses compared with live-born piglets. The majority of cells were either full of PRRSV or apoptotic but not both. Apoptotic cells outnumbered PRRSV cells. PRRSV may replicate in the fetal implantation sites and cause apoptosis of infected macrophages and the surrounding cells.<sup>242</sup> In a review of the pathogenesis and prevention of placental and transplacental PRRSV infection, it was found that the virus replicates in the endometrium and placenta in late gestation, and this is responsible for the range of PRRSV-related reproductive problems.<sup>243</sup>

PRRSV is shed in the milk of infected sows, and the antigen is present in the mammary glands of experimentally infected sows.<sup>244</sup>

Today with the original European strains there may be just outbreaks of rolling inappetence or occasional early farrowings. However, there are serious clinical outbreaks in Italy, Poland, and the UK associated with new variants.

Reproductive disease may be preceded by, or follow, respiratory disease in the breeding herd, finishing pigs, or younger pigs. The reproductive aspect of the disease typically lasts from 4 to 5 months, occupying an entire reproductive cycle within a herd. This is followed by a return to normal performance. Repeated incidents of reproductive failure in individual gilts and sows are unusual, but recurrent episodes may occur in herds

purchasing replacement gilts that do not have sufficient immunity.

Vaccinating sows with the North American PRRSV-based modified live vaccine does not prevent reproductive failure after insemination with European PRRSV-spiked semen.<sup>245</sup>

Outbreaks of the disease are characterized by a period of severe reproductive problems in the breeding herd, followed by a return to near normal reproductive performance, punctuated by recurrent episodes of reproductive failure. Most herds eventually return to preoutbreak levels of reproductive performance, but some herds never achieve preoutbreak performance levels.

Boars may also be affected with anorexia, fever, coughing, lack of libido, and temporary reduction in semen quality. PRRSV infection affects seminal quality for a limited period only. The virus can be transmitted to sows through insemination.<sup>238</sup>

Boars naturally coinfect with PRRSV and PCV2 can be found, and at least two different strains of virus from serum and semen can be detected.<sup>246</sup> A group of spontaneously infected boars seroconverted 4 weeks postinfection. There was an increase in the acrosome-defective spermatozoa and sperm motion patterns.<sup>247</sup>

### Respiratory Disease

The most important problem facing many of the larger pig industries in the world is PRDC. The most important contributor to this syndrome is PRRSV. The generation of immunity capable of protecting pigs by mediating virus inhibition through virus-neutralizing antibodies or IFN takes time.

Disease occurs in pigs of any age, but especially in nursing and weaned pigs, and is characterized by anorexia, fever, dyspnea, polypnea, coughing, and subnormal growth rates. A bluish discoloration of the ears, abdomen, or vulva may also occur (blue-eared disease). Death may occur in the acute phase. In some herds, up to 50% of pigs are anorexic, up to 10% may have a fever, up to 5% are cyanotic, and up to 30% have respiratory distress. In weaning pigs, the morbidity may be as high as 30%, with a mortality of 5% to 10%. Nursery pigs exhibit respiratory distress and growth retardation. Conjunctivitis, sneezing, and diarrhea are common. All of these signs may appear to move through the various age groups in the herd over several days and a few weeks. The course of the disease in a herd may last 6 to 12 weeks. In gilts and sows of any parity, anorexia and fever, lasting for several days, are noted initially. The acute-phase respiratory disease may last several months but is often followed by a long period of postweaning respiratory disease, which may last up to 2 years. This long course is often accompanied by secondary infections in successive batches of weaned pigs. Unthriftiness may persist throughout the finishing period with

an ineffective response to antibiotics and vaccines.

Preweaning morbidity and mortality is a major feature of the disease. Litters are often unthrifty, and many deaths occur within the first week of age.

In a study of a newly established farrow-to-finish farm in Poland that was negative for PRRS on establishment but positive for PCV2, it was found that the conception rate dropped from 89% to 51% and the abortion rate increased from 0.5% to 11.0% with the onset of PRRS infection. Then the mortality was elevated, and clinical disease typical of PMWS occurred. The abortion level returned to normal 4 months later, and the conception rate returned to normal 4 months after that.<sup>248</sup>

### CLINICAL SIGNS IN HIGH PATHOGENICITY PORCINE REPRODUCTIVE AND RESPIRATORY SYNDROME VIRUS

Infection with these signs is associated with severe clinical signs, pulmonary lesions, and aberrant host responses.<sup>249,250</sup>

### CLINICAL PATHOLOGY

#### Acute Phase Proteins

Acute phase proteins (APPs) are synthesized by the liver hepatocytes in response to proinflammatory cytokines. They induce inflammatory reactions and fever, but overproduction may produce an antiinflammatory state. PRRSV may not produce an APP response caused by a poor preinflammatory cytokine response. There is an early expression of haptoglobin (modulates immune response and interacts with CD163), which is the receptor for PRRSV, increasing expression of IL-10 (antiinflammatory), and pig major acute protein, but the response of C-reactive protein (CRP; activates complement and opsonization) and serum amyloid A (chemoattractant for monocytes, T cells, and polymorphs) is delayed and variable.<sup>201</sup> The haptoglobin may modulate the immune response and induce the antiinflammatory IL-10.

The CD163 removes the hemoglobin-haptoglobin complexes circulating in the blood and decreases the amount of iron available for bacteria and reduces oxidative stress.

Haptoglobin levels and pig major acute proteins were increased at 10 DPI, but CRP and serum amyloid showed a delayed and highly variable increase. All three proinflammatory cytokines (IL-1 $\beta$ , IL-6, and TNF- $\alpha$ ) were poorly expressed, and only a mild increase in IL-1 $\beta$  was observed at 7 DPI. The increased expression of haptoglobin coincided with the light enhancement observed in both IL-6 and TNF- $\alpha$  and might be related with an increased expression of IL-10. The low expression of TNF- $\alpha$  may point to a possible mechanism of viral evasion of the host immune response.<sup>201</sup>

An 8-plex Luminex assay has been developed to detect swine cytokines after vaccination. It will detect innate (IL-1 $\beta$ , IL-8, IFN- $\alpha$ , TNF- $\alpha$ , and IL-12), regulatory (IL-10), Th1 (IL-4), and Th2 (IL-4) cytokines.<sup>251</sup>

PRRSV infection significantly increases the number of alveolar macrophages in bronchoalveolar lavage fluid approximately 10-fold between day 10 and day 21 of infection. Approximately 63% of the cells were cytotoxic T cells (CTLs) and NK cells. Serum haptoglobin levels were increased from 7 to 21 DPI.

Piglets also become anemic in PRRSV infections, and the most highly pneumovirulent strains induced the most severe anemia. This is probably caused by a direct or indirect effect on the erythroid precursor cells of the bone marrow.

A definitive diagnosis requires detection of virus in infected animals and detection of antibodies in fetal fluid or in precolostral blood of stillborn and weak-born piglets. Detection of antibodies in sera of groups of pigs of different ages is also necessary. The most suitable body fluid and tissue samples and diagnostic tests for the etiologic diagnosis of PRRS are dependent on several variables including:

- Age of pigs from which samples are collected
- Stage of infection (acute or persistent)
- Available complement of diagnostic reagents
- Urgency of obtaining results

When congenitally or neonatal pigs are affected, both serum and alveolar macrophages are reliable samples. For older pigs, alveolar macrophages are more reliable than serum.

### Detection or Isolation of Virus

The gold standard is the isolation of the virus. A PAM cell line has been developed for the growth of PRRSV.<sup>252</sup>

In an interlaboratory ring trial in Europe to test the real-time RT-PCR tests it was found that there were great differences in the qualitative diagnostics as well as analytical sensitivity. False negatives were a problem, and to achieve maximum safety in the results it was suggested that different assays or kits should be used.<sup>253</sup>

### Boars

Serum is the best method to detect PRRSV during an acute infection in boars.<sup>254</sup> Semen samples failed to detect the virus in most cases. Pooling of samples resulted in a decline of sensitivity.

In a study of commercial tests (RT-PCRs) for diverse strains of PRRSV in boars, in serum, semen blood swabs, and oral fluids<sup>255</sup> from experimentally infected animals, it was found that serum and blood swabs had the best performance and highest detection rates. These were at their highest between 3 and 5 DPI. Oral fluids had the lowest

detection rates. The virus can be demonstrated by isolation using cell cultures, by direct detection of viral antigen in tissue sections, or by the detection of virus-specific RNA. Two commercial ELISAs and an in-house fluorescent microbead immunoassay were tested to detect IgG antibodies in serum and oral fluids for both type 1 and type 2 virus. The tests were similar in sensitivity and specificity but the commercial test kit IDEXX Se detected positive animals earlier than the test kit HIPRA Se. The oral fluid and serum had similar detection rates.<sup>256</sup>

Samples used for virus isolation include serum, thoracic fluid, spleen, and lung. Porcine pulmonary alveolar macrophages are used for isolation of virus. Alveolar macrophages using immunofluorescence microscopy can be used for detection of virus during acute infections. The PCR assay is a reliable, sensitive, and rapid test for the detection of virus in boar semen. It can also be used to determine whether suckling piglets are infected with PRRSV before vaccination and for determining the relationship between parity and shedding of virus. It can also be used to obtain PRRSV piglets. PCR followed by RFLP analysis using several restriction enzymes provides a good genetic estimate for isolate differentiation. A reverse transcription and PCR, coupled with a microplate colorimetric assay, is an automated system that is a reliable and easy test for the routine detection of the virus in semen samples from seropositive boars. Multiplex RT-nested PCR can be applied to formalin-fixed tissues.

A nested PCR has been described that is 100 to 1000 times more sensitive than the usual PCR. An assessment of the viral load can possibly be made by using the quantitative competitive RT-PCR. A quantitative TaqMan RT-PCR is time-saving, easy to handle, less likely to be cross-contaminated, and highly sensitive and specific. Immunohistochemical techniques are available for the detection of virus in formalin-fixed tissues. The virus was detected in 11% to 23% of animals with interstitial pneumonia. It was found in 21% to 31% of animals less than 3 months of age but in only 6% to 17% of those more than 4 months of age. The immunogold silver staining is superior to the immunoperoxidase staining systems for detection of virus in formalin-fixed tissues. RT-PCR is also available and can distinguish between North American and European strains.

A double in situ hybridization (ISH) technique has been developed that can show both PRRSV and PCV2 and a small number of alveolar macrophages stain for both antigens.

A rapid detection method using RT-loop mediated isothermal amplification assay has been described.<sup>257,258</sup>

RT-PCRs have been developed for the detection and differentiation of European

and U.S. PRRSV.<sup>259,260</sup> These cannot differentiate U.S. and HP-PRRS, but the duplex real-time RT-PCR test developed<sup>261</sup> will do this. The test was also compared with standard single PCRs, and the results were found to be in 98.7% agreement.

A method using phages harboring specific peptides that recognize the N protein of PRRSV has been used to distinguish it from other viruses.<sup>262</sup>

### Serology

A recent study has described the production of GP3, GP5, and N-specific hybridomas and an extensive collection of monoclonal antibodies that may help in diagnosis because they reacted with a range of genetically different PRRS viruses.<sup>263</sup> ELISAs differ in their sensitivity, and those that showed higher sensitivity could be used for early detection in individual pigs, especially in PRRSV-free herds.<sup>264</sup>

In a study of the humoral responses in boars measured in serum samples and oral fluid specimens, it was found that IgM, IgA, and IgG were first detected in serum samples collected on DPI 1, 7, and 10, respectively, and in oral fluids from 3 to 7 DPI for IgM, 7 to 10 DPI for IgA, and 8 to 14 DPI for IgG, respectively.<sup>265</sup>

Serologic tests have good sensitivity and specificity for diagnosis on a herd level but less so on the individual animal. The tests in common usage are described below. One of the problems is that the serologic response to a nonvirulent strain is the same as it is to a virulent strain. It is also important to realize that although a positive result for antibody indicates exposure to virus, a negative test does not necessarily mean that the pig is free from PRRSV or has not been in contact with the virus.

### Immunoperoxidase Monolayer Assay Test

The immunoperoxidase monolayer assay (IPMA) is often the first test used. Approximately 75% of sows infected with the virus seroconvert to the Lelystad virus. However, the IPMA does not allow for large-scale surveys.

### Indirect Enzyme-Linked Immunosorbent Assay (iELISA)

The iELISA is used for the routine serodiagnosis; it is simple, inexpensive, effective, and a better alternative to the indirect immunofluorescent assay or the immunoperoxidase assay. It is suitable for the screening of large numbers of samples and is best used as a herd test. Because of marked differences between and within North American and European virus isolates, serologic tests using only one antigenic type of the virus may potentially yield false-negative results with antisera against diverse antigenic types of the virus. A mixture of ELISA antigens from North American and European strains gives



superior results when both types of viruses are known to exist.

A meat juice ELISA has been developed that gives complete agreement with the serum ELISAs.

Unexpected positives have been shown following the use of commercial ELISA testing kits, and these results can be improved by using competitive and blocking ELISA.<sup>266</sup>

A multiplex method for simultaneous serologic detection of PRRS and PCV2 has been described.<sup>267</sup>

### Indirect Florescent Antibody Assay (IFAT)

The IFAT is a highly sensitive test. Antibody titers are detectable in infected pigs 8 days after inoculation. The IgM IFAT is also a rapid and simple test for diagnosing recent infection as early as 5 to 28 DPI in 3-week-old piglets, and 7 to 21 DPI in sows.

### Modified Serum Neutralization Test

This test is useful for the detection of later and higher levels of antibody when the conventional methods cannot detect antibody. The test can differentiate between strains. The serum neutralization test is not used for routine diagnosis because neutralizing antibodies do not appear early in the infection.

### Herd Diagnosis

The serologic diagnosis must be used and applied on a herd basis and acute and convalescent sera submitted for optimal results. A baseline herd sampling is necessary to evaluate the status of a herd and to determine whether and in which groups the virus is circulating. In large herds of over 500 sows, samples are taken from 30 animals in each breeding, gestation, and farrowing group, with representation from all parties. In addition, 10 nursery pigs (5 weeks old), 10 pigs at the end of the nursery period, and 10 pigs in the late finishing stage constitute a **herd profile**. Thus serologic monitoring can be used to monitor the circulation of virus within a closed herd and to determine infection status of breeding animals that are to be introduced into seronegative herds. Results from the sow sera indicate whether the sow herd is virus negative, stable, or has an active virus circulation. Comparison of the early and late nursery pigs indicates if the virus is circulating in the nursery. Comparing the nursery results with the end of the finishing period indicates if the virus is circulating in the finishing groups of pigs. IFAT titers in pigs range from 1:256 to 1:1024 by 2 to 3 weeks after infection. Titers decline over 3 to 4 months unless reintroduced by exposure to circulating virus. Uninfected nursing pigs are negative or have maternal antibody. Seropositive 9- to 10-week-old pigs leaving the nursery indicate virus circulation in the nursery. If pigs leaving the nursery are negative and positive later in the finishing

unit, virus circulation is occurring in the finishing unit.

Sera from outbreaks of the disease in the United States, Canada, and Europe have been compared, and although the isolates from both continents are closely related, the strains isolated in the United States and Canada are more closely related serologically than they are to the European strains.

### Oral Fluids

Saliva has also been used for haptoglobin and CRP estimations in PRRS-affected pigs under field conditions.<sup>268,269</sup> The values were higher in a conventional herd with chronic PRRS than a specific pathogen-free herd. Increases were also found independently with age. The use of preweaning oral fluid samples detects the circulation of wild-type PRRSV.<sup>270</sup> Overall, preweaning litter oral fluid samples could provide a sensitive approach to surveillance for PRRSV in infected, vaccinated, or presumed negative pig breeding herds.

### Antigen Detection

PCR reactions were partially inhibited in the oral fluid matrix compared with RNA extraction, and it should not be assumed that methods designed for use in serum would perform as well in oral fluid.<sup>271-275</sup> Oral fluid testing was found to be useful for virus detection<sup>276</sup> and superior to serum for the detection of PRRSV using PCR over the 21-day observation period of their study. Individually penned oral-fluid sampling could be an efficient, cost-effective way to maintain surveillance in a boar stud.

### Serology

An assay was developed and validated for use in oral fluids.<sup>277</sup> A titer of 1:8 in oral-fluid samples was considered to be virus specific and could be detected 28 days after vaccination or infection. It had 94.3% specificity and 90.5% repeatability. The levels were correlated with serum levels.

The IgG oral fluid ELISA can provide efficient, cost-effective PRRSV monitoring in commercial herds and be used in elimination programs.<sup>278</sup> In a study of 100 oral-fluid samples from pens containing positive pig at five levels of PRRSV prevalence tested at six laboratories, it was found that the mean positivity for PRRSV RNA was 62% and for antibodies it was 61%. The study supported the use of pen-based oral-fluid sampling for PRRSV surveillance.<sup>279</sup> An oral fluid assay was ring tested in the United States<sup>280</sup> in 12 laboratories and was found to be highly repeatable and reproducible.

### NECROPSY FINDINGS

There is a high level of viremia for 102 weeks, then a lower level for another 2 to 3 weeks, and subsequently low levels of virus may persist for several months, but finally PRRSV is eliminated after 2 to 4 months.

PRRSV-specific nonneutralizing antibodies arise quickly from 7 DPI, but low titers of neutralizing antibody are only detected from 25 to 35 DPI. In some pigs, both low levels of replicating virus are found in the presence of neutralizing antibodies. The adaptive cell-mediated immune response is exerted by CTLs and Th cell lymphocytes in cooperation with Th1-activated NK and macrophages. The CTLs may reduce viral replication in the lungs and lymphoid tissue after 2 weeks DPI and in the complete clearance of virus in 2 to 4 months. It was shown that peripheral blood monocytes fail to exert CTL activity toward PRRSV-infected macrophages.<sup>281</sup>

Type 2 PRRSV is more virulent than type 1 in the experimental setup with higher mean viral titers and greater macroscopic and microscopic lesions at the same points on a timescale similar to a type 1 virus. Mean numbers of PRRSV-positive cells in lungs and lymph nodes were also higher for the type 2 virus.<sup>282</sup>

Type 2 PRRSV infection mediates apoptosis in B- and T-cell areas in lymphoid organs of experimentally infected pigs, and the increased apoptosis may play a part in the impairment of the host immune response during PRRSV infection.<sup>283</sup>

In a study of three European viruses it was shown that a Belgian strain was more highly pathogenic than the Lelystad virus and a British field strain, not because of increased viral load and better replication but because of an enhanced inflammatory immune response.<sup>284</sup>

A series of postmortem examinations of different aged pigs from different stages of production will reveal what is going on over time. A series of such examinations will probably show more than any other investigations.

No characteristic gross lesions are present in sows, aborted fetuses, or stillborn piglets. Microscopic lesions that may be present in aborted fetuses include vasculitis of the umbilical cord (not recorded in European strain infections) and other large arteries, myocarditis, and encephalitis. Unfortunately, none of these changes is present consistently, and the majority of fetuses and placentas are histologically normal. These lesions are all more common in the North American virus infections.

In suckling and grower pigs, infection with the PRRSV is usually characterized by an interstitial pneumonia. The PRRSV affects both pulmonary intravascular macrophages, which may be important as a replication site, and alveolar macrophages. Loss of bactericidal function in pulmonary intravascular macrophages may facilitate hematogenous bacterial infections. When Danish isolates were injected into piglets, PRRSV was isolated from the lungs and/or tonsillar tissues from both dead and culled piglets under 14 days of age. Tracheobronchial and

mediastinal lymph nodes are usually enlarged and firm. The gross pulmonary changes vary from lungs that appear normal but fail to collapse, to lungs that are diffusely red, meaty, and edematous. Porcine proliferative and necrotizing pneumonia has been linked to infection with PRRSV, although the involvement of an unidentified copathogen cannot yet be discounted. Grossly, this form of pneumonia appears as confluent consolidation of the cranial, middle, and accessory lobes, together with the lower half of the caudal lobe. Affected lobes are red-gray, moist, and firm (meaty) in consistency. On cross-section, the affected lobes are bulging and dry, and the pulmonary parenchyma appears similar to thymic tissue.

Generally, histologic lesions in piglets are focal nonsuppurative inflammatory conditions particularly in the lung and heart. Most of the cells undergoing apoptosis do not have markers for PRRSV, which suggests that there is an indirect mechanism for the induction of apoptosis.

Multifocal areas of interstitial pneumonia (more extensive at 10 DPI rather than 21 DPI) were regarded as the structural basis for reduced lung compliance and gas exchange disturbances.<sup>237</sup> There was a cough that the authors interpreted as caused by bronchospasm because there was no evidence of tracheitis, bronchiolitis, or airway mucus, and this was supported by the presence of peripheral airway obstruction. Cell death occurs through both apoptosis and necrosis.<sup>285</sup>

Histologically, in addition to marked proliferation of type II pneumocytes in alveoli, there is severe necrosis of bronchiolar epithelium, with necrotic cellular debris plugging the airway lumina.

In pigs infected with HP-PRRSV, there was a distinct thymus atrophy. The lesions in the thymus were found to have severe cortical depletion of thymocytes. There was a 40-fold increase in apoptosis of thymocytes compared with piglets infected with non-HP-PRRSV at 7 DPI.<sup>286</sup>

In the less severe and more common forms of PRRSV pneumonia, the alveoli contain protein-rich fluid and large macrophages, some of which may appear degenerate. There is patchy thickening of the alveolar septa caused by infiltrating mononuclear leukocytes and mild, type II pneumocyte hyperplasia. Lymphoplasmacytic cuffing of arterioles is common, and syncytial cells are occasionally seen. In field outbreaks, it is usual for the lung pathology to be complicated by concurrent respiratory pathogens.

Microscopic lesions may be found in many other tissues and include multinucleate cell formation within lymph nodes; infiltrates of lymphocytes and plasma cells in the heart, the brain, and the turbinates; and a lymphocytic perivascularitis in various sites. Thymic lesions include severe cortical depletion of thymocytes. An ISH technique is a rapid, highly specific, and sensitive detection

method for the diagnosis of PRRS virus in routinely fixed and processed tissues. Immunohistochemical techniques can also be used to detect the virus in neurovascular lesions. PRRSV and reovirus 2 have been found in brain, lung, and tonsil by inoculation into Marc 145 and CPK cells. IHC on one section would give a positive in 48% of cases, but if five sections were studied then there are positives in >90% of PRRSV-infected pigs. If the animals are vaccinated then the positives fall to 14%.

PNP is a common finding in Spain and is characterized by hypertrophy and proliferation of type 2 pneumocytes and the presence of necrotic cells in the alveolar lumina. PCV2 was found in 85.1% of the cases by ISH and IHC and PRRSV was found in 44.6% of the cases; 39.1% had PCV2 as the sole agent and only 4.1% had PRRSV as the sole agent.<sup>287</sup>

### Samples for Confirmation of Diagnosis

Lung appears to be the best tissue for identification of the virus in various ages of the pig and at various times following infection. Thymus is probably the best choice for aborted fetuses.

- **Histology:** lung, tonsil thymus, thoracic lymph node, brain, kidney, heart, (umbilicus from fetus) (light microscopy, immunohistochemistry (IHC)); a monoclonal antibody-based IHC method for the detection of European and U.S. PRRSV was shown to be useful in detecting both types.<sup>288</sup>
- **Virology:** lung, thoracic lymph node, tonsil (virus isolation, fluorescent antibody test (FAT), PCR).

### DIFFERENTIAL DIAGNOSIS

**Respiratory disease** must be differentiated from the following:

- Swine influenza
- Porcine respiratory coronavirus
- Enzootic pneumonia (*Mycoplasma hyopneumoniae*)
- *Actinobacillus pleuropneumoniae*
- *Pasteurella multocida*
- Glasser's disease (*Haemophilus parasuis*)
- *Streptococcus suis*.

**Reproductive disease** must be differentiated from other causes of abortion, stillbirths, and weak neonates in pigs:

- Leptospirosis
- Encephalomyocarditis virus
- Hog cholera virus
- Pseudorabies virus
- Parvovirus
- Fumonisin, which is a recently identified mycotoxin produced by *Fusarium moniliforme*, has been associated with the appearance of PRRS in swine herds in the United States

A definitive diagnosis requires a detailed epidemiologic investigation of the epidemic

including a detailed analysis of the breeding and production records for the previous several months, and the submission of tissue and serum samples for laboratory investigation.

### TREATMENT

There is no specific treatment against the virus. In outbreaks of respiratory disease, mortality can be reduced by ensuring that the environmental conditions in the barns and pens are adequate, the stocking density is kept low, and the feeds and feeding programs are monitored. Routine procedures such as tail docking, iron injections, castrations, teeth clipping, and cross-fostering should be delayed or not done during the acute phase of the disease. Supplemental heat for neonatal pigs should be provided if necessary. Sows that have aborted their litters should not be bred until the normal time of weaning. This will reduce the incidence of infertility common at the first estrus after the abortion or premature farrowing. Culling of sows should be minimized and weekly breedings increased by 10% to 15%. Replacement gilts may be introduced into the premises for exposure to infection before breeding. The consequences of boar infertility and low libido may be minimized by use of artificial insemination or by using multiple sires on each sow. Recurrent illness and secondary infections in weaner and growing pigs can be continuing problems for a few months after an acute outbreak. Reducing the stocking density and an all-in/all-out strategy have been successful in reducing the chronic problem. If there is the possibility of treating secondary infections, then this should be undertaken. Serum inoculation of naive gilts has been described, and this was shown to be capable of stabilizing sow herds, as shown by the production of negative weaned pigs.

Tylvalosin, a macrolide antibiotic, and to some extent tilmicosin inhibit the in vitro replication of European and American PRRSV possibly by raising the endosomal pH (PRRSV requires a low endosomal pH).<sup>289</sup>

A report has suggested that *N*-acetylpenicillamine will inhibit PRRSV replication.<sup>290</sup>

### CONTROL

It is the stealthy nature of PRRSV infection and its efficient transmission that has prevented elimination.<sup>291</sup> The challenges of control have resulted in the development of regional control systems.<sup>292,293</sup> These involve cooperation in a region, new technologies, and the demonstration that PRRSV has been eliminated.

The potential role of noncommercial swine populations in the United States in the spread of PRRSV have been highlighted.<sup>294</sup> They comment on the lack of knowledge of biosecurity in this group of swine herders,

the practice of showing pigs at many events, evidence that exposure to PRRS is very frequent, and close interactions with commercial herds and that these facts make it necessary to involve these groups in regional control.

Control of PRRSV is difficult, unreliable, and frustrating because of the complexity of the disease; the uncertainty of some aspects such as immunity, persistence, diagnosis, and the lack of published information based on control programs have been evaluated under naturally occurring field conditions. Much of the information available on control is anecdotal and not based on well-designed control programs that can be compared and evaluated. A major problem is the difficulty of obtaining a definitive etiologic diagnosis when presented with young growing pigs with respiratory disease and the possibility that other pathogens could be involved. The diagnosis of reproductive failure in gilts and sows is also commonly uncertain.

Some characteristics of the disease are important in planning control programs for individual herds:

- Infection is highly contagious and is transmitted by direct contact. Nonimmune pregnant gilts and sows and young pigs are highly susceptible to infection, resulting in large economic losses.
- Infection of breeding stock results in immunity. The efficacy of vaccination is not well established.
- Maternal immunity is present in piglets born from seropositive sows.
- Infection can persist for many weeks and months in individuals and in subpopulations of animals.
- Infections are usually introduced into a herd by the introduction of infected pigs.

There are two main options for control: eradication of the virus from individual swine herds and controlling the disease in individual herds to create a stable positive system that allows to live with the disease. Controlling the disease requires developing strategies to make pigs immune to the infection by controlling infection pressure in the herd and inducing naturally acquired immunity in the herd or inducing acquired immunity through vaccination. The recommendations for control set out here are guidelines that can be applied and modified to meet different circumstances.

Dietary plant extracts (capsicum, garlic, and turmeric) improve immune responses and growth efficiency of pigs experimentally infected with PRRSV.<sup>295</sup>

## FILTRATION SYSTEMS

A production region model was used to assess the spread of PRRSV<sup>296</sup> and showed the importance of aerosol spread. More than 30 swine systems in the Midwest have remained free from PRRSV for 2 to 3 years

following implementation of an air-filtration system using MERV 16 filters, and this system should be regarded as the gold standard.<sup>297-299</sup>

Retrograde air movement is a real risk for PRRSV introduction into filtered airspaces in animal houses, and different treatments have been investigated.<sup>300</sup>

In a study of before and after filtration it was found that outbreaks occurred at a rate of 0.5 outbreaks a year before filtration, but after the risk was reduced by introducing air filtration the outbreaks were reduced to 0.06 to 0.22 outbreaks a year.<sup>301</sup>

The financial implications of air-filtration systems have been studied.<sup>302</sup> Model outputs suggested that the filtered farm produced 5927 more pigs on a 3000-sow farm and paid for the installations within 5.35 to 7.13 years, depending on the sow herd productivity. If there was a premium of \$5 per PRRS-negative piglet, then the payback period was reduced to 2.1 to 2.8 years.

## Eradication of the Virus From the Herd

### Depopulation and Repopulation

Eradication of the virus from the herd by depopulation of the entire herd followed by repopulation with virus-free breeding stock is biologically possible, but in most cases it is impractical and too expensive. Obtaining virus-free breeding stock is usually not possible and, if possible, the herd is highly susceptible to accidental reinfection.

## Control in Infected Herds

### Nursery Depopulation

Control within a breeding herd is based on the observation that pigs commonly seroconvert to the virus during the nursery period. Pigs are seronegative shortly after weaning, but 80% to 100% are seropositive at 8 to 10 weeks of age. A control program based on **nursery depopulation** consists of emptying the nurseries and moving **all of the pigs** to off-site finishing facilities or selling them as feeder pigs. Test and removal has been described. This is combined with batch farrowing and weaning at intervals of at least 3 weeks. The nurseries are completely emptied, cleaned three times with hot water and disinfectant, the slurry pits are pumped out after each cleaning, and the facilities are kept empty for 14 days, during which time all pigs weaned are moved to off-site nurseries and after which the conventional flow of pigs into the cleaned facilities is resumed. The control program can result in significant improvements in both average daily gain and percentage mortality, but it will not eliminate the virus from the herd. Using a partial budget model to measure the profitability of nursery depopulation, the financial consequences indicate that it is a profitable strategy to improve pig performance in herds affected with the virus. Additional income is generated by the increased number and

**Table 18-4** Nursery depopulation and cleanup protocol for elimination of PRRS

Day	Procedure
1	Empty all nurseries, off-site weaning, pump out slurry pits, clean and wash rooms with hot water (>95°C, 203°F), and disinfect with formaldehyde-based product; allow disinfectant water to remain in pits overnight
2	Pump out pits, repeat washing procedure, and disinfect in phenol-based product; allow disinfectant to remain in pits
311	Allow facility to remain vacant
12	Pump out slurry pits, repeat washing procedure, and disinfect with formaldehyde-based product
13	Allow facility to remain vacant
14	Resume conventional flow of pigs into clean nurseries

weight of marketable pigs, as a result of their increased growth rate and decreased mortality. Lower treatment costs reduce overall expenses, but there are additional costs because of the extra feed necessary to raise the additional pigs and the costs required to house the depopulated pigs. However, it is possible that the economic benefits are from the control of other pathogens and not merely the PRRS virus.

The details for nursery depopulation and cleanup protocol for the elimination of the virus are shown in [Table 18-4](#).

In an experimental infection with PRRSV, it was found that the infected pigs had greater serum concentrations of IL-1 $\beta$ , TNF- $\alpha$ , IL-12, IFN- $\gamma$ , IL-10, and haptoglobin than sham controls. The results indicated that PRRSV-stimulated secretion of cytokines involved in innate, Th1, and T-reg immune responses. Mannan oligosaccharides regulated the expression of nonimmune and immune genes in pig leukocytes<sup>303</sup> and were able to enhance the immune response without overstimulation. Mannan oligosaccharide-containing compounds were found to decrease the levels of the serum TNF- $\alpha$ . The levels of IL-1 $\beta$  and IL-12 may help to promote innate and T-cell immune functions.<sup>304</sup>

## Management of the Gilt Pool

Management of the gilt pool is the single most important strategy for long-term effective control. Controlling the infection in the breeding herd is a prerequisite to controlling infection in the nursery and finishing pig groups. Strategies like partial depopulation and piglet vaccination are ineffective unless the breeding herd is first stabilized, preventing piglets from becoming infected



before weaning. Replacements are a major source of introduction of the virus and activating existing virus in the breeding herd. They also initiate the formation and maintenance of breeding herd replacements.

**Subpopulations** are subsets of naive or recently infected gilts or sows that coexist within chronically infected herds. These subpopulations perpetuate viral transmission in the breeding herd and farrowing units, which ultimately produces successions of infected piglets before weaning. Modifications in gilt management that may minimize subpopulations include ceasing introduction of replacement animals for a 4-month period, beginning to select replacements from the finishing unit, or introducing a 4-month allotment of gilts at one time.

Exposure to the virus in the breeding herd can be controlled by managing the gilt pool using two strategies. In one strategy, herds may be closed to outside replacements, and replacement males and females are raised on the farm. In the other strategy, replacement gilts are held in an off-site holding facility from 9 to 12 weeks of age until breeding age at 7 to 7.5 months, or even much earlier. This is combined with nursery depopulation as described earlier. Before entry of the gilts into the herd, they are serologically tested for evidence of seronegativity or a declining titer, which is required for entry into the herd. The gilts are isolated and quarantined for acclimatization for 45 to 60 days. This may be combined with two vaccinations, 30 days apart, after entering quarantine. This method reduces the risk of introducing potentially viremic animals into the existing population. The method selected will depend on the production system, management capabilities, and facilities available on each farm. The introduction of younger gilts, in larger groups, less frequently throughout the year, is being recognized as the most effective method for introducing replacement stock to virus-infected herds and long-term control of the disease.

### Controlled Infection of Breeding Herd

The presence of subpopulations of highly susceptible breeding animals in the herd can be a major risk factor for maintaining viral transmission within problem herds and may explain recurrent outbreaks of reproductive failure. By intentionally exposing all members of a population to the virus, it may be possible to eliminate subpopulations and produce consistent herd immunity. In endemic herds, exposure of gilts to the virus before breeding is critical for prevention of reproductive failure. Seronegative replacement gilts can be introduced into seropositive herds at 3 to 4 months of age to allow for viral exposure before breeding. If the status is uncertain, quarantine and exposure to

nursery pigs of the importing unit is a suitable policy if replacement gilts are bought in before they are bred. It is possible to convert a PRRS-positive unit to a negative herd by managing the gilt pool and regulating the pig flow. It appears that PRRSV infection eventually either disappears or becomes inactive in the donor gilt population. Similarly, serum from nursery pigs (thought to be PRRSV viremic) given to negative replacement gilts resulted in seroconversion of all 50 gilts receiving the serum.

### Control of Secondary Infections

When outbreaks of the disease occur in nursing piglets, and virus circulation is occurring continuously in the farrowing facility, the following are recommended:

- Cross-foster piglets only during the first 24 hours of life
- Prevent movement of pigs and sows between rooms
- Eliminate the use of nurse sows
- Euthanize piglets with low viability
- Minimize injections of suckling pigs
- Stop all feedback of pig and placental tissues
- Follow strict all-in/all-out pig flow in the farrowing and nursery rooms.

These are similar to the system developed in the United States called the McRebel system. This was a method of control showing that cross-fostering of piglets should be minimal within the first 24 hours and banned after this time.

Feedback has been tried, although there are a lot of reasons not to do so. Minced whole piglets were fed to sows and the herd then closed for 23 weeks. No clinical signs were observed. One-third of the sows present at the time of the outbreak were still seropositive 20 months after the deliberate infection. Disinfection at cold temperatures was described.

### Biosecurity

Standard methods, such as quarantining and serologic screening of imported breeding stock and restrictions on visitors, are recommended to keep units free of infection. Control of infection between herds depends on restricting the movement of pigs from infected herds to uninfected herds. If pigs have to be bought in, then seropositive animals should be imported into seropositive herds. Only seronegative boars should be allowed entry into artificial insemination units.

Biosecurity practices regarding PRRSV have been investigated in Quebec in two areas of different swine density. A questionnaire was sent to 125 breeding sites and 120 growing sites. The frequency of biosecurity practices ranged from 0% to 2% for a barrier at the site entrance, 0% to 19% for showering, 20% to 25% for truck washing between loads, 51% to 57% for absence of rendering or rendering without access to the site, and 26% to

51% for absence of gilt purchase or purchase with quarantine. Better practices were found in the breeding herds. In the high-density area, there was a lower level of biosecurity on the growing sites. There were two patterns of biosecurity, a low one and a high one. For the breeding sites the higher pattern was observed when the site was away from other pig sites, more than 300 m from a public road, with a higher number of sows or being part of integrated production.<sup>305</sup> In a second part of the study, on prevalence and risk factors, it was found that the overall prevalence of PRRS was 74.0%. Four main factors were associated with PRRS positivity, and these were large pig inventory, proximity to closest site (16%), absence of shower (27%), and free access to the site by the rendering truck (10%).<sup>305</sup> Boar studs that are free should only import boars that are certified free from tested herds. The status of the boar stud should be tested every 2 weeks with a combination of ELISA and PCR.

Testing protocols that used PCR on serum detected the PRRSV introduction earlier than the protocols that used PCR on semen, and these were earlier than those that used ELISA on serum. The most intensive protocol (testing 60 boars three times a week by PCR on serum) would need 13 days to detect 95% of the PRRSV introductions.<sup>306</sup>

A vaccination study using a modified live PRRSV vaccine on European and North American PRRSV shedding from boars showed that boar vaccination decreased the shedding of U.S. PRRSV but not the European strain.<sup>307</sup>

### Vaccine and Vaccination

The inefficiency of current vaccines to cross-protect against all strains of PRRSV may be caused by variability within GP5.<sup>2</sup>

Adjuvants for use in PRRSV vaccines have been reviewed.<sup>308</sup> Of 11 adjuvants tested 5 enhanced cell-mediated immunity to PRRSV. In particular, IL-12 and CpG ODN significantly enhanced the protective efficacy of PRRSV vaccines in challenge models. The immunostimulatory oligodeoxynucleotides have been used previously.<sup>309</sup>

TLR ligands enhance the protective effects of vaccination against PRRS syndrome in swine using killed vaccines.<sup>310</sup>

Vaccination with a combined PRRSV/MH vaccine did not differ in protective efficacy compared with the protective efficacy of the two single vaccines. This indicates that neither vaccine interfered with each other.<sup>311</sup>

Vaccine efficacy of PRRSV chimeras has been described,<sup>312</sup> and the study suggested that only specific chimeras can attenuate clinical signs in swine and that attenuation cannot be directly linked to primary virus replication.

Pigs infected with PRRSV at the time of vaccination for swine influenza had an increased level of macroscopic and microscopic pneumonia, suggesting that there was

a reduced SIV vaccine efficiency.<sup>313</sup> In addition, there was also increased clinical disease and shedding of SIV during the acute phase of SIV infection.

Immunologic solutions for the treatment and prevention of PRRSV have been reviewed.<sup>314</sup> No differences were found between intradermal and IM vaccinated pigs and those subsequently exposed to a heterologous Italian strain.<sup>315</sup>

The antibody response and the maternal immunity when PRRSV-immune sows were boosted with experimental farm-specific and commercial PRRSV vaccines has been described.<sup>316</sup> The study was designed to boost PRRS-immune sows against circulating viruses. Three PRRSV isolates were taken. Booster vaccinations used either commercial vaccines or inactivated farm-specific isolate vaccines. A boost was found in all three farm-specific vaccinations. The commercial attenuated vaccine boosted immunity in 2/3 herds but the commercial nonattenuated dead vaccine did not affect the immunity on any of the three farms. In a second part of the study, similar vaccines were given at 60 days' gestation. The farm-specific vaccines produced a significant increase in farm-specific neutralizing antibodies in all sows. Virus-neutralizing antibodies were also transferred to the piglets via colostrum and were detectable in the serum of these animals until 5 weeks after parturition. Not all sows vaccinated with the commercial attenuated vaccine showed an increase in the farm-specific virus-neutralizing antibodies, and the piglets in this group received a lower level of colostrum antibodies. The number of viremic animals was significantly lower in the piglets of both groups of vaccinated animals than among mock vaccinated animals until at least 9 weeks of age.

### Vaccination of Gilts

The two commercial modified live virus vaccines against PRRSV in pregnant gilts were shown to replicate in pregnant gilts and to cross the placenta.<sup>317</sup> It was concluded that the vaccines had no marked detrimental effects in pregnant gilts but that they could cross the placenta and lead to the birth of congenitally affected piglets.

Intranasal delivery of PRRS-MLV with a potent adjuvant (from *M. tuberculosis* whole-cell lysate) to elicit cross-protective immunity to a heterologous strain of PRRSV generated effective cross-immunity. There was reduced lung pathology, enhanced neutralizing antibodies, and reduced viremia. There was a reduced secretion of immunosuppressive cytokines (IL-10 and TGF- $\beta$ ) and an upregulation of the Th-1 cytokine IFN- $\gamma$  in blood and lungs.<sup>318</sup>

The ORF5a antibody response is neither neutralizing nor protective.<sup>319</sup>

Vaccination is an aid to management in developing effective immunity. The goal is to produce a constant level of immunity across

a defined population. This effectively immunizes the entire population and eliminates the nonimmune, susceptible subpopulations. Vaccination is most effective when used in replacement gilts combined with adequate isolation and acclimatization and in sows after farrowing and prebreeding. The routine vaccination of sows is not economically viable in herds affected with PRRSV. The vaccine is best suited for stabilizing the herd and is a necessity before nursery depopulation or commingling segregated early weaning piglets from virus-positive herds. Vaccination is also intended to produce protective immunity in weaned and growing pigs. The PRRS virus exists in many forms and therefore the closer the genetic makeup between the immunizing virus and the challenge virus the better.

Both inactivated and modified live virus vaccines are available.

Previous vaccination with a live attenuated strain produced an increase in proinflammatory cytokines and proimmune cytokine gene expression. In addition, a higher level of cortisol production suggested that there was an activation of the hypothalamus-pituitary-adrenal axis response. Vaccination produces an early immune response in pigs and a more efficient control of inflammation.<sup>320</sup>

### Inactivated Vaccines

Immunization of pigs with a genotype I attenuated vaccine provided partial protection against challenge with a highly virulent genotype II strain. There was a lower mortality, fewer days of fever, lower frequency of catarrhal bronchopneumonia, higher weight gains and lower viremia compared with unvaccinated control pigs.<sup>321</sup>

Killed vaccines that are inactivated using methods that preserve the PRRSV entry-associated domains are most useful for the development of effective inactivated vaccines because they facilitate internalization into macrophages.<sup>322</sup> An experimental inactivated PRRSV vaccine that induces virus-neutralizing antibodies has been described.<sup>323</sup> The vaccine uses an optimized inactivation procedure and a suitable adjuvant, and by using these methods it was shown that inactivated PRRS vaccines can be developed that induce virus-neutralizing antibodies and offer partial protection on challenge.

Killed vaccines may not produce a measurable antibody response stimulation, but activation of lymphocytes does occur and any subsequent exposure with vaccine or field virus increases that response. There is no possibility of producing a viremia and no chance of producing shedding, and there are no detrimental effects on the host. However, there is no evidence that killed vaccines protect against heterologous challenge.

A killed, oil-adjuvanted vaccine based on a Spanish isolate of the virus is intended for protection against reproductive disease in

gilts and sows. Initial vaccination involves 2 vaccinations, 21 days apart, with the second vaccination at least 3 weeks before breeding and with booster vaccinations recommended during subsequent lactations. Experimental challenge provides 70% protection based on pigs born alive and surviving to 7 days.

An autogenous inactivated vaccine was compared with commercial vaccines against homologous and heterologous challenge.<sup>324</sup> In this study the experimental inactivated homologous vaccines shortened the viremia on challenge, but the experimental heterologous and commercial inactivated vaccine had no or only a limited effect on the viremia.

### Live Vaccines

A study in China<sup>325</sup> on farms with a complex microbial ecology showed that mass vaccination with an attenuated virus vaccine can improve health status and production performance of sows and their offspring.

Modified live vaccines do give a safe and efficacious protection against a wide variety of heterologous challenge strains. The vaccine virus can be transmitted from vaccinated to naive pigs and to naive herds. Vaccination of boars causes the virus to be shed, but if they have been previously exposed and then are vaccinated then there is no release of virus.

The live vaccine given to finishing pigs will protect against respiratory infections. A modified live virus vaccine given once is safe for use in pregnant sows, and vaccine virus is not transmitted to susceptible contact pigs. In growing pigs vaccinated at 3 to 18 weeks of age, the vaccine elicits protective immunity within 7 days and lasts 16 weeks. Compared with controls, vaccinated animals have a reduced level of viremia, their growth rates are superior, and they have a reduced number of lung lesions. Field trials suggest that the vaccine provides protection to nursery pigs in units with endemic infection. Live viral vaccines in sows may or may not be a good idea because they demonstrated that reduced numbers of pigs were born alive and there were increased numbers of stillborn piglets to vaccinated sows irrespective of the stage of vaccination. Both single-strain and multi-strain vaccines can be attenuated and be useful immunogens, but additional studies are needed to make sure that the multistrain vaccines can be recommended for routine field use.

In Denmark in 1996, the use of a modified live virus vaccine licensed for use in pigs 3 to 18 weeks of age was used in a large number of PRRSV seropositive herds. Following vaccination, a large number of herds experienced an increased incidence of abortions, stillbirths, and poor performance during the nursery period. The vaccine virus was isolated from fetuses, and it was concluded that the virus was transmitted to seronegative nonvaccinated pregnant gilts and sows (see the section [Methods](#) of

**Transmission**). The viruses were collected and sequenced and shown to have only a 60% homology to Lelystad virus, the European type strain, but a 98.5% homology to strain ATC-2332, which is the North American reference strain. It was therefore thought that the vaccine viruses were reverting to their natural antecedents and their virulence. Describing the vaccine virus it was shown that given to piglets it could infect nonvaccinated sows. Given to sows it can produce congenital infection, fetal death, and an increased preweaning mortality.

The vaccine virus can be maintained in the population where it may undergo considerable genetic change and then lead to the establishment of new variants. Vaccination with the U.S. type vaccine produces little effect on viremia with EU PRRSV. Vaccination with EU type vaccines produced complete suppression of EU PRRSV isolates.

A modified live virus vaccine has been evaluated in pigs vaccinated at 3 weeks of age and challenged at 7 weeks of age. Efficacy was evaluated using homologous and heterologous strains of virus known to cause respiratory and reproductive disease. The vaccine controlled respiratory disease but did not prevent infection and viremia. There are no published reports of randomized clinical trials evaluating the vaccines under naturally occurring conditions. In many cases of PRDC, vaccination fails simply because it was given too late or because there was no cross-protection to heterologous strains.

DNA vaccination is said to produce both humoral and cellular responses and neutralization epitopes on the viral envelope glycoproteins encoded by ORF4. Possibly recombinants can be used as vaccines.

In a survey in Germany, 18.5% of the samples were positive for the EU wild-type virus, EU genotype vaccine virus was detected in 1.3%, and the North American genotype vaccine virus was found in 8.9% of all samples. North American vaccine virus was frequently detected in nonvaccinated animals.<sup>326</sup>

The first modified-live vaccine was first released in 1994 and since then a number of other modified live and killed-virus vaccines have been developed. Vaccines should induce rapid immunity, have no adverse reactions, and be able to differentiate vaccinated from naturally infected animals (DIVA vaccine).<sup>308,327,328</sup>

Mass vaccination using modified live virus against homologous infection was shown to be effective in reducing economic losses from PRRSV. It did not eliminate the virus but it did reduce viral shedding 97 DPI.<sup>329</sup> Two vaccines were compared (one inactivated and one modified live), and the modified live virus was the only type of vaccine capable of establishing protective immunity as measured by viral load in blood and tissues. The inactivated vaccine evoked no measurable protective immunity. The

modified live vaccine seemed to be based on cell-mediated immunity.<sup>330</sup>

A modified live vaccine partially protected a group of pigs given a heterologous virus vaccine; intervention reduced the duration of shedding but did not reduce the viral load in tissues or the proportion of persistently infected pigs. When the pigs were subsequently given the highly virulent virus, infection and shedding were not prevented.<sup>331</sup>

The modified live vaccines for PRRSV have been reviewed.<sup>332</sup> None of the vaccines studied (Ingelvac PRRS MLV, Amervac PRRS, Pyrsvac-183, and Porcilis PRRS by the IM route) caused detectable clinical signs in vaccinated pigs, although lung lesions were found. Neither Pyrsvac-183 nor Porcilis PRRS could be detected in the pulmonary alveolar macrophages or in lung sections by IHC, suggesting that these viruses may have lost their ability to replicate in PAM. In these pigs, there was also a lower transmission rate and a delay in the onset of viremia, which may be explained by the lack of infection and therefore replication in the alveolar macrophage.

Novel strategies for the next generation of vaccines have been described<sup>333</sup> and stress the future importance of reverse genetics system-based vaccine development. Serologic marker candidates have been identified.<sup>334,335</sup> Vectored vaccines may have a place in the future.<sup>336-338</sup>

Recombinant fowlpox virus-based virus with coexpression of GP5/GP3 proteins of PRRSV and swine IL-18 has been described<sup>339</sup> as potential vaccines.

The fusion of the heat shock protein (HSP70) of *H. parasuis* with GP3 and GP5 of PRRSV enhanced the immune responses and protective efficacy of a vaccine.<sup>340</sup> The strategy of coexpressing GPGP-linked GP5 and M fusion protein may be a promising approach for future PRRSV vaccine development.<sup>341</sup> A canine adenovirus has also been used as a vehicle.<sup>342</sup>

Overattenuation of an HP-PRRSV (over 100 passages) was used to produce a possible vaccine<sup>343</sup> suggesting that loss of pathogenicity has to be balanced with loss of antigenicity.

Vaccination against PRRSV resulted in significantly lower viral loads of PCV2 in animals over 13 weeks compared with nonvaccinated animals but it had no effect on quantitative PCR results for PRRSV in 4- to 12-week-old pigs. PRRS vaccinates had significantly lower levels of PCV2 viral loads when peak wasting disease was seen.<sup>344</sup>

Concurrent PRRSV and PCV2 vaccination produced no interference with the development of the specific humoral and cell-mediated immunity and is associated with clinical protection on natural challenge.<sup>345</sup> PRRSV vaccine induced a low but significant virus-specific response IFN- $\gamma$  secreting cell response on stimulation with

both the vaccine strain and two heterologous PRRSV isolates.<sup>346</sup>

An isolate of PRRSV has been shown to produce IFNs and may be useful for the development of vaccines.<sup>347</sup>

### Vaccination Against High Pathogenicity Porcine Reproductive and Respiratory Syndrome

A live attenuated vaccine was successfully produced from an HP-PRRSV strain TJ and the attenuation produced a further 120 amino acid deletion as well as the 30 amino acid deletion found in these HP-PRRSV strains.<sup>348</sup> The pigs were protected from the lethal challenge and did not develop fever and clinical disease. The vaccinated pigs also gained more weight and had milder pathologic lesions. The effective protection lasted at least 4 months.

A live attenuated vaccine has been used against HP-PRRSV.<sup>349</sup>

### Vaccination of Boars

The use of an attenuated virus vaccine in boars resulted in a marked reduction in viremia and shedding of the virus in semen compared with nonvaccinated control animals. Introducing a vaccination program using the live virus vaccine may be considered as a potential method to reduce the risk of transmission of virus by artificial insemination. In contrast, no changes in onset, level, and duration of viremia, or shedding of virus in semen, were observed using the inactivated virus vaccine.

### FURTHER READING

- Dee S, et al. Use of a production region model to assess the efficacy of various air filtration systems for preventing airborne transmission of PRRS and *M. hyopneumoniae*: Results from a 2 year study. *Virus Res.* 2010;154:177-184.
- Dokland T. The structural biology of PRRSV. *Virus Res.* 2010;154:86-97.
- Frossard J-P. Porcine reproductive and respiratory syndrome virus evolution and its effect on control strategies. *Pig J.* 2013;68:20-25.
- Gomez-Laguna J, et al. Immunopathogenesis of PRRSV in the respiratory tract of pigs. *Vet J.* 2013;195:148.
- Karniychuk UU, Nauwynck HJ. Pathogenesis and prevention of placental and transplacental porcine reproductive and respiratory syndrome virus infection. *Vet Res.* 2013;44:95.
- Murtaugh MP, Genzow M. Immunological solutions for treatment and prevention of PRRS. *Vaccine.* 2011;29:8192-8204.
- Murtaugh MP, et al. The ever-expanding diversity of PRRSV. *Virus Res.* 2010;154:18-30.
- Nauwynck HJ, et al. Microdissecting the pathogenesis and immune response of PRRSV infection paves the way for more efficient PRRSV vaccines. *Transboundary Emerg Dis.* 2012;59(suppl 1):50-54.
- Sang Y, et al. Interaction between innate immunity and PRRSV. *Anim Health Res Rev.* 2011;12:149-167.
- Shi M, et al. Molecular epidemiology of PRRSV: A phylogenetic perspective. *Virus Res.* 2010;154:7-17.
- Thanawongnuwech R, Suradhat S. Taming PRRSV: Revisiting the control strategies and vaccine design. *Virus Res.* 2010;154:133-140.



- Yoo D, et al. Modulation of host cell responses and evasion strategies for PRRSV. *Virus Res.* 2010;154:48-60.
- Zhou L, Yang H. PRRSV in China. *Virus Res.* 2010;154:31-37.

## REFERENCES

1. Opriessnig T, et al. *Anim Health Res Rev.* 2011;12:133.
2. Murtaugh MP, et al. *Virus Res.* 2010;154:18.
3. Gorbalenya AE, et al. *Virus Res.* 2006;117:17.
4. Fang Y, et al. *Arch Virol.* 2007;152:1009.
5. Shi M, et al. *Virus Res.* 2010;154:7.
6. Martinez-Lobo FJ, et al. *Vaccine.* 2011;29:6928.
7. Fang Y, Snijder EJ. *Virus Res.* 2010;154:61.
8. Firth AE, et al. *J Gen Virol.* 2011;92:1097.
9. Johnson CR, et al. *J Gen Virol.* 2011;92:1107.
10. Wei Z, et al. *J Virol.* 2012;86:9941.
11. Xia Pa, et al. *Vet Microbiol.* 2009;138:297.
12. Lee C, Yoo D. *Virology.* 2006;346:238.
13. Kim W-I, et al. *Vet Microbiol.* 2013;162:10.
14. de Lima M, et al. *Virology.* 2009;390:31.
15. Brockmeier S, et al. *Virus Res.* 2012;169:212.
16. Johnston CR, et al. *J Gen Virol.* 2011;92:1107.
17. Wenhui L, et al. *J Virol.* 2012;86:9543.
18. Stadejek T, et al. *J Gen Virol.* 2006;87:1835.
19. Costers S, et al. *Virus Res.* 2010;154:104.
20. Kvisvgaard LK, et al. *Virus Res.* 2013;178:197.
21. Kvisvgaard LK, et al. *Vet Microbiol.* 2013;167:334.
22. Zhu L, et al. *Vet Microbiol.* 2011;147:274.
23. Li Y, et al. *Vet Microbiol.* 2009;138:150.
24. Cha S-H, et al. *Vet Microbiol.* 2006;117:248.
25. Frossard J-P, et al. *Vet Microbiol.* 2012;158:308.
26. Frossard J-P, et al. *Vet Microbiol.* 2013;162:507.
27. Mateu E, et al. *Virus Res.* 2006;115:198.
28. Prieto C, et al. *Vet J.* 2009;180:363.
29. Carlsson U, et al. *Transbound Emerg Dis.* 2009;56:121.
30. Amonsin A, et al. *Viol J.* 2009;6:143.
31. Tian K, et al. *PLoS ONE.* 2007;2:3526.
32. Xiao XL, et al. *J Virol Methods.* 2008;149:49.
33. Normile D. *Science.* 2007;317:1017.
34. Feng Y, et al. *Emerg Infect Dis.* 2008;14:1774.
35. Wu J, et al. *Arch Virol.* 2009;154:1589.
36. Li B, et al. *Vet Microbiol.* 2010;146:226.
37. Wang L, et al. *J Virol.* 2012;86:13121.
38. Zhang G, et al. *J Virol.* 2012;86:11396.
39. Li B, et al. *J Clin Microbiol.* 2011;49:3175.
40. Kim HK, et al. *Vet Microbiol.* 2011;150:230.
41. Kim S-H, et al. *Vet Microbiol.* 2010;143:394.
42. Miller LC, et al. *Vet Res.* 2012;8:208.
43. Xiao S, et al. *BMC Genomics.* 2010;11:544.
44. Hu SP, et al. *Transbound Emerg Dis.* 2012;60:351.
45. Lv J, et al. *J Gen Virol.* 2008;89:2075.
46. Shen J, et al. *Genome Announc.* 2013;1:e00486-13.
47. Zhou L, et al. *Virus Res.* 2009;145:97.
48. Zhou Y-J, et al. *Virus Res.* 2009;144:136.
49. Yu X, et al. *Vet Microbiol.* 2012;158:291.
50. Metwally S, et al. *Transbound Emerg Dis.* 2010;57:315.
51. Guo B, et al. *Virology.* 2013;446:238.
52. Song T, et al. *J Virol.* 2012;86:4040.
53. Guo B, et al. *Virology.* 2013;435:372.
54. Descotes J, Gourand A. *Expert Opin Drug Metab Toxicol.* 2008;4:1537.
55. Tarrant JM. *Toxicol Sci.* 2010;117:4.
56. Sun Y, et al. *Viruses.* 2012;4:424.
57. Behrens EM, et al. *J Clin Invest.* 2011;121:2264.
58. Nieuwehuis N, et al. *Vet Rec.* 2012;170:225.
59. Corbellini LG, et al. *Vet Microbiol.* 2006;118:267.
60. Lopez-Soria S, et al. *Transbound Emerg Dis.* 2010;57:171.
61. Reiner G, et al. *Vet Microbiol.* 2009;136:250.
62. Greiser-Wilke I, et al. *Vet Microbiol.* 2010;143:213.
63. Kinman TG, et al. *Vaccine.* 2009;8:2704.
64. Rosendal T, et al. *Can J Vet Res.* 2010;74:118.
65. Brar MS, et al. *J Gen Virol.* 2011;92:1391.
66. Evans CM, et al. *Vet Res.* 2008;4:48.
67. Holtkamp DJ, et al. *Prev Vet Med.* 2010;96:186.
68. Lambert M-E, et al. *Vet Res.* 2012;8:76.
69. Velasova M, et al. *Vet Res.* 2012;8:184.
70. Lewis CRG, et al. *J Anim Sci.* 2009;87:876.
71. Doeschl-Wilson AB, et al. *J Anim Sci.* 2009;87:1638.
72. Badaoui B, et al. *BMC Vet Res.* 2013;9:58.
73. Kwong GPS, et al. *Prev Vet Med.* 2013;110:405.
74. Charpin C, et al. *Vet Res.* 2012;43:69.
75. Evans CM, et al. *Prev Vet Med.* 2010;93:248.
76. Dee S, et al. *Can J Vet Res.* 2006;69:64.
77. Pitkin A, et al. *Vet Microbiol.* 2009;136:1.
78. Hermann J, et al. *Vet Res.* 2007;38:81.
79. Otake S, et al. *Vet Microbiol.* 2010;145:198.
80. Pitkin A, et al. *Vet Microbiol.* 2009;136:1.
81. Cho JG, et al. *Can J Vet Res.* 2006;70:297.
82. Pitkin A, et al. *Vet Microbiol.* 2009;136:1.
83. Cutler TD, et al. *Vet Microbiol.* 2011;151:229.
84. Dee S, et al. *Vet Res.* 2009;40:39.
85. Pitkin A, et al. *Can J Vet Res.* 2009;73:298.
86. Cano JP, et al. *Vet Rec.* 2007;160:907.
87. Molina RM, et al. *Transbound Emerg Dis.* 2008;56:1.
88. Pitkin A, et al. *Can J Vet Res.* 2009;73:91.
89. De Baere MI, et al. *Vet Res.* 2012;43:47.
90. Wang X, et al. *Arch Virol.* 2007;152:289.
91. Gomez-Laguna J, et al. *Transbound Emerg Dis.* 2012;10:1865.
92. Klionsky DJ. *Nat Rev Mol Cell Biol.* 2007;8:931.
93. Liu Q, et al. *Virology.* 2012;429:136.
94. Butler JE, et al. *J Immunol.* 2007;178:6320.
95. An T-Q, et al. *Vet Microbiol.* 2010;143:371.
96. Kim JK, et al. *J Virol.* 2006;80:689.
97. De Baere MI, et al. *Vet Res.* 2012;43:47.
98. Welch S-K, Calvert JG. *Virus Res.* 2010;154:98.
99. Calvert JG, et al. *J Virol.* 2007;81:7371.
100. Cafruny WA, et al. *Viol J.* 2007;3:90.
101. Lee YJ, Lee C. *Vet Immunol Immunopathol.* 2012;150:213.
102. Patton JB, et al. *Virus Res.* 2009;140:161.
103. Gruenberg J, van der Goot FG. *Nat Rev Mol Cell Biol.* 2006;7:495.
104. Misinzio GM, et al. *Vet Res.* 2008;39:55.
105. Van Gortp H, et al. *Arch Virol.* 2009;154:1939.
106. Van Breedam W, et al. *J Gen Virol.* 2010;91:1659.
107. Music N, Gagnon CA. *Anim Health Res Rev.* 2010;11:135.
108. Lee C, et al. *Virology.* 2006;346:238.
109. Pei Y, et al. *Virus Res.* 2008;135:107.
110. Kwon B, et al. *Virology.* 2008;380:371.
111. Wang C, et al. *Vet Microbiol.* 2008;131:339.
112. Faaberg KS, et al. *Virus Res.* 2010;154:77.
113. Rowland RR. *Virus Res.* 2010;154:1.
114. Zhang X, Moser DM. *J Pathol.* 2008;214:161.
115. Lee YJ, Lee C. *Virus Res.* 2010;152:50.
116. Lee C, Yoo D. *Virology.* 2006;355:30.
117. Du Y, et al. *Virus Res.* 2010;147:294.
118. Chang HC, et al. *Vet Microbiol.* 2008;129:281.
119. Flores-Mendoza L, et al. *Clin Vaccine Immunol.* 2008;15:720.
120. Loving CI, et al. *Immunology.* 2007;120:217.
121. Gimeno M, et al. *Vet Res.* 2011;42:9.
122. Gomez-Laguna J, et al. *J Comp Pathol.* 2010;142:51.
123. Zhang Y, et al. *Vet Microbiol.* 2012;160:473.
124. Sagong M, Lee C. *Virus Res.* 2010;151:88.
125. Li Y, et al. *J Gen Virol.* 2012;93:829.
126. Chaung H-C, et al. *Comp Immunol Microbiol Infect Dis.* 2010;33:197.
127. Liu C-H, et al. *Vet Microbiol.* 2009;136:266.
128. Manickam C, et al. *Vet Microbiol.* 2013;162:68.
129. Silva-Campo E, et al. *Virology.* 2012;430:73.
130. Pintaric M, et al. *Vet Immunol Immunopathol.* 2008;121:61.
131. Lodoen MB, Lainier LL. *Curr Opin Immunol.* 2006;18:391.
132. Costers S, et al. *Arch Virol.* 2008;153:1453.
133. Cao J, et al. *Vet Microbiol.* 2013;164:261.
134. Caliguri MA. *Blood.* 2008;112:461.
135. Renukaradhya GJ, et al. *Viral Immunol.* 2010;23:457.
136. Dvivedi V, et al. *Viol J.* 2012;9:45.
137. Cecere TE, et al. *Vet Microbiol.* 2012;160:233.
138. Silva-Campo E, et al. *Virology.* 2009;387:373.
139. Silva-Campo E, et al. *Virology.* 2010;396:264.
140. Silva-Campo E, et al. *Virology.* 2012;85:23.
141. Rodriguez-Gomez IM, et al. *Transbound Emerg Dis.* 2013;60:425.
142. Halstead SB, et al. *Lancet Infect Dis.* 2010;10:712.
143. Belkaid Y. *Nat Rev Immunol.* 2007;7:875.
144. Dwivedi V, et al. *Vaccine.* 2011;29:4067.
145. LeRoith T, et al. *Vet Immunol Immunopathol.* 2011;140:312.
146. Wongyanin P, et al. *Vet Immunol Immunopathol.* 2010;132:170.
147. Silva-Campo E, et al. *Virology.* 2012;430:73.
148. Chen Z, et al. *J Gen Virol.* 2010;91:1047.
149. Costers S, et al. *Vet Res.* 2009;40:46.
150. Gomez-Laguna J, et al. *Comp Immunol Microbiol Infect Dis.* 2011;34:143.
151. Subramaniam S, et al. *Virology.* 2010;406:270.
152. Subramaniam S, et al. *Virology.* 2012;432:241.
153. Barranco I, et al. *Vet Immunol Immunopathol.* 2012;149:262.
154. Gomez-Laguna J. *Vet Microbiol.* 2012;158:187.
155. Backus GS, et al. *Environ Health Perspect.* 2010;118:1721.
156. Diaz I, et al. *Vet Res.* 2012;43:30.
157. Weaver LK, et al. *J Leucocyte Biol.* 2007;81:663.
158. Hou J, et al. *Viol J.* 2012;9:165.
159. Gomez-Laguna J, et al. *Vet J.* 2013;195:148.
160. Lunnay JK, et al. *Virus Res.* 2010;154:185.
161. Beura LK, et al. *J Virol.* 2010;84:1574.
162. Subramaniam S, et al. *Proc 90th Meet Conf Res Work Anim Dis, Chicago 2009; Abstr.* 176.
163. Overend C, et al. *J Gen Virol.* 2007;88:925.
164. Bao D, et al. *Vet Immunol Immunopathol.* 2013;156:128.
165. Shi X, et al. *Virus Res.* 2010;153:151.
166. Calzada-Nova G, et al. *Vet Immunol Immunopathol.* 2010;135:20.
167. Peng Y-T, et al. *Vet Microbiol.* 2009;136:359.
168. Miguel JC, et al. *Vet Immunol Immunopathol.* 2010;135:314.
169. Klinge KL, et al. *Viol J.* 2009;6:177.
170. Dotti S, et al. *Res Vet Sci.* 2013;94:510.
171. Beura LK, et al. *J Virol.* 2011;85:12939.
172. Beura LK, et al. *J Virol.* 2010;84:1574.
173. Bowie AG, Unterholzer L. *Nat Rev Immunol.* 2008;8:911.
174. Kawai T, Akira S. *Int Immunol.* 2009;21:317.
175. Beura LK, et al. *Virology.* 2012;433:431.
176. Versteeg GA, GarciaSastre A. *Curr Opin Microbiol.* 2010;13:508.
177. Beura LK, et al. *J Virol.* 2010;84:1574.
178. Song C, et al. *Virology.* 2010;407:268.
179. Patel D, et al. *J Virol.* 2010;84:11405.
180. Li H, et al. *J Gen Virol.* 2010;81:2947.
181. Sun Z, et al. *J Virol.* 2010;84:7832.
182. Kimman TG, et al. *Vaccine.* 2009;27:315.
183. Nan Y, et al. *Virology.* 2012;43:261.
184. Yoo D, et al. *Virus Res.* 2010;154:48.
185. Zhou Y, et al. *Can J Vet Res.* 2012;76:255.
186. Chen Z, et al. *Virology.* 2010;198:87.
187. Huber JP, Farrar JD. *Immunology.* 2011;132:446.
188. Luo R, et al. *Mol Immunol.* 2008;45:2839.
189. Brockmeier SL, et al. *Viral Immunol.* 2009;22:173.
190. Brockmeier SL, et al. *Clin Vaccine Immunol.* 2012;19:508.
191. Kim O, et al. *Virology.* 2010;402:315.

192. Sagong M, Lee C. *Arch Virol*. 2011;156:2187.
193. Lee YJ, Lee C. *Virology*. 2012;427:80.
194. Ait-Ali T, et al. *Immunogenetics*. 2011;63:437.
195. Sun Z, et al. *J Virol*. 2012;86:3839.
196. Barranco I, et al. *Transbound Emerg Dis*. 2012;59:145.
197. Van Gorp H, et al. *J Gen Virol*. 2008;89:2943.
198. Dong S, et al. *Res Vet Sci*. 2012;93:1060.
199. Gudmundsdottir I, Risatti GR. *Virus Res*. 2009;145:145.
200. Hou J, et al. *Virus Res*. 2012;167:106.
201. Gomez-Laguna J, et al. *Comp Immunol Microbiol Infect Dis*. 2010;33:51.
202. Gomez-Laguna J, et al. *Vet Microbiol*. 2012;158:187.
203. Darwich L, et al. *Vet Microbiol*. 2011;150:49.
204. Mateu E, Diaz I. *Vet J*. 2008;177:345.
205. Dotti S, et al. *Res Vet Sci*. 2011;90:218.
206. Martinez-Lobo FJ, et al. *Vet Microbiol*. 2011;154:58.
207. Garcia-Nicolas O, et al. *Virus Res*. 2014;179:204.
208. Weesendorp E, et al. *Vet Microbiol*. 2013;163:1.
209. Weesendorp E, et al. *Vet Microbiol*. 2013;167:638.
210. Kim W-I, et al. *Vet Microbiol*. 2007;123:10.
211. Frydas IS, et al. *Vet Res*. 2013;44:73.
212. Wang G, et al. *Virol J*. 2014;11:2.
213. Wang G, et al. *Vet Immunol Immunopathol*. 2011;142:170.
214. Han K, et al. *J Comp Pathol*. 2012;147:275.
215. Hou J, et al. *Virus Res*. 2012;167:10.
216. Li L, et al. *Virol J*. 2012;9:203.
217. Cao J, et al. *J Vet Diagn Invest*. 2012;24:767.
218. Guo B, et al. *Virology*. 2013;435:372.
219. Mege JL, et al. *Lancet Infect Dis*. 2006;6:557.
220. Borghetti P, et al. *Comp Immunol Microbiol Infect Dis*. 2011;34:143.
221. Parcina M, et al. *J Immunol*. 2013;190:1591.
222. Butler JE, et al. *J Immunol*. 2007;178:6329.
223. Butler JE, et al. *J Immunol*. 2008;180:2347.
224. Sun XZ, et al. *Vaccine*. 2012;30:3646.
225. Parida R, et al. *Virus Res*. 2012;169:13.
226. Diaz I, et al. *Virus Res*. 2010;154:61.
227. Han J, et al. *J Virol*. 2010;84:10102.
228. Kinman TG, et al. *Vaccine*. 2009;27:3704.
229. Li J, Murtaugh MP. *Virology*. 2012;433:367.
230. Tong GZ, et al. *Emerg Infect Dis*. 2007;13:1434.
231. An T-Q, et al. *Emerg Infect Dis*. 2010;16:365.
232. Li L, et al. *Virus Res*. 2010;154.
233. Murtaugh M Proc 40th Ann Meet Am Assoc Swine Vet, Dallas, TX, 459.
234. Qiao S, et al. *Vet Microbiol*. 2011;149:213.
235. Diaz I, et al. *Vet Res*. 2012;43:30.
236. Jung K, et al. *J Gen Virol*. 2009;90:2713.
237. Wagner J, et al. *Vet J*. 2011;187:310.
238. Beilage EG, et al. *Tierartzl Prax*. 2007;35:294.
239. Cano JP, et al. *Can J Vet Res*. 2009;73:303.
240. Lewis CRG, et al. *Anim Prod Sci*. 2010;50:890.
241. Han K, et al. *J Comp Pathol*. 2013;148:396.
242. Karniyuchuk U, et al. *Microb Pathog*. 2011;51:194.
243. Karniyuchuk U, Nauwynck HJ. *Vet Res*. 2013;44:95.
244. Kang I, et al. *Res Vet Sci*. 2010;88:304.
245. Han K, et al. *Clin Vaccine Immunol*. 2012;19:319.
246. Burgara-Estrella A, et al. *Transbound Emerg Dis*. 2012;59:532.
247. Schulze M, et al. *Acta Vet Scand*. 2013;55:16.
248. Stadejek T, et al. *Vet Rec*. 2011;169:441.
249. Xiao S, et al. *BMC Genomics*. 2010;11:544.
250. Hu SP, et al. *Transbound Emerg Dis*. 2012;10:1865.
251. Lawson S, et al. *Vaccine*. 2010;28:5356.
252. Lee YJ, et al. *J Virol Methods*. 2010;163:410.
253. Wernike K, et al. *J Vet Diagn Invest*. 2012;24:855.
254. Rovira A, et al. *J Vet Diagn Invest*. 2007;19:502.
255. Gerber PF, et al. *J Clin Microbiol*. 2013;51:547.
256. Gerber PF, et al. *J Virol Methods*. 2014;197:63.
257. Li Q, et al. *J Virol Methods*. 2009;155:55.
258. Rovira A, et al. *J Vet Diagn Invest*. 2009;21:350.
259. Lurchachaiwong W, et al. *Lett Appl Microbiol*. 2008;46:55.
260. Balka G, et al. *J Virol Methods*. 2009;115:1.
261. Chen N-H, et al. *J Virol Methods*. 2009;161:192.
262. Ren X, et al. *J Clin Microbiol*. 2010;48:1875.
263. Van Breedam W, et al. *Vet Immunol Immunopathol*. 2011;141:246.
264. Diaz I, et al. *J Vet Diagn Invest*. 2012;24:344.
265. Kittawornrat A, et al. *Vet Res*. 2013;9:61.
266. Okinaga T, et al. *Vet Rec*. 2009;164:455.
267. Lin K, et al. *J Clin Microbiol*. 2011;49:3184.
268. Gutierrez AM, et al. *Vet Immunol Immunopathol*. 2009;132:218.
269. Gomez-Laguna J, et al. *Vet J*. 2010;85:83.
270. Kittawornrat A, et al. *Vet Microbiol*. 2014;168:331.
271. Chittick WA, et al. *J Vet Diagn Invest*. 2011;23:248.
272. Prickett JR, et al. *J Swine Health Prod*. 2008;16:86.
273. Prickett JR, et al. *J Vet Diagn Invest*. 2008;20:156.
274. Prickett JR, Zimmerman JJ. *Anim Health Res Rev*. 2010;10:1.
275. Ramirez A, et al. *Prev Vet Med*. 2012;104:292.
276. Kittawornrat A, et al. *Virus Res*. 2010;154:1700.
277. Ouyang K, et al. *Clin Vaccine Immunol*. 2013;20:1305.
278. Kittawornrat A, et al. *J Vet Diagn Invest*. 2012;24:262.
279. Olsen C, et al. *J Vet Diagn Invest*. 2013;25:328.
280. Kittawornrat A, et al. *J Vet Diagn Invest*. 2012;24:1057.
281. Costers S, et al. *Vet Res*. 2009;40:46.
282. Han K, et al. *Vet J*. 2013;195:313.
283. Gomez-Laguna J, et al. *Transbound Emerg Dis*. 2013;60:273.
284. Morgan SB, et al. *Vet Microbiol*. 2013;163:13.
285. Lee S-M, Kleiboeker SB. *Virology*. 2007;365:419.
286. He Y, et al. *Vet Microbiol*. 2012;160:455.
287. Grau-Roma L, Segales J. *Vet Microbiol*. 2007;119:144.
288. Han K, et al. *J Vet Diagn Invest*. 2012;24:719.
289. Stuart AD, et al. *Pig J*. 2008;61:42.
290. Jiang Y, et al. *Vet Res Commun*. 2010;34:607.
291. Rowland RR. *Sci Direct*. 2007;174:451.
292. Rowland RR, Morrison RB. *Transbound Emerg Dis*. 2012;59(suppl 1):55.
293. Mondaca-Fernandez E, Morrison RB. *Vet Rec*. 2007;161:137.
294. Wayne SR, et al. *J Am Vet Med Assoc*. 2012;240:876.
295. Liu Y, et al. *J Anim Sci*. 2013;91:5668.
296. Pitkin A, et al. *Vet Microbiol*. 2009;136:1.
297. Dee S, et al. *Vet Microbiol*. 2009;138:106.
298. Dee S, et al. *Vet Rec*. 2010;167:976.
299. Spronk G, et al. *Vet Rec*. 2010;166:758.
300. Alonso C, et al. *Vet Microbiol*. 2012;157:304.
301. Alonso C, et al. *Prev Vet Med*. 2013;112:109.
302. Alonso C, et al. *Prev Vet Med*. 2013;111:268.
303. Che TM, et al. *J Anim Sci*. 2011;89:3016.
304. Che TM, et al. *J Anim Sci*. 2012;90:2784.
305. Lambert M-E, et al. *Prev Vet Med*. 2012;104:74.
306. Rovira A, et al. *J Vet Diagn Invest*. 2007;19:492.
307. Han K, et al. *Clin Vaccine Immunol*. 2011;18:1600.
308. Charentantanakul W. *Vet Immunol Immunopathol*. 2009;129:1.
309. Linghua Z, et al. *Vaccine*. 2007;25:1735.
310. Zhang L, et al. *Vet Microbiol*. 2013;164:253.
311. Drexler CS, et al. *Vet Rec*. 2010;166:70.
312. Thanawongnuweh R, Suradhat S. *Virus Res*. 2010;154:133.
313. Kitkoon P, et al. *Vet Microbiol*. 2009;139:235.
314. Murtaugh MP, Genzow M. *Vaccine*. 2011;29:8192.
315. Martelli P, et al. *Vaccine*. 2007;25:3400.
316. Geldhof MF, et al. *Vet Microbiol*. 2013;167:260.
317. Scotti M, et al. *Vet J*. 2006;172:506.
318. Dwivedi V, et al. *Vaccine*. 2011;29:4058.
319. Robinson SR, et al. *Vet Microbiol*. 2013;164:281.
320. Borghetti P, et al. *Comp Immunol Microbiol Inf Dis*. 2011;34:143.
321. Roca M, et al. *Vet J*. 2012;193:92.
322. Delrue I, et al. *Vet Res*. 2009;40:62.
323. Vanhee M, et al. *Vet Res*. 2009;40:63.
324. Geldof MF, et al. *BMC Vet Res*. 2012;8:182.
325. Zhao Z, et al. *Vet Microbiol*. 2012;155:247.
326. Beilage EG, et al. *Prev Vet Med*. 2009;92:31.
327. de Lima J, et al. *Vaccine*. 2008;26:3594.
328. Fang Y, et al. *J Gen Virol*. 2008;89:3086.
329. Cano JP, et al. *Am J Vet Res*. 2007;68:565.
330. Zuckerman FA, et al. *Vet Microbiol*. 2007;123:69.
331. Cano JP, et al. *Vaccine*. 2007;25:4382.
332. Martinez-Lobo F, et al. *Vet Res*. 2013;44:115.
333. Huang YW, Meng XJ. *Virus Res*. 2010;154:141.
334. de Lima M, et al. *Virology*. 2006;353:410.
335. Vu HLX, et al. *Vaccine*. 2013;31:4330.
336. Cruz JLG, et al. *Virus Res*. 2010;154:150.
337. Pei Y, et al. *Virology*. 2009;389:91.
338. Huang Q, et al. *Vet Microbiol*. 2009;160:22.
339. Guoshan S, et al. *Vaccine*. 2007;25:4193.
340. Li J, et al. *Vaccine*. 2009;27:825.
341. Chia M-Y, et al. *Vet Microbiol*. 2010;146:189.
342. Cai J, et al. *J Vet Med Sci*. 2010;72:1035.
343. Yu X, et al. *Clin Vaccine Immunol*. 2013;20:613.
344. Genzow M, et al. *Can J Vet Res*. 2009;73:87.
345. Martelli P, et al. *Vet Microbiol*. 2013;162:358.
346. Ferrari L, et al. *Vet Immunol Immunopathol*. 2013;151:193.
347. Nan Y, et al. *Virology*. 2012;432:261.
348. Leng X, et al. *Clin Vaccine Immunol*. 2012;19:1199.
349. Tian Z-J, et al. *Vet Microbiol*. 2009;138:34.
350. Hu SP, et al. *Transbound Emerg Dis*. 2013;60:351.

## MENANGLE

This causative virus was first identified in a three-farm disease outbreak in New South Wales in 1997. It causes reproductive problems in pigs and congenital defects and has the fruit bat as an asymptomatic reservoir. It can cause a flu-like disease in man. Only one outbreak has been described. It normally lives asymptotically in fruit bats.

## ETIOLOGY

The causative agent is an RNA virus in the family Paramyxoviridae in the genus *Rubulavirus*. It is closely related to Tioman virus found in fruit bats on Tioman Island, Malaysia.

## EPIDEMIOLOGY

A variety of fruit bats are seropositive, including the gray-headed flying fox, black fruit bat, and spectacled fruit bat, but the virus has not been isolated from them. These fruit bats have been found in other areas of Australia as well as the original area around Menangle, New South Wales.

Bat feces and urine are probably the source of infection. Transmission from pig to pig is slow and probably requires close contact. In one building, it took a long time for the sows to become affected. It probably spreads from farm to farm via infected animals. There is no sign of persistent infection and no evidence of long-term virus shedding. Present evidence suggests that

virus survival in the environment is short because sentinel pigs placed in an uncleaned area did not seroconvert.

### CLINICAL SIGNS

There is no knowledge of the incubation period as yet. In the initial outbreak, clinical signs were seen only on the farrow-to-finish farm but infected pigs were found in all three farms.

The disease was an outbreak of reproductive disease with fetal death; fetal abnormalities including congenital defects, such as skeletal and neurologic defects<sup>1</sup>; mummified fetuses; stillborn fetuses; smaller litters with fewer live piglets; and a reduced farrowing rate. The farrowing rate fell from over 80% to around a low of 38% reaching an average of 60%. Many sows returned to estrus 28 days after mating, which suggests that there has been an early death of the litter. Some sows remain in pseudopregnancy for more than 60 days. It probably crosses the placenta and spreads fetus to fetus. Once the infection became endemic in the farrow-to-finish herd the reproductive failures ceased.

### PATHOLOGY

The mummified fetuses vary in size and are 30 days or older. The virus causes the degeneration of brain and spinal cord. In particular, the cerebral hemispheres and cerebellum are smaller. Occasionally there may be effusions and pulmonary hypoplasia. Eosinophilic inclusions are found in the neurons of the cerebrum and spinal cord. Sometimes there is a nonsuppurative meningitis, myocarditis, and hepatitis. Experimental infections show shedding 2 to 3 days after infection in nasal and oral secretions. A tropism for secondary lymphoid tissues and intestinal epithelium has been demonstrated.<sup>2</sup> No lesions have been seen in piglets born alive or other postnatal pigs.

### DIAGNOSIS

The diagnosis is suspected when the reproductive parameters change very suddenly, as shown earlier.

Diagnosis is confirmed by virus culture, and electron microscopy and virus neutralisation tests confirm the identity of the virus. Serologic tests include ELISAs, and the best way to test the herd is to use this for the sows for antibody.

### DIFFERENTIAL DIAGNOSIS

The differential diagnosis includes porcine parvo virus (PPV), classical swine fever (CSF), porcine reproductive and respiratory syndrome (PRRS), encephalomyocarditis virus (EMCV), pseudorabies virus (PRV), Japanese encephalitis, swine influenza virus (SIV), and blue eye. Noninfectious causes such as toxins or nutritional deficiencies should also be considered.

### TREATMENT

It seems likely that young pigs are infected by the virus when the maternal antibody concentration declines at 14 to 16 weeks of age. By the time they enter the breeding herd their immunity is quite strong.

### CONTROL

The best advice is to avoid contact with all fruit bats.

### FURTHER READING

Philbey AW, et al. An apparently new virus (family *Paramyxoviridae*) infection for pigs, humans and fruit bats. *Emerg Infect Dis.* 1998;4:269.

### REFERENCES

1. Philbey AW, et al. *Aust Vet J.* 2007;85:134.
2. Bowden TR, et al. *J Gen Virol.* 2012;93:1007.

## JAPANESE ENCEPHALITIS (JE; JAPANESE B ENCEPHALITIS)

Japanese encephalitis is an infectious disease primarily affecting horses and to a lesser extent pigs, with important zoonotic potential. It causes in excess of 50,000 human cases a year, with a case mortality rate of 25%. The condition in equides is associated with encephalitis and is covered in detail in [Chapter 14](#) under Japanese encephalitis. In pigs the condition is associated with reproductive failure, which is covered hereunder.

### ETIOLOGY

The causative agent is the Japanese encephalitis virus of the family *Flaviviridae*, genus *flavivirus*. Based on the phylogenetic analysis of the viral envelope “E” gene, 5 different genotypes have been identified.

### EPIDEMIOLOGY

The natural distribution range of the virus is southeast Asia and Australasia. The vectors are *Culex* spp and in particular *C. tritaeniorhynchus*. The virus activity is naturally maintained through bird–mosquito cycles with the heron family in particular. The night herons, little egrets and plumed egrets are particularly active as a reservoir. Pigs are important “amplifying hosts.” Pigs and these birds may allow the overwintering of the virus when mosquitoes are absent.

### PATHOGENESIS

Viremia results from the mosquito bite and usually nothing is seen. Occasionally there may be a mild fever, but quite often the virus goes straight to the testicles and causes an orchitis.

### CLINICAL SIGNS

Fetal death is common with mummified fetuses as well as stillborn and weak pigs. Boars undergo reproductive failure.

### PATHOLOGY

Largely related to the abnormal fetuses.

### DIAGNOSIS

RT-PCR and nested RT-PCR can be used to detect the virus when virus isolation is negative. Antibody can be detected by haemagglutination inhibitor, ELISAs (IgM capture ELISA), and latex agglutination tests.

### CONTROL

Live attenuated vaccines should be given to breeding stock 2 to 3 weeks before the start of the mosquito season. Attenuated and adjuvanted vaccines are also available.

### FURTHER READING

Mackenzie JS, Williams DT. The zoonotic flaviviruses of southern, southeastern and eastern Asia and Australasia: The potential for emergent viruses. *Zoonoses Public Health.* 2009;56:338.

## NEOSPOROSIS

### SYNOPSIS

**Etiology** The protozoan parasite *Neospora caninum*; the dog is identified as the definitive host of *N. caninum*, but the main route of infection in cattle appears to be by vertical transmission.

**Epidemiology** An infection of cattle worldwide and associated with epidemic and endemic abortion. Point source and congenital infections occur.

**Clinical findings** Abortion in cows and perinatal mortality and encephalomyelitis in congenitally infected calves.

**Clinical pathology** Serologic testing of maternal serum and fetal fluids.

**Necropsy findings** Fetal lesions of multifocal nonsuppurative encephalitis, myocarditis, and/or periportal hepatitis. Infection confirmed by immunohistochemistry or polymerase chain reaction-based tools.

**Diagnostic confirmation** A presumptive diagnosis can be based on the fetal histologic lesions and seropositivity of the dam, but the definitive diagnosis requires the demonstration of the parasite in fetal tissues by immunohistochemical labeling, coupled with serologic examinations.

**Control** Feed hygiene and calving hygiene. Cull congenitally infected cattle.

### ETIOLOGY

*Neospora caninum* is a cyst-forming coccidial (apicomplexan) parasite with an indirect life cycle.<sup>1-9</sup> *N. caninum* primarily infects dogs and cattle; however, it has a **wide host range** and infects all major domestic livestock species as well as companion animals and some wildlife animals. Dogs are the definitive host and cattle the major intermediate host. Natural infection is infrequently reported in sheep, goats, and deer.<sup>1-3</sup> *N. caninum* is a sporadic cause of



encephalomyelitis and myocarditis in several species, but its principal importance is its association with **endemic and epidemic abortion in cattle**. It is now the most common diagnosis for abortion in cattle in most countries.

## EPIDEMIOLOGY

### Occurrence

*N. caninum* was initially associated with abortion in the early 1990s in pastured cattle in Australia and New Zealand and as a major cause of abortion in dairies in the United States. Since then, abortion associated with *N. caninum* has been reported in many countries in cattle under varying management conditions and has a **worldwide occurrence**.<sup>2,3</sup>

Abortion may be **epizootic or sporadic**. In epizootic abortion, the number of cows aborting varies. It is usually between 5% and 10%, but up to 45% of cows may abort within a short period. The period of abortion may be a few weeks to a few months. There is no major seasonal occurrence, and abortion occurs in both beef and dairy cows. Sporadic abortions occur mainly in cows that have been infected congenitally, and seropositive cows have greater risk for repeat abortions. Seropositivity in herds can be high but varies considerably. Seropositive dams have a 3- to 7-fold greater risk of abortion than seronegative dams.

### Methods of Transmission

There are two routes of infection of cattle. The dog is the definitive host of *N. caninum*. Infection of cattle can occur via the ingestion of oocytes from dog feces contaminating feed or water. However, vertical (i.e., congenital) transmission occurs in both cattle and dogs, and vertical transmission appears the major route for infection in most cattle.<sup>1,3</sup> Live-born calves from congenitally infected cows are themselves congenitally infected; the infection is thought to be **persistent and lifelong**. A study conducted on two dairies found 81% of seropositive cows gave birth to congenitally infected calves.<sup>1</sup> Seroprevalence did not increase with cow age and was stable through the study period. The probability of a calf being congenitally infected was not associated with dam age, dam lactation number, dam history of abortion, calf gender, or length of gestation. Other studies have shown that this route of transmission is highly efficient, resulting in infection of 50% to 95% of the progeny of seropositive dams.

Congenital infection can result in abortion or the birth of a “normal,” infected calf, and an infected cow can give birth to a clinically normal, infected calf at one pregnancy and abort in the subsequent pregnancy.<sup>2,3</sup> The occurrence of infection in some herds can be associated with specific family lines.

Although vertical transmission is the major route of infection that leads to

sporadic abortions in cattle associated with *N. caninum*, epidemiologic evidence suggests that postnatal (point) infection is often the cause of outbreaks of abortion. Where dog feces are the source of infection, many cattle are often exposed, and this point source of infection commonly results in outbreaks of abortion. Farm dogs have been shown to have a higher seroprevalence to *N. caninum* than urban dogs, suggesting that neosporosis cycles between cattle and dogs in rural environments.<sup>4</sup>

The importance of postnatal infection versus vertical infection in the genesis of abortion may vary among countries, and be associated with differences in farm management systems.<sup>4</sup>

### Experimental Studies

Abortion has been produced by experimental challenge of fetuses and pregnant cattle with culture-derived tachyzoites of *N. caninum*.<sup>1</sup> Fetal death and resorption or abortion has been reproduced in ewes challenged at 45, 65, and 90 days' gestation, but not 120 days, and lesions resemble those of ovine toxoplasmosis.<sup>2</sup> The disease has also been reproduced experimentally in goats,<sup>1</sup> but the importance and prevalence of this infection in naturally occurring abortions in small ruminants remains to be determined. Contaminated placenta, milk, and colostrum can result in infection of calves less than 1 week of age.

### Risk Factors

Outbreaks of abortion often appear to be point source infections, but the risk factors, other than probable mass exposure to dog feces containing sporulated *N. caninum* oocysts, are not known. Neosporosis in dairy herds often occurs as an epizootic, with multiple abortions occurring in a 1- to 2-month period. Severely autolytic fetuses are aborted between 5 and 7 months of pregnancy in most reports, but earlier or later abortions can occur (range is between 3 and 8.5 months of pregnancy).

Endemic abortion is more likely associated with the presence of **congenitally infected** cattle in the herd, which are at **high risk of aborting**, particularly in the initial pregnancy and in the pregnancy during the first lactation.<sup>2,3</sup> Cows that have aborted have a higher risk for abortion in subsequent pregnancies, but this risk decreases with each subsequent pregnancy. It has been postulated that immunosuppression resulting from concurrent infection with other agents, such as bovine viral diarrhea virus (BVD), may increase the risk for infection with *N. caninum* and precipitate abortion outbreaks.

### Economic Importance

Economic losses relate to abortion and costs associated with establishing the diagnosis and rebreeding or replacement costs.<sup>5</sup> Seropositivity is also associated with increased risk of

stillbirth and increased risk of retained placenta. Losses associated with epidemic abortion have been estimated at tens (20–85) of millions of dollars to the dairy or beef industries in Australasia and the United States.

Although seropositive heifers have been reported to produce less milk than seronegative herd mates, this difference in milk production between seropositive and seronegative animals is not necessarily apparent in herds unaffected by an abortion problem. Study of beef cattle has suggested that seropositivity might be associated with reduction in average daily weight gain, but production performance and carcass measures are not consistently reported to be affected.

## PATHOGENESIS

*N. caninum* has a predilection for fetal chorionic epithelium and fetal placental blood vessels, producing a fetal vasculitis and inflammation and degeneration of the chorioallantois, and widespread necrosis in the placentome.<sup>6</sup> Tachyzoites penetrate host cells and are located in a parasitophorous vacuole. They can be found in macrophages, monocytes, vascular endothelial cells, fibroblasts, hepatocytes, renal tubular cells, and in the brain of infected animals. With neuromuscular disease, cranial and spinal neural cells are infected. Cell death is caused by the replication of tachyzoites (during endodyogeny).

## CLINICAL FINDINGS

Abortion is the cardinal clinical sign observed in infected cows.<sup>2,3</sup> Fetuses may die in utero, or can be reabsorbed, mummified, stillborn, born alive but diseased, or born clinically normal but infected. Cows that are infected can have **decreased milk production** in the first lactation, producing approximately 1 L less of milk per cow per day than uninfected cows, are prone to abort, and have a higher risk of being culled from the herd at an early age.

In addition to the occurrence of early abortion, the disease in beef herds is associated with the birth of live-born, premature, **low birthweight** calves. Depending on the degree of prematurity, these calves can be kept alive with intensive care during the neonatal period.

Most congenitally infected calves are born alive without clinical signs. Occasionally, congenital infection can be manifest with ataxia, loss of conscious proprioception, paralysis, and/or other **neurologic deficits** in new-born calves,<sup>2</sup> but most congenitally infected calves appear as clinically normal and, surprisingly, some evidence suggests that congenital infection does not necessarily have a detrimental effect on calf health and survival.<sup>3</sup>

*N. caninum* infection has been demonstrated in the nervous system of a **horse** with progressive debilitation, followed by a sudden onset of neurologic disease with paraplegia. It appears to be a rare cause of

neurologic disease in horses, but should be considered in the differential diagnosis of equine protozoal myeloencephalitis.

### CLINICAL PATHOLOGY

Serologic testing can be conducted using IFAT or ELISA, and there appears to be good agreement in results between the two tests. ELISA using recombinant protein appears to have a higher diagnostic specificity and sensitivity than using whole-tachyzoite lysates.<sup>7</sup> IFAT is commonly used and achieves a relatively high diagnostic specificity and sensitivity for the detection of maternal infection.<sup>7</sup> The persistence of serum antibody titers following infection is uncertain, and they might fluctuate during pregnancy. A positive titer in a cow that has aborted indicates exposure but not causality. IgG avidity patterns have been used to predict the duration of infection. Diagnosis can also be conducted by detecting anti-*N. caninum* antibody or genomic DNA of *N. caninum* in fetal pleural fluid or sera.<sup>7</sup>

### NECROPSY FINDINGS

Gross findings are not specific and the fetus may be fresh, autolyzed, or in early stages of mummification; in the placenta, the cotyledons are usually necrotic.<sup>10</sup> The brain may be autolyzed, but should still be submitted for examination as well as the heart, liver, and placenta, if available. Histologic findings commonly relate to multifocal nonsuppurative encephalitis, myocarditis hepatitis, and/or placentitis. Liver lesions may be more prominent in epizootic abortions. IHC or PCR can be used to detect tachyzoites or their DNA in tissues (particularly in the brain).<sup>7</sup> IHC can be specific, but insensitive for identifying *Neospora* in the placenta; therefore, maternal serology should be used in conjunction.

### TREATMENT

There is no treatment that can be used to curtail an ongoing abortion epidemic. Possible drug therapies are generally not considered an option because of likely unacceptable milk and meat residues and withdrawal problems.

#### DIFFERENTIAL DIAGNOSIS

Serology and/or polymerase chain reaction can confirm infection in individual cows.

Because of the high prevalence of infection, and the occurrence of congenital infection, care must be taken in extrapolating the results of a single positive diagnosis to problems of abortion. The high rate of natural congenital infection means that evidence of infection in an aborted fetus is not proof of causation of abortion, and fetal examination should be coupled to serologic examination of aborting and nonaborting animals in the herd to assess statistical differences.

- Other causes of abortion in cattle
- Weak calf syndrome

### CONTROL

All efforts should be made to exclude the possibility of dog fecal contamination of cattle feed and water and of the grazing environment.<sup>4</sup> Placentas, aborted fetuses, and dead calves should be removed immediately and disposed of so that the definitive host and cattle cannot gain access to them.

Congenitally infected cows are at high risk of abortion, and abortion rates in infected herds can be substantially reduced by culling infected animals.<sup>2-4</sup> Congenitally infected calves can be identified by testing precolostral blood samples using a specific and sensitive serologic test and culled at a young age. If precolostral blood sampling is not feasible, examination of sera at 6 months of age should identify infected calves, with positive titers indicating either congenital infection or postnatal infection. Calves introduced into a herd should be seronegative.

It is possible that strategic therapy of pregnant cows with an appropriate antiprotozoal drug could abort the infection. This could be effective in beef cattle, but would probably not be legal or appropriate in lactating dairy cattle.

Although evidence for increased risk for *Neospora* abortion caused by immunosuppression resulting from concurrent infection with BVD virus is equivocal, control of BVD infections should be a component of anti-neosporosis control.

There has been a considerable effort to develop vaccines against neosporosis.<sup>8,9</sup> An inactivated tachyzoite vaccine was approved in the United States for use in pregnant cows. There are no controlled studies on its efficacy in mitigating the effects of bovine neosporosis in dairy cattle. Vaccination of dairy cattle may interfere with a herd test and cull policy.

### FURTHER READING

- Goodswen SJ, Kennedy PJ, Ellis JT. A review of the infection, genetics, and evolution of *Neospora caninum*: from the past to the present. *Infect Genet Evol.* 2003;13:133-150.
- Gondim LF. *Neospora caninum* in wildlife. *Trends Parasitol.* 2006;22:247-252.
- Hemphill A, Vonlaufen N, Naguleswaran A. Cellular and immunological basis of the host-parasite relationship during infection with *Neospora caninum*. *Parasitology.* 2006;133:261-278.
- Innes EA. The host-parasite relationship in pregnant cattle infected with *Neospora caninum*. *Parasitology.* 2007;134:1903-1910.
- Innes EA, Bartley PM, Maley SW, Wright SE, Buxton D. Comparative host-parasite relationships in ovine toxoplasmosis and bovine neosporosis and strategies for vaccination. *Vaccine.* 2007;25:5495-5503.
- Williams DJ, Hartley CS, Björkman C, Trees AJ. Endogenous and exogenous transplacental transmission of *Neospora caninum*—how the route of transmission impacts on epidemiology and control of disease. *Parasitology.* 2009;136:1895-1900.

### REFERENCES

1. Radostits O, et al. Diseases associated with protozoa. In: *Veterinary Medicine: A Textbook of the*

2. Dubey JP, Lindsay DS. *Vet Clin North Am Food Anim Pract.* 2006;22:645.
3. Dubey JP, Schares G. *Vet Parasitol.* 2011;180:90.
4. Dubey JP, et al. *Clin Microbiol Rev.* 2007;20:323.
5. Reichel MP, et al. *Int J Parasitol.* 2013;43:133.
6. Dubey JP, et al. *J Comp Pathol.* 2006;134:267.
7. Dubey JP, Schares G. *Vet Parasitol.* 2006;140:1.
8. Innes EA, Vermeulen AN. *Parasitology.* 2006;133(suppl):S145.
9. Reichel MP, Ellis JY. *Int J Parasitol.* 2009;39:1173.
10. Schlafer DH, Miller RB, Maxie MG, eds. Female genital system. In: *Jubb, Kennedy and Palmer's Pathology of Domestic Animals.* Vol. 3. 5th ed. Edinburgh, UK: Saunders; 2007:429.

## DOURINE (MALADIE DU COIT)

### SYNOPSIS

**Etiology** *Trypanosoma equiperdum*.

**Epidemiology** Venereal disease of horses, mules, and donkeys, endemic in southern and northern Africa, Asia, and possibly South and Central America.

**Clinical signs** Primary genital signs, secondary cutaneous signs, and tertiary nervous signs and emaciation.

**Lesions** Edematous swelling and later, depigmentation of external genitalia, emaciation, anemia, and subcutaneous edema.

#### Differential diagnosis list

- Nagana
- Surra
- Coital exanthema
- Equine infectious anemia.
- Purulent endometritis

**Treatment** Chronic cases unresponsive to trypanocides and may become carriers. Treatment is thus not recommended.

**Control** Elimination of reactors, control of breeding and movement of animals in affected regions or countries.

### ETIOLOGY

*Trypanosoma equiperdum* belongs to the *brucei* group, subgenus *Trypanozoon*, but occurs only as long, slender, and monomorphic form. It may be more appropriately referred to as *T. brucei equiperdum*. Unlike *T. brucei*, *brucei*, it has lost part of its kinetoplast DNA (hence dyskinetoplastic). The parasite is morphologically indistinguishable from *T. evansi* in blood smears. *T. equiperdum* is the only pathogenic trypanosome that does not require an arthropod vector for its transmission. It resides more in extra vascular tissue fluid than in blood.

### EPIDEMIOLOGY

#### Occurrence

Dourine is endemic in Asia, Africa, southeastern Europe, and Central America. It has been eradicated from North America, and strict control measures have reduced the

incidence to a low level in most parts of Europe. It occurred in Italy in 2011.<sup>1</sup> The disease is endemic in parts of Ethiopia and Namibia and is rarely reported in other parts of sub-Saharan Africa. It has not been reported in Latin America for over 20 years. It is possible that lack of reporting in some countries may be caused by very strict international regulations that tend to discourage official notification of the disease. All Equidae are susceptible, and natural infection is known to occur only in horses, mules, and donkeys. In Ethiopia, the disease is more prevalent during the breeding season from June to September.<sup>2</sup>

### Measures of Disease Occurrence

In most countries, dourine now occurs only sporadically; its prevalence has declined generally because the horse is no longer that important militarily, economically, and agriculturally, and because of strict control measures in many countries. A recent survey of 237 horses from an endemic area of Ethiopia showed that infection rates varied with the method of examination.<sup>3</sup> The rates were 4.6% based on standard parasitologic methods, 27.6% on serology, and up to 47.6% on DNA detection by PCR. This was the first time in more than 30 years that a fresh strain of *T. equiperdum* was isolated from clinical cases of dourine. Case mortality varies; in Europe, it may be as high as 50% to 70%, but it is much lower elsewhere, although many animals may have to be destroyed as a means of control.

### Methods of Transmission

Natural transmission occurs only by coitus, but infection can also be acquired through intact oral, nasal, and conjunctival mucosae in foals at birth. The source of infection may be an infected stallion or mare actively discharging trypanosomes from the urethra or vagina, or an uninfected male acting as a physical carrier after serving an infected mare. The trypanosomes inhabit the urethra and vagina but disappear periodically so that only a proportion of potentially infective matings result in infection. Invasion occurs through intact mucosa, and no abrasion is necessary.

### Risk Factors

*T. equiperdum* is incapable of surviving outside the host. Like other trypanosomes, it also dies quickly in cadavers. Some animals, especially donkeys and mules, may be clinically normal but act as carriers of the infection for many years. Because the disease does not require an arthropod vector for its transmission, and in view of the extensive movement of horses across continents that now takes place, the risk of infection, though small, is present in every country, as with any other venereal disease. Thoroughbred horses are more susceptible than indigenous horses, and donkeys tend to show more chronic signs.

### Immune Mechanisms

Infected animals produce antibodies to successive antigenic variants, as in *T. brucei*. Recovered animals often become carriers. Blood from infected horses is rarely infective to other horses, and the disease is not easily transmitted to ruminants under experimental conditions. Humans are not affected.

### Biosecurity Concerns

There are none except when animals have to be moved internationally.

### PATHOGENESIS

*T. equiperdum* shows a remarkable tropism for the mucosa of genital organs, the subcutaneous tissues, and the peripheral and CNSs. Trypanosomes deposited during coitus penetrate the intact genital mucosa, multiply locally in the extracellular tissue space, and produce an edematous swelling that may later undergo fibrosis. Subsequent systemic invasion occurs, and localization in other tissues causes vascular injury and edema, manifested clinically by subcutaneous edema. Invasion of the peripheral nervous system and the spinal cord leads to incoordination and paralysis.

### CLINICAL FINDINGS

The severity of the clinical syndrome varies depending on the strain of the trypanosome and the general health of the horse population. The disease in Africa and Asia is much more chronic than in South America or Europe and may persist for many years, often without clinical signs, although these may develop when the animals' resistance is lowered by other disease or malnutrition.

The incubation period varies between 1 and 4 weeks, but could extend to more than 3 months in some animals. Initial signs may not be recognized until the breeding season. The ensuing disease will manifest genital signs in the primary stage, cutaneous signs in the secondary stage, and nervous signs in the tertiary stage.

In stallions, the **initial signs** are swelling and edema of the penis, scrotum, prepuce, and surrounding skin, extending as far forward as the chest. Paraphimosis may occur, and inguinal lymph nodes are swollen. There is a moderate mucopurulent urethral discharge. In mares, the edema commences in the vulva and is accompanied by a profuse fluid discharge, hyperemia, and sometimes ulceration of the vaginal mucosa. The edema spreads to the perineum, udder, and abdominal floor. In Europe, the disease is more severe; genital tract involvement is often accompanied by sexual excitement and more severe swelling.

In the **secondary stage**, cutaneous urticaria-like plaques, 2 to 5 cm in diameter, develop on the body and neck and disappear within a few hours up to a few days. These so-called silver dollar spots are pathognomonic for dourine but are not always present

and are uncommon in endemic areas. Succeeding crops of plaques may result in persistence of the cutaneous involvement for several weeks.

Progressive anemia, emaciation, weakness, and nervous signs that appear at a variable time after genital involvement characterize the **tertiary stage**. Stiffness and weakness of the limbs are evident and incoordination develops, progressing terminally to ataxia and paralysis. Marked atrophy of the hindquarters is common, and in all animals there is loss of condition, in some to the point where extreme emaciation necessitates destruction. Lack of coordination of the hind legs, swelling of the external genitalia, and emaciation were the most common clinical signs in horses suspected to have dourine in Ethiopia.

### CLINICAL PATHOLOGY

Trypanosome detection is difficult, but should be attempted in edema fluid, subcutaneous plaques, and vaginal or urethral washings or blood in early stages. Inoculation of blood into laboratory rodents is not as helpful as with other members of the *brucei* group.

An efficient CFT is available and was the basis for a successful eradication program in Canada. However, the test does not distinguish between members of the *brucei* group. Other serologic tests that can be used include the IFAT, the capillary agglutination test for trypanosomes, and the ELISA, but the CFT remains the most reliable. Serologic tests do not distinguish between members of the *brucei* group; hence they are of limited value in areas where *T. brucei* or *T. evansi* is endemic, even when monoclonal antibodies are used. In recent interlaboratory ring trials to evaluate serologic methods for dourine diagnosis, 9 out of 22 laboratories observed a false-positive result with a known *T. evansi*-positive serum, whether by CFT or IFAT.<sup>4</sup> However, diagnosis can be made based on serologic tests and characteristic clinical signs under the right epidemiologic setting.<sup>2</sup>

PCR has been used to detect trypanosome DNA and is an indication of an active infection, unlike serologic tests that detect past and current infections. Still, the PCR test cannot yet distinguish *T. equiperdum* from *T. evansi* or *T. brucei*.<sup>5,6</sup>

With the recent isolation of new strains of *T. equiperdum* from clinical cases in Ethiopia,<sup>3</sup> the first in 4 decades worldwide, there is hope that new internationally recognized tests for the diagnosis of dourine will be developed soon.

### NECROPSY FINDINGS

Emaciation, anemia, and subcutaneous edema are always present, and edema of the external genitalia may be evident or the external genitalia may have healed, leaving the characteristic depigmented scars of permanent leukodermic patches. Lymph nodes



are enlarged, and there is softening of the spinal cord in the lumbosacral region.

Histologic lesions consist of lymphoplasmacytic infiltration in the spinal nerves, ganglia, and meninges of the lumbar and sacral regions and in affected skin and mucosa. Trypanosomes can be found in sections of the skin and genital mucosa during the primary and secondary phases of the infection. Affected lymph nodes show non-specific lymphoid hyperplasia.

### DIFFERENTIAL DIAGNOSIS

The full clinical syndrome is diagnostic, when present, because no other disease has the clinical and epizootiologic characteristics of dourine. However, when the full clinical picture is not developed, other diseases like nagana, surra, coital exanthema, equine infectious anemia, and purulent endometritis should be considered. With one exception, all recent reports of the disease have been based on clinical signs, serology, and detection of trypanosome DNA, but not on parasitologic detection.

### TREATMENT

#### TREATMENT AND CONTROL

None is recommended.

Many trypanocidal drugs have been used in the treatment of dourine, but results are variable, chronic cases in particular are unresponsive to treatment. The main drawback is that treated animals may remain inapparent carriers and could continue to spread the disease or complicate serologic tests. Nevertheless, in Ethiopia, treatment of experimentally infected horses with Cymelarsan at 0.25 mg/kg BW was found to be effective for both acute and chronic cases.<sup>7</sup>

Berenil (diminazene) at 7 mg/kg BW as a 5% solution injected IM, with a second injection of half the dose 24 hours later, or suramin (10 mg/kg IV for two to three treatments at weekly intervals), or quinapyrimine sulfate (3–5 mg/kg in divided doses injected subcutaneously) have been tried in the past.

### CONTROL

In dourine-free countries, an embargo should be placed on the importation of horses from countries in which the disease is endemic, unless the animals have been properly tested and found negative. Eradication on an area or herd basis is by the application of the CFT, along with strict control of breeding and movement of horses. Positive reactors are disposed of, and two negative tests not less than a month apart can be accepted as evidence that the disease is no longer present. Castration or neutering of infected

animals is not adequate because mating can still occur.

### FURTHER READING

- Abebe G. Trypanosomosis in Ethiopia. *Ethiopia J Biol Sci.* 2005;4:75-121.
- Barrowman P, et al. Dourine. In: Coetzer JAW, Thomson GR, Tustin RC, eds. *Infectious Diseases of Livestock With Special Reference to Southern Africa*. Vol. 1. Cape Town: Oxford University Press; 1994:206-212.
- Desquesnes M. *Livestock Trypanosomoses and Their Vectors in Latin America*. Paris: OIE (World Organization for Animal Health); 2004.
- Hunter AG, Luckins AG. Trypanosomosis. In: Sewell MMH, Brocklesby DW, eds. *Handbook on Animal Diseases in the Tropics*. 4th ed. London: Baillière Tindall; 1990:204-226.
- Luckins AG, et al. Dourine. In: Coetzer JAW, Tustin RC, eds. *Infectious Diseases of Livestock*. Vol. 1. 2nd ed. Cape Town: Oxford University Press; 2004:297-304.
- OIE. *Manual of Diagnostic Tests and Vaccines for Terrestrial Animals*. Vol. 2. 6th ed. 2008:845-851.
- Stephen LE. *Trypanosomiasis: A Veterinary Perspective*. Oxford: Pergamon Press; 1986.

### REFERENCES

- Pascucci I, et al. *Vet Parasitol.* 2013;193:30.
- Hagos A, et al. *Proceedings of ISCTRC*. Kampala, Uganda: 2009:317.
- Gari FR, et al. *Trop Anim Health Prod.* 2010;42:1649.
- Cauchard J, et al. *Vet Parasitol.* 2014;205:70.
- Li FJ, et al. *Mol Cell Probes.* 2007;21:1.
- Tran T, et al. *Parasitology.* 2006;133:613.
- Hagos A, et al. *Vet Parasitol.* 2010;171:200.

## Toxic Agents Primarily Affecting the Reproductive System

### ESTROGENIC SUBSTANCES

#### ETIOLOGY

Poisoning occurs either accidentally or intentionally from administration of a number of different products. Supplementation may be by addition to the feed, but is usually by subcutaneous implants. Many of them are used as growth promotants to increase weight gain and feed efficiency in animals.<sup>1</sup> Estrogen in some form can be found in the following four categories of growth promotants:

- Endogenous hormones (estradiol-17- $\beta$ , progesterone, testosterone)<sup>1,2</sup>
- Synthetic hormones (ethinylestradiol, others)<sup>1</sup>
- Xenobiotics (zearalenone [ $\alpha$ -zearalanol; zeranone], trenbolone)<sup>1,3</sup>
- Miscellaneous (diethylstilbestrol and related compounds such as hexestrol and dienestrol)<sup>1</sup>

#### EPIDEMIOLOGY

##### Occurrence

Poisoning by estrogenic substances occurs in the following circumstances:

- Natural substances such as genistein present in plants and as zearalenone in fungi<sup>1,3</sup>

- Dietary supplements for fattening cattle<sup>1</sup>
- Overdosage of medications used in clinical infertility cases
- Pigs fed hexestrol implants in capon necks
- Cattle fed on chicken litter from farms on which estrogens are used as supplements.

### Risk Factors

#### Animal Risk Factors

Steers implanted with an estrogen at a standard dose rate may respond in an exaggerated manner and show signs of toxicity. Estradiol implants are reputed to be associated with more of these problems than zeranol.

#### Environmental Risk Factors

Estrogens from treated animals are found in the environment in water and animal manure and may act as endocrine disrupters. Water treatment plants are able to remove most of the estrogens, but animal manure is not regulated in the many parts of the world unless it is discharged into a water supply.<sup>4-6</sup>

#### Farm Risk Factors

Pasture may be contaminated by manure from cattle treated orally or by subcutaneous implants with estrogenic substances that pass significant amounts in the feces.<sup>2,6</sup> Ensilage made from the pasture may also be contaminated.

#### Human Risk Factors

Estrogenic substance administration as a management tool is regarded unfavorably in many countries because of the risk of intoxication occurring in humans eating contaminated meat. Their use is banned in some and strictly controlled in others. In one small study, a palpable mammary tumor was observed in a rat implanted with a 12-mg zeranol pellet.<sup>3</sup> The presence of environmental zearalenone has been proposed as a link to early puberty and anabolic growth effects in young girls.<sup>7</sup>

### PATHOGENESIS

Signs and lesions are the direct result of amplification of the pharmacologic effects of the substances.

### CLINICAL SIGNS

#### Idiopathic Female Estrogenism

In addition to the toxic effects associated with estrogens in specific plants, increased estrogenic activity is also encountered in mixed pasture, generally only at certain times and on particular fields. Clinically the effects are those of sterility, some abortions, swelling of the udder and vulva in pregnant animals and virgin heifers, and endometritis with a slimy, purulent vaginal discharge in some animals. Estrous cycles are irregular. In milking cows, there is depression of the milk yield, reduction in appetite, and an increase in the cell count of the milk.

### Male Estrogenism

Steers in feedlots may exhibit excessive mounting by other steers, sometimes to the point of causing death. Head injuries caused by head-to-head butting, frequent bawling, stampedes, and pawing the ground to the point of hole-digging are other reported signs. These problems tend to pass off after a short time. Preputial prolapse may be a problem in *Bos indicus* cattle. Experimental feeding of zeranone to young bulls is associated with retardation of testicular and epididymal development.

### Nymphomania in Cows

Larger doses of stilbestrol, usually administered accidentally to cows, may be associated with prolapse of the rectum and vagina and elevation of the tail head caused by relaxation of the pelvic ligaments. Susceptibility to fracture of the pelvic bones and dislocation of the hip are common sequelae. Nymphomaniac behavior in such animals results in other skeletal injuries, especially fracture of the wing of the ilium.

### Swine Estrogenism

Common clinical signs include weight loss, decreased feed efficiency, straining, prolapse of the rectum, incontinence of urine, anuria, and death.<sup>8</sup> Estrogens such as zearalenone ingested by sows after day 11 to 13 of the estrous cycle can be associated with retention of corpora lutea and a syndrome of anestrus or pseudopregnancy, which typically persists for 45 to 60 days postestrus. This effect may occur at zearalenone concentrations of 3 to 10 ppm in the diet. Pregnant sows given zearalenone postbreeding may have failure of implantation and early fetal abortion.

### Urethral Obstruction

Heavy mortalities have occurred in feeder lambs after the use of implants of estrogens as a result of prolapse of the rectum, vagina, and uterus, together with urethral obstruction by calculi. The calculi consist largely of desquamated epithelial and inflammatory cells that form a nidus for the deposition of mineral; the desquamation is probably stimulated by the estrogen. Also, urethral narrowing caused by the estrogen facilitates complete obstruction by the calculi.

### CLINICAL PATHOLOGY

High blood levels of estrogens are characteristic. In swine, the syndrome of anestrus associated with zearalenone will be accompanied by elevated progesterone concentrations caused by the retention of corpora lutea.

### NECROPSY FINDINGS

Enlargement and vascular engorgement of accessory sex organs, especially in neutered animals, are characteristic. Uterine enlargement and keratinization of vaginal

epithelium may be detected, and in mature female swine there may be persistent multiple retained corpora lutea. Swine also show inflammation and necrosis of the rectal wall, enlargement of the kidneys, thickening of the ureters and distension of the bladder, and gross enlargement of the prostate and seminal vesicles. Histopathology on jejunum obtained from pigs treated with low doses of zearalenone and T-2 toxin showed normal crypts and villi but decreased numbers of goblet cells and acidophilic granulocytes in the mucous membrane and numerous plasma cells in the intestinal epithelium.<sup>8</sup>

### FURTHER READING

- Adams NR. Detection of the effects of phytoestrogens on sheep and cattle. *J Anim Sci*. 1995;73:1509-1515.
- Burnison BK, Hartman A, Lister A, et al. A toxicity identification evaluation approach to studying estrogenic substances in hog manure and agricultural runoff. *Environ Toxicol Chem*. 2003;22:2243-2250.
- Leffers H, Naesby M, Vendelbo B, et al. OEstrogenic potencies of zeranone, oestradiol, diethylstilbestrol, bisphenol-A and genistein; implications for exposure assessment of potential endocrine disruptors. *Hum Reprod*. 2001;16:1037-1045.
- Soto AN, Calabro JM, Prechtl NV, et al. Androgenic and estrogenic activity in water bodies receiving cattle feedlot effluent in Eastern Nebraska, USA. *Environ Health Persp*. 2004;112:346-352.

### REFERENCES

1. Biswas S, et al. *J Soil Water Con*. 2013;66:325.
2. Khanal SK, et al. *Environ Sci Technol*. 2006;40:6537.
3. Zhong S, et al. *Anticancer Res*. 2011;31:1659.
4. Chen TS, et al. *Sci Total Environ*. 2010;408:3223.
5. Alvarez DA, et al. *Water Res*. 2013;47:3347.
6. Gadd JB, et al. *Environ Pollut*. 2010;158:730.
7. Massart F, et al. *J Pediatr*. 2008;152:690.
8. Andretta I, et al. *Arch Zootech*. 2010;59:123.

## PHYTOESTROGEN TOXICOSIS

### SYNOPSIS

**Etiology** Ingestion of plants that produce estrogen (phytoestrogens) resulting in a number of reproductive problems.

**Epidemiology** Pastures dominated by specific strains of legumes, in lush growth mode, or hay or silage made from such pasture, are associated with problems if exposure is prolonged. Sheep are much more susceptible than cattle.

**Clinical pathology** Positive estrogen assay in blood.

### Lesions

**Live animals:** Severe flock infertility in sheep; prolongation of estrus periods, interestrus periods shortened.

**Postmortem:** Ewes show cystic endometrial degeneration.

**Diagnosis confirmation** Laboratory assay of feed, blood, and tissue; the appearance of genital pathology at necropsy, or with a uterine biopsy or laparoscopy.

**Treatment** None.

**Control** Grazing management, use of low-phytoestrogen cultivars.

### ETIOLOGY

Important estrogenic substances found in plants and fungi include the following:

- Plants
  - Coumestans (coumestrol, 4-methoxycoumestrol, repensol, trifoliol)<sup>1</sup>
  - Isoflavones (daidzein, formononetin, genistein, biochanin A, glycitein)<sup>2,3</sup>
  - Isoflavan (equol, a metabolite of daidzein)<sup>3</sup>
- Fungi (resorcylic acid lactones [zearalenone])<sup>4</sup>

Compared with pharmaceutical agents, these substances have low estrogenic activity, but they are associated with serious clinical effects because of the high concentrations they reach in some plants and daily intake over long periods. The coumestans are most common in plants of the *Medicago* genus; isoflavones are most common in the *Trifolium*, *Baptisia*, and *Cytisus* genera. Only *Medicago* and *Trifolium* spp. are of any importance to animals. Those likely to contain sufficient amounts to be associated with disease are

*Fusarium* (variety of species); contains zearalenone<sup>4</sup>

*Glycine max* (soybean; contains coumestans and isoflavones; affects pigs)

*Medicago sativa* (alfalfa, lucerne; contains coumestans; affects cattle, sheep)

*Trifolium alexandrinum* (isoflavones)  
*T. alpestre* (alpestrine clover; contains isoflavones)

*T. pratense* (red clover; contains isoflavones; affects sheep)<sup>1</sup>

*T. repens* (white clover, Ladino clover; contains coumestans)<sup>1</sup>

*T. subterraneum* (subterranean clover; contains isoflavones; affects sheep).

### EPIDEMIOLOGY

#### Occurrence

Animals on pasture are at the greatest risk, but poisoning can also occur on diets containing prepared feeds such as soybean (*Glycine max*) meal, or moldy feed containing *Fusarium* fungi.

### Risk Factors

#### Animal Factors

Phytoestrogen toxicosis is clinically important only in sheep. Cattle are generally considered to be less sensitive than sheep.<sup>1,5,6</sup> For example, cows can ingest large amounts of estrogens (over 40 g per day per cow) in red clover without showing any reduction in reproductive efficiency. Horses usually graze the toxic pasture without ill effects.

Massive reproductive wastage has been experienced in sheep on pastures dominated by such plants as *Trifolium subterraneum*, and the death rate from dystocia and prolapse of the uterus can also be high. The most common abnormality is a failure to conceive, even with multiple matings, and the flock breeding status worsens progressively, with the lambing percentage falling from a normal 80% down to 30%. Sheep eating a lot of estrogenic clover in the spring can become temporarily infertile, but are normally fertile again by the usual breeding season in the autumn. However, ingestion of the plant in several successive years is associated with “permanent clover disease”—infertility from which ewes do not recover. Under these conditions sheep farming becomes unprofitable, and large areas of country have been made unsuitable for sheep raising because of this disease.

### Human Factors

Various phytoestrogens have been found in foods of animal origin (eggs, milk, meat, fish, and seafood). Equol was found in several foods, including eggs, milk, and meat.<sup>7</sup> Not all phytoestrogens are harmful and many of them are have known human health benefits.<sup>8</sup> Many, however, are endocrine disruptors, which means that they can produce adverse health effects as well.

### Plant Factors

The estrogenic activity of pastures depends on the degree of domination of the pasture by the toxic plants, the variety of the plant species, and the duration of the animal's exposure to them. Newly sown pastures are usually most toxic because of domination by the sown legume. Pastures deficient in phosphorus are also likely to be clover dominant. High nitrogen fertilizer applications reduce phytoestrogen content. Varieties of *Trifolium subterraneum*, e.g., Yarloop, Dwalganup, Dinninup, and Geraldton, are much more toxic than Bacchus Marsh and Daliak. Pastures containing more than 30% of the first four varieties are likely to be unsafe. In some clovers, e.g., red clover, the estrogen content varies with the season, and is high in early spring, low in midsummer, and high again in the autumn after the hay has been taken off. Insect damage to pasture can increase the estrogen content 10-fold, and bacterial infection (e.g., by *Pseudopezzia medicaginnis*, a leaf-spotting organism on alfalfa) and fungal infection by 100-fold. Plants that have matured in the field and set seed have no estrogenic potency, but the making of potent fodder into hay causes little depression of estrogen content. Clover ensilage can contain high levels of estrogens, and the ensiling process is considered to increase the estrogenic effect of clover 3- to 5-fold.

*Trifolium repens* (white clover, in contrast to Ladino clover), does not have

a high content of estrogens.<sup>1</sup> However, when heavily infested with fungi it can contain significant amounts. It is thought that the production of estrogens is a byproduct of the plant's mechanism of resistance to the fungal infection. Ladino clover, a large-growing variety of white clover, may contain large quantities of a highly active estrogen (coumestrol), and when it dominates a pasture and is grazed when the pasture is lush, it may be associated with the cornification of vaginal epithelium and functional infertility in ewes. Three estrogenic compounds have been isolated from *T. pratense* (red clover), and where this plant dominates the pasture a clinical syndrome similar to that associated with subterranean clover may be observed. Ewes grazing on red clover pasture, especially a toxic cultivar of the plant, may have their conception rate at the first mating cycle reduced from 75% to as low as 25%.

### PATHOGENESIS

Much of the metabolism of phytoestrogens in ruminants occurs in the rumen as well as in the liver.<sup>1</sup> The differences between sheep and cattle in the ruminal metabolism of these compounds are thought to be the reason for the comparative freedom of cattle from the clinical disease.

The amount of phytoestrogen ingested by a ewe on a highly poisonous pasture may equal her daily estrogen secretion at the peak of her estrous cycle. The effect of the phytoestrogens is exerted mainly on the uterus and ovaries. Structurally, there is hyperplasia and hypertrophy of the epithelium of the uterus, vagina, and cervix, and dysplasia of the granulosa cells of the ovary, with a consequent reduction in secretion of estradiol. Increases in teat size and milk secretion are additional, secondary effects.

The functional abnormality is not one of estrus; in sheep the demonstration and duration of estrus may be normal or depressed, and the defect is one of sperm transport because of changes in the composition of cervical mucus and the structure of cervical glands. The change is to more watery mucus, and this is the basis of a test in affected sheep in which the watery mucus is more readily absorbed by a cottonwood plug inserted in the vagina. The increased weight of the plug is a positive test.

It is possible that a good deal of the infertility seen in ewes on improved clover pasture may be associated with its high estrogen content, in spite of the absence of the more dramatic evidence of hyperestrogenism described earlier. Because it is necessary to use this pasture, a great deal more needs to be known about the seasonal occurrence of the estrogenic substances and the management of sheep grazing the pasture so that the effects of the disease can be minimized.

## CLINICAL FINDINGS

### Ewes

Clover disease, the severe clinical manifestation of phytoestrogen poisoning, and rarely seen today, includes dystocia, prolapse of the uterus or vagina, severe infertility, and death. The more common and less severe field expression of phytoestrogen poisoning is a significant decrease in fertility rate. It may be temporary with normal reproductive efficiency returning soon after the ewes are moved to clover-free pasture. In ewes exposed to a low level intake of estrogens over a long period, e.g., in excess of two grazing seasons, a process of irreversible “defeminization” may occur. This is a state of permanent subfertility. The estrous cycle is normal, but an abnormally large number of ewes fail to conceive. In affected flocks, there may also be a high incidence of maternal dystocia caused by uterine inertia, or failure of the cervix or vagina to dilate. Affected ewes show little evidence of impending parturition and many full-term fetuses are born dead.

### Male Castrates

Wethers may secrete milk, and metaplasia of the prostate and bulbourethral glands is evident. These can be detected at an early stage of development by digital rectal palpation. Continuing hyperplasia and cystic dilatation of these glands is associated with their prolapse in a subanal position, followed by rapid weight loss and fatal rupture of the bladder. Rams usually show no clinical abnormality, and their fertility is not impaired.

Cattle exhibit clinical signs less often than sheep, with experimental reports of decreases in conception and fertilization caused by prolongation of oocyte maturation and decreased sensitivity of the corpus luteum to luteolytic agents.<sup>5,6</sup> Temporary infertility; discharge of cervical mucus; and swelling of the mammary gland, vulva, and uterus have all been recorded in cattle.

Glits exposed to genistein may develop structural changes and abnormalities in the cervix and uterus.<sup>9</sup>

## CLINICAL PATHOLOGY

Laboratory assays are available and essential to diagnosis and monitoring of feed contents of phytoestrogens.<sup>7</sup> Chemical assays are not as sensitive as biologic assessments based on increased size of genitalia in subject animals.

## NECROPSY FINDINGS

Severe cystic degeneration of the endometrium is present in the most severe cases. Similar clinical and histopathologic changes have been produced by the daily injection of 0.03 mg of diethylstilbestrol per ewe for a period of 6 months. There is also a long-term change in the cervix with an increased incidence of cervicitis and a histologically observable transformation to a uterine-like



appearance. In ewes on a long-term intake of toxic pasture, the lesions include elevation of the tail head, partial fusion of the vulvar labia, and clitoral hypertrophy.

Diagnostic confirmation of phytoestrogen poisoning requires laboratory assay of feed, blood, and tissue, and the appearance of genital pathology at necropsy, or with a uterine biopsy, or laparoscopy.

### DIFFERENTIAL DIAGNOSIS

#### Differential diagnosis list

- Overdose of pharmaceutical preparation as part of a program to improve fertility in a herd.
- Overdose of an implant or feed additive with a growth stimulant that has estrogenic capability.

### TREATMENT

Administration of testosterone is a logical response to poisoning but appears to be an unlikely commercial proposition.

### CONTROL

Avoidance of high estrogenic activity strains of the respective plants, grazing management to avoid dangerous pasture at the most toxic part of the season, and dilution of the estrogen intake by providing additional and alternative feeds, are all used to control the disease. Prevention of clover disease can only be achieved by proper management of sheep and pasture to avoid ingestion of excessive amounts of estrogens. Vaccination with a phytoestrogen-immunogenic protein conjugate has produced good levels of antibodies, but has not been successful in preventing the problem. Careful management of flocks on estrogenic pasture can significantly improve reproductive output.

### FURTHER READING

- Adams NR. Detection of the effects of phytoestrogens on sheep and cattle. *J Anim Sci*. 1995;73:1509-1515.
- Hughes CL. Phytochemical mimicry of reproductive hormones and modulation of herbivore fertility by phytoestrogens. *Environ Health Persp*. 1988;78:171.
- Kuiper G, et al. Interaction of estrogenic chemicals and phytoestrogens with estrogen receptor  $\beta$ . *Endocrinology*. 1998;139:4252-4263.
- Radostits O, et al. Phytoestrogen poisoning. In: *Veterinary Medicine: A Textbook of the Disease of Cattle, Horses, Sheep, Goats and Pigs*. 10th ed. London: W.B. Saunders; 2007:1873.

### REFERENCES

1. Steinshamn H, et al. *J Dairy Sci*. 2008;91:2715.
2. Hoikkala A, et al. *Mol Nutr Food Res*. 2007;51:782.
3. Jackman KA, et al. *Curr Med Chem*. 2007;14:2824.
4. Zinedine A, et al. *Food Chem Toxicol*. 2007;45:1.
5. Borzym E, et al. *Med Weter*. 2008;64:1107.
6. Piotrowska KK, et al. *J Reprod Dev*. 2006;52:33.
7. Kuhnle GGC, et al. *J Agric Food Chem*. 2008;56:10099.
8. Patisaul HB, et al. *Front Neuroendocrinol*. 2010;31:400.
9. Ford JA, et al. *J Anim Sci*. 2006;84:834.

## ZEARALENONE TOXICOSIS

### SYNOPSIS

**Etiology** Zearalenone is an estrogenic mycotoxin produced primarily by fungus in the genus *Fusarium*, which is the causative agent. *F. graminearum* is the species most responsible for animal reproductive problems, but *F. cerealis*, *F. culmorum*, *F. cookwellense*, *F. equiseti*, and *F. semitectum* are contaminants of moldy maize, wheat, oats, and barley grain and cause issues as well.

**Epidemiology** Global issue with zearalenone found in a variety of cereals and foodstuffs in many countries.

**Clinical pathology** None in particular; progesterone levels may be decreased.

**Lesions** Associated with hyperestrogenism and include abortions, stillbirths, mammary gland enlargement and secretions, vulvar edema, and vaginitis in females as well as testicular atrophy and mammary gland enlargement in males.

**Diagnostic confirmation** Presence of zearalenone and/or metabolites in feces, urine, and serum; presence in feedstuffs.

**Treatment** Remove animals from contaminated feed and correct prolapses.

**Control** Keep moisture content of stored grain below 15%–16%; feed contaminated grains to less susceptible animals.

### ETIOLOGY

Zearalenone is a nonsteroidal estrogenic mycotoxin produced primarily by fungi in the genus *Fusarium*. *F. graminearum* is the species most responsible for animals' reproductive problems, but *F. cerealis*, *F. culmorum*, *F. cookwellense*, *F. equiseti*, and *F. semitectum* are contaminants of moldy maize, wheat, oats, and barley grain and are associated with toxicosis.<sup>1,2</sup> Swine are most commonly affected, but cases have occurred in sheep and cattle<sup>3,4</sup> and more rarely in horses.<sup>5</sup>

### EPIDEMIOLOGY

#### Occurrence

The fungi that produce zearalenone primarily colonize corn, but they also infect other cereal grains such as barley, wheat, and oats.<sup>1,2</sup> Zearalenone has also been detected in a number of other plants including rice, sorghum, millet, and soybeans. Most typically, contamination occurs from high moisture during storage; field contamination has been reported but occurs less often. Zearalenone has been detected in pastures in New Zealand, which has been associated with infertility in ewes.<sup>6</sup> Contamination of food and animals is considered a global problem because zearalenone has been found in Africa, Asia, Australia, Europe, North America, and South America.<sup>2</sup>

### Risk Factors

#### Animal Risk Factors

Swine of all ages, but especially prepubertal gilt, are the most sensitive to the effects of zearalenone. The primary effects are reproductive and depend on the dose and time of administration in relationship to the animal's estrous cycle.<sup>5,6</sup>

#### Farm Risk Factors

Elevated levels of zearalenone in the feed are primarily associated with improper storage and not contamination in the field.<sup>2</sup>

#### Human Risk Factors

There is considerable concern that humans, especially young girls, will be adversely affected by zearalenone in cereal products, milk and milk-based products, and meats. In Europe, 32% of mixed cereal samples from nine countries were found to be contaminated with zearalenone. Zearalenone is excreted in milk and present in some concentration in meats in animals with high intake, but currently the risk to humans is thought to be low.<sup>2</sup>

### PATHOGENESIS

Zearalenone is rapidly absorbed following an oral exposure, with an estimated uptake of 80% to 85%.<sup>1,2</sup> In swine, it can be detected in the serum within about 30 minutes after ingestion.<sup>2</sup> Distribution is primarily to the adipose tissue and the ovary and uterus. The liver is the main site of metabolism, but other tissues such as the intestine, kidney, ovary, and testis are metabolic sites.<sup>1</sup> Two different biotransformation pathways have been proposed and likely play a role in the susceptibility of different species.<sup>1,5</sup> Zearalenone is either conjugated with glucuronic acid or hydroxylated to  $\alpha$ - and  $\beta$ -zearalenol.<sup>1,5</sup> In swine, the preferred route is conjugation with conversion to primarily  $\alpha$ -zearalenol.<sup>1,4,5</sup> Sheep are similar to swine but cattle convert to  $\beta$ -zearalenol, a less estrogenic metabolite.<sup>4</sup> Excretion is biliary in most species with significant enterohepatic recirculation occurring.<sup>1</sup>

Zearalenone crosses cell membranes and binds to cytosolic 17 $\beta$ -estradiol receptors. Once this occurs, it is translocated into the nucleus where it binds to estrogen-responsive elements and stimulates mRNA synthesis resulting in estrogen-like effects.<sup>1,3</sup>

### CLINICAL FINDINGS

#### Swine

Pigs of all ages are affected, including piglets nursing on sows, which themselves show no signs of estrogenism. The most significantly affected are the 6 to 7-month-old gilts. Vulvovaginitis, including swelling of the vulva to three to four times normal size, enlargement of mammary glands, a thin catarrhal exudate from the vulva, and increased size and weight of the ovaries and uterus, is the severest form

of the poisoning.<sup>3,6</sup> Prolapse of the vagina is common (up to 30% of affected pigs) and there is prolapse of the rectum in some pigs (5%–10%). The toxin reduces serum progesterone levels in sows, but the administration of progesterone to affected gilts does not counteract the estrogenic effects. The syndrome is indistinguishable from that produced by long-term overdosing with diethylstilbestrol. Signs appear 3 to 6 days after feeding of moldy grain commences and disappear soon after the feeding stops. The mortality rate is high because of the secondary development of cystitis, uremia, and septicemia.

The more important manifestation of the poisoning may be infertility, including absence of estrus, high levels of stillbirth, neonatal mortality, and reduced litter size. Small fetal size, fetal malformations, splayleg and hindlimb paresis, pseudopregnancy, and constant estrus are also recorded.<sup>3</sup>

Zearalenone in male pigs can induce feminizing characteristics; suppress libido; and decrease spermatogenesis, testicular weights, and serum testosterone concentrations.<sup>2</sup>

### Ruminants

In cattle, the effect of zearalenone is largely on conception rate, and the rate of services per conception may rise, but the overall effect is less than in sows. Milk production may be decreased.<sup>2</sup> Behavioral estrus occurs at times unrelated to ovarian cycles and in late pregnant cows. There is idiopathic vaginitis. Symmetric enlargement of the mammary glands is recorded in prepubertal dairy heifers feeding on fungus-infected corn. Estrogenic disturbances are also suspected in sheep. Abortion is suspected to occur, and mild vulvovaginitis and hypertrophy of the uterus are recorded. Experimental feeding of zearalenone to lactating cows and ewes does result in minor contamination of their milk sufficient to produce hyperestrogenism in a lamb sucking a poisoned ewe.

### Horses

Zearalenone toxicosis is rarely reported in horses.<sup>1</sup> A recent study using equine ovarian cultured granulosa cells demonstrated that zearalenone may play a role in some equine reproductive disorders.<sup>5</sup>

### CLINICAL PATHOLOGY

Zearalenone and its metabolites can be identified in urine, plasma, and feces by high-performance liquid chromatography<sup>7</sup> and in feedstuffs by liquid chromatography mass spectrometry and a rapid immunoassay.<sup>8,9</sup> In 2003, 16 countries limited the amount of allowable zearalenone in maize and cereals; the allowable concentration varies from 50 to 1000 µg/kg depending on the country.<sup>5</sup>

### NECROPSY FINDINGS

On necropsy, there are nonspecific findings other than expected changes associated

with estrogen-related reproductive tract abnormalities. These include changes in ovarian weight with decreased numbers of corpora lutea, increased dead piglets, vaginal and rectal prolapses, vulvar edema and vaginitis in females, and testicular atrophy and mammary gland enlargement in males.<sup>10</sup>

### DIFFERENTIAL DIAGNOSIS

#### Differential diagnosis list

- Accidental overdose of synthetic estrogen substances
- Estrogenic substances
- Phytoestrogens

### TREATMENT

Complete recovery follows when the feeding of the affected grain is stopped and no treatment other than surgical repair of the prolapsed organs is attempted.

### CONTROL

The moisture content of grains should be kept below 15% to 16% during storage. If contaminated feeds must be used, they should be fed to animals less susceptible to toxicosis. The 2006 EU guidelines for zearalenone in feeds recommend that piglets and gilts do not receive more than 0.1 mg zearalenone/kg BW; sows and fattening pigs no more than 0.25 mg zearalenone/kg BW; and sheep, goats, calves, and dairy cows no more than 0.5 mg zearalenone/kg BW.<sup>10</sup>

### FURTHER READING

- Etienne M, Jemmali M. Effects of zearalenone (F2) on estrous activity and reproduction in gilts. *J Anim Sci*. 1982;55:1-10.
- Tanaka T, Hasegawa A, Yamamoto S, et al. Worldwide contamination of cereals by the *Fusarium* mycotoxins nivalenol, deoxynivalenol, and zearalenone. Survey of 19 countries. *J Agric Food Chem*. 1988;36:979-983.
- Radostits O, et al. Zearalenone. In: *Veterinary Medicine: A Textbook of the Disease of Cattle, Horses, Sheep, Goats and Pigs*. 10th ed. London: W.B. Saunders; 2007:1911.

### REFERENCES

1. Minervini F, et al. *Int J Mol Sci*. 2008;9:2570.
2. Zinedine A, et al. *Food Chem Toxicol*. 2007;45:1.
3. Kanora A, et al. *Vet Med-Czech*. 2009;12:565.
4. Malekineja HR, et al. *Vet J*. 2006;172:96.
5. Minervini F, et al. *Reprod Biol Endocrinol*. 2006;4:62.
6. Upadhya SD, et al. *Asian-Aus J Anim Sci*. 2010;23:1422.
7. Songsermsakul P, et al. *J Chromatography B*. 2006;843:252.
8. Tanaka H, et al. *Rapid Commun Mass Spectrom*. 2006;20:1422.
9. Kolosova AY, et al. *Anal Bioanal Chem*. 2007;389:2103.
10. Tiemann U, et al. *Food Addit Contam*. 2007;24:306.

## MARE REPRODUCTIVE LOSS SYNDROME (EARLY FETAL LOSS, LATE FETAL LOSS, FIBRINOUS PERICARDITIS, AND UNILATERAL UVEITIS)

### SYNOPSIS

**Etiology** Exposure to Eastern tent caterpillars (ETCs; *Malacosoma americanum*), in particular during the spring when the caterpillars are most active.

**Epidemiology** Occurs primarily in the Ohio River valley, but reported in other states. Risk factors are the presence of black cherry trees on pasture, ETC, and feeding hay on the ground.

**Clinical pathology** Culture of fetal and placental tissue most commonly results in growth of non-β-hemolytic streptococci and/or *Actinobacillus*.

**Lesions** Inflammation of the intraamniotic umbilical cord (funisitis), premature placental separation, placental edema, placentitis, diffuse alveolitis, and hemorrhage in a variety of organs.

**Diagnostic confirmation** Based on the presence of appropriate clinical signs with a history of exposure of affected horses to ETCs.

**Treatment** Supportive care only.

**Control** Removal of cherry trees from pasture, spraying ETC nests and pastures with pyrethrin pesticides, keeping horses off pasture or muzzling mares on pasture during active ETC months.

### ETIOLOGY

In 2001 an epidemic of early fetal loss (40–80 days; range 40–140 days) and late fetal loss (about 340 days) was recognized in north central Kentucky, southern Ohio, and Tennessee affecting over 3500 mares.<sup>1,2</sup> It occurred again in 2002 but far fewer horses were affected. The epidemic was termed mare reproductive loss syndrome (MRLS). At the same time there was also a marked increase in incidence of birth of weak foals and fibrinous pericarditis and unilateral uveitis in adult horses in the same region.<sup>1-3</sup> Research in horses and pigs confirmed the causative agent as *Malacosoma americanum*, the Eastern tent caterpillar (ETC). Similar episodes of equine abortions, now referred to as equine amnionitis and fetal loss (EAFL), occurred in Australia and have been associated with the *Ochrogaster lunifer*, the processionary caterpillar.<sup>4,5</sup>

### EPIDEMIOLOGY

Historically, many epidemiologic studies were performed to determine the source of the epidemic. Several toxins such as fescue, nitrate/nitrite, phytoestrogens, and mycotoxins were examined and ruled out leaving a

strong association between the presence of ETCs (*M. americanum*, black cherry trees (*Prunus serotina*), and feeding horses hay off the ground. Black cherry trees were involved because they are the preferred host tree for ETC and may be a source of cyanide. Black cherry trees (i.e., cyanide) were ruled out as a cause of MRLS, and an association with ETC was examined experimentally. In several different experiments, pregnant horses (50 to 200 days' gestation) were exposed to various forms of ETC and only those mares exposed to live ETC larvae aborted. These were the first studies to reproduce MRLS and demonstrate that ETC could cause pregnancy loss in mares. Further studies demonstrated that the cuticle (setae; hairs) is the structure responsible for the abortigenic activity.<sup>1,2</sup> Culture of the placental fluid or fetal tissues in both early and late losses showed non- $\beta$ -hemolytic streptococci and *Actinobacillus*, which are bacteria routinely found in the oral cavity of horses.<sup>2,6</sup> Finally, the syndrome was reproduced in pigs with abortions occurring 13 to 16 days after first ingestion.<sup>1</sup> More important, histopathologic examination showed ETC setae imbedded in the gastrointestinal mucosa that were surrounded by microgranulomatous lesions.<sup>1,2,6</sup> A similar pattern was subsequently confirmed in pregnant and nonpregnant mares.

### Occurrence

The first well-studied and documented outbreak of abortions occurred from April 26 through mid-June of 2001, with a lower incidence of disease during the same months in 2002. An abortion storm, which may have been related, occurred in Kentucky in 1991 and 1982, but no epidemiologic studies were performed.<sup>1</sup> In 2006, a similar syndrome associated with large numbers of ETC was reported in Florida.<sup>2</sup>

The 2001 to 2002 outbreak caused early fetal loss in 25% to 63% of mares on one-third of farms, 14% to 24% on another third, and 2% to 13% on the remaining one-third. Approximately 21% of mares pregnant at 42 days' gestation were not pregnant when examined at 70 to 90 days' gestation. The expected pregnancy loss rate between 42 days and parturition is 12%. Over 3500 mares (3000 early fetal losses; 500 late fetal losses) aborted during the outbreak.<sup>1,3</sup> The economic losses incurred because of MRLS during 2001 and 2002 are estimated to be \$500 million.<sup>1</sup>

### Risk Factors

#### Animal Risk Factors

Risk factors for the disease are the presence of black cherry trees, exposure to ETC (especially the presence of large numbers of caterpillars on pasture), and pasturing or feeding hay to horses at pasture.

For late-term abortion the risk factors include increased amount of time at pasture, less time in stall, feeding concentrate on the ground, increased proportion of feed

obtained from pasture, and being fed exclusively in pasture during the final 4 weeks of gestation. All of these factors favor exposure to ETC.

Risk factors for pericarditis include presence of mares or foals with MRLS on the farm, grazing, and exposure to ETC. Risk factors for uveitis have not been defined.

#### Farm Risk Factors

ETCs are endemic to the eastern United States including the Ohio River valley. Egg masses are laid on many trees in the Rosaceae family including black cherry trees, which are the preferred host. Eggs hatch in the early spring when the cherry trees bud. Local populations of the caterpillars fluctuate dramatically from year to year, but mares are likely exposed to small numbers of the caterpillars every spring. Climatic conditions that favor survival of ETC and synchronize their maturation result in simultaneous hatching of large numbers of eggs. The rapid emergence of large numbers of caterpillars results in abrupt and heavy exposure of horses and consequent development of MRLS. Weather conditions thought to contribute to the 2001 outbreak include a period of low temperatures in March, above normal temperatures in April, and a frost and freeze in late April immediately followed by several warm days.

### PATHOGENESIS

The pathogenesis of the diseases associated with MRLS has not been well defined. Based on experimental studies and natural cases, ETC setae are likely involved in the pathophysiology. Two different hypotheses have been proposed:

- Setae lodged in the gastrointestinal submucosa causes inflammation, form microgranulomas, and disrupt the mucosal barrier. Resident bacteria such as *Actinobacillus* spp. penetrate the barrier, resulting in bacteremia and hematogenous spread to the placenta, fetus, pericardium, uvea, and meninges.<sup>1,6</sup>
- Setae or parts of the exoskeleton contain an as yet unidentified toxin that is toxic to the placenta and fetus.<sup>1</sup>

### CLINICAL FINDINGS

#### Early Fetal Loss

This is detected by per rectum uterine examination, either manual or using ultrasonographic visualization of uterine contents, during early pregnancy. Fetal loss occurs after 35 days, conception not being affected, and affected mares do not come into estrus because of the presence of endometrial cups, which do not regress until 100 to 180 days after ovulation.<sup>3</sup>

Mares have no clinically detectable premonitory signs of fetal loss.<sup>1,2</sup> Ultrasonographic examination of the uterus of pregnant mares reveals that the allantoic fluid of fetuses <80 days of age has increased echogenicity on

the day of fetal death. Allantoic fluid increases in echogenicity with increasing fetal age, and care should be taken when interpreting this observation.

#### Late Fetal Loss

Late fetal loss occurs as a late-term abortion (final several weeks of gestation), birth of a stillborn foal at full term, and the birth of a foal that is weak and of reduced viability. The birth of an affected foal is associated with premature placental separation ("red bag" deliveries), foaling while standing, and explosive expulsion of the fetus and placenta. Foals born alive are weak, have sunken eyes, progressive neurologic signs consistent with hypoxia, and have a high death rate (50%) despite intensive care. Severe leukopenia at birth often progresses to leukocytosis at 24 to 48 hours of age. Serum biochemical abnormalities include elevated serum creatinine concentrations, hypoglycemia, and increased serum creatine kinase activity. Bacteria isolated from stillborn foals at necropsy or on culture of blood samples from sick foals are nonspecific organisms, including nonhemolytic streptococci and *Actinobacillus* spp.

#### Fibrinous Pericarditis

Clinical signs in horses of both genders include tachycardia, pleural effusion, pericardial effusion, ascites, fever, abdominal pain, and sudden death.<sup>1,2</sup> Younger horses (<2 years of age) may be more susceptible to developing pericarditis. There is accumulation of large quantities of pericardial fluid and fibrin deposition on the parietal and visceral pericardial surfaces evident on ultrasonographic examination of the chest. The lungs have ultrasonographic evidence of consolidation consistent with pneumonia in approximately 50% of cases. Pericardiocentesis yields abundant fluid that is light yellow and has a low white blood cell count (<5 × 10<sup>9</sup>/L) characterized by well-preserved neutrophils. Horses with a prolonged course of the disease (>2 weeks) can have elevated white cell counts in pericardial fluid secondary to opportunistic infection, usually with *Actinobacillus* spp.<sup>6</sup> Hematologic abnormalities are minimal and characterized by a slight leukocytosis in approximately 50% of cases. Azotemia occurs in horses with severe cardiac tamponade.

#### Unilateral Uveitis

Clinical signs are acute and unilateral and include corneal edema, exudates in the anterior and posterior chambers, and iris hemorrhage.<sup>1</sup> Progression of the syndrome leads to blindness and global atrophy. There is no age predilection and no organisms have been found on culture.

### CLINICAL PATHOLOGY

Culture of fetal and placental tissue most commonly results in growth of non- $\beta$ -



hemolytic streptococci and/or *Actinobacillus*. *Actinobacillus* spp., along with several other bacteria, has been isolated from fibrinous pneumonia.

Diagnostic confirmation is based on the presence of appropriate clinical signs with a history of exposure of affected horses to ETCs.

#### DIFFERENTIAL DIAGNOSIS

##### Differential diagnosis list:

Cyanide toxicosis  
Ergot/fescue  
Infectious causes of placentitis  
Mycotoxigenesis  
Nitrate toxicosis  
Phytoestrogens

#### NECROPSY FINDINGS

Examination of the placenta, stillborn foals, and foals that die after birth reveals inflammation of the intraamniotic umbilical cord (funisitis), premature placental separation, placental edema, placentitis, diffuse alveolitis, and hemorrhage in a variety of organs. Horses with pericarditis have impressive accumulation of hairy fibrin in the pericardial space with marked thickening of the visceral and parietal pericardium (a hoary heart).

#### TREATMENT

Treatment of affected foals is primarily supportive in nature. Horses with pericarditis should have the fluid drained to relieve or prevent cardiac tamponade and to minimize the accumulation of fibrin. Pericardial fluid may need to be drained several times, and its accumulation should be monitored ultrasonographically. Administration of broad-spectrum antibiotics should be based on culture and sensitivity of pericardial fluid. Treatment for uveitis is standard and includes atropine, antiinflammatory agents, topical and systemic antibiotics (culture and sensitivity as indicated), and other agents such as cyclosporin or tissue plasminogen activator.

#### CONTROL

This is based on prevention of ingestion of ETC by horses. Preventing horses from ingesting caterpillars by minimizing access to pasture and feeding hay in stalls is likely to be beneficial.

Other control measures include removing wild or black cherry trees, the favored host species for ETCs, from pastures, hedges, and fence rows; applying pesticides to trees to kill overwintering eggs or, after hatching, caterpillars; installation of barriers to caterpillar migration onto pasture; manual removal of egg tents; installing pheromone traps; and restricting access of mares to pasture.<sup>7,8</sup>

Application of bifenthrin or permethrin, but not 3% horticultural oil, to egg masses (tents) during the winter prevents emergence of caterpillars in the spring. Insecticidal soap or oils sprayed on neonatal caterpillars is minimally effective. Bifenthrin or spinosad are effective against all instars for 7 days when sprayed on foliage. Injection of trunks of cherry trees with dicotophos or emamectin is effective against all instars, but injection with milbemectin or avermectin is not effective. A spray of 50 mL of 39% permethrin diluted in 4 L of water and applied to a 2-m wide band of pasture outside the fence line kills migrating caterpillars and prevents them obtaining access to pasture. This solution can also be sprayed on the trunks of trees to kill caterpillars as they leave the tree.

#### FURTHER READING

- Cohen ND, Donahue JG, Carey VJ, et al. Case-control study of late-term abortions associated with mare reproductive loss syndrome in central Kentucky. *J Am Vet Med Assoc.* 2003;222:199-209.
- Cohen ND, Carey VJ, Donahue JG, et al. Descriptive epidemiology of late-term abortions associated with the mare reproductive loss syndrome in central Kentucky. *J Vet Diagn Invest.* 2003;15:295-297.
- Dwyer RM, Garber LP, Traub-Dargatz JL, et al. Case-control study of factors associated with excessive proportions of early fetal losses associated with mare reproductive loss syndrome in central Kentucky during 2001. *J Am Vet Assoc.* 2003;222:613-619.
- Sebastian MM, Gantz MG, Tobin T, et al. The mare reproductive loss syndrome and the eastern tent caterpillar: a toxicokinetic/statistical analysis with clinical, epidemiologic, and mechanistic implications. *Vet Ther.* 2003;4:324-339.

#### REFERENCES

- Sebastian MM, et al. *Vet Pathol.* 2008;45:710.
- McDowell KJ, et al. *J Anim Sci.* 2010;88:1379.
- Volkman D, et al. *Reprod Domest Anim.* 2008;43:578.
- Perkins NR, et al. Pregnancy loss in mares associated with exposure to caterpillars in Kentucky and Australia. In: Panter KE, Wierenga TL, Pfister JA, eds. *Poisonous Plants: Global Research and Solutions.* Wallingford, UK: CAB International; 2007:165.
- Cawdell-Smith AJ, et al. *Equine Vet J.* 2012;44:282.
- Donahue JM, et al. *Am J Vet Res.* 2006;67:1426.
- Townsend L, et al. *J Equine Vet Sci.* 2007;27:249.
- Haynes KF, et al. *Environ Entomol.* 2007;36:1199.

#### EQUINE AMNIONITIS AND FETAL LOSS

EAFI is the name given to a syndrome of abortions that occurred in horses in New South Wales between April and October 2004.<sup>1</sup> Mares from 4 months to term aborted fetuses with signs of inflammatory changes primarily involving the amnion (amnionitis) and amniotic portion of the umbilical cord (funisitis).<sup>2,3</sup> Clinical signs in mares before abortion were minimal.

The syndrome, while occurring several years after the epidemic of MRLS in the United States, had some similarities and

caterpillars were looked at as a possible source of the problem. Several caterpillars were examined with the *O. lunifer* (the processionary caterpillar) ultimately causing abortion in two different experimental studies involving early pregnancy and midlate pregnancy.<sup>3,4</sup>

There are some differences between the two syndromes. An infectious agent has been identified in both EAFI and MRLS, but they are not the same bacteria. The predominant bacteria isolated from EAFI cases were environmental coryneforms and gram-negative rods, whereas *Actinobacillus* and non- $\beta$ -hemolytic streptococci were common isolates from MRLS cases.<sup>2,5</sup> Fibrinous pericarditis and unilateral uveitis affected a number of horses in the MRLS epidemic but did not occur with EAFI.<sup>1</sup> Finally, although devastating, the number of horses involved in the 2004 EAFI outbreak was considerably less than the 2001 to 2002 MRLS epidemic.

#### REFERENCES

- Todhunter KH, et al. *Aust Vet J.* 2009;87:35.
- Cadwell-Smith AJ, et al. *Equine Vet J.* 2012;44:282.
- Cadwell-Smith AJ, et al. *Proceedings Australian College of Veterinary Science Annual Conference.* 2009:31.
- Cadwell-Smith AJ, et al. *J Equine Vet Sci.* 2013;33:321.
- Todhunter K, et al. *Aust Vet J.* 2013;91:138.

#### PLANTS AND FUNGI (UNKNOWN TOXINS) AFFECTING THE REPRODUCTIVE SYSTEM

##### PLANTS

##### Plants Associated With Abortion

- Iva angustifolia* (narrow-leaved sumpweed)
- Salvia coccinea* (red salvia)
- Tanacetum vulgare* (tansy)
- Verbena bonariensis* (purple top)

##### Plants Associated With Prolonged Gestation

- Lysichiton americanus* (skunk cabbage)
- Salsola tuberculatifomis* (cauliflower saltwort; in ewes it is associated with atrophy of the pituitary, adrenal, and thymus glands of the fetus and prolongation of pregnancy to as long as 213 days).

##### Plants Associated With Congenital Defects

- L. americanus* (skunk cabbage; is associated mostly with craniofacial deformity).

##### FUNGI

##### Fungi Associated With Reproductive Dysfunction

- Penicillium roqueforti*, growing on moldy mixed grain and ensilage, is suspected of causing bovine abortion and retained placenta.

- *T. repens* (white clover) does not normally contain estrogens, but when heavily infested with fungi it may contain significant amounts.
- *Ustilago hordei* (barley smut) fungus is thought to be toxic to farm animals; feeding it to experimental animals has been associated with infertility and stillbirths.
- In southeastern Australia a common infertility syndrome, including abortion and fetal mummification, has been ascribed to an onion-like weed, *Romulea rosea*. There is a suspicion that the disease may be caused by a toxin produced by a fungus, *Helminthosporium biseptatum*, which grows on the weed.

## Congenital and Inherited Diseases Primarily Affecting the Reproductive System

### CHROMOSOMAL TRANSLOCATIONS IN CATTLE

A chromosomal translocation is a mutation occurring when two nonhomologous chromosomes exchange parts, which results in a chromosomal rearrangement. The most common type or translocation is the **reciprocal translocation (RCP)** in which a segment from one chromosome is exchanged with a segment of another nonhomologous chromosome, creating a pair of translocation chromosomes. A particular form of reciprocal translocation is the **Robertsonian translocation (ROB)**. During a ROB participating chromosomes break at their centromeres (center pieces) and the long arms of the two chromosomes merge to form a single chromosome with one centromere and two long arms. At the same time, a new chromosome containing both short arms is also created, which typically only contains nonessential genetic information and is lost during following cell divisions. Chromosomal translocations are identified by the chromosomal series involved. Thus a 1/29 translocation represents a fusion between a chromosome of each of the pairs numbered 1 and 29.

A number of chromosomal rearrangements have been identified in different livestock species over the years and have been associated with clinical conditions such as intersexuality, congenital malformations, and reproductive dysfunction.<sup>1</sup> Some of the translocations that occur endemically in certain regions have been associated with significant economic losses.<sup>2</sup> Several European countries have established cytogenetic screening programs to monitor the occurrence of chromosomal translocations in the

livestock population.<sup>1</sup> In Italy the incidence of RCP in cattle determined in an official cytogenetic screening program was 0.3%, whereas 7.1% of studied animals were carriers of a ROB.<sup>2</sup> By far the most common ROB identified was the so-called translocation 1/29, which is endemic in the region, accounting for 99.6% of all ROB.<sup>2</sup>

**Translocation 1/29** has been identified in many breeds of cattle and has been associated with significant reductions in the fertility of cows bred by artificial insemination services. Early embryonic death occurs in embryos produced by fertilization of affected gametes or fertilization of normal gametes by spermatozoa carrying the 1/29 translocation. There is no abnormality of serving behavior or semen quality. The translocation has been shown to be inherited in most European beef breeds including the Blonde d'Aquitaine, Swedish Red and White, Charolais, Danish Limousin, British Friesian and Red Poll breeds, and in the wild British White cattle. In Bolivian Creole cattle breeds, in the Creole-like cattle, the average frequency was 10.42% with a variation from 0% to 28.2%. In contrast, Yacumeño and Creole-type cattle did not show the centric fusion. The highly significant differences between Creole cattle breeds in relation to the 1/29 translocation could be the consequence of factors such as founder group, genetic drift, and selection. The low frequency observed in the Saavendreaño Creole dairy cattle might be caused by breeding under a more intensive system and selection according to milk yield and fertility traits. The frequency of affected animals in a breed may vary between 1% and 20%. Karyotyping and culling of abnormal bulls in most artificial breeding centers has reduced the impact of the defect.

**Translocations 1/21, 2/4, 14/20, and 13/2** have also been identified in bulls, the 1/21 in Holstein Friesian cattle, and the latter two seem to be widespread in Simmental cattle. None of them has been linked with a disease, but it is becoming accepted practice not to use such animals for artificial insemination and in some countries to refuse their importation.

A cytogenetic survey of Holstein bulls at a commercial artificial insemination unit to determine the prevalence of bulls with centric fusion and chimeric anomalies found that chimeric fusion is extremely rare in Holstein bloodlines available by artificial insemination in the United States. However, chimeric bulls are more common and reportedly have decreased reproductive performance. Because of the possibility of de novo onset of chimeric fusion at any time, early cytogenetic screening should be encouraged for prospective bulls intended for artificial insemination programs.

**Translocation 27/29** is suspected of being associated with reduced fertility in Guernsey cattle. These and other abnormalities of chromosomal structure were detected

in an examination of a large number of infertile dairy heifers.

### REFERENCES

1. Ducos A, et al. *Cytogenet Genome Res.* 2008;120:26.
2. DeLorenzi L, et al. *J Anim Breed Genet.* 2012;129:409.

## INHERITED PROLONGED GESTATION (ADENOHYPOPHYSEAL HYPOPLASIA)

Prolonged gestation occurs in cattle and sheep in several forms and is usually, although not always, inherited.<sup>1</sup>

The forms of the disease are prolonged gestation with fetal gigantism or prolonged gestation with deformed or normal or small size fetuses. Differential diagnoses include: mistaken breeding date, intrauterine death and fetal mummification, and pituitary abnormalities in the fetus caused by infection by BVD virus, Akabane virus or bluetongue virus, ingestion of *Veratrum californicum*, and genetic abnormalities.<sup>1</sup>

The disease is caused by lack of a functioning fetal hypothalamic-pituitary axis and consequent inability of the fetus to initiate parturition. The result is prolonged gestation and continued growth of the fetus. The hypothalamic-pituitary axis is also critical for survival of the newborn and affected animals are not viable.

### PROLONGED GESTATION WITH FETAL GIGANTISM

The inherited disease is recorded in Holstein,<sup>2</sup> Ayrshire, and Swedish cattle with prolongation of pregnancy from 3 weeks to 5 months. The cows may show marked abdominal distension, but in most cases the abdomens are smaller than one would expect. Parturition, when it commences, is without preparation. Udder enlargement, relaxation of the pelvic ligaments, and loosening and swelling of the vulva do not occur, and there is also poor relaxation of the cervix and a deficiency of cervical mucus. Dystocia is usual and cesarean section is advisable in Holstein cattle, but the Ayrshire calves have all been reported as having been born without assistance. The calves are very large (48 to 80 kg BW) and show other evidence of postterm growth, with a luxuriant hair coat and large, well-erupted teeth that are loose in their alveoli, but the birthweight is not directly related to the length of the gestation period.

The calves exhibit a labored respiration with diaphragmatic movements more evident than movements of the chest wall. They invariably die within a few hours in a hypoglycemic coma. At necropsy there is adeno-hypophyseal hypoplasia and hypoplasia of the adrenal cortex and the thyroid gland. The progesterone level in the peripheral blood of cows bearing affected

calves does not fall before term as it does in normal cows.

### PROLONGED GESTATION WITH CRANIOFACIAL DEFORMITY

This form of the disease has been observed in Guernsey, Jersey, and Ayrshire cattle. It differs from the previous form in that the fetuses are dead on delivery, show gross deformity of the head, and are smaller than the normal calves of these breeds born at term. In Guernsey cattle the defect has been shown to be inherited as a single recessive character, and it is probable that the same is true in Jersey cattle. The gestation period varies widely with a mean of 401 days.

**Clinical examination** of the dams carrying defective calves suggests that no development of the calf or placenta occurs after the seventh month of pregnancy. Death of the fetus is followed in 1 to 2 weeks by parturition unaccompanied by relaxation of the pelvic ligaments or vulva or by external signs of labor. The calf can usually be removed by forced traction because of its small size. Mammary gland enlargement does not occur until after parturition.

The calves are small and suffer varying degrees of hypotrichosis. There is hydrocephalus and in some cases distension of the gut and abdomen caused by atresia of the jejunum. The bones are immature and the limbs are short. Abnormalities of the face include cyclopic eyes, microphthalmia, absence of the maxilla, and the presence of only one nostril. At **necropsy** there is partial or complete aplasia of the adenohypophysis. The neural stalk is present and extends to below the diaphragm sellae. Brain abnormalities vary from fusion of the cerebral hemispheres to moderate hydrocephalus. The other endocrine glands are also small and hypoplastic.

The disease has been produced experimentally in ewes by severe ablation of the

pituitary gland, or destruction of the hypothalamus, or section of the pituitary stalk in the fetus and by adrenalectomy of the lamb or kid. Infusion of adrenocorticotrophic hormone into ewes with prolonged gestation caused by pituitary damage produces parturition but not if the ewes have been adrenalectomized beforehand.

### PROLONGED GESTATION WITH ARTHROGRYPOSIS

A form of prolonged gestation, which occurs in Hereford cattle and is thought to be inherited, is accompanied by arthrogyrosis, scoliosis, torticollis, kyphosis, and cleft palate.

Prolonged gestation is also reported in **Belgium Blue cattle** and appears to have a genetic component. Affected calves were not grossly abnormal.<sup>1</sup>

### REFERENCES

1. Cornillie P, et al. *Vet Rec.* 2007;161:388.
2. Buczinski S, et al. *J Vet Med A.* 2007;54:624.

### INHERITED INGUINAL HERNIA AND CRYPTORCHIDISM

Inguinal hernias and cryptorchidism in pigs have been considered to be inherited defects for many years, but the evidence is uncertain.

#### INGUINAL HERNIAS

Inguinal hernias of pigs have been shown to be inherited in some breeds (e.g., Duroc and Landrace), but not in others (e.g., Yorkshires). The genetic basis has been investigated in Large White pigs and Landrace pigs and the candidate genes narrowed to a region on SSC13 (*Sus scrofa* chromosome) between 34 and 37 Mb.<sup>1</sup> In Pietrain pigs, genes involved in collagen metabolism (homeobox A10 [HOXA10] and matrix metalloproteinases 2 [MMP2]) and one gene encoding zinc finger protein multitype 2 (ZFPM2;

important in the development of diaphragmatic hernia) were significantly associated with hernias.<sup>2</sup>

#### Cryptorchidism

Evidence suggesting the inheritance of cryptorchidism in swine, sheep, horses, and Hereford cattle and hermaphroditism in swine is also available.

Cryptorchidism is a common congenital anomaly in pigs, and a genome-wide association study of Large White and Landrace pigs localizes the associated gene or genes to candidate genes to SSC8 (*Sus scrofa* chromosome) between 65 and 73 Mb.<sup>1</sup>

Cryptorchidism is common in equids, and there is concern that it might be hereditary.<sup>3</sup> Unilateral cryptorchidism is overrepresented in Percherons, American Saddle Horses, and American Quarter Horses among hospital admissions for cryptorchid castration and has an incidence of 15% among Friesian colt foals.<sup>4</sup> Approximately 9% of the ~600 Icelandic Horse yearling stallions did not have both testes in the scrotum.<sup>5</sup> The likelihood of cryptorchidism in yearlings was significantly influenced by farm and time period of birth. Heritability estimates for cryptorchidism ranged from 0.12 to 0.32 (standard error [SE] 0.08–0.12) on the observable scale, and from 0.35 to 0.96 (SE 0.24–0.40) when transformed to the underlying continuous scale.<sup>5</sup> Cryptorchidism in horses appears to be inherited with a polygenic pattern of transmission, although analysis of microsatellite markers of 24 affected horses did not reveal significant associations with allelic or genotypic frequencies.<sup>6</sup>

### REFERENCES

1. Sevillano CA, et al. *Genet Sel Evol.* 2015;47:18.
2. Zhao X, et al. *Am J Vet Res.* 2009;70:1006.
3. Hartman R, et al. *J Am Vet Med Assoc.* 2015;246:777.
4. Stout TAE. *Equine Vet J.* 2013;45:531.
5. Eriksson S, et al. *Livestock Sci.* 2015;180:1.
6. Diribarne M, et al. *J Equine Vet Sci.* 2009;29:37.



**INTRODUCTION 1830****PERINATAL AND POSTNATAL DISEASES 1830**

General Classification 1830

Perinatal Disease—General Epidemiology 1831

Perinatal Disease—Special Investigation of Any Neonatal Deaths (Illness) 1835

**PERINATAL DISEASE—CONGENITAL DEFECTS 1835**

Intrauterine Growth Retardation 1840

**PHYSICAL AND ENVIRONMENTAL CAUSES OF PERINATAL DISEASE 1840**

Perinatology 1841

Prematurity and Dysmaturity of Foals 1842

Parturient Injury and Intrapartum Death 1843

Fetal Hypoxia 1843

Hypothermia in Newborns 1844

Maternal Nutrition and the Newborn 1846

Poor Mother–Young Relationship 1847

Teeth Clipping of Piglets 1848

**FAILURE OF TRANSFER OF PASSIVE IMMUNITY (FAILURE OF TRANSFER OF COLOSTRAL IMMUNOGLOBULIN) 1848****CLINICAL ASSESSMENT AND CARE OF CRITICALLY ILL NEWBORNS 1856**

Stillbirth/Perinatal Weak-Calf Syndrome 1867

Diseases of Cloned Offspring 1870

Equine Neonatal Maladjustment

Syndrome (Neonatal Encephalopathy, Dummy Foal, Barkers, and Wanderers) 1871

**NEONATAL INFECTIOUS DISEASES 1874**

Principles of Control and Prevention of Neonatal Infectious Diseases 1877

Colibacillosis of Newborn Calves, Piglets, Lambs, Kids, and Foals 1879

Watery Mouth of Lambs (Rattle Belly, Slavers) 1899

Omphalitis, Omphalophlebitis, and Urachitis in Newborn Farm Animals (Navel Ill) 1900

Neonatal Streptococcal Infection 1901

**NEONATAL NEOPLASIA 1903****Introduction**

This chapter considers the principles of the diseases that occur during the first month of life in animals born alive at term. Diseases causing abortion and stillbirth are not included. The specific diseases discussed are presented separately under their own headings.

The inclusion of a chapter on diseases of the newborn, and at this point in the book, needs explanation. The need for the chapter arises out of the special sensitivities that newborns have:

- Their immunologic incompetence
- Their dependence on adequate colostrum containing adequate antibodies at the right time
- Their dependence on frequent intake of readily available carbohydrate to maintain energy
- Their relative inefficiency in maintaining normal body temperature, upward or downward

All of these points require emphasis before proceeding to the study of each of the body systems.

There are no particular aspects of a clinical examination that pertain only to or mostly to neonates. The same clinical examination as is applied to adults is used, with additional, careful examination for congenital defects and diseases, which may involve the umbilicus, the liver, the heart valves, the joints and tendon sheaths, the eyes, and the

meninges, and for birth-related trauma (e.g., rib fracture, joint luxation, distal limb fracture).

Because there is a much greater susceptibility to infectious disease, dehydration, and death, diagnosis and treatment must be reasonably accurate and rapid. Supportive therapy in the form of fluids, electrolytes and energy, and nursing care are especially important in the newborn to maintain homeostasis.

**Perinatal and Postnatal Diseases**

One of the difficulties in the study of perinatal and postnatal diseases is the variation in the type of age classification that occurs between publications, which makes it difficult to compare results and assessments. The term *perinatal* is usually used to describe morbidity or mortality that occurs at birth and in the first 24 hours of life. The term *neonatal* is usually used to describe morbidity or mortality between birth and 14 days. However, there is variation in the use of these terms. To ensure that our meanings are clear, we set out in the following section what we think is the most satisfactory classification of all the diseases of the fetus and the newborn, which is adapted from a scheme proposed for lambs. The importance of this type of classification is in the assessment of risk for a given type of disease and in the prediction

of likely causes that should be investigated by further examinations. This approach is not of major importance in the assessment of disease in an individual animal, although it is of importance in helping establish the priority in diagnostic rule-outs. The classification is, however, of considerable value in the approach to perinatal morbidity and mortality in large flocks or herds, where an assessment of the age occurrence of morbidity and mortality can guide subsequent examinations to the probable group of cases, with optimal expenditure of investigative capital.

**GENERAL CLASSIFICATION****FETAL DISEASES**

Fetal diseases are diseases of the fetus during intrauterine life, for example, prolonged gestation, intrauterine infections, abortion, fetal death with resorption or mummification, and goiter.

**PARTURIENT DISEASES**

Parturient diseases are diseases associated with dystocia, causing cerebral anoxia or fetal hypoxemia, and their consequences and predispositions to other diseases; injury to the skeleton or soft tissues and maladjustment syndrome of foals are also included here.

**POSTNATAL DISEASES**

Postnatal diseases are divided into early, delayed, and late types:

- **Early postnatal disease** (within 48 hours of birth). Deaths that occur during this period are unlikely to be caused by an infectious disease unless it has been acquired congenitally. Most diseases occurring in this period are noninfectious and metabolic (e.g., hypoglycemia and hypothermia as a result of poor mothering, hypothermia as a result of exposure to cold, low vigor in neonates as a result of malnutrition). Congenital disease will commonly manifest during this period but may sometimes manifest later. Infectious diseases are often initiated during this period, but most manifest clinically at a later age because of their incubation period; some (e.g., navel infection, septicemic disease, and enterotoxigenic colibacillosis) have a short enough incubation to occur during this period.
- **Delayed postnatal disease** (2 to 7 days of age). Included in this category are desertion by the mother, mammary incompetence resulting in starvation, and diseases associated with increased susceptibility to infection as a result of failure in the transfer of colostral immunoglobulins (the predisposing causes to these occur in the first 12 to 24 hours of life). Examples include colibacillosis, joint ill, lamb dysentery, septicemic disease, and most of the viral enteric infections in young animals (e.g., rotavirus and coronavirus).
- **Late postnatal disease** (1 to 4 weeks of age). There is still some influence of hypogammaglobulinemia, with late-onset enteric diseases and the development and severity of respiratory disease in this period, but other diseases not directly associated with failure of transfer of immunoglobulins, such as cryptosporidiosis, white muscle disease, and enterotoxemia, start to become important.

## PERINATAL DISEASE—GENERAL EPIDEMIOLOGY

Diseases of the newborn and neonatal mortality are a major cause of economic loss in livestock production. In cattle, sheep, and pigs, the national average perinatal mortalities exceed by far the perinatal mortality experienced in herds and flocks with good management. In these species the identification of the management deficiencies that are the cause of a higher-than-acceptable mortality in a herd or a flock is a most important long-term responsibility of the practicing veterinarian and, in most instances, is more important than the identification of the causal agent or the short-term treatment of individual animals with neonatal disease. In contrast, in horses, the individual is of extreme importance, and the primary thrust is in the treatment of neonatal disease.

All animals must be born close to term if they are to survive in a normal farm environment. Minimal gestational ages for viability (in days) for each of the species are as follows:

- Calf—240
- Foal—311
- Lamb—138
- Piglet—108
- Cria—295

### LAMB'S Mortality Rates

Neonatal lamb mortality is one of the major factors in impairment of productivity in sheep-raising enterprises around the world, and nearly half of all preweaning lamb deaths occur on the day of birth.<sup>1</sup> Mortality can obviously vary with the management system (intensive versus extensive lambing, highly supervised versus minimally supervised, variations in the provision of shelter, etc.) and according to whether there is a particular disease problem in a given flock. Nonselective mortality surveys have shown population mortality rates in lambs, from birth to weaning, that vary from 10% to 30%, and there are flocks that may exceed this upper figure in the face of a major problem. In well-managed flocks, neonatal mortality is less than 10% and in some is below 5%.

### Major Causes

The major cause of neonatal mortality in lambs is noninfectious disease. Many studies have explored the causes for neonatal lamb mortality, which are broadly categorized as follows:<sup>2</sup>

- Death related to birth process
- Failure of neonatal adaptation to postnatal life
- Infectious disease
- Functional disorders
- Predation

### Fetal Disease

Infectious abortion can cause considerable fetal, parturient, and postnatal mortality in infected flocks, but it is a relatively minor cause of perinatal mortality overall. In contrast to other large animal species, abortion storms in sheep are often accompanied by significant mortality in liveborn animals. Many agents associated with abortion in ewes produce placentitis and cause abortion in late pregnancy. This frequently results in the birth of liveborn growth-retarded and weak lambs that die during the first few days of life. Any investigation of perinatal mortality in sheep should also consider the presence of agents causing abortion, although abortion and the birth of dead lambs is always prominent in abortion outbreaks.

### Parturient Disease

Stillbirth occurs largely as a result of prolonged birth and fetal hypoxemia. Prolonged birth and dystocia are particular problems in large single lambs. Higher rates of stillbirth

can also occur in flocks that are in poor condition. Prolonged birth is a major risk factor for subsequent postnatal disease.

### Postnatal Disease

Starvation and hypothermia are common causes of death of neonatal lambs that can result from decreased vigor, pain or trauma after a difficult delivery, failure to adapt to postnatal life, or infectious disease. A number of studies have consistently identified **low birth weight** as the single most important factor associated with lamb mortality.<sup>1,2</sup> Other common factors associated with the mortality rates of neonatal lambs are litter size (which cannot entirely be attributed to lower birth weight of twins), lamb sex (with males having higher mortality than females), and lamb behavior.<sup>1</sup> Management practices that have been found to reduce lamb mortality include winter feeding of pregnant ewes and housing at lambing.<sup>2</sup>

### Birth Weight

Birth weight is determined by the nutrition and genetics of the ewe and by litter size, which is also determined by the parity and genetics of the ewe. Reflecting these influences, most surveys of neonatal mortality in lambs show the following characteristics:

- A significant association between the body condition score or **nutrition of the late pregnant ewe** and perinatal mortality
- A relation between **birth weight** and mortality (depending on the breed, a birth weight of less than 2.5 to 3.0 kg has increased risk for death)
- A higher mortality in lambs from **primiparous ewes**<sup>1</sup>
- A pronounced effect of **litter size**, with mortality in lambs born as triplets being higher than in those born as twins, which in turn is higher than that in lambs born as singles

Lambs with low birth weight are born with fewer body reserves, are less vigorous at birth, and take longer to stand (and thus to reach the teat and ingest colostrum). They are also more susceptible to hypothermia because of higher body surface relative to body mass, lower body fat content, and lower thermogenic capacity as a result of lower muscle mass.

The association between birth weight and lamb mortality has a U-shaped pattern, with the lowest mortality rates with normal birth weight and increasing mortality rates with both decreasing and increasing birth weight. An increase in mortality in large-birth-weight lambs born as singles has been associated with increased risk for dystocia.

### Environmental Factors

Environmental factors of temperature, wetness, and wind can greatly affect lamb mortality rates; their influence varies according to the management system.

The identification of the determinants of mortality just described is of more than academic value because almost all can be modulated by the identification of **at-risk groups** and the adjustment of management procedures or by the identification and mitigation of adverse environmental factors.

### Infectious Disease

Infectious disease can be important in some flocks but commonly contributes to lamb mortality from 2 days of age on. The major infectious diseases of lambs that cause mortality are enteritis and pneumonia. Their prevalence varies with the management system—enteric disease and liver abscess are more common in shed lambing systems than with lambing at pasture. Risk for pneumonia is greatest in very light or heavy lambs and in lambs from maiden ewes and ewes with poor milk production.

### Other Factors

Other factors can be important in individual flocks or regions. Lambs found dead or missing may account for significant losses in some conditions, such as mountain or hill pastures. **Predation**, or predation injury, is an important cause of loss in some areas of the world and, depending on the region, can occur from domestic dogs, coyotes, birds, or feral pigs. **Poor mothering** and an inability of the ewe to gather and bond to both lambs in the case of twins can be a problem in Merinos and can cause permanent separation of lambs from the ewe and subsequent death from starvation.

Management at lambing can also influence the patterns of mortality. Intensive stocking at the time of lambing allows increased periparturient supervision and tends to reduce the incidence of stillbirths and lamb mortality related to parturition. It can furthermore ensure the early feeding of colostrum to weak lambs. On the other hand, it can result in a greater occurrence of mis-mothering associated with the activities of “robber” ewes and may increase lamb mortality related to infectious disease.<sup>3</sup> Mortality rates can differ between breeds, and lambs from crossbred dams may have higher survival rates.

### Recording Systems

Simple systems for recording, determining, and evaluating the major causes of lamb mortality in a flock, for determining the time of death in relation to birth, and for relating the deaths to the weather and management system are available. These systems of examination are effective in revealing the extent of lamb losses and the areas of management that require improvement, and they are much more cost-effective than extensive laboratory examinations, which may give little information on the basic cause of the mortality. More intensive examination systems that combine these simple

examinations with selected biochemical indicators of determinant factors are also available.

### DAIRY CALVES Mortality Rates

Mortality rates of neonatal calves reported in the literature are often subdivided into **perinatal mortality**, which frequently—but not consistently—includes stillborn calves, and **postnatal mortality**, which in most cases includes calf mortalities occurring from 48 or 72 h onward to several months of age. Comparing numbers from different studies is difficult not only because of different definitions of the perinatal and postnatal periods, but also because some studies include all births, whereas others only include births of heifer calves.

#### Perinatal Mortality Rates

Perinatal mortality rates for dairy calves reported from countries with a developed dairy industry range from 2% to 10%, with a consistently increasing trend over the past decades.<sup>4,5</sup> The majority of perinatal deaths, approximately 75%, are considered to occur in the first hour of life, with the remainder occurring either before parturition (approximately 10%) or between 1 and 72 h after birth (approximately 15%).<sup>4</sup> Mortality rates in dairy calves in the first 24 h of life are between 6.5% and 9.7%.<sup>6,7</sup>

#### Neonatal Mortality Rates

Studies reporting neonatal mortality rates in calves, defined as mortality from day 3 of life on, are difficult to compare because different time ranges are considered, and some studies include all calves, whereas others only include heifer calves. In a recent U.S. study including 1138 births, a mortality rate of 4.6% for the period until 135 days of life was reported; a French study based on over 3 million calvings determined a mean mortality rate of 4.2% for the period between 3 and 30 days for the years 2005/2006.<sup>8,9</sup> In general, mortality rates for the perinatal period (0 to 48 h) tend to be higher than mortality rates for neonatal calves (from 3 days on), which underscores how critical the perinatal period is for the newborn calf.

Mortality rates for unweaned dairy heifers in the United States were surveyed repeatedly between 1996 and 2007 and were found to have declined from 10.8% in 1996 to 7.8% in 2007.<sup>10</sup>

#### Fetal Disease/Abortion

Abortion is a term generally used to describe the expulsion of a dead fetus from 45 to 265 days of gestation. A large dairy survey conducted in the United States in 2007 estimated that approximately 4.5% of all pregnant dairy heifers and cows had aborted in 2006.<sup>13</sup> The majority of these have no diagnosed cause.

### Major Causes

#### Perinatal Mortality

The exact cause of death in the perinatal period, which often includes stillborn and weakborn calves, frequently remains undetermined. Epidemiologic studies investigating the risk factors for perinatal mortality in dairy calves have identified a number of genetic and nongenetic factors that are consistently associated with perinatal mortality.<sup>4,7,11,12</sup> Dystocia has consistently been identified as the single most important factor associated with perinatal mortality. Reported odds ratios (ORs) vary widely (2.7 to 14.6), but suggest that calves requiring assisted delivery have a 2.7 to 14.6 higher risk of death in the perinatal period than spontaneously born calves.<sup>4</sup> Other factors contributing to perinatal mortality include **lactation number** (calves born from heifers being more likely to die in the first hours of life than calves from multiparous cows), **birth weight** (calves with a birth weight of less than 20 kg and over 60 kg being at increased risk),<sup>7</sup> and **days of gestation** (calves born before 272 days of gestation being 6.7 times more likely to die than calves born between 272 and 302 days of gestation).<sup>7</sup> The OR for the death of a **twin calf** in the perinatal period was estimated at 13.4 times greater compared with singleton calves.<sup>4</sup>

Calving-associated anoxia may be an important contributing factor in these deaths.

#### Postnatal Mortality

Mortalities of neonatal dairy calves in the first days and weeks of life are attributable in large part to diarrheal disease. In a large survey conducted in the United States in 2007, diarrhea was by far the most common cause of death in unweaned dairy heifers, accounting for 56.5% of all deaths in that age category.<sup>13</sup> Other causes included respiratory problems (22.5%), undetermined causes (7.8%), lameness or injury (1.7%), and navel or joint infections (1.6%).<sup>13</sup>

#### Postnatal Disease

Calves are at highest risk for death in the first 2 weeks of life and especially in the first week. Septicemic and enteric diseases are most common during this period, with respiratory disease being more common after 2 weeks of age. **Failure of transfer of passive immunity** is a major determinant of this mortality.<sup>14</sup> The economic significance of neonatal disease can be considerable, and the occurrence of disease as a calf can also subsequently affect days-to-first-calving intervals and long-time survival in the herd. Death also causes a loss of genetic potential, both from the loss of the calf and the reluctance of the farmer to invest in higher-priced semen in the face of a calf mortality problem.

Meteorologic or **seasonal influences** may have an effect on dairy calf mortality rate,



and this can vary with the region.<sup>4,7</sup> In cold climates during the winter months, an increase in mortality may be associated with the effects of cold, wet, and windy weather, whereas in hot climates there may be an increase in mortality during the summer months in association with heat stress.

### Management

Management is a major influence, and in well-managed dairy herds, calf mortality usually does not exceed 5% from birth to 30 days of age. Risk factors for disease morbidity and mortality in dairy calves relate to the **infection pressure** to the calf and factors that affect its **nonspecific and specific resistance** to disease. It is generally recognized that mortality is associated with the **type of housing** for calves, calving facilities, the person caring for the calves, and attendance at calving.<sup>4</sup> Thus calves that are born in separate calving pens have a lower risk of disease than those born in loose housing or stanchion areas, and the value of good colostrum feeding practices is apparent. Studies on the role of calf housing and the value of segregated rearing of calves in reducing infection pressure generally show beneficial health results.

The quality of management will be reflected in rates of failure of transfer of passive immunity and will also affect the infection pressure on the calf during the neonatal period. Quality of management is very hard to measure but is easily recognized by veterinary practitioners.

The epidemiologic observations that calf mortality is lower when females or family members of the ownership of the farm manage the calves, rather than when males or employees perform these duties, is probably a reflection of this variation in quality of management and suggests that owner managers and family members may be sufficiently motivated to provide the care necessary to ensure a high survival rate in calves. Even so, calf health can be excellent with some hired calf-rearers and very poor with some owner calf-rearers.

### BEEF CALVES

#### Mortality Rates

Mortality in beef herds is usually recorded during the period from birth to weaning and has ranged from 3% to 7% in surveys, with higher rates in calves born to heifers; significantly higher mortality can occur in herds with disease problems. In a survey conducted in the United States in 2007, a perinatal mortality rate (including stillbirths) of 2.9% and a postnatal mortality rate (for the period from birth to weaning) of 3.5% was determined.<sup>15</sup> The majority of this mortality occurs within the first week of life, and most of it occurs in the parturient or immediate postnatal period as a result of prolonged birth or its consequences.

### Major Causes

Dystocia resulting in death is common, and dystocial calves, twin-born calves, and calves born to heifers are at greater risk for postnatal disease. Enteric and respiratory diseases occur in outbreaks in some years, and very cold weather can result in high loss from hypothermia. In a 2007 survey conducted in the United States, beef calf mortality before weaning was found to be attributable to birth-related problems in 25.7%, to weather-related causes in 25.6%, to undetermined causes in 18.6%, to digestive tract problems (including diarrhea) in 14.0%, and to respiratory tract problems in 8.2% of all deaths.<sup>15</sup> Diarrhea and other infectious diseases become the most important cause of death in calves from their third day of life on.

### Fetal Disease

Abortion rates appear to be lower than in dairy cattle, usually less than 1%. The majority of these are not diagnosed as to cause, but of those that are, infectious abortion is the most common diagnosis.

### Parturient Disease

Accurate prospective and retrospective studies have shown that 50% to 60% of the parturient deaths in beef calves are associated with slow or difficult birth and that the mortality rate is much higher in calves born to heifers than from mature cows. **Dystocial birth** can lead to injury of the fetus and to hypoxemia and may not necessarily be associated with fetal malposition. **Birth size** is highly heritable within all breed types of cattle, and perinatal mortality will vary between herds depending on their use of bulls with high ease-of-calving ratings in the breeding of the heifer herd. Milk fever and overfatness at calving are other preventable causes of mortality. Selective intensive supervision of calving of the heifer herd can also result in a reduction of perinatal mortality.

### Postnatal Disease

Scours and pneumonia are the next most important causes of mortality in beef calves, followed by exposure to extremely cold weather or being dropped at birth into deep snow or a gully.<sup>15</sup> The incidence of diarrhea is greatest in the first 2 weeks of life, and there is considerable variation in incidence between herds. However, explosive outbreaks of diarrhea or exposure chilling can be significant causes of mortality in certain years. The purchase of a calf for grafting, often from a market, is a significant risk for introduction of disease to a herd.

The **body-condition score** of the dam can influence calf mortality; dams with high condition scores have a higher risk for dystocial mortality, and those with low scores have a higher risk for infectious disease. Mortality from diarrhea is often higher in

calves born to heifers, possibly because heifers are more closely congregated for calving supervision or because of a higher risk for failure of transfer of passive immunity in this age group. Congenital abnormalities can be an occasional cause of mortality in some herds.

### PIGLETS

#### Mortality Rates

Prewaning mortality rates in commercial pig farms reported from different parts of the world range between 11% and 20%, with more than 30% of the mortality occurring in the first 24 hours and more than 50% in the first 4 days of life.<sup>16-18</sup> Mortality increases as the mean litter size increases and as the mean birth weight of the piglets decreases. In most herd environments, the minimal **viable weight** is approximately 1 kg. The mean number of piglets weaned is related to the size of the litter up to an original size of 14 and increases with parity of sows up to their fifth farrowing. Prewaning mortality is negatively correlated with herd size and farrowing crate utilization, and it is positively correlated with the number of farrowing crates per room. The use of farrowing crates was found to reduce neonatal mortality by 50% in some studies, mainly as a result of decreased frequency of crushing of piglets by the sow.

### Major Causes

Surveys of neonatal mortality in piglets have repeatedly indicated that the most important causes of death in piglets from birth to weaning are noninfectious in origin.<sup>16,17,19</sup> The major causes are **starvation and crushing** (75% to 80%; although these may be secondary to, and the result of, hypothermia), congenital abnormalities (5%), and infectious disease (6%). The major congenital abnormalities are congenital splayleg, atresia ani, and cardiac abnormalities. Infectious diseases may be important on certain individual farms but do not account for a major cause of mortality.

### Fetal Disease

Fetal disease rates in most herds are low unless there is an abortion storm or poor control of endemic infections such as parvovirus. In contrast to other species, the majority of abortions are diagnosed and are infectious.

### Parturient Disease

Stillbirths account for 4% to 8% of all deaths of piglets born, and 70% to 90% are type II or intraparturient deaths, in which the piglet was alive at the beginning of parturition.<sup>16</sup> The viability of newborn piglets can be accurately evaluated immediately after birth by scoring skin color, respiration, heart rate, muscle tone, and ability to stand. Stillbirths are more commonly born in the later birth orders of large litters, and it is a relatively

common practice for sows to be routinely given oxytocin at the time of the birth of the first piglet to shorten parturition. Controlled trials have shown that although oxytocin administration at this time will result in a significant decrease in farrowing time and expulsion intervals, there is a significant increase in fetal distress, fetal anoxia, and intrapartum death and an increase in piglets born alive with ruptured umbilical cords and meconium staining.

### Postnatal Disease

The large percentage of mortality caused by **crushing** and trampling likely includes piglets that were starved and weak and thus highly susceptible to being crushed. The estimated contribution of crushing and starvation to neonatal mortality varies from 19% to 58% of liveborn mortality.<sup>16</sup> The body-condition score of the sow at the time of farrowing, the nursing behavior of the sow, the sow's ability to expose the teats to all piglets, and the sucking behavior of the piglets also have a marked effect on survival.

Cold stress is also an important cause of loss, and the provision of a warm and comfortable environment for the newborn piglet in the first few days of life is critical.<sup>17</sup> The lower critical temperature of the single newborn piglet is 34°C (93°F). When the ambient temperature falls below 34°C (93°F), the piglet is subjected to cold stress and must mobilize glycogen reserves from the liver and muscles to maintain deep body temperature. The provision of heat lamps over the creep area and freedom from draughts are two major requirements.

### Management

Minimizing the mortality rate of newborn piglets will depend on management techniques, which include the following:

- Proper selection of the breeding stock for teat numbers, milk production, and mothering ability
- The use of farrowing crates and creep escape areas to minimize crushing injuries
- Surveillance at farrowing time to minimize the number of piglets suffering from hypoxia and dying at birth or a few days later
- Batch farrowing, which allows for economical surveillance
- Fostering to equalize litter size
- Cross-fostering to equalize nonuniformity in birth weight within litters
- Improvement in the thermal comfort of the piglets
- Supplemental iron
- Artificial rearing with milk substitutes containing purified porcine gammaglobulin to prevent enteric infection

## FOALS

### Mortality Rates

Foals are usually well supervised and cared for as individual animals. Neonatal death is less frequent than in other species, but equivalent rates of morbidity and mortality occur on some farms. Infectious disease is important, along with structural and functional abnormalities that are undoubtedly better recognized and treated than in any of the other large animal species. In a large survey of thoroughbred mares in the United Kingdom, only 2% of newborn foals died, only 41% of twins survived, and 98% of singles survived. In contrast, a mortality rate of 22% between birth and 10 days was recorded in an extensively managed system. A recent retrospective study from Ireland determined a foal mortality rate of 5% during the first 12 months; 64.7% of deaths occurred during the first 30 days, and 82% of all deaths occurred within the first 6 months of life.<sup>20</sup>

### Major Causes

#### Fetal Disease

Fetal disease is a major cause of loss; in one study, infections accounted for approximately 30% of abortions. In a retrospective study of 1252 fetuses and neonatal foals submitted for postmortem examination over a 10-year period in the United Kingdom, equine herpes virus and placentitis accounted for 6.5% and 9.8% of the diagnoses, respectively. The placentitis occurred in late gestation, was concentrated around the cervical pole and lower half of the allantochorion, and was associated with ascending chronic infections of bacteria or fungi resident in the lower genital tract.

#### Parturient Disease

Neonatal asphyxia, dystocia, umbilical cord abnormality, congenital abnormalities, and musculoskeletal trauma are important causes of foal mortality. A retrospective study from Ireland found that 45.5% of all deaths that occurred in the first 30 days of life were attributable to congenital abnormalities, 18.2% to the perinatal asphyxia syndrome, and 18.2% to musculoskeletal trauma.<sup>20</sup> In a UK study, umbilical cord disorders accounted for 38.8% of the final diagnoses. Umbilical cord torsion usually resulted in death of the fetus in utero, but the long cord/cervical pole ischemia disorder resulted in intrapartum death and a fresh fetus with lesions consistent with acute hypoxia.

Twins are at higher risk for spontaneous abortion.

#### Postnatal Disease

Postnatal disease causing mortality from birth to 2 months of age includes lack of maturity (36%), structural defect (23%), birth injury (5%), convulsive syndrome (5%), alimentary disorder (12%), generalized infection (11%), and other (miscellaneous; 9%). Of the **infectious diseases**, gastrointestinal

and septicemic diseases have the greatest importance. Whereas in the past many of these conditions would have been fatal, significant advances in the science of equine perinatology were made in the 1980s and 1990s, and protocols for the treatment of neonatal disease have been developed that are based on equivalents in human medicine. These have proved of value in the management and treatment of prematurity, immaturity, dysmaturity, and neonatal maladjustment syndromes in newborn foals and in enteric and septicemic diseases. Different levels of intensive care have been defined, starting from those that can be applied at the level of the farm and increasing in sophistication, required facilities, and instrumentation to those that are the province of a specialized referral hospital. Early follow-up studies indicate that this approach is of considerable value in foals with neonatal disease and that most surviving foals become useful athletic adults.

## NEW WORLD CAMELID CRIS

### Mortality Rates

Mortality of newborn llamas and alpacas is low compared with other production animal species, which in part because New World camelids (NWCs) are frequently kept as companion animals and receive better attention and more intensive treatment in cases of disease. Prewaning mortality rates for llama and alpaca crias are in the range of 2% to 6%, with the great majority of deaths occurring in the first week of life.<sup>21,22</sup>

### Major Causes

#### Fetal Disease

Abortion and fetal loss after 100 days of gestation have been estimated to occur in 5% of all pregnancies in NWCs.<sup>23</sup> Common noninfectious causes for abortion include stress (e.g., related to transport), nutritional deficiencies, and iatrogenic administration of PGF2 $\alpha$  or glucocorticoids. Documented infectious causes for abortion include toxoplasmosis, brucellosis, chlamydiosis, listeriosis, leptospirosis, and neosporosis.<sup>23</sup>

#### Parturient Disease

Perinatal mortality of crias is strongly associated with the course of parturition and the age of the dam at birth. Dystocia and assisted birth clearly increase the risk for postnatal morbidity and perinatal and postnatal mortality in NWC crias, as in other species.<sup>21</sup>

#### Postnatal Disease

The great majority of preweaning mortality occurs in the first week of life, and hypothermia and starvation were determined to be the most common causes of death. Low birth weight was found to considerably increase the risk of perinatal death, as was young age of the dam. Primiparous dams 2 to 3 years old give birth to lighter calves than do older dams and are considered to produce less

colostrum, and of inferior quality, than their multiparous herd mates. Small crias have more difficulties standing and getting sufficient amounts of colostrum and lose more body heat because of greater body surface relative to body mass, and thus they are at increased risk of starving to death or of developing perinatal or postnatal diseases.<sup>21</sup> A difficult parturition negatively affects perinatal vitality and thereby considerably increases the risk for postnatal morbidity and mortality.<sup>22</sup>

### FURTHER READING

- Dwyer CM. The welfare of neonatal lambs. *Small Rumin Res.* 2008;76:31-41.
- Mee JF, Berry DP, Cromie AR. Prevalence of, and risk factors associated with, perinatal calf mortality in pasture based Holstein-Friesian cows. *Animal.* 2008;2:613-620.

### REFERENCES

- Dwyer CM. *Small Rumin Res.* 2008;76:31-41.
- Dwyers CM. *J Anim Sci.* 2008;86:E246-E258.
- Holmøy IH, et al. *Prev Vet Med.* 2012;107:231-241.
- Mee JF, et al. *Animal.* 2008;2:613-620.
- Bicalho RC, et al. *J Dairy Sci.* 2007;90:2797-2803.
- Lombard JE, et al. *J Dairy Sci.* 2007;90:1751-1760.
- Bleul U. *Livest Sci.* 2011;135:257-264.
- Linden TC, et al. *J Dairy Sci.* 2009;92:2580-2588.
- Raboison D, et al. *J Dairy Sci.* 2013;96:2913-2924.
- USDA. 2007. (Accessed 10.01.14, at <[http://www.aphis.usda.gov/animal\\_health/nahms/dairy/downloads/dairy07/Dairy07\\_dr\\_PartII.pdf](http://www.aphis.usda.gov/animal_health/nahms/dairy/downloads/dairy07/Dairy07_dr_PartII.pdf)>).
- Gundelach Y, et al. *Theriogenology.* 2009;71:901-909.
- Guliksen SM, et al. *J Dairy Sci.* 2009;92:2782-2795.
- USDA. 2007. (Accessed 10.01.14, at <[http://www.aphis.usda.gov/animal\\_health/nahms/dairy/downloads/dairy07/Dairy07\\_ir\\_CalfHealth.pdf](http://www.aphis.usda.gov/animal_health/nahms/dairy/downloads/dairy07/Dairy07_ir_CalfHealth.pdf)>).
- Stilwell G, Carvalho RC. *Can Vet J.* 2011;52:524-526.
- USDA APHIS. 2010. (Accessed 10.01.14, at <[http://www.aphis.usda.gov/animal\\_health/nahms/beefcowcalf/downloads/beef0708/Beef0708\\_is\\_Mortality.pdf](http://www.aphis.usda.gov/animal_health/nahms/beefcowcalf/downloads/beef0708/Beef0708_is_Mortality.pdf)>).
- KilBride AL, et al. *Prev Vet Med.* 2012;104:281-291.
- O'Reilly KM, et al. *Vet Rec.* 2006;159:193-196.
- Li YZ, et al. *Can J Anim Sci.* 2012;92:11-22.
- Weber R, et al. *Livest Sci.* 2009;124:216-222.
- Galvin NP, Corley KTT. *Ir Vet J.* 2010;63:37-43.
- Bravo PW, et al. *Anim Reprod Sci.* 2009;111:214-219.
- Sharpe MS, et al. *Aust Vet J.* 2009;87:56-60.
- Vaughan JL, Tibary A. *Small Rumin Res.* 2006;61:259-281.

## PERINATAL DISEASE—SPECIAL INVESTIGATION OF ANY NEONATAL DEATHS (ILLNESS)

The following protocol is a generic guide to the investigation of deaths of newborn animals. It will require modification according to the species involved.

- Determine the duration of pregnancy to ensure that the animals were born at term.
- Collect epidemiologic information on the problem. Where possible, the information should include the following:

- What is the abnormality?
  - What are the apparent age at onset and the age at death?
  - What clinical signs are consistently associated with the problem?
  - What is the prevalence and proportional risk in particular groups (maternal, paternal, nutritional, vaccinated, etc.)?
  - What is the parity of the dam that gave birth to the animal, and what proportional risk does this reflect within the group?
  - What is the birth history of affected animals? Are births supervised, and if so, what is the frequency of observation and what are the criteria for intervention? What is the proportional risk associated with prolonged birth?
  - Is there an effect of litter size, and what is the health of the other littermates?
  - Was there any difference in management of the dams of the affected animals compared with the group as a whole?
  - What is the farm policy for feeding colostrum?
  - What were the environmental conditions during the past 48 hours? (In housed animals, the quality of the environment should be measured objectively.)
- Conduct a postmortem examination of all available dead neonates. The determination of body weight is essential, and measures of **crown-rump length** can also give an indication of gestational age. In order of precedence, the purpose of the postmortem examination is to determine:
    - The time of death in relation to parturition (e.g., fetal disease, parturient disease, early or delayed postnatal death). This can be determined from the state of the lungs, the nature of the severed end of the umbilical artery and the presence of a clot, the state of the brown-fat deposits, whether the animal has walked, and whether it has suckled before death.
    - The possibility that animals born alive have died because of cold stress, hypoglycemia, and starvation. An indication can be obtained from an examination of the brown-fat reserves and observation of the presence or absence of milk in the gastrointestinal tract and fat in the intestinal lymphatics. The presence of subcutaneous edema in the hind limbs is also relevant.
    - The possible presence of birth injury or trauma. In addition to examination of the ribs and liver for trauma and the presenting areas for

subcutaneous edema, the brain should be examined for evidence of hemorrhage.

- The presence of infectious disease. If necessary, samples can be submitted for examination.
  - The presence of congenital disease
- If abortion is suspected, specimens of fetal tissues and the placenta are sent for laboratory examination. Examinations requested are pathologic and microbiological for known pathogens for the species of animal under consideration.
  - A serum sample should be collected from the dam for serologic evidence of teratogenic pathogens, followed by another sample 2 weeks later. Samples from unaffected dams should also be submitted. A precolostral serum sample from affected animals may assist in the diagnosis of intrauterine fetal infections.
  - Investigate management practices operating at the time, with special attention to clemency of weather, feed supply, maternalism of dam, and surveillance by the owner—all factors that could influence the survival rate. Where possible, this should be performed using objective measurements. For example, in calf-rearing establishments, the efficacy of transfer of colostrum immunoglobulins should be established by the bleeding of a proportion of calves and actual measurement, food intake should be established by actual measurement, and so forth.

### FURTHER READING

- English PR, Morrison V. Causes and prevention of piglet mortality. *Pig News Info.* 1984;4:369-376.
- Haughey KC. Perinatal lamb mortality: its investigation, causes and control. *J S Afr Vet Assoc.* 1991;62:78-91.
- Kasari TR, Wikse SE. Perinatal mortality in beef herds. *Vet Clin North Am Food Anim Pract.* 1994;10:1-185.
- Mellor DJ, Stafford KJ. Animal welfare implications of neonatal mortality and morbidity in farm animals. *Vet J.* 2004;168:118-133.
- Randall GCB. Perinatal mortality. Some problems of adaptation at birth. *Adv Vet Sci.* 1978;22:53.
- Rook JS, Scholman G, Wing-Procter S, Shea M. Diagnosis and control of neonatal losses in sheep. *Vet Clin North Am Food Anim Pract.* 1990;6:531-562.
- Rossdale PD, McGladdery AJ. Recent advances in equine neonatology. *Vet Annu.* 1992;32:201-208.

## Perinatal Disease—Congenital Defects

### SYNOPSIS

**Etiology** Genetic, infectious, toxic, and physical causes are recognized for some defects, but the etiology of most is not known.

*Continued*



**Epidemiology** Low but significant incidence in all animals; epidemiology depends on cause.

**Clinical findings** Congenital defects can be structural or functional; clinical signs depend on organ system(s) affected.

**Clinical pathology** Specific serologic and biochemical tests can be used in the diagnosis and control of some congenital disease and, if available, are detailed under specific disease headings.

**Necropsy findings** Specific to the particular problem.

**Diagnostic confirmation** Abnormalities of structure or function that are present at birth are obviously congenital defects; they may or may not be inherited, and inherited defects may or may not be manifest at birth; genome analysis for inherited defects.

**Control** Avoidance of exposure to teratogenic agents; vaccination for some teratogenic infections; identification of carriers for genetic defects.

## ETIOLOGY

Congenital disease can result from defective genetics or from an insult or agent associated with the fetal environment. A neonate with a congenital defect is an adapted survivor from a disruptive event of a genetic or environmental nature or of a genetic–environmental interaction at one or more of the stages in the sequences of embryonic and fetal development.

**Genetic** abnormalities may result in a wide spectrum of disorders that can vary from severe morphologic malformations to the presence of inborn errors of metabolism in animals that may be born apparently normal and develop disease later in life.

Susceptibility to injurious **environmental agents** depends on the nature and the severity (dose size and duration of application) of the insult and decreases with fetal age. Before attachment, the zygote is resistant to teratogens but susceptible to chromosomal aberrations and genetic mutations. Agents that disrupt blastula and gastrula stages and that interfere with normal apposition of the uterine mucosa are usually embryotoxic and induce early embryonic death.

The period during which an **organ system** is being established is a particularly critical period for that system, and different teratogens, if applied at that time, can produce similar defects. One example is the complex of arthrogryposis and cleft, which can occur in the calves of cattle grazing certain species of lupine, in calves infected in utero with Akabane virus, and as an inherited disease in Charolais calves.

Many noninherited congenital defects in animals occur in “**outbreaks**,” which is a reflection of the exposure of the pregnant herd to a virus, poisonous plant, or other teratogen during a period of fetal susceptibility. Because this occurs in early pregnancy, it is often very difficult to determine the nature of this exposure at the time the animals are born.

Some teratogens are quite **specific** in the defect that they produce, and their action may be limited to a single species; a tentative diagnosis as to cause can be based on this association. Others produce a wide variety of abnormality that may also occur with other teratogens, and cause is less obvious.

The exact etiology of most congenital defects is unknown. Influences that are known to produce congenital defects are presented here.

## Chromosomal Abnormality and Inheritance

Most chromosomal abnormalities are associated with poor fertility and early embryonic death. A few are structural or numerical aberrations of chromosomes. The importance of chromosomal abnormality to congenital defects in farm animals has not been studied extensively, but a study of 55 aborted and stillborn calves found 6 with an abnormal chromosome component. Chromosomal abnormality is usually associated with multiple deformations. Most chromosomal abnormalities are mutant genes, and the majority are inherited as recessive traits. There are many examples among domestic animals.

## Viral and Other Infections

Members of the Bunyaviridae (Akabane virus, Cache valley virus, and Rift Valley fever virus), *Orbivirus* (bluetongue virus, epizootic hemorrhagic disease virus, and Chuzan virus), and *Pestivirus* (bovine virus diarrhea virus, border disease virus, and hog cholera virus) families; Japanese B encephalitis virus; and Wesselsbron virus are recognized teratogens. Other viruses also can result in fetal death without malformation. Examples are as follows:

- Akabane virus—this infection of pregnant cattle, sheep, and goats causes arthrogryposis, microencephaly, and hydrocephalus. Infection of, and disease of, the fetus depends on the stage of pregnancy and the fetus’s immunologic status. In cattle infected between 76 and 104 days of pregnancy, hydranencephaly predominates; arthrogryposis predominates with infections between 104 and 173 days of gestation, and poliomyelitis predominates after 173 days. In sheep the window of susceptibility for congenital defects is between 30 and 50 days.

- Cache valley virus—congenital infection of lambs with Cache valley virus produces disease very similar to that produced by Akabane virus in cattle. The period of susceptibility for congenital defects is 36 to 45 days of pregnancy.
- Rift Valley fever virus infection of pregnant sheep results in placentitis and abortion, but attenuated vaccine strains produce arthrogryposis and brain defects.
- Bluetongue virus—vaccination of ewes with attenuated vaccine virus between days 35 and 45 of pregnancy causes a high prevalence of porencephaly in lambs. Natural infections of sheep (50 to 80 days of gestation) and cattle (60 to 120 days of gestation) can result in fetal death and resorption or the birth of stillborn animals, weakborn animals, and animals with hydrocephalus, hydranencephaly, and, occasionally, arthrogryposis. Similar defects are produced by Chuzan, Aino, and Kasba virus infections.
- Bovine viral diarrhea—infection with cytopathogenic strains before 100 days can result in abortion and mummification, cerebellar hypoplasia, and optic defects, including cataracts, retinal degeneration, and hypoplasia and neuritis of the optic nerves. Other defects are brachygnathia, curly coats, abortion, stillbirth, and mummification. Infection of the bovine fetus between 45 and 125 days of gestation with a noncytopathic biotype of the virus can result in the development of a persistently viremic and immunotolerant calf that is carried to term, is born alive, remains persistently viremic, and may later develop mucosal disease.
- Border disease virus—the window of susceptibility is from 16 to 90 days of gestation, and, depending on the fetal age at infection and the presence of a fetal immune response, fetal infection may result in fetal death, growth retardation, the birth of persistently infected lambs, or lambs born with hypomyelinogenesis, hydranencephaly, and cerebellar dysplasia. Coat defects may also be seen.
- Hog cholera virus—vaccination of sows with modified vaccine virus between days 15 and 25 of pregnancy produces piglets with edema, deformed noses, and abnormal kidneys. Natural infection with field virus can cause reproductive inefficiency and cerebellar hypoplasia in piglets.
- An unidentified virus is associated with the AII type of congenital tremor in pigs.
- Congenital infection with Wesselsbron virus and with Rift Valley fever is

recorded as producing central nervous system disease in cattle and sheep.

- Japanese B encephalitis virus in pigs can result in abortion or in the birth of weak, mummified, or stillborn piglets and live piglets with neurologic abnormalities. The window of susceptibility is from 40 to 60 days of gestation.
- Pseudorabies virus infection of the pregnant sow can result in myoclonia congenita in piglets.
- Viral, bacterial, and protozoal agents that produce abortion in animals can also produce intrauterine growth retardation and the birth of weakborn neonates that are highly susceptible to mortality in early life.

### Nutritional Deficiency

Many congenital defects in animals are known to be caused by deficiencies of specific nutrients in the diet of the dam. Examples are as follows:

- Iodine—goiter and increased neonatal mortality are caused in all species; prolonged gestation occurs in horses and sheep. Congenital musculoskeletal lesions are seen in foals (congenital hypothyroid dysmaturity syndrome). Deficiency may result from a primary deficiency or be induced by nitrate or *Brassica* spp. Syndromes are also produced by iodine excess, often associated with feeding excess seaweed or seaweed products.
- Copper—enzootic ataxia in lambs can result from either to a primary copper deficiency or a secondary deficiency in which the availability of copper is interfered with by other minerals (e.g., molybdenum and iron).
- Manganese—chondrodystrophy and limb deformities in calves
- Vitamin D—neonatal rickets
- Vitamin A—eye defects, harelip, and other defects in piglets
- Vitamin E and/or selenium—congenital cardiomyopathy and muscular dystrophy
- Congenital cobalt deficiency is reported to reduce lamb vigor at birth and to increase perinatal mortality because of impaired immune function in the lamb. A similar effect on immune function in neonatal lambs and calves has been proposed with copper deficiency.
- Malnutrition of the dam can result in increased neonatal mortality and is suspected in the genesis of limb deformities and in congenital joint laxity and dwarfism in calves.
- Vitamin A deficiency induced by feeding potato tops or water with high nitrate content has been associated with congenital blindness in calves.

### Poisonous Plants

The teratogenic effects of poisonous plants have been reviewed in detail. Some examples are as follows:

- *Veratrum californicum* fed to ewes at about the 14th day of pregnancy can cause congenital cyclopia and other defects of the cranium and brain in lambs, in addition to prolonged gestation. When fed at 27 to 32 days of pregnancy, it can produce limb abnormalities. Tracheal stenosis has been produced by feeding at 31 to 33 days of gestation. The alkaloid cyclopamine is the teratogenic substance.
- “Crooked-calf disease” is associated with the ingestion of *Lupinus* sp. during pregnancy. This is a major problem on some rangelands in western North America. There are approximately 100 species of *Lupinus* in Canada and the United States, but the disease has been mainly associated with *L. sericeus*, *L. leucophyllus*, *L. caudatus*, and *L. laxiflorus*. These species are thought to be toxic because of their content of anagryne, but some piperidine alkaloids may also produce the disease. The disease has been reproduced by feeding anagryne-containing lupines to pregnant cattle between 40 and 90 days of gestation, but it can occur with later feeding in natural grazing. The syndrome is one of arthrogryposis, torticollis, scoliosis, and cleft palate.
- *Astragalus* and *Oxytropis* spp. locoweeds cause limb contracture in calves and lambs, in addition to fetal death and abortion.
- Tobacco plants—ingestion of *Nicotiana tabacum* (burley tobacco) and *Nicotiana glauca* (tree tobacco) by sows between 18 and 68 days of gestation, with peak susceptibility between 43 and 55 days, can cause limb deformities in their piglets. The teratogen is the piperidine alkaloid anabasine. Cleft palate and arthrogryposis have also been produced experimentally in the fetuses of cattle and sheep fed *N. glauca* during pregnancy, but the plant is not palatable, and thus this is an unlikely cause of natural disease.
- *Conium maculatum*, poison hemlock, fed to cows during days 55 to 75 of pregnancy, to sheep in the period of 30 to 60 days of pregnancy, and to sows in the period of 30 to 62 days of pregnancy will cause arthrogryposis, scoliosis, torticollis, and cleft palate in the fetuses. Cattle are most susceptible. The piperidine alkaloids coniine and coniceine are responsible.
- *Leucaena leucocephala* (or mimosine, its toxic ingredient) causes forelimb polyplodia (supernumerary feet) in

piglets when fed experimentally to sows.

- Fungal toxicosis from the feeding of moldy cereal straw has been epidemiologically linked to outbreaks of congenital spinal stenosis and bone deformities associated with premature closure of growth plates in calves.

### Farm Chemicals

Certain farm chemicals are associated with teratogenic effects, including the following:

- Some benzimidazoles (parbendazole, cambendazole, oxfendazole, albendazole netobimin) are important teratogens for sheep, producing skeletal, renal, and vascular abnormality when administered between 14 and 24 days of pregnancy.
- Methallibure, a drug used to control estrus in sows, causes deformities in the limbs and cranium of pigs when fed to sows in early pregnancy.
- Apholate, an insect chemosterilant, is suspected of causing congenital defects in sheep.
- The administration of trichlorfon to pregnant sows can result in the birth of piglets with cerebellar hypoplasia and congenital trembles.
- Organophosphates have been extensively tested and found to be usually nonteratogenic. A supposed teratogenic effect is probably more a reflection of the very common usage of these substances in agriculture (see the discussion in the section on poisoning by organophosphates).
- Griseofulvin given to a mare in the second month of pregnancy is suspected of causing microphthalmia and facial bone deformity in a foal.

### Physical Insults

Physical insults can also result in fetal abnormalities; examples are as follows:

- Severe exposure to beta or gamma irradiation (e.g., after an atomic explosion) can cause a high incidence of gross malformations in developing fetuses.
- Rectal palpation of pregnancy using the amniotic slip method between 35 and 41 days of pregnancy in Holstein Friesian cattle is associated with atresia coli in the calf at birth, but there is also a genetic influence. It is probable that the cause is palpation-induced damage to the developing colonic vasculature.
- Hyperthermia applied to the dam experimentally causes congenital deformities, but this appears to have no naturally occurring equivalent. The most severe abnormalities occur after exposure during early pregnancy (18 to 25 days in ewes). Disturbances of central nervous system development are the most common. Defects of the spinal

cord manifest themselves as arthrogryposis, and exposure of ewes to high temperatures (42°C, 107.5°F) causes stunting of limbs; the lambs are not true miniatures because they have selective deformities, with the metacarpals selectively shortened. The defect occurs whether nutrition is normal or not. Hyperthermia between 30 and 80 days of pregnancy in ewes produces growth retardation in the fetus. Developmental abnormalities have been reproduced experimentally in explanted porcine embryos exposed to environmental temperatures similar to those that may be associated with reproductive failure resulting from high ambient temperatures in swine herds.

### Environmental Influences

Currently, there is considerable interest in the possible teratogenic effects of human-caused changes in the environment. The concern is understandable because the fetus is a sensitive biological indicator of the presence of noxious influences in the environment. For example, after an accidental release of polybrominated biphenyls, much of the angry public commentary related to the probable occurrence of congenital defects. The noxious influences can be physical or chemical. In one examination of the epidemiology of congenital defects in pigs, it was apparent that any environmental causes were from the natural environment; human-caused environmental changes, especially husbandry practices, had little effect. A current concern in some regions is an apparent increase in congenital defects thought to be associated with exposure to radiofrequency electromagnetic fields associated with mobile telephone networks, but there are few hard data.

### EPIDEMIOLOGY

Individual abnormalities differ widely in their spontaneous occurrence. The determination of the cause of congenital defects in a particular case very often defies all methods of examination. Epidemiologic considerations offer some of the best clues, but they are obviously of little advantage when the number of cases is limited. The possibility of inheritance playing a part is fairly easily examined if good breeding records are available. The chances of coming to a finite conclusion are much less probable. The determination of the currently known teratogens has mainly been arrived at following epidemiologic studies suggesting possible causality followed by experimental challenge and reproduction of the defect with the suspected teratogen.

An expression of the **prevalence** of congenital defects is of very little value unless it is related to the size of the population at risk, and almost no records include this vital data. Furthermore, most of the records

available are retrospective and based on the number of cases presented at a laboratory or hospital.

Reported prevalence rates of 0.5% to 3.0% for calves and 2% for lambs are comparable with the human rate of 1% to 3%. A much higher rate for animals of 5% to 6% is also quoted. A study of over 3500 cases of abortion, stillbirth, and perinatal death in horses found congenital malformations in almost 10%. A very extensive literature on congenital defects in animals exists, and a bibliography is available.

Some breeds and families have extraordinarily high prevalence rates because of intensive inbreeding. The extensive use, by artificial insemination, of certain genetics can result in a significant increase in the occurrence and similar nature of congenital defects when the bulls are carriers of genetic disease. The use of bulls that were carriers for complex vertebral malformation syndrome, for example, resulted in an approximately threefold increase in the presence of arthrogryposis, ventricular septal defect, and vertebral malformations in Holstein Friesian calves submitted to diagnostic laboratories in the Netherlands between 1994 and 2000.

Checklists of recorded defects are included in the Further Reading section.

### PATHOGENESIS

The pathogenesis of many of the congenital defects of large animals is poorly understood, but it is apparent that the disease produced by each teratogen is likely to have its own unique pathogenesis. Congenital defects in large animals include defects induced from structural malformations, from deformations, from the destruction of tissue by extraneous agents, and from enzyme deficiencies, or from a combination of these.

### Structural Malformations and Deformations

**Structural malformations** result from a localized error in morphogenesis. The insult leading to the morphogenic error takes place during organogenesis and thus is an influence imposed in early gestation. **Deformations** occur where there is an alteration in the shape of a structure of the body that has previously undergone normal differentiation. Deforming influences apply later in the early gestational period, after organogenesis.

Deformation is the cause of arthrogryposis and cleft palate produced by the piperidine alkaloids from *Conium maculatum* and *Nicotiana* spp. and by anagryrine from *Lupinus* spp., which produce a chemically induced reduction in fetal movements. Ultrasound examination of the normal fetus shows that it has several periods of stretching and vigorous galloping during a 30-minute examination period. In contrast, the fetus that is under the influence of anagryrine has

restricted movement and lies quietly, often in a twisted position. Restricted fetal limb movement results in arthrogryptic fixation of the limbs, and pressure of the tongue on the hard palate when the neck is in a constant flexed position inhibits closure of the palate. In experimental studies there is a strong relation between the degree and duration of reduced fetal movement, as observed by ultrasound, and the subsequent severity of lesions at birth.

Restriction in the movement of the fetus, and deformation, can also result from teratogens that produce damage and malfunction in organ systems, such as the primary neuropathy that occurs in the autosomal-recessive syndrome in Charolais cattle and the acquired neuropathy in Akabane infection, both of which result in arthrogryposis through absence of neurogenic influence on muscle activity.

It has been suggested, with some good evidence, that the etiology and pathogenesis of congenital torticollis and head scoliosis in the equine fetus are related to an increased incidence of transverse presentation of the fetus. Flexural deformities of the limbs are also thought to be a result of errors in fetal positioning and limited uterine accommodation, which may be further complicated by maternal obesity. Abnormal placental shape may also be important in the genesis of skeletal deformations.

### Viral Teratogenesis

Viral teratogenesis is related to the susceptibility of undifferentiated and differentiated cells to attachment, penetration, and virus replication; the pathogenicity of the virus (cytopathogenic versus noncytopathogenic strains of bovine viral diarrhea); the effects that the virus has on the cell; and the stage of maturation of immunologic function of the fetus at the time of infection. Viral infections can result in prenatal death, the birth of nonviable neonates with severe destructive lesions, or the birth of viable neonates with growth retardation or abnormal function (tremors, blindness). The gestational age at infection is a major influence. In sheep infected with border disease virus between 16 and 90 days of gestation, the occurrence of the syndromes of early embryonic death, abortion, and stillbirth and the birth of defective, small, and weak lambs are related to the fetal age at infection. Certain viruses cause selective destruction of tissue and of organ function late in the gestational period, and the abiotrophies are examples of selective enzyme deficiencies. The pathogenesis of the viral diseases is given under their specific headings in later chapters.

### Inherited Congenital Defects

A number of **inherited congenital defects**, some of which are not clinically manifest until later in life, are associated with specific



enzyme deficiencies. Examples are maple syrup urine disease (MSUD), citrullinemia, factor XI deficiency in cattle, and the lysosomal storage diseases. Inherited lysosomal storage diseases occur when there is excessive accumulation of undigested substrate in cells. In mannosidosis, the disease occurs as a result of an accumulation of saccharides caused by a deficiency of either lysosomal  $\alpha$ -mannosidase or  $\beta$ -mannosidase. In GM<sub>1</sub> gangliosidosis, disease is caused by a deficiency of  $\beta$ -galactosidase; in GM<sub>2</sub> gangliosidosis, the cause is a deficiency of hexosaminidase.

The age at development of clinical signs and their severity are dependent on the importance of the enzyme that is deficient, the biochemical function and cell type affected, and, in storage disease, the rate of substrate accumulation. Factor XI deficiency is manifest with bleeding tendencies, but the condition is not necessarily lethal. In contrast, calves with citrullinemia and MSUD develop neurologic signs and die shortly after birth, whereas the onset of clinical disease can be delayed for several months with  $\alpha$ -mannosidosis.

### CLINICAL AND NECROPSY FINDINGS

The intention is to give details of the clinical signs of all the congenital defects here, but some general comments are necessary. Approximately 50% of animals with congenital defects are **stillborn**. The defects are usually readily obvious clinically. Diseases of the nervous system and musculoskeletal system rate high in most published records, which may be related to the ease with which abnormalities of these systems can be observed. For example, in one survey of congenital defects in pigs, the percentage occurrence rates in the different body systems were as follows:

- Bones and joints, 23%
- Central nervous system, 17%
- Special sense organs, 12%
- Combined alimentary and respiratory tracts (mostly cleft palate and atresia ani), 27%
- Miscellaneous (mostly monsters), 9%
- Genitourinary and abdominal wall (hernias), each 5%
- Cardiovascular system, 3%

In a survey of congenital defects in calves, the percentage occurrence rates were as follows:

- Musculoskeletal system, 24%
- Respiratory and alimentary tracts, 13%
- Central nervous system, 22%
- Abdominal wall, 9%
- Urogenital, 4%
- Cardiovascular, 3%
- Skin, 2%
- Others, 4%
- (Anomalous-joined twins and hydrops amnii accounted for 20%.)

In a survey of foals, the approximate percentage occurrence rates were as follows:

- Musculoskeletal system, 50%
- Respiratory and alimentary tracts, 20%
- Urogenital, 9%
- Abdominal wall, 6%
- Cardiovascular, 5%
- Eye, 5%
- Central nervous system, 5%

Contracted foal syndrome and craniofacial abnormalities were the most common congenital defects in a study of stillbirth and perinatal death in horses.

Many animals with congenital defects have more than one anomaly. In pigs, for example, the average is two, and considerable care must be taken to avoid missing a second and third defect in the excitement of finding the first. In some instances, the combinations of defects are repeated often enough to become specific entities. Examples are microphthalmia and cleft palate, which often occur together in piglets, and microphthalmia and patent interventricular septum in calves.

There are a number of defects that cannot be readily distinguished at birth and others that disappear subsequently. It is probably wise not to be too dogmatic in predicting the outcome in a patient with only a suspicion of a congenital defect or one in which the defect appears to be causing no apparent harm. A specific instance is the newborn foal with a cardiac murmur.

Sporadic cases of congenital defects are usually impossible to define etiologically, but when the number of affected animals increases, it becomes necessary and possible to attempt to determine the cause.

### CLINICAL PATHOLOGY

The use of clinical pathology as an aid to diagnosis depends on the disease that is suspected and its differential diagnosis. The approach varies markedly with different causes of congenital defects: **specific tests** and procedures are available for some of the viral teratogens, for congenital defects associated with nutritional deficiencies, and for some enzyme deficiencies and storage diseases, and the specific approach for known teratogens is covered in the individual diseases section.

When an unknown viral teratogen is suspected, precolostral blood samples should be collected from the affected neonates and also from normal contemporaries that are subsequently born in the group. Precolostral serum can be used for investigating the possible fetal exposure of the group to an agent, and the buffy coat or blood can be used for attempted virus isolation. IgG and IgM concentrations in precolostral serum may give an indication of fetal response to an infecting agent even if the agent is not known and there is no serologic titer to known teratogenic agents.

Enzyme-based tests have been used to virtually eradicate carriers of  $\alpha$ -mannosidosis in cattle breeds in Australia and New Zealand, and DNA-based tests are used to detect and eliminate the carriers of such diseases as generalized glycogenosis in cattle.

### DIFFERENTIAL DIAGNOSIS

- The diagnostic challenge with congenital defects is to recognize and identify the defect and to determine the cause.
- Syndromes of epidemic disease resulting from environmental teratogens are usually sufficiently distinct that they can be diagnosed on the basis of their epidemiology combined with their specific clinical, pathologic, and laboratory findings and on the availability of exposure.
- Congenital defects occurring sporadically in individual animals pose a greater problem. There is usually little difficulty in defining the condition clinically, but it may be impossible to determine the cause. With conditions where there is not an obvious clinical diagnosis, an accurate clinical definition may allow placement of the syndrome within a grouping of previously described defects and suggest possible further laboratory testing for further differentiation.

The examination for cause of an unknown congenital defect is usually not undertaken unless more than a few newborn animals in a herd or area are affected in a short period of time with similar abnormalities. A detailed epidemiologic investigation will be necessary, which will include the following:

- Pedigree analysis. Does the frequency of occurrence of the defect suggest an inherited disease, or is it characteristically nonhereditary?
- Nutritional history of dams of affected neonates and alterations in usual sources of feed
- Disease history of dams of affected neonates
- History of drugs used on dams
- Movement of dams during pregnancy to localities where contact with teratogens may have occurred
- Season of the year when insults may have occurred
- Introduction of animals to the herd

The major difficulty in determining the cause of nonhereditary congenital defects is the long interval of time between when the causative agent was operative and when the animals are presented, often 6 to 8 months. Detailed clinical and pathologic examination of affected animals offers the best opportunity in the initial approach to determine the etiology based on the presence of lesions that are known to be caused by certain teratogens.

### FURTHER READING

Angus K. Congenital malformations in sheep. *In Pract.* 1992;14:33-38.

- De Lahunta A. Abiotrophy in domestic animals: a review. *Can J Vet Res.* 1990;54:65-76.
- Dennis SM. Congenital abnormalities. *Vet Clin North Am Food Anim Pract.* 1993;9:1-222.
- Dennis SM, Leipold HW. Ovine congenital defects. *Vet Bull.* 1979;49:233.
- Leipold HW, Huston K, Dennis SM. Bovine congenital defects. *Adv Vet Sci Comp Med.* 1983;27:197-271.
- Panther KE, Keeler RC, James LF, Bunch TD. Impact of plant toxins on fetal and neonatal development. A review. *J Range Manag.* 1992;45:52-57.
- Parsonson IM, Della-Porta AJ, Snowdon WA. Development disorders of the fetus in some arthropod-bovine virus infection. *Am J Trop Med Hyg.* 1981;30:600-673.
- Rousseaux CG. Congenital defects as a cause of perinatal mortality of beef calves. *Vet Clin North Am Food Anim Pract.* 1994;10:35-45.
- Rousseaux CG. Developmental anomalies in farm animals. I. Theoretical considerations. *Can Vet J.* 1988;29:23-29.
- Rousseaux CG, Ribble CS. Developmental anomalies in farm animals. II. Defining etiology. *Can Vet J.* 1988;29:30-40.
- Whitlock BK, Kaiser L, Maxwell HS. Heritable bovine fetal abnormalities. *Theriogenology.* 2008;70:535-549.

## INTRAUTERINE GROWTH RETARDATION

Intrauterine growth retardation is a special form of congenital defect. It is a failure to grow properly, in contrast to a failure to gain body weight, and occurs when the developmental age is less than the chronologic (gestational) age. **Runt** is a common colloquial agricultural term. Normal fetal growth rate is determined by genetic and epigenetic factors, and cross-breeding experiments suggest that fetal size is regulated by the embryonic/fetal genotype and also is an effect of maternal genotype. Litter size has an effect on birth weight in all species, most likely through effects on the placental delivery of nutrients and removal of waste products relative to total fetal mass. A **genetic** association with intrauterine growth retardation has been shown in Japanese Black calves.

There is a strong positive association between placental mass and fetal size at birth in all species, and the majority of cases of growth retardation result from inadequate placentation, disturbance in utero of placental blood flow, or placental pathology.

### ETIOLOGY

There are a number of different etiologies.

**Heat stress** to ewes in the final third of pregnancy will result in intrauterine growth retardation, but the condition is not as severe as when ewes are exposed in the second third of pregnancy, which is the period of placental growth. Hyperthermia results in a redistribution of blood away from the placental vascular bed and a decrease in cotyledon mass, with consequent reduction in birth weight. The degree of growth restriction is directly related to the degree of hyperthermia to which the ewe is exposed and her heat

tolerance. The growth retardation affects fetal weight more than fetal length, and although there is some reduction in the growth of the brain, it is relatively less than that of the internal organs, resulting in an increased brain:liver weight ratio at birth.

**Viral infections**, such as border disease and bovine virus diarrhea in ruminants and parvovirus in pigs, produce growth-retarded neonates, as do bacterial and other infections that result in postentitis.

**Inadequate placentation** is the cause of runt piglets. Runts are smaller and thinner and have disproportionately larger, domed heads compared with normal pigs. A deficiency in specific **trace elements** is suspect in some field cases of growth retardation in ruminants, but there is no evidence for deficient trace-element nutrition in runt pigs.

**Inadequate nutrition** can result in growth retardation in utero. Growth retardation can be produced in fetal pigs, lambs, and calves by **maternal caloric undernutrition**. Nutritional restriction in ewes reduces the number of placental lactogen receptors that mediate amino acid transport in fetal liver and glycogen synthesis in fetal tissue, leading to depletion of fetal liver glycogen stores. This has been postulated as a possible cause of the fetal growth retardation that accompanies maternal caloric undernutrition; runt pigs have a reduced metabolic rate and lower skeletal muscle respiratory enzyme activity. This deficiency persists after birth; runt pigs have a lower core temperature and a lessened ability to increase their metabolic rate and heat production in response to cold.

Paradoxically, **overnourishing the adolescent ewe** will also result in placental growth restriction and in utero growth retardation. This effect is most evident in the second third of pregnancy. This syndrome is accompanied by the birth of lambs with a shorter gestational age, commonly reduced by 3 days. It is thought that the fetal hypoxia and hypoglycemia that accompany placental insufficiency might stimulate the maturation of the fetal hypothalamic-pituitary-adrenal axis, initiating early parturition. The growth of those lambs that survive initially lags behind that of normal lambs, but there is compensatory growth and no difference in weight at 6 months of age.

**Measurements** that can be used to determine the presence of growth retardation in a **dead fetus** include crown-rump (anal) length, brain weight, body weight, ratios of brain to body weight, long-bone weight, and appendicular ossification centers. Formulas are available to determine the degree of growth retardation.

In the **live animal** the presence of radiodense lines in long bones and the examination of closure of ossification centers can provide evidence for prior stressors in pregnancy that induce fetal growth retardation, such as malnutrition or infection of

the dam, that may not be found by other examinations.

Intrauterine growth retardation is accompanied by an impaired cellular development of tissues, such as the small intestine and skeletal muscle, and disproportionately large reductions in the growth of some organs, such as the thymus, spleen, liver, kidney, ovary, and thyroid. There is an associated impairment of thermogenesis, immune function, and organ function at birth. In lambs there is impaired development of secondary wool follicles.

The **survival** of fetuses with growth retardation requires special nutritional care and the provision of adequate heat; this topic is discussed in the section on critical care for the newborn. In large piggeries that practice batch farrowing, the survival of runts can be significantly improved by the simple practice of fostering them together in one litter on one sow so that they do not have to compete with larger-birth-size and more vigorous pigs, by ensuring adequate colostrum intake and adequate environmental warmth, and by feeding using a stomach tube in the first few hours of life, if indicated.

### FURTHER READING

- Ferenc K, Pietrzak P, Godlewski MM, et al. Intrauterine growth retarded piglet as a model for humans—studies on the perinatal development of the gut structure and function. *Reprod Biol.* 2014;14(1):51-60.
- Wu G, Bazer FW, Wallace JM, et al. Board-invited review: intrauterine growth retardation: implications for the animal sciences. *J Anim Sci.* 2006;84(9):2316-2337.

## Physical and Environmental Causes of Perinatal Disease

Neonatal animals are newborns. The definition of a neonate is not precisely defined in terms of age of the animal and likely will vary from species to species dependent on the ability of the newborn to survive relatively independently and on the maturity or degree of postnatal development. Most farm mammals can be considered neonates until they are 2 weeks of age.<sup>1</sup>

The health of neonates is determined by factors that influence their growth and development in utero and their capacity to adapt to extrauterine life. Neonates affected by intrauterine conditions that impede their normal development (intrauterine growth retardation or premature birth) might not be prepared for the rapid and extensive physiologic changes needed to survive after birth. Furthermore, conditions experienced by the newborn can adversely affect its health and well-being; key among these factors are adequate nutrition, transfer of passive immunity from the dam, a thermoneutral environment or protection from the adverse effects of

excessive cold or heat, and protection from risk of injury.

## PERINATOLOGY

Clinical care of the newborn animal in large animal veterinary medicine has traditionally started at the time of birth, but there is a growing recognition of the importance of antenatal and parturient events to the subsequent viability of the neonate.<sup>2</sup> This has been particularly recognized by equine clinicians and has led to the clinical concept of perinatology. One purpose of perinatology is to expand the care of the neonate into the antenatal and parturient period through the use of measurements that reflect fetal health or that can predict risk to fetal viability. Measures that can be used are still being developed and evaluated, but the following discussion includes those that have apparent value.

### HEART RATE

**Fetal heart rate** recorded by electrocardiography (ECG) or by ultrasound can be used as a measure of fetal viability, for the detection of twins, and as a monitor for fetal distress during parturition.<sup>3</sup> The fetal heart rate of foals declines during gestation (Fig. 19-1) to approximately 60 to 80 beats/min near to term, and that of fetal calves is approximately 110 beats/min during the final 2 weeks of gestation.<sup>4</sup>

It has been suggested that a base heart rate of 80 to 92 beats/min with baseline variations of 7 to 15 beats/min and occasional accelerations above this is normal for the fetal heart rate of equids, and that bradycardia is evidence of abnormality. Continued monitoring traces may be needed to assess fetal distress.

Cardiac arrhythmia is common at the time of birth and for the first few minutes following and is thought to result from the transient physiologic hypoxemia that occurs during the birth process.

An alternative to fetal ECG monitoring is use of per rectum or percutaneous

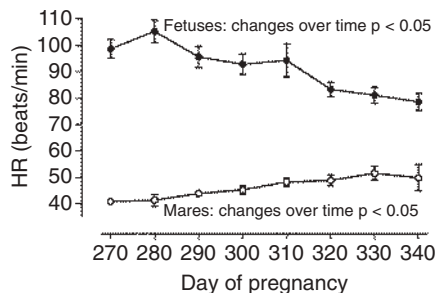

**Fig. 19-1** Heart rate of mare and fetus from 270 days of gestation until foaling. The heart rate of the mare increases, whereas that of the foal declines, as the duration of gestation increases. (Reproduced from Nagel et al., 2011.<sup>16</sup>)

ultrasonography to detect carotid or peripheral pulse rates in foals and calves.<sup>4,5</sup>

### ULTRASOUND EXAMINATION

The fetus can be examined by **ultrasound** to establish the presentation, the presence of twins, the heart rate, the presence and quality of fetal movement, the presence of placentitis, placental thickness, the presence of echogenic particles in the amniotic fluid, the depth of allantoic and amniotic fluid, and an estimate of body size from the measurement of the aortic and orbit diameters.<sup>3,5-8</sup> Measurements of fetal heart rate, fetal aortic diameter (an indicator of fetal size and, if measured near parturition, fetal birth weight),<sup>8</sup> uteroplacental contact, maximal fetal fluid depths, uteroplacental thickness, and fetal activity have allowed the development of objective measures to assess fetal well-being (Fig. 19-2).<sup>6</sup>

Clinicopathologic examination of samples of the **amniotic fluid** for the determination of pulmonary maturity and other measures of foal health is limited because there is a considerable risk for abortion and placentitis, even with ultrasound-guided amniocentesis, and the technique is not recommended for routine clinical use.

### PREMATURITY

The average gestational length for mares is 343 days (range, 307 to 381), with the duration of gestation being longer for mares foaling later in the spring and for mares giving birth to a male foal (344 versus 341 days for a filly foal, respectively). There is no effect of breed of the mare or her age on gestational length.<sup>9</sup> Approximately 95% of mares were found to foal between 320 and 360 days of gestation, with 1.1% foaling at less than 320 days. Death rates were 8.3%, 3.6%, and 4.8% for foals born at less than 320 days, 320 to 360 days, and more than 360 days of gestation, respectively.<sup>9</sup> The difference was not statistically significant, but the number of foals born at less than 320 days was small (12), and this could have masked a statistical difference in case fatality rates. No foal lived if it was born at less than 311 days of gestation. Foals born at less than 320 days of gestational age are considered premature, and those born at less than 310 days are at significant risk for increased rate of death.<sup>10</sup>

Dystocia is associated with increased morbidity and case fatality rate in foals. Stage II labor lasting longer than 40 minutes is associated with increased risk of stillbirth (16×), death after birth (8×), and illness in the foal (2×).<sup>9</sup>

Similar data are available for cattle. For instance, in 41,116 calvings of Japanese Black cattle, there were 1013 stillbirths (2.46%) and 3514 dystocias (8.55%). Stillbirth rates were greater for those born at 301 or more days of pregnancy (OR: 1.049 [1.035 to 1.062]) and at 270 or fewer days of pregnancy (OR: 2.072 [2.044 to 2.101]) compared with those at

between 281 and 290 days of pregnancy.<sup>11</sup> Among Holsteins, Jerseys, and crossbreds, gestation length was ~275 days, with male calves having a gestation length 1.2 days longer. The percentage of stillbirths was 6.6% across all observations, with 9.6% among first-parity dams and 5.1% among multiparous dams.<sup>12</sup>

Traditionally, external signs have been used to predict a premature foaling, and the common signs used are the enlargement of the udder, milk flow, and the occurrence of vaginal discharge. Causes of early foaling include bacterial or fungal placentitis and twin pregnancy. Several **assays** are used as alternate methods of determining whether foaling is imminent and if problems are present.

Plasma **progesterone** concentrations in mares decline in pregnancy to reach a low around 150 days of gestation. Plasma progesterone cannot be used to accurately predict the time of foaling, and a single sample is not diagnostic. There is a strong correlation between the presence of plasma progesterone concentrations above 10 ng/mL before a gestational age of 310 days and the presence of placental lesions, and a rapid drop in concentration to below 2 ng/mL that persists for more than 3 days indicates impending abortion. Current research is examining the profiles of individual progesterones during pregnancy to determine whether the profile of any progesterone can be used as a predictor of fetal distress.

There is considerable interest in predicting the time of parturition in mares. Recognition that significant changes occur in udder secretions during the last week of gestation, including a drop in pH on the day of foaling and increases in concentrations of calcium and potassium and declines in levels of sodium and chloride, has led to the development of several relatively simple tests.<sup>13</sup> These tests include measurement of the refractive index, pH, and calcium concentration of udder secretions during the week before anticipated parturition. Samples can be analyzed for calcium carbonate concentration using a water hardness kit, for pH with pH test paper, and for refractometry index with a Brix or similar refractometer. The positive predictive value (PPV) of parturition occurring within 72 hours and the negative predictive value (NPV) within 24 hours for calcium carbonate concentration ( $\geq 400$   $\mu\text{g/g}$ ) were 94% and 98%, respectively.<sup>14,15</sup> The PPV within 72 hours and the NPV within 24 hours for the pH test ( $\leq 6.4$ ) were 98% and 99%, respectively. The PPV within 72 hours and the NPV within 24 hours for the Brix test ( $\geq 20\%$ ) were 73% and 97%, respectively. The high negative predictive value of measurement of calcium concentrations (by either method) and pH provides a way of determining when the mare is not likely to foal within the next 24 hours.<sup>14</sup>



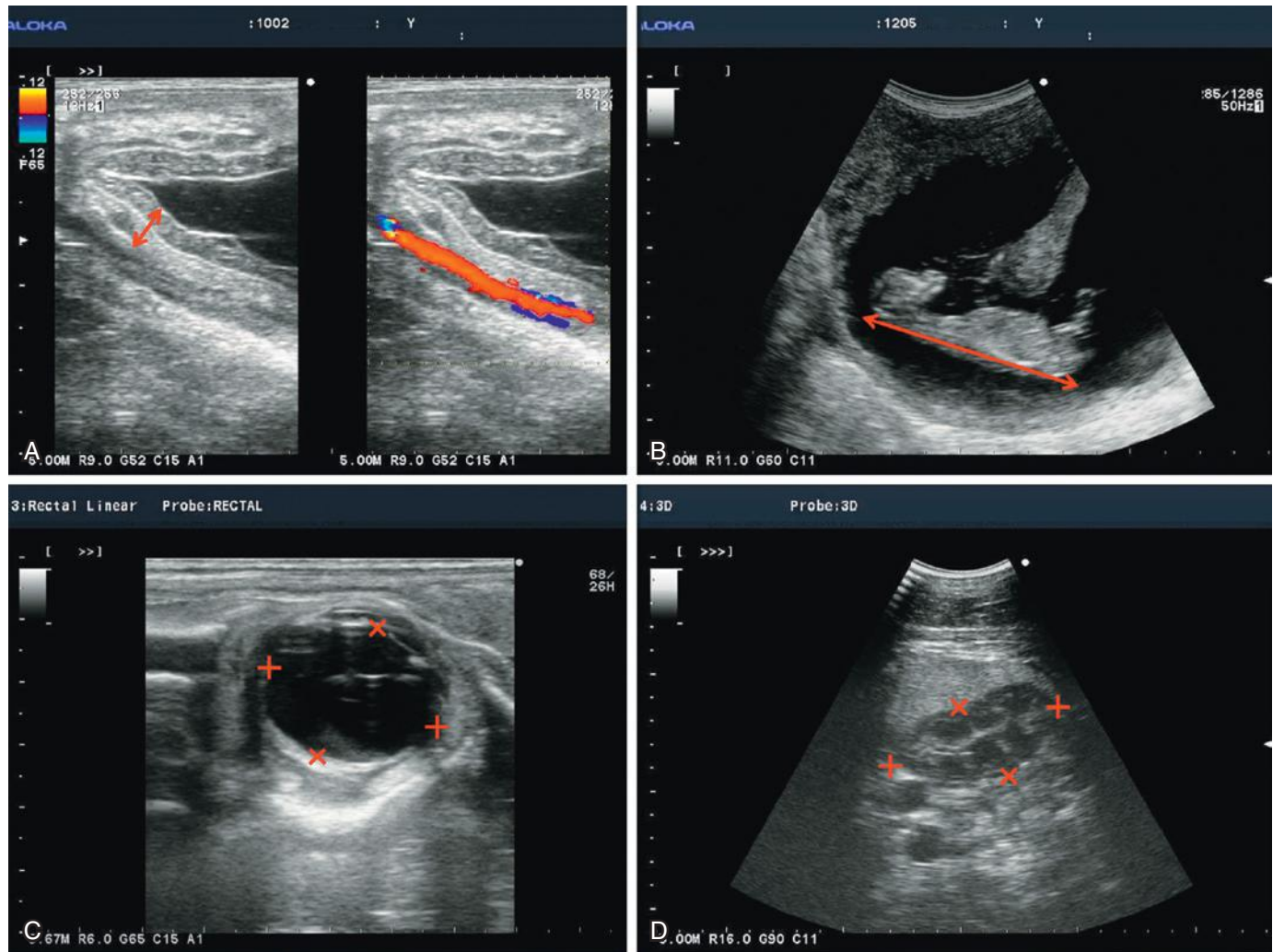

**Fig. 19-2** Measurement of ultrasonographic indices of pregnant mare. **A**, Transrectal images in the ventral part of the uterine body, near the cervix. Headers show the combined thickness of the uterus and placenta (CTUP). **B**, Transrectal image of crown rump length (CRL) (header). **C**, Transrectal image of fetal eye orbit. Eye length (=) and width (x) measurements are shown. Eye length is measured from the maximum length of the inner margins of the vitreous body, and eye width is measured from the margin of the anterior portion of the capsule of the lens to the inner margin of the optic disc. **D**, Transabdominal image of the fetal abdomen at the level of the kidney. Kidney cross-sectional length (=) and width (x) measurements are shown. (Reproduced with permission from Murase et al., 2014.<sup>9</sup>)

## FURTHER READING

Satue K, et al. Factors influencing gestational length in mares: a review. *Livest Sci.* 2011;136:287-294.

## REFERENCES

1. Studdert VP, et al. *Comprehensive Veterinary Dictionary*. London: Elsevier; 2012.
2. Foote AK, et al. *Equine Vet J.* 2012;44:120.
3. Gargiulo GD, et al. *BMC Vet Res.* 2012;8:1.
4. Breukelman S, et al. *Theriogenology.* 2006;65:486.
5. Bucca S, et al. *Proc Amer Assoc Equine Pract.* 2007;335.
6. Murase H, et al. *J Vet Med Sci.* 2014;76:947.
7. Ferrer MS, et al. *Theriogenology.* 2014;82:827.
8. Buczinski S, et al. *Can Vet J.* 2011;52:136.
9. McCue PM, et al. *Equine Vet J.* 2012;44:22.
10. Satue K, et al. *Livest Sci.* 2011;136:287.
11. Uematsu M, et al. *Vet J.* 2013;198:212.
12. Dhakal K, et al. *J Dairy Sci.* 2013;96:690.
13. Canisio IF, et al. *Vet Rec.* 2013;173:218.
14. Korosue K, et al. *J Am Vet Med Assoc.* 2013;242:242.

15. Korosue K. *Vet Rec.* 2013;173:216.

16. Nagel C, et al. *Reprod Domest Anim.* 2011;46:990.

## PREMATURITY AND DYSMATURITY OF FOALS

Foals that are born before 300 days are unlikely to survive, and foals born between 300 and 320 days of gestation are considered premature but can survive (see earlier discussion).<sup>1</sup> **Premature foals** are characterized clinically by low birth weight, generalized muscle weakness, poor ability to stand, lax flexor tendons, weak or no suck reflex, lack of righting ability, respiratory distress, short and silky haircoat, pliant ears, soft lips, increased passive range of limb motion, and sloping pastern axis. Radiographs may show incomplete ossification of the carpal and

tarsal bones and immaturity of the lung, and there may be clinical evidence of respiratory distress. **Full-term foals** born after 320 days of gestation but exhibiting signs of prematurity are described as **dysmature**.

**Premature foals** have hypoadrenal corticalism. They are neutropenic and lymphopenic at birth and have a narrow neutrophil-to-lymphocyte ratio. In premature foals older than 35 hours the neutrophil count can be used to predict survival, and foals that remain neutropenic after this time have a poor prognosis. Premature foals also have low plasma glucose, low plasma cortisol, and a blood pH of less than 7.25. An extensive collaborative investigation of equine prematurity has been conducted, and information on foal metabolism and guidelines for laboratory and clinical assessment

of maturity are available.<sup>2</sup> Foals that are born with clinical abnormalities suggestive of intrauterine growth retardation, prematurity, or dysmaturity are more likely to have an abnormal placenta and have higher serum concentrations of creatinine.<sup>3</sup>

The **placenta** is critical to the fetus in the antenatal period, and pregnancies involving placental lesions commonly result in foals that suffer premature-like signs at whatever stage they are delivered.<sup>3,4</sup> Placental edema, placental villous atrophy, and premature separation of the placenta are significant causes of fetal ill-health and delayed development.<sup>5</sup>

**Precocious lactation** of the mare can be associated with placentitis. The examination of the placenta for evidence of placentitis and for the presence of larger-than-normal avillous areas should be part of normal foaling management. There is a high correlation between both allantochorionic weight and area and foal weight in normal placentas. Normal placentas had a low association with subsequent perinatal disease in the foals.<sup>3,4</sup> In contrast, abnormal placental histology was associated with poor foal outcome (three normal foals from 32 abnormal placentas). Edema, sacculation, and strangulation are other abnormalities and can be associated with microscopic deposits of minerals within the lumen of placental blood vessels.

## REFERENCES

1. Satue K, et al. *Livest Sci.* 2011;136:287.
2. Dunkel B, et al. *Equine Vet J.* 2012;44:1.
3. Pirrone A, et al. *Theriogenology.* 2014;81:1293.
4. Bianco C, et al. *Theriogenology.* 2014;82:1106.
5. Wilsher S, et al. *Equine Vet J.* 2012;44:113.

## PARTURIENT INJURY AND INTRAPARTUM DEATH

During parturition extreme mechanical forces are brought to bear upon the fetus, and these can result in direct traumatic damage or can impair fetal circulation of blood by entrapment of the umbilical cord between the fetus and the maternal pelvis, which can lead to hypoxemia or anoxia and death of the fetus during the birth process. Neonates that suffer birth trauma and anoxia but survive are at risk for development of signs of neurologic disease, have reduced vigor, are slower to suck, and are at increased risk for postnatal mortality.<sup>1</sup>

In all species, but in ruminants in particular, the **condition of the dam** can have a marked influence on the prevalence of birth injury and its consequences. The effect is well illustrated in sheep, where the two extremes of condition can cause problems. Ewes on a high plane of nutrition produce a large fetus and also deposit fat in the pelvic girdle, which constricts the birth canal, predisposing to dystocia. Conversely, thin ewes may be too weak to give birth rapidly. **Pelvic size** can influence the risk of birth injury, and ewe

lambs and heifers mated before they reach 65% of mature weight are at risk. **Pelvimetry** is used to select heifers with adequate pelvic size for breeding, but the accuracy and validity of this method are seriously questioned. **Breed** is also a determinant of length and ease of labor and the subsequent quickness to time to first suckle.

## TRAUMA AT PARTURITION

**Traumatic injuries** can occur in apparently normal births, with prolonged birth, and as a result of dystocia, which may or may not be assisted by the owner. Incompatibility in the sizes of the fetus and the dam's pelvis is the single most important cause of dystocia, and birth weight is the most important contributing factor. In cattle, expected progeny difference (EPD) estimates for calf birth weight are good predictors of calving ease. In foals, calves, and lambs the chest is most vulnerable to traumatic injury, but there is the chance of vertebral fracture and physical trauma to limbs with excessive external traction.<sup>2</sup>

**Fractured ribs** are common in foals and can lead to laceration of the lungs and heart and internal hemorrhage.<sup>3</sup> **Rupture of the liver** is common in some breeds of sheep and can also occur in calves and foals. A retrospective study of rib and vertebral fractures in calves suggests that most result from excessive traction and that, as a result, smaller dystocial calves are more at risk. **Vertebral fractures** occur as the result of traction in calves with posterior presentations and in calves with hip lock. Trauma is a major cause of neonatal mortality in piglets, but it occurs in the postparturient phase and is associated with being overlain or stepped on by the sow. It is possible that the underlying cause of crushing mortality in piglets is hypothermia.

**Intracranial hemorrhage** can result in damage to the brain. A high proportion (70%) of nonsurviving neonatal lambs at birth or within 7 days of birth have single or multiple intracranial hemorrhages, with the highest incidence being in lambs of high birth weight.<sup>4</sup> Similar lesions have been identified in foals and calves, but they are not a common finding in foals with neonatal maladjustment syndrome. Experimentally controlled parturition in ewes showed that duration and vigor of the birth process affected the severity of intracranial hemorrhages, and further studies indicated that these birth-injured lambs had depressed feeding activity and that they were particularly susceptible to death from hypothermia and starvation.

Birth anoxia associated with severe dystocia in cattle can result in calves with lower rectal temperatures in the perinatal period than normal calves and a decreased ability to withstand cold stress. Intracranial hemorrhage, especially subarachnoid hemorrhage, occurs in normal full-term deliveries as the

result of physical or asphyxial trauma during or immediately following delivery.

In a prolonged birth, **edema** of parts of the body, such as the head and particularly the tongue, may also occur. Edema occurs particularly in the calf and the lamb, possibly because of less close supervision at parturition, and also because the young of these species can sustain a prolonged birthing process for longer periods than the foal without their own death or death of the dam. The edema can interfere with subsequent sucking, but the principal problem relative to neonatal disease is the effect of the often prolonged hypoxia to which the fetus is subjected. There is interference with the placental circulation and failure of the fetus to reach the external environment. The hypoxia may be sufficient to produce a stillborn neonate, or the neonate may be alive at birth but not survive because of irreparable brain damage. Intrapartum deaths resulting from prolonged parturition occur in piglets.

## REFERENCES

1. Murray CF, et al. *Vet J.* 2013;198:322.
2. Barrier AC, et al. *Vet J.* 2013;197:220.
3. Jean D, et al. *Equine Vet J.* 2007;39:158.
4. Dutra F, et al. *Aust Vet J.* 2007;85:405.

## FETAL HYPOXIA

Hypoxemia and hypoxia can occur as a result of influences during the birth process or because of pulmonary immaturity in premature births. The most common causes are dystocia, interrupted or restricted blood flow through the umbilical vein (carrying oxygenated blood to the fetus) and artery, and placental lesions, including premature separation of the placenta during labor, that reduce the effective surface area of the placenta in contact with the endometrium.<sup>1</sup> Intrapartum hypoxemia of the fetus resulting from **prolonged parturition** is common, particularly in calves born to first-calf beef heifers, and is presumed to be associated with the greater case fatality rate and morbidity in foals born after stage 2 labor of greater than 40 minutes.<sup>2</sup> Prolonged duration of parturition in ewes increases the risk of asphyxia (90× for each 10-min increase), decreases the viability score of lambs, and increases the latency to suckle the udder. Twin-born lambs were found to have a 16-fold greater risk of asphyxia.

**Transient tachypnea** occurs immediately after birth and is normal. **Prolonged tachypnea**, with flaring of the nostrils, open-mouth breathing, exaggerated rib retraction, and paradoxical breathing patterns, is highly suggestive of primary pulmonary abnormality. Failure of respiration can occur at this stage and creates an urgent need for resuscitation measures. In the foal, **body position** can have a major effect on arterial oxygen tension. A foal that is unable to stand or to right itself from lateral recumbency is at risk

from atelectasis and should be assisted to lie in sternal recumbency to stand. Hypoxia and hypercapnia resulting from mismatching of ventilation and perfusion are accentuated by prolonged recumbency.

Placental dysfunction or restriction of blood flow in the umbilical vessels during the second stage of labor can result in fetal hypoxia and death. Blood flow in umbilical vessels is reduced during uterine contractions and ceases during stage 2 labor in cattle as the calf's head appears at the vulva and just before delivery of the calf.<sup>1</sup> Before this stage, blood flow in the umbilical vein is significantly lower in acidotic than in nonacidotic calves, indicating impairment of oxygen delivery to the fetus and development of increased blood lactate concentrations.<sup>1</sup>

Fetal capillary blood pH and oxygen and carbon dioxide tensions can be measured during parturition, as is common practice in human obstetrics.<sup>3</sup> Fetal blood is collected from capillaries in the front feet as they project from the vulva by making a small incision (nick) in the skin and collecting blood into a capillary tube, which is then sealed before blood-gas analysis.<sup>3</sup> In 38 calves, some of which were born as a result of relieved dystocia or cesarean section, fetal capillary blood-gas values and pH (mean  $\pm$  standard deviation [SD]) during the final 30 minutes of stage 2 labor were as follows: pH =  $7.30 \pm 0.10$  (min 6.99, max 7.43),  $P_{O_2}$  =  $19.5 \pm 9.4$  mm Hg,  $P_{CO_2}$  =  $55.9 \pm 26.0$  mm Hg,  $HCO_3^-$  =  $26.0 \pm 4.4$  mm Hg, base excess =  $-0.9 \pm 5.3$  mM/L, and oxygen saturation =  $21.9 \pm 16.6$ %.<sup>3</sup> These compare with the following values in capillary blood obtained after recovery from birth in healthy calves: pH =  $7.37 \pm 0.11$ ,  $P_{O_2}$  =  $58.4 \pm 17.0$  mm Hg,  $P_{CO_2}$  =  $38.1 \pm 13.2$  mm Hg,  $HCO_3^-$  =  $20.8 \pm 4.9$  mm Hg, base excess =  $-3.2 \pm 4.4$  mM/L, and oxygen saturation =  $82.4 \pm 14.9$ %.<sup>3</sup> Similarly, jugular vein blood collected from 79 lambs immediately after birth (before onset of regular breathing) had the following values: pH =  $7.21 \pm 0.09$  (range, 6.99 to 7.41),  $P_{O_2}$  =  $18.4 \pm 9.8$  mm Hg (4 to 53),  $P_{CO_2}$  =  $65.4 \pm 12.5$  mm Hg (29.6 to 103.7),  $HCO_3^-$  =  $26.5 \pm 4.0$  mm Hg (13.9 to 35.4), base excess =  $-1.3 \pm 5.1$  mM/L (-16 to 9), and oxygen saturation =  $21.2 \pm 16.6$ % (0 to 85).<sup>4</sup> Both normal calves and lambs are acidotic, hypoxemic, and hypercapnic during birth as a result of impaired placental blood flow, and prolonged duration of stage 2 of parturition likely exacerbates this hypoxia and increases morbidity and fatality rate.<sup>1</sup>

A similar syndrome has been produced experimentally by clamping the umbilical cord of the bovine fetus in utero for 6 to 8 minutes, followed by a cesarean section 30 to 40 minutes later. Calves born following this procedure may die within 10 to 15 minutes after birth or survive for up to 2 days. During the experimental clamping of the umbilical cord, there is a decline in the blood pH,  $P_{O_2}$ , and standard bicarbonate levels and an

increase in  $P_{CO_2}$  and lactate levels. There is also increased fetal movement during clamping and a release of meconium, which stains the calf and the amniotic fluid. Those that survive for a few hours or days are dull and depressed, cannot stand, and have poor sucking and swallowing reflexes, and their temperature is usually subnormal. They respond poorly to supportive therapy. A slight body tremor may be present, and occasionally tetany and opisthotonus occur before death. Calves that are barely able to stand cannot find the teats of the dam because of uncontrolled head movements. At necropsy of these experimental cases, there are petechial and ecchymotic hemorrhages on the myocardium and endocardium, there is an excess of pericardial fluid, and the lungs are inflated. When the experimental clamping lasts only 4 minutes, the calves usually survive.

**Meconium staining** (brown discoloration) of the coat of the newborn at birth is an important indicator that it has suffered hypoxia during or preceding the birth process,<sup>5,6</sup> and such neonates merit close supervision in the early postnatal period. In lambs, severe hypoxia during birth results in death within 6 days of birth. **Neurologic lesions** in lambs that died between birth and 6 days of age include hemorrhages in the meninges, brain congestion and edema, neuronal ischemic necrosis, intraparenchymal hemorrhages in the medulla oblongata and cervical spinal cord, parasagittal cerebral necrosis, and periventricular leukomalacia.<sup>7</sup> Edema was more severe in the brain than in other regions of the central nervous system. Ischemic neurons first appeared 24 hours postpartum, increased linearly in number between 48 hours and 5 days postpartum, and had a laminar distribution in the cerebral cortex, indicating a hypoxic-ischemic encephalopathy.<sup>7</sup> No significant lesions were found in anteparturient deaths or in those aged between 7 and 16 days. Lesions in the central nervous system can explain most deaths at birth and within 6 days of birth. The lesions were hypoxic-ischemic and appeared to be related to birth injury in some cases.<sup>7</sup> Similar lesions are not found in foals with neonatal maladjustment syndrome (see page 1871).

Fetal anoxia associated with **premature expulsion of the placenta** occurs in all species. Anoxia occurs in all parities of cow and with little relation to calving difficulty, although malpresentation is a predisposing factor. Prepartum diagnosis in cattle is hindered by the low prevalence of prepartum vaginal hemorrhage, and the majority of fetuses die during the birth process. The placenta is expelled with the fetus. **Premature separation of the placenta** ("red bag") occurs in foals and is an emergency that requires immediate attention. Premature placental separation occurs in approximately 1.6% of births and is associated with a case fatality rate of 18% in the foals.<sup>2</sup>

In all species the prevention of intrapartum hypoxia depends on the provision of surveillance. Universal surveillance is usually not practical for species other than the horse, and in cattle, for example, it tends to concentrate on the group at most risk so that surveillance, and assistance if necessary, is provided for first-calf heifers at the time of calving. Heifers that do not continue to show progress during the second stage of parturition should be examined for evidence of dystocia, and obstetric assistance should be provided if necessary.

The treatment and care of foals with this syndrome is described in the section on critical care of the newborn later in the chapter. The monitoring, treatment, and care of agricultural animals with this syndrome should follow the same principles but is usually limited by the value of the animal and the immediate access to a laboratory. Measures such as the time from birth to sternal recumbency, the time from birth to standing, and the time from birth to first suckle have been used to grade calves and identify those that might require intervention and treatment, but the best method of evaluation is an assessment of muscle tone. There is no effective practical treatment for calves affected with intrapartum hypoxia other than the provision of ventilation, as for the foal, and the correction of the acidosis. The airway should be cleared, and if physical stimulation of ventilation gives no response, then mechanical ventilation should be attempted. The practice of direct mouth-to-mouth ventilation assistance should be strongly discouraged, especially in lambs, because of the risk from zoonotic disease agents. Doxapram hydrochloride has been used in calves to stimulate respiration, but without demonstrated efficacy.

## REFERENCES

1. Bleul U, et al. *Theriogenology*. 2007;67:1123.
2. McCue PM, et al. *Equine Vet J*. 2012;44:22.
3. Bleul U, et al. *Theriogenology*. 2008;69:245.
4. Dutra F, et al. *J Anim Sci*. 2011;89:3069.
5. Mota-Rojas D, et al. *Livest Sci*. 2006;102:155.
6. Castro-Najera JA, et al. *J Vet Diagn Invest*. 2006;18:622.
7. Dutra F, et al. *Aust Vet J*. 2007;85:405.

## HYPOTHERMIA IN NEWBORNS

The environment of the neonate has a profound effect on its survival. This is especially true for lambs and piglets, in which hypothermia and hypoglycemia are common causes of death. Hypothermia can also predispose to inadequate milk intake, including colostrum, and increase the risk and severity of infectious disease. A fuller description, including hypothermia affecting adults, is provided under "Hypothermia" in Chapter 5.

## LAMBS

Cold stress and resultant death rates of lambs is an important animal welfare issue.<sup>1</sup> Lambs



are very susceptible to cold, and hypothermia is an important cause of mortality in the early postnatal period.<sup>3</sup> **Cold stress** to neonatal lambs is attributable to heat loss resulting from one or more of the factors of low ambient temperature, wind, and evaporative cooling. The healthy newborn lamb has a good ability to increase its metabolic rate in response to a cold stress by shivering and nonshivering thermogenesis (brown adipose tissue). The energy sources in the neonatal lamb are liver and muscle glycogen, brown adipose tissue, and, if it nurses, the energy obtained from colostrum and milk. The ingestion of colostrum can be essential for early thermogenesis in lambs, especially twin lambs.

The **critical temperature** (the ambient temperature below which a lamb must increase metabolic heat production to maintain body temperature) for light-birth-weight lambs is 31°C to 37°C (88°–99°F) in the first days of life.

The risk of death from hypothermia is highest in lambs of small birth size. **Heat production** is a function of body mass, whereas **heat loss** is a function of body surface area. Large-birth-size lambs have a greater body mass in relation to surface area and are thus more resistant to environmental cold stress. In contrast, small-birth-size lambs, with a smaller body mass relative to surface area, are more susceptible to chilling. The dramatic nature of this relationship was shown in early studies on cold stress and survival in lambs many years ago. Birth weight is lower in twins and triplets and in the progeny of maiden ewes. Susceptibility is also influenced by maternal nutrition in pregnancy (see the next section) because this can both influence placental mass, birth weight, and the energy reserves of the neonate and also affect the activity of the ewe at parturition, and the resultant poor mothering behavior and mismothering can result in starvation in the lamb.

Lambs are particularly susceptible to cold stress during the first 5 days of life. During this period hypothermia can result from heat loss in excess of summit metabolism or from depressed heat production caused by intrapartum hypoxia, immaturity, and starvation.

Heat loss is a function of the surface area available for convective, conductive, and evaporational heat loss; ambient temperature; wetness of the skin (fleece); and wind speed. These factors can be described mathematically as follows:

$$\begin{aligned} \text{Chill index (kJ/m}^2\text{/hr)} \\ = 481 + (11.7 + 3.1 * V) * (40 - T) \\ - (418 * [1 - e^{-0.04Ra}]), \end{aligned}$$

where temperature ( $T$ ), rain ( $Ra$ ), and wind speed ( $V$ ) are considered and are related to mortality rate in newborn lambs (Fig. 19-3).

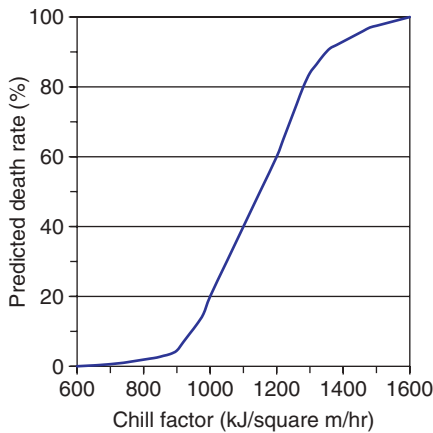

**Fig. 19-3** Predicted death rate for neonatal lambs as a function of wind chill. (Data generated from LambAlive. Horizon Agriculture [[www.hzn.com.au/lambalive.php](http://www.hzn.com.au/lambalive.php)] and courtesy of Dr. John Larsen, University of Melbourne.<sup>6,7</sup>)

### Heat Loss in Excess of Summit Metabolism

Low-birth-weight lambs born into a cool environment where there is wind are especially susceptible because of the evaporative cooling of fetal fluids on the fleece. For a small newborn lamb, the evaporative cooling effect of a breeze of 19 km/h (12 mph) at an ambient temperature of 13°C (55°F), common in lambing seasons in many countries, can be the equivalent of a cold stress equivalent to 25°C (77°F). The heat loss in these circumstances can exceed the lamb's ability to produce heat (summit metabolism), and progressive hypothermia and death result. Hypothermia as a result of heat loss in excess of summit metabolism can also occur when there is rain or just with cold and wind. Death occurs primarily in the first 12 hours of life.

### Hypothermia From Depleted Energy Reserves

Hypothermia occurring in lambs after 12 hours of age is usually a result of depletion of energy reserves in periods of cold stress; milk is the sustaining energy source. There are three major causes of hypothermia from depleted energy reserves.

One of the early manifestations of developing hypothermia is the **loss of sucking drive**; severe cold stress and developing hypothermia can result in behavioral changes that cause low milk intake and subsequent depletion of energy reserves.

The second important cause is **mismothering**; the third is related to **birth injury**. Most researched measures of maternal behavior, temperament, and lambing difficulty are poorly correlated genetically with lamb survival.<sup>3</sup> Dystocia-related hypoxia is associated with acidemia, a reduction in summit metabolism, and disturbance in

thermoregulation and can result in hypothermia. Birth-injured lambs, usually large single-born lambs, have depressed sucking and feeding activity, and actions to increase the birth weight of lambs above a certain point are likely to be counterproductive.<sup>4</sup> The relationship between mortality of lambs and birth weight is a U-shaped curve, with smaller and larger lambs at increased risk of death.<sup>2</sup>

In lambs that have hypothermia associated with heat loss in excess of summit metabolism, heat is required for **therapy**, but in lambs with starvation hypothermia the administration of glucose is also necessary. Glucose is administered intraperitoneally at a dose of 2 g/kg body weight using a 20% solution. Following the administration of the glucose, the lambs should be dried with a towel if wet and rewarmed in air at 40°C (104°F). This can be done in a warming box using a radiant heater as the heat supply. Care should be taken to avoid hyperthermia. Careful attention must be given to the nutrition of the lambs after rearming; otherwise, relapse of hypothermia will occur. A feeding of 100 to 200 mL of colostrum will also be beneficial, but lambs should not be fed before they are normothermic because aspiration pneumonia is a risk. Experimental hypothermia in lambs has shown little direct long-term pathologic effect.

In most countries the selection of time of lambing is dictated by nutritional considerations and the seasonality of the ewes' sexual behavior, and lambing occurs at a time of year when cold stress is likely. The **control** of loss from hypothermia in newborn lambs requires supervision at lambing and protection from cold. Shed lambing will reduce cold-stress loss. The provision of shelter in lambing paddocks is effective at reducing mortality rate and in increasing profitability.<sup>3</sup> The site is important because birth sites in lambing paddocks are not randomly distributed, and there is variation in the preferred sites between breeds. Some ewes will seek shelter at lambing, but many ewes in wool will not. In some flocks, sheep are shorn before lambing in an attempt to force this shelter-seeking trait.

Experimentally, there is a strong relationship between breed and the degree of hypothermia produced. There is also convincing evidence that rearing ability is heritable in sheep, that some of this relates to traits within the newborn lamb, and that a significant reduction in neonatal mortality associated with susceptibility to hypothermia could be achieved with a genetic approach.

Lambs are also susceptible to **hyperthermia**, and thermoregulation is not efficient at high environmental temperatures. Heat prostration and some deaths can occur in range lambs when the environmental temperature is high, especially if lambs have to perform prolonged physical exercise and if there is an absence of shade.

## CALVES

Hypothermia as a result of environmental influence is less common in full-term healthy calves than in lambs, but mortality rates have been shown to increase with decreasing ambient temperature and increasing precipitation on the day of birth. The **critical temperature** for neonatal calves is much lower than that for lambs, approximately 13°C (55°F), and *Bos taurus* calves are more resistant to cold stress than are *Bos indicus*.

Experimentally produced hypothermia in calves causes little overt injury except for peripheral damage to exterior tissues. During cooling there can be significant peripheral hypothermia before any marked reduction in core body temperature. Calves have a remarkable ability to resist and overcome the effects of severe cold temperatures. However, there is a relationship between the occurrence of cold weather and calf deaths, including those resulting from “weak-calf syndrome,” and deficiencies in thermoregulation occur in animals born prematurely and in dystocial calves. As in lambs, dystocia will reduce teat-seeking activity and sucking drive, and dystocial calves have lower intakes of colostrum, lower body temperatures, and decreased ability to withstand cold stress.

Rewarming of hypothermic calves can be by radiant heat, but immersion in warm water produces a more rapid response and with minimal metabolic effort. The prevention of hypothermia requires the provision of shelter from wet and wind for the first few days of life. Cows can be calved in a shed; alternatively, sheds for calves can be provided in the fields. Beef calves will use shelters in inclement weather; these may not improve their health status, although they are in common use.

## PIGLETS

Hypothermia from heat loss and hypothermia/hypoglycemia from starvation are major causes of loss in neonatal pigs. Newborn piglets have a reasonably good ability to increase their metabolic rate in response to cold stress, but they have limited energy reserves, especially limited brown adipose tissue, and they consequently rely on a continual intake of milk for their major energy source, sucking approximately every hour. Young pigs have a good ability for peripheral vasoconstriction at birth, but surface insulation is deficient because at this age there is no subcutaneous layer of fat. The **critical temperature** for young pigs is 34°C (93°F).

Thermoregulation is inefficient during the first 9 days of life and is not fully functional until the 20th day. Newborn piglets must be provided with an external heat source in the first few weeks of life. The body temperature of the sow cannot be relied upon for this, and the preferred air temperature for neonatal pigs is 32°C (89.5°F) during the first day and 30°C (86°F) for the first week. In contrast, the preferred

temperature for the sow is about 18°C (64°F). A **separate environment** (creep area) must be provided for the piglets. Provided that there is an adequate ambient temperature to meet the requirements of the piglets and good floor insulation, hypothermia will not occur in healthy piglets of viable size unless there is a failure of milk intake.

Birth anoxia, with resultant reduced vigor, reduced teat-seeking activity, and **risk for hypothermia**, occurs particularly in later-birth-order pigs in large litters from older sows. Failure of milk intake can also occur with small-birth-size piglets and is influenced by litter size, low number of functional teats relative to litter size, and teat-sucking order.

## FOALS

There have been few studies on thermoregulation in foals, but the large body mass in relation to surface area renders healthy newborn foals, like healthy calves, relatively resistant to cold. Also, foals are less likely to be born in a hostile environment than are other farm animals. Significant foal mortality from hypothermia as a result of starvation and exposure can occur in extensively managed herds, and dystocia, low birth weight, and poor mothering are contributing factors.

Sick and **premature foals** can have difficulty in maintaining body temperature in normal environments, and the metabolic rates of sick foals and premature foals are approximately 25% lower than those of healthy foals.

The relatively larger ratio of surface area to mass, lower energy reserves, and lower insulation of the coat of premature foals, coupled with the lower metabolic rate, place them at particular risk for hypothermia. **Dystocial foals** also have lower metabolic rates, but dysmature foals appear to thermoregulate normally. Methods of investigation that allow postmortem differentiation of placental insufficiency, acute intrapartum hypoxemia, inadequate thermogenesis, and starvation as causes of mortality in foals are available.

Hypothermia should be suspected in premature foals when the rectal temperature falls below 37.2°C (99°F) and should be corrected with external warmth, rugging, or moving to a heated environment. If fluids are being administered, they should be heated to normal body temperature.

## REFERENCES

1. Dwyer CM. *Small Rumin Res.* 2008;76:31.
2. Hinch GN, et al. *Anim Prod Sci.* 2014;54:656.
3. Brien FD, et al. *Anim Prod Sci.* 2014;54:667.
4. Hatcher S, et al. *J Anim Sci.* 2009;87:2781.
5. Young JM, et al. *Anim Prod Sci.* 2014;54:773.
6. Lamb Alive. Horizon Agriculture. (Accessed June 15, 2016, at <<http://www.hzn.com.au/lambalive.php>>).
7. Nixon-Smith WF. The forecasting of chill risk ratings for new born lambs and off-shears sheep by the use of a cooling factor derived from synoptic data.

Working Paper No. 150. Commonwealth Bureau of Meteorology, Melbourne, Vic.; 1972.

## MATERNAL NUTRITION AND THE NEWBORN

There is increasing evidence that the maternal environment for a fetus affects lifelong characteristics of offspring and the subsequent generation of offspring (“grandchildren”). Although the effects of the maternal environment on the development of offspring are complex and involve factors such as maternal nutrition and health during gestation, birth weight of the fetus, sex of the fetus, quality of lactation by the dam, and environmental conditions, there is now solid evidence of epigenetic effects (“programming”) in determining the growth and productivity of offspring in domestic species, and reviews are available.<sup>1-4</sup> It is now well understood that factors such as maternal nutrition can have long-lasting effects on an animal’s health and productivity and that these effects can be transmitted to progeny separate from changes in the genotype (DNA composition).<sup>2</sup> This phenomenon, recognized in human medicine,<sup>5</sup> is well documented in pigs and cattle<sup>6,7</sup> and has risen to have considerable economic importance as part of the Australian Lifetime Wool project.<sup>8-10</sup> The concept is that early life (including in utero) environmental conditions cause epigenetic changes that can persist for the life of the individual and that can be transmitted to offspring.

Epigenetic changes involve methylation of cytosine in cytosine-guanine dinucleotides and alteration of histones in genetic material such that the accessibility of DNA for transcription is reduced or eliminated. The result is that methylated genes are silenced and not transcribed. Methylation of DNA and histones thereby affects the phenotype of the animal because the changes are transmitted during mitosis to daughter cells. Epigenetic effects can be cell and organ specific and can be transmitted to offspring.

An associated phenomenon important to animal breeding is the concept of imprinted genes. Genomic imprinting is a phenomenon in mammals in which the father and mother contribute different epigenetic patterns to the fetus. A limited number of monoallelic expressed genes exert their effect in a parent-of-origin-specific manner through specific genomic loci in the parents’ germ cells. For these genes, expression is restricted to one of the two parentally inherited chromosomes. Imprinted chromosomes are silenced, allowing the other chromosome to be expressed, which is referred to as maternally expressed/paternally imprinted or paternally expressed/maternally imprinted.<sup>1</sup> Although the number of genes that can imprint is limited, many of these genes encode for proteins that regulate a wide variety of biological processes, including embryonic and neonatal growth,

metabolism, and behavior.<sup>1</sup> Understanding of this process has followed observations on abnormalities in animals born as a result of assisted reproductive technologies (including in vitro fertilization and somatic-cell nuclear transfer cloning) that alter methylation of chromosomes in gametes.<sup>1,11</sup> (See “Disorders of Cloned Offspring,” page 1870).

Fetal programming describes the lifelong effects of in utero exposure of the fetus to various conditions.<sup>2</sup> Experimental maternal undernutrition during gestation adversely affects intermediate energy metabolism in lambs tested at ~20 weeks of age, evident as lower insulin secretory capacity and greater tissue insulin sensitivity.<sup>12</sup> Some of the effects of in utero exposure to the fetus could have lifelong effects on attributes important for agricultural productivity. This has been demonstrated for sheep in the Lifetime Wool project, in which numerous studies have revealed the importance of providing optimal nutrition and body condition for ewes for both the ewes' productivity and the lifetime productivity of their lambs.<sup>13,14</sup> The body weight profile of Merino ewes determines the fleece weight and fiber diameter of their progeny, with an optimal weight profile of the ewe resulting in higher fleece weight and finer wool in the progeny.<sup>8</sup> It does not appear that nutrition of the ewe affects milk production by her daughter and, therefore, live weight at weaning of the ewe's daughter's progeny.<sup>15</sup>

There is interest in fetal programming and epigenetics for horses, but currently there are no practical implications, although these can be anticipated.<sup>3,4</sup>

Effects on both the dam and the fetus can occur from overfeeding or underfeeding of the dam,<sup>9</sup> and there can be effects from the influences of trace-element deficiencies or toxic substances. Severe **undernutrition** of the dam can affect fetal size and its thermogenic rate, with consequences as described earlier. Prepartum protein restriction has the greatest effect. Severe undernutrition of the dam can also lead to weak labor and increased rates of dystocia and can limit the development of the udder. Colostragenesis may be impaired, with a greater risk of infectious disease in the neonate, and milk production may be significantly reduced or delayed, with a risk of starvation.

Most information is available for the effects of nutrition of the pregnant ewe on fetal growth rate, udder development, the availability of energy in the body reserves of fetuses at term, and the amount and energy content of colostrum. In sheep, maternal nutrition can have a significant influence on fetal growth rate and placental size.<sup>16</sup> The underfeeding of hill sheep in late pregnancy markedly reduces the term weight of the udder and the prenatal accumulation and subsequent rates of secretion of colostrum. A low plane of nutrition in late pregnancy results in a marked decrease in fetal body-lipid and brown-fat reserves, a marked

reduction in the total production of colostrum, and a reduction in the protein concentration in colostrum during the first 18 hours after parturition. However, exposure of late pregnant ewes to cold by shearing increases lamb birth weight and lamb brown-fat reserves.

**Inadequate nutrition** can also result in in utero growth retardation. Growth retardation can be produced in fetal pigs, lambs, and calves by **maternal caloric undernutrition**. Nutritional restriction in ewes reduces the number of placental lactogen receptors that mediate amino acid transport in fetal liver and glycogen synthesis in fetal tissue, leading to depletion of fetal liver glycogen stores. This has been postulated as a possible cause of the fetal growth retardation that accompanies maternal caloric undernutrition. Runt pigs have a reduced metabolic rate and lower skeletal muscle respiratory enzyme activity. This deficiency persists after birth; runt pigs have a lower core temperature and a lessened ability to increase their metabolic rate and heat production in response to cold. Paradoxically, **overnourishing the adolescent ewe** will also result in placental growth restriction and in utero growth retardation. This effect is most evident in the second third of pregnancy. This syndrome is accompanied by the birth of lambs with a shorter gestational age, commonly reduced by 3 days. It is thought that the fetal hypoxia and hypoglycemia that accompany placental insufficiency might stimulate the maturation of the fetal hypothalamic-pituitary-adrenal axis, initiating early parturition.

Maximum lamb survival is achieved at intermediate lamb birth weights, and the **nutritional management** of the pregnant ewe in fecund flocks is very important. Ewes with multiple lambs can be selected using ultrasound and fed separately from those with singles. Pregnant maiden ewes should also be fed to their separate requirements. The recommendation is for a body-condition score of 3.0 to 3.5 at mating, with a fall of 0.5 in score during the second and third months of pregnancy and a subsequent rise in score to 3.55 to the point of lambing, and with a distinct weight gain in late pregnancy. Equivalent condition scores are also appropriate for other species.

Toxic substances and trace-element deficiencies can result in increased risk for fetal and neonatal mortality and are discussed under those headings. Of particular significance is the agalactia, prolonged gestation, and fetal distress at birth seen in mares fed grain contaminated with ergot (*Claviceps purpurea*) and in mares grazing tall fescue (*Festuca arundinacea*) containing the endophyte fungus *Acremonium coenophialum*.

#### FURTHER READING

Kenyon PR, Blair HT. Foetal programming in sheep—effects on production. *Small Rumin Res.* 2014;118:16-30.

O'Doherty AM, et al. Genomic imprinting effects on complex traits in domesticated animal species. *Front Genet.* 2015;6:156.

#### REFERENCES

- O'Doherty AM, et al. *Front Genet.* 2015;6:156.
- Kenyon PR, et al. *Small Rumin Res.* 2014;118:16.
- Kenyon AL, et al. *J Equine Vet Sci.* 2013;33:295.
- Dindot SV, et al. *J Equine Vet Sci.* 2013;33:288.
- Heijmans BT, et al. *Proc Natl Acad Sci USA.* 2008;105:17046.
- Altmann S, et al. *J Nutr Biochem.* 2013;24:484.
- Micke GC, et al. *Reproduction.* 2011;141:697.
- Thompson AN, et al. *Anim Prod Sci.* 2011;51:794.
- Oldham CM, et al. *Anim Prod Sci.* 2011;51:776.
- Lifetime Wool project—more lambs, better wool, healthy ewes. Department of Agriculture and Food Western Australia. (Accessed 06.15, at <<http://www.lifetimewool.com.au/>>).
- Tian X. *Annu Rev Anim Biosci.* 2014;2:23.
- Husted SM, et al. *Am J Physiol.* 2007;293:E548.
- Ferguson MB, et al. *Anim Prod Sci.* 2011;51:763.
- Behrendt R, et al. *Anim Prod Sci.* 2011;51:805.
- Kenyon PR, et al. *Anim Prod Sci.* 2014;54:1465.
- Gardner DS, et al. *Reproduction.* 2007;133:297.

#### POOR MOTHER-YOUNG RELATIONSHIP

Any examination of neonatal mortality suspected of being caused by hypothermia, starvation, or infection as a result of failure of transfer of passive immunity, and even trauma by crushing in piglets, must take into account the possibility that poor mothering and a poor mother-young bond could be the primary cause. Inadequate maternal care leads to rapid death of the newborn under extensive conditions where there is no human intervention to correct the problem.<sup>1</sup> The defect is most likely to be on the side of the dam, but it may originate with the offspring, especially in those that are hypothermic.<sup>2</sup> A poor relationship may be genetic or nutritional, and, on the part of the offspring, it may be the result of birth trauma.

For both the dam and the young, there is a much greater chance of establishing a good bond if the animal has been reared in a group rather than as an individual. Because sight, smell, taste, and hearing are all important in the establishment of seeking and posturing to suckle activity by the dam and seeking, nuzzling, and sucking activity by the offspring, any husbandry factor that interferes with the use of these senses predisposes to mortality. Weakness of the offspring as a result of poor nutrition of the dam, harassment at parturition by overzealous attendants, and high growth of pasture are obvious examples. Poor mother-young relationship can be a problem in cattle, pigs, and sheep, and occasionally in horses, especially with extensive foaling practices. In pigs a poor mother-young relationship may be developed to an intense degree in the form of farrowing hysteria, which is dealt with under that heading. In sheep a poor mother-young relationship can be a significant contributor to neonatal death from starvation, especially



**Table 19-1** Scoring system for assessing vigorousness of newborn lambs<sup>1</sup>

Score	Description
1	Does not stand for at least 40 min; little or no teat-seeking drive; does not appear alert or active
2	Attempts to stand after 30 min; low teat-seeking drive and tendency to follow ewe; shows some alertness but not very active; does not appear coordinated in attempts
3	Shakes head within 30 s; attempts to stand within 15 min; seeking teat within 10 min of standing; follows ewe but distracted by other moving objects; generally alert and active; coordination may be lacking
4	Attempts to stand within 10 min of birth; seeking teat within 5 min of standing; strong tendency to follow ewe; alert and active and well-coordinated movements
5	Attempts to stand within 5 min of birth; follows ewe closely; very alert and active

**Table 19-2** Definitions for lamb behaviors<sup>2</sup>

Behavior	Definition
Shakes head	Lamb raises and shakes head
To knees	Lamb rolls onto chest, gathers legs under it, and pushes front half of the body up off the ground
Attempts to stand	Lamb supports bodyweight on at least one foot
Stands	Lamb stands unsupported on all four feet for > 5 s
Reaches udder	Lamb approaches ewe and nudges her in the udder region
Unsuccessful suck	Lamb places head under ewe in contact with the udder, but either fails to grasp the teat or releases it without sucking
Sucks	Lamb hold teat in its mouth and appears to be sucking with appropriate mouth and head movements, may be tail-wagging, remains in this position for > 5 s

in highly strung breeds such as the Merino, which have a higher mismothering rate than do Romney ewes.<sup>2,3</sup>

**Bonding** occurs rapidly after birth, although there is some minor variation between species, with bonding starting within a few minutes of birth in sheep but taking up to 2 to 3 hours in some horses, for example. The strength of bonding also appears to vary between species. The bonding of the dam to the neonate is usually quite specific, although this can be modulated by management systems, and the neonate may be less selective and will often attempt to suck other dams. With sheep lambed under intensive lambing practices, this can lead to high rates of mismothering and subsequent abandonment, when preparient “robber” ewes adopt lambs from multiple births. A high degree of shepherding is required to minimize loss in these management systems, whereas in extensive systems a strong bonding is established if the ewe and lamb are allowed to remain relatively undisturbed on the lambing site for 6 hours. A scoring system is available to allow objective assessment of the vigor of newborn lambs (Tables 19-1 and 19-2).

There is evidence of genetic and parental (sire) effects on the ability of lambs to follow

the dam and to avoid mismothering. These effects appear to be modest.<sup>2,4,5</sup>

Vaginal cervical stimulation and the central release of oxytocin are thought to be important in initiating maternal behavior, although caudal epidural anesthesia for delivery does not effect mothering or bonding. Sucking is also a major determinant. Recognition is olfactory and auditory and mediated by the release of neurotransmitters.

Bonding is often slower with primiparous dams and is also delayed where there is postpartum pain. A failure of bonding leads to rejection and abandonment of the neonate.

Maternal care is also important to neonatal survival, and there is significant difference in litter mortality from crushing and injury among sows related to sow behavior and their response to piglet distress calls. A description of normal and abnormal behavioral patterns of the mare and foal is available, and techniques for fostering have been described.

## REFERENCES

1. Bickell SL, et al. *Anim Prod Sci.* 2010;50:675.
2. Hergenhan RL, et al. *Anim Prod Sci.* 2014;54:745.
3. Plush KJ, et al. *Appl Anim Behav Sci.* 2011;134:130.
4. Brien FD, et al. *Anim Prod Sci.* 2014;54:667.
5. Hinch GN, et al. *Anim Prod Sci.* 2014;54:656.

## TEETH CLIPPING OF PIGLETS

It is necessary to shorten the needle teeth of the upper and lower jaw of the newborn pig using a clean pair of sharp nail clippers or a grinding wheel. It is essential to practice good hygiene or infection of tooth roots can occur, leading to local inflammation and infection with the possibility of abscessation associated with *Fusobacterium* and *Trueperella*. It is not done before 6 hours of age because it will interfere with the absorption of colostrum. It is done to prevent damage to the sow's teats or to other piglets before 7 days after birth. Damage to the sow's teats will cause pain and reluctance to allow suckling. Damage to other piglets may interfere with the establishment of the “pecking order” in the litter.

## Failure of Transfer of Passive Immunity (Failure of Transfer of Colostral Immunoglobulin)

The acquisition and absorption of adequate amounts of colostral immunoglobulins is essential to the health of ruminant, porcine, and equine neonates because they are born virtually devoid of circulating immunoglobulin. **Failure of passive transfer (FPT)** has been a commonly used term to describe the transfer of passive immunity (immunoglobulins, specifically IgG1 in colostrum) from the dam to the neonate. The process by which colostral immunoglobulin is absorbed is far from passive; it is an active and focused activity. Accordingly, FPT provides an incorrect summary of this process, and **failure of transfer of passive immunity (FTPI)** provides a more accurate descriptive term. Adequate antibody transfer is the cornerstone of all neonatal preventive health programs, but FTPI remains an important problem particularly affecting the dairy industry. Educational campaigns targeting dairy producers have been launched in the past decades, and, encouragingly, the prevalence of FTPI in dairy heifers in the United States decreased from over 40% in 1992 to 19% in 2007.<sup>1</sup>

Much of the description that follows refers to the calf because more studies on transfer of passive immunity have been conducted in calves. However, most of the information is applicable to the other species; where there are differences, these are mentioned.

## NORMAL TRANSFER OF IMMUNOGLOBULINS

Immunoglobulins in colostrum are present in different concentrations. The major immunoglobulin in colostrum is IgG. IgG consists of two fractions, IgG<sub>1</sub> and IgG<sub>2</sub>, which contribute 80% and 5% to 10%,

respectively, to the total colostral immunoglobulin concentration. IgM and IgA each account for approximately 5% of the colostral immunoglobulin content. IgG is concentrated in colostrum by an **active, selective, receptor-mediated transfer** from the blood of the dam across the mammary secretory epithelium. This transfer to colostrum begins approximately 4 to 6 weeks before parturition and results in colostral IgG concentrations in first milking colostrum that are several-fold higher than maternal serum concentrations. This active IgG transfer ceases suddenly at the onset of lactation, presumably in response to increased prolactin secretion around parturition.<sup>2</sup> IgA and IgM are largely derived from local synthesis by the mammary gland rather than transfer from plasma.

Following ingestion by the newborn, a significant proportion of these immunoglobulins is transferred across the epithelial cells of the small intestine during the first few hours of life and transported via the lymphatic system to the blood. Immunoglobulins in blood are further variably distributed to extravascular fluids and to body secretions depending on the immunoglobulin class.

These absorbed immunoglobulins protect against systemic invasion by microorganisms and septicemic disease during the neonatal period. Unabsorbed immunoglobulins and immunoglobulins resecreted into the gut play an important role in protection against intestinal disease for several weeks following birth. FTPI has unequivocally been associated with increased morbidity and mortality and reduced growth rates of neonates. Adequate immunoglobulin supply at birth is associated with higher first- and second-lactation milk production and decreased risk of culling during the first lactation.<sup>5</sup>

In foals, FTPI presents a significant risk for the development of illness during the first 3 months of life.

**Lactogenic Immunity**

The IgG concentration in milk falls rapidly following parturition in all species, and immunoglobulin concentrations in milk are low (Table 19-3). In the sow, the

concentration of IgA falls only slightly during the same period, and it becomes a major immunoglobulin of sows' milk. IgA is synthesized by the mammary gland of the sow throughout lactation and serves as an important defense mechanism against enteric disease in the nursing piglet. IgA in milk is an important mucosal defense mechanism in piglets, whereas in the calf there is little IgA in milk, but some enteric protection is provided by colostral and milk IgG and IgG derived from serum that is resecreted into the intestine.

**FAILURE OF TRANSFER OF PASSIVE IMMUNITY**

FTPI is the major determinant of septicemic disease in most species. It also modulates the occurrence of mortality and severity of enteric and respiratory disease in early life and performance at later ages.

In terms of the modulation of disease, there can be no set cut-point for circulating immunoglobulins because this cut-point will vary according to the farm, its environment, infection pressure, and the type of disease. Values are given as guidelines. **FTPI in calves** has been defined as a **serum IgG concentration below 1000 mg/dL (10 mg/mL)** when measured between 24 hours and 7 days of age. With **foals**, the equivalent IgG cutoff concentrations for **FTPI** and **partial FTPI** are given as **400 mg/dL** and **800 mg/dL**, respectively. Although a serum IgG concentration above 400 mg/dL might be adequate for healthy foals kept in a clean environment with minimal pathogen exposure, a concentration above 800 mg/dL is considered optimal.<sup>6</sup> For **New World camelid crias**, a cut-point value for the serum IgG concentration of **1000 mg/dL** measured at around 36 hours of life has been recommended.<sup>7</sup>

Rates of FTPI in dairy calves can vary widely between farms, but they were estimated to be in the range of 20% in a recent nationwide survey conducted in the United States.<sup>1</sup> In beef calves FTPI rates tend to be lower; a recent Canadian study reported the incidence of FTPI, defined as serum IgG concentrations below 800 mg/dL, of 6% and a rate of marginal transfer of passive immunity (800 mg/dL < IgG < 1600 mg/dL) of

10%.<sup>8</sup> Failure rates in foals reported in the literature are approximate 13% to 16%. Rates in lambs are also comparatively low, and the incidence of FTPI in crias has been estimated to be around 10%.<sup>7</sup>

In animals that are **fed colostrum artificially**, risk for FTPI is primarily dependent on the amount or mass of immunoglobulin present in a feeding of colostrum, the time after birth that this is fed, the efficiency of its absorption from the digestive tract, and possibly also the degree of bacterial contamination.<sup>1</sup> The mass of immunoglobulins fed is determined by the concentration of immunoglobulin in the colostrum and the volume that is fed. Feeding trials with calves suggest that a **mass of at least 150 g** of IgG is required in colostrum fed to a 45-kg calf to obtain adequate ( $\geq 1000$  mg/dL IgG) colostral immunoglobulin concentrations in serum.

In animals that **suck colostrum naturally**, such as foals, risk for FTPI is primarily dependent on the concentration of immunoglobulin in the colostrum, the amount that is ingested, and the time of first suckling. Inadequate colostral immunoglobulin concentration and delay in ingestion of colostrum are the two important factors in FTPI in foals.

**DETERMINANTS OF TRANSFER OF COLOSTRAL IMMUNOGLOBULINS**

1. Amount of immunoglobulin in colostrum fed:
  - a. Volume of colostrum fed
  - b. Concentration of immunoglobulins in colostrum
2. Amount of colostrum actually suckled or fed
3. Rate of abomasal or gastric emptying after colostrum ingestion
4. Efficiency of absorption of immunoglobulins by neonate
5. Time after birth of suckling or feeding
6. Time of collection of colostrum after calving (with artificial colostrum feeding)
7. Degree of bacterial contamination of colostrum

**Table 19-3** Failure of transfer of passive immunity;<sup>1</sup> concentrations and relative percentage of immunoglobulins in serum and mammary secretions of cattle and pigs

Animal	Immunoglobulin	CONCENTRATION (mg/ml)			TOTAL IMMUNOGLOBULIN (%)		
		Serum	Colostrum	Milk	Serum	Colostrum	Milk
Cow	IgG <sub>1</sub>	11.0	75.0	0.59	50	81	73
	IgG <sub>2</sub>	7.9	2.9	0.02	36	5	2.5
	IgM	2.6	4.9	0.05	12	7	6.5
	IgA	0.5	4.4	0.14	2	7	18
Sow	IgG	21.5	58.7	3.0	89	80	29
	IgM	1.1	3.2	0.3	4	6	1
	IgA	1.8	10.7	7.7	7	14	70

### Determinants of Immunoglobulin Concentration in Colostrum

Nominal concentrations of immunoglobulin in the first milking colostrum of cows and sows are shown in Table 19-4.<sup>1</sup> Current conventional wisdom posits that **high-quality bovine colostrum** should contain at least **50 g/L IgG**,<sup>2</sup> and that 3 L of high-quality colostrum should be fed as soon as possible after birth.<sup>3,4</sup> This strategy will provide the needed 150 g of colostral IgG. There can be substantial variation in the concentration of immunoglobulin in colostrum in all species, and the ingestion of a “normal” amount of colostrum that has low immunoglobulin concentration may provide an insufficient amount of immunoglobulin for protection. In a study of over 900 first-milkings colostrum from Holstein Friesian cows, only 29% of the colostrum samples contained a sufficiently high concentration of immunoglobulin to provide 100 g IgG in a 2-L volume. The equivalent percentages for 3- and 4-L volume feedings were 71% and 87%, respectively.

It is apparent that variation in colostral immunoglobulin concentration can be a cause of FTPI. Some causes of this variation are the following:

- The concentrations of immunoglobulin in colostrum fall dramatically after parturition. The concentrations in second-milking colostrum are approximately half those in the first milking, and by the fifth postcalving milking, concentrations approach those found during the remainder of lactation. A similar situation exists with **horses**. The mean concentrations of IgG in colostrum of mares 3 to 28 days before foaling is greater than 1000 mg IgG/dL, whereas at parturition the mean concentrations may vary from 4000 to 9000 mg/dL. The concentrations decrease markedly to 1000 mg/dL in 8 to 19 hours after parturition.
- The immunoglobulin concentration of colostrum decreases after calving even when the cow is not milked. It is important that this colostrum be **milked as soon as possible after parturition**. Colostrum that is collected 6 hours or later after calving has a significantly lower concentration than that collected 2 hours after calving. In a study documenting the effect of time since parturition on colostral IgG concentration, it was observed that colostral IgG concentration decreased by 3.7% during each subsequent hour after calving because of postparturient secretion of IgG-poor milk by the mammary glands.
- Colostrum from cows or mares that have been **premilked** to reduce udder edema or from dams that **leaked colostrum** before parturition have low immunoglobulin concentrations, and alternate colostrum should be fed for immunoglobulin transfer.
- In cattle, **dry periods** of less than 30 days may result in colostrum of lower immunoglobulin concentration.
- **Premature foaling** or the **induction of premature parturition** using long-acting corticosteroids in cattle can result in colostrum with low immunoglobulin concentration and/or low volume.
- In cattle, average colostral immunoglobulin concentrations are higher in cows in third or higher **lactation groups** compared with younger cows. However, colostrum from all lactation numbers can produce adequate immunoglobulin mass. There is no scientific basis for not feeding first-milking colostrum from first-lactation cows.
- Larger-volume first-milking colostrum tends to have lower immunoglobulin concentrations than smaller-volume colostrum, presumably as a result of dilution.
- Immunoglobulin concentrations were found to be higher in the early temporal fractions of a single milking of first-milking colostrum. This might suggest that segregation of the first portion of the first-milking colostrum could provide colostrum with higher immunoglobulin concentration for feeding.
- There are **breed differences** in the concentration of immunoglobulins in first-milking colostrum. In **cattle**, beef breeds have higher concentrations. Many dairy breeds, including Holstein Friesian, produce colostrum of relatively low immunoglobulin concentration, and a significant proportion of calves that suckle cows of these breeds ingest an inadequate mass of immunoglobulin. Channel Island breeds have a greater concentration of immunoglobulin in colostrum than Holstein Friesians. **Breed differences** are also seen in **horses**, with Arabian mares having higher colostral immunoglobulin concentrations than Standardbreds, which in turn are higher than those of Thoroughbreds. Breed differences also occur in **sheep**, with higher concentrations in meat and wool breeds than dairy breeds.
- Heat **stress** to cattle in the latter part of pregnancy results in lower colostral immunoglobulin concentrations.
- Colostral volume but not colostral immunoglobulin concentration is reduced in mastitic quarters, and it is unlikely that mastitis is a major determinant of the high rate of FTPI in dairy calves. Colostrum from cows with clinical mastitis should nonetheless not be fed because it may contain pathogens in large amounts and has unphysiologic composition.

- The **pooling of colostrum** in theory could avoid the variation in immunoglobulin concentration of individually fed colostrum and could provide a colostrum that reflects the antigenic experience of several cattle. In practice, colostrum pools from Holsteins invariably have low immunoglobulin concentrations because high-volume, low-concentration colostrum dilutes the concentration of the other samples in the pool. If pools are used, the diluting influence of low-immunoglobulin-concentration, high-volume colostrum should be limited by restricting any individual cow's contribution to the pool to 9 kg (20 lb) or less. However, pooling increases the risk of disease transmission because multiple cows are represented in a pool and the pool is fed to multiple calves. This can be important in the control of Johne's disease, bovine leukosis, *Mycoplasma bovis*, *E. coli*, and *Salmonella* spp.
- **Bacterial contamination** of colostrum can have a negative effect on transfer of passive immunity. The current recommendation is that fresh colostrum should contain less than 100,000 cfu/mL total bacteria count and less than 10,000 cfu total coliform count.<sup>2</sup> One study found that 85% of colostrums sampled from 40 farms in the United States exceeded this threshold. Colostrum that is to be fed or stored should be collected with appropriate preparation and sanitation of the cow and of the milking equipment used on fresh cows.
- **Pasteurization of colostrum** either at 63°C (145°F) for 30 min or 72°C (162°F) for 15 s was shown to reduce colostrum IgG concentration by at least 30% and to thicken or congeal the colostrum. In contrast, **pasteurization at 60°C (140°F) for 60 min** was found to affect neither colostral IgG concentration nor fluid characteristics while eliminating or at least significantly decreasing the content of major pathogens, including *Mycobacterium avium* subsp. *paratuberculosis*, *M. bovis*, *E. coli*, and *Salmonella* spp.
- **Old mares** (older than 15 years) may have poor colostral immunoglobulin concentration.

### Volume of Colostrum Ingested Dairy Cows

The volume of colostrum that is fed has a direct influence on the mass of immunoglobulin ingested at first feeding. The average volume of colostrum ingested by nursing Holstein Friesian calves in the first 24 hours of life is reported as 2.4 L, but there is wide variation around this mean. In **natural suckling** situations, calves may fail to ingest



adequate colostrum volumes before onset of the closure process and therefore absorb insufficient colostrum immunoglobulin. Early assisted suckling may help avoid this. In dairy calves the volume of colostrum that is ingested can be controlled in **artificial feeding systems** using nipple bottle feeders or esophageal tube feeders. **Bucket feeding** of colostrum is not recommended because training to feed from a bucket can be associated with erratic intakes.

The **traditional recommendation** for the volume of colostrum to feed at first feeding to calves is 2 L (2 quarts). However, only a small proportion of first-milking colostrum from Holsteins contains a sufficiently high concentration of immunoglobulin to provide 100 g IgG in a 2-L volume, and higher volumes of colostrum are required to achieve this mass intake. Some calves fed with a **nipple bottle** will drink volumes greater than 2 L, but others will refuse to ingest even 2 L of colostrum in a reasonable period of time, and calf rearers may lack the time or patience to persist with nipple bottle feeding until the required volume has been ingested by all calves.

Larger volumes of colostrum can be fed by an **esophageal feeder**, and single feedings of large volumes of colostrum (3.5 to 4.0 L per 45 kg of body weight) result in the lowest percentage of calves with FTPI by allowing calves fed colostrum with relatively low immunoglobulin concentrations to receive an adequate immunoglobulin mass before closure. Feeding this volume by an esophageal feeder causes no apparent discomfort to a minimally restrained calf and was not found to negatively affect intestinal IgG absorption compared with voluntary intake of the same (large) volume.<sup>10</sup> There is nonetheless some debate around the recommendation to systematically tube feed neonatal calves because of animal welfare concerns. In several European countries animal welfare legislation prohibits force-feeding of animals without medical indication.<sup>20</sup>

### Beef Cows

With beef breeds very effective colostrum immunoglobulin transfer is achieved with natural sucking. This is thought to be a result of the greater vigor at birth exhibited by these calves and the higher immunoglobulin concentrations in beef colostrum, requiring a smaller volume intake to acquire an adequate mass. **Natural sucking** will give an adequate volume intake, and there is no need to artificially feed colostrum unless the dam is observed to refuse nursing or the calf's viability and sucking drive are compromised. The **yield of colostrum** and colostrum immunoglobulins in beef cows can vary widely, and range beef heifers may produce critically low volumes of colostrum. Differences in yield can be attributed to breed or to nutritional status, although undernutrition is not an effect unless it is very severe.

### Ewes

Colostrum yield is high in ewes in good condition at lambing, but it may be low in ewes with condition scores of 1.5 to 2.0.

### Sows

In sows there is also very effective colostrum immunoglobulin transfer with natural sucking, and piglets average an intake of 5% to 7% of body weight in the first hour of life. There is between-sow variation in the amount of colostrum, and there can be a large variation in colostrum supply from teat to teat, which may explain variable health and performance. During farrowing and for a short period following, colostrum is available freely from the udder, but thereafter it is released in ejections during mass suckling. A strong coordinated sucking stimulus is required by the piglet for maximum release of colostrum, and this requires that the ambient temperature and other environmental factors be conducive to the optimum vigor of the piglets. Small-birth-weight piglets, **late-birth-order** piglets, and piglets sucking posterior teats obtain less colostrum.

### All Species

In all species a low-volume intake may also occur because of the following factors:

- Poor **mothering behavior**, which may prevent the newborn from sucking; occurrence of disease; or milk fever
- Poor **udder and/or teat conformation** so that the newborn cannot suck normally or teat seeking is more prolonged. Udder-to-floor distance is most critical, and low-slung udders can account for significant delays in intake. Bottle-shaped teats (35-mm diameter) also significantly reduce intake.
- Delayed and **inadequate colostrum intake** frequently accompanies perinatal asphyxia or acidemia because of the greatly decreased vigor of the calf in the first few hours of life. Perinatal asphyxia can occur in any breed and is greatly increased by matings resulting in fetal-maternal disproportion and dystocia.
- The newborn may be weak, traumatized, or unable to suck for other reasons; a **weak sucking drive** can be a result of congenital iodine deficiency, cold stress, or other factors.
- Disease of the periparturient dam, such as clinical hypocalcemia in cattle or the mastitis metritis agalactia complex in sows, may preclude adequate colostrum intake by offspring.
- Failure to allow newborn animals to ingest colostrum may occur under some management systems.

### Efficiency of Absorption

After ingestion of colostrum by the newborn, colostrum immunoglobulins are absorbed

from the small intestine, by a process of pinocytosis, into the columnar cells of the epithelium. In the newborn calf this is a very rapid process, and immunoglobulin can be detected in the thoracic duct lymph within 80 to 120 minutes of its being introduced into the duodenum. The **period of absorption** varies between species and with immunoglobulin class. The mechanism by which absorption ceases is not well understood, but it may be related to replacement of the fetal enterocyte. The region of maximum absorption is in the lower small intestine, and peak serum concentrations are reached by 12 to 24 hours in all species. Absorption is not limited to immunoglobulin, and **proteinuria** during the first 24 hours of life is associated with the renal excretion of low-molecular-weight proteins such as  $\beta$ -lactoglobulin.

### Feeding Methods, "Closure of the Gut," and Immunoglobulin Absorption

Under normal conditions complete loss of the ability to absorb immunoglobulin (closure of the gut) occurs by 24 to 36 hours after birth in all species, and there is a significant reduction in absorptive ability (as much as 50% in some studies but minimal in others) by 8 to 12 hours following birth. The **time from birth to feeding** is a crucial factor affecting the absorption of colostrum immunoglobulin in all species, and any delay beyond the first few hours of life, particularly after 8 hours, significantly reduces the amount of immunoglobulin absorbed.

The recommendation is that all neonates should be fed colostrum within the first 2 hours of life.

### Natural Sucking

**Natural sucking** is the desired method of intake of colostrum and is the most efficient, but it is influenced by the sucking drive and **vigor** of the neonate at birth. Newborns that suck colostrum can achieve very high concentrations of colostrum immunoglobulin, and the efficiency of absorption is best with this feeding method. However, in dairy calves natural sucking is commonly associated with a high rate of FTPI because of **delays in sucking** coupled with low intake. Rates of FTPI in calves allowed to obtain colostrum via voluntary nursing reported in the literature can be as high as 40% to 60%.<sup>1</sup> Many factors influence the occurrence of delayed sucking, but calf vigor and birth-related asphyxia are the most important. Parity of the dam, conformation of the udder, and breed were also found to be significantly associated with the rate of FTPI. One older study reported that 46% of all calves born to multiparous cows had failed to nurse within 6 hours of birth compared with 11% of calves of primiparous cows.<sup>11</sup> Jersey calves have better rates of successful transfer of passive immunity with natural sucking than do Holsteins Friesians.

### Artificial Feeding

In contrast, when calves are **fed colostrum artificially**, minimal delays from birth to the time of colostrum feeding occur, and maximal colostrum immunoglobulin absorption results. In breeds such as Holstein Friesians, where colostrum immunoglobulin concentrations tend to be low and maximal efficiency of absorption is necessary, the logical way to minimize risk of FTPI is to feed the maximum volume of colostrum that is well tolerated within the first few hours of life. The published literature consistently reports higher calf serum IgG concentrations and a lower rate of FTPI in response to larger colostrum feeding volumes.<sup>2,10,12</sup>

### Other Influences

Even with the best available on-farm colostrum-selection methods, **large colostrum-feeding volumes are essential** to minimize the risk of FTPI in breeds with relatively low colostrum immunoglobulin concentrations. The method is particularly advantageous where time constraints of other farm activities limit the time available for calf feeding. The major detrimental influence on absorptive efficiency of immunoglobulin is **delayed feeding after birth**. Other factors that may affect absorptive efficiency include the following:

- **Perinatal asphyxia or acidemia** may have both direct and indirect effects on colostrum immunoglobulin transfer. Asphyxia has a major effect on subsequent sucking drive, and acidemic calves ingest far less colostrum than calves with more normal acid–base status at birth. In carefully controlled colostrum feeding studies, a significant negative correlation between the degree of hypercapnia and the efficiency of absorption of colostrum immunoglobulin in the first hours of life was demonstrated. However, this effect was only transient because there was no difference in serum IgG concentration at the time of gut closure between normoxic and hypoxic calves.
- In one early study, a **mothering effect** was reported in which calves remaining with their dams absorbed colostrum immunoglobulin more efficiently than calves removed immediately to individual pens. However, other studies have shown much smaller or no effects of mothering using similar experimental designs. The different results of these studies have not been reconciled.
- There can be **seasonal and geographic** variations in transfer of immunoglobulin in calves, although these are not always present on farms in the same area, and their cause is unknown. Where seasonal variation occurs in temperate climates, the mean monthly serum IgG concentrations are lowest in the winter and increase during

the spring and early summer to reach their peak in September, after which they decrease. The cause is not known, but a decrease in sucking drive is observed in colder months and may contribute. In subtropical climates, peak levels occur in the winter months, and low levels are associated with elevated temperatures during the summer months. **Heat stress** in late pregnancy will reduce colostrum immunoglobulin concentration, but high ambient temperature is a strong depressant of absorption, and the provision of shade will help to obviate the problem.

- The efficiency of absorption may be decreased in **premature calves** that are born following induced parturition using long-acting corticosteroids; in contrast, medical **induction of parturition** with short-acting corticosteroids in cattle does not interfere with the efficiency of absorption of immunoglobulins in calves.
- The absorption of small volumes (1 to 2 L) fed by an esophageal feeder is usually suboptimal and inferior to the absorption after sucking the same small volume.<sup>10</sup> This effect may at least in part be attributable to retention of some colostrum in the immature forestomachs for several hours. The calf will feel satiated and not inclined to suck naturally for the next few hours.
- A **trypsin inhibitor** in colostrum may serve to protect colostrum IgG from intestinal degradation. It varies in concentration between colostrums. The addition of a trypsin inhibitor to colostrum improves immunoglobulin absorption.
- In a study of **mare-associated determinants of FTPI** in foals (based on serum Ig measurements), there was a trend to increase rates of FTPI in foals from mares aged over 12 years, but no significant association with age, parity, or gestational age of foals over 325 days was found. There was an association with season, with a lower incidence in the late spring compared with foals born earlier in the year and with a foal score based on a veterinary score of foal health and “fitness.”

Traditionally it has been considered that the **movement** of animals, either the dam just **before parturition** or the newborn animal during the first few days of life, is a special hazard for the health of the calf. The postulated reason is that the dam may not have been exposed to pathogens present in the new environment and thus not have circulating antibodies against these pathogens. The newborn animal may be in the same position with regard to both deficiency of antibodies and exposure to new infections. Although this may be the case in some

situations, the developing practice of contract-rearing of dairy heifers away from the farm to be brought back as close-up springers and the practice of purchase of close-up heifers on the farm are not associated with appreciable increase in mortality in their calves.

### Decline of Passive Immunity

Colostrum antibody concentrations in blood fall quickly after birth and have usually disappeared by 6 months of age. In the **foal**, they have fallen to less than 50% of peak level by 1 month of age and to a minimum level between 30 and 60 days. This is the point at which naturally immunodeficient foals are highly susceptible to fatal infection.

In **calves**, the level of IgG declines slowly and reaches minimum values by 60 days, in contrast to IgM and IgA, which decline more rapidly and reach minimum values by approximately 21 days of age. The half-lives for IgG, IgM, and IgA in calves are approximately 20, 4, and 2 days, respectively, and the half-lives of IgG, IgGb, IgG(T), and IgA in foals are approximately 18, 32, 21, and 3.5 days, respectively.

**Immunologic competence** is present at birth, but endogenous antibody production does not usually reach protective levels until 1 month, and maximum levels are not reached until 2 to 3 months of age. The endogenous production of intestinal IgA in the piglet begins at about 2 weeks of age and does not reach significant levels until 5 weeks of age.

Foals that acquire low concentrations of immunoglobulins from colostrum may experience a transitory hypogammaglobulinemia at several weeks of age as the levels fall and before autogenous antibodies develop. They are, as expected, more subject to infection than normal.

### OTHER BENEFITS OF COLOSTRUM

In addition to its immunoglobulin content, colostrum contains considerably more protein, fat, vitamins, and minerals than milk and is especially important in the transfer of fat-soluble vitamins. It has **anabolic effects**, and lambs that ingest colostrum have a higher summit metabolism than colostrum-deprived lambs. Colostrum also contains growth-promoting factors that stimulate DNA synthesis and cell division, including high concentrations of insulin-like growth factor (IGF)-1.

Colostrum contains approximately  $1 \times 10^6$  leukocytes/mL, and several hundred million are ingested with the first feeding of colostrum. In calves, 20% to 30% of these are lymphocytes and cross the intestine into the circulation of the calf. It is postulated that they have importance in the development of neonatal resistance to disease, but there is little tangible evidence. Calves fed colostrum depleted of leukocytes are thought to be more poorly protected against neonatal disease than those fed normal colostrum.

## ASSESSMENT OF TRANSFER OF PASSIVE IMMUNITY

Because of the importance of transfer of colostrum antibodies to the health of the neonate, it is common to quantitatively estimate the levels of immunoglobulins, or their surrogates, in colostrum and in serum to predict risk of disease and to take preventive measures in the individual or to make corrective management changes where groups of animals are at risk.

### Assessment in the Individual Animal

When samples are taken from an individual animal to determine the risk for infection, sampling is undertaken early so that replacement therapy can be given promptly if there has been inadequate transfer. IgG is detectable in serum 2 hours following a colostrum feeding and **sampling at 8 to 12 hours** after birth will give a good indication of whether early sucking has occurred and has been effective in transfer. This type of monitoring is commonly performed in foals and camelid crias.<sup>7,13</sup> There are a number of different tests that can be used; some are quantitative and others semiquantitative. In calves, sampling may be undertaken for similar reasons, but the cost of replacement therapy is limiting.

### Assessment Tests on Serum

Sampling to **monitor** the efficacy of a farm policy for feeding and handling colostrum, to evaluate the passive immunity status in **calves to be purchased**, or to determine the **rates of FTPI** in investigations of neonatal disease can be conducted at any time in the first week of life after 24 hours with most tests. Numerous tests are currently available, some of which directly measure serum IgG concentration and some of which estimate the IgG concentration based on the serum concentration of the total globulin or other protein fractions.

### Radial Immunodiffusion

The radial immunodiffusion (RID) is based on the precipitation of antigen and antibody to an insoluble precipitin complex and thus directly measures IgG concentration in serum or plasma. The RID is considered the reference method to measure serum/plasma IgG, but it takes at least 24 h to perform and thus longer than is desirable for most clinical purposes. In a recent study two commercial RID test kits for calves were compared, and a large bias and wide limits of agreements between the two tests were found, which has raised questions about the reliability of the results.<sup>21</sup>

### Lateral-Flow Immunoassay

The lateral-flow immunoassay is a calf-side test directly measuring IgG in serum or plasma with reportedly high sensitivity and specificity. Although the test can be performed on-site and results are available

within 20 min, it only provides a pass/fail result using a cutoff value of 10 mg/mL.<sup>2</sup>

### Turbidimetric Immunoassay

The turbidimetric immunoassay (TIM) is commercially available and can be run on a handheld chemistry analyzer to be used with bovine serum. In a preliminary study conducted at the University of Minnesota, the test was found to be more accurate than indirect tests such as serum refractometry.

### Zinc Sulfate Turbidity Test

The zinc sulfate turbidity test is based on a selective precipitation reaction of the salt with high molecular weight proteins such as immunoglobulin (not specifically IgG). The test is commonly used with a test solution containing 200 mg/L zinc sulfate but was found to have poor specificity and would only classify 69% of tested calves correctly. Increasing the zinc sulfate concentration from 200 to 350 mg/L considerably improved the specificity and positive predictive values of the test, but this test modification is not widely used.<sup>15</sup> Another inconvenience is that hemolyzed blood samples will give artificially high readings, and the reagent must be kept free of dissolved carbon dioxide.

### Sodium Sulfite Precipitation Test

The sodium sulfite precipitation test is based on the selective precipitation of high-molecular-weight proteins with sodium sulfate at different concentrations. Test solutions of 14%, 16%, and 18% sodium sulfite are commonly used, and the development of turbidity at a certain concentration allows for a crude estimate of the serum immunoglobulin concentration; the lower the concentration at which turbidity occurs, the higher is the concentration of immunoglobulin. Particularly the use of the 14% and 16% sodium sulfite solutions was found to result in an unacceptably high percentage of calves being misclassified as FTPI while having adequate serum immunoglobulin concentrations.<sup>15</sup>

### Serum $\gamma$ -Glutamyltransferase Activity

Serum  $\gamma$ -glutamyltransferase (GGT) activity has been used as a surrogate for determining the efficacy of transfer of passive immunity in calves and lambs (not in foals). GGT activity is high in the colostrum of ruminants (but not horses), and serum GGT activity in calves and lambs that have sucked or been fed colostrum is 60 to 160 times greater than normal adult serum activity and correlates moderately well with serum IgG concentrations. The half-life of GGT from colostrum is short, and serum GGT activity falls significantly in the first week of life. Serum GGT values equivalent to a serum IgG concentration of 10 mg/mL are 200 IU/L on day 1 of life and 100 IU/L on day 4. Serum GGT concentrations less than 50 IU/L indicate FTPI.

### Serum Total Protein

Measuring total protein concentrations in serum or plasma with a refractometer is a practical, rapid, and inexpensive method to estimate the immunoglobulin concentration by extrapolating it from the total protein concentration. Despite the indirect nature of the test, there is a reliable correlation between the refractometer reading and total immunoglobulin concentration measured by RID. In healthy calves a serum total protein of 5.5 g/dL or greater is associated with adequate transfer of passive immunity.

Serum total protein has a good predictive value for fate of the newborn, and the facile and practical nature of the test and its predictive ability commend it for survey studies in calves and lambs but not foals. Cut-points will vary with the environment and the infection pressure to the calves. The sensitivity of the test is maximal using a cut-point of 5.5 g/dL, and the specificity is maximal at a cut-point of 5.0 g/dL. Because serum total protein concentration measured by refractometry can result in an incidental misclassification of an individual calf, this test is primarily recommended as a screening tool to assess the colostrum management on a herd level, but not as diagnostic tool for an individual animal. Herd screening could be conducted by testing a minimum of 12 calves on a farm between 24 hours and 7 days old. At least 80% of tested calves should have serum protein concentrations above 5.5 g/dL to consider the colostrum management satisfactory at the herd level.

Serum total protein concentration can also be estimated using the same Brix refractometer used for measuring colostrum IgG concentration, with an appropriate adjustment factor.<sup>14</sup>

### Glutaraldehyde Coagulation Test

The glutaraldehyde test was initially introduced to identify hypergammaglobulinemia in adult cattle with chronic inflammatory disease. The semiquantitative test is based on a clotting reaction of glutaraldehyde in the presence of high immunoglobulin concentration, where the time to clot formation is negatively correlated with the serum IgG.<sup>16</sup> A modified glutaraldehyde coagulation test is also available for the detection of hypogammaglobulinemia in neonatal calves, but it is less accurate.<sup>15</sup> The test may yield false-positive results with hemolysis and is difficult to quantitate.

### Latex Agglutination Test

A commercial latex agglutination test is available for horses. It is rapid and provides semiquantitative results, but results were reported to be inconsistent.

### ELISA Snap-Test

ELISA snap-tests are foal-side immunologic tests directly measuring IgG in a



semiquantitative manner. Test kits are commercially available for foals and have been available for calves. In foals the available snap-tests were found to be rapid and accurate.

### Monitoring Colostrum Brix Refractometry

The most accurate and practical way to ensure that an adequate colostrum mass is fed is to test the colostrum using a Brix refractometer (the digital version is preferred). This instrument was designed for use in food processing but was adapted in the late 1970s to provide a low-cost test of colostrum quality. A Brix refractometer value of 21% or 22% or higher indicates acceptable colostrum (same value for fresh or frozen samples; approximately equivalent to a colostrum IgG concentration of 50 g/L); colostrum with a value below 21% or 22% should be discarded.<sup>17,18</sup>

### Specific Gravity

Specific gravity, determined by refractometry, can be used as a measure of the immunoglobulin content of colostrum. In **mares** the concentration of immunoglobulin in colostrum is highly correlated with the specific gravity of the colostrum, which in turn is highly correlated with the serum immunoglobulin levels achieved in foals. Temperature-corrected measurements are most accurate. Measurement of colostrum specific gravity provides a rapid and easy method of identifying foals likely to be at a high risk for FTPI and the need to provide them with colostrum of a higher Ig content. To prevent FTPI, it is recommended that the colostrum specific gravity should be equal to or greater than 1.060, and the colostrum IgG concentration should be a minimum of 3000 mg/dL.

In **cattle** the relation of specific gravity of colostrum to colostrum immunoglobulin concentration is linear but is better in Holstein Friesian than in Jersey cows. The measurement is simple, but there is a correction for temperature, and air trapped in colostrum taken by a milking machine can give a false reading if the measurement is taken too quickly after milking. The cut-point recommended to distinguish moderate from excellent colostrum has been set at 1.050, approximating an IgG concentration of 50 g/L, and is based on the amount of immunoglobulin required for a 2-L (2-quart) feeding. Specific gravity is not a perfect surrogate for immunoglobulin concentration with cattle colostrum. It has good negative prediction, but it will falsely pass 2 out of 3 colostrums that have unacceptably low immunoglobulin concentrations. An analysis of first-milking colostrum in mid-western U.S. dairies found that specific gravity differed among breeds and was influenced by month of calving, year of calving, lactation number, and protein yield in

previous lactation and that it was more closely associated with colostrum protein concentration ( $r = 0.76$ ) than IgG<sub>1</sub> concentration ( $r = 0.53$ ).

### Glutaraldehyde Test

This test for mare colostrum is available commercially and is reported to have a high predictive value for colostrums that contain more than 38 mg/mL of IgG and have a specific gravity greater than 1.060.

### ELISA

Recently a cow-side immunoassay kit has become available commercially in the United States. The kit provides a positive or a negative response, with the cut-point being a concentration of 50g/L of IgG in colostrum, and has accuracy sufficient to recommend its use for rejection of colostrums with low immunoglobulin concentration.

### CORRECTION OF FAILURE OF TRANSFER OF PASSIVE IMMUNITY Oral Therapy

Oral therapy can be considered in individual animals (generally foals and crias), provided that FTPI—or the risk thereof—is diagnosed and the treatment is administered before gut closure (i.e., not later than 18 h of life). For foals, oral administration of at least 0.5 L frozen equine colostrum of good quality (specific gravity > 1.060) that has been properly stored and thawed is recommended. Alternatives include colostrum substitutes containing lyophilized IgG or good-quality bovine colostrum. The latter option is probably the least effective and requires at least 4 L of good-quality (specific gravity > 1.050) colostrum.

### Parenteral Immunoglobulins

Blood transfusion is commonly used in food animal practice, and the method is described elsewhere in this text. Fresh plasma from a random donor or purified hyperimmune plasma that is commercially available for foals and crias in some countries are alternatives. Large amounts are required to obtain the required high serum concentrations of immunoglobulins, and intravenous infusion can be accompanied by transfusion-type reactions.

### AVOIDANCE OF FAILURE OF TRANSFER OF PASSIVE IMMUNITY

With all species, with the exception of dairy calves, the common practice is to allow the newborn to suck naturally. The policy for avoidance of FTPI with naturally sucking herds should be to provide supplemental colostrum by artificial feeding of those neonates with a high risk for FTPI, based on the risk factors detailed earlier. In the dairy calf, rates of FTPI with natural sucking are so high that many farms opt to remove the calf at birth and feed colostrum by hand to ensure adequate intake.

### Colostrum

Colostrum can be stripped from the dam and fed fresh, or the neonate can be fed stored (banked) colostrum.

### Colostrum for Banking

With **dairy cows**, first-milking colostrum from a cow with a first-milking yield of less than 10 kg should be used. The temptation for the farmer is to store the leftover from the feeding of large-volume colostrum. The leftover colostrum should not be used because it has a high probability of containing a low immunoglobulin concentration.

Colostrum from **mares** should have a specific gravity of 1.060 or more, and 200 mL can be milked from a mare before the foal begins sucking.

### Storage of Colostrum

Colostrum can be kept at **refrigerator temperature** for approximately 1 week without significant deterioration in immunoglobulins; bacteria counts, however, may reach unacceptably high levels (above 100,000 cfu/mL) after 2 days in refrigerated milk.<sup>2</sup> Addition of potassium sorbate in a 0.5% final solution impairs bacterial growth for several days.<sup>2</sup> The addition of 5 g of propionic or lactic acid per liter extends the storage life to 6 weeks, but, more commonly, colostrum is frozen for storage. **Frozen colostrum**, at  $-20^{\circ}\text{C}$  ( $-4^{\circ}\text{F}$ ), can be stored for at least 1 year, and there is no impairment in the subsequent absorption of immunoglobulins. Frozen colostrum should be stored in flat plastic bags in the amount required for a feeding, which facilitates thawing. **Thawing** should be at temperatures below  $55^{\circ}\text{C}$  ( $131^{\circ}\text{F}$ ). Higher temperatures and microwave thawing result in the deterioration of immunoglobulins and antibodies in frozen colostrum and frozen plasma.

### Pasteurization of Colostrum

There are several indications for pasteurization of colostrum. This procedure can be a suitable instrument in a program for the control of specific infectious diseases, such as paratuberculosis, salmonellosis, or *M. bovis* infection, but it can also be useful to ameliorate calf health by improving colostrum quality and reducing the exposure of the neonate to pathogens. On-farm pasteurization of bovine colostrum for 60 min at  $60^{\circ}\text{C}$  ( $140^{\circ}\text{F}$ ) results in elimination or at least significant reduction of bacterial contamination without impairing fluid characteristics or availability of IgG for intestinal absorption.<sup>9</sup> One recent study reported significantly higher serum IgG concentrations at 24 h of life when calves were fed pasteurized colostrum compared with calves receiving the same quality and amount of raw colostrum.<sup>19</sup> The authors attributed this effect to reduced bacterial interference with intestinal IgG absorption. Pasteurization extends the shelf life of refrigerated colostrum without

additives to 8 to 10 days when stored in clean, sealed containers.

### Cross-Species Colostrum

Colostrum from another species can be used to provide immunologic protection when same-species colostrum is not available. Bovine colostrum can be fed to a number of different species. Although absorption of immunoglobulin occurs and significant protection can be achieved, the use of cross-species colostrum is not without risk, and the absorbed immunoglobulin has a short half-life. Bovine colostrum has been successfully used for many years to improve the survival rate of hysterectomy-produced artificially reared pigs. It has also been used as an alternate source of colostral antibody for rearing goats free of caprine arthritis–encephalitis (CAE). Colostrum from some cows can result in the development of hemolytic anemia, occurring at around 5 to 12 days of age, in lambs and kids because the IgG of some cows attaches to the red cells and their precursors in bone marrow, resulting in red cell destruction by the reticuloendothelial system. Bovine colostrum can be tested for “antisheep” factors by a gel precipitation test on colostral whey, but this test is not generally available. Bovine colostrum can provide some protection to newborn foals against neonatal infections, and protection appears to result from factors in addition to the immunoglobulins, which have a short half-life in foals.

### Colostrum Supplements

In recent years there has been a move to develop supplements or even replacements for colostrum to feed calves. These have been attempted using IgG concentrated from bovine colostrum, milk whey, eggs, or bovine serum. The search for colostrum substitutes or colostrum replacers has been prompted by the problem of the variability of IgG concentration in natural colostrum. It has also been prompted by possible limitations of availability of high-quality colostrum on dairy farms as a result of discarding colostrum from cows that test positive for diseases that can transmit through colostrum, such as paratuberculosis, bovine leukosis, and *M. bovis*.

There is evidence that the inclusion of **colostrum replacer (CR)** or **colostrum supplement (CS)** products can impair the efficiency of colostral immunoglobulin, and if they are fed, they should be fed after normal colostrum rather than mixed into the colostrum. It has been proposed that the distinction between a colostrum supplement and a colostrum replacer should be the immunoglobulin mass contained in the product, with a colostrum supplement containing less than 100 g IgG per dose and a colostrum replacer having sufficient immunoglobulin mass in a dose to result in a serum IgG concentration greater than 10 mg/mL following a feeding.

Furthermore, CR products are formulated to provide adequate protein, energy, minerals, and vitamins to completely replace colostrum, which is not the case for CS supplement products. When fed as the sole source of immunoglobulin to colostrum-deprived calves, CS products achieve circulating concentrations of immunoglobulin that are lower than those achieved by natural colostrum containing equivalent amounts of immunoglobulin.

A large mass of immunoglobulin is required for acquisition of adequate serum immunoglobulin concentrations. Calves fed a colostrum replacement containing a high mass (250 g) of an IgG derived from bovine serum and fed at 1.5 and again at 13.5 hours after birth achieved equivalent serum IgG concentrations to calves fed normal colostrum and showed no difference in gain or health parameters during the first 4 weeks of life. However, the performance of commercially available products for IgG supplementation varies greatly, with many of them faring badly. The choice of a specific product should therefore be based on the availability of convincing data supporting the efficacy of the product in question.

The use of colostrum replacers should be limited to situations where sufficient amounts of colostrum of adequate quality are unavailable. There can be little justification for more widespread use, particularly because there are limited independent health-related publications documenting their efficacy. Also, as mentioned earlier, in addition to immunoglobulin, natural colostrum contains various substances important to neonatal physiology.

### Lacteal-Secretion-Based Preparations

Colostrum supplements prepared from whey or colostrum are available commercially in many countries. Depending on the manufacturer, they contain varying amounts of immunoglobulin, but significantly less than first-milking colostrum. The amount of immunoglobulin contained varies, but the recommendations for feeding that accompany these products indicate that they will supply approximately 25% or less of the immunoglobulin required to elevate calf serum IgG concentrations above 1000 mg/dL. There is a further problem in that the immunoglobulins in products made from colostrum or whey are poorly absorbed, and trials assessing their ability to increase circulating immunoglobulins when fed with colostrum have generally shown little improvement and no improvement in health-related parameters.

### Bovine-Serum-Based Preparations

Colostrum supplements prepared from bovine serum are also available commercially, but regulations governing the feeding of blood or blood products to calves (risk reduction for bovine spongiform

encephalopathy) may limit their availability in some countries. The absorption of immunoglobulin from these bovine-serum-derived commercial products appears better than from milk-protein-derived products, and consequently they are also marketed as colostrum replacers.

The IgG in a commercially available bovine serum colostrum replacer has been shown to be effectively absorbed when fed to newborn lambs. The feeding of 200 g of IgG in the first 24 hours of life resulted in a mean plasma concentration of 1800 mg/dL.

### Administration of Colostrum

#### Foals

Foals should be allowed to suck naturally. The specific gravity of the mare's colostrum can be checked at foaling; if this is less than 1.060, supplemental colostrum may be indicated. Foals that do not suck, or that have serum IgG concentrations less than 400 mg/dL at 12 hours of age, or that require supplementation for other reasons, should be fed colostrum with a specific gravity of 1.060 or more at an amount of 200 mL at hourly feedings.

#### Dairy Calves

##### *Assisted Natural Sucking*

Leaving the newborn dairy calf with the cow is no guarantee that the calf will obtain sufficient colostrum, and a high proportion of dairy calves fail either to suck early or to absorb sufficient immunoglobulins from ingested colostrum. This problem can be alleviated to some extent by **assisted natural sucking**, but this can fail because not all calves requiring assistance are detected. An alternate approach is to milk 2 L of colostrum from the dam, bottle feed each calf as soon after birth as possible, then leave the calf with the cow for 24 hours and allow it to suck voluntarily. Although this will not be as effective as a system based entirely on artificial feeding of selected colostrum, it is an approach that is suitable for the smaller dairy farm.

##### *Artificial Feeding Systems*

With **artificial feeding systems**, the calf is removed from the dam at birth and fed colostrum by hand throughout the whole absorptive period. Nipple bottle feeding can be used, with 2 L of colostrum given every 12 hours for the first 48 hours of life. The first feeding is usually milked from the cow by hand, and the remaining feedings are from the colostrum obtained from the cow after the first machine milking. With care and patience, this system can result in good transfer of passive immunity in all calves except those born to dams that have very low concentrations of immunoglobulin in their colostrum. Unfortunately, with Holstein Friesians this can be a significant percentage. An extension of this system is to bottle feed at the same frequency but to feed stored

colostrum selected for its superior immunoglobulin content. Bottle feeding of newborn calves requires considerable **patience**, and its success is very much dependent on the calf feeder and on the availability of the feeder's time when faced with a calf that has a slow intake.

Where the diligence of the calf feeders is poor, or where there is a time constraint on their availability, the feeding of a large volume of colostrum (4 L to a 45 kg calf) by **esophageal feeder** at the initial feeding immediately after birth can be a successful practice. The **large-volume feeding** also allows the delivery of an adequate mass of immunoglobulin with colostrum that has low immunoglobulin concentrations without impairing the intestinal IgG absorption rate compared with voluntary intake of the same large amount of colostrum.<sup>10</sup> The practice usually uses stored colostrum, and the feeding can be achieved within a few minutes. It can be supplemented by bottle feeding of a second feeding at 12 hours of life.

The practice of feeding stored colostrum as the sole source of colostrum is limited to larger dairy herds, but it does allow the selection of superior colostrum for feeding, with selection based on weight and specific gravity as detailed earlier.

### Beef Calves

Beef calves should be allowed to suck naturally, and force-feeding of colostrum to beef breeds should not be practiced unless there is obvious failure of sucking. Where colostrum is required, as with weak beef calves, calves with edematous tongues, and calves that have been subjected to a difficult birth, it can be administered with an esophageal feeder or a stomach tube.

### Lambs

Lambs are allowed to suck naturally, but there can be competition between siblings for colostrum; one large single lamb is capable of ingesting, within a short period of birth, all the available colostrum in the ewe's udder. Lambs require a total of 180 to 210 mL colostrum/kg body weight during the first 18 hours after birth to provide sufficient energy for heat production. This amount will usually provide enough immunoglobulin for protection against infections. **Supplemental feeding** of colostrum may be advisable for lambs from multiple birth litters, lambs that lack vigor, and those that have not nursed by 2 hours following birth. This can be done with a nipple bottle or an esophageal feeder.

### Piglets

Colostrum supplementation is not commonly practiced with piglets. An immunoglobulin dose of 10 g/kg body weight on day 1 followed by 2 g/kg on succeeding days for 10 days is sufficient to confer passive immunity on the colostrum-deprived pig.

### FURTHER READING

- Barrington GM, Parish SM. Bovine neonatal immunology. *Vet Clin North Am Food Anim Pract.* 2001;17:463-476.
- Black L, Francis ML, Nicholls MJ. Protecting young domestic animals from infectious disease. *Vet Annu.* 1985;25:46-61.
- Godden S. Colostrum management for dairy calves. *Vet Clin North Am Food Anim Pract.* 2008;24:19-39.
- McGuirk SM, Collins M. Managing the production, storage, and delivery of colostrum. *Vet Clin North Am Food Anim Pract.* 2004;20:593-603.
- Mellor D. Meeting colostrum needs of lambs. *In Pract.* 1990;12:239-244.
- Norcross NL. Secretion and composition of colostrum and milk. *J Am Vet Med Assoc.* 1982;181:1057.
- Quigley JD, Drewry JJ. Nutrient and immunity transfer from cow to calf pre- and postcalving. *J Dairy Sci.* 1998;81:2779-2790.
- Rooke JA, Bland IM. The acquisition of passive immunity in the newborn piglet. *Livest Prod Sci.* 2002;78:13-23.
- Staley TE, Bush LJ. Receptor mechanism of the neonatal intestine and their relationship to immunoglobulin absorption and disease. *J Dairy Sci.* 1985;68:184-205.
- Weaver DM, Tyler JW, VanMetre D, Hoetzel DE, Barrington GM. Passive transfer of colostrum immunoglobulins in calves. *J Vet Intern Med.* 2000;14:569-577.

### REFERENCES

- Beam AL, et al. *J Dairy Sci.* 2009;92:3973-3980.
- Godden S. *Vet Clin North Am Food Anim Pract.* 2008;24:19-39.
- Morin DE, et al. *J Am Vet Med Assoc.* 2010;237:420-428.
- Mokhber-Dezfooli MR, et al. *J Dairy Sci.* 2012;95:6740-6749.
- Faber SN, et al. *Prof Anim Sci.* 2005;21:420-425.
- McCue PM. *Am J Vet Res.* 2007;68:1005-1009.
- Whitehead CE. *Vet Clin North Am Food Anim Pract.* 2009;25:353-366.
- Waldner CL, Rosengren LB. *Can Vet J.* 2009;50:275-281.
- Godden S, et al. *J Dairy Sci.* 2006;89:3476-3482.
- Godden SM, et al. *J Dairy Sci.* 2009;92:1758-1765.
- Edwards SA, Broom DM. *Res Vet Sci.* 1979;26:255-256.
- Godden SM, et al. *J Dairy Sci.* 2009;92:1750-1757.
- Austin SM. *Equine Vet Educ.* 2013;25:585-589.
- Deelen SM, et al. *J Dairy Sci.* 2014;97:1-7.
- Weaver DM, et al. *J Vet Intern Med.* 2000;14:569-577.
- Metzner M, et al. *J Vet Med A Physiol Pathol Clin Med.* 2007;54:449-454.
- Bielmann V, et al. *J Dairy Sci.* 2010;93:3713-3721.
- Quigley JD, et al. *J Dairy Sci.* 2013;96:1148-1155.
- Johnson J, et al. *J Dairy Sci.* 2007;90:5189-5198.
- Lorenz I, et al. *Ir Vet J.* 2011;64:10.
- Ameri M, Wilkerson MJ. *J Vet Diagn Invest.* 2008;20:333-336.

## Clinical Assessment and Care of Critically Ill Newborns

The following discussion focuses on care and treatment of critically ill foals, although the principles are applicable to any species. The increasing availability of secondary and

tertiary care for ill newborns has allowed the development of sophisticated care for newborns of sufficient emotional or financial value.<sup>1</sup> This level of care, at its most intensive, requires appropriately trained individuals (both veterinarians and support staff) and dedicated facilities. True intensive care of newborns requires 24-hour monitoring. The following discussion is not a comprehensive guide to intensive care of newborns, but is rather an introduction to the general aspects of advanced primary or basic secondary care. Sophisticated interventions, such as mechanical ventilation and cardiovascular support, are mentioned but not discussed in detail.

### CLINICAL EXAMINATION

Initial assessment of an ill newborn should begin with collection of a detailed history, including length of gestation, health of the dam, parturition, and behavior of the newborn after birth, including the time to stand and to commence nursing activity. Physical examination should be thorough, with particular attention to those body systems most commonly affected. A form similar to that in [Figure 19-4](#) is useful in ensuring that all pertinent questions are addressed and that the physical examination is comprehensive.

Examination of ill neonates should focus on detection of the common causes of disease in this age group: sepsis, either focal or systemic; prematurity or dysmaturity; metabolic abnormalities (such as hypoglycemia or hypothermia); birth trauma; diseases associated with hypoxia; and congenital abnormalities. Detailed descriptions of these conditions are provided elsewhere in this chapter.

### Sepsis

**Sepsis** is an important cause of illness in neonates that can manifest as localized infections without apparent systemic signs, localized infections with signs of systemic illness, or systemic illness without signs of localized infection.<sup>2</sup>

**Localized infections** without signs of systemic illness include septic synovitis or osteomyelitis and omphalitis. Signs of these diseases are evident on examination of the area affected and include lameness, distension of the joint, and pain on palpation of the affected joint in animals with synovitis or osteomyelitis and an enlarged external umbilicus with or without purulent discharge in animals with infections of the umbilical structures. Specialized imaging and hematologic and serum biochemical examinations (see following discussion) are useful in confirming the infection.

**Systemic signs** of sepsis include depression, failure to nurse or reduced frequency of nursing, somnolence, recumbency, fever or hypothermia, tachypnea, tachycardia, diarrhea, and colic, in addition to any signs of



## Foal Examination Protocol (age < 1 mon)

The Ohio State University Veterinary Teaching Hospital

Special considerations:

\_\_\_\_\_

\_\_\_\_\_

\_\_\_\_\_

Clinician: \_\_\_\_\_

Student: \_\_\_\_\_

Date: \_\_\_\_\_ Time: \_\_\_\_\_ AM/PM

### History

#### Mare

Age: \_\_\_\_\_ No of previous foals: \_\_\_\_\_ Problems with previous foals? \_\_\_ No \_\_\_ Yes \_\_\_\_\_

Uterine infections/Vaginal discharge? \_\_\_ No \_\_\_ Yes \_\_\_\_\_

Illness during pregnancy? \_\_\_ No \_\_\_ Yes \_\_\_\_\_

Milk dripping? \_\_\_ No \_\_\_ Yes How long? \_\_\_\_\_

Vaccinations? \_\_\_ No \_\_\_ Yes What/When? \_\_\_\_\_

Deworming? \_\_\_ No \_\_\_ Yes When? \_\_\_\_\_

Feeding: \_\_\_\_\_

Breeding date: \_\_\_\_\_ Duration of pregnancy: \_\_\_\_\_ → \_\_\_ on term \_\_\_ early \_\_\_ overdue (\_\_\_\_ days)

Dystocia? \_\_\_ No \_\_\_ Yes \_\_\_\_\_

Early cord rupture? \_\_\_ No \_\_\_ Yes \_\_\_\_\_ Premature placental separation? \_\_\_ No \_\_\_ Yes \_\_\_\_\_

Placenta completely passed? \_\_\_ No \_\_\_ Yes Condition of placenta: \_\_\_\_\_

Meconium staining? \_\_\_ No \_\_\_ Yes \_\_\_\_\_

Udder: \_\_\_ Normal \_\_\_ Abnormal \_\_\_\_\_

Colostrum quality: \_\_\_ Normal \_\_\_ Low-quality \_\_\_\_\_ Amount: \_\_\_ Normal \_\_\_ Reduced \_\_\_\_\_

#### Foal

Spontaneous breathing? \_\_\_ No \_\_\_ Yes \_\_\_\_\_ Time to stand: \_\_\_\_\_ Time to nurse: \_\_\_\_\_

Nursing normally? \_\_\_ No \_\_\_ Yes \_\_\_\_\_ Colostrum/Milk given? \_\_\_\_\_

Behavior normal? \_\_\_ No \_\_\_ Yes \_\_\_\_\_ IgG tested? \_\_\_ No \_\_\_ Yes \_\_\_\_\_

Urination? \_\_\_ No \_\_\_ Yes \_\_\_\_\_ Meconium passed? \_\_\_ No \_\_\_ Yes \_\_\_\_\_ Enema given? \_\_\_ No \_\_\_ Yes \_\_\_\_\_

Medications given? \_\_\_ No \_\_\_ Yes \_\_\_\_\_

Umbilicus treated? \_\_\_ No \_\_\_ Yes \_\_\_\_\_

**Presenting complaint:** \_\_\_\_\_

\_\_\_\_\_

\_\_\_\_\_

Previous treatment: \_\_\_\_\_

**Fig. 19-4** Examples of forms used to document and record historical aspects and findings on physical examination of foals less than 1 month of age.

*Continued*

**Physical Examination**      **Date:** \_\_\_\_\_ **Time:** \_\_\_\_\_ **AM/PM**

Temperature: \_\_\_\_\_°F    Pulse rate: \_\_\_\_\_/min    Respiratory rate: \_\_\_\_\_/min    Body weight: \_\_\_\_\_ kg / \_\_\_\_\_ lb

Inspection:

Behavior: \_\_\_\_\_

Signs of prematurity?  no  yes (  Haircoat  Forehead  Ears  Joints  Tendons \_\_\_\_\_ )

Skin and haircoat: \_\_\_\_\_

Body condition: \_\_\_\_\_

Suckle reflex:  good  moderate  weak  none \_\_\_\_\_Eyes:  normal  Entropion (L)(R)  Uveitis (L)(R)  Corneal ulcer (L)(R) \_\_\_\_\_CardiovascularPulse quality:  strong  moderate  weak /  regular  irregular \_\_\_\_\_

Mucous membranes: \_\_\_\_\_ CRT: \_\_\_\_\_ sec.      Skin turgor: \_\_\_\_\_

Jugular veins:  normal  collapsed  distended \_\_\_\_\_ Catheter  left  rightCardiac auscultation: HR: \_\_\_\_\_ Intensity: \_\_\_\_\_ Rhythm:  regular  irregular \_\_\_\_\_Murmurs:  no  yes \_\_\_\_\_RespirationNasal discharge:  no  yes \_\_\_\_\_ Cough:  no  yes \_\_\_\_\_Lymph nodes:  normal: \_\_\_\_\_ Auscultation:  normal: \_\_\_\_\_GI tractColic:  no  yes \_\_\_\_\_ GL sounds: \_\_\_\_\_ Abd. distention:  no  yes \_\_\_\_\_

Fecal consistency: \_\_\_\_\_ Digital palpation/Meconium: \_\_\_\_\_

UrogenitalUmbilicus:  normal \_\_\_\_\_Urination:  no  yes  straining \_\_\_\_\_ Scrotum/Testes – Vulva/Vagina:  normal \_\_\_\_\_MusculoskeletalJoints:  normal \_\_\_\_\_Lameness:  no  yes \_\_\_\_\_Deformations/Angular limb deformities:  no  yes \_\_\_\_\_Neurologic: normal \_\_\_\_\_Seizures:  no  yes \_\_\_\_\_

Senior Student: \_\_\_\_\_ Attending Clinician: \_\_\_\_\_

**Foal Examination Protocol**

Fig. 19-4, cont'd

localized disease. Fever is a specific, but not sensitive, sign of sepsis in foals. The presence of petechia in oral, nasal, ocular, or vaginal mucous membranes, the pinna, or coronary bands is considered a specific indicator of sepsis, although this has not been documented by appropriate studies. A similar comment applies for injection of the scleral vessels. A scoring system (the sepsis score) has been developed to aid in the identification of foals with sepsis.

The **sepsis score** was developed with the intention of aiding identification of foals with sepsis, thereby facilitating appropriate treatment. A table for calculation of the sepsis score (the modified sepsis score) is provided in Table 19-11. Foals with a score of 12 or greater are considered to be septic, with a sensitivity of 94% in the original report. However, more recent studies, including one of 1095 foals, have found the sensitivity and specificity of the sepsis score to be less than the original report. The modified sepsis score detected sepsis with a sensitivity of 56% and a specificity of 73% using a cutoff value of 11 or more. A cutoff value of 7

yielded a sensitivity of 84% and specificity of 42%.<sup>3</sup> These recent studies are broadly consistent with earlier studies that demonstrate that the sepsis score has limited sensitivity (67%, 95% CI 59% to 75%) and specificity (76%, 95% CI 68% to 83%) in foals less than 10 days of age. Similarly, 49% of 101 foals with positive blood cultures had a sepsis score of 11 or less, indicating a low specificity of the test. The low to moderate sensitivity of the sepsis score for detection of sepsis or bacteremia means that many foals with sepsis are incorrectly diagnosed as being nonseptic (i.e., a high false-negative rate), whereas a moderate to low specificity means that the false-positive rate might be excessive, with a number of foals being considered septic when they are not. This is an important shortcoming of the test because accurate and prompt identification of foals with sepsis is assumed to be important for both prognostication and selection of treatment. The sepsis score might be useful in some situations, but its shortcomings should be recognized when using it to guide treatment or determine prognosis.

### Prematurity and Dysmaturity

Detection of **prematurity** is important because it is a strong risk factor for development of other diseases during the immediate postpartum period. The detection of prematurity is often based on the length of gestation. However, the duration of gestation in Thoroughbred horses varies considerably, with 95% of mares foaling after a gestation of 327 to 357 days. The generally accepted “average” gestation is 349 days, with fillies having shorter gestations than do colts (348 versus 350 days) and gestation length declining by approximately 20 days, from 360 to 340 days, in Standardbred mares in New Zealand.<sup>4</sup> Ponies have a shorter gestation (333 days, range 315 to 350 days). Therefore a diagnosis of prematurity should be based not just on gestational age but also on the results of physical, hematologic, and serum biochemical examination of the newborn. Factors helping in the determination of prematurity are listed in Table 19-4. Foals that are immature (premature) at birth typically have low birth weight and small body size, a short and silky hair coat, and laxity of the

**Table 19-4** Criteria to assess stage of maturity of the newborn foal

Criterion	Premature	Full term
<b>Physical</b>		
Gestational age	320 d	Normally > 330 d
Size	Small	Normal or large
Coat	Short and silky	Long
Fetlock	Overextended	Normal extension
<b>Behavior</b>		
First stand	>120 min	<120 min
First stand	>3 h	<3 h
Suck reflex	Poor	Good
Righting reflexes	Poor	Good
<b>Adrenal activity</b>		
Plasma cortisol values over first 2 h postpartum	Low levels (<30 ng/mL)	Increasing levels (120–140 ng/mL) at 30–60 min postpartum
Plasma ACTH values over first 2 h postpartum	Peak values (≈650 pg/mL) at 30 min postpartum and declining subsequently	Declining values from peak (300 pg/mL at birth)
Response to synthetic ACTH1-24 (short-acting Synacthen), dose 0.125 mg IM	Poor response shown by a 28% increase in plasma cortisol and no changes in neutrophil:lymphocyte ratio	Good response shown by a 208% increase in plasma cortisol and widening of neutrophil:lymphocyte ratio
<b>Hematology</b>		
Mean cell volume (fl)	>39	<39
White blood cell count ( $\times 10^9/L$ )	6.0	8.0
Neutrophil:lymphocyte ratio	<1.0	>2.0
<b>Carbohydrate metabolism</b>		
Plasma glucose levels over first 2 h postpartum	Low levels at birth (2–3 mmol/L), subsequently declining	Higher levels at birth (4.1 mmol/L), maintained
Plasma insulin levels over first 2 h postpartum	Low levels at birth (8.6 $\mu U/mL$ ), declining	Higher levels at birth (16.1 $\mu U/mL$ ), maintained
Glucose tolerance test (0.5 mg/kg body weight IV)	Slight response demonstrated by a 100% increase in plasma insulin at 15 min postadministration	Clear response demonstrated by a 250% increase in plasma insulin at 5 min postadministration
<b>Renin–angiotensin–aldosterone system</b>		
Plasma renin substrate	Higher and/or increasing levels during 15–60 min postpartum	Low (<0.6 $\mu g/mL$ ) and declining levels during 15–30 min postpartum
Acid–base status (pH)	<7.25 and declining	>7.3 and maintaining or rising

IM, intramuscularly; IV, intravenously.



flexor and extensor tendons. The cranium is rounded, and the pinnae lack tone (droopy ears). The foals are typically weak and have trouble standing, which is exacerbated by laxity of the flexor tendons and periarticular ligaments. **Dysmature** (postmature) foals are typically large, although they can be thin, and have a long hair coat and flexure tendon contracture. These signs are consistent with prolonged gestation combined with inadequate intrauterine nutrition. Healthy foals stand approximately 65 min (interquartile range, 45 to 100 minutes) after birth.<sup>4</sup> Examination of the placenta, either by ultrasonographic examination before birth or by direct examination, including histologic and microbiologic testing, after birth is useful in identifying abnormalities that have significance for the newborn.

### Hypoxia

Hypoxia during late gestation, birth, or the immediate postpartum period has a variety of clinical manifestations depending on the tissue or organ most affected. Signs of central nervous system dysfunction are often assumed to be a result of cerebral hypoxia during birth, although neonatal maladjustment syndrome does not appear to be related to hypoxia (see “Neonatal Maladjustment Syndrome,” page 1871). Other signs suggestive of peripartum hypoxia include colic and anuria.

### Hypoglycemia

Foals that are hypoglycemic because of inadequate intake, such as through mismothering, congenital abnormalities, or concurrent illness, are initially weak, with rapid progression to somnolence and coma.

### Endocrine Abnormalities

Abnormalities in endocrine function of foals are common and often associated with risk of death.<sup>1,5-10</sup> Septic foals have higher serum ACTH, cortisol, and ACTH:cortisol ratios, and higher serum parathyroid hormone concentrations (but not calcitonin concentrations) than do healthy foals of the same age.<sup>5,6</sup> Septic foals have lower insulin and IGF-1 and higher ghrelin, growth hormone, and glucagon concentrations than do healthy foals.<sup>7,8</sup> Arginine vasopressin concentrations are higher in septic foals.<sup>9</sup> Plasma adrenomedullin concentrations are highest in sick foals (both septic and nonseptic) and might be a useful marker of foal health.<sup>10</sup> Critically ill foals may also have evidence on nonthyroidal illness syndrome (see “Diseases of the Thyroid,” Chapter 17).<sup>11</sup>

### DIAGNOSTIC IMAGING

Radiographic and ultrasonographic examination of neonates can be useful in determining maturity and the presence of abnormalities. Prematurity is evident as failure or inadequate ossification of cuboidal bones in the carpus and tarsus. Radiographs

of the thorax should be obtained if there is any suspicion of sepsis or pneumonia because thoracic auscultation has poor sensitivity in detecting pulmonary disease in newborns. The severity of abnormalities in the lungs of foals detected by radiographic examination is related to prognosis, with foals with more severe disease having a worse prognosis for recovery. Abdominal radiographs may be useful in determining the site of gastrointestinal disease (see discussion of foal colic).

**Ultrasonography** is a particularly useful tool for examination of neonates, in large part because their small size permits thorough examination of all major body cavities. Ultrasonography of the umbilical structures can identify omphalitis and abscesses of umbilical remnants and, when available, is indicated as part of the physical examination of every sick neonate.

Examination of the **umbilical structures** can reveal evidence of infection, congenital abnormalities, and urachal tears. Examination of the umbilicus can be achieved using a 7.5-MHz linear probe (such as that commonly used for reproductive examination of mares), although sector scanners provide a superior image. Examination of the umbilical structures should include examination of the navel and structures external to the body wall, the body wall, the umbilical stump as it enters the body wall and separates into the two umbilical arteries, the urachus and apex of the bladder, and the umbilical vein. The size and echogenicity of each of these structures should be determined. For foals less than 7 days of age, the intraabdominal umbilical stump should be less than 2.4 cm in diameter, the umbilical vein less than 1 cm, and the umbilical arteries less than 1.4 cm (usually < 1 cm). Examination of these structures should be complete: the umbilical vein should be visualized in the umbilical stump and then followed as it courses along the ventral abdominal wall and into the liver; the umbilical arteries should be visualized in the umbilical stump and then as they separate from that structure and course over the lateral aspects of the bladder; the urachus should be visualized from the external umbilical stump through the body wall and as it enters the bladder.

Abnormalities observed frequently in the umbilical structures include overall swelling, consistent with omphalitis; gas shadows in the urachus or umbilical stump, which are indicative of either a patent urachus allowing entry of air or growth of gas-producing bacteria; and the presence of flocculent fluid in the urachus, vein, or artery, which is consistent with pus. Urachal tears can be observed, especially in foals with uroperitoneum.

Ultrasonographic examination of the **abdomen** is useful in identifying abnormalities of gastrointestinal function and structure, including intestinal distension or thickening of the intestinal wall. Thickness of the wall of the intestinal tract of healthy

Standardbred foals of less than 5 days of age are as follows (95% predictive interval): 1.6 to 3.6 mm for the stomach, 1.9 to 3.2 mm for the duodenum, 1.9 to 3.1 mm for the jejunum, 1.3 to 2.2 mm for the colon, and 0.8 to 2.7 mm for the cecum.<sup>12</sup> Intussusceptions are evident as “donut” lesions in the small intestine, but evaluation of the clinical importance of these findings should be considered in the context of the foal. Intussusceptions are detected in a large proportion of healthy neonatal foals as incidental findings.<sup>12</sup> Gastric outflow obstruction should be suspected in foals with a distended stomach evident on ultrasonographic examination of the abdomen. Herniation through the umbilicus or inguinal ring can be confirmed by ultrasonographic examination.<sup>13</sup> Uroperitoneum is readily apparent as excessive accumulation of clear fluid in the abdomen. Hemorrhage into the peritoneum can be detected as accumulation of echogenic, swirling fluid. Accumulation of inflammatory fluid, such as in foals with ischemic intestine, is detected by the presence of flocculent fluid.

Ultrasonographic examination of the **chest** can reveal the presence of pleural abnormalities, consolidation of the lung (provided that the consolidated lung is confluent with the pleura), accumulation of fluid in the pleural space (hemorrhage secondary to birth trauma and fractured ribs, inflammatory fluid in foals with pleuritis), pneumothorax (usually secondary to lung laceration by a fractured rib), or congenital abnormalities of the heart.

Advanced imaging modalities, such as **computed tomography (CT) and magnetic resonance imaging (MRI)**, are available at referral centers and are practical in foals and other neonates because of the small size of the animals. These modalities are useful in detection of intrathoracic and intraabdominal abnormalities, including abscesses, gastrointestinal disease, and congenital abnormalities. MRI is particularly useful for diagnosis of diseases of the brain and spinal cord.

### CLINICAL PATHOLOGY

#### Serum Immunoglobulin Concentration

Serum or plasma immunoglobulins are associated with the risk of death in hospitalized foals. Foals with serum IgG concentration less than or equal to 4.0 g/L were 4.7 (95% CI 2.6 to 8.5) times as likely to die as were foals with a concentration greater than 8 g/L. Foals with an IgG of greater than 4 g/L and less than 8 g/L were 3.7 (2.0 to 6.8) times as likely to die as were foals with concentrations above 8 g/L.<sup>14</sup>

Serum immunoglobulin G (IgG) concentration, or its equivalent, must be measured in every ill or at-risk newborn and should be repeated every 48 to 96 hours in critically ill neonates. A variety of tests are available for

rapid detection of FTPI in foals and calves. Although measurement of serum IgG concentration is ideally performed by the gold standard test, a radial immunodiffusion, this test requires at least 24 hours to run, whereas the stall-side or chemistry analyzer tests can be run in a few minutes. The sensitivity and specificity have been determined for a number of these rapid tests. Overall, most tests have high sensitivity (>80%), meaning that the few foals that have low concentrations of IgG are missed, but poor specificity (50% to 70%), meaning that many foals that have adequate concentrations of immunoglobulin are diagnosed as having inadequate concentrations. The exact sensitivity and specificity depend on the test used and the concentration of immunoglobulin considered adequate. The high sensitivity and low specificity of most of the available rapid tests result in a number of foals that do not need a transfusion receiving one. However, this error is of less importance than that of foals that should receive a transfusion not receiving one.

Serum or plasma concentrations of IgG should be measured after approximately 18 hours of age, and preferably before 48 hours

of age—the earlier FTPI is recognized, the better the prognosis for the foal. Foals that ingest colostrum within the first few hours of birth have minimal increases in serum IgG concentration over that achieved at 12 hours of age, suggesting that measurement of serum IgG concentration as early as 12 to 18 hours after birth is appropriate. This early measurement of serum IgG concentration could be especially important in high-risk foals. The oldest age at which measurement of serum IgG is useful in foals is uncertain, but depends on the clinical condition of the foal. Typically, immunoglobulin concentrations of foals that have adequate concentrations of IgG within the first 24 hours reach a nadir at about 6 weeks of age and then rise to concentrations similar to adults over the next 2 to 3 months.

### Hematology

It is important to recognize that the hemogram of neonates differs from that of older animals (Table 19-5) because these differences can affect the clinical assessment of the animal. The hematologic and serum biochemical values of foals and calves can vary markedly during the first days and weeks of

life, and it is important that these maturational changes are taken into account when assessing results of hematologic or serum biochemical examination of foals. Hematologic examination can reveal evidence of hemolytic disease, bacterial or viral infection, or prematurity/dysmaturity (Table 19-4). Repeated hemograms are often necessary to monitor for development of sepsis and responses to treatment.

Foals with sepsis can have a leukocyte count in the blood that is low, within the reference range, or high. Approximately 40% of foals with sepsis have blood leukocyte counts that are below the reference range. Most foals with sepsis (approximately 70%) have segmented neutrophil counts that are below the reference range, with fewer than 15% of foals having elevated blood neutrophil counts. Concentrations of band cells in blood are above the reference range in almost all foals with sepsis. Some foals born of mares with placentitis have a very pronounced mature neutrophilia without other signs of sepsis; these foals typically have a good prognosis. Lymphopenia is present in foals with equine herpesvirus-1 septicemia or Arabian foals with severe

**Table 19-5** Hematologic values of normal foals and calves

Variable	FOALS			CALVES		
	<12 h	1 week	1 month	24 h	48 h	3–4 weeks
PCV (%)	42.5 ± 3.4	35.3 ± 3.3	33.9 ± 3.5	34 ± 6	32 ± 6	35 ± 3
(L/L)	0.43 ± 0.03	0.35 ± 0.03	0.33 ± 0.04	0.34 ± 0.06	0.32 ± 0.06	0.35 ± 0.03
Plasma protein (g/dL)	6.0 ± 0.8	6.4 ± 0.6	6.1 ± 0.5	6.4 ± 0.7	6.4 ± 0.7	6.4 ± 0.3
(g/L)	60 ± 8	64 ± 6	61 ± 5	64 ± 7	64 ± 7	64 ± 3
Fibrinogen (mg/dL)	216 ± 70	290 ± 70	400 ± 130	290 ± 105	335 ± 120	285 ± 145
(g/L)	2.16 ± 0.7	2.90 ± 0.7	4.00 ± 1.30	2.90 ± 1.05	3.35 ± 1.20	2.85 ± 1.45
Hemoglobin (g/dL)	15.4 ± 1.2	13.3 ± 1.2	12.5 ± 1.2	10.9 ± 2.1	10.5 ± 1.8	11.3 ± 1.02
(g/L)	154 ± 12	130 ± 12	125 ± 12	109 ± 21	105 ± 18	113 ± 10
Red blood cells (×10 <sup>6</sup> /μL)	10.7 ± 0.8	8.8 ± 0.6	9.3 ± 0.8	8.17 ± 1.34	7.72 ± 1.09	8.86 ± 0.68
(10 <sup>12</sup> /L)	10.7 ± 0.8	8.8 ± 0.6	9.3 ± 0.8	8.17 ± 1.34	7.72 ± 1.09	8.86 ± 0.68
MCV (fL)	40 ± 2	39 ± 2	36 ± 1	41 ± 3	41 ± 3	39 ± 2
MCHC (g/dL)	36 ± 2	38 ± 1	37 ± 1	32.1 ± 0.8	32.6 ± 1.0	32.8 ± 1.6
(g/L)	360 ± 20	380 ± 10	370 ± 10	320 ± 8	326 ± 10	328 ± 16
MCH (pg)	14 ± 1	15 ± 1	14 ± 1			
Nucleated cells (10 <sup>6</sup> /μL)	9500 ± 2500	9860 ± 1800	8150 ± 2030	9810 ± 2800	7760 ± 1950	8650 ± 1690
(10 <sup>9</sup> /L)	9.5 ± 2.5	9.86 ± 1.80	8.15 ± 2.03	9.81 ± 2.80	7.76 ± 1.95	8.65 ± 1.69
Neutrophils (10 <sup>6</sup> /μL)	7950 ± 2200	7450 ± 1550	5300 ± 200	6500 ± 2660	4110 ± 2040	2920 ± 1140
(10 <sup>9</sup> /L)	7.95 ± 2.20	7.45 ± 1.55	5.30 ± 0.20	6.50 ± 2.66	4.11 ± 2.04	2.92 ± 1.14
Band neutrophils (10 <sup>6</sup> /μL)	24 ± 40	0	4 ± 13	310 ± 460	210 ± 450	10 ± 30
(10 <sup>9</sup> /L)	0.02 ± 0.04	0	0.00 ± 0.01	0.31 ± 0.46	0.21 ± 0.45	0.01 ± 0.03
Lymphocytes (10 <sup>6</sup> /μL)	1350 ± 600	2100 ± 630	2460 ± 450	2730 ± 820	2850 ± 880	5050 ± 800
(10 <sup>9</sup> /L)	1.35 ± 0.6	2.10 ± 0.63	2.46 ± 0.45	2.73 ± 0.82	2.85 ± 0.88	5.05 ± 0.80
Thrombocytes (10 <sup>3</sup> /μL)	266 ± 103	250 ± 70	300 ± 80			
(10 <sup>9</sup> /L)	266 ± 103	250 ± 70	300 ± 80			
Serum Fe (μg/dL)	380 ± 60	175 ± 80	138 ± 60		71 ± 60	127 ± 60
(mg/L)	3.80 ± 0.6	1.75 ± 0.8	1.38 ± 0.6		0.7 ± 0.6	1.27 ± 0.6
TIBC (μg/dL)	440 ± 50	385 ± 80	565 ± 65		420 ± 67	
(mg/L)	4.40 ± 0.5	3.85 ± 0.8	5.65 ± 0.65		4.2 ± 0.7	
UIBC (μg/dL)	55 ± 40	210 ± 100	430 ± 85			
(mg/L)	0.55 ± 0.4	2.10 ± 1.00	4.30 ± 0.85			
Iron saturation (%)	87 ± 9	46 ± 20	25 ± 12			

Sources: Harvey JW et al. *Equine Vet J* 1984; 16:347; Adams R et al. *Am J Vet Res* 1992; 53:944; Tennant B et al. *Cornell Vet* 1975; 65:543.

combined immunodeficiency. Thrombocytopenia occurs in some foals with sepsis. Hyperfibrinogenemia is common in foals that have sepsis, although the concentration might not be above the reference range in foals examined early in the disease.

Hyperfibrinogenemia is common in foals born of mares with placentitis and reflects systemic activation of the inflammatory cascade even in foals that have no other evidence of sepsis. Serum amyloid A concentrations are above 100 mg/L in foals with sepsis. Septic foals also have blood concentrations of proinflammatory cytokines, and of plasma C-reactive protein,<sup>15</sup> that are higher than those in healthy foals. Plasma haptoglobin concentrations are not different between surviving and nonsurviving foals and are only minimally lower in foals with sepsis than in nonseptic hospitalized foals.<sup>15</sup> Indices of coagulation are prolonged in foals with sepsis, and concentrations of antithrombin and protein C antigen in plasma are lower than in healthy foals. These abnormalities indicate that coagulopathies are common in septic foals.

**Prematurity** is associated with a low neutrophil:lymphocyte ratio (<1.5:1) in blood and red cell macrocytosis (Table 19-4). A neutrophil:lymphocyte ratio above 2:1 is considered normal. Premature foals that are not septic can have low blood neutrophil

counts but rarely have immature neutrophils (band cells) or toxic changes in neutrophils.

### Serum Biochemistry

Care should be taken in the interpretation of the results of serum biochemical examinations because normal values for newborns are often markedly different from those of adults, and they can change rapidly during the first days to weeks of life (Table 19-6). Serum biochemical examination can reveal electrolyte abnormalities associated with renal failure, diarrhea, and sepsis. Elevations in serum bilirubin concentration or serum enzyme activities may be detected. As a minimum, blood glucose concentrations should be estimated using a chemical strip in depressed or recumbent newborns.

Markedly elevated serum **creatinine** concentrations are not uncommonly observed in foals with no other evidence of renal disease. The elevated serum creatinine in these cases is a consequence of impaired placental function during late gestation, with the consequent accumulation of creatinine (and probably other compounds). In foals with normal renal function, which most have, the serum creatinine concentration should decrease to 50% of the initial high value within 24 hours. Other causes of high serum creatinine concentration that should be ruled out are renal failure (dysplasia, hypoxic

renal failure) and postrenal azotemia (uroperitoneum).

Blood or plasma **l-lactate concentrations** are useful indicators of the presence and severity of systemic disease that impairs oxygen delivery to tissue (hypoxemia, poor perfusion, anemia) or use by tissue (endotoxemia), but it is not specific for any one disease or group of diseases, with the exception that septic foals have higher concentrations than do nonseptic foals.<sup>16-19</sup> However, the difference between septic and nonseptic foals (4.8 [range, 0.6 to 37] and 3.3 [range, 0.3 to 21] mmol/L) is not sufficiently different to make it useful in an individual animal.<sup>20</sup> Blood lactate concentrations of healthy foals are greatest at birth to 12 hours of age and then decline.<sup>16</sup> Blood lactate concentrations of foals that do not survive their acute illness do not decline in response to therapy,<sup>16</sup> and risk of death increases by 1.1 for each mmol/L increase in blood lactate concentration of foals at time of admission to a veterinary hospital.<sup>17,20</sup> Serial measurement of blood lactate concentrations and calculation of an “area-under-the-curve” measure also provides useful information related to risk of death, but not the cause of the disease.

**Sepsis** is usually associated with hypoglycemia, although septic foals can have normal or elevated blood glucose concentrations. Hypoglycemia is attributable to failure

Table 19-6 Serum biochemical values of normal foals and calves

Variable	FOALS			CALVES		
	<12 h	1 week	1 month	24 h	48 h	3 weeks
Na <sup>+</sup> (mEq/L) (mmol/L)	148 ± 8	142 ± 6	145 ± 4	145 ± 7.6	149 ± 8.0	140 ± 6
K <sup>+</sup> (mEq/L) (mmol/L)	4.4 ± 0.5	4.8 ± 0.5	4.6 ± 0.4	5.0 ± 0.6	5.0 ± 0.6	4.9 ± 0.6
Cl <sup>-</sup> (mEq/L) (mmol/L)	106 ± 6	102 ± 4	103 ± 3	100 ± 4	101 ± 5.0	99 ± 4
Ca <sup>2+</sup> (mg/dL)	12.8 ± 1	12.5 ± 0.6	12.2 ± 0.6	12.3 ± 0.2	12.3 ± 0.3	9.4 ± 0.6
(mmol/L)	3.2 ± 0.25	3.1 ± 0.15	3.05 ± 0.15	3.1 ± 0.1	3.1 ± 0.1	2.3 ± 0.2
PO <sub>4</sub> <sup>-</sup> (mg/dL)	4.7 ± 0.8	7.4 ± 1.0	7.1 ± 1.1	6.9 ± 0.3	7.6 ± 0.2	7.1 ± 6.4
(mmol/L)	1.52 ± 0.26	2.39 ± 0.32	2.29 ± 0.36	2.3 ± 0.1	2.5 ± 0.1	2.3 ± 1.8
Total protein (g/dL)	5.8 ± 1.1	6.0 ± 0.7	5.8 ± 0.5	5.6 ± 0.5	6.0 ± 0.7	6.5 ± 0.5
(g/L)	58 ± 11	60 ± 7	58 ± 5	56 ± 5	60 ± 7	65 ± 5
Albumin (g/dL)	3.2 ± 0.3	2.9 ± 0.2	3.0 ± 0.2			
(g/L)	32 ± 3	29 ± 2	30 ± 2			
Creatinine (mg/dL)	2.5 ± 0.6	1.3 ± 0.2	1.5 ± 0.2			
(μmol/L)	221 ± 53	115 ± 18	133 ± 18			
Urea nitrogen (mg/dL)	19.7 ± 4.4	7.8 ± 3.4	9.0 ± 3.0	12.6 (7.1–21.2)		
(mmol/L)	3.4 ± 1.6	1.6 ± 0.6	1.7 ± 0.5	2 (1.5–3.6)		
Glucose (mg/dL)	144 ± 30	162 ± 19	162 ± 22	130 ± 27	114 ± 19	70 (52–84)
(mmol/L)	8.0 ± 1.6	9.0 ± 1.0	9.0 ± 1.2	7.23 ± 1.5	6.34 ± 1.1	3.9 (2.9–4.7)
Total bilirubin (mg/dL)	2.6 ± 1.0	1.5 ± 0.4	0.7 ± 0.2	<2.5	<0.9	<0.6
(μmol/L)	45 ± 17	26 ± 6	12 ± 4	<42	<15	<10
Direct bilirubin (mg/dL)	0.9 ± 0.1	0.5 ± 0.2	0.3 ± 0.2	<0.6	<0.3	<0.3
(μmol/L)	15 ± 2	8.5 ± 3	5 ± 3	<10	<5	<5
GGT (IU/L)	47.5 ± 21.5	49.1 ± 21.2		890 ± 200	600 ± 180	70 ± 10
ALK (IU/L)	3040 ± 800	1270 ± 310	740 ± 240	<1150	<1000	<770
AST (IU/L)	199 ± 57	330 ± 85	340 ± 55	<60	<33	<32

Values are mean ± standard deviation.

ALK, alkaline phosphatase; AST, aspartate aminotransferase; GGT, gammaglutamyl transpeptidase.

Sources: Bauer JE et al. Equine Vet J 1984; 16:361; Pearson EG et al. J Am Vet Med Assoc 1995; 207:1466; Jenkins SJ et al. Cornell Vet 1982; 72:403; Dalton RG. Br Vet J 1967; 123:48; Wise GH et al. J Dairy Sci 1947; 30:983; Diesch TJ et al. New Zeal Vet J 2004; 52:256; Patterson WH, Brown CM. Am J Vet Rev 1986; 47:2461; Thompson JC, Pauli JV. New Zeal Vet J 1981; 29:223



to nurse, whereas hyperglycemia indicates loss of normal sensitivity to insulin. Indicators of renal, hepatic, or cardiac (troponin) damage can increase in foals with sepsis, causing organ damage or failure. Foals with sepsis tend to have elevated concentrations of cortisol in serum.

**Prematurity** is associated with low concentrations of cortisol in plasma or serum and minimal increase in response to intramuscular administration of 0.125 mg of exogenous ACTH (corticotropin). Plasma cortisol concentration of normal full-term foals during the first 24 hours of life increases from a baseline value of approximately 40 ng/mL to over 100 ng/mL 60 minutes after ACTH administration, whereas plasma cortisol concentrations in premature foals do not increase from values of slightly less than 40 ng/mL. At 2 and 3 days of age, plasma cortisol concentrations of full-term foals increase twofold after ACTH administration, albeit from a lower resting value, but do not increase in premature foals. Blood glucose concentrations of premature foals are often low, probably because of inability to nurse.

### Blood Gas

Arterial blood pH,  $P_{CO_2}$ , and  $P_{O_2}$  should be measured to determine the newborn's acid-base status and the adequacy of respiratory function. Foals with hypoxemia are five times more likely to have pulmonary radiographic abnormalities. Prolonged lateral recumbency of foals compromises respiratory function, and arterial blood samples should be collected with the foal in sternal recumbency. Repeated sampling may be necessary to detect changes in respiratory function and to monitor the adequacy of oxygen supplementation or assisted ventilation.

### Blood Culture

Identification of causative organisms of sepsis in foals can aid in prognostication and potentially in selection of therapy, although there does not appear to be a relation between antimicrobial sensitivity of organisms isolated from blood, as determined by Kirby-Bauer testing, and survival of foals. Anaerobic and aerobic blood cultures should be performed as early in the disease process as possible, and preferably before initiation of antibiotic treatment, although antimicrobials should not be withheld from a newborn with confirmed or suspected sepsis to obtain a result from blood culture. Strict aseptic technique should be used when collecting blood for culture. Blood cultures should also be collected if there is a sudden deterioration in the newborn's condition.

Gram-negative enteric bacteria are the most common isolates from blood of newborn foals, with *E. coli* the most common isolate. *A. equuli* is also a common isolate from foals. There are important differences in diseases produced by the various organisms, with foals with *A. equuli* septicemia

being twice as likely to die, seven times more likely to have been sick since birth, six times more likely to have diarrhea, five times more likely to have a sepsis score of more than 11, and three times more likely to have pneumonia than foals with sepsis associated with other bacteria.

A problem with blood culture is the time needed to obtain either interim or final results because this can delay detection of infection or decisions to use focused antimicrobial therapy. Use of real-time polymerase chain reaction (PCR) to detect bloodstream infection of foals will likely supplement conventional blood culture in foals.<sup>21</sup>

### Other Body Fluids

Synovial fluid should be submitted for aerobic and anaerobic culture, Gram stain, and cytologic examination when signs of synovitis, such as lameness, joint effusion, or joint pain, are present.

Analysis of cerebrospinal fluid (CSF) is indicated in newborns with signs of neurologic disease. Samples of CSF should be submitted for cytologic examination, measurement of total protein concentration, Gram stain, and bacterial culture.

Urinalysis may provide evidence of renal failure (casts) or urinary tract infection (white blood cells).

Abdominal fluid should be collected in foals with abdominal pain or distension and should be submitted for cytologic examination and, if uroperitoneum is suspected, measurement of creatinine concentration.

### TREATMENT

The principles of care of the critically ill newborn farm animal are as follows:

- The newborn should be kept in a sanitary environment to minimize the risk of nosocomial infections.
- Systemic supportive care should be provided to maintain homeostasis until the newborn is capable of separate and independent existence.
- There should be frequent and comprehensive reevaluations of all body systems to detect signs of deterioration and allow early correction.
- Provision should be made to ensure adequate passive immunity (serum or plasma IgG concentration > 8 g/L) to reduce the risk of secondary infections or to treat existing infections. Transfer of passive immunity should be evaluated using laboratory methods that measure serum or plasma IgG concentration.

The level of care provided depends on the value of the animal and the available facilities, personnel, and expertise. Newborns of limited financial worth are usually treated on the farm, whereas valuable foals and calves can be referred for specialist care. Referral of sick neonates to institutions and practices with expertise in provision of critical care to newborns should be timely and prompt and,

when necessary, should be recommended on the first visit.

### Nursing Care

The sophistication of care for critically ill newborns depends on the facilities and personnel available, with intensive management requiring dedicated facilities and trained personnel available 24 hours a day. The minimum requirement for providing basic care of ill newborns is a sanitary area in which the newborns can be protected from environmental stress. Often this means separating the newborn from its dam.

Excellent nursing care is essential for maximizing the likelihood of a good outcome. Critically ill animals might benefit from constant nursing care. Strict attention must be paid to maintaining the sanitary environment to minimize the risk of nosocomial infections. The newborn should be kept clean and dry and at an ambient temperature in its thermoneutral zone. Bedding should prevent development of decubital ulcers. Foals should be maintained in sternal recumbency, or at least turned every 2 hours, to optimize their respiratory function.

### Correction of Failure of Transfer of Passive Immunity

#### Colostrum Immunoglobulin

Ideally, adequate transfer of passive immunity is achieved by the newborn nursing its dam and ingesting an adequate amount of colostrum containing optimal concentrations of immunoglobulins, principally IgG (IgGb) in foals. Foals need approximately 2 g of IgG per kilogram of body weight to achieve a plasma concentration of 2000 mg/dL (20g/L); therefore a 45-kg foal needs approximately 90 g of IgG to attain a normal serum IgG concentration (or approximately 40 g to achieve a serum IgG concentration of 800 mg/dL [8 g/L]). Assuming that colostrum contains on average 10,000 mg/dL (100 g/L), foals must ingest at least 1 L of colostrum to obtain sufficient immunoglobulin. Because colostrum IgG concentration varies considerably (from 2000 to 30,000 mg/dL), specific recommendations regarding the quantity of colostrum to be fed to neonatal foals cannot be made with certainty. However, colostrum with a specific gravity of more than 1.060 has an IgG concentration of more than 3000 mg/dL (30 g/L), suggesting that foals should ingest at least 1.5 L to achieve serum IgG concentrations above 800 mg/dL (8 g/L).

#### Critical Plasma IgG Concentrations in Foals

There is some debate as to what constitutes a critical serum or plasma IgG concentration. Foals that ingest an adequate amount of colostrum typically have serum immunoglobulin concentrations during the first week of life greater than approximately 2000 mg/dL (20 g/L). Both 400 mg/dL

(4 g/L) and 800 mg/dL (8 g/L) have been recommended as concentrations below which foals should be considered to have increased likelihood of contracting infectious disease, but recent evidence strongly supports the use of 800 mg/dL (8 g/L) as the minimal concentration in hospitalized foals. However, on a well-managed farm the serum IgG concentration was not predictive of morbidity or mortality among foals, suggesting that serum immunoglobulin concentration in some populations of foals is not an important risk factor for infectious disease. The foals in this study were from an exceptionally well-managed farm. Other researchers have found that foals with serum IgG concentration below 800 mg/dL (8 g/L) are at markedly increased risk of subsequent development of infectious disease, including sepsis, pneumonia, and septic arthritis. It is likely that there is no single concentration of IgG in serum that is protective in all situations, and the concentration of IgG in serum that is desirable in an individual foal depends on the risk factors for infectious disease of that foal. Our opinion is that a minimum serum IgG in foals free of disease and housed in closed bands on well-managed farms is 400 mg/dL (4 g/L). For foals at increased risk of disease—for instance, those on large farms with frequent introduction of animals and foals that are transported or housed with foals with infectious disease—the minimum advisable serum IgG concentration is 800 mg/dL (8 g/L). Foals that have infectious disease should have serum IgG concentrations of at least 800 mg/dL, and it might be advantageous for these foals to have even higher values, as indicated by the enhanced survival of foals with septic disease administered equine plasma regardless of their serum IgG concentration. This therapeutic advantage could be because of the additional IgG or because of other factors included in the plasma. Transfusion of plasma to sick foals improves neutrophil function, an important advantage given that oxidative burst activity of neutrophils from septic foals is reduced compared with that in healthy foals.

### Plasma Transfusion

The ability of foals to absorb macromolecules, including immunoglobulins, declines rapidly after birth, being 22% of that at birth by 3 hours of age and 1% of that at birth by 24 hours of age. Consequently, by the time that FTPI is recognized, it is no longer feasible to increase serum IgG concentrations by feeding colostrum or oral serum products. Foals should then be administered plasma or serum intravenously. The **amount of plasma** or serum to be administered depends on the target value for serum IgG concentration and the initial serum IgG concentration in the foal. For each gram of IgG administered per kilogram of body weight of the foal, serum IgG concentration increases

by approximately 8.7 mg/dL (0.87 g/L) in healthy foals and 6.2 mg/dL (0.62 g/L) in sick foals. To achieve serum IgG concentrations above 800 mg/dL (8 g/L) in foals with serum IgG concentrations below 400 mg/dL (4 g/L), they should be administered 40 mL/kg of plasma containing at least 20 g/L of IgG. Similarly, foals with serum IgG concentrations above 400 mg/dL (4 g/L) but below 800 mg/dL (8 g/L) should be administered 20 mL/kg of plasma. For 45-kg foals, these recommendations translate to administration of 1 or 2 L of plasma, respectively.

The ideal product for transfusion into foals with FTPI is **fresh frozen plasma** harvested from horses that are Aa and Qa antigen-negative and that do not have antibodies against either or both of these red blood cell antigens (see the discussion of neonatal isoerythrolysis). The donor horses should have been vaccinated against the common diseases of horses and have tested negative for equine infectious anemia. Good-quality commercial products specify the minimum concentration of IgG in the plasma. Concentrated serum products that do not need to be frozen until use are available. These are much more convenient for field use than are plasma products that must be frozen until immediately before transfusion. However, the IgG concentration of these products is often not specified, and the manufacturer's recommendations for dosing often result in administration of inadequate amounts of immunoglobulin. Serum products can produce adequate concentrations of IgG in foals, but the dose is usually two to three times that recommended by the manufacturer. An adequate dose of concentrated serum products is approximately 1 L for some products. The crucial point is that it is not the volume of plasma or serum that is administered that is important, but rather the quantity of immunoglobulin delivered to the foal. A total of 20 to 25 g of IgG is required to raise the serum IgG concentration of a 50-kg foal by 400 mg/dL (4 g/L).

**Plasma** should be administered intravenously; oral administration is likely to be wasteful, especially in foals more than a few hours old. Frozen plasma should be thawed at room temperature or by immersion in warm (<37°C, 100°F) water. Thawing by immersion in water at temperatures higher than body temperature can cause denaturation and coagulation of proteins, with loss of efficacy of transfused immunoglobulins. Plasma should never be thawed or warmed using a microwave because this denatures the proteins.

**Administration of plasma** should be intravenous; intraperitoneal administration, such as used in pigs or small ruminants, has not been investigated in foals. The thawed plasma should be administered through a jugular catheter using a blood administration set containing a filter (160- to 270- $\mu$ m mesh) to prevent infusion of particulate

material. Strict asepsis should be used. The foal should be adequately restrained for the procedure, with some active foals needing moderate tranquilization. Premedication with antihistamines or nonsteroidal anti-inflammatory drugs is usually not necessary. The plasma should be infused slowly at first, with the first 20 to 40 mL administered over 10 minutes. During this period the foal should be carefully observed for signs of transfusion reaction, which is usually evident as restlessness, tachycardia, tachypnea, respiratory distress, sweating, or urticaria. If these signs are observed, the transfusion should be stopped, and the foal should be reevaluated and treated if necessary. If no transfusion reactions are noted during the first 10 minutes, the infusion can then be delivered at 0.25 to 1.0 mL/kg/min (i.e., about 1 L/h for a 50-kg foal). Rapid infusion can result in acute excessive plasma volume expansion, with the potential for cardiovascular and respiratory distress.

Serum IgG concentration should be measured after the infusion to ensure that an adequate concentration of IgG has been achieved. Serum IgG can be measured as early as 20 minutes after the end of the transfusion.

### Nutritional Support

Provision of adequate nutrition is essential to the recovery of ill newborns. Healthy newborn foals have estimated energy requirements of 500 to 625 kJ/kg/d (120 to 150 kcal/kg/d) and consume approximately 20% of their body weight as milk per day. Measurements of foal energy expenditure using indirect calorimetry reveal expenditure of ~60 to 80 kcal/kg/d in healthy foals, which is reduced to ~50 kcal/kg/d for critically ill foals.<sup>22</sup>

The best food for newborns is the dam's milk, and newborns that are able to do so should be encouraged to nurse the dam. However, if the foal is unable to nurse or the dam is not available, then good-quality milk substitutes should be used. Soy and other plant-protein-based milk replacers are not suitable for newborns. Commercial products formulated for foals, calves, and lambs are available. Human enteral nutrition products supplying 0.7 to 1 kcal/mL (2.8 to 4.1 kJ/mL) can also be used for short-term (several days to a week) support of foals.

It is preferable to provide enteral, rather than parenteral, nutrition to ill newborns with normal or relatively normal gastrointestinal function. Sick neonatal foals should initially be fed 10% of their body weight as mare's milk, or a suitable replacer, every 24 hours, divided into hourly or 2-hour feedings. If the foal does not develop diarrhea or abdominal distension, then the amount fed can be increased over a 24- to 48-hour period to 20% to 25% of the foal's body weight (or 150 kcal/kg/day; 620 kJ/kg/day). Newborns can be fed by nursing a

bottle or bucket or via an indwelling nasogastric tube such as a foal feeding tube, stallion catheter, human feeding tube, or enema tube. Every attempt should be made to encourage the newborn to nurse its dam as soon as the newborn can stand. Adequacy of nutrition can be monitored by measuring blood glucose concentrations and body weight.

**Parenteral nutrition (PN)** can be provided to newborns that are unable to be fed by the enteral route. This can be achieved by administration of various combinations of solutions containing glucose (dextrose), amino acids, and fat. A commercial product that does not include lipid has been used successfully for up to 12 days in foals. One product that has been used successfully for foals is a solution of amino acids (5%), dextrose (25%), and electrolytes (Clinimix E; Baxter Healthcare Corporation, Deerfield, IL). Lipid emulsion is not added to the preparation. Additional multivitamin supplements including calcium gluconate (provided 2.5 mmol/L), magnesium sulfate (6 mEq/L), B-vitamin complex (thiamine 12.5 mg/L; riboflavin 2 mg/L; niacin 12.5 mg/L; pantothenic acid 5 mg/L; pyridoxine 5 mg/L; cyanocobalamin 5 µg/L), and trace elements (zinc 2 mg/L; copper 0.8 mg/L; manganese 0.2 mg/L; chromium 8 µg/L) are added. Administration is through a catheter, a single-lumen 14-gauge over-the-wire catheter (Milacath), inserted in the jugular vein with its tip placed in the cranial vena cava. A double-T extension set is used to allow concurrent constant-rate infusion of isotonic crystalloid fluids and intravenous administration of medication in one line and PN solution in the other. An infusion pump is used for continuous-rate infusion of the solutions. The PN solution should be prepared under aseptic conditions just before administration and used for only a period of 24 hours after preparation. A 0.22-µm filter is included in the administration line to remove all bacteria, glass, rubber, cellulose fibers, and other extraneous material in the PN solution. The filters and administration sets are changed with each new bag of PN solution.

The rate of PN infusion is determined based on the weight and physical and metabolic condition of the foal. The general protocol is based on the assumption that sick foals expend approximately 50 kcal/kg body weight per day (basal rate).<sup>22</sup> The PN is started at half the basal rate for 12 hours, increasing to the basal rate over 24 to 48 hours, and then in some foals increased slowly to 75 kcal/kg/d if tolerated by the foal. The clinical condition of the foal is assessed frequently. Blood glucose concentrations should be measured every 6 to 8 hours during the introduction and weaning of PN until the blood glucose concentration is stabilized. Insulin can be administered during hyperglycemic crises ( $\gg 250$  mg/dL) at a

dose of 0.1 to 0.4 U/kg regular insulin intramuscularly, but this is rarely needed. When a constant rate of PN is achieved, glucose concentrations should be measured every 8 to 12 hours, depending on the clinical condition of the foal. Foals are weaned off the PN as their clinical condition improves, and enteral feeding is gradually increased. The rate of PN is halved every 4 to 12 hours if blood glucose concentration is stable until half the basal rate is obtained, at which time the infusion is discontinued if the foal is bright, alert, and nursing well.

PN is supplemented with isotonic fluid therapy administered intravenously. The fluid rate and composition are determined based on clinical condition, packed cell volume, total protein, and serum electrolyte concentrations (Na, Cl, Ca, K and HCO<sub>3</sub>). The composition and rate are adjusted to maintain normal hydration and electrolyte and acid–base status. During the period that foals receive PN, enteral feeding is initially withdrawn, and the foals are muzzled or separated from the mare. Beginning 24 hours after the institution of PN, 20 to 40 mL of mare's milk (“trophic” feeding) is administered enterally every 4 hours. The trophic feeding provides nutrition to enterocytes and stimulates production of lactase in the small intestine in preparation for resumption of enteral feeding. As the foals are weaned off the PN, enteral feedings are gradually increased from small trophic feeding every 4 hours to allowing the foal to nurse from the mare for 2 to 5 minutes every 2 hours and eventually unrestricted nursing from the mare.

### Antimicrobial Treatment

Normal newborns are at risk of acquiring life-threatening bacterial infections, and the risk increases when they do not ingest adequate colostrum in a timely fashion or are subjected to environmental stresses (see the discussion on [neonatal infection](#)). Newborns in which bacterial infection is suspected and those at high risk of developing an infection, such as sick newborns with FTPI, should be administered antimicrobials. Antimicrobial therapy should not be delayed pending the results of bacterial culture and antimicrobial sensitivity testing.

The choice of antimicrobial is determined by the likely infecting agent and clinical experience with antimicrobial susceptibility of local strains of pathogens. In general, broad-spectrum antimicrobials are chosen because it is almost impossible to predict, based on clinical signs, the nature of the infecting agent and its antimicrobial susceptibility. Although *Streptococcus* spp. were historically reported to be the cause of most infections in neonatal foals, currently infections of neonatal foals are usually a result of gram-negative organisms, including *E. coli*, *Klebsiella* spp., and *Salmonella* spp. Because of the wide variety of infecting agents and

their varying antimicrobial susceptibility, it is possible to make only general recommendations for antimicrobial therapy of neonates. A frequently used antimicrobial regimen is an aminoglycoside (gentamicin or, more commonly, amikacin) and penicillin. Some commonly used drugs and their doses are listed in [Table 19-7](#). Dosage of antimicrobials in foals differs somewhat from that of adults, and the pharmacokinetics of drugs in normal foals are often different from those of the same drug in sick foals. Consequently, higher dosages administered at prolonged intervals are often indicated in sick foals, especially when concentration-dependent drugs such as the aminoglycosides are used.

The response to antimicrobial therapy should be monitored, using physical examination and clinical pathology data, on at least a daily basis. Failure to improve should prompt a reconsideration of the therapy within 48 to 72 hours, and a worsening of the newborn's condition may necessitate changing the antimicrobial sooner than that. The decision to change antimicrobial therapy should be guided, but not determined, by the results of antimicrobial sensitivity testing of isolates from the affected newborn. These antimicrobial susceptibility patterns should be determined locally because the results can vary geographically, although results of studies are published.<sup>23,24</sup> The utility of antimicrobial sensitivity testing in determining optimal antimicrobial therapy for foals has not been determined, although it is likely that, as with mastitis in cows, sensitivity to antimicrobials determined by the Kirby–Bauer method will not be useful in predicting efficacy.

### Fluid Therapy

Fluid therapy of newborns differs from that of adult animals because of important differences in fluid and electrolyte metabolism in newborns. The following guidelines are suggested:

- **Septic shock**—sequential boluses of 20 mL/kg delivered over 5 to 20 minutes with reevaluation after each bolus. Usually, 60 to 80 mL/kg is the maximum dose before use of pharmacologic support of blood pressure is considered. Care should be taken to avoid fluid overload, and the foal should be reevaluated after each bolus and the need for continued fluid therapy determined. Continuous infusion of fluid is not indicated.
- **Maintenance support**—this should be determined based on the ongoing losses and the clinical status of the animal. However, general recommendations are as follows:
  - First 10 kg of body weight—100 mL/kg/d
  - Second 10 kg of body weight—50 mL/kg/d



Table 19-7 Antimicrobials used in neonatal foals

Antimicrobial	Dose and route	Frequency	Comments
Amikacin sulfate	25 mg/kg, IM or IV	24 h	Excellent Gram-negative activity, potentially nephrotoxic. Use with a penicillin.
Amoxicillin trihydrate	25 mg/kg, PO	6–8 h	Variable absorption decreasing with age. Limited Gram negative spectrum.
Amoxicillin–clavulanate	15–25 mg/kg, IV	6–8 h	Enhanced Gram-negative spectrum.
Amoxicillin sodium	15–30 mg/kg, IV or IM	6–8 h	Limited Gram-negative spectrum. Use with an aminoglycoside. Safe.
Ampicillin sodium	10–20 mg/kg, IV or IM	6–8 h	Limited Gram-negative spectrum. Use with an aminoglycoside. Safe.
Ampicillin trihydrate	20 mg/kg, PO	6–8 h	Limited Gram-negative spectrum. Variable absorption decreasing with age.
Cefotaxime sodium	15–25 mg/kg, IV	6–8 h	Use for bacterial meningitis. Expensive.
Cefoperazone sodium	20–30 mg/kg, IV	6–8 h	Use for <i>Pseudomonas</i> spp. infections.
Cefpodoxime proxetil	10 mg/kg PO	8–12 h	Broad spectrum and well absorbed by foals after oral administration.
Ceftazidime sodium	20–50 mg/kg, IV	6–8 h	Third-generation cephalosporin. Save for refractory infections.
Ceftiofur sodium	10 mg/kg, IV over 15 min	6 h	Broad spectrum. Note higher dose than used in adults.
Chloramphenicol palmitate	50 mg/kg, PO	6–8 h	Broad spectrum, bacteriostatic. Human health risk. Restricted use.
Chloramphenicol sodium succinate	50 mg/kg, IV	6–8 h	Broad spectrum, bacteriostatic. Human health risk. Restricted use.
Ciprofloxacin	5 mg/kg, IV	12 h	Broad spectrum. Potentially toxic to developing cartilage.
Enrofloxacin	5–7.5 mg/kg, PO or IV	12–24 h	Broad spectrum. Potentially toxic to developing cartilage.
Gentamicin sulfate	12 mg/kg, IV or IM	36 h	Good Gram-negative spectrum. Nephrotoxic. Use with a penicillin. Dose should be decreased to 6.6 mg/kg IV or IM every 24 hours for foals > 2 weeks of age.
Metronidazole	15–25 mg/kg, IV or PO	8–12 h	Active against obligate anaerobes and protozoa only.
Oxytetracycline	5 mg/kg, IV	12 h	Variable Gram-negative activity. Safe. Cheap. High and prolonged dose protocols have the potential to result in discoloration of the teeth.
Procaine penicillin G	20,000–40,000 IU/kg, IM	12 h	Very limited Gram-negative activity. Muscle soreness. Cheap.
Sodium or potassium penicillin G	20,000–40,000 IU/kg, IV or IM	6 h	Limited Gram-negative activity. Use with an aminoglycoside.
Pivampicillin	15–30 mg/kg, IV or IM	8 h	Ampicillin prodrug.
Ticarcillin sodium	50 mg/kg, IV	6 h	Active against Gram-negative organisms. Expensive.
Ticarcillin–clavulanate	50 mg ticarcillin/kg, IV	6 h	Extended activity. Expensive.
Trimethoprim-sulfonamide	15–30 mg/kg, PO, IV	12 h	Cheap. Broad spectrum. Limited efficacy in treating septicemia in foals.

- Weight in excess of 20 kg—25 mL/kg/d

Neonates with high ongoing losses, such as those with diarrhea or gastric reflux, can have higher fluid requirements.

Care should be taken to prevent administration of **excess sodium** to foals because they have a limited ability to excrete sodium. The recommended intake is 2 to 3 mEq/kg/d, and this includes sodium administered in parenteral fluids. One liter of isotonic sodium chloride provides a 50-kg foal's sodium requirements for 1 day.

A suitable maintenance fluid for foals is isotonic dextrose (5%) with supplemental potassium (10 to 40 mEq/L).

### Respiratory Support

Respiratory failure, evidenced by elevated arterial  $PCO_2$  and decreased  $PO_2$ , may be a result of depressed central activity, weakness of respiratory muscles, or lung disease. Regardless of the cause, should the hypoxemia become sufficiently severe, oxygenation must be improved by increasing respiratory drive, increasing the inspired oxygen tension, or employing mechanical ventilation. Foals should always be maintained in sternal recumbency to allow optimal respiratory function.

Provision of respiratory support should be considered when the arterial  $PO_2$  is less than 60 mm Hg (8 kPa) and the arterial  $PCO_2$  is more than 60 mm Hg (8 kPa) in a

foal in sternal recumbency. Pharmacologic respiratory stimulants have only a very short duration of action and are of limited use. Nasal insufflation of oxygen is achieved by placing a nasopharyngeal tube and providing oxygen at a rate of 5 L/min.

Mechanical ventilation is useful for maintaining oxygenation in foals with botulism, with more than 80% of foals surviving in one small study. However, this intervention requires considerable expertise and sophisticated equipment. The prognosis is much worse for foals with diseases of the lungs that require mechanical ventilation.

### Gastrointestinal Ulcer Prophylaxis

Ill neonatal foals are often treated with antacid drugs in an attempt to prevent the development or progression of gastrointestinal ulcers, although the efficacy of this approach is unproven. There is a trend toward not administering antiulcer medications to foals except for those with demonstrated gastric ulceration, in part because of the recognition that critically ill foals often have gastric pH above 7.0, and administration of ranitidine does not affect this pH. (See “Gastric Ulcers in Foals” for further discussion.)

### COMMON COMPLICATIONS

Complications of the neonate's disease or its treatment occur frequently:

- Entropion is common in critically ill foals and, although readily treated, can cause corneal ulceration if undetected.
- Aspiration pneumonia occurs in weak foals, often as a result of aggressive bottle feeding or regurgitation of milk around a nasogastric tube.
- Nosocomial infections can be severe and life-threatening and are best prevented by strict hygiene and asepsis.
- Septic synovitis/arthritis occurs as a consequence of bacteremia and should be treated aggressively.
- Omphalitis and omphalophlebitis occur and can be an undetected cause of fever and relapse. These are best detected by ultrasonographic examination of the abdomen.
- Patent urachus, evident as urine at the navel, usually resolves with time and local treatment.
- Uroperitoneum as a result of urachal rupture occurs in critically ill foals and should be suspected in any ill foal that develops abdominal distension.
- Angular limb deformities and excessive flexor tendon laxity occur frequently in ill neonatal foals but usually resolve with minimal symptomatic treatment as the foal recovers its strength.

### PROGNOSIS

The prognosis for critically ill neonates depends on many factors, including the

nature and severity of the disease, facilities available for care, and the expertise of the personnel caring for the neonate. There is a consensus that the recovery rate for severely ill foals has improved over the last decade because of provision of better care. There are reports of survival rates of around 80% for foals treated at a specialized intensive care unit. However, the high cost of providing care for these animals has prompted studies to determine outcome, as a means of deciding whether, financially, treatment is warranted. Surviving Thoroughbred foals do not differ from siblings with regard to percentage of starters, percentage of winners, or number of starts, but surviving foals achieve significantly fewer wins and total earnings.<sup>25</sup>

The increased number of foals being treated intensively has resulted in prospective studies of outcome. The prognosis for athletic activity for foals with septic arthritis is poor. Thoroughbred foals with **septic arthritis** have odds of 0.28 (95% CI 0.12 to 0.62; roughly one-quarter of the likelihood) for racing compared with a cohort of healthy foals. Multisystemic disease, in addition to the presence of septic arthritis, decreased the likelihood of racing to one-tenth that of healthy foals (OR 0.12, 95% CI 0.02 to 0.90). Affected foals that survive take almost 40% longer to race for the first time. Approximately 30% to 48% of affected Thoroughbred foals eventually race, compared with approximately 65% of normal foals.

Attempts to determine prognostic indicators for survival of foals have been partially successful, but they tend to be most applicable to the intensive care unit in which they were developed. The common theme is that sicker foals are less likely to be discharged from the hospital alive.

Characteristics of foals that are more likely to survive include ability to stand when first examined, normal birth, white blood cell (WBC) count in blood that is within or above the reference range, lack of dyspnea, normal plasma fibrinogen concentration, and short duration of disease. The odds of a hospitalized neonatal foal surviving can be calculated using the following formula:

$$\begin{aligned} \text{Logit (Probability of survival)} \\ = & -0.3072 - 2.0115 (\text{Cold extremities}) \\ & - 0.8166 (\text{Prematurity}) \\ & - 0.7685 (\geq 2 \text{ Infection/} \\ & \text{inflammation sites}) + 0.9877 (\text{IgG}) \\ & + 1.1331 (\text{Glucose}) + 0.9043 (\text{WBC}) \end{aligned}$$

In addition, the survival odds can be summarized in a much more useful form by the methods shown in [Tables 19-8 and 19-9](#). An app to calculate survival probabilities is available for Android phones.<sup>26</sup>

**Table 19-8** Method for calculating survival score in hospitalized neonatal foals<sup>1</sup>

Variables	Score	
Cold extremities	No	Yes
	2	0
Prematurity (<320 days)	No	Yes
	1	0
≥2 infection/ inflammation sites	No	Yes
	1	0
IgG (mg/dL)	<400	≥400
	0	1
Glucose (mg/dL)	<80	≥80
	0	1
WBC × (10 <sup>3</sup> /μL)	≤4	>4
	0	1
<b>TOTAL SCORE</b>		

**Table 19-9** Probability of survival for hospitalized neonatal foals with survival scores calculated according to [table 19-8](#)

Total foal survival score	Probability of survival
0	3%
1	8%
2	18%
3	38%
4	62%
5	82%
6	92%
7	97%

#### FURTHER READING

- Austin SM. Assessment of the equine neonate in ambulatory practice. *Equine Vet Educ*. 2013;25:585-589.
- Toribio RE. Endocrine dysregulation in critically ill foals and horses. *Vet Clin North Am Equine Pract*. 2011;27:35.

#### REFERENCES

- Dembek KA, et al. *PLoS ONE*. 2014;9.
- Taylor S. *Equine Vet Educ*. 2015;27:99.
- Weber EJ, et al. *Equine Vet J*. 2015;47:275.
- Dicken M, et al. *N Z Vet J*. 2012;60:42.
- Gold JR, et al. *J Vet Intern Med*. 2007;21:791.
- Hurcombe SDA, et al. *J Vet Intern Med*. 2009;23:335.
- Barsnick RJM, et al. *J Vet Intern Med*. 2011;25:123.
- Barsnick RJ, et al. *Equine Vet J*. 2014;46:45.
- Borchers A, et al. *Equine Vet J*. 2014;46:306.
- Toth B, et al. *J Vet Intern Med*. 2014;28:1294.
- Himler M, et al. *Equine Vet J*. 2012;44:43.
- Abraham M, et al. *J Vet Intern Med*. 2014;28:1580.
- Bodaan CJ, et al. *Equine Vet Educ*. 2014;26:341.
- Liepman R, et al. *Equine Vet J*. 2015;47:526-530.
- Zabrecky KA, et al. *J Vet Intern Med*. 2015;29:673.
- Castagnetti C, et al. *Theriogenology*. 2010;73:343.
- Borchers A, et al. *Equine Vet J*. 2012;44:57.
- Tennent-Brown B. *Vet Clin North Am Equine Pract*. 2014;30:399.
- Pirrone A, et al. *Theriogenology*. 2012;78:1182.
- Borchers A, et al. *Equine Vet J*. 2013;45:2.

- Pusterla N, et al. *Vet Rec*. 2009;165:114.
- Jose-Cunilleras E, et al. *Equine Vet J*. 2012;44:48.
- Russell CM, et al. *Aust Vet J*. 2008;86:266.
- Theelen MJP, et al. *Equine Vet J*. 2014;46:161.
- Sanchez LC, et al. *J Am Vet Med Assoc*. 2008;233:1446.
- <[https://play.google.com/store/apps/details?id=edu.ohio\\_state.org.foalscore.foalscore](https://play.google.com/store/apps/details?id=edu.ohio_state.org.foalscore.foalscore)>.

## STILLBIRTH/PERINATAL WEAK-CALF SYNDROME

### SYNOPSIS

**Etiology** Uncertain; probably multiple etiologies and multifactorial.

**Epidemiology** Most commonly several cases on a farm; several farms affected in a geographic region in a single season; problem may not occur for several years and then occur as “epidemic” in a region.

**Clinical findings** Calves may be born weak and unable to stand. More commonly, they are born apparently normal and stand but subsequently collapse with hypothermia and die within a few hours of birth.

**Lesions** Petechial hemorrhages, subcutaneous edema, and hemorrhage commonly in the subcutaneous tissue of the carpal and tarsal joints.

**Diagnostic confirmation** Specific to cause.

**Treatment** Supportive.

**Control** Specific to cause.

### HISTORICAL ASPECTS

A syndrome of newborn calves called *weak-calf syndrome* was first recognized in Montana in 1964. It has been recognized throughout the United States and other countries since then, and it is considered a major economic loss in beef cattle herds. In the earlier descriptions of the syndrome, calves were affected by 10 days of age, and approximately 20% were affected at birth. Morbidity ranged from 6% to 15%. In some herds, sporadic abortions occurred before calving season of the herd began. In some cases, affected calves died within minutes after being born with varying degrees of obstetric assistance.

In calves that survived for a few days, clinical findings included lassitude, depression, weakness, variable body temperature, a reddened and crusty muzzle, lameness, reluctance to stand, enlargement of the carpal and tarsal joint capsules along with periarticular subcutaneous swellings, and a hunched-up back if they stood. Diarrhea occurred in some calves after a few days of illness, but it was not a major clinical finding. Treatment was ineffective, and the case fatality rates ranged from 60% to 80%.

At necropsy, the prominent lesions were hemorrhage and edema of the subcutaneous tissues over the tarsal and carpal joint regions and extending distally. Polysynovitis with

hemorrhagic synovial fluid often containing fibrin was also common. Erosive and hemorrhagic lesions of the forestomachs and abomasum also occurred. Several different pathogens were isolated from these calves, but no consistent relationship between the pathogens and the lesions was ever determined.

In retrospect, the case definitions were not well described, and it is probable that several different diseases of newborn calves were lumped into the enigma of weak-calf syndrome. As more detailed clinical and laboratory examinations of sick newborn calves have been done over the years, some of the causes of the original syndrome have been identified as specific diseases of newborn calves.

Widely ranging clinical and pathologic findings have been associated with weak-calf syndrome. In the most common situation, calves are born weak and die within 10 to 20 minutes after birth; sometimes they live for up to a few days. At necropsy there are no obvious or only few lesions to account for the illness. Calves that are weak after birth because of traumatic injuries associated with dystocia or other significant lesions can be accounted for according to the nature and severity of the lesions. Reports from Northern Ireland in recent years indicate that in dairy herds the incidence of weak-calf syndrome has ranged from 10% to 20% of all calves born. Field observations in problem herds found that the gestation period is of normal duration, but parturition is usually prolonged, with the first and second stages of labor lasting 24 hours. Affected calves usually are born alive but are unable to sustain breathing following birth. Despite resuscitation efforts, they commonly die within 10 minutes, often accompanied by prominent uncoordinated movements of the limbs. Some calves are stillborn, and whether or not this is a variation of the syndrome is uncertain. In a report from the United Kingdom, the syndrome occurred in calves born from heifers and was characterized by failure to breathe at birth or breathing with difficulty, and/or failing to move after birth, and failure to suck. The term *stillbirth/perinatal weak-calf syndrome* has been suggested as more appropriate.

### Dummy-Calf Syndrome

A variation of weak-calf syndrome is dummy-calf syndrome, which has been reported in the southern United States. Affected calves appear normal at birth and are generally alert, but they lack the instinct or the desire to seek the teat or suck after birth and for up to several hours later. The syndrome may occur in calves of any birth weight. The incidence has been highest in purebred Brahman females, but it has also occurred in Aberdeen Angus, Hereford, Chianina, and Brown Swiss breeds of cattle. Field observations indicate that affected

calves did not stand for up to 1 to 2 hours after birth to initiate teat-seeking behavior. Dummy calves appear to lack the sensitivity to teat-seek, and if they fail to locate a teat by about 4 to 5 hours after birth, they commonly lose the sucking reflex and then require intensive nursing care by bottle feeding to initiate sucking. In calves that fail to suck and ingest colostrum, hypothermia, hypoglycemia, and neonatal infections are common complications. Concurrently, the dam loses interest in the calf and may abandon it.

### ETIOLOGY AND EPIDEMIOLOGY

The etiology of weak-calf syndrome is unclear, but several epidemiologic observations have suggested some possible causes. These include the following:

- Fetal infection near term
- Underdevelopment because of nutritional inadequacy of the maternal diet during pregnancy
- Placental insufficiency
- Maternal dietary deficiencies of selenium and vitamin E
- Hypothyroidism
- Traumatic injuries associated with dystocia and excessive force during obstetric assistance
- Fetal hypoxia from prolonged parturition

### Fetal Infections

Fetal infections in the last few days before term can result in stillbirth or weak calves that may die within hours or days after birth. In one series of 293 weak calves in Northern Ireland, **leptospirosis** was present in 25% of the calves. Calves in which leptospiral antigen was detected in the placenta were significantly lighter by an average of 6 kg to 10 kg than calves with no antigen in the placenta. Calves infected with *Leptospira* in utero were more likely to be infected by *T. (formerly Arcanobacterium) pyogenes* or *Bacillus* species, and infection of the placenta is associated with a lower body weight. The adrenal gland, lung, and placenta are the most useful tissues to examine for leptospiral antigen.

**Bovine viral diarrhea (BVD)** virus infection has been identified in several herds with high occurrence rates of weak-calf syndrome. Effects of intrauterine infection with this virus will depend on the stage of pregnancy at which infection occurs, but birth of stillborn, weak, or dummy calves certainly warrants taking this differential into consideration (see also “Bovine Viral Diarrhea”).

An unidentified type of adenovirus has been associated with weak-calf syndrome on a large dairy farm in Israel. At birth the calves were reluctant to suck or drink colostrum and were force-fed colostrum with an orogastric tube. Affected calves were weak at birth and unable to rise without assistance; when forced to move they walked stiffly,

suggestive of polyarthritis. An adenovirus was detected in the feces, synovial fluid, and aqueous humor of affected calves.

### Maternal Nutritional Deficiency Causing Fetal Underdevelopment

**Hypothyroidism as a result of iodine deficiency** in the pregnant dam has been considered on the basis of thyroid hyperplasia in some calves. Analysis of the laboratory data from 365 calves that died from the stillbirth/perinatal weak-calf syndrome in Ireland found some differences between calves with abnormal versus normal thyroid glands. Glands weighing more than 30 g were probably abnormal. Abnormal glands were heavier, constituted a greater percentage of the calf's body weight, and had a lower iodine concentration. A higher proportion of calves with an abnormal thyroid gland had uninflated lungs and pneumonia. Abnormal thyroid glands had a lower selenium concentration in the kidneys.

Hypothyroidism as a result of iodine deficiency can be caused by either inadequate dietary iodine supply or the presence of goitrogens in feed. Goitrogens are substances that impair thyroid hormone synthesis, either by inhibiting iodine uptake (cyanogenic goitrogens) or by inhibiting organic binding of iodine by the thyroid glands (goitrogens of the thiouracil type).<sup>1</sup>

However, the experimental reproduction of iodine deficiency in pregnant heifers by feeding an iodine-deficient diet over the last 4 to 5 months of pregnancy resulted in clinicopathologic changes and pathologic changes in the thyroid glands of both the heifers and their calves, but all calves in the iodine-deficient group were born clinically normal.

Because selenium plays a role in the function of the thyroid glands, selenium deficiency can cause hypothyroidism despite adequate dietary iodine supply. **Maternal dietary deficiency of selenium** in pregnant cattle has also been examined, but field trials have failed to show any protective effect from the parenteral administration of pregnant cattle with selenium. The parenteral administration of both selenium and iodine to pregnant cattle did not have any effect on the incidence of the syndrome between treated and untreated herds; the incidences were 7.9% and 7.4%, respectively.

A general nutritional inadequacy in the maternal diet can result in underdevelopment of the fetus and the birth of smaller-than-normal calves, but the deficiency usually must be grossly inadequate. A clinical trial showed that feeding a protein-restricted ration (7% crude protein) during the last trimester of pregnancy resulted in 11.4% lower birth weights than in control animals and in compromised thermogenic ability of the newborn calves, which has been proposed as a contributing factor to perinatal mortality of calves.<sup>2</sup> Another study



reported a selective decrease in absorption of colostral IgG<sub>1</sub> and IgG<sub>2</sub> from the gut in calves from heifers fed protein-deficient diets during the last trimester of pregnancy, which implies a higher risk for FTPI in these calves.<sup>3</sup>

#### Placental Insufficiency

Intrauterine growth retardation associated with fetoplacental dysfunction has been described in Japanese Black beef calves.<sup>4</sup> Affected calves were weak when born at term and were underweight compared with normal calves. Anemia as a result of bone marrow dysfunction was present in affected calves and presumably was associated with intrauterine growth retardation. Thymic hypoplasia is another common finding in Japanese Black calves that died during the perinatal period, which also has been attributed to intrauterine growth retardation and is thought to contribute to perinatal weak-calf syndrome, which has a high occurrence rate in this breed.<sup>4,5</sup> There is some evidence that an immune inadequacy based on T-lymphocyte function may be associated with weak-calf syndrome in Japanese Black calves, which could be related to the thymic hypoplasia because the thymus is the site of T-cell maturation.

Dams delivering weak calves also had lower serum concentrations of estrone sulfate during late pregnancy than those of normal calves, suggesting a fetoplacental dysfunction. The dysfunction was influenced by sires and maternal families.

#### Fetal Hypoxemia

Fetal hypoxemia resulting from prolonged parturition or dystocia may be a cause or contributing factor to weak-calf syndrome. Various predisposing factors can cause prolonged interference with fetal blood or oxygen supply, which can result in death during delivery or shortly after.

Examination of blood-gas values in newborn calves has shown that a prolonged parturition or delivery terminated by forced extraction results in a severe acidemia as a result of oxygen deprivation and ensuing anaerobic glycolysis with lactate accumulation in combination with hypercapnia, resulting in respiratory acidosis. As blood pH drops, first vitality is reduced, subsequently vital organs such as the brain are damaged, and ultimately the fetus dies.

The bovine fetus appears relatively susceptible to hypoxia and hypercapnia, which has been studied experimentally by clamping the umbilical cords of fetuses for 4 to 8 minutes, at 24 to 48 hours before expected birth, followed by a cesarean section 30 to 40 minutes later. Calves born following this procedure may die in 10 to 15 minutes after birth or survive for only up to 2 days. Under these experimental conditions, fetuses can survive anoxia for 4 minutes, but most will die following 6 or 8 minutes of anoxia.<sup>6</sup> During the clamping there is also increased

fetal movement and a release of meconium that stains the calf and the amniotic fluid. Those that survive for a few hours or days are dull and depressed, cannot stand, and have poor sucking and swallowing reflexes, and their temperatures are usually subnormal. They respond poorly to supportive therapy. Some calves whose umbilical cords were clamped for 4 minutes were born weak and made repeated efforts to raise their heads and move onto the sternum, but they were unable to maintain an upright position for long. These calves become hypothermic and dull, and their sucking and swallowing reflexes are present but weak. These calves are usually too weak to suck the cow even when assisted, and they commonly develop diarrhea and other complications.

#### Dystocia and Traumatic Injuries at Birth

Over 50% of perinatal mortality is generally attributed to dystocia, and dystocia may be an important contributing factor to weak-calf syndrome because of fetal hypoxia or traumatic injuries associated with obstetric assistance.<sup>7</sup> In a study of 13,296 calvings over a period of 15 years in two research herds in Montana, calf mortality as a result of dystocia accounted for the single largest loss category through the first 96 hours postpartum. Reported ORs vary widely (2.7 to 14.6), but they suggest that calves requiring assisted delivery had a 2.7 to 14.6 higher risk of death in the perinatal period than spontaneously born calves.<sup>8</sup> At necropsy of the calves that died as a result of dystocia, the findings included a froth-filled trachea, nonfunctional lungs, bruises, contusions, hemorrhages, bone fractures, and joint dislocations. It was concluded that the provision of adequate obstetric assistance at the right time could have reduced the mortality associated with dystocia.

**Traumatic injuries of calves at birth** are caused primarily by the mechanical influence of traction during delivery and can result in asphyxia and a high perinatal mortality rate. Excessive traction is the most important cause of rib and vertebral fractures in the calf during dystocia. A series of 235 calves that died perinatally were examined by necropsy to determine the possible causes of death related to dystocia. Most of the parturitions were protracted and needed veterinary assistance, and 58% of the calves had pathologic evidence of asphyxia. Calves delivered by extraction had pathologic evidence of asphyxia more often than those born unassisted or delivered by cesarean section. Intrapulmonary amniotic material may be present in the lungs, representing evidence of perinatal respiratory distress. The aspiration of small amounts of amniotic fluid with or without meconium is common in calves and is not associated with hypoxemia, respiratory acidosis, or failure of passive transfer.

#### Premature Expulsion of Placenta

Premature expulsion of the placenta has been associated with perinatal calf mortality. Field observations indicate that the majority of affected fetuses die of fetal hypoxia during stage 2 of calving. The most significant risk factor associated with premature expulsion of the placenta was fetal malpresentation and malposture. Prolongation of the second stage of parturition allows for sufficient detachment of the placenta for it to occupy the posterior part of the genital tract. The placenta is frequently expelled together with the calf. In one series of cases, there was no significant relationship between the occurrence of premature expulsion of the placenta and parity, calving difficulty, previous calving history, or sex of the calf.

#### NECROPSY FINDINGS

All calves that die should be examined by necropsy to identify possible causes. It is important to establish if there is one disease complex or several different diseases of newborn calves.

In the weak-calf syndrome described in Northern Ireland, at necropsy many calves had petechial hemorrhages in the thymus gland, on the ventricular epicardium, and in the parietal pleura and endocardium. These lesions were similar to those present in animals that died of acute terminal asphyxiation. The gasps made in response to asphyxia in utero result in amniotic fluid being inhaled into the respiratory tract. In one study, 84% of stillborn calves had these lesions of asphyxia. It is well established that asphyxiation during birth is a major factor in intrapartum stillbirth in piglets and contributes to early postnatal mortality. Froth may be present in the caudal trachea of some calves that die within 10 to 20 minutes after birth.

Varying degrees of subcutaneous edema of the head and/or bruising of the rib cage are also common. Fractures of the ribs are common, accompanied by intrathoracic hemorrhage. Vertebral body fractures occur commonly at the thoracolumbar region and may be accompanied by intraabdominal hemorrhage. The lungs may be inflated normally, partially inflated, or not inflated. Severe bruising and hemorrhage occur around the costochondral junctions, at the sternal extremities of the costal cartilages, and over the sternum and shoulder regions. In some cases, the traumatic lesions are severe and may involve primarily the right side of the rib cage. Severe subcutaneous hemorrhage and edema may be present over the carpal and fetlock joints as a result of the pressure applied by the obstetric chains or ropes.

In the syndrome described in the United States, the lesions either appeared at birth or developed in the first few weeks of life. At necropsy the prominent lesions are marked edema and hemorrhages of the subcutaneous tissues over the carpal and tarsal joints

and extending distally down the limbs. The synovial fluid may be tinged with blood and contain fibrinous deposits. Erosions or ulceration of the gastrointestinal tract, petechial hemorrhage of internal organs, involution of the thymus gland, and hemorrhages in skeletal muscle have also been present.

The weak-calf syndrome described in Japanese Black calves was associated with atrophy of the red bone marrow and thymic hypoplasia.<sup>9</sup> Degeneration of brainstem nerve cells, attributed to protracted hypoxia, was also noticed.

Samples for confirmation of diagnosis include the following:

- Bacteriology—fetal liver, lung, stomach content, adrenal gland; placenta (culture); special detection techniques for *Leptospira* antigens
- Histology—fixed placenta, lung, spleen, brain, liver, kidney; maternal caruncle (light microscopy, Immunohistochemistry)

#### DIFFERENTIAL DIAGNOSIS

Determination of the cause of weak-calf syndrome in a herd is often difficult because the limits of the case definition cannot be determined. Several risk factors may interact to contribute to the disease. The most common definition is a calf that is alive at birth, appears normal otherwise, but either fails to breathe or breathes for less than approximately 10 minutes and then dies. If they survive for several hours or a few days, affected calves are usually in sternal recumbency, depressed, reluctant to stand unassisted, reluctant to walk, and not interested in sucking. They may not respond favorably to supportive therapy.

#### Case definition

When an epidemic of the disease is encountered, an epidemiologic investigation of the herd is necessary in an attempt to identify possible risk factors.

The patterns of occurrence should be determined:

- Is the problem more common in calves born to heifers than cows? In some situations, the owner may provide more surveillance for the calving heifers and less for the mature cows, with a consequent greater incidence of weak calves born from the cows.
- Is there any evidence that parturition is prolonged in the heifers or the cows? If so, what are the possible reasons?
- How long are heifers and cows in the herd allowed to calve unassisted before obstetric assistance is provided?
- Is it possible that some nutritional, management, or environmental factor is interfering with normal parturition?
- Is the condition more common in male or female calves, and what are the relative birth weights?

- How soon after birth are the calves affected?
- What is the course of the illness after the first clinical abnormalities are noted?
- Is the serologic herd status regarding specific infectious diseases known (e.g., leptospirosis, BVD, bluetongue)?
- The veterinarian should make every effort to clinically examine a representative number of affected calves.

#### TREATMENT

Calves born weak, unable to stand, lacking the instinct to seek the teat, or lacking a suck reflex need intensive care, including force-feeding of colostrum and the provision of warm surroundings to prevent hypothermia and other complications. Affected calves must be assisted to suck the dam normally. Bottle feeding for a few days may be necessary until the calf becomes strong enough to suck the dam on its own.

#### CONTROL AND PREVENTION

Control and prevention of weak-calf syndrome is based on empirical observations, beginning with insuring **adequate nutrition of the dam** to avoid any possible nutritional factors affecting neonatal calf vitality. The provision of **adequate surveillance at calving time** and competent obstetric assistance when necessary is also crucial to avoid prolonged parturition and fetal hypoxia in calves.

When epidemics of the disease are occurring, the surveillance of calving must be intensified, and it may be necessary to intervene with obstetric assistance earlier than usual. Determination of the cause may require that the veterinarian attend several calvings, make detailed clinical examinations of the length of parturition, and observe the parturition process and the health of the calves at birth.

#### FURTHER READING

- Mee JF. The role of micronutrients in bovine periparturient problems. *Cattle Pract.* 2004;12:95-108.
- Meijering A. Dystocia and stillbirth in cattle—a review of causes, relations and implications. *Livest Sci.* 1984;11:143-177.
- Randall GCB. Perinatal mortality: some problems of adaptation at birth. *Adv Vet Sci Comp Med.* 1978;22:53-81.

#### REFERENCES

1. Tripathi MK, et al. *Anim Feed Sci Tech.* 2007;132:1-27.
2. Cartsens GE, et al. *J Anim Sci.* 1987;65:745-751.
3. Blecha F, et al. *J Anim Sci.* 1981;53:1174-1180.
4. Uematsu M, et al. *Vet J.* 2013;198:212-216.
5. Takasu M, et al. *J Vet Med Sci.* 2008;70:1173-1177.
6. Duffy JH, et al. *Aust Vet J.* 1977;53:262-267.
7. Mee JF, et al. *Vet J.* 2014;199:19-23.
8. Mee JF, et al. *Animal.* 2008;2:613-620.
9. Ogata Y, et al. *J Vet Med A.* 1999;46:327-334.

## DISEASES OF CLONED OFFSPRING

The successful cloning of domestic animals using somatic-cell nuclear transfer has resulted in birth of offspring with a high frequency of clinical abnormalities. Cloning of livestock and horses is achieved by transfer of nuclear material from the cell of an adult animal to the enucleated egg of an animal of the same species (somatic-cell nuclear transfer), with subsequent implantation of the resulting embryo in a surrogate dam and birth of a live, viable offspring. However, the use of nuclear material from somatic cells of adult animals, and from fetal cells, frequently does not result in normal development of the embryo and placenta.

The abnormal development in cloned embryos is a consequence of altered methylation of the genome in transferred nuclear material. This applies particularly for imprinted genes, which are those genes for which only one copy is expressed in the embryo, compared with nonimprinted genes for which both parental copies of the gene are expressed. The lower frequency of expression of imprinted genes (i.e., only one copy, paternal or maternal) is a result of methylation of DNA or chromatin proteins that makes the DNA inaccessible for transcription.<sup>1</sup> Imprinting is a form of epigenetic control of gene expression. To date, 132 imprinted genes have been identified in mice, but only 25, 21, and 14 in cattle, pigs, and sheep, respectively.<sup>1</sup> Imprinted genes encode proteins involved in regulation of many cell processes, including embryonic and neonatal growth and development.<sup>1,2</sup>

In normal reproduction, the paternal genome is demethylated during passage through the oocyte and fusion with the maternal genome. Consequently, the methylation marks of the two genomes (paternal and maternal) are different at the end of the cleavage process. Transfer of somatic nuclear material into an enucleated oocyte results in exposure of both genomes to the active demethylating process in the cytoplasm of the oocyte and uniform or variable demethylation of both genomes. The loss of these parent-specific epigenetic markers results in widespread dysregulation of imprinted genes and subsequent abnormalities in the placenta, fetus, and newborn. Imprinting marks (methylation) are erased during early development, and reprogramming of somatic-cell nuclei used in cloning and these abnormalities in epigenetic control of expression of imprinted genes result in biallelic expression of imprinted genes.<sup>3</sup> The loss of epigenetic control of imprinted genes causes at least some of the abnormalities common in cloned ruminants, including large-offspring syndrome (LOS).<sup>3</sup>

A small proportion of transferred blastocysts develop in viable animals. For cattle, of 134 recipients that received blastocysts, 50

were pregnant 40 days after blastocyst transfer, and 23 had full-term pregnancies. For all species studied, fewer than 3% of cloned embryos result in birth of viable animals. Abnormalities in the placenta and newborn cloned animals are reported for cattle and sheep, but are less frequently reported, if at all, for pigs and equids (horses and mules). Factors influencing the risks of abnormalities in newborns include the source of the nuclear material, type of in vitro culture media, coculture with somatic cells, hormonal treatments, and manipulation of the embryo.<sup>1,4</sup> The frequency of birth of live animals born after somatic-cell nuclear transfer from well-differentiated tissue (e.g., fibroblasts) or fetal somatic cells is lower than after nuclear transfer from embryonic cells (7%, 15%, and 34%, respectively).

The cause of placental, fetal, and neonatal abnormalities is abnormal expression of imprinted genes as a consequence of transfer of nuclear material from differentiated somatic cells,<sup>5</sup> conditions and media used for maintenance and culture of cytoplasts and blastocysts, and techniques used for handling cells.<sup>3,6-8</sup> The key abnormality is loss of methylation of imprinted genes contributed by each parent, with subsequent biallelic expression of these genes. There is debate about which epigenetic or genetic abnormalities underlay the development of placental and fetal abnormalities. Aberrant hypomethylation of IGF-2 and CDKC1C genes has been identified in calves with LOS and results in biallelic expression in the liver and placenta of affected animals.<sup>1</sup> Abnormalities in embryologic development of vasculature is identifiable early during embryogenesis in calves and might be the defect underlying pulmonary, circulatory, and umbilical abnormalities in cloned calves.<sup>9</sup> Furthermore, there is decreased expression of genes in the lungs of cloned goats that do not survive compared with those of healthy kids. Compared with normal goats of the same age from conventional reproduction, expression of 13 genes (BMP4, FGF10, GHR, HGFR, PDGFR, RABP, VEGF, H19, CDKNIC, PCAF, MeCP2, HDAC1, and Dnmt3b) decreased in transgenic cloned goats that died at or shortly after birth.<sup>6</sup> Expression of eight genes (FGF10, PDGFR, RABP, VEGF, PCAF, HDAC1, MeCP2, and Dnmt3b) decreased in fetal death of transgenic cloned goats.<sup>6</sup> A comprehensive list of genes known to be involved in embryogenesis and fetal and placental growth and a description of the effect of decreased expression of these genes are available.<sup>10</sup>

**Clinical findings** in cloned calves and lambs include abortion, placental abnormalities, large birth size, poor extrauterine viability, respiratory disease, cardiovascular abnormalities, and neurologic disease compatible with neonatal encephalopathy. LOS is confined to ruminants and is characterized by overgrowth, evident as abnormally high birth weight, enlarged tongue, umbilical

hernias, and hypoglycemia.<sup>3</sup> Abortion occurs after day 90 of gestation in 30% to 50% of pregnancies in cattle, resulting from transfer blastocysts containing transferred nuclear material. Abnormalities, including hydroallantois, are present in approximately 25% of advanced pregnancies. **Placental abnormalities** include hydroallantois, a reduction in the number of placentomes (from a normal value of approximately 100 to as few as 26 to 70 in cloned calves), abnormally large placentomes (140 g in cloned calves versus 33 g in conventional calves), and edema of the placenta.<sup>10</sup> Maternal retention of the placenta is common and occurs in most cows. Duration of gestation is probably longer in cloned calves, although the frequent delivery of cloned calves by cesarean section makes assessment of gestational duration difficult. Cloned calves are heavier than conventional calves, often by as much as 25%, a well-recognized part of the **large-offspring syndrome** that affects calves born as a result of reproductive manipulation, including in vitro fertilization. Viability of cloned calves that are born alive (commonly by cesarean section) is less than that of conventional calves; only approximately two-thirds of cloned calves born alive survive more than 1 month, although others have reported better survival. Similar results are reported for horses.

A high proportion of cloned calves have **clinically detectable abnormalities** at or soon after birth, including sepsis, neonatal encephalopathy, respiratory failure, umbilical abnormalities, anemia, flexure contracture, abdominal distension, and renal dysfunction. Respiratory failure is a common finding and might reflect persistent fetal circulation or inadequate surfactant production, as evidenced by the high pulmonary artery pressures and signs consistent with patent ductus arteriosus.<sup>11</sup> Left heart failure, which can also cause pulmonary hypertension, is reported in cloned calves. Umbilical abnormalities are evident as abnormal umbilical cord structure (multiple arteries and veins) and large size, with a high risk of hemorrhage from the umbilical cord after birth. Cloned calves have higher body temperatures than do conventional calves.

Of 27 cloned calves delivered alive, 7 were bradypneic or apneic at birth, 5 had flexural limb deformities, and at least 23 had enlarged umbilical cords. The calves were acidotic at birth as a result of both respiratory and lactic acidosis. Calves had normocytic hypochromic anemia, stress leukogram (leukocytosis, neutrophilia, and lymphopenia), and hypoproteinemia (with both hypoalbuminemia and hypoglobulinemia) and had increased serum creatinine concentration.<sup>12</sup> Three of the calves did not develop other clinical signs and were considered healthy after birth, whereas 22 had at least one important clinical abnormality detected during the week

after birth. Twelve of the calves developed omphalitis. Fourteen of the calves died or were euthanized.<sup>12</sup>

Hematologic abnormalities include anemia and decreased mean corpuscular volume. Biochemical abnormalities include hypoxemia, azotemia, and hypoglycemia. Plasma leptin and IGF-2 concentrations are higher, and thyroxine lower, in cloned calves. Serum cortisol and adrenocorticotrophic hormone (ACTH) stimulation tests do not differ between cloned and conventional calves. Cloned calves can mount normal immune responses.<sup>13</sup> Failure of transfer of passive immunity can occur if calves are unable to suckle or are not administered colostrum or plasma.<sup>12</sup>

**Necropsy** examination reveals placentomegaly, presence of excess pleural and peritoneal fluid, hepatomegaly, interstitial pneumonia or pulmonary consolidation and alveolar proteinosis, right ventricular dilation, and hepatocellular vacuolation.

**Treatment** is supportive and directed toward correcting hypoxemia and providing nutritional, fluid, and environmental support (see earlier discussion).

There are currently no recognized methods for preventing these abnormalities, but incremental improvements in methodology and culture techniques will continue to result in fewer cloned offspring with these abnormalities.

## FURTHER READING

- Hill JR. Incidence of abnormal offspring from cloning and other assisted reproductive technologies. *Annu Rev Anim Biosci.* 2014;2:307-321.
- O'Doherty AM, et al. Genomic imprinting effects on complex traits in domesticated animal species. *Front Genet.* 2015;6:156.
- Smith LC, et al. Developmental and epigenetic anomalies in cloned cattle. *Reprod Domest Anim.* 2012;47:107-114.

## REFERENCES

- O'Doherty AM, et al. *Front Genet.* 2015;6:156.
- Tian X. *Annu Rev Anim Biosci.* 2014;2:23.
- Smith LC, et al. *Reprod Domest Anim.* 2012;47:107.
- Hill JR. *Annu Rev Anim Biosci.* 2014;2:307.
- Liu J, et al. *Reprod Domest Anim.* 2013;48:660.
- Meng L, et al. *Theriogenology.* 2014;81:459.
- Smith LC, et al. *Anim Reprod.* 2010;7:197.
- Su J, et al. *Livest Sci.* 2011;141:24.
- Maiorka PC, et al. *PLoS ONE.* 2015;10:e0106663.
- Palmieri C, et al. *Vet Pathol.* 2008;45:865.
- Brisville AC, et al. *J Vet Intern Med.* 2011;25:373.
- Brisville AC, et al. *J Vet Intern Med.* 2013;27:1218.
- Chavatte-Palmer PM, et al. *Cloning Stem Cells.* 2009;11:309.

## EQUINE NEONATAL MALADJUSTMENT SYNDROME (NEONATAL ENCEPHALOPATHY, DUMMY FOAL, BARKERS, AND WANDERERS)

This is a syndrome of foals less than 36 hours of age characterized by a spectrum of changes in mentation ranging from failure



to suckle, abnormal behavior, and seizures through coma in otherwise apparently healthy foals. The syndrome is defined by the clinical abnormalities and not by a common etiology.

## ETIOLOGY

The clinical signs associated with this syndrome can be produced by a number of diseases, each of which has its particular etiology. Diseases that contribute to this syndrome include antenatal, natal, or postnatal hypoxia;<sup>1</sup> a range of congenital abnormalities (hydrocephalus, hydronephrosis,<sup>2</sup> and such); metabolic disorders;<sup>3</sup> placental abnormalities;<sup>4</sup> intracranial hemorrhage; prematurity; and thoracic trauma. Fetal or perinatal hypoxia has achieved some prominence as a cause of neonatal maladjustment syndrome in the absence of consistent demonstration of lesions of hypoxia on histopathologic examination of foals. There are isolated cases in which histologic evidence of hypoxia exists, but these are the exception rather than the rule. Finally, most foals with neonatal maladjustment syndrome improve rapidly and completely recover within several days—a clinical course not expected with neonatal or perinatal asphyxia in other species.

Recent evidence implicates a role of neuroactive progesterone derivatives in the etiology of neonatal maladjustment syndrome.<sup>5,6</sup> Plasma concentrations of these neuroactive steroids in foals are high immediately after birth and decline rapidly in healthy foals, but not in foals with neonatal maladjustment syndrome.<sup>5</sup> Foals with neonatal maladjustment syndrome and foals with other illness have higher concentrations of progesterone derivatives than do healthy foals.<sup>7</sup> Plasma concentrations of progesterone derivatives decline in sick foals that do not have neonatal maladjustment syndrome, but not in foals with the syndrome.<sup>5</sup> Progesterone derivatives include progesterone, pregnenolone, androstenedione, dehydroepiandrosterone, and epitestosterone.<sup>5</sup> Evidence from other species and limited experimental evidence in foals indicate that allopregnanolone infusion induces changes in mental status that mimic those seen in foals with neonatal maladjustment syndrome.<sup>6</sup> It is proposed that a subset of foals with signs of neonatal maladjustment syndrome have disease attributable to persistence of the fetal hypothalamic–pituitary–adrenal axis after birth.

## EPIDEMIOLOGY

The disease is sporadic and occurs worldwide, with an annual **incidence** in foals of less than 1%.<sup>7</sup> Foals of either sex and of any breed born to mares of any age or reproductive history can be affected. The **case fatality rate** is very low for appropriately treated foals without other systemic illness.

## PATHOGENESIS

Hypoxia resulting from intracranial vascular accidents, asphyxia at birth, or placental insufficiency before birth damages the central nervous system, causing a wide variety of signs of neurologic dysfunction.

A proposed pathogenesis for foals with persistently high plasma concentrations of progesterone derivatives after birth is failure of the foal's hypothalamic–pituitary–adrenal axis to rapidly adjust to extrauterine life.<sup>6</sup> In utero, foal movement and activity is suppressed, presumably at least in part by high concentrations of neuroactive progesterones. At birth in healthy foals there is a rapid reduction in concentration of these hormones coincident with increases in activity of the foal. Progesterone derivatives, some of which can cross the blood–brain barrier, modulate the activity of the GABA<sub>A</sub> receptor and at high concentrations completely inhibit its activity, providing a potential explanation for the somnolence and other signs displayed by foals with neonatal maladjustment syndrome and high plasma progesterone concentrations.<sup>5</sup>

Neurologic abnormalities and a failure to nurse result in a failure of the transfer of maternal immunoglobulins, which predisposes the foal to septicemia and hypoglycemia. Failure to nurse also results in hypoglycemia and malnutrition.

## CLINICAL SIGNS

**Foals that are abnormal at birth** can display a range of behavioral abnormalities, from lack of suckle reflex to convulsions with extensor rigidity. The placenta of affected foals is often abnormal, or there is a history of prolonged parturition. Affected foals either do not develop or lose the suck reflex, have no affinity for the mare, and are unable to locate the udder or teat. Aimless wandering and a characteristic “barking” vocalization are sometimes present. Recumbent foals struggle wildly and in an uncoordinated fashion to stand. Convulsing foals usually display opisthotonus with extensor rigidity. Other signs of convulsive activity include facial twitching and grimacing, nystagmus, rapid blinking, sucking, chewing, and drooling. Between episodes foals are usually depressed or somnolent. Affected foals display little or no interest in the mare. Convulsing foals are tachypneic, tachycardic (>180 bpm), and hyperthermic (>39°C, 102°F) during and immediately after convulsions. It is important to recognize that the severity of clinical signs varies from very mild (foals are often described by owners as being a bit slow or dimwitted) through to grand mal seizures.

**Foals that are normal** at birth can develop signs by 24 hours of age. The signs are similar to those described previously, with the exception that the foals are initially able to ambulate. It is important to realize that healthy newborn foals lack a menace reflex, have a hypermetric gait and intention

tremor, and become flaccid when restrained. The reflex response of healthy foals to restraint by a handler placing one arm under the foal's neck and another around the buttocks and squeezing is to become “floppy” and somnolent.<sup>6</sup> Foals restrained in this way become immobile, lie down, and have an increased pain threshold during restraint.<sup>6</sup>

Affected foals can take days to weeks to recover completely. Blind foals that do not have ocular lesions can take as long as 4 to 6 weeks to regain vision.

Ancillary testing is not usually indicated unless the foal fails to respond after approximately 7 days. At that time, CT or MRI examination of the brain might be indicated to detect congenital anomalies such as hydrocephalus. Examination of CSF should be performed in any foal with signs of central nervous system dysfunction in the presence of fever or other signs of sepsis.

## CLINICAL PATHOLOGY

There are no routine hematologic or serum biochemical abnormalities characteristic of the disease, although it is prudent to conduct such examinations to eliminate other diseases; common characteristics are as follows<sup>3</sup>:

- Affected foals usually have **failure of transfer** of maternal immunoglobulins (serum IgG < 400 mg/dL).
- They may be **hypoglycemic** (<80 mg/dL, 4 mmol/L).
- **Cerebrospinal fluid** is often normal, although it may contain red blood cells or appear xanthochromic as a result of bleeding.

Detection of **biomarkers of brain injury** has been investigated. Plasma concentrations of **ubiquitin C-terminal hydrolase (UCHL1)** are higher (6.57, range 2.35 to 11.9 ng/mL) in foals with signs of neonatal maladjustment syndrome (defined as neonatal hypoxic-ischemic encephalopathy in the study) than in healthy foals (2.52, range 1.4 to 4.01 ng/mL).<sup>8</sup> The sensitivity and specificity for diagnosis of neonatal maladjustment syndrome based on a cutoff of ubiquitin C-terminal hydrolase concentrations in plasma of 4.01 ng/mL were 70% and 94%, respectively.<sup>8</sup>

Measurement of **plasma progesterone concentrations** of foals with signs of neonatal maladjustment syndrome might prove to be useful in diagnosis of the disease. Foals with high concentrations of progesterone could be treated appropriately, and those with low or normal concentrations could be further investigated for other diseases such as intracranial hemorrhages or hydrocephalus.

## DIAGNOSTIC CONFIRMATION

**Definitive diagnosis** of the disease is difficult and is based on exclusion of other diseases that can cause similar signs and, at necropsy, demonstration of intracranial lesions consistent with the disease.

## NECROPSY FINDINGS

Gross changes are typically limited to diffuse pulmonary congestion with a variable degree of atelectasis. In cases in which dystocia has been a contributing factor, fractured ribs and foci of subcutaneous edema and hemorrhage are sometimes noted. Occasionally, macroscopic cerebral hemorrhages are visible. Histologically, the key findings are hemorrhagic foci within the brain and areas of ischemic necrosis in the cerebral cortex. Meconium and other components of aspirated amniotic fluid accompanied by atelectasis and a mild inflammatory response may be present within the lung. In less affected foals the brain lesions are restricted to hemorrhage, cerebral swelling, and edema. Some affected foals subject to necropsy examination have evidence of intracranial vascular accidents, but it must be recognized that this is a biased sample; many foals recover from the disorder. Affected foals that are euthanized for financial or management reasons often have no detectable lesions in the brain.

## Samples for Postmortem Diagnostic Confirmation

Samples for postmortem diagnostic confirmation include formalin-fixed brain, including cerebral cortex, cerebellum, and brainstem, and lung for light microscopic examination.

### DIFFERENTIAL DIAGNOSIS

The disease must be differentiated from other diseases that cause neurologic or behavioral abnormalities in foals, including sepsis; renal, hepatic, or gastrointestinal disease, which can occur secondary to fetal hypoxia; hydrocephalus; hypoglycemia; meningitis; neonatal isoimmune hemolytic anemia; and prematurity, dysmaturity, or immaturity (Table 19-10).

### TREATMENT

The principles of treatment are as follows:

- Control of convulsions
- Treatment of cerebral edema and hemorrhage

- Correction of FTPI
- Nutritional support and general nursing care

The management of affected foals is mainly supportive and is a time-consuming and labor-intensive endeavor. Provision of nutritional support, treatment of failure of transfer of maternal immunoglobulins, and nursing care are discussed in detail in the section "Principles of Care of the Critically Ill Neonate."

For other than emergency treatment of seizures, in which **diazepam** (0.1 to 0.4 mg/kg, intravenously, as required) or **midazolam** (0.05 to 0.1 mg/kg IV, as required) are useful, **phenobarbital** (phenobarbitone), **phenytoin**, and **primidone** are the drugs of choice for long-term control of seizure activity. Phenobarbital is administered initially at a dose of 9–20 mg/kg intravenously in 30 mL of isotonic saline infused over 15 to 30 minutes. Maintenance therapy is a similar dose intravenously (7–9 mg/kg IV over 20 min every 8–12 hours) or a lower dose (1–5 mg/kg) orally, every 8 hours, and the dose is adjusted

**Table 19-10** Differential diagnosis of comatose ("sleeper") neonatal foals

Disease	Epidemiology	Clinical findings	Clinical pathology	Lesions	Treatment and prognosis
Septicemia	<i>E. coli</i> , <i>Klebsiella</i> spp., <i>Streptococcus</i> spp., <i>Salmonella</i> spp., <i>Actinobacillus suis</i> , Equine herpesvirus-1. Failure of transfer of passive immunity.	Abrupt onset of depression, fever, failure to nurse, and recumbency. Later diarrhea, pneumonia, and joint distension.	Culture of organism from blood or lesions (joints, lungs, feces).	Consistent with septicemia. Pneumonia. Septic synovitis, arthritis, and osteomyelitis.	Broad-spectrum antibiotics, supportive care (see "Principles of Providing Care to the Critically Ill Neonates"). Guarded to poor prognosis.
Isoimmune hemolytic anemia	Incompatible mating of Aa + or Qa + stallion with negative mare.	Normal at birth. Subsequent depression, cessation of nursing, exercise intolerance, icterus, and anemia. Hemoglobinuria in severe cases.	Positive Coombs' test to demonstrate immunoglobulin on foal's red cells. Dam's colostrum agglutinates or lyses foal red cells.	Anemia, icterus. Death from anemic hypoxia.	Transfusion of washed dam's red blood cells or of compatible donor (check dam's plasma with donor's red cells). Fair prognosis.
Uroperitoneum	Ruptured bladder, urachus or ureteral defect. Colts 1–3 days of age. Foals of either sex with other systemic diseases.	Normal at birth. Onset of abdominal distension, mild colic, depression, and recumbency. May urinate small volumes.	Peritoneal fluid has high creatinine concentration. Hyperkalemia, hyponatremia, and hypochloremia.	Uroperitoneum. Rupture bladder, urachus or ureter.	Surgical correction AFTER drainage of abdomen and resolution of hyperkalemia with intravenous dextrose or 0.9% NaCl. Good prognosis with appropriate care.
Hypoglycemia	Failure to nurse. Rejection by mare. Mare has no milk (agalactia).	Normal at birth, repeated attempts to nurse. Gradual onset (hours) of weakness and depression.	Low blood glucose concentration (<60 mg/dL, 3 mmol/L).	None. No food in stomach.	Excellent response to feeding or intravenous glucose.
Neonatal maladjustment syndrome	Sporadic.	Onset of abnormal behavior, recumbency, failure to nurse or orient to mare. Aimless wandering and vocalization.	None characteristic. Frequently failure of transfer of passive immunity.	Usually none apparent. Occasional intracranial vascular accidents.	Supportive care (see "Principles of Providing Care to Critically Ill Neonates"). Good prognosis.
Congenital defects	Sporadic.	Depends on nature of cardiac, gastrointestinal, or central nervous system defect.	None.	Consistent with defect.	Usually no treatment. Poor prognosis depending on defect.

to provide control of seizures while minimizing the degree of sedation. Because of the long elimination half-life of phenobarbital in foals (~200 hours) and the transient nature of the disease, once seizure control is achieved, administration of phenobarbital can be discontinued. Drug concentrations will be at or above the target concentration (5 to 30 µg/mL) for several days after the final dose. **Phenytoin** (5 to 10 mg/kg intravenously or orally initially, then 1 to 5 mg/kg every 4 hours) or **primidone** (20 to 40 mg/kg orally every 12 to 24 hours, to effect) are also used to control convulsions.

Definitive demonstration of the presence of cerebral edema or intracranial hemorrhage is impossible without sophisticated imaging devices, such as MRI or CT. However, treatment is often initiated on the basis of clinical signs. None of the treatments has demonstrated efficacy, and some are controversial. **Dimethyl sulfoxide** (DMSO) is given intravenously at 0.5 to 1 mg/kg once or twice daily for 3 days as a 10% solution. **Mannitol** (0.25 g/kg, intravenously as a 20% solution) may be effective in treating cerebral edema, but it is contraindicated if intracranial hemorrhage is present. **Glucocorticoids** (dexamethasone, 0.2 to 1 mg/kg, or prednisone, 1 to 2 mg/kg) might reduce intracranial inflammation and swelling. They might be contraindicated in foals with sepsis.

**Magnesium sulfate** (0.05 mg/kg per hour for 1 hour, then 0.025 mg/kg/h intravenously for up to 48 hours) is often administered to foals with suspected hypoxic encephalopathy in an attempt to minimize neuronal damage. There is no objective evidence of its efficacy in foals.

Foals with respiratory depression can be administered **caffeine** (10 mg/kg orally once and then 3.0 mg/kg orally q 24 hours). There is objective evidence of the lack of efficacy of this treatment in improving survival or decreasing arterial carbon dioxide tension in foals with a diagnosis of neonatal hypoxia-ischemia.<sup>9</sup> Adverse effects include agitation, hyperesthesia, tachycardia, and convulsions.

**Good nursing care** is critical in affected foals, and a concerted and persistent effort should be made to encourage the foal to nurse the mare. Encouraging the foal to nurse can be frustrating for the handler and mare, but should be done regularly, about every 4 hours, and preferably when the foal is hungry. Affected foals often begin to nurse quite suddenly. Foals should be provided with nutritional support, such as with mare's milk administered by indwelling nasogastric tube, until they are able to suckle.

Affected foals can require up to 4 to 6 weeks to recover completely, although most do so within 1 week of birth, and hasty decisions regarding euthanasia should not be made without recognition of the sometimes long time required for complete recovery.

## CONTROL

Prevention of hypoxia in neonates by close monitoring of the health of the mare and of parturition may reduce the incidence of the disease.

## FURTHER READING

Diesche TJ, Mellor DJ. Birth transitions: pathophysiology, the onset of consciousness and possible implications for neonatal maladjustment syndrome in the foal. *Equine Vet J*. 2013;45:656-660.

## REFERENCES

- Dickey EJ, et al. *J Vet Intern Med*. 2011;25:1231.
- Baiker K, et al. *Equine Vet Educ*. 2010;22:593.
- Johnson AL, et al. *Equine Vet Educ*. 2012;24:233.
- Wilcox AL, et al. *Vet Pathol*. 2009;46:75.
- Estell KE, et al. *J Vet Intern Med*. 2013;27:663.
- Madigan JE, et al. *Equine Vet J*. 2012;44:109.
- Wohlfender FD, et al. *Equine Vet J*. 2009;41:179.
- Ringger NC, et al. *J Vet Intern Med*. 2011;25:132.
- Giguere S, et al. *J Vet Intern Med*. 2008;22:401.

## Neonatal Infectious Diseases

### SYNOPSIS

**Etiology** Common infections for each animal species are listed under "Etiology" in the discussion. Most etiologies are bacterial, but some are viral.

**Epidemiology** Commonly predisposed by management and environmental factors and difficult delivery that increase the exposure risk and load and decrease the resistance of the neonate.

**Clinical findings** Depending on the pathogen and portal of entry, local infection or septicemia with following localization can occur; signs can be specific for the agent and the affected organ(s).

**Clinical pathology** White blood cell and differential counts, toxic change, serum immunoglobulin concentrations, blood gas analysis, acute-phase protein concentrations, blood culture.

**Necropsy findings** Specific to disease.

**Diagnostic confirmation** Specific to disease.

**Treatment** Treatment may include antimicrobial therapy, correction of acid-base disturbance, fluid and electrolyte therapy, blood or plasma transfusion, antiinflammatory therapy, and other supportive treatment.

Infection is a common cause of morbidity and mortality in neonates. There are a number of specific infectious pathogens that can cause disease. Other microorganisms normally present in the neonate's environment can become opportunistic pathogens whenever the immunologic status of the neonate is impaired. Maternal immunoglobulins are not transferred transplacentally in ungulates, and the newborns rely on the

acquisition of immunoglobulins from colostrum for passive antibody protection.

## ETIOLOGY

In domestic farm animals the common infections that can produce disease during the neonatal period are described in the following subsections. (Relative importance and prevalence statistics are not given because these vary from area to area and with differing management systems.)

### Calves

- Enteritis associated with enterotoxigenic *Escherichia coli*; *Salmonella* spp.; rotavirus and coronavirus; *Cryptosporidium parvum*; *Clostridium perfringens* types A, B, and C; and occasionally by the virus of infectious bovine rhinotracheitis and bovine viral diarrhea
- Bacteremia and septicemia associated with *E. coli*, *Listeria monocytogenes*, *Pasteurella* spp., streptococci, or *Salmonella* spp.

### Pigs

- Septicemia with or without localization in joints, endocardium, and meninges associated with *Streptococcus suis*, *Streptococcus equisimilis*, *Streptococcus zooepidemicus*, and *L. monocytogenes*
- Bacteremia, septicemia, and enteritis associated with *E. coli*
- Transmissible gastroenteritis, Aujeszky's disease, swine pox, enterovirus infections, and vomiting and wasting disease associated with viruses
- Enteritis associated with *C. perfringens*, *Campylobacter* spp., rotavirus, and *Coccidia* spp.
- Arthritis and septicemia associated with *Erysipelothrix rhusiopathiae*

### Foals

- Septicemia with localization associated with *E. coli*, *Actinobacillus equuli*, *Klebsiella pneumoniae*,  $\alpha$ -hemolytic streptococci, *S. zooepidemicus*, *L. monocytogenes*, *Rhodococcus equi*, and *Salmonella typhimurium*
- Enteritis associated with *C. perfringens* types A, B, and C; *Clostridium difficile*; *R. equi*; *Salmonella* spp.; *Strongyloides westeri*; *C. parvum*; and rotavirus.

### Lambs

- Septicemia or bacteremia with localization in joints and/or synovia and/or leptomeninges associated with *E. coli*, *L. monocytogenes*, streptococci, micrococci, *E. rhusiopathiae*, and *Chlamydomphila* spp.
- Enteritis associated with enterotoxigenic *E. coli*, *Salmonella* spp., rotavirus and coronavirus, and *C. parvum*
- Lamb dysentery associated with *C. perfringens* types B and C



- Gas gangrene of the navel associated with *Clostridium septicum*, *Clostridium novyi*, and *Clostridium chauvoei*
- Pyemia associated with *Staphylococcus aureus*, *Fusobacterium necrophorum*, and *Trueperella* (formerly *Arcanobacterium*) *pyogenes*
- Pneumonia, polyserositis, and peritonitis associated with *Pasteurella multocida* and *Mannheimia hemolytica*

The agents listed in the following subsections are recorded as causing neonatal infections but are less common than those listed in the previous subsections and not of as great importance.

#### Calves

*Pseudomonas aeruginosa*, *Streptococcus pyogenes*, *Streptococcus faecalis*, *S. zooepidemicus*, *Pneumococcus* spp.; enteritis resulting from *Providencia stuartii*, *Chlamydothila* spp., *A. equuli*.

#### Lambs

*S. aureus* (tick pyemia); enteritis resulting from *E. coli*, rotavirus; pneumonia resulting from *Salmonella abortus-ovis*.

#### Foals

Enterobacter cloacae, *S. aureus*, *Pasteurella multocida*, *P. aeruginosa*, *T. pyogenes*, *Serratia marcescens*.

#### All Species

Nonspecific infections are associated with pyogenic organisms, including *T.* (formerly *Arcanobacterium*) *pyogenes* and *Fusobacterium necrophorum*; *S. faecalis*, *S. zooepidemicus*, *Micrococcus* spp., and *Pasteurella* spp. occur in all species.

### EPIDEMIOLOGY

The occurrence of neonatal disease is broadly influenced by two main factors: the exposure or infection pressure of the infectious agent to the neonate and the ability of the neonate to modulate the infection so that disease does not occur. Some agents are sufficiently virulent in their own right that an exposure can lead to disease. With others, the majority, the defenses of the host must be compromised or the infection challenge must be very high before clinical disease occurs. Management of the neonate has a great influence on both of these factors, and the recognition and correction of these risks is the key to the prevention of neonatal disease in both the individual and the group.

#### Sources of Infection

##### Postnatal Infection

The vast majority of infections are acquired by the neonate after birth, directly from the environment into which it is born. The source of infection can be any adult animal present in the maternity area, an infected neonate housed in close proximity, contamination of the environment, or an animal

caretaker functioning as mechanical or biological vector. Details for the common neonatal diseases are given under the individual disease headings.

#### Prenatal Infection

Some bacterial and viral infections that manifest with neonatal disease are acquired in utero and are associated with bacteremia/viremia in the neonate.<sup>1</sup> The majority of these are agents that cause abortion, and neonatal septicemia is only part of the disease spectrum associated with these pathogens. Examples include many of the agents producing abortion in sheep.

Some septicemic infections in foals, particularly those associated with *A. equuli*, *S. zooepidemicus*, *Salmonella abortusequi*, and possibly some *E. coli* septicemic infections, are acquired by prenatal infection. If the disease is intrauterine in origin, it reaches the foal's organism via the placenta, probably by means of placentitis resulting from a blood-borne infection or endometritis of the mare.

**Viral** infections that are acquired in utero are listed in the section on congenital disease.

#### Routes of Transmission

The **portal of infection** is commonly by oral ingestion, but infection may also occur via aerosol inhalation. Invasive organisms capable of producing bacteremia and septicemia invade through the nasopharynx or through the intestinal epithelium. An alternate route of infection and invasion is via the umbilicus. Routes of **excretion** are via the feces in enteric disease and the nasal secretions, urine, and sometimes the feces in septicemic disease, resulting in contamination of the neonatal environment.

Where neonates are in groups or in close contact, direct transmission by fecal, respiratory secretion, and urine aerosols are common routes for transmission of infection. Neonatal bull calves that are group-housed and that suck one another's navels can transmit infection by this activity.

#### Risk Factors and Modulation of Infection

##### Immunity

Neonates are generally more susceptible to infection than their adult counterparts. The calf, lamb, piglet, and foal are born without significant levels of immunoglobulins and possess almost no resistance to certain diseases until after they have ingested colostrum and absorbed sufficient quantities of immunoglobulins from the colostrum. **Failure of transfer of passive immunity** is a major determinant and is discussed under that heading.

##### Immune Responsiveness

All components of the immune system are present in foals and calves at birth, but the immune system of the newborn animal is less mature than its adult counterpart, at

least for the first 30 days of life, and does not respond as effectively to an antigen stimulus.

Immune responsiveness is age-dependent but also varies with the antigen. In colostrum-fed animals, part of the inefficiency of the newborn to produce humoral antibodies following exposure to antigens is the interference from circulating colostrum antibody and the downregulation by colostrum of endogenous immunoglobulin production.

Colostrum-deprived calves respond actively to injected antigens and are thought to be immunologically competent at birth with respect to most antigens. Immune competence begins during fetal life, and the age of gestation at which this occurs varies according to the nature of the antigen. The bovine fetus will produce antibodies to some viruses, beginning at 90 to 120 days, and by the third trimester of gestation it will respond to a variety of viruses and bacteria. The lamb will respond to some antigens beginning as early as 41 days and not until 120 days for others. The piglet at 55 days and the fetal foal also respond to injected antigens.

The presence of high levels of antibodies in the precolostral serum of newborn animals suggests that an in utero infection was present, which is useful for diagnostic purposes. The detection of immunoglobulins and specific antibodies in aborted fetuses can be a useful aid in the diagnosis of abortion in cattle.

#### Exposure Pressure

The exposure pressure is a factor of the cleanliness of the environment of the neonate. The phenomenon of a "buildup of infection" in continual-throughput housing for neonatal animals has been recognized for decades and has been translated to many observations of risk for neonatal disease associated with suboptimal hygiene and stocking density in both pen and paddock birthing areas. Details for the individual species are provided in the section on perinatal disease.

#### Age at Exposure

With several agents that produce neonatal disease, the age of the neonate at infection and the infecting dose have a significant influence on the outcome. Examples are the importance of age with respect to susceptibility to disease associated with some enteric infections. Disease associated with enteropathogenic *E. coli* and with *C. perfringens* types B and C occurs only in young animals, and if infection can be avoided by hygiene in this critical period, disease will not occur regardless of subsequent exposure. Colostrum-deprived calves show significant resistance to challenge at 7 days of age with strains of *E. coli* that invariably produce septicemic disease if challenged at the time of birth, and isolation of

an immunocompromised neonate is an important factor in its survival. Thus the management of the neonate and its environment is a critical determinant of its health. Age at exposure also varies with the epidemiology of the pathogen, and segregated early weaning is used to reduce transmission of and infection with certain pathogens in pigs.

### Animal Risk Factors

Animal risk factors that predispose to infection include those that interfere with sucking drive and colostrum intake, such as cold stress and dystocia. These are detailed in the preceding section on perinatal disease.

### PATHOGENESIS

The pathogenesis varies with the neonatal infectious disease under consideration and is given for each of these in the special medicine section.

An infection can remain localized at the initial site of infection, as is the case with uncomplicated omphalitis or enterotoxigenic *E. coli* infection, or it can spread by invading the organism (e.g., via the nasopharynx, the gastrointestinal tract, or the umbilical vein or urachus). In the latter case the usual pattern of development is bacteremia followed by **septicemia** with severe systemic signs, or **bacteremia** with few or no systemic signs followed by **localization** in various organs.<sup>2</sup> **Localization** is most common in the joints, producing a suppurative or nonsuppurative arthritis. Less commonly there is localization in the eye to produce panophthalmitis, in the heart valves to cause valvular endocarditis, or in the meninges to produce meningitis.

Secondary lesions often take time to develop, and signs usually appear at 1 to 2 weeks of age. This is especially true with some of the streptococcal infections, in which bacteremia may be present for several days before localization in the joints and meninges produces clinical signs. Bacterial meningitis in newborn ungulates is preceded by bacteremia followed by a fibrinopurulent inflammation of the leptomeninges, choroid plexuses, and ventricle walls, but it does not affect the neuraxial parenchyma. It is proposed that the bacteria are transported in monocytes, which do not normally invade the neuraxial parenchyma.

Dehydration and acid–base and electrolyte imbalance can occur very quickly in newborn animals, whether diarrhea and vomiting (pigs) are present or not, but obviously are more severe when there is fluid loss into the gastrointestinal tract. In gram-negative sepsis the prominent signs are those of endotoxemia.

### CLINICAL FINDINGS

The clinical findings depend on which organ systems are affected, the rapidity of growth of the organism, its propensity to localize,

and its potential to produce toxemia. Clinical signs are often vague and unspecific in the initial phase of septicemia until the infection localizes and affects one or several organs.<sup>1,2</sup> Organisms that have a low propensity for toxemia present with fever, depression, anorexia, and signs referable to localization. These include endocarditis with a heart murmur; panophthalmitis with pus in the anterior chamber of the eye; meningitis with rigidity, pain, and convulsions; and polyarthritis with lameness and swollen joints. With more virulent organisms there are clinical signs of toxemia and bacteremia, including fever, and advanced stages result in hypothermia, severe depression, obtundation, coma, petechiation of mucosae, dehydration, acidemia, and rapid death.

The clinical and clinicopathologic characteristics of the septicemic foal were detailed in an outbreak of septicemia in colostrum-deprived foals and in the clinical records of 38 septicemic foals admitted to a referral clinic. The major clinical findings included lethargy, unwillingness to suck, inability to stand without assistance but remaining conscious, unawareness of environment and thrashing or convulsing, diarrhea, respiratory distress, joint distension, central nervous system abnormalities, uveitis, and colic. Fever was not a consistent finding.

A **sepsis score** has been developed for foals based on 14 measures related to historical, clinical, and laboratory data (Table 19-11). The score derived from the collective differential scoring of these data has been found to be more sensitive and specific for infection than any parameter taken individually. However, a subsequent study of 168 foals presented to a university hospital found that the sepsis score correctly predicted sepsis in 58 out of 86 foals and nonsepsis in 24 out of 45 foals, resulting in a sensitivity of 67%, a specificity of 75%, a positive predictive value of 84%, and a negative predictive value of 55%, and it was suggested that the score system should be used with care because the low negative predictive value limited its clinical utility.

A sepsis score for calves, based on fecal consistency, hydration, behavior, ability to stand, state of the umbilicus and degree of injection of scleral vessels, and presence of hypoglycemia and abnormal neutrophil cell count, was found to have reasonable predictive value.<sup>3</sup>

The clinical findings specific to individual etiologic agents are given under their specific headings in the special medicine section of this book.

### CLINICAL PATHOLOGY

Clinical pathology is used as an integral part of the evaluation of a sick neonate and to help formulate a treatment plan. A major evaluation is to attempt to confirm the presence or absence of sepsis, and this type of evaluation has been developed most successfully in the

foal. **Blood culture** is part of this examination, but the time for a positive result limits its value in the acutely ill neonate. Laboratory findings in foals with neonatal sepsis are variable and depend on the severity, stage, and site of infection. **Serial examinations** are commonly used. In examinations relating to the possible presence of septicemia, particular emphasis is placed on the results of the white blood cell and differential counts, the presence of toxic change (toxic granulation and vacuolization), serum immunoglobulin concentrations, arterial oxygen concentrations, the presence of metabolic acidosis, abnormal blood glucose concentrations, and elevated fibrinogen levels.<sup>1,4</sup>

### DIFFERENTIAL DIAGNOSIS

- The principles of diagnosis of infectious disease in newborn animals are the same as for older animals. However, in outbreaks of suspected infectious disease in young animals, there is usually a need for more diagnostic microbiology and pathology.
- With outbreaks, owners should be encouraged to submit all dead neonates as soon as possible for a meaningful necropsy examination.
- In addition to postmortem examination, it is necessary to identify the factors that may have contributed to an outbreak of disease in newborn calves, piglets, or lambs, and only detailed epidemiologic investigation will reveal these.

### TREATMENT

The first principle is to obtain an etiologic diagnosis if possible. Ideally a drug sensitivity of the causative bacteria should be obtained before treatment is given, but this is not always possible. It may be necessary to choose an **antibiotic** based on the tentative diagnosis and previous experience with treatment of similar cases.

Outbreaks of infectious disease are common in litters of piglets and groups of calves and lambs, and individual treatment is often necessary to maximize survival rate. Supportive fluid and electrolyte therapy and correction of acid–base disturbances are described in detail under “Disturbances of Free Water, Electrolytes, and Acid–Base Balance.”

The provision of **antibodies** to sick and weak newborn animals through the use of blood transfusions or serum is often practiced, especially in newborn calves in which the immunoglobulin status is unknown. Whole blood given at the rate of 10 to 20 mL/kg body weight, preferably by the intravenous route, will often save a calf that appears to be in shock associated with neonatal diarrhea. The blood is usually followed by fluid therapy. Serum or plasma can also be given at half the dose rate. The blood should not be taken from a cow near parturition because the circulating immunoglobulins

**Table 19-11** Worksheet for calculating a sepsis score for foals less than 12 days of age

Variable	NUMBER OF POINTS TO ASSIGN					Score for this case
	4	3	2	1	0	
1. Historical data						
a. Placentitis, vulvar discharge before delivery, dystocia, sick dam, induced parturition		Present			Absent	
b. Gestation length (days)		<300	300–310	311–330	>330	
2. Clinical examination						
a. Petechiation or scleral injection (nontraumatic)		Marked	Moderate	Mild	None	
b. Rectal temperature (° C)			>38.9	<37.8	37.9–38.7	
c. Hypotonia, convulsions, coma, depression			Marked	Moderate	Mild	
d. Anterior uveitis, diarrhea, respiratory distress, swollen joints or open wounds		Present			Absent	
3. Hemogram						
a. Neutrophil count (cells × 10 <sup>9</sup> /L)		<2.0	2.0–4.0 or 8.0–12.0	4.0–8.0		
b. Band neutrophils (cells × 10 <sup>9</sup> /L)		>0.2	0.05–0.2		<0.05	
c. Toxic changes in neutrophils	Marked	Moderate	Slight		None	
d. Fibrinogen concentration (g/L)			>6.0	4.1–6.0	4.0	
4. Laboratory data						
a. Blood glucose (mmol/L)			<2.7	2.7–4.4	>4.4	
b. IgG concentration (g/L)	<2.0	2.0–4.0	4.1–8.0		>8.0	
c. Arterial oxygen tension (Torr)		<40	40–50	51–70	>70	
d. Metabolic acidosis (base excess < 0)				Present	Absent	
Total points for this foal						

To calculate the sepsis score, assign foal a score corresponding to the historical physical examination and laboratory data included in the table. A score of 11 or less predicts the absence of sepsis correctly in 88% of cases, whereas a score of 12 or higher predicts sepsis correctly in 93% of cases. For foals less than 12 hours of age that have nursed or received colostrum, assign a value of 2 for the serum immunoglobulin score. If the foal has not nursed, assign a value of 4.

will be low from the transfer into the mammary gland.

Plasma is often incorporated into the therapeutic regimen in foals, both for its immunoglobulin content and for its effect on blood volume and osmotic pressure. Stored plasma can be used. A dose of 20 mL plasma/kg body weight given slowly intravenously is often used, but significantly higher doses are required to elevate circulating immunoglobulins by an appreciable amount. Blood may be collected, the red blood cells allowed to settle, and the plasma removed and stored frozen. The donor plasma should be prescreened for compatibility. Lyophilized hyperimmune equine serum as a source of antibodies may also be fed to foals within 4 hours after birth. Good nursing care is also essential.

Further information on treatment is given in the section on critical care for the newborn later in this chapter.

## CONTROL

Methods for avoidance of failure of transfer of passive immunity and the principles for prevention of infectious disease in newborn farm animals follow in this chapter. The control of individual diseases is given under specific disease headings elsewhere in this book.

## REFERENCES

1. Sanchez LC. *Vet Clin North Am Equine Pract.* 2005;21:273-293.

2. Fecteau G, et al. *Vet Clin North Am Food Anim Pract.* 2009;25:195-208.
3. Biolatti C, et al. *Schweiz Arch Tierheilkd.* 2012;154:239-246.
4. Holis AR, et al. *J Vet Intern Med.* 2008;22:1223-1227.

## PRINCIPLES OF CONTROL AND PREVENTION OF NEONATAL INFECTIOUS DISEASES

The four principles of control and prevention of infectious diseases of newborn farm animals are as follows:

- Reduction of risk of acquisition of infection from the environment
- Removal of the newborn from the infectious environment if necessary
- Increasing and maintaining the nonspecific resistance of the newborn
- Increasing the specific resistance of the newborn through the use of vaccines

The application of each of these principles will vary depending on the species, the spectrum of diseases that are common on that farm, the management system, and the success achieved with any particular preventive method used previously.

## REDUCTION OF RISK OF ACQUISITION OF INFECTION FROM THE ENVIRONMENT

The animal should be born in an environment that is clean, dry, sheltered, and conducive for the animal to get up after birth, suck the dam, and establish bonding.<sup>1,2</sup> Calving

and lambing stalls or grounds, farrowing crates, and foaling stalls should be prepared in advance for parturition. No conventional animal area can be sterilized, but it can be made reasonably clean to minimize the infection rate before colostrum is ingested and during the first few weeks of life when the newborn animal is very susceptible to infectious disease.

With seasonal calving or lambing there can be buildup of infection in the birth area, and animals born later in the season are at greater risk of disease. In these circumstances it may be necessary to move to secondary lambing or calving areas. In northern climates snow may constrict the effective calving area and result in a significant buildup of infection. Buildup of infection pressure must be minimized by a change to a fresh calving/lambing area and by the frequent movement of feed bunks or feed areas. Any system that concentrates large numbers of cattle in a small area increases environmental contamination, and close confinement of heifers and cows around calving time is a known risk factor for calf mortality. With large herds both the cow herd and heifer herd should be broken into as many subgroups as is practical. Extensive systems where cows calve out over large paddocks are optimal, and with more intense systems a group size no larger than 50 has been suggested.

Lambing sheds and calving areas for beef cattle should be kept free of animal traffic during the months preceding the period of



parturition. In dairy herds, maternity pens separate from other housing functions should be provided and cleaned and freshly bedded between calvings. Certainly they should not also be used as hospital pens.

In swine herds, the practice of batch farrowing, with all-in all-out systems of management and disinfection of the farrowing rooms, is essential. Sows should be washed before entry to the farrowing area, and the floor of the farrowing crate should be of the type that minimizes exposure of the piglet to fecal material at birth.

The swabbing of the **navel** with tincture of iodine or chlorhexidine solutions to prevent entry of infection is commonly practiced by some producers and seldom by others. In a heavily contaminated environment it is recommended, although hard evidence supporting the efficacy of this procedure is currently lacking.<sup>1</sup> Severance of the umbilical cord too quickly during the birth of foals can deprive the animal of large quantities of blood, which can lead to neonatal maladjustment syndrome.

When deemed necessary, some **surveillance** should be provided for pregnant animals that are expected to give birth, and assistance provided if necessary. The major objective is to avoid or minimize the adverse effects of a difficult or slow parturition on the newborn and the dam. Physical injuries, hypoxia, and edema of parts of the newborn will reduce the vigor and viability of the newborn and, depending on the circumstances and the environment in which it is born, may lead to disease or even death soon after birth.

When possible, every effort should be made to minimize exposure of the neonate to extremes of temperature (heat, cold, snow). Shelter sheds should be built if necessary.

In beef herds, the practice of purchasing male dairy calves to foster on to cows whose calves have died should be discouraged. If calves are purchased, they should be from a herd whose health status is known to the veterinarian and certainly never through a market. Similarly, colostrum should be obtained from cows within the herd and stored frozen for future use. Colostrum obtained from a different herd presents a biosecurity risk because it can transmit diseases such as bovine enzootic leukemia or John's disease. Furthermore, purchased dairy colostrum is commonly second- or third-milking colostrum and of limited immunologic value. The use of a commercial colostrum supplement or replacer is possible, although they have significant limitations.

### REMOVAL OF THE NEWBORN FROM THE INFECTIOUS ENVIRONMENT

In some cases of high animal population density (e.g., a crowded dairy barn) and in

the presence of known disease, it may be necessary to transfer the newborn to a noninfectious environment temporarily or permanently. Adult cows shedding enteric pathogens are a risk for calf infection. Thus dairy calves are often removed from the dam at birth and placed in individual pens inside or outdoors in hutches and reared in these pens separately from the main herd. This reduces the severity of neonatal diarrhea and pneumonia and risk for mortality compared with calves allowed to remain with the dam.

**Individual housing** in hutches is preferred because this avoids navel sucking and other methods of direct-contact transmission of disease. Humans entering these hutches should also practice interhutch hygiene. The prevalence of disease is higher in enclosed artificially heated barns than in hutches. However, despite the well-established value of individual rearing of calves, animal welfare regulations in several countries require that there be visual and tactile contact between calves. The removal of the cow-calf pair from the main calving grounds to a "nursery pasture" after the cow-calf relationship (neonatal bond) is well established, at 2 to 3 days of age, has proved to be a successful management practice in beef herds. This system moves the newborn calf away from the main calving ground, which may be heavily contaminated because of limited space. It necessitates that the producer must plan the location of the calving grounds and nursery pastures well in advance of calving time. Calves that develop diarrhea in the calving grounds or nursery pasture are removed with their dams to a "**hospital pasture**" during treatment and convalescence. The all-in all-out principle of successive population and depopulation of farrowing quarters and calf barns is an effective method of maintaining a low level of contamination pressure for the neonate.

### INCREASING THE NONSPECIFIC RESISTANCE OF THE NEWBORN

Following a successful birth, the next important method of preventing neonatal disease is to ensure that the newborn ingests colostrum as soon as possible. With natural sucking the amount of colostrum ingested by the neonate will depend on the amount available, the vigor of the animal, the acceptance by the dam, and the management system used, which may encourage or discourage the ingestion of liberal quantities of colostrum. Beef cows that calve at a condition score lower than 4 (out of 10) are at higher risk of having calves that develop failure of transfer of passive immunity, and the ideal condition score at calving is 5 to 6.

The method of colostrum delivery that is needed to optimize transfer of passive immunity to the dairy calf will vary with the breed of cow, the management level of the farm, and the priority given to calf health. Owner

acceptance of alternate feeding systems to natural sucking also is a consideration. The success of the farm policy for the feeding of colostrum is easily monitored by one of the tests described earlier, as is the effect of an intervention strategy.

Newborn male dairy calves are commonly assembled and transported to market or to calf-rearing units within a few days of birth. Studies have repeatedly shown high rates of FTPI in this class of calf. The high rates occur either because the original owner does not bother to feed colostrum to the calf, knowing it is to be sold, or because calves are purchased off the farm before colostrum feeding is completed. The effects of the transportation can have a further deleterious effect on the defense mechanism of the calves, and they are at high risk of disease.

Calf-rearing units should preferably purchase calves directly from a farm with an established policy of feeding colostrum before the calf leaves the farm, and every effort should be made to reduce the stress of transportation by providing adequate bedding, avoiding long distances without a break, and attempting to transport only calves that are healthy. In some countries there is now legislation requiring the feeding of colostrum and limiting the transport of newborn calves.

The honesty of the stated farm colostrum feeding policy can be monitored by testing the calves for their immunoglobulin concentration in serum. Where this is not possible and market calves must be used, the entry immunoglobulin concentration should be tested; the incidence of infectious disease in low-testing calves will be high unless hygiene, housing, ventilation, management and nutrition are excellent. The entry immunoglobulin concentration of calves entering veal or other calf-rearing units is a prime determinant of subsequent health and performance. The "alert" cut-point can be established for an individual farm by monitoring of individual immunoglobulin concentrations and subsequent calf fate.

Following the successful ingestion of colostrum and establishment of the neonatal bond, emphasis can then be given to provision, if necessary, of any special nutritional and housing requirements. Newborn piglets need supplemental heat, and attention must be given to the special problems of intensive pig husbandry. Orphan and weak piglets can now be reared successfully under normal farm conditions with the use of milk replacers containing added porcine immunoglobulins. Heat is often provided to lambs for the first day in pen lambing systems.

**Milk replacers** for the newborn must contain high-quality ingredients. Calves younger than 3 weeks are less able to digest nonmilk proteins, and the fats best used by the calf are high-quality animal source fats and slightly unsaturated vegetable oils. A 22% crude protein is recommended for milk

replacers comprised only of milk proteins and 24% to 26% in replacers that contain nonmilk protein sources. The level of fat should be at least 15%; higher fat concentration will provide additional energy, which may be required in colder climates. Feeding utensils must be cleaned and disinfected between each feeding if disease transmission is to be minimized.

With animals at pasture, the mustering and close contact associated with management procedures such as castration and docking pose a risk for disease transmission. These procedures should be performed in yards prepared for the purpose—preferably temporary yards erected for this sole purpose in a clean area.

### INCREASING THE SPECIFIC RESISTANCE OF THE NEWBORN

The specific resistance of the newborn to infectious disease may be enhanced by vaccination of the dam during pregnancy to stimulate the production of specific antibodies that are concentrated in the colostrum and transferred to the newborn after birth. Vaccination of the dam can provide protection for the neonate against enteric and respiratory disease. Details are given under the specific disease headings in this text. The vaccination of the late fetus in utero stimulates the production of antibody but its practical application has yet to be determined.

### FURTHER READING

- Black L, Francis ML, Nicholls MJ. Protecting young domestic animals from infectious disease. *Vet Annu.* 1985;25:46-61.
- Brenner J. Passive lactogenic immunity in calves: a review. *Israel J Vet Med.* 1991;46:1-12.
- Dwyer CM. The welfare of the neonatal lamb. *Small Rumin Res.* 2008;76:31-41.
- Godsen S. Colostrum management for dairy calves. *Vet Clin North Am Food Anim Pract.* 2008;24:19-39.
- Larson RL, Tyler JW, Schultz LG, Tessman RK, Hostetler DE. Management strategies to decrease calf death losses in beef herds. *J Am Vet Med Assoc.* 2004;224:42-48.
- Mee JF. Newborn dairy calf management. *Vet Clin North Am Food Anim Pract.* 2008;24:1-17.

### REFERENCES

- Mee JF. Newborn dairy calf management. *Vet Clin North Am Food Anim Pract.* 2008;24:1-17.
- Dwyer CM. The welfare of the neonatal lamb. *Small Rumin Res.* 2008;76:31-41.

## COLIBACILLOSIS OF NEWBORN CALVES, PIGLETS, LAMBS, KIDS, AND FOALS

### SYNOPSIS

**Etiology** Pathogenic serotypes of *Escherichia coli*: septicemic, enterotoxigenic (ETEC); enteropathogenic (EPEC); enterohemorrhagic (EHEC), also referred to as verocytotoxigenic (VTEC) or Shiga-toxin-

producing (STEC); and necrotoxicogenic *E. coli* (NTEC).

**Epidemiology** Affects newborn calves, piglets, lambs, and goat kids. Risk factors include colostrum deprivation, overcrowding, adverse climatic conditions, and inferior milk replacers. Prevalence of ETEC varies between herds. EHEC (O157:H7) in cattle is not normally associated with clinical disease, but it presents a major zoonotic concern.

**Signs** Weakness and collapse (septicemia), diarrhea, and dehydration; complications such as meningitis or polyarthritis.

**Clinical pathology** Isolation of organism from feces or blood; hematology and serum biochemistry to evaluate inflammation and acid-base and electrolyte imbalance.

**Lesions** Septicemic lesions, dehydration, enteritis.

**Diagnostic confirmation** Culture of organism and serotyping.

**Treatment** Antimicrobials, antiinflammatory drugs, fluid and electrolyte therapy.

**Control** Reduce infection pressure on neonates. Ensure adequate transfer of passive immunity, and vaccinate pregnant dams to induce specific colostrum antibody. Minimize stressors and their effect on neonates.

### ETIOLOGY

Colibacillosis is associated with pathogenic serotypes of *E. coli*. For the most part, *E. coli* is a group of harmless bacteria that serve as indicator organisms for fecal contamination and breaches in hygiene. However, several strains have acquired virulence factors, turning them into potentially dangerous pathogens.<sup>1</sup> The prevalence of the different pathogenic serotypes of *E. coli* in farm animals has remained relatively constant for many years. Certain serotypes cause diarrhea and others cause septicemia. Serotypes include the following:

- Enterotoxigenic *E. coli* (ETEC)** is the most common enteropathogen that causes diarrhea in newborn farm animals. The bacteria cause diarrhea by adhering to enterocytes, colonizing the intestinal mucosa, and **producing enterotoxins**. Enterotoxins cause hypersecretion of electrolytes and water into the small intestine without causing significant morphologic damage or invading tissue.<sup>2</sup>
- Enteropathogenic *E. coli* (EPEC)** are the “**attaching and effacing**” strains that colonize the small intestine, where they attach tightly to the epithelial cells of the villus and cause typical **attaching and effacing lesions**. They do not produce toxins and seldom invade the intestinal mucosa.

- Enterohemorrhagic *E. coli* (EHEC)** also cause attaching and effacing lesions and are among the *E. coli* strains capable of producing toxins similar to the one produced by *Shigella dysenteriae* type I. They are therefore also referred to as **Shiga-toxin-producing *E. coli* (STEC)**. Because Shiga toxins are detected with the Vero cell-toxicity test, STEC are also known as **verotoxin or verocytotoxin-producing *E. coli* (VTEC)**. Shiga toxins may cause anything from mild diarrhea to severe hemorrhagic colitis. In humans EHEC is responsible for the highly fatal hemolytic-uremic syndrome in children.<sup>3</sup> **EHEC are highly prevalent in cattle** but in general do not cause clinical disease in this species, although some Shiga-toxin-producing *E. coli* have been associated with diarrhea in calves. Cattle are the main reservoir of *E. coli* O157:H7, one of the important EHEC strains, causing a broad range of clinical disease in humans (see the section on enterohemorrhagic *E. coli* in farm animals and zoonotic implications). Shiga-toxin-producing *E. coli* strains have been associated with edema disease in swine.<sup>2</sup>
- Necrotoxicogenic *E. coli* (NTEC)** strains produce cytotoxic necrotizing factor (CNF)1 or 2. NTEC2 isolates are restricted to ruminants, particularly calves and lambs with diarrhea and septicemia.
- Septicemic *E. coli*** strains of serogroup O78 are invasive and cause septicemia in calves, piglets, and lambs. Their powerful endotoxins cause endotoxic shock, with a high case fatality rate.

### EPIDEMIOLOGY

#### Occurrence and Prevalence of Infection

The prevalence of colibacillosis has increased in recent years. There are several possible reasons for this, including size of herds, shortage of qualified labor, automated livestock-rearing systems, and increased population density.

Colibacillosis occurs most commonly in newborn farm animals and is a significant cause of economic loss in raising livestock. It is a complex disease in which several different risk factors interact with certain pathogens, resulting in the disease. There are at least two different types of the disease: **enteric colibacillosis** is characterized by varying degrees of diarrhea, dehydration, acidosis, and death in a few days if not treated; **coli-form septicemia** is characterized by severe illness and rapid death within hours.

#### Cattle and Calves

The infection prevalence of **enterohemorrhagic *E. coli***, particularly the *E. coli* O157:H7 strain, has been studied extensively because of concerns with beef and raw milk as source

of foodborne disease in humans. In the United States *E. coli* O157:H7 infection prevalence rates based on positive fecal samples were between 0.2% and 8.4% for cows, 1.6% and 3.0% for heifers, and 0.4% to 40% for calves. Infection prevalence rates reported from Canada, Italy, Japan, and the United Kingdom were 0.3% to 16.1% for cows, 10.0% to 14.1% for heifers, and 1.7% to 48.8% for calves.<sup>4</sup> These numbers underscore the obvious effect of animal age on the epidemiology of infection with *E. coli* O157:H7. The **considerable prevalence of this EHEC strain** in cattle has little impact on animal health because EHEC infection in this species is normally not associated with clinical disease, but it presents a **serious public health concern**.

The prevalence of **enterotoxigenic *E. coli* (ETEC)** in diarrheic calves varies widely geographically, between herds, and depending on the age of the animals. The prevalence can be as high as 50% to 60% in diarrheic calves under 3 days of age and only 5% to 10% in diarrheic calves 8 days of age. In some countries the prevalence is only 5% to 8% in diarrheic calves under 3 days of age. Thus **enterotoxigenic colibacillosis is a major cause of diarrhea in calves less than 3 days of age** and is not associated with outbreaks of diarrhea in calves older than 3 days. ETEC infection in calves older than 2 to 3 days will in most cases be associated with a viral infection. The prevalence of ETEC infection is very low or nil in clinically normal calves in herds that have not had a problem with diarrhea. In some beef herds affected with diarrhea in young calves there may be little evidence of infection with enterotoxigenic *E. coli*, and other factors need to be examined.

### Piglets

The prevalence of ETEC in diarrheic piglets varies geographically and with herds. In some areas the F5 (K99) pilus was found more frequently than F4 (K88) or F6 (987P), whereas in other regions the F4 pilus is more common. The F4 and F18 pilus adhesins are most commonly associated with postweaning diarrhea of pigs.

### Morbidity and Mortality Rates Calves

In dairy calves raised under intensive and poorly managed conditions the morbidity rate of infection with ETEC may reach 75%, but it is usually about 30%. Case fatality rates vary from 10% to 50% depending on the level of clinical management.

In beef calves the morbidity rates vary from 10% to 50% and the case fatality rates from 5% to 25% or even higher in some years. The population mortality rate in both beef and dairy calves can vary from a low of 3% in well-managed herds to a high of 60% in problem herds in certain years.

### Piglets

In piglets the morbidity rate of preweaning diarrhea varies widely between herds, but it averages about 6% of litters, mostly in the first week of life. The morbidity rates increase with increased litter size and decrease with increasing parity of the sow. Losses as a result of stillbirths, traumatic injuries, starvation, and undersize at birth account for a much greater combined total preweaning loss, but colibacillosis accounts for approximately 50% of the gastroenteropathies encountered during the preweaning period.

Postweaning diarrhea (PWD) occurring in the 2 weeks following weaning is one of the economically most important diarrheal diseases in piglets in which colibacillosis plays an important etiologic role.<sup>5</sup> ETEC associated PWD commonly occurs in the immediate postweaning period. Outbreaks can occur suddenly, with mortality rates of 50% and higher. Affected animals can die acutely or show profuse diarrhea for up to 4 days. In uncomplicated cases mortality rates rarely exceed 10%.<sup>5</sup> Postweaning diarrhea of pigs is covered in detail under this heading.

### Risk Factors

Several risk factors influence the occurrence of the disease, each one of which must be considered, evaluated, and modified or removed if necessary when investigating the cause of an outbreak so that effective clinical management and control of the disease may be achieved.

### Animal Risk Factors

#### *Animal Species*

The pathogenesis of colibacillosis involves a number of host factors, of which the presence of specific receptors for adhesins and enterotoxins is probably among the most important.<sup>6</sup> Clinical disease associated with *E. coli* infection is largely dependent on the presence of specific receptors that usually only occur in one or few animal species, because of this receptor specificity of adhesins and enterotoxins, **ETEC strains have considerable species specificity**.<sup>7</sup>

#### *Age and Birth Weight*

Diarrhea associated with ETEC occurs in **calves** mainly during the first few days of life, rarely in older calves, and never in adults. Epidemiologic studies of both beef and dairy calves indicate that more than 80% of clinical cases associated with ETEC F5 (K99) occur in calves younger than 4 days of age. The ability of the F5 ETEC to adhere to the small intestinal epithelium of calves decreases continuously from 12 hours of age to 2 weeks of age.<sup>8</sup> The mechanism of this age-related resistance is not well understood, but it may be related to development of resistance to colonization of the small intestine as the calf becomes older. This could be associated with the replacement of villous

epithelial cells that occurs in the first few days after birth.

The disease is more common in **piglets** born from gilts than from sows, which suggests that immunity develops with developing age in the sow and is transferred to the piglets. In a survey of approximately 4400 litters of piglets over a period of 4 years in a large piggery, 64% of the litters were treated for diarrhea before weaning, and piglets born to sows under parity 2 were 1.7 times more likely to develop diarrhea before weaning than litters born to sows over parity 3. The susceptibility or resistance to *E. coli* diarrhea in piglets has an inherited basis. The cell surface receptor for the F4 (K88) antigen is inherited in a simple mendelian way, with adherence (S) dominant over nonadherence (s). Homozygous dominants (SS) and heterozygotes (Ss) possess the receptor and are susceptible, whereas in the homozygous recessive (ss) the receptor is absent and the pigs are resistant. The highest incidence of diarrhea occurs in susceptible progeny born from resistant dams and sired by susceptible sires. Most if not all pigs have intestinal receptors for F5 (K99<sup>+</sup>) pili and an inheritance pattern similar to F4 (K88) receptors does not exist for F5 receptors.

### *Immunity and Colostrum*

Newborn farm animals are agammaglobulinemic and must ingest colostrum and absorb colostrum immunoglobulin within hours of birth to obtain protection against septicemic and enteric colibacillosis. The transfer of immunoglobulin from the dam to the neonate is termed *transfer of passive immunity*. **Failure of transfer of passive immunity** predisposes the neonate to development of infectious diseases (see also the section “**Failure of Transfer of Passive Immunity**”).

Transfer of maternal immunoglobulin to calves depends on three successive processes:

- Formation of colostrum with a high concentration of immunoglobulin by the dam
- Ingestion of an adequate volume of colostrum by the calf
- Efficient absorption of colostrum immunoglobulin by the calf

Colostrum immunoglobulin is absorbed for up to 24 hours after birth in calves and up to 48 hours in piglets. However, in calves the maximum efficiency of absorption occurs during the first 6 to 12 hours after birth and decreases rapidly from 12 to 24 hours after birth. Following absorption, transfer to the intestinal lumen is a major means of IgG clearance in calves, and this transfer results in antigen-binding antibody in the intestinal lumen. Both blood-derived antibody and lactogenic antibody are significant sources of passive antibodies in the intestinal lumen of the neonatal calf. Maintenance of high concentrations of



milk-derived antibodies in the small intestinal lumen may require more than twice-a-day feedings because antibodies derived from a milk diet are predominantly cleared from the intestinal lumen by 12 hours after feeding. Transfer of passively acquired antibodies from the circulation to the small intestinal lumen is therefore a reasonable hypothesis to explain the strong association between high serum passive immunoglobulin concentrations and reduced morbidity in neonatal calves.

Newborn dairy calves should ingest 80 to 100 g of colostrum IgG, and ideally up to 150 g, within a few hours after birth to achieve serum immunoglobulin of 1000 mg/dL.

## Environmental and Management Risk Factors

### *Meteorologic Influences*

Although few epidemiologic data are available to support the claim, many veterinarians have observed a relationship between adverse climatic conditions and colibacillosis in both calves and piglets. During inclement weather, such as a snowstorm, a common practice in beef herds is to confine the calving cows in a small area, where they can be fed and watered more easily. The overcrowding is commonly followed by an outbreak of acute calf diarrhea. There is evidence that cold, wet, and windy weather during the winter months and hot, dry weather during the summer months have a significant effect on the incidence of dairy calf mortality.

The risk factors for mortality from diarrhea in beef calves in Alberta, Canada, have been examined. The odds of mortality were increased when the cows and heifers were wintered on the same grounds, when the herd was wintered and calved on the same grounds, and if the cows and heifers were calved on the same grounds. The morbidity and mortality rates from diarrhea during the first 30 days of life increased with an increasing percentage of heifers calving in the herd. Heifers are commonly more closely confined during the calving season for more effective observation and assistance at parturition. This may lead to increased contamination of the environment and the abdominal wall and udder of the heifers. Additional factors in heifers include a higher incidence of dystocia and maternal misbehavior and lower volume and quality of colostrum, all of which can result in weak calves that may not acquire sufficient colostrum immunity.

### *Nutrition and Feeding Methods*

Dairy calves fed milk substitutes may be more susceptible to acute undifferentiated diarrhea, some of which may be a result of enteric colibacillosis, compared with those fed cows' whole milk. Extreme heat treatment of the liquid skim milk in the processing of dried skim milk for use as milk

substitutes for calves results in denaturation of the whey protein, which interferes with digestibility of the nutrients and causes destruction of any lactoglobulins that are present and may have a protective effect in the young calf.

Irregular feeding practices resulting in dietetic diarrhea may contribute to a higher incidence of enteric colibacillosis in calves. The person feeding and caring for the calves is an important factor influencing calf mortality a result of diarrhea. Although it is generally thought that general or specific nutritional deficiencies, such as a lack of energy, protein, or vitamin A, in the maternal diet predispose to colibacillosis, particularly in calves and piglets, there is no direct evidence that specific nutritional deficiencies are risk factors. However, they probably are, at least in indirect ways, for example, by having an effect on the amount of colostrum available at the first milking after parturition in first-calf heifers underfed during pregnancy.

### *Standard of Housing and Hygiene*

Housing and hygienic practices are probably the most important environmental risk factors influencing the incidence of colibacillosis in calves and piglets, but they have received the least amount of research effort compared with other aspects, for example, control of the disease through vaccination. As the size of herds has increased, and as livestock production has become more intensified, the quality of hygiene and sanitation, particularly in housed animals, has assumed major importance. The disease is much less common when calves are run at pasture or are individually tethered, or penned, on grass.

### *Source of the Organism and Its Ecology and Transmission*

Ingestion is the most likely portal of infection in calves, piglets, and lambs, although infection via the umbilical vessels and nasopharyngeal mucosa can occur. It has been suggested that certain serotypes of *E. coli* may enter by the latter route and lead to the development of meningitis.

In most species, it is assumed that the primary source of the infection is the feces of infected animals, including the healthy dams and neonates, and diarrheic newborn animals, which act as multipliers of the organisms. In some cases, the organism may be cultured from the vagina or uterus of sows whose litters become affected. In pig herds the total number of organisms on each sow is highest in the farrowing barn, decreases when the sow is returned to the breeding barn, and is lowest when the sow is in the gestation barn.

Calves acquire the infection from contaminated bedding and calf pails, dirty calf pens, nearby diarrheic calves, overcrowded calving grounds, and the skin of the perineum

and udder of the cow. The organism is spread within a herd through the feces of infected animals and all the inanimate objects that can be contaminated by feces, including bedding, pails, boots, tools, clothing, and feed and water supplies. The organism is one of the first encountered by newborn farm animals, usually within minutes after birth. In cattle, the tonsil can be a reservoir for STEC in healthy animals. It is possible that virulent *E. coli* can be present and may be transferred to calves when they are licked by their dams at birth. The high population density of animals that occurs in overcrowded calving grounds in beef herds and heavily used calving pens in dairy herds and the continuous successive use of farrowing crates without a break for cleanup contribute to a large dynamic population of *E. coli*. The population of bacteria in an animal barn will continue to increase with the length of time the barn is occupied by animals without depopulation, clean-out, disinfection, and a period of vacancy. In some countries where lambing must be done in buildings to avoid exposure to cold weather, the lambing sheds may become heavily contaminated within a few weeks, resulting in outbreaks of septicemic and enteric colibacillosis.

Infected animals are the main reservoir for ETEC, and their feces are the major source of environmental contamination with the bacteria. Passage of the *E. coli* through animals causes a "multiplier effect"; each infected animal excretes many more bacteria than it originally ingested. Diarrheic calves are the most extreme multipliers because they often pass 1 L or more of liquid feces containing  $10^{10}$ /g ETEC within 12 hours, and recovered calves can continue to shed bacteria for several months.

Normal calves and adult cows can serve as reservoirs of infection, and the bacteria can persist in a herd by circulating through animals of all ages. Carrier animals introduced to an uninfected herd are thought to be one of the main causes of natural outbreaks. The duration and amount of shedding probably depend on the degree of confinement, resulting population density, herd immunity, environmental conditions, and perhaps the serotype of the organism.

## Pathogen Risk Factors

### *Virulence Factors of E. coli*

Virulence factors of *E. coli* include *pili* (*fimbriae*), *enterotoxins* (*exotoxins*), *endotoxins*, and *capsules*. The adhesins in the pili of ETEC allow them to adhere to intestinal villous epithelial cells and prevent peristaltic elimination by the gut and to produce enterotoxins.

The virulence factors are relevant to vaccine efficacy. The species-specific adhesin antigens must be identified and incorporated into vaccines, which are given to pregnant females in an attempt to stimulate the production of specific antibody in the

colostrum, which will provide protection against enterotoxigenic colibacillosis. An essential element of vaccine development is the detection of common fimbrial antigens occurring among most pathogenic isolates and able to induce antibodies that block bacterial adhesion. The great diversity of potential pathogenic serotypes encountered in colisepticemia and the failure of serotype-specific antibody to cross-protect against a heterologous challenge in experimental infection have made it difficult to develop vaccines against septicemic colibacillosis.

The major virulence factors of ETEC in calves are the F5 (K99) adhesin antigen and the heat-stable enterotoxin (ST). The colonization in the small intestine of calves by F5 ETEC appears to be site specific, having a predilection for the ileum. Some serogroups also elaborate the F41 adhesin to the F5. Other surface-adhesive antigens, such as Att 25 and F17, have been identified on bovine enteropathogenic and septicemic *E. coli*. The F17a-positive ETEC strains are no longer isolated from diarrheic calves in some countries. It is postulated that the use of a vaccine including O101, K32, and H9 antigens in addition to F5 explains the strongly reduced incidence of the O101:K32:H9, F5 *E. coli* clone. A F4-related fimbrial antigen occurs on some enterotoxigenic and septicemic strains.

Enterotoxins are plasmid-regulated secreted peptides of ETEC bacteria that affect the intestinal epithelium. Two types of enterotoxins are differentiated, large-molecular-weight (88 kDA) heat-labile enterotoxins (LT) and small-molecular-weight heat-stable enterotoxins (ST).<sup>7</sup> LT enterotoxins are predominantly produced by human and porcine ETEC strains, whereas ST enterotoxins are produced by human, porcine, and bovine ETEC strains. The heat-stable enterotoxin from bovine ETEC has been purified and characterized. There is evidence of a form of ST enterotoxin that is common to bovine, porcine, and human strains of ETEC.

Most strains of **septicemic *E. coli*** belong to certain serogroups with virulence properties that enable them to resist the defense mechanisms that would normally eliminate other *E. coli*. **Septicemic strains produce endotoxin**, which results in shock and rapid death, usually in calves that are less than 5 days of age and with FTPI. Isolates of *E. coli* from the blood of critically ill bacteremic calves on a calf-rearing farm in California constituted a heterogeneous group and were found to be aerobactin positive and often resistant to the bactericidal effects of serum. The relative importance of individual serogroups varies between countries. However, it has been established that typeable isolates of *E. coli* from septic calves belong to a relatively small number of serogroups.<sup>9</sup> Strains commonly isolated from calves with septicemia belong to serogroups O78 and O15.<sup>9,10</sup>

**Enterohemorrhagic *E. coli* (EHEC) and Shiga-toxin-producing *E. coli* (STEC)** are recognized in humans and animals with increased frequency and constitute a major zoonotic concern (see the discussion of enterohemorrhagic *E. coli* in farm animals and zoonotic implications). These organisms are members of O111, O103, O5, and O26 serogroups, and none produces enterotoxin, nor do they possess the F5 pili. They produce the potent Shiga toxins or verotoxins SLT1 and SLT2; and some strains, the **attaching and effacing *E. coli* (AEEC)**, attach to and efface the microvilli of the enterocytes, causing diarrhea and dysentery as a result of hemorrhagic colitis in calves 2 to 5 weeks of age. The effacing (*eae*) gene and the gene coding for the Shiga toxin 1 (*SLT1*) are associated with most isolates of AEEC in cattle. They have been isolated from both diarrheic and healthy sheep and goats.

A study of the onset and subsequent pattern of shedding of STEC O26, O103, O111, O145, and O157 in a cohort of beef calves on a mixed cattle and sheep farm in Scotland found that O26 was shed by 94% of the calves and that 90% of the O26 isolates carried the *vtx1*, *eae*, and *ehf* genes. *E. coli* O103 was the second most commonly shed serogroup of the tested calves, and the pattern of shedding was sporadic and random. There was an absence of shedding of *E. coli* O111, and the prevalence of shedding of O145 was low. Although some shedding of O157 occurred, shedding in calves was sporadic and infrequent. For O26, O103, and O157, there was no association between shedding by calves and shedding by dams within 1 week of birth. For O26 and O103, there was no association between shedding and diarrhea and no significant change in shedding following housing. In a sample of Australian dairy farms, calves as young as 48 to 72 hours had evidence of fecal excretion of STEC, indicating that dairy cattle are exposed to STEC from birth. Calves at weaning are most likely to shed STEC O26 or *E. coli* O157, similar to the prevalence surveys in the northern hemispheres.

Naturally occurring cases of attaching and effacing lesions of the intestines in calves with diarrhea and dysentery and infected with *E. coli* O126:H11, the predominant STEC strain in humans, have been described in the United Kingdom. STEC and *eae*-positive non-STEC have been isolated from diarrheic dairy calves 1 to 30 days of age.

*E. coli* O157 has been isolated from neonatal calves and has been implicated as a cause of diarrhea in calves. The isolates carried various virulence genes, such as *Ehly*, *eae*, *stx1*, and *stx2*. The *Ehly* gene may be a virulence marker for bovine enterohemorrhagic *E. coli* O157 strains. Similar findings have been reported in dairy cattle herds in Brazil. Strains of *E. coli* possessing a subtype beta intimin, normally found in human

enteropathogenic *E. coli*, have been found in diarrheic calves in Brazil.

Non-O157 STEC have been isolated from diarrheic calves in Argentina, and the serotypes carried virulence traits associated with increased pathogenicity in humans and cattle. Severe clinical syndromes associated with non-O157 STEC are common in children under 4 years of age and may be associated with diarrheic calves, which shed highly virulent STEC strains and could act as a reservoir and contamination source in these areas.

*E. coli* O116, a serogroup previously associated with cases of hemolytic-uremic syndrome in humans, has been associated with an outbreak of diarrhea and dysentery in 1- to 16-week-old calves in India. *E. coli* O103:H2, an STEC strain causing disease in humans, has been isolated from calves with dysentery and from a sheep in Australia.

**Necrotizing *E. coli* (NTEC)**, which produce **cytotoxic necrotizing factor (CNF)**, have been isolated from cattle in Northern Ireland and Spain and from diarrheic piglets in England. NTEC1 strains from cattle, pigs, and humans can belong to the same serogroups/biogroups, carry genes coding for adhesions belonging to the same families, and possess other identical virulence-associated properties, and they therefore do not exclude the possibility of cross-infection between humans and farm animals in some cases. In Spain NTEC were detected by tissue culture and PCR in 15.8% of diarrheic dairy calves from 1 to 90 days of age; the majority were NTEC producing CNF2, and the risk increased with age. There was also a strong association between CNF2 and F17 fimbriae. The NTEC, with their associated adhesins and toxins, were present in diarrheic and septicemic calves as early as 1958, and their prevalence seems to be increasing. Their role in causing disease needs further examination.

Most ETEC from **neonatal pigs** belong to the so-called "classical serogroups": O8:K87, O45, O138:K81, O141:K85, O147:K89, O149:K91, and O157:KXVX17. Strains of these serogroups usually express and produce F4 (K88), F5 (K99), F6 (987P), F18 and F41 pilus antigens. With the exception of F18, these pilus antigens mediate adhesion of *E. coli* to ileal villi in neonates, causing profuse diarrhea in unweaned pigs. The F4 and F5 pilated strains are the most common cause of enteric disease in piglets under 2 weeks of age. ETEC strains that produce F6 pili colonize the small intestines and cause diarrhea in neonatal pigs under 6 days of age, but not older pigs. F18, in contrast, is not associated with neonatal colibacillosis in piglets, but together with F4 is the most common adhesin associated with postweaning colibacillosis. There are also some ETEC strains that produce none of the antigens mentioned previously.

F4 produces heat-labile enterotoxin (LT), F5 and F6 do not produce LT, and all three

types produce heat-stable enterotoxin STa in infant mice. Some isolates produce neither LT nor STa but produce enterotoxin in ligated intestinal loops of pigs (STb). Other “nonclassical” strains colonize the small intestine to a certain extent, do not strongly adhere to the intestinal epithelium, and produce enterotoxin and diarrhea in neonatal piglets.

The porcine ETEC strains that induce diarrhea in piglets less than 2 weeks of age but not in older pigs are designated class 2, whereas those strains that induce diarrhea in older pigs are class 1 ETEC. The bovine ETEC strains have several features in common with the porcine class 2 organisms, which include the possession of the 0 antigens 8, 9, 20, or 101; characterization as mucoid colonies; possession of F5 pili; and production of heat-stable enterotoxin. Most ETEC strains of pigs belong to a restricted number of serogroups.

### Lambs

Enterotoxigenic strains of *E. coli* can be isolated from the feces of approximately 35% of diarrheic lambs. ETEC strains have also been isolated from the blood of a small percentage of diarrheic lambs. F5 (K99) piliated *E. coli* are associated with outbreaks of diarrhea in lambs under a few days of age. F17 fimbriae *E. coli* have been isolated from diarrheic lambs and kids, but none of the isolates produced any of the toxins normally associated with ETEC strains. Attaching and effacing *E. coli* negative for Shiga toxin but positive for *eae* have been isolated from goat kids affected with severe diarrhea, with a high case fatality rate.

### Zoonotic Implications of *E. coli*

Cattle are a major source of EHEC strain O157:H7, which is associated with food-borne disease in humans. (See “Enterohemorrhagic *Escherichia coli* in Farm Animals and Zoonotic Implications.”)

### PATHOGENESIS

The factors important in understanding the pathogenesis of colibacillosis are the affected species, the age and the immune status of the animal, and the virulence factors of the strain of *E. coli*, particularly its capacity to invade tissues and produce septicemia or to produce an enterotoxin. Diarrhea, dehydration, metabolic acidosis, bacteremia, and septicemia are the major pathogenetic events in the various forms of colibacillosis.

### Septicemic Colibacillosis (Coliform Septicemia)

Septicemic colibacillosis occurs in all species as a result of invasive strains of *E. coli* invading the tissues and systemic circulation via the intestinal lumen, nasopharyngeal mucosa, and tonsillar crypts, or umbilical vessels. The intestinal permeability to macromolecules in the newborn piglet may

predispose to the invasion of septicemia-inducing *E. coli*. These strains are able to invade extraintestinal tissues, to resist the bactericidal effect of complement in blood, to survive and multiply in body fluids, to escape phagocytosis and intracellular killing by phagocytes, and to induce tissue damage by the release of cytotoxins. Calves and piglets that are deficient in colostral immunoglobulins are highly susceptible to septicemia. Colostrum provides protection against colisepticemia, but it may not prevent diarrhea associated with *E. coli*. Also, colostrum-fed calves are much more resistant to endotoxin than colostrum-deprived calves. Calves, piglets, and lambs that have normal levels of serum immunoglobulins are generally protected from septicemia. The clinical findings and lesions in septicemic colibacillosis are attributable to the effects of endotoxin, which causes shock. The general effects of endotoxin in cattle include hypothermia, decreased systemic blood pressure, tachycardia and decreased cardiac output, changes in WBC counts, alterations in blood coagulation, hyperglycemia followed by hypoglycemia, and depletion of liver glycogen. Animals that recover from septicemia may later develop lesions as a result of local infection of other organs at varying periods of time. Arthritis is a common associated finding in calves, foals, and lambs. Meningitis is common in calves and piglets. Polyserositis as a result of *E. coli* has been recorded in pigs.

### Enteric Colibacillosis

#### Enterotoxigenic Colibacillosis

Enterotoxigenic strains of *E. coli* (ETEC) colonize and proliferate in the upper small intestine and produce enterotoxins, which cause an increase in net secretion of fluid and electrolytes into the gut lumen. The adhesion of *E. coli* to the intestinal epithelial cells is mediated by bacterial pili. The enterotoxigenic form of colibacillosis occurs most commonly in calves and piglets and less commonly in lambs and kids.

The factors that allow or control the colonization and proliferation of these strains and their production of enterotoxin are not well understood. The bacterial fimbriae attach to specific receptor sites on villous epithelial cells, following which the bacteria multiply and form microcolonies that cover the surface of the villi. The capsular polysaccharide of *E. coli* may also be involved in adhesion and colonization. The fimbriae of *E. coli* are strongly immunogenic, a factor that is utilized in the production of vaccines. Because the F5 antigen is only expressed at an environmental pH above 6.5, colonization of the mucosa of the small intestinal tract starts in the ileum, where the intraluminal pH is the highest, and progresses proximally from there.<sup>8</sup> Once established in the gut, ETEC strains start producing and secreting a heat-stable enterotoxin. Similar to the

expression of F5, production of enterotoxin is pH dependent, with very limited production at an environmental pH below 7.0.<sup>8</sup> Although this does not appear to have been studied specifically, it can be hypothesized that any factor resulting in an increase of the pH in the gut lumen will facilitate the proliferation of the organism; conversely, lowering the pH may reduce the severity of colibacillosis.

### Diarrhea, Dehydration, Metabolic Acidosis, and Electrolyte Imbalance

The production of the enterotoxin results in net secretion of fluid and electrolytes from the systemic circulation into the lumen of the intestine, resulting in varying degrees of diarrhea, dehydration, electrolyte imbalances, acidemia, circulatory failure, shock, and death. The hyperkalemia that is observed in a subset of calves with severe dehydration and acidemia has been associated with cardiac arrhythmias, including bradycardia and atrial standstill.

The effect of the enterotoxin on the gut of calves, piglets, and other species is similar to the effect of cholera enterotoxin in humans and takes place through an intact mucosa. Enterotoxin stimulates mucosal adenylcyclase activity, leading to an increase in cyclic adenosine monophosphate (AMP), which increases intestinal chloride secretion. The increased intraluminal chloride content osmotically drags water into the gut to an amount that exceeds the absorptive capacity of the intestinal mucosa, thereby causing diarrhea. The secretion originates primarily in the intestinal crypts, but the villous epithelium also has a secretory function. The mucosal membrane colonized by ETEC remains morphologically intact. The fluids secreted are alkaline and, in comparison to serum, isotonic, low in protein, and high in sodium and bicarbonate ions. Distension of the abdomen of diarrheic calves may occur, which may be associated with fluid distension of the abomasum and the intestines.

When the disease is confined to the intestine, it responds reasonably well to treatment in the early stages. If death occurs, it is a result of acidemia, electrolyte imbalance, and dehydration. The acid-base and electrolyte changes in piglets 1 to 3 days of age infected naturally and experimentally with ETEC reveal severe dehydration, acidemia, and metabolic acidosis.

Severe metabolic changes can occur in calves with diarrhea. If the disease is progressive, acidemia and metabolic acidosis become more severe as lactic acidosis develops, and severe hypoglycemia may occur. If large amounts of fluid are lost, hypovolemia and shock occur.

Historically, conventional wisdom held that **metabolic acidosis** in diarrheic calves is the result of fecal bicarbonate loss and formation of L-lactate as a result of increased anaerobic glycolysis in dehydrated animals



with decreased tissue perfusion. However, accumulation of L-lactate in neonatal diarrheic calves only appears to occur in calves in their first week of life. Because the relationship between L-lactic acid accumulation and the severity of metabolic acidosis could not be confirmed in clinical cases, it was proposed that exogenous acid supply to the organism must be the major contributor to the so-called **anion-gap acidosis** typically observed in diarrheic calves.<sup>12</sup> The anion gap, defined as the sum of the major cations minus the sum of the major anions, is a measure of “unspecified organic and inorganic acids,” of which lactic acid forms a considerable part. It was not until the end of last century that **D-lactic acid accumulation** was first identified as a major contributor to elevated anion gaps in diarrheic calves. In the meantime, several studies confirmed that D-lactic but not L-lactic acidosis is a common occurrence in diarrheic calves. Furthermore D-lactic acidosis was identified as a major contributory factor in calves with high anion-gap acidosis.<sup>12</sup> It is currently assumed that D-lactic acidosis is caused by increased intestinal absorption of this compound in diarrheic calves, where malabsorption results in bacterial fermentation of unabsorbed carbohydrates to D-lactate.<sup>12</sup> Recent retrospective studies suggested that the major driving factor of the acidemia of diarrheic calves was an increase in unmeasured anions, of which lactic acid forms a considerable part. The loss of fluid through the intestinal tract with high sodium and low chloride content is likely to contribute to the so-called strong-ion acidosis. The increase of the total plasma protein concentration that is commonly observed with marked dehydration and resulting in a so-called weak-acid acidosis was found to be a minor contributor to acidemia in diarrheic calves.<sup>13</sup>

The severity and nature of the acidosis in diarrheic calves vary with the age of the calf. Younger calves tend to dehydrate more rapidly and severely than older calves, which may be related to the greater incidence of enterotoxigenic colibacillosis in the young age group. The severity of dehydration, hypothermia, and acidemia is associated with the level of obtundation. Accordingly, the degree of deterioration of the patient's demeanor in combination with the age of the calf are used to predict the severity of acidemia; the more severe the acidemia, the greater the depression.

Conventional wisdom posits that neurologic effects such as ataxia, somnolence, or even coma are primarily caused by severe acidemia or metabolic acidosis, but a series of recent studies unequivocally demonstrated that disturbed neurologic function can better be explained by the frequently observed increase in plasma D-lactate concentration than acidemia/metabolic acidosis per se.<sup>14,15</sup> Experimental studies conducted on euhydrated calves showed that neurologic

signs similar to the ones observed in severely diarrheic calves can be reproduced by inducing hyper-D-lactatemia without concomitant acidosis. In contrast, experimentally inducing severe hyperchloremic acidosis in calves did not result in noteworthy effects on the demeanor of treated calves.<sup>16,17</sup>

#### Hyperkalemia in the Diarrheic Calf

Hyperkalemia is the most prominent electrolyte disturbance recognized in dehydrated diarrheic calves that are severely acidemic. It occurs despite significant net losses of potassium into the gut in diarrheic animals. A recent retrospective study conducted on patients of a teaching hospital revealed an incidence of hyperkalemia in diarrheic calves of 34%.<sup>18</sup> The predominant clinical finding associated with hyperkalemia is bradycardia and arrhythmia that can lead to atrial standstill, with fatal outcome. Although the association between hyperkalemia and acidemia is well established, the underlying mechanism is poorly understood.<sup>19</sup> The long-held mechanism responsible for hyperkalemia in diarrheic calves is directly associated with extracellular acidosis and the electrochemical exchange of  $K^+$  for  $H^+$  across the cell membrane, leading to a shift of potassium from the extracellular to the intracellular space in exchange for  $H^+$  that tends to shift into the opposite direction with increasing extracellular  $H^+$  concentrations. Although widely accepted, this proposed mechanism lacks a sound physiochemical basis because a decrease in plasma pH from 7.4 to 7.0 would increase the extracellular  $H^+$  concentration from 0.000,040 mmol/L to 0.000,100 mmol/L. An equimolar exchange of  $K^+$  for  $H^+$  can therefore only account for an increase of the serum potassium concentration of 0.000,06 mmol/L, an effect that not only is not measurable with current laboratory equipment but also is physiologically irrelevant.<sup>19</sup> An alternative mechanism that has been proposed is impaired activity of Na/K-ATPase in states of acidemia, resulting in impaired transport of potassium into the intracellular space.<sup>19</sup> The previously mentioned retrospective study found the occurrence and the degree of hyperkalemia to be more closely associated to the degree of dehydration than to the decrease in venous blood pH or base excess, suggesting that the impaired ability to excrete potassium through the urinary tract may play a more important role than metabolic acidosis/acidemia in the etiology of hyperkalemia in dehydrated calves.<sup>18</sup>

#### Hypernatremia in the Diarrheic Calf

Hypernatremia is uncommon in diarrheic calves generally suffering from isotonic or mildly hypotonic dehydration. However, incidental cases of hypernatremia have been reported. It is presumed that mixing errors in the preparation of oral electrolyte solutions to treat diarrhea rather than diarrheic

itself is the cause. The experimental oral administration of 1 L of electrolyte concentrate containing 2750 mEq sodium found that calves would willingly consume the solution mixed with milk, and developed signs of hypernatremia within 6 hours of administration.

#### Effect of Colostral Immunoglobulin Status

An adequate level of serum immunoglobulin can protect calves from death as a result of the effects of diarrhea, but not necessarily from diarrhea. The best protection is provided if both the immunoglobulin levels in the serum and the levels in the colostrum and milk during the first week after birth are high. The immunoglobulin subclasses in the plasma of calves that have received sufficient colostrum are IgG, IgM (and IgM is probably the more important of the two for the prevention of septicemia), and IgA. The serum IgG concentrations of calves under 3 weeks of age dying from infectious disease were much lower than those in normal calves. Of the dead calves, 50% had serum IgG levels that were more than 2 standard deviations below the normal mean, and an additional 35% had concentrations greater than 1 standard deviation below the normal mean. In the intestine, no single subclass of immunoglobulin is known to be responsible for protection against the fatal effects of diarrhea. Individually, each immunoglobulin subclass can prevent death from diarrhea even though calves may be affected with varying degrees of diarrhea. In contrast to the situation in the pig, IgA appears to be least effective.

In pigs, IgA becomes the dominant immunoglobulin in sow colostrum after the first few days of lactation, and this is the immunoglobulin that is not absorbed but is retained in, and reaches a high level in, the gut and plays a major role in providing local protection against enteric colibacillosis in piglets. Porcine colostrum IgA is more resistant to gastrointestinal proteolytic enzymes than IgG<sub>2</sub> and IgM. On the other hand, IgG is at a peak concentration in colostrum in the first day after parturition, is readily absorbed by the newborn piglet, and is vital in providing protection against septicemia. Lysozyme in sows' milk may assist in the control of the bacterial population in the gut of the unweaned piglet.

#### Intestinal Mucosa

In general, ETEC exert their effects by the enterotoxin causing hypersecretion through an intact intestinal epithelium. However, the intraluminal exposure of the jejunum of 3-week-old pigs to sterile crude-culture filtrates from strains of *E. coli* known to produce two types of ST will induce microscopic alterations of the villous epithelium. Focal emigration of neutrophils, especially through the epithelium above aggregated lymphatic follicles; stunting of jejunal and

ileal villi; and adherence of bacteria to jejunal and ileal mucosae are the most consistent findings. These changes are useful in making the diagnosis of enterotoxigenic colibacillosis in calves. Although enterotoxigenic strains are considered to be noninvasive, this does not preclude the possibility that invasion into the systemic circulation may occur, resulting in septicemia, or that septicemic strains may not also be present.

Enzyme histochemistry studies of the small intestinal mucosa in experimental infections of calves with rotavirus and ETEC indicate a marked decrease in enzyme activity in dual infections and a lesser decrease in mono-infections. Increased enzyme activity occurred in parts of the intestinal mucosa that were not affected or only slightly affected by the enteropathogens, which may be an adaptation of the mucosa to maintain absorptive function. Lactose digestion is slightly impaired in calves with mild diarrhea. Calves with acute diarrhea are in a catabolic state and respond with a larger increase of plasma glucose concentration to a given amount of absorbed glucose than do healthy calves.

Fat and carbohydrate malabsorption frequently occurs in diarrheic calves over 5 days of age and contributes to the development of D-lactic acidosis, which has been associated with a strong neurotoxic effect that is presumably responsible for the impaired demeanor of diarrheic calves.

### Attaching and Effacing Colibacillosis

Attaching and effacing enteropathogenic *E. coli* can cause naturally occurring diarrhea and dysentery in calves at 18 to 21 days. They do not produce enterotoxin but adhere to the surface of the enterocytes of the large intestine. Affected calves pass bright red blood in the diarrheic feces. The lesions in experimentally infected calves are indistinguishable from those produced by some *E. coli* that are enteropathogenic for humans, rabbits, and pigs. The bovine O118:H16 EHEC strain is able to colonize the intestine of newborn calves, inducing diarrhea 24 hours after challenge and producing attaching and effacing lesions in the small and large intestines.

### Synergism Between Enteropathogens

Enterotoxigenic colibacillosis occurs naturally and can be reproduced experimentally using ETEC in calves less than 2 days of age but not in calves 1 week of age. Diarrheic calves older than 3 days of age may be infected with enterotoxigenic F5 (K99) *E. coli* and rotavirus. There is evidence that prior or simultaneous infection of the intestine with rotavirus will enable the *E. coli* to colonize in older calves. Thus there may be synergism between rotavirus and ETEC in calves older than 2 days; this may explain the fatal diarrhea that can occur in calves at 1 week of age, which normally would not be fatal with a

single infection. The rotavirus may enhance the colonization of *E. coli*.

The simultaneous experimental infection of neonatal gnotobiotic calves at 24 hours of age with rotavirus and ETEC results in a severe diarrheal disease. The same situation occurs in piglets. However, in both species the effect was considered to be additive rather than synergistic.

### Summary of Pathogenesis

Septicemic colibacillosis occurs in newborn animals, and FTPI is the major predisposing factor. Enteric colibacillosis occurs in colostrum-fed animals and is associated with the colonization and proliferation of ETEC, which produce enterotoxin and cause varying degrees of diarrhea, acidemia, and dehydration. Although single infections occur commonly, as in piglet diarrhea, and what was previously described as enteric-toxicemic colibacillosis in calves, multiple infections with ETEC and viruses and other agents are more common.

## CLINICAL FINDINGS

### Calves

#### Coliform Septicemia

Coliform septicemia is most common in calves during the first 4 days of life and is described as the systemic inflammatory response syndrome (SIRS) to an active infectious process.<sup>20</sup> Most affected calves have low levels of serum IgG because of inadequate transfer of colostrum immunoglobulin.<sup>21</sup> The illness is peracute, with the course varying from 24 to 96 hours, with a survival rate of less than 12%. Early clinical signs are vague and nonspecific. Affected animals are weak and obtunded, commonly recumbent, and dehydrated; tachycardia is present, and although the temperature may be high initially, it falls rapidly to subnormal levels when the calf becomes weak and moribund. The suck reflex is weak or absent, the oral mucous membranes are dry and cool, and the capillary refill time may be prolonged. Cold extremities, weak peripheral pulse, and prolonged capillary refill time are common. Scleral injection is common. Diarrhea and dysentery may occur but are uncommon.

The involvement of multiple body systems and organs is characteristic of neonatal septicemia, and careful clinical examination is required to detect abnormalities. If a calf survives the septicemic state, clinical evidence of postsepticemic localization may appear in about 1 week. This includes arthritis, meningitis, panophthalmitis, and, less commonly, pneumonia. In a series of 32 cases of meningitis in neonatal calves, the most frequent clinical findings were lethargy, anorexia, recumbency, loss of the suck reflex, stupor, and coma. Opisthotonos, convulsions, tremors, and hyperesthesia were seen less frequently. The case fatality rate was 100% in spite of intensive therapy, and lesions of septicemia were present at necropsy.

### Predictors of Septicemia

The early clinical findings of septicemia in neonatal calves are vague and nonspecific and are often indistinguishable from the findings of noninfectious diseases or those of focal infections such as diarrhea. Positive blood cultures are required for a definitive diagnosis of septicemia, but results are not usually available for 48 to 72 hours, and false negatives are common. Laboratory parameters that have been proposed to identify potentially septic calves include hypoglycemia, left shift of neutrophils, and signs of toxicity of neutrophils.<sup>20</sup>

No single laboratory test has emerged as being completely reliable for the early diagnosis of septicemia in farm animal neonates, and therefore scoring systems and predictive models using obtainable historical, clinical, and clinicopathologic data have been developed.<sup>20</sup> The goal of these mathematical models is to identify septicemic neonates early in the course of disease when appropriate therapy would be most likely to result in a favorable outcome. In a study of diarrheic calves under 28 days of age submitted to a referral clinic for treatment, 31% of the calves were septicemic, based on blood culture. Two models to predict septicemia were used. Clinicopathologic variables associated with an increased risk of septicemia were moderate (1.99 to 5.55 mg/dL) and marked (>5.66 mg/dL) increases in serum creatinine (OR 8.63), moderate to marked toxic changes in neutrophils (OR 2.88), and FTPI (IgG concentrations  $\beta$  800 mg/dL, globulin  $\beta$  2 g/dL [OR 2.72], and total serum protein  $\beta$  5 g/dL). The clinical variables associated with an increased risk of septicemia were age under 5 days (OR 2.58), focal infection (OR 2.45), recumbency (OR 2.98), and weak suck reflex (OR 4.10).

### Enteric Colibacillosis

Enteric colibacillosis is the most common form of colibacillosis in newborn calves, primarily 3 to 5 days of age. It may occur in calves as early as 1 day of age and only rarely up to 3 weeks. The clinical severity will vary depending on the number and kind of organisms causing the disease. The presence of a single ETEC may cause a state of collapse usually designated as **enteric toxemia**. In this form of the disease the outstanding clinical signs include severe weakness, coma, subnormal temperature, cold and clammy skin, pale mucosae, wetness around the mouth, collapse of superficial veins, slowness and irregularity of the heart, mild convulsive movements, and periodic apnea. Diarrhea is usually not evident, although the abdomen may be slightly distended, and auscultation may reveal fluid-splashing sounds suggesting a fluid-filled intestine. The prognosis for these calves is poor, and they commonly die 2 to 6 hours after the onset of signs.

In the more common form of the disease in calves, there is diarrhea in which the feces

are profuse and watery to pasty, usually pale yellow to white in color, and occasionally streaked with blood flecks and very foul-smelling. The dry-matter content of the feces is commonly below 10%. Defecation is frequent and effortless, and the tail and perineum are soiled with feces. The temperature is usually normal in the initial stages but becomes subnormal as the disease worsens. Affected calves may or may not suck or drink depending on the degrees of acidosis, dehydration, and weakness. Calves under 8 days of age may be weak, primarily from the effects of rapid and severe dehydration; in calves older than 8 days the acidemia and metabolic acidosis, a considerable part of which is a result of the accumulation of D-lactic acid, tend to be more severe and make a greater contribution to obtundation and weakness. In the early stages of the disease, the abdomen may be slightly distended as a result of distension of fluid-filled intestines, which can be detected by succussion and auscultation of the abdomen. In some of these calves the diarrhea is not yet obvious but is delayed for several hours, when it can become quite profuse. Mildly to moderately affected calves may be diarrheic for a few days and recover spontaneously with or without treatment. However, 15% to 20% of calves with enteric colibacillosis become progressively worse over a period of 3 to 5 days, gradually become more weak, lose the desire to suck, and progressively appear more obviously dehydrated.

Throughout the course of the diarrhea the degree of dehydration will vary from just barely detectable clinically (4% to 6% of body weight [BW]) to up to 10% to 16% of body weight. The degree of dehydration can be estimated by “tenting” the skin of the lateral portion of the cervical region and measuring the time required for the skin fold to return to normal. In calves with 8% dehydration, 5 to 10 seconds will be required for the skin fold to return to normal; in 10% to 12% dehydration, up to 30 seconds will be required. Recession of the eyeball (enophthalmos) is an alternative method validated to reliably estimate the degree of dehydration in diarrheic calves. Slight sinking of the eyeball without an obvious space between

the eyeball and the orbit represents 6% to 8% dehydration, moderate separation of the eyeball from the orbit represents 9% to 12% dehydration, and marked separation of the eyeball from the orbit represents over 12% and up to 16% dehydration. A summary of the relationship between degree of dehydration (% BW), depth of enophthalmos (mm), cervical skin tent duration in seconds, and the state of the mucous membranes and extremities in calves with experimentally induced diarrhea is set out in Table 19-12.<sup>1</sup>

Affected calves can lose 10% to 16% of their original body weight during the first 24 to 48 hours of the diarrhea. The hyperkalemia in calves with neonatal diarrhea has been associated with cardiac rate and rhythm abnormalities, including bradycardia and atrial standstill. Herd outbreaks of the disease in beef calves may last for several weeks, during which time almost every calf will be affected within several days after birth.

**Veal calf hemorrhagic enteritis** is a fatal syndrome of veal calves characterized by anorexia, fever, diarrhea with mucus-containing feces that become bloody in the later stages, and hemorrhagic diathesis on the conjunctivae and mucous membranes of the mouth and nose. The etiology is unknown; the *E. coli* strains isolated from the feces of affected calves produced enterotoxins and Shiga toxins, but their significance is uncertain.

In some calves between 10 and 20 days of age with a history of diarrhea in the previous several days, from which they have recovered, there will be metabolic acidosis without clinical signs of dehydration. Affected calves are depressed, weak, ataxic, and sometimes recumbent, and they appear comatose. Affected calves respond quickly to treatment with intravenous sodium bicarbonate. A similar syndrome occurs in goat kids.

### Lambs and Goat Kids

Although some cases manifest enteric signs, and chronic cases may occur, colibacillosis in lambs is commonly septicemic and peracute. Two age groups appear to be susceptible: lambs 1 to 2 days of age and lambs 3 to 8 weeks old. Peracute cases are found dead

without premonitory signs. Acute cases show collapse and occasionally signs of acute meningitis manifested by a stiff gait in the early stages, followed by recumbency with hyperesthesia and tetanic convulsions. Chronic cases are usually manifested by arthritis. The disease in goat kids is similar to that in lambs.

### Piglets

#### Coliform Septicemia

Coliform septicemia is uncommon but occurs in piglets within 24 to 48 hours of birth. Some are found dead without any premonitory signs. Usually more than one piglet, and sometimes the entire litter, will be affected. Severely affected piglets seen clinically are weak and almost comatose, appear cyanotic, feel cold and clammy, and have a subnormal temperature. Usually there is no diarrhea. The prognosis for these piglets is poor, and most will die in spite of therapy.

**Edema disease** is unique form of colibacillosis occurring in piglets between a few days after birth to well after weaning. It is caused by Shiga-toxin-producing *E. coli* strains that induce degenerative angiopathy of small arteries and arterioles.

### Enterotoxigenic Colibacillosis

#### Newborn Piglet Diarrhea

Newborn piglet diarrhea, a form of colibacillosis in piglets, occurs from 12 hours of age up to several days of age, with a peak incidence at 3 days of age. As with the septicemic form, usually more than one pig or the entire litter is affected. The first sign usually noticed is the fecal puddles on the floor. Affected piglets may still nurse in the early stages, but they gradually lose their appetite as the disease progresses. The feces vary from a pasty to watery consistency and are usually yellow to brown in color. When the diarrhea is profuse and watery, there will be no obvious staining of the perineum and hindquarters with feces, but the tails of the piglets will be straight and wet. Sick piglets occasionally vomit, although vomiting is not as prominent as with transmissible gastroenteritis. The temperature is usually normal or subnormal. The disease is progressive; diarrhea and dehydration continue, and the piglets become very weak and lie in lateral recumbency and make weak paddling movements. Within several hours they appear very dehydrated and shrunken, and they commonly die within 24 hours after the onset of signs if not treated. In severe outbreaks the entire litter may be affected and die within a few hours of birth. The prognosis is favorable if treatment is started early, before significant dehydration and acidosis occur.

#### Postweaning Diarrhea

The postweaning diarrhea (PWD) form of colibacillosis in piglets presents an economically important cause of death of weaned piglets. It is commonly seen within days of

**Table 19-12** Degree of dehydration in calves with experimentally induced diarrhea

Degree of dehydration (% BW)	Depth of enophthalmos (mm)	Cervical skin-tent duration (s)	Mucous membranes and extremities
0	None	Less than 2	Moist
2	1	3	Dry
4	2	4	Dry
6	3	5	Dry
8	4	6	Cool extremities
10	6	7	Cool extremities
12	7	>8	Cool extremities
>14	>8	>10	White mucous membranes



weaning. In peracute cases piglets are found dead with an obviously dehydrated appearance, deeply sunken eyes, and cyanotic extremities. In less acute cases the first sign may be a loss in condition that is largely a result of dehydration. Diarrhea may not be apparent in all cases because fluid may just accumulate in the gut in some animals. If present, diarrhea can be watery to pasty, may contain blood in some instances, and may last between 1 and 5 days (see also “Post-weaning Diarrhea of Pigs”).

## CLINICAL PATHOLOGY

### Culture and Detection of Organism

If septicemia is suspected, blood should be submitted for isolation of the organism and determination of its drug sensitivity. Blood for culture must be taken aseptically and inoculated directly into brain–heart infusion broth. Because of the limited sensitivity to detect bacteremia by a single culture, the blood sample should be repeated a few hours later to enhance recovery rate and confirm septicemia.

The **definitive etiologic diagnosis of enteric colibacillosis** depends on the isolation and characterization of *E. coli* from the intestines and the feces of affected animals. The best opportunity of making a diagnosis is when untreated representative affected animals are submitted for pathologic and microbiological examination. The distribution of the organism in the intestine; determination of the presence of F4 (K88), F5(K99), or F6 (987P) antigens; and the histopathologic appearance of the mucosa contribute to the diagnosis.

The routine culture of feces and intestinal contents for *E. coli* without determining their virulence determinants is of limited value. The laboratory tests used to identify enterotoxigenic F4 (K99) *E. coli* include a direct fluorescent antibody technique with conventional culturing methods and the ELISA, with or without monoclonal antibody, to detect the organism or the enterotoxin in the feces. DNA gene probes specific for genes encoding enterotoxin and adhesins are available and are being used to evaluate *E. coli* isolated from diarrheic animals. Isolates of the organism can also be examined for the presence of toxins using an enzyme immune assay test and latex agglutination test.

Detection of STEC in feces has relied on cytotoxicity testing and DNA hybridization. Several ELISAs are available, and monoclonal antibodies to the Shiga toxins ST1 and ST2 have been used to examine feces from animals. The isolation of *E. coli* O157:H7 has relied on its ability to ferment sorbitol. A sandwich ELISA using monoclonal antibodies to *E. coli* Shiga toxins 1 and 2 for capture and detection is available for detection of STEC in animal feces. A PCR test is also available for detection of ST genes in *E. coli* isolated from cattle, sheep, and pigs affected with diarrhea.

The determination of drug sensitivity of the *E. coli* isolated from the feces of diarrheic calves and piglets is commonly done, but it is of limited value without determining which isolate is enteropathogenic.

### Hematology and Serum Biochemistry

A total and differential leukocyte count and remarkable changes in the fibrinogen concentration may indicate the presence of septicemia or severe intestinal infection. However, severely affected calves may not have grossly abnormal hemograms.<sup>21</sup> In enteric disease, the major changes in plasma composition are dehydration, electrolyte imbalance, and metabolic acidosis/acidemia. The total plasma osmolality tends to be decreased.

The packed cell volume and the total protein concentration of the blood will indicate the degree of dehydration, although the increase of total protein in calves with FTPI may underestimate the degree of dehydration. The blood urea nitrogen (BUN) concentration may be increased in severe cases because of inadequate renal perfusion. The blood bicarbonate concentration is markedly reduced, indicating the presence of metabolic acidosis. Decreased blood pH values represent acidemia. Calves with a venous blood pH below 7.0 require immediate parenteral therapy for acidemia. Other serum electrolytes are variable, but there may be a slight decrease in serum sodium and a slight increase in serum chloride. In severely dehydrated animals hyperkalemia may occur, which may result in bradyarrhythmia.<sup>18</sup>

Hematologic abnormalities associated with **septicemia** vary with the stage and severity of the disease. Abnormal neutrophil counts (neutrophilia or neutropenia), a left shift of neutrophils, and signs of toxicity in neutrophils are commonly seen in septic animals.<sup>11,20,21</sup> Hypoglycemia is another common, although certainly not pathognomonic, finding in septic calves.

### NECROPSY FINDINGS

In **coliform septicemia** there may be no gross lesions, and the diagnosis may depend on the isolation of the organism from the filtering organs. In less severe cases there may be subserosal and submucosal hemorrhages. A degree of enteritis and gastritis may be present. Occasionally, fibrinous exudates are found in the joints and serous cavities, and there may be omphalophlebitis, pneumonia, and meningitis. The histologic features of such presentations of colibacillosis are those of septicemia and toxemia.

In **enteric colibacillosis** of piglets and calves the carcass appears dehydrated, but the intestine is flaccid and filled with fluid. In calves, the abomasum is usually distended with fluid and may contain a milk clot. Clots are typically absent in calves fed whey milk replacers that do not contain casein. The abomasal mucosa may contain numerous

small hemorrhages. In both calves and pigs, the intestinal mucosae may appear normal or hyperemic, and there may be edema of the mesenteric lymph nodes. Mild atrophy or even fusion of jejunal and ileal villi is often seen, but the key microscopic observation is the **presence of bacilli adherent to the brush borders of enterocytes**. Ultrastructurally, there is increased epithelial cell loss from the villus about 12 hours after experimental inoculation of calves with an ETEC.

In calves affected with attaching and effacing *E. coli* there is pseudomembranous ileitis, mucohemorrhagic colitis, and proctitis. Microscopic examination of well-preserved gut segments reveals bacterial adherence, atrophy of ileal villi, and erosion of enterocytes.

In addition to traditional bacteriologic culture techniques, the ETEC may be identified by several tests, including indirect fluorescent antibody (IFA) tests specific for F4 (K88), F5 (K99), and F6 (987P) pilus antigens. The IFA tests can be performed on impression smears or frozen sections of ileal tissue, and the results are available within a few hours. Newer techniques such as DNA gene probes, enzyme immune assays, and latex agglutination tests are now available to identify those isolates that are enterotoxin producers and have adhesin properties.

During severe disease outbreaks it is often necessary to conduct the necropsy examination on diarrheic animals that have been killed specifically for the purpose of obtaining a definitive etiologic diagnosis. The combined use of bacteriologic, parasitologic, and virological methods, together with histologic and immunofluorescent studies of fresh intestinal tissue, will provide the most useful information about the location of the lesions and the presence of enteropathogens. Postmortem autolysis of the intestinal mucosae and invasion of the tissues by intestinal microflora occurs within minutes after death, so gut samples should be collected immediately following euthanasia of the animal.

### Samples for Confirmation of Diagnosis

#### Coliform Septicemia

- Bacteriology—chilled spleen, lung, liver, culture swabs of exudates, umbilicus, meninges (culture)
- Histology—fixed samples spleen, lung, liver, kidney, brain, and any gross lesions

#### Enteric Colibacillosis

- Bacteriology—chilled segments of ileum and colon (including content; culture and/or FAT, latex agglutination, PCR)
- Histology—fixed duodenum, jejunum, ileum, colon, and mesenteric lymph node

**Table 19-13** Possible causes of bacteremia/septicemia and acute neonatal diarrhea in farm animals

Calves	Piglets	Lambs and kids	Foals
<b>Bacteremia/septicemia</b>			
<i>Escherichia coli</i>	<i>E. coli</i>	<i>E. coli</i>	<i>E. coli</i>
<i>Salmonella</i> spp.	<i>Streptococcus</i>	<i>Salmonella</i> spp.	<i>Actinobacillus equuli</i>
<i>Listeria monocytogenes</i>	<i>L. monocytogenes</i>	<i>L. monocytogenes</i>	<i>Salmonella abortusovae</i>
<i>Pasteurella</i> spp.		<i>Erysipelothrix rhusiopathiae</i>	<i>Salmonella typhimurium</i>
<i>Streptococcus</i> spp.			<i>Streptococcus pyogenes</i>
<i>Pneumococcus</i> spp.			<i>L. monocytogenes</i>
<b>Acute neonatal diarrhea</b>			
Enteropathogenic and enterotoxigenic <i>E. coli</i>	Enteropathogenic <i>E. coli</i>	<i>Clostridium perfringens</i> type C	Foal-heat diarrhea
Rotavirus	<i>Salmonella</i> spp.	<i>C. perfringens</i> type B (lamb dysentery)	Rotavirus
Coronavirus	Transmissible gastroenteritis virus	Rotavirus	<i>C. perfringens</i> type B
Bovine torovirus (Breda virus)	<i>C. perfringens</i> type C (rarely A)	Caprine herpesvirus	
Bovine calicivirus	<i>Clostridium difficile</i>		
Bovine norovirus	Rotavirus		
<i>Cryptosporidium</i> spp.	PRRSV		
<i>Giardia</i> spp.	<i>Isospora</i> spp.		
<i>Salmonella</i> spp.			
<i>Eimeria</i> spp. (calves at least 3 weeks old)			
<i>C. perfringens</i> type C			

PRRSV, porcine reproductive and respiratory syndrome virus.

## DIFFERENTIAL DIAGNOSIS

The definitive etiologic diagnosis of septicemic colibacillosis is dependent on the laboratory isolation of the causative agent, which is usually a single species or organism. The septicemias of the newborn cannot be distinguished from one another clinically. The definitive etiologic diagnosis of enteric colibacillosis in newborn calves and piglets may be difficult and often inconclusive because the significance of other organisms in the intestinal tract and feces of diarrheic animals cannot be easily determined.

Table 19-13 lists the possible causative agents of diarrhea and septicemia in newborn farm animals. Using the combined diagnostic approach of detection of enteropathogens in the feces before death and in the intestinal mucosa after death, it is possible to identify where ETEC, rotavirus, coronavirus, *Salmonella* spp., and *Cryptosporidium* spp. appear to be the only or principal causative agents. However, mixed infections are more common than single infections.

Every effort that is economically possible should be made to obtain an etiologic diagnosis. This is especially important when outbreaks of diarrhea occur in a herd or when the disease appears to be endemic. The use of an interdisciplinary approach will increase the success of diagnosis. This includes making a visit to the farm or herd and making a detailed epidemiologic investigation of the problem. The diagnosis depends heavily on the epidemiologic findings, the microbiological and pathologic findings, and sometimes on the results of treatment.

The major difficulty is to determine whether or not the diarrhea is infectious in origin and to differentiate it from dietetic diarrhea, which is most common in hand-fed

calves and in all newborn species that are sucking high-producing dams. In dietetic diarrhea the feces are voluminous and pasty to gelatinous in consistency; the animal is bright and alert and is usually still sucking, but some may be inappetent.

## TREATMENT

### Coliform Septicemia

**Intensive critical care** is required for the treatment of neonatal coliform septicemia. Early identification of animals suspected of being septicemic and early therapeutic intervention are important determinants of the treatment success. Evidence from human medicine indicates that the survival rate must be expected to decrease by 10% for every hour antimicrobial therapy is delayed in patients in septic shock.<sup>22</sup> A recent consensus statement in human medicine recommends initiation of intravenous antimicrobial therapy within the first hour after having recognized severe septicemia.<sup>23</sup> Thus, in most cases antimicrobial therapy has to be initiated before confirmatory culture results are available.

Although *E. coli* may be cultured from the blood of septicemic foals and calves, a significant percentage of isolates are gram-positive, which justifies the use of antimicrobials that have a broad spectrum. Antimicrobials are given parenterally and may be given continuously intravenously, more than once daily and daily until recovery is apparent. Isolation of the organisms from blood and determination of drug sensitivity constitute the ideal protocol. Intravenous fluid and electrolyte therapy are administered continuously until recovery is apparent

(see “Principles of Fluid and Electrolyte Therapy”). Whole blood transfusions are used in calves and foals, especially when immunoglobulin deficiency is suspected from the history or is determined by measurement of serum immunoglobulins of blood. In one series on neonatal septicemia in calves, in which *E. coli* accounted for 50% of the bacterial isolates, the survival rate was only 12%.

### Enteric Colibacillosis

The considerations for treatment of enteric colibacillosis include the following:

- Fluid and electrolyte replacement
- Antimicrobial and immunoglobulin therapy
- Antiinflammatory therapy
- Antimotility drugs
- Intestinal protectants
- Alteration of the diet
- Probiotics
- Clinical management of outbreaks

### Fluid and Electrolyte Replacement

The dehydration, acidosis, and electrolyte imbalance are corrected by the parenteral and oral use of simple or balanced electrolyte solutions. The provision of fluid therapy in diarrheic dehydrated calves under field conditions in veterinary practice has been described. It is important to obtain an adequate history of the case, including age of the calf, duration of the diarrhea, and all treatments already given by the owner. The physical examination of the calf includes a standard clinical examination with emphasis on evaluating the degree of dehydration and acidosis.

**Dehydration** is evaluated by two clinical observations:

- **Skin elasticity.** The skin of the middle of the neck is better than the eyelid. A portion of the skin is tented and twisted for 1 second, and then the time to return to the initial position is measured—less than 2 seconds in the normal calf, 6 seconds in moderate (8%) dehydration, and more than 8 seconds in severe (12%) dehydration (Table 19-12).
- **Position of eyeball in the orbit and extent of enophthalmos.** This is determined by measuring the distance between the globe and the orbit. The eyeball is not sunken in healthy calves. Degrees of dehydration of 4%, 8%, and 12% are represented by 2-mm, 4-mm, and 7-mm enophthalmos, respectively (Table 19-12).

The degree of metabolic acidosis can be evaluated by determining the degree of obtundation, muscular tone, ability to stand, intensity of the sucking reflex, temperature of the inside of the oral cavity, and age of the calf that correlate with an estimate of the base deficit. The following categories for diarrheic calves are being used under field conditions:

1. Calves with good muscular tone and the ability to stand, strong suck reflex, and warm oral cavity have no base deficit if younger than 8 days of age and up to 5 mEq/L if older than 5 days.
2. Calves that can stand, have a slightly cool oral cavity, and have a weak suck reflex have a base deficit of 5 mEq/L if under 8 days of age and 10 mEq/L if older than 8 days.
3. Calves in sternal recumbency with a cool oral cavity and no suck reflex have a base deficit of 10 mEq/L if under 8 days of age and 15 mEq/L if older than 8 days.
4. Calves in lateral recumbency that lack a suck reflex and have a cold oral cavity have a base deficit of 10 mEq/L if under 8 days of age and 20 mEq/L if older than 8 days.

### Categorizing Diarrheic Calves Into Treatment Groups

Based on the history and clinical findings, affected calves can be divided into the following categories according to the type of therapy required and which is most economical:

1. **Oral fluid therapy**—calves with a history of acute diarrhea, less than 7% dehydrated, slightly dry oral mucosa, good suck reflex, good muscle tone, alert, able to stand, and warm mouth. These can be treated with oral fluids and electrolytes.
2. **Oral fluid therapy and hypertonic saline solution**—calves with 7% to 9% dehydration and slight acidosis, weak suck reflex, good muscular tone, and warm mouth. Administer hypertonic

saline solution (7.5% NaCl) intravenously at 3 to 4 mL/kg BW in 5 minutes. Assure voluntary intake of oral fluids, or administer oral fluids and electrolytes by stomach tube at 40 to 60 mL/kg BW. Reevaluate in 6 to 8 hours.

3. **Intravenous fluid therapy with alkalinizing agents**—calves that are more than 9% dehydrated, have dry and cool oral mucous membranes, are recumbent, have no suck reflex, and are very depressed. Provide intravenous replacement and maintenance fluid and electrolyte therapy including an alkalinizing agent for a period of 6 to 8 hours and up to 24 to 36 hours if necessary.

The details for parenteral and oral fluid and electrolyte therapy are described under “Principles of Fluid and Electrolyte Therapy.”

### Antimicrobial Therapy

Antimicrobials have been used extensively for the specific treatment of colibacillosis in calves and piglets because it was assumed that an infectious enteritis was present. It has been difficult to evaluate the efficacy of antimicrobials for the treatment of enteric colibacillosis because of the complex nature of the interactive factors that affect the outcome in naturally occurring cases. These include the presence of mixed infections, the effects of whether or not milk is withheld from the diarrheic calves, the effects of the immune status of individual calves, the variable times after the onset of diarrhea when the drugs are given, the possible presence of antimicrobial resistance, and the confounding effects of supportive treatment such as electrolyte and fluid therapy.

### Change in Small Intestinal Bacterial Flora in Calves With Diarrhea

There has been a paradigm shift in the last 40 years toward categorizing an episode of calf diarrhea as being the result of a specific etiologic agent, such as rotavirus, coronavirus, cryptosporidia, *Salmonella* spp., or ETEC. Although the etiologic approach has correctly focused attention on preventive programs, including vaccination and optimizing transfer of colostrum immunity, the approach has diverted attention from the universal finding of all studies, which is that calves with diarrhea of whatever etiology have coliform bacterial overgrowth of the small intestine.

Studies completed more than 70 years ago documented increased numbers of *E. coli* bacteria in the abomasum, duodenum, and jejunum of scouring calves. Moreover, calves severely affected with diarrhea had increased numbers of *E. coli* bacteria in the anterior portion of their intestinal tracts compared with mildly affected animals. More recent studies have consistently documented the fact that calves with naturally

acquired diarrhea, regardless of age and the etiologic cause for the diarrhea, have altered small intestinal bacterial flora. Specifically, *E. coli* bacterial numbers were increased 5- to 10,000-fold in the duodenum, jejunum, and ileum of calves with naturally acquired diarrhea, even when the diarrhea was not attributable to ETEC, and where rotavirus and coronavirus were identified in the feces. The largest increase in *E. coli* bacterial numbers occurs in the distal jejunum and ileum, whereas the *E. coli* or coliform bacterial numbers in the colon and feces are similar or higher for calves with diarrhea than calves without diarrhea, with *E. coli* being more numerous in the feces of colostrum-deprived than colostrum-fed calves. Small intestinal overgrowth with coliform bacteria can persist after departure of the initiating enteric pathogen.

In calves with naturally acquired diarrhea, increased small-intestinal colonization with *E. coli* has been associated with impaired glucose, xylose, and fat absorption.

Mixed infections with enteric pathogens are commonly diagnosed in calves with naturally acquired diarrhea, and the clinical signs and pathologic damage associated with rotavirus infection are more severe when *E. coli* is present than when it is absent. Primary viral morphologic damage to the small intestine also facilitates systemic invasion by normal intestinal flora, including *E. coli*.

In calves with experimentally induced ETEC diarrhea, colonization of the small intestine by *E. coli* has been associated with impaired glucose and lactose absorption, decreased serum glucose concentration, and possibly increased susceptibility to cryptosporidial infection.

In summary, calves with diarrhea have increased coliform bacterial numbers in the small intestine, regardless of etiology, and this colonization is associated with altered small-intestinal function, morphologic damage, and increased susceptibility to bacteremia. It therefore follows that administration of antimicrobials that decrease small-intestinal coliform bacterial numbers in calves with diarrhea may prevent the development of bacteremia, decrease mortality, and decrease morphologic damage to the small intestine, thereby facilitating digestion and absorption and increasing growth rate.

### Incidence of Bacteremia in Calves With Diarrhea

Calves with diarrhea are more likely to have FTPI, and this group of calves, in turn, is more likely to be bacteremic. Colostrum-deprived calves that subsequently developed diarrhea were frequently bacteremic, whereas bacteremia occurred much less frequently in colostrum-fed calves that developed diarrhea.

Based on field studies of diarrheic calves, it can be assumed that, on average, 30% of



**severely ill calves with diarrhea are bacteremic**, with *E. coli* being the predominantly isolated pathogen. The risk of bacteremia is higher in calves with FTPI than in calves with adequate transfer of passive immunity, and the risk of bacteremia is higher in calves 5 days of age or younger. Veterinarians should also assume that 8% to 18% of diarrheic calves with adequate transfer of passive immunity and systemic illness are bacteremic. The prevalence of bacteremia is sufficiently high in systemically ill calves that effective antimicrobial treatment for potential bacteremia should be routinely instituted, with emphasis on treating potential *E. coli* bacteremia, regardless of transfer of passive immunity status and treatment cost. Withholding an effective treatment for a life-threatening condition, such as bacteremia in calves with diarrhea, cannot be condoned on animal welfare grounds.

#### Antimicrobial Susceptibility of Fecal *Escherichia coli* Isolates

The most important determinant of antimicrobial efficacy in calf diarrhea is obtaining an effective antimicrobial concentration against bacteria at the sites of infection (small intestine and blood). The results of fecal antimicrobial susceptibility testing have traditionally been used to guide treatment decisions; however, susceptibility testing in calf diarrhea probably has clinical relevance only when applied to fecal isolates of ETEC or pathogenic *Salmonella* spp. and blood culture isolates from calves with bacteremia. Validation of susceptibility testing as being predictive of treatment outcome for calves with diarrhea is currently lacking.

The ability of fecal bacterial culture and antimicrobial susceptibility testing using the Kirby–Bauer technique to guide treatment in calf diarrhea is questionable when applied to fecal *E. coli* isolates that have not been identified as enterotoxigenic. There do not appear to be any data demonstrating that fecal bacterial flora is representative of the bacterial flora of the small intestine, which is the physiologically important site of infection in calf diarrhea. Marked changes in small-intestinal bacterial populations can occur without changes in fecal bacterial populations, and the predominant strain of *E. coli* in the feces of a diarrheic calf can change several times during the diarrhea episode. Furthermore, and most importantly, 45% of calves with diarrhea had different strains of *E. coli* isolated from the upper and lower small intestine, indicating that fecal *E. coli* strains are not always representative of small-intestinal *E. coli* strains. Marked discrepancies in antimicrobial resistance among *E. coli* strains isolated from different segments of the upper and lower intestinal tract of healthy veal calves at slaughter have also been reported in a more recent study.<sup>24</sup>

An additional bias present in most antimicrobial susceptibility studies conducted

on fecal *E. coli* isolates is that data are frequently obtained from dead calves, which are likely to be treatment failures. The time since death is also likely to be an important determinant of the value of fecal culture because such a rapid proliferation of bacteria occurs in the alimentary tract after death that the results of examinations made on dead calves received at the laboratory can have little significance. Calves that die of diarrhea are likely to have received multiple antimicrobial treatments, and preferential growth of antimicrobial-resistant *E. coli* strains starts within 3 hours of antimicrobial administration. A further concern with fecal susceptibility testing is that the Kirby–Bauer breakpoints (minimum inhibitory concentration [MIC]) are not based on typical antimicrobial concentrations in the small intestine and blood of calves. Studies documenting the antimicrobial susceptibility of *E. coli* isolates from the small intestine of untreated calves, based on achievable drug concentrations and dosage regimens, are urgently needed. Until these data are available, it appears that antimicrobial efficacy is best evaluated by the clinical response to treatment, rather than the results of in vitro antimicrobial susceptibility testing performed on fecal *E. coli* isolates. Thus, the value of antimicrobial susceptibility testing as a tool to guide the choice of an antibiotic to treat enterotoxigenic colibacillosis must currently be considered as very limited. Nonetheless, antimicrobial susceptibility testing presents an important tool to monitor the development of resistances not only of pathogens, but also of so-called indicator bacteria normally isolated in healthy animals in the field.<sup>25,26</sup> Because antimicrobial resistance can be transferred via plasmids from apathogenic bacteria to pathogens, monitoring trends in resistance patterns in the field is of critical importance.

#### Surveillance for Antimicrobial Resistance in *Escherichia coli* Isolates

The purpose of monitoring antimicrobial resistance through so-called indicator bacteria is to avoid misjudgment (overestimation) of resistance levels that would be extrapolated from resistance of pathogenic bacteria.<sup>24</sup> As mentioned earlier, pathogens isolated from sick or deceased animals have frequently been exposed to antimicrobial therapy, which is likely to alter resistance patterns. A comparison of antibiotic resistance for *E. coli* populations isolated from groups of diarrheic and control calves in the United Kingdom found a higher incidence of antibiotic-resistant *E. coli* in samples obtained from farms with calf diarrhea than from farms without the disease. Considering all samples, bacterial colonies in 84% were resistant to ampicillin, in 13% to Apramycin, and in 6% to nalidixic acid. Antibiotic resistance among ETEC from piglets and calves with diarrhea in a diagnostic laboratory survey of one

geographic area in Canada over a 13-year period found that the least resistance occurred against ceftiofur for all isolates, followed by apramycin and gentamicin for porcine and florfenicol for bovine isolates.

In a UK study over a 5-year period, *E. coli* isolates from calves with diarrhea became more resistant to furazolidone, trimethoprim-potentiated sulfonamide, clavulanic-acid-potentiated amoxicillin, and tetracycline. *E. coli* strains from outbreaks of diarrhea in lambs in Spain became increasingly resistant to nalidixic acid, enoxacin, and enrofloxacin. Some antimicrobial-resistant *E. coli* strains from diarrheic calves in the United States may possess a chromosomal *flo* gene that specifies cross-resistance to both florfenicol and chloramphenicol, and its presence among *E. coli* isolates of diverse genetic backgrounds indicates a distribution much wider than previously thought. In Spain, 5.9% of *E. coli* strains from cattle were resistant to nalidixic acid, and 4.9% were resistant to enrofloxacin and ciprofloxacin. In sheep and goats, only 0.5% and 1.4%, respectively, of the strains were resistant to nalidixic acid, and none was resistant to fluoroquinolones. Most of the quinolone-resistant strains were nonpathogenic strains isolated from cattle. Susceptibility data obtained from 10 European countries for the years 2002 to 2004 revealed that although there was a generally high prevalence of resistance of *E. coli* isolated from diarrheic calves, resistance patterns varied considerably between countries.<sup>25</sup> Generally high resistance of *E. coli* in the range of 50% or higher was reported from most countries for ampicillin, streptomycin, sulfonamides, trimethoprim, combinations of trimethoprim and sulfonamides, and tetracyclines.<sup>25</sup> Although resistance of *E. coli* isolated from diarrheic calves against fluoroquinolones was rare in several countries, resistance rates at or above 20% were reported from Spain, Belgium, and France.<sup>25</sup> In certain regions of Italy the incidence of enrofloxacin-resistant *E. coli* strains was reported to have increased from 14.2% in 2002 to over 40% in 2008.<sup>27</sup>

The CTX-M-14-like enzyme has been detected in *E. coli* recovered from the feces of diarrheic dairy calves in Wales. The enzyme is an extended-spectrum beta-lactamase (ESBL), which confers resistance to a wide range of beta-lactam (penicillin and cephalosporin) compounds. Organisms possessing ESBLs are considered to be resistant to second-, third-, and fourth-generation cephalosporins, and in vitro resistance to amoxicillin/clavulanate among producers is variable, reflecting the amount of beta-lactamase produced. In addition to this enzyme, the isolates produced a TEM-35 (IRT-4) beta-lactamase that conferred resistance to the amoxicillin/clavulanate combination. These two enzymes confer resistance to all the beta-lactamase compounds approved for veterinary use in the United

Kingdom. Thus their occurrence in animals may be an important development for both animal and public health. ESBLs in human infections have emerged as a significant and developing problem, occurring in patients in the community and in those with recent hospital contact. Spread of this form of resistance in bacteria affecting the animal population could have serious implications for animal health, rendering many therapeutic options redundant.

Antimicrobial resistance to intestinal bacteria also occurs in dairy calves fed milk from cows treated with antibiotics and has been associated with the prophylactic administration of medicated milk replacer.<sup>28</sup> The resistance increases with higher concentrations of antibiotics in the milk. Susceptibility of fecal and environmental *E. coli*, *Salmonella* spp., and *Campylobacter* spp. to tetracyclines was monitored on farms during use of medicated milk replacer and after discontinuation of this practice. Discontinuing the use of medicated milk replacer resulted in increased susceptibility of these organisms to tetracyclines within 3 months, without causing an increase of disease occurrence.<sup>28</sup>

#### Antimicrobial Susceptibility of Blood *Escherichia coli* Isolates

The Kirby–Bauer technique for antimicrobial susceptibility testing has more clinical relevance for predicting the clinical response to antimicrobial treatment when applied to blood isolates rather than fecal isolates. This is because the Kirby–Bauer breakpoints (MICs) are based on achievable antimicrobial concentrations in human plasma and MIC<sub>90</sub> values for human *E. coli* isolates, which provide a reasonable approximation to achievable MIC values in calf plasma and MIC<sub>90</sub> values for bovine *E. coli* isolates. Unfortunately, susceptibility results are not available for at least 48 hours, and very few studies have documented the antimicrobial susceptibility of blood isolates in calves with diarrhea. In a 1997 study of dairy calves in California, the antimicrobial susceptibility of isolates from the blood of calves with severe diarrhea or illness produced the following results: ceftiofur, 19/25 (76%) sensitive; potentiated sulfonamides, 14/25 (56%) sensitive; gentamicin, 12/25 (48%) sensitive; ampicillin, 11/25 (44%) sensitive; tetracycline, 3/25 (12%) sensitive, although there was a clinically significant year-to-year difference in the results of susceptibility testing that may have reflected different antimicrobial administration protocols on the farm.

#### Evidence-Based Recommendations for Antimicrobial Treatment of Diarrheic Calves

The four critical measures of success of antimicrobial therapy in calf diarrhea are as follows (in decreasing order of importance): (1) mortality rate, (2) growth rate in

survivors, (3) severity of diarrhea in survivors, and (4) duration of diarrhea in survivors.

In his review of the literature on the use of antibiotics for the treatment of calf diarrhea, Constable concluded that the statement that oral or parenteral antimicrobials should not be used is not supported by a critical evidence-based review of the literature.<sup>29</sup> The arguments used to support a nonantimicrobial treatment approach have included the following:

- Orally administered antimicrobials alter intestinal flora and function and thereby induce diarrhea, which has been documented on more than one occasion with chloramphenicol, neomycin, and penicillin.
- Antimicrobials harm the “good” bacteria in the small intestine more than the “bad” bacteria (an undocumented claim in the calf).
- Antimicrobials are not effective (a statement that is clearly not supported by the results of some published peer-reviewed studies).
- Antimicrobial administration promotes the selection of antimicrobial resistance in enteric bacteria.

In calves with diarrhea and moderate to severe systemic illness, the positive predictive value (0.65) of clinical tests (sensitivity = 0.39, specificity = 0.91) and the positive predictive value (0.77) of laboratory tests (sensitivity = 0.40, specificity = 0.95) for detectable bacteremia are too low, assuming reasonable estimates for the prevalence of bacteremia (30%). Accordingly, it is recommended that clinicians routinely assume that 30% of ill calves with diarrhea are bacteremic and that bacteremia constitutes a threat to the life of the calf. Antimicrobial treatment of diarrheic calves should therefore be practiced and focused against *E. coli* in the small intestine and blood because these constitute the two sites of infection. In addition, the antimicrobial must reach therapeutic concentrations at the site of infection for a long enough period (the treatment interval) and, ideally, have only a narrow gram-negative spectrum of activity to minimize collateral damage to other enteric bacteria. Fecal bacterial culture and antimicrobial susceptibility testing is not recommended in calves with diarrhea because fecal bacterial populations do not accurately reflect small-intestinal or blood bacterial populations, and the breakpoints for susceptibility test results have not been validated. Antimicrobial efficacy is therefore best evaluated by the clinical response to treatment.

The efficacy of antimicrobial therapy can vary with the route of administration and when given orally, whether the antimicrobial is dissolved in milk, oral electrolyte solutions, or water. Oral antimicrobials administered as a bolus or contained in a gelatin capsule are deposited into the rumen and

therefore have a different serum concentration–time profile than antimicrobials dissolved in milk replacer that are suckled by the calf. Antimicrobials that bypass the rumen are not thought to alter rumen microflora, potentially permitting bacterial recolonization of the small intestine from the rumen. Finally, when oral antimicrobials are administered to calves with diarrhea, the antimicrobial concentration in the lumen of the small intestine is lower and the rate of antimicrobial elimination faster than in healthy calves.

In the United States parenterally administered oxytetracycline and sulfachloropyridazine and orally administered amoxicillin, chlortetracycline, neomycin, oxytetracycline, streptomycin, sulfachloropyridazine, and sulfamethazine are currently labeled for the treatment of calf diarrhea. Unfortunately, there is little published data supporting their efficacy in treating calves with diarrhea. Extralabel antimicrobial use (excluding prohibited antimicrobials) is therefore justified in treating calf diarrhea because of the apparent lack of published studies documenting clinical efficacy of antimicrobials with a label claim and because the health of the animal is threatened; suffering or death may result from failure to treat systemically ill calves.

#### Administration of Oral Antimicrobials to Treat *Escherichia coli* Overgrowth of the Small Intestine

Based on published evidence for the oral administration of these antimicrobial agents, only amoxicillin can be recommended for the treatment of diarrhea; dosage recommendations are amoxicillin trihydrate (10 mg/kg every 12 h) or amoxicillin trihydrate–clavulanate potassium (10 mg/kg amoxicillin trihydrate and 2.5 mg/kg clavulanate potassium every 12 h) for at least 3 days; the latter constitutes extralabel drug use. Concurrent feeding of milk and amoxicillin does not change the bioavailability of amoxicillin, although amoxicillin is absorbed faster when dissolved in an oral electrolyte solution than in milk replacer, and absorption is slowed during endotoxemia, presumably because of a decrease in abomasal emptying rate. Amoxicillin trihydrate is preferred to ampicillin trihydrate for oral administration in calves because it is labeled for the treatment of calf diarrhea in the United States and is absorbed to a much greater extent. However, a field study comparing oral amoxicillin (400 mg every 12 h) and ampicillin (400 mg every 12 h) treatments for diarrhea reported similar proportions of calves with a good to excellent clinical response (79%, 49/62 for amoxicillin bolus; 80%, 59/74 for amoxicillin powder; 65%, 47/65 for ampicillin bolus;  $p > 0.30$  for all comparisons). The addition of clavulanate potassium to amoxicillin trihydrate is recommended because clavulanate potassium, although not having a direct antimicrobial

effect, is a potent irreversible inhibitor of beta-lactamase, increasing the antimicrobial spectrum of activity.

Oral administration of potentiated sulfonamides is not recommended for treating calf diarrhea because of the lack of efficacy studies. Gentamicin (50 mg/calf orally every 12 h) markedly decreased *E. coli* bacterial concentrations in the feces of healthy calves, and treatment with gentamicin has been shown to improve stool consistency in calves with experimentally induced *E. coli* diarrhea. However, oral administration of gentamicin is not recommended because antimicrobials administered to calves with diarrhea should have both local and systemic effects, and orally administered gentamicin is poorly absorbed.

Colistin administered orally is frequently used in calves in piglets to treat enterotoxigenic colibacillosis. Oral colistin will decrease the number of *E. coli* bacteria in the intestinal lumen and thereby the amount of enterotoxin affecting the intestinal mucosa and can present an effective treatment of uncomplicated cases of enteric colibacillosis. Because colistin is poorly absorbed from the alimentary tract, this treatment is not indicated in cases of suspected septicemia.

Oxytetracycline and chlortetracycline are not recommended for the oral treatment of bacteremia, although tetracyclines may have some efficacy for treating *E. coli* bacterial overgrowth of the small intestine. Tetracyclines are bound to calcium, and oral bioavailability when administered with milk is 46% for oxytetracycline and 24% for chlortetracycline.

Florfenicol achieves high concentrations in the lumen of the small intestine and is 89% absorbed when orally administered to milk-fed calves; however, florfenicol does not provide the most appropriate antimicrobial for treating calf diarrhea, because the MIC<sub>90</sub> for *E. coli* is very high at 25 µg/mL and florfenicol (11 mg/kg orally) was shown to fail to reach the MIC<sub>90</sub> value in plasma.

Fluoroquinolones clearly have proven efficacy in treating calf diarrhea, and a label indication exists in Europe for oral and parenteral enrofloxacin and oral marbofloxacin for the treatment of calf diarrhea. Oral fluoroquinolones have a high oral bioavailability. However, it must be emphasized that extralabel use of the fluoroquinolone class of antimicrobials in food-producing animals in the United States is illegal and obviously not recommended. Also, in other countries it may be illegal to use some of the antimicrobials mentioned here because of the regulations regarding their use in food-producing animals.

The indiscriminate use of antibiotics in milk replacers for the treatment of newborn calves and piglets is widespread and must be viewed with concern when the problem of drug-resistance transfer from animal to animal and to humans is considered.

In calves with diarrhea and no systemic illness (normal appetite for milk or milk replacer, no fever), it is recommended that the clinician should monitor the health of the calf and should not administer oral antimicrobials.

#### Administration of Parenteral Antimicrobials to Treat *Escherichia coli* Bacteremia

A common and widely recommended treatment is ceftiofur (2.2 mg/kg intramuscularly/subcutaneously every 12 h) for at least 3 days. Ceftiofur is a broad-spectrum third-generation cephalosporin and beta-lactam antimicrobial that is resistant to the action of beta-lactamase; the MIC<sub>90</sub> for *E. coli* is less than 0.25 µg/mL, the recommended dosage schedule maintains free plasma antimicrobial concentrations at the desired value of four times the MIC<sub>90</sub> value for the duration of treatment in 7-day-old calves, and 30% of the active metabolite of ceftiofur (desfuroyl-ceftiofur) is excreted into the intestinal tract of cattle, providing antimicrobial activity in both the blood and the small intestine. Parenteral (2 mg/kg, intramuscularly once) administration of ceftiofur hydrochloride decreased mortality rate and the severity of diarrhea in pigs with experimentally induced enteric colibacillosis, although these pigs were not suspected to be bacteremic. The beneficial effects of parenteral ceftiofur in these pigs was attributed to decreasing intestinal luminal concentration of pathogenic *E. coli*. Administration of ceftiofur to treat bacteremia and diarrhea in calves constitutes extralabel drug use.

In those countries where the use of fluoroquinolones in food-producing animals is permitted for this indication, parenteral administration to calves with diarrhea has been recommended because of their broad-spectrum bactericidal activity, particularly against gram-negative bacteria. It must be emphasized that extralabel use of the fluoroquinolone class of antimicrobials in food-producing animals in the United States and other countries is illegal and obviously not recommended.

Cephalosporins and fluoroquinolones are among the most commonly used antimicrobials to treat colibacillosis in farm animals because of their proven efficacy and because they have largely maintained their activity against *E. coli*. Recent trends of decreasing susceptibility of *E. coli* and other pathogens mainly to fluoroquinolones and to a lesser degree to third- and fourth-generation cephalosporins have, however, been reported and present a serious public health issue (see following discussion under “Use of Antimicrobials That Are of Critical Importance for Human and Veterinary Medicine”).<sup>25-27</sup>

Another recommended treatment is parenteral amoxicillin trihydrate or ampicillin trihydrate (10 mg/kg intramuscularly every 12 h) for at least 3 days. Although par-

enteral ampicillin has proven efficacy in treating naturally acquired diarrhea, whereas ceftiofur has unproven efficacy, the broad-spectrum beta-lactam antimicrobials amoxicillin and ampicillin are theoretically inferior to ceftiofur because parenterally administered ampicillin and amoxicillin reach lower plasma concentrations and require a higher MIC than ceftiofur, and they are not beta-lactamase-resistant. The intramuscular administration of amoxicillin and ampicillin is preferable over subcutaneous administration because the rate and extent of absorption are superior after intramuscular injection.

Parenteral treatment with potentiated sulfonamides (20 mg/kg sulfadiazine with 5 mg/kg trimethoprim, intravenously or intramuscularly depending on the formulation characteristics, every 24 h for 5 d) is also widely used. The efficacy of potentiated sulfonamides has only been proved when treatment commenced before clinical signs of diarrhea were present. It is therefore unknown whether potentiated sulfonamides are efficacious when administered to calves with diarrhea and depression, although it is likely that potentiated sulfonamides are efficacious in the treatment of salmonellosis.

Parenteral administration of gentamicin and other aminoglycosides (amikacin, kanamycin) cannot currently be recommended as part of the treatment for calf diarrhea because of the lack of published efficacy studies, prolonged slaughter withdrawal times (15 to 18 months), potential for nephrotoxicity in dehydrated animals, and availability of amoxicillin, ampicillin, and ceftiofur.

Chloramphenicol had proven efficacy in treating calf diarrhea resulting from *Salmonella enterica* serotypes Bredeney and Dublin, but it is now illegal for use in food-producing animals in the United States and in many other countries. The related antimicrobial florfenicol (20 mg/kg intramuscularly) failed to reach the MIC<sub>90</sub> value in plasma and only exceeded the MIC<sub>90</sub> value for less than 60 minutes when administered intravenously (11 to 20 mg/kg IV).

In calves with diarrhea and no systemic illness (normal appetite for milk or milk replacer, no fever), the clinician should monitor the health of the calf and refrain from administering oral or parenteral antimicrobials.

#### Use of Antimicrobials That Are of Critical Importance for Human and Veterinary Medicine

Antimicrobials commonly used for the treatment of colibacillosis in food-producing animals include third- and fourth-generation cephalosporins and fluoroquinolones, some of which have a label for the treatment of septicemia caused by *E. coli* in calves in some European and other countries and some of which can be used in an extralabel



manner in certain countries.<sup>30</sup> These classes of antimicrobials are considered to be **critically important for human and animal health**, and thus recent reports of increasing prevalence of resistance of *E. coli*, *Salmonella* spp., and *Enterobacter* spp. against these classes of antimicrobials are very concerning.<sup>25-27</sup> Although there appears to be general consensus that these antimicrobials should be used restrictively in veterinary medicine, there is currently no harmonized approach on prudent use of cephalosporins and fluoroquinolones in animals. Guidance on prudent use of antimicrobials for animals have been published in many countries, but most are on a general level, and cephalosporins and fluoroquinolones are not always specially addressed.<sup>30</sup>

The World Organization for Animal Health (OIE) issued the following recommendations for these classes of antimicrobials:<sup>31</sup>

- They are not to be used as preventive treatment applied by feed or water in the absence of clinical signs.
- They are not to be used as first-line treatment unless justified. When used in a second-line treatment, such use should ideally be based on the results of bacteriologic tests.
- Extralabel/off-label use should be limited and reserved for instances in which no alternatives are available. Such use should be in agreement with the national legislature in force.

### Immunoglobulin Therapy

One of the important factors determining whether or not an animal will survive enteric colibacillosis is the serum immunoglobulin status of the animal before it develops the disease. The prognosis is unfavorable if the level of immunoglobulin is low at the onset of diarrhea, regardless of intensive fluid and antimicrobial therapy. Most of the literature on therapy omits this information and is therefore difficult to assess. There is ample evidence that the mortality rate will be high in diarrheic calves that are deficient in serum immunoglobulin, particularly IgG, in spite of exhaustive antimicrobial and fluid therapy. This has stimulated interest in the possible use of purified solutions of bovine gamma-globulin in diarrheic calves that are hypogammaglobulinemic. However, they must be given by the intravenous route and in large amounts, the cost of which would be prohibitive. In addition, they are unlikely to be of value once the calf is affected with diarrhea; they are protective and probably not curative. Whole blood transfusion to severely affected calves may be used as a source of gammaglobulin, but unless given in large quantities will not significantly elevate serum immunoglobulin concentrations in deficient calves. Limited controlled trials indicate that there is no significant difference in the survival rate of diarrheic calves treated with

either a blood transfusion daily for 3 days; fluid therapy given orally, subcutaneously, or intravenously, depending on the severity of the dehydration; or fluid therapy with antibiotics. Those calves that survived, regardless of the type of therapy, had high immunoglobulin concentrations before they developed diarrhea. This emphasizes the importance of the calf ingesting liberal quantities of colostrum within the first few hours after birth.

### Analgesic and Antiinflammatory Therapy

Pain in sick farm animals has become an important issue for veterinarians and producers and is perceived as important animal welfare issue by the public. Adequate pain management should be part of any state-of-the-art treatment approach.

Diarrhea can be accompanied by abdominal pain as a result of intestinal inflammation and cramping. In addition to controlling pain, the main objectives of antiinflammatory therapy in animals with colibacillosis are to control the inflammatory process in the intestinal tract and to ameliorate the effects of endotoxemia and septicemia.<sup>32</sup> Several field studies reported that diarrheic calves receiving nonsteroidal antiinflammatory drugs (NSAIDs) in conjunction with fluid therapy showed less signs of pain, made a faster recovery, and had better weight gains in the convalescent period.<sup>33</sup> Although the underlying mechanisms do not appear to have been studied in detail, the proven beneficial effects of several NSAIDs have been attributed to their analgesic, antiinflammatory, antipyretic, and antisecretory properties.

Two broad categories of antiinflammatory agents that are available are the corticosteroids and the NSAIDs. Little evidence documenting the efficacy of corticosteroids for the treatment of calf diarrhea is available, but the use of this class of antiinflammatory drugs has been discouraged on the theoretical grounds that diarrheic calves already tend to have higher concentrations of plasma cortisol of endogenous origin and because of the immunosuppressive effect of these compounds.<sup>32</sup>

The efficacy of different NSAIDs such as meloxicam, ketoprofen, or flunixin meglumine in diarrheic calves that were systemically ill has been investigated in several studies.<sup>32</sup> A single treatment with meloxicam (0.5 mg/kg intravenously [IV]) and treatment with ketoprofen (6 mg/kg IV) twice, 4 hours apart, were both found to improve general attitude, the fecal score, and the feed intake of systemically affected calves with diarrhea.<sup>32</sup> Flunixin meglumine (2.2 mg/kg IV) hastened clinical recovery, but only for animals that had visible amounts of blood in feces.<sup>34</sup>

Because treatment with NSAIDs in diarrheic animals bears the risk of causing renal

damage by further decreasing renal perfusion in already dehydrated animals, adequate oral and/or parenteral fluid therapy must be assured. An empirical guideline posits that treatment with NSAIDs should be limited to a single treatment whenever possible but should not exceed three treatments, a recommendation that has been justified by the risk of abomasal ulceration that is associated with prolonged use of these antiinflammatory agents.<sup>32</sup>

### Antimotility Drugs

Administration of substances reducing intestinal motility to treat diarrhea in farm animals is advocated by some veterinarians. Compounds such as hyoscine-N-butylbromide and atropine have a proven inhibitory effect on intestinal motility, which undisputedly results in a rapid decrease of the fecal output in diarrheic patients. Although reducing fecal production may be interpreted as positive treatment outcome, it can also be seen as sequestration of gut fluid in the intestinal tract. Delaying the excretion of intestinal contents in patients suffering from malabsorptive diarrhea bears the risk of enhanced fermentation of unabsorbed carbohydrates and other nutrients. This could not only exacerbate enteric dysbiosis, but also the accumulation of D-lactic acid, which was found to markedly contribute to the clinical symptoms observed in diarrheic calves.<sup>12</sup> There does not appear to be any hard evidence in favor or against the use of antimotility drugs in diarrheic animals. Their use is nonetheless discouraged based on the possible negative effects that certainly outweigh the subjective perception of clinical improvement that is based on the apparent reduction of feces production.<sup>32,35</sup>

### Intestinal Protectants

Intestinal protectants such as kaolin and pectin are in general use for diarrheic animals; however, as with antimotility drugs, their value is uncertain. When they are used, the feces become bulky, but intestinal protectants do not have any known effect on the pathogenesis of the disease.

### Alteration of the Diet

Whether or not diarrheic newborn animals should be deprived of milk during the period of diarrhea is under controversial debate. Diarrheic piglets are usually treated with an antimicrobial orally and left to nurse on the sow. Diarrheic beef calves are commonly treated with oral fluids and electrolytes and left with the cow. However, in dairy calves it is a common practice to reduce the milk intake of diarrheic animals for up to 24 hours or until there is clinical evidence of improvement. The withholding of milk from diarrheic calves has been advocated based on the consideration that lactose digestion is impaired and that "resting" the intestine for a few days will consequently minimize

additional osmotic diarrhea caused by fermentation of undigested lactose in the large intestine. In contrast, the argument in favor of continuous feeding of milk is that the intestinal tract requires a constant source of nutrition, which it receives from the ingesta in the lumen of the intestine. To date, there is no scientific evidence available confirming that transiently starving diarrheic animals has any beneficial effects on the clinical outcome. Studies exploring the effect of continuous milk feeding in diarrheic calves failed to confirm any deleterious effect, such as prolonged morbidity time, higher mortality rate, or higher treatment frequency. To the contrary, calves kept on milk had higher weight gains during the period of reconvalescence.<sup>32,36</sup> Although diarrheic animals clearly should be supplemented with oral electrolyte solutions to assist the compensation of excessive fluid and electrolyte loss, the currently available evidence is clearly in favor of maintaining the animal on milk or milk replacer. Calves should be offered reduced quantities of whole milk per feeding with higher feeding frequency. Milk should not be diluted with water because this may interfere with the clotting mechanism in the abomasum. In contrast to oral electrolyte solutions, milk should not be force-fed with an esophageal tube feeder because this will prevent closure of the reticular groove and thus foster accumulation of milk in the rumen, where it would be subject to bacterial fermentation.

### Probiotics

The use of so-called probiotics for treatment and prevention of diarrhea has become increasingly popular over the past decades. Probiotics are defined as live microorganisms that, when administered in adequate amounts, confer a beneficial effect on the health of the host.<sup>37</sup> Most probiotics intended for veterinary use belong to the broad class of lactic acid bacteria, which include *Lactobacillus*, *Bifidobacterium*, *Enterococcus*, and *Streptococcus* spp. Probiotics have been claimed to promote gastrointestinal health and immunity, to reduce the shedding of potential pathogens in feces, and to reduce the need for therapeutic intervention.<sup>38</sup> Most importantly, probiotics are widely considered not to be present any health risk for the patient. Unfortunately, to date there are no published clinical data obtained in animals supporting any of these claims. Of particular concern is that the use of probiotics in humans has been associated with *Lactobacillus* bacteremia in several immunocompromised patients, and deleterious effects with some commercial products have been observed in neonatal foals.<sup>39</sup> In veterinary medicine concerns have been voiced about the uncritical use of probiotics, particularly in neonates with systemic disease or with a compromised intestinal mucosa.<sup>40,41</sup> With the current knowledge, the use of probiotics

cannot be recommended for treatment or prevention of neonatal diarrhea.

### Clinical Management of Outbreaks

Veterinarians should consider the following principles when outbreaks of colibacillosis in neonatal farm animals are encountered:

- Visit the farm and conduct an epidemiologic investigation to identify risk factors.
- Examine each risk factor and how it can be minimized.
- Examine affected animals.
- Identify and isolate all affected animals if possible.
- Treat all affected animals as necessary.
- Take laboratory samples from affected and normal animals.
- Make recommendations for the control of diarrhea in animals to be born in the near future.
- Prepare and submit a report to the owner describing the clinical and laboratory results and how the disease can be prevented in the future.

### TREATMENT

#### Calf enterotoxigenic colibacillosis

##### Fluid therapy (highest priority)

Parenteral fluid therapy to correct acid-base and water and electrolyte imbalances\* (R-1)  
Oral rehydration solution\* (R-1)

##### Antimicrobial therapy

Amoxicillin (10 mg/kg IM/PO every 12h for at least 3 days) (R-2)  
Amoxicillin-clavulanate (12 mg combined/kg PO/IM every 12h for at least 3 days) (R-2)  
Ampicillin (10 mg/kg PO/IM every 12h for at least 3 days) (R-2)  
Colistin (100,000 IU/kg PO every 24h for at least 3 days) (R-2)  
Enrofloxacin (2.5 to 5 mg/kg IV/IM/SC/PO every 24h for at least 3 days) (R-2)  
Neomycin (10 mg/kg PO q12h) (R-2)  
Trimethoprim-sulfonamide (25 mg combined/kg IV/IM/PO every 12h for at least 3 days) (R-2)

##### Antiphlogistic therapy

Flunixin meglumine (2.2 mg/kg IV once) (R-2)  
Ketoprofen (6 mg/kg IM once) (R-2)  
Meloxicam (0.5 mg/kg IV/SC once) (R-2)

##### Antimotility drugs (R-3)

##### Probiotics (R-3)

#### Calf septicemic colibacillosis

##### Antimicrobial therapy

Amoxicillin-clavulanate (25 mg/kg IV/IM every 6–8h) (R-2)  
Ampicillin-sodium (10 mg/kg IV/IM every 8h) (R-2)  
Cefquinome (2 mg/kg IM every 24h) (R-2)  
Ceftiofur (2.2 mg/kg IM/SC every 12 h) (R-2)  
Enrofloxacin (5 mg/kg IV/IM every 24 h) (R-2)  
Florfenicol (20 mg/kg IM every 24h) (R-2)  
Trimethoprim-sulfonamide (25 mg combined/kg IV every 8–12h) (R-2)

#### Piglet enterotoxigenic colibacillosis

##### Fluid therapy (highest priority)

Oral rehydration solution\* (R-1)  
Amoxicillin (10 mg/kg PO/IM every 12h for at least 3 days) (R-2)  
Amoxicillin-clavulanate (12 mg combined/kg PO/IM every 12h for at least 3 days) (R-2)  
Ampicillin (10 mg/kg PO/IM every 12h for at least 3 days) (R-2)  
Ceftiofur (1.1 to 2.2 mg/kg IM every 24h for at least 3 days) (R-2)  
Chlortetracycline (20 mg/kg PO every 24h for at least 3 days) (R-2)  
Enrofloxacin (2.5 to 5 mg/kg IV/IM/SC/PO every 24h for at least 3 days) (R-2)  
Colistin (100,000 IU/kg PO every 24h for at least 3 days) (R-2)  
Oxytetracycline (10 mg/kg IM every 24h for at least 3 days) (R-2)  
Neomycin (10 mg/kg PO every 12h for at least 3 days) (R-2)  
Trimethoprim-sulfonamide (25 mg combined/kg IV/IM/PO every 12h for at least 3 days) (R-2)

\*See "Principles of Fluid and Electrolyte Therapy."

### CONTROL

Because of the complex nature of the disease, it is unrealistic to expect total prevention, and control at an economical level should be the major goal. Effective control of colibacillosis can be accomplished by the application of three principles:

- Reduce the degree of exposure of the newborn to the infectious agents.
- Provide maximum nonspecific resistance with adequate colostrum and optimum animal management.
- Increase the specific resistance of the newborn by vaccination of the dam or the newborn.

### Reduction of the Degree of Exposure of the Newborn to the Infectious Agents

The emphasis is on ensuring that newborns are born into a clean environment. Barns, confinement pens, and paddocks used as parturition areas must be clean and should preferably have been left vacant for several days before the pregnant dams are placed in them.

### Dairy Calves

The following comments are directed particularly at calves born indoors, where contamination is higher than outdoors:

- Greatest attention must be paid to maternity pen hygiene. Calves should be born in well-bedded clean and dry box stalls.
- Obstetric intervention and assistance to calving should be provided by adequately trained personnel in a calm and hygienic manner.

- Immediately after birth the umbilicus of the calf should be swabbed or dipped 2% iodine tincture or chlorhexidine solution.
- In herds with high disease incidence the residence time of calves in the maternity pen should be kept as short as possible and calves moved to clean, dry, and well-bedded individual calf pens or hutches as soon as possible after birth.
- Calves affected with diarrhea should be removed from the main calf barn if possible and treated in isolation.

### Beef Calves

Beef calves are usually born on pasture or on confined calving grounds, and the following guidelines apply:

- Calving grounds should have been free of animals previous to the calving period; the grounds should be well drained, dry, and scraped free of snow if possible. Each cow–calf pair should be provided with at least 2000 sq ft of space. Calving on pasture with adequate protection from wind is ideal. Covering the calving grounds with straw or wood shavings provides a comfortable calving environment.
- In large beef herds, in a few days following birth when the calf is nursing successfully, the cow–calf pair should be moved to a nursery pasture to avoid overcrowding in the calving grounds.

In beef herds, breeding plans should ensure that heifers calve at least 2 weeks before the mature cows. Limiting the breeding and therefore the calving season to 45 days or less for heifers also offers several advantages. A short calving season allows the producer to more effectively and economically concentrate personnel resources on calving management compared with a longer calving season. Calving heifers earlier allows them additional time required before the next breeding season to be on an increasing plane of nutrition necessary to maintain a high conception rate. The earlier calving of heifers also provides less exposure of their calves to infection pressure from the mature animals in the herd.

The incidence and severity of neonatal disease will typically increase, and the age at disease onset will decrease, as the calving season progresses. This phenomenon is common in beef herds because of the effect of the calf as a biological amplifier. The more the calving season is shortened, the more the biological amplification effect is negated.

For beef herds, it is necessary to have a plan for cattle movement throughout the calving season. This requires a minimum of four or five separate pastures: a gestation pasture, a calving pasture, and a series of nursery pastures. To ensure that beef calves are born in a sanitary environment, the herd should be moved from the gestation pasture to the calving pasture 1 to 2 weeks before

calving. One day after birth, the cow or heifer and her calf should be moved to a nursery pasture. Cow–calf pairs should be added to a single nursery pasture until the appropriate number of pairs has been reached. Thereafter, cow–calf pairs can be added to a second nursery pasture. The difference in age between the oldest and youngest calf in a nursery pasture should never exceed 30 days, and smaller differences are preferable. This negates the biological amplification effect. The longer the calving season, the greater the need for a large number of nursery pastures. Calves that develop diarrhea should be removed immediately to an area away from healthy calves, treated, and not returned until all calves in the group are at low risk for developing diarrhea (>30 days of age).

The nutrition of the pregnant cows, and particularly the first-calf heifers, must be monitored throughout gestation to ensure an adequate body condition and sufficient resources to provide an adequate supply of good-quality colostrum.

### Veal Calves

Veal calves are usually obtained from several different sources, and 25% to 30% or higher may be deficient in serum immunoglobulin. The following guidelines apply to veal calves:

- On arrival, calves should be placed in their individual calf pens, which were previously cleaned, disinfected, and left vacant to dry.
- Feeding utensils are a frequent source of pathogenic *E. coli* and should be cleaned and air-dried daily.
- Calves affected with diarrhea should be removed and isolated immediately.

### Lambs and Kids

The principles described earlier for calves apply to lambs and kids. Lambing sheds can be a source of heavy contamination and must be managed accordingly to reduce infection pressure on newborn lambs.

### Piglets

Piglets born in a total-confinement system may be exposed to a high infection rate. The following guidelines apply to piglets:

- The all-in/all-out system of batch farrowing, in which groups of sows farrow within a week, is recommended. This system will allow the herdsman to wean the piglets from a group of sows in a day or two and clean, disinfect, and leave vacant a battery of farrowing crates for the next group of sows. This system will reduce the total occupation time and the infection rate. The continuous farrowing system without regular breaks is not recommended.
- Before being placed in the farrowing crate, sows should be washed with a suitable disinfectant to reduce the bacterial population of the skin.

### Provision of Maximum Nonspecific Resistance With Adequate Colostrum and Optimum Animal Management

The first step of fostering maximum nonspecific resistance is the provision of optimal nutrition to the pregnant dam, which will result in a vigorous newborn animal and adequate quantities of colostrum. At the time of parturition, surveillance of the dams and the provision of any obstetric assistance required will ensure that newborns are born with as much vigor as possible. Parturition injuries and intrapartum hypoxemia must be minimized as much as possible.

### Colostrum Management

The next most important control measure is to ensure that liberal quantities of good-quality colostrum are available and ingested within minutes and no later than a few hours after birth. Although the optimum amount of colostrum that should be ingested by a certain time after birth is well known, the major difficulty with all species under practical conditions is to know how much colostrum a particular neonate has ingested. Because modern livestock production has become so intensive, it is imperative that the animal attendants make every effort to ensure that sufficient colostrum is ingested by that particular species. In a recent national survey in the United States, the estimated prevalence of failure of passive immunity transfer in female dairy calves was 19.2%.<sup>41</sup>

**Failure of transfer of passive immunity (FTPI)**, as determined by calf serum immunoglobulin IgG<sub>1</sub> concentration below 1000 mg/dL at 48 hours of age, occurred in 61.4% of calves from a dairy in which calves were nursed by their dams, 19.3% of calves from a dairy using nipple bottle feeding, and 10.8% of calves from a dairy using tube feeding. A higher prevalence of FTPI in dairy calves can occur because an insufficient volume of colostrum is ingested by the calf. When artificial feeding is used, inadequate immunoglobulin concentration in the colostrum fed is the most important factor resulting in FTPI. The prevalence of FTPI in dairy herds can be minimized by artificially feeding all newborn calves large volumes (3 to 4 L) of fresh or refrigerated first-milking colostrum from cows that had nonlactating intervals of normal duration. This volume is considerably greater than the intake that Holstein calves usually achieve by sucking and also exceeds the voluntary intake of most calves fed colostrum by nipple bottle.

Calves need to ingest at least 100 g of IgG<sub>1</sub> in the first colostrum feeding to ensure adequate transfer of passive immunity. Thus the routine force-feeding of a sufficient amount of pooled colostrum immediately after birth results in high serum levels of colostrum immunoglobulin in dairy calves and is becoming a common practice in dairy herds.

Encouraging and assisting the calf to suck within 1 hour after birth is also effective. The



provision of early assisted sucking of colostrum to satiation within 1 hour after birth will result in high concentrations of absorbed immunoglobulin in the majority of calves. The ingestion of 100 g or more of colostrum immunoglobulin within a few hours after birth is more effective in achieving high levels of colostrum immunoglobulin in calves than either leaving the calf with the cow for the next 12 to 24 hours or encouraging the calf to suck again at 12 hours, which will not result in a significant increase in absorbed immunoglobulin.

Despite early assisted sucking, a small proportion of calves will remain hypogammaglobulinemic because of low concentrations of immunoglobulin in their dams' colostrum, usually associated with leakage of colostrum from the udder before calving.

In large herds where economics permit, a laboratory surveillance system may be used on batches of calves to determine the serum levels of immunoglobulin acquired. An accurate analysis may be done by electrophoresis or an estimation using the zinc sulfate turbidity test. Blood should be collected from calves at 24 hours of age. Samples taken a few days later may not be a true reflection of the original serum immunoglobulin concentrations. The information obtained from determination of serum immunoglobulin in calves at 24 hours of age can be used to improve management practices, particularly the early ingestion of colostrum.

### Quality of Colostrum

#### *Specific Gravity*

Differentiating high-immunoglobulin-concentration colostrum from low-immunoglobulin-concentration is problematic. Measurement of the specific gravity of the colostrum of dairy cows with a commercially available hydrometer (Colostrometer) has been explored. Originally it was claimed that measurement of specific gravity provided an inexpensive and practical method for estimating colostrum immunoglobulin concentration. However, the specific gravity of colostrum is more correlated with its protein concentration than immunoglobulin concentration and varies with colostrum temperature, thus limiting the predictive accuracy of the test. In addition, different relationships between specific gravity and immunoglobulin concentration of colostrum have been observed for different populations of Holstein Friesian and Jersey cows and between herds. Specific gravity may also vary considerably according to season of the year. Specific gravity was measured in 1085 first-milking colostrum samples from 608 dairy cows of four breeds on a single farm during a 5-year period. The specific gravity more closely reflected protein concentration than IgG concentration and was markedly affected by month of calving. Colostrum specific gravity values were highest for Holstein and Jersey cows, cows in third or later

lactation, and cows calving in autumn. They were lowest in Brown Swiss and Ayrshire cows, cows in first or second lactation, and cows calving in summer. Thus using the specific gravity of colostrum as an indicator of IgG concentration has potential limitations.

#### *Frozen and Thawed Colostrum*

Colostrum can be banked as frozen colostrum for future use. Excess colostrum can be stored frozen and thawed as necessary to provide an IgG source when administration of dam colostrum is impractical or insufficient. Experience has shown that the composition of frozen colostrum remains constant throughout storage. No significant changes in pH, percentage acidity, milk fat, total solids, total nitrogen, or nonprotein resulted from colostrum being stored. Feeding 4 L of frozen thawed colostrum (which had been frozen at  $-20^{\circ}\text{C}$  ( $-4^{\circ}\text{F}$ ) for 24 h) to calves by orogastric tube at 3 hours after birth did not result in a significant difference in IgG absorption compared with calves receiving fresh colostrum.

#### *Pasteurization of Colostrum*

There are several indications for pasteurization of colostrum. This procedure can be a suitable instrument in a program for the control of specific infectious diseases, such as paratuberculosis, salmonellosis, or *M. bovis* infection, but it can also be useful to ameliorate calf health by improving colostrum quality and reducing the exposure of the neonate to pathogens. On-farm pasteurization of bovine colostrum for 60 min at  $60^{\circ}\text{C}$  ( $140^{\circ}\text{F}$ ) results in elimination or at least significant reduction of bacterial contamination without impairing fluid characteristics or availability of IgG for intestinal absorption.<sup>7</sup> One recent study reported significantly higher serum IgG concentrations at 24 hours of life when calves were fed pasteurized colostrum compared with calves receiving the same quality and amount of raw colostrum.<sup>42</sup> The authors attributed this effect to reduced bacterial interference with intestinal IgG absorption. Pasteurization extends the shelf life of refrigerated colostrum without additives to 8 to 10 days when stored in clean, sealed containers.

### Colostrum Supplements and Replacers

Some colostrum-derived oral supplements containing immunoglobulin are available for newborn calves in which colostrum intake is suspected or known to be inadequate. **Colostrum supplement** products have been developed to provide exogenous IgG to calves when the dam's fresh colostrum is of low IgG concentration. Many producers also use these products to replace colostrum when it is unavailable as a result of maternal agalactia, acute mastitis, or other causes of inadequate colostrum supply. However, they contain low immunoglobulin concentrations

compared with those found in high-quality first-milking colostrum. Most colostrum supplements provide only 25 to 45 g of IgG/dose of 454 g, which is reconstituted in 2 L of water. Feeding one or even two doses of such supplements is insufficient to provide a mass of 100 g of IgG within the first 12 hours after birth. **Colostrum replacers** are intended to provide the sole source of IgG and thus must provide at least 100 g of IgG. Newborn colostrum-deprived dairy calves fed spray-dried colostrum containing 126 g of immunoglobulin in 3 L of water as their sole source of immunoglobulin achieved normal mean serum immunoglobulin concentrations. Whey protein concentrate as a colostrum substitute, administered to calves as a single feeding, was ineffective in preventing neonatal morbidity and mortality compared with a single feeding of pooled colostrum.

The IgG derived from bovine serum or immunoglobulin concentrates from bovine plasma are well absorbed by neonatal calves when given in adequate amounts. The serum concentration of IgG in calves at 2 days of age force-fed a colostrum supplement containing spray-dried serum (total of 90 g immunoglobulin protein) within 3 hours after birth was much lower than in calves fed 4 L of fresh colostrum. The mass of IgG and the method of processing are critical. Products providing less than 100 g of IgG/dose should not be used to replace colostrum.

To be successful, colostrum supplements and replacers must provide enough IgG mass to result in 24-hour calf serum IgG concentrations of more than 10 g/L.

### Purified Bovine Immunoglobulin

The administration of purified bovine gammaglobulin to calves that are deficient appears to be a logical approach, but the results have been unsuccessful. Large doses (30 to 50 g) of gammaglobulin given intravenously would be required to increase the level of serum gammaglobulin from 0.5 g/dL to 1.5 g/dL of serum, which is considered an adequate level. The cost would be prohibitive. The administration of gammaglobulin by any parenteral route other than the intravenous route does not result in a significant increase in serum levels of the immunoglobulin.

To be effective, infusion of immunoglobulin derived from blood must increase serum IgG concentrations and reduce morbidity and mortality before weaning without affecting later production. Parenteral infusions of immunoglobulin will increase the concentrations of serum IgG in calves, but may not necessarily have an effect on morbidity or mortality. High levels of specific circulating immunoglobulin can serve as a reservoir of antibodies to move into the intestine and prevent enteric infection. Thus immunoglobulin sources other than colostrum may not provide immunoglobulins that are specific for antigens present in the environment

or might be insufficient when calves are exposed to a heavy infection pressure.

### Beef Calves

The management strategies to decrease calf death losses in beef herds have been described. The role of management intervention in the prevention of neonatal deaths includes measures to improve host defenses and environmental hygiene to minimize outbreaks of neonatal disease. Specific attention is centered on preventing dystocia, improving transfer of colostrum immunoglobulin, and limiting environmental contamination.

The following practices should be implemented:

- Management of the beef herd must emphasize prevention of dystocia, which involves limiting calf size and ensuring adequate pelvic area of the dams.
- Beef calves should be assisted at birth, if necessary, to avoid exhaustion and weakness from a prolonged parturition.
- Normally beef calves will make attempts to get up and suck within 20 minutes after birth, but this may be delayed for up to 8 hours or longer. Beef calves that do not suck within 2 hours should be fed colostrum by nipple bottle or stomach tube. Whenever possible, they should be encouraged and assisted to suck to satiation within 1 hour after birth. The dam can be restrained and the calf assisted to suck. If the calf is unable or unwilling to suck, the dam should be restrained and milked out by hand, and the calf should be fed the colostrum with a nipple bottle or stomach tube. The mean volume of colostrum and colostrum immunoglobulin produced in beef cows and the absorption of colostrum immunoglobulin by their calves can vary widely. Beef calves deserted by indifferent dams need special attention. FTPI is common and estimated at 10% to 40% of beef calves.
- Constant surveillance of the calving grounds is necessary to avoid overcrowding, to detect diarrheic calves that should be removed, to avoid mismothering, and to ensure that every calf is seen to nurse its dam. Although up to 25% of beef calves may not have sufficient serum levels of immunoglobulin, the provision of excellent management will minimize the incidence of colibacillosis. The recently developed practice of corticosteroid-induced parturition in cattle may result in a major mismothering problem if too many calves are born too quickly in a confined space. Every management effort must be used to establish the cow-calf herd as soon as possible after birth. This will require high-quality management to reduce the infection rate

even further and minimize any stressors in the environment.

### Lambs

Lambs require 180 to 210 mL of colostrum/kg BW during the first 18 hours after birth to provide sufficient energy for heat production. Such an intake will usually also provide enough colostrum immunoglobulin. Early encouragement and assistance of the lambs to suck the ewe is important. Well-fed ewes usually have sufficient colostrum for singletons or twins. Underfed ewes may not have sufficient colostrum for one or more lambs, and supplementation from stored colostrum obtained by milking other high-producing ewes is a useful practice.

### Piglets

The following practices should be implemented for piglets:

- Every possible economical effort must be made to ensure that each newborn piglet obtains a liberal supply of colostrum within minutes of birth. The farrowing floor must be well drained, and it must be slip-proof to allow the piglets to move easily to the sow's udder. Some herdsmen provide assistance at farrowing, drying off every piglet as it is born and placing it immediately onto a teat.
- The washing of the sow's udder immediately before farrowing with warm water and soap will reduce the bacterial population and may provide relief in cases of congested and edematous udders.
- The piglet creep area must be dry, appropriately heated for the first week, and free from drafts. During farrowing, colostrum is released in discrete ejections, possibly by discrete release of oxytocin associated with parturition. Therefore, as the piglets are born they must be as close to the udder as possible to take advantage of these discrete ejections.

### Increasing Specific Resistance of the Newborn by Vaccinating the Pregnant Dam or the Newborn

The immunization of neonate farm animals against colibacillosis by vaccination of the pregnant dam or by vaccination of the fetus or the neonate has received considerable research attention in recent years, and the results appear promising.

Such vaccines are practical and effective for the following reasons:

- Most fatal ETEC infections in farm animals occur in the early neonatal period when antibody titers in colostrum and milk are highest.
- More than 90% of the ETEC in farm animals belong to a small family of fimbrial antigens.
- Fimbriae consist of good protein antigens on the bacterial surface,

where they are readily accessible to antibodies.

- Fimbriae are required for a critical step (adhesion-colonization) early in the pathogenesis of the disease.
- Novel or previously low-prevalence fimbrial antigens have not emerged to render the vaccines ineffective.

The pregnant dam is vaccinated 2 to 4 weeks before parturition to induce specific antibodies to particular strains of enteropathogenic *E. coli*, and the antibodies are then passed on to the newborn through the colostrum. The mechanism of protection is the production of antibodies against the pilus antigens, which are responsible for colonization of *E. coli* in the intestine.

**Vaccination is an aid to good management and not a replacement for good management practices.** Vaccines to prevent ETEC diarrhea in calves and piglets are based on the prevailing fimbrial antigens for colonization by ETEC in calves (F5) and newborn pigs (F4, F5, and F6). Reliable data on the efficacy of the commercial vaccines based on randomized clinical field trials are not available, but most animal health professionals perceive that the vaccines are effective and that disease occurs primarily in unvaccinated herds. There are unpublished anecdotal reports that use of the vaccine in cattle has shifted the peak occurrence of diarrhea in calves from the first week to the third and fourth week after birth. The extensive use of fimbria-based vaccines can select against the prevailing fimbrial antigen types as reflected in the vaccines, and emergence of new or previously low-prevalence fimbrial antigens may occur. Fimbriae antigenically distinct from F1, F4, F6, F41 occur among ETEC. However, these antigen types are less prevalent than those currently used in commercial vaccines. There is no evidence that ETEC with novel colonization mechanisms or new fimbrial antigens have emerged under the selection pressure of vaccination. Nor is there evidence that previously "low-prevalence" fimbrial antigen types of ETEC, not represented in the vaccines, have emerged as "common pathogens" filling an ecological niche left by the fimbrial antigen types targeted by the vaccines.

### Calves

Vaccination of pregnant cattle with either purified *E. coli* F5 (K99) pili or a whole-cell preparation containing sufficient F5 antigen can significantly reduce the incidence of enterotoxigenic colibacillosis in calves. Good protection is also possible when the dams are vaccinated with a four-strain *E. coli* whole-cell bacterin containing sufficient F5 pilus antigen and the polysaccharide capsular K antigen. Colostrum antibodies specific for F5 pilus antigen and the polysaccharide capsular K antigen on the surface of the challenge exposure strain of ETEC are protective. There is a highly significant correlation

between lacteal immunity to the F5 antigen and the prevention of severe diarrhea or death in calves challenged with enterotoxigenic *E. coli*. The colostral levels of F5 antibody are highest during the first 2 days after parturition, which is the most susceptible period for enterotoxigenic colibacillosis to occur in the newborn calf. The continuous presence of the F5 antibody in the lumen of the intestine prevents adherence of the bacteria to the intestinal epithelium. The F5 antibody is also absorbed during the period of immunoglobulin absorption and may be excreted into the intestine during diarrhea. This may be one of the reasons that mortality is inversely proportional to serum immunoglobulin levels. The pregnant dams are vaccinated twice in the first year, 6 and 2 weeks before parturition. Each year thereafter they are given a single booster vaccination. An oil-emulsion *E. coli* F5 bacterin given once or twice to pregnant beef cows 6 weeks before calving elicited high levels of serum antibodies that provided protection against experimental infection of newborn calves for up to 87 weeks after vaccination.

Vaccines containing both the F5 antigen of ETEC and rotavirus, and in some cases coronavirus, have been evaluated, with variable results. The colostral antibodies to the F5 antigen are higher in vaccinated than unvaccinated dams, but the colostral antibodies to rotavirus and coronavirus may not be significantly different between vaccinated and unvaccinated dams. In these field trials vaccination had no effect on the prevalence of diarrhea, calf mortality, or the presence of the three enteropathogens. In other field trials the combined vaccine did provide some protection against outbreaks of calf diarrhea. The use of an inactivated oil-adjuvanted rotavirus *E. coli* vaccine given to beef cows in the last trimester of pregnancy decreases the mortality from diarrhea and has a positive influence on the average weight gains of the calves at weaning. To be effective the rotavirus and coronavirus antibodies must be present in the postcolostral milk for several days after parturition, during the period when calves are most susceptible to the viral infection. Vaccination of pregnant cows twice during the dry period at intervals of 4 weeks can increase the colostral antibody levels to *E. coli* F5 by 26 times on day 1 compared with controls. Much lower increases occur at the levels of coronavirus and rotavirus.

A commercially inactivated vaccine containing bovine rotavirus (serotype G6 P5), bovine coronavirus (originally isolated from a calf with diarrhea), and purified cell-free *E. coli* F5 (adsorbed on to aluminum hydroxide gel), formulated as an emulsion in a light mineral oil, has been evaluated in a herd of Ayrshire/Friesian cows vaccinated once at 31 days before the first expected calving date. Compared with control cows, a significant increase in the mean specific antibody titer against all three antigens occurred in the

serum of vaccinated animals (even in the presence of preexisting antibodies), which was accompanied by increased levels of protective antibodies to rotavirus, coronavirus, and *E. coli* F5 in their colostrum and milk for at least 28 days.

Because naturally acquired antibodies to the **J5 antigen** may have an important role in the control of neonatal disease caused by bacterial infections with associated pathogens that share antigens with *E. coli* (J5 strain), vaccination of calves with an *E. coli* O111:B4(J5) vaccine at 1 to 3 days of age and 2 weeks later has been evaluated to control morbidity and mortality in dairy calves up to 60 days of age. The use of either a killed *E. coli* O111:B4(J5) bacterin or a modified live, genetically altered (aro-) *Salmonella dublin* vaccine, or both, in neonatal calves was effective in reducing mortality resulting from colibacillosis and salmonellosis. Such a vaccine may be beneficial in controlling mortality in well-managed herds, but it is contraindicated in poorly managed herds.

Passive immunotherapy of calves under 2 days of age with J5 *E. coli* hyperimmune plasma given subcutaneously at a dose of 5 mL/kg BW has been examined. The plasma was found to be safe and potent. It was not superior to control plasma or to no treatment for calf morbidity and mortality.

The oral administration of a F5-specific monoclonal antibody to calves during the first 12 hours after birth may be an effective method of reducing the incidence of fatal enterotoxigenic colibacillosis, particularly when outbreaks of the disease occur in unvaccinated herds. Clinical trials indicate that the severity of dehydration, depression, and weight loss and the duration of diarrhea were significantly reduced in calves that had received the F5-specific monoclonal antibody. In experimentally challenged calves the mortality was 29% in the treated calves and 82% in the control calves.

The decision to vaccinate in any particular year will depend on the recognition of risk factors. Such risk factors include the following:

- A definitive diagnosis of ETEC F5 in the previous year
- A population density in the calving grounds that is conducive to the disease
- Calving during the year when the environmental conditions are wet and uncomfortable for the calves
- A large percentage of primiparous dams that do not have protective levels of F5 antibody in their colostrum

### Piglets

Piglets born from gilts are more susceptible than those from mature sows, which suggests that immunity improves with parity. On a practical basis this suggests that gilts should be mixed with older sows that have been resident on the premises for some time. The length of time required for such natural

immunization to occur is uncertain, but 1 month during late gestation seems logical.

Naturally occurring enteric colibacillosis in newborn piglets can be effectively controlled by vaccination of the pregnant dam. Field trials in large-scale farm conditions indicate that the vaccines are efficacious. Partial budget analysis of vaccinating pregnant sows with *E. coli* vaccines revealed an economic return on investment of 124% because of the decrease in morbidity and mortality resulting from diarrhea in piglets at 1 to 2 weeks of age. Three antigen types of pili, designated F4, F5, and F6, are now implicated in colonization of the small intestine of newborn piglets by ETEC. The vaccination of pregnant sows with oral or parenteral vaccines containing these antigens will provide protection against enterotoxigenic colibacillosis associated with *E. coli* bearing pili homologous to those in the vaccines. The parenteral vaccines are cell-free preparations of pili, and the oral vaccines contain live enteropathogenic *E. coli*. The oral vaccine is given 2 weeks before farrowing and is administered in the feed daily for 3 days as 200 mL per day of a broth culture containing  $10^{11}$  *E. coli*. A simple and effective method of immunization of pregnant sows is to feed live cultures of ETEC isolated from piglets affected with neonatal colibacillosis on the same farm. The oral vaccine can be given in the feed, beginning about 8 weeks after breeding and continued to parturition. The oral vaccine results in the stimulation of IgA antibody in the intestinal tract, which is then transferred to the mammary gland and into the colostrum. A combination of oral and parenteral vaccination is superior to either route alone. The parenteral vaccine is given about 2 weeks after breeding and repeated 2 to 4 weeks before parturition. The parenteral vaccination results in the production of high levels of IgM antibody for protection against both experimental and naturally occurring enterotoxigenic colibacillosis. This vaccination also reduces the number of *E. coli* excreted in the feces of vaccinated sows, which are major sources of the organism. Immunization of pregnant sows with an *E. coli* bacterin enriched with the F4 antigen results in the secretion of milk capable of preventing adhesion of F4 *E. coli* to the gut for at least 5 weeks after birth, at which time the piglet becomes naturally resistant to adhesion by the organism.

The possibility of selecting and breeding pigs that may be genetically resistant to the disease is being explored. The highest incidence of diarrhea occurs in progeny of resistant dams sired by susceptible sires. The homozygous dominants (SS) and the heterozygotes (Ss) possess the receptor and are susceptible, whereas it is absent in the homozygous recessives (ss) and the pigs are resistant. Sows that are genetically resistant may not be able to mount an immune response to the F4 antigen because of the inability of the organism to colonize the intestinal tract.



### Competitive Exclusion Culture

An alternative method of control is the use of competitive exclusion cultures. The theory of competitive exclusion technology is to colonize the neonatal gastrointestinal tract with beneficial/commensal bacteria considered to be the normal flora of the healthy animals of a particular species. The mechanism of action is not known, but hypotheses include the following: exclusion of enteropathogens by competitive attachment sites and/or for nutrients; stimulation of the local immune mechanisms, which precludes colonization/invasion by enteric pathogens; and the production of various antimicrobial substances that either have direct action on pathogenic bacteria or produce conditions within the intestine that are unfavorable for the growth and colonization by pathogens. Experimentally, the oral administration of a porcine competitive exclusion culture to piglets within 12 hours after birth resulted in significant reductions in mortality, incidence of fecal shedding, and intestinal colonization by *E. coli* compared with control values. Mortality decreased from 23% in the control group to 2.7% in the treated group.

### Lambs and Kids

Vaccination of pregnant ewes with F5 antigen will confer colostral immunity to lambs challenged with homologous ETEC. The pregnant ewes are vaccinated twice in the first year, at 8 to 10 weeks and 2 to 4 weeks before lambing; in the second year, one vaccination 2 to 4 weeks before lambing is adequate.

Immunization of pregnant goats has been used to stimulate the development of lacteal immunity against naturally occurring colibacillosis in kids. Vaccination of pregnant does 1 month before parturition with a subunit vaccine containing F4, F5, and F6 fimbrial antigens of *E. coli* and *C. perfringens* types B, C, and D toxins in an aluminum hydroxide adjuvant, along with improved management conditions, was highly successful in reducing neonatal morbidity and mortality resulting from diarrhea. Compared with two control groups, one in which no improvement in management was made and the second in which improvements were made without vaccination, in the vaccinated group with improved management conditions, neonatal morbidity and mortality were both reduced by a factor of 3 in group 1 and by factors of 9.5 and 12.5 in groups 2 and 3, respectively. Also, the duration of diarrhea was 3.7 and 12 times shorter in the kids of groups 2 and 3, respectively.

### FURTHER READING

- Acres SD. Enterotoxigenic *Escherichia coli* infections in newborn calves: a review. *J Dairy Sci.* 1985;68:229-256.
- Constable PD. Antimicrobial use in the treatment of calf diarrhea. *J Vet Intern Med.* 2004;18:8-17.
- DeRoy C, Maddox CW. Identification of virulence attributes of gastrointestinal *Escherichia coli* isolates

of veterinary significance. *Anim Health Res Rev.* 2001;1:129-140.

- Gyles CL, Prescott JF, Songer JG, Thoen CO. *Pathogenesis of Bacterial Infections in Animals.* 3rd ed. Ames, IA: Blackwell; 2004.
- Larson RL, Tyler JW, Schultz LG, et al. Management strategies to decrease calf death losses in beef herds. *J Am Vet Med Assoc.* 2004;224:42-48.
- Moxley RA. *Escherichia coli* O157H:7: an update on intestinal colonization and virulence mechanisms. *Anim Health Res Rev.* 2004;5:15-33.
- Renter DG, Sargeant JM. Enterohemorrhagic *Escherichia coli* O157H:7: epidemiology and ecology in bovine production environments. *Anim Health Res Rev.* 2002;3:83-94.

### REFERENCES

- Farrokh C, et al. *Int J Food Microbiol.* 2013;162:190-212.
- Mainil J. *Vet Immunol Immunopathol.* 2013;152:2-12.
- ECDC/EFSA. 2011. (Accessed 10.01.16, at 2014 <[http://www.ecdc.europa.eu/en/publications/Publications/1106\\_TER\\_EColi\\_joint\\_EFSA.pdf](http://www.ecdc.europa.eu/en/publications/Publications/1106_TER_EColi_joint_EFSA.pdf)>).
- Hussein HS, Sakuma T. *J Dairy Sci.* 2005;88:450-465.
- Laine TM, et al. *Acta Vet Scand.* 2008;50:21.
- Duan Q, et al. *Ann Microbiol.* 2012;62:7-14.
- Nagy B, Fekete PZ. *Int J Med Microbiol.* 2005;295:443-454.
- Foster DM, Smith GW. *Vet Clin North Am Food Anim Pract.* 2009;25:13-36.
- Fecteau G, et al. *Vet Microbiol.* 2001;78:241-249.
- Ghanbarpour R, Oswald R. *Trop Anim Health Prod.* 2009;41:1091-1099.
- Corley KTT, et al. *Equine Vet J.* 2007;39:84-99.
- Lorenz I. *Vet J.* 2009;179:197-203.
- Gomez DE, et al. *J Vet Intern Med.* 2013;27:1604-1612.
- Abeyskara S, et al. *Am J Physiol Endocrinol Metab.* 2007;293:E356-E365.
- Lorenz I. *Vet J.* 2004;168:323-327.
- Lorenz I, et al. *Vet Rec.* 2005;156:412-415.
- Gentile A, et al. *J Vet Intern Med.* 2008;22:190-195.
- Trefz FM, et al. *Vet J.* 2013;195:350-356.
- Constable PD, Grünberg W. *Vet J.* 2013;195:217-272.
- Biolatti C, et al. *Schweiz Arch Tierheilkd.* 2012;154:239-246.
- Fecteau G, et al. *Vet Clin North Am Food Anim Pract.* 2009;25:195-208.
- Kumar A. *Curr Infect Dis Rep.* 2010;12:336-344.
- Dellinger RP, et al. *Crit Care Med.* 2004;32:853-873.
- Catry B, et al. *Microb Drug Resist.* 2007;13:147-150.
- Hendriksen RS, et al. *Acta Vet Scand.* 2008;50:28.
- Hendriksen RS, et al. *Acta Vet Scand.* 2008;50:19.
- Manchese A, et al. *Microb Drug Resist.* 2012;18:94-99.
- Kaneene JB, et al. *J Clin Microbiol.* 2008;46:1968-1977.
- Constable PD. *J Vet Intern Med.* 2004;18:8.
- Scientific Advisory Group on Antimicrobials of the Committee for Medicinal Products for Veterinary Use. *J Vet Pharmacol Ther.* 2009;32:515-533.
- World Organization for Animal Health. OIE list of antimicrobial agents of veterinary importance, 2013. (Accessed 15.12.13, at <[http://www.oie.int/fileadmin/Home/eng/Our\\_scientific\\_expertise/docs/pdf/OIE\\_List\\_antimicrobials.pdf](http://www.oie.int/fileadmin/Home/eng/Our_scientific_expertise/docs/pdf/OIE_List_antimicrobials.pdf)>).
- Constable PD. *Vet Clin North Am Food Anim Pract.* 2009;25:101-120.
- Todd CG, et al. *J Anim Sci.* 2007;85(suppl 1):369.
- Barnett SC, et al. *J Am Vet Med Assoc.* 2003;223:1329-1333.
- Lorenz I, et al. *Ir Vet J.* 2011;64:9.

- Garthwaite BD, et al. *J Dairy Sci.* 1994;77:835-843.
- Nomoto K. *J Biosci Bioeng.* 2005;100:583-592.
- Senok AC, et al. *Clin Microbiol Infect.* 2005;11:956-966.
- Wynn SG. *J Am Vet Med Assoc.* 2009;5:606-613.
- Weese JS, Rousseau J. *J Am Vet Med Assoc.* 2005;226:2031-2034.
- Beam AL, et al. *J Dairy Sci.* 2009;92:3973-3980.
- Godden SM, et al. *J Dairy Sci.* 2012;95:4029-4040.

## WATERY MOUTH OF LAMBS (RATTLE BELLY, SLAVERS)

### SYNOPSIS

**Etiology** Nonenteropathogenic *E. coli* endotoxemia predisposed by failure of passive transfer.

**Epidemiology** Higher risk with intensive housing with poor hygiene.

**Clinical findings** Loss of sucking reflex, retention of meconium or feces, excessive mucoid saliva, abomasal distension.

**Lesions** None specific.

**Diagnostic confirmation** Nothing pathognomonic.

**Treatment** Fluids and energy via stomach tube; antimicrobials.

**Control** Antimicrobials at birth, pen hygiene, ensure adequate colostrum transfer.

### ETIOLOGY

Watery mouth of lambs is thought to be the result of endotoxemia in young lambs. It is postulated that the neutral pH of the abomasum in newborn lambs coupled with low concentrations of colostral immunoglobulin in the gut allow rapid multiplication of non-enteropathogenic strains of *E. coli* in the gut, and to some extent systemically, which results in endotoxemia.

### EPIDEMIOLOGY

#### Occurrence

The syndrome is primarily reported in lambs in Great Britain but has also been reported in New Zealand and in goat kids in Spain and North America. A related but perhaps separate entity, termed *salivary abomasum disease*, has been reported as common in 3- to 17-day-old lambs and kids in Greece.<sup>1</sup>

#### Animal and Environmental Risk Factors

Lambs 12 to 72 hours of age are affected. The disease is seen under all management systems, but it is rare in pastured flocks and occurs most commonly in lambs kept in intensive housing where there is poor hygiene of the lambing environment. Lambs from prolific ewes are at risk, and the disease is more common in triplets than twins or singles.

Delayed or poor colostrum intake is a major risk factor, and situations that

predispose this may lead to outbreaks. A high prevalence has occurred in ram lambs castrated by the use of an elastic band at a very young age, and the resulting pain may have dissuaded them from feeding.

Other risk factors, all of which reduce sucking by the lamb, are inclement weather, mismothering, maternal agalactia, competition between twins or triplets, low vitality, and ewes in poor condition.

### Experimental Disease

An equivalent clinical syndrome is reproducible by administering nonenterotoxigenic strains of *E. coli* by mouth to colostrum-deprived lambs, all of whom died within 24 hours.

### Economic Importance

Watery mouth disease is a major cause of mortality of housed newborn lambs in Great Britain and is reported to be the cause of approximately 25% of all deaths of lambs in indoor intensive lambing systems. Where conditions allow, morbidity rates may approach 24%; without early treatment, case fatality rates are high.

### PATHOGENESIS

Gram-negative bacteria, nonenterotoxigenic and nonenteropathogenic *E. coli*, in the environment are ingested as a result of a contaminated environment, or from a contaminated fleece, and survive passage through the neutral pH of the abomasum to be absorbed into the systemic circulation by the natural pinocytosis that occurs in the intestinal epithelium of newborn ruminants, producing endotoxemia.

### CLINICAL FINDINGS

Affected lambs are normal at birth but become sick at 24 to 48 hours and up to 72 hours old. The disease is characterized by dullness, lethargy, a complete failure to suck, and excessive mucoid saliva around and drooling from the mouth. As the disease progresses there is hypothermia, failure to pass feces, cold extremities, depression to the point of coma, anorexia, and, in the late stages, abdominal distension and recumbency, but rarely diarrhea. The alimentary tract is full of fluid, and the lamb rattles when it is shaken. Some lambs are hypothermic, but the temperature is normal at the onset of the condition and falls to subnormal as the disease progresses. Progress is rapid, with death 6 to 24 hours after the first signs of illness. Salivary abomasum disease is reported in flocks that vaccinate against clostridial disease.<sup>2</sup>

### CLINICAL PATHOLOGY

Total protein concentrations and base excess values are significantly elevated compared with normal lambs. Blood glucose concentrations are normal but may be low in the terminal phase of the disease.

### NECROPSY FINDINGS

There are no findings specific to watery mouth syndrome. The abomasal contents are fluid and mucoid and contain small milk curds, and the intestine is filled with gas. A case series of lambs with salivary abomasum disease found pale kidneys and acute tubular necrosis in 90%. *E. coli* was cultured from only 6 of 37 abomasa in this study.<sup>2</sup>

### TREATMENT

Treatment with intramuscular amoxicillin and clavulanic acid, intravenous flunixin meglumine, and oral rehydration fluid, when administered early in the clinical course, has resulted in a high recovery rate in field cases. Dextrose solution should also be given to those lambs that are hypoglycemic, and external warming should be provided. Other recommended treatments include emptying the alimentary tract by purgation or enema.

### DIFFERENTIAL DIAGNOSIS

Most neonatal disease of lambs is manifest with diarrhea, which is not present in watery mouth. The early stages of *Colisepticemia* and *Clostridium perfringens* type B or C present with similar clinical signs, but they are easily differentiated later in the clinical course or at postmortem examination. Hypothermia/starvation/cold stress can present with similar clinical findings, but the history and environmental circumstances of occurrence differ.

### CONTROL

In outbreaks the administration of antibiotics to all newborn lambs within 15 minutes to 2 hours of birth dramatically reduces the occurrence of further cases. Fresh or frozen sheep or cow colostrum should be supplemented to lambs at risk. The provision of ewe colostrum at 50 mL/kg BW within 6 hours of birth prevents the disease.

Lambing areas and associated pens and yards should be kept clean and freshly bedded. Contaminated fleece should be removed from around the udder of the ewe before lambing, and every effort should be made to ensure early and adequate colostrum intake by newborn lambs, especially for twins and triplets.

### REFERENCES

1. Christodoulouopoulos G. *Vet Rec.* 2008;162:732.
2. Christodoulouopoulos G, et al. *Vet Rec.* 2013;172:100.

### OMPHALITIS, OMPHALOPHLEBITIS, AND URACHITIS IN NEWBORN FARM ANIMALS (NAVEL ILL)

Infection of the umbilicus and its associated structures occurs commonly in newborn farm animals and appears to be particularly common in calves. The umbilical cord

consists of the amniotic membrane, the umbilical veins, the umbilical arteries, and the urachus. The amniotic membrane of the umbilical cord is torn at birth, and gradually the umbilical vein and the urachus close, but they remain temporarily outside the umbilicus. The umbilical arteries retract as far back as the top of the bladder.

In many countries regulations govern the minimal age at which neonatal calves can be shipped or sent to market and slaughter. The wetness or dryness of the umbilicus is used as a surrogate measure of age in welfare regulations, and the requirement is that the umbilical cord at the junction with the abdominal skin should be dry and shriveled. The drying time varies from 1 to 8 days, with variation between breeds and a longer drying period in bull calves. As might be expected, this measure is only an approximate surrogate for age, but approximately 90% of calves have dry navels by 4 days of age.<sup>1</sup>

Incidence of the disease is scarcely reported. The 30-day incidence of clinically apparent omphalitis in Thoroughbred foals in the United Kingdom was 0.7%, which was not reduced by administration of antimicrobials prophylactically.<sup>2</sup> Omphalitis was considered the cause of death in 23% of 247 calves 4 to 7 days of age that died during the preslaughter period (12 to 18 hours) at abattoirs in New Zealand.<sup>1</sup> The death rate was 0.7%, of which 23% was attributable to omphalitis. Omphalitis was the cause of wastage (condemnation of the carcass) in 54% of calves examined after slaughter.<sup>1</sup>

Infection of the umbilicus occurs **soon after birth** and can result in omphalitis, omphalophlebitis, omphaloarteritis, or infection of the urachus, with possible extension to the bladder, causing cystitis. There is usually a **mixed bacterial flora** including *E. coli*, *Proteus* spp., *Staphylococcus* spp., *T. pyogenes*, *Bacteroides* spp., *F. necrophorum*, and *Klebsiella* spp. The most common, and presumed clinically important, infections in foals are by *E. coli* and *S. zooepidemicus*. Infection of umbilical remnants in foals by *Clostridium sordelli* causes peritonitis, urachitis, omphalophlebitis, and omphaloarteritis.<sup>3</sup>

Bacteremia and localization with infection may occur in joints, bone, meninges, eyes, endocardium, and end-arteries of the feet, ears, and tail. The navel can also be the source of infection, leading to septicemia, arthritis, and fever of unknown origin in neonates with FTPI. The incidence of abnormalities of the umbilicus and consequent rate of umbilical infection is high in cloned calves.<sup>2-5</sup>

### OMPHALITIS

Omphalitis is inflammation of the external aspects of the umbilicus and occurs commonly in calves and other species within 2 to 5 days of birth and often persists for several weeks. The umbilicus is enlarged, is painful on palpation, and can be closed or draining

purulent material through a small fistula. The affected umbilicus can become very large and cause subacute toxemia. The calf is moderately depressed, does not suck normally, and is febrile. Treatment consists of surgical exploration and excision. A temporary drainage channel may be necessary.

### OMPHALOPHLEBITIS

Omphalophlebitis is inflammation of the umbilical veins. It can involve only the distal parts or extend from the umbilicus to the liver. Large abscesses can develop along the course of the umbilical vein and spread to the liver, with the development of a hepatic abscess that can occupy up to one-half of the liver. Affected foals and calves are usually 1 to 3 months of age and are unthrifty because of chronic toxemia. The umbilicus is usually enlarged with purulent material; however, in some cases the external portion of the umbilicus appears normal-sized. Placing the animal in dorsal recumbency and deep palpation of the abdomen dorsal to the umbilicus in the direction of the liver might reveal a space-occupying mass. **Ultrasonographic** examination, including measurement of the size of umbilical structures, allows detection of omphalophlebitis, including any extension along the vein to the liver.

Affected calves and foals are inactive, inappetent, and unthrifty and may have a mild fever. Parenteral therapy with antibiotics is not uniformly successful and may need to be administered for prolonged times. Exploratory laparotomy and **surgical removal** of the abscess is often necessary. Large hepatic abscesses are usually incurable unless surgically removed, but the provision of a drain to the exterior and daily irrigation may be attempted if resection is not feasible.

### OMPHALOARTERITIS

In omphaloarteritis, which is less common, the abscesses occur along the course of the umbilical arteries from the umbilicus to the internal iliac arteries. The clinical findings are similar to those in omphalophlebitis: chronic toxemia, unthriftiness, and failure to respond to antibiotic therapy. An unusual presentation is that of distal aortic aneurysm secondary to ascending infection of the umbilical artery.<sup>6</sup> The affected foal was 3 months of age and was examined because of colic and frequent urination. Treatment of omphalophlebitis consists of surgical removal of the abscesses.

### URACHITIS

Infection of the urachus may occur anywhere along the urachus, from the umbilicus to the bladder. The umbilicus is usually enlarged and draining purulent material, but it can appear normal. Deep palpation of the abdomen in a dorsocaudal direction from the umbilicus may reveal a space-occupying mass. Extension of the infection to the bladder can result in cystitis and pyuria.<sup>5</sup>

**Contrast radiography** of the fistulous tract and the bladder will reveal the presence of the lesion. The treatment of choice is exploratory laparotomy and surgical removal of the abscesses. Recovery is usually uneventful.

### CONTROL

The control of umbilical infection depends primarily on **good sanitation and hygiene** at the time of birth. The application of drying agents and residual disinfectants such as tincture of iodine is widely practiced. However, there is limited evidence that chemical disinfecting is of significant value. Chlorhexidine is more efficient in reducing the number of organisms than 2% iodine or 1% povidone iodine. High concentrations of iodine (7%) are most effective, but these are damaging to tissue and should not be used.

### REFERENCES

1. Thomas GW, et al. *N Z Vet J.* 2013;61:127.
2. Wohlfender FD, et al. *Equine Vet J.* 2009;41:179.
3. Ortega J, et al. *Vet Pathol.* 2007;44:269.
4. Brisville AC, et al. *J Vet Intern Med.* 2013;27:1218.
5. Lores M, et al. *Can Vet J.* 2011;52:888.
6. Archer RM, et al. *N Z Vet J.* 2012;60:65.

## NEONATAL STREPTOCOCCAL INFECTION

### SYNOPSIS

**Etiology** Various *Streptococcus* spp.

**Epidemiology** Neonatal foals, calves, lambs, piglets.

**Signs** Acute painful swelling of joints, lameness, fever; signs of meningitis, omphalophlebitis, ophthalmitis; sudden death.

**Clinical pathology** Culture organism from joint fluid.

**Necropsy findings** Fibrinopurulent synovitis, purulent meningitis and omphalophlebitis.

**Diagnostic confirmation** Recovery of organism from joint fluid.

**Differential diagnosis** Other infectious causes of arthritis, meningitis, and omphalophlebitis.

**Treatment** Antimicrobials, usually penicillin.

**Control** See "Principles of Control and Prevention of Infectious Diseases of Newborn Farm Animals" in Chapter 3.

### ETIOLOGY

Streptococci are an important cause of septicemia, polyarthritis, meningitis, polyserositis, endocarditis, and unexpected death in the neonates of all farm animal species. Meningitis associated with streptococcal infection is restricted to the neonate in all species except piglets, in which outbreaks can occur in pigs after weaning, and lambs infected with *S. suis*, in which meningitis can occur as a sporadic disease at 3 to 5 months of age. Historically, there are reports of isolates

of most of the Lancefield groups of beta-hemolytic streptococci, of nonbeta-hemolytic streptococci, and of viridans group streptococci from neonatal disease in farm animals. Commensal skin streptococci can occasionally cause disease in presumably immunocompromised neonates. However, the majority of neonatal disease is associated with a limited number of streptococcal species, although there can be geographic variation in their relative prevalence within animal species.

In **foals**, *S. zooepidemicus* (*S. equi* subsp. *zooepidemicus*) is the most common streptococcal species recovered from septicemic disease and polyarthritis and is also a cause of placentitis and abortion in mares.<sup>1,2</sup> *S. equisimilis* (*S. dysgalactiae* subsp. *equisimilis*) is a less common isolate.<sup>2</sup>

*S. suis* and *S. equisimilis* are the most common species incriminated in **piglets**. *S. suis* is especially important and is presented separately in the next section. Other Lancefield groups have been associated with sporadic disease. In **calves**, *S. dysgalactiae* and *S. uberis* are the common streptococcal isolates from synovial fluid of neonatal calves with arthritis. Beta-hemolytic streptococci are isolated from approximately 16% of septicemic calves in South Africa.<sup>3</sup> *Streptococcus pluranimalium* infection is reported in a single premature calf.<sup>4</sup>

*S. dysgalactiae* is also reported to be the most common cause of outbreaks of arthritis in neonatal lambs in Great Britain. *Streptococcus bovis* biotype 1 is reported to cause meningoencephalitis in llama cria.<sup>5</sup> *Streptococcus agalactiae* causes periarticular abscesses in camel foals in Africa.<sup>6</sup>

Streptococci can also contribute to purulent infections at local sites, such as navel ill of all species or otitis media in neonatal calves, although the latter is more commonly caused by *M. bovis*.<sup>7</sup>

### EPIDEMIOLOGY

#### Occurrence and Prevalence

The importance and relative prevalence of streptococcal infections in neonatal disease varies among countries and with surveys.

Streptococci are a common cause of postnatal infections of **foals**, representing 50% of such cases in some surveys, but with a lower prevalence in others. Up to 20% of abortions in mares are a result of placentitis from streptococcal infection. Streptococcal septicemia as a result of beta-hemolytic streptococci may occur in foals under 5 days of age that have been stressed and have FTPI.

In **calves**, neonatal infections with streptococci are usually sporadic and less common than infections with gram-negative bacteria and may be predisposed by FTPI. In **lambs**, *S. dysgalactiae* is associated with outbreaks with high morbidity, and in Great Britain *S. dysgalactiae* is reported to be the cause of over 70% of cases of polyarthritis in lambs during their first 3 weeks of life. Despite the



high attack rate in these outbreaks, it is rare for more than one of twins or triplets to have disease. Streptococcal arthritis associated with *S. suis* infection in piglets is a common disease and is covered in a separate section.

### Source of Infection

The source of the infection is usually the environment, which may be contaminated by uterine discharges from infected dams or by discharges from lesions in other animals. *S. dysgalactiae* is reported to survive for up to a year on clean straw, as opposed to wood shavings, which do not support the persistence of the organism.

The portal of infection in most instances appears to be the umbilicus, and continued patency of the urachus is thought to be a contributing factor in that it delays healing of the navel. In piglets there can be high rates of infection associated with infection entering through skin abrasions such as carpal necrosis resulting from abrasive floors or facial lesions following fighting. Contaminated knives at castration and tail docking, or contaminated ear taggers, can result in infection and disease. Other mechanical vectors include the screwworm fly (*Cochliomyia americana*).

The organism can be isolated from the nasopharynx of the sow, and direct infection from the sow to the piglet is suggested by some epidemiologic data.

### Economic Importance

Affected foals and other species may die or be worthless as working animals because of permanent injury to joints. There is also loss resulting from condemnation at slaughter.

### Zoonotic Implications

*S. zooepidemicus* is associated with human infections,<sup>8</sup> particularly nephritis, and many human infections can be traced back to the consumption of contaminated animal food products. Some strains of *S. equisimilis* can also infect humans.

### PATHOGENESIS

The infection spreads from the portal of entry to produce a bacteremia that is not detectable clinically. The period of bacteremia is variable but it may last several days in piglets. A terminal acute fatal septicemia is the common outcome in animals under 1 week of age; in older animals, suppurative localization in various organs is more common. Arthritis is the most common manifestation, with synovitis and invasion of medullary bone of the epiphysis with microabscessation and ischemic necrosis of bone. Other manifestations of infection include ophthalmitis in foals and calves, meningitis and endocarditis in piglets, meningitis in calves, and endocarditis and sudden death in lambs. Streptococcal endocarditis can be produced by the intravenous inoculation of group I *Streptococcus*. Lesions are well established within 5 days, the left

heart is most commonly affected, and myocardial and renal infarction occur.

### CLINICAL FINDINGS

#### Foals

The disease is one of septicemia, often with localization of infection in joints (septic arthritis) or an eye (hypopyon), and is described in detail under “Neonatal Infection” (page 1874). Infection of the umbilicus can cause omphalitis and omphalophlebitis.

#### Piglets

Arthritis and meningitis may occur alone or together and are most common in the 2- to 6-week age group. More commonly, several piglets within a litter are affected. The arthritis is identical to that previously described in foals. With meningitis there is a systemic reaction comprising fever, anorexia, and depression. The gait is stiff, the piglets stand on their toes, and there is swaying of the hindquarters. The ears are often retracted against the head. Blindness and gross muscular tremor develop, followed by inability to maintain balance, lateral recumbency, violent paddling, and death. In many cases there is little clinical evidence of omphalophlebitis. With endocarditis the young pigs are usually found comatose or dead, without premonitory signs having been observed.

#### Lambs

Lameness in one or more limbs of lambs up to 3 weeks of age is the common presenting sign of infection with *S. dysgalactiae*, but approximately 25% of lambs can be initially recumbent. With this infection there is not major joint swelling in the early stages, and myopathy or delayed swayback may be initial considerations. In contrast with outbreaks that occur following docking, the incubation period is short, usually 2 to 3 days, and there is intense lameness, with swelling of one or more joints appearing in a day or two. Pus accumulates, and the joint capsule often ruptures. Recovery usually occurs with little residual enlargement of the joints, although there may be occasional deaths as a result of toxemia.

#### Calves

Calves show polyarthritis, meningitis, ophthalmitis, and omphalophlebitis. The ophthalmitis may appear very soon after birth. The arthritis is often chronic and causes little systemic illness. Calves with meningitis show hyperesthesia, rigidity, and fever.

### CLINICAL PATHOLOGY

Pus from any source may be cultured to determine the organism present and its sensitivity to the drugs available. Bacteriologic examination of the uterine discharges of the dam may be of value in determining the source of infection. The success rate with blood cultures is not very high, but an attempt is worthwhile. The identification of

the causative bacteria is important, but the sensitivity of the organism may mean the difference between success and failure in treatment. The specific identity of the streptococcus should be determined.

### NECROPSY FINDINGS

Suppuration at the navel and severe suppurative arthritis affecting one or more joints are usual. Abscesses may also be present in the liver, kidneys, spleen, and lungs. Friable tan masses of tissue are common on the heart valves of affected piglets, and this valvular endocarditis may also be observed in other species. Peracute cases may die without suppurative lesions having had time to develop. Necropsy findings in the meningitic form in pigs include turbidity of the CSF, congestion of meningeal vessels, and the accumulation of white, purulent material in the subarachnoid space. Occasionally this exudate blocks the flow of CSF in the ventricular system, causing internal hydrocephalus. Histologically there is infiltration of the affected tissue by large numbers of neutrophils, usually accompanied by fibrin deposition.

### Samples for Confirmation of Diagnosis

Confirmation of diagnosis is made with the following samples:

- Bacteriology—culture swabs from joints, meninges, suppurative foci; tissue pieces of valvular lesions, lung, spleen, synovial membrane (culture)
- Histology—formalin-fixed samples of a variety of organs, including brain, lung, spleen, liver (light microscopy)

### DIFFERENTIAL DIAGNOSIS

Omphalophlebitis and suppurative arthritis in foals may result from infection with *Escherichia coli*, *Actinobacillus equuli*, or *Salmonella abortusequi*, but these infections tend to take the form of a fatal septicemia within a few days of birth, whereas streptococcal infections are delayed in their onset and usually produce a form of polyarthritis. In pigs there may be sporadic cases of arthritis as a result of staphylococci, but the streptococcal infection is the common one. Arthritis as a result of *Mycoplasma hyorhinis* is less suppurative, but it may require cultural differentiation. Glasser's disease occurs usually in older pigs and is accompanied by pleurisy, pericarditis, and peritonitis. Erysipelas in very young pigs is usually manifested by septicemia. Nervous disease of piglets may resemble arthritis on cursory examination, but there is an absence of joint enlargement and lameness. However, the meningitic form of the streptococcal infection can easily be confused with viral encephalitis. Meningitis in young calves may also be associated with *Pasteurella multocida*. Polyarthritis in calves, lambs, and

piglets may also be associated with infection with *Trueperella pyogenes* and *Fusobacterium necrophorum*. *S. suis* type 2 can also be the cause of meningitis in older pigs at 10 to 14 weeks of age.

The response of streptococcal infections to treatment with penicillin may be of value in the differentiation of the arthritides, and the microscopic and histologic findings at necropsy enable exact differentiation to be made. In lambs, suppurative arthritis occurs soon after birth and after docking. The other common arthritis in the newborn lamb is that associated with *Erysipelothrix rhusiopathiae*, but this usually occurs later and is manifested by lameness without pronounced joint enlargement. Calves may also develop erysipelatosus arthritis.

## TREATMENT

Penicillin is successful as treatment in all forms of the disease if irreparable structural damage has not occurred. In newborn animals, the dosage rate should be high (20,000 IU/kg BW) and should be repeated at least once daily for 3 days. If suppuration is already present, a longer course of antibiotics will be necessary, preferably for 7 to 10 days. Piglets treated early in the course of the disease will survive but may runt. Because of the common litter incidence in piglets and the occurrence of subclinical bacteremia, it is wise to also treat all littermates of affected piglets. Benzathine or benethamine penicillins can be used in conjunction with shorter-acting penicillins.

## CONTROL

The principles of control of infectious diseases of the newborn are described elsewhere. Because the most frequent source of infection in foals is the genital tract of the dam, some attempt should be made to treat the mare and limit the contamination of the environment. Mixed bacterins have been widely used to establish immunity in mares and foals against this infection, but no proof has been presented that they are effective. On heavily infected premises the administration of long-acting penicillin at birth may be advisable. A major factor in the control of navel and joint ill in lambs is the use of clean fields or pens for lambing because umbilical infection originating from the environment seems to be more important than infection from the dam in this species. Docking should also be done in clean surroundings; if necessary, temporary yards should be erected. Instruments should be chemically sterilized between lambs. Regardless of species and where practicable, all parturition stalls and pens should be kept clean and disinfected, and the navels of all newborn animals should be disinfected at birth. Where screwworms are prevalent, the unhealed navels should be treated with a reliable repellent.

## REFERENCES

1. Russell CM, et al. *Aust Vet J.* 2008;86:266.
2. Erol E, et al. *J Vet Diagn Invest.* 2012;24:142.
3. Kirecci E, et al. *J S Afr Vet Assoc.* 2010;81:110.
4. Seimiya YM, et al. *J Vet Med Sci.* 2007;69:657.
5. Twomey DF, et al. *Vet Rec.* 2007;160:337.
6. Younan M, et al. *J Camel Pract.* 2007;14:161.
7. Gosselin VB, et al. *Can Vet J.* 2012;53:957.
8. Pelkonen S, et al. *Emerg Infect Dis.* 2013;19:1041.

## Neonatal Neoplasia

Congenital neoplasia is rare, occurring at a substantially lower rate than in adults, and accounts for a minor percentage of findings in surveys of neonatal mortality. It is probable that genetic rather than environmental factors influence its development.

Clinical signs depend on the type of neoplasm and its site, and they can result in dystocia or abortion. A variety of tumors have been recorded in all large animal species and are predominantly of mesenchymal origin.

In calves, malignant lymphoma is most commonly reported. It is usually multicentric and also affects the skin. Sporadic bovine leukosis of young calves may also be present at birth. Other tumors reported predominant in calves include diffuse peritoneal mesothelioma, mixed mesodermal tumor, mast cell tumor, hemangiomas, and cutaneous melanoma.

Melanomas (both benign and malignant) also occur in foals and piglets. Duroc Jersey, Vietnamese pot-bellied pigs, and Sinclair miniature pigs have a high incidence of congenital malignant melanoma, which is fatal in approximately 15% of affected pigs but regresses spontaneously, and without recurrence, in the remainder.

A breed predisposition to cardiac rhabdomyoma is recorded in Red Wattle pigs.

Papillomatosis is rare, but **lingual papillomatosis** is reported as a cause of enzootic disease of piglets in China.

**INTRODUCTION 1904****BOVINE MASTITIS 1904****DIAGNOSIS OF BOVINE MASTITIS 1914**

Treatment of Bovine Mastitis 1921

**MASTITIS PATHOGENS OF CATTLE 1930****MASTITIS OF CATTLE ASSOCIATED WITH COMMON CONTAGIOUS PATHOGENS 1930***Staphylococcus aureus* 1930*Streptococcus agalactiae* 1937*Corynebacterium bovis* 1939*M. bovis* and Other *Mycoplasma* sp. 1940**MASTITIS OF CATTLE ASSOCIATED WITH TEAT SKIN OPPORTUNISTIC PATHOGENS 1942**

Coagulase-Negative Staphylococci 1942

**MASTITIS OF CATTLE ASSOCIATED WITH COMMON ENVIRONMENTAL PATHOGENS 1943**Coliform Mastitis Associated With *Escherichia coli*, *Klebsiella* sp., and *Enterobacter aerogenes* 1943

Environmental Streptococci 1955

*Trueperella pyogenes* 1958**MASTITIS OF CATTLE ASSOCIATED WITH LESS COMMON PATHOGENS 1960***Pseudomonas aeruginosa* 1960*Mannheimia (Pasteurella)* species 1960*Nocardia* sp. 1960*Bacillus* sp. 1961*Campylobacter jejuni* 1962*Clostridium perfringens* Type A 1962*Fusobacterium necrophorum* 1962*Histophilus somni* 1962*Listeria monocytogenes* 1962*Mycobacterium* sp. 1962*Serratia* sp. 1963

Fungi and Yeasts 1963

Algae 1963

Traumatic Mastitis 1963

**CONTROL OF BOVINE MASTITIS 1964**

Options in the Control of Mastitis 1964

Principles of Controlling Bovine Mastitis 1965

Mastitis Control Programs 1966

Ten-Point Mastitis Control Program 1967

Assessment of the Cost-Effectiveness of Mastitis Control 1984

**MISCELLANEOUS ABNORMALITIES OF THE TEATS AND UDDER 1985**

Lesions of the Bovine Teat 1985

Lesions of the Bovine Teat and Udder 1986

Bovine Herpes Mammillitis 1986

Lesions of the Bovine Udder Other Than Mastitis 1988

Udder Edema 1989

Rupture of the Suspensory Ligaments of the Udder 1990

Agalactia 1990

"Free" or "Stray" Electricity as a Cause of Failure of Letdown 1990

Neoplasms of the Udder 1991

Teat and Udder Congenital Defects 1991

**MILK ALLERGY 1991****MASTITIS OF SHEEP 1991****MASTITIS OF GOATS 1993****CONTAGIOUS AGALACTIA IN GOATS AND SHEEP 1994****MASTITIS OF MARES 1996****POSTPARTUM DYS GALACTIA SYNDROME OF SOWS 1996****Introduction**

**Mastitis** is inflammation of the parenchyma of the mammary gland regardless of the cause. Mastitis is therefore characterized by a range of physical and chemical changes in the milk and pathologic changes in the glandular tissue. The most important changes in the milk include discoloration, the presence of clots, and the presence of large numbers of leukocytes. There is **swelling, heat, pain, and edema** in the mammary gland in many clinical cases. However, a large proportion of mastitic glands are not readily detectable by manual palpation or by visual examination of the milk using a strip cup; these quarters represent subclinical infections. Because of the large numbers of subclinical cases, the diagnosis of mastitis depends largely on indirect tests, which depend, in turn, on the somatic cell concentration or electrolyte (sodium or chloride) concentration of milk. It seems practicable and reasonable to define mastitis as a disease characterized by the presence of a significantly increased somatic cell concentration in milk from affected glands. The increased somatic cell

concentration is, in almost all cases, caused by an increased neutrophil concentration, which represents a reaction of glandular tissue to injury and is preceded by changes in the milk that are the direct result of damage to glandular tissue. However, the exact clinical and laboratory changes that occur in the udder as a result of infection can also be caused by other factors in the absence of infection. Until it becomes common usage to define mastitis in terms of the sodium or chloride concentration of the milk (as measured by electrical conductivity) or increased permeability of the blood-milk barrier (as measured by albumin concentration), there appears to be no point in changing the current definition of mastitis based on an abnormal-looking secretion or an increased somatic cell concentration. Characterization of mastitis depends on the identification of the causative agent whether it be infectious or physical.

Most of the information presented here deals almost entirely with bovine mastitis because of its economic importance, but small sections on ovine, caprine, porcine, and equine mastitis are included at the end of the chapter.

**Bovine Mastitis****GENERAL FEATURES**

A total of about 140 microbial species, subspecies, and serovars have been isolated from the bovine mammary gland. Microbiological techniques have enabled precise determination of the identity of many of the mastitis pathogens. Based on their epidemiology and pathophysiology, these pathogens have been further classified as causes of **contagious, teat skin opportunistic** or **environmental** mastitis.

**SYNOPSIS****Etiology**

- **Contagious pathogens:** *Staphylococcus aureus*, *Streptococcus agalactiae*, *Corynebacterium bovis*, and *Mycoplasma*
- **Teat skin opportunistic pathogens:** Coagulase-negative staphylococci
- **Environmental pathogens:** Environmental *Streptococcus* spp. including *Streptococcus uberis* and *S. dysgalactiae*, which are the



most prevalent; less prevalent is *S. equinus* (formerly referred to as *S. bovis*). Environmental coliforms include the gram-negative bacteria *Escherichia coli*, *Klebsiella* spp., and *Enterobacter* spp., and *Trueperella* (formerly *Arcanobacterium*, or *Actinomyces*, or *Corynebacterium*) *pyogenes*.

- **Uncommon pathogens:** Many, including *Nocardia* spp., *Pasteurella* spp., *Mycobacterium bovis*, *Bacillus cereus*, *Pseudomonas* spp., *Serratia marcescens*, *Citrobacter* spp., anaerobic bacterial species, fungi, and yeasts

#### Epidemiology

- Incidence of clinical mastitis ranges from 10%–12% per 100 cows at risk per year. Prevalence of intramammary infection is about 50% of cows and 10%–25% of quarters. Case–fatality rate depends on cause of mastitis.
- Contagious pathogens are transmitted at time of milking; teat skin opportunistic pathogens take any opportunity to induce mastitis; environmental pathogens are from the environment and induce mastitis between milkings.
- Environmental pathogens are the most common cause of clinical mastitis in herds that have controlled contagious pathogens.
- Prevalence of infection with contagious pathogens ranges from 7%–40% of cows and 6%–35% of quarters.
- Prevalence of infection with environmental pathogens: coliforms 1%–2% of quarters; streptococci less than 5%

#### Risk factors

- **Animal risk factors:** Prevalence of infection increases with age. Most new infections occur in the dry period and in early lactation. Highest rate of clinical disease occurs in herds with low somatic cell counts (SCCs). Morphology and physical condition of the teat are risk factors. Selenium and vitamin E status influence incidence of clinical mastitis. High-producing cows are more susceptible.
- **Environmental risk factors:** Poor quality management of housing and bedding increases infection rate and incidence of clinical mastitis caused by environmental pathogens.
- **Pathogen risk factors:** Ability to survive in the environment, virulence factors (colonizing ability and toxin production), susceptibility to antimicrobial agents
- **Economics:** Subclinical mastitis is a major cause of economic loss caused by loss of milk production, costs of treatment, and early culling.

#### Clinical signs

- **Gross abnormalities in secretion** (discoloration, clots, flakes, and pus)
- **Physical abnormalities of udder:** Acute, diffuse swelling and warmth, pain, and gangrene in severe cases; chronic, local fibrosis and atrophy

- **Systemic response:** May be normal or mild, moderate, acute, peracute with varying degrees of anorexia, toxemia, dehydration, fever, tachycardia, ruminal stasis, and recumbency and death

#### Clinical pathology

- **Detection at the herd level:** Bulk tank milk SCCs. Culture of bulk tank milk
- **Detection at the individual cow level:** Abnormal looking milk, culture of composite or quarter milk samples. Indirect tests include SCCs of composite or quarter milk samples, California mastitis test of quarter milk samples, and in-line milk conductivity tests of quarter milk samples.
- **Use of selective media to differentiate gram-positive and gram-negative pathogens** in cases of clinical mastitis
- **Differential diagnosis list:** Other mammary abnormalities include periparturient udder edema, rupture of the suspensory ligament, and hematomas; blood in the milk of recently calved cows.

#### Treatment

- **Clinical mastitis in lactating cow:** Mild cases of clinical mastitis (abnormal secretion only) may not require treatment; however, all clinical mastitis episodes accompanied by an abnormal gland or systemic signs of illness should be treated with antimicrobial agents given by intramammary infusion (all cases) and parenterally (selected cases). Acute and peracute mastitis cases also require supportive therapy (fluid and electrolytes) and nonsteroidal antiinflammatory agents. Culture milk of representative clinical cases but antimicrobial susceptibility testing has not been validated.
- **Dry cow therapy:** Intramammary infusion of long-acting antimicrobial agents at drying off provides the best treatment for subclinical mastitis caused by contagious pathogens. Must adhere to milk withholding times after treatment with antimicrobial agents to prevent milk drug residues, which is a major public health issue. Currently available cow-side antimicrobial residue tests are not reliable.

#### Control

- Principles of control:
  1. Eliminate existing infections
  2. Prevent new infections
  3. Monitor udder health status
- Components of a mastitis control program:
  1. Use proper milking management methods.
  2. Proper installation, function, and maintenance of milking equipment
  3. Dry cow management
  4. Appropriate therapy of mastitis during lactation
  5. Culling chronically infected cows
  6. Maintenance of an appropriate environment
  7. Good record keeping
  8. Monitoring udder health status
  9. Periodic review of the udder health management program
  10. Setting goals for udder health status

## Contagious Mastitis Pathogens

There are many contagious mastitis pathogens. The most common are *Staphylococcus aureus* and *Streptococcus agalactiae*. The usual source of contagious pathogens is the infected glands of other cows in the herd; however, the hands of milkers can act as a source of *S. aureus*. The predominant method of transmission is from cow to cow by contaminated common udder washcloths, residual milk in teat cups, and inadequate milking equipment. Programs for the control of contagious mastitis involve improvements in hygiene and disinfection aimed at disrupting the cow-to-cow mode of transmission. In addition, methods to eliminate infected cows involve antimicrobial therapy and the culling of chronically infected cows.

Generally, a conscientious mastitis control program will eradicate *S. agalactiae* from most dairy herds. It is much more difficult to deal with a herd that has a high prevalence of *S. aureus*, but it can be eradicated from low-prevalence herds.

*Mycoplasma bovis* is a less common cause of contagious mastitis; it causes outbreaks of clinical mastitis that do not respond to therapy and are difficult to control. Most outbreaks of *M. bovis* are associated with recent introductions of new animals into the herd. Characteristically, clinical mastitis occurs in more than one quarter, there is a marked drop in milk production, and there is little evidence of systemic disease. The laboratory diagnosis of mycoplasmal mastitis requires specialized media and culture conditions. Antimicrobial therapy is relatively ineffective, and culling is the predominant strategy.

## Teat Skin Opportunistic Mastitis Pathogens

The incidence of mild clinical mastitis associated with bacterial pathogens that normally reside on the teat skin is increasing, particularly in herds that have controlled major contagious mastitis pathogens. Teat skin opportunistic pathogens have the ability to create an intramammary infection via ascending infection through the streak canal. Accordingly, their epidemiology of infections differs from those of contagious and environmental pathogens, and it is useful to consider them in a separate category. Coagulase-negative staphylococci (CNS) are the most common teat skin opportunistic mastitis pathogens.

## Environmental Mastitis Pathogens

Environmental mastitis is associated with three main groups of pathogens, the coliforms (particularly *Escherichia coli* and *Klebsiella* spp.), environmental *Streptococcus* spp., and *Trueperella pyogenes*. The source of these pathogens is the environment of the cow. The major method of transmission is from the environment to the cow by inadequate management of the environment. Examples

include wet bedding, dirty lots, milking wet udders, inadequate premilking udder and teat preparation, housing systems that allow teat injuries, and poor fly control. Control strategies for environmental mastitis include improved sanitation in the barn and yard areas, good premilking udder preparation so that teats are clean and dry at milking time, and fly control. Special attention is necessary during the late dry period and in early lactation.

Coliform organisms are a common cause of clinical mastitis, occasionally in a severe peracute form. Clinical cases of coliform infection are generally found in low levels in most herds and do not routinely result in chronic infections. There is increasing evidence that, as the contagious pathogens are progressively controlled in a herd, the incidence of clinical cases associated with coliform organisms increases. The pathogenesis, epidemiology, predisposing risk factors, diagnostic problems, therapy, and control methods have been the subject of extensive, worldwide research efforts.

Environmental streptococci have become a major cause of mastitis in dairy cattle. Streptococcal infections are associated with many different species; however, the most prevalent species are *Streptococcus uberis* and *Streptococcus dysgalactiae*. Infections with these organisms can cause clinical mastitis that is commonly mild to moderate in nature. More frequently, these organisms cause a chronic subclinical infection with an increased milk somatic cell concentration. Many herds that have implemented the five-point program for mastitis control have found that environmental streptococci represent their most common mastitis problem.

*T. pyogenes* is an important seasonal cause of mastitis in dry cows and late pregnant heifers in some parts of the world. Intramammary infections with *T. pyogenes* are severe, and the gland is almost always lost to milk production.

Several other pathogens are included in the environmental class of infections. These pathogens invade the mammary gland when defense mechanisms are compromised or when they are inadvertently delivered into the gland at the time of intramammary therapy. This group of opportunistic organisms includes *Pseudomonas* spp., yeast agents, *Prototheca* spp., *Serratia marcescens*, and *Nocardia* spp. Each of these agents has unique microbiological culture characteristics, mechanisms of pathogenesis, and clinical outcomes. These infections usually occur sporadically. However, outbreaks can occur in herds or in an entire region and are usually the result of problems with specific management of hygiene or therapy. For example, mastitis associated with *Pseudomonas aeruginosa* has occurred in outbreaks associated with contaminated wash hoses in milking parlors. Iodide germicides used in wash lines are often at too low a concentration to

eliminate *Pseudomonas* spp. Outbreaks of clinical mastitis associated with *Nocardia* spp. have been associated with the use of blanket dry cow therapy and the use of a specific neomycin-containing dry cow preparation.

The mastitis pathogens, and their relative importance, continue to evolve as new management methods and control practices are developed. Thus there is an ongoing need for epidemiologic studies to characterize the pathogens and describe their association with the animals and their environment. Improved control methods can develop only from investigations into the distribution and pathogenic nature of the microorganisms isolated.

### ETIOLOGY

Bovine mastitis is associated with many different infectious agents, commonly divided into those causing **contagious mastitis**, which are spread from infected quarters to other quarters and cows, those that are normal teat skin inhabitants and cause **opportunistic mastitis**, and those causing **environmental mastitis**, which are usually present in the cow's environment and reach the teat from that source. Pathogens causing mastitis in cattle are further divided into **major pathogens** (those that cause clinical mastitis) and **minor pathogens** (those that normally cause subclinical mastitis and less frequently cause clinical mastitis).

### Major Pathogens

#### Contagious Pathogens

- *S. agalactiae*
- *S. aureus*
- *M. bovis*

#### Environmental Pathogens

Environmental *Streptococcus* species include *S. uberis* and *S. dysgalactiae*, which are the most prevalent; less prevalent is *S. equinus* (formerly referred to as *S. bovis*). The environmental coliforms include the gram-negative bacteria *E. coli*, *Klebsiella* spp., and *Enterobacter* spp. *T. pyogenes* mastitis can be an important problem in some herds.

### Minor Pathogens

Several other species of bacteria are often found colonizing the teat streak canal and mammary gland. They rarely cause clinical mastitis and are known as **minor pathogens**. They include the **coagulase-negative Staphylococcus spp.** such as *S. hyicus* and *S. chromogenes*, which are commonly isolated from milk samples and the teat canal. *S. xylosus* and *S. sciuri* are found free living in the environment; *S. warneri*, *S. simulans*, and *S. epidermidis* are part of the normal flora of the teat skin (and therefore are teat skin opportunistic pathogens). The prevalence of coagulase-negative *Staphylococcus* spp. is higher in first-lactation heifers than in cows and higher immediately after calving than in

the remainder of lactation. In recent studies, they have been found as teat canal and intramammary infections in nulliparous heifers.

*Corynebacterium bovis* is also a minor pathogen; it is mildly pathogenic and the main reservoir is the infected gland or teat duct. However, in some herds, *C. bovis* appears to be a common cause of mild clinical mastitis. *C. bovis* spreads rapidly from cow to cow in the absence of adequate teat dipping. The prevalence of *C. bovis* is low in herds using an effective germicidal teat dip, good milking hygiene, and dry cow therapy. The presence of *C. bovis* in a gland will reduce the likelihood of subsequent infection with *S. aureus*.

### Uncommon Mastitis Pathogens

Many other bacteria can cause severe mastitis, which is usually sporadic and usually affects only one cow or a few cows in the herd. These include *Nocardia asteroides*, *N. brasiliensis*, and *N. farcinica*, *Histophilus somni*, *Pasteurella multocida*, *Mannheimia* (formerly *Pasteurella*) *haemolytica*, *Campylobacter jejuni*, *Bacillus cereus*, and other gram-negative bacteria including *Citrobacter* spp., *Enterococcus faecalis*, *E. faecium*, *Proteus* spp., *Pseudomonas aeruginosa*, and *Serratia* spp. Anaerobic bacteria have been isolated from cases of mastitis, usually in association with other facultative bacteria, e.g., *Peptostreptococcus indolicus*, *Prevotella melaninogenica* (formerly *Bacteroides melaninogenicus*), *Eubacterium combesii*, *Clostridium sporogenes*, and *Fusobacterium necrophorum*.

Fungal infections include *Trichosporon* spp., *Aspergillus fumigatus*, *A. nidulans*, and *Pichia* spp.; yeast infections include *Candida* spp., *Cryptococcus neoformans*, *Saccharomyces* spp., and *Torulopsis* spp. Algal infections include *Prototheca trispora* and *P. zopfii*.

Leptospiras, including *Leptospira interrogans* serovar Pomona, and especially *Leptospira interrogans* Hardjo, cause damage to blood vessels in the mammary gland and gross abnormality of the milk. They are more correctly classified as systemic diseases with mammary gland.

Some viruses may also cause mastitis in cattle, but they are of little importance.

### EPIDEMIOLOGY

This section deals with the general aspects of epidemiology of bovine mastitis. For information about the epidemiology of mastitis in the other animal species see the appropriate sections at the end of this chapter.

### Occurrence and Prevalence of Infection

**Occurrence** refers to the location of the disease and the kinds of animals affected. **Prevalence** is the percentage of the population affected with a specific disease in a given population at a certain point in time. The **incidence** is a rate, such as the total number

of new cases of clinical mastitis, and is a percentage of the animals at risk that develop a specific disease during a certain period of time. Prevalence is a function of the incidence and the duration of infection.

### Prevalence

In most countries, surveys in dairy herds indicate that the **prevalence of infection** of mastitis pathogens is approximately 50% of cows and 10% to 25% of quarters. The prevalence of infection in dairy heifers of breeding age and in pregnant dairy heifers varies widely from 30% to 50% of heifers and 18% of quarters to as high as 97% of heifers and 75% of quarters.

### Incidence

The **average annual incidence of clinical mastitis**, calculated as the number of clinical quarter cases per 100 cows at risk per year, including the dry period, in individual herds ranges from 10% to 12% in most herds, but higher incidences, ranging from 16% to 65%, occur in some herds. The greatest risk of first acquiring mastitis occurs early in lactation, usually in the first 50 days. The risk of clinical mastitis also increases with increasing parity. In beef herds, 32% to 37% of cows and 18% of quarters may have intramammary infection, which has a significant negative effect on calf weaning weights.

**Case-fatality rates** vary widely depending largely on the identity of the causative organism. For example, *S. agalactiae* mastitis is not a fatal disease, but peracute staphylococcal mastitis in a recently calved cow often may be fatal. Details of the occurrence of the different types of mastitis are presented in their individual sections in this chapter.

### Relative Prevalence of Infection With Intramammary Pathogens

The prevalence of infection with intramammary pathogens in cattle with clinical mastitis differs from country to country, primarily based on whether cows are pasture based or confinement fed, and whether cattle were housed in free stalls or tie stalls. For example, in the United States, coliform bacteria are most frequently isolated from cows with clinical mastitis. The most frequently isolated bacteria from cattle with clinical mastitis in Canada are *S. aureus*, *E. coli*, *S. uberis*, and CNS.<sup>1</sup> In Europe, clinical mastitis caused by *Klebsiella* spp. occurs less frequently than *E. coli* mastitis, whereas the two pathogens are of equal importance in the United States because of the more frequent use of sawdust and wood shavings for bedding. In Norway, *S. aureus* is the predominant pathogen, followed by *S. dysgalactiae*. In Sweden, *S. aureus* is the predominant pathogen, followed by *E. coli*, *S. dysgalactiae*, *S. uberis*, CNS, *T. pyogenes*, and *Klebsiella* spp.<sup>2</sup> In Finland, *S. aureus* is also the predominant pathogen from clinical mastitis cases, followed by CNS, *S. uberis*, *S. dysgalactiae*, and

*E. coli*.<sup>3</sup> *S. uberis* was the most common cause of clinical mastitis in Belgium, followed by *E. coli*.<sup>4</sup> In comparison, *S. uberis* is the most common cause of clinical mastitis in New Zealand,<sup>1</sup> and *S. aureus* is the predominant pathogen in Ireland, followed closely by *S. uberis*, coliform bacteria, environmental streptococci, and finally CNS.<sup>5</sup>

The bacteriologic identification of mastitis pathogens is important because optimal control and eradication procedures depend on the prevalent pathogens in the herd. In addition, the validity of epidemiologic investigations aimed at determining transmission patterns or the impact of environmental and management factors to a large extent depends on exact bacteriologic diagnosis.

### Contagious Pathogens

The prevalence of infection with *S. aureus* in cows ranges widely, usually from 7% to 40%, but it is higher in some herds. A survey of Danish dairy herds found that 21% to 70% of all cows and 6% to 35% of all quarters were infected. *S. aureus* was isolated from 10% of quarter samples and was the most common species isolated. The prevalence of streptococci, including *S. agalactiae*, ranges from 1% to 8% of cows. A relative incidence of *S. agalactiae*, other streptococci and *S. aureus* of 1 : 1 : 2 is a common finding. *S. aureus* may still assume some importance as a cause of subclinical mastitis, but its prevalence has been reduced by modern mastitis control programs, leading to a higher proportion of culture-negative mastitic quarters and a corresponding, and perhaps consequent, increase in infections by *E. coli* and *Klebsiella* spp. The prevalence of infection caused by *Mycoplasma* spp. varies widely.

The prevalence of infection caused by an individual pathogen, and therefore the ratio between its incidence and that of other pathogens, depends on several risk factors such as size of herd and quality of management, especially milking parlor hygiene and cleanliness of accommodation, and parity of animal (heifer or cow). For example, large, zero-grazed herds kept in drylot conditions are likely to encounter more hygiene problems than conventionally housed herds mainly because of constant soiling of the udder by inadequate or improper bedding in larger units. In those circumstances there is likely to be a much higher prevalence than usual of mastitis associated with *E. coli* and *S. uberis*.

### Teat Skin Opportunistic Pathogens

Coagulase-negative staphylococcal species were found in 4.1% of samples; the most frequently isolated were *S. epidermidis* (1.3%), *S. chromogenes* (1.0%), and *S. simulans* (0.7%).

### Environmental Pathogens

The prevalence of intramammary coliform infections in a dairy herd seldom exceeds 1%

to 2%; the prevalence of intramammary environmental streptococci is less than 5% in well-managed herds but may exceed 10% in some problem herds. A characteristic of intramammary coliform infections is the short duration, with 40% to 50% persisting less than 7 days. The majority of environmental streptococci infections last less than 30 days. In a survey of Danish dairy herds, *S. dysgalactiae* (1.6%) and *S. uberis* (1.4%) were the second and third most common species isolated.

### Heifers

Surveys of intramammary infection of heifers in regions such as Louisiana indicate variability in prevalence and duration of intramammary infection according to species of bacteria present around the time of parturition. About 20% of heifers were infected with *S. aureus* and 70% with CNS, the minor pathogens that are part of the normal teat skin flora of heifers. *S. chromogenes* was isolated from 15% of all quarters of heifers before parturition but decreased shortly after parturition to 1%. Up to 97% of breeding age and pregnant dairy heifers and 75% of their quarters may be infected with *S. aureus*, *S. hyicus*, and *S. chromogenes*. Infections with *S. simulans* and *S. epidermidis* occurred in 1% to 3% of quarters both before and after parturition. *S. dysgalactiae* was isolated from 4% to 6% of quarters before and immediately after parturition. Intramammary infections with *S. aureus* rarely occurred before parturition but increased during the first week after parturition. There was no association between the prevalence of *S. aureus* in heifers before parturition and the prevalence in lactating cows.

### Distribution of Pathogens in Clinical Mastitis

The distribution of pathogens isolated from cases of clinical mastitis has changed with the adoption of control programs from a high frequency of isolation of *S. aureus* and *S. agalactiae* to a higher isolation rate of other pathogens, particularly environmental pathogens. For example, in 171 randomly selected dairy herds, the average annual incidence of clinical mastitis was 13 quarter cases per 100 cows per year. The most frequent isolates from clinical cases were *E. coli* (16%), *S. aureus* (14%), *S. uberis* (11%), and *S. dysgalactiae* (8%). In another survey, the most common isolates from clinical cases were CNS and *E. coli*, each at 15% of samples taken. In a 2-year observational study of 65 dairy herds in Canada, there was considerable variation in the incidence of clinical mastitis among farms. Overall, 20% of cows experienced one or more cases of clinical mastitis during lactation. The pathogens isolated were coliforms (17%), other *Streptococcus* spp. (14%), *S. aureus* (7%), gram-positive bacilli (6%), *C. bovis* (2%), *S. agalactiae* (1%), and other *Staphylococcus* spp. (29%). There



was no growth in 18% of samples, and 8% were contaminated. Clearly the main difference is that the rate of *S. aureus* in clinical cases is higher in continental Europe and lower in England and North America.

### Source of Infection

#### Contagious Pathogens

*S. agalactiae* and *S. aureus* reside primarily in the udder of infected cows; the source of infection is other infected cows and exposure to uninfected quarters is limited to the milking process.

#### Teat Skin Opportunistic Pathogens

A number of species of coagulase-negative staphylococcus reside primarily on the teat skin of cattle.

#### Environmental Pathogens

*S. uberis*, *S. dysgalactiae*, and coliforms are common inhabitants of the cow's environment such as bedding. The exposure of uninfected quarters to environmental pathogens can occur at any time during the life of the cow, including milking time, between milkings, during the dry period, and before first calving in heifers.

### Methods of Transmission

Infection of each mammary gland occurs via the teat canal, with the infection originating from either an infected udder or the environment; in dairy cattle the infection originating from infected udders is transmitted to the teat skin of other cows by milking machine liners, milkers' hands, washcloths, and any other material that can act as an inert carrier.

### Risk Factors

Risk factors that influence the prevalence of infection and the incidence of clinical mastitis are outlined here. Individual factors that are of particular importance in the individual types of mastitis are described under those headings.

#### Animal Risk Factors

##### Age and Parity

The prevalence of infected quarters increases with age, peaking at 7 years. Surveys of the prevalence of intramammary infection in dairy heifers a few days before their first parturition reveals that 45% are infected, and the quarter infection rate may be 18%. Some studies found intramammary infections in 97% of heifers and 74% of quarters.

##### Stage of Lactation

Most new infections occur during the **early part of the dry period** and in the **first 2 months of lactation**, especially with the environmental pathogens. In heifers, the prevalence of infection is often high in the last trimester of pregnancy and several days before parturition, followed by a marked decline after parturition. In dairy heifers, most of these perpartum infections are

associated with the minor pathogens, but some surveys have found evidence of infection by the major pathogens.

Some of these differences may be related to changes in the milk as a medium for bacterial growth. For example, bacteria such as *C. bovis* grow best in milk secreted in the middle of lactation, whereas dry period secretion inhibits its growth. During the dry period the quarter's capacity to provide phagocytic and bactericidal activities diminishes.

##### Season of Year

The relationship between the incidence of mastitis and season of the year is variable, depending on geographic and climatic conditions. In subtropical and tropical areas the incidence may be higher during winter or spring calvings from the increase in infection pressure associated with increased humidity. In temperate climates and confined dairy herds, the incidence of mastitis is typically higher in summer; this has been attributed to ambient temperatures facilitating the growth of mastitis pathogens in bedding.<sup>6</sup>

##### Somatic Cell Count

The highest average incidence of clinical mastitis caused by environmental bacteria may occur in herds with the lowest bulk tank milk somatic cell count (SCC; <150,000 cells/mL) and a low prevalence of subclinical infection.<sup>6</sup>

##### Breed

Generally, the incidence of mastitis is greater in Holstein Friesians than in Jerseys, but this may reflect differences in management rather than a true genetic difference. Valid comparisons between breeds have not been reported.

##### Milking Characteristics and Morphology of Udder and Teat

High milking rate and large teat canal diameter have been associated with increased SCC or risk of intramammary infection. Milk leaking in cows in herds with a low bulk tank milk SCC has also been associated with an increased rate of clinical mastitis. Decreasing teat-end-to-floor distance is also a risk factor for clinical mastitis and may be associated with an increased incidence of teat lesions.<sup>7</sup> Heritability estimates of teat-end-to-floor distance or udder height range from 0.2 to 0.7, which may be a consideration in the selection indices of bulls. Periparturient udder edema is also a risk factor for clinical mastitis.<sup>7</sup>

##### Physical Condition of Teat

The teat end is the first barrier against invading pathogens, and the efficiency of teat defense mechanisms depends on the integrity of teat tissue; its impairment leads to an increase in the risk of intramammary infection. Teat thickness is an aid to evaluating

teat tissue status. Milking machine characteristics can induce a decrease or increase in teat thickness after milking compared with premilking values. Increases in teat thickness of more than 5% are significantly associated with infection and new infection, but the association was not significant when teat thickness decreased by more than 5%. Coagulase-negative staphylococcal infections are significantly associated with both increases and decreases in teat thickness numerically greater than 5%, but there is no association between teat thickness and *S. aureus* infections. In a longitudinal study of 135 dairy cows teat condition, as assessed immediately after milking, did not appear to be associated with the risk of new intramammary infections, inflammatory response, or mastitis.<sup>8</sup>

Hyperkeratosis of the teat orifice is a commonly observed condition in the dairy cow because of machine milking; the degree of hyperkeratosis may be increased by a poor milking system. There is wide variation in the degree of hyperkeratosis between herds; the score increases with lactational age and peaks, for any lactation, and at 3 to 4 months after parturition, and declines as the cows dry off. There is no significant relationship between mean SCC and the degree of hyperkeratosis at the herd level. However, there is an association between higher hyperkeratosis scores and higher microbial teat canal load, particularly for two common environmental mastitis pathogens, *E. coli* and *S. uberis*, but surprisingly not for *S. aureus* teat canal load.<sup>9</sup> Severe hyperkeratosis of the teat end is associated with an increased risk of clinical mastitis in the UK, but moderate hyperkeratosis was not predictive of clinical mastitis incidence.<sup>10</sup> Together, these data indicate that only severe disruption of the normal anatomy of the teat orifice is associated with an increased risk of developing clinical mastitis.<sup>10</sup>

##### Udder Hygiene

Dirty udders are associated with increased SCC and an increased prevalence of intramammary infection caused by contagious and environmental pathogens.<sup>7</sup> It makes sense that an increased bacterial challenge of the teat and udder is associated with an increased risk of mastitis (Fig. 20-1). Udder hygiene could be a proxy for general mastitis management skills, because good mastitis control programs result in a low prevalence of infection with contagious and environmental pathogens.

##### Nutritional Status

Vitamins E and A as well as selenium may be involved in resistance to certain types of mastitis. Early reports found that supplementation with antioxidants such as selenium and vitamin E had a beneficial effect on udder health in dairy cattle by decreasing the incidence and duration of



**Fig. 20-1** The environmental bacterial challenge can be formidable in confinement dairy operations, as demonstrated from a Midwest dairy in the United States.

clinical mastitis. An increase in selenium concentration in whole blood was associated with a decrease in all infections, including *S. aureus*, *T. pyogenes*, and *C. bovis*. There was no association between different infections or SCC and concentrations of vitamin E, vitamin A, or  $\beta$ -carotene, but an association existed between vitamin A concentration and SCC. There may be an association between feed intake and risk of clinical mastitis: milk fat to protein ratios  $<1.0$  (typically indicating the presence of subacute ruminal acidosis) or  $>1.5$  (typically indicating the presence of excessive fat mobilization) predicts an increased likelihood of clinical mastitis within the following week.<sup>8</sup>

#### Genetic Resistance to Mastitis

A variety of morphologic, physiologic, and immunologic factors contribute to a cow's resistance or susceptibility to mastitis, and each of these factors is influenced to some extent by heredity.<sup>7</sup> Differences in udder depth, teat length, teat shape, and teat orifice morphology are thought to be associated with differences in mastitis occurrence. The production of keratin in the streak canal and the physical and biochemical characteristics of keratin are important contributors to mastitis resistance. Many of the defense mechanisms of the udder, including lysozyme, lactoferrin, immunoglobulins, and leukocytes, are direct products of genes and have a genetic basis. For dairy cattle, heritability estimates for clinical mastitis average about 0.05. These low heritability estimates indicate that there is very little genetic influence on clinical mastitis but a very strong environmental influence.

**Somatic Cell Count.** Differences in heritability between herds with high and low SCCs

are not significant. However, differences among bulls' daughter groups for both clinical mastitis and SCC are reasonably large, suggesting that selection of sires can be important in mastitis control. An analysis of the disease and breeding records of a large number of Swedish bulls siring daughters whose milk had a low SCC count found genetic correlations from 0.71 to 0.79 between SCC and clinical mastitis. It was concluded that it is possible to improve resistance to clinical mastitis by selecting for a low SCC.

The strong phenotypic and genetic association between SCC and mastitis indicates that breeding programs based on SCC may be effective as an indirect means of improving mastitis resistance. However, greater emphasis on SCC may decrease genetic gain in yield traits, which are economically more important.

#### Milk Yield

The genetic correlation between milk yield and mastitis is about 0.2 to 0.3, which suggests that animals genetically above average for milk yield are more susceptible to mastitis and that low-yielding cows tend to be more resistant. However, the low correlation value suggests that this relationship is not a strong tendency. The positive correlation implies that genetic improvement for milk yield is accompanied by a slow decline in genetic resistance to mastitis. Examination of the association between milk yield and disease in a large number of dairy cows found that higher milk yield was not a factor for any disease except mastitis. However, the association between milk yield and mastitis does not imply causation. At least two biological explanations are plausible: increased injury and leaking of milk between milkings.

Improved mastitis control efforts have offset the genetic trend for increased susceptibility to mastitis. The low heritability for mastitis indicates the great importance of environmental factors in causing differences in the prevalence of infection and the incidence of clinical mastitis.

In summary, selection for milk yield alone results in increased incidence of mastitis. The positive genetic correlation between milk yield and mastitis suggests that genes that increase milk yield tend to increase susceptibility to mastitis. Selection indices that maximize genetic improvement for net economic benefit will not decrease the incidence of mastitis, but indices that include SCC, udder depth, or clinical mastitis will diminish the rate of increase in mastitis by 20% to 25%. Using **predicted transmitting ability (PTA)**, an estimate of genetic merit, it has been found on average that daughters of bulls with high PTAs for SCC have a higher incidence of mastitis; sires with low PTA for somatic cell scores (SCCs) should therefore be selected. All of the economically important traits are weighted into a selection index for the selection of bulls, which will improve net income over cost of production.

Dairy cattle with enhanced and optimally balanced antibody and cell-mediated immune responses are known as **high immune responders**. These adaptive immune responses are separate to innate immunity and are heritable, with heritability estimates of 0.25 to 0.35. These estimates are similar in magnitude to those for milk production traits, indicating that an appropriately weighted selection index would improve overall cow health and production.<sup>11</sup>

#### Other Concurrent Diseases

These may be important risk factors for mastitis. Retained placentas, teat injuries, and teat sores may be associated with a higher incidence of mastitis. Sole ulceration of any severity occurring in more than one digit has been associated with an approximately three-fold higher risk of *S. aureus* infections in the first lactation. It is suggested that sore feet could increase the risk of teat lesions, presumably as a result of difficulty in standing.

#### Immunologic Function of Mammary Gland

The immune function of the mammary gland is impaired during the periparturient period; it is susceptible to mastitis during transition periods, such as drying off and colostrum genesis. As a result, the **incidence of new intramammary infections is highest during the early nonlactating period and the periparturient period**.

Innate immunity plays an important role in maintaining a healthy mammary gland.<sup>12</sup> **Pattern recognition receptors (PRRs)** recognize well-conserved patterns on the surface of microbes called **pathogen-associated molecular patterns (PAMPs)**.

The initial interaction between PAMPs and PRRs plays an important role in the subsequent inflammatory response.<sup>13,14</sup> Lactoferrin is another component of innate immunity. It reaches high concentrations in the glandular secretions during the dry period, particularly during involution of the mammary gland. Because of its high secretion concentration and ability to bind iron, lactoferrin provides important innate antimicrobial activity against new intramammary infections in the dry period, particularly coliform bacteria.<sup>14,15</sup>

The most important components of the defense against common bacterial pathogens are blood-derived **neutrophils** and **opsonizing antibodies**. An inadequate rate of neutrophil recruitment to combat a new intramammary infection has a profound effect on the outcome of infection, because cows with a rapid and massive recruitment of neutrophils to an infected gland clear an intramammary infection within 12 to 18 hours postinfection.

It is also important that an early inflammatory response in the infected mammary gland enables leakage of IgG<sub>2</sub> (opsonizing antibodies) because this facilitates neutrophil phagocytosis of bacteria. The **staggered one-two punch of peak IgG<sub>2</sub> concentrations** within 4 hours of infection and **peak neutrophil response** within 6 to 12 hours of infection greatly facilitates clearance of new intramammary infections.

Blood-derived neutrophils must undergo **margination, adherence, and migration** to arrive in the mammary gland, in which they perform **phagocytosis, respiratory burst, and degranulation**. Margination is via expression of three adhesion molecules from the selectin family, specifically L-selectin (also called CD62L) on neutrophils, E-selectin (also called CD62E), and P-selectin (also called CD62P) on vascular endothelial cells. Neutrophil L-selectin makes the initial contact between “streaming” neutrophils in the bloodstream and the vascular wall; this contact slows neutrophil movement and allows them to “roll” along the endothelium while surveying for the presence of proinflammatory mediators at the sites of tissue infection. When the rolling neutrophils detect the presence of one or more proinflammatory mediators, they immediately shed surface L-selectin (CD62L) adhesion molecules and upregulate and activate Mac-1 (CD11b/CD18) adhesion molecules, stopping neutrophil rolling and permitting tight adherence of the neutrophil to the endothelium. Once adhered, neutrophils commence diapedesis by migrating between endothelial cells to the site of infection. Neutrophil migration therefore has three components: hyperadherence (cessation of rolling), diapedesis, and chemotaxis. Any delay or inhibition in this process can lead to peracute mastitis and severe clinical disease. This is best illustrated by bovine

leukocyte adhesion deficiency in Holstein Friesian cattle; affected calves cannot produce Mac-1 molecules and have a prominent neutrophilia because streaming neutrophils cannot migrate to the site of infection. Migration of neutrophils is slow during the first few weeks of lactation, and this delay in neutrophil migration is thought to be responsible for the increased incidence and severity of intramammary infections during early lactation.

#### Previous Mastitis

Cows with a history of mastitis in the preceding lactation may be almost twice as susceptible to clinical mastitis in the current lactation as those without mastitis in the preceding lactation.

#### Preexisting Intramammary Infections

Existing intramammary infections with minor pathogens has a **protective effect** against infections with major pathogens that is prominent in experimental infection studies that involve a large inoculum that bypasses the teat canal.<sup>16</sup> The observed protective effect of minor pathogen infection may not occur under commercial dairy conditions. The strongest protective effect was observed with coagulase-negative staphylococci, whereas intramammary infection with *C. bovis* did not provide protection against intramammary infection by a major pathogen.<sup>16</sup> Elimination of minor pathogens with postmilking teat disinfection may therefore result in an increase in the incidence of subclinical and clinical mastitis. Discontinuation of teat dipping may be associated with an increase in the prevalence of minor pathogens, increase in the incidence of *S. aureus* infections, and decrease in the incidence of *E. coli* infections.

#### Use of Recombinant Bovine Somatotropin

Because the risk of clinical mastitis increases as milk production increases, there has been considerable scientific and public controversy over the potential effects that the use of recombinant bovine somatotropin (bST) might have on the incidence of clinical mastitis and the subsequent use of antimicrobials from therapy. In some field trials, the use of bST did not result in an increase in the incidence of clinical mastitis compared with controls. In other trials, a significant increase in the incidence of clinical mastitis occurred in treated cows compared with controls. However, the incidence of clinical mastitis was greater in treated cows compared with controls before bST was used. In trials done on well-managed farms that had controlled contagious mastitis and had low rates of clinical mastitis caused by environmental pathogens, the use of bST was not associated with an increase in clinical mastitis, discarded milk because of therapy, or culling for mastitis. Interpretation of a direct effect of

bST on mastitis incidence is confounded by the higher incidence of mastitis in cows of higher milk production.

#### Environmental and Management Risk Factors

*Quality and Management of Housing*  
Factors such as climate, housing system, type of bedding, and rainfall interact to influence the degree of exposure of teat ends to mastitis pathogens. Because dairy cattle spend 40% to 65% of their time lying down, **the quality and management of housing for dairy cattle has a major influence on the types of mastitis pathogen that infect the mammary gland, as well as the degree of infection pressure.**

The major sources of environmental pathogens are the cow's environment, including bedding, soil, feedstuffs, and water supplies. Environmental pathogens multiply in bedding materials, with which the cow's teats are in close and prolonged contact. Bacterial growth in bedding depends on temperature, amount of moisture and nutrients available, and the pH. Fresh bedding can be a source of contamination even before it is used: *Klebsiella pneumoniae* can be present in green, hardwood sawdust in higher numbers than in other types of bedding, and major outbreaks of environmental mastitis caused by *K. pneumoniae* have occurred following the use of contaminated wood products in bedding, described in detail in that section. Dry, unused bedding contains few pathogens, but after being used it becomes contaminated and provides a source in which pathogens multiply to high numbers in 24 hours. Organic bedding materials such as straw, sawdust, wood shavings, and paper support the growth of pathogens. Inorganic materials such as sand retain less moisture and do not provide a supply of nutrients for the pathogens; bacterial counts in these materials are usually lower than in organic materials. Housing lactating cattle on sawdust leads to six times more *Klebsiella* bacteria and twice as much coliform bacteria on the teat ends compared with housing cattle on sand. In contrast, there were 10 times more environmental streptococci bacteria on teat ends when cows were housed on sand, compared with housing on sawdust. Surveys indicate that herds using wood chips or sawdust as bedding material have higher rates of clinical mastitis compared with those using straw bedding.

High humidity and high ambient temperatures favor growth of pathogens. Cows in confinement housing with organic bedding materials have the highest incidence of environmental mastitis in the warm, humid months of the year. Pasturing herds during the summer months usually reduces the incidence of coliform mastitis, although rates of environmental streptococci may remain high. In drylot systems the incidence of coliform mastitis may be associated with



periods of high rainfall. Herds with more months on pasture may have a higher incidence of clinical mastitis, which may be associated with factors such as sanitation and the stress of transition between pasture and confinement housing.

The **management and design of housing systems** influence the prevalence of intramammary infection and the incidence of clinical mastitis. Any housing factor or management system that allows cows to become dirty or damage teats or that causes overcrowding will result in an increase in clinical mastitis. This includes the size and comfort of free stalls, the size of the alleyways, ease of movement of cattle, and the cleaning system. Failure to keep alleyways, cow stalls and bedding clean and dry will increase the level of contamination of the teats. Overcrowding, poor ventilation, and access to dirty ponds of water and muddy areas in which cows congregate are major risk factors.

The **size of the milking cowherd** may be positively associated with an increased incidence of clinical mastitis, because it can be more difficult to control contagious mastitis in a herd with a greater prevalence of infection and a larger number of cow-to-cow contacts. As herd size increases, manure disposal and sanitation problems may increase exposure to environmental pathogens. However, regional and management differences may confound the association of size with infection status. Some recent data suggest lower SCC in large herds. The use of designated maternity areas providing an isolated and clean environment for parturition may be associated with a lower incidence of clinical mastitis.

If hygiene and bedding maintenance are neglected in the housing accommodation the prevalence of environmental forms of mastitis may increase markedly. Periodic inspection of dry cows is an essential part of mastitis control.

#### Milking Practices

**The failure to use established and reliable methods of mastitis control is an important risk factor.** This is a major subject, which includes efficiency of milking personnel, milking machines, high milking speed, and especially hygiene in the milking parlor. Wet teats and udders are a risk factor for increased SCC, especially in the presence of teat impacts from liner slippage. The use of a separate drying cloth for each cow is associated with a lower SCC. Effective use of a postmilking germicidal teat dip is critical for the control of contagious mastitis. Increasing person-hours spent milking per cow may be associated with a higher rate of clinical mastitis. Contaminated milking equipment—including milk hoses, udder wash towels, and teat dip products—has been associated with outbreaks of environmental mastitis from *S. marcescens* and *P. aeruginosa*. Drying off procedures at the end of lactation and an

active policy on drying off treatment are equally important.

**The absence of milk quality regulations that place emphasis on SCC is also a risk factor.** Conversely, the presence of strict regulations with penalties for high SCC is an important incentive to institute mastitis control programs that improve the quality of milk. The absence of a health management program consisting of regular farm visits by the veterinarian may also be a risk factor for mastitis, which may be associated with a relative lack of awareness by the producer of the importance of the principles of mastitis control.

#### Pathogen Risk Factors

##### Viability of Pathogens

The ability of the pathogen to survive in the cow's immediate environment (resistance to environmental influences including cleaning and disinfection procedures) is a characteristic of each pathogen. The causes of contagious mastitis are more susceptible to disinfection than the causes of environmental mastitis.

##### Virulence Factors

There is a wide variety of virulence factors among the mastitis pathogens. These are described under specific mastitides. The influence of many bacterial virulence factors depends on the stage of lactation and severity of the intramammary infection and the effects elicited by the virulence factors on bovine mammary tissue. A few examples of the common virulence factors are noted here.

##### Colonizing Ability

The ability of the pathogens to colonize the teat duct, then to adhere to mammary epithelium, and to initiate mastitis is a major characteristic of the major bacterial causes of mastitis. *S. aureus* strains that cause mastitis can bind to ductular udder epithelial cells and to explant cultures of bovine mammary glands. There are differences in the adhesion characteristics among strains of the organism, which may explain the different epidemiologic characteristics of the organisms in some herds. Comparison of strains isolated from different *S. aureus* mastitis cases between herds reveals that only a limited number of genotypes of *S. aureus* are most prevalent.

##### Toxins

*E. coli* isolates that cause mastitis produce lipopolysaccharide endotoxin, which is responsible for many of the inflammatory and systemic changes observed during acute coliform mastitis. *S. aureus* isolated from intramammary infections produces many potential virulence factors, including enterotoxins; coagulase and alpha-, beta-, and delta-toxins; hemolysin; hyaluronidase; and leukocidins, which are considered to be involved in the varying degrees

of inflammation characteristic of staphylococcal mastitis from subclinical to peracute gangrenous mastitis. Virulence factors of *S. uberis* include hyaluronidase and the hyaluronic capsule.

#### Production and Economic Losses

Although mastitis occurs sporadically in all species, it assumes major economic importance in dairy cattle and may be one of the most costly diseases in dairy herds. Mastitis results in economic loss for producers by increasing the costs of production and by decreasing productivity. The premature culling of potentially profitable cows because of chronic mastitis is also a significant loss. Because of the large economic losses, there is a potential for high returns on investment in an effective control program. The component economic losses can be divided into the following:

- Loss of milk production
- Discarded milk from cows with clinical mastitis and treated cows
- Replacement cost of culled cows
- Extra labor required for treatment and monitoring
- Veterinary service for treatment and control
- Cost of first trimester abortions caused by clinical mastitis
- Cost of decreased conception rate caused by clinical mastitis 1 week before or 2 weeks after artificial insemination<sup>17</sup>
- Cost of control measures

There are additional costs such as antimicrobial residues in milk from treated cows, milk quality control, dairy food manufacturing, nutritional quality of milk, degrading of milk supplies caused by high bacteria or SCC, and interference with the genetic potential of some cows from early involuntary culling because of chronic mastitis.<sup>18</sup> The total annual cost of mastitis in the dairy cattle population is estimated to be 10% of the total value of farm milk sales, and about two-thirds of this loss is caused by reduced milk production in subclinically affected cows. The production and economic losses are commonly divided into those associated with subclinical and clinical mastitis.

#### Subclinical Mastitis

Total milk losses from quarters affected with subclinical mastitis have been estimated to range from 10% to 26%. Lower SCCs are associated with higher milk production, and rolling herd average milk production has been estimated to decrease by 190 kg per unit increase of linear SCS. Most estimates indicate that on average an affected quarter results in a 30% reduction in productivity, and an affected cow is estimated to lose 15% of its production for lactation. This loss is sometimes expressed as a loss of about 340 kg of saleable milk, which is caused by the loss of production and the value of milk that has to be withheld from sale. The loss in

production by an infected quarter may be largely compensated by increased production in the other quarters so that the net loss from the cow may be less than expected. In addition to these losses, there is an added loss of about 1% of total solids by changes in composition (fat, casein, and lactose are reduced and glycogen, whey proteins, pH, and chlorides are increased), which interferes with manufacturing processes, and other losses include increased culling rates and costs of treatment. Comparisons between low- and high-prevalence herds always show a financial advantage of about 20% to the low-prevalence herds, with the gain varying with the local price of milk or butter fat. In beef herds the losses are in the form of rare deaths of cows and failure of the calves to gain weight.

Approximately 75% of the economic loss from subclinical mastitis is attributable to loss of milk production. Other costs include discarding milk from treated cows, drug costs, veterinary costs, labor, and loss of genetic potential of culled cows.

### Clinical Mastitis

Clinical mastitis results in marked decreases in milk production, which are much larger in early than late lactation.<sup>19</sup> Milk production losses are also greater in cows with multiple lactations than first-lactation cows<sup>19</sup> and vary with pathogen type. Generally, gram-negative clinical mastitis cases have a greater milk loss than gram-positive and other cases.<sup>20</sup> In primiparous cattle, the greatest production losses were associated with *E. coli* and “untreatable” mastitis pathogens including *T. pyogenes*, *Mycoplasma* spp., *Prototheca*, and yeast.<sup>21</sup> In multiparous cattle, the greatest production losses were associated with *Klebsiella* spp. and untreatable mastitis pathogens. Clinical mastitis episodes caused by CNS were not associated with a detectable production loss.<sup>21</sup>

Clinical mastitis also decreases the duration of lactation and increases the likelihood of culling. Clinical cases of brief duration that occur after the peak of lactation affect milk production very little but can induce abortion during the first 45 days of gestation. Clinically affected quarters may not completely recover milk production in subsequent lactations, but these carry-over losses are not as large as the losses from acute mastitis.

The **costs of clinical mastitis** in dairy herds have been estimated in a number of countries. In a large 5-herd study in New York state in 2008 each clinical mastitis case cost \$71 per cow-year, with a mean cost per clinical episode of \$179. The latter estimate was based on \$115 for milk yield loss, \$14 for increased mortality, and \$50 for treatment-associated costs.<sup>22</sup> These estimates did not include the cost of control programs.

The component causes of economic loss associated with mastitis outlined previously

vary according to the causative pathogen and are described under specific mastitides. In general terms *S. aureus* and *E. coli* may cause death from peracute mastitis; *T. pyogenes* causes complete loss of quarters; staphylococci and streptococci cause acute clinical mastitis, but their principal role is in causing subclinical mastitis, resulting in a reduction of milk produced and a downgrading of its quality. Of these, *S. agalactiae* causes the greatest production loss, whereas *S. aureus* has the higher infection rate, greater resistance to treatment, and longer duration of infection. At one time *S. aureus* represented the impassable barrier to mastitis control programs.

Other factors that affect the magnitude of the loss associated with mastitis include age (the loss is greatest in mature cows) and when the attack occurs in the first 150 days of lactation.

### Zoonotic Potential

With mastitis there is the danger that the bacterial contamination of milk from affected cows may render it unsuitable for human consumption by causing food poisoning, or interfere with manufacturing processes or, in rare cases, provide a mechanism of spread of disease to humans. Tuberculosis, listeriosis, salmonellosis, and brucellosis may be spread in this way. Raw (unpasteurized) milk can be a source of food-borne pathogens, and consumption of raw milk can result in sporadic disease outbreaks. For instance, sampling bulk tank raw milk in Ontario revealed the presence of *Listeria monocytogenes*, *Salmonella* spp., *Campylobacter* spp., or verocytotoxigenic *E. coli* in 2.7, 0.2, 0.5, and 0.9% of milk samples, respectively. These findings emphasize the importance of continued diligence in the application of hygiene programs within dairies and the separation of raw from pasteurized milk and milk products.

### PATHOGENESIS

Infection of the mammary gland always occurs via the teat canal and on first impression the development of inflammation after infection seems a natural sequence. However, the development of mastitis is more complex than this and can be most satisfactorily explained in terms of three stages: **invasion**, **infection**, and **inflammation**. Of the three phases, prevention of the invasion phase offers the greatest potential for reducing the incidence of mastitis by good management, notably in the use of good hygienic procedures.

**Invasion** is the stage at which pathogens move from the teat end to the milk inside the teat canal.

**Infection** is the stage in which the pathogens multiply rapidly and invade the mammary tissue. After invasion the pathogen population may be established in the teat canal and, with this as a base, a series of multiplications and extensions into

mammary tissue may occur, with infection of mammary tissue occurring frequently or occasionally depending on its susceptibility. Multiplication of certain organisms may result in the release of endotoxins, as in coliform mastitis, which causes profound systemic effects with minimal inflammatory effects.

**Inflammation** follows infection and represents the stage at which clinical mastitis occurs with varying degrees of clinical abnormalities of the udder and variable systemic effects from mild to peracute; gross and subclinical abnormalities of the milk appear. Abnormalities of the udder include marked swelling, increased warmth and, in acute and peracute stages, gangrene in some cases and abscess formation and atrophy of glands in chronic stages. The systemic effects are caused by the mediators of inflammation. Gross abnormalities of the milk include a decrease in milk yield, the presence of the products of inflammation, and marked changes in the composition of the milk.

The most significant subclinical abnormality of the milk is the increase in the SCC, the most common measurement of milk quality and udder health. Milk somatic cells in a healthy gland consist of several cell types, including neutrophils (<11%), macrophages (66%–88%), lymphocytes (10%–27%), and a smaller percentage of epithelial cells (0%–7%). Neutrophils are the predominant cell type found in mammary tissues and secretions during inflammation, and in mastitis they constitute more than 90% of total mammary gland leukocytes. Once at the site of infection, neutrophils phagocytose and kill pathogens. Neutrophils exert their bactericidal effect through a respiratory burst that produces hydroxyl and oxygen radicals, which are important components of the oxygen-dependent killing mechanism.

In the healthy lactating mammary gland, the SCC is less than 100,000 cells/mL of milk. During intramammary infection, the glandular SCC can increase to more than 1,000,000 cells/mL of milk within a few hours because of the combined effect of an increased number of neutrophils (numerator) and a decreased glandular secretion volume (denominator). **The severity and duration of mastitis are critically related to the promptness of the neutrophil migratory response and their bactericidal activity at the site of infection.** As they colonize and multiply in the mammary gland, some bacteria release metabolic by-products or cell-wall components (endotoxin if a gram-negative bacteria) that serve as chemoattractants for leukocytes. If neutrophils move rapidly from the bloodstream and are able to eliminate the inflammatory stimuli (bacteria), then recruitment of neutrophils ceases and the SCC returns to normal levels. If bacteria are able to survive this immediate host response, then the inflammation continues,

resulting in neutrophil migration between adjacent mammary secretory cells toward the alveolar lumen. Prolonged diapedesis of neutrophils damages mammary tissue, resulting in decreased milk production. The duration and severity of the inflammatory response therefore has a major impact on the quantity and quality of milk produced.

The major factor affecting the SCC at the herd and individual cow level is the prevalence of intramammary infection at a glandular level. Because marked increases in SCC are a result of cells being attracted to the mammary tissue because of the mediators produced during a local infection, events that do not affect udder health are unlikely to have a direct or dramatic effect on SCC. Little evidence exists that any factor other than normal diurnal variation has a major influence on SCC in the absence of intramammary infections.

The effects of mastitis on milk yield are highly variable and depend on the severity of the inflammation, the causative agents and the lesions produced, the efficiency of treatment, the production level, and the stage of lactation. Mastitis in early lactation causes a larger decrease in milk yield with long-term effects than mastitis in late lactation. Mastitis caused by *S. aureus* generally evolves into persistent but moderate infections, unlike those associated with coliforms. Mastitis associated with *T. pyogenes* results in suppurative lesions, poor response to treatment, and culling. *M. bovis* causes chronic induration and almost complete loss of milk production without recovery.

## CLINICAL FINDINGS

Details of the clinical findings are provided under each specific type of mastitis. The clinical findings should be used only as a guide because different pathogens can cause chronic, subclinical, subacute, acute, and peracute forms of the disease, and clinical differentiation of the different causes of mastitis is difficult. The greatest clinical accuracy achievable, even in a specialist hospital environment and after adaptation to suit local conditions, is about 70%, which is not sufficiently accurate to be clinically useful. In other words, bacteriologic culture of milk from an affected gland is required before specific pathogen-directed treatment can be implemented.

Clinical mastitis is detected using only the results of the physical examination, and a useful definition of clinical mastitis is a negative answer to the question: Would you drink this? In other words, “undrinkable” is a simple and generalizable concept for defining clinical mastitis, because milk from cows with clinical mastitis is not suitable for drinking. New cases of clinical mastitis are defined as being separated by at least 14 days.

The clinical findings in mastitis include abnormalities of secretion, abnormalities of

the size, consistency and temperature of the mammary glands and, frequently, a systemic reaction. In other words, there are **three categories of clinical mastitis: abnormal secretion, abnormal gland, and an abnormal cow** (systemic disease). Abnormal secretion is visibly abnormal (i.e., is not drinkable). An abnormal gland is larger and firmer than other quarters. An abnormal cow is pyrexia, depressed, or has decreased appetite or milk production. This three-part categorization scheme has excellent clinical utility, is readily understood by everyone, and provides a sound pathophysiological basis for treatment. In particular, it is likely that optimal treatment protocols can be developed for the three levels of clinical mastitis. Other categorization systems have been developed, but they lack the simplicity and generalizability of the secretion, gland, and cow system.

Clinical mastitis episodes are also categorized according to their severity and duration.

**Severity** is characterized as follows:

- **Peracute:** severe inflammation with swelling and heat and pain of the quarter with a marked systemic reaction, which may be fatal
  - **Acute:** severe inflammation without a marked systemic reaction
  - **Subacute:** mild inflammation with persistent abnormality of the milk
- Duration** is characterized as follows:
- **Short-term** (as in *E. coli* and *Klebsiella* spp.)
  - **Recurrent** (as in *S. aureus* and *S. dysgalactiae*)
  - **Persistent** (as in *S. agalactiae* and *M. bovis*)

## Abnormal Secretion

Proper examination of the milk requires the use of a **strip cup**, preferably one with a **shiny, black plate** that permits the detection of discoloration as well as clots, flakes, and purulent material. Milk is drawn on to the black plate in pools, and comparisons are made between the milk of different quarters. Because the herdsman frequently has little time to examine milk for evidence of mastitis, it is customary to milk the first few streams onto the floor; in some parlors black plates are set in the floor. The practice does not appear to be harmful if the floor is kept washed down.

Discoloration may be from blood staining or wateriness, with the latter usually indicating chronic mastitis when the quarter is lactating. Little significance is attached to barely discernible wateriness in the first few streams but, if this persists for two to three streams or more, it is an abnormality. One of the major unresolved issues in bovine mastitis is how to treat a cow with abnormal secretion on the first one to two streams that subsequently has normal-looking milk. Clots or flakes are usually accompanied by discoloration and they are always significant,

indicating a severe degree of inflammation, even when small and present only in the first few streams. Blood clots are of little significance in a mastitis case, and neither are the small plugs of wax that are often present in the milk during the first few days after calving, especially in heifers. Flakes at the end of milking may be indicative of mammary tuberculosis in cattle.

During the **dry period** in normal cows, the secretion changes from normal milk to a clear watery fluid, then to a secretion the color and consistency of honey, and finally to colostrum in the last few days before parturition. Some variation may occur between individual quarters in the one cow; if this is marked, it should arouse suspicion of infection.

The **strip cup** provides a valuable tool for detecting clinical mastitis and constitutes part of the routine physical examination of the lactating cow. The most sensitive use of the strip cup is to observe the ability of milk from one quarter to mix with milk from another quarter; incomplete mixing (evidence of streaming) indicates that secretions from the two quarters differ and suggests the presence of an intramammary infection in one of the quarters. However, it should be remembered that the strip cup can only detect clinical mastitis, and detection of subclinical mastitis requires use of indirect tests such as SCC of composite milk samples from individual cows, or application of the California mastitis test (CMT) to quarter samples or measuring the electrical conductivity of quarter samples.

## Abnormal Gland

Abnormalities of size and consistency of the quarters may be seen and felt. Palpation is of greatest value when the udder has been recently milked, whereas visual examination of both the full and empty udder may be useful. The udder should be viewed from behind, and the two hindquarters should be examined for symmetry. By lifting up the hindquarters, the forequarters can be viewed. A decision on which quarter of a pair is abnormal may depend on palpation, which should be performed simultaneously on the opposite quarter of the pair. Although in most forms of mastitis the observed abnormalities are mainly in the region of the milk cistern, the whole of the quarter must be palpated, particularly if tuberculosis is suspected. The teats should be inspected and palpated for skin lesions, especially around the teat end. The supramammary lymph nodes should also be palpated for evidence of enlargement.

Palpation and inspection of the udder are directed at the detection of fibrosis, inflammatory swelling, and atrophy of mammary tissue. Fibrosis occurs in various forms. There may be a diffuse increase in connective tissue, giving the quarter a firmer feel than its opposite number and usually a more nodular



surface on light palpation. Local areas of fibrosis may also occur in a quarter; these may vary in size from pealike lesions to masses as large as a fist. Acute inflammatory swelling is always diffuse and is accompanied by heat and pain and marked abnormality of the secretion. In severe cases there may be areas of gangrene, or abscesses may develop in the glandular tissue. The terminal stage of chronic mastitis is atrophy of the gland. On casual examination an atrophied quarter may be classed as normal because of its small size, whereas the normal quarter is judged to be hypertrophic. Careful palpation may reveal that, in the atrophic quarter, little functioning mammary tissue remains.

### Abnormal Cow (Systemic Response)

A systemic response including toxemia, pyrexia, tachycardia, tachypnea, ruminal hypomotility, depression, recumbency, and anorexia may or may not be present, depending on the type and severity of the infection.<sup>23</sup> The hock-to-hock distance is increased in cattle with clinical mastitis (Fig. 20-2), reflecting a change in stance caused by the presence of localized pain in the udder.<sup>23</sup> The mechanical threshold to pain of cows with clinical mastitis is lower than that of control cows.<sup>23</sup> Daily feed intake is decreased by approximately 1.2 kg during the 5 days before clinical mastitis is detected, and cows eat more slowly and are less competitive at the feed bunk when they have clinical mastitis.<sup>24–26</sup> Cows with clinical mastitis also spend more time standing and less time lying with affected quarter(s) on the down side.<sup>25,26</sup>

A systemic response is usually associated with severe mastitis associated with *E. coli*,



**Fig. 20-2** Increased hock-to-hock distance in a Holstein Friesian cow with clinical mastitis in the right rear quarter.

*Klebsiella* spp., or *T. pyogenes* and occasionally with *Streptococcus* spp. or *Staphylococcus* spp. Clinical mastitis episodes caused by *T. pyogenes* produces the greatest decrease in milk production. In contrast, clinical mastitis caused by environmental streptococci and CNS is associated with the smallest decrease in milk production. Clinical mastitis episodes caused by *S. aureus* are associated with the highest risk of culling.

### FURTHER READING

Pyörälä S. Mastitis in post-partum dairy cows. *Reprod Domest Anim.* 2008;43(suppl 2):252-259.

### REFERENCES

- Riekerink RGMO, et al. *J Dairy Sci.* 2008;91:1366.
- Unnerstad HE, et al. *Vet Microbiol.* 2009;137:90.
- Koivula M, et al. *Acta Agr Scand Sect A.* 2007;57:89.
- Verbeke J, et al. *J Dairy Sci.* 2014;97:6926.
- Keane OM, et al. *Vet Rec.* 2013;173:17.
- Elghafghuf A, et al. *Prev Vet Med.* 2014;117:456.
- Compton CWR, et al. *J Dairy Sci.* 2007;90:4171.
- Zoche-Golob V, et al. *Prev Vet Med.* 2015;121:64.
- Paduch JH, et al. *Vet Microbiol.* 2012;158:353.
- Breen JE, et al. *J Dairy Sci.* 2009;92:2551.
- Thompson-Crispi K, et al. *Front Immunol.* 2014;5:493.
- Oviedo-Boyso J, et al. *J Infect.* 2007;54:399.
- de Souza FN, et al. *Am J Immunol.* 2012;8:166.
- Aitken SL, et al. *J Mammary Gland Biol Neoplasia.* 2011;16:291.
- Adlerova L, et al. *Vet Med (Praha).* 2008;53:457.
- Reyher KK, et al. *J Dairy Sci.* 2012;95:6483.
- Hertl JA, et al. *J Dairy Sci.* 2014;97:6942.
- Petrovski KR, et al. *Tydskr S Afr Vet Ver.* 2006;77:52.
- Hagnestam C, et al. *J Dairy Sci.* 2007;90:2260.
- Schukken YH, et al. *J Dairy Sci.* 2009;92:3091.
- Hertl JA, et al. *J Dairy Sci.* 2014;97:1465.
- Bar D, et al. *J Dairy Sci.* 2008;91:2205.
- Kemp MH, et al. *Vet Rec.* 2008;163:175.
- Sepúlveda-Varas P, et al. *Appl Anim Behav Sci.* 2014. DOI: 10.1016/j.applanim.2014.09.022.
- Siiivonen J, et al. *Appl Anim Behav Sci.* 2011;132:101.
- Fogsgaard KK, et al. *J Dairy Sci.* 2015;98:1730.

## Diagnosis of Bovine Mastitis

### Detection of Clinical Mastitis

The initial diagnosis of clinical mastitis is made during routine physical examination. Laboratory culturing of milk samples for bacteria and *Mycoplasma* spp., and for determining the antimicrobial susceptibility of *S. aureus* (specifically whether it produces  $\beta$ -lactamase), is very useful for instituting optimal treatment protocols for cows with clinical mastitis and for instituting appropriate control measures. However, because subclinical mastitis has the greatest influence on the cost of mastitis to the producer, it is also advantageous to diagnose subclinical mastitis on a cow and quarter level.

### Detection of Subclinical Mastitis

Culturing large numbers of milk samples, although the gold standard for diagnosing intramammary infection, is too expensive and impractical for routine use. Much

attention has therefore been given to the development of indirect inexpensive tests to predict the presence of an intramammary infection. Currently available indirect tests detect only the presence of inflammation (subclinical mastitis) and not intramammary infection, but are of value as screening tests; milk from quarters or cows with a positive screening test are then submitted to bacteriologic culture. **Subclinical mastitis can only be detected by laboratory examination** and cannot, by definition, be detected during routine physical examination. In other words, the secretion from a quarter with subclinical mastitis appears drinkable.

### Detection at the Herd Level

The prevalence of intramammary infection or subclinical mastitis is monitored by determining the **bulk tank milk SCC**, and the most likely mastitis pathogens are identified by **culturing bulk tank milk**. These two methods are recommended for diagnosing the presence and prevalence of mastitis pathogens on a herd basis.

### Bulk Tank Milk Somatic Cell Counts

The SCC of bulk tank milk is an indirect measure of the prevalence of mastitis within a dairy herd. The SCC is increased primarily, but not exclusively, because of subclinical mastitis associated with gram-positive bacterial intramammary infections. There is a good correlation between the number of streptococci (*S. agalactiae*, *S. dysgalactiae*, and *S. uberis*) colony forming units (CFUs) found in bulk tank milk and its SCC. The number of CFUs of *S. aureus* is moderately correlated to the bulk tank milk SCC. As contagious mastitis has become more effectively controlled, environmental mastitis pathogens have become a relatively more important cause of high SCC in bulk tank milk, especially in herds with moderate (<400,000 cells/mL) to low (<150,000 cells/mL) bulk tank milk SCC.

The SCC of bulk tank milk has become a widely used test because it provides a sensitive and specific indicator of udder health and milk quality. The sample for analysis is obtained by agitating the milk for 5 to 10 minutes and collecting a sample from the top of the bulk tank milk using a clean dipper. The sample should not be collected near the outlet valve because this varies from that in the rest of the tank. The SCC of bulk tank milk is widely used to regulate whether milk may be legally sold and to determine the price paid for raw milk. Premium and penalty payments are calculated on the basis of a 3-month geometric mean of weekly bulk tank milk SCC measurements. Milk processing plants in most developed countries use automatic electronic somatic cell counters routinely to provide a monthly report of the bulk tank milk SCC. The test requires only that the sample for examination be taken randomly and not frozen, that it be prepared

**Table 20-1** Estimated prevalence of infection and losses in milk production associated with bulk tank milk somatic cell count

Bulk tank milk somatic cell count (cells/mL)	Infected quarters in herd (%)	Production loss (%)
200,000	6	0
500,000	16	6
1,000,000	32	18
1,500,000	48	29

with the correct reagent, that the laboratory counter be set at the right calibration, and that the sample be examined quickly or preserved with formalin to prevent cell losses during storage. The bulk tank milk SCC is extremely useful in creating awareness of the existence of a mastitis problem, so that when the SCC of bulk tank milk exceeds permissible limits further investigation of the herd is indicated. In a seasonal herd in which all cows are at the same stage of lactation, the bulk milk cell count will normally be high in early lactation and just before drying off. To overcome these and other factors that are likely to transiently influence bulk tank milk SCC, it is recommended that correction factors be introduced into the estimation or that a rolling SCC, in which monthly data are averaged for the preceding 3 months, be used. Consideration of this figure will avoid too hasty conclusions on one high count caused by an extraneous factor.

It is not possible to use the bulk tank milk SCC to determine the number of cows in a herd affected by mastitis, but it is possible to estimate fairly accurately the number of infected quarters. Generally, as the bulk tank milk SCC increases, the prevalence of infection increases and losses in production increase. Production losses calculated as a percentage of production expected with a count of 200,000 cells/mL are shown in Table 20-1. A bulk tank milk SCC of more than 300,000 cells/mL is considered to indicate a level of mastitis in the herd that warrants examination of individual cows. Herds with a high bulk tank milk SCC have significantly lower production levels and are less likely to use a postmilking teat dip or to have a regular program of milking machine maintenance or automatic cluster removal.

#### Culture of Bulk Tank Milk

Bacteria present in bulk tank milk may originate from infected udders, from teat and udder surfaces, or from a variety of other environmental sources; however, despite the large number of potential sources for bacteria, culture of bulk tank milk is a useful technique for screening for major mastitis pathogens. The culture of *S. aureus* and *S. agalactiae* from bulk tank milk is a reliable indicator of infection by those pathogens in

the herd. The number of those pathogens found on culture is determined by the number of bacteria shed, the number of infected cows, the milk production level of infected cows relative to herd mates, and the severity of infection. A single culture of bulk tank milk has low sensitivity but high specificity for determining the presence of *S. agalactiae* or *S. aureus* in the herd. Thus many infected herds will be called negative, but very few uninfected herds will be called positive. Pathogens such as *Nocardia* spp. and *Mycoplasma* spp. have also been identified by culture of bulk tank milk. Generally, the sensitivity of a single bulk tank milk culture to detect the presence of intramammary infections caused by *S. agalactiae* ranges from 21% to 77%, for *S. aureus* it ranges from 9% to 58%, and for *M. bovis* it is 33%.

Environmental bacteria such as *S. uberis*, *S. dysgalactiae*, and coliforms may enter milk from intramammary infections, but also from nonspecific contamination. The presence of these organisms in bulk tank milk may relate to the general level of environmental contamination and milking hygiene in the herd. Udder infections with these environmental pathogens are predominantly of short duration and characterized by clinical disease, which makes their inadvertent introduction to the bulk tank less likely.

**String sampling** or milk line sampling from the positive pressure side of the milking system is the collection of milk samples from a group of cattle instead of the entire herd, as in bulk tank milk sampling. String sampling may have some merit in identifying subgroups of cattle with the highest prevalence of infection. It is thought to be more sensitive in monitoring herds for contagious pathogens than bulk tank milk sampling. If a production group tests positive on a string culture, then individual composite milk cultures can be performed to identify individual animals. Information of the culture results from string sampling should assist development of control programs; however, milk samples left in the pipeline from one string can confound the culture results of subsequent strings.

Numerous bacteriologic techniques have been used to isolate and identify pathogens in bulk tank milk, but none has been established as the gold standard method for the culture of milk from bulk tanks. The most suitable laboratory medium for growth and classification of the pathogens from bulk tank milk needs to be determined. Sampling strategies have included weekly and monthly samples, but it remains to be determined which strategy is optimal relative to herd size and management, disease characteristics, and practicality.

#### Detection at the Individual Cow Level

**Abnormalities of the udder and gross abnormalities of milk** in cattle with clinical

mastitis have been described earlier. In individual cows with clinical mastitis, culture of the secretion from an infected quarter can be done. In animals without clinical mastitis, culture of the secretion represents a direct test for intramammary infection. The objective is to identify cows with contagious mastitis so that they can be treated or culled, or to identify the nature and source of environmental mastitis pathogens. Fulfillment of these requirements requires bacteriologic culture of milk samples so that the pathogens can be named; this is because **identification of mastitis pathogens is central to the development of effective treatment and control programs**. Detection of infected cows requires an individual cow examination and application of an indirect (screening) test for subclinical mastitis, such as the SCC of a composite milk sample, followed by culture of a representative subset of cows to determine the most prevalent pathogen. **Indirect tests estimate the prevalence of infection, and microbiological examination identifies the mastitis pathogens;** from this information an appropriate control plan can be formulated.

#### Culture of Individual Cow Milk

Individual cow milk can be cultured as part of a herd examination for mastitis, or on individual **quarter samples**, or on **composite samples** including milk from all four quarters. A variety of definitions have been used for diagnosing the presence of an intramammary infection in research studies, such as the presence of the same pathogen in duplicate samples collected immediately after each other, or the presence of the same pathogen in two of three consecutive cultures obtained on different sampling dates. These definitions are too expensive and impractical for clinical practice. **Individual quarter samples are preferred** by some at dry off because the costs of treatment dictate that the least possible number of quarters be treated. With this technique only affected quarters are treated at dry off; if the quarter infection rate is low the saving in treatment costs is relatively large if the cost of culturing is low. A full economic comparative analysis of the balance between the cost of diagnosis versus the cost of treatment on a quarter or cow basis does not appear to have been performed. A confounding issue is that within a cow the four quarters are not independent in relationship to intramammary infection or subclinical mastitis; if one quarter is infected then there is an increased probability that one or more of the remaining quarters are infected or have subclinical mastitis.<sup>1</sup> On this basis, when treating subclinical intramammary infection at dry off, it makes more sense to treat the cow (i.e., all four quarters) and not specific quarters within a cow.

A consensus has been reached as to how best to interpret a single milk culture from a quarter (Table 20-2).<sup>2-4</sup> A reasonable

**Table 20-2** Sensitivities and specificities for diagnosing an intramammary infection based on the culture of a single milk sample from a quarter using a 10- $\mu$ L volume

Threshold for detection (CFU/10 $\mu$ L)	SENSITIVITY (%) / SPECIFICITY (%)			
	CNS <sup>a</sup>	<i>Staphylococcus aureus</i>	<i>Streptococcus</i> spp. <sup>b</sup>	<i>Escherichia coli</i>
$\geq 1$	61.2/84.3	90.4/99.8	29.1/94.8	76.5/99.9
$\geq 10$	26.0/98.1	72.0/100.0	6.9/99.9	47.1/100.0

<sup>a</sup>CNS, coagulase-negative staphylococci.  
<sup>b</sup>Primarily *S. uberis*.  
Source: Data are categorized by pathogen type and two different detection thresholds. (Reprinted, with permission, from the National Mastitis Council [[www.nmconline.org](http://www.nmconline.org)].)

definition of an intramammary infection is  $\geq 1$  CFU/10  $\mu$ L. Culturing duplicate milk samples from the quarter (at the same milking or close together in time) can improve the sensitivity or specificity definition, but not both.

Milk sampling for culture must be performed with due attention to cleanliness because samples contaminated during collection are worthless. The technique of cleaning the teat is of considerable importance. If the teats are dirty, they must be washed and then properly dried or water will run down the teat to the teat end and infect the milk sample. The end of the teat is cleaned with a swab or gauze dipped in 70% alcohol, extruding the external sphincter by pressure to ensure that dirt and wax are removed from the orifice. Brisk rubbing is advisable, especially of teats with inverted ends. The first two or three streams are rejected because their cell and bacterial counts are likely to be a reflection of the disease situation within the teat rather than within the udder as a whole. The next few streams, the premilking sample, are the approved ones because of their greater accuracy. For complete accuracy a premilking and a postmilking sample are taken. Indirect and chemical tests for mastitis can be performed more accurately on foremilk as on later milk, partly because the strippings have a higher fat concentration that alters the water compartment of milk on a volume basis.

If individual quarter samples are collected, screw-cap vials are most satisfactory. During collection the vial is held at an angle to the ground to avoid as much as possible the entrance of dust, skin scales, and hair. If there is delay between the collection of samples and laboratory examinations, the specimens should be refrigerated or frozen. Freezing of milk samples appears to have variable effects on bacterial counts, depending on the bacteria. *T. pyogenes* and *E. coli* counts are decreased by freezing, coagulase-negative *Staphylococcus* spp. counts are increased, and *Streptococcus* and *S. aureus* counts are either unaffected or increased.

The laboratory techniques used vary widely and depend to a large extent on the facilities available. Incubation on blood agar

is most satisfactory, because selective media for *S. agalactiae* have the disadvantage that other pathogens may go undetected. Smears of incubated milk are generally unsatisfactory because not all bacteria grow equally well in milk, and the bacterial count has to be high for microscopic detection. Augmented systems of culturing milk samples, which can provide superior results in terms of the number of infected quarters detected depending on the pathogen, include a variety of approaches, such as preculture incubation,<sup>5</sup> centrifugation,<sup>6</sup> freezing of the milk sample at  $-20$  or  $-196^{\circ}\text{C}$  ( $-4$  or  $-321^{\circ}\text{F}$ ),<sup>7,8</sup> and inoculation of the medium with a larger inoculum volume (100  $\mu$ L) than the standard inoculum volume of milk.<sup>9</sup> The concern with augmented culture methods is that they may amplify contaminants obtained during sampling and therefore decrease the specificity of milk culture. Laboratory culturing techniques can be very time-consuming and expensive unless modern, prepackaged identification systems are used that provide the speed needed to make the examination a worthwhile one.

A milk sample is considered contaminated when three or more species of bacteria are isolated. A quarter is considered to be cured when bacteria, isolated at initial sample, are not present in any samples 14, 21, or 28 days later. An uninfected quarter at the initial sampling time that is infected when resampled at 14, 21, or 28 days indicates a new intramammary infection. A quarter that is infected at initial sampling but infected with another bacteria 14, 21, or 28 days later also indicates a new intramammary infection.

Selective culture media plates, such as biplates (MacConkey agar and blood agar with 1% esculin), triplates (MacConkey agar, blood agar, and TKT agar [thallium, crystal violet, and staphylococcal toxin] in 5% blood agar with 1% esculin), AccuMast, Minnesota Easy Culture System II, Petrifilm, and Veto-Rapid plates can be used to differentiate between gram-positive and gram-negative pathogens and no growth, and they may aid in the rational and targeted use of antimicrobial agents for clinical cases of mastitis.<sup>10-14</sup> A major advance in mastitis pathogen identifi-

cation is the use of an automated mass spectrometry (MS) system that uses matrix-assisted laser desorption ionization time-of-flight (MALDI-TOF) technology. MS of representative bacterial colonies provides species information on bacterial isolates, particularly CNS.

There is interest in developing other cow-side tests to determine whether the causative pathogen is gram-negative or gram-positive. One such approach uses dilution of the milk sample, filtration through a membrane with a pore size that retains bacteria, and staining of the bacteria with specific stains. The filtration procedure takes 5 minutes, but the need for microscopic examination decreases the utility of this as a cow-side test. A commercially available cow-side test for endotoxin (Limast-test), which indicates the presence of gram-negative bacteria, was used in Scandinavia but appears to be no longer available.

A common diagnostic problem is a bacteriologically negative culture in cows with clinical mastitis. Even when milk samples are collected appropriately and bacteriologic culture is done using routine laboratory methods, 15% to 40% of samples from clinical mastitis episodes are bacteriologically negative (yield no growth). Failure of these samples to yield a mastitis pathogen may be the result of spontaneous elimination of infection, a low concentration of pathogens in the milk, intermittent shedding of the pathogen, intracellular location of the pathogens, or the presence of inhibitory substances in the milk. Augmented culture techniques may reduce, but do not eliminate, negative culture results and may facilitate growth of contaminant organisms. Dairy producers and veterinarians therefore face a dilemma when no bacteria or bacteria commonly regarded to be of minor pathogenicity, such as *C. bovis* or coagulase-negative *Staphylococcus* spp., are cultured from the milk of cows with clinical mastitis, particularly if clinical signs persist. Most bacteriologically negative cases of clinical mastitis appear to be caused by low-grade infections with gram-negative bacteria. When no bacterial pathogen can be isolated from cases of clinical mastitis using standard culture techniques, enzyme-linked immunosorbent assays (ELISAs) may be used to detect antigens against *S. aureus*, *E. coli*, *S. dysgalactiae*, and *S. agalactiae*. Antigens to these pathogens may be detectable using an ELISA in up to 50% of quarter samples from cows with clinical mastitis in which no pathogens were isolated but in which the SCC was more than 500,000 cells/mL. Despite these promising findings, ELISAs are not widely used in the identification of mastitis pathogens.

A real-time commercially available multiplex polymerase chain reaction (PCR) test (PathoProof) was globally launched in 2008 for the diagnosis of mastitis pathogens. The test has potentially valuable advantages of



greater sensitivity and faster time to produce a definitive result. The major disadvantages are cost (typically more expensive than routine milk culture), the inability to determine whether bacterial remnants detected by PCR in a milk sample reflect the presence of viable bacteria, and the lack of susceptibility testing results.<sup>15-19</sup> The bacterial remnant versus viability issues is particularly problematic when low amounts of pathogenic DNA have been detected, and a consensus on the economic value of PCR testing has not been reached.<sup>20,21</sup> In 2015, more than 80% of quarter milk samples in Finland were diagnosed using PCR.<sup>16</sup> Currently, PCR tests appear to provide their greatest value in the routine testing of bulk tank milk for pathogen surveillance, for research studies related to clinical mastitis episodes with no bacterial growth on culture, and for investigating mastitis epidemics caused by an unusual pathogen.

### Indirect Tests for Subclinical Mastitis

Indirect tests include SCCs using automated electronic counters, the CMT, increases in **electrical conductivity** of milk, and increases in the activity of cell associated enzymes (such as **NAGase**) in milk. ELISA tests to detect neutrophil components have been developed but are not commercially available. Of these indirect tests, only the CMT and electrical conductivity can be used cowside, with CMT providing a more accurate screening test than electrical conductivity. It is important to understand that these indirect tests detect the presence of inflammation (subclinical mastitis) and not the presence of intramammary infection, although the vast majority of subclinical mastitis episodes are caused by intramammary infection.

### The Somatic Cell Count of Composite or Quarter Samples

There is a strong relationship between the SCC of quarter samples of milk and the milk yield, with SCC increasing slightly as milk production decreases but increasing markedly with intramammary infection of the quarter. The distribution of SCC in a herd reflects the distribution of subclinical mastitis and therefore the likely distribution of intramammary infections. The most important factor affecting SCC in an individual cow is the number of quarters infected with a major or minor pathogen. In most herds, the prevalence of infection will increase through a lactation and will also increase with the age of the cow. Cell counts in the first few days of the lactation are often exceptionally high and unreliable as indicators of intramammary infection, and in uninfected cows the counts will drop to a low level within 2 weeks of calving and remain low throughout the lactation unless an intramammary infection occurs. The SCC of a cow that remains free of infection

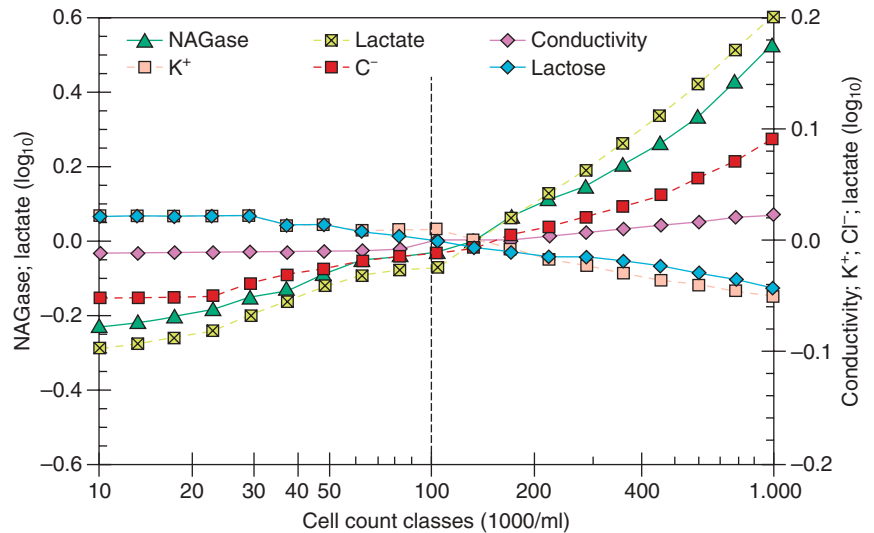

**Fig. 20-3** Mean deviation (in log<sub>10</sub>) of selected milk constituents from the overall means in relation to somatic cell count ( $n = 9326$  quarter milk samples). (Reproduced with permission from Hamann J. *XXII World Buiatrics Congress*, Hannover, August 18-23, 2002, 334-345.)

throughout her life will remain very low. However, older cows may have higher counts because the prevalence of infection is higher with age, and older cows are more likely to have had previous infections with residual lesions and leaking of somatic cells into the milk. There are also consistent and significant differences in actual SCC between cows, with individual cows tending to maintain the same class of count throughout their lives. Cows that have consistently low SCC do not seem to be more susceptible to mastitis than others. Attempts to base a breeding program to reduce the prevalence of mastitis on the selection of cows with an innately low composite SCC have been discarded because of fluctuations in numbers within cows.

Healthy quarters have an SCC below 100,000 cells/mL, and **this cut point should be used to indicate the absence or presence of intramammary infection on a gland basis**. This cut point looks very solid for a gland, because many milk components differ from normal values whenever the SCC exceeds 100,000 cells/mL (Fig. 20-3). Moreover, mean SCC counts for bacteriologically negative quarters, quarters infected with minor pathogens, and quarters infected with major pathogens were 68,000, 130,000, and more than 350,000 cells/mL, respectively.

Because of the time and labor saved it is now customary to do automated electronic cell counts on **composite milk samples** that have already been collected for butterfat testing. Regular reports of individual cow SCCs are therefore widely available in herds that routinely test production parameters of their cattle. An exciting new development in mastitis control is the **portable somatic cell counter**, which was designed for on-farm use, providing targeted and immediate SCC information for quarter or composite milk

samples. Using the composite sample technique does distort the SCC; for example, the dilution of high-SCC milk from a bad quarter by low-SCC milk from three normal quarters could mean that a cow with one infected quarter might not be detected. Composite SCCs of less than 200,000 cells/mL are considered to be below the limit indicative of inflammation, even though uninfected quarters have an SCC of less than 100,000 cells/mL. Factors that affect the composite milk SCC include the number of quarters infected, the kind of infection (*S. agalactiae* is a more potent stimulator of cellular reaction than *S. aureus*), the strictness with which milk from cows with clinical mastitis is kept out of the bulk tank, the age of the cows (older cows have higher counts), the stage of lactation (counts are highest in the first days after calving and toward the end of lactation), and the herd's average production with the cell count reducing as milk yield increases.

An SCC scoring system that divides the SCC of composite milk into 10 categories from 0 to 9, known as the somatic cell score (SCS) (originally called the linear score), is becoming more widely used. The SCS is a base 2 logarithm of the SCC (in cells/mL), in which  $SCS = \log_2(SCC/100,000) + 3$ . Likewise, to calculate SCC (in cells/mL) from the SCS, the following formula is used:  $SCC = 100,000 \times 2^{(SCS - 3)}$ . An SCC of 100,000 cells/mL therefore converts to an SCS of 3. Each 1-unit increase (or decrease) in SCS is associated with a doubling (or halving) of the SCC. For example, score 2 is equivalent to an SCC of 50,000 cells/mL, and scores of 4 and 5 correspond to 200,000 and 400,000 cells/mL. Conversion of SCC to SCS values is performed as shown in Tables 20-3 and 20-4. The principal reason for using the SCS is to achieve properties that are required to use

conventional statistical methods: mean equal to median, normal distribution, and uniform variance among samples within lactation, among cows within herd or among daughters within sire.

The proportion of neutrophils in the SCC is very low (<11%) in healthy quarters but is

**Table 20-3** Calculating somatic cell score (previously called linear score) from the somatic cell count

Example: SCC = 200,000 cells/mL

- Divide the SCC by 100,000 cells/mL (200,000/100,000 = 2)
- Determine the natural log (ln) of the results of step 1 (ln 2 = 0.693)
- Divide this value by 0.693 (i.e., 0.693/0.693 = 1)
- Add 3 to the result of step c = 1 + 3 = 4 (SCS)

SCC, somatic cell count; SCS, somatic cell score.

markedly increased in quarters with intramammary infection (to >90%). Accordingly, the percentage of neutrophils in the SCC may provide a useful indication of intramammary infection, but it is not currently performed.

SCSs can also be determined for colostrum, in which they are useful in indicating the presence of intramammary infection (Table 20-5).

### California Mastitis Test of Quarter Samples

The CMT is the most reliable and inexpensive cowside test for detecting subclinical mastitis. It is also known as the rapid mastitis test, Schalm test, or the Mastitis-N-K test, which was developed in 1957 and constituted a modification of the Whiteside test. The CMT reagent contains a detergent that reacts with DNA of cell nuclei and a pH indicator (bromocresol purple) that changes color when the milk pH is increased above

its normal value of approximately 6.6 (mastitis increases pH to 6.8 or above). The CMT is mixed with quarter milk samples that have been previously collected into a white container, and the sample is gently swirled; the result is read within 15 seconds as a negative, trace, 1, 2, or 3 reaction depending on the amount of gel formation in the sample. Maximum gel formation actually occurs from 1 to 2.5 minutes, depending on the quarter SCC, and continued swirling of the mixture after the time of peak viscosity produces an irreversible decrease in viscosity. Cows in the first week after calving or in the last stages of lactation may give a strong positive reaction.

The close relationships between the CMT reaction and the SCC of milk, and the reduced productivity of affected cows, are shown in Tables 20-4 and 20-5, respectively. If the CMT is used to minimize the false-negative rate (produce the highest sensitivity), then the test should be read as negative (CMT = negative) or positive (CMT = trace, 1, 2, or 3). If the CMT is used to minimize the false-positive rate (produce the highest specificity) for culling decisions, then the test should be read as negative (CMT = negative or trace) or positive (CMT = 1, 2, or 3).

CMT scores can also be determined for colostrum, in which the score is useful in indicating the presence of intramammary infection (see Table 20-5). The equivalent SCC for CMT scores of negative or trace are different for colostrum and milk, but the SCC for CMT scores of 1, 2, and 3 are similar for colostrum and milk.

### NAGase Test of Composite or Quarter Samples

The NAGase test is based on the measurement of the activity of a cell-associated enzyme (*N*-acetyl- $\beta$ -D-glucosaminidase) in

**Table 20-4** Conversion of somatic cell scores (previously called linear scores) to somatic cells counts (cells/mL) and predicted loss of milk

SCS	Somatic cell count midpoint (cells/mL)	POUNDS OF MILK LOST PER LACTATION	
		First lactation	Second lactation
0	12,500	0	0
1	25,000	0	0
2	50,000	0	0
3	100,000	200	400
4	200,000	400	800
5	400,000	600	1,200
6	800,000	800	1,600
7	1,600,000	1,000	2,000
8	3,200,000	1,200	2,400
9	6,400,000	1,400	2,800

SCS, somatic cell score.

**Table 20-5** California mastitis test reactions and equivalent somatic cell counts and somatic cell scores for bovine milk and somatic cell counts for bovine colostrum

Test result	Reaction observed	Equivalent milk SCC	Equivalent SCS	Colostrum geometric mean SCC
Negative	The mixture remains fluid without thickening or gel formation.	0–200,000 cells/mL	0–4	500,000 cells/mL
Trace	A slight slime formation is observed. This reaction is most noticeable when the paddle is rocked from side to side.	150,000–500,000 cells/mL	5	670,000 cells/mL
1+	Distinct slime formation occurs immediately after mixing solutions. This slime may dissipate over time. When the paddle is swirled, fluid does not form a peripheral mass, and the surface of solution does not become convex or “domed up.”	400,000–1,500,000 cells/mL	6	890,000 cells/mL
2+	Distinct slime formation occurs immediately after mixing solutions. When the paddle is swirled the fluid forms a peripheral mass, and the bottom of the cup is exposed.	800,000–5,000,000 cells/mL	7–8	3,400,000 cells/mL
3+	Distinct slime formation occurs immediately after mixing solutions. This slime may dissipate over time. When the paddle is swirled the surface of the solution becomes convex or domed up.	>5,000,000 cells/mL	9	6,260,000 cells/mL

SCC, somatic cell count; SCS, somatic cell score.

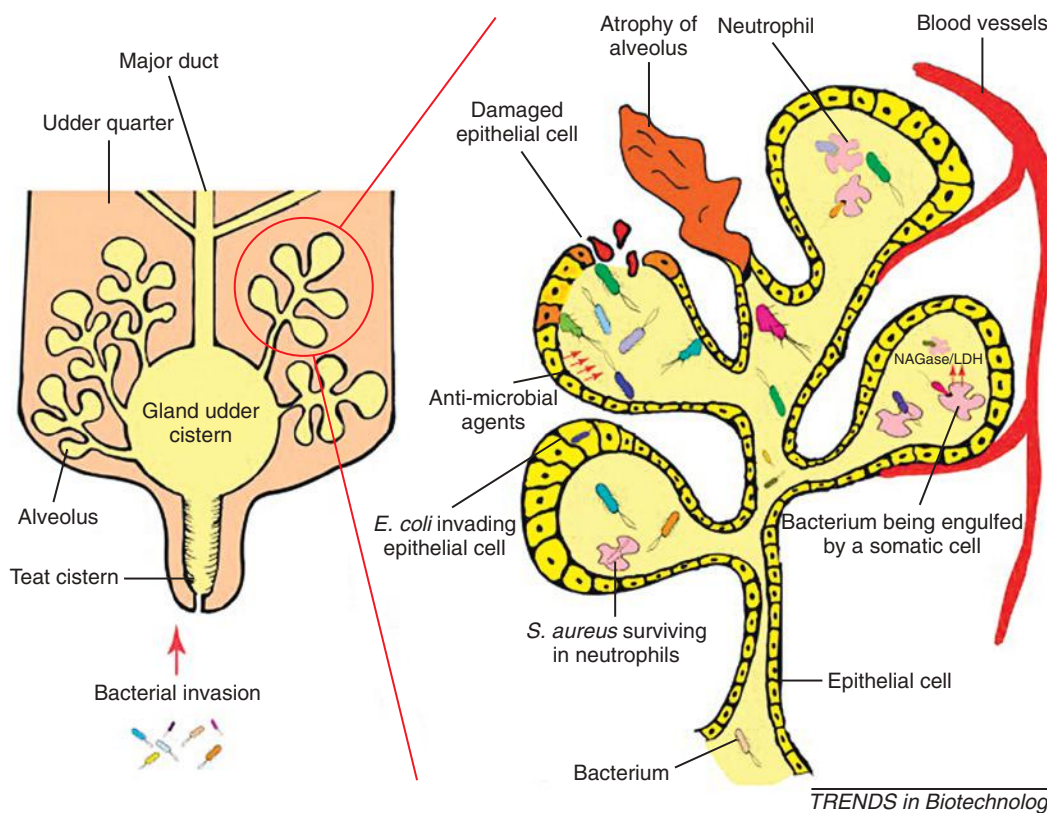

TRENDS in Biotechnology

**Fig. 20-4** Schematic representation of the development of mastitis in an infected udder. Contagious and environmental pathogens invade the udder via the streak canal and teat cistern. The pathogens then multiply in the udder in which they are attacked by neutrophils. Epithelial cells lining the alveoli are damaged during bacterial multiplication and subsequent immunologic response, with release of enzymes such as NAGase and lactate dehydrogenase (depicted). The tissue response to infection varies based on pathogen, infective dose, immunologic state, and response of the cow, as well as other factors. (Reproduced with permission from Viguier C, Arora S, Gilmartin N, Welbeck K, O Kennedy R (2009) Mastitis detection: current trends and future perspectives. *Trends Biotechnol* 27:486-493.)

the milk, with a high enzyme activity indicating a high cell count (Fig. 20-4). NAGase is an intracellular lysosomal enzyme derived primarily from damaged mammary epithelial cells with a small contribution from neutrophils.<sup>22</sup> The test is suited to the rapid handling of large numbers of samples because of the ease of its automation, and the test can be done on fresh milk and read on the same day. However, because most of the NAGase activity is intracellular, samples should be frozen and thawed before analysis to induce maximal NAGase activity. The NAGase test is reputed to be the most accurate of the indirect tests and as good as SCC in predicting the infected status of a quarter.<sup>23,24</sup> It uses a less sophisticated reading instrument than the average automatic cell counter. If all tests are available it is best to consider the NAGase test and SCC as complementary tests and perform both of them. Milk NAGase levels are high at the beginning and the end of lactation, as with cell counts. The test has also been validated for use with goat milk.

Related tests that have not been studied as extensively as NAGase but show promise in the detection of subclinical mastitis are milk lactate dehydrogenase (LDH) and

alkaline phosphatase (ALP) activity.<sup>24-29</sup> Both enzymes are cytoplasmic constituents of cells, and an increase in milk activity of LDH or ALP indicates the presence of cellular injury.

#### Electrical Conductivity Tests of Quarter Samples

A test that has received a great deal of attention because it can be used in robotic milking systems is based on the increase in concentration of sodium and chloride ions, and the consequent increase in electrical conductivity, in mastitic milk. The electrolyte changes in milk are the first to occur in mastitis, and the test is attractive for this reason. A number of factors affect these characteristics; however, and to derive much benefit from the test it is necessary to examine all quarters and use differences between the quarters to indicate affected quarters. For greater accuracy all quarters need to be monitored each day. An experimental unit that takes all these factors into consideration has been fitted to a milking machine and, by a computer-prepared analysis, monitors variations in electrical conductivity in each quarter every day. Electrical conductivity is attractive as a test because it measures actual injury to the

udder rather than the cow's response to the damage like SCC and NAGase activity do. However, a meta-analysis indicated that using an absolute threshold for conductance did not provide a suitable screening test, because both sensitivity and specificity were unacceptably low. In addition, in a study of 173 dairy cows in South Africa, the CMT was more accurate than electrical conductivity for identifying quarters having an intramammary infection or an SCC > 200,000 cells/mL.<sup>30</sup> The use of differential conductivity (within cow quarter comparison) results in improvement in test sensitivity and specificity and is currently the only recommended application of this indirect test.

The most commonly promoted method for measuring electrical conductivity is a handheld device with a built-in cup into which milk is squirted (foremilk is preferred). Experimentally induced clinical mastitis caused by *S. aureus* and *S. uberis* was detectable by changes in electrical conductivity of foremilk: 90% of cases were detectable when clots first appeared and 55% of cases were detectable up to two milkings before the appearance of clots. This suggests that clinical mastitis associated with these



two major pathogens may be able to be detected earlier by electrical conductivity than by waiting for milkers to detect visible changes in the milk.

Changes in electrical conductivity reflect changes in secretion Na, K, and Cl concentration, and it is likely that measurement of Na and K ion concentrations in milk will provide a low-cost clinically useful diagnostic test for subclinical mastitis.<sup>30,31</sup>

L-lactate, glucose, lactose, and haptoglobin concentration in quarter samples. L-lactate concentration is markedly increased in the milk of cows with clinical mastitis, and is mildly to moderately increased in cows with subclinical mastitis.<sup>29,31</sup> The magnitude of the increase appears to be correlated with the leukocyte count in milk and the number of CFUs.<sup>32</sup> Glucose concentration is decreased in the milk of cows with clinical mastitis and subclinical mastitis through a yet to be determined mechanism.<sup>31</sup> Milk lactose percentage is decreased in cows with subclinical mastitis because milk is isotonic and inflammation increases the secretion concentration of Na, K, and Cl. Because milk is isotonic and lactose is the predominant osmotic agent in milk, the increase in electrolyte concentrations directly leads to a decrease in lactose concentration, measured on a percentage basis.<sup>22</sup>

The concentration of serum amyloid A and haptoglobin, which are acute phase reactants, increases in the secretion from glands with subclinical mastitis.<sup>28</sup> Skim milk haptoglobin concentration can discriminate between mastitis episodes caused by major or minor pathogens,<sup>27</sup> although this is most likely an indirect association, because major pathogens, by definition, cause greater injury to the mammary gland.

### Comparison of Indirect Methods

The effects of subclinical intramammary infection on several parameters in foremilk from individual quarter milk samples have been compared. The SCC, electrical conductivity, pH, NAGase activity, and the concentrations of sodium, potassium, lactose, and  $\alpha$ -1-antitrypsin were measured from individual quarters. The SCC, NAGase activity, electrical conductivity, and concentrations of sodium,  $\alpha$ -1-antitrypsin, and lactose were all useful indirect indicators of infection. The SCC was able to discriminate between infected and uninfected quarters in cows better than electrical conductivity, pH, and NAGase activity.

### Hematology and Serum Biochemistry

In severe clinical mastitis there may be marked changes in the leukocyte count, packed cell volume, and serum creatinine and urea nitrogen concentration because of the effects of severe infection and toxemia. In particular, clinical mastitis episodes associated with gram-negative bacteria frequently cause a profound leukopenia, neutropenia,

lymphopenia, and monocytopenia as a result of the endotoxemia, as well as an increased packed cell volume. In contrast, the leukogram in cattle with clinical mastitis associated with gram-positive bacteria is normal or mildly increased.

### Ultrasonography of the Mammary Gland

Two-dimensional (2D) ultrasonographic images of the gland cistern, parenchymal tissue, and teat are easily obtained using a 5-, 7.5-, or 8.5-MHz linear array transducer, and ultrasonography is becoming more widely used to guide treatment of teat and gland cistern abnormalities. However, there are few reports of the use of ultrasonography to diagnose or prognose clinical mastitis episodes, although this is likely to be a fruitful area for investigation.

The best 2D images of the udder parenchyma are obtained by clipping the hair on the udder and applying a coupling gel. This minimizes the air between the transducer face and skin. Imaging the normal adjacent quarter is very helpful in identifying abnormalities. Imaging should be performed in two planes, sagittal to the teat (and therefore perpendicular to the ground), and transverse to the teat (and therefore horizontal to the ground). The injection of sterile 0.9% NaCl through a teat cannula into the gland provides a practical contrast agent that can help further define the extent of any abnormalities. The superficial supermammary lymph nodes can be seen on ultrasound using a 7.5-MHz linear transducer, and the lymph node is well demarcated from the surrounding tissues. Mean lymph node length was 7.4 cm (range 3.5–15.0 cm) and mean depth was 2.5 cm (range 1.2–5.7 cm). Lymph node size increased with age and is predictive of the presence of subclinical intramammary infection in cattle.<sup>33</sup> Similarly, superficial inguinal lymph node size is predictive of SCC in sheep.<sup>34</sup>

Mastitis produces an increased heterogeneous echogenicity to the milk in the gland cistern, compared with an uninfected quarter.<sup>35</sup> It is important to make this visual comparison without altering the contrast and brightness setting on the ultrasonographic unit.

### Infrared Thermography of the Mammary Gland

Infrared thermography shows promise for the real-time noninvasive diagnosis of mastitis in dairy cattle. This will be particularly valuable in cattle that are robotically milked, in which the diagnosis of clinical mastitis remains problematic.

Methodology for infrared thermography has been developed for the mammary gland.<sup>36</sup> Thermograms should be obtained with the animal in an environment to which it has been adapted for 30 minutes and out of direct sunlight and wind. The udder

should be free from moisture, dirt, and foreign material; this is usually accomplished by brushing the hair on the udder or washing and drying the udder. Thermography is effective for the early diagnosis of clinical mastitis.<sup>37–39</sup> There have been mixed reports regarding the accuracy of thermography to detect subclinical mastitis in dairy cattle<sup>40,41</sup> using mean quarter temperature and maximum quarter temperature.<sup>36,39</sup>

### Biopsy of Mammary Tissue

A biopsy of mammary tissue can be used for histologic and biochemical evaluation in research studies. The use of a rotating stainless steel cannula with a retractable blade at the cutting edge has been described for obtaining biopsy material from cows. Despite some postoperative bleeding, milk yield and composition in the biopsied gland were affected only transiently.

### NECROPSY FINDINGS

Necropsy findings are not of major interest in the diagnosis of mastitis and are omitted here but included in the description of specific infections.

### DIFFERENTIAL DIAGNOSIS

The diagnosis of clinical mastitis is not difficult if a careful clinical examination of the udder is performed as part of the complete examination of a cow with systemic clinical findings. Examination of the udder is sometimes omitted in a recumbent animal only for severe mastitis to be discovered later. The diagnosis of mastitis depends largely on the detection of clinical abnormalities of the udder and gross abnormalities of the milk or the use of an indirect test like the California mastitis test to detect subclinical mastitis.

Other mammary abnormalities that must be differentiated from clinical mastitis include **udder edema**, **rupture of the suspensory ligament**, and **hematoma**. These are not accompanied by abnormalities of the milk unless there is hemorrhage into the udder. The presence of stray voltage in the milking plant should not be overlooked in herds in which the sudden lowering of production arouses an unfounded suspicion of mastitis. Differentiation of the different causes of mastitis is difficult on the basis of clinical findings alone but must be attempted, especially in peracute cases in which specific treatment must be given before results of laboratory examinations are available. A pretreatment sample of milk from the affected glands for culture and antimicrobial sensitivity may provide useful information about the health record of the cow and the need to consider alternative therapies, and could provide information on new infections in the herd.

### FURTHER READING

Brandt M, Haeussermann A, Hartung E. Technical solutions for analysis of milk constituents and abnormal milk. *J Dairy Sci.* 2010;93:427–436.

- Franz S, Floek M, Hofmann-Pariset M. Ultrasonography of the bovine udder and teat. *Vet Clin North Am Food Anim Pract.* 2009;25:669-685.
- Gurjar A, Gioia G, Schukken Y, et al. Molecular diagnostics applied to mastitis problems on dairy farms. *Vet Clin North Am Food Anim Pract.* 2012;28:565-576.
- Lam TJGM, Riekerink O, Sampomom OC, Smith H. Mastitis diagnostics and performance monitoring: a practical approach. *Ir Vet J.* 2009;62(suppl 4):S34-S39.
- Pyörälä S. Indicators of inflammation in the diagnosis of mastitis. *Vet Res.* 2003;34:565-578.
- Viguier C, Arora S, Gilmartin N, et al. Mastitis detection: current trends and future perspectives. *Trends Biotechnol.* 2009;27:486-493.

## REFERENCES

- Berry DP, Meaney WJ. *Prev Vet Med.* 2006;75:81.
- Dohoo IR, et al. *J Dairy Sci.* 2011a;94:250.
- Dohoo IR, et al. *J Dairy Sci.* 2011b;94:5515.
- Reyher KK, Dohoo IR. *J Dairy Sci.* 2011;94:3387.
- Artursson K, et al. *J Dairy Sci.* 2010;93:1534.
- Punyapornwithaya V, et al. *J Dairy Sci.* 2009;92:4444.
- Petzer IM, et al. *Onderstepoort J Vet Res.* 2012;79:343.
- Pehlivanoglu F, et al. *Vetrinarski Arhiv.* 2015;85:59.
- Walker JB, et al. *J Vet Diagn Invest.* 2010;22:720.
- Royster E, et al. *J Dairy Sci.* 2014;97:3648.
- McCarron JL, et al. *J Dairy Sci.* 2009;92:5326.
- Cameron M, et al. *Prev Vet Med.* 2013;111:1.
- de Vries EMM, et al. *Prev Vet Med.* 2014;113:620.
- Viora L, et al. *Vet Rec.* 2014;10.1136/vr.102499.
- Keane OM, et al. *Vet Rec.* 2013;173:268.
- Hiitö H, et al. *J Dairy Res.* 2015;82:200.
- Koskinen MT, et al. *J Dairy Sci.* 2010;93:5707.
- Taponen S, et al. *J Dairy Sci.* 2009;92:2610.
- Cantekin Z, et al. *Kafkas Univ Vet Fak Derg.* 2015;21:277.
- Murai K, et al. *Prev Vet Med.* 2014;113:522.
- Mahmmod YS, et al. *Prev Vet Med.* 2013;112:309.
- Zhao X, Lacasse P. *J Anim Sci.* 2008;86(suppl 1):57.
- Nielsen NI, et al. *J Dairy Sci.* 2005;88:3186.
- Mizeck GG, et al. *J Dairy Res.* 2006;73:431.
- Babaei H, et al. *Vet Res Commun.* 2007;31:419.
- Kalantari A, et al. *Ann Biol Res.* 2013;4:302.
- Hiss S, et al. *Vet Med (Praha).* 2007;52:245.
- Åkerstedt M, et al. *J Dairy Res.* 2011;78:88.
- Lehmann M, et al. *J Dairy Res.* 2015;82:129.
- Fosgate GT, et al. *Vet J.* 2013;196:98.
- Silanikove N, et al. *J Dairy Res.* 2014;81:358.
- Lindmark-Månsson H, et al. *Int Dairy J.* 2006;16:717.
- Khoramian B, et al. *Iran J Vet Res.* 2015;16:75.
- Hussein HA, et al. *Small Rumin Res.* 2015;129:121.
- Santos VJC, et al. *Reprod Domest Anim.* 2015;50:251.
- Metzner M, et al. *Vet J.* 2014;199:57.
- Hovinen M, et al. *J Dairy Sci.* 2008;91:4592.
- Pezeshki A, et al. *Vet Res.* 2011;42:15.
- Metzner M, et al. *Vet J.* 2015;204:360.
- Polat B, et al. *J Dairy Sci.* 2010;93:3525.
- Colak A, et al. *J Dairy Sci.* 2008;91:4244.

## TREATMENT OF BOVINE MASTITIS

The treatment of the different causes of clinical and subclinical mastitis may require specific protocols, which are described under specific mastitis pathogens later in the chapter. The general principles of mastitis treatment are outlined here.

## Historical Aspects of Antimicrobial Therapy for Clinical and Subclinical Mastitis

Between about 1950 and 1990, on a worldwide basis, all forms of both clinical and subclinical bovine mastitis were treated with a wide variety of antimicrobial agents either by intramammary infusions or parenterally and commonly by both routes in acute and peracute cases. Most veterinarians treated clinical mastitis and evaluated the response on the basis of clinical outcome. Generally, it was thought that antimicrobial agents were effective for the treatment of clinical and subclinical mastitis in lactating cows. However, there are very few scientific publications based on randomized clinical trials in which the efficacy of intramammary antimicrobial agents for treatment of clinical mastitis was compared with untreated controls. If antimicrobial agents were used and the animal recovered, it was assumed that treatment was efficacious. If the cow did not respond favorably, several reasons were usually enumerated for the treatment failure. However, most of these reasons, although biologically attractive, are hypothetical and have not been substantiated scientifically. Gradually, over the years, veterinarians began to doubt the efficacy of antimicrobial agents for the treatment of all cases of clinical mastitis. In addition, and of major importance, milk from treated cows had to be discarded for up to several days after the last day of treatment because of antimicrobial residues; this was a major expense. Currently, optimized treatment strategies focus on efficacy, economics, animal welfare aspects, and the milk withhold time of antimicrobial treatment.

Efficacy is assessed on the basis of **clinical cure** or **bacteriologic cure**. Most producers are interested in the return to normal milk (clinical cure) and are much less interested in the return to a sterile quarter (bacteriologic cure). Because clinical mastitis is defined as abnormal milk, the return to normal (drinkable) milk represents a clinical cure. Bacteriologic cure represents the inability to isolate the initial pathogen 14 to 28 days after the start of treatment. Other important indicators of efficacy are milk production, dry matter intake, the amount of saleable milk, and mortality or culling rates after treatment.

Some examples of the efficacy or inefficacy of antimicrobial agents illustrate the controversy. It is well accepted that the cure rate following intramammary treatment of clinical or subclinical mastitis caused by *S. agalactiae* in the lactating cow is high (80%–90%). In contrast, the cure rate of clinical and subclinical mastitis caused by *S. aureus* in the lactating cow is considerably lower (40%–50%), but certainly not 0%. In herds with a low prevalence of contagious mastitis, most cases of mild clinical mastitis (abnormal secretion only) in lactating cows are caused by environmental streptococci and coliforms

and may recover without antimicrobial therapy, although antimicrobial administration increases the clinical and bacteriologic cure rate. Antimicrobial agents may be ineffective for the treatment of clinical mastitis associated with *M. bovis*, *T. pyogenes*, *Nocardia* spp., and *P. aeruginosa*.

In the 1970s dairy processing plants, veterinarians, consumer advocates, public health authorities, and milk-quality regulating agencies began to express concern about antimicrobial residues in milk from cows treated for mastitis. The public health and milk industry concerns about residues combined with the controversy about the efficacy of antimicrobial agents for clinical mastitis has also provided a stimulus to evaluate the efficacy and consequences of using antimicrobial agents. Since the early 1990s, much emphasis has been placed on alternative methods of treating clinical mastitis, leading to a reduction in the use of antimicrobial agents during the lactating period. Such strategies have been defended based on a lack of information concerning the efficacy and economics of antimicrobial therapy associated with pathogens other than *S. agalactiae*, and by the need to reduce the risk of residue violation. However, a recent study concluded that not administering antibiotics to cows with clinical mastitis was imprudent and unethical.

There is a need for additional randomized controlled field trials to evaluate the use of antimicrobial agents for the treatment of clinical mastitis. Well-conducted clinical mastitis treatment trials represent an invaluable, although difficult and expensive, effort to evaluate efficacy of antimicrobial agents under field conditions. It should be noted that the use of antimicrobial agents for the treatment of **subclinical mastitis** at the end of lactation, known as **dry cow therapy**, is accepted worldwide and is based on scientific evidence using randomized clinical trials. Dry cow therapy is one of the principles applied in the effective control of bovine mastitis, in which much progress has been made since the early 1970s.

## Treatment Strategy

The treatment strategy will depend on whether the mastitis is **clinical** or **subclinical** and the health status of the herd, including its mastitis history. Clinical mastitis is further categorized as **abnormal secretion**, **abnormal gland**, or **abnormal cow**, as described previously. If treatment is indicated, the major decision is whether to administer antimicrobial agents parenterally or by intramammary infusion.

An important aspect of treatment is the accurate positive identification of the animal(s) to be treated, the recording of the relevant clinical and laboratory information, the treatments being used, and monitoring the response. Useful information would include:

- Cow identification
- Quarters affected
- Date of mastitis event
- Lactation number
- Date of calving
- Identification of pathogen(s)
- Treatment used, including dose, route, and duration
- Milk withholding time and time when returned to the milking string
- Most recent level of milk production

Options for treating cows with clinical mastitis include treating all cows with antimicrobial agents, treating none of the cows with antimicrobial agents, or treating only specific cows with antimicrobial agents. Treating all cows results in increased costs for those cows with clinical mastitis associated with pathogens not susceptible to the antimicrobial agent used, especially if the signs are likely to resolve before the milk withholding period has expired. Treatment of all cows is also associated with increased risk of violative residues in the bulk milk. Treating none of the cows with antimicrobial agents has animal welfare implications, because an effective treatment is not administered to some cattle with clinical mastitis, and non-treatment allows gram-positive pathogens to persist, increasing the probability of a recurrence of clinical mastitis or causing a herd epidemic of mastitis. Accordingly, **nontreatment of all cases of mastitis is not a viable option.** Treating only specific cows with antimicrobial agents requires an accurate method of determining which animals should be treated. However, clinical judgment and predictive models are too inaccurate to distinguish between clinical mastitis associated with gram-negative and gram-positive pathogens. To select cows for antimicrobial therapy on the basis of bacteriologic culture is costly and delays treatment; clinical judgment would still be necessary because bacteria are not isolated from 15% to 40% of milk samples from cows with clinical mastitis.

Veterinarians should always ask and answer four questions related to antimicrobial therapy in bovine mastitis:

1. Is antimicrobial therapy indicated?
2. Which route of administration (intramammary, parenteral, or both) should be used?
3. Which antimicrobial agent should be administered?
4. What should be the frequency and duration of treatment?

#### Is Antimicrobial Therapy Indicated?

The first decision is **whether to treat** a particular case with antimicrobial agents and whether supportive therapy is required. Therapy decisions should be made in context with the overall objectives of the lactating cow treatment protocol. The availability of approved, effective treatment products is an essential component of the program. A

number of factors are important in determining which cases of mastitis should be treated during lactation. These factors include the type of pathogen involved, the type and severity of the inflammatory response, the duration of infection, the stage of lactation, and the age and pregnancy status of the cow.

#### Type of Pathogen Involved

There are marked differences in the bacteriologic cure rates of the various major mastitis pathogens after therapy during lactation. The outcome of treatment during lactation is poor for cases of *S. aureus* mastitis. On the other hand, *S. agalactiae* responds extremely well to lactating cow therapy, and all infected cows should be treated. Cases of mastitis associated with environmental organisms have reasonable, but variable, cure rates.

#### Type and Severity of the Inflammatory Response

The predominant type of inflammatory process involved influences the objectives of the therapy program. Herds with clinical mastitis problems will aim at reducing clinical signs, returning the milk to saleable quality and avoiding residue violations. Herds with a predominance of subclinical mastitis are concerned with avoiding the spread of infection and reducing the prevalence of the major pathogens involved. Both types of herd have the primary objective of restoring the production potential.

The severity of the inflammatory response is also important in the selection of cases for mastitis therapy during lactation. Heat, pain and swelling of the quarter (abnormal gland) are clinical signs that indicate the need for antimicrobial therapy. Many producers, however, will treat any cow that shows clots in the milk (abnormal milk). There are no reports to verify that treatment of cows exhibiting abnormal milk only is efficacious and economically justifiable, although it is probable that treatment of clinical mastitis episodes of abnormal milk but normal gland caused by *S. agalactiae* is efficacious and economic. Treatment success is lower in cows with high NAGase concentrations in milk compared with cows with low NAGase concentrations.

#### Duration of Infection

For the contagious organisms, especially *S. aureus*, the duration of infection is an important determinant of its susceptibility to therapy during lactation. In chronic *S. aureus* mastitis, the organism survives intracellularly in leukocytes, becomes walled off in small abscesses of mammary ducts, and has the ability to exist in the L-form state. At this point *S. aureus* is virtually incurable during lactation. With new methods of automated detection of subclinical intramammary infection such as in-line electrical conductivity measurement, new infections may be detected much earlier. The cure rate

of *S. aureus* during lactation needs to be reevaluated when treatment is administered early in the course of infection.

#### Stage of Lactation

The stage of lactation is an important determinant of the benefit:cost ratio of mastitis therapy during lactation. It may be uneconomical to treat even cases with a high probability of cure during late lactation.

#### Age and Pregnancy Status of Cow

The probability of a cure is greater in young cows, and age should be considered in selecting cases for mastitis therapy during lactation.<sup>1</sup> The economic aspects of treatment for late-lactation, nonpregnant cows are obviously different from those for midlactation pregnant cows.

A mastitis therapy program for lactating cows should be based on a complete understanding of the mastitis status of the herd, and individual cow treatment decisions should be consistent with the overall herd mastitis therapy program.<sup>2</sup> A record system for treatment should be established so that it is possible to monitor the efficacy of the mastitis treatment program.

The udder health status in a particular herd will determine whether the lactating cow mastitis therapy strategy should be targeted at the individual cow level or at the herd level. The level of emphasis should clearly reflect the objectives of the therapy program. For example, a herd with low bulk tank milk SCC and sporadic cases of environmental mastitis should target the lactating cow therapy strategy at the cow level. The primary objectives would be to alleviate clinical signs, to achieve a bacteriologic cure, and to restore the cow's production. On the other hand, a herd with moderate to high bulk tank milk SCCs and a significant prevalence of contagious organisms should aim the program at the herd level. In this case the objective would be to limit the spread of infection, markedly reduce or eradicate a specific pathogen, and increase herd production. A clear statement of treatment philosophy (individual cow level or herd level) in a particular herd is needed to direct establishment of well-defined treatment protocols for mastitis in lactating cows.

Intramammary infection (mastitis) is identified by the presence of clinical signs or the results of a direct test (culture of milk) or indirect tests such as SCC, CMT, or electrical conductivity. The detection of clinical or subclinical mastitis does not necessarily indicate that therapy should be administered, although animal welfare issues dictate that treatment must be administered to cattle with an abnormal gland or systemic signs (abnormal cow) because these animals are undergoing pain and discomfort. A decision to use treatment during lactation should be based on the likelihood of achieving the objectives of the therapy program. Several



factors are important in the selection of cows for treatment. These factors can significantly influence the cure rate achieved with therapy or the economic benefit realized.

The herd history of udder health will indicate the probable cause of clinical mastitis. Cows with mild cases of clinical mastitis (abnormal secretion only) in herds with a low prevalence of contagious mastitis pathogens are likely to be affected with environmental pathogens and commonly return to clinically normal milk in four to six milkings. This has led to the development of treatment algorithms based on the results of culturing clinical cases using selective media. Using this approach, milk cultures are obtained from all cattle with clinical mastitis and plated using biplates or triplates. All cattle with abnormal glands or signs of systemic illness (abnormal cow) are immediately treated with antimicrobial agents and appropriate ancillary treatment, with subsequent antimicrobial treatment based on the preliminary culture results at 18 to 24 hours or the final culture results at 48 hours. In contrast, treatment is initially withheld from all cattle demonstrating abnormal secretion only; antimicrobial treatment is instituted based on the culture results. One such scheme recommends using intramammary antibiotics to treat affected quarters with *S. aureus*, CNS, and environmental streptococci, infusing intramammary antibiotics into all quarters of cows with one or more quarters infected with *S. agalactiae* and not administering antibiotics to cows with coliform bacteria or no growth. When using this delayed approach to antimicrobial treatment, it is important that cattle with abnormal milk only are closely monitored, and that antimicrobial treatment is immediately instituted when signs of an abnormal gland or abnormal cow are present. The major difficulty with implementing the delayed approach is the difficulty in transporting the milk sample to and receiving the results from the diagnostic laboratory in a time-effective manner. For practical reasons, this approach works only if on-farm culturing is performed.

An 8-herd study involving 422 cows with clinical mastitis in the Great Lakes region of North America was conducted to investigate the effectiveness and safety of selective treatment of clinical mastitis using on-farm culture results. The secretion from affected quarters was cultured for 18 to 24 hours using a biplate. Quarters with a gram-positive or mixed growth were treated with intramammary cephapirin sodium. Quarters with a gram-negative or no growth were not treated. Unfortunately, the study design enrolled cattle with clinical mastitis and abnormal secretion (72% of total), or abnormal secretion and abnormal gland (28% of total); as discussed previously the latter group should not have an effective treatment withheld for 24 hours, because an abnormal

**Table 20-6** Summary of three-compartment model for anatomic location of infection caused by mastitis pathogens in cattle

Mastitis pathogen	PHARMACOLOGIC COMPARTMENT		
	Milk and ducts (abnormal secretion)	Parenchyma (abnormal gland)	Systemic (abnormal cow)
<b>Contagious pathogens</b>			
<i>Staphylococcus aureus</i>	+	++	-
<i>Streptococcus agalactiae</i>	++	+	-
<i>Mycoplasma bovis</i>	+	+	++
<i>Corynebacterium bovis</i>	++	-	-
<b>Teat skin opportunistic pathogens</b>			
Coagulase-negative staphylococci	++	-	-
<b>Environmental pathogens</b>			
<i>Escherichia coli</i>	+	-	++
<i>Klebsiella pneumoniae</i>	+	-	++
Environmental streptococci	++	+	-
<i>Trueperella pyogenes</i>	+	++	-
<b>Antimicrobial therapy</b>			
Intramammary	Good to excellent	Moderate	Poor
Parenteral	Poor to moderate	Moderate to excellent	Good to excellent

*Antimicrobial therapy is categorized on the basis of route of administration and likely efficacy when treating a susceptible infection.*  
 ++, extensive infection; +, moderate infection; -, minimal or no infection  
 Source: Adapted from Erskine RJ et al. *Vet Clin North Am Food Anim Pract* 2003;19:109.

gland is associated with pain and discomfort. Use of selective antibiotic treatment based on 24-hour culture results reduced intramammary antibiotic use by half without impacting days to clinical cure, bacteriologic cure risk, and treatment failure risk within 21 days.<sup>3</sup> Selective treatment also had no impact on long-term outcomes, such as recurrence of clinical mastitis in the same quarter, increased SCS, decreased milk production, or cow survival for the remainder of the lactation.<sup>4</sup> This study supports the selective treatment of clinical mastitis episodes using intramammary cephapirin and an on-farm culture system for those mastitis episodes that have abnormal secretion.

A decision tree analysis of treatment strategies, including selective treatment of clinical mastitis using on-farm culture results, indicated that the optimal economic strategy was to treat clinical mastitis episodes caused by gram-positive organisms for 2 days (compared with a 5-day or 8-day treatment protocol) and to not treat mild clinical mastitis episodes caused by gram-negative organisms or associated with no bacterial growth.<sup>1</sup> This economic analysis needs to be updated based on recent studies with naturally occurring mastitis documenting improved efficacy with extended treatment durations.<sup>5,6</sup>

#### Which Route of Administration (Intramammary, Parenteral, or Both?)

The second decision is the route of administration. The goal of antimicrobial treatment is to attain and maintain an effective

concentration at the site of infection. Three pharmacologic compartments are recognized for infection by mastitis pathogens:

- Milk and epithelial lining of the ducts and alveoli
- Parenchyma of the mammary gland
- The cow (Table 20-6)

Generally, infections confined primarily to the milk and ducts (such as *C. bovis* and CNS) are easily treated with intramammary antibiotics. In contrast, infections caused by mastitis pathogens with the potential for systemic infection (such as *E. coli*, *K. pneumoniae*, and *M. bovis*) are best treated with parenteral antibiotics. Mastitis pathogens that are the most difficult to treat are those that are principally infections of parenchymal tissue (such as *S. aureus* and *T. pyogenes*); this is because it is more difficult to attain and maintain an effective antibiotic concentration at this anatomic site when administering antibiotics by the intramammary or parenteral routes.

#### Which Antimicrobial Agent Should Be Administered?

The third decision is the antimicrobial agent. The selection of the antimicrobial class for the particular mastitis pathogen has traditionally been based on culture and susceptibility testing and, although some in vivo data are now available, the choice is still largely dependent on case studies rather than on controlled experiments. Culture and antimicrobial susceptibility testing of the pathogen is not necessarily a justifiable basis for selecting the antimicrobial agent to be used

in individual cows, and the response to treatment of clinical mastitis in two recent studies was unrelated to the results of in vitro susceptibility tests.

Antimicrobial agents are usually selected based on availability of labeled drugs, clinical signs in the cow, milk culture results for previous mastitis episodes in the herd, experience of treatment outcome in the herd, treatment cost and withdrawal times for milk, and slaughter. Many veterinarians and researchers have also recommended the routine use of susceptibility testing to guide treatment decisions. Susceptibility testing for guiding treatment of clinical mastitis should not be a routine recommendation for a number of reasons. First, the cost of susceptibility testing and a minimum 2-day delay in obtaining the results makes susceptibility testing irrelevant to the initial treatment protocol. Second, the medical profession does not routinely apply susceptibility testing to the initial treatment of a non-life-threatening illness; it is therefore difficult to understand why treatment of bovine mastitis should be held to a higher standard. Third, and most importantly, the validity of agar diffusion susceptibility breakpoints derived from humans in the treatment of bovine mastitis has not been established and is extremely questionable because bovine mastitic milk pH, electrolyte, fat, protein, and neutrophil concentrations; growth factor composition; and pharmacokinetic profiles differ markedly from those of human plasma. Moreover, antibiotics are distributed unevenly in an inflamed gland, and high antibiotic concentrations can alter neutrophil function in vitro, having the potential to inhibit bacterial clearance in vivo.

Adequate databases of in vitro minimum inhibitory concentration (MIC) values for clinical mastitis pathogens are currently unavailable, although adequate databases are available for subclinical mastitis isolates. Although we have a good knowledge of the pharmacokinetics of many parenteral antibiotics used to treat clinical mastitis, most pharmacokinetic data have been obtained in healthy cattle, and it has become increasingly clear that the pharmacokinetic values in healthy cows are different to those in cows with clinical mastitis. In addition, pharmacokinetic values for many of the intramammary antibiotics used to treat clinical mastitis are unknown, and there is a limited understanding of the pharmacodynamics of antibiotics in treating mastitis. More importantly, the breakpoints currently recommended for all parenterally and almost all intramammarily administered antibiotics used to evaluate susceptibility or resistance<sup>7-10</sup> are based on achievable serum and interstitial fluid concentrations in humans after oral or intravenous antibiotic administration. The relevance of these breakpoints to achievable milk concentrations in lactating dairy cows after

intramammary, subcutaneous, intramuscular, or intravenous administration is dubious at best.

Results from field studies are available to evaluate the validity of susceptibility breakpoints in guiding treatment of cows with clinical or subclinical mastitis. The results from these field studies suggest that the following antibiotics may have valid (but not necessarily optimal) breakpoints for treating clinical or subclinical mastitis associated with specific bacteria: parenteral penicillin G for subclinical *S. aureus* infections, intramammary cephalosporin for clinical *Streptococcus* spp. infections, and parenteral trimethoprim-sulfadiazine for clinical *E. coli* infections. Of these three antibiotics, the breakpoints for penicillin G and cephalosporin have only been validated for bacteriologic cure, whereas the breakpoint for trimethoprim-sulfadiazine is validated for clinical cure. Because duration of infection before treatment, antibiotic dosage, dosage interval, and duration of treatment influence treatment outcome, many more field studies must be completed to validate the currently assigned antibiotic breakpoints for pathogens causing clinical mastitis.

To properly use the known pharmacokinetics of parenterally and intramammarily administered drugs, it is necessary to know something about their diffusion into mammary tissue, the degree of binding of a drug to mammary tissues and secretions, the ability to pass through the lipid phase of milk, and the degree of ionization. All of these factors influence the level of the antibiotic in the mammary gland.<sup>11</sup> Major challenges with modeling the milk concentration-time relationship exist for antibiotics administered parenterally or by the intramammary route. As a consequence, a new pharmacokinetic modeling approach for the treatment of mastitis has been developed.<sup>12</sup> Much of the published pharmacokinetic data are based on foremilk concentration, which is not representative of the antibiotic concentration in quarter milk<sup>13,14</sup> and has been conducted in healthy cows without clinical mastitis. The latter issue is of great importance because clinically important differences in pharmacokinetic values have been identified for ruminants with and without experimentally induced mastitis.<sup>15</sup> For lactating cows the preferred treatment is one that maintains an MIC for 72 hours without the need for multiple infusions and without prolongation of the withdrawal time. The most successful antimicrobial agents for dry period treatment are those that persist longest in the udder, preferably as long as 8 weeks. These characteristics depend on the release time from the transport agent in the formulation and the particle size and diffusion capabilities of the antibiotic.

The formulation of the preparation will affect the duration of the maintenance of the MIC. The third-generation cephalosporins

(such as ceftiofur) and fluoroquinolones are the drugs of choice for use in cases in which the infection may be associated with either a gram-positive or gram-negative organism; however, these antimicrobial agents may not be able to be used to treat mastitis in some countries. Mixtures of penicillin and an aminoglycoside are also in common use for this purpose. Penicillin G and penethamate are favored for gram-positive infections. Of special importance are the  $\beta$ -lactamase-producing strains of *S. aureus*, against which  $\beta$ -lactam penicillins are ineffective; cloxacillin is a commonly used and effective intramammary formulation for these strains of *S. aureus*. The drugs that have the best record of diffusion through the udder after intramammary infusion are penethamate, ampicillin, amoxicillin, erythromycin, and tylosin. Those of medium performance are penicillin G, cloxacillin, and tetracyclines. Poor diffusers, which have a longer half-life in the udder because they bind to protein, include streptomycin and neomycin. Streptomycin is not used much now because of the high level of resistance to it, especially by *S. uberis* and *E. faecalis*.

In summary, treatment of clinical mastitis should be based on bacteriologic diagnosis or assessment of the likely causative agent and take current guidelines on the prudent use of antimicrobials into account. The initial treatment of clinical mastitis episodes should be based on herd data and personal experience for the geographic region<sup>16</sup> or the results of on-farm culture for clinical mastitis episodes with only abnormal secretion.<sup>3,4</sup> The treatment of subclinical mastitis during lactation is rarely economical.

#### What Should Be the Frequency and Duration of Treatment?

The fourth decision is the **frequency and duration of treatment**. The frequency of administration for parenterally administered antimicrobial agents is dependent primarily on their pharmacokinetics and pharmacodynamics. Fluoroquinolones and aminoglycosides are **concentration-dependent** antimicrobial agents in which increasing concentrations at the site of infection increase the bacterial kill rate. Macrolides,  $\beta$ -lactams, and lincosamides are **time-dependent** antimicrobial agents in which exceeding the MIC at the site of infection for a prolonged percentage of the interdosing interval correlates with improved efficacy. In contrast, the frequency of administration for intramammary formulations is dependent primarily on the milking schedule, because these agents are primarily cleared by milk removal. For example, the clearance of pirlimycin is strongly and positively correlated ( $r = 0.97$ ) to 24-hour milk production at the time of dosing. With all intramammary formulations being licensed based on the results of studies of twice-daily milking, the recent industry trend in some

parts of the world toward thrice-daily milking has created uncertainty as to whether intramammary treatment should be repeated after every milking or even whether once-a-day intramammary administration is as efficacious as twice- or thrice-daily administration.<sup>13,17,18</sup>

Recent studies have confirmed long-held beliefs that **appropriate antimicrobial therapy** (commonly called **extended or aggressive antimicrobial therapy**) for 5 to 8 days is more effective in treating intramammary infections than label intramammary therapy (2–3 days).<sup>5,6,19</sup> In other words, increasing the duration of antimicrobial administration increases treatment efficacy. Extended antimicrobial therapy is opposed by some producers because such treatment may be off-label and results in a longer milk withhold time and, consequently, the amount of milk that has to be discarded. In contrast, extended therapy of clinical mastitis episodes that have been treated for 2 to 3 days but the secretion remains abnormal is perceived by some producers as part of the social norm of “being a good farmer.”<sup>20</sup> Extended therapy is opposed by dairying administrators because of the inevitable increase in the number of infringements of health regulations relating to antibiotic residues in milk. The inappropriately short treatment duration for most intramammary products has been a major hindrance to developing effective antimicrobial treatment protocols.

### Intramammary Antimicrobial Therapy

For reasons of convenience and efficiency, antimicrobial udder infusions are in common use for the treatment of certain causes of mastitis in lactating cows and for dry cow therapy. For example, the cure rate of *S. agalactiae* using intramammary infusions in lactating cows exceeds 95%. Disposable tubes containing suitable antimicrobials in a water-soluble ointment base are ideal for dispensing and for the treatment of individual cows. Multiple-dose bottles containing aqueous infusions are adequate and much cheaper per dose when large numbers of quarters are to be treated, but repeated use of the same container increases the risk of contamination. The degree of diffusion into glandular tissue is the same when either water or ointment is used as a vehicle for infusion; the duration of retention within the gland depends on the vehicle.

Most antimicrobial agents currently available in the United States in commercial intramammary infusion products are active against the staphylococci and streptococci, with cephalosporin (a first-generation cephalosporin) having good activity against coliform bacteria, and ceftiofur (a third-generation cephalosporin) having excellent activity against coliform bacteria. Until recent years the emphasis was on the elimination of gram-positive cocci from the udder, but

gram-negative infections, especially *E. coli*, have increased in prevalence to the point where a broad-spectrum preparation is almost essential for both lactation and dry period treatments. Generally, antimicrobials administered by the intramammary route for the treatment of clinical mastitis should be bactericidal because neutrophil phagocytosis of bacteria is impaired in milk.

The choice of antimicrobial agents for intramammary infusion should be based on the following:

- Mechanism of antimicrobial action and spectrum of bacteria controlled
- Diffusibility through mammary tissue
- Cost

Strict hygiene is necessary during treatment to avoid the introduction of bacteria, yeasts, and fungi into the treated quarters; the use of a short cannula that just penetrates the external sphincter is preferred because it is less likely to introduce bacteria and leaves more of the keratin plug in place in the streak canal. This is important because the keratin plug has antimicrobial properties. Care must be taken to ensure that bulk containers of mastitis infusions are not contaminated by frequent withdrawals and that individual, sterilized teat cannulas, usually part of commercial, single-dose ointment tubes, are used for each quarter. Bulk treatments are best avoided because of the high risk of spread of pathogens.

### Infusion Procedure

The teats must be cleaned and sanitized before infusing the quarter to avoid introduction of infection. The following steps are recommended:

- Clean and dry the teats.
- Dip teats in an effective germicidal product. Allow 30 seconds' contact time before wiping teats with an individual disposable towel (one towel per cow, use one corner of the towel for each teat).
- Thoroughly clean and disinfect each teat end with cotton soaked in 70% alcohol. Use a separate piece of cotton for each teat.
- Prepare teats on the far side of the udder first, followed by teats on the near side.
- Treat quarters in reverse order: near side first, far side last.
- Insert only the tip of the cannula into the teat end (**partial insertion**). Do not allow the sterile cannula to touch anything before infusion. Most approved dry cow infusion products (and lactating tubes) are marketed with a dual cover that can be used for partial or full insertion.
- Dip teats in a germicidal product after treatment.
- Identify treated cows and remove them from the milking herd to prevent antimicrobials from entering the milk supply.

Diffusion of infused intramammary drugs is often impeded by the blockage of lactiferous ducts and alveoli with inflammatory debris. Complete emptying of the quarter by the parenteral injection of oxytocin (10–20 IU intramuscularly) followed by hand stripping of affected quarters before infusion has been recommended in cases of clinical mastitis, but efficacy studies are lacking, the volume stripped is usually small, and the procedure is painful to the cow. If stripping is performed, the intramammary infusion is given after the last stripping of the day has been done, avoiding any further milking of the gland until the next milking.

### Parenteral Antimicrobial Therapy

This should be considered in all cases of mastitis in which there is an abnormal gland and is preferred in all cases of mastitis in which there is an abnormal cow (fever, decreased appetite, or inappetence). The systemic reaction can usually be brought under control by standard doses of antimicrobial agents, but a bacteriologic cure of the affected glands may not be achieved because of the relatively poor diffusion of the antimicrobial from the blood into the milk. However, the rate of diffusion is greater in affected than in normal quarters. Parenteral treatment is also recommended when the gland is markedly swollen and intramammary infusions are unlikely to diffuse to all parts of the glandular tissue.<sup>19</sup> To achieve adequate therapeutic levels of an antimicrobial in the mammary gland by parenteral treatment it is necessary, for the above reasons, to use higher than normal dose rates daily for 3 to 5 days.<sup>19</sup> Milk from treated cows must be withheld from the bulk tank for the stated period of time of that antimicrobial following the date of last treatment.

### Treatment of Lactating Quarters

There are three situations to consider: the emergency single case of clinical mastitis requiring immediate treatment; the herd with a problem of too many clinical cases or intractable cases, but where the identity of the pathogen is known; and the cow with subclinical mastitis.

### Emergency Treatment When the Type of Infection Is Unknown

Cases of acute and peracute mastitis (abnormal cow) in lactating cows, and in dry cows close to calving, are serious problems for the field veterinarian. The need for treatment is urgent; it is not possible to wait for the results of laboratory tests to guide the selection of the most appropriate antibiotic. Clinical findings, season of the year; and management practices may give a broad hint as to the specific bacterial cause, but in most such circumstances it is necessary to use a broad-spectrum approach to treatment. Parenteral therapy with oxytetracycline (administered intravenously to increase bioavailability and therefore plasma and milk concentrations),



penethamate hydriodide, a potentiated sulfonamide or similar broad-spectrum antimicrobial agent should be supplemented with intramammary infusion with a  $\beta$ -lactamase-resistant antimicrobial such as a first-generation cephalosporin (cephapirin), a third-generation cephalosporin (e.g., ceftiofur), penicillin G–neomycin combination, or other approved broad-spectrum intramammary infusion. Parenteral ceftiofur is not effective in clinical mastitis episodes that have abnormal secretion or abnormal gland and secretion.

A consensus is developing that clinical mastitis episodes that manifest as abnormal secretion or abnormal secretion and gland should be treated only by the intramammary route, and that clinical mastitis episodes that manifest as abnormal secretion, gland, and cow should be treated by both the intramammary and parenteral routes. The latter group would also benefit from the administration of antiinflammatory agents and intravenous fluid therapy, depending on the severity of the systemic signs. A consensus is also developing that extended intramammary therapy (effectively more appropriate duration therapy) beyond the traditional 2- to 3-day treatment regimen is preferred when permitted by label directions and country recommendations<sup>5,6</sup>; however, the optimal duration of intramammary therapy remains to be determined.

In a multicenter study in Europe comparing three  $\beta$ -lactam–based intramammary products for the treatment of 491 clinical mastitis episodes, the bacteriologic cure rate for intramammary administration of a combination of cephalexin (200 mg, first-generation cephalosporin) and kanamycin (133 mg) or cefquinome (75 mg, fourth-generation cephalosporin) were similar but higher than that for intramammary infusion of cefoperazone (100 mg, third-generation cephalosporin).<sup>16</sup> In a multifarm ( $n = 28$ ) study in New Zealand comparing three cephalosporin-based intramammary products for the treatment of 1462 clinical mastitis episodes, the bacteriologic cure rates were similar for intramammary administration of procaine penicillin (1 g), cefuroxime sodium (250 mg, second-generation cephalosporin), or a combination of procaine penicillin G (1,000,000 U) and dihydrostreptomycin (0.5 g).<sup>21</sup> However, quarters treated with cefuroxime were more likely to be retreated within 30 days than quarters receiving either of the other two treatments.<sup>21</sup>

Field studies show that, in herds in which clinical mastitis is often caused by environmental pathogens, intravenous administration of oxytetracycline, intramammary infusion of cephalosporin, and supportive therapy (including intravenous administration of flunixin meglumine or fluids) produce a higher rate of clinical and bacteriologic cure than supportive treatment alone. In addition, antimicrobial treatment is more

effective than supportive treatment alone. In cows with clinical mastitis caused by *E. coli* the use of procaine penicillin G intramuscularly was no more effective than not using antimicrobial agents; this result is expected based on penicillin's gram-positive spectrum of activity. Knowledge of the likely causative agent is therefore helpful when making decisions about therapy of clinical mastitis episodes during lactation.

Provision of other supportive therapy, such as fluids and electrolytes, is also crucial to the survival of the cow and minimization of the severity of the mastitis and extent of permanent injury to the udder. The efficacy of frequent stripping, with or without intramammary infusion, is uncertain. Nonsteroidal antiinflammatory drugs (NSAIDs) decrease pain associated with an abnormal gland; in addition, they enhance recovery and reduce fever in severe cases.

### Treatment When the Infecting Organism Is Known

A common situation encountered by a bovine practitioner is the dairy herd that has had an outbreak of clinical mastitis or has received a warning notice from the milk processor that the bulk milk SCC or bacterial count is above acceptable limits. The situation calls for a complete mastitis control program, including conducting an investigation to determine the causative bacteria present, the source of the infection, hygiene in the milking parlor, and the importance of risk factors such as milking machine management, plus recommended antimicrobial preparations selected on the basis of the causative agent. Treatment of a number of identified subclinical cases at the commencement of the program, and of individual cases subsequently, can be based on the known common infection in the herd. Among gram-positive cocci, the response to antimicrobial agents is excellent for streptococci. For staphylococci a cure rate of 65% is about the best that can be expected, and unless there are good reasons for doing otherwise it is recommended that treatment be postponed until the cow is dry. Standard treatments for lactating cows include penicillin alone (100,000 units) or in combination with streptomycin (1 g) or neomycin (500 mg), and a combination of ampicillin (75 mg) and sodium cloxacillin (200 mg). Acid-resistant penicillins, e.g., phenoxymethylpenicillin, are probably best not used as mammary infusions because of their ability to pass through the human stomach, thus presenting a more serious potential threat to humans drinking contaminated milk. Because of the widespread and often indiscriminate use of penicillin, a large part of the mastitis that occurs is associated with penicillin-resistant bacteria, especially *S. aureus*. Treatment programs need to take this into account when recommendations are made about the antibiotic to be used.

Intramammary infections associated with **environmental streptococci** that manifest signs of clinical mastitis are usually acute but only moderately severe. In most of these cases the streptococci are sensitive to antimicrobial agents, and they often recover spontaneously with good management and nursing care. If not, they usually respond well to therapy.<sup>22</sup> Bacteriologic cure rates of 60% to 65% can be expected following a single intramammary infusion of a cephalosporin product.

In one randomized controlled field trial of clinical mastitis associated with *Streptococcus* spp. or coliform bacteria, the clinical cure rate by the 10th milking was significantly higher when intramammary cephalosporin, intravenous oxytetracycline, or both were used along with supportive therapy (oxytocin and stripping of affected glands and, in severely affected cows, the use of flunixin meglumine and fluids) compared with supportive treatment alone. These results indicate that, in herds in which clinical mastitis is often associated with environmental pathogens, antimicrobial therapy and supportive therapy may result in a better outcome than supportive therapy alone.

### Treatment of Subclinical Mastitis

It is generally considered not advisable to treat subclinical mastitis during lactation.<sup>23,24</sup> However, it is important to consider the causative organism, the age of the cow, the number of intramammary infections for the cow, and the udder health status of the herd.<sup>25</sup> There are several situations in which lactational therapy of subclinical mastitis is indicated; for example, herds with *S. agalactiae* infections should consider several approaches to therapy during lactation. *S. agalactiae* infections respond well to therapy during lactation, with cure rates of 80% to 100% expected. All approved intramammary therapy preparations are efficacious, including penicillin, cephalosporins, cloxacillin, and erythromycin. In herds with a high prevalence of *S. agalactiae* mastitis, **blitz therapy** can be used for eradication of the pathogen, increased milk production, and reduced penalties for high SCCs. There is, however, a risk of residue violation, problems with disposal of milk from treated cows, and considerable costs involved. It is also important to ensure that standard mastitis control procedures, such as postmilking teat disinfection and blanket dry cow therapy, have been implemented. The benefit:cost ratios for various approaches to blitz therapy of *S. agalactiae*-infected herds have been studied. The prevalence of infected cows, and their stage of lactation, are important determinants of the type of program selected.

Therapy of cows with subclinical mastitis caused by *S. aureus* during lactation is much less rewarding. Under field conditions, cases of *S. aureus* are difficult to cure during lactation. Reported cure rates following

intramammary therapy are between 15% and 60%. Lactational therapy of subclinical *S. aureus* mastitis using intramuscular penicillin along with intramammary amoxicillin infusion, compared with the intramammary infusion alone, increased the cure rate to 40%, which represented a doubling of the cure rate with intramammary therapy alone. Improvements in the cure rate of subclinical gram-positive intramammary infections have also been obtained with parenteral penethamate hydroiodide.<sup>25</sup> If treatment by this method is used in combination with data on the age of cow, stage of lactation, duration of infection, and level of SCC, the economic benefit of treating some cases of *S. aureus* mastitis during lactation may be attractive.

Subclinical infections associated with environmental streptococci, and occasionally by coliform organisms, can be found in moderate numbers in some herds. Although spontaneous cure rates are higher with these environmental infections, individual cows may merit treatment during lactation. In these cases, the previously listed factors should be used and are important in the selection of cases to be treated.

Prepartum antibiotic treatment of heifers is of benefit in herds experiencing a high incidence of clinical mastitis in recently calved heifers. CNS are frequently isolated from late-gestation heifers, and intramammary treatment with sodium cloxacillin (200 mg) or cephapirin sodium (200 mg) 7 days before expected parturition is highly effective and economically beneficial.

### Antiinflammatory Agents

NSAIDs have been evaluated for the treatment of field and experimental cases of acute and peracute mastitis. They have beneficial effects on decreasing the severity of clinical signs based on changes in rectal temperature, heart rate, rumen motility, and pain associated with the mastitis and are routinely administered as part of the initial treatment of cattle with severe clinical mastitis and marked systemic signs (pyrexia, tachycardia, tachypnea, and ruminal hypomotility). On the basis of one comparative study, NSAIDs appear to ameliorate systemic abnormalities to a greater degree than corticosteroids. The strongest evidence to support the administration of NSAIDs is available for meloxicam, ketoprofen, and phenylbutazone.

Administration of meloxicam (250 mg subcutaneously once) to dairy cows in New Zealand with acute clinical mastitis being treated with three daily intramuscular injections of penethamate hydroiodide (5 g) decreased posttreatment SCC and decreased culling from the herd from 28% to 16%.<sup>26</sup> Ketoprofen at 2 g intramuscularly once daily combined with sulfadiazine and trimethoprim intramuscularly given daily to cows with acute clinical mastitis, and complete milking of affected quarters several times daily, significantly improved survival and

milk production compared with cows not receiving the NSAID. A reanalysis of the published results indicated that phenylbutazone at 4 g intramuscularly once daily combined with sulfadiazine and trimethoprim intramuscularly given daily to cows with acute clinical mastitis significantly improved the percentage of cows with milk production returning to more than 75% of previous levels compared with cows not receiving the NSAID. However, intramuscular administration of phenylbutazone is not currently recommended because of the potential for myonecrosis. Moreover, phenylbutazone is not permitted to be administered to dairy cattle greater than 20 months of age in the United States. Dipyrone (20 g, intramuscularly) administered once daily in the same study was not effective. It is not permitted to be administered to food-producing animals in some countries, including the United States.

There is minimal evidence that treatment of clinical cases with NSAIDs alters the inflammatory response in the udder, although pretreatment of cattle with experimentally induced mastitis does alter the local (glandular) inflammatory response to infection. Flunixin meglumine concentrations are low in milk, which is consistent with its properties as a weak acid that has difficulty crossing the blood-milk barrier. Flunixin meglumine (2 mg/kg, intravenously, twice 24 hours apart) did not alter the survival rate of dairy cows with severe *E. coli* or *S. uberis* mastitis compared with intravenous administration of 45 L of isotonic crystalloid fluids. Flunixin meglumine is often administered as part of the initial treatment of clinical mastitis in cows manifesting systemic signs of illness, and flunixin residues are being detected in milk from dairy cattle being sent for human consumption. This may reflect the markedly slower clearance of flunixin in cows with clinical mastitis.<sup>27</sup> The one-time administration of 1 g of flunixin meglumine intravenously or 4 g of phenylbutazone intravenously, along with intramammary infusion of gentamicin (150 mg) at 12-hour intervals for four treatments, had no significant beneficial effect in cows with acute toxic mastitis associated with *E. coli* and *Klebsiella* spp. However, the results of this study do not indicate a lack of effectiveness of flunixin meglumine or phenylbutazone, because it is difficult for one dose of any NSAID to have a detectable effect on clinical signs in naturally occurring mastitis cases.

### Supportive Therapy

Supportive treatment, including the intravenous administration of large quantities of isotonic crystalloid fluids, is indicated in cattle with severe systemic illness. Large volumes of isotonic crystalloid fluids can be rapidly administered under pressure at 0.5 L/min through a 12-gauge catheter in the jugular vein, using a 7.5-L garden weed killer

spray pump. The administration of hypertonic saline followed by immediate access to drinking water is a practical method of providing fluid therapy to cows with severe mastitis, especially peracute coliform mastitis. A dose of 4 to 5 mL/kg body weight (BW) of 7.5% saline is given intravenously over 4 to 5 minutes. This is usually followed by the animal consuming large quantities of water. Circulating blood volume is increased and there is mild strong ion (metabolic) acidosis, improved renal function, and changes in calcium and phosphorus homeostasis compared with cows given a similar volume of 0.9% NaCl. Fluid therapy is covered extensively in Chapter 5.

### Adjunctive Therapy

Cytokines may be useful as adjunctive therapy with existing antimicrobials to improve therapeutic efficacy, particularly in lactating cows. Cytokines are natural regulators of the host defense system in response to infectious diseases. The combination of a commercial formulation of cephapirin with recombinant interleukin (IL)-2 consistently improved the cure rate of treating *S. aureus* mastitis by 20% to 30% compared with use of the antimicrobial alone.

Ozone is a gas (O<sub>3</sub>) that rapidly inactivates bacteria and viruses. It was prepared with a commercially available ozone therapy device and administered to cattle with clinical mastitis. The administration of 100 mL of 70% ozone decreased SCC over 1 week, suggesting that ozone may be an effective adjunct therapy.<sup>28</sup>

### Magnitude of Response to Therapy

The treatment of some causes of mastitis can be highly effective in removing infection from the quarter and returning the milk to normal composition. However, the yield of milk, although it can be improved by the removal of congestion in the gland and inflammatory debris from the duct system, is unlikely to be returned to normal in severe clinical cases, at least until the next lactation. The degree of response obtained depends particularly on the causative agent, the speed with which treatment is commenced, and other factors described earlier. A “cure” may mean disappearance of clinical signs, elimination of the infectious cause, or both of those plus return to normal function and productivity. Which of these is the objective in any particular case or herd will influence the decisions to be made about treatment in an individual case of the disease.

**Failure to respond to therapy** of the lactating cow may be caused by the following:

- The presence of microabscesses and inaccessibility of the drug to the pathogen
- Ineffective drug diffusion
- Inactivation of the antimicrobial by milk and tissue proteins

- Inefficient killing of the bacteria and intracellular survival of bacteria
- Increased antimicrobial resistance
- The development of L-forms of bacteria

### Dry Cow Therapy

Dry cow therapy is the use of intramammary antimicrobial therapy immediately after the last milking of lactation and is an important component of an effective mastitis control program. Intramammary infusions at drying off **decrease the number of existing infections and prevent new infections during the early weeks of the dry period.** Dry cow therapy should be routinely administered and remains one of the cornerstones of an effective mastitis control program. **Blanket dry cow therapy** is treatment of all four quarters at drying off, compared with **selective dry cow therapy** based on treatment of only those quarters that are infected. When subclinical mastitis is very low in some herds, selective dry cow therapy can be considered, but nearly all herds use blanket dry cow therapy. The problem with selective dry cow therapy is the accuracy of available indirect tests to “select” cows for treatment or nontreatment. Currently available indirect tests are not sufficiently accurate (the exception being quarter milk cultures) to be used as a basis for selective dry cow therapy.

Intramammary infusions approved for dry cow therapy contain high levels of antimicrobial agents in a slow-release base that maintains therapeutic levels in the dry udder for long periods of time. Most dry cow therapy infusion products are intended to eliminate existing infections caused by *S. aureus* and *S. agalactiae* at drying off and to prevent new infections caused by the same pathogens and environmental streptococci in the early dry period.

In herds with a high prevalence of contagious mastitis, dry cow therapy has been efficacious and economically beneficial in reducing the prevalence of intramammary infections. The consistent application of effective mastitis control procedures has reduced the prevalence of contagious pathogens and the bulk tank milk SCC (<300,000 cells/mL), and owners of these herds questioned dry cow therapy because of the economics and the concerns of residues in the milk. Field trials in herds with a low prevalence of contagious mastitis indicate that dry cow therapy at the end of lactation increased 17-week milk production during the subsequent lactation and was economically beneficial compared with not treating them. However, in the subsequent lactation, the incidence of clinical mastitis was not reduced and the SCCs were not significantly different from those of cows not treated at the end of lactation.

The most effective time to treat subclinical intramammary infections is at drying off. Dry cow therapy has the following advantages over lactation therapy:

- The cure rate is higher than that achieved by treatment during lactation.
- A much higher dose of antimicrobial can be used safely.
- Retention time of the antimicrobial in the udder is longer.
- The incidence of new infections during the dry period is reduced.
- Tissue damage by mastitis may be regenerated before parturition.
- Clinical mastitis at calving may be reduced.
- The risk of contaminating milk with antimicrobial residue is reduced.

Selection of a suitable dry period treatment should take into account the fact that gram-negative infections are not common at that time because of the high concentration of lactoferrin in the dry secretions. Accordingly, attention should be directed at the inclusion of a potent antibiotic against *Streptococcus* spp.,  $\beta$ -lactamase-producing *S. aureus*, and *T. pyogenes*. Cloxacillin and cephalosporins are popular for the purpose; for example, a recommended treatment is cephapirin or sodium cloxacillin in a slow-release base with an expected cure rate of 80% against streptococci and 60% against *S. aureus*. A large North American trial involving 6 dairy herds and 1091 cows identified no difference in the risk of cure between dry off and calving, and no effect of treatment on the risk for the presence of a new intramammary infection for the first 6 days in milk after calving, for cattle treated at dry off with intramammary procaine penicillin G (1,000,000 U) and dihydrostreptomycin (1 g), ceftiofur hydrochloride (500 mg), or cephapirin (300 mg) dry cow formulations.<sup>29</sup> In contrast, a study in Central Florida involving 2 dairy herds and 402 cows identified that cattle treated at dry off with intramammary ceftiofur hydrochloride (500 mg) had lower odds of having clinical and subclinical mastitis in the early part of the subsequent lactation than cows treated with intramammary procaine penicillin G (1,000,000 U) and dihydrostreptomycin (1 g).<sup>30</sup>

Most dry cow preparations maintain an adequate minimum concentration in the quarter for about 4 weeks, but some persist for 6 weeks. There is little, if any, value in treating cows again before the due calving date. There is always a possibility of introducing infection while infusing an intramammary preparation and farmers are reluctant to break the teat canal seal, but it may be necessary to do so if summer mastitis is prevalent in the area.

### Prepartum Antimicrobial Therapy in Heifers

Intramammary infusion of a cephapirin dry cow therapy preparation into pregnant heifers 10 to 12 weeks prepartum eliminated over 90% of the intramammary infection caused by *S. aureus*, *Streptococcus* spp., CNS spp., and coliforms. The SCCs of cured

quarters were comparable to uninfected control quarters after parturition. At parturition, 24% of treated quarters were positive for the antimicrobial; however, no quarters were positive at 5 days postpartum.

### Treatment of Mastitis on Organic Dairy Farms

The sale of organic dairy products is increasing worldwide, and the common occurrence of mastitis in dairy cattle provides an animal welfare challenge about how to appropriately treat clinical mastitis episodes in organic dairy farms. In the United States, use of antimicrobials to treat dairy cattle results in permanent loss of organic status for that animal,<sup>31</sup> whereas organic dairy farms in the European Union and Canada are permitted limited use of antimicrobials for emergency treatments per year.<sup>32</sup> Consequently, organic farmers use a variety of treatments for clinical mastitis, including homeopathy, vitamin supplements, and botanicals.<sup>31</sup> They also use veterinarians less frequently than similarly sized conventionally managed dairy herds.<sup>33</sup>

Treatment with a botanical preparation containing extracts of *Thymus vulgaris*, *Gaultheria procumbens*, *Glycyrrhiza uralensis*, *Angelica sinensis*, and vitamin E did not affect the resolution of clinical mastitis at day 4 of treatment, but it decreased the time to clinical recovery in cattle with clinical mastitis in Colorado.<sup>32</sup> This botanical formulation contained chemicals with documented antiinflammatory, antiseptic, or nutritional effects. Intramammary infusion of a live culture of *Lactococcus lactis* may be efficacious in the treatment of subclinical and clinical mastitis in dairy cattle.<sup>34</sup>

### Antimicrobial Residues in Milk and Withholding Times

Label instructions must be followed to ensure that drug residues do not occur, especially from cows with a shorter than normal dry period. Antibiotic residue testing of the milk of a recently calved cow can be done if there is a suspicion of residues, but this is a misuse of a test designed for bulk tank milk testing and therefore suffers from problems with sensitivity and specificity.

Treatment and control of mastitis accounts for the largest percentage of antimicrobial use on dairy farms. Following treatment by the intramammary or parenteral route, the concentration of antimicrobial agents in the milk declines over time to levels that are considered safe and tolerable for humans. The duration of time for the concentrations to decline to acceptable limits is known as the **withholding time** or the **withdrawal period** during which the milk cannot be added to the bulk tank supply but must be withheld and discarded. The presence of residues in milk is a major public health concern that adversely affects the dairy industry, the practicing veterinarian, and the perception the public has of the safety of milk for human



consumption. The public perception of the safety of milk is crucial, and veterinarians have a responsibility to respond to these concerns through public education and quality control of milk production.

Other serious consequences of antimicrobial residues in milk are their effect on the manufacture of dairy products and the potential development of antimicrobial sensitivity syndromes in humans. In most countries the maximum intramammary dose of antimicrobial agents is limited by legislation, and the presence of detectable quantities of antimicrobial agents in milk constitutes adulteration. Attention has also been directed to the excretion of antimicrobial agents in milk from untreated quarters, after treatment of infected quarters, and after their administration by parenteral injection or by insertion into the uterus. The degree to which this excretion occurs varies widely between animals and in the same animal at different points in the lactation period, and it differs from one antibiotic to another. Milk from cows subjected to dry period treatment is usually required to be withheld for 4 days after calving. The use of any dry period treatments in lactating cows causes prolonged retention of the antimicrobial in milk and is a most serious violation of the legislation.

Veterinarians have the responsibility to warn farmers of the need to withhold milk, and both should be aware of the withholding times of each product, the details of which are usually required to be included on its label. Marking the cow in some way to remind the farmer, by application of a leg band or placing dye on the udder, is advisable.

### Antimicrobial Residue Tests

Several cowside tests are available to detect antimicrobial residues in the milk of cows that have been treated for mastitis. The goal of cowside testing is to assist in the production of high-quality, antimicrobial-residue-free milk from dairy herds. To be consistent with the intent of a quality assurance program, cowside testing would be used only on cows recently treated with antimicrobial agents and only after appropriate milk withholding times had been followed. The ideal test would have a high sensitivity and high specificity.

Most of the cowside screening tests for antimicrobial residues are imperfect because of a high rate of false-positive results when used on field samples. The direct costs to producers can be high because of the unnecessary disposal of milk and imposition of fines and penalties. False-positive results also cause the unnecessary culling of some cows, and concern about the interpretation of positive assay results, the appropriateness of withholding periods, and the safety of milk creates mistrust among consumers, producers, veterinarians, and regulatory personnel.

The specificity of four commercially available tests ranged from 0.78 to 0.95. None of the test kits has been validated to meet performance standards for sensitivity and specificity. This applies to individual cow samples, bulk tank milk samples, and tanker truck samples.

The presence of naturally occurring bactericidal products in the milk of cows with acute and convalescent mastitis is the most likely cause of the false-positive results of the tests (such as Delvotest) that are based on bacterial growth inhibition of  $\beta$ -lactam antimicrobial agents. Immunoglobulins, complement, lysozyme, lactoferrin, and phagocytic cells are products of inflammation in the milk of cows with mastitis that can inhibit bacterial growth. The milk from cows with experimental endotoxin-induced mastitis is at increased risk for false-positive assay results using commercial residue tests. The incidence of false-positive results is very low in milk from cows that have not had a history of mastitis or antimicrobial therapy. Naturally occurring bactericidal products in mastitic milk can be removed by heating at 82°C (180°F) for 5 minutes; this temperature does not denature antimicrobial agents present in milk. Heat treatment therefore appears to provide a very practical way to reduce false-positive results on milk from individual cows.

A sample of milk can be submitted for antimicrobial residue testing up to three times. First, a producer may test a sample from a specific cow at the end of her withdrawal period. Second, milk is sampled at the tanker truck level. Third, should the tanker truck sample have positive results, bulk tank milk samples from each dairy herd that contributed to that tanker truck are tested.

There is a need for validation of the diagnostic assays used to detect antimicrobial residues in milk. Acceptance of assays for regulatory purposes must be based on protocols that include field estimates of assay performance before the assays are used by the public. Three strategies have been suggested to balance public health concerns with economic concerns of dairy producers caused by false-positive results:

1. Retest samples that yield positive results with a confirmatory assay of specificity close to 100%. Only those samples that also yield positive results on the second assay are considered to be positive for violative residues.
2. Recalibrate the assay to increase specificity. This will usually result in loss of sensitivity.
3. Use an alternative assay of higher specificity.

It is suggested that regulatory monitoring of residues at a national level will be best served by use of a combination of at least two assays: initial screening with a highly sensitive and inexpensive assay followed by confirmation

testing with an assay of high specificity (>99%) that can quantify the concentration of the antimicrobial residue. All tanker samples that yield positive results with a screening assay should be rechecked with a quantitative assay. If the quantitative assay detects a concentration greater than the safe level, safe concentration, or tolerance level, only then would the milk be deemed to have violative residue and fines and penalties be imposed. The complex dynamics of current milk residue tests discourage practitioners from recommending testing procedures to dairy producers.

As an approximate guide, the recommended periods for which milk should be withheld from sale after different methods of antimicrobial administration are (in times after last treatment)

- Udder infusion in a lactating cow (72 hours)
- Parenteral injection, one only (36 hours)
- Parenteral injections, series of (72 hours)
- Antimicrobial agents parenterally in long-acting bases (10 days)
- Intrauterine tablet (72 hours)
- Dry cow intramammary infusion (to be administered at least 4 weeks before calving and the milk withheld for at least 96 hours afterward)

### Permanently Drying Off Chronically Affected Quarters

If a quarter does not respond to treatment and is classified as incurable, the affected animal should be isolated from the milking herd, or the affected quarter may be permanently dried off by inducing a chemical mastitis. Historically used methods, arranged in decreasing order of severity, are infusions of

- 30 to 60 mL of 3% silver nitrate solution
- 20 mL of 5% copper sulfate solution
- 100 to 300 mL of 1:500, or 300 to 500 mL of a 1:2000 acriflavine solution

If a severe local reaction occurs, the quarter should be milked out and stripped frequently until the reaction subsides. If no reaction occurs, the quarter is stripped out 10 to 14 days later. Two infusions of these solutions may be necessary.

The **best method for permanently drying off a quarter is infusion of 120 mL of 5% povidone iodine solution (0.5% iodine)** after complete milk out and administration of flunixin meglumine (1 mg/kg BW, intravenously). This causes permanent cessation of lactation in the quarter but does not alter total milk production by the cow. If the goal is chemical sterilization, then three daily infusions of 60 mL of chlorhexidine suspension should be administered after complete milk out. The majority of treated cows (5/7) returned to milk production in the quarter in the subsequent lactation. The

infusion of 60 mL of chlorhexidine, followed by milking out at the next subsequent milking and repeat of the infusion 24 hours after the initial treatment, is also effective in making infused quarters nonfunctional within 14 to 63 days. Histologic evaluation of the infused quarters revealed that secretory tissues had involuted to a nonsecretory state and appeared similar to blind or nonfunctional quarters. However, as noted earlier, milk production may return in the gland in the subsequent lactation. Studies have demonstrated that the intramammary infusion of 10 mL of a peptide concentrate of casein hydrolysate is efficacious in drying off a quarter for the remainder of the lactation, but the quarter recovers over the dry period and milk production returns to similar levels the following lactation.<sup>22,35</sup> The infusion of casein induces an accelerated involution of the mammary gland. The effectiveness of this approach in drying off infected quarters does not appear to have been evaluated.

#### TREATMENT AND CONTROL OF CLINICAL MASTITIS IN LACTATING DAIRY COWS<sup>a</sup>

##### Treatment

###### Abnormal secretion

Perform on-farm culture and treat gram-positive isolates 18–24 hours later with an intramammary formulation that has proven efficacy against common gram-positive mastitis pathogens per label directions (R-1).

Administer broad-spectrum intramammary formulation per label directions (R-2).

###### Abnormal secretion and abnormal gland

Administer broad-spectrum intramammary formulation per label directions (R-1)

Administer extended duration of intramammary therapy (R-2).

###### Abnormal secretion, abnormal gland, and abnormal cow

Administer broad-spectrum intramammary formulation per label directions (R-1).

Administer extended duration of intramammary therapy (R-2).

Parenteral cefquinome, ceftiofur, fluoroquinolones, penethamate hydriodide, or oxytetracycline per label directions (R-1)

Intravenous fluid therapy with low-volume hypertonic saline or high-volume isotonic crystalloids (R-2)

Antiinflammatory agents, including meloxicam (250 mg, subcutaneously, once) (R-2)

##### Control

See extensive section on control of mastitis later in this chapter.

<sup>a</sup>Causative agent unknown. If the causative agent is known, then refer to specific treatment and prophylaxis recommendations for the etiologic agent in this chapter.

#### FURTHER READING

- Constable PD, Morin DE. Treatment of clinical mastitis: using antimicrobial susceptibility profiles for treatment decisions. *Vet Clin North Am Food Anim Pract.* 2003;19:139-156.
- Leslie KE, Petersson-Wolfe CS. Assessment and management of pain in dairy cows with clinical mastitis. *Vet Clin North Am Food Anim Pract.* 2012;28:289-305.
- Pyörälä S. Treatment of mastitis during lactation. *Ir Vet J.* 2009;62(suppl 4):S40-S44.
- Roberson JR. Treatment of clinical mastitis. *Vet Clin North Am Food Anim Pract.* 2012;28:271-288.
- Royster E, Wagner S. Treatment of mastitis in cattle. *Vet Clin North Am Food Anim Pract.* 2015;31:17-46.

#### REFERENCES

- Pinzón-Sánchez C, et al. *J Dairy Sci.* 2011;94:1873.
- Oliveira L, Ruegg PL. *J Dairy Sci.* 2014;97:5426.
- Lago A, et al. *J Dairy Sci.* 2011;94:4441.
- Lago A, et al. *J Dairy Sci.* 2011;94:4457.
- Swinkels JM, et al. *Vet J.* 2013;197:682.
- Truchetti G, et al. *Can J Vet Res.* 2014;78:31.
- Petrovski KR, et al. *Aust Vet J.* 2015;93:227.
- Lindeman CJ, et al. *J Vet Diagn Invest.* 2013;25:581.
- Bengtsson B, et al. *Vet Microbiol.* 2009;136:142.
- Cortinhas CS, et al. *Am J Vet Res.* 2013;74:683.
- Gehring R, Smith GW. *J Vet Pharmacol Ther.* 2006;29:237.
- Whittem T, et al. *J Vet Pharmacol Ther.* 2012;35:460.
- Stockler RM, et al. *J Dairy Sci.* 2009;92:4262.
- Stockler RM, et al. *J Vet Pharmacol Ther.* 2009;32:345.
- Badawy SA, et al. *Small Rumin Res.* 2015;133:67.
- Bradley AJ, Green MJ. *J Dairy Sci.* 2009;92:1941.
- Gordon PJ, et al. *J Dairy Sci.* 2013;96:4455.
- Lindquist DA, et al. *J Dairy Sci.* 2015;98:1856.
- Kalmus P, et al. *J Dairy Sci.* 2014;97:2155.
- Swinkels JM, et al. *J Dairy Sci.* 2015;98:2369.
- McDougall S, et al. *New Zeal Vet J.* 2007;55:161.
- Pinzón-Sánchez C, Ruegg PL. *J Dairy Sci.* 2011;94:3397.
- Sandgren CH, et al. *Vet J.* 2008;175:108.
- Leitner G, et al. *Israel J Vet Med.* 2012;67:162.
- Steele N, McGougall S. *New Zeal Vet J.* 2014;62:38.
- McDougall S, et al. *J Dairy Sci.* 2009;92:4421.
- Kissell LW, et al. *J Am Vet Med Assoc.* 2015;246:18.
- Enginler SO, et al. *Acta Scientiae Veterinariae.* 2015;43:1260.
- Arruda AG, et al. *J Dairy Sci.* 2013;96:4419.
- Pinedo PJ, et al. *J Dairy Sci.* 2012;95:7015.
- Ruegg PL. *J Anim Sci.* 2009;87(suppl 1):43.
- Pinedo P, et al. *Can Vet J.* 2013;54:479.
- Richert RM, et al. *J Am Vet Med Assoc.* 2013;242:1732.
- Klostermann K, et al. *J Dairy Res.* 2008;75:365.
- Leitner G, et al. *Livestock Sci.* 2007;110:292.

## Mastitis Pathogens of Cattle

In the following sections, the special features of each mastitis associated with one or a group of pathogens will be described using the usual format of the book. Mastitis in cattle is categorized as being associated with contagious, teat skin opportunistic or environmental pathogens, and as being common (major pathogen) or less common (minor pathogen). The features that are unique to the diagnosis, treatment, and control of each mastitis pathogen will be outlined, but details

applicable to all causes of mastitis were presented earlier.

## Mastitis of Cattle Associated With Common Contagious Pathogens

### STAPHYLOCOCCUS AUREUS

#### SYNOPSIS

**Etiology** *Staphylococcus aureus* is a major pathogen of the mammary gland and a common cause of contagious bovine mastitis. *S. aureus* also causes mastitis in sheep and goats.

**Epidemiology** Major cause of mastitis in dairy herds without an effective mastitis control program. Prevalence of infection 50%–100%; prevalence of 1%–10% in herds with low bulk tank milk SCCs, 50% in high-SCC herds, quarter infection rate 10%–25% in high-SCC herds. Source of infection is infected udder; infection transmitted at milking. Chronic or subclinical *S. aureus* mastitis is of major economic importance.

#### Clinical findings

- Chronic *S. aureus* mastitis is most common and is characterized by high SCC and gradual induration of udder, drop in milk yield, and atrophy with occasional appearance of clots in milk or wateriness.
- Acute and peracute *S. aureus* mastitis most common in early lactation. Acute swelling of gland with fever; milk is abnormal with thick clots and pus; gangrene of gland and teat in peracute form. Systemic reaction with anorexia, toxemia, fever, ruminal stasis

**Clinical pathology** Culture individual cow milk sample (composite or quarter) or polymerase chain reaction (higher sensitivity); indirect tests are high SCC and California mastitis test results.

**Necropsy findings** Peracute, acute, and chronic (recurrent) clinical mastitis, subclinical mastitis common

**Diagnostic confirmation** Culture milk for pathogen

#### Differential diagnosis

- Peracute mastitis
- Peracute coliform mastitis
- Trueperella* (formerly *Arcanobacterium* or *Corynebacterium*) *pyogenes* mastitis
- Parturient paresis
- Acute and chronic mastitis. Not clinically distinguishable from other causes of mastitis. Must culture milk

#### Treatment

- Lactating cows:** Cure rates for lactating cows with subacute staphylococcal mastitis less than 50%. Intramammary infusions daily for at least 3 days, preferably 5–8 days

- **Peracute mastitis:** Antimicrobial agents parenterally and intramammary that are  $\beta$ -lactamase resistant, fluid and electrolyte therapy
- **Dry cow therapy:** Chronic or subclinical mastitis best treated at drying off with long-acting intramammary antimicrobial infusions that are  $\beta$ -lactamase resistant

#### Control

- Prevent new infections by early identification, culling infected cows, and good milking procedures, including hygienic washing and drying of udders and teats before milking and postmilking germicidal teat dips. Regular milking machine maintenance. Consider segregation of infected cows.
- Eliminate existing infections by dry cow therapy.
- Immunization with vaccines may be possible in future.

SCC, somatic cell count.

## ETIOLOGY

**Coagulase-positive *S. aureus*** is a major pathogen of the bovine mammary gland and a common cause of contagious mastitis in cattle. It also causes mastitis in sheep and goats.

## EPIDEMIOLOGY

### Occurrence and Prevalence of Infection

#### Coagulase-Positive Staphylococci

Historically, *S. aureus* was one of the most common causes of bovine mastitis in dairy cattle worldwide. In the last 25 years, the prevalence of infection and the occurrence of clinical mastitis caused by *S. aureus* has decreased in herds using effective mastitis control measures. However, surveys indicate that 50% to 100% of herds may be infected. In low-SCC herds, the prevalence of infection in cows ranges from 1% to 10%. In other herds, especially those with high SCCs, up to 50% of cows may be infected with *S. aureus*, with quarter infection rates ranging from 10% to 25%. The prevalence of infection of *S. aureus* in heifers at parturition can range from 5% to 15%. **The majority of intramammary infections caused by *S. aureus* are subclinical.** The incidence of clinical mastitis caused by *S. aureus* is dependent on its prevalence of infection in the herd. With an effective mastitis control program, the most common causes of clinical mastitis are the environmental pathogens. However, in some herds with a low rolling SCC, incidence of clinical mastitis caused by *S. aureus* ranges from 190 to 240 cases per 100 cows per year, with about 47% of the clinical cases being *S. aureus*.

### Source of Infection and Method of Transmission

*S. aureus* is ubiquitous in the environment of dairy cattle. The infected mammary gland of

lactating cows is the major reservoir and source of the organism. The prevalence of intramammary infection in primiparous heifers at parturition ranges from 2% to 50% and may represent an important reservoir of infection in herds with a low prevalence of infection. The organism may be present on the skin of the teats and external orifices of heifers, bedding materials, feedstuffs, housing materials, nonbovine animals on the farm, and equipment. In herds with a high prevalence of infection (>10% of cows), the organism was present in bedding, the hands and noses of dairy herd workers, insects, and water supplies. Transmission between cows occurs at the time of milking by contaminated milkers' hands and teat cup liners. Although *S. aureus* can multiply on the surface of the skin and provide a source of infection for the udder, the teat skin lesions are usually infected originally from the udder, and teat skin is a minor source of infection. In herds with a low prevalence of infection, most new cases of *S. aureus* mastitis may be from extramammary sources rather than indicating cow-to-cow transmission.<sup>1</sup>

The horn fly (*Hameotobia irritans*) is an important vector for transmitting *S. aureus* mastitis in heifers, particularly in heifers with scabs on the teat ends. Prevention of high populations of flies in heifers is therefore needed to decrease new infections in this group.<sup>2</sup>

## Risk Factors

### Animal Risk Factors

Several animal risk factors influence the prevalence of infection and the occurrence of clinical mastitis caused by *S. aureus*.

### Local Defense Mechanisms

**Abrasions of the teat orifice epithelium** are an important risk factor for *S. aureus* mastitis. In experiments, teat canal infection or colonization may develop in 93% of experimentally abraded teat canal orifices compared with 53% in control quarters. Chapping of the teats and thickness of the teat barrel are correlated and significantly influence recovery of *S. aureus* from the skin.

### Colonization With Minor Pathogens

The presence of minor pathogens such as CNS protects against new intramammary infections associated with the major pathogen *S. aureus*. This may be the result of an elevated SCC or an antimicrobial-like substance provided by the CNS that inhibits the growth of *S. aureus*. Conversely, quarters infected with CNS may be more susceptible to new infections with *S. agalactiae*. Quarters that are infected with *C. bovis* are protected against *S. aureus* infection but not against most streptococcal species.

### Parity of Cow

The prevalence of intramammary infection and subclinical infection caused by *S. aureus*

increases with the parity of the cow. This is probably from the increased opportunity of infection with time and the prolonged duration of infection, especially in a herd without a mastitis control program.

### Presence of Other Diseases

The presence of periparturient diseases such as dystocia, parturient paresis, retained placenta, and ketosis has been identified as a risk factor for mastitis. The occurrence of sole ulcers in multiple digits may be associated with *S. aureus* in the first lactation.

### Heredity

Experimentally, the presence of certain bovine lymphocyte antigens increased the susceptibility to *S. aureus* infection, but heritability estimates of susceptibility after experimental challenge were low and unstable.

### Immune System

The infection rate of *S. aureus* is dependent on the ability of the immune system to recognize and to eliminate the bacteria. Staphylococcal antibodies are present in the blood of infected cows, but they appear to afford little protection against mastitis associated with *S. aureus*. This may be because of the low titer of the antibodies in the milk. Antibody titers in the serum rise with age and after an attack of mastitis.

The development or persistence of *S. aureus* mastitis depends on the interaction between invading bacteria and the host's defense system, principally the somatic cells in an infected gland, which are more than 95% polymorphonuclear cells. The number of bacteria isolated from milk samples of *S. aureus*-infected mammary glands is characterized by a cyclic increase and decrease concomitant with an inverse cycling of the SCC. This relationship between SCC and numbers of bacteria indicates that the cells within the mammary gland have a central role in the pathogenesis of *S. aureus* infection. There appear to be qualitative changes in the ability of the animal's somatic cells to phagocytose the bacteria. During the period of high SCC, the cells are able to kill bacteria 9000 times more efficiently than during the low-SCC period. The relative inability of the polymorphonuclear cells to kill bacteria during the low-SCC period may explain the source of reinfection. Phagocytosis and killing of the bacteria may also be inefficient because of low concentrations of opsonins, a lack of energy source, and the presence of casein and fat globules in the milk. The function of the intramammary polymorphonuclear cell (somatic cells) may also be affected by immunosuppression induced by cortisol and dexamethasone in treated cows.

## Environmental and Management Risk Factors

Several herd-level management risk factors are important for the spread of *S. aureus*.



Poor teat and udder cleaning can allow spread of the organism among quarters of the same cow, and can allow contamination of milking units, which are commonly transferred among cows without washing or rinsing. The use of high-line parlors is a risk; this may be caused by the greater fluctuation in vacuum, especially when units are removed, leading to a greater occurrence of teat-end impacts in which bacteria in the milking unit may enter the teat canal to establish a new udder infection.

Extensive surveys reveal that management procedures that are most effective in reducing infection rates and cell counts associated with infections with *S. aureus* are

- Postmilking teat dipping
- Maintaining a good supply of dry bedding for housed cows
- Thorough disinfection of the teat orifice before infusing intramammary preparations
- Milking clinical cases last

Failure to use these management techniques will increase the risk of intramammary infection with *S. aureus*.

## Pathogen Risk Factors

### Virulence Factors

It has been known since 1961 that a variety of strains of *S. aureus* associated with clinical mastitis exist and that some of these strains appear to be more infectious within a herd, differing in the severity of clinical signs and persistence of infection.<sup>3-9</sup> *S. aureus* has several virulence factors that account for its pathogenicity and persistence in mammary tissue in spite of adequate defense mechanisms and antimicrobial therapy. **Most isolates from cattle appear to be host adapted and different from human *S. aureus* isolates.** *S. aureus* has the ability to **colonize the epithelium** of the teat and the streak canal and can adhere and bind to epithelial cells of the mammary gland. The specific binding is to the extracellular matrix proteins fibronectin and collagen, which can induce the epithelial cell to internalize the organism, protecting it from both exogenous and endogenous bactericidal factors. Some strains of *S. aureus* are capable of **invading bovine mammary epithelial cells** in culture, and the invasion process requires eukaryotic nucleic acid and protein synthesis as well as bacterial synthesis.

Some strains of *S. aureus* produce **toxins**, some of which may cause **phagocytic dysfunction**. The  $\beta$ -toxin, or a combination of  $\alpha$ - and  $\beta$ -toxins, is produced by most pathogenic strains isolated from cattle, but its pathogenic significance is uncertain. The  $\beta$ -toxin damages bovine mammary secretory epithelial cells, increases the damaging effects of  $\alpha$ -toxin, increases the adherence of *S. aureus* to mammary epithelial cells, and increases the proliferation of the organism. All strains produce **coagulase** (hence the term coagulase-positive *S. aureus*), which

converts fibrinogen into fibrin; this appears to assist the invasion of tissues. **Leukocidin** produced by *S. aureus* may inactivate neutrophils. There is one report in a small number of cases that the presence of small colonies on bacterial culture (reflecting a slower rate of growth) is associated with chronic mastitis in cattle.<sup>10</sup>

Many staphylococcal strains (coagulase negative and coagulase positive) are able to produce an **extracellular exopolysaccharide layer** surrounding the cell wall called a **biofilm**. This capsular structure and its production of slime have been associated with virulence against host defense mechanisms because it facilitates bacterial adherence and colonization on mammary glandular epithelial cells and provides a protective “blanket” against immunologic attack and barrier to antibiotic diffusion. In addition, bacteria contained in a biofilm can have a low metabolic rate and therefore be less susceptible to antibiotic activity.<sup>11-14</sup> Biofilm-forming ability has been identified in 36% to 38% of cows with subclinical *S. aureus* mastitis.<sup>12,14</sup>

A major pathogenic factor is the ability of the organism to colonize and produce microabscesses in the mammary gland so that it is protected from normal defense mechanisms, including phagocytic activity from neutrophils. The difficulty in removing staphylococci from an infected quarter is largely caused by the bacteria's ability to survive in intracellular sites. There is also an ability to convert to a **nonsusceptible L-form** when exposed to antimicrobial agents and to return to standard forms when the antimicrobial is withdrawn.

### Genotype of Strains

**Phage typing and ribotyping** can be used to classify strains from clinical and subclinical *S. aureus* mastitis. **DNA fingerprinting techniques**, using PCR, are also being used to differentiate various strains of the organism. A large number of different types of *S. aureus* can be isolated from cases of bovine mastitis, but a few types predominate within different countries. Surveys have found that only a small number of genotypes cause most cases of *S. aureus* mastitis, which may be useful information in determining the dynamics of infection in a herd and how infection spreads from cow to cow. Fine-structure molecular epidemiologic analysis of *S. aureus* recovered from cows in the United States and Ireland indicates that only a few specialized clones of *S. aureus* are responsible for the majority of cases of bovine mastitis and that these clones have a broad geographic distribution. **A predominant strain is usually responsible for most clinical and subclinical *S. aureus* infections in a herd**, and it is currently thought that *S. aureus* is a clonal organism that spreads from cow to cow.<sup>3,5,6</sup> Moreover, most strains isolated from milk are different from strains isolated from the teat skin. In

other words, most *S. aureus* strains isolated from mastitis demonstrate both host and site specificity. This has important implications in the control of mastitis associated with *S. aureus*, because a rational and effective strategy for control of intramammary infections should be directed against clones that commonly cause disease.

### Methicillin-Resistant *Staphylococcus Aureus*

The increased concern about nosocomial **methicillin-resistant *S. aureus* (MRSA)** infections in human medicine and small animal practice<sup>15</sup> has led to surveys of MRSA prevalence in cattle with mastitis. In a study of 207 clinical mastitis cases in Iran, 20% were caused by *S. aureus* and 2.4% were caused by MRSA.<sup>16</sup> In 36 cows with subclinical mastitis in Brazil, 11% of infections were caused by MRSA,<sup>17</sup> and in Serbia 5% of 213 *S. aureus* isolates were identified as MRSA.<sup>18</sup> There are no data available indicating that the clinical course of MRSA mastitis episodes in cattle differs from episodes caused by methicillin-susceptible strains of *S. aureus*; however, MRSA isolation in Italian herds was more likely to be isolated in herds with low *S. aureus* prevalence, with 9% of *S. aureus* isolates being MRSA.<sup>19</sup>

### Economic Importance

The overall prevalence of mastitis caused by *S. aureus* is much higher than for *S. agalactiae*, and the need for culling causes much greater economic consequences. The risk of new infections is a continuing concern. Response to treatment is comparatively poor, and satisfactory methods for the eradication of staphylococcal mastitis from infected herds have yet to be devised.

### Zoonotic Implications

The presence of *S. aureus* in market milk may present a degree of risk to the consumer because of the organism's capacity to produce enterotoxins and a toxic shock syndrome toxin, which cause serious food poisoning. Mastitic milk does not constitute any large risk for *S. aureus* enterotoxin food poisoning.

## PATHOGENESIS

The disease can be reproduced experimentally by the injection of *S. aureus* organisms into the udder of cattle and sheep, but there is considerable variation in the type of mastitis produced. This does not seem to be caused by differences in virulence of the strains used, although strain variations do occur, but may be related to the size of the inoculum used or, more probably, to the lactational status of the udder at the time of infection. It is possible to induce *S. aureus* infection in the bovine teat cistern; the teat tissues are able to mount a marked local inflammatory response, but in spite of large numbers of neutrophils that invade the teat

they are unable to control the infection, except when the numbers of bacteria are low.

Infection during early lactation may result in the peracute form of mastitis, with gangrene of the udder. During the later stages of lactation or during the dry period new infections are not usually accompanied by a systemic reaction but result in the chronic or acute forms. Chronic *S. aureus* mastitis in cows has been converted to the peracute, gangrenous form by the experimental production of systemic neutropenia.

In the **gangrenous form** the death of tissue is precipitated by thrombosis of veins causing local edema and congestion of the udder. *S. aureus* is the only bacteria that commonly causes this reaction in the udder of the cow, and the resulting toxemia is caused by bacterial toxins and tissue destruction. Secondary invasion by *E. coli* and *Clostridium* spp. contributes to the severity of the lesion and production of gas.

The pathogenesis of acute and chronic *S. aureus* mastitis in the cow is the same; the variation occurs only in degree of involvement of mammary tissue. In both forms each focus commences with an acute stage characterized by proliferation of the bacteria in the collecting ducts and, to a lesser extent, in the alveoli. In **acute** mastitis the small ducts are quickly blocked by fibrin clots, leading to more severe involvement of the obstructed area.

In the **chronic** form there are fewer foci of inflammation, and the reaction is milder; the inflammation is restricted to the epithelium of the ducts. This subsides within a few days and is replaced by connective tissue proliferations around the ducts, leading to their blockage and atrophy of the drained area. The leukocyte infiltration into the stroma, the epithelial lining, and the lumina indicate an obvious deficiency of secretory and synthesizing capacity caused by limitation of the alveolar lumina and the distension of the stroma area.

A characteristic of chronic *S. aureus* mastitis that is important in its diagnosis is the cyclical shedding of the bacteria from the affected quarter. Paralleling this variation is a cyclical rise and fall in the number of polymorphonuclear cells in the milk and their capacity to phagocytose bacteria. In some cases abscesses develop and botryomycosis of the udder, in which granulomata develop containing gram-positive cocci in an amorphous eosinophilic mass, is also seen.

## CLINICAL FINDINGS

### Chronic *Staphylococcus aureus* Mastitis

The most important losses are caused by the chronic form or subclinical form of mastitis. Although 50% of cattle in a herd may be affected, only a few animals will have abnormalities recognizable by the milker. Many cases are characterized by a slowly developing induration and atrophy with

the occasional appearance of clots in the milk or wateriness of the first streams. The SCC of the milk is increased, as well as the CMT results of infected quarters, but the disease may go unnoticed until much of the functional capacity of the gland is lost. The infection can persist and the disease may progress slowly over a period of many months.

### Acute and Peracute *Staphylococcus aureus* Mastitis

Acute and peracute staphylococcal mastitis are rare but do occur and can be fatal, even if aggressively treated. **Acute *S. aureus* mastitis** is most common in early lactation. There is severe swelling of the gland, and the milk is purulent or contains many thick clots. Extensive fibrosis and severe loss of function always result.

**Peracute *S. aureus* mastitis** occurs usually in the first few days after calving and is highly fatal. There is a severe systemic reaction with elevation of the temperature to 41°C to 42°C (106°F–107°F), rapid heart rate (100–120 beats/min), complete anorexia, profound depression, absence of ruminal movements, and muscular weakness, often to the point of recumbency. The onset of the systemic and local reactions is sudden. The cow may be normal at one milking and recumbent and comatose at the next. The affected quarter is grossly swollen, hard and sore to touch, and causes severe lameness on the affected side.

**Gangrene** is a constant development and may be evident very early. A bluish discoloration develops that may eventually spread to involve the floor of the udder and the whole or part of the teat, or may be restricted to patches on the sides and floor of the udder. Within 24 hours the gangrenous areas become black and ooze serum and may be accompanied by subcutaneous emphysema and the formation of blisters. The secretion is reduced to a small amount of bloodstained serous fluid without odor, clots, or flakes. Unaffected quarters in the same cow are often swollen, and there may be extensive subcutaneous edema in front of the udder caused by thrombosis of the mammary veins. Toxemia is profound, and death usually occurs unless early, appropriate treatment is provided. Even with early treatment the quarter is invariably lost and the gangrenous areas slough. Separation begins after 6 to 7 days, but without interference the gangrenous part may remain attached for weeks. After separation, pus drains from the site for many more weeks before healing finally occurs.

## CLINICAL PATHOLOGY

### Culture of Individual Cow Milk

Bacteriologic culture of milk is the best method for identifying cows with *S. aureus* intramammary infection. A problem in the laboratory identification of *S. aureus* is that **bacteria are shed cyclically from infected**

**quarters, thus a series of samples are necessary to increase overall test sensitivity when culture is used.** The sensitivity of a composite (4-quarter) sample may be as low as 53%, but it is higher when performed on a quarter basis.<sup>20</sup> Factors that have the greatest impact on the sensitivity of culture, in order of importance, are the

- Type of milk sample
- Volume of milk cultured
- Time interval between repeated milk sample collection strategies

Quarter samples taken on day 1 and repeated either on day 3 or day 4, and cultured separately using 0.1 mL of milk for culture inoculum, were predicted to have sensitivities of 90% to 95% and 94% to 99%, respectively. Repeated quarter samples collected daily and cultured separately gave a sensitivity of 97% and a specificity from 97% to 100%. Culturing of composite milk samples instead of individual quarter samples increases the number of false-negative results in diagnosing *S. aureus* mastitis, but the sensitivity of composite samples can be increased by using 0.05 mL of milk for inoculation instead of 0.01 mL, which is the volume recommended by the National Mastitis Council (NMC). Freezing of milk samples before processing either does not affect the bacterial count or enhances it by about 200%; the latter response is attributed to fracturing of cells containing viable *S. aureus* bacteria. Bacterial counts of more than 200 CFU/mL are commonly used as a criterion for a positive diagnosis of infection.

Milk is typically plated onto sheep blood agar plates to facilitate the growth of a large range of potentially pathogenic microorganisms, but this does not facilitate the growth of all known pathogens. Biochemical tests such as a positive coagulase test and a positive catalase test are routinely used to differentiate *S. aureus* from other gram-positive cocci. *S. aureus* grows very well on sheep blood agar and typically produces a zone of incomplete lysis of erythrocytes around the colony, which may contain an inner zone of complete lysis called double hemolysis.<sup>21</sup> The presence of double hemolysis is diagnostic for *S. aureus*, but colony types that do not demonstrate this morphology need a tube coagulase test to be positive to make a diagnosis of *S. aureus* mastitis with 100% specificity. However, it needs to be recognized that not all coagulase-positive staphylococci are *S. aureus*. Differentiation is best performed by subculturing colonies on sheep blood agar with complete hemolysis at 24 hours' incubation onto CHROMagar plates; *S. aureus* isolates grow on this media as mauve to rose colonies.<sup>21</sup>

**MALDI-TOF MS** shows great promise as a rapid method for accurately differentiating *S. aureus* from the other seven staphylococcal spp. that are coagulase positive by analyzing the metabolic signature of a bacterial colony in under 4 hours.<sup>22</sup>

The Pathoproof Mastitis PCR assay has the highest test sensitivity (91%) and specificity (99%) from cow-level composite samples,<sup>20</sup> and it may provide the preferred test method for composite milk samples when the trade-off between test cost, sensitivity, and specificity is evaluated.

Numerous immunodiagnostic tests have been developed to diagnose *S. aureus* mastitis, with an emphasis on rapid cow-side diagnostic tests, but none of these tests has been able to achieve the appropriate balance between sensitivity, specificity, and cost.<sup>23</sup> Increased concentrations of haptoglobin and mammary-associated serum amyloid A occur in the milk of cows with *S. aureus* mastitis, accompanied by increases in serum concentrations of haptoglobin and serum amyloid A.<sup>24</sup>

### Culture of Bulk Tank Milk

The culture of 0.3 mL of bulk tank milk for *S. aureus* using special Baird–Parker culture media is a practical method for detecting the organism in bulk tank milk and monitoring its spread in dairy herds; the sensitivity and specificity for detection of the bacteria ranged from 90% to 100%.

### Somatic Cell Counts and California Mastitis Test

In an attempt to decrease the cost of sampling all quarters for culture, an alternative strategy is to use the SCC as a screening test to identify which cows to culture for *S. aureus*. For all intramammary infections, the sensitivity and specificity of SCC range from 15% to 40% and 92% to 99%, respectively. Composite milk sample SCCs have a low sensitivity, ranging from 31% to 54% for detecting cows with *S. aureus*. Individual quarter SCCs have a higher sensitivity, ranging from 71% to 95% depending on the study and cut point chosen, but quarter sampling is impractical because SCC is usually performed on a composite sample. Both composite and quarter milk SCC testing result in an unacceptably high proportion of infected cows being missed, and are therefore not currently recommended as a screening test if the goal is to identify all cows with an *S. aureus* intramammary infection in the herd.

CMT has also been used as a screening test to identify quarters or cows to culture. Using a CMT trace, 1, 2, or 3 to indicate the presence of an intramammary *S. aureus* infection produced a range of sensitivities from 0.47 to 0.96 and specificities of 0.41 to 0.80.<sup>20</sup>

In summary, culture of quarter milk samples (preferably) or a composite milk sample is superior to a quarter SCC or CMT for the diagnosis of *S. aureus* intramammary infection. Culture is strongly preferred if it is important to identify all positive cows in a herd because the sensitivity of indirect tests (such as SCC and CMT) is inadequate.

### Enzyme-Linked Immunosorbent Assays for Antibody in Milk

ELISA tests for detecting *S. aureus* antibody in milk have been developed but are not widely used. Rapid laboratory tests incorporating these ELISAs, including the Staph-Zym test, have demonstrated 84% to 90% accuracy in identifying staphylococci.

### Acriflavine Disk Assay

The acriflavine disk assay is a practical, accurate method for differentiating *S. aureus* isolates from non-*S. aureus* staphylococci.

### NECROPSY FINDINGS

In peracute staphylococcal mastitis, the affected quarter is grossly swollen and may contain bloodstained milk dorsally but only serosanguineous fluid ventrally. There is extreme vascular engorgement and swelling, often progressing to moist gangrene of the overlying skin. Bacteria are not isolated from the bloodstream or tissues other than the mammary tissue and regional lymph nodes. Histologically, there is coagulation necrosis of glandular tissue and thrombosis of veins.

In milder forms of staphylococcal mastitis the invading organisms often elicit a granulomatous response. Microscopically, such “botryomycotic” cases are characterized by granulomas with a central bacterial colony and by progressive fibrosis of the quarter.

### Samples for Confirmation of Diagnosis

- Bacteriology: chilled mammary tissue, regional lymph node
- Histology: fixed mammary tissue

### DIFFERENTIAL DIAGNOSIS

Because of the occurrence of the peracute form in the first few days after parturition, the intense depression, and inability to rise, the dairy producer may conclude that the cow has **parturient paresis**, which is characterized by weakness, recumbency, hypothermia, rumen stasis, dilated pupils, tachycardia with weak heart sounds, and a rapid response to intravenous calcium gluconate. The mammary gland is usually normal in parturient paresis.

**Peracute *S. aureus* mastitis** is characterized by marked tachycardia, fever, weakness, and evidence of severe clinical mastitis with swelling, heat, abnormal milk with serum and blood, and sometimes gas in the teat and often with gangrene of the teat up to the base of the udder. Other bacterial types of mastitis, particularly *Escherichia coli* and *Trueperella pyogenes*, may cause severe systemic reactions, but gangrene of the quarter is less common.

**Peracute coliform mastitis** is a much more common cause of severe mastitis than *S. aureus* mastitis. The chronic and acute

forms of staphylococcal mastitis are indistinguishable clinically from many other bacterial types of mastitis, and bacteriologic examination is necessary for identification.

### TREATMENT

The bacteriologic cure rates for the treatment of *S. aureus* mastitis with either intramammary infusion or parenteral antimicrobial administration are notoriously less than satisfactory, particularly in the lactating cow. Bacteriologic cure rates after antimicrobial treatment seldom exceed 50%, and infections commonly persist throughout the lifetime of the cow. There are three likely reasons: inadequate penetration of the antimicrobial agent to the site of infection, formation of L-forms of *S. aureus*, and  $\beta$ -lactamase production.

### Inadequate Penetration of Antimicrobial Agent

There is **inadequate penetration of the antimicrobial agent** into the site of intramammary infection in the lactating cow, and the organism survives in phagocytes that are inaccessible. There may also be inactivation of the antimicrobial by milk and serum constituents, and the formation of L-forms of the organism during treatment, varying between 0% and 80% of bacteria.

### Antimicrobial Resistance

**Antimicrobial-resistant strains** of *S. aureus* occur in specific geographic regions because of predominant *S. aureus* clones and are often  $\beta$ -lactamase producers; the enzyme confers resistance to  $\beta$ -lactam antimicrobial agents such as penicillin G, penethamate hydrochloride, ampicillin, and amoxicillin.<sup>25</sup> This emphasizes the need for knowledge of local epidemiologic factors when determining treatment in cases in which the results of culture and susceptibility testing are not available. Cloxacillin and nafcillin are effective, but only against gram-positive bacteria; they are less effective against nonlactamase staphylococci. Clavulanic acid added to amoxicillin overcomes this  $\beta$ -lactamase resistance as does **cloxacillin** added to ampicillin, and this is made use of in a popular intramammary formulation. First- and third-generation cephalosporins and erythromycin are effective against  $\beta$ -lactamase-producing staphylococci, and first- and third-generation cephalosporins are also effective against gram-negative bacteria. A cephalirin dry cow product administered to heifers with *S. aureus* infections resulted in bacteriologic cure and left the quarters clear well into their first lactation. Intramammary cloxacillin and ampicillin is generally considered to be the preferred initial treatment for *S. aureus* mastitis because  $\beta$ -lactamase production by *S. aureus* is sufficiently common.

Antimicrobial therapy for *S. aureus* subclinical mastitis during the lactating period



is not economically attractive because of low bacteriologic cure rates, discarding of milk during the withholding period, and the lack of an economically beneficial increase in production following treatment. Dry cow treatment at the end of lactation is much more effective, being successful in 40% to 70% of cases, although treatment should be attempted in heifers infected early in lactation. Cows that are infected with *S. aureus* should be appropriately identified, segregated if possible, and milked last or with separate milking units. Culling of infected cows is also an option for consideration, but a detailed economic analysis of this popular recommendation is lacking.

### Lactating Cow Therapy

The treatment of clinical cases of *S. aureus* mastitis using intramammary antimicrobial infusions is less than satisfactory but is often done. However, clinical recovery following therapy does not necessarily eliminate the infection, and some of the published literature on cure rates has not made the distinction between clinical and bacteriologic cure rates. Generally, the cure rate depends on the duration of infection, the number of quarters infected, whether it is a hindquarter or front quarter, whether the strain of *S. aureus* is a  $\beta$ -lactamase producer, the immune status of the cow, the antimicrobial agent administered, and the duration of treatment. Current recommendations to ensure the best treatment success rate are to combine intramammary and parenteral antimicrobial treatment or **use extended intramammary treatment alone for 4 to 8 days**. Penicillin G is regarded as the antimicrobial agent of choice for *S. aureus* strains that are penicillin sensitive. Intramammary pirlimycin also has good clinical efficacy when administered as extended therapy for 8 days.<sup>1</sup> An additional advantage of extended therapy with pirlimycin is decreased transmission of *S. aureus* infection within the herd and decreased incidence of strain-specific clinical mastitis within the herd.<sup>1</sup>

The following intramammary infusions, given daily at 24-hour intervals for 3 treatments (unless stated otherwise), have been used for the treatment of clinical cases of *S. aureus* mastitis, with expected clinical cure rates of about 27% to 60% in lactating cows. Subclinical cases are left until the cow is dried off:

- Sodium cloxacillin (200–600 mg for three infusions)
- Tetracyclines (400 mg)
- Penicillin-streptomycin combination (100,000 units, 250 mg)
- Penicillin-tylosin combination (100,000 units, 240 mg)
- Novobiocin (250 mg per infusion for three infusions)
- Cephalosporins (most strains of *S. aureus* are sensitive to cephalpirin)

- Cefquinome (75 mg per infusion for three infusions; fourth-generation cephalosporin)
- Pirlimycin-extended therapy (eight 50-mg doses, 24 hours apart, for 8 days)

In a study of 184 cases of subclinical *S. aureus* mastitis in New York, commercially available intramammary infusions were not significantly more effective than untreated controls (43% bacteriologic cure), with the following bacteriologic cure rates: erythromycin (65%), penicillin (65%), cloxacillin (47%), amoxicillin (43%), and cephalpirin (43%). In a multicentered randomized clinical trial in Europe, extended intramammary treatment with cefquinome improved clinical cure in lactating dairy cattle from 60% (three infusions 12 hours apart) to 84% (additional three infusions 24 hours apart), but did not alter bacteriologic cure.<sup>26</sup>

A slightly more effective treatment for subclinical *S. aureus* intramammary infection, with a cure rate of 50%, is simultaneous intramammary infusion of amoxicillin (62.5 mg) and intramuscular injection of procaine penicillin G (9,000,000 units). This study was the first to demonstrate that combined parenteral and intramammary therapy was more effective than intramammary infusion alone. Because of the persistence of the infection in each herd, the final choice of the antimicrobial to be used should be based on a culture and susceptibility test; the latter is to determine whether the predominant *S. aureus* strain in the herd is a  $\beta$ -lactamase producer; this is because  **$\beta$ -lactamase-producing strains are harder to cure and require a specific antibiotic protocol**. The bacteriologic cure rate for penicillin-sensitive infections treated with parenteral and intramammary penicillin G was 76%, compared with  $\beta$ -lactamase-producing strains treated with parenteral and intramammary amoxicillin-clavulanic acid (29%).

The application of cytokines as an adjunct to antimicrobial therapy may help to increase the number of phagocytes in the mammary gland and enhance cell function. The experimental intramammary infusion of recombinant interleukin into infected or uninfected mammary glands elicited an influx of polymorphonuclear leukocytes exhibiting subsequent enhanced activity and increased the cure rate 20% to 30% in quarters infected with *S. aureus*.

A novel method for decreasing the transmission of *S. aureus* within a herd is to **selectively cease lactation in infected quarters of lactating cattle**. The best method for permanently drying off a quarter is infusion of 120 mL of 5% povidone iodine solution (0.5% iodine) after complete milk out and administration of flunixin meglumine (1 mg/kg BW, intravenously). Therapeutic cessation of milk production in one quarter does not alter daily milk production but does decrease individual cow SCC and its contribution to

the bulk tank milk SCC. The final outcome of selectively drying off infected quarters is a decrease in the rate of new intramammary infections in the herds and a lowering in the bulk tank milk SCC.

### Peracute Mastitis

Early parenteral treatment of peracute cases with adequate doses of antimicrobials such as trimethoprim-sulfonamide or penicillin is deemed necessary to improve the survival rate. When penicillin is used the initial intramuscular injection should be supported by an intravenous dose of crystalline penicillin, with subsequent intramuscular doses to maintain the highest possible blood level of the antimicrobial over a 4- to 6-day period; ampicillin or penethamate hydriodide are preferred to achieve this. Intramammary infusions are of little value in such cases because of failure of the drugs to diffuse into the gland. The intravenous administration of large quantities of electrolyte solutions is also recommended. Hypertonic saline, as recommended for peracute coliform mastitis, has not yet been evaluated but may be indicated. Frequent massage of the udder with hot wet packs and milking out the affected gland is recommended. Oxytocin is used to promote letdown but is relatively ineffective in severely inflamed glands. Surgical amputation of the teat may be indicated to promote drainage of the gland, but only in cows with necrotic teats.

### Dry Cow Therapy

It has become a common practice to leave chronic *S. aureus* cases until they are dried off before attempting to eliminate the infection. The material is infused into each gland after the last milking of the lactation and left in situ. The major benefits of dry cow therapy are the **elimination of existing intramammary infections and prevention of new intramammary infections during the dry period**. In addition, milk is not discarded and bacteriologic cure rates are superior to those obtained during lactation.

The factors associated with a bacteriologic cure after dry cow therapy of subclinical *S. aureus* mastitis have been examined. The probability of cure of an infected quarter *decreased* when

- SCC increased (>250,000 cells/mL)<sup>26</sup>
- Age of cow increased
- Another quarter was infected in the same cow
- Infection was in a hindquarter
- The percentage of samples that were positive for *S. aureus* was higher before drying off

Cows with more than one infected quarter were 0.6 times less likely to be cured than cows with one infected quarter. The cure rate of quarters affected with *S. aureus* can be predicted using a formula that considers several cow factors and quarter factors. The prediction of the probability of cure in an 8-year-old cow with three quarters infected

with the organism and an SCC of 2,300,000 is 36%. In a 3-year-old cow with one quarter infected and an SCC of 700,000, the probability of cure is 92%. This information is often available at drying off and can be used to select cows that are unlikely to be cured to be removed from the herd by designating them as “do not breed” and culling when it is economically opportune.

Most intramammary antimicrobial infusions are satisfactory for dry cow therapy provided they are combined with slow-release bases. Bacteriologic cure rates vary between herds from 25% to 75% and average about 50%. The use of parenteral antimicrobials such as oxytetracycline along with an intramammary infusion of cephalixin did not improve the cure rate for *S. aureus*.

### CONTROL

Because of the relatively poor results obtained in the treatment of staphylococcal mastitis, any attempt at control must depend heavily on effective methods of preventing the transmission of infection from cow to cow. *S. aureus* is a contagious pathogen, the udder is the primary site of infection, and hygiene in the milking parlor is of major importance. To reduce the source of the organism, a program of early **identification, culling, and segregation** is important to control *S. aureus* mastitis in a dairy herd, although successful implementation of all three aspects is challenging. Satisfactory control of *S. aureus* mastitis has historically been difficult and unreliable; however, at the present time the quarter infection rate can be rapidly and profitably reduced from the average level of 30% to 10% or less.

The strategies and practices described under the control of bovine mastitis later in this chapter are highly successful for the control of *S. aureus* mastitis when applied and maintained rigorously. The control program includes the following:

- Ensure optimal teat condition, particularly around the teat orifice.
- Hygienic washing and drying of udders before milking, wearing disposable gloves during milking
- Regular milking-machine maintenance
- Teat dipping after milking. Teat dipping in 1% iodine or 0.5% chlorhexidine, either in 5% to 10% glycerin, is effective against *S. aureus* mastitis. In vitro studies have demonstrated that bacteria can grow at concentrations of iodine at  $\leq 0.1\%$  and chlorhexidine at  $\leq 0.0002\%$ .<sup>27</sup> Teat dipping helps to eliminate infected quarters and reduces the new infection rate by 50% to 65% compared with controls, and the addition of glycerin to the teat dip improves teat and teat-orifice condition. The disinfection of hands or use of rubber gloves provides additional advantages.
- Dry cow treatment on all cows
- Culling cows with chronic mastitis

- Milking infected cows last (very difficult to implement in free-stall housing or pasture feeding)

An alternative but radical control strategy when all else has failed is to permanently dry off the infected quarter using a povidone iodine infusion.

### Vaccination

Immunization against *S. aureus* mastitis has been widely researched for 100 years. Different vaccines based on cellular or soluble antigens with and without adjuvants have been given to dairy cows, but protection against infection and clinical disease has been unsatisfactory when used in the field. Currently available vaccines are autogenous bacterins (made to order using isolates from clinical cases on the farm), recombinant protein, DNA-recombinant protein, or contain one or more *S. aureus* strains that are thought to provide good cross-protection.<sup>28</sup> The goals of such vaccines are to decrease the severity of clinical signs and increase the cure rate, particularly when administered to heifers before they calve. Vaccination has also been used simultaneously with antimicrobial therapy during lactation or at dry off in an attempt to augment the cow's immune response, with mixed success. For example, combined administration of 3 doses of a polyvalent *S. aureus* bacterin over 21 days and intramammary administration of pirlimycin in all 4 quarters once daily for 5 days (days 16–20) eliminated *S. aureus* infection at a higher rate (40%) than untreated controls (9%).<sup>29</sup>

Based on published efficacy studies, currently available vaccines cannot be recommended as part of the routine measures for controlling *S. aureus* mastitis. Challenges with developing an effective vaccine include the intracellular location of infection, ability to produce a biofilm, and insufficient vaccine-induced opsonizing antibody in milk to facilitate phagocytosis and clearance of *S. aureus* from infected mammary gland tissue.<sup>30,31</sup>

Development of an effective *S. aureus* vaccine remains one of the most important issues confronting the control of infectious diseases in cattle.

### TREATMENT AND CONTROL

#### Treatment

Treat mild to moderate clinical cases during lactation with penicillin G formulation if susceptibility is known, otherwise administer  $\beta$ -lactamase-resistant intramammary formulation; consider using extended therapy (R-1).

Treat moderate to severe clinical cases during lactation with parenteral  $\beta$ -lactamase antimicrobial (such as penethamate hydriodide) and intramammary formulation; consider using extended therapy (R-1).

Treat subclinical infections in freshly calved heifers with penicillin G formulation if susceptibility is known, otherwise administer  $\beta$ -lactamase-resistant intramammary formulation; consider using extended therapy (R-1).

Treat subclinical infections during lactation (R-3).

#### Control

Implement 10-point mastitis control plan (R-1).

Cull chronically infected *S. aureus* mastitis cows (R-1).

Blanket dry cow therapy with  $\beta$ -lactamase-resistant intramammary formulation (R-1)

Milk *S. aureus*-infected cows last (R-2).

Eradicate infection from herd (R-2).

Vaccinate using *S. aureus* bacterins (R-3).

### FURTHER READING

- Barkema HW, Schukken YH, Zadoks RN. Invited Review: the role of cow, pathogen, and treatment regimen in the therapeutic success of bovine *Staphylococcus aureus* mastitis. *J Dairy Sci.* 2006;89:1877-1895.
- Keefe G. Update on control of *Staphylococcus aureus* and *Streptococcus agalactiae* for management of mastitis. *Vet Clin North Am Food Anim Pract.* 2012;28:203-216.
- Scali F, Camussone C, Calvino LF, et al. Which are important targets in development of *S. aureus* mastitis vaccine? *Res Vet Sci.* 2015;100:88-99.
- Zecconi A. *Staphylococcus aureus* mastitis: what we need to know to control them. *Israel J Vet Med.* 2010;65:93-99.

### REFERENCES

1. Barlow JW, et al. *BMC Vet Res.* 2013;9:28.
2. Ryman VE, et al. *Res Vet Sci.* 2013;95:343.
3. Anderson KL, et al. *Am J Vet Res.* 2006;67:1185.
4. Fournier C, et al. *Res Vet Sci.* 2008;85:439.
5. Graber HU, et al. *J Dairy Sci.* 2009;92:1442.
6. Capurro A, et al. *Vet J.* 2010;185:188.
7. Oliveira L, et al. *Am J Vet Res.* 2011;72:1361.
8. Piccinini R, et al. *J Dairy Res.* 2012;79:249.
9. Lundberg A, et al. *Acta Vet Scand.* 2014;56:2.
10. Atalla H, et al. *Foodborne Pathog Dis.* 2008;5:785.
11. Melchior MB, et al. *J Vet Med B.* 2006;53:326.
12. Oliveira M, et al. *Vet Microbiol.* 2006;118:133.
13. Oliveira M, et al. *Vet Microbiol.* 2007;124:187.
14. Snel GGM, et al. *Vet Microbiol.* 2014;174:489.
15. Middleton JR, et al. *J Clin Microbiol.* 2005;43:2916.
16. Jamali H, et al. *J Dairy Sci.* 2014;97:2226.
17. Silva NCC, et al. *Lett Appl Microbiol.* 2014;59:665.
18. Savic NR, et al. *Acta Vet Beograd.* 2014;64:115.
19. Luini M, et al. *Vet Microbiol.* 2015;178:270.
20. Mahmmoud YS, et al. *Prev Vet Med.* 2013;112:309.
21. Graber HU, et al. *Res Vet Sci.* 2013;95:38.
22. Motta CC, et al. *African J Microbiol Res.* 2014;8:3861.
23. Febres-Klein MH, et al. *Eur J Clin Microbiol Infect Dis.* 2014;33:2095.
24. Eckersall PD, et al. *J Dairy Sci.* 2006;89:1488.
25. Sakwinska O, et al. *Appl Environ Microbiol.* 2011;77:3428.
26. Swinkels JM, et al. *J Dairy Sci.* 2013;96:4983.
27. Azizoglu RO, et al. *J Dairy Sci.* 2013;96:993.
28. Pereira UP, et al. *Vet Microbiol.* 2011;148:117.
29. Smith GW, et al. *J Am Vet Med Assoc.* 2006;228:422.
30. Middleton JR, et al. *J Dairy Res.* 2006;73:10.
31. Middleton JR, et al. *Vet Microbiol.* 2009;134:192.

## STREPTOCOCCUS AGALACTIAE

### SYNOPSIS

**Etiology** *Streptococcus agalactiae* is a major pathogen of the mammary gland and a common cause of contagious bovine mastitis in some countries.

**Epidemiology** Major cause of mastitis in dairy herds without an effective mastitis control program. Prevalence of infection 10%–50% of cows and 25% of quarters. In herds with an effective control program there is a prevalence of less than 10% of cows. Has been eliminated from many herds with treatment and control. Highly contagious obligate pathogen. Infection is transmitted at milking.

**Clinical findings** Individual repeated episodes of subacute to acute mastitis are most common. Gland is swollen and warm, and milk is watery and contains clots. Gradual induration of udder if not treated

**Clinical pathology** Culture of individual cow milk samples or bulk tank milk samples. Latex agglutination test

**Necropsy findings** Not important

**Diagnostic confirmation** Latex agglutination test for specific identification of organism

**Differential diagnosis** Cannot differentiate clinically from other causes of acute and chronic mastitis. Must culture milk

**Treatment** Mastitis associated with *S. agalactiae* in lactating cows is sensitive to intramammary therapy with a wide variety of antimicrobial agents resulting in a high rate of clinical and bacteriologic cures. Blitz therapy (simultaneous treatment of all positive cows in a herd) is commonly used to reduce prevalence of infection in herd.

**Control** Eradication is possible. Identify and treat infected quarters, cull incurable cows. Premilking teat and udder sanitation, postmilking teat dipping, and dry cow therapy

### ETIOLOGY

*Streptococcus agalactiae* infections with environmental streptococci are described in the next section.

### EPIDEMIOLOGY Occurrence and Prevalence of Infection

*S. agalactiae* was the major cause of mastitis before the antimicrobial era and is still a significant cause of chronic mastitis in which control procedures for contagious mastitis are not used. Herd prevalence rates of infection range from 11% to 47%. Typically, in a herd infected with the pathogen, the prevalence of infection could be as high as 50% of cows, but more recent surveys indicate much lower within-herd prevalences, ranging from 8% to 10%. Where good hygienic measures and the efficient treatment of clinical cases are in general use, the prevalence of infection

within a herd will be less than 10% of cows. Following the use of antimicrobial agents, *S. agalactiae* was superseded by *S. aureus* and coagulase-negative *Staphylococcus* spp. as the major cause of bovine mastitis. In herds with a high bulk tank milk SCC, the probability is high that *S. agalactiae* infection is the most prevalent pathogen.

### Source of Infection

*S. agalactiae* is a highly contagious obligate parasite of the bovine mammary gland. The main source of infection is the udder of infected cows, although when hygiene is poor contamination of the environment may provide an additional source. The teats and skin of cattle, milkers' hands, floors, utensils, and clothes are often heavily contaminated. Sores on teats are the most common sites outside the udder for persistence of the organism. The infection may persist for up to 3 weeks on hair and skin and on manure and bricks. The importance of environmental contamination as a source of infection is given due recognition in the general disinfection technique of eradication. Spread of infection between herds is most often associated with purchase of infected cows and heifers but can also result from hiring of relief milkers.<sup>1</sup>

### Transmission of Infection

Transmission from animal to animal is most common from the medium of milking machine liners, hands, udder cloths, and possibly bedding.

The streak canal is the portal of entry, although there is doubt as to how invasion into the teat canal and then gland occurs. Suction into the teat during milking or immediately afterward does occur, but growth of the bacteria into the canal between milking also appears to be an important method of entry. It is difficult to explain why heifers that have never been milked may be found to be infected with *S. agalactiae*, although suckling between calves after ingestion of infected milk or contact with infected inanimate materials may be sources of infection.

### Risk Factors

There is no particular breed susceptibility, but infection does become established more readily in older cows and in the early part of lactation. Poor hygiene, incompetent milking personnel, and faulty or maladjusted machinery are important risk factors. **The most important risk factors are the failure to use postmilking teat dip and the selective or nonuse of dry cow therapy.** The use of a common washrag or sponge is also a risk factor. Inadequate treatment of clinical cases of mastitis is also a frequent risk factor in infected herds.

*S. agalactiae* has the ability to adhere to the mammary gland tissue, and the specific microenvironment of the udder is necessary for growth of the organism. The virulence of

various strains of the organism is related to differences in their ability to adhere to the mammary epithelium. Bacterial ribotyping has been used to characterize strains of the organism to determine their geographic distribution. The physical characteristics of the teat canal may influence the susceptibility to streptococcal infection. The mechanisms used by *S. agalactiae* to penetrate the teat canal are influenced more by the diameter of the teat canal lumen, as reflected by the peak flow rate, than by teat canal length.

### Economic Importance

The disease is of major economic importance in milk production. In individual cows, the loss of production associated with *S. agalactiae* mastitis is about 25% during the infected lactation, and in affected herds the loss may be of the order of 10% to 15% of the potential production. Reduction of the productive life represents an average loss of one lactation per cow in an affected herd. Deaths caused by *S. agalactiae* infection rarely if ever occur, and complete loss of productivity of a quarter is uncommon; the losses are incurred in the less dramatic but no less important fashion of decreased production per cow.

### PATHOGENESIS

When the primary barrier of the streak canal is passed, if bacteria are not flushed out by the physical act of milking they proliferate and invasion of the udder tissue follows. There is considerable variation between cows in the developments that occur at each of the three stages of invasion, infection, and inflammation. The reasons for this variation are not clear, but resistance appears to depend largely on the integrity of the lining of the teat canal. After the introduction of infection into the teat, the invasion, if it occurs, takes 1 to 4 days and the appearance of inflammation 3 to 5 days. Again there is much variation between cows in the response to tissue invasion, and a balance may be set up between the virulence of the organism and undefined defense mechanisms of the host so that very little clinically detectable inflammation may develop despite the persistence of a permanent bacterial flora.

The **development of mastitis** associated with *S. agalactiae* is essentially a process of invasion and inflammation of lobules of mammary tissue in a series of crises, particularly during the first month after infection. Each crisis develops in the same general pattern. Initially there is a rapid multiplication of the organism in the lactiferous ducts, followed by passage of the bacteria through the duct walls into lymphatic vessels and to the supramammary lymph nodes, and an outpouring of neutrophils into the milk ducts. At this stage of initial tissue invasion, a short-lived systemic reaction occurs, and the milk yield falls sharply as a result of inhibition and stasis of secretion caused by damage to acinar and ductal epithelium.



Fibrosis of the interalveolar tissue and involution of acini result even though the tissue invasion is quickly cleared. Subsequently, similar crises develop and more lobules are affected in the same way, resulting in a step-wise loss of secretory function with increasing fibrosis of the quarter and eventual atrophy.

The **clinicopathologic findings** vary with the stage of development of the disease. Bacterial counts in the milk are high in the early stages but fall when the SCC rises at the same time as swelling of the quarter becomes apparent. In some cases bacteria are not detectable culturally at this acute stage. The SCC rises by 10 to 100 times normal during the first 2 days after infection and returns to normal over the next 10 days. The febrile reaction is often sufficiently mild and short-lived to escape notice. When the inflammatory changes in the epithelial lining of the acini and ducts begin to subside, the shedding of the lining results in the clinical appearance of clots in the milk. Thus the major damage has already been done when clots are first observed. At the stage of acute swelling, it is the combination of inflamed interalveolar tissue and retained secretion in distended alveoli that causes the swelling. Removal of the retained secretion at this stage may considerably reduce the swelling and permit better diffusion of drugs infused into the quarter. Inflammatory reactions also occur in the teat wall of affected quarters.

The variations in resistance between cows and the increased susceptibility with advancing age are unexplained. Hormonal changes and hypersensitivity of mammary tissue to streptococcal protein have both been advanced as possible causes of the latter. Local immunity of mammary tissue after an attack probably does not occur, but there is some evidence to suggest that a low degree of general immunity may develop. The rapid disappearance of the infection in a small proportion of cows in contrast to the recurrent crises that are the normal pattern of development suggests that immunity does develop in some animals. The antibodies are hyaluronidase inhibitors and are markedly specific for specific strains of the organism. A nonspecific rise in other antibodies may occur simultaneously, and this is thought to account for the field observations that coincident streptococcal and staphylococcal infections are unusual and that the elimination of one infection may lead to an increased incidence of the other.

### CLINICAL FINDINGS

In the experimentally produced disease, there is initially a sudden episode of acute mastitis, accompanied by a transient fever, followed at intervals by similar attacks, which are usually less severe. In natural cases fever, lasting for a day or two, is occasionally observed with the initial attack, but the inflammation of the gland persists and the

subsequent crises are usually of a relatively mild nature. These degrees of severity may be classified as **abnormal cow** when the animal is febrile and off its feed; **abnormal gland** when the inflammation of the gland is severe, but there is no marked systemic reaction; and **abnormal secretion** when the gland is not greatly swollen, pain and heat are absent, and the presence of clots in watery foremilk may be the only apparent abnormality. Induration is most readily palpable at the udder cistern and in the lower part of the udder and varies in degree with the stage of development of the disease.

The milk yield of affected glands is markedly reduced during each crisis but, with proper treatment administered early, the yield may return to almost normal. Even without treatment the appearance of the milk soon becomes normal, but the yield is significantly reduced and subsequent crises are likely to reduce it further.

### CLINICAL PATHOLOGY

The **CAMP test**, which has served as the universally used means of identifying *S. agalactiae* for many years, has been displaced by a commercial **latex agglutination test**, which contains specific reagents necessary for the identification of *S. agalactiae* and is suitable for general laboratory use. When used on isolates of samples from bulk tank milk, the sensitivity and specificity are 97.6% and 98.2%, respectively. An ELISA test correlates well with the bulk tank milk SCC and provides a suitable alternative.

The critical judgment to be made is deciding when the quarter infection rate is so high that control or eradication measures are necessary. A decision can be made on the basis of the bulk tank milk SCC as an indicator of the prevalence of mastitis on a quarter basis and on culture of the bulk tank milk sample to indicate that *S. agalactiae* is the important pathogen, but this approach is too inaccurate to be recommended. There seems to be no alternative to performing bacteriologic culture and determining SCC on milk samples from individual cows or quarters. Milk samples collected for bacteriologic examination for the presence of *S. agalactiae* can be stored in the frozen state. The number of samples that will be culturally positive when the stored frozen samples are thawed will either be unchanged or enhanced up to 200%; the latter response is attributed to fracturing of cellular debris containing *S. agalactiae*.

### Culture From Bulk Tank Milk Samples

The presence of the organism in bulk tank milk is caused by shedding of bacteria from infected quarters, and cyclic shedding is typical. The specificity of culture from bulk tank milk is very high; the sensitivity is more variable and typically much lower but can be increased by using selective media. A rapid, real-time quantitative PCR assay, the

PathoProof mastitis PCR, provides a useful herd test when performed on bulk tank milk, because the test detects both growth-inhibited and nonviable bacteria.<sup>2</sup> When used at a cycle threshold of <40 this PCR test can be considered as a positive; however, for cycle thresholds >40 bacteriologic culture is recommended to confirm the presence of infection. A quantitative PCR assay specific for *S. agalactiae* has been developed.<sup>3</sup>

### Total Bacterial Count

The total bacterial count in bulk tank milk can be markedly increased because of the presence of *S. agalactiae* mastitis in the herd. Samples of bulk tank milk from infected herds commonly contain bacterial counts in the range of 20,000 to 100,000 CFU/mL, because a cow in the early stages of infection can shed up to 100,000,000 bacteria/mL. The standard plate count can drop from 100,000 to 2,000 CFU/mL after implementation of a modified blitz therapy and control program to control *S. agalactiae*.

### Culture From Individual Cow Samples

Composite milk samples are satisfactory, because the number of cows identified as positive does not increase by quarter sampling. The sensitivity and specificity of a single culture from individual cows ranges between 95% and 100%.

### Somatic Cell Count

*S. agalactiae* produces high SCC in individual cows, which has a significant influence on the bulk tank milk SCC.

### NECROPSY FINDINGS

The gross and microscopic pathology of mastitis associated with *S. agalactiae* are not important in the diagnosis of the disease.

### DIFFERENTIAL DIAGNOSIS

The clinical diagnosis of *S. agalactiae* mastitis depends entirely on the isolation of *S. agalactiae* from the milk. Differentiation from other types of acute and chronic mastitis is not possible clinically.

### TREATMENT

*S. agalactiae* is **very sensitive to intramammary therapy** using a wide variety of commercially available intramammary infusion preparations. Systemic therapy is also effective but offers no advantages over the intramammary route. Clinical cases should be treated whenever they occur because of the need to prevent transmission to uninfected quarters and cows. Subclinical cases identified at any stage of lactation should be treated immediately because of the excellent response to treatment. Treatment of *S. agalactiae* mastitis with intramammary infusions will result in a high percentage of infections being eliminated economically

and with few residual concerns, provided the milk withholding times are observed.

Infections at all stages of lactation have 90% to 100% cure rates with penicillin, erythromycin, cloxacillin, and cephalosporins. Gentamicin, neomycin, nitrofurazone, and polymyxin B have poor activity. Procaine penicillin G is universally used as a mammary infusion at a dose rate of 100,000 units. Higher dose rates have the disadvantage of increasing penicillin residues in the milk. A moderate increase in efficiency is obtained by using procaine penicillin rather than the crystalline product, and by using 100,000 units of penicillin in a long-acting base the cure rate (96%) is significantly better than with quick-acting preparations (83%).

To provide a broader spectrum of antimicrobial efficiency penicillin is often combined with other drugs that are more effective against gram-negative organisms. A mixture of penicillin (100,000 units) and novobiocin (150 mg) provides a cure rate ranging from 89% to 98%. It is necessary to maintain adequate milk levels for 72 hours: three infusions at intervals of 24 hours are recommended, but dosing with two infusions 72 hours apart, or one infusion of 100,000 units, in a base containing mineral oil and aluminum monostearate, gives similar results. As a general rule clinical cases should be treated with three infusions, and subclinical cases, particularly those detected by routine examination in a control program, with one infusion. Recovery, both clinically and bacteriologically, should be achieved in at least 90% of quarters if treatment has been efficient. Intramuscular administration of ceftiofur is not efficacious as a treatment to eliminate the organism, compared with intramammary infusion of penicillin (100,000 units) and novobiocin (150 mg) daily for two treatments. Likewise, intramuscular administration of penethamate hydriodide (5 g) was not as effective as a treatment to eliminate *S. agalactiae* compared with intramammary infusion of ampicillin (75 mg) and cloxacillin (200 mg) twice daily for 3 days.<sup>4</sup>

Other antimicrobial agents used in the treatment of *S. agalactiae* infections include the tetracyclines and cephalothin, which are as effective as penicillin and have the added advantage of a wider antibacterial spectrum, an obvious advantage when the type of infection is unknown. Neomycin is inferior to penicillin in the treatment of *S. agalactiae* mastitis, whereas tylosin and erythromycin appear to have equal efficacy. A single treatment with 300 mg of erythromycin is recommended as curing 100% of quarters infected with *S. agalactiae*. Lincomycin (200 mg) combined with neomycin (286 mg) and administered twice at 12-hour intervals also has good efficacy. In a study of 1927 cases of subclinical *S. agalactiae* mastitis in New York, all commercially available intramammary infusions were more effective than

untreated controls (27% bacteriologic cure), with the following bacteriologic cure rates: amoxicillin (86%), erythromycin (81%), cloxacillin (77%), cephalirin (66%), penicillin (63%), hetacillin (62%), pirlimycin (44%).

In dry cows, one infusion is sufficient, and milk concentrations of penicillin remain high for 72 hours. Cloxacillin eliminated the organism from 98% and 100% of infected cows in two different studies.

### Blitz Therapy

The prevalence of subclinical mastitis caused by *S. agalactiae* can be reduced more rapidly by treatment of infected cows during lactation than by dry cow therapy and postmilking teat dipping. *S. agalactiae* is one of the few pathogens causing subclinical mastitis that can be treated economically during lactation and can be eliminated from herds with **blitz antimicrobial therapy followed by good sanitation procedures**. All cows are sampled, and those that are positive are treated simultaneously with penicillin and novobiocin. Cows not responsive to the first treatment are identified and retreated or culled. Failure to institute sanitation procedures for the control of the pathogen may result in subsequent outbreaks of mastitis.

If blitz therapy of all infected cows is not possible because of the short-term effect of lost milk production on income, a modified treatment protocol is recommended. The herd is divided into two groups, based on a composite milk SCC of 500,000. Those cows in the high category are treated with 300 mg of erythromycin, intramammarily. When lactating cow numbers reach their lowest point, all animals are treated with the same product. At drying off, cows are treated with 500 mg of cloxacillin and 250 mg of ampicillin.

### CONTROL

Eradication on a herd basis of mastitis associated with *S. agalactiae* is an accepted procedure and has been undertaken on an area scale in some countries. The control measures as outlined later in this chapter are designed especially for this disease and should be adopted in detail. If suitable hygienic barriers against infection can be introduced and if the infection can be eliminated from individual quarters by treatment, the disease is eradicable fairly simply and economically.

The control program consists of

- Identifying infected quarters
- Treating infected quarters on two occasions if necessary
- Culling incurable cows

The control program is particularly applicable in herds in which an unacceptable level of clinical cases is backed by a high incidence of subclinical infections. **Premilking teat dipping, and dry cow therapy** are vital aspects of the control program.

### Vaccination

Vaccination against *S. agalactiae* has been attempted and elicits systemic hyperimmunity but no apparent intramammary resistance. Development of an effective vaccine will be difficult because of the multiplicity of strains involved and the known variability between animals in their reaction to intramammary infection.

### Biosecurity

As with any eradication program a high degree of vigilance is required to maintain a "clean" status. This is particularly so with mastitis caused by *S. agalactiae*. Breakdowns are usually caused by the introduction of infected animals, even heifers that have not yet calved, or the employment of milkers who carry infection with them. Most dairy farms in the United States are in an ongoing process of herd expansion or replacement acquisition by the addition of purchased animals. Introduction of contagious mastitis associated with *S. agalactiae*, *S. aureus*, and *M. bovis* is a common result. It has been recommended that herd additions should be screened for these important pathogens; however, currently available screening tests do not have perfect sensitivity.

#### TREATMENT AND CONTROL

##### Treatment

Treat clinical cases during lactation with penicillin G formulation (R-1).

Consider blitz therapy of herd using intramammary formulation during lactation (R-2).

Treat clinical cases during lactation with parenteral antimicrobial (such as penethamate hydriodide) (R-3).

##### Control

Implement 10-point mastitis control plan, including postmilking teat dip or spray (R-1).

Blanket dry cow therapy with intramammary formulation (R-1)

Eradicate infection from herd (R-1).

Vaccinate against *S. agalactiae* (R-3).

### FURTHER READING

Keefe G. Update on control of *Staphylococcus aureus* and *Streptococcus agalactiae* for management of mastitis. *Vet Clin North Am Food Anim Pract.* 2012;28:203-216.

### REFERENCES

1. Mweu MM, et al. *Prev Vet Med.* 2012;106:244.
2. Mweu MM, et al. *Vet Microbiol.* 2012;159:181.
3. de Carvalho NL, et al. *Curr Microbiol.* 2015;71:363.
4. Reyes J, et al. *J Dairy Sci.* 2015;98:5294.

## CORYNEBACTERIUM BOVIS

### ETIOLOGY

*Corynebacterium* spp. are a common contagious cause of subclinical mastitis in dairy

cows, and 89% of isolates are *C. bovis*.<sup>1</sup> For this reason, mastitis isolates identified as *Corynebacterium* spp. are frequently termed *C. bovis*. It has been cultured from dairy cattle with clinical mastitis in 1.7% of cases and, in a herd that had controlled contagious mastitis pathogens, *C. bovis* was the only pathogen isolated in 22% of clinical mastitis episodes. There is considerable debate about the significance of *C. bovis* infections for mammary gland health and cow productivity. For this reason, *C. bovis* is classified as a **minor pathogen**.

### EPIDEMIOLOGY

The main reservoir of infection appears to be the teat canal region, but *C. bovis* is also isolated from the teat cistern, gland cistern, and mammary parenchyma.<sup>2</sup> *C. bovis* spreads rapidly from cow to cow in the absence of adequate teat dipping. It is extremely contagious, and the duration of intramammary infection is long (many months). The prevalence of *C. bovis* is typically low in herds using an effective germicidal teat dip, good milking hygiene, and dry cow therapy.

In vivo and in vitro studies have demonstrated that the bacteria has a predilection for the streak canal, and this predilection has been associated with a requirement for lipids (possibly in the keratin plug) for growth. It is possible that *C. bovis* infection in the streak canal may compete with ascending bacterial infections for nutrients, decreasing the new intramammary infection rate. Alternatively, the mild increase in SCC associated with *C. bovis* infection might increase the ability of the quarter to respond to a new intramammary infection. The *C. bovis* genome has been sequenced, and this indicated a bacteria that is well equipped to reside in the bovine udder, particularly the streak canal. The genome contains a number of genes related to lipolysis, including metabolism of glycerols and phosphoacylglycerols, and utilization of casein and lactose.<sup>3</sup>

Intramammary infection with *C. bovis* induces a higher than normal SCC,<sup>2</sup> increasing the resistance of the colonized quarter to invasion by a major pathogen. In particular, the lowest rate of intramammary infection with major pathogens is observed in quarters infected with *C. bovis*.

### CLINICAL FINDINGS

An intramammary infection with *C. bovis* is infrequently associated with clinical disease but usually causes a mild to moderate increase in the SCC and a small increase in the CMT score.<sup>4</sup> Milk production losses are usually not detectable, and the mastitis is typically a thicker than normal milk (abnormal secretion); occasional cases also have a large firm gland (abnormal gland), with systemic signs of illness being unusual (abnormal cow). There are clear herd-to-herd differences in the apparent clinical

pathogenicity of *C. bovis*, suggesting that strains of different virulence are present.

### TREATMENT

*C. bovis* is very susceptible to penicillin, ampicillin, amoxicillin, cephapirin, and erythromycin and most other commercially available intramammary infusions. There is no need for parenteral treatment. The duration of infection is prolonged (months) in animals not treated with antimicrobial agents.

### CONTROL

Long-term intensive programs of teat dipping and dry cow therapy will markedly reduce the prevalence of *C. bovis*. Because of its status as a minor pathogen, specific control measures (such as vaccination) are not indicated.

#### TREATMENT AND CONTROL

##### Treatment

Treat *Corynebacterium bovis* clinical mastitis episodes during lactation with an intramammary formulation (R-1).

##### Control

Implement 10-point mastitis control plan, with particular emphasis on teat dipping/spraying and blanket dry cow intramammary treatment (R-1).

### REFERENCES

1. Gonçalves JL, et al. *Vet Microbiol*. 2014;173:147.
2. Blagitz MG, et al. *J Dairy Sci*. 2013;96:3750.
3. Schröder J, et al. *J Bacteriol*. 2012;194:4437.
4. Madut NA, Gadir AEA. *J Cell Anim Biol*. 2011;5:6.

## **M. BOVIS AND OTHER MYCOPLASMA SP.**

### ETIOLOGY

A number of species of *Mycoplasma*, especially *M. bovis* and occasionally *Mycoplasma* species group 7, *Mycoplasma* F-38, *M. arginini*, *M. bovirhinis*, *M. canadensis*, *M. bovirhinis*, *M. alkalescens*, *M. capricolium*, *M. californicum*, and *M. dispar*, have been isolated from clinical cases. Other mycoplasmas, not usually associated with the development of mastitis, also cause the disease when injected into the udder. There is also evidence of mastitis associated with *Ureaplasma* spp. A striking characteristic of the mycoplasmas is that they seem to be able to survive in the presence of large numbers of leukocytes in the milk. Antibodies to the bacteria have not been detectable in sera or whey from animals infected with some strains, but complement-fixing antibodies are present in the sera of animals recovered from infection with other strains.

### SYNOPSIS

**Etiology** *Mycoplasma bovis*, other *Mycoplasma* spp.

**Epidemiology** A highly contagious mastitis causing outbreaks of clinical mastitis. Most common in large herds with recent introductions. Transmitted within herds by bulk mastitis treatments and poor milking hygiene. Cows of all ages and any stage of lactation but those in early lactation are most severely affected.

**Clinical findings** Sudden onset of clinical mastitis in many cows, usually all four quarters, marked drop in milk production and may stop lactating, swelling of the udder and gross abnormality of the milk without obvious signs of systemic illness, eventually udders atrophy and do not return to production. Can cause clinical, subclinical, and chronic intramammary infections. Calves suckling milk from infected cows may develop otitis media/interna.

**Clinical pathology** Special culture and staining of milk techniques

**Necropsy findings** Purulent interstitial mastitis

**Diagnostic confirmation** Identification of pathogen in milk

**Differential diagnosis** Epidemiology and clinical findings are characteristic of *Mycoplasma* mastitis. May resemble other causes of chronic mastitis unresponsive to treatment

**Treatment** Not responsive to commonly used mastitis treatments protocols. Identify and cull affected cows for slaughter.

**Control** Prevent entry of infected cows into herd. Eradicate infection by culling affected cows.

*Acholeplasma laidlawii* is not a mastitis pathogen, but it has been observed that a high proportion of bulk tanks will give positive cultural tests for it, especially during wet, rainy weather. This increase is accompanied by an increase of clinical mycoplasma mastitis caused by pathogenic mycoplasma. *A. laidlawii* is considered to be a milk contaminant in these circumstances.

The group of diseases, including mastitis, that are associated with *Mycoplasma* spp. in sheep and goats are dealt with separately.

### EPIDEMIOLOGY

#### Occurrence and Prevalence of Infection

The disease was first reported in 1961 in the United States and since then has been recorded in Canada, Europe, Israel, and Australia. The quarter infection rate in infected herds varies widely.

#### Source of Infection

The epidemiology of the disease has been incompletely characterized. *Mycoplasma*



mastitis is most common in large herds and in herds in which milking hygiene is poor and when cows are brought in from other farms or from public saleyards. *Mycoplasma* mastitis usually breaks out subsequently after a delay of weeks or even months. The delay in development of an outbreak may be related to the long-term persistence of the organism (more than 12 months) in some quarters, and some cows become shedders of the organism without ever exhibiting signs of severe clinical mastitis.

*M. bovis* is capable of colonizing and surviving in the upper respiratory tract and the vagina, and extramammary colonization explains many of its epidemiologic paradoxes. An interesting epidemiologic observation is the detection of mycoplasmas and infectious bovine rhinotracheitis virus in affected udders at the same time. The virus could be the much sought after unknown factor in the etiology of the disease. Outbreaks of mastitis are recorded concurrently with outbreaks of vaginitis and otitis media/interna vestibulitis.

### Transmission

Entry of the disease to a herd is usually by the purchase of animals and their introduction without quarantine. Transmission within a herd is most common at milking via machine milking or the hands of milkers.<sup>1</sup> Transmission can also be through the use of bulk mastitis treatments administered through a common syringe and cannula. Although the disease occurs first in the inoculated quarter, there is usually rapid spread to all other quarters.

Hematogenous spread of *M. bovis* has been demonstrated. Colonization of body sites other than the mammary gland is common, and *M. bovis* isolates from the respiratory and urogenital systems are frequently the same *M. bovis* subtypes that cause mastitis.

*Mycoplasma* spp. group 7 has also been isolated from cases of pneumonia and polyarthritis in calves fed milk from cows with mycoplasmal mastitis.

### Risk Factors

Cows of all ages and at any stage of lactation are affected, and cows that have recently calved show the most severe signs and dry cows the least severe signs. There are several recorded outbreaks in dairy herds in dry cows, and one of them is immediately after mammary infusions of dry period treatment that affected all quarters of all cows.

Experimental production of the disease with *M. bovis* causes severe loss of milk production, a positive CMT reaction, and clots in the milk. Experimental infection produces little tissue necrosis, but *Mycoplasma* are detectable in many tissues, including blood, vagina, and fetus, indicating that hematogenous spread has occurred. It is also apparent that spread of infection between quarters in

one cow can be hematogenous. There are no significant pathologic differences between mastitis produced by *M. bovis* and *M. bovis*; however, *M. bovis* remains the most common cause of mycoplasmal mastitis in dairy cattle.

### Economic Importance

The disease is a disastrous one because of the high incidence in affected herds and the almost complete cessation of lactation. Many cows fail to ever return to milking; as many as 75% of affected cows may have to be culled.

### PATHOGENESIS

This is a purulent interstitial mastitis. Although infection probably occurs via the streak canal, the rapid spread of the disease to other quarters of the udder and occasionally to joints suggests that hematogenous spread may occur. The presence of the infection in heifers milked for the first time also suggests that systemic invasion may be followed by localization in the udder.

*M. bovis* appears to have a number of virulence attributes, with **variable surface lipoproteins** (Vsp) an important virulence factor. Some of these surface antigens are involved in the adherence of *M. bovis* to epithelial cells; adherence is important because the small genome of *M. bovis* means that the organism is dependent on the host for essential biosynthetic pathways, such as amino acids, lipids, and nucleotides. The Vsp also play an important role in interacting with the cow's immune system.

### CLINICAL FINDINGS

In lactating cows, there is a sudden onset of swelling of the udder, a sharp drop in milk production, and grossly abnormal secretion in one or more quarters. In most cases all four quarters are affected, and a high-producing cow may fall in yield to almost zero between one milking and the next. Dry cows show little swelling of the udder. Although there is no overt evidence of systemic illness, and febrile reactions are not observed in most field cases in lactating cows, those that have recently calved show the most obvious swelling of the udder and may be off their feed and have a mild fever. However, cows infected experimentally show fever up to 41°C (105.5°F) on the third or fourth day after inoculation, which is at the same time the udder changes appear. The temperature returns to normal in 24 to 96 hours. In some cases the supramammary lymph nodes are greatly enlarged. **The classic clinical presentation is severe clinical mastitis in multiple quarters of multiple cows with minimal systemic signs of disease.** A few cows, with or without mastitis, develop arthritis in the knees and fetlocks. The affected joints are swollen, with the swelling extending up and down the leg. Lameness may be so severe that the foot is not put to

the ground.<sup>2</sup> *Mycoplasma* may be present in the joint.

The secretion from affected quarters is deceptive in the early stages because it appears fairly normal at collection; on standing, however, a deposit, which may be in the form of fine, sandy material, flakes, or flocules, settles out leaving a turbid whey-like supernatant. Subsequently the secretion becomes scanty and resembles colostrum or soft cheese curd in thin serum. The secretion may be tinged pink with blood or show a gray or brown discoloration. Within a few days the secretion is frankly purulent or curdy, but there is an absence of large, firm clots. This abnormal secretion persists for weeks or even months.

Affected quarters are grossly swollen. Response to treatment is very poor, and the swollen udders become grossly atrophied. In infection with one strain of the *Mycoplasma*, many cows do not subsequently come back into production, although some may produce moderately well at the next lactation. With other strains there is clinical recovery in 1 to 4 weeks without apparent residual damage to the quarter.

Mycoplasma mastitis caused by *M. bovis* may be very mild and disappear from the herd spontaneously and without loss of milk production.

### CLINICAL PATHOLOGY

The causative organism can be cultured without great difficulty by a laboratory skilled in working with *Mycoplasma*. Samples for culture should be freshly collected and transported at 4°C (39°F), and concurrent infection with other bacteria is common. Diagnosis at the herd level can be made by culturing bulk tank milk or milk from cows with clinical mastitis or increased SCC. However, the sensitivity of bulk tank milk culturing is poor (33%–59%). A marked leukopenia, with counts as low as 1,800 to 2,500 cells/μL, is present when clinical signs appear and persists for up to 2 weeks. SCCs in the milk are very high, usually over 20,000,000 cells/mL. In the acute stages the organisms may be able to be visualized by the examination of a milk film stained with Giemsa or Wright-Leishman stain. Species identification of *Mycoplasma* isolates is usually done using immunofluorescence and homologous fluorescein-conjugated antibody or an indirect immunoperoxidase test (immunohistochemistry). Speciation of the causative *Mycoplasma* species is recommended.

### NECROPSY FINDINGS

Grossly, diffuse fibrosis and granulomatous lesions containing pus are present in the mammary tissue. The lining of the milk ducts and the teat sinus is thick and roughened. On histologic examination the granulomatous nature of the lesions is evident. Metastatic pulmonary lesions have been found in a few longstanding cases.

### Samples for Confirmation of Diagnosis

- Mycoplasma: chilled mammary tissue, regional lymph node (special media)
- Histology: fixed mammary tissue

#### DIFFERENTIAL DIAGNOSIS

A presumptive diagnosis can be made based on the clinical findings, but laboratory confirmation by culture of the organism is desirable. Because the organism does not grow on standard media and other pathogenic bacteria are commonly present often lead to errors in the laboratory diagnosis unless attention is drawn to the characteristic field findings.

### TREATMENT

The majority of *M. bovis* strains isolated from cattle are susceptible in vitro to fluoroquinolones, florfenicol, and tiamulin. Approximately half of the isolates are susceptible to spectinomycin, tylosin, and oxytetracycline, and very few isolates are susceptible in vitro to gentamicin, tilmicosin, ceftiofur, ampicillin, or erythromycin. The clinical relevance of these in vitro susceptibility data to treating mycoplasmal mastitis remains questionable.

Cows diagnosed with mycoplasmal mastitis should be considered to be infected for life. None of the common antimicrobial agents appear to be effective and oil-water emulsions used as intramammary infusions appear to increase the severity of the disease. Parenteral treatment with oxytetracycline (5 g intravenously, daily for 3 days) has been shown to cause only temporary improvement. A mixture of tylosin 500 mg and tetracycline 450 mg used as an infusion cured some quarters. Unless treatment is administered very early in the course of the disease, the tissue damage has already been done.

A puzzling observation in one study was that identification of infected cows and preferential culling of these cows was not associated with eliminating the infection from the herd, provided that good milking practices were followed.<sup>3</sup> Infection was eliminated from most herds in that study within 1 month of the initial diagnosis.<sup>3</sup>

### CONTROL

Prevention of introduction of the disease into a herd appears to depend on avoidance of introductions, or isolating introduced cows until they can be checked for mastitis. A popular biosecurity recommendation is to culture the milk of all replacement cows for *M. bovis*, but the sensitivity and specificity of milk culture in cows with subclinical infections appears to be low. The disease spreads rapidly in a herd, and affected animals should be culled immediately or placed in strict isolation until sale. Eradication of the disease can be achieved by culling infected cows

identified by culturing milk and nasal swabs, especially at drying off and calving. When eradication is completed the bulk tank milk SCC is the best single monitoring device to guard against reinfection. An alternative program recommended for large herds is the creation of an infected subherd that is milked last. There appears to be merit in the frequent culturing of bulk milk samples as a surveillance strategy for problem herds and areas. Frequent culturing overcomes the poor sensitivity of bulk tank milk culturing. Cows with infected quarters are segregated into the subherd, and cows developing clinical illness or decreased milk yield are culled.

Intramammary infusions must be performed with great attention to hygiene and preferably with individual tubes rather than multidose syringes. Most commercial teat dips are effective in control. Use of disposable latex gloves with disinfection of the gloved hands between cows may minimize transmission at milking.

Vaccination is a possible development but is unlikely to be a satisfactory control measure because the observed resistance of a quarter to infection after a natural clinical episode is less than 1 year. This may be because of the presence of variable surface proteins that enable the pathogen to evade host immunity or because mycoplasmas appear to activate the host immune system via secreted secondary metabolites.<sup>4</sup> An *M. bovis* bacterin is commercially available in the United States that contains multiple strains of *M. bovis*. Autogenous bacterins have also been made for specific herds; however, no vaccine has proven efficacy for preventing, decreasing the incidence of, or decreasing the severity of clinical signs of mycoplasmal bovine mastitis.

*Mycoplasma* are sensitive to drying and osmotic changes but more resistant than bacteria to the effects of freezing or thawing. Amputating the teats of affected quarters may result in heavy contamination of the environment and is not recommended. Because *M. bovis* can cause respiratory disease, otitis media/interna, and arthritis in calves, all colostrum and waste milk fed to calves should be pasteurized.

#### TREATMENT AND CONTROL

##### Treatment

Identify, segregate, but do not treat infected cattle with confirmed subclinical or clinical mastitis caused by *Mycoplasma bovis* mastitis (R-1).

##### Control

Implement 10-point mastitis control plan (R-1).

Eradicate infection from herd as soon as practical (R-1).

Pasteurize waste colostrum or milk fed to suckling calves (R-2).

Screen purchased cows for intramammary infection with *M. bovis* (R-2).

Vaccinate using *M. bovis* bacterins (R-3).

### FURTHER READING

Burki S, Frey J, Pilo P. Virulence, persistence, and dissemination of *Mycoplasma bovis*. *Vet Microbiol*. 2015;179:15-22.

### REFERENCES

1. Aebi M, et al. *Vet Microbiol*. 2012;157:363.
2. Wilson DJ, et al. *J Am Vet Med Assoc*. 2007;230:1519.
3. Punyapornwithaya V, et al. *Can Vet J*. 2012;53:1119.
4. Zbinden C, et al. *Vet Microbiol*. 2015;179:336.

## Mastitis of Cattle Associated With Teat Skin Opportunistic Pathogens

### COAGULASE-NEGATIVE STAPHYLOCOCCI

Because of the intense investigation of coagulase-positive staphylococcal mastitis (*S. aureus*), coagulase-negative staphylococcal intramammary infections have come under closer scrutiny and are now among the most common bacteria found in milk, especially in herds in which the major pathogens have been adequately controlled. There is considerable debate about the significance of these pathogens for the mammary gland and for cow productivity.<sup>1-3</sup> For this reason, these pathogens continue to be classified as **minor pathogens**.

### ETIOLOGY

CNS are common but minor contagious pathogens that include *S. epidermidis*, *S. hyicus*, *S. chromogenes*, *S. simulans*, and *S. warneri* that are normal teat skin flora, and *S. xylosum* and *S. sciuri* that come from an uncertain site. At least 10 different species of CNS have been isolated from cattle with mastitis. *S. simulans*, *S. chromogenes*, and *S. epidermidis* are the predominant CNS species in bovine mastitis and are associated with persistent intramammary infection<sup>4</sup>; *S. simulans* is a common isolate from older cows, whereas *S. chromogenes* is most frequently isolated from heifers before calving and during their first lactation.

### EPIDEMIOLOGY

CNS are predominantly **teat skin opportunistic pathogens** and cause mastitis by ascending infection via the streak canal. They appear to have a protective effect against colonization of the teat duct and teat skin by *S. aureus* and other major pathogens, with the exception of *E. coli* and the environmental streptococci. Sources of CNS, other than the mammary gland and teat skin, are suspected to be in the dairy environment for some species, and it is likely that further investigation on a species level will identify species that are predominantly found in the environment<sup>5</sup> or have close human contact.<sup>6</sup> Preliminary findings indicate that *S. chromogenes* and *S. epidermidis* may be more host adapted to the bovine mammary gland and therefore have contagious characteristics. In

comparison, *S. simulans* and *S. haemolyticus* may have environmental reservoirs; therefore their epidemiology may be more similar to that of environmental mastitis pathogens.<sup>5</sup> Large differences from farm to farm have been reported.<sup>7</sup>

Studies in the United States found that 20% to 70% of heifer quarters are infected before parturition with CNS, but these infections are usually eliminated spontaneously or with antimicrobial therapy during early lactation. A survey of the prevalence and duration of intramammary infection in heifers in Denmark in the peripartum period found *S. chromogenes* in 15% of all quarters before parturition, but this decreased to 1% of all quarters shortly after parturition. In Finland, CNS are the most commonly isolated bacteria from milk samples of heifers with mastitis. Infections with *S. simulans* and *S. epidermidis* occurred in 1% to 3% of quarters both before and after parturition. Infection with *S. simulans* persisted in the same quarter for several weeks, but intramammary infections with *S. epidermidis* were transient.

Coagulase-positive *S. hyicus* and *S. intermedius* have been isolated from some dairy herds and can cause chronic, low-grade intramammary infection and be confused with *S. aureus*. The prevalence of infection with *S. hyicus* was 0.6% of all cows and 2% of heifers at parturition; the prevalence of infection of *S. intermedius* was less than 0.1% of cows.

The major economic impact of CNS infection is that the mild to moderate increase in SCC, when coupled with a moderate to high prevalence of infection, may discount the price paid for milk.<sup>8</sup> *S. simulans*, *S. chromogenes*, and *S. xylosum* appear to increase SCC to a much greater degree during subclinical infection than other CNS.<sup>7,9</sup> Intramammary infection with CNS does not appear to have an effect on milk yield or composition.<sup>3</sup> For heifers, the presence of a CNS intramammary infection at calving was associated with fewer cases of clinical mastitis and higher milk yield in their first lactation.<sup>1</sup> Based on these findings, the authors concluded that CNS intramammary infection around calving should not be a cause of concern.<sup>1</sup>

### CLINICAL FINDINGS

CNS are usually associated with mild clinical disease (abnormal secretion only and occasionally abnormal gland) and are commonly isolated from mild clinical cases of mastitis and subclinical infections. For example, *Staphylococcus* spp. have been cultured from dairy cattle with clinical mastitis in 29% of cases, and subclinical infections usually induce a moderate increase in SCC.

### CLINICAL PATHOLOGY

Intramammary infections by minor pathogens such as CNS result in a higher than

normal SCC, increasing the resistance of the colonized quarter to invasion by a major pathogen. Although these bacteria are capable of causing microscopic lesions, they are not nearly as pathogenic as *S. aureus*, and necropsy reports are lacking.

A small number of CNS isolates are methicillin resistant,<sup>10</sup> and 54% of CNS in one study were identified to have slime-producing ability.<sup>11</sup> The epidemiologic or clinical relevance of these observations are not known.

A major challenge with research into the role of CNS in bovine mastitis has been the lack of a sufficiently accurate but low-cost method for identifying CNS on the species level. Commercially available test kits that use biochemical tests do not appear to be sufficiently accurate to be used for research purposes, whereas analytical methods using MALDI-TOF technology and molecular methods involving PCR show promise.<sup>9</sup>

### TREATMENT

Spontaneous cure is common. CNS, including *S. chromogenes*, *S. hyicus*, and others, are very susceptible to ampicillin, amoxicillin, clavulanic acid, cephapirin, erythromycin, gentamicin, potentiated sulfonamides, and tetracyclines, with some studies reporting resistance to penicillin. In a study of 139 cases of subclinical coagulase-negative staphylococcal mastitis in New York, the bacteriologic cure rates of commercially available intramammary infusions were similar to that of untreated controls (72% bacteriologic cure), with the following bacteriologic cure rates: cephapirin (89%), amoxicillin (87%), cloxacillin (76%), and penicillin (68%). The current consensus view is that an intramammary treatment duration of 2 to 3 days should be used for cows with clinical signs of mastitis caused by CNS, because the mastitis usually responds well to treatment. Subclinical CNS infections usually do not need treatment because spontaneous elimination is common, and the presence of bacteria in a milk sample may reflect contamination of the sample with teat skin flora.

The use of a combination of novobiocin and penicillin, and cloxacillin as dry cow therapy for CNS gave cure rates of over 90%.

### CONTROL

Implementation of a mastitis control program will be very effective in decreasing intramammary infection and clinical mastitis episodes caused by CNS. Because of its current categorization as an opportunistic teat skin bacteria that can cause milk mastitis, attention should be focused on postmilking test dipping and optimizing teat skin condition, particularly around the teat orifice. Specific control measures (such as vaccination) are not indicated because of its status as a minor pathogen.

### TREATMENT AND CONTROL

#### Treatment

Treat clinical coagulase-negative staphylococci mastitis episodes during lactation with an intramammary formulation per label directions (R-1).

Treat subclinical coagulase-negative staphylococci intramammary infections during lactation with an intramammary formulation (R-3).

#### Control

Implement 10-point mastitis control plan, with particular emphasis on postmilking teat dipping/spraying and optimizing teat condition, particularly around the teat orifice (R-1).

### FURTHER READING

- Pyörälä S, Taponen S. Coagulase-negative staphylococci—emerging mastitis pathogens. *Vet Microbiol.* 2009;134:3-8.
- Taponen S, Pyörälä S. Coagulase-negative staphylococci as cause of bovine mastitis—not so different from *Staphylococcus aureus*? *Vet Microbiol.* 2009;134:29-36.

### REFERENCES

- Piepers S, et al. *J Dairy Sci.* 2010;93:2014.
- Pate M, et al. *J Dairy Res.* 2012;79:129.
- Tomazi T, et al. *J Dairy Sci.* 2015;98:3071.
- Thorberg BM, et al. *J Dairy Sci.* 2009;92:4962.
- Piessens V, et al. *Vet Microbiol.* 2012;155:62.
- Schmidt T, et al. *J Dairy Sci.* 2015;98:6256.
- De Visscher A, et al. *J Dairy Sci.* 2015;98:5448.
- Schukken YH, et al. *Vet Microbiol.* 2009;134:9.
- Supré K, et al. *J Dairy Sci.* 2011;94:2329.
- Febler AT, et al. *J Antimicrob Chemother.* 2010;65:1576.
- Bochniarz M, et al. *Polish J Vet Sci.* 2014;17:447.

## Mastitis of Cattle Associated With Common Environmental Pathogens

**Environmental mastitis** is associated with bacteria that are transferred from the environment to the cow rather than from other infected quarters. *E. coli*, *Klebsiella* spp., and **environmental streptococci** are the major pathogens causing environmental mastitis.

### COLIFORM MASTITIS ASSOCIATED WITH *ESCHERICHIA COLI*, *KLEBSIELLA* SP., AND *ENTEROBACTER AEROGENES*

#### ETIOLOGY

Many different serotypes of *E. coli*, numerous capsular types of *Klebsiella* spp. (most commonly *K. pneumoniae*), and *Enterobacter aerogenes* are responsible for coliform



mastitis in cattle. *E. coli* isolated from the milk of cows with acute mastitis cannot be distinguished as a specific pathogenic group on the basis of biochemical and serologic test reactions. The incidence of antimicrobial resistance is also low in these isolates because they are opportunists originating from the alimentary tract, from which antimicrobial resistant *E. coli* are rarely found in adults. Other gram-negative bacteria that are not categorized as coliforms but can cause mastitis include *Serratia*, *Pseudomonas*, and *Proteus* spp.

## SYNOPSIS

**Etiology** Many different serotypes of *Escherichia coli*, numerous capsular types of *Klebsiella* spp., and *Enterobacter aerogenes*. These are commonly called coliform bacteria; other gram-negative bacteria (such as *Pseudomonas aeruginosa*) can cause environmental mastitis but are not categorized as coliform bacteria.

**Epidemiology** Dairy cattle housed in total confinement or drylot; uncommon in pastured cattle. Most important mastitis problem in well-managed, low-SCC herds. Quarter infection rate low at 2%-4%. Incidence highest in early lactation. Eight percent to 90% of coliform infections result in clinical mastitis; 8%-10% are peracute. Causes clinical mastitis rather than subclinical mastitis. Source of infection is environment between milkings, during dry period and parturition in heifers. Isolates of *E. coli* are opportunists. Sawdust and shavings bedding contaminated with *E. coli* and *Klebsiella* spp. (particularly *K. pneumoniae*) are a major source of bacteria; much worse when wet (rainfall or high humidity). Coliform intramammary infection highest during 2 weeks following drying off and in 2 weeks before calving. Animal risk factors include:

- Low SCC
  - Decrease of neutrophil function in periparturient cow
  - High susceptibility in early lactation
  - Contamination of teat duct
  - Selenium and vitamin E status
- Outbreaks of coliform mastitis do occur, and are commonly associated with major change in management of the environment (introduction of sawdust for bedding may result in outbreaks of *Klebsiella* mastitis).

### Clinical findings

**Acute:** Swelling of gland, watery milk with small flakes, mild systemic response, recovery in a few days

**Peracute:** Sudden onset of severe toxemia, fever, tachycardia, impending shock; cow may be recumbent. Quarter may or may not be swollen and warm, secretions thin and serous and contain very small flakes. May die in few days

**Clinical pathology** Culture milk. Somatic cell count. Marked leukopenia, neutropenia, and degenerative left shift. Bacteremia may occur, particularly in severely affected cattle.

**Necropsy findings** Edema, hyperemia, hemorrhages and necrosis of mammary tissue. Major changes in teat and lactiferous sinuses and ducts; invasion of organism into parenchyma is not a feature of *E. coli*.

**Diagnostic confirmation** Culture of organism from milk and high SCC

### Differential diagnosis:

- Parturient hypocalcemia paresis
  - Carbohydrate engorgement lactic acidosis
- Other causes of acute and severe mastitis (must culture milk):
- Environmental streptococci
  - *Staphylococcus aureus* and *Streptococcus agalactiae*

**Treatment** Must consider status and requirements for each case based on severity. Use of antimicrobial agents is indicated in moderately to severely affected animals; efficacy uncertain in mild cases. Some infections become persistent if antibiotics are not administered. Severely affected cattle also need supportive fluid and electrolyte therapy (such as hypertonic saline), and possibly NSAIDs for endotoxemia.

**Control** Manage outbreaks by examination of environment. Improve sanitation and hygiene. Regular cleaning of barns. Dry bedding. Avoid crowding. Keep dry cows on pasture if possible. Replace sawdust and shavings with sand for bedding. Emphasize premilking hygiene, including premilking germicide teat dipping and keep cows standing for at least 30 minutes after milking. Core lipopolysaccharide antigen vaccine in dry period and early lactation to reduce incidence of clinical mastitis caused by gram-negative bacteria

## EPIDEMIOLOGY

### Occurrence of Clinical Mastitis

The occurrence of coliform mastitis has increased considerably in recent years and is a cause for concern in the dairy industry and among dairy practitioners. Coliform mastitis occurs worldwide and is most common in dairy cattle that are housed in total confinement during the winter or summer months. Where cows are kept in total confinement in a drylot, outbreaks of coliform mastitis may occur during wet, heavy rainfall seasons. The disease is uncommon in dairy cattle that are continuously in pasture, but it has been reported in pastured dairy cattle in New Zealand.

In contrast to contagious mastitis, environmental mastitis associated with coliform bacteria is primarily associated with clinical mastitis rather than subclinical

mastitis. Clinical mastitis associated with environmental pathogens (including the environmental streptococci) is now the most important mastitis problem in well-managed, low-SCC herds. In a survey of the incidence of clinical mastitis and distribution of pathogens in dairy herds in the Netherlands, the average annual incidence was 12.7 quarter cases per 100 cows per year. The most frequent isolates from clinical cases were *E. coli* (16.9%), *S. aureus* (14.4%), *S. uberis* (11.9%), and *S. dysgalactiae* (8.9%).

The incidence of clinical coliform mastitis is highest early in lactation and decreases progressively as lactation advances. The rate of intramammary infection is about four times greater during the dry period than during lactation. The rate of infection is also higher during the first 2 weeks of the dry period and during the 2 weeks before calving. Eighty percent to 90% of coliform infections result in varying degrees of clinical mastitis in the lactating cow; approximately 8% to 10% of coliform infections result in peracute mastitis, usually within a few days after calving. The disease also is common in herds that concentrate calving over a short period of time.

### Prevalence of Infection

The prevalence of both intramammary infection and the incidence of clinical mastitis caused by coliform bacteria has increased, particularly in dairy herds with a low prevalence of infection and incidence of clinical mastitis caused by *S. aureus* and *S. agalactiae* as a result of an effective mastitis control program. Compared with other causes of mastitis, coliform infections are relatively uncommon and, in databases on herd surveys, the percentage of quarters infected with these pathogens is low. The percentage of quarters infected at any one time is generally low, at about 2% to 4%.

In the UK, about 0.2% of quarters of cows may be infected at any one time. Surveillance of a dairy herd in total confinement in the United States indicated that infection with coliform bacteria by either day of lactation or day of the year never exceeded 3.5% of quarters, and this maximum was reached on the day of calving. However, coliform infections may cause 30% to 40% of clinical mastitis episodes. In herds with a problem, up to 8% of cows have been infected with coliform bacteria, and 80% of the cases of clinical mastitis may be caused by coliform infections.

### Duration of Infection

Coliform intramammary infections are usually of short duration. Over 50% last less than 10 days; about 70% less than 30 days; and only 1.5% exceed 100 days in duration.

### Source of Infection and Mode of Transmission

The primary reservoir of coliform infection is the dairy cow's environment (environmental

pathogen); this is in contrast to the infected mammary gland, which is the reservoir of major contagious pathogens (*S. aureus* and *S. agalactiae*) and the main reservoir of infection in cattle with *M. bovis*. Exposure of uninfected quarters to environmental pathogens can occur at any time during the life of the cow, including during milking, between milkings, during the dry period, and before calving in heifers.

### Morbidity and Case Fatality

In dairy herds with low bulk tank milk SCCs the average herd incidence of clinical mastitis is 45 to 50 cases per 100 cows annually, with coliforms isolated from 30% to 40% of the clinical cases. This is similar to an average incidence of 15 to 20 cases of coliform mastitis per 100 cows in herds with low bulk tank milk SCCs. Other observations indicate that the number of clinical cases of coliform mastitis varies from 3 to 32 per 100 cows per year, but the average incidence in dairy herds can be as low as 6 to 8 per 100 cows per year.

Coliform mastitis is one of the most common causes of fatal mastitis in cattle. The case-fatality rate from peracute coliform mastitis is usually high and may reach 80% in spite of intensive therapy. Outbreaks of the disease can occur with up to 25% of recently calved cows affected within a few weeks of each other.

### Risk Factors

#### Pathogen Risk Factors

The isolates of *E. coli* from bovine mastitic milk are simply opportunist pathogens and represent a number of different strains that mostly lack known *E. coli* virulence factors.<sup>1-3</sup> This finding suggests that specific cow factors probably play a more important role in determining the severity of clinical signs after intramammary infection.<sup>3</sup> The isolates that cause coliform mastitis possess lipopolysaccharides (endotoxin), which form part of the outer layer of the cell wall of all gram-negative bacteria. Coliform bacteria isolated from the milk of cows or from their environment have different degrees of susceptibility to the bactericidal action of bovine sera, and the majority of isolates that cause severe mastitis are serum resistant in some, but not all studies.<sup>4,5</sup> Serum-sensitive organisms are unable to multiply in normal glands because of the activity of bactericidins reaching milk from the blood. Of the strains of *E. coli* isolated from cases of mastitis in cattle in England and Wales, only those that were serum resistant were reisolated from expressed milk following intramammary inoculation of lactating cows. Other observations indicate that serum-resistant coliforms have no selected advantage over serum-susceptible coliforms in naturally occurring intramammary infections. Strains of *Klebsiella* that cause mastitis were resistant to bovine serum in one study.

There are also somatic and capsular factors of coliforms that affect resistance to bovine bactericidal activity. The presence of long polar fimbriae and an enteroaggregative heat-stable enterotoxin are also prevalent in the majority, but not all, of the strains isolated from cattle with clinical *E. coli* mastitis.<sup>5</sup> The fibronectin binding property of *E. coli* from bovine mastitis may be an important virulence factor that allows the organism to adhere to the ductular epithelium. *E. coli* isolates from clinical mastitis cases were able to resist phagocytosis by neutrophils, multiply faster, and ferment lactose more quickly than environmental *E. coli* isolates from the environment.<sup>4</sup>

A minority of *E. coli* intramammary infections result in persistent infection. *E. coli* strains that are more likely to result in persistent infections are better able to invade and replicate within mammary epithelial cells than strains that do not result in persistent infections and were more likely to be resistant to multiple antibiotics.<sup>6,7</sup>

#### Environmental Risk Factors

All the environmental components that come in contact with the udder of the cow are considered potential sources of the organisms. The coliform bacteria are opportunists, and contamination of the skin of the udder and teats occurs primarily between milkings when the cow is in contact with contaminated bedding rather than at the time of milking. Feces, which are a common source of *E. coli*, can contaminate the perineum and the udder directly or indirectly through bedding, calving stalls, drylot grounds, udder wash water, udder wash sponges and cloth rags, teat cups, and milkers' hands. Cows with chronic coliform mastitis also provide an important source of bacteria, and direct transmission probably occurs through the milking machine. Inadequate drying of the base of the udder and the teats after washing them before milking can lead to a drainage of coliform-contaminated water down into the teat cups and subsequent infection.

#### Bedding

Sawdust and shavings used as bedding that are contaminated and harbor *E. coli*, and particularly *K. pneumoniae*, are major risk factors for coliform mastitis. Cows bedded on sawdust have the largest teat-end population of total coliforms and klebsiellae; those bedded on shavings have an intermediate number, and those on straw have the least. Experimentally, the incubation of bedding samples at 30°C to 44°C (86°F–111°F) resulted in an increase in the coliform count; at 22°C (71°F) the count was maintained, and at 50°C (122°F) the bacteria were killed. Wet bedding, particularly sawdust and shavings, promotes the growth of coliform bacteria, especially *Klebsiella* spp.

The relationship between the bedding populations of Enterobacteriaceae was studied over a 12-month period in a dairy herd. The analyses revealed that rainfall bedding populations of *E. coli* and coliform mastitis incidence were statistically independent, whereas there was a strong association between rainfall and *K. pneumoniae* bedding populations and the incidence of *K. pneumoniae* mastitis. The lack of an association between bedding population of *E. coli* and coliform mastitis, along with the observation that cows are most susceptible immediately after parturition, suggest that the ability of the bacteria to penetrate the streak canal may be a factor of resistance in the cow and not a characteristic of the organism. Also, it appears that the cow in early lactation is not as susceptible to *K. pneumoniae* as to *E. coli*.

The ability of several different bedding materials to support the growth of environmental pathogens has been outlined under controlled conditions. Bedding materials vary in their ability to support growth of different pathogens, and under barn conditions it appears that high bacterial counts are influenced by factors more complex than the type of bedding alone. Even clean damp bedding may support bacterial growth.

High populations of coliform bacteria on the teat end, unless accompanied by actual chronic quarter infection, are probably transitory and represent recent environmental contamination that would usually be eliminated by an effective sanitation program at milking time. However, any teat skin population, whether associated with infection in another quarter, from contaminated teat cup liners or from other environmental sources, must be considered as a potential source of new infection.

#### Animal Risk Factors

Factors that influence the susceptibility of cows to coliform mastitis include the SCC of the milk, the stage of lactation, and the physiologic characteristics and defense mechanisms of the udder (particularly the speed of neutrophil recruitment), teat characteristics, and the ability of the cow to counteract the effects of the endotoxins elaborated by the organisms.

#### Somatic Cell Count

Experimentally, an SCC of 250,000 cells/mL in the milk of a quarter may limit significant growth of bacteria and development of mastitis when small inocula of coliform organisms are experimentally introduced into the gland. SCCs of 500,000 cells/mL provided complete protection. Thus cows in herds with a low incidence of streptococcal and staphylococcal mastitis have a low milk SCC and are more susceptible to coliform mastitis. Dairy herds with low herd bulk tank milk SCCs may have a greater incidence of severe toxic mastitis than herds with higher counts.

### Neutrophil Recruitment and Function

Increased susceptibility to coliform mastitis in the periparturient cow is primarily caused by impaired neutrophil recruitment to the infected gland. In fatal cases of peracute mastitis in cows within 1 week after parturition there may be large numbers of bacteria in mammary tissues and an absence of neutrophilic infiltration. Other observations indicate a high correlation between poor preinfection chemotactic activity of blood neutrophils and susceptibility to intramammary *E. coli* challenge exposure. Experimentally, in periparturient cows the inability to recruit neutrophils rapidly into the mammary gland following intramammary infection is associated with an overwhelming bacterial infection and peracute highly fatal mastitis. The periparturient cows are unable to control bacterial growth during the first few hours after bacterial inoculation and, consequently, the bacterial load is much higher when neutrophils finally enter the milk. The lack of neutrophil mobilization could be caused by

- Failure to recognize bacteria
- Lack of production of inflammatory mediators
- A defect in the ability of the cells to move into the milk compartment

In ketonemic cows, experimental *E. coli* mastitis is severe, regardless of preinfection chemotactic response.

High levels of cytokines are present in the milk of cows that lack the ability to recruit leukocytes, which is evidence that the cells recognized the bacteria. All of this suggests that the critical defect is in the neutrophils of the periparturient cow. Certain cell-surface receptors on leukocytes may be important defense mechanisms against *E. coli* polysaccharides. Bovine mammary neutrophils possess cell surface C14 and C18 and lectin—carbohydrate interactions mediating nonopsonic phagocytosis of *E. coli*—which may be important in controlling these infections.

### Selenium and Vitamin E Status

The positive effects of supplemental vitamin E and selenium on mammary gland health are well established. An adequate dietary level of selenium enhances the resistance of the bovine mammary gland to infectious agents. Experimentally induced intramammary *E. coli* infections are significantly more severe, and of longer duration, in cows whose diets have been deficient in selenium than in cows whose diets were supplemented with selenium. The enhanced resistance is thought to be associated with a more rapid diaporesis of neutrophils into the gland of cows fed diets supplemented with selenium, which limits the numbers of bacteria in the gland during infection.

Vitamin E is especially important to mammary gland health during the periparturient period. Plasma concentrations of  $\alpha$ -tocopherol begin to decline at 7 to 10 days before parturition, reach nadir at 3 to 5 days

after calving, and then start increasing. When plasma concentrations are maintained during the periparturient period by injections of  $\alpha$ -tocopherol, the killing ability of blood neutrophils is improved. The supplementation of the diets of dry cows receiving 0.1 ppm of selenium in their diets with vitamin E at 1000 IU/day reduced the incidence of clinical mastitis by 30% compared with cows receiving 100 IU/day. The reduction was 88% when cows were fed 4000 IU/day of vitamin E during the last 14 days of the dry period.

There are also marked effects of dietary selenium on milk eicosanoid concentrations in response to an *E. coli* infection, which may be associated with the altered pathogenesis and outcome of mastitis in a selenium-deficient state.

### Stage of Lactation and Defense Mechanism

Coliform mastitis occurs almost entirely in the lactating cow and rarely in the dry cow. The disease can be produced experimentally in lactating quarters much more readily than in dry quarters. The difference in the susceptibility may be caused by the much higher SCCs and lactoferrin concentrations in the secretion of dry quarters than in the milk of lactating quarters. Cows with known uninfected quarters at drying off may develop peracute coliform mastitis at calving, suggesting that infection occurred during the dry period. New intramammary infections can occur during the nonlactating period, especially during the last 30 days, remain latent until parturition, and cause peracute mastitis after parturition.

The **rate of coliform intramammary infection** is highest during the 2 weeks following drying off and in the 2 weeks before calving. The fully involuted mammary gland appears to be highly resistant to experimental challenge by *E. coli*, but it becomes susceptible during the immediate preparturient period. More than 93% of *E. coli* intramammary infection associated with the nonlactating period originated during the second half of that period.

Several physiologic factors may influence the level of resistance of the nonlactating gland to coliform infection. The rate of new intramammary infection is highest during transitions of the mammary gland from lactation to involution and during the period of colostrum production to lactation. There can be a sixfold increase in coliform infections from late lactation to early involution, but 50% of these new infections do not persist into the next lactation. Also, the rate of spontaneous elimination of minor pathogens is high during the nonlactating period. The difference in susceptibility or resistance to new intramammary infection may be due, in part, to changes in concentration of lactoferrin, IgG, bovine serum albumin, and citrate, which are correlated with *in vitro* growth

inhibition of *E. coli*, *K. pneumoniae*, and *S. uberis*.

There is also a slower increase in polymorphonuclear neutrophils in milk after new intramammary infection in early lactation than in mid and late lactation. These conditions may explain the occurrence of peracute coliform mastitis in early lactation. This suggests latent infection or, more likely, that infection occurred at a critical time just a few days before and after calving, when the streak canal became patent and the population of coliform bacteria on the teat end was persistently high because the cow was not being milked routinely and thus would not be subjected to udder washing and teat dipping. Coliform bacteria can pass through the streak canal unaided by machine milking; this may be associated with the high incidence of coliform mastitis in high-yielding older cows, which may have increased patency of the streak canal with age.

Newly calved cows can be classified as moderate or severe responders to experimentally induced coliform mastitis. Following infection there is a diversity of responses varying from very mild to very acute inflammation of the gland and evidence of systemic effects such as fever, anorexia, and discomfort. Losses in milk yield and compositional changes are most pronounced in inflamed glands and, in severe responders, milk yield and composition did not return to preinfection levels. It is proposed that the severe and long-lasting systemic disturbances in severe responders can be attributed to absorption of endotoxin.

In summary, coliform mastitis is more severe in periparturient cows because of the inability to slow bacterial growth early after infection. This inability is associated with low SCC before challenge and slow recruitment of neutrophils. There may also be deficits in the ability of leukocytes to kill bacterial pathogens.

### Contamination of Teat Duct

The sporadic occurrence of the disease may be associated with the use of contaminated teat siphons and mastitis tubes and infection following traumatic injury to teats or following teat surgery. Several teat factors are important in the epidemiology of *E. coli* mastitis. It is generally accepted that *E. coli* is common in the environment of housed dairy cows and that mastitis can be produced experimentally by the introduction of as few as 20 organisms into the teat cistern via the teat duct. However, the processes by which this occurs under natural conditions are unknown. *E. coli* does not colonize the healthy skin of the udder or the teat duct.

The teat duct normally provides an effective barrier to invasion of the mammary gland by bacteria. As a result of machine milking there is some relaxation of the papillary duct, followed by gradual reduction in the duct lumen diameter in the 2 hours



following milking. This period of relaxation after milking may be a risk factor predisposing to new intramammary infection.

Experimental contamination of the teat ends with a high concentration of coliform bacteria by repeated wet contact; however, this does not necessarily result in an increase in new intramammary infection. The experimental application of high levels of teat-end contamination with *E. coli* after milking repeatedly led to high rates of intramammary infection, which suggests that penetration of the teat duct by *E. coli* occurs in the period between contamination and milking. Milking machines that produce cyclic and irregular vacuum fluctuations during milking can result in impacts of milk against the teat ends, which may propel bacteria through the streak canal and increase the rate of new infections caused by *E. coli* and outbreaks of peracute coliform mastitis.

#### Downer Cows

Cows affected with the downer cow syndrome following parturient paresis, or recently calved cows that are clinically recumbent for any reason, are susceptible to coliform mastitis because of the gross contamination of the udder and teats with feces and bedding.

#### Other Defense Factors

**Lactoferrin and Citrate.** The failure of lactoferrin within mammary secretions to prevent new infections and mastitis near and after parturition may be caused by a decrease in lactoferrin before parturition. Lactoferrin normally binds the iron needed by iron-dependent organisms; these multiply excessively in the absence of lactoferrin. Also, citrate concentrations increase in mammary secretions at parturition and may interfere with iron binding by lactoferrin.

**Serum Antibody to *E. coli*.** The serum IgG<sub>1</sub> ELISA titers recognizing core lipopolysaccharide antigens of *E. coli* J5 in cattle are associated with a risk of clinical coliform mastitis. Titers less than 1:240 were associated with 5.3 times the risk of clinical coliform mastitis. Older cattle in the fourth or greater lactations were also at greater risk, even though titers increased with age. There is a titer-independent age-related increase in clinical coliform mastitis. Active immunization of cattle with an Rc-mutant *E. coli* (J5) vaccine resulted in a remarkable decrease in the incidence of clinical coliform mastitis.

#### PATHOGENESIS

After invasion and infection of the mammary gland, *E. coli* proliferates in large numbers and releases endotoxin on bacterial death or during rapid growth when excess bacterial cell wall is produced. Endotoxin causes a change in vascular permeability, resulting in edema and acute swelling of the gland

and a marked increase in the number of neutrophils in the milk. The neutrophil concentrations may increase 40 to 250 times and strongly inhibit the survival of *E. coli*. This marked diapedesis of neutrophils is associated with the remarkable systemic **leukopenia** and **neutropenia** that occurs in peracute coliform mastitis. Large numbers of epithelial cells are sloughed into the glandular secretion very early in infection before the influx of immune cells into the affected gland and probably contribute to the breakdown in the blood-milk barrier.<sup>8</sup> The severity of the disease is influenced by the

- Degree of the preexisting neutrophils in the milk
- Rate of invasion and total number of neutrophils that invade the infected gland
- Susceptibility of the bacteria to serum bactericidins that are secreted into the gland
- Amount of endotoxin produced<sup>9</sup>

#### Stage of Lactation

The severity of disease is dependent on the stage of lactation. Experimental infection of the mammary gland of recently calved cows with *E. coli* produces a more severe mastitis compared with animals in midlactation. This may be caused by a delay in diapedesis of neutrophils into the mammary gland of recently calved cows. Furthermore, because of this delay there may be no visible changes in the milk for up to 15 hours after infection, but the systemic effects of the endotoxin released by the bacteria are evident in the cow (fever, tachycardia, anorexia, rumen hypomotility or atony, and mild diarrhea). The net result is endotoxemia, which persists as long as bacteria are multiplying and releasing endotoxin. This persistent endotoxemia is probably a major cause of failure to respond to therapy compared with the transient endotoxemia in the experimental inoculation of one dose of endotoxin.

#### Neutrophil Response

The final outcome is highly dependent on the degree of neutrophil response. If the neutrophil response is delayed and growth of the organisms is unrestricted, the high levels of toxin produced could cause severe destruction of udder tissue and general toxemia. If the animal responds quickly there is often little effect on milk yield because the injury is confined to the sinuses without involvement of secretory tissues. The ability of the neutrophils to kill *E. coli* varies among cows. Experimental infection of the mammary gland of cows with *E. coli* results in the stimulation of a long-lasting opsonic activity for the phagocytosis and killing of the homologous strain of the organism by neutrophils. Thus it is not opsonic deficiency that is the problem in early lactation; rather, it is a **failure of rapid migration of neutrophils into the gland cistern.**

The rapidity and efficiency of the neutrophil response are major factors in determining the outcome. If the neutrophil response is rapid, clinical disease will be mild or go undetected, self-cure will occur, and the cow returns to normal; the milk may be negative for the bacteria. This may be one important cause of an increase in the percentage of clinical mastitis cases in which no pathogens can be isolated from the milk. Failure of the cow to mount a significant neutrophil response results in the multiplication of large numbers of bacteria, the elaboration of large amounts of endotoxin, and severe highly fatal toxemia. In these cases, bacteria are readily cultured from the milk. In less serious and nonfatal cases, the recruitment of neutrophils does not fail but is delayed; this results in acute clinical mastitis with progressive inflammation and permanent loss of secretory function. The bacteria are not always readily eliminated from the infected gland by the neutrophils. Coliform bacteria may remain latent in neutrophils and, in naturally occurring cases, it is not uncommon to be able to culture the organism from the mammary gland during and after both parenteral and intramammary antibacterial therapy.

#### Numbers of Bacteria in Milk

The numbers of bacteria in the milk also influence the outcome. If bacterial numbers exceed 10<sup>6</sup> CFU/mL, the ability of the neutrophil to phagocytose is impaired. If the bacterial count is less than 10<sup>3</sup> CFU/mL at 12 hours postinfection, the bacteria will be rapidly eliminated and the prognosis will be favorable. This response is seen as a subacute form of the disease with spontaneous self-cure. If the neutrophil response is slow or delayed, the cow will exhibit more severe signs of coliform mastitis caused by toxemia. This is most common in recently calved cows and is characterized clinically by a serous secretion in the affected quarter that later becomes watery along with fever, depression, ruminal hypomotility, and mild diarrhea. The prognosis in these cases is unfavorable. These more severe forms of coliform mastitis usually occur after calving and in the first 6 weeks of lactation. Cows with coliform mastitis in mid to late lactation generally generate a rapid neutrophil response rate, and their prognosis is likely to be favorable.

#### Experimental Endotoxin-Induced Mastitis

In an attempt to further understand the pathogenesis of coliform mastitis, the effect of experimentally introducing *E. coli* endotoxin into the mammary gland has been examined. The intramammary infusion of 1 mg *E. coli* endotoxin induces acute mammary inflammation and transient, severe shock from which cows recover within 48 to 72 hours. Udder edema is apparent within 2 hours but begins to subside in 4 to

6 hours. The SCC increases within 3 to 5 hours, and at 7 hours the count is 10 times normal. A mild systemic reaction with a transient fever occurs in some cows. High concentrations of IL-1 and IL-6 are detectable in the milk of infused glands, beginning 3 to 4 hours after infusion. Milk concentrations of bovine serum albumin are increased from baseline levels to peak levels within 2 hours, indicating increased vascular permeability induced by inflammatory mediators. The infusion of endotoxin into the teat cistern of cows induces a rapid local inflammatory response of short duration with an influx of neutrophils into the teat cistern.

The intramammary infusion of endotoxin results in a sequential increase of immunoglobulin in milk whey and of phagocytosis of staphylococci by milk polymorphonuclear cells. This is consistent with spontaneous recovery of cows with acute coliform mastitis. Endotoxin infusion can also result in increases in arachidonic acid metabolites such as thromboxanes, and cytokines, which may be involved in mediation of local quarter inflammation, and the systemic signs observed in acute coliform mastitis. Histamine, serotonin, leukotrienes, and arachidonic acid metabolites are also released following experimental *K. pneumoniae* mastitis. There is also a marked increase in prostaglandin concentrations, which indicates that they may play a role in the pathogenesis of endotoxin-induced mastitis and that the use of NSAIDs may be of value therapeutically.

In **peracute coliform mastitis**, severe toxemia with fever, shivering, weakness leading to recumbency in a few hours, and mild diarrhea are common and probably caused by the absorption of large quantities of endotoxin. For many years it was thought that bacteremia did not occur in severe cases of coliform mastitis. However, **bacteremia is present in 32% to 48% of naturally occurring cases of coliform mastitis**. In experimental endotoxemia in cattle there is profound leukopenia (neutropenia and lymphopenia), a mild hypocalcemia, and elevation in plasma cortisol concentration. Hypocalcemia also occurs in naturally occurring cases and is thought to be caused by a decreased abomasal emptying rate associated with the endotoxemia. Experimentally infused endotoxin is detoxified very rapidly after absorption into the circulation.

In the acute form, the systemic changes are usually less severe than in the peracute form. However, in both forms, there is marked agalactia and the secretions in the affected quarter become serous and contain small flakes. Coliform organisms are not active tissue invaders, and in affected cattle that survive the systemic effects of the endotoxin the affected quarter(s) will usually return to partial production in the same lactation, and even full production in the next. However, in some cows that survive the

peracute form, subsequent milk production in the current lactation is inadequate and cows are commonly culled.

A retrospective analysis of cows with clinical and laboratory features of coliform mastitis revealed that 60% returned to produce a milk-like secretion in the affected quarters in the current lactation and 40% did not. However, only 63% of the former group and 14% of the latter group remained in the herd and produced milk in the next lactation. Some cows were culled during the current lactation for low milk production and other reasons, some died, and others were culled for mastitis. Of the original 88 cows with coliform mastitis, only 38 (43%) remained in the herd and produced milk in the next lactation.

### CLINICAL FINDINGS

**Peracute coliform mastitis** in the cow is a severe disease characterized by a sudden onset of agalactia and toxemia. The cow may be normal at one milking and acutely ill at the next. Complete anorexia, severe depression, shivering and trembling, cold extremities (particularly the ears), and a fever of 40°C to 42°C (104°F–108°F) are common. Within 6 to 8 hours after the onset of signs the cow may be recumbent and unable to stand. At that stage, the temperature may be normal or subnormal, all of which may superficially resemble parturient paresis. The heart rate is usually increased up to 100 to 120 beats/min, the rumen is static, there may be a mild watery diarrhea, and dehydration is evident. Polypnea is common, and in severe cases an expiratory grunt may be audible because of pulmonary congestion and edema.

The **affected quarter(s)** is usually swollen and warm but not remarkably so, and for this reason coliform mastitis may be missed on initial clinical examination. The cow may be severely toxemic, febrile, and have cold extremities before there are visible changes in the mammary gland or the milk. The mammary secretion is characteristic, and there are changes from the consistency of watery milk initially to a thin, yellow serous fluid containing small meal-like flakes that are barely visible to the naked eye; these are best seen on a black strip plate used for gross examination of milk. Additional quarters may become affected within a day or two of the initial infection.

**The course of peracute coliform mastitis is rapid.** Some cows will die in 6 to 8 hours after the onset of signs, and others will live for 24 to 48 hours. Those that survive the peracute crisis will either return to normal in a few days or remain weak and recumbent for several days and eventually develop the complications associated with prolonged recumbency. Intensive intravenous fluid therapy may prolong the life of the cow for up to several days, but significant improvement may not occur and eventually

euthanasia may appear to be the desirable course of action.

**Acute coliform mastitis** is characterized by varying degrees of swelling of the affected gland and variable systemic signs of fever and inappetence. The secretions of the gland are watery to serous in consistency and contain flakes. Recovery with appropriate treatment usually occurs in a few days. During the first day of infection affected cows spend approximately 10% less time lying than when they were healthy. This small difference would not be clinically detectable unless the animal was monitored with an activity monitor.<sup>10,11</sup>

A clinically useful disease severity scoring system is helpful in directing treatment protocols.<sup>12</sup> The most useful and easily understood system uses three easily identified categories of clinical mastitis: (1) abnormal secretion only, (2) abnormal secretion combined with abnormal gland (such as swelling, heat, erythema, pain, and decreased quarter milk production), and (3) abnormal cow (systemic signs of illness, such as fever, tachycardia, decreased rumen contraction rate, and depression) combined with abnormal secretion and abnormal gland.

### Accuracy of Clinical Diagnosis

Various diagnostic schemes that use clinical parameters to differentiate cows with clinical mastitis caused by gram-negative bacteria from those with clinical mastitis associated with gram-positive bacteria have been developed. Generally, all these schemes predict gram-negative bacteria as the cause if the milk is watery or yellow, if the mastitis episode occurs in summer, and if rumen motility is decreased or absent. Experienced clinicians are not much better at predicting the causative agent than inexperienced clinicians. The conclusion from all of these studies is that **clinical observations do not allow sufficiently accurate prediction of clinical mastitis pathogens** and should not be used as the sole criteria for deciding whether cows are treated with antibiotics, or even the class of antibiotic to be administered. Even the best predictive algorithm was wrong 25% of the time if the prevalence of gram-negative mastitis was 50%, which is too high an error rate to be used to guide treatment. In comparison, flipping a coin to attribute the causative agent as being gram-positive or gram-negative is wrong only 50% of the time.

An increase in the ability of a positive test to predict a gram-negative bacterial infection as the cause for a clinical mastitis episode is provided by examining for the presence of endotoxin in milk (sensitivity [Se] = 0.72; specificity [Sp] = 0.95), whether the **segmented neutrophil count** is less than 35% of the total leukocyte count (Se = 0.87; Sp = 0.71), whether the segmented neutrophil count is less than 3200 cells/μL (Se = 0.93; Sp = 0.89; Fig. 20-5), and by culturing

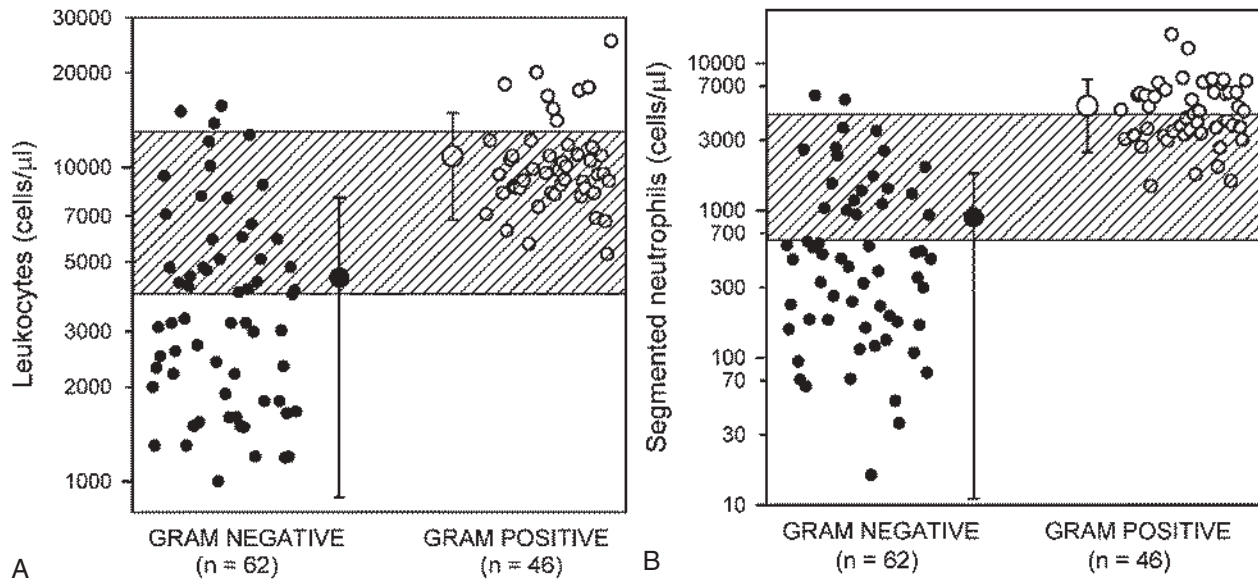

**Fig. 20-5** Scatter plot of blood leukocyte count (left panel) and segmented neutrophil count (expressed on a logarithmic scale; right panel) for 108 lactating dairy cattle with acute clinical mastitis caused by Gram-negative bacteria or Gram-positive bacteria. The hatched area represents the reference range, and data are expressed as mean  $\pm$  standard deviation. Cattle with acute Gram-negative mastitis are much more likely to be leukopenic and neutropenic. (Reproduced with permission from Smith GW, Constable PD, Morin DE. *J Vet Intern Med* 2001;15(4):394-400.)

on selective media (Se = 0.60; Sp = 0.98). The **endotoxin test** is a cowside test (Limast-test) that was commercially available in Scandinavia. Assessment of the white blood cell count and differential count is widely available in veterinary practice but is not a cowside test and is therefore not ideal. Both the milk endotoxin test and blood neutrophil count have adequate sensitivity and specificity for use to guide treatment decisions.

**Chronic coliform mastitis** is characterized by repeated episodes of subacute mastitis, which cannot be readily clinically distinguished from other common causes of mastitis.

**Subclinical coliform mastitis** is characterized by the presence of coliform organisms in the milk samples of cows without clinical evidence of mastitis. The prevalence of intramammary infection in quarters with coliform bacteria is low relative to contagious mastitis pathogens, ranging from 0.9 to 1.2%.

## CLINICAL PATHOLOGY

### Culture of Milk

Milk samples should be submitted for culture to identify the causative agent, but antimicrobial susceptibility testing has not been validated and is currently not recommended to guide treatment decisions. In the peracute case, the milk samples will yield a positive culture. In less acute cases, the milk sample may be negative because the neutrophils have cleared the bacteria.

Application of newer methods for bacterial identification suggest that *K. variicola* may be misidentified as *K. pneumoniae* in dairy cattle with clinical mastitis culture using routine procedures.<sup>13</sup>

## Somatic Cell Count and California Mastitis Test Scores

In the experimental disease the SCC of milk from the inoculated quarter ranges from 14,000,000 to 25,000,000 cells/mL at 5 hours after inoculation. The CMT on secretions from affected quarters is usually +3.

## Hematology

In peracute coliform mastitis there is hemoconcentration, a marked leukopenia, neutropenia, and a degenerative left shift caused by the margination of large numbers of neutrophils in response to endotoxin. There is also a moderate lymphopenia, monocytopenia, and thrombocytopenia (see Fig. 21-5). If the degenerative left shift, leukopenia, neutropenia, and thrombocytopenia become worse on the second day after the onset of clinical signs, the prognosis is unfavorable.<sup>14</sup> An improvement in the differential white count on the second day is a good prognostic sign.

## Endotoxin Presence in Milk and Plasma

A commercially available cowside test (Limast-test) for endotoxin was available in Scandinavia. The test required at least  $10^4$  to  $10^5$  CFU of gram-negative bacteria for a positive test result. The test took 15 minutes to run on milk samples and was able to detect the presence of endotoxin and therefore gram-negative bacteria, but it did not differentiate between *E. coli* and *K. pneumoniae*.

## Serum Biochemistry

The biochemical abnormalities observed in naturally occurring cases include uremia,

high aspartate aminotransferase activity, and strong ion (metabolic) acidosis in fatal cases, whereas in surviving cases there were decreased concentrations of sodium, potassium, and chloride, and strong ion (metabolic) alkalosis.<sup>14,15</sup> In acute cases there is a transient early hyperglycemia.<sup>16</sup>

## NECROPSY FINDINGS

There is edema and hyperemia of the mammary tissue. In severe cases hemorrhages are present and are accompanied by thrombus formation in the blood and lymphatic vessels; there is necrosis of the parenchyma.

A study of the progressive pathologic changes in experimental and natural cases of *E. coli* mastitis in cows reveals that damage is most marked in the epithelium of the teat and lactiferous sinuses and diminishes rapidly toward the ducts. In hyperacute cases, the organisms are largely confined to the ductular and secretory lumen and there is little invasion of the parenchyma, despite the presence of large numbers of organisms. In some cases there may be intense neutrophil infiltration, subepithelial edema, and epithelial hyperplasia of the sinuses and large ducts. In hyperacute cases in the immediate postpartum period, infiltration of neutrophils may be negligible. Bacteremia can occur in dairy cattle with coliform mastitis.

## Samples for Confirmation of Diagnosis

- Bacteriology: chilled mammary tissue, regional lymph node
- Histology: formalin-fixed mammary tissue



## DIFFERENTIAL DIAGNOSIS

- **Peracute coliform mastitis** in cattle is characterized clinically by a sudden onset of toxemia, weakness, shivering, often recumbency, fever in the early stages followed by a normal temperature or hypothermia in several hours, and characteristic gross changes in the milk, which usually is watery and contains some particles barely visible to the unaided eye. The peracute form of the disease is most common in recently calved cows.
- **Parturient hypocalcemia paresis** occurs in recently calved cows. The weakness and recumbency resembles peracute coliform mastitis but the marked increase in heart rate, and dehydration and mild diarrhea if present, are not characteristic of parturient paresis and should prompt further clinical examination, particularly of the udder. In the early stages of coliform mastitis the changes in the milk may be just barely visible. Those clinical findings that are most useful to predict peracute coliform mastitis include watery consistency of milk, shivering, firmness of udder, tachycardia, polypnea, fever, weakness, and mastitis of less than 24 hours' duration. A marked leukopenia and neutropenia are characteristic of coliform mastitis, whereas in parturient paresis there is usually a neutrophilia and stress leukon (neutrophilia, no left shift, lymphopenia, monocytosis, and eosinopenia). The differential diagnosis of recumbency in the immediate postpartum period is discussed under parturient paresis.
- **Carbohydrate engorgement lactic acidosis** causes rapid onset of weakness, recumbency, diarrhea, dehydration, and ruminal stasis and resembles the clinical findings of shock in peracute coliform mastitis. However, the rumen contains an excess of watery fluid, and the pH is below 5.0.
- **Acute coliform mastitis** cannot be accurately differentiated from all other common causes of acute mastitis with abnormal gland and abnormal milk, including the environmental streptococci *S. uberis* and *S. dysgalactiae*, and the contagious pathogens *S. aureus* and *S. agalactiae*. Culture of the milk is necessary.

## TREATMENT

The treatment of coliform mastitis in cattle has been controversial, but recent studies have clarified the **important role that antimicrobial agents play in treating severely affected cattle**. Historically, the treatment of coliform mastitis was based on the principles of treating a bacterial infection with varying degrees of inflammation. A combination of broad-spectrum antimicrobial agents administered parenterally and by intramammary infusion, fluid and electrolyte therapy, frequent stripping out of the

affected glands with the aid of oxytocin, and antiinflammatory drugs have been used with varying degrees of success based on empirical and anecdotal experience. Only a handful of clinical trials have evaluated the efficacy of therapeutic agents used in naturally occurring cases of coliform mastitis, especially for the peracute form of the disease.

Most of the controversy has centered on the rational use of antimicrobial agents. The use of antimicrobial agents for the treatment of coliform mastitis has been questioned for several reasons:

- Clinical signs are primarily caused by the effects of endotoxin in the mammary gland, with formation of endogenous inflammatory mediators within the udder and their subsequent release into the systemic circulation.
- The severity of clinical signs is correlated with the number of bacteria in the affected gland.
- Most mild cases of coliform mastitis (abnormal milk but normal gland and cow) are self-limiting and resolve without antimicrobial therapy. However, a small percentage of these mild clinical cases develop persistent infection.
- There is speculation that the use of bactericidal antimicrobial agents may result in the bolus release of large quantities of lipopolysaccharides in the mammary gland associated with a rapid kill of bacteria, but this has not been observed in any study. In contrast, endotoxin release occurs from rapid bacterial growth alone, which will be prevented by administration of an effective antibiotic.
- Many, but not all, of the broad-spectrum antimicrobial agents currently approved for use in lactating cattle do not result in high enough concentrations in the milk when given parenterally.

Most of the antimicrobial agents currently used for the treatment of coliform mastitis in lactating dairy cows are not approved for use in food-producing animals. Because of this extralabel use and the lack of pharmacokinetic data for adequate withholding times, the risk of drug residues in milk and meat is increased.

The prognosis in the peracute form of the disease is unfavorable if severe clinical toxemia is present. Severe depression, weakness, diarrhea and dehydration, recumbency, and a heart rate over 120 beats/min are indicators of an unfavorable prognosis. The successful treatment of peracute coliform mastitis requires the earliest possible action and clinical surveillance until recovery is apparent.

### Treatment Trials Using Antimicrobial Agents and Untreated Controls

Treatment trials with **experimentally induced** coliform mastitis in cattle during lactation have failed, for the most part,

to demonstrate efficacy of antimicrobial therapy. This is because all experimental models do not accurately reproduce the naturally occurring disease, and not because antibiotics are ineffective. Accordingly, treatment efficacy should be based on the results of randomized field trials. The major considerations for antimicrobial use in coliform mastitis include:

- Early administration to decrease the exposure of the cow to endotoxin
- The severity of clinical signs are positively associated with the bacterial and endotoxin concentration in the affected quarter.<sup>9</sup>
- Ensuring appropriate withholding periods for milk and meat
- The benefit:cost ratio

The antimicrobial susceptibilities of *E. coli* isolates from coliform mastitis vary considerably; drug susceptibility determination is not routinely recommended because the breakpoints have not been validated and the bacteria come from diverse sources in the environment.

### Parenteral Antimicrobial Agents

Broad-spectrum antimicrobial agents should be administered parenterally to cattle with systemic signs of disease (abnormal cow), preferably by the intravenous route initially, followed by intramuscular administration to maintain appropriate plasma concentrations. The first reason to administer parenteral antibiotics is that the **severity of clinical signs is correlated with the numbers of bacteria in milk from the affected gland**. The second main reason to administer parenteral antibiotics is to **combat bacteremia, which is present in 32% to 48% of severely affected cattle**. Based on pharmacokinetic/pharmacodynamic values, the results of experimentally induced and naturally acquired infections, and in vitro antimicrobial susceptibility testing (if this has any relevance to in vivo susceptibility), most *E. coli* isolated from the mammary glands of cattle are theoretically susceptible to third-generation cephalosporins (such as ceftiofur), fourth-generation cephalosporins (such as cefquinome), fluoroquinolones, gentamicin, amikacin, trimethoprim-sulfonamide, and oxytetracycline. Of these antimicrobials, third-generation cephalosporins, fourth-generation cephalosporins, fluoroquinolones, and potentiated sulfonamides have documented efficacy in naturally acquired or experimentally induced cases of acute *E. coli* mastitis, with moderate evidence supporting the efficacy of intravenous oxytetracycline.

- **Ceftiofur** is a third-generation cephalosporin that is resistant to  $\beta$ -lactamases and has excellent in vitro activity against *E. coli*. When given parenterally to cows with experimental coliform mastitis, ceftiofur did not produce drug concentrations in milk

above the reported MICs for coliform bacteria. However, when administered to cows with naturally occurring coliform mastitis, ceftiofur-treated cows (2.2 mg/kg BW intramuscularly every 24 hours) were three times less likely to die or be culled from the herd and had more saleable milk than nontreated cattle.

- **Cefquinome** is a fourth-generation cephalosporin that is resistant to  $\beta$ -lactamases and has excellent in vitro activity against *E. coli*. Parenteral cefquinome therapy (1 mg/kg BW intramuscularly twice at 24 hours apart), with or without intramammary cefquinome (75 mg, three times at 12-hour intervals), increased the bacteriologic cure rate and significantly improved clinical recovery and return to milk production in experimentally induced *E. coli* mastitis.
- **Danofloxacin**, a fluoroquinolone with excellent in vitro activity against *E. coli*, given intravenously once at 6 mg/kg BW was effective in treating experimentally induced *E. coli* mastitis.<sup>17</sup>
- **Enrofloxacin**, a fluoroquinolone with excellent in vitro activity against *E. coli*, given intravenously initially then subcutaneously once (5 mg/kg BW) was effective in treating experimentally induced *E. coli* mastitis, but had minimal efficacy in treating naturally acquired *E. coli* mastitis in a randomized clinical trial.<sup>18</sup> Generally, parenterally administered enrofloxacin increased the rate of initial *E. coli* clearance from the infected mammary gland. In a randomized clinical trial, a lower dose of enrofloxacin (2.5 mg/kg intramuscularly daily for 3 days) did not improve the survival rate of cows with *E. coli* mastitis, but it did result in a lower SCC at the first monthly herd recording after treatment.<sup>19</sup>
- **Gentamicin** has been used on an extralabel basis for the treatment of acute and peracute coliform mastitis because more than 90% of isolates from milk from affected cows are susceptible in vitro. However, the parenteral administration of gentamicin at 2 g intramuscularly every 12 hours until the appetite improved to dairy cows with mastitis predicted to be associated with gram-negative bacteria did not result in significant improvement compared with cows with similar mastitis that did not receive an antimicrobial or received erythromycin.
- **Trimethoprim-sulfadiazine** (trimethoprim 4 g, sulfadiazine 20 g, intramuscularly every 24 hours for 3–5 days) is efficacious in treating naturally acquired cases of coliform mastitis. The recovery rate of cows with clinical mastitis caused by coliform bacteria

susceptible to sulfonamide-trimethoprim was 89% compared with 74% in cows infected with coliforms resistant to the combination given parenterally, combined with NSAIDs and complete milking of affected quarters several times daily. Sulfadiazine or sulfamethazine (sulfadimidine) are preferred to sulfadoxine because the latter produces much lower milk concentrations after parenteral administration.

- **Oxytetracycline** (16.5 mg/kg BW intravenously every 24 hours for 3–5 days), combined with intramammary cephalirin (200 mg) and supportive care (intravenous or oral fluids, flunixin meglumine, and stripping of the mammary gland) was more effective in treating coliform mastitis than similar treatment without antibiotics in cattle with naturally acquired mastitis.

### Intramammary Antimicrobial Agents

Intramammary preparations of antimicrobial agents can be infused into the affected quarters after they have been stripped out completely at the start and end of the day. Evidence supporting the use of intramammary treatment for naturally acquired mild to moderate cases of *E. coli* mastitis (abnormal secretion and abnormal gland) is available for ceftiofur (125 mg daily for 5 consecutive days)<sup>20</sup> and cephalirin (200 mg per treatment). On theoretical grounds mild to moderate *Klebsiella* spp. mastitis episodes should also respond to intramammary ceftiofur or cephalirin treatment, because the spontaneous cure rate appears to be lower than that for *E. coli*.<sup>20</sup> The initial choice of antimicrobial will depend on previous experience of treatment efficacy in the herd.

- **Ceftiofur**: Based on clinical response and the results of antimicrobial susceptibility testing of coliform isolates from cows with naturally occurring mastitis (if relevant to in vivo performance), ceftiofur is an excellent choice for intramammary infusion in suspected cases of coliform mastitis.
- **Cephalirin**: Based on clinical response in lactating dairy cattle with experimentally induced *E. coli* mastitis, intramammary infusion of cephalirin (300 mg per quarter) at 4-, 12-, 24-, and 36-hour postinfection inhibited bacterial growth in milk decreased the inflammatory response.<sup>21</sup> The relevance of these findings to the treatment of naturally occurring cases of *E. coli* mastitis remains to be determined. This is because treatments were applied 4 hours after intramammary inoculation of *E. coli* when clinical signs of mastitis are usually not evident or are very mild.
- **Gentamicin**: The intramammary infusion of 500 mg of gentamicin did not affect the duration or severity of

experimentally induced coliform mastitis. The numbers of *E. coli* in the milk after intramammary inoculation were not affected by the intramammary infusion of gentamicin, despite maintaining a mean minimal gentamicin concentration in milk of 181  $\mu$ g/mL between dose intervals. The infusion did not affect the body temperature or the magnitude and duration of the inflammatory process in the glands as measured by the SCCs and peak albumin and immunoglobulin concentrations in the milk. It should be noted that gentamicin is not approved for use in the treatment of bovine mastitis, and in some jurisdictions it is not approved for any use.

A study of the efficacy of intramammary antibiotic therapy for the treatment of naturally occurring clinical mastitis associated with environmental pathogens found no difference in the short-term clinical or bacteriologic cure rates between quarters infused with 62.5 g of amoxicillin every 12 hours for three milkings or 200 mg of cephalirin every 12 hours for two milkings and those treated with 100 units of oxytocin intramuscularly every 12 hours immediately before milking for two or three milkings alone. However, the cost per episode of mastitis associated with the use of cephalirin was higher than the other two treatments, partly because of the longer milk withdrawal time (96 hours) associated with the drug. The percentage of relapses was higher for cows in the oxytocin treatment group, especially when the mastitis-associated pathogen was an environmental *Streptococcus* sp.

### Stripping of the Affected Quarter

An artificial intramammary environment has shown that milking 12 times daily could lead to elimination of *E. coli*, suggesting that frequent stripping would be an effective treatment. Indeed, stripping (augmented by oxytocin) is a popular but largely unsubstantiated recommendation for treating severe cases of coliform mastitis. There is one report of cattle with acute coliform mastitis that suggests irrigation of the affected quarter with 1 to 3 L of 0.9% NaCl resulted in a higher recovery rate 30 days later.<sup>22</sup>

Oxytocin at 10 to 20 units per adult cow given intramuscularly, followed by vigorous hand massage and hourly stripping of the affected quarter, may assist in removing inflammatory debris. Oxytocin doses higher than this are not needed, and intravenous administration is not needed because oxytocin is rapidly absorbed when injected intramuscularly. Oxytocin can be repeated and used as long as an effect is obtained.

Effective removal of coliform bacteria and endotoxin will minimize their local effects in the mammary gland and decrease the systemic signs of endotoxemia. The main problems with stripping are the labor

involved, the small volumes produced, the potential for creating additional pain and discomfort for the cow (and the producer when the cow kicks), and potential contamination of the environment if the secretion is stripped onto the ground. The role of frequent stripping, if any, in the treatment of clinical mastitis remains to be determined.

### Fluid and Electrolyte Therapy

Fluid and electrolyte therapy are essential for the treatment of acute and peracute coliform mastitis to counteract the effects of the endotoxemia. Isotonic polyionic electrolyte solutions (such as Ringer's solution) are given at 80 mL/kg BW for the first 24 hours by continuous intravenous infusion and at a slower rate than that over the following days. For a mature dairy cow (400–600 kg) a total of 32 to 48 L is therefore needed in the first 24-hour period, with 20 L given during the first 4 hours and the remainder over the next 20 hours. A favorable response is usually clinically evident in 6 to 8 hours. If the animal has not improved after 5 days of intensive fluid therapy (the 5-day rule for clinical improvement), the prognosis for survival is poor.

The large amounts of isotonic fluids and electrolytes that have been advocated and used are expensive to administer by continuous intravenous infusion and require monitoring over many hours. A possible alternative is the use of small volumes of hypertonic saline, which can be transported easily and administered rapidly. **Hypertonic saline** can be safely administered to cattle with endotoxin-induced mastitis. Hypertonic saline (7.2% NaCl) is given intravenously at 4 to 5 mL/kg BW intravenously over 4 to 5 minutes followed by immediate access to drinking water. The changes following administration of hypertonic saline include transient expansion of the plasma volume, hypernatremia, and hyperchloremia. The intravenous administration of hypertonic saline to clinically normal cows with access to water increases circulatory volume rapidly, induces slight strong ion (metabolic) acidosis, and increases glomerular filtration rate. Fluid therapy is covered in detail in Chapter 5.

### Antiinflammatory Agents

NSAIDs are frequently administered as adjunctive therapy in coliform mastitis, particularly in the peracute form of the disease. **Ketoprofen**, a cyclooxygenase type 1 and type 2 inhibitor and lipoxygenase inhibitor, is the only currently available NSAID with documented efficacy in naturally acquired cases of coliform mastitis.

Ketoprofen has been evaluated as adjunctive therapy for the treatment of acute clinical mastitis in dairy cows, most cases of which were associated with gram-negative pathogens. All cases were treated with 20 g of sulfadiazine and 4 g of trimethoprim

intramuscularly followed by one-half dose daily until recovery. Ketoprofen was given at 2 g intramuscularly daily for the duration of the antimicrobial therapy. Recovery rates for the nonblind contemporary controls and the blind placebo controls were 84% and 71%, respectively. In the nonblind controlled ketoprofen and placebo-controlled ketoprofen treatment groups, recovery rates were 95% and 92%, respectively. The odds ratio (OR) of recovery was significantly high in the placebo-controlled study (OR = 6.8), and high but not significant in the nonblind controlled study (OR = 2.6). It was concluded that ketoprofen significantly improved recovery rate in clinical mastitis. Oral ketoprofen (4 mg/kg in 500 mL of water and administered orally) was similarly effective in lactating dairy cattle to intramuscular ketoprofen (3 mg/kg) administered 2 hours after intramammary endotoxin infusion.<sup>23</sup> This does not necessarily translate to efficacy in the treatment of field cases of acute *E. coli* mastitis because bacterial multiplication is not present following endotoxin infusion, and overt clinical signs were not apparent when treatments were applied.

A similar clinical field trial evaluating the efficacy of phenylbutazone and dipyron for the treatment of mastitis caused mostly by coliforms revealed a beneficial effect but no difference between the efficacies of the two drugs. Neither phenylbutazone nor dipyron is permitted for use in lactating dairy cattle in the United States, but their use is permitted in some countries.

A single administration of flunixin meglumine (2.2 mg/kg, intravenously) to lactating dairy cattle when clinical mastitis was evident after intramammary infusion of *E. coli* increased dry matter intake on day 1 and milk yield on days 3 and 4 after treatment.<sup>24</sup> The antiinflammatory effect of either flunixin meglumine or dexamethasone was evaluated compared with controls in experimentally induced coliform mastitis. Dexamethasone at 0.44 mg/kg intravenously and flunixin meglumine at 1.1 mg/kg intravenously were both given 2 hours after inoculation of the quarter with *E. coli*, which is essentially a pretreatment administration because clinical signs are not evident at this time. Flunixin meglumine was also administered once 8 hours after the initial dose. Dexamethasone reduced the rectal temperature and the mammary surface temperatures and prevented further increase in rectal temperature above 39.2°C (102.5°F). The response to flunixin meglumine was less than expected, which suggested that a higher dose of 2.2 mg/kg may be necessary in lactating dairy cattle. The administration of flunixin meglumine at 2.2 mg/kg intramuscularly or flurbiprofen at 2 mg/kg intravenously before clinical signs appeared in experimental *E. coli* mastitis abolished the febrile response during the first 9 hours after infection and lessened the decrease in rumen

motility. In a separate study flunixin meglumine at 1.1 mg/kg intravenously 4 hours after inoculation of the *E. coli* mitigated the small reduction in lying time seen with acute *E. coli* mastitis;<sup>11</sup> this finding has minimal clinical relevance because this protocol is effectively a pretreatment administration because clinical signs of mastitis are usually not evident or very mild at this time.

The intramammary administration of prednisolone (20 mg) in conjunction with intramammary cephalosporin (300 mg) had an antiinflammatory effect in cattle with experimental *E. coli* mastitis, as indicated by lower density of leukocytes in mammary tissue, lower IL-4 concentration in the glandular secretion of infected quarters, and a faster restoration of milk quality.<sup>21</sup> The relevance of these findings to the treatment of naturally occurring cases of *E. coli* mastitis is questionable because treatments were applied 4 hours after intramammary inoculation of *E. coli* when clinical signs of mastitis are usually not evident or very mild.

Carprofen, a long-acting NSAID, reduced the fever, tachycardia, and udder swelling associated with *E. coli*-endotoxin-induced mastitis. The long-acting properties of carprofen may be considered a therapeutic advantage over flunixin meglumine, which requires frequent dosing.

### Combination Therapy

Fluid and electrolyte therapy and flunixin meglumine, in combination and individually, have been evaluated in a 3-year study of a large number of cows with toxic mastitis. Cows were allotted to one of three groups:

- Fluid therapy (45 L of intravenous isotonic electrolyte solution) and flunixin meglumine at 2 g
- Fluid therapy intravenously only
- Flunixin meglumine only

All cases were treated with parenteral and intramammary antimicrobial agents, oxytocin, and calcium borogluconate. There was no significant difference in the rate of survival between the treatment groups, and 54% of the cows survived.

### CONTROL

The control of coliform mastitis is characteristically difficult, unreliable, and frustrating. Several cases of fatal peracute coliform mastitis may occur in a herd of 100 cows during a period of a year, in spite of the existence of apparently excellent management. The general principles of mastitis control that have been effective for the control of *S. aureus* and *S. agalactiae* mastitis have been unsuccessful for the control of coliform mastitis because infection of the mammary gland occurs by direct contact with the environment, usually between milkings. For the control of coliform mastitis, the emphasis is on the prevention of new infection. Core lipopolysaccharide antigen vaccines are useful and are discussed later.



## Management of Outbreaks

When an outbreak of peracute coliform mastitis is encountered the following procedures are recommended in an attempt to prevent new cases:

- Culture milk samples and obtain a definitive etiologic diagnosis (in other words, **put a name to the causative pathogen**).
- Examine the bedding for evidence of heavy contamination with coliform bacteria. If sawdust or wood shavings are being used, replace with sand, if possible, or change more frequently.
- Conduct a general clean-up of the stall and lounging areas.
- Improve premilking hygiene.
- Examine milking machine function.
- Allow cows access to fresh feed immediately after milking to ensure that they remain standing for at least 30 minutes to allow time for the streak canal to close.

## Housing and Environment

The normal presence of coliform bacteria in every aspect of the cow's environment must be recognized, but every effort must be made to avoid situations that allow a buildup of bacterial numbers. This is especially important in dairy herds that have been on an effective mastitis control program, resulting in a high percentage of cows with low SCCs in their milk, which increases their susceptibility to coliform mastitis. The overall level of sanitation and hygiene must be improved and maintained in these herds.

## Bedding

Dairy cows lay down for 12 to 14 hours each day, and during this time their teats are in direct contact with a contaminated environment. The key to control is to minimize the number of bacteria in the bedding environment that are mastitis pathogens. Most coliform infections in periparturient cows occur very early in the dry period or just before calving, so efforts to prevent infection should be centered on these periods. Management of the dry cow environment may provide the best opportunity for prevention of infection. Although no reliable recommendations are available, cows that are housed during part or all of the day or night should be bedded on **clean** and **dry** bedding and not overcrowded to prevent heavy fecal contamination. When possible, dry and preparturient cows are best maintained on pasture. There remains an urgent need for the determination of optimum space and bedding requirements for the lounging areas of dairy cows kept under loose housing. Bedding should be kept as dry as possible. Excessively wet bedding should be removed from the back one-third of the stalls daily and replaced with fresh bedding. The addition of lime may decrease bacterial growth. Sawdust and shavings harbor more coliform bacteria than

straw and require special attention. The buildup of high numbers of coliform bacteria in the bedding of cow cubicles can be controlled by the daily removal of the sawdust from the rear of the cubicle and rebedding with clean sawdust, which is usually of low coliform count. The use of a paraformaldehyde spray on sawdust bedding reduced the coliform count for 2 to 3 days, but it returned to its predisinfection level in 7 days. When outbreaks of coliform mastitis are encountered that are possibly associated with heavily contaminated sawdust or shavings, the bedding should be removed immediately and replaced with clean, fresh, dry straw. The use of sawdust or shavings as bedding should be avoided if possible. Sand is now considered to be the "gold standard" and the most suitable alternative.

## Regular Daily Cleaning of Barns

This is necessary to minimize contamination of teats. In free-stall and loose-housing dairy barns, every management technique available must be used to ensure that cows do not defecate in their stalls and increase the level of contamination. This requires daily raking of the bedding in free-stall barns and adjusting head rails to ensure that cows do not lie too far forward in the stall and to ensure that they defecate in the alleyway.

In dairy herds that are confined for all or part of the year, the level of contamination usually increases as herd size increases; and usually the ventilation is inadequate. This leads to excessively humid conditions, which promote the development of coliform bacteria in wet bedding. This will require increased attention to sanitation and hygiene.

## Milking Procedures

Postmilking teat dipping with a disinfectant has little effect on reducing the incidence of coliform mastitis because contamination of the teats occurs between milkings rather than at milking. Thus one logical approach to the control of coliform mastitis is to reduce environmental contamination. In the event of gross fecal contamination of the udder and teats, additional time and care will be required at milking time. Premilking udder preparation can significantly influence milk quality. Lowest bacterial counts in milk are observed when the teats of cows are cleaned with water followed by thorough drying with paper towels, or when a teat disinfectant is applied to the teats followed by drying with paper towels. In addition, premilking teat disinfection in association with good udder preparation reduces the rate of intramammary infections by environmental pathogens by about 51% compared with good udder preparation only.

## Premilking Teat Disinfection

Many dairy producers have now incorporated premilking teat disinfection into their mastitis control strategy, and many different

teat dips are used. Premilking teat dips containing 0.25% iodine, 0.1% iodophor, 0.25% iodophor, and 0.55% iodophor with 1.9% linear dodecylbenzene sulfonic acid (LDBSA) have been evaluated and have provided consistent results. Premilking and postmilking teat disinfection, in association with good udder preparation, are significantly more effective in prevention of environmental pathogen intramammary infection than good udder preparation and postmilking teat disinfection. No chapping or irritation of teats was observed. However, premilking teat disinfection has not been shown to decrease the incidence of clinical mastitis.

## Postmilking Barrier Teat Dips

Barrier test dips include latex, acrylic, and polymer-based products that create a physical seal between the teat and the environment and theoretically decrease the exposure of the teat end to environmental mastitis pathogens, decreasing the incidence of new coliform intramammary infections during lactation. The efficacy of this barrier product was thought to be caused by the persistency of the dip on teats between milkings; however, barrier dips were not consistently successful. In summary, barrier teat dips with germicidal agents are no more effective in decreasing the incidence of environmental mastitis than postmilking germicidal teat dips.

## Nutrition

Vitamin E or selenium deficiency decreases neutrophil chemotaxis into the mammary gland and decreases the intracellular killing of bacteria by neutrophils. It is therefore important to ensure that vitamin E and selenium intakes are adequate; this is best achieved by daily ingestion of 1000 IU of vitamin E and 3 mg of selenium for dry cows and daily ingestion of 400 to 600 IU vitamin E and 6 mg of selenium for lactating cows.

Vitamin C is the most important water-soluble antioxidant in mammals and, consequently, plasma vitamin C concentration may impact neutrophil function.<sup>25</sup> Daily ingestion of Vitamin C (30 g/day orally) had no effect on neutrophil phagocytosis, bacterial killing, or the severity of mastitis in dairy cattle following intramammary infusion of endotoxin.<sup>25</sup> The current data do not support the administration of Vitamin C in the diet as part of the control measures for *E. coli* mastitis.

## Prevention of Infection During Dry Period

Considerable movement of coliform bacteria can occur from the teat apex into the teat sinus in cows that are not being milked, so cows that are ready to calve should be kept on grass or moved into a clean area at least 2 weeks before calving, their udders and teats washed daily if necessary, and teat dipping with a teat disinfectant begun 10 days before

calving. This is particularly necessary for older cows and those that are known to be easy milkers. The teats of those cows that are “leakers” just before calving may have to be sealed with a barrier teat dip or collodion to minimize the chance of infection.

### Recumbent Cows

Cows that are recumbent and unable to stand (e.g., the downer cow) should be well bedded on clean dry straw; their udders should be kept clean and dry, and the teats should be dipped with a teat disinfectant. Strict hygiene must be practiced when using teat siphons and teat creams, and strict asepsis should be observed when doing teat surgery.

### Milking Machine

Irregular vacuum fluctuations in the milking machine may induce coliform mastitis in quarters exposed to a high level of contamination. The operation and sanitation of the milking machine, especially those parts in direct contact with the teats, must therefore be examined.

### Vaccination

#### Core Lipopolysaccharide Antigen Vaccine

The vaccination of cows during the dry period and early lactation with core lipopolysaccharide antigen vaccine (such as the Re mutant *Salmonella typhimurium* or the Rc mutant *E. coli* O111:B4, named the J5 vaccine) provides one tool to reduce the incidence and severity of clinical coliform mastitis. These vaccines are available in the United States and are based on mutated gram-negative bacteria with exposed core antigens of lipopolysaccharide. The core antigen (lipid A component) is uniform between bacterial species possessing lipopolysaccharide and is immunogenic. On theoretical grounds, the Re mutant (*S. typhimurium*) should provide better protection than the Rc mutant (*E. coli* J5) because the lipid A component is more accessible to the immune system; however, comparative studies of vaccine efficacy have not been performed. Generally, core lipopolysaccharide vaccines are weakly immunogenic, and frequent dosing (hyperimmunization) appears to increase vaccine efficacy. However, the economic benefits of hyperimmunization have not been determined.

The Re and Rc mutant vaccines are protective against natural and experimental challenge to gram-negative bacteria, and in most, but not all studies, **reduce the incidence and severity of clinical gram-negative bacterial mastitis in lactating dairy cows.**<sup>26–29</sup> In a prospective cohort study in two commercial dairy herds, during the first 90 days of lactation, cows vaccinated with *E. coli* J5 vaccine were at five times lower risk of developing clinical coliform mastitis than unvaccinated cows. This is

corroborated with the observation that cows with naturally occurring serum IgG ELISA titers higher than 1:240 against the gram-negative core antigen of *E. coli* J5 had 5.3 times lower risk of developing clinical coliform mastitis than cows with lower titers. Vaccination reduced the severity of clinical signs following intramammary experimental challenge with a heterologous *E. coli* strain. In cows vaccinated with the J5 bacterin at drying off, at 30 days after drying off and within 48 hours after calving, and challenged 30 days after calving with a strain of *E. coli* known to cause mild clinical mastitis, the duration of intramammary infection and local signs of mastitis were reduced compared with controls. Also, the concentrations of bovine serum albumin in milk 24 hours after challenge were greater in control cows than in vaccinated cows.

A partial budget analysis of vaccinating dairy cattle with one core lipopolysaccharide antigen vaccine (the Rc mutant of *E. coli* or J5 strain) indicated that herd vaccination programs were predicted to be profitable when more than 1% of cow lactations resulted in clinical coliform mastitis and predicted to be profitable at all herd milk production levels.

Core lipopolysaccharide antigen vaccines have the potential to have deleterious effects because of their endotoxin content. For instance, vaccination of late lactation and dry cattle with the *S. typhimurium* Re mutant transiently decreased leukocyte and blood-segmented neutrophil concentration, but the decrease is probably clinically insignificant. This response is typical for endotoxin administration. Vaccination of lactating dairy cattle with the *E. coli* Rc mutant decreased milk production by 7% at the second and third milkings after vaccination. These two studies indicate that core lipopolysaccharide antigen vaccines should not be administered to diseased cattle or to healthy cattle in hot and humid weather because of their decrease in cardiovascular reserve. Moreover, to minimize the total bolus exposure to endotoxin, core lipopolysaccharide vaccines should not be administered at the same time as other gram-negative vaccines.

### TREATMENT AND CONTROL

#### Treatment

Treat mild and moderate *Escherichia coli*, *Klebsiella* spp., and *Enterobacter aerogenes* clinical mastitis episodes (abnormal secretion and abnormal gland) during lactation with a  $\beta$ -lactamase-resistant intramammary formulation with activity against gram-negative bacteria per label directions (R-1).

Treat severe *E. coli*, *Klebsiella* spp., and *E. aerogenes* clinical mastitis episodes (abnormal secretion, abnormal gland, and

abnormal cow) during lactation with parenteral third- or fourth-generation cephalosporins, fluoroquinolones, potentiated sulfonamides, or intravenous oxytetracycline per label directions, in conjunction with intramammary treatment that may be extended to 5 days or 8 days per label directions (R-1).

Administer intravenous small-volume hypertonic saline or large-volume isotonic crystalloid solutions to severe clinical mastitis episodes (R-1).

Administer nonsteroidal antiinflammatory agents (ketoprofen, possibly flunixin meglumine) to cattle with systemic signs of illness (R-2).

Treat subclinical intramammary infections during lactation with an intramammary formulation (R-3).

#### Control

Implement 10-point mastitis control plan, with particular emphasis on ensuring cows are housed in a clean dry environment and that clean dry teats are milked (R-1).

Ensure cows remain standing for at least 30 minutes after milking (R-1).

Ensure adequate vitamin E and selenium intake in periparturient dairy cattle (R-1).

Consider implementing premilking teat disinfection (probably with 0.1%–0.5% iodophor formulation) (R-2).

Administer core-lipopolysaccharide antigen vaccine (Re mutant *Salmonella typhimurium* or Rc mutant *E. coli* O111:B4) at least every 6 months in herds with a high incidence of coliform mastitis (R-2).

### FURTHER READING

- Hogan J, Smith KL. Managing environmental mastitis. *Vet Clin North Am Food Anim Pract.* 2012;28:217–224.
- Schukken Y, Chuff M, Moroni P, et al. The “other” Gram-negative bacteria in mastitis. *Vet Clin North Am Food Anim Pract.* 2012;28:239–256.
- Suojala L, Kaartinen L, Pyorala S. Treatment for bovine *Escherichia coli* mastitis—an evidenced-based approach. *J Vet Pharmacol Ther.* 2013;36:521–531.

### REFERENCES

- Silva VO, et al. *Can J Microbiol.* 2013;59:291.
- Blum SE, et al. *PLoS ONE.* 2015;10(9):30136387.
- Wenz JR, et al. *J Dairy Sci.* 2006;89:3408.
- Blum S, et al. *Vet Microbiol.* 2008;132:135.
- Blum SE, Leitner G. *Vet Microbiol.* 2013;163:305.
- Dogan B, et al. *Vet Microbiol.* 2006;116:270.
- Fairbrother JH, et al. *Vet Microbiol.* 2015;176:126.
- Wagner SA, et al. *Am J Vet Res.* 2009;70:796.
- Jacobsen S, et al. *Vet Res.* 2005;36:167.
- Cyple JA, et al. *J Dairy Sci.* 2012;95:2571.
- Zimov JL, et al. *Am J Vet Res.* 2011;72:620.
- Wenz JR, et al. *J Am Vet Med Assoc.* 2006;229:259.
- Podder MP, et al. *PLoS ONE.* 2014;9(9):e106518.
- Hagiwara S, et al. *J Vet Med Sci.* 2014;76:1431.
- Bluel U, et al. *Vet Rec.* 2006;159:677.
- Moyes KM, et al. *J Anim Sci Biotechnol.* 2014;5:47.17.
- Poutrel B, et al. *J Dairy Res.* 2008;75:310.
- Suojala L, et al. *J Dairy Sci.* 2010;93:1960.

19. Persson Y, et al. *Vet Rec.* 2015;176:673.
20. Schukken YH, et al. *J Dairy Sci.* 2011;94:6203.
21. Sipka A, et al. *J Dairy Sci.* 2013;96:4406.
22. Shinozuka Y, et al. *J Vet Med Sci.* 2009;71:269.
23. Banting A, et al. *Vet Rec.* 2008;163:506.
24. Yeiser EE, et al. *J Dairy Sci.* 2012;95:4939.
25. Weiss WP, Hogan JS. *J Dairy Sci.* 2007;90:731.
26. Gurjar AA, et al. *J Dairy Sci.* 2013;96:5053.
27. Erskine RJ, et al. *J Am Vet Med Assoc.* 2007;231:1092.
28. Wilson DJ, et al. *J Dairy Sci.* 2007;90:4282.
29. Wilson DJ, et al. *J Dairy Sci.* 2008;91:3869.

## ENVIRONMENTAL STREPTOCOCCI

### SYNOPSIS

**Etiology** *Streptococcus uberis*, *S. dysgalactiae*, other *Streptococcus* spp. are most common; occasionally *Enterococcus* spp.

**Epidemiology** Common cause of subclinical and clinical mastitis in herds and countries that have controlled contagious mastitis. Responsible for approximately one-third of all cases of clinical mastitis in herds without contagious pathogens. Rate of infection high during first 2 weeks following drying off and 2 weeks before calving. Duration of infection usually short (<8 days). Prevalence of infection at calving: 11% of cows and 3% of quarters. Bedding materials (high in straw bedding) most important source of environmental streptococci; bacteria can be isolated from many different feedstuffs and several locations on cow (teats, rumen, feces, saliva, lips, and nares). Bacterial numbers low in sand, which is bedding of choice

**Clinical findings** Abnormal secretion, abnormal gland, usually no systemic signs. Recovery in two to three milkings with intramammary treatment

**Clinical pathology** Culture of milk

**Necropsy findings** Not applicable

**Diagnostic confirmation** Culture bacteria from milk and milk somatic cell count

**Differential diagnosis** Cannot differentiate from other causes of subacute and acute mastitis without culture of milk

**Treatment** Antimicrobial intramammary infusions increase bacteriologic cure rate and decrease percentage of relapses. Intramammary antibiotics should be routinely administered to all clinical cases of mastitis caused by environmental streptococci.

**Control** Decrease exposure of teat end to pathogens by attention to environment, dry bedding, sand for bedding, premilking hygiene, and premilking germicide teat dipping. Dry cow therapy with penicillin G, cloxacillin, erythromycin, and first-generation (cephapirin) or third-generation (ceftiofur) cephalosporins. Application of an internal teat sealant of bismuth subnitrate at dry off may decrease new infection rate in dry period.

## ETIOLOGY

*S. uberis* and *S. dysgalactiae* and the enterococci are the most commonly isolated environmental streptococci from intramammary infections. Other uncommon environmental streptococci involved in bovine mastitis include *S. equi* var. *zooepidemicus*, *S. viridans*, *S. equinus* (*S. bovis*), *Streptococcus* spp. group G, *S. pyogenes*, and *S. pneumoniae*. Both *S. uberis* and *S. dysgalactiae* are widespread in the animal's environment and on the skin of the teats. *Enterococcus* spp. are also a common cause of environmental intramammary infections.

## EPIDEMIOLOGY

### Occurrence and Prevalence of Infection

In countries in which the prevalence of intramammary infections caused by the contagious pathogens *S. agalactiae* and *S. aureus* has been reduced or eradicated, the proportion of intramammary infections associated with **environmental streptococci** has increased markedly; in some areas these organisms are the leading or second leading cause of both subclinical and clinical mastitis in dairy cattle. *S. uberis* is now a common cause of intramammary infection occurring during the dry period, with most clinical cases occurring during the first part of lactation. Many infections acquired during the dry period persist to lactation and contribute to the incidence of clinical mastitis in early lactation. *S. uberis* has become the most commonly isolated pathogen from clinical mastitis episodes in grazing dairy cattle in Australia and is present in 33% of submitted samples in southeast Australia.<sup>1</sup>

The rate of new infection caused by environmental streptococci is elevated during the first 2 weeks following drying off and the 2 weeks before calving; the rate of new infections is greater during the first month of lactation than during the remainder of the lactation. Approximately 50% of new infections occur during the dry period and 50% in the early part of lactation. The rate of new infections during the dry period is about five times greater than during lactation. Based on data from surveys of milk samples over a 10-year period, the point prevalence of infection of environmental streptococci was 4% of quarters and 12% of cows. The percentage in heifers at calving is similar to that in cows. The prevalence of environmental streptococci isolation at drying off and calving was 2.5% and 3.0%. Environmental streptococcal intramammary infections are usually short-lived (<28 days), with only a small percentage becoming chronic.

The most important change in the epidemiology of bovine mastitis over the past decade has been the rise in the importance of environmental pathogens, mainly causing clinical mastitis, relative to contagious pathogens. Remarkable increases in both the coliforms and environmental

streptococci as causes of clinical mastitis have occurred. The percentage of clinical cases of mastitis from which environmental streptococci can be isolated ranges from 14% in Ontario to 26% in the UK. When expressed as a percentage of clinical cases from which a major pathogen was isolated, environmental streptococci are isolated in 37% to 45% of cases.

## Source of Infection

The environmental streptococci, especially *S. uberis*, have been isolated from bedding materials and the lips and tonsils of cows, with the abdominal skin of cows often harboring the largest population. Some cows are permanently colonized with *S. uberis* and may pass large numbers of the bacteria in the feces. Fecal shedding is thought to play an important role in the maintenance of *S. uberis* populations on dairy farms, and is the likely source of large numbers of the organism in straw bedding on farms in which this form of mastitis persists. The numbers of environmental streptococci in organic bedding materials vary with the type of bedding. Large numbers of *S. uberis* are found in straw bedding and much lower numbers in sawdust and wood shavings. The numbers of streptococci recovered from the teats of cows bedded on sawdust are lower than those bedded on straw. Long straw used in calving box stalls or as bedding in loose housing can be a source of considerable exposure to environmental streptococci.

*S. dysgalactiae* can also be found in the environment of dairy cattle and has been isolated from the tonsils, mouth, vagina, and the mammary glands. It has characteristics of both a contagious and an environmental pathogen, and some categorization schemes place it in the contagious category, although it is primarily an environmental pathogen. *S. dysgalactiae* is also associated with summer mastitis, which affects dry cows and heifers during the summer months. It has been isolated from the common cattle fly *Hydrotoea irritans*, which may be involved in the establishment and maintenance of bacterial contamination of teats. *S. dysgalactiae* may colonize the teat before infection with *T. pyogenes* and anaerobic bacteria such as *P. indolicus* and *F. necrophorum*.

## Risk Factors

### Environmental Risk Factors

The major risk factor for environmental streptococci infection is **exposure of the teat end to mastitis pathogens in the environment**. Transmission is predominantly from the environment. Exposure of uninfected teats to environmental streptococci can occur during the milking process, between milkings, during the dry period, and before parturition in first-lactation heifers. The rate of new infections is greatest during the summer months in North America.



Housing and management practices on dairy farms may contribute to contamination of bedding materials and exposure of teats to environmental streptococci. Housing facilities that predispose to the accumulation of feces on cows will increase the rate of exposure of the teat end to the pathogens. Straw bedding appears to increase the risk of *S. uberis* mastitis, and an increase in *S. uberis* mastitis cases occurs when cows are housed in deep straw pack.

Pastured cattle are generally at reduced risk for environmental streptococcal mastitis compared with cows in confinement housing. However, certain pasture conditions, such as areas under shade trees, poorly drained ground surfaces, ponds and muddy areas, may result in a high rate of exposure to the pathogens, particularly to *S. uberis*. The environmental streptococci are the most significant environmental pathogen in New Zealand dairy herds in which cows spend almost 100% of their time on pasture.

*S. dysgalactiae* is commonly isolated from heifers and cows in the dry period and is one of the most prevalent pathogens isolated from cases of summer mastitis. The spread of *S. dysgalactiae* between cows within dairy herds may occur directly or by way of the milking machine or environment.

#### Animal Risk Factors

*S. uberis* is the most common cause of clinical mastitis at calving in cattle in pasture-based dairy systems.<sup>2</sup> The risk of new infections is influenced by the stage of lactation and parity of the cow. The **rate of new infection is highest during the 2 weeks following drying off and the 2 weeks before calving**. The high rates of new infection following drying off may be associated with the lack of flushing action of milking, changes in the composition of the mammary secretion, which may enhance the growth of the pathogens, and the lack of a keratin plug in the streak canal. The primary defense mechanisms for *S. uberis* are the length of the teat canal and the amount of keratin in the lining. Antimicrobial dry cow therapy reduces the infection rate in the early part of the dry period but has little or no effect on preventing infection with *S. uberis* at the end of the dry period. The increase in susceptibility to infection just before parturition may be associated with the lack of milking when the gland is accumulating fluid, loss of keratin plugs from streak canals, or immunosuppression of the periparturient period. The **rate of infection is also higher in older cows** than for either heifers or cows in second lactation, and highest during the summer months for both cows in lactation and cows in the dry period. This is in contrast to contagious pathogens, in which exposure occurs primarily during the milking process. A small percentage of animals have highly resistant phenotypes for *S. uberis* infection.<sup>2</sup>

#### Pathogen Risk Factors

*S. uberis* is ubiquitous in the cow's environment with multiple environmental habitats. Consequently, the mammary gland is exposed continuously to the pathogen during lactation and the dry period, and infections are associated with a large variety of strains, some of which are not capable of inducing clinical mastitis or prolonged infections of subclinical mastitis.<sup>3</sup> Several virulence factors of *S. uberis* have been identified that are important in the pathogenesis of environmental mastitis. Antiphagocytic factors allow *S. uberis* to infect and multiply in the gland and to adhere to and invade the mammary tissue. Bovine mammary macrophages are capable of phagocytosis of the organism, but certain strains of *S. uberis* are capable of resisting phagocytosis by neutrophils because of their **hyaluronic acid capsule**. The ability of *S. uberis* to invade the bovine mammary epithelial cells could result in chronic infection and protection from host defense mechanisms and the action of most antimicrobial agents, which may explain the intractable response to therapy in some cases. However, most apparently "intractable" infections are caused by an inappropriately short duration of treatment.

*S. dysgalactiae* behaves like both a contagious and an environmental pathogen<sup>4</sup> and can invade bovine mammary epithelial cells, which may explain the persistence of infection. Different biotypes of *S. dysgalactiae* have been identified, and strains can possess several antiphagocytic factors, including M-like protein,  $\alpha$ -2-macroglobulin, capsule and fibronectin binding, and virulence factors, including hyaluronidase and fibrinolysin.

An existing intramammary infection caused by *C. bovis* is a risk factor for environmental streptococcal infection through an unidentified mechanism.

#### Economic Importance

The major economic losses associated with environmental streptococcal mastitis are caused by clinical mastitis resulting in lost production, milk withholding, premature culling, increased labor, and costs of therapy and veterinary services. Eighty-eight percent of the loss associated with clinical mastitis is attributed to loss of milk production and milk withholding. Pluriparous cows lost 2.6 times as much as first-calf heifers, and cows less than 150 days in milk lost 1.4 times more than cows more than 150 days in milk. Intramammary infection with *S. uberis* at calving in heifers resulted in a decreased lactational milk yield, even with subclinical infections, which means that *S. uberis* infections at calving should be routinely treated.<sup>5</sup>

#### PATHOGENESIS

The current consensus is that environmental streptococci (with the possible exception

of *S. dysgalactiae*) are not contagious pathogens.<sup>4</sup>

In experimental infection of dairy cows with *S. uberis* there is acute inflammation, resulting in the accumulation of large numbers of neutrophils in the secretory acini in 24 hours. Adherence to mammary epithelial cells followed by internalization appears to be important in the establishment of infection.<sup>6,7</sup> Infection also leads to the recruitment of activated T cells that are able to kill *S. uberis* and appear to play an important role in an effective immune response.<sup>8</sup> After 6 days of infection, the neutrophil response is still evident, but there is cellular infiltration, septal edema, extensive vacuolation of secretory cells, focal necrosis of alveoli, small outgrowths of the secretory and ductular epithelium, and widespread hypertrophy of the ductular epithelium. The organism is present free or phagocytosed, in macrophages in the alveolar lumina, adherent to damaged secretory or ductular epithelium, in the subepithelium and septal tissue, and in lymphatic vessels and lymph nodes. The macrophage and activated T cells are important as the primary phagocytic cells,<sup>7,8</sup> but the marked neutrophil response may be ineffective as a defense mechanism. It is hypothesized that the marked neutrophil response following infection with *S. uberis*, rather than the organism, may be responsible for most of the effects of the mastitis. At least 11 virulence-associated genes have been identified in *S. uberis*, but it is not clear which are of major importance.<sup>9</sup>

#### CLINICAL FINDINGS

Approximately 50% of environmental streptococcal intramammary infections cause clinical mastitis during lactation. Clinical abnormalities occur in 42% to 68% of these infections in the same herd in different years. The clinical findings are usually limited to abnormal secretion or abnormal gland. In about 43% of cases the findings are limited to abnormal milk, 49% involve abnormal secretion and an enlarged (abnormal) gland, and in only 8% of cases do systemic signs include a fever and anorexia (abnormal cow). Clinical recovery commonly occurs in 24 to 48 hours. Natural infections with *S. uberis* appear to be more severe than natural infections with *S. dysgalactiae*, based on higher milk SCC for *S. uberis* mastitis episodes during the 4-month period after treatment.<sup>4</sup>

#### CLINICAL PATHOLOGY

The laboratory diagnostic tests for these pathogens are the same as for *S. agalactiae*. All the environmental streptococci except *S. dysgalactiae* hydrolyze esculin on blood agar. Species can be differentiated with reasonable success using a variety of biochemical tests, such as the API20 Strep and serologic grouping using specific antisera of Lancefield groups; however, this approach is laborious, time-consuming, and does not accurately

differentiate every streptococcal mastitis pathogen. Biophysical analytical techniques have recently been applied with success to accurately differentiate streptococcal mastitis pathogens, including MALDI-TOF MS, which is mainly based on ribosomal proteins, and Fourier transform infrared spectroscopy, which covers the entire biochemical composition of a bacterial cell.<sup>10</sup>

#### DIFFERENTIAL DIAGNOSIS

*Streptococcus uberis* mastitis in dry cows may be sufficiently severe to resemble mastitis associated with *Trueperella pyogenes*. Diagnosis depends on cultural examination of the milk.

#### TREATMENT

##### Antimicrobial Agents

The in vitro susceptibility of environmental streptococci to antimicrobial agents is high. Most isolates of *S. uberis* and *S. dysgalactiae* are susceptible to penicillin, novobiocin, amoxicillin, and cephapirin. A high percentage (96%) are also susceptible to tetracycline, but susceptibility to aminoglycosides is much lower. Most cases of clinical mastitis associated with *S. uberis* and *S. dysgalactiae* respond well to intramammary infusions of penicillin, cephalosporins, cloxacillin, erythromycin, and tetracyclines. Spontaneous cures can also occur. Clinical cases in lactating cows should be treated by at least two intramammary infusions 12 hours apart; this may produce a clinical cure but fail to produce a bacteriologic cure. Subclinical infections in **late lactation** may be left until the dry period. For clinical cases in the first 100 days of lactation there is substantial economic benefit from intramammary treatment. Some cases associated with strains of *S. uberis* appear intractable to treatment; extended treatment is necessary in these animals. Failure of treatment may be caused by epithelial cell invasion and movement of the bacteria into subepithelial layers, possibly reducing the effectiveness of the antimicrobial. Apparently recurrent episodes of clinical mastitis caused by *S. uberis* despite adequate treatment are more likely from a subsequent infection with a new strain, rather than ineffective treatment.<sup>1</sup> Parenteral treatment is rarely needed to treat cattle with confirmed *S. uberis* clinical mastitis.

Extended therapy (for 5 days or 8 days) with intramammary ceftiofur (125 mg), pirlimycin (50 mg), or penethamate hydriodide, dihydrostreptomycin sulfate, and framycetin sulfate, every 24 hours, increases the bacteriologic cure rate for cattle with experimentally induced *S. uberis* mastitis. In a study of 1148 cases of subclinical environmental streptococci mastitis in New York, commercially available intramammary infusions were more effective than untreated

controls (66% bacteriologic cure), with the following bacteriologic cure rates: amoxicillin (90%), penicillin (82%), and cloxacillin (79%).

Treatment using oxytocin and frequent stripping of the affected glands without intramammary antibiotic administration is not recommended because cure rates are much lower. Moreover, not administering antimicrobial agents results in a higher relapse rate. Many of the relapses were associated with the environmental streptococci; therefore **intramammary antimicrobial treatment should be routinely performed**. In particular, because clinical mastitis with an abnormal gland or abnormal cow induces some pain and discomfort in the cow, **withholding an effective treatment (intramammary antimicrobials) cannot be condoned on animal welfare grounds**.

Meloxicam (250 mg subcutaneously once) was administered to dairy cows in New Zealand with mild clinical mastitis receiving three daily intramuscular injections of penethamate hydriodide (5 g). In this population, *S. uberis* was the most common isolate, and the addition of meloxicam to the treatment protocol decreased the posttreatment SCC and decreased culling from the herd from 28% to 16%.<sup>11</sup>

#### CONTROL

The control of mastitis caused by environmental streptococci is achieved by **decreasing the exposure of pathogens to the teat end** and by increasing the resistance to intramammary infections. A specific control recommendation for environmental streptococci mastitis is **not to bed on straw**, but this may not be a practical or economic recommendation for some producers. If straw bedding is used, a reduction in the teat-end exposure to *S. uberis* can result from frequent (daily) replacement of bedding. The key factor promoting environmental streptococci mastitis is bedding on wet or damp straw.

**Reducing the exposure of the teat end to manure and dirt** depends on **maintenance of a clean and dry environment**. The alleys and holding pens should be frequently scraped, and places in which cows lie down should be dry. Special attention must be directed to the dry cow and close-up heifer housing, the calving area, lactating cow housing, and the milking parlor and milking hygiene. Organic bedding materials such as straw that support large numbers of environmental pathogens when wet should be kept dry. Sand is the ideal bedding material because it has the lowest number of coliform and environmental pathogens. Milking time hygiene should emphasize milking of clean, dry teats and udder, with a properly functioning milking machine. Predipping with a teat dip germicide may reduce environmental mastitis by as much as 50%, but this reduction does not occur in all herds.

**Dry cow therapy** to prevent new infections has not been as successful for the control of all causes of environmental mastitis as it has been for contagious mastitis. However, dry cow therapy is more effective against the environmental streptococci than against coliform bacteria. Application of an **internal teat sealant** of bismuth subnitrate at dry off is effective in preventing infections associated with *S. uberis* during the dry period. Combined administration of a dry cow intramammary formulation and an internal teat sealant has become routine in Australia as a fundamental plank in dairy herds with endemic *S. uberis* mastitis.<sup>12</sup>

A long-acting intramammary infusion dry cow therapy containing 250 mg of cephalonium administered after the last milking of lactation reduced the incidence of new infections caused by *S. uberis* from 12.3% to 1.2%. Clinical infections during the dry period were most prevalent in quarters identified as having open teat canals. Fewer open teat canals were observed among treated quarters over the first 4 weeks of the dry period. It is proposed that the teat canal of treated quarters closed earlier than those of untreated quarters. Most of the new infections in the untreated controls occurred within the first 21 days of the dry period. Normally, the teat canal is dilated for up to 7 days after drying off, with a keratin plug then forming over the following 14 to 21 days. It is suggested that once a physical keratin seal has formed in the teat canal after drying off, an uninfected quarter has a very low risk of infection over the remainder of the dry period. Treated quarters had a lower incidence of new clinical infections during the next lactation and lower SCCs.

#### Vaccination

Experimentally, multiple intramammary vaccinations with whole killed *S. uberis* cells resulted in complete protection against experimental infection in cattle. Bacteria could not be isolated from the quarters after challenge, and protection occurred in the absence of a marked neutrophil response. Preparations containing plasminogen activator or recombinant *S. uberis* adhesion molecule may form the basis of a vaccine against *S. uberis*.<sup>13</sup>

Vaccines are presently commercially unavailable, and vaccination is not currently recommended as part of the control program for mastitis caused by environmental streptococci.

#### TREATMENT AND CONTROL

##### Treatment

Treat clinical mastitis episodes during lactation with an intramammary formulation that is effective against gram-positive bacteria per label directions; consider extended

Continued

intramammary therapy in chronic cases (R-1).

Treat subclinical *S. uberis* intramammary infections at calving with an intramammary formulation that is effective against gram-positive bacteria per label directions (R-1).

Administer nonsteroidal antiinflammatory agents (meloxicam) to cattle with clinical mastitis that is predominantly caused by environmental streptococci (R-2).

#### Control

Implement 10-point mastitis control plan, with particular emphasis on ensuring cows are housed in a clean dry environment and that clean dry teats are milked (R-1).

Ensure cows remain standing for at least 30 minutes after milking (R-1).

Administer a long-acting intramammary formulation with activity against gram-positive bacteria at dry off to all cows, followed by infusion of an intramammary teat sealant (R-1).

## REFERENCES

1. Abureema S, et al. *J Dairy Sci.* 2014;97:285.
2. Turner SA, et al. *J Dairy Res.* 2013;80:360.
3. Tassi R, et al. *J Dairy Sci.* 2013;96:5129.
4. Lundberg A, et al. *Acta Vet Scand.* 2014;56:80.
5. Pearson LJ, et al. *J Dairy Sci.* 2013;96:158.
6. Almeida RA, et al. *Vet Microbiol.* 2015;179:332.
7. Tassi R, et al. *Vet Res.* 2015;46:123.
8. Denis M, et al. *Vet Res Commun.* 2011;35:145.
9. Reinoso EB, et al. *FEMS Microbiol Lett.* 2011;318:183.
10. Schabauer L, et al. *BMC Vet Res.* 2014;10:156.
11. McDougall S, et al. *J Dairy Sci.* 2009;92:4421.
12. Runciman DL, et al. *J Dairy Sci.* 2010;93:4582.
13. Prado ME, et al. *Vet Immunol Immunopathol.* 2011;141:201.

## TRUEPERELLA PYOGENES

### ETIOLOGY

*T. pyogenes* (formerly *Arcanobacterium pyogenes*, *Actinomyces pyogenes*, and *Corynebacterium pyogenes*) causes two forms of severe clinical mastitis: sporadic cases of suppurative mastitis, mostly in housed cattle, referred to as **pyogenes mastitis**, and a clinically similar disease that occurs in outbreaks in cattle during the summer months in Europe and Scandinavia and is referred to as **summer mastitis**. Successful transmission of infection has been performed, but the bacteria is rarely present in pure culture in the naturally occurring disease and is not the specific cause of summer mastitis. When the organism is applied to the teat skin at the end of the teat, infection of the quarter does not occur unless the teat end is injured, which is when anaerobic bacteria are also involved in the infection.

### SYNOPSIS

**Etiology** *Trueperella pyogenes*, formerly known as *Arcanobacterium pyogenes*, *Actinomyces pyogenes*, or *Corynebacterium pyogenes*

**Epidemiology** Important cause of sporadic suppurative mastitis, most common in dry cows or pregnant heifers. Outbreaks occur in Europe in summer (called summer mastitis) associated with seasonally active biting flies, such as *Hydrotoea irritans*. Other bacteria (*Streptococcus dysgalactiae* and *Peptostreptococcus indolicus*) may be required to initiate clinical mastitis.

**Clinical findings** Gland is severely swollen and hard, usually only one quarter affected. Secretion from infected quarters is initially watery with clots and later purulent. Initially severe systemic signs including fever, inappetence, tachycardia, depression, and mortality rate up to 50%. In cattle surviving the initial infection, the affected quarter becomes abscessed, with drainage of purulent material at the base of the teat.

**Clinical pathology** Culture of milk

**Necropsy findings** Abscesses in one gland and severe systemic reaction are strong presumptive necropsy findings of *T. pyogenes* mastitis.

**Differential diagnosis** Cannot definitively differentiate from other causes of acute mastitis without culture of milk; however, the presence of abscesses in mastitis is strongly suggestive of *T. pyogenes*.

**Treatment** Responds poorly to treatment with parenteral procaine penicillin G or oxytetracycline and intramammary penicillin. Affected quarter is almost always lost for milk production.

**Control** Intramammary infusion with dry cow preparation every 3 weeks during the dry period. Control fly populations. Isolate cows with draining abscesses.

In summer mastitis the purulent material in the quarter usually contains *T. pyogenes* as a primary pathogen, but the severity of the disease is determined by the presence of anaerobes such as *P. indolicus*; *S. dysgalactiae*; *F. necrophorum*; *P. melaninogenica*; *Fusobacterium* spp.; a microaerophilic, gram-positive coccus (Stuart-Schwan coccus); and other Bacteroidaceae and *Micrococcus* spp. are also found. These bacterial species are found on the teats and conjunctiva and in the oral cavity of healthy cattle. *F. necrophorum* was recovered almost exclusively from the oral cavity, *P. indolicus* and *T. pyogenes* most frequently from teat skin, and isolates of *P. melaninogenica* subsp. *levii* were evenly distributed between conjunctiva and teat tip samples. There is also a distinct seasonal pattern of the isolation of the pathogens, which corresponds closely to the seasonal activity of the fly *H. irritans*.

It has also been proposed that *S. dysgalactiae* is the primary cause, and the others secondary invaders, but all these bacteria are capable of causing suppurative mastitis when infused into the udder. *T. pyogenes* alone establishes itself readily in mammary tissue after experimental introduction but causes only a subclinical disease, but inclusion of summer mastitis exudate provokes the classical syndrome of summer mastitis. Experimental infections with *T. pyogenes* and *P. indolicus* cause a much more serious disease, and are less responsive to treatment if the infection is introduced into a dry quarter instead of into a lactating one. The bacterial flora in cases of summer mastitis is quite variable. In some years in the UK, many cases are apparently caused by pure infections of *M. haemolytica*. In pyogenes mastitis, *T. pyogenes* is often found in pure culture, but the other bacteria listed in summer mastitis are also common accompaniments. *A. ulcerans* is an uncommon cause of a subacute mastitis.

### EPIDEMIOLOGY

#### Occurrence and Prevalence of Infection

Bovine mastitis associated with *T. pyogenes* occurs sporadically and is most common in dry cows or pregnant heifers, although lactating cows may also be affected. A high prevalence is also recorded in heifer calves as young as 2 months. In the UK, Japan, northern Europe, Florida, and infrequently in a group of countries scattered all over the world, there is a much higher incidence of suppurative “summer mastitis” during the summer months when nonlactating females are left at pasture and not kept under close observation. In the UK 20% to 60% of farms are affected, the same herds are affected each year, and about 40% of farms never experience the disease.

#### Source of Infection and Mode of Transmission

The portal of infection is unknown, although it is presumed to be via the streak canal. The method of spread is uncertain in sporadic cases but insects, especially biting ones such as *H. irritans*, appear to play an important role in outbreaks of summer mastitis in northern Europe. The prevalence of the disease is related to the peaks of the fly populations and the prevailing climate, especially the wind force and direction.

#### Risk Factors

The incidence is much higher in wet summers and on heavily wooded and low-lying farms when the fly population is high. Dairy breeds are the predominant target, mostly at the end of gestation or in the first few days of the lactation. Heavy fly populations are a common accompaniment of an outbreak. It has been suggested that some triggering mechanism is needed before contamination



of the teat and invasion and infection of the gland can occur. The infection rate of *T. pyogenes* in udders is much less in housed cattle than in the same cattle at pasture. In Australia the disease occurs mostly in lactating cows and usually after injury or the development of black spot on the teat. Outbreaks are also recorded in association with outbreaks of foot-and-mouth disease and herpes mamillitis virus damage to the teats.

### Economic Importance

Summer mastitis is a serious disease because the mortality rate without adequate treatment is probably about 50%, and the affected quarters of surviving cows are always totally destroyed. In pyogenes mastitis the mortality rate is much less, but the loss of the quarter means that the cow is culled.

### PATHOGENESIS

It is suggested that the infection is carried from udder to udder by flies and that massive invasion of the mammary tissue occurs via the teat canal that is damaged. The greater part of the gland is affected at the first attack, causing a severe systemic reaction and loss of function of the entire quarter. The disease has been reproduced by inoculation of the mammary gland of pregnant heifers with *T. pyogenes*, *F. necrophorum*, and *P. indolicus*. All animals developed moderate to severe clinical mastitis: 4 out of 10 animals recovered completely and had a normal lactation after calving. In 6 of 10 animals, the course of the disease was severe and affected quarters failed to produce milk after calving.

### CLINICAL FINDINGS

Mastitis associated with *T. pyogenes* is usually peracute with a severe systemic reaction, including fever (40°C–41°C; 105°F–106°F), rapid heart rate, complete anorexia, and severe depression and weakness. Abortion may occur during this stage. In almost all cases only one quarter is affected, most commonly a front one. The teat is swollen and inflamed and the quarter is very hard, swollen, and sore; the secretion is watery with clots early and later purulent, with a typical putrid odor. The SCC from the secretion of affected cows is extremely high, and the secretion resembles a purulent process more than milk.<sup>1</sup> Affected cows usually carry a large fly population. If the cow survives the severe toxemia, the quarter becomes extremely indurated and abscesses develop, later rupturing through the floor of the udder, commonly at the base of the teat. These may be presented as chronic cases, but they are usually residual after an acute episode. True gangrene, such as occurs in staphylococcal mastitis, rarely if ever occurs in uncomplicated infections with *T. pyogenes*, but quarters may be so severely affected that sloughing occurs. Lameness in the hindlimb on the affected side occurs in some cases, and the limb joints may be

swollen. The function of the quarter is permanently lost, and cows that have calved recently may go completely dry. Severe cellulitis with extreme thickening and obstruction of the teat is a common sequel. Partial or complete obstruction of the teat and damage to the teat cistern can also occur independently of an acute attack of mastitis. Fetal growth retardation is thought to be a feature of calves born to cows affected by summer mastitis during pregnancy.

### CLINICAL PATHOLOGY

Isolation of the bacteria is required. Freezing of milk samples reduces the number of samples giving a positive cultural result. MALDI-TOF MS provides a promising tool for the rapid identification of *T. pyogenes*.<sup>2</sup>

### NECROPSY FINDINGS

Details of the pathology of the disease are not available.

### DIFFERENTIAL DIAGNOSIS

The seasonal incidence of the disease in some areas, the acute inflammation of the quarter, the suppurative nature of the mastitis, the development of abscesses, and the severe systemic reaction make this form of mastitis one of the easiest to diagnose clinically in cattle.

### TREATMENT

Summer mastitis normally responds extremely poorly to treatment, and the affected quarter is almost always lost for milk production. Failure of therapy is caused by the extensive purulent processes in the udder and not to antimicrobial resistance. Bacterial isolates from cases of summer mastitis are susceptible to penicillin G and other  $\beta$ -lactam antimicrobials. However, penicillin G has limited distribution throughout the inflamed udder. Given parenterally to experimental cases of summer mastitis, it was effective in about 40% of cases if treatment was initiated within 32 hours after inoculation. In peracute cases parenteral treatment with sodium sulfadimidine or one of the tetracyclines is preferable and should be accompanied by repeated stripping of the quarter. Broad-spectrum antimicrobial agents are usually given by intramammary infusion, but the quarter is almost always rendered functionless.

Affected quarters can also be treated by permanently drying the quarter off. The best method for permanently drying off a quarter is infusion of 120 mL of 5% povidone iodine solution (0.5% iodine) after complete milk out and administration of flunixin meglumine (1 mg/kg BW, intravenously). This causes permanent cessation of lactation in the quarter but does not alter total milk production by the cow.

Clearing of proteinaceous debris from the affected quarter may be aided by the intramammary application of proteolytic enzymes, but the outcome as far as the quarter is concerned is unlikely to be much altered and amputation of the teat to facilitate drainage is a common treatment. Even with intensive therapy, at least 80% of quarters are rendered useless and many of those that respond are greatly reduced in productivity.

### CONTROL

The question of control of this form of mastitis centers largely on summer mastitis. Many prophylactic measures, including infusion of the quarter when the cow is dried off, sealing the teat ends with collodion, and vaccination with toxoid, have been tried but with inconclusive results. The most favored technique is intramammary infusion with a dry cow preparation (e.g., cloxacillin 500 mg and ampicillin 250 mg in a long-acting base) at 3-week intervals during the dry period. Less frequent administration offers less protection. An alternative intramammary infusion procedure is to use cephalonium at 4-weekly intervals.

Repeated spraying of the udder, for example automatically at watering points, with a contact insecticide is commonly performed during the fly season and is thought to be effective. An alternative to spraying is the use of insecticide-impregnated ear tags, or pour-ons. Careful daily examination of dry cows during the summer may enable affected quarters to be identified, the cows to be isolated, and the quarters treated at an early stage, limiting the spread of infection. In particular, cows with purulent material draining from an affected quarter need to be isolated from other cattle. Early treatment of teat lesions to limit bacterial colonization by bacteria, possibly transported by flies, is recommended. The known susceptibility of particular farms, and particular paddocks on those farms, demands proper care in planning the pasturing of dry cows during the danger period.

### TREATMENT AND CONTROL

#### Treatment

Treat clinical mastitis episodes immediately with intravenous oxytetracycline (R-1).

Permanently dry off affected quarters if cow is to remain in the herd (R-2).

#### Control

Isolate cow from the rest of the herd if spontaneous purulent discharge from udder is present (R-1).

Fly control during summer months for pastured cattle (R-1).

## FURTHER READING

Egan J. *Actinomyces pyogenes* mastitis with particular emphasis on summer mastitis. *Ir Vet J*. 1994;47:180-186.

## REFERENCES

- Zastempowska E, Lassa H. *Vet Microbiol*. 2012;161:153.
- Nagib S, et al. *PLoS ONE*. 2014;9:e104654.

## Mastitis of Cattle Associated With Less Common Pathogens

### *PSEUDOMONAS AERUGINOSA*

Mastitis in cattle and sheep associated with *P. aeruginosa* is rare and occurs usually as sporadic cases after intramammary infusion with contaminated material.

### ETIOLOGY

*P. aeruginosa* is the most common cause, although other *Pseudomonas* spp. can cause disease. *P. aeruginosa* produces a number of extracellular toxins; hemolysin is cytotoxic for most cells and is considered the most potent toxin produced, lecithinase (phospholipase) can destroy cell membranes, and protease degrades proteins. In 25 *P. aeruginosa* isolates from the milk of cattle with mastitis in Egypt, 80% carried the hemolysin virulence factor, whereas 72% were lecithinase positive and 16% were protease positive.<sup>1</sup>

### EPIDEMIOLOGY

*P. aeruginosa* is common in the environment of cattle because of its innate ability to survive for long periods in dry and moist conditions. Occasionally a number of animals in the herd are affected with *P. aeruginosa* mastitis; the infection usually originates in contaminated water used for washing udders. The organism has the capacity to colonize inert materials such as loops of hose and the interior surface of water heaters, so that high bacterial concentrations may be in the water left in the hose between milkings. It may be an advantage in these circumstances to flush out the udder washing system before commencing each milking. Once the teats are contaminated, the entry of the organisms to the teats is facilitated by overmilking and by putting the milking cups on while the udder is still wet. Serious outbreaks in cows have also occurred in association with the use of a suspected contaminated mastitis infusion used as a dry period treatment. The cows became affected soon after calving. Prolonged herd outbreaks are rare.

Rarely, strains of this organism are highly virulent and cause fatal mastitis with generalized lesions. Less commonly there is a high level of infection in a herd caused by a contaminated water supply but with no clinical

cases. Reinfection is common unless the source of infection is removed.

### CLINICAL FINDINGS

The mastitis in cattle is usually mild, subacute, or chronic, but can be clinically severe with a mortality rate as high as 17% of affected cows. Clinically, there is a severe systemic reaction and acute swelling of the gland with the appearance of clotted, discolored milk; the function of the gland is usually completely lost at the first attack, but recurrent crises may occur.

### CLINICAL PATHOLOGY

Culture of the organism in milk is necessary to confirm the diagnosis.

### NECROPSY FINDINGS

The disease can be fatal, and the gross and histologic findings are similar to other causes of clinical mastitis in cows.

### DIFFERENTIAL DIAGNOSIS

Bovine mastitis associated with *Pseudomonas aeruginosa* must be differentiated from the many other forms of acute mastitis associated with this species; this can be done only by bacteriologic examination of the milk.

### TREATMENT

**Treatment with antimicrobial agents is generally unsuccessful.** *P. aeruginosa* is an intrinsically multidrug-resistant bacteria because it has decreased outer membrane permeability, efflux systems, and produces  $\beta$ -lactamase.<sup>2,3</sup> Most bovine mastitis strains are also strong biofilm producers that further decrease antimicrobial effectiveness.<sup>4</sup> However, *P. aeruginosa* isolates from cattle with mastitis are susceptible to a wider variety of antimicrobials than similar isolates from humans.<sup>2</sup> This has been attributed to a lack of selection pressure in the cow's environment.<sup>2</sup> Third-generation cephalosporins such as ceftiofur, aminoglycosides such as gentamicin and amikacin, and fluoroquinolones are most likely to be efficacious in treating affected animals,<sup>4</sup> but susceptibility testing may be helpful in identifying which antimicrobials not to administer on the basis of a very high MIC.

### CONTROL

The standard control program described later in the chapter should control the disease in cows. The oral administration of an organic iodine compound and vaccination with a killed autogenous vaccine are credited with bringing the disease under control in one herd.

### REFERENCES

- Younis G, et al. *Adv Anim Vet Sci*. 2015;3:522.
- Ohnishi M, et al. *Vet Microbiol*. 2011;154:202.
- Ghazy AE, et al. *Alexandria J Vet Sci*. 2015;44:80.
- Park HR, et al. *Acta Vet Hung*. 2014;62:1.

### *MANNHEIMIA (PASTEURELLA) SPECIES*

Mastitis associated with *Mannheimia* (formerly *Pasteurella*) *haemolytica* and *Pasteurella multocida* is common in ewes, occurring in a peracute gangrenous form, but is comparatively rare in cattle and goats.

### ETIOLOGY

In cattle *M. haemolytica* and *P. multocida* are the causative organisms; *M. haemolytica* has also been isolated from many cases of **summer mastitis** in the UK.

### EPIDEMIOLOGY

In cattle the disease is encountered rarely, and usually sporadically, but it may be a problem in individual herds, particularly in which calves are reared by nurse cows.

### CLINICAL FINDINGS

In cattle the mastitis is severe with fever, profound toxemic shock, weak pulse, tachycardia, and recumbency. The affected quarter is very swollen and the milk is watery, red-tinged, and contains flakes. Disseminated intravascular coagulopathy may cause internal bleeding at many sites. All four quarters may be affected. There is complete cessation of milk flow in affected and unaffected quarters and subsequent fibrosis and atrophy. Newborn calves allowed to suck colostrum from affected cows may die of pasteurellosis.

### Clinical Pathology

Culture of the organism in the milk is necessary to confirm the diagnosis.

### NECROPSY FINDINGS

The disease is not fatal in cows.

### DIFFERENTIAL DIAGNOSIS

Bovine mastitis associated with *Pasteurella multocida* must be differentiated from the many other forms of acute mastitis associated with this species; this can only be done by bacteriologic examination of the milk.

### TREATMENT

In cattle, streptomycin administered by intramammary infusion is effective, but tetracycline is preferred. Recurrence in quarters that appear to have recovered is not infrequent, and response to treatment is often poor.

### CONTROL

The standard control program described later in the chapter should control the disease in cows.

### *NOCARDIA SP.*

Nocardial mastitis is an uncommon occurrence in cattle and is manifested as an acute

or subacute mastitis accompanied by extensive granulomatous lesions in the udder.

## ETIOLOGY

*Nocardia* are aerobic, gram-positive, filamentous, branching rods.<sup>1</sup> *Nocardia* spp. are ubiquitous environmental saprophytes with more than 30 named species.<sup>2</sup> *N. asteroides* can be cultured from the milk of affected quarters, and the disease can be produced experimentally by this organism. The most common species isolated from bovine mastitis are *N. nova* and *N. farcinica*.<sup>3</sup> Occasional cases of chronic mastitis associated with *N. africana*, *N. arthritidis*, *N. asteroides*, *N. brasiliensis*, *N. cyriacigeorgica*, *N. neocaledoniensis*, and *N. puris* have also been recorded.<sup>3</sup>

## EPIDEMIOLOGY

### Occurrence

With rare exceptions, nocardial mastitis in cattle has been recorded as a sporadic infection affecting only one or two cows in a herd. Accidental introduction of the causative bacteria into udders when infusions are being administered may create a herd problem. A large number of cases occurred in Canada from 1987 to 1989 because of intrinsic contamination of a neomycin-containing dry cow formulation with an amikacin-resistant strain of *N. farcinica*.<sup>4,5</sup> *N. neocaledoniensis* was isolated from the quarters of nine dairy cattle in Italy with chronic mastitis; intramammary infection was attributed to inadequate hygiene procedures during administration of intramammary therapy.<sup>2</sup> *Nocardia* is recorded as being a relatively common chronic mastitis in Cuba. Confinement of dairy cattle in muddy pens has been associated with an increased incidence of nocardial mastitis.

### Source of Infection and Mode of Transmission

The bacteria is a common soil contaminant and probably gains entrance to the udder when udder washing is ineffective or udder infusion is not performed aseptically. *Nocardia* can survive in ineffective teat dips and may be spread by their use. The disease is most common in freshly calved adult cows, particularly if infusion of the udder with contaminated materials is performed in the dry period. *N. farcinica* is capable of surviving in mixtures used for intramammary infusion for up to 7 weeks. There is one record of a massive outbreak with many deaths in dairy cattle that was probably caused by the use of a contaminated homemade udder infusion.

### Risk Factors

A sharp increase in isolations of *N. farcinica* in milk samples at veterinary diagnostic laboratories in Canada was related to the extensive use of a particular dry period treatment. Teat dips containing recommended concentrations of iodine or dodecylbenzene

are effective against *Nocardia*, whereas those containing chlorhexidine acetate are not effective. When the dip is contaminated during use it may spread the organism to other quarters and other cows.

### Economic Importance

The disease is a serious one because there is extensive destruction of tissue, loss of production, and occasionally death of a cow. Also, there is a possibility that human infection may occur, because the organism may not be destroyed by usual pasteurization procedures.

### PATHOGENESIS

The inflammation of the teat sinus and lower parts of the gland suggests invasion via the teat canal. Infection of mammary tissue results in the formation of discrete granulomatous lesions and the development of extensive fibrosis, and the spread of inflammation occurring from lobule to lobule. Infected animals are not sensitive to tuberculin.

When infection occurs early, in the first 15 days of lactation, the reaction is systemic with fever and anorexia. At other times the lesions take the form of circumscribed abscesses and fibrosis. There may also be infected foci in supramammary and mesenteric lymph nodes.

### CLINICAL FINDINGS

Affected animals may show a systemic reaction with high fever, depression, and anorexia, but an acute or subacute inflammation is more usual. Fibrosis of the gland and the appearance of clots in a grayish, viscid secretion that also contains small, white particles is the usual clinical picture. The fibrosis may be diffuse but is usually in the form of discrete masses 2 to 5 cm in diameter. Badly affected glands become grossly enlarged and may rupture or develop sinus tracts to the exterior. None of these cases recovers sufficiently to justify retention, and all are eventually culled.

Laboratory examinations of herds in which cases occur may also reveal subclinical cases that have intermittent flare-ups.

### CLINICAL PATHOLOGY

The bacteria can be detected on culture of the milk. Small (1-mm diameter) specks are visible in the milk and, on microscopic examination, these prove to be felted masses of mycelia. Herds containing infected cows have been readily identified by culture of bulk milk samples. A gentamicin-blood culture medium has good selectivity. The normal blood agar plates need to be kept for an extended period of time to detect growth. Colonies may not appear until 72 hours.

### NECROPSY FINDINGS

Grossly, diffuse fibrosis and granulomatous lesions containing pus are present in the

mammary tissue. The lining of the milk ducts and the teat sinus is thick and roughened. On histologic examination the granulomatous nature of the lesions is evident. Metastatic pulmonary lesions have been found in occasional longstanding cases.

### Samples for Confirmation of Diagnosis

- Bacteriology: mammary tissue, regional lymph node
- Histology: formalin-fixed mammary tissue for light microscopy

### DIFFERENTIAL DIAGNOSIS

The appearance of the milk is distinctive, but cultural examination is necessary for positive identification.

### TREATMENT

The disease does not respond well to treatment because of its chronic granulomatous nature. In vitro susceptibility tests suggest amikacin, gentamicin, and neomycin should be effective but will probably need to be administered for 1 to 2 weeks.

### CONTROL

Invasion probably occurs via the teat canal from a soil-borne infection; proper hygiene at milking and strict cleanliness during intramammary infusion are therefore necessary on farms in which the disease is enzootic. Treatment in late cases is unlikely to be of value because of the nature of the lesions, and in affected herds particular attention should be given to the early diagnosis of the disease.

### REFERENCES

1. Rieg S, et al. *BMC Microbiol.* 2010;10:61.
2. Pisoni G, et al. *J Dairy Sci.* 2008;91:136.
3. Condas LAZ, et al. *Vet Microbiol.* 2013;167:708.
4. Brown JM, et al. *Vet Microbiol.* 2007;125:66.
5. Kogure T, et al. *Antimicrob Agents Chemother.* 2010;54:2385.

### **BACILLUS SP.**

*Bacillus* spp. are considered part of the normal microflora of the bovine teat.<sup>1</sup> *Bacillus cereus* and *B. subtilis* are saprophytic organisms and only chance mastitis pathogens; they have been known to cause an acute hemorrhagic mastitis in cattle. *B. cereus* cases are often associated with contamination associated with teat injuries or surgery. The mastitis may also occur in cows at the time of calving and is associated with the feeding of brewers' grains in which the spores of *B. cereus* are present. Some strains of *Bacillus* spp. appear nonpathogenic and the strain isolated from the teat of clinically healthy cattle can change rapidly over time.<sup>1</sup>



The infection is thought to occur during the dry period following the use of dry cow therapy preparations that may have been contaminated with the organism. Infection probably occurs at the time of infusion, but the acute mastitis does not occur until after parturition. *B. cereus* is a spore former and may remain dormant in the mammary gland for long periods, unaffected by the presence of the antibiotic. In one outbreak, 62 of 67 cows infused with a dry cow infusion product contaminated with the organism developed acute hemorrhagic mastitis. Six cows died; the remainder survived but were subsequently culled and slaughtered because of recurrent mastitis, inadequate milk production, and loss of weight.

Clinically, there is peracute to acute mastitis affecting one or more quarters. There is severe swelling and pain and the secretions are red-tinged and serous in consistency. Initially there is a high fever (40°C–41°C; 104°F–106°F) and severe toxemia. Affected cows are weak and quickly become recumbent; death may occur in 24 to 36 hours. Gangrene may occur and, in cows that survive, portions of affected gland will slough out and a chronic relapsing mastitis will persist. Experimentally produced mastitis caused by *B. cereus* causes toxemia, acute swelling of the quarter, and clots in the milk. The mastitis persists in a chronic form, and the quarter eventually dries up.

The organism can be usually cultured from milk samples from affected quarters. At necropsy there is focal hemorrhagic necrosis of the mammary tissue, acute lymphadenitis, and disseminated intravascular coagulation.

Treatment consists of intensive fluid therapy, a broad-spectrum antibiotic intravenously, and vigorous massage and stripping of the affected gland. Intramammary infusion of the most suitable antibiotic determined by culture and sensitivity is indicated, but the results are often not good because of the presence of severe hemorrhage and necrosis and plugging of the lactiferous ducts. Prevention depends on the use of sterile techniques during teat surgery and the use of sterile intramammary infusions and instruments. In problem herds, autogenous bacterins have been prepared but not extensively evaluated. If *B. cereus* infection is identified in the mammary glands of dry cows the recommended prevention program is infusion of each quarter with 750 mg of neomycin and 375 mg of framycetin.

*B. subtilis* is recorded less frequently as a cause of acute mastitis. Infection is characterized by yellow or bloody milk, sometimes with clots, and the cow is febrile.

### **CAMPYLOBACTER JEJUNI**

Only one case of clinical mastitis has been recorded, but the incident is of some importance because of its zoonotic impact.

Infection of the udder by the organism is easy to establish, and the infection is persistent but subclinical for the most part. Other experimental cases have been recorded, and campylobacters that have not been further identified have also been observed in naturally occurring cases. These are characterized by fine granular clots in the milk, very high cell counts, and a transient episode of fever and swelling of the quarter.

### **CLOSTRIDIUM PERFRINGENS TYPE A**

This is a rare form of mastitis characterized by high fever, swelling, and superficial hyperemia of the affected quarter, followed later by gangrene, enlargement of the supramammary lymph nodes, a thin brown secretion containing gas, and subcutaneous emphysema. Early treatment with a broad-spectrum antibiotic can be successful, but advanced cases are uniformly fatal.<sup>2</sup>

### **FUSOBACTERIUM NECROPHORUM**

This is a rare type of mastitis but is likely to have a high incidence in the herd when it occurs. Mixed infections of *F. necrophorum* appear to play an important role in summer mastitis caused by *T. pyogenes* (see section earlier in this chapter). Affected quarters have a viscid, clotty, stringy secretion but there is little fibrosis. No systemic reaction occurs, but treatment with a variety of antibiotics is unsuccessful.

### **HISTOPHILUS SOMNI**

*Histophilus somni* (formerly *Haemophilus somnus*) has caused mild, chronic mastitis, including an acute form with high fever and bloodstained milk and a gangrenous form.

### **LISTERIA MONOCYTOGENES**

Udder infection with *L. monocytogenes* is reported more often in sheep and goats than cattle.<sup>3</sup> However, it is a gram-positive facultative anaerobe that is being recorded with increasing frequency as a cause of bovine mastitis because of the zoonotic importance of the organism in dairy products. Most cases in cattle are subclinical and abnormal milk is rare.<sup>3,4</sup> The SCC is usually greater than 10<sup>7</sup> cells/mL milk. An ELISA and PCR have been used to detect antibody or bacterial antigen, respectively, in milk. One cow in Ireland with clinically normal milk was persistently infected for 6 months with a serotype 1/2b strain.<sup>3</sup> The milking system can be exposed to a variety of *L. monocytogenes* strains, but only a small percentage of these strains are able to persist within the milking system, suggesting that these strains possess factors that promote survival in this

ecological niche.<sup>5</sup> Culture of bulk tank milk samples is an adequate means of locating herds with infected cows. Over a 23-year period in Denmark, the percentage of cows infected with the organism varied from 0.01% to 0.1% and that of herds with an infected cow from 0.2% to 4.2%.

Identifying listeriosis-infected cows is not easy because most infections are subclinical and clinical mastitis is usually mild; the milk is often normal in appearance, but the quarter does lose productivity and the milk carries a high SCC. The disease is characteristically unresponsive to treatment with penicillin, although the organism may be sensitive to the antibiotic in *in vitro* tests. The persistence of the clinical signs should arouse suspicion of *L. monocytogenes* as a cause.

### **MYCOBACTERIUM SP.**

Tuberculous mastitis is described under tuberculosis. Other mycobacteria, especially *M. lacticola*, have been isolated from cases of mastitis in cattle that occur after the intramammary infusion of therapeutic agents in oils. The disease can be reproduced by the intramammary injection of the organism in oil but not when it is in a watery suspension. Subsequent oily infusions exacerbate the condition. Clinically, there is tremendous hypertrophy of the quarter with the appearance of clots in discolored milk, but there is no systemic reaction. Affected animals do not show sensitivity to avian or mammalian tuberculin. No treatment is effective. It is suggested that the treatment of injured teats and quarters with oil-based intramammary preparations is inadvisable because of the risk of them already being infected with mycobacteria.

A mild, acute mastitis, self-terminating and unresponsive to treatment, has occurred in outbreak form. It may be unassociated with intramammary infusion but is apparently predisposed because of stress and associated with an unidentified mycobacterium.

*M. fortuitum* is encountered rarely as a cause of a severe outbreak of bovine mastitis. Infected quarters are seriously damaged and do not respond to treatment, and affected cows die or are salvaged. The disease can be reproduced experimentally, and affected animals show positive reactions to mammalian and avian tuberculosis and some sensitivity to johnin. Similar experiences are recorded with *M. smegmatis* and *M. chelonae*. The mammary secretion of affected quarters varies from pus to a watery fluid containing flakes, and there is a high milk loss and irreparable damage to quarters. *M. smegmatis* causes hypertrophy of the gland of such proportions that all cases need to be culled. At least 15 different unique mycobacterial species have been cultured from unpasteurized bovine milk in Brazil.<sup>6</sup>

## **SERRATIA SP.**

*S. marcescens* is the most common *Serratia* species causing mild chronic mastitis in cattle in which swelling of the quarters with clots in the milk appear periodically.<sup>7</sup> *Serratia* mastitis occurs naturally and has been produced experimentally.<sup>7</sup> *S. liquefaciens* has caused a similar mastitis. Most cases are sporadic, but herd outbreaks caused by the use of contaminated sawdust as bedding and inadequate cleaning of the teats before milking may occur. An epidemic in New York state was associated with the use of a chlorhexidine-containing teat disinfectant that permitted the growth of *Serratia* spp.<sup>8,9</sup> Generally, *Serratia* mastitis is not as severe as that caused by *E. coli* or *Klebsiella* spp.

*S. marcescens* is susceptible to a large number of antimicrobials in vitro with the exceptions being penicillin, ampicillin, and cephalosporin.<sup>10</sup> Neomycin (2 g initially followed by 3 daily doses of 1 g by intramammary infusion) has provided a satisfactory treatment.

## **FUNGI AND YEASTS**

A larger variety of fungi and their unicellular form (yeasts) have been isolated from the glands of cattle with clinical mastitis, but the true pathogenic potential of a number of these isolates has yet to be determined.

*Cryptococcus neoformans*, the yeast that causes human cryptococcosis, has caused acute mastitis in cattle and buffaloes. Contaminated infusion material and spread from other infected quarters are the probable sources of infection. Infection in humans drinking the milk is unlikely to occur because the yeast does not withstand pasteurization, but there may be some hazard to farm families. Although there is no systemic reaction, the mastitis may be acute, with marked swelling of the affected quarter and the supramammary lymph node; a severe fall in milk yield; and the appearance of a viscid, mucoid, gray-white secretion. Clinical mastitis persists for some weeks and, in many cases, subsides spontaneously, but in others the udder is so severely damaged that the cow has to be slaughtered. Systemic involvement occurs rarely. At necropsy, there is dissolution of the acinar epithelium and in chronic cases a diffuse or granulomatous reaction in the mammary tissue and lymph node. Similar lesions have been found in the lungs.

Many other fungi, including *Candida* spp., *Saccharomyces* spp., *Pichia* spp., and *Torulopsis* spp. have also caused mastitis in cattle. A survey of 91 bovine cases of fungal/yeast mastitis in the United States showed that 78% belonged to *Candida* spp.; this genus contains at least seven different species that have been isolated from the bovine mammary gland.<sup>11</sup> Infection is probably introduced by contaminated intramammary

infusions or teat cup liners. Establishment of the infection is encouraged by damage to the mammary epithelium and stimulated by antibiotic therapy; for example, *Candida* spp. use penicillin and tetracyclines as sources of nitrogen.

A fever (41°C; 106°F) is accompanied by a severe inflammation of the quarter, enlargement of the supramammary lymph nodes, and a marked fall in milk yield. The secretion consists of large, yellow clots in a watery supernatant fluid. Lesions are limited to the walls of the milk cistern, and there is no invasion of the mammary gland itself. Usually the disease is benign and spontaneous recovery follows in about a week.

*Trichosporon* spp. can cause mastitis in cattle and is manifested clinically by swelling of the gland and clots in the milk. The infection rate is low, and the fungi disappear spontaneously. Experimental transmission of the disease has been effected. In cases of infection by *Aspergillus fumigatus* or *A. nidulans* there are multiple abscesses in the quarter. These are surrounded by granulation tissue, but the milk ducts are generally unaffected.

**None of these infections responds well to antimicrobial therapy** but treatment with iodides, either sodium iodide intravenously, organic iodides by mouth, or iodine in oil as an intramammary infusion, might be of value. A number of drugs, including cycloheximide, nystatin, polymyxin B, neomycin, and isoniazid, have been tested for efficiency against mastitis in cattle produced experimentally by the infusion of *C. neoformans* but did not alter the clinical course of the disease. Merthiolate (20 mL of a 0.1% solution) as an infusion daily for 2 to 3 days is reported to have a beneficial effect if administered early in the course of the disease. Actinomycotic agents tested in vitro against fungi, mostly *Candida* spp., from cases of mastitis showed sensitivity to clotrimazole, nystatin, polymyxin, miconazole, and amphotericin B, and least sensitivity to 5-fluorocytosine. Miconazole (200 mg as an intramammary infusion administered a total of 8 times at 12-hour intervals) was not effective in treating dairy cows with moderate to severe clinical mastitis.<sup>12</sup> Sulfamethoxypyridazine given parenterally (22 mg/kg BW for 2–3 days) has resulted in more than 50% clinical cures in quarters infected with *C. krusei*. A case of mastitis caused by *A. fumigatus* has been successfully treated by concurrent intraarterial injection and intramammary infusion of 100 mg of miconazole at each site. Clinical signs included fever, anorexia, and depression; a hard, swollen, hot gland with clots in the milk; and a negative response to treatment with intramammary antibiotics.

## **ALGAE**

The only known plants that cause infectious diseases in animals are unicellular round to

ovoid colorless algae in the genus *Prototheca*, which lack chlorophyll.<sup>13</sup> *Prototheca* is ubiquitous in the environment. It is a zoonotic disease that can be transmitted to humans when they ingest milk from infected cows.

*P. zopfii* and *P. blaschkeae* have been identified as causes of chronic bovine mastitis.<sup>14,15</sup> *P. zopfii* consists of different biotypes based on biochemical and serologic grounds, and all clinical and subclinical mastitis isolates are genotype 2,<sup>13,16–19</sup> or genotype 3, now renamed *P. blaschkeae*. Extremely strong herd-level risk factors identified associated with the presence of *Prototheca* in composite milk samples were intramammary infusions with a nonintramammary formulation (OR = 136.8), the use of a dry cow internal teat sealant (OR = 34.2), or the use of a dry cow external teat sealant (OR = 80.0).<sup>20</sup> These high OR estimates support the presence of a causal effect between poor teat hygiene practices and intramammary infection with *Prototheca* spp. Reduced milk yield, large white clots in watery milk, and induration of the affected quarter may be the only clinical signs. Cases of this disease are usually sporadic, but one severe outbreak is recorded. Experimental transmission of the disease causes a progressive pyogranulomatous lesion in the gland, and the organism can be isolated from draining lymph nodes. *Prototheca* spp. are commonly isolated from animal environments, particularly mud and standing water.

*P. zopfii* strains isolated from mammary glands are resistant to many antimicrobials, but are susceptible to kanamycin, gentamicin, amphotericin, and ketoconazole.<sup>19</sup> Treatment is usually unsuccessful, and affected cows should be culled; because of a high prevalence rate in many affected herds the loss to the farmer can be considerable.

Control measures should focus on implementing good hygiene practices at milking and identifying environmental sources for contamination. Iodine teat dip concentrations (0.16%–0.63%) and sodium hypochlorite teat dip concentrations (0.04%–0.16%) were effective in killing *Prototheca* in one study<sup>21</sup>; another study identified minimal microbiocidal concentrations of 0.3% to 1.3% for iodine and 0.005% to 0.020% for chlorhexidine.<sup>22</sup> *Prototheca* can form biofilms, even on stainless steel, and this may facilitate their persistence in the dairy environment.<sup>23</sup> Bedding type appears to impact growth of *Prototheca* spp.,<sup>24</sup> but the recommended strategy of housing cattle on clean dry bedding should decrease the risk of mastitis caused by *Prototheca* spp.

## **TRAUMATIC MASTITIS**

Injuries to the teats or udder that penetrate to the teat cistern or milk ducts, or involve the external sphincter, are commonly followed by mastitis. Any of the organisms that cause mastitis may invade the udder after

such injury, and in such cases mixed infections are usual. All injuries to the teat or udder, including surgical interference, should be treated prophylactically with broad-spectrum antibiotics.

## REFERENCES

1. Al-Qumber M, Tagg JR. *J Appl Microbiol*. 2006;101:1152.
2. Osman KM, et al. *Comp Immunol Microbiol Infect Dis*. 2010;33:505.
3. Hunt K, et al. *Ir Vet J*. 2012;65:13.
4. Rawool DB, et al. *Int J Food Microbiol*. 2007;113:201.
5. Latorre AA, et al. *Appl Environ Microbiol*. 2011;77:3676.
6. Franco MMJ, et al. *BMC Vet Res*. 2013;9:85.
7. Harp JA, et al. *Vet Immunol Immunopathol*. 2006;109:13.
8. Mueller P, et al. *Spat Spatiotemporal Epidemiol*. 2011;2:159.9.
9. Schukken Y, et al. *Vet Clin North Am Food Anim Pract*. 2012;28:239.
10. Ohnishi M, et al. *Vet Microbiol*. 2011;154:202.
11. Dworecka-Kaszak B, et al. *Scientific World J*. 2012;196347.
12. Roberson JR, Kalck KA. *Bovine Pr*. 2010;44:52.
13. Möller A, et al. *Vet Microbiol*. 2007;120:370.
14. Marques S, et al. *J Clin Microbiol*. 2008;46:1941.
15. Osami T, et al. *Vet Microbiol*. 2008;131:419.
16. Ricchi M, et al. *Vet Microbiol*. 2013;162:997.
17. Cremonesi P, et al. *J Dairy Sci*. 2012;95:6963.
18. Sobukawa H, et al. *J Dairy Sci*. 2012;95:4442.
19. Jagielski T, et al. *J Antimicrob Chemother*. 2012;67:1945.
20. Pieper L, et al. *J Dairy Sci*. 2012;95:5635.
21. Salerno T, et al. *Res Vet Sci*. 2010;88:211.
22. Krukowski H, et al. *Turk J Vet Anim Sci*. 2013;37:106.
23. Goncalves JL, et al. *J Dairy Sci*. 2015;98:3613.
24. Adhikari N, et al. *J Dairy Sci*. 2013;96:7739.

## Control of Bovine Mastitis

Improvement in udder health has been a major initiative of the dairy industry for over 50 years. The thrust of these efforts has been on the implementation and use of management techniques to limit the spread of major mastitis pathogens, reducing the quarter infection rate. Detailed mastitis control strategies have been outlined and promoted by the National Institute for Research in Dairying (NIRD) and the NMC ([www.nmconline.org/](http://www.nmconline.org/)). With proper implementation, these programs result in a dramatic decrease in the prevalence of common contagious mastitis pathogens. Herds that have successfully implemented a comprehensive mastitis control program also need to develop strategies to control infection with environmental organisms, as well as using an effective monitoring system for new infections. Achievement of excellent udder health for the production of high-quality milk is a realistic and important goal for all aspects of the dairy industry.

The adoption of effective mastitis control programs has often been less than desirable, even with extensive research validation of

the recommended control practices and with major extension efforts at both national and local levels. The reasons for this slow adoption of proven mastitis control strategies are not well documented, even though producers look to the veterinary profession for information on mastitis and its control. Veterinarians usually become involved in mastitis control in one of the following circumstances:

- The herd is experiencing a higher than normal incidence of clinical cases.
- The milk processing plant reports a higher than permissible total bacterial count or bulk tank milk SCC.
- A farmer who is not performing the standard program of postmilking teat dipping and dry period treatment asks for advice—either as a single mastitis control program or, more probably, as part of a herd health management program.

The procedure is the same in all these situations, and any variation is in terms of speed and intensity. It consists of an assessment of the herd's mastitis status and the implementation of a recommended mastitis control program.

### Udder Health Improvement

The benefit of an integrated mastitis program is improved udder health; this improvement is progressive and can usually be observed within a few years after implementation at the herd level. Methods now exist to control contagious pathogens and reduce the bulk tank milk SCCs to below 400,000 cells/mL. With good management, the incidence of clinical mastitis can be kept low (7–21 cases per 100 cows per year) by culling any cow with chronic or recurrent mastitis and paying great attention to housing and management standards.

Although the rate of contagious mastitis has been decreased with implementation of an integrated mastitis program, the rate of infections and the incidence of mastitis associated with environmental pathogens such as *S. uberis* and the coliform bacteria have not decreased. Approximately 65% of clinical cases are now caused by environmental pathogens. Organisms prevalent in the cow's environment currently cause the most costly types of mastitis in the United States.

### Economic Benefits, Incentives, and Penalties

Mastitis is one of the most costly diseases in dairy herds. Some surveys indicate that the cost incurred by producers because of clinical mastitis is much higher than the cost of prevention. An integrated mastitis control program has always been an excellent investment for the dairy farmer, with a revenue to cost ratio of approximately 6:1; most of the additional revenue is from increased milk production.

Differential payments to farmers for milk quality are also an **economic** incentive to adopt a control program. The widespread adoption of bulk tank milk SCCs as a measure of milk quality, and the adoption of payment schemes of increasing severity, has stimulated farmers to reduce their cell count. Many milk marketing cooperatives have established both penalty and incentive programs based on bulk tank milk SCC and total bacterial counts as global measures of milk quality.

### Requirements

The requirements for a successful mastitis control program include a willing farmer, a capable diagnostic laboratory, an enthusiastic and knowledgeable veterinarian, a record keeping system, adequate milking machinery, and adequate housing facilities.

The farmer must have health and production goals and be willing to achieve them by making a commitment to invest the resources to control mastitis. Wide variations in the costs of controlling and monitoring mastitis in herds are evident because of lack of client compliance with accepted recommendations for mastitis control. There are also variations in the level of mastitis control procedures adopted by producers that affect the success of a program. Lack of adoption may result from a lack of awareness of the economic returns from a complete program, adoption of a new practice only in response to a problem, or competition for liquid financial resources from other aspects of the enterprise.

The veterinarian must be knowledgeable about all aspects of mastitis and be willing to invest the time and effort required to provide sound advice based on the health and production information obtained from monitoring the herd. A data recording system that records all the udder health and production data and the milk quality of each cow and the herd on a regular basis is a vital requirement. A diagnostic laboratory or milk recording agency that provides regular SCCs of individual cows is necessary to monitor udder health. The milking machine and the housing facilities must be adequate for the size of the herd. Farmworkers must be aware of the health and production goals of the herd and adhere to the principles of mastitis control.

### OPTIONS IN THE CONTROL OF MASTITIS

The broad options for control are either eradication or decreasing the infection rate, either by legislative control or implementing a voluntary program.

#### Eradication

Complete eradication of bovine mastitis from a herd or geographic region is not a practicable target in most circumstances. The exception is mastitis caused by *S. agalactiae*,



which can be eradicated from individual herds by a blitz antibiotic technique. The difficulty in attempting to eradicate mastitis is that the contagious causes of mastitis, *S. agalactiae* and *S. aureus*, are so contagious, and the sources of infection so widespread, that adequate quarantine would be very difficult to maintain. In the case of *S. aureus* there is the additional difficulty of eliminating the infection from its intracellular sites in mammary tissue. The environmental infections, especially *E. coli*, pose an even greater problem. They are so ubiquitous that reinfection would be almost immediate in cows housed in economically practicable surroundings.

### Decreasing the Infection Rate

This is a practicable proposition; the degree of limitation is dependent on the need to maintain cost-effectiveness. One of the virtues deriving from this necessity is the concept that subclinical mastitis causes a continuous low-level leukocytosis in the milk that acts as a protective mechanism against other infections. Present-day knowledge about immunity in the mammary gland suggests that control programs that reduce milk SCCs to unrealistically low concentrations may reduce the gland's resistance to clinical mastitis. Correspondingly, the complete elimination of common udder pathogens such as *S. agalactiae* and *S. aureus* is thought to increase the susceptibility of the udder to environmental pathogens, especially coliform bacteria. Another relevant example is the commonly encountered minor pathogen *C. bovis*, which may be a significant microbial agent in maintaining the resistance of udders. The mastitic effect of this organism is too low to warrant specific action, but the infection rate with major pathogens is significantly lower in quarters that harbor *C. bovis* than in those that do not. An intensive program to disinfect udders could well eliminate *C. bovis* and increase susceptibility to other pathogens. *C. bovis* is likely to be more important where cows are housed, or confined in straw yards, and therefore more exposed to teat contamination with coliforms. The question of whether it is better practice to maintain some level of bacterial infection with innocuous organisms in the udder as a protection against more damaging pathogens, rather than to attempt complete bacterial sterilization, is still unresolved. For now it is generally agreed that decreasing the infection rate is the appropriate target.

### Legislative Control

Mastitis does not lend itself to eradication (as set out under the section Eradication), so legislative control of the disease is not widely implemented. Norway has implemented national control of mastitis, starting with a requirement in 1975 that records of mastitis treatments were to be maintained. This was

followed by implementation of the Norwegian Mastitis Control Program in 1982.<sup>1</sup>

### A Voluntary Program

Most of what is done in mastitis control in dairy herds is through voluntary involvement by producers in programs aimed at reducing the incidence of mastitis and maintaining the infection rate at a low level. The justification for control of the disease is purely economic, and a control program must therefore be based on its applicability on each individual farm. Area or national control can only be in the form of providing incentives by educational and laboratory assistance to individual farmers who wish to participate. The value of a mastitis awareness program, and the part played by the two-way flow of information between farmers and the program operators, is most apparent when an area campaign is conducted by a government or industrial sponsor. Once a control program is in place it is customary for milk processors, aided in some places by government agencies, to encourage participation by paying incentives for bulk tank milk with low SCCs or bacteria counts, or refusing to accept milk for processing or, in some cases, refusing to transport milk that does not satisfy statutory requirements. This could be the first step in incorporating the program into planned health and production programs that promote mastitis control and maintenance of milk production at financially optimal levels.

Mastitis infections in beef cattle herds are currently at too low a level for a mastitis control program to be financially advantageous.

## PRINCIPLES OF CONTROLLING BOVINE MASTITIS

### DYNAMICS OF INFECTION

The principles of a bovine mastitis control program are based on changing the dynamics of infection, which are as follows:

- **Prevalence of infection is a function of the rate of new infection minus the rate of elimination**
- **Rate of new infection is a function of the level of exposure times the number of susceptible quarters**
- **Rate of elimination is a function of the number of infections times the efficacy of treatment plus spontaneous cure**

Successful control occurs when the level of infection is held low or is decreased, either by preventing new infections or eliminating existing infections.

The dynamics are not, however, so simple in reality. They vary with the susceptibility of the individual animal, which changes with **age and stage of lactation** (Fig. 20-6) and is **season dependent**. The dynamics may vary with the pathogens involved, and the relative importance between herds can be very considerable and also vary with time. The

duration of infection may be extremely different for different pathogens. *E. coli* causes mild to severe acute clinical disease but usually self-eliminates quickly; it is rarely found in subclinical infections. *S. agalactiae* and *S. aureus* are very persistent, and *S. aureus* responds poorly to treatment. The rate of elimination and the persistency of these pathogens are highly variable. Similarly, there can be large variations in the rate of new infections, which is closely related to the identifiable risk factors, including rate of teat contamination, mechanisms aiding teat penetration, and effectiveness of establishment and growth of bacteria in the mammary gland.

The success of a control program can be measured by the decrease in level of infection and the speed with which this is achieved. The farmer must be able to appreciate progress within a year to remain enthusiastic about application of the methods. The level of infection can be controlled significantly by lowering the rate of new infections, but the speed of change really depends on the duration of the infection and is thus related more to the rate of elimination. No control procedures are available to prevent all new infections, and only culling of chronically infected cows is absolutely successful in eliminating infections. Control schemes therefore require both prevention and elimination to give optimal effect, and that optimum will vary with each pathogen.

The specific components of a mastitis control program must be devised to fulfill three basic principles: (1) **eliminate existing infections**, (2) **prevent new infections**, and (3) **monitor udder health**.

### 1. ELIMINATE EXISTING INFECTIONS

The control program must reduce the duration of infection in the cows. Antimicrobial therapy during the dry period remains the best method of achieving this objective (Fig. 20-7). Treatment during lactation can be useful to eliminate some existing infections, depending on the causative agent, and is often effective in resolving clinical mastitis episodes. Culling of chronic cases that are not eliminated with dry period treatment is also used to remove the most persistent existing infections. Further study needs to focus on development of treatment protocols and on cowside identification of the causative bacterial agent.

### 2. PREVENT NEW INFECTIONS

The control program must reduce the rate at which new infections occur. The dipping of all teats in an effective teat dip after each milking is the best method to reduce the new infection rate. Ensuring that the milking machine is functioning properly and used correctly will result in less spread of infection. The dry period is the time of greatest risk of new infection, and blanket dry cow

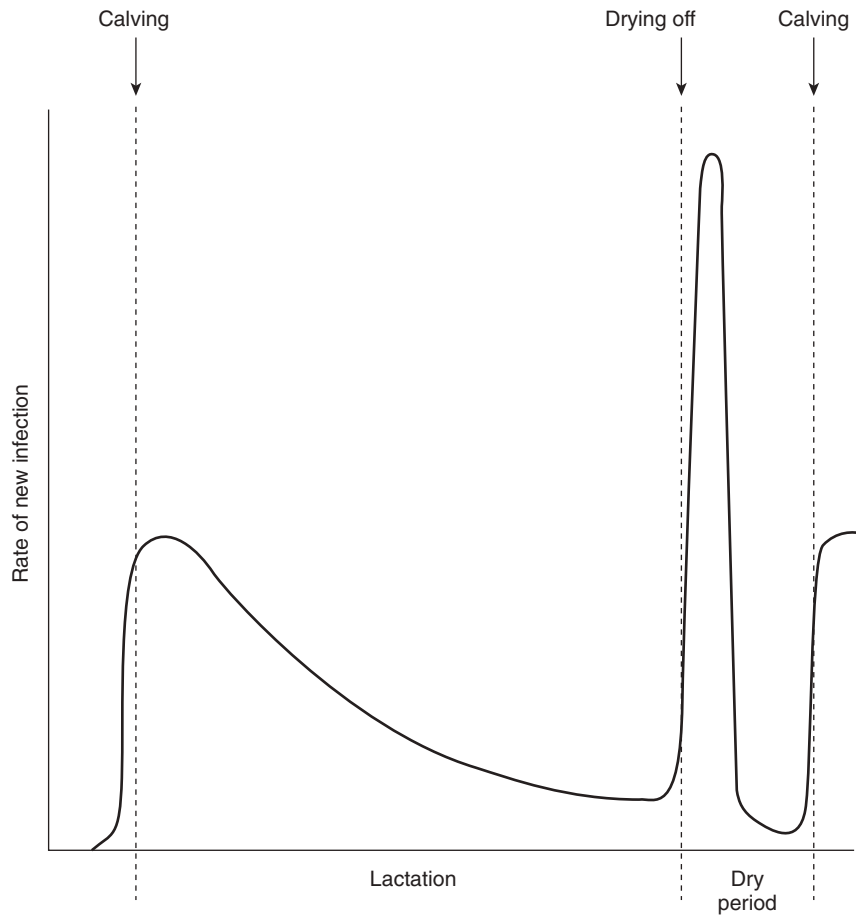

**Fig. 20-6** New infection rate in cows by stage of lactation. (Reproduced with permission from Natzke RP. *J Dairy Sci* 1981;64:1431-1441.)

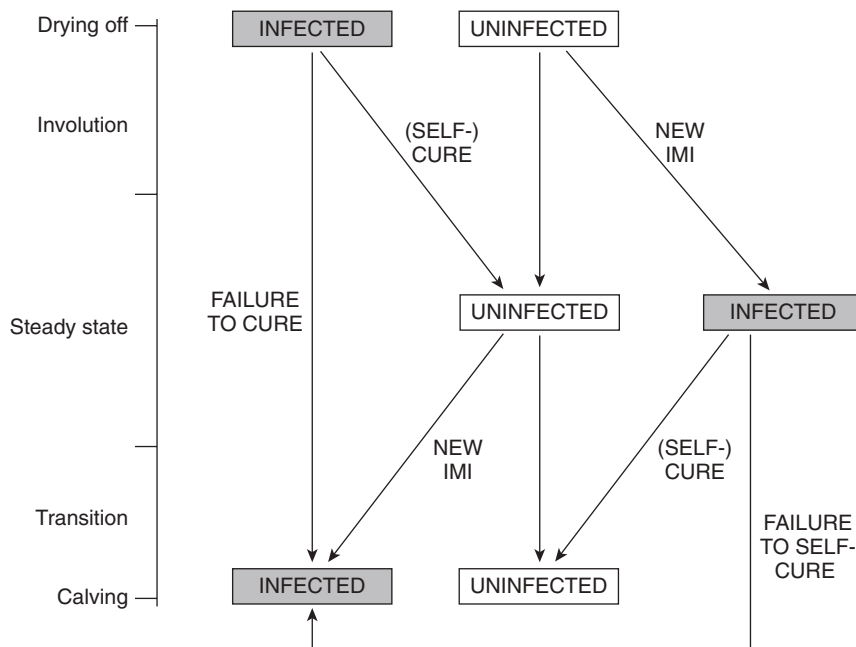

**Fig. 20-7** A summary of the possible outcomes for individual quarters during the dry period. IMI, intramammary infection. (Reproduced with permission from Bradley A, Barkema H, Biggs A, et al. *Dairy Herd Health*, Wallingford, UK: CAB International 2012;144.)

therapy or application of an internal teat sealant is efficacious in preventing new infections during the dry period. Environmental and nutritional management have also become important for the prevention of new infections. Specific recommendations for methods of reducing new infection rate depend on the predominant pathogen in the herd.

A novel method for preventing new infections during the second half of the dry period and the start of lactation is to administer polyethylene glycol-conjugated **bovine granulocyte colony-stimulating factor (bG-CSF)** subcutaneously approximately 7 days before the anticipated calving date followed by a second injection immediately after calving. Administration of **bG-CSF** markedly increased the blood neutrophil count and decreased the number of clinical mastitis episodes caused by environmental pathogens.<sup>2</sup>

### 3. MONITOR UDDER HEALTH STATUS

An ongoing program to monitor the udder health status of individual cows as well as the herd is needed to evaluate the effectiveness of the control efforts. Monitoring methods should also assist with specific decision making, such as optimized treatment protocols or culling. In the five-point mastitis control programs recommended by the NIRD and the NMC, monitoring was not emphasized. As udder health status improves, and as milk quality premiums and penalty programs become meaningful, there is a need to continuously monitor udder health.

### MASTITIS CONTROL PROGRAMS

A major step forward in mastitis control occurred in 1970 with the publication of the results of controlled field studies performed by the NIRD. The **five-point control plan** was based on attacking the key areas in the dynamic processes of mastitis, and the individual components of the plan were evaluated as efficacious by field testing in dairy herds. Its success has been well documented. **The five-point plan has been highly successful for the control of contagious mastitis but is not adequate for the control of environmental mastitis.** The plan depends heavily on the motivation, education, and financial commitment of the milkers and the herd owner to achieve good and consistent results.

The five-point mastitis control program is as follows:

1. Udder hygiene and proper milking methods
2. Proper installation, function, and maintenance of milking equipment
3. Dry cow management and therapy
4. Appropriate therapy of mastitis cases during lactation
5. Culling chronically infected cows

Five additional management practices are recommended to make a **10-point mastitis control program**, which includes emphasis on an appropriate environment, particularly for the control of environmental mastitis, and the keeping of records, monitoring udder health, and setting goals for udder health status.

6. Maintenance of an appropriate environment
7. Good record keeping
8. Monitoring udder health status
9. Periodic review of the udder health management program
10. Setting goals for udder health status

The 10-point mastitis control program satisfies the basic needs of the farmers, which is an essential prerequisite in the implementation of a voluntary program. The program is profitable, within the scope of the producer's technical skill and understanding, capable of being introduced into current management systems, and encourages farmers to continue the program by rapidly reducing the occurrence of clinical mastitis and the rejection of milk by milk processors on the grounds of quality. Very helpful checklists that include all components of the recommended mastitis control program are available for North America and international dairy enterprises ([www.nmconline.org](http://www.nmconline.org); accessed July 2016).

The components of the recommended 10-point mastitis control program are the same for all situations. The exact level of severity at which it will be implemented depends on its cost-effectiveness; higher milk and cattle prices will justify higher financial inputs. The program has the virtues of simplicity, profitability, and widespread applicability, and most countries with a significant dairy industry have devised their own variant of it to suit their own local needs, especially the targets of freedom from infection and other quality-control criteria. The 10-point program was designed primarily for the control of the common contagious mastitis pathogens and may encounter difficulties unless measures to control the environmental infections receive special attention.

## TEN-POINT MASTITIS CONTROL PROGRAM

### 1. UDDER HYGIENE AND PROPER MILKING METHODS

The principles of a proper milking procedure include:

- Premilking udder hygiene
- Stimulation of milk letdown
- Efficient removal of the milk
- Postmilking teat disinfection

These principles are important for controlling the spread of contagious pathogens and for preventing new intramammary infections associated with environmental organisms. There is much farm-to-farm and region-to-region variation in how these

milking procedures are applied. Milking methods are often taught to milkers by observation of the current methods used on the farm, and milkers are seldom objectively evaluated, especially in family farm operations with only one or two farm employees.

Several important steps are necessary in establishing a milking management routine, including the following.

### Establish and Maintain a Regular Milking Schedule in a Stress-Free Environment

A management routine using twice-daily milking should strive for a 12-hour interval. In the same way, an 8-hour interval between milkings is necessary for thrice-daily milking. The milking schedule is obviously less important with robotic milking. Consistency is as important as maintaining these exact intervals. Any influence that may add stress to the milking environment is to be avoided. For example, harsh crowd gates, rough handling, barking dogs, and people shouting can be associated with epinephrine release, which will counteract the effect of oxytocin for efficient milk letdown.

### Ensure That Teats Are Clean and Dry Before Milking

The major objective of premilking udder preparation and teat sanitation is to reduce the microbial population of teat skin, particularly at the teat end. The aim of these techniques is to minimize the probability of new intramammary infection and have good milking performance. Milking time hygiene is extremely important because of the potential interaction between milking machine function and the microflora of teat skin. The incidence of intramammary infection is highly correlated with the number of mastitis pathogens on the teat end at milking.

### Udder Hygiene Score

An udder hygiene scoring system has been developed, with the udder viewed from behind. Score 1 is an udder free of dirt, score 2 has 2% to 10% of the surface area dirty, score 3 has 10% to 30% of the surface area covered with dirt, and score 4 has more than 30% of the surface area covered with caked-on dirt. A hygiene scoring system is repeatable and easy to use, but only hygiene scores for the udder and hindlimbs are associated with cow composite milk SCCs.

### Premilking Cow Preparation

Premilking cow preparation is a step in milking management in which there is considerable variability between what is recommended and what is actually practiced. **The goal is to milk clean and dry teats.** Current recommended procedures for premilking udder preparation range from water hose washing and manual drying of teats, to washing teats with a paper towel wetted in warm sanitized solution plus drying with a

single service paper towel, to the use of pre-milking teat dipping in germicide plus paper towel drying. The additional step of premilking teat disinfection (predipping) has been incorporated as part of the milking routine on many dairy farms. It is argued that manual teat washing improves stimulation and the release of oxytocin for milk letdown, in addition to cleaning debris from the teats and teat ends. However, with properly functioning milking equipment, there is little evidence that the manual massage is necessary for good milk letdown. In milking parlors in which handheld spray washers are used, it is important to avoid wetting the udder. Excessive water use can lead to bacterial contamination of the teat cups and to an increase in the incidence of mastitis. In addition to individual paper towels, the use of disposable latex or nitrile gloves is also recommended to minimize the transfer of mastitis pathogens from the milkers' hands to the teats. Gloves that become soiled with organic and fecal material should be replaced.

### Check Foremilk and Udder for Mastitis

Early clinical mastitis can be detected by physical examination of the udder for swelling, heat, or pain, and by using a strip cup or black plate to examine foremilk from each quarter of each cow before every milking. This step has been a standard NMC management recommendation, but the supporting evidence has been inconsistent. The rate of implementation of foremilk stripping (forestripping) is widely variable and depends on the management system used. Forestripping is more common in milking parlor situations.

Checking foremilk has three major advantages:

1. Detection of clinical mastitis (such as the presence of clots and stringy or watery milk), as early as possible: Detection of abnormalities is enhanced if the milk is evaluated against a dark surface such as a black strip plate.
2. Forestripping: This theoretically aids in preventing new infections of the mammary gland by flushing pathogens from the teat streak canal before milking. Bacterial colonization of the teat canal may not represent a problem until the organisms gain access to the teat sinus beyond the rosette of Furstenburg.
3. Stimulation of the milk letdown process: This could be helpful in systems in which minimal cow preparation is used, such as a premilking program consisting of only a dry wipe.

In tie-stall barns, a strip cup is necessary to avoid contaminating the stall bedding or the cow herself. In milking parlors, it is common to use the concrete floor surface for detection of abnormalities in the milk. In either case it is important to recognize the potential for



cow-to-cow transmission of pathogens by milk contact from one teat to another. For this reason, forestripping must be done before the predipping or udder washing step.

Foremilk stripping is often not done in pasture-based dairy industries, such as Australia and New Zealand, because it takes time and slows down the milking process. Moreover, if the clinical mastitis incidence is 2 cases per month per 100 lactating dairy cattle, then in herds milking twice a day, milkers have to forestrip 12,000 teats to identify one clinical case of mastitis. Despite the very low incidence of clinical mastitis detected by foremilk stripping, in seasonal calving herds that are pasture based it is probably helpful to examine the foremilk for the first 2 to 4 weeks after calving, because this is the highest incidence of clinical mastitis in this dairy system.

### Premilking Teat Disinfection

Premilking teat disinfection, more commonly referred to as **predipping**, is used by some dairy producers as a component of a mastitis control program. Premilking teat disinfection in association with good udder preparation and postmilking teat disinfection can further reduce the occurrence of new intramammary infections during lactation. The use of predipping is increasing as the predominant cause of mastitis shifts from contagious pathogens to environmental pathogens. Controlled studies on the effectiveness of predipping indicate significant merit in the use of iodine predipping for the reduction of udder infections caused by environmental pathogens in some, but not all studies. Some studies found that premilking teat dipping with 0.25% iodophor did not reduce the incidence of clinical mastitis caused by environmental pathogens, and the use of 0.5% iodophor plus good udder preparation did not affect the prevalence of infection of coagulase-negative *Staphylococcus* spp., but the rate of clinical mastitis in the control group was 1.38 cases per 1000 cow-days compared with 1.06 cases per 1000 cow-days in the predipped group. The benefit:cost ratio of 0.37 indicated that the benefit of reduced incidence of clinical cases of mastitis did not justify the added expense required to predip the herd. A study in New Zealand with pasture-based dairy cattle found that the addition of premilking chloramine-T teat disinfection provided no benefit to that obtained by postmilking chloramine-T teat disinfection applied as a spray.<sup>3</sup>

Although premilking teat dipping with iodine-based sanitizers may play a role in reducing new intramammary infections, there are some precautions that should be taken. The major concern is the potential for increased iodine residues in milk. Predipping with either 0.5% or 1% iodophor does not significantly increase milk iodine residues if a paper towel is used to dry the teats. Without drying, iodine residues are

significantly increased. In addition, predipping in combination with postmilking teat disinfection may increase the potential for residues.

Implementation of predipping into the cow preparation methods may require significant management changes, such as the drying of teats. Some, or possibly all, of the improvement in udder health associated with the implementation of a predipping program may be attributable simply to the milking of clean, dry teats. Before the commencement of predipping, attaching the unit to wet or dirty teats may have been common. Whatever management methods are adopted on a particular farm, premilking hygiene and udder preparation can have a significant effect on milk bacterial counts and on the incidence of mastitis. In summary, the current evidence supports the use of premilking teat disinfection as a routine procedure in dairy herds in which environmental pathogens are the predominant cause for mastitis. A 2008 survey in the United States indicated that the most commonly used germicidal predip formulations were iodine (60%), chlorhexidine (12%), unspecified (8%), chlorine (7%), fatty-acid based (2.5%), and quaternary ammonium (0.3%).

### Attach the Milking Unit Properly

The milking unit teat cups should be carefully attached to the udder within 90 seconds of starting udder preparation. The milk letdown process that follows the release of oxytocin after udder stimulation is at maximum for 3 to 5 minutes. Some effects of the oxytocin may last up to 8 minutes. It is important to use this physiologic event to its maximum for the most efficient removal of the milk. The proper timing of attaching the milking unit has been shown to shorten milk-out time and increase lactation productivity. However, consistency in the time interval from stimulation to attachment of the unit is as important as the exact time.

When attaching the teat cups, it is imperative to minimize the amount of air drawn into the system. Excessive air inlet could result in vacuum fluctuations, which may predispose to milk aerosol impacts of the teat end and machine-induced infections.

The machine position and support should be adjusted as necessary during milking. This will ensure that quarters milk out properly. The milking unit should hang on the cow as straight and level as possible. Improperly adjusted support could contribute to uneven milk out and to an unbalanced udder on some cows; in addition, there is an increased probability of liner slips and squawking, which in turn will increase the risk of new intramammary infections. The mechanics and importance of liner slips will be discussed with milking machine function later in this chapter.

The use of proper milking machine attachment and adjustment methods affects

the number of milker units that can be efficiently handled per person. With a tie-stall barn pipeline milking system it is recommended that a maximum of three units per person be used. It is unlikely that producers who milk with more than three units in a tie-stall barn are using appropriate cow preparation and milking machine attachment methods.

### Minimize Machine Stripping and Avoid Liner Slips

The majority of milking-machine-induced intramammary infections occur near the end of milking. Liner slips occur with a greater frequency near the end of milking. During a liner slip, air sneaks in between the teat and liner (heard as a squawk), increasing the potential for small droplets of contaminated milk to be propelled backward against the end of the other teats (**teat-end impacts**). Over a sustained period of time, liner slips and milk impacts may result in an intramammary infection.

Machine stripping is the act of putting hand pressure on the milker unit at the end of milking to remove extra milk. Machine stripping is habit forming, and will eventually lead to increased milking time. It also increases the risk of squawking, liner slips, and milk impacts.

### Avoid Overmilking or Removing the Unit Under Vacuum

As soon as a cow is milked out, the vacuum to the milker unit should be shut off, and the teat cups should be removed. The milker unit should gently “fall off” the teats, causing no irritation. This is best performed using automatic take-offs that detect a low flow of milk from the teat end and automatically detach the milking cluster from the udder. Removing the unit under vacuum will cause milk and air to impact onto the teat ends. Overmilking should be avoided to prevent teat-end irritation. The unit should be removed as soon as the first quarter is milked out. The risk of liner slip is also increased during overmilking, but there is little evidence that overmilking will result in an increased rate of intramammary infection, unless liner slips and teat-end impacts occur. The practice of removing teat cups individually is also discouraged.

### Use an Effective and Safe Postmilking Teat Germicide (Teat Dip) After Every Milking

Teat dipping or spraying with a germicidal solution immediately after every milking is an effective milking management practice to reduce the rate of new intramammary infections. **Postmilking teat antiseptics are regarded as the single most effective mastitis control practice in lactating dairy cows.** The prevalence of *C. bovis* in milk cultures usually reflects inadequate teat disinfection, because spread of *C. bovis* is easily

controlled by postmilking test disinfection. Quarters colonized with *C. bovis* usually remain so until treated with an effective dry-cow intramammary formulation. In other words, the prevalence of *C. bovis* infection will usually not decrease for approximately a year after implementing an optimal postmilking disinfection protocol.

Teat dipping or spraying is a simple, effective, and economical means to reduce bacterial populations on teat skin. There is general agreement that the numbers and types of bacteria on teat skin have a direct relationship to the incidence and types of intramammary infections that develop in a herd. An effective teat dip, correctly used, will reduce the incidence of new udder infections by 50% to 90%.<sup>3</sup>

There are several major classes of postmilking teat sanitizer and many available products within each class. The classes of product vary widely in their composition, formulation, and mode of action. Each product should be evaluated for its safety, efficacy, advantages, and disadvantages. The most commonly used teat dips fall into several major classes, with geographic differences in availability. A 2008 survey in the United States indicated that the most commonly used germicide postdip formulations were iodine (69%), chlorhexidine (13%), fatty-acid based (7%), unspecified (4%), chlorine (2%), and quaternary ammonium (0.6%).

### Iodine Formulations

Iodine teat dips are used extensively and marketed in a variety of formulations, ranging from 0.1% to 1.0% available iodine. Iodine formulations are active against bacteria, viruses, and fungi, and ideally they should be used at a minimum 0.5% available iodine concentration. The safety and efficacy of these products are well established, and it is difficult to identify a reason why iodine formulations should not be the preferred choice for postmilking teat antisepsis. They were historically called iodophor teat dips because many contained phosphoric acid, which is no longer the case.

### Chlorhexidine

Chlorhexidine teat dips are also widely used and effective for reducing new infections. They are more efficacious in the presence of organic material than other classes of product. Chlorhexidines have a broad spectrum of antimicrobial activity and excellent persistence on teat skin, but they are minimally effective against viruses and fungi. Commercial preparations are formulated with a dye to make the product visible and with glycerin to minimize teat skin irritation.

### Linear Dodecyl Benzene Sulfonic Acid Products

LDBSA teat dips contain an organic acid and are formulated with emollients. They are generally nonstaining, tolerant of organic

matter, and less irritating than most other products; their efficacy against major mastitis organisms is well established.

### Quaternary Ammonium Compounds

A variety of quaternary ammonium chemicals, in combination with lanolin or glycerin, are available as teat dip germicides and are safe and effective. They are readily broken down in the environment and depend heavily on proper formulation for effectiveness.

### Sodium Hypochlorite

Many dairy farmers prepare their own teat dip by dilution of commercial laundry bleach to a final concentration of 4% sodium hypochlorite. It is effective and extremely low cost. However, these dips are not government approved, have a strongly disagreeable odor, and can be inactivated by organic material. There is also a risk of mixing errors, resulting in the potential for irritation of teats and milkers' hands.

### External Teat Sealants (Barrier Teat Dips)

A goal that has yet to be achieved is development of a barrier teat dip that provides an effective teat sealant for use in lactating cows and withstands environmental contamination but is easily removed with minimal pre-milking udder preparation. Latex and acrylic latex-based products have been developed to act as a physical barrier to the entrance of mastitis pathogens into the udder. These products were aimed at the prevention of coliform mastitis. However, it has proved to be difficult to remove the residual product from teats. Furthermore, the barrier product alone is not intended to be effective against other major mastitis organisms.

External teat sealants have been formulated in combination with disinfectants to provide protection as both a barrier and a germicide. A postmilking teat disinfectant containing 0.64% sodium hypochlorite in a gel formulation was an effective and safe teat dip preparation. However, in experimental studies, barrier teat dips were no more efficacious in preventing new intramammary infections caused by *S. aureus* and *S. agalactiae* than no teat dip or the use of a nonbarrier product. In contrast to their current use in lactating dairy cows, external and internal teat sealants are increasingly applied at dry off (see the section [Dry Cow Management and Therapy](#)).

### Selection and Use of Teat Disinfectants

With the extensive array of commercially available postmilking teat germicidal preparations, producers need some guidelines to make an appropriate selection for use on their farms. Manufacturers of teat dips should provide the producer with documentation of the efficacy and safety of each product. In the United States, teat dip

products must be listed with the Food and Drug Administration (FDA). The FDA regulates teat dips for compliance with label accuracy and manufacturing quality, but efficacy data are not required for registration. In Canada, teat dips must be approved by the Bureau of Veterinary Drugs. This approval process requires extensive data on human safety, animal safety, and the efficacy of each new teat dip submission. Standard protocols have been endorsed for the evaluation of teat dip efficacy under conditions of experimental challenge with mastitis pathogens, as well as under conditions of natural exposure in commercial dairy herds.

In the United States, iodine-based teat dips are the most commonly used product for postmilking disinfection, and an **iodine-based teat dip in 10% glycerin is generally regarded as the gold standard teat dip** against which all other teat dips are compared. Dairy producers should request information on effectiveness when selecting a teat dip. Veterinarians should assist producers with interpretation of the data. There is no evidence that changing teat dips on a regular basis is necessary to prevent the development of resistant mastitis bacteria. Monitoring several measures of udder health status will signal the need for a change in teat dip product. The teat dip selected must be compatible with other chemical preparations used in the milking management system.

Postmilking teat dips can be applied by dipping or spraying. In North America, **dipping has been the most popular method**. However, with the increase in herd size and parlor automation, there is an increase in the use of teat spraying because it is quicker and easier. Spray and dip application of the same product result in equal efficacy, when done appropriately; however, it is easier to do a bad job of teat coverage with spraying than dipping. Under field conditions, the effectiveness of either method will depend on adequate coverage of each teat. A general recommendation is that **as much of each teat should be covered as is possible and no less than the lower half**.

Teat dips should be stored in a cool dry place and not be allowed to freeze. Contamination should be prevented and expiry dates observed. For economic reasons, producers are tempted to dilute commercially available products; however, their effectiveness and safety may not be maintained. **At the end of milking, unused teat dip solution should not be poured back into the original container**. Dipping devices should be cleaned regularly.

In cold weather conditions, precautions should be taken with respect to teat dipping. A high emollient concentration product should be used. Dipped teats should be allowed to dry before cows are exposed to cold and windy conditions. This may be accomplished by allowing the dip 30 minutes of contact time, followed by removal of

excess disinfectant with a laundered dairy cloth or a single-use paper towel. Wind-breaks should be provided for cows that have access to outside areas. These combined strategies will minimize the occurrence of frostbite of wet teats.

### Establish Milking Order and Segregation Programs

In herds with a significant prevalence of contagious pathogens, such as *S. aureus*, establishing a specific milking order may be helpful to limit the rate of new infections. This is a popular veterinary recommendation that is **difficult to implement** because it usually requires massive disruption of the milking procedure. Generally, first-lactation heifers and fresh cows should be milked first. Cows with high SCCs, chronic clinical mastitis, and current clinical cases should be milked last. The maintenance and management of both SCCs and clinical mastitis records becomes important to make milking order programs work.

In larger herds, cows are usually grouped according to stage of lactation and production level. For nutritional management reasons, it is often suggested to have high-, medium-, and low-production groups. In herds with a high prevalence of *S. aureus* mastitis, it has been suggested that the problem of spread would be stopped by simply isolating infected cows and milking them last. In theory, segregation combined with culling and effective dry cow management should allow the prevalence of *S. aureus* to approach zero. However, the change in prevalence of *S. aureus* infection in unsegregated herds compared with herds using a segregated program indicates no significant difference. A more significant decrease in prevalence of *S. aureus* mastitis was found in herds that gave priority to a full milking hygiene program in combination with dry cow therapy and culling. Segregation is not a simple, stand-alone solution to a contagious mastitis problem.

### Disinfect Teat Liners

Disinfection of the milking machine teat cup liners between cows has the potential of limiting the spread of contagious organisms from cow to cow because bacterial populations in liners can be greatly reduced by sanitization. However, there is considerably less documentation that flushing liners will result in major reductions in contagious mastitis problems.

In tie-stall milking barns, **liner disinfection** is a laborious process that involves dipping the claw in a series of solutions. Liners must be put through a rinse, a disinfectant, and another rinse to remove the germicide. The solutions should be kept hot and replaced when they become overly contaminated. Only two liners can be dipped at one time if the milk hose remains connected to the pipeline to avoid an air lock in the claw, which will reduce the disinfection process.

However, if the milk hose is disconnected from the milk pipeline, then all four liners can be dipped at one time. Even with these limitations, dairy herds with intensive management, utilizing individual cow SCCs and culture information, can effectively use liner sanitization to limit the spread of contagious pathogens. Electric hot pails are commercially available to maintain the disinfection solution at a sterilization temperature.

In large milking parlor operations, automatic **backflushing** of milking units between cows is commercially available but expensive to install. In conjunction with automatic take-offs, the claw is flushed with rinse water, followed by disinfectant, and again rinsed, immediately after the unit detaches from a cow. An alternative procedure (**cluster dunking**) involves backflushing the milking units with water until a clear stream is obtained and then dunking the milking units in a bucket containing disinfectant while avoiding trapping of air in the dunking process. Large numbers of pathogens can be removed from teat cups by the backflushing process, but documented reductions in the new intramammary infection rate are not available. For instance, backflushing decreased the numbers of staphylococci and gram-negative bacteria on liners by 98.5% and 99.5%, respectively and caused a small decrease in the number of new infections by *C. bovis* but had no effect on the incidence of new infections by staphylococci, streptococci, or coliforms. Until backflushing has been demonstrated to decrease the new infection rate, the procedure cannot be a routine recommendation.

## 2. PROPER INSTALLATION, FUNCTION, AND MAINTENANCE OF MILKING EQUIPMENT

The milking machine plays an integral role in the efficiency of the operation of a dairy farm, and it has direct contact with teat tissue. It must perform properly and consistently, two or three times a day (or much more frequently in robotic milkers), day after day, year after year. For these reasons, it is important that the milking system is installed according to approved guidelines. Regularly scheduled maintenance should be performed, and machine function should be evaluated by periodic analysis of the system. All persons in the milking management process should thoroughly understand the basic components, function, and operation of the milking equipment. They should also be aware of the significance of regular equipment maintenance and of the importance of good milking techniques.

### Milking System Function and Objectives

The milking system performs several basic functions to achieve its objectives:

- Causing milk to flow from the teat by exposing the teat ends to a partial vacuum

- Massaging the teat in an effort to relieve the effects of a continuous milking vacuum
- Protecting the milk from contamination while it is transported to a storage device, which cools and stores the milk until it can be transported to the processing plant

### Components of a Milking System

To perform the basic functions and to achieve the objective of efficient removal of the milk with minimal opportunity for intramammary infection, milking and milk handling equipment requires three basic components:

- Vacuum system
- Milk pipeline system
- Bulk milk tank for milk cooling and storage

Considerable engineering expertise goes into the proper design, installation, and function of milking equipment. For the purposes of understanding the basic principles of machine milking, a brief description of these three components will be provided.

#### Vacuum System

##### *Vacuum Pump*

The function of milking equipment depends on the creation of a partial vacuum. A **vacuum pump** is used to continuously remove some of the air from the various lines in the milking system. The amount of air removed determines the system vacuum level, which is important for proper function. The vacuum level is monitored using a gauge that is read in either kilopascals (kPa), millimeters of mercury (mm Hg), or inches of mercury (in.Hg). If one-half of the air is removed from the system, then the vacuum gauge will read 50 kPa (15 in.Hg) vacuum. Vacuum pumps are rated on the basis of the volume of air they can move when the intake vacuum is at 50.7 kPa (15.0 in.Hg). Cubic feet per minute (CFM) is the standard air flow measurement used. The CFM rating of a vacuum pump determines the number of milking units that can be used on the system. For example, to operate 6 units, the minimum vacuum pump capacity is 52 CFM.

##### *Vacuum Reserve Tank*

Because the vacuum pump continuously removes a constant amount of air from the system, a **vacuum reserve tank** is placed between the pump and the vacuum supply line. The purpose of this tank is to provide a common site for connecting the vacuum header lines and to provide a reserve of vacuum to help buffer the sudden admission of air into the system. For example, when a milking unit falls off a cow, there should be enough reserve vacuum to maintain the system function. The amount of reserve vacuum needed in a system is a function of pump capacity, pump performance, regulator operation, and the degree of system



leakage. Vacuum reserve tanks are usually constructed of PVC plastic and should not be less than a 75-L capacity.

#### Vacuum Regulator

A **vacuum regulator** or controller is an important component of the vacuum system. The function of the regulator is to keep the vacuum of the milking system at a preset level by responding to changing air admissions into the system. The regulator should be located in proximity to, or directly on, the vacuum reserve tank. It should be sensitive to handle a rapid response to changes in vacuum. Servo-diaphragm regulators are the most sensitive style available and are highly recommended. An increase in vacuum pump capacity cannot compensate for poor regulator function. Likewise, a sensitive regulator cannot compensate for a deficiency in pump capacity. The two components must work together.

It is recommended that two vacuum gauges be installed in the system to monitor the system vacuum. One gauge should be located on the milking vacuum supply line near the regulator. A second gauge is best situated at the far end of the vacuum pulsation line. A portable mercury manometer should be used on a regular basis to calibrate the accuracy of the system vacuum gauges and to make adjustments to the vacuum regulator. The preferred vacuum system installation consists of two header lines from the vacuum reserve tank, continuing to form a completely looped pulsation line. The recommended vacuum lines are 76-mm diameter PVC pipe, adequately supported, and slightly sloped in the direction of air flow and with automatic drain valves. This line allows for attachment of the milking unit pulsators.

#### Pulsation System

A properly functioning pulsation system is critical to teat and udder health. The pulsator causes the chamber between the teat cup shell and the liner to alternate regularly from vacuum to air source. Pulsators are either electromagnetic or pneumatic. In an electromagnetic system, all pulsators function together off an electrical signal. An electronic control circuit turns current on and off to the electromagnet. Pneumatic pulsators run off the vacuum system and use air to move a plunger or slide valve to cover and uncover the air passage, producing the pulsating action.

An understanding of the dynamics within the teat cup and the characteristics of pulsation is crucial to ensuring that the objectives of mechanical milking are achieved. The chamber between the teat cup shell and the liner is regularly subjected to a vacuum source, whereas the inside of the liner is under stable milking vacuum at all times. The pulsation cycle involves a milk phase and a rest or massage phase. When air is admitted between the shell and the liner, the liner

collapses around the cow's teat. The collapsed liner has a massaging action on the teat, which is called the **rest** or **massage phase**. Milk does not flow from the teat during this phase. When the pulsator opens, the space between the liner and the shell is exposed to system vacuum. This creates equal pressure on both sides of the liner, causing it to open. The cow's teat end is now exposed to the milking vacuum. This vacuum, in combination with the internal pressure of milk letdown within the cow's udder, causes milk to be drawn out through the teat streak canal. This component of pulsation is called the **milk phase**. The process of milking involves repeatedly opening (milk phase) and closing (rest phase) the teat cup liner.

The **pulsation cycle** is measured by the time, in seconds, for the completion of one milk phase and one rest phase. The **pulsation rate** refers to the number of cycles completed by a pulsator in 1 minute. Pulsation rates range from 45 to 60 cycles per minute. The **pulsation ratio** is the length of time in each cycle that the pulsator is in its milk phase compared with its rest phase. A common pulsation ratio is 60:40, indicating that in each pulsation cycle the teat cup chamber will be milking 60% of the time and massaging the teat 40% of the time. Wide pulsation ratios can speed up milking time but can put undue stress on the teats and teat ends from insufficient rest, predisposing to new intramammary infections.

**Pulsation phase** refers to the method of pulsation for the whole milking unit and is either simultaneous or alternating. In simultaneous pulsation all four teat cups milk at the same time and rest at the same time. With alternating pulsation, two teat cups milk while two teat cups rest, then alternate to complete the pulsation cycle. The alternating action may be from side to side or from front to rear. Alternating pulsation has several advantages. It allows a more uniform milk flow into and out of the claw, which helps to minimize flooding of the claw, resulting in fluctuations in the teat-end vacuum. In addition, front/rear alternating pulsation allows for a wider pulsation ratio on the rear quarters, which encourages a more uniform and timely milk out of all four quarters. For alternating pulsation systems with two different ratios, care must be taken to ensure that air hoses are not reversed when attached to the claw.

Electromagnetic pulsators are unaffected by environmental temperature and can function at a constant preset pulsation rate and ratio. Pneumatic pulsators can be greatly affected by changes in temperature and system vacuum. They require more maintenance and constant checking of the settings. Thus **electromagnetic pulsators using alternating pulsation are most recommended**, particularly for high-producing cows with fast milk letdown.

If a teat cup is not positioned properly on a teat, the liner may slip down the teat and produce a squawking sound. As this is happening, air is entering around the teat into the liner. The entrance of this air changes the system of stable milking vacuum within the claw and the other teat cups. These changes lead to droplets of milk being driven in a reverse direction back at the teat ends of the other teats. These are referred to as **milk impacts**. Repeated teat-end milk impacts, particularly with milk contaminated by mastitis pathogens, can result in new intramammary infections.

#### Milk Transport System

Milking parlors and stanchion barn pipelines have similar systems for transporting milk from the cow to the bulk tank. The components of the transport system will be described in the direction of milk flow. The rubber or silicone insert in each teat cup is referred to as a **liner** or **inflation**. The liner should milk cows safely, with a minimal number of squawks from downward slippage, and without the teat cup crawl action of riding up on the teats to the base of the udder. Liner performance depends on many interrelated characteristics of the milking system. **Narrow bore liners are recommended**. Liners must be compatible with the teat cup shell. The most important management consideration with respect to teat cup liners is to **ensure regular replacement, as recommended by the manufacturer**. As a general guideline, natural rubber liners last 500 to 700 cow milkings, synthetic rubber liners 1000 to 1200 cow milkings, and silicone liners 5000 to 10,000 cow milkings. The desired milking inflation replacement interval (in days) can be calculated using the following formula:

$$\begin{aligned} \text{Number of days between changes} &= ((\text{number of cow milkings/set of liners}) \\ &\quad \times (\text{number of units})) / \\ &\quad ((\text{number of cows milking}) \\ &\quad \times (\text{number of milkings/day})) \end{aligned}$$

Other rubber parts of the unit, such as the short air tubes on the claw, should be constantly checked for cracks or signs of wear. These problems could seriously affect air flow and liner pulsation. Proper storage in dark, cool conditions, as well as the correct use of cleaners and sanitizers, can affect the life of rubber parts.

#### Milk Claw

The **milk claw** is an important component of the milking unit. The claw is the collection point for milk from the four teat cups and should have adequate capacity to handle peak milk flow without flooding. Each claw should have a means of shutting off the vacuum to the teat end, so that the unit is not removed under vacuum. Most claws have an air vent in the upper half to allow a

predetermined quantity of air into the unit to facilitate milk flow away from the cow and into the pipeline. Claws should routinely be **inspected for cleanliness, plugged air vents, and dented liner connectors.**

A long milk hose is used to carry milk from the claw to the pipeline. The hoses can be made of plastic, rubber, or silicone. **They should be as short as possible,** with an appropriate hose hanger. If the milk hose is crimped or allowed to loop, milk flows will be interrupted, which leads to irregular fluctuations in teat-end vacuum. The milk hose should attach to an inlet located in the top third of the milk pipeline, at the 11 o'clock or 12 o'clock position. Inlets should be self-draining, self-closing, and should not cause milk flow restrictions that would result in irregular teat-end vacuum fluctuations.

### Milk Pipeline

The **milk pipeline** serves two important functions: transporting milk from the cow to the receiver jar and carrying air flow to provide milking vacuum to the teat end. Either glass or stainless steel can be used for milk pipeline construction. The milk line should form a complete circuit and must be rigidly supported from the floor to maintain the appropriate slope. It is generally recommended that **milk lines be installed as low as is practical.** In milking parlors, low pipelines are installed below udder level. In stall barns, high pipelines are used, but they should be no higher than 2 m above the cow platform. Milk moves by gravity through the pipeline to the receiver jar. The milk line must be self-draining and should have a continuous slope from the high point toward the milk receiver jar. The **correct slope** is important for the movement of milk and air during milking and for proper cleaning of the system. In the construction of new tie-stall barns, it is recommended that the foundation, floor, and gutter be sloped toward the milk house end. This will help to minimize pipeline height and to ensure that line slope will facilitate drainage during milking and washing.

Line diameter is another important feature of milk pipeline design. In addition to line slope and the level of herd production, pipeline diameter will determine the number of milking units that a system can handle. Too many units will lead to milk line flooding and a reduction in air flow rate. Slugs of milk moving through the line is an obvious sign of milk line flooding. This problem will have a negative impact on milking time, herd production, and udder health. The recommended minimum pipeline diameter is 51 mm (2.0 in.). At this pipeline size, high-producing herds should not use more than three milking units per pipeline slope. Thus larger pipeline sizes are often recommended for new installations. Pipeline couplers or welds must prevent air leakage into the system.

Milk should flow into the receiver jar in a continuous, unimpeded fashion. When sufficient milk has accumulated, an electronic probe triggers the milk pump to transfer milk from the receiver jar to the bulk tank. A milk filter is inserted into the transfer system to remove coarse impurities that may have entered the line. The receiver jar is connected to the main vacuum supply. A device called a sanitary trap is used to separate the "air-only" portion of the milking system from the "milk-handling" side of the system. The sanitary trap is designed to protect the vacuum supply from potential damage caused by the chemical cleaning and sanitizing solutions used to clean milk pipelines.

A milking system should have the capability of measuring the amount of milk from each cow. In older milking parlor systems, weight jars were often used for this purpose. They allowed for a quick visual means of monitoring individual cow production at each milking, as well as providing vacuum stability to the cow. However, they were expensive and represented a challenge to clean. More recently, milk metering systems have been developed that give an **electronic digital readout of the milk volume produced** at each parlor station. These systems can often be adapted to provide automatic data recording in an on-farm computer system. In stall barn pipeline installations, several types of mechanical milk meters are in use. It is important that any metering system should not be restrictive to the flow of air and milk. These restrictions can cause a drop in teat-end vacuum and the occurrence of irregular teat-end vacuum fluctuations. Increased milking time, incomplete milk out, and new intramammary infections can result.

### Bulk Milk Tank

The bulk milk tank is the vessel used to cool and store raw milk until it is picked up by the bulk milk transport truck. All tanks must be of an approved sanitary design and construction. They must be of sufficient capacity to cool and store up to 3 days of milk production. The cooling capabilities of bulk milk tanks are clearly specified. Appropriate cleaning and sanitizing procedures for bulk tanks are critical to prevent bacterial growth and contamination of raw milk.

### Relationship of Milking Equipment to Udder Health

The milking machine can influence new intramammary infection rates in several ways:

- It may be a carrier of mastitis pathogens from one cow to the next.
- It may serve as a pathway of cross-infection within cows.
- Malfunctioning or improperly used equipment may result in failure to relieve congestion in teat tissue. Eventually, teat-end damage and intramammary infection can occur.

- Abrupt loss of milking vacuum may create changes in air movement of sufficient force to move pathogens past the streak canal defenses. This phenomenon, known as the impact mechanism, was described earlier.

The pathogenesis of new infections related to machine milking probably involves all four of these factors. However, even though the milking system becomes the focus of many herd udder health investigations, there is little evidence that machine factors are of primary importance in most problem herds. It has been difficult to link milking machine factors and prevalence of herd infection, with the clear exceptions being **pulsation failure** and the **impact mechanism**. Mastitis has been difficult to produce experimentally by altering machine function.

Appropriate pulsation is important for sufficient teat-end massage. Although continuous vacuum will remove milk from cows' teats, eventually it will result in excessive congestion, edema, and teat-end damage. An adequate compressive load by the liner on the teat tissue is necessary to relieve the congestion. Mechanical failure of the pulsator, shortness of the liner barrel, and a too-short liner rest phase are the most common examples of pulsation problems. The impact mechanism results from an abrupt loss of milking vacuum. Poor liner design has been shown to increase the frequency of liner slips. During a liner slip, a reverse pressure gradient occurs across the streak canal of the other three teats. Liner design has been shown to be very important in reducing the amount of slippage. In combination with liner slips, the vacuum fluctuations that result from pulsation problems can lead to new intramammary infection.

Even with the myriad of potential machine problems, milking equipment is not usually the major risk factor for poor udder health.

### Maintenance and Evaluation of Milking Equipment

The most important aspect of udder health management related to milking equipment is the establishment of an appropriate evaluation, maintenance, and service schedule. Farm personnel should incorporate an inspection of the equipment into their regular milking process. Many of the problems discussed in conjunction with the description of milking system components can be discovered during this daily inspection. In addition, the producer should have milking equipment serviced on a regular basis. Items such as the vacuum pump, regulator, pulsators, and sanitary trap would be included in this check list. Also included in this inspection will be regular changing of the teat cup liners and other rubber parts. It is common for equipment dealers to schedule a regular visit to each farm client for the purpose of conducting this periodic maintenance schedule and for dispensing

chemical cleaners and disinfectants used in the udder health management program.

A complete milking system analysis should be conducted on a regularly scheduled basis. This regular analysis is perhaps just as important as the initial design and installation of the system. Many dairy cattle specialists believe that a regular independent analysis will ensure proper equipment function. Milking system analysis can be conducted by equipment dealers, government extension staff, veterinarians, or independent technicians. All these individuals need the appropriate knowledge and training. It is essential to use some type of systematic milking system analysis worksheet to record various performance measurements and to identify components requiring service or upgrading. A complete system analysis should be conducted at least once a year, and records should be kept for future reference.

### Robotic Milking

Mastitis control in robotic milking systems has specific challenges related to ensuring that clean dry teats are milked, diagnosing clinical mastitis, and the treatment of cows with clinical mastitis. Additional information is provided in a review article by Edmondson listed in additional reading.

## 3. DRY COW MANAGEMENT AND THERAPY

The proper management of dry cows and late-gestation heifers is an important component of a mastitis control program. The dry period offers a valuable opportunity to improve udder health while cows are not lactating. However, the beginning and the end of the dry period represent periods of increased risk of infection. **The objective of udder health management during the dry period is to minimize the number of infected quarters at calving.** Two of the three major principles of udder health management must be met to achieve this objective. **Infections present at the time of drying off should be eliminated, and the rate of new intramammary infections during the dry period must be minimized.** Thus dry cow therapy has a dual role in eliminating existing infections and preventing new infections during the dry period and has been widely adopted by dairy farmers. If these two principles are followed, udders will be free of infection at calving and can be expected to produce a maximum amount of low-cell-count milk in the subsequent lactation. Intramammary administration of long-acting antimicrobial agents to all cows at drying off remains a routine recommendation.

### Epidemiology of Intramammary Infection During the Dry Period

The development of effective udder health management strategies for the dry period requires an understanding of the epidemiology of intramammary infections in

dry cows. This in turn requires an understanding of the incidence of new infections during the dry period and the types of pathogen involved. Risk factors that affect the susceptibility of dry cows should also be understood.

### Incidence of New Infections

The rate of new intramammary infections is significantly higher in the dry period than during lactation. The greatest increase in susceptibility is during the first 3 weeks of the dry period. In this period, the new infection rate is many times higher than during the preceding lactation as a whole. A second period of heightened susceptibility occurs just before parturition. The reported rates of new intramammary infection in the dry period vary widely. Reasons for these differences include the diagnostic criteria used and the types of organism considered to be major pathogens. There are also important herd-level effects, such as the prevalence of existing infections at drying off and the method of dry off. The average rate of new infections in untreated dry cows is expected to be between 8% and 12% of quarters.

### Types of Pathogen Causing New Infections During the Dry Period

**Contagious pathogens** are transmitted among cows and quarters in association with the milking process. **Environmental pathogens** are primarily contracted from contamination with organisms in manure and bedding. **Teat skin opportunistic pathogens** are present on the teat, particularly the teat end. Contagious, environmental, and teat skin opportunistic pathogens need to be considered in designing mastitis control schemes for the dry period.

Exposure to environmental pathogens is likely to continue throughout the dry period; thus prevention of new dry period infection with environmental agents represents a considerably greater challenge. Herds that have implemented a basic mastitis control program still need to be aware of the importance of preventing environmental infections in the dry period. There are different rates of infection by the various environmental agents as the dry period progresses. For example, infections with environmental streptococcal species, *Klebsiella* spp., and *Enterobacter* spp. occur more frequently early in the dry period. On the other hand, *E. coli* infections tend to occur immediately before calving. Dry cow management strategies need to account for the risk of infection during the entire period from last milking until the next calving.

### Risk Factors That Affect Susceptibility in Dry Cows

Several factors contribute to the variation in susceptibility during the dry period. These factors are included in the following sections.

### Teat-End Protection

The cessation of routine milking-time hygienic practices such as teat dipping allows bacterial subpopulations on teat skin to increase in number and diversity. *S. aureus* numbers are high immediately after drying off, and environmental pathogens are more prevalent on teat skin late in the dry period and at calving time. Teat-end lesions increase the likelihood of intramammary infections during the dry period. A plausible mechanism to explain this association is that teat-end lesions increase the surface area available for bacterial colonization while presenting a variety of environmental niches. For instance, quarters with cracked teat ends were 1.7 times more likely to develop a new intramammary infection during the dry period than unaffected quarters.

The streak canal of the teat is more penetrable by bacteria during the early dry period. The **keratin plug** in the streak canal must form early and completely in the early dry period to prevent penetration and growth of bacteria and decrease the incidence of new intramammary infections. However, this natural internal teat sealant does not form in some cows, and delay in formation is common. For instance, in cows in New Zealand, 45% of teats are open on day 7 of the dry period, and 25% are still open on day 35 of the dry period. Similar results were obtained in North American dairy cows. Quarters that remain open during the dry period are 1.8 times more likely to develop a new intramammary infection than quarters that have developed an effective keratin plug. Internal and external teat sealants are discussed later in this chapter.

Swelling of the mammary gland, an increasing volume of secretion, and leaking colostrum contribute to the high risk of new infection during the prepartum period.

### Resistance Mechanisms Within the Mammary Gland

Throughout the dry period there are marked changes in the composition of mammary gland secretions and in the concentration of protective factors such as leukocytes, immunoglobulins, and lactoferrin. These changes probably influence the variation in susceptibility to both environmental and contagious pathogens.

Substantial evidence exists that innate and acquired defense mechanisms are lowest from 3 weeks precalving to 3 weeks postcalving. This lowered responsiveness includes aspects of systemic and mammary gland immunity that may account, in part, for the increased incidence of peripartum disease. Polymorphonuclear neutrophil function is impaired during the peripartum period and may contribute to the increased incidence of mastitis following calving. Diminished lymphocyte responsiveness around calving has also been observed. The role of the cow in effectively transferring antibodies and cells



to the mammary gland before parturition to ensure high-quality colostrum is also an important function, and this may be affected by prepartum vaccination schedules and the ability of the animal to respond effectively.

#### *Milk Production at Dry Off*

A high level of milk production at dry off increases the incidence of new intramammary infections at calving. It is reasonable to assume that high milk production at dry off will produce a higher intramammary pressure, increasing the likelihood of an open streak canal early in the dry period. High milk production at dry off will also decrease the concentration of protective fractions such as phagocytic cells, immunoglobulin, and lactoferrin, decreasing resistance within the mammary gland. The finding that cows leaking milk following dry off are four times more likely to develop clinical mastitis in the dry period supports the concept that **increased milk production at dry off increases the rate of new intramammary infections.**

#### *Method of Drying Off*

The industry standard method for cessation of lactation (drying off) is abrupt cessation of milking, in which milking stops on the day scheduled for dry off (all cows are usually scheduled to “go dry” on the same day each week) to facilitate administration of dry cow intramammary antibiotics, vaccinations, and vitamin E/selenium injections.

The large increase in milk production over the past 50 years has led to a new challenge; producers are forced to dry off dairy cattle at the end of lactation that have high milk production (>15–20 kg/day). Abrupt drying off high-producing dairy cattle leads to rapid mammary distention and the leakage of milk that appears to be associated with an increased incidence of environmental intramammary infection. Abrupt drying off of high-producing dairy cattle also results in stress (based on increased fecal corticosteroid concentrations)<sup>4</sup> and behavioral changes, including bellowing, increased standing time looking at the milking parlor (indicating a preference to be milked), and reduced number of lying bouts.<sup>5</sup> Consequently, abrupt dry off of high-producing dairy cattle is increasingly viewed as an animal welfare and mastitis problem, and many producers are interested in effective and practical methods that alleviate stress at dry off.

For decades, the standard recommendation to decrease mammary distention and therefore stress when abruptly drying off high-producing dairy cattle has been to decrease energy intake over 1 to 2 weeks before dry off. In North America in component fed systems, this recommendation is implemented by decreasing the amount of grain fed. In total mixed ration systems, this recommendation is implemented by decreasing the total amount fed when cows are individually housed; however, this

recommendation is impractical in free-stall systems. Other approaches have been a gradual cessation of milking (such as once a day for the last 5 days).<sup>5</sup> Generally, gradual cessation of milking has not provided any significant production advantages, and as a result, abrupt cessation of milking remains the industry standard at dry off, coupled with an immediate change in diet.

A longstanding recommendation has been to decrease water intake at dry off, because this decreases milk production. This practice is rarely undertaken in northern Germany,<sup>6</sup> and it has been discouraged by the New Zealand dairy industry to comply with animal welfare codes. However, water intake is likely to be decreased at abrupt dry off because drinking behavior appears to be closely coupled with milking in dairy cattle and is also dependent on dry matter intake.<sup>7</sup>

#### *Parity*

Older cows are more likely to develop new intramammary infections during the dry period. This increased predilection may be caused by increased milk production at dry off, increased prevalence of abnormal teat placement (increasing exposure of the teat end to pathogens), or increased prevalence of open streak canals because older cows have higher milk production.

#### **Risk Factors That Affect Susceptibility in Heifers**

An increased risk for intramammary infection in the preparturient period in heifers is associated with the presence of *S. aureus* or *M. bovis* in the herd, calving in summer, high herd bulk tank milk SCCs, poor fly control, mastitic milk fed to calves, and contact with adult cows. Other risk factors are increased age at first calving, prepartum milk leakage, blood in milk, and udder edema.

#### **Udder Health Management Strategies for Dry Cows**

##### **Antimicrobial Therapy (Dry Cow Therapy)**

Antimicrobial therapy at the end of lactation (dry cow therapy) has been one of the key steps in mastitis control programs and has become the most effective and widely used control method for dry cows. The efficacy and advantages of antimicrobial therapy are well known. A meta-analysis concluded that the use of effective dry cow products resulted in a 78% increase in the elimination of existing infections,<sup>8</sup> with no detectable difference for pathogen type, including *S. aureus*. An accompanying meta-analysis indicated that dry cow therapy provided significant protection against new intramammary infections caused by *Streptococcus* spp. during the dry period and the first 21 days of lactation, but no protection was observed for new coliform or *Staphylococcus* spp. intramammary infection.<sup>9</sup>

Long-acting antimicrobial preparations have been formulated to **eliminate existing**

##### **infections and to prevent new infections.**

These preparations include benzathine cephapirin, benzathine cloxacillin, and sustained-release formulations of erythromycin, novobiocin, and penicillin. The withholding period for milk from animals treated with these dry cow formulations ranges from 30 to 42 days after treatment. It is important that the label directions are followed carefully for the recommended dosage level, required withdrawal period, storage guidelines, and expiry dates. A general recommendation is that dry cow treatment should never be administered within 1 month of the expected calving date. Single-dose syringe preparations of dry cow antibiotic treatment are recommended. The risk of contamination by environmental bacteria and yeast is much higher for multiple-dose bottles than for single-dose syringes. If bulk containers are used, great attention should be paid to maintaining sterility.

The use of long-acting and short-acting antimicrobial intramammary infusions at dry off have been compared. In some cases, short-acting antimicrobial agents were more effective than long-acting ones in eliminating infections caused by *S. aureus* or treating cows infected with major pathogens diagnosed twice before drying off. Intramammary infusion of cephapirin sodium 15 days prepartum in heifers was effective in reducing intramammary infections during late gestation and reduced the occurrence of residues in milk during early lactation. The milk of heifers that calve less than 15 days after treatment may contain antimicrobial residues.

Intramammary infusion is a widely used and highly recommended procedure for mastitis therapy; however, there is a potential for the introduction of pathogens during the infusion process. Insanitary infusion practices can introduce antibiotic-resistant environmental organisms into the udder. Infection with opportunistic microorganisms, such as yeast or *Nocardia* spp., may cause more extensive udder damage than the original organism for which treatment was being administered. Adequate teat-end preparation and careful dry cow treatment procedures can reduce this risk. Dry cow treatment procedures should be performed as follows:

- Milk out the udder completely.
- Immediately following teat cup removal, dip all teats in an effective teat dip.
- Allow the teat dip to dry. If necessary, remove excess dip from teat ends with a clean single-service paper towel.
- Disinfect each teat end by scrubbing for a few seconds with a separate alcohol-soaked cotton swab. Start with the teats on the far side of the udder and work to the near side.
- Infuse each quarter with a single-dose syringe of a recommended dry cow treatment. Start with the teats on the near side of the udder. Use the partial insertion method of administration into

the teat streak canal. Preferably, a modified infusion cannula should be provided with the treatment product.

- Dip all teats in an effective teat dip immediately following treatment.

The necessity of using appropriate dry cow treatment procedures cannot be overemphasized. An increased incidence of *Nocardia* spp. mastitis has been associated with blanket dry cow therapy, especially neomycin-containing products. However, *Nocardia* spp. were not found as a contaminant of the suspected products. Teat-end preparation by scrubbing with an alcohol-soaked cotton swab was protective against the occurrence of *Nocardia* spp. infection when teats were experimentally contaminated with organisms immediately before drying off. Most commercial dry cow treatment products provide individually wrapped alcohol-soaked cotton swabs for use with each syringe. The use of good teat-end preparation before intramammary infusion needs to be continually emphasized.

The method of intramammary infusion may be important. Partial insertion of the infusion cannula (up to 4 mm) results in fewer new intramammary infections and improved cure rates. The improvement with a short cannula is attributed to fewer organisms being delivered beyond the streak canal and decreased physical trauma to the streak canal. In addition, antimicrobial agents that are deposited within the streak canal should control local infections. Modified infusion cannulas for the convenient use of a partial insertion method of administration are now available for commercial dry cow products.

Another approach to preventing the problems associated with intramammary infusion would be the development of an effective systemically administered dry cow treatment. Preliminary results have indicated improved efficacy against *S. aureus* infections using a systemically administered fluoroquinolone antibiotic (norfloxacin nicotinate).

#### Blanket Versus Selective Dry Cow Therapy

Three strategies for intramammary antimicrobial treatment of dry cows are available, although the current recommendation for all herds is blanket therapy:

- **Blanket therapy** (treat all quarters of all cows)
- **Selective cow therapy** (treat all quarters of any cow infected in one or more quarters)
- **Selective quarter therapy** (treat infected quarters only).

Although blanket dry cow therapy is a cornerstone of any mastitis control program, there is some controversy concerning the need to treat all quarters of all cows (**blanket therapy**) or only those quarters or cows requiring treatment. The controversy has gained momentum because the implementation of udder health management practices

has reduced the prevalence of infection and global interest in decreasing the use of antibiotics. As a result, Nordic countries have implemented selective dry cow therapy as part of their national mastitis control program.<sup>10</sup> The major reasons for selective therapy are to

- Avoid the elimination of minor pathogens, which may make cows more susceptible to environmental agents
- Reduce the expense of treatment
- Address increasing consumer concern regarding the routine administration of antibiotics to food-producing animals
- Avoid the possible emergence of antibiotic-resistant organisms

Each of these reasons should be carefully considered in making a decision between blanket and selective dry cow therapy. Selective dry cow therapy is preferable provided that an accurate, practical, and inexpensive method for selecting infected cows is available. This is the major problem with selective dry cow therapy because in most herds the sensitivity and specificity of the test used for selection is not adequate. The majority of economic analysis studies indicate that the optimum return on investment is provided by treating every quarter of every cow at drying off.

As general udder health improves and bulk tank milk SCC remains low, producers question the need to continue dry treatment on all cows and are attracted by a potential reduction in costs for the purchase of dry cow treatment. However, selective therapy requires a decision as to which cows or quarters are to be treated. The sensitivity and specificity of currently available screening tests are inadequate as a basis for decisions concerning selective therapy. The history of the number of episodes of clinical mastitis, lactation number, individual cow composite SCC during lactation and at dry off, CMT results during lactation or at dry off, and even bacteriologic culture toward the end of lactation all result in leaving some infected cows untreated; conversely these result in the treatment of many uninfected cows. An important requirement for large-scale implementation of selective dry cow therapy is the development of a cheap, practical, sensitive, and specific test to identify infected cows. The failure to prevent new intramammary infections during the dry period with the selective approach must also be considered. New infections in the dry period will become increasingly important as contagious pathogens are eliminated from herds. Finally, blanket dry cow therapy reduces new infection rates for quarters from approximately 14% to 7%. The increase in milk production alone resulting from prevention of these new infections provides enough return to offset the cost of treatment for all cows.

The most practical method currently available for implementing selective dry cow treatment appears to be a low SCC on a cow basis at the last milk recording before drying

off, with a low SCC defined as <150,000 cells/mL for primiparous and <250,000 cells/mL for multiparous cows.<sup>10</sup> In a split udder study of 1657 low-SCC cows in the Netherlands, the incidence of clinical mastitis in untreated quarters in the first 100 days of lactation was 70% higher than in quarters infused with a dry cow intramammary product containing 314 mg of potassium benzylpenicillin, 1000 mg of procaine benzylpenicillin, and 500 mg of neomycin sulfate. Clinical mastitis was most commonly caused by *S. uberis*. The SCC at calving and 14 days in milk were also higher in quarters dried off without antibiotics.<sup>10</sup> Despite increased antibiotic use for treating additional cases of clinical mastitis, total antibiotic use was decreased by 85% in low-SCC cows not administered an intramammary dry cow antibiotic.<sup>10</sup> This study highlights the balance the veterinarian must reach between increased incidence of clinical mastitis (and therefore more pain and discomfort) and overall reduction in antibiotic use when a selective dry cow therapy approach is applied using the most practical test.

Information presently available indicates that the general recommendation should be for **routine treatment of all quarters of all cows at the time of drying off (blanket dry cow therapy)**. There is a need to identify important management practices to limit new infections in untreated dry cows and to develop new screening tests to determine which cows should be treated. New environmental management methods and modern information processing capabilities may lead to the development of better selective dry cow treatment programs. These may include the administration of ancillary therapeutic agents. For instance, the intramammary infusion of recombinant bovine IL-2 along with cephapirin sodium at drying off marginally increased the cure rate of intramammary infections associated with *S. aureus*, but not other pathogens, during the dry period compared with the administration of cephapirin only. Interleukin did not affect the incidence of new intramammary infections for any pathogen group. However, the intramammary infusion of interleukin at drying off was associated with an increased incidence of abortion in dairy cows 3 to 7 days after the infusion.

#### Factors Affecting the Success of Antimicrobial Treatment of Dry Cows

Despite blanket dry cow therapy, some cows calve with infected quarters and some with clinical mastitis. Several risk factors affecting the results of dry cow treatment have been evaluated. Some of these factors are

- **Number of quarters infected.** With *S. aureus* infections, there is a significant decrease in cure rate as the number of quarters infected per cow increases. Quarters from cows with either three or four of their quarters infected have a very poor cure rate.

- **Age of the cow.** As the age of the cow increases, the probability of *S. aureus* infections being cured by dry cow therapy decreases.
- **SCC before drying off.** The cure rate of *S. aureus*-infected quarters diminishes as the SCC before treatment increases. Controlling for age and number of quarters infected, there was a significantly lower cure rate in quarters with an SCC of more than 1,000,000 cells/mL.
- **Herd of origin.** There is a distinct herd effect on the success of dry cow therapy. The cure rate of *S. aureus* has been shown to be higher in herds with good hygiene and with a low prevalence of *S. aureus* infections at drying off.

There is considerable potential in using individual cow and herd-level information to predict the likelihood of a cure with dry cow therapy. For example, an older cow with three quarters infected with *S. aureus* and a persistently high SCC has a low probability of a cure. Continued development of information management systems to assist with therapy and culling decisions will clarify the expectations of dry cow treatment.

Persistent *S. aureus* infections represent only one of the shortcomings of antibiotic treatment for dry cows. Most dry cow products are formulated for efficacy against gram-positive cocci. These antibiotics are of limited usefulness against gram-negative bacteria. In other words, new coliform infections would not be prevented by this therapy.<sup>11</sup> Even though dry cow products are formulated for sustained activity, the provision of adequate protection during the critical prepartum period is questionable. The persistence of effective levels of antimicrobial agents has been evaluated for various dry cow treatments and depends on the formulation; very few products have persistent activity until the time of calving.

### Internal Teat Sealants

As discussed previously in risk factors for infection in the dry period, **the keratin plug is a natural internal teat sealant** that provides an effective barrier to new intramammary infections. High milk production at dry off increases the likelihood that the streak canal remains open and presumably compromises formation of the keratin plug, increasing the risk of intramammary infection.

A recent promising development in mastitis control has been **exogenous internal teat sealants** that are applied at dry off. The teat sealant product most extensively evaluated contains a heavy inorganic salt (**bismuth subnitrate**) in a paraffin wax base; this product does not have antibacterial properties but acts as a **physical barrier** to ascending intramammary infections. Because it is not an antibiotic use of the product may be permitted on organic dairies in some

countries. The formulation of bismuth subnitrate used has a higher density than milk causing it to sink to the bottom of the teat canal in which it creates a physical barrier. Administration of internal teat sealants alone requires meticulous attention to aseptic technique because it is easy to facilitate transfer of bacteria on the teat end into the gland during infusion.<sup>12</sup>

A meta-analysis of 18 publications concluded that internal teat sealants decreased new intramammary infections by 73% compared with untreated cows and decreased the risk of clinical mastitis after calving by 48% compared with untreated cows.<sup>13</sup> The same meta-analysis also concluded that internal teat sealants combined with antibiotic dry cow therapy decreased new intramammary infections by 25% compared with cows treated with antibiotic dry cow therapy alone and further decreased the risk of clinical mastitis after calving by 29%. The addition of an antimicrobial agent is a logical addition to the bismuth subnitrate internal teat sealant and has been a routine addition to the teat sealant for some years in Ireland. An experimental challenge study in New Zealand indicated that the addition of 0.5% chlorhexidine to the internal teat sealant at dry off increased the protection against intramammary infection after calving.<sup>14</sup>

Dry period length may be a factor to consider when deciding whether to use internal teat sealants, which persist for at least 100 days in treated cattle. As such, internal teat sealants are theoretically more likely to prevent new intramammary infections in cows with long dry periods than infusion of a long-acting intramammary antibiotic because an effective antibiotic concentration after infusion rarely persists longer than 70 days in glandular secretions.<sup>15</sup> However, study results have been mixed on this topic, with dry period length having no impact on the new infection rate or incidence of clinical mastitis in New Zealand dairy cattle administered an internal teat sealant. In contrast, a UK study found in cattle with a dry period length >70 days that the new infection rate was 11% in quarters treated with cephalonium compared with 4% in cows receiving combined cephalonium and internal teat sealant.<sup>16</sup>

Insertion of an internal teat sealant before calving shows promise as a control measure for heifer mastitis. In a New Zealand study of first-calf heifers, infusion of an internal teat sealant at approximately 30 days before calving decreased the incidence of *S. uberis* intramammary infection by 84% and the incidence of clinical mastitis by 68% in the first 14 days of lactation.<sup>17</sup>

Bismuth subnitrate internal teat sealants clearly show promise for the prevention of new intramammary infections during the dry period. However, because **bismuth subnitrate teat sealants do not eliminate existing intramammary infections**, and an

accurate method for determining the infection status of a quarter is unavailable (the exception being milk culture), the recommended application of internal teat sealants requires combined application with intramammary dry cow therapy, with the teat sealant infused immediately after infusion of the intramammary dry cow antibiotic. The teat sealant should not be massaged upward after infusion. This combined therapy is more effective than either treatment alone but may be uneconomical; however, a study conducted on grazing dairy cattle in Australia concluded that the use of combined therapy was likely to be of benefit in herds that had a clinical mastitis incidence of 6% or more in the first 3 weeks of lactation.<sup>18</sup> Widespread adoption of internal teat sealants will be facilitated by development of an accurate low-cost test for determining intramammary infection status at dry off.

It is important that the internal teat sealant does not reach the bulk milk tank. At the first milking after calving, each quarter should be stripped 10 to 12 times and colostrum should be withheld for a minimum of 4 days.

### External Teat Sealants

A longer-standing approach to providing a physical barrier to ascending infections is the use of external teat sealants, which were originally developed for use in lactating cows. The major problem with external teat sealants is the duration of adherence, which is too long for lactating cow use and too short for dry cows. Teat-end lesions and teat length influence the adherence of external teat sealants. Widespread adoption of external teat sealants will require a product that provides prolonged protection but is easily removed at calving.

### Teat Disinfection

Postmilking teat disinfection is a very effective means of reducing new infections in lactating cows. However, the efficacy of teat disinfection in decreasing the incidence of new intramammary infections in the dry period has been discouraging. Daily teat dipping for the first week of the dry period is not effective in reducing *S. uberis* infections. The lack of efficacy of teat disinfection needs to be contrasted to the efficacy of internal teat sealants.

### Intramammary Devices

Intramammary devices have been developed for use in preventing new infections in both lactating and dry cows. However, there is conflicting evidence as to the reduction in infection rate in quarters fitted with these devices, and such devices are no longer being investigated. The incidence of clinical mastitis may be less in cows fitted with these devices compared with control cows, but the prevalence of subclinical infection is unaffected. Intramammary



devices induce a significant increase in postmilking SCC compared with control cows, and test-day SCCs may be higher than in control cows.

#### Vaccination of the Dry Cow

Immunization and immunotherapy for the control and prevention of mastitis have been active areas of research. Effective vaccines would have to eliminate chronic intramammary infections, prevent new intramammary infections, or decrease the incidence or severity of clinical mastitis. Currently available mastitis vaccines may reduce the incidence and severity of clinical mastitis but have not eliminated chronic intramammary infections or prevented new intramammary infections. The inability of vaccines to prevent infection may be caused by the wide variety of pathogens, inadequate specific antibodies, or the failure of antibodies to enter the mammary gland before infection. Currently available vaccines should be used as adjuncts to other more effective control strategies.

Vaccines have been developed to reduce the incidence and severity of clinical mastitis associated with gram-negative pathogens. R-mutant bacteria have an exposed inner wall structure (core lipopolysaccharide antigens) that is highly uniform, even among diverse and distantly related gram-negative bacteria. Vaccines containing killed R-mutant bacteria provide broad-spectrum immunity against a wide variety of unrelated gram-negative bacteria. The most commonly used coliform mastitis vaccines are the Rc-mutant *E. coli* O111:B4, known as the J5 vaccine, and the Remutant *S. typhimurium*, both of which are commercially available in the United States. R-mutant vaccines have been efficacious in reducing the incidence and severity of clinical mastitis caused by gram-negative bacteria. More than 50% of large (>200 cows) dairy herds and more than 25% of all dairy herds in the United States are using core lipopolysaccharide antigen vaccines. No protection is provided against environmental streptococci and staphylococci, or the contagious pathogens.

No effective vaccines are currently available for the control of mastitis caused by *S. aureus*, *S. agalactiae*, environmental streptococci, and *M. bovis*.

The use of recombinant bovine cytokines as adjuvants to enhance specific immunity in the mammary gland of cows after primary immunization indicate an enhancement of specific immunity in the mammary gland, which may be effective in mastitis immunization protocols.

#### Management of the Environment for Dry Cows

Dry cows should be provided with an environment that is as clean and dry as possible. If this is not feasible in confinement housing, it is probably better to maintain dry cows on pasture. Variations in the load of

coliforms and environmental streptococci in the environment are important predictors of new infection rates. Minimizing the exposure to environmental bacteria will reduce the new infection rate. However, some pasture conditions promote the crowding of cows under shade trees. In hot, humid, and muddy conditions, heavy contamination of such a small area can result in a significant risk of new environmental infections in the dry period. In good weather, it is ideal to hold parturient cows in a clean, grassy area in which they can be observed and assisted if necessary.

In confinement housing systems for dry cows, it is important to provide adequate space, ventilation, bedding, and lighting to ensure cleanliness and comfort. Maternity (calving) stalls should be bedded with clean straw, sawdust, or shavings. Other important procedures for managing the environment for dry cows include adopting an effective fly control program. Clipping the hair on the udders, flanks, and inside the hind legs will help reduce contamination. **The words clean, dry, cold, and comfortable summarize the ideal environment for dry cows.** The words clean and dry also summarize the goal for the teat before attachment of the inflation during milking.

#### Nutritional Management of Dry Cows

A nutritionally balanced dry cow feeding program is important to ensure udder health. A role has been suggested for specific nutritional factors in resistance to mastitis, especially over the dry period. Adequate levels of vitamin E and selenium in dry cow rations appear to be important for udder health at calving and in early lactation. This effect may be mediated through enhanced resistance mechanisms. Other vitamins and minerals may be important in udder health, but their role is less well substantiated.

Nutritional management of dry cows is also important for reducing the risk of milk fever, which is an important predisposing factor to mastitis in fresh cows. Appropriate body condition can be achieved by good nutritional management in late lactation. The association between body condition, energy metabolism, and udder health needs further clarification.

#### 4. APPROPRIATE THERAPY OF MASTITIS DURING LACTATION

The early recognition and treatment of clinical cases remains an important part of a mastitis control program. Improvements in understanding of the epidemiology, pathophysiology, and response to therapy of various mastitis pathogens have clarified the role of intramammary and parenteral antimicrobial agents for the treatment of clinical and subclinical mastitis during lactation. This was covered extensively earlier in this chapter.

#### 5. CULLING CHRONICALLY INFECTED COWS

The final step of the five-point mastitis control program is the selective removal of cows with chronic intramammary infection from the herd. Most producers have interpreted this recommendation to mean that cows with recurrent episodes of clinical mastitis should be eliminated. For example, some herds have established that cows having three or more clinical cases of mastitis in a lactation will be culled (**the popular three strikes and out approach**). However, very little research has been conducted to determine the effect of various culling strategies on herd udder health status and on the incidence of clinical cases.

Nevertheless, culling chronically infected cows meets one of the three guiding principles of mastitis control, namely the elimination of existing intramammary infections. Through the use of available monitoring techniques and the establishment of a defined culling program, a valuable opportunity exists to improve udder health by culling.

Generally, a record of chronic mastitis and severe fibrosis detected on deep udder palpation should be the basis of a recommendation to cull. Culling is an effective and documented mastitis control measure for some specific mastitis pathogens. For example, the removal of infected cows is a key element of the recommended mastitis control program for herds with a high prevalence of *S. aureus* infection. Removal of cows found to be infected with *S. aureus* accounted for more than 80% of the costs involved in the control program. Culling is also important in the control of other mastitis pathogens that respond poorly to antimicrobial therapy. Herds with mastitis cases associated with *M. bovis*, *Nocardia* spp., and *P. aeruginosa* should be aware of the benefits of culling infected cows.

A dairy herd culling program should be based on consideration of the net present value of each cow in the herd compared with the value of a replacement heifer. The net present value depends on the age of the cow, her potential for milk production, the stage of lactation, and her pregnancy status. Factors that determine the likelihood of treatment success, such as pathogen and duration of mastitis, as well as the cost of treatment, also need to be considered in calculating the net present value of the cow with mastitis. After consideration of the relative importance of udder health in the overall herd health management program, additional economic pressure may be applied to cows with a specific udder health status. For example, if an *S. aureus* control program is a major priority in the health management program, additional economic pressure should be applied in removal decisions of cows with known *S. aureus* infections. As health management data collection and

analysis improve in sophistication, decision analysis methods and expert computer models will be used to provide this information automatically.

### Biosecurity for Herd Replacements

Replacement animals may be purchased to increase herd size or to maintain cow numbers following culling. Biosecurity measures must be used to ensure that herd replacements are not infected with contagious mastitis pathogens (specifically *S. aureus*, *S. agalactiae*, and *M. bovis*). However, an economic analysis of the different components of a biosecurity program has not been performed, and it is likely that some components of currently used programs are not cost-effective.

An optimal biosecurity program includes knowing the herd of origin, knowing the cows, and protecting the home herd.

#### Know the Farm of Origin

- Request a bulk tank milk culture from the farm of origin
- Request the following data: 6 to 12 months of bulk tank milk SCC, bulk tank milk bacterial counts, and 6 to 12 months of records for clinical mastitis

#### Know the Cows

When purchasing single or small groups of animals the following prepurchase procedures are recommended:

- SCC and clinical mastitis records for each cow to be purchased
- Results of bacteriologic culturing of quarter milk samples from each cow on arrival (if lactating) or at calving (if late gestation) for *S. aureus*, *S. agalactiae*, and *M. bovis*. Generally, the sensitivity of a single milk culture to detect the presence of intramammary infections caused by *S. agalactiae* is approximately 95%, for *S. aureus* it ranges from 30% to 86%, and for *M. bovis* it is 24%.
- A physical examination of each cow, including udder, milk quality, and teat ends

#### Protect the Home Herd

Consider all purchased animals as potential health risks to the home herd by doing the following:

- Maintain all newly purchased animals in separate or isolated facilities until diagnostic tests for udder health have been completed and there is no evidence of infection that may spread to the rest of the herd (usually <14 day quarantine).
- Evaluate all herd replacements for evidence of antimicrobial residues in milk.
- Milk all purchased animals last or with separate milking equipment until it is

determined that they are free of infection.

- Obtain results of bacteriologic culturing of bulk tank milk samples or string samples for *S. aureus*, *S. agalactiae*, and *M. bovis*; culturing should be done on more than one occasion because the sensitivity of bulk tank milk culturing is not 100%, and is less than 50% for *M. bovis*.

## 6. MAINTENANCE OF AN APPROPRIATE ENVIRONMENT

The multifactorial nature of mastitis has been emphasized throughout this chapter. Intramammary infection results from a complex interaction between the cow, the mastitis pathogens, and the environment. Thus the control of unfavorable environmental influences is extremely important in dairy herd udder health management programs.

Intramammary infection involves exposure of the teat surface to potentially pathogenic microorganisms, entry of the pathogens into the gland via the teat duct, and establishment of the pathogens in the mammary tissue, producing an inflammatory response. Many environmental factors can influence this process of exposure, bacterial entry, and establishment of infection. For example, the type of bedding and manure management can have a great impact on the contamination of teat skin with microorganisms. Housing design can have an impact on the prevalence of teat injuries, which will influence intramammary invasion by mastitis pathogens. Extreme climatic conditions, poor nutritional management, and cow stocking densities will influence the immune system and the establishment of intramammary infection. A comprehensive udder health management program should involve steps to minimize the detrimental influences of the environment.

### Global Environmental Influences

Worldwide, there are major differences in dairy herd health and production systems. For example, the type of animal used, economics of production, climatic conditions, housing structures, and management methods are widely variable. These differences greatly affect the interaction of cows with their environment, even though the predominant causative organisms are the same under different systems. Thus there are major variations in the relative incidences of different pathogens and in the importance of various approaches to mastitis control.

### Classification of Environmental Influences

The influences of the total environment can be divided into the following:

- **External environment.** All aspects of the environment outside the housing facilities make up the external

environment. This includes the regional differences in climate, geography, and agricultural tradition. There are also local factors within a region that can have an important influence. These local factors include the topographic features of the land, natural shelters from the climate, and the availability of pasture.

- **Internal environment.** All environmental conditions inside the cow buildings make up the internal environment. The general internal environment includes the type of housing system, temperature, humidity, and air quality. There are also specific internal environmental influences such as stall design, type of bedding, nutritional management, and manure disposal. The milking environment has a major influence through the equipment, cow preparation methods, and approach to general hygiene.

### External Environmental Influences on Mastitis Control

There is minimal evidence that external environmental factors directly influence the incidence of mastitis; however, the external environment determines the way in which cows are housed, fed, and milked. Through these associations, the external environment can be an important risk factor in problems with udder health in dairy herds.

### Regional Environment

The climate and geographic features of a region have implications for the prevalence of mastitis. The ambient temperatures and amount of rainfall often determine the types of housing and nutritional program used. Extremely hot or cold conditions interact with other predisposing management factors. In areas prone to severe rainstorms, teats may be exposed to wet or muddy conditions. The soil type, cropping policy, and presence of other industries can also have an indirect impact on the prevalence of mastitis; for example, regions suitable for growing cereal grains will commonly use straw as a bedding material, which may favor the growth of environmental streptococcal organisms. In contrast, dairying areas close to the forestry industries may favor sawdust or shavings as bedding. The use of these materials may influence the incidence of coliform mastitis.

The socioeconomic structure and agricultural policy of a particular region can affect management factors known to influence udder health. These factors determine herd size and labor costs. Large herd sizes necessitated by economic conditions will dictate the housing, feeding, and milking management practices used. More recently, regional policy toward regulation of bulk tank milk SCC levels has had a profound impact on udder health status.

### Local Environment

The local environmental factors such as the topography of the land, the presence of natural shelters, and the type of pasture grown are thought to influence udder health status. However, direct scientific evidence is lacking. One important exception is summer mastitis, which affects nonlactating heifers and cows. This udder infection with *T. pyogenes* is greatly affected by the local environment, probably through the propagation of insects important in its transmission. Protected pastures increase insect populations and can result in a high incidence of infection.

### Internal Environmental Influences on Mastitis Control

The incidence of new intramammary infections can be greatly affected by the management and facilities used in confinement dairying systems. General aspects of the internal environment exert their influence on all cows in the herd, such as the type of housing and milking system. Tie-stall barns pose different environmental stresses from a free-stall system. The air quality and noise levels can have an impact on animal health. The nutrient content of component feed-stuffs can affect disease resistance.

Specific internal environmental factors exert their influence on an individual cow basis. For example, the stall design and tying system affect individual cows differently. Many epidemiologic studies have revealed interactions between udder disease and internal environmental conditions. Most of these studies relate to European tie-stall and seasonal grazing systems. However, the results are generally relevant to most housing and management systems. Some of the most important general and specific influences of the internal environment are as follows.

### Housing

Housing factors account for a great deal of the variation in udder health status between herds. In both tie-stall and free-stall barns, short and narrow stalls are associated with increased incidence of teat tramps and mastitis. An appropriate partition between stalls is beneficial. Stanchions or neck straps with chains can restrict the movement of the cow and increase the risk of teat injury. This occurs especially as cows are rising. In addition, the use of electrical cowtrains has been associated with an increase in the rate of subclinical mastitis. The use of adequate amounts of a good bedding material will reduce mastitis incidence in both tie-stall and free-stall housing systems. Even though there are reports of specific bedding materials being associated with certain mastitis problems, the use of adequate amounts of properly maintained bedding is beneficial. Straw, shavings, sawdust, sand, shredded newspaper, and other cushion systems have all been used effectively.

The climate and air quality maintained within a building can have a major influence on udder health. Draughty conditions, high relative humidity, and marked changes in indoor temperature over a 24-hour period are factors that contribute to higher mastitis rates. Adaptation to adverse internal environmental conditions may cause stress, which can reduce the cow's defense mechanisms. Indoor climate, especially temperature and humidity, can also account for differences in the concentration of pathogenic organisms to which cows are exposed.

### Nutritional Management

A complex relationship exists between the quantity and quality of feed and udder health status. Improper nutritional management can result in an increase of new intramammary infections, the exacerbation of preexisting chronic infections, and an increase in clinical mastitis. Several mechanisms have been suggested for this association. An improper anion to cation balance in the dry cow ration is a predisposing factor for periparturient hypocalcemia, which in turn increases the risk of new intramammary infections. Feeding programs that result in excessively fat or abnormally thin cows may affect resistance to disease. Also, there is some evidence that feeds high in estrogenic substances may be detrimental to udder health status.

The dietary concentration of some vitamins and minerals may have an important relationship to udder health. Studies have shown that intramammary infection is related to plasma concentrations of vitamin E and blood concentrations of selenium. Dietary supplementation of vitamin E and selenium improved the natural resistance of the mammary gland to infection. Associations between udder health and the levels of vitamin A,  $\beta$ -carotene, zinc, and other nutrients have been proposed but are not well documented.

### Management Approach

Cow supervision, decision making, and general animal care by dairy herd managers may be important epidemiologic factors in the relationship between environment and udder health. For example, lack of consistency in the performance and timing of various herd activities results in decreased udder health status. Irregular intervals between milkings should be avoided.

### General Hygiene

Even outside the milking environment, general hygiene can greatly influence the exposure of the udder and teats to pathogenic bacteria. The degree of hygiene achieved is directly related to the type of housing, the amount of bedding, and the efficiency of manure removal. Worldwide trends toward increasing herd sizes and decreasing labor force necessitate more emphasis on the importance of cow hygiene.

### Udder Singeing

Hair on the udder facilitates the accumulation of fecal material and other organic material that, when wet, can contaminate the teat orifice and result in new intramammary infections, or enter the bulk tank milk vat. Udder hair can be removed by clipping or more quickly by "udder singeing" every 2 to 3 months, which has become popular in parts of North America. A soft yellow flame from a handheld propane torch is held about 15 to 20 cm below the udder to singe the udder hair and the ash brushed away using a gloved hand. Studies have demonstrated that udder singeing results in cleaner udders, but a beneficial effect on decreasing herd SCC, milk bacterial count, or the incidence of clinical mastitis does not appear to have been reported. Appropriate clinical studies documenting the pain and discomfort associated with the procedure do not appear to have been conducted.

### Use of Recombinant Bovine Somatotropin

It has been suggested that the use of bST may increase the incidence of clinical mastitis by an indirect mechanism that acts through increased milk production. Controlled field studies have shown that the use of bST is not associated with an increase in the incidence of clinical mastitis, milk discarded because of therapy for clinical mastitis, or culling for mastitis.

### Environmental Control in an Udder Health Management Program

There is a strong association between herd udder health status and the number of stress factors operating within the herd. It has been proposed that mastitis occurs when stress factors exceed the cow's ability to adapt. It follows that a major objective of an udder health management program should be to limit the number and severity of environmental stress factors.

Veterinarians responsible for udder health management programs should have a good understanding of the importance of environmental management. The three major objectives of environmental control for improvement of udder health are to prevent

- Contamination of the teat end
- Invasion of mastitis pathogens
- Pathogens from establishing in the mammary gland

The important steps in achieving these three objectives have been discussed. For example, an adequate housing system and manure handling are important to limit bacterial contamination of the teats. The prevention of environmentally induced teat injuries will aid in preventing invasion of pathogens into the gland. The producer's approach to cow management, control of the nutritional program, and ensuring that the internal environment is appropriate will all greatly



improve host defense mechanisms and prevent intramammary pathogens from establishing within the gland.

## 7. GOOD RECORD KEEPING

Good record keeping involves the collection of useful data to monitor performance, calculation of appropriate indices, and decision making based on comparison to target levels. For acceptable performance the monitoring process is repeated and the cycle continues. If performance is not acceptable, further evaluation and analysis is performed, and a plan of action is instituted. Once again, the monitoring process carries on and the cycle continues. For many of the health management programs in food animal practice, a limiting factor is the availability of accurate and objective data. With respect to udder health, data have been readily available. Bulk tank milk SCC, individual cow composite SCC, and bacteriologic culture results are all accessible and useful. These data provide the information necessary to monitor udder health status and to make specific health management decisions. However, problems can still exist. Herds with a low prevalence of infection and very low bulk tank milk SCC can still have a high incidence of environmental infections and clinical mastitis cases. Thus an important step in an effective udder health management program is the maintenance and use of mastitis records. The increasing adoption of computerized dairy health management record systems provides an opportunity to make effective use of a clinical mastitis episode and therapy data. Even without a computerized system, manual records for clinical mastitis are easy to implement and use.

### Objectives and Uses of Clinical Mastitis Records

The objective of maintaining computerized or manual records of clinical mastitis episodes is to complete the decision-making capabilities of a mastitis control program. The availability of this information will allow completion of the health management cycle over the entire spectrum of herd udder health situations.

There are several important uses of clinical mastitis records:

- To assess the risk factors associated with clinical mastitis episodes
- To evaluate lactational and dry cow therapy programs

To provide information useful in the evaluation of net present value of individual cows for the purposes of culling decisions. Without the ready availability of accurate data surrounding mastitis events, decisions associated with therapy, culling, and the removal of risk factors are difficult to make.

### Recording Clinical Mastitis Data

There is a limited amount of specific data necessary to make effective use of mastitis

records as a health management tool. The cow identification, date of the clinical episode occurrence, type of therapy used, and the date that milk withholding will be complete are the essential pieces of information. If a manual record system is used, it will be important to add the lactation number, the date of calving, and the most recent test date production. A standard form that calculates the distribution of clinical episodes by lactation number and by stage of lactation is desirable. These are the same distributions often provided with an individual cow SCC report.

### Using Clinical Mastitis Monitoring Systems

Because clinical mastitis is a common event in dairy production, it is ironic that these records have not traditionally been kept. The key to overcoming this hurdle is the regular use of this information for health management decisions. Some of these uses and decisions are as follows.

#### *Cow Versus Herd Clinical Mastitis Problems*

Calculation of the percentage of cows affected in the herd and the average number of clinical episodes per affected cow will aid in determining whether the clinical mastitis is more of an individual cow problem or a herd-level issue.

#### *Probability of Recurrence of Clinical Mastitis in the Same Lactation*

The number of animals with repeat cases of mastitis divided by the total number of clinical cases gives an estimate of the likelihood of recurrence. The same calculation can be made for specific parity groups. This information can be useful to characterize the problem, and for culling decisions.

#### *Stage of Lactation and Seasonal Profile*

If clinical mastitis data are collected consistently over a considerable period of time, potentially useful problem-solving information can be derived. For example, calculating days in lactation at first occurrence can help to identify specific risk factors for new intramammary infections. There is a higher proportion of clinical occurrences during the first few weeks after calving. However, analysis of clinical mastitis records might yield a different stage-of-lactation profile. In these cases, the evaluation of potential nutritional, environmental, or other stress factors would be indicated. There may be different immediate and long-term solutions that should be implemented.

Analysis of clinical mastitis records over several years may identify a significant seasonal pattern, such as the documented seasonal pattern for bulk tank milk SCC data and antibiotic residue violations. Action may be necessary to deal with seasonal

environment and housing problems that impact new infection rates.

### *Days of Discarded Milk*

It is very common for producers to have an aggressive attitude toward the treatment of clinical mastitis. This approach may result in huge economic losses if waste milk is not fed to calves. These losses are largely the result of discarded milk during the clearance of antibiotic residues from treated cows. Calculating the days of discarded milk may suggest that the mastitis therapy program during lactation should be evaluated. Establishment of an appropriate treatment program and careful selection of cows for therapy might significantly decrease the need for discarding milk. In addition, cows that are responsible for a large percentage of the discarded milk should be identified for selective removal. The calculations from mastitis records that can help to clarify these issues include:

- Total days of discarded milk for the herd
- Days of discarded milk per episode
- Days of discarded milk by lactation number
- Accrued days of discarded milk for individual cows

## 8. MONITORING UDDER HEALTH STATUS

An important step missing from early mastitis control programs was the monitoring of udder health status. Although intuitively it appears necessary to chart the progress of any program, it is only quite recently that monitoring has been included as an integral component of udder health management. **Monitoring is now recognized as the third key principle of mastitis control.** The development of objective, inexpensive, and efficient methods of monitoring udder health has made it much easier to complete the health management cycle for this component of herd programs.

The implementation of SCC measurement on bulk tank milk and on individual cow samples has been widespread throughout the major dairy regions of the world. Because SCC is objective and standardized, it can be used to evaluate the progress of regional control programs. This has allowed rapid improvement in udder health compared with most of the other components of dairy health management programs. Regional authorities have established new regulatory limits and targets for milk quality performance.

Implementing an effective system of monitoring udder health involves:

- Monitoring udder health at the herd level
- Monitoring udder health of individual cows
- Use of cowside diagnostic tests

This discussion will emphasize the use of monitoring methods for decision making and problem solving in udder health management programs. Monitoring of udder health should be done at the **herd level** and **individual cow level**.

### Monitoring Udder Health at the Herd Level

The monitoring of bulk tank milk provides the best method to evaluate the overall udder health status of dairy herds and the effectiveness of mastitis control programs. **Herd-level monitors of udder health include bulk tank milk SCC, bulk tank milk bacteriologic culture, and herd summaries of individual cow SCC data.** Analysis of clinical mastitis records is also useful for monitoring udder health at the herd level.

#### Bulk Tank Milk Somatic Cell Counts

Most milk marketing organizations and regional authorities regularly measure SCC on bulk tank milk as a monitor of the milk quality and udder health status of each herd. Many of these agencies use bulk tank milk SCC for penalty deductions or incentive payments. Improvement in bulk tank milk SCC is associated with improvement in other measures of milk quality such as bacterial counts, inhibitor test violations, and milk freezing point. Countries and regions set milk quality targets using this SCC data, with milk being rejected from processing plants when the bulk tank milk SCC exceeds 400,000 to 1,000,000 cells/mL, depending on the country.

Several management practices are associated with low, medium, and high SCC in bulk tank milk. Postmilking teat disinfection and dry cow therapy are most frequently associated with herds with a low bulk tank milk SCC. In herds with a low bulk milk SCC, more attention is given to hygiene than in herds with a medium or high bulk tank milk SCC. Cubicles, drinking buckets, and cows are cleaner in herds with a low bulk tank milk SCC. Cleaner calving pens and cubicles for herds with low bulk tank milk SCC coincide with the observations that bedding for lactating cows and in maternity pens is drier for herds with a low bulk tank milk SCC. In herds with a high bulk tank milk SCC, a higher percentage of cows are culled because of a high SCC.

The incidence of clinical mastitis in dairy herds may not be different among those with low, medium, and high bulk tank milk SCC. However, clinical mastitis associated with gram-negative pathogens such as *E. coli*, *Klebsiella* spp., or *Pseudomonas* spp. occurs more commonly in herds with a low bulk tank milk SCC. Clinical mastitis associated with *S. aureus*, *S. dysgalactiae*, and *S. agalactiae* occurs more often in herds with a high bulk tank milk SCC. Systemic signs of illness associated with clinical mastitis occur more

often in herds with a low bulk tank milk SCC. In herds with a high bulk tank milk SCC, more cows with a high milk SCC were culled. In herds with a low bulk tank milk SCC, more cows were culled for teat lesions, milkability, udder shape, fertility, and character than in herds with a high bulk tank milk SCC. In herds with a low bulk tank milk SCC, cows were culled more for export and production reasons.

#### Herd Average of Weighted Individual Cow Somatic Cell Count

The arithmetic mean of individual cow SCC values, weighted by the cow's milk production, is also a good measure of the general udder health status of the herd. It should be noted that the high degree of variability of SCC measurements makes it inappropriate to compare this mean directly with the bulk tank milk SCC.

#### Other Herd-Level Somatic Cell Count Monitors

There are several other calculations using individual cow SCC data that are useful for monitoring herd udder health. Generally, these indices attempt to use mathematical calculations to reduce the impact of individual cows and to measure the change over time. These summaries are used to assist producers in the use of individual cow SCC information at the herd level. These indices include the following.

##### *Herd Average Somatic Cell Score*

The use of the somatic cell score (SCS, linear score; Tables 20.4 and 20.5) can simplify SCC interpretation and buffer the effects of individual cows with very high values. Thus the herd average of SCS is a very useful monitor of herd udder health status. A realistic goal for most dairy herds is an average SCS of less than 3.0, equivalent to fewer than 100,000 cells/mL. It is not correct to estimate herd production loss from the average linear score using the individual cow linear score–production loss relationship developed for bulk tank milk SCC.

##### *Percentage of Herd Over Somatic Cell Count Threshold*

Interpretation of SCC and SCS requires the choice of a threshold value for classification of cows as positive and negative. The threshold value used ranges from 200,000–400,000 cells/mL (SCS, 4 to 5). A useful herd goal for subclinical mastitis is to have less than 15% of cows with SCC values greater than 200,000–250,000 cells/mL (prevalence). A second goal is to have fewer than 5% of cows developing new subclinical infections each month (incidence).

##### *Percentage of Herd Changing Somatic Cell Count to Over Threshold*

Most uses of SCC data focus on the determination of current udder health status. In

other words, SCC is used as an estimate of the prevalence of existing infections in the herd; however, an important objective of a mastitis control program is to minimize the number of new intramammary infections. The change in the SCC of individual cows from month to month can be used as an estimate of the rate of new infections, and the use of SCC data in this way has been evaluated. Using SCC changes from month to month as a test for the rate of new infections has low sensitivity and high specificity. More research is needed on the usefulness of SCC to monitor the occurrence of new infections.

A popular way to represent these data graphically is to plot the SCC value (or linear score) for the current month on the y-axis and the SCC value (or linear score) for the preceding month on the x-axis. This graphing arrangement is preferred because the current SCC value is dependent, in part, on the previous SCC value. Using this graphical approach, individual SCC values in the upper left quadrant are new infections, values in the upper right quadrant are persistent infections, and values in the lower right quadrant are resolved infections.

#### Bacteriologic Culture of Bulk Milk

Although SCC is widely used for monitoring udder health status in dairy herds, decision making often requires information about the prevalence of specific pathogens. With the regular collection of bulk tank milk samples for the purposes of quality monitoring programs, culturing of the bulk tank milk is an attractive alternative to culturing milk from individual cows. Bulk tank milk culture has been formally evaluated as a mastitis screening test. For the major mastitis pathogens, bulk milk culture had a low sensitivity. Even in herds infected with *S. agalactiae*, repeated bulk milk cultures were necessary to detect positive herds. Mastitis pathogens of greatest interest are contagious pathogens, such as *S. agalactiae*, *S. aureus*, *M. bovis*, and *C. bovis*.

The **standard plate count** (plate loop count) provides an estimate of the total numbers of aerobic bacteria in bulk tank milk and is an important measure of milk quality and udder health. It is most commonly used to evaluate the efficiency of cleaning the milking system. **A standard plate count of less than 10,000 CFU/mL can be achieved on most farms, and less than 5,000 CFU/mL should be the goal.** Standard plate counts higher than 10,000 CFU/mL indicate milking of cows with dirty teats or mastitis, poorly sanitized milking equipment, or delayed cooling of milk in the bulk tank. Many herds routinely have bacteria counts of 1,000 CFU/mL or less. Total bacterial counts have some value as an early warning system because up to 50% of violations of the standard are associated with mastitis-related bacteria. For example, bacterial counts in the milk of acute clinical cases

may be as high as 10,000,000 CFU/mL. Milk from subclinically infected quarters may contain 1,000 to 10,000 CFU/mL, and normal quarters yield less than 1000 CFU/mL. In nonmastitic cows, higher counts (up to six times higher) are seen in housed cows than in pastured cows.

The **preliminary incubation count** is an estimate of the total number of cold-loving bacteria. As such, the preliminary incubation count provides an index of milk production on the farm. A preliminary incubation count below 50,000 CFU/mL can be achieved on most farms, with less than 10,000 CFU/mL being the goal. The preliminary incubation count should be less than 3 to 6 times the standard plate count.

### Herd-Level Measures of Clinical Mastitis

The incidence of clinical mastitis, calculated as cases per 100 cows per year, can provide a rough assessment of new intramammary infections. The goal is less than 2 new cases per 100 cows each month (equivalent to <24% of cows affected each year). Calculation of the total treatment days can provide a herd-level assessment of the approach to therapy of clinical mastitis, as well as an estimate of the economic losses.

In a random sample of dairy herds in the Netherlands, the following risk factors were associated with a higher incidence of clinical mastitis: one or more cows leaking milk, one or more cows with trampled teats, no disinfection of the maternity area after calving, consistent use of postmilking teat disinfection, Red and White cattle as the predominant breed, and an annual bulk tank milk SCC of less than 150,000 cells/mL. Factors associated with a higher rate of clinical mastitis caused by *E. coli* included cows with trampled teats, no disinfection of the maternity area after calving, consistent use of postmilking teat disinfection, use of a thick layer of bedding in the stall, and the stripping of foremilk before cluster attachment. Factors associated with a higher rate of clinical mastitis caused by *S. aureus* included Red and White cattle as the predominant breed, cows with trampled teats, stripping of foremilk before cluster attachment, no regular disinfection of the stall, no regular replacement of stall bedding, and an annual bulk tank milk SCC of less than 150,000 cells/mL. Teat disinfection appeared to increase the incidence of clinical mastitis associated with *E. coli*, which may be explained by the higher incidence around calving and during early lactation, when the resistance of cows is low combined with an increase in the numbers of environmental bacteria associated with maternity pens.

### Monitoring Udder Health of Individual Cows

Earlier in this chapter, one direct test (culture) and several indirect tests for

intramammary infection were described. Currently, four methods are widely used to detect subclinical mastitis: culture of composite or quarter samples, SCC values of composite or quarter samples, and CMT and electrical conductivity of quarter samples. Currently, cow-level data (culture or SCC) are the most commonly used of these four monitoring tools, but the usefulness of these tests varies depending on their cost, sensitivity, specificity, convenience, and availability.

### Bacteriologic Culture of Milk

Culture of aseptically collected milk samples has been a cornerstone of mastitis control programs. Extensive diagnostic laboratory systems have been developed for the culture of milk. For many years, milk bacteriology has been recognized as the gold standard of mastitis diagnostic tests. The sensitivity and specificity of milk bacteriology are now being examined and, as the costs of laboratory procedures have risen, there is an increasing need to justify diagnostic expenses. However, there is still an important need for information concerning the predominant types of mastitis organism active in a herd.

Several schemes have been proposed for obtaining a pathogen profile of the mastitis pathogens in a herd. The following suggestions are offered as the most appropriate times to collect samples for milk bacteriology:

- **Pretreatment milk samples from clinical cases.** Samples should be frozen, collected at a herd visit, and submitted for culture.
- **Cows that have an increased SCC.** At each scheduled herd visit, each cow that has an increase in SCC over a preset threshold is sampled, and the sample is submitted for culture.
- **A composite milk sample from each lactating cow in the herd.** This whole-herd culture would be conducted annually, or more frequently, depending on the herd situation. This method is most appropriate for herds having problems with contagious pathogens, but the economics of this approach have not been evaluated.
- **Culture of cows at a specific management event.** One example is milk culture at drying off and at the first milking after calving. This can be useful for assessment of the dry cow management program.

The cost-effectiveness of any one or a combination of these methods of obtaining a bacteriologic profile of a herd's milk will depend on the current situation in the herd. For the vast majority of dairy herds, the routine culture of cows for subclinical mastitis diagnosis is not cost-effective. Herds with a low bulk tank milk SCC and a low incidence of clinical mastitis episodes can conduct an efficient udder health

management program without culturing milk. It is very wise, however, to collect pretreatment milk samples from clinical mastitis cases. These samples can be frozen without significant alterations of the culture results for most pathogens. The samples are collected at a scheduled herd visit and submitted to the laboratory. In most herds, this approach will give a meaningful bacteriologic profile of the herd and assist in assessment of the treatment protocol.

*C. bovis* is not a common cause of clinical mastitis on most farms but is frequently found in random milk samples. Because *C. bovis* is highly infectious and susceptible to teat disinfection, it has been suggested that its prevalence could be used as an indicator of teat-dipping efficiency in a herd, either of the intensity of the dipping or of the efficacy of the dip. Because *C. bovis* is limited in its colonization to the streak canal, it is valuable as a monitor of teat disinfection.

### Somatic Cell Counts

Several management decisions can be based on individual cow composite SCCs. Before any decisions can be made using SCC, criteria must be established to categorize cows based on their SCC results. This involves establishing threshold values or other criteria. The **recommended threshold is 250,000 cells/mL in herds with a low prevalence (<5%) of subclinical mastitis**, providing a sensitivity of 0.55 and specificity of 0.96. In comparison, the **recommended threshold is 200,000 cells/mL in herds with a high prevalence (40%) of subclinical mastitis**, providing an apparent sensitivity of 0.73 to 0.89 and a specificity of 0.86. A clinically more appropriate approach is to calculate likelihood ratios using test sensitivity and specificity, estimated herd prevalence, and a spreadsheet. Cows are identified for further investigation based on their SCC, using three different methods:

- **Change in SCC to over the threshold.** A cow with a marked increase in SCC from one month to the next would be identified as potentially being infected.
- **Persistently elevated SCC.** Cows with a persistently elevated SCC month after month would be identified for management intervention. The lactation average linear score and the lifetime linear score are also useful in this respect. This information is especially useful if dry period therapy has already been unsuccessful for the cow in question.
- **Percentage contribution to herd average.** An estimate of the percentage of the SCC in bulk tank milk contributed by each problem cow can be calculated using individual cow test-day milk weights and SCC data. It should be noted that cows with high milk production and intermediate SCC levels can make a significantly higher



contribution to SCC than some cows with a very high SCC but low production. It is not uncommon for a few problem cows to be responsible for more than 50% of the cells in the bulk tank, particularly in small herds. In most circumstances, the cows with the highest percentage contribution merit immediate action.

With these methods of identifying individual cows based on SCC results, several udder health management decisions can be made, including:

- **Selection of cows for milk bacteriologic culture.** The importance of having a good bacteriologic profile of the intramammary infections in the herd has been emphasized. Several lactation events are suggested as useful times to collect milk for bacteriology. One such event is a clinical mastitis episode. Selection of cows for culture can also be based on an elevated SCC.
- **Selection of cows for dry cow treatment.** Blanket dry cow therapy is currently recommended for most herds. However, herds that use selective dry cow therapy need a suitable screening test to make therapy decisions; such a test is currently unavailable, although individual cow SCCs may be of some help in this decision-making process. Cows with a very high SCC have significantly lower cure rates after dry cow treatment than cows that are infected but have a lower SCC. The SCC can be used as a general indicator of the expected success of dry cow treatment.
- **Treatment during lactation.** The development of a treatment protocol and the criteria for selecting cows to treat during lactation were presented earlier. Treatment on the basis of a change in individual cow SCC from month to month is not economically justifiable. Many other factors need to be considered for a cost-effective treatment decision, and SCC could be one of these criteria.
- **Evaluation of the response to treatment.** Individual cow SCC data can be used as a preliminary evaluation of the mastitis therapy program. With good records on clinical cases and the treatment administered, individual cow SCC data in the months following treatment can be used as a general indicator of the response to therapy. Spontaneous cures and new infections will confound this evaluation, but with data from multiple farms and over a considerable time period a low-cost preliminary evaluation can be achieved.
- **Culling decision.** The lifetime average SCC or linear score of an individual cow is useful additional information in making specific culling decisions. In conjunction with milk culture results,

the SCC data are useful to help establish a cow's net present value. An elevated SCC month after month serves to emphasize that culling is the only method of elimination of some chronic cases of mastitis. Removal of these cows eliminates a source of infection for the rest of the herd, as well as assisting in general improvement in the quality of the bulk tank milk.

- **Alter the milking order.** It is generally recommended that infected cows be milked last, although this is often impractical for free-stall and pasture-based dairy enterprises. Individual cow SCC can be used to establish a milking order in tie-stall barns. Alternatively, some large herds establish a special milking string for infected cows. These milking order and segregation programs can be based on SCC results, but cows with an elevated SCC but no intramammary infection may be incorrectly classified. In segregation programs these false-positive cows may be at increased risk.
- **Management procedures to limit the effect of individual cows.** There is some evidence that machine disinfection after milking infected cows may limit the spread of contagious pathogens. In an intensively managed tie-stall herd, it is possible to manually disinfect the milking unit between cows. To maximize the efficiency of this labor-intensive step, individual cow SCC can be used to identify the cows after which machine disinfection would be useful. Another management method involves using the milk from specific cows for feeding calves. In situations in which there are significant financial incentives for low SCC bulk milk, removal of the milk from one or two cows can have an impact on the amount of premium received. Individual cow SCC values can be used to identify specific cows that should be eliminated from the bulk tank. Precautions need to be taken to prevent intersucking between calves receiving this high-SCC milk.
- **Use of individual cow SCC in economic decision analysis.** The relationship between individual cow SCC and milk production losses has been well established. SCC values can be used to estimate the economic losses from subclinical mastitis. This information may be extremely useful in calculating the potential economic benefit of implementing a new udder health management strategy.

#### Problem Solving Using Individual Cow Somatic Cell Counts

A simple approach to problem solving involves defining the problem by **answering the questions: who, when, where, and what**

**is involved** in the situation. Individual cow SCCs provide an inexpensive consistent source of information to answer these questions. This process is completed by dividing the herd into subgroups and calculating the percentage of cows with SCCs over a threshold (250,000 cells/mL) in each group.

- **Who is affected?** The herd can be subdivided based on several defining characteristics. These include production level, genetic factors (sire), and other characteristics such as having a previous clinical mastitis episode. A gradual increase in the proportion of elevated SCC would normally occur as lactation number increases. Thus a higher percentage of older cows are expected to have elevated SCCs than first-lactation and second-lactation animals. A high proportion of elevated SCC values in heifers would suggest a problem in the replacement program or a breakdown of hygiene in the immediate periparturient period for first-calf heifers. A markedly elevated percentage of high-SCC cows in older animals suggests that infections have become chronic and that the culling strategy should be reevaluated.
- **When does high SCC occur?** It is appropriate to examine SCC distributions according to stage of lactation and season of the year. Normally there is a gradual increase in the prevalence of elevated counts as the lactation progresses. If the prevalence of cows with elevated SCCs is high in early lactation, it suggests a problem with dry cow management or with new infections occurring around the time of calving. If the distribution of cows over threshold shows a dramatic increase during lactation, cow-to-cow transmission of contagious organisms is suspected. Measures of new infection rate are also helpful in solving these problems. The percentage of cows over threshold in the herd can be charted over time. It is expected that this indicator will indicate the same seasonal trends as found in bulk tank milk SCC in the population. For example, the percentage of the herd over threshold should be highest in the fall and lowest in the spring. An increase in this index in the spring would contradict the population trend and should be investigated.
- **Where are the affected cows located?** The distribution of cows with elevated SCC according to their location in the tie-stall barn, in milking strings, or according to milking order may provide evidence for some risk factors for new infections. A mastitis problem caused by environmental pathogens in a free-stall operation can be difficult to solve. Calculating the percentage of cows with

an SCC greater than 250,000 cells/mL for each milking group can help to determine where the problem is most severe. If a specific milking order is followed, as is the case in most tie-stall systems, the distribution of cows with elevated counts according to milking order can demonstrate weaknesses in milking hygiene.

- **What is the problem and why has it occurred?** The information obtained by answering the questions **who**, **when**, and **where** in the problem-solving process can go a long way toward defining **what** the problem is. Prevalence distributions can be combined with the incidence of clinical mastitis, information from milk cultures, and an estimate of the financial losses to complete the picture. Subsequently, specific solutions will be aimed at **why** this problem might exist.

With the development of computerized dairy health management records systems, the epidemiologic analysis of udder health information can be greatly simplified. Ultimately, specific risk factors would be automatically tested for statistical significance. In addition, the relative importance of many potential risk factors would be evaluated.

## 9. PERIODIC REVIEW OF THE UDDER HEALTH MANAGEMENT PROGRAM

Many aspects of mastitis control, such as milking management and therapy of clinical cases, become routine practices. However, changes continue to occur in the udder health status of the herd, environmental conditions, and available technology. With these changes, the current udder health management program may no longer be appropriate. New employees may be introduced, and it is possible that various steps are not being appropriately implemented. In some dairy herds, management practices are passed on from previous generations without critical examination. Mastitis results from a continually evolving relationship between microorganisms, the cow, and the environment. Any program intended to limit problems from these relationships needs to be reevaluated on a regular basis.

An effective udder health management program should undergo regular periodic review. The review process should involve the producer and the herd veterinarian, although input may be sought from various farm management advisors. The review should be objective and thorough, but simple and easy to conduct. The use of a standard investigation form structured on the 10 steps of the mastitis control program is recommended. The same standard form can be used for the investigation of problem herds.

## 10. SETTING GOALS FOR UDDER HEALTH STATUS

The establishment of realistic targets of performance for various udder health parameters is the final component in an udder health management program. These goals are important to determine whether there have been shortfalls in the milk quality and udder health performance. The goals should be realistic and achievable, as well as having economic significance. In addition, the targets must be easily measured and should be accepted by all members of the farm management and labor team.

The setting of appropriate goals for mastitis control efforts is crucial for completion of the health management cycle. In some cases, the target will be the industry reference value; however, in most situations it will be a farm-specific level of performance.

### Relationship of Udder Health to Productivity and Profitability

Mastitis is generally considered to be the most costly disease facing the dairy industry. The reduced profitability is caused by two major factors:

- Reduced milk production associated with subclinical mastitis accounts for approximately 70% of the economic loss.
- The treatment costs, culling, and reduced productivity associated with clinical mastitis are responsible for the remaining losses.

### Production Losses From Increased Somatic Cell Count

It is well accepted that milk production decreases as SCC increases, but the relationship between SCC and milk production is curvilinear for individual cattle but approximates a straight line when a logarithmic transformation (such as somatic cell score) is used. Estimates of the milk production losses range from 3% to 6% with each one unit increase of somatic cell score (SCS) above 3. The loss in first-lactation heifers is greater than that in older cows. A general rule of thumb would suggest that there is 5% loss for each unit of SCS increase above a linear score of 3.

There is also a relationship between bulk tank milk SCC and milk production because there is a linear decrease in herd milk production with an increase in bulk tank milk SCC. Estimates of the production loss range from 1.5% to 3.0% for each increase of 100,000 cells/mL over a baseline of 150,000 cells/mL. Using an average of these estimates, daily milk and dollar losses can be calculated from bulk tank milk SCC and herd production levels.

**Clinical Mastitis and Lost Productivity**  
Economic losses associated with the treatment of clinical mastitis arise from the cost of drugs, veterinary services, and milk discarded. In addition, decreased milk

production, premature culling, and replacement heifer costs are also significant. However, more than 80% of the loss attributed to a clinical episode involves the discarding of nonsaleable milk and decreased milk production.

## ASSESSMENT OF THE COST-EFFECTIVENESS OF MASTITIS CONTROL

Dairy producers look to their veterinarian for information and services related to mastitis and its control. With this motivation, veterinarians should be able to implement comprehensive udder health management programs on the majority of dairy farms. To achieve a high rate of implementation of mastitis control strategies, it may be necessary to demonstrate the cost:benefit ratio of the suggested practices before they are adopted. A reassessment of their impact over time may also be useful. A 2008 study in the Netherlands estimated that a single episode of clinical mastitis cost €210, with subclinical and clinical mastitis costing an estimated €140 per cow per year, and found that the majority of farmers underestimated the cost of mastitis.<sup>19</sup>

Mastitis control is feasible, practical, and cost-effective. The economics of the efforts of a mastitis control program in a herd can be estimated. There are several steps necessary to complete this assessment.

1. Programs for monitoring udder health and for establishing achievable goals must be in place for an economic assessment.
2. The losses resulting from mastitis must be quantified. The amount of reduced milk production resulting from increased SCC is calculated. In addition, costs associated with the discarded milk and treatment of clinical cases must be estimated.
3. The udder health management program to be implemented must be described. An accounting system should be established to calculate the costs associated with this program.
4. Using an estimate of the potential loss for a hypothetical herd with no mastitis control efforts, the profitability of the herd's current udder health management program is determined.
5. By estimating the costs of implementing new udder health management measures, the remaining potential profits from mastitis control can be calculated.

This economic assessment is done using a computer spreadsheet program. With such a computer program, veterinarians can simply and rapidly input actual values for a particular farm and assess the economic circumstances. The impact of each element of control can be considered from the point of view of a cost:benefit ratio. The results of

economic assessment will vary widely from farm to farm, but usually the following conclusions are made:

- Mastitis will remain a costly disease, even with implementation of properly applied, effective control programs.
- Loss of milk production attributable to subclinical infection will remain a major cause of economic loss because of mastitis in most herds.
- Proper application of simple, inexpensive mastitis control procedures will have a significant impact on profitability and will bring higher returns on investment.

### FURTHER READING

- Bradley A, Barkema H, Biggs A, et al. Control of mastitis and enhancement of milk quality. In: Green M, ed. *Dairy Herd Health*. Wallingford, UK: CAB International; 2012:117-168.
- Edmondson P. Mastitis control in robotic milking systems. *In Pract*. 2012;34:260-269.
- Mein GA. The role of the milking machine in mastitis control. *Vet Clin North Am Food Anim Pract*. 2012;28:307-320.
- Nickerson SC. Control of heifer mastitis: antimicrobial treatment—an overview. *Vet Microbiol*. 2009;134:128-135.

### REFERENCES

1. Østerås O, Solverød L. *Ir Vet J*. 2009;62(suppl 26):S26.
2. Hassfurther RL, et al. *Am J Vet Res*. 2015;76:231.
3. Williamson JH, Lacy-Hulbert SJ. *New Zeal Vet J*. 2013;61:262.
4. Bertulat S, et al. *J Dairy Sci*. 2013;96:3774.
5. Zobel G, et al. *J Dairy Sci*. 2013;96:5064.
6. Bertulat S, et al. *Vet Rec*. 2015;2:e000068.
7. Cardot V, et al. *J Dairy Sci*. 2008;91:2257.
8. Halasa T, et al. *J Dairy Sci*. 2009b;92:3150.
9. Halasa T, et al. *J Dairy Sci*. 2009a;92:3134.
10. Scherpenzeel CGM, et al. *J Dairy Sci*. 2014;97:3606.
11. Bradley AJ, et al. *J Dairy Sci*. 2011;94:692.
12. Bradley AJ, et al. *J Dairy Sci*. 2010;93:1566.
13. Rabiee AR, Lean IJ. *J Dairy Sci*. 2013;96:6915.
14. Petrovski KR, et al. *J Dairy Sci*. 2011;94:3366.
15. Laven RA, et al. *New Zeal Vet J*. 2014;62:214.
16. Berry EA, Hillerton JE. *J Dairy Sci*. 2007;90:760.
17. Parker KI, et al. *J Dairy Sci*. 2007;90:207.
18. Runciman DJ, et al. *J Dairy Sci*. 2010;93:4582.
19. Huijps K, et al. *J Dairy Res*. 2008;75:113.

## Miscellaneous Abnormalities of the Teats and Udder

Several diseases are characterized clinically by lesions of the skin of the teats and udder. These diseases are most common in dairy cattle and are of economic importance because teat lesions cause pain and discomfort during milking, and udder edema and udder cleft dermatitis are very common in heifers at calving.

The skin of the wall of the teat and the skin surrounding the teat canal orifice must be inspected closely to observe lesions and

palpated to detect lesions covered by scabs. It may be necessary to superficially irrigate and gently wash teat lesions with warm 0.9% NaCl solution to see the morphology and spatial arrangement of the lesions. The entire skin of the cranial, lateral, and posterior aspects of the udder should be examined by inspection and palpation. Lesions may be restricted to the lateral aspects of the udder and teats, as in photosensitization, or completely surround the teats, as in pseudocowpox.

In North America, the most common viral diseases of the teats of cattle, which result in vesicles or erosion of the teats, include pseudocowpox and bovine herpes mammillitis, with vesicular stomatitis occurring occasionally. The vesicular diseases of the teats are particularly important because they require differentiation from the exotic vesicular diseases such as foot-and-mouth disease. The appearances of the lesions of each of these diseases are similar, which makes clinical diagnosis difficult. However, in most cases, the morphologic and epidemiologic differences in the lesions in groups of animals aid in the diagnosis.

In pigs, **necrosis of the skin of the teats of newborn piglets** may occur in outbreak form. Abrasion of the nipples of baby pigs raised on rough nonslip concrete may be observed as acute lesions or be apparent only when the piglets mature and are found to have deficient teat numbers, as described underagalactia.

The skin of the mammary gland and teats of lactating ewes may be affected by the lesions of **contagious ecthyma**, which are transmitted from the lips of suckling lambs. **Ulcerative dermatosis** of the teats in lactating ewes has lesions similar to those of herpes mammillitis in cows. It is a disease of housed ewes and may be initiated by bedding on infected straw. Mastitis and teat deformity are common sequels. The etiology varies from *S. aureus* to CNS or *Pasteurella* spp.

### LESIONS OF THE BOVINE TEAT

**Traumatic injuries to teats** are very common and range from superficial lacerations to deep lacerations into the teat cistern with the release of milk through the wound. Accidental trampling of a teat by a cow may cause amputation of the teat.

**Chapping and cracking of the skin of the teats** is common in dairy and beef cattle. The cracks in the skin are often linear and multiple and are painful when palpated or when the milking machine teat cups are applied to the affected teats. Cracks of the skin of the teats initiated by milking machine action can be aggravated by environmental factors to create chapping of the teats. The condition is common when adverse weather conditions follow turn out in spring. Linear lesions appear on the teat wall near the teat-udder junction and extend transversely

around the teat. The addition of **10% glycerin** to the teat dip provides an excellent method of improving teat skin condition.

**Frostbite of teats** occurs in dairy cows housed outdoors during severely cold weather without adequate bedding. The skin of the teats is cold, necrotic, and oozes serum. Usually the front teats are more severely affected than the rear teats because the latter are less exposed to adverse ambient temperatures.

**Teat-end lesions** are common in dairy cattle. Lesions include teat canal eversion, teat canal prolapse, prolapse of the meatus, eversion of the meatus, and teat orifice erosion. Limited information is presently available about the mechanism of development for these lesions and their clinical significance; one study found no association between the presence or absence of a teat-end lesion and intramammary infection.

It is normal to see a 2-mm wide white ring around each teat orifice of machine milked cows. The first stage of a teat orifice abnormality occurs when this ring undergoes hypertrophy, keratinization, and radial cracking. Progression leads to increased hypertrophy, secondary bacterial infection, scab formation, eversion of the distal teat canal, and eventually teat orifice erosion. Improper milking machine function can produce teat orifice abnormalities. Excessive or fluctuating vacuum levels, faulty teat cup liners, incorrect pulsation ratios, and other faults attributed to inadequate maintenance and careless use of milking machines have been shown to cause teat injury. A high milking vacuum combined with a relatively low pulsation chamber vacuum can result in bruising and hemorrhage of the teat-end teat wall by the slapping action of the liner.

**Black spot (black pox)** is a sporadic lesion of the teat tip characterized by a **deep, crater-shaped ulcer** with a **black spot** in the center. Black spot lesions occurring at the ends of the teats commonly involve the teat sphincter and are responsible for a great deal of mastitis. This abnormality is caused in most cases by excessive vacuum pressure or overmilking in teats that are naturally firm and have pointed ends. There is no specific bacteriology, although *F. necrophorum* is commonly present, and *S. aureus* is frequently isolated from the lesions. Lesser lesions of teat sphincters are listed under vacuum pressure in bovine mastitis control. The lesions are painful, leading to kicking by the cows, sometimes to repeated kicking off of the teat cups, and to blockage of the sphincter. *T. pyogenes* mastitis is a common sequel. Black spot lesions are poorly responsive to treatment, even if the machine error is corrected.

Treatment of black spot is usually by topical application of ointments: Whitfield's, 10% salicylic acid, 5% sulfathiazole and 5% salicylic acid, and 5% copper sulfate are all recommended. An iodophor ointment, or iodophor teat dip with 35% added glycerol,



is also effective, but treatment needs to be thorough and repeated and milking machine errors need to be corrected.

**Thelitis** or inflammation of the tissues of the teat wall leading to gangrene is a common complication of gangrenous mastitis, and is most commonly associated with peracute *S. aureus* mastitis. The skin of the teats is cold, edematous, and oozes serum. The subcutaneous aspects are commonly distended with gas. The skin is commonly dark-red to purple-black. Sloughing of the skin may be evident.

Inflammation of the wall of the teat (thelitis) is a nonspecific lesion usually associated with traumatic injury to the lining of the teat cistern. The wall of the cistern is thickened, hardened, painful, and, in chronic lesions, irregular in its internal lining. The lesion can be felt as a dense, vertical cord in the center of the teat tip. The lesions have historically been intractable to treatment, which usually consists of intramammary antibiotics and refraining from milking. The recent application of teat endoscopy has assisted in identifying cattle that are most likely to respond to medical or surgical treatment.

**Bovine nodular thelitis** was first described in France in 1963, with subsequent reports in Japan and Switzerland. The disease is characterized by nodular lesions in the teat wall and ventral portion of the udder. The lesions are multicentric nodules containing atypical acid-fast mycobacteria, including *M. terrae* and undescribed *Mycobacterium* species that are related to *M. leprae* and *M. lepromatosis*.<sup>1</sup> Some nodules evolve to ulcers, demonstrating cicatrization and fibrosis.

**Photosensitization of the teats (photosensitive thelitis)** is a local manifestation of generalized photosensitization, but occasionally photosensitive thelitis is the first clinical abnormality detected by the producer. There is a characteristic erythema and hardness of the unpigmented or white parts of the lateral aspects of each teat. The medial aspect is soft and cool. The teats are also painful and in the early stages apparently irritable, because affected cows will also stand in ponds or waterholes in such a way that the teats are immersed, and then rock backward and forward. They will also brush the sides of the udder with the hind feet in a way that could suggest the stamping movements of abdominal pain. In cases in which the photosensitization is related to the induction of parturition by the administration of corticosteroids, the skin lesions are usually restricted to the teats. In cases due to other causes there are usually obvious lesions of photosensitive dermatitis on the dorsal aspects of the body but confined to the white parts.

**Corpora amylacea** are inert concretions of amyloid that may become calcified and detached from the mammary tissue so that they cause blockage of the teat canal and cessation of milk flow. They are formed as the result of stasis caused by blocked mammary tissue ducts and resorption of the milk fluids.

**Papillomatosis of the teats** is caused by bovine papillomavirus and is characterized clinically by small, white, and slightly elevated nodules with a 0.3-cm diameter or elongated tags 1 cm long that are removable by traction. This is covered more extensively in Chapter 16.

**Pseudocowpox** is characterized clinically by painful localized edema and erythema with a thin film of exudate over the edematous area. Vesicle formation is uncommon. Within 48 hours of onset of signs, a small orange papule develops, shortly followed by the formation of an elevated, small, and dark-red scab. The edges of the lesion then extend and the center becomes umbilicated; at 1 week the lesion measures approximately 1 cm in diameter. By 10 days the central scab tends to desquamate, leaving a slightly raised circinate scab commonly termed a “ring” or “horseshoe” scab. One teat may have several such lesions, which coalesce to form linear scabs. The majority of lesions desquamate by 6 weeks without leaving scars, although occasionally animals develop chronic infection.

#### REFERENCE

1. Pin D, et al. *Emerg Infect Dis*. 2014;20:2111.

### LESIONS OF THE BOVINE TEAT AND UDDER

**Thermal burns of the skin of the udder and teats** may occur in mature cattle exposed to grass fires. The hairs of the udder and base of the teats are singed black. Thermal injury to the skin varies from marked erythema of the teats to blistering and necrosis and weeping of serum.

### BOVINE HERPES MAMMILLITIS

#### SYNOPSIS

**Etiology** Bovine herpesvirus-2, rarely bovine herpesvirus-4

**Epidemiology** Occurs as an outbreak in cows, particularly heifers, usually within 2 weeks after calving. Commonly followed by persistent infection in the herd

**Clinical findings** Lesions confined to teats and udder. Vesicles leading to sloughing of skin and necrotic ulceration. Prolonged clinical course

**Clinical pathology** Virus isolation and electron microscopy on fresh lesions and serology

**Treatment** Antiseptic and emollient ointments

**Control** Isolation and milking hygiene, but not effective. Control of periparturient udder edema

#### ETIOLOGY

The causative virus, **bovine herpesvirus-2** (BHV-2), is an  $\alpha$ -herpesvirus. Infection with BHV-2 can produce two distinct syndromes

in cattle, **bovine herpes mammillitis**, in which there are vesicular and erosive lesions with necrotic ulceration on the skin of the udder and teats, and **pseudolumpy skin disease** (Allerton virus), which manifests with generalized superficial skin lesions over the body. Pseudolumpy skin disease is uncommon. The difference in clinical manifestations between the two diseases may be caused by the strain of the virus or the method of infection. **BHV-4** (DN599 strain), which is usually associated with respiratory disease in cattle, is also capable of causing mammary pustular dermatitis.

#### EPIDEMIOLOGY

##### Occurrence

Herpes mammillitis is recorded in North America, Australia, Europe, and Africa, but probably has **widespread occurrence**. Herds infected for the first time have a high morbidity rate; subsequently, the incidence is low and is limited to fresh heifers. The **morbidity** rate varies between 18% and 96%, with susceptible herds recording more than 30% affected. The **mortality** rate is negligible.

#### ORIGIN OF INFECTION AND TRANSMISSION

Introduction of bovine ulcerative mammillitis into a herd may occur with the introduction of infected animals, but outbreaks have been observed in self-contained herds. Spread within a herd is consistent with the presence of carrier animals, which may shed virus during times of stress, particularly in the periparturient period. Latent infection is an intrinsic trait of herpesvirus infections, and BHV-2 has been isolated from the trigeminal ganglion of healthy cattle.<sup>1</sup> It is presumed that the virus also remains latent in inguinal nerves but this has not been verified in cattle. However, BHV-2 has been demonstrated in lumbar ganglia of ewes experimentally inoculated with BHV-2; these ganglia are sensory to the ovine udder.<sup>2</sup> There is a seasonal incidence of clinical disease that has been related to the activity and presence of insect vectors. Experimental studies indicate that transmission requires virus inoculation at or below the level of the stratum germinativum of the teat or udder skin; therefore trauma associated with milking, teat cracks, or biting flies is a requirement for infection to be transferred. Milking machine liners, hands, and udder cloths may act as carriers of virus when a large amount of it is being released.

Seasonal and circumstantial evidence in the **UK** and **Australia** suggest an insect vector, but this has not been confirmed by attempts at transmission with the stable fly (*Stomoxys calcitrans*), and in the Midwest of the **United States**, the disease is more common in the winter months between November and April.

Survival of the virus for long periods in carrier animals occurs, and it is thought that

this may be the means of survival of the virus within a herd that has become immune. Infection in some cows is suspected to result in chronic infection at the teat end with the cows becoming **hard milkers** and **carriers** of the disease.

### Animal and Pathogen Risk Factors

Lesions are most common in animals within the **first 2 weeks after calving**, particularly in **heifers**, and the disease is more severe in heifers. Heifers that have **udder edema** at calving are particularly prone to develop severe lesions. Occasionally, lesions may be seen on the teats of replacement heifers, and calves suckling infected dams often develop mouth lesions.

The disease is **usually self-limiting**, persisting in a herd for 6 to 15 weeks, and the severity of the lesions decrease as the outbreak progresses. Immunity appears to last about a year; herds infected naturally can suffer recurrences a year later. **Large herds** may have **persisting** disease, particularly in heifers.

The virus is relatively resistant to environmental influences and can survive freezing. It is susceptible to **iodophor disinfectants** and less so to hypochlorites.

### Economic Importance

Forms of loss include a much higher incidence of mastitis, reduction in milk in affected herds by up to 20%, the **culling** of some cows because of severe mastitis and of heifers because of intractable ulcers, and a great deal of interference with normal milking procedure.

### Zoonotic Implications

There are anecdotal reports of herpetic lesions in farmers exposed to infected cattle.

### PATHOGENESIS

Typical clinical lesions and histopathological changes can be produced locally by introduction of the virus into scarifications of the skin of the teat and the oral mucosa and by intradermal and intravenous injection. There is no viremia, and spread is by local extension. In contrast to the poxes, the characteristic lesion in mammillitis is destructive. The higher incidence of the disease and the greater severity of the lesions close to calving are thought to be from the immunosuppression caused by parturition and to a greater predisposition from periparturient udder edema.

### CLINICAL FINDINGS

There is an **incubation period** of 5 to 10 days. There is no systemic illness, and lesions are confined to the teats and udder. When the disease occurs in a herd for the first time the first case is usually in a cow that has calved during the previous 2 to 3 days. Rapid lateral spread then occurs to other cows.

**Bovine herpes mammillitis** is characterized by the formation of variable-sized vesicles, severe edema, and erythema of the teat with subsequent erosion of the teat epithelium. The vesicles rupture within 24 hours, and copious serous fluid often exudes from the dermis. Scabs form over the lesions by the fourth day, and the epithelium is reestablished under the scab by the third week, although the trauma of milking may delay healing, especially when secondary infection occurs. Scar formation on recovery is uncommon. Lesions may be present on several teats and the base of the udder.

In cows calved more than a few weeks previously, the characteristic lesions are almost entirely confined to the skin of the teats; in recently calved cows they are restricted to the skin of the teats and the udder. The severity of the disease in recently calved cattle appears to be directly proportional to the degree of postparturient edema which is present. **Vesicles** occur but are not commonly seen. They are characteristically thin walled, 1 to 2 cm in diameter, variable in outline, and often commence at the base of the teat and spread over much of the udder surface (Fig. 20-8). Rupture and confluence of vesicles leads to weeping and extensive **sloughing** of the skin.

In the most **severe cases**, the entire teat is swollen and painful, the skin is bluish in color, and it exudes serum and sloughs, leaving a raw ulcer covering most of the teat. In less severe cases, there are raised, deep red to blue, circular plaques, 0.5 to 2 cm in diameter, which develop shallow ulcers. In most cases, scab formation follows, but machine milking causes frequent disruption of them, resulting in frequent bleeding. The least severe lesions are in the form of lines of erythema, often in circles and enclosing dry skin or slightly elevated papules, which occasionally show ulceration. Mild lesions tend to heal in about 10 days, but severe ulcers may persist for 2 or 3 months. The severity of lesions on the teats on longer-calved cows varies, but in all cases the lesions are



**Fig. 20-8** Vesicles on the left foreteat of a Holstein heifer with acute herpes mammillitis infection. The vesicles are fragile and appear as the first sign of infection.

sufficiently painful to make milking difficult. Lesions on the skin of the udder heal more rapidly because of the absence of trauma.

Ulcers in the mouth of affected cows have been observed rarely, and calves suckling affected cows develop lesions on their oral mucosae and muzzles. Ulcerative lesions on the vaginal mucosa have been recorded rarely. During the recovery phase there is obvious scar formation and depigmentation. Infrequently, secondary infections are severe and animals are euthanized.<sup>3</sup>

### CLINICAL PATHOLOGY AND NECROPSY FINDINGS

Material for tissue culture, electron microscopy, or cutaneous transmission tests is best obtained by syringe from early vesicles, or as swabs from early ulcers or oral lesions. The virus may be difficult to demonstrate if the lesions are as old as 7 days and if there has been intensive application of teat disinfectants such as iodophors.

**Serology** is more commonly used for diagnosis. The presence of high virus-neutralizing antibody titers in serum taken during the acute phase of the disease, and a fourfold increase or decrease in titer in paired samples, are all supportive for diagnosis. Titers of 1:16 or higher for BHV-2 and 1:20 for BHV-4 indicate exposure. Antibody to both viruses should be tested for diagnostic purposes.

Necropsy is not commonly performed, and no necropsy reports of cases of bovine ulcerative mammillitis are available.

### DIAGNOSIS

#### DIFFERENTIAL DIAGNOSIS

Diagnosis is made on the basis of clinical signs in multiple animals. Virus may be isolated from aspirating the fluid from vesicles before they rupture. Serology has been performed to identify a threefold to fourfold rising titer but it is not widely available, and many animals seroconvert early in the disease process.

Differentiation of other diseases of the skin of the teat and udder is dealt with in the section on cowpox.

### TREATMENT

There is no specific treatment, and the aim should be to develop scabs that can withstand machine milking. This is most easily effected by the application of a water-miscible, antiseptic ointment just before putting the cups on, followed by an astringent lotion, such as triple dye, immediately after milking. Crystal violet dyes have an excellent reputation as treatments. Cattle that develop a thickened teat caused by secondary bacterial infections are likely to develop clinical mastitis, and treatment success of affected quarters is poor.

## CONTROL

Isolation of affected animals and strict hygiene in the milking parlor are practiced but have little effect on the spread of the disease. Milking heifers first also has minimal impact on disease spread. An **iodophor** disinfectant is recommended for use in the dairy to prevent spread because it has good virucidal activity. Reducing the incidence and severity of **periparturient edema** in heifers may reduce the severity of herpes mammillitis. Inoculation of the natural virus away from the teats produces a local lesion and good immunity, but the method has not been tested as a control procedure.

## REFERENCES

1. Campos FS, et al. *Vet Microbiol.* 2014;171:182.
2. Torres FD, et al. *Res Vet Sci.* 2009;87:161.
3. Kemp R, et al. *Vet Rec.* 2008;163:119.

## LESIONS OF THE BOVINE UDDER OTHER THAN MASTITIS

### Udder Impetigo

**Udder impetigo** associated with *S. aureus* is characterized by small, 2- to 4-mm diameter pustules at the base of the teats that may spread to involve the entire teat and the skin of the udder. This disease is important because of the discomfort it causes, its common association with staphylococcal mastitis, the occasional spread to milkers' hands, and the frequency with which it is mistaken for cowpox. The lesions are usually small pustules (2- to 40-mm diameter), but in occasional animals they extend to the subcutaneous tissue and appear as furuncles or boils. The most common site is the hairless skin at the base of the teats, but the lesions may spread from here on to the teats and over the udder generally. Spread in the herd appears to occur during milking, and a large proportion of a herd may become affected over a relatively long period. The institution of suitable sanitation procedures, such as dipping teats after milking, washing of udders before milking, and treatment of individual lesions with a suitable antiseptic ointment, as described earlier, usually stops further spread. An ancillary measure is to vaccinate all cows in the herd with an autogenous bacterin produced from the *S. aureus* that is always present. Good immunity is produced for about 6 months, but the disease recurs unless satisfactory sanitation measures are introduced.

Sores of bovine teat skin in Norway, characterized by the presence of *S. aureus* and referred to as "**bovine teat skin summer sore**" are thought to be caused by cutaneous invasion by *Stephanofilaria* spp. nematodes. The differential diagnosis of discrete lesions on bovine teat skin is dealt with in the subject of cowpox.

### Udder Cleft Dermatitis

Severe clinical disease caused by **udder cleft dermatitis (udder rot, flexural seborrhea)**

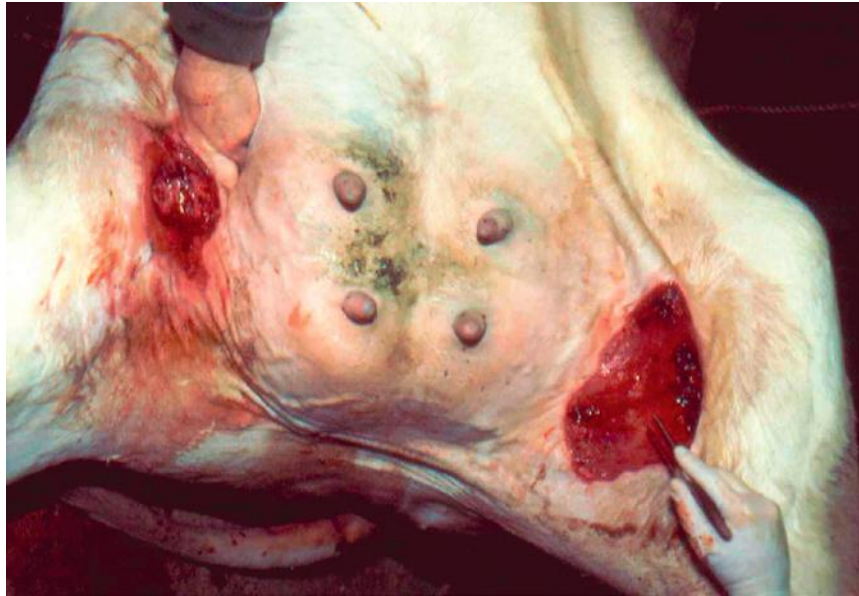

**Fig. 20-9** Healing udder cleft dermatitis in the caudodorsolateral aspect of the udder of a Holstein Friesian heifer. The heifer is in dorsal recumbency. Smooth beds of granulation tissue are developing 1 week after aggressive debridement of the focal areas of dermatitis.

of cattle is most common in dairy heifers that have calved recently. Lesions are present in three locations on the udder: between the halves of the udder (udder cleft dermatitis), on the ventral midline immediately cranial to the udder, and on the caudodorsolateral aspect of the udder in which it comes into contact with the medial aspect of the thigh. Lesions are usually detected during foot trimming or milking and are clearly underdiagnosed—cross-sectional studies in Sweden and the Netherlands identified a prevalence of lesions in the cranial udder of 18% in 1084 cows in 30 dairy herds, and 5% in 948 cows in 20 dairy herds, respectively.<sup>1,2</sup> Udder cleft dermatitis occurs is most common in older dairy cattle; higher producing dairy cattle; and cows with a deep udder relative to the hock, large front quarters, and a small angle between the udder and the abdominal wall.<sup>1,2</sup> Although the etiology remains uncertain, there is speculation that bacteria associated with digital dermatitis may be associated with the development of udder cleft dermatitis.<sup>3</sup>

Udder edema is thought to play an important role in development of lesions on the caudodorsolateral aspect of the udder, because these are most common in periparturient dairy heifers and typically are more severe. The etiology of caudodorsolateral lesions in heifers may be different to that of cranial lesions in older cows.

In lesions of all three anatomic sites, there is variable inflammation and outpouring of sebum. Extensive skin necrosis may develop in a small number of cases, characterized by a prominent odor of decay. The irritation and pain of the caudodorsolateral lesion may cause the animal to appear lame when walking, and the animal may attempt to lick

the affected part. Shedding of the oily, malodorous skin leaves a raw surface beneath, which heals in 3 to 4 weeks. Anecdotal reports exist of extension of infection into the subcutaneous veins resulting in severe hemorrhage and death.<sup>2</sup>

Freshly calved heifers with lesions on the caudodorsolateral aspect of the udder benefit from resolution of udder edema and mechanical debridement using a towel drawn repeatedly across the inguinal area. In advanced cases, a soft tissue curette is used to facilitate debridement of necrotic material after casting the cow in dorsal recumbency, or in lateral recumbency and elevating the upper hindlimb, so that the inguinal area can be adequately visualized (Fig. 20-9).

The efficacy of topical treatment is unknown. Lesions in the other two sites are usually asymptomatic and treatment efficacy is unknown.

### Blood in the Milk (Mammary Gland Hematoma)

Blood in the milk is usually an indication of a rupture of a blood vessel in the gland by direct trauma (such as getting caught on top of a wooden fence or the result of a kick) or more commonly by capillary bleeding in heifers with udder edema. Although in the latter circumstance the bleeding usually ceases in 2 to 3 days, it may persist beyond this period and render the milk unfit for human consumption. The discoloration varies from a pale pink to a dark chocolate brown and may still be present 7 to 8 days after parturition. Rarely, the blood loss may be sufficiently severe to require treatment for hemorrhagic shock (see Chapter 4). Cases of blood in the milk are usually sporadic in occurrence, but there are records of herds



with over 50% of cows affected; clotting defects were not detected in these herds.

Treatment is often requested, although the cow is clinically normal in all other respects. Intravenous administration of calcium borogluconate or parenteral coagulants such as intravenous formaldehyde (see Chapter 5) is widely practiced, but efficacy studies are lacking and it is difficult to believe that either treatment has therapeutic value. Difficulty may be experienced in milking the clots out of the teats, but they will usually pass easily if they are broken up by compressing them inside the teat. The presence of bloodstained milk in all four quarters at times other than immediately postpartum should arouse suspicion of leptospirosis or diseases in which extensive capillary damage occurs.

### UDDER EDEMA

Edema of the udder at parturition is physiologic, but it may be sufficiently severe to cause edema of the belly, udder, and teats in dairy cows and occasionally in mares. In most cases the edema disappears within a day or two of calving, but if it is extensive and persistent it may interfere with suckling and milking. Udder edema is symmetric and extends cranially to the udder along the ventral abdomen (Fig. 20-10). The presence of an asymmetric ventral edema should alert the veterinarian to a mammary vein hematoma or thrombophlebitis of the mammary vein secondary to intravenous injection. The tissue feels colder to the touch than surrounding skin and pits on finger pressure. In severe cases, it extends caudodorsally in the perineal region. A 10-level scale of severity

has been devised for dairy cattle and could be applied in assessing the effects of treatment (Table 20-7). Edema is a prominent sign in inherited rectovaginal constriction of Jersey cows, and is described under that heading.

**Table 20-7** Scale used in rating udder edema

Score	Definition
0	No edema apparent
1	Edema in the base of the udder around one or two quarters
2	Edema in the base of the udder around two or three quarters
3	Edema covering the lower half of the udder
4	Edema beginning to show in the midline and umbilicus
5	Extensive fluid accumulation along the midline and umbilicus
6	Edema covering entire udder. Median suspensory ligament crease has disappeared.
7	Midline fluid accumulation extended to the brisket
8	Midline fluid accumulation extended dorsally; the subcutaneous abdominal vein is indistinguishable.
9	Fluid accumulation extended to the thighs
10	Severe edema; marked fluid accumulation in the vulva; edema extensive in all of the areas mentioned earlier

Source: From Tucker WB et al. *J Dairy Sci* 1992; 75:2382.

**Udder edema is most severe in periparturient dairy heifers**, and the mechanism for its development is not well understood. Hypoproteinemia is not a precursor of udder edema. One epidemiologic study identified an increased risk of udder edema in dairy heifers if calving was in winter, the heifer was taller at the withers, and a bull calf was born.<sup>4</sup>

It is a common recommendation that the amount of grain fed in the last few weeks of pregnancy be limited, and there is evidence that heavy grain feeding predisposes to the condition, at least in heifers. High sodium or potassium intakes increase the incidence and severity of udder edema, especially in housed cattle; the disease often disappears when cows are turned out to pasture. The tendency for udder edema may be heritable in some herds and selection against bulls that sire edematous daughters is thought to be worthwhile. Such a tendency could be mediated through a complex interaction between sex steroids, which are thought to play a role in the etiology. There is also a reduction in blood flow through, and an increase in blood pressure in, the superficial epigastric or milk veins of cows with chronic edema, through an unidentified mechanism.

A mild form of udder edema is the presence of a hard localized plaque along the ventral abdomen immediately cranial to the udder after parturition in heifers. This is common and relatively innocuous but may interfere with milking or ventral abdominal surgical repair of a left displaced abomasum. If the mild udder edema occurs repeatedly over a number of lactations it may result in permanent thickening of the skin (scleroderma) of the lateral aspect of the udder. Hot fomentations, massage, and the application of liniments are of value in reducing the hardness and swelling. A chronic form of the disease is recorded from New Zealand, but no credible etiologic agent has been proposed.

If udder edema is severe, one or more of the following empirical treatments is recommended. Milking should be started some days before parturition, but colostrum from heifers should be discarded because it is likely to be of poor quality. After parturition, frequent milking and the use of diuretic agents is recommended. Corticosteroids appear to exert no beneficial effect. Acetazolamide (1–2 g twice daily orally or parenterally for 1–6 days) gives excellent results in a high proportion of cases, with the edema often disappearing within 24 hours. Chlorthiazide (2 g twice daily orally or 0.5 g twice daily by intravenous or intramuscular injection, each for 3–4 days) is also effective. Furosemide is the most potent diuretic agent and should be administered parenterally (1 mg/kg BW, intramuscularly or intravenously; 5 mg/kg BW orally) in severe cases of udder edema, but prolonged use can result in hypokalemia, hypochloremia,



**Fig. 20-10** Udder edema in a 2-year-old Holstein Friesian heifer that calved a few days previously. Note the extension of edema cranial to the udder. This is a grade 5/10 udder edema score.

and metabolic alkalosis. The use of diuretics before calving may be dangerous if considerable fluid is lost. When there is a herd problem, detection of the cause is often difficult.

An outbreak of udder edema in ewes has been recorded. Affected animals were afebrile, bright, and clinically normal except for the udder, which within 24 hours of lambing was white, cool, and firm, with edema. The milk was normal grossly and laboratory tests detected no abnormalities. Most ewes recovered within 5 to 10 days of lambing.

Hard udder or indurative mastitis in goats is described under the heading of caprine arthritis-encephalitis, and that in ewes under maedi.

### RUPTURE OF THE SUSPENSORY LIGAMENTS OF THE UDDER

Rupture of the suspensory ligaments is most common in adult cows and develops gradually over a number of years. The cause is thought to be severe udder edema at calving, with excessive weight on the udder causing breakdown of the udder attachments, particularly the median suspensory ligament. The result is that the teats on affected cows are not vertically aligned but point more laterally. When rupture of the suspensory ligament occurs acutely, just before or after parturition, the udder drops markedly and is swollen and hard, the teats point laterally, and serum oozes through the skin. Severe edema occurs at the base of the udder. The condition may be confused with gangrenous mastitis or abdominal rupture caused by hydrops allantois on cursory examination. Partial relief may be obtained with a suspensory apparatus, but complete recovery does not occur.

### AGALACTIA

The most important cause of agalactia in farm animals is postpartum dysgalactia syndrome (PPDS) in sows, formerly named mastitis-metritis-agalactia (MMA) syndrome, which is addressed later in this chapter. The general principles that apply to PPDS also apply to the less common cases of agalactia that occur in all species. There is partial or complete absence of milk flow, which may affect one or more mammary glands. The condition is of major importance in gilts and sows, although it occurs occasionally in cattle. The importance of the disease in gilts and sows derives from the fact that piglets are very susceptible to hypoglycemia. The condition may be caused by failure of letdown or absence of milk secretion.

The causes of **failure of letdown** include painful conditions of the teat; sharp teeth in the piglets; inverted nipples that interfere with suckling; primary failure of milk ejection, especially in gilts; and excessive

engorgement and edema of the udder. In many sows the major disturbance seems to be hysteria, which is readily cured by the use of tranquilizing drugs. Treatment of the primary condition and the parenteral administration of oxytocin, repeated if necessary, is usually adequate.

**Ergotism** may be a specific cause of agalactia in sows and has been recorded in animals fed on bullrush millet infested with ergot.

Apparent **hormonal defects** do occur, particularly in cattle. Sporadic cases occur in which cows calve normally and have a normal udder full of milk but fail to let it down when stimulated in the normal way. A single injection of oxytocin is often sufficient to start the lactation. In rare cases repeated injections at successive milkings are required. There is one report of a number of cows in a herd being affected. The cows were under severe stress for a number of reasons and had depressed serum cortisol levels. In heifers and gilts there may be complete absence of mammary development and, in such cases, no treatment is likely to be of value. In animals that have lactated normally after previous parturitions, the parenteral administration of chorionic gonadotrophin has been recommended but often produces no apparent improvement.

Mares grazing fescue may fail to lactate after parturition because of inhibition of prolactin release.

### Milk Drop Syndrome

This is a herd syndrome in which the milk yield falls precipitately without there being any clinical evidence of disease, especially mastitis, or obvious deprivation of food or water. Heat stress (particularly the combination of heat and humidity), summer fescue toxicosis, and leptospirosis caused *Leptospira hardjo* are among the more common causes.

### Low Milk Fat Syndrome

In this syndrome the concentration of fat in milk is reduced, often to less than 50% of normal, although milk volume is maintained. This syndrome is a significant cause of wastage in high-producing cows. Low concentration of fat in milk occurs with ruminal acidosis in cattle.<sup>5</sup> The cause appears to be an increase in concentrations of conjugated linoleic acid in the diet, with subsequent reduction in lipogenesis in the udder.<sup>6</sup> A supply of polyunsaturated fatty acids in the cows' ration and alteration in fermentation in the rumen results in biohydrogenation of linoleic acid (abundant in oils and seeds) and formation of intermediate fatty acids in the rumen. These incompletely hydrogenated fatty acids are absorbed into the blood and have an inhibitory effect on lipogenesis.<sup>7</sup> It is most common in cows on low-fiber diets, for example, lush, irrigated pasture, or grain rations that are ground very finely or fed as pellets. Treatment is achieved by

administration of sodium bicarbonate or magnesium oxide, which increase fiber digestibility and hence the propionate:acetate ratio. Magnesium oxide also increases the activity of lipoprotein lipase in the mammary gland and increases uptake of triglycerides by the mammary gland from the plasma.<sup>8</sup>

### REFERENCES

1. Persson Waller K, et al. *J Dairy Sci.* 2014;97:310.
2. Olde Riekerink RGM, et al. *J Dairy Sci.* 2014;97:5007.
3. Stamm LV, et al. *Vet Microbiol.* 2009;136:192.
4. Melendez P, et al. *Prev Vet Med.* 2006;76:211.
5. Atkinson O. *Cattle Pract.* 2014;22:1.
6. Gulati SK, et al. *Can J Anim Sci.* 2006;86:63.
7. Dubuc J, et al. *Point Veterinaire.* 2009;40:45.
8. Radostits O, et al. Low milk fat syndrome. In: *Veterinary Medicine: A Textbook of the Diseases of Cattle, Horses, Sheep, Pigs, and Goats.* 10th ed. London: W.B. Saunders; 2006:1686.

### "FREE" OR "STRAY" ELECTRICITY AS A CAUSE OF FAILURE OF LETDOWN

Free electrical current is common in dairies, especially recently built ones. The problem is most common when a herd moves into a new shed, but it also occurs with alterations to electrical equipment and wiring or with ordinary wear and tear. The stray current is present in the metallic part of the building construction, much of which is interconnected. Cows are very sensitive to even small amperages and are highly susceptible because they make good, often wet contact with the metal and with wet concrete on the floor. People working in the dairy are not likely to notice the electrical contact because they are usually wearing rubber boots. The voltage present would be too low to be of much interest to the local power authority, and an independent technician may be necessary to perform the examination, which should be performed while the milking machine is working. The effects of free electricity in the milking shed may be as follows:

- Fatal electrocution, stunning causing unconsciousness, frantic kicking, and bellowing, which are all manifested when the animal contacts the electrified metal, as set down under the heading of electrocution
- Restlessness, frequent urination, defecation, failure to let milk down, and in tie-stalls frequent lapping at the water bowl but refusing to drink; the abnormal behavior may be apparent only when the cow is in a particular position or posture.
- Startled, alert appearance with anxiety, bawling, and refusal to enter the milking parlor
- Failure of letdown leads to lower milk production and recrudescence of existing subclinical mastitis leading to appearance of clinical signs.

**Table 20-8** Diagnosis of free electricity problems based on voltage difference between two points that can be accessed by an animal with resultant current flow

Normal	0–0.5 V
Suspicious as possible cause for abnormal behavior	1.0–2.0 V
Moderate behavioral reactions possible	1.5–3.0 V
Behavioral reactions likely	>3.0 V

*The estimates are guidelines and there is marked individual animal variability.*

In spite of the many field observations of these abnormalities experimental application of AC current up to 8 mA causes changes in behavior but not in milk yield or letdown. Additional information on stray voltage is provided in Chapter 4.

Recommended guidelines for a diagnosis of free electricity problems are set out in Table 20-8. For simplicity it can be assumed that cows will behave abnormally if the free voltage exceeds 1 V AC, although 2 V and a current of 3.6 to 4.9 mA does not reduce milk production. A safer threshold is 0.35 V AC as a maximum. A proper voltmeter is necessary to make a diagnosis, and in most circumstances a qualified electrician is necessary for the exercise.

The development of voltages in the metalwork of the milking shed can arise from many factors. Obvious short circuits from faulty wiring are the least common cause. Most cases are caused by accumulation of relatively low voltages because of increased resistance in the earth or ground system, thus neutral to earth voltages. Reasons for the accumulation include a poor earthing or grounding system, grounding rods that are too short to reach the water table, insufficient grounding rods, or dry seasons lowering the water table. The problem may be intermittent and even seasonal, depending on climatic conditions that facilitate the passage of current through the cow as an alternative grounding system.

## NEOPLASMS OF THE UDDER

The most common neoplasm of cows' teats is viral papillomatosis. It is esthetically unattractive and may play a part in harboring mastitis organisms on the teat skin. It is dealt with in detail under the heading of papillomatosis. Similar papillomata occur on the teat and udder skin of lactating Saanen goats. Rarely, these lesions may develop a squamous cell carcinoma lesion of low malignancy.

Neoplasms of the bovine udder are extraordinarily rare. In a report by the United States Department of Agriculture in 1945, 13 million bovine udders were inspected and none were found to have gross evidence of

cancer. There are a handful of isolated reports of fibrosarcoma, carcinoma, and fibroadenoma of the mammary gland in cattle.<sup>1</sup> Carcinomas are rarely reported in goats, and adenoma and carcinoma are very rare in sheep.<sup>1,2</sup> Malignant mammary carcinoma occurs occasionally in mares. The extremely low rate of mammary gland neoplasia in female ruminants is primarily attributed to their herbivore diet and because many ruminants are slaughtered before reaching middle age.<sup>1</sup> An additional reason for the low rate is that female ruminants that are retained in the herd or flock have an extremely low lifetime exposure to estrogen as they spend most of their reproductive life being pregnant or not cycling.

## TEAT AND UDDER CONGENITAL DEFECTS

The common sporadic defects in cows are supernumerary teats, fused teats with two teat canals opening into one teat sinus, hypomastia, absence of a teat canal and sinus, and absence of a connection between the teat sinus and the udder sinus; in sows insufficient and inverted teats are the common errors. Supernumerary teats are common (up to 33%) in Simmental and Brown Swiss heifers and are removed surgically. A high prevalence of defects is recorded in Murrah buffaloes and inheritance of hypomastia, rudimentary teats, and angulation of teats is suspected in cows.

Traditionally sows are required to have at least 12 functional teats and sows deficient in this regard are likely to be culled. Reasons for the deficit include inherited shortage (teat number is highly heritable), misplaced teats (usually too far posteriorly to be accessible to the piglets), or unevenly placed, inverted teats, either congenital or acquired as a result of injury; vestigial nipples that do not acquire a lumen, cistern, or gland; and normal-sized teats that are occluded. Inverted teats in sows may be this way because they lack a teat upturn, which is the teat duct opening directly into the mammary gland cistern.

### FURTHER READING

Reinemann DJ. Stray voltage and milk quality. A review. *Vet Clin North Am Food Anim Pract.* 2012;28:321-345.

### REFERENCES

- Mihevč SP, Dovc P. Mammary tumors in ruminants. *Acta Argic Slovenica.* 2013;102:83.
- McElroy MC, Bassett HF. *J Vet Diagn Invest.* 2010;22:1006.

## MILK ALLERGY

Signs of allergy, principally urticaria, are often manifested by cows during periods of milk retention. Most of these occur as the cow is being dried off. The Channel Island breeds of cattle are most susceptible, and the disease is likely to recur in the same cow at

subsequent drying off periods; it is almost certainly inherited as a familial trait.

The important clinical signs relate to the skin. There is urticaria, which may be visible only on the eyelids or be distributed generally. Local or general erection of the hair may also be seen. A marked muscle tremor, respiratory distress, frequent coughing, restlessness to the point of kicking at the abdomen and violent licking of themselves, and even maniacal charging with bellowing may occur. Other cows may show dullness, recumbency, shuffling gait, ataxia, and later inability to rise. The temperature and pulse rates are usually normal or slightly elevated, but the respiratory rate may be as high as 100 beats/min.

Diagnosis of milk allergy can be made by the intradermal injection of an extract of the cow's own milk. A positive reaction occurs with milk diluted as much as 1 in 10,000, and edematous thickening is present within minutes of the injection. Other clinicopathologic observations include the development of eosinopenia, neutrophilia, and hyperphosphatemia during an attack.

Spontaneous recovery is the rule, but antihistamines are effective, especially if administered early and repeated at short intervals for 24 hours. Prevention is usually a matter of avoiding milk retention in susceptible cows, but in many cases it is preferable to cull them.

## Mastitis of Sheep

### ETIOLOGY

Most cases of clinical mastitis are caused by *S. aureus* or *Mannheimia* spp. (predominantly *M. haemolytica* and *M. glucosida*, but also *M. ruminalis*). Each is responsible for around 40% of cases in ewes suckling lambs for meat or wool production, whereas in dairy sheep *S. aureus* has a higher prevalence, and is responsible for around 80% of clinical cases.<sup>1,2</sup> *S. agalactiae* is also important, with other agents including CNS (often associated with persistent subclinical infections and elevated SCCs), *E. coli*, *H. somni* (formerly *H. ovis*), *Clostridium perfringens* type A, *Pseudomonas* spp., *C. pseudotuberculosis*, or *E. faecalis*. *Acholeplasma oculi* is predominantly isolated from cases of contagious ophthalmia but can cause mastitis and agalactia.

Another important cause is *M. agalactiae*, the agent of contagious agalactia, which is described under that syndrome.

### EPIDEMIOLOGY

#### Occurrence

Most cases of clinical mastitis in ewes occur up to 4 to 8 weeks after parturition or immediately after weaning. Compared with housed ewes, those grazing pasture have a lower prevalence with cases predominantly caused by *M. haemolytica* or *Staphylococcus* spp.



Many cases are associated with teat injury from any cause, such as when ewes are housed on abrasive floors.

Clinical mastitis in grazing ewes averages only about 2% per year, but mastitis can be responsible for up to 10% of all ewe deaths. More than 30% of dairy ewes can have subclinical mastitis.

The forms of loss in milk sheep are the same as those for dairy cattle: reduced milk production, reduced milk quality, which can negatively affect cheese production, and the culling of affected ewes. In meat and fiber sheep the most obvious losses are deaths, usually from gangrenous mastitis, and decreased growth and deaths in lambs. Where suckling lambs have access to supplemental feed the effect of subclinical mastitis on lamb performance is negligible.

The sheep dairy industry in many countries is developing, so anything that adversely affects the quantity and quality of ovine milk, especially for the production of cheese, will cause financial loss. In Greece, where ewe milk is used to produce feta cheese, the prevalence of subclinical mastitis in flocks varies from 29% to 43%, with CNS and *S. aureus* isolated from 44% and 33% of the positive milk samples, respectively.

### Staphylococcal Mastitis

The most prevalent mastitis pathogen of the ewe is *S. aureus*. The incidence of clinical mastitis may be as high as 20%, with ewe mortality rates of from 25% to 50%. The affected halves in surviving ewes are usually necrotic and destroyed. Chronic mastitis can cause a 25% to 30% reduction in milk yield from the affected udder halves. Consequently, this disease is very important in countries, such as Greece, in which ewes' milk is an important component of the human diet. The disease is probably spread from infected bedding grounds, with the infection gaining entry through teat injuries caused by suckling lambs. Intensive housing can be associated with an increased prevalence of lesions, probably caused by cross-suckling by lambs with oral or nasal infections.<sup>3</sup>

Other staphylococcal mastitides in ewes include *S. epidermidis*; many clinically normal quarters show a high rate of infection with coagulase-negative staphylococcus. Experimental infection with *S. chromogenes* causes clinical mastitis, *S. simulans* causes subclinical mastitis, and *S. xylosum* causes a transient increase in the SCC.

### Mannheimia Mastitis

Peracute, gangrenous mastitis associated with *Mannheimia* spp. is a common mastitis. *M. haemolytica* and *M. glucosida* can be isolated from affected halves, and the disease can be reproduced experimentally by the intramammary infusion of cultures of the organism. *S. aureus*, *T. pyogenes*, and streptococci are often present as secondary invaders.

*Mannheimia* mastitis occurs sporadically in the western United States, Australia, and Europe in ewes kept under systems of husbandry varying from open pasture to enclosed barns. Mastitis is most common in ewes suckling large lambs up to 3 months old. Infection is thought to occur through injuries to teats, perhaps caused by over vigorous suckling. Occurrence is not related to hygiene, and many outbreaks occur in grazing sheep. However, because of sheep's behavior (using "sheep camps" at night), it is possible that these areas become contaminated and facilitate transmission by contact with infected soil or bedding. There is a high diversity among *Mannheimia* isolates, and horizontal transmission by lamb suckling probably occurs.<sup>4</sup>

### Streptococcal Mastitis

Streptococcal mastitis can be reproduced by the introduction of *S. agalactiae* into the mammary glands and occurs naturally in dairy ewes. The infection originates from an infected udder and is transmitted to the teat skin of other ewes by milking machine liners, milkers' hands, washcloths, and any other material that can act as an inert carrier. *S. dysgalactiae* and *S. uberis* are also occasionally isolated.

### PATHOGENESIS

The mechanisms of pathogenesis are similar to those for bovine mastitis.

### CLINICAL FINDINGS

In milking ewes clinical mastitis is similar to that in cows, with acute and subacute forms manifested by swelling of the gland and wateriness and clots in the milk. Most clinical cases occur with 2 to 3 weeks of parturition or at weaning, and take the form of gangrenous mastitis, affecting one or both halves.

### Staphylococcal Mastitis

In sheep there is a strong similarity between this form of mastitis and that associated with *M. haemolytica*. They are both peracute, gangrenous infections. The ewe is usually recumbent and profoundly toxic, and the affected gland and the surrounding area of belly wall are blue-green in color and cold to the touch. A few drops of clear, bloodstained liquid is all that can be expressed from the udder. A fatal clinical course of 1 to 2 days is usual.

### Mannheimia Mastitis

*Mannheimia* mastitis is an acute systemic disturbance, with a high fever (40°C–42°C; 105°F–107°F), anorexia, dyspnea, and profound toxemia, with acute swelling of the gland and severe lameness on the affected side. This lameness is an important early sign and is useful in locating affected animals in a group. The udder is at first hot, swollen, and painful and the milk watery, but within

24 hours the half is discolored blue-black and cold, with a sharp line of demarcation from normal tissue. The secretion is watery and red and contains clots. The temperature subsides in 2 to 4 days, the secretion dries up entirely, and the animal either dies of toxemia in 3 to 7 days or survives with sloughing of a gangrenous portion of the udder. This is followed by the development of abscesses and the continual draining of pus. Usually only one side is affected. Cases of pneumonia caused by the same organism may occur in lambs in flocks in which ewes are affected.

### Clostridial Mastitis

*C. perfringens* A is a rare and highly fatal cause of acute mastitis in ewes. Clinical signs of infection are principally hemolytic and are characterized by hemoglobinuria, jaundice, and anemia, plus fever, anorexia, and recumbency. The affected half is swollen, painful, and hot and contains watery, brown, flocculent secretion.

### Caseous Lymphadenitis and Mastitis

Suppurative lesions associated with *C. pseudotuberculosis* are common in ovine mammary glands, but they usually involve only the supramammary lymph nodes and are not true mastitis. However, the function of the mammary gland may be lost when the infection spreads from the lymph node to mammary tissue.

### Pseudomonas Mastitis

Naturally occurring pseudomonas mastitis in ewes is likely to be gangrenous and lethal, as well as accompanied by severe lameness in the hindlimb on the affected side. Infected intramammary infusions or milking machine malfunction are the usual means of introducing the infection.

### CLINICAL PATHOLOGY

The SCC is a useful predictor of mammary gland infection of individual dairy ewes, although thresholds are not as uniform or as widely accepted as for dairy cows.<sup>5,6</sup> The SCC in normal ewe milk ranges from 0.5 to 1.0 × 10<sup>6</sup> cells/mL, with 95% of samples having counts <0.5 × 10<sup>6</sup> cells/mL. Ewe milk SCC tends to increase more in later lactation compared with the cow, but consecutive testing when counts range from 0.5 to 1.0 × 10<sup>6</sup> cells/mL will improve its diagnostic accuracy. In bulk milk samples, counts of 0.65 × 10<sup>6</sup> cells/mL indicate that from 10% to 15% of ewes in a flock have subclinical mastitis.<sup>5</sup>

Other tests include the California Milk Test, a reliable indicator of SCC, and staining milk films with Giemsa or May-Grunwald stains to detect what type and proportion of cells are present. Early mammary gland infections change the proportion of ions in milk; thus measuring electrical conductivity can indicate mastitis. However, there are

large interanimal and intrainimal variations, so specific algorithms that account for this daily variation are required.<sup>7</sup> Ultrasound examination of the udder and supramammary lymph nodes and infrared thermography of the udder are potentially rapid and sensitive tests for subclinical mastitis in specialist dairy flocks.<sup>8,9</sup> Infection of ewes with maedi-visna virus does not alter their SCC.

### NECROPSY FINDINGS

The gross appearance of the affected glands varies with the agent involved and the duration of the process. Generally, the swollen, hemorrhagic, and/or gangrenous nature of fatal acute ovine mastitis is obvious. A purulent exudate is sometimes present, especially in the case of chronic *C. pseudotuberculosis* infection.

### Samples for Confirmation of Diagnosis

- Bacteriology: chilled mammary gland for aerobic culture; anaerobic culture if *Clostridium* sp. is suspected.

#### DIFFERENTIAL DIAGNOSIS

*Mannheimia* mastitis is peracute and resembles mastitis associated with *Staphylococcus aureus*. A similar disease in ewes has been ascribed to *Actinobacillus lignieresii*. Suppurative mastitis associated with *Corynebacterium pseudotuberculosis* is chronic, and no systemic signs occur.

### TREATMENT

Broad-spectrum parenteral and intramammary antimicrobial agents are effective. Although ewes probably require smaller doses of intramammary infusions than cows, it is customary to use ordinary cow-type mammary infusion treatments. However, this results in a much longer period during which the milk in the half has a level of antibiotic greater than acceptable limits for human consumption (the “withhold period”). The treatment of ewes with peracute gangrenous mastitis requires systemic treatment, but this is often not successful and the affected half sloughs after several weeks.

### CONTROL

Control programs for milking sheep flocks are less well defined, but principles similar to those outlined for dairy cows apply. This requires early detection and prompt treatment of affected ewes with an effective antimicrobial. Results of culture and sensitivity testing will not be immediately available, but milk samples should be collected aseptically from affected and nonaffected ewes to inform future treatment options, with the aim of testing up to 10 isolates of each species present.<sup>2</sup> Dry treatment with intramammary infusions into both halves of dairy ewes has been shown to reduce subclinical infections

and/or SCC during the next lactation.<sup>10</sup> Selective treatment of ewes with a consistently high SCC, rather than treatment of all ewes, will be a more cost-effective strategy, but this information will only be available within well-developed dairy operations. For flocks of suckling ewes with a high prevalence of mastitis the use of dry period treatment at weaning may be useful, but care and aseptic technique is required to prevent iatrogenic infections.

Phenotypic culling of affected dairy or suckling ewes is often undertaken, although this will not reliably prevent further clinical or subclinical infections in the flock. Genetic selection of dairy ewes with a reduced SCC is an indirect way of reducing susceptibility to mastitis infections and may offer a longer-term option for the control of subclinical mastitis. However, to have the most chance of success this needs reliable pedigree information, performance recording, and estimates of breeding values.<sup>6</sup>

### Staphylococcal Mastitis

Two multivalent bacterins have been released for use against staphylococcal mastitis in dairy cattle, Lysigin (United States) and Startvac (Europe and Canada), but as yet they have not been systematically evaluated in sheep. The former, a multivalent whole-cell lysed bacterin, did not prevent infections but reduced the severity of mastitis after experimental challenge of heifers with *S. aureus*. Vaccination did not lower SCC, increase milk yields, or reduce the staphylococcal infection rate.<sup>10</sup> The second product includes an inactivated *E. coli* strain. It does not eliminate new staphylococci infections, but field studies in dairy cattle show a reduced time and transmissibility of infections.<sup>11</sup>

For dairy ewes, frequent changing of pasture areas and culling of affected ewes may help reduce environmental contamination and control the spread of infection.

### Mannheimia Mastitis

In older studies polyvalent hyperimmune serum and an autogenous vaccine of killed *M. haemolytica* were shown to prevent intramammary infections with *Mannheimia* spp. More recently, *M. haemolytica* serotype 1 has been used in vaccines in an attempt to control respiratory disease in cattle and pasteurellosis in sheep. However, a primary virulence factor of *Mannheimia* spp. isolates is leukotoxin A (LktA), and this may have an important role in immunity to disease caused by *Mannheimia* spp. A comparison of the similarity of the LktA of *Mannheimia* spp. isolated from clinical cases of mastitis found that the LktA from *M. glucosida* may be more suitable for a monovalent vaccine than the LktA from *M. haemolytica*.<sup>12</sup>

### FURTHER READING

Arsenault J, et al. Risk factors and impacts of clinical and subclinical mastitis in commercial

meat-producing sheep flocks in Quebec, Canada. *Prev Vet Med.* 2008;87:373.

### REFERENCES

1. Omaleki L, et al. *J Clin Microbiol.* 2010;48:3419.
2. Mavrogianni VS, et al. *Vet Clin North Am Food Anim Pract.* 2011;27:115.
3. Mørk T, et al. *Vet Microbiol.* 2012;155:81.
4. Omaleki L, et al. *J Vet Diagn Invest.* 2012;24:730.
5. Fragkou IA, et al. *Small Rum Res.* 2014;118:86.
6. Riggio V, et al. *Small Rum Res.* 2015;126:33.
7. Romero G, et al. *Small Rum Res.* 2012;107:157.
8. Hussein HA, et al. *Small Rum Res.* 2015;129:121.
9. Martins RFS, et al. *Res Vet Sci.* 2013;94:722.
10. Spanu C, et al. *Small Rum Res.* 2011;97:139.
11. Middleton JR, et al. *Vet Microbiol.* 2009;134:192.
12. Schukken YH, et al. *J Dairy Sci.* 2014;97:5250.

## Mastitis of Goats

*S. aureus* and *E. coli* are the most common causes of clinical mastitis. Other infectious agents include *Pseudomonas* spp., *S. hyicus* (much less pathogenic than *S. aureus*), *S. dysgalactiae* spp., *Streptococcus* spp., *Corynebacterium* spp., *Actinobacillus* spp., and more rarely, *K. pneumoniae*, *C. pseudotuberculosis*, *M. haemolytica*, and *Actinobacillus equuli* causes a systemic reaction and granulomatous lesions in the udder and lungs. The gland prevalence of subclinical mastitis *N. asteroides* in goats, caused predominantly by infection with CNS, can range from 9% to 65%, although these organisms are often present in clinically normal halves.<sup>1</sup>

Goats have intrinsically higher SCCs than cows or sheep, which increase with age and stage of lactation, so goat milk can often exceed legal thresholds for human consumption mandated in some jurisdictions in the absence of a high prevalence of clinical or subclinical mastitis.<sup>2</sup>

Mastitis is also an important sign in the infectious diseases associated with *M. agalactiae* and *M. mycoides* var. *mycoides*.

### Staphylococcal Mastitis

This is the most common cause of mastitis in goats and the same CNS can persist in subclinical infections for up to 7 months.<sup>1</sup> A New Zealand study of over 600 does from 18 herds found bacteria in 23.3% of glands, and CNS (13.4%) and *Corynebacterium* spp. (7.3%) were the most common isolates.<sup>3</sup> The incidence of new infections was highest in early lactation, and prevalence of infections increased with age.

*S. aureus* is commonly isolated from clinical mastitis but at a much lower prevalence than CNS. Experimentally produced *S. aureus* mastitis in goats has a similar pathogenesis to that in the cow except for a marked tendency for the staphylococci to invade and persist in foci in the interacinar tissue. As in cattle, some staphylococci in goats' milk produce enterotoxins and the toxic shock syndrome toxin, so these can cause food poisoning in humans. Latex agglutination tests

are available for the identification of the enterotoxins.

### Streptococcal Mastitis

Goats are susceptible to *S. agalactiae* and *S. uberis*, and sporadic cases or outbreaks of mastitis associated with these and other streptococci do occur. In flocks of milking goats the infection is passed from infected quarters to others by means of the milkers' hands, the teat cups of milking machines, and washcloths used to disinfect the udder before milking. *S. zooepidemicus* causes chronic suppurative mastitis in does, and artificially induced infections with *S. dysgalactiae* are indistinguishable from mastitis associated with *S. agalactiae*. The pathogenesis is probably similar in all streptococcal mastitides.

### Pseudomonas Mastitis

Experimental pseudomonas mastitis in goats is acute, with extensive necrosis and fatal septicemia. As for dairy cattle, infection is often introduced through contaminated water.<sup>1</sup>

### Summer Mastitis

Summer mastitis associated with *T. pyogenes* has been produced experimentally in goats with udder lesions typical of acute suppurative mastitis. Nonlactating goats developed a severe mastitis, whereas lactating animals were less severely affected.

### Other Infections

Mastitis in goats is associated with an organism tentatively identified as *M. haemolytica*. *Yersinia pseudotuberculosis* has caused mastitis in an aborting goat doe that probably experienced a bout of systemic yersiniosis. This infection would be a potential zoonosis. Granulomatous lesions in the mammary glands and in internal organs have been observed in goats experimentally infected with *Cryptococcus neoformans*.

### CLINICAL FINDINGS

Clinical mastitis in goats is similar to that in cattle, with subclinical, chronic, acute, and peracute gangrenous forms occurring. Particular care is needed in the clinical examination of goat's milk because of its apparent normality when there are severe inflammatory changes in the udder.

SCCs in milk of goats are higher than in cattle or sheep but vary widely because of the apocrine nature of milk secretion.<sup>2</sup> The counts increase with stage of lactation, lower milk production, and increased parity, and goats without intramammary infection may have an SCC of more than  $1 \times 10^6$  cells/mL, which is the mandated limit of goat milk for human consumption in some jurisdictions.<sup>4</sup> These variations make the value of SCC as a guide to diagnosis in goats controversial.

In staphylococcal mastitis, infected halves have higher NAGase and CMT than normal

halves. However, they and the LDH and anti-trypsin tests give variable results, thus they are still not considered to be as reliable as in dairy cows.<sup>5</sup>

### Treatment and Control

Treatment and control of mastitis techniques to be used in goat does have been adapted from those used for cattle, with the details of dry period and lactational treatments informed by laboratory culture. If cow dose rates are used, retention of the antibiotic in the udder of goats will be prolonged, even for short-acting products such as ampicillin, so withholding periods need to be increased.<sup>6</sup>

For treatment of acute cases, intravenous flunixin meglumine is an effective antipyretic and leads to clinical improvement in the mammary gland when combined with intravenous dextrose and electrolytes. The preferred antimicrobials to achieve therapeutic tissue concentrations in the mammary gland include macrolides, trimethoprim, tetracyclines, and fluoroquinolones.<sup>7</sup>

Vaccination using killed bacterins has been investigated for a number of years, and two multivalent bacterins are available for use against staphylococcal mastitis in dairy cattle, Lysigin (United States) and Startvac (Europe and Canada). The effect of the former on the prevalence of staphylococcal mastitis and SCC in a 30-doe U.S. dairy goat herd was evaluated over 18 months.<sup>8</sup> The average SCC of vaccinates was lower ( $1.3$  versus  $1.5 \times 10^6$  cells/mL for controls), which reduced the milk below the mandated level for human consumption, and they had more spontaneous cures (1.28 versus 0.6 per doe for controls).

### REFERENCES

1. Contreras A, et al. *Small Rum Res.* 2007;68:145.
2. Leitner G, et al. *Vet Immunol Immunopathol.* 2012;147:202.
3. McDougall S, et al. *New Zeal Vet J.* 2014;62:136.
4. Paape MJ, et al. *Small Rum Res.* 2007;68:114.
5. McDougall S, et al. *J Dairy Sci.* 2010;93:4710.
6. Ferrini AM, et al. *J Agric Food Chem.* 2010;58:12199.
7. Mavrogiani VS, et al. *Vet Clin North Am Food Anim Pract.* 2011;27:115.
8. Kautz FM, et al. *Res Vet Sci.* 2014;97:18.

## Contagious Agalactia in Goats and Sheep

### SYNOPSIS

**Etiology** Classic disease caused by *Mycoplasma agalactiae* in sheep and goats; also *M. agalactiae*, *M. mycoides* subsp. *capri* (formerly *M. mycoides* large colony type), and *M. capricolum* subsp. *capricolum* in goats

**Epidemiology** Outbreaks and severe disease are especially problematic in the Mediterranean area of Europe and Africa.

Introduction of infected animals. Direct spread by infected milk and ocular discharge to suckling young and to adults by contamination of bedding, feed, and milking equipment

**Clinical findings** Triad of mastitis, arthritis, and ocular disease. Sometimes accompanied with respiratory disease, abortion, and diarrhea

**Lesions** Indurative mastitis with abscessation, polyarthritis

**Diagnostic confirmation** Culture, polymerase chain reaction, serology

**Treatment** Antimicrobials may mitigate disease severity but not achieve a bacteriologic cure.

**Control** Flock/herd biosecurity, milking-time hygiene. Test and slaughter eradication. Vaccines have poor efficacy.

### ETIOLOGY

Contagious agalactia is a disease of sheep and goats, particularly those used for milk production. *M. agalactiae* is the main causal agent in sheep and goats, but *M. mycoides* subsp. *capri* and *M. capricolum* subsp. *capricolum* produce a similar if not identical clinical presentation. There is apparent variation in virulence between isolates from different regions and countries. The situation in goats is quite complex, and frequently more than one of these agents can be isolated from the same outbreak.

*M. putrefaciens*, first isolated from the joints of arthritic goats in California, has been isolated and implicated in some outbreaks of contagious agalactia, but experimental challenge with this organism does not produce classical contagious agalactia. *M. putrefaciens* can cause septicemia, pneumonia, and mastitis in small ruminants that are predisposed by other diseases.

### EPIDEMIOLOGY

#### Occurrence

Contagious agalactia is endemic in most European countries and Africa and occurs in many other areas of the world including Asia and the Indian subcontinent, the Middle East, and North and South America. The disease is common in Mediterranean countries, and is particularly widespread and problematic in Spain.

#### Prevalence

In endemic areas the disease is cyclic in occurrence with periods of outbreaks of severe disease interspersed with periods of chronic or mild disease.

Peak rates of clinical disease occur after parturition in both the dams and their young with another peak occurring in association with the onset of machine milking after the young are removed from suckling. The mortality rate can be high (10%–30%), and many



adult females are culled because the udder is permanently damaged.

### Transmission

The organisms are present in the milk and ocular secretions of infected animals and in respiratory secretions in which the pulmonary form of the disease is present. Transmission is by direct contact, aerosol transmission, ingestion, and by contact with infected fomites. The young are infected through the ingestion of infection present in colostrum and milk. Infected milk can also contaminate bedding, feed and dairy equipment, and spread occurs with machine milking. The organisms reside in the ear canal of asymptomatic carrier sheep and goats, and are thought to be transmitted by ear mites. Venereal transmission is also thought to occur.

The common practice of transhumance and communal grazing in endemic areas promotes transmission between herds and flocks, either from direct contact or grazing over infected pastures. The organisms have been isolated from outbreaks of disease in a range of wild ruminants, but the role of these in the epidemiology of contagious agalactia in domestic small ruminants is unclear.<sup>1</sup> Illegal importation of animals from an endemically infected area can introduce the disease to disease-free areas.

### Experimental Reproduction

Contagious agalactia can be reproduced experimentally and reflects the natural disease with acute and chronic multifocal necrotizing mastitis, acute arthritis, conjunctivitis, and subacute enteritis. Shedding of the organism precedes the onset of clinical disease by 1 to 10 days. The experimentally produced disease is much more severe in pregnant animals.

### Host Risk Factors

The relative severity of clinical disease in sheep versus goats depends on the infecting mycoplasma and varies with region. There are also breed and age differences in susceptibility. Septicemia and acute disease is more common in young lambs and kids and lactating females, with less severe disease in adult males and nonlactating nonpregnant females. Asymptomatic carriers are important in transmission of the organisms.

### Pathogen Risk Factors

There is regional variation in the virulence of isolates; *M. agalactiae*, *M. mycoides* subsp. *mycoides* subsp. *capri*, *M. capricolum* subsp. *capricolum*, and *M. putrefaciens* have all been isolated from goats in Australia and the United States over several decades, but clinical disease in these countries associated with these organisms is extremely rare.

Molecular studies show a high genetic diversity of *M. agalactiae* isolates from goats in Spain compared with relatively

low diversity from sheep isolates in France and Spain.<sup>2,3</sup> This has implications for vaccines developed to control the disease in goats.

### CLINICAL FINDINGS

The classical signs of contagious agalactia include septicemia, arthritis, mastitis, conjunctivitis, and localization in abscesses, but these are not all consistently present in outbreaks.

In acute cases the onset is sudden with pyrexia, abrupt and complete agalactia, and unilateral or bilateral swelling of the udder with enlargement of the mammary lymph nodes and the development of multiple abscesses in the mammary gland. Induration of the udder may result in culling. In animals that survive, mycoplasma are excreted in the milk for several months and will persist in the udder to subsequent lactations.

Arthritis may be manifested by lameness or recumbency and its presence detected in the carpal and tarsal joints by the occurrence of heat and palpable joint fluid and confirmed by aspiration and examination of joint fluid. Conjunctivitis progresses to keratitis with corneal revascularization in one or both eyes. Some cases have diarrhea.

In less acute cases, there is a long period of illness of from one to several months. Abortion may also occur and genital disease with vulvovaginitis and metritis occurs in some outbreaks.

### CLINICAL PATHOLOGY

Herd diagnosis is possible by the isolation of the organism *M. agalactiae* from the bloodstream, joint fluid, and mammary tissue. A multiplex real-time PCR on a range of samples, including bulk milk, can be used to identify the disease if the causative *Mycoplasma* spp. are present.<sup>4</sup>

Herd diagnosis can also be made serologically. The complement fixation (CFT) test becomes positive soon after clinical signs, although commercial ELISA kits can have variable sensitivity and specificity depending on the strain of *M. agalactiae* and cross-reactions with nonpathogenic *Mycoplasma* spp.<sup>5</sup>

### NECROPSY FINDINGS

Lesions are indicative of indurative mastitis with abscessation, lymphadenopathy, arthritis, and ocular disease.

### Samples for Confirmation of Diagnosis

- **Bacteriology (aerobic culture) and PCR:** milk, ocular fluid, joint fluid aspirate, nasal swabs, ear swabs, lung lesions, brain
- **Serology:** CFT, ELISA

### TREATMENT

Antimicrobial therapy can reduce the severity of disease and mortalities and is an

alternative to culling, especially for animals of high genetic merit. The preferred antibiotics are fluoroquinolones, tetracyclines, and macrolides. Antibiotic resistance to tetracyclines, or an intrinsic lack of efficacy, is a problem as is the cost and practicality of therapy in many endemic areas. In vitro sensitivity testing of field isolates of *M. agalactiae* found enrofloxacin most effective, followed by tylosin, tetracycline, lincomycin, and spectinomycin, with high cure rates reported with lincomycin, spectinomycin, and tylosin. However, treatment of bucks with marbofloxacin did not eliminate *Mycoplasma* from the ear canal of goat bucks, so it would have little impact on eliminating carriers in chronically affected herds.<sup>6</sup>

### CONTROL

The majority of infections in healthy flocks come from introduction of carriers or contact with infected animals. Thus isolation from infected flocks and herds and a closed herd policy are important control measures. Where disease is restricted to a small number of flocks in a geographically isolated area, slaughter of serologically or culturally positive flocks can be an effective control method. In endemic areas disease is common, so eradication by slaughter is not an option and control relies on biosecurity, hygiene, antibacterial therapy, and the use of killed monovalent and polyvalent vaccines.

The efficacy and duration of immunity to vaccines is relatively poor, but they do reduce excretion of mycoplasma and clinical disease. Vaccination of sheep and goats with either an attenuated live vaccine or a killed adjuvant vaccine of *M. agalactiae* gives mixed results; in late pregnant ewes the former is too virulent, and the latter insufficiently so unless it is used in ewes before mating, when efficiency is good. Early vaccination is recommended because of the susceptibility of young animals but should not be performed before 10 weeks of age. Extensive use of both vaccines over a period of 13 years resulted in almost complete disappearance of the disease from Romania, but live attenuated vaccines are not permitted in many countries.

Comparison between commercial vaccines shows that a saponified vaccine gives better results than a live, egg-cultured vaccine, and saponin and phenol inactivated vaccines show better efficacy against experimental disease than do vaccines killed by heat or formalin. An *M. agalactiae* bacterin combined with a mineral oil adjuvant has given good results when three doses are given before, and one dose after, each parturition, and the herd is kept isolated. Intramammary vaccination provides the highest level of antibody.

Autogenous vaccines prepared from milk, brain, and mammary gland homogenates from infected sheep have been used for many years in parts of Europe but have been linked to outbreaks of scrapie.

In infected herds, hygiene at milking time is important in limiting the spread of disease. Pasteurization of colostrum (60 minutes at 60°C; 140°F) eliminates *M. mycoides* subsp. *capri*, but *M. agalactiae* can survive for 120 minutes at 60°C (140°F).<sup>7</sup>

### FURTHER READING

- Gómez-Martin A, Amores J, et al. Contagious agalactia due to *Mycoplasma* spp. in small ruminants: epidemiology and prospects for control. *Vet J.* 2013;198:48-56.
- Radostits O, et al. Contagious agalactia of sheep and goats. In: *Veterinary Medicine: A Textbook of the Diseases of Cattle, Horses, Sheep, Pigs, and Goats.* 10th ed. London: W.B. Saunders; 2007:1138-1139.

### REFERENCES

1. Chazel M, et al. *BMC Vet Res.* 2010;6:32.
2. De la Fe C, et al. *BMC Vet Res.* 2012;27:146.
3. Nouvel LX, et al. *Microbiol Infect Dis.* 2012;35:487.
4. Becker CA, et al. *J Microbiol Methods.* 2012;90:73.
5. Poumarat F, et al. *BMC Vet Res.* 2012;8:109.
6. Gómez-Martin A, et al. *Small Rum Res.* 2013;112:186.
7. Paterna A, et al. *Vet J.* 2012;196:263.

## Mastitis of Mares

Mastitis in mares is generally regarded as rare, but it might be more common in breeding animals than has previously been recognized. The percentage of mastitis in breeding mares is about 5% and is most common during udder involution, but lactating and juvenile mares as well as suckling foals are also affected.<sup>1</sup> *C. pseudotuberculosis*, *P. aeruginosa*, *S. zooepidemicus*, *S. equi*, *S. pyogenes*, *S. aureus*, *E. coli*, *Klebsiella* spp., and *Neisseria* spp. can cause the disease.  $\beta$ -Hemolytic streptococci have been found in the milk of many normal, just-foaled mares. Mastitis in non-lactating mares can be caused by *S. aureus* and evident as chronic, draining abscessation (botryomycosis).<sup>2</sup> Predisposing factors, other than lactation, are not identified. Mastitis can be traumatic (as a result of a kick), extension of an abdominal incision into the mammary gland, secondary to teat suckling of nonlactating mares, and in filly foals.<sup>3</sup>

Other causes of mammary gland enlargement in mares include fungal infection, neoplasia (lymphoma, adenocarcinoma), and idiopathic causes.<sup>4,5</sup>

Clinical cases occur at any time during the lactation and many occur in nonlactating mares. Many mares with typical signs of severe swelling and soreness of the udder, but without abnormal milk, are first observed when a sick foal has not suckled for 24 hours. In streptococcal mastitis there may be severe local pain and moderate systemic signs. In most cases both halves are affected.

The milk, or udder secretions, are usually abnormal. Cell counts exceeding 100,000 cells/mL during lactation and 400,000 cells/mL during involution are regarded as abnormal.<sup>1</sup>

Severe cases, sometimes accompanied by fever, depression, and anorexia, show swelling, pain, and heat in the affected half, and ventral edema and clots in the milk; the mare is lame in the leg on the affected side. Gangrene and sloughing of the ventral floor of a gland can occur.

Because of the high frequency of gram-negative bacteria as causative agents in mares, treatment should include a broad-spectrum antibiotic in an intramammary infusion plus parenteral antibacterial treatment such as with gentamicin-penicillin or trimethoprim-sulfonamide combinations. Hot packs and frequent milking are also recommended.

### REFERENCES

1. Boehm KH, et al. *Praktische Tierarzt.* 2009;90:842.
2. Smiet E, et al. *Equine Vet Educ.* 2012;24:357.
3. Gilday R, et al. *Can Vet J.* 2015;56:63.
4. Brendemuehl JP. *Equine Vet Educ.* 2008;20:8.
5. Brito MdF, et al. *Ciencia Rural.* 2008;38:556.

## Postpartum Dysgalactia Syndrome of Sows

PPDS is a failure to provide sufficient colostrum and milk to piglets during the early stages of lactation. It is usually not accompanied by inflammatory lesions. A whole variety of names have previously been given to this complex syndrome including the mastitis-metritis-agalactia (MMA) syndrome. (The term mastitis-metritis-galactia was originally developed to describe sows with agalactia that had swollen udders, assumed to be caused by mastitis, and the appearance of a vulval discharge, assumed to be caused by metritis.) Progress in this field has only been made possible by the efforts of Guy-Pierre Martineau and Chantal Farmer and their colleagues. Most practicing veterinarians might now recognize MMA as the most serious version of PPDS in which there is clinical mastitis or metritis or recognizable toxemia, but there are many more cases of PPDS than there are MMA.

### ETIOLOGY

The etiology is unclear and complex. Lactation is a very complex physiologic process. Many factors are involved, but they all result in a disturbed gilt or sow that is unable to deliver a proper colostrum/milk supply through adverse hormonal, biochemical, (collectively been called dys-homeorhesis), farrowing, and nursing responses (collectively called behavioral responses). There are four main areas that are involved in the PPDS syndrome:

- Toxemia: The sow may contribute toxins from the gut following constipation, from the bladder following cystitis, from the mammary gland following mastitis, and from the uterus following endometritis postfarrowing.<sup>1</sup> The levels of toxins may also be affected by low

feed intake, low water intake, stress, lack of exercise, overfeeding in late gestation, and inadequate vitamin E levels.

- Bad management of the gilt in preparation for farrowing by incorrect feeding: This happens by moving at the wrong time and because of new social groupings. This may be complicated by the effects of moving sows into crates from loose housing, etc., and poor environment (too hot for sows, rarely too cold). These factors distress the sow, cause stress, and affect lactation through neurophysiologic mechanisms.
  - The sow may be too fat, over muscled, or undergoing inflammation as a result of disease or toxemia or be in pain or suffering from anorexia as a result of a multitude of factors. She may not have developed the normal mammary development to sustain the required level of lactation, which may in part be from genetics.
  - Colostrum and milk production may be faulty for a whole variety of reasons that lead to the individual piglet not receiving sufficient colostrum and/or milk. A major problem in the determination of the etiology is the difficulty of being precise in the description of the clinical findings of the abnormal mammary glands of affected sows. The common clinical findings are swelling of the glands, agalactia, toxemia, and fever. There is a very considerable farm effect in the appearance of the condition because sow care and management are so individual and important. There is considerable overlap in the clinical findings from one affected sow to another, but the lesion present in the mammary glands may vary from uncomplicated physiologic congestion and edema to severe necrotizing mastitis.
- Ringarp published the classic work on this disease based on 1180 cases of postparturient illness in sows in which agalactia was present. At least five causes of agalactia or hypogalactia were recognized, which are as follows (the incidence of each group as a percentage of the total cases is given in parentheses):
- Eclampsia (0.6%), usually of older sows, responding to calcium and magnesium therapy
  - Failure of milk ejection reflex (3.3%), affecting primarily first-litter gilts and usually treated satisfactorily with oxytocin
  - Mammary hypoplasia (1.5%) in gilts, resulting in deficient milk secretion
  - Primary agalactia (6%), in which reduced milk supply is the only abnormality
  - Toxic agalactia (88.6%), the most important numerically and economically. It is characterized by

anorexia, depression, fever, swelling of the mammary glands, and a course of 2 to 4 days. Mastitis was commonly present, but there was no evidence of metritis.

### Mastitis

Postweaning mastitis is not uncommon after drying off. Chronic mastitis as a result of traumatic contact between udders and dirty infected floors or traumatic piglets' teeth resulting in abscesses, granulomas, and fibrous udders at weaning or after are also common. Where there are damaged glands sows are not usually agalactic but they may be producing less.

In many instances, traumatic injury from unclipped piglets' teeth and infected sawdust bedding are factors in mastitis in sows. Quite often, the condition occurs in the first 3 days postpartum and in many cases, if severe and untreated, will lead to the death of sows. Infectious mastitis is suggested as a major cause in many clinicopathologic investigations, and there is a greater incidence of intramammary infection in PPDS-affected sows compared with normal sows. Peracute mastitis in sows is readily recognized as a clinical entity, but less severe infections may result in small foci of inflammation within the gland that cannot be detected on clinical examination. Single gland mastitis is uncommon except when there are particularly vindictive piglets causing severe teat trauma. Glands may then become unusable, and this may cause more piglet pressure on available teats and functional glands, which may in turn increase the trauma to the remaining glands and accelerate the process. Mastitis is recognizable clinically by inflammation, edema, skin congestion, pyrexia, and inappetence in the sow and failing piglets. Gram-negative organisms predominate (*E. coli*, *Enterobacter*, and *Klebsiella* spp.), but there are also gram-positive organisms (streptococci and staphylococci).<sup>2</sup> *E. coli* and *K. pneumoniae* have been recovered from the mammary glands of naturally affected cases, and both bacterial species are associated with histopathological changes of mastitis. Experimental intramammary inoculation of sows with field isolates of *E. coli* and *K. pneumoniae* has resulted in cases of lactation failure and mastitis that closely resemble naturally occurring cases. Unfortunately, they cannot always be demonstrated. *Streptococcus* spp. and *Staphylococcus* spp. have also been isolated, but these are frequently isolated from healthy glands not associated with pathologic changes. It is unlikely that *Mycoplasma* spp. are important.

Coliforms are the most significant pathogens isolated from sows with mastitis. Coliform mastitis is often the most visible of the disorders involved in this syndrome.<sup>3,4</sup> In the second study, there were no differences in virulence genes demonstrated in the *E. coli* from healthy sows and sows with mastitis.

Pathologic examination of affected sows that were euthanized within 3 days after parturition revealed the presence of varying degrees of mastitis, and *E. coli* and *Klebsiella* spp. were the most common organisms recovered. A recent study has shown that *E. coli* strains from mastitis in sows are highly variable in serotype, biochemical profile, virulence factors, and random amplified polymorphic DNA (RAPD) type. No relationship between serotypes, virulence factors, and RAPD types was found. Toxic agalactia can be produced experimentally by the introduction of *E. coli* endotoxin into the mammary gland of sows at parturition. The clinical, hematologic, and serum biochemical changes are similar to those that occur in naturally occurring cases of toxic agalactia. *E. coli* endotoxin acting at the level of the hypothalamus can suppress prolactin release, which results in a pronounced decline in milk production. Experimental *Klebsiella* mastitis in sows is an excellent model for the study of toxic agalactia because of infectious mastitis.

Agalactia may also be the result of a deficiency of prolactin. Prolactin levels may be dramatically reduced by even the smallest amounts of endotoxin. Any factor that interferes with the release of prostaglandin from the uterus may affect the increase in prolactin that must occur to stimulate lactogenesis immediately before parturition.

In summary, field observations have suggested many different causes and predisposing factors, including infectious mastitis, nutritional disturbances, metabolic disorders, and the stress of farrowing in total confinement in a crate. Based on the examination of spontaneously occurring cases, infectious mastitis appears to be a major cause. Both prolactin and oxytocin release can be stopped by stressors and toxins from bacteria such as *E. coli*.

### EPIDEMIOLOGY

#### Occurrence

PPDS is most common in sows at farrowing or within the first 48 hours after parturition, and in sows that farrow in crates indoors. A peak incidence during the summer months has also been observed. The disease will often occur in one batch and then disappear again for months.

#### Morbidity and Case Fatality

Morbidity and mortality data are not readily available or precise because of the difficulty of making a reliable clinical diagnosis. Epidemiologic observations indicate that the risk of sows developing toxic mastitis increases with increasing age up to the third or fourth litter. The population incidence of toxic agalactia ranges from 4% to 10% of all farrowings, whereas the herd incidence may vary from 0% to 100%. A recent study in Denmark<sup>5</sup> suggested that 32.5% of sows on the first day of farrowing, 31.5% on the second day, and 10.1% on the third

day after farrowing were affected (using the criteria of inappetence, reddened or swollen mammary glands, and temperature over 39.4°C; 102.9°F).

The fatality rate in sows is usually less than 2%, but piglet losses caused by starvation and crushing may be as high as 80%. The disease does not usually recur in the same animal, and this suggests that immunity develops and sows should not necessarily be culled.

### RISK FACTORS

#### Feed

The risk factors that have been proposed based on field observations include overfeeding during pregnancy and a drastic change of feed at farrowing.

Reduced feeding on the day of farrowing followed by an increase over the first week of lactation reduces PPDS,<sup>6</sup> and a fish diet before farrowing improves feed intake after farrowing.<sup>7</sup> It is best to switch diets 7 days before farrowing.

Constipation of the sow at farrowing<sup>8</sup> has been suggested as a cause of PPDS. Higher rates of PPDS do occur in constipated sows, which may be associated with pain.<sup>9</sup> However, clinical and pathologic examinations of both spontaneously occurring cases of agalactia and experimental agalactia induced by the introduction of *E. coli* endotoxin into the mammary gland have been unable to support the observation of constipation. Both sick and normal sows defecate less frequently from 1 day before farrowing until 2 days later. There is no difference in the weight of feces in the terminal colon and rectum between sick and normal sows.

Digestive disturbances and certain feeding practices have been associated with the disease. Sows that have been on high-level feeding during pregnancy appear to be susceptible to the disease, especially if they are subjected to a change of feed immediately before parturition. Also, any management practice that results in a marked change in feed intake at or near farrowing may appear to precipitate the disease. A sudden change of feed severe enough to result in gastrointestinal stasis has been used to reproduce the condition experimentally.

The effects of different feed allowances during late pregnancy may affect the incidence rate of the disease. Feeding sows during the last 15 days of gestation a diet at a level of 3.4 kg daily compared with 1.0 kg daily resulted in an incidence rate of 26.6% and 14.0%, respectively. The explanation for the effects of feeding is unknown. It has been proposed that intense feeding may promote toxin production in the alimentary tract, but how this is related to mastitis is unknown. Another hypothesis suggests that increased feeding in late gestation may intensify the initiation of lactation and result in udder engorgement and increased susceptibility to intramammary infection. A further



suggestion is that moldy food may play a part, but this has never been proven.

The clinical status of the mammary glands, the bacteriologic findings, and the total cell count and its percentage of polymorphonuclear leukocytes and pH in colostrum and milk secretion during the first 3 weeks of lactation of sows on high- or low-feeding regimes during late pregnancy have been examined. *E. coli* infection was present in 80% of the sows affected with toxic agalactia and 30% of the healthy sows. The *E. coli* were eliminated at between 3 and 8 days of lactation and were not isolated from sows examined at the time of weaning. The different feeding regimes did not influence the total cell count, the polymorphonuclear cells, or the pH in milk from bacteriologically negative glands or glands with *E. coli* mastitis. The two feeding regimes had no influence on total cell count, the percentage of polymorphonuclear cells, or the pH of colostrum and milk of healthy sows.

The only mycotoxin found to be important in PPDS was shown to be ergot,<sup>10</sup> which probably affects prolactin production. Insufficient water may also be a factor. Omega 3 reduces inflammation and omega 6 increases inflammation.

A variety of ingredients may influence PPDS; probiotics reduce PPDS, as do formic acid, lactulose, and fermented potato protein.

### Housing

Moving sows only 4 days before farrowing has been associated with more PPDS than moving them at 7 days.<sup>6</sup> Housing sows so that they can in fact nest rather than placement in crates may reduce PPDS.<sup>8</sup> Houses that are too hot encourage sows not to eat.

### Management

Insufficient time for the sow to adjust to the farrowing crate after being transferred from the gestation unit is thought to be an important factor, as is the induction of farrowing.<sup>7</sup> Frequent supervision of farrowing sows may reduce the problems of PPDS. Cross-fostering may also help.<sup>11</sup>

The disease occurs under management, environmental, and sanitation conditions ranging from very poor to excellent; however, the possible relationship between the level of bacterial contamination in the farrowing barn and on the skin of the sow and the incidence of the disease has apparently not been examined. Dirty conditions greatly increase the bacterial contamination of the udder. Environmental or other animal noises and disturbances and uncomfortable farrowing crates are potential PPDS factors.

### Animal Factors

The initiating factors have not been identified. The incidence of the disease may be higher in sows with larger litters than sows in the same herd that remain healthy and in those with a higher number of stillbirths and

pigs found dead after birth. Long gestation and long farrowing times increase the incidence of PPDS. It is more common in young sows and relatively rare in older sows. Low exercise has also been suggested as a cause, and this also contributes to constipation. The role of water intake or lack of it and stress or disturbance during parturition has also not been investigated. This may also contribute to the fat sow and the over muscled sow syndrome,<sup>12,13</sup> which may also contribute to PPDS.

The nursing behavior of the sow and the suckling behavior of the piglets may provide an explanation for the pathogenesis and clinical findings of some cases of agalactia in sows. Successful ejection of milk by the sow is dependent on proper stimulation of the sow's udder by the piglets followed by a complex response by the sow. A period of time ranging from 15 to 45 minutes must elapse from the last successful milk ejection to the next. Failure of milk ejection may occur in up to 27% of sows that attempt to suckle their piglets within 40 minutes after the previous milk ejection. The failure of milk ejection in sows within the first few crucial adjustment days after farrowing might possibly contribute to the cause of mastitis and engorgement of the mammary glands.

The over fat sow has a lower glucose tolerance postpartum with a lower appetite, and drinks less and lies down more. The sow may have already switched to a catabolic state at or before farrowing using body reserves to produce milk.<sup>14</sup> Just before farrowing the circulating levels of nonesterified fatty acids also rise,<sup>8</sup> which indicates a catabolic state. There may also be a resistance to insulin at farrowing if there have been high levels of glucose fed in late pregnancy.<sup>15</sup>

### Microorganisms

Each section of the mammary gland of the sow is divided into a separate rostral and caudal section, each with its own teat cistern and teat canal. In a sow with 14 teats there are 28 potential portals of entry, so mastitis is common immediately after parturition when the teat canals have become patent. Bacteria in the gut and in endometritis have been proposed as a source of endotoxin, particularly as  $\beta$ -hemolytic streptococci and coliforms have been associated with the condition.

Some clinicopathologic examinations of affected sows have revealed the presence of a slightly enlarged, flaccid uterus from which coliform and streptococcal organisms can be recovered. However, pathologic evidence of metritis in affected sows is uncommon; the organisms that can be recovered are common in the reproductive tract of normal sows after parturition, and their recovery from vaginal mucus is difficult to interpret.

### PATHOGENESIS

The pathogenesis of infectious mastitis caused by *E. coli* or *Klebsiella* spp. is probably

similar to that of bovine mastitis in which the infection gains entry through the teat canal and invades the mammary tissue causing mastitis. Endotoxemia accounts for the fever initially as well as for the depression, anorexia, and agalactia, even in glands that are unaffected. The lipopolysaccharide endotoxins acting at the level of the hypothalamus and hypophysis suppress the release of prolactin, which results in a marked decline in milk production. The endotoxin may also have a direct inhibitory effect on the mammary gland. There is a higher prevalence of bacterial endotoxin in the blood of affected sows compared with control animals. The endotoxin can be detected in the blood of about 33% of sows affected with coliform mastitis. However, the oral administration of endotoxin daily to prepubertal gilts did not result in any clinical abnormalities. Experimentally, mastitis can be produced in sows by contamination of the skin of the teats with *K. pneumoniae* either shortly before or after parturition. The clinical signs are similar to those described for MMA; mastitis is present in more than 50% of the mammary gland subsections, and a marked leukopenia and degenerative left shift occurs. A total of 120 organisms is sufficient to produce the mastitis when the organisms are inoculated into the teats. In recent experimental infections with *E. coli* it was shown that the time of infection of the mammary gland relative to parturition and the number of circulating neutrophils at the time of infection influenced the development of clinical coliform mastitis in the sow. Similarly, parturition allows the penetration of vaginal organisms into the reproductive tract, and the absorption of endotoxin reduces F2 $\alpha$  in the uterus. This stimulates prolactin, which may contribute to the hypogalactia and agalactia.

### CLINICAL FINDINGS

At one extreme is the sow that has no signs but has poor growth in piglets,<sup>16</sup> and this may have meant that colostrum provision has failed and not been noticed until the piglets begin to fade away. At the other extreme is a severely affected sow with high mortality in piglets.

PPDS occurs in sows between 12 and 48 hours (sometimes 72 hours) after farrowing and is characterized clinically by anorexia, lethargy, restlessness, lack of interest in the piglets, fever, swelling of the mammary glands (udder edema), and agalactia. Most affected animals respond to therapy within 12 to 24 hours. Pathologically, there are varying degrees of mastitis. In some sows the level of oxytocin may be half the level in unaffected sows. The disease is of major economic importance when outbreaks occur because the inadequate milk production leads to high piglet mortality from starvation and secondary infectious diseases. In cases of subclinical MMA there is often a failure to achieve weaning weights (<4 kg at 24 days).

Necropsy of spontaneously occurring cases has frequently confirmed the presence of mastitis, but the incidence of metritis has been insignificant.

The prevalence of the condition appears to have reduced recently with the increased attention to hygiene in the farrowing house and the use of more porous and less traumatic floorings. When it does occur it can be quite common, with up to 11% to 58% of the sows affected. A recent case definition suggests that the pathognomonic signs are poor piglet growth and sow rectal temperatures greater than 39.5°C (103.1°F).

Sometimes there may be a delay in parturition of more than 5 hours. The sow is usually normal, with a normal milk flow, for the first 12 to 18 hours after farrowing. Normally, the sow will suckle her piglets for about 20 seconds once an hour. One of the first indications of the disease is the failure of the sow to suckle her piglets. She is uninterested in the piglets, generally lies in sternal recumbency, and is unresponsive to their squealing and suckling demands. Litters of affected sows are noisier and are generally scattered around the pen searching for an alternative food supply. Such piglets may drink surface water or urine in the pen and infectious diarrhea may occur. If suckling is permitted, it does not progress from the vigorous nosing phase to the quiet letdown stage, and it is accompanied by much teat-to-teat movement by the piglets. Many piglets may die of starvation and hypoglycemia. A failure to grow at more than 105 g per day is a sure sign of piglet problems. Some sows are initially restless and stand up and lie down frequently, which contributes to a high mortality from crushing and trampling.

Affected sows do not eat, drink very little, and are generally lethargic. The body temperature is usually elevated and ranges from 39.5°C to 41°C (103.1°F to 105°F), especially if there is mastitis. However, there is a wide range of "normal temperatures" in newly lactating sows from 38.4°C to 40.5°C (101.1°F to 104.9°F),<sup>17</sup> but this may be lactational hyperthermia. Mild elevations in body temperatures of sows in the first 2 days after parturition are difficult to interpret because a slight elevation occurs in normal healthy sows. This is known as uncomplicated farrowing fever. However, temperatures above 40°C (104°F) are usually associated with acute mastitis that requires treatment. One detailed investigation of the disease in Sweden concluded that 78% of sows with a temperature exceeding 39.5°C (103.1°F) had clinical evidence of mastitis. It is suggested that a temperature of 39.4°C (102.9°F) at 12 to 18 hours after farrowing is an appropriate threshold at which to give preventive treatment for the disease. The heart and respiratory rates are usually increased.

Initial temperatures greater than 40.5°C (104.9°F) are usually followed by severe

illness and toxemia. Normally, the sows get better within 3 days, but not always if the temperature is very high.

Characteristic findings are present in the mammary glands including varying degrees of swelling and inflammation. In most cases, several glands are affected, which may appear as diffuse involvement of the entire udder. Individual sections (half glands) are enlarged, warm, and painful, and may feel "meaty" and lack the resilience of normal mammary tissue. There may be extensive subcutaneous edema around and between each section, which results in a ridge of edema on the lateral aspects of the udder extending for its entire length. The skin overlying the sections is usually reddened and is easily blanched by finger pressure. The teats are usually empty and may be slightly edematous. A few drops of milk may be expressed out of some teats after gentle massage of the section or the administration of oxytocin but rarely can a normal stream of milk be obtained. In severe cases of mastitis the milk contains flakes and pus or is watery.

The feces are usually scant and drier than normal, but whether or not constipation is present in most cases is uncertain. The inappetence and anorexia and failure to drink normally could account for the reduced volume of feces. Constipation with impaction of the rectum with large quantities of feces is uncommon in sows, and when it does occur as the only abnormality it has little effect on appetite and milk production.

A vaginal discharge is normal following parturition, and normal sows frequently expel up to 50 ml of a viscid, nonodorous, and clear mucus that contains variable amounts of white material within the first 3 days following farrowing. Tenacious strands of this discharge may also be observed within the vagina. The presence of this discharge has been misleading and has been interpreted as evidence of the presence of metritis. Necropsy examination after euthanasia of affected sows has failed to reveal evidence of significant metritis. The clinical diagnosis of metritis in sows is difficult, but generally large quantities of dark-brown, foul-smelling fluid are expelled several times daily, accompanied by severe toxemia. This is uncommon in sows. Diagnosis is usually made on clinical signs.

## CLINICAL PATHOLOGY

### Examination of Milk

The number of somatic cells in the milk from sows with mastitis will range from 2 to 20 × 10<sup>9</sup> cells/mL compared with the normal of less than 2 × 10<sup>9</sup> cells/mL. Significant numbers of bacteria are present in the milk of more than 80% of sows with toxic agalactia. Milk obtained for laboratory examination and culture should be taken after thorough cleaning and disinfection of the teats to minimize contamination by skin flora. However, because mastitis may be

present in only one or a few of the mammary gland subsections in the sow and because it is often impossible to clinically identify affected subsections and distinguish them from unaffected adjacent glands, which may be swollen and agalactic because of continuous swelling, a valid assessment of intramammary infection is not possible unless milk samples are obtained from each subsection. Subclinical mastitis may not be easy to detect with cells not reaching 2 × 10<sup>9</sup> cells/mL but 75% may be polymorphs. Normally, milk is around 1 × 10<sup>9</sup> cells/mL.

## Hematology and Serum Biochemistry

Some hematologic and biochemical changes are present in affected sows but may not be marked enough to be a routine reliable diagnostic aid. In severe cases of infectious mastitis, a marked leukopenia with a degenerative left shift is common. In moderate cases there is a leukocytosis and a regenerative left shift. The serum biochemical changes that occur in naturally occurring cases and in the experimental disease are recorded. The plasma cortisol levels are commonly elevated, which may be caused by a combination of the stress of parturition and infectious mastitis. The plasma protein-to-fibrinogen ratio is lower than normal, and the plasma fibrinogen levels are commonly increased in severe cases that occur 8 to 16 hours after parturition.

## NECROPSY FINDINGS

Lesions in the udder and the reproductive tract are not consistent. If they are found, the most important lesions are in the mammary gland. There may be extensive edema and some slight hemorrhage of the subcutaneous tissue. Grossly, on cross-section of the mammary tissue there is focal to diffuse reddening and often only one subsection of a mammary gland may be affected. Histologically, the mastitis may be focal or diffuse in distribution, and the intensity of the lesion varies from a mild catarrhal inflammation to a severe purulent and necrotizing mastitis usually involving more than 50% of all the mammary glands. There are no significant lesions of the uterus compared with the state of the uterus in normal healthy sows immediately after parturition. The adrenal gland is enlarged and heavier than normal, presumably caused by adrenocortical hyperactivity. In a series of spontaneous cases, *E. coli* and *Klebsiella* spp. were most commonly isolated from the mammary tissues. The abscesses of the mammary glands of sows examined at slaughter are not sequelae to coliform mastitis but rather probably caused by injuries and secondary infection.

## Samples for Confirmation of Diagnosis

- Bacteriology: mammary gland, regional lymph node
- Histology: formalin-fixed mammary gland

## DIFFERENTIAL DIAGNOSIS

The characteristic clinical findings in toxic mastitis and agalactia are a sudden onset of anorexia and lack of interest in the piglets, acute swelling of the mammary gland, hypogalactia or agalactia, a moderate fever, and a course of about 2 days. The mammary secretion from mastitic glands may be watery or thickened and contain pus, and the cell count will be increased up to  $20 \times 10^9$  cells/mL. The acute swelling and agalactia of infectious mastitis must be differentiated from other noninfectious causes of acute swelling or "caking" of the mammary glands, which also results in agalactia as follows:

- Agalactia caused by a failure in milk letdown is most common in first-litter gilts and is characterized by a fullness of the mammary glands and an inability of the gilt to suckle her piglets in spite of her grunting at them. The gilt is usually bright and alert and systemically normal. The response to oxytocin is dramatic, and repeat treatment is rarely necessary.
- Farrowing fever is characterized clinically by loss of appetite, inactivity, and a body temperature of  $39.3^\circ\text{C}$ – $39.9^\circ\text{C}$  ( $102.7^\circ\text{F}$ – $103.8^\circ\text{F}$ ) with minimal detectable changes of the mammary gland.
- Parturient psychosis of sows is characterized by aggressive and nervous behavior of the sow after the piglets are born. The sow does not call the piglets, and does not allow them to suck. When the piglets approach the sow's head, she will back away, snap, and make noisy staccato nasal exhalations. Some sows will bite and kill their piglets. The mammary gland is usually full of milk, but the sow will not let it down. Ataractic drugs and/or short-term general anesthesia are indicated, and the response is usually excellent. Some sows need repeated tranquilization or sedation for the first few days until the maternal–neonatal bond is established.
- Other causes of agalactia accompanied by enlargement of the mammary gland include inherited inverted teats and blind teats caused by necrosis of the teats occurring when the gilt was a piglet. These are readily obvious on clinical examination. The sharp needle teeth of piglets may cause the sow to refuse to suckle her piglets. The sow attempts to suckle but leaps up suddenly, grunting and snapping at the piglets. The piglets squeal and fight to retain a teat, thus causing more damage to the teats, which is obvious on clinical examination. Other causes of agalactia accompanied by systemic illness include retained piglets and infectious disease such as outbreaks of transmissible gastroenteritis and erysipelas. The common causes of agalactia in pigs in which there is lack of mammary development include ergotism, immature gilts, and inherited lack of mammary development.

## TREATMENT

Most affected sows will recover within 24 to 48 hours if treated with a combination of antimicrobials, oxytocin, and antiinflammatory agents. The treatment should begin when the temperature reaches  $39.4^\circ\text{C}$  ( $102.9^\circ\text{F}$ ).

Antimicrobials are indicated in most cases because infectious mastitis and metritis are two common causes of the disease. The choice is generally determined by previous experience in the herd or region, but broad-spectrum antimicrobials are indicated because *E. coli* and *Klebsiella* spp. are the most common pathogens involved. They should be given daily for at least 3 days. Usually ampicillin, tetracyclines, trimethoprim-sulfonamide, or enrofloxacin is used.

As soon as possible after the disease is recognized every effort must be made to restore normal mammary function through the use of oxytocin and warm water massaging of the affected mammary glands.

Oxytocin 30 to 40 U intramuscularly or 20 to 30 U intravenously is given, frequently, to promote the letdown of milk. If there is a beneficial response the piglets should be placed on the sow if she is willing to allow them to suck. This will assist in promoting milk flow. Massage of the mammary glands with towels soaked in warm water and hand milking for 10 to 15 minutes every few hours may assist in reducing the swelling and inflammation and promote the flow of milk. It will also relieve the pain and encourage the sow to suckle her piglets. Intramuscular injections of oxytocin may be repeated every hour, along with massaging of the glands with warm water. Failure of milk letdown or a low response following the use of oxytocin may be caused by a reduced sensitivity of the sow to oxytocin during the first week of lactation. In the normal, healthy sow the peak response to oxytocin occurs in the second week of lactation and gradually decreases to a low response by the eighth week.

Oxytocin has an effect for about 14 minutes, whereas the long-acting analog has an effect for about 6 hours. Preliminary results of its use in agalactic sows indicate superior results compared with oxytocin.

Antiinflammatory agents are commonly used for their antiinflammatory effect but are rarely used on their own; flunixin meglumine has been shown to be beneficial as well as ketoprofen<sup>18</sup> to alleviate pyrexia and endotoxemia. Recently meloxicam and oxytocin were shown to reduce mortality compared with flunixin. Plasma cortisol levels are increased in the experimental disease and for this reason may be contraindicated. However, field reports suggest that their use along with antimicrobials and oxytocin provides a better response than when they are not used. Corticosteroids used alone do not appear to prevent the disease or enhance recovery. To be effective they must be used in combination with antimicrobials and oxytocin.

Dexamethasone at the rate of 20 mg intramuscularly daily for 3 days for sows weighing 150 to 200 kg has been recommended.

Sows with toxemia almost invariably dehydrate, so fluid therapy is essential.<sup>19</sup>

## Supplementation of Piglets

The hypoglycemic piglets must be given a supply of milk and/or balanced electrolytes and dextrose until the milk flow of the sow is resumed, which may take 2 to 4 days, and most importantly they must be kept warm until body reserves are reestablished. Piglets should receive 300 to 500 mL of milk per day divided into hourly doses of 40 to 50 mL given through a 12- to 14-French plastic tube passed orally into the stomach. A solution of balanced electrolytes containing 5% glucose can also be given for 1 to 2 days if a supply of cows' milk is not available. Intraperitoneal injection of 15 ml of 5% glucose will prevent starvation. Condensed canned milk diluted with water 1:1 is a satisfactory and readily available supply of milk. In severe cases in which the return to milk production and flow are unlikely, the piglets should be fostered onto other sows. If these are unavailable, the use of milk substitute fortified with porcine gamma globulin is recommended to prevent the common enteric diseases. This is discussed under colibacillosis. Many more piglets are treated for diarrhea when the sows are treated for MMA, perhaps up to 19% compared with up to 9% normally.

## CONTROL

It is necessary for modern pig farms to develop control measures<sup>6,20</sup> and to assess the six major areas outlined previously.<sup>21</sup> It has been difficult to develop a rational approach to control because the disease has been considered to be a complex syndrome caused by several different factors. However, the control of infectious mastitis would seem to be of major importance. The routine use of antibiotics and oxytocin without indication does not appear to be helpful. Farrowing crates should be vacated, cleaned, disinfected, and left vacant for a few days before pregnant sows are transferred from the dry sow barn and placed in the crates. Pregnant sows should be washed with soap and water before being placed in the crate. Farrowing crates must be kept clean and hosed down if necessary, particularly a few days before and after farrowing to minimize the level of intramammary infection. In problem herds, it may be necessary to wash and disinfect the skin over the mammary glands immediately after farrowing. All-in/all-out in the farrowing area with proper cleaning and disinfection facilitated by batch farrowing will reduce the disease. An opportunity for exercise will help, because under outdoor conditions (sows in paddocks) the condition is rare.

To minimize the stress to the sow of adjusting to the farrowing crate and the farrowing facilities, the sow should be placed in



the crate at least 1 week before the expected date of farrowing.

The nature and composition of the diet fed to the sow while in the farrowing crate should not be changed. To minimize the risk of toxic agalactia, it is recommended that the daily feed allowance be related to body condition score. It may be necessary to reduce the feed to 1 kg/day (from 100 days' gestation) before farrowing. The daily intake (compared with the intake during the dry period) may be increased on the day after the sow has farrowed and in increments thereafter as the stage of lactation proceeds. The inclusion of bran at the rate of one-third to one-half of the total diet for 2 days before and after farrowing has been recommended to prevent constipation. In some herds the use of lucerne meal or other vegetable protein at the rate of 15% of the diet may help control the disease. However, under intensified conditions it may be impractical to prepare and provide these special diets on a regular basis. Although field observations suggest that a bulky diet at the time of farrowing will minimize the incidence of toxic agalactia, there is little scientific evidence to support the practice.

Antimicrobial agents used prophylactically have apparently been successful in controlling some outbreaks. A trimethoprim-sulfadimidine and sulfathiazole combination at 15 mg/kg in feed from day 112 of gestation to day 1 after farrowing may reduce the prevalence. Using oxytocin early may also help. In a recent study where *E. coli*, streptococci, and staphylococci were the most cultured pathogens, marbofloxacin (10% solution) was found to be superior to amoxicillin. All *E. coli* were susceptible to the former, but 32% were resistant to the latter antibiotic.

The use of prostaglandins for the induction of parturition in sows has not been associated with a marked consistent change in the incidence of the disease. Some field trials have shown a reduction, whereas others have had no effect.

#### FURTHER READING

- Martineau G-P, et al. Postparturient dysgalactia syndrome: a simple change in homeorhesis. *J Swine Health Prod.* 2013;21:85-95.
- Ringarp N. A post-parturient syndrome with agalactia in sows. *Acta Vet Scand Suppl.* 1960;7:1-153.

#### REFERENCES

1. Foisnet A, et al. *J Rech Porcine France.* 2010;42:15.
2. Foisnet A. PhD thesis Univ. Rennes France. 2010; 250.
3. Gerjets I, Kemper N. *J Swine Health Prod.* 2009;17:97.
4. Gerjets I, et al. *Vet Microbiol.* 2011;152:361.
5. Larsen I, Thorup R. *Proc Int Pig Vet Soc.* 2006;256.
6. Papadopoulos GA. PhD thesis Ghent Univ. 2008; 229.
7. Papadopoulos GA, et al. *Vet J.* 2010;184:167.
8. Oliviero C, et al. *Anim Reprod Sci.* 2009;119:85.
9. Cowart RP. Parturition and dystocia in swine. In: Youngquist RS, Threlfall WR, eds. *Large Animal Theriogenology.* St. Louis: Saunders; 2007:778.
10. Kopinski J, et al. *Aust Vet J.* 2007;85:169.
11. Martel G, et al. *Livestock Sci.* 2008;116:96.
12. Solignac T. *Porc Mag.* 2008;424:133.
13. Solignac T, et al. *Proc Int Cong Pig Vet Soc.* 2010;124.
14. Van den Brand H. *Proc 7th Int Cong Pig Vet Soc.* 2006;177.
15. Boren CA, Carlson MS. *Arbeitsr.* 2006;100:14.
16. Foisnet A, et al. *J Anim Sci.* 2010;88:1672.
17. Bories P, et al. *J Rech Porcine France.* 2010;42:233.
18. Sabatate D, et al. *Pig J.* 2012;67:19.
19. Reiner G, et al. *Tierarztl Praxis.* 2009;37:305.
20. Maes D, et al. *Tierarztl Praxis.* 2010;1:15.
21. Martineau G-P, Morvan H. *Les Mal Prod.* 2010;18:514.

**DISEASES OF COMPLEX OR****UNDETERMINED ETIOLOGY 2003**

- Cold Cow Syndrome 2003  
 Recumbency in Horses of Undetermined Etiology 2003  
 Thin Sow Syndrome 2006  
 Wild Boar as Vectors for Infectious Diseases 2007

**MULTI-ORGAN DISEASES DUE TO BACTERIAL INFECTION 2011**

- Anthrax 2011  
 Bovine Tuberculosis 2015  
 Tuberculosis Associated With *Mycobacterium tuberculosis* 2023  
 Mycobacteriosis Associated With *Mycobacterium avium intracellulare* Complex and With Atypical Mycobacteria 2024  
 Yersiniosis 2025  
 Tularemia 2027  
 Melioidosis 2029  
 Heartwater (Cowdriosis) 2031  
*Histophilus* Septicemia of Cattle (*Histophilus somni* or *Haemophilus somnus* Disease Complex) 2033  
 Septicemia and Thrombotic Meningoencephalitis in Sheep Associated With *Histophilus somni* 2038  
 Tick Pyemia of Lambs (Enzootic Staphylococcosis of Lambs) 2039  
 Septicemic Pasteurellosis of Cattle (Hemorrhagic Septicemia) 2040  
 Pasteurellosis of Sheep and Goats 2042  
 Pneumonic Pasteurellosis Affecting Wildlife 2043  
 Pasteurellosis of Swine 2043  
*Streptococcus suis* Infection of Young Pigs 2045  
 Streptococcal Lymphadenitis of Swine (Jowl Abscesses, Cervical Abscesses) 2051  
 Erysipelas in Swine 2051  
*Actinobacillus* Septicemia in Piglets 2056  
 Klebsiella Pneumoniae Septicemia in Pigs 2057  
 Chlamydial Infection in the Pig 2057
- MULTI-ORGAN DISEASES DUE TO VIRAL INFECTION 2058**
- Foot-and-Mouth Disease (Aphthous Fever) 2058  
 Rift Valley Fever 2067  
 Bluetongue 2069  
 Malignant Catarrhal Fever (Bovine Malignant Catarrh, Malignant Head Catarrh) 2076

- Malignant Catarrh in Pigs 2080  
 Jembrana Disease 2080  
 Bovine Ephemeral Fever 2081  
 Nairobi Sheep Disease 2084  
 Wesselsbron Disease 2084  
 Caprine Herpesvirus-1 Infection 2086  
 Equine Viral Arteritis 2087  
 African Horse Sickness 2091  
 Equine Encephalosis 2097  
 Getah Virus Infection 2097  
 Classical Swine Fever (Hog Cholera) 2098  
 African Swine Fever 2110  
 Porcine Circovirus–Associated Disease 2117  
 Torque Teno Virus 2134  
 Nipah 2135  
 Tioman Virus 2136  
 Porcine Retroviruses 2136  
 Menangle 2136  
 Japanese B Encephalitis (Japanese Encephalitis) 2136  
 Reston Virus 2137  
 Bungowannah Virus 2137  
 Porcine Parvovirus 2137  
 Novel Porcine Parvoviruses 2137

**MULTI-ORGAN DISEASES DUE TO PROTOZOAL INFECTION 2137**

- Sarcocystosis (Sarcosporidiosis) 2137  
 Toxoplasmosis 2140  
 Theileriosis 2144  
 East Coast Fever (ECF) 2145  
 Tropical Theileriosis (Mediterranean Coast Fever) 2148

**MULTI-ORGAN DISEASES DUE TO TRYPANOSOME INFECTION 2150**

- Nagana (Samore, African Trypanosomiasis, Tsetse Fly Disease) 2150  
 Surra (Mal De Caderas, Murrina) 2156

**MULTI-ORGAN DISEASES DUE TO FUNGAL INFECTION 2158**

- Protothecosis and Chlorellosis (Algal Bacteremia) 2158  
 Coccidioidomycosis 2159  
 Paracoccidioidomycosis (Paracoccidioides Infection) 2159  
*Rhodotorulua* spp. Infection 2159  
 Histoplasmosis 2159  
 Cryptococcosis (European Blastomycosis, Torulosis) 2160  
 North American Blastomycosis 2160

**MULTI-ORGAN DISEASES DUE TO METABOLIC DEFICIENCY 2161**

- Sodium and/or Chloride Deficiency 2161

- Magnesium Deficiency 2162  
 Copper Deficiency 2163  
 Riboflavin Deficiency (Hyporiboflavinosis) 2176  
 Choline Deficiency (Hypocholinosis) 2176

**MULTI-ORGAN DISEASES DUE TO TOXICITY 2176**

- Snakebite 2176  
 Bee and Wasp Stings (*Hymenoptera*) 2179  
 Red Fire Ant Stings (*Solenopsis invicta*) 2179  
 Moths 2179  
 Sweating Sickness (Tick Toxicosis) 2179  
 4-Aminopyridine Toxicosis 2180  
 Cadmium Toxicosis 2181  
 Chromium Toxicosis 2181  
 Cobalt Toxicosis 2181  
 Primary Copper Toxicosis 2182  
 Toxicosis from Dried Poultry Wastes 2185  
 Toxicosis from Defoliants 2185  
 Toxicosis from Fungicides 2185  
 Toxicosis from Herbicides 2186  
 Hydrocarbon Toxicosis 2187  
 Iron Toxicosis 2188  
 Toxicosis from Feed Additives 2189  
 Toxicosis from Miscellaneous Farm Chemicals 2189  
 Toxicosis from Seed Dressings 2190  
 Toxicosis from Miscellaneous Rodenticides 2190  
 Sulfur Toxicosis 2191  
 Vanadium Toxicosis 2193  
 Toxicosis from Wood Preservatives 2193  
 Zinc Toxicosis 2194  
 Diterpenoid Alkaloid Toxicosis 2196  
 Ergotism 2198  
 Neotyphodium (*Acremonium*) spp. Toxicosis 2199  
 Fescue Toxicosis 2199  
 Fumonisin Toxicosis 2200  
 Glucosinolate Toxicosis 2202  
 Miscellaneous Mycotoxins 2204  
 Mushroom Toxicosis 2204  
*Phalaris* spp. (Canary Grass) Toxicosis 2205  
 Toxicosis from Plant Phenols (Gossypol and Tannins) 2206  
 Gossypol 2206  
 Tannins 2207  
 Miscellaneous Plant Toxicosis 2207  
 Toxicosis From Brewer's Residues 2212  
 Trichothecene Toxicosis 2213  
 Triterpene Plant Toxicosis 2214

## Diseases of Complex or Undetermined Etiology

### COLD COW SYNDROME

Cold cow syndrome is a herd disease problem reported only from the United Kingdom in the early 1980s in cows freshly turned out onto lush pasture with a high (27% to 43%) soluble carbohydrate content. There is a high morbidity (up to 80%) and a large number of outbreaks in an area. The syndrome includes hypothermia, dullness, inappetence, agalactia, and profuse diarrhea. Affected cows feel cold to the touch. Some have perineal edema; some collapse. The herd milk yield falls disastrously, but there is a quick return to normal if the cows are moved to a different field. The problem may occur on the same pasture each year and recur if the cows are returned to the same pasture. There is no obvious clinicopathologic abnormality. It is postulated that the syndrome might be a result of zearalenone or related metabolites produced by microfungi in the pasture.

### RECUMBENCY IN HORSES OF UNDETERMINED ETIOLOGY

Diagnosis and management of adult horses that are recumbent can be challenging. The large size of adult horses, the variety of conditions that can cause recumbency, the difficulty in performing a thorough clinical examination, and the need for prolonged and intensive care all present formidable obstacles to management of recumbent horses. Causes of prolonged (>8 h) recumbency in horses are listed in Table 21-1. Other causes of acute recumbency of shorter duration are usually obvious on initial examination.

### EPIDEMIOLOGY

The epidemiology of recumbent horses is covered in detail in the sections dealing with each of the specific diseases, and information on large series of recumbent horses is sparse. Overall, for 148 horses treated in a referral veterinary hospital with excellent resources and expertise to manage recumbent horses, there were 109 nonsurvivors and 39 survivors (case-fatality rate of 74%). Odds of death within the first 3 days of hospitalization increased with longer duration of clinical signs before presentation, with horses showing clinical signs for over 24 hours being 4.16 (95% confidence interval [CI] 1.04 to 16.59) times more likely to die; presence of band neutrophils (odds ratio [OR] 7.9, 95% CI 1.39 to 45.5); not using the sling (OR 4, 95% CI 1.1 to 15.7); and horses that were unable to stand after treatment (OR 231, 95% CI 23 to 2341). Increasing cost was associated with lower odds of death (OR 0.96, for each additional \$100 billed, 95% CI 0.93 to 0.99), likely because of greater financial resources increasing the chance of success.<sup>1</sup>

There does not appear to be any breed, age, or sex distribution beyond that anticipated for the specific diseases.

### EXAMINATION OF THE RECUMBENT HORSE

#### History

Careful questioning of the horse's attendants can reveal valuable information regarding the cause of recumbency. Causes such as observed trauma, foaling, and excessive unaccustomed exercise are readily determined from the history. In addition to inquiries about the cause of the recumbency, estimates of the duration of recumbency should be obtained from the attendants. This can often be best elicited by asking when the horse was last observed to be standing. A history of recent illness, abnormal behavior or unusual use immediately before the horse became recumbent is useful. The horse's age, sex, breed, and use should be determined. Information regarding management, vaccination and deworming status, feeding, and health of other horses can be revealing. Outbreaks of recumbency suggest either an infectious (equine herpesvirus-1) or toxic (botulism, ionophore) cause. Questions should be directed toward discerning the cause of the horse's recumbency rather than collecting information.

#### Physical Examination

Physical examination of recumbent horses is challenging but should be as complete as practical and safe. The examination should begin with a general assessment of the horse and its surroundings and can be directed at answering a series of questions:

- Are the surrounding conditions safe for the horse and people? Is the footing sound?
- Is there evidence of the horse struggling or thrashing?
- Has the horse defecated and urinated recently?
- Is there evidence of exposure to toxins or physical evidence of the reason for recumbency?

Examination of the horse should begin with measurement of heart rate, respiratory rate and temperature (rectal temperature might not be accurate if there is dilation of the anus), examination of mucous membranes and an assessment of its hydration, body condition and level of consciousness. The horse should be thoroughly examined for evidence of trauma. Although the examination should be complete, initial examination of cases for which the cause of recumbency is not immediately obvious should focus on the nervous and musculoskeletal systems.

- Is the horse alert and able to sit in sternal recumbency, or is it unconscious and in lateral recumbency? Can the horse rise with assistance?
- Is the horse's mentation normal?

- Are there any spontaneous voluntary or involuntary movements?
- Can the horse eat and drink?
- Are the cranial nerves normal?
- Is there evidence of trauma to the head or neck?
- Is there evidence of paresis or paralysis? Are only the hindlimbs involved, or are both the hindlimbs and forelimbs involved?
- Are the peripheral reflexes normal (withdrawal, patellar, cervicofacial, cutaneous, anal, penile)?
- Is cutaneous sensation present in all regions? If not, what are the anatomic boundaries of desensitized areas?
- Is the position of the limbs normal? Is there evidence of crepitus, swelling, or unusual shape of the limbs or axial skeleton?
- Are the horse's feet normal? Does it have laminitis? What is the response to application of hoof testers?
- Are abnormalities detected on rectal examination (fractured pelvis, distended bladder, fecal retention, pregnancy), provided that it is safe to perform one?

Other body systems should be evaluated as indicated or necessary. The heart and lungs should be auscultated, although detecting abnormal lung sounds in a recumbent horse is difficult. The horse should be rolled and thus a complete examination can be performed. Assisting the horse to stand using a rope tied to the tail and thrown over a rafter, or preferably using a sling, can be useful in assessing the severity of the horse's illness (i.e., can it stand at all?) and in facilitating a complete physical examination. If there is a suspicion that the horse has colic, a nasogastric tube should be placed to check for accumulation of liquid gastric contents, a rectal examination performed, and peritoneal fluid collected.

**Ancillary diagnostic** testing includes radiography of limbs and/or axial spine as indicated by the history or physical examination, myelography if a compressive lesion of the cervical spinal cord is suspected, endoscopic examination of the pharynx and guttural pouches (especially in horses with a history of falling; see section on rupture of the longus capitis muscle), ultrasonography of the chest and abdomen, collection of cerebrospinal fluid, and electromyography.

Hematologic abnormalities are sometimes reflective of the causative disease. Serum **biochemical abnormalities** are reflective of the causative disease and in addition are influenced by muscle damage caused by the horse being recumbent (increased creatine kinase and aspartate aminotransferase activity), inappetent (increased total and indirect bilirubin and triglyceride concentrations), and unable to drink or gain access to water (increased serum urea nitrogen, creatinine, sodium, chloride, total protein, and



Table 21-1 Causes and diagnostic features of recumbency of more than 8 hours in duration in adult horses

Cause	Clinical signs and diagnosis	Treatment	Prognosis and comments
<b>Neurologic disease</b>			
Botulism <sup>3</sup>	Horse alert. Flaccid paralysis, dysphagia, weak corneal or palpebral reflex.  Often multiple animals affected. Toxin isolation in mice.	Administration of specific antitoxin or multivalent antitoxin.  Supportive care.	Can require prolonged treatment. Prognosis poor for recumbent horses.
Tetanus	Horse alert. Rigid paralysis. Signs worsened by stimuli. Often history of recent wound and lack of vaccination.	Tetanus antitoxin (IV or intrathecally). Penicillin. Wound debridement. Sedation (acepromazine, chloral hydrate). Minimize stimulation (dark, quiet stall).	Guarded prognosis.
Trauma—vertebral	Alert horse. Signs depend on site of lesion. Can be difficult to detect vertebral fractures in adult horses. Radiography.	None specific.	Poor prognosis.
Trauma—cranial	Unconscious or severely altered mentation. Seizures. Head wounds. Blood from ears and nostril. Imaging (radiography, CT, MRI).	Antiinflammatory drugs including flunixin meglumine, phenylbutazone, corticosteroids. Drugs to reduce swelling (mannitol and hypertonic saline). Control of seizures (diazepam, midazolam, barbiturates). Heroic craniotomy.	Very poor prognosis.
Cervical vertebral instability	Alert horse. Acute-onset ataxia and recumbency. Young horse (<4 years old). Radiography and myelography.	Antiinflammatory drugs. Rest. Surgical vertebral stabilization.	Poor prognosis.
Vestibular disease	Normal to depressed, depending on cause. Signs of vestibular disease include circling and falling to one side, head tilt, and nystagmus. Diagnosis by endoscopic examination of guttural pouches, radiography of skull, and examination of CSF.	Antibiotics, antiinflammatory drugs. Surgical or medical treatment of guttural pouch disease.	Poor to guarded prognosis.
Equine herpesvirus-1 myoencephalopathy	Usually alert horse. Recumbency follows period of posterior ataxia with fecal and urinary incontinence. Fever in early stages of disease. CSF xanthochromic. Viral isolation or detection of virus by PCR. Serology. Often multiple horses affected.	Supportive care. Valacyclovir or similar drug in early stages.	Guarded prognosis. Affected horses can be infectious.
Arboviral encephalitis (Eastern, Western, West Nile, Japanese B encephalitis)	Alert horse or altered mentation, depending on the disease. CSF consistent with inflammation. Viral isolation or detection by PCR. Serology.	Supportive care. Dexamethasone for West Nile encephalitis.	Epidemiology is characteristic. Prognosis is poor for recumbent horses. Vaccines available.
Migrating parasite larvae	Mentation depends on anatomic site of parasite. Eosinophils in CSF.	Ivermectin 400 µg/kg orally. Corticosteroids.	Sporadic disease.
Neoplasia (melanoma, lymphosarcoma, cholesterol granuloma)	Alert horse. Signs of spinal cord compression. Diagnosis by imaging (radiography, myelography, CT). CSF usually normal.	No specific treatment.	Hopeless prognosis.
Equine motor neuron disease	Alert horse. Good appetite. Profound muscle weakness and atrophy. Prolonged periods of recumbency but usually able to stand when stimulated.	Supportive care. Vitamin E.	Guarded to poor prognosis. Lifelong disease.
Equine protozoal myeloencephalitis	Variable mentation and signs of neurologic disease. Diagnosis based on neurologic examination and results of Western blot of CSF or serum.	Antiprotozoal medications.	Guarded to fair prognosis.
Rabies	Variable mentation. Protean signs of neurologic disease. Important zoonosis. Diagnosis by immunofluorescent antibody testing of brain.	No treatment. If suspected, then appropriate barrier isolation measures must be instituted until the horse dies or recovers, or another diagnosis is confirmed.	Rare cause of recumbency in horses.
Postanesthetic myelopathy	Acute-onset posterior paresis evident on recovery from general anesthesia.	Supportive care.	Poor to hopeless prognosis.
<b>Musculoskeletal disease</b>			
Acute rhabdomyolysis (exertional, atypical)	Alert horse. History of unaccustomed or strenuous exercise. Painful. Sweating. Firm painful muscles. Pigmenturia.  High CK and AST activity in serum.	Fluid diuresis. Pain control. Supportive care.	Guarded to fair prognosis. Can recur. Can progress to acute renal failure.

**Table 21-1** Causes and diagnostic features of recumbency of more than 8 hours in duration in adult horses—cont'd

Cause	Clinical signs and diagnosis	Treatment	Prognosis and comments
Laminitis	Alert horse. Assumes sternal recumbency easily. Bounding digital pulses. Pain on application of hoof tester to feet.	Pain control. Corrective shoeing.	Guarded to poor prognosis for long-term care.
Fracture of long bone or pelvis	Horse usually able to stand on three legs. Bilateral fracture of femurs. Diagnosis by physical examination and radiography.	Euthanasia.	
Foaling paralysis (obturator nerve paresis)	Dystocia. Mare unable to stand after difficult foaling. Legs excessively abducted.	Supportive care. Antiinflammatory drugs. Sling horse.	Guarded prognosis.
Bilateral femoral nerve paresis	Occurs in horses suspended by the hind limbs during anesthesia.	Supportive care.	Guarded prognosis.
Hyperkalemic periodic paralysis	Alert horse. Anxious. Muscle fasciculations. Muscle weakness. High serum potassium concentration. Electromyography. Unusual for recumbency to persist for < 1–2 hours. Diagnosis by detection of appropriate genome.	Administration of dextrose or calcium solutions. Prevention by administration of acetazolamide, feeding low-K <sup>+</sup> diet and selective breeding.	Guarded to good prognosis. Lifelong care needed.
<b>Environmental</b>			
Heat stress/exhaustion	Depressed mentation. Compatible history of exercise in hot and humid conditions or exposure to extreme heat. Hyperthermia.	Rapid cooling. Administration of fluids.	Guarded to poor prognosis. Death often associated with DIC.
Hypothermia	Depressed mentation. History of exposure to extreme cold. Hypothermia.	Warming. Prolonged care necessary.	Guarded to poor prognosis.
Lightning strike	Horses at pasture. History of electrical storm activity. One or more horses can be affected. There can be evidence of burns, fractures of long bones or the axial skeleton, or vestibular disease.	Supportive care. Euthanasia for animals with severe disease.	
Gunshot wounds	Horses at pasture. Often during hunting season. Can be malicious. Physical examination variable. Entry hole and exit hole can be difficult to identify.	Supportive care, depending on site of wound.	Horses that have been shot and are recumbent have a poor prognosis.
<b>Metabolic</b>			
Starvation, inanition	Alert horse. Grade 1 or 2 of 9 body condition score.	Careful refeeding and supportive care.	Poor to fair prognosis.
Hypocalcemia, hyponatremia	Depressed mentation. Seizures. Confirmed by measurement of serum electrolyte concentrations. Unusual cause of recumbency in adult horses.	Correction of electrolyte deficit. Gradual correction of hyponatremia.	Good prognosis.
Liver disease	Depressed, seizures, head pressing. Jaundice. Elevated serum concentrations of bilirubin, ammonia, and bile acids and increased activity of gammaglutamyl transpeptidase and sorbitol dehydrogenase.	Supportive care. Provision of hydration and nutrition. Correction of hypoglycemia. Administration of lactulose.	Poor prognosis. History of exposure to hepatotoxins.
Hypoglycemia	Seizures. Measurement of blood glucose concentrations. Iatrogenic or malicious, associated with insulin administration. Unusual cause in adult horses.	Administration of glucose intravenously.	
Water deprivation	Variable mentation from normal to seizures. Associated with inadequate water intake (e.g., broken bore or dry tank supplying horses at pasture).	Judicious rehydration. Provision of unrestricted access to water can result in water intoxication.	Cause is usually obvious (lack of access to water). Guarded prognosis.
Senile collapse	Alert horse. Old horse. History of progressive weakness. No other causes of recumbency identified.	Supportive care. Correction of metabolic abnormalities. Provision of good-quality nutrition.	Poor prognosis.
<b>Intoxications</b>			
Ionophores (monensin, salinomycin, etc.)	Alert. Acute-onset colic and muscle weakness. Recumbency. Diagnosis is based on history of exposure and measurement of drug concentrations in blood or tissues, and feed.	Supportive. No specific treatment.	Poor to guarded. Horses surviving the acute episode can have exercise intolerance as a result of persisting myocardial disease.

AST, aspartate transferase; CK, creatine kinase; CSF, cerebrospinal fluid; CT, computed tomography; DIC, disseminated intravascular coagulation; IV, intravenously; MRI, magnetic resonance imaging; PCR, polymerase chain reaction.

albumin concentrations). Cerebrospinal fluid is reflective of any inciting disease but is usually normal.

## MANAGEMENT AND CARE

The principles of care are treatment of the primary disease, prevention of further illness or injury, assisting the horse to stand, and provision of optimal nutrition and hydration. Median duration of hospitalization in one report of 148 horses treated at a referral hospital was 2.8 days (interquartile range of 1.5 to 8 days).<sup>1</sup>

Treatment of the primary disease is covered in other sections of this book. Similarly, maintenance of hydration and electrolyte status is covered elsewhere. Maintenance of normal hydration is sometimes problematic in recumbent horses because of limited access to water and unwillingness to drink. Provision of fresh, palatable water is essential. Intravenous or enteral (nasogastric intubation) administration of fluids and electrolyte solutions might be necessary in some recumbent horses, especially early in their illness.

Horses with diseases that cause recumbency often have problems with fecal and urinary incontinence or retention. Catheterization of the urinary bladder might be necessary to relieve distension in horses with neurogenic upper motor bladder or lower motor bladder dysfunction, or in male horses that are reluctant to urinate when recumbent. Catheterization of the bladder is often repeated. To minimize the risk of iatrogenic cystitis, the procedure should be performed aseptically. Administration of bethanechol might increase detrusor muscle tone and aid urination, and phenoxybenzamine (0.5 mg/kg intravenously over 15 minutes) might decrease sphincter tone in horses with upper motor neurone bladder.

Horses that can eat should be fed a balanced, palatable, and nutritious diet. Tempting horses with reduced appetite with treats such as apples, carrots, and horse treats might stimulate appetite for hay and grain. Horses that are unable to eat should be fed through a nasogastric tube. Slurries of alfalfa pellets or commercial diets can be administered through nasogastric tubes. The maintenance needs of a sedentary 425-kg horse are approximately 15 to 18 Mcal/d. The maintenance needs of a recumbent horse are unknown, but are probably less than that of normal sedentary horses.

## COMPLICATIONS—PREVENTION

A major challenge in managing recumbent horses is preventing further injury. Abnormalities caused by recumbency include abrasions and lacerations, gastric ulceration, corneal ulceration, pneumonia, cystitis, pigmenturia, muscle hemorrhage and tearing, impaction colic, laminitis, and catheter-site infection or inflammation.<sup>1</sup>

Recumbent horses often make repeated efforts to stand, which, although encouraging

to all involved, can result in further injury. An attempt to stand can injure the horse's head, especially the periorbital regions, and skin over bony prominences such as over the wing of the ilium. Minimization of further injury is achieved by use of a sling or tail rope to assist horses to stand; housing in a padded stall with deep, soft bedding (although this can interfere with the horse's ability to stand); and protection of the head and distal limbs with a helmet and bandages, respectively. Recumbent horses kept in well-grassed pasture often do well and have minimal self-inflicted trauma.

Decubital ulcers occur over pressure points, such as the wing of the ilium, point of the shoulder, and zygomatic arch, and can become severe. Recumbent horses that paddle can abrade the skin over limb joints, with subsequent increased risk of septic arthritis. Bandages, helmets, ointments such as silver sulfadiazine paste, and soft bedding minimize but do not eliminate these abrasions. Recumbent horses that cannot or do not voluntarily move from side to side should be rolled every 2 to 4 hours.

Peripheral pressure neuropathy can occur in recumbent horses. The radial nerve and facial nerve are most often affected. Prevention is achieved by use of padded bedding, slings, frequent rolling, and a helmet.

Recumbent horses can sustain muscle damage from pressure on large muscle groups. For large or well-muscled horses this can result in large increases in serum creatine kinase activity and myoglobinuria. Myoglobinuria can cause acute renal failure, although this degree of myoglobinuria in recumbent horses is unusual.

Pneumonia can occur as a result of recumbency. Horses that are dysphagic are at increased risk of aspiration of feed material and saliva, and hence development of aspiration pneumonia. Horses receiving corticosteroids are at increased risk of bacterial and fungal (*Aspergillus* spp.) pneumonia. Although not every recumbent horse should be administered antimicrobials, this is indicated in horses at increased risk of developing pneumonia. Antimicrobials should have a broad spectrum, including activity against *Streptococcus* spp., such as a combination of penicillin and an aminoglycoside.

Slings of horses is labor intensive and requires a sling that is designed for use with horses. Horses that accept being supported by a sling have increased chances of survival (OR of 4 for death for horses not using a sling [1.1% to 16%, 95% CI]) than do horses that cannot or will not use a sling.<sup>1</sup> Horses should not be lifted using hip slings intended for use with cattle. Use of these slings to lift horses by grasping over the wing of each ilium is inhumane and unsuccessful. There are slings designed specifically for use with horses (e.g., Anderson Sling Support Device).<sup>2</sup>

Horses in slings should be closely monitored and not allowed to hang in the sling.

The horses should be assisted to stand in the sling every 6 or 8 hours. The sling should be used to help the horse to get up and provide some support while it is standing, but the horse should not have all its weight borne by the sling for more than a few minutes. Horses that have an excessive amount of weight borne by the sling for a prolonged period of time have trouble breathing and might develop colic, rupture of the urinary bladder, diaphragmatic hernia, or rectal prolapse.

Potentially catastrophic complications include septic arthritis, radial nerve injury, bladder rupture, diaphragmatic hernia, rectal prolapse, colon torsion, and long bone fracture. The risk of these complications can be minimized by the practices detailed previously, but they cannot be eliminated.

## FURTHER READING

Gardner R. Evaluation and management of the recumbent adult horse. *Vet Clin North Am.* 2011;27:527-534.

Pusterla N, et al. How to lift recumbent equine patients in the field and hospital with the UC Davis large animal lift. *AAEP Proceedings.* 2006;52:87-92.

## REFERENCES

1. Winfield LS, et al. *Equine Vet J.* 2014;46:575.
2. Pusterla N, et al. *AAEP Proceedings.* 2006;52:87.

## THIN SOW SYNDROME

### SYNOPSIS

**Etiology** The syndrome is the result of inadequate nutrition and unbalanced nutrition in pregnancy and lactation but may also result from parasitic or chronic infectious disease.

**Epidemiology** Loss of weight to the point of inanition, particularly in first- and second-litter gilts.

**Clinical findings** Inanition.

**Control** Recognition of the relation between voluntary feed intake in pregnancy and lactation; feeding based on condition scores.

Thin cow syndrome is a condition of sows, particularly sows at the end of lactation or in the early dry period where there has been tremendous lactational weight loss and this has not been regained. It was formerly common in outdoor or yard systems, particularly in the United Kingdom, but currently is rarely seen because management practices and nutritional knowledge have advanced markedly. There are a number of causes of wasting and the occurrence of thin sows.

## ETIOLOGY

Historically, the major cause of thin sow syndrome was the complete lack of awareness that sows needed to be fed correctly in pregnancy to prepare for farrowing and in lactation to provide milk for 9 or more piglets consuming 800+ ml of milk per piglet per day.



## EPIDEMIOLOGY

It emerged as a problem in the 1970s as a result of poor understanding of the interrelationship between feed intake in pregnancy and that in lactation. The syndrome is most common in first- and second-litter gilts but can affect all parities when nutrition is inadequate. The voluntary intake of food by sows during lactation is inversely related to the intake in pregnancy. Consequently, sows that are fed at high levels during pregnancy will gain excessive weight during pregnancy but will voluntarily restrict feed intake during lactation and lose excessive weight during lactation. In contrast, sows that are fed what is basically a maintenance ration 2.0 to 2.5 kg (4.5 to 5.5 lbs) of a balanced sow ration during pregnancy will gain adequate weight for conceptus and body growth and during lactation will consume adequate feed for lactation requirements and lose minimal weight in this period. Knowledge of sow nutrition has improved such that major problems with this syndrome should not occur, but there is still a risk of inadequately feeding sows selected for lean genotype and high litter size and weaning weights. First- and second-litter gilts may require more feed to provide for body growth. This was combined with the move to intensive indoor housing of pregnant sows. Penning of sows exacerbated social dominance/submissive relationships.

Modern commercial highly bred sows do not have the subcutaneous fat reserves necessary for outdoor production and thus are prone to body-weight loss in exposed fields and yards. The second major group of causes is environmental. Often sows are kept in yards or arks with minimum straw for bedding, which alleviates to some extent low environmental temperatures. Environmental causes include cold or drafty housing, fluctuating temperatures, too high a temperature in the farrowing house, wet bedding, and lack of drinking water.

Early weaning increases the risk of thin sow syndrome, especially if the nutrition is inadequate. Afflicted animals were often on low-level feeding to avoid obesity.

Parasitic disease, particularly associated with infestation with *Oesophagostomum* spp. and *Hyostrogylus* spp., contributes to wasting in sows and the occurrence of thin sow syndrome.

Thin sows can be a component of the syndrome of infectious diseases such as cystitis and pyelonephritis.

## CLINICAL FINDINGS

Within a herd, thin sow syndrome develops over a period of months and often one or two pregnancy cycles, with a gradually decline in the body condition of the group until 20% to 30% of sows have a low body-condition score. No abnormalities are evident on clinical examination, but the sows fail to regain weight after weaning, particularly sows after

their first litter. The most critical period for weight loss is the first 2 weeks after weaning. Affected sows have a poor appetite but often show pica and excessive water intake and may be anemic.

## CONTROL

### Feeding During Pregnancy

Currently the risk for thin sow syndrome exists where it is assumed that all pregnant sows can be fed a standard amount of ration. Problems are likely to occur when sows are run in groups and fed as a group, where timid sows are likely to be bullied out of their required share of food. Individual feeders or stall feeding, and particularly electronic feeders, will prevent this.

### Feeding During Lactation

The critical issue is to ensure adequate feed and energy intake during lactation. This can be achieved by not feeding to excess during pregnancy, restricting the feed intake of sows in the first few days after farrowing to encourage better feed intake in later lactation, ensuring an adequate and constant supply of water, ad lib feeding during lactation, and providing a high-energy-density lactation diet.

In addition, enclosing the creep with heat for the piglets and thus the farrowing house can be kept at a lower temperature for the sow and controlling parasitic disease will help.

**Condition scoring** is a valuable guide to the feeding of individual sows and for a judgment of feeding practices in the herd as a whole. On a score of 1 to 5, it should be very rare to find sows with condition scores of 1 or 5. The optimum is to have sows entering the farrowing house between condition score 3 and 4 and not less than 2.5 at weaning. First- and second-parity sows in poor condition at weaning are best "skipped" at the first heat and mated on the second heat.

Methods for condition scoring and guidelines can be found at <http://www.defra.gov.uk/animalh/welfare/farmed/pigs/pb3480/pigstoc.htm>.

## WILD BOAR AS VECTORS FOR INFECTIOUS DISEASE

There is an increasing worldwide focus on wild boar and escaped domesticated (feral) pigs as a reservoir of infection for pig diseases of epizootic nature,<sup>1-3</sup> particularly in Europe and the United States, where the hunting fraternity has a vested interest in these animals. Wild animals have great potential as a source of both viral and parasitic diseases, and the wild boar (*Sus scrofa*) is no exception. In many cases, they are shy and retiring, frequently inhabiting woodland, where their numbers are not really appreciated. Where there is a high density, there is a high transmission rate of infection.<sup>4</sup>

There is wide variation in populations in different countries in Europe. It is the second most important wild ungulate in Europe and is important in Germany, France, Spain, Poland, and the Czech Republic; in the United States, they are found in 39 of 50 states.

Wild boar have become increasingly common across Europe because they free range. In Switzerland, the population of wild boar has shown a steady increase over the last 15 years.<sup>5</sup> Commercial pigs have also become increasingly reared outside, so the possibility of disease transmission has increased rapidly. To illustrate this, a recent study in Switzerland of contacts between piggeries and wild boar<sup>6</sup> showed that 5% of the piggeries recorded the presence of cross-bred pigs on their premises. The pigs of the Mangalitz breed were the most at risk of such matings. A study of the risk of such happenings was made,<sup>7</sup> and it showed that the risk was highest when the disease under consideration was spread by aerosol (e.g., African swine fever, classical swine fever) rather than those spread by venereal means (e.g., brucellosis). They can also possibly be a hazard to humans as well.<sup>8</sup>

There is a technique for assessing relative abundance and aggregation.<sup>9</sup>

Overall, the disease situation in the wild boar is not well understood. Various diseases are outlined in the following discussion; the diseases are arranged alphabetically.

## RISK FACTORS

The greater the distance between the outdoor pigs and the managing homestead, the greater the risk of intrusion by wild boar. Unsupervised units are definitely at risk. Close proximity to forest also increases the risk of disease. Piggeries with pasture paddocks are also at considerable risk from wild boar. Commercial hunting sites maintain an overabundant wild boar population.<sup>9,10</sup> The role of fences has been discussed.<sup>11</sup> Concentrated feed sources are a high point of contact, and these fields for outdoor pigs should be effectively fenced. Feral swine require dense vegetation for thermoregulation. They also require areas of surface water and moist areas in which to wallow.

## DISEASE IN GENERAL

Generally, if wild boar are farmed, then the diseases are the same as for domestic pigs.<sup>12</sup> A large study of wild boar in Campania in southern Italy<sup>13</sup> showed that 4.4% were positive for *Brucella* spp., 2.6% for *Leptospira interrogans*, 19.3% for *Salmonella* spp., 30.7% for Aujeszky's disease, 7.9% for porcine parvovirus, and 37.7% for porcine reproductive and respiratory virus, but all were negative for African swine fever, classical swine fever. Thus the wild boar does provide a challenge to the domestic pig if there is contact between the two groups.

## AFRICAN SWINE FEVER

Wild boar are natural hosts for African swine fever (ASF), but a survey in Spain in an area previously infected showed neither virus nor antibody,<sup>14</sup> suggesting that permanent recovery of freedom is possible. The outbreak was extremely expensive in Spain and took 30 years to eradicate. This was because of poor biosecurity, *Ornithodoros* ticks, and the presence of wild boar. The study suggested that even in highly dense wild boar populations, such as in the natural parks, ASF circulation cannot be maintained in the absence of other sources of infection. The recent incursion into Russia has shown wild boar affected in Russia, Ukraine, and Lithuania.

## ASTROVIRUSES

Astroviruses were found in the feces of wild boar in Hungary.<sup>15</sup>

## AUJESKY'S DISEASE

Aujesky's disease virus (ADV) has been found in wild boar in Switzerland.<sup>16,17</sup> Culling of wild boar appeared to have no effect on the presence of ADV.<sup>18</sup> It has now largely disappeared from domestic pigs in Europe.<sup>17,19</sup> However, it was found recently in wild boar in Austria.<sup>20</sup> In Germany, two cases of ADV were reported in 2010 and had central nervous system (CNS) signs and nonsuppurative panencephalitis.<sup>21</sup> It is quite a widespread infection in wild boar in some regions. In wild boar, ADV virus is relatively attenuated, and it may have adapted to coexistence with the specific host population. There is also a wide diversity in the wild boar population. It is probably spread by direct contact and not aerosols, especially over long distances. Currently, oral vaccination for wild boar is not an option, but it has been successful experimentally.<sup>22</sup> Fencing is the main control method. Adequate monitoring is the only real control.

## BRUCELLOSIS

The most commonly isolated strain from wild boar in central, eastern, and western Europe is *Brucella suis* biovar 2. It has been found in the Czech Republic, Hungary, Poland, Slovakia, Slovenia and Switzerland,<sup>16,23</sup> and Germany.<sup>24</sup> *B. suis* was found in 28.8% of wild boar, and antibodies were found in 35.8%.<sup>5</sup>

In Croatia, 424 sera from wild boar were looked at in 2003 to 2004,<sup>25</sup> and 27.6% were shown to have seropositivity.

In northeastern Spain, the presence of *Brucella* was studied in wild boar because in Spain the presence of fencing, supplemental feeding, and illegal restocking of wild boar have become common management practices to increase the number of wild boar in an area. They have been bred illegally, cross-bred to domestic pigs, or imported, particularly from France.<sup>26</sup> *Brucella* antibodies were detected in 28/256 samples (10.9%).<sup>27</sup> In the United States, spillover from wild boar to

domestic pigs has been suspected but never been confirmed (in the United States, there are also bison and elk as a possible source), but strain analysis can help in this situation.<sup>28</sup> In this study, *Brucella* isolates were found in 77% of pigs, and 68% had *B. suis* isolates that were biovar 1, with 92% in males and only 34% in females. The authors also pointed out that wild boar could also be a reservoir for *Brucella abortus* in addition to *B. suis*. In the southeastern United States (South Carolina), wild boar have antibodies to porcine parvovirus (PRV), *B. suis*, and porcine circovirus type 2 (PCV2), but not to Swine Influenza virus (SIV) or porcine reproductive and respiratory syndrome virus (PRRS). In North Carolina there was no PRV or *B. suis*, but 1/20 had PRRS, 86/120 had PCV2, and 9/19 had SIV. In other words, infection in wild and feral pigs can be highly local.

## CAMPYLOBACTER SPP.

*Campylobacter* strains were isolated from feral swine in California following an *Escherichia coli* O157:H7 outbreak associated with spinach. Of the swine samples, 40% were positive, and six species were isolated: *coli*, *fetus*, *hyointestinalis*, *jejuni*, *lanienae*,<sup>29</sup> and *sputorum*. The study highlighted the need to keep wild animals clear of vegetable crops and highlighted the potential of infecting humans, particularly hunters.

## CHLAMYDIAE

A high seroprevalence of Chlamydiaceae has been demonstrated in Spain,<sup>30</sup> but until the report of conjunctivitis and ocular lesions,<sup>31</sup> it was not possible to show diseases related to *Chlamydia*. The affected pig had ulcerations and corneal opacities. The lesions in the wild boar were similar to those seen in experimental infections of commercial pigs.

## CLASSICAL SWINE FEVER

In Germany, classical swine fever (CSF) has been present for several decades. The reverse transcription polymerase chain reaction (RT-PCR) has been used to study the evolution to CSF in wild boar.<sup>32</sup> Wild boar were an important source of outbreaks for domestic pigs. Many of the animals were less than 1 year old; thus, the removal of young animals, particularly boar, by hunting reduces the risk of infection. Oral immunization for wild boar was begun in 1993<sup>33</sup> (C-strain bait vaccine<sup>34</sup>) and does help in the control effort.<sup>35</sup> Younger animals are less efficiently vaccinated and are more frequently affected than older boar.<sup>36</sup> Baits may be more attractive to older pigs. The optimal vaccination time for pigs is October/November.<sup>37</sup> Increasing the level of baiting does not seem to improve the situation. Baiting is not of great usage in controlling CSF because of low bait usage (62%); however, it does help to describe patterns of

feral swine movement, facilitate observation, and improve efficacy.<sup>38</sup>

Most of the previous outbreaks in the wild boar population with high-pathogenicity CSF were largely self-limiting,<sup>39</sup> but morbidity and mortality rates in outbreak regions are high. Recent outbreaks have involved the less damaging genotype 2.3 strains. The change from high to moderate virulence prolonged the virus circulation. It is also possible that monitoring and detection have improved, leading to declining severity following an outbreak rather than selection against a highly virulent virus.

The multiplex RT-PCR can be used to differentiate natural CSF from vaccinated animals,<sup>40</sup> and the marker vaccine is safe.<sup>41</sup> The three outbreaks in northeastern France, between 2002 and 2011, occurred in wild boar and a pig herd in Moselle, and the third occurred in wild boar in the Bas-Rhin area. All were genotype 2.3 and were derived from lineages from the Rhineland-Palatinate lineages in Germany. The Bas-Rhin outbreak lasted until 2007, and the virus evolved slightly over this period.<sup>83</sup>

## CRYPTOSPORIDIA

Two species of *Cryptosporidia*, *C. suis* and *C. scrofarum*, were described in wild boar in central Europe (Austria, Czech Republic, Poland, and the Slovak Republic). In none of the detected cases was clinical disease found. In most cases the infections were single, but in some both species were found together. The PCR was a better detection method than the microscopic.<sup>81</sup>

## ESCHERICHIA COLI

*E. coli* O157:H7 was found in feral swine in central California near spinach fields responsible for disease outbreaks.<sup>42</sup> Not much is known about *E. coli* in wild boar, but it appears to be individual and diverse. In a study in central Europe, it was found that wild boar carried antimicrobial-resistant *E. coli* in their feces. In the wild boar, the level of resistance was 6%. Five multiresistant isolates producing extended-spectrum beta-lactamase (ESBL) were recovered from the wild boar.<sup>89</sup> The detection and characterization of O157:H7 and non-O157 Shiga-toxin-producing *E. coli* in wild boars have been described in wild boar in Spain.<sup>90</sup>

## ERYSIPELAS

In Iberian wild boar the prevalence was 15%,<sup>18</sup> and infection has been described in Spain.<sup>27</sup>

## FASCIOLA HEPATICA

The *Fasciola hepatica* parasite has recently been found in a feral wild boar in Scotland,<sup>43</sup> although it has been described previously in feral Nebrodi black pigs in Sicily, Italy.<sup>44</sup> Occasionally the flukes are found to be adults in the liver, although the pig is considered resistant to the development of liver fluke.

## FOOT-AND-MOUTH DISEASE

Contact with the virus in cattle occurs most commonly at water courses for feral and wild boar.<sup>45</sup>

## HEPATITIS E

Hepatitis E (Hep E) in humans is thought to be associated with eating raw pig meat or wild boar, particularly liver. Hunting is associated with a higher prevalence<sup>46-48</sup> of antibodies in humans. Wild boars in southeastern France may be a source of infection for humans.<sup>46</sup>

There is a high seroprevalence of antibodies to Hep E in forestry workers (31%) and wild boars (14%) in France<sup>49</sup> and in Iberian wild boars.<sup>50</sup> The wild boar prevalence is related to the geographic location. In Italy, there were seropositive wild boar.<sup>51</sup> In Germany, the prevalence in wild boars was studied using liver samples from wild boar, and 14.9% were found to be positive.<sup>52,53</sup> A further study in Germany showed a 29.9% prevalence, but it varied considerably between the regions that were analyzed. All the isolates were genotype 3 (3i, 3h, 3f, and 3e), but the type depended on the hunting spot.<sup>54</sup> It was found in all areas and all regions but more frequently in rural areas. There were three sources of infection: hunting, wild boar meat, and fecal contamination. Even in Japan there is a risk from wild boars.<sup>55</sup> In Spain, 28% of wild boar tested were found to be positive<sup>56</sup> and 12% in the Netherlands.<sup>57</sup> It was found in Croatia,<sup>58</sup> Czechoslovakia,<sup>59</sup> and Sweden.<sup>60</sup> Within these overall prevalence rates, there is evidence of quite high local prevalence rates.<sup>61</sup> The suspicion is that wild boar infection may spill over into the domestic pig population and then into the human population, but there is no proof that this happens.<sup>62</sup> Several studies in Germany have shown hepatitis E virus (HEV) genotype 3 within the wild boar population and in domestic pigs.<sup>52-54,96,97</sup>

## LEPTOSPIRA SPP.

In wild boar, antibodies to *Leptospira* spp. and leptospiral cells have been seen,<sup>63</sup> and they have been detected in Japan.<sup>64,65</sup> Wild boars (15.2%) were found to carry *Leptospira* more commonly than deer, although cases in both have increased rapidly in Japan in recent years. The supposition is that they wallow in the mud to keep cool and can get infected under these conditions. The suggestion is that wild boar leptospirae may prove a hazard to hunters, meat-processing workers, and hunting dogs in Japan. A study in Swedish wild boar suggested that the infection was much less common than in the rest of Europe.<sup>66</sup> In Poland, the level of antibodies detected was 25%, in Germany it was 18%, and in Italy it was 12%.

## LYMPHADENITIS

In a study of lymphadenitis in wild boar in Brazil,  $\beta$ -hemolytic streptococci (10%),

*Mycobacterium* spp. (8.4%), and *Rhodococcus equi* (6.6%) were the most common cause of lesions.<sup>67</sup>

## MYCOBACTERIUM BOVIS

The risk of infection in wild boar is age dependent and correlates with abundance and spatial aggregation.<sup>9</sup> In some parts of Spain, the wild boar is a maximum risk for domestic pigs.<sup>1</sup> In south-central Spain, wild boar tuberculosis (TB) may be the main driver of bovine TB. Culling of 50% of the population of European wild boar (*Sus scrofa*) in south-central Spain showed that *M. bovis* reduced by 21% to 48%. In Portugal, in the 2005 to 2006 hunting season, 18/162 wild boars from 3/8 study areas were positive for *M. bovis*.<sup>68</sup> Detection of *M. bovis* was most consistently associated with variables linked to the wild ungulate's relative abundance; thus, wild boar may be a reservoir for *M. bovis*.

In New Zealand, the transmission of *M. bovis* to cattle occurs through the reservoir of the bush-tailed possum. In those areas where control of the possum was carried out, the level of *M. bovis* in the feral pigs was reduced. The feral pigs do not seem to pass the disease to other pigs.<sup>69</sup> Data from Corsica suggest that wild and domestic animals are in an epidemiologic bovine tuberculosis (bTB) transmission cycle.<sup>70</sup>

Experimental infection of wild boar with *M. avium* subsp. *avium* has been carried out and was similar to the natural disease.<sup>71</sup> The lesions in wild boar are frequently in the thoracic lymph nodes and lungs, suggesting that respiratory infection occurs. In the Iberian Peninsula, it may well be that the wild boar contribute to the persistence of the infection in domestic pigs, depending on the size of the local population.<sup>82</sup> *M. bovis* was first isolated from a feral wild boar in the United Kingdom in 2010,<sup>86</sup> although it had been isolated from farmed wild boar previously; there are now several pockets of wild boar in the United Kingdom countryside. Many lymph nodes, particularly the mandibular, retropharyngeal, and mesenteric, were affected. There was a granulomatous lymphadenitis with small numbers of acid-fast bacteria. Spoligotype 17 was identified and is also found in other wildlife in the area.

The immunopathology of granulomas in naturally infected wild boar has been described.<sup>87</sup> In wild boar, the pattern of infection is contained, not generalized. The majority of granulomas did not have any acid-fast bacteria, and only a few had multinucleate giant cells.

There was a large presence of T cells and macrophages exhibiting a high level of interferon gamma (IFN- $\gamma$ ) activity at all stages of granuloma development. A high level of nitric oxide production from macrophages was also found.

The influence of PCV2 on bTB in wild boar populations has been studied.<sup>88</sup> In

Spain, two of the risk factors for TB in wild boar include the density of the population and the age of the boar. The role of other pathogens has not been investigated. The presence of bTB in 551 hunted wild boar from southwestern Spain was studied. A statistical relationship was found between the prevalence rates of bTB and PCV2. Where PCV2 was highest, so was the occurrence of bTB. Wild boar with PCV2 were also more likely to have generalized lesions.

In a recent study in the United Kingdom of the hotspots for *M. bovis* infections, it was found that infected pigs were found on farms where there was poor biosecurity or where the animals were raised outdoors. In some cases, the strains found in pigs correlated better with the strains found in badgers rather than in cattle, suggesting that pigs could be a sentinel for detecting *M. bovis* in wildlife.<sup>91</sup>

In Spain, the intradermal bovine tuberculin test in wild boar was only approximately 77.4% effective (24/31). The enzyme-linked immunoabsorbent assay (ELISA) has been used more recently and may give a better result in wild boar.<sup>98</sup> Wild boar can act as maintenance hosts,<sup>99</sup> but they are usually regarded as a "dead-end" host.<sup>100</sup> A number of other species of *Mycobacteria* other than *M. bovis* and *M. avium* have been found in domestic pigs and wild boar in Brazil.<sup>101</sup>

## MYCOPLASMA HYOPNEUMONIAE

*Mycoplasma hyopneumoniae* (MH) is common in Swiss wild boar,<sup>72</sup> as detected by RT-PCR. There was little information on enzootic pneumonia (EP) in wild boar until the study in Spain in 2010,<sup>102</sup> which showed that antibodies were detected in 21% of 428 serum samples and in 20% of nasal swabs. MH was detected by nested polymerase chain reaction (nPCR) and in 8% (of 156) of lung samples. No gross lesions were seen in any of the pigs, but histologic lesions were seen in 18 of 63 (29%) of lung samples. The conclusion was that the EP lesions were likely to be subclinical.

## PARASITES

Over 30 species of parasites have been found in wild boars (in particular, flukes, tapeworms, and nematodes are included in this list).

## PORCINE CIRCOVIRUS TYPE 2

PCV2 has a variable prevalence in Europe, but there is a high prevalence in Spain in Iberian wild boar<sup>50</sup> and in Romania.<sup>73,92-94</sup> In Germany, only 0.3% of wild boar were positive compared with 8.7% of domestic pigs.<sup>74</sup> The wild boar had much lower levels of PCV2 load than domestic pigs.

In a study in Korea, the prevalence of PCV2 infection was found to be 4.98% (91/1825).<sup>95</sup> The PCV2 ORF2 sequences belonged solely to subgroups 1A/B and 1C of the PCV2b genotype.



## PORCINE PARVOVIRUS

Porcine parvovirus (PPV) is widespread in wild boar (14% to 77%) depending on the country but does not seem to cause lesions, although it may cause problems to wild boar sows in their first pregnancy in midgestation. The forces that drive the evolution of PPV are unknown. However, it appears that in the presence of antibodies, the neutral selection seems to be more important than adaptive evolution.<sup>103</sup> In wild boar populations, phylogenetic analysis has revealed that PPV is more diverse than in domestic pigs.<sup>104</sup> Thus, wild boar populations may have played a vital part in the emergence of new PPV phenotypes.

## PORCINE REPRODUCTIVE AND RESPIRATORY SYNDROME

In Spain there was a low prevalence of porcine reproductive and respiratory syndrome (PRRS) in wild boar,<sup>18</sup> whereas in Italy<sup>13</sup> and Germany it was quite high,<sup>61</sup> but it is probably not a reservoir status.<sup>27</sup> In China, high-pathogenicity PRRS may be transmitted in hybrid wild boar.<sup>6</sup>

## PORCINE SAPELOVIRUS

Porcine sapelovirus type 1 (PSV1) has recently been isolated from a wild boar in Japan. It was formerly known as porcine enterovirus A.<sup>105</sup>

## SALMONELLA SEROTYPES

Wild boar in northern Italy<sup>75</sup> (1313 boars) were examined, and 326 salmonellae were isolated (24.8%). Thirty different serovars were isolated from three different *Salmonella enterica* spp.

In a study of wild boars in the Latium region of Italy, 10.8% were positive; many serovars were found but *S. typhimurium* was only found in 1.8%. The most important point was that most of these salmonellae carried resistance genes, particularly to sulfonamides (92.5%) sulfonamide-trimethoprim (14.8%), colistin (14.8%), and streptomycin (18.5%), with the others at much lower levels.<sup>85</sup>

Wild boars may act as healthy carriers of a wide range of *Salmonella* species.<sup>76</sup> In a study in Australia of an isolated wild boar population, it was found that there were *Salmonella* spp. in 36.3% of fecal samples and 11.9% of mesenteric lymph nodes.<sup>77</sup> Thirty-nine serovars were found (29 in feces and 24 in the lymph nodes). The transmission is from old to young pigs, possibly through the water features.

Wild boar in Spain, northern Italy, Portugal, and Slovenia<sup>84</sup> have also been found to be seropositive or have had the organism isolated from wild boar populations.

## SWINE INFLUENZA

A survey in the United States showed wide state-to-state variation, with up to 14.4% positive for H3N2 in Texas<sup>106</sup> and with higher prevalence levels in the Carolinas.<sup>107</sup> In a

recent survey, 2% were positive for H1 and 40% for H3.<sup>108</sup> In Germany, 5.2% of pigs had antibodies to both H1N1 and H3N2.<sup>109</sup>

## TOXOPLASMA

A case of congenital toxoplasmosis has been described in a wild boar from Spain.<sup>79</sup> The histopathologic results suggest that the shot sow and her three fetuses all had toxoplasmosis. Myositis was found in many samples and interstitial pneumonia in the fetuses. The absence of cysts is consistent with the experimental infection reported in pigs.<sup>80</sup> The parasite was detected by PCR in nearly all the tissues.

## TRICHINELLA

*Trichinella* has been found in wild boar in Corsica,<sup>78</sup> where the muscle antibody ELISA was positive. It necessitates proper veterinary controls on wild boar meat and proper cooking of meat.

## CONTROL

Tight biosecurity to separate wild boar from domestic pigs is essential to prevent the incursion of disease into the domestic pig herds. Fencing of water tanks is something that is not normally considered, but it should be with wild boar. You can raise water tanks and thus cattle can drink but wild pigs cannot. Similarly, feeding deer with corn also attracts feral pigs.

## REFERENCES

- Naranjo V, et al. *J Vet Microbiol.* 2008;127:1.
- Ruis-Fons F, et al. *Eur J Wildl Dis.* 2008;54:549.
- Munoz P, et al. *BMC Infect Dis.* 2010;10:46.
- Ruis-Fons F, et al. *Vet J.* 2008;176:158.
- Wu N, et al. *J Wildl Dis.* 2011;47:868.
- Wu J, et al. *J Virol.* 2012;86:13882.
- Hartley M, et al. *Eur J Vet Res.* 2010;56:401.
- Meng XJ, Lindsay DS. *Philos Trans R Soc Lond B Biol Sci.* 2009;364:2697.
- Acevedo P, et al. *Epidemiol Infect.* 2007;135:519.
- Gortazar C, et al. *PLoS ONE.* 2010;3:7.
- Lavelle MJ, et al. *J Wildl Manage.* 2012;75:1200.
- Halli O, et al. *Vet J.* 2012;194:98.
- Montagnaro S, et al. *J Wildl Dis.* 2010;46:316.
- Mur L, et al. *Transbound Emerg Dis.* 2012;59:526.
- Reuter G, et al. *Arch Virol.* 2012;157:1143.
- Koppel C, et al. *Eur J Wildl Res.* 2007;58:212.
- Muller T, et al. *Arch Virol.* 2011;156:1691.
- Boadella M, et al. *Prev Vet Med.* 2012;107:214.
- Muller T, et al. *Epidemiol Infect.* 2010;138:1590.
- Steinrikel A, et al. *Vet Microbiol.* 2012;157:276.
- Schultze C, et al. *Berl Munch Tierarztl Wschr.* 2010;123:359.
- Maresch C, et al. *Vet Microbiol.* 2012;161:20.
- Leuenberger R, et al. *Vet Rec.* 2007;160:362.
- Metzel E, et al. *Eur J Wildl Res.* 2007;58:153.
- Wu N, et al. *J Wildl Dis.* 2011;47:868.
- Cvetnic Z, et al. *Rev Sci Tech Off Int Epiz.* 2009;28:1057.
- Closa-Sebastian F, et al. *Eur J Wildl Res.* 2011;57:977.
- Stoffregen WC, et al. *J Vet Diag Invest.* 2007;19:227.
- Schweitzer N, et al. *Foodborne Pathogen Dis.* 2011;8:615.
- Salinas J, et al. *Vet Microbiol.* 2009;135:46.
- Riso D, et al. *J Zoo Wildl Med.* 2013;44:159.
- Depner K, et al. *J Vet Res B.* 2006;53:317.
- Ballesteros C, et al. *Prev Vet Med.* 2011;98:198.
- Kaden V, et al. *Rev Off Int Epizoot.* 2008;25:989.
- Rossi S, et al. *Vet Microbiol.* 2010;142:99.
- Rossi S, et al. *Vet Microbiol.* 2010;142:99.
- Ruden S, et al. *Vet Microbiol.* 2008;132:2938.
- Campbell TA, et al. *Prev Vet Med.* 2012;104:249.
- Lange M, et al. *Prev Vet Med.* 2012;106:185.
- Blome S, et al. *Vet Microbiol.* 2011;153:373.
- Koenig P, et al. *Vaccine.* 2007;25:3391.
- Jay MT, et al. *Emerg Infect Dis.* 2008;13:1908.
- Thompson H, et al. *Vet Rec.* 2009;165:697.
- Capucchio MT, et al. *Vet Paras.* 2009;159:37.
- Cooper SM, et al. *J Wildl Dis.* 2010;46:152.
- Kaba M, et al. *Vet J.* 2010;186:259.
- Kim Y, et al. *J Clin Virol.* 2011;50:253.
- Mansuy JM, et al. *J Clin Virol.* 2009;44:74.
- Carpentier A, et al. *J Clin Path.* 2012;50:2888.
- Boadella M, et al. *Transbound Emerg Dis.* 2012;58:39549.
- Martelli P, et al. *Vet Microbiol.* 2008;126:74.
- Schielke A, et al. *Virology J.* 2012;6:58.
- Kaci S, et al. *Vet Microbiol.* 2008;128:380.
- Adlhoeh C, et al. *Vet Microbiol.* 2009;139:270.
- Toyoda K, et al. *Jap J Gastro Hepat.* 2008;23:1885.
- de Deus N, et al. *Vet Microbiol.* 2008;129:163.
- Rutjes SA, et al. *J Virol Methods.* 2010;168:197.
- Jemersic L, et al. *Ecohealth.* 2011;7(suppl 1):S144.
- Sedlak K, et al. *J Wildl Dis.* 2008;44:777.
- Widen F, et al. *Epidemiol Infect.* 2011;139:361.
- Reiner GC, et al. *Vet Microbiol.* 2009;145:1.
- Wichmann O, et al. *J Infect Dis.* 2008;198:172.
- Jansen A, et al. *Emerg Infect Dis.* 2007;13:739.
- Koizumi N, et al. *Jap J Infect Dis.* 2008;61:465.
- Koizumi N, et al. *J Vet Med Sci.* 2009;71:797.
- Boqvist S, et al. *J Wildl Dis.* 2012;48:492.
- Lara GH, et al. *Res Vet Sci.* 2011;90:185.
- Santos N, et al. *J Wildl Dis.* 2009;45:1048.
- Nugent G, et al. *Epidemiol Infect.* 2012;140:1036.
- Richomme C, et al. *J Wildl Dis.* 2010;46:627.
- Garrida JM, et al. *Vet Microbiol.* 2010;144:240.
- Kuhnert P, et al. *Vet Microbiol.* 2009;152:191.
- Turcitu MA, et al. *Res Vet Sci.* 2011;91:e103.
- Reiner G, et al. *Vet Microbiol.* 2010;145:1.
- Chiari M, et al. *Acta Vet Scand.* 2013;55:42.
- Wachek S, et al. *Foodborne Pathog.* 2010;7:307.
- Ward MP, et al. *Vet Microbiol.* 2013;162:921.
- Richomme C, et al. *Vet Parasitol.* 2010;172:150.
- Calero-Bernal R, et al. *J Wildl Dis.* 2013;49:1019.
- Garcia JL, et al. *Exp Parasitol.* 2006;113:267.
- Nemejc K, et al. *Vet Parasitol.* 2013;197:504.
- Gortazar C, et al. *Mammal Rev.* 2012;42:193.
- Simon G, et al. *Vet Microbiol.* 2013;166:631.
- Vengust G, et al. *J Vet Med B.* 2006;53:24.
- Zottola T, et al. *Comp Immunol Microbiol Infect Dis.* 2013;36:161.
- Foyle KL, Delahay RJ. *Vet Rec.* 2010;doi:10.1136/vr.c2681.
- Garcia-Jimenez WL, et al. *Vet Immunol Immunopathol.* 2013;156:54.
- Risco D, et al. *Transbound Emerg Dis.* 2013;60(suppl 1):121.
- Literak I, et al. *J Appl Microbiol.* 2009;108:1702.
- Sanchez S, et al. *Vet Microbiol.* 2010;143:420.
- Bailey SS, et al. *Vet J.* 2013;198:391.
- Cadar D, et al. *Acta Vet Hung.* 2010;58:475.
- Cadar D, et al. *Virus Genes.* 2011;43:376.
- Cadar D, et al. *Infect Genet Evol.* 2012;12:420.
- An D-J, et al. *Vet Microbiol.* 2014;169:147.
- Baechlein C, et al. *Berl Munch Tierarztl Wschr.* 2013;126:25.
- Wenzel JJ, et al. *J Clin Virol.* 2011;52:50.
- Boadella M, et al. *J Vet Diag Invest.* 2011;23:77.
- Naranjo V, et al. *Vet Microbiol.* 2008;127:1.
- Corner LA. *Vet Microbiol.* 2006;112:303.
- Lara GH, et al. *Res Vet Sci.* 2011;90:185.

102. Sibila M, et al. *Vet Microbiol.* 2010;144:214.  
 103. Streck AF, et al. *J Gen Virol.* 2013;94:2050.  
 104. Cadar D, et al. *Infect Genet Evol.* 2012;12:1163.  
 105. Abe M, et al. *Virus Genes.* 2011;doi:10.1007/s11262-011-0628-2.  
 106. Hall JS, et al. *J Wildl Dis.* 2008;44:362.  
 107. Corn JL, et al. *J Wildl Dis.* 2009;45:713.  
 108. Baker SR, et al. *Vet Rec.* 2011;168:564.  
 109. Kaden V, et al. *Vet Microbiol.* 2008;131:123.

## Multi-Organ Diseases Due to Bacterial Infection

### ANTHRAX

#### SYNOPSIS

**Etiology** *Bacillus anthracis*.

**Epidemiology** Global occurrence and often occurs as outbreaks. Spores survive in soil for many years and disease is enzootic in certain areas. Pastoral outbreaks associated with periods of climatic extremes. Outbreaks also associated with infected feedstuffs.

**Clinical findings** Ruminants and horses—acute/peracute disease characterized by fever, septicemia, and sudden death. This may be accompanied by subcutaneous edematous swellings in horses. More prolonged disease with cellulitis of the neck and throat in swine.

**Clinical pathology** Because of risk for human exposure hematology and blood chemistry are not performed. Demonstration of organism in blood or subcutaneous fluid.

**Necropsy findings** Carcass should not be opened if anthrax suspected; the diagnosis is made from the examination of aspirated carcass blood. Exudation of tarry blood from the body orifices of the cadaver, failure of the blood to clot, absence of rigor mortis and the presence of splenomegaly.

**Diagnostic confirmation** Identification of organism in blood or tissues by polychrome methylene blue stain of smear or by monoclonal antibody-fluorescent conjugates. Culture, Ascoli test, polymerase chain reaction (PCR).

**Treatment** Antibiotics, antiserum.

**Control** Prevention of further spread. Vaccination.

#### ETIOLOGY

*Bacillus anthracis*, a gram-positive, rod-shaped, aerobic, immobile, capsulated, spore-forming bacterium belonging to the family Bacillaceae is the causative agent of the disease.<sup>1</sup> Although the vegetative form of *B. anthracis* is not very robust, the spores persist in the environment for decades, easily withstand cold temperatures, and even survive in dried and salted hides. Sporulation occurs

with exposure of the bacillus to free oxygen, which is the case when it is shed from the host organism into the environment. Although ingested spores readily return to the vegetative state once the host organism is infected, the vegetative form is practically not encountered in the environment. Sporulation of *B. anthracis* requires an environmental temperature range between 12° and 42° C (53–107° F) and does not occur at temperatures below 9° to 12° C (48–53° F).<sup>2</sup>

#### EPIDEMIOLOGY Occurrence

Anthrax is a disease known since ancient times. It probably originated in sub-Saharan Africa and has spread to have a worldwide distribution. During the late nineteenth and early twentieth centuries, anthrax was the infectious disease with the highest case-fatality rate in domestic and wild animals. For instance, in 1923 an anthrax outbreak in South Africa was responsible for the death of an estimated 60,000 animals. The development of the so-called **Sterne vaccine** and the discovery of antibiotics in the middle of the last century provided effective tools to control the disease, which has lost its importance in large parts of the world since then. In recent years, anthrax received increased attention because it is a **potential agent of bioterrorism**. The reality of this threat became apparent after a bioterrorist attack in the fall of 2001 in the United States, when five letters sent by mail containing small amounts anthrax spores contaminated more than 30,000 people, killed 5 people, and infected 17.<sup>3</sup>

Currently anthrax is a sporadic disease in western Europe, North America, and Australia, although there are regions in these parts of the world where the disease remains enzootic. Such areas include specific zones in the North-Western Territories and Alberta in Canada and in eastern North and South Dakota, northwest Minnesota, and southwest Texas in the United States.<sup>1</sup> Anthrax is essentially absent from northern and central **Europe** but remains enzootic in Greece, Turkey, Spain, southern Italy, and Albania. The disease also persists in certain countries of **Latin America**, such as Bolivia, Peru, and Mexico, and is enzootic in Haiti. Endemic regions of **Asia** include the Philippines, South Korea, eastern India, the mountainous region of western China, and Mongolia.<sup>1</sup>

In tropical and subtropical climates with high annual rainfalls, the infection persists in the soil, and thus frequent, serious outbreaks of anthrax are commonly encountered. In some **African countries** the disease occurs every summer and reaches a devastating occurrence rate in years with a heavy rainfall. Wild fauna—including hippos, cape buffalo, and elephants—die in large numbers.

In **temperate, cool climates** only sporadic outbreaks derive from the soil-borne infection. Accidental ingestion of contaminated

bone meal or pasture contaminated by tannery effluent are more common sources. In this circumstance outbreaks are few, and the number of animals affected is small.

#### Source of the Infection

Infection can occur directly from the soil or from fodder grown on infected soil, from contaminated bone meal or protein concentrates, or from infected excreta, blood, or other discharges from infected animals. The initial source is often from old anthrax graves where the soil has been disturbed.

Spread of the organism within an area may be accomplished by streams, insects, dogs, feral pigs, and other carnivores, and by fecal contamination from infected animals and birds. Avian scavengers such as gulls, vultures, and ravens can carry spores over considerable distances, and the feces of carrion-eating birds can contaminate waterholes. Infected wildlife is also a source for domestic animals on common grazing land. Water can be contaminated by the effluent from tanneries, from infected carcasses, and by flooding and the deposition of anthrax-infected soil.

Introduction of infection into a new area is usually through contaminated animal products, such as bone meal, fertilizers, hides, hair, and wool, or by contaminated concentrates or forage. This form of transmission presents a particular danger because it can cause clinical disease silently anywhere, even where anthrax is unknown, and at any time of the year.<sup>1</sup> In recent years as many as 50% of consignments of bone meal imported into the United Kingdom have been shown to be contaminated with the anthrax bacillus. Outbreaks in pigs can usually be traced to the ingestion of infected bone meal or carcasses.

#### Transmission of the Infection

Infection gains entrance to the body by ingestion, inhalation, or through the skin. Although the exact mode of infection is often in doubt, it is generally considered that most animals are infected by the ingestion of contaminated food or water. Microwounds of the mucous membrane of the digestive are thought to serve as portal of entry for *B. anthracis*. The increased incidence of the disease on sparse pasture is thought to be attributable to both the ingestion of contaminated soil and to injury to the oral mucosa facilitating invasion by the organism.

Inhalation infection is thought to be of minor importance in animals, although the possibility of infection through contaminated dust must always be considered.<sup>2</sup> It has been proposed that inhalation of spores can lead to some sort of chronic carriage, with onset of disease any time after inhalation.<sup>2</sup> “Woolsorter’s disease” in humans is a result of the inhalation of anthrax spores by workers in the wool and hair industries, but even in these industries cutaneous anthrax is much more common.

**Biting flies**, mosquitoes, ticks, and other insects have often been found to harbor anthrax organisms, and the ability of some to transmit the infection has been demonstrated experimentally. However, there is little evidence that they are important in the spread of naturally occurring disease, with the exception of tabanid flies. The transmission is mechanical only, and a local inflammatory reaction is evident at the site of the bite. The tendency, in infected districts, for the heaviest incidence to occur in the late summer and autumn may be a result of the increase in the fly population at that time, but an effect of higher temperature on vegetative proliferation of *B. anthracis* in the soil is more likely.

An outbreak of anthrax has been recorded following the injection of infected blood for the purpose of immunization against anaplasmosis. There have been a number of reports of the occurrence of anthrax after vaccination, probably as a result of inadequately attenuated spores. Wound infection with *B. anthracis* occurs occasionally.

## Risk Factors

### Host Risk Factors

The disease occurs in all vertebrates but is most common in cattle and sheep and less frequent in goats and horses. Humans occupy an intermediate position between this group and the relatively resistant pigs, dogs, and cats. In farm animals, the disease is almost invariably fatal, except in pigs, and even in this species the case-fatality rate is high.

Algerian sheep are reported to be resistant and, within all species, certain individuals seem to possess sufficient immunity to resist natural exposure. Whether or not this immunity has a genetic basis has not been determined. The most interesting example of natural resistance is the dwarf pig, in which it is impossible to establish the disease. Spores remain in tissues ungerminated, and there is complete clearance from all organs by 48 hours. The ability to prevent spore germination appears to be inherited in this species.

### Pathogen Risk Factors

Pathogenic strains of *B. anthracis* possess two important virulence factors: the **capsule** and the **toxin complex**, consisting of **three proteins known as protective antigen (PA), lethal factor (LF), and edema factor (EF)**. These virulence factors are encoded in two plasmids, pXO1 (encoding PA, LF and EF) and pXO2 (encoding the capsule). Both plasmids are required for full virulence.

The ability of the bacillus to establish itself in the tissues of the host was found to be inherently dependent on the possession of a capsule. Variants of *B. anthracis* having lost the capsule were also found to have lost their virulence.<sup>4</sup> Although the presence of this polypeptide capsule was found to be an

important factor allowing the bacterium to multiply within the host, its precise mechanism of action is not entirely understood.<sup>2</sup> It was long held that its primary function was to discourage the phagocytic activity of lymphocytes and to neutralize anthracidal substances normally present in tissue, but this is not supported by results of more recent *in vitro* studies.<sup>2</sup> In any case, the capsule appears to facilitate the evasion of the bacillus from the host's immune system, possibly also by protecting surface antigens of the bacterium from exposure to antibodies.

As noted, the **anthrax toxin complex** consists of three synergistically acting proteins: **PA, LF, and edema factor (EF)**. Whereas independently each of these proteins is innocuous, the combination of them provokes death in infected animals. PA appears to be important for the binding to specific target cells and the introduction of LF and EF into these target cells. EF is an adenylate cyclase that triggers the abnormal production of cyclic-AMP, causing altered ion and water movement and thereby resulting in the edema formation that is characteristic of anthrax.<sup>2</sup> Alteration of the c-AMP signaling pathways was shown to disturb activation of immune cells. LF is a zinc-dependent protease that disrupts regulatory pathways in eukaryotic cells associated with phosphorylation. The mechanism through which this disruption leads to the known effects of LF remains to be fully determined.

### Environment Risk Factors

Outbreaks originating from a soil-borne infection always occur after a major climate change, for example, heavy rain after a prolonged drought or dry summer months after prolonged rain, and always in warm weather when the environmental temperature is over 15°C (60°F). Sporulation of the vegetative state of *B. anthracis* shed into the environment rapidly occurs with environmental temperatures above 12°C (53°F), and thus vegetative bacilli are practically not found in the environment.<sup>5</sup> It has been proposed that spores may collect and concentrate in so-called storage areas. Spores have a high surface hydrophobicity, giving them a tendency to clump, become concentrated, and remain suspended in standing water, with further concentration on the soil surface as the water evaporates. This relationship to climate has made it possible to predict "anthrax years."

Other risk factors in the environment include close grazing of tough, scratchy feed in dry times, which results in abrasions of the oral mucosa, and confined grazing on heavily contaminated areas around water holes. Some genotypes appear to persist better in calcium-rich soils and organic soils, and poorly drained soils have risk in endemic areas.

## Economic Importance

In most developed countries, vaccination of susceptible animals in enzootic areas has reduced the prevalence of the disease to negligible proportions on a national basis, but heavy losses may still occur in individual herds. Loss occurs as a result of mortality but also from withholding of milk in infected dairy herds and for a period following vaccination.

## Zoonotic Potential

Anthrax has been an important cause of fatal human illness in most parts of the world, but in developed countries it is no longer a significant cause of human or livestock wastage because of appropriate control measures. However, it still holds an important position because of its potential as a zoonosis, and it is still an important zoonosis in developing countries. It is a **major concern as an agent of bioterrorism** and is listed as a category A agent by the U.S. Centers for Disease Control and Prevention.

An account of an outbreak in a piggery in the United Kingdom should be compulsory reading for veterinary students as an example of the responsibilities of veterinarians in a modern public-health-conscious and litigation-minded community.<sup>6,7</sup> In developing countries, anthrax can still be a major cause of livestock losses and a serious cause of mortality among humans who eat meat from infected animals and develop the alimentary form of this disease, or those who handle infected carcasses.

Cutaneous anthrax has occurred in veterinarians following postmortem examination of anthrax carcasses. The areas at particular risk for infection are the forearm above the glove line and the neck. Infection begins as a pruritic papule or vesicle that enlarges and erodes in 1 to 2 days, leaving a necrotic ulcer with subsequent formation of a central black eschar.

## PATHOGENESIS

Upon ingestion of the spores, infection may occur through defects or microwounds of the mucosa of the digestive tract. Alternatively, infection can occur through skin abrasions or skin lesions (e.g., from biting flies) or inhalation of spores.

From the site of entry spores are transported by macrophages to the regional lymph nodes, where they can enter the bloodstream and spread throughout the rest of the organism; septicemia, with massive invasion of all body tissues, follows.

The severity of the clinical signs depends on the infectious dose, the quality of the bacillary capsule, the amount of toxin produced, and the susceptibility of the host species. The previously mentioned toxin complex produced by *B. anthracis* causes edema and tissue damage, acute renal failure, terminal anoxia, and death resulting from shock. The characteristic terminal



hemorrhage to the exterior from orifices of the animal at death is caused by the action of the toxin on the endothelial cell lining of blood vessels, resulting in breakdown and bleeding.<sup>2</sup>

In pigs, localization occurs in the lymph nodes of the throat after invasion through the upper part of the digestive tract. Local lesions usually eventually lead to a fatal septicemia.

### CLINICAL FINDINGS

The incubation period after field infection is not easy to determine but is probably 1 to 2 weeks.

#### Cattle and Sheep

The disease occurs in a peracute and acute form in cattle and sheep.

The **peracute** form of the disease is most common at the beginning of an outbreak. The animals are usually found dead without premonitory signs, the course being probably only 1 to 2 hours, but fever, muscle tremor, dyspnea, and congestion of the mucosae may be observed. The animal soon collapses, and it dies after terminal convulsions. After death, discharges of blood from the nostrils, mouth, anus, and vulva can occur.

The **acute** form runs a course of about 48 hours. Severe depression and listlessness are usually observed first, although they are sometimes preceded by a short period of excitement. The body temperature is high, up to 42°C (107°F), the respiration rapid and deep, the mucosae congested and hemorrhagic, and the heart rate much increased. No food is taken, and ruminal stasis is evident. Pregnant cows may abort. In milking cows, the yield is very much reduced, and the milk may be bloodstained or deep yellow in color. Alimentary tract involvement is usual and is characterized by diarrhea and dysentery. Local edema of the tongue and edematous lesions in the region of the throat, sternum, perineum, and flanks may occur.

#### Pigs

In pigs, anthrax may be acute or subacute. There is fever, with dullness and anorexia, and a characteristic inflammatory edema of the throat and face. The swellings are hot but not painful and may cause obstruction to swallowing and respiration. Bloodstained froth may be present at the mouth when pharyngeal involvement occurs. Petechial hemorrhages are present in the skin, and when localization occurs in the intestinal wall, there is dysentery, often without edema of the throat. A pulmonary form of the disease has been observed in baby pigs that inhaled infected dust. Lobar pneumonia and exudative pleurisy were characteristic. Death usually occurs after a course of 12 to 36 hours, although individual cases may linger for several days.

#### Horses

Anthrax in the horse is always acute but varies in its manifestations with the mode of infection. When infection is by ingestion, there is septicemia with enteritis and colic. When infection is by insect transmission, hot, painful, edematous, subcutaneous swellings appear about the throat, lower neck, floor of the thorax and abdomen, prepuce, and mammary gland. There is high fever and severe depression, and there may be dyspnea as a result of swelling of the throat or colic as a result of intestinal irritation. The course is usually 48 to 96 hours.

### CLINICAL PATHOLOGY

Hematology and blood chemistry examinations are not conducted because of the risk for human exposure. In the living animal the organism may be detected in a stained smear of peripheral blood. The **reference standard** for diagnosis is the detection, by **microscopic examination**, of a clearly defined metachromatic capsule on square-ended bacilli (often in chains) in a blood smear stained with polychrome methylene blue. The blood should be carefully collected in a syringe to avoid contamination of the environment. When local edema is evident, smears may be made from aspirated edema fluid or from lymph nodes that drain that area. For a more certain diagnosis, especially in the early stages when bacilli may not be present in the bloodstream in great numbers, blood culture or the injection of syringe-collected blood into guinea pigs is satisfactory.

Fluorescent antibody techniques are available for use on blood smears and tissue sections. Monoclonal antibodies are also used to provide specific identification of anthrax organisms.

The Ascoli test can be used to demonstrate antigen in severely decayed tissue samples, and a nested PCR technique has been used to demonstrate antigen in environmental samples; PCR methods can also be used to confirm the identity of bacterial isolates. If other detection methods fail, experimental animal inoculation can be attempted.

As the carcass decomposes and the vegetative forms of *B. anthracis* die, diagnosis by smear is more difficult; an immunochromatographic test for antigen has been developed that has high specificity and does not give positive results in recently vaccinated cattle. In cases where antibiotic therapy has been used, the identification from blood smears or culture may be difficult, and animal passage may be necessary.

Because antibodies develop in the late stage of disease serology will be of use only for retrospective studies and only in species with low susceptibility to *B. anthracis*, such as pigs. In these cases acute and convalescent sera can be assayed for their antibody titer by means of an ELISA.

**Shipping infectious material presents risk for spread of the pathogen and human exposure.** Before planning to ship infectious material to a diagnostic laboratory, local authorities and the diagnostic laboratory should be consulted. The reader is furthermore referred to the guidelines of the World Health Organization (WHO) for the transport of infectious substances.<sup>8</sup>

### NECROPSY FINDINGS

There is a striking absence of rigor mortis, and the carcass undergoes gaseous decomposition, quickly assuming the characteristic “sawhorse” posture. All natural orifices usually exude dark, tarry blood that does not clot. **If there is a good reason to suspect the existence of anthrax, the carcass should not be opened.** If a necropsy is carried out, the failure of the blood to clot, widespread ecchymoses, bloodstained serous fluid in the body cavities, severe enteritis, and splenomegaly are strong indications of the presence of anthrax. The enlarged spleen is soft, with a consistency likened to blackberry jam. Subcutaneous swellings containing gelatinous material and enlargement of the local lymph nodes are features of the disease in horses and pigs. Lesions are most frequently seen in the **soft tissues of the neck and pharynx** in these species.

To confirm the diagnosis on an **unopened carcass**, peripheral blood or local edema fluid should be collected by needle puncture. Because the blood clots poorly, jugular venipuncture may permit sample collection. Smears prepared from these fluids should be stained with polychrome methylene blue and examined. These fluid samples can also be used for bacteriologic culture if smear results are equivocal. The smears should be prepared and interpreted by an experienced and qualified microbiologist.

If decomposition of a carcass is advanced, a small quantity of blood may be collected from the fresh surface of an amputated tail or ear. A portion of spleen is the specimen of choice for bacteriologic culture if the carcass has been opened.

Anthrax is a **reportable disease** in many countries, requiring the involvement of government regulatory agencies when the disease is suspected or when the diagnosis is confirmed. Representatives of these agencies can often facilitate sample collection and transportation to an appropriate laboratory. **If anthrax is suspected, then shipping diagnostic samples via the mail or courier systems is strongly discouraged** (see previous discussion).<sup>8</sup>

### Samples for Confirmation of Diagnosis

- Bacteriology—unopened carcass: blood or edema fluid in sealed, leakproof container; opened carcass: previously described samples plus spleen (local lymph nodes in horses, pigs) in sealed,

leakproof containers (direct smear, culture, bioassay)

- Histology—formalin-fixed spleen/local lymph nodes if carcass has been opened (light microscopy)

**Note the zoonotic potential of this organism when handling the carcass and submitting specimens.**

### DIFFERENTIAL DIAGNOSIS

There are many causes of sudden death in farm animals, and differentiation is often difficult. Diseases where there can be multiple deaths suggestive of anthrax include the following:

- Lightning strike
- Peracute blackleg
- Malignant edema
- Bacillary hemoglobinuria
- Hypomagnesemic tetany

### TREATMENT

Severely ill animals are unlikely to recover, but in the early stages, particularly when fever is detected before other signs are evident, recovery can be anticipated if the correct treatment is provided. Penicillin (20,000 IU/kg BW twice daily) has had considerable vogue, but concerns have been raised in recent years because of the occasional appearance of  $\beta$ -lactamase-producing strains that were thus resistant to penicillin. The range of occurrence rates of penicillin-resistant strains reported in the literature is broad, ranging from 0% to 11.5%.<sup>2</sup> Reports of naturally occurring resistance to penicillin among fresh animal isolates are exceedingly rare.<sup>2</sup> Penicillin has remained the recommended antibiotic in both animals and humans, at least in developing countries, where it is affordable and available almost everywhere. Because of the susceptibility of *B. anthracis* to a broad range of antimicrobials, a wide range of alternative choices exists among them tetracyclines, aminoglycosides, macrolides, and quinolones. It is desirable to prolong treatment to at least 5 days to avoid a recrudescence of the disease.

Antibiotics are effective against *B. anthracis*, but there are currently no effective therapeutic options against toxemia, which persists even after antimicrobial therapy may have eliminated the bacteria.<sup>1</sup>

The treatment of anthrax in livestock is legally prohibited in certain countries. In those countries the destruction of animals with clinical signs of anthrax without spilling of blood is required. Some countries even require the slaughter of the entire herd following a case of anthrax, a procedure that is considered unnecessary and wasteful.<sup>2</sup>

### TREATMENT AND CONTROL

#### Treatment

Penicillin G sodium/potassium (20,000 IU/kg IV every 12h at least as loading dose IV) (R-2)

Procaine penicillin (22,000 IU/kg IM every 12h or 44,000 IU/kg IM q24h) (R-2)

Oxytetracycline (10 mg/kg IV or IM every 24h) (R-2)

Anthrax hyperimmune serum (R-2)

#### Control

Anthrax vaccine (R-1)

Anthrax hyperimmune serum to animals at risk (R-2)

Procaine penicillin (44,000 IU/kg every 24h to animals at risk) (R-2)\*

Oxytetracycline (long-acting formulation 20 mg/kg every 72h to animals at risk) (R-2)\*

\*Antibiotics administered within 7 to 10 days of vaccination with anthrax vaccine will impair efficacy of vaccine.<sup>2</sup>

### CONTROL

The control of meat- and milk-producing animals in infected herds in such a way as to avoid any risk to the human population is a special aspect of the control of anthrax. When an outbreak occurs, the placing of the farm in quarantine, the destruction of discharges and cadavers, and the vaccination of survivors are part of the animal disease control program and indirectly reduce human exposure. Prohibition of movement of milk and meat from the farm during the quarantine period should prevent entry of the infection into the human food chain.

**Disposal of infected material** is most important, and hygiene is the biggest single factor in the prevention of spread of the disease. Infected carcasses should not be opened but immediately burned in situ together with manure, bedding, and soil contaminated by discharges. Deep burial, with an ample supply of quicklime, may also be used but is less desirable because it bears the risk of groundwater contamination. If the carcass and infectious material cannot be disposed of immediately, a liberal application of 5% formaldehyde on the carcass and its immediate surroundings will discourage scavengers.

All suspected cases and in-contact animals must be segregated until cases cease, and for 2 weeks thereafter the affected farm must be kept in quarantine to prevent the movement of livestock. The administration of hyperimmune serum to in-contact animals may prevent further losses during the quarantine period, but prophylactic administration of a single dose of long-acting tetracycline or penicillin is a much commoner tactic. Because currently used anthrax vaccines contain live attenuated

bacteria, they should not be used in combination with antimicrobial therapy.

**Disinfection of premises**, hides, bone meal, fertilizer, wool, and hair requires special care. When disinfection can be carried out immediately, before spore formation can occur, ordinary disinfectants or heat (60°C [140°F]) for a few minutes are sufficient to kill vegetative forms. This is satisfactory when the necropsy room or abattoir floor is contaminated. When spore formation must be expected to have begun (i.e., within a few hours of exposure to the air), disinfection is almost impossible by ordinary means. Strong disinfectants such as 5% Lysol require being in contact with spores for at least 2 days. Strong solutions of formalin or sodium hydroxide (5% to 10%) are probably most effective. Peracetic acid (3% solution) is an effective sporicide; if applied to the soil in appropriate amounts (8 L/m<sup>2</sup>), it is an effective sterilant. Infected clothing should be sterilized by soaking in 10% formaldehyde. Shoes may present a difficulty, and sterilization is most efficiently achieved by placing them in a plastic bag and introducing ethylene oxide. Contaminated materials should be damp and left in contact with the gas for 18 hours. Hides, wool, and mohair are sterilized commercially by gamma-irradiation, usually from a radioactive cobalt source. Special care must be taken to avoid human contact with infected material; if such contact does occur, the contaminated skin must be thoroughly disinfected. The source of the infection must be traced and steps taken to prevent further spread of the disease. Control of the disease in a feral animal population presents major problems.

### Immunization

Immunization of animals as a control measure is extensively used. Veterinary anthrax vaccines contain spores from attenuated strains of *B. anthracis* and are classified into two categories:

- **Live attenuated vaccines, capsulated and nontoxic (cap +/tox-).** Strains used in these vaccines are devoid of the plasmid pX01 that encodes the toxin complex of *B. anthracis* (e.g., Pasteur vaccine).
- **Live attenuated vaccines, noncapsulated and toxic (cap-/tox+).** Strains in these vaccines lost the plasmid pX02 encoding the capsule antigen (e.g., Sterne vaccine).

The sporulation character of both vaccine classes has the advantage of keeping the live vaccine viable over long periods. The **Pasteur vaccines** have the disadvantage that the various animal species show varying susceptibility to the vaccines, and anthrax may result from vaccination in some cases. This has been largely overcome by preparing vaccines of differing degrees of virulence for use in different species and in varying circumstances. Another method of overcoming the

virulence is the use of saponin or saturated saline solution in the vehicle to delay absorption. This is the basis of the carbozoo vaccine.

The **Sterne vaccine** has overcome the risk of causing anthrax by vaccination and produces a strong immunity. It is the vaccine used in most countries. Although only one dose was originally thought to be necessary, with cases ceasing about 8 days after vaccination, it now appears that two vaccinations are necessary in some situations.

Currently only a few countries use Pasteur vaccines, whereas the Sterne vaccine is widely used because it is characterized by its elevated protective capacity and very low residual residence.<sup>1</sup>

A febrile reaction does occur after vaccination; the milk yield of dairy cows will be depressed, and pregnant sows will probably abort.

When the disease occurs for the first time in a previously clean area, all in-contact animals should either be treated with hyper-immune serum or be vaccinated. The measures used to control outbreaks, and the choice of a vaccine depend largely on local legislation and experience. Ring vaccination has been used to contain outbreaks of the disease, and in enzootic areas annual revaccination of all stock is necessary. Surface contamination of a pasture (as opposed to deep soil contamination) can persist for 3 years, and cattle grazing these pastures should be revaccinated annually for this period. In endemic areas cattle are routinely vaccinated yearly.

Milk from vaccinated cows is usually discarded for 72 hours after the injection in case the organisms in the vaccine should be excreted in the milk. Ordinarily the organisms of the Sterne vaccine do not appear in the milk and cannot be isolated from the blood for 10 and 7 days, respectively, after vaccination. Vaccinated animals are usually withheld from slaughter for 45 days.

Deaths as a result of anthrax have occurred in 3-month-old llamas after vaccination with a Sterne vaccine and may occur in goats. Older crias and adults were unaffected. It was assumed that the dose of vaccine was excessive for such young animals. In these species two vaccinations 1 month apart with the first dose one-quarter of the standard dose can be used.<sup>1</sup>

## FURTHER READING

Dragon DC, Rennie RP. The ecology of anthrax spores: tough but not invincible. *Can Vet J.* 1995;36:295-301.

World Health Organization (WHO). Anthrax in humans and animals. 4th ed. 2008 at: <[http://www.who.int/csr/resources/publications/anthrax\\_webs.pdf](http://www.who.int/csr/resources/publications/anthrax_webs.pdf)>; Accessed 20.01.14.

## REFERENCES

1. Fasanella A, et al. *Vet Microbiol.* 2010;140:318.
2. World Health Organization (WHO). Anthrax in humans and animals. 4th ed. 2008 at: <<http://>

[www.who.int/csr/resources/publications/anthrax\\_webs.pdf](http://www.who.int/csr/resources/publications/anthrax_webs.pdf)>; Accessed 20.01.14.

3. Jernigan JA, et al. *Emerg Infect Dis.* 2001;7:933.
4. Schwartz M. *Mol Asp Med.* 2009;30:347.
5. Hugh-Jones M, Blackburn J. *Mol Asp Med.* 2009;30:356.
6. Edgington AB. *Vet Rec.* 1990;127:321.
7. Williams DR, et al. *Vet Rec.* 1992;131:363.
8. WHO. 2013 at: <[http://apps.who.int/iris/bitstream/10665/78075/1/WHO\\_HSE\\_GCR\\_2012.12\\_eng.pdf](http://apps.who.int/iris/bitstream/10665/78075/1/WHO_HSE_GCR_2012.12_eng.pdf)>; Accessed 20.01.14.

## BOVINE TUBERCULOSIS

### SYNOPSIS

**Etiology** *Mycobacterium bovis* and, to a lesser extent, *Mycobacterium caprae*.

**Epidemiology** All age groups and species are susceptible, but infection is predominantly in cattle and pigs. Infected cattle are the main source of infection, but wildlife reservoirs are important in some regions and preclude the eradication of bovine tuberculosis in some countries. Inhalation is the major method of transmission between cattle. Pigs get primarily infected orally. Zoonosis, with most common route of infection through consumption of unpasteurized dairy products; other routes of infection include inhalation and direct contact.

**Clinical findings** Progressive emaciation, capricious appetite, and fluctuating temperature with signs referable to localization, such as respiratory disease, pharyngeal obstruction, reproductive disorder, and mastitis. In pigs, the disease is subclinical, but tuberculous lesions in cervical lymph nodes.

**Clinical pathology** Tuberculin testing. Single intradermal test is the official test in most countries, with the single intradermal comparative test for cattle suspected as false-positive reactors; interferon-gamma testing.

**Necropsy findings** Tuberculous granulomas may be found in any of the lymph nodes, or there may be generalized tuberculosis.

**Diagnostic confirmation** Culture of organism or identification by polymerase chain reaction (PCR) or other molecular techniques.

**Control** Test and slaughter. Most countries have official eradication programs.

### ETIOLOGY

Bovine tuberculosis is defined as infection of any bovide with disease causing mycobacterial species within the ***Mycobacterium tuberculosis complex (MTC)***.<sup>1</sup> The MTC comprises a range of mycobacterial species, including *Mycobacterium tuberculosis*, *M. bovis*, *M. africanum*, *M. microti*, *M. canettii*, *M. pinnipedii* and *M. caprae*, but the most common etiologic agents of bovine tuberculosis are *M. bovis* and to a lesser extent to *M. caprae*. *M. caprae* was previously considered

to be a subspecies of *M. bovis* but is now recognized as genetically distinct species within the MTC.<sup>2</sup>

Mycobacteria are acid-fast gram-positive bacteria of the family Mycobacteriaceae. These organisms can survive for months outside the animal host, particularly in a cold, dark, and moist environment. At temperatures between 12° and 24° C (54–75° F), survival times between 18 and 332 days have been reported.<sup>2</sup>

*M. bovis* is the mycobacterial species most commonly associated with tuberculosis in cattle. A wide range of species, including humans, are susceptible to *M. bovis* infection, but only cattle and in certain geographic regions some wildlife species function as maintenance hosts for *M. bovis*. Cattle, goats, and pigs are most susceptible to infection, whereas sheep and horses show a high natural resistance. *M. caprae*, formerly designated as *M. tuberculosis* subsp. *caprae* and later as *M. bovis* subsp. *caprae*, was initially only recognized as the main etiologic agent of caprine tuberculosis, but is currently also recognized as a common etiologic agent of tuberculosis in cattle, domesticated pigs, wild boar, wild and farmed red deer, and camelids in many Central and western European countries.<sup>3</sup>

### EPIDEMIOLOGY

#### Occurrence

During the first part of the twentieth century, bTB was widespread and present in most parts of the world, with herd prevalence rates of up to 63% and animal prevalence rates in the range of 20% to 45%. With the introduction of rigorous bTB control programs in many developed countries during the second half of the twentieth century, the occurrence of bTB in the cattle population of these countries decreased dramatically, and many countries were able to virtually eradicate the disease and are now classified as officially bTB free (OTF). bTB is a disease notifiable to the World Organization of Animal Health (OIE) and is included in the so called OIE List A, comprising “transmissible diseases that are considered to be of socioeconomic and/or public health importance within countries and that are significant in the international trade of animals and animal products.”<sup>2</sup> Clinical tuberculosis in animals is now a rarity in countries with eradication programs in place; occasional smaller outbreaks affecting one or few herds, however, occur regularly even in countries recognized as OTF. The presence of the disease is usually signaled by detection in carcasses at abattoirs.

Within the European Union, where all member states have TB eradication programs in place, the herd prevalence of bTB has been relatively stable in recent years, with rates between 0.37% and 0.67% from 2007 to 2012.<sup>4</sup> Thirteen member states of the European Union, including France, Germany,



Belgium, Poland, and Sweden, in addition to Norway and Switzerland, have the status of OTF, nonofficially free member states are, among others, the United Kingdom (Great Britain and Ireland), Italy, Greece, Spain, and Portugal.<sup>4</sup> A slight increase in the herd prevalence in nonofficially TB-free member states from 0.46% to 1.26% was recorded between 2007 and 2012.<sup>4</sup> The highest herd prevalence rates in 2012 were reported from Great Britain (10.40%), Ireland (4.37%), Spain (1.18%), and Greece (0.41%).<sup>4</sup> Herd outbreaks of *M. bovis* infection were recorded in several OTF member states in 2012, including France (169 herds), Germany (23 herds), Poland (7 herds), the Netherlands (2 herds), and Belgium and Slovenia (1 herd each). Three herds infected with *M. caprae* were identified in Austria.<sup>4</sup> With the national herd prevalence remaining below 0.1%, the OTF status of affected countries is not suspended.

In the United States, all states with exception of Michigan and California only have cattle herds certified as officially free of bTB. *M. bovis* infection of white-tailed deer, which is a maintenance host, remains a significant barrier to the U.S. bTB eradication program. *M. bovis* is still endemic in the white-tailed deer population in northeastern Michigan and northern Minnesota, presenting a potential source of infection for the local cattle population in that region. The number of confirmed cases of TB in Michigan livestock could, however, be reduced to single-digit figures since 2005.<sup>5</sup>

Australia obtained OTF status in 1997 after nearly 30 years of sustained bTB eradication. In New Zealand, where the eradication is complicated by the presence of the possum, also functioning as maintenance host for *M. bovis*, the implemented eradication program was highly successful in reducing the number of infected herds from 1700 in the mid-1990s to 66 in 2012.<sup>5</sup>

## Source of Infection

### Cattle

Infected cattle are the main source of infection for other cattle. Organisms are excreted as aerosol in exhaled air and in sputum, feces (from both intestinal lesions and swallowed sputum from pulmonary lesions), milk, urine, vaginal and uterine discharges, and discharges from open peripheral lymph nodes. Animals with gross lesions that communicate with airways, skin, or intestinal lumen are obvious disseminators of infection. Cattle in the early stages of the disease, before any lesions are visible, may also excrete viable mycobacteria in nasal and tracheal mucus. In experimentally infected cattle, excretion of the organism commences about 90 days after infection.

### Wildlife Reservoirs

A large number of wildlife and feral species can be naturally infected with *M. bovis* or *M.*

*caprae*. Although most wildlife and feral animals are unimportant as sources for infection to cattle, in some areas of the world certain species function as significant maintenance hosts and reservoirs for infection in cattle. These reservoirs escape traditional test and slaughter control programs and result in regions where the disease remains endemic in cattle herds.

- In areas of southwestern **England** and the Republic of **Ireland**, infected **badgers** (*Meles meles*) are significant in the epidemiology of the disease in cattle, and infection of cattle is thought to be from badger urine contamination of pastures. Badgers have also been found to make nocturnal visits to farm buildings and cattle troughs to feed, during which they defecate and urinate directly onto the cattle feed.
- In **New Zealand** infection occurs in the **brush-tail possum** (*Trichosurus vulpecula*) and produces lesions in peripheral lymph nodes with discharging sinuses. Much of New Zealand's residual problem with bTB is in cattle running on the pasture–brush margin, where there is ample opportunity for cattle–possum contact. Infection of cattle is thought to occur when curious cattle sniff moribund possums.
- Mule **deer** (*Odocoileus hemionus*), white-tailed deer (*O. virginianus*), elk (*Cervus elaphus canadensis*), and **bison** (*Bison bison*) in **North America** and red deer in Great Britain and Ireland can all act as maintenance hosts and in some regions spread infection to cattle through comingling or sharing of winter feed, resulting in foci of herd infections.
- **Buffaloes** (*Syncerus caffer*) in **South Africa** and water buffaloes (*Bulbalis bulbalis*) in the Northern Territory of **Australia** can also act as maintenance hosts.
- High infection rates approaching 50% have been reported in the **wild boar** (*Sus scrofa*) population of the **Iberian Peninsula**, where this species is regarded as maintenance host for *M. bovis*.<sup>6</sup> In northwestern Italy, wild boar are considered as spillover hosts that are unable to maintain infection without continued introduction from other species.<sup>7</sup>

## Methods of Transmission

In most cases infection occurs through inhalation or ingestion and, to a lesser degree, contact through penetration of the agent through breaks in the skin. Inhalation is the almost invariable portal of entry in housed cattle, and even in those at pasture it is considered to be the principal mode of transmission.

## Ingestion

Infection by ingestion is possible at pasture when feces contaminate the feed and communal drinking water and feed troughs, but a large infective dose is required. Under natural conditions, stagnant drinking water containing the pathogen may cause infection up to 18 days after its last use by a tuberculous animal, whereas a running stream does not represent an important source of infection to cattle in downstream fields.

The survival of the organism in the environment is influenced by temperature, moisture, exposure to the desiccating effect of sunlight, and ultraviolet light. The organism can survive for long periods in feces and soil, but most studies show that survival on pasture is measured in weeks rather than months and that environmental contamination of pasture is not of major importance in the epidemiology of the disease in cattle.

## Other Routes

The drinking of infected milk by young animals is a common method of transmission where the disease is endemic, but mammary infection occurs late in the course of the disease and is less common in countries with advanced control programs. Other uncommon routes of infection include intrauterine infection at coitus, by the use of infected semen or of infected insemination or uterine pipettes, and intramammary infection by the use of contaminated teat siphons or by way of infected cups of milking machines. The feeding of tuberculous cattle carcasses to pigs has also caused a severe outbreak of the disease. Unusual sources of infection are infected cats, goats, and even humans. Stockmen with genitourinary infections have transmitted infection to cattle through urinating in the cattle environment.

## Risk Factors

### Environment Risk Factors

Housing predisposes to the disease, as do high stocking intensity and a large number of animals on a farm, and thus the disease is more common and serious where these forms of husbandry are practiced. The closer the animals are in contact, the greater is the chance that the disease will be transmitted.

Among beef cattle the degree of infection is usually much lower because of the open-range conditions under which they are kept. However, individual beef herds may suffer a high morbidity if infected animals are introduced and large numbers of animals have to drink from stagnant water holes, especially during dry seasons.

### Host Risk Factors

Zebu (*Bos indicus*) type cattle are thought to be much more resistant to tuberculosis than European cattle, and the effects on these cattle are much less severe, but under

intensive feedlot conditions a morbidity rate of 60% and a depression of weight gain can be experienced in tuberculous Zebu cattle.

**Pigs** are susceptible to infection with *M. bovis*, and disease levels in general reflect those in the local cattle population from which the infection derives, either by the ingestion of dairy products or by grazing over the same pasture as cattle. The lower relative prevalence in pigs is attributable to a number of factors, particularly the tendency of the disease to remain localized in this species and the early age of slaughter. Prevalence is higher in older pigs. When the disease is common among dairy cattle in an area, 10% to 20% of the local pigs are likely to be infected. Tuberculosis in pigs is now rare in countries with bTB control programs in place, but reports from Portugal and Spain showing that *M. bovis* strains can circulate in cattle, pigs, and wild boar indicate that infection of domesticated and feral pigs can be of epidemiologic relevance under certain circumstances.<sup>5</sup>

Infection of **goats** with *M. bovis* or *M. caprae* has a worldwide occurrence and is well recognized in many European countries with a large small ruminant population, such as the United Kingdom, Italy, Portugal, Spain, and Greece. In countries that are not officially free of bTB, infection can circulate between cattle and goats, particularly if these species are kept in close proximity to each other and share pastures or water sources. This underscores the importance to include caprine flocks in the TB surveillance in these countries, which, however, is not done in most cases.<sup>8</sup>

**Sheep** have historically been considered to be resistant. However, the increasing number of reports of TB infection in this species either with *M. bovis* or *M. caprae*, particularly in non-TB-free countries, suggests that the prevalence of infection in sheep may have been underestimated.<sup>8</sup> Experience in New Zealand has shown that the disease can be quite prevalent in this species, with up to 5% of flocks being infected, probably as a result of a high prevalence in local cattle and possums.

In **horses** the disease occurs rarely, largely as a result of limited exposure to infection, but natural resistance also appears to play a part.

Over the past decades, infection with *M. bovis* and also with *M. microti* has been diagnosed with increased frequency in **New World camelids (NWCs)**, particularly in regions that are not free of bTB.<sup>8</sup> NWCs are highly susceptible to infection with *M. bovis* and *M. microti*, and they may function as reservoir of the disease for cattle and wildlife.<sup>8</sup> A complicating factor is that antemortem diagnosis of infection with *M. bovis* is difficult in NWC. Diagnostic tests successfully used to control and eradicate tuberculosis in cattle were found to have a low sensitivity and specificity in NWC.<sup>8</sup>

Tuberculosis can be a problem in **farmed deer** and may also be encountered in elk, wild deer of various species, water buffalo, camels, bison, elephants, wild carnivores, monkeys and other wild fauna, and birds. Most are dead end-hosts, but some may act as important reservoirs of infection for cattle, as mentioned earlier. Infection with *M. bovis* in **zoo animals** may present a particular problem because of the longer life expectancy of potentially infected animals and the relatively close contact with other species, including humans.

### Pathogen Risk Factors

The causative organism is moderately resistant to heat, desiccation, and many disinfectants. It is readily destroyed by direct sunlight unless it is in a moist environment. In warm, moist, protected positions, it may remain viable for weeks.

### Economic Importance

bTB is a serious infectious disease of cattle and other ruminant species and has been classified as disease of socioeconomic and public health importance that is significant in the international trade of animals and animal products by the World Organization for Animal Health (OIE). bTB is under strict control in most developed countries but still has important economic and social implications in the beef and dairy cattle industry of countries affected by the disease. Incurred costs not only result from losses of cattle because of tuberculosis, decreased productivity, and losses of carcass value, but also from control and eradication measures. On a national level, costs are incurred for increased regulation, animal movement control, and enforcement of compliance and indemnification programs. Trade restrictions for farms, regions, or countries that are not certified as OTF will add to the economic damage.

### Zoonotic Importance

Historically, bTB was an important zoonotic disease transmitted from cattle to humans through the consumption of unpasteurized dairy products and to a lesser extent through direct animal contact when the organism is inhaled or penetrates the body through a break in the skin. In countries where bTB is still endemic, it presents an occupational hazard for farmers, veterinarians, workers in the meat industry and slaughterhouse, and hunters. The widespread occurrence of tuberculosis in exotic animals maintained in captivity adds to the public health importance of these infections.

With introduction of pasteurization of dairy products as standard procedure and intensive veterinary surveillance of the cattle population, in many countries the disease has lost its importance as zoonotic disease. Whereas over 30% of all human TB cases were attributable to infection with *M. bovis*

before introduction of pasteurization, this number has plummeted to less than 2% of all confirmed cases today.<sup>9</sup> Nonetheless, in regions of the world where bTB control programs have not been implemented and the disease in cattle remains endemic, this condition is still an important zoonotic disease. In these countries, between 10% and 20% of all human cases of tuberculosis are associated with infection with *M. bovis*.<sup>10</sup> The currently increasing incidence of tuberculosis in humans, particularly in immunocompromised humans, has led to a renewed interest in the zoonotic importance of *M. bovis*.

In the United States, the Centers for Disease Control and Prevention (CDC) records approximately 220 cases of tuberculosis in humans associated with *M. bovis* every year, which is equivalent to less than 2% of all human cases of tuberculosis.<sup>11</sup> The highest percentage levels on a national basis are recorded in Mexico with 13.8%, Uganda with 7%, and Nigeria with 5% of all human TB cases caused by *M. bovis*.<sup>10</sup>

Within the European Union, a total of 125 confirmed cases of human *M. bovis* infections were recorded in 2012. Most cases were reported from Germany (44 cases), followed by the United Kingdom (35 cases), Spain (15 cases), Italy (9 cases), and the Netherlands (8 cases); Switzerland, a non-EU member state, reported 5 confirmed cases in that year.<sup>4</sup>

### PATHOGENESIS

Tuberculosis spreads in the body by two stages, the primary complex and postprimary dissemination. The **primary complex** consists of the lesion at the point of entry and in the local lymph node. A lesion at the point of entry is common when infection is by inhalation. When infection occurs via the alimentary tract, a lesion at the site of entry is unusual, although tonsillar and intestinal ulcers may occur. More commonly the only observable lesion is in the pharyngeal or mesenteric lymph nodes.

A visible primary focus develops within 8 days of entry being effected by the bacteria. **Calcification** of the lesions commences about 2 weeks later. The developing necrotic focus is soon surrounded by granulation tissue, monocytes, and plasma cells, and the pathognomonic "tubercle" is established. Bacteria pass from this primary focus, which is in the respiratory tract in 90% to 95% of cases in cattle, to a regional lymph node and cause the development of a similar lesion there. The lesions in the lungs in cattle occur in the caudal lobes in 90% of cases. In calves fed tuberculous milk, the primary focus is likely to be in the pharyngeal or mesenteric lymph nodes, with hepatic lesions as the major manifestation of postprimary spread.

**Postprimary dissemination** from the primary complex may take the form of acute miliary tuberculosis, discrete nodular lesions in various organs, or chronic organ

tuberculosis caused by endogenous or exogenous reinfection of tissues rendered allergic to tuberculo-protein. In the latter case, there may be no involvement of the local lymph node. Depending on the sites of localization of infection, clinical signs vary, but because the disease is always progressive, there is the constant underlying toxemia, which causes weakness, debility, and the eventual death of the animal.

In cattle, horses, sheep, and goats, the disease is progressive; although generalized tuberculosis is not uncommon in pigs, localization as nonprogressive abscesses in the lymph nodes of the head and neck is the most common finding.

## CLINICAL FINDINGS

### Cattle

Although signs referable to localization in a particular organ usually attract attention to the possible occurrence of tuberculosis, some general signs are also evident. Some cows with extensive miliary tubercular lesions are clinically normal, but in most cases progressive emaciation unassociated with other signs occurs, which should arouse suspicion of tuberculosis. A capricious appetite and fluctuating temperature are also commonly associated with the disease. The hair coat may be rough or sleek. Affected animals tend to become more docile and sluggish, but the eyes remain bright and alert. These general signs often become more pronounced after calving.

### Lungs

Pulmonary involvement is characterized by a chronic cough as a result of bronchopneumonia. The **cough** is never loud or paroxysmal, occurring only once or twice at a time, and is low, suppressed, and moist. It is easily stimulated by squeezing the pharynx or by exercise and is most common in the morning or in cold weather. In the advanced stages when much lung has been destroyed, dyspnea with increased rate and depth of respiration becomes apparent. At this stage, abnormalities may be detected by auscultation and percussion of the chest. Areas with no breath sounds and dullness on percussion are accompanied by areas in which squeaky crackles are audible, often most audible over the caudal lobes. Tuberculous pleurisy may occur but is usually symptomless because there is no effusion. Involvement of the bronchial lymph nodes may cause dyspnea because of constriction of air passages, and enlargement of the mediastinal lymph node is commonly associated with recurrent and then persistent ruminal tympany.

### Intestine

Rarely, tuberculous ulcers of the small intestine cause diarrhea. Retropharyngeal lymph node enlargement causes dysphagia and noisy breathing as a result of pharyngeal obstruction. Pharyngeal palpation, or

endoscopy, reveals a large, firm, rounded swelling in the dorsum of the pharynx. Chronic, painless swelling of the submaxillary, prescapular, precrucial, and supramammary lymph nodes is relatively rare.

### Uterus

Reproductive disorders include uterine tuberculosis, which is uncommon with bovine strains except in advanced cases. Spread by contiguity from the uterus causes peritonitis, bursitis, and salpingitis, with the lesions in the salpinx taking the form of small enlargements containing a few drops of yellow fluid. In tuberculous metritis, there may be infertility, or conception may be followed by recurrent abortion late in pregnancy, or a live calf is produced that in most cases dies quickly of generalized tuberculosis. Lesions similar to those of brucellosis occur on the placenta.

In cows that fail to conceive, there may be a chronic purulent discharge heavily infected with the organism, and the condition is very resistant to treatment. A number of cows will have an associated tuberculous vaginitis affecting chiefly the ducts of Gartner. Rare cases of tuberculous orchitis are characterized by the development of large, indurated, painless testicles.

### Mastitis

Tuberculous mastitis is of major importance because of the danger to public health, risk of spread of the disease to calves, and the difficulty of differentiating it from other forms of mastitis. Its characteristic feature is a marked induration and hypertrophy, which usually develops first in the upper part of the udder, particularly in the rear quarters. Palpation of the supramammary lymph nodes is essential in all cases of suspected tuberculous mastitis. Enlargement of the nodes with fibrosis of the quarter does not necessarily indicate tuberculosis, but enlargement without udder induration suggests either tuberculosis or lymphomatosis. In the early stages, the milk is not macroscopically abnormal, but very fine floccules appear later and settle after the milk stands, leaving a clear, amber fluid. Later still, the secretion may be an amber fluid only.

### Pigs

Pigs get infected through oral ingestion of the pathogen, leading to primary lesions in the oropharyngeal lymph node and the digestive tract. Tuberculous lesions in cervical lymph nodes usually cause no clinical abnormality unless they rupture to the exterior. Generalized cases present a syndrome similar to that seen in cattle, although tuberculous involvement of the meninges and joints is more common.

### Horses

As in pigs, infection in horses commonly occurs through the digestive route, again

leading to primary lesions in the oropharyngeal lymph node and the digestive tract.<sup>12</sup> The commonest syndrome in horses is caused by involvement of the cervical vertebrae in which a painful osteomyelitis causes stiffness of the neck and inability to eat off the ground. Less common signs include polyuria, coughing as a result of pulmonary lesions, lymph node enlargement, nasal discharge, and a fluctuating temperature.

### Sheep and Goats

Bronchopneumonia is the commonest form of the disease in these species and is manifested by cough and terminal dyspnea. In some goats, intestinal ulceration, diarrhea, and enlargement of the lymph nodes of the alimentary tract occur. In both species the disease is only slowly progressive, and in affected flocks many more reactors and necropsy-positive cases are often found than would be expected from the clinical cases that are evident. In kids the disease may be more rapidly progressive and cause early death.

### New World Camelids

Infection of a camelid herd with either *M. bovis* or *M. microti* may go unnoticed until one or several animals die, presenting suspicious lesions at necropsy. Affected animals may either be found dead or show signs of general distress with weight loss and respiratory symptoms before dying.<sup>13</sup>

## CLINICAL PATHOLOGY

The antemortem diagnosis of bovine tuberculosis still presents a challenge because all available and routinely employed tests suitable for antemortem diagnosis have limitations regarding sensitivity and specificity.<sup>14</sup> Diagnostic tests for bTB can broadly be classified into direct and indirect diagnostic tests, with direct tests identifying the presence of the causative agent in the host and indirect tests using immunologic markers to determine whether an infection had occurred in an individual animal. Current bTB eradication programs are based on a screening and slaughter policy, and all use indirect tests determining the presence of a cellular or humoral immune response to a challenge with bovine tuberculin. Knowledge of the various tests used, including their deficiencies and advantages, is essential.

### Direct Tests

Direct tests targeted at directly identifying the agent in postmortem specimens include microscopic examination, culture, and nucleic acid recognition methods. Direct tests targeted at identifying the causative agent in an animal form part of the passive abattoir surveillance that is an integral part of all bTB eradication programs and can be applied on samples collected during postmortem examination. All carcasses of slaughtered cattle are visually screened for



characteristic gross pathologic findings that may be indicative of infection. Histopathology, culture, and molecular methods are then used to identify bacteria in abnormal tissue. Passive abattoir surveillance is considered highly cost effective but has the major drawback of lack of sensitivity. Extensive lesions are present in advanced stages of tuberculosis only, which have become a rarity in regions with ongoing bTB surveillance; small organ lesions are easily missed during abattoir meat inspection.<sup>2</sup>

The collection and pooling of samples from several grossly unremarkable lymph nodes from the head and thorax has been suggested as suitable material for bacteriological culture.

### Microscopic Examination

Mycobacteria can be demonstrated microscopically in smears and tissue material from clinical samples. Special stains such as the Ziehl-Neelsen or fluorescent acid-fast stain are used to determine the presence of acid-fast bacteria, which, together with the characteristic histologic lesions, can lead to a presumptive diagnosis; however, the diagnosis requires further confirmation.<sup>2</sup> Particularly in ruminants, histologic lesions contain few bacteria which may lead to a negative result, although *M. bovis* can be isolated in cultures.

### Culture

Specimens for culture are first homogenized following decontamination and are then centrifuged. The sediment is used for microscopic examination and culture. Cultures are incubated on specific media at 37°C (99°F) for at least 8 weeks, but preferably 10 to 12 weeks. If growth occurs, smears are prepared using specific acid-fast stains. Growth of *M. bovis* is generally observed between 3 and 6 weeks of culture.<sup>2</sup> Because *M. bovis* must be differentiated from other species of the *M. tuberculosis* complex, further testing is required. The major disadvantage of cultures is the long turnaround time, and the primary limitation results from the poor quality of samples often submitted to the diagnostic laboratory.

### Nucleic Acid Recognition Methods

The polymerase chain reaction (PCR) is a laboratory technique for identifying the presence of bacteria-specific DNA that has been extensively evaluated for the detection of *M. tuberculosis* complex in specimens of human and, more recently, also of animal origin. In principle, the PCR presents an attractive diagnostic procedure allowing for the identification and differentiation of specific pathogens. The method is rapid, cost effective, and easy to standardize. For the diagnosis of tuberculosis in animals, however, commercial kits and in-house methods have been evaluated with unsatisfactory results.<sup>2</sup> The reasons why the PCR

does not yet fulfill its diagnostic potential as diagnostic test for tuberculosis are various. False-positive and false-negative results have not only been attributed to the low number of bacteria often present in samples, but also to difficulties with the decontamination methods, the presence of polymerase enzyme inhibitors in the samples, and difficulties in extracting DNA from mycobacteria that possess a robust cell wall.<sup>15</sup> Current molecular methods are therefore not yet considered adequate for direct detection of *M. bovis*, either from ante- or postmortem samples.<sup>15</sup>

### Indirect Tests

Indirect tests can again be subdivided into cellular-immunity-based and humoral-immunity-based diagnostic tests. Cellular-immunity-based tests determine the occurrence of a delayed hypersensitivity reaction in general in the form of swelling after intradermal application of tuberculin protein. These so-called intradermal tuberculin tests are the standard diagnostic tools of bTB eradication programs used for ante-mortem diagnosis of *M. bovis* infection.

Blood-based cellular immunity tests include the interferon- $\gamma$  test, which is now accepted as complementary test in many national bTB eradication programs and is recognized as alternative test of international trade, and the lymphocyte proliferation assay. Humoral-immunity-based tests are serologic diagnostic tools that determine the presence of specific antibody indicating prior exposure to antigen of *M. bovis*.

### Intradermal Tuberculin Test

The intradermal tuberculin test is the standard diagnostic tool for detection of bTB and consists of the intradermal injection of **bovine tuberculin purified protein derivative (PPD)** into a skin fold of a specific location of the body and the subsequent detection of swelling as a result of delayed hypersensitivity 72 hours later.<sup>2</sup> Because of differences in sensitivity of the skin of different body parts, different approaches for the intradermal tuberculin test are in use. The **caudal skin fold** at the base of the tail (**caudal fold test [CFT]**) is used primarily for practicality reasons in the United States, Canada, and New Zealand, and formerly also in Australia, whereas in Europe and the United Kingdom a **cervical skin fold** of the lateral aspect of the neck is used for the so-called **single intradermal test (SIT)**. Applying the intradermal test in the cervical region results in higher sensitivity and specificity compared with the caudal skin fold but is more labor intensive because it requires better restraint of the animal and clipping of the skin.<sup>16</sup> Whereas the interpretation of the CFT consists of manual palpation to determine swelling approximately 72 hours after injection, the interpretation of the SIT and SICT (described in the following discussion) is done by measuring the thickness of the

skinfold before and 72 hours after injection using calipers.

Where the presence of paratuberculosis (John's disease), avian tuberculosis, or a high prevalence of infection with environmental mycobacteria is suspected, nonspecific sensitization must be considered. In these cases, the **single intradermal comparative test (SICT)**, consisting of the simultaneous intradermal administration of bovine and avian tuberculin on two different injection sites of the neck, either one on each side or both on the same side approximately 12 cm apart and one above the other, is administered. The test is read 72 hours later and the reaction to both tuberculins compared with each other. The greater of the two reactions indicates the organism responsible for the sensitization. This test is not generally intended for primary use in detecting reactors but only to follow up known reactors to determine the infecting organism. Its use as a primary test is recommended when a high incidence of avian tuberculosis or John's disease is anticipated or when vaccination against John's disease has been carried out. The comparative test is adequate to differentiate between vaccination against John's disease and tuberculosis, and the distinction is easier the longer the time between vaccination and testing.

Historically, other tests using bovine tuberculin to determine hypersensitivity—such as the vulvar, ophthalmic, or palpebral test; the short thermal test; and the Stormont test—have been used but are now obsolete.

### Special Aspects of Sensitivity to Tuberculin

- Potency and standardization of tuberculins: Modern-day tuberculin used for diagnostic purposes is a purified protein derivative (PPD) of bovine or avian tuberculin that is prepared from the heat-treated products of growth and lysis of *M. bovis* (or *M. avium* in the case of avian tuberculin). Production methods have in the meantime largely been standardized, and with PPD being a licensed product, it requires production under good manufacturing practice conditions that comply with official requirements of the World Organization for Animal Health (OIE).<sup>2</sup> The standardized preparation is meant to ensure that the final product contains a precise concentration of standardized quality; nevertheless, the protein content of tuberculin does not precisely predict its biological activity or potency, which is a critical parameter strongly affecting the outcome of the test.<sup>14</sup> Potency testing is therefore required as further step in the manufacturing process to standardize product quality, which is done by comparing the potency to a reference standard in guinea pigs. It must,

however, be noted that the clinical potency determined in tuberculous guinea pigs is not necessarily representative of the clinical potency in cattle.<sup>16</sup> A bovine tuberculin is considered adequate for diagnosis as part of an official test program when providing a minimum of 2000 IU PPD per dose, with an estimated potency of between 66% and 150%.<sup>14</sup>

- Dose: The dose of tuberculin must be at least 2000 IU of bovine (or avian for the SCIT) tuberculin; in cattle with diminished allergic sensitivity, higher doses of up to 5000 IU may be required. In any case the injection volume should not exceed 0.2 mL.<sup>2</sup> The exact dose for the particular tuberculin that is officially prescribed must be strictly adhered to when the cervical skin test is used. In the United States 0.1 mL is recommended for herds of unknown status and 0.2 mL in known infected herds when cases with low sensitivity are to be carefully sought. The method of injection of tuberculin also has some importance when the cervical site is used. A careful intradermal injection produces the largest swelling, and a quick thrust produces the least.
- Desensitization during tuberculin testing: When a suspicious reactor is encountered, the question of when to retest is complicated by the phenomenon of desensitization caused by the absorption of tuberculin and other foreign proteins. Desensitization is more marked and of longer duration after an (accidental) subcutaneous than after an intradermal injection. After an SID test the period of desensitization is short, but as a practical procedure, it is recommended that animals giving a suspicious result to an SID test not be retested before 60 days.

The desensitization phenomenon can be used to obscure a positive reaction. If tuberculin is injected and thus the test is made in the desensitized period, no reaction will occur in infected animals.

- Postparturient desensitization: Tuberculous cattle go through a period of desensitization immediately before and after calving, and as many as 30% give false-negative reactions returning to a positive status 4 to 6 weeks later. The loss of sensitivity is probably a result of the general immunologic hyporeactivity that occurs associated with parturition. Calves drinking colostrum from infected dams give positive reactions for up to 3 weeks after birth even though they may not be infected.
- Anergy: Anergic animals are those with visible lesions of tuberculosis but that do not react to a cutaneous delayed hypersensitivity test. The number of these can be reduced by being careful to

inject sufficient tuberculin (2000 IU) at the right site and to read the test at 72 hours. There is still a residuum of cases that do not respond, especially those with extensive pulmonary involvement.

### Summary of Testing Procedures in Cattle

In summary, it is usual to use the single intradermal test as a routine procedure.

Annual testing of all cattle, quarantine of test-positive herds, and a movement ban into TB-free areas have historically been effective in TB control schemes. The sensitivity and specificity of the skin test are moderately high, but false-positive and false-negative reactions occur.

**False-positive reactions** (no gross lesion reactors) may be given by the following:

- Animals sensitized to other mycobacterial allergens, including those of human or avian tuberculosis or paratuberculosis (Johne's disease); relatively nonpathogenic mycobacteria (e.g., skin tuberculosis); and, by ingestion, nonpathogenic mycobacteria in permanent waters inhabited by birds, or poultry litter fed to cattle when the birds are infected with *M. avium*
- Animals sensitized to other allergens (e.g., *Nocardia farcinicus*)
- Animals injected with irritants at the injection site before reading of the tuberculin test, when compensation rates for reactors exceed true cattle prices

The proportion of false-positive reactions is likely to increase as control programs progress toward eradication and can undermine farmers' confidence in the control program. Reactors that are thought to be nonspecific should be retested by the comparative test in the cervical region 7 days after the response to the SID or CFT. Alternatively, cattle can be retested using the whole-blood interferon-gamma assay 8 to 28 days after the skin test.

**False-negative reactions** may be given by the following:

- Advanced cases of tuberculosis
- Early cases until 6 weeks after infection
- Cows that have calved within the preceding 6 weeks
- Animals desensitized by tuberculin administration during the preceding 8 to 60 days
- Old cattle
- Low-potency tuberculin or bacterial contamination of the tuberculin
- Variable dose with multidose syringes

### Tuberculin Testing in Other Species

#### Pigs

The most generally used method is the SID test, injecting 0.1 mL of standard-potency mammalian tuberculin into a fold of skin at the base of the ear, but the test is relatively inaccurate in this species. The test is read 24 to 48 hours later; an increase in skin

thickness of 5 mm or more constitutes a positive reaction. In positive animals the skin thickening often exceeds 10 mm and shows superficial necrosis and sloughing.

If the animal is infected with *M. avium*, the maximum skin thickening may not occur until 48 hours after injection. When no attempt is being made to determine the type of infection, mixed avian and mammalian tuberculins may be used and the test read at 24 to 48 hours. If avian tuberculin alone is used, the test should be read at 48 to 72 hours, and an increase in skin thickness of 4 mm is classed as positive.

Many suspicious reactions occur in pigs because of the tendency of lesions to regress and the sensitivity to tuberculin to diminish, with maximum sensitivity occurring 3 to 9 weeks after infection. A retest in 6 to 8 weeks should determine whether or not the disease is progressing. Although positive reactors may in time revert to a negative status, there may be macroscopic lesions in these animals at necropsy. However, viable organisms are not usually recoverable from the lesion, the infection apparently having been overcome.

Some decrease in skin sensitivity after parturition occurs in sows infected with *M. bovis* but may not occur when the infection is associated with *M. avium*. Comparative tests work efficiently in this species, with little or no reaction to heterologous tuberculin.

#### Horses

The results obtained with subcutaneous and intradermal tuberculin tests are very erratic and must be assessed with caution, especially when the test is positive because many false-positives occur. The horse appears to be much more sensitive than cattle to tuberculin, and much smaller doses of standardized tuberculin are required. As little as 0.1 mL of PPD tuberculin is sufficient to elicit a positive reaction, and testing may provoke an anaphylactic reaction. No safe recommendations can be made on tests in this species because of lack of detailed information, but the occurrence of a systemic reaction with a positive cutaneous test can be accepted as indicating the presence of infection.

#### Sheep and Goats

The single intradermal test is relatively inaccurate, with some tuberculous animals giving negative reactions, although on the basis of results achieved in experimentally infected goats, it is adequate. The test injection is usually given in the caudal fold as in cattle, but injection into the skin of the inside of the thigh of sheep is also satisfactory. An increase in thickness of 5 mm in the fold constitutes a positive reaction.

#### New World Camelids

Diagnostic tests used for in vivo identification of cattle infected with *M. bovis* are considered highly unreliable in NWCs because

they have demonstrated a lack of sensitivity and specificity when applied according to the protocol used in cattle.<sup>8</sup> In dromedaries the diagnostic performance of the SCIT was found to be improved somewhat when the test was performed on the axillar skin and read after 5 days, although a considerable number of animals also reacted to avian tuberculin.<sup>15</sup>

### Interferon- $\gamma$ Assay (IFN- $\gamma$ )

An in vitro assay of cell-mediated reactivity by detection and quantitation of  $\gamma$ -interferon known as the interferon- $\gamma$  assay (IFN- $\gamma$ ) is licensed and commercially available in some countries. It is based on the detection of IFN- $\gamma$  liberated from white blood cells in whole-blood cultures incubated with PPD tuberculin and has the advantage that tested cattle need only be handled once. It can detect infected cattle as early as 3 to 5 weeks after infection even with low exposure level. It also has value in retesting skin-test-positive cattle that may be false-positive reactors, but for this purpose it should be used between 8 and 28 days after skin testing because assay reactions are diminished if conducted on samples taken at the 3-day reading revisit after skin testing. Ideally, the test should be set up in the laboratory on the same day as sampling or, at the most, after overnight storage of the blood. Current testing is with *M. bovis* PPD, which can contain cross-reacting antigens to other mycobacterial species, and more specific and sensitive tests using antigens specific to *M. bovis* are being evaluated.

A recent meta-analysis reported an estimated sensitivity of 67%, which is superior to the SCIT, and a specificity of 96%, which is inferior to the SCIT, for the IFN- $\gamma$ .<sup>16</sup> The IFN- $\gamma$  is available as commercial test kit and is now approved as official diagnostic test in several national bTB eradication and control programs, including programs in the European Union, the United States, New Zealand, and Australia.

### Lymphocyte Proliferation Test

Like the IFN- $\gamma$  test, the lymphocyte proliferation test is an in vitro test that is conducted either on whole blood or purified lymphocytes and determines and compares the reactivity of peripheral lymphocytes to avian and bovine tuberculin. The test result is the difference in reactivity of lymphocytes to bovine (B) and avian (A) tuberculin; the B-A value is calculated and compared with a cutoff value. The test is not used for routine diagnostics because it requires the handling of radioactive material and long incubation periods.<sup>2</sup>

### Serologic Tests for Diagnosis of Tuberculosis

In the final stages of a tuberculosis eradication program, the percentage of reactors, which are not in fact tuberculous, increases

to the point where a more discerning test than the one based on cutaneous hypersensitivity is required. Most of the tests tried so far have been serologic ones. Their aim is to identify anergic animals and cases sensitized by some other bacteria.

Serologic tests, including complement fixation, fluorescent antibody, direct bacterial agglutination, precipitin, and hemagglutination tests, have been developed but have little potential value for the routine diagnosis of tuberculosis.

Early enzyme-linked immunosorbent assay (ELISA) tests to crude mycobacterial antigens had limited value, but an ELISA that examines antibody to defined antigens of *M. bovis* before and after skin testing appears useful in detecting nonspecific reactors.

Serologic tests may, however, be of some value for the diagnosis of tuberculosis in domestic animal and wildlife species such as farmed deer, NWCs, badgers, nonhuman primates, or elephants, where cellular-immunity-based diagnostic tests are not available and intradermal tuberculin test have been proven unreliable.<sup>2</sup>

## NECROPSY FINDINGS

### Cattle, Sheep, and Goats

These show similar lesions with a standard distribution. Tuberculous granulomas may be found in any of the lymph nodes, but particularly in bronchial, retropharyngeal, and mediastinal nodes. In the lung, miliary abscesses may extend to cause a suppurative bronchopneumonia. The pus has a characteristic cream to orange color and varies in consistency from thick cream to crumbly cheese. Tuberculous nodules may appear on the pleura and peritoneum.

All localized lesions of tuberculosis tend to stimulate an enveloping fibrous capsule, but the degree of encapsulation varies with the rate of development of the lesion. Generalized cases are denoted by the presence of **miliary tuberculosis**, with small, transparent, shot-like lesions in many organs, or by pulmonary lesions that are not well encapsulated and caseated. The presence of bronchopneumonia or hyperemia around pulmonary lesions is highly suggestive of active disease. Cases with tuberculous mastitis or discharging tuberculous metritis must also be considered as likely to be potent spreaders of the infection.

Chronic lesions are characteristically discrete and nodular and contain thick, yellow to orange, caseous material, often calcified and surrounded by a thick, fibrous capsule. Although such lesions are less likely to cause heavy contamination of the environment than open lesions, affected animals are important as sources of infection. It should be noted that suspect cattle slaughtered as part of bovine tuberculosis eradication programs may be culture-positive and yet have no typical gross or microscopic lesions.

## Pigs

Generalized tuberculosis, with miliary tubercles in most organs, is seen in pigs, but the common finding is localization in the tonsils and the submaxillary, cervical, hepatic, bronchial mediastinal, and mesenteric lymph nodes. The nodes are markedly enlarged and consist of masses of white, caseous, sometimes calcified, material, surrounded by a strong, fibrous capsule and interlaced by strands of fibrous tissue. Because of the regressive nature of the disease in pigs, these lesions are often negative on culture.

## Horses

The characteristic distribution of tubercles in horses includes the intestinal wall, mesenteric lymph nodes, and spleen. The cut surface of these firm nodules has a fleshy appearance similar to that of neoplastic tissue. There is also a tendency for lesions to develop in the skeleton, particularly the cervical vertebrae.

Histologically, there is some variation between the domestic species with regard to features such as mineralization and the degree of tissue necrosis. In some cases acid-fast bacilli may be difficult to demonstrate using conventional stains. A comparison of the infection in cattle and cervid species suggests that tuberculosis should be considered in cervids even when the lesions have a suppurative and necrotizing character, with a minimal granulomatous component. Culture of *M. bovis* is difficult and time consuming, and it poses a considerable public health risk. Methods such as immunoperoxidase staining and PCR can permit detection of the organisms while minimizing public health risks.

### Samples for Confirmation of Diagnosis

- Bacteriology—affected lymph nodes, lung, granulomas from viscera (culture [has special growth requirements], PCR)
- Histology—formalin-fixed samples of these tissues (light microscopy, immunohistochemistry, PCR)

**Note the zoonotic potential of this organism when handling the carcasses and submitting specimens.**

### DIFFERENTIAL DIAGNOSIS

Because of the chronic nature of the disease and the multiplicity of signs caused by the variable localization of the infection, tuberculosis is difficult to diagnose on clinical examination. If the disease occurs in a particular area, it must be considered in the differential diagnosis of many diseases of cattle. In pigs, the disease is usually so benign that cases do not present themselves as clinical problems and are found only at necropsy. The rarity of the disease in horses, sheep, and goats makes it an unlikely diagnostic risk, except in groups that have

*Continued*



had abnormally high exposure to infected cattle. Differential diagnoses include the following:

- Mycobacteriosis associated with the *M. avium-intracellulare* complex and atypical
- Mycobacteria and *M. tuberculosis* in particular in pigs
- Lung abscess as a result of aspiration pneumonia
- Pleurisy and pericarditis following traumatic reticulitis
- Chronic contagious bovine pleuropneumonia
- Upper respiratory disease
- Actinobacillosis
- Bovine leukosis
- Lymphadenopathy
- Other causes of mastitis

## TREATMENT

Treatment of tuberculosis in cattle is not permitted in countries with an established bTB eradication program, requiring removal of reactors from the herd. Treatment may, however, be permitted in some cases, such as in valuable zoo animals.

Because of the progress being made in the treatment of human tuberculosis with such drugs as isoniazid, combinations of streptomycin and *para*-aminosalicylic, and other acids, the treatment of animals with tuberculosis has undergone some examination, and claims have been made for the efficiency of long-term oral medication with isoniazid both as treatment and as control. It is not a favored option in eradication-conscious countries.

## CONTROL

Eradication of bTB has been virtually achieved in many countries. The methods used have depended on a number of factors, but ultimately the **test and slaughter policy** has been the only one by which effective eradication had been achieved.

### Control on a Herd Basis

Control in a herd rests on removal of the infected animals, prevention of spread of infection, and avoidance of further introduction of the disease.

### Tuberculin Testing

Detection of infected animals depends largely on the use of the intradermal tuberculin test. All animals over 3 months of age should be tested and positive reactors disposed of according to local legislation. Suspicious reactors are retested at intervals appropriate to the test used. At the initial test, a careful clinical examination should be conducted on all animals to ensure that there are no advanced clinical cases that will give negative reactions to the test. Doubtful cases and animals likely to have reduced sensitivity, particularly old cows and those that have calved within the previous 6 weeks, may be

tested by one of the special sensitivity or serologic tests described previously or retested subsequently. The single comparative intradermal test (SCIT) should be used where infection with *M. avium* is anticipated or where a high incidence of reactors occurs in a herd not showing clinical evidence of the disease.

### Retesting

Until recently, if the incidence of reactors was high at the first test or if "open" lesions were found at necropsy in culled animals, emphasis was placed on repeat testing at short intervals to avoid the situation in which the spread of the disease might overtake the culling rate. It is now thought that all animals with tuberculosis should be regarded as equally potent disseminators of the infection. Retests of the herd should be carried out at 3-month intervals until a negative test is obtained. A further test is conducted 6 months later, and if the herd is again negative, it may be classed as free of the disease. Subsequent check tests should be carried out annually.

### Prevention of Spread

Hygienic measures to prevent the spread of infection should be instituted as soon as the first group of reactors is removed. Feed troughs, water troughs, and drinking cups should be cleaned and thoroughly disinfected. Suspicious reactors being held for retesting should be isolated from the remainder of the herd. Separation of infected and susceptible animals by a double fence provides practical protection against spread of the disease.

It is important that calves being reared as herd replacements be fed on tuberculosis-free milk, either from known free animals or pasteurized. Rearing calves on skim milk from a communal source is a dangerous practice unless the skim milk is sterilized. All other classes of livestock on the farm should be examined for evidence of tuberculosis. Farm attendants should be checked because they may provide a source of infection.

If a number of reactors are culled, attention must be given to the possibility of infection being reintroduced with replacements, which should come from accredited herds. Failing this, the animals should be tested immediately, isolated, and retested in 60 days. Infection from other herds should be addressed by preventing communal use of watering facilities or pasture and by maintaining adequate boundary fences.

It is inadvisable to attempt a control program until it can be guaranteed that all animals can be gathered, identified, tested, and segregated, a difficult proposition in cattle run on extensive range country with little manpower and few fences.

### Control on an Area Basis

The method used to eradicate bovine tuberculosis from large areas will depend on the

incidence of the disease, methods of husbandry, attitude of the farming community, and the economic capacity of the country to stand losses from a test and slaughter program.

### Education

An essential first step is the prior education of the farming community. Livestock owners must understand the economic and public health significance of the disease, its manifestations, and the necessity for the various steps in the eradication program. Eradication must also be compulsory because voluntary schemes always leave foci of infection. Adequate compensation must be paid to encourage full cooperation by way of payment for animals destroyed or bonuses for disease-free herds or their milk or beef.

### Staging

It is essential at the beginning of a program to determine the incidence and distribution of the disease by tuberculin testing of samples of the cattle population and a meat inspection service. Eradication can commence in herds and areas that have a low incidence of the disease. These will provide a nucleus of tuberculosis-free cattle to supply replacements for further areas as they are brought into the eradication scheme.

### Vaccination

Vaccination may offer a major alternative to test and slaughter in the control of bovine tuberculosis but currently suffers from both lack of efficacy and the problem of vaccinated cattle reacting to current tests for TB. Vaccination may be used as a temporary measure when the incidence of tuberculosis is high and a routine test and slaughter program may be economically impossible until it is lowered, or when an eradication program cannot be instituted for some time but it is desired to reduce the incidence of the disease in preparation for eradication.

*Bacillus Calmette-Guérin* (BCG) vaccination is the only method available for field use. Vaccination must be repeated annually, and the vaccinated animal remains positive to the tuberculin test. Calves must be vaccinated as soon after birth as possible and do not achieve immunity for 6 weeks. The immunity is not strong, and vaccinated animals must not be submitted to severe exposure. In field circumstances where the disease is prevalent, only modest results, if any, can be expected.

There are a number of newer, prospective vaccines, including subunit and synthetic peptide vaccines, antigenically improved BCG, attenuated mutants of *M. bovis*, and protective antigens expressed in attenuated live vaccine vectors. Detection of vaccinated cattle from naturally infected cattle could be possible with vaccine-specific antigens in the interferon-gamma assay.

## Test and Slaughter

When the overall incidence of tuberculosis is 5% or less, compulsory testing and the slaughter of reactors is the only satisfactory method of eradication. A combination of lines of attack is usually employed.

Accredited areas are set up by legislation, and all cattle within these areas are tested and reactors removed. Voluntary accreditation of individual herds is encouraged outside these areas. In some countries, focal points of extensive infection outside accredited areas have been attacked under special legislation.

When an area or country has been freed from the disease, quarantine barriers must be set up to avoid its reintroduction. Within the area, the recurrent cost of testing can be lessened by gradually increasing the interest period to 2 and then to 3 or even 6 years as the amount of residual infection diminishes. Meat inspection services provide a good observation point should any increase in incidence of the disease occur. Among range beef cattle it is usual to check samples of animals at intervals rather than the entire cattle population.

## Problems in Tuberculosis Eradication

Complete eradication of tuberculosis has not really been achieved in any country. In many, a state of virtual eradication has been in existence for years, but minor recrudescences occur. In the final stages of an eradication program a number of problems achieve much greater importance than in the early stages of the campaign. The major problems that arise are as follows.

### No-Visible-Lesion Reactors

The percentage of reactors with no gross lesions or no visible lesions (NVL) at slaughter rises steeply as the disease prevalence decreases. In part this occurs because gross examination has poor sensitivity for detection of infection, but it is also inevitable given the falling prevalence of disease and the specificity of the tuberculin test. NVL reactors create administrative and public relations difficulties. Resolution of this problem awaits the validation of the interferon-gamma assay or other accepted serologic tests.

### “Breakdowns”

Individual herds that have been accredited after a number of free tests may be found to have the disease again, often with a very high incidence. This may be because an anergic carrier has been left in the herd and tests have been too far apart or because of a break in the security of the herd, with infection from purchased cattle or transmission between cattle in neighboring herds.

### “Traceback”

A principal source of information on the location of infected herds in the final stages

of a program could be a traceback originating from infected animals at packing plants. It is often impossible, and a major advance would be a suitable method of identifying individual animals that could be utilized up to the killing floor. The two most popular methods are fabric labels stuck on the rump with skin contact glue and wraparound plastic or metal tail-tags bearing an identification number for the farm of origin. They have two problems. They can be removed at the abattoir and reused; they fall off if the tail is docked, a popular practice in some areas. Electronic identification might solve this problem but meets political and other resistance in many countries. Recent experience with bovine spongiform encephalopathy and other concerns for food safety will likely remove this resistance, and most countries have or are developing effective traceback programs.

### Large Herds

Another kind of difficulty in eradication is where cattle are run under very extensive conditions on large ranches or stations as in North America, South America, and Australia. There can be difficulty in ensuring a complete muster, and there is a great need for a test that does not require that cattle be held in a mustering site for 3 days before the test is read. Problems with continuing infection also occur in large intensive dairies where the policy is test and cull, and the whole dairy cannot be depopulated at one time.

### Wildlife Reservoirs

Spread to cattle from wild fauna is a major problem in the United Kingdom, where badgers and deer are important sources of infection; in New Zealand, where the brush-tailed possum plays the same role; and a risk from deer exists in several countries. In New Zealand, the possum is considered a pest and does considerable damage to the ecosystem; possum control programs are accepted. However, the badger in Britain, and deer in most countries, are protected species and suitable control programs, acceptable to animal protectionists, are difficult to negotiate in this sensitive area of public relations. DNA fingerprinting can establish sources of infection and the importance of wildlife reservoirs to cattle.

### Control of Tuberculosis in Pigs

*M. bovis* infection in pigs usually results from the feeding of infected milk, skim milk, or whey to pigs or allowing cattle and pigs to graze the same pasture. The first step in the control of tuberculosis in a pig herd is to remove the source of infection, and then to test and remove the reacting animals, which is not an efficient procedure because of the relative inaccuracy of the tuberculin test in this species. The nonprogressive nature of the disease means that transmission between

pigs is unlikely to occur to a significant extent, except perhaps in breeding animals.

## FURTHER READING

- Cousins DV. *Mycobacterium bovis* infection and control in domestic livestock. *Rev Sci Tech Off Int Epiz.* 2001;20:71-85.
- Good M, Duignan A. Perspectives on the history of bovine TB and the role of tuberculin in bovine TB eradication. *Vet Med Int.* 2011;410-470.
- Pérez-Lago L, Navarro Y, García de Viedma D. Current knowledge and pending challenges in zoonosis caused by *Mycobacterium bovis*: a review. *Res Vet Sci.* 2014;97:S94-S100.
- Pesciaroli M, Alvarez J, Boniotti MB, et al. Tuberculosis in domestic animal species. *Res Vet Sci.* 2014;97:S78-S85.
- Pritchard DG. A century of bovine tuberculosis 1888-1988: conquest and controversy. *J Comp Pathol.* 1988;99:357-399.
- Wood PR, Monahan ML, eds. Bovine tuberculosis. *Vet Microbiol.* 1994;40:1-205.

## REFERENCES

- European Commission Health, Consumer Protection Directorate-General. 2013 at: <[http://ec.europa.eu/food/animal/diseases/eradication/tb\\_workingdoc2006\\_en.pdf](http://ec.europa.eu/food/animal/diseases/eradication/tb_workingdoc2006_en.pdf)>; Accessed 03.03.15.
- OIE. 2009 at: <[http://www.oie.int/fileadmin/Home/eng/Health\\_standards/tahm/2.04.07\\_BOVINE\\_TB.pdf](http://www.oie.int/fileadmin/Home/eng/Health_standards/tahm/2.04.07_BOVINE_TB.pdf)>; Accessed 03.03.15.
- Rodriguez-Campos S, et al. *Res Vet Sci.* 2014;97:S5.
- EFSA. *EFSA J.* 2014;12(2):3547.
- DEFRA. 2014 at: <[https://www.gov.uk/government/uploads/system/uploads/attachment\\_data/file/300447/pb14088-bovine-tb-strategy-140328.pdf](https://www.gov.uk/government/uploads/system/uploads/attachment_data/file/300447/pb14088-bovine-tb-strategy-140328.pdf)>; Accessed 02.03.15.
- Palmer MV. *Transbound Emerg Dis.* 2013;60:1.
- Hardstaff JL, et al. *Res Vet Sci.* 2014;97:S86.
- Pesciaroli M, et al. *Res Vet Sci.* 2014;97:578.
- Pérez-Lago L, et al. *Res Vet Sci.* 2014;97:S94.
- Bezons J, et al. *Res Vet Sci.* 2014;97:S3.
- CDC. 2011 at: <<http://www.cdc.gov/tb/publications/factsheets/general/mbovis.pdf>>; Accessed 03.03.15.
- Domingo M, et al. *Res Vet Sci.* 2014;97:S20.
- Twomey DF, et al. *Vet J.* 2012;192:246.
- Bezons J, et al. *Res Vet Sci.* 2014;97:S44.
- Wernery U, et al. *Vet Microbiol.* 2007;192:246.
- Downs S, et al. *Proc Soc Vet Epidemiol Prev Vet Med.* 2011;139.

## TUBERCULOSIS ASSOCIATED WITH MYCOBACTERIUM TUBERCULOSIS

*Mycobacterium tuberculosis* is occasionally isolated from cattle or pig livestock with tuberculous lesions, but this is rare. Outbreaks of tuberculosis in animals associated with *M. tuberculosis* of human origin are transitory, and removal of tuberculous humans from the environment usually results in the disappearance of positive reactors in cattle.

In recent years a considerable increase in the occurrence rate of tuberculosis associated with *M. tuberculosis* was noticed among the wildlife population of South African zoos.<sup>1</sup> The considerable genetic diversity of strains involved in cases of TB in wild animals suggests that animals contracted the

infection from human visitors to the zoos rather than from an internal source. This development is considered to be the result of the human tuberculosis epidemic in South Africa spilling over to wild animals.<sup>1</sup>

*M. tuberculosis* has been isolated from a subset of pig carcasses that have been condemned because of the presence of tuberculous lesions at two slaughterhouses in Ethiopia.<sup>2</sup> The presence of *M. tuberculosis* in pig carcasses suggests transmission of the pathogen between both species and supports the idea that pigs may indeed not be dead-end hosts for mammalian tuberculosis.<sup>2</sup>

In cattle herds, the reactors and necropsy lesions are most common in the young stock. Many reactors have no visible lesions; those that do occur are small and confined to the lymph nodes of the digestive and respiratory systems. Pigs may develop minor lesions in lymph nodes, but sheep, goats, and horses appear to be resistant. *M. tuberculosis* infections in pigs are usually the result of feeding offal from a tubercular household or contact with a tuberculous attendant.

## REFERENCES

1. Michel AL, et al. *Transbound Emer Dis*. 2013;6046-6052.
2. Arega SM, et al. *BMV Vet Res*. 2013;9:97.

## MYCOBACTERIOSIS ASSOCIATED WITH MYCOBACTERIUM AVIUM INTRACELLULARE COMPLEX AND WITH ATYPICAL MYCOBACTERIA

### SYNOPSIS

**Etiology** *Mycobacterium avium-intracellulare* complex and other mycobacteria.

**Epidemiology** Ubiquitous in nature. Infection by ingestion. High concentration can build up in animal bedding of various types. Domestic or wild birds are a source of classic avian tuberculosis serovars. Can cause disease in humans particularly when immunocompromised.

**Clinical findings** Most infections are of the draining lymph nodes of the alimentary tract and are subclinical, but they can result in carcass condemnation. Generalized cases manifest with chronic weight loss and diarrhea.

**Clinical pathology** Tuberculin testing in cattle and swine. Culture, polymerase chain reaction (PCR).

**Necropsy findings** Microgranulomas, with or without caseation, in lymph nodes.

**Control** Reduction of environmental contamination.

## ETIOLOGY

The *M. avium-intracellulare* complex (MAC) comprises two mycobacterial species: *M.*

*avium* and *M. intracellulare*. *M. avium* is further subdivided into four subspecies: *M. avium* subsp. *avium*, *M. avium* subsp. *paratuberculosis*, *M. avium* subsp. *sylvaticus*, and *M. avium* subsp. *hominissuis*. The classical *M. avium* serovars are the cause agents of tuberculosis in poultry, whereas *M. avium* subsp. *hominissuis* is an opportunistic pathogen primarily infecting swine and humans. *M. avium* subsp. *paratuberculosis* is the causative agent of paratuberculosis in cattle and small ruminants (Johne's disease) and is discussed in the corresponding chapters of this book.

The MAC comprises ubiquitous opportunistic pathogens of a large range of species, and in livestock these pathogens have the most importance in swine. Tuberculosis associated with these organisms in livestock is usually not manifest clinically and is not a major disease problem, but infected animals react to the intradermal tuberculin test, creating difficulty in *M. bovis* tuberculosis eradication programs. Outbreaks in pig herds can cause significant losses because of carcass condemnation. In pigs, a significant proportion of reactors to tuberculin are attributable to infection with organisms of this complex, and infected cattle and pigs are potential sources of infection for the increasing number of MAC (particularly *M. avium* subsp. *hominissuis*) infections in humans.

## EPIDEMIOLOGY

### Occurrence

Lymphadenitis in pigs associated with these organisms is reported from all continents.

### Source and Transmission

Organisms of the MAC are ubiquitous in nature and can be isolated from soil, plants, water, and animal feed and animal bedding. Infected birds nesting in animal or feed buildings are the most common source of *M. avium* subsp. *avium* and contaminate feed and water supplies. In contrast, isolates of *M. avium* subsp. *hominissuis* are commonly isolated from the environment and can be isolated from various species of flies and beetles that inhabit the ground, bedding, and feed in farm environments. Several studies have confirmed the role of peat that is used for bedding or as feed additive as source of infection with *M. avium* subsp. *hominissuis* for piglets.<sup>1</sup> The organisms are resistant to acidic environments, which allows them to survive in the acidic, humid environments of peat bogs and decomposed feces, and the lipopolysaccharide bacterial wall promotes survival in environments inside and outside barns for extended periods of time.<sup>2</sup>

**Ingestion** appears the normal route of infection, and pigs infected with *M. avium* subsp. *hominissuis* excrete the organism in **feces**.<sup>3</sup> In pigs the use of dirt floors or deep litter, rather than bare concrete or slats, increases the risk of infection and the development of macroscopic lymphadenitis in large numbers of pigs. The length of time that

pigs are kept on the litter is also important, and severe outbreaks can occur in pigs kept on litter for the entire period from weaning to slaughter. Sawdust, straw, peat, and wood shavings have all been found to be highly contaminated. Sphagnum moss contaminated with *M. cookii* and environmental exposure to other mycobacteria may result in sensitization of cattle to bovine tuberculin.

*M. avium* subsp. *avium* is the cause of tuberculosis in domestic and wild birds, which are infected by ingestion of contaminated feed or soil and excrete large numbers of organisms in feces. Although infection in domestic livestock is commonly contracted from domestic poultry, from soil-borne infection, or from pen floors or feeds contaminated by wild birds, pig-to-pig transmission can also occur.

## Economic Importance

Clinical disease is not important, but at slaughter organs with tuberculous lesions are discarded, and the entire carcass may be condemned or require heat treatment before being released for human consumption.

## Zoonotic Importance

Infections with atypical mycobacteria are not uncommon in humans and have higher prevalence in immunocompromised humans. Members of the MAC, in particular *M. avium* subs. *hominissuis*, cause both pulmonary infections in immunocompetent individuals and disseminated diseases in acquired immunodeficiency syndrome. Another typical manifestation of *M. avium* infection is lymphadenitis in the head and neck region of children.<sup>4</sup>

Animals, or animal products, may be a source for human infection, but direct associations are difficult to prove. Although not clinically ill, human workers have been found to be infected on farms when the disease occurred in pigs. It is likely that infections in humans and animals on the one farm come from the one source, but it is also possible that spread from animals to humans occurs.

## CLINICAL AND NECROPSY FINDINGS

### Cattle

With classic avian tuberculosis, sensitivity to tuberculin may disappear soon after cattle are removed from contact with infected birds. Infection with this group of organisms produces microgranulomas in lymph nodes. Local lesions may persist in the mesenteric lymph nodes, the meninges, and in the uterus and udder, and occasional cases of open pulmonary tuberculosis have been observed. In uterine infections recurrent abortion may occur, and mammary localization causes induration and involvement of lymph nodes, similar to the lesions associated with *M. bovis*. Generalized tuberculosis can occur in up to 50% of cases.



## Goats and Sheep

Goats and sheep appear to have a strong natural resistance to infection with *M. avium* complex. A high incidence of avian tuberculosis has been observed in a herd of goats, and although the disease progresses slowly, this species may act as reservoirs for other species. Animals with progressive disease show anorexia and chronic diarrhea and wasting.

## Deer

Infection in wild and farmed deer occurs and may serve as a source of infection for carrion-eating birds.

## Horses

Horses are resistant to infection with *M. avium* complex, although rare, generalized cases of tuberculosis have been reported in this species. It is possible that disease occurs only in horses that are immunosuppressed by other factors. A common history is chronic diarrhea and weight loss. Less common manifestations include dermatitis, alopecia, and skin ulceration. Granulomatous enteritis is commonly present at necropsy. Two cases have been recorded in which the lesions in the cervical lymph nodes were accompanied by lesions in cervical vertebrae. The lesions were similar to those seen in cervical vertebral osteomyelitis associated with *M. bovis*.

## Pigs

Infection is usually sporadic in pigs in herds but in some herds can be enzootic.<sup>5</sup> The naturally occurring disease is nonprogressive and usually restricted to the lymph nodes of the head and neck and the mesenteric lymph nodes. Occasional generalized cases with involvement of liver, lungs, and kidneys occur; an outbreak of pulmonary tuberculosis associated with *M. avium* and clinical symptoms such as wasting and abortion has been reported in pigs. The lesions may be free of suppuration and resemble neoplastic tissue, but granulomatous and occasionally caseous lesions in lymph nodes also occur. Similar lesions are associated with *Rhodococcus equi*. Granulomatous lesions that develop in the tonsils and intestinal wall result in the passage of organisms in the feces for at least 55 days, and transmission to in-contact pigs occurs readily.<sup>1</sup>

Tuberculosis produced experimentally in pigs by the oral administration of *M. avium* is generalized, provided the inoculation dose is sufficiently large. Transmission from these pigs to contact pigs occurs. Vaccination of pigs with BCG vaccine provides partial protection against experimental infection with *M. avium*.

## CLINICAL PATHOLOGY

The lesions at postmortem or slaughter inspection are characteristic, but culture and identification of the organism is required for

confirmation. Growth is slow, and PCR technologies offer faster diagnosis, with some ability to distinguish between individual species and serovars. Smears of lesions associated with some of these agents do not stain positive with acid-fast stains.

## Tuberculin Testing

With infections in cattle, sensitivity to tuberculin occurs to both avian and bovine tuberculin, but is greater to avian tuberculin. With atypical mycobacteria the response is also short-lived, with significant changes in sensitivity occurring between successive tests. The comparative tuberculin test is becoming more widely used because of the growing importance of these infections. It is not uncommon to have more than one species of mycobacteria causing disease in a herd at the one time.

The single intradermal comparative tuberculin (SCIT) test consisting of the simultaneous intradermal injection of bovine and avian tuberculin has been used to differentiate between infections with MAC and *M. bovis*, which pertains to the *M. tuberculosis* complex (MTC) in swine. Animals infected with mycobacteria of the MTC tend to show a stronger reaction to bovine than to avian tuberculin, whereas animals previously exposed to organisms of the MAC show a reverse reaction.<sup>3</sup>

Tuberculin skin testing in horses is not conducted because 70% of clinically normal horses show positive reactions.

## TREATMENT AND CONTROL

Treatment is not usual, except possibly in horses. Antimicrobial treatment in humans for this complex of organisms includes amikacin, ciprofloxacin, rifampin, and the macrolide azithromycin.

In swine herds with enzootic infection, culling on the basis of skin sensitivity is usually not practical because of the high prevalence of infection and high environmental contamination. Control procedures concentrate on the reduction of environmental contamination by a change from bedding to solid or slatted floors, frequent washing and disinfection of pen floors, separate weaner and grower facilities, and exclusion of wild birds from buildings and feed areas.

## FURTHER READING

Thorel MF, Huchzermeyer HF, Michel AL. *Mycobacterium avium* and *Mycobacterium intracellulare* infection in mammals. *Rev Sci Tech Off Int Epiz.* 2001;20:204-218.

## REFERENCES

- Johansen TB, et al. *Biomed Res Int.* 2014;189649.
- Biet F, et al. *Vet Res.* 2005;36:411.
- Agdelstein A, et al. *Vet Res.* 2014;46.
- Jarzebowski JA, Young MB. *Arch Pathol Lab Med.* 2008;132:1333.
- Alvarez J, et al. *Epidemiol Infect.* 2011;139:143.

## YERSINIOSIS

### ETIOLOGY

There are pathogenic and nonpathogenic strains of *Yersinia pseudotuberculosis* and *Yersinia enterocolitica*. The pathogenic strains of both organisms possess chromosomal and plasmid-mediated virulence determinants.

*Y. pseudotuberculosis* can be divided into 15 major serogroups, based on O-antigens, some of which can be further divided into subgroups on the basis of type-specific somatic and flagellar antigens. There is variation in animal and human pathogenicity between the serogroups.

*Y. enterocolitica* is divided into six major biotypes, designated as 1A (generally regarded as nonpathogenic), and 1B, 2, 3, 4, and 5. It is serologically heterogeneous, with 54 serotypes originally identified on the basis of somatic antigens, which was subsequently simplified to 18 serogroups.<sup>1</sup> Bioserotypes may be host-specific. Serotypes O:2, O:3, O:5, O:8, and O:9 have been most often associated with infection in farm animals and humans. Other serotypes appear to be largely nonpathogenic, although virulence factors have recently been detected in some biotypes previously regarded as nonpathogenic. Serotype O:9 is antigenically very similar to *Brucella* spp., and infection with this serotype is a cause of false-positive reactions to *Brucella* agglutination and complement fixation tests.

### EPIDEMIOLOGY

#### Occurrence

Yersiniosis has worldwide occurrence, although there appear to be regional differences in the species of animal infected, the prevalence of disease, and the organism involved. *Y. pseudotuberculosis* has historically been associated with sporadic pyemic disease in sheep manifest with extensive abscessation of internal organs such as liver and spleen. Subsequently, *Y. pseudotuberculosis* and *Y. enterocolitica* have been associated with enterocolitis in cattle, sheep, pigs, goats, buffalo, and farmed and feral deer. Enteric disease in ruminants has been most reported from Australia, New Zealand, and the United States.<sup>2</sup>

#### *Yersinia pseudotuberculosis*

*Y. pseudotuberculosis* is a common inhabitant of the intestine in a wide variety of domestic and wild mammals. Wild birds and rodents are also reservoirs of the organism, and fecal-oral spread on pastures and in water is a major method of transmission. Spring migratory birds can spread pathogenic types over long distances, although these are usually not associated with disease in ruminants.

There may be differences in the host specificity of different serotypes and strains. Rodents and birds may be the major reservoirs for serotypes I and II, which infect deer and goats, whereas sheep and cattle may be maintenance hosts for serotype III.

In an Australian study, *Y. pseudotuberculosis* serotype III was isolated from the feces of healthy sheep in 5% of flocks examined, although the prevalence was probably much higher because only a small number of sheep were sampled in each flock. Infection was more common in young sheep and occurred during the winter and spring months, and excretion of the organism persisted for 1 to 14 weeks. A 23-year retrospective study of disease caused by *Y. pseudotuberculosis* in goats in California found that cases occurred predominantly in winter and spring and were clustered in certain years. The most common syndromes were enteritis and/or typhlocolitis (64%), abscessation (14%), and abortion (12%).<sup>2</sup>

In cattle, the organism has been found without disease in up to 26% of normal cattle and on 84% of farms tested. The fecal excretion that occurs in clinically normal sheep and cattle possibly results from a subclinical infection of the intestine; experimental challenge of ruminants can result in the establishment of the organism in the intestine, with the presence of microscopic abscessation in the lamina propria and serologic conversion in the absence of clinical disease.

Enteric disease associated with this organism in both cattle and sheep appears to occur as the result of a heavy infection pressure in animals that are debilitated from other influences. These include cold wet weather, inanition and starvation, trace-element deficiency, change of diet, management procedures such as marking, and, in farmed deer, procedures such as capture, yarding, and recent transport.

In sheep, attack rates in the flock for clinical disease have ranged from 1% to 90%, with a mean of 18% and a population mortality varying from 0% to 7%. *Y. pseudotuberculosis* may also cause sporadic abortion in cattle, goats, and sheep. In sheep, abortion rates of 1% to 9% are recorded, with abortion occurring in the latter part of pregnancy and without clinical illness in the ewes. The organism is the cause of occasional cases of bovine caprine mastitis, epididymitis, and orchitis in rams, and it may be found in sporadic cases of abscessation and lymphangitis in ruminants.

### *Yersinia enterocolitica*

*Y. enterocolitica* is less commonly associated with clinical disease in farm animals, although apparently healthy animals can excrete strains that are potentially pathogenic for humans for much of the year. Diarrhea associated with this organism can occur in sheep, and the organism can be isolated from affected lambs. However, harmful strains of *Y. enterocolitica* tend to be less pathogenic to sheep and goats than pathogenic strains of *Y. pseudotuberculosis*.

Enterocolitis is recorded in sheep and goats. Biotype 5, serotype O:2,3 has been isolated from some of these. In an Australian

survey in the early 1990s this organism was detected in 17% of flocks and was isolated from young sheep at all seasons of the year. In a study of goat flocks in New Zealand, 80 of 82 *Y. enterocolitica* isolated from 18 flocks were biotype 5 O:2,3.<sup>3</sup> Young goats (those < 1 year old) had from 2.2 to 12.9 times the risk of shedding potentially pathogenic isolates than older goats. Clinical disease appears to be predisposed by the same stress factors as apply with disease associated with *Y. pseudotuberculosis*. For example, *Y. enterocolitica* was isolated from the caecum of lambs with severe diarrhea grazing fodder beet in the United Kingdom.<sup>4</sup> The weather at the time of the outbreak was cold and wet, and the yearling sheep were seen congregating around pools of water in the paddock. Parasitism and poor nutrition were also thought to be contributing factors. Disease is typically recorded in sheep less than 1 year of age, with attack rates varying from 2% to 55% and population mortalities ranging from 0.3% to 17%. *Y. enterocolitica* is also an occasional cause of abortion in sheep, and this has been reproduced experimentally.

Whereas *Y. enterocolitica* is commonly isolated from pigs, and pigs are a major reservoir for human disease, it is a rare cause of clinical disease in pigs, although clinical enteric disease can be produced by experimental challenge of colostrum-deprived pigs. Normal pigs challenged with serotype O:3 excreted the organism in feces but were fecal-culture-negative 10 weeks after challenge and at slaughter, even though the organism could be isolated from the tonsils at slaughter. Pigs seroconverted 19 days after challenge and remained seropositive until slaughter 70 days later.

### Zoonotic Implications

#### *Yersinia pseudotuberculosis*

Human infection with *Y. pseudotuberculosis* is primarily manifest with septicemia, and renal failure is a sequela. In addition to food-borne infection, the consumption of water contaminated by animal feces appears to be a major risk factor. Raw milk consumption is also a risk. Human cases are usually sporadic, although outbreaks have been reported from Finland and Russia.<sup>5</sup>

#### *Yersinia enterocolitica*

Gastrointestinal disease associated with *Y. enterocolitica* appears to have increasing prevalence in humans, being the third most commonly reported zoonosis in Europe, and can be associated with a reactive arthritis as a sequela. Septicemia does occur but is largely limited to those with other underlying disease. The bioserotype most often associated with human disease is 4/O:3, with other bioserotypes including 2/O:5,27, 1B/O:8, and 2/O:9.<sup>1</sup> Pigs are a major reservoir for *Y. enterocolitica*, and pork and pork products are sources for human infection.<sup>6</sup> Bioserotype 4/O:3, in particular, is

commonly isolated from the tonsils and pharynx of pigs at slaughter and less commonly from feces. The rate of isolation varies geographically and with farm source, and it has been suggested that pathogen-free breeding is a method for control. A high rate of biotype 1A, which is a common isolate from livestock and generally thought to be non-pathogenic for humans, was isolated from sheep feces, but not tonsil, from sheep at slaughter in Gotland, Sweden.<sup>6</sup> Recently, the virulence gene *ail* (adhesion invasion locus) has been identified in some strains of *Y. enterocolitica* biotype 1A, and thus a more thorough examination of these biotypes may be justified.<sup>7-9</sup>

In contrast to Australia and New Zealand, it is thought that in Europe the pig is the only domestic animal consumed by humans that regularly harbors pathogenic *Yersinia*. There is an apparent increasing prevalence of bioserotype 4/O:3 infections in humans in the Northern Hemisphere, and pigs and pork products are considered to be important sources. A survey in Great Britain comparing isolates of *Y. enterocolitica* from cattle, sheep, and pigs with those from humans over a 2-year period did not find a strong correlation between pathogenic serotypes isolated from the two groups, with the exception of isolates from pigs. The importation of meat products has been incriminated as the vehicle of introduction of pathogenic serotypes into Japan. There would appear to be an increased risk for infection in humans handling pigs at slaughter and in veterinarians in pig practice.

Bioserotype 3/O:5,27 is common in animals in the United Kingdom, but not isolated from humans. This bioserotype increased the secretion of the cytokines IL-6 and IL-8 from macrophages infected in vitro, compared with other biotype 3 and 4 isolates.<sup>10</sup> It was proposed that these differences in the interaction of the bacteria with the host immune system may explain why this bioserotype is not pathogenic for humans.

### PATHOGENESIS

Invasion of the intestinal epithelium is followed by inflammation in the mucosa and the formation of microabscesses in the lamina propria and mesenteric lymph nodes. Ulcers and disruption of the intestinal mucosa lead to loss of fluid and function. The intestinal lesions are accompanied by villous atrophy and lead to malabsorption and ill-thrift, diarrhea, or a combination of the two.

### CLINICAL FINDINGS

Affected animals may present with a syndrome of chronic ill-thrift and in a wasted condition with or without diarrhea. Where diarrhea is present, the feces are watery, foul-smelling, and black in color, but occasionally they also contain mucus and blood. Diarrhea persists for 2 to 3 weeks in an individual animal and may require the removal of soiled

wool (“crutching” or “dagging”) to reduce the risk of fly strike.

### CLINICAL PATHOLOGY

There is a neutrophilia with a left shift. Affected animals are often hypoproteinemic and anemic, although this may be a reflection of the underlying malnutrition. In experimental infections antibody develops by 9 to 19 days after infection and may be an aid to diagnosis. The organism can be isolated from the feces. Multiplex PCR, capable of detecting 10 pathogenic serotypes of *Y. enterocolitica*, and real-time PCR have been developed to discriminate pathogenic *Y. enterocolitica* from other members of this genus.<sup>11</sup>

### NECROPSY FINDINGS

There are liquid intestinal contents but usually no gross findings. Some sheep may have thickening of the mucosa of the small intestine and the cecum and colon, and the mesenteric lymph nodes may be enlarged and edematous.

The characteristic findings on histopathology consist of a segmental suppurative erosive enterocolitis. Microabscesses, consisting of aggregations of neutrophils with prominent colonies of gram-negative coccobacilli, are present in the mucosa. Lesions are most prevalent in the jejunum and ileum and are accompanied by atrophy of villi and hyperplasia of cryptal epithelium. Microabscesses may coalesce to produce extensive erosions, and there may be microabscesses in the liver.

The placenta from sheep that have aborted in association with *Y. pseudotuberculosis* is thickened and edematous, with necrotic debris in the intercotyledonary zone, and must be differentiated from enzootic abortion.

### Samples for Confirmation of Diagnosis

- Bacteriology—jejunum, ileum, colon, mesenteric lymph node (culture—sometimes requires cold enrichment)
- Histology—formalin-fixed jejunum, ileum (several sections), colon, mesenteric lymph node (light microscopy)

**Note the zoonotic potential of this organism when handling the carcasses and submitting specimens.**

### DIFFERENTIAL DIAGNOSIS

The major differential is the syndrome of weaner ill-thrift, caused mainly by undernutrition and gastrointestinal parasitism, and other agents that cause diarrhea, such as salmonellosis.

### TREATMENT AND CONTROL

Isolates vary in their sensitivity to antibiotics, and a sensitivity test is advisable. Most

isolates show in vitro sensitivity to the aminoglycosides, to tetracyclines, and to sulfonamides or a combination of sulfonamides and trimethoprim. Sulfonamides and trimethoprim are reported not to be effective in the treatment of yersiniosis in cattle; long-acting tetracyclines are recommended for the treatment of both infections, in combination with supportive therapy.

A vaccine is available for deer in New Zealand, but in other countries there is no specific control for ruminants and pigs. Live attenuated oral vaccines have been evaluated in laboratory animals and afforded good cross-protection against heterologous strains of *Y. pseudotuberculosis*.<sup>12</sup> In grazing animals mitigating the effects of parasitism, particularly during winter, and maintenance of good nutrition are thought to be important factors in avoiding clinical disease.

### FURTHER READING

- Bergsbaken BT, Cookson T. Innate immune response during *Yersinia* infection: critical modulation of cell death mechanisms through phagocyte activation. *J Leuk Biol.* 2009;86:1153-1158.
- Fredriksson-Ahomaa M, et al. Molecular epidemiology of *Yersinia enterocolitica* infections. *FEMS Immunol Med Microbiol.* 2006;47:315-329.
- Laukkanen-Ninios R, et al. Population structure of the *Yersinia pseudotuberculosis* complex according to multilocus sequence typing. *Env Microbiol.* 2011;13:3114-3127.
- Radostits O, et al. Yersiniosis. In: *Veterinary Medicine: A Textbook of the Diseases of Cattle, Horses, Sheep, Goats and Pigs*. 10th ed. London: W.B. Saunders; 2007:954-956.
- Slee KJ, Skilbeck NL. The epidemiology of *Yersinia pseudotuberculosis* and *Y. enterocolitica* infections in sheep in Australia. *J Clin Microbiol.* 1992;30:712-715.

### REFERENCES

1. Drummond N, et al. *Food Path Dis.* 2012;17:179.
2. Giannitti F, et al. *J Vet Diag Invest.* 2014;26:88.
3. Lánada EB, et al. *Aust Vet J.* 2005;83:563.
4. Otter A, Callaghan G. *Vet Rec.* 2008;162:699.
5. Laukkanen-Ninios R, et al. *Env Microbiol.* 2011;13:3114.
6. Söderquist K, et al. *Acta Vet Scand.* 2012;54:39.
7. Kraushaar B, et al. *J Appl Microbiol.* 2011;111:997.
8. Sihvonen LM, et al. *Food Path Dis.* 2011;8:455.
9. Kumar P, Virdi JS. *J Appl Microbiol.* 2012;113:1263.
10. McNally A, et al. *J Med Microbiol.* 2006;55:725.
11. Lambert ST, et al. *Appl Environ Microbiol.* 2008;74:6060.
12. Quintard B, et al. *Comp Immunol Microbiol Infect Dis.* 2010;33:e59.

## TULAREMIA

### SYNOPSIS

**Etiology** *Francisella tularensis* subsp. *tularensis* in North America; *Francisella tularensis* subsp. *holarctica* in Asia, Europe, and North America.

**Epidemiology** Primarily wild animal disease with wide occurrence in the Northern Hemisphere. Among domesticated animals,

cats and lambs are most, and pigs less, susceptible; seasonal, associated with heavy tick infestation. Tabanidae, rodents, and lagomorphs function as hosts and vectors. Zoonosis, potential bioterrorist agent.

**Clinical findings** Tick infestation. Fever, stiffness of gait, diarrhea, weight loss, recumbency. Wool break.

**Clinical pathology** None specific.

**Necropsy findings** Subcutaneous swellings at site of tick attachment, lymphadenitis, and septicemia in sheep. Pigs have pleuritis, pneumonia, and abscessation of submaxillary and parotid lymph nodes.

**Diagnostic confirmation** Identification of agent by immunohistochemistry, polymerase chain reaction (PCR) or culture; serology in survivors.

**Treatment** Tetracyclines, streptomycin.

**Control** Tick control, repellents.

### ETIOLOGY

*Francisella tularensis*, the causative organism of tularemia is a gram-negative, nonspore-forming coccobacillus pertaining to the family Francisellaceae. The bacterium survives in the environment for prolonged periods. Viable bacteria can be found after weeks and months in the carcasses and hides of infected animals and in fomites, which include grain, straw, dust and water. It is highly resistant to freezing and can survive in meat of infected animals stored at  $-15^{\circ}\text{C}$  ( $5^{\circ}\text{F}$ ) for 3 years.<sup>1</sup>

Currently, four subspecies with different animal hosts and different geographic distribution are recognized:<sup>2</sup>

- *F. tularensis* subsp. *tularensis* (type A): This is the most virulent subspecies; it is found in North America and associated with rabbits, ticks, and sheep.
- *F. tularensis* subsp. *holarctica* (*palaeartica*, type B): This subspecies is less virulent and is found in Asia, Europe and North America. It is often isolated in association with streams, ponds, lakes, and rivers. Beavers and muskrats in North America and lemmings and beavers are presumably responsible for maintaining the water association of this bacterium. There is evidence suggesting that the pathogen can persist in water (possibly associated to protozoa) for prolonged periods of time.
- *F. tularensis* subsp. *mediasiatica*: This serotype has only been isolated in Kazakhstan and Turkmenistan. Little is known about its virulence, but is considered to comparable to that of subsp. *holarctica*.
- *F. tularensis* subsp. *novicida*: This strain has thus far only been isolated from humans; it has been linked to waterborne transmission in Australia,



Spain, and the United States. The strain of subsp. *novicida* isolated in Australia is the only one identified in the Southern Hemisphere thus far.

### EPIDEMIOLOGY

Tularemia is a highly contagious disease occurring principally in wild animals, but it may transmit to farm animals and cats, causing septicemia and high mortality. It can occur either as epizootics or as sporadic disease. It is a zoonosis that is responsible for approximately 100 clinical cases in humans every year in the United States.

### Occurrence

Tularemia is primarily restricted in its occurrence to countries in the **Northern Hemisphere** and occurs in most of them. In the United States tularemia is recognized in all states except Hawaii. It is most prevalent in the central-western states of the United States, including Missouri, Arkansas, Oklahoma, South Dakota, and Kansas.<sup>3</sup> In Europe, the disease is more prevalent in eastern European countries and less common in continental western Europe.<sup>2</sup> Epidemics affecting the human population have occurred in Spain, Portugal, Sweden, and Kosovo.

### Risk Factors

#### Animal Risk Factors

*F. tularensis* has a wide host range and is recorded in over 100 species of bird and wild and domestic animals. Common wild animal hosts include rabbits, muskrats, beavers, and a variety of rodents, including voles, squirrels and lemmings. Disease in domesticated animals most commonly occurs in **cats and sheep** and to a lesser extent in pigs, dogs, and horses; cattle appear to be relatively resistant but can be infected in association with heavy tick infestation. Sheep and pigs of all ages are susceptible, but most losses occur in lambs; in pigs, clinical illness occurs only in piglets. There is a sharp seasonal incidence, with the bulk of cases occurring during the spring months. The morbidity rate in affected flocks of sheep is usually about 20% but may be as high as 40%, and the mortality rate may reach 50%, especially in young animals.

#### Transmission

The **major reservoirs** and transmitters of the infection are rabbits, hares, wild rodents, **ticks**, and flies. The principal mammalian target host in North America is the cottontail rabbit (*Sylvilagus* spp.). With sheep, transmission occurs chiefly by the bites of the wood tick, *Dermacentor andersoni*, and from *Haemaphysalis otophila*, with the ticks becoming infected in the early part of their life cycle when they feed on rodents. In Europe, *Ixodes ricinus* and *Dermacentor reticulatus* are vectors. Transmission to pigs and horses is thought to occur chiefly by tick bites, but **mechanical transmission** to

laboratory animals does occur with tabanid and blackflies. In the former Soviet Union and northern Europe, the bacterium has been demonstrated to be transmitted by mosquitoes.<sup>2</sup> Tabanid flies, which include the horsefly and the deerfly, have been implicated as vectors in the western United States and northern Europe.<sup>1</sup> At least 20 flea species were identified as potential vectors, although their role in the spread of the disease is uncertain. Neither in flies nor mosquitoes the pathogen was confirmed to reside in the salivary glands, suggesting that they may function as mechanical rather than biological vectors.

In contrast, **transstadial** and **transovarial transmission** occurs in the tick. The adult ticks infest sheep, and pastures bearing low shrubs and brush are particularly favorable to infestation. The ticks are found in greatest numbers on the sheep around the base of the ears, top of the neck, throat, axillae, and udder.

#### Pathogen Risk Factors

There is little information concerning virulence mechanisms of *F. tularensis*. The capsule appears to be a necessary component for expression of full virulence and protects against serum-mediated lysis. The lipopolysaccharide has unusual biological and structural properties and low toxicity in vitro and in vivo.

Pronounced differences in virulence between subtypes are well established. *F. tularensis* subsp. *tularensis* is by far the most virulent subspecies for all affected species and is associated with the highest mortality rates in animals and humans.

#### Zoonotic Implications

Humans can acquire *F. tularensis* from various sources. Most exposures appear to result from the handling of infected rabbits and other wildlife (e.g., during hunting activities), but infections can arise from **bites** of ticks and haematophagus flies, from the **ingestion** of contaminated meat and water, and from the bite or scratch of infected cats. Inhalation of aerosolized bacteria appears to be a less common route of infection but is associated with respiratory tularemia, which has the highest fatality rate of all clinical presentations of tularemia.<sup>2</sup> The disease is an occupational hazard to hunters and workers in the sheep industry in areas where the disease occurs. Spread of the disease to humans may also occur in abattoir workers who handle infected sheep carcasses. Person-to-person transmission has not been documented.

*F. tularensis* is one of the most infectious pathogens known in human medicine, with an extremely low infectious dose (10 bacteria when injected subcutaneously and 25 bacteria when inhaled as aerosol). Because of its high infectivity, the fact that it causes infection through inhalation in combination with

its stability in aerosols, *F. tularensis* is recognized as **potential bioterrorist agent**.

### PATHOGENESIS

Tularemia is an acute septicemia, but localization occurs, mainly in the parenchymatous organs, with the production of granulomatous lesions.

### CLINICAL FINDINGS

#### Sheep

The incubation period has not been determined. A heavy tick infestation is usually evident.

The **onset** of the disease is slow with a gradually increasing stiffness of gait, dorsiflexion of the head, and a hunching of the hindquarters; affected animals lag behind the group. The pulse and respiratory rates are increased, the temperature is elevated up to 42°C (107°F), and a cough may develop. There is diarrhea, the feces being dark and fetid, and urination occurs frequently, with the passage of small amounts of urine. Body weight is lost rapidly, and progressive weakness and recumbency develop after several days, but there is no evidence of paralysis, with the animal continuing to struggle while down. Death occurs usually within a few days, but a fatal course may be as long as 2 weeks. Animals that recover commonly shed part or all of the fleece but are solidly immune for long periods.

#### Pigs

The disease is latent in adult pigs, but young piglets show fever up to 42°C (107°F), accompanied by depression, profuse sweating, and dyspnea. The course of the disease is about 7 to 10 days.

#### Horses

In horses, fever (up to 42°C [107°F]) and stiffness and edema of the limbs occur. Foals are more seriously affected and may show dyspnea and incoordination in addition to the previously mentioned signs.

### CLINICAL PATHOLOGY

**Isolation of the pathogen** can be attempted from impression smears or fixed specimens of organs such as liver, spleen, bone marrow, kidney, or lung and from blood smears. Immunologic methods such as the fluorescent antibody test are considered most reliable to identify the agent.<sup>4</sup> Polymerase chain reaction (PCR) protocols are now widely used to confirm the presence of bacterial DNA.

**Serologic tests** are the standard tests used for the diagnosis of tularemia in humans. In veterinary medicine serology may be employed for epidemiologic surveys of animal species resistant to the infection, but it is of limited value in susceptible species that commonly die before seroconversion occurs. The agglutination test is the most commonly used test for the diagnosis of tularemia, with a titer of 1:50 being regarded as

a positive test in pigs. Serum from pigs affected with brucellosis does not agglutinate tularemia antigen, but serum from pigs affected with tularemia agglutinates brucellosis antigen. Cross-agglutination between *F. tularensis* and *Brucella abortus* is less common in sheep, and an accurate diagnosis can be made on serologic grounds because of the much greater agglutination that occurs with the homologous organism. Titers of agglutinins in affected sheep range from 1:640 to 1:5000 and may persist at levels of 1:320 for up to 7 months. A titer of 1:200 is classed as positive in sheep. In horses the titers revert to normal levels in 14 to 21 days.

Enzyme-linked immunosorbent assays (ELISAs) are available to identify either IgM, IgA, or IgG in infected animals. Because IgM levels are sustained for prolonged periods after infection, a high titer cannot be used as an indication for recent infection.<sup>4</sup>

### NECROPSY FINDINGS

In sheep, large numbers of ticks may be present on the hides of fresh carcasses. In animals that have been dead for some time, dark-red subcutaneous areas of congestion up to 3 cm in diameter are found and may be accompanied by local swelling or necrosis of tissues. These lesions mark the attachment sites of ticks. Enlargement and congestion of the lymph nodes draining the sites of heaviest tick infestation are often noted. Pulmonary edema, congestion, or consolidation are inconsistent findings.

In pigs the characteristic lesions are pleuritis, pneumonia, and abscessation of submaxillary and parotid lymph nodes. The organisms can be isolated from the lymph nodes and spleen and from infected ticks. Isolation can also be effected by experimental transmission to guinea pigs. Techniques such as immunoperoxidase staining of fixed specimens and PCR of fresh tissues can circumvent the need for culture of this zoonotic agent.

### Samples for Confirmation of Diagnosis

- Bacteriology—lung, liver, lymph node, spleen, kidney, bone marrow, blood (immunohistochemistry, PCR, culture—requires cystine-enriched media)
- Histology—previously mentioned tissues fixed in formalin (light microscopy, immunohistochemistry)

**Note the zoonotic potential of this organism when handling the carcasses and submitting specimens.**

### DIFFERENTIAL DIAGNOSIS

The occurrence of a highly fatal septicemia in sheep during spring months when the sheep are heavily infested with *Dermacentor andersoni* should suggest the possibility of tularemia, especially if the outbreak occurs in an enzootic area.

**Tick paralysis.** This occurs in the same area and at the same time of the year as tularemia but is not accompanied by fever, and there is marked flaccid paralysis. Recovery from tick paralysis occurs commonly if the ticks are removed.

**Other septicemias** include *P. trehalosi* in sheep and *Haemophilus* spp. in sheep and cattle. These are unusual in the age group in which tularemia occurs and are not associated with tick infestation. In pigs, local lesions can resemble tuberculosis.

**Anthrax.**

### TREATMENT

Streptomycin, gentamicin, tetracyclines, and fluoroquinolones are effective treatments in humans and companion animals. Oxytetracycline (10 mg/kg body weight [BW] IV or IM every 24 hours).

### TREATMENT AND CONTROL

#### Treatment

Streptomycin (10 mg/kg IM every 24h) (R-2)  
 Oxytetracycline (10 mg/kg IV or IM every 24h) (R-2)  
 Enrofloxacin (2.5 mg/kg IM/SC every 24 hours for 3 to 5 days) (R-2)

#### Control

Tick control  
 Repellents

### CONTROL

An outbreak of tularemia in sheep can be rapidly halted by spraying or dipping with an insecticide to kill the vector ticks. In areas where ticks are enzootic, sheep should be kept away from shrubby, infested pasture or sprayed regularly during the months when the tick population is greatest. An experimental live attenuated vaccine has been developed, but there is no routine vaccination of livestock.

### FURTHER READING

- Feldman KA. Tularemia. *J Am Vet Med Assoc.* 2003;222:725-730.  
 Petersen JM, Schriefer ME. Tularemia: emergence/re-emergence. *Vet Res.* 2005;36:455-467.  
 Tarnvik A, Priebe HS, Grunow R. Tularemia in Europe: an epidemiological overview. *Scand J Infect Dis.* 2004;36:350-355.  
 World Health Organization (WHO). WHO guidelines on tularemia. 2007 at: <<http://www.cdc.gov/tularemia/resources/whotularemiamanual.pdf>>; Accessed 01.02.14.

### REFERENCES

1. The Center for Food Security and Public Health. 2009 at: <<http://www.cfsph.iastate.edu/Factsheets/pdfs/tularemia.pdf>>; Accessed 01.02.14.
2. WHO. 2007 Available at: <<http://www.cdc.gov/tularemia/resources/whotularemiamanual.pdf>>; Accessed 01.02.14.
3. Anon. *MMWR.* 2013;62:963.

4. OIE. Terrestrial manual. 2008 at: <[http://www.oie.int/fileadmin/Home/eng/Health\\_standards/tahm/2.01.18\\_TULAREMIA.pdf](http://www.oie.int/fileadmin/Home/eng/Health_standards/tahm/2.01.18_TULAREMIA.pdf)>; Accessed 01.02.14.

## MELIOIDOSIS

### SYNOPSIS

**Etiology** *Burkholderia pseudomallei*.

**Epidemiology** Ubiquitous soil saprophyte endemic to Southeast Asia, northern Australia, and the South Pacific. Occurs primarily 20° north and south of the equator. Transmission is by inhalation of contaminated dust and cutaneous abrasion. Primarily a disease of sheep and goats and humans, occasional disease in horses, and subclinical infection in pigs.

**Clinical findings** Septicemia, weakness, recumbency, and death in sheep. Septicemia, pneumonia, and lymphangitis in horses.

**Clinical pathology** Culture, serology, allergic skin test.

**Necropsy findings** Abscessation of internal organs.

**Treatment and control** General hygienic procedures. Little specific information available.

### ETIOLOGY

*Burkholderia pseudomallei* is the sole cause. There is considerable genetic variability, and strains vary in pathogenicity. The organism causes latent (asymptomatic), acute, or chronic disease, depending largely on the host resistance to the organism.<sup>1</sup>

### EPIDEMIOLOGY

#### Occurrence

The disease occurs almost exclusively in tropical countries 20° north and south of the equator and is endemic in Southeast Asia, Asia, and northern and subnorthern areas of Australia. Disease occurs in rodents, rabbits, pigeons, humans, animals in zoologic gardens, dogs, cats, horses, pigs, sheep, goats, alpacas, reptiles, and camels, but rarely in cattle.<sup>2-6</sup> In domestic animals the disease has occurred in outbreak form in pigs, goats, and sheep in Australia; in the Caribbean area and in Cambodia; in horses in Malaysia and Iran; in pigs and cattle in Papua New Guinea and Australia; in horses in France in 1976 to 1978; and in cattle in Argentina. Goats appear to be more susceptible than cattle or horses.<sup>4</sup>

The incidence rate in Thailand during 2006 to 2010 was 1.6 cases per 100,000 goats, 0.02 cases per 100,000 pigs, and 0.01 cases per 100,000 cattle. There were reports of the disease in a single camel, crocodile, deer, horse, monkey, and zebra. However, incidence rates varied considerably with region of the country, with rates as high as 101 cases per 100,000 goats and 19 cases per 100,000

people.<sup>4</sup> The estimates for animals are likely an underrepresentation of the actual incidence of the disease because not all dead animals are subject to postmortem examination.

### Risk Factors

The risk factors for occurrence of melioidosis on small ruminant farms in Malaysia include the following: bush clearing around farms (odds ratio [OR] = 661, 95% confidence interval [CI] = 112-3884,  $P = 0037$ ), *B. pseudomallei* present in the soil (OR = 623, 95% CI = 103-3768,  $P = 0046$ ), other animal species present (OR = 796, 95% CI = 114-5599,  $P = 0037$ ), and flooding or waterlogging conditions (OR = 1195, 95% CI = 139-1026,  $P = 0024$ ).<sup>7</sup>

### Source and Methods of Transmission

In endemic areas the organism is a ubiquitous soil saprophyte and is present in moist soil and waterholes which are the primary reservoirs from which most infections are acquired. A variety of free-living amoebae, including *Acanthamoeba* and *Hartmannella* spp., are potential hosts to *B. pseudomallei*. The majority of cases in livestock are associated with the “wet season” and exposure to surface water and mud. Infection occurs through inhalation, ingestion, in association with skin wounds via contaminated dust particles or water, or by insect bites. Infected animals pass the organism in their feces, and the disease in rodents runs a protracted course, making these animals important reservoirs of infection.

### Pathogen Risk Factors

*B. pseudomallei* is very hardy and can survive in water at room temperature for up to 10 years, in muddy water for up to 7 months, and in soil in the laboratory for up to 30 months.<sup>1</sup> The organism can survive in contaminated injectable drugs and has ability to survive for some time in cetrimide 3% and chlorhexidine 0.3% solution. Varying degrees of virulence are observed in different strains of the organism, but starvation or other conditions of stress appear to increase the susceptibility of experimental animals to infection.

### Experimental Production

The disease can be produced experimentally in goats, sheep, rats, mice, hamsters, and pigs.

### Zoonotic Implications

Humans are at risk for infection within endemic areas, and although this can be zoonotic, it can also occur without direct animal contact through inhalation. The disease of humans presents with various clinical pictures ranging from asymptomatic state, to localized infection such as pneumonia, to acute fatal septicemia.

Veterinarians and animal owners are at risk from localized or generalized infection from infected animals. Pregnant women handling goats aborting with this infection have risk for infection and abortion. Infected areas are often rural in nature, and pasteurization of commercially sold milk should be ensured, as should condemnation of infected carcasses at abattoirs.

### Pathogenesis

The pathogenesis of melioidosis involves infection of animals by *B. pseudomallei* in the environment, with subsequent transepithelial spread in infected macrophages. There is initial bacteremia or septicemia and subsequent localization in various organs. Experimentally induced melioidosis in goats induced by percutaneous administration of the organism is characterized by septicemia with undulating fever, wasting, anorexia, hindlimb paresis, mastitis, and abortion.<sup>8</sup> Necropsy lesions include widely scattered microabscesses after intraperitoneal injection and a chronic disease with abscesses in the lungs and spleen when the infection is administered subcutaneously. In pigs, experimental infection results in a generalized chronic infection.

### CLINICAL FINDINGS

#### Sheep

Signs consist mainly of weakness, respiratory disease, and recumbency, with death occurring in 1 to 7 days. In experimentally infected sheep, a severe febrile reaction occurs and is accompanied by anorexia, lameness, and a thick, yellow exudate from the nose and eyes. Some animals show evidence of central nervous system involvement, including abnormal gait, deviation of the head and walking in circles, nystagmus, blindness, hyperesthesia, and mild tetanic convulsions. The disease is usually fatal. Skin involvement is not recorded.

#### Goats

The syndrome may resemble the acute form as seen in sheep, but it more commonly runs a chronic course with abscessation. Mastitis is common in infected goats, with one study finding mammary infection in 35% of infected goats.

#### Pigs

Disease is usually chronic and manifested by cervical lymphadenitis, but in some outbreaks there are signs similar to those in other species. In such outbreaks slight posterior paresis, mild fever, coughing, nasal and ocular discharge, anorexia, abortion, and some deaths may occur.

#### Horses

The syndrome is one of an acute metastatic pneumonia with high fever and a short course. Cough and nasal discharge are minimal, and there is a lack of response to

treatment with most drugs. Other signs in horses include colic, diarrhea, and lymphangitis of the legs. Subacute cases become debilitated and emaciated and develop edema. Affected horses may survive for several months. A case of acute meningoencephalitis is described in a horse. The onset was sudden and manifest with violent convulsions.

### CLINICAL PATHOLOGY

The organism is easily cultured and may be isolated from nasal discharges. The organism can be differentiated from *B. mallei* on multiplex quantitative PCR (qPCR) or using a PCR allelic discrimination assay.<sup>9,10</sup> Injection into guinea pigs and rabbits produces the typical disease. An allergic skin test using melioidin as an antigen, a complement fixation test (CFT), and an indirect hemagglutination (IHA) test are available. An ELISA is available that can detect antibodies to *B. pseudomallei* in goats.<sup>11</sup> The IHA test is recommended for screening and the CFT for confirmation in cases of active melioidosis in goats and pigs. Affected horses can give a positive reaction to the mallein test.

### NECROPSY

Multiple abscesses in most organs, particularly in the lungs, spleen, and liver, but also in the subcutis and the associated lymph nodes, are characteristic of the disease in all species. In sheep respiratory infection is common, and these abscesses in the lung contain thick or caseous, green-tinged pus similar to that found in *Corynebacterium pseudotuberculosis* lesions. Lesions in the nasal mucosa proceed to rupture, with the development of ragged ulcers. An acute polyarthritis, with distension of the joint capsules by fluid containing large masses of greenish pus, and acute meningoencephalitis have been observed in experimental cases.

A high incidence of lesions in the aorta of goats is reported in Australia. Nine out of 43 (21%) goats had aortic lesions at autopsy. Seven of these goats died as a result of a ruptured aortic aneurysm.

### DIAGNOSTIC CONFIRMATION

Culture of the organism confirms the diagnosis.

#### DIFFERENTIAL DIAGNOSIS

##### Sheep

Caseous lymphadenitis

Actinobacillosis

##### Horses

Glanders

Strangles

##### Pigs

Tuberculosis



## TREATMENT

Treatment is unlikely to be undertaken in farm animals because of the nature of the disease and the risk of exposure to humans. Little information is available on satisfactory treatments of melioidosis in farm animals, but recommendations for humans are available. Penicillin, streptomycin, chlortetracycline, and polymyxin are ineffective, but in vitro tests suggest that oxytetracycline, novobiocin, chloramphenicol, and sulfadiazine are most likely to be valuable, with oxytetracycline the preferred drug. In horses, chloramphenicol is an effective treatment.

## CONTROL

There is currently no vaccine for melioidosis.<sup>12</sup>

Prevention involves removing animals from the contaminating source. Water supplies can be chlorinated. This and the elimination of infected animals and the disinfection of premises should be the basis of control procedures. Housed animals can be removed from soil by raising them from the ground on wooden slats or with concrete or paved floors. Treatment of soil with lime reduces the risk (OR = 0.028) of animals developing melioidosis.<sup>7</sup>

## FURTHER READING

Adler NRL, et al. The molecular and cellular basis of pathogenesis in melioidosis: how does *Burkholderia pseudomallei* cause disease? *FEMS Microbiol Rev.* 2009;33:1079-1099.

## REFERENCES

- Adler NRL, et al. *FEMS Microbiol Rev.* 2009;33:1079.
- Hampton V, et al. *Emerg Infect Dis.* 2011;17:1310.
- Johnson CH, et al. *Comp Med.* 2013;63:528.
- Limmathurotsakul D, et al. *Emerg Infect Dis.* 2012;18:325.
- Parkes HM, et al. *J Fel Med Surg.* 2009;11:856.
- Zehnder AM, et al. *Emerg Infect Dis.* 2014;20:304.
- Musa HI, et al. *J Appl Micro.* 2015;119:331.
- Soffler C, et al. *Int J Exp Pathol.* 2014;95:101.
- Janse I, et al. *BMC Infect Dis.* 2013;13.
- Bowers JR, et al. *PLoS ONE.* 2010;5.
- Mekaprateep M, et al. *J Microbiol Meth.* 2010;83:266.
- Choh L-C, et al. *Front Cell Inf Micro.* 2013;3.

## HEARTWATER (COWDRIOSIS)

### SYNOPSIS

**Etiology** *Ehrlichia (Cowdria) ruminantium*, a rickettsial organism.

**Vectors** *Amblyomma variegatum* and *Amblyomma hebraeum*.

**Epidemiology** Endemic disease of cattle, sheep, goats and wild ruminants in Africa and the Caribbean; high mortality in exotic animals.

**Clinical signs** High fever, nervous signs, diarrhea, and death if acute; may be mild and inapparent.

**Clinical pathology** Nonspecific.

**Diagnostic confirmation** Rickettsial colonies in capillary endothelium (brain preparations), polymerase chain reaction (PCR).

**Lesions** Ascites, hydrothorax, hydropericardium, and severe pulmonary edema.

**Differential diagnosis list** Anthrax, rabies, cerebral babesiosis, cerebral theileriosis, meningitis or encephalitis.

**Treatment** Short- and long-acting tetracyclines.

**Control** Vaccination based on infection and treatment methods, tick control, and chemoprophylaxis.

## ETIOLOGY

*Ehrlichia (Cowdria) ruminantium* is a gram-negative, intracellular rickettsial organism in the order of Rickettsiales. It occurs in colonies or morulae with a predilection for the vascular endothelium and stains blue with Giemsa stain. The organism is coccoid, 0.2 to 0.5 microns in diameter. It can now be cultivated in vitro, and it can also grow in mice. Cyclical development takes place in intestinal and salivary epithelia of ticks. Widely ranging *E. ruminantium* genotypes with differing cross-protection capacities usually circulate simultaneously in the same region, leading to a poor vaccine efficacy.<sup>1</sup> However, all isolates obtained at different geographic levels (village, region, and continent) possess a major antigenic protein 1 (MAP1) that is conserved.<sup>2</sup> This protein is used for serologic diagnosis, but the antigen cross-reacts with other *Ehrlichia* spp., including *E. equi*, the cause of equine granulocytic ehrlichiosis. Variants of *E. ruminantium* that do not cause disease in livestock have also been reported from South Africa.<sup>3</sup>

## EPIDEMIOLOGY

### Occurrence

Heartwater was first recognized in South Africa in the nineteenth century.<sup>4</sup> The disease is limited in its occurrence to sub-Saharan Africa, including the islands of Madagascar, Sao Tome, Reunion, Mauritius, Zanzibar, and Mayotte in the Indian Ocean. It is also present on the three Caribbean islands of Guadeloupe, Marie-Galante, and Antigua, where it threatens the American mainland because of the risk of spread of its tick vector by migratory birds or by uncontrolled movement of animals.<sup>5</sup> Heartwater is one of the main causes of death in imported breeds of cattle, sheep, and goats in endemic areas.

### Measures of Disease Occurrence

In endemic areas, morbidity and mortality rates are low, but the percentage of seropositive titers for heartwater could be as high as 100% in adult cattle, depending on the abundance of tick vectors. In Tanzania,

antibodies to *E. ruminantium* were found in 68.6% of the sheep and 64.7% of the goats examined by ELISA, but the infection was unevenly distributed within districts.<sup>6</sup> Case mortality can be as high as 100% in peracute cases in sheep and goats and as low as 0 to 10% in cattle. The disease is less severe in indigenous breeds and related game animals reared in enzootic areas, some of which may become symptomless carriers. The N'Dama breed in West Africa is reported to be well adapted to heartwater, partly because it can resist tick burdens under traditional farming system. Conversely, the Angora goat is highly susceptible, and Merino sheep are moderately so.

## Method of Transmission

Heartwater is transmitted by many ticks of the *Amblyomma* genus, especially by *A. variegatum* (the tropical bont tick) mostly in western, central, and eastern Africa and the Caribbean, and by *A. habraeum* mostly in southern Africa. The geographic distribution of the ticks appears to be spreading. Infection in ticks is transmitted transstadially and possibly transovarially. A single infected tick can transmit the disease to the host, and this can occur 1 to 2 days after attachment as nymph or 2 to 3 days as adult. Vertical transmission to calves and lambs in utero and in colostrum milk has been reported. Several wild ruminants can be infected and become subclinical carriers and reservoirs. Tick feeding on them can transmit the disease to domestic ruminants. In the Caribbean, cattle egrets are suspected to spread *A. variegatum* between islands. However, recent molecular studies of isolates from the Caribbean and Africa would suggest that there was a simultaneous introduction of several strains of *E. ruminantium* from Africa into the Caribbean.<sup>7</sup> Nevertheless, heartwater is considered to be a threat to the American mainland, where potential vectors such as *A. maculatum* are present but do not harbor the disease or where the vector may be introduced by migratory birds and become established. Similarly, southern Italy is considered at risk of introduction and establishment of infected *Amblyomma* ticks through migratory birds.<sup>8</sup> The organism does not infect humans.

## Risk Factors and Immune Mechanisms

Animals at greatest risk are exotics imported into endemic areas and at times when the vector population is high, usually during the rains. Angora goats are also highly susceptible and therefore difficult to immunize by the current method of infection and treatment. Cattle and sheep recovering from the disease are immune for 6 months to 4 years but may be carriers for 8 months or longer. Immunity is related to the ability of lymphocytes in infected animals to produce interferon gamma (IFN- $\gamma$ ).<sup>9</sup> An age-dependent

resistance has long been recognized, and young animals were thought to have innate resistance. This was later shown to be attributable to low-grade infection of the young in colostrum cells or following intrauterine transmission. In small ruminants, the resistance begins to wane at the age range of 4 and 12 weeks when they are most susceptible.<sup>10</sup>

### ECONOMIC IMPORTANCE

Heartwater is the most important rickettsial infection of ruminants in Africa and the second most important tick-borne disease after East Coast fever. In southern Africa, it is regarded as the most important disease of ruminants. In general, heartwater is a more serious problem where *A. habraeum* is the vector. In countries or regions where there is endemic stability, losses from heartwater are minimal until new animals are introduced or moved from nonendemic to endemic areas. On the other hand, because most losses are in exotic animals, heartwater is a major constraint to livestock improvement in sub-Saharan Africa. Furthermore, it has the potential to spread from North Africa to Europe and from the Caribbean to the American mainland.

### Biosecurity Concerns

Heartwater requires the vector tick to get established in any community. Therefore there is concern about possible illegal importation of infected animals or ticks to the southern United States where potential vectors exist. Migratory birds can also introduce infected ticks to parts of the Mediterranean countries where the environment is suitable for the establishment of *Amblyomma*.

### PATHOGENESIS

There is limited new information on the pathogenesis of heartwater. The rickettsial organisms are introduced into the host in the saliva of an infected tick. They multiply in reticuloendothelial cells of the local lymph node, rupture the cells, and are released into the circulation, where they invade endothelial cells of blood vessels in all organs, where further multiplication takes place. Organisms can be found in phagosomes of circulating neutrophils but are more abundant in endothelial cells. Invasion of vascular endothelium causes increased vascular permeability, leading to edema, especially in the lungs, body cavities, and the brain, by mechanisms that are not understood because infected endothelial cells show minimal cytopathic effects. Brain edema is responsible for the nervous signs, severe hydropericardium will impair cardiac function, and severe pulmonary edema with hydrothorax would lead to death from asphyxia. In goats, renal ischemia and nephrosis have been described, and irreversible kidney damage may be the cause of death in such cases.

### CLINICAL FINDINGS

The incubation period is 1 to 3 weeks after transmission in tick saliva. Depending on the susceptibility of individual animals and the virulence of the infecting organism, the resulting disease may be peracute, acute, subacute, or mild and inapparent. Peracute cases show only high fever, prostration, and death with terminal convulsions in 1 to 2 days. Acute cases are more common and have a course of about 6 days. A sudden febrile reaction is followed by inappetence, listlessness, and rapid breathing, followed by the classical nervous syndrome that is characteristic of heartwater. It comprises ataxia, chewing movements, twitching of the eyelids, circling, aggression, apparent blindness, recumbency, convulsions, and death. Profuse, fetid diarrhea is frequent.

Subacute cases are less severe but may terminate in death in 2 weeks or the animal may gradually recover. The mild form is often subclinical and is seen mainly in indigenous animals and wild ruminants with high natural or induced resistance. The case-mortality rate in peracute cases is 100%; in acute cases, 50% to 90%; and in calves at less than 4 weeks of age, it is 5% to 10%; most animals recover in mild cases.

### CLINICAL PATHOLOGY

Hematologic changes in heartwater are not specific, but there may be thrombocytopenia, neutropenia, eosinopenia and lymphocytosis. Confirmatory diagnosis is based on identifying the rickettsia in capillary endothelial cells using a Giemsa-stained squash preparation of brain tissue at postmortem. The rickettsiae occur as blue to reddish-purple colonies or morulae of five to several hundred coccoid organisms (0.2 to 0.5 microns in diameter) in the cytoplasm of the cells close to the nucleus. An immunohistochemical staining technique has also been described. Injection of blood into sheep may also be used as a diagnostic procedure because sheep are highly susceptible.

The polymerase chain reaction (PCR) assay is preferred for confirmatory diagnosis in a sick animal. To this end, a quantitative pCS20 real-time PCR has been developed and can be performed within 2 hours in live animals; it is also an effective assay for epidemiologic surveillance and monitoring of infected animals, and it can be used by paraveterinary staff.<sup>11-12</sup> However, it cross-reacts with at least two other *Ehrlichia* spp. Nested pCS20 PCR is highly sensitive and can be used to detect infected ticks.<sup>13</sup> A more sensitive and highly specific new test has been reported. It is the loop-mediated isothermal amplification (LAMP) assay, in which DNA amplification is completed in 1 hour.<sup>14</sup> Assays using two sets of LAMP primers designed from the pCS20 and sodB genes were more sensitive than conventional pCS20 PCR assay. LAMP detected 16 different isolates from geographically distinct countries, and

no cross-reaction was observed with genetically related Rickettsiales. Because of its simplicity and specificity, LAMP also has the potential for use in clinical laboratories in resource-poor countries where heartwater is endemic and for active screening in areas under threat of introduction of the disease.

Serologic tests are used for surveys, and the two tests recommended are indirect fluorescent antibody (IFA) and ELISA. The close antigenic relationship between *E. ruminantium* and other *Ehrlichia* spp. often leads to false positives. The ELISA based on recombinant MAP1 protein of *E. ruminantium* is more sensitive, but all serologic assays have poor sensitivity and specificity.

### NECROPSY FINDINGS

Standard lesions are ascites, hydrothorax, and hydropericardium. Pulmonary edema is often severe, accompanied by copious froth in the tracheobronchial airways. There may be subserosal hemorrhages in most cavities. Lymph nodes are swollen and wet, and the spleen is markedly enlarged. In goats with nephrosis, the kidneys will be soft. Although hemorrhages have been described in the brain, this organ often has no remarkable gross lesions; microscopically, there is perivascular mononuclear infiltration and edema along with presence of rickettsial colonies in capillary endothelial cells. The colonies disappear quickly as autolysis sets in. Foci of malacia may be present. Tissues for histopathology should include brain, lungs, lymph nodes, spleen, and kidneys. In addition, squash preparations of brain should be submitted for direct staining with Giemsa or for PCR detection.

### DIFFERENTIAL DIAGNOSIS

In endemic areas, heartwater should be suspected in susceptible animals infected with *Amblyomma* and having a fever of unknown origin, especially when accompanied by nervous signs. The clinical and pathologic findings are not specific, and the diagnosis must be based on detection of rickettsial organisms.

The peracute form should be differentiated from anthrax and the acute form from rabies, sporadic bovine encephalomyelitis, tetanus, cerebral forms of theileriosis, babesiosis, trypanosomiasis, meningitis, listeric or other encephalitis, hypomagnesemia, and poisoning with strychnine, lead and organophosphates. Appropriate laboratory tests are utilized to eliminate these differentials.

### TREATMENT

#### TREATMENT AND CONTROL

##### Treatment

Oxytetracycline (10–20 mg/kg IM in early stages) (R-1)

Sulfamethazine (55 mg/kg SC) (R-2)  
Hyperimmune serum (R-4)

#### Control

Infection and treatment with tetracycline IM or with doxycycline implant SC (R-1)  
Attenuated vaccine from cell culture (R-1)  
Vector control (R-1)

Field cases of heartwater are difficult to treat successfully because available drugs are effective only in early febrile stages before neurologic signs develop. In the early stages, short-acting tetracyclines (oxytetracycline at 10 to 20 mg/kg BW or doxycycline at 2 mg/kg) and long-acting forms at reduced doses are effective. Sulfonamides (e.g., sulfamethazine) were also used in the early stages but are less effective. Hyperimmune serum is reported to be of no curative value. Supportive therapy to reduce either the pulmonary edema or the neurologic signs or to stabilize membranes in general is being investigated, but with little success.

Chemoprophylaxis involves administration of tetracyclines or subcutaneous implantation of doxycycline in susceptible animals when they are introduced into an endemic area. Results are not always predictable.

#### CONTROL

Heartwater has traditionally been controlled by four different approaches: controlling the tick vector by dipping, establishing endemic stability, performing immunization by infection and treatment, and preventing the disease by regular administration of prophylactic antibiotics.<sup>15</sup> Control efforts have been hindered by abundance of ticks in endemic areas, by high rate of the carrier state following infection, and by lack of efficient vaccine in the field as a result of the high genetic diversity of strains circulating in any given area.<sup>16</sup>

Past efforts to control heartwater were based on intensive acaricide treatment to control ticks in endemic areas. It involved frequent use of acaricides (plunge dipping) up to 52 times a year. This has now been shown to be environmentally unfriendly and economically unsustainable, and it would invariably lead to animals that remained always susceptible. For example, it was observed in Zimbabwe that large farms applying acaricides very frequently (more than 30 times per annum) had higher morbidity and mortality than farms applying acaricides less frequently.

Long-acting acaricides have largely replaced the earlier ones applied frequently. Apart from being more environmentally friendly, occasional use of acaricides helps in the establishment of endemic stability in treated animals because they can still be exposed to low levels of infection. For example, flumethrin 1% pour-on at 45-day intervals was found to provide effective

protection of Friesian-Zebu crossbred cattle against important ticks, but it must be applied correctly at the recommended dose. Pure Zebu and N'Dama cattle would probably require less frequent applications. Flumethrin pour-on is gradually replacing plunge dipping for the control of ticks and tickborne diseases in general.

Vaccination is based on infection and treatment regimen that was first developed more than 50 years ago. It involves an intravenous injection of virulent organisms in cryopreserved sheep blood, followed by treatment with tetracyclines at the first indication of fever. The exposure of calves and lambs up to 3 weeks of age, without treatment, is considered optimal for the development of resistance, but kids may still be susceptible. Vaccination may lead to some deaths, the immunity may wane in absence of reinfection, and animals may become carriers. Nevertheless, the use of inactivated vaccines from cell-cultured *E. ruminantium* combined with an adjuvant led to a reduction in mortality from heartwater in cattle, sheep, and goats exposed to field challenges in Botswana, Zambia, Zimbabwe, and South Africa. Recently, an attenuated vaccine from *E. ruminantium* (Welgevonden) stock given intramuscularly was found to provide protection against virulent homologous needle challenge in Merino and Angora goats; injection did not produce disease, and protection was for at least 12 months after immunization.<sup>17</sup> In the Gambia, an attenuated vaccine was found to be superior to an inactivated vaccine for sheep.<sup>18</sup> Mass production of *E. ruminantium* variants from different regions of sub-Saharan Africa is one of the difficulties that must be overcome in producing a heartwater vaccine from cell culture.<sup>19</sup> Recently, a process for the large-scale production of a ready-to-use inactivated vaccine against heartwater was described.<sup>20</sup>

Experimental studies using DNA recombinant vaccines so far have met with only limited success, and none has been as effective as immunization with live organisms.<sup>9,21</sup> The development of a universal recombinant vaccine would require increased knowledge of *E. ruminantium* biology, including virulence mechanisms.<sup>5</sup> So far, the goal of producing an effective vaccine against the disease in the field still remains frustratingly just beyond reach.<sup>4</sup>

What is advocated today is integrated control based on the establishment of endemic stability by vaccination or natural challenge and general reduction in tick infestation through periodic application of long-acting insecticides when warranted.

#### FURTHER READING

Bezuidenhout JD, et al. Heartwater. In: Coetzer JAW, Thomson GR, Tustin RC, eds. *Infectious Diseases of Livestock With Special Reference to Southern Africa*. Vol. 1. Cape Town: Oxford University Press; 1994:351.

Bigalke RD. Heartwater: past present and future.

*Onderstepoort J Vet Res*. 1987;54:163.

OIE. *Manual of Diagnostic Tests and Vaccines for Terrestrial Animals*. Paris: OIE; 2008 chapter 2.01.06:217.

Scott GR. Cowdriosis. In: Sewell MMH, Brocklesby DW, eds. *Handbook on Animal Diseases in the Tropics*. 4th ed. London: Baillière Tindall; 1990:234.

#### REFERENCES

- Nakao R, et al. *Parasite Vectors*. 2011;4:137.
- Railiniaina M, et al. *Vet Parasitol*. 2010;167:187.
- Allsopp BA, et al. *Vet Microbiol*. 2007;120:158.
- Allsopp BA. *Vet Parasitol*. 2010;167:123.
- Vachieri N, et al. *Dev Biol (Basel)*. 2013;135:191.
- Swai ES, et al. *Trop Anim Health Prod*. 2009;41:959.
- Vachieri N, et al. *Ann NY Acad Sci*. 2008;1149:191.
- Pascucci I, et al. *Vet Ital*. 2007;43:655.
- Liebenberg J, et al. *Vet Immunol Immunopathol*. 2012;145:340.
- Faburay B, et al. *BMC Infect Dis*. 2007;7:85.
- Stein HC, et al. *J S Afr Vet Assoc*. 2010;81:160.
- Steyn HC, et al. *Vet Microbiol*. 2008;131:258.
- Kelley PJ, et al. *J Med Entomol*. 2011;48:485.
- Nakao R, et al. *BMC Microbiol*. 2010;10:296.
- Allsopp BA. *Onderstepoort J Vet Res*. 2009;76:81.
- Adakal H, et al. *Infect Genet Evol*. 2009;9:1320.
- Zweygarth E, et al. *Vaccine*. 2008;26(suppl 6):G34.
- Feburay B, et al. *Vaccine*. 2007;25:7939.
- Pedregal A. *Ann N Y Acad Sci*. 2008;1149:286.
- Marcelino I, et al. *Vaccine*. 2015;33:678.
- Pretorius A, et al. *Vaccine*. 2007;25:2316.

### HISTOPHILUS SEPTICEMIA OF CATTLE (HISTOPHILUS SOMNI OR HAEMOPHILUS SOMNUS DISEASE COMPLEX)

#### SYNOPSIS

**Etiology** *Histophilus somni* (formerly *Haemophilus somnus*)

**Epidemiology** High prevalence of infection in cattle population; low incidence of disease. Occurs in North American feedlot cattle, in the United Kingdom, and in some European countries. Young growing cattle are most commonly affected. Originally, thrombotic meningoencephalitis (TME) was most common lesion, but pleuropneumonia and myocarditis are more common now. Several virulence factors of organism may account for different forms of disease. Organism resides in respiratory and reproductive tracts of both females and males.

**Signs** Thrombotic meningoencephalitis with fever, ataxia, joint swellings, weakness, recumbency, and death in 12 to 24 hours; pleuropneumonia and myocarditis with rapid death; reproductive failure with abortion.

**Clinical pathology** Marked changes in leukon. Demonstrate and culture organism from cerebrospinal fluid, joint fluid, pleural cavity, and myocardium.

**Lesions** Meningoencephalitis, hemorrhagic infarcts in brain, retinal hemorrhages,

*Continued*



pleuropneumonia, myocarditis. Vasculitis in infected tissue.

**Diagnostic confirmation** Culture, polymerase chain reaction (PCR).

**Treatment** Antimicrobials.

**Control** *H. somni* bacterin vaccines are available but unreliable; metaphylactic treatment with antimicrobials at time of placement in feedlot is frequently used.

## ETIOLOGY

*Histophilus somni* (formerly *Haemophilus somnus*) is a gram-negative, fastidious pleomorphic coccobacillus of the family Pasteurellaceae. Earlier investigations have shown that *H. somni*, *Haemophilus agni*, and *Histophilus ovis* represent the same species, and recent analysis of genes of strains supports the allocation of this species to a novel genus within the family Pasteurellaceae as *Histophilus somni*.<sup>1</sup> *H. somni* causes a variety of diseases in cattle, including septicemia, thrombotic meningoencephalitis (TME), pleuropneumonia, myocarditis, reproductive failure with abortion, polyarthritis, and, in sheep, mastitis, septicemia, and epididymitis.

## EPIDEMIOLOGY

### Prevalence of Infection

*H. somni* is an obligate inhabitant of mucosal surfaces of bovines, ovines, and related ruminants with worldwide occurrence. It is frequently found as an asymptomatic commensal in the male prepuce, the female vagina, and occasionally in the upper respiratory tract.<sup>1</sup> More than 50% of normal bulls, 8% to 10% of normal cows, and 10% of normal rams have *H. somni* in the reproductive tract. Among those that have had the disease and survived, the serologic reactor rate varies from 50% to 100%. Some surveys found more positive reactors in beef cattle and dairy cattle from infected herds than in dairy cattle from herds without clinical disease.

### Occurrence of Disease

*H. somni* is responsible for a variety of clinical syndromes in cattle, most of which occur in feedlot and dairy calves, although disease was also observed in grazing cattle.<sup>2</sup> Infection of cattle with *H. somni* may cause septicemia, thrombotic meningoencephalitis (TME), polysynovitis, pleuritis, suppurative bronchopneumonia, myocarditis, otitis media, mastitis, and reproductive tract diseases. When infection of cattle with the organism was first described in 1956, the primary form of the disease was TME. Since then, many different clinical forms of the infection have been described. Suppurative bronchopneumonia, fibrinous pleuritis, and myocarditis are now being recognized with increased frequency in feedlot cattle and are being attributed to *H. somni* infection. Based on necropsy examinations

over a 20-year period in a Saskatchewan diagnostic laboratory, there has been an increasing percentage of cattle with pneumonia and myocarditis associated with the organism and a decreasing percentage with TME. However, because of the practical difficulties in making a specific clinical, pathologic, and microbiological diagnosis in situations where the disease complex occurs, there is some uncertainty about the relative importance of the organism in causing certain diseases, such as pneumonia of feedlot cattle. For example, because of the variability of nature and extent of the lesions in bovine respiratory disease and the common occurrence of mixed infections, it is difficult to determine whether *H. somni* or *M. haemolytica* is the primary pathogen.

The disease occurs most commonly in **feedlot cattle** in North America after they have been commingled from different sources. The disease has also been recognized in the United Kingdom, Germany, Switzerland, and Israel. The organism has been found in the tonsillar tissues of American bison (*Bison bison*) and has been the cause of bronchopneumonia in bison.

The incidence rate of TME in a susceptible group of calves is low, averaging about 2%, but may be up to 10% in some outbreaks. The case-fatality rate, however, is 90% if affected animals are not identified and treated early in the course of the disease.

TME was historically a disease of feedlot cattle from 6 to 12 months of age with highest occurrence during the fall and winter months. In Canada TME occurred most commonly in cattle about 4 weeks after arrival in the feedlot, with a range of 1 week to 7 months. It also occurred in feedlot cattle in Argentina.

The disease complex that is encountered more commonly now is characterized by **pleuritis, pneumonia, and myocarditis** and can be the most significant cause of mortality in feedlot calves. Death from pneumonia attributable to the infection occurs mainly during the first 5 weeks in the feedlot; death from myocarditis, pleuritis, TME, septicemia, and euthanasia because of polysynovitis occurs mainly after the third week. This disease complex is occurring despite routine vaccination of calves on arrival in the feedlot. A history of respiratory tract disease preceding the outbreak is common, and in some cases TME had occurred in the same herd in the previous year.

*H. somni* also causes various forms of reproductive failure in cattle. The importation of infected young rams into a flock can have a deleterious effect on the percentage of ewes that lamb. Purchasing replacement animals and having cattle on the same farm were risk factors for infection in the flock. The possibility of interspecies transmission between cattle and sheep requires further study.

## Risk Factors

### Animal Risk Factors

Thrombotic meningoencephalitis, pleuropneumonia, and myocarditis occur most commonly in feedlot calves 6 to 12 months of age.

### Pathogen Risk Factors

The literature on the virulence factors of the organism has been reviewed.<sup>2,3</sup> Several virulence factors have been identified, including adherence, synthesis of lipooligosaccharide (LOS) and LOS phase variation, antigen variation of surface proteins, synthesis of immunoglobulin binding proteins, or the production of histamine and hemolysin.

**Adherence.** *H. somni* colonizes the surface of mucous membranes. In the asymptomatic carrier state the organism remains at the mucosal surface without invading cells; it attaches to nonepithelial cells, as has been documented in the example of bovine aortic endothelial cells. It is assumed that nonpilus adhesins are involved in the adherence of the organism to the cell surface.<sup>2</sup> *H. somni* attaches in large numbers to bovine vaginal epithelial cells, and attachment may be all that is necessary to produce infertility as a result of endometritis or degeneration of embryos during early gestation. The organism is able to persist in the lungs of calves for 6 to 10 weeks in the presence of specific antibody and in the absence of clinical abnormalities other than sporadic coughing.

### Lipooligosaccharides (LOS or Endotoxin).

Endotoxin produced by *H. somni* lacks the long, repeated polysaccharide chains that are characteristic for some gram-negative bacteria and is thus more appropriately designated as lipooligosaccharide (LOS) rather than lipopolysaccharide. The microorganism can vary the structure of the LOS by switching on and off specific genes encoding individual glycosyltransferases that are responsible for attaching individual glycoses to the oligosaccharide molecule, a phenomenon termed as **LOS phase variation**. The structure of the LOS outer core oligosaccharides of some strains mimics that of host glycosphingolipids, which may allow the organism to evade the host's immune system by camouflaging bacterial antigen.<sup>1</sup> LOS specifically triggers bovine platelet aggregation and may thereby contribute to adherence and colonization of respiratory epithelial cells and bovine endothelial cells. LOS was furthermore found to mediate apoptosis of bovine endothelial cells; the cytotoxic properties and the serum resistance of some strains have also been proposed to be associated with the production of LOS.<sup>4</sup>

### Antigen Variation of Surface Proteins.

Surface proteins or outer membrane proteins (OMPs) are important immunologic structures accessible for the host's immune system.

Strains of *H. somni* are diverse in molecular mass and antigenic reactivity. Although the precise role of OMPs in the pathogenesis of histophilosis is not yet understood, they may play an important role in the ability of the organism to evade the host's immune system and cause disease.<sup>2</sup>

**Immunoglobulin-Binding Proteins.** Immunoglobulin-binding proteins (IgBPs) are characterized by their affinity to IgG<sub>2</sub> immunoglobulin and are thought to enable *H. somni* to evade antibody defense. Although it is well accepted that IgBPs are important determinants of serum resistance of pathogenic *H. somni* strains, the underlying mechanism is not yet well explained.<sup>3</sup> Some isolates of the organism are indeed able to multiply *in vivo* because they are resistant to complement, and bovine leukocytes are incapable of destroying the organism in the absence of specific antibody.

**Transferrin-Binding Proteins.** *H. somni* is inherently dependent on the availability of iron and in absence of available iron produces transferrin-binding proteins (TBPs) that specifically bind bovine transferrin but not transferrin of other species.<sup>3</sup> This was proposed as one of the underlying causes for the host specificity of *H. somni*.

**Biofilm Synthesis.** *H. somni* was found to produce biofilm *in vitro* and *in vivo*, which is a virulence factor likely contributing to the pathogenesis of histophilosis. Strains of *H. somni* isolated from diseased tissue often have the greatest capacity to form a biofilm.<sup>5</sup> Furthermore, different strains were found to produce biofilm with different structures, and difference in biofilm architecture may correlate with resistance to the host's immune defense mechanisms.<sup>1</sup>

Some strains are serum resistant and others serum sensitive, which may explain the ability of certain strains to invade beyond mucous membrane surfaces. Virulence differences also exist between *H. somni* strains following intratracheal challenge of bovine lungs. Those strains isolated from encephalitic lesions, or from the prepuce, will not produce the same degree of experimental pneumonia as those strains isolated from lung lesions. Preputial and septicemic isolates of ovine *H. somni* are similar to bovine *H. somni* in pathogenicity and in surface antigens. Ovine isolates given by intracysternal inoculation to 2- to 3-month-old lambs caused fatal meningoencephalitis and myelitis.

In summary, many virulence factors are involved in several steps of pathogenesis. Adherence is likely to be important in colonization, complement resistance in survival in the circulation or inflammatory sites, and cytotoxicity in evading killing by phagocytes and in initiation of vasculitis, and invasion through the endothelium. The host damage

that occurs as a result may be further exacerbated by inflammatory mediators released by the host in response to *H. somni*.

### Methods of Transmission

The method of transmission and portal of entry are unclear. A feature of infections with this organism is its persistence at mucosal sites in both subclinical and diseased animals. The organism can be isolated from the respiratory and reproductive tracts of normal animals.

In bulls, the organism has been isolated from semen and the preputial orifice, preputial cavity, urinary bladder, accessory sex glands, ampulla of the ductus deferens, and the preputial washings of steers. Most bulls harbor the organism in the prepuce. Thus the potential exists for venereal transmission of *H. somni*, for lateral spread from the genital tract, and for environmental contamination by the organism.

The organism has also been isolated from the vagina, vestibular gland, cervix, uterus, and bladder of cows. The prevalence of infection in normal cows varies depending on the herd and geographic location, but 10% to 27% can harbor the organism. The organism can colonize the vagina of cows without causing disease, and it is thought to have a primary etiologic role in vaginitis and cervicitis in cows.

The organism has been isolated from the udder secretions of cattle with naturally occurring mastitis.

Urine is also a source of the organism. The young beef calf in a cow-calf herd can become infected as early as 1 month of age and become a nasal carrier of the organism without showing any signs of clinical disease. The mature cow is considered to be a major source of infection for the calf. The method of transmission is presumed to be by contact with infective respiratory and reproductive secretions or by aerosol transmission, especially in close-contact feedlots.

The organism can survive more than 70 days when it is mixed with cerebrospinal fluid, whole blood, blood plasma, vaginal mucus, or milk and frozen at  $-70^{\circ}\text{C}$  ( $-94^{\circ}\text{F}$ ). At  $23.5^{\circ}\text{C}$  ( $73.5^{\circ}\text{F}$ ) it can survive beyond 70 days when mixed with whole blood and nasal mucus. The viability of the organism in urine at all temperatures is less than 24 hours and less than 15 minutes at  $20^{\circ}\text{C}$  ( $68^{\circ}\text{F}$ ) and  $37^{\circ}\text{C}$  ( $98^{\circ}\text{F}$ ). It survives for less than 1 day in milk at room temperature or when incubated at  $37^{\circ}\text{C}$  ( $98^{\circ}\text{F}$ ) and should be considered as a possible cause of mastitis in cases that are negative on routine bacteriologic culture.

### Immune Mechanisms

Serum antibody titers do not correlate with susceptibility to clinical disease. Naturally acquired humoral immunity does not influence the outcome of experimental intravenous inoculation of the organism. Also, the

role of naturally acquired antibody in protecting cattle from disease is uncertain. The levels of naturally occurring serum bactericidal activity to *H. somni* are low or absent in calves at 4 to 6 months of age, when they are most susceptible to TME. The levels increase with age and are high in mature cows; yearlings have intermediate levels.

Convalescent sera from calves with experimental *H. somni* pneumonia protect calves against acute *H. somni* pneumonia. Marked serum exudation characterizes the early stages of experimental pneumonia, and antibody should be involved in protection. The specificity of this protection is directed primarily against outer-membrane proteins (OMPs) of the organism. These antigens may also be useful in serologic diagnosis because convalescent calves have high IgG<sub>1</sub> and IgG<sub>2</sub> titers to *H. somni* for several weeks. The measurement of serum IgG<sub>1</sub> is a more reliable test to detect a current or recently active infection. Later, there is a sustained increase in IgG<sub>2</sub>. The development of a systemic IgG<sub>2</sub> antibody response is the basis for local immunologic protection in the bovine reproductive tract.<sup>3</sup>

The immune response in cattle to the major outer membrane proteins during infection is weak and directed to antigenically variable determinants in a strain specific manner that may have important implications in protective immunity. Vaccination of 1- to 2-month-old calves with commercial aluminum-hydroxide-adsorbed *H. somni* bacterins elicits an ELISA-detectable IgE response 14 days after injection, which may be associated with severe clinical disease associated with type I hypersensitivity.

### PATHOGENESIS

*H. somni* first establishes itself in the host by colonizing the surface of the mucous membranes. It is not known if strains harbored in the respiratory tract or the genital tract invade the circulatory system to cause septicemia with ensuing localization in many tissues and organs. Although respiratory disease preceding TME has been described, experimental intratracheal inoculation resulted in colonization of the upper and lower respiratory tract without concomitant septicemia.<sup>2</sup>

The ability of *H. somni* to survive in both mononuclear phagocytes and neutrophils may be important in the establishment of the chronic multisystemic infection characteristic of bovine histophilosis. With TME the sequence of events may be initiated by adhesion of the bacterium to vascular endothelial cells. The organism's LOS induces endothelial cell apoptosis and contraction and desquamation of cells, with exposure of subendothelial collagen; thrombosis and vasculitis is followed by ischemic necrosis of adjacent parenchyma. The common site of localization is the brain. Multifocal areas of hemorrhagic necrosis occur throughout the

brain, resulting in TME and causing the typical clinical findings of depression, paresis, and recumbency. Localization in synovia results in polysynovitis. Fibrin thrombi occur in the small vessels and capillaries of the liver, spleen, kidney, lung, heart, and brain, which suggests that **disseminated intravascular coagulation** may be a feature of the pathogenesis of *Histophilus* septicemia. Myocarditis has been recognized with increased frequency and is characterized by acute or chronic heart failure.<sup>6</sup>

The pathogenesis of *Histophilus* pneumonia is not clear. Although *H. somni* has been isolated from cattle with bronchopneumonia and fibrinous pneumonia in pure culture and in combination with *Pasteurella* spp., the lungs of cattle dying of TME are not usually affected with a fibrinous pneumonia. The pneumonia that is attributed to the organism is characteristically subacute or chronic, and it is probable that the portal of entry is via the upper respiratory tract. However, it is difficult to reproduce the disease by aerosol challenge with *H. somni*. The organism produces and secretes histamine, which may be enhanced by carbon dioxide concentrations that approximate those in the bronchial tree.

The microscopic lesions in the lungs of cattle with pneumonia from which *H. somni* is isolated consist of suppurative to necrotizing bronchiolitis, particularly in calves with subacute to chronic pneumonia. The experimental pneumonia is characterized by purulent to fibrinopurulent bronchiolitis accompanied by alveolar filling with fibrin, neutrophils, and macrophages. Laryngitis and polypoid tracheitis have also been attributed to *H. somni*, but the evidence for a cause and effect relationship is limited.

Hemorrhagic necrotic lesions also occur in the spinal cord, which contribute to the muscular weakness, recumbency, and paralysis encountered in some cases with or without brain lesions. Lesions in the esophagus, forestomachs, and intestines may account for the bloat and alimentary tract stasis that occurs in the experimental disease.

The septicemia usually causes marked leukopenia, neutropenia, and degenerative left shift.

Cattle dying of experimentally induced and naturally occurring disease have high levels of agglutinating *H. somni* antibody, but not of complement-fixing antibody. Because septicemia can occur even with high levels of serum antibody, it is hypothesized that the formation of antigen-antibody complexes may contribute to the development of vasculitis. It is possible that previous exposure to *H. somni* infection is necessary for typical TME to occur. Inoculation of colostrum-deprived calves with *H. somni* causes septicemia but does not produce lesions typical of TME. This suggests that the disease may be an example of a type III hypersensitivity reaction or serum sickness.

The organism can cause inflammatory disease in the genital tract of cows or may merely colonize the healthy genital mucosa. Vaginitis, cervicitis, and endometritis have been associated with infection by *H. somni*. Experimentally, the organism can be embryocidal, which indicates a possible role in early embryonic mortality. Sporadic abortions have been reported following septicemia and placentitis, the latter being characterized by thrombosis and vasculitis as observed with TME and *Histophilus* pneumonia.<sup>3</sup>

### CLINICAL FINDINGS

The range of clinical findings associated with *H. somni* infection in cattle has changed remarkably over the last decades. Historically, TME was the major form of the disease. However, fewer cases of this presentation are being diagnosed now, whereas many more cases of other forms of the disease are becoming prevalent.

#### Thrombotic Meningoencephalitis (TME)

In the typical nervous form of the disease, thrombotic meningoencephalitis (TME), it is common for several animals to be affected within a few days or at one time, but single cases do occur. Some affected animals may be found dead without any premonitory signs, and often this may be the first sign of disease in the group.

In the more common acute form, in which there is usually neurologic involvement, cattle may be found in lateral or sternal recumbency and may or may not be able to stand. The temperature is usually elevated up to 41 to 42°C (105.8–107.6°F) but may be normal in some cases. Depression is common, the eyes are usually partially or fully closed, and unilateral or bilateral blindness may be present. Originally the disease was called the “**sleeping syndrome**” because the eyes were partially closed. Recumbent cattle that attempt to stand may have considerable difficulty and exhibit obvious ataxia and weakness. Others that are able to stand, when attempting to walk, knuckle over on the hind fetlocks, are grossly atactic, and usually fall after walking a short distance. In the recumbent position, opisthotonos, nystagmus, muscular tremors, hyperesthesia, and occasionally convulsions will occur, but the emphasis is on muscular weakness and paralysis rather than signs of irritation. Otitis media with concurrent meningitis may also occur.

TME is rapidly fatal in 8 to 12 hours if not treated when signs are first noticed. Affected cattle that are treated before becoming recumbent commonly recover in 6 to 12 hours, which is an important clinical characteristic of the disease. Once recumbent, particularly with obvious neurologic involvement, the affected animal will either die in spite of treatment or remain recumbent and

deteriorate over a period of several days. Secondary complications, such as pneumonia and decubitus ulcers, usually result.

The **ocular lesions** consist of foci of retinal hemorrhages and accumulations of exudate that appear like “cotton tufts.” Although these fundic lesions are not present in all cattle affected with *H. somni*, they are a valuable aid to the diagnosis. The organism has been isolated from the conjunctival sacs of feedlot cattle affected with conjunctivitis.

**Otitis in feedlot cattle** has also been attributed to the organism. The ears are commonly drooping, and affected animals appear depressed. A combination of otitis and meningitis in young cattle associated with the organism has been described.

The **synovitis** is characterized by distension of the joint capsules, usually the major movable joints such as the hock and stifle joints, but any joint may be involved. Pain and lameness are only mild; when treated early, the synovitis usually resolves in a few days. In a few cases there is marked lameness and a preference for recumbency associated with hemorrhages in muscle. The organism has been isolated from a calf with a urachal abscess.

#### Respiratory Disease

The clinical findings of the respiratory form of the disease, which has been diagnosed with increased frequency in the last decades, have not been clearly described. It is unlikely that there are any distinctive clinical features. Most feedlot calves with pleuritis attributable to *H. somni* die in the pen without ever having been treated.

Epidemiologic surveys of weaned beef calf mortality attributable to pneumonia and pleuritis associated with *H. somni* suggest that death from pneumonia occurred during the first 5 weeks after arrival in the feedlot. The median fatal disease onset for pneumonia was day 12, and for myocarditis and pleuritis, day 22. It is suggested that pneumonia and pleuritis should be suspected in feedlot cattle that have been treated unsuccessfully for bovine respiratory disease in the previous several days. Laryngitis, tracheitis, pleuritis, and pneumonia can occur alone or in combination with the acute neurologic form of the disease. The laryngitis is characterized clinically by severe dyspnea, mouth-breathing, and stertor. Conjunctivitis similar to that seen in infectious bovine rhinotracheitis (IBR) may occur, and isolation of the organism from ocular swabs is necessary to make the definitive diagnosis. Chronic suppurative orchiepididymitis in a calf from which *H. somni* was isolated has been described.

#### Myocarditis

In the myocardial form of the disease, affected animals may be found dead without any previous illness having been recorded or they may have been treated for respiratory



disease within the previous few weeks with a variable response. If seen early in the course of the myocarditis, the most common clinical findings are a fever and depression. With advanced stages of myocarditis, exercise intolerance, mouth-breathing, and protrusion of the tongue occur. Affected animals may collapse and die while being moved from their home pen to the hospital pen in the feedlot. Most animals with myocarditis have a previous history of being treated for an undifferentiated fever and depression within the previous 10 to 14 days. When returned to their home pens, they may be found dead or in severe respiratory distress.

**Chronic free-gas bloat** is a not uncommon finding in naturally occurring cases and occurs frequently in the experimental disease.

## CLINICAL PATHOLOGY

### Hematology

In most cases there are changes in the total and differential leukocyte count. Leukopenia and neutropenia may be present in severe cases, whereas in less severe cases a neutrophilia with a left shift is more common. In the cerebrospinal fluid, the total cell count is markedly increased, and neutrophils predominate. The Pandy globulin test on cerebrospinal fluid is usually strongly positive. In the synovial fluid the total cell count is also increased, and neutrophils predominate.

### Culture of Organism

The organism can be cultured from blood, cerebrospinal fluid, synovial fluid, urine, brain, kidney, and liver, less commonly from pleuritic fluid and tracheal washings. In vivo *H. somni* was isolated more often from bronchioalveolar lavage fluid than from nasopharyngeal swabs.<sup>3</sup> Culture of *H. somni* is poorly sensitive because the organism is fragile and fastidious. Collected samples must be shipped in a timely manner using special transport media and under refrigeration. Growth of *H. somni* is slow, requiring at least 48 to 72 hours on selective culture media and incubated on presence of 10% CO<sub>2</sub>. Previous antimicrobial therapy may further decrease the chances of successful recovery of the germ from an infected animal. The PCR technique is a more sensitive method for detection of the organism than bacterial culture and immunochemistry. The interpretation of a culture positive result is complicated by the common occurrence of asymptomatic carriers. Only large numbers of *H. somni*, ideally in pure culture obtained from a lesion, are considered confirmatory.<sup>3</sup>

### Serology

Cattle with experimental or naturally occurring disease have high levels of agglutinating anti-*H. somni* antibody. Recovered animals are positive to the complement fixation test (CFT) within 10 days following infection,

and titers begin to decline to low levels 30 days after infection.

A microagglutination test is available, but this test preferentially detects IgM antibody, an antibody class commonly cross-reacting with other members of the family Pasteurellaceae. Immunologic cross-reaction may explain why most cattle are positive on microagglutination in the absence of a history of *H. somni* disease or related clinical signs. ELISAs identifying the presence of IgG<sub>2</sub> are more specific; however, there is no significant difference in serum IgG<sub>2</sub> titers between culture-negative and culture-positive but asymptomatic animals. It was proposed that seroconversion could also occur in asymptotically infected carrier animals.<sup>3</sup>

An immunoblot test can detect an immune response after experimental abortion, experimental pneumonia, or vaccination with a killed vaccine. It is also able to distinguish between animals with an immune response as a result of disease or vaccination with the organism and those animals that are asymptomatic carriers, culture negative, or infected with closely related bacteria.

Paired serum samples obtained during acute and convalescence phase can be useful retrospectively.

## NECROPSY FINDINGS

The characteristic lesions of TME are hemorrhagic infarcts in any part of the brain and spinal cord. These are usually multiple and vary in color from bright red to brown and in diameter from 0.5 to 3 cm. Cerebral meningitis may be focal or diffuse, and the cerebrospinal fluid is usually cloudy and slightly yellow-tinged. Hemorrhages may also be present in the myocardium, skeletal muscles, kidneys, and serosal surfaces of the gastrointestinal tract.

There may be petechiation and edema of the synovial membranes of joints. There is an excessive quantity of synovial fluid, which is usually cloudy and may contain fibrinous flecks. The articular cartilage is usually not affected.

Pulmonary involvement is characterized by a fibrinopurulent bronchopneumonia, although the posterior aspects of the lung may be edematous and have a rubbery consistency. Histologically, there is fibrinosuppurative bronchiolitis accompanied by filling of the alveoli with fibrin, neutrophils, and macrophages. Peribronchiolar fibrosis and bronchiolitis obliterans, interlobular fibrosis and thrombosis of interlobular and pleural lymphatics develop in chronic cases. Fibrinous or serofibrinous inflammation of the peritoneum, pericardium, or pleura is found in more than 50% of cases. There may be focal ulceration and fibrinonecrotizing inflammation extending from the pharynx down into the trachea. Polypoid tracheitis has also been reported.

**Histologically, vasculitis and thrombosis** with or without infarctions and a cellular component composed almost entirely of neutrophils may be seen in all tissues where localization occurs, especially the heart but also the placenta in case of abortion.<sup>3</sup> Myocardial abscesses may develop and are most common in the left ventricular free wall, particularly in the papillary muscles.

## Samples for Confirmation of Diagnosis

- Bacteriology—culture swabs from brain/ meningeal and joint lesions; lung, spleen, heart (culture, PCR)
- Histology—formalin-fixed brain, lung, heart, kidney, synovial membrane (light microscopy, immunohistochemistry)

## DIFFERENTIAL DIAGNOSIS

### Thrombotic meningoencephalitis

attributable to *Histophilus somni* is characterized by sudden onset of weakness, ataxia, depression, fever, enlarged joints, and rapid death within 12 to 24 hours. There are marked changes in the cell count of the cerebrospinal fluid and the leukogram. There is a rapid response to treatment in the early stages.

In **polioencephalomalacia**, blindness, normal temperature, nystagmus, opisthotonos, and convulsions are common.

In **Listeria meningoencephalitis**, there is unilateral facial paralysis with deviation of the head and neck and a normal or slightly increased temperature. The cerebrospinal fluid in listeriosis usually contains an increased number of mononuclear cells.

**Mycoplasma bovis infection** can cause polyarthritis, otitis media in calves, and, in rare instances, meningoencephalitis.

**Hypovitaminosis A** in young cattle 6 to 12 months of age is characterized by sudden onset of short-term convulsions and syncope lasting 10 to 30 seconds, during which they may die but from which they more commonly recover to appear normal. Exercise such as walking from pasture to the farmstead will commonly precipitate the seizures. Eyesight may be slightly impaired, but the menace reflex is usually present.

**Pneumonia and pleuritis** associated with *H. somni* cannot be distinguished clinically from the other common causes of pneumonia in cattle, and the diagnosis is usually made at necropsy.

**Myocarditis** attributable to *H. somni* may cause sudden death or congestive heart failure, which will require a necropsy examination for a diagnosis.

## TREATMENT

Cattle with TME must be treated with antimicrobials as soon as clinical signs are obvious. Florfenicol, an analog of thiamphenicol, at a dose of 20 mg/kg BW intramuscularly and repeated 48 hours later, is effective for the treatment of acute undifferentiated fever in

feedlot calves and may be the antimicrobial of choice if *H. somni* infection is a major cause of mortality in feedlot calves. Oxytetracycline at 20 mg/kg BW intravenously daily for 3 days is effective when treatment is begun within a few hours after the onset of clinical signs. The prognosis in recumbent cattle is unfavorable, but treatment for 2 to 4 days may be attempted. A failure to respond after 3 days of treatment usually indicates the presence of irreversible lesions. The MICs of 33 antimicrobial agents for *H. somni* indicated high in vitro susceptibility to penicillin G, ampicillin, colistin, and novobiocin; oxytetracycline also revealed high activity. Once the disease has been recognized in a group, all in-contact animals should be observed closely for the next 7 to 10 days to detect new cases in the initial stages so that early treatment can be given. The treatment of pneumonia and pleuritis attributable to *H. somni* is the same as for acute undifferentiated bovine respiratory disease.

#### TREATMENT AND CONTROL

##### Treatment

Oxytetracycline (20 mg/kg IV every 24h for at least 3 days) (R-2)

Florfenicol (20 mg/kg IM every 48h) (R-2)

##### Control

*H. somni* bacterin vaccine

Florfenicol (40 mg/kg IM as single treatment)

Oxytetracycline (long acting formulation 20 mg/kg IM as single treatment)

#### CONTROL

Satisfactory control procedures are not available because the pathogenesis and epidemiology of the disease are not well understood. When an outbreak of the nervous form of the disease is encountered, the provision of constant surveillance and early treatment is probably the most economical and effective means of control.

#### Metaphylactic Antimicrobial Therapy

Postarrival metaphylactic treatment with antibiotics is widely used in feedlots to control undifferentiated bovine respiratory disease (UBRD) and was shown to reduce morbidity and mortality associated with this disease complex.<sup>7,8</sup> Evidence supporting the metaphylactic or prophylactic use of antimicrobials to reduce occurrence rate and mortality directly associated with *H. somni* infection is scant. Mass medication with long-acting oxytetracyclines did not reduce the risk of histophilosis mortality, but it reduced the risks of bovine respiratory disease morbidity and mortality by 14% and 71%, respectively.<sup>2</sup>

#### Vaccination

Vaccines have been available for use in North America and are mainly labeled

for protection from TME but not the other forms of histophilosis; their efficacy is uncertain.<sup>9</sup> One bacterin is immunogenic and will protect vaccinated cattle against the nervous form of the infection produced by intravenous and intracisternal inoculation of the organism. Two injections of the bacterin given subcutaneously 2 to 3 weeks apart are recommended. Controlled field trials indicate that the bacterin reduces the morbidity and mortality rates of nervous system disease in vaccinated cattle compared with nonvaccinated animals. However, the efficacy of the bacterin has been difficult to evaluate because the incidence of naturally occurring disease in nonvaccinated control animals is usually low and may not be significantly greater than in vaccinated animals.

The efficacy of a *H. somni* bacterin to reduce mortality was evaluated in auction-market-derived beef calves vaccinated immediately upon arrival at the feedlot. The vaccine had no significant effect on overall crude mortality but appeared to reduce the incidence rate of fatal disease during the first 2 months in the feedlot when the risk of fatal disease onset was highest. When mortalities unlikely to be associated with *H. somni* were removed from the analysis, the mortality rate in male calves was reduced by about 17% in the vaccinated group. A second vaccination 2 weeks after arrival did not reduce the mortality risk.

Vaccination of feedlot calves on arrival with a genetically attenuated leukotoxin of *M. haemolytica* combined with bacterial extracts of *H. somni* increased serum antibody titers to both organisms and reduced acute undifferentiated bovine respiratory disease. However, it is not known what proportion of the respiratory disease was attributable to *H. somni*.

Vaccinating calves twice with a killed whole-cell bacterin reduced the clinical and pathologic effects of experimentally induced *H. somni* pneumonia. Calves vaccinated once were incompletely protected.

There is no published evidence to indicate that vaccination of feedlot calves before or after entry into the feedlot with any of the available *H. somni* vaccines will provide protection against the various forms of clinical disease, particularly the respiratory and myocardial types described earlier.<sup>9</sup> The disease complex is occurring in feedlot calves in spite of vaccination. A rational vaccination program would consist of vaccinating calves at least twice, 2 to 4 weeks apart, with the second vaccination occurring at least 2 weeks before entry into the feedlot.

#### FURTHER READING

Corbeil LB. *Histophilus somni* host-parasite relationships. *Anim Health Res Rev.* 2008; 8:151-160.

Kwiecien JM, Little PB. *Haemophilus somnus* and reproductive disease in the cow: a review. *Can Vet J.* 1991;32:595-601.

Miller RB, Lein DH, McEntee KE, et al. *Haemophilus somni* infection of the reproductive tract: a review. *J Am Vet Med Assoc.* 1983;182:1390-1392.

Pérez DS, Pérez FA, Bretschneider G. *Histophilus somni*: pathogenicity in cattle. An update. *An Vet (Murcia).* 2010;26:5-21.

Sandal I, Inzana TJ. A genomic window into the virulence of *Histophilus somni*. *Trends Microbiol.* 2009;18:90-99.

Siddararamppa S, Inzana TJ. *Haemophilus somni* virulence factors and resistance to host immunity. *Anim Health Res Rev.* 2004;5:79-93.

#### REFERENCES

- Sandal I, Inzana TJ. *Trends Microbiol.* 2010;18:90.
- Pérez DS, et al. *An Vet (Murcia).* 2010;26:5.
- Corbeil LB. *Anim Health Res Rev.* 2007;8:151.
- Elsawasifi SF, et al. *Vet Res.* 2012;43:49.
- Sandal I, et al. *J Bacteriol.* 2007;189:8179.
- O'Toole D, et al. *Vet Pathol.* 2009;46:1015.
- Nickel JS, White BJ. *Vet Clin North Am Food A.* 2010;26:285.
- Taylor JD, et al. *Can Vet J.* 2010;51:1351.
- Larson RL, Step DL. *Vet Clin North Am Food A.* 2012;28:97.

### SEPTICEMIA AND THROMBOTIC MENINGOENCEPHALITIS IN SHEEP ASSOCIATED WITH *HISTOPHILUS SOMNI*

#### SYNOPSIS

**Etiology** *Histophilus somni* (formerly *Haemophilus agni*, *Histophilus ovis*)

**Epidemiology** Worldwide occurrence but not a common disease. In affected flocks, cases occur over several weeks to result in a significant population mortality.

**Clinical findings** Acute disease and affected sheep commonly found dead. Septicemia, polyarthritis, and occasionally meningitis primarily in lambs 4 to 7 months of age.

**Necropsy findings** Multiple hemorrhages throughout the carcass. Focal hepatic necrosis. Polyarthritis, meningoencephalitis.

**Diagnostic confirmation** Isolation of the organism.

**Treatment and control** Oxytetracycline.

#### ETIOLOGY

*Histophilus somni* falls within the family Pasteurellaceae. This organism, previously known as *Haemophilus agni* and *Histophilus ovis*, has been isolated from sheep, bighorn sheep, and bison with a number of different pyogenic conditions, including septicemia, polyarthritis, thrombotic meningoencephalitis, general pyemia, metritis, mastitis, abortion, neonatal mortality, and epididymitis.<sup>1</sup>

#### EPIDEMIOLOGY

Disease associated with *H. somni* in sheep has worldwide occurrence but is not common.

The most common presentation is lameness and septicemia in lambs aged 4 to 7 months, but infection with this organism can

also result in polyarthritis in lambs 1 to 4 weeks of age. The morbidity rate varies between outbreaks, but the case-fatality rate is likely to be 100% unless treatment is undertaken, and the population mortality rate can approach 10%. Outbreaks may last several weeks; within a flock, cases of the disease occur sporadically but over a long period.

In some outbreaks, both in lambs and adult sheep, meningoencephalitis is the primary presentation, and the clinical and pathologic findings are similar to those of thromboembolic meningoencephalitis in cattle. The method of transmission is unknown, but the disease does not appear to spread by pen contact and cannot be produced by oral, nasal, or conjunctival exposure to the organism. Environmental or other stress may be a predisposing factor. *H. somni* has been isolated from the genital mucosa of goats that are in contact with sheep flocks, but their role in transmission of this organism is not clear.<sup>2</sup>

### PATHOGENESIS

The organism colonizes the respiratory and reproductive tract mucosa and invades to produce septicemia and disseminated bacterial thrombosis, leading to a severe focal vasculitis.

### CLINICAL FINDINGS

Affected sheep are often found dead. Depression, high fever (42°C [107°F]), disinclination to move, and collapse with movement are the obvious clinical signs, and affected lambs may die within 12 hours of becoming ill. Lambs that survive more than 24 hours develop a severe arthritis with a palpable increase in joint fluid and heat in the joints. They are usually recumbent, and those with meningoencephalitis show hypersalivation, convulsions, and opisthotonos. The clinical course is short.

### CLINICAL PATHOLOGY

Hematology and blood chemistry are not commonly conducted because of the acute nature of the disease and the availability of carcasses for postmortem. Initially there is leukopenia and neutropenia, with neutrophilia and left shift in more prolonged cases. Total cell count is elevated in cerebrospinal fluid and joint fluid, and these also can be cultured for the organism. Antibody detected by complement fixation persists for about 3 months in animals that survive.

### NECROPSY FINDINGS

At necropsy the most striking feature is the presence of multiple hemorrhages throughout the carcass. Focal hepatic necrosis surrounded by a zone of hemorrhage is also a constant finding. Lambs that die in the early stages of the disease show minimal joint changes, but those that survive for more than 24 hours develop fibrinopurulent arthritis.

Histologically, the disease is a disseminated bacterial thrombosis leading to a severe focal vasculitis. This change is most apparent in the liver and skeletal muscles. More protracted cases can have hemorrhages in the leptomeninges and foci of liquefactive necrosis at the gray–white junction of cerebral hemispheres, basal gray nuclei, and thalamus. Microscopically, these foci exhibit suppurative necrosis and vascular thrombosis, with bacterial colonies inside the abscesses.<sup>3</sup>

### Samples for Confirmation of Diagnosis

- Bacteriology—swabs from joint fluid, liver, meningeal fluid for culture and PCR
- Histology—formalin-fixed liver and brain for histology and immunochemistry

### DIFFERENTIAL DIAGNOSIS

Because of the acute nature of the clinical disease, the disease is likely to be confused with acute septicemia associated with *E. coli* or *P. trehalosi*, and with enterotoxemia. The characteristic hepatic lesions and histology serve to identify the disease, and final diagnosis depends on isolation of the organism.

### TREATMENT AND CONTROL

Antimicrobials, such as tetracyclines or trimicosin,<sup>4</sup> need to be given very early in the course of the disease if they are to be effective. Because of the acute nature of the disease, vaccination is likely to be the only satisfactory method of control. Although there is no label, vaccine immunity after a field attack seems to be solid. Mass treatment of the group of sheep at risk with long-acting tetracyclines is a possible strategy to reduce the occurrence of further cases.

### FURTHER READING

- Corbeil LB. *Histophilus somni* host–parasite relationships. *Anim Health Rev.* 2008;8:151-160.
- Radostits O, et al. Focal symmetrical encephalomalacia. In: *Veterinary Medicine: A Textbook of the Diseases of Cattle, Horses, Sheep, Goats and Pigs.* 10th ed. London: W.B. Saunders; 2007:997-998.

### REFERENCES

1. Corbeil LB. *Anim Health Rev.* 2008;8:151.
2. Janosi K, et al. *Vet Micro.* 2009;133:383.
3. Romero A, et al. *Veterinaria.* 2013;49:38.
4. Blackall PJ, et al. *Aust Vet J.* 2007;85:503.

### TICK PYEMIA OF LAMBS (ENZOOTIC STAPHYLOCOCCOSIS OF LAMBS)

#### SYNOPSIS

**Etiology** Infection with *Staphylococcus aureus* predisposed by infection with *Anaplasma* (formerly *Ehrlichia*) *phagocytophila*.

**Epidemiology** Disease of young lambs that occurs in areas that are habitats for *Ixodes ricinus*.

**Clinical and necropsy findings** Septicemia and subsequent abscessation in internal organs.

**Diagnostic confirmation** Isolation of organism.

**Treatment** Long-acting antimicrobials.

**Control** Tick control.

### ETIOLOGY

The disease has a complex causality and results from a septicemia produced by *Staphylococcus aureus* predisposed by infection with *Anaplasma* (formerly *Ehrlichia*) *phagocytophila*, which is transmitted by *Ixodes ricinus*.

### EPIDEMIOLOGY

Enzootic disease has been recorded only in the United Kingdom and occurs only in the hill areas that are habitats for the tick *I. ricinus*. The disease occurs in the spring and early summer. The annual incidence varies with the year and between farms. On average, 5% of lambs at risk are affected, but on some farms the incidence may be as high as 29% in certain years.

In enzootic areas the disease has considerable economic importance and has been stated to affect as many as 300,000 lambs every year, the majority of which die or fail to be profitable.

### PATHOGENESIS

Experimental and epidemiologic studies have established a clear relationship between infection with *A. phagocytophila*, the agent of tick-borne fever, and susceptibility to infection with *S. aureus*. The role of the tick is in the transmission of *A. phagocytophila*, which produces waves of bacteremia detectable by quantitative PCR as early as 1 day following experimental infection.<sup>1</sup>

Infection with *A. phagocytophila* produces a significant lymphocytopenia that develops 6 days after infection and affects all subsets of T- and B-lymphocytes, and also a prolonged neutropenia lasting for 2 to 3 weeks combined with a thrombocytopenia. Up to 70% of the neutrophils are parasitized from the onset of the parasitemia and have impaired function, and lambs with tick-borne fever have a much higher susceptibility to experimental infection with *S. aureus* than noninfected lambs. The ticks are not thought to necessarily provide portals of entry for, nor to be the primary carriers of, the infection with *S. aureus*, although they are important in this respect. *S. aureus* can gain entry through a variety of sources, and in affected flocks there is a high incidence of lambs carrying the same infection on their nasal mucosa.



## CLINICAL AND NECROPSY FINDINGS

Lambs aged 2 to 10 weeks are affected. They may die quickly of septicemia or show signs of localization of infection. Clinically, this is most evident by infections that localize in joints or the meninges to manifest as arthritis or meningitis, but on postmortem examination abscesses can be found in any organ, including the skin, muscles, tendon sheaths, joints, viscera, and brain.

## TREATMENT AND CONTROL

Treatment of the established disease has limited value, and efforts should be directed at prevention or mitigation of early infection during the bacteremic phase.

The strategic use of long-acting antibiotics has shown success in this respect. On farms with enzootic disease, benzathine penicillin administered at 3 weeks of life has been shown to result in a marked decrease in the incidence of subsequent clinical disease. The use of long-acting tetracyclines has the additional advantage of protecting against infection with the agent of tick-borne fever and *S. aureus* infection; two treatments of lambs, the first between 1 and 3 weeks of age and the second between 5 and 7 weeks, has been shown to result in a significant reduction in morbidity and mortality. In addition, the treatment has been accompanied by increased weight gain.

Tick control by dipping lambs or using a pour-on insecticide significantly reduces the incidence of clinical disease and increases weight gain of clinically normal lambs. Separation of the lambs for dipping has not been associated with problems of mis-mothering. A combination of antibiotic and acaricide treatment may be the most effective and in one trial reduced losses from 10.3% to 0.6%. Dipping the whole flock in an acaricide in spring, although it will not completely eradicate tick infestation, will reduce the incidence of tick pyemia.

Pyemic infection with *S. aureus* is also recorded in association with tick infestation in camels in Saudi Arabia.

## FURTHER READING

Woldehiwet Z. The natural history of *Anaplasma phagocytophilum*. *Vet Parasitol*. 2010;167:108-122.

## REFERENCE

1. Thomas RJ, et al. *J Comp Path*. 2012;147:360.

## SEPTICEMIC PASTEURELLOSIS OF CATTLE (HEMORRHAGIC SEPTICEMIA)

### ETIOLOGY

Hemorrhagic septicemia (HS) is mainly associated with two specific serotypes of *P. multocida*, a gram-negative, aerobic coccobacillus of the family Pasteurellaceae. The Asian serotype is designated B:2 and the

African serotype is E:2 by the Carter-Heddlestone system, corresponding to 6:B and 6:E by the newer Namioka-Carter system. The letter denotes the capsular antigen and the cipher the somatic antigen. Other serotypes—namely, A:1, A:1,3, A:3, A:4, B:1, B:2,5, and others—have occasionally been isolated from HS outbreaks.<sup>1</sup> Serotype E:2 has thus far only been retrieved in Africa, whereas serotype B:2 was isolated from cases on other continents but also from Egypt and Sudan.

Although *P. multocida* does not readily survive in the environment, it is thought that it can survive for hours and probably days in moist soil and water.

## EPIDEMIOLOGY

### Occurrence

Hemorrhagic septicemia is a highly fatal acute septicemic disease predominantly affecting **water buffaloes and cattle**. Occasional outbreaks among pigs and less frequently among sheep, goats and bison have been reported. Incidental cases have been reported in horses, donkeys, elephants, yaks and camels.<sup>2</sup>

HS is considered economically important in Asia, Africa, and the Middle East, with highest incidences in Southeast Asia. Cases have also been reported from countries in southern Europe and the United States, where outbreaks among bison were reported. In regions where the disease is endemic it causes heavy death losses and has emerged as the economically most important bacterial disease following the successful eradication of rinderpest and the continued low mortality of food-and-mouth disease.<sup>1</sup> HS is listed on list B of the World Organization for Animal Health (OIE), which includes “transmissible diseases that are considered to be of socioeconomic and/or public health importance within countries, and that are significant in the international trade of animals and animal products.”<sup>3</sup>

Both morbidity and case-fatality rates vary between 50% and 100%, and animals that recover require a long convalescence. Morbidity will depend on the immune status of the herd, either acquired naturally or induced by vaccination. The greater the percentage of immune to nonimmune animals, the lower will be the morbidity. In endemic areas, adult animals develop a naturally acquired immunity, and large outbreaks no longer occur in these areas. The incidence of disease is reduced significantly in areas where the vaccine is used.

### Risk Factors

#### Animal Risk Factors

The disease predominantly affects water buffaloes and cattle, but buffaloes are considered to be more susceptible to clinical disease. These species also present the most important host reservoir for the pathogen. It is estimated that in endemic areas up to 5%

of water buffaloes and cattle are carriers and thus potential shedders of the pathogens.<sup>1</sup>

All age groups are susceptible to infection, but in endemic regions, older animals previously exposed to the pathogen may have antibodies providing some protection. In these regions the most susceptible age group is 6 months to 2 years of age. Colostral immunity of calves from cows vaccinated against hemorrhagic septicemia peaks at 8 to 16 weeks of age and then declines. There is no difference in susceptibility between breeds.

The immune status and health of the individual animal and the herd are considered important factors in the epidemiology of HS. Stress resulting from inadequate feed supply, disease, or exhaustion is considered an important predisposing factor for clinical disease.<sup>2</sup>

### Pathogen Risk Factors

*P. multocida* possesses a number of virulence factors, which include the capsule, fimbriae, and adhesins; outer membrane proteins (OMPs); endotoxin (lipopolysaccharide [LPS]); siderophores; and a number of extracellular enzymes.<sup>1</sup> Endotoxin appears to be the most important virulence factor responsible for clinical disease. LPS of serogroups B and E were found to be identical, and intravenous inoculation with LPS from these strains allowed for reproduction of clinical disease and death within hours, consistent with severe endotoxemia in water buffaloes.<sup>1</sup> Synthesis of the extracellular enzyme hyaluronidase appears to be a specific feature of serotype B:2, but the significance of the enzyme for the virulence of the pathogen is not known.<sup>1</sup>

### Environmental Risk Factors

Although clinical disease can occur at any time of the year, close herding and wet conditions clearly contribute to the spread of the disease. Outbreaks of the disease are often associated with wet, humid weather during the rainy season.

Stressors such as inadequate feed supply or exhaustion are considered important predisposing factors that not only increase the susceptibility to clinical disease, but also stimulate shedding of the bacterium from subclinically infected animals.

During intervening periods the causative organism persists on the tonsillar and nasopharyngeal mucosae of carrier animals.

### Transmission

Transmission of *P. multocida* occurs either through oral ingestion or inhalation, either during direct contact between infected and susceptible individuals or via fomites such as contaminated feed or water. The saliva of affected animals contains large numbers of *Pasteurella* during the early stages of the disease. Although infection occurs by ingestion, the organism does not

survive on pasture for more than 24 hours. Biting insects do not seem to be significant vectors.<sup>2</sup>

## **PATHOGENESIS**

The portal of entry of infection is thought to be the tonsils. A fulminating septicemia occurs, which is associated with the capsular material of the organism and its endotoxin. In acute and peracute cases death ensues within 8 to 24 hours of appearance of the first clinical signs. The effects of the septicemia are most severe in the respiratory tract, heart, and gastrointestinal tract. In cattle and buffalo there is rapid translocation of bacteria from the respiratory tract to the blood, liver, and spleen, suggesting that the bacteria are able to invade via the mucosal epithelial layers.

## **CLINICAL FINDINGS**

The disease is an acute septicemia and is clinically characterized by a sudden onset of fever (41 to 42°C [106–107°F]), followed by profuse salivation, submucosal petechiation, severe depression, and death in about 24 hours. On range lands, animals may be found dead without any clinical signs having been observed. Localization may occur in subcutaneous tissue, resulting in the development of warm, painful swellings about the throat, dewlap, brisket, or perineum, and severe dyspnea may occur if the respiration is obstructed. In the later stages of an outbreak, some affected animals develop signs of pulmonary or alimentary involvement. *P. multocida* may be isolated from the saliva and the bloodstream. The disease in pigs is identical to that in cattle.

## **CLINICAL PATHOLOGY**

### **Culture and Detection of Bacteria**

Laboratory diagnosis is by isolation and identification of the causative agent. The organism can be cultured from blood or a nasal swab from an animal within a few hours of death. Blood or a nasal swab during the clinical phase of the disease is not reliable because the septicemia is a terminal event.<sup>2</sup> From older carcasses, a long bone is used for culture from the bone marrow. Biochemical and serologic tests are used for identification and serotyping of *P. multocida*. Serotyping can be done by rapid slide agglutination, indirect hemagglutination, agar gel immunodiffusion, and counterimmunoelectrophoresis.<sup>4</sup> DNA fingerprinting and other molecular techniques are suitable for epidemiologic studies to trace an outbreak back to its origin.

### **Serology**

Serology is not normally used for diagnosis because of the peracute and highly fatal course of disease; however, high titers (1:160 or higher) by indirect hemagglutination (IHA) in surviving in-contact animals are suggestive of disease.<sup>2</sup>

## **NECROPSY FINDINGS**

At necropsy, the gross findings are usually limited to generalized petechial hemorrhages, particularly under the serosae, and edema of the lungs and lymph nodes. Subcutaneous infiltrations of gelatinous fluid may be present, and in a few animals there are lesions of early pneumonia and a hemorrhagic gastroenteritis. Varying degrees of lung involvement range from generalized congestion to patchy or extensive consolidation. Thickening of the interlobular septa may be prominent. Lymph nodes in the thoracic region are enlarged and hemorrhagic. Isolation of the causative bacteria is best attempted from heart, blood, and spleen samples.

## **DIFFERENTIAL DIAGNOSIS**

The differential diagnoses for hemorrhagic septicemia include many other conditions causing peracute death, sometimes without specific clinical signs:

- Blackleg
- Anthrax
- Rinderpest
- Lightning strike
- Acute salmonellosis

More protracted cases with signs of respiratory distress:

- Pneumonic pasteurellosis (shipping fever, enzootic calf pneumonia)
- Atypical interstitial pneumonia
- Mycoplasmosis

## **TREATMENT**

Treatment is of little use once clinical signs have become apparent because of the acute/peracute course of disease.<sup>2</sup> Various antimicrobials have been used to treat HS in cattle and other species, including tetracyclines, penicillin, and sulfonamides, but monitoring of antimicrobial susceptibility of *P. multocida* strains associated with HS revealed a gradual development of in vitro resistance, particularly against sulfonamides.<sup>1</sup> Treatments described in the section on pneumonic pasteurellosis of cattle should also be effective in this disease. Whatever antimicrobial is chosen, an initial intravenous loading dose is required to reach bactericidal concentrations in blood as fast as possible.

## **TREATMENT AND CONTROL**

### **Antimicrobial therapy**

Penicillin G sodium/potassium (22,000 IU/kg initial IV then IM every 12h) (R-2)

Procaine penicillin (22,000 IU/kg IM every 12h or 44,000 IU/kg IM every 24h after initial IV loading dose of penicillin G sodium/potassium) (R-2)

Oxytetracycline (10 mg/kg initial IV then IM every 24 for 4 days) (R-2)

Trimethoprim ([2.66 mg/kg] + sulfadoxine [13.33 mg/kg] initial IV then IM every 12h) (R-2)

Enrofloxacin\* (2.5-5 mg/kg SC q24h)

Ceftiofur sodium\* (1.2-2.2 mg/kg IV every 24h)

Ceftiofur hydrochloride\* (2.2 mg/kg SC every 24 after initial IV loading dose of ceftiofur sodium)

### **Metaphylaxis**

Tulathromycin (2.5 mg/kg SC as single dose)

Florfenicol (40 mg/kg SC as single dose)

Tilmicosin (10 mg/kg SC as single dose)

Gamithromycin (6 mg/kg SC/IM as single dose)

Oxytetracycline long-acting formulation (20 mg/kg IM as a single dose)

Enrofloxacin\* (7.5-12.5 mg/kg SC/IM as single dose) (R-3)

Danofloxacin\* (8 mg/kg SC as single dose) (R-3)

Ceftiofur\* crystalline acid free (6.6 mg/kg SC posterior pinna as single treatment) (R-3)

### **Vaccination**

Vaccination with inactivated HS vaccine (R-1)\*\*

Vaccination with modified live vaccine (intranasal) (R-1)\*\*

*\*Classified as critically important antimicrobials in human and veterinary medicine. Use as first-line treatment is discouraged.<sup>5</sup>*

*\*\*Colostrum antibody interferes with vaccine efficacy in calves.*

## **CONTROL**

Hemorrhagic septicemia can be eradicated from nonendemic areas by animal movement control, quarantines, tracing of contacts, culling of infected and exposed animals, and disinfection of the premise. Although treatment may be successful when initiated early in the course of the disease, up to 20% of surviving animals are estimated to become clinically unapparent shedders, thereby creating a host reservoir.<sup>2</sup>

In endemic areas the condition is mainly controlled by vaccination. Removing identified carrier animals, avoiding stress by providing adequate feed supply, and avoiding overcrowding, particularly during the rainy season, can further reduce the risk of clinical disease and transmission of the infection.

Treatment of animals that were in contact with clinical herd mates may be suitable to limit morbidity and mortality rates during an outbreak.<sup>2</sup>

### **Antimicrobial Metaphylaxis**

Although the metaphylactic use of antimicrobials as disease control is debatable from the point of view of prudent antimicrobial use, the treatment of clinically still healthy in-contact animals during an outbreak may

be indicated and justified by the high case-fatality rate that is largely attributable to the peracute course of disease.<sup>2</sup>

### Vaccines

Vaccines against HS are widely used in endemic areas and are the only practical approach to prevent HS.<sup>1</sup> Initially, inactivated vaccines based on plain bacterins of *P. multocida* were used, to which various adjuvants were added later to enhance immune response. The commonly used vaccines are alum precipitated vaccines, aluminium hydroxide gel vaccines, oil-adjuvant vaccines (OAVs), and multiemulsion vaccines (MEVs), which vary considerably in the duration of immunity induced and in side effects. Alum-precipitated vaccines are widely used. Plain broth bacterins, or alum-precipitated and aluminum hydroxide gel vaccines, are administered twice a year because these vaccines offer immunity of 4 to 6 months. OAVs give both a higher degree and a longer duration of immunity, up to 1 year, but have not been popular because they are difficult to inject and because of local tissue reactions and abscess formation at the site of injection. To overcome this issue, an (MEV of a thinner viscosity has been developed that provide immunity parallel to the OAV.

Generally, inactivated vaccines are widely used in endemic areas and are effective in reducing the disease incidence. Disadvantages of these vaccines are the short duration of immunity they provide and the high costs of production.<sup>2</sup>

A fallow deer strain aerosol vaccine (strain B:3,4) developed in Myanmar is currently the only available modified live (MLV) HS vaccine. The safety, efficacy, and cross-protectivity of this vaccine has been tested in young cattle and buffaloes in Myanmar, where more than 1.5 million animals were inoculated with the vaccine between 1989 and 1999. A recommended dose of  $2 \times 10^7$  viable organisms was used for the efficacy test. The administration of 100 times the recommended dose to 50 cattle and 39 buffalo calves was innocuous. Three out of three buffaloes were protected 7 months after they were vaccinated, and 12 months after they were vaccinated, 3 out of 4 buffaloes were protected against a subcutaneous challenge with serotype B:2, which killed 3 of 3 unvaccinated buffaloes; 12 months after they were vaccinated, 8 out of 8 cattle survived a serotype B:2 challenge that killed 4 out of 4 unvaccinated controls. The vaccinated cattle had developed serum antibodies detectable by the passive mouse protection test. Indirect hemagglutination tests on sera taken from cattle 10 days and 5 weeks after they were vaccinated showed high titers on antibodies. The serum of vaccinated cattle cross-protected passively immunized mice against infection with *P. multocida* serotypes E:2, F:3,4, and A:3,4. The intranasal aerosol

vaccination is safe, even at very high dose levels, and does not induce anaphylactic shock even after repeated vaccinations. The freeze-dried live vaccine is stable for at least 3 years at room temperatures of 30 to 36°C (86 to 97°F), and thus a “cold chain,” which is impracticable for many hemorrhagic-septicemia-endemic areas, is not necessary for the storage and transport of the vaccine.

The Food and Agriculture Organization (FAO) of the United Nations has reviewed development and use of this MLV vaccine in Myanmar and has commended the intranasal use of live B:3,4 vaccine as safe and potent and has suggested that the technology be transferred to other countries. Nevertheless, no other country is currently using the MLV vaccine.<sup>2</sup>

### FURTHER READING

- Shivachandra SB, Viswas KN, Kumar AA. A review of hemorrhagic septicemia in cattle and buffalo. *Anim Health Res Rev.* 2011;12:67-82.
- Verma R, Jaiswal TN. Hemorrhagic septicemia vaccines. *Vaccine.* 1998;16:1184-1192.

### REFERENCES

- Shivachandra SB, et al. *Anim Health Res Rev.* 2011;12:67.
- OIE. 2009 at: <[http://www.oie.int/fileadmin/Home/eng/Animal\\_Health\\_in\\_the\\_World/docs/pdf/HAEMORRHAGIC\\_SEPTICEMIA\\_FINAL.pdf](http://www.oie.int/fileadmin/Home/eng/Animal_Health_in_the_World/docs/pdf/HAEMORRHAGIC_SEPTICEMIA_FINAL.pdf)>; Accessed 20.01.14.
- OIE. 2014 at: <<http://www.oie.int/en/animal-health-in-the-world/the-world-animal-health-information-system/old-classification-of-diseases-notifiable-to-the-oie-list-b/>>; Accessed 20.01.14.
- OIE. 2008 at: <[http://www.oie.int/fileadmin/Home/eng/Health\\_standards/tahm/2.04.12\\_HS.pdf](http://www.oie.int/fileadmin/Home/eng/Health_standards/tahm/2.04.12_HS.pdf)>; Accessed 20.01.14.
- World Organization for Animal Health. OIE list of antimicrobial agents of veterinary importance. 2013 <[http://www.oie.int/fileadmin/Home/eng/Our\\_scientific\\_expertise/docs/pdf/OIE\\_List\\_antimicrobials.pdf](http://www.oie.int/fileadmin/Home/eng/Our_scientific_expertise/docs/pdf/OIE_List_antimicrobials.pdf)>; Accessed 14.12.13.

## PASTEURELLOSIS OF SHEEP AND GOATS

*Mannheimia (Pasteurella) haemolytica* and *Bibersteinia trehalosi* are the main causes of pasteurellosis in sheep and goats. Under the old classification system, *M. haemolytica* was classified into two biotypes, A and T, which were then subdivided into serotypes based on antigenic differences in capsular polysaccharide.

- The serotypes within biotype A are now classified as *Mannheimia haemolytica* with the exception of serotype A11, which is a separate species, *Mannheimia glucosida*.
- The most common manifestation of *M. haemolytica* in sheep is pneumonic pasteurellosis, which occurs in all ages.
- M. haemolytica* is a secondary invader, and a cause of death, in chronic enzootic pneumonia in sheep and goats that is initiated by *Mycoplasma ovipneumoniae*.

- M. haemolytica* infections in sheep also cause septicemic pasteurellosis in young suckling lambs, which often occurs in association with pneumonic pasteurellosis in the same flocks, and mastitis in ewes.<sup>1,2</sup>
- Palpable lesions in the testicles of rams have also been associated with heavy pure growth of organisms from the *Pasteurella* cluster.<sup>3</sup> Lesions include epididymitis, spermatic granulomas, testicular atrophy, and adhesions between the vaginal tunic and scrotum.
- M. glucosida* comprises a heterogeneous group of organisms that cause opportunistic infections of sheep, especially mastitis.<sup>1,2</sup>
- Biotype T of *M. haemolytica* contains four serotypes and is now classified as *Bibersteinia trehalosi*. Isolates of *B. trehalosi* that are leukotoxin A (LkTA) positive are associated with septicemic disease in weaned sheep.
- Genetic analyses show that bovine and ovine strains of *M. haemolytica* represent genetically distinct subpopulations that are specifically adapted to, and elicit disease in, either cattle or sheep.
- These analyses also demonstrate that traditional classification based upon metabolic characteristics lack the resolution and accuracy to reliably classify isolates. Consequently, for reliable epidemiologic investigations they should be augmented by molecular techniques such as 16s rRNA and LkTA screening using PCR assays.<sup>4</sup>
- P. multocida* is an uncommon respiratory pathogen in sheep in temperate areas but may be of greater importance in tropical areas.

## SEPTICEMIC PASTEURELLOSIS OF SUCKLING LAMBS

Septicemic pasteurellosis is a disease of young lambs typically associated with *M. haemolytica* biotype A. It occurs in lambs from 2 days to 2 months of age but presents most commonly at 2 to 3 weeks of age. The young lamb is highly susceptible to biotype A infections, which progress rapidly from the tonsils and lungs to a fatal septicemia. The organism is also a primary pathogen in goat kids. Septicemic pasteurellosis in suckling lambs may occur as an isolated disease but more commonly occurs in conjunction with pneumonic pasteurellosis, with younger lambs succumbing to the former and ewes and older lambs to the latter. This disease probably does not warrant a separate classification but is kept separate because some outbreaks are manifest only by septicemia in lambs.

There is a significant difference in the incidence of death from septicemic pasteurellosis in lambs between flocks that are



infested with *Ixodes ricinus* and flocks that are *Ixodes* free. It is thought that immune suppression from tick-borne fever caused by *A. phagocytophilum* can predispose to septicemic pasteurellosis. Lambs that die are usually 4 to 8 weeks of age. *B. trehalosi* can also cause of this condition.<sup>5</sup>

A single subcutaneous injection of 10 mg/kg tilmicosin or intramuscular injection of 20 mg/kg oxytetracycline is effective in preventing disease. Tulathromycin (2.5 mg/kg, SC), a semisynthetic macrolide, may also be an effective treatment.<sup>6</sup>

*P. multocida* is a rare cause of septicemic disease in neonatal lambs but can occur with a high morbidity and high case-fatality rate. Clinically, it presents with a syndrome resembling watery mouth with marked salivation, abdominal distension, and a short clinical course. On postmortem examination, there is excess peritoneal and pleural pericardial fluid. Prophylactic long-acting tetracycline at a dose of 100 mg per lamb has prevented further cases.

### MANNHEIMIA MASTITIS IN SHEEP

*M. haemolytica*, *M. glucosida*, and *M. ruminalis* have been isolated from cases of peracute, gangrenous acute mastitis in sheep.<sup>1</sup> *M. haemolytica* is the most common cause of mastitis in meat-producing flocks. It occurs in the Canada, United States, Australia, New Zealand, and Europe in ewes kept under systems of husbandry that vary from open pasture to enclosed barns, and is a major cause of mastitis in ewes in Britain. A variety of typed and untyped strains within biotype A are isolated, with serotype A2 most common from cases of acute mastitis. Mastitis is most common in ewes suckling large lambs up to 3 months old. There is a high diversity among *Mannheimia* isolates. Horizontal transmission by lamb suckling probably occurs, supported by the observation that the prevalence of mastitis associated with this organism is less in dairy sheep than in meat flocks.<sup>7</sup>

### PNEUMONIC PASTEURELLOSIS AFFECTING WILDLIFE

*Pasteurella* and *Mannheimia* spp. have been isolated from a number of different species of wildlife, but there has been particular concern with outbreaks of acute fatal pneumonic pasteurellosis that have occurred in Rocky Mountain and desert bighorn sheep (*Ovis canadensis*) following commingling with domestic sheep or feral goats. This appears to be a complex polymicrobial disease, with *M. ovipneumoniae*, *M. haemolytica*, LktA-positive *B. trehalosi*, *P. multocida*, respiratory syncytial virus, and parainfluenza-3 virus isolated from natural cases, and some argument over which agent is the primary cause.<sup>8</sup> Experimental challenge with *M. haemolytica* will induce disease, and bighorn sheep are particularly

susceptible to pathogenic (LktA positive) biotype A strains acquired from commingling with domestic sheep. This, coupled with the stress of high densities and food shortage, was thought to be important in the epidemiology of this disease. However, bighorn sheep are not naturally infected with *M. ovipneumoniae*, and spread of this agent from domestic sheep to susceptible populations of bighorn sheep, which then increases their susceptibility to *M. haemolytica*, has been proposed as an alternative explanation.<sup>8</sup> If this is the case, vaccinating domestic sheep against *M. ovipneumoniae* may be an effective way to reduce exposure and disease in bighorn sheep.

Nevertheless, whereas previous vaccines were not effective, repeated doses of an experimental multivalent vaccine containing *M. haemolytica* serotypes A1 and A2 and *B. trehalosi* serotype 10 did protect bighorn sheep against experimental challenge with a pathogenic *M. haemolytica*.<sup>9</sup> A commercial multivalent killed vaccine (OviPast Plus™) with five strains of *M. haemolytica* (A1, 2, 6, 7, 9) and four strains of *B. trehalosi* (T3, 4, 10, 15) is available in the United Kingdom for the reduction of mortalities as a result of pneumonic pasteurellosis in sheep. However, this vaccine did not increase weight gain or reduce lung scores in a study in seven flocks in New Zealand.<sup>10</sup> A primary virulence factor of *Mannheimia* spp. isolates is leukotoxin A (LktA), which are toxic to ruminant leukocytes and probably have an important role in immunity to disease caused by *Mannheimia* spp. A comparison of the similarity of the LktA of *Mannheimia* spp. isolated from clinical cases of mastitis found that the LktA from *M. glucosida* may be a more suitable candidate for a monovalent vaccine than the LktA from *M. haemolytica*.<sup>11</sup>

### REFERENCES

- Omaleki L, et al. *J Clin Microbiol*. 2010;48:3419.
- Omaleki L, et al. *J Vet Diag Invest*. 2012;24:730.
- Garcia-Pastor L, et al. *Small Rumin Res*. 2009;87:111.
- Miller MW, et al. *J Wildlife Dis*. 2013;49:653.
- Daniel R, et al. *Vet Rec*. 2015;177:24.
- Clothier KA, et al. *Vet Microbiol*. 2012;156:178.
- Omaleki L, et al. *J Vet Diag Invest*. 2012;24:730.
- Besser TE, et al. *Prev Vet Med*. 2013;108:85.
- Subramaniam R, et al. *Clin Vaccine Immunol*. 2011;18:1689.
- Goodwin-Ray KA, et al. *Vet Rec*. 2008;162:9.
- Omaleki L, et al. *Vet Micro*. 2014;174:172.

### PASTEURELLOSIS OF SWINE

*Pasteurella multocida* (PM) is an important pathogen of pigs. Toxigenic strains, in conjunction with *Bordetella bronchiseptica*, are recognized as the etiologic agents of atrophic rhinitis described under that heading. Pneumonic pasteurellosis and septicemic pasteurellosis are also manifestations of infection with *P. multocida* in pigs. *P. multocida* capsular type A can cause pneumonia in growing

pigs but also septicemia and arthritis. It has been consistently isolated from skin lesions in sporadic cases of porcine dermatitis and nephropathy syndrome. Strains from pigs may be found in nasal passages of pig workers, and pig strains have been found in bronchopneumonia in humans. There is therefore the possibility of occupational exposure. Some forms are very similar to pleuropneumonia, with dyspnea, cyanosis, and sudden death.

### PNEUMONIC PASTEURELLOSIS

#### Etiology

*P. multocida* is commonly isolated from the lungs of pigs with chronic pneumonia, purulent bronchopneumonia, and pleurisy. Isolates are predominantly capsular serotype A strains with some serotype D strains. It is possible to serotype *P. multocida* and of the 16 serotypes, serotypes 3 and 5 are the predominant isolates.<sup>1</sup> In most herds, there is a single isolate, and this is usually A3. In one study, 88% of the lung strains were type A (OMP strains 1:1, 2:1, 3:1, 5:1, and type 6:1). It may be a primary pathogen with a relatively high degree of virulence and a considerable transfer of capsular biosynthesis and *tox*A genes between strains of both type A and type D. Virulence genotypes have also been studied.<sup>2</sup> It may be that most *P. multocida* strains have the *tox*A gene, which suggests widespread genetic diversity in the capsular type A strains<sup>3</sup> and that a single clone might be more predominant in a particular pig population. For many years it was thought that toxigenic strains were not found in the lung, but in three surveys, 25% to 90% of the pneumonic strains were toxigenic. A study looked at 230 isolates from 250 pigs and found that 200 (88%) were A, 4% were D, and 9% were untypeable. The *tox*A gene was found in 13%, of which 11% belonged to A, 1% to D, and 1% could not be typed. Serotype D strains were specifically associated with abscesses in the lung. A wide diversity is found in the lung.

*P. multocida* is a common secondary infection in the lungs of pigs with enzootic pneumonia associated with *M. hyopneumoniae*. The pneumonic lesions from dual infections are more severe than those from *M. hyopneumoniae* alone. The organism is also commonly associated with *A. pleuropneumoniae*.

#### Epidemiology

In the microbiome of the soft palate of swine it was found that members of the Pasteurellaceae predominate.

Although found in other species, it is generally assumed that there is little interspecies transfer. The tonsils of the pig are an important site of colonization of many pathogenic and commensal organisms. In a study of the microbiome of the tonsils in 12 healthy pigs from two herds, it was found that Pasteurellaceae dominated the tonsillar

biome of all the pigs, comprising 60% of the total.

It is generally considered that *P. multocida* is not a primary pathogen of the lower respiratory tract and that its involvement in pneumonia is secondary to infection with other respiratory pathogens. A large-scale survey in Germany of 6560 postmortem examinations found that pneumonia was present in 24.4% of cases. In 49.3% of these *P. multocida* was found, and with increasing age there was an increasing rate of recovery of *P. multocida*. Most of the lung cultures (54.2%) showed multiple infections. Pneumonic pasteurellosis cannot be reproduced by the intranasal or intratracheal challenge of healthy pigs with *P. multocida* but can be reproduced by challenge to pigs whose pulmonary clearance mechanisms have been compromised by infections with *M. hyopneumoniae*, pseudorabies virus, or by anesthesia and other stresses, and also lungworms. Although atmospheric ammonia may predispose to nasal attachment of *P. multocida* type D, it seems unlikely that this applies to pulmonary infection. The organism is carried in the nasal cavity and tonsils of pigs, and carriage rates are higher in herds with a history of chronic respiratory disease.

Transmission is by aerosol or more probably by direct nose-to-nose contact and thence by inhalation or ingestion. The bacterium has a short-term survival in aerosols, particularly of low humidity (less than 1 hour), but it survives for longer at high humidity and lower temperature. Heating to 60°C (140°F) will kill it, but it can survive for up to 14 days in water, 6 days in slurry, and up to 7 weeks in nasal washings at room temperature. There is always the feeling that the condition is most common under conditions where mycoplasmosis is common and where there is poor husbandry, notable overcrowding, and poor hygiene and where environmental stress is high. As a result, it is often seen after transport, mixing, or moving groups of pigs.

### Pathogenesis

Pneumonic pasteurellosis results from the colonization of existing lung lesions by inhaled organisms, often from reservoirs in the nasopharynx and tonsil, and the major virulence mechanisms are unknown. It is suspected that they may attach particularly to the alveoli by means of fimbriae or pili. Serotype A strains are resistant to phagocytosis, which has been attributed to the presence of capsular hyaluronic acid and might allow their colonization of lung lesions. Isolates from lung lesions are not invariably toxigenic. A recent study has shown that there is a change in the functional capabilities of the blood cells, with oxygen radical formation and phagocytosing neutrophils elevated after infection. The disease is difficult to produce experimentally, and large

volumes of inoculum must be used in the trachea together with other infectious agents or their toxins to produce pathology. It has been reproduced when nontoxigenic strains are given repeatedly by intrabronchial injection following *A. pleuropneumoniae* or *M. hyopneumoniae* infections. Strains vary in their ability to produce secondary pneumonia and pleuritis in these experimental models, suggesting the existence of specific pneumotropic and pleurotropic strains, which is supported by epidemiologic studies that have found that a single strain predominates in problem herds.

### Clinical Findings

There is a possibility of a hyperacute condition in which the only sign is sudden death.

Pneumonic pasteurellosis is a common cause of sporadic cases of acute bronchopneumonia in grower–finisher pigs. Affected pigs have fever of up to 41°C (106°F), are anorectic and disinclined to move (lethargic), and show significant respiratory distress with labored respiration and increased lung sounds, often breathing through the mouth. Cyanosis may occur. Without treatment, death is common after a clinical course of 4 to 7 days. There is a marked tendency for the disease to become chronic, resulting in reduced weight gain and frequent relapses, and real recovery seldom occurs. It can occur as an outbreak, spreading to affect several pigs within a group. The first indication of disease within a group and of an impending outbreak may be the finding of a pig dead with a peracute infection. In an intermediate stage there may be fever, coughing, and poor growth rate for about 3 to 5 weeks before recovery. The disease may also exist in a chronic form as part of the porcine respiratory disease complex, with little evidence of overt clinical disease but with an adverse effect on growth rate and food-conversion efficiency.

### Necropsy Findings

At necropsy the lesions are considered to be typical of what is normally called enzootic pneumonia—a chronic bronchopneumonia with abscessation. Pleuritis is common, and there may also be pericarditis. In some instances, there may be carcass congestion, and the trachea may be full of frothy fluid. Experimental infections have caused between 15.5% and 39.4% of lung tissue to be affected with pneumonia. Histologically, the airways are filled with degenerate leukocytes, but the overall lung pathology is often complicated by other pathogens. Peracute fatalities show an acute necrotizing and fibrinous bronchopneumonia reminiscent of bovine pneumonic pasteurellosis. There is edema, congestion, and hemorrhage with bronchiolar exudation containing bacteria, neutrophils, and macrophages, which are also

present in the alveoli. Small bronchi and bronchioles may be completely occluded by the exudates.

### Diagnosis

Diagnosis is through the clinical signs (fever, dyspnea, cyanosis, sudden death), lesions at gross postmortem, histopathology, and isolation of *P. multocida*. Aerobic culture from these cases usually produces a pure culture of the organism.

### DIFFERENTIAL DIAGNOSIS

The disease must be differentiated from other causes of respiratory disease in pigs.

**Enzootic pneumonia** of pigs, unless accompanied by pasteurellosis, is not manifested by a marked systemic or pulmonary involvement.

Dyspnea is a prominent sign in **Glässer's disease**, but there is obvious arthritis; at necropsy the disease is characterized by arthritis, a general serositis, and meningitis.

**Pleuropneumonia associated with *A. pleuropneumoniae*** causes a severe pneumonia with rapid death, and differentiation from pasteurellosis is necessary at necropsy.

The septicemic and acute enteric forms of salmonellosis in pigs are often accompanied by pulmonary involvement, but these are usually overshadowed by signs of septicemia or enteritis. Chronic pasteurellosis has to be differentiated from lungworm infestations and ascariasis.

### Treatment

The animals are usually severely ill, and therefore treatment is first by parenteral injection and then by water medication; once they start to eat, medication should continue with in-feed antibiotics.

Treatment is with antibiotics, commonly with tetracyclines. There is also a case for using ceftiofur, penicillin, streptomycin, trimethoprim/sulfonamides, ampicillin, spiramycin, and spectinomycin for 3 to 5 days. Tilmicosin and telithromycin would also be suitable antibiotics. There is significant variation in the antibiotic sensitivity of isolates, and the choice of antibiotic should be based on a sensitivity established for the organism for that farm. In a recent survey in the United Kingdom, 15% of *P. multocida* isolates were resistant to tetracyclines, and it was also reported that resistance to trimethoprim/sulfonamides, Apramycin, and neomycin was found in some isolates. A German survey showed that 55% were resistant to sulfonamides.

### Control

Vaccination is ineffective, although autogenous vaccines have been produced that are effective (need to be certain that you have the

strain causing the problem). Control depends on management of the risk factors, which are described under enzootic pneumonia of swine because pasteurellosis is often secondary to that condition. In particular, all-in, all-out management with vaccination for enzootic pneumonia is essential. Tiamulin at 40 ppm in the feed has also been used strategically at the time of stress, for example, over mixing and moving.

### SEPTICEMIC PASTEURELLOSIS

Septicemic disease with death occurring within 12 hours and without signs of pneumonia is occasionally observed in neonatal pigs. They are associated with *M. haemolytica* infection (occasionally *P. trehalosi* that is untypeable), and in many cases there is an association with sheep. Septicemic disease is also recorded in India in association with infection with capsular serotype B. The disease occurs in all ages of pigs, including adults, and is manifest with fever, dyspnea, and edema of the throat and lower jaw. A population mortality of 40% in a group of pigs is recorded. Clinical signs are rarely seen. Acute septicemic disease in grower pigs aged 14 to 22 weeks and associated with serotype D has been recorded in Australia. Cases can be confused with those caused by taxon 15 of APP.

An outbreak of hemorrhagic septicemia was reported from Australia associated with *P. multocida* subsp. *gallicida* in a large pig herd. Affected pigs were found dead, with swelling of the pharyngeal region and blue discoloration of the ventral abdomen and ears. On gross postmortem there was hemorrhage and congestion on serosal surfaces. The postmortem picture is reported to resemble that seen in *A. suis* infection with a superimposed pneumonic pasteurellosis. Histologic examination of the viscera showed widespread vascular damage with thrombus formation and intravascular colonies of bacteria.

### Samples for Confirmation of Diagnosis

- Bacteriology—lung, bronchial node (plus liver, spleen, kidney for septicemic form). Culture produces large mucoid colonies 3 mm to 5 mm in diameter on blood agar. In the past the recovered organisms were rarely toxigenic. Some isolates did have fimbriae. On a smear gram-negative coccobacilli may be seen. In early cases aerobic cultures of heart blood and lung lesions will give a pure culture. Anaerobic cultures often yield *Bacteroides* spp. as well, and if *Haemophilus* cultures will also often prove positive. Further identification using electrophoretic typing may be necessary, as in the case of secondary infection in sporadic cases of porcine dermatitis and nephropathy syndrome.

Here a high proportion had a single electrophoretic type (01) isolated from a range of tissues. In the septicemic form the organism was readily cultured from the liver, spleen, and lymph nodes.

- Histology—formalin-fixed lung (variety of organs for septicemic form) (light microscopy)

### REFERENCES

1. Garcia N, et al. *Vet Rec.* 2011;169:362.
2. Ewers C, et al. *Vet Microbiol.* 2006;114:304.
3. Berthe A, et al. *Vet Microbiol.* 2009;139:97.

## STREPTOCOCCUS SUI S INFECTION OF YOUNG PIGS

There are three organisms that infect the neonatal pig quite commonly—*Haemophilus parasuis*, *S. suis*, and *Actinobacillus suis*, which have been dubbed the “suis-cides.” *S. suis* (SS) is therefore one of the early colonizers of the pig; by the end of the nursery period, most pigs are infected. Virulence may be an attribute of strains that colonize the young pig poorly but infect older animals more easily, in the absence of maternal antibody. They also have public health importance.

### SYNOPSIS

**Etiology** *Streptococcus suis*; 35 capsular serotypes exist if you include 1/2. Worldwide, type 2 is probably the most common, and types 1 through 9 are more frequent than types 10 to 34.

**Epidemiology** - Occurs principally in piglets under 12 weeks of age

**Signs** Septicemia, arthritis, meningitis, pericarditis, endocarditis, polyserositis, and pneumonia.

**Clinical pathology** Culture organism.

**Lesions** Fibrinous polyserositis, purulent meningitis, myocarditis, vegetative endocarditis, fibrinous arthritis, or fibrinous or hemorrhagic pneumonia may be a secondary problem.

**Diagnostic confirmation** Culture organism from body tissues and blood.

**Differential diagnosis** Arthritis as a result of the following:

*Mycoplasma hyorhinis*

Erysipelas

Glässer's disease

Meningitis as a result of the following:

*Escherichia coli*

*Trueperella pyogenes*

*Pasteurella multocida*

**Treatment** Antimicrobials based on culture and sensitivity.

**Control** Provision of optimum environment (temperature and relative humidity). Avoid overcrowding in nursery pens. Age spread of pigs in pens should not exceed 2 weeks. Use all-in, all-out pig flow. Control of other common infectious diseases. Avoid nutritional deficiencies. Consider mass medication of feed with antimicrobials. Possible use of autogenous vaccines.

### ETIOLOGY

The streptococci are gram-positive, encapsulated, facultative anaerobes; are coccoid or ovoid; and occur singly or in pairs or in chains. *S. suis* (SS) type 1 (SS1) and *S. suis* type 2 (SS2) were the original capsular types of the organism, which appeared to account for most epidemics of the disease. SS types are related to Lancefield's group D. The Lancefield's groups R, S, RS, and T are no longer used.<sup>1</sup> There are now 35 known SS capsular types. Even now, new species of *Streptococcus*, such as *S. ferus*, are being isolated from pigs. The important species of *Streptococcus* that have been isolated in the pig are shown in Table 21-2.<sup>2,3</sup>

At least 40% of the genome of SS is distinct from the other species of *Streptococcus*.<sup>4,5</sup> The strains within each capsular serotype are also very diverse genetically.<sup>6-8</sup>

### EPIDEMIOLOGY

The epidemiology of SS is very complex. The isolation of different strains within the same herd and the predominance of particular strains within some herds are evidence that infection by SS is a dynamic process and reinforce the idea that the epidemiology is complex.

The distribution of the serotypes varies widely across the world. In general, SS1-9 is the most commonly found type and likely to cause disease.<sup>9,10</sup> SS9-34 will colonize, but this type is less likely to cause disease. There may be one, two, or even more serotypes in a single pig. In some countries one serotype is more important (e.g., SS14 in Scotland or SS7 in Scandinavia).<sup>11</sup> The position is complicated because a certain serotype in one

**Table 21-2** Species of streptococci isolated from the pig with principal locations

Intestine	Tonsils	Oral cavity	Vagina
<i>hyointestinalis</i>	<i>suis</i>	<i>orisuis</i>	<i>hyovaginalis</i>
<i>suis</i>	<i>porcinus</i>	<i>mutans</i> -like	<i>thoraltensis</i>
<i>alactolyticus</i>	<i>dysgalactiae</i> ssp. <i>equisimilis</i>		
<i>bovis</i>			



country is not necessarily of the same virulence and importance in another because the genetic makeup of the strains varies geographically. It is further complicated in that, following culture, the strains may lose their capsules and become untypeable.<sup>9,10</sup> Again, in general, in Eurasia, SS2 is the most common,<sup>12</sup> and in North America it is SS2 and SS3, but SS2 is not necessarily the most prevalent.<sup>9,10</sup> There are considerable differences between the SS2 in Europe and the SS2 in North America.

### Occurrence

Diseases associated with SS occur worldwide, generally affecting pigs 2 weeks to 22 weeks of age but capable of causing disease in any age of susceptible pig. Most cases occur just after weaning and are associated with weaning stressors such as moving, mixing, overcrowding, and inadequate ventilation. SS2 causes outbreaks of meningitis in young pigs 10 to 14 days after weaning. The disease occurs most commonly in intensive systems of high population density, such as flat-deck rooms and early (grower) finishing pens. Sporadic cases occur in older pigs, including adults, depending on immunity.

The organism has also been isolated from cattle, sheep, goats, a horse with meningitis, fallow deer, and cats and increasingly from other species. It has also been isolated from wild boar.<sup>13</sup>

### Prevalence of Infection

SS2 is the most prevalent serotype. Types 3, 4, 7, 8, and 14 have been isolated from affected pigs in the United Kingdom. In Australia, SS2 was detected in 58% of the palatine tonsils, in 66% of the pneumonic lungs, and in 28% of the healthy lungs. Overall, the carrier rate in piggeries was 60%. The organism was also present in the blood of 3% of apparently normal pigs at slaughter. It could also be cultured from many other tissues, including the vagina of sows, and it is possible that piglets are infected during birth. Specific pathogen-free herds are free of the organism, and hysterectomy-derived piglets are born SS free.

The rate of infection of the environment of the pigs can also be very high. In Canada, all 35 serotypes have been isolated, with SS2 being the most prevalent of all isolates. The other capsular types in decreasing order were 3, 7, 1/2, 8, 23, and 4. Over a period of several years, more than 60% of isolates belong to capsular types 2, 1/2, 3, 4, 7, and 8. In a survey of clinically healthy piglets 4 to 8 weeks of age in Quebec, the organism could be isolated from 94% of piglets and 98% of farms. The typeable isolates of the organism are more frequently recovered from pigs between 5 and 10 weeks of age, whereas untypeable isolates are most frequently found in animals more than 24 weeks old. In the United States, serotype 3 was most prevalent (26.1%), followed by serotypes 8 (17.4%),

2, 4, and 7 (15.2%). There were no significant differences in the epidemiologic features, clinical signs, or lesions in pigs infected with multiple serotypes compared with a single serotype of SS.

Only some Scandinavian countries reported a higher incidence of type 7 over type 2. In Denmark, SS2 accounted for 29% of the isolates; SS7 for 17%; and 3, 4, and 8 for a further 9% to 10%. SS7 was isolated more frequently than reported in other countries, causing septicemia, arthritis, and meningitis. In Finland, the most common types isolated from dead pigs were 7, 3, and 2, respectively, and they were most frequently isolated from cases of pneumonia. In the Netherlands, SS2 was most frequently isolated from pigs with meningitis. SS9 and SS2 have been isolated as the cause of septicemia and meningitis in weaned pigs in Australia.

### Morbidity and Case Fatality

The incidence of clinical disease ranges from 0% to 15%. In a 3-year survey of a breeding herd, the combined morbidity and mortality rates attributable to meningitis from SS2 were 3%, 8%, and 9.1%, respectively.

### Methods of Transmission

The organism is usually transmitted by healthy carriers. The organism is carried in the tonsils and occasionally in the nose of healthy pigs<sup>14,15</sup> of all ages, and transmission to uninfected pigs can occur within 5 days of mixing. In a herd where there are no clinical signs there is usually a low carriage of SS. There is a higher carriage in herds where there is clinical disease.<sup>16</sup> The introduction of breeding gilts from infected herds results in disease appearing subsequently in weanlings and growing pigs in the recipient herds. The detectable carrier rates in different groups of pigs can vary from 0% to 80% and are highest in weaned pigs aged 4 to 10 weeks. Over 80% of the sows in an individual herd may be subclinical carriers. They do not normally carry the organism in the nasal cavity but in the vagina. Based on the results of sampling of sows and piglets at parturition, and being able to culture multiple serotypes of the organism from the sow's vaginal secretions and oropharyngeal samples of piglets, it is highly probable that the newborn piglet is infected during birth by the organism, which is transferred from the sow's vagina to the dorsal surface and oral cavity of the piglet. However, even though most pigs are colonized by weaning age, colonization by the virulent strains of SS2 takes longer and usually does not occur before 15 days of age. This could constitute a risk factor for developing disease later when maternal immunity has waned.

Weaned carrier pigs transmit the infection to previously uninfected pigs after mixing following weaning. The organism can persist in the tonsils of carrier pigs for more than 1 year, and in the presence of circulating

opsonic and binding antibodies, and in pigs receiving penicillin-medicated feed. Thus the organism can be endemic in some herds without causing recognizable clinical disease. House flies can carry the organism for at least 5 days and can contaminate feed for at least 4 days.

The carrier rate in some surveys of slaughter pigs ranges from 32% to 50% of pigs 4 to 6 months of age. Sporadic cases of SS2 have also been found in pigs with bronchopneumonia (secondary to enzootic pneumonia), pleuropneumonia, arthritis, vaginitis, and aborted fetuses and in neonatal piglets 1 to 2 days of age affected with fatal septicemia. It appears that the organism is found in the lungs of pigs affected with pneumonia more frequently in North America than in other countries. Although airborne infection of type 2 has been described, it is thought that indirect transmission is a much better way to infect piglets because it is easily transmitted via fomites. It can survive in feces for 104 days at 0°C (32°F) and for 10 days at 9°C (48°F) and in dust for 54 days at 0°C and 25 days at 9°C. Experimentally, pure cultures of the organism placed on rubber and plastic surfaces, especially when protected by swine manure, are viable up to 55°C (131°F) and can survive if kept frozen for up to 10 days. In the summer, at a temperature in the middle range, it may survive for about 8 days. The organism is readily destroyed by disinfectants. It can be spread by contaminated pig nose snares and needles used for blood sampling. SS can also be transmitted by flies.

### Risk Factors

#### Animal Risk Factors

The host factors that render pigs susceptible to clinical disease are uncertain. Over 30 different gram-positive bacterial organisms may occur in the nasal cavities and tonsils of unweaned pigs between 2 weeks and 6 weeks of age. It is suggested that strains of SS2 vary in pathogenicity and that the occurrence of disease is dependent on both exposure to a pathogenic strain and undetermined secondary factors. The peak incidence of SS from 5 to 10 weeks of age suggests that the stressors of weaning may render pigs susceptible to clinical disease and certainly to the horizontal spread of the infection. At this point any infected pig may be shedding large numbers of organisms. Most weaned pigs carry SS, but few appear to carry virulent strains.<sup>16</sup> In an outbreak, one strain of SS usually predominates. The presence of other infectious diseases, such as porcine reproductive and respiratory syndrome (PRRS) and *Actinobacillus pleuropneumoniae*, may be associated with a higher-than-average prevalence of infection with SS. PRRS certainly increases susceptibility to SS infection experimentally. In utero infection with PRRS makes pigs more susceptible to subsequent neonatal SS infections. Infection of specific-pathogen-free pigs with PRRS virus may be

a risk factor for infection and disease associated with SS. Similarly, the pseudorabies virus may enhance clinical disease associated with SS. In addition, faulty teeth clipping may be associated with the condition in young pigs.

### Environmental and Management Factors

The incidence of clinical disease appears to depend on environmental factors (which may be important in the spread of SS), such as inadequate ventilation, high population density, and other stressors. Several environmental and management risk factors have been associated with a high prevalence of pigs harboring SS in swine herds. Excessive environmental temperature fluctuation in the nursery pig facilities was the most common factor. Nursery pig environmental temperatures should not fluctuate more than 1.1° to 1.7°C (34° to 35° F) over a 24-hour period to prevent chilling of pigs. Fluctuations in temperature are caused by drafts, inadequate heaters, or poorly insulated buildings. Excessive relative humidity was also a factor; the recommended range for nursery pigs is 55% to 70%. The third and fourth most common factors were age spread of more than 2 weeks for pigs in the same room and crowding (both increasing SS transmission rates). The fifth most common factor was the use of continuous flow facilities, which allows for build-up of dust and manure (and therefore SS) and increased infection pressure. An unusual case where SS was isolated from the lumen of the small intestine occurred when a feed was formulated with no salt and 58.5 kg instead of 3.5 kg of vitamin premix. Once the ration was corrected, the problem disappeared.

SS2 can survive in feces for 104 days at 0° C (32° F), up to 10 days at 9° C (48° F), and up to 8 days at 22 to 25° C (71 to 77° F). It can survive in dust for up to 25 days at 9° C (48° F) but could not be isolated from dust stored at room temperature for 24 hours. The organism is rapidly inactivated by disinfectants commonly used on farms. Liquid soap inactivates SS2 in less than 1 minute at a dilution in water of 1 in 500. The organism can survive in pig carcasses at 40° C (104° F) for 6 weeks and may therefore be an important source of the organisms for infection in humans.

### Pathogen Risk Factors

Most studies of virulence have been associated with studies on SS2. Some have proved to be virulent, others not so.<sup>11</sup> New factors are being discovered all the time. For example, a new virulence gene *virA* was discovered that only occurs in virulent strains.<sup>17</sup> Many other secreted substances, important as virulence factors, are probably awaiting discovery.

Colonization of piglets occurs very early in life, with most pigs being colonized by

weaning age; virulent strains of SS2 may not colonize until later. Early colonization reduces the subsequent clinical signs. Despite the association of bacteria with disease, they may also be recovered from the nasal cavities and tonsils of healthy pigs. High numbers of organisms were isolated from the cerebrospinal fluid of clinically normal pigs. A study also showed that a persistent epidemic strain of SS was consistently isolated from the brains of pigs over a 2-year period.

There are differences in pathogenicity between serotypes and between strains of the same serotype. In the United Kingdom there are differences in pathogenicity between types 1 and 2; type 1 causes less severe disease in piglets, whereas type 2 causes a more severe and acute disease in older and growing pigs. Highly virulent and completely avirulent type 2 strains exist. Different strains of SS2 vary in their ability to cause meningitis. Streptococci require manganese but not iron as a growth factor, which affects the activity of superoxide dismutase in cell cultures.

### Capsules

One of the main virulence factors is the presence of the capsules, which are powerfully antiphagocytic. The organism is classified into serotypes on the antigenic specificity of its capsular polysaccharide. The capsule, certainly for SS2, plays an important role in pathogenesis. It is an important antiphagocytic factor.<sup>18</sup> Because many nonpathogenic strains are capsulated, there are probably many other interrelating factors.

There are also modifications of the cell wall, such as lipoteichoic acids and peptidoglycans.<sup>11,19,20-22</sup>

### Proteins

The virulence markers of the organism include the structural proteins muramidase-related protein (MRP) and extracellular factor (EF). There are virulence differences between strains of the same serotype based on the presence or absence of muramidase-released proteins. It has also been reported that some of these proteins are not essential for virulence; on the other hand, there is sometimes a strong association between proteins and strain virulence.<sup>12,23</sup> Most Canadian field isolates of SS2 do not produce these virulence-related proteins.

Fibronectin and fibrinogen-binding protein played a role in the colonization of specific organisms involved in a SS infection.<sup>24</sup> An IgG binding protein in the 60-kDa range has been shown to bind IgG in a non-immune way. A 44-kDa protein has been isolated as a virulence marker of SS2, and the presence of antibodies against this protein appears to be necessary to obtain complete protection against the disease.

Recently, 36 environmentally regulated genes have been identified. Strains of SS2 from Europe are genotypically different from

those of North America. A serum opacity-like factor has also been identified as a novel virulence determinant.<sup>11</sup>

### Suilysin

Suilysin, an extracellular protein with hemolytic properties, has been described, and it is cytotoxic.<sup>25</sup> In one study most SS2 field strains from four different European countries produced this hemolysin. Between 58% to 90% of strains from the Netherlands, Denmark, France, England, and Italy produced the suilysin but only 1% of Canadian strains. A total of 164 field isolates from diseased pigs in four countries were serotyped and tested for suilysin. SS2 was the most prevalent type isolated from all four countries. After SS2, SS9 was most prevalent in the Netherlands and France and SS7 in Denmark. All the English isolates were SS2. No nonvirulent suilysin-producing SS2 strains have been reported.

### Hemolysin

The hemolysin gene was found in over 80% of the strains that were associated with meningitis, septicemia, and arthritis but in only 44% of pneumonia isolates.

### Other Properties

The organism bears fimbriae and pili, and the capsular materials from different serotypes have distinct morphologies. Certain strains possess hemagglutinating properties.

Glutamine synthetase is required for the full expression of virulence in SS2.<sup>26</sup> Recently glutamate dehydrogenase, glyceraldehyde 3-phosphate dehydrogenase, and a secreted nuclease have been suggested as aiding the virulence of SS2.<sup>27</sup>

### Adhesion

There are also adhesins.<sup>5,21,28</sup> SS2 isolates possess a factor that allows them to adhere to porcine lung. Australian isolates of SS are genetically very diverse, which suggests that serotyping is not a reliable technique for identifying specific strains and not a good predictor of the genetic background of a given isolate.

### Zoonotic Implications

Splenectomized humans are particularly at risk from certain infections, including streptococci, and should not handle or come into contact with pigs in particular. Death is not common in humans in North America but does occur in Europe and is much more common in Asia,<sup>29</sup> which may be a feature of greater contact with SS2. It has been identified as an important emerging zoonotic agent,<sup>30</sup> particularly in the East.

Infections with SS2 are the most common infections in humans (from pigs or raw pork). The Chinese outbreaks may be associated with undercooked or raw pork.<sup>28,31</sup> A high percentage of pork in Asian markets is contaminated with SS.<sup>32</sup> It is possible that

many human cases are misdiagnosed, such as in those that were described in Southeast Asia, where 5 of 8 cases of SS were described as *S. viridans*. SS in humans is associated with the nasopharynx<sup>33</sup> and the gastrointestinal tract; diarrhea is often a prominent feature,<sup>34</sup> but SS can produce very variable clinical signs in humans. The clinical manifestations in humans include meningitis and septicemia, which may be accompanied by arthritis, endophthalmitis, and disseminated intravascular coagulation. Endocarditis and acute gastroenteritis have also been reported. Deafness occurred in 50% to 60% of cases and is a result of cochlear sepsis following invasion of the organism from the subarachnoid space into the perilymph of the inner ear. Vertigo and ataxia occurred in 30% and arthritis in 53% of patients. There was a case-fatality rate of 13%. The organism invades the cerebrospinal fluid within monocytes, an example of the “Trojan horse” mechanism of entry.

A truck driver has recently been described with septic shock. It is thought that SS25 has evolved to become the highly pathogenic SS1, which has in turn evolved to become epidemic strain SS7, which in turn stimulates the production of large amounts of proinflammatory cytokines, leading to streptococcal shock syndrome.<sup>35</sup>

In the United Kingdom, the highest incidence of meningitis attributable to SS2 is in butchers and abattoir workers; transmission is thought to be mainly via minor skin abrasions, and often there is no visible point of entry. Subclinical infection in pigs sent to slaughter represents a potential source of infection for abattoir workers; eviscerators who remove the larynx and lungs have a significantly higher risk of exposure to the organism than other abattoir workers.

Within infected herds in New Zealand, up to 100% of pigs are carriers, and SS2 infection may be one of the most infectious potentially zoonotic pathogens present in New Zealand, although very rarely resulting in clinical disease. The annual incidence of subclinical infection and seroconversion in pig farmers in New Zealand is close to 28%.

## PATHOGENESIS

Streptococci exist in extremely different phenotypes with regard to adhesion, invasion, and cytotoxicity. These features depend on the state of encapsulation and environmental growth conditions.

The crypts of the tonsils are a site of persistence, multiplication, and portal of entry of a variety of pathogens, including SS. Invasive disease occurs in a minority of infected pigs. It is not clearly known how SS travels from the mucosal surfaces to the blood and produces a bacteremia, then septicemia, and finally meningitis. Most bacteria remain extracellular, with fewer than 2% of monocytes containing bacteria.<sup>36,37</sup> Persistent

bacteremia is an important phase in the pathogenesis of SS2 meningitis. There is a high level of adhesion of bacteria to phagocytic cells. SS adheres to brain microvascular endothelial cells, and sulysin can damage these. It has been shown that SS capsular strains stimulate tumor necrosis factor alpha (TNF- $\alpha$ ) and interleukin (IL)-6, but the sulysin and the extracellular protein do not do so on their own. It is likely that the enhanced production of inflammatory cytokines contributes to the more severe signs and an early death.<sup>38,39</sup> A terminal acute fatal septicemia is the common outcome in young animals, but in older animals localization can occur in synovial cavities, endocardium, eyes, and meninges. Virulent isolates of SS2 possess capsules and are relatively resistant to phagocytosis. Isogenic mutants defective in capsule production were not virulent. SS is able to adhere to but not to invade epithelial cells, and the adhesins are partially blocked by the capsule and are part of the cell wall. The highly virulent isolates possessed the sulysin, muramidase-releasing protein, and extracellular protein factor phenotype.<sup>40</sup> SS are able to survive and replicate within macrophages, and the bacteria enter the cerebrospinal fluid space in association with migrating monocytes, which move through choroid plexuses. They therefore enter the cerebrospinal fluid by a “Trojan horse” mechanism similar to that used by some viral pathogens of the central nervous system (CNS). The predominant lesions are suppurative or fibrinopurulent inflammation in brain, heart, lungs, and serosae. SS9 may produce a different distribution of lesions compared with SS2. The disease has been reproduced experimentally in pigs and laboratory animals by intravenous, intranasal, and subarachnoid routes. Certain strains of streptococci can cause vascular lesions, with the development of fibrinohemorrhagic pneumonia and septal necrosis. Of importance in the pathogenesis of SS infections is the predisposing role of PRRS. This effect of PRRS has still only been experimentally demonstrated with SS.

## CLINICAL FINDINGS

Multiple *Streptococcus* spp. are implicated in lameness and CNS signs in piglets and sows. There is significant variation of carrier states and clinical signs with the individual serotypes. Although morbidity is usually less than 5% in an endemic infection, the case-mortality rate may be as high as 20%. The earliest clinical sign is often a raised temperature, followed by reduced appetite, depression, shifting lameness. In a new infection on a premises, only sudden death may be seen at first. It does occur as hyperacute, acute, subacute, and chronic pictures, with the basic difference being the time scale of events.

Arthritis and meningitis may occur alone or together and are most common in the

2- to 6-week age group. More commonly several piglets within a litter are affected. Meningitis is particularly associated with serotypes 1, 2, 1/2, 3, 4, 8, 9, 14, and 16; septicemia with 2; arthritis with 7 and 14; abscesses with 2; bronchopneumonia with 2, 3, 7, 10, 15, and 27; and reproductive damage with 2, 13, and 22; 14 can be associated with any clinical condition.

An experimental infection with SS9 in SPF pigs produced meningitis, arthritis, and serositis.<sup>41</sup>

The arthritis is characterized by enlarged and distended joint capsules, lameness, and pain on palpation of the affected joints. Fever, depression, reluctance to move, and inactivity are common.

Meningitis is characterized by fever, anorexia, and depression. The gait is stiff, the piglets stand on their toes, and there is swaying of the hindquarters. The ears are often retracted against the head. Blindness and gross muscular tremor develop, followed by inability to maintain balance, lateral recumbency, violent paddling, and death. In many cases there is little clinical evidence of omphalophlebitis.

In epidemics of meningitis attributable to SS2, sudden death in one or more pigs may be the first sign. The eyes may stare. Affected pigs found alive are uncoordinated and rapidly become recumbent. There is opisthotonos, paddling, and convulsions and death in less than 4 hours. A fever of up to 41°C (105°F) is common. In the United Kingdom, meningitis of recently weaned pigs is the most striking feature of SS2 infection.

Otitis interna is a common sequela to many cases of SS meningitis. Arthritis is common in younger pigs.

In endocarditis, which is a relatively rare clinical sign (except in North America), and in septicemia the piglets are usually found comatose or dead without premonitory signs having been observed.

Valvular endocarditis attributable to SS2 has also been reported in a 13-week-old finishing pig in a breeding herd that had a long history of SS meningitis. Occasionally, the infection results in conjunctivitis, rhinitis abortion, and vaginitis.

## CLINICAL PATHOLOGY

### Culture or Detection of Organism

The organism can be cultured from joint fluid, cerebrospinal fluid, blood, and the brain at necropsy. Often the lungs will yield SS, but the role of SS in primary lung disease is not understood. The tonsils of live pigs may be swabbed and cultured for the organism. Improved and selective media are available for the isolation and serotyping of the organism. An indirect fluorescent antibody test can be used to identify the organism on tonsillar swabs of live pigs. Because of multiple antimicrobial resistance among strains of the organism, drug sensitivity testing on a



routine basis is recommended. Highly virulent strains of SS2 and SS1 were detected in tonsillar specimens using a PCR. Rapid serotype-specific PCR assays have been developed. A multiplex PCR for identifying four capsular types and four associated virulence markers was described.<sup>23</sup>

### Serology

The specific serotype of SS should be determined. A simplified laboratory method is available for the identification of SS strains associated with different animal hosts or located in different body regions. An ELISA using monoclonal antibodies directed against virulence markers of SS can distinguish between virulent and avirulent strains of the organism. A rapid and specific double-sandwich ELISA is available for the detection and capsular typing of the organism, with a specificity of 97.6% and sensitivity of 62.5%. However, many laboratories are not readily equipped to identify the numerous serotypes of the organism.

### NECROPSY FINDINGS

In pigs dying from SS2 infection, the gross and microscopic findings are usually found in the brain, heart, and joints and include one or more of fibrinopurulent polyserositis, fibrinous polyarthritis, fibrinous or hemorrhagic bronchopneumonia, suppurative meningitis, hemorrhagic necrotizing myocarditis, and vegetative valvular endocarditis. Gross myocardial lesions cannot be distinguished from those of mulberry heart disease. In cases with meningitis, there is turbidity of the cerebrospinal fluid, congestion of meningeal vessels, and variable amounts of white exudate in the subarachnoid space. The brain may be so swollen that the cerebellum herniates into the foramen magnum. Suppuration is usually most evident along the ventral aspect of the brain, and the meninges may appear grayish as a result of neutrophilic inflammation.

The typical histologic picture is one of acute inflammation—neutrophils and fibrin dominate the response. There is a choroiditis, encephalitis, and meningitis. Other changes that may be observed in SS infections of the central nervous system include internal hydrocephalus, foci of liquefaction necrosis, subacute (mononuclear cell-rich) meningoencephalitis, or meningoencephalomyelitis with bilateral subacute optic perineuritis and Gasserian ganglioneuritis. In the tonsils, SS organisms can be seen in the subepithelial lymphoid tissue and in the crypt lumen and crypt epithelium. SS9 is more prone to cause bronchopneumonia than the spectrum of lesions typical of SS.

### Samples for Confirmation of Diagnosis

- Bacteriology—spleen; culture swabs from serosal surfaces, joints, and meninges are best. The significance of

SS-positive lungs is not yet resolved. Biochemical tests can be used (Amylase and Vosges-Proskauer tests are positive for SS). Cerebrospinal fluid is the material for the best diagnosis. Bacterial culture is difficult if the animals have been treated, and this is so even when they receive growth-promoting antibiotics. Immunomagnetic isolation of SS2 and SS1/2 from swine tonsils has been described, and it is better than the standard procedure.

- PCRs have been used in human medicine but not in veterinary medicine.<sup>1</sup>
- Histology—formalin-fixed samples of a variety of organs, including lung, brain, heart, liver (light microscopy) are best. Immunohistochemistry 42 and in situ hybridization have been described for use on formalin-fixed tissue and are able to detect single infected cells. Using immunohistochemistry (IHC) the bacteria can be seen in the cytoplasm of the neutrophils and macrophages, and the IHC may be positive even though culture is negative following antibiotic or growth promotant administration.

**Note the zoonotic potential of this organism when handling the carcass and submitting specimens.**

### DIAGNOSIS

Diagnosis is often possible based on clinical signs, gross pathology, histopathology, and culture if the carcasses are fresh and the correct sites are examined. A colloidal gold-based immunodiagnostic assay has been described for SS2 and SS1/2.<sup>43</sup> Serotyping by coagglutination will enable the SS strain to be identified. The genetic diversity within and between strains is increasing.<sup>6</sup> The same SS isolated from different geographic regions may be genetically and phenotypically very different.<sup>42</sup>

Serologic tests are generally not very useful because of the diversity of the strains involved, but an ELISA has been developed for human exposure.<sup>33</sup>

### DIFFERENTIAL DIAGNOSIS

In pigs, there may be sporadic cases of arthritis attributable to staphylococci but the streptococcal infection is the common one. Arthritis attributable to *M. hyorhinis* is less suppurative but may require cultural differentiation. Glässer's disease occurs usually in older pigs and is accompanied by pleurisy, pericarditis, and peritonitis. Erysipelas in very young pigs is usually manifested by septicemia. Nervous disease of piglets may resemble arthritis on cursory examination, but there is an absence of joint enlargement and lameness. However, the meningitic form of the streptococcal infection can easily be confused with viral encephalitis. Meningitis

in young pigs may also be associated with *P. multocida* and *E. coli*. Polyarthritis in calves, lambs, and piglets may also be associated with infection with *T. pyogenes* and *F. necrophorum*. SS2 can also be the cause of meningitis in older pigs of 10 to 14 weeks of age.

### TREATMENT

#### Antimicrobials

In summary, there has been an increasing level of resistance to tetracyclines and erythromycin and a variable resistance to ciprofloxacin and penicillin.<sup>43</sup> Most SS are resistant to tetracyclines.<sup>44</sup> If treatment is based on serotyping and sensitivity testing, then there is much less chance of treating or creating resistant organisms.

In Denmark, over the last 15 years there has been an increase in resistance of SS isolates to the two most commonly used antibiotics, tylosin and tetracyclines. The strains show a varying pattern of resistance dependent on to which of the 21 ribotype profiles they belong. For example, strains causing meningitis were more resistant to sulfamethoxazole, but those causing pneumonia were more resistant to tetracyclines. Tilmicosin has been used successfully to remove clinical signs of streptococcal meningitis from a herd.

Penicillin has been the treatment of choice, but penicillin-resistant isolates have emerged. Penicillin sensitivity can no longer be assumed for all strains of SS, and the routine use of penicillin must be reevaluated. In one study, more than 50% of isolates of SS were not susceptible to penicillin. Penicillin did not eliminate the organism from the tonsils of carrier pigs treated daily for several days. In some surveys, the antimicrobial sensitivity of SS indicates a high degree of sensitivity to ampicillin, cephalothin, and trimethoprim-sulfamethoxazole, and resistance to the aminoglycosides gentamicin and streptomycin. It is recommended that trimethoprim-sulfamethoxazole be used for the treatment of affected pigs and be given daily for 3 days. An occasional strain may be resistant to trimethoprim-sulfamethoxazole.

None of the resistant strains produced beta-lactamase. Conjugation of antibiotic resistance in SS has been reported, which may explain the multiple antimicrobial resistance. The genes responsible for resistance appear to be homologous to genes found in many other species of bacteria. Treatment of pigs affected with meningitis attributable to SS2 with either trimethoprim-sulfadiazine or penicillin reduced the case-fatality rate from 55% to 21%. Cefquinome has been shown to improve cure rates (67%) compared with ampicillin (55%) and to reduce mortality from 35% with ampicillin to 24% with cefquinome.

Passive immunization against SS2 has been described.

## CONTROL

At the present time there are no known specific methods for the prevention of the disease complex associated with SS2. The recommendations are based on empirical field observations. Regular isolation of the agent from any clinical cases will confirm the continuation of a strain or the arrival of a new strain and hopefully differentiate virulent from nonvirulent.<sup>15</sup>

It has been suggested that ceftiofur administered by injection for 3 consecutive days following SS challenge is the most effective regimen for minimizing disease associated with PRRS virus and SS infection. The use of potassium penicillin G in drinking water for several days was reported as being successful<sup>45</sup> and will reduce mortality. A combination of medication and vaccination was seen to remove SS from the tonsils of carrier sows.<sup>47</sup>

## Environment and Management

Good management and hygiene techniques should be emphasized. Based on observations of the effects of management practices on SS carrier rate in nursery pigs, excessive temperature fluctuations, high relative humidity, crowding, and an age spread exceeding 2 weeks of pigs in the same room were associated with a higher-than-average percentage of carrier pigs.

Nursery pig environmental temperature should not fluctuate more than 1.1° to 1.7° C (34° to 35° F) over a 24-hour period.

Excessive relative humidity must be avoided; the recommended range of relative humidity for nursery pigs is 55% to 70%.

The age spread between pigs in the same room should not exceed 2 weeks. Young, potentially naive piglets raised in the same air space as older animals may be exposed to high concentrations of the organism.

Adequate space to avoid crowding is also necessary. Crowding occurs when less than 0.18 m<sup>2</sup> is provided for each 22.7 kg of pig. The use of an all-in, all-out production system is recommended, compared with a continuous flow system, which allows for a build-up of pathogens. The control of the most commonly encountered infectious diseases is also important. A well-fortified nutritional program may also aid in the control of SS infection and the carrier state in a swine herd.

Segregated early weaning programs have been used in an attempt to control the disease but appear to be unsuccessful in reducing the carrier state. Pigs are weaned at an early age and moved to a separate site in an effort to separate the piglets from the sows, which are the primary source of the organism. Carrier pigs readily transmit the infection to uninfected pigs, and the main method of spread between herds is the movement of infected

breeding stock or weaner pigs. In herds that are free of the infection, it is necessary to avoid the importation of infected pigs. Eradication of SS2 infection can be attempted by depopulation of suspected carrier sows and replacement with noninfected breeding stock.

## Mass Medication of Feed

Mass medication of individual pigs or medication of the feed during periods of high risk may control the incidence of clinical disease. Outbreaks in sucking piglets have been controlled by a single injection of benethamine penicillin to all piglets given 5 days before the average age of onset of clinical signs. The feeding of oxytetracycline (400 g/ton) for 14 days immediately before the usual onset may control the occurrence of the disease at a low level in weaned pigs, although there is increasing evidence of resistance. The use of a medicated feed containing trimethoprim-sulfadiazine (1:5) at a rate of 500 g/ton for the first 6 weeks after weaning did not significantly reduce the incidence of disease. Oral prophylactic medication with either procaine penicillin G or a mixture of chlortetracycline, sulfadimidine, and procaine penicillin G reduced the incidence of meningitis. Penicillin V administered orally provided higher plasma concentrations of drug. The inclusion of penicillin V potassium (10%), at a rate of 2 kg/ton of feed, significantly reduced the incidence of streptococcal meningitis when fed to the pigs for a total of 6 weeks from 4 to 10 weeks of age.

Tiamulin in the drinking water at 180 mg/L of water for 5 days significantly reduced the effects of experimentally induced SS infections.

## Vaccination

Most vaccination studies have been carried out with piglets.<sup>46</sup> Either commercial or autogenous bacterins are available. Autogenous vaccines need to use strains from systemic sites such as the meninges, spleen, liver, and joints, nasal cavity, or tonsils, but not the lungs because they are more likely to be the nonvirulent SS. A study showed that SS9 bacterin produced a much lower level of efficacy than a SS2 vaccine.<sup>47</sup> Homologous protection is always more successful than for heterologous strains, which is why it is essential to continually monitor the strains in an endemically affected herd. A commercial vaccine reduced mortality from 17% to 2.6%. What constitutes an effective antigen is still a matter of conjecture. High levels of antibody against MRP and EF proteins did not confer protection.<sup>48</sup>

Studies are being conducted on the use of vaccines containing the immunogenic polysaccharide from SS2. However, the protection provided by whole-cell vaccines is probably type specific, which suggests that such vaccines should contain many

serotypes if broad protection is desired. A trial minimizing variation in weaning age to achieve a uniform size with a combination of an autogenous vaccine and ceftiofur sodium has been reported. The protective levels of antibody did not prevent the survival of the organism in either tonsils or joints. An ELISA can be used to evaluate the antibody response in pigs vaccinated with SS2.

Different components of the organism are being examined to identify possible fractions for the preparation of a subunit vaccine. A subunit vaccine containing both MRP and EF, formulated with an oil/water adjuvant, that protected pigs against challenge with a virulent SS2 has been proposed. Vaccination of sows with 2 mL of bacterin prevented neurologic signs but not lameness, bacteriuria, or mortality in their progeny from challenge at 13 to 21 days of age. Immunization of experimental mice with a live avirulent strain of SS2 provided protection, which may be extrapolated for consideration in pigs. A vaccine containing purified suilysin protected mice against a lethal homologous challenge and induced protection against clinical signs in pigs after homologous challenge. Pigs vaccinated with a vaccine containing purified suilysin were protected from challenge with the homologous strain of the organism, whereas pigs vaccinated with a vaccine containing most of the extracellular antigens, and the placebo pigs, developed clinical disease. Suilysin is produced by most of the field strains tested and could be an important cross-protection factor.

Medicated early weaning does not produce eradication. The establishment of a new herd by hysterectomy and artificial rearing will allow this, and freedom can only be maintained by intense 24/7 biosecurity. Complete degreasing, cleaning, disinfection, and drying and letting a building rest before repopulating with SS-free stock from a known SS-free pyramid is the only way to get rid of a persistent infection.

## REFERENCES

1. Gottschalk M, et al. *Future Microbiol.* 2010;5:371.
2. Takada K, Hirasawa M. *Int J Syst Evol Microbiol.* 2007;57:1272.
3. Takada K, et al. *Microbiol Immunol.* 2008;52:64.
4. Chen C, et al. *PLoS ONE.* 2007;2:e315.
5. Holden M, et al. *PLoS ONE.* 2009;4:e6072.
6. Blume V, et al. *Int Microbiol.* 2009;12:161.
7. Luey C, et al. *J Microbiol Method.* 2007;68:648.
8. Marois C, et al. *Canad J Vet Res.* 2006;70:94.
9. Fittipaldi N, et al. *Vet Microbiol.* 2009;139:320.
10. Messier S, et al. *Can Vet J.* 2008;49:461.
11. Baums CG, et al. *Infect Immunol.* 2006;74:6154.
12. Wei Z, et al. *Vet Microbiol.* 2009;137:196.
13. Baums C, et al. *Appl Environ Microbiol.* 2007;73:711.
14. Luque I, et al. *Vet J.* 2010;186:396.
15. MacInnes J, et al. *Canad J Vet Res.* 2008;72:242.
16. Marois C, et al. *Canad J Vet Res.* 2007;71:14.
17. Li P, et al. *Microbiol Pathog.* 2010;49:305.
18. van Calsteren MR, et al. *Biochem Cell Biol.* 2010;88:513.
19. Chabot-Roy G, et al. *Microbiol Pathog.* 2006;41:121.
20. Fittipaldi N, et al. *Mol Microbiol.* 2008;70:1120.

21. Fittipaldi N, et al. *PLoS ONE*. 2010;5:e8426.
22. Takamatsu D, et al. *Vet Microbiol*. 2009;138:132.
23. Silva L, et al. *Vet Microbiol*. 2006;115:117.
24. Essglass M, et al. *Microbiol*. 2008;154:2668.
25. Lecours MP, et al. *J Infect Dis*. 2011;204:919.
26. Si Y, et al. *Vet Microbiol*. 2009;139:80.
27. Zhang X-H, et al. *Microbiol Pathog*. 2009;47:267.
28. Ye C, et al. *Emerg Infect Dis*. 2006;12:1203.
29. Gottschalk M, et al. *Anim Hlth Res Rev*. 2007;8:29.
30. Lun Z-R, et al. *Lancet Infect Dis*. 2007;7:201.
31. Tang J, et al. *PLoS ONE*. 2006;3:e151.
32. Cheung P, et al. *Int J Food Microbiol*. 2008;127:316.
33. Smith T, et al. *Emerg Infect Dis*. 2008;14:1925.
34. Wertheim H, et al. *Clin Infect Dis*. 2009;48:617.
35. Ye C, et al. *J Infect Dis*. 2009;199:97.
36. Tenenbaum T, et al. *Brain Res*. 2006;1100:1.
37. Tenenbaum T, et al. *Cell Biol*. 2009;11:323.
38. Dominguez-Punaro M, et al. *J Immunol*. 2007;179:1842.
39. Feng Y, et al. *Trends Microbiol*. 2010;18:124.
40. Vanier G, et al. *Microbiol Pathog*. 2009;46:13.
41. Beineke A, et al. *Vet Microbiol*. 2008;128:423.
42. Rehm T, et al. *J Med Microbiol*. 2007;56:102.
43. Hendriksen R, et al. *Acta Vet Scand*. 2008;50:19.
44. Wisselink H, et al. *Vet Microbiol*. 2006;113:73.
45. Byra C, et al. *Can Vet J*. 2011;52:272.
46. Swilders B, et al. *Vet Rec*. 2007;160:619.
47. Buttner N, et al. *Vet Immunol Immunopathol*. 2012;146:191.
48. Kock C, et al. *Vet Immunol Immunopathol*. 2009;132:135.

## STREPTOCOCCAL LYMPHADENITIS OF SWINE (JOWL ABSCESSSES, CERVICAL ABSCESSSES)

Cervical or “jowl” abscess of pigs is observed mainly at slaughter. Clinically, there is obvious enlargement of the lymph nodes of the throat region, particularly the mandibular and the retropharyngeal. It is of considerable importance because of the losses resulting from rejection of infected carcasses at meat inspection.

The condemnation rate of pig heads at slaughter was as high as 78% to 94% in some herds in the 1960s. However, since then, the incidence of jowl abscesses in pigs has declined steadily. This may be a result of changes in management of pig herds and the use of antibiotic feeding.

Most jowl abscesses in swine are associated with beta-hemolytic streptococci of Lancefield’s group E type IV, although *P. multocida*, *E. coli*, and *T. pyogenes* may also be present. Some additional serotypes have been isolated. Jowl abscessation occurs primarily in postweaning and finishing pigs. Piglets under 28 days of age are relatively resistant, and even colostrum-deprived piglets are resistant to clinical disease following experimental infection.

The disease has been produced by feeding or the intranasal or intrapharyngeal instillation of streptococci, and they are thought to be the cause, with infection occurring through the tonsil or pharyngeal mucosa from contaminated food and water. The contamination occurs from abscess material

leaking into food or water. In herds where cervical abscess is a problem, streptococci can commonly be isolated from the vaginas of pregnant sows and the pharynges of normal young pigs. The persistence of the infection in herds is thought to depend on the presence of carrier animals. Transmission occurs via feed and drinking water. After infection has occurred, bacteremia develops, and abscesses are initiated in the cervical lymph nodes in a high proportion of pigs. Infrequently, abscesses occur in atypical sites other than the head and neck. Pigs that have recovered from the natural disease are immune to experimental challenge. A microtitration agglutination test is available to detect infections associated with type IV streptococci.

Vaccination of pregnant sows with an autogenous or commercial bacterin containing streptococci and staphylococci is thought to be of value in protecting the litters of the vaccinated sows. Vaccination of young pigs with a whole-culture bacterin has provided some protection. The use of an oral vaccine prepared from an avirulent strain of group E streptococci and sprayed into the oropharynx is highly effective as a preventive measure. None of these vaccines is widely used because the condition is very sporadic. A number of prophylactic regimens based on the feeding of antibiotics have been proposed and generally give good results. Chlortetracycline fed to young pigs at the rate of 220 g/ton for 1 month is an example. Treatment of breeding pigs at the same time is likely to have a beneficial effect in reducing the severity of exposure of the young pigs to infection. A similar advantage can be gained by keeping the treated groups isolated from untreated groups of older pigs. Because piglets under 28 days of age are relatively resistant to clinical disease, the weaning and isolation from older pigs is a successful control program.

## ERYSIPELAS IN SWINE

Erysipelas of pigs is the major disease of animals associated with *Erysipelothrix rhusiopathiae*, and it can occur in all stages of pig production. The condition is seen as sudden death; as an acute disease, possibly with diamond-shaped skin lesions; and also as a chronic disease with arthritis and vegetative endocarditis and reproductive failure in adults. In many minimal-disease herds they have tended not to vaccinate, and then the epizootics have occurred as a result of an increasing lack of immunity. It is zoonotic, most commonly causing erysipeloid in the fingers.

### SYNOPSIS

**Etiology** *Erysipelothrix rhusiopathiae*.

**Epidemiology** Pigs worldwide. Common in unvaccinated pigs raised outdoors. High

case-fatality rate if not treated. Organism in environment and transmitted by carrier pigs. Important zoonosis.

**Clinical signs** Hyperacute sudden death. Sudden onset of acute disease, fever, anorexia, typical diamond-shaped skin lesions. Arthritis, endocarditis in chronic form.

**Clinical pathology** Organism in blood. Hemogram and serology.

**Necropsy findings** Skin lesions, widespread ecchymotic hemorrhages (kidney, pleura, peritoneum), venous infarction of stomach. Nonsuppurative proliferative arthritis. Vegetative endocarditis.

**Diagnosis** Culture and isolate organism from blood in acute case and then tissues.

**Differential diagnosis** Other septicemias of pigs:

- Septicemic salmonellosis
- Hog cholera and African swine fever
- Streptococcal septicemia and arthritis
- Streptococcal endocarditis

Other arthritides of pigs:

- Glässer’s disease
- Mycoplasma synoviae and hyorhinis arthritis
- Ricketts and chronic zinc poisoning
- Foot rot of pigs
- Leg weakness

**Treatment** Penicillin.

**Control** Vaccination, with at most 6 month-interval until new and improved vaccines appear.

## ETIOLOGY

*Erysipelothrix rhusiopathiae* (formerly insidiosa) (ER) is the causative bacterium, and the disease can be produced in hyperacute, acute, and subacute septicemic and chronic forms by the injection of cultures of the organism. The organism occurs as rough and smooth strains; the smooth are more virulent. At least 29 antigenic types have been identified, and usually types 1 and 2 are isolated from the septicemic forms.<sup>1</sup> The species has recently been divided into two species on the basis of the DNA tests that reflect biochemical and serologic characteristics. Many of the serotypes have been regrouped and called *Erysipelothrix tonsillarum* (ER), which is nonpathogenic.<sup>2</sup> This is found in the tonsil and is morphologically and biochemically similar to ER but has a very distinctive genetic profile. However, some species identified as ET on serology have been shown to be ER on multilocus enzyme electrophoresis. In addition, the restriction fragment length polymorphism (RFLP) typing using the PCR products of the Spa A gene have been used to subdivide the serotypes.<sup>3</sup> Recently, a new classification has been put forward based on Spa genes.<sup>4,5</sup> These are proteins, and at least three genes are known (Spa1, Spa2 and Spa3).<sup>6,7</sup>



*Erysipelas rhusiopathiae* now contains the former serotypes 1, 2, 4, 5, 6, 8, 9, 11, 12, 15, 16, 17, 19, 21, and N.

*Erysipelas tonsillarum* now contains serotypes 3, 7, 10, 14, 20, 22, and 23. Serotypes 13 and 18 are intermediate and called *Erysipelas* species strains 1 and 2 (also contains a few 9 and 10), respectively, and strain 3, which contains some strains of 7 and is as yet untypeable.<sup>3</sup> The identification and characterization of *E. inopinata* has not yet been determined.<sup>8</sup>

## EPIDEMIOLOGY

### Occurrence

Erysipelas in pigs occurs worldwide and causes serious economic loss, substantially as a result of deaths, morbidity and devaluation of pig carcasses because of arthritis. However, because the indoor confinement of swine and no contact with contaminated soil has followed, the occurrence of the disease has decreased markedly. The exception to this would be outdoor units where no regular vaccination is practiced. The other major exceptions are those parts of the world where the backyard or enthusiast's pigs are still found and where hygiene and biosecurity are usually nonexistent. Historically, the disease occurred most commonly in unvaccinated growing pigs over 3 months of age and adults. This is primarily because the maternal antibody is thought to last up to 3 months. The infection, usually with serotypes 1a or 2, has also been demonstrated in wild boars, so these should not be forgotten as a reservoir. Perhaps more important, these strains were resistant to oxytetracycline and/or dihydrostreptomycin.

### Prevalence of Infection

The prevalence of infection with ER in carrier pigs ranges from 3% to 98%, with most surveys indicating that 20% to 50% of pigs are carriers, particularly in the tonsils. Carriers occur among vaccinated and unvaccinated pigs. The organism has been isolated from 10% of apparently healthy slaughter pigs and may explain its wide prevalence. In addition, the organism has been isolated from over 30 species of wild birds and 50 species of wild animals.

### Morbidity and Case Fatality

Morbidity and case-fatality rates in pigs vary considerably from area to area, largely because of variations in virulence of the particular strain of the organism involved. On individual farms or in particular areas the disease may occur as a chronic arthritis in finishing pigs or as extensive outbreaks of the acute septicemia, or both forms may occur together. In unvaccinated pigs, the morbidity in the acute form will vary from 10% to 30%; the case-fatality rate may be as high as 75%.

### Methods of Transmission

Soil contamination occurs through the feces of affected or carrier pigs. Other sources of

infection include infected animals of other species, mouse contamination, open muck heaps and effluent on the soil, and birds. Straw-based systems are often highly contaminated. The clinically normal carrier pig is the most important source of infection, with the tonsils being the predilection site for the organism. Young pigs in contact with carrier sows rapidly acquire the status of carriers and shedders. Because the organism can pass through the stomach without loss of viability, carrier animals may reinfest the soil continuously, and this appears to be the main cause of environmental contamination. The organism can survive in feces for several months. All effluent contains species of *Erysipelothrix* but not necessarily ER. However, its persistence in soil is variable and may be governed by many factors including temperature, pH, and the presence of other bacteria. The organism can be isolated from the effluent of commercial piggeries and from the soil and pasture of effluent disposal sites for up to 2 weeks after application of the effluent containing the organism. Although the environment is considered to be secondary to animals as a reservoir of infection, the survival of the organism in the environment could create an infection hazard. Flies are known to transmit the disease, and a lowered prevalence has been attributed to the use of insecticides.

Under natural conditions, skin abrasions and the alimentary tract mucosa are considered to be the probable portals of entry, and transmission is by ingestion of contaminated feed. Occasional outbreaks occur after the use of virulent and incomplete avirulent cultures as vaccines. Abortion storms in late pregnant sows with septicemic death in sucklers may be the first indication of the disease in specific-pathogen-free herds.

Spread of the infection can also occur to most other species. The organism has been recovered from sylvatic mammals in northwestern Canada. It has been isolated from a horse affected with vegetative endocarditis. It has, at times, been found in fish meal, but this is now less used in pig diets. It is possible that other species, such as cattle, may harbor strains that are pathogenic for swine.

### Risk Factors

It may be that some serotypes are resident in a single farm, and an outbreak may represent the arrival of a new serotype on that farm.

There is considerable variation in the ease with which the disease can be reproduced and in its severity. Many factors, such as age, health and intercurrent disease, exposure, and heredity, influence both natural and artificial transmission. Stress may predispose to the condition, but virulence of the strain is probably the most important factor. Smooth strains can be used successfully to produce the disease experimentally, but rough strains appear to be nonpathogenic. This variation

in virulence between strains of the organism has been utilized in the production of living, avirulent vaccines.

### Animal Risk Factors

Infected pigs probably shed the agent in feces and oronasal secretions and also in urine, and direct contact is probably the most usual method.

Pigs of all ages are susceptible. Recently farrowed sows seem to be particularly susceptible. This suggests that fatigue may be a factor. Sudden diet changes have also predisposed, as have heat and cold stress. When the strain is virulent, pigs of all ages, even sucklers a few weeks old, develop the disease. Almost entire litters under 2 weeks of age may be affected. Piglets from an immune sow may get sufficient antibodies in the colostrum to give them immunity for some weeks. It is likely that the animals are immune to the strains that are normally found in their particular environment. Possibly the arrival of new serotypes through new pig arrivals or the turning over of previously contaminated land together with an increase in stress are the main factors. It is known that ER from bovine tonsils is pathogenic for mice and pigs and possibly pathogenic for other animals and humans.

### Pathogen Risk Factors

At least 32 serotypes are known to exist and many strains; however, 15 probably commonly affect pigs. Serotypes 1 and 2 are the most common types isolated from swine affected with clinical erysipelas and are generally thought to be the only serotypes that cause the acute disease. The other serotypes are relatively uncommon, and none of them has yet been a cause of acute epidemics, but some have been isolated from lesions of chronic erysipelas. Serotypes 1a, 3, 5, 6, 8, 11, 21, and type N have been isolated from pigs with chronic erysipelas, mainly arthritis and lymphadenitis.

Not all serotypes isolated from pigs are virulent. In a survey in Japan, the organism was found in 10% of the tonsils of healthy slaughter pigs: 54% were serotype 7, 32% serotype 2, 9.5% serotype 6, and 1.6% each of serotypes 11, 12, and 16. All serotype 2 isolates were highly virulent for pigs, whereas the other serotypes were only weakly virulent. Members of the other nonvirulent or weakly virulent group, mainly serotype 7 strains, are considered to be resident in porcine tonsils. Serotypes 1a or 2 were found most commonly in pigs in Australia, less commonly in sheep, and infrequently in other animals. Serotypes 1a and 1b accounted for 79% of the isolates from diseased pigs. The genetic diversity of Australian field isolates of ER and ET indicates widespread diversity. Those recovered from sheep or birds were more diverse than those isolated from pigs, and isolates of serovar 1 were more diverse than those of serovar 2. The

diversity indicated that serotyping of ER is unreliable as an epidemiologic tool.

The serotype antigens of ER are immunologically distinct, and commercial bacterins prepared from the common serotypes will not provide protection against other pathogenic serotypes. This may be an explanation for the epidemics that may occur in vaccinated pigs. The 64 to 66 kDa protein appears to be most immunogenic. Also, a variety of serotypes may be recovered from pigs affected with the septicemic and arthritic forms of the disease.

The organism is resistant to most environmental influences, and to heat (15 minutes at 60°C [14°F]), and can survive in animal tissues at 40°C (105°F) and frozen tissues and is not readily destroyed by chemical disinfection, including 0.2% phenol and by drying agents. It can survive for 60 months in frozen or refrigerated media, 4 months in flesh, and 90 days in highly alkaline soil and is resistant to drying. It will also resist salt preparations and other food preservatives.

### Zoonotic Implications

Because of human susceptibility, swine erysipelas has some public health significance. Veterinarians in particular are exposed to infection when vaccinating with virulent cultures. It commonly contaminates pig products and therefore is quite a common infection in abattoir workers or butchers or those employed in similar trades. It usually produces a swollen finger and is known as erysipeloid. In this context, there have been recent advances in slide agglutination and latex agglutination tests for rapid diagnosis, which have a good correlation with each other and subsequent culture. Now a PCR identifying four species has been described, principally for use in the abattoir. Recently a case of endocarditis and presumptive osteomyelitis has been described, so care is needed. Type 21 is recorded as having produced a septicemia in humans.<sup>1</sup>

### PATHOGENESIS

The invasion of the susceptible pig by ER can occur under particular circumstances, for example, if weather conditions are hot and humid or in particular fields or buildings. Experimentally, it is often easier to infect the pig through scarified wounds than through intravenous infusions, through the gut, or through intravenous injections. There are marked differences in virulence between strains.

There is the presence in the pathogenic serotypes of a capsule that resists phagocytosis. Some virulent strains also produce a phosphorylcholine which resists phagocytosis. Some others may produce a neuraminidase, which may cleave the mucopolysaccharides in cell walls and cause vascular damage leading to hemorrhage and thrombosis. The surface protective antigen, a protein, Spa is also important in

pathogenesis. There is also the possibility of novel adhesins called RspA and RspB. Apparently, avirulent strains do not have these four important features. Invasion of the bloodstream occurs in all infected animals in the first instance. Septicemia results within 1 to 7 days. The subsequent development of either an acute septicemia or a bacteremia with localization in organs and joints is dependent on undetermined factors. Virulence of the particular strain may be important, and this may depend on the number of recent pig passages experienced. Coagulase activity is a possible virulence factor. Concurrent viral infection, especially hog cholera, may increase susceptibility of the host.

Localization in the chronic form is commonly in the skin, joints, and other heart valves, with probable subsequent bacteremic episodes, and it may start from as early as 4 days after initial infection, although the cartilage lesions may be delayed until about 8 months, and they can then continue to progress for at least 2 years. Selective adherence of some strains of ER to heart valves may be a factor in the pathogenesis of endocarditis. In joints, the initial lesion is an increase in synovial fluid and hyperemia of the synovial membrane, followed in several weeks by the proliferation of synovial villi (really a synovitis), thickening of the joint capsule, and enlargement of the local lymph nodes. Diskospondylitis also occurs in association with chronic polyarthritis attributable to erysipelas. Amyloidosis may occur in pigs with chronic erysipelas polyarthritis. The heart lesions may begin with early inflammatory changes associated with emboli.

There has been some controversy over whether the arthrodial lesions result from primary infection or whether they result from hypersensitivity to the *Erysipelothrix* or other antigens. Current opinion suggests that the former is the case but that the lesions are enhanced by immunologic mechanisms to persistent antigen at the site. There are increased levels of immunoglobulins IgG and IgM in the synovial fluids of pigs with polyarthritis attributable to ER, and the levels are considered to be only partly a result of serum and increased permeability. The presence of antibody does not remove the organism from the joints.

Abortion is thought to occur as a result of high fever, but the organism has been isolated from the fetus. Congenital erysipelas has also been recorded. In these cases, the organism can be recovered from the anterior vagina.

### CLINICAL FINDINGS

There are several forms of disease. These include hyperacute, acute, subacute, and chronic.

#### Hyperacute Form

Quite often the disease is seen for the first time in pigs approaching market weight. The

animal is usually found dead or is dull, is depressed, has a temperature of 42°C (106–109°F), and dies quickly; it usually occurs in finishing pigs and is uncommon in sows.

#### Acute and Subacute Forms

This form is uncommon in adults. The signs vary with age and immune status. The acute usually die within 12 to 48 hours of the onset of signs. After an incubation period of 1 to 7 days, there is a sudden onset of high fever (up to 42°C [108°F]), which is followed some time later by severe prostration, complete anorexia, thirst, and occasional vomiting. Initially, affected pigs may be quite active and continue to eat even though their temperatures are high. However, generally in an outbreak one is initially presented with one or two dead or severely affected pigs showing marked red (scarlet flush) to purple discoloration of the skin of the jowl and ventral surface (may even be whole-body cyanosis), with others in the group showing high fever, reluctance to rise, and some incoordination while walking. Dyspnea is a common feature. Conjunctivitis with ocular discharge may be present.

Skin lesions are almost pathognomonic but may not always be apparent. These may take the form of the classical diamond-shaped, red, urticarial plaques about 2.5 by 5 cm square that occur within the 24 to 48 hours of the onset of clinical signs, or a more diffuse edematous eruption with the same appearance. These lesions can also be palpated as raised patches. In the early stages the lesions are often palpable before they are visible. The lesions are most common on the belly, inside the thighs, and on the throat, neck, and ears, and usually appear about 24 hours after the initial signs of illness. Sometimes they can be felt rather than seen. After a course of 2 to 4 days the pig recovers or dies, with diarrhea, dyspnea, and cyanosis evident terminally. The mortality rate may reach 75%, but wide variation occurs. Pregnant animals may abort, and it is thought that this is a result of the fever, but it may be that there is a direct fetal action because congenital infections and isolations of the organism from the fetus have occurred. There may occasionally be waves of returns to service and abortion storms. Inflected boars recover but may be infertile for 6 to 8 weeks.

The so-called “skin” form is usually the acute form with more prominent skin localization but less severe signs of septicemia and with a low mortality. The skin lesions disappear in about 10 days without residual effects. In the more serious cases the plaques spread and coalesce, often over the back, to form a continuous deep-purple area extending over a greater part of the skin surface. The affected skin becomes black and hard, and the edges curl up and separate from an underlying, raw surface. The dry skin may hang on for a considerable time and rattle while the pig walks, or it may slough off.

### Chronic Form

Many of the chronic cases require euthanasia because they deteriorate rapidly.

Signs are vague and indistinct except for the joint lesions characteristic of this form of the disease. Bacteria may localize in the joints. There may be alopecia, sloughing of the tail and tips of the ears, and dermatitis in the form of hyperkeratosis of the skin of the back, shoulders, and legs; growth may be retarded. Joint lesions are most common in the elbow, hip, hock, stifle, and knee joints and cause lameness and stiffness. The joints are obviously enlarged and are usually hot and painful at first but in 2 to 3 weeks are quite firm and without heat. This is especially the case when the arthritis has been present for some time, allowing healing and ankylosis to develop. Paraplegia may occur when intervertebral joints are involved or when there is gross distortion of limb joints.

A subclinical form of synovitis may occur that affects feed intake and results in a reduced rate of growth.

Endocarditis also occurs as a chronic form of the disease with or without arthritis. Suggestive clinical signs are often absent, with the animals dying suddenly without previous illness, especially at times of exertion, such as mating, or movement between pens. In others there is progressive emaciation and inability to perform exercise. With forced-exercise dyspnea, cyanosis and even sudden death may occur. The cardiac impulse is usually markedly increased, the heart rate is faster, and a loud murmur is audible on auscultation if the valves are badly damaged. Cyanosis, tachycardia and tachypnea, and heart murmurs may feature in these cases.

In Switzerland, chronic swine erysipelas is suspected where there is vegetative endocarditis, arthritis, and the culture of ER from vulval discharges. These signs are also accompanied by poor fertility and increased prevalence of abortions, stillbirths, and small litter size. Vaccine was used to control an outbreak of purulent periparturient vulval discharge in which ER was the only organism isolated. In one study anterior vaginal samples from 64 sows all yielded ER.

### CLINICAL PATHOLOGY

#### Detection of Organism

In the acute form, examination of blood smears may reveal the presence of the bacteria, particularly in the leukocytes, but blood culture is likely to be more successful as a method of diagnosis. Repeated examinations in the chronic forms of the disease may by chance give a positive result during a bacteremic phase. Final identification of the organism necessitates mouse or pigeon inoculation tests and protection tests in these animals using antierysipelas serum.

#### Hematology

In the early stages of the acute form there is first leukocytosis, followed by leukopenia

and monocytosis. The leukopenia is of moderate degree (40% reduction in total leukocyte count at most) compared with that occurring in hog cholera. The monocytosis is quite marked, varying from a 5-fold to a 10-fold increase (2.5% to 4.5% normal levels rise to 25%).

#### Serology

The efficiency of agglutination tests for ER is not clear. They appear to be satisfactory for herd diagnosis but not sufficiently accurate for identification of individual affected pigs, particularly clinically normal carrier animals. A more accurate and reliable complement fixation test is available, but an enzyme immunoassay test is much quicker, easier, and more economical to perform. An ELISA test has been used.

### NECROPSY FINDINGS

Experimentally the disease can be produced by oral dosing; by intradermal, intravenous, and intraarticular injection; and by application to scarified skin, conjunctiva, and nasal mucosa. The arthritic form of the disease can be reproduced by multiple intravenous inoculations of ER.

The microscopic lesions include vasculitis in capillaries and venules in many sites, including glomeruli, pulmonary capillaries, and the skin. Sometimes, it is possible to see emboli of bacteria without specific stains to demonstrate bacteria.

#### Acute and Subacute Forms

In the hyperacute cases, all that may be seen is a congested carcass with discoloration of the skin. The degree of skin discoloration may provide a clue to prognosis, in that it is said that if the skin lesions are pink to light purple, then resolution will often occur within 4 to 7 days, but the dark angry black/purple lesions have a grave prognosis.

Classic “diamond skin” lesions may be present. They are almost pathognomonic. However, the diffuse, purplish discoloration of the belly and cyanosis of the extremities common to other septicemic diseases of pigs is a more reliable finding. Internally, petechial and ecchymotic hemorrhage occurs, mainly on the pleura and peritoneum and beneath the renal capsule but also on the heart, kidney, pleura, liver, and spleen. Venous infarction of the stomach is accompanied by swollen, hemorrhagic mesenteric lymph nodes, and there is congestion of the lungs and liver. Infarcts may be present in the spleen and kidney and the former much enlarged. Histologic changes in all tissues are those of toxemia and thrombosis. Large numbers of intravascular organisms are often visible. There are no specific histologic changes.

#### Chronic Form

There may be necrotic skin lesions and embolic lesions in organs and the enlarged joints,

A nonsuppurative proliferative arthritis involving limb and intervertebral joints is characteristic. Synovitis, with a serous or serofibrinous amber-colored intraarticular effusion, occurs first; degenerative changes in the subendochondral bone, cartilage, and ligaments follow. When the synovial changes predominate, the joint capsule and villi are thickened. There are enlarged, dark-red pedunculations or patches of vascular granulation tissue, which spread as a pannus onto the articular surface. When bony changes predominate, the articular cartilage is detached from the underlying bone, causing abnormal mobility of the joint. Ulceration of the articular cartilage may also be present. Local lymph node enlargement is usual. With time, the joint lesions often repair by fibrosis and ankylosis sufficiently to permit use of the limb.

Endocardial lesions, when present, are large, friable vegetations on the valves, often of sufficient size to block the valvular orifice. Occasionally, endocarditis may be the only lesion seen, but this is a rare occurrence. Erysipelas is often said to rank below *S. suis* as a cause of endocarditis in growing pigs, but ER was the most frequent isolate from cases of endocarditis seen in slaughtered pigs. Infarcts occur in the kidney, and these may also yield pure cultures of the organism. Chronic joint lesions are often sterile, but bacteriologic culture should nevertheless be attempted. The probability of positive isolation increases with the number of joints sampled, and isolations are more frequent from the smaller, distal joints.

### DIAGNOSIS

Clinical signs (fever, lameness, and skin lesions) and the absence of respiratory signs and anorexia are suggestive and confirmed by isolation of the agent from blood in the acute stages. Diagnosis from joints in chronic stages is more difficult. Postmortem examination of the acute case cases will usually allow culture from the heart, blood, spleen, and bone marrow, particularly the long bones.

#### Samples for Confirmation of Diagnosis

With acute cases, the tests are more successful. Bacteriologic examination of subacute cases is less successful, and chronic cases often not successful.

- Bacteriology—culture swabs from joints; synovial membranes in culture media; heart valve masses, spleen, kidney, skin and bone marrow, particularly from a long bone. Smears of heart blood are particularly useful in the first 1 to 2 days of the acute diseases. The organism is a slender, facultative anaerobe and gram-positive rod that produces a 1-mm gray colony after 24 hours of incubation on blood agar. It may be observed singly, in short chains, or as a palisade.



There are a variety of short gram-positive rods that can be confused with *Erysipelas* organisms.<sup>9</sup> Different morphologic types (rough and smooth colonies), exist and the rough are considered less virulent. Enrichment techniques and the use of selective media will also increase the frequency of isolation.<sup>9</sup>

- Florescent techniques have been developed to show antigen in joints. New PCR techniques have also been used.
- Histology—formalin-fixed synovial membranes, heart valve masses, spleen, kidney, and skin lesions (light microscopy) are useful. There may be granulation tissue on the heart valves. The synovial lesions are characterized by macrophages and lymphocytes with synovocyte proliferation. The vasculitis is extensive, and thrombi and bacterial colonies may be seen. Immunohistochemistry aids in the differential diagnosis from the other bacteria (*Mycoplasma*, *S. suis*, and *H. parasuis*).<sup>10</sup>

Antigen detection has helped greatly in detection. PCR and RT-PCR have been developed. A multiplex PCR has been developed to differentiate ER and ET11, and strain 2 was then added.<sup>11</sup> A qRT-PCR has been described for ER and ET13 and for differentiating vaccine strains from field strains.<sup>12</sup>

Note the zoonotic potential of this organism when handling the carcass and submitting specimens.

#### DIFFERENTIAL DIAGNOSIS

Erysipelas in pigs is not ordinarily difficult to diagnose because of the characteristic clinical and necropsy findings. In the occasional situation in which anthrax may have occurred in the past, it is worth testing a smear of edema fluid taken by a needle from the jowl or ear region for this pathogen before opening of the carcass. The acute disease may be confused with the other septicemia affecting pigs, but pigs with erysipelas usually show the characteristic skin lesions and are less depressed than pigs with hog cholera or salmonellosis. Rarely, *A. pleuropneumoniae* and *H. parasuis* may also appear similar.

Other septicemias of pigs:

- Septicemic salmonellosis is characterized by gross bluish-purple discoloration of the skin, especially the ears, some evidence of enteritis, and polypnea and dyspnea.
- Hog cholera is characterized by large numbers of pigs affected quickly, weakness, fever, muscle tremors, skin discoloration and rapid death; convulsions are also common.
- Streptococcal septicemia and arthritis are almost entirely confined to suckling pigs in the first few weeks of life as is septicemia associated with *Actinobacillus suis*.

- Streptococcal endocarditis has a similar age distribution to erysipelas endocarditis and bacteriologic examination is necessary to differentiate them.

Other arthritides of pigs:

The chronic disease characterized by joint disease occurs in pigs of all ages but less commonly in adults and must be differentiated from the following conditions:

- Glässer's disease in pigs is accompanied by a severe painful dyspnea. At necropsy there is serositis and meningitis
- *Mycoplasma hyorhinis* arthritis generally affects pigs less than 10 weeks of age and produces a polyserositis and polyarthritis. However, *Mycoplasma hyosynoviae* can produce simple polyarthritis in growing pigs. In general, the periarticular, synovial, and cartilaginous changes are less severe in these infections compared with erysipelas; however, cultural differentiation is frequently necessary.
- Rickets and chronic zinc poisoning produce lameness in pigs, but they occur under special circumstances and are not associated with fever, and rickets is accompanied by abnormalities of posture and gait that are not seen in erysipelas.
- Foot rot of pigs is easily differentiated by the swelling of the hoof and the development of discharging sinuses at the coronet.

Leg weakness. In recent years there has been a marked increase in chronic osteoarthritis and various forms of "leg weakness" in growing swine, probably related to the increased growth rate resulting from modern feeding and management practices.

#### TREATMENT

##### Antimicrobial Therapy

Penicillin and antierysipelas serum (available only in some countries) comprise the standard treatment, often administered together by dissolving the penicillin in the serum. The antiserum lasts about 2 weeks. Penicillin alone is usually adequate when the strain is mildly virulent. Standard dose rates give a good response in the field, but experimental studies suggest that 50,000 IU/kg BW of procaine penicillin intramuscularly for 3 days and preferably 5 days is required for complete chemotherapeutic effect. Most animals are significantly improved within 2 days. Oxytetracycline is also useful, but in a Japanese study, over 70% of the strains were resistant. Chronic cases do not respond well to either treatment because of the structural damage that occurs to the joints and the inaccessibility of the organism in the endocardial lesions. Most strains are susceptible to ampicillin, cloxacillin, benzylpenicillin, ceftiofur, tylosin, enrofloxacin, and danofloxacin. Most strains are resistant to apramycin, neomycin, streptomycin, and spectinomycin and also to sulfonamides and polymyxins.

#### CONTROL

Successful control depends on good hygiene (cleaning, disinfection, and separation from feces and contaminated fields); biosecurity (other pigs and other species); reduction of stress, an effective 6-month vaccination policy, preferably two doses, for all animals over 3 months of age, including boars; and rapid diagnosis, quarantine, and treatment. The organism is inactivated by most disinfectants but is never completely eliminated. Effective bird and rodent control is important, especially if they are near feed such as in outdoor herds. Where there are scrape-through systems, there is never complete control. Do not forget that sheep and turkeys may also be a source of infection.

#### Eradication

Eradication is virtually impossible because of the ubiquitous nature of the organism and its survival in suitable environments. Complete removal of all pigs and leaving the pens unstocked is seldom satisfactory. Eradication by slaughter of reactors to the agglutination test is not recommended because of the uncertain status of the test.

General hygienic precautions should be adopted. Clinically affected animals should be disposed of quickly, and all introductions should be isolated and examined for signs of arthritis and endocarditis. This procedure will not prevent the introduction of clinically normal carrier animals. All animals dying of the disease should be properly incinerated to avoid contamination of the environment. Although thorough cleaning of the premises and the use of very strong disinfectant solutions is advisable, these measures are unlikely to be completely effective. The organism is susceptible to all the usual disinfectants, particularly caustic soda and hypochlorites. Whenever practicable, contaminated feedlots or paddocks should be cultivated for a spell before repopulating.

Specific-pathogen-free piggeries established on virgin soil may remain clinically free of erysipelas for several years. However, because of the high risk of introduction of the organism, it is advisable to vaccinate routinely.

#### Immunization

Because of the difficulty of eradication, biological prophylactic methods are in common use. Immunizing agents available include hyperimmune serum and vaccines.

#### Antierysipelas Serum

The parenteral administration of 5 to 20 mL of serum, with the amount depending on age, will protect in-contact pigs for a minimum of 1 to 2 weeks, possibly up to 6 weeks, during an outbreak. Suckling pigs in herds where the disease is endemic should receive 10 mL during the first week of life and at monthly intervals until they are actively vaccinated, which can be done as

early as 6 weeks, provided the sows have not been vaccinated. Repeated administration of the serum may cause anaphylaxis because of its equine origin. For this reason, it has been withdrawn from sale in many countries.

### Vaccination

There is no fully satisfactory vaccine available for erysipelas because of the strain variation and short duration of immunity, but vaccines have reduced the occurrence of clinical disease. Regular administration at 6-month intervals overcomes this to some extent, but there is always the possibility of a new strain appearing. Most vaccines are formalized whole cultures. Most bacterins are serotype 215, and most of the attenuated live vaccines (only available in some countries, such as the United States and Japan) contain 1a. Vaccines containing serotypes 2 and 10 protect against both *Erysipelothrix* species. Serum-simultaneous vaccination has been largely replaced by the use of bacterins, for which lysate and absorbate preparations are available, or by the use of attenuated or avirulent live-culture vaccines, which are administered orally or by injection. The use of live-culture vaccines is prohibited in many countries because of the risk of variation in virulence of the strains used and the possibility of spreading infection.

None of these vaccines gives lifelong protection from a single vaccination, and the actual duration of protection achieved following vaccination varies considerably. It should not be assumed that protection lasts longer than 6 months. The recent identification of the region responsible for protective immunity should improve these vaccines in future. Most of the commercially available vaccines are formalin-treated whole cultures with an adjuvant.

There is considerable difficulty in the experimental evaluation of the efficacy of erysipelas vaccines. Strain differences in immunogenicity and variation in host response to vaccination attributable to innate and acquired factors influence this evaluation, as does variation in virulence of the challenge strain and the method of challenge. A recent experiment has shown that an antigen of serotype 1a will elicit a protective response to a challenge with serotypes 1a and 2b. Similar factors are involved in the variations seen in field response to the use of these vaccines. Cross-protection of mice and pigs given a live-organism vaccine against 10 serovars of ER has been demonstrated. The use of culture filtrate from a broth culture of an attenuated strain of the organism has been evaluated to produce cross-protective antibody.

Vaccination will reduce the incidence of polyarthritis attributable to erysipelas, but not mild cases of arthritis. Passively acquired maternal immunity may significantly affect the immune response to vaccination in the young piglet. Also, the immunity

engendered by standard vaccines is not uniformly effective against all strains. Vaccine breakdown occurs when the vaccine type is very different from that occurring on the farm. For example, a vaccine made from serotypes 1 and 2 will protect against serotype 10 (ET), but it is not certain that it will protect against serotype 20. Under certain conditions, some unusual serotypes have the potential for causing disease in animals vaccinated with vaccines containing the common serotypes. This possibility cannot be ignored and must be considered when vaccination failures occur. Nevertheless, these vaccines are valuable immunizing agents in field situations.

### Vaccination Program

Following a single vaccination at 6 to 10 weeks of age, significant protection is provided to market age. However, a second “booster” vaccination given 2 to 4 weeks later is advisable. In herds where sows are routinely vaccinated before farrowing, a persisting maternal passive immunity (6 to 9 weeks) may require that piglet vaccination be delayed until 10 to 12 weeks of age for effective active immunity.

Replacement gilts and adults should also be vaccinated. Bacterins are effective, and field evidence suggests that vaccination provides immunity for approximately 6 months. Sows should be vaccinated twice yearly, preferably 3 to 6 weeks before farrowing, because this will also provide significant protection against the septicemic form in young sucklers. If possible, a closed herd should be maintained. Abortion may occur sporadically following the use of live vaccines.

Vaccination is subcutaneous in the skin behind the ear or at the axilla and the flank. Reactions at the site of injection are not uncommon. Swelling with subsequent nodule formation and occasional abscessation may occur following the injection of bacterins, and modified live vaccines may produce hemorrhage in the skin at the injection site. Granulomatous lesions may occur following the use of oil-based vaccines. There is little evidence that vaccination increases the incidence of arthritis. It has been suggested by a very limited study that maternal antibody does not appear to interfere with the vaccination. These vaccines were also used in pigs with PRRS and found to be safe and effective. In those cases where the vaccine has not worked, it may be that the correct serotype was not in the vaccine or the administration and storage instructions were not followed.

### REFERENCES

1. Ozawa M, et al. *J Vet Med Sci*. 2009;71:697.
2. Wang Q, et al. *Vet Microbiol*. 2010;140:405.
3. To H, Nagai S. *Clin Vaccine Immunol*. 2007;14:813.
4. Ingebritson AL, et al. *Vaccine*. 2010;28:2490.
5. Shen HG, et al. *J Appl Microbiol*. 2010;109:1227.
6. Bender JS, et al. *Clin Vaccine Immunol*. 2010;17:1605.

7. Bender JS, et al. *J Vet Diag Invest*. 2011;23:139.
8. Takahashi T, et al. *Microbiol Immunol*. 2008;52:469.
9. Bender JS, et al. *J Vet Diag Invest*. 2009;21:863.
10. Opriessnig T, et al. *J Vet Diag Invest*. 2010;22:86.
11. Pal N, et al. *J Appl Microbiol*. 2009;108:1083.
12. Nagai S, et al. *J Vet Diag Invest*. 2008;20:336.

## ACTINOBACILLUS SEPTICEMIA IN PIGLETS

*Actinobacillus suis* and *Actinobacillus equuli* sometimes cause a fatal septicemia in piglets of 1 to 6 weeks of age. Occasionally in older animals there may be skin lesions or necrotizing pneumonia. It is probably underdiagnosed because most cases are possibly assumed to be *S. suis*.

### ETIOLOGY

It is gram negative and produces small translucent colonies on blood agar. In Canada, two groups appear, one associated with healthy pigs and the other with severely diseased pigs. The organism also produces the Apx toxins I and II. The organism should be distinguished from APP biotype II.

### EPIDEMIOLOGY

It is probably widespread. In one study 94% of the tested herds were positive,<sup>1</sup> but no clinical cases were reported. It is reported infrequently. The introduction of carrier animals may be the cause of infections. Maternal antibodies are usually present in colostrum. Active antibodies are produced at 6 to 8 weeks of age.

### PATHOGENESIS

The organism is probably carried in the nasal cavity and under stress or in the absence of immunity becomes septicemic. It may die at this point or may develop as endocarditis or arthritis. The virulence factors of *A. suis* are unknown, but outer membrane proteins are thought to be important.<sup>2</sup>

### CLINICAL SIGNS

Sudden death may occur and may be attributed to hypoglycemia, starvation, or crushing and not investigated.

Piglets may be pyrexic and have dyspnea, cough, lameness, wasting, abscesses, neurologic components, and cyanosis, with congestion and hemorrhages on the skin and possibly swollen joints. Recovered animals have poor growth. Older animals are not often affected but can be if the bacteria are entering a susceptible herd for the first time. Finishers may also die suddenly, and in the older animals, the condition may resemble swine erysipelas.

### NECROPSY FINDINGS

Animals may have petechiae on the lung; microabscesses throughout the body, particularly the lungs; and skin discoloration. Chronic cases may have endocarditis, pericarditis, pneumonia, or

polyarthritis. Histologically, the lesions are often microabscesses with central necrosis surrounded by neutrophils with bacterial thromboemboli.

## DIAGNOSIS

The clinical signs and pathology are not diagnostic. The infection can be confirmed by pure culture from the liver, kidney, or heart blood and from lesions. Quite often, the organism can be recovered from tonsils of young pigs, vaginas of sows, and the preputial diverticulum of boars. Because there is production of Apx I and II, PCR testing may be useful, but it should be remembered that the level of toxin production is much lower in *A. suis*.

A real-time TaqMan PCR assay for the detection of *A. suis* has been described.<sup>3</sup> It was highly specific, sensitive, and reproducible and gave results within 3 hours.

## TREATMENT

A wide range of antibiotics have proved useful, and most infections clear up in 2 to 5 days. Ceftiofur, gentamicin, and trimethoprim/sulfadiazine seem to be the drugs of choice. Resistance to amoxicillin, ampicillin, and tetracyclines has been recorded.

## REFERENCES

1. MacInnes J, et al. *Can J Vet Res.* 2008;72:242.
2. Ojha S, et al. *Vet Microbiol.* 2010;140:122.
3. Kariyawasam S, et al. *J Vet Diag Invest.* 2011;23:885.

## KLEBSIELLA PNEUMONIAE SEPTICEMIA IN PIGS

*Klebsiella pneumoniae* subspecies *pneumoniae* (KPSP) is an opportunist pathogen causing mastitis in sows but has recently been recognized in the United Kingdom as a cause of septicemia in preweaned pigs in outdoor herds. The organism is commensal in the healthy porcine alimentary tract and is present in the environment in soil and water. It can cause infections in humans, but it is not a recognized zoonosis and is more likely to occur in immunocompromised patients in hospitals. Pigs are found dead, with lesions consistent with septicemia and pure/predominant growth of KPSP isolated from internal sites.

The condition has been seen in preweaned pigs 17 to 28 days of age, in good bodily condition, and occasionally they are found in extremis, recumbent, with cyanosis and mouth breathing, with death within 30 minutes. All the cases occurred in outdoor commercial units in the summer (June through September). The mortality is estimated to be 1% to 4%, with one or a whole litter succumbing. The outbreak lasts from a period as short as 7 to 10 weeks to others lasting for more than 12 weeks.

The lesions can only be described as non-specific, with the most common finding being the presence of fibrin strands in the abdominal cavity. Other findings include ventral skin reddening, serosal hemorrhages, pleural effusions, and reddened lymph nodes. Standard bacteriologic methods recover KPSP from several visceral sites.

The bacteria recovered have an innate resistance to ampicillin. Once weaned, the piglets do not appear to suffer from the condition.

## CHLAMYDIAL INFECTION IN THE PIG

*Chlamydia* spp. infection in the pig has been known in pigs since 1955. These organisms may cause conjunctivitis, pneumonia, pleurisy, pericarditis, polyarthritis, orchitis, infertility, abortion, and the birth of weak piglets. They are also thought to be a cause of enteritis. Many infections are inapparent. Diagnostic laboratories may also not routinely test for *Chlamydia*, and therefore the diagnoses of such infections may be greatly underestimated.

The transmission of *C. abortus* from pigs to humans has not been proven but cannot be excluded. *Parachlamydiae* are probably not involved in abortion, and their potential as a zoonotic agent is also unknown.

## ETIOLOGY

The Chlamydiaceae family includes the genus *Chlamydia*, with nine species. *Chlamydomphila* and *Chlamydia* both occur in the pig, as do *Chlamydia*-like *Parachlamydiae* spp. and *Waddila* spp.<sup>1</sup>

The several species occurring in the pig have been identified by PCR, gene sequencing, DNA probes, and immunohistochemistry.

*Chlamydia suis* has been particularly associated with growing pigs with or without diarrhea and finishing pigs with conjunctivitis.<sup>2,3</sup> Infection is sporadic in pigs, but evidence for infection has been found in boar semen, fetuses, intestinal samples, reproductive tissues, and lungs from pigs in Germany, Switzerland, and Estonia.<sup>4</sup> Although it is considered that the intestine is the natural reservoir for this species, it may also cause lung function disorders, together with pleurisy, pericarditis, polyarthritis, and polyserositis, and reproductive problems. *C. suis* was formerly known as the porcine serovar of *C. trachomatis*, and the only known host is the pig. There is a high genetic diversity in the pig.

*Chlamydia pecorum* is associated with enteritis.

*Chlamydia psittaci* has been associated with respiratory and reproductive problems in pigs.

*Chlamydia abortus* has been associated with aborted material.<sup>5</sup> *Chlamydia trachomatis* has been isolated from the uteri of sows with conception failure.

## EPIDEMIOLOGY

They have been found in pigs in all continents, but particularly North America, Europe, and Asia. Recently, studies have described them in Poland, Italy, Austria, Germany, Scotland, Switzerland, and Belgium. Pigs of all ages may be affected. The presence of antibodies is widespread in the pig population. They have also been found in wild boar; for example, a study of wild boar in Thuringia in Germany found three species: *abortus*, *psittaci*, and *suis*.

They can be spread by aerosol, direct contact, and ingestion of contaminated feed. Venereal transmission may be particularly important. *Chlamydiae* may survive for a long time in the environment, especially if there is a moist organic base. *Chlamydia* have been found to survive up to 30 days in feces and bedding.

Vertical transmission can occur if infections are contracted in utero. Flies and dust are also thought to transmit the organism. There is a suspicion that they may be transmitted by birds. In the United Kingdom, an outbreak of suspected brucellosis subsequently turned out to be chlamydiosis associated with the arrival of thousands of gulls at the morning feeding time of sow rolls to the sows held in outside paddocks. In experimental infections with *C. suis*, it has been found that the diarrhea was dose dependent. In a study of pigs with intestinal lesions, using PCR and immunohistochemistry, it was found that although *C. suis* was identified, there was no correlation with isolation of the organism and clinical signs.<sup>6</sup>

There is no doubt that the occurrence of the agent may be associated with the immunosuppressive disorders that affect the pig (PRRS, PCV2, and SIV). A large pig production unit in Estonia with a problem of postweaning multisystemic wasting syndrome (PMWS) and PCV2 infection and *Chlamydia* was studied.<sup>7</sup> It was found that chlamydial disease occurred 3 days after the introduction of Swedish boars and PMWS 11 days after the introduction.

## PATHOGENESIS

The development of lesions may depend on different factors, such as the virulence of the strain, infectious dose, route of infection, age of the animal, and immunologic status of the host.

Experimental infection of the respiratory tract results in acute exudative or interstitial pneumonia within 4 to 8 days of infection.

The organism is an obligate intracellular parasite characterized by a unique developmental cycle. Elementary bodies (EBs) attach to the host cell by endocytosis and differentiate into noninfectious metabolically active reticulate bodies (RBs). These multiply by binary fission, resulting in mature chlamydial intracytoplasmic inclusion bodies approximately 48 to 72 hours after infection. The



RBs reorganize to form infective EBs, which are released by rupture of host cells and can initiate new cycles. There are also intermediate bodies between EBs and RBs.<sup>8</sup> There are also mostly enlarged RB-like structures called aberrant bodies, and these may allow the persistence of Chlamydiaceae. These aberrant bodies may occur when there are dual infections with other agents.<sup>9</sup> The organism lives in the mucosal epithelial cells, placental trophoblastic epithelium, and monocytes and macrophages.

*C. suis* enteritis may develop within 4 to 5 days following infection and may last for up to 8 days. Villus atrophy develops, and antibodies occur within 2 weeks.

Chlamydial replication was particularly marked at 2 to 4 days following infection and primarily located in the small intestinal epithelium.<sup>10</sup> Further sites of replication included large intestinal enterocytes, lamina propria, and tunica submucosa and mesenteric lymph nodes.

### CLINICAL SIGNS

The clinical signs may vary considerably because of the early development of immunity. They are also variable depending on the presence of concurrent infections, such as PRRS, PCV2, and SIV, and in some cases there appears to be an association with *Lawsonia* and *Brachyspira* infections. In general, most infections are inapparent, but respiratory and systemic infections may result in inappetence and pyrexia (39–41°C, [103–106° F]). Dyspnea, conjunctivitis, and pneumonia may occur and last 4 to 8 days, accompanied by pleurisy and pericarditis with occasional lameness. Clinical signs following experimental infection included moderate to severe diarrhea, slight and transient anorexia, weakness, and body-weight loss.

Pigs experimentally infected with an aerosol challenge of *C. suis* resulted in severe acid-base disturbance characterized by respiratory acidosis and strong ion metabolic acidosis secondary to anaerobic metabolism and hyperlactatemia. Maximal changes were seen at 3 days following inoculation, when severe clinical signs of respiratory dysfunction were evident.<sup>14</sup>

### NECROPSY FINDINGS

The pathologic role of the organism has yet to be clearly defined. However, confirmed cases may show consolidation in the lungs (particularly the caudal lobes), pericarditis, pleurisy, splenic enlargement, synovitis, orchitis, and dead fetuses and mummified piglets. The enteritis is typified by watery contents, undigested food in the stomach, villus atrophy, multifocal necrosis of the villi of the distal jejunum in particular and the ileum, and membranous colitis in the large intestine. Histologically, the villus atrophy can be severe, with villus tip erosions, necrosis of the villi, inflammatory changes, and

lymphangitis. Chlamydial antigens can be demonstrated in the enterocytes.<sup>10</sup>

### DIAGNOSIS

The clinical signs may be suggestive. Bear in mind that most laboratories do not routinely test for *Chlamydia*.

Preparations of intestine, lungs, and other suspect tissues can be stained by Koster's method or by MZN stains, but the acid-fast result is not specific for *Chlamydia* (*Brucella* and *Coxiella* are also acid fast).

Recently, species-specific nucleic acid amplification tests have been developed. These, including PCRs and DNA probes, can identify strains and species. A multiplex PCR has been developed for the usual four species.<sup>11</sup> These PCR techniques target the *omp A* gene, the 16S–23S RNA, or the *inc A* gene.<sup>12</sup> Immunofluorescence and immunoperoxidase methods have been developed for frozen and fixed tissues.

Serology using CF tests (limited use in pigs) or ELISAs can confirm infection, particularly if rising titers can be seen on paired samples. The kits do not allow identification of species and strains, have a high cost, and lack sensitivity and specificity.

### TREATMENT

Tetracyclines are the drug of choice, but resistant strains are not unknown. There is now thought to be a stable tetracycline-resistant phenotype.<sup>13</sup> Second-choice treatments are quinolones or macrolides.

A recent study showed that short-term antimicrobial treatment at dosages recommended for treatment for other bacterial infections in the pig was not effective in the treatment of *Chlamydiosis*. Such treatment did not eradicate subclinical infections.<sup>14</sup> However, it is most important that treatment should last at least 21 days at therapeutic levels to achieve effective eradication.

### CONTROL

Proper cleaning and disinfection in indoor units with effective rodent and bird control is essential. Disinfection with a 1 : 1000 dilution of a quaternary ammonium compound will work, as will a solution of 7% isopropyl alcohol, 1% Lysol, 1 : 100 bleach, or chlorophenols. Outside pig production requires the same techniques but is infinitely more difficult to achieve. In some cases in the United Kingdom, one of the most effective techniques is to get all outside sows fed at the same time because this spreads the descending gull population over several outdoor sites.

Probiotic strains of *E. faecium* have been used to reduce carry-over infections from sows to piglets.

### REFERENCES

1. Koschwanec M, et al. *J Vet Diag Invest.* 2012;24:833.
2. Pospischil A, et al. *Vet Microbiol.* 2009;135:1570.
3. Becker A, et al. *J Vet Med A.* 2007;54:307.
4. Kauffold J, et al. *Theriogenology.* 2006;65:1750.

5. Salinas J, et al. *Vet Microbiol.* 2012;135:157.
6. Englund S, et al. *BMC Vet Res.* 2012;8:9.
7. Schautteet K, et al. *Vet Rec.* 2010;166:329.
8. Pospischil A, et al. *Vet Microbiol.* 2009;135:147.
9. Deka S, et al. *Cell Microbiol.* 2006;8:149.
10. Guscetti F, et al. *Vet Microbiol.* 2009;135:157.
11. Pantchev A, et al. *Comp Immunol Microbiol Infect Dis.* 2010;33:473.
12. Schautteet K, Van Rompay D. *Vet Res.* 2011;42:29.
13. Dugan J, et al. *Microbiol.* 2007;153:71.
14. Rheingold P, et al. *Vet J.* 2011;187:405.

## Multi-Organ Diseases Due to Viral Infection

### FOOT-AND-MOUTH DISEASE (APHTHOUS FEVER)

#### SYNOPSIS

**Etiology** Foot-and-mouth disease virus, an aphthovirus.

**Epidemiology** Affects ruminants and pigs. Highly contagious, usually low mortality but great economic impact worldwide.

**Clinical signs** Fever, profuse salivation, vesicles in mouth and feet, sudden death in young animals.

#### Clinical pathology/diagnostic confirmation

Virus isolation, serology and reverse-transcription polymerase chain reaction (RT-PCR) detection. Typing confirmed in a reference laboratory.

**Lesions** Vesicular, erosive/ulcerative stomatitis and esophagitis, vesicular/ulcerative dermatitis (feet and teats); in neonates, interstitial mononuclear and necrotic myocarditis.

#### Differential diagnostic list

Vesicular stomatitis  
Vesicular exanthema  
Swine vesicular disease  
Rinderpest  
Bovine viral diarrhea

**Treatment** None except symptomatically.

**Control** Mass vaccination with killed vaccines in endemic areas, eradication by slaughter when feasible, and strict quarantine during outbreaks.

### ETIOLOGY

Foot-and-mouth disease (FMD) is a highly contagious disease of cloven-footed animals and is caused by the foot-and-mouth disease virus (FMDV), a small, nonenveloped virus that belongs to the genus of *Aphthovirus*, family Picornaviridae. The picornaviruses include the human rhinovirus causing the common cold and poliovirus causing polio. FMDV occurs as seven major distinct serotypes: A, O, C, Southern African Territories (SAT) 1, SAT 2, SAT 3, and Asia 1. Each serotype has multiple subtypes with varying antigenicity and degrees of virulence, especially within the A and O types. Because there is no

cross-immunity between serotypes, immunity to one type does not confer protection against the others. This presents difficulties for vaccination programs. Furthermore, there can be great changes in antigenicity between developing serotypes; virulence may also change dramatically. There are also biotypical strains that become adapted to particular animal species and then infect other species only with difficulty. There are strains that are much more virulent for pigs (so-called porciphilic strains), some for buffalo, and some even for tropical breeds of cattle, which generally react only mildly to endemic strains. Newer techniques for identifying subtypes involve enzyme-linked immunosorbent assay (ELISA), reverse-transcriptase polymerase chain reaction (RT-PCR) and nucleotide sequence analysis.

## EPIDEMIOLOGY

### Occurrence

FMD affects all cloven-footed animals, and outbreaks are reported from Africa and Asia and less frequently from South America and parts of Europe. The disease can occur in any country or continent, but New Zealand and Australia have always been disease-free, and North America has been so for about 60 years. In nonendemic countries, FMD often occurs as devastating epidemics resulting in great economic losses from the control measures that must be instituted to regain disease-free status. Worldwide, countries have been classified into categories with respect to FMD occurrence as follows<sup>1</sup>:

- Endemic, as in most of sub-Saharan Africa and Asia
- Intermediate, sporadic, as in Eastern Europe and parts of Asia
- Free with vaccination or multizone, as in most of South America
- Free with virus in game parks, as in South Africa
- Free, as in North America, Western Europe, and Australia

By 2009, 70 countries in the world were officially recognized by the OIE as free from FMD with or without vaccination, whereas more than 100 countries were considered as either endemically or sporadically infected with the disease.<sup>2</sup> Three examples of recent major outbreaks since the turn of this century are as follows:

1. An outbreak in Great Britain in 2001 spread to Ireland, France, and the Netherlands before it was eventually contained. The outbreak was traced to illegal import to the United Kingdom of infected meat products. Spread within the country and to other countries was mostly through the movement of livestock not showing obvious clinical signs. Over 10 million animals were culled or died.
2. An outbreak occurred in the Republic of Korea in 2010/2011, during which more than 3 million animals were destroyed.<sup>3</sup>

3. An outbreak in Japan in 2010 involved cattle and pigs. Nearly 300,000 animals were culled, but the epidemic was contained within a localized area and was eradicated within 3 months.<sup>4</sup>

As for North America, the last outbreak in the United States was in 1929, Canada in 1951 to 1952, and Mexico in 1946 to 1954. During the outbreaks, movement of cattle and cattle products between the United States and either Canada or Mexico was brought to a standstill. The importance of the Darien Gap in maintaining the disease-free status of North America is well known. This tract of impassable territory between Colombia and Panama prevents any chance of direct contact between cattle populations in North and South America.

### Prevalence

There are no reliable figures for the prevalence of FMD in different countries. Cases in endemic countries may go unreported unless they occur as outbreaks in previously uninfected regions or herds. Worldwide, the cumulative incidence of FMD serotypes show that six of the seven serotypes (O, A, C, SAT-1, SAT-2, SAT-3) have occurred in Africa, Asia contends with four (O, A, C, Asia-1), South America with only three (O, A, C), and the Middle East periodically has incursions of types SAT-1 and SAT-2 from Africa.<sup>5</sup> Thus, the serotypes and strains are distributed into several major virus ecological reservoirs, each containing distinct regional viral strains from which new variants may emerge.<sup>2</sup> These regional differences are more attributable to the pattern of the meat trade and livestock movements than to any inherent properties of the serotypes. Overall, outbreaks of types O and A occur more frequently than the others, and recently, outbreaks of type C have become uncommon. Whereas the disease in endemic countries may not be clinically apparent and therefore not be promptly reported, it usually occurs as outbreaks in nonendemic countries and rapidly spreads from herd to herd, making international news, before it is controlled.

### Morbidity and Case-Fatality Rate

The morbidity rate in outbreaks of FMD in susceptible animals can rapidly approach 100%, but some strains are limited in their infectivity to particular species, mostly cattle and pigs. However, the case fatality is generally very low, about 2% in adults and 20% in young stock. Nonetheless, severe outbreaks of a more violent form sometimes occur, as in the 1997 Taiwan outbreak in pigs, where case fatality was 18% and reached 100% in piglets, and the outbreak in calves of exotic dairy animals in Nigeria in the 1970s. During outbreaks in nonendemic countries, most deaths are attributable to a slaughter policy that usually involves all susceptible animals and herds in

contact with, or within a certain radius of, the infected herd.

### Methods of Transmission

FMD is transmitted by a variety of methods between herds, countries, and continents, but spread from one animal to another is by **inhalation or by ingestion.** In endemic areas, the most important method of spread is probably by direct contact between animals moving across state and national boundaries as trade or nomadic cattle. In nonendemic areas such as Europe, the first introduction to a new area is often via pigs that contract infection by ingestion of infected meat scraps. Spread from these pigs to cattle is via movement of people, abattoir waste, or animals. Further spread between cattle is more likely to be by airborne means. The virus can persist in aerosol form for long periods in temperate or subtropical climates but not in hot and dry climates. The speed and direction of the wind are important factors in determining the rate of airborne spread. Humidity is also important, but rain as such appears not to be. In the most favorable circumstances, it is now estimated that sufficient virus to initiate an infection can be windborne as far as 250 km (156 miles). There are peaks of spread at dawn and dusk. Animals in the United Kingdom are thought to be vulnerable to airborne transmission of the virus from the European mainland. It has been shown that pigs are the most potent excretors of airborne virus and cattle the most susceptible to airborne infections. During the 2001 outbreak in England, there was no indication of airborne spread to the mainland, perhaps because ruminants rather than pigs were mostly affected.

The risk of airborne infection varies with the FMD serotype and animal species. In a study involving serotypes A, O, and Asia 1, it was found that each serotype demonstrated distinct transmission characteristics and required different exposure times to achieve successful contact transmission.<sup>6</sup> In that study, serotype A required less time of exposure (4 hours) for contact transmission, had the highest levels of viral shedding in saliva and nasal swabs, and also had the highest virus levels in room air compared with serotypes O and Asia 1. Furthermore, under experimental conditions in which virus from affected pigs was given via the intranasal route to cattle, sheep, and pigs, cattle were found to require the least amount of virus to cause infection and give rise to lesions, followed by sheep, whereas pigs were not readily infected by the intranasal route.<sup>7</sup>

In cattle, the first site of virus infection and subsequent rapid multiplication is the pharynx, and the virus is first detectable in the oropharyngeal fluid. The onset of clinical signs is associated with high levels of virus in the blood, oropharyngeal fluid, and nasal fluid.<sup>8</sup> Following a few days of viremia, the virus appears in milk and saliva for up to 24

hours before vesicles appear in the mouth. All other excretions, including urine, feces, and semen, may be similarly infective before the animal is clinically ill and for a short period after signs have disappeared. However, the period of maximum infectivity is when vesicles are discharging because vesicular fluid contains the virus in maximum concentration. Although it is generally conceded that affected animals are seldom infective for more than 4 days after the rupture of vesicles, except insofar as the virus may persist on the skin or hair, some animals may remain as **carriers** and are important in the epidemiology of the disease in the field. In cattle, carriers may develop during convalescence from the natural disease or, more important, in vaccinated animals that are exposed to infection. Up to 50% of cattle, sheep, and goats may become carriers, but pigs do not.

The nasopharynx is the main site for persistence of the FMDV, and erratic low-level excretion may occur for up to 2 years. Using molecular techniques, intact, nonreplicating virus was found in the germinal centers of lymph nodes in the oropharyngeal region for up to 38 days.<sup>9</sup> The virus may also persist in mammary tissue for 3 to 7 weeks. Wild fauna may serve as the FMDV reservoir, and in southern, central, and eastern Africa, the African buffalo (*Syncerus caffer*) is a significant reservoir. Similarly, viral persistence may be a common outcome in the farmed Indian buffaloes (*Bubalis bubalis*) following FMDV Asia 1 infection.<sup>10</sup>

Humans are often a vehicle for transmission of the virus. It has been recovered from the nasal mucosa of persons working with infected cattle for up to 28 hours after contact. Nose-blowing did not eliminate it, nor did cotton face masks prevent infection. In a more recent study, the virus could not be detected in nasal secretions 12 hours after contact, and contaminated personnel could not transmit the disease to susceptible pigs and sheep after they had showered and changed into clean outer wear.

The disease is **spread from herd to herd** either directly by the movement of infected animals or indirectly by the transportation of FMDV on inanimate objects, including farm equipment, uncooked and unprocessed meat products, and other animal products, including milk. The pH and temperature of milk significantly affect survival, which may be as long as 18 hours. Flash pasteurization procedures, as distinct from the holding method, do not inactivate the virus in milk—neither does evaporation to milk powder or processing into butter, cheese, or casein products. The risk of spreading FMDV through importation of vaccinated cattle, sheep, and pigs is extremely small, and the risk from products derived from vaccinated animals is even smaller, provided appropriate risk mitigation measures are applied.<sup>11</sup>

Introduction of FMD into a herd or country as a result of the use of infected

cattle semen for artificial insemination is possible. The virus can also be detected in the semen of infected boars, but this has not been a means of transmitting it. Similarly, it is not transmitted through the transfer of embryos from viremic donor cows.

Epidemics in free areas occur intermittently and from a number of sources. In England it was estimated that outbreaks arose in the following manner:

- Meat products used as pig food—40%
- Completely obscure causes—28%
- Transportation by birds—16%
- Contact with meat and bones other than swill—9%
- Unknown causes (probably swill)—7%

The greatest danger appears to be from uncooked meat scraps fed to pigs. A common pattern is the importation of the virus in sheep meat from sheep that showed no illness, an initial infection in pigs, and then spread to cattle. However, more unusual methods of introduction must not be disregarded. With modern methods of transport, farm workers can carry the virus long distances in their clothing. In Tanzania, where the disease is endemic, roads played a dominant role in epidemic situations between 2001 and 2006, and FMD occurrence was more related to animal movement and human activity via communication networks than transboundary movements or contact with wildlife.<sup>12</sup> Human activity was also the main factor in the spread of the FMD epidemic in South Korea in 2010/2011.<sup>3</sup> However, movement restrictions during the 2010 FMD outbreak in Japan proved insufficient to prevent spread of the disease for about 3 months.<sup>13</sup>

## Risk Factors

### Host Factors

The disease is most important in cattle and pigs, but goats, sheep, and buffaloes in India and llama in South America are also affected. Some strains of the virus are limited in their infectivity to particular species. Although cattle, sheep, and goats can be carriers, they are not regular sources of infection, and early studies in Kenya showed that goats were infrequent carriers, and sheep not at all. Immature animals and those in good condition are relatively more susceptible, and hereditary differences in susceptibility have also been observed. Horses are not susceptible to the disease. Old World camels (dromedaries) are also not susceptible, but New World (Bactrian) camels can contract the disease.<sup>14-15</sup>

A variety of **wildlife species**, such as the deer in England, the water buffalo (*Bubalus bubalis*) in Brazil, and wild ungulates in Africa, become infected periodically but are thought to play little or no role as reservoirs of infection for domestic animals. A notable exception is the **African buffalo** (*Syncerus caffer*), probably the natural host of the SAT types of the virus and the major source of

infection for cattle in southern Africa. The disease in buffalo populations is mild, but the infection rate is often high and can be persistent. On the other hand, the domesticated **Asian buffalo** shows typical clinical disease and spread from buffalo to other species. Small rodents and hedgehogs in Europe and capybaras in South America may also act as reservoirs. **Yaks** that live in high altitudes in China (*Bos grunniens* yaks) are susceptible and can keep carrier status for at least 8 months.<sup>16</sup> In Bulgaria, infection in **wild boar** was found to be a short-lived event that failed to develop into a large-scale epidemic.<sup>17</sup> Feral swine in the United States are susceptible, they can transmit the disease to domestic swine, and FMD viral RNA can persist in their tonsils up to 36 days following infection, by which time virus isolation is negative.<sup>18</sup> The North American bison and elk are also susceptible, but the virus may not be isolated from animals past 28 days postinoculation.<sup>19</sup>

## Environmental and Pathogen Factors

The virus is resistant to external influences, including common disinfectants and the usual storage practices of the meat trade. It may persist for over 1 year in infected premises, for 10 to 12 weeks on clothing and feed, and up to a month on hair. It is particularly susceptible to changes in pH away from neutral. Sunlight destroys the virus quickly, but it may persist on pasture for long periods at low temperatures. Boiling effectively destroys the virus if it is free of tissue, but autoclaving under pressure is the safest procedure when heat disinfection is used. The virus can survive for more than 60 days in bull semen frozen to  $-79^{\circ}\text{C}$  ( $-110^{\circ}\text{F}$ ). In general, the virus is relatively susceptible to heat and insensitive to cold. Most common disinfectants exert practically no effect, but sodium hydroxide or formalin (1% to 2%) or sodium carbonate (4%) will destroy the virus within a few minutes.

All uncooked meat tissues, including bone, are likely to remain infective for long periods, especially if quick-frozen, and to a lesser extent meat chilled or frozen by a slow process. The survival of the virus is closely associated with the pH of the medium. The development of acidity in rigor mortis inactivates the virus, but quick-freezing suspends acid formation, and the virus is likely to survive. However, on thawing, the suspended acid formation recommences, and the virus may be destroyed. Prolonged survival is more likely in viscera, bone marrow, and blood vessels and lymph nodes, where acid production is not so great. Meat pickled in brine or salted by dry methods may also remain infective. For example, dry-cured Serrano and Iberian hams from experimentally infected pigs were shown to contain viable virus for up to 6 months. Fomites, including bedding, mangers, clothing, motor tires, harness, feedstuffs, and hides, may also



remain a source of infection for long periods. There are claims that the virus can pass unchanged through the alimentary tracts of birds, which may thus act as carriers and transport infection for long distances and over natural topographic barriers such as mountain ranges and sea.

Some outbreaks in Europe have been associated with vaccine virus either accidentally escaping from the laboratory or that was incompletely inactivated. The 2007 outbreaks in southern England were caused by a derivative of a virus strain handled in two nearby FMD laboratories.<sup>20</sup>

### Immune Mechanism

In endemic areas, periodic outbreaks occur that sweep through the animal populations and then subside. A 6-year epidemic cycle was demonstrated in India in the 1990s. This was probably as a result of the disappearance of immunity that develops during an epidemic and the sudden flaring up from small foci of infection when the population becomes susceptible again. Immunity after natural infection lasts for 1 to 4 years in cattle and for a shorter time in pigs. When outbreaks follow each other in quick succession, the presence of more than one strain of virus should be suspected. In countries where general vaccination is practiced every year, outbreaks are usually associated with different strains imported in carrier animals or infected meat.

Studies of the interaction of FMDV with cells mediating the early, innate immune response of the host have shown that the virus has a distinct inhibitory effect on the response of the cells.<sup>21</sup> Following aerogenous administration of the virus, cattle were shown to develop a rapid and vigorous local antibody response throughout the respiratory tract in 4 to 5 days postinfection, and this led to IgM-mediated virus clearance.<sup>22</sup>

### Experimental Reproduction

The clinical signs and lesions of FMD can be reproduced by rubbing virus-containing material on the oral mucosa of susceptible cattle or by intradermal inoculation into the dorsum of the tongue. The disease can easily spread from infected to susceptible animals housed in close proximity (cohabitation). With mice and guinea pigs, inoculation of footpads of hindfeet is preferred (see “Clinical Pathology” section).

### Economic Importance

With the possible exception of bovine spongiform encephalopathy (mad cow disease), FMD is the most feared animal disease in the developed world, even though the mortality rate is low. This is because it is the most contagious disease of livestock, and it has a great potential for causing severe economic loss in high-producing animals. Losses occur in many ways, although loss of production, the expense of eradication, and the interference

with movement of livestock and meat between countries are the most important economic effects. There are also significant losses in agriculture and tourism as a result of restriction on human movement. The 2001 outbreak in the United Kingdom was eradicated within 7 months but resulted in the death of nearly 10 million livestock, with losses of up to 8 billion pounds sterling (about US\$12 billion). In the United States the median economic impact of an FMD outbreak in a dairy herd in California was estimated to result in national agriculture welfare losses of up to \$69 billion if the outbreak was not detected within 21 days.<sup>23</sup> However, in unimproved or low-grade *Bos indicus* cattle reared under an extensive or a nomadic system of management, or in pigs in some southeast Asian countries, FMD is often less severe and has fewer effects for the subsistent producer. Nevertheless, because of its severity in exotic or improved breeds and because of its effects on international trade, FMD control and eradication in such countries will still result in a strong benefit–cost ratio in places like Thailand.

### Zoonotic Implications

Humans are thought to be slightly susceptible to infection with the virus, and vesicles may develop in the mouth or hands. Very few cases have been reported, even among people working with infected carcasses and at laboratories. However, humans and particularly their clothing can be vehicles for transmission to animals.

### Biosecurity Concerns

Because FMD is highly contagious, there are biosecurity concerns regarding intentional or accidental introduction of the virus into nonendemic countries. Intentional introduction would be a form of agroterrorism, and this would be devastating in any country that is FMD-free because it would probably take some days before the disease would be recognized and much longer before it could be stamped out. Laboratories working with FMD virus or producing FMD vaccines and reagents must comply with OIE requirements for Containment Group 4 pathogens to ensure that there is no escape of the virus. There are also strict regulations for shipping diagnostic samples to national or international laboratories.

### PATHOGENESIS

The pathogenesis of FMD has been extensively studied and was recently reviewed.<sup>24-25</sup> The surface-exposed capsid proteins (VP1, VP2, and VP3) of the virus determine its antigenicity and the ability of the virus to interact with host receptors and cause disease.<sup>26</sup> Although strain and species differences have been reported, the basic pathogenesis involves the following three phases: (i) previremic phase characterized by infection and replication at the primary

replication sites or sites, (ii) viremic phase with generalization and vesiculation at secondary infection sites, and (iii) postviremia/convalescent phase including resolution of clinical disease that may result in long-term persistent infection.<sup>24</sup>

The previremic phase lasts for about 3 days depending on the infecting dose and the strain of virus and the host. Infection of cattle, sheep, and other ruminants generally occurs via the respiratory route by aerosolized virus attaching to cells lining the route. Infection can occur less efficiently through abrasions on the skin or mucous membranes. Pigs are much less susceptible to aerosol infection and usually become infected by eating FMDV-contaminated food or by direct contact with infected animals, or by being placed into recently infected premises. Following exposure, FMDV particles first attach to mucosal epithelial cells and penetrate into the cytoplasm of the cell. To survive in the host, the virus has evolved a mechanism to block host innate immunity by temporarily blocking interferon (IFN) response and influencing the ability of natural killer cells to recognize and eliminate FMDV-infected cells. This allows the virus to replicate rapidly for a few days, cause viremia, and become highly contagious.<sup>27-28</sup> There is no consensus in reports regarding the anatomic sites involved in early virus replication.<sup>29</sup> The primary replication site in cattle is probably the epithelial cells of the nasopharyngeal region and subsequent widespread replication in the lungs coinciding with onset of viremia.<sup>30</sup> In experimentally infected pigs, FMDV accumulated in mandibular lymphoid tissue up to 6 hours after infection and in the tissues draining the mandibular lymph node and tonsil, then disseminated throughout the body, where epithelial cells were the favored sites of (secondary) replication.<sup>31</sup>

Irrespective of the portal of entry, once infection gains access to the bloodstream (viremic phase), the virus is widely disseminated to many epidermal sites, probably in macrophages, but gross lesions develop only in areas subjected to mechanical trauma or unusual physiologic wear, such as the epithelium of the mouth and feet, the dorsum of the snout of pigs, and the teats. Characteristic lesions develop at these sites after an incubation period of 1 to 21 days (usually 3 to 8 days in most species). The initial phase of viremia is often unnoticed, and it is only when localization in the mouth and on the feet occurs that the animal is found to be clinically abnormal. Furthermore, the virus can be excreted in exhaled air, saliva, milk, semen, urine, and feces during this phase for about 2 weeks.

The postviremic phase is characterized by healing of lesions. The process can be rapid in the oral mucosa but often slow in the feet. Associated mastitis in dairy animals can also become chronic. Most adult animals will

recover from FMD, become immune to the serotype for years, and no longer be contagious. A few recovered ruminants can become carriers for several months, whereas the African buffalo are lifelong carriers. The virus is thought to persist in the oropharyngeal region, the germinal centers of lymph nodes,<sup>32</sup> and possibly in dendritic cells in lymphoid organs.

The experimental disease in sheep is characterized by an incubation period of 4 to 9 days after contact or 1 to 3 days after virus inoculation. Thereafter, viremia occurs at 17 to 74 hours and hyperthermia from 17 to 96 hours. Clinical signs are serous nasal discharge, salivation, and buccal lesions in 75% of cases and foot lesions in 25%. At the end of viremia, the animal recovers, but the virus may persist in the pharyngeal area of convalescent ruminants as previously discussed.

Bacterial complications generally aggravate the lesions, particularly those of the feet and the teats, leading to severe lameness and mastitis, respectively. In young animals, especially neonates, the virus frequently causes necrotizing myocarditis, and this lesion may also be seen in adults infected with some strains of the virus, particularly type O.

### CLINICAL FINDINGS

In typical field cases in cattle, there is an incubation period of 3 to 6 days, but it may vary between 1 and 7 days. The onset is heralded by a precipitate fall in milk yield and a high fever (40° to 41°C [104° to 106° F]), accompanied by severe dejection and anorexia, followed by the appearance of an acute painful stomatitis. At this stage, the temperature reaction is subsiding. There is abundant salivation, with the saliva hanging in long, rope-like strings; a characteristic smacking of the lips is present; and the animal chews carefully. Vesicles and bullae (1 to 2 cm in diameter) appear on the buccal mucosa, dental pad, and tongue. These rupture within 24 hours, leaving a raw, painful surface that heals in about 1 week. The vesicles are thin walled, rupture easily, and contain a thin, straw-colored fluid. Concurrently with oral lesions, vesicles appear on the feet, particularly in the clefts and on the coronet. Rupture of vesicles causes acute discomfort, and the animal is grossly lame and often recumbent, with a marked, painful swelling of the coronet.

Secondary bacterial invasion of foot lesions may interfere with healing and lead to severe involvement of the deep structures of the foot. Vesicles may occur on the teats; when the teat orifice is involved, severe mastitis often follows. Vesicles on the teats may be the primary clinical sign observed by the dairy farmer, as in the 2010/2011 epidemic in the Republic of Korea.<sup>33</sup> Pregnant animals may abort or have stillbirths. Very rapid loss of condition and fall in milk yield occur during the acute period, and these signs are

much more severe than would be anticipated from the extent of the lesions. Eating is resumed in 2 to 3 days as lesions heal, but the period of convalescence may be as long as 6 months. Young animals are more susceptible and may suffer heavy mortality from myocardial damage, even when typical vesicular lesions are absent in mouth and feet.

In most outbreaks, the rate of spread is high and clinical signs are as described earlier, but there is a great deal of variation in virulence, especially in beef cattle, and this may lead to difficulty in field diagnosis. For example, there is a malignant form of the disease in adults in which acute myocardial failure occurs. There is a typical course initially but a sudden relapse occurs on days 5 to 6 with dyspnea, a weak and irregular heart action, and death during convulsions. Occasional cases show localization in the alimentary tract with dysentery or diarrhea, indicating the presence of enteritis. Ascending posterior paralysis may also occur. On the other hand, there is a mild form that usually occurs when endemic strains infect only indigenous *Bos indicus* (Zebu) cattle. This is the form most commonly seen in endemic countries in Africa, Asia, and South America.

A sequela to FMD in cattle, probably as a result of endocrine damage, is a chronic syndrome of dyspnea, anemia, overgrowth of hair, and lack of heat tolerance. Affected cattle are described colloquially as “hairy panter.” The syndrome has been reported in European cattle breeds but has not been described in zebu cattle from India.<sup>34</sup>

In sheep and goats, the disease is often mild and may go unnoticed. FMD in small ruminants is important mainly because of the danger of transmission to cattle. Adult sheep may develop a syndrome identical to that of cattle, and thus it becomes a crippling disease with occasional loss of hooves from bacterial complications. Goats are sometimes spared during an outbreak. The more common syndrome in these species is the appearance of a few small lesions, but with more severe involvement of all four feet. As in cattle, young stock are more susceptible.

FMD in pigs can be very severe, and devastating epidemics involving pigs only or pigs and other species are reported from time to time in Asia. A porcophilic strain (0/Taiwan/97) has been identified and studied. Following intradermal inoculation, symptoms of depression and inappetence appeared at 1 day postinoculation (dpi), whereas vesicles were observed at the inoculation site at 1 dpi and on the mouth and snout the following day.<sup>35</sup> Teats can also be affected in nursing sows. Large vesicles and bullae may rupture to expose large, raw surfaces. Remnants of feet lesions may persist for more than 2 months, and such residual lesions may aid in clinical diagnosis. Experimentally infected feral swine were fully susceptible but exhibited a higher tolerance to

FMD than domestic swine; the latter showed clinical signs of the disease within 24 hours after contact with the feral swine, whereas feral swine did not do so until 48 hours after contact with domestic and feral swine.<sup>18</sup>

### CLINICAL PATHOLOGY

During FMD outbreaks, laboratory investigations are carried out to diagnose the disease rather than for clinical assessment as with most other diseases. Exhaustive laboratory studies are needed for diagnosis, determination of the type of the virus involved, and to differentiate the disease from vesicular stomatitis, vesicular exanthema, and swine vesicular disease. A handbook of the standard tests used worldwide is provided from time to time.<sup>36</sup> Fresh vesicular fluid and surrounding epithelial tissue should be collected in a transport medium composed of equal amounts of glycerol and 0.04 M phosphate buffer, pH 7.2 to 7.6, or glycerol and phosphate buffered saline for laboratory tests. This is the sample of choice. If the vesicles are already healing, blood should be collected, along with esophageal-pharyngeal (OP) fluid samples from ruminants or throat swabs from pigs. The OP samples should be collected from up to five animals with the use of a probang cup. In tropical countries with maximum temperature fluctuations, spoilage of FMD-suspect samples originating from remote areas can be minimized by using FTA Classic Cards for collection, shipment, storage, and identification of the FMDV genome by RT-PCR and real-time RT-PCR.<sup>37</sup> The major methods for diagnosis are as follows:

1. Identification of the agent in tissue or fluid
  - **Virus isolation** by inoculation into cell cultures or unweaned mice. The cell cultures should be examined for cytopathic effect for 48 hours. If no CPE is detected, the cells should be frozen and thawed, used to inoculate fresh cultures, and examined for CPE for another 48 hours. Alternatively, unweaned mice 2 to 7 days old can be used (see following discussion of experimental transmission). With diagnostic samples, neutralization of the virus by known antisera makes the technique highly efficient and specific.
  - Immunologic methods:
    - **Enzyme-linked immunosorbent assay (ELISA)**: This is the preferred test for the detection of FMD viral antigen and identification of viral serotype. It is an indirect sandwich test in which different rows in multiwell plates are coated with rabbit antisera to each of the seven serotypes of FMD virus. It can simultaneously test for swine vesicular disease (SVD) or

vesicular stomatitis (VS) where appropriate.

- **Complement fixation test (CFT):** This can be used if reagents for ELISA are not available. It is less sensitive and is affected by pro- and anticomplementary factors. Direct CFT on epithelial suspension used to be one of the fastest methods of making a positive diagnosis, within a few hours, but negative samples must be checked in tissue cultures because of the number of false negatives that occur with the CFT, especially in poorly collected and packaged samples.

- **Nucleic acid recognition methods:** These include reverse transcription polymerase chain reaction (RT-PCR) and in situ hybridization (ISH). The RT-PCR amplifies fragments of FMD genome in samples and can be used for typing. It is more sensitive than ELISA. The procedures used include agarose gel-based RT-PCR assay, real-time RT-PCR assay, and molecular epidemiology based on the comparison of genetic differences between viruses.<sup>36</sup> A reverse-transcription loop-mediated isothermal amplification (RT-LAMP) assay has been described that is simple and rapid and can be read within 1 hour, whereas conventional RT-PCR methods require 2 to 4 hours.<sup>38</sup> More recently, a lateral flow immunochromatographic (LFI) strip test has been reported that can diagnose FMD serotypes O, A, and Asia 1 using a generic rapid assay device.<sup>39</sup> The procedure takes only 10 minutes and can be done on-site; it also has high specificity and can be used for early detection of FMD in the field. In addition, a field-portable nucleic acid extraction and real-time PCR amplification platform has been developed for rapid detection of FMD.<sup>40</sup> The ISH detects FMD virus RNA in infected tissues, including those obtained during necropsy.

## 2. Serologic tests

- Serologic tests for FMD are of two types: those detecting antibodies to viral structural proteins (SPs) and those detecting antibodies to viral nonstructural proteins (NSPs).<sup>36</sup> The SP tests detect antibodies elicited by vaccination and infection and are serotype-specific and highly sensitive, provided that the virus or antigen used in the test is closely matched to the strain circulating in the field. They are the prescribed tests for international trade. Examples are as follows:
  - Virus neutralization (VN)

- Solid-phase competitive ELISA, another prescribed test
- Liquid-phase blocking ELISA
  - The NSP tests can be used to identify past or current infection with any of the seven serotypes of the virus, whether or not the animal has been vaccinated. The tests are more useful on a herd basis. For certifying animals for trade, the tests have the advantage over the SP methods in that the serotype of the virus does not have to be known. The assays measure antibodies to NSPs using antigens produced by recombinant techniques. Antibodies to polyproteins 3AB or 3ABC are generally considered to be the most reliable indicators of infection. Examples include:
    - Indirect ELISA
    - Enzyme-linked immunoelectrotransfer blot assay.
 Where vaccination has been carried out and a diagnosis has to be made by serologic methods, it is necessary to differentiate between infected and vaccinated animals (DIVA). An epitope-based ELISA has been described that can differentiate infected from vaccinated animals and appears to be promising test for FMD control and eradication.<sup>41</sup>

## 3. Experimental transmission

- The propagation of the virus in unweaned white mice can be used to detect the presence of virus in suspected material, the presence of antibodies in serum, and for investigations into the transmission of immunity and the pathogenesis of the disease. In guinea pigs, intradermal injection of fresh vesicular fluid into the plantar pads causes vesicles to appear on the pads in 1 to 7 days and secondary vesicles in the mouth 1 to 2 days later. Large-animal inoculation may be used for the differentiation of FMD, vesicular stomatitis, and vesicular exanthema based on the different species' susceptibilities to the three viruses (Table 21-3) and to test the potency of vaccines. To avoid disseminating the virus, animal inoculation should be done only in specially equipped facilities.

## NECROPSY FINDINGS

The lesions of FMD consist of vesicles and erosions in the mouth and on the feet and udder. The erosions often become ulcers, especially if secondary bacterial infection has occurred. In some cases, vesicles may extend to the pharynx, esophagus, forestomachs, intestines, trachea, and bronchi. The

teats and mammary gland are often swollen. In the malignant form and in neonatal animals, epicardial hemorrhages with or without pale areas are also present. Grossly, the ventricular walls appear streaked with patches of yellow tissue interspersed with apparently normal myocardium, giving the typical "tiger heart" appearance. If the animal survives, there is replacement fibrosis, and the heart is enlarged and flabby.

Histologically, vesicles start as foci of progressive swelling, necrosis, and lysis of infected keratinocytes in the deeper layers of the epidermis and accumulation of fluid in the space. This is followed by necrosis of overlying keratinocytes and rupture of vesicles to form erosions that may extend deep into the dermis to form ulcers, especially on the feet. There is only mild leukocytic infiltration around the erosions and ulcers. Similar changes in mammary gland epithelium lead to acinar necrosis and mild interstitial cellular infiltration. Heart (and occasionally skeletal muscle) lesions in the malignant form are characterized by severe hyaline degeneration, necrosis, and occasional calcification of myocardial fibers and marked interstitial infiltration by mononuclear cells. In addition, pancreatic islet and acinar degeneration has been reported in chronically infected cattle.

Tissues to be submitted for histopathology should include oral mucosa and skin containing vesicles or fresh erosions. The heart, mammary gland, and pancreas should also be included. Viral antigen can be detected in tissues by immunohistochemistry. Because most animals infected with FMD will not die and because it is important to make prompt diagnosis from clinical cases, histopathology of necropsy materials is often secondary.

## DIFFERENTIAL DIAGNOSIS

The need to identify foot-and-mouth (FMD) is of paramount importance in all countries. It is of particular importance in those countries in which the disease is not endemic because of the need to introduce strict control measures quickly. The field or zoo veterinarian must be able to recognize suspicious cases, take appropriate samples, and submit them to a laboratory facility able to confirm the diagnosis promptly. Clinical signs in sheep, goats, and zoo animals such as elephants, giraffes, and camels may be difficult to recognize. In countries where the disease is endemic, there are special difficulties in clinical recognition because of the frequent subdued severity of the oral and feet lesions, even in cattle. Where the other vesicular diseases do not occur, suspicions will be readily aroused, but in North America, the presence of vesicular stomatitis and vesicular exanthema may result in misdiagnosis. Vesicular stomatitis in horses, cattle, and swine, vesicular

*Continued*



Table 21-3 Differentiation of acute vesicular disease

Animal species	Route of inoculation	FMD	Vesicular stomatitis	Vesicular exanthema of swine	Swine vesicular disease	Bluetongue
<b>Natural infection</b>						
Cattle		+	+	–	–	+ (occurs rarely)
Pig*		+	+	+	+	–
Sheep and goat		+	±	–	–	+
Horse		–	+	–	–	–
<b>Experimental transmission</b>						
Cattle	Intradermal in tongue, gums, lips	+	+	–	–	+
	Intramuscular	+	–	–	–	–
Pig*	Intradermal in snout, lips	+	+	+	+	–
		+	+	+	+	–
	Intravenous	+	–	–	+	–
	Intramuscular	+	–	–	+	–
Sheep and goat	Various	+	+	–	+ (no lesions)	+
Horse	Intradermal in tongue	–	+	+ (some strains)	–	–
	Intramuscular	–	–	+ (some strains)	–	–
Guinea pig	Intradermal in footpad	+	+	–	–	–
Unweaned white mice	Intradermal	+	+	–	+	+ (hamsters also)
Adult chicken		+	+	–	–	–

\*White-skinned pigs fed on parsnips or celery and exposed to sunlight develop vesicles.

exanthema of swine, and swine vesicular disease resemble FMD closely (Table 21-3). Three other vesiculoviruses—Piry, Chandipura, and Isfahan—cross-react with vesicular stomatitis virus<sup>18</sup> but are much less virulent. The observations that white-skinned pigs fed parsnips or celery and exposed to sunlight will develop vesicles on the snout and feet and that cattle fed on grain treated with caustic soda can develop profuse salivation are further confounding factors in the differentiation of the vesicular diseases.

Bluetongue of sheep may also present a problem in differentiation. Details of these are provided separately, but a summary is given in Table 21-3. Rapid laboratory differentiation and diagnosis of these diseases may be achieved, as described under Clinical Pathology (see previous discussion).

Bovine viral diarrhea/mucosal disease, rinderpest, malignant catarrhal fever, and lumpy skin disease are easily differentiated by the lesions that develop in the mucosa and sometimes on the feet. The lesions are never vesicular, commencing as superficial erosions and proceeding to the development of ulcers. Pox infections of the mammary gland and foot rot in sheep should also be differentiated from FMD. Ingestion of any caustic material may cause oral vesiculation and salivation. Among zoo animals, giraffes, elephants, and camels are susceptible.

## TREATMENT

### TREATMENT AND CONTROL

**Treatment**  
Nonspecific

### Control

Vaccination with killed vaccine (R-1 in endemic areas)

Treatment with mild disinfectant and protective dressings to inflamed areas to prevent secondary infection is recommended in endemic countries where a slaughter policy is not in force. A good symptomatic response is reported to the administration of flunixin meglumine. In Kenya, ethnoveterinary remedies of natural soda ash solution (97% sodium bicarbonate), honey, and finger millet flour were used to manage FMD lesions during an outbreak in a medium-scale dairy farm.<sup>42</sup> The lesions were washed with soda ash solution to remove the necrotic tissue, after which raw honey and finger millet flour were applied daily for 3 days. Experimentally, it has been shown that administration of porcine type I interferon to pigs or bovine type III interferon to cattle can protect swine or significantly delay and reduce the severity of FMD in cattle challenged with FMDV for up to 7 days.<sup>43-44</sup> These interferons can thus inhibit FMDV replication before an inactivated vaccine can induce protection in the face of an outbreak in endemic areas.

### CONTROL

Many factors govern the control procedure in a given area. The procedures commonly used are (a) control by eradication and (b) control by vaccination, or a combination of the two. In countries where the disease is endemic, or where there are wildlife reservoirs, eradication is seldom practicable. In

areas with only occasional epidemics, slaughter of all infected and in-contact animals is usually carried out. It must be remembered that vaccination is costly and sometimes ineffective and that eradication would be the ideal objective in all countries. For countries in large continents, international cooperation is required for eradication. The European Union phased out mass vaccination in 1991 to increase its international competitiveness in trade in livestock and livestock products. Soon after, outbreaks of FMD in Italy were controlled by surveillance and slaughter of thousands of cattle, sheep/goats, and pigs in all-infected and contact herds. A similar procedure was adopted in 2001 in England, Ireland, and France and with some modification in the Netherlands, and the outbreaks were successfully controlled within months. Similar results were obtained in Taiwan during periodic outbreaks between 1997 and 2011. On the other hand, a 2010 epidemic in Japan was eradicated within 3 months in an area with high density of cattle and pigs by strict movement control and emergency vaccination.<sup>4</sup>

As in the control of all epidemic infectious diseases, the problems posed for administrators are complex and continually changing. For example, the prospect of making a wrong decision about when to switch from an eradication-by-slaughter program to a containment-by-vaccination program, when an outbreak is raging and public sentiments are running high, is a daunting one. A wrong decision may cost a livestock industry many millions of dollars. To avoid making such errors, it is customary to develop a mathematical or computer

model that simulates the progress of an outbreak in terms of numbers of animals infected, affected, and dead, and how these numbers will change under pressure from control procedures, management practices, and prevailing weather. An essential aspect of such an analysis is the economic effect of various control programs and their outcomes. The cost–benefit aspects of computer simulation models and the meteorologic predictions of the likely spread of the disease are used to determine an appropriate strategy for control. Even then, conclusions from such models may still be controversial, as was the case in the 2001 outbreak in England, where a culling policy driven by unvalidated predictive models rather than experience contributed to the death of approximately 10 million animals.<sup>44–45</sup>

### Control by Eradication

The success of an eradication program depends on the thoroughness with which it is applied. As soon as the diagnosis is established, all cloven-footed animals in the exposed groups should be immediately slaughtered and burned or buried on site. No reclamation of meat should be permitted, and milk must be regarded as infected. Inert materials that may be contaminated must not leave infected premises without proper disinfection. This applies particularly to human clothing, motor vehicles, and farm machinery. Bedding, feed, feeding utensils, animal products, and other articles that cannot be adequately disinfected must be burned. Barns and small yards must be cleaned and disinfected with 1% to 2% sodium hydroxide or formalin or 4% sodium carbonate solution. Acids and alkalis are the best inactivators of the virus, and their activity is greatly enhanced by the presence of a detergent. The effective pH at a disinfection surface may be grossly altered by the presence of organic matter and needs to be adequately maintained. When all possible sources of infection are destroyed, the farm should be left unstocked for 6 months and restocking permitted only when “sentinel” test animals are introduced and remain uninfected. There are strict international requirements for demonstrating freedom from infection.

Recommendations for outdoor sites are difficult to make. Observations in Argentina suggest that contaminated pastures and unsheltered yards are clear of infection if left unstocked for 8 to 10 days. No animal movement can be permitted, and human and motor traffic must be reduced to a minimum. Persons working on the farm should wear waterproof clothing, which can be easily disinfected by spraying and subsequently removed as the person leaves the farm. Clothing not suitable for chemical disinfection must be boiled. Because of the rapidity with which the disease may spread, immediate quarantine must be imposed on all farms

within a radius of 16 to 24 km (10 to 15 miles) of the outbreak.

Although the eradication method of control is favored when the incidence is low, it imposes severe losses on the animal industry in affected areas and is economically impracticable in many countries. However, it must be regarded as the final stage in any control program. The standard strategy is the containment of the disease by ringing the outbreak with a zone of vaccinated animals and setting about reducing the infection rate within the ringed area and eventually eradicating remaining hotspots by slaughter. Containment of an outbreak is a difficult task with high rewards, as shown by various cost–benefit analyses.

The controversy about whether to eradicate or vaccinate is ongoing. For example, the 1967–1968 epidemic in the United Kingdom involving the slaughter of nearly half a million animals at a cost of US\$250 million was so damaging financially that it was arranged for vaccination to be available should there be a recurrence of such an epidemic. Nevertheless, the slaughter policy was still adopted in 2001, and many more animals were killed. Part of the increased concern about a test and slaughter policy derives from the following factors:

- Increasing size of herds
- Risks involved if infection is introduced
- Environmental concerns regarding carcass disposal if thousands or millions of animals are to be slaughtered within a short time. During the 1997 epidemic in Taiwan, it was reported that a disposal capacity of 200,000 pigs per day was reached despite ring vaccination. In England, disposal capacity was overwhelmed in 2001, even with military intervention, and carcasses were sometimes left for days before burial or burning. A recent study in the United States concluded that depopulation of a large feedlot during an FMD outbreak would be difficult to complete in a humane and timely fashion.<sup>46</sup>

### Vaccination

Regular vaccination against FMD is a way of life for most of the world, and vaccine production is a major industry. In the endemic countries, eradication does not seem possible within the foreseeable future, and countries free of the disease may require regional vaccination during outbreaks. Consequently, it has been estimated that 1.5 billion monovalent doses of the FMD vaccine are administered annually, with South America alone accounting for some 1300 million doses.

Killed trivalent (containing O, A, and C strains) vaccines are in general use, but because of the increasing occurrence of antigenically dissimilar substrains, the production of vaccines from locally isolated virus is becoming a more common practice. The

virus is obtained from infected tongue tissue, a cell culture of bovine tongue epithelium, or other cell culture. Baby hamster kidney (BHK) is a favored viral cultural medium, and BHK vaccine is now in general use. Its principal virtue is its adaptability to deep suspension culture, in contrast with its growth on monolayer culture, enabling large-scale production of the virus to be carried out within practicable space limits. Inactivation of the virus to produce a killed vaccine used to be done with formalin, but there are disadvantages with its use, and more sophisticated agents, especially binary ethylene imine (BEI) are now used. Serviceable immunity after a single vaccination can be relied on for only 6 to 8 months. Vaccines produced from “natural” virus give longer immunity than those produced from “culture” virus. Vaccines produced in oil-adjuvant form offer promise of providing longer immunity and require only annual revaccination in adult cattle and biannual revaccination for young stock or every 4 to 6 months in pigs.

A general vaccination program for an area must be planned for that area. Thus in continental Europe, the program until 1991 included an annual vaccination of all adults, with an additional campaign every 6 months to vaccinate calves as they reached about 4 months of age. In South America, the specific recommendations are that calves from unvaccinated dams should be vaccinated at 4 months and revaccinated at 8 months of age, but calves from vaccinated cows should be vaccinated twice, the first at 6 months and the second at 10 months of age. The important considerations in calves are to avoid vaccination while the calf is still carrying maternal antibodies derived from colostrum and to avoid infection before they can develop active immunity. Calves as young as 1 week old respond as actively to vaccination as adult animals, provided they are free of maternally derived antibody. Immunity is present 7 to 20 days after vaccination, depending on the antigenicity of the vaccine. It is not usual to include sheep, goats, and pigs in a general vaccination program unless they are also affected during outbreaks. After the outbreak in Taiwan, it was recommended that piglets be vaccinated at 8 to 12 weeks followed by a boost 4 weeks later, and that sows be vaccinated 3 to 4 weeks before farrowing or every 4 to 6 months.

Because of the short duration of the immunity produced by killed vaccines, attention has been focused on the production of an attenuated living-virus vaccine. The major difficulty encountered so far has been the narrow margin between loss of virulence and loss of immunogenicity. Attenuated vaccines have been produced by passage through white mice, embryonated hen eggs, rabbits, and tissue culture. Their use has contributed to the eradication of the disease in cattle in South Africa. Vaccines

have also been instrumental in eliminating FMD from most countries in South America under the Pan American Centre for Foot and Mouth Disease (PANAFTOSA).

Provided constant surveillance can be maintained over vaccinated animals, their value in such circumstances cannot be denied. However, their early promise has not been fulfilled, and improved killed vaccines are most generally favored. In spite of the uncertain stability of the lapinized virus, control of the disease in Russia was reported after the use of a rabbit-passaged vaccine. In those countries where vaccination of very large numbers of animals is carried out annually, one of the emerging problems is the quality control of vaccines with respect to innocuity and to immunizing capacity or potency. The techniques to monitor these characteristics are available, but they do add to the costs of the vaccine, and if commercial competition is keen, this aspect of production may be spared. Some outbreaks have been linked to attenuated vaccines.

A great deal has been written about genetically engineered FMD vaccines produced by biotechnological manipulation and their distinct safety advantages over whole-virus vaccines. Initial reports of a polypeptide vaccine (protein VP1) in cattle are encouraging, and the peptide can be chemically synthesized and incorporated into the core of hepatitis B virus to produce a vaccine. Research is ongoing, and at least one novel molecular vaccine has been licensed for emergency use in the United States.<sup>47</sup> However, much work still needs to be done, and these newly developed vaccines cannot yet replace the classical inactivated vaccines.

General vaccination as a means of control is recommended for countries where the disease is enzootic or where the threat of introduction is very great (e.g., Israel). If an outbreak occurs, a booster vaccination with the relevant serotype will greatly increase the resistance of the population. However, the strategy of general vaccination has many difficulties. The following disadvantages are suggested:

- To be effective, the program should consist of vaccination against a number of strains three times yearly. More frequent vaccination may be necessary in the face of outbreaks during optimum conditions for spread. Young animals with maternally derived antibodies do not respond to vaccination.
- Vaccination of sheep and pigs is also used in control programs. In pigs, a bi- or trivalent, inactivated, adjuvant vaccine gives strong immunity for 6 months and some resistance for 12 months. Severe local reactions (abscesses and granulomas) at vaccination sites can be reduced by the inclusion of an oil-adjuvant. However, vaccination of pregnant sows leads to a

high rate of abortions and stillbirths. In sheep, monovalent or trivalent vaccines give immunity for 5 to 6 months, but the sheep may act as inapparent carriers. One study suggested that a single emergency vaccination would be effective in the control of an epidemic involving cattle and sheep, but would be less effective in pigs.<sup>47</sup>

- Inapparent infections may occur in animals whose susceptibility has been reduced by vaccination, permitting the existence of “carrier” foci. It has become generally recognized that the number of carrier animals produced by vaccination is very much greater than was previously thought. Apart from the fact that these animals are a potent method of spreading the disease, they also provide an excellent medium for the mutation of existing virus strains because the hosts are immune. The carrier state in vaccinated and unvaccinated cattle may persist for as long as 6 months and be capable of causing new outbreaks in all species. But the problem must be kept in perspective. The number of carriers produced in this way is directly related to the rate of occurrence of the disease in the population, and if this is kept to a minimum by an assiduous vaccination program and a strict limitation on the movement of infected animals into the population, the rate of occurrence of carriers can be very small. Nevertheless, in FMD-free countries, vaccinated animals are subsequently slaughtered to comply with OIE regulations so as to resume meat export as soon as possible. However, this policy is now being challenged from the point of view of animal welfare.
- Importation of vaccinated animals is often prohibited even though trade in these animals and their products poses minimal risk of transmitting FMD.<sup>11</sup> An additional disadvantage is the production of sensitivity resulting in anaphylaxis in 0.005% of cattle vaccinated repeatedly, especially when the vaccines contain antibiotics or the vaccine contains foreign protein not associated with the antigen, or the virus has been killed with formalin that has also denatured the protein in the vaccine. Edema, urticaria, dermatitis, abortion, and fatal anaphylaxis all occur. Cows in early and late pregnancy or otherwise stressed from other diseases are most susceptible to adverse effects of vaccination. Satisfactory purification and standardization of the vaccine can eliminate many of the problems because the hypersensitivity is to the culture medium and to the agent used to kill the virus, rather than the virus itself.
- Countries that vaccinate during an outbreak have to reestablish their FMD-free status to the satisfaction of their trading partners. This is difficult because currently available vaccines stimulate production of antibodies indistinguishable from those following infection, and because vaccinated animals can be infected and become carriers. The detection of antibodies to nonstructural proteins is helpful in making the distinction at herd level, and further research is ongoing to standardize the techniques. Alternatives to general vaccination are modified programs, including “ring” vaccination to contain outbreaks, “frontier” vaccination to produce a buffer area between infected and free countries, and vaccination of selected herds on a voluntary basis when an outbreak is threatened. Such emergency vaccinations can reduce the risk of spreading infection by reducing the rate of virus excretion. It is generally conceded that vaccination of an entire population may be necessary when eradication is incapable of preventing the spread of the disease. For this reason, many countries have strategic reserves of concentrated vaccines, but no such vaccine banks exist in Africa. Prevention of entry of the disease into free areas is an ever-increasing problem because of modern developments in communications. The following prohibitions are necessary if the disease is to be excluded:
  - There must be a complete embargo on the importation of animals and animal products from countries where FMD is endemic. The embargo should include hay, straw, and vegetables. Where the disease occurs only as occasional outbreaks, importation of animals can be permitted provided they are subjected to a satisfactory period of quarantine.
  - Particular attention should be given to preventing entry of uncooked meats from ships, airplanes, and other forms of transport and in parcels originating in infected areas. In danger areas, all swill fed to pigs must be cooked and all food waste satisfactorily disposed of.
  - Personal clothing and other items belonging to people arriving from infected areas should be suitably disinfected. Persons arriving from endemic countries or countries experiencing outbreaks should keep away from livestock for several days.
  - The risk of introducing the disease through importation of semen or fertilized ova is now thought to be minimal. The virus can survive in frozen bull semen and possibly in some fertilized ova (e.g., zona pellucida-free bovine embryos) but not in others (e.g., zona pellucida-intact bovine embryos). However, because even viremic animals



do not transmit the disease through their embryos, bovine embryos with intact zona pellucida can be safely imported from enzootic areas regardless of the serologic status of the donor. Consequently, if exotic or special animals have to be imported from enzootic countries, embryo transfer may be a means of controlling the transmission of FMD. Even for llama embryos that lack a zona pellucida, the risk of FMD transmission was calculated to be close to zero if favorable epidemiologic or ecological conditions exist in the region of origin of the embryos.

In summary, the control and eventual eradication of FMD in a country, region or worldwide can only be achieved if the international community recognizes that the control of FMD is a global public good that will benefit all populations and future generations.<sup>2</sup> In South America, under the auspices of the PANAFTOSA's new Plan of Action 2011–2020, it is hoped that several challenges will be overcome to ensure eradication of FMD from the Americas by 2020.<sup>48</sup>

#### FURTHER READING

- Blackwell JH. Internationalism and survival of foot-and-mouth disease virus in cattle and food products. *J Dairy Sci.* 1980;63:1019.
- Brown F. Review literature Foot-and-mouth disease—one of the remaining great plagues. *Proc R Soc Lond Biol.* 1986;229:215.
- Donaldson AI, Doel TR. Foot-and-mouth disease: the risk for Great Britain after 1992. *Vet Rec.* 1992;131:114.
- Grubman MJ, Barry B. Foot and mouth disease. *Clin Microbiol Rev.* 2004;17:465.
- Rweyemamu MM, et al. The control of foot and mouth disease by vaccination. *Vet Ann.* 1982;22:63.
- Scott GR. Foot-and-mouth disease. In: Sewell MMH, Brocklesby DW, eds. *Handbook on Animal Diseases in the Tropics.* 4th ed. London: Baillière Tindall; 1990:309.
- Thomson GR, Bastos ADS. Foot-and-mouth disease. In: Coetzer JAW, Tustin RC, eds. *Infectious Diseases of Livestock.* Vol. 2. 2nd ed. Cape Town: Oxford University Press; 2004:1324.

#### REFERENCES

- Paton DJ, et al. *Philos Trans R Soc Lond B Biol Sci.* 2009;364.
- OIE/FAO Global conference on foot and mouth disease—final recommendations. Asuncion, Paraguay. 2009 Accessed at: <<http://www.oie.int/en/for-the-media/press-releases/detail/article/oiefao-global-conference-on-foot-and-mouth-disease-final-recommendations/>>. Accessed 01.08.2016.
- Yoon H, et al. *Transbound Emerg Dis.* 2013;doi:10.1111/tbed.12109; [Epub ahead of print].
- Muroga N, et al. *J Vet Med Sci.* 2012;74:399.
- Rweyemamu M, et al. *Transbound Emerg Dis.* 2008;55:57.
- Pacheco JM, et al. *Vet J.* 2012;193:456.
- Sellers R, Gloster J. *Vet J.* 2008;177:159.
- Chase-Topping ME, et al. *Vet Res.* 2013;44:46.
- Juleff ND, et al. *Vet Immunol Immunopathol.* 2012;15:148.
- Maddur MS, et al. *Clin Vaccine Immunol.* 2009;16:1832.

- Garland AJ, de Clercq K. *Rev - Off Int Epizoot.* 2011;30:189.
- Allepuz A, et al. *Transbound Emerg Dis.* 2013;doi:10.1111/tbed.12087; [Epub ahead of print].
- Muroga N, et al. *BMC Vet Res.* 2013;9:150.
- Wernery U, Kinna J. *Rev - Off Int Epizoot.* 2012;31:907.
- Larska M, et al. *Epidemiol Infect.* 2009;137:549.
- Chang H, et al. *Virology.* 2013;10:81.
- Alexandrov T, et al. *Vet Microbiol.* 2013;doi:10.1016/j.vetmic.2013.05.016; [Epub ahead of print]; S0378-1135(13)00298-8.
- Mohamed F, et al. *Transbound Emerg Dis.* 2011;58:358.
- Rhyan J, et al. *J Wildl Dis.* 2008;44:269.
- Cottam EM, et al. *PLoS Pathog.* 2008;4:e1000050.
- Toka FN, Golde WT. *Immunol Lett.* 2013;152:135.
- Pega J, et al. *J Virol.* 2013;87:2489.
- Carpenter TE, et al. *J Vet Diagn Invest.* 2011;23:26.
- Arzt J, et al. *Transbound Emerg Dis.* 2011;58:291.
- Arzt J, et al. *Transbound Emerg Dis.* 2011;58:305.
- Lohse L, et al. *Vet Res.* 2012;43:46.
- Toka FN, et al. *Clin Vaccine Immunol.* 2009;16:1738.
- Wang D, et al. *J Virol.* 2012;86:9311.
- Stenfeldt C, Belsham GJ. *Vet Microbiol.* 2012;154:230.
- Arzt J, et al. *Vet Pathol.* 2010;47:1048.
- Murphy C, et al. *Vet Rec.* 2010;166:10.
- Juleff N, et al. *PLoS ONE.* 2008;3:e3434.
- Yoon H, et al. *Transbound Emerg Dis.* 2012;59:517.
- Maddur MS, et al. *Transbound Emerg Dis.* 2011;58:274.
- Lee SH, et al. *Transbound Emerg Dis.* 2009;56:189.
- OIE Manual of Diagnostic Tests and Vaccines for Terrestrial Animals.* Paris: OIE; 2008 chapter 2.1.5:190.
- Muthukrishnan M, et al. *J Virol Methods.* 2008;151:311.
- Chen HT, et al. *Virology.* 2011;8:510.
- Yang M, et al. *Virology.* 2013;10:125.
- Madi M, et al. *Vet J.* 2012;193:67.
- Gao M, et al. *Appl Microbiol Biotechnol.* 2012;93:1271.
- Duas CC, et al. *J Interferon Cytokine Res.* 2011;31:227.
- Perez-Martin E, et al. *J Virol.* 2012;86:4477.
- Kitching RP, et al. *Rev - Off Int Epizoot.* 2006;25:293.
- Mansley LM, et al. *Rev - Off Int Epizoot.* 2011;30:483.
- McReynolds SW, Sanderson MW. *J Am Vet Assoc.* 2014;244:291.
- Ludi A, Rodriguez L. *Dev Biol (Basel).* 2013;135:107.
- Orsel K, Bouma A. *Can Vet J.* 2009;50:1059.

#### RIFT VALLEY FEVER

##### SYNOPSIS

**Etiology** Rift Valley fever virus, genus *Phlebovirus*, a member of the family *Bunyaviridae*.

**Epidemiology** Enzootic in sub-Saharan Africa and Egypt. First occurrence outside African continent in 2000 affecting Arabian Peninsula. Virus maintained in floodwater mosquitoes and transmitted by hematophagous insects. Ruminants are amplifying hosts. Epizootics in high rainfall periods. A major zoonosis with mortality rate of 1% in humans.

**Clinical findings** Acute febrile disease in lambs and calves characterized by hepatitis

and high mortality; abortion in adult sheep and in cattle. In humans, influenza-like disease and, in rare instances, hemorrhagic fever.

**Necropsy findings** Hepatic necrosis.

##### Diagnostic confirmation

Immunohistochemical localization of viral antigens in tissues.

**Treatment** No specific treatment available; supportive.

**Control** Vaccination, vector control, control of livestock movement.

#### ETIOLOGY

Rift Valley fever virus is a single-stranded RNA virus of the family *Bunyaviridae*, genus *Phlebovirus*. There is only one serotype recognized, with only minor genetic variation between strains.<sup>1</sup>

The virus remains viable in aerosols at 25°C (77°F) for 1 hour or longer but can survive in serum at 4°C (40°F) for several months. Infected sheep plasma can retain its infectivity over years with storage and shipment under a variety of refrigeration conditions. Infectious material thus presents a potential source of infection for laboratory personnel or veterinarians for a prolonged period of time.<sup>2</sup>

#### EPIDEMIOLOGY

##### Occurrence

Rift Valley fever (RVF) was first recognized in 1930 in the Rift Valley in Kenya but now exists and occurs as epizootics throughout sub-Saharan Africa, with recent extensions into Egypt, Mauritania, and Madagascar. The first RVF outbreaks outside Africa were recorded in 2000 in Yemen and Saudi Arabia. The most recent outbreaks recorded by the World Health Organization (WHO) occurred in Somalia (2006/2007), Kenya (2007/2008), Tanzania (2007), Sudan (2007/2008), Madagascar (2008/2009), South Africa (2008, 2009, and 2010), Mauritania (2010 and 2012), Botswana (2010), and Namibia (2010).<sup>3</sup> The disease has great potential for spread to other countries either through legal or illegal movement of infected livestock or the encroachment of mosquitoes into new areas.<sup>4</sup> The pattern of occurrence is cyclical epidemics that are inherently linked to regional climate variability, particularly to rainfall patterns.<sup>4</sup> Outbreaks occur with periods of quiescence of 5 to 15 years in duration.<sup>2</sup>

Climate changes and livestock movement facilitate the spread of the disease and present an increasing risk of introduction of the disease into the Mediterranean basin and Europe.<sup>2</sup>

#### Risk Factors

##### Animal Risk Factors

Rift Valley fever is an infectious disease primarily affecting ruminants but to which

other species, including humans, are also susceptible. There is a clear age predisposition to clinical disease rendering lambs, goat kids, puppies, and kittens extremely susceptible, with mortality rates between 70% and 100%. Adult sheep and calves have been categorized as highly susceptible, with mortality rates between 20% to 70%. Adult cattle, goats, African and domestic buffalo, and humans are moderately susceptible, with mortality rates of less than 10%.<sup>1</sup> Camelids, equids, pigs, and adult dogs and cats are considered resistant to clinical disease, with infection being inapparent in these species. A large number of different African wildlife species were found to have seroconverted in endemic areas.

### Environmental Risk Factors

Outbreaks of RVF have been associated with above-normal rainfall and climatic conditions favorable to competent vectors. More precisely, epidemics have been reported in four epidemiologic systems<sup>2</sup>:

- **“Dambo” areas in East Africa.** These areas are valleys near a river in which outbreaks occur following heavy rainfall events.
- **Semiarid areas of western Africa** (including Senegal and Mauritania). In these regions, which are characterized by temporary areas of water, outbreaks could not be directly related to flood-like rainfalls; rather, they occurred during the rainy season with abundant regular rainfall.
- **Irrigated areas** (including the Nile Delta or Senegal River basin). In artificially irrigated areas the permanent availability of water favors the persistence of a vector population throughout the year.
- **Temperate and mountainous areas** (including regions in Madagascar). Transmission of RVFV in these regions results from vector-borne transmission associated with livestock movement.

RVF outbreaks were found to occur with a cyclic pattern in association with the warm phase of the El Niño/Southern Oscillation (ENSO) phenomenon. The ENSO is associated with varying climate effects on a 3- to 7-year interval.<sup>4</sup>

### Source of Infection

The live cycle of RVFV consists of an epizootic cycle that is associated with outbreaks of RVF and an enzootic or interepizootic cycle, during which the virus persists in a host but is not associated with clinical disease. During the interepizootic cycle the RVFV is maintained through vertical transmission in *Aedes* mosquito eggs. These eggs are drought-resistant and survive several years without hatching, thereby maintaining the virus during interepizootic periods. These interepizootic vectors belong to the *Aedes* subgenus *Neomelanicion* in East Africa

and the subgenus *Aedimorphus* in West Africa. Epizootics occur in enzootic areas when wet and flood conditions enable the infected eggs to mature and hatch. *Aedes* mosquitoes hatched from infected eggs transmit the virus to susceptible animals, particularly domestic ruminants on which they feed preferentially.

Once a susceptible animal, which is considered an amplifying host, is infected, a transient viremic phase occurs, permitting virus transmission between susceptible individuals through any hematophagous insect species. These insects, which include *Culex* and *Anopheles* spp., function as secondary arthropod vectors but do not transmit the virus transovarially and therefore do not act as RVFV reservoirs during interepizootic periods.<sup>1</sup>

For **humans**, direct contact with infected animal tissues, blood, or other body fluids and also inhalation of aerosolized infected material are considered the predominant routes of infection.<sup>5</sup> Accordingly, certain occupational groups, such as farmhouse, slaughterhouse, or laboratory personnel and veterinarians, are at increased risk of infection. Biting insects appear to have a limited role in the transmission of RVFV to humans. Nevertheless, during the 2000/2001 outbreak of RVF in Saudi Arabia, with over 400 confirmed clinical cases in humans and 85 deaths, 23% of all infections were estimated to have occurred through mosquito exposure.<sup>5</sup> In contrast, during a South African outbreak, 89% of clinical cases in humans were associated with direct contact with infectious material. Ingestion of unpasteurized milk was incriminated as a possible route of infection based on epidemiologic evidence, but this has not been demonstrated conclusively.<sup>5</sup>

### Method of Transmission

In ruminants RVFV is transmitted between animals through primary and secondary arthropod vectors. Direct transmission between animals through contact with viremic fluid, such as blood or lochial fluid, is strongly suspected but has thus far not been confirmed. The presence of virus in the nasal or lachrymal secretions, urine, or feces of infected animals has not been demonstrated.<sup>2</sup>

In humans there is no evidence for person-to-person transmission of infection. Vertical transmission from an infected mother to her baby has been reported in two instances during the outbreaks in Saudi Arabia in 2000 and in Sudan in 2007.<sup>6</sup>

### Experimental Reproduction

The disease can be transmitted by most routes, including inoculation and the inhalation of aerosols. Following inoculation of sheep and cattle the incubation period is 1 to 2 days, and high virus titers are found in blood. The virus persists in the body for

approximately 3 weeks, but long-term carriage has not been observed. Pregnant animals abort, but infection may be clinically mild in nonpregnant animals. IgM antibody can be detected as early as 4 days after infection and persists for 2 to 6 months.

### Zoonotic Implications

Although humans are susceptible to infection and disease, infection with RVFV in the large majority of cases is asymptomatic, as is suggested by retrospective serologic studies following epidemics. If clinically apparent, the disease is usually a transient flulike illness, but complications of hemorrhagic fever, retinal and renal disease, and encephalitis occur.<sup>1</sup> Traditionally, the occupational groups at greatest risk are laboratory workers handling the virus and those working among infected animals or their products, including veterinarians. However, cases were not limited to these groups in the large outbreaks in Egypt in 1977 and 1978 and the more recent outbreaks in the Arabian Peninsula. The occurrence rate of clinical disease in humans was very high in Egypt (more than 20,000 cases and 600 deaths). The mortality rate in humans is estimated to be 1% to 2%.<sup>7</sup> The pathogen is identified as a potential agent for bioterrorism.

### Economic Importance

The disease causes significant morbidity and mortality in calves and lambs and has been associated with abortion storms in adult ruminants, with pronounced health and economic impacts. The economic losses solely attributable to trade disruptions occurred during the RVF outbreaks of 2007 in Sudan have been estimated to exceed \$60 million.<sup>8</sup>

### PATHOGENESIS

Hepatocytes are the primary site of viral replication in lambs and calves, and age is a determining factor in the progression and outcome of infection. In very young animals, hepatic lesions progress from degeneration and necrosis of individual hepatocytes to extensive necrosis throughout the liver, resulting in hepatic insufficiency and failure. In young animals, encephalomyelitis may also occur.

### CLINICAL FINDINGS

The clinical presentation of RVF varies by species and age. The disease is most severe in young ruminants, particularly lambs. After an incubation period of between 12 and 36 hours, anorexia, weakness associated with fever, and lymphadenopathy become apparent. Hemorrhagic diarrhea with abdominal pain may be seen. In calves, icterus is a common clinical finding. Mortality rates are high and can reach 90% to 100% in lambs and 70% in calves.

In adult sheep and cattle, abortion is the outstanding and in many cases only clinical

sign. Abortion storms affecting up to 100% of ewes and 85% of cows can occur. In clinical cases in cattle and adult sheep there is febrile disease, with anorexia, weakness, and a drop in milk production that can be associated with hemorrhagic diarrhea. In severe cases the mortality rate in adult sheep may be as high as 25% and 10% in cattle. Goats show a febrile reaction but few other clinical signs.

Clinical signs can be unspecific when considering an individual animal, but RVF should be suspected whenever high abortion rates in adult ruminants and high mortality rates in neonatal ruminants occur in combination with flulike disease in humans who had contact with sick ruminants.

### CLINICAL PATHOLOGY

Severe leukopenia is a common finding.

**Virus isolation** is usually performed from inoculated hamsters, mice, or cell cultures. Virus identification can also be done by immunofluorescence carried out on impression smears of liver, spleen, or brain or immunostaining of histology slides.<sup>1</sup> The agar gel immunodiffusion (AGID) test is an alternative for laboratories without tissue culture facility. Polymerase chain reaction (PCR) is used for rapid detection of viral RNA.

Serology can be conducted by virus neutralization (VN), which is the prescribed test for international trade, by means of an enzyme-linked immunosorbent assay (ELISA) or by hemagglutination inhibition. The virus neutralization test requires the use of live RVFV, making this test unsuitable to be used outside endemic areas.<sup>1</sup> Several RVFV antibody ELISAs are available as commercial test kits and can be performed with inactivated antigen and thus are suitable for the use outside RVFV-endemic areas. The IgM-capture ELISA allows diagnosis of a recent infection.<sup>1</sup> Antibodies appear in the serum about 1 week after infection, and persistence depends on antibody type.

### NECROPSY FINDINGS

**Extensive hepatic necrosis** is the characteristic lesion in RVF. In neonates, the liver is enlarged and has a yellow–orange discoloration, whereas in older animals, pale foci of necrosis impart a mottled appearance to the organ. Other nonspecific lesions include congestion and petechiation in the heart, lymph nodes, gallbladder, and alimentary tract. Abomasal and intestinal content may be dark brown to red as a result of hemorrhage.

Microscopically there is multifocal or diffuse necrosis of the liver, and there may be acidophilic intranuclear inclusion bodies in hepatic cells. The lesions are much more extensive in newborn lambs and calves than in older animals. Immunohistochemical localization of viral antigens in tissues provides a specific diagnosis.

### Samples for Confirmation of Diagnosis

- **Virology**—liver, spleen, brain (virus isolation, fluorescence antibody test, PCR)
- **Histology**—liver, spleen, brain (light microscopy, immunohistochemistry)

**Note the zoonotic potential of this disease when handling these specimens.**

#### DIFFERENTIAL DIAGNOSIS

In regions where this disease has not occurred it should be suspect when there is an area outbreak of abortion and neonatal mortality in sheep and cattle coupled with an area outbreak of flu-like disease in humans.

- Wesselsbron disease
- Bluetongue
- Ephemeral fever
- Bacterial septicemias
- Anthrax
- Vibriosis
- Trichomoniasis
- Toxic plants

### TREATMENT

Little attention has been given to the aspect of treatment of the disease, and no known treatment is of any value.

### CONTROL

Measures to control Rift Valley fever include the following:

- Control of livestock movement
- Vector control
- Vaccination

The role of **livestock movement** over long and short distances in the spread of the disease throughout the African continent is well documented, and phylogenetic studies suggest that ruminant trade is the main reason for the spread of the disease from the African continent to the Arabian Peninsula.

**Vector control** is most effective when larvicides are used in mosquito breeding sites. Limitations of this approach are that breeding sites must be clearly identified and must have a limited surface to be manageable. Particularly with heavy rainfalls and flooding, mosquito-breeding sites are too numerous and wide to be controlled. Ecological, health, and financial issues around applying large amounts of insecticides to the environment further complicate this type of control.

### Vaccines

**Live attenuated vaccines (Smithburn strain)** and mutagenized live virus vaccines provide good protection that lasts for at least 28 months but are not recommended for pregnant animals because they are abortigenic, causing fetal death and some teratogenic anomalies. The recorded problems include hydrops amnii, arthrogryposis, hydranencephaly, and microencephaly. There is also a concern for reversion to virulence.

Live attenuated vaccines, furthermore, are pathogenic for humans, and exposure to live attenuated vaccines may present a health risk.<sup>5</sup>

**Killed-virus vaccines** require repeat administration for good immunity, and annual vaccination of all dairy cattle is recommended as a cost-effective control program in endemic countries. They are also recommended for pregnant and young animals.

A **mutagen attenuated vaccine** protects against challenge in both sheep and cattle. Viremia following vaccination is minimal and thought not to be a risk for infection of susceptible mosquitoes. Mutagenic vaccines were initially thought to have no deleterious effect on the fetus, but abortion and teratogenicity have been observed in the lambs of sheep vaccinated early in pregnancy.

Prevention of the introduction of Rift Valley fever into countries free of the disease requires the prohibition of the importation of all susceptible species from Africa. All necessary steps to prevent the introduction of infective insects and infected biological materials should be taken. The possibility of humans carrying the infection from country to country is very real.

### FURTHER READING

Gerdes GH. *Vet Clin North Am Food A.* 2002;18:549-555.

Shimshony A, Barzilai R. Rift Valley fever. *Adv Vet Sci Comp Med.* 1983;21:347-425.

### REFERENCES

1. OIE. 2009 at: <[http://www.oie.int/fileadmin/Home/eng/Animal\\_Health\\_in\\_the\\_World/docs/pdf/RIFT\\_VALLEY\\_FEVER\\_FINAL.pdf](http://www.oie.int/fileadmin/Home/eng/Animal_Health_in_the_World/docs/pdf/RIFT_VALLEY_FEVER_FINAL.pdf)>; Accessed 20.01.14.
2. Chevalier V. *Clin Microbiol Infect.* 2013;19:705.
3. Balenghien T, et al. *Vet Res.* 2013;44:78.
4. El Vilaly, et al. *Progr Phys Geo.* 2013;37:219.
5. Archer B, et al. *Emerg Infect Dis.* 2013;19:1918.
6. Hassan OA, et al. *PLoS ONE.* 2011;5:e1229.
7. Dar O, et al. *Trop Med Int Health.* 2013;18:1036.
8. Little PD. 2009 <[http://www.caadp.net/pdf/COMESA%20CAADP%20Policy%20Brief%202020%20Cross%20Border%20Livestock%20Trade%20\(2\).pdf](http://www.caadp.net/pdf/COMESA%20CAADP%20Policy%20Brief%202020%20Cross%20Border%20Livestock%20Trade%20(2).pdf)>; Accessed 20.01.14.

### BLUETONGUE

#### SYNOPSIS

**Etiology** Bluetongue virus (BTV), an orbivirus with several serotypes and considerable genetic heterogeneity.

**Epidemiology** An infectious, noncontagious disease primarily of sheep, but also occurring in cattle, wild ruminants, New World camelids, and goats. Transmitted by *Culicoides* spp. Cattle are the reservoir and amplification hosts. Severe disease is most common in European fine wool and mutton breeds of sheep. Certain serotypes can cause severe disease in cattle.

*Continued*



Infection, but not disease, is endemic in tropical and subtropical regions. Disease occurs in epidemic and incursive areas when climatic conditions allow the expansion of vector occurrence or when naïve animals are introduced into an endemic area.

**Clinical findings** Fever, apathy, serous to bloody nasal discharge, respiratory distress, oral erosions and ulcerations with hypersalivation. Lameness as a result of coronitis, myositis, and muscle necrosis.

**Clinical pathology** Virus isolation or detection of viral RNA (reverse-transcription polymerase chain reaction [RT-PCR]) in blood or tissue specimens. Serologic tests to identify BTV-specific antibodies or a rise in antibody titer (competitive enzyme-linked immunosorbent assay [C-ELISA], virus neutralization test, agar gel immunodiffusion [AGID]).

**Necropsy findings** Mucosal lesions, hemorrhage and necrosis of skeletal and cardiac muscles, hemorrhagic lesion at base of pulmonary artery. Congestion of heart, lung, liver and kidney.

**Diagnostic confirmation** Detection of viral nucleic acid, virus isolation, rising titer with serology.

**Treatment** None specific, supportive.

**Control** Reduction of exposure to vector is attempted, but major method of control in epidemic areas is by vaccination.

## ETIOLOGY

Bluetongue virus (BTV) is an arthropod-borne *Orbivirus* in the family Reoviridae with a genome composed of 10 dsRNA segments. The bluetongue viruses are stable and resistant to decomposition and to some standard virucidal agents, including sodium carbonate. They are sensitive to acid, inactivated below pH 6.0, and susceptible to 3% sodium hydroxide solution and organic iodides.

Worldwide there are currently 26 recognized serotypes of BTV.<sup>1-4</sup> The virus is characterized by its high genetic variability resulting from the genetic drift of individual gene segments and from reassortment of gene segments when ruminants or the vectors are infected with more than one strain. The occurrence of different BTV serotypes varies by geographic region.

## EPIDEMIOLOGY

### Occurrence

Bluetongue virus has been identified on all continents except Antarctica and is considered endemic in the domestic livestock populations of all tropical and subtropical countries. Until the end of last century, BTV was considered an exotic disease in the Palearctic, but a series of outbreaks caused by different serotypes apparently originating from adjacent enzootic regions has occurred in the Mediterranean basin since 1998.<sup>5</sup>

Whereas historically the enzootic area was considered to be limited to the area between latitude 35° S and 50° N, this zone appears to have extended to areas north of 53° N over the last decade. BTV outbreaks observed in these new regions in the past years are thought to be the result of climate change from global warming.

The distribution and intensity of infection in regions of the continents is determined by the climate, geography, and altitude, which affect the occurrence and activity of the *Culicoides* vectors, and by the presence of susceptible mammalian hosts. There is a gradation from continuous BTV activity in tropical areas to absence of virus transmission in colder areas. In large countries that span different latitudes, such as the United States and Australia, there are endemic areas and regions that are free of BTV infection.

In **endemic areas**, the infection is always present, but clinical disease of the indigenous species is unusual. It can occur with new BTV strains and when nonindigenous susceptible species are introduced to the area.

**Epidemic zones** also exist, where infection and clinical disease occur every few years. Infection in these areas is highly focal, and outbreaks occur when climatic conditions allow the vector to spread beyond its usual boundaries and to infect susceptible ruminants.

**Incursive disease** can occur in regions that do not normally experience infection and may be caused by windborne movement of infected *Culicoides* with subsequent insect breeding in the summer before “die-out” in the autumn and winter. This method of spread is thought to have been the genesis of several serious outbreaks of bluetongue in countries normally free of the disease and of the outbreaks in Portugal in 1956, in Cyprus in 1977, in Turkey and Greece in 1979 to 1980, and in Israel in 1960 to 1980. The recent epidemic of BTV-8 in northern and central Europe between 2006 and 2008, which caused the most severe outbreak of the disease on record, made clear that alternative, thus far unidentified, ways of virus introduction into previously unaffected regions must be considered. This serotype 8, which was previously only identified in the sub-Saharan region, was first isolated in the Netherlands in 2006, having entirely bypassed the southern part of the continent. To this day no plausible explanation for the introduction of serotype 8 into the northern European region has been proposed.

In the **United States** the prevalence of seropositive cattle varies from high in the southern and western states to low in the northern states, especially the northeastern states. In the northwestern region, there are epidemics of infection in the summer and fall every few years, associated with movement of infected vectors from the south. **Canada** is free of infection except for

periodic incursions into the Okanagan Valley in British Columbia from windborne-infected *Culicoides* from south of the border. In **Australia**, there has been a sequential introduction of bluetongue serotypes from Indonesia by windborne *Culicoides* spp., but endemic infection is limited to northern cattle areas with extension down the East Coast. In **central and northern Europe and the United Kingdom**, no new cases of BTV have been recorded since 2009, and thus wide parts of the continent have been declared free of BTV. In **southern Europe** BTV is currently present in the southern part of Italy, Spain, Portugal, and Corsica.<sup>6</sup>

### Host Occurrence

Under natural conditions infection occurs in sheep and cattle, but it is also recorded in New World camelids, elk, white-tailed deer, pronghorn antelope, camels, and other wild ruminants. Natural infection rarely occurs in goats, but the infection can be transmitted experimentally. Although clinical disease primarily occurs in sheep, certain strains are highly virulent in cattle and wild ruminants. **Cattle** are the major **reservoir host**. In carnivores, infection after vaccination with BTV-contaminated vaccines has been documented.

### Method of Transmission

The disease is not contagious and is almost exclusively **transmitted biologically** by specific species of *Culicoides*. There are approximately 1500 species of *Culicoides* worldwide, of which only limited types have been associated with BTV. Only about 50 *Culicoides* species are susceptible to BTV infection. Of these species, only those having ruminants as sole or predominant hosts are epidemiologically relevant for the transmission of BTV.

*Culicoides* breed in damp, wet areas, including streams, irrigation channels, muddy areas, and fecal runoff areas around farms, and habitats for them exist on the majority of farm environments. Only female *Culicoides* are hematophagous and feed on their main or preferred host species, requiring at least one blood meal for the completion of the ovarian cycle. They feed nocturnally on animals in open pens and fields, and the optimal temperatures for activity are between 13°C and 35°C (55° and 95° F).

Virus present in ingested blood cells infects cells of the midgut of the vector, replicates, and subsequently is released to the salivary gland. The virus is then transmitted through saliva to the host the infected midge is feeding on. Vertical transmission of infectious virus from adult midge to its larvae does not appear to occur. In temperate areas the disease is **seasonal** because *Culicoides* do not tolerate low ambient temperatures, resulting in a vector-free season during late fall and winter.

### Culicoides Species

Different *Culicoides* species have different geographic occurrence, and their distribution in a country is determined by climatic factors and the presence of a preferred host. In the **United States**, *C. sonorensis* is the predominant vector throughout much of the country, except in the southeast, where it is *C. insignis*. *C. insignis* is also the predominant vector for most BTV strains in the **Caribbean** and Central and **South America**. Other epidemiologically relevant *Culicoides* species in this region are *C. pucillus*, *C. insignis*, *C. pusillus*, and *C. filarifer*. In **Africa**, *C. imicola* is a predominant vector, and in the **Middle East and Asia**, *C. fulvis*, *C. imicola*, *C. obsoletus*, *C. nudipalpis*, and *C. orientalis*. In **Australia**, *C. wadai*, *C. actoni*, *C. brevipalpis*, *C. peregrinus*, *C. oxystoma*, *C. brevipalpis*, and *C. fulvus* are vectors or potential vectors. They have different distribution in the country, which oscillates depending on climate. *C. imicola* has been involved in the recent expansion of bluetongue in **southern Europe**, but *C. obsoletus*, *C. pulicaris*, and *C. dewulfi* have been implicated as new vectors associated with recent BTV outbreaks in **central and northern Europe**, where *C. imicola* does not occur.

### Other Vectors

Other vectors may transmit the disease mechanically but are unlikely to be of major significance in disease epizootics. The argasid tick *Ornithodoros coriaceus* has been shown experimentally to be capable of transmitting the virus and be a potential vector. The sheep ked (*Melophagus ovinus*) ingests the virus when sucking the blood of infected sheep and can transmit the infection in a mechanical manner. Mosquitoes may play a role in transmission, and *Aedes lineatopennis* and *Anopheles vagus* have been suspect.

### Overwintering

Survival of the virus during the vector-free season is termed *overwintering*. As is documented by an annual recrudescence of bluetongue in several temperate areas, BTV can survive several months of cold season presumably in the absence of adult biological vectors. The mechanisms involved are not yet fully understood. Proposed hypotheses to explain the overwintering ability of BTV include persistence of the virus within surviving adult vectors, transovarian transmission within the vector, and prolonged or even persistent infection of viremic or aviremic vertebrate hosts.<sup>5</sup> The average life span of an adult *Culicoides* is between 10 and 20 days but can occasionally extend up to 3 months.<sup>7</sup> In addition, entomologic surveillance in northern Europe has demonstrated the presence of a small number of active *Culicoides* during the winter season inside barns.<sup>8</sup> Overwintering within the adult vector population has therefore been proposed as a plausible explanation for a

sustained BTV transmission cycle. In contrast, no evidence supporting vertical (transovarian) transmission of BTV within the vector is currently available.

Overwintering of BTV could also occur in hosts with prolonged viremic phases, such as cattle, where viremia commonly lasts between 20 and 50 days.<sup>9</sup> It is assumed that, in general, **viremia in cattle ceases by 60 days** after infection, although viremic phases of up to 100 days have been reported.<sup>10</sup>

### Transplacental Infection

Transplacental infection has been documented experimentally and under field conditions after **infection with modified live laboratory strains** commonly used for vaccine production (modified live vaccines), suggesting that modification of BTV field strains can markedly increase the ability of the virus to cross the placenta and cause fetal infection. Of the 26 currently known wild-type serotypes, only **serotype 8** was repeatedly documented to cause fetal infection through transplacental transmission in cattle and sheep under field conditions.<sup>11,12</sup> Before the appearance of BTV-8 the observed incidence of transplacental transmission was estimated to be near zero, and the few documented cases were associated to the use of modified live vaccines.<sup>13</sup> In contrast, transplacental virus transmission after infection with wild-type BTV-8 was shown to occur with considerable frequency.<sup>14</sup> A study conducted during the BTV-8 epidemic in northern Europe between 2006 and 2008 revealed that virus RNA could be retrieved from 41% of aborted fetuses where BTV was suspected as causative pathogen and from over 18% of fetuses where BTV was not suspected as cause of abortion.<sup>11</sup>

Although the epidemiologic relevance of the vertical transmission of certain BTV serotypes is to be determined, intrauterine infection of the fetus, possibly resulting in a virus-shedding neonate, also presents a possible mechanism for virus survival during the vector-free season.

The outcome of transplacental infection primarily depends on the stage of pregnancy at the time of infection of the dam and can range from abortion to different sorts of congenital defects to healthy-looking lambs or calves. Infection or vaccination of the dam with virus strains capable of crossing the placenta at early stages of pregnancy most commonly results in abortion. Congenital defects of the nervous system can occur when pregnant ewes or cows are exposed to BTV-8 or vaccinated with attenuated vaccine virus before midgestation. At birth, affected neonates characteristically also have circulating BTV-specific antibodies before ingestion of colostrum but no infectious BTV. Dams infected at a later stage of pregnancy give birth to calves without congenital malformation that may be viremic with or without BTV-specific

antibody titer. The viremic phase of newborn calves infected in utero is of similar duration as in animals infected after birth. BTV infection in cattle is therefore considered to be transient and neither persistent nor immunotolerant.<sup>15</sup>

Observed congenital defects include excessive gingival tissue, agnathia (tilted mandible), arthrogryposis, hydranencephaly, and porencephaly. The severity of the brain lesions decreases with increasing fetal age. Infection at 243 days results in a mild encephalitis and the premature birth of calves that are still viremic but poorly viable.

### Persistent Infection

Persistent infection in immunotolerant animals following in utero infection has been implied in a single study and was consequently thought to be of paramount epidemiologic importance. However, a large number of experimental and field studies failed to produce any evidence supporting the occurrence of persistent infection or the existence of a BTV carrier status. Persistent infection is therefore currently considered a highly unlikely scenario.

### Venereal Transmission

Bluetongue virus can be found in the **semen** of infected bulls during the viremic period, and infection has been transmitted through bull semen to susceptible cows, but it is unlikely that this is a significant mechanism of transmission. Transplanted **embryos** from infected donors are free of the virus because it does not appear to penetrate the zona pellucida. Embryo transfer is regarded as a minimal risk procedure for the transmission of BTV in cattle and sheep as long as the guidelines of the International Embryo Transfer Society (IETS) are followed. Recommended procedures include visual inspection, rigorous washing of the embryo, and, in some instances, treating with trypsin to inactivate infectious virus particles. Virus transmission when doing embryo transfers could occur as a result of contamination of media or equipment used to manipulate the embryos.<sup>16</sup>

### Oral Transmission

Studies reporting or suggesting oral transmission BTV have been published recently. These studies include one report of infection of adult cattle after ingestion of BTV-8-infected placenta and several reports where infection of newborn calves after consumption of infected colostrum was described.<sup>17-19</sup> The epidemiologic relevance if this route of transmission remains to be determined.

### Pathogen and Vector Risk Factors

The geographic occurrence of bluetongue serotypes varies and is changing with time. There are differences in virulence between serotypes. The virulence of the virus is also

related to the infectious dose, which, among other factors, depends on the vector species, its competence, and its occurrence. Different *Culicoides* species vary in susceptibility to infection (i.e., vector competence), and some known vectors are resistant to infection with some serotypes, which in part explains regional differences in serotype occurrence.

### Climate

Climate is a major risk factor because *Culicoides* require warmth and moisture for breeding and calm, warm, humid weather for feeding. A cold winter or a dry summer can markedly reduce vector numbers and risk for disease. Moisture may be in the form of rivers and streams or irrigation, but rainfall is the predominant influence; rainfall in the preceding months is a major determinant of infection.

Precipitation affects the size and persistence of breeding sites and the availability of humid microhabitats to allow shelter from desiccation during hot summer and autumn periods. Optimal temperature is also essential for survival and activity of the vector and for virus replication within the vector. Ambient temperatures for survival of adult midges and larvae must be above a mean of 13°C (55°F) and range between 18° and 30°C (64° and 86°F) for optimal adult activity. The rate of virus replication within an infected midge also largely depends on the ambient temperature. Whereas at 30°C midges may start shedding virus within days of infection, this takes several weeks at ambient temperatures of 15°C (59°F).<sup>1</sup> Virus replication within the vector apparently ceases completely at temperature below approximately 12°C (54°F), although the virus may persist in infected midges and replication may resume with increasing temperatures.<sup>1</sup> Geographic information systems (GIS) can be used to predict area risk.

### Serotype Occurrence

Genetic studies indicate that BTV tends to exist in discrete, stable ecosystems and that BTV serotypes that circulate in one region of the world are largely different from those in other regions. In the **United States**, four serotypes (10, 11, 13, and 17) associated with *C. sonorensis* are considered endemic south of the so-called “Sonorensis Line” going from Washington in the West to Maryland in the East. Serotype 2 is another strain occurring in the United States, but it is restricted to the southeast of the country, the habitat of *C. insignis*.

In the **Caribbean** region and **South and Central America**, serotypes 1, 3, 5, 6, 8, 12, 14, 17, 19, 22, and 24 were reported. In **Australia**, BTV is endemic in the northern and northeastern areas of the country, and most of the western, southern, and central parts of the country are considered free of bluetongue.<sup>20</sup> Serotypes 1 and 21 are the predominant strains in northwestern Australia, the

Northern Territory, Queensland, and the northeastern areas of New South Wales.<sup>21</sup> In total 10 serotypes (1, 2, 3, 7, 9, 15, 16, 20, 21, and 23) have been isolated in the country. Six of these (3, 9, 15, 16, 20, and 23) have only been found in the north of the Northern Territory. Since 2008, BTV-2 has been detected in northern and eastern Australia, in regions in which only serotypes 1 and 21 had been recorded previously.<sup>21</sup> The virus has been isolated from infected *Culicoides* and sentinel animals, and although there is serologic evidence of infection in Queensland and New South Wales, there has been no clinical disease. In **Africa**, 22 of the known 26 serotypes have been identified. Serotypes 1, 16, 18, 19, and 24 are the predominant serotypes isolated, and serotypes 20, 21, 25 and 26 are considered exotic.<sup>22</sup> In **Asia**, serotypes 1, 4, 7, 9, 10, 12, 16, 17, 20, 21, and 23 have been identified. The new serotype 26 was recently identified in Kuwait.<sup>4</sup> Serotypes 1, 2, 4, 6, 8, 9, 11, and 16 are associated with disease in the expansion of BTV infection in **Europe** since 1998. BTV serotype 8 is the strain associated with repeated BTV outbreaks observed between 2006 and 2008 affecting most of central and northern Europe, including the United Kingdom and parts of Scandinavia.<sup>23</sup> Serotypes 6 and 11 isolated in northern Europe in that same period have been related to vaccine strains used in modified live vaccines produced in South Africa and are thought to have been introduced through the illegal use of modified live vaccines in the region.<sup>1</sup> Currently, large parts of Europe are declared free of BTV. Exceptions are Spain (serotypes 1 and 4), Portugal (serotype 1), the southern part of Italy (serotypes 1, 2, 4, 8, 9, 16), Corsica (serotypes 1, 2, 4, 8, 16), the Channel Islands (serotypes 1, 8), Cyprus (serotypes 4 and 6), and the Greek islands of Lesbos, Dodekanisa, and Samos (serotypes 1, 4, 8, 16).<sup>6</sup>

### Host Risk Factors

Although all ruminant species are susceptible to infection with BTV, most virulent strains cause clinical disease primarily in sheep, whereas infection often remains asymptomatic in the majority of infected cattle, goats, and wild ruminants.

### Cattle

Although some BTV strains, such as serotype 8, can cause severe clinical disease in cattle, infection with most other virulent BTV strains remains subclinical or causes only mild clinical signs in this species. Cattle are therefore considered the **reservoir and amplifying host** and have a high titer viremia. Cattle appear to be much more attractive to *Culicoides* spp., and this may enhance the importance of cattle as carriers. A **critical density** of cattle in a region may be required to sustain bluetongue in regions where the *Culicoides* vector is strongly cattle associated. Seroprevalence increases with

age, probably a reflection of increased duration of exposure.

### Sheep

All breeds of sheep are susceptible to infection, although to varying degrees. **European fine-wool and mouton breeds** are most susceptible to severe clinical disease. There are also differences in age susceptibility to clinical disease, which, inexplicably, vary with different outbreaks. Exposure to **solar radiation** can increase the severity of the disease, as can excessive droving, shearing, poor nutrition, and other forms of stress.

### Goats and Wild Ruminants

Goats, like other ruminant species, are susceptible to infection but rarely show clinical signs. Among wild ruminants, **white-tailed deer** and pronghorn antelopes were found to be highly susceptible to infection resulting in clinical disease. Surveys conducted throughout Europe during the epidemic caused by BTV serotype 8 documented the broad susceptibility to infection of the wild ruminant population.<sup>24,25</sup>

### New World Camelids

Evidence for natural infection of South American camelids with different BTV serotypes is available from Peru, the United States, and Europe, where seroconversion in unvaccinated animals has been reported.<sup>26-28</sup> Following the recent BTV-8 outbreak in northern and central Europe, a mean animal seroprevalence of 14.3% of the tested New World camelid population was reported in Germany, a value that is considerably below prevalence rates determined in other ruminant species in the same region.<sup>28</sup> Historically, South American camelids were considered to be resistant to clinical bluetongue, but incidental case fatalities that have been associated with BTV infection have been reported in the recent literature.<sup>29-31</sup>

### Morbidity and Case Fatality

When the disease occurs in a flock for the first time, the incidence of clinical disease may reach 50% to 75% and the mortality 20% to 50%. Outbreaks in Cyprus and Spain were accompanied by mortality rates of 70% in affected flocks, but most outbreaks result in much lower mortality. Mortality rates of 2% to 30% are reported under field conditions in South Africa and from 0% to 14% in field outbreaks in the United States. High mortality can occur when a new strain of BTV emerges in an area.

Before the occurrence of BTV-8 in northern and central Europe, bluetongue in cattle was considered a predominantly subclinical disease, and clinical cases were observed sporadically only. During the European BTV-8 outbreak between 2006 and 2008, morbidity rates ranging from 0% to 32% were reported. Mortality ranged between 0% and 17% in sheep and 0% and 4% in cattle.<sup>32</sup>



Immunity to BTV tends to be strain specific, and in epizootics, more than one strain may be introduced into an area. Infections caused by different serotypes may follow one another in quick succession in a sheep population. The serotypes vary widely in their virulence, with a corresponding variation in the severity of the disease produced. However, sequential infection with more than one type of BTV results in the development of heterotypic antibody and may result in protection against heterologous serotypes not previously encountered.

### Experimental Reproduction

Infection is readily produced by experimental infection of sheep, cattle, and New World camelids, but it is common for the clinical presentation of the experimental disease to be **very mild** despite the fact that the isolate might have been associated with severe disease in the field. In many cases experimental infection produces viremia, fever, leukopenia, and an antibody response, but the localizing, identifying lesions are often minimal, with erythema of the coronary bands as the only visible abnormality in some cases.

### Economic Importance

Economic losses from bluetongue are attributable to direct effects of the infection, such as animal losses and abortion, to which costs associated with treatment and disease control have to be added. Production losses are also of great importance in sheep and cattle alike. Adult sheep either lose their fleece from a break in the growth of the staple or develop a weakness (tender wool) that causes breaks in processing and markedly reduces the value of the fleece. Pregnant ewes commonly abort. There is a severe loss of condition, and convalescence is prolonged, particularly in lambs. The loss from clinical disease and from reduced wool quality and suboptimal production following infection in sheep are significant. Production losses associated with the BTV-8 outbreak in Europe affecting the dairy industry were estimated to be considerably higher compared with sheep in part because of the higher value of the individual animal, but also because of the marked and sustained effect on milk production lasting for several weeks (up to 2 kg per cow and day) and the increased incidence of reproductive failures.<sup>33</sup>

Major financial losses result from **restrictions in international trade**. The severe disease that occurred in the outbreaks in Cyprus and the Iberian Peninsula in the 1940s and 1950s resulted in bluetongue being placed on List A of veterinary diseases by the OIE. At the time, persistent infection of ruminants resulting in carrier animals was thought to be a major factor explaining the worldwide spread of the disease; as a result, restrictions on the international movement of cattle and sheep and their products from

countries that have this infection to those that do not have been instituted. For countries where BTV virus is endemic and clinical disease is rare, such as the United States, costs resulting from these trade restrictions by far outweigh direct costs related to the disease. It is estimated that the United States has an annual loss of \$144 million because of the inability to trade with BTV-free countries.

### PATHOGENESIS

#### Sheep

The pathology of bluetongue can be attributed to vascular endothelial damage resulting in changes to capillary permeability and fragility, with subsequent disseminated intravascular coagulation and necrosis of tissues supplied by damaged capillaries. These changes result in edema, congestion, hemorrhage, inflammation, and necrosis.

Following inoculation of the virus through the skin by a bite of an infected vector, the virus reaches the regional lymph node, where a first replication occurs. The virus that targets all blood cells and thrombocytes is then disseminated by these cells throughout the entire organism. Secondary virus replication takes place in lymphoid tissues such as the lymph nodes and spleen and particularly in the lungs. Viremia is detectable by day 3, and peak viremia, associated with fever and leukopenia, usually occurs 6 to 7 days after infection. Circulating virus concentrations subsequently fall with the appearance of circulating interferon and specific neutralizing antibodies. With the viremia, there is localization of the virus in vascular endothelium, which causes endothelial cell degeneration and necrosis with thrombosis and hemorrhage. There is also the development of a hemorrhagic diathesis and coagulation changes consistent with disseminated intravascular coagulation. The distribution of the lesions is thought to be influenced by mechanical stress and the lower temperatures of these areas in relation to the rest of the body.

#### Cattle and Wild Ruminants

With infection in cattle and wild ruminants by most virus strains, endothelial cell damage is minimal. The viremia in cattle is highly cell associated, particularly with erythrocytes and platelets. Although the virus does not replicate in the erythrocytes, it is protected from circulating neutralizing antibody, and infected erythrocytes are likely to circulate for their life span. With the life span of bovine erythrocytes being longer than that of ovine erythrocytes, this results in the prolonged viremia in cattle with concomitant presence of neutralizing antibodies. Although virus RNA may be detectable for up to 140 days after infection, the viremic phase (i.e., period of presence of infectious virus in blood) rarely exceeds 60 days. Viremic phases of up to 100 days have been reported

incidentally.<sup>10</sup> Before the BTV-8 outbreak in Europe, sporadic clinical cases observed in cattle were thought to be the result of type I hypersensitivity reaction triggered by repeated exposure to virus-specific IgE.

In white-tailed deer, which are highly susceptible to bluetongue, disseminated intravascular coagulopathy (DIC) develops as a result of BTV-induced vascular damage. Affected animals develop potentially life-threatening hemorrhagic diathesis.<sup>15</sup>

### CLINICAL FINDINGS

#### Sheep

Naturally occurring florid bluetongue in sheep has the following clinical characteristics. After an incubation period of less than a week, a severe febrile reaction with a maximum temperature of 40.5° to 41° C (105–106° F) is usual, although afebrile cases may occur. The **fever** continues for 5 or 6 days. About 48 hours after the temperature rise, nasal discharge and salivation, with reddening of the buccal and nasal mucosae, are apparent. The **nasal discharge** is mucopurulent and often blood stained, and the saliva is frothy. Swelling and edema of the lips, gums, dental pad, and tongue occur, and there may be involuntary movement of the lips. **Excoriation** of the buccal mucosa follows, the saliva becomes blood stained, and the mouth has an offensive odor.

Lenticular necrotic ulcers develop, particularly on the lateral aspects of the tongue, which may be swollen and purple in color, but more commonly is not. **Hyperemia** and ulceration are also common at the commissures of the lips, on the buccal papillae, and around the anus and vulva. Swallowing is often difficult for the animal. Respiration is obstructed and stertorous and is increased in rate up to 100/min. Diarrhea and dysentery may occur.

Foot lesions, including **laminitis** and **coronitis** and manifested by lameness and recumbency, appear only in some animals, usually when the mouth lesions begin to heal. The appearance of a dark-red to purple band in the skin just above the coronet, as a result of coronitis, is an important diagnostic sign. **Wryneck**, with twisting of the head and neck to one side, occurs in a few cases, appearing suddenly around day 12. This is apparently attributable to the direct action of the virus on muscle tissue, as is the pronounced muscle stiffness and weakness, which is severe enough to prevent eating. There is a marked and rapid loss of condition. There is **facial swelling** with extensive swelling and drooping of the ears, and hyperemia of the nonwooled skin may be present. Some affected sheep show severe conjunctivitis, accompanied by profuse lacrimation. A break occurs in the staple of the fleece. Vomiting and secondary aspiration pneumonia may also occur. Death in most fatal cases occurs about 6 days after the appearance of signs.

In animals that recover, there is a **long convalescence**, and a return to normal may take several months. Partial or complete loss of the **fleece** is common and causes great financial loss for the farmer. Other signs during convalescence include separation or cracking of the hooves and wrinkling and cracking of the skin around the lips and muzzle. Although the subsequent birth of lambs with porencephaly and cerebral necrosis is usually recorded after vaccination with attenuated virus, it also occurs rarely after natural infections.

In sheep in **enzootic areas**, the disease is much less severe and often inapparent. Two syndromes occur: (i) an abortive form in which the febrile reaction is not followed by local lesions and (ii) a subacute type in which the local lesions are minimal, but emaciation, weakness, and extended convalescence are severe. A similar syndrome occurs in lambs, which become infected when colostrum immunity is on the wane.

### Cattle

**Most infections are inapparent**, although some BTV strains, such as serotype 8, are highly virulent in cattle. Affected animals may develop a clinical syndrome not unlike that seen in severely affected sheep. The incubation period was estimated to be between 6 and 8 days. Although fever in the range of 40° to 41° C (104–106° F) is often but not consistently observed, affected animals are lethargic and show anorexia and a drop in milk production. Skin and mucosal lesions on the muzzle, oral cavity, and tongue develop in early stages of the disease. Lesions are characterized by ulceration, necrosis, and eventually by superficial crusting. Mucopurulent and sometimes blood-tinged nasal discharge and fetid breath is a common finding. Hypersalivation and regurgitation are often observed. Skin lesions with erythema, ulcers, and necrosis can be found on the udder skin, on and around the coronary band, and sometimes around the eyes. Localized distal limb edema contributes to the observed reluctance to move of affected animals. Photodermatitis may develop at later stages of the disease (2–3 weeks after infection) on unpigmented skin. Contraction of the infection during early pregnancy may cause abortion, stillbirth, or **congenital deformities**, including hydranencephaly, microcephaly, arthrogryposis, blindness, and deformity of the jaw.

During the viremic phase, infected bulls are likely to shed virus in semen. The presence of BTV in the **semen** of bulls is accompanied by structural abnormalities of the spermatozoa and by the presence of virus particles in them.

### Goats

Infected goats show very little response clinically. There is a mild to moderate fever and hyperemia of the mucosae and conjunctivae.

BTV infections in deer produce an acute disease that is clinically and pathologically identical to epizootic hemorrhagic disease of deer and characterized by multiple hemorrhages throughout the body.

### New World Camelids

Although New World camelids were considered to be resistant to clinical disease associated with BTV, several reports of clinical disease with fatal outcome have been published in the recent literature.<sup>29–31</sup> Common to all reports is that only individual animals of a flock were affected while the rest of the flock remained clinically healthy. Common clinical findings were a rapid onset with anorexia, lethargy, and rapidly progressing respiratory distress. In most cases animals became recumbent and died within 24 hours of first clinical signs. Postmortem findings were severe alveolar edema of the lungs, hydrothorax, and hydropericardium, and severe congestion of the liver, spleen, and kidneys. In one case abortion was reported, and virus RNA was retrieved in fetal tissue.<sup>30</sup>

Experimental infection studies and epidemiologic field survey suggest that New World camelids are susceptible to infection, showing seroconversion, but only very rarely show clinical signs of disease.<sup>26,34</sup>

### Wild Ruminants

Among wild ruminants, **white-tailed deer** were found to be most susceptible to blue-tongue. Clinical presentation resembles the epizootic hemorrhagic disease of deer. Acute cases are characterized by **hemorrhagic diathesis** resulting from disseminated intravascular coagulopathy (DIC). Affected animals have widespread hemorrhages throughout the body, bloody diarrhea, swelling of head and neck, and blood-stained nasal discharge.

### CLINICAL PATHOLOGY

There is a fall in packed cell volume and initial leukopenia followed by leukocytosis. In severe disease there is marked leukopenia, largely as a result of lymphopenia. Infected cattle show a similar manifestation of leukopenia. The skeletal myopathy that occurs in this disease is reflected by a rise in creatine phosphokinase.

Specific diagnosis is either by isolation of the virus, detection of viral antigen or nucleic acid, or detection of specific antibodies in serum. Serologic assays can detect prior exposure to BTV but cannot establish if the animal is viremic, which is currently still important for movement decisions concerning cattle.

Material that can be used for virus isolation include heparin or EDTA blood; biopsies or postmortem tissue samples of the spleen, lung, lymph nodes, liver, and bone marrow; and, when indicated, heart or skeletal muscle tissue and brain tissue of aborted or stillborn fetuses.

### Virus Isolation

Virus isolation commonly is carried out by tissue culture or culture in embryonated chicken eggs (ECEs). Material obtained from inoculated chick embryos can either directly be examined (e.g., by using molecular methods such as PCR or in vitro hybridization) or be further propagated in cell cultures. Cell lines used for this purpose can be of insect origin, such as the KC cell lines derived from *Culicoides sonorensis* or mammalian cell lines such as the baby hamster kidney cells (BHK), calf pulmonary artery endothelium cells (CPAE), or African green monkey kidney cells (Vero). The cytopathic effect produced by BTV is only observed in cell lines of mammalian origin. Virus identification from cell cultures can then be conducted by methods such as immunofluorescence and immunoperoxidase assays using BTV-specific monoclonal antibodies. Virus isolation is the most reliable confirmation of BTV infection because there are difficulties with the interpretation of serologic test results. However, traditional isolation methods require 2 to 4 weeks.

Less commonly, diagnosis is by inoculation of blood into susceptible sheep, a method that is considered as one of the most sensitive and reliable methods of BTV isolation. A positive test depends on the appearance of clinical signs and/or the mounting of a BTV-specific antibody response. This method is used occasionally with samples containing very low virus titers but has widely been replaced by ECE inoculation.

### Detection of Antigen or Nucleic Acid

Immunohistochemical tests, including immunofluorescence, immunoperoxidase, and immunoelectron microscopic techniques using monoclonal antibody, can be used for rapid sensitive and specific detection of antigen. In situ nucleic acid hybridization and reverse-transcription polymerase chain reaction (**RT-PCR**) can be used for detection of the virus even after the viremic phase. This method has the advantage of speed over tissue culture virus isolation and can also differentiate between wild-type isolates and vaccine strains. Tests that detect viral RNA prove exposure to the virus but do not necessarily indicate that infectious virus is still present.

### Serologic Tests

Serologic tests for detection of either group-reactive antibodies or serotype-specific antibodies are available. The commonly available tests include the complement fixation test (CFT), the agar gel immunodiffusion test (AGID), a number of different ELISA tests, and serum neutralization (SN). The **AGID test** is easy to perform and inexpensive but is also relatively **insensitive** and detects cross-reacting antibodies to other orbiviruses. Over the last decades the CFT and AGID have been replaced in many

laboratories by the more rapid, sensitive, and specific competitive ELISA.

Numerous ELISA tests have been developed using group-specific monoclonal antibodies and present valuable alternatives to the AGID for routine diagnosis and international trade. The **competitive ELISA (c-ELISA)**, which is the most sensitive and highly specific group-specific test, is the preferred test for serodiagnosis of bluetongue. The c-ELISA cannot differentiate between infection and vaccination with modified live vaccines but is ideally suited to identify seroconversion in an unvaccinated population or to monitor the efficiency of a vaccination campaign in noninfected animals.

The **serum neutralization test (SNT)** is serotype specific and thus allows differentiation between antibodies against specific BTV serotypes. The biological detection system (either ECE or cell cultures) is reacted with a reference serum for specific BTV serotypes, and the amount of virus neutralization is determined. Although the SNT is highly sensitive and specific, it is also expensive and time consuming and is therefore not used as routine diagnostic procedure.

## NECROPSY FINDINGS

### Sheep

Sheep dying from bluetongue show edematous face and ears and a dry, crusty exudate on the nostrils and the conjunctiva. The coronary bands of the hooves are often hyperemic, and hemorrhages may extend down to the horn. The oral mucosa is usually cyanotic or hemorrhagic, with erosions and ulcers commonly affecting the tongue and dental part and sometimes extending to the rumen and abomasum. Acute cases will show subcutaneous and intermuscular edema, which may be serous or suffused with blood; the lesion is most marked in the head, neck, and abdominal regions. There may be serous effusions in the pleura, pericardium, and peritoneum. A characteristic and almost pathognomonic lesion for bluetongue is hemorrhage at the base of the pulmonary artery. Foci of muscle necrosis may be present in the heart, esophagus, pharynx, and other muscles. There may be aspiration pneumonia secondary to damaged esophageal/pharyngeal musculature, or the lungs may be diffusely edematous, especially when there are cardiac lesions.

The outcome of fetal infection in both sheep and cattle is age-dependent, with distinctive cavitating lesions of the brain (hydranencephaly or porencephaly) in fetuses that survive infection during early gestation, whereas fetuses infected in late gestation may be born viremic but without brain malformations.<sup>35</sup>

### Cattle

Mortality is less common in cattle. Lesions can include severe and extensive ulceration of the muzzle, oral mucosa, and teats;

rhinitis and mucohemorrhagic nasal discharge; epiphora and periorcular inflammation; and limb edema and interdigital necrosis and ulceration.<sup>35</sup> In some cases, the skin is ulcerated or eroded with a dry, crusty exudate, or it may have thick folds, particularly in the neck region. The coronary band is often hyperemic, and there may be pulmonary edema and serous effusion into body cavities. As in sheep, infected fetuses may develop central nervous lesions depending on the strain of the virus and the stage of gestation when infected. Several cases of congenital hydranencephaly and other anomalies were reported in calves during the initial outbreaks of BTV serotype 8 in Europe.<sup>35,36</sup>

Microscopically, bluetongue virus infection in sheep and cattle is characterized by thrombosis and widespread microvascular damage leading to hemorrhage, edema, myodegeneration, and necrosis. Inflammation is mild.

## Samples for Confirmation of Diagnosis

- **Histology**—fixed oral and mucocutaneous lesions, abomasum, pulmonary artery, skeletal muscle from a variety of sites, left ventricular papillary muscle; brain from aborted fetus (light microscopy, immunohistochemistry)
- **Virology**—chilled lung, spleen; CNS tissues, thoracic fluid from aborted fetus (ISO, PCR, in situ hybridization, ELISA, etc.)

## DIFFERENTIAL DIAGNOSIS

Foot-and-mouth disease
Epizootic hemorrhagic disease (wild ruminants)
Contagious ecthyma (sheep)
Sheep pox (sheep)
Bovine viral diarrhea/mucosal disease (cattle)
Malignant catarrhal fever (cattle)
Acute photodermatitis (cattle)
Bovine herpes mammillitis (cattle)

## TREATMENT

There is currently no specific treatment for bluetongue available. Symptomatic and supportive treatment should be considered to provide relief. Local irrigations with mild disinfectant solutions may afford some relief. Affected sheep should be housed and protected from weather, particularly hot sun, and fluid and electrolyte therapy and treatment to control secondary infection may be desirable.

## CONTROL

### Reduction of Infection Through Vector Abatement

Attempts to control bluetongue through a reduction of infection consist of reducing the

risk of exposure to infected *Culicoides* and reduction in *Culicoides* numbers. Neither is particularly effective.

Reducing the risk of exposure is attempted by spraying cattle and sheep with repellents and insecticides and housing sheep at night. Biweekly application of permethrin was found not to be effective in preventing infection.

During transmission periods, avoidance of low, marshy areas or moving sheep to higher altitudes may reduce risk. Because of the preference of some *Culicoides* for cattle as a host, cattle have been run in close proximity to sheep to act as vector decoys. Widespread spraying for *Culicoides* control is not usually practical and has only a short-term effect.

There is a high mortality in *Culicoides* that fed on cattle that have been treated with a standard anthelmintic dose of ivermectin and also a larvicidal effect in manure passed for the next 28 days for *Culicoides* that breed in dung.

Movement of ruminants from areas where specific BTV strains are circulating to regions where this serotype does not occur should only be considered after confirmation of absence of viremia.

## Vaccination

Vaccination is the only satisfactory control procedure once the disease has been introduced into an area. Vaccination will not prevent or eliminate infection, but it is successful in keeping losses to a very low level, provided immunity to all local strains of the virus is attained. Current vaccines are usually **polyvalent attenuated** virus vaccines and are in use in South Africa and Israel and available in other countries. These vaccines have been used in South Africa for more than 50 years, and they are known to induce effective and long-lasting immunity.

Reactions to vaccination are slight, but ewes should not be vaccinated within 3 weeks of mating because anestrus often results. **Annual revaccination** 1 month before the expected occurrence of the disease is recommended. Immunity is present 10 days after vaccination, and thus early vaccination during an outbreak may substantially reduce losses. Lambs from immune mothers may be able to neutralize the attenuated virus and fail to be immunized, whereas field strains may overcome their passive immunity. In enzootic areas, it may therefore be necessary to postpone lambing until major danger from the disease is passed, and lambs should not be vaccinated until 2 weeks after weaning. Rams should be vaccinated before mating time.

Live attenuated vaccines should not be used in **pregnant ewes** because of the risk of congenital defects in the lambs or embryonic death. The danger period is between the 4th and 8th weeks of pregnancy, with the greatest



incidence of deformities occurring when vaccination is carried out in ewes pregnant for 5 to 6 weeks. The incidence of congenital defects may be as high as 13%, with an average of 5%. Abortions do not occur, although some lambs are stillborn.

The preparation and use of **attenuated vaccines** against BTV is **problematic**. The neutralizing epitopes are highly conserved on some serotypes, but they are highly plastic on others. It is therefore necessary to continually monitor the identity and prevalence of the serotypes that need to be in the vaccine.

There are also concerns for the use of attenuated live vaccines to control insect-borne diseases because of the risk of the vaccine strain being transmitted, of being exalted in virulence by passage, and of recombinants resulting in the development of new virus strains with unwanted characteristics. There is evidence for the emergence of a **reassortment strain** from a vaccine virus in the United States and Europe and suspicion of occurrence elsewhere. However, attenuated live vaccines are used for practical reasons, including the fact that inactivated vaccines do not provide protection against infection. The difficulty in obtaining safe vaccines may be overcome by the use of recombinant DNA technologies. There is also good reason to suggest that cattle should be a major target of vaccination for bluetongue control.

### International Movement of Livestock

Countries that are free of BTV infection have traditionally erected barriers to avoid its introduction by prohibiting the importation of any ruminant animals from countries where the disease occurs. Others have less severe restrictions, and several procedures aimed at permitting limited movement are in force; their stringency varies with the importing country. Some countries only require a negative serologic test or series of tests before movement. Others require a negative test in conjunction with a period of quarantine. The introduction of bovine **semen** from low-risk areas after suitable tests of donors and a prolonged storage period is accepted by most countries. Most countries allow the importation of **embryos**.

A more enlightened understanding of the epidemiology of bluetongue will probably result in a reevaluation of these requirements in the future, including regionalization within a country to allow exports from areas where there is no prevalence or transmission.

### FURTHER READING

- Dal Pozzo F, et al. Bovine infection with bluetongue virus with special emphasis on European serotype 8. *Vet J*. 2009;182:142-151.
- Gibbs EPJ. Bluetongue: an analysis of current problems with particular reference to importation of

ruminants to the USA. *J Am Vet Med Assoc*. 1983;182:1190-1194.

- MacLachlan NJ. The pathology and pathogenesis of bluetongue. *J Comp Pathol*. 2009;141:1-16.
- MacLachlan NJ, Osburn BI. Impact of bluetongue virus infection on the international movement and trade of ruminants. *J Am Vet Med Assoc*. 2006;228:1346-1349.
- Mellor PS, Boorman J, Baylis M. *Culicoides* biting midges: their role as arbovirus vectors. *Ann Rev Entomol*. 2000;45:307-340.
- Osburn BI. Bluetongue virus. *Vet Clin North Am Food A*. 1994;103:547-560.
- Purse BV, et al. Climate change and the recent emergence of bluetongue in Europe. *Nature Rev Microbiol*. 2005;3:171-181.
- Roy P, Gorman BM. Bluetongue viruses. *Curr Top Microbiol Immunol*. 1990;162:1-200.
- Savini G, et al. Vaccines against bluetongue in Europe. *Comp Immunol Microbiol Infect Dis*. 2008;31:101-120.
- Wilson AJ, Mellor PS. Bluetongue in Europe: past, present and future. *Phil Trans R Soc B*. 2009;364:2669-2681.

### REFERENCES

- Wilson AJ, Mellor PS. *Phil Trans R Soc*. 2009;364:2669.
- Hofmann MA, et al. *Emerg Infect Dis*. 2008;14:1855.
- Chaignat V, et al. *Vet Microbiol*. 2009;138:11.
- Maan S, et al. *Emerg Infect Dis*. 2011;17:886.
- Saegerman C, et al. *Emerg Infect Dis*. 2008;14:539.
- European Commission. 2013 at: <[http://ec.europa.eu/food/animal/diseases/controlmeasures/bt\\_restrictedzones-map\\_2012.jpg](http://ec.europa.eu/food/animal/diseases/controlmeasures/bt_restrictedzones-map_2012.jpg)>; Accessed 03.08.13.
- Lysyk TJ, Danyk TJ. *Med Entomol*. 2007;44:741.
- Losson B, et al. *Vet Rec*. 2007;160:451.
- Dal Pozzo F, et al. *Vet J*. 2009;182:142.
- Sperlova A, Zendulkova D. *Vet Medicina*. 2011;56:430.
- De Clercq K, et al. *Vet Rec*. 2008;162:564.
- Desnecht D, et al. *Vet Rec*. 2008;163:50.
- EFSA. 2013 at: <<http://www.efsa.europa.eu/en/efsajournal/doc/2189.pdf>>; Accessed 03.08.13.
- van der Sluis M, et al. *Vet Microbiol*. 2011;149:113.
- MacLachlan NJ, et al. *J Comp Pathol*. 2009;141:1.
- Van Soom A, Nauwynck HJ. *Rev Persp Ag Vet Sci Nutr Nat Res*. 2008;2(60).
- Menzies FD, et al. *Vet Rec*. 2008;163:203.
- Mayo CE, et al. *Transbound Emerg Dis*. 2010;57:277.
- Backx A, et al. *Vet Microbiol*. 2009;38:235.
- Animal Health Australia. 2013 at: <[http://namp.animalhealthaustralia.com.au/public.php?page=namp\\_public&program=2](http://namp.animalhealthaustralia.com.au/public.php?page=namp_public&program=2)>; Accessed 03.08.13.
- Boyle DB, et al. *J Virol*. 2012;86:6724.
- Coetzee P, et al. *Virology*. 2012;9:198.
- MacLachlan NJ. *Prev Vet Med*. 2011;102:107.
- Linden A, et al. *Vet Rec*. 2008;162:459.
- Ruiz-Fons F, et al. *Emerg Infect Dis*. 2008;14:951.
- Rivera A, et al. *Am J Vet Res*. 1987;48:189.
- Mattson DE. *Vet Clin North Am Food A*. 1994;10:341.
- Schulz C, et al. *Vet Microbiol*. 2012;160:35.
- Heinrich M, et al. *Vet Rec*. 2007;161:764.
- Meyer G, et al. *Emerg Infect Dis*. 2009;15:608.
- Ortega J, et al. *J Vet Diagn Invest*. 2010;22:134.
- Elbers ARW, et al. *Prev Vet Med*. 2009;92:1.
- Nusinovici S, et al. *J Dairy Sci*. 2013;96:877.
- Schulz C, et al. *Vet Microbiol*. 2011;154:257.
- MacLachlan NJ, et al. *J Comp Pathol*. 2009;141:1.
- Vercauteren G, et al. *Transbound Emerg Dis*. 2008;55:293.

## MALIGNANT CATARRHAL FEVER (BOVINE MALIGNANT CATARRH, MALIGNANT HEAD CATARRH)

### SYNOPSIS

**Etiology** Alcelaphine herpesvirus-1, the wildebeest-associated malignant catarrhal fever (MCF) virus; ovine herpesvirus-2, the sheep-associated MCF virus

**Epidemiology** Highly fatal disease of cattle, farmed deer, and bison in the United States; Bali cattle (Banteng) in Indonesia; and occasionally pigs but rarely goats. Disease associated with contact with sheep, often weaned lambs, and in Africa also with wildebeest calves. Disease may occur sporadically or in outbreaks.

**Clinical findings** Fever, ocular and nasal discharge, erosive stomatitis and gastroenteritis, erosions in the upper respiratory tract, keratoconjunctivitis, encephalitis, cutaneous exanthema, and lymph node enlargement. The head and eye form is most common, and there is a distinctive lesion in the cornea.

**Clinical pathology** Competitive inhibition enzyme-linked immunosorbent assay (ELISA) for serology. Polymerase chain reaction (PCR) detection of viral DNA.

**Necropsy findings** Lymphoproliferative disorder involving dysregulation of T-lymphocytes. Erosions in gastrointestinal tract and lymphadenopathy. Necrotizing vasculitis.

**Diagnostic confirmation.** Detection of viral DNA by PCR.

**Treatment** Supportive.

**Control** Avoid cattle having contact with sheep and wildebeest.

### ETIOLOGY

Malignant catarrhal fever (MCF) is really two diseases, clinically and pathologically indistinguishable, but associated with two different infectious agents with different ecologies:

- Alcelaphine herpesvirus-1 (AIHV1) is now allocated to a new genus *Macavirus* (previously known as *Rhadinovirus*) of the subfamily Gammaherpesvirinae in the family Herpesviridae. This is the **wildebeest-associated MCF virus**, transmitted to cattle from blue wildebeest (*Connochaetes taurinus*).
- Ovine herpesvirus-2 (OvHV2) is also a *Macavirus* of the subfamily Gammaherpesvirinae. This is the **sheep-associated MCF virus** transmitted to cattle from sheep.

Neither agent appears to transmit from cattle to cattle, and neither of the viruses causes any disease in the principal hosts, the wildebeest and the sheep. AIHV1 can be grown in eggs and tissue culture, but OvHV2

has never been propagated *in vitro*. The molecular genomic structure of these viruses is described. A gammaherpesvirus closely related to OvHV2 has been isolated from goats and called caprine herpesvirus-2 (CpHV2), and another, also closely related, has been isolated from deer and called deer herpesvirus (DVH). The pathogenicity of these newly recognized viruses is not known. Complete genome sequences of AIHV1 (130,608 base pairs) and OvHV2 (135,621 base pairs) have been published.<sup>1</sup>

## EPIDEMIOLOGY

### Occurrence and Prevalence

The broad range of natural hosts for MCF can be divided into two categories: reservoir hosts (sheep, goats, wildebeest) and clinically susceptible hosts (cattle, bison, deer).<sup>2</sup>

### Alcelaphine MCF

Wildebeest-associated MCF occurs in most African countries in cattle that commingle with clinically normal wildebeest and hartebeest. It is epizootic and seasonal. It can also occur in zoologic gardens in other countries.

### Sheep-Associated MCF

Sheep-associated MCF occurs worldwide. Cases mostly occur when cattle have had contact with lambing ewes and usually start 1 to 2 months later. Goats can also act as a source of OvHV2 infection for cattle, and rare reports of clinical disease in goats exist.<sup>3</sup> Cases without apparent or recent exposure to sheep do occur but are uncommon.

The morbidity rate varies. Usually the disease is sporadic and presents as a single or small number of cases over a short period, but on occasion up to 50% of a herd may be affected in rare but devastating outbreaks that may be short-lived or last for several months. The disease with both agents is **almost always fatal, with rare reports of recovery in cattle.**

Besides cattle, MCF is also an important disease of farmed deer. It is an occasional disease of pigs and is recorded in pigs that had contact with sheep on a farm and in a petting zoo.

### Methods of Transmission

Both AIHV1 and OvHV2 appear to be transmitted by contact or aerosol, primarily from respiratory secretions of wildebeest calves (AIHV1) and weaned lambs (OvHV2) under 1 year of age. Nose-to-nose contact appears to provide the most efficient method of spread, but transmission can also occur via fomites.<sup>4</sup> The MCF-susceptible species are thought to be dead-end hosts that do not shed virus and are therefore not infectious. Acute MCF in cattle is caused by either AIHV1 or OvHV2, with almost all cases in North American cattle being caused by OvHV2.

### Alcelaphine MCF

Infection with AIHV1 in wildebeest occurs in the perinatal period by horizontal and occasional intrauterine transmission, and infected young wildebeest up to the age of about 4 months have viremia and shed virus in ocular and nasal secretions. The disease is transmitted from wildebeest to cattle by contact or over short distances, probably by inhalation of aerosol or ingestion of pasture contaminated by virus excreted by young wildebeest in nasal and ocular discharges. In contrast, infected cattle do not excrete virus in nasal or ocular secretions. The disease can transmit between wildebeest and cattle over a distance of at least 100 m, and it is suggested that cattle need to be kept at least 1 km from wildebeest to avoid disease.

In Kenya the peak incidence of alcelaphine MCF occurs when 3- to 4-month-old wildebeest are in maximum numbers. In South Africa the peak incidence is at a time when young wildebeest are 8 to 10 months old and not infectious, requiring that there be another, high-volume source of the infection. The proportion of sheep in a wildebeest area that are serologically positive and presumably infected with the wildebeest-associated virus is very high.

### Sheep-Associated MCF

Virtually all domestic sheep raised under natural flock conditions are infected with OvHV2, which causes an inapparent infection in sheep. **High rates of seropositivity** have been found in domestic sheep and goats over 1 year of age in several surveys. In a study of 14 species of North American wildlife, a high rate of seropositivity was also found in muskox (*Ovibos moschatus*) and bighorn sheep (*Ovis canadensis*), suggesting that they might be sources of infection. There were low seropositivity rates in clinically susceptible species such as deer and bison.

In contrast to AIHV1 infection in wildebeest, the transmission of OvHV2 between sheep appears minimal in the perinatal period. There is no evidence for transplacental infection, and although antigen, detected by PCR, is present in colostrum and milk from infected ewes, the majority of lambs are not infected until after 2 to 3 months of age. The rate of infection in lambs and the age at infection is not influenced by passively acquired maternal immunity and appears to be dose dependent. Infected sheep excrete OvHV2 in nasal secretions, but **very high levels of excretion occur between 6 and 9 months of age**, suggesting that the 6- to 9-month period is the time when most virus is shed into the environment. Viral antigen has been detected in the ejaculate of rams, but there is little epidemiologic evidence for significant venereal transmission.

The means by which OvHV2 spreads from infected sheep to cattle is not known

but is presumably by inhalation or ingestion of respiratory secretions. The common epidemiologic association of diseased cattle having had contact with lambing ewes suggests that perinatal lambs play a role in transmission similar to that played by wildebeest calves; however, the age at infection of lambs and the excretion patterns of the virus do not fit this assumption. Shedding from ewes does not increase in the lambing period. Contact with ewes is not a prerequisite, one outbreak having occurred when cattle commingled with rams. Infection can also occur when sheep and cattle are housed in the same building but with no common contact through feeding or watering points.

An interesting insight into transmission is provided by a Canadian outbreak where 45/163 bison died following exposure for less than 1 day to sheep at a sale barn.<sup>5</sup> Bison deaths started 50 days later and peaked at 60 to 70 days after exposure to sheep, with the last death occurring 7 months after initial exposure. Despite the high mortality rate, there was no evidence of bison-to-bison transmission.

Occasional cases occur in cattle that have had no apparent contact with sheep, and the persistence of the infection in a particular feedlot, or on a particular farm, from year to year when no contact with sheep exists, is unexplained. Persistence of the virus on inanimate fomites has been suggested, but the virus is a most fragile one, and this seems unlikely. The observation that some recovered cattle show a **persistent viremia** for many months suggests that carrier cattle may be the source of these carryover infections. In addition, the virus, detected by PCR, has been demonstrated in cattle and farmed deer with no evidence of MCF disease. It is possible that stress could activate a latent infection in animals with no sheep contact.

### Experimental Reproduction

Sheep-associated MCF virus does not replicate in tissue culture. It has a close association with lymphoblastoid cells, particularly large granular lymphocytes, which can be grown in tissue culture and induce MCF when injected. MCF can also be transmitted to cattle by transfusion of large volumes of blood if given within 24 hours of collection. Wildebeest-associated MCF virus can be readily transmitted by several routes. It has been adapted to grow on egg yolk sac and tissue culture, and transmission to rabbits to yolk sac to cattle has been achieved.

### Environment Risk Factors

The disease shows the greatest incidence in late winter, spring, and summer months. There have been suggestions that copper deficiency or exposure to bracken fern might be environmental stressors that predispose the expression of the disease in cattle.

### Animal Risk Factors

Clinical disease had been described in over 30 species of ruminants. In Africa, assorted **wild ruminants** contract the disease and suffer a severe illness and a high mortality rate. Similar species in zoos are also commonly affected, for example, Père David's deer (*Elaphurus davidianus*) and Greater kudu (*Strepsiceros kudu*).

Among **domestic animals**, all ages, races, and breeds of cattle are equally susceptible, but banteng (*Banteng sondaicus*), buffalo (*Bubalus bubalis*), bison (*Bison bison*), and deer are more susceptible and suffer a more severe form of the disease than do commercial cattle. Bison are estimated to be approximately 1000 times more susceptible to clinical MCF than cattle.<sup>2</sup> Disease is recorded in captive deer or farmed deer including sika deer (*Cervus nippon*), roe deer (*Capreolus capreolus*), white-tailed deer (*Odocoileus virginianus*), rusa deer (*C. timorensis*), and red deer (*C. elaphus*).

MCF is considered one of the most important diseases of **farmed deer**. The clinical signs and necropsy findings closely resemble those of MCF in cattle, but the morbidity and mortality can be disastrously high, resulting in heavy losses for the deer farmer.

### Economic Importance

Losses attributable to the disease can be catastrophic on rare individual farms. For the most part it is a nuisance because of its resemblance to mucosal disease and bluetongue and its historic resemblance to rinderpest, which has been eradicated.

### PATHOGENESIS

MCF is a fatal, multisystemic disease characterized by lymphoid proliferation and infiltration and widespread **vascular** epithelial and mesothelial lesions, which are morphologically associated with lymphoid cells. CD8+ T-lymphocytes are the predominant cells associated with the vascular lesions. Involvement of the vascular adventitia accounts for the development of gross lesions, including the epithelial erosions and keratoconjunctivitis. The lymph node enlargement is a result of atypical proliferation of sinusoidal cells. The cerebromeningeal changes, usually referred to as encephalitis, are in fact a form of vasculitis. There is commonly synovitis, especially involving tibiotarsal joints, and this also is associated with a lymphoid vasculitis. It is thought that the pathogenesis of this disease is the result of direct virus–cell interactions or perhaps immune-mediated responses directed against infected cells.

### CLINICAL FINDINGS

The **incubation period** in natural infection varies from 3 to 8 weeks, and after artificial infection averages 22 days (14 to 37 days). MCF is described as occurring in a number

of forms, although fever, corneal edema, and oculonasal and oral lesions are almost always present in cattle with acute MCF. The forms identified are:

- Peracute
- Alimentary tract form
- Common “head-and-eye” form
- Mild form

However, these forms are all gradations, with cases being classified on the predominant clinical signs. In serial transmissions with one strain of the virus, all of these forms may be produced. The most common manifestation is the head-and-eye form.

In cattle, the presence of nasal discharge, corneal edema, fever, and lymphadenopathy is very helpful in differentiating MCF from mucosal disease or bluetongue.<sup>6</sup> The mean duration of clinical signs before death in one outbreak was 6 days, with a range of 1 to 26 days.<sup>7</sup>

### Head-and-Eye Form

There is a sudden onset of the following symptoms:

- Extreme dejection
- Anorexia
- Agalactia
- High fever (41° to 41.5°C [106–107°F])
- Rapid pulse rate (100 to 120/bpm)
- Profuse mucopurulent nasal discharge
- Severe dyspnea with stertor as a result of obstruction of the nasal cavities with exudate
- Ocular discharge with variable degrees of corneal edema
- Blepharospasm and uveitis
- Congestion of scleral vessels

Superficial necrosis is evident in the anterior nasal mucosa and on the buccal mucosa. This begins as a diffuse reddening of the mucosa and is a consistent finding at about day 19 or 20 after infection. Discrete local **areas of necrosis** appear on the hard palate, gums, and gingivae. The mouth is painful at this time, and the animal moves its jaws carefully, painfully, and with a smacking sound. The mucosa as a whole is fragile and splits easily. The mouth and tongue are slippery, and the mouth is hard to open. The erosive mucosal lesions may be localized or diffuse. Lesions may occur on the following areas:

- Hard palate
- Dorsum of the tongue
- Gums below the incisors
- Commissures of the mouth
- Inside the lips

The cheek papillae inside the mouth are hemorrhagic, especially at the tips, which are later eroded. At this stage there is excessive salivation, with saliva that is ropelike and bubbly hanging from the lips. The skin of the muzzle is extensively involved, commencing with discrete patches of necrosis at the nostrils that soon coalesce, causing the entire muzzle to be covered by tenacious scabs. Similar lesions may occur at the skin–horn junction of the feet, especially at the back of

the pastern. The skin of the teats, vulva, and scrotum in acute cases may slough off entirely upon touch or become covered with dry, tenacious scabs.

**Nervous signs**, particularly weakness in one leg, incoordination, a demented appearance, and muscle tremor, may develop very early, and nystagmus, head-pushing, paralysis, and convulsions may occur in the final stages. Trismus has been described, but it is probably a result of pain in the mouth rather than a neuromuscular spasm. There is one report in young calves where nervous signs were the predominant feature.<sup>8</sup>

In natural cases the superficial lymph nodes are often visibly and usually palpably enlarged. **Lymphadenopathy** is also one of the earliest, most consistent, and persistent signs of the experimental disease. The consistency of the feces varies from constipation to profuse diarrhea with dysentery. In some cases there is gross hematuria, with the red coloration most marked at the end of urination.

**Edema (opacity) of the cornea** is always present to some degree, commencing as a narrow, gray ring at the corneoscleral junction (perilimbal) and spreading centripetally with conjunctival and episcleral hyperemia (Fig. 21-1). Anterior uveitis (keratic precipitates, aqueous flare, fibrin deposition in the anterior chamber, hypopyon, iris hyperemia and edema, miosis) is observed in some

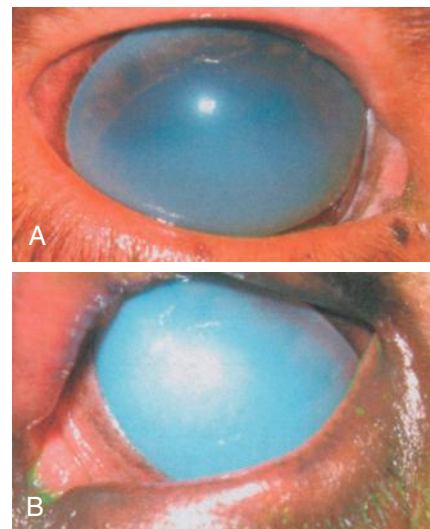

**Fig. 21-1** A, The right eye of an adult cow with early clinical signs of malignant catarrhal fever. Moderate corneal edema is present. Intraocular structures can be seen but not in detail. B, The left eye of an adult cow with advanced malignant catarrhal fever. Severe corneal edema is present, and intraocular structures cannot be observed. (Reproduced with permission from Zemljič T, Pot SA, Haessig M, Spiess BM. Clinical ocular findings in cows with malignant catarrhal fever: ocular disease progression and outcome in 25 cases [2007-2010]. *Veterinary Ophthalmology* 2012; 15:46-52.)



cases. The progression of corneal edema and nonimprovement of anterior uveitis indicate that survival is unlikely.<sup>9</sup>

In cases of longer duration, **skin changes**, including local papule formation with clumping of the hair into tufts over the loins and withers, may occur. In addition, eczematous weeping may result in crust formation, particularly on the perineum, around the prepuce, in the axillae, and on the inside of the thighs. Infection of the cranial sinuses may occur, with pain on percussion over the area. The horns and rarely the hooves may be shed. Persistence of the fever is a characteristic of MCF, even in cases that persist for several weeks, with a fluctuating temperature that usually exceeds 39.5°C (103°F).

During some outbreaks an occasional animal makes an apparent recovery but usually dies 7 to 10 days later of acute encephalitis. In the more typical cases the illness lasts for 3 to 7 days and rarely up to 14 days.

### Peracute and Alimentary Tract Forms

In the peracute form the disease runs a short course of 1 to 3 days, and characteristic signs and lesions of the head-and-eye form do not appear. There is usually a high fever, dyspnea, and acute gastroenteritis. The alimentary tract form resembles the head-and-eye form, except that there is marked diarrhea and only minor eye changes consisting of conjunctivitis rather than ophthalmia. This form of the disease has been encountered in outbreak form in cattle in large dairy herds in drylots, with only indirect contact with sheep, and in cattle to which transmission was attempted and farmed deer. A feature of this form of the disease is reported to be a brief period of slight illness followed by the final fulminating disease, which is common in deer.

### Mild Form

The mild form occurs most commonly in experimental animals but is observed in natural outbreaks. There is a transient fever, and mild erosions appear on the oral and nasal mucosae. Mild disease may be followed by complete recovery, recovery with recrudescence, or chronic MCF. A distinctive clinical feature in chronic MCF is persistent bilateral ocular leukomata.

### Pigs

The disease in pigs is similar to the head-and-eye form in cattle and manifests with fever and tremor, ataxia, hyperesthesia, and convulsions and death.

### CLINICAL PATHOLOGY

Leukopenia, commencing at first illness and progressing to a level of 3000 to 6000/ $\mu$ L, has been recorded but is not a general observation. The leukopenia recorded was mainly the result of agranulocytosis. In our experience moderate leukocytosis is more common.

**Virus isolation** is not practical with either virus because of the instability of cell-associated AIHV1 and the fact that OvHV2 does not replicate in cell culture. **Transmission** can be used for diagnosis using whole blood, nasal swabs or washings, and preferably lymph node collected by biopsy, with histologic lesions in the recipient rabbits or calves as the criterion. **Detection of viral nucleic acid** by PCR has largely replaced transmission experiments.

There are a number of **serologic tests** that can be used, but they have limited value for diagnosis of clinical cases because only a small percentage of animals seroconvert and do so late in the course of the disease. The antibody titer is low, and there is cross-reaction with other herpes viruses. A **competitive-inhibition ELISA** using a monoclonal antibody to a broadly conserved epitope of the MCF virus can be used for detection of antibody and has largely replaced other serologic tests. It is of particular value for epidemiologic studies. The development of antibody following infection is delayed in a significant proportion of young animals, and serology is unreliable for determining infection status until after 1 year of age.

Uninfected lambs or kids under 4 months of age may test positive because of the presence of maternal antibody.

**Detection of viral nucleic acid** by PCR techniques is the current accepted diagnostic technique. The buffy coat is probe-positive 2 days after experimental infection with alcelaphine herpesvirus-1. Virus can be present in cattle without clinical MCF, and if these have a disease that is not MCF, but test probe positive, a **false diagnosis** is possible.

### NECROPSY FINDINGS

Lesions in the mouth, nasal cavities, and pharynx vary from minor degrees of hemorrhage and erythema through extensive, severe inflammation to discrete ulcers. These lesions may be shallow and almost imperceptible or deeper and covered by cheesy diphtheritic deposits. **Erosion** of the tips of the cheek papillae, especially at the commissures, is common. Longitudinal, shallow erosions are present in the esophagus. The mucosa of the forestomachs may exhibit erythema or sparse hemorrhages or erosions. Similar but more extensive lesions occur in the abomasum. Catarrhal enteritis of moderate degree and swelling and ulceration of the Peyer's patches are constant. The feces may be loose and blood stained.

Similar lesions to those in the mouth and nasal cavities are present in the trachea and sometimes in the bronchi, but the lungs are not usually involved except for occasional emphysema or secondary pneumonia. The liver is swollen, and severe hemorrhage may be visible in the urinary bladder. All lymph nodes are swollen, edematous, and often hemorrhagic. The gross ocular lesions are as described clinically. Petechial hemorrhages

and congestion may be visible in brain and meninges.

**Histologically**, MCF is characterized by perivascular mononuclear cell cuffing in most organs and by degeneration and erosion of affected epithelium. The pathognomonic lesion is a **necrotizing vasculitis** that features infiltration of the tunica media and adventitia by lymphoblast-like cells and macrophages. Acidophilic, intracytoplasmic inclusion bodies in neurons have been described, but their identity as viral inclusions has not been established. Large numbers of inclusion bodies have been observed in the tissue of artificially infected rabbits. The histologic features of the panophthalmitis have been described.

Cattle with chronic MCF have chronic bilateral central stromal keratitis with or without corneal pigmentation. An **obliterative arteriopathy** is characteristic, and this vascular lesion is present in all major organs. Results of a competitive inhibition ELISA serologic test suggesting a role for the virus in the development of obliterative arterial lesions in cattle have been supported by in situ PCR and immunohistochemical studies of the disease in bison that demonstrated OvHV2 within the infiltrating lymphocytes. These lymphoblast-like cells were also shown to be CD8+ T cells.

A PCR technique or immunohistochemical stains can be used to confirm the presence of viral antigen in whole blood or in tissues harvested at necropsy. When transmitted to rabbits, both the wildebeest- and sheep-associated viruses elicit a rapidly fatal lymphoproliferative disorder. The newer molecular biology-based techniques have made this bioassay method obsolete.

### Samples for Confirmation of Diagnosis

- **Histology**—fixed brain, lymph node, alimentary tract mucosa including pharynx, esophagus, rumen and Peyer's patch, liver, adrenal gland, kidney, urinary bladder, salivary gland (immunohistochemistry, light microscopy); Bouin's-fixed eye (light microscopy)
- **Virology**—lymph node, spleen, lung (PCR)

### DIFFERENTIAL DIAGNOSIS

- Mucosal disease
- Infectious bovine rhinotracheitis (IBR)
- Bluetongue
- Sporadic bovine encephalomyelitis
- Rinderpest (included for historic reasons)
- Jembrana disease

### TREATMENT

Treatment of affected animals is unlikely to influence the course of the disease.

Nonsteroidal antiinflammatories may ease the discomfort.

### CONTROL

Isolation of affected cattle is usually recommended, but its value is questioned because of the slow rate of spread and the uncertainty regarding the mode of transmission. Because of the field observation that sheep are important in the spread of the disease, **separation** of cattle and sheep herds is recommended. The introduction of sheep from areas where the disease has occurred to farms with cattle should be avoided. A program to produce sheep free of OvHV2 infection by separation and isolation of lambs before they become infected is recommended for sheep used in petting zoos.

An effective vaccine is not available and is likely to remain unavailable in the foreseeable future.<sup>10</sup> Attempts to immunize cattle with live or inactivated culture vaccines with Freund's incomplete adjuvant do not provide protection against experimental challenge or natural challenge by exposure to wildebeest herds. High and persistent levels of virus-neutralizing antibody are demonstrable following vaccination, but humoral mechanisms are probably not important in determining resistance to infection with the virulent virus. An inactivated wildebeest-associated MCF virus vaccine has provided protection against challenge with virulent viruses. Establishing a respiratory mucosal barrier of antibody is currently thought to provide the best chance of protective immunity,<sup>11</sup> but this will be challenging to attain with IM or SC vaccines.

### FURTHER READING

- Callan RJ, Van Metre DC. Viral diseases of the ruminant nervous system. *Vet Clin North Am Food A.* 2004;20:327-362.
- O'Toole D, Li H. The pathology of malignant catarrhal fever with an emphasis on ovine herpesvirus 2. *Vet Pathol.* 2014;51:437-452.
- Russell GC, Stewart JP, Haig DM. Malignant catarrhal fever: a review. *Vet J.* 2009;179:324-335.

### REFERENCES

- Ababneh MM, et al. *Transbound Emerg Dis.* 2014;61:75.
- Li H, et al. *Int J Mol Sci.* 2011;12:6881.
- Jacobsen B, et al. *Vet Microbiol.* 2007;124:353.
- Taus NS, et al. *Vet Microbiol.* 2006;116:29.
- Berezowski JA, et al. *J Vet Diagn Invest.* 2005;17:55.
- Bexiga R, et al. *Vet Rec.* 2007;161:858.
- Moore DA, et al. *J Am Vet Med Assoc.* 2010;237:87.
- Mitchell ESE, Scholes SFE. *Vet Rec.* 2009;164:240.
- Zemljic T, et al. *Vet Ophthalmol.* 2012;15:46.
- Li H, et al. *Expert Rev Vacc.* 2006;5:133.
- Russell GC, et al. *Vet Res.* 2012;43:51.

### MALIGNANT CATARRH IN PIGS

Malignant catarrh virus outbreaks are not common in pigs, but they do occur sporadically, usually when pigs are kept together with sheep, which are the main reservoir of infection. Information on the disease is not extensive.

### ETIOLOGY

The cause is ovine herpes virus 2 (OvHV2), and there is a sheep-associated form and a wildebeest-associated form.<sup>1</sup>

### EPIDEMIOLOGY

The condition has been reported in pigs in Europe in Germany, Norway, Italy, Finland,<sup>2,3</sup> and Switzerland. In a recent outbreak in the United Kingdom it was described in two ailing Kune Kune<sup>4</sup> that lived in a "traveling circus" with sheep and goats and other species that were often transported together in a mobile trailer.

In most cases described, pigs have had contact or been housed together with sheep.<sup>5</sup> Nasal discharges may be the source of infection, particularly from lambs.

The pig is a dead-end host, and thus spread is limited.<sup>6</sup> In the cases in Brazil,<sup>7</sup> there was transfer of the infection from asymptomatic boars to sows via the semen of infected boars.

### PATHOGENESIS

Pathogenesis is unknown as yet in the pig.

### CLINICAL SIGNS

Pigs are depressed and recumbent, have abnormal respiration, and produce hard, mucus-covered scant feces. The condition develops to ataxia and severe balance loss, which is sometimes violent. There is corneal edema with severe uveitis. In the Kune cases, they were blind, with bilateral corneal opacity, excessive lacrimation, and eyelid thickening. Eventually there was a fine tremor with circling.

A recent report described the infection in asymptomatic swine without any history of contact with sheep in Norway.<sup>8</sup> The disease is difficult to diagnose in pigs because of the nonspecific nature of the clinical signs and the sporadic nature of the disease. Usually only one or two animals are affected, although an outbreak in 41 pigs has been described.<sup>3</sup>

In the Brazilian cases, gilts and sows had depression, abortion, and anorexia. Subsequently, a whole range of neurologic signs developed, such as ataxia, tremors, convulsions, and aggressive behavior. Animals that survived had locomotory abnormalities with forelimb paralysis and were dog-sitting. Infected boars shed virus but remained clinically healthy. In the Finnish study the dead sows had anorexia and high fever.<sup>1</sup>

### PATHOLOGY

There are quite often very few gross signs. There may be a crusty skin and areas of cyanosis. The respiratory tract may be covered in a mucopurulent exudate. Lungs may be congested and edematous. In the Finnish study, the sows had swollen lymph nodes, a pale-brown liver, and congested kidneys. There may be pale kidneys with petechiae, small erosions on the lining of the stomach,

and congested meninges. In many cases, there were only small lesions in the lung and pancreas.

In the Kune Kune<sup>4</sup> there were ulcerations of the skin, and mucocutaneous ulcerations were found in the mouth. There was also ulceration of the soft palate and tonsils and lymphadenopathy with enlarged spleen and adrenals and meningeal edema and meningitis.

The disease is essentially a lymphoproliferative vasculitis. Histopathologically, there was a severe nonpurulent meningoencephalitis with lymphocytic cuffing around vasculitis. Edema, fibrinoid necrosis, and lymphocytic infiltration were also observed. The lesions are more severe in the kidneys (severe, multifocal, interstitial, nonsuppurative nephritis) associated with fibrinoid necrosis of the vessels.

### DIAGNOSIS

The differential diagnosis includes Aujeszky's disease (ADV), classical swine fever (CSF), porcine enterovirus (PEV), and rabies. OHV2 DNA can be detected in the clinically affected pigs. A combination of clinical signs, histopathology, and the detection of virus-specific antibodies is usually suggestive. A competitive inhibition ELISA test has been developed and also a direct ELISA. PCR and quantitative reverse-transcription PCR (qRT-PCR) have also been developed for the detection of the virus in tissues.

### REFERENCES

- Meier-Trummer CS, et al. *Vet Microbiol.* 2010;141:191.
- Syrjala P, et al. *Vet Rec.* 2006;159:406.
- Gauger PC, et al. *J Swine Hlth Prod.* 2010;18:244.
- Wessels M, et al. *Vet Rec.* 2011;169:156a.
- Alcaraz A, et al. *J Vet Diagn Invest.* 2009;21:250.
- Russell GC, et al. *Vet J.* 2009;179:324.
- Costa EA, et al. *Emerg Infect Dis.* 2010;16:2011.
- Loken T, et al. *J Vet Diagn Invest.* 2009;21:257.

### JEMBRANA DISEASE

Jembrana disease is the name of a fatal infectious disease that occurs in Bali cattle (*Bos javanicus*) and buffaloes (*Bubalus bubalis*) on the island of Bali in Indonesia. The disease is endemic in areas of Indonesia only, but the severe disease of the initial outbreak has modified with time.

### ETIOLOGY

The disease is caused by a lentivirus, the Jembrana disease virus (JDV), genetically related to but distinct from bovine immunodeficiency virus (BIV), a more benign infection found in Indonesia and many other countries. Both viruses resemble human immunodeficiency virus (HIV) in their structural, genomic, antigenic, and biological properties. JDV has a capsid protein (p26) that is used as an antigen source for serologic diagnosis, but it cross-reacts with sera from

BIV-infected cattle.<sup>1</sup> Furthermore, although JDV is genetically very stable, it has strain variation, and under experimental conditions, atypical responses to infection characterized by reduced viral loads, lower or absent febrile responses, and absence of specific antibody responses were observed in 15% of infected cattle.<sup>2-3</sup>

## EPIDEMIOLOGY

### Occurrence

The disease originally occurred in Jembrana district on the Island of Bali, Indonesia, in 1964 and rapidly spread to the rest of the island, resulting in the deaths of approximately 17% of Bali cattle. Since 1964, the disease has been endemic on Bali island but with lower morbidity and mortality rates. It has subsequently spread to the Indonesian islands of Sumatra, Java, and Kalimantan, producing initial epidemic disease with high mortality followed by endemic disease with lower morbidity and mortality. The current mortality rate is approximately 15% to 20%.<sup>4-5</sup>

### Transmission

Transmission probably occurs by direct contact with infective secretions in the acute phase of the disease when viral titers are greater than 10(6) genomes/ml<sup>6</sup> and by mechanical transmission by hematophagous insects or mechanically by needles during mass vaccination of animals for the control of diseases such as hemorrhagic septicemia.

### Experimental Reproduction

The disease can be experimentally transmitted by intravenous (IV) or intraperitoneal inoculation of blood or spleen into *B. javanicus*. The virus is present in high titer in the blood during the febrile phase and in the saliva and milk. In *B. javanicus* an incubation period of 4 to 12 days is followed by fever lasting from 5 to 12 days and clinical signs typical of the enzootic form of the disease. Persistent infection occurs for periods of at least 2 years following recovery.

Experimental challenge of *B. indicus*, *B. Taurus*, and crossbred (*B. javanicus* and *B. indicus*) cattle results in only a transient febrile response, mild clinical disease, and viremia that persist for 3 months, although antibody persists for at least 4 years following infection. Infection, as determined by antibody response, but not clinical disease, can be transmitted experimentally to pigs, sheep, goats, and buffaloes.

### PATHOGENESIS

Jembrana disease is not typical of other lentivirus infections, which are usually characterized by chronic progressive disease with long incubation periods. Instead, JDV causes an acute and sometimes fatal disease after a short incubation period. There is a high viremia during the febrile stage, with virus titers being as high as 10(12) virus/mL of

plasma. Initial virus proliferation in the spleen is followed by widespread dissemination during a second proliferative phase and infection in lymph nodes, lungs, bone marrow, liver, and kidney. Affected animals do not develop detectable antibodies to the virus until at least 6 weeks after recovery from the acute phase, and surviving animals are resistant to reinfection but remain infectious for at least 2 years.

The specific cell types infected by Jembrana disease virus have not yet been identified, but during the febrile phase, there is marked depletion of CD4+ T cells and increase in CD8+ T cells and CD21+ B cells.<sup>7</sup> The persistent depletion of CD4+ T-cell numbers, through lack of T-cell helper to B cells, may explain the lack of production of JDV-specific antibodies for several weeks after recovery despite an increase in CD21+ B-cell numbers.<sup>7</sup> Furthermore, viral antigen is present in IgG-containing cells, including plasma cells in lymphoid tissues, and in macrophage-like cells in the lungs.<sup>8</sup>

### CLINICAL FINDINGS

Natural clinical disease is reported only in *B. javanicus*; other cattle types and buffalo are subclinically infected in natural outbreaks. After an incubation period of 4 to 12 days, clinical signs include fever (40–42°C [104–107°F]) that lasts up to 12 days, anorexia, generalized lymphadenopathy, nasal discharge, increased salivation, and anemia. In severely affected cattle there is diarrhea followed by dysentery. Mucosal erosions can occur but are rare. Hemorrhages are present in the vagina, mouth, and occasionally the anterior chamber of the eye in severe disease. Where the disease is enzootic and less severe in presentation, clinical signs include inappetence, fever, lethargy, reluctance to move, enlargement of the superficial lymph nodes, mild erosions of the oral mucosa, and diarrhea.

### CLINICAL PATHOLOGY

During the febrile period there is a moderate normocytic normochromic anemia and leukopenia with lymphopenia, eosinopenia, and thrombocytopenia. The lymphopenia is attributable to a significant decrease in both the proportion and absolute numbers of CD4+ T cells.<sup>7</sup> Bone marrow shows no microscopic changes. Elevated blood urea concentrations and diminished total plasma protein are seen in *B. javanicus* but not *B. taurus*. An ELISA test and an agar gel immunodiffusion test can be used for serologic surveys. Both are specific, but the ELISA test has greater but limited sensitivity. A combination of real-time PCR and JDV p26-his ELISA has been recommended for the detection of infection with JDV in Indonesia.<sup>1</sup>

### NECROPSY FINDINGS

Necropsy lesions in *B. javanicus* include generalized lymphadenopathy, with enlarge-

ments up to 20-fold, and generalized hemorrhages. The spleen is enlarged to 3 to 4 times its normal size. Histologically, there is marked proliferation of lymphoblasts in parafollicular (T-cell) areas of lymph nodes and spleen, and atrophy of the follicles (B-cell areas). In addition, there is lymphoproliferation around blood vessels in the liver, kidney, and other organs.<sup>5</sup>

Specimens for histopathology should include lymph nodes, spleen, liver, and kidney.

## TREATMENT AND CONTROL

### TREATMENT AND CONTROL

#### Treatment

None except supportive

#### Prophylaxis

Vaccination (R-2)

Treatment is supportive. There is currently no specific control. Vaccination has been attempted using virus-containing plasma and spleen tissue from acutely affected cattle with the virus inactivated with triton X-100 and the vaccine adjuvanted with either mineral oil or Freund's incomplete adjuvant. Protection is only partial and not of real value in control, except perhaps in reducing the risk of virus transmission, because vaccinated animals have a greatly reduced viral load.<sup>6</sup>

### FURTHER READING

- Desport M, Lewis J. Jembrana disease virus: host responses, viral dynamics and disease control. *Curr HIV Res.* 2010;8:53.
- Wilcox GE, Chadwick BJ, Kertayadnya G. Recent advances in the understanding of Jembrana disease. *Vet Microbiol.* 1995;46:249.
- Wilcox GE. Jembrana disease. *Aust Vet J.* 1997;75:492.

### REFERENCES

- Lewis J, et al. *J Virol Methods.* 2009;159:81.
- Desport M, et al. *Virus Res.* 2007;126:233.
- Desport M, et al. *Virology.* 2009;386:310.
- Desport M, Lewis J. *Curr HIV Res.* 2010;8:53.
- Su Y, et al. *Viol J.* 2009;6:179.
- Ditcham WG, et al. *Virology.* 2009;386:317.
- Tenaya IW, et al. *Vet Immunol Immunopathol.* 2012;149:167.
- Desport M, et al. *Virology.* 2009;393:221.

## BOVINE EPHEMERAL FEVER

### SYNOPSIS

**Etiology** Arthropod-borne rhabdovirus of the genus *Ephemerovirus*.

**Epidemiology** Enzootic in tropical areas. Transmitted by insect vectors. Episodic epizootics in summer in incursive areas probably initiated by wind-borne transmission of insect vector. High morbidity but low case fatality.

*Continued*



**Clinical findings** Disease of cattle with fever, respiratory distress, muscular shivering, stiffness, lameness, and enlargement of the peripheral lymph nodes.

Generally spontaneous recovery in 3 days and low case-fatality rate.

**Clinical pathology** Leukocytosis, hyperfibrinogenemia, hypocalcemia, elevated creatine kinase. Blocking enzyme-linked immunoabsorbent assay (ELISA) for serology.

**Necropsy findings** Serofibrinous polyserositis.

**Diagnostic confirmation** Demonstration of specific bovine ephemeral fever (BEF) viral antigen by immunofluorescence or by isolation in mice.

**Treatment** Nonsteroidal antiinflammatory drugs cause remission of clinical signs.

**Control** Vaccination and supportive treatment.

## ETIOLOGY

Bovine ephemeral fever (BEF) is associated with an arthropod-borne rhabdovirus that is the type species of the genus *Ephemerovirus*. There are a number of strains that vary antigenically. Other antigenically related but nonpathogenic species of *Ephemerovirus* occur in the same environment in Australia. The BEF virus is closely associated with the leukocyte-platelet fraction of the blood, and it can be maintained deep frozen or on tissue culture and chick embryos.

## EPIDEMIOLOGY

### Occurrence

A disease of cattle, ephemeral fever is enzootic in the tropical areas of Africa, in most of Asia, the Middle East, the East Indies, and in much of Australia, with extensions into the subtropics and some temperate regions. In these areas the disease presents as episodic epidemics. Area outbreaks can last several months, with the spread of infection following prevailing winds, and during this period most herds within a region will be infected. The proportions of herds affected in outbreaks in the Jordan Valley in Israel in 1990 and 1999 were 79% and 98% respectively.

The morbidity rate in outbreaks is usually between 25% and 45%, but if the population is highly susceptible or the infecting strain virulent, the morbidity rate may reach 100%. In enzootic areas, only 5% to 10% will be affected. A rate of 1% for case fatality and loss from involuntary culling is usual with low-virulence strains but can approach 10%.

### Source of Infection

The source of infection is the animal affected with the clinical disease and biological vectors (hematophagous biting insects).

### Method of Transmission

A great deal of work in recent years has not clearly defined the **vector** list, which

probably includes the mosquitoes *Aedes* spp., *Culex annulirostris*, *Anopheles bancroftii* and *A. annulipes*, and the biting midge *Culicoides brevitarsis*. *Culex annulirostris* has been identified as a biological vector in Australia. This mosquito can transmit infection within a week of feeding on an infected animal, and the epidemiology of the disease in Australia supports transmission by mosquitoes rather than *Culicoides* spp.

The **reservoir** host, other than cattle, has not been identified. This is of particular importance when the epidemiologic pattern of occurrence of the disease changes, as it has done in Australia after being introduced in approximately 1936.<sup>1</sup> The disease now occurs annually in areas where it used to occur only once each decade, probably because of establishment of the virus in indigenous vectors.

Spread by **wind-borne carriage** of vectors has been documented.<sup>2,3</sup> Epidemiologic studies suggest that outbreaks in Japan originate from Korea, and those in Israel originate from Turkey.<sup>2</sup> Transboundary movement can also occur by animal transport,<sup>2</sup> although transmission does not occur through contact with infected animals or their saliva or ocular discharge. The disease is not spread through semen, nor is intrauterine administration of the virus a suitable route of transmission.

### Experimental Reproduction

The disease can be transmitted by the injection of whole blood or the leukocyte fraction of it. Experimental reproduction in cattle requires IV administration, and viremia lasts 3 days with a maximum of 2 weeks. There is no carrier state.

### Environment Risk Factors

The disease occurs in the **summer** months, outbreaks are **clustered** and relatively **short-lived**, and spread depends largely on the insect vector population and the force and direction of prevailing winds. The disease tends to disappear for long periods to return in epizootic form when the resistance of the population is diminished.

Recurrence depends primarily on suitable environmental conditions for increase and dissemination of the insect vector and the degree of population immunity, as indicated by neutralizing antibody titers and immunity coverage.<sup>4</sup> During periods of quiescence the disease is still present, but the morbidity is reputed to be very low. However, in many enzootic areas the degree of surveillance is less than intense, and clinical cases may occur without being observed. Temporary protection against infection is provided by subclinical infections by other unrelated arboviruses (e.g., Akabane, Aino, and others).

### Animal Risk Factors

Among domestic animals, only **cattle** are known to be naturally affected, but antibod-

ies can be found in African ruminant wildlife. All **age groups** of cattle are susceptible, but calves less than 3 to 6 months old are not affected by the natural disease. With experimental infections calves as young as 3 months old are as susceptible as adults to experimental infection but do not show clinical disease.

In dairy cattle, higher-producing cows are at greater risk, and clinical disease may be minimal in cows under 2 years of age. A recent Israeli study in 10 beef herds found average morbidity and mortality rates of 46.2% and 4.8%, respectively, with higher rates in bulls than cows and a higher morbidity in cows 2 to 5 years of age than in heifers less than 2 years of age. In natural outbreaks there is no breed susceptibility.

In Africa, based on serologic results, the virus is thought to be cycling in populations of wild ruminants between epidemics in domestic cattle. Buffalo (*Bubalus bubalis*) are susceptible to experimental infection, but it is unlikely that they play any part as a reservoir host. After experimental infection of cattle there is solid immunity against homologous strains for up to 2 years. Immunity against heterologous strains is much less durable, which probably accounts for the apparent variations in immunity following field exposure.

### Economic Importance

Although the case-fatality rate is very low, considerable loss occurs in **dairy herds** as a result of the depression of milk flow—up to 80% in cows in late lactation. In an Israeli study of eight infected dairy herds, the decline in milk yield from preinfection levels varied between cows and ranged from 30% to 70%, with the highest-yielding cows having the greatest drop. Following recovery from disease, milk production was still less than that of preinfection levels.

There is also a lowered resistance to mastitis. Reproductive inefficiency is associated with a significant delay in the occurrence of estrus, abortion in cows, and temporary sterility in bulls. Occasional animals die of intercurrent infection, usually pneumonia, or prolonged recumbency. Bovine ephemeral fever can have a serious effect on the agricultural economy in countries where cattle are used as **draught animals**. For cattle-exporting countries such as Australia, BEF causes interference with movement of cattle when receiving countries insist on evidence of freedom from the disease.

### PATHOGENESIS

Experimental production of the disease requires the IV route of transmission. Virus multiplication probably occurs primarily within the **vascular system**. The BEF virus alters cellular biology in cattle to enhance virus entry and replication. This includes activation of intracellular signaling pathways to up-regulate clathrin and

dynamin 2 expression and activation of COX-2-mediated E-prostanoid receptors 2 and 4 to enhance clathrin-mediated endocytosis of the virus.<sup>5-7</sup> After an incubation period of 2 to 10 days, there is a biphasic fever with peaks 12 to 24 hours apart. The fever lasts 2 days, and increased respiratory rate, dyspnea, muscle trembling, limb stiffness, and pain are characteristic at this time.

There is **generalized inflammation** with vasculitis and thrombosis, serofibrinous inflammation in serous and synovial cavities, and increased endothelial permeability at the same sites. The virus can be detected in circulating neutrophils and plasma, the serosal and synovial fluids, the mesothelial cells of synovial membrane and epicardium, and in neutrophils in the fluids. Clinical signs are thought caused by the expression of mediators of inflammation coupled with a secondary hypocalcemia.

### CLINICAL FINDINGS

Calves are least affected, with those less than 3 to 6 months of age showing no clinical signs. Overweight cows, high-producing cows, and bulls are affected the most. Deaths are relatively uncommon and are usually less than 1% of the herd.<sup>3</sup>

In most cases the disease is acute. After an incubation period of 2 to 4 days, sometimes as long as 10 days, there is a sudden onset of **fever** (40.5°–41°C [105°–106°F]), which may be biphasic or have morning remissions. **Anorexia** and a sharp **fall in milk yield** occur. There is severe constipation in some animals and diarrhea in others. Respiratory and cardiac rates are increased, and stringy nasal and watery ocular discharges are evident. The animals shake their heads constantly, and muscle shivering and weakness are observed. There may be swellings about the shoulders, neck, and back.

Muscular signs become more evident on the second day, with severe **stiffness**, clonic muscle movements, and weakness in one or more limbs. A **posture** similar to that of acute laminitis, with all four feet bunched under the body, is often adopted. On about the third day, the animal begins eating and ruminating, and the febrile reaction disappears, but lameness and weakness may persist for 2 to 3 more days. A common name of “**3-day sickness**” is applied because animals typically progress through onset of disease to severe illness and recovery within 3 days.<sup>3</sup>

Some animals remain standing during the acute stages, but the majority go down and assume a position reminiscent of parturient paresis, associated with **hypocalcemia**, with the hindlegs sticking out and the head turned into the flank. Occasionally, animals adopt a posture of lateral recumbency. Some develop clinically detectable pulmonary and subcutaneous (SC) emphysema, possibly related to a nutritional deficiency of

selenium. In most cases recovery is rapid and complete unless there is exposure to severe weather or unless aspiration of a misdirected drench or ruminal contents occurs. Some cases have a second episode of clinical disease 2 to 3 weeks after recovery.

Occasional cases show persistent recumbency and have to be destroyed, and abortion occurs in a small proportion of cases. Affected bulls are temporarily sterile. Milder cases, with clinical signs restricted to pyrexia and lack of appetite, may occur at the end of an epizootic.

### CLINICAL PATHOLOGY

Blood taken from cattle in the febrile stage clots poorly. Marked **leukocytosis** with a relative increase in neutrophils occurs during the acute stage of the disease. There is a shift to the left and lymphopenia. Plasma fibrinogen levels are elevated for about 7 days, and there is a marked increase in **creatinine kinase activity**. In natural cases, but not experimentally produced ones, significant **hypocalcemia** occurs.<sup>8</sup> Available serologic tests include a complement fixation test, serum neutralization, fluorescent antibody test, agar gel immunodiffusion (AGID) test, and a **blocking ELISA**, which is reported to be simple and the preferred test.

### NECROPSY FINDINGS

Postmortem lesions are not dramatic. The most consistent lesions are a **serofibrinous polyserositis**, involving the synovial, pericardial, pleural, and peritoneal cavities, with a characteristic accumulation of neutrophils in these fluids and surrounding tissues. Hemorrhage may also be observed in the periarticular tissues, and there may be foci of necrosis in the musculature of the limbs and back. All lymph nodes are usually enlarged and edematous. **Pulmonary emphysema** and fibrinous bronchiolitis are standard findings, and subcutaneous emphysema along the dorsum may be observed. Characteristic microscopic findings consist of a mild vasculitis of small vessels, with perivascular neutrophils and edema fluid plus intravascular fibrin thrombi.

Necropsy examinations of animals that develop persistent recumbency have shown severe degenerative changes in the spinal cord similar to those produced by physical compression, but the pathogenesis of these lesions remains uncertain. Although nucleic acid sequences of the agent are known, PCR tests are not yet widely utilized.

Antigen in reticuloendothelial cells can be detected by immunoperoxidase and immunofluorescent techniques.

### Samples for Confirmation of Diagnosis

- **Virology**—chilled lung, spleen, synovial membrane, pericardium (virus isolation)
- **Serology**—pericardial fluid (ELISA)
- **Histology**—formalin-fixed samples of previously mentioned tissues

### DIFFERENTIAL DIAGNOSIS

The diagnosis of ephemeral fever in a cattle population is not difficult on the basis of its epidemiology and clinical presentation. It can produce difficulties in individual animals where differentials include the following:

- Botulism
- Parturient paresis
- Pneumonia
- Traumatic reticulitis

### TREATMENT

Palliative treatment with **nonsteroidal anti-inflammatory** drugs such as IV or IM flunixin meglumine (2.2 mg/kg/d), or IM ketoprofen (3 mg/kg/d) results in **remission** of signs without in any way influencing the development of the disease. There is little effect on the respiratory manifestations of the disease but a major effect on stiffness, lameness, and anorexia. All treatments are continued for 3 days. Phenylbutazone may be most effective, but the injection frequency is not practical and creates slaughter residue concerns. Moreover, phenylbutazone use in cattle is not permitted in some countries. Parenteral treatment with **calcium borogluconate** should be given to cows that show signs of hypocalcemia, and field observations are that parenteral treatment with calcium solutions often helps to get a recumbent cow to her feet. Proper nursing of the recumbent animal is required.

### CONTROL

Restriction of movement from infected areas is practiced, but **vaccination** is the only effective method of control. Vaccines prepared from **attenuated** tissue culture virus or in mouse brain and adjuvanted in Freund's incomplete or Quil A adjuvants are commercially available in Australia, Japan, Taiwan, and South Africa. Two vaccinations are required and are effective in preventing disease in natural outbreaks for periods up to 12 months. The use of vaccination in Japan is credited with preventing further major outbreaks. Attenuated vaccines are expensive to produce and have a short shelf-life, and breakdowns are recorded after their use. There is also concern about back-mutation of the attenuated strain to a virulent form, particularly given the high mutation rate of RNA viruses, and contamination with other viruses during preparation of the vaccine.<sup>9,10</sup> The use of inactivated vaccines therefore offers an attractive alternative, such as formalin **killed** vaccines with and without adjuvants. Unfortunately, inactivated vaccines appear to need at least three vaccinations to provide longer-term immunity,<sup>9,10</sup> requiring frequent boosting for effect. Immunity is positively correlated with the level of specific antibody measured with a blocking ELISA or as virus-neutralizing antibody.

## REFERENCES

1. Trinidad L, et al. *J Virol*. 2014;88:1525.
2. Aziz-Boaron O, et al. *Vet Microbiol*. 2012;158:300.
3. Finlaison DS, et al. *Aust Vet J*. 2010;88:301.
4. Ting LJ, et al. *Vet Microbiol*. 2014;173:241.
5. Cheng CY, et al. *J Virol*. 2012;86:13653.
6. Cheng CY, et al. *Cell Microbiol*. 2015;17:967.
7. Joubert DA, et al. *J Virol*. 2014;88:1591.
8. Mohammad M, Saeid S. *Adv Environ Biology*. 2011;5:1579.
9. Aziz-Boaron O, et al. *PLoS ONE*. 2013;8(12):e82217.
10. Aziz-Boaron O, et al. *Vet Microbiol*. 2014;173:1.

## NAIROBI SHEEP DISEASE

Nairobi sheep disease (NSD) is a tick-transmitted disease of small ruminants, particularly sheep, caused by the Nairobi sheep disease virus (NSDV) and characterized by fever, hemorrhagic gastroenteritis, abortion, and high mortality. NSDV was first recognized at the beginning of the twentieth century as a disease of sheep and goats in Kenya. The virus is the prototype of the genus *Nairovirus*, family *Bunyaviridae*, and it is endemic in East and Central African countries of Kenya, Uganda, Tanzania, Ruanda, Somalia, and Ethiopia. A similar virus known as Ganjam virus (GV) has been recognized in India and Sri Lanka, where it is associated with febrile illness in humans and disease in sheep and goats. Recent genomic analysis has shown that NSDV is highly diverse and that the Ganjam virus is a variant of the NSDV.<sup>1</sup> Furthermore, it has been suggested that GV probably spread from India to Africa in the nineteenth century and that both virus variants could be referred to as NSDV/GV.<sup>2</sup> Other antigenically related viruses are the Crimean Congo hemorrhagic fever virus in humans and the Dugbe fever virus in cattle in the drier parts of West and East Africa. The *Bunyaviridae* family also include two significant pathogens of animals, Cache Valley virus and Akabane virus, both of which have a tropism for fetal tissues and are responsible for embryonic losses and multiple congenital deformities in domestic ruminants.<sup>3</sup> Nairobi sheep disease virus does not affect cattle, horses, or pigs, but can cause a mild febrile disease in humans, hence a zoonosis.

The most common vector for NSDV in Africa is the brown ear tick *Rhipicephalus appendiculatus*, but other species may be involved, including the bont tick, *Amblyomma variegatum*. In India, GV is found in a number of ticks, primarily *Haemophysalis intermedia*.<sup>1</sup> Transmission by *R. appendiculatus* is both transstadial and transovarial. Animals bred in endemic areas are usually immune, and hence the virus is of little consequence in stable populations of sheep and goats. The virus can persist in ticks for long periods, more than 2 years in unfed adults, thereby enhancing endemic stability in resident animals.

The pathogenesis of NSDV/GV infection has been investigated recently.<sup>4</sup> The virus is regarded as one of the most pathogenic

agents for sheep and goats, with mortality ranging from 40% in Merino sheep to 90% in Masai sheep. Like other viral hemorrhagic diseases, including Crimean Congo hemorrhagic fever in humans, MSDV/GV has developed an efficient mechanism to circumvent or inhibit innate immunity of the host by inhibiting interferon induction and action.<sup>4</sup> This makes it easier for the virus to invade cells and replicate in them. In experimentally infected sheep, the virus has also been shown to cause profound leukopenia, most likely as a result of large-scale apoptosis, and to cause increased levels of some proinflammatory cytokines, including tumor necrosis factor (TNF $\alpha$ ), which has the effect of increasing endothelial permeability, leading to hemorrhages.<sup>2</sup> As the sheep began to recover from the infection, the level of interferon gamma was found to increase.

Clinical disease occurs when susceptible animals are moved into endemic areas (e.g., for marketing purposes or for livestock improvement) or when there is a breakdown in tick control measures. Outbreaks occur outside endemic areas when there has been unusual increase in tick population brought about by excessive or prolonged rains. There are differences in susceptibility among different breeds of sheep and goats, and unlike in most other diseases, some indigenous breeds are more susceptible than exotic breeds, like the Merino. A sudden onset of fever is followed by anorexia, nasal discharge, dyspnea, and severe diarrhea, sometimes with dysentery, abortion, and death in 3 to 9 days. There may be hyperemia of the coronary band and hemorrhages in the oral mucosa.<sup>2</sup> The case-mortality rate is 30% to 90% but is lower in goats.

The necropsy picture is typical of a hemorrhagic diathesis and consists of hemorrhages on serous surfaces of visceral organs and on mucosal surfaces, particularly the abomasum, colon, and female genital tract. Lymph nodes and spleen are enlarged. Later, a hemorrhagic gastroenteritis becomes more obvious, and there may be zebra striping in the mucosa of the colon and rectum. The uterus and fetal skin are hemorrhagic. Ticks are likely to be found on the body, especially on the ears and head. Common histopathologic lesions outside the gastrointestinal tract include myocardial degeneration, nephritis, and necrosis of the gall bladder.

Differential diagnoses include peste des petits ruminants (PPR), Rift Valley fever, heartwater, parasitic gastroenteritis, and salmonellosis, all to be confirmed by laboratory tests.

Specimens for laboratory diagnosis should include uncoagulated blood, mesenteric lymph node, and spleen, collected safely to avoid aerosol infections. The virus is first isolated in tissue culture or in infant mice, and the disease can be reproduced in susceptible sheep. The polymerase chain reaction (PCR) technique has been used on whole

blood or the buffy coat.<sup>2</sup> The blood should be collected in EDTA. A quantitative PCR assay can also be used on ticks and for carrying out surveys.<sup>5</sup>

The recommended serologic test is the indirect fluorescent antibody test, but others are the complement fixation test (CFT) and the indirect hemagglutination test. For viral identification, the recommended tests used to be immunofluorescence, agar gel immunodiffusion, CFT, and ELISA.

There is no treatment for NSD and no vaccine for commercial use, even though a killed tissue culture vaccine or an attenuated vaccine has been suggested. Vector control is crucial when animals have to be moved to endemic areas.

## FURTHER READING

*OIE Manual of Diagnostic Tests and Vaccines for Terrestrial Animals*. Paris: OIE; 2008 chapter 2.9.1:1165.

## REFERENCES

1. Yadev PD, et al. *Infect Genet Evol*. 2011;11:1111.
2. Bin Tarif A, et al. *Vet Res*. 2012;43:71.
3. *OIE Manual of Diagnostic Tests and Vaccines for Terrestrial Animals*. Paris: OIE; 2008 chapter 2.9.1:1165.
4. Holzer B, et al. *PLoS ONE*. 2011;6:e28594.
5. Mutai BK, et al. *Vector Zoonot Dis*. 2013;13:360.

## WESSELSBRON DISEASE

## SYNOPSIS

**Etiology** Wesselsbron virus, genus *Flavivirus*, a member of the family *Flaviviridae*.

**Epidemiology** Enzootic in sub-Saharan Africa. Maintenance host not yet identified but presumably domesticated herbivores. Transmitted by mosquitoes of the genus *Aedes*. Infection can occur in small and large ruminants, pigs, donkeys, horses, and ostriches. Infections occur year round in warmer and moister coastal areas; dryer regions have lower prevalence and outbreaks in high rainfall periods often occurring in conjunction with Rift Valley fever.

**Clinical findings** Acute febrile disease in lambs characterized by hepatitis, abortion in pregnant ewes with congenital central nervous system malformation and arthrogryphosis in aborted fetuses; subclinical infection predominates in calves, adult nonpregnant sheep, goats, and cattle; occasional abortions.

**Necropsy findings** Jaundice, diffuse hepatic necrosis.

**Diagnostic confirmation** Virus isolation, serum neutralization, or immunohistochemical localization of viral antigens in tissues; serology.

**Treatment** No specific treatment available, supportive.

**Control** Vaccination is no longer available; vector control not cost effective.



## ETIOLOGY

Wesselsbron virus is an arthropod-borne enveloped single stranded RNA virus of the family Flaviviridae, genus *Flavivirus*, that has not been well characterized thus far.

## EPIDEMIOLOGY

### Occurrence

Wesselsbron disease (WBD) was first described in 1955 in an 8-day-old lamb in the Wesselsbron district of the Orange Free State in South Africa. Serologic evidence indicates high infection prevalence in the moister and warmer regions of South Africa, Mozambique, and Zimbabwe. Animals with antibody titer are, in contrast, less common in the dryer South African inland.<sup>1</sup> Wesselsbron virus has been isolated from vertebrates and arthropod vectors in many African countries, including Cameroon, the Central African Republic, Nigeria, Senegal, South Africa, Uganda, and Zimbabwe and in Madagascar. Although serologic studies suggest an enzootic presence of virus over wide parts of the subcontinent, the incidence of clinical disease is very low.<sup>2</sup>

The pattern of occurrence is year round in the warmer and moister coastal regions of southern and eastern Africa. Cyclical outbreaks that are typically linked to periods of heavy rainfall, in contrast, occur in the dryer areas of the continent. Outbreaks frequently occur in conjunction with Rift Valley fever epizootics.

### Risk Factors

#### Animal Risk Factors

Wesselsbron disease is an infectious disease primarily affecting sheep, with a clear age predisposition. Newborn lambs in the first days of life are most susceptible to clinical disease, with mortality rates in the range of 30%. In adult pregnant ewes a common presentation of the disease is abortion that may be associated with a febrile episode.

Other species, including cattle, goats, camels, donkeys, horses, and ostriches, are susceptible to infection but do not typically develop disease; abortions that have been associated with Wesselsbron virus infection have, however, been reported in cattle and goats.<sup>3,4</sup>

#### Environmental Risk Factors

A warm and moist environment that is favorable to competent vectors is an important risk factor for the spread of the virus. Abnormally heavy rainfalls and the ensuing increase in the mosquito population can result in epizootics in dryer regions of the African continent.<sup>1</sup>

### Source of Infection and Method of Transmission

Floodwater breeding mosquitoes of the genus *Aedes*, including the species *A. caballus* and *A. circumluteolus*, are considered the principal vectors of the Wesselsbron virus. The high seroprevalence of infection in

domesticated herbivores in affected areas suggests that these species may function as maintenance hosts for the virus. Direct transmission of the virus between animals has not been documented. In humans, however, infection after handling infectious material has been reported.<sup>4</sup>

### Zoonotic Implications

Although humans are susceptible to infection and disease, infection with the Wesselsbron virus in the large majority of cases is asymptomatic. If clinically apparent, the disease is usually a transient flulike illness associated with a transient fever, headache, and muscle and joint pain; cutaneous hypersensitivity and skin rashes may occur.<sup>4,5</sup> Person-to-person transmission of infection has not been reported.

### Economic Importance

The disease primarily causes disease in lambs and pregnant ewes; evidence that the disease causes significant economic damage is, however, lacking.<sup>1</sup>

### PATHOGENESIS

Wesselsbron virus has been classified as pantropic virus with marked hepatotropic properties in newborn lambs and latent neurotropic properties in embryonic and fetal tissue in pregnant ewes.<sup>6</sup> Hepatocytes are the primary site of viral replication in lambs, and age seems to be a determining factor in the progression of infection. Liver necrosis is the most consistent finding in infected young lambs, resulting in hepatic insufficiency and cholestasis. In general, the extent and severity of liver necrosis is considerably less severe than in lambs infected with the Rift Valley fever virus.<sup>6</sup>

### CLINICAL FINDINGS

The clinical presentation of WBD varies by species and age. The disease is most severe in young lambs. After an incubation period of between 1 and 4 days, nonspecific clinical signs, such as anorexia, listlessness, and fever, become apparent. Similar symptoms are rarely observed in neonates of other species. Jaundice associated with liver cell necrosis may become apparent in more severe cases. Mortality rates are in the range of 25% in lambs.

In adult sheep and cattle, the only apparent sign may be a fever episode. In pregnant ewes, infection may result in abortion, mummification, stillbirth, or birth of weak lambs. Stillborn or aborted lambs may show congenital neurologic defects or arthrogryposis. The occurrence of hydrops amnii has also been associated with Wesselsbron virus infection in pregnant ewes.<sup>2,6</sup> Death of the ewe may occur, presumably as a complication of the abortion.

### CLINICAL PATHOLOGY

Wesselsbron disease is diagnosed by identification of the causative virus or by serology.

Virus identification can be done by direct virus isolation, by means of the complement fixation test (CFT) or the serum neutralization test (SNT).<sup>2</sup> The virus can be isolated from most organs of clinically affected lambs, but blood serum or liver tissue from aborted fetuses and liver or spleen of dead lambs are most commonly used. Immunohistochemistry has also been used for virus identification in liver tissue of deceased lambs.<sup>5</sup>

Serology can be conducted by virus neutralization (VN), complement fixation, and hemagglutination inhibition. The hemagglutination inhibition test shows a high degree of cross-reactivity with other flaviviruses. More recently, an antibody ELISA has been developed that is more sensitive and less cross-reactive than the hemagglutination inhibition test.<sup>5</sup>

### NECROPSY FINDINGS

In aborted fetuses, congenital malformations of the central nervous system, such as porencephaly and cerebellar hypoplasia, have been reported. These were associated in some instances with arthrogryposis.<sup>6</sup> In neonates, moderate to severe icterus is a prominent finding. The liver is friable with a yellow to orange-brown color and may be congested and enlarged in some instances. Other nonspecific lesions include petechiation on the serosal surface of the entire digestive tract and on the abomasal mucosa.<sup>2</sup> Subcutaneous edema has also been reported.

On histopathology, mild to severe necrosis of the liver characterized by diffuse necrosis of individual or few grouped hepatocytes that are scattered randomly throughout the liver is the predominant finding. Proliferation of Kupffer cells and bile ducts is another consistent finding.<sup>2</sup> Hepatic lesions associated with Wesselsbron disease can be differentiated from those observed with Rift Valley fever by the absence of well-defined primary foci of coagulative necrosis of hepatocytes and the lacking parenchymal hemorrhage that characterize infection with Rift Valley fever.<sup>1</sup>

### Samples for Confirmation of Diagnosis

- **Virology**—liver, spleen, brain (virus isolation, serum neutralization, complement fixation)
- **Histology**—liver, spleen, brain (light microscopy, immunohistochemistry)

### DIFFERENTIAL DIAGNOSIS

- Rift Valley fever
- Bluetongue
- Ephemeral fever
- Bacterial septicemias
- Anthrax
- Vibriosis
- Trichomoniasis
- Toxic plants

## TREATMENT

Little attention has been given to the aspect of treatment of the disease, and no known treatment is of any value.

## CONTROL

Measures to control Wesselsbron disease that have been proposed in the past include vector control and vaccination. Although vector control is in theory possible, it requires that *Aedes* spp. breeding sites have been identified and have a limited surface to be manageable. Particularly with heavy rainfalls and flooding mosquito-breeding sites are too numerous and wide to be controlled. Ecological, health, and financial issues around applying large amounts of insecticides to the environment further complicate this type of control.

A modified live vaccine was available in the past. Injudicious vaccination of pregnant ewes, however, resulted in considerable economic loss as a result of abortion and a high incidence of fetal malformations. Because of the limited economic damage caused by WBD and the complications experienced with vaccination, the production of the vaccine has been discontinued.

## REFERENCES

1. Van der Lugt JJ, et al. *Onderstepoort J Vet Res.* 1995;62:143.
2. Coetzer JAW, et al. *Onderstepoort J Vet Res.* 1978;45:93.
3. Mushi EZ, et al. *J Vet Diagn Invest.* 1998;10:191.
4. Weiss KE, et al. *Onderstepoort J Vet Res.* 1956;27:183.
5. Center for Food Security. Public health. 2007 at: <<http://www.cfsph.iastate.edu/Factsheets/pdfs/wesselsbron.pdf>>; Accessed 10.03.15.
6. Coetzer JAW, et al. *Onderstepoort J Vet Res.* 1979;46:165.

## CAPRINE HERPESVIRUS-1 INFECTION

### SYNOPSIS

**Etiology** Caprine herpesvirus-1

**Epidemiology** Most infections subclinical. High seroprevalence in Mediterranean countries. Latent infection common and outbreaks of abortion and neonatal mortality with no known precipitating cause.

**Clinical findings** Abortion, neonatal disease, vulvovaginitis, balanoposthitis.

**Clinical pathology** Leukopenia in systemic disease in kids.

**Lesions** Ulceration and necrosis of vulva and prepuce. Multifocal necrosis in intestine and organs of aborted fetus and young (1–2 week olds) kids with systemic disease.

**Diagnostic confirmation** Virus isolation, polymerase chain reaction (PCR).

**Treatment and control** No effective treatment. Herd biosecurity. Experimental vaccine shows protection.

## ETIOLOGY

Caprine herpesvirus-1 (CpHV1) is an alpha-herpesvirus within the family Herpesviridae. Restriction endonuclease analysis indicates that there are different strains, but these are not geographically clustered.

## EPIDEMIOLOGY

### Occurrence

The disease is recorded in the United States, Canada, Australia, New Zealand, South America, and many countries in Europe, and it probably has worldwide distribution. Within the countries where it occurs, there is serologic evidence that the infection is widespread. Seroprevalence is particularly high in Mediterranean countries with high goat populations, such as Greece, Italy, France,<sup>1</sup> and Spain.

In adults, the systemic disease is clinically inapparent, but a genital form of the disease can be transmitted sexually. The virus mostly causes latent or subclinical infections, such as vulvovaginitis and balanoposthitis, which may sometimes present with very serious lesions.<sup>2</sup> It is also associated with occasional but severe outbreaks of abortion, where the abortion rate may exceed 50%.<sup>3</sup> CpHV1 is also associated with severe systemic disease in 1- to 2-week-old kids. This may occur in herds where does are also aborting or occasionally in herds without accompanying abortion.

### Transmission and Experimental Reproduction

Transmission is thought to be by inhalation, ingestion or genitally. The virus is found in nasal, pharyngeal, and vaginal discharges; the prepuce; and feces. It is shed by affected females for 10 to 12 days after infection and for up to 24 days by males.<sup>4</sup> The extended shedding period in bucks is probably important in the high transmission rates of infection that occur with the genital form of this disease.

Only goats are affected naturally; lambs and calves are not infected by intranasal inoculation, but lambs can be infected by IV injection. After primary infection, CpHV1 establishes a latent infection in the third and fourth sacral ganglia, but it is difficult to reactivate these infections by experimental or natural means. Reactivation occurs at the time of estrus, and outbreaks of vulvovaginitis often occur during or after the mating period.<sup>1</sup>

Abortion occurs 1 to 7 weeks after experimental challenge. However, the factors that precipitate occasional outbreaks of abortion and disease in young kids are not known. Challenge of females in early pregnancy is followed by fetal stunting and death, whereas challenge in midpregnancy causes no impairment of fetal growth, with the fetus carried to term but born dead.

### Economic Importance

Losses include deaths of young goats, in which the morbidity and case-fatality rates

are high, and abortion and stillbirths in does. Although the disease is not common, abortion rates can be high in those herds that experience disease.

## PATHOGENESIS

Viremia can occur in 1- to 2-week-old unweaned kids, with infection of various organs, especially the alimentary and respiratory tract. The virus can infect the placenta, causing placentitis and invading the fetus.

## CLINICAL SIGNS

### Adults

In both the experimentally produced and the natural disease there is no prodromal clinical disease preceding abortion, and aborted kids are usually full term. Where there are twins, one may be born dead and the other alive. With the genital disease, there is erythema and edema of the vulva and shallow erosions, ulcers, and occasionally a diphtheritic membrane on the mucosae of the vulva and vagina.<sup>1</sup> The vaginal discharge is clear to mucopurulent, and lesions heal in approximately 1 week. Outbreaks occur during or after mating and are not necessarily followed by abortion. In males, there is an ulcerative balanoposthitis, with hyperemia, edema, and ulceration of the penis and prepuce, often with a purulent exudate, with lesions healing within 15 days of infection.<sup>4</sup>

### Newborn Kids

Consistent signs include weakness, anorexia, cyanosis and dyspnea, increased heart and respiratory rates, abdominal pain, and fluid gut contents accompanied by diarrhea, and, in some cases, dysentery. Vesicles and ulcers may also be present on the coronets. Conjunctivitis, seropurulent nasal discharge, erosions of the oral mucosa, and petechial hemorrhages in the skin are also seen.

## CLINICAL PATHOLOGY

Leukopenia is a consistent finding in sick newborn kids. The virus can be isolated from all secretions or identified by PCR and restriction endonuclease analysis. In serum, antibodies can be demonstrated by serum neutralization or ELISA tests.<sup>5</sup>

## NECROPSY FINDINGS

### Adults

In does, ulceration and necrosis of the vaginal and vulval mucosae and placentitis are standard findings. Males have inflammation and ulceration of the penis and prepuce. A few adults develop an acute pneumonia with thick fibrinous exudate in the pleural cavity. Miliary foci of hepatic necrosis may or may not be grossly visible in aborted fetuses, but microscopic multifocal necrosis is commonly seen in the liver, adrenal glands, lung, and kidney. Herpesvirus intranuclear inclusions can be found in some of these tissues.

## Newborn Kids

Prominent lesions include ulceration and necrosis of the mucosae of the rumen, abomasum, intestine, cecum, and colon. Lesions are particularly severe in the large intestine. Vesicles and ulcers on the coronet of the feet may also be seen. Microscopically, foci of necrosis are often seen in the adrenal glands, urinary bladder, spleen, liver, lungs, and other tissues. Characteristic intranuclear inclusion bodies may be seen in mononuclear cells associated with these lesions.

## Samples for Confirmation of Diagnosis

- **Virology**—*Kids, fetuses*—liver, lung, adrenal gland. *Adults*—genital ulcers, vesicles. Chilled swabs in viral transport media (virus isolation, PCR). It may be difficult to isolate virus from aborted fetuses, but it can be demonstrated by real-time PCR.<sup>6</sup>
- **Histology**—formalin-fixed samples of affected tissues

## DIFFERENTIAL DIAGNOSIS

The systemic disease needs to be differentiated from the severe mycoplasmal infections and bacterial septicemias. Ulcerative dermatosis may be a confusing diagnosis in the genital form.

The differential diagnosis of causes of abortion in the ewe and doe are summarized in [Table 18-1](#).

## TREATMENT AND CONTROL

The immunosuppressive drug mizoribine enhances the antiviral activity of acyclovir, but this combination is a model for treatment of human herpesvirus infections rather than a practical treatment for goats.<sup>7</sup> NSAIDs may ease the discomfort from the genital lesions caused by CpHV1, but effective quarantine and serologic testing of all introduced goats is the only effective control measure that can be suggested at the present time.

The disease is probably not of sufficient economic importance to justify developing a commercial vaccine. However, experimental vaccines based upon glycoprotein D from a nonpathogenic bovine herpes virus-4 have provided good protection against challenge with pathogenic CpHV1.<sup>8</sup>

## REFERENCES

1. Thiry J, et al. *Vet Microbiol.* 2008;128:261.
2. Piper KL, et al. *Aust Vet J.* 2008;86:136.
3. McCoy MH, et al. *JAVMA.* 2007;231:1236.
4. Camero M, et al. *Small Rumin Res.* 2015;128:59.
5. Marinaro M, et al. *J Vet Diag Invest.* 2010;22:245.
6. Elia G, et al. *J Virol Meth.* 2008;148:155.
7. Elia G, et al. *Res Vet Sci.* 2015;99:208.
8. Donofrio G, et al. *PLoS ONE.* 2013;8:e52758.

## EQUINE VIRAL ARTERITIS

### SYNOPSIS

**Etiology** Equine arteritis virus

**Epidemiology** Infection and disease in equids. Outbreaks of disease as a result of lateral transmission by infected body fluids. Venereal transmission by persistently infected but clinically normal stallions, with subsequent lateral spread among mares.

**Clinical signs** Abortion. Upper respiratory disease with systemic signs including edema and respiratory distress.

**Clinical pathology** Serology. No characteristic changes in hemogram or serum biochemistry.

**Diagnostic confirmation** Virus isolation or reverse-transcription polymerase chain reaction (RT-PCR) detection of viral genome in blood, sperm-rich fraction of semen, nasopharyngeal swabs or tissue. Seroconversion or increase in complement fixation titer or enzyme-linked immunosorbent assay (ELISA).

### Differential diagnosis:

- The systemic disease—viral respiratory disease
- Abortion—equine herpesvirus-1 (EHV1), mare reproductive loss syndrome
- Similar disease in neonates—EHV1 or other septicemia

**Treatment** There is no specific treatment

**Control** Vaccination, especially of stallions and seronegative mares to be inseminated with seropositive stallions and to control outbreaks at racetracks. Quarantine. Hygiene.

## ETIOLOGY

Viral arteritis of horses, donkeys, zebras, and mules (EVA) is associated with an **arterivirus**—equine arteritis virus (EAV). There is an as yet unsubstantiated suspicion that New World camelids can be infected.<sup>1</sup> EAV is a small enveloped, positive-sense, single-stranded RNA virus that is the prototype virus in the family Arteriviridae (genus: *Arterivirus*), order Nidovirales. This taxonomic grouping includes porcine reproductive and respiratory syndrome virus (PRRSV; see [Chapter 18](#)), simian hemorrhagic fever virus (SHFV), lactate dehydrogenase-elevating virus (LDV) of mice, and newly identified wobbly possum disease virus (WPDV), the cause of neurologic disease among free-ranging Australian brushtail possums (*Trichosurus vulpecula*) in New Zealand.<sup>2,3</sup> Although there is only one known EAV serotype, field strains of the virus differ in their virulence and neutralization phenotype,<sup>4</sup> with some strains causing no detectable disease and others being associated with severe clinical signs in adult horses and death in foals.<sup>5-7</sup>

The structural proteins of the EAV virion include seven envelope proteins (E, GP2, GP3, GP4, ORF5a protein, GP5, and M) and the nucleocapsid (N) protein.<sup>4,8</sup> Equine EAV-specific polyclonal antisera and EAV neutralizing monoclonal antibodies bind to the N-terminal hydrophilic ectodomain of GP5.<sup>4</sup> Interactions among the GP2, GP3, GP4, GP5, and M envelope proteins play a major role in determining the CD14+ monocyte tropism, whereas tropism for CD3+ T-lymphocytes is determined by the GP2, GP4, GP5, and M envelope proteins but not the GP3 protein.<sup>9</sup>

There is considerable genomic variation among isolates, with EAV of North American and European origin clustering in geographically approximate, but distinct, viral clades. Phylogenetic analysis based on sequences of the hypervariable region of ORF5 is valuable for tracing the origin of EAV strains.<sup>8,10-19</sup> Isolates of EAV cluster into two distinct groups: North American and European, with there being two clusters within the European clades (EU-1 and EU-2). Viral clades within a country tend to be consistent—for example, most isolates from horses in South Africa, Poland, and Argentina are from one of the European clades,<sup>11,12,15,20</sup> whereas those in Turkey cluster within the North American clade.<sup>16</sup> An outbreak in Quarter horses (which characteristically have a very low prevalence of serum antibody titers to EAV) and Arabians in North America in 2006 to 2007 was associated with a novel strain of virus from the EU-1 clade.<sup>6</sup> However, increasing international movement of horses has resulted in the geographic spread of virus clades, with there being molecular genetic evidence of recent introduction of new viral clades into France and Argentina (and likely elsewhere).<sup>10,18</sup> For instance, of 22 French EAV isolates, 11 isolates obtained before January 28, 2003 clustered within either the EU-1 (9 isolates) or EU-2 (2 isolates) subgroup, whereas 11 isolates obtained after January 30, 2003 belonged to the North American group, strongly suggesting that these strains were recently introduced into France.<sup>10,21</sup> Infected stallions, or infected straws of semen, are the most frequent mode of introduction of new strains to an area.<sup>10,12,18,19</sup>

Nine South African strains isolated from a single donkey are phylogenetically distinct and different from EAV strains isolated from horses in North America and Europe, donkeys in Europe, and the group of South African Lipizzaner stallions.<sup>10</sup>

Novel phenotypic variants of EAV can emerge during persistent infections in stallions, and this is an important feature in the development of disease in exposed mares and foals.<sup>4-6</sup> Persistently infected carrier stallions harbor EAV between breeding seasons, enabling emergence of genetic diversity of the virus.<sup>4</sup> The degree of nucleotide sequence identity among EAV strains isolated from a



single persistently infected stallion on 11 occasions over 7 years ranged from 98.92% to 100%, and amino acid homology ranged from 98.06% to 100%.<sup>17</sup> An outbreak of EVA in France in 2007 was linked to a single persistently infected stallion in which the EAV evolved from relatively innocuous strains into a pathogenic strain. The stallion was monitored, and EAV strains available for examination, from 2000 to 2007, enabled determination that the source of the outbreak was a viral strain that developed in this horse.<sup>21</sup> This means of development of new quasispecies is likely more important for the emergence of genetic diversity among EAV strains than is the minimal virus diversity that is generated during small or restricted outbreaks of EVA when the virus is transmitted by respiratory or venereal, or both, routes.<sup>6</sup>

## EPIDEMIOLOGY

### Occurrence

**Serologic evidence** of infection by EAV with or without evidence of disease is found in horse populations in North and South America, Europe, Africa, Asia, Australia, Britain, Spain, Italy, France, Poland, the Netherlands, South Africa, and Germany. It is probable that the disease is now present in most countries with substantial populations of horses. New Zealand has evidence that it is free of infection, and there are no reports of the disease from Japan.<sup>22</sup> International shipment of horses and frozen semen contributes to the spread of the EAV.

The proportion of seropositive horses varies considerably among populations, with there being marked differences among breeds. Overall, 2% of horses in the United States are seropositive to EAV (serum neutralization titer >1:4), with 8.4% of horse operations having seropositive horses. Twenty-five percent of operations whose principal activity was breeding had at least one unvaccinated seropositive horse, whereas 4% of racing operations had a least one unvaccinated seropositive horse. The prevalence of titers to EAV is higher in mares and in horses used for breeding. The frequency with which horses in the United States have serum titers greater than 1:4 varies with breed, with 24% of Standardbreds, 4.5% of Thoroughbreds, 3.6% of Warmbloods, and 0.6% of Quarter horses being seropositive. Approximately 19% of Warmblood horses imported into the United States have antibodies to EAV, with horses from Germany and the Netherlands having the highest prevalence (21% and 25% respectively). Between 55% and 93% of Warmblood and Lipizzan breeds in Austria have serologic evidence of exposure to EAV. Of horses in Anatolia, Turkey, ~24% are seropositive.<sup>23</sup> Of approximately 8000 sera tested in Greece, 3.3% were positive for antibodies to EAV.<sup>24</sup>

Disease in Great Britain and North America has been associated with

importation of infected stallions or semen. The disease spreads rapidly in a group of susceptible horses, and although the course of clinical disease is short, an outbreak in a group of horses may persist for a number of weeks. Naturally acquired infections in newborn foals can occur as an outbreak and cause severe disease.

### Origin of Infection and Transmission

EAV is spread in two ways:

1. **Horizontal transmission** of virus by predominantly nasal fluid, but also by urine, feces, lacrimal fluid, and vaginal discharge of infected horses
2. **Venereal transmission** from stallions to susceptible (seronegative) mares

#### Horizontal Transmission

Through infected nasal discharge and body fluid, horizontal transmission is effective and is the means of disease spread in outbreaks in racing stables, and among mares and foals at breeding farms. The virus is found in respiratory secretions for 7 to 14 days and in other tissues for 28 days. Close contact between horses is probably required for transmission of the virus—it has been reported to spread after contact of horses across a fence. The duration of viability of the virus in the environment has not been reported, but the potential for spread of infection on fomites including clothing and tack should be considered when dealing with an outbreak.

#### Venereal Transmission

**Stallions** are infected by horizontal transmission of the virus, subsequently excrete the virus in semen, and infect susceptible mares at the time of mating. Clinically normal stallions are also capable of transmitting the virus horizontally to other stallions in a breeding operation, demonstrating the potential for horizontal spread of infection from stallions in the absence of clinical disease or sexual contact. This is demonstrated by the high frequency of infection in stallions sharing a stable and infection of semen in a virgin stallion.<sup>15</sup> Between 30% and 60% of infected stallions excrete the virus in semen for weeks to months. Some stallions excrete virus for years, and lifelong infection and virus excretion can occur. Prolonged infection of stallions is associated with mutation of the virus and secretion by the stallion of viral strains that vary over time.<sup>21</sup> However, disease resulting from transmission of infection from a stallion to a mare, and subsequent spread of infection to other horses, is associated with a single viral strain. In other words, stallions can excrete a variety of strains of the virus during their lifetime, but outbreaks of disease are associated with an initial single viral strain that evolves slowly, if at all, during the weeks or months of the outbreak but that can develop into multiple viral strains.<sup>5,6</sup> For

instance, at least 22 strains of EAV were detected in the 2007 outbreak in France, with the original inciting virus having developed in a stallion persistently infected before 2002.<sup>5,6,10</sup>

Prolonged excretion of the virus in semen is likely important in the maintenance of the virus in populations of horses. Introduction of a **persistently infected stallion** into a naive population, insemination of seronegative mares with semen from an infected stallion, and emergence of a virulent strain of EAV from a persistently infected stallion have been implicated as the cause of outbreaks of viral arteritis.<sup>5,10,13,18</sup> The carrier stallion infects mares at mating; the mares then develop disease and shed the virus in nasal and other body fluids and infect in-contact susceptible horses and foals by horizontal transmission.

Artificial breeding practices in which large numbers of mares, often over geographically dispersed areas, are inseminated within a short time or single season from an infected stallion can result in widespread outbreaks. This situation occurred among Quarter horses in the United States in 2006 to 2007 and in draft breed horses in France in 2007.<sup>5,6</sup> Furthermore, transfer of EAV-infected embryos to EAV serologically negative recipient mares can result in infection of the recipients, although this has only been demonstrated experimentally and has not been identified as a means of EAV spread in the field.<sup>25</sup>

The possibility of fomite spread on veterinary instruments, clothing, or personnel, as was possibly the case in France, should be considered.<sup>5</sup>

### Immunity

Vaccination or recovery from natural infection results in the development of a strong serum antibody virus-neutralizing response, which is thought to be important in clearance of the virus and resistance to infection. The humoral immune response to EAV includes development of complement-fixing and virus-specific neutralizing antibodies. Complement-fixing antibodies develop 1 to 2 weeks after infection, peak after 2 to 3 weeks, and disappear by 8 months, whereas virus-neutralizing antibodies are detected within 1 to 2 weeks after exposure, peak at 2 to 4 months, and persist for at least 3 years.<sup>4</sup>

Naive pregnant mares infected by horizontal transmission may abort or, less commonly, give birth to infected foals that subsequently die, whereas foals of immune mares are resistant to infection. Viral neutralization antibodies are present in mare's colostrum and foal's serum after sucking, with persistence of the antibodies to the age of 2 to 6 months in the foals. Persistence of passive immunity in foals has important implications for resistance to infection and for timing of administration of modified live vaccines.

### Animal Risk Factors

There are clear differences in susceptibility of individual horses to infection and disease, with the clinical outcome of EAV infection determined by host genetic factors. Horses can be segregated into susceptible and resistant phenotypic groups based on the in vitro susceptibility of CD3+ T-lymphocytes to EAV infection.<sup>26-28</sup> A genetically dominant haplotype associated with the in vitro susceptible phenotype has been identified in four horse breeds studied and is located in the region of ECA11, based on genome-wide association studies.<sup>26</sup> There are several proteins associated with virus attachment and entry, cytoskeletal organization, and NF- $\kappa$ B pathways encoded by this region of ECA1.<sup>26</sup> There does not appear to be an association between polymorphisms in major histocompatibility antigens (the equine lymphocyte antigen) and susceptibility to EAV infection.<sup>29</sup>

Horses of all age groups are susceptible to infection, but adult horses are generally resistant to disease. In the 2007 outbreak in France, deaths were recorded of one fetus, 5 young foals, and 2 mature horses.<sup>5</sup>

### Economic Importance

The chief impact of the disease on breeding farms is the loss of foals through abortion and the cost of quarantine and control measures. The systemic illness can be severe, but the mortality rate is low. The outbreak in western France in 2007 affected 18 (index, 8 primary and 9 secondary) premises in five counties in western France. Eight mortality cases were observed, including one fetus, five young foals and two mature horses. During outbreaks at race tracks, the economic impact is a result of lost opportunities for training and racing sick or convalescing horses and the effect of quarantine and control measures. Additional costs are incurred by the inconvenience and cost of vaccinating mares to be bred to stallions infected with the virus and import regulations controlling movement of horses and semen, including the inability to export mares, fillies, and noncarrier stallions that are seropositive (perhaps as a result of vaccination), and the limited opportunities for export of semen from infected stallions or export of the stallions themselves.

### PATHOGENESIS

The clinical manifestations of EVA result from vascular injury; the pathogenesis of EVA has not yet been comprehensively defined but involves infection of CD3+ T-lymphocytes.<sup>9</sup> The highly virulent, horse-adapted *Bucyrus* strain of EAV causes death in horses by severe vascular damage. The pathogenesis of disease associated with horizontal transmission of EAV has been elucidated. After inhalation of the virus, it binds to the respiratory epithelium and infects alveolar macrophages and is detectable in

bronchial lymph nodes by 48 hours after infection. Three days after infection, the virus is detectable in circulating monocytes, with subsequent systemic distribution of infection. The virus has localized in vascular endothelium and medial myocytes by days 6 to 9, and there is significant damage to blood vessels by day 10. The virus infects renal tubular epithelium and can persist there for up to 2 weeks. Medial necrosis of blood vessels might cause anoxia of associated tissues. The virus is not detectable in any tissue by 28 days after infection, with the exception of accessory sex glands in intact male horses.

Abortion is caused by a severe necrotizing myometritis and presumed consequent reduction in fetal blood flow. There are usually no lesions in the fetus, although the fetus is infected with the virus, sometimes at titers higher than those in the dam. The mechanism underlying abortion of foals from EAV-infected mares is unclear.<sup>4</sup>

### CLINICAL FINDINGS

Infection by EAV is usually **clinically inapparent**, especially after venereal infection of mares. **Abortion** is not necessarily associated with clinical disease in the mare. Systemic disease is usually mild to moderate and self-limiting, with recovery in 5 to 9 days in the vast majority of horses.

**Systemic disease is characterized** by an incubation period of 1 to 6 days followed by the appearance of fever (39–41°C [102–106°F]). A serous nasal discharge presents that may become purulent and be accompanied in some horses by congestion and petechiation of the nasal mucosa, urticaria, conjunctivitis, excessive lacrimation developing to purulent discharge, keratitis, palpebral edema, and blepharospasm. Opacity of the aqueous humor and petechiation of the conjunctiva may also occur. Signs of pulmonary disease, such as respiratory distress and coughing, are attributable to pulmonary edema and congestion but are uncommon. The appetite is reduced or absent; in severe cases, there may be abdominal pain, diarrhea, and jaundice. Edema of the limbs is common and more marked in stabled horses than those at pasture. In stallions, edema of the ventral abdominal wall may extend to involve the prepuce and scrotum. Depression is usual and varies in degree with the severity of the syndrome. The disease is acute and severe, and deaths may occur without secondary bacterial invasion. In these cases dehydration, muscle weakness, and prostration develop quickly. It must be emphasized that the disease may be much milder than that described previously.

**Clinical disease in neonatal foals** is characterized by fever, profound depression, weakness, limb and facial edema, and respiratory distress.<sup>30</sup> Severely affected foals usually die. Foals can be affected at birth or

be born apparently normal and develop disease 1 to 19 days after birth.

**Abortion** occurs within a few days of the onset of clinical illness, although it is not usually associated with clinically apparent disease. Abortions may occur in 10% to 60% of at-risk mares during an outbreak and during the 3rd through 10th months of gestation. Abortion occurs 12 to 30 days after exposure. The abortion is not foreshadowed by premonitory signs, and the placenta is not retained.

### CLINICAL PATHOLOGY

**Hematologic examination** of adults and foals during the acute phase of the systemic disease is characterized by leukopenia and thrombocytopenia.

**Antemortem** confirmation of infection has historically been achieved by serology or virus isolation. However, modern diagnostic techniques involving PCR and genetic sequencing technology have greatly facilitated prompt diagnosis of infection, monitoring for the presence of EAV in semen (fresh or for artificial insemination), and genetic epidemiology of infection to track the source of the outbreak and its progression.<sup>5,6,10-12</sup> PCR tests are described for detection of the EAV.<sup>31,32</sup> Recommended use of testing is described in [Table 21-4](#).

**Serologic confirmation of infection** is achieved using complement fixation, serum neutralization, and ELISA tests.<sup>33-36</sup> Seroconversion occurs within 1 week of infection, and demonstration of a rising antibody titer, based on acute and convalescent serum samples, or seroconversion is considered evidence of recent infection. False-positive results for the virus neutralization test have occurred using OIE prescribed rabbit kidney (RK-13) indicator cells when testing serum from horses vaccinated with an EHVI/4 tissue cultured derived vaccine. The false-positive results are likely a result of vaccine-induced antibody response against the RK-13 cells.

**Virus isolation** from blood, body fluids, and fetal or placental tissue is readily achieved during the acute phase of the disease. Appropriate samples for virus isolation include nasopharyngeal or conjunctival swabs and anticoagulated whole blood (heparin, EDTA, or citrate are suitable anticoagulants). Virus is continuously excreted in the semen of infected stallions and is readily isolated from the sperm-rich fraction of the semen. A nested PCR can detect the presence of virus in naturally infected semen at concentrations as low as 2.5 plaque-forming units per mL with a specificity of 97% and a sensitivity of 100%, and may be useful for the rapid diagnosis of EAV shedding stallions.

Antemortem diagnosis of EVA disease can be achieved by examination of skin samples using monoclonal antibody immunoperoxidase histochemistry. Examination

Table 21-4 Test methods available for the diagnosis of equine viral arteritis and their purpose

Method	PURPOSE					
	Population freedom from infection	Individual animal freedom from infection	Efficiency of eradication policies	Confirmation of clinical cases	Prevalence of infection—surveillance	Immune status in individual animals or populations postvaccination
Virus isolation	–	+++	–	+++	–	–
Agar gel immunodiffusion	–	–	–	–	–	–
Complement fixation	–	–	–	+++	–	–
Enzyme-linked immunosorbent assay	+	++	+	++	+++	+
Polymerase chain reaction	–	+++	–	+++	–	–
Virus neutralization	+	+++	+	+++	+++	+++

Key: +++ = recommended method; ++ = suitable method; + = may be used in some situations, but cost, reliability, or other factors severely limit its application; – = not appropriate for this purpose.

Although not all of the tests listed as category +++ or ++ have undergone formal standardization and validation, their routine nature and the fact that they have been used widely, without dubious results, makes them acceptable.

of skin samples obtained by biopsy reveals edema and vasculitis and presence of intracytoplasmic EAV antigen.

### NECROPSY FINDINGS

Gross lesions include edema of the eyelids and petechiation of the upper respiratory tract and the serosae of the abdominal and thoracic viscera. There is an abundant serofibrinous pleural and peritoneal effusion with generalized edema of the lungs, mediastinum, and abdominal mesenteries. A hemorrhagic enterocolitis and hemorrhage and infarction in the spleen may be noted. Characteristic histologic changes are found in the small arteries and include **fibrinoid necrosis of the tunica media and karyorrhexis of the infiltrating leukocytes**. Fluorescent antibody or immunohistochemical staining demonstrates viral antigen within the endothelial cells of these blood vessels. An immunoperoxidase method has also revealed viral antigen within endothelial cells and macrophages of an aborting mare and her fetus and within skin biopsies of animals exhibiting a maculopapular rash. Serologic tests performed on samples collected at necropsy can also be used to confirm that exposure to the virus has occurred.

The virus can be isolated from the lung and spleen of aborted fetuses, but no consistent, specific lesions are present. Necrotizing arteritis, similar to that in the mare, may be detectable.

### Samples for Confirmation of Diagnosis

- **Virology**—chilled lung, spleen, and thymus (virus isolation, PCR, fluorescence antibody test)
- **Serology**—heart-blood serum or fetal thoracic fluid (virus neutralization, ELISA, complement fixation)
- **Histology**—fixed lung, spleen, adrenal, jejunum, colon, and heart (light microscopy, immunohistochemistry)

### DIFFERENTIAL DIAGNOSIS

Definitive diagnosis is based on isolation of EAV from affected cases, or the demonstration of seroconversion or an increase in serum antibody titer.

The systemic disease must be differentiated from that associated with equine herpesvirus type 1 (EHV1) or type 4 (EHV-4) infection, equine influenza, strangles (see Tables 12-13 and 12-14—Infectious respiratory diseases of horses), infection with Getah virus in Japan, equine infectious anemia, African horse sickness, and purpura hemorrhagica, equine infectious anemia, equine encephalosis virus infection, Hendra virus infection, Getah virus infection, and toxicosis caused by hoary alyssum (*Berteroa incana*).

Abortion should be differentiated from that associated with EHV1, *Salmonella abortusequi*, leptospirosis, mare reproductive loss syndrome, and congenital malformations.

Similar disease in neonates can be associated with EHV1, immaturity or premature birth, and bacterial septicemia.

### TREATMENT AND CONTROL

There is no specific treatment for equine viral arteritis. Most horses recover without specific care. Severely affected foals require intensive care.

**Control** of EAV infection is based on the strong **immunity** induced by natural infection or vaccination with a modified live virus and an understanding of the role of carrier stallions in the disease. The following practices are suggested:

1. Isolate all new arrivals (and returning horses) to farm or ranch for 3 to 5 weeks.
2. If possible, segregate pregnant mares from other horses.
3. Blood test all breeding stallions for EAV antibodies.

4. Check semen of any unvaccinated, antibody-positive stallions for EAV to identify carriers before breeding.
5. Once tested negative for EAV antibodies, vaccinate all breeding stallions annually.
6. Physically isolate any EAV carrier stallions.
7. Restrict breeding EAV carrier stallions to vaccinated mares or mares that test positive for naturally acquired antibodies to the virus.
8. Vaccinate mares against EVA at least 3 weeks before breeding to a known carrier stallion.
9. Isolate mares vaccinated for the first time against EVA for 3 weeks following breeding to an EAV carrier stallion.
10. In breeds or areas with high rates of EAV infection, vaccinate all intact males between 6 to 12 months of age.

**Testing of mares and stallions** permits identification of serologically negative, and therefore at-risk, animals. Seronegative mares should not be mated with infected stallions nor inseminated with fresh or frozen semen from infected stallions because of the risk of transmission of infection to the mare. Seropositive mares, or mares that have been vaccinated for at least 3 weeks, can safely be bred to stallions that have serologic evidence of infection. Seropositive mares should be separated from seronegative mares for at least 3 weeks after mating to a seropositive stallion. Seropositive stallions that have not been vaccinated should have their semen cultured to determine whether they are excreting the virus. Stallions excreting virus in their semen should be kept isolated from susceptible horses but can be bred to seropositive mares, as described previously. Because the virus survives cooling and freezing, similar principles should be applied to the use of artificial insemination in horses. One control program requires that all



stallions be vaccinated with a modified live virus vaccine 28 days before the beginning of each breeding season.

**Vaccination with a modified live virus vaccine** induces strong immunity, although revaccination is necessary to ensure continuing immunity. The vaccine protects mares exposed to stallions shedding the virus in semen and has been used to control outbreaks of the respiratory form of the disease at racetracks. The modified live virus vaccine is regarded as safe, although there is mild fever and leukopenia, and there is evidence that the vaccine virus replicates in the vaccinates. A killed-virus vaccine is also available and is used to vaccinate Thoroughbred stallions in the United Kingdom.<sup>37</sup> Antibodies induced by the vaccine cannot be differentiated from those resulting from natural infection, a situation that may be problematic when import restrictions require the horse to be seronegative, presumably as proof of lack of exposure to virulent EAV.

Vaccination of foals from immune mares results in good protection, provided that the timing of vaccination is delayed until maternal antibodies to EAV are no longer present in the foal.

Control of an outbreak of EVA involves cessation of all movement on and off the farm and all breeding to control both horizontal and venereal transmission. All cases and contacts should be traced, sampled, and isolated. All horses on the affected premises should be screened and grouped according to infectious status. Testing and screening should continue on all possible affected premises until the end of the outbreak, seropositive animals and pregnant mares should be isolated for 4 weeks after first sampling, and stallions must have their shedding status determined. It is critical that all breeding of stallions is stopped and that concerted efforts are made to control horizontal spread of infection to stallions.

For breeds that permit use of assisted breeding technologies, all semen and embryos should be traced and recipients informed of the situation.

A protocol for managing an outbreak of EVA on a breeding facility is as follows (modified from the Horserace Betting Levy Board<sup>38</sup>):

1. Stop mating, teasing, and collection/insemination of semen, and stop movement of horses on and off the premises immediately.
2. Notify the appropriate regulatory authority.
3. Isolate and treat clinical cases.
4. Group the in-contacts away from other horses on the premises and take samples for virus detection (preferably RT-PCR). When the results are available, separate any healthy horses that have tested negative away from those that have tested positive. Horses

that have tested positive should be kept in isolation until freedom from active infection is confirmed.

5. Screen all other horses at the premises to determine their serologic status (EAV positive or negative). If any of these return positive results, they should be separated from those with negative results and kept in isolation until freedom from active infection is confirmed by RT-PCR testing.
6. Arrange for one straw from each ejaculate of stored semen from infected stallions and their in-contacts to be tested by a laboratory. If any straw is infected, all straws from that ejaculate should be destroyed.
  - Inform the following of infection:
    - owners (or persons authorized to act on their behalf) of horses at, and soon to arrive at, the premises;
    - owners (or persons authorized to act on their behalf) of horses which have left the premises;
    - recipients of semen from the premises;
    - the national breeders' association, if applicable.
7. Clean and disinfect stables; equipment, including that used for semen collection and processing; and vehicles used for horse transport.
8. Good hygiene must be exercised. If possible, separate staff should be used for each different group of horses to prevent indirect transmission of infection between the groups.
9. Repeat the serologic testing after 14 days and again every 14 days until freedom from active infection is confirmed. Use the same laboratory for repeat samples as for the first samples. If any of the previously healthy or seronegative horses become ill or seropositive, they should be moved into the appropriate group. Testing of these horses should continue until freedom from active infection is confirmed. Seropositive stallions and teasers must be investigated to determine whether they are shedders. Those that prove to be shedders must be kept in strict isolation until their future is decided and must not be used for breeding activities during this time.
10. Do not resume any breeding activities or movement on and off the premises until freedom from active infection is confirmed in all infected and in-contact horses.
11. Pregnant mares must be isolated for at least 28 days after leaving the premises. Those remaining on the premises should be kept in isolation for at least 28 days after active infection has stopped.

12. Any mares that became infected after their pregnancy began should be foaled in isolation.

## FURTHER READING

Balauriya UBR, et al. Equine arteritis virus. *Vet Microbiol.* 2013;167:93-122.

## REFERENCES

1. World Organization for Animal Health. Terrestrial animal health code. 2013 at: <[www.oie.int/fileadmin/Home/fr/Health\\_standards/.../2.05.10\\_EVA.pdf](http://www.oie.int/fileadmin/Home/fr/Health_standards/.../2.05.10_EVA.pdf)>; Accessed 30.11.15.
2. Dunowska M, et al. *Vet Microbiol.* 2012;156:418.
3. Archambault D, et al. *Biomed Res Int.* 2014;2014:303841.
4. Balauriya UBR, et al. *Vet Microbiol.* 2013;167:93.
5. Pronost S, et al. *Equine Vet J.* 2010;42:713.
6. Zhang J, et al. *J Gen Virol.* 2010;91:2286.
7. Vairo S, et al. *Vet Microbiol.* 2012;157:333.
8. Firth AE, et al. *J Gen Virol.* 2011;92:1097.
9. Go YY, et al. *J Virol.* 2010;84:4898.
10. Zhang J, et al. *Arch Virol.* 2007;152:1977.
11. Echeverria MAG, et al. *Virus Genes.* 2007;35:313.
12. Larska M, et al. *Vet Microbiol.* 2008;127:392.
13. Metz GE, et al. *Arch Virol.* 2008;153:2111.
14. Ernesto Metz G, et al. *Intervirology.* 2011;54:29.
15. Rola J, et al. *Vet Microbiol.* 2011;148:402.
16. Ataseven VS, et al. *Rev Med Vet.* 2013;164:67.
17. Rola J, et al. *Vet Microbiol.* 2013;164:378.
18. Metz GE, et al. *Rev Sci Tech OIE.* 2014;33:937.
19. Miszczak F, et al. *Virologie.* 2015;19:7.
20. Surma-Kurusiewicz K, et al. *Res Vet Sci.* 2013;94:361.
21. Miszczak F, et al. *Virology.* 2012;423:165.
22. McFadden AMJ, et al. *NZ Vet J.* 2013;61:300.
23. Bulut O, et al. *J Anim Vet Adv.* 2012;11:924.
24. Mangana-Vougiouka O, et al. *Rev Sci Tech OIE.* 2013;32:775.
25. Broaddus CC, et al. *Therio.* 2011;76:47.
26. Go YY, et al. *J Virol.* 2011;85:13174.
27. Go YY, et al. *J Virol.* 2012;86:12407.
28. Go YY, et al. *Vet Microbiol.* 2012;157:220.
29. Kalemkerian PB, et al. *Res Vet Sci.* 2012;93:1271.
30. Gryspeerdt A, et al. *Vlaams Dier Tijd.* 2009;78:189.
31. Lu Z, et al. *J Vet Diagn Invest.* 2008;20:147.
32. Miszczak F, et al. *J Clin Micro.* 2011;49:3694.
33. Chung C, et al. *J Vet Diagn Invest.* 2013;25:182.
34. Chung C, et al. *J Vet Diagn Invest.* 2013;25:727.
35. Ernesto Metz G, et al. *J Virol Meth.* 2014;205:3.
36. Hu Y, et al. *Chin J Prev Vet Med.* 2014;36:651.
37. Newton JR. *Equine Vet Educ.* 2007;19:612.
38. Horserace Betting Levy Board. 2015 at: <<http://codes.hblb.org.uk/index.php/page/55>>; Accessed 29.11.15.

## AFRICAN HORSE SICKNESS

### SYNOPSIS

**Etiology** African horse sickness virus.

**Epidemiology** Infectious, noncontagious, arthropod-borne disease of horses, donkeys, and mules endemic to sub-Saharan Africa. Epizootics occur in the Iberian Peninsula, Mediterranean coast, Middle East, and Indian subcontinent. Heightened concern over risk of spread to areas, particularly western Europe, that are currently free of the disease.

Continued

**Clinical signs** *Pulmonary form*: fever, respiratory distress, frothy nasal discharge, death. *Cardiac form*: fever, edema of the head and ventral chest, hydropericardium. *Mixed form* has characteristics of both pulmonary and cardiac forms. *Horse fever*: mild fever, often inapparent infection.

**Clinical pathology** Leukopenia; disseminated intravascular coagulation. Serology often negative in horses that die acutely. Detection of viral genome by polymerase chain reaction (PCR).

**Lesions** Pulmonary edema, hydropericardium, ascites, edema of the gastrointestinal tract.

**Diagnostic confirmation** Histopathology. Detection of virus by cultivation or reverse-transcription PCR (RT-PCR) in blood or tissues.

**Differential diagnosis list:**

- Pulmonary form—rupture of cordae tendineae of mitral valve (single horse), acute bacterial pneumonia, anthrax, piroplasmiasis
- Cardiac form—intoxication with monensin or similar ionophore.

**Treatment** None. Supportive care.

**Control specific** *Enzootic area*: vaccination, reduce exposure to biting insects. Quarantine and eradication in nonenzootic areas.

African horse sickness is an important disease of horses and mules in southern and central Africa and, during epizootics, in northern Africa (including Ethiopia)<sup>1</sup> and the Arabian and Iberian peninsulas. The disease in southern Africa occurs as frequent, intermittent small outbreaks and as periodic epidemics that kill large numbers of horses. An epidemic during 1854 to 1855 killed over 17,000 horses, 40% of the horse population, in the Western Cape region. During premechanized exploration and development of southern and central Africa and during the Boer War, the disease had a major economic and military impact. For example, during a single campaign in the Boer War, of 1732 British horses involved, 323 died of African horse sickness within a 17-day period in late April of 1901. An outbreak that extended through northern Africa into the Indian subcontinent from 1959 to 1961 resulted in the death of 300,000 horses.

## ETIOLOGY

African horse sickness (AHS) is associated with a viscerotropic orbivirus (RNA, family Reoviridae), of which nine antigenic strains (serotypes) are recognized. The genome of AHS virus (AHSV), which is available,<sup>2</sup> is composed of 10 double-stranded RNA segments, which encode seven structural proteins (VP1-7) and four nonstructural proteins.<sup>3,4</sup> Proteins VP2 and VP5 form the outer capsid of the virion, and proteins VP3 and VP7 are the major inner capsid proteins.

Proteins VP1, VP4, and VP6 constitute minor inner capsid proteins. The NS3 proteins are the second most variable AHSV proteins and are associated with viral release from cells and total viral yield.<sup>3,5</sup>

The serotypic differences are attributable to variations in the capsid proteins, predominantly VP2 and to a lesser extent VP5. VP2 contains the predominant neutralizing epitopes, although antibodies to VP5 are one of the earliest serologic markers of infection and have neutralizing activity. Lineages are also evident within serotypes, and the resultant clades are grouped geographically, at least for the serotypes studied. Identification of clades facilitates epidemiologic studies. There are also variants of each serotype with attenuated virulence. No new serotypes have been identified since 1960, and virtually all epidemics outside of southern Africa before 1987 were caused by serotype 9. Since then, outbreaks attributable to AHSV-4 (Iberian Peninsula 1987–1990); AHSV2, -4, -6, -8, and -9 in Ethiopia since 2007 (although AHSV-9 is endemic and was the serotype isolated from ~80% of cases)<sup>6</sup>; and AHSV-2 in Nigeria, Ghana, Senegal, Morocco, and neighboring countries from 2007 (again, with AHSV-9 being endemic in some of this region) have occurred.<sup>7,8</sup> Serotype 7 has been reported to cause disease in equids in Ethiopia but was not detected during 2007 to 2010.<sup>1</sup>

An avirulent form of AHS 9 circulates in the Gambia, with 96% of clinically normal unvaccinated horses and donkeys seropositive for the serotype. The avirulent strain of AHSV-9 is identical to a vaccinal strain, raising the suggestion that the virus circulating in the Gambia region is highly likely to have derived from a live-attenuated AHSV-9 vaccine.<sup>9</sup> Passage of AHSV-7 through cell lines to produce an attenuated strain does not reduce its infectivity for midges, indicating the potential for vector-borne spread of avirulent strains of the virus.<sup>10</sup> The practice of vaccinating horses with polyvalent, avirulent vaccines has led to concerns about reassortment of the virus and reversion to virulence. However, although reassortment of vaccine virus occurs *in vivo*, there is currently no evidence that the reassortants are pathogenic, noting the limitation on this conclusion imposed by the small number of horses studied and the short duration of the study.<sup>11</sup>

There have been three outbreaks of AHS in the AHS-controlled zone near the Cape of Good Hope in South Africa since the zone was established in 1997. Serotypes involved in these outbreaks were serotype 1 (2004 and 2011) and serotype 7 in 1999. The 1999 and 2004 outbreaks were traced to unauthorized movement of horses into the zone. The source of the 2011 outbreak is unknown.<sup>12</sup>

There is real concern among AHS-free countries, including those in Europe, the Americas, and Australia, that AHS will gain entry, either by movement of midges, through introduction of subclinically infected equids

(likely mules, donkeys, or zebras), or through fraudulent (unauthorized) importation of equids. Recognition of this risk, which appears to be increasing with global warming and climate change and is exemplified by the emergence of Bluetongue and Schmallenberg viruses in Europe,<sup>8,13,14</sup> has resulted in many countries developing contingency plans for exclusion of the virus or management plans should it emerge.<sup>8,14-19</sup>

The virus is similar to other animal orbiviruses, including bluetongue virus, enzootic hemorrhagic disease virus, and equine encephalosis virus. The host range includes equids (horses, donkeys, mules, zebra), elephants, camels, sheep, goats, and predatory or scavenging carnivores. Infection produces disease in horses and mules, and less commonly African donkeys, but rarely in the other herbivorous hosts.<sup>3</sup> The disease occurs in dogs, although apparently rarely, and can occur in dogs that have not had known access to infected meat.<sup>20</sup>

The virus is inactivated by heating at 50°C (122°F) for 3 hours or 60°C (140°F) for 15 minutes, is stable at 4°C (39°F), and survives for 37 days at 37°C. It remains viable at pH of 6 to 12, but it is inactivated by acid and in 48 hours by 0.1% formalin or phenol, sodium hypochlorite, and iodophors.

Infection with African horse sickness virus is listed by the World Organization for Animal Health (OIE).<sup>21</sup>

## EPIDEMIOLOGY

African horse sickness is an **infectious but not contagious** disease of Equidae. It is spread by the bite of blood-feeding insects.

## Occurrence

The disease is **enzootic in sub-Saharan Africa**, causing clinical disease in horses, donkeys, mules, and dogs and infecting zebras, elephants, and perhaps other wildlife. The disease occurs from Senegal through sub-Saharan Africa to Somalia and Ethiopia. The disease makes occasional incursions into Iran, Pakistan, India, Turkey, and the eastern Mediterranean and Cyprus. The virus occurs in the Middle East, including Saudi Arabia and Yemen. It does not appear to be enzootic to Saudi Arabia, although the long-term status of this region is uncertain. In 1987 the disease recurred in Spain through introduction of infected zebras into a game park. By 1990 the disease had spread throughout Spain and Portugal but was eliminated by 1991.

Sero-epidemiologic surveys in Ethiopia indicate a prevalence rate of 10.4%, 29.7%, and 10.3% in horses, donkeys, and mules, respectively, with some regions having 51% seroprevalence in donkeys, 30% in mules, and 28% in horses, with an overall seroprevalence of 33%.<sup>1</sup>

## South Africa

The disease has been recognized in South Africa since shortly after introduction of

domesticated horses in the 1600s. The disease occurred throughout what is now South Africa in the nineteenth and early twentieth centuries, but as an enzootic disease became restricted to the northeastern areas of the country in the middle and later part of the twentieth century. The geographic contraction of disease was associated with elimination of large herds of wild zebra from all except the game parks of the northeastern areas of the country. Elimination of zebra, the reservoir of infection, reduced the occurrence of the disease dramatically. Outbreaks of disease outside of the endemic areas in the northeastern areas of South Africa are associated with introductions of virus from endemic areas at times of high abundance of *Culicoides* spp., the vector. The disease does not overwinter in the essentially zebra-free nonendemic areas. Serotype 9 causes enzootic disease in central Africa in the absence of zebra; the wildlife host has not been identified.

African horse sickness occurred in 1999 in the surveillance zone of the Cape Province of South Africa surrounding the disease-free area of Cape Town. The virus (serotype 7) was of a clade identical to that found in Kwazulu Natal Province, and its introduction was by the movement of infected horses from that region into the Cape Province.

### Transmission of Infection

African horse sickness virus (AHSV) is transmitted by the bite of **hematophagous insects**, including midges (*Culicoides* spp.), ticks (*Hyalomma dromadarii* and the brown dog tick, *Rhipicephalus sanguineus*), and mosquitoes (various species in laboratory studies). **Midges** are by far the most important vector in the spread of the spontaneous disease. The source of virus for midges is blood of infected horses, donkeys, mules, and zebra. Horses and mules have clinical signs of disease while viremic, but donkeys are often and, most important, zebra are always, apparently uninfected. Zebras may remain viremic for 6 weeks, donkeys for 12 days, and horses for 18 to 21 days. Dogs are usually infected by eating infected animals, although transmission to and from dogs by ticks can occur.<sup>20</sup>

Transmission of the virus to areas where it does not usually exist occurs both by movement of infected animals, such as zebras and horses, and by transportation of midges by wind or in aircraft.<sup>7,8</sup> Mechanical transmission of the virus on contaminated surgical instruments and needles should be considered a possibility.

### Zebra

In areas in which the disease is enzootic, the virus persists by cycling between the mammalian host, the zebra, and vectors year round. Zebra in enzootic areas can seroconvert during any month of the year, indicating that persistence of the virus is associated

with sequential infection of zebra within a herd or region. Persistence of the virus in a region is attributable to the long period of viremia in zebra and the presence of a herd of sufficient size to support cycling of infection among animals. The minimum size of a zebra population to maintain an enzootic infection is unknown. However, in areas in which the disease is not enzootic, the virus does not persist over the cooler winter months, when viremic animals recover and the vectors die. Concern exists that reintroduction of zebra to areas of the country currently free of enzootic AHS might permit reestablishment of the virus and disease in horses.

### Midges

Knowledge of the ecology of midges (*Culicoides* spp.), and which of them can be vectors for AHSV, is critical to developing an understanding of the risk of introduction and spread of infection in disease-free areas.<sup>22,23</sup> Although much is known about the ecology of midges, it is unclear which species, apart from *C. imicola* and *C. bolitinos*, can be vectors for AHSV and the capacity of these potential vectors to spread disease. A number of species of culicoides that feed on horses, and other herbivores, are present in rural and urban regions of the southeastern United Kingdom and could be potential vectors for AHSV.<sup>23,24</sup> And being present and capable of being infected by AHSV, midges must feed on horses with sufficient frequency to spread the infection. The frequency with which midges feed on horses could be influenced by the host preference of midges—they might prefer to feed on other herbivores, thereby reducing the risk of spread of infection between horses.<sup>25</sup> Whether midges have this preference, and the influence of variable densities of alternative hosts on midge feeding, is unclear at this time.<sup>25</sup>

Finally, the risk of introduction and establishment of breeding populations of species of midges to areas in which they are not currently present must be considered.<sup>8,15</sup> Such introductions could be by wind or aircraft. The biosecurity risks of African horse sickness viruses need to be reevaluated in regions where the vector's niche is suitable as a result of climate change or human manipulation of local ecosystems, such as by irrigation.<sup>26</sup> Under some likely climate change scenarios the distribution of *C. imicola* could expand northward in the Northern Hemisphere. The risk of spread of African horse sickness virus is likely to increase as the climate suitability for *C. imicola* shifts poleward, especially in Western Europe.<sup>26</sup> The range of *C. imicola* in Africa might well decrease as a result of a warming climate.<sup>26</sup> Other human activities, such as irrigations programs and alterations in herbivore populations, that alter the ecology of local areas in such a way as to provide an ecological niche and environment where midges exotic to the

area can thrive will influence the risk of introduction of AHSV.

Midges are infected with AHSV; that is, they are not mechanical vectors, but rather the virus infects and replicates in the midge,<sup>27</sup> although transovarian transmission of infection between generations of midges does not occur. *C. imicola* is the primary vector responsible for the transmission of AHSV within its enzootic area and during epizootics. *C. bolitinos* is also a vector of AHSV in southern Africa, whereas a number of other *Culicoides* spp. are unlikely to be vectors because they are unable to maintain infection with the virus 10 days after ingesting a meal of infected blood. At least 11 species of culicoides from South Africa can be infected by a variety of AHSV serotypes after feeding on infected blood meals in a laboratory setting. There are evident complex relationships between species of culicoides and serotype of AHSV affecting viral infection and titer in the vectors.<sup>10</sup> However, *C. varipennis*, *C. pulicaris*, and *C. obsoletus* are competent and likely important vectors because of their ability to maintain infection over the winter, as demonstrated in Portugal.

The abundance of midges can be predicted from measures of soil moisture content and land surface temperature. Midges breed in damp soils that are rich in organic material, such as irrigated pastures, that provide soil moisture adequate for completion of the life cycle (at least 7–10 days). Higher temperatures increase the rates of infection of midges, virogenesis within midges, and transmission rate but decrease midge longevity. Replication of AHSV in midges does not occur at temperatures less than 15°C (59°F), although midges continue to be active at 12°C (54°F). The absence of AHSV in the midges during winter in parts of South Africa can be ascribed to their relatively low numbers, low infection prevalence, low virus replication rates, and low virus titers in the potentially infected midges.<sup>28</sup>

Midges can be transported by winds for up to 700 km.

### Risk Factors

#### Environment Factors

The incidence of the disease is often **seasonal** because of the seasonal variations in the number of *Culicoides* spp. present and possibly other weather-related factors such as host (zebra) behavior (Fig. 21-2). Vector activity is favored by temperatures between 12.5° and 29°C (54.5° and 84°F), and it is likely that several cool or cold episodes, rather than one “killing frost,” are necessary to kill all or most vectors. Local factors, including topography, influence the distribution of midges within their overall range, and therefore the disease has a geographic distribution: the areas most severely affected are low lying and swampy.

Epizootics of AHS occur in southern Africa in association with variations in the El



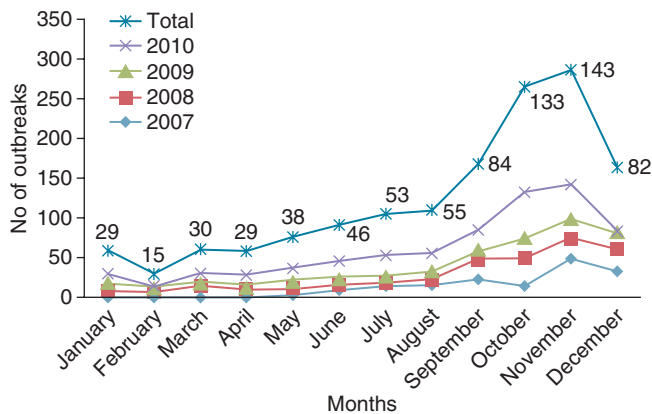

**Fig. 21-2** Seasonal occurrence of outbreaks of African horse sickness in central Ethiopia (2007–2010).<sup>1</sup> (Reproduced with permission from Aklilu N, Batten C, Gelaye E, et al: African Horse Sickness Outbreaks Caused by Multiple Virus Types in Ethiopia. *Transboundary & Emerging Diseases* 2014;61:185-192.)

Niño/Southern Oscillation. Epizootics of the disease occur in years in which the oscillation produces drought followed by heavy rains. The reason for this association, which was first anecdotally reported in the 1800s, is unknown but could be related to congregation of zebra around water holes during the drought. Congregation of large numbers of zebra might increase the infection rate among midges, which then disseminate the infection when rains produce widespread conditions favorable to their reproduction.

### Animal Factors

Natural infection occurs in Equidae, the most severe disease occurring in horses, with mules, donkeys, and zebras showing lesser degrees of susceptibility, in that order. The risk of death is greatest in weanlings but for all horses does not appear to be related to sex of the animal. The case-fatality rate varies depending on the severity of disease (see under “Clinical Signs”) but can be as high as 90% in susceptible horses,<sup>12,29</sup> but it is lower in mules and donkeys.

Elephants seroconvert when exposed to infection but are probably not an important reservoir. White rhinoceros sampled in Kruger National Park in 1989 had a 60% seroprevalence to AHSV, whereas in 2007 the seroprevalence was zero. The reasons for this difference are unclear.<sup>30</sup>

**Vaccination** is effective in reducing risk of the disease (odds ratio for risk of death ~0.1 [0.04 to 0.4]).<sup>29</sup> After natural infection or vaccination, immunity to that strain, but not to heterologous strains, is solid. The development of immunity is slow and may require 3 weeks to be appreciable; titers may continue to rise for 6 months after infection.

Foals from immune dams derive passive immunity, the titer of which varies depending on the mare’s titer, the serotype, and the time after ingestion of colostrum. Mare titers before foaling and foal serum titers after suckling are highly correlated regardless of serotype.<sup>31</sup> Mare serum titers for some

serotypes (1, 4, 6, and 9) are higher than for other serotypes, and this is mirrored in the titers in foal serum. Estimated mean half-life for neutralizing antibodies in foals to all 9 serotypes was 20.5 ( $\pm$  2.6 standard deviation) days, with a range from 15.4 days for serotype 8 to 22.6 days for serotype 3. The estimate for the mean time until the serum neutralization test became negative at a 1:10 dilution, considered absence of protection from infection, was 96 days for all nine serotypes, with a range from 62 days for serotype 5 to 128 days for serotypes 3 and 4.<sup>31</sup>

### Economic Importance

The disease was of tremendous economic concern in southern Africa when horses were important for transportation and as draft animals. The disease is currently an economic concern because of the costs associated with preventive measures in enzootic areas, monitoring for introduction of disease in unaffected areas, and restrictions on importation of horses from countries in which the disease is enzootic. The high case-fatality rate and morbidity of the disease in outbreaks is another source of loss. The cost of disease epizootics can be large, as demonstrated by the outbreak in the Iberian Peninsula, where control of the disease in Portugal in 1990 to 1991 was achieved at a cost of US\$2,000,000. Direct costs of managing the 2011 outbreak in the AHS-controlled zone in South Africa were at least R850,000, with estimated export losses of greater than R20,000,000.<sup>12</sup>

### Zoonotic Disease

African horse sickness caused encephalitis and chorioretinitis in eight workers in an AHS vaccine factory. Infection was likely to be through inhalation of freeze-dried virus.

### PATHOGENESIS

AHSV affects vascular endothelium and monocytes/macrophages.<sup>32</sup> The tissue tropism of the infecting serotype determines

which organs are most severely affected, although all serotypes infect the heart and lungs and, to a lesser extent, the spleen.<sup>32</sup> After infection, the virus multiplies in local lymph nodes, and a primary viremia ensues, with dissemination of infection to endothelial cells and intravascular macrophages of lung, spleen, and lymphoid tissues. Viral multiplication then results in a secondary cell-associated (red cell and white cell) viremia in horses of up to 9 days in duration. Fever and viremia occur at the same time, and resolution of the viremia is associated with defervescence. Localization of antigen depends on the form of the disease—horses with horse sickness have most of the antigen in the spleen, whereas horses with the more severe cardiopulmonary form have abundant antigen in cardiovascular and lymphatic systems.

Infection of endothelial cells results in degenerative changes, increases in vascular permeability, impaired intercellular junctions, loss of endothelium, subendothelial deposition of cell debris and fibrin, and evidence of vascular repair. Edema, hemorrhage, and microthrombi are associated with the vascular lesions. Abnormalities in the lungs include development of alveolar and interstitial edema, sequestration of neutrophils and platelet aggregates, and formation of fibrinous microthrombi. Combined, these changes likely result in coagulopathy, systemic inflammatory response syndrome, edema, impaired cardiovascular and pulmonary function, and hypovolemia.

### CLINICAL FINDINGS

The **incubation period** in natural infections is about 5 to 7 days. Three or four clinical forms of the disease occur, an acute or pulmonary form, a cardiac or subacute form, a mixed form, and a mild form known as “horse sickness fever.” An intermittent fever of 40° to 41° C (105–106° F) is characteristic of all forms.

### Acute (Pulmonary) Horse Sickness (Dunkop)

Acute horse sickness is the most common form in epizootics and has a case-fatality rate of 95%. Fever is followed by labored breathing, severe paroxysms of coughing, and a **profuse nasal discharge** of yellowish serous fluid and froth. Profuse sweating, profound weakness, and a staggering gait progress to recumbency. Death usually occurs after a total course of 4 to 5 days, although it can be so acute as to be without observed premonitory signs in some horses. Severe respiratory distress persists for many weeks in surviving animals. This is the form of the disease that occurs naturally in dogs.

### Subacute (Cardiac) Horse Sickness (Dikkop)

Subacute (cardiac) horse sickness is most common in horses in enzootic areas and has

a case-fatality rate of 50%. The incubation period may be up to 3 weeks, and the disease has a more protracted course than does the acute, pulmonary form. There is **edema** in the head, particularly in the temporal fossa, the eyelids, and the lips, and the chest, which may not develop until the horse has been febrile for a week. The oral mucosa is bluish in color, and petechiae may develop under the tongue. Examination of the heart and lungs reveals evidence of **hydropericardium**, endocarditis, and pulmonary edema. Restlessness and mild abdominal pain and paralysis of the esophagus, with inability to swallow and regurgitation of food and water through the nose, is not uncommon. Recovery is prolonged. A fatal course may last as long as 2 weeks.

A **mixed form** of the disease, with both pulmonary and cardiac signs, is evident as an initial subacute cardiac form that suddenly develops acute pulmonary signs. Also, a primary pulmonary syndrome may subside, but cardiac involvement causes death. This mixed form is not common in field outbreaks.

### Horse Sickness Fever

A mild form of horse sickness fever, which may be easily overlooked, is common in enzootic areas. The disease occurs in horses with some immunity or infection by serotypes of low virulence. This is the only form of the disease that occurs in zebras. The temperature rises to 40.5°C (105°F) over a period of 1 to 3 days but returns to normal about 3 days later. The appetite is poor, and there is slight conjunctivitis and moderate respiratory distress.

### CLINICAL PATHOLOGY

**Leukopenia** with lymphopenia, neutropenia and a left shift, mild thrombocytopenia, and hemoconcentration are characteristic of the acute forms of AHS. **Serum biochemical abnormalities** include increases in creatine kinase, lactate dehydrogenase, and alkaline phosphatase activities and creatinine and bilirubin concentrations. There is evidence of activation of coagulation cascade and fibrinolysis, although disseminated intravascular coagulation is unusual.

**Confirmation** of diagnosis is based on seroconversion (in horses that survive) or presence of AHSV in horses with compatible clinical or epidemiologic characteristics of the disease.<sup>3</sup> Detection of the virus can be made by demonstration of viral genome by one or more of a variety of PCR tests.<sup>3,33-41</sup> Each of these tests has its particular advantages, but all have the advantage of rapidity of diagnosis, often within hours of the sample being delivered to the laboratory, and many allow prompt identification of the serotype involved. Type-specific gel-based RT-PCR and real-time RT-PCR using hybridization probes for identification and differentiation AHSV genotypes provides a rapid typing

method for AHSV in tissue samples and blood.<sup>34,37,39,42</sup> ELISA tests provide rapid detection of AHSV antigen in blood, spleen, and supernatant from cell culture. The virus neutralization (VN) assay was formerly the “gold standard” for typing and identifying virus isolates, but because it takes 5 days and culture of the virus, it has been replaced by PCR assays.<sup>3</sup> The virus can be cultured in baby hamster kidney-21 (BHK-21), monkey stable (MS) or African green monkey kidney (Vero), or insect cells (KC); intravenously in embryonated eggs; or intracerebrally in newborn mice.<sup>3</sup>

**Serologic diagnosis** of the acute disease may be difficult because many horses die before they mount a detectable antibody response. In horses that survive for at least 10 days, agar gel immunodiffusion (AGID), indirect fluorescent antibody (IFA), complement fixation (CF), VN and ELISA tests are all effective in detecting antibody to the virus. An indirect ELISA (I-ELISA) is more sensitive in detecting early immunologic responses to vaccination or infection and the declining immunity in foals. However, in outbreaks of disease early and accurate diagnosis of disease and identification of the serotype involved is important to guide selection of vaccine and thereby control spread of the disease. Blocking ELISA, indirect ELISA, and complement fixation are all prescribed tests in the *OIE Terrestrial Manual*.<sup>3</sup> Suitable samples are blood collected into heparin during the febrile stage of the disease or lung, spleen, or lymphoid tissue collected at necropsy.

Tests approved for testing horses for international trade include a complement fixation test and an indirect sandwich ELISA.

### DIFFERENTIAL DIAGNOSIS

The fulminant disease in groups of horses is characteristic, although acute intoxication by monensin, salinomycin, or similar compounds can produce similar signs. Individual horses affected with purpura hemorrhagica and groups of horses affected with equine viral arteritis can have signs similar to horses with African horse sickness (AHS). Piroplasmiasis (*B. caballi* or *T. equi*) and trypanosomiasis cause fever and depression. Anthrax can cause acute deaths in solitary horses or groups of horses.

### NECROPSY FINDINGS

Gross findings in acute cases include **severe hydrothorax and pulmonary edema** and moderate ascites. The liver is acutely congested, and there is edema of the bowel wall. The pharynx, trachea, and bronchi are filled with yellow serous fluid and froth. In cases of cardiac horse sickness there is marked hydropericardium, endocardial hemorrhage, and myocardial degeneration. Edema of the head and neck is common, especially of the supraorbital fossa and nuchal ligament. Microscopic lesions are minimal in the acute

form; pulmonary edema may be present but no obvious vascular injury. Myocardial damage, including foci of necrosis, hemorrhage, and mild leukocytic infiltrates, may be seen during histologic examination of many cardiac (subacute) cases. An immunoperoxidase test is sensitive in detecting viral antigen in formalin-fixed, paraffin-embedded tissues.<sup>43</sup>

### Samples for Confirmation of Diagnosis

- **Virology**—chilled spleen, lung, lymph node (PCR, VIRUS ISOLATION)
- **Histology**—fixed lung, heart (light microscopy, immunohistochemistry)

### TREATMENT

There is no specific treatment for AHS. Supportive care and treatment of complication of the disease should be provided.

### CONTROL

The **principles of control** in enzootic areas are **vaccination** and **reduction of exposure** of horses to biting insects, whereas in **non-enzootic** areas the aim is to **prevent introduction** of the disease and **eradication** if it is introduced. The objectives of a control program for African horse sickness are as follows:

- Prevention of introduction of infection by clinically ill or apparently uninfected animals
- Slaughter of viremic animals where animal welfare and economic considerations permit this course of action
- Management changes to reduce exposure to midges
- Vector control
- Induction of active immunity in animals at risk of disease

### Prevention of Introduction

Many countries now have specific plans to prevent introduction of AHSV-infected equids and emergency management of introduction of the virus or occurrence of the disease.<sup>8,13,14,16,17,19,44</sup>

Infection can be introduced into an area free of AHSV by infected animals or midges. Control of midges is discussed later in the chapter. Infected animals can be horses incubating the disease; clinically ill animals; or animals, including donkeys and zebras, that have no clinical signs of illness but are infected and viremic, as was the case of the Portuguese epizootic. Appropriate control measures to prevent movement of animals at risk of being infected should be instituted and include the following:<sup>3</sup> completion of a vaccination protocol effective against all important serotypes at least 42 to 60 days before introduction of the horse, positive identification of all horses by microchipping and passport documenting vaccination status, and a veterinary certificate confirming

health and issued no more than 48 hours before introduction. Equids imported from areas in which the disease is enzootic, or from neighboring regions, should be housed in isolation in insect-proof enclosures for 60 days. Recommendations that call for vaccination of all equids within 10 miles (16 km) of imported horses are not appropriate for most countries to which the disease is exotic.

### Slaughter of Sick or Viremic Animals

The extreme measure of slaughter is appropriate in controlling infection recently introduced into areas previously free of the disease. It is an effective adjunct in control of spread of infection, as demonstrated in Portugal. There are obvious economic, animal welfare, and public relations aspects to this practice, especially in areas where horses have high intrinsic worth or are companion animals.

### Reduce Exposure to Biting Midges<sup>22</sup>

Horses should be housed in insect-proof buildings or, at a minimum, buildings that limit exposure of horses to midges by closure of doors and covering of windows with gauze. Impregnation of gauze with an insecticide further reduces biting rates. Stables should be situated in areas, such as on hill-tops or well-drained sites, that have minimal midge populations. Midge numbers on individual farms should be reduced by habitat alteration, and thus areas of damp, organically enriched soils are eliminated. Widespread use of insecticides is unlikely to be environmentally acceptable.

The feeding pattern of midges is such that housing of horses during the crepuscular periods and at night will significantly reduce biting rates and likelihood of infection. Horses kept at pasture should have insect repellents applied regularly and especially to provide protection during periods of high-insect-biting activity. DEET (*N,N*-diethyl-*m*-toluamide) is the only commercially available repellent with documented activity against *Culicoides* spp. Application of deltamethrin (10 mL of 1% solution) to skin of horses did not reduce the frequency of midge feeding in an experimental trial in the United Kingdom.<sup>24</sup> Installation of alphacypermethrin impregnated mesh to jet stalls reduced the attach rate by *Culicoides* species by 6- to 14-fold and markedly reduced the number of *Culicoides* collected from horses housed in the stalls compared with sentinel horses, suggesting that this might be a useful means of reducing exposure of housed horses to midges.<sup>15</sup>

### Vaccination

Vaccination is effective in reducing both morbidity and mortality from AHSV infection in horses in enzootic areas and to control epizootics of the disease.<sup>7,29</sup> Vaccination is used in two circumstances: in areas in which the disease is endemic and in regions with an

epizootic of the disease. Vaccination can be used in enzootic or neighboring regions to provide active immunity of all resident equids because of the continual risk of the disease in these areas. Vaccination in this instance is initiated as soon as foals no longer have passive immunity to the virus, and it continues annually throughout the horse's life. Alternatively, vaccination can be used in the face of an epizootic to induce active immunity in horses in contact or in regions surrounding the outbreak. In this instance vaccination is stopped when the infection is eradicated from the area.

Early attenuated virus vaccines, although effective in preventing AHS, were associated with significant adverse effects, such as encephalitis. More recent vaccines of virus attenuated by passage through tissue culture are effective in preventing disease but do not prevent viremia. They were used to control the most recent outbreak in Spain and Portugal. Currently available vaccines are polyvalent or monovalent preparations containing attenuated strains of the virus. Protection against heterologous serotypes is usually weak, and most vaccines are polyvalent.

The polyvalent vaccines contain serotypes 1, 3, and 4 or serotypes 2, 6, 7, and 8, respectively. AHSV-9 is not included because serotype 6 is cross-protective.<sup>46</sup> A monovalent vaccine containing attenuated serotype 9 is used in western Africa, where this was, until recent emergence of AHSV-2, the only serotype present.<sup>7</sup> Vaccination of foals with either monovalent or polyvalent vaccine did not affect the serologic response to each serotype; that is, the response to vaccination with a monovalent vaccine did not differ to the response to that serotype when it was delivered in a polyvalent vaccine.<sup>47</sup> Foals have markedly varying serologic responses to differing serotypes, similar to the situation in adult to horses,<sup>31</sup> and they fail to develop protective immunity to some serotypes.<sup>47</sup>

Inactivated vaccines are effective in preventing viremia in most animals and disease without adverse effects. Inactivated vaccines are no longer available.

A number of recombinant canary-pox or vaccinia subunit vaccines have been trialed experimentally and provide protective immunity against challenge exposure of horses or appear to be effective using guinea pig models of the disease. The remaining challenge is to ensure that vaccines provide protection against all 9 serotypes.<sup>48-52</sup>

The recommended vaccination program for horses in South Africa that all race horses shall be vaccinated against African horse sickness using a registered, nonexpired, polyvalent horse sickness vaccine (e.g., Horse Sickness Vaccine I [AHS I] and Horse Sickness Vaccine II [AHS II]) according to the manufacturers' recommendations including two times as foals between the ages of 6 and 18 months, not less than 90 days

apart and, where possible, between June 1 and October 31, and thereafter every year between June 1 and October 31.<sup>53</sup> Foals are not vaccinated until they are at least 6 months of age to prevent any effect of colostral passive immunity on efficacy of vaccination. Horses resident in the AHS controlled area may not be vaccinated without written permission from authorities.

**Immunity** after vaccination is protective for at least 1 year, but annual revaccination of all horses, mules, and donkeys is recommended.

There is concern over the use of attenuated virus vaccines in epizootic situations, that is, in regions where AHSV is not enzootic. These reasons include the lack of vaccines approved for use in the European Community; the availability of only two types of polyvalent vaccines and one type of monovalent vaccine; delays in availability of vaccine for emergency vaccination; introduction of the virus, even attenuated virus, into regions in which it is not present; attenuated-virus viremia in some vaccinated horses; and reversion of vaccine strains to virulence.<sup>9,11,54</sup> These concerns have heightened the need for availability of inactivated virus or subunit vaccines.

### REFERENCES

1. Bitew M, et al. *Trop Animal Health Prod.* 2011;43:1543.
2. Anon. *Genome Announc.* 2015;3:e00921.
3. World Organisation for Animal Health. African horse sickness. 2012.
4. Zwart L, et al. *PLoS ONE.* 2015;10.
5. Meiring TL, et al. *Arch Virol.* 2009;154:263.
6. Aklilu N, et al. *Transbound Emerg Dis.* 2014;61:185.
7. Diouf ND, et al. *Vet Rec.* 2013;172:152.
8. van den Boom R, et al. *Vet Rec.* 2013;172:150.
9. Oura CAL, et al. *Epidemiol Inf.* 2012;140:462.
10. Venter GJ, et al. *Med Vet Ent.* 2009;23:367.
11. von Teichman BF, et al. *Vaccine.* 2008;26:5014.
12. Grewar JD, et al. *J Sth Afr Vet Assoc.* 2013;84:Art. #973.
13. MacLachlan NJ, et al. *Vet Res.* 2010;41.
14. Thompson GM, et al. *Irish Vet J.* 2012;65.
15. Carpenter S. *Vet Rec.* 2014;174:299.
16. de Vos CJ, et al. *Prev Vet Med.* 2012;106:108.
17. African horse sickness: how to spot and report the disease. 2014 at: <<https://www.gov.uk/guidance/african-horse-sickness#how-african-horse-sickness-is-spread>>; Accessed 06.09.15.
18. Faverjon C, et al. *BMC Vet Res.* 2015;11.
19. AUSVETPLAN. Animal Health Australia. 2014 at: <<http://www.animalhealthaustralia.com.au/programs/emergency-animal-disease-preparedness/ausvetplan/disease-strategies/>>; Accessed 06.09.15.
20. Sittert SJV, et al. *J Sth Afr Vet Assoc.* 2013;84:Art. #948.
21. OIE-listed diseases, infections and infestations in force in 2015. 2015 at: <<http://www.oie.int/animal-health-in-the-world/oie-listed-diseases-2015/>>; Accessed 06.09.15.
22. Carpenter S, et al. *Med Vet Ent.* 2008;22:175.
23. Robin M, et al. *Vet Rec.* 2014;174.
24. Robin M, et al. *Vet Rec.* 2015;176.
25. Lo Iacono G, et al. *J R Soc Interface.* 2013;10.
26. Guichard S, et al. *PLoS ONE.* 2014;9:e112491.
27. Wilson A, et al. *Vet Res.* 2009;40.



28. Venter GJ, et al. *J Sth Afr Vet Assoc.* 2015;85.
29. Gordon S, et al. *Ond J Vet Res.* 2013;80.
30. Miller M, et al. *J Zoo Wildlife Med.* 2011;42:29.
31. Crafford JE, et al. *Equine Vet J.* 2013;45:604.
32. Clift SJ, et al. *Vet Pathol.* 2010;47:690.
33. Aradaib IE. *J Virol Meth.* 2009;159:1.
34. Bachanek-Bankowska K, et al. *PLoS ONE.* 2014;9.
35. Bremer CW. *Open Vet Sci J.* 2012;6:8.
36. Fernandez-Pinero J, et al. *Res Vet Sci.* 2009;86:353.
37. Guthrie AJ, et al. *J Virol Meth.* 2013;189:30.
38. Koekemoer JJO. *J Virol Meth.* 2008;154:104.
39. Maan NS, et al. *PLoS ONE.* 2011;6.
40. Monaco F, et al. *Molecular Cellular Probes.* 2011;25:87.
41. Quan M, et al. *J Virol Meth.* 2010;167:45.
42. Maan NS, et al. *J Virol Meth.* 2015;213:118.
43. Clift SJ, et al. *J Vet Diagn Invest.* 2009;21:655.
44. Marcos A, et al. *Archivos De Medicina Veterinaria.* 2015;47:101.
45. Page PC, et al. *Vet Parasitol.* 2015;210:84.
46. von Teichman BF, et al. *Vaccine.* 2010;28:6505.
47. Crafford JE, et al. *Vaccine.* 2014;32:3611.
48. Kanai Y, et al. *Vaccine.* 2014;32:4932.
49. Alberca B, et al. *Vaccine.* 2014;32:3670.
50. El Garch H, et al. *Vet Immunol Immunopath.* 2012;149:76.
51. Guthrie AJ, et al. *Vaccine.* 2009;27:4434.
52. Chiam R, et al. *PLoS ONE.* 2009;e5997.
53. Vaccinations. 2015 at: <<http://www.nhra.co.za/vet/vaccinations.php>>; Accessed 06.09.15.
54. Weyer CT, et al. *Equine Vet J.* 2013;45:117.

## EQUINE ENCEPHALOSIS

### ETIOLOGY

The equine encephalosis virus is an insect-borne orbivirus, transmitted by a variety of *Culicoides* spp., that is closely related to bluetongue and epizootic hemorrhagic disease viruses.<sup>1,3</sup> It has characteristics in cell culture similar to African horse sickness (see “African Horse Sickness”). There are multiple serotypes of equine encephalosis virus that infect equids of southern, eastern, and western Africa, with serologic evidence of infection or virus isolation from equids in Kenya, Botswana, Namibia, South Africa, Ghana, the Gambia region, and Ethiopia, but not Morocco. Seven serotypes have been identified as circulating among equids in South Africa, with additional phylogenetically distinct isolates from horses in Israel.<sup>1,4,5</sup> The virus was detected in horses in Israel in 2008, in which it caused a mild febrile illness in large numbers of horses, and there is serologic evidence of its presence in Israel since 2001.<sup>5</sup> The virus isolated from horses in Israel was phylogenetically distant to those serotypes circulating in South Africa and similar to an isolate obtained from horses in Ghana.<sup>5</sup>

### EPIDEMIOLOGY

Horses, donkeys, and zebra in southern, western, and eastern Africa frequently have antibodies to the virus, indicating widespread infection of these equidae. Seventy-seven percent of 1144 horses, 57% of 518 horses, 49% of 4875 donkeys, and up to 88% of zebra in South Africa have antibody to EEV. All of 144 equids (horses and donkeys)

sampled in the Gambia region, 129 of 159 (81%) in Ghana, and 206 of 220 in Ethiopia had serologic evidence of infection by equine encephalosis virus.<sup>6</sup> None of 120 horses sampled in Morocco had serologic evidence of infection. An intensive study of all 127 foals on a single stud farm in South Africa revealed that 94% of the 93 foals that had a pyrexia episode were infected with EEV, despite 34% having maternally acquired antibodies soon after birth.<sup>7</sup> Zebra foals develop antibodies to the virus within months of losing their maternally acquired passive immunity. Elephants seldom have antibodies to EEV.

Seroprevalence in Thoroughbred yearlings has varied in South Africa markedly from year to year. Seroprevalence varies between 17.5 and 34.7% (of approximately 500 sampled each year) in most years but can be as low as 3.6%.<sup>1</sup>

The virus replicates in midges, although the rate differs depending on species of midge and strain of the virus. The genetic and phenotypic stability of strains of the virus are unknown, and there exists the potential for emergence of new strains or recognition of currently undetected strains, as demonstrated by the recent isolation of a phylogenetically distinct form of the virus from horses in Israel and Ghana. Variations in pathogenicity are not recognized but might exist. There is independent persistence of virus serotypes in a maintenance cycle based on observation of increased rates of seasonal seroconversion to a specific serotype with ongoing low level of infection by other serotypes. For example, infection by serotype 1 is most common (60%), whereas that by serotype 2 is uncommon (0.7%), despite the latter having been first documented as infecting horses in 1967.<sup>1</sup>

### CLINICAL SIGNS

The clinical importance of the virus is uncertain, and three syndromes are described: asymptomatic infection, clinical disease, and, on less evidence, encephalitis. Seroconversion in closely managed horses without evidence of clinical disease suggests that in most instances infection by the virus is asymptomatic. Whereas 94% of foals experiencing a pyrexia episode had virus recovered from their blood, only ~50% of foals from which virus was recovered had pyrexia, indicating that asymptomatic infections are common.<sup>7</sup> Most infections are subclinical based on the high seroprevalence rate and lack of reports of outbreaks of the disease. Clinical signs commonly attributed to EEV infection include fever, lassitude, edema of the lips, and congesta mucosal membranes, as reported in horses in Israel in 2008 and 2009. The virus was originally isolated from a horse with signs of neurologic disease—hence the name. However, the disease associated with infection by EEV is poorly documented, and, given the high prevalence

of infection, EEV might be falsely incriminated as the cause of more severe disease in some situations. Acute neurologic disease, abortion, and enteritis are anecdotally reported. In an outbreak report in late 2008 in Israel, the morbidity rate on 60 premises varied from 2% to 100%.<sup>4,5</sup> No horses died of the disease during that outbreak. Disease associated with EEV has not been recorded in donkeys or zebra.

### CLINICAL PATHOLOGY

Characteristic abnormalities in serum biochemistry or hematology are not reported. Antibodies to the virus are detected by serum neutralization assays and ELISA, both of which are group specific.<sup>8</sup> Complement fixation and agar gel immunodiffusion tests have been used to detect group-specific antibodies. A group-specific, indirect sandwich ELISA detects EEV antigen and does not cross react with African horse sickness virus, bluetongue virus, or epizootic hemorrhagic disease virus. A competitive ELISA suitable for use with serum from horses, donkeys, or zebras detects antibodies to all seven equine encephalosis virus serotypes but does not detect antibodies to other orbiviruses (such as African horse sickness or bluetongue).

### NECROPSY FINDINGS

Necropsy examination reveals cerebral edema, localized enteritis, degeneration of cardiac myofibers, and myocardial fibrosis but whether these abnormalities are attributable to EEV is unclear.<sup>3</sup> Definitive diagnosis of individual animals is difficult at the current time because of the high prevalence of seropositive animals and the ill-defined clinical and necropsy characteristics of the disease. Detection of seroconversion and/or virus isolation associated with clinical signs consistent with the disease in groups of horses permits detection of outbreaks of the disease, such as occurred in Israel. There are no recognized measures for treatment, control, or prevention. There is no vaccine.

### REFERENCES

1. Howell PG, et al. *Ond J Vet Res.* 2008;75:153.
2. MacLachlan NJ, et al. *Vet Res.* 2010;41.
3. Attoui H, et al. *Rev Sci Tech OIE.* 2015;34:353.
4. Mildenberg Z, et al. *Transbound Emerg Dis.* 2009;56:291.
5. Wescott DG, et al. *PLoS ONE.* 2013;8.
6. Oura CAL, et al. *Epidemiol Inf.* 2012;140:1982.
7. Grewar JD, et al. *Ond J Vet Res.* 2015;82.
8. Crafford JE, et al. *J Virol Meth.* 2011;174:60.

## GETAH VIRUS INFECTION

### ETIOLOGY

Getah virus is an alphavirus within the Semliki Forest complex of togaviruses. These are small enveloped viruses with a single-stranded, positive-sense RNA genome. Getah virus causes disease in horses and

pigs, and this occurs in Japan, Hong Kong, China, Southeast Asia, Korea, and India. Reports from the 1960s document antibodies to Getah virus in animals in Australia, but the presence of this virus in Australia has not been confirmed using modern techniques that are able to differentiate antibodies to Getah virus from those of the related Ross River virus and other viruses in this complex. There are no reports of disease caused by Getah virus in Australia. There is considerable sequence homology between Getah and Ross River virus genomes. There is temporal, but not geographic, variability among isolates of Getah virus from Southeast Asia and Japan.<sup>1,2</sup>

### EPIDEMIOLOGY

Getah virus is arthropod-borne, and infection is through the bite of an infected mosquito. The life cycle of Getah virus has not been completely explicated. The virus is maintained in the mosquito-vertebrate-mosquito host cycle typical of arboviruses. The definitive, amplifying vertebrate host for Getah virus is unknown, although a number of vertebrates, including horses, cattle, and pigs, can be infected by the virus. Antibodies to the virus have been detected in humans. Horses and pigs become viremic and presumably can infect mosquitoes, although this does not appear to have been confirmed experimentally. The virus is assumed to be maintained in a mosquito-pig-mosquito cycle in those areas in which there is mosquito activity year round. Persistence of the virus in areas in which mosquito activity is seasonal has not been explained, and whether transovarial or transtadial transmission occurs within the mosquito population is not reported.

There is suspicion that during outbreaks of disease Getah virus is spread by horse-to-horse contact, based on the rapidity of spread among horses, the short duration of the outbreak, and the lack of mosquito activity at the time that some horses developed the disease. However, experimental evidence suggests that this route of spread is likely of limited importance in propagation of epidemics because of the low concentration of the virus in nasal and oral secretions of infected horses and the large inoculum required to cause disease in horses by the intranasal route.

A recent outbreak in Japan saw 75 of 2000 Thoroughbred race horses develop a pyrexial episode, with Getah virus isolated from 25 of the 49 blood samples collected.<sup>3,4</sup> This contrasts with the 770 of 1900 horses affected in a 1974 outbreak at the same facility in Japan.<sup>3</sup> The prevalence of serologic evidence of infection of horses by Getah virus in Japan ranges from 8% to 93%, depending on the region of the country in which the samples were collected and the disease history of the band or stable of horses. Seroprevalence was 17% in India,

12.4% in Thoroughbred racehorses in Korea (with 28% of horses > 6 years of age positive), and 25% in Hong Kong.<sup>5</sup> These results confirm the widespread incidence of subclinical infection of horses by Getah virus in endemic areas.

Disease of humans caused by Getah virus has not been documented.

### CLINICAL SIGNS

Disease associated with Getah virus infection is characterized by pyrexia, edema of the limbs, and an abnormal gait, often described as “stiffness.” Eruptions of the skin, urticaria, and submandibular lymphadenopathy are reported in some horses with the disease in Japan, but not in India. The clinical disease persists for 7 to 10 days. Abortion is not a feature of the disease, and foals born of mares that have had the disease during gestation are normal. Subclinical infection is very common in endemic areas. However, Getah virus has been isolated from aborted swine fetuses.

Hematologic abnormalities induced by Getah virus infection in horses include lymphopenia. Increases in serum activity of muscle-derived enzymes, such as creatine kinase, are not characteristic of the disease. Affected horses can have mild to moderate hyperbilirubinemia secondary to inappetence.

Diagnosis of disease caused by Getah virus is achieved by detection of clinical signs consistent with the disease, isolation of the virus from blood of affected horses, and seroconversion to the virus. Interpretation of serologic data from horses in Japan is hindered by the widespread use of a vaccine against Getah disease that induces detectable antibodies to Getah virus in serum. A multiplex RT-PCR is available for use on samples from pigs.<sup>6</sup>

### NECROPSY FINDINGS

Reports of postmortem examination of horses with disease caused by Getah virus are limited to experimental studies because the disease is typically not fatal. Horses with disease induced by inoculation with pathogenic Getah virus typically have mild changes, including atrophy of splenic and lymphoid tissue with destruction of lymphocytes, and perivascular and diffuse infiltration of focal skin lesions by lymphocytes, histiocytes, and eosinophils. Lesions in the central nervous system are equivocal and limited to mild perivascular cuffing in the cerebrum and small hemorrhagic foci in the spinal cord.

### TREATMENT

Treatment of affected horse is supportive. Affected horses might benefit from administration of analgesics and antipyretics such as phenylbutazone. Administration of antimicrobials is not indicated in uncomplicated cases.

### CONTROL

An inactivated virus vaccine is available in Japan for immunization of horses against disease caused by Getah virus. The vaccine, which is combined with that for Japanese encephalitis, is considered effective. Race horses are vaccinated every 6 months.<sup>4</sup> Minimizing the exposure of horses to infected mosquitoes is prudent, although the efficacy of this technique in preventing infection is unknown. During outbreaks of disease caused by Getah virus, it is prudent to isolate affected horses, given the potential for horse-to-horse spread of the virus.

### REFERENCES

1. Seo HJ, et al. *Acta Virol.* 2012;56:265.
2. Feng Y, et al. *Chin J Zoonoses.* 2014;30:353.
3. Nemoto M, et al. *Emerg Infect Dis.* 2015;21:883.
4. Bannai H, et al. *J Clin Micro.* 2015;53:2286.
5. Jo H-Y, et al. *J Bact Virol.* 2015;45:235.
6. Ogawa H, et al. *J Virol Meth.* 2009;160:210.

### CLASSICAL SWINE FEVER (HOG CHOLERA)

Hog cholera, also known as classical swine fever (CSF), is a highly infectious pestivirus infection of pigs. At one time it was characterized clinically by an acute highly fatal disease and pathologically by lesions of a severe viremia. It is now known that chronic or inapparent disease also occurs, including persistent congenital infection in newborn pigs infected during fetal life. In many countries where it is endemic, clinical ability will diagnose it more often than laboratory skills.

Swine can also be affected by ruminant pestiviruses (BVD and BD); these seldom cause disease in pigs, but there are exceptions.<sup>1</sup> The risk factors for these are large numbers of cattle or sheep and goats sharing the same accommodation and watering facilities.<sup>2</sup> Knowledge of these viruses is important for the interpretation of diagnostic tests for CSF because BVDV can transmit between pigs and may prevent the transmission of CSF.<sup>3</sup>

### SYNOPSIS

**Etiology** Hog cholera virus, a pestivirus belonging to the genus *Flaviviridae* and related to the bovine virus diarrhea virus.

**Epidemiology** Affects domestic pig of all ages; causes major economic losses interfering with trade when outbreaks occur in pig-raising countries. Occurs in Europe, South America, and the Far East. Highly virulent virus causes high morbidity high mortality; less virulent strains cause milder form. Transmitted by direct contact, feeding of uncooked pork products. Neutralizing antibodies provide protection.

**Signs** Sudden onset of peracute deaths first indication in herd. Many pigs affected within days. Severe depression, fever, anorexia, purplish discoloration of skin, ocular discharge, nervous signs, and death in few days. Nervous form may predominate. Reproductive failure in pregnant sows (abortions, mummification, stillbirths, birth of persistently infected pigs).

**Clinical pathology** Leukopenia. Detection of virus in tissues and serologic testing.

**Lesions** Diffuse hemorrhages subcapsular of kidney, lymph nodes, bladder, larynx, swollen lymph nodes, splenic infarcts, congestion of liver and bone marrow, button ulcers in colon, nonsuppurative encephalitis. Hydropic degeneration and proliferation of vascular endothelium.

**Diagnostic confirmation** Detection of virus in tissues and serologic tests.

**Differential diagnosis list:**

- African swine fever
- Erysipelas
- Salmonellosis

**Treatment** None

**Control** Eradication in hog cholera-free countries by slaughter of all in-contact and affected pigs. Use of vaccines in endemic areas. Eradication in countries where endemic by use of vaccination followed by test and slaughter, quarantine farms.

## ETIOLOGY

It is a small, enveloped positive-sense, single-stranded, RNA virus in the genus *Pestivirus* of the family *Flaviviridae*. A new virus, Bungowannah virus, found in two herds in Australia, is also a pestivirus.<sup>4</sup> Most are non-cytopathogenic in culture, but there are some CSF and BVD that are cytopathogenic.<sup>5</sup>

It is antigenically and genetically diverse, with recombination possible between strains.<sup>6</sup> There is considerable antigenic variability. There are four structural proteins (C, E<sup>ns</sup>, E1, and E2) and eight nonstructural proteins. Genetic typing is most commonly based on E2 glycoprotein because abundant sequence data are available. The E2 glycoprotein of CSF is a virulence determinant in swine.<sup>7</sup> There are three major groups, each with three of four subgroups.<sup>8</sup> Typing used full-length encoding sequences of E2, which proved to be the most reliable for significant phylogeny and were proved to be useful in recent outbreaks in Lithuania.

**Group 1** types are present in South America and Russia. There have been subgroups 1.1, 1.2, and 1.3 in the past, but now it is proposed that there is a group 1.4 found in Cuba.<sup>9</sup>

**Group 2** types were isolated from Europe<sup>10</sup> and some Asian countries.<sup>11</sup> It has been shown that there is the possibility of a long-term persistence of genotype 2.3 CSF virus strains in affected areas at an almost

undetectable level even after long-term oral vaccination campaigns.<sup>12</sup>

**Group 3** types are confined to Asia. Four genetic groups are found in China (1.1, 1.2, 2.2, and 2.3), and a recent study has shown the wide range of antigenic differences in 21 strains.<sup>13</sup>

The virus is an enveloped virus and thus is susceptible to detergents and lipid solvents. High or low pH and temperature above 60°C (140°F) will inactivate the virus, but this depends on the substances in which the virus is contained.

There is evidence of natural recombination in CSF virus.<sup>6</sup> A sequence database allowing automated genotyping has been established.<sup>14</sup>

Classification of virulence has been based on a clinical and pathologic score and extended further by additional parameters such as case-fatality rate, antibody production, and leukocyte count to provide a modified clinical score<sup>15</sup> that gives a more reliable classification of virulence.

## EPIDEMIOLOGY

Although eradicated in many parts of the world, the countries that are free are always open to reinfection from illegal imports of fresh products, tourism, hunting, and illegal swill feeding.<sup>13,16</sup>

## Occurrence

The pig is the only domestic animal species naturally infected by the virus. Wild boar are also affected. Antibodies against CSF virus in fecal samples from wild boar in Korea have been described.<sup>16</sup>

A study of common warthogs and bushpigs in South Africa showed that they were capable of supporting CSF infection and could transmit to other pigs that were in contact.<sup>17</sup> The warthogs did not develop clinical signs, but the bushpigs did.<sup>18,19</sup> CSF of the type 1.1 cluster has also been described in pygmy hogs in India at a conservation center.<sup>20</sup> All breeds and ages are susceptible, and adults are more likely to survive an acute infection. The disease is found in eastern Europe, Southeast Asia, Central and South America, and in parts of Europe in wild boar.

Canada, Australia, New Zealand, and South Africa have not experienced the disease for many years. A mild form of the disease occurred in Australia in 1960 to 1961. The disease was eradicated from the United Kingdom during the period 1963 to 1967, and the United States was declared free of the disease in 1978.

Outbreaks of acute hog cholera have occurred occasionally in other countries but were quickly controlled by a rigorous policy of slaughter and quarantine. The disease occurred in the United Kingdom in 1986 in which three primary outbreaks were identified; all outbreaks were attributed to the feeding of unprocessed waste feed containing imported pig meat products. A similar

origin was suspected for the outbreak in the United Kingdom in 2000. In this outbreak an interesting feature was the transport of infected pig carcasses from a site where bodies were dumped for quite long distances by scavenging foxes, infecting new outside pig arcs across fields as they went.

Between 1982 and 1984 epidemics occurred in Germany, the Netherlands, Belgium, France, Italy, Greece, and the Iberian Peninsula. As of 1985, six countries in Europe were free of classical swine fever: Denmark, Ireland (including Northern Ireland), Norway, Sweden, Finland, and Switzerland.

There were three outbreaks of CSF in France between 2002 and 2011, one in wild boar and a pig herd in 2002 in Moselle, and a further one in wild boar in 2003 in Bas-Rhin, and they appeared to be from two lineages in wild boar in Germany. The wild boar in Bas-Rhin remained infected until 2007.<sup>21</sup> The role of wild boar in France has been described.<sup>22</sup>

The costs are astronomical (the Belgian outbreak of 1997 cost an estimated €11 million), and the 1997 to 1998 outbreak in the Netherlands was very serious. The disease has also concentrated in certain parts of Europe where the pig populations are intense and live in close proximity to wild boar and feral pig populations. For instance, outbreaks occurred regularly between 1997 and 2001 in Croatia. One source was imported pig meat; the other was strains reaching domestic pigs from wild boar. The wild boar areas include parts of Germany and Poland and probably most of eastern Europe. The outbreak in Spain in 2001 to 2002 was related to wild boar.<sup>23</sup>

In Europe, the disease, together with ASF, is endemic in the central highlands of Sardinia. Many outbreaks of classical swine fever occurred in Germany between 1993 and 1995, and major outbreaks occurred in 1996 to 1997 in Germany and the Netherlands. The risk factors for Germany have been described. In these countries, over the past 25 years, the disease occurred as a series of epidemics in which many swine herds in a geographic area were affected within a few months.

Infection with the classical swine fever virus has also occurred in the wild boar population in Tuscany in Italy, Germany, France, Austria, Czechoslovakia, and Croatia. Serologic surveys of wild boar in Sardinia found an overall prevalence of 11%, and seropositive boars were found not only in areas where they share their habitat with free-ranging domestic pigs but also in areas of the island where contacts between wild and domestic pigs are unlikely to occur. Thus there may be transmission and persistence of the virus within the wild boar population. This has occurred with the low-virulence strain in Germany. The persistence of infection in a wild boar population in the



Brandenburg region of Germany provided optimum conditions for the establishment of a CSF epidemic in Germany.

The disease is currently endemic in most countries of South America and the Far East except Japan and Korea. In Asia the problem is the backyard pig that is not vaccinated and is always a reservoir. Here extension services, appropriate vaccination schemes, and regulatory control are difficult to implement, but it may be time to try for worldwide eradication. In the Philippines, the disease is endemic on many large-scale swine farms. In spite of vaccination of the sows and boars every 6 months and piglets at 6 to 8 weeks of age, the disease causes suboptimal performance in 10% to 30% of pigs between 7 and 16 weeks of age.

### Morbidity and Case Fatality

The disease usually occurs in epidemics, often with a morbidity of 100% and a case-fatality rate approaching 100%, when a virulent strain of the virus infects a susceptible population. However, in recent years, outbreaks of a relatively slowly spreading, mild form of the disease have caused great concern in many countries. The disease associated with strains of low virulence may be unnoticed in growing and adult pigs, but the infection can be associated with perinatal mortality, abortions, and mummified fetuses. In a recent outbreak a mild form given experimentally to sows only produced a mild viremia with widespread antigen distribution, but without clinical signs, except lesions of hemorrhagic dermatitis. It did, however, produce an antibody response and transplacental infection.

### Methods of Transmission

The source of virus is always an infected pig or its products, and the infection is usually acquired by ingestion; inhalation is also a possible portal of entry. Direct animal-to-animal contact is the most important method of spread. Infected pigs shed a large amount of the virus in all secretions and excretions of pigs infected with highly or moderately virulent strains.<sup>24</sup> The effect of strain and inoculation dose of CSF on within-pen transmission has been described.<sup>25</sup> It is excreted in the urine for some days before clinical illness appears and for 2 to 3 weeks after clinical recovery.

Virus spread via excretions is more important in early stages of an outbreak. Highly contagious by direct contact, it is likely to be transmitted by aerosol only when all the pigs in the same airspace are viremic, and even then only for a distance of 1 meter. Viral RNA and infectious virus were detected in air samples in 2008.<sup>26</sup> It has been spread experimentally by aerosol, which followed the pattern of air currents,<sup>25</sup> but the importance under field conditions is not known. The higher the dose of virus or the more virulent the virus strain, the sooner the virus

should be detected in air samples in experimental infections.<sup>26</sup> Analysis of the 1997 to 1998 outbreak in the Netherlands suggested that it did not occur over long distances but did occur within a holding or within a radius of less than 500 meters. The transmission of CSF depends on the clinical course of infection, which is determined by the levels of high or low levels of virus excretion.<sup>27</sup> Different strains of the virus can differ in the relative contribution of secretions and excretions to the transmission of the virus, although blood is a high risk for spreading infection from pig to pig.<sup>28</sup>

Infected boars can shed the virus in semen. Rats and mice are unlikely to be involved in the spread.

Silent circulation of CSF occurs before the first outbreak is detected. The most severely affected animals have a higher infectivity than the less affected ones. Three transmission experiments suggested that the most severely affected animals could play a prominent role in CSF transmission.<sup>29</sup>

Sick pigs excrete virus until they die, or until after recovery. The resistance and high infectivity of the virus make spread of the disease by inert materials, especially uncooked meat, a major problem. The UK virus in the 2000 outbreak probably came from an infected pork product, imported illegally and fed to an outdoor pig. Outside pens, in warm weather and exposed to sunlight, lose their infectivity within 1 to 2 days. The ability of the virus to survive in the environment in more favorable situations is uncertain. However, it is probable that it can survive for considerable periods because the virus is quite resistant to chemical and physical influences. Transmission from neighboring units is very easy. One of the major features of the recent Dutch outbreak was the proof that transmission from boar studs (AI) was possible because infected boars excreted virus in semen, and the virus probably infects spermatogonia. It was shown that following insemination with semen containing CSF antibodies, infection could occur as early as 7 days; all pigs were positive by 14 days. The transmission rates in the Dutch outbreak have been calculated.

In areas free of the disease, introduction is usually by the importation of infected pigs or the feeding of garbage containing uncooked pork scraps. Hopefully, in Europe the ban on swill feeding will prevent further cases of infected meat causing the problems. Movement of pigs that are incubating the disease or are persistently infected is the most common method of spread. The infection usually originates directly from infected breeding farms. Birds and humans may also act as physical carriers of the virus. In endemic areas, transmission to new farms can occur in feeder pigs purchased for finishing, indirectly by flies and mosquitoes, or on bedding, feed, boots, automobile tires, or transport vehicles. Farmers, veterinarians,

and vaccination teams can transmit the virus by contaminated instruments and drugs, but recent evidence suggests that mechanical transmission may have been overestimated. People can spread the virus.<sup>30</sup>

Farmers can spread the virus within a herd by treating sick animals or employing routine health management procedures such as iron injections of newborn pigs. The common practice of not changing syringes and needles between farm visits constitutes a major risk when viremic animals are present. The most common cause of dissemination occurs through the movement and sale of infected or carrier pigs through communal sale yards when there is ample opportunity for infection of primary and secondary contacts. Transmission of excretions without direct contact from pig to pig may have been overestimated.

When the disease is introduced into a susceptible population, an epidemic usually develops rapidly because of the resistance of the virus and the short incubation period. In recent years, outbreaks have been observed in which the rate of spread is much reduced, and this has delayed field diagnosis. It is not spread by dogs, cats, or rats, and bird transmission is unlikely.

### Risk Factors

Following the 1997 to 1998 severe epizootic in the Netherlands, analysis showed that there were five major increased risk factors identified: (i) presence of commercial poultry on the farm, (ii) visitors to the units not being provided with protective clothing, (iii) drivers of lorries using their own clothes rather than protective clothing provided by the premises they were visiting, (iv) larger size, and (v) aerosols produced by high-pressure hosing. Reduced risk was associated with (i) over 30 years of experience in farming and (ii) additional lorry cleaning before being allowed on to the farm.

### Animal Risk Factors

It has been shown at least experimentally that the virulence of the strain can influence the dynamics of the virus spread.<sup>29</sup> Pigs infected with such a virus excrete significantly more virus than pigs infected with moderately or low virulent virus. The exception was the chronically infected pig, which, over the period of its disease, excreted significantly more virus. It showed the importance of virus type and excretion data in modeling studies.<sup>28</sup>

Historically, infection with the hog cholera virus rapidly resulted in severe clinical disease. It is now recognized that with less virulent strains, a carrier state can occur, at least for a period of time. Following exposure to these strains, pigs may become infected without showing overt signs of the disease, and although they may eventually develop clinical disease, this latent period is of importance in dissemination of infection

when such pigs are sold and come in contact with others. In recent outbreaks in high-pig-density areas in Belgium, the interval between the first occurrence of clinical signs and the report of a suspect herd was shorter when the disease was first diagnosed in finishing pigs rather than in sows, boars, or nursing piglets. The proportion of clinically affected animals was positively correlated with the proportion of serologically positive animals.

Susceptible pregnant sows, if exposed to less virulent strains of the virus, may remain clinically healthy, but infection of the fetuses in utero is common, and the virus may be introduced into susceptible herds by way of these infected offspring. The sow with "carrier sow syndrome" can give birth to normal, healthy-appearing piglets that are persistently infected and immuno-tolerant; these pigs, along with those with chronic infections, are responsible for the perpetuation of the virus in the pig population. A fully virulent virus may also be transmitted in this manner if the sows are treated with inadequate amounts of antiserum at the time of exposure or if they are exposed following inadequate vaccination. Piglets infected in utero, if they survive, may support a viremia for long periods after birth.

During outbreaks of classical swine fever in Germany between 1993 and 1995, differing clinical courses were observed, ranging from mild clinical signs to severe typical disease. The genotype of pigs may influence the outcome of hog cholera virus infection. In certain pig breeds the chronic form of the disease is more likely to occur, and these pigs may excrete the virus over prolonged periods. Experimental inoculation of purebred pigs resulted in acute fatal infections, whereas crossbred pigs experienced acute, chronic, and transient infections.

### Pathogen Risk Factors

#### *Virulence Characteristics*

The most virulent strains produce clinical disease in pigs of all ages. But there are differences in the clinical and pathologic features between strains of the virus and in their virologic characteristics. The less virulent strains cause only mild clinical disease or disease restricted primarily to fetal and newborn piglets. It is probable that this variation has always occurred in field strains of the virus, but the use of inadequately attenuated live virus vaccines is also a contributory factor. The occurrence of variation in virulence and antigenicity has been recognized as a cause of failure of vaccination and "vaccine breakdowns." It is equally important in causing problems with the diagnosis of hog cholera in eradication programs when infection is manifest in patterns not traditionally associated with this disease.

Genetic analysis of isolates of the virus for a series of epidemics of swine fever in Italy

affecting both domestic pigs and wild boar has provided useful epidemiologic information. The isolates were divided into three subgroups, and it is suggested that there have been at least two separate introductions of classical swine fever over a 7-year period and that the virus has been transmitted between domestic pigs and wild boar. Molecular analysis can aid in tracing the transmission of the virus from domestic pigs to wild pigs and back to domestic pigs.

In the outbreaks of hog cholera in England in 1986, affected pigs in the first outbreak exhibited clinical signs and necropsy lesions indicative of a virulent strain of the virus. However, in subsequent outbreaks, clinical disease was much milder and case-fatality rates low. Experimental infection of pigs with a field isolate of the virus resulted in variations in clinical response, from acute illness to inapparent infection, including minimal changes visible at necropsy, all of which indicate that genotype may influence the pathogenesis of the disease. High titers of virus were found in several tissues of one experimental pig that was recovering, even in the presence of serum-neutralizing antibodies. It is clear that some infected pigs may pass through an abattoir without detection because of the absence of lesions.

### Resistance of Virus

Survival of the virus is very dependent on the strain of the virus.<sup>26</sup> The CSF virus (CSFV) is destroyed by boiling, 5% cresol, or 2% sodium hydroxide and by sunlight, but it persists in meat that is preserved by salting, smoking, and particularly by freezing. It is able to survive in cool, moist protein-rich environments for 2 weeks at 20°C (68°F) but for 6 weeks at 4°C. The virus can be inactivated in at least 80% of pork hams after exposure to a flash temperature of 71°C (159°F). It can survive in infected uncooked ham pork for at least 84 days and 140 days in diced ham or sausage; it can survive in bacon for 27 days after traditional curing processes and for at least 102 days in hams cured in salt concentrations of up to 17.4%, which is much higher than that normally used in curing bacon. The use of lower-salt concentrations in curing solutions and the decreased time between slaughter and consumption as a result of modern abattoir practices increase the risk of disease transmission. It survives pH ranges from 3 to 11. Persistence in frozen meat has been observed after 4.5 years. The virus persists for 3 to 4 days in decomposing organs and for 15 days in decomposing blood and bone marrow.

### Immune Mechanisms

Maternal antibodies may interfere with the production of viral-specific cell-mediated immunity. Neutralizing antibodies occur as early as 9 days after infection in recovering pigs and after 15 days in fatally infected pigs. Neutralizing antibodies are the most

important antibodies in terms of protection. The maximum antibody response occurs 3 to 4 weeks after infection, and levels may persist indefinitely but last at least 6 months. In chronic hog cholera, neutralizing antibodies may be transiently detectable during the phase of partial recovery between 3 and 6 weeks after infection. Low-virulence strains of hog cholera may cause inapparent infections and are described as poorly immunogenic but in some instances may induce considerable titers of neutralizing antibodies in immunocompetent pigs. Cellular immunity mechanisms are probably very important in that it has been shown that there is CSFV-specific IFN- $\gamma$  formed early after antigen exposure. These mechanisms produce a higher response after intranasal or oral vaccination than after IM vaccination, and therefore vaccines should be looked at for their potential to induce higher T-cell responses. Intrauterine infection of piglets with the virus may induce a state of specific immunologic unresponsiveness. The piglets are persistently viremic and may continue to live for several weeks or months, but the majority die within the first 3 weeks of life. Piglets with PRRSV infections have been shown to produce a poorer response.

### Economic Importance

Hog cholera has been responsible for large economic losses in the swine industry worldwide. It is considered to be the most important disease of pigs in the European Union, and a common program of eradication in the member states is in effect. The magnitude of the economic importance of the disease is directly proportional to the size of the pig population and the standards of the swine industry. In countries with intensified systems of pig production, such as the Netherlands, it is estimated that the direct costs of transport and destruction of infected herds, disinfection of premises, indemnities to farmers, vaccination, and identification and registration of pigs on behalf of the control of the disease amounted to a large percentage of the gross slaughter value. The additional indirect damage as a result of loss of production on infected farms, standstill of pig movements in affected areas or regions, and restrictions on export is difficult to evaluate. Losses as a result of the death of pigs are aggravated by the high cost of vaccination programs in enzootic areas and by the problem that vaccination may not be completely effective in controlling epidemics. Recovered or partially recovered pigs are very susceptible to secondary infections, and exacerbations of existing chronic infections such as enzootic pneumonia are likely to occur during the convalescent period.

### PATHOGENESIS

The tonsil is the primary site of virus invasion following oral exposure. Primary multiplication of the virus occurs in the tonsils,

beginning within several hours after infection. It then spreads to the peripheral lymph nodes. The virus is first found in plasma before the mononuclear cell populations. The primary cell in the peripheral blood to be infected is the mixed granulocyte. The virus then moves through lymphatic vessels and enters blood capillaries, resulting in an initial viremia at approximately 24 hours. At this time the virus is present in the spleen and other sites such as peripheral and visceral lymph nodes, bone marrow, and Peyer's patches. The virus exerts its pathogenetic effect on endothelial cells, lymphoreticular cells and macrophages, and epithelial cells. In particular, B-lymphocytes, T-helper cells, and cytotoxic T cells are affected, and these changes take place before the RT-PCR picks up the virus in the blood.

The changes in gene expression of 148 genes during the first 48 hours following infection have been described.<sup>31</sup> Mutations in CSF nonstructural protein NS4B affect the virulence of CSF.<sup>32</sup>

The enhanced pathogenicity of some strains is associated with the presence of residues in E2 and NS4B of CSFV that can act synergistically to influence viral replication efficiency *in vitro* and pathogenicity in pigs.<sup>33</sup>

CSF virus is accompanied by depression of cellular immune defenses,<sup>34</sup> particularly innate responses mediated by interferon.<sup>35</sup> CSFV is not often found in apoptotic cells, so there are other mechanisms that cause this apoptosis. CSFV appears to be able to inhibit apoptotic signaling at multiple levels, and by supporting viral replication, endothelial cells may promote the pathogenesis of CSF.<sup>36</sup> A B-lymphocyte deficiency associated with viral destruction of germinal centers in lymphoid tissues is the most significant patho-immunologic consequence of acute hog cholera infection. This lymphocyte apoptosis, which is activation-induced programmed cell death, is one of the key features of CSF infections. CSF affects cellular antiviral activity, which suggests that the lesions may have an immunopathologic component, possibly through the infection of dendritic cells<sup>37</sup> and possibly by damaging the interferon production.<sup>38</sup> It is likely that CSFV up-regulates some of the adhesion molecules, such as integrin- $\beta 3$  in vascular endothelial cells, which may alter hemostatic balance in CSF.<sup>39</sup>

Certain virus infections are associated with high levels of IFN-1 (type 1), which is a potent antiviral defense mechanism. Despite the presence of viral anti-IFN-1, inhibitors the plasmacytoid dendritic cells can continue to produce IFN-1. CSFV prevents IFN-1 secretion in its main target cells (macrophages, monocytes, and endothelial cells) by interacting with interferon regulatory factor.<sup>40</sup> The ability to activate dendritic cells, the ability to spread systemically, and the tropism for lymphoid tissues also contribute strongly to a raised IFN-1 response.

There is a novel virulence determinant within the E2 structural glycoprotein of CSFV.<sup>41</sup> In highly and moderately virulent strains of CSF there was a decrease in antiviral and apoptotic gene expression, and this coincided with higher levels of virus in these immune tissues (spleen, tonsil, retropharyngeal lymph nodes).<sup>42</sup>

In recovered pigs (from infection with a moderately severe strain) it was found that antiviral defense mechanisms were rapidly activated, whereas in chronically affected pigs several genes with the power to inhibit production of type 1 interferons were up-regulated. The chronic pigs failed to activate NK or cytotoxic T-cell pathways, and they also showed reduced gene activity in antigen-presenting monocytes/macrophages.<sup>43</sup> A highly virulent CSF virus produced significant changes in the mononuclear cell proteome in porcine peripheral blood, with 66 protein spots showing altered expression; 44 of these were identified as 34 unique proteins.<sup>44</sup>

CSFV can evade the immune response and establish chronic infection, and in an *in vitro* study it was shown that immune response genes were generally down-regulated.<sup>45</sup> The gene transcriptional profiles in peripheral blood mononuclear cells following a virulent strain of CSF have been studied. Many genes were up-regulated and many down regulated.<sup>46</sup> CSFV strains may exacerbate the alpha-response, leading to bystander killing of lymphocytes and lymphopenia, the severity of which might be attributable to the host's loss of control of IFN production and downstream effectors regulation.<sup>47</sup>

Most of the lesions are produced by hydropic degeneration and proliferation of vascular endothelium, which results in the occlusion of blood vessels. This effect on the vascular system results in the characteristic lesions of congestion, hemorrhage, and infarction from changes in arterioles, venules, and capillaries. Thrombosis of small and medium-sized arteries is another feature. Vascular changes are most severe in the lymph nodes, spleen, kidneys, and gastrointestinal tract. Lesions related to the effects on the endothelial cells also occur in the adrenals, central nervous system, and eyes. Atrophy of the thymus, depletion of lymphocytes and germinal follicles in peripheral lymphoid tissues, renal glomerular changes, and splenitis are characteristic. Leukopenia is common in the early stages, followed by leukocytosis in some animals, and anemia and thrombocytopenia occur. The thrombocytopenia may be caused by massive platelet activation and subsequent phagocytosis of platelets secondarily to the release of platelet activating factors by activated macrophages. Disseminated intravascular coagulation is common with microthrombi in small vessels, particularly of the kidney, liver, spleen, lymph nodes, lung, intestine, and intestinal

lymph nodes. The end stage of a lethal infection in the natural host is associated with a marked depletion preferentially of B-lymphocytes in the circulatory system and in the lymphoid tissues. Macrophage activation, and subsequent release of proinflammatory cytokines, plays an important role in the development of the classical signs of CSF. This is particularly true for the pulmonary intravascular macrophages.

It has been shown that there is a significant expression of TNF- $\alpha$  in virus infected lymph nodes. It may be that commitment to apoptosis may depend on the IFN production. In these lymph nodes lymphocyte death occurred by apoptosis, and some of the cells were positive on IHC for both TNF- $\alpha$  and apoptosis. It may be that the release of the TNF- $\alpha$  may induce the apoptosis in the uninfected bystander cells. Early immunosuppression is an important feature of the development of CSF, with the depression of CD1+, CD4+, and CD8+ common thymocytes. It has recently been shown that CSF can replicate in the dendritic cells and control IFN type 1 responses without interfering with immune reactivity. It is still not clear, even though it is known that there is clear targeting of macrophages and monocytes, how these cells produce this immunosuppression and account for the death of the T-lymphocytes. It is known that the dendritic cells are the sentinels of the immune system and respond to easy viral contact. They then develop the effective immune responses by migrating into the lymphoid tissue to present the processed viral antigens to the T-lymphocytes. However, in both CSF and BVD infections there is no activation of the dendritic cells, and this may be a feature of pestivirus infections and enable them to evade the immune response. At the same time, there is no interference with the maturation of the dendritic cells. The virus induces proinflammatory cytokine production (IL-1, IL-6, and IL-8) by 3 hours, and even further at 24 hours postinfection, and also increases the coagulation factors, tissue factor, and vascular endothelium cell growth factor. Endothelial cells that were chronically infected were unable to produce IFN type 1, and these cells were also protected from apoptosis. This establishes a long-term infection of endothelial cells with virus replication and increasing levels of IL-1, IL-6, and IL-8. It shows that there has been long-term interference with cellular antiviral defenses, possibly by targeting interferon regulating factor 3, as BVDV does, or by increased binding of NF- $\kappa\beta$ , which modulates an apoptotic pathway controlling several anti-apoptotic genes.

CSFV infections significantly increased the mRNA expression of IL-10 and tumor necrosis factor (TNF) alpha, and they inhibited IL-12 expression, with little effect on IFN- $\alpha$  and IFN- $\gamma$  expression. CSFV suppresses maturation and modulates functions



of monocyte-derived dendritic cells without activating nuclear factor kappa B, which is involved in immune regulation, inflammatory response, and antiapoptosis effect.<sup>48</sup>

In many cases, secondary bacterial infection occurs and plays an important part in the development of lesions and clinical signs.

The experimental disease is characterized by a biphasic temperature elevation at the 2nd and 6th day after inoculation, a profound leukopenia and an appreciable anemia 24 hours after inoculation, diarrhea at the 7th day, and anorexia and death on the 4th to 15th day in slaughter pigs. The anemia can be explained by the infection of 2% to 9% of the megakaryocytes 2 to 9 days after infection.

The inoculation of pregnant sows with a low-virulence field strain of hog cholera virus at various stages of pregnancy results in prenatal mortality in litters from sows infected at pregnancy day 40 and postnatal death at 65 days. The later that infection occurs in pregnancy, the greater the number of uninfected piglets born in infected litters. Transplacental infection of the porcine fetus with both field and vaccine strains of the virus may induce a spectrum of abnormalities, including hypoplasia of the lungs, malformation of the pulmonary artery, micrognathia, arthrogryposis, fissures in the renal cortex, multiple septa in the gallbladder, and malformations of the brain. Infection of the fetus at a critical stage of gestation (30 days) induces retardation in growth and maturation of the brain, resulting in microcephaly. The teratogenicity of the virus clearly depends on the stage of gestation. In general, the earlier the infection occurs, the more severe the abnormalities are likely to be. The virus can be found in the ovaries because the blood vessels deliver peripheral macrophages to the ovaries through atretic follicles.

One of the sequelae of transplacental hog cholera virus infection of the fetus is congenital persistent virus infection with the evolution of a runt-like syndrome during the first few months of life. At birth, affected piglets appear normal, although they are viremic; the viremia persists throughout life of the animals. The first evidence of clinical disease may occur at about 10 weeks of age, but it may be delayed until 4 months of age. Growth retardation, anorexia, depression, conjunctivitis, dermatitis, intermittent diarrhea, and locomotor disturbance with posterior paresis occur. At necropsy, the most remarkable lesion is atrophy of the thymus gland, and lesions of classical hog cholera are not present. In experimental congenital persistent hog cholera infection, the earlier the infection occurs in pregnancy, the greater the number of persistent infections in piglets born alive with immunologic tolerance. The immunologic tolerance is specific to the virus because affected piglets respond to other selected antigens.

The experimental infection of pregnant goats with the hog cholera virus on days 64 to 84 of gestation can result in transplacental infection, with the virus replicating and persisting in the fetuses for at least 40 to 61 days. The virus is highly pathogenic for goat fetuses, and serum antibodies may be present in the precolostral sera of the kids.

It appears that disseminated intravascular coagulation does not play a major role in the pathogenesis of CSF.<sup>49</sup>

### CLINICAL FINDINGS

The early identification of clinical signs would facilitate diagnosis and control, but a recent paper on experimental infections with a type 2.1 genotype virus and a genotype 3.3 virus that is genetically divergent from European viruses has shown differences in outcome.<sup>50</sup> The UK 2001 virus was similar to other European type 2 viruses, but the 3.3 virus produced fewer and delayed clinical signs, notably with little fever, making it more difficult to recognize in the field. Another complicating factor is that it poorly recognized by the CSF-specific antibody.

Six uncharacterized CSFV isolates from 1996 to 2007 were examined<sup>51</sup> and assessed in animal experiments for their clinical virulence. They were assessed as either moderately or highly virulent.

### Diagnosis

Nearly always, the detection is too late because it has been missed. The clinical signs are often nonspecific, but the score system suggested by the Dutch may help to suggest it. The differences in the four most recent German outbreaks in terms of clinical and pathologic signs were minimal. In former times, most of the European outbreaks were associated with the virulent genotype 1 of the virus, but now there are types 2:1, 2:2, and 2:3, which are much less virulent and produce a milder clinical course that is much more difficult to recognize over the first 14 days postinfection. In a recent set of experiments (with a strain of virus SF0277) all the pigs died, but in other experiments some of the pigs survived.

A recent report has suggested that the occurrence of PRRS does not appear to potentiate the clinical outcome of CSF in young pigs, but this has been disputed.

Simultaneous infection with *Trypanosoma evansi* does seem to produce a poor response to CSF vaccination.

As a result of the recent outbreak in the Netherlands, a quantitative retrospective analysis was made of the clinical signs, which suggested that the clinical inspection was the most important part of detection but was not very specific. Moderate-virulence and low-virulence strains cause a mild disease that may be so mild that clinical disease is not suspected.

Differential diagnosis should include PRRS, PDNS, ASF, salmonellosis, and coumarin poisoning.

### Peracute and Acute Disease

In the acute form the disease is characterized by anorexia, lethargy, conjunctivitis, respiratory signs, and constipation.<sup>51,52</sup> Diagnosis on clinical signs is more difficult since the 1980s, and therefore the CSF may not be recognized immediately,<sup>27</sup> but nearly always the major clinical sign is pyrexia. Clinical signs usually appear 5 to 10 days after infection, but incubation periods up to 35 days or more are recorded. At the beginning of an outbreak, young pigs may die in a peracute state without evidence of clinical signs having occurred. Acute cases are the most common. Affected pigs are depressed, do not eat, and stand in a drooped position with their tails hanging. They are disinclined to move and, when forced, do so with a swaying movement of the hindquarters. They tend to lie down and burrow into the bedding, often piled one on top of the other. Before the appearance of other signs, a high temperature (40.5–41.5°C [105–107°F]) is usual. In recent European outbreaks, respiratory signs have not been common. Constipation followed by diarrhea and vomiting also occurs. Later, a diffuse purplish discoloration of the abdominal skin occurs. Small areas of necrosis are sometimes seen on the edges of the ears, tail, and lips of the vulva. A degree of conjunctivitis is usual, and in some pigs the eyelids are stuck together by dried, purulent exudate. Nervous signs often occur in the early stages of illness and include circling, incoordination, muscle tremor, and convulsions. Death can be expected 5 to 7 days after the commencement of illness. Infection with *Salmonella Choleraesuis* may also be potentiated by hog cholera infection, and the two diseases in combination can result in high mortality.

### Nervous Manifestations

A form of the disease in which nervous signs predominate is attributed to a variant strain of the virus. The incubation period is often shorter and the course of the disease more acute than usual. Pigs in lateral recumbency show a tetanic convulsion for 10 to 15 seconds followed by a clonic convulsion of 30 to 40 seconds. The convulsion may be accompanied by loud squealing and may occur constantly or at intervals of several hours, often being followed by a period of terminal coma. In some cases, convulsions do not occur, but nervous involvement is manifested by coarse tremor of the body and limb muscles. Apparent blindness and stumbling have also been observed.

### Chronic Disease

Low-virulence strains of virus result in less severe disease syndromes. A chronic form occurs in field outbreaks and occasionally

after serum–virus simultaneous vaccination. The incubation period is longer than normal, and there is depression; anorexia; persistent mild fever; unthriftiness; and the appearance of characteristic skin lesions, including alopecia, dermatitis, blotching of the ears, and a terminal, deep-purple coloration of the abdominal skin. Pigs may apparently recover following a short period of illness but subsequently relapse and die if stressed.

Pigs infected with the low-virulence strains of the virus appear more susceptible to intercurrent bacterial disease. The changeable nature of this combination is such that hog cholera should be suspected in a herd or area where there is an increase in mortality from any apparent infectious cause that either does not respond, or responds only temporarily, to therapeutic ploys that are usually effective.

### Reproductive Failure

Reproductive failure can be a significant feature and may occur without other clinical evidence of disease within the herd. It may occur when inadequately protected pregnant sows are exposed to virulent virus or when susceptible pregnant sows are vaccinated with live attenuated vaccines or exposed to low-virulent field strains. Infection of the sow can occur at any stage of pregnancy and may result in no clinical signs other than a mild pyrexia, but it may be followed by a high incidence of abortion, low litter size, and mummification, stillbirth, and anomalies of piglets. Piglets infected at 50 to 70 days may be clinically normal at birth and then waste away and may develop tremors; such cases are said to be late-onset CSF. They are like BVDV cases in that they shed virus and are persistently affected for months. Live-born pigs, although carriers, may be weak or clinically normal. Persistent congenital infection is characterized by persistent viremia, continuous virus excretion, and late onset of disease, with death occurring 2 to 11 months after birth. No antibodies to the virus are present in spite of the persistent infection; affected pigs have a normal immune response to other antigens, but they do not respond to the hog cholera virus. Cell-mediated immunity appears to be normal. A high incidence of myoclonia congenita (congenital trembles) associated with cerebellar hypoplasia has been observed in some outbreaks where prenatal infection with hog cholera virus has occurred, and this syndrome has been reproduced experimentally. The prevalence of any one of these manifestations appears to vary with the strain of the virus and the stage of gestation at the time of infection.

## CLINICAL PATHOLOGY

### Hematology

A valuable antemortem diagnostic test is the total and differential leukocyte count. In the early stages of the disease there is marked

leukopenia, with the total count falling from a normal range of 14,000 to 24,000 cells/ $\mu$ l to 4000 to 9000 cells/ $\mu$ l. This is specifically granulocytopenia caused by bone-marrow atrophy. It is a result of apoptosis or necrosis, from 1 to 3 days postinfection, probably as a result of cytokine interaction. Depletion of the lymphocyte subpopulations occurs 1 to 4 days before the virus can be detected by RT-PCR on serum. If a virulent form, depletion is evident by 2 days.

B-lymphocytes, T-helper cells, and cytotoxic T cells are the most affected by the virus. The loss of the circulating B-lymphocytes is consistent with the failure to generate a circulating neutralizing antibody. Virulent strains produce greater reduction in B-lymphocytes than do mild forms. This can be of value in differentiation from bacterial septicemias, but it should not be used as the sole method of differentiation. In the late stages of hog cholera, leukocytosis as a result of secondary bacterial invasion may develop. Piglets less than 5 weeks of age normally have low leukocyte counts.

In a study of CSFV in 6- and 11-week-old pigs,<sup>53</sup> it was found that although only the mild disease resulted, there were depletions in B-cell numbers and a number of T-cell populations in peripheral blood, which were most marked in the 6-week-old pigs. A population of large granulocytes developed in the peripheral blood before the start of viremia.

### Diagnostic Tests

A comparison of diagnostic tests shows that the best results are detected by RT-PCR (98.9%), which is earlier than virus isolation (VI) on blood, which gives only a result of 94.5%. RT-PCR is expensive and labor intensive. The antigen-ELISA gives a later detection and the worst results. The leukocyte count gives the earliest pointer to CSF infection but of course does not confirm the disease.

The advent of eradication programs has resulted in the development of diagnostic tests for hog cholera. These tests must be accurate and rapid so that control measures can be rapidly instituted or lifted as required. Diagnosis by virus isolation is slow, the cytopathic effect may be minimal, and some strains have low infectivity and limited growth in tissue culture. This method is seldom used as a primary diagnostic method. Animal inoculation tests still provide an excellent method for the diagnosis of hog cholera and involve the challenge of susceptible and immune pigs with suspect material followed by subsequent challenge at a later date with fully virulent hog cholera virus. However, this test is time consuming and costly, and although it is used for the final confirmatory test for the presence of hog cholera infection in various situations, it is not satisfactory for a rapid diagnostic test.

### Detection of Virus

The more rapid tests rely on the detection of antigen in infected pig tissues or the detection of antibody following infection.

### Fluorescent Antibody Techniques

This technique allows the rapid detection of antigen in frozen sections of tissue or impression smears and in infected tissue cultures, and these methods have been adopted as a primary test in the eradication program in the United States. Antigen can be detected up to 2 days after death, and this method has been considered more reliable than the agar gel precipitation test. The method is capable of detecting virus carriers among vaccinated pigs.

### Antigen-Capture ELISA

The antigen-capture ELISA can detect the virus antigens in blood and tissues from experimentally infected pigs at 4 to 6 days after infection with a moderate- to high-virulence strain (Weybridge virus) and 7 to 9 days after infection with a low-virulence strain (New South Wales virus). The technique does not require tissue culture and takes less than 36 hours for a definitive result.

### Agar Gel Precipitation Test

The agar gel precipitation test detects antigen in tissue by means of a precipitin formed with immune sera. Usually pancreas from suspect pigs is tested. This test was used widely in the UK eradication program and is the standard primary test in many countries.

### Differentiation of Swine Fever Virus From Other Pestiviruses

#### PCR Tests

A PCR assay can be used to differentiate classical swine fever virus from ruminant pestiviruses. An international reference panel of monoclonal antibodies for the differentiation of hog cholera virus from other pestiviruses has been developed. Restriction endonuclease cleavage of PCR amplicons can distinguish between vaccine strains and European field viruses. The RT-PCR can also detect CSF in boar semen. A RT-PCR was then described. Rapid detection of CSF using a portable real-time RT-PCR (TaqMan) has been described. Further modifications have been described, and thus the test can be performed in a single tube with all the ingredients. It can then be used as a pen-side test and detects virus in nasal and tonsil scrapings 2 to 4 days before the onset of clinical signs. A further modification of RT-PCR and ISH has been described that they can be used on formalin-fixed sections. A multiplex PCR is available to separate BVD from CSF.

A multiplex RT-PCR for the simultaneous detection of both ASFV and CSFV has been described,<sup>133</sup> with a diagnostic

sensitivity of 100% for both viruses and 100% specificity for CSFV and 97.3% for ASFV. The inclusion of a heterologous internal control allowed the detection of false negatives.

### Serologic Tests

Antibody can be detected by the fluorescent antibody neutralization test, tissue culture serum neutralization test, or an indirect ELISA. Serologic tests are less satisfactory for detection of hog cholera in the acute phase and are of limited value in vaccinated animals. They are of value in the detection in sows of the subclinical infection of hog cholera associated with reproductive failure and for survey studies to determine the prevalence of hog cholera infection. BVDV may infect pigs, especially those in close contact with cattle, and may give false-positive serologic reactions. The incidence rates of these false-positive reactions may be high, and they pose a problem for hog cholera identification in eradication programs. The neutralizing peroxidase-linked antibody assay is a highly sensitive and specific test for hog cholera and will distinguish between pigs infected with different strains of the hog cholera virus and BVDV. The complex, trapping, blocking ELISA is sensitive, specific, and reliable for screening purposes for early identification of infected herds and their elimination in an eradication program. A peroxidase-labeled antibody assay can be used to detect swine IgG antibodies to hog cholera and BVDVs. Monoclonal antibodies to pestiviruses are also available to discriminate between both viruses. A competitive ELISA using a truncated E2 recombinant protein has been described, which can be used when a large number of samples are to be tested.

### Samples for Laboratory

When hog cholera is suspected, tissues submitted for examination should include the brain and sections of intestine and other internal organs in formalin, and pancreas, lymph node, and tonsil unpreserved in sealed containers. Local regulations and requirements should be followed. The viral antigens are densely distributed in the skin and tongue of infected pigs, and biopsies of the ear may be useful for diagnosis on a herd basis.

### NECROPSY FINDINGS

In many cases the single most important diagnostic aid is the postmortem examination, although in the Dutch outbreaks it was thought that the contribution to the detection of CSF was limited. The reason for this is that there is a tremendous individual variation in necropsy findings. In the outbreak in the United Kingdom in 2000, there were few lesions in fetuses or in neonates; in the sows, lesions were often restricted to conjunctivitis and lesions in the hepatic and

splenic lymph nodes, even though 15 animals in each group were examined. The age group showing relatively consistent lesions were the growers, and in these the lesions were similar to those that are reported in the classical outbreaks.

In peracute cases, there may be no gross changes at necropsy. In the more common acute form, there are many submucosal and subserosal hemorrhages, but these are inconstant; to find them, it may be necessary to examine several carcasses from an outbreak. The hemorrhage results from erythrodiapedesis and increased vascular permeability, probably aided by mast cell degranulation. The hemorrhages are most noticeable under the capsule of the kidney, near the ileocecal valve, in the cortical sinuses of the lymph nodes, and in the bladder and larynx. The hemorrhages are usually petechial and rarely ecchymotic. The lymph nodes are enlarged, and the spleen may contain marginal infarcts. Infarction in the mucosa of the gallbladder is a common but not constant finding and appears to be an almost pathognomonic lesion. There is congestion of the liver and bone marrow and often of the lungs. Circular, raised button ulcers in the colonic mucosa are usual but cannot be distinguished from those of salmonellosis. Although these gross necropsy findings are fairly typical in cases of hog cholera, they cannot be considered as diagnostic unless accompanied by the clinical and epizootiological evidence of the disease. They can occur in other diseases, particularly salmonellosis. A recent study found that the lymph nodes had the highest score for lesions and that the fewest lesions were found in the spleen and tonsil because infection of these organs was also rare. The most common lesions were also in the lymph nodes, around the ileocecolic junction, and around the blood vessels of the brain. Atypical broncholar cilia have been reported.

There are characteristic microscopic lesions of a nonsuppurative encephalitis in most cases, and a presumptive diagnosis of hog cholera can be made if they are present. It is thought that the most common lesion in chronic CSF is the mononuclear cell cuff in the CNS. Here ISH is capable of detecting viral nucleic acid even when viral antigen is not detected. Histologically, the main site of tissue injury is the reticuloendothelial system. There is always a progressive lymphoid depletion and mucosal necrosis. The depletion is probably caused by apoptosis but not by direct apoptosis. Atrophy of the thymic cortex and loss of thymocytes is also a feature and may be related to synthesis of the cytokines, TNF- $\alpha$  and IL-1 $\alpha$  in particular, which may increase the apoptosis of the thymocytes.

Fibrinoid necrosis of the tunica media combined with hydropic degeneration and proliferation of the vascular endothelium causes occlusion of blood vessels. The

more virulent “neurotropic” strains produce lesions of a similar nature but greater severity.

In the intestinal tract mucosa there are large, usually infected macrophages. The gut-associated lymphoid tissue areas are lymphocyte depleted, usually because of massive lymphocyte apoptosis, particularly in the B-cell areas. These changes are possibly attributable to the large amounts of TNF $\alpha$  and IL-1 $\alpha$  released from the infected macrophages. They also showed that the macrophages in the splenic marginal zone were among the first cells to be infected. The infection, mobilization, and apoptosis of splenic macrophages play a very important role in the course of the infection through cytokine release. An unusual manifestation of CSF infection is the onset of metaphyseal bone formation caused by the partly thrombosed vessels in the bone, with strong CSF viral specific fluorescence.

Histology showed swelling and vacuolation of megakaryocytes in the bone marrow 2 days after infection, and they were necrotic 4 days after infection. Severe swelling and necrosis of endothelial cells in the vascular endothelium were observed 3 days after infection. It was concluded that the thrombocytopenia resulting from direct viral damage to MKC and endothelial damage can cause hemorrhagic diathesis, whereas coagulation disorders are not involved in early stages of the disease.

In the chronic form of the disease, ulceration of the mucosa of the large intestine is usual. Secondary pneumonia and enteritis commonly accompany the primary lesions of hog cholera.

Infection of the fetus produces a persistent immunologically tolerant noncytolytic infection, often with little evidence of cell necrosis or inflammatory reaction to suggest the presence of a virus. Aborted fetuses show nondiagnostic changes of petechial hemorrhage and ascites. Malformations such as microcephaly, cerebellar hypoplasia, pulmonary hypogenesis, and joint deformity appear as a result of inhibition of cell division and function in these areas. Antibody is not detected in fetal blood when infection occurs early in fetal life. In pigs showing signs of myoclonia congenita, cerebellar hypoplasia is highly suggestive of hog cholera infection.

An immune complex glomerulonephritis has been described in which there is macrophage infiltration of the mesangium with immune complex deposits of IgM, IgG, and Clq in mesangial, subepithelial, and subendothelial areas from 10 days postinfection, and by 14 days neutrophils had also congregated.

This is a disease of major economic importance, and confirmation of the diagnosis is usually performed in specialized governmental laboratories. Virus isolation and fluorescent antibody tests are most commonly used, but other techniques, including



immunoperoxidase staining of cryostat sections, are available. The demonstration of viral antigen in the crypts of the tonsils, tubular epithelial cells of the kidney, bronchiolar mucosal gland cells, and the pancreatic epithelial cells has been shown to be possible even after 18 years in formalin.

## DIAGNOSIS

The European Union Reference laboratory in Hanover is responsible for the testing in the European Union. A survey of pig farmers and practitioners in the Netherlands investigated their attitudes regarding CSF and found there were six sets of problems identified:<sup>54</sup>

1. Lack of knowledge of CSF
2. Guilt, shame, and prejudice
3. Negative opinion of control measures
4. Dissatisfaction with postreporting procedures
5. Lack of trust in government bodies
6. Uncertainty about and lack of transparency in reporting procedures

The authors recommended procedures to deal with these problems. Diagnostic methods for CSF have been reviewed.<sup>55,56</sup>

## Detection of Antigen

Virus isolation is the sensitive, highly specific, time-consuming, and labor-intensive method to find CSF.

For the rapid detection of viral antigen, immunofluorescence and ELISAs are being used. The former uses thin sections of tissues (lymph node, spleen, tonsils, and other organs); the specificity is good, but the sensitivity is not so good. In the early stages of infection there may be false-negative results because there may not be high levels of virus.

The RT-PCR is considered the most sensitive and most specific tool for the detection of CSFV.

A real time RT-PCR is available for differentiating vaccine and field virus, and this will probably become available as a field test.<sup>136,137</sup> Next-generation technology allows the full genome of CSFV to be identified and is the best basis for high-resolution phylogenetic studies.<sup>138</sup>

Pyrexia is one of the key indicators for CSFV, together with high mortality.

## Samples for Confirmation of Diagnosis

Laboratory diagnosis is always required. Fresh tonsil can be used for polyclonal direct fluorescent antibody, which also detects BVDV and BDV, and can then be used for additional tests. The sensitivity of this test was shown to be only 78%, so to give a 99% chance of infection being detected five post-mortems would need to be performed. Even when suffering from tissue degradation, tonsil and spleen will still yield infectious virus and RNA.<sup>64</sup>

A comparative study of the signs and lesions produced by six field strains of CSF

virus<sup>51</sup> showed that the most characteristic lesions were found in the lymph nodes, followed by necrotic lesions in the ileum and hyperemia of the brain. Splenic infarction and necrotic tonsils when they occur are spectacular but are less frequent, and respiratory signs are also less frequent than was reported in the last century.

A one-step gel-based RT-PCR assay with comparable performance to RT-PCR for detection of CSF virus has been described.<sup>57</sup>

Two RT-PCR assays of CSF were developed for genetic differentiation of naturally infected from vaccinated wild boars.<sup>58</sup>

C-strain “Riems” or other vaccinated animals can be differentiated from infected animals using a RT-PCR.<sup>59</sup>

Two new E<sup>ms</sup>-based ELISAs allow differentiation of infected from marker-vaccinated animals and discrimination of pestivirus antibodies.<sup>60</sup>

Meat juice ELISA can be used as a suitable substrate for diagnosis of CSF.<sup>61</sup> Viral RNA was detected in meat juice at a lower level than in serum.<sup>62</sup> Sensitivity was calculated to be 91% and specificity to be 97%. Difficulties were encountered when there were low-virulence strains involved and when samples were taken very early in infections.

Pan-pestivirus assays will detect the pestivirus, and then CSF specific assays are required. qRT-PCR is routinely used. Specific assays for CSF include VI, fluorescence antibody test (FAT), and ELISAs.

Irrespective of virulence, whole-blood and tonsil scrapings are the samples of choice for the early detection of CSF.<sup>63</sup> At least eight RT-PCRs have been developed for detection of wild-type CSF,<sup>65-69</sup> and some are used routinely.<sup>70,71</sup>

A loop-mediated isothermal amplification assay for detection of wild-type CSF was described<sup>72</sup> and proved to be a simple, rapid, and sensitive tool for detection of wild-type CSFV under field conditions.

A multiplex nested RT-PCR for the differentiation of wild-type viruses from the C-strain vaccine of CSF was developed.<sup>73</sup>

Multiplex PCRs for the simultaneous detection and differentiation of CSFV field strains and the C-strain vaccine virus have been developed.<sup>59,68</sup>

A multiplex RT-PCR assay for the rapid and differential diagnosis of CSF and other pestiviruses was developed<sup>74</sup> and was shown to be rapid, highly sensitive, and cost effective.

A triplex TaqMan RT-PCR assay for differential detection of wild-type and hog cholera lapinized vaccine strains of CSF and BVDV type 1 has also been devised.<sup>75</sup>

Most CSF reference laboratories use more than one test (virus isolation, antigen ELISA, RT-PCR for detection and confirmation). It has been shown<sup>70</sup> that the RT-PCR is 100% sensitive but VI only about 72% and antigen ELISA only 39%.

A novel RT-PCR assay based on primer-probe energy transfer has also been developed.<sup>58,76</sup> This has been shown to be a highly sensitive and specific confirmatory tool.

The qRT-PCRs have high specificity and sensitivity.<sup>71,77,78</sup> Viral RNA can be detected in samples where the virus is in tissues that are autolysed.<sup>79</sup> Viral RNA can be detected in animals that have recovered.<sup>80</sup> The qRT-PCR can also be used to differentiate between virus species BD, BVD and CSF, and strains of CSF. It can also be used to differentiate infected from vaccinated animals (DIVA).<sup>81</sup> There are some tests that are specific for wild-type virus<sup>58,68</sup> irrespective of the vaccination status of the animal. A negative RT-PCR generally means that the animal is not infectious, but a positive RT-PCR does not mean that it is infectious.<sup>82</sup> Antigen-capture ELISA is recommended for animals with clinical signs or lesions.

A primer-probe energy transfer RT-PCR assay for CSF was described<sup>83</sup> and can differentiate between wild-type CSFV and certain C-strain vaccines. A one-step RT-PCR detection of CSFV using a minor groove binding probe was described<sup>84</sup> and was found to be rapid and of high specificity and sensitivity.

A reverse transcription multiplex RT-PCR was developed for the detection and genotyping of CSF.<sup>85</sup> It was said to be a rapid, sensitive, reproducible, sensitive, and specific genotyping tool. RT-PCR was able to detect CSF 2 days earlier than virus isolation and 2 to 4 days earlier than with antigen ELISA.<sup>86</sup> A high-speed RT-PCR was able to detect FMD, CSF, and SIV-A,<sup>87</sup> and it took only about 28 minutes.

A gold-nanoparticle-based oligonucleotide microarray for the simultaneous detection of seven swine viruses, including CSF, has been described.<sup>88</sup>

- **Histology**—formalin-fixed brain, spleen, lymph nodes, colon, cecum, ileum, kidney, tonsil, skin, tongue (LM). Tissue sections can also be used for ISH and IHC.
- **Virology**—lymph nodes, tonsil, spleen, distal ileum, skin, tongue, brain (FAT, ISO, IHC, PCR); heparinized blood. Virus can be isolated from tissue, serum, plasma, buffy coat, or whole blood in heparin.<sup>89</sup>

## Serology

The gold standard is the virus neutralization test. However, ELISAs in microtiter are easy to perform, rapid, and automated. Differentiation between pestiviruses is possible and depends on the design of the test, and detection of DIVA vaccines is also possible.<sup>60</sup>

The immuno-chromatographic strip or lateral flow device<sup>139</sup> can be used as a penside test.

The evaluation of assays<sup>90</sup> showed that the Chekit CSF-Sero and the HerdChek CSFV

Ab were both practical and had highest sensitivity. The PrioCHECK (Rcircle) CSFV<sup>ms</sup> was the only ELISA suitable for use in DIVA but is less sensitive and cannot be recommended.

ELISAs for the detection of anti-CSF antibodies are useful for epidemiologic surveys and for monitoring CSF-free areas. These antibodies occur 10 to 15 days postinfection, the same as for neutralizing antibodies.

A recombinant E2-based indirect ELISA for the detection of specific IgM antibody responses to CSF has been shown to detect antibodies 2 weeks after vaccination.<sup>91</sup>

An immunochromatographic strip for rapid detection of antibodies to CSF was described<sup>92</sup> and was found to be 97% sensitive and 100% specific and could be performed within 5 minutes.

### DIFFERENTIAL DIAGNOSIS

A positive diagnosis of hog cholera is difficult to make without laboratory confirmation. This is particularly true of the chronic, less dramatic forms of the disease. A highly infectious, fatal disease of pigs with a course of 5 to 7 days in a group of unvaccinated animals should arouse suspicion of hog cholera, especially if there are no signs indicative of localization in particular organs. Nervous signs are probably the one exception. The gross necropsy findings are also nonspecific, and reliance must be placed on the leukopenia in the early stages and the nonsuppurative encephalitis visible on histologic examination. Both of these bacterial infections, particularly salmonellosis, may be present.

The major diseases that resemble hog cholera include the following:

- **Salmonellosis**, usually accompanied by enteritis and dyspnea.
- **Erysipelas**, in which there are characteristic diamond skin lesions, and the subserous hemorrhages are likely to be ecchymotic rather than petechial.
- **Pasteurellosis**, in which respiratory signs predominate and lesions of pleuropneumonia at necropsy are characteristic.

Epidemiologic considerations and hematologic and bacteriologic examination will usually differentiate these conditions.

Recently, hemorrhagic septicemia in a pig caused by extraintestinal *E. coli* has been suggested as a differential diagnosis.<sup>93</sup>

In the United Kingdom, many of the cases reported as suspected classical swine fever (CSF) have turned out to be *Purpura hemorrhagica*.

**Other encephalitides**, particularly **viral encephalomyelitis** and **salmonellosis**, cause similar nervous signs.

**African swine fever**, apart from its greater severity, is almost impossible to differentiate from hog cholera without laboratory testing.

### TREATMENT

Hyperimmune serum is the only available treatment and may be of value in the very early stages of the illness if given in doses of 50 to 150 mL. It has more general use in the protection of in-contact animals. A concentrated serum permitting the use of much smaller doses is now available.

In the future, capsid-targeted viral inactivation (CTVI), which involves the use of the viral capsid protein containing a deleterious enzyme such as a nuclease, could be used to bind native viral protein.<sup>94</sup>

There is also the future possibility of imidazolepyridines, which have a potent in vitro activity against CSFV, being used for treatment.<sup>95</sup> The reduction of CSFV transmission to untreated pigs has been shown by the pestivirus inhibitor BPiP.<sup>96</sup>

### CONTROL

Strategies for Control Have Been Reviewed.<sup>97</sup>

The methods used in the control include **eradication** and control by **vaccination**. Both modeling and real-time prediction have been described. In areas where effective barriers to reintroduction of the disease can be established, eradication of the disease by slaughter methods is feasible and usually desirable. In contrast, in areas where the structure and economics of the pig industry require considerable within-country and across-border movement of pigs, it may not be practical or economically feasible to institute a slaughter eradication program. The establishment of a highly susceptible population in a high-risk area is unwise. If repeated breakdowns occur, the restriction of movement of pigs within the quarantine areas creates considerable management problems for pig owners, and they may, as a result, eventually become noncooperative in the program. In these areas, control and possibly even eradication by vaccination is the approach of choice, and this method is used in some countries, such as the Philippines. The Commission for the European Communities has declared its policy, supported by appropriate community legislation, to eliminate hog cholera without vaccination. A full discussion of the possibility of using vaccination in the future has been outlined. A computerized framework for the risk assessment for CSF has been produced. In Germany, there are big risks with regard to the import of pigs, the presence of wild boar populations, and the import of pig meat. A retrospective spatial and statistic simulation to compare two vaccination techniques with the nonvaccination scenario in the Dutch 1997/1998 CSF outbreak showed that both emergency vaccination techniques would hardly have been more efficient.

In the following discussion, general procedures are described first, followed by a description of the immunizing products available.

### Control of Outbreaks in Hog Cholera-Free Areas

Modeling for the control of CSF in such areas has been described, and a simulation model for low- and moderate-density pig areas has been described.<sup>98</sup> A simulation of an outbreak of CSF in Denmark suggested that the outbreak would be of fewer than 10 cases and last less than 2 weeks on average,<sup>99</sup> although in some cases it may be longer lasting, and a large epidemic would result. Any outbreak would have a considerable cost to the export industry. A modeling study suggested that movement restrictions have had the dominant effect on control strategy for CSF and that preventive culling only became relevant under imperfect compliance.<sup>100</sup>

In areas where the disease does not normally occur, eradication by slaughter of all in-contact and infected pigs is possible and recommended. The pigs are slaughtered and disposed of, preferably by burning. All herds in the area should be quarantined and no movement of pigs permitted unless for immediate slaughter. In areas with high pig densities, control strategies depend on highly effective identification and recording systems, which provide information on herd inventories and animal movements, and thus herd epidemics can be traced back to their origin. Recent experiences with epidemics of swine fever in Belgium and the Netherlands found that with the current eartag with manual recording and use of a documentation system, most epidemics could not be traced back to their origin. The tracing and removal of carrier herds prevents these herds from becoming infectious and prevents the spread of disease at an early stage.

All vehicles used for the transport of pigs, all pens and premises, and all utensils must be disinfected with strong chemical disinfectant such as 5% cresylic acid. Contaminated clothing should be boiled. Entry to and departure from infected premises must be carefully controlled to avoid spread of the disease on footwear, clothes, and automobile tires. Legislation prohibiting the feeding of garbage or commanding the boiling of all garbage before feeding must be enforced. This eradication procedure has controlled outbreaks that have occurred in Canada and Australia and has served to maintain these countries as free from the disease.

### Control Where Hog Cholera Is Endemic

One of the major problems in Europe is the wildlife reservoir in the wild boar population. A retrospective analysis of oral wild boar vaccination in the Eifel region of Rhineland-Palatinate has been described.<sup>101</sup> In areas where there is little risk, there are few positive animals; where there is a high risk, many animals may be positive. In Switzerland 179 of 528 boars in a risk area were positive. The oral vaccination of wild boar described in Germany had no risk for the

establishment of a persistent wild boar CSF infection. However, it was shown that more than 50% of the wild boar did not feed on the vaccination baits and therefore did not become immune. There is evidence from wild boar studies in Italy that the level of infection in the free population gradually reduces in any case. When wild pigs with maternal antibodies contract live CSF virus, they have transient clinical signs, but the disease is not lethal. Infected wild boars could therefore play a very big part in the transmission of a natural outbreak. The vaccination studies in wild boar were reported recently and showed that after the fifth vaccination, there was no viremia, no virus excretion, and no postmortem virus recovery. Oral vaccination of wild boar usually reduces the presence of CSF, but only a low number of wild boars (30% to 35%) become seropositive. The isolated case in Israel in 2009 showed the problem of transfer of virus from wild boar.<sup>102</sup>

After CSF occurred in wild boar in north-eastern Bulgaria, it was decided to trap them; 124 were removed from the area, and of these, 119 were trapped. Further outbreaks of CSF were prevented.<sup>103</sup>

In endemic areas, control is mostly a problem of selecting the best vaccine and using it judiciously. In Asia almost all the control is vested in the use of vaccines and their proper use. Most problems are caused by policy failures or changes in demographics, whereas most of a vaccination policy should be determined by the epidemiology of the disease. Much can also be done to keep the incidence of the disease low by the education of farmers, whose cooperation can be best assured by a demonstration that eradication is both desirable and practicable. Once farmers are motivated to act, the greatest stumbling block to control, failure to notify of outbreaks, is eliminated. Education of the farmer should emphasize the highly contagious nature of the disease and the ease with which it can be spread by the feeding of uncooked garbage and the purchase and sale of infected or in-contact pigs. The common practice of sending pigs to market as soon as illness appears in a group is one of the major methods by which hog cholera is spread.

Vaccination in the EU finished in 1990 mainly because of the difficulty of differentiating infected and vaccinated animals. The exception is as an emergency vaccine or as bait for wild boar. Vaccination of wild boar has been carried out in France and Germany to reduce the shedding of the virus by the vaccinated boars. Outside the European Union, there is widespread use of the Chinese live C-strain vaccine and a biotech CSF E2 glycoprotein subunit marker vaccine.

There are two sorts of vaccine:

1. The first group is the classical live group containing attenuated virus, and these are preferred. Live, virulent-virus vaccines produce a solid immunity

within just a few days and give lifelong protection. The reaction to live-virus vaccine may be severe, and the susceptibility of pigs to other diseases may be increased. Eradication of the disease is impossible while the use of this type of vaccine is permitted. Commercially available modified live vaccines are able to induce complete protection in vaccinated pigs, but several factors, including maternal immunity, age of primary vaccination, vaccination protocol, and complications caused by other pathogens, can affect the effectiveness in the field.<sup>107</sup>

2. There is a recently developed second group of live vaccines aimed as marker vaccines based on the E2 protein, but these are still undergoing development. The marker vaccine strategies have been reviewed.<sup>108</sup> There appears to be no complete protection against congenital infection, they do reduce transmission of the virus, but they seem to last only about 1 year. They have the potential to allow tests to be used to differentiate between naturally infected and vaccinated animals. They may also fail in the face of natural infection. Recent further developments of these marker vaccines possibly include a chimeric vaccine in which one of the genes has been replaced by a BVD gene and a second vaccine in which a DNA vaccine expresses the E2 protein after entering the host cell and others with E2 peptides.

There are also several other vaccines: the E2 subunit marker vaccines expressed in baculovirus, E2 subunit vaccines, a chimeric BVDV-CSF marker vaccine, and a recombinant PRV vaccine expressing CSFV glycoprotein that is protective for both diseases.

A safe glycoprotein E2 vaccine expressing an ORFF virus recombinant has been described.<sup>104</sup> Protective efficacy of a CSF virus C-strain deletion mutant was described,<sup>105</sup> but the commercially available E2 ELISA was unsuitable as an accompanying test.

The strategy of exchanging specific epitopes between pestiviruses is useful, as was shown<sup>106</sup> when parts of the E2 gene were replaced by the corresponding sequence from a BDV strain.

When an outbreak occurs in a herd, the immediate need is to prevent infection from spreading further. This can be best achieved by removing the source of infection and increasing the resistance of in-contact animals by the administration of hyperimmune serum or one of the available vaccines. Removal of the source of infection necessitates the following:

- Isolation of infected animals—this was highlighted in the recent Dutch outbreak.
- Suitable hygienic precautions to prevent the spread of infections on boots, clothing, and utensils

- Disposal of carcasses by burning
- Disinfection of pens—the pens should be scraped, hosed, and sprayed with 5% cresylic acid solution or another suitable disinfectant. The choice of serum or vaccine may depend on local legislation and will depend on circumstances. Pigs in the affected pen should receive serum (20 to 75 mL, depending on size), and pigs in unaffected pens should be vaccinated. Pigs receiving serum only will require active vaccination at a later date if a strong immunity is to be achieved.

### Hog Cholera Eradication

The elimination of hog cholera from a country where it is well established presents a formidable problem. Before the final stage of eradication can be attempted, the incidence of the disease must be reduced to a low level by widespread use of vaccination and enforcement of garbage-cooking regulations.

One of the most important problems encountered in eradication programs is the clinically normal “carrier” animal, and steps need to be taken to avoid the sale of all pigs from infected premises. A procedure that has been particularly effective in the control of this and other diseases of pigs is the complete prohibition of all community sales of feeder pigs. There are obvious political difficulties in such a prohibition, but despite their usefulness as marketing agencies, community sales continue to be a major source of swine infections. When the occurrence of virulent hog cholera has been eliminated, further necessary steps include the prohibition of use of any vaccine and serologic studies to detect low-virulence carrier states.

The eradication of swine fever in the United Kingdom in 1986 was an important achievement. Control was radical in that all herds in which the disease was diagnosed were slaughtered and all carcasses burned or buried to avoid missing atypical cases and recurrence through the swill cycle. The two focal points that became apparent were the need to avoid vaccination and the need to diagnose accurately. Vaccination was not permitted because it was not completely effective, produced “carriers,” and encouraged the development of mild and chronic forms of the disease. The need to diagnose accurately led to changes in diagnostic procedure as the campaign progressed. As the proportion of classical epidemics declined, there was increasing dependence on serologic and antigen-detection tests. The program in the United States, which currently appears complete, is an equivalent achievement.

### Immunization Methods

There is a common neutralizing epitope on envelope glycoprotein E2 of different pestiviruses, which may have implications for the



development of DIVA vaccines and serologic diagnosis of CSF.<sup>109</sup>

Very few pigs possess natural immunity to hog cholera, and until the introduction of the serum-virus method of vaccination, an outbreak of the disease in a herd meant that the herd would be eliminated. The situation changed rapidly thereafter, and it can be safely claimed that the development of the swine industry in the United States would have been impossible without the protection that the serum and virus provided. On the other hand, the dangers inherent in the use of fully virulent or partially avirulent virus do not recommend their use and have led to a continuing search for safe methods of immunization. The ideal vaccine should retain strong immunogenicity but should be completely avirulent, even for pregnant sows, the fetus, and young or stressed pigs. It should be stable in the degree of attenuation and should not persist in the vaccinee or transmit from the vaccinee to in-contact pigs. Killed vaccines are safe and do not directly spread virus, but, in general, they engender only a limited immunity. Live vaccines provide a longer-lasting immunity but frequently have not met the criteria listed previously.

#### Serum-Virus Vaccination

The serum-virus vaccination produces an immediate, solid, and lasting immunity when properly administered to healthy swine. The virus, produced by collecting blood 6 to 7 days after artificial infection, is injected SC in 2-mL doses followed immediately by serum in doses graduated to the size of the pigs and varying from 20 mL for suckling pigs to 75 mL for adults. Overdosing with serum will not prevent the development of immunity. Vaccination is performed at any age after 4 weeks. Because of the availability of safer vaccines, this method is not recommended.

#### Attenuated Vaccines

The first attenuated vaccine was the Chinese lapinized vaccine (C-strain), which induced antibody- and cell-mediated immunity. C-strain-vaccinated pigs produce interferon-gamma at about 9 days postvaccination, and it is a potent inducer of type 1 T-cell responses with significant levels of proinflammatory cytokines.<sup>110</sup> There are certain CD8 cells that play an important role in the protection derived from the C strain vaccine, particularly in the early period before the presence of neutralizing antibody occurs.<sup>134</sup>

CSF infection results in the rapid onset of leucopenia, and it was shown that this affects the T cells. The inability to prime IFN- $\gamma$ -secreting virus-specific T cells may be attributable to their depletion before activation or to the phenomenon of apoptotic cell-induced dendritic-cell-mediated suppression.<sup>111</sup> It may also be that the affected dendritic cells have a deranged cytokine production that overexpresses IFN- $\gamma$  and TNF- $\alpha$ .<sup>112</sup>

The most notable development has been the introduction of the first generation of marker vaccines against CSF. These are E2-subunit vaccines that protect pigs by inducing high levels of neutralizing antibodies to E2 after vaccination. A serologic test against E<sup>rns</sup> was approved within the European Union.<sup>55</sup> However, this test also detects antibodies against E<sup>rns</sup> from ruminant pestiviruses and therefore produces cross-reactivity in diagnostic tests.<sup>113</sup> E2 glycoprotein contains epitopes that produce neutralizing antibodies, which confer protective immunity and are frequently used for designing DIVA vaccines.<sup>114</sup> The E2 glycoprotein is the major antigenic protein exposed on the outer surface of the virion that induces the main neutralizing antibody, and there are differences between the E2 of the vaccine and field strains of CSF.<sup>115</sup> There are conserved residues, and these may be useful in the development of future diagnostic tests and marker vaccines.

A live attenuated antigenic CSF marker vaccine involving a positive antigenic marker in E1 and a negative marker in E2 has been designed.<sup>116</sup>

A yeast-expressed CSF virus glycoprotein E2 was also shown to produce a protective response.<sup>117</sup>

There has been the rational design of a CSF C-strain vaccine virus that enables the differentiation between infected and vaccinated animals.<sup>118</sup> These findings provide the molecular basis for the development of a novel, genetically stable, live attenuated CSF DIVA vaccine. Some C-strain vaccine virus is not detected by C-strain-specific RT-PCR as a result of a point mutation in the primer binding site.<sup>119</sup>

The efficacy of marker vaccine candidate CP7\_E2alf in piglets with maternally derived C-strain antibodies was studied.<sup>120</sup> It provides early protection against lethal challenge infection with CSF virus after both intramuscular and oral immunization.<sup>121,122</sup> It was shown to be effective in preventing mortality, severe clinical signs, and pathologic lesions in 5- or 8-week-old pigs, positive for maternal antibodies derived from sows vaccinated 4 weeks before farrowing, with one dose of C-strain vaccine. The vaccine was able to produce stable antibodies that led to protection for 6 months after vaccination.<sup>123</sup> The primary replication site in vaccinated animals is the tonsils. It persists for up to 63 days after oronasal administration, and it also allows the use of DIVA in the serologic tests.<sup>124</sup> It was confirmed as a promising marker candidate for oronasal vaccination for both wild boar and domestic pigs.

Enhanced immunity to CSF was described after inducement by prime boost immunization using an alphavirus replicon-vectored DNA vaccine and a recombinant adenovirus,<sup>125</sup> and it is able to produce cell-mediated immunity.<sup>126</sup>

Attenuated vaccines include tissue culture vaccines attenuated by repeated passage through tissue culture of porcine or other origin, lapinized vaccines produced by repeated rabbit passage, and vaccines from mutant strains. Many of the early vaccines of this type were not stable and could cause disease when not used in conjunction with serum. Furthermore, transmission to in-contact pigs, especially with porcine origin vaccines, and fetal disease following vaccination of pregnant sows have been problems. Attenuated vaccines are in wide use in Europe and Asia and include the Chinese or LPC and GPE strains. Recently, a safe and efficacious CSF marker vaccine based on the E2 protein (major immunogen) of the virus has been developed. This protein has neutralizing antibodies, and it is also conserved. It can be used where there is an endemic problem and also after the outbreak. It also prevents or reduces drastically the problem of transplacental infection. Experimental nontransmissible marker vaccines have also been developed. Highly passaged preparations are antigenically stable and show no evidence of reversion. They produce a very limited viremia, or none, and no leukopenia or clinical illness. Protection is evident within 5 to 10 days of vaccination. Piglets from nonimmune sows can be vaccinated within the first 2 weeks of life. Because the presence of maternal immunity can interfere with effective immunization, the vaccination of piglets from immune sows should be delayed until at least the second month. The French Thiverval strain is a cold mutant strain that has lost its virulence but retained good immunogenicity. Vaccination of piglets even with 10 times the regular dose produced no clinical illness and virtually no viremia. A single IM vaccination will produce resistance to challenge by 5 to 10 days, and immunity persists for 3 years. Colostral immunity will protect piglets for periods up to 2 months after birth. When given to pregnant sows, even the highly attenuated strains have the ability to cross the placenta and produce fetal infection even though no clinical evidence of this may be manifest. Consequently, it is recommended that replacement gilts be vaccinated at least 2 weeks before mating and that recently vaccinated animals be kept separate from susceptible pregnant sows.

In the Netherlands, the control of swine fever has relied on a slaughter policy on affected farms plus an emergency vaccination program in which all pigs over 2 weeks of age in areas of risk are vaccinated. The mass vaccination program is followed by supplementary vaccination of pigs at 7 to 9 weeks of age and revaccination of breeding gilts when they reach 6 to 7 months of age. The serologic response of piglets born from vaccinated sows is best at 9 to 10 weeks of age rather than at 5 to 6 weeks of age. A vaccine-induced neutralizing antibody titer

of less than 32 is adequate to provide protection against clinical disease and to prevent virus transmission.

In the future, a recombinant adenovirus expressing the E2 protein of CSF virus may be useful as a candidate vaccine for preventing CSF.<sup>127</sup> Another possibility is the use of synthetic RNA corresponding to the nucleotides 1130 to 1148 of the CSF virus targeting the nucleocapsid protein, which was shown to inhibit viral replication.<sup>128</sup>

Modification of the glycosylation of the E1, as for the other E proteins, could be useful for the development of CSF live-attenuated vaccines.<sup>129</sup>

Oral vaccination of backyard pigs against CSF with bait vaccine was proven to be useful in an emergency-type situation.<sup>130</sup>

### Inactivated Vaccines

Inactivated vaccines are usually prepared from the blood or tissues of infected pigs. Crystal violet vaccine has been the most widely used of this type and was used in the United Kingdom before eradication but never gained full acceptance in the United States. It is completely safe, but its immunogenicity is poor. Immunity does not develop until 12 days after vaccination. Its duration is short, and booster injections are required for maintenance. Vaccinated sows may still develop fetal infection when exposed to virulent virus, and there is a danger that the use of this vaccine in enzootic areas may in this way induce virus carriers. The production of immune antibodies to the blood components of the vaccine may result in the occurrence of isoimmune hemolytic anemia in some breeds. For these reasons inactivated vaccines are not in common use.

Wild boar populations in some countries have risen considerably, particularly in Germany. It is seemingly harmless in wild boar. It can be confined to certain areas until eliminated.<sup>131</sup> Routine vaccination around an area of infection has been proposed as a method of control.<sup>132</sup> Only then can the DIVA qRT-PCR be used to separate vaccinated from field cases.

### FURTHER READING

Moening V, et al. Classical Swine fever. *Dev Biol*. 2013;135:167-174.

### REFERENCES

- Bingham PC, et al. *NZ Vet J*. 2010;58:253.
- Loeffen WLA, et al. *Vet Microbiol*. 2009;136:240.
- Wieringa-Jelsma T, et al. *Vet Microbiol*. 2006;118:26.
- Vilcek S, et al. *Virus Res*. 2007;108:187.
- Gallei A, et al. *J Virol*. 2008;82:9717.
- He C-Q, et al. *Virus Res*. 2007;126:179.
- Risatti GR, et al. *Virology*. 2007;364:371.
- Postel A, et al. *Vet Res*. 2012;43:50.
- Postel A, et al. *Vet Microbiol*. 2013;161:334.
- Blome S, et al. *Vet Microbiol*. 2010;146:276.
- Kamakawa A, et al. *Vet Microbiol*. 2006;118:47.
- Leifer I, et al. *J Gen Virol*. 2010;91:2687.
- Zhu Y, et al. *Virus Res*. 2009;142:169.
- Dreier S, et al. *J Virol Methods*. 2007;140:95.

- Floegel-Niesmann G, et al. *Vet Microbiol*. 2009;139:165.
- Seo SW, et al. *Vet Microbiol*. 2012;161:218.
- Everett H, et al. *Transbound Emerging Dis*. 2011;58:128.
- Gers S, et al. *Transbound Emerging Dis*. 2011;58:135.
- Gers S. *Transbound Emerging Dis*. 2011;58:128.
- Barman NN, et al. *Rev Sci Tech Off Int Epiz*. 2012;31:919.
- Simon G, et al. *Vet Microbiol*. 2013;166:631.
- Pol F, et al. *Vet Rec*. 2008;162:811.
- Allepuz A, et al. *Vet Rec*. 2007;160:398.
- Weesendorp E, et al. *Vet Microbiol*. 2009;133:9.
- Weesendorp E, et al. *Vet Res*. 2009;40:59.
- Weesendorp E, et al. *Vet Microbiol*. 2008;127:50.
- Weesendorp E, et al. *Vet Microbiol*. 2009;135:222.
- Weesendorp E, et al. *Vet Microbiol*. 2011;147:262.
- Durand B, et al. *Vet Microbiol*. 2009;135:196.
- Ribbens S, et al. *Vet Rec*. 2007;160:687.
- Gladue DP, et al. *Virus Res*. 2010;152:10.
- Fernandez-Sainz I, et al. *J Virol*. 2010;84:1536.
- Tamura T, et al. *J Virol*. 2012;86:8602.
- Ganges L, et al. *Vet J*. 2008;177:169.
- Seago J, et al. *J Gen Virol*. 2007;88:3002.
- Johns HL, et al. *J Gen Virol*. 2010;91:1038.
- Jamin A, et al. *Vet Res*. 2008;39:7.
- Renson P, et al. *Vet Res*. 2010;41:7.
- Tang Q-H, et al. *Vet Immunol Immunopathol*. 2010;133:237.
- Summerfield A. *Vet Immunol Immunopathol*. 2012;148:168.
- Risatti GR, et al. *Virology*. 2006;355:94.
- Durand SVM, et al. *Arch Virol*. 2009;154:1417.
- Hulst M, et al. *Arch Virol*. 2013;158:325.
- Sun J, et al. *J Gen Virol*. 2010;91:2254.
- Luo TR, et al. *Virus Res*. 2012;9:175.
- Li J, et al. *Virus Res*. 2010;148:60.
- Renson P, et al. *Vet Res*. 2010;41:7.
- Chen L-J, et al. *Res Vet Sci*. 2012;93:529.
- Blome S, et al. *Vet Microbiol*. 2013;162:360.
- Everett H, et al. *Vet Microbiol*. 2010;142:26.
- Floegel-Niesmann G, et al. *Vet Microbiol*. 2009;139:165.
- Cariolet R, et al. *J Recherc Porc*. 2008;40:45.
- Nielsen J, et al. *Vet Immunol Immunopathol*. 2010;138:159.
- Elbers ARW, et al. *Vet Microbiol*. 2010;142:108.
- Blome S, et al. *Rev Sci Tech Int Off Epiz*. 2006;25:1025.
- Greiser-Wilke I, et al. *Vaccine*. 2007;25:5524.
- Liu L, et al. *J Virol Methods*. 2007;139:203.
- Liu L, et al. *J Virol Methods*. 2009;159:131.
- Leifer I, et al. *J Virol Methods*. 2009;158:114.
- Aebischer A, et al. *Vet Microbiol*. 2013;161:274.
- Kaden V, et al. *Dtsch Tierarztl Wochenschr*. 2009;116:173.
- Lohse L, et al. *J Vet Diag Invest*. 2011;23:1005.
- Donahue BC, et al. *J Virol Methods*. 2011;179:108.
- Weesendorp E, et al. *Vet Microbiol*. 2010;141:275.
- Ophuis RJ, et al. *J Virol Methods*. 2006;131:78.
- Liu L, et al. *J Virol Methods*. 2007;139:203.
- Liu L, et al. *J Virol Methods*. 2009;160:69.
- Zhao JJ, et al. *Vet Microbiol*. 2008;126:1.
- Jannikar Ciglenecki U, et al. *J Virol Methods*. 2008;147:257.
- Depner K, et al. *J Vet Med B Infect Dis Vet Publ Hlth*. 2006;53:317.
- Le Dimma M, et al. *J Virol Methods*. 2008;147:136.
- Zhang X-J, et al. *J Virol Methods*. 2010;167:74.
- Li Y, et al. *J Virol Methods*. 2007;143:16.
- de Arce HD, et al. *Vet Microbiol*. 2009;139:245.
- Zhang X-J, et al. *Res Vet Sci*. 2012;92:512.
- Zhang X-J, et al. *J Virol Methods*. 2010;168:259.
- Le Potier MF, et al. *Dev Biol (Basel)*. 2006;126:179.
- Hoffmann B, et al. *J Virol Methods*. 2008;130:36.
- Depner K, et al. *Vet Microbiol*. 2007;12:338.
- Blome S, et al. *Rev Sci Tech Off Int Epiz*. 2006;25:1025.
- Beer M, et al. *Vaccine*. 2007;25:5665.
- Haegeman A, et al. *J Virol Methods*. 2006;136:44.
- Liu L, et al. *J Virol Methods*. 2009;160:69.
- Wen G, et al. *Vet Res Commun*. 2010;34:359.
- Huang Y-L, et al. *J Virol Methods*. 2009;160:111.
- Depner K, et al. *Vet Microbiol*. 2007;121:338.
- Wernike K, et al. *J Virol Methods*. 2013;193:50.
- Wang X, et al. *J Virol Methods*. 2013;191:9.
- Greser-Wilke I, et al. *Vaccine*. 2007;25:5524.
- Schroeder S, et al. *Rev Sci Tech Off Epiz*. 2012;31:997.
- Li W, et al. *J Virol Methods*. 2013;191:63.
- Li X, et al. *J Virol Methods*. 2012;180:32.
- Reiner G, et al. *Berl Munch Tierarztl Wschr*. 2010;123:119.
- Zhou B, et al. *J Virol Methods*. 2010;167:79.
- Vrancken R, et al. *J Gen Virol*. 2009;90:1335.
- Vrancken R, et al. *Vet Microbiol*. 2009;139:365.
- Penrith M-L, et al. *Transbound Emerg Dis*. 2011;58:187.
- Durr S, et al. *Prev Vet Med*. 2013;108:73.
- Boklund A, et al. *Prev Vet Med*. 2009;90:180.
- Thulke H-H, et al. *Prev Vet Med*. 2011;99:28.
- Froelich A, et al. *Vet Microbiol*. 2008;132:29.
- David D, et al. *Vet J*. 2011;190:e146.
- Alexandrov T, et al. *Rev Sci Tech Off Epiz*. 2011;30:91.
- Voigt H, et al. *Vaccine*. 2007;25:5915.
- Kortekaas J, et al. *Vet Microbiol*. 2011;147:11.
- Wehrle F, et al. *J Gen Virol*. 2007;88:2247.
- Suradhat S, et al. *Vet Microbiol*. 2007;119:1.
- Dong X-N, Chen Y-H. *Vaccine*. 2007;25:205.
- van Rijn PA. *Vet Microbiol*. 2007;125:150.
- Graham SP, et al. *Vet Microbiol*. 2010;142:34.
- Williams CA, et al. *Immunology*. 2008;124:89.
- Jamin A, et al. *Vet Res*. 2008;39:7.
- Koenig P, et al. *Vaccine*. 2007;25.
- Beer M, et al. *Vaccine*. 2007;25:5665.
- Chang C-Y, et al. *Virus Res*. 2010;149:183.
- Holinka LG, et al. *Virology*. 2009;384:106.
- Lin G-J, et al. *Vet Microbiol*. 2009;139:369.
- Kritekas J, et al. *J Virol Methods*. 2010;163:175.
- Leifer I, et al. *J Virol Methods*. 2010;166:98.
- Reimann I, et al. *Vet Microbiol*. 2010;142:45.
- Leifer I, et al. *Vaccine*. 2009;27:6522.
- Rangelova D, et al. *Vaccine*. 2012;30:6376.
- Gabriel C, et al. *Vaccine*. 2012;30:2928.
- Tignon M, et al. *Vet Microbiol*. 2010;142:59.
- Sun Y, et al. *Vet Immunol Immunopathol*. 2010;137.
- Zhao H-P, et al. *Vet Immunol Immunopathol*. 2009;129:57.
- Sun Y, et al. *Res Vet Sci*. 2010;88:77.
- Porntrakulpipat S, et al. *Vet Microbiol*. 2010;142:41.
- Fernandez-Sainz I, et al. *Virology*. 2008;386:210.
- Milicevic V, et al. *Vet Microbiol*. 2013;163:167.
- Pol F, et al. *Vet Rec*. 2008;162:811.
- Rossi S, et al. *Vet Microbiol*. 2010;142:99.
- Haines FJ, et al. *PLoS ONE*. 2013;7:e71019.
- Franzoni G, et al. *Clin Vaccine Immunol*. 2013;20:1604.
- Rosell R, et al. *Vet Rec*. 2013;doi:10.1136/vr.101920.
- Moening V, et al. *Dev Biol*. 2013;135:167.
- Liu L, et al. *J Virol Methods*. 2011;175:170.
- Blome S, et al. *Vet Microbiol*. 2011;151:53:373.
- Leifer I, et al. *BMC Res Notes*. 2011;4:521.

### AFRICAN SWINE FEVER

African swine fever (ASF) is an OIE List A disease. It is on the move and dangerous.<sup>1</sup>

For many years only the Pirbright, Spanish, Portuguese, and South African groups have been interested in the virus, with limited resources to pursue a vaccine, but with the incursion into Europe, this has changed. It is indistinguishable in the field from classical swine fever because both are hemorrhagic diatheses, and it is just as contagious. It is responsible for a highly fatal disease in domesticated pigs. It is the greatest limitation to the development of the pig industry in Africa.<sup>2</sup> However, it is associated with a totally different virus. It is also very important because of its spread into Europe, because of its economic effect, and because of the difficulties of control in wild pig populations and eradication in the face of no effective vaccination. It has no public health significance. An online training course put together by a consortium of experts working on ASF is offered through the link <http://asforce.org/course/>.

## SYNOPSIS

**Etiology** Large icosahedral cytoplasmic DNA virus.

**Epidemiology** Disease of major threat to pig-producing countries. Occurs in Africa, western and eastern European countries, Caribbean countries. High morbidity, high case-fatality rate in classic form; low-virulence form less fatal. In Africa, transmitted by argasid tick from wild pigs to domestic pigs. In Europe, transmitted by direct contact with infected pigs and wild and feral pigs. Antibodies in colostrum of recovered sows provide passive protection to piglets.

**Signs** High fever, purplish skin, depression, anorexia, huddling, disinclination to move, weakness, incoordination, nasal and ocular discharges, diarrhea, vomiting, abortions, death in a few days. Historically, highly virulent forms; in recent decades, subacute and chronic forms common, with fever, depression, and lethargy; recover in few weeks but remain persistently infected; chronic cases are intermittently pyrexial and become emaciated, with soft edematous swelling over joints and mandible.

**Clinical pathology** Severe leukopenia and lymphopenia. Detect antigen or serologic tests.

**Lesions** Marked petechiation of all serous surfaces, lymph nodes, epicardium and endocardium, renal cortex, bladder; edema and congestion of colon and lungs. Renal hemorrhages are considered pathognomonic.

**Diagnostic confirmation** Identify virus in tissues.

### Differential diagnosis list:

- Hog cholera
- Erysipelas
- Salmonellosis

**Treatment** None.

**Control** Identification of affected pigs, slaughter, and quarantine premises.

Establish disease-free areas.

## ETIOLOGY

It is associated with a DNA virus that is the sole member of the family Asfarviridae and as such is the only known DNA arbovirus. It is a large icosahedral virus that contains a linear, double-stranded DNA genome (170 to 190 kbp). The viral genome may encode for 165 genes and encodes for approximately 113 virus-induced proteins and over 28 structural proteins in intracellular viral particles, most with an as yet unknown function. The variable ends of the genome contain five multigene families, and the large differences in these between the different isolates may account for the large differences in antigens that are seen between the various isolates. There are large differences between the genomes of isolates from different regions and types of pig<sup>3</sup> and between virulent and avirulent viruses. Morphologically, it is similar to the iridoviruses but resembles the pox viruses in genome construction and gene expression. There are different forms from highly lethal to subclinical with different field strains and tissue-culture-adapted strains. These are recognized by restriction fragment length polymorphism (RFLP), and protein p72 recognizes all viral groups. Partial p72 gene characterization allows genotyping of field strains. It does not produce neutralizing antibodies, and therefore there is no serotypic classification, but 22 ASF genotypes have been identified using partial sequencing from the p72 gene.<sup>4</sup> Genotype 1 is West African, which also circulated in Europe in the previous outbreaks, and the other 21 are East African. The strain at present circulating primarily in Russia is also an East African strain. It grows well in porcine bone marrow and buffy coat with the production of syncytia.

## EPIDEMIOLOGY

Because there is no vaccination as yet, the presence of antibodies always denotes infection, and these antibodies appear early and last for long periods. There is high genetic variability, which seems to be related to the sylvatic cycle present in the region and may be responsible for the complex epidemiology in the region.<sup>4</sup>

## Geographic Occurrence

### Africa

African swine fever is indigenous to the African continent, where it affects wild pigs. These include warthogs, bush pigs, and escaped (feral) forest hogs, which act as reservoirs of the virus, which cycles between the pigs and the ticks. Wild pigs in some areas are free of infection, and consequently the

disease is not endemic in all areas. It was always considered to be a disease of sub-Saharan Africa but over the years has reached new areas. It is endemic in over 20 sub-Saharan countries. It reached Cuba (1971 and 1980). In 1978 outbreaks occurred in Malta, Brazil, and the Dominican Republic and in 1979 in Haiti. It reached Madagascar and Mozambique in 1994, Kenya in 1994, Ivory Coast in 1996, Benin in 1997, and Togo and Nigeria in 2001. The Kenyan outbreak seemed to be maintained in the domestic pigs without sylvatic hosts. The Nigerian strain was 92% to 97% homologous to the strains from Uganda, the Dominican Republic, and Spain. The serious worry was the appearance of the virus in Madagascar in 1998. Although studies showed a seropositivity of only 5.3%, infection of wild pigs produced no clinical disease. With virulent strains, infection in the domestic pig is almost always fatal. Since its recognition, occurrence of the disease in South Africa has been cyclical, with periods of 10 to 12 years of clinical disease and then an absence of disease. Until 1957, ASF had not occurred outside the African continent. To the rest of the world it represented the most formidable of the exotic diseases of swine, a disease that had to be kept within its existing boundaries at all costs.

## Europe

In 1957, it spread from Africa to Lisbon and then to Spain in 1960; France in 1964; Italy in 1967, 1969, and 1993; Malta in 1978; Belgium in 1985; and the Netherlands in 1986. It was eradicated from the Iberian Peninsula in 1964.

In Malta (1978), the disease resulted in the death or slaughter of the entire population of 80,000 pigs within 12 months of the diagnosis. This is one of the few examples where a country had to slaughter an entire species of a domestic animal to eliminate a disease. The source of infection was thought to be pork imported from Spain, which was fed to only one boar. Once the official diagnosis was made, all animals on affected farms were slaughtered. Animals that had direct commercial contact with infected herds were also slaughtered, and the disease was declared eradicated in September 1985.

In Spain, the disease had been present since 1960, but the implementation of regulations for eradication adopted in 1985 made it possible to divide the country into an ASF-free region and an infected region. Since 1995, Spain and Portugal have been declared free from the disease, although there was an isolated outbreak in Portugal in 1995. This has resulted in a marked change in the distribution and incidence of the disease.

Europe has remained free after the eradication from Iberia, with one exception, Sardinia, where the disease is endemic in the Central Highlands, although it decreased from October 1994 to March 1996. In a



survey in 1998, 45 of 82 municipalities in the province of Nuoro in Sardinia were found to have ASF. In 2010 there were 87 cases in Italy, the principal reasons being the extensive pig farming and the occurrence of wild boar. The partial confinement farms have less seropositivity than the free-range farms, and those in total confinement have only 20% of the level of the free-range farms.

### The Recent Disease Outbreak

On the basis of sequence studies,<sup>5</sup> it is likely that the virus in Georgia originated from East Africa (Mozambique or Madagascar) and went by boat (uncooked pork) to the Black Sea and then to the port of Poti in Georgia. In 2007 ASF was recognized in Georgia. It killed all the pigs within 5 to 10 days<sup>6</sup> and remains as virulent now. It then spread rapidly to the Caucasus<sup>5</sup> and then rapidly to Armenia, Azerbaijan, and the Russian Federation. It has reached the Ukraine and now has reached the northwestern areas of Russia near the Baltic States and the Barents Sea. It is currently circulating out of control in both domestic and wild pig populations.<sup>7</sup> There are two populations at risk: the low-biosecurity population (backyard pigs, etc.: 77%) and the high-security domestic pigs (23%). The disease has spread widely in the southern part of the Russian Federation, and since 2011 a secondary endemic center has shifted to the center of the country.<sup>8,9</sup> In 2010, pigs were dumped at a poultry manure storage site just 30 km from St. Petersburg and 100 km from the EU border with Estonia, but where the pigs came from is unknown. It is a risk being near to one of the largest ports in Russia, and it must be ensured that trucks emanating from these ports are properly disinfected. This present virus is genotype 11, and nearly all the cases are acute cases, as you would expect in a naïve, susceptible population.

In June 2013, the Russian authorities reported outbreaks in backyard pigs along the border with the Ukraine and in wild boar in the Smolensk region north of Moscow. Belarus also reported ASF in backyard pigs in the Grodno region in the west of the country. This is of danger to the European Union because this is close to the border with Lithuania, where there have been cases in the wild boar as a result of transborder movements. It is a threat to the European Union because of wild boar, backyard pig keeping, illegal entry of meat from infected pigs into the food chain and possible import into the United Kingdom, and swill feeding. Three-quarters of all ASF events are reported between June and November in the backyard sector, whereas a quarter of wild boar outbreaks are reported in May and June when there is an increasing population. The virus has also been found in illegally disposed carcasses and meat-processing plants. Low temperatures do not destroy the virus, and chilled meats are a source of infection where

swill feeding is practiced. A model has been developed for the spread of ASF into the European Union during the high-risk period.<sup>10</sup> One of the key suggestions is that spread during the high-risk period is likely to be limited especially if the high risk period is short. There is a risk of ASF being transported into the European Union through transport-associated routes (returning trucks, and waste from planes and ships), and this risk has been examined.<sup>11</sup> The study showed that the risk through transport-associated routes was low, except for in some countries, such as Lithuania and Poland, and the returning trucks were the highest risk. The risk of introduction of live pigs was highest in Poland,<sup>12</sup> particularly in November and December, and from the Russian Federation. The ASF virus found in Georgia can replicate efficiently in ticks.<sup>13</sup> An epidemiologic update has been provided.<sup>14</sup>

In early 2014, ASF was discovered in wild boar in Lithuania less than 200 km from the Polish border. It is likely to be the result of movement of infected animals from affected regions in Belarus.

### Species Affected

Only pigs are affected; domestic pigs of all ages and breeds are highly susceptible, but the virus can be passed in tissue cultures of rabbits, goats, and embryonated hen eggs. The three African wild species (warthogs, giant forest hogs, and bush pigs) are resistant to infection, but European wild boar are susceptible.

Until recently, the occurrence of the disease in Africa was limited to explosive outbreaks in European pigs that came in contact with indigenous African pigs. These outbreaks tended to be self-limiting because all pigs in affected herds died or were destroyed, but after a number of years the disease became enzootic in domestic herds. Surveys of the disease in countries such as Malawi illustrate the changing behavior of the disease over a period of years. The virus, which was introduced to Europe in 1957, was capable of persisting in European pigs, and after a period of several years in which the disease was epizootic, a change to an enzootic character occurred. The outbreak in Cuba was of a comparatively virulent form.

When the disease occurred in the Caribbean region, it posed a major threat to the large swine industry of the United States principally because of the possible spread of the virus to the feral swine population in Florida. The feral swine population in Florida is the largest in the United States and is of major recreational and economic importance to hunters, trappers, taxidermists, and dealers who sell feral swine to hunting clubs. The feral swine in Florida are descendants of domestic swine that were allowed to run wild. Experimental inoculation of these pigs with virulent isolates of the virus will cause fatal disease.

### Morbidity and Case Fatality

Early in the history of African swine fever, the morbidity rate could be as high as 100%, and the case-fatality rate was also often over 90%. However, a decrease in the virulence of the virus occurs with time in enzootic areas, and the case-fatality rate may now be as low as 2% to 3%.

### Methods of Transmission

There are three main methods of transmission cycle. Firstly, a wild pig/soft ticks/domestic pigs cycle; second, a domestic pig/tick cycle without warthogs; and third, a domestic pig/pig cycle.<sup>15</sup> Local spread and outdoor production facilities in association with wandering wild boar may be the most common methods of transmission.

In Africa, the method of transmission of the disease from the reservoir in wild pigs to the domestic pig has been the subject of considerable interest. Infection is primarily transmitted to domestic pigs via the argasid tick *Ornithodoros moubata*. The viremic warthog is a source of infection for the ticks. The virus can be maintained in warthog-associated argasid ticks by a transstadial, transovarial, and sexual (male to female, but usually not vice versa) transmission mechanism. It needs to replicate in the midgut epithelium of the tick for successful ASF infection of the tick. The tick is relatively restricted in its habitat, and if contact between domestic pigs and wild pigs and their burrows is prevented, transmission can be prevented. The virus can be maintained in these ticks for long periods in the absence of fresh sources of infection, with a low level of viremia lasting a long time. The young warthogs in the burrows are infected early on, and thus they act as reservoirs and vectors of infection. Sporadic outbreaks may thus occur in endemic areas when the virus spreads from infected ticks or warthogs to domestic pigs. In some areas where infected warthogs are common but where *O. moubata* is apparently absent, *O. savignyi* may be a natural field vector of the virus. It is also found in *O. porcinus*. The ASF virus replicates to a high titer in the developing cells of the egg of the tick. Ticks infected with ASF virus also have a higher mortality than uninfected ticks.

The long-held belief that the source of the virus in primary epidemics of African swine fever in southern and eastern Africa is the carrier, wild pig, is not tenable. It is postulated that infected ticks are transported to the vicinity of domestic pigs either by warthogs or on the carcasses of warthogs.

In Africa, the virus is maintained primarily by a cycle of infection between warthogs and soft ticks (*Ornithodoros moubata*). The virus does not have an apparent effect on either warthogs or ticks, and it is only when infection of domestic pigs occurs that the virus produces disease. Indeed, most warthogs are aviremic but seropositive. The tick

has a wide distribution in Africa south of the Sahara, and its main habitat is in burrows that are inhabited by the warthog. There is a good correlation between antibodies in warthogs and the presence of ticks. Newborn warthogs can become infected soon after birth if bitten by infected ticks, and the consequent viremia would be high enough to infect previously uninfected ticks feeding on them. It is also found in the bush pig (*Potamochoerus porcus*), which, following infection, may be viremic for 35 to 91 days, and these also transmit the infection to ticks.

In Europe there is direct transmission between sick and healthy animals irrespective of whether they are domesticated or wild or feral animals. In **Spain and Portugal**, the methods of spread are contact between neighboring farms and the introduction of infected pigs either during the incubation period or as persistently infected virus carriers. During the last 20 years, an increasing number of outbreaks occurred in which clinical disease was not readily recognized. The mortality rates decreased, and a wide range of clinical disease occurred, ranging from acute to chronic and including apparent recovery to normal health. The major consequence of the emergence of these less virulent forms of the virus was the development of persistently viremic carriers and a large population of pigs with inapparent infection. The African swine fever virus may persist in the pig population by persistent infection in recovered pigs for several months, during which time the virus must be reactivated before transmission can occur. The virus can also persist by reinfection of recovered pigs in which the virus replicates without producing clinical disease, and transmission occurs by excretion and by infected blood and tissues. Wild boars in Spain carry the virus without clinical signs.

The **European vector** of the virus is the soft tick *O. erraticus*.<sup>16</sup> It can maintain and transmit the virus for at least 300 days. In various areas of Spain, *O. erraticus* was found in 42% to 64% of the pens occupied by pigs. Following the outbreak of the disease in Spain, abandonment of these pig pens has resulted in the elimination of most soft ticks infected with the virus. The adults and large nymphs can survive for about 5 years or longer in the soil of pig pens when animals occasionally enter them. There is a relationship between the persistence of the disease and the distribution of the tick in Spain. Hungry tick populations may transmit the virus when feeding in the winter, but populations that have continuous access to pigs do not feed until the pig pens reach a temperature of 13° to 15°C (55°–59°F). The development from larva to adults takes 2 to 3 years. In a recent study of the ticks (*O. erraticus*) from farms in southern Portugal, two types of ASF were isolated. One produced the acute, 100% fatal disease, and the other just a low viremia in pigs.

In **Sardinia**, the major factors involved in the spread of the disease are related to the following factors:

- Mountainous terrain in which pigs may range freely in previously infected areas
- Movement of pigs that may survive infection and mingle with other herds
- Introduction of infected pigs from unknown sources into healthy herds because of the uncontrolled movement of pigs
- Feeding of waste food containing meat from infected pigs

The virus has been experimentally transmitted to healthy swine by *O. coriaceus*, an argasid tick indigenous to the United States. The potential arthropod vectors of the virus in **North America and the Caribbean basin** have been examined. Most *Ornithodoros* spp. of ticks that will feed on pigs may be capable of acting as vectors of the virus, and the possible existence of potential vectors among the other blood-sucking arthropods should not be ignored. The soft tick *O. (Alectorobius) puertoricensis* found on the Caribbean island of Hispaniola (Haiti and Dominican Republic), where African swine fever was endemic from 1978 to 1984, was experimentally able to transmit the virus from infected to susceptible pigs. The *O. coriaceus* tick is able to harbor and transmit the virus for more than 440 days, passing it transstadially from the first nymphal stage to the adult, sustaining it through at least four molts. *O. puertoricensis* has all of the prerequisites for becoming a true biological vector and reservoir of the virus.

Once established in domestic pigs the disease can spread rapidly. Virus is present in high titer in nasopharyngeal excretions at the onset of clinical signs and is present in all organs and excretions in acutely sick pigs. In experimentally inoculated domestic pigs, the virus is present in substantial amounts in secretions and excretions of acutely infected pigs for only 7 to 10 days after the onset of fever and is present in the greatest amount in the feces. The virus can persist in the blood of some recovered pigs for 8 weeks and in the lymphoid tissues for 12 weeks. Feces are the environmental contaminant most likely to spread the infection, but blood is also highly infective, and transmission could occur by contamination of wounds created by fighting. Infection occurs via oral and nasal routes, and with the short incubation period once the disease is established in a herd, it spreads rapidly by direct contact. Infection among domestic pigs can also reputedly be spread by the following activities:

- Indirect contact by infected pens
- Ingestion of contaminated feed and water
- Feeding uncooked garbage containing infected pig material

Transmission via the hog louse *Haematopinus suis* is also probable. An important source of infection is the recovered pig,

which may remain persistently infected and a carrier indefinitely. Pigs that have recovered from the Western Hemisphere isolates (Brazilian and Dominican Republic) may be persistently infected and are resistant to experimental challenge.

Little is known as yet about the transmission of the virus by ticks in eastern Europe. However, all *Ornithodoros* spp. ticks tested so far have been susceptible to ASF virus and are therefore potential biological vectors.

## Risk Factors

### Pathogen Factors

The ASF virus is a multiclonal population of viruses in which all combinations of at least four markers (hemadsorption, virulence, plaque size, and antigenicity) are found. This may explain the epidemiologic observation that when the disease was confined to Africa and the Iberian Peninsula in the early 1960s, the viruses isolated were highly virulent to swine, but in subsequent years mortality decreased and subacute and chronic infection became more common. Experimentally, moderately virulent ASF virus obtained from the Dominican Republic, when inoculated into pigs, results in an acute febrile illness along with viremia and a transient neutrophilia from which the pigs recover. The Malta 78 isolate of the virus experimentally produces a clinical syndrome similar to that of the African isolates of the virus.

A huge amount of research is continuing apace into the genes and the proteins produced from the expression of these genes, but these are beyond the scope of this text. However, recent studies of ASF have suggested that the virulence may depend on their ability to regulate the expression of macrophage-derived cytokines, which in turn regulate T-helper type 1 cells (Th1) and T-helper type 1 cells (Th2) responses and control the host protective responses. The less virulent cultures of ASF with macrophages produce more TNF- $\alpha$ , IL-6, IL-12, and IL-15, whereas virulent strains inhibit their production. The ASF virus also affects chemotactic responses and phagocytic capacity and causes a reduction in the release of toxic oxygen radicals.

The virus is very stable at pH 4.0 but not so stable at levels above or below this. It is highly resistant to putrefaction, heat (it will survive 2 hours at 56°C [133°F]) and dryness and survives in chilled carcasses for up to 6 months and at 4°C (39°F) for 2 years. It survives in serum for 6 years at 5°C (41°F). Probably 0.5% to 0.66% of all the genes of ASF are not connected with virus replication but are important for viral transmission and survival in the host. It is inactivated by 1% formaldehyde in 6 days and by 2% sodium hydroxide in 24 hours.

### Immune Mechanisms

Antibodies against the ASF virus occur in the colostrum of sows previously infected

with the virus and are transferred passively to nursing pigs. Experimentally, passively transferred virus-specific immunoglobulins alone will protect swine against lethal infection with a highly virulent homologous strain of the virus. The antibody-mediated protective effect is also an early event that effectively delays disease onset. The construction of blocking antibodies by some of the viral proteins probably prevents the complete neutralization of the virus by antibodies.

Pigs infected with virulent or attenuated virus may recover and resist challenge exposure with virulent homologous and, under certain conditions, heterologous viruses. Although pigs develop antibodies that are detectable by different tests, virus-neutralizing antibodies have only recently been demonstrated against viral protein p72. However, it has recently been suggested that p30, p54, p72, and p22 proteins are not associated with neutralizing antibodies. The sera from pigs that have been infected and are resistant will inhibit virus replication, but the nature of the inhibition is not understood. Neutralization of virulent virus isolates in both Vero cell cultures and swine macrophages using swine immune sera has been demonstrated. Experimental exposure of pigs to a low-virulent field isolate of the virus results in a range of virus-induced specific cellular responses.

The virus induces strong *in vitro* blastogenesis of primed blood mononuclear cells, when less virulent but live virus isolates are used. Pigs recovering from an acute infection with the virus have significant levels of virus-specific cytotoxic T-lymphocytes after *in vitro* stimulation. Viral protein p36 induces a helper T-cell response in mice. Resistance to infection appears to be related to the level of antibody-dependent cell-mediated cytotoxicity. Virus-specific blastogenic and cytotoxic T cells are prime candidates for the cells inducing and conferring protective immunity against challenge with the virus, suggesting that cellular-based mechanisms are highly important.

In persistently infected animals the virus may be shed into the environment for at least 70 days.<sup>17</sup>

The incubation period varies widely from 4 to 19 days depending on the isolate and the route of infection. Infected domestic pigs begin shedding the virus before they are showing clinical signs. The virus is shed in large amounts from all excretions and secretions. Surviving pigs demonstrate a long-term viremia, and virus may be recovered.

### **PATHOGENESIS**

The virus replicates in the monocytes and macrophages of the lymph nodes nearest the point of virus entry to the body. It is often the tonsils and respiratory tract and replicates in the lymphoid tissues of the nasopharynx before the occurrence of a

generalized viremia, which can occur within 48 to 72 hours of infection and is followed by secondary replication in the lymph nodes, spleen, lungs, liver, and kidney. The viremia may begin after 4 to 8 days and may last for weeks because there are no neutralizing antibodies.

Infectivity and contact transmission develops at this time and continues for at least 7 days. Pigs inoculated with field isolates of the virus from the Western Hemisphere develop thrombocytopenia with a characteristic pattern. Infected pigs become thrombocytopenic over a 48-hour period after 3 to 4 days of illness. After several days of thrombocytopenia, the platelet count returns to baseline level even with a continuing viremia. Experimentally, the virus causes hematopoiesis in bone marrow, which coincides with macrophage activation, and bone-marrow function is not impaired. Membrane proteins on the surface of permissive cells act as receptors for ASF, and specific interactions take place at this site. ASF is associated with red blood cell membranes and platelets. The subacute form is characterized by a transitory thrombocytopenia.

The effects of ASF are primarily hemorrhages and apoptosis. A newly found protein (p54) encoded by the virus has just been shown to be the first that directly induces apoptosis. The disease is characterized by apoptosis with abundant lymphocyte, particularly B-cell, death. Both T and B cells, particularly in the spleen, are affected as early as 3 days after infection, with the apoptosis being induced by cytokines or apoptotic mediators released from ASF-infected macrophages. In all probability there is an intracellular pathway triggered at the same time as the process of virus encoding. It is probable that the inducers of apoptosis are balanced by the inhibitors of apoptosis.

Tissue necrosis and generalized endothelial cell infection are not features of the disease caused by isolates of moderate virulence.

The virus causes hemorrhages through its effect on hemostatic mechanisms by affecting vascular endothelium. After about 4 to 5 days the vascular damage extends to the basement membranes, and death ensues, usually because of the serious edema and hemorrhage. The mechanisms related to hemorrhage consist of the following:

1. Activation and extensive destruction of monocytes and macrophages—serum TNF- $\alpha$  and IL-1 $\beta$  increase in the serum. The lymphocytes also appear to have decreased activity. Apoptosis of thymocytes has been reported.
2. Disseminated intravascular coagulation
3. Infection and necrosis of megakaryocytes—many apoptotic and also pyknotic and karyorrhectic megakaryocytes can be seen, which are induced either by cytokine damage or

peripheral destruction of platelets.

Between 0.2% and 9.5% of cells may be affected. Early in the infection there is prolongation of coagulation times as a result of inhibition of fibrin formation; later, thrombocytopenia develops. The thrombocytopenia and coagulation defects lead to the development of the following:

- Hemorrhage
- Serous exudates
- Infarction
- Local edema
- Engorgement of tissues

All clinical forms of the disease are characterized by extensive hemorrhage at necropsy, and it is this feature that often establishes a presumptive diagnosis in the field. A highly virulent virus produces renal hemorrhage as a result of intense endothelial injury, facilitated by phagocytic activity. With strains of moderate virulence, hemorrhage is a consequence of an increase in vascular permeability with diapedesis of erythrocytes. Activation of platelets by the virus may also contribute to increased permeability. After 4 to 5 days the basement membranes are affected, which leads to pulmonary edema, and this results in death.

The virus mainly infects cells of the mononuclear phagocyte system and also impairs lymphocyte function. Pulmonary intravascular macrophages demonstrate intense TNF- $\alpha$  and IL-1 $\alpha$  activity, which coincides with the pulmonary edema, neutrophil sequestration, and fibrin microthrombi. The lymphopenia that is so characteristic of the disease is attributable to a significant increase in lymphocyte death by apoptosis (programmed cell death). In the experimental disease, there is marked apoptosis of lymph node lymphocytes, and this occurs in both compartments of cortical tissue but is more intense in diffuse lymphoid tissue (T area). The peripheral lymphopenia is associated with T-lymphocyte depletion. There is no evidence of virus replication in lymphocytes in the lymph nodes, but there is a high rate of viral replication in macrophages in diffuse lymphoid tissue compared with the low rate in lymphoid follicles. In summary, there is lymphoid tissue impairment and programmed cell death of a high percentage of lymphoid and monocyte/macrophage cell populations. This accounts for the lymphopenia and the state of immunodeficiency. There are also a variety of proteins encoded by the virus that are apoptosis inhibiting proteins. Experimentally, the virus also causes activation and degranulation of platelets from day 3 after inoculation onward, coinciding with activation of the mononuclear phagocyte system and virus replication in monocyte/macrophages. Virions of the virus also appear in the platelets, which suggests that platelets assist in disseminating the virus within the body, especially in subacute infections. Probably 95% of the infectivity of



blood is in the form of virus adsorbed to the red blood cells.

The virus can cross the placenta, replicate in fetal tissues, and cause abortion. However, the pregnancy failure is probably the result of the effects of the virus infection on the dam more than from direct viral damage to the placenta or fetus.

The reasons for the lack of viremia in wild African pigs is unknown, as is the higher resistance of European wild boar to ASF.

## CLINICAL FINDINGS

The disease occurs in acute to chronic forms. When it occurs as a new infection (epidemic), it is often acute, but it is subacute to chronic when endemic. In the acute form of the disease the animals die in an acute state of shock characterized by a disseminated intravascular coagulation with multiple hemorrhages in all tissues. The incubation period after contact exposure varies from 4 to 19 days depending on virus dose and the route of infection, but only 2 to 5 days in experimental infections.

Most often the morbidity is 40% to 85%, and the mortality may be as high as 90% to 100% when a virulent virus is involved but may be only 20% to 40% in less virulent outbreaks.

A high fever (40.5°C [105°F]) appears abruptly and persists, without other apparent signs, for about 4 days. The fever then subsides, and the pigs show marked cyanotic blotching of the skin, depression, anorexia, huddling together, disinclination to move, weakness, and incoordination. Extreme congestion and discoloration of the hindquarters with difficulty in walking are early and characteristic signs. Coordination remains in the front legs, and affected pigs may walk on them, dragging the hindlegs. Tachycardia and serous to mucopurulent nasal and ocular discharges occur, and dyspnea and cough (sometimes up to 30%) are present in some pigs. Diarrhea, sometimes dysentery, and vomiting occur in some outbreaks, and pregnant sows usually abort. Purple discoloration of the skin may be present on the limbs, snout, abdomen, and ears. Abortion may occur in all stages of gestation about 5 to 8 days after the infection commences or after 1 to 2 days of fever. Death usually occurs within a day or two after the appearance of obvious signs of illness, and death is often preceded by convulsions. Subacute is characterized by thrombocytopenia, leucopenia, and numerous hemorrhagic lesions.

High fever and varying degrees of depression and lethargy are observed during the acute phase, but some pigs continue to eat; the case-fatality rate is usually less than 5%; the fever subsides in 2 to 3 weeks; and the pigs return to full feed and grow at a normal rate. Recovered pigs have no lesions suggestive of the disease but may be viremic for several weeks. These persistently infected

pigs would pass routine antemortem inspection at slaughter and potentially infectious offal and carcass trimming could be fed unknowingly to other pigs. Chronic cases are intermittently febrile, become emaciated, and develop soft edematous swellings over limb joints and under the mandible.

Diagnosis depends on clinical signs (which are not distinguishable in the field from acute PDNS or CSF), postmortem examination (it is said that button ulcers and “turkey egg kidney” are less common rare in ASF, but this cannot and must not be relied upon), and, most important, on diagnostic tests to rule out CSF and confirm ASF. **A definitive diagnosis is only obtainable by exclusion of CSF and confirmation of ASF by laboratory testing.**

## CLINICAL PATHOLOGY

### Hematology

As in hog cholera, there is a fall in the total leukocyte count to about 40% to 50% of normal by the fourth day of fever. In particular, there is the emergence of immature cells and atypical lymphocytes in the host blood following ASF infection, but the mechanisms are as yet unknown.<sup>18</sup> There is a pronounced lymphopenia and an increase in immature neutrophils. In chronic cases there is hypergammaglobulinemia. Clotting times are increased from about 4 days postinfection. Thrombocytopenia is detectable from day 6 to 9. Serum concentrations of C-reactive proteins, serum amyloid A, and haptoglobin have been measured<sup>19</sup> and all increased significantly in pigs inoculated with either ASF or CSF. Pig major acute-phase protein and apolipoprotein correlate with the clinical course of experimental ASF infection.<sup>19</sup>

### Diagnosis

The viremia persists, as do the antibodies, for long periods of time; therefore, diagnosis is best achieved by parallel detection of antigen and antibodies.<sup>20</sup> Pen-side tests are just around the corner.

### Detection of the Virus

The safest and most commonly used techniques are PCR, direct immunofluorescence (DIF), and the hemadsorption (HA) technique, which is used in reference laboratories. DIF and HA should be used with other techniques because they both can produce false negatives.<sup>20</sup> The original PCR techniques have also been developed to include novel real-time PCR,<sup>21</sup> universal probes,<sup>22</sup> and loop amplification systems. More recently, a genotyping microarray has also been developed.<sup>26</sup>

Antigen can be detected by the fluorescent antibody technique in tonsil and submandibular lymph node within 24 to 48 hours of infection and elsewhere once generalization has occurred. The indirect fluorescence antibody and direct fluorescence

tests are commonly carried out on pooled visceral fluid samples.

## Serologic Tests

The ELISA is frequently used to screen large numbers of samples because it is easily automated, and many tests have been developed, including a recombinant that works well in poorly preserved sera.<sup>23</sup> Antibody to the virus may be detected within 7 days of infection. The ELISA is highly sensitive and specific and can be automated for screening large numbers of sera. It has been developed for a variety of ASF proteins, such as p73 or p30. More than 90% of infected pigs can be detected by the demonstration of specific antibodies against the virus. An immunoblotting assay is a highly specific and sensitive test that is easy to interpret, provides an alternative to immunofluorescence, and can be carried out in less than 90 minutes under field conditions. Complement testing is also a possibility. The inadequate storage or transport of sera may lead to samples being kept at high temperatures for long periods, and up to 20% of these may be false negatives by ELISA. All blood samples should be held at 4°C before testing and if incorrectly stored or handled should be tested by immunoblotting. A monoclonal antibody immunoperoxidase test is also useful for screening purposes.

To confirm positive or ambiguous ELISA results, immunoblotting, indirect immunofluorescence, and immuno-peroxidase techniques are used. The first two used together will confirm ASF in over 90% of infected animals.<sup>20</sup>

## NECROPSY FINDINGS

Gross changes at necropsy resemble closely those found in hog cholera, except that in the acute ASF, the lesions are more severe. The pathology varies with virulence of the virus but is essentially extensive hemorrhages and lymphoid tissue necrosis in the acute cases. In the subacute and chronic cases, the lesions may be minimal or absent. The lesions are most pronounced in the spleen, heart, lymph nodes, and kidneys. In many organs there is a hyperemia or edema, with fibrinous microthrombi. The most common gross findings are swollen and hemorrhagic gastrohepatic and renal lymph nodes, often so badly affected that they may resemble the spleen; subcapsular petechiation of the kidneys; ecchymoses of the cardiac surfaces and various serosae; and pulmonary edema with hydrothorax. There may be hemopericardium. The renal hemorrhages are considered almost pathognomonic and are a consistent lesion following inoculation of pigs with the virulent or moderately virulent virus. Splenomegaly is usual, but in contrast to hog cholera, splenic infarcts are rarely seen. There may be congestion of the liver and gall bladder and petechiae in the bladder. Hydrothorax is not unknown. There may be

congestion in the meninges, in the choroid plexuses, and on the brain. The gallbladder is edematous and hemorrhagic, but this is not a pathognomonic lesion, as sometimes thought. In chronic cases the lesions are essentially the same but also include pericarditis, interstitial pneumonia, and lymphadenitis. There is severe submucosal congestion in the colon, although button ulcers in the large intestine are less common than in hog cholera.

It is said that button ulcers and “turkey egg kidney” are less common but this must not be relied upon.

Histologically, the lesions are more diagnostic. The virus causes destruction of the mononuclear phagocyte system and then infects megakaryocytes, tonsillar crypt cells, renal cells, hepatocytes, and endothelial cells. Postcapillary venules undergo hyalinization and endothelial swelling. Destruction of monocytes/macrophages is visible in the lymph nodes, the spleen, and the bone marrow. In the liver, there is extensive destruction of hepatocytes. Marked karyorrhexis of lymphocytes is visible in both normal lymphoid tissues and in the infiltrating population of cells within parenchymatous organs. Encephalitis may be present with lymphoid infiltration of the leptomeninges, but is generally less severe than that of hog cholera. In recovered animals the presence of virus and antibody simultaneously (persistent infection) can cause the formation of immune glomerulonephritis.

Diagnosis depends on laboratory diagnosis because it cannot be determined on clinical signs and pathology.

As for hog cholera, the diagnostic testing to confirm ASF tends to be restricted to specialized laboratories.

### Samples for Confirmation of Diagnosis

Samples can be collected on filter papers to detect antigen and antibody,<sup>20</sup> and oral fluids have also been used to detect antibody.<sup>24</sup>

- Histology—formalin-fixed spleen, lung, lymph nodes, kidney, liver, colon, cecum, brain (light microscopy).

The virus can be detected by immunohistochemistry, particularly in the tonsil,<sup>25</sup> or ISH.

- Virology—spleen, kidney, submandibular and abdominal lymph nodes, tonsil, and bone marrow should be collected for fluorescence antibody test and PCR. Direct immunofluorescence and hemadsorption are reliable, as are a range of PCR tests, including a TaqMan. A PCR has also been developed that can be used on a blood sample on filter paper and also a plaque assay. The PCR developed using the p72 protein will enable detection of ASF within 5 hours

of clinical sample submission and full characterization of the virus within 48 hours. A new RT-PCR using the universal probe library has been described.<sup>22</sup>

### SEROLOGY

The immunity to ASF is unknown. Surviving animals are persistently infected, and viremia persists in spite of high levels of antibody as a result of high levels of incomplete antibody. Antibodies first appear after 10 days. Most of the virus is bound to erythrocytes. There is an absence of neutralizing antibodies and a huge variation in viruses. Cell-mediated immunity may be important in the immune response to ASF and in the protection against reinfection. The serologic responses have been described.<sup>28</sup>

The presence of anti-ASF antibodies is indicative of infection because a vaccine is not available. ELISA is the most useful method for large-scale investigation of outbreaks, and the new methods are not affected by the quality of the samples.<sup>23,29</sup>

### DIFFERENTIAL DIAGNOSIS

The disease is easily confused with hog cholera, and very careful examination is required to differentiate the two. Clinically, the illness is much shorter (2 days versus 7 days) than in hog cholera. Gross necropsy changes are similar to but more severe than those of hog cholera. The marked karyorrhexis of lymphocytes characteristic of African swine fever (ASF) is not observed in hog cholera. Differential diagnosis must rely on laboratory testing. In the past, differentiation has been achieved by the challenge of hog cholera-susceptible and immune pigs with suspect material. More recently, reliance has been placed on the demonstration of hemadsorbing activity with virus from suspected outbreaks grown on pig leukocyte tissue cultures. But hemadsorbing activity may be weak, delayed, or even absent, and there is sometimes difficulty in isolating virus from subacute or chronic cases in enzootic areas. Demonstration of antigen by fluorescent antibody staining will allow diagnosis of acute cases. For chronic cases, serologic testing has been recommended, and with the use of more than one test a high degree of accuracy can be achieved. Several sensitive laboratory tests for detection of the virus in tissues and serum antibody are now available. Enzyme-linked immunosorbent assay (ELISA) tests are highly sensitive. Radioimmunoassay tests are also sensitive, and isolates of the virus may be titrated in swine monocyte cultures using a microtechnique. In the lymphocyte response test to virus infection, there is a cytolytic effect on the lymphocytes; the effect is greater on the B-lymphocytes than on the T-lymphocytes. Pigs with demonstrable antibody should be considered as chronic carriers of the virus because it is doubtful that true recovery ever occurs.

### TREATMENT

There is no treatment for ASF.

### CONTROL

Immediately restrict pig movements. There is no vaccine for ASF as yet, but ASF has been eradicated before from countries without the use of a vaccine.

Slaughter affected pigs and their ticks as quickly as possible.

The control and eradication of ASF is difficult because of the following factors:

- Lack of an effective vaccine
- Transmission of the virus in fresh meat and cured pork products
- Recognition of persistent infection in some pigs, particularly wild feral pigs, and possibly warthogs and bush pigs
- Clinical similarity of hog cholera and African swine fever
- Recognition that in some parts of the world soft ticks of the genus *Ornithodoros* (*erraticus*, *moubata*, *porcinus* *porcinus*) are involved in the biological transmission of the disease and can remain carriers for long periods (possibly 5 years)

Prevention of introduction of the disease to free countries is based on the prohibition of importation of live pigs or pig products from countries where African swine fever occurs. Strict application of the prohibition has prevented the spread of the disease from enzootic areas within South Africa. If a breakdown does occur, control must consist of prevention of spread by quarantine, slaughter of infected and in-contact animals, and suitable hygienic precautions. The need for close contact between pigs for the disease to spread and the ease with which this can be prevented by the erection of pig-proof fences facilitate control. Conversely, the disease is virtually uncontrollable when pigs from a number of farms have access to communal grazing. The virus is highly resistant to external influences, including chemical agents, and the most practical disinfectant to use against the virus is a strong solution of caustic soda. Contaminated sites can remain infective for periods exceeding 3 months. These factors and the persistence of the virus in recovered pigs probably contributed to the difficulties encountered in the eradication program in Portugal, where the disease was stamped out but reappeared in 1960. However, the most important factor appears to have been the indiscriminate use of attenuated vaccines, which fostered the development of carrier pigs. In this outbreak, very little was seen in the form of clinical signs.

In Spain in 1985, a comprehensive nationally coordinated program for the eradication of the disease was begun, and substantial progress had been made. Before 1985, the only method of control of the disease in Spain was depopulation of herds with clinical disease. The current eradication program consists of the following:

- Depopulation of herds with clinical disease
- Serologic surveillance of all sows and boars in every herd
- Improvement of sanitary conditions of housing
- Improved hygiene (safe disposal of manure, vehicle disinfection, insect and rodent extermination)
- Veterinary control of all swine livestock transfers (with individual identification of every animal moved for finishing or breeding purposes)
- Health certification of every animal used for herd replacement
- Destruction of every seropositive animal
- Formation of mobile veterinary field teams exclusively dedicated to support the program

Following introduction of this program, it has been possible to divide Spain into a disease-free region (the criteria is a minimum of 2 years without the disease) and an infected region. Eradication of the disease in Spain occurred by 2001. In 1991 the Spanish government claimed that 96% of the Spanish territory was free of ASF. The calculated benefit–cost ratio is estimated to vary from 1.23 to 1.47, depending on the intensity of the program. A reduction in the funding for control would result in a benefit–cost ratio of 0.97, making the program unprofitable.

It has been shown that the use of chemical disinfectants containing at least 2% citric acid for porous surfaces is effective in removing ASF<sup>30</sup> and foot and mouth disease (FMD), whereas 2000 ppm of sodium hypochlorite will disinfect ASF but not FMD.

In a study of the risk factors for ASF in major pig-producing areas in Nigeria 1997 to 2011,<sup>31</sup> it was found that the presence of an infected pig farm in the same area and an abattoir will increase the likelihood of ASF infection of farms. Vermin and birds are also a risk. Strict food and water control, immediate separation (isolation) of sick pigs from healthy pigs, and the washing and/or disinfection of farm equipment will assist in reducing the chance of infection. Region-based control and farm-based biosecurity will help control ASF in Nigeria. Biosecurity is the likely key to successful control in Africa.<sup>2</sup>

### Vaccines

The prospects for the development of vaccines have been discussed,<sup>32</sup> and the key factor is that knowledge of the antigens that encode the dominant protective epitopes recognized by CD8+ T cells is lacking at present.

It is difficult to make a vaccine because of the large size of the virus and the many proteins in the genome. Many of these alter the immune response.<sup>20</sup> It is also variable. The host response to the virus is very complex, with only partial protection produced by neutralizing antibodies.<sup>33</sup> Several different

vaccines have been used, including an ineffective inactivated-virus vaccine and modified live-virus vaccines.<sup>34</sup> The modified live-virus vaccines provide some protection, but the results following their use have been neither satisfactory nor safe, and they have the two disadvantages of confounding laboratory tests and producing “carrier” pigs. The cell-mediated immunity component is very important.<sup>27</sup> The administration of individual recombinants proteins and/or DNA only gives partial protection.<sup>32</sup>

### FURTHER READING

- Blome S, et al. Pathogenesis of African swine fever in domestic pigs and European wild boar. *Virus Res.* 2013;173:122-130.
- Burrage TC. African swine fever virus infection in *Ornithodoros* ticks. *Virus Res.* 2013;173:31-139.
- Costard S, et al. Epidemiology of African swine fever virus. *Virus Res.* 2013;173:191-197.
- De Leon P, et al. Laboratory methods to study African swine fever. *Virus Res.* 2013;173:168-179.
- Dixon LK, et al. Prospects for development of African swine fever virus vaccines. *Dev Biol.* 2013;135:147.
- Oura CAL, Arias M. African swine fever. In: *Manual of Diagnostic Tests and Vaccines for Terrestrial Animals*. Vol. 2. 6th ed. Paris: OIE; 2008:1069-1082.
- Penrith ML, Vosloo WJS. Review of African swine fever: transmission, spread and control. *J South Afric Vet Assoc.* 2009;80:58-62.
- Sanchez-Vizcaino JM, Mur L. African swine fever diagnosis update. *Transbound Emerg Dis.* 2013;135:159.

### REFERENCES

1. Oura C. *Vet Rec.* 2013;doi:10.1136/vr.f5327.
2. Fasina FO, et al. *Transbound Emerg Dis.* 2012;59:244.
3. De Villier EP, et al. *Virology.* 2010;400:128.
4. Boshoff CI, et al. *Vet Microbiol.* 2007;121:45.
5. Rowlands RJ, et al. *Emerg Infect Dis.* 2008;14:1870.
6. Gogin A, et al. *Virus Res.* 2013;178:198.
7. Oganesyan AS, et al. *Virus Res.* 2013;173:204.
8. Gulenkin VM, et al. *Prev Vet Med.* 2011;102:167.
9. Nigsch A, et al. *Prev Vet Med.* 2013;108:262.
10. Mur L, et al. *BMC Vet Res.* 2012;8:149.
11. Mur L, et al. *Transbound Emerg Dis.* 2011;59:134.
12. Diaz AV, et al. *Emerg Infect Dis.* 2012;18:1026.
13. Sanchez-Vizcaino JM, et al. *Transbound Emerg Dis.* 2012;59(suppl 1):27.
14. Jori E, Bastos ADS. *Ecohealth.* 2010;6:296.
15. Basto AP, et al. *J Gen Virol.* 2006;87:1863.
16. de Carvalho Ferreira HC, et al. *Vet Microbiol.* 2012;160:327.
17. Karalyan Z, et al. *BMC Vet Res.* 2012;8:18.
18. Sanchez-Cordon PJ, et al. *Am J Vet Res.* 2007;68:772.
19. Fernandez de Marco F, et al. *Res Vet Sci.* 2007;83:198.
20. Fernandez-Pinero J, et al. *Transbound Emerg Dis.* 2013;60:48.
21. Reis AL, et al. *J Gen Virol.* 2007;88:2426.
22. Gallardo C, et al. *Virus Genes.* 2009;38:89.
23. Krug PW, et al. *Vet Microbiol.* 2012;156:96.
24. Fasina FO, et al. *Prev Vet Med.* 2012;107:65.
25. Escribano JM, et al. *Virus Res.* 2013;173:101.
26. King DP, et al. *Vaccine.* 2012;29:593.
27. Takamatsu HH, et al. *Virus Res.* 2013;173:110.
28. Dixon LK, et al. *Dev Biol.* 2013;135:147.
29. Gabriel C, et al. *Emerg Infect Dis.* 2011;17:2342.
30. Sanchez-Vizcaino JM, Mur L. *Transbound Emerg Dis.* 2013;135:150.
31. Tignon M, et al. *J Virol Methods.* 2011;178:161.
32. Fernandez-Pinero J, et al. *Transbound Emerg Dis.* 2012;doi:10.1111/j.1865-1682.
33. Boshoff CI, et al. *Vet Microbiol.* 2007;121:45.
34. Gallardo C, et al. *Clin Vaccine Immunol.* 2009;16:1012.

## PORCINE CIRCOVIRUS-ASSOCIATED DISEASE

Originally, the condition associated with porcine circovirus type 2 (PCV2) was called *postweaning multisystemic wasting syndrome* (PMWS), but we now know that PCV2 is associated with a wider spectrum of conditions now referred to as porcine circovirus associated disease (PCVAD). PCV1 was known for some time beforehand in tissue culture but has always been considered nonpathogenic. Infection with PCV2 is necessary for PMWS to develop, but one or more cofactors are necessary to facilitate this.<sup>1</sup>

The other diseases in PCVAD include porcine dermatitis and nephropathy syndrome (PDNS), reproductive disorders, enteritis, proliferative and necrotizing pneumonia, and the porcine respiratory disease complex (PRDC). Only once has congenital tremor been linked to PCV2, so it is no longer regarded as a PCVAD.<sup>2</sup>

Two initial features of the disease are the effects on the lymph nodes of the pig and the lack of response of the condition to antibiotic therapy.<sup>3</sup>

Very simply, the disease occurs where there is a high serum viral load (compared with nonaffected pigs) and where there is a lack of neutralizing antibody. In other words, if there is a successful immune response, it limits PCV2 replication and avoids clinical disease.

PCV2 is one of the three viral diseases that destabilize the enzootic bacterial diseases in a herd.<sup>1</sup> It is a cause of considerable economic loss.

### ETIOLOGY

Circoviruses are relatively new, probably having existing for only around 500 years.<sup>4</sup> PCV has the highest mutation rate reported for any DNA virus and approaches the higher rate of genetic change seen usually in RNA viruses.<sup>5</sup> PCV2 belongs to the genus *Circovirus* of the *Circoviridae* family (includes PCV1) and is described as the prime causative agent of PMWS.<sup>6</sup>

Porcine circoviruses are small but powerful,<sup>7</sup> and PCV1 and PCV2 have similar genomic organization, with two ambisense open reading frames (ORFs) flanking the origin of replication.<sup>7</sup>

PCV2 has been retrospectively identified by serology in swine populations as an asymptomatic infection at least 25 years before the first case of PMWS, and a recent study of the genome showed that the archival PCV2 was avirulent, as is the new PCV2, as a result of mutational events within a



sequence of nine base nucleotides in the nucleocapsid gene of PCV2.<sup>8</sup>

The experimental reproduction of the disease and its occurrence under field conditions are usually associated with a number of risk or triggering factors.<sup>9</sup> It has been suggested that PCV2 is a necessary but not sufficient cause of the condition of PMWS.<sup>1</sup>

A novel porcine circovirus-like agent P1, also associated with wasting disease, has been isolated with 896 nucleotides.<sup>10,11</sup> No single viral cofactor has yet been identified.<sup>12</sup> Different isolates may vary in virulence,<sup>13</sup> but PMWS has been produced in gnotobiotic pigs following exposure to various amounts of PCV2a and PCV2b<sup>14</sup> without the presence of any detectable infectious cofactors.

There are two subtypes, 2a and 2b, with sequence differences mostly found in the capsid region,<sup>15,16</sup> and the antigenic profiles are not identical.<sup>15-19</sup>

The current classification scheme for grouping viruses is complicated by genetic recombination.<sup>20-23</sup>

## GENOME STUDIES

The viruses are the smallest known mammalian viruses. The details of the genome and the virus proteins produced have been described.<sup>7</sup> The PCV2 genome is a circular, single-stranded DNA with a size of 1766 to 1768 nucleotides that contains three major ORFs.<sup>19</sup>

ORF1 encodes the replicase proteins *rep* and *rep'* involved in virus replication. They bind to specific sequences within the origin of replication located in the 5' intergenic region, and both are essential for viral replication.<sup>24-26</sup>

ORF2 encodes the viral capsid (*cap*) protein, which has the ability to bind to the host cell receptor.<sup>19,27,28</sup>

ORF3 encodes a protein that is involved in PCV2 apoptosis,<sup>29,30</sup> and in vitro ORF3 is found within ORF1. The ORF3 proteins of both PCV1 and PCV2 induce apoptotic cell death<sup>31</sup> and code for a 105 amino acid protein that causes apoptosis of PCV2 infected cells<sup>32</sup> but is dispensable for virus infection.<sup>33</sup>

An ORF4 has also been detected in PCV2 productive infection.<sup>34</sup> It is not essential for PCV2 replication but plays a role in the suppression of caspase activity and regulating CD4+ and CD8+ T-lymphocytes during PCV2 replication.

The signature motif<sup>25</sup> discriminating between 2a and 2b lies within the virus capsid protein, which often contains virus pathogenicity characteristics. There are several genotyping studies.<sup>16,29,35-37</sup>

Genetic variation and newly emerging genotypes in China have been described,<sup>38</sup> and 19 isolates were identified in three genotypes, 2a, 2b, and 2d. PCV2d was a new genotype for China, and PCV2b had become the predominant genotype. The subtypes described in Asia (2d and 2e)<sup>39,40</sup> may belong to the previously described groups (a, b, or c), depending on classification interpretation.<sup>41</sup>

In a recent study, the complete genome sequence of a novel PCV2b variant was described in cases of vaccine failure in animals with PMWS,<sup>42</sup> and this was similar to the reported Chinese PCV2d strain.

A new natural PCV2 virus with a very low incidence was identified in Quebec in September 2008, in which it was found that the virus contained the ORF1 of PCV1 and ORF2 of PCV2a; using the nomenclature of Segales et al.,<sup>65</sup> it was decided to call this virus PCV1/2a.<sup>43</sup>

It is to be noted that very small differences in the amino acid sequence may result in major changes in the pathogenicity of the virus.<sup>13</sup>

## TRANSCRIPTION

Little is known about the cellular events triggered by infection with PCV2 in PMWS. Several porcine genes were found to be up-regulated in lymph nodes and also in PK-15 cells. At least five have been identified.<sup>7</sup> It has recently been shown that PCV2 induces the activation of NF- $\kappa$ B by phosphorylation and degradation and subsequent translocation of NF- $\kappa$ B p65 from the cytoplasm to the nucleus. Many of the events point to intracellular signaling and endocytic pathways.<sup>7</sup>

## EMBRYO INFECTIVITY

Embryonic cells are susceptible to infection but not while in the zona pellucida. Extensive replication in embryos leads to death and resorption in utero.<sup>44</sup> In fetuses of 40 to 70 days of gestation the virus replicates mainly in the heart, followed by the liver, lymphoid tissue, and lungs;<sup>45</sup> with increasing age of the fetus, the replication decreases. After birth, replication is mainly in the lymphoblasts and the monocytes.<sup>46</sup>

## VIRUS IMPORT

Internalization is slow and inefficient via endocytosis. Clathrin-mediated endocytosis also plays a part. No substantial replication was found in lymphoid cells but rather in endothelial cells particularly aortic endothelial cells, gut epithelial cells, and fibrocytes<sup>47</sup> by an increase in Cap and Rep proteins. The glycosaminoglycans heparin, heparin sulfate, chondroitin sulfate A, and keratin sulfate serve as attachment receptors.<sup>28</sup> After internalization, PCV2 is localized in endosomes.<sup>48</sup> A dynamin- and cholesterol-independent, but actin- and small GTPase-dependent pathway allows PCV2 internalization in epithelial cells that leads to infection, and clathrin-mediated PCV2 internalization in epithelial cells is not followed by a full replication.<sup>49</sup> Disassembly involves serine proteases.<sup>48</sup>

## REPLICATION

Upon infection, in step 1 the viral ssDNA genome is converted by host cell factors into a dsDNA replicate form that serves

as a template. Further complex processes occur,<sup>26,50,51</sup> and only *Rep* and *Rep'* are essential for viral replication in mammalian cells.<sup>24</sup> PCV2 replication is impaired by inhibition of the extracellular signal-regulated kinase (ERK) signaling pathway,<sup>52</sup> which indicates that it is involved in PCV2 infection and beneficial to PCV2 replication in cultured cells.

Six cellular proteins were found to react with *cap* and three with *rep* in a study of the interactions of the replication proteins and the capsid protein of PCV1 and PCV2 with host proteins.<sup>53</sup> It appears that only the *rep*, *rep'*, and *cap* genes are responsible for replication. It has been proposed that PCV replicates by means of a rolling-circle melting-pot mechanism.<sup>24</sup> The *rep* and *cap* genes are oriented in the opposite direction, resulting in an ambisense genome organization. An intergenic region between the 5' ends of the *rep* and *cap* genes forms a stem-loop structure containing the origin of virus replication and the replication factors between PCV1 and PCV2. Replacement of the replication factors of PCV2 with those of PCV1 greatly enhances the viral replication in vitro.<sup>54</sup> Reactive oxygen species regulate the replication of PCV2 via a NF- $\kappa$ B pathway.<sup>55</sup>

Viral replication is enhanced by stimulation by mitogens (Con A or pokeweed mitogen) but does not depend strictly on whether a cell is in mitosis.<sup>56</sup> Monocyte-derived dendritic cells enhance cell proliferation and PCV2 replication in concanavalin A-stimulated swine peripheral blood lymphocytes in vitro.<sup>57</sup>

A recent study has shown that ORF1-dependent but not ORF2-dependent differences are important for in vitro replication of PCV2 in porcine alveolar macrophages singularly or coinfecting with PRRSV.<sup>58</sup> The PCV2 ISRE sequence not only plays a role in the whole viral genome in vivo and in vitro but also works in the Rep promoter. It plays a significant role in the viral replication efficiency and regulation of IFN- $\alpha$ -mediated PCV2 replication in PK-15 cells.<sup>59</sup> PCV2 could trigger autophagosome formation and enhance autophagic flux in PK-15 cells and thereby increase replication.<sup>60,61</sup> PCV2 replicates in lymphoblastoid cells, and viral infection could result in the lysis of infected cells.<sup>62</sup>

## GENOTYPES

Early studies focused on differences in genotype,<sup>16,29,63,64</sup> and further studies have led to the naming of the two major genotypes, PCV2a and PCV2b.<sup>65</sup> Since then, a new genotype has been added, and the three PCV2 genotypes have been designated PCV2a, PCV2b, and PCV2c.<sup>41,65</sup> In this system, the ORF2 sequences are assigned to different genotypes when the genetic difference between them is at least 0.035.<sup>65</sup>

PCV2a is divided into five clusters (2A to 2E), whereas PCV2b is divided into three

clusters (1A to 1C).<sup>16</sup> PCV2c was identified in pigs from Denmark.<sup>66</sup>

Some countries have detected a shift from PCV2a to PCV2b on sequencing studies.<sup>66-68</sup>

An association between the genotype shift from PCV2a to PCV2b and the sudden increase of PMWS has been suggested. The genotype shift was reported from Switzerland and Denmark in 2003,<sup>66,68</sup> in Canada in 2005,<sup>69</sup> and in the United States in 2005.<sup>15</sup> In Spain, it was reported in 2011 in cases from 1985 to 2008.<sup>70</sup> In Korea, the shift occurred in 2002 or even earlier.<sup>71,72</sup> In England, there appeared to be a shift from PCV2a to PCV2b at the time as an outbreak of PMWS on a farm.<sup>73</sup> PCV2a may have been associated with non-PMWS-affected farms, and it is the switch to 2b that has been associated with the upsurge in PMWS. This may also mean that 2a is less virulent than 2b. In Australia, where PMWS has not been seen, only 2a has been reported.<sup>66</sup>

PCV2b is currently the most prevalent form of the virus in naturally occurring infections.<sup>29,66,74-77</sup>

Recombination between lineages in natural populations of PCV2 in Hong Kong and China has been shown.<sup>78</sup>

Evidence for recombination between PCV2a and PCV2b has been found.<sup>79-81</sup>

In the study from the United States, PCV2a and PCV2b were found in the tissues of the same infected pig.<sup>79</sup>

Forty strains from China were sequenced from 2004 to 2008,<sup>82</sup> and they could be grouped into four genotypes based on their genetic distances and phylogenetic trees. PCV2a, PCV2b, PCV2d, and PCV2e were found, but the Danish type PCV2c was not found. The study also showed that PCV2b had become the most common type in China. Since this study,<sup>82</sup> the existence of 2d and 2e has been discounted on the basis of classification studies.<sup>41</sup>

An emerging recombinant cluster from 2b (recombination between the 2a and 2b strains within the ORF2 gene) has been shown to be circulating in China and other Asian countries.<sup>83</sup>

Multiple strains of PCV2 have been found in the same pig in China,<sup>84</sup> and this coexistence may contribute to the development of more severe clinical signs in coinfecting pigs.

There is a high degree of heterogeneity of PCV2 within a geographic region in both domesticated and wild boar populations.<sup>85,86</sup>

During 2012, a new variant PCV2 strain designated mPCV2 was identified in the United States,<sup>42</sup> and it was found to be more virulent than the traditional 2a and 2b strains.<sup>87</sup> This mPCV2b strain appears to be present in Europe and based on limited data appears to be replacing other PCV2b strains in Southeast Asia and North America.<sup>88</sup> It also has significance in that this variant has also been found in possible vaccine failure cases.<sup>89</sup>

Dual heterologous PCV2a/2b infection induces severe disease in germ-free pigs when given 7 days apart. PCV2a or PCV2b when administered singly or in combination with keyhole limpet hemocyanin appeared to be of equal virulence.<sup>90</sup> Gross lesions were more severe in heterologously infected pigs than in 2b/2b infected pigs, and these were more severe than in 2a/2a infected pigs.

## EPIDEMIOLOGY

Other than the mouse,<sup>91</sup> nonporcine species are not susceptible.

PCV2 can be considered to be enzootic throughout the world and becomes epizootic when there is a significant increase in mortality.<sup>92</sup> Initially, the viruses isolated (1997–2006) were PCV2a, but there was a shift on a global scale to PCV2b, except in Korea, Japan, and Australia.<sup>66</sup> PCV2b was isolated in Korea from 2005 to 2007,<sup>93</sup> and in Japan (isolates from 2006–2007), the change from PCV2a to 2b occurred very quickly.<sup>76</sup>

In a study of 148 PCV2 isolates, 63.5% were PCV2b.<sup>16</sup> In Ireland, 5/6 isolates were PCV2a, but the other one, associated with increased mortality, was a PCV2b.<sup>74</sup> The most recent discovery of a PCV2 was probably in Australia<sup>94</sup> and was a PCV2a, but the criteria for the Australian definition of PMWS were not met,<sup>95</sup> possibly because a PCV2b has not yet been found.

Many epidemiologic studies have suggested that the shift from PCV2a to PCV2b has been associated with an increase in PMWS infections.<sup>64,66,67,69</sup>

A new emerging genotype subgroup within the PCV2b dominates the PMWS epidemiology in Switzerland.<sup>68</sup>

In North America, the shift occurred later and may have been initially in South and Latin America, and then followed importation of infected animals into North America.<sup>75,96</sup>

In a study in Canada, most of the strains were PCV2a, but PCV2b was also found, and in a few cases both types;<sup>64,97</sup> for example, one pig had both 2a and 2b in the liver.<sup>98</sup>

In a study of the prevalence of 2a and 2b in pigs with and without PMWS in Korea, it was found that there was a significant increase over time in animals with PCV2b that had and did not have PMWS.<sup>71</sup>

In the United States, the emergence of novel mutant PCV2b associated with PCVAD (PCV2b was first seen in 2005 to 2006) was described<sup>67</sup> and was found to be 99.9% identical to a mutant virus found in China.<sup>89</sup>

A similar progression from PCV2a to PCV2b has been seen in Asia, in both China<sup>39,99</sup> and in Korea.<sup>100</sup> The genetic diversity of PCV2 from pigs in Korea has been described,<sup>100</sup> and there are two main groups and four subgroups (1A, 1C, 2D, and 2E). Most cases from PMWS-affected herds were in group 1, whereas cases with no clinical signs of PCV2 infection were within group 2.

It is not just the variations in the genotype of the virus that may be related to the pathogenicity of the virus;<sup>101</sup> the dynamics of PCV2 infection in a herd are strongly influenced by management and husbandry,<sup>102</sup> with everything that favors early infection being particularly important, such as the size of the pens and cross-fostering.

## Wild Boar

It has been found in Transylvanian wild boar (in a Hungarian study), where 13.5% proved to be positive for PCV2 by RT-PCR.<sup>107</sup> It was found in wild boar in Poland<sup>108</sup> in over 70% of animals and was found to be of either 2a or 2b genotype.

PMWS has been described in wild boar in several countries, including the United States, Brazil,<sup>111</sup> Germany, Croatia,<sup>112</sup> Greece,<sup>113</sup> and Italy.<sup>114</sup>

## Prevalence

The prevalence varies considerable from country to country and survey to survey, often with results between 40% and 80%, but it may be as low as 23% in Japan<sup>103</sup> on PCV2 antigen detection or viral DNA, even though 50.45% of the farms were positive (65/129 farms). One of the other conclusions was that it may exist in several forms, including an epidemic form or a subtle endemic or sporadic form. The prevalence was 50% in Taiwan and 8% in Korea.<sup>104</sup> It has been found in 30% to 40% of archived tissue in the United Kingdom and in 10% in the United States.

In a study in the United States of 185 farms, it was found that 82% of the farms were positive for PCV2, and only 2.45% were positive for PCV1.<sup>105</sup> It was found in Cuba in 2010.<sup>106</sup>

It has also been found in 50% of animals in Spain<sup>109</sup> and in 43% in the Czech Republic.<sup>110</sup> PCV2 infections associated with PMWS are only sporadically present in the Czech Republic,<sup>115</sup> although positive serology for PCV2 was widespread. The spread of PMWS in Sweden has been described,<sup>116</sup> and the change from an exotic to endemic disease was described.

In a study of seven PCVAD-affected farms, the risk of PCVAD was increased by early PCV2 infection but significantly decreased when pigs were born to PCV2-seropositive sows.<sup>117</sup> Nonaffected animals also had higher titers earlier than piglets that developed PCVAD<sup>118</sup> and higher PCV2 viremia.<sup>119</sup>

## Environmental Survival

The virus is extremely difficult to eradicate from the environment because it has an ability to resist the environment and therefore increase its survival time.

It is resistant to pH 3.0, chloroform, and temperatures of 70°C (158°F) for 15 minutes.<sup>120-122</sup> Animals exposed to nondisinfected trailers for 2 hours became viremic

and seroconverted, but no seroconversion or viremia was found after disinfection using one of four protocols.<sup>123</sup>

It has been suggested that because of its survival in the environment, animal-to-animal contact is not necessary for its spread.<sup>124</sup>

### Transmission

Both vertical and horizontal transmission is possible. Multiple routes of transmission to piglets in the presence of maternal immunity have been described.<sup>125</sup> Piglets are regularly infected with PCV2 in utero and are under constant challenge by PCV2 through contact with infected sows and a contaminated farrowing environment. Maternal immunity did not affect PCV2 transmission to piglets or the viral load in sows. This emphasizes the importance of maternal infection in early infection in newborn piglets.

As fetuses near term, the replication of the virus takes place in the cells of the monocyte–macrophage series.

### Horizontal Transmission

It is transmitted principally by the oronasal route. The widespread distribution in the lymphatic system, respiratory system, urogenital system, and gastrointestinal system suggests that it may be present in all secretions and transudates. It is also present in colostrum,<sup>126</sup> milk, and semen.<sup>127</sup> It was found in the macrophages of the mammary ducts within 3 days.<sup>128</sup>

A study showed that the virus was shed in similar amounts by the nasal, oral, and fecal routes,<sup>118</sup> and in sows until at least 27 days,<sup>129</sup> or 209 days postfarrowing.<sup>130</sup> The maximum level of genomic load was detected at 28 days postfarrowing (5 to 7 log<sub>10</sub> genome copies/mL) and steadily decreased until 209 days postfarrowing.

In a study of five experimentally infected gnotobiotic pigs, there were between 6 and 12 log<sub>10</sub> PCV2 genome copies/mL in the serum and liver.<sup>131</sup> In one study, infectious PCV2 was detected in colostrum samples and milk samples. Anti-PCV2 IgA was found in high levels in colostrum and milk. Infectious PCV2 may be present in milk and colostrum of naturally infected sows even in the presence of neutralizing antibody.<sup>132</sup> Shedding of PCV2 in milk has been shown from experimentally infected sows.<sup>129</sup> The animals excreted from day 1 until day 27 of lactation. There is also the possibility of PCV2 replication in the mammary gland.<sup>128</sup> Antibodies in milk protect against clinical disease but not against infection. Shedding of PCV1 and PCV2 was found in whey for the first time.<sup>138</sup>

Vaccination decreases the shedding of virus in colostrum and milk.<sup>132,133</sup>

Pigs shed virus for a prolonged period following viral exposure, and growing pigs were the source of horizontal PCV2

transmission in PCV2-infected herds.<sup>134</sup> There is a high level of PCV2 DNA in colostrum, sow sera, and piglet sera.<sup>135</sup>

The intermingling of affected and healthy pigs<sup>136</sup> showed transmission by direct nose-to-nose contact, and two were infected without being in direct contact with infected animals. On-site control animals in a separate compartment did not develop clinical disease.

When pigs from affected herds were mingled with healthy pigs from unaffected herds,<sup>137</sup> it led to horizontal transmission, as did pigs being in adjacent pens but not directly in contact.

In a study of infectiousness and transmission, it was suggested that the probability of horizontal transmission was negligible after 55 days postinfection, even though there was still significant viremia.<sup>102</sup>

Transmission can occur from diseased pigs to healthy in-contacts after mingling, especially if there is very close contact.<sup>139</sup> It can be transmitted in uncooked tissue from viremic animals.<sup>140</sup> A lower infectious dose in some of these tissues (bone marrow and skeletal muscle compared with lymphoid tissue) may result in a delayed onset of infection.

Experimentally produced spray-dried plasma spiked with PCV2 was transmissible.<sup>141</sup>

Airborne transmission has also been shown in an experimental setup.<sup>142</sup> In a study of Canadian swine confinement buildings, up to 10<sup>7</sup> genomes per cubic meter of air were found. Airborne dust concentrations were correlated with airborne PCV2 and total bacterial counts.<sup>143</sup>

The verification of natural infection of peridomestic rodents by PCV2 on commercial swine farms was confirmed,<sup>144</sup> with PCV2 being found in the spleen, lung, and kidney, although transmission from rodents to pigs has not been confirmed.

PCV2b has been transmitted by house flies.<sup>145</sup> The flies in the nursery and weaner areas were most likely to be positive.

In practice, there is often a pattern of elevated antibody levels in the herd because it is a mixture of passive and active immunity<sup>130</sup> and, as a result, may maintain consistent infection dynamics in the farm.

Under field conditions, PCV2 can be recovered from mice and rats at quite high prevalence levels, and therefore there is the possibility of indirect transmission and persistence on a farm site.<sup>146</sup>

There is also the possibility that vaccines may introduce the virus. In Canada, the appearance of the PCV1/PCV2 chimera may have been associated with the use of inactivated PCV2 vaccines.<sup>147</sup>

Pigs from PMWS-affected herds had at least 10<sup>3</sup> higher mean serum titer of PCV2 compared with pigs from PMWS-free herds. Pigs that were able to control the infection (as measured by PCV2 titer in serum)

recovered clinically (from PMWS-affected herds) or stayed healthy (from unaffected herds). Pigs with titers below 5 × 10<sup>8</sup> copies/mL serum during the study period had a chance of recovery, but those above this generally died.<sup>136</sup>

### Vertical Transmission

Transplacental infection was demonstrated following the intranasal infection of sows 3 weeks before farrowing, and the virus was recovered from both aborted and live-born piglets.<sup>148</sup>

PMWS was reproduced in pigs fed colostrum and milk from PCV2-infected sows and infected postnatally with PPV or immunostimulated.<sup>149</sup> PCV2 was detected in mammary and other tissues in experimentally infected sows.<sup>128</sup>

The virus has also been demonstrated in myocarditis in aborted fetuses and still-born piglets.<sup>150</sup> In earlier experiments, the cardiomyocytes of the fetus were found to be the main target of PCV2.

In a study in Poland, the heart of the fetus contained the highest amounts of virus and the highest number of antigen positive cells. The myocardium was full of hypertrophic cells and showed multiple and irregular pale areas that corresponded to histologic lesions of necrosis.<sup>151</sup>

Boars show excretion of PCV2 virus in semen (with no differences between 2a and 2b) continuously until at least 50 days after inoculation of the boars.<sup>152</sup> The virus has been shown to be excreted in the semen of boars with serum antibodies.<sup>153</sup>

Naïve sows inseminated with PCV2 spiked semen exhibited reproductive failure, and their fetuses were infected.<sup>154</sup> The mummified fetuses died between 42 and 105 days of gestation.

PCV2-seropositive gilts can be infected with PCV2 after intrauterine exposure, and low maternal antibody may increase the probability of a fetal infection.<sup>155</sup>

PCV2 viremic sows had a higher number of exposed fetuses compared with nonviremic sows, which means that PCV2 can cross the placenta and cause fetal damage. Sows with low antibody titers had greater mortality in their piglets than those with higher levels.<sup>119</sup>

In a study of porcine circovirus viremia in newborn piglets in five clinically normal swine breeding units in North America, it was found that all sow colostrum samples (125/125) and 96.8% (121/125) of the sow serum samples were positive for anti-PCV2 antibodies. The overall PCV2 DNA prevalence was 47.2% (59/125) in the sow serum and 40.8% (51/125) for sows' colostrum and 39.9% in presuckle piglet serum. PCV2b was detected more frequently than PCV2a. Concurrent 2a and 2b was detected in 11.9% of the sow sera, 5.9% of the colostrum, and 15.6% of the piglet sera.<sup>135</sup> Natural exposure to PCV2 results in long-term infection, and



PCV2 is shed in similar amounts by nasal, oral, and fecal routes.<sup>130</sup> When the PCV2 viremic pigs were segregated from their dams, PCV2 DNA was detected for extended periods (81-day observation period).

Experimental PCV2 exposure results in long-term infection. PCV2 is shed in similar amounts by nasal, oral, and fecal routes and is infectious to naïve pigs.<sup>156</sup>

PCV2 has also been detected in the semen of naturally and experimentally infected boars, including seropositive animals.<sup>127,153,157</sup> The PCV2 material in semen is infectious.<sup>158</sup> The younger the boar, the more likely it is to be shedding virus in the semen.

Maternal antibodies have an effect on PCV2 shedding in vertically infected pigs.<sup>159</sup>

### Risk Factors

A cross-sectional study of 147 pig farms in the United Kingdom was undertaken from 2008 to 2009 and risk factors identified. Increased PMWS was associated with rearing growers indoors, more veterinary visits, poorly isolated hospital pens, buying replacements, and seropositivity to *M. hyopneumoniae*. Factors associated with a decreased risk were low stocking density for growers, adjusting diets at least three times between weaning and 14 weeks of age, and requiring visitors to be “pig-free” for at least 2 days.<sup>160</sup>

The spatio-temporal patterns and risks of herd breakdowns in pigs with PMWS<sup>161</sup> and closeness to another infected pig farm, large herds, and no prevention of visitors who had not been through a pig-free period were identified as being risks for infection. The affected farms were also more likely to have other infections.

There is a “litter effect,” which is mainly explained through the sow PCV2 status (viremia), in that fewer piglets died when born to nonviremic sows.<sup>119</sup>

In the individual pig, low levels of antibody at 7 weeks of age is considered a risk factor, as is being born to a seronegative sow.

Pigs with PMWS have greater amounts of PCV2 in their serum and shed larger amounts of the virus than do nonaffected pigs.<sup>136</sup>

In many ways, the risk factors are the same as for many other diseases and are listed as follows:

- Infection in the herd or vaccination
- The occurrence of type 2 strains in a country only normally having type 1 (e.g., Denmark, which used the U.S. vaccine based on ATC-2332)
- Other affected herds in the area, especially if they are close
- Purchasing large numbers of replacement gilts (>500 a year)
- A herd size of over 400 sows
- Purchase of replacement gilts
- A high prevalence of PCV2 antibodies
- PPV antibodies in the finishers
- Active PPV infection in the gilts

- On-farm semen collection and artificial insemination (AI)

Other factors include the following:

- The presence of visitors to the farm without a 3-day pig-free period before their visit is regarded as a hazard
- Large pens in the nursery and grower stages
- A high level of cross-fostering
- Early weaning less than 21 days
- Mixed ages and weights in the same airspace
- Lack of proper cleaning, disinfection, drying, and rest periods between batches—continuous flow through the nursery is a source of environmental contamination.
- Vaccination for PRRSV, *E. coli*, and separate use of PPV and *Erysipelas* vaccines may be disadvantageous.

The risk to a herd is reduced when there is a high level of biosecurity, including reducing the numbers of visitors; proper isolation and quarantine for new arrivals; use of semen from an AI station; group housing of sows during pregnancy; protective clothing on entry to the unit and showering in and out; separate sites for removal and arrival of pigs; long empty periods of rest for the buildings before restocking; proper vaccination protocols for other diseases, which also help to control concurrent infections<sup>162</sup>; sorting pigs by sex in the nursery; greater minimum weights at weaning; regular vaccinations for endemic disease and following the recommendations for use; routine anthelmintic treatments and for ectoparasites; and oxytocin during parturition, which may also help reduction of PMWS. The use of spray-dried plasma in initial rations also is helpful, and it was shown<sup>163</sup> that commercial spray-dried porcine plasma does not transmit PCV2 in weaned pigs challenged with PRRSV. On the other hand, it was shown that PCV2b in an experimental spray-dried product was not effectively inactivated by the process used.<sup>141</sup> The efficiency of the process therefore determines the likelihood of PCV2b resisting the spray drying.

Studies have found that the earlier the infection occurs, the higher the risk of PMWS, and also if the offspring are weaned early<sup>117</sup>; however, other studies<sup>118</sup> have stated there is no effect of the timing of infection on subsequent PMWS development. Colostrum-deprived piglets are more sensitive to PMWS development.<sup>164</sup> Healthy pigs had higher titers at an earlier age than piglets that subsequently developed PMWS.<sup>118</sup>

More piglets die of viremic sows and from sows with low antibody levels.<sup>119</sup>

### Occurrence

It has also been found in wild boar.<sup>86</sup> An antigen shift was shown in the wild boar from PCV2a to PCV2b. It was originally described in western Canada and has

subsequently spread to Europe,<sup>165</sup> North and South America, Australia,<sup>95</sup> and Asia, including Japan.<sup>103</sup> It was first described in Slovakia in 2009,<sup>166</sup> and this was similar to the Austrian PCV2 isolate. It was described in Israel in 2008.<sup>167</sup> In Poland, 50% of the farms in a study had PMWS, and PMWS was confirmed in all herds with over 1000 sows in the study, but the small herds with less than 100 breeding sows were free.<sup>168,172</sup>

A Romanian isolate was closely related to viruses from France and Hungary.<sup>169</sup> A Romanian isolate from wild boar was recently shown to be closely related to PCV2a and PCV2b types and to possess a high degree of sequence heterogeneity.<sup>170</sup> In Korean wild boar, the prevalence was 4.98%,<sup>171</sup> and all were type PCV2b.

The epizootic onset in Switzerland was observed in late 2003,<sup>68</sup> and before that infection with PCV2 was mainly subclinical. The epizootic was accompanied by a switch to PCV2b, but this was present in the Swiss population as far back as 1979.

Retrospective studies on the occurrence of PCV2 in Germany showed that it was first detected in a pig in 1962, with a low incidence between 1962 and 1984 and with a subsequent increase between 1985 and 1998. Associated lesions such as PMWS and PDNS were not observed before 1985, and it appears that there were no major changes in the sequence analyses over the period from 1962 to 1998, suggesting that other factors were involved in the altered virulence.<sup>173</sup>

It was found to be ubiquitous (106/108 farms had at least one positive pig) in Mexican backyard pigs.<sup>174</sup>

### Breeding

The clinical expression of PMWS under field conditions is modulated by the pig's genetic background.<sup>175</sup> Certain breeds have been shown to be more susceptible. Landrace were more susceptible than Duroc or Large Whites<sup>176</sup>; in an earlier study, Large White and Duroc were more susceptible than purebred Pietrain pigs. Sometimes, field studies suggest that the boar lines used may have an influence on the occurrence of PMWS, but other studies do not support this.

Two regions of the porcine genome may have genes that are linked to increased susceptibility.<sup>177</sup> In a study of over 16,000 piglets from 2034 sows inseminated by 13 Hungarian Landrace boars, it was found that there was a considerable difference in the proportion of the piglets with signs of PMWS, still-born piglets, and mummified piglets sired by the different boars. Rates varied from 3.06% to 15.6% for PMWS, 1.76% to 8.52% for still-borns, and 0% to 3.22% for mummies.<sup>178</sup>

### Concurrent Infections

As yet, no novel agents have been found to be associated with the triggering of PCVAD.<sup>12</sup>

Pigs infected with PCV2 and immunized with a modified live-virus CSFV vaccine

developed mild to moderate PMWS, whereas none of the pigs infected with PCV2 alone or immunized with modified live-virus CSF alone developed PMWS.<sup>179</sup>

Concurrent viral or bacterial infections often enhance the effects of PCV2 infection in terms of occurrence, severity, and duration. The effect of PCV2 on the immune system also predisposes to viral, bacterial, fungal, and metazoal infections in turn.

One of the first agents to be associated with PCV2 was PPV. It is not normally the cause of disease in piglets, but in early Canadian studies coinfection was found frequently, and the association of both had been confirmed in studies of microscopic lesions.<sup>148</sup> In cell culture, concurrent PCV2/PPV infection has been shown to decrease the ability of pulmonary macrophages to phagocytose.<sup>180</sup> Another contributor may be TNF- $\alpha$ ,<sup>181</sup> which may be produced by PPV and could promote the high levels of PCV2 typically seen in conjunction with PPV. High levels of TNF- $\alpha$  are induced by this coinfection, and the high level of proinflammatory cytokines may lead to PMWS.<sup>181</sup>

Random amplification methodologies have been used to discover new viruses, and in one study using random multiple displacement amplification (MDA) and large-scale sequencing, a unique novel porcine boca-like virus was isolated from two Swedish pigs with systemic PCVAD<sup>182</sup> (the genus *Bocavirus* of the subfamily Parvovirinae). The occurrence of this virus was confirmed in a further study,<sup>183</sup> and a PPV4 virus was also found.<sup>184</sup>

PRRSV has long been associated with PCV2 in Spain<sup>119,185,186</sup> and in Japan,<sup>103,187</sup> the United States,<sup>188</sup> the Netherlands and Canada,<sup>64</sup> and Italy.<sup>189</sup> The immunosuppression and immune-response modifications have been shown to play a part in respiratory infections, with a possible increased apoptosis.<sup>190</sup>

Swine alveolar macrophages infected with PCV2 first and then with PRRSV later or simultaneously displayed marked reductions in PRRSV antigen-containing rate, cytopathic effect, and TNF- $\alpha$  expression level. In this study,<sup>191</sup> PCV2 was easily internalized in the cytoplasm of alveolar macrophages (AMs) but caused no noticeable cell death, and PRRSV displayed a low infection rate but severe cytopathic effect and strong TNF- $\alpha$  induction in AMs. PCV2-induced IFN- $\alpha$  likely caused a reduction in the PRRSV infection rate and PRRSV-related AMs dysfunction when AMs were coinoculated with PCV2 and PRRSV simultaneously. Similar PCV2-induced IFN- $\alpha$  effects were seen in the PCV2/PRRSV group but not in the PRRSV/PCV2 group where there was also a significant induction of IFN- $\alpha$ . If pre-existing damage has been caused by PRRSV infection, it is unlikely that IFN- $\alpha$  production induced by the PCV2 will be able to stop the adverse effects of the PRRSV.

PRRSV can cause enhanced PCV2 replication, as evidenced by higher serum and tissue PCV2 loads, increased severity of the pathologic changes and clinical manifestations, and higher incidence of PCVAD.

PCV2 that was inoculated first or simultaneously with PRRSV not only hinders PRRSV replication but also reduces the PRRSV-induced adverse effects on the phagocytosis of AMs. The impaired microbicidal capability in PCV2- and/or PRRSV-inoculated groups may be attributable to the reduction in reactive oxygen groups produced. PCV2a and PCV2b would also appear to have the same effects on the reduction of killing capability of AMs.<sup>191</sup> Fas (CD95) and FasL play a major role in the induction of apoptosis. In this same study, it was shown that PCV2 could induce swine AMs to produce FasL but PRRSV could not, except when they were both present, when there was an additive effect. The increased expression of IFN- $\alpha$ , TNF- $\alpha$ , IL-8, and FasL mRNA in AMs from pigs with various infections with PCV2 and PRRSV observed<sup>191</sup> in this study may contribute to some extent to the pneumonia and bronchiolar epithelial cell damage in the lungs of PCV2- and/or PRRSV-infected pigs.

The risk of PRRSV and PCV2 coinfection was 1.85 times greater in piglets from a sow with low titers of PCV2 antibodies than in piglets from sows with medium to high titers. It was also greater in piglets from primiparous sows, PCV2-infected sows, and farms in an area of high pig density than in piglets from sows of higher parity, noninfected sows, and farms in a low-pig-density area.<sup>192</sup>

Compared with infections with PRRSV alone, combined infections with PCV2 resulted in significantly more severe macroscopic and microscopic lung lesions and a stronger anti-PRRS IgG response.<sup>193</sup> In the origin of the replication of the genome of PCV2, an interferon-stimulated response element (ISRE) was identified. During the early stages of infection, at 14 days postinoculation (PI), the mutant reduced viral replication and elicited low antibody responses. However, at 28 days PI, viremia in the infected pigs showed an upward trend, and lesion scores were more severe than with the wild-type virus. With the mutant and PRRSV the lesions were more severe than with wild-type PCV2 and PRRS. These results suggest that the ISRE element may play a part in viral pathogenesis.<sup>194</sup>

The severity of microscopic lesions and the PCV2 antigen load associated with these lesions were higher in the PRRSV-vaccinated piglets compared with those detected in the PCV2-only infected animals.<sup>195</sup>

Torque teno sus virus (TTSuV) has two main species: TTSuV1 and TTSuV2.<sup>196</sup> It is not known whether they cause disease or not,<sup>197</sup> and they were found in a higher prevalence in PCVAD-affected animals than in controls.<sup>198</sup>

A Spanish study found that TTSuV2 viral loads were related to PCVAD but not TTSuV1,<sup>198,199</sup> and a similar finding was found in Japan.<sup>200</sup> It may not exacerbate PCVAD in all instances,<sup>182,201</sup> and this was also noted in Canada<sup>64</sup> and in the United States.<sup>202</sup>

PCV2 also has a complex relationship with hepatitis E virus<sup>203,204</sup> and was found more commonly where there were lesions of hepatitis. In an experiment with gnotobiotic pigs, it was found that TTSuV1 had to be given 7 days before PCV2 challenge to produce any effects.<sup>205</sup> Tissues from systemically infected PCV2 showed widespread loads, but the higher TTSuV2 loads were in the affected animals' tissues compared with the healthy group.<sup>206</sup> A similar trio of agents has been associated with PMWS in the United Kingdom.<sup>207</sup>

There was no evidence of a relationship between hepatitis E (HEV) and PCV2 in a study in Italy from necropsied pigs.<sup>208</sup> There was an association demonstrated in Spain in sick pigs,<sup>209</sup> especially in pigs evidencing hepatitis lesions. The detection of PCV2 and HEV in the liver of aborted fetuses and from sera and feces of the dams suggests the possibility of transplacental infection and associated reproductive disorders in cases of coinfection.<sup>210</sup>

PCV2, a porcine boca-like virus, and a torque teno virus were isolated from PMWS cases. In 71% of the PMWS cases, the three viruses were found, but in 33% of the pigs, PMWS was not found.<sup>183</sup> It is possible that TTV may contribute to the development of PMWS.<sup>211</sup>

There is probably an influence of transplacental PCV2 infection on neonatal diarrhea associated with an epidemic diarrhea virus.<sup>212,213</sup> In a study of transplacental PCV2 infection on porcine epidemic diarrhea virus-induced enteritis in preweaning piglets,<sup>213</sup> it was found that the mean villous height and crypt depth ratio in PEDV-infected piglets from PCV2-infected sows were significantly different from those of PEDV-infected piglets from PCV2-negative sows. It is concluded that the clinical course of PEDV disease was markedly affected by transplacental infection with PCV2.

It has also been associated with Aujeszky's virus (before 2006), but a study recently showed that subclinical PCV2 does not modulate the immune response to an Aujeszky's disease virus vaccine<sup>214</sup> or porcine Teschovirus in Japan.<sup>200</sup>

Swine influenza can frequently be identified with PCV2 in the field,<sup>188</sup> but experimentally, SIV did not increase the severity of clinical disease or gross or microscopic lesions.<sup>215</sup>

Experimental coinfection with bovine viral diarrhea virus (BVD) type 1 and PCV2 suggested that ruminant pestivirus and/or vaccination with BVD might have a role in the development of PCVAD.<sup>216</sup>

In a study in the United Kingdom, one of the identified factors associated with increased PCVAD was *M. hyopneumoniae* (MH) infection,<sup>160</sup> which also occurs in the United States.<sup>188</sup> The mycoplasma probably potentiates the severity of PCV2-associated lung and lymphoid lesions by increasing the amount and the duration of the PCV2 antigen. Recently, experiments with MH have shown that the MH potentiated PCV2 infection by increasing IFN- $\gamma$  and IL-10 mRNA expression levels,<sup>217-219</sup> which suggests that the severity of the lesions in dual-infected pigs is associated with PCV2 antigen and alterations of cytokine expression. Overall, MH potentiated PCV2 infection by increasing IFN- $\gamma$  and IL-10 mRNA expression levels. *Mycoplasma* infection or vaccination does increase the incidence of PMWS.<sup>220</sup> Simultaneous PCV2 and *M. hyorhinis* coinoculation does not potentiate disease in conventional pigs.<sup>221</sup>

There is often an association between PCV2 and *M. hyorhinis* in healthy pigs and pigs with pneumonia, with *M. hyorhinis* being detected more frequently than MH.<sup>222,223</sup> Pigs with the dual infection naturally show respiratory disease and microscopic lesions and clinical signs suggestive of PCV2 infection,<sup>224</sup> and PCV2 vaccination reduces considerably the number of coinfections with *M. hyorhinis*.<sup>225</sup>

In a study of the presence of endemic pig diseases in England, it was found that there was a significant association of *A. pleuropneumoniae* antibodies with the presence of a positive PCR for PCV2 in weaners.<sup>226</sup>

An association between *M. hyorhinis* and PCV2 was also noticed in Canada<sup>64</sup> and in Japan<sup>103</sup> and between *M. suis* and PCV2 in Argentina.<sup>227</sup>

In a study of PMWS in Korea, it was found that the most common lesions were multifocal, granulomatous inflammation in the lymph nodes, liver, and spleen characterized by infiltration of epithelioid macrophages and multinucleated giant cells. In 85% of pigs there was a dual infection, and a combination with *H. parasuis* was the most common combination.

With *Salmonella* it is likely that prior exposure to PCV2 may increase the clinical effects of salmonellosis in the field.<sup>463</sup> In a study in Japan, it was found that prior PCV2 infection potentiated the severity of clinical signs, lung lesions, and fecal shedding and tissue dissemination of *S. Choleraesuis* in infected pigs. *Salmonella* Choleraesuis was implicated in PMWS in Japan.<sup>228</sup>

Bacterial lipopolysaccharide has been shown to induce PCV2 replication in swine alveolar macrophages.<sup>229</sup>

Experimental reproduction of PCV2-associated enteritis in pigs infected with PCV2 alone or concurrently with *Lawsonia intracellularis* (LI) or *Salmonella* Typhimurium<sup>230</sup> showed that PCV2 could

induce enteritis independently from other enteric pathogens. A study of low growth rate in grower-finishing pigs was examined for associations between *Lawsonia* and PCV2. Gross lesions in the small intestine and an LI load were significant risk factors for low growth, but no association with PCV2 was found.<sup>231</sup>

*Aspergillus* and *Cryptosporidium* had been found before 2003. *Pneumocystis carinii* is commonly found with PCV2 in Brazilian pigs<sup>232</sup> and in wild boar.<sup>233,234</sup>

*Candida albicans* in Brazil and *Zygomycetes* spp. were found in Hungary.<sup>235</sup> Toxoplasmosis was diagnosed in a fattening pig with PCV2 infection<sup>236</sup> using immunohistochemistry. Either PCV2 may have triggered systemic toxoplasmosis, or *T. gondii* may have caused extensive replication of PCV2.

Recently, a case of fatal bronchopneumonia was found with *Metastrongylus elongatus* in a PCV2-infected pig,<sup>237</sup> and it is suggested that a concurrent PVCAD condition may trigger metastrongylosis.

A pie chart<sup>92</sup> from earlier data on the existence of coinfections suggested that PCV2 was found in 1% of cases. A joint infection with SIV was found in 4% of cases, bacterial pneumonia in 6%, bacterial septicemia in 10%, PPV in 11%, *M. hyopneumoniae* in 27%, and PRRSV in 41%.

## PATHOGENESIS

Pathogenicity was reported to be a function of the individual properties of an isolate and not related to genotype.<sup>238</sup> In one study, tissues from diseased pigs showed infection with both PCV2a and PCV2b, but those with subclinical infection had either PCV2a or PCV2b.<sup>239</sup>

In all cases of PMWS, the common factor is PCV2, but the discussion on the other factors continues. Although PCV2 alone is not sufficient to produce the full spectrum of disease, none of the other currently recognized "trigger factors" is considered essential on its own.<sup>164</sup> These include changes in husbandry on the farm, immuno-stimulation by vaccination strategies, and the occurrence of other primary and secondary agents or new agents.<sup>6</sup>

The most pivotal step in the pathogenesis of PMWS associated with PCV2 is activation of the immune system. This may lead to increased lymphoid depletion in swine cells in both PCV2- and PRRSV/PCV2-infected swine cells.<sup>190</sup>

In a study of inguinal lymph nodes, PCV2, PRRSV, and PPV had their own contributions to the development of lymphoid lesions in PMWS, with PCV2 as the main causative agent. B-lymphocyte depletion and macrophage proliferation/infiltration are two hallmarks of PCV2-associated lymphoid lesions. Apart from blood recruitment, local T-cell and macrophage proliferation may play a part in the granulomatous inflammation. Apoptosis is an apparent feature in

association with lymphoid depletion. The higher apoptotic rate and the PCV2 load in the germinal center and a higher apoptotic rate but lower PCV2 load in the interfollicular region suggest that there may be a direct cell injury to B cells by PCV2 infection; associated lymphoid lesions may develop through the combination of several different mechanisms with the help of coinfecting viruses.<sup>240</sup> It is possible that lymphoid depletion in PMWS is attributable to a combination of apoptosis, viral induced lysis, destruction of lymphoid architecture, and other unknown mechanisms.

PCV2 is most frequently associated with monocytes, macrophages, and dendritic cells (DCs). These cells may accumulate viral antigen for long periods and therefore may play a role in persistence.<sup>241</sup> It appears not to affect the DCs or interfere with their relationships with lymphocytes and is not transmitted to the lymphocytes, which do carry antigen or viral nucleic acid for a short period.<sup>242</sup> It may be that these cells are not sites of replication but have phagocytosed or endocytosed PCV2 antigen.<sup>47,243</sup> The asymptomatic piglet does produce antibodies and cytotoxic responses, so lymphocyte communication is not affected.<sup>244</sup>

The most characteristic pathologic features of PMWS are lymphocyte depletion and granulomatous infiltration of lymphoid tissues. PCV2 alone induces cell proliferation, cell fusion, and chemokine expression in swine monocytic cells in vitro<sup>245</sup> and therefore may be capable of causing granulomatous inflammation unaided by other pathogens. There is a subcellular immunolocalization of PCV2 in lymph nodes from pigs with PMWS. PCV2 has been detected exclusively in histiocytes. The endoplasmic reticulum was dilated, and the mitochondria were swollen, associated with PCV2-labeled intracytoplasmic inclusions with recognizable virions.<sup>246</sup> There is a close relationship between the PCV2 and the mitochondria, which may suggest that the mitochondria may be involved in replication. It is likely that lymphocyte cell populations support the initial PCV2 replication.<sup>247</sup>

PCV2 induces apoptosis both in vitro and in vivo.<sup>248-251</sup> PCV2-induced apoptosis involves activating both the caspase-8 and caspase-3 pathways and a variety of other pathways and factors.<sup>252-255</sup> The regulatory role of ASK 1 in PCV2-induced apoptosis has been described.<sup>256</sup>

Apoptosis is increased following PCV2 infection under certain stimulation conditions, and the rate of replication increases with the cell stimulation. This same study suggests that there may be a specific stimulation or trigger for increased viral replication that is independent of cell proliferation.<sup>257</sup>

PCV2a and PCV2b coinfection administered 35 days apart is not sufficient to induce clinical disease. Experimental infection of conventional SPF pigs with PCV2 results in



persistent viral infection despite the presence of high levels of PCV2 antibodies without the presence of clinical disease.<sup>258</sup>

PCV2 induces a procoagulant state in naturally infected swine and in cultured epithelial cells.<sup>259</sup>

In some studies, vascular disorders have been highlighted. Animals in Brazil were found to have blood hypercoagulation, petechiae, and vasculitis associated with lymph node atrophy and organ failure. Widespread petechiae have also been reported in kidneys.<sup>249</sup> The presence of PCV2 antigen has been revealed in lymphatics and blood vessels with severe degeneration of the endothelial cells of the blood vessel thrombi and vasculitis associated with organ necrosis and ischemia.<sup>260</sup> In another study, the activation of the hemostatic system was highlighted, with PCV2 being shown to modulate the swine hemostasis.<sup>259</sup> Plasma coagulation times were diminished, which points to the activation of coagulation systems in PCV2-affected animals. Fibrinogen was lower in the PCV2 group, and fibrinogen was found in the brain vasculature.<sup>261</sup> PCV2-affected animals had lower platelet counts. The platelet function was 40% higher in the PCV2-affected animals, and this implies a likely prothrombotic state. Thrombin plasma activity was also increased. The occurrence of PCV2 antigen in the vascular endothelium and the procoagulant state suggests an activation of the endothelium.<sup>262</sup> In one study,<sup>259</sup> PCV2-infected cells had higher viral loads. How PCV2 causes lymphadenopathy has yet to be elucidated.

### Host-Virus Interactions

Because of its very small size, PCV2 relies entirely on the host for completing its life cycle. Several porcine proteins have been identified.<sup>53,261,263</sup>

### Cytokine Studies

Immune gene expression profiles in swine inguinal lymph nodes with different viral loads of PCV2 support a close interaction between immune activation and suppression of PMWS development.<sup>264</sup>

There are many *in vitro* studies on the immunomodulatory effects of PCV2 on lymphoid cells. It can suppress the release of some cytokines and stimulate the release of other proinflammatory cytokines.

The PCV2 genome as a whole was found to induce IFN- $\alpha$  in culture of monocytes and may help in immune-evasion mechanisms.<sup>265</sup>

Proinflammatory cytokines (IL-8, TNF- $\alpha$ , and IL-1 $\beta$ ) and immune (IFN- $\gamma$ , IL-10) cytokines were evaluated in PCV2-vaccinated and unvaccinated pigs exposed to natural PCV2 infection. PMWS-affected animals were not able to mount an efficient innate proinflammatory response to cope with PCV2 infection because there were low levels of IL-8, TNF- $\alpha$ , IL-1 $\beta$ , and IFN- $\gamma$ . Conversely,

there was a high expression of IL-8, TNF- $\alpha$ , and IL-1 $\beta$  in the vaccinated group. A significant increase of IL-10 occurred in the early phase of infection in the PMWS-infected animals, whereas vaccinated pigs had low viremia and absence of PMWS and had a more stable IFN- $\gamma$  response.<sup>266</sup>

Studies *in vitro* have shown that in PBMCs and macrophages from PMWS pigs, there were reduced antiviral activities and an increase in proinflammatory cytokines (IL-1 $\beta$  and IL-8 expressions). Peripheral blood monocytes from PMWS-affected pigs are less able to produce IL2, IL-4, and IFN- $\gamma$  upon challenge and are able to produce IL-10 after stimulation with recall viral antigens. Different components of PCV2 have been shown to play an important role in the modulation of the *in vitro* responses by PBMCs.<sup>267</sup> IFN- $\gamma$  is up-regulated in the tonsils. PCV2-induced IL-10 may participate in down-regulation of specific responses through the inhibition of IFN- $\gamma$ , IFN- $\alpha$ , and IL-12. PCV2 induced production of IL-10 (immunosuppressive), and when this was neutralized, a clear increase in IL-12 was noted.<sup>268</sup> These effects are independent of viral replication. The PCV2 capsid does not influence dendritic or monocytic responses, although the viral DNA does.<sup>268</sup>

These studies suggest that DNA sequences may be found in the genome that modify DC function. The immunosuppressive component is strongest in the whole genome or the circular replicative form. The full-length genome induced a clear suppression of IFN- $\alpha$  in responses in a dose-dependent manner.<sup>269</sup>

In addition, PCV2 is able to inhibit IL-2 through an IL-10-independent mechanism.<sup>268</sup>

Swine alveolar macrophages show reduced microbicidal activity, with a decrease in the production of O<sub>2</sub> free radicals and H<sub>2</sub>O<sub>2</sub> and an increased production of TNF- $\alpha$ , IL-8, and other factors.<sup>270</sup>

*In vitro* data indicate that PMWS-affected animals also show elevated serum IL-10 levels; subclinically, PCV2-infected pigs develop transient IL-10 PCV2-specific responses during the viremic phase of the infection.<sup>271</sup>

In pigs suffering from PMWS, mRNA expression levels of IL-1 $\alpha$  and IL-10 increase, whereas levels of IL-2, IL-8, TNF- $\alpha$ , and IFN- $\gamma$  decrease.

Increased levels of IL-10 in the thymus were associated with the thymic depletion and atrophy that is observed in PMWS pigs. IL-10 was elevated from 10 to 14 days in experimentally infected pigs that subsequently developed PMWS.<sup>272</sup> IL-10, IL-12p40 in the spleen, IL-4 in the tonsils, and IL-10, IL-12p40 and IL-4 in the lymph nodes were detected in PMWS pigs.<sup>271</sup> Increased levels of IL-10 in PCV2-infected pigs are responsible for the depression of the Th1 responses in the peripheral blood monocytes of the infected

pigs. PCV2-induced IL-10 leads to impaired IFN and antigen-recalled responses to pseudorabies immunized animals.

The IL-10 elevated expression is common in PCV2 infections—in the thymus,<sup>273</sup> lymph nodes, spleen, and tonsil<sup>273</sup>—and is mainly located in T-cell areas. IL-10 was increased in PMWS-affected pigs<sup>274</sup> and was mainly associated with CD163+, CD4+, and CD8+ cell populations in the spleen. IL-1 is expressed at higher levels by bystander cells than by PCV2-infected cells, suggesting that IL-10 production is the result of paracrine action.<sup>273,274</sup> In a pig suffering from interstitial pneumonia, elevated IL-10 and IL-8 mRNA would be expected, and this is what was shown in a pig with PCV2-associated respiratory disease.<sup>100</sup>

A variety of substances that are proinflammatory cytokines are also up-regulated, including TNF- $\alpha$ , macrophage inflammatory protein, and C-reactive proteins.<sup>272</sup>

In pigs, the main acute-phase proteins (APPs) are CRP, SAA, Pig-MAP, haptoglobin, and AGP. In PMWS-affected pigs, the concentrations of Pig-MAP, C-reactive protein, and serum amyloid in infected animals were increased at 14 and 21 days postinfection.<sup>275</sup>

In a study of the spleen in PMWS-affected animals it was found the CD163+, CD4+, and CD8+ cell produced IL-10 in the spleen, and IL-10+ cell numbers were higher in PMWS animals compared with their levels in healthy counterparts. IL-10-producing cells were not infected by PCV2 and were mainly localized in the periarteriolar lymphoid sheaths.<sup>274</sup>

### Interferons

The immune response produced by many PCV2 components varies with the cell type. Infection of natural IFN-producing cells may prevent the maturation of dendritic cells.<sup>276</sup>

An interferon-stimulated response element (ISRE) sequence was found in the in the PCV2 genome, which influences the interferon-mediated enhancement of PCV2 replication *in vitro* and may play a role in virus pathogenesis in pigs.<sup>194,277</sup>

In a study of cell-mediated immunity to PCV2 in CD/CD piglets, it was shown that viral clearance might be mediated by the development of PCV2 IFN- $\gamma$ -secreting cells in contribution to the PCV2-specific neutralizing antibodies.<sup>278</sup>

### IMMUNITY

In an infected but nonclinically diseased animal, PCV2 may exist with the host by undergoing minimal replication, inducing a limited but balanced Th1/Th2 response, and a trigger then sets disease in operation.

Clinical PMWS was preceded by low levels of serum antibodies and a high load of PCV2 but did not develop in all such animals.<sup>279</sup>

The interaction with the host immune system is the key to PCV2 infections and the development of PMWS. It was originally thought that it required cofactors to produce PMWS, but now it is known that it can produce PMWS on its own.

In affected piglets there is a lymphoid depletion, leucopenia, and destruction of lymphoid follicles. The absolute numbers of total T cells, Th cells, cytotoxic T cells, and  $\gamma/\delta$  T cells—but not memory/activated T cells—decreased after PCV2 infection.<sup>280</sup> There is a reduction of numbers of interfollicular dendritic cells, interdigitating cells, B cells, natural killer (NK) cells,  $\gamma/\delta$  T cells, CD4+, and CD8+ T-lymphocytes and reduced expression of high endothelial venules, together with an increase in monocytes and granulocytes. The amount of PCV2 antigen in tissues is directly related to the amount of depletion.<sup>281</sup> Coinfection with PRRSV increases the immune cell depletion.<sup>282</sup> CD4+ and CD8+ T cells are important in the response to PCV2 infection.<sup>244</sup>

PCV2 can persist in dendritic cells without affecting their performance, but in cells producing interferons, it reduces IFN- $\alpha$  and TNF- $\alpha$  production, thereby interfering with immune priming. In diseased pigs there is a state of activation with higher level and earlier expression of MHC-II on T and B cells and a higher level of CD25, IL2 receptor expression.<sup>281</sup> Both T and B cells are important targets for PCV2.<sup>242,247</sup>

IgM antibodies were first detected at week 8 PI and reached their highest at week 12. IgG antibody appeared at week 10, and levels were at their highest at week 16, with an average titer of 1:3500. Viral load peaked at week 10 ( $7 \times 10^7$  genomes copy/mL of sera) and persisted to adult age ( $10^5$  genomes copy/mL of sera).<sup>283</sup>

PCV2 capsid specific antibodies appear within 10 to 28 days postinfection,<sup>284</sup> and their appearance coincides with a decrease in serum viral load<sup>284</sup>; however, in clinically diseased pigs the level of neutralizing antibody is greatly reduced.<sup>284</sup> It is not clear why some pigs can remove the infection, whereas others succumb to disease. Pigs infected with PCV2 appear to mount strong PCV2-specific antibody responses.

In the field, there is a decrease in maternal antibodies from 3 to 11 weeks, and then there is an active response around 15 weeks that persists for life. Experimental infections produce antibodies within 14 days PI and neutralizing Abs at about 21 days PI.

Antibodies particularly IgM Abs, may be lower in pigs with PMWS. The IgM is not neutralizing but indicates an infection.<sup>284</sup> Increased levels of IL-10 lead to a high ratio of IgG to IgM.<sup>271</sup>

There is a strong correlation between antibody titers and protection.<sup>285,286</sup>

High PCV2 antibody levels in sows at parturition did not prevent early PCV2

infection and viremia in piglets from the first day of life or peripartum maternal viremia and virus shedding into the lacteal secretions. Vertical transmission of PCV2 could generate PCV2 seropositivity in viable piglets even on farms with no signs of reproductive failure.<sup>287</sup>

Lack of antibody protection against PCV2 and PPV in naturally infected dams and their offspring has been shown.<sup>288</sup> After ingesting colostrum, piglets from vaccinated sows had significantly higher numbers of PCV2-specific gamma-interferon-producing cells, an increased PCV2-specific delayed-type hypersensitivity response, and a stronger proliferative response of peripheral blood mononuclear cells compared with piglets from nonvaccinated sows.<sup>289</sup> This is the first report of a transfer of a maternally derived adaptive cellular immune responses from vaccinated dams to their offspring.

The PCV2 Cap and Rep proteins are involved in the development of cell-mediated immunity upon PCV2 infection. In the course of subclinical infection, the development of and the strength of these responses may be related to the level of PCV2 replication.<sup>290</sup>

The T-helper type 2 response primarily stimulates B-cell proliferation and specific antibody formation. This humoral response is largely regulated by the secretion of IL-4, IL-5, IL-10, and IL-13 by T-helper type 2 cells. The interleukins were up-regulated differently in different lymph nodes and peripheral blood mononuclear cells.<sup>291</sup>

Pigs with high neutralizing antibody levels and high IFN- $\gamma$  responses showed the lowest levels of viral replication, whereas pigs with weak or nil responses had the highest levels of replication. The levels of NA could be correlated with the clinical status of the pig and the viral load.<sup>284</sup>

## NECROPSY FINDINGS

Not all pigs with PCV2 infection develop PMWS. PMWS incidence is highest where there is coinfection. Lymph nodes in affected pigs had the highest levels of viral load, but there was no significant difference between lesion severity and the viral load in these structures. There was no difference in the viral load in inguinal lymph nodes with or without PMWS, but in the former, the lesions were more severe.<sup>292</sup>

## Gross Pathology

### Fetal Pathology

PCV1 can, when used to experimentally, infect midgestational porcine fetuses, replicate, and produce pathology (severe hemorrhages in the lung) in the fetuses inoculated at 55 days of gestation.<sup>293</sup>

There are increased numbers of mummified and stillborn fetuses. The mummified can be as small as 6 to 7 cm.<sup>154</sup> Frequently, gross lesions are not seen at all. If lesions are seen, they are generally associated with myocardial failure.

Generally, in a fetus the lesions are found in the cardiovascular system, particularly the heart. Myocardocytes may be degenerate, necrotic, or lost and replaced by fibrous connective tissue. There is often abundant PCV2 antigen in these lesions.

Dilated cardiomyopathy, pulmonary edema, hepatomegaly with congestion in an accentuated lobular pattern, hydrothorax, ascites, and subcutaneous edema are also seen.<sup>154</sup> Sometimes there is lymphadenopathy,<sup>18</sup> thymic atrophy, perirenal edema,<sup>18,154</sup> mesocolic edema,<sup>154,294</sup> and cerebral and splenic petechiation.<sup>18,154</sup>

Microscopically, there are often lesions in the myocardium in mummified, stillborn, and weak live-born piglets.<sup>154</sup> The myocardocytes are often necrotic, degenerate, or lost, and are replaced by fibrous tissue and mineralization with inflammatory cells, including macrophages, plasma cells, and multinucleated giant cells. Occasionally, there are inclusion bodies.<sup>54,294</sup> Sometimes, lesions may include interstitial pneumonia, bronchopneumonia, and hepatic congestion with hepatocellular loss; nonsuppurative hepatitis with periportal necrosis; and lymph node and splenic lymphocyte depletion with occasional multinucleated cells or lymph node follicular hyperplasia.

Myocarditis with high viral load of PCV2 in several tissues in cases of fetal death and high mortality in piglets has been described.<sup>150</sup> A high load of PCV2 DNA was observed in the myocardium, liver, and spleen from mummified or stillborn piglets.

## Pathology in Piglets and Pigs

In some cases all lymph nodes are affected, but in others only a few; thus, a range of nodes is essential in any postmortem examination.

Necrotizing lymphadenitis associated with PCV2 infection has been characterized.<sup>251</sup> The pathogenesis of the lesion has been linked to apoptosis induced by PCV2. Lymphoid necrosis in PMWS-affected pigs may be related to hypertrophy and hyperplasia of high endothelial venules. Necrotizing lymphadenitis may develop following vascular damage, with thrombosis and subsequent follicular necrosis.

A reactive hyperplastic lymphadenopathy was shown in submaxillary lymph nodes with granulomatous lymphadenitis and necrotic foci.<sup>295</sup>

Based on the necropsy of three unthrifty pigs from all herds in a case-control study, approximately 78% had PMWS in the case herds and 26% in the control herd.<sup>296</sup>

Postmortem examination may reveal the following:

- Lesions in the liver, which are often yellowish-orange, indicating jaundice, with mild to moderate mottling; wasting is often seen.
- Noncollapsed lungs that are rubbery, with pronounced grayish nodules;

in some cases, there may be pulmonary edema, pleurisy, and pneumonia.

- Swollen, pale, homogeneous lymph nodes, particularly the inguinal, mesenteric, and tracheobronchial
- Thymic atrophy
- In the kidneys, there may be either no lesions or scattered white foci visible on the subcapsular surface and edema of the peripelvic connective tissue. Interstitial nephritis lesions were classified into three groups: lymphoplasmacytic, tubulointerstitial, or lymphohistiocytic to granulomatous and mixed patterns.<sup>295</sup>
- There may be limb edema and hemorrhagic joint fluid, and the spleen may be enlarged, meaty, and noncongested.
- The classical blue/purple skin lesions of PDNS may be a feature.
- There may be gastric ulcers and enteritis, with fluid-filled, thin-walled sections of the lower intestine, particularly the ileum and the spiral colon, with occasional edema of the cecal wall.

Mid- to late-term abortions may be seen, with affected fetuses showing necrotizing myocarditis and the presence of PCV2 antigen in cardiac tissues. Pathologic and virologic findings have been described in midgestational fetuses after experimental inoculation with PCV2a or PCV2b.<sup>293</sup> At 21 days PI 11/12, were edematous and had distended abdomens, and 1/12 looked normal. All PCV2-inoculated fetuses had internal hemorrhages and congestion and an enlarged liver. High PCV2 titers were found in all tissues, especially the heart, spleen, and liver. High numbers of infected cells were seen in the heart. The 2a and 2b types produced similar lesions and replicated to similar titers in the organs of 55-day-old immunocompetent pig fetuses.

Acute enteritis may be seen in otherwise normal pigs. In the early cases, particularly in the United Kingdom and Spain, porcine dermatitis and nephropathy syndrome was a feature and closely resembled African or classical swine fever cases. It was not common but was associated with a high mortality. There were coalescing red to purple skin lesions, particularly over the perineal region; glomerular and interstitial nephritis; vasculitis; and deposition of immune complexes in the kidneys. In the cases with brain and cord lesions described,<sup>297</sup> there was hemorrhage on the cut surface, as multifocal to coalescent areas of hemorrhage extending from the cervical to the lumbar region. Brain lesions in pigs affected with PMWS have been described.<sup>298</sup> They included cerebellar multiple hemorrhages and edema, which were microscopically associated with mononuclear vasculitis in the molecular zone of the cerebellum; hypertrophied endothelium;

and perivascular lymphohistiocytic infiltrate with deposits of fibrin.

An acute pulmonary edema was described in the Midwest of the United States. The pigs were found dead without previous signs and had clear fluid in the thoracic cavity and diffusely heavy and wet lungs with moderate to severe expansion of interlobular septae. Histopathology revealed the edema and also a diffuse interstitial pneumonia. There was often a fibrinoid necrosis of the blood vessel walls.<sup>299</sup>

### Histopathology

PCV2 has been associated with primarily PMWS and PDNS, proliferative and necrotizing pneumonia, cerebellar vasculitis,<sup>249</sup> granulomatous enteritis, reproductive failure with abortion and premature farrowing, neonatal losses with tremor, and myocarditis.

The major histopathologic lesions in PCV2 diseases are lymphoid, with a depletion of T and B-lymphocytes. There should be PCV2 antigen in moderate to large amounts in the lymphoid tissues. This lymphocyte depletion is the result of a combination of factors, including destruction of lymphoid architecture, apoptosis, and cell lysis induced by PCV2 infection.<sup>300</sup> The main cellular changes are a decrease in follicular DCs, interdigitating cells, interfollicular lymphocytes, and B cells. Typical microscopic findings in lymph nodes include lymphocyte depletion, histiocytic infiltrations, and occurrence of multinucleated giant cells. There are losses of both B cells and T cells. There is a loss of lymph node architecture. These may be atrophic or necrotizing. Occasionally basophilic intracytoplasmic inclusions are found in the B-cell-dependent areas. Necrotizing lymphadenitis, interstitial nephritis, and interstitial pneumonia may also be found.

Lesions in the liver may include those such as infectious hepatitis and apoptosis.<sup>248</sup> There is often lymphohistiocytic infiltration of the portal areas, with occasional atrophy of the bile duct epithelium. Single-cell necrosis may be seen. In late stages there may be hepatocyte swelling and karyomegaly.

PCV2 inclusion bodies have been found in pulmonary (bronchial and bronchial glandular) and renal epithelial cells,<sup>301</sup> but pathologic experience suggests that these are now much less frequent than when the disease first occurred.

CNS lesions in PCV2 infections are rare but if found are usually in the brain and are usually found in the cerebellum.<sup>249,302</sup> In the Zlotowski cases, there was a moderate lymphohistiocytic vasculitis with thrombosis and marked mural fibrinoid degeneration with perivascular edema in meninges and parenchyma. Marked Wallerian degeneration and occasional Gitter cells were seen in the white matter of the cord. In animals experimentally inoculated with PCV2b, vasculitis was a hallmark of the lesions.<sup>303</sup> Two

cases of nonsuppurative encephalitis were attributed to PCV2 infection by virtue of ISH when viral nucleic acid was found in the mesencephalon, cerebellum, and medulla oblongata, mainly in the cytoplasm of macrophages, endothelial cells, and some glial cells, and real-time PCR detected PCV2 in the brain samples from seven other pigs.<sup>304</sup> In natural cases of PCV2 infection there may be interstitial nephritis, tubulointerstitial nephritis, and granulomatous or lymphoplasmacytic nephritis. Lesions are often associated with PCV2 antigen. The renal lesions tend to occur later on in PCV2 infections. Renal tubular necrosis and interstitial hemorrhage (“turkey-egg kidney”) have been seen in a PCV2-infected Yorkshire cross pig.<sup>305</sup> There was edema and petechiation of both kidneys, with renal tubular epithelial necrosis with extensive interstitial edema, and hemorrhage and inclusions in renal tubular epithelium. PCV2 was readily identified within these lesions. In the lungs, there may be interstitial pneumonia, lymphohistiocytic infiltration in the interstitium, granulomatous inflammation with syncytia, epithelial airway destruction, and bronchiolitis obliterans. There may be peribronchiolar fibrous hyperplasia, often with PCV2 antigen. Association of PCV2 with vascular lesions in porcine pneumonia has been seen in PCV2-infected lungs in Hungarian swine, particularly type 2b infections.<sup>306</sup> Vascular lesions are often reported in PCV2-affected pigs in the form of distension of interlobular septae with edema and fibrinoid necrosis. In the heart, the PCV2 antigen is associated with the myocyte swelling or necrosis.

Lesions in the sow's reproductive tract or the boar's reproductive tract are rarely reported.

Granulomatous enteritis may be seen with inclusion bodies in the Peyer's patches. There may be lymphohistiocytic infiltration of the gastric, cecal, and colonic mucosa. There may also be sloughing of crypt or glandular epithelium. There may be dilation of lymphatics. The pancreas may show areas of acinar epithelial atrophy and lymphoid aggregates in the interstitial regions.

The liver may show inflammatory and apoptotic changes with mononuclear cell infiltration in the parenchyma. Hepatitis may be seen. Singular 2a and 2b infection results in apoptosis of hepatocytes in clinically affected gnotobiotic pigs.<sup>250</sup> There were higher amounts of PCV2 antigen in clinically affected pigs.

### Porcine Dermatitis and Nephropathy Syndrome

Porcine dermatitis and nephropathy syndrome (PDNS) is characterized by systemic vasculitis and glomerulonephritis affecting pigs of 20 to 65 kg. It is often solely associated with the occurrence of *Pasteurella* as a specific condition known in the United Kingdom as sporadic PDNS before the onset



of the condition associated with PCV2. It has been seen in pigs, from 5-week-old nursery pigs to 9-month-old gilts. The affected animals are usually febrile, anorectic, and depressed and show ventrocaudal subcutaneous edema. The course of the disease is rapid, and most pigs die within 3 days of the onset of clinical signs. This condition is now regarded as being part of the PCVAD complex.

Except in the condition of PDNS, PCV2 is rarely found in the skin of the pig, except in ear necrosis, as mentioned earlier.

### Ultrastructural Changes

The ultrastructural changes in lymph nodes suffering from PMWS showed swelling of histiocytes, proliferation of mitochondria, and proliferation and swelling of endoplasmic reticulum and Golgi complex. Infected histiocytes contained large numbers of intracytoplasmic inclusions.<sup>307</sup> Lymphocyte depletion was a striking feature. Viral replication is probably a frequent event in macrophages.

### CLINICAL SIGNS

PCV2 infection is widespread worldwide,<sup>105</sup> but clinical PCVAD is only seen in a minority of pigs. Subclinical infection is the normal occurrence in PCV2 infection, but it may be associated with decreased vaccine efficacy.<sup>162</sup> Clinical signs of PMWS were only visible in pigs 1 to 2 weeks before death, when they wasted rapidly. There were no other characteristic clinical signs and no obvious gross lesions at postmortem. PCV2 antigen level was higher from 4 to 6 weeks of age in pigs that died from other causes.<sup>308</sup> When it first occurred, it was seen a classical PMWS in weaners with a high mortality but now seems to be a more chronic disease associated with finishers with nonspecific signs (unthrifty, increase in mortality, decreased productivity, and increased disease from concurrent infections) in both the United States and Europe.

The first 41 cases in Denmark showed an average postweaning mortality of 11% in the nursery (7–30 kg), with comparable figures in other countries.

PCV2 is suspected to be associated with other diseases, such as PRDC, reproductive disorders, PDNS, and congenital tremor.

During their lives, most pigs will get PCV2, will seroconvert, and will never show any signs of the disease. It can also be recovered from healthy units that have never had any disease incidents.

PMWS most commonly affects pigs from 60 to 120 days of age at the end of the nursery phase or the beginning of the finishing phase.

The age at which the disease occurs is similar in Spain, but no pigs under 4 weeks have been affected, and the maximum age was 6 months.<sup>309</sup> A study of fattening pigs in the Netherlands with respiratory disease but no signs of PMWS looked at the contribution

of PCV2. Eight herds had a high percentage of pneumonia at slaughter, and eight had a low percentage of pneumonia at slaughter. High PCV2 viral loads were found in 58% of the high group but only in 29% of the low group. High loads were found more frequently with other pathogens in the high group.<sup>310</sup> The study confirmed that PCV2 plays a role in pneumonia in pleurisy in pigs from 10 to 24 weeks in herds with PMWS and in herds with no clinical signs of PMWS.

The PCV2 genome plasticity is a major contributing factor to the PMWS disease manifestation.<sup>68</sup> Piglets of 5 to 12 weeks are most commonly affected, but occurrence of signs 5 to 16 weeks is not unknown. In the initial cases the condition affected the nursery pigs, but now more finishing pigs are reported with the signs. Pigs under 5 weeks are probably protected by maternal antibody, and the lowest levels of antibody are usually around 7 weeks under natural conditions. Infection levels peak at around the same age as the peak of PMWS outbreaks (12–13 weeks of age) and then decrease progressively following seroconversion.<sup>118</sup> The incubation period is thought to be 7 to 28 days.

The clinical signs are highly variable and are said to be multisystemic, which is their main characteristic. Some farms had high morbidity, mainly in weaners and others in the finishing pigs.<sup>311</sup> Mortality may be high.<sup>67</sup> Morbidity may be high or low, and only a small proportion may actually develop clinical signs (5% to 30%).<sup>2</sup>

There is a blurred border between PCV2 systemic disease and PRDC, and it is probable that PCV2 lung disease is a negligible condition and that PCV2 mainly contributes to PRDC in relation to PCV2 systemic disease occurrence.<sup>312</sup> There may be fever. Other signs may include weight loss; wasting is the extreme effect, but reduced weight gain is now typical. This is a frequent occurrence. In a case-control study in Denmark, affected weaners had a lower weight gain of 36 g/day and finishers of 52 g/day.<sup>296</sup> Feed utilization is also reduced, with an increased daily gain-to-feed value (396 g/kg of feed in vaccinated pigs) compared with 390 g/kg of feed in unvaccinated animals.<sup>313</sup> Respiratory dysfunction, including dyspnea, is also a frequent occurrence. Enlargement of superficial lymph nodes, particularly the superficial inguinal, which is not palpable in normal healthy animals, is a frequent occurrence. Antibiotic usage is increased with PMWS when comparing usage before an outbreak to that until a year after the outbreak.<sup>314,315</sup> Anemia or pallor is often present. Diarrhea is often present. Jaundice may occur but is not frequent. Generalized depletion of lymphocytes and secondary infections with opportunist and secondary infections are a feature. Necrotizing dermatitis and renal failure<sup>316</sup> may also occur.

Reproductive failure is a feature in breeding units.<sup>317</sup> The authors think there

is a distinction between PCV2-associated reproductive failure and subclinical PCV2 in utero infection. For the diagnosis of PCV2-associated reproductive failure the following must be confirmed:

1. Clinical signs, which include early termination of pregnancy and increased numbers of mummified fetuses, stillborn, or weak-born pigs
2. Microscopic lesions within fetal tissues
3. PCV2 antigen or DNA within fetal tissues

Subclinical infection in utero is identified by the detection of PCV2 DNA or antibodies in fetal tissues, presuckle serum, or fetal thoracic fluid. Some piglets were found to be infected with both PCV2a and PCV2b.<sup>135</sup> A high level of reproductive losses was seen in a herd in Japan,<sup>318</sup> where there were 48.8% stillborn piglets and 14.5% preweaning mortality rate; the problem was rapidly solved after vaccination.

PCV2 infection in pregnant sows was reproduced using isolates from reproductive failure<sup>319</sup> and in naïve sows inseminated with semen contaminated with a PCV2b virus.<sup>154</sup> Any PCV2 isolate is capable of causing PCV2-associated reproductive failure. PPV has been recognized in fetal tissues,<sup>294,320,321</sup> as have PRRSV,<sup>294</sup> PCV1,<sup>294</sup> porcine TTV viruses,<sup>322</sup> and *E. coli*.<sup>294</sup>

Reproductive failure often occurs in gilts and start-up herds and is probably a reflection of seronegative populations.<sup>150,323–325</sup>

Homologous anti-PCV2 antibodies are at least partially protective for in utero PCV2 infection and the development of reproductive failure.<sup>133,159</sup> Abortion is not a major feature. The PCV2 virus is capable of infecting and damaging embryos in early pregnancy, leading to failure or reduction in litter size. In later gestation, damage to the fetus may result in stillbirth, mummification, embryonic death and infertility (SMEDI), mainly in primiparous sows,<sup>326</sup> and a potential return to estrus.<sup>44</sup> The most consistent feature of PCV2 infection in sows is stillbirth or mummified fetuses. Pyrexia and anorexia are often features of aborting sows. Delayed farrowing may also be seen. In a recent outbreak of PCV2-associated reproductive failure, gilt displayed pneumonia, diarrhea, and wasting.<sup>324</sup>

Paralysis in pigs with a spinal cord injury has been described<sup>327</sup> in Brazil.

Clinical signs are not usually seen in boars. In Poland, a reduction in ear necrosis was noted after a vaccination program for PCV2 was started.<sup>328</sup>

A clinical syndrome that affected healthy nursery and younger finisher pigs in the Midwest of the United States has been described in PCV2-vaccinated herds. Mortality reached 20% in some affected groups. Clinical signs included the rapid onset of respiratory distress followed almost immediately by death.<sup>329</sup>

One of the most important aspects of PCV2 infection is that vaccination using the Lapinized Philippines Coronel (LPC) vaccine was shown to have an effect in decreasing the efficacy of the vaccine. The level of neutralizing antibodies produced and the presence of lymphocyte subsets were reduced by the PCV2.<sup>330</sup>

### CLINICAL PATHOLOGY

Acute-phase proteins are synthesized mainly by the liver and are used as biomarkers of diseases for diagnosis and prognosis.<sup>331-333</sup> They are under the control of cytokines that are released during the inflammatory process. IL-6 and IL-1 type cytokines that are produced mainly by macrophages and monocytes (IL-1 $\alpha$ , IL-1 $\beta$ , IL-6, TNF- $\alpha$ , and IFN- $\gamma$ ) appear to be the major regulators.<sup>334</sup> It is controlled largely at the level of transcription. The regulators include NF- $\kappa$ B and the STAT proteins.

In the blood there is a reduction of both B cells and all T-cell subpopulations (naïve Th, activated Th, Tc, and gammadelta cells and also NK cells). In the 14 days postinfection with PCV2, there is a decrease of leukocytes, followed by an increase in neutrophils 7 to 14 days later. No changes in circulating monocytes, basophils, and eosinophils were detected.<sup>335</sup>

The major acute-phase protein (MAP) and haptoglobin serum concentrations correlate with PCV2 viremia and the clinical course of PMWS.<sup>336</sup> There was a significant correlation between PCV2 loads and both MAP and haptoglobin concentrations in serum of PMWS-affected pigs.

### Diagnosis

Diagnosis of systemic PCVAD requires the presence of microscopic lesions and detection of PCV2 antigen or nucleic acids associated with the microscopic lesions. This is achieved using IHC or ISH. The ISH stain may be easier to read with more stained cells.<sup>337</sup>

Diagnosis of fetal infection on clinical signs is impossible to differentiate from other infections and effects of management changes. Sows with PCV2 infection frequently have no signs, are usually seropositive, and can be viremic or nonviremic.<sup>157</sup> Sampling of four to six fetuses per litter is recommended. Immunohistochemistry (IHC) and in-situ hybridization (ISH) are the gold standard for detection of antigen in the myocardium. DNA can be detected by PCR in the heart, liver, kidney, spleen, lymph node, and brain. Liver and myocardium have the highest amounts of DNA. Myocardium, liver, and splenic tissues were positive for PCV2 DNA in all live-born piglets.<sup>279</sup> The DNA extraction method has an important role in the usefulness of PCV2 quantification in swine lymph nodes,<sup>338</sup> and it casts doubt on comparable results unless the extraction methods are comparable. Laboratories in

North America have been compared, and it has been shown that there are considerable differences in their detection limits and quantification.<sup>339</sup>

In utero infection can also be diagnosed by demonstrating ABs in fetal or live-born presuckle piglets using an ELISA.<sup>135,340</sup> Fluorescent antibody and IPMA have also been used.

Virus isolation is more difficult, but PCV2 can be isolated from most fetal tissues, particularly the myocardium.

Piglets from dams with low PCV2 antibody titers or with viremia had more morbidity and mortality associated with PMWS.<sup>119</sup> A protocol for the diagnosis of PMWS was developed in Italy.<sup>341</sup> Samples were examined histologically first and then by IHC for PCV2 when histologic lesions were first recognized. The lymphoid tissues were more reliable for diagnosis of PMWS than lungs.

### Serology

An immunochromatographic strip for the detection of antibodies against PCV2 has been described,<sup>342</sup> and it agreed with the ELISA in 94% of cases.

Neither viral load nor antibodies can be used for diagnosing herds as PMWS-affected pigs or free herds (serology and qPCR are used<sup>118,308,343</sup>) because the diagnostic sensitivity and specificity are low.<sup>118</sup>

An indirect ELISA using a recombinant truncated capsid protein of PCV2 has been described as a serodiagnostic assay for detection of PCV2 antibodies.<sup>344</sup> Histopathology plus detection of PCV2 in tissues is necessary for diagnosis in the individual animal.

The pathogen is ubiquitous, which hinders the diagnosis because many pigs are infected without clinical signs or have subclinical infections. To make a diagnosis, the following must be present:

1. Recognizable clinical signs
2. Moderate to severe histopathologic lesions
3. Moderate amounts of PCV2 antigen in the lesions

During the PCVAD outbreak in Ontario from 2004 to 2006, the probability of a positive PCR for PRRSV decreased. It was concluded that when a decrease in test positivity occurred for a known disease, it may suggest that a new disease agent is emerging in the population.<sup>345</sup>

The diagnosis of PCV2 infection, mostly PMWS, is based on the clinical signs of the condition in individuals and groups of animals and by laboratory detection of PCV2.

In the individual animal, histopathologic examination together with viral detection in the lymphoid tissue is the definitive diagnosis.<sup>118,346</sup>

For herd diagnosis, there is a problem, because individuals may have the disease although the herd may have good production

figures.<sup>347</sup> In some herds, 32% may not fulfill the diagnostic criteria,<sup>348</sup> or even 55%.<sup>118</sup> In these cases there must be (1) a significant increase in postweaning mortality and wasting and (2) the use of individual diagnoses in at least 1/5 of every group of animals subjected to postmortem examination

### Diagnosis in Boars

PCV2 is found 5 days after experimental infection of boars. Shedding in semen has been reported in the absence of viremia. Antibodies develop within about 2 weeks of infection. Intermittent shedding was continued over an 8-week observation period,<sup>157,349</sup> with continuous shedding of the virus for 90 days.

Naturally infected boars shed for 27.3 weeks in a positive boar stud.<sup>127</sup> Peak shedding occurs at around 9 to 20 days.<sup>157,349</sup>

Experimentally infected boars can be viremic for at least 90 days, and blood swabs can be positive for DNA at least 47 days after cell-free viremia was last detected.<sup>157</sup>

The virus DNA can be detected in the bulbourethral glands, testes, epididymis, prostate, and seminal vesicles.<sup>350-353</sup> Detection of PCV2 DNA in boar semen is variable and depends on age.<sup>127,153,354</sup> Infectivity of PCV2 is possible, but because of the low amount semen in each dose after extension, the virus in each ampule is very low, so the risk of infection is low. PCV2 DNA can be detected using a quantitative real-time PCR.<sup>355</sup>

Postmortem examination of one and preferably up to five piglets is necessary to ascertain the spectrum of gross lesions.<sup>2</sup>

### Virus Detection

Samples should be taken and examined histologically for the presence of characteristic PCV2 cytoplasmic inclusion bodies; second, IHC should be applied to confirm the PMWS cases with positive histochemistry. The lymph nodes were more reliable than the lungs for the diagnosis of PMWS, both in individual pigs and in groups of pigs.<sup>356</sup> PCV2-DNA was subsequently detected in the formalin-fixed lymph nodes by PCR.<sup>357</sup>

### Detection of Viral Antigen by Immunohistochemistry

PCV2 antigen was identified by IHC in the tissues of 61% of Danish finishing pigs examined.<sup>358</sup> Up to 78% of the pigs had mild lymphoid depletion, indistinct follicle development, and/or histiocytic infiltration of the lymph nodes. But these lesions were not associated with PCV2. No association was found between lung and kidney lesions and the detection of PCV2. Three patterns of PCV2 labeling were seen:

1. Labeling of cells with stellate morphology and reticular distribution
2. Labeling of isolated nonepithelial cells
3. Epithelial labeling

PCV2 may interface with FDCs to cause depletion of B-lymphocytes. Follicular dendritic cells may be a reservoir of infective PCV2 in subclinically infected animals or be a simple storage site for PCV2 antigen.

In a study of reproductive failures in Danish pigs, it was found that IHC was only useful in the diagnosis of reproductive failure in the early stages of reproductive failure, whereas quantitative PCR can be used over a wider time span.<sup>325</sup>

It can also be detected in primary lymphoid organs from naturally and experimentally infected pigs by ISH.<sup>359</sup> PCV2 nucleic acids and replication were found in bone marrow and thymus of PMWS-affected pigs, but there was no evidence that primary lymphoid organs were major supporters of PCV2 replication.

Multiplex PCR and multiplex RT-PCR for inclusive detection of major swine DNA and RNA viruses in pigs with multiple infections<sup>360</sup> were described as a useful combination for the rapid and accurate identification of major pathogenic viruses with multiple infections.

An indirect in situ PCR for the detection of PCV2 in formalin-fixed and paraffin-embedded tissue specimens has been described<sup>361</sup> and was shown to be a useful technique.

A quantitative PCR for PCV2 in swine feces in a PCV2-affected commercial herd and a nonaffected commercial herd proved useful for the detection of virus shedding.<sup>362</sup>

Quantification of PCV2 was described.<sup>131</sup> Detection of viral genome by ISH and/or PCR is necessary for diagnosis. There is considerable variance between labs in the qPCR test.<sup>363,364</sup>

A DNA miniarray was devised for the simultaneous detection of PCV1 and PCV2,<sup>365</sup> and a multiplex real-time PCR has also been used to differentiate PCV1 and PCV2.<sup>366</sup>

Many types of real-time in vitro amplification techniques<sup>367</sup> and real-time PCR assays using SYBR Green,<sup>131</sup> TaqMan PCR,<sup>242</sup> and molecular beacon technology<sup>368</sup> have been developed.

A simultaneous detection of PCV2, CSF, PPV, and PRRSV by using multiplex PCR was described.<sup>369</sup> It was found to be a rapid, sensitive, and cost-effective diagnostic tool for the routine surveillance of viral disease in pigs. Also, oligo-microarray has been used.<sup>370</sup>

Multiply primed rolling-circle amplification (MPRCA) of PCV2 genomes has applications for detection, sequencing, and virus isolation.<sup>371</sup> It was concluded that this is a useful tool to amplify PCV2 genomes for sequencing and virus isolation. However, it is less sensitive than PCR for diagnostic purposes.

A LUX real-time PCR assay has been described,<sup>372</sup> which was more specific for the generation of fluorogenic signals than the SYBR Green PCR.

## Oral Fluids

Surveillance methods used in oral fluids have been described.<sup>373,374</sup> PCR methods have been described for use in porcine fluid oral samples.<sup>375</sup> Antibody methods have been described for oral fluid samples.<sup>376</sup>

## CONTROL

Management may influence the appearance of the condition, and the application of the Madec principles<sup>377</sup> will undoubtedly ameliorate the condition. The Madec 20-point plan is in fact no more than the rules of good husbandry and pig practice crystallized to make control easier. Most people follow some of the points, but not the majority or all of the points. However, the more that are implemented, the better the control. Essentially, the 20-point plan recommends the following:

1. Improvements in hygiene
2. Minimization of the mixing of pigs
3. Provision of clean feed, water, and air
4. Minimization of the stress on pigs through overstocking, draughts, poor husbandry conditions, and so forth<sup>103,188,378</sup>

All-in, all-out by age is particularly significant in control of the infection.

Vaccinating pigs against *Mycoplasma* 2 weeks before suspected exposure to PCV2 will also help.<sup>379</sup>

Serum from pigs recovered from PMWS by injection could prevent PMWS in some cases, but in other cases it did not work.<sup>380</sup> It is not to be recommended for health transmission reasons and is no longer necessary now that there is vaccination.

The absence of an external envelope leaves the virus resistant to lipid-dissolving disinfectants, but it can be inactivated by alkaline disinfectants (sodium hydroxide), oxidizing agents (sodium hypochlorite), and quaternary ammonium compounds.<sup>381</sup> Results of a study<sup>120</sup> showed that Virkon S, Clorox bleach, and sodium hydroxide were the most effective agents for disinfection. Disinfection of an airspace could be achieved using formaldehyde vapor, assuming optimal temperature and humidity.

Infected boar semen is a possible source of infection, so AI centers should use boars that are free from infections.<sup>382</sup>

Attention to good nutrition will help, and there is some evidence that a selenomethionine supplement may help by reducing PCV2 replication in PK-15 cells (probably by enhancing glutathione peroxidase).<sup>383</sup>

Dietary aluminium silicate given to experimentally infected pigs produced a significant decrease in the load of viral genome in nasal swabs, serum, and lung tissue of pigs compared with a control group 28 days after PCV2 infection. Pigs in the treated group also had less severe histopathologic lesions.<sup>384</sup>

In theory, plasma-containing products may contain PCV2, but in a recent study, piglets fed spray dried plasma containing PCV2 DNA did not become infected.<sup>163</sup>

A modeling approach was used to estimate the effects of husbandry and control measures on the dynamics of PCV2 infection,<sup>385</sup> and it was found that early infection was significantly reduced when mixing of piglets was reduced by avoiding cross-fostering and mixing of groups. Sow targeted vaccination reduced the infectious process until waning of passive immunity. Piglet vaccination considerably decreased the force of infection. Changing from a low prevalence of PCV2-infected semen to a high one significantly increased the risk of early infections. Reducing replacement rate or changing sow housing from individual crates to sow group housing had little effect.

Increased morbidity occurred for an extended period before the diagnosis of PMWS both in the sow units and the weaner pig units, and there was an increased use of antibiotics in the third (35%) and fourth quarters (43%) before diagnosis was made.<sup>314</sup>

After a herd had an outbreak of PMWS (PCV2) in Danish herds, the use of antibiotics in the weaners was increased for about 1 year, and the use of antibiotics before the outbreak was 37% higher in herds with weaners and 17% higher in herds with finishers in the year compared with herds that did not have PMWS.<sup>315</sup> In the 4-year period when the incidence of PMWS rose from almost zero to 20%, the national use of antibiotics increased by 4% to 5%.

## Vaccination

The relationship between antibody titers and protection is unknown, but PMWS-affected pigs do show an impaired PCV2 humoral response.

The vaccines were developed to control PMWS but are now used for all PCVAD. The vaccines have been successful in reducing mortality in Europe, Canada, and the United States.<sup>6</sup> The vaccines probably work by activating both humoral and cellular immunity.<sup>386,387</sup> Vaccination of sows does not prevent PCV2 infections but reduces the viremia.<sup>287,388</sup> The antibody titers do not appear to influence the occurrence of disease because gilts and sows with high antibody titers against PCV2 and PPV presented viremia, and fetal exposure during gestation occurred in these animals.

It has been shown that IFN- $\gamma$ -secreting cells develop during the adaptive response to PCV2 and probably contribute to viral clearance in infected pigs,<sup>389</sup> and CD4+ and CD8+ cells contribute to this response.<sup>244</sup>

The efficacy of the five commercial PCV2 vaccines has been described experimentally,<sup>135,389-394</sup> and studies have been made in the field.<sup>395-404</sup>

## The Vaccines

The Vaccines Use Different Adjuvants.

Circovac (Merial) is an inactivated oil-adjuvanted vaccine originally designed for



sows (2 ml) and now available in a reduced dosage for piglets (0.5 ml).<sup>404</sup>

Four additional vaccines were licensed for use in piglets; three are based on ORF2 capsid protein (main neutralizing epitope) expressed in the baculovirus system: Circoflex (Boehringer Ingelheim), Circumvent Intrvet (Merck; North America), and Porcilis PCV (Schering Plough/Merck; Europe).

Suvaxyn PCV2 One Dose (Pfizer Animal Health/Fort Dodge Animal Health) is another vaccine but is based on a chimeric PCV1/2 virus using the genome of PCV1 with the ORF2 from PCV2. This was replaced using a natural PCV1/PCV2 chimera from Canada,<sup>405</sup> and this was relaunched as Fostera PCV (Pfizer Animal Health).

All the commercial vaccines are based on PCV2a, which does protect against the more common strain of PCV2b,<sup>390,393</sup> which appears to be essential for triggering PCV2 into PVCAD (16/17).<sup>15,406,407</sup> The four commercial vaccines are all killed or recombinant vaccines based on PCV2a,<sup>387,389,399</sup> even though PCV2b has now become the globally dominant genotype. These vaccines still continue to provide good protection even though PCV2a and PCV2b differ in nucleotides by up to 10%.<sup>54,389</sup> An experimental 2b vaccine has also been shown to provide protection from both 2a and 2b.<sup>389</sup>

### Vaccine Effects

In a study of four vaccines, it has been shown that the average daily gain of vaccinated animals was much higher than that of nonvaccinated animals. There were more IFN- $\gamma$ -secreting cells and CD4+ cells in the vaccinated animals. The histologic lesions and the PCV2-antigen scores in the lymph nodes were significantly lower in vaccinated animals.<sup>408</sup>

As always with pig farmers, one-dose vaccines are preferred to two-dose vaccines. One-dose vaccines improve daily gain in the field by 16 to 69 g/day from 3 to 19 weeks and decrease mortality by 1.9% to 9.3%. PCV2 vaccines reduce the proportion of viremic pigs and the viral load in blood and reduce the length of the viremic period in both experimental and field situations. They also reduce nasal and fecal shedding of the virus. The presence of NA is induced by commercial PCV2 vaccines, and there is a decreased replication of virus correlated with the absence of clinical signs. The induced presence of IFN- $\gamma$ -secreting cells in vaccinated animals is also likely to increase PCV2 clearance. Vaccination of pigs reduces the number of PMWS-associated microscopic lesions and the PCV2 load in lymphoid tissues compared with nonvaccinated animals. The vaccines will control PMWS under field conditions, but their role in protecting against the PCV2 component of PRDC is still unknown.

When the killed vaccines were originally introduced in the United Kingdom, it was noted that it had the following results:

- An improved growth rate (7–10 days faster to slaughter)
- A 1% to 5% reduction in nursery mortality
- A 1% to 6% reduction in finisher mortality
- An improvement in numbers weaned/litter by up to 0.5 piglets (sow vaccine), with improvements in fertility and litter size
- More even growth within a litter
- Improvement in fat measurements, probably as a result of more rapid growth

Most pigs in commercial production are now vaccinated against PCV2 infections. The introduction of the sow vaccine was beneficial for the following reasons:

- Lower cost
- Lower workload and reduced stress on piglets
- Prevention of *in utero* infection and early fetal death
- Control of reproductive losses.

On some farms where disease occurs over 10 weeks, the sow vaccination may not help in prevention, probably because maternal derived antibody has disappeared.

In the United Kingdom the initial use of the piglet vaccines was associated with a reduction in mortality of up to 50% and an improvement in growth rate of 50 gm/day, with most of the increase occurring in the finishing stage.

PCV2 infection may be a factor contributing to weight variation in vaccinated, market pigs.<sup>409</sup> The mean antibody titer, proportion of viremic pigs, and virus load differed between the light and heavy pigs on three different farms.

Mortality rate reduction with the PCV2 vaccination might depend on the genetic types of PCV2 that occur on the farm.<sup>410</sup>

With a vaccination program in operation, there is a large decrease in mortality, a reduced viremia, reduced back-fat depth, reduced number of culls, a reduced time to market, and reduced medication costs when vaccinated pigs are compared with unvaccinated pigs.<sup>411-418</sup>

PCV2-vaccinated pigs also have a better daily gain, a higher percentage of lean meat, a better feed conversion, a higher number of pigs reaching slaughter, and a higher carcass weight.<sup>400,412-416,418,419</sup>

An early antibody boost was sufficient to protect pigs from contracting PVCAD before the fattening period and also enhanced pigs' growth<sup>401</sup> and performance in the fattening period, although new infections were detected as early as 56 days after birth (on the basis of PCV2-specific IgM measurements).

It was shown that sow vaccination, piglet vaccination, or vaccination of sow and piglet produced similar control of PMWS.<sup>400</sup> However, decreased mortality in piglets

before weaning was only observed in the piglets from vaccinated sows.

### Sow Compared with Piglet Vaccination

Under field conditions, piglets born to sows that are vaccinated have a preweaning weight gain. Experimentally vaccinated 8-week-old piglets have lower PCV2 loads than those receiving passive protection from MDA.<sup>393,400</sup> The duration of protection may be 11 to 13 weeks.<sup>135,396</sup> Sow vaccination is to be used if there is a high level of infection before weaning, but piglet protection is best to ensure that there is active immunization.

A comparison was made of the effectiveness of dam (passive) versus piglet (active). Immunization and the impact of passively derived PCV2 vaccination induced immunity on vaccination.<sup>393</sup> Both dam and piglet vaccines had similar efficacy in reducing PCV2 viral loads and antigen levels in the growing pigs. Vaccination of the piglets with the same vaccine as used on their dams did not appear to affect the vaccine efficacy because they had the same levels of AB and genome copies of PCV2 as those receiving the piglet vaccine alone.

### Sow Vaccination

Vaccination of sows appeared to improve reproduction in sows and provided protection for the piglets.<sup>422</sup>

Vaccination of sows before mating is designed to protect sows against PCV2 reproductive disease<sup>423</sup> and also leads to stabilization and homogenization of the PCV2 immune status of the sow population during gestation.<sup>424-427</sup> The effect of vaccinating sows before farrowing is to increase the transfer of PCV2 antibodies to piglets and to protect piglets against systemic disease.<sup>399,425,426</sup>

Vaccination of sows reduces the prevalence of PCV2 viremia in their piglets in the field.<sup>426</sup> Vaccinated sows had less PCV2 in the colostrum than nonvaccinated sows.<sup>424</sup> Vaccinated sows had more PCV2 antibody in their serum and colostrum than unvaccinated sows.<sup>428</sup> A study compared sow vaccination, piglet vaccination, and sow + piglet vaccination<sup>429</sup> and found similar efficacy. Sow vaccination and piglet vaccination were found to be similar in another study.<sup>393</sup>

Vaccination of sows during pregnancy reduces the viral load in the blood and the rate of transplacental infection,<sup>133</sup> but it does not eliminate intrauterine infection completely. It also reduced the numbers of nonviable fetuses.<sup>133,154</sup> It may therefore reduce reproductive failure.<sup>340</sup>

Colostrum from vaccinated sows may also contain PCV2-specific IFN- $\gamma$ -secreting cells.<sup>430</sup>

### Semen Shedding in Boars

Boars can shed PCV2 for a long time without showing clinical signs or changes in semen

quality,<sup>127,157</sup> and thus AI may be a possible source of virus.<sup>152</sup>

Vaccination of boars with an inactivated PCV2 vaccine was followed by challenge with a PCV2b virus.<sup>431</sup> The number of PCV2b genomes in the semen correlated with that in the blood in both vaccinated challenged and nonvaccinated challenged boars. The PCV2b vaccine significantly decreased the amount of PCV2b DNA shedding in semen from vaccinated boars after experimental infection with PCV2b, and also the duration.<sup>432</sup>

### Piglet Vaccination

Piglet vaccination of 5-day-old or 21-day-old piglets using either a chimeric or subunit PCV2 vaccine produced a detectable humoral immune response and provided reduction or complete protection against PCV2 viremia and PCV2-associated lesions after triple challenge with PCV2, PPV, and PRRSV.<sup>434</sup>

A single dose of vaccine to sows produced a higher level of antibody in piglets at 4 weeks and a different level of PCV2 infection dynamics than in nonvaccinated piglets. Piglet vaccination in any case caused an earlier seroconversion and lower percentages of PCV2-infected piglets. There was some interference with piglet vaccination, but this was overcome by the vaccination because the average daily gain was improved in both groups of vaccinated piglets.<sup>435</sup>

Unusual manifestations of PCVAD in vaccinated finishing pigs have been described.<sup>420</sup> Vaccinated pigs also have a much lower prevalence of PRRSV and *M. hyorhinis* in lung tissues than do unvaccinated pigs.<sup>398</sup> There was a larger average daily gain in herds free from PRRSV infection.<sup>421</sup>

In a study of a one-shot, inactivated PCV2 vaccine, it was found that it reduced clinical signs, PCV2 viral load in sera and feces, and overall mortality in nurseries and fattening units.<sup>404</sup> Average daily gain was increased, but maternally derived antibody (MDA) did interfere with the development of an active humoral response.

### Maternally Derived Antibodies

Maternally derived antibodies are found in nearly all piglets because most sows are infected with PCV2 and are therefore producing colostral antibodies. The vaccine efficiency is determined by the level of colostral antibody at the time of vaccination. It appears that the vaccines are not affected in the field because PCV2 associated lesions and viral load are not inhibited.<sup>390,391</sup> The vaccines produce specific antibodies and IFN- $\gamma$ -secreting cells even in the presence of MDA.<sup>389,390,433</sup>

There may or may not be an effect of maternal antibody on piglet vaccination. It was shown that there was an effect of maternal antibody,<sup>390,396</sup> but it has also been said there is no such effect.<sup>395</sup> Vaccination at 3 weeks seems to be a good compromise

between wanting to vaccinate and waiting for maternal antibody to wane. It produces neutralizing antibodies and prevents PCV2 infection during weaning.<sup>390</sup> A comparison of one-shot and two-shot vaccinations has been described.<sup>392</sup> PCV2 vaccination reduced PCV2 in a PCV2/*S. choleraesuis* (SCS) coinfection model and in animals with SCS challenge.<sup>436</sup> Piglets were given the vaccine at 3 weeks of age followed by PCV2 and SCS at 5 and 7 weeks of age.

### Experimental Vaccines

RNA aptamers, which are RNA molecules that bind specifically to a target, have been shown to block the infectivity of PCV2 in vitro in a dose-dependent manner.<sup>437</sup> Short-hairpin RNA has also been shown to result in a reduced PCV2 level in vitro.<sup>438</sup>

A PCV2 vaccine based on genotype PCV2b is more effective than a 2a-based vaccine to protect against PCV2b or a combined 2a/2b viremia in pigs with concurrent PCV2, PRRSV, and PPV infection.<sup>439</sup> The piglets had significantly higher levels of PCV1-2b viremia and shedding but also a much more robust humoral immune response. The PCV1-2b vaccine reduced the amount of viremia compared with the PCV1-2a vaccine. Concurrent PCV2a/PCV2b infection is necessary for optimal PCV2 replication.

A genetically engineered chimeric vaccine against PCV2 improves clinical, pathologic, and virological outcomes in PMWS affected farms.<sup>399</sup> The vaccine reduced clinical signs, viral load in lymphoid organs and/or sera, and overall mortality in nurseries and finishing units. This is the first time that a vaccine has been shown to reduce PMWS mortality. The vaccine also reduced the severity of histologic lesions in the PMWS cases.

The live chimeric PCV12a vaccine is attenuated, immunogenic, and genetically stable, providing similar protection as the commercial inactivated and subunit vaccines.<sup>440,441</sup> It is not uncommon to vaccinate piglets with PRRSV and PCV2 concurrently.<sup>442,443</sup> The chimeric PCV12b live vaccines have the advantage in that they are not likely to revert.

A potential PCV12b vaccine was shown to be effective in preventing infection with 2a and 2b,<sup>444</sup> with decreased lymphoid lesions and viral load. One-dose and two-dose commercial PCV2 vaccines were evaluated in a PRRSV-PCV2-SIV model.<sup>392</sup>

Viremia was reduced by 78.5% in pigs vaccinated by one dose and by 97.1% in pigs vaccinated with two doses. Overall, the microscopic lesions were reduced by 78.7% and 81.8%, respectively.

A triple-coinfection model was used to show that the chimeric PCV12b vaccine was efficacious.<sup>441,445</sup> Vaccines, both commercial and experimental PCV2, used a triple challenge with PCV2, PRRSV, and PPV, and it

was found that both vaccines reduced the PCV viremia at 16 weeks of age and after PCV2 challenge,<sup>441</sup> even though there was PCV2 viremia at the time of vaccination.

PCV2 vaccination usually reduces the prevalence and severity of clinical disease.<sup>445,446</sup> A longitudinal study on the efficacy of Ingelvac CircoFLEX against PRDC showed that there was a significant improvement in the economics of late-occurring PRDC.<sup>447</sup>

A single-dose schedule for *M. hyopneumoniae* bacterin at 1 week of age and PCV2 vaccine at 3 weeks of age improved ADG (122.4%) and slaughter weight (120.5%) and reduced the incidence of clinical signs and lung and lymph node lesions.<sup>72</sup> Mineral oil-adjuvanted bacterins carry with them heightened potential for induction of PMWS, whereas the other adjuvanted bacterins tested have minimal or no potentiating effects on PMWS.<sup>220</sup>

In a study of PCV2 and PRRSV vaccination in a PCV2-PRRSV challenge model,<sup>448</sup> it was found that vaccination against PCV2 reduced PCV2 viremia, PCV2-induced lesions, and PCV2 antigens in the dually infected pigs. Therefore, the PCV2 vaccination reduced the potentiation of PCV2-induced by PRRSV in dually infected pigs. In contrast, the PRRSV vaccine did not decrease the potentiation of PCV2-induced lesions by PRRSV in dually infected pigs.

Some evidence of priming of young piglets in the presence of maternal antibodies was shown<sup>449</sup> using a prototype adjuvanted PCV2 vaccine.

Vaccination against PCV2 can reduce antibody titers when given postinfection and has no dramatic effects on semen characteristics.<sup>432</sup> There was also evidence that vaccination reduced the reoccurring infections in the vaccinated boars.

A comparison of the effectiveness of dam (passive) or piglet (active) immunization was carried out, and both had similar efficacies.<sup>393</sup>

In this study,<sup>450</sup> the PCV2 vaccine response was evaluated in a PCVAD challenge model. Dual challenge with PCV2 and PRRSV resulted in high mortality and the presence of clinical signs. PRRSV increased PCV2 infection. The results of IFA tests showed that PCV2 infection and vaccination resulted in similar levels of total serum antibody. Vaccination produced nearly 4 times as much virus neutralizing activity as infection and disease. The magnitude of the total antibody response cannot be used as the measure of protective immunity.

Only occasionally has vaccine failure been reported, possibly as a result of off-label uses. In some herds vaccinated against PCV2, acute pulmonary edema with a peracute onset has been reported.<sup>451</sup>

In one study of an apparent vaccine failure, it was found that only 50% of the pigs developed a detectable immune response to

vaccination, and this may have been associated with simultaneous 2a and 2b infection.

It may be necessary to produce vaccines based on 2b rather than 2a now that this is much more common, because the efficacy of currently available PCV2 vaccines depends on the genotypes of PCV2 on the farm.<sup>410</sup>

Some experimental vaccines have been suggested, including an ORF2 baculovirus vaccine,<sup>452</sup> an ORF2 DNA vaccine, a recombinant pseudorabies vaccine expressing ORF1, an ORF2 fusion protein,<sup>453</sup> and a recombinant adenovirus vaccine expressing the ORF2 protein,<sup>454</sup> and these have been shown to provide protection under experimental conditions.

Vaccination with inactivated or live-attenuated chimeric PCV1-2 results in decreased viremia in challenge-exposed pigs and may reduce transmission of PCV2.<sup>455</sup> Both of these vaccines did not reach the higher level of antibody of the commercial inactivated vaccine. The results suggested that 140-day closure of a small pig population in a controlled environment may result in stabilization and elimination of PCV2.

A similar study using a reformulated inactivated chimeric PCV12 vaccine induced humoral and cellular immunity after experimental PCV2 challenge.<sup>456</sup>

The induction of mucosal immunity by intranasal immunization with recombinant adenovirus expressing major epitopes of PCV2-capsid protein has been described.<sup>457</sup> It can elicit both humoral and Th1-type cellular protective immunity in mice. A *B. bronchiseptica* mutant has been used as a live vehicle for heterologous PCV2 major capsid protein expression.<sup>458</sup>

Small interfering RNAs have also been suggested as a potential treatment for PCV infection because *Rep* gene expression was inhibited.<sup>459</sup>

### Vectored Vaccines

The preparation of bacteriophage lambda particles displaying PCV2 capsid epitopes, in the absence of an adjuvant, induced PCV2-neutralizing ABs and elicited both cellular and humoral immune responses in pigs, with no reactions.<sup>460</sup>

Subunit vaccines may also play a part in the future, such as capsid protein in yeast,<sup>461</sup> recombinant baculovirus,<sup>462</sup> recombinant pseudorabies expressing PCV2 capsid protein,<sup>454</sup> and an attenuated *Bordetella* vaccine expressing the capsid of PCV2,<sup>459</sup> which have all been shown to be immunogenic.

### FURTHER READING

- Baekbo P, et al. Porcine circovirus diseases; a review of PMWS. *Transbound Emerg Dis.* 2012;59(suppl 1):60-67.
- Beach NM, et al. Efficacy and future prospects of commercially available and experimental vaccines against porcine circovirus type 2 (PCV2). *Virus Res.* 2012;164:33-42.

- Chae C. Commercial porcine circovirus type 2 vaccines: efficacy and clinical application. *Vet J.* 2012;194:151-157.
- Cheung AK. Porcine circovirus: transcription and DNA replication. *Virus Res.* 2012;154:46-53.
- Darwich L, Mateu E. Immunology of porcine circovirus type 2. *Virus Res.* 2012;164:61-67.
- Finsterbusch T, Mankertz A. Porcine circoviruses—small but powerful. *Virus Res.* 2009;143:177-183.
- Grau-Roma L, et al. Recent advances in the epidemiology, diagnosis and control of diseases caused by porcine circovirus type 2. *Vet J.* 2011;187:23-32.
- Kekarainen T, et al. Immune responses and vaccination induced immunity against Porcine circovirus type 2. *Vet Immunol Immunopathol.* 2010;136:185-193.
- Madec F, et al. Post-weaning multisystemic wasting syndrome and other PCV2-related problems in pigs: a 12-year experience. *Transbound Emerg Dis.* 2008;273-283.
- Madec F, et al. PMWS in pigs in France. Clinical observations from follow up studies on affected farms. *Livestock Prod Sci.* 2000;63:223-233.
- Madson DM, Opriessnig T. Effect of porcine circovirus type 2 (PCV2) infection on reproduction: disease, vertical transmission, diagnostics and vaccination. *Anim Health Res Rev.* 2011;12:47-65.
- Mankertz A. Molecular interactions of porcine circoviruses type 1 and type 2 with its host. *Virus Res.* 2012;164:54-60.
- Meng XJ. Emerging and re-emerging swine viruses. *Transbound Emerg Dis.* 2012;59(suppl 1):85-102.
- Nauwynck HJ, et al. Cell tropism and entry of porcine circovirus 2. *Virus Res.* 2012;164:43-45.
- Opriessnig T, Halbur PG. Concurrent infections are important for expression of porcine circovirus associated disease. *Virus Res.* 2012;164:20-32.
- Opriessnig T, Langohr I. Current state of knowledge on porcine circovirus type 2-associated lesions. *Vet Pathol.* 2013;50:23.
- Rose N, et al. Epidemiology and transmission of PCV2. *Virus Res.* 2012;164:78-89.
- Segales J. Porcine circovirus type 2 (PCV2) infections: clinical signs, pathology and laboratory diagnosis. *Virus Res.* 2012;164:10.
- Trible BR, Rowland RR. Genetic variation of PCV2 and its relevance to vaccination, pathogenesis and diagnosis. *Virus Res.* 2012;164:68.
25. Cheung AK, et al. *Virology.* 2007;152:1035.
26. Steinfeldt T, et al. *J Virol.* 2006;80:6225.
27. Khayat R, et al. *J Virol.* 2011;85:7856.
28. Misinzio G, et al. *J Virol.* 2006;80:3487.
29. Timmusk S, et al. *Virus Genes.* 2008;36:509.
30. Karuppanan AK, et al. *Virology.* 2010;398:1.
31. Chaiyakul M, et al. *J Virol.* 2010;84:1144.
32. Karuppanan AK, et al. *Virology.* 2009;383:338.
33. Juhán NM, et al. *Virus Res.* 2010;147:60.
34. He J, et al. *J Virol.* 2013;87:1420.
35. Carman S, et al. *Can J Vet Res.* 2008;72:259.
36. Grau-Roma L, et al. *Vet Microbiol.* 2008;128:23.
37. Martins Gomez de Castro AM, et al. *Arch Virol.* 2007;152:1435.
38. Guo LJ, et al. *Virology J.* 2010;7:273.
39. Wang F, et al. *Virus Res.* 2009;145:151.
40. Janafong T, et al. *Virus J.* 2011;8:88.
41. Cortey M, et al. *Vet Microbiol.* 2011;149:522.
42. Xiao C-T, et al. *J Virol.* 2012;86:12469.
43. Gagnon CA, et al. *Vet Microbiol.* 2010;144:18.
44. Mateusen B, et al. *Theriogenology.* 2007;68:896.
45. Saha D, et al. *Vet Microbiol.* 2010;145:62.
46. Lefebvre DJ, et al. *Vet Microbiol.* 2008;25:74.
47. Steiner E, et al. *Virology.* 2008;378:311.
48. Misinzio G, et al. *J Virol.* 2008;82:1128.
49. Misinzio G, et al. *Virus Res.* 2009;139:1.
50. Vega-Rocha S, et al. *J Mol Biol.* 2007;9:9.
51. Steinfeldt T, et al. *J Virol.* 2007;81:5696.
52. Wei L, Liu J. *Virology.* 2009;386:203.
53. Finsterbusch T, et al. *Virology.* 2009;386:122.
54. Beach NM, et al. *J Virol.* 2010;84:8986.
55. Chen X, et al. *Virology.* 2012;426:66.
56. Yu S, et al. *Vet Immunol Immunopathol.* 2009;127:350.
57. Lin C-M, et al. *Vet Immunol Immunopathol.* 2012;145:368.
58. Sinha A, et al. *Vet Microbiol.* 2012;158:95.
59. Gu J, et al. *Virology J.* 2012;9:152.
60. Zhu B, et al. *Virus Res.* 2012;163:476.
61. Zhu B, et al. *J Virol.* 2012;86:12003.
62. Rodriguez-Carino C, et al. *J Comp Path.* 2011;144:91.
63. Carman S, et al. *Can Vet J.* 2006;47:761.
64. Gagnon CA, et al. *Can Vet J.* 2007;48:811.
65. Segales J, et al. *Vet Rec.* 2008;162:867.
66. Dupont K, et al. *Vet Microbiol.* 2008;128:56.
67. Cheung AK, et al. *Arch Virol.* 2007;152:1035.
68. Wiederkkehr DD, et al. *Vet Microbiol.* 2009;136:27.
69. Ellis JA, et al. *Proc 19th IPVS Copenhagen.* Denmark: 2006:23-34.
70. Cortey M, et al. *Vet J.* 2011;187:363.
71. Kim HK, et al. *Vet J.* 2011;118:115.
72. Kim HK, et al. *Vaccine.* 2011;29:3206.
73. Wieland B, et al. *Vet Rec.* 2012;170:596.
74. Allan G, et al. *J Vet Diag Invest.* 2007;19:668.
75. Chiarelli-Neto O, et al. *Virus Res.* 2009;140:57.
76. Takahagi Y, et al. *J Vet Med Sci.* 2008;70:603.
77. Segales S, Cortey M. *Vet Rec.* 2010;67:940.
78. Ma C-M, et al. *J Gen Virol.* 2007;88:1733.
79. Cheung AK. *Arch Virol.* 2009;154:531.
80. Hesse R, et al. *Virus Res.* 2008;132:201.
81. Lefebvre DJ, et al. *J Gen Virol.* 2009;89:177.
82. Wang F, et al. *Virus Res.* 2009;145:151.
83. Cai L, et al. *Virus Res.* 2012;165:95.
84. Zhai S-L, et al. *Virology J.* 2011;8:517.
85. Sofia M, et al. *J Wildl Dis.* 2008;44:864.
86. Csagola A, et al. *Arch Virol.* 2006;151:495.
87. Guo L, et al. *PLoS ONE.* 2012;7:e1463.
88. Wei C, et al. *Infect Genet Evol.* 2013;17:87.
89. Opriessnig T, et al. *Vet Microbiol.* 2013;163:177.
90. Harding JCS, et al. *Vet Microbiol.* 2010;145:209.
91. Opriessnig T, et al. *Can J Vet Res.* 2009;73:81.
92. Ramamoorthy S, Meng X-J. *Anim Hlth Res Rev.* 2008;10:1.
93. Kim WI, et al. *J Clin Microbiol.* 2008;46:1758.
94. O'Dea MA, et al. *Aust Vet J.* 2011;89:122.

### REFERENCES

- Baekbo P, et al. *Transbound Emerg Dis.* 2012;59(suppl 1):60.
- Grau-Roma L, et al. *Vet J.* 2011;187:23.
- Darwich L, Mateu E. *Virus Res.* 2012;154:61.
- Firth C, et al. *J Virol.* 2009;83:12813.
- Duffy S, et al. *Nat Rev Genet.* 2008;9:267.
- Opriessnig T, et al. *J Vet Diag Invest.* 2007;19:591.
- Finsterbusch T, Mankertz A. *Virus Res.* 2009;141:177.
- Krakowka S, et al. *Virus Res.* 2012;164:90.
- Tomas A, et al. *Vet Microbiol.* 2008;132:260.
- Wen L, et al. *PLoS ONE.* 2012;7:e41565.
- Wen L, et al. *J Virol.* 2012;86:639.
- Lohse L, et al. *Vet Microbiol.* 2008;129:97.
- Opriessnig T, et al. *J Gen Virol.* 2006;87:2923.
- Gauger PC, et al. *Vet Microbiol.* 2011;153:229.
- Cheung AK, et al. *Virology.* 2007;363:229.
- Olvera A, et al. *Virology.* 2007;357:175.
- Dupont K, et al. *Vet Microbiol.* 2008;139:219.
- Lefebvre DJ, et al. *J Gen Virol.* 2008;89:177.
- Shang SB, et al. *Mol Immunol.* 2009;46:327.
- Cai LB, et al. *Virus Res.* 2011;158:251.
- Hesse RB, et al. *Virus Res.* 2008;132:201.
- Lefebvre DJB, et al. *J Gen Virol.* 2009;89:177.
- Ma C-M, et al. *J Gen Virol.* 2007;88:1733.
- Cheung AK. *J Virol.* 2006;80:8686.



95. Finlaison D, et al. *Aust Vet J*. 2007;85:304.
96. Perez LJ, et al. *Res Vet Sci*. 2010;89:301.
97. Gagnon C, et al. *J Vet Diagn Invest*. 2008;20:545.
98. McIntyre L, et al. *Canad J Vet Res*. 2010;74:149.
99. Li W, et al. *Virus Genes*. 2010;40:244.
100. Chae J-S, Choi K-S. *Res Vet Sci*. 2010;88:333.
101. Firth C, et al. *J Virol*. 2009;83:12813.
102. Andraud M, et al. *J R Soc Interface*. 2009;6:39.
103. Kawashima K, et al. *J Vet Diagn Invest*. 2007;19:60.
104. Chae C. *Virus Res*. 2012;164:107.
105. Punanendiran S, et al. *Virus Res*. 2011;157:92.
106. Perez LJ, et al. *Res Vet Sci*. 2010;88:528.
107. Cadar D, et al. *Acta Vet Hung*. 2010;58:475.
108. Fabsiak M, et al. *J Wildl Dis*. 2012;48:612.
109. Ruiz-Fons F, et al. *Theriogenology*. 2006;65:731.
110. Sedlak K, et al. *J Wildl Dis*. 2008;44:777.
111. Correa AM, et al. *Pesq Vet Bras*. 2006;26:154.
112. Lipej Z, et al. *Acta Vet Hung*. 2007;55:389.
113. Sofia M, et al. *J Wildl Dis*. 2008;44:864.
114. Petrini S, et al. *Europ J Wildl Dis*. 2009;55:465.
115. Ficek R, et al. *Acta Vet Brno*. 2010;79:81.
116. Wallgren P, et al. *Pig J*. 2010;63:12.
117. Rose N, et al. *Prev Vet Med*. 2009;90:168.
118. Grau-Roma L, et al. *Vet Microbiol*. 2009;135:272.
119. Calsamiglia M, et al. *Res Vet Sci*. 2007;82:299.
120. Kim HB, et al. *Vet Rec*. 2009;164:599.
121. O'Dea MA, et al. *J Virol Methods*. 2008;147:61.
122. Welch J, et al. *Transfusion*. 2006;46:1951.
123. Patterson AR, et al. *J Swine Hlth Prod*. 2011; 19:156.
124. Dupont K, et al. *Vet Microbiol*. 2007;128:56.
125. Dvorak CMT, et al. *Vet Microbiol*. 2013;166:365.
126. Shibata I, et al. *J Vet Med Sci*. 2006;65:405.
127. McIntosh KA, et al. *J Vet Diagn Invest*. 2006;18:380.
128. Park JS, et al. *J Comp Path*. 2009;140:208.
129. Ha Y, et al. *Res Vet Sci*. 2009;86:108.
130. Patterson AR, et al. *Vet Microbiol*. 2011;149:225.
131. McIntosh KA, et al. *Vet Microbiol*. 2009;133:23.
132. Gerber PF, et al. *Vet J*. 2011;188:240.
133. Madson DM, et al. *Theriogenology*. 2009;72:747.
134. Chiou M-T, et al. *J Vet Med Sci*. 2011;73:521.
135. Shen H, et al. *Prev Vet Med*. 2010;97:228.
136. Dupont K, et al. *Vet Microbiol*. 2009;139:219.
137. Kristensen CS, et al. *Vet Microbiol*. 2009;138:244.
138. Shibata I, et al. *J Vet Med B*. 2006;53:278.
139. Jaros P, et al. *Proc Cong (Copenhagen) IPVS*. 2006;1:168.
140. Opriessnig T, et al. *Vet Microbiol*. 2009;133:54.
141. Patterson AR, et al. *J Anim Sci*. 2010;88:4078.
142. Kristensen CS, et al. *Proc 5th Int Symp Emerg and Re-emerg Pig Dis (Krakow)*. 2007;5:73.
143. Verreault D, et al. *Vet Microbiol*. 2010;141:224.
144. Pinheiro ALBC, et al. *Res Vet Sci*. 2013;94:764.
145. Blunt R, et al. *Vet Microbiol*. 2011;149:452.
146. Lorincz M, et al. *Acta Vet Hung*. 2010;58:265.
147. Gagnon CA, et al. *Vet Microbiol*. 2010;144:18.
148. Ha Y, et al. *Vet Path*. 2008;45:842.
149. Ha Y, et al. *J Gen Virol*. 2010;91:1601.
150. Brunborg JM, et al. *J Vet Diagn Invest*. 2007;19:368.
151. Truszczynski M, Pejsak Z. *Med Wet*. 2009;65:6.
152. Madson DM, et al. *Vet Res*. 2009;40:10.
153. Schmoll F, et al. *Theriogenology*. 2008;69:814.
154. Madson DM, et al. *Vet Path*. 2009;46:707.
155. Bianco C, et al. *Acta Vet Scand*. 2012;54:51.
156. Patterson AR, et al. *Vet Microbiol*. 2011;149:91.
157. Madson DM, et al. *J Vet Diagn Invest*. 2008;20:725.
158. Madson DM, et al. *Vet Res*. 2009;40:10.
159. Rose N, et al. *J Comp Path*. 2007;136:133.
160. Alarcon P, et al. *Prev Vet Med*. 2011;101:182.
161. Woodbine KA, et al. *Vet Rec*. 2007;160:751.
162. Opriessnig T, et al. *Clin Vaccine Immunol*. 2006;13:923.
163. Pujols J, et al. *Vet Rec*. 2008;163:536.
164. Tomas A, et al. *Vet Microbiol*. 2008;132:260.
165. Wellenberg G, Segales J. *Tijdschr Diergen*. 2006;131:195.
166. Pistl J, et al. *Dtsch Tierarztl Wochenschr*. 2009;116:19.
167. Pozzi SP, et al. *Israel J Vet Med*. 2008;63:122.
168. Podgorska K, et al. *Med Wet*. 2009;65:330.
169. Cadar D, et al. *Acta Vet Hung*. 2007;55:151.
170. Turcitu MA, et al. *Res Vet Sci*. 2011;91:103.
171. An D-J, et al. *Vet Microbiol*. 2014;169:147.
172. Stadejek T, et al. *Med Wet*. 2006;62:297.
173. Jacobsen B, et al. *Vet Microbiol*. 2009;138:27.
174. Ramirez-Mendoza H, et al. *Res Vet Sci*. 2007;83:130.
175. Lopez-Soria S, et al. *Vet Microbiol*. 2011;149:352.
176. Opriessnig T, et al. *Vet Path*. 2006;43:281.
177. Karlakov-Mortensen P, et al. *Proc 2nd Eur Conf Pig Genomi, Ljubljana*. Slovenia: 2008:60.
178. Szabo I, et al. *Vet Rec*. 2009;165:143.
179. Ha Y, et al. *Vet Rec*. 2009;164:48.
180. Liu X, et al. *Wei Sheng Wu Xue Bao*. 2011;51:105.
181. Kim J, et al. *Vet Pathol*. 2006;43:718.
182. Blomstrom A-L, et al. *Virus Res*. 2009;146:125.
183. Blomstrom A-L, et al. *Virus Res*. 2010;152:59.
184. Cheung AK, et al. *Arch Virol*. 2010;152:1035.
185. Grau-Roma L, Segales J. *Vet Microbiol*. 2007;119:144.
186. Fraile L, et al. *J Swine Hlth Prod*. 2009;17:32.
187. Murakami S, et al. *J Vet Med Sci*. 2006;68:387.
188. Dorr PM, et al. *J Am Vet Med Assoc*. 2007; 230:244.
189. Morandi F, et al. *J Comp Path*. 2010;142:74.
190. Chang HW, et al. *Vet Microbiol*. 2007;122:72.
191. Tsai Y-C, et al. *Vet Res*. 2012;8:174.
192. Fraile L, et al. *Can J Vet Res*. 2009;73:308.
193. Opriessnig T. *Vet Microbiol*. 2012;158:69.
194. Ramamoorthy S, et al. *Vet Microbiol*. 2011;147:49.
195. Allan GM, et al. *Zoon Publ Hlth*. 2007;54:214.
196. Huang YW, et al. *Virus Res*. 2011;118:79.
197. Hino S, Miyata H. *Rev Med Virol*. 2007;17:45.
198. Kekarainen T, et al. *J Gen Virol*. 2006;87:833.
199. Aroumouni M, et al. *Vet Microbiol*. 2011;153:377.
200. Takahashi M, et al. *J Vet Med Sci*. 2008;70:497.
201. Rittersbusch GA, et al. *Res Vet Sci*. 2011;92:519.
202. Horlen KP, et al. *J Am Vet Med Assoc*. 2007;232:906.
203. Savic B, et al. *Vet Res Commun*. 2010;34:641.
204. Martin M, et al. *Vet Microbiol*. 2007;122:16.
205. Ellis JA, et al. *Am J Vet Res*. 2008;69:1608.
206. Nieto D, et al. *Vet Microbiol*. 2013;163:364.
207. McMenamy MJ, et al. *Vet Microbiol*. 2013;164:293.
208. Martelli F, et al. *Res Vet Sci*. 2010;88:492.
209. de Deus N, et al. *Vet Microbiol*. 2007;119:105.
210. Hosmillo M, et al. *Arch Virol*. 2010;155:1157.
211. Ellis JA, et al. *Am J Vet Res*. 2008;69:1608.
212. Jung K, et al. *Vet J*. 2006;171:166.
213. Jung K, et al. *Vet J*. 2006;171:445.
214. Diaz I, et al. *Vet J*. 2012;194:84.
215. Wei H, et al. *Comp Med*. 2010;60:45.
216. Langohr I, et al. *J Vet Diagn Invest*. 2012;24:51.
217. Zhang H, et al. *Vet Immunol Immunopathol*. 2011;140:152.
218. Zhang H, et al. *Epidemiol Infect*. 2011;19:1.
219. Zhang H, et al. *Vet Immunol Immunopathol*. 2012;140:152.
220. Krakowka S, et al. *Can Vet J*. 2007;48:716.
221. Sibila M, et al. *J Comp Path*. 2012;147:285.
222. Palzer A, et al. *Vet Rec*. 2008;162:267.
223. Kixmoller M, et al. *Vaccine*. 2008;26:3443.
224. Santos DL, et al. *Proc Int Pig Vet Soc Cong*. 2008;P01:100.
225. Mette A, et al. *Proc IPVS Durban*. 2008;P01:0613.
226. Wieland B, et al. *Pig J*. 2010;63:20.
227. Pereyra NB, et al. *Rev Argent Microbiol*. 2006;38:130.
228. Murakami S, et al. *J Vet Med Sci*. 2006;68:387.
229. Chang H-W, et al. *Vet Microbiol*. 2006;115:311.
230. Opriessnig T, et al. *J Comp Path*. 2011;145:209.
231. Johansen M, et al. *Prev Vet Med*. 2013;108:63.
232. Cavallini-Sanches EM, et al. *J Eukaryot Microbiol*. 2006;53:92.
233. Borba MR, et al. *Med Mycol*. 2011;49:1720.
234. Zlotowski P, et al. *Vet J*. 2006;171:566.
235. Szeredi L, Szentirmai C, et al. *Acta Vet Hung*. 2008;56:207.
236. Klein S, et al. *J Comp Path*. 2010;142:228.
237. Marruchella G, et al. *Res Vet Sci*. 2012;93:310.
238. Opriessnig T, et al. *J Gen Virol*. 2008;89:177.
239. Khaiseb S, et al. *J Virol*. 2011;85:11111.
240. Lin C-M, et al. *Vet Microbiol*. 2011;149:72.
241. Perez-Martin E, et al. *J Virol Met*. 2007;146:86.
242. Yu S, et al. *Vet Microbiol*. 2007;123:34.
243. Kekarainen T, et al. *Vet Immunol Immunopathol*. 2010;136:185.
244. Steiner E, et al. *BMC Vet Res*. 2009;5:45.
245. Tsai Y-C, et al. *Vet Res*. 2010;41:60.
246. Rodriguez-Carino C, et al. *J Comp Path*. 2010;142:291.
247. Yu S, et al. *Vet Immunol Immunopathol*. 2007;115:261.
248. Resendes AR, et al. *Vet J*. 2011;189:72.
249. Seeliger FA, et al. *Vet Pathol*. 2007;44:621.
250. Sinha A, et al. *Res Vet Sci*. 2012;92:151.
251. Galindo-Gardiel I, et al. *J Comp Path*. 2011;144:63.
252. Wei L, et al. *Virology*. 2008;378:177.
253. Wei L, Liu J. *Virology*. 2009;386:203.
254. Wei L, et al. *J Virology*. 2009;83:6039.
255. Wei L, et al. *J Virol*. 2012;86:13589.
256. Wei L, et al. *Virology*. 2013;147:285.
257. Yu S, et al. *Vet Immunol Immunopathol*. 2009;127:350.
258. Opriessnig T, et al. *Vet Res*. 2010;41:31.
259. Marks FS, et al. *Vet Microbiol*. 2010;141:220.
260. Szeredi L, Szentirmai C. *Acta Vet Hung*. 2008;56:101.
261. Correa AM, et al. *Braz J Vet Res*. 2006;26:9.
262. Behling-Kelly E, Czuprynski CJ. *Anim Hlth Res Rev*. 2007;8:47.
263. Timmusk S, et al. *J Gen Virol*. 2006;87:3215.
264. Lin C-M, et al. *Vet Microbiol*. 2013;162:519.
265. Wikstrom FH, et al. *J Virology*. 2007;81:4919.
266. Borghetti P, et al. *Vet Microbiol*. 2013;163:42.
267. Kekarainen T, et al. *Vet Immunol Immunopathol*. 2008;124:41.
268. Kekarainen T, et al. *J Gen Virol*. 2008;89:760.
269. Vincent IE, et al. *Immunology*. 2007;120:47.
270. Chang HW, et al. *Vet Immunol Immunopathol*. 2006;110:207.
271. Darwich L, et al. *Res Vet Sci*. 2008;84:194.
272. Stevenson LS, et al. *Viral Immunol*. 2006;19:189.
273. Doster AR, et al. *J Vet Sci*. 2010;11:177.
274. Crisci E, et al. *Vet Immunol Immunopathol*. 2010;136:305.
275. Lv Y, et al. *Res Vet Sci*. 2013;95:1235.
276. Vincent IEI, et al. *Immunol*. 2007;120:47.
277. Ramamoorthy S, et al. *Virus Res*. 2009;145:187.
278. Fort M, et al. *Vet Immunol Immunopathol*. 2009;129:101.
279. Brunborg IM, et al. *Acta Vet Scand*. 2010;52:22.
280. Li J, et al. *Vet J*. 2012;193:199.
281. Grierson SS, et al. *Vet Immunol Immunopathol*. 2007;119:254.
282. Shi K, et al. *Vet Microbiol*. 2007;129:367.
283. Carasova P, et al. *Res Vet Sci*. 2007;83:274.
284. Fort M, et al. *Vet Microbiol*. 2007;125:244.
285. Fan H, et al. *Vet Res Commun*. 2007;31:487.
286. Song Y, et al. *Vet Microbiol*. 2007;119:97.
287. Gerber PF, et al. *Can J Vet Res*. 2012;76:38.
288. Dias AS, et al. *Res Vet Sci*. 2013;94:341.
289. Oh Y, et al. *J Gen Virol*. 2012;93:1556.
290. Fort M, et al. *Vet Immunol Immunopathol*. 2010;137:226.
291. Quereda JJ, et al. *Am J Vet Res*. 2013;74:110.
292. Silva FMF, et al. *J Comp Path*. 2011;144:296.
293. Saha D, et al. *BMC Vet Res*. 2011;7:64.

294. Pescador CA. *Pesq Vet Brasil*. 2007;27:425.
295. Sarli G, et al. *Proc 19th IPVS Congress*. 2006;5.
296. Nielsen EO, et al. *Vet Rec*. 2008;162:505.
297. Zlotowski P, et al. *Vet Rec*. 2013;172:637.
298. Correa AMR, et al. *J Vet Diag Invest*. 2007;19:109.
299. Cino-Ozuna AG, et al. *J Clin Microbiol*. 2011;49:2012.
300. Darwich L, Mateu E. *Virus Res*. 2012;164:61.
301. Huang YY, et al. *Vet Pathol*. 2008;45:640.
302. Correa AM. *J Vet Diag Invest*. 2007;19:109.
303. Langohr IM, et al. *Vet Pathol*. 2010;47:140.
304. Bukovsky C, et al. *Vet Rec*. 2007;161:552.
305. Imai DM, et al. *J Vet Diag Invest*. 2006;18:496.
306. Szeredi L, et al. *Vet Pathol*. 2012;49:264.
307. Rodriguez-Carino C, Segales J. *Vet Pathol*. 2009;46:729.
308. Woodbine KA, et al. *Prev Vet Med*. 2010;97:100.
309. Segales J, Cortey M. *Vet Rec*. 2010;167:940.
310. Wellenberg GJ, et al. *Vet Microbiol*. 2010;142:217.
311. Alarcon P, et al. *Prev Vet Med*. 2011;98:19.
312. Tico G, et al. *Vet Microbiol*. 2013;163:242.
313. Jacela JY, et al. *J Swine Hlth Prod*. 2011;19:10.
314. Jensen VF, et al. *Prev Vet Med*. 2010;95:239.
315. Vigre H, et al. *Prev Vet Med*. 2010;93:98.
316. Phaneuf LR, et al. *J Am Ass Lab Anim Sci*. 2007;46:68.
317. Madson DM, Opriessnig T. *Anim Hlth Res Rev*. 2011;12:47.
318. Togashi K, et al. *J Vet Med Sci*. 2011;73:941.
319. Lefebvre D, et al. *Proc IPVS Congress*. 2008;20:38.
320. Sharma R, Saikumar G. *Trop Anim Hlth Prod*. 2010;42:515.
321. Woods A, et al. *J Swine Hlth Prod*. 2010;14:210.
322. Rittersbusch GA, et al. *Proc 21st IPVS Congress*. 2010;21:466.
323. Hogedal P, et al. *Proc IPVS Congress*. 2008;20:221.
324. Pittman JS, et al. *J Swine Hlth Prod*. 2008;16:144.
325. Hansen MS, et al. *Vet Microbiol*. 2010;144:203.
326. Meyns T, et al. *Proc 22nd IPVS*. 2012:879.
327. Zlotowski P, et al. *Vet Rec*. 2013;doi:10.1136/vr.101409.
328. Pejsak Z, et al. *Res Vet Sci*. 2011;91:125.
329. Cino-Ozuna AG, et al. *J Clin Microbiol*. 2011;49:2012.
330. Huang Y-L, et al. *Vet Res*. 2011;42:1150.
331. Salamano G, et al. *Vet J*. 2008;177:110.
332. Tsiakalos A, et al. *Liver Int*. 2009;29:1538.
333. Eckersall PD, Bell R. *Vet J*. 2010;185:23.
334. Bode JG, et al. *J Immunol*. 2012;167:1469.
335. Gauger PC, et al. *Vet Microbiol*. 2011;154:185.
336. Grau-Roma L, et al. *Vet Microbiol*. 2009;138:53.
337. Opriessnig T, Langohr I. *Vet Pathol*. 2013;50:23.
338. Faccini S, et al. *J Vet Diag Invest*. 2011;23:1189.
339. Harding JCS, et al. *Can J Vet Res*. 2009;73:7.
340. Madson DM, et al. *Clin Vaccine Immunol*. 2009;16:830.
341. Sarli G, et al. *Vet Rec*. 2009;164:519.
342. Jin Q, et al. *J Vet Diag Invest*. 2012;24:1151.
343. Turner MJ, et al. *Prev Vet Med*. 2009;88:213.
344. Jittimanee S, et al. *J Vet Diag Invest*. 2012;24:1129.
345. O'Sullivan T, et al. *Vet Res*. 2012;8:192.
346. Fort M, et al. *Vet Microbiol*. 2007;125:244.
347. Jorsal SE, et al. *Proc 19th IPVS Congress*. Copenhagen: 2006:311.
348. Sarli G, et al. *Vet Rec*. 2006;164:519.
349. Grasland B, et al. *Proc 20th IPVS Cong*. 2008;20:56.
350. Opriessnig T, et al. *J Swine Hlth Prod*. 2006;14:42.
351. Ciacci-Zanella JR, et al. *Proc Int Symp Emerg Re-Emerg Pig Dis*. 2007;5:94.
352. Ciaccia-Zanella JR, et al. *Proc IPVS Cong*. 2008;20:23.
353. Gava D, et al. *Pesq Vet Brasil*. 2008;28:70.
354. Reicks DI, et al. *Proc Allen D Leman Swine Conf*. 2007;34:104.
355. Pal N, et al. *J Virol Methods*. 2008;149:217.
356. Sarli G, et al. *Vet Rec*. 2009;164:519.
357. Morandi F, et al. *Acta Vet Scand*. 2012;54:17.
358. Hansen MS, et al. *J Comp Pathol*. 2010;142:109.
359. Hansen MS, et al. *Vet Pathol*. 2013;50:980.
360. Ogawa H, et al. *J Virol Methods*. 2009;160:210.
361. Lin C-M, et al. *Vet Med*. 2009;138:225.
362. McIntosh KA, et al. *Can Vet J*. 2008;49:1189.
363. Hjulstager CK, et al. *Vet Microbiol*. 2009;133:172.
364. Harding JC, et al. *Can J Vet Res*. 2009;73:7.
365. An DJ, et al. *Vet Res Comm*. 2009;33:139.
366. Li J, et al. *Vet Rec*. 2013;173:346.
367. Belak S. *Dev Biol*. 2007;128:103.
368. McKillen J, et al. *J Virol Methods*. 2007;140:155.
369. Jiang Y, et al. *Vet J*. 2010;183:172.
370. Jiang Y, et al. *Res Vet Sci*. 2010;89:133.
371. Dezen D, et al. *Res Vet Sci*. 2010;88:436.
372. Vilcek S, et al. *J Virol Methods*. 2010;165:216.
373. Prickett JR, et al. *J Swine Hlth Prod*. 2008;16:86.
374. Ramirez A, et al. *Prev Vet Med*. 2012;104:292.
375. Chittick WA, et al. *J Vet Diagn Invest*. 2011;23:248.
376. Prickett JR, et al. *Transbound Emerg Dis*. 2011;58:121.
377. Madec F, et al. *Transbound Emerg Dis*. 2008;55:273.
378. Woeste K, Gross Beilage E. *Dtsch Tierarztl Wochenschr*. 2007;114:324.
379. Opriessnig T, et al. *Vet Rec*. 2006;158:149.
380. Hassing A-G, et al. *Proc 4th Int Symp Emerg Pig Dis (Rome)*. 2006:211.
381. Martin H, et al. *Vet J*. 2008;177:388.
382. Maes D, et al. *Theriogenology*. 2008;70:1337.
383. Pan Q, et al. *J Trace Elements Med Biol*. 2008;22:143.
384. Jung B-G, et al. *Vet Microbiol*. 2010;143:117.
385. Andruad M, et al. *Prev Vet Med*. 2009;92:38.
386. Kekarainen T, et al. *Vet Immunol Immunopathol*. 2010;136:185.
387. Beach NM, Meng XJ. *Virus Res*. 2012;164:33.
388. Madson D, et al. *Am Assoc Swine Vet*. 2009;151.
389. Fort M, et al. *Vaccine*. 2009;27:4031.
390. Fort M, et al. *Vaccine*. 2008;26:1063.
391. Opriessnig T, et al. *Clin Vaccine Immunol*. 2008;9:33.
392. Opriessnig T, et al. *Vaccine*. 2009;27:1002.
393. Opriessnig T, et al. *Vet Microbiol*. 2010;142:177.
394. Hemann M, et al. *Vet Microbiol*. 2012;158:180.
395. Cline G, et al. *Vet Rec*. 2008;163:737.
396. Fachinger V, et al. *Vaccine*. 2008;26:1488.
397. Horlen KP, et al. *J Am Vet Med Assoc*. 2008;232:906.
398. Kixmoller M, et al. *Vaccine*. 2008;26:3443.
399. Segales J, et al. *Vaccine*. 2009;27:7313.
400. Pejsak Z, et al. *Comp Immunol Microbiol Infect Dis*. 2010;33:e1.
401. Kurmann J, et al. *Clin Vaccine Immunol*. 2011;18:1644.
402. Lyoo K, et al. *Vet J*. 2011;189:58.
403. Martelli P, et al. *Vet Microbiol*. 2011;149:339.
404. Fraile L, et al. *Vet Microbiol*. 2012;161:229.
405. Gagnon CA, et al. *Vet Microbiol*. 2010;144:18.
406. Lohse L, et al. *Vet Microbiol*. 2008;129:97.
407. Timmusk S, et al. *Virus Genes*. 2008;36:509.
408. Seo H-S, et al. *Vet J*. 2014;doi:10.1016/j.tvj.2014.02.002.
409. Lyoo K-S, et al. *Can J Vet Res*. 2012;76:221.
410. Takahagi Y, et al. *J Vet Med*. 2010;72:35.
411. Desrosiers R, et al. *J Swine Hlth Prod*. 2008;17:148.
412. Horlen KP, et al. *J Am Vet Med Assoc*. 2008;232:906.
413. Jacela JY, et al. *J Swine Hlth Prod*. 2011;19:10.
414. Fachinger V, et al. *Vaccine*. 2008;26:1488.
415. Kixmoller M, et al. *Vaccine*. 2008;26:3443.
416. Martelli P, et al. *Vet Microbiol*. 2011;149:339.
417. Segales J, et al. *Vaccine*. 2009;27:7313.
418. Venegas-Vargas MC, et al. *J Swine Hlth Prod*. 2011;19:233.
419. Young MC, et al. *J Swine Health Prod*. 2011;19:175.
420. Strugnell BW, et al. *Pig J*. 2011;66:67.
421. Kristensen CS, et al. *Prev Vet Med*. 2011;98:250.
422. Pejsak Z, et al. *Bull Vet Inst Pulawy*. 2009;53:159.
423. Pejsak Z, et al. *Pol J Vet Sci*. 2012;15:37.
424. Gerber PF, et al. *Vet J*. 2011;188:240.
425. Kurmann J, et al. *Clin Vaccine Immunol*. 2011;18:1644.
426. O'Neill KC, et al. *Vet Rec*. 2012;171:425.
427. Sibila M, et al. *Vet J*. 2013;doi:10.1016/j.tvj.2013.04.01.
428. Opriessnig T, et al. *J Anim Sci*. 2009;87:1582.
429. Pejsak Z, et al. *Comp Immunol Microbiol Infect Dis*. 2010;33:e1.
430. Goubier A, et al. *Proc 18th IPVS Congress*. 2008;1:16.
431. Seo HW, et al. *Clin Vaccine Immunol*. 2011;18:1091.
432. Alberti KA, et al. *J Anim Sci*. 2011;89:1581.
433. Fort M, et al. *Vet Immunol Immunopathol*. 2009;129:101.
434. O'Neill KC, et al. *Clin Vaccine Immunol*. 2011;18:1865.
435. Fraile L, et al. *Vet Microbiol*. 2012;161:229.
436. Takada-Iwao A, et al. *Vet Microbiol*. 2013;162:219.
437. Yoon S, et al. *Antiviral Res*. 2010;88:19.
438. Feng Z, et al. *Antiviral Res*. 2008;77:186.
439. Opriessnig T, et al. *Vaccine*. 2013;31:487.
440. Gillespie J, et al. *Vaccine*. 2008;26:4231.
441. Shen HG, et al. *Vaccine*. 2010;28:5960.
442. Opriessnig T, et al. *Vet Microbiol*. 2008;131:103.
443. Sinha A, et al. *Clin Vac Immunol*. 2010;17:1940.
444. Beach NM, et al. *Vaccine*. 2010;29:221.
445. Opriessnig T, et al. *Clin Vaccine Immunol*. 2011;18:1261.
446. Opriessnig T, et al. *Theriogenology*. 2011b;76:351.
447. Bischoff R, et al. *Prakt Tierarztl*. 2009;90:58.
448. Park C, et al. *Clin Vaccine Immunol*. 2013;20:369.
449. Lakshman NA, et al. *Can J Vet Res*. 2012;76:301.
450. Tribble BR, et al. *Vaccine*. 2012;30:4079.
451. Cino-Ozuna AG, et al. *J Clin Immunol*. 2011;49:2012.
452. Takahagi Y, et al. *J Vet Med Sci*. 2009;70:603.
453. Fan H, et al. *Vet Res Commun*. 2007;31:487.
454. Song Y, et al. *Vet Microbiol*. 2007;119:97.
455. Wang X, et al. *Vaccine*. 2006;24:3374.
456. Hemann M, et al. *Vet Microbiol*. 2012;158:180.
457. Seo HW, et al. *Vet Res*. 2012;8:194.
458. Liu Y-F, et al. *Vet Immunol Immunopathol*. 2013;154:48.
459. Kim T, et al. *Vet Microbiol*. 2009;138:318.
460. Sun M, et al. *Vet Microbiol*. 2007;123:203.
461. Hayes S, et al. *Vaccine*. 2010;28:6789.
462. Bucarey SA, et al. *Vaccine*. 2009;27:5781.
463. Takada-Iwao A, et al. *Vet Microbiol*. 2011;154:104.

## TORQUE TENO VIRUS

Torque teno virus is, as far as is known at the moment, a nonpathogenic commensal inhabitant of vertebrates. It is one of a newly created family of Anelloviridae, which has nine genera. It may be one of what are now called "bystander viruses."<sup>1</sup>

## ETIOLOGY

These are emerging circular DNA viruses affecting many species, including pigs. Currently, two genera have been found in pigs: type 1 (TTSuV1), now known as *Iotatorquevirus*, which has 1a and 1b subtypes; and type 2 (TTSuV2), now known as *Kappatorquevirus*, which has 2a and 2b subtypes. In addition, a novel virus was also discovered in

New Zealand in 2012, and this has also been found in China.<sup>2,3</sup> The virus may have an immunosuppressive effect when found as a natural infection before vaccination with PRRS.<sup>1</sup> The replication site of the virus is unknown.<sup>4</sup> Several strains have been found in one pig.<sup>5</sup> They can also be widely divergent in genotype.<sup>6</sup> In a study measuring TTV quantitatively, there was no difference in viral load between PCV2-negative and PCV2-positive pigs.<sup>7</sup>

## EPIDEMIOLOGY

These viruses have also been found in pig commercial vaccines, enzymes for laboratory use, and human drugs containing components of porcine origin.<sup>8</sup>

They were first linked to PCV2-associated diseases (PCVAD)<sup>9</sup> and PDNS<sup>10</sup> and may be a cofactor in the disease. They were found very commonly in animals with nephropathy. They are widely distributed in tissues in the pig. The virus is found in fetal tissues, blood, semen,<sup>11</sup> and colostrum. In piglets, it can be found in week 1 of life, and the highest detection is at 11 weeks for type 1 and 16 weeks for type 2.<sup>12</sup> A study in the United States showed that it was common and increased with age.<sup>13</sup>

It has a long-lasting viremia, probably because there is a very poor immunologic response. The virus load increases progressively for suckling pigs to finisher pigs and then decreases in mature animals. It can be transmitted vertically and horizontally.

It has been found in wild boar,<sup>14</sup> in Spain,<sup>15,16</sup> Czechoslovakia,<sup>17</sup> Italy,<sup>18</sup> Hungary,<sup>19</sup> China,<sup>20-22</sup> the United States,<sup>13</sup> and Austria.<sup>23</sup>

In Japan, it is widespread in postweaning pigs and may play a part in pig disease. There is a low incidence in young pigs, less than 11% in pigs under 30 days old but 54% to 85% in older pigs.<sup>24</sup> The two species differ in their viral infection dynamics in PMWS-affected herds.<sup>25</sup> In a South Korean study, there was shown to be an early onset of viremia and a chronic viremic state regardless of the PCV2 vaccination status.<sup>7</sup>

In a Spanish retrospective study of pigs from 1985 to 2005, 113/162 pigs were infected with one or another type; 38/162 had both types of virus, 90/162 had type 2, and 54/162 had type 1.<sup>16</sup>

There is evidence for vertical transmission<sup>14</sup> and in utero infection.<sup>26</sup> An increased viral load and prevalence of TTSuV2 in pigs experimentally infected with a highly pathogenic CSFV has been shown.<sup>4</sup>

## CLINICAL SIGNS

There are no clinical signs. Coinfection of TTSuV and PCV2 in a reproductive problem was demonstrated, but no clinical disease was found.<sup>27</sup>

## DIAGNOSIS

There are several PCR assays for TTSuV1<sup>16</sup> and for TTSuV.<sup>28</sup> There is a nonspecific

qPCR for both viruses,<sup>29</sup> and ELISAs are available for the detection of antibodies.

## FURTHER READING

Kekrainen T, Segales J. *Sus virus in pigs: an emerging pathogen?* *Transbound Emerg Dis.* 2012;59(suppl S1):103-108.

## REFERENCES

- Zhang Z, et al. *Arch Virol.* 2012;157:927.
- Zhai S-L, et al. *Arch Virol.* 2012;157:927.
- Zhai S-L, et al. *Arch Virol.* 2013;158:1567.
- Aramouni M, et al. *Vet Microbiol.* 2010;146:350.
- Huang YW, et al. *Virology.* 2010;396:289.
- Wang MM, et al. *J Virol.* 2012;86:11953.
- Lee S, et al. *Res Vet Sci.* 2012;92:519.
- Kekrainen T, et al. *J Gen Virol.* 2009;90:648.
- Ellis J, et al. *Am J Vet Res.* 2008;69:1608.
- Krakowka S, et al. *Am J Vet Res.* 2008;69:1615.
- Kekrainen T, et al. *Theriogenology.* 2007;68:966.
- Sibila M, et al. *Vet Microbiol.* 2009;139:213.
- Xiao C-T, et al. *J Virol Meth.* 2012;183:40.
- Martinez L, et al. *Vet Microbiol.* 2006;98:81.
- Kekrainen T, et al. *J Gen Virol.* 2006;68:966.
- Segales J, et al. *Vet Microbiol.* 2009;134:199.
- Jarosova V, et al. *Folia Microbiol.* 2011;56:90.
- Martelli F, et al. *J Vet Med.* 2006;53:234.
- Takacs M, et al. *Acta Vet Hung.* 2008;56:547.
- Zhu CX, et al. *J Clin Virol.* 2010;48:296.
- Liu X, et al. *Vet Rec.* 2011;168:410.
- Zhu CX, et al. *Virus Res.* 2012;165:225.
- Lang C, et al. *Berl Munch Tierarztl Wschr.* 2011;124:142.
- Tara O, et al. *Vet Microbiol.* 2011;139:347.
- Nieto D, et al. *Vet Microbiol.* 2011;152:284.
- Pozzuto T, et al. *Vet Microbiol.* 2009;137:375.
- Ritterbusch GA, et al. *Res Vet Sci.* 2012;92:519.
- Lee S-S, et al. *J Vet Diag Invest.* 2010;22:261.
- Brassard J, et al. *J Appl Microbiol.* 2010;108:2191.

## NIPAH

Nipah is a zoonotic virus encephalitic disease of pigs and humans in Southeast Asia. It probably jumped from a wildlife reservoir to domestic pigs first. Infection with two strains of the virus was responsible for fatal respiratory disease in Malaysia in 1999. The outbreak resulted in numerous deaths of pig farmers (fatal febrile encephalitis) and others in contact with pigs, including abattoir workers. About 90% of outbreaks in humans can be associated with close contact with pigs. Recently, outbreaks in humans have occurred without reference to pigs.<sup>1,2</sup> It can cause huge economic loss in the pig industry. The pig serves as an “amplifying host.”

## ETIOLOGY

Pigs are highly susceptible to Nipah virus.

The virus is a member of the *Henipavirus* genus in the Paramyxoviridae family, which includes Hendra virus, which is transmitted from frugivorous bats (*Pteropus* spp.) to pigs, among which it spreads horizontally to other pigs and humans. Horses can be exposed and develop antibodies to the virus, and there is one anecdotal report of dilated meningeal vessels in a horse from which Nipah virus was isolated. It grows readily in cell culture to produce syncytia.

## EPIDEMIOLOGY

There is strong evidence that the reservoir from which the virus originated was pteropid bats.

It is highly contagious in swine, and transmission may be by several routes, including direct contact with large droplets. The oronasal route is the most common method because the virus can be demonstrated in nasal secretions. Cats and dogs can be affected but probably do not transmit to pigs.

## PATHOGENESIS

The virus affects the vascular, nervous, and lymphoreticular systems, leading to a viremia and specific infections of the endothelial cells<sup>3</sup> and immune cells,<sup>4</sup> particularly some T cells and monocytes. Nipah can then cross the blood-brain barrier. The virus infects monocytes and a subset of T-lymphocytes.

## CLINICAL SIGNS

It may be asymptomatic in pigs, but it is usually a severe, fatal disease with respiratory or CNS signs. Affected weaners may have a temperature in excess of 40°C (104°F), with a harsh characteristic (but not pathognomonic) barking cough, mouth breathing, and poor exercise tolerance. There is hindleg weakness, thrashing, and recumbency, with head pressing, titanic spasms, and fits. In adults there may be sudden death, which is quite rare, and sometimes there are neurologic signs, such as pharyngeal muscle paralysis, frothy salivation, and drooping of the tongue. In experimental infections, piglets often only showed a mild temperature rise.<sup>4</sup>

## NECROPSY FINDINGS

There are few gross lesions. There may be lung consolidation and froth in the trachea. The lymph nodes may be enlarged. Histologically, there is a pneumonia and the presence of syncytia and multinucleated alveolar macrophages; if neurologic signs, there may be a nonsuppurative meningitis.

## DIAGNOSIS

Diagnosis is based on exposure to affected pigs or fruit bats; the presence of the harsh barking cough, which is said to be almost pathognomonic; and the nervous signs. Specimen collection and diagnostic assays have been reviewed,<sup>5</sup> but any handling of suspect material should be carried out in category 4 laboratories. It is possible to demonstrate the antigens in formalin-fixed material.

The virus can be demonstrated in the tissues using a tagged monoclonal antibody or RT-PCR. There is high sensitivity of qRT-PCR.<sup>6</sup>

For the presence of antibodies, blocking ELISAs are superior to virus neutralization.<sup>6</sup>

## TREATMENT

No treatment is available.



## CONTROL

Neutralizing antibodies appear 7 to 10 days postinfection<sup>7</sup> and reach a maximum at 14 to 16 days postinoculation.

It is necessary to keep the pigs on farms where there are no fruit bats nesting in trees. Isolation and quarantine are the best control methods, rapid slaughter of infected pigs is absolutely necessary, and other species must be kept away from infected farms.

## REFERENCES

- Gurley ES, et al. *Emerg Infect Dis.* 2007;13:1031.
- Luby SP, et al. *Emerg Infect Dis.* 2006;12:1888.
- Meisner A, et al. *Thromb Haemost.* 2009;102:1014.
- Berhane Y, et al. *Transbound Emerg Dis.* 2008;55:165.
- Daniels P, Narasiman M. *Manual of Diagnostic Tests and Vaccines for Terrestrial Animals.* Vol. 2. Geneva: WHO; 2008:1227.
- Li M, et al. *Vet Res.* 2010;41:33.
- Weingartl HM, et al. *J Virol.* 2006;80:7929.

## TIOMAN VIRUS

Tioman virus is another paramyxovirus of pigs of fruit bat origin, found in Malaysia,<sup>1</sup> which causes a mild disease in pigs and has a predilection for the lymph nodes.

## REFERENCE

- Yalw KC, et al. *J Virol.* 2008;82:565.

## PORCINE RETROVIRUSES

All mammals have leftover traces of past viral infections in their genetic makeup.<sup>1</sup> Commercial pigs carry high and variable titers of retroviral RNA in their blood, with differences according to their age and herd health status. These endogenous retroviruses<sup>2</sup> may contribute up to 8% of the genome of all vertebrates.<sup>3</sup> All pigs carry endogenous porcine retroviruses (PRs) in their genome.<sup>4</sup> There may be an association between PRs and mortality in commercial herds.<sup>1,5,6</sup> The discovery that PRs can infect human cells triggered research into how xenotransplantation infection may be prevented.

## FURTHER READING

- Denner J, Tonjes RR. Infection barriers to successful xenotransplantation focusing on porcine endogenous retroviruses. *Clin Microbiol Rev.* 2012;25:318-343.
- Pal N, et al. The importance of ubiquitous viruses such as the different PERV types may be currently underestimated and especially PERV-A/C may play a role in multifactorial disease in pigs. *Transbound Emerg Dis.* 2011;58:344-351.

## REFERENCES

- Tucker AW, Scobie L. *Vet Rec.* 2006;159:367.
- Tucker AW, et al. *J Clin Microbiol.* 2006;44:3846.
- Kurth R, Bannert N. *Int J Cancer.* 2009;126:306.
- Wilson CA. *Cell Molec Life Sci.* 2008;65:3399.
- Dieckhoff B, et al. *Vet Microbiol.* 2007;123:53.
- Pal N, et al. *Transbound Emerg Dis.* 2011;58:344.

## MENANGLE

Menangle virus was first identified in a three-farm disease outbreak in New South

Wales in 1997. It causes reproductive problems in pigs and congenital defects and has the fruit bat as an asymptomatic reservoir. It can cause a flulike disease in humans. Only one outbreak has been described. The virus normally lives asymptotically in fruit bats.

## ETIOLOGY

It is a RNA virus in the family Paramyxoviridae, probably in the genus *Rubalovirus*. It is closely related to Tioman virus found in fruit bats on Tioman Island, Malaysia.

## EPIDEMIOLOGY

A variety of fruit bats are seropositive, but the virus has not been isolated from them, including the gray-headed flying fox, black fruit bat, and spectacled fruit bat. These fruit bats have been found in other areas of Australia and the original area around Menangle, New South Wales.

Bat feces and urine are probably the source of infection. Transmission from pig to pig is slow and probably requires close contact. In one building, it took a long time for the sows to become affected. It probably spreads from farm to farm via infected animals. There is no sign of persistent infection and no evidence of long-term virus shedding. Present evidence suggests that virus survival in the environment is short because sentinel pigs placed in an uncleaned area did not seroconvert.

## CLINICAL SIGNS

Currently, there is no knowledge of the incubation period. In the initial outbreak, clinical signs were seen only on the farrow-to-finish farm, but infected pigs were found in all three farms.

The disease was an outbreak of reproductive disease with fetal death; fetal abnormalities, including congenital defects such as skeletal and neurologic defects,<sup>1</sup> mummified fetuses, and stillborn fetuses; smaller litters with fewer live piglets; and a reduced farrowing rate. The farrowing rate fell from 80%+ to a low of approximately 38%, reaching an average of 60%. Many sows returned to estrus 28 days after mating, which suggests that there has been an early death of the litter. Some sows remain in pseudopregnancy for more than 60 days. It probably crosses the placenta and spreads from fetus to fetus. Once the infection became endemic in the farrow-to-finish herd, the reproductive failures ceased.

## NECROPSY FINDINGS

The mummified fetuses vary in size and are of 30 days' gestation or older.

The virus causes degeneration of the brain and spinal cord. In particular, the cerebral hemispheres and cerebellum are smaller. Occasionally there may be effusions and pulmonary hypoplasia. Eosinophilic inclusions are found in the neurons of the cerebrum and spinal cord. Sometimes there is

nonsuppurative meningitis, myocarditis, and hepatitis. Experimental infections show shedding 2 to 3 days after infection in nasal and oral secretions. A tropism for secondary lymphoid tissues and intestinal epithelium has been demonstrated.<sup>2</sup> No lesions have been seen in piglets born alive or other post-natal pigs.

## DIAGNOSIS

The diagnosis is suspected when the reproductive parameters change very suddenly, as previously described.

Diagnosis is confirmed by virus culture, and electron microscopy (EM) and virus neutralization (VN) tests confirm the identity of the virus. Serologic tests include ELISAs, and the best way to test the herd is to use this for the sows for antibody.

## DIFFERENTIAL DIAGNOSIS

The differential diagnosis includes porcine parvovirus (PPV), classical swine fever (CSF), porcine reproductive and respiratory syndrome (PRRS), encephalomyocarditis virus (EMCV), pseudorabies virus (PRV), Japanese encephalitis, swine influenza virus (SIV), and blue eye. Noninfectious causes such as toxins or nutritional deficiencies should also be considered.

## TREATMENT

It seems likely that young pigs are infected by the virus when the maternal antibody falls at 14 to 16 weeks of age. By the time they enter the breeding herd, their immunity is quite strong.

## CONTROL

Avoiding contact with all fruit bats is the best advice.

## FURTHER READING

- Philbey AW, et al. An apparently new virus (family Paramyxoviridae) infection for pigs, humans and fruit bats. *Emerg Infect Dis.* 1998;4:269.

## REFERENCES

- Philbey AW, et al. *Aust Vet J.* 2007;85:134.
- Bowden TR, et al. *J Gen Virol.* 2012;93:1007.

## JAPANESE B ENCEPHALITIS (JAPANESE ENCEPHALITIS)

This is the most important of the encephalotogenic flaviviruses. It causes in excess of 50,000 human cases a year, with a case-mortality rate of 25%. It causes reproductive failure in pigs.

## ETIOLOGY

It is a *Flavivirus* and is found in at least five genotypes.

## EPIDEMIOLOGY

The natural distribution range of the virus is Southeast Asia and Australasia. The vectors are *Culex* spp., in particular, *C. tritaeniorhynchus*. The virus activity is naturally maintained through bird-mosquito

cycles, with the Heron family in particular. The night herons, little egrets, and plumed egrets are particularly active as a reservoir. Pigs are important “amplifying hosts.” Pigs and these birds may allow the overwintering of the virus when mosquitoes are absent.

### PATHOGENESIS

Viremia results from the mosquito bite, and usually nothing is seen; occasionally there may be a mild fever, but quite often the virus goes straight to the testicles and causes orchitis.

### CLINICAL SIGNS

Fetal death is common, with mummified fetuses, stillborns, and weak pigs. Boars undergo reproductive failure.

### NECROPSY FINDINGS

Pathology is largely related to the abnormal fetuses.

### DIAGNOSIS

RT-PCR and nested RT-PCR can be used to detect the virus when virus isolation is negative. Antibody can be detected by hemagglutination inhibition (HI), ELISAs (IgM-capture ELISA), and latex agglutination tests.

### CONTROL

Live attenuated vaccines should be given to breeding stock 2 to 3 weeks before the start of the mosquito season. Killed and adjuvanted vaccines are also available.

### FURTHER READING

Mackenzie JS, Williams DT. The zoonotic flaviviruses of southern, south-eastern and eastern Asia and Australasia; the potential for emergent viruses. *Zoon Pub Hlth*. 2009;56:338.

### RESTON VIRUS

Reston virus, an *Ebolavirus*, was recently detected in pigs in the Philippines. Specific antibodies were found in the pig farmers, indicating exposure to the virus. In an experimental situation, pigs were infected with Zaire Ebola virus (ZEBOV), and it was found to replicate to high titers, mainly in the respiratory tract, and developed severe lung pathology.<sup>1</sup> Shedding from the oronasal mucosa was detected for up to 14 days after infection, and transmission was confirmed in all naïve pigs cohabiting with inoculated animals. These results confirm an unexpected site of virus amplification and shedding linked to transmission of infectious virus

### REFERENCE

1. Kobinger GP, et al. *J Infect Dis*. 2011;204:200.

### BUNGOWANNAH VIRUS

Bungowannah virus is possibly a new species of pestivirus that was found on a pig farm in

New South Wales, Australia. Sudden death was experienced by 3- to 4-week-old pigs, and at the same time, there was an increase in the number of stillborn piglets with multifocal nonsuppurative myocarditis and myonecrosis leading to a secondary congestive heart failure.

### PORCINE PARVOVIRUS

Usually parvoviruses are described with the acronym SMEDI, are associated with reproductive failure in pregnant sows, and are characterized by embryonic and fetal death, mummification, stillbirths, and delayed return to estrus. In other groups of postnatal nonpregnant pigs, the acute infection is usually subclinical, but it has been linked to skin lesions in piglets, interstitial nephritis in slaughter pigs, and nonsuppurative myocarditis in piglets. Tonsils are the main site of replication of the virus, but it also occurs in the heart, lungs, spleen, kidney, and endometrium. In the fetus, the replication is mainly in the heart, spleen, lung, and testis.

### NOVEL PORCINE PARVOVIRUSES

Several new members of the subfamily Parvoviridae have been discovered in animals, particularly pigs.<sup>1</sup>

The subfamily Parvoviridae infects birds and mammals. Two of the five genera in this group contain pig viruses. These are *Bocavirus* and *Parvovirus* genera, and recently the newly proposed genus *Hokovirus* may contain newly identified pig viruses.

The viruses are called porcine parvoviruses (PPVs). These new viruses are important because they have been associated with PCVAD,<sup>2-4</sup> or “high-fever” disease.<sup>5</sup>

PPV1 is ubiquitous in swine and is associated with reproductive disease.<sup>6</sup>

In 2001, a new parvovirus was discovered in Myanmar and called porcine parvovirus 2;<sup>5</sup> it is of a novel and distinct lineage. It was also recently isolated in Hungary,<sup>7</sup> and two strains were isolated in the United States.<sup>8</sup> This virus, like other parvoviruses and RNA viruses, has a high substitution rate in the capsid gene. These new viruses may not have the same protection following use of the old vaccines. PPV2 does not belong to any of the known clusters, has been found in swine serum, and has not been associated with any known disease. It was the second of the new viruses discovered and is now found worldwide.<sup>5,8</sup> Not much is known about porcine parvovirus 2 and disease, but on one Chinese farm the virus was detected 3 weeks before a severe respiratory disease outbreak. In one study, DNA was detected in the lung tissues from nursery pigs and grow-finish pigs. Porcine parvovirus 3 was found in Hong Kong and originally called *Hokovirus*.<sup>9</sup> PPV3 of the proposed *Hokovirus* genus has been found in both sick and healthy pigs<sup>10</sup> and was also

called partetravirus.<sup>11</sup> Coinfection with both PPV3 and PCV2 was shown in China and Hong Kong.<sup>3</sup> PPV4<sup>12</sup> and the porcine bocavirus<sup>13</sup> belong to the group. PPV4<sup>9</sup> was identified in association with PCV2. It is not clear whether it can cause disease on its own or whether it exacerbates PCV2 infections. It has been reported since in Asia, Europe, and Africa.<sup>1,7,14-16</sup>

A novel porcine parvovirus was identified in the lung lavage of a diseased pig coinfecting with PCV2.

In a recent study in Germany, it was shown that PPV1 through PPV4 strains were found in the tonsils of piglets,<sup>17,18</sup> and PPV1 and PPV4 were found in the hearts. A real-time PCR has been developed to detect and analyze virulent PPV loads in artificially challenged sows and piglets,<sup>19</sup> using a conserved region of the genome. Previous RT-PCR methods have used the VP2 gene.<sup>20,21</sup> Diagnosis is through use of PCRs, virus isolation, hemagglutination inhibition tests, and immunofluorescence. Anti-PPV antibodies occur in the fetus at about 56 to 70 days.

### REFERENCES

1. Cadar D, et al. *J Gen Virol*. 2013;94:2330.
2. Xiao CT, et al. *Vet Microbiol*. 2012;160:290.
3. Li S, et al. *Arch Virol*. 2013;158:1987.
4. Opriessnig T, et al. *Vet Microbiol*. 2013;163:177.
5. Wang F, et al. *Virus Genes*. 2010;41:305.
6. Wolf VH, et al. *Genet Mol Res*. 2008;7:509.
7. Csagoia A, et al. *Arch Virol*. 2012;157:1003.
8. Xiao CT, et al. *Vet Microbiol*. 2013;161:325.
9. Cheung AK, et al. *Arch Virol*. 2010;155:801.
10. Lau SK, et al. *J Gen Virol*. 2008;89:1840.
11. Tse H, et al. *PLoS ONE*. 2011;26:e25619.
12. Xiao CT, et al. *Vet Microbiol*. 2012;160:290.
13. Szelei J, et al. *Emerg Infect Dis*. 2010;16:561.
14. Huang L, et al. *Virology*. 2010;7:333.
15. Zhang HB, et al. *Epidemiol Infect*. 2011;139:1581.
16. Ndzé VN, et al. *Infect Genet Evol*. 2013;17:277.
17. Streck AF, et al. *Berl Munch Tierarztl Wschr*. 2013;124:242.
18. Streck AF, et al. *Arch Virol*. 2013;158:1173.
19. Miao L-F, et al. *Vet Microbiol*. 2009;138:145.
20. Wilhelm S, et al. *J Virol Meth*. 2006;134:257.
21. McKillen J, et al. *J Virol Meth*. 2007;140:155.

## Multi-Organ Diseases Due to Protozoal Infection

### SARCOCYSTOSIS (SARCOSPORIDIOSIS)

#### SYNOPSIS

**Etiology** *Sarcocystis* species. There are numerous species, with various carnivore species as their final host, but usually a specific intermediate host species.

**Epidemiology** High prevalence of infection in most areas. Source of infection is feces from carnivores. Primary definitive hosts include farm dogs and cats fed raw meat,

Continued

or other carnivores if they have access to ruminant carcasses.

**Clinical findings** Severity of disease is dose dependent. Most infections are subclinical. Abortion and depressed growth rate. Neurologic disease and ataxia in sheep. Severe infection in some species results in carcass condemnation.

**Clinical pathology** Anemia and elevated concentrations of enzymes in blood associated with tissue damage during acute disease.

**Lesions** Nonsuppurative encephalitis in sheep with neurologic signs. Nonsuppurative encephalitis, myocarditis, and hepatitis in aborted fetus. Cysts in carcasses in chronic cases.

**Diagnostic confirmation** Identification of parasite microscopically in biopsy or postmortem material.

**Treatment and control** No effective treatment. Amprolium or salinomycin may aid in control. Proper disposal of carcasses. Raw meat not to be fed to farm dogs or cats. Control of carnivores.

## ETIOLOGY

*Sarcocystis* species are cyst-forming coccidial parasites with indirect life cycles.<sup>1-3</sup> They are obligate two-host apicomplexan parasites. There are numerous species, each with omnivorous or carnivorous definitive hosts. One system of naming the species identifies the intermediate and definitive host in the name (e.g., *S. bovifelis*) and has been commonly used in the literature. However, currently the organisms are known by their original names. Table 21-5 shows the currently accepted name of *Sarcocystis* species of importance in agricultural animals and their definitive hosts.

## EPIDEMIOLOGY

### Occurrence

In all countries where there have been surveys, the prevalence of infection in cattle, sheep, and horses approaches 100%, with a lower, but significant, infection rate in swine.<sup>1</sup> Clinical disease is relatively rare.

### Source of Infection

*Sarcocystis* spp. have an obligatory prey-predator life cycle in which the definitive host is a predator or scavenger.<sup>1,2</sup> The **carnivorous definitive host** becomes infected by ingesting tissue from a suitable intermediate host that contains mature sarcocysts. Following ingestion, bradyzoites are released from the sarcocyst in the stomach and intestine, and they transform into micro- and macrogamonts. The microgamonts (male) mature to release microgametes, which fertilize the macrogamont to form a zygote and then an oocyst. Within the intestine, the oocyst sporulates to produce two **sporocysts**. The sporulated oocyst ruptures in the

**Table 21-5** Definitive and intermediate hosts for *Sarcocystis* spp.—associated infections in agricultural animals

Intermediate host	<i>Sarcocystis</i> spp.	Synonyms	Definitive host
Cattle	<i>S. cruzi</i>	<i>S. bovicanis</i>	Dog, wolf, fox, raccoon, coyote
	<i>S. hirsuta</i>	<i>S. bovifelis</i>	Cat
	<i>S. hominis</i>	<i>S. bovihominis</i>	Humans
Sheep	<i>S. tenella</i>	<i>S. ovicanis</i>	Dog, coyote, fox
	<i>S. arieticanis</i>	—	Dog
	<i>S. gigantea</i>	<i>S. ovifelis</i>	Cat
	<i>S. medusiformis</i>	—	Cat
Goats	<i>S. capracanis</i>	—	Dog, coyote, fox
	<i>S. hericanis</i>	—	Dog
	<i>S. moulei</i>	—	Cat
Pigs	<i>S. miescheriana</i>	<i>S. suicanis</i>	Dog, raccoon, wolf
	<i>S. sui hominis</i>	—	Human
	<i>S. porcifelis</i>	—	Cat
Horses	<i>S. bertrami</i>	<i>S. equicanis</i>	Dog
	—	<i>S. fayeri</i>	—
	<i>S. neurona</i>	—	New World opossums

intestine. Sporocysts (each containing four sporozoites) are passed in the feces and are directly infective to the intermediate host.

The prepatent period is variable, approximately 14 days, and there is no illness in the carnivore host in association with this cycle. However, the replicative cycle of the parasite in the intestine results in the production of large numbers of sporocysts in the feces, and the infection can be **patent for a relatively long period**. Intermediate hosts become infected by **ingesting sporulated sporocysts** in the food or water.<sup>1,2</sup>

## Risk Factors

### Climate

Sporocysts develop and mature before excretion in feces, and they are quite resistant to environmental factors. Under experimental conditions, they can survive freezing, but they are susceptible to desiccation. Consequently, they might overwinter in the environment. Some studies have shown a lower herd prevalence of sarcocystosis in cattle in arid and semiarid environments compared with cattle from temperate and tropical areas, which might be a consequence of relative aridity and a lower density of definitive and intermediate hosts for *Sarcocystis* spp. in arid climatic zones.<sup>1</sup>

### Species of *Sarcocystis*

Individual species vary in their **pathogenicity** and in their ability to produce clinical disease in intermediate hosts. In cattle, for example, *S. cruzi* is considerably more pathogenic than *S. hominis*.<sup>1,2</sup>

*S. tenella* is the most pathogenic species of sheep, and *S. capricanis* for goats; naturally occurring clinical disease in sheep is not observed with *S. gigantea* or *S. medusiformis*.<sup>5</sup> There is a strong correlation between the number of sporocysts ingested and the

severity of disease. The size of the sarcocyst that occurs in the tissues of the intermediate host also varies with the infecting species. Those from cats and occurring in sheep (*S. gigantea*, *S. medusiformis*) or cattle (*S. hirsuta*) are of particular economic importance because they produce macroscopically visible sarcocysts that can result in meat condemnation. *S. cruzi* is pathogenic but produces microscopic sarcocysts in muscle and will escape gross detection at meat inspection.

### Farm Dogs

There is a positive association between herds infected with *Sarcocystis* and the presence of working dogs on a farm, the practice of leaving carcasses in the field, and the feeding of dogs with raw meat.<sup>1,2</sup> Virtually all reported clinical cases of sarcocystosis in cattle in the literature record that the dogs on a farm were fed offal or uncooked beef. Housing of dogs and cattle in the same shed or area can be linked to an increased risk for infection and clinical disease, and cattle pastured close to farm buildings where there are dogs are at greater risk. The presence of foxes on farms is also strongly associated with *Sarcocystis* infection in those herds that leave carcasses on the field.

### Cats

The main risk for cat-associated sarcocystosis is the farm cat that is fed raw meat. Farm cats use hay barns as dens and can contaminate hay and other feedstuffs.<sup>1,2</sup> Feral cats have the potential to distribute sporocysts widely in the grazing environment; however, the presence of feral cats on a farm may not increase the risk for *Sarcocystis* infection of cattle because scavenged sheep or cattle carcasses are a relatively unimportant part of the diet of feral cats.



### Stocking Density

The risk for infection with *Sarcocystis* is higher with higher stocking densities,<sup>4</sup> which might reflect a more intense contamination of pastures by working dogs. Cattle on farms that graze sheep and cattle on the same pastures are less likely to be infected.

### Economic Importance

The major economic loss occurs with those sarcocysts that produce macroscopic cysts and meat condemnation, although acute outbreaks of sarcosporidiosis have been reported. More severe infection can depress growth rates, and there is a greater risk for abortion in infected herds.

### PATHOGENESIS

In the intermediate host, sporozoites are released from ingested sporocysts in the small intestine, where they penetrate the mucosa and enter the endothelial cells of blood vessels. The schizogony stages and the distribution of merozoites vary according to *Sarcocystis* species, but in cattle endothelial infection is followed by **parasitemia**, with merozoites subsequently localizing in striated muscles (usually) or nervous tissue, where they develop into sarcocysts. Immature sarcocysts can be found in muscle 45 to 60 days following ingestion of sporocysts and are infective at approximately 70 days.<sup>2</sup>

Schizogony in the endothelial cells of the arterioles and capillaries results in **wide-spread hemorrhage** and anemia. Fever is associated with the parasitemia, and in the experimental disease it coincides with the time of maturation and rupture of schizonts.<sup>2</sup> The **vascular lesion** appears to be an essential part of the disease's pathogenesis. It has been proposed that the parasite produces growth retardation as a result of changes in plasma concentrations of somatostatin and growth hormone and changes in cytokine interactions with the endocrine system.<sup>1</sup>

The severity of the illness and the degree of infection of tissues at postmortem appear to relate to **infective dose**. The number of asymptomatic infections probably reflects the early ingestion of a few sporocysts that provoke a strong immunity to subsequent challenge. When groups of animals that have not been exposed to infection previously are suddenly exposed to large numbers of sporocysts, originating from dogs and cats, outbreaks of disease are likely to occur.

### CLINICAL FINDINGS

Infection and disease can occur at all ages. Clinical disease may be more severe in situations where there is **intercurrent nutritional stress**, and copper deficiency may be an exacerbating factor. Monensin is suspected of being able to potentiate recent infections to cause a severe myositis.<sup>1,2</sup>

### Cattle

**Acute illness** is recorded with experimental infections, but it is rarely seen or recognized in the field. Illness commences with a rise in temperature and heart rate, followed by anorexia, anemia, weight loss, a fall in milk production, nervousness, muscle twitching, hypersalivation, lameness, abortion, and, in heavy infections, death. The agent is an occasional cause of nonsuppurative encephalomyelitis in cattle and manifests with ataxia and recumbency.

**Chronic disease** in cattle is manifest by poor weight gains; loss of hair of the neck, rump, and the switch of the tail ("rat-tail"); anemia; and/or abortion.

### Sheep

In sheep, naturally occurring sarcocystosis has been associated with *S. tenella* and *S. arieticanis* and presents primarily as a **neurologic disorder**, with muscle weakness, trembling, ataxia of varying severity, followed by hindlimb paresis or flaccid paralysis and lateral recumbency. All ages of sheep can be affected, although lambs under 6 months of age are most susceptible.

Infection may also be manifest with depressed growth, reduced wool growth, and anemia. Less common manifestations include signs of congestive heart failure associated with endocardial and myocardial infection. Infestation of the muscle of the esophagus in sheep is thought to be a cause of **esophageal dysfunction** and regurgitation in sheep.<sup>1,2</sup>

### Swine

Disease does not seem to be associated with natural infections. Sarcocystosis produced experimentally in pigs is manifested by cutaneous purpura on the snout, ears, and buttocks, and dyspnea, tremor, and weakness or recumbency.<sup>1</sup> There is evidence that the breed of pig affects the severity of disease with experimental infections and also the subsequent severity of the parasite burden.

### Abortion and Perinatal Fatality

Fetal infection, with abortion or neonatal mortality, is recorded in both cattle and sheep when pregnant animals are infected experimentally or naturally with pathogenic species or strains.

### CLINICAL PATHOLOGY

Characteristic laboratory findings for systemic disease include a responsive anemia, a prolonged prothrombin time, and high titers of antibody to *Sarcocystis*. Blood creatine phosphokinase, lactic dehydrogenase, and aspartate aminotransferase are significantly elevated. Indirect hemagglutination (IHA) and ELISA tests can be used for serologic surveys, although there are limitations with the specificity immunologic assays. Many animals have been exposed to *Sarcocystis* spp., and serologic examination cannot

differentiate reliably current infection from past infection or exposure, and there are problems with serologic cross-reactivity.

### NECROPSY FINDINGS

Emaciation, lymphadenopathy, laminitis, anemia, and ascites can be present, but an obvious feature is the presence of petechial and ecchymotic hemorrhages throughout the body.<sup>2</sup> There are also erosions and ulcerations in the oral cavity and esophagus, likely as a result of microvascular damage. Cysts of *S. gigantea* on the esophagus of sheep are usually visible with the naked eye. Microscopically, schizonts are found in endothelial cells throughout the body, and hemorrhages, lymphocytic infiltration, and edema are observed in heart, brain, liver, lung, kidney, and striated muscle. Death is probably a result of the severe necrotizing myocarditis that occurs. There is an association between **eosinophilic myositis** and sarcosporidiosis, but this relationship is not proven in all cases.

In sheep presenting with **neurologic disease**, there may be no findings at gross postmortem examination, but a nonsuppurative encephalomyelitis is evident upon histologic examination.<sup>1,2</sup> Aborted bovine fetuses show nonsuppurative encephalitis, myocarditis, and/or hepatitis.

Different options are available to achieve a definitive diagnosis of the *Sarcocystis* species involved, including animal transmission studies, immunohistochemistry, electron microscopy, and/or PCR. Although such techniques are seldom used for routine diagnosis, there have been some efforts toward developing specific and sensitive molecular diagnostic tools.<sup>3-5</sup>

### Samples for Confirmation of Diagnosis

- **Histology**—formalin-fixed heart, skeletal muscle (several sites, and tongue, diaphragm, and masseter muscle) (light microscopy)

### DIFFERENTIAL DIAGNOSIS

Clinical diagnosis of disease can be difficult because of the nonspecific signs observed and the widespread prevalence of infection. Sarcosporidiosis is a consideration in the examination of problems of fever and anemia of undetermined origin in cattle and of ill-thrift in cattle or sheep.

The examination of muscle biopsies can aid in the determination of the presence of infection, but still begs the question of its relationship with disease.

The differential diagnoses for abortion are covered under brucellosis of cattle and sheep. Causes of encephalitis and ataxia in sheep are listed under those headings.

### TREATMENT

No approved treatment is available, but **amp-rolium** or **salinomycin** may relieve clinical

signs.<sup>1</sup> Amprolium 100 mg/kg BW, given daily, can reduce the severity of infection in experimentally infected calves and sheep and might be used to control outbreaks in sheep. Treatment of experimentally infected calves with salinomycin (4 mg/kg BW daily; in divided doses for 30 days) can reduce the severity of disease. Monensin may have a similar ameliorating effect, but is also suspected to exacerbate muscle lesions. Oxytetracycline, at very high dose rates, and halofuginone might be effective in acute infections.<sup>1</sup>

## CONTROL

Control is challenging because it involves the **separation of carnivores from stock**, which is not possible on most farms. However, infection in farm dogs and cats can be reduced if all meat fed to them is thoroughly cooked. Feral canids and felids should be controlled, and livestock carcasses should not be left on paddocks. Prior exposure to small numbers of pathogenic sarcocysts produces a strong immunity, but no vaccine is readily or commercially available.

## FURTHER READING

- Dubey JP, Speer CA, Fayer R. *Sarcocystosis of Animals and Man*. Boca Raton, Florida: CRC Press; 1989.
- Pozio E. Epidemiology and control prospects of foodborne parasitic zoonoses in the European Union. *Parassitologia*. 2008;50:17-24.
- Tappe D, Abdullah S, Heo CC, Kannan Kutty M, Latif B. Human and animal invasive muscular sarcocystosis in Malaysia - recent cases, review and hypotheses. *Trop Biomed*. 2013;30:355-366.

## REFERENCES

- Radostits O, et al. Diseases associated with protozoa. In: *Veterinary Medicine: A Textbook of the Disease of Cattle, Horses, Sheep, Goats and Pigs*. 10th ed. London: W.B. Saunders; 2007:1507.
- Dubey JP, Lindsay DS. *Vet Clin North Am Food A*. 2006;22:645.
- Moré G, et al. *Vet Parasitol*. 2011;177:162.
- Moré G, et al. *Vet Parasitol*. 2013;197:85.
- Pritt B, et al. *J Food Prot*. 2008;71:2144.

## TOXOPLASMOSIS

### SYNOPSIS

**Etiology** *Toxoplasma gondii*.

**Epidemiology** Infection from the ingestion of oocytes excreted in the feces of cats. Any vertebrate can acquire infection from ingestion of different stages of *T. gondii*.

**Clinical findings** Abortion and stillbirths in ewes is the major veterinary manifestation; other manifestations can be neonatal mortality, encephalitis and/or pneumonia. Major importance as a zoonosis.

### Pathologic findings:

- Lesions**—granulomatous lesions in organs of all species, with abortions, placentitis, and focal necrotic lesions in brain, liver, and kidney of aborted fetus.

**Diagnosis** Detection of the parasite in tissues or tissue fluids. Serologic and DNA-based tests, which vary in diagnostic sensitivity and specificity.

**Treatment** Not usually indicated in livestock. Sulfamethazine and pyrimethamine in abortion outbreak.

**Control** Reduce exposure to infective stages, including oocysts. In pregnant sheep, prophylactic feeding of monensin or decoquinate; vaccination.

## ETIOLOGY

The causative agent *Toxoplasma gondii* is cyst-forming coccidial parasite (*Apicomplexa*). Felids (cat family) are **definitive hosts**, and vertebrates are intermediate hosts. Different strains can differ in their virulence and epidemiology.<sup>1,2</sup>

*T. gondii* has three infective stages:

- Tachyzoites—rapidly replicating stage of the parasite during the acute phase of infection (endodyogeny) in the intermediate or accidental host
- Bradyzoites—slowly replicating or dormant stage of the parasite (usually within a cyst or pseudocyst) during the chronic phase of infection in the intermediate or accidental host
- Oocysts (containing sporocysts and sporozoites)—present in cat feces

Oocysts are the **infective stage** of importance in farm animals, and they are the only environmental infective stage for herbivores. Oocysts excreted in the feces of cats can survive in soil for months or years and are ingested by the intermediate (livestock) host. The parasite (sporozoite stage) invades any host cell, with the exception of nonnucleated erythrocytes, and undergoes tachyzoite replication (acute phase of infection). Any tissue (including nervous system, myocardium, lung tissue, and placenta) of the host or fetus can be infected and affected. An inoculum of as few as 10 oocysts can be infective to goats. Following the acute phase of infection, as host immunity develops, the replication rate decreases. The bradyzoites replicate slowly within cells and then stop replicating to become dormant within cysts (“tissue cysts” containing many bradyzoites). These cysts, containing live bradyzoites, are a source of infection to carnivorous or omnivorous animals (including pigs and humans).

## EPIDEMIOLOGY

### Occurrence

Toxoplasmosis occurs in domesticated and wild animals and birds in most parts of the world, although surveys indicate considerable variation in prevalence.<sup>2-4</sup> Although some studies indicate a relatively high seroprevalence in some farm animals, infection is often subclinical. With the exception of abortion and neonatal disease in sheep, *T. gondii* has limited importance as a cause of

disease in farm animals. *T. gondii* has major importance as a **zoonotic parasite**.

## Source of Infection

### Cat Feces

The source of infection in sheep, pigs, and other livestock is **oocysts** excreted in the feces from felids. In almost all agricultural areas, the feces originate from domestic or feral cats.

Cats become infected as a result of ingesting tissues from intermediate hosts infected with tachyzoites or bradyzoites (within cysts) and then shed oocysts in the feces. All vertebrates can act as intermediate hosts; rodents and small birds are common intermediate hosts for infection to cats. For instance, rodents pass the parasite from generation to generation through congenital infection and thus can provide a reservoir of infection in an area for a long time. Cats ingest infected rodents and develop an intestinal infection, leading to oocyst excretion into the environment. The prevalence of infection is highest in young cats hunting for the first time. Following infection of the cat, the period of excretion of oocysts is short, usually ~2 weeks, but it can be high, with several million oocysts being excreted during patency. In a given environment, the number of cats excreting oocysts in their feces at any point in time is likely to be quite small, but the contamination of the environment over time can be significant.

**Domestic and barn cats** in farm environments tend to nest and to defecate in hay and straw mows, grain stores, or loose piles of commodity feeds, thus providing the potential for direct contamination of livestock feeds with *T. gondii* oocysts.<sup>5</sup> Fields fertilized with manure and bedding contaminated with cat feces can also be a source of infection. **Feral cats** bury feces superficially in the soil, but contamination can spread, for example, via the elements or invertebrates, to pasture and be ingested by livestock. Feral cats can have territories of up to 250 acres and are capable of widely distributing oocysts of *T. gondii*.<sup>1</sup> Oocysts may be found in feed, water, and soil in the vicinity of livestock units.

### Other Sources

Oocysts are also an important source of infection to swine, although it is possible for swine to be infected by the ingestion of tachyzoites or bradyzoites present in meat (**dead rodents**, cannibalized piglets, etc.) or through the ingestion of blood while **tail- or ear-biting**. *T. gondii* infection has been shown in all wildlife mammalian species tested in the environment of swine units. Direct sheep-to-sheep transmission by close contact with grossly infected placenta and transmission via the semen of infected rams could occur but is not thought to be of significance. There is some evidence that *T. gondii* can be present in the placental tissue from sheep following

successful pregnancies, suggesting that congenital infection perpetuates infection in sheep flocks in the absence of cats.<sup>3</sup>

### Risk Factors

#### Pathogen Risk Factors

Oocysts are very resistant to external influences and can often survive in the environment for at least 1 year. They can **overwinter** in cold climates but are more susceptible to desiccation. Fifty grams of infected cat feces can contain as many as 10 million oocysts, and infection in farm animals can be established by the ingestion of fewer than 40 oocysts.<sup>1</sup> Oocysts are destroyed by exposure to high temperatures and freezing.

#### Environmental and Management Risk Factors

In sheep, a high rate of infection can relate to areas of **high rainfall**, allowing increased survival of oocysts on pasture. The prevalence of infection in small ruminants is much lower in hot, arid countries than in regions with wet climates.

Sheep raised in **cat-free areas** have almost no toxoplasmosis, whereas sheep raised in similar environments with cats can have a high level of exposure or infection.<sup>1</sup> In many recorded toxoplasmosis outbreaks with high prevalence rates in sheep and goats, there was a link to stored feed contaminated with cat feces. Cat access to sows is also a risk factor for toxoplasmosis in swine.<sup>4</sup>

Other management risk factors include **housing**. Swine housed outdoors can be at a greater risk for infection in some areas. Prevalence is low in sows that are kept indoors. Infected pork is a significant source of infection to humans, and the trend to outdoor rearing on free-range farms may increase the risk for human infection.

### Experimental Studies

#### Sheep

Experimental disease can be achieved by challenge with oocysts, tissue cysts, or tachyzoites.<sup>1</sup> Ewes may show a febrile response during the parasitemic phase 5 to 12 days following inoculation. Abortion and fetal mortality occur in sheep that suffer a primary infection during pregnancy. The parasite invades the placenta and can be detected in the fetus between 5 and 10 days following the onset of parasitemia. Infection may result in resorption, abortion, or the birth of stillborn or congenitally infected live lambs. Infection in early pregnancy (less than 60 days), before the fetus acquires immunologic competence, usually results in embryonic death and resorption and a barren ewe. Infection in mid-pregnancy usually results in abortion and the birth of stillborn lambs, whereas ewes infected in late pregnancy (more than 110 days) may give birth to live but congenitally infected lambs.

### Cattle

Cattle are **relatively resistant** to infection.<sup>2</sup> Diarrhea, anorexia, poor weight gain, depression, weakness, fever, and/or dyspnea follow challenge infection of calves with pathogenic strains. Using strains of low virulence, there is a mild fever and lymphadenopathy, and the parasite is detectable only in the lymph nodes for only a few weeks. Adult cows are usually not susceptible to infection, and it is apparent that cattle do not readily acquire persistent *T. gondii* infection. *T. gondii* is not important in causing abortion or clinical disease in cattle. It is probable that many cases previously diagnosed as bovine toxoplasmosis were actually cases of neosporosis or sarcosporidiosis.

### Other Ruminants

High numbers of oocysts fed to (susceptible) goats cause a febrile, anorectic, fatal illness and pregnant goats abort. The pathogenesis of the abortion is as for sheep. Disease in buffalo calves is described as peracute, with pulmonary consolidation, necrotic foci in all organs, and fluid accumulations in body cavities.

### Pigs

Infection is relatively readily established in pigs,<sup>4</sup> but it is usually not associated with disease or only with a short period of fever and growth suppression. Congenital toxoplasmosis is not readily induced experimentally. Young pigs (less than 12 weeks of age) are considerably more susceptible than older pigs. Infections induced by tissue cysts are usually less severe than those induced by the ingestion of oocysts.

### Horses

Horses appear to be **relatively nonsusceptible** to *T. gondii* and toxoplasmosis.

### Economic Importance

Abortion and neonatal mortality in sheep and goats are the major clinical manifestations of toxoplasmosis in livestock and result when primary infection occurs during pregnancy. Ovine abortion and neonatal mortality as a result of toxoplasmosis are important problems in New Zealand, Australia, Canada, the United States, and the United Kingdom; in most countries, they are second in importance only to chlamydial abortion. Perinatal mortality rates (including abortions and neonatal death) in affected flocks may be as high as 50%. Toxoplasmosis can be a primary cause of economic losses in flocks with an abortion problem. Toxoplasmosis of goats is also associated mummification of fetuses and perinatal death.

### Zoonotic Implications

Humans are accidental intermediate hosts for *T. gondii*, and approximately one-half of the population in the United States is infected.<sup>1</sup> Infection can result from the

ingestion of oocysts from cat feces that contaminate waterways or food, that contaminate the hair of domestic dogs and cats, or that are inadvertently ingested because of poor hygiene practices. However, the major risk for human infection relates to the ingestion of bradyzoites and/or tachyzoites in **meat** or tissues that are eaten or handled. The risk is with raw or undercooked meats. Adequate freezing and/or cooking will kill the parasite. Beef is a minor source of infection, with pork and, to a lesser degree, sheep meat posing a greater risk. Tachyzoites can be passed in the milk of goats challenged with oocysts; **raw goat milk** has some public health risk for toxoplasmosis, although the risk is low.

Usually, *T. gondii* infection in immunocompetent humans is asymptomatic. However, disease can occur in people suffering from **AIDS** or malignancy, in those treated with cytotoxic or immunosuppressive drugs, and in children and the elderly. There is also the risk in **pregnant women** for abortion or congenital infection of the fetus with resultant hydrocephalus, intracranial calcification, and retinochoroiditis. Maternal infection in the first and second trimesters may result in severe congenital toxoplasmosis and death of the fetus in utero and subsequent abortion. Infection late during pregnancy may result in the birth of an apparently normal child who is at risk of developing chorioretinitis later in life.

Toxoplasmosis poses an **occupational risk** for veterinarians, farmers, and slaughterhouse workers who handle infected tissues, such as placenta, brain, or muscle. For instance, the risk can be high during contact with lambing ewes in infected flocks; veterinarians and farm workers, particularly if pregnant or immunocompromised, should take precautions to avoid infection when handling infected material.

### PATHOGENESIS

*T. gondii* is an **intracellular parasite** that attacks most tissues and organs, with predilection for the **reticuloendothelial and central nervous systems**.<sup>2-4</sup> Sporozoites from oocysts or bradyzoites from tissue cysts invade and penetrate cells of the intermediate host by an active process and then replicate as tachyzoites, initially in intestinal epithelial cells. After invasion of various cell types, the tachyzoites multiply (rapidly during endodyogeny) and eventually fill and destroy cells. Following their release from ruptured cells, liberated tachyzoites reach other organs via the bloodstream. **Parasitemia** commences ~5 days following infection and declines with the development of immunity 2 to 3 weeks after infection. At this stage, the parasite undergoes bradyzoite replication within cells/tissues to produce tissue cysts.

The presentation of disease varies depending on the organ(s) affected and on



whether the disease is congenital or acquired. The principal manifestations are encephalitis when infection is **congenital** and febrile exanthema with pneumonitis and enterocolitis when heavy infections occur **postnatally**. However, most infections are asymptomatic; tissue cysts can be found in many animals and appear to cause no harm. When the immunity of the animal declines, because of stress, disease, immunosuppressive therapy or an immunocompromised state, tissue cysts can rupture, and granulomatous lesions can develop. Immunodeficient or immunocompromised animals can develop severe disease.

### Pregnant Sheep and Goats

Abortion and fetal mortality occur in sheep or goats that contract a primary infection during pregnancy. In the dam, the infection is limited by a developing immune response, but it is not limited in the placenta or in the immuno-incompetent fetus. The fetus, and the ability of the fetus and its associated placenta, to mount a protective response depend on the age of the fetus at the time of infection.

**Immunocompetence against *T. gondii*** does not usually develop before 60 days of gestation. Infection in early or midpregnancy results in fetal death, with resorption or mummification. Some lambs infected in midpregnancy may survive to near term and be stillborn, or they may survive to parturition but are weak and die shortly after birth. Parasite replication in the placenta results in multiple foci of necrosis, and these lesions likely contribute to abortion or to the birth of weak lambs. In addition, congenital infection of the central nervous system may result in locomotory and sucking dysfunction. Only sheep that become infected during pregnancy abort. With infection in late pregnancy, the fetus can mount an immune response and is usually born live, infected, and immune. Infection of pregnant and nonpregnant sheep usually provokes sufficient protective immunity to prevent abortion in future pregnancies.

### CLINICAL FINDINGS

The clinical syndrome and the course of toxoplasmosis vary a great deal among species and among age groups.<sup>3-5</sup> The only clinical syndrome recognized with any regularity in the field is abortion and neonatal mortality in sheep. The other, less common, syndromes are described in the following subsections.

#### Sheep

In sheep, although a syndrome of fever, dyspnea, generalized tremor, abortions, and stillbirths can occur,<sup>3</sup> the clinical manifestation of the systemic disease in the ewe is rare. The principal manifestations of toxoplasmosis in sheep are fetal resorption, abortion, the birth of mummified or stillborn lambs,

neonatal death, and the birth of full-term lambs that show locomotor and sucking disorders.

Abortion commonly occurs during the last 4 weeks of pregnancy, and the rate may be as high as 50%. Full-term lambs from infected ewes may be born dead, or alive but weak, with death occurring within 3 to 4 days of birth. Lambs affected after birth show fever and dyspnea, but a fatal outcome is uncommon. Fetal resorption can occur in ewes infected in early pregnancy.

#### Goats

Toxoplasmosis of sheep and goats is similar. Caprine toxoplasmosis is manifested by perinatal deaths, including abortion and stillbirth. Systemic disease, with a high case-fatality rate, can occur, particularly in young goats.

#### Pigs

Pigs are **susceptible**. If an outbreak occurs, pigs of all ages can be affected.<sup>4</sup> Clinical signs include debility, weakness, incoordination, cough, tremor and/or diarrhea, but no fever. Young pigs can be acutely ill, with a high fever of 40° to 42°C (104–107°F); they develop diarrhea and can die after several weeks. Pigs of 2 to 4 weeks of age have additional signs, including wasting, dyspnea, coughing, and nervous signs, particularly ataxia. Pregnant sows commonly **abort**; piglets are premature or **stillborn**, or they survive and can develop disease at 1 to 3 weeks of age. Toxoplasmosis should be considered in the case of a resident problem of abortion and stillbirth in a pig herd.

#### Cattle

Rare bovine toxoplasmosis may be manifested in fever, dyspnea, and nervous signs, including ataxia and hyperexcitability, in the early stages, followed by extreme lethargy. Stillborn or weak calves that die soon after birth may also occur. However, usually, toxoplasmosis does not play a significant role in bovine abortion. Congenitally affected calves can show fever, dyspnea, coughing, sneezing, nasal discharge, clonic convulsions, grinding of the teeth, and/or tremor of the head and neck. Death can occur after 2 to 6 days.

#### Horses

Toxoplasmosis is **rare** in horses.

### CLINICAL PATHOLOGY

**Serologic tests** available for the detection of humoral antibodies to *T. gondii* include the Sabin–Feldman dye test, the indirect hemagglutination assay, the indirect fluorescent antibody test (IFAT), the modified agglutination test (MAT), the latex agglutination test (LAT), the enzyme-linked immunosorbent assay (ELISA), and the immunosorbent agglutination assay test (IAAT).<sup>2-4</sup> Serologic tests are commonly used to estimate the seroprevalence of *T. gondii* exposure or

infection in animal populations, but their **sensitivity and specificity can vary** considerably depending many factors, including the actual assay used and the species of animal being tested.

#### Abortion

**Serologic testing** to establish toxoplasmosis as the cause of abortion is of limited value. A test-negative titer will likely rule out toxoplasmosis, but because serum antibody can persist for some years, a test-positive titer will only indicate that an animal has been exposed to or infected with *T. gondii* at some stage of its life. Seroprevalence can be high in sheep and swine. **Rising titers** in paired samples are more informative but are likely of limited value for the diagnosis of *T. gondii*-related abortion in sheep, where infection and serum antibody responses may precede the abortion storm. It is informative to test **pleural or peritoneal fluid** of aborted fetuses for the presence of antibody or nucleic acids of *T. gondii*. PCR assays can be used to specifically detect or quantitate *T. gondii* DNA or RNA in infected fetal and any other tissues from suspected cases.

### NECROPSY FINDINGS

Macroscopic lesions consist of **multiple foci of necrosis in various organs**, including the lungs, brain, spinal cord, liver, spleen, kidneys, and heart. Interstitial pneumonia hydrothorax, ascites, lymphadenitis, and intestinal ulceration may be observed. Microscopically, foci of **coagulative necrosis** are present, with little evidence of inflammation, except in the lungs, where there is interstitial pneumonia, and in the nervous system, where there is usually nonsuppurative meningoencephalitis. Stages (tachyzoites, bradyzoites, and/or cysts) of *T. gondii* can be found in the viscera and/or brain.<sup>11,12</sup>

#### Abortion

In **sheep**, there may be involvement of the uterine wall, the **placenta**, and the fetus. The lesions in the fetal lambs are usually limited to focal necrosis in brain, liver, kidney, and lungs; characteristic lesions are common and severe in the **placenta**.<sup>1</sup> The lesions are confined to the cotyledons and consist of **multiple white foci of necrosis in the villi**. On histologic examination, there is multifocal necrosis and desquamation of trophoblastic epithelium, sometimes with calcification. *T. gondii* stages can be found in the placenta and other organs.

In **swine**, the prominent lesions are necrotic placentitis, nonsuppurative encephalomyelitis, and/or myocardial degeneration. In contrast to sheep, grossly visible areas of necrosis are not present in the placenta, but numerous organisms may be visible on microscopic examination of the placenta.

Immunohistochemical staining can be used to identify the parasite in formalin-fixed material. Serologic testing of fetal

thoracic fluid can be useful in those fetuses that are immunocompetent at the time of abortion. PCR can be used for the specific detection of *T. gondii* DNA in tissues and can be used on autolyzed tissue.<sup>2-4</sup> On rare occasions, a diagnostic bioassay can be performed to induce infection and propagate the parasite in specific-pathogen-free (SPF) rodents, which is a very sensitive but time-consuming method. Aseptically collected brain, lung, and diaphragm is homogenized and administered orally, or by intraperitoneal or intracerebral injection to mice, or orally to SPF cats. A positive diagnosis depends on the presence of *T. gondii* cysts in the brains of the mice ~8 weeks after the inoculation or the excretion of oocysts in the feces of infected cats. Cats are a more sensitive assay because of the volume of tissue that can be tested. The mouse bioassay is useful to propagate *T. gondii* for subsequent molecular or genetic analyses or in vitro experiments.

### Samples for Diagnostic Testing

- **Parasitology**—fresh or chilled brain, lung, placenta
- **Serology**—fetal thoracic fluid
- **Histology**—placental cotyledons, lung, liver, brain, spinal cord, kidney, heart

### DIFFERENTIAL DIAGNOSIS

Toxoplasmosis is rarely considered in a primary diagnostic list other than with problems of abortion and associated neonatal mortality. The differential diagnosis of abortion in cattle is dealt with under brucellosis, in sheep under brucellosis, and in pigs under leptospirosis. The causes of encephalitis and pneumonitis in animals are listed under respective headings.

### TREATMENT

Treatment with a combination of sulfamethazine and pyrimethamine (administered over 3 days for three periods with an interval of 5 days between the start of each treatment period) has proved effective in mitigating the effects of experimentally induced toxoplasmosis in pregnant ewes. This therapy should be considered in the face of an outbreak of abortion associated with toxoplasmosis.<sup>1</sup> These drugs appear to be effective against proliferating tachyzoites in the acute stage of toxoplasmosis, but they will not eliminate infection and will have limited activity on bradyzoites within tissue cysts.

### CONTROL

There are two key issues in the control of toxoplasmosis in agricultural animals. The first is to reduce the economic impact of disease; the second is to reduce the risk for human disease associated with consumption of infected meat.

### Cat Control

The elimination of cats from the farm environment will preclude feed contamination

and contamination of pasture areas. Although it is possible to **ban domestic cats** from the farm, this will not usually eliminate the risk of toxoplasmosis because of the range of activities of cats from adjacent areas, the presence of feral cats, and the possibility of spread of oocysts.<sup>5</sup> Nevertheless, risk of infection/disease will be reduced by eliminating cats from the farm environment or restricting them to **neutered animals**. Where **possible, feeds should be stored in cat-proof areas**. In swine units, rodent control and preventing the access of pigs to any **carriion** are key measures. On farms, any animal carcass or material (e.g., placenta and fetus) linked to suspected or confirmed cases of toxoplasmosis should be eliminated immediately.

### Serologic Monitoring

Serologic testing can be used to estimate seroprevalence and seroconversion in sows housed indoors and outdoors, and it may assist in assessing whether changes need to be made to farm management practices. Such testing can also be employed to assess seroprevalence and monitor specific antibody titers in sheep to support a risk management strategy against toxoplasmosis and to assess whether antitoxoplasmal drugs or vaccination should be implemented for prevention/protection.

There is an effective and long-lasting immunity following primary *T. gondii* infection, and ewes that have aborted should be kept in the flock. Exposure of ewes to natural infection in a contaminated environment before breeding would be possible means of preventing toxoplasmosis but is difficult to control.

### Prophylaxis

Feeding **monensin** at a dose of 15 mg/animal per day during the first 100 days of pregnancy has been shown to reduce lamb loss following experimental infection with *T. gondii*, as has decoquinatate fed at 2 mg/kg daily.<sup>1</sup> **Decoquinatate** is more palatable and has less risk of toxicity. Preventative medication offers an option for ewes that are test-negative for anti-*T. gondii* serum antibodies and likely to be exposed in pregnancy to feed, water, or an environment contaminated with oocysts. Both drugs are best fed to ewes before they encounter infection and are not effective as therapeutic agents.

### Vaccination

Tachyzoites from an attenuated strain of *T. gondii* are used in a vaccine to protect sheep, which is available commercially in some countries.<sup>3,6-8</sup> Such tachyzoites readily infect seronegative sheep but do not initiate chronic infection or tissue cysts, and the parasite cannot be detected in muscle or brain 6 weeks after vaccination. Ewes should be vaccinated at least 3 weeks before mating, and a single injection will protect for the life of the

sheep. In flocks where toxoplasmosis is a cause of lamb loss, initial vaccination of the whole flock, followed by vaccination of replacement ewes, is a better economic option than only vaccinating replacement ewes.<sup>3</sup> Vaccination does not completely protect pregnant ewes against parasitemia or the infection of the fetus following challenge with virulent *T. gondii* oocysts, but there is a significant reduction in the birth rates of dead lambs. It has been postulated that vaccination results in reduced numbers of tachyzoites invading the gravid uterus or fetus, with a consequent reduced potential for inducing significant pathologic changes in the placenta and the fetus. Immunity appears to be cell mediated. Experiments with an adjuvanted vaccine in pigs show protection from clinical challenge and a reduction in recoverable *Toxoplasma* from tissues of vaccinated challenged pigs.<sup>1</sup>

### Reduction of Zoonotic Risk From Food and Water

Oocysts from cat feces are an important source of human infection, as is meat from sheep, swine, and sometimes from other livestock animals that are infected with tachyzoites or bradyzoite cysts.<sup>2</sup> The implementation of control procedures on farms will reduce infection risk, and the major aspect will be to reduce the numbers of cats on farms or eliminate them. The infectivity of meat can be destroyed by freezing, proper cooking, or irradiation. Reviews of other strategies for the control of food-borne toxoplasmosis are readily available.<sup>9,10</sup>

### FURTHER READING

- Buxton D, Maley SW, Wright SE, et al. *Toxoplasma gondii* and ovine toxoplasmosis: new aspects of an old story. *Vet Parasitol.* 2007;149:25-28.
- Elsheikha HM. Congenital toxoplasmosis: priorities for further health promotion action. *Public Health.* 2008;122:335-353.
- Hill D, Dubey JP. *Toxoplasma gondii*. Transmission diagnosis and prevention. *Clin Microbiol Infect.* 2002;8:634-640.
- Innes EA, Vermeulen AN. Vaccination as a control strategy against the coccidial parasites *Eimeria*, *Toxoplasma* and *Neospora*. *Parasitology.* 2006;133(suppl):S145-S168.
- Montoya JG, Remington JS. Management of *Toxoplasma gondii* infection during pregnancy. *Clin Infect Dis.* 2008;47:554-566.

### REFERENCES

1. Radostits O, et al. Diseases associated with protozoa. In: *Veterinary Medicine: A Textbook of the Disease of Cattle, Horses, Sheep, Goats and Pigs*. 10th ed. London: W.B. Saunders; 2007:1518.
2. Dubey JP. *J Eukaryot Microbiol.* 2008;55:467.
3. Dubey JP. *Vet Parasitol.* 2009;163:1.
4. Dubey JP. *Vet Parasitol.* 2009;164:89.
5. Elmore SA, et al. *Trends Parasitol.* 2010;26:190.
6. Innes EA, et al. *Vaccine.* 2007;25:5495.
7. Garcia JL. *Expert Rev Vaccines.* 2009;8:215.
8. Innes EA, et al. *Mem Inst Oswaldo Cruz.* 2009;104:246.
9. Jones JL, Dubey JP. *Clin Infect Dis.* 2012;55:845.
10. Jones JL, Dubey JP. *Exp Parasitol.* 2010;124:10.

11. Brown CC, et al. Alimentary system. In: Maxie MG, ed. *Jubb, Kennedy and Palmer's Pathology of Domestic Animals*. Vol. 2. 5th ed. Edinburgh: Saunders; 2007:1.
12. O'Donovan J, et al. *Vet Pathol*. 2012;49:462.

## THEILERIOSES

Theilerioses are those tick-borne protozoan diseases associated with *Theileria* spp. in cattle, sheep, goats, and horses and in wild and captive ungulates. The genus *Theileria* belongs to the Apicomplexa group, which includes *Babesia*, *Toxoplasma*, *Neospora*, and *Plasmodium*, among others. The life cycle of *Theileria* spp. involves cyclical development in ticks to form sporozoites; on being injected with tick saliva into the mammalian host, sporozoites develop into schizonts in leukocytes and then piroplasms (merozoites) in erythrocytes. The diseases in ruminants are characterized by fever and lymphoproliferative disorders and are associated with varying degrees of leucopenia and/or anemia.

*Theileria* spp. are found throughout the world, and their nomenclature and classification, although still controversial, are being gradually elucidated through molecular characterization. The important pathogens of cattle are restricted to certain geographic regions after which the diseases are named (Table 21-6). **East Coast fever (ECF)**, caused by *Theileria parva*, and **tropical theileriosis (or Mediterranean Coast fever)**, caused by *T. annulata*, are the two most important theilerioses and are dealt with separately in the following discussion.

**Oriental theileriosis (or Japanese theileriosis)** caused by *T. orientalis* is increasingly being associated with disease outbreaks

in Asia and Australia. Molecular analysis has revealed four genotypes of *T. orientalis* (ikedai, chitose, buffeli, and type 5), with the ikeda genotype being the most pathogenic.<sup>1</sup> The disease is transmitted by *Haemophysalis* ticks, which occur in Europe, the Mediterranean basin, Asia, and Australia. In addition, transplacental (vertical) transmission from pregnant cows to calves has been reported in some countries.

Oriental theileriosis is characterized by moderate to severe anemia in heavily parasitized cattle and moderate enlargement of lymph nodes. Outbreaks of more severe clinical signs and economic losses have been reported occasionally from India, Australia, and New Zealand.<sup>2-4</sup> Such outbreaks are characterized by severe anemia and heavy parasitemia, especially in European breeds of cattle, in their crossbreeds, or in naïve animals moved to endemic areas. Affected animals show high fever, lacrimation, nasal discharge, swollen lymph nodes, and hemoglobinuria.<sup>2</sup> Abortion, significant loss in milk production, and deaths were reported in the Australian outbreaks.<sup>3-6</sup> Postmortem lesions include punched-out ulcers in the abomasum, enlargement of the spleen, and massive pulmonary edema, as in East Coast fever and Mediterranean Coast fever (see following discussion).

The pathogenesis of the anemia and hemoglobinuria in oriental theileriosis is not clear but may be related to a hemolytic factor in the serum of acutely affected cattle or to an oxidative damage of the red blood cell membrane leading to hemolysis, as in ovine malignant theileriosis (see following discussion).<sup>7</sup> European breeds are more susceptible than zebu breeds.

Methods of diagnosis include parasitologic, serologic, and PCR assays.<sup>8</sup> In one study involving beef cattle in Australia, prevalence of infection was 28.1% by parasitologic method and 70.8% by PCR assay employing a region within the major piroplasm surface protein (MPSP) gene as marker.<sup>5</sup> With such high infection rates in clinically normal animals, it is important that calves used for the production of live vaccines against babesiosis and anaplasmosis should be free of oriental theileriosis. In Australia, concurrent treatment with primaquine phosphate and halofuginone lactate is effective for this purpose.

*T. mutans*, confined to Africa and the Caribbean islands, causes a usually innocuous disease (**benign theileriosis**), but it may be manifested by fever, anorexia, and anemia. Some genotypes of *T. orientalis* are also associated with subclinical infections in Asia and Australia. Another species, *T. velifera*, is associated with very mild theileriosis in tropical Africa. *Amblyomma* ticks transmit both species. *T. taurotragi* of the eland antelope is generally nonpathogenic to cattle, but it is one of the causes of **cerebral theileriosis (turning sickness)** in southern Africa (cerebral theileriosis can also be associated with *T. parva*). Parasitized lymphoblasts accumulate in cerebral, spinal, and meningeal arteries, with resultant thrombosis and infarction of affected organs. *T. taurotragi* is transmitted by *Rhipicephalus* spp.

The important pathogen of sheep and goats is *T. hirci* (synonym *T. lestoquardi*), the cause of **malignant ovine theileriosis**. The disease is enzootic from North Africa throughout the Middle East to India and China, approximately the same geographic

**Table 21-6** Summary of the theilerioses of domestic ruminants

Disease	Distribution	<i>Theileria</i> spp.	Main vector
<b>Cattle</b>			
East coast fever	East and central Africa	<i>T. parva</i>	<i>Rhipicephalus appendiculatus</i>
Turning sickness (cerebral theileriosis)	Southern Africa	<i>T. parva</i> , <i>T. taurotragi</i>	<i>Rhipicephalus</i> spp.
Tropical theileriosis (Mediterranean coast fever)	Mediterranean countries Indo-China	<i>T. annulata</i>	<i>Hyalomma anatolicum</i>
Oriental theileriosis (Japanese theileriosis)	Asia, Australia	<i>T. orientalis</i> (genotype ikeda)	<i>Haemophysalis</i> spp.
Benign theileriosis	Africa/Caribbean Africa Asia	<i>T. mutans</i> <i>T. velifera</i> <i>T. buffeli</i> <i>T. sergenti</i>	<i>Amblyomma</i> spp. <i>Amblyomma</i> spp. <i>Haemophysalis longicornis/H. punctata</i>
Sheep and goats			
Malignant ovine theileriosis	North Africa, Middle East, India	<i>T. hirci</i> ( <i>T. lestoquardi</i> )	<i>Hyalomma</i> spp./ <i>Haemophysalis</i> spp.?
Benign theileriosis	Worldwide	<i>T. ovis</i>	<i>Rhipicephalus</i> spp.?
<b>Horses, other equidae</b>			
Equine theileriosis	East and South Africa Worldwide	<i>T. separata</i> <i>T. equi</i>	<i>Rhipicephalus</i> spp. <i>Boophilus microplus</i> , <i>Rhipicephalus</i> spp., <i>Hyalomma</i> spp.



region as bovine tropical theileriosis. Malignant theileriosis in sheep and goats is similar to bovine tropical theileriosis as a result of *T. annulata*. Like the latter, it is also transmitted by *Hyalomma* spp., but in China, the main vector is *Haemaphysalis* spp. The disease can be acute, subacute, or chronic, depending on the resistance of the sheep or goats, and is seasonal, depending on availability of ticks. The acute disease is characterized by fever and very high mortality in 3 to 6 days. Anemia, jaundice, and enlargement of lymph nodes are characteristic, and both piroplasms and schizonts can be demonstrated in smears of blood and tissues, respectively. The anemia is severe, progressive, and hemolytic and is associated with oxidative damage.<sup>7</sup> In subacute and chronic cases, signs are generally less marked except for anemia and emaciation. An indirect fluorescent antibody test is available and parasites can be identified by PCR methods. Parvaquone and buparvaquone may be used to treat early cases. **Benign ovine theileriosis** is caused either by *T. ovis* or by *T. separata*, *T. luwenshuni*, or *T. uilenbergi*.<sup>9</sup> Piroplasms are found in blood, but there are no overt clinical signs.

Equine theileriosis is caused by *Theileria equi* (formerly *Babesia equi*) and has been reported from all continents, including North America, where it has reemerged as a persistent subclinical infection of horses in the United States.<sup>10</sup> The term *equine piroplasmosis* is used to refer to *T. equi* infection alone or concurrently with *Babesia cabali*. Horses, donkeys, camels, and zebras are affected. Transmission is by *Boophilus microplus*, *Rhipicephalus* spp., and *Hyalomma* spp. In addition, transplacental transmission from mare to foals is quite common. The disease is generally a benign form of theileriosis detected during routine blood examination or through serology and molecular techniques (PCR). Treatment with imidocarb dipropionate is largely successful in eliminating carrier state and transmission risk in nonendemic countries.<sup>10</sup>

In summary, the pathogenesis of various forms of theileriosis is dependent on the production of schizonts in lymphocytes and piroplasms in erythrocytes. Thus *T. parva*, *T. annulata*, and *T. hirci* produce numerous schizonts and piroplasms and are very pathogenic; *T. orientalis*, *T. mutans*, and *T. ovis* rarely produce schizonts but may cause varying degrees of anemia when piroplasms are many in red blood cells; and with *T. velifera* and *T. separata*, no schizonts have been described, the parasitemia is usually scanty, and the infection is mild or subclinical. Transmission is from tick saliva to the mammalian host, but cases of transplacental infection have been reported rarely for *T. orientalis* and more frequently for *T. equi*.

## REFERENCES

1. Eamens G, et al. *Aust Vet J*. 2013;91:332.
2. Aparna M, et al. *Parasitol Int*. 2011;60:524.

3. Islam MK, et al. *Infect Genet Evol*. 2011;11:2095.
4. Mcfadden AM, et al. *NZ Vet J*. 2011;59:79.
5. Perera PK, et al. *Vet Parasitol*. 2013;doi:10.1016/j.vetpar.2013.06.023; [Epub ahead of print].
6. Perera PK, et al. *Parasit Vect*. 2014;7:73.
7. Nazifi S, et al. *Parasitol Res*. 2011;109:275.
8. *OIE Manual of Diagnostic Tests and Vaccines for Terrestrial Animals*. 6th ed. Paris: OIE; 2008 chapter 2.4.17:789.
9. Yin H, et al. *Trends Parasitol*. 2009;25:85.
10. Ueti MW, et al. *PLoS ONE*. 2012;7:e44713.

## EAST COAST FEVER (ECF)

### SYNOPSIS

**Etiology** *Theileria parva*, an Apicomplexa protozoon. Vector is *Rhipicephalus appendiculatus* and, rarely, *R. zambeziensis*.

**Epidemiology** Endemic disease of cattle in East and Central Africa; high mortality and great economic importance.

**Clinical signs** Fever, enlarged superficial lymph nodes, dyspnea, wasting, and terminal diarrhea.

**Clinical pathology** Schizonts in lymphoblasts, piroplasms in erythrocytes, serology.

**Lesions** Massive pulmonary edema, hydrothorax, hydropericardium, emaciation, hemorrhages, lymphadenopathy, and widespread proliferation of lymphoblastoid cells.

#### Differential diagnosis list

- Trypanosomosis/babesiosis/anaplasmosis
- Heartwater
- Malignant catarrhal fever/bovine virus diarrhea/rinderpest

**Treatment** Limited success with halofuginone, parvaquone, and tetracyclines.

**Control** Integrated approach involving resistant animal breeds, strategic application of acaricides, and vaccination by infection-and-treatment methods.

## ETIOLOGY

East Coast fever is caused by *Theileria parva* transmitted by ticks. The genus *Theileria* belongs to the apicomplex group (see “Theilerioses”). There has been considerable naming and renaming of *T. parva* and the associated diseases in Africa. “Classic” East Coast fever (ECF) occurs in East Africa and is associated with *T. parva* transmitted from cattle to cattle by the brown ear tick, *Rhipicephalus appendiculatus*. ECF also occurs either as **corridor disease** in eastern and southern Africa or as **January disease** in central Africa. Corridor disease is transmitted from buffalo to cattle by either *R. appendiculatus* or *R. zambeziensis*, and the agent responsible used to be called *T. parva lawrencei*. Close contact between buffalo, cattle, and ticks is essential. The disease is more acute than classical ECF, but after serial passage in cattle, it is indistinguishable from classical ECF. January disease occurs mainly between January and March, and the agent was named

*T. parva bovis*. The disease is also more acute than classical ECF, with death sometimes occurring within 4 days. These three clinical diseases are otherwise indistinguishable from one another, and hence the causative agents are currently referred to simply as *T. parva*.

## EPIDEMIOLOGY

### Occurrence

ECF affects mainly cattle but also buffalo, and occurs in 13 countries in eastern, central, and southern Africa. Its occurrence is related to the distribution of the vector tick, which has been recorded from large areas extending from southern Sudan in the north to western Zambia and eastern Zaire in the west, and to Mozambique and Zimbabwe in the south. The disease is prevalent throughout the wetter areas favoring the development of the tick, but is absent from the wet highlands in the horn of Africa. An outbreak was reported in the Comoros following importation of immunized cattle from Tanzania.<sup>1</sup> The disease has been eradicated from southern Africa up to the Zambezi River. The endemic scenarios range from a stable situation with high prevalence of herd infection but low fatality rates (endemic stability) to a low-prevalence/high-fatality scenario (endemic instability). Endemic stability develops in indigenous zebu cattle exposed to constant tick challenge, such as those in wetter areas, whereas endemic instability is seen with commercial production systems utilizing imported breeds or crossbreeds and in areas with a unimodal rainfall pattern that restricts tick activity. Epidemics occur when there is a breakdown in tick control, especially during the rainy season or when susceptible animals are introduced into an endemic area.

### Morbidity and Case Fatality

All susceptible cattle in endemic areas are at the risk of contracting ECF unless they are vaccinated or the tick population is under stringent control. The morbidity and case-fatality rates are very high, approaching 90% to 100% in recently introduced exotic (*Bos taurus*) breeds and in previously unexposed or naive indigenous cattle. However, indigenous zebu cattle (*Bos indicus*) and African buffalo in endemic areas have a strong resistance to the disease, and calfhood mortality is around 5%.

### Methods of Transmission

The vector of ECF is *Rhipicephalus appendiculatus*; in the field, the disease occurs only where this tick is found, except for corridor disease, which may be transmitted by *R. zambeziensis*. Other species of *Rhipicephalus* and *Hyalomma* spp. can transmit ECF experimentally, but they are not significant. Developmental stages of the parasite occur in the tick, and they pass transstadially through the stages of larva, nymph, and adult, but there

is no transovarian transmission. Consequently, larvae or nymphs become infected and transmit infection as nymphs or adults, respectively. Adults are more efficient vectors than nymphs but each developmental stage results in amplification of the vector's competence in parasite transmission and the ability to infect more than one host during the life cycle of the tick.<sup>2</sup> Infected ticks start transmission of the parasite from 72 hours postattachment,<sup>3</sup> and mechanical transmission is of no significance. The epidemiology of the disease is thus largely dependent on the distribution and habitat of the tick and its ability to complete development to the adult stage, usually during the rainy season. Ticks may live for 1 to 2 years, but they lose their infection within 11 months.

### Risk Factors

The most important risk factors relate to the presence of the brown ear tick in a given area and the level of tick burden per animal, even though it takes only one tick to establish an infection that could be fatal. At low infestation rates, an average of five ticks per head (two to three per ear) will sustain endemicity; one to four per head will invite epidemicity, whereas an average of less than one can allow sporadic outbreaks. In addition, there is evidence that *R. appendiculatus* populations that originate from eastern Africa tend to become more highly infected with *T. parva* than those that originate from southern Africa, and consequently the disease they transmit is more virulent.

The infection rate in ticks in endemic areas is usually low (1% to 2%), even though the immunity conferred on recovered or vaccinated animals is no longer thought to be sterile. However, soon after ECF becomes established in susceptible herds, infection rates in ticks become much higher.

Young animals are less susceptible, and indigenous breeds and buffaloes are less clinically affected than exotic breeds, but buffaloes are the carriers of corridor disease. Other wild *Bovidae* may help to sustain the population of the tick vector but are not carriers of *T. parva*. Asiatic or water buffalo are fully susceptible.

### Environmental Factors

In eastern Africa, *R. appendiculatus* normally occurs in grass-covered savannah and savannah woodlands, but it is usually absent from extensive heavily wooded forest habitats. Areas that are too high, too cold, or too dry will not allow the tick to undergo more than one life cycle in a year, thereby reducing the period of transmission of theilerial parasites by the nymphs or adults. For example, the disease is most prevalent in eastern Africa, where adult and immature stages of the tick occur simultaneously on cattle, leading to rapid and continuous transmission. In southern Africa, by contrast, there is a seasonal life cycle for the tick, and thus

there is little overlap between the activity periods of adults (January to March) and immature stages, thereby reducing the frequency of disease transmission.

### Immune Mechanisms

Cattle recovering from ECF have a solid immunity to homologous challenge, but the immunity is not sterile. In endemic areas, premunity is established early, and this provides lifelong protection if reinfection continues and the cattle are not moved to a different location where they may be exposed to a different strain of the parasite. Indigenous cattle are able to limit explosive multiplication of schizonts during the acute phase. Nutritional or climatic stress may seriously reduce the animal's premunity, even among resistant breeds. Although antibody responses to the sporozoite may play some part in protection, immunity is mediated mainly by cellular mechanisms involving cell-mediated cytotoxic T-cell (CTL) responses against surface antigens of macroschizont-infected cells. The CTL response is parasite specific and genetically restricted (major histocompatibility complex [MHC] antigens), and the protection can be transferred between immune and naïve calves in the CD8+ T-cell fraction emanating from a responding lymph node.

### Experimental Reproduction

ECF can easily be reproduced by feeding infected ticks on susceptible cattle or by inoculating cattle with infected tick material, sporozoites, or macroschizont-infected tissue culture cells. This is used as a method of immunization. When working with ticks or tick materials, care should be taken to avoid the risk of contracting other tick-borne diseases.

### Economic Importance

ECF has a major impact on cattle production in eastern, central, and southern Africa. It is estimated that in 1989, ECF killed 1.1 million head of cattle and caused US\$168 million in losses. Serious losses occur in exotic and indigenous cattle, mainly from reduced production of milk and meat as a result of morbidity and mortality, and from the heavy costs incurred in implementing effective tick control. *T. parva* does not infect human beings.

### Biosecurity Concerns

The vector of ECF has strict requirements that limit the spread and establishment of the disease beyond the geographic areas where it normally occurs. Where the vector occurs but there is no disease, as in the Comoros, precautions should be taken to avoid importation of carrier cattle from endemic areas. ECF is not contagious.

### PATHOGENESIS

Sporozoites of *T. parva* are injected into the bovine host by the tick in its saliva. Ticks

must feed for 2 to 4 days before sporozoites in their salivary glands will mature and become infective to cattle. One tick can transmit sufficient sporozoites to cause a fatal infection in a susceptible animal. The sporozoites then enter lymphocytes and develop into schizonts in the lymph node draining the area of attachment of the tick, usually the parotid node. Infected lymphocytes are transformed to immortalized lymphoblasts and continue to divide synchronously with the schizonts, and thus each daughter cell is also infected. Eventually, infected lymphoblasts are disseminated throughout the lymphoid system and in non-lymphoid organs, where they continue to proliferate. The strategy used by the parasite to transform the infected cell is via reprogramming the cell's glucose metabolism and redox signaling.<sup>4,5</sup> It has been suggested that only a proportion of infected lymphocytes will actually proliferate and disseminate.<sup>6</sup> Furthermore, the survival of infected lymphoblasts is promoted by cytoplasmic sequestration of p53, the central effector molecule of the p53 apoptotic pathway.<sup>7</sup> Later, some schizonts differentiate into merozoites and are released from the lymphoblasts. Without the schizonts, proliferation of such lymphoblasts is arrested.<sup>5</sup> Meanwhile, the released merozoites invade erythrocytes, where they are referred to as piroplasms. The latter are the form infective to ticks. Piroplasms ingested by ticks undergo several developmental stages and eventually form sporozoites in salivary glands, thus completing the cycle.

The dominating pathologic lesion is generalized lymphoid proliferation resulting from uncontrolled proliferation of T-lymphocytes containing schizonts. This is followed later by necrosis of infected lymphoblasts induced by cytotoxic T-lymphocytes. In one study involving 3-month old calves, massive necrosis of lymphocytes without initial proliferation was reported.<sup>8</sup> The severe lymphocytolysis often leads to immunosuppression. Terminally, the animal develops severe pulmonary edema, probably as a result of release of vasoactive substances from lymphocytes disintegrating in the lungs. Erythrocytic indices are usually unchanged, but there may be terminal anemia in January disease.

### CLINICAL FINDINGS

The basic syndrome caused by *T. parva* infection lasts for a few weeks. The incubation period is 1 to 3 weeks, depending on the virulence of the strain and the size of the infecting dose. Experimentally, the first clinical sign is enlargement of lymph nodes in the area draining the site of tick attachment (i.e., 8 to 16 days after attachment). One or 2 days later, there is fever, depression, anorexia, and a drop in milk in dairy animals. In later stages, there may be nasal and ocular discharges, dyspnea, generalized lymph node

enlargement, and splenomegaly. In severe cases, diarrhea occurs, sometimes with dysentery, but usually only late in the course of the disease. Emaciation, weakness, and recumbency lead to death from asphyxia in 7 to 10 days. Terminally, there is often a frothy nasal discharge. Occasional cases of brain involvement occur and are characterized by circling, hence “turning sickness,” or cerebral theileriosis.

In southern Africa, cerebral theileriosis is associated with an aberrant form of *T. taurotragi* originating from the eland (see “Theilerioses”). There are localized nervous signs and convulsions, tremor, profuse salivation, and head pressing. Infection with the strain of *T. parva* (formerly *T. parva lawrencei*) responsible for corridor disease causes a similar acute syndrome, with the additional lesion of keratitis and accompanying blepharospasm. ECF in Zimbabwe (formerly attributed to *T. parva bovis*) is generally slightly less virulent but is still frequently fatal.

### CLINICAL PATHOLOGY

The parasites are evident as schizonts, sometimes in circulating lymphocytes, but mainly in biopsy smears of enlarged lymph nodes stained with Giemsa. Piroplasms are also easily visible in erythrocytes from day 16 after tick attachment, and they increase in number until death. Over 30% of the red cells may be infected, but the level of intraerythrocytic piroplasms is not correlated with the severity of the disease. *T. parva* piroplasms are difficult to differentiate from other piroplasms—hence the necessity to find schizonts. Blood counts will reveal a panleukopenia and thrombocytopenia with little or no anemia. The protozoa can be grown on a tissue culture of lymphoblastoid cells.

A range of serologic tests is available, including indirect immunofluorescent antibody test (IFAT), complement fixation test, indirect hemagglutination test, and enzyme-linked immunosorbent assay (ELISA). The ELISA test is increasingly being used for seroepidemiologic studies, and the polymerase chain reaction (PCR) technology can be used as with other theilerioses. However, the IFAT is the most widely used test.<sup>9</sup>

### NECROPSY FINDINGS

The most striking lesion is massive pulmonary edema, hyperemia, and emphysema, along with hydrothorax and hydropericardium. Copious froth is present in the airways. The carcass is emaciated, and hemorrhages are evident in a variety of tissues and organs. There is enlargement of the liver, lymph nodes, and spleen and ulceration of abomasum and intestines. Small lymphoid nodules (the so-called pseudoinfarcts) are present in liver, kidney, and alimentary tract. In protracted cases, animals may have small, exhausted lymphoid organs.

Microscopic lesions are characterized by proliferating lymphoblastoid cells and

varying amounts of necrosis in lymphoid organs, lungs, liver, kidneys, the gastrointestinal tract, and other tissues, somewhat similar to a multicentric lymphoid tumor. Some lymphoblasts contain schizonts, which are better seen in impression smears stained with Giemsa stain. In cerebral theileriosis, infected lymphoblasts sequester in cerebral blood vessels and cause infarction.

Specimens to submit for pathology should include lymph nodes, lungs, kidneys, liver, and any other organ with gross lesions.

### DIFFERENTIAL DIAGNOSTIC

The fever, depression, and lymphadenopathy of ECF can be confused with such diseases as theileriosis attributable to

- *T. annulata*
- trypanosomiasis
- heartwater
- malignant catarrhal fever
- bovine virus diarrhea and rinderpest

The lymphoid hyperplasia may also simulate lymphoma. Knowledge of the disease history, coupled with hematologic and lymph node smear examinations, is usually adequate to make a definitive diagnosis.

### TREATMENT

#### TREATMENT AND CONTROL

##### Treatment

Buparvaquone (2.5 mg/kg IM, 2 doses 48 hours apart) (R-1)

Parvaquone (10 mg/kg IM 2 doses 48 hours apart) (R-1)

Halofuginone lactate (1.2 mg/kg PO) (R-1)

Oxytetracycline (20 mg/kg IM) (R-2)

##### Control

Vaccination by infection and treatment method using tetracycline or parvaquone (R-1)

Vaccination by infection with low-pathogenicity isolate (R-2)

Once an animal is manifesting clinical signs of ECF, treatment is generally considered to be either unsatisfactory or too expensive. Tetracyclines were the recommended treatment for many years, but they have only moderate efficacy, especially if the disease has been present for a few days. Two recently introduced drugs, halofuginone lactate and parvaquone, have had a much higher success rate, but recovered animals may become carriers unless the correct dose is used. Halofuginone lactate is an effective oral treatment for the acute syndrome at two doses, 1.2 mg/kg BW. Parvaquone (10 mg/kg BW, two doses 48 hours apart) or the related buparvaquone (2.5 mg/kg BW, two doses 48 hours apart) given IM is effective in most cases. In field trials, buparvaquone gives

results comparable to those of parvaquone, and cure rates are maximized by accurate diagnosis and prompt treatment of both ECF and intercurrent infections. Cure rates are even higher if the animals are also treated for pulmonary edema with dexamethasone or the diuretic furosemide. A recovery rate of 95.2% was reported in field cases in Tanzania treated with buparvaquone alone.<sup>10</sup>

### CONTROL

Until recently, the main method of control of ECF was to break the transmission cycle between cattle and ticks. This was achieved through widespread and strict application of acaricides at 3-, 5-, or 7-day intervals throughout the year (intensive dipping), adherence to legislation on cattle movements and quarantine, and good livestock and pasture management. With the ever-rising costs of acaricides, their effect on the environment, the development of acaricide resistance, and frequent political problems in the affected regions, this strategy to control ECF and other tick-borne diseases in Africa has been revised. Furthermore, it has been observed that indigenous cattle, constituting the majority of the herds in some of the affected countries, may lose their endemic stability with intensive dipping, and the process is not cost-effective. An integrated approach is now advocated involving the use of genetically resistant breeds, a judicious and selective application of acaricides at 3-week intervals (strategic dipping) or when there are at least 100 ticks per animal (tactical dipping), and the use of vaccines. It has been reported that monthly applications of deltamethrin-based pour-on insecticide significantly reduce the incidence of ECF and other hemoparasitic diseases in smallholder dairy farms in Kenya.

The technique used for vaccination is immunotherapy or “infection-and-treatment method.” Initially, cryopreserved suspensions of *T. parva* sporozoites from ground-up infected ticks were injected into the patient. Now, sporozoites from cell culture are used. The infection they cause is controlled with long-acting oxytetracycline (20 mg/kg BW IM), or preferably parvaquone given at the same time, and thus premunity is established. It is preferably to use a cocktail of different stocks of parasites. Vaccination, coupled with strategic dipping only when ticks are abundant, is usually successful and economically attractive, provided local stocks of *Theileria* are included. The Muguga cocktail vaccine is being used throughout eastern, central, and southern Africa and has been recommended for use in southern Sudan.<sup>11</sup> Reports indicate that calves in high-risk areas should be vaccinated at 1 to 2 months of age, that immunization campaigns are more efficient when concentrated in the period of low adult tick activity, and that immunization is of no benefit in herds under intensive tick control



but is of high value when combined with strategic tick control. Strategic control plus immunization can markedly reduce the risk of clinical ECF, but immunized animals are carriers, and all stages of *R. appendiculatus* can transmit infection from them to naïve animals.

Studies have indicated that cattle could be successfully immunized without current tetracycline therapy by using low-pathogenicity isolates as vaccines, for example, *T. parva* (Boleni) in Zimbabwe, or low-infectivity sporozoite stabilates stored at  $-196^{\circ}\text{C}$  ( $-321^{\circ}\text{F}$ ) for over 6 months. Because of the high cost of tetracyclines, this procedure would reduce the cost of vaccination by more than threefold in the first year of field application. Furthermore, the *T. parva* (Boleni) isolate was reported to induce protection against a wide spectrum of *Theileria* stocks in Zimbabwe.<sup>12</sup> Economic analyses in Kenya have demonstrated that integrated control in which ECF immunization is always an important component can play an important role in the overall control of the disease.<sup>2</sup> In Tanzania, annual theileriosis costs were US\$205.40 per head, whereas the introduction of immunization reduced this by 40% to 68% depending on the postimmunization dipping strategy adopted.<sup>13</sup>

It needs to be stated that immunity is engendered so far only with live parasites that can establish an infection but can also produce carriers, from which the parasites can be transmitted to unvaccinated cattle that share grazing.<sup>14</sup> Hence, there is inherent risk in the widespread use of such vaccines across national boundaries. On the other hand, this process may be accelerating progress to endemicity.

The possibility of immunizing cattle with recombinant surface molecules from either the sporozoite (the p67 antigen) or the schizont, or a mixture of several antigens derived from both stages, has been investigated but without much success. Such a recombinant vaccine would probably avoid the breakdowns that occur with any immunotherapeutic technique, and if the right antigens are found for the vaccine, it is hoped that the immunity engendered is likely to be broad, robust, and not parasite stock specific.

## FURTHER READING

- Brown CGD. Theileriosis. In: Sewell MMH, Brocklesby DW, eds. *Handbook on Animal Diseases in the Tropics*. 4th ed. London: Baillière Tindall; 1990:183.
- Lawrence JA, Perry BD, Williamson SM. East coast fever. In: Coetzer JAW, Tustin RC, eds. *Infectious Diseases of Livestock*. Vol. 1. 2nd ed. Cape Town: Oxford University Press; 2004:448.
- Losos GJ. Theileriosis. In: *Infectious Tropical Diseases of Domestic Animals*. London: Longman; 1986:98.
- Norval RAI, Perry BD, Young AS. *The Epidemiology of Theileriosis in Africa*. San Diego: Academic Press; 1992:481.
- OIE Manual of Diagnostic Tests and Vaccines for Terrestrial Animals. Paris: OIE; 2008 chapter 2.04.16:789.

## REFERENCES

- De Deken R, et al. *Vet Parasitol*. 2007;143:245.
- Gachohi J, et al. *Parasit Vect*. 2012;7:194.
- Konnai S, et al. *Vector Zoonot Dis*. 2007;7:241.
- Medjkane S, et al. *Oncogene*. 2014;33:1809.
- Metheni M, et al. *Cell Microbiol*. 2015;doi:10.1111/cmi.12421; [Epub ahead of print].
- Rocchi MS, et al. *Int J Parasitol*. 2006;36:771.
- Haller D, et al. *Oncogene*. 2010;29:3079.
- Mbassa GK, et al. *Vet Parasitol*. 2006;142:260.
- OIE Manual of Diagnostic Tests and Vaccines for Terrestrial Animals. 6th ed. Paris: OIE; 2008 chapter 2.4.17:789-804.
- Mbwambo HA, et al. *Vet Parasitol*. 2006;139:67.
- Martins SB, et al. *Prev Vet Med*. 2010;97:175.
- Latif AA, Hove T. *Ticks Tick Borne Dis*. 2011;2:163.
- Kivaria FM, et al. *Vet J*. 2007;173:384.
- Oura CA, et al. *Parasitology*. 2007;134:1205.

## TROPICAL THEILERIOSIS (MEDITERRANEAN COAST FEVER)

### SYNOPSIS

**Etiology** *Theileria annulata*, an Apicomplexa protozoon. Vectors are *Hyalomma* ticks.

**Epidemiology** Endemic disease of cattle in Mediterranean basin and parts of Asia.

**Clinical signs** Inapparent in local stock; fever, lymphadenopathy, wasting, anemia, and jaundice in exotics.

**Clinical pathology** Schizonts in macrophages and lymphocytes especially in liver smears; piroplasms in erythrocytes.

**Lesions** As in East Coast fever (ECF); also anemia and jaundice.

#### Differential diagnosis list:

- Other theilerioses
- Babesiosis
- Anaplasmosis
- Trypanosomosis
- Malignant catarrhal fever

**Treatment** Buparvaquone is effective.

**Control** None required for indigenous cattle; vaccination and strategic tick control for exotics.

## ETIOLOGY

*Theileria annulata* is a member of the Apicomplexa group, like *T. parva*, the cause of East Coast fever. It is highly virulent for European dairy cattle, whereas infection in local zebu cattle is often subclinical.

## EPIDEMIOLOGY Occurrence and Methods of Transmission

The disease occurs from Morocco and Portugal in the west through the Mediterranean basin and the Middle East to India and China in the east. An outbreak in a Scottish dairy farm over a decade ago was thought to have been attributable to mechanical transmission from experimentally infected calves on a research institute associated with the

farm. In the absence of natural vectors, that outbreak was quickly controlled.

*T. annulata* affects cattle and is transmitted transstadially by the three-host tick *Hyalomma anatolicum* in central-western Asia and northeastern Africa, and by the two-host tick *H. detritum* in the Mediterranean basin. The extent of its distribution may overlap with that of *T. parva* in Sudan and Eritrea and with *T. orientalis* in the Far East.

In endemic areas, virtually all adult cattle are infected, but infection rates vary with the method of examination. For example, surveys carried out in different parts of Turkey showed the prevalence to be between 0% and 60.5% by microscopic examination of blood and lymph node smears, 1.8% and 91.4% by serology (IFAT), and between 15.4% and 61.2% by molecular techniques.<sup>1</sup>

Case fatality is approximately 10% to 20% and is confined mainly to calves. Exotic animals recently introduced may have 20% to 90% mortality. The disease occurs when there is much tick activity, mainly in summer and the rainy seasons, and in crossbred animals. A single tick can cause fatal infection because its salivary glands usually contain numerous sporozoites.

## Risk Factors and Immune Mechanisms

The normal state is that of endemic stability. This balance is disturbed when exotic animals are introduced, and heavier losses occur. Recovered animals show a solid, long-lasting immunity, but they remain as carriers. Buffaloes are thought to be the natural hosts, and they may also act as carriers, whereas yaks are highly susceptible. In one study in Egypt, water buffaloes were more severely affected than cattle.<sup>2</sup> As with *T. parva*, immunity is mainly cell mediated but is poor in calves. Experimental reproduction is by feeding infected ticks on cattle or by needle inoculation of sporozoites in macerated ticks, schizonts in lymphocytes, or of merozoites in erythrocytes. Humans are not affected.

## Economic Importance

The disease is a major constraint to livestock improvement programs in many parts of the Middle East and Asia. Around one-sixth of the world cattle population is at risk. Economic losses arising from the disease in Turkey were estimated to vary from US\$130,000 to US\$598,000 per annum in the endemic stable zones.<sup>1</sup> In carrier animals in Tunisia, the greatest loss is from reduced milk production.<sup>3</sup>

## Biosecurity Concerns

There are no biosecurity concerns.

## PATHOGENESIS

The life cycle of *T. annulata* is cattle-tick-cattle, as for *T. parva*, but unlike *T. parva*, the sporozoites of *T. annulata* invade and form

schizonts, mostly in macrophages/monocytes that express major histocompatibility (MHC) class II antigens. The macrophages then stimulate uninfected lymphocytes to undergo lymphoblastic transformation and proliferate.<sup>4</sup> Schizont-infected cells multiply in the draining lymph nodes and disseminate rapidly along with lymphoblasts throughout the lymphoid tissues and in nonlymphoid organs, including the liver, kidney, lung, abomasum, and brain. Virulence of the disease is associated with the capacity of infected cells to disseminate inside the host.<sup>5</sup> Later, schizonts differentiate into merozoites and invade erythrocytes (as piroplasms). The pathogenesis therefore involves proliferation of macrophages induced by schizonts, and anemia with icterus induced mostly by the piroplasms. Macrophages/monocytes are the main producers of inflammatory cytokines that can induce an acute-phase protein response. The response is greater in *Bos taurus* Holstein breed than the *Bos indicus* Sahiwal breed,<sup>6</sup> and this would explain the more severe disease in the Holstein. Infected macrophages from taurine breeds are also more capable of aggressive invasiveness than zebu breeds.<sup>7</sup>

Over 90% of erythrocytes may be parasitized, each by one or more merozoites. Merozoites induce hemolysis most likely by lipid peroxidation of the red cell membrane. The level of hemolysis is dependent on the parasitic burden.<sup>8</sup> Immunosuppression may occur in the acute stages of the disease but is generally less marked than in ECF, probably because leukocyte numbers return to normal soon after the acute phase.

## CLINICAL FINDINGS

In a stable endemic situation, there may be only mild or no clinical disease in local zebu cattle. Clinical signs are acute and severe in exotic cattle and less severe in crossbreeds and are similar to those in ECF. However, the course is longer in tropical theileriosis and may last for weeks before death. Clinical signs include marked fever, swelling of superficial lymph nodes, inappetence, tachycardia, dyspnea, pale mucous membranes, and icterus. Others are diarrhea, weight loss, convulsions, torticollis, and other nervous signs. In chronic cases, there may be small subcutaneous nodules, from which schizonts can be demonstrated in smears. In Egypt, affected cattle and buffaloes also showed ocular signs, including severe lacrimation, bilateral conjunctivitis, photophobia, and corneal opacity,<sup>2</sup> whereas in Spain, there were coalescing skin nodules similar to multicentric malignant lymphoma.<sup>4</sup>

## CLINICAL PATHOLOGY

As with ECF, examination of smears of blood and lymph node biopsy will reveal piroplasms in erythrocytes and schizonts in lymphocytes. Schizonts of *T. annulata* tend to be more common in the liver than in lymph

node smears, but they are otherwise indistinguishable from those of *T. parva*. Furthermore, the piroplasms are predominantly round and oval, as opposed to *T. parva*, which has comma- and rod-shaped piroplasms. Anemia is a significant feature of tropical theileriosis, unlike in ECF, and is associated with bilirubinemia, hemoglobinuria, and bilirubinuria. The anemia results from destruction of erythrocytes containing piroplasms, but other factors may include autoimmune hemolysis and poor bone-marrow response. Reduction in white cell and platelet counts is less severe than in ECF, but animals dying from the disease show persistent and severe lymphocytopenia involving mainly T-lymphocytes.

The most commonly used serologic diagnostic technique is the indirect fluorescent antibody test.<sup>9</sup> For surveys, an indirect enzyme-linked immunosorbent assay (ELISA) test using a recombinant *T. annulata* surface protein has been described. The ELISA tests provide higher sensitivity and specificity than the IFAT. The polymerase chain reaction (PCR) test is more sensitive and more specific<sup>10</sup> and can detect carriers; it can also be used to detect infected ticks. A multiplex PCR method can simultaneously detect single and coinfections with *T. annulata*, *Babesia bigemina*, and *Anaplasma marginale* in cattle.<sup>11</sup> The test is simple, specific, and sensitive and can be applied to epidemiologic studies aimed at assessing the burden of multiple infection with tick-borne pathogens.

## NECROPSY FINDINGS

Apart from pallor of mucous membranes and yellowish discoloration of tissues, the postmortem lesions in animals dying from tropical theileriosis are similar to those of ECF. Lymphoid proliferation can resemble multicentric malignant lymphoma.<sup>4</sup> Liver, spleen, and lymph nodes should be submitted for laboratory examination to detect schizonts, whereas merozoites are detected in blood smears.

## DIFFERENTIAL DIAGNOSIS

Tropical theileriosis may be confused with the other theilerioses that may occur in the region, and with babesiosis, anaplasmosis, trypanosomosis, and malignant catarrhal fever. Liver biopsy and blood examination will help to confirm a clinical diagnosis.

## TREATMENT

### TREATMENT AND CONTROL

#### Treatment

Buparvaquone 2.5 mg/kg IM, 2 doses 48 hours apart) (R-1)

Halofuginone lactate (1.2 mg/kg PO) (R-1)

Oxytetracycline (20 mg/kg IM) (R-2)

### Control

Vaccination by infection and treatment method using tetracycline (R-1 for exotic animals)

Vaccination with attenuated schizont vaccine (R-2)

Buparvaquone is the most effective agent available, and the recommended dose is 2.5 mg/kg BW. In calves, supportive treatment for anemia is indicated. Halofuginone at 1.2 mg/kg is also effective, but tetracycline at 20 mg/kg is less so.

## CONTROL

Indigenous cattle live with the disease and do not require any intensive tick control or treatment. For valuable exotic stock or their crossbreeds, vaccination and strategic tick control are recommended. Vaccines can be made from either the sporozoite or the schizont. The sporozoite vaccine is based on the infection-and-treatment method using schizont-infected cell lines and simultaneous tetracycline treatment, as for *T. parva*. It has been suggested that the most economical way to control theileriosis in India is to vaccinate calves and to reserve buparvaquone for treating clinical cases. The schizont vaccine was formerly blood containing a mild strain of the parasite. The newer vaccines are prepared from live schizonts grown in lymphoid cell culture and attenuated by prolonged passage. They cause virtually no adverse reactions, and vaccinated cattle show good resistance to the disease for at least 3.5 years. Therefore it is necessary to revaccinate, preferably with a different cell-line vaccine, if tick population is too low to establish endemic stability. The risk for spread of the vaccine strains in the field is very low. The disease has been successfully controlled in China by vaccination.<sup>12</sup>

## FURTHER READING

- Brown CGD. Theileriosis. In: Sewell MMH, Brocklesby DW, eds. *Handbook on Animal Diseases in the Tropics*. 4th ed. London: Baillière Tindall; 1990:183.
- OIE *Manual of Diagnostic Tests and Vaccines for Terrestrial Animals*. 6th ed. Paris: OIE; 2008 chapter 2.4.17:789-804.
- Pipano E, Shkap V. *Theileria annulata* theileriosis. In: Coetzee JA, Tustin RC, eds. *Infectious Diseases of Livestock*. Vol. 1. 2nd ed. Cape Town: Oxford University Press; 2004:486-487.

## REFERENCES

- Cicek H, et al. *Turkiye Parazitoloj Derg.* 2009;33:273.
- Mahmmod YS, et al. *Ticks Tick Borne Dis.* 2011;2:168.
- Gharbi M, et al. *Rev - Off Int Epizoot.* 2011;30:763.
- Branco S, et al. *J Vet Sci.* 2010;11:27.
- Ma M, Baumgartner M. *PLoS ONE.* 2013;8(9):e75577. doi:10.1371/journal.pone.0075577; eCollection 2013.
- Glass EJ, et al. *Vet Immunol Immunopathol.* 2012;148:178.
- Chaussepied M, et al. *PLoS Pathog.* 2010;6:e1001197.

8. Saleh MA, et al. *Vet Parasitol.* 2011;182:193.
9. *OIE Manual of Diagnostic Tests and Vaccines for Terrestrial Animals.* 6th ed. Paris: OIE; 2008 chapter 2.4.17:789-804.
10. Khattak RM, et al. *Parasite.* 2012;19:91.
11. Bilgic HB, et al. *Exp Parasitol.* 2013;133:222.
12. Yin H, et al. *Vaccine.* 2008;26(suppl 6):G11-G13.

## Multi-Organ Diseases Due to Trypanosome Infection

Trypanosomes are flagellated protozoan parasites belonging to the genus *Trypanosoma*, family Trypanosomatidae. They live in the blood and other body fluids of vertebrate hosts, where some of them cause disease. With the help of the flagellum, trypanosomes swim within the vertebrate bloodstream and prosper despite being constantly attacked by the host immune system. The parasites generally possess a kinetoplast and undergo cyclical development in an arthropod vector but can be transmitted mechanically. Their biological adaptations, morphology, and pathogenicity are fascinating and have been extensively studied. The parasites cause several diseases, each of which was referred to as trypanosomiasis. The currently preferred term is *trypanosomosis*, plural *trypanosomoses*. The diseases are summarized in Table 21-7.

*Trypanosoma evansi* is the first known pathogenic trypanosome. It was first described in India as the cause of surra in animals, but the disease is widespread in the tropics and is transmitted mechanically rather than by a biological vector. In Africa, three species (*Trypanosoma congolense*, *T. vivax*, and *T. brucei*) are the main pathogens for animals and humans. The parasites are

transmitted by the tsetse fly (*Glossina* spp.), and the resulting animal disease is referred to as African trypanosomosis or nagana. Two subspecies of *T. brucei* are responsible for African sleeping sickness in human beings, *T. brucei gambiense* in West and Central Africa, and *T. brucei rhodesiense* in East Africa. Another disease, dourine, specifically affects equines and camels and is caused by *T. equiperdum* transmitted sexually during coitus. *T. evansi* and *T. equiperdum* are regarded as subspecies of *T. brucei*, which have lost their ability to infect tsetse and are therefore able to spread outside Africa. In South and Central America, a different trypanosome, *T. cruzi*, transmitted by reduviid bugs (*Rodnius* spp. and *Triatoma* spp.), is the cause of Chagas's disease or American trypanosomosis, mostly in humans, but it also affects dogs, cats, and pigs. Trypanosomoses of veterinary importance are discussed here.

## NAGANA (SAMORE, AFRICAN TRYPANOSOMIASIS, TSETSE FLY DISEASE)

### SYNOPSIS

**Etiology** *Trypanosoma congolense*, *T. vivax*, *T. brucei brucei*, and *T. simiae*, all salivarian trypanosomes. Tsetse flies (*Glossina* spp.) serve as biological vector, other biting flies as mechanical vectors.

**Epidemiology** Endemic disease of all mammals in tropical Africa, also Central and South America; of greatest economic importance in cattle. Two subspecies of *T. brucei* cause African sleeping sickness, an

important human disease (zoonosis) in tropical Africa.

**Clinical signs** Fever, apathy, pale mucous membranes, swollen lymph nodes, progressive emaciation, cachexia, and death, sometimes preceded by nervous signs. May be acute, subacute or, often, chronic disease.

**Clinical pathology** Progressive anemia, parasite detection in blood by various methods, including polymerase chain reaction (PCR).

**Lesions** Not definitive but include pallor, emaciation, and enlargement of lymph nodes, spleen, and liver.

### Differential diagnosis list:

- Malnutrition
- Helminthosis
- East coast fever
- Babesiosis
- Anaplasmosis
- Hemorrhagic septicemia

**Treatment** Trypanocides such as Berenil, Samorin, Suramin, and Antrycide, but drug resistance is a problem.

**Control** Integrated methods involving tsetse fly control, prophylaxis, good husbandry, and use of trypanotolerant breeds, no vaccine.

## ETIOLOGY

*Trypanosoma vivax*, *T. congolense*, *T. brucei*, and *T. simiae* are the four main species responsible for African trypanosomosis affecting virtually all domestic mammals. *T. vivax* and *T. congolense* mostly affect cattle, sheep, goats, and horses. Horses are also severely affected by *T. brucei brucei*, whereas pigs suffer mostly from *T. simiae*. All four species are members of the *Salivaria* group of trypanosomes and are transmitted cyclically via the mouthparts of tsetse flies—hence the name salivarian trypanosomes. Cyclical development in the vector is a result of the presence of kinetoplast DNA in these trypanosomes.

The morphology and movement of the trypanosomes are characteristic for each species and are helpful in making a diagnosis. In acute infections, *T. vivax* is usually numerous in blood samples and can be identified by its very fast movement in wet films. In stained smears, it is 20 to 26  $\mu\text{m}$  long, slender, and monomorphic, with a rounded posterior end, a terminal kinetoplast, and a long free flagellum, but no prominent undulating membrane. *T. congolense* is smaller, is sluggish in wet films, and often adheres to red blood cells by the anterior end. In stained smears, it is 9 to 18  $\mu\text{m}$  long, with a marginal kinetoplast, no free flagellum, and no prominent undulating membrane. *T. brucei* is large like *T. vivax*, but its rapid movement is in confined areas of the wet film. In stained smears, it is pleomorphic and may occur as long and slender forms up to 35  $\mu\text{m}$ ,

Table 21-7 Summary of the trypanosomoses of domestic animals and humans

Disease	Distribution	<i>Trypanosoma</i> spp.	Main vector
<b>Animals</b>			
Nagana or African trypanosomosis (most mammals)	Tropical Africa	<i>T. brucei brucei</i> <i>T. congolense</i> <i>T. vivax</i> <i>T. simiae</i>	<i>Glossina</i> spp. Other biting flies
Surra (horses, camels, buffaloes)	Africa, Asia, South and Central America	<i>T. evansi</i>	Biting flies
Dourine (horses and donkeys)	Africa, Asia, South and Central America	<i>T. equiperdum</i>	None (venereal transmission)
Nonpathogenic (cattle and sheep)	Worldwide	<i>T. theileri</i> <i>T. melophagium</i>	Biting flies
<b>Humans</b>			
Rhodesian sleeping sickness	East, central, and southern Africa	<i>T. brucei rhodesiense</i>	<i>Glossina</i> spp.
Gambian sleeping sickness	Western and central Africa	<i>T. brucei gambiense</i>	<i>Glossina</i> spp.
Chagas' disease (also in dogs, cats, and pigs)	South and Central America, southern United States	<i>T. cruzi</i>	<i>Rhodnius</i> spp. <i>Triatoma</i> spp.



intermediate forms, or short and stumpy forms about 12  $\mu\text{m}$  long. The slender and intermediate forms have a long free flagellum, pointed posterior end, subterminal kinetoplast, and prominent undulating membrane, whereas the stumpy forms resemble *T. congolense* but are bigger and have a prominent undulating membrane. The strains or species of *T. brucei* infective to animals only are often referred to as *T. brucei brucei* to distinguish them from *T. brucei gambiense* and *T. brucei rhodesiense*, which are infective to humans. *T. simiae* is morphologically indistinguishable from *T. congolense*, and it is adapted to pigs, in which parasitemia can be very heavy (swarming).

## EPIDEMIOLOGY

### Occurrence

The epidemiology of African trypanosomiasis is determined mainly by the ecology of the tsetse fly found only in tropical Africa. However, *T. vivax* is also transmitted mechanically by biting flies and has been responsible for disease outbreaks in Costa Rica and some South American countries, including Bolivia, Brazil, and Venezuela, where it affects mainly cattle and sheep. In general, *T. congolense* and *T. vivax* are responsible for severe disease in cattle, sheep, and goats, and *T. brucei brucei* usually causes a subclinical infection in cattle but a severe disease in sheep, goats, horses, and, occasionally, pigs. *T. simiae* causes a hyperacute and highly fatal disease in exotic pigs and in camels. Warthogs act as its reservoir, and the parasite is not pathogenic to cattle, sheep, or goats.

### Prevalence

Infection rates reported in cattle in endemic areas vary considerably and could be over 60% in some herds. However, as a result of various control methods, including those under the auspices of the Pan African Tsetse and Trypanosomiasis Eradication Campaign (PATTEC), the prevalence of infection is decreasing in many African countries, particularly in West Africa. Recent surveys in the region report prevalence rates of 5% or less in cattle by parasite detection methods and higher rates with serology or with polymerase chain reaction (PCR) techniques detecting parasite nucleic acids. For example, prevalence studies in villages in Burkina Faso involving 2002 cattle, 1466 small ruminants, and 481 donkeys reported only a 0.77% infection rate in cattle, 0% in goats, and 0.6% in donkeys by routine parasitologic methods, whereas by serology, the rates were 34.2% for cattle, 20.9% for sheep, 8.5% for goats, and 5.8% for donkeys.<sup>1</sup> Seventy-five percent of the cases were attributable to *T. vivax* and 25% to *T. congolense*. In an Ethiopian study involving 1524 animals, the overall prevalence of infection was 5.5% by conventional parasitologic methods and 31.0% by PCR.<sup>2</sup> A major factor affecting

reported prevalence rates is the chronically low parasitemias in indigenous African zebu cattle, which often necessitates repeated sampling before an animal can be regarded as being uninfected. Using repeated PCR testing in East Africa, infection rates in 35 village cattle were found to be *T. brucei* (34.3%), *T. congolense* (42.9%), and *T. vivax* (29.9%).<sup>3</sup> Mixed infections with two or more species are common in endemic areas, and such infections are more readily detected by the PCR technique.<sup>4</sup> It should be mentioned that a positive serology does not necessarily imply current infection, whereas a positive PCR test, when properly carried out, indicates current or very recent infection because trypanosome DNA persists in host blood for only 14 days after successful treatment.<sup>5</sup> In general, it would seem that *T. vivax* is more commonly encountered and more pathogenic in West and Central Africa, whereas *T. congolense* appears more prevalent and more pathogenic in East and South Africa. Exceptions to this general rule are two recent reports, one from Mali,<sup>6</sup> and the other from Nigeria,<sup>7</sup> where *T. congolense* was found to be more prevalent than *T. vivax* in the herds studied.

Pigs and horses are less frequently affected than ruminants, perhaps because they are less exposed to tsetse flies than cattle that normally graze over long distances. The clinical disease in pigs is usually attributable to *T. simiae*, but there have been no reports of natural outbreaks of this form of trypanosomiasis in many years. Horses in Africa are affected by the three major species, and the disease syndrome is similar.

In Central and South America, *T. vivax* infections appear to be spreading to new areas, where they cause periodic outbreaks of serious disease mostly in cattle but also in horses.

### Morbidity and Case Fatality

Morbidity rates during outbreaks are variable and may reach 70% in cattle infected with *T. vivax* and up to 100% in pigs infected with *T. simiae*. Morbidity is usually much lower in sheep, goats, and horses because these are not often the preferred hosts for tsetse or are less exposed to tsetse challenge. Sheep and goats are more vigorous than cattle in defending themselves against successful feeding by tsetse flies.

Case fatality also depends on the trypanosome species, host, and its level of resistance. *T. simiae* is invariably fatal in exotic pigs. Some strains of *T. vivax* in East Africa cause similar heavy mortalities in exotic dairy cows, and infected horses are likely to die if left untreated. However, most infections in cattle in endemic areas run a chronic course and are not invariably fatal, but the animal may remain unproductive and unthrifty. West African strains of *T. vivax* are generally more pathogenic to cattle than East African strains, and *T. congolense* is generally

the more pathogenic species in East Africa. Subspecies of *T. congolense* are also recognized, with *T. congolense* savannah type being much more pathogenic than other types (*T. congolense* forest type, *T. congolense* kilifi type, and *T. congolense* godfreyi).

## Methods of Transmission

### Cyclical

African trypanosomes can be transmitted by 23 species of tsetse (*Glossina*) found only in sub-Saharan Africa between latitudes 14°N and 29°S, excluding areas of high altitude, extreme drought, or cold temperatures where tsetse cannot survive. The flies can be grouped according to their preferred habitats as savannah species, riverine species, and forest species. The savannah species (including *G. morsitans*, *G. austeni*, *G. pallidipes*, *G. swynnertoni*, and *G. longipalpis*) pose the greatest threat to livestock because they inhabit the grasslands where cattle are traditionally reared, they can easily adapt to other ecological niches, they feed primarily on cattle and pigs, and they are efficient vectors of trypanosomes. They are also the main vectors of Rhodesian sleeping sickness associated with *T. b. rhodesiense* in humans (Table 21-8). The riverine species (*G. palpalis*, *G. tachinoides*, and *G. fuscipis*) are important vectors of bovine and porcine trypanosomiasis, and of Gambian sleeping sickness as a result of *T. b. gambiense*. On the other hand, the 13 or so forest species (including *G. fusca*, *G. brevipalpis*, and *G. longipennis*) are not frequently incriminated vectors of animal trypanosomes even though their preferred food hosts are ruminants and suids.

The life cycle of trypanosomes in tsetse involves cyclical development for a varying length of time, depending on species and ambient temperatures, leading to the production of mature procyclic (metacyclic) parasites infective to the mammalian host. *T. vivax* completes its developmental cycle in the proboscis and pharynx of the fly and can be transmitted to a host within a week of the initial infective feed. The cycle of *T. congolense* involves the midgut and proboscis and is completed in about 2 weeks. That of *T. brucei* is more complex: it takes 3 or more weeks in the fly and involves the midgut and salivary glands. Once infected, flies remain so for life (1 to 2 months). It follows that for any fly, its vectorial capacity and efficiency are highest for *T. vivax* and least for *T. brucei*. Even then, infection rates in tsetse flies are generally low by conventional parasitologic methods of detection. Using the more sensitive PCR technique, 10.5% of 550 field-captured flies (*Glossina pallidipes*) were found to harbor trypanosome DNA in an endemic area in southwestern Zambia.<sup>8</sup>

### Noncyclical

After trypanosomes have been introduced into a herd, further transmission is possible

in the absence of *Glossina*. Biting flies such as *Tabanus*, *Stomoxys*, and *Hippobosca* are capable of mechanically transmitting bloodstream trypanosomes in their mouthparts when they feed on more than one host within a short interval. This is how *T. vivax* is spread in areas outside the tsetse belt in Africa and in Central and South America. Mechanical transmission can also occur through the needle during inoculations and in carnivores feeding on infected carcasses. There are occasional reports of intrauterine (vertical) transmission in animals and in human beings.

### The Carrier State

Reservoirs of infection are found in many wild animals, in trypanotolerant animals, and in chronically infected animals. Tsetse caught in and around game reserves tend to have relatively high infection rates, and the relative abundance of wildlife in East Africa compared with West Africa may explain, at least in part, why the prevalence of the disease appears to be declining more rapidly in the west.

### Risk Factors

#### Host Factors

The effect of infection varies with the host in that most wild and some domestic animals establish a balance with the parasite and remain as clinically normal carriers for long periods. Specifically, some breeds of cattle indigenous to Africa can tolerate light to moderate challenge with tsetse flies by limiting the multiplication of trypanosomes in their blood and also limiting the degree of anemia caused. The phenomenon is called **trypanotolerance**; it is both genetic and environmental in origin, and the level of tolerance varies. Thus the indigenous taurine breeds, such as the N'Dama, Baoule, and Muturu, are more tolerant than the West African zebu, and among East African zebu cattle, the Orma Boran and Maasai zebu have superior tolerance compared with Galana Boran and Friesian breeds. In a study involving N'Dama crossed with more susceptible Kenya-Boran animals reared under natural field situations, the trypanotolerant trait derived from the N'Dama was found to be primarily additive in nature, being expressed in heterozygous condition and in three-quarters Boran crosses.<sup>9</sup> In addition, females were more trypanotolerant than males. Thus the tolerance of the more productive but susceptible breeds can be improved by crossbreeding. However, because of the uncertain genetic makeup of animals within these so-called breeds and crossbreeds, the level of trypanotolerance may also vary with individual animals within a given category, and it can be overcome by heavy tsetse challenge, malnutrition, or other stress factors.

Trypanotolerance also occurs in some indigenous breeds of small ruminants but is less pronounced than in cattle. The breeds

include the Djallonke sheep, the West African Dwarf (WAD) sheep and goat, and the East African goat, whereas the Toggenburg, British Alpine, Saanen, Anglo-Nubian, and Sahel breeds of goats are fully susceptible. Because of unintentional and indiscriminate crossbreeding of the WAD goat populations with more susceptible breeds from the Sahel region, the former are becoming less trypanotolerant.<sup>10</sup>

### Environmental Factors

The density of tsetse population in an area and the level of tsetse contact with the host will determine the level of infection. This is further influenced by the vectorial capacity of the fly and the availability of its preferred host. For example, cattle are more attractive to tsetse flies than pigs, and pigs are more attractive than goats.<sup>11</sup> Trekking of livestock through tsetse-infested vegetation is a risk nomadic farmers face from time to time, and the risk is even greater where cattle routes converge, for example, at major bridges or watering holes. Agricultural and industrial developments generally lead to a lowering of tsetse density by destroying their habitat, whereas the establishment of game or forest reserves provides large numbers of preferred hosts or a suitable habitat for tsetse, respectively. Herds located near such reserves are therefore at a higher risk. So also are tourists visiting such game parks.

### Pathogen Factors

In cattle, *T. vivax* generally produces a higher level of parasitemia than other species. And because its life cycle in the tsetse is also shorter, *T. vivax* is more readily transmitted than the others when animals are newly introduced into a tsetse-infested area. Higher parasitemias also facilitate mechanical transmission. Conversely, *T. brucei* is infrequently detected by microscopic examination of cattle blood, even though infection can be confirmed through other, more sensitive diagnostic methods. Furthermore, some animals carry infection without showing clinical signs, especially if they are trypanotolerant, like the Muturu in Nigeria, or if infected with nonpathogenic genetic types, such as *T. congolense* kilifi type in cattle.

### Immune Mechanisms

Animals recovering from infection with one strain/serodeme or species of trypanosome are not immune to infection with another strain/serodeme or species. This is attributable to the ability of trypanosomes to periodically replace a monolayer or their protective coat of variant surface glycoproteins (VSGs) in an immunocompetent host through a process called **antigenic variation**. Each trypanosome cell expresses only one of many VSGs at a time, and the coat is continually shed and replaced to avoid the host immune system. During each peak parasitemia, a mixture of variable antigenic types of

parasites may be present, but the dominant VSG antigen determines the specific antibody response. These antibodies kill off the dominant population, leaving others with different antigens to emerge; these multiply and become dominant, and the process continues in cycles until the animal dies or the immune mechanisms catch up with the parasite and the animal recovers. This phenomenon is also responsible for the successive waves of parasitemia in infected animals.

The molecular mechanisms involved in the switching or activation of new VSGs are now being studied.<sup>12-13</sup> In *T. brucei*, the mechanisms involve DNA repair mechanism in that a double-strand break (DSB) initiates a switch in the expressed variant surface coat.<sup>14</sup> Furthermore, it has been shown that the DSB site determines the probability and mechanism of antigenic switching, and that DSBs can trigger switching via recombination or transcription inactivation.<sup>15</sup> The frequency of recombination is comparable between *T. congolense* and *T. brucei* but is much lower in *T. vivax*.<sup>13</sup> Following repeated episodes of infection and recovery (with or without treatment) in an endemic area, animals will encounter a variety of antigenic types and therefore become less susceptible to strains/serodemes in that area.

Infected animals are more susceptible to secondary infections by other microorganisms, particularly bacteria. The immune system of an infected animal is disrupted by mechanisms not fully understood, but they may vary with the species of animals. In ruminants, the state of immunosuppression is abrogated once the trypanosomes are eliminated by chemotherapy.

### Experimental Reproduction

Infection can be easily reproduced by inoculation of infected blood or other serous fluid into a susceptible host. Infected flies can also be fed on the host to transmit the disease. Several laboratory animal models of nagana and sleeping sickness are available, and lots of studies have been done with mice and rats. These studies help to elucidate the pathogenesis of the disease and approaches to chemotherapy and drug resistance.

### Economic Importance

Tsetse flies infest 10 million square kilometers of Africa, involving 38 countries and placing 50 million cattle at risk. Hence, nagana is still the most important disease of livestock in the continent. The added risk of human infections has greatly affected social, economic, and agricultural development of rural communities. Because nagana is a wasting disease, affected animals are chronically unproductive in terms of milk, meat, manure, and traction, and the mortality rate can be high, especially in exotic and more productive animals. The disease in Africa costs livestock producers and consumers an estimated US\$4.5 billion each year. The

anticipated losses as a result of *T. vivax* in South America exceed \$160 million. Furthermore, the disease may affect various immunization campaigns in endemic areas because it can cause immunosuppression.

### Zoonotic Implications

The animal pathogens (*T. vivax*, *T. congolense*, *T. simiae*, and *T. brucei brucei*) are not infective to humans, but animals can serve as reservoirs of *T. brucei rhodesiense* and *T. brucei gambiense*, the causes of human African trypanosomiasis (HAT), or sleeping sickness. *T. brucei brucei* is morphologically indistinguishable from the human pathogens, but when it is incubated in human serum, it is lysed and becomes non-infective to laboratory animals, unlike the human pathogens, which are human serum resistant.<sup>16</sup>

As in animals, human infections with *T. brucei gambiense* or *T. brucei rhodesiense* result from tsetse bites, generally in game parks, in forest reserves, along streams, or in other rural settings. The incidence of human infections fell to a few thousand cases per year in the 1960s and then started to rise as a result of relaxation of previous control measures and especially because of civil unrest forcing people to leave their homes to seek shelter in tsetse-infested areas. Currently, a total of 70 million people are at risk of infection. In 2012, over 175,000 cases were reported in 20 countries; *T. brucei gambiense* accounted for 82.2% of them, and *T. brucei rhodesiense* accounted for the remaining 17.8%.<sup>17</sup> High-risk countries are in Central Africa, especially the Democratic Republic of the Congo, Angola, the Central African Republic, and southern Sudan, where civil wars have hampered control efforts. During the period 2009 to 2013, most cases of Rhodesian sleeping sickness were reported from Uganda, Malawi, Tanzania, and Zambia<sup>18</sup> and from foreign tourists who had visited East African game parks. A comprehensive review of the human disease was published recently.<sup>18</sup>

A rash (chancre) develops at the site of tsetse bite in humans, and this is soon followed by fever, persistent headache, and swelling of lymph nodes, spleen, and liver. Weakness and signs of cardiac involvement may be noticed early in the Rhodesian form encountered in eastern and southern Africa. This form is rapidly fatal if it is not diagnosed early and treated promptly. The Gambian form is usually chronic and often asymptomatic for months before the patient gradually wastes away and dies from the disease or from secondary infections years later. It is encountered in West and Central Africa, including the northwestern part of Uganda. In both forms, the disease progresses from a hemolymphatic first stage (S1) to a meningo-encephalitic second stage (S2) corresponding to when parasites invade the cerebrospinal fluid (CSF) and brain across the blood-brain

barrier.<sup>19</sup> Stage 2 results in progressive non-suppurative meningo-encephalitis, causing the patient to fall asleep often—hence the name sleeping sickness.

### Biosecurity Concerns

There are no biosecurity concerns for nagana because tsetse flies require strict environmental conditions to survive and breed. However, because *T. vivax* can be transmitted mechanically by biting flies, this fact should be taken into consideration when infected animals are moved outside the tsetse zone in Africa and in South and Central America. People working with *T. brucei gambiense* and *T. brucei rhodesiense* should take precautions to avoid accidental inoculation of themselves or their coworkers with infected material in syringes or tsetse flies.

### PATHOGENESIS

Nagana in most domestic animal species is a progressive but not always fatal disease, and the main features are anemia, tissue damage, and immunosuppression. Metacyclic trypanosomes are inoculated intradermally as the fly feeds. They multiply at this site, provoking a local skin reaction (chancre), which is most pronounced in a fully susceptible host and may be slight or absent with some strains or species of trypanosomes. Within the chancre, metacyclic parasites change to trypomastigote form, enter the bloodstream directly or through the lymphatics, and initiate characteristic intermittent parasitemias associated with intermittent fever. The behavior of the parasites thereafter depends largely on the species of trypanosome transmitted and the host.

In the acute phase, *T. vivax* usually multiplies rapidly in the blood of cattle, sheep, and goats, and it is evenly dispersed throughout the cardiovascular system, whereas *T. congolense* tends to be aggregated in small blood vessels and capillaries of the heart, brain, and skeletal muscle. *T. congolense* parasitemias in ruminants is not usually as high as with *T. vivax*, even though the anemia may be more marked. Both species exert their effect mainly by causing severe anemia and mild to moderate organ damage in the form of cellular degeneration and perivascular mononuclear cellular infiltration. Very acute infections with *T. vivax* in cattle or with *T. simiae* in pigs result in fulminating parasitemia and disseminated intravascular coagulation, with hemorrhages leading rapidly to death. Such syndromes resemble septicemia, and anemia may not be severe.

*T. brucei brucei* and, less often, *T. vivax* have the added capability of escaping from the capillaries into the interstitial tissues and serous cavities, where they continue to multiply. Such infections result in more severe organ damage in horses, sheep, and goats, in addition to anemia. The cerebrospinal fluid and brain parenchyma

can be invaded by the parasites, resulting in a nonsuppurative meningo-encephalitis and encephalomalacia.<sup>20-21</sup> Parasites in the CSF are not easily reached by some drugs and may be a source of relapsing infection when they reinvade the bloodstream. In addition, pregnant animals may abort, and transplacental fetal infections occasionally occur.

The pathogenesis of anemia in trypanosomiasis has been studied extensively, and it may vary with the parasite, the host species, and the stage of infection.<sup>22-23</sup> The three mechanisms generally recognized in the development of anemia are (a) extravascular red cell destruction as a result of massive erythrophagocytosis in the spleen and liver at all stages of infection, (b) intravascular hemolysis in the acute stage, and (c) inadequate bone-marrow response (dys-hemopoiesis) in the chronic stage. Increased erythrophagocytosis occurs in activated macrophages that are induced by parasite-derived glycolipids to become hyperactive against trypanosomes and red blood cells. During the acute phase of infection, erythrophagocytosis may also be triggered by trypanosome transsialidases acting on erythrocyte membranes.<sup>24</sup> Intravascular hemolysis is less commonly reported but has been attributed to several factors, including hemolysins from parasites, cleavage of sialic acids from the red cell membrane, passive absorption of trypanosome molecules in the red cell membrane, and, more recently, oxidative stress from free radicals. In the chronic stage, bone-marrow response to ongoing red cell loss is poor, and this is attributed to increased sequestration of iron (as hemosiderin) in macrophages.<sup>25</sup> Thus, the pathogenesis of anemia in the chronic stage of nagana is analogous to that of anemia of chronic disease or chronic inflammation.<sup>22-23</sup>

Animals infected with any pathogenic trypanosome may develop concurrent and even fatal bacterial, viral, and other protozoan infections as a result of immunosuppression. This is thought to be attributable to trypanosome-induced B-cell apoptosis resulting in loss of protective antiparasite antibody responses and abolishment of memory responses against nonrelated pathogens.<sup>26</sup>

Trypanotolerant animals control parasitemias better and have less severe anemia and organ damage. They usually recover from the disease, but they may act as carriers. On the other hand, human beings have a sterile immunity to these parasites, except *T. brucei gambiense* and *T. brucei rhodesiense*.

### CLINICAL FINDINGS

Although anemia is the cardinal feature, there are no pathognomonic signs that would help in pinpointing a diagnosis of trypanosomiasis in farm animals. The general clinical picture is as follows, but there are many variations determined by the level of tsetse challenge, the species and strain of the



trypanosome, and the breed and management of the host. Acute episodes last for a few days to a few weeks, from which the animal dies or lapses into a subacute to chronic stage, or the illness may be chronic from the beginning. Chronic cases may run a steady course, may be interrupted by periodic incidents of severe illness, or may undergo spontaneous recovery.

The basic clinical syndrome appears after an incubation period of 8 to 20 days following the infective tsetse fly bite. Chancre is not readily noticed under field conditions. There is fever, which is likely to be intermittent or cyclic for weeks. Affected animals are dull, anorexic, and apathetic; have a watery ocular discharge; and lose condition. Superficial lymph nodes become visibly swollen, mucous membranes are pale, diarrhea occasionally occurs, and some animals have edema of the throat and underline. Estrus cycles become irregular, pregnant animals may abort, and semen quality progressively deteriorates. The animal becomes very emaciated and cachectic and dies within 2 to 4 months or longer. Thin, rough-coated, anemic, lethargic cattle with generalized lymph node enlargement are reported to have a “fly struck” appearance.

In general, *T. congolense* is more pathogenic to cattle in eastern and southern Africa, whereas *T. vivax* produces a more serious disease in most of West and Central Africa. However, severe outbreaks of *T. vivax* involving exotic dairy animals in East Africa occur; affected animals show mucosal petechiation, rhinorrhagia, dysentery, and death after an illness of only a few weeks.

Mixed infections with more than one species of trypanosomes are common and are usually more severe. Furthermore, intercurrent bacterial, viral, or other parasitic infections may mask or complicate the basic clinical syndrome. Immune response to bacterial and some viral vaccines is also depressed unless trypanocidal therapy is given at the time of vaccination.

Clinical findings peculiar to the individual trypanosome are as follows:

- *T. vivax* affects all agricultural species except pigs. Acute and chronic outbreaks occur, anemia is severe, and fever is usually associated with high parasitemia. A chronic form of the disease is more usual in East Africa, but an acute hemorrhagic form can occur with exotic cattle. Furthermore, outbreaks in Brazil have been associated with nervous signs in cattle<sup>20</sup> and in sheep,<sup>27</sup> characterized by head pressing, lateral recumbency, paddling movements, and muscle tremors. *T. vivax* is less commonly seen in trypanotolerant cattle breeds.
- *T. congolense* affects all species, usually with an acute disease lasting 4 to 6 weeks, but some chronic cases occur, especially in West Africa. Anemia and

emaciation are severe. The savannah subspecies is more pathogenic than the other subspecies.

- *T. brucei brucei* affects all species with a subacute to chronic disease. In addition to fever and anemia, there is often marked subcutaneous edema and keratoconjunctivitis. Nervous signs are manifested in horses, pigs, and small ruminants by ataxia, circling, head pressing, and paralysis. Cattle show chronic clinical signs, and they can act as carriers.
- *T. simiae* affects exotic pigs with a fulminating infection leading to death in hours or a few days of first appearing ill. The clinical signs are fever, stiff gait, dyspnea, and cutaneous hyperemia, without significant anemia. However, no outbreak has been reported in decades.

### CLINICAL PATHOLOGY

A progressive drop in packed cell volume is a nonspecific but useful indicator of trypanosomosis in endemic areas. The classic method of confirming nagana diagnosis is to demonstrate parasites in a wet blood film and in a thin or thick blood smear stained with Giemsa. This is fairly reliable in the early stages of the disease when parasitemia is usually high and parasitemic peaks correspond with fever. As the disease progresses, parasitemias become infrequent and the intervals between peaks grow longer, even though the animal is still sick. To increase the accuracy of parasitologic diagnosis, it is now routine to concentrate the parasites in the buffy-coat layer of a microhematocrit capillary tube. The buffy layer is then examined directly at low power (Woo's method) or in a wet preparation with a dark-ground/phase-contrast microscope (Murray's method). Both tests are simple, sensitive, and applicable to field use on individual animals and in herds. Blood should be examined fresh but may be refrigerated for up to 24 hours, beyond which most parasites will die and disappear from the sample.

Blood can also be inoculated into experimental animals, usually rodents, but this is cumbersome and is accurate for only *T. brucei*, and possibly *T. congolense*, but not *T. vivax*.

During surveys, a series of tests can be used to detect antibodies in serum or other body fluids. The three tests used most often are the indirect immunofluorescent antibody test (IFAT), the capillary agglutination test (CAT), and the ELISA. These tests indicate past and current infections, are difficult to standardize for different laboratories, and are not species specific. The ELISA technique was modified to detect circulating trypanosome antigens (antigen-ELISA) using monoclonal antibodies that would distinguish between *T. vivax*, *T. congolense*, and *T. brucei*, and it would detect only current or very

recent infections. Results from field trials in Africa and South America have not been encouraging.

The polymerase chain reaction (PCR) technique is now being used to detect trypanosome DNA in blood, serum, and in tsetse tissues. The technique targets the gene encoding the small ribosomal subunit to identify and differentiate all clinically important African trypanosome species and some subspecies. The test is sensitive, economical, and suitable for large-scale epidemiologic studies, usually in combination with other tests. Dried blood spots on filter papers are also a useful source of DNA for the detection of trypanosomes.<sup>28</sup> PCR technology is currently being made available in some laboratories in endemic areas and has led to increased rates of detection.

Examination of the cerebrospinal fluid is used routinely in human sleeping sickness to establish the stage of infection to select the appropriate drug for treatment. In animals, CSF examination for parasites, turbidity, protein content, and leukocytes can be done at necropsy if there have been neurologic signs.<sup>21</sup>

### NECROPSY FINDINGS

#### Gross Pathology

The postmortem lesions are, like the clinical findings, not definitive. The carcass is marked by anemia, emaciation, and enlargement of the liver, spleen, and lymph nodes. Body-fat stores are depleted or show marked serous atrophy, especially around the heart and in bone marrow. The bone marrow may be red (active) in the acute stage, but it becomes pale and gelatinous (unresponsive) in the chronic stage. Subcutaneous edema, corneal opacity, and testicular degeneration may be present. Thickening of the meninges and softening of the brain have been reported in some cattle naturally infected with the South American *T. vivax*.

In acute cases, there will be a general congestion of the viscera and extensive hemorrhages in all tissues. Chronic cases show cachexia, often complicated with secondary bacterial pneumonia or other parasitic diseases.

#### Histology

Microscopic lesions are also not specific, except in very acute infections, in which clumps of trypanosomes mixed with fibrin thrombi are found in blood vessels. Lymphoid organs are usually hyperplastic and may show varying degrees of erythrophagocytosis and hemosiderosis. The interstitial tissues and perivascular spaces of various parenchymatous organs may contain a lymphoplasmacytic infiltrate. This tends to be most marked with *T. brucei*, in which the parasites often localize extravascularly in the interstitial tissue. A severe nonsuppurative meningoencephalitis, myocarditis, and dermatitis may result. Degenerative changes

may also be present in the liver, testis, ovary, brain, and pituitary gland.

### Specimens for Pathology

Smears from tissues, usually the cut surface of a lymph node or heart muscle, are examined for trypanosomes before or shortly after the animal dies. Trypanosomes will not be detectable if postmortem examination is delayed for even a few hours because the parasites die and disintegrate soon after the host dies. For PCR detection, blood or buffy coat is spotted on Whatman filter paper (Whatman No. 4) stored at room temperature and sent to the appropriate laboratory.<sup>27</sup> With *T. brucei*, smears of serous fluids, including the CSF, may contain many parasites even when they are undetectable in blood.

The following organs should be taken for histopathology: lymph nodes, spleen, liver, heart, kidney, brain, and any other organ showing gross lesions. The immediate cause of death is often a combination of trypanosome-induced anemia and a concurrent bacterial or parasitic infection.

### DIFFERENTIAL DIAGNOSIS

Diagnosis is based on detecting parasites in blood. Because parasitemias fluctuate, multiple samples from a herd or repeated sampling of a suspected case may be required before a specific diagnosis can be made. Furthermore, an infected animal may be suffering from a concurrent disease.

Emaciation and anemia can also be associated with the following:

- Malnutrition
- Helminthosis
- Babesiosis
- Anaplasmosis
- East coast fever

Acute trypanosomosis may be confused with hemorrhagic septicemia and anthrax. Laboratory examination of blood, feces, and other tissues is required to confirm diagnosis.

### TREATMENT

#### TREATMENT AND CONTROL

##### Treatment

Diminazene aceturate (Berenil) (3.5–7 mg/kg IM) (R1 for ruminants, R-3 for equines)

Homidium chloride/bromide (Ethidium/Novidium) (1 mg/kg IM) (R-1 for ruminants and equines)

Isometamedium chloride (Samorin) (0.25–1 mg/kg IM) (R-1 for ruminants)

Quinapyramine sulfate (Antrycide) (5 mg/kg SC) (R1 for equines)

Suramin (Antrypol) (10 mg/kg IV) (R-2 for equines, camelids, 2–3 times weekly)

##### Control

Isometamedium chloride (2 mg/kg IM) (R-1)

Homidium chloride/bromide (1 mg/kg IM) (R-2)

Prothridium (2 mg/kg IM) (R-2)

Antrycide prosalt (7.4 mg/kg SC) (R-2)

Antrycide/Suramin complex (35 mg/kg SC) (R-2 for *T. simiae* in pigs)

The number of trypanocidal drugs available for treating and preventing infections in endemic areas is limited, and 35 million doses are administered yearly in Africa.<sup>29</sup> The drugs have been in the market for half a century or more; their range of therapeutic safety is small; many of them cause severe local reactions, especially in horses; and some may be fatal in high doses. Furthermore, because drugs are expensive and can now be purchased without prescription, inappropriate dosing, improper administration, and use of fake or poor-quality drugs are common. These, plus the fact that some drugs are used both prophylactically and therapeutically, have led to cases of drug resistance, which is universally regarded as a threat to livestock production and health.

Ideally, each country or region establishes a group of sanative drugs that are to be used only as a break in a course of one of the more common drugs. The sanative drug should provide moderate prophylaxis and avoid the development of resistance to the prime drug. These measures have not been well executed in many countries, especially with the privatization of veterinary practice in Africa. This may explain the increasing reports of multiple resistance to curative, sanative, and prophylactic drugs over the years.<sup>6,30–31</sup> On the other hand, a high prevalence of drug resistance to diminazene aceturate has been reported for *T. congolense* without a recent history of drug exposure.<sup>5</sup> The isolates were obtained from tsetse or wildlife in parks in Tanzania, Zambia, and South Africa. Furthermore, it has been observed that clones of *T. congolense* resistant to isometamedium chloride are more easily transmissible to tsetse flies (*G. morsitans*).<sup>32</sup> This may be another factor contributing to the high prevalence of drug-resistant strains in the African region.

Strains are regarded as resistant when they fail to respond to the drug or when they relapse in blood sometime after an apparent cure. More cases of relapses are likely to be observed with the more sensitive PCR method for blood examination. However, it has been observed that relapses, where the host controls the level of parasitemia to a level below the sensitivity of routine microscopic examination, do not affect the productivity of the host.<sup>33</sup> Relapses are more likely to occur if the commencement of treatment is delayed or the dose rate is inadequate. However, in field situations, there is hardly any regular monitoring of drug efficacy, and animals may be reinfected with the same or other species of trypanosomes soon after an otherwise effective cure.

The common drugs in use against trypanosomes are set out in the following discussion. The specific dose rates vary with animal species, the specific trypanosome, and the specific purpose (curative, prophylactic, or sanative).

- Diminazene aceturate (Berenil) is used widely against *T. vivax* and *T. congolense* as a curative and sanative drug at 3.5 to 7 mg/kg BW IM. It is well tolerated by ruminants, and it is one of the two recommended drugs for bovine trypanosomosis. It is not well tolerated by horses.
- Isometamidium (Samorin or Trypamidium) is the other preferred drug against *T. vivax* and *T. congolense* in ruminants. It is used as a curative and prophylactic drug at 0.25 to 1 mg/kg BW IM. At much higher doses (12.5 to 35 mg/kg BW) it can be used prophylactically against *T. simiae* in pigs but not without the risk of death from acute cardiovascular collapse.
- Homidium bromide (ethidium) and homidium chloride (novidium) are also widely used against *T. congolense* and *T. vivax* as curative and sanative drugs at 1 mg/kg BW IM.
- Pyrrithidium bromide (prothridium) is less widely used against *T. congolense* and *T. vivax* as prophylaxis at 2 mg/kg BW IM.
- Quinapyramine sulfate (Antrycide) is no longer used extensively in cattle. It is the preferred curative drug against *T. brucei brucei* in horses at 5 mg/kg BW IM. Quinapyramine sulfate and chloride (Antrycide prosalt) is used prophylactically at 7.4 mg/kg BW SC.
- Suramin (naganol) may also be used against *T. brucei* as a curative and prophylactic drug at 10 mg/kg BW in horses and camels.
- Antrycide–Suramin complex is the only other drug effective against *T. simiae* in pigs, and it is used prophylactically at 40 mg/kg BW.

### CONTROL

The control of trypanosomosis in endemic countries involves control of tsetse fly population, prophylactic treatment of animals at risk, good husbandry of animals, and use of trypanotolerant animals. There is no vaccine against the disease, and in spite of intensive research, vaccines appear unlikely in the near future because of the ability of trypanosomes to readily change their glycoprotein surface coat through the process of antigenic variation.

Control of tsetse has been successfully attempted in some African countries, but reinvasion is frequent if the land is not properly utilized. The earliest methods involved bush clearing and elimination of game animals on which tsetse feed. These methods were effective in eradicating or

controlling tsetse in some parts of the continent, especially in southern Africa, but they resulted in destroying valuable plant and animal resources and also led to soil erosion. More recent methods involved the use of insecticides, especially DDT and endosulfan, applied strategically in the form of ground and aerial spraying over large expanses of land. Because tsetse flies are sensitive to insecticides and no resistance has developed, considerable successes were achieved in some countries. Under the Pan African Tsetse and Trypanosomiasis Eradication Campaign (PATTEC) program, tsetse was eliminated from an area of over 10,000 km<sup>2</sup> in Botswana and Namibia in 2006 using a sequential aerial spraying technique to apply deltamethrin.<sup>34</sup> However, spraying insecticides is costly and harmful to the environment. These harmful effects are considerably reduced if the insecticides, for example, synthetic pyrethroids, are applied directly on the animal in the form of spray or pour-on formulation, or the recently described footbath.<sup>34-35</sup> The insecticides also reduce tick infestations in treated animals.

Other effective methods involve use of targets impregnated with insecticides and traps that attract and catch tsetse. These are simple and cheap and can be constructed and maintained by local communities. Furthermore, they do not pollute the environment and are suitable for both small- and large-scale farming. They have been used to drastically reduce tsetse fly population and incidence of trypanosomiasis in some countries.

Another method of control is the sterile male technique. Because the female tsetse only mates once in a lifetime, this technique is theoretically able to eradicate a targeted tsetse species in areas where other methods have been used to reduce its density. But it is expensive.

Finally, it should be stated that development of the land for agriculture, industries, highways, and so forth effectively destroys the habitat for tsetse flies. This is occurring in many parts of Africa, including Nigeria, with rapid economic activities and expanding human population.

Attempts at trypanosomiasis control have also been directed to prophylactic dosing with chemicals such as suramin, prothidium, and isometamidium (Samorin). Prophylaxis is used along with other methods in areas where there is a heavy tsetse challenge. The prophylactic effect is supplemented by the development of antibodies, and the total period of protection may be as long as 5 months. However, it is customary to give four or five treatments per year. The productivity response to this pattern of treatment is good if general husbandry is also adequate. The downside of this approach is that it is thought to be one of the factors leading to drug resistance in many countries, in

addition to the ready availability of fake and poor-quality drugs.

Trypanotolerant animals are being used to establish ranches in areas where tsetse challenge is not too heavy. These indigenous breeds are not well accepted in some countries because their productivity is generally low. To offset this, the breeds are increasingly being crossed with other indigenous and improved breeds. The crosses are more productive, and they retain the trait for trypanotolerance.<sup>9</sup>

For effective control of trypanosomiasis in Africa and in Central and South America, an integrated approach will mostly likely produce the desired results in each region. In the absence of a vaccine, control methods must combine reduced exposure to the vectors (large-scale tsetse trapping and pour-on applications) with strategic treatment of exposed animals (chemotherapy and chemoprophylaxis) along with use of trypanotolerant animals when feasible. The Pan African Tsetse and Trypanosomiasis Eradication Campaign launched in the last decade is applying many of these methods in different countries, with the hope of eliminating tsetse from Africa in the near future.

#### FURTHER READING

- Abebe G. Trypanosomiasis in Ethiopia. *Ethiop J Biol Sci*. 2005;4:75. [The Biological Society of Ethiopia review article].
- Anosa VO. Haematological and biochemical changes in human and animal trypanosomiasis. *Rev Elev Med Vet Pays Trop*. 1988;41:65, 151.
- Connor RJ, Van den Bossche P. African animal trypanosomoses. In: Coetzer JAW, Tustin RC, eds. *Infectious Diseases of Livestock*. Vol. 1. 2nd ed. Cape Town: Oxford University Press; 2004:251.
- Desquesnes M. *Livestock Trypanosomoses and Their Vectors in Latin America*. Paris: OIE (World Organisation for Animal Health); 2004.
- Franco JR, et al. Epidemiology of human African trypanosomiasis. *Clin Epidemiol*. 2014;6:257.
- Gibson W. The origins of the trypanosome genome strains *Trypanosoma brucei brucei* TREU 927, *T. b. gambiense* DAL 972, *T. vivax* Y486 and *T. congolense* IL3000. *Parasite Vect*. 2012;5:71.
- Hunter AG, Luckins AG. Trypanosomiasis. In: Sewell MMH, Brocklesby DW, eds. *Handbook on Animal Diseases in the Tropics*. 4th ed. London: Baillière Tindall; 1990:204.
- Ikede BO. African trypanosomes. Honigberg BM. Mechanisms of pathogenicity among protozoa. *Insect Sci Applic*. 1986;7:363.
- Jordan AM. *Trypanosomiasis Control and African Rural Development*. London: Longman; 1988.
- Losos G. Trypanosomiasis. In: *Infectious Tropical Diseases of Domestic Animals*. London: Longman; 1986:182.
- Stephen LE. *Trypanosomiasis: A Veterinary Perspective*. Oxford: Pergamon Press; 1986.

#### REFERENCES

- Sow A, et al. *Res Vet Sci*. 2013;doi:10.1016/j.rvsc.2012.12.011; [Epub ahead of print].
- Fikru R, et al. *Vet Parasitol*. 2012;[Epub ahead of print].
- Cox AP, et al. *Parasite Vect*. 2010;3:82.
- Nakayima J, et al. *Parasite Vector*. 2012;5:217.
- Chitanga S, et al. *PLoS Negl Trop Dis*. 2011;5:1454.

- Mungube EO, et al. *Parasite Vect*. 2012;5:155.
- Takeet MI, et al. *Res Vet Sci*. 2013;94:555.
- Mekata H, et al. *J Vet Med Sci*. 2008;70:923.
- Orenge CO, et al. *BMC Genet*. 2012;13:87.
- Geerts S, et al. *Trends Parasitol*. 2009;25:132.
- Simukoko H, et al. *Vet Parasitol*. 2007;147:231.
- Horn D, McCulloch R. *Curr Opin Microbiol*. 2010;13:700.
- Jackson AP, et al. *Proc Natl Acad Sci USA*. 2012;109:3416.
- Alsford S, et al. *Genome Biol*. 2009;10:223.
- Glover L, et al. *PLoS Pathog*. 2013;9:e1003260.
- Stephens NA, et al. *Trends Parasitol*. 2012;28:539.
- Simarro PP, et al. *PLoS Negl Trop Dis*. 2012;6:e1859.
- Franco JR, et al. *Clin Epidemiol*. 2014;6:257.
- Batista JS, et al. *Vet Parasitol*. 2007;143:174.
- Batista JS, et al. *Vet Res*. 2011;42:63.
- Stijlemans B, et al. *Immunobiology*. 2008;213:823.
- Noyes HA, et al. *PLoS ONE*. 2009;4:e5170.
- Guegan F, et al. *Cell Microbiol*. 2013;doi:10.1111/cmi.12123; [Epub ahead of print].
- Stijlemans B, et al. *Endocr Metab Immune Disord Drug Targets*. 2010;10:71.
- Radwanska M, et al. *PLoS Pathog*. 2008;4:e1000078.
- Galiza GJ, et al. *Vet Parasitol*. 2011;182:359.
- Vitoulley HS, et al. *PLoS Negl Trop Dis*. 2011;5:e1223.
- van Gool F, Mattioli R. *30th ISCTRC Conference*. Kampala, Uganda: 2009:305.
- Moti Y, et al. *Vet Parasitol*. 2012;189:197.
- Sow A, et al. *Vet Parasitol*. 2012;187:105.
- van den Bossche P, et al. *Vet Parasitol*. 2006;135:365.
- Vitoulley HS, et al. *Vet Parasitol*. 2012;190:349.
- Kgori PM, Modo S. *30th ISCTRC Conference*. Kampala, Uganda: 2009:461.
- Bouyer J, et al. *Prev Vet Med*. 2007;78:223.
- Bouyer F, et al. *PLoS Negl Trop Dis*. 2011;5:e1276.

## SURRA (MAL DE CADERAS, MURRINA)

### SYNOPSIS

**Etiology** *Trypanosoma evansi* (synonym *T. equinum*), a subspecies of *T. brucei*, but transmitted mechanically by biting flies, mainly tabanids, and by vampire bats in Latin America.

**Epidemiology** Endemic disease of mainly horses, camels, and buffaloes in the tropics and subtropics, seasonality is related to fly population. Rare outbreaks in Spain and France.

**Clinical signs** Fever, progressive emaciation, anemia, subcutaneous edema, nervous signs, death. May be acute, but mostly subacute to chronic.

**Clinical pathology** Progressive anemia, parasite detection in blood by various methods, serology.

**Lesions** Not definitive but include pallor, emaciation, muscle atrophy of hindquarters in horses, lymphadenomegaly, and jaundice.

#### Differential diagnosis list:

- Nagana
- Malnutrition
- Helminthosis



- Babesiosis
- Anaplasmosis
- Hemorrhagic septicemia

**Treatment** Trypanocides as in nagana, but less effective.

**Control** Chemotherapy, no vaccine.

## ETIOLOGY

*Trypanosoma evansi*, the first pathogenic trypanosome to be identified in 1880 in India, belongs to the *brucei* group (subgenus *Trypanozoon*) but has lost its kinetoplast DNA (akinetoplastic) and is therefore not capable of cyclical development in tsetse *Glossina* spp.<sup>1</sup> The parasite is believed to have originated from a mutated form of *T. equiperdum* characterized by being dyskinetoplastic (has lost part of its kDNA). *T. evansi* was formerly referred to as *T. equinum*, *T. hippicum*, or *T. venezuelense* in South America. Worldwide, it is the most widespread species of pathogenic trypanosomes. In blood smears, *T. evansi* is morphologically indistinguishable from *T. brucei*, but at the molecular level, the structure of the kinetoplast DNA of *T. evansi* is different.

## EPIDEMIOLOGY

### Occurrence

Surra has a wide distribution in areas of Asia, Middle East, Central and South America, Africa north of the tsetse belt, and occasionally in Europe. The disease is called “mal de caderas” (meaning “sickness of the hips”) in South America, “murrina” in Panama, and “surra” in other parts of the world. In some countries, the incidence of surra increases significantly during the rainy season when there are large biting fly populations, the so-called surra season. The disease affects mainly camels and horses, but buffaloes and cattle are also affected. Some endemic areas have been identified in Las Palmas and the Canary Islands, and two recent outbreaks of the disease in Spain and France were traced to camel importation from the areas.<sup>2</sup> A two-part comprehensive review of *T. evansi* and surra has been published recently.<sup>3-4</sup>

### Morbidity and Case Fatality

Infection rates in camels, horses, and buffaloes in endemic countries vary considerably and can be as high as 100% in buffalo herds in high-risk areas.<sup>5</sup> During a recent outbreak in Spain, 76% of the camels, 36% of the donkeys, and 26% of the horses examined were affected.<sup>6</sup> Fewer cases are detected by standard parasitologic methods than by serology or PCR methods. The case fatality in horses and camels is nearly 100% if untreated, but it is much lower in cattle and buffaloes, where the disease tends to run a chronic course. Nonetheless, strains highly pathogenic for water buffaloes and cattle have been reported in the Philippines.<sup>7</sup>

## Method of Transmission

Several hematophagous flies can transmit *T. evansi* mechanically, but the most important is the horse fly (*Tabanus* spp.), followed by the stable fly (*Stomoxys* spp.). Transmission is enhanced when horses or camels congregate or are closely herded and when they have high numbers of parasites in their blood. In South America, the vampire bat also can transmit the disease in its saliva. The process can be mechanical as for flies but also biological in that parasitemia occurs in the bats, and the bats may die of the infection or recover and serve as carriers. Therefore vampire bats are simultaneously hosts, reservoirs, and vectors of *T. evansi*. Indigenous cattle, buffalo, and several species of wildlife may act as reservoirs of infection for horses and camels. Several workers in South America have incriminated capybaras, small marsupials, armadillos, feral pigs, and peccary as possible reservoirs of *T. evansi*.<sup>8-9</sup> Carnivores can also be infected peri-orally when they feed on an infected carcass.

## Immune Mechanisms

Immune mechanisms are related to antigenic variation of the parasite and production of antibodies by the host, as in *T. brucei* and all its subspecies. Infected animals are also immunosuppressed and respond poorly to vaccination. As with other trypanosome infections, the immunosuppressive effect is abrogated following successful antitrypanosome treatment.<sup>10</sup> The disease can be reproduced experimentally by blood inoculation.

## Zoonotic Implications

Humans are generally not susceptible to *T. evansi* infection. However, two cases of human infection and disease have been reported, one from India and the other from Egypt.<sup>11-12</sup> In the Indian case, the serum of the infected patient was found to have no trypanolytic activity, and this finding was linked to a lack of apolipoprotein L-1, the pathway in normal human serum for killing most trypanosomes.<sup>13</sup>

## Economic Importance

Surra is one of the most important diseases of camels in Africa and Asia, and outbreaks are increasingly being reported in South American horses and occasionally in European camels. Camel raising in Africa and buffalo production in Asia are particularly affected by the disease. As in nagana, losses are attributable to reduced productivity, infertility, abortion, mortality, and cost of treatment. In Indonesia, losses as a result of surra were estimated at more than US\$20 million in the 1980s. More recently, it has been estimated that in the Philippines, the total net benefit for surra control for herds in a typical village in an endemic area is \$158,000 per annum.<sup>14</sup>

## Biosecurity Concerns

There are no biosecurity concerns, except with regard to importation of carrier animals to nonendemic countries.

## PATHOGENESIS

Trypanosomes are inoculated into the host from the contaminated mouthparts of biting insects or the saliva of vampire bats. Parasites multiply in blood, causing anemia and spread to serous fluids and interstitial tissue, resulting in inflammatory changes just like those seen with *T. brucei*. The anemia of surra is probably similar to that of nagana. There is increased erythrophagocytosis and intravascular hemolysis resulting from lipid peroxidation of erythrocytes.<sup>15</sup> As for emaciation, it has been suggested that protein breakdown and lipolysis might contribute to the cachexia in infected horses.<sup>16</sup> In horses, *T. evansi* frequently invades the central nervous system, including the spinal cord, where it is less exposed to chemotherapeutic agents.

## CLINICAL FINDINGS

The main clinical findings are intermittent fever, progressive anemia, edema of dependent parts of the body, dullness, listlessness, loss of body condition despite a good appetite, nasal and ocular discharge, abortion, and infertility. In the late stages, there are marked nervous signs, including marked paraplegia, paralysis, delirium, and convulsions. In a recent outbreak involving horses in Brazil, the nervous signs were ataxia, blindness, head tilt, circling, head pressing, and paddling movements before death.<sup>17</sup> Surra is invariably fatal in camels and horses, with death occurring in days or months, but camels may exhibit chronic signs for years. These signs include a reduction in milk yield and capacity for work, and a high abortion rate in pregnant females. Abortion and high neonatal mortality characterized the camel outbreak in the Canary Islands.<sup>18</sup> In endemic areas, cattle and buffalo usually have a milder disease that may be exacerbated by stress from adverse climatic conditions, work, or intercurrent disease. Signs may include a reduction in milk yield and capacity for work, irregular estrus, a high rate of abortion and stillbirth, and poor semen quality in bulls. Outbreaks of a more severe disease in indigenous zebu cattle are reported from time to time.<sup>7</sup> In such cases, there may be nervous signs and high mortality rate.

## CLINICAL PATHOLOGY

As with tsetse-transmitted trypanosomosis, routine parasite detection is more reliable in the acute phase. Examination of wet blood films and stained smears of blood and lymph node should be carried out, and this should include the buffy-coat method. In the chronic phase, repeated sampling for some days may be required. In addition, suspected blood samples may be inoculated into rats or mice, both of which are highly susceptible.

A number of nonspecific serologic tests have been used, especially in areas where other forms of trypanosomes are not prevalent. These include the mercuric chloride, formol gel, or stilbamidine test for increased serum protein levels. Specific antibody detection tests are also available and include the direct card agglutination test (CAAT) for antibodies, the latex agglutination test (Suratex) for circulating antigens, the indirect fluorescent antibody test (IFAT), and the enzyme-linked immunosorbent assay (ELISA). Serologic tests are probably more sensitive than parasitologic methods in revealing the true extent of surra in camel herds.

Where the facilities exist, the PCR technique is more sensitive and specific and can detect trypanosome DNA antemortem in the cerebrospinal fluid and in brain tissue postmortem.<sup>19</sup>

### NECROPSY FINDINGS

The carcass is emaciated and pale and may be icteric but, as in *T. brucei* infections, there are no pathognomonic gross and microscopic lesions unless the parasites are detectable. Infected horses will show hindquarter muscle atrophy, splenomegaly, and lymphadenomegaly. Asymmetric leukomalacia has been described in naturally infected horses, but it is not clear whether or not this was a result of treatment with diminazene aceturate.<sup>15</sup> Microscopic changes are characterized by a lymphoplasmacytic infiltrate of various organs, including the brain and spinal cord. If the carcass is very fresh, trypanosomes can be detected in blood and CSF with routine microscopy, and in the parenchyma of central nervous system by immunoperoxidase method<sup>17</sup> or by PCR technique identifying parasite DNA.<sup>19</sup>

### DIFFERENTIAL DIAGNOSIS

Laboratory services are required to confirm a diagnosis; even then, without the use of molecular techniques, surra cannot be easily distinguished from *T. brucei brucei* infection where both coexist. Clinical signs and gross and microscopic lesions of both diseases in horses and camels are identical. Specimens to take for laboratory diagnosis are blood, brain, spinal cord, lymph nodes, spleen, and liver.

### TREATMENT

#### TREATMENT AND CONTROL

##### Treatment

Quinapyramine sulfate (Quintricide) (5 mg/kg SC) (R-1 for camels)

Diminazene aceturate (Berenil) (3.5–7 mg/kg IM) (R-1 for ruminants, R-3 for equines)

Melarsomine (Cymerlasan) (0.25 mg/kg IM for camels and 0.5 mg/kg for cattle) (R-1)

Isometamedium chloride (Samorin) (0.25–1 mg/kg IM) (R-1 for ruminants)

Suramin (Antrypol) (10 mg/kg IV) (R-2 for equines, camelids, 2–3 times weekly)

##### Control

Isometamedium chloride (2 mg/kg IM) (R-1)

Antrycide prosalt (7.4 mg/kg SC) (R-2)

Suramin (Antrypol) (10 mg/kg IV) (R-2 for equines, camelids, 2–3 times weekly)

Drugs used for treating nagana could be used for surra, but the outcome is less favorable because of their low trypanocidal activity against *T. evansi* and their specific toxicity for camels and horses. Furthermore, the drugs are not able to cross the blood–brain barrier to reach parasites in the cerebrospinal fluid and nervous tissue. As a result, relapses are common and may present as drug resistance. Three Brazilian isolates of *T. evansi* tested for drug resistance were found to be fully susceptible to a single dose of suramin sodium at 10 mg/kg BM in mice.<sup>20</sup>

Quinapyramine sulfate (quintricide) is used curatively for camels, and diminazene aceturate (Berenil) is used for horses. A water-soluble arsenical, melarsomine hydrochloride (Cymerlasan), given IM is recommended for camels at 0.25 mg/kg BW and for cattle at 0.5 mg/kg BW.<sup>21</sup> For both curative and prophylactic use, quinapyramine prosalt (trypacide), suramin (naganol), and isometamedium chloride (samorin or trypanidium) are recommended (see section on nagana or African trypanosomosis).

### CONTROL

Unlike in nagana, control measures are aimed primarily at the host rather than the vector, which is abundant. The measures include detection and treatment of infected animals, prophylactic treatment of susceptible animals, and their protection from biting flies and bats, where possible. As in nagana, there is no vaccine.

### FURTHER READING

Abebe G. Trypanosomosis in Ethiopia. *Ethiop J Biol Sci.* 2005;4:75-121. [The Biological Society of Ethiopia review article].

Desquesnes M. *Livestock Trypanosomoses and Their Vectors in Latin America*. Paris: OIE (World Organisation for Animal Health); 2004.

Desquesnes M, et al. *Trypanosoma evansi* and surra: a review and perspectives on origin, history, distribution, taxonomy, morphology, hosts and pathogenic effects. *Biomed Res Intern.* 2013;194176.

Desquesnes M, et al. *Trypanosoma evansi* and surra: a review and perspectives on transmission, epidemiology and control, impact and zoonotic aspects. *Biomed Res Intern.* 2013;321237.

Hunter AG, Luckins AG. Trypanosomosis. In: Sewell MMH, Brocklesby DW, eds. *Handbook on Animal Diseases in the Tropics*. 4th ed. London: Baillière Tindall; 1990:204-226.

OIE *Manual of Diagnostic Tests and Vaccines for Terrestrial Animals*. Vol. 1. 6th ed. Paris: OIE; 2008 chapter 2.1.17:252-260.

Stephen LE. *Trypanosomiasis: A Veterinary Perspective*. Oxford: Pergamon Press; 1986.

### REFERENCES

- Lai DH, et al. *Proc Natl Acad Sci USA.* 2008;105:1999.
- Gutierrez C, et al. *Vet Parasitol.* 2010;174:26.
- Desquesnes M, et al. *Biomed Res Intern.* 2013;194176.
- Desquesnes M, et al. *Biomed Res Intern.* 2013;321237.
- Dargantes AP, et al. *Int J Parasitol.* 2009;39:1109.
- Tamarit A, et al. *Vet Parasitol.* 2010;167:74.
- Mekata H, et al. *Parasitol Res.* 2013;[Epub ahead of print].
- Rademaker V, et al. *Acta Trop.* 2009;111:102.
- Herrera HM, et al. *Parasitol Res.* 2008;103:619.
- Singla LD, et al. *Trop Anim Health Prod.* 2010;42:589.
- Powar RM, et al. *Indian J Med Microbiol.* 2006;24:72.
- Haridy FM, et al. *J Egypt Soc Parasitol.* 2011;41:65.
- Vanhollebeke B, et al. *N Engl J Med.* 2006;355:2752.
- Dobson RJ, et al. *Int J Parasitol.* 2009;39:1115.
- Habila N, et al. *Res Vet Sci.* 2012;93:13.
- Ranjithkumar M, et al. *Trop Anim Health Prod.* 2013;45:417.
- Rodrigues A, et al. *Vet Pathol.* 2009;46:251.
- Gutierrez C, et al. *Vet Parasitol.* 2005;130:163.
- Berlin D, et al. *Vet Parasitol.* 2009;161:316.
- Faccio L, et al. *Exp Parasitol.* 2013;134:309.
- Desquesnes M, et al. *Parasitology.* 2011;138:1134.

## Multi-Organ Diseases Due to Fungal Infection

### PROTOTHECOSIS AND CHLORELLOSIS (ALGAL BACTEREMIA)

Protothecosis and chlorellosis are rare pseudofungal diseases in animals caused by the opportunistic algae of the Chlorellaceae family, *Prototheca* spp. (achlorophyllous mutant) and *Chlorella* spp. (chlorophyll-containing green alga), respectively.<sup>1</sup> Asymptomatic systemic infections and lymphadenitis associated with the achlorophyllous alga *Prototheca zopfii* or the green alga *Chlorella* spp. are extremely rare in cattle and sheep. Peritonitis and lymphadenitis associated with *Scenedesmus* spp., which is closely related to *Chlorella* spp., occurs rarely in cattle.<sup>2</sup> More common is mastitis in cattle caused by *P. zopfii*, or the more recently recognized *Prototheca blaschkeae*.<sup>3</sup> Protothecosis in goats is caused by *Prototheca wickerhamii* and presents as chronic weight loss and signs of respiratory disease.<sup>4</sup> Infections are considered opportunistic, with the exception of increased risk for disseminated infection in sheep grazing sewage-contaminated pasture. Lesions are typically granulomas.<sup>5</sup> Diagnosis is based on demonstration of alga in granulomatous lesions predominantly in the lymph nodes.<sup>1</sup> PCR-based testing is available.

### REFERENCES

- Ramirez-Romero R, et al. *Mycopathologia.* 2010;169:461.
- Hafner S, et al. *Vet Pathol.* 2013;50:256.
- Ricchi M, et al. *Vet Microbiol.* 2013;162:997.

4. Camboim EKA, et al. *Mycoses*. 2011;54:e196.
5. Onozaki M, et al. *Jap J Infect Dis*. 2013;66:383.

## COCCIDIOIDOMYCOSIS

### ETIOLOGY

*Coccidioides immitis* is associated with the disease in all species, including humans. *Coccidioides posadasii* appears to be increasingly recognized as a pathogen.<sup>1</sup>

### EPIDEMIOLOGY

Coccidioidomycosis is a comparatively benign disease of farm animals, usually causing no apparent illness, although disseminated or overt pulmonary disease is associated with a high case-fatality rate in horses.<sup>2</sup> Sporadic cases are recorded in all species but are most common in dogs and in cattle and, to a much less extent, in pigs, sheep, and horses. Pulmonary coccidioidomycosis has been described in a 13-day-old foal. Approximately 4% of horses in areas in which the disease is endemic have serum antibodies to *C. immitis*.<sup>2</sup> The disease tends to affect young to middle-aged animals (median age of 8 years in affected horses), presumably because they are naïve to the infection, with older animals likely to have been exposed and subsequently resistant to the disease.<sup>2</sup> Case-fatality rates are low for mares with abortion (~0%) and animals with superficial abscesses compared with a fatality rate greater than 90% in horses with pneumonia and pleural effusion, or with pneumonia and at least one extrapulmonary site of disease.

The disease is enzootic in the southwestern United States, and up to 20% of cattle finished in feedlots in the area may harbor the fungus. The incidence of the disease in humans in the area provides a major problem in public health. It is not contagious, with infection occurring by inhalation of spores of the fungus, which grows in the soil, and possibly by ingestion and through cutaneous abrasions. The disease is common in dogs and is reported in aquatic wildlife (walrus), rhinoceros, and a koala (in San Diego, California).<sup>3-6</sup>

### CLINICAL FINDINGS

Clinical manifestations of infection in any species can include fever, abortion, pneumonia, pleural effusion, severe weight loss, osteomyelitis, and external abscessation.<sup>2</sup>

In horses, findings include weight loss up to severe emaciation, a fluctuating temperature, persistent cough, muscle pain, and superficial abscesses, often recurring, and most commonly in the pectoral area. Increased lung sounds, wheezing, and dullness are audible over the ventral chest. Other signs include edema of the legs, anemia, and intermittent colic as a result of internal abscesses and peritoneal adhesions. Liver rupture may cause death. Affected sheep

show fever and abscesses in peripheral lymph nodes.

### CLINICAL PATHOLOGY

A leukocytosis is usual, and there can be increases in serum or plasma markers of inflammation (serum amyloid A, fibrinogen).

Fungal cultures or biopsies can be positive for *C. immitis*. *Coccidioides* spp. grows within 2 to 5 days on several media, although fungal culture should be restricted to bio-safety level 3 laboratories.<sup>7</sup> A PCR assay is available to detect and determine the species of *Coccidioides* involved in the disease.<sup>1</sup>

Microscopic examination of tissues or of transtracheal or bronchoalveolar lavage fluids, lymph nodes, and pleural fluid exudates can be performed using KOH (or KOH-ink), lactophenol cotton blue, H&E, Papanicolaou, PAS, and methenamine silver stains.<sup>7</sup>

Serologic tests (i.e., agar gel immunodiffusion [AGID] assays and ELISA for the detection of IgM and IgG antibodies) may assist the diagnosis of coccidioidomycosis. Serum antibody titers are highest in animals with disseminated or pulmonary disease and lowest in animals with localized disease or abortion.<sup>2</sup>

### NECROPSY FINDINGS

The lesions produced in cattle and pigs are granulomatous, contain a cream-colored pus, are sometimes calcified, and are found in the bronchial, mediastinal, and, rarely, the mesenteric, pharyngeal and submaxillary lymph nodes and in the lungs. In a neonatal foal, the lungs were diffusely infiltrated with a miliary pattern of multiple, coalescing, pale-tan to red, irregularly shaped, slightly raised, firm foci, 0.1 to 0.5 cm in diameter.

### DIFFERENTIAL DIAGNOSIS

Microscopic or cultural examination may be used to identify the disease. Isolation of the organism or detection of DNA by polymerase chain reaction (PCR) is preferred.<sup>1</sup>

#### Differential diagnosis list:

- Cattle and pigs—tuberculosis
- Sheep and goats—caseous lymphadenitis
- Horses—*C. pseudotuberculosis* infection, pneumonia and pleuropneumonia, metastatic *Streptococcus equi* infection

### TREATMENT

Administration of azole compounds (fluconazole, itraconazole, voriconazole) or amphotericin B is advised, although the efficacy of these compounds remains to be determined.<sup>7</sup> Animals treated with these compounds must be monitored for adverse effects, including nephropathy induced by amphotericin.

Because infection occurs by the inhalation of soil-borne spores, control of dust in feedlots may help to prevent the spread of

the disease. Dust control is a major factor in prevention of human coccidioidomycosis because there is no vaccine or effective therapeutic agent available, and the eradication of *C. immitis* from the soil is not practicable.

### REFERENCES

1. Sheff KW, et al. *Med Mycol*. 2010;48:466.
2. Higgins JC, et al. *Vet J*. 2007;173:118.
3. Wallace RS, et al. *J Zoo Wildlife Med*. 2009;40:365.
4. Schmitt TL, et al. *J Zoo Wildlife Med*. 2014;45:173.
5. Burgdorf-Moisuk A, et al. *J Zoo Wildlife Med*. 2012;43:197.
6. Ajithdoss DK, et al. *J Comp Pathol*. 2011;145:132.
7. Cafarchia C, et al. *Vet Microbiol*. 2013;167:215.

## PARACCOCCIDIOIDOMYCOSIS (PARACCOCCIDIOIDES INFECTION)

Paracoccidioidomycosis in humans caused by *Paracoccidioides brasiliensis* is endemic in parts of South and Central America.<sup>1,2</sup> The disease affects mainly men, causing oral mucosal lesions and disseminated granulomatous disease.<sup>3</sup> There is serologic evidence of widespread exposure of horses,<sup>4</sup> free-ranging pigs,<sup>5</sup> dairy cattle,<sup>6</sup> sheep,<sup>7</sup> and goats<sup>8</sup> in endemic regions, but no reports of disease caused by this organism in large animals. Pigs appear to be resistant to the disease.<sup>5</sup> The organism was identified in tuberculous lesions obtained at slaughter from cattle in Kenya, but the etiologic role for *B. brasiliensis* was unclear.<sup>9</sup>

### REFERENCES

1. Teixeira MM, et al. *PLoS Pathog*. 2014;10.
2. Seyedmousavi S, et al. *Clin Micro Infect*. 2015;21:416.
3. Lopez-Martinez R, et al. *Mycoses*. 2014;57:525.
4. Neuschrank Albano AP, et al. *Brazil J Micro*. 2015;46:513.
5. Belitardo DR, et al. *Mycopathologia*. 2014;177:91.
6. Silveira LH, et al. *Mycopathologia*. 2008;165:367.
7. Oliveira GG, et al. *Mycopathologia*. 2012;173:63.
8. Ferreira JB, et al. *Mycopathologia*. 2013;176:95.
9. Kuria JN, et al. *Ond J Vet Res*. 2013;80.

## RHODOTORULUA SPP. INFECTION

Infection by *Rhodotorula* spp. is a rare cause of disease in humans and animals.<sup>1</sup> In large animals it is associated with pneumonia and fungemia in sheep.<sup>2</sup>

### REFERENCES

1. Wirth F, et al. *Interdisc Pers Infect Dis*. 2012;46:5717.
2. Chitko-McKown CG, et al. *Transbound Emerg Dis*. 2014;61:E76.

## HISTOPLASMOSIS

Histoplasmosis, associated with infection with *Histoplasma capsulatum*, is a rare systemic mycosis in farm animals, with a high prevalence in specific geographic localities, such as the Ohio River and Mississippi River system and areas of South and Central America, Mediterranean countries, Asia,



Africa, and Australia. Cases have been recorded in horses, cattle, and pigs. The disease is relatively common in cats and dogs and occurs in a wide variety of other species, including wildlife and humans.<sup>1-4</sup>

The fungus is able to survive for periods as long as 4 months in soil and water. Infection occurs by the inhalation of contaminated dust, and primary invasion usually takes place in the lung. The disease can spread from animals to humans. Attempts at experimental infection in cattle, sheep, horses, and pigs have resulted in nonfatal infections, unless the agent is given intravenously, but the test animals become positive to the histoplasmin cutaneous sensitivity test.

Clinical syndromes vary greatly and include pneumonia with dyspnea and nasal discharge, hepatic insufficiency with jaundice and anasarca, placentitis with abortion, and widespread lesions in neonates, especially foals. Infections in horses can be evident as intra-abdominal masses.<sup>5</sup>

As a diagnostic aid for herd or area, the histoplasmin skin test appears to be satisfactory. Keratitis attributable to *Histoplasma* spp. has been described. Histoplasmosis may be secondary to yersiniosis in the horse.

Necropsy lesions are as variable as the clinical syndrome and include gross hepatic enlargement containing necrotic foci, pulmonary consolidation and granulomatous pneumonia, and enlargement of splanchnic lymph nodes. Aggregation of the fungal bodies in lymphoid tissue and other tissues in which large numbers of phagocytes are in residence is characteristic of the disease; the lesions consist of groups of macrophages packed with fungal cells. Fungal culture can yield the organism.

Triazoles (e.g., fluconazole, itraconazole) or imidazoles (e.g., ketoconazole) appear to be sensible choices for pharmacologic therapy, but efficacy has not been demonstrated. The treatment of choice for histoplasmosis in dogs and cats is itraconazole, either alone or in combination with ketoconazole or amphotericin B.<sup>3</sup> Voriconazole is also used, but without documented efficacy in large case series in dogs or cats.

The disease associated with infection with *H. farciminosum* is dealt with under the heading "Epizootic Lymphangitis."

## REFERENCES

1. Clothier KA, et al. *J Vet Diagn Invest.* 2014;26:297.
2. Brandao J, et al. *J Vet Diagn Invest.* 2014;26:158.
3. Aulakh HK, et al. *J Am Anim Hosp Assoc.* 2012;48:182.
4. Atiee G, et al. *Vet Radiol Ultra.* 2014;55:310.
5. Nunes J, et al. *J Vet Diagn Invest.* 2006;18:508.

## CRYPTOCOCCOSIS (EUROPEAN BLASTOMYCOSIS, TORULOSIS)

Infection with the yeast *Cryptococcus neoformans* or *C. gattii* (the *C. neoformans*-*gattii*

complex) occurs in most species, including humans, cattle, horses, goats, dogs and cats, and wildlife, either as a generalized disease, sometimes with localization in particular tissues, or as a granulomatous meningoencephalitis.<sup>1-7</sup> In humans, pulmonary lesions are more likely with *C. gattii* infection, and neurologic disease more likely with *C. neoformans*.<sup>4</sup> *C. neoformans* is a basidiomycetous fungus with a worldwide distribution, commonly found in soil contaminated with avian feces.<sup>8</sup> Two pathogenic variants of *C. neoformans* are *C. neoformans var. neoformans* and *C. neoformans var. gattii*, and these variants are separate species, based on DNA sequence analysis, but are not distinguishable by the routinely performed and rapidly available *C. neoformans* capsular antigen latex agglutination titer.<sup>8</sup>

The frequency of disease or animal risk factors are not reported. Of 260 horses examined in an area in which the disease was considered endemic (Vancouver Island, Canada), 4 had cryptococcus isolated from nasal swabs and none had detected serum antibody titers to the organism.<sup>9</sup>

Nervous system involvement is manifested by stiffness, hyperesthesia, blindness, or incoordination. Clinical signs in cattle include multifocal neurologic deficits manifested by hypermetria, ataxia, depression, circling, impaired vision, head pressing, low head carriage, wide-based stance, and falling to the side or backward.<sup>4,10</sup> Systemic involvement includes cases of myxomatous lesions of nasal mucosa, pulmonary abscess or pneumonia, jejunal granuloma, lymphadenitis, osteomyelitis, placentitis with abortion, and systemic involvement in the fetus. *C. neoformans* is a cause of bovine mastitis. The disease can manifest as sinonasal granulomas in horses with local extension to the cranial vault.<sup>3</sup>

CSF of affected animals is xanthochromic, with elevated white cell count and markedly increased protein concentration.<sup>8</sup> Cryptococci can be detected in cerebrospinal fluid of animals with neurologic disease by microscopic examination of the fluid, or detection of serum or CSF antibodies to the organism (detected by latex agglutination test).<sup>8</sup>

Successful treatment of neurologic disease in horses is by administration of triazole antifungals, such as fluconazole (14 mg/kg PO once, and then 5 mg/kg PO q24h) for weeks to months;<sup>8</sup> or, for sinonasal granulomas, a combination of systemic therapy with fluconazole, debulking of the lesions in the nasal cavity, and intralesional injection of fluconazole, amphotericin, and/or formalin,<sup>3</sup> or irrigation of the nasal sinuses with enilconazole.<sup>11</sup>

## REFERENCES

1. Vorathavorn VI, et al. *J Vet Emerg Crit Care.* 2013;23:489.
2. Stilwell G, et al. *BMC Vet Res.* 2014;10.

3. Stewart AJ, et al. *JAVMA.* 2009;235:723.
4. Riet-Correa F, et al. *J Vet Diagn Invest.* 2011;23:1056.
5. McGill S, et al. *Med Mycol.* 2009;47:625.
6. Huckabone SE, et al. *J Wildlife Dis.* 2015;51:295.
7. Govendir M, et al. *J Vet Pharmacol Ther.* 2015;38:93.
8. Hart KA, et al. *J Vet Int Med.* 2008;22:1436.
9. Duncan C, et al. *Med Mycol.* 2011;49:734.
10. Magalhaes GM, et al. *J Comp Pathol.* 2012;147:106.
11. Cruz VC, et al. *JAVMA.* 2009;234:509.

## NORTH AMERICAN BLASTOMYCOSIS

The fungus associated with North American blastomycosis, an important disease in humans<sup>1</sup> and dogs,<sup>2</sup> is *Blastomyces dermatitidis*, which is genetically diverse, having over 100 haplotypes divided into two important genetic groupings (Groups 1 and 2), although it has yet to be fully classified.<sup>3,4</sup> More veterinary isolates are in Group 2 than in Group 1, with some haplotypes in each group being identified in only human infections (Group 1) or animals (Group 2).<sup>4</sup> The asexual phase is called *Blastomyces dermatitidis* and its sexual phase, *Ajellomyces dermatitidis*.<sup>1</sup> The organism affects both animals and humans; although it does not appear to be zoonotic (direct transfer of infection from animals to humans), caution should be exercised when treating animals with the disease. Presence of disease, or prevalence of antibodies to the organism, can be indicative of endemicity of infection in geographic areas.

The disease is relatively common in dogs in the upper Midwest of the United States, but it is rare in horses and other large animals.<sup>5</sup> It is reported in horses, goats, sheep, alpaca, and cattle and in miscellaneous other species such as ferrets.<sup>4,6-10</sup> The disease is reported, although infrequently, worldwide, with cases in animals recorded in Italy,<sup>11</sup> West Africa,<sup>6</sup> India, and South America, in addition to well-recognized foci in North America.<sup>4</sup>

Risk factors for large animals are not identified.

There is little information on the pathogenesis of this disease in large animals. In humans and dogs, infection is either by inhalation of organism, with subsequent development of granulomatous pneumonia, or it follows direct infection of skin, presumably through wounds or macerated dermis, resulting in skin lesions. Infection from either site can then become systemic, with pulmonary infection disseminating to other organs, including the brain, urogenital tract, viscera, and skin. Infection originating in the skin can spread to other organs.<sup>1,5</sup> Systemic infection in dogs is associated with increases in concentration or activity of markers of systemic inflammation and hypercoagulability.<sup>12</sup>

The disease in horses can affect the skin (Fig. 21-3), bones,<sup>8</sup> temporomandibular joint, mammary gland, and both thoracic and abdominal organs. Skin lesions in horses



**Fig. 21-3** Lesions of blastomycosis in horse demonstrating combination of verrucous, raised, hairless lesions (black arrow) and subcutaneous lesions (white arrow). (Reproduced with permission from Funciello B, et al. *Equine Vet Educ* 2014;26:458.)

occur mainly in the skin of perianal, perivulvar, neck, pectoral, inguinal areas, ventrum, mammary gland, and hindlegs,<sup>5</sup> and are typically of either of two forms, or a mix of each (Fig. 21-3): subcutaneous nodules or verrucous, irregularly shaped lesions with hair loss and crusty raised margins.<sup>5,11</sup> The verrucous lesions are often located over subcutaneous abscesses. Skin lesions can be ulcerated and have draining tracts from deeper lesions.

The pulmonary form is reported in sheep,<sup>7</sup> disseminated disease with clinical manifestations of central neurologic dysfunction in an alpaca,<sup>10</sup> and granulomatous disease resembling tuberculosis in cattle.<sup>13</sup>

Organisms can occasionally be identified as budding yeast bodies in the exudate of ulcerative lesions or draining tracts. Demonstration of organism in typical lesions confirms the disease. *B. dermatitidis* antigens can be detected in urine of animals with blastomycosis.<sup>8,14</sup> The degree of antigenuria has diagnostic utility in dogs, being moderately sensitive but highly specific for the presence of the disease, and is useful in monitoring response to therapy, decisions on cessation of pharmacotherapy, and monitoring for recrudescence of infection.<sup>14</sup>

Differential diagnoses include tuberculosis (especially in cattle), metastatic *S. equi* in equids, equine multinodular pneumonia, neoplasia, and abscesses caused by *C. pseudotuberculosis*.

Treatment consists of surgical debulking or debridement of accessible solitary lesions and administration of antifungal agents. Treatment of choice in dogs and humans is administration of itraconazole or fluconazole or, in cases of severe infection, amphotericin B.<sup>5</sup> Successful treatment of cutaneous

blastomycosis in a horse involved administration of fluconazole (14 mg/kg PO loading dose followed by 5 mg/kg PO once daily) for 5 weeks.<sup>11</sup> Discontinuation of therapy resulted in recrudescence of infection, which was resolved by further administration of the drug. Use of potassium iodide (20 mg/kg PO every 24h) was not efficacious in preventing recrudescence of infection. Antifungal therapy should be continued for months. Monitoring of efficacy of therapy by measurement of urine *B. dermatitidis* antigens in urine might be useful in large animals, as it is in dogs and humans.<sup>14</sup>

#### FURTHER READING

Wilson JH. Blastomycosis in horses. *Equine Vet Educ.* 2014;26:464-466.

#### REFERENCES

- Lopez-Martinez R, et al. *Clin Dermatol.* 2012;30:565.
- Anderson JL, et al. *Med Mycol.* 2014;52:774.
- Meece JK, et al. *Med Mycol.* 2010;48:285.
- Anderson JL, et al. *BMC Vet Res.* 2013;9.
- Wilson JH. *Equine Vet Educ.* 2014;26:464.
- Dalis JS, et al. *J Anim Vet Adv.* 2007;6:773.
- Deshmukh GR, et al. *Ind J Vet Pathol.* 2011;35:202.
- Mendez-Angulo JL, et al. *Can Vet J.* 2011;52:1303.
- Darrow BG, et al. *J Exotic Pet Med.* 2014;23:158.
- Imai DM, et al. *J Vet Diagn Invest.* 2014;26:442.
- Funciello B, et al. *Equine Vet Educ.* 2014;26:458.
- McMichael MA, et al. *J Vet Int Med.* 2015;29:499.
- Kuria JN, et al. *Ond J Vet Res.* 2013;80.
- Foy DS, et al. *J Vet Int Med.* 2014;28:305.

## Multi-Organ Diseases Due to Metabolic Deficiency

### SODIUM AND/OR CHLORIDE DEFICIENCY

A dietary deficiency of sodium is most likely to occur in the following instances:

- During lactation, as a consequence of losses of the element in the milk, in rapidly growing young animals fed on low-sodium, cereal-based diets
- Under very hot environmental conditions where large losses of water and sodium occur in the sweat and where the grass forage and the seeds may be low in sodium
- In animals engaged in heavy or intense physical work and in animals grazing pastures on sandy soils heavily fertilized with potash, which depresses forage sodium levels

Naturally occurring salt deficiency causing illness in grazing animals is uncommon except under specific circumstances. The most commonly cited occurrences are on alpine pastures and heavily fertilized pasture leys. Pasture should contain chloride at least 0.15 g/100 g dry matter (DM), and clinical signs are evident after about 1 month on pasture containing 0.1 g chloride/100 g DM. Under experimental conditions,

lactating cows give less milk until the chloride deficiency is compensated. After a period of up to 12 months there is considerable deterioration in the animal's health, and anorexia, a haggard appearance, lusterless eyes, rough coat, and a rapid decline in body weight occur. High-producing animals are most severely affected, and some may collapse and die. The oral administration of sodium chloride is both preventive and rapidly curative. Experimental sodium depletion in horses for up to 27 days has no deleterious effect on general health.

In dairy cattle on a sodium-deficient diet, there is polyuria; polydipsia; salt hunger; pica, including licking dirt and each other's coats and drinking urine; loss of appetite and weight; and a fall in milk production. Urination is frequent, the urine has a lower-than-normal specific gravity, and the urine concentrations of sodium and chloride are decreased and the potassium increased. The salivary concentration of sodium is markedly decreased, the potassium is increased, and the salivary sodium:potassium ratio is decreased. The concentrations of serum sodium and chloride are also decreased, but the measurement of urinary or salivary sodium concentration is a more sensitive index of sodium intake than plasma sodium concentration. Of these, it is urinary sodium that is depressed first and is therefore the preferred indicator in cattle and horses. The polyuria associated with severe sodium depletion may be an antidiuretic hormone insensitivity as a result of lack of an effective countercurrent mechanism and hyperaldosteronism.

Supplementation of salt to dairy cows on a pumice soil in New Zealand resulted in a 12.8% increase in milk yield with unaltered composition. The cows were grazing ryegrass/clover pastures averaging 0.05% sodium, whereas the recommended concentration for dairy cows is 0.12%. Measurement of the sodium content of the pasture is the most simple and reliable method of diagnosing salt deficiency compared with saliva sodium:potassium ratio. It is considered likely that sodium deficiency will become more prevalent on dairy farms in the future and that there are cost-effective benefits to using salt where deficiencies occur.

Experimental restriction of chloride in the diet of dairy cows in early lactation results in a depraved appetite, lethargy, reduced feed intake, reduced milk production, scant feces, gradual emaciation, and severe hypochloremia and secondary hypokalemic metabolic alkalosis. Lethargy, weakness, and unsteadiness occur after about 6 weeks on the chloride-deficient diet. Bradycardia is also common. The concentration of chloride in cerebrospinal fluid is usually maintained near normal, whereas the serum concentrations decline. The experimental induction of a severe, total body chloride deficit by the provision of a low-chloride

diet and the daily removal of abomasal contents results in similar clinical findings to those described previously and lesions of nephrocalcinosis.

The **diagnosis of salt deficiency** is dependent on the clinical findings, analysis of the feed and water supplies, serum levels of sodium and chlorine, and determination of the levels of sodium in the saliva, urine, and feces of deficient animals. The concentration of sodium in saliva is a sensitive indicator of sodium deficiency. In cattle receiving an adequate supply of sodium and chlorine, the sodium levels in saliva vary from 140 to 150 mmol/L; in deficient cattle the levels may be as low as 70 to 100 mmol/L. The levels of sodium in the urine are low, with a reciprocal rise in potassium. The serum sodium levels are less reliable, but licking begins when the level falls to 137 mmol/L, and signs are intense at 135 mmol/L.

The biochemical methods have been evaluated to estimate the sodium intake of dairy cows. Groups of cows were given 10 to 20, 30 to 50, or 70 to 100 g salt per day, and two groups were given salt ad libitum either in bowls or in salt blocks. The concentrations of sodium and potassium were measured in serum and urine. Cows receiving 70 to 100 g salt daily and those in the ad libitum group had higher urinary sodium concentrations than the other groups. Those receiving 10 to 20 g day had a higher urinary ratio of potassium:sodium in their urine than all other groups, in which the ratio decreased as the level of supplementary salt increased.

**Experimentally induced sodium deficiency in young pigs** causes anorexia, reduced water intake, and reduced weight gains.

The provision of salt in the diet at a level of 0.5% is considered to be fully adequate for all farm animal species. Under practical conditions, salt mixes usually contain added iodine and cobalt. In some situations, the salt mixes are provided on an ad libitum basis rather than adding them to the diet. However, voluntary consumption is not entirely reliable. The daily amount consumed by animals having unrestricted access to salt can be highly variable and often wasteful. Two factors influencing voluntary salt intake are the physical form of the salt and the salt content of the water and feed supplies. Some cattle consume much more loose than block salt, although the lower intakes of block salt may be adequate. Also, animals dependent on high-saline water for drinking consume significantly less salt than when drinking nonsaline water. Voluntary salt consumption is generally high in cows on low-sodium pastures, which are low inherently or as a result of heavy potash fertilization. Lactating gilts may require 0.7% salt in their diets, and energy efficiency in feedlot cattle may be improved by feeding high levels (5% of diet) of salt in the diet of finishing steers.

## MAGNESIUM DEFICIENCY

Magnesium (Mg), the second most abundant intracellular cation, plays a vital role as a cofactor for many enzymes, acts as a modulator of ion channels, and affects many cellular processes, such as neuromuscular excitability and secretion of hormones, and antagonizes the actions of  $\text{Ca}^{2+}$ .<sup>1-3</sup> Magnesium deficiency or depletion causes disturbances in a multitude of physiologic processes and is evident from severe clinical disease and death, in hypomagnesemic tetany of cattle, through to reduced production and impaired health.<sup>2,4</sup> Nutritional deficiency of magnesium plays a role in causing lactation tetany in cows and hypomagnesemic tetany of calves, and these diseases are dealt with in **Chapter 18** on metabolic diseases. Magnesium deficiency in late pregnant dairy cows can predispose to periparturient hypocalcemia by impairing the secretion of parathyroid hormone (PTH). In both diseases, there are complicating factors that may affect the absorption and metabolism of the element.

Hypomagnesemia occurs in up to 50% of adult horses hospitalized for severe gastrointestinal disease such as colic, acute diarrhea, and infectious respiratory disease.<sup>5</sup> Serum magnesium concentrations of healthy horses vary with age, parturition, lactation, and sex.<sup>6</sup> Cattle with any one of a number of diseases that decrease feed intake,<sup>2,3</sup> or magnesium absorption, are at increased risk of magnesium deficiency. Postpartum cows with retained placenta have lower concentrations of Mg, and some other minerals, than do postpartum cows without retained placenta.<sup>7</sup> Dairy cows at risk of hypokalemia and supplemented by oral administration of KCl might be at increased risk of magnesium deficiency because of the competitive inhibition of increased ruminal potassium concentrations on magnesium absorption from the rumen.<sup>8</sup>

Magnesium is an essential constituent of rations for recently weaned pigs. Experimentally induced deficiency causes weakness of the pasterns, particularly in the forelegs, causing backward bowing of the legs, sickled hocks, approximation of the knees and hocks, arching of the back, hyperirritability, muscle tremor, reluctance to stand, continual shifting of weight from limb to limb, and eventually tetany and death. A reduction in growth rate, feed consumption and conversion, and levels of magnesium in the serum also occurs. The requirement of magnesium for pigs weaned at 3 to 9 weeks of age is 400 to 500 mg/kg of the total ration.

Diagnosis of magnesium deficiency is challenging because measurement of serum magnesium concentration is not a reliable indicator of whole-body magnesium status.<sup>9</sup> Plasma Mg makes up only 0.3% of total body Mg, and concentration of Mg in plasma is held constant over a wide range of Mg

intakes and is only weakly correlated with the functionally important intracellular pools of Mg.<sup>1,4,9</sup> Increasing or decreasing renal magnesium excretion primarily regulates the extracellular Mg concentration, and whole-body Mg status can be monitored rather by assaying total urinary Mg excretion. Because the collection of all urine produced over a 24-hour period is difficult or impossible in practice, urinary magnesium concentration can be measured in a spot sample. However, urinary magnesium concentration is markedly affected by urine volume and can be difficult to interpret. Estimates of magnesium status can be obtained by measuring urine creatinine and magnesium concentrations, measuring plasma magnesium and urine concentrations, and calculating urinary fractional excretion of Mg, thereby avoiding the need for collection of all urine produced over a 24-hour, or other prolonged, period.<sup>1,4</sup> Fractional excretion of Mg is a more sensitive indicator of Mg availability than is plasma, or serum, Mg concentration and a better predictive indicator of the need for supplementation.<sup>4</sup> Methodology for determining magnesium status in cattle and horses is described. A method in cattle involves collection of basal blood and urine samples 60 minutes before starting a magnesium challenge infusion (2.5 mg/kg BW in 250 mL of 0.9% saline was infused at 2.1 mL/min for 120 min) with blood and urine samples collected at 30-minute intervals until 60 minutes after the end of the infusion. Urinary fractional clearance (FC) of magnesium is calculated using the formula:

$$FC\% (Mg) = \frac{[Cr]_{pl}}{[Cr]_u} \times \frac{[Mg]_u}{[Mg]_{pl}} \times 100$$

The reference interval is generally considered to be 2.64% to 43.6% for cows at the end of lactation. Herds with mean fractional clearance of Mg less than 10% are likely to have a deficient Mg status and might benefit from Mg supplementation.<sup>4</sup> A magnesium challenge test can reveal cows with low total body magnesium content because these cows retain much of the infused magnesium, with consequent unchanged fractional clearance values, whereas cows with adequate magnesium status have an increase in fractional clearance of the electrolyte.<sup>4</sup>

Feeding of a magnesium-deficient diet for 29 days in young horses did not result in detectable changes in total or ionized magnesium concentrations in serum, but magnesium excretion over 24 hours and fractional clearance of magnesium in urine were markedly reduced.<sup>9</sup>

## FURTHER READING

- Goff JP. Calcium and magnesium disorders. *Vet Clin Nth Am Food A.* 2014;30:359-369.
- Schonewille JT. Magnesium in dairy cow nutrition: an overview. *Plant Soil.* 2013;368:167-178.
- Stewart AJ. Magnesium disorders in horses. *Vet Clin Equine.* 2011;27:149-161.



## REFERENCES

1. Stewart AJ. *Vet Clin Equine*. 2011;27:149.
2. Schonewille JT. *Plant Soil*. 2013;368:167.
3. Goff JP. *Vet Clin Nth Am Food A*. 2014;30:359.
4. Schweigel M, et al. *J Anim Physiol Nutr*. 2009; 93:105.
5. Borer KE, et al. *Equine Vet Educ*. 2006;18:266.
6. Berlin D, et al. *Vet J*. 2009;181:305.
7. Bicalho MLS, et al. *J Dairy Sci*. 2014;97:4281.
8. Constable PD, et al. *J Dairy Sci*. 2014;97:1413.
9. Stewart AJ, et al. *Am J Vet Res*. 2004;65:422.

## COPPER DEFICIENCY

## SYNOPSIS

**Etiology** Primary deficiency as a result of inadequate copper in the diet. Secondary copper deficiency is associated with antagonistic factors, particularly excess molybdenum and sulfur, which form thiomolybdates in the rumen. Thiomolybdates can bind copper in the rumen, or, if insufficient copper is present, they are absorbed (especially tetra-thiomolybdate) and bind to several enzymes and compounds that have diverse biological activities. Dietary iron forms complexes with copper in the rumen, and so can exacerbate this process.

**Epidemiology** Herd or flock problem, mainly in young growing ruminants (cattle, sheep, goats, and farmed deer) on pasture in spring and summer. Primary deficiency occurs in sandy and heavily weathered soils; secondary in peat or muck soils high in molybdenum. Feed and water supplies may also contain molybdenum, sulfate, and iron salts, which interfere with copper absorption and metabolism. Some breeds of sheep, and possibly Simmental cattle, are more susceptible.

**Signs** Unthriftiness, altered hair color, chronic diarrhea in molybdenosis (secondary deficiency), chronic lameness, neonatal ataxia in newborn lambs (swayback) if ewes are copper deficient in mid-pregnancy, delayed ataxia in older lambs (enzootic ataxia), anemia in more prolonged deficiency, falling disease in adult cattle (now rare).

**Clinical pathology** Low plasma and liver copper, low ceruloplasmin, anemia.

**Necropsy findings** Demyelination in enzootic ataxia, anemia, emaciation, hemosiderosis, osteodystrophy, cardiomyopathy.

**Diagnostic confirmation** Low liver and plasma copper, response to treatment.

**Differential diagnosis** Copper deficiency must be differentiated from herd problems associated with the following:

- Unthriftiness as a result of intestinal parasitism
- Malnutrition as a result of energy–protein deficiency
- Lameness caused by osteodystrophy (calcium, phosphorus, and vitamin D imbalance)
- Anemia as a result of sucking lice
- Neonatal ataxia in lambs (congenital swayback and enzootic ataxia) from border disease; cerebellar hypoplasia (daft lamb disease); hypothermia; meningitis
- Sudden death as a result of other causes

**Treatment** Oral slow-release bolus or capsule, parental copper glycinate, oral copper sulfate.

**Control** Oral dosing with controlled-release glass bolus or capsule with copper oxide needles; supplementation pasture by top-dressing with copper sulfate; parenteral administration of copper at strategic times; remove sulfates from water supply; genetic selection may be an option.

## ETIOLOGY

Copper (Cu) deficiency may be primary, when the intake in the diet is inadequate, or secondary (“conditioned”), when the dietary intake is sufficient but the absorption of copper and its utilization by tissues is impeded.

## Primary Copper Deficiency

The amount of Cu in the diet may be inadequate when the forage is grown on deficient soils, typically sandy or weathered soils, or soils in which the Cu is unavailable.

## Secondary Copper Deficiency

This is the predominant deficiency; the amount of Cu in the diet is adequate, but other dietary factors (mainly molybdenum, sulfur, and iron, but also manganese and zinc) interfere with the availability and utilization of Cu (Table 21-8). A dietary excess of molybdenum (Mo) is the most common factor, and a high intake can induce Cu deficiency even when the Cu content of the pasture is quite high. A higher Cu intake can overcome this effect. Conversely, supplementing the diet with Mo can be used to counteract a dangerously high intake of Cu. There are species differences in response to high Cu and Mo intake, with sheep being much more susceptible to Cu toxicity and cattle more susceptible to excess Mo.

Zinc, lead, calcium carbonate, and manganese are other conditioning factors. For example, using zinc sulfate to control facial eczema decreases plasma Cu, which can be corrected by the injection of copper glycinate. On the other hand, in New Zealand the administration of selenium to sheep on Cu-deficient pastures increases Cu absorption and can improve the growth rate of lambs.

Dietary inorganic sulfate, in combination with Mo, has a profound effect on the absorption of Cu by ruminants. For example, sheep consuming a complete diet low in sulfur and Mo, and with modest Cu (12 to 20 mg/kg DM), may die of Cu toxicity, whereas others grazing pasture of similar Cu content but high in Mo and sulfur can give birth to lambs affected with swayback. Increasing the sulfate concentration of a sheep diet from 0.1% to 0.4% can potentiate a Mo content as low as 2 mg/kg (0.02 mmol/kg) and reduce absorption of Cu below normal. Increasing sulfate in the diet also decreases absorption of selenium, and thus deficiencies of both Cu and selenium can occur in areas with soils deficient in both elements, especially when sulfate is added in the form of superphosphate fertilizer. Such combined deficiencies are becoming more common with higher applications of fertilizer that enable higher stocking rates on improved pastures. Interactions between Cu, selenium, and sulfates

**Table 21-8** Conditions associated with secondary copper deficiency

Disease	Country	Species	Liver copper	Probable initiating factor
Swayback	Britain, United States	Sheep	Low	Unknown
Renguerra	Peru	Sheep	Low	Unknown
Teart	Britain	Sheep and cattle	Unknown	Molybdenum
Scouring disease	Holland	Cattle	Unknown	Unknown
Peat scours	New Zealand	Cattle	Low	Molybdenum
Peat scours	Britain	Cattle	Unknown, low blood Cu	Unknown
Peat scours	Canada	Cattle	Unknown	Molybdenum
Salt sick	Florida (United States)	Cattle	Unknown	Unknown
“Pine” (unthrifty)	Scotland	Calves	Low	Unknown

must be considered when animals fail to respond to treatment unless both Cu and selenium are provided.

## EPIDEMIOLOGY

### Occurrence

Copper deficiency is endemic in ruminants worldwide and causes diseases of economic importance that can render large areas of otherwise fertile land unsuitable for grazing by ruminants of all ages, particularly young, rapidly growing animals. Based on surveys of serum and plasma Cu in cattle herds in Britain, Cu deficiency remains a serious problem requiring constant vigilance. It is estimated that clinical signs of Cu deficiency develop annually in about 0.9% of the cattle population in the United Kingdom. In some surveys, the lowest concentrations of serum Cu were in heifers being reared as heifer replacements. Although heavy mortalities can occur in affected areas, the major loss is from the failure of animals to thrive. Enzootic ataxia may affect up to 90% of a lamb flock in badly affected areas, with most of these lambs dying of inanition. In falling disease, up to 40% of cattle in affected herds may die.

Copper deficiency is the most common trace-element deficiency in farmed deer in New Zealand, producing mainly enzootic ataxia but also osteochondrosis.

### Geographic Distribution

#### Primary Copper Deficiency

Disease caused by a primary deficiency of Cu occurs in grazing livestock in many parts of the world, including enzootic ataxia of sheep in Australia, New Zealand, and the United States, licking sickness, or *liksucht*, of cattle in Holland and falling disease of cattle in Australia (now rarely seen). Copper deficiency is endemic in the Salado del Sur River basin in Buenos Aires Province, Argentina, affecting over 50% of beef cattle.

Concurrent deficiencies of both Cu and cobalt in Australia (“coast disease”) and Florida in the United States (“salt sickness”), characterized by the appearance of clinical signs of both deficiencies in all ruminant species, are controlled by supplementation with both Cu and cobalt.

In the United States, Cu deficiency is not restricted to a single region, with a third of 256 beef herds classified as deficient or marginally deficient based on a survey of serum Cu concentrations. Approximately 50% of the producers used Cu supplements, but a significant proportion of cattle from those herds were classified as marginally deficient or deficient.

In Canada, a survey of cattle at slaughter in Saskatchewan found that 67% had a liver Cu less than 25 mg copper/kg dry weight (DW). However, this indicator of deficiency is now obsolete, with concentrations less than 10 mg Cu/kg DW (160  $\mu\text{mol}$  Cu/kg DW), or 40 mg Cu/kg fresh weight

(FW) (630  $\mu\text{mol}$  Cu/kg FW) indicative of Cu deficiency in ruminants.<sup>1</sup> The concentrations of Cu in the liver of fetuses were proportional to the liver Cu concentrations in the dams, progressively decreasing in the dam during gestation and increasing in the fetus to meet postnatal requirements of the calf because cow milk is a poor source of Cu.

Copper deficiency has been diagnosed in captive musk-oxen in Canada, and it causes anemia in sucking pigs and reduced growth rate and cardiac disease in growing pigs. Adult horses are unaffected, but abnormalities of the limbs and joints of foals reared in Cu-deficient areas do occur.

#### Secondary Copper Deficiency

Diseases caused by secondary Cu deficiency, mostly as a result of high dietary intakes of Mo and sulfate, are listed in Table 21-8. They include syndromes characterized by ataxia, abnormal wool or hair, diarrhea (peat scours, teart), or unthriftiness. Anemia develops after severe or prolonged Cu deprivation.

Swayback and enzootic ataxia of lambs is induced by feeding pregnant ewes a diet deficient in Cu or high in Mo and sulfur. Two phases of rapid myelination of the central nervous system occur in sheep, the first during midpregnancy, and then in the spinal cord a few weeks after birth. Consequently, the timing of the ataxia in lambs and goat kids depends on when the induced Cu deficiency occurs; neonatal ataxia corresponds with deficiency during midpregnancy, delayed ataxia when deficiency occurs in late pregnancy or soon after birth. Heavy top-dressing of pasture with lime may predispose lambs to swayback. The central nervous system of calves undergoes a slow, progressive myelination, and so they are not affected by neonatal ataxia.

A dietary excess of Mo is known to be the conditioning factor in the diarrheic diseases; “peat scours” in Australia, New Zealand, California, and Canada; and “teart” in Britain.

In Canada, high concentrations of Mo (21–44 mg/kg DM) have been identified in forage on reclaimed mining areas in British Columbia, but cattle can graze these areas for short periods (12 weeks) each year without developing secondary Cu deficiency. Animals given a Cu supplement had no differences in weight gain, liver Mo, or serum and milk Cu and Mo, suggesting that the upper tolerable dietary concentrations of 5 to 10 mg molybdenum and the minimum safe Cu:Mo ratio of 2:1, described by the National Research Council, may not be universal.

Moose sickness, also known as “Alvsborg disease” and “wasting disease,” has affected up to 4% to 5% of moose (*Alces alces* L.) in Sweden. The appearance of the disease coincided with heavy liming of wetlands, lakes, and forests during the 1980s, undertaken to counteract the deleterious effects of acid rain. The increase in soil pH caused by the

liming reduced the availability of Cu and increased the availability of Mo. Copper deficiency may also be a factor contributing to the decline of moose in northwestern Minnesota, with deficient or marginally deficient concentrations of liver copper in 69% of moose found dead. Low liver Cu concentrations have also been recorded in ill-thrifty moose in Norway.<sup>2</sup>

#### Seasonal Occurrence

Primary Cu deficiency occurs most commonly in spring and summer, coinciding with the lowest concentration of Cu in the pasture. The Cu status of beef and dairy cattle can vary quite widely each month, with higher rainfall usually associated with a lower availability of Cu.

Secondary Cu deficiency may occur at other times, depending on the concentration of the conditioning factors, predominantly Mo or sulfur, in the forage. For example, the Mo content of herbage may be highest in the autumn or spring, when rains stimulate the growth of legumes.

#### Risk Factors

Several factors influence the plasma and tissue concentrations of copper in ruminants, including the following:

- Breed, age, and growth of animal
- Demands of pregnancy and lactation
- Dietary factors—type of pasture or feed source, season
- Soil characteristics and concentration of minerals—particularly Mo and sulfur, which can form thiomolybdates and reduce the availability of Cu by binding with it in the rumen or with biological compounds in the plasma and tissues

#### Animal Factors

##### Age

Young animals are more susceptible to primary Cu deficiency than adults. Calves of dams fed deficient diets may show signs at 2 to 3 months of age, with clinical signs more severe in calves and yearlings, less severe in 2-year-olds, and less important in adults. Enzootic ataxia is primarily a disease of neonatal or suckling lambs whose dams receive insufficient dietary copper during mid- or late-pregnancy. Ewes with a normal Cu status take some time to lose their liver reserves, and thus they do not produce affected lambs for at least 6 months after starting to graze Cu-deficient pastures. The predominance of Cu deficiency in suckling lambs indicates the importance of fetal stores and the inadequacy of milk as a source of Cu. Milk from normal ewes contains 3.1 to 9.4  $\mu\text{mol/L}$  (20 to 60  $\mu\text{g/dL}$ ) Cu, but with severe deficiency this may be reduced to 0.16 to 0.31  $\mu\text{mol/L}$  (1 to 2  $\mu\text{g/dL}$ ).

##### Breed and Species Susceptibility

There are marked genetic differences in the Cu metabolism of sheep breeds; Welsh

Mountain and Texels can absorb Cu 50% more efficiently than Scottish Blackface, and Texel cross Blackface 145% more efficiently than pure Blackface lambs. The susceptibility to Cu deficiency, or protection from Cu poisoning, is influenced from birth by genetic effects. These affect Cu status of the lamb at birth, through the maternal environment controlled by the dam's genes and the effect of the lamb's own genes. These genetic differences have physiologic consequences, reflected in differences in the incidence of swayback, both between and within breeds, and in effects on growth and possibly on reproduction. The differences are attributable to genetic differences in the efficiency of absorption of dietary Cu.

In sheep, the existence of genes determining plasma Cu has been shown by the continued selection for high and low concentrations in closed lines of a single breed. Ram selection was made on the basis of plasma Cu concentrations at 18 and 24 weeks of age, with this trait having a heritability of 0.3, similar to that calculated for Angus cattle.<sup>3</sup> The high-line ewes retain more Cu in the liver than the low-line ewes, caused by a positive correlation between the concentration of Cu in plasma and the efficiency of absorption.

Genetic variation in the Cu metabolism of sheep has important physiologic consequences. The incidence of swayback may vary from 0% to 40% between different breeds within the same flock, with the incidence more closely related to differences in the concentration of Cu in the liver than in blood. When high and low female lines are placed on improved and limed pasture, which can induce a severe Cu deficiency, swayback, dullness, lack of vigor, and mortality are evident in lambs soon after birth. At 6 weeks of age the mortality rate was higher in the lambs from the low-Cu line and they were 2 kg lighter than those from the high-Cu line.

Goats are more prone to Cu deficiency than sheep, probably as a result of lower accumulation of liver Cu. The dietary requirement for goats is 8 to 10 ppm Cu. However, an intake of Cu that could cause toxicity in sheep (100 to 150 ppm) enhanced growth rate and immune function and did not cause toxicity in Boer crossbred goats.<sup>4</sup>

Cattle are less efficient absorbers of Cu, with evidence for genetic differences between breeds growing stronger. For example, certain breeds, such as Simmental and Charolais, may have higher Cu requirements than other breeds, such as Angus. Based on an assessment of liver Cu, diets containing 4.4 or 6.4 mg of Cu/kg DM did not meet the requirements of either Angus or Simmentals during gestation and lactation or growth, but the addition of 7 mg of copper/kg DM to both diets met the requirements of both breeds. Similar to sheep, these differences are

probably related to differences in Cu absorption.

#### *Fetal Liver Copper*

During gestation, the concentration of Cu in the ovine and bovine fetal liver progressively increases, whereas it decreases in the maternal liver. The bovine fetus obtains Cu by placental transfer, and thus at birth the liver concentration of Cu is initially high and then declines to normal adult levels within a few months. Placental transfer is less efficient in sheep, and thus lambs are often born with low liver reserves, making them susceptible to Cu deficiency.

In deficient cattle, the accumulation of liver Cu in the fetus continues independent of the dam's liver Cu until the fetus is about 180 days, after which it gradually declines. In contrast, the liver Cu concentration in fetuses from dams on adequate diets continues to increase. Thus during the last month of pregnancy the daily requirement for Cu in cattle increases to about 70% above maintenance requirements, so the dietary allowance of 10 mg/kg DM increases to 25 mg/kg DM during pregnancy.

Colostrum is rich in Cu, allowing the newborn to absorb Cu and increase its hepatic stores. The Cu content of milk then declines rapidly and is usually unable to meet the requirements of the suckling neonate. Young milk-fed animals absorb about 80% of Cu intake, but this efficiency declines rapidly as the rumen becomes functional, when only 2% to 10% of available Cu is absorbed.

#### **Dietary Factors**

##### *Pasture Composition*

The absorption (or availability) of Cu is influenced by the type of diet; the presence of other substances in the diet, such as Mo, sulfur, and iron; the interaction between the type of diet and the chemical composition of the diet; and the genetic constitution of the animals. Copper is well-absorbed from diets low in fiber, such as cereals and Brassicas. However, it is poorly absorbed from fresh pasture, although conservation as hay or silage generally improves its availability. This explains why Cu deficiency is predominantly a problem of grazing ruminants but only rarely seen in housed animals fed diets with adequate Cu.

##### *Molybdenum and Sulfur*

Only small increases in the molybdenum (Mo) and sulfur (S) concentration of grass will cause major reductions in the availability of Cu. This is especially so for ruminants grazing improved pastures in which the Mo and S concentrations are increased. The Cu content of feedstuffs should be expressed in terms of available copper concentration, using appropriate equations, which permits a more accurate prediction of clinical disease and can be used for more effective control strategies.<sup>1</sup>

The effect of Mo and S on the availability of copper in grass is changed by conservation; at a given concentration of S, the antagonistic effect of Mo is proportionately less in hay than in fresh grass. At a low concentration of Mo, the effect of S is more marked in silage than in fresh grass, but the use of formaldehyde as a silage additive may weaken the Cu-S antagonism. Thus herbage high in Mo should be used for conservation when possible, and sulfuric acid should not be used as an additive for silage unless accompanied by a Cu salt because it significantly raises the S concentration of the silage.

An Mo-induced secondary copper deficiency in cattle has occurred when motor oil containing Mo bisulfide was spilled onto pasture.

##### *Copper in the Diet*

In general, pasture containing less than 3 mg/kg DM of copper will result in signs of deficiency in grazing ruminants. Concentrations of 3 to 5 mg/kg DM are marginal, whereas greater than 5 mg/kg DM (preferably 7 to 12) is safe unless Mo-S interactions cause secondary copper deficiency. These complex interactions require an examination of each particular set of circumstances. For example, plant Mo concentrations are directly related to the soil pH. Grasses grown on strongly acidic Mo-rich soils have low Mo (<3 mg/kg DM), whereas those growing on alkaline Mo-poor soils may contain up to 17 mg/kg DM. Thus conditioned copper deficiency can be related to enhanced levels of plant-available Mo rather than the absolute soil levels. Heavily limed pastures are often associated with a less-than-normal intake of Cu and a low copper status of sheep grazing them.

Secondary copper deficiency is also recorded in pigs when drinking water contains very large amounts of sulfate.

##### *Dietary Iron*

Dietary iron can interfere with Cu metabolism.<sup>1,5</sup> Concentrations of iron in silage and pasture forage can range from 500 to 1500 mg/kg DM or higher and can induce Cu deficiency in ruminants when Cu intake is marginal or Mo and S intake is increased. Ruminants obtain iron from ingested soil and mineral supplements. In areas where hypocuprosis is likely to occur, the risk can be minimized by avoiding mineral supplements with high iron content, minimizing the use of bare winter pasture, and avoiding excessive contamination of silage with soil during harvesting. The effect of soil ingestion on Cu deficiency can vary, which is understandable given the differences in soil physical and chemical composition (principally pH, Fe, Mo, and S).<sup>6</sup>

##### *Stored Feeds*

Livestock that are housed for all or part of the year have a different dietary intake of Cu



compared with those on pasture. Concentrates and proprietary feeds usually contain adequate Cu, whereas pasture is more likely to be deficient, especially in early spring when the grass growth is lush. Consequently, silage may be Cu deficient, but hay is more mature and usually contains more of all trace elements and minerals, and hence housed animals are usually protected against Cu deficiency for a few weeks after they come out onto pasture in the spring. In these circumstances, young, rapidly growing animals will be the first affected by hypocuprosis.

#### Soil Characteristics

**Copper Deficiency.** In general, there are two types of soil in which Cu deficiency occurs. First are the sandy soils, poor in organic matter and heavily weathered, such as on the coastal plains of Australia and marine and river silts (these are often deficient in other trace elements, especially cobalt). The second important group is “peat” or muck soils reclaimed from swamps, which are more commonly associated with Cu deficiency in the United States, New Zealand, and Europe. These soils may have an absolute deficiency of Cu, but more commonly it is not available to plants, and so they do not contain adequate amounts of Cu.

The cause of the lack of availability of the copper is uncertain, but is probably a result of the formation of insoluble organic copper complexes. An additional factor is the production of secondary copper deficiency on these soils because of their high content of molybdenum. The concentration of Cu in a range of soils and plants is summarized in Table 21-9.

**Molybdenum Excess.** Pastures containing less than 3 mg/kg DM of molybdenum (Mo) are usually safe, but disease may occur at 3 to 10 mg/kg DM if the intake of Cu is low. Pastures containing greater than 10 mg/kg DM of molybdenum are of high risk unless the diet is supplemented with Cu. Soil Mo

may be as high as 10 to 100 mg/kg, which can be exacerbated by the application of Mo in fertilizer to increase the fixation of nitrogen by legumes.

In the United Kingdom, much farming land is underlain by marine black shales, which are rich in Mo, and hence there is a high concentration of Mo in soil and pastures, and secondary Cu deficiency is common. Secondary Cu deficiency also occurs in cattle in many parts of Canada. For example, large areas of west-central Manitoba are underlain by molybdeniferous shale bedrocks, and soils can contain up to 20 mg/kg of molybdenum.

In New Zealand, some peat soils or the heavy application of Mo in superphosphate to stony soils can produce pastures with a Mo concentration of 3.5 to 20 mg/kg DM, which can induce Cu deficiency. For example, increasing the pasture Mo concentrations from 2 to 4.6 mg/kg DM significantly reduced serum and liver Cu concentrations in grazing red deer, and reduced growth rate occurred when pasture Mo was greater than 10 mg/kg DM. However, an assessment of the elemental composition of pastures found that 95% of pastures from over 800 farms in New Zealand had a Mo content less than 2 mg/kg DM.<sup>7</sup> This, combined with increasing reports of lethal Cu toxicity in dairy herds associated with overly exuberant supplementation, suggests that Mo-induced copper deficiency may not be as widespread as thought.

#### PATHOGENESIS Effects on Tissues

Copper is incorporated into and essential for the activity of many enzymes, cofactors, and reactive proteins.<sup>1</sup> Some pivotal functions of major enzymes include cellular respiration (cytochrome oxidase), protection from oxidants (superoxide dismutase [SOD], ceruloplasmin), the transport of iron (ceruloplasmin [ferroxidase I] and hepcetin [ferroxidase II]), conversion of tyrosine to melanin

(tyrosinase), and the formation of collagen and elastin (lysyl oxidase). Consequently, the consequences of Cu deficiency are diverse but relate to decreased function of Cu metalloenzymes and Cu-binding proteins.

SOD acts as an antioxidant by the dismutation of superoxide anions ( $O_2^-$ ), producing molecular oxygen and hydrogen peroxide ( $H_2O_2$ ), with the latter usually metabolized by glutathione peroxidase and catalase. The ferroxidase activity of ceruloplasmin mediates the oxidation of ferrous ions ( $Fe^{2+}$ ) to the ferric state ( $Fe^{3+}$ ), thereby preventing ferrous ion-dependent formation of hydroxyl radicals (OH) via the Fenton reaction. In Cu-deficient animals, the activities of SOD and glutathione peroxidase are decreased, causing increased oxidative damage to cells from lipid peroxidation. Ceruloplasmin is the predominant Cu-containing protein in plasma, but it also acts as an antioxidant by scavenging free radicals in many tissues.

The pathogenesis of most of the lesions seen with Cu deficiency is explained in terms of faulty tissue oxidation associated with the failure of these enzyme systems. This role is exemplified by failure of myelination, which produces swayback and enzootic ataxia, or wool abnormalities (“steely wool”) in deficient sheep, after myelination is complete. Reduced growth (abnormal bone and cartilage) is also influenced by reduced lysyl oxidase activity, decreased pigmentation (white bands in the wool of pigmented sheep, changed coat color in cattle) by reduced tyrosinase activity, and a terminal anemia by reduced ferroxidase activity.

#### Changes in Gene Expression

Differences in the expression of genes associated with Cu metabolism have been demonstrated in Cu-deficient cattle, including less duodenal Cu transporter 1 (*Ctrl*) and up-regulation of genes in the liver of Cu-deficient fetuses (antioxidant 1 [*Atox1*]), cytochrome c oxidase assembly protein 17 (*Cox17*), and copper metabolism MURR domain 1 (*Comm1*).<sup>8</sup> In naturally occurring Cu deficiency of Angus cattle in Argentina, cytogenetic analysis of peripheral lymphocyte cultures found a significant increase in the frequency of abnormal metaphases in moderate to severely deficient groups.

#### Wool

Loss of crimp causes “stringy” or “steely” wool with reduced tensile strength, which is most obvious in Merinos. This follows inadequate keratinization, probably as a result of imperfect oxidation of free thiol groups. Provision of Cu to affected sheep is followed by oxidation of these free thiol groups and a return to normal keratinization within a few hours.

#### Body Weight

Poor growth is a feature of the later stages of Cu deficiency, more often associated with

**Table 21-9** Copper levels of soils and plants in primary and secondary copper deficiency

Condition	Area	Soil type	Soil copper (mg/kg)	Plant copper (mg/kg DM)
Normal	—	—	18–22	11
Primary copper deficiency	Western Australia	Various	1–2	3–5
	New Zealand	Sand	0.1–1.6	3
	New Zealand	Peat	—	3
	Holland	Sand	—	<3
Secondary copper deficiency	New Zealand	Peat	5	7
	Britain	Peat	—	7–20
	Britain	Limestone	—	12–27
	Britain	Stiff clay	—	11
	Ireland	Shale deposits, peat marine, alluvial soils	—	—
	Holland	Sand	—	>5
Canada	Burned-over peat	20–60	10–25	

excess Mo, when the impairment of tissue oxidation causes interference with intermediary metabolism and loss of condition or failure to grow in sheep, cattle, and deer. This can be accompanied by poor feed-conversion efficiency if Mo-induced Cu deficiency begins in utero.<sup>9</sup>

### Diarrhea

The pathogenesis of diarrhea in Mo-induced secondary Cu deficiency (peat scours, tear) is uncertain. There are no histologic changes in gut mucosa of naturally affected cattle, although villous atrophy was recorded in severe experimental cases. Sheep and goats are far less susceptible to diarrhea induced by molybdenosis, although it can occur.

### Anemia

Anemia develops with severe or prolonged Cu deficiency and is associated with the role of Cu in the formation of hemoglobin. Hemosiderin deposits in the tissues of deficient animals suggest that Cu is necessary for the recycling of iron released from the normal breakdown of hemoglobin. There is no evidence of excessive hemolysis. Heinz-body anemia, an indicator of oxidative stress, can occur when Cu- or selenium-deficient lambs are moved onto rape (*Brassica napus*). The unusual relationship between Cu deficiency and postparturient hemoglobinuria seen in New Zealand has not been explained.

### Bone

Bone abnormalities vary considerably between and within species of ruminants.<sup>1</sup> The osteoporosis that occurs in some natural cases of Cu deficiency is caused by the depression of osteoblastic activity. In experimentally induced primary Cu deficiency, the skeleton is osteoporotic, and there is a significant increase in osteoblastic activity. There is a marked overgrowth of epiphyseal cartilage, especially at costochondral junctions and in metatarsal bones. This is accompanied by beading of the ribs, enlargement of the long bones, and an impairment of collagen formation. When the Cu deficiency is secondary to dietary excesses of Mo and sulfate, the skeletal lesions are quite different and characterized by widening of the growth plate and metaphysis and active osteoblastic activity.

In foals, Cu deficiency causes severe degenerative disease of cartilage, characterized by breaking of articular and growth-plate cartilage through the zone of hypertrophic cells, resulting in osteochondrosis of the articular-epiphyseal complex (A-E complex). The incidence and severity of osteochondrosis in foals can be decreased by supplementation of the diets of mares during the last 3 to 6 months of pregnancy and the first 3 months of lactation. Foals from nonsupplemented mares have separation of the thickened cartilage from the subchondral bone. Clinical, radiographic, and

biochemical differences occur between copper-deficient and Cu-supplemented foals, and there may be a relationship between low Cu intake in rapidly growing horses, inferior collagen quality, biomechanically weak cartilage, and osteochondritis.

Copper is essential for the function of lysyl oxidase, which produces aldehydic groups on hydroxylysine residues as a prerequisite for eventual cross-link formation in collagen and elastin. Similar lesions in foals have been attributed to zinc toxicity from exposure to pasture polluted by smelters. Experimentally, the addition of varying amounts of zinc to the diet of foals containing adequate Cu will result in zinc-induced Cu deficiency, but there are no effects with zinc intakes up to 580 ppm, and it is suggested that 2000 ppm or higher is necessary to affect Cu absorption in horses.

### Connective Tissue

Copper is a component of the enzyme lysyl oxidase, secreted by the cells involved in the synthesis of the elastin component of connective tissues, and has important functions in maintaining the integrity of tissues such as capillary beds, ligaments, and tendons. Naturally occurring examples of connective tissue dysfunction are rare, but lesions of osteochondrosis described in young farmed red deer and wapiti-red deer hybrids in New Zealand also have defective articular cartilage.<sup>1</sup>

### Heart

The myocardial degeneration of falling disease, now rarely seen, may be a terminal manifestation of anemic anoxia, or it may be a result of interference with tissue oxidation. In this disease, it is thought that the stress of calving and lactation contribute to the development of heart block and ventricular fibrillation when there has already been considerable decrease in cardiac reserve. Experimentally induced Cu deficiency in piglets causes cardiac pathology and electrical disturbances and a marked reduction in growth and hematocrit.

### Blood Vessels

Experimentally induced Cu deficiency has caused sudden death as a result of rupture of the heart and great vessels in a high proportion of pigs fed a Cu-deficient diet. The basic defect is degeneration of the internal elastic laminae. There is no record of a similar, naturally occurring disease. A similar relationship appears to have been established between serum Cu levels and fatal rupture of the uterine artery at parturition in aged mares.

### Pancreas

Lesions of the pancreas may be present in normal cattle with a low blood copper status.<sup>1</sup> The lesions consist of an increase in dry matter content and reduced concentrations of protein and Cu in wet tissue; cytochrome

oxidase activity and protein:RNA ratio are also decreased. There are defects in acinar basement membranes, splitting and disorganization of acini, cellular atrophy and dissociation, and stromal proliferation.

### Nervous Tissue

Copper deficiency halts the formation of myelin and causes demyelination in lambs, probably by a specific relationship between Cu and myelin sheaths. Defective myelination can commence in the midterm fetus, causing lesions in the cerebrum, with lambs affected at birth (congenital swayback), or lesions in the white matter of the spinal cord in delayed cases of enzootic ataxia (the predominant form in goats and deer). This distribution reflects peaks of myelin development at those sites, at 90 days of gestation and 20 days after birth. Copper deficiency interferes with the synthesis of phospholipids, and anoxia may also be involved in demyelination. Anemic anoxia is more likely in highly deficient ewes, and anemic ewes produce a higher proportion of lambs with enzootic ataxia. However, there is often no anemia in ewes that produce lambs with the more common subacute form of nervous disease. Severely deficient ewes tend to have lambs affected at birth, whereas the lambs of less severely deficient ewes have normal myelination at birth and develop demyelination later.

### Reproductive Performance

There is no clear evidence that Cu deficiency causes infertility in dairy cows, and both improvement and impairment of fertility have been reported in normocupremic cows given parenteral Cu.<sup>1</sup> Copper glycinate given to dairy cattle does not affect the average interval in days between calving and first observed heat, services per conception, or first-service conception rate compared with untreated cows in the same population. Experimentally, the addition of Mo to the diet of heifers delayed the onset of puberty, decreased the conception rate, and caused anovulation and anestrus in cattle without accompanying changes in Cu status or live-weight gain. Thus the presence of Mo rather than low Cu status may affect the reproductive performance of cattle. It is inadvisable to ascribe poor reproductive performance to subclinical hypocuprosis on the evidence of low blood Cu alone, and other factors, such as management and energy and protein intake, should be examined.

### Immune System

Copper has an important role in the immune response, but the precise mechanism is not well understood. In secondary Cu deficiency in cattle, induced by 30 ppm molybdenum and 225 ppm sulfate, the intracellular copper content of peripheral blood lymphocytes, neutrophils, and monocyte-derived macrophages was reduced between 40% and 70%.

In Cu deficiency, serum ceruloplasmin activity is decreased to 50% of control values, and superoxide dismutase and cytochrome c oxidase activities of leukocytes are significantly reduced. Thus Cu deficiency alters the activity of several key enzymes that mediate antioxidant defense and ATP formation. These effects may impair cellular immune function and make animals more susceptible to infection.

Copper deficiency decreases humoral and cell-mediated immunity and reduces nonspecific immunity regulated by phagocytic cells, such as macrophages and neutrophils. The decreased resistance to infection in deficient sheep responds to treatment with Cu, but also genetic selection, with mortalities from birth to 24 weeks of age 50% lower in lambs genetically selected for high concentrations of plasma Cu compared with those selected for low concentrations. Experimental viral and bacterial infections of cattle can also cause a rapid, although transient, increase in serum ceruloplasmin and plasma Cu in Cu-replete animals, suggesting a major protective role for copper in infectious diseases. These changes evolve from an interleukin-1-mediated increase in hepatic synthesis and release of ceruloplasmin, an acute-phase protein. The concentration of Cu in organs involved in immune regulations, such as the liver, spleen, thymus, and lung, is substantially reduced by Cu deficiency, again suggesting that deficient animals have a greater risk of infection than Cu-adequate ones. However, experiments using low-Cu diets, with or without supplemental Mo, did not alter specific indicators of immunity in stressed cattle.

The severity of Cu depletion needed for immune dysfunction is less than that required to induce clinical signs of Cu deficiency, and endogenous Cu may contribute to the regulation of both nonimmune and immune inflammatory responses. Low-molecular-weight complexes may have an antiinflammatory effect in animal models of inflammation, and it is postulated that the increased plasma Cu-containing components seen during inflammatory disease represent a physiologic response.

In experimental coliform mastitis in Holstein heifers fed 20 mg Cu/kg DM, from 60 days prepartum to day 42 of lactation, the clinical response but not duration of mastitis was reduced compared with animals receiving 6.5 mg Cu/kg DM. In a subsequent experiment, supplementation a basal diet of 7.1 mg Cu/kg DM with 10 mg/kg Cu DM with an organic supplement (Cu proteinate) tended to be more effective than an inorganic one (with Cu sulfate), although somatic cell count, plasma Cu, and plasma ceruloplasmin were not significantly different.<sup>10</sup>

### Development of Clinical Signs

In experimental Cu deficiency in calves, beginning at 6 weeks of age, hypocupremia

developed at 15 weeks, growth retardation from 15 to 18 weeks, rough hair coat at 17 weeks, diarrhea at 20 weeks, and leg abnormalities at 23 weeks. Thus the appearance of clinical signs correlated reasonably well with the onset of hypocupremia and was indicative of a severe deficiency. However, even with severe clinical signs, histologic abnormalities may only be quite minor.

In another study, beginning at 12 weeks of age, clinical signs of Cu deficiency did not develop until after 6 months, with musculoskeletal abnormalities including a stilted gait, “knock-kneed” appearance of the forelimbs, overextension of the flexors, splaying of the hooves, and swellings around the metacarpophalangeal and carpometacarpal joints. Changes in hair pigmentation occurred after about 5 months of deficiency, and diarrhea occurred between 5 and 7 months after deficiency. The diarrhea stopped within 12 hours after oral administration of 10 mg of Cu.

### Copper–Molybdenum–Sulfate Relationship

The interaction between copper (Cu), molybdenum (Mo), and sulfur (S), and its effects on health and production in ruminants, is unique among mammals.<sup>1</sup> Molybdenum and sulfate, alone or in combination, can affect Cu metabolism. Much of the Cu released in the rumen is precipitated with sulfides (S<sup>2-</sup>) to form Cu sulfide (CuS). In addition, whether derived from organic or inorganic sources, Mo and S bind with Cu in the rumen to form thiomolybdates.<sup>5</sup> These compounds have two effects. First, they reduce the amount of Cu available for absorption, with the Cu–thiomolybdate complexes binding to particulate matter in the digesta and reducing the proportion of Cu absorbed to 1% of that ingested. Second, thiomolybdates can be rapidly absorbed and reversibly bound to Cu in biological compounds, including ceruloplasmin, cytochrome oxidase, superoxide dismutase, and tyrosine oxidase. This induces a secondary Cu deficiency (technically a thiomolybdate toxicosis), with tetrathiomolybdate (MoS<sub>4</sub><sup>2-</sup>) by far the most potent of the thiomolybdates.<sup>5</sup> Thus, secondary (conditioned) Cu deficiency occurs when the dietary intake of Cu is adequate but absorption and utilization of Cu are not. These effects also occur in the fetus, interfering with Cu storage in the fetal liver. In cattle, reduced growth rate and changes in the hair texture and color occur after 16 to 20 weeks of supplementation with Mo, accompanied by decreased feed intake and reduced efficiency of feed utilization.

In addition to the Mo–S–Cu relationship, additional interactions with iron (Fe), selenium (Se), Zinc (Zn), and manganese (Mn) can occur. Iron reduces absorption of Cu by adsorption of Cu into insoluble iron compounds and down-regulation of a Cu carrier

(DMT).<sup>1</sup> In calves, liver and plasma concentrations of Cu decrease and become severely deficient within 12 to 16 weeks of including iron in the diet. In sheep, the administration of Se to sheep on Cu-deficient pastures improves the absorption of Cu.

The toxicity of dietary Mo is determined by the ratio of the dietary Mo to dietary Cu. The critical ratio of Cu:Mo in animal feeds is 2.0, and feeds or pasture with a lower ratio may induce a secondary copper deficiency. For example, in some regions of Canada the Cu:Mo ratio varies from 0.1 to 5.3, with a higher critical ratio of 4 to 5 recommended for safety.

### Copper Utilization

Sulfate and molybdate interfere with mobilization of Cu from the liver, inhibition of Cu intake by the tissues, inhibition of Cu transport (both into and out of the liver), and inhibition of the synthesis of Cu storage complexes and ceruloplasmin.

Clinical signs of hypocuprosis, such as steely wool, occur in sheep on diets containing high levels of Mo and sulfate, even though blood Cu concentrations are high. This suggests that Cu is not available, and hence blood Cu rises in response to this demand.

### Hepatic Storage

If animals are receiving a Cu-deficient diet, and thus Cu is removed from the liver, those supplemented with molybdate plus sulfate retain more Cu in the liver than do animals not being supplemented. This supports the hypothesis that, together, molybdate and sulfate impair the movement of Cu into or out of the liver, possibly by affecting copper transport. Sulfate alone exerts an effect, with an increased intake reducing hepatic storage of both Cu and Mo.

### Phases of Copper Deficiency

The development of a deficiency can be divided into four phases (Fig. 21-4):

1. Depletion
2. Deficiency (marginal)
3. Dysfunction
4. Disease

During the depletion phase, there is loss of Cu from storage, principally liver storage, but the plasma concentrations of Cu remain constant. With continued dietary deficiency the concentrations of Cu in the blood decline during the phase of marginal deficiency. However, it may be some time before the concentrations or activities of copper-containing enzymes in the tissues begin to decline, and it is not until this happens that the phase of dysfunction is reached. There may be a further lag before the changes in cellular function are manifested as clinical signs of disease.

### CLINICAL FINDINGS

The general effects of Cu deficiency are the same in sheep and cattle, but in addition to



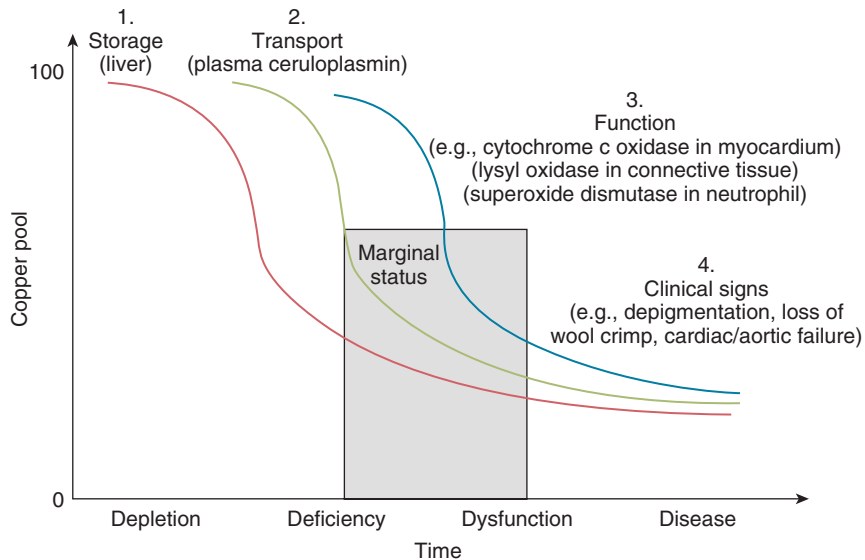

**Fig. 21-4** The biochemical changes that lead to copper deficiency and disease. (From Suttle NF. The mineral nutrition of livestock, 4th ed., Wallingford, Oxon: CAB International, 2010: 255-305.)

these general syndromes there are specific syndromes more or less restricted to species and to areas. Following is a general description of disease caused by Cu deficiency, then details of specific syndromes of enzootic ataxia, swayback, falling disease, peat scours, teart, and unthriftiness (pine).

## Cattle

### Subclinical Hypocuprosis

No clinical signs occur, plasma Cu is marginal (<9.0 mmol/L [57 mg/dL]), and there is a variable response after supplementation with Cu. Surveys in some Cu-deficient areas show that about 50% of beef herds and 10% of dairy herds within the same area have low blood Cu associated with a low dietary intake from pasture (natural forages). Deficiency will only be suspected if production is monitored and found to be suboptimal.

A feature of subclinical hypocuprosis under field conditions is the wide variation in increased growth rate when cattle of the same low-Cu status are given supplementary Cu.

### General Syndrome

#### Primary Copper Deficiency

Primary deficiency causes unthriftiness, decreased milk production, and anemia in adult cattle. The coat becomes rough, and its color is affected, with red and black cattle changing to a bleached, rusty red. In severely deficient states, which are now uncommon, calves grow poorly, and there is an increased tendency for bone fractures, particularly of the limbs and scapula. Ataxia may occur after exercise, with a sudden loss of control of the hindlimbs and the animal falling or assuming a sitting posture and then returning to normal after rest. Itching and hair-licking are also seen in Cu-deficient cattle.

Although diarrhea may occur, persistent diarrhea is not a characteristic of primary Cu deficiency, and its occurrence should arouse suspicion of molybdenosis or helminthiasis. In some areas, affected calves develop stiffness and enlargement of the joints and contraction of the flexor tendons, causing them to stand on their toes. These signs may be present at birth or before weaning. Unlike in sheep, paresis and incoordination are not seen.

An increased occurrence of postparturient hemoglobinuria is also recorded in New Zealand, but it is not well understood.

#### Secondary Copper Deficiency

Signs can be similar to primary Cu deficiency, although anemia is less common, probably as a result of the relatively better Cu status in secondary deficiency. For example, anemia occurs in peat scours of cattle in New Zealand when the Cu intake is marginal. However, with increased Mo intake, there is a tendency for diarrhea, particularly in cattle.

#### Falling Disease

The characteristic behavior in falling disease is for apparently healthy cows to throw up their heads, bellow, and fall. In most cases death is instantaneous, but some cattle struggle on their sides for a few minutes, with intermittent bellowing, paddling, and attempts to rise. Rare cases show signs for up to 24 hours or more. These animals periodically lower their heads and pivot on the front legs, with sudden death usually occurring during one of these episodes.

#### Peat Scours ("Teart")

Persistent diarrhea, with watery, yellow-green to black feces with an inoffensive odor, occurs soon after the cattle start grazing

affected pasture, in some cases within 8 to 10 days. Defecation often occurs without lifting of the tail. Severe debilitation is common, although appetite remains. The hair coat is rough, with depigmentation manifested by reddening or gray flecking, especially around the eyes in black cattle. These signs vary greatly from season to season, and spontaneous recovery is common. Affected animals usually recover in a few days following treatment with Cu.

#### Unthriftiness (Pine) of Calves

The earliest signs are a stiff gait and ill-thrift. The epiphyses of the distal ends of the metacarpus and metatarsus may be enlarged and resemble the epiphysitis of rapidly growing calves deficient in vitamin D or calcium and phosphorus. The epiphyses are painful on palpation, and some calves are severely lame. The pasterns are upright, and the animals may appear to have contracted flexor tendons. Progressive ill-thrift and emaciation progress and can lead to death in 4 to 5 months. Gray hair occurs, especially around the eyes of black cattle, and diarrhea may occur in a few cases.

## Sheep

### General Syndrome

#### Primary Copper Deficiency

Abnormalities of the wool are the first, and often only, sign in areas of marginal deficiency. Fine wool loses its crimp and luster, assuming a straight, "steely" appearance. This is more obvious in Merinos but can occur in meat breeds with broader and plainer wool. Dark wool loses pigment to become gray or white, often in bands coinciding with the seasonal occurrence of Cu deficiency. Anemia, scouring, unthriftiness, and infertility may occur in conditions of extreme deficiency, but in sheep the characteristic findings are swayback or enzootic ataxia in lambs. Reduced growth, diarrhea, and increased mortality are seen in lambs genetically selected for low plasma Cu when they are grazed on improved and limed pastures. Osteoporosis with fractures of the long bones is also recorded with Cu deficiency that was not severe enough to cause enzootic ataxia.

#### Swayback and Enzootic Ataxia in Lambs and Goat Kids

Swayback and enzootic ataxia have a lot in common, but there are subtle differences in their clinical signs and epidemiology.

Swayback is the only true manifestation of a primary deficiency of Cu in the United Kingdom. Its prevalence can vary considerably, reflecting genetic differences in Cu metabolism, both between and within breeds of sheep. A congenital cerebrospinal form occurs when the Cu deficiency is extreme. Affected lambs are born dead or weak and are unable to stand and suckle. They have spastic paralysis, are more uncoordinated with erratic movements compared with

enzootic ataxia, and are occasionally blind. There is softening and cavitation of the cerebral white matter, which corresponds to demyelination of the cerebral cortex commencing around day 120 of gestation. Progressive (delayed) spinal swayback is characterized by a stiff and staggy gait and hindlimb incoordination, and it appears at 3 to 6 weeks of age. In Wales, a third form in older lambs is associated with cerebral edema. It resembles the more usual delayed form, but it develops suddenly with onset of recumbency and death within 1 to 2 days.

Enzoootic ataxia occurs in unweaned lambs. In severe outbreaks, lambs may be affected at birth, but most cases occur at 1 to 2 months of age. The severity of the paresis decreases with increasing age at onset. Lambs affected at birth or within the first month usually die within 3 to 4 days, whereas older lambs may survive for 3 to 4 weeks or longer. However, surviving lambs always have some ataxia and atrophy of the hindquarters. The first sign of enzoootic ataxia is incoordination of the hindlimbs, often when the lambs are mustered. Cardiac and respiratory rates are greatly increased by exertion, and incoordination progressively becomes more severe and may be obvious after walking only a few meters. There is excessive flexion of joints, knuckling of the fetlocks, wobbling of the hindquarters, and finally falling. The hindlegs are affected first, and the lamb may be able to drag itself about in a sitting posture. When the forelegs are eventually involved, recumbency persists, and the lamb dies of starvation. However, there is no true paralysis because the lamb is able to kick vigorously, even in the recumbent stage, and appetite is unaffected.

### Goats

Enzoootic ataxia attributable to Cu deficiency occurs in goat kids. The disease is similar in most respects to that in lambs, except cerebellar hypoplasia is a frequent finding in goats. Kids may be affected at birth, or the clinical signs may be delayed until the animals are several weeks of age.

### Other Species

#### Deer

Enzoootic ataxia of red deer is quite different from the disease in sheep in that it develops in weaned deer and adults. Clinical signs include ataxia, swaying of the hindquarters, a dog-sitting posture, and, eventually, hindlimb paresis. This is associated with demyelination of the spinal cord and neuronal degeneration in the midbrain.

Osteochondrosis of young, farmed deer in New Zealand is characterized by lameness, one or more swollen joints, an abnormal “bunny-hopping” gait, and “cow-hocked” stance. In Australia, secondary Cu deficiency of red deer during drought was associated with weight loss in lactating hinds and steely hair coats of reduced luster, similar to steely

wool of Cu-deficient sheep. This was associated with the high sulfur content of the diet, possibly exacerbated by ingestion of iron from increased soil ingestion when supplementary feed was trailed onto the ground.

### Pigs

Naturally occurring enzoootic ataxia has occurred in 4- to 6-month-old growing pigs, with posterior paresis progressing to complete paralysis in 1 to 3 weeks. Liver Cu concentration was 3 to 14 mg/kg (0.05 to 0.22 mmol/kg), but dosing with Cu salts had no effect on the clinical condition. Copper deficiency in piglets 5 to 8 weeks of age has been described, characterized by ataxia, posterior paresis, nystagmus, inability to stand, paddling of the limbs, and death in 3 to 5 days. Lesions included demyelination of the spinal cord and degeneration of the elastic fibers of the walls of the aorta and pulmonary arteries.

Including 125 to 250 mg/kg of Cu (as Cu sulfate) in the diet of growing pigs (11 to 90 kg) fed ad libitum results in slight improvements in growth rate and feed efficiency, but has no significant effect on carcass characteristics. The addition of Cu causes a marked increase in liver Cu, which is a potential food hazard, and so it is recommended that Cu supplementation be limited to starter and grower diets fed to pigs weighing less than 50 kg.

### Horses

Adult horses are not affected by Cu deficiency, but there are anecdotal reports of limb abnormalities in foals. Foals in Cu-deficient areas may be unthrifty and slow-growing, with limb stiffness, enlarged joints, and contraction of the flexor tendons, which causes the animal to stand on its toes. Signs may be present at birth or develop before weaning, but there is no ataxia or involvement of the central nervous system. Affected foals recover slowly after weaning but can display ill-thrift for up to 2 years.

In Australia, geophagia (soil eating) in horses has been associated with higher concentrations of iron and Cu in soil, suggesting that these elements are a stimulus for geophagia.

### CLINICAL PATHOLOGY

The laboratory evaluation of the copper status of farm animals can be complex, with biochemical values often difficult to interpret and correlate with the clinical state of animals as they progress through the phases of Cu depletion, marginal deficiency, dysfunction, and disease (Fig. 21-4). Consequently, testing is usually undertaken on a herd basis, rather assessing the Cu status of individual animals. Guidelines for the laboratory diagnosis of primary and secondary Cu deficiency in cattle and sheep are summarized in Table 21-10.

**Table 21-10** Concentrations of copper in plasma, liver, milk, and hair; dietary intake and ratios of copper and its antagonists in normal, marginal, and copper-deficient situations

Species and tissue	Normal	Marginal	Primary [secondary] copper deficiency
<b>Cattle</b>			
Plasma ( $\mu\text{mol/L}$ ) <sup>A</sup>	10–20	3–9	<8 (often 1.6–3.2)
Adult liver ( $\mu\text{mol/kg DW}$ ) <sup>B</sup>	380–1600	160–380	<160
Milk (mg/L)	0.05–0.20	0.02–0.05	0.01–0.02
Hair (mg/kg)	6.6–10.4	4–8	1.8–3.4 [5.5]
<b>Sheep</b>			
Plasma ( $\mu\text{mol/L}$ )	10–20	3–9	1.6–3.2 [6.3–11]
Adult liver ( $\mu\text{mol/kg DW}$ )	350–3140	100–300	10–100
Milk	3.1–9.4	0.3–3.0	0.16–0.30
<b>Deer</b>			
Plasma ( $\mu\text{mol/L}$ )	>8	5–8	<5
Adult liver ( $\mu\text{mol/kg DW}$ )	>400	240–400	<240
<b>Pasture {forage}<sup>1</sup></b>			
Cu (mg/kg DM)	10 <sup>D</sup>	6–8 [4–6]	
Cu: Mo ratio	>2.0 (beef cattle growth)–4.0 (to prevent swayback) <sup>E</sup>	1.0–3.0 [0.5–2.0] <sup>F</sup>	
Fe: Cu ratio	15–20	–	[50–100]

<sup>A</sup>Divide by 15.7 to convert to  $\mu\text{g/mL}$ ; neonatal liver from 3000–6000  $\mu\text{mol/kg DW}$ .

<sup>B</sup>Multiply by 4 to convert to fresh weight.

<sup>C</sup>This ratio is quite variable and influenced by other antagonists (Fe, S, Mn, and Zn).

<sup>D</sup>When dietary Mo is < 1.5 mg/kg.

<sup>E</sup>When dietary Mo is < 8 mg/kg for sheep and < 1.5 mg/kg for cattle.

**Herd Diagnosis.** The diagnosis of copper deficiency in a herd is based on the collection and interpretation of the history, clinical examination of affected animals, laboratory tests on blood and liver samples, and examination of the environment, including analysis of the feed, water, and, occasionally, soil.

When collecting samples for analysis, it is important to avoid contamination, which can occur with Cu-distilled water, vial caps, specimen containers, and other endogenous sources of Cu. Intercurrent disease may also affect plasma Cu concentrations.

**Treatment Response Trial.** A comparison between a group of animals treated with Cu and a similar group not treated is often a cost-effective and desirable approach. Variables include growth rates, mortality, and reproductive performance.

**Copper Status of Herd or Flock.** To assess the copper status of herd or flock, a standard practice is to take blood samples at random from at least 10% of clinically affected and 10% of normal animals. However, this may be inappropriate when there is a wide variability in the blood Cu within a herd. In some cases a 10% sample may be too large, whereas in others too small. The minimal sample size for random samples from a finite population of a normal continuously distributed variable can be calculated as follows:

$$\{n = t_2 cv - 2 / [(N1)E_2 t_2 cv - 2]\}$$

where  $n$  = minimal sample size;  $N$  = herd size;  $t$  = Student's  $t$  value;  $cv$  = coefficient of variation; and  $E$  = allowable error.

Initial testing can be used to estimate the variability of serum or plasma Cu concentration within a herd, which will help calculate a minimum sample size for more detailed investigations. This may differ between each class of animal according to age, diet, and production status, so a range of groups should be sampled if appropriate. Follow-up samples can be taken from the same animals following therapy or the institution of control measures.

### Laboratory Diagnosis

Historically, laboratory tests for Cu deficiency in cattle and sheep have centered on the measurement of blood and liver Cu. However, because of the relationships summarized in Fig. 21-4, estimates of serum or plasma Cu, by themselves, are not reliable as the sole indicator of Cu status. Within an affected herd, clinically normal animals may have normal or marginal values, whereas unthrifty animals may have marginal or deficient values. Furthermore, when either the normal animals with marginal values or the unthrifty animals with the marginal or deficient values are treated with Cu, there may or may not be an improvement in weight gain, as might be expected in the former, or

improvement in clinical condition in the latter. Consequently, liver samples, collected either by biopsy or at slaughter, can be used to more accurately assess Cu status.

In addition, for most mammalian species values for serum and plasma Cu are interchangeable. However, this is not the case for bovid ruminants, including cattle, sheep, and goats, where there is a significant and variable loss of Cu into the clot. The 95% limits of agreement are similar for sheep and goats, with serum Cu values being from 70% to 104% and 66% to 100% of the corresponding plasma Cu, respectively.<sup>11</sup> However, unlike cattle, sequestration of Cu into the clot in sheep and goats is proportional to the concentration of Cu. Thus although plasma is the preferred sample, the effect of using serum to assess marginal deficiencies is probably minimal, provided the results are not used to assess individual animals. It is recommended that experimental studies should use plasma Cu to estimate the acellular fraction of Cu in blood. In cattle, the difference between serum and plasma Cu is unrelated to Cu status, and thus plasma is the preferred sample, but the difference between serum and plasma ceruloplasmin is proportional to Cu status.<sup>12</sup> Sequestration of Cu into the clot does not occur in deer.<sup>13</sup>

### Interpretation of Laboratory Results

The liver is the main storage site of Cu, and so the first sign of depletion is a decline in liver Cu (Fig. 21-4). Concentrations of liver Cu in replete neonatal calves and lambs are much higher than those in adults: 3000 to 6000  $\mu\text{mol/kg}$  DW (190 to 380 mg/kg DW), which corresponds to 750 to 1500  $\mu\text{mol/kg}$  fresh weight (FW) (50 to 95 mg/kg FW).

When liver reserves of Cu are close to being exhausted, ceruloplasmin synthesis decreases and plasma Cu falls.<sup>1</sup> Broad guidelines are that an average value less than 9  $\mu\text{mol/L}$  (57  $\mu\text{g/dL}$ ) indicates marginal deficiency, but plasma Cu may have to fall to below 3  $\mu\text{mol/L}$  (19  $\mu\text{g/dL}$ ) before there is dysfunction and lost production in sheep and cattle. However, there is considerable biological variation according to species, breed, the time during which depletion has occurred, and the presence of intercurrent disease.

Estimates of Cu in liver and blood are of diagnostic value, but they should be interpreted with caution because clinical signs of deficiency may appear before there are significant changes in these measures. Conversely, the plasma Cu may be very low in animals that are otherwise normal and performing well. For example, in the Netherlands the Cu status of groups of dairy heifers was monitored at regular intervals for 18 months. One group was supplemented with Cu sulfate, and the other was not. The concentrations of Cu and Mo in pasture were within normal limits for the Netherlands: 7 to 15 mg Cu/kg DM and less than 5 mg Mo/

kg DM. The concentration of Cu in both blood and liver was below the reference ranges used in that country (6 to 15  $\mu\text{mol/L}$  in blood and > 470  $\mu\text{mol/kg}$  [30 mg/kg] DW in liver), but no clinical signs of Cu deficiency occurred, and there were no differences in growth rate and reproductive performance. This highlights that the ranges used to indicate marginal and deficient Cu status can vary between veterinary laboratories, and the thresholds for marginal status may often be set too high.

### Cattle and Sheep

The internationally recognized threshold for Cu deficiency in the plasma of cattle and sheep is 9.4  $\mu\text{mol/L}$ . A plasma Cu concentration between 3.0 and 9.0  $\mu\text{mol/L}$  (19 to 57  $\mu\text{g/dL}$ ) is interpreted as marginal deficiency, and less than 3  $\mu\text{mol/L}$  (19  $\mu\text{g/dL}$ ) is interpreted as a functional deficiency or hypocuprosis. In both species, 11  $\mu\text{mol/L}$  is associated with adequate liver Cu (790 to 3750  $\mu\text{mol/kg}$  DW [50 to 240 mg/kg]). A decrease to 9.3  $\mu\text{mol/L}$  can indicate liver Cu values of 315 to 790  $\mu\text{mol/kg}$  DW (20 to 50 mg/kg DW), which is interpreted as marginal in some areas, and a plasma Cu less than 7.9  $\mu\text{mol/L}$  (50  $\mu\text{g/dL}$ ) is associated with low liver Cu.

Of the two measures, liver Cu is the most informative about deficiency because the concentration of Cu in plasma can remain normal long after liver stores start to decrease and early signs of Cu deficiency appear. Normal concentrations of Cu in adult liver are 1570 and 3140  $\mu\text{mol/kg}$  DW (100 and 200 mg/kg DW) for cattle and sheep, respectively. Those from 160 to 380  $\mu\text{mol/kg}$  DW (11 to 24 mg/kg DW) are classed as marginal, and less than 160  $\mu\text{mol/kg}$  DW (10 mg/kg DW) as low. However, the lower critical value is influenced by species and breed. In New Zealand, a liver Cu concentration of 45 to 95  $\mu\text{mol/kg}$  FW (180–380  $\mu\text{mol/kg}$  DW) in dairy cattle is interpreted as marginal. It is recommended that at least 10 to 12 samples of liver need to be collected at slaughter or biopsy to reliably estimate the liver Cu status of a herd.<sup>14</sup>

Nevertheless, because the liver is the primary storage organ for Cu, estimates of liver Cu indicate a state of depletion rather than deficiency. Consequently, there is no rigid threshold for liver Cu below which the performance and health of livestock will definitely be impaired, and a broad range of values may coincide with a marginally deficient state (say, 80 to 380  $\mu\text{mol/kg}$  DW). In sheep, the concentration of copper throughout the liver is uniform, and thus a single biopsy sample is representative of the whole liver. The frequency of biopsy does not affect Cu concentration, and there is little variability between successive samples.

In calves, the concentration of liver Cu copper varies according to age and class (dairy or beef). In calves submitted for



necropsy, liver Cu concentrations were up to 940  $\mu\text{mol/kg}$  FW (60 mg/kg) higher in dairy than beef calves. The concentration increased to 2 months old, declined until 9 months of age, and then increased again. Thus interpreting liver Cu concentration in calves should account for both age and production class.

Copper concentrations in the kidney cortex may be useful because they have a narrower normal range, 200 to 300  $\mu\text{mol/kg}$  DW (12.7 to 19.0 mg/kg). Thus concentrations less than 200  $\mu\text{mol}$  Cu/kg DW in the kidney may be an indicator of dysfunction.

The difficulties interpreting plasma Cu led to the use of plasma copper-protein complexes, especially ceruloplasmin, which in normal cattle contains more than 80% of the plasma Cu. There is a high correlation between plasma Cu and plasma ceruloplasmin activity (0.83 for cattle and 0.92 for sheep). However, although estimating ceruloplasmin is less complicated and quicker, it is an enzymatic assay and thus inherently more variable than plasma Cu.<sup>1</sup> In cattle, normal plasma ceruloplasmin concentrations range from 15 to 35 IU/L, but calculating a simple ratio of ceruloplasmin activity/plasma Cu does not appear to improve the diagnostic capability of these tests.<sup>15</sup> Estimates for Cu and ceruloplasmin are higher in plasma than serum, with less Cu associated with ceruloplasmin in serum (55%) compared with plasma (66%). In experimental primary Cu deficiency of calves, decreased plasma ceruloplasmin activity occurred at least 80 days before clinical signs of deficiency.

Erythrocyte superoxide dismutase (ESOD), a Cu-containing enzyme, has been used to assess Cu status. In deficient animals the activity of this enzyme decreases more slowly than plasma or liver Cu, and thus it may be a better measure of impending hypocuprosis. ESOD activity ranges from 2 to 5 U/mg hemoglobin in marginal and less than 2 U/mg hemoglobin in functional Cu deficiency.

Anemia can occur in advanced cases of primary copper deficiency, with hemoglobin being as low as 50 to 80 g/L and erythrocytes  $2$  to  $4 \times 10^{12}/\text{L}$ . A high proportion of cows in affected herds may have a Heinz-body anemia without evidence of hemoglobinuria, with the severity of the anemia related to the degree of hypocupremia.

Copper concentrations in milk and hair are lower in deficient cattle compared with normal ones, and thus estimating the Cu content of hair is an acceptable diagnostic test. It also provides a progressive record of the dietary intake of Cu, and it decreases when additional dietary Mo is fed.

### Horses

A threshold of 16  $\mu\text{mol/L}$  is used to distinguish between the normal and subnormal values of plasma Cu in horses, but many

healthy horses have serum values between 12 and 16  $\mu\text{mol/L}$ . Estimates of liver Cu from slaughtered horses varied widely about a mean of 114  $\mu\text{mol/kg}$  FW, and a threshold of 52.5  $\mu\text{mol/kg}$  FW was proposed to distinguish deficient and marginal concentrations. The mean liver and plasma Cu concentrations of horses fed diets containing 6.9 to 15.2 mg Cu/kg DM were 270 to 330  $\mu\text{mol/kg}$  DW and 22.8 to 28.3  $\mu\text{mol/L}$  (3.58 to 4.45  $\mu\text{g/dL}$ ), respectively, but there was no simple mathematical relationship between plasma and liver Cu concentrations.

### Farmed Red Deer (*Cervus Elaphus*)

Suggested reference ranges for deficient, marginal, and adequate serum Cu in deer are less than 5, 5 to 8, and greater than 8  $\mu\text{mol/L}$ , respectively, and for liver Cu are less than 60, 60 to 100, and greater than 100  $\mu\text{mol/kg}$  FW, respectively. Enzootic ataxia and osteochondrosis occur when liver Cu is less than 60  $\mu\text{mol/kg}$  fresh tissue and serum Cu concentrations less than 3 to 4  $\mu\text{mol/L}$ . Growth responses to supplementation are equivocal when blood Cu is less than 3 to 4  $\mu\text{mol/L}$ , but responses are significant when they are 0.9 to 4.0  $\mu\text{mol/L}$ . No antler growth or body-weight response to copper supplementation occurred when blood ceruloplasmin activity was 10 to 23 IU/L (equivalent to serum Cu of 6 to 13  $\mu\text{mol/L}$ ) and liver Cu was 98  $\mu\text{mol/kg}$  FW.

### NECROPSY FINDINGS

The characteristic gross findings in Cu deficiency of ruminants are anemia and emaciation. Hair and wool abnormalities may be present, as described in the section on clinical findings. Extensive deposits of hemosiderin can cause darkening of the liver, spleen, and kidney in most cases of primary Cu deficiency and in the secondary form if the Cu status is sufficiently low. In lambs, there may be severe osteoporosis and long-bone fractures. Osteoporosis is less evident in cattle but can be confirmed radiographically and histologically. In naturally occurring secondary Cu deficiency in cattle, associated with high dietary molybdenum and sulfate, there is widening of the growth plates as a result of abnormal mineralization of the primary spongiosa, resulting in a grossly rachitic appearance to the bones.

The most significant histologic finding in enzootic ataxia is degeneration of axons and myelin within the cerebellar and motor tracts of the spinal cord, with chromatolysis of neurons in a variety of locations within the central nervous system. In a few extreme cases, and in most cases of swayback, myelin loss also occurs in the cerebrum, with destruction and cavitation of the white matter. In these cases there is marked internal hydrocephalus, and the convolutions of the cerebrum are almost obliterated. In affected lambs, acute cerebellar edema, with marked brain swelling and

cerebellar herniation reminiscent of polioencephalomalacia, may accompany the more typical myelopathy and multifocal cerebral leukomalacia.

In falling disease, the heart is flabby and pale, there is generalized venous congestion, and the blood may appear watery. The liver and spleen are enlarged and dark. Histology reveals atrophy of the cardiac muscle fibers and considerable cardiac fibrosis. Deposits of hemosiderin are present in the liver, spleen, and kidney.

Necropsy findings associated with Cu deficiency in nonruminant species are not well documented. Degenerative changes with subsequent rupture of the aorta have been induced experimentally in pigs, but this has not been described as a naturally occurring disease. Myelopathy with white-matter changes similar to those of enzootic ataxia has also been reported in 4- to 5-month-old Cu-deficient pigs. Musculoskeletal changes similar to those described for calves have also been reported in foals with hypocuprosis.

Ideally, necropsy examinations should include assays for Cu, and also Mo if a secondary deficiency is suspected. In primary deficiency the concentration of Cu in liver will usually be low (see Table 21-10), whereas in secondary Cu deficiency there may be elevated kidney Cu and high concentrations of Mo in the liver, kidney, and spleen (see Table 21-10).

### Samples for Confirmation of Diagnosis

- **Biochemistry**—50 g liver, kidney (ASSAY [Cu] [Mo])
- **Histology**—formalin-fixed samples of long bone (including growth plate), skin, liver, and spleen. Enzootic ataxia/swayback: half of midsagittally sectioned brain, lumbar, and cervical spinal cord. Falling disease: heart (several sections), bone marrow, spleen (light microscopy).

### DIFFERENTIAL DIAGNOSIS

Clinical findings are most common in young, rapidly growing ruminants. They include a herd problem of unthriftiness and progressive weight loss, changes in hair coat color or texture of wool, chronic lameness, neonatal ataxia in lambs and kids, and terminal anemia. Chronic diarrhea is characteristic in adult cattle on pastures with excess Mo. A combination of plasma and liver Cu, and possibly serum Mo, is used to distinguish between Cu deficiency and other diseases.

Several herd or flock problems in cattle and sheep may resemble both primary and secondary Cu deficiency. A key indicator of Cu deficiency is that many animals are affected at the same time with a chronic debilitating disease complex, under the same dietary and seasonal circumstances.

The differential diagnosis of mineral and vitamin responsive disorders in beef cattle herds with suboptimal performance should investigate three major areas: malnutrition (lack of feed), chronic infectious disease, and lack of specific micronutrients.

#### Cattle

Unthriftiness and progressive weight loss may be attributable to protein–energy malnutrition; examination of the diet will reveal if it is deficient.

**Changed hair coat color** in young, rapidly growing cattle is caused only by Cu deficiency.

**Chronic lameness** in young, rapidly growing cattle may be caused by a calcium, phosphorus and vitamin D imbalance, determined by evaluating the diet and examining the long bones at necropsy or by radiography. Radiographic changes in cattle with secondary Cu deficiency are widened, irregular epiphyseal plates with increased bone density in the metaphysis, and metaphyseal lipping. These are similar to those described for rickets and secondary nutritional hyperparathyroidism.

**Chronic diarrhea** in young cattle may be attributable to intestinal parasitism; fecal egg counts and response to therapy are diagnostic. Diarrhea in a group of adult cattle on pasture known to be high in Mo is probably attributable to secondary Cu deficiency; response to therapy is diagnostic.

Winter dysentery of cattle, salmonellosis, coccidiosis, and mucosal disease are acute infectious diseases characterized by diarrhea, but have other distinctive signs and clinicopathologic findings. Johne's disease can cause diarrhea with a retained appetite, but cattle are usually 4 years or older. Many poisons cause diarrhea in ruminants, particularly arsenic, lead, and salt, but there are usually additional diagnostic signs and evidence of access to the poison. Assay of feed and tissues helps confirm a diagnosis of poisoning.

**Peat scours** is usually diagnosed if there is an immediate response to oral dosing with a copper salt.

**Falling disease** occurs only in adult cattle and must be differentiated from other causes of sudden death. Poisoning by the gidgee tree (*Acacia Georginae*) produces a similar syndrome.

#### Sheep and goats

**Unthriftiness and abnormal wool** or hair as a flock or herd problem are characteristic of Cu deficiency in sheep and goats, which must be differentiated from protein–energy malnutrition, intestinal parasitism, cobalt deficiency, and external parasites.

**Lameness in lambs** several weeks of age must be differentiated from nutritional osteodystrophy as a result of deficiencies or an imbalance of calcium, phosphorus, and vitamin D and stiff lamb disease as a result of enzootic muscular dystrophy.

**Neonatal ataxia** caused by congenital swayback and enzootic ataxia in newborn lambs and kids as a result of maternal Cu deficiency must be differentiated from border disease of newborn lambs, characterized by an outbreak of newborn lambs with hairy fleece and tremors, cerebellar hypoplasia (daft lamb disease), and hypothermia.

## TREATMENT

The treatment of Cu deficiency is relatively simple, but if advanced lesions are already present in the nervous system or myocardium, complete recovery will not occur. Oral dosing with 4 g of Cu sulfate for 2- to 6-month-old calves, or 8 to 10 g for mature cattle, given weekly for 3 to 5 weeks, is recommended for the treatment of primary or secondary Cu deficiency. Parenteral injections of copper glycinate may also be used.

If feasible, the diet of affected animals can also be supplemented with Cu. Copper sulfate may be added to the mineral–salt mix at 3% to 5% of the total mixture. A commonly recommended mixture for cattle is 50% calcium–phosphorus mineral supplement, 45% cobalt-iodized salt, and 3% to 5% Cu sulfate. This mixture is offered free of choice, or it can be added to a complete diet at the rate of 1% of the total diet.

## CONTROL

### Dietary Requirements

The minimum dietary Cu requirements for cattle and sheep are often cited as 10 mg copper/kg DM and 5 mg/kg DM, respectively. However, this is overly simplistic because the requirement to prevent subclinical or clinical Cu deficiency depends on the presence of interfering substances in the diet, such as Mo, S, and Fe, which can cause the absorption of Cu to vary from 0.01 (1% of Cu ingested) to 0.10. Absorption is also influenced by age, physiologic state, and the genotype of the animal.<sup>1</sup> For example, in sheep the requirement has been modified from 5 mg/kg DM in 1975 to 7 to 11 mg/kg DM in 1985, 1.0 to 8.6 mg/kg DM in 1980 and then 4.3 to 28.4 mg/kg DM in 1999. The latter estimate was more detailed, assuming different absorption of Cu from different feedstuffs (0.06 from roughage, 0.03 from grasses, and 0.015 from grass with increased Mo [ $>5$  mg/kg DM]), assuming increased Cu absorption in neonates that decreased in older animals, and allowing for the demands of the lamb in pregnant ewes (0.2 mg/d for a 4-kg lamb). The latest estimate from the NRC uses a factorial method to estimate requirements for sheep.<sup>1,16</sup>

There is insufficient data to do more detailed estimates for goats or deer, but they probably have increased requirements compared with sheep and thus are more similar to cattle (8–10 mg/kg DM).<sup>1,16,17</sup> Concentrations of Cu that could cause toxicity in sheep do not cause toxicity in goats, and some data show a stimulatory effect on

growth of 100 to 300 ppm Cu in the diet of Nubian goats.

Under some circumstances, providing additional Cu to feedlot cattle can adversely affect performance, with as little as 20 mg Cu/kg DM reducing growth in finishing steers. Adding 10 or 20 mg Cu/kg DM of a high-concentrate diet containing 4.9 mg Cu/kg DM altered lipid and cholesterol metabolism in steers, but it did not alter ruminal fermentation. Reducing cholesterol and altering the fatty acid composition of beef, from saturated to unsaturated fats, has potential health benefits for humans, but this has yet to be exploited.

### Copper Toxicity

Sheep are more susceptible to Cu toxicity than cattle, and hence preventing excess supplementation or accidental overdosing and monitoring of dietary intake of Cu are essential. As an example, in a Canadian study, 50% of cull ewes and 40% of market lambs had concentrations of liver Cu that were high to toxic.

Excessive or unnecessary supplementation with Cu is associated with Cu toxicity in many developed countries, with serious outbreaks described in dairy cattle that had recently been dried off.<sup>18,19</sup> In the United Kingdom, submissions to veterinary laboratories for chronic Cu poisoning increased from negligible before 2000 to 0.23% and 0.66% of all submissions in 2005 and 2007, respectively. In one case, high-yielding Jersey cows were identified at higher risk and had an estimated Cu intake of 50 mg/kg DM.<sup>18</sup> In New Zealand, deaths were associated with elevated concentrations of Cu in the liver (3990  $\mu$ mol/kg FW) and kidney (440  $\mu$ mol/kg FW) in Jersey cattle fed palm kernel expeller, which contains a high concentration of Cu (20 to 29 mg/kg DM).<sup>19</sup> Removing all Cu supplements and feeding 200 mg Mo/head per day as sodium molybdate reduced the average concentration of liver Cu from 3100 to 1320  $\mu$ mol/kg FW within 26 days.<sup>19</sup>

Another presentation of excess Cu intake in lactating dairy cattle is a subclinical hepatopathy with no clinical disease. Affected cows received an average of 963 mg Cu/d from a mineral supplement, with total dietary intake of Cu of high- and low-producing cows being 1325 and 1250 mg/day, respectively, compared with their estimated requirement of 290 and 217 mg/cow per day. Consequently, excessive supplementation with Cu may be a significant problem in dairy herds, even those without overt clinical signs of toxicity.

### Copper Supplementation

Copper can be supplied by several different methods. The following dose rates are recommended for the control of primary Cu deficiency, and they may have to be increased or given more frequently for secondary Cu

deficiencies. In these cases, it is often necessary to determine the most satisfactory dosing strategy through a field trial.

### Oral Dosing

Oral dosing with 1 g Cu sulfate will prevent swayback in lambs if the ewes are dosed weekly throughout pregnancy, then lambs can be protected after birth by dosing with 35 mg of Cu sulfate every 2 weeks. However, such regular oral dosing is time consuming and no longer widely practiced, especially in large, extensively managed flocks in which labor efficiency is an essential determinant of profitability.

Copper sulfate is considered a better supplement than Cu oxide or injectable Cu if cattle consume diets containing excess Mo, or Mo plus S.

### Dietary Supplementation

Copper sulfate may be mixed with other minerals into a **mineral premix**, which is then incorporated into the concentrate part of the ration. The final concentration of Cu is usually adjusted to provide an overall intake of at least 10 mg/kg DM in the final ration. Thus, if the forage components of the ration contain much less than 10 mg/kg DM, the concentrate ration may need to contain a higher Cu concentration. Where a secondary Cu deficiency is attributable to excess Mo in the forage, up to 1200 mg Cu (approximately 5 g of hydrated Cu sulfate) is added to the concentrate daily.

For sheep grazing toxic lupin stubble, signs of lupinosis may be exacerbated by supplementing with 10 mg Cu/kg DM as Cu sulfate, and thus additional Cu should not be fed unless there are suitable amounts of Mo and S in the ration.

If animals are not receiving concentrates, an alternative is to provide free access to a mineral mixture or **salt-lick** containing Cu sulfate (0.25% to 0.5% for sheep and 2% for cattle; typically added to iodized salt, cobalt, calcium, phosphorus, and other trace minerals). This will supply sufficient Cu, provided there is an adequate intake of the mixture, although this is often highly variable between individuals and thus may not be the case.

In some areas, an effective method of administering copper is by the **top-dressing** of pasture with 5 to 10 kg Cu sulfate/ha, although the amount required will vary according to soil type, rainfall, and stocking rate. Early studies in Australia found that 5 to 7 kg Cu sulfate/ha was effective for 3 to 4 years, whereas in New Zealand hill country, 3 kg/ha increased pasture Cu for only 100 days.<sup>1</sup> Copper poisoning may occur if livestock are turned onto pasture while the Cu salt is still on the leaves, and thus treated pasture should be left unstocked for 3 weeks or until the first heavy rain. Chronic copper poisoning may also occur if the soil Cu status increases sufficiently as a result of repeated applications over a number of years.

In New Zealand the top-dressing of pastures grazed by farmed red deer was compared with oral administration of copper oxide wire particles. Pastures top-dressed with Cu sulfate at a rate of 12 kg/ha in mid-March increased the Cu status of weanling hinds, whereas top-dressing in mid-March and dosing hinds with 10 g copper oxide in late July effectively increased the Cu status of pregnant hinds, and it also significantly improved the Cu status of the progeny of yearling hinds from birth to weaning.

Addition of Cu salts to **drinking water** is usually impractical because it corrodes metal piping, and it is difficult to maintain the correct concentration of Cu in large bodies of water. However, systems have been devised to automatically supplement drinking water for short periods, and such systems have effectively controlled Cu deficiency in cattle. Calves can tolerate copper in milk replacers at a concentration of 50 ppm, but there is no advantage in providing more than 10 ppm.

Copper can also be provided in **molasses-based supplements**. However, the high sulfur content of the molasses may affect the availability of Cu, through the formation of Cu sulfide and thiomolybdates in the rumen, and actually decrease liver Cu concentrations. Consequently, a dietary Cu concentration greater than 10 ppm may be necessary to ensure absorption of Cu in beef cattle fed molasses-based supplements.

### Removal of Sulfates

The removal of sulfates from drinking water by purification using reverse osmosis may be beneficial, with beef cows drinking desulfated water having an increased availability of Cu compared with those drinking water with a high concentration of sulfates.

### Parenteral Injections of Copper

To overcome the difficulty of frequent individual dosing or top-dressing of pasture, the periodic injection of compounds that gradually release Cu is used and has given good results. These injections can be given at strategic times, avoid fixation of Cu by Mo and sulfides in the alimentary tract, and are commonly used for the prevention of swayback in lambs.

The following have been evaluated under field conditions: Cu calcium ethylenediamine tetra-acetate (copper calcium edetate), Cu methionate, Cu heptonate, Cu glycinate, Cu oxyquinoline sulfonate, and Cu phenylalanine complex. The criteria used to compare these compounds are minimal damage at the injection site, satisfactory liver storage (90% to 100% of the administered dose), and the safety margin between therapeutic and toxic doses. The typical dose of Cu in these compounds is 400 mg for cattle and 150 mg for sheep.

Copper heptonate (25 mg of Cu in 2 mL of preparation) given by IM injection to ewes in midpregnancy is not toxic and will prevent

swayback in lambs. The Cu is removed from the injection site within 7 days, with most transferred to the liver and little or no deposition in skeletal muscle. Injection of 1 to 2 mg Cu/kg BW as heptonate has increased liver Cu to values associated with copper toxicity (13,000 to 52,000  $\mu\text{mol/kg DM}$ ). In sheep on pasture with high Mo content, a single IM injection of copper heptonate (37.5 mg Cu to adults, or 25 mg Cu to weaners) increases liver Cu reserves for at least 9 and 3 months, respectively. It was an acceptable alternative to copper oxide wire particles for preventing copper deficiency in sheep in southern Australia, but it is no longer available.

Copper calcium edetate increases blood Cu within hours and increases liver Cu within a week after injection. However, because of this rapid absorption, toxicity can occur with accidental overdosing. Some unexplained deaths also occurred in groups of treated sheep, and thus it is important to reduce handling and other stress during and after treatment. Marked local reactions occur at the site of injection; thus, SC injection is preferable, especially in animals to be used for meat. This treatment has a small risk of precipitating blackleg in cattle.

For sheep, a single injection of 45 mg of Cu as copper glycinate in midpregnancy is sufficient to prevent swayback in the lambs.

Cu calcium edetate or Cu oxyquinoline sulfonate given SC to sheep increases the concentration of Cu in whole blood, serum, and urine within 24 hours. In contrast, the injection of copper methionate increases the concentration of Cu in blood more gradually over 10 days, and there is no increase in urinary copper. After the injection of any of these three compounds, there is a steady increase in serum ceruloplasmin activity over 10 to 20 days, followed by a slow fall to the activity before treatment at 40 days. The lower toxicity of Cu methionate compared with Cu calcium edetate or Cu oxyquinoline sulfonate is a result of the slower absorption and transport of the Cu to the liver and kidney. Deaths have also occurred in sheep following the parenteral administration of diethylamine oxyquinoline sulfonate at recommended doses, with signs of hepatic encephalopathy and an acute, severe, generalized, centrilobular hepatocellular necrosis at necropsy. The use of Cu disodium edetate at the recommended dose rates in calves has caused deaths associated with liver necrosis and clinical signs of hepatic encephalopathy.

A single dose of Cu glycinate (120 mg for cows, 60 mg Cu for calves) will maintain adequate Cu concentrations for about 60 to 90 days. Milk is a poor source of Cu, particularly from Cu-deficient cows, but even treated cows can have insufficient Cu in their milk. Consequently, calves on pasture will often need a Cu supplement because they cannot increase or maintain their stores of liver Cu from marginal or deficient pastures. Copper reserves accrue in fetal liver at the



expense of the dam's liver Cu, and thus newborn calves usually have sufficient liver Cu and will not need treatment until they are 6 weeks old. In pregnant cows, Cu supplementation should be timed to provide for the higher Cu requirement for Cu from the demands of the fetal liver during the last trimester.

One dose of Cu glycinate is sufficient when cattle are grazing forage with less than 3 mg/kg DM of Mo and less than 3 g/kg DM of S. With higher concentrations of Mo and S, repeated injections (or, alternatively, slow-release boluses) are often needed. The injectable copper may be supplemented by the use of 1% Cu sulfate in a mineral supplement, which will provide adequate Cu for cows, but calves may not consume enough mineral and may need multiple injections. The supplementation required to prevent a decrease in serum Cu during the grazing season will vary according to the concentration of dietary Mo and S and their effect upon the absorption of Cu.

In Canada, 100 mg of Cu as copper edetate, 120 mg copper glycinate, and 120 mg of copper methionate all improved and maintained an adequate Cu status for 90 days in deficient cattle. Copper methionate was least acceptable because of the severity of reactions at the injection site.

In horses, 100 mg and 250 mg copper edetate given IM to mares during months 9 and 10 of gestation had no effect on the liver concentration of their foals at birth, and thus would have little or no effect on the occurrence and severity of developmental bone and joint disease associated with Cu deficiency in newborn foals.

### Slow-Release Treatments

There is a risk of Cu toxicity from mineral supplements because of variable ingestion of the supplement, and from injectable Cu compounds because it is difficult to control the rate at which the Cu is released. This risk, and a more constant supplementation with Cu, can be overcome by using slow- or controlled-release devices.

### Glass Bolus

Soluble glass boluses are available for use in sheep and cattle in the United Kingdom and Europe, but not in New Zealand or Australia. They lodge in the rumen and release Cu at a uniform rate for up to 8 months, although the rate of dissolution is increased by the lower rumen pH associated with concentrate feeding. It is proposed that the additional rumen available Cu is complexed with thiomolybdates in the rumen, preventing absorption of thiomolybdates and their binding to biologically active compounds in blood and tissues, although there appears to be no direct experimental confirmation of this hypothesis. Commercially available glass boluses typically contain 13.4% Cu, 0.5% cobalt, and 0.3% selenium, with two boluses given to

cattle greater than 100 kg (a 100-g bolus) or one to sheep greater than 25 kg (a 33-g bolus).

### Copper Oxide Needles

Copper oxide wire particles ("needles"), incorporated into a soluble polyethylene glycol capsule and given orally, are a safe and effective way of controlling Cu deficiency in ruminants. These are relatively cheap, and a single treatment can be effective for an entire grazing season. The needles are gradually released from the rumen-reticulum and lodge in the folds of the abomasum, where they gradually release Cu for up to 100 days or more. The absorbed Cu is transported to and stored in the liver. An additional minor benefit may be some limited efficacy against gastrointestinal parasites in the abomasum (*Ostertagia* and *Haemonchus*), particularly newly ingested larvae.

### Sheep

The response is dose dependent, with liver Cu peaking 10 weeks after administration of 2.5 to 20 g per animal, and then declining linearly over the next 40 weeks. A dose of 0.1 g/kg live weight (5 g) did not induce copper toxicity in the susceptible North Ronaldsay breed.

A single dose of 2 g cupric oxide needles maintained normal blood and liver Cu, prevented signs of ill-thrift, and improved growth rate in 3- to 5-week-old lambs grazing newly established, limed pastures. Copper oxide needles given to ewes in early pregnancy increases their liver Cu throughout gestation and in early lactation and the Cu status of their lambs from birth to 36 days old. Serum copper concentration was not affected by treatment, but a marked rise was observed in all lambs between birth and 10 weeks of age.

The administration of Cu oxide needles to ewes in the first half of pregnancy prevents swayback in their lambs, and when given at parturition it prevents hypocupremia for up to 17 weeks in animals grazing pasture known to have excess Mo and S. Treatment of ewes at parturition also increased the concentration of Cu in milk during early lactation. However, this increase in milk Cu will not prevent hypocupremia and hypocuprosis in lambs, which can be treated with cupric oxide needles at 6 weeks of age.

Some breeds of sheep are more susceptible to Cu toxicity because they accumulate Cu in the liver, and thus it is important not to exceed the recommended dosage. A dose of 4 g of Cu oxide needles has been used for the prevention of swayback in goats.

### Cattle

Commercial capsules have 39% Cu oxide and in many countries are available in a 20-g dose for adults and a 10-g dose for calves. A dose of 20 g will maintain adequate Cu status for at least 5 months in lactating cows, and it prevented decreased growth and

hypocupremia in young cattle weighing 190 kg for 70 days. The currently recommended doses for beef cattle are 10 g for calves and yearlings less than 200 kg and 20 g for cattle greater than 200 kg, which will provide protection for at least 6 months.

### Farmed Red Deer

The need for Cu supplementation in young deer is not clear-cut. For example, 5 g of Cu oxide wire particles given to 4- to 7-month-old deer in New Zealand had no effect on live-weight gain despite hypocupremia in 38% of untreated deer, which gained weight at similar rates to those with adequate plasma Cu. In another study, 20-g boluses of Cu oxide wire particles did not significantly alter velvet weight, daily velvet growth rate, days from casting to removal, grade or value velvet, or the live weight gain of 2-year-old stags. Growth responses to supplementation are equivocal when blood Cu is less than 3 to 4  $\mu\text{mol/L}$ , but responses are significant when they are 0.9 to 4.0  $\mu\text{mol/L}$ .

### Genetic Selection

It is possible to manipulate trace-element metabolism by genetic selection. For example, the selection of sheep based on plasma concentration of Cu resulted in two divergent sets of progeny within 5 years, one with a high Cu status, the other low, which resulted in clinical signs of Cu deficiency in the low group and protection in the high. This has not been exploited in commercial production.

### Summary and Guidelines

Several rules of thumb are important and useful:

- Cattle are more susceptible to Cu deficiency than sheep.
- Sheep are more susceptible to Cu toxicity than either cattle or goats.
- The newborn calf is protected against neonatal hypocuprosis by donations from the dam, but newborn lambs assume the same copper status as the ewe.
- In general, a dietary intake of Cu equivalent to 10 mg/kg DM will prevent the occurrence of primary copper deficiency in both sheep and cattle.
- Diets containing less than 6 mg/kg DM will cause hypocuprosis.
- Diets with Cu:Mo ratios of less than 3:1 are conducive to secondary Cu deficiency (<2:1 for deer and goats).

### FURTHER READING

- Committee on Nutrient Requirements of Small Ruminants, Board on Agriculture and Natural Resources, National Research Council. *Nutrient Requirements of Small Ruminants: Sheep, Goats, Cervids and New World Camelids*. Washington, DC: National Academy Press; 2007.
- Gould L, Kendall NR. Role of the rumen in copper and thiomolybdate absorption. *Nutr Res Rev*. 2011;24:176-182.

- Grace ND, Knowles SO. Trace element supplementation of livestock in New Zealand: meeting the challenges of free-range grazing systems. *Vet Med Int*. 2012;63:9742.
- Lee J, Masters DG, White CL, Grace ND, Judson GJ. Current issues in trace element nutrition of grazing livestock in Australia and New Zealand. *Aust J Agric Res*. 1999;50:1341-1364.
- Radostits O, et al. Copper deficiency. In: *Veterinary Medicine: A Textbook of the Diseases of Cattle, Horses, Sheep, Goats and Pigs*. 10th ed. London: W.B. Saunders; 2007:1707-1722.
- Suttle NF. Copper. In: *The Mineral Nutrition of Livestock*. 4th ed. Wallingford, Oxon: CAB International; 2010:255-305.

## REFERENCES

- Suttle NF. *The Mineral Nutrition of Livestock*. 4th ed. Wallingford, Oxon: CAB International; 2010:255-305.
- Vikoren T, et al. *J Wildl Dis*. 2011;47:661.
- Morris CA, et al. *Anim Sci*. 2006;82:799.
- Solaiman SG, et al. *Small Rumin Res*. 2007;69:115.
- Gould L, Kendall NR. *Nutr Res Rev*. 2011;24:176.
- Grace ND. *NZ Vet J*. 2006;54:44.
- Knowles SO, Grace ND. *J Anim Sci*. 2014;92:303.
- Fry RS, et al. *J Anim Sci*. 2014;91:861.
- Legleiter LR, Spears JW. *J Anim Sci*. 2007;85:2198.
- Scaletti RW, Harmon RJ. *J Anim Sci*. 2012;95:654.
- Laven RA, Lawrence KE. *Vet J*. 2012;192:232.
- Laven RA, et al. *Vet J*. 2008;176:397.
- Laven RA, Wilson PR. *NZ Vet J*. 2009;57:166.
- Laven RA, Nortje R. *NZ Vet J*. 2013;61:269.
- Laven RA, et al. *NZ Vet J*. 2007;55:171.
- NRC. *Nutrient Requirements of Small Ruminants: Sheep, Goats, Cervids and New World Camelids*. Washington, DC: National Academy Press; 2007.
- Grace ND, et al. *NZ J Agric Res*. 2008;51:439.
- Bidewell CA, et al. *Vet Rec*. 2012;170:464.
- Morgan PL, et al. *NZ Vet J*. 2014;62:167.

## RIBOFLAVIN DEFICIENCY (HYPORIBOFLAVINOSIS)

Although riboflavin is essential for cellular oxidative processes in all animals, the occurrence of deficiency under natural conditions is rare in domestic animals because actively growing green plants and animal protein are good sources, and some synthesis by alimentary tract microflora occurs in all species. Synthesis by microbial activity is sufficient for the needs of ruminants, but a dietary source is required in these animals in the preruminant stage. Milk is a very good source. Daily requirements for pigs are 60 to 80 µg/kg BW, and 2 to 3 g/ton of feed provides adequate supplementation. The trend toward confinement feeding of pigs has increased the danger of naturally occurring cases in that species.

On experimental diets the following syndromes have been observed:

- Pigs: slow growth, frequent scouring, rough skin, and matting of the hair coat with heavy, sebaceous exudate are characteristic. There is a peculiar crippling of the legs with inability to walk and marked ocular lesions, including conjunctivitis, swollen eyelids, and cataract. The incidence of stillbirths may be high.

- Calves: anorexia, poor growth, scours, excessive salivation and lacrimation, and alopecia occur. Areas of hyperemia develop at the oral commissures, on the edges of the lips, and around the navel. There are no ocular lesions.

## CHOLINE DEFICIENCY (HYPOCHOLINOSIS)

Choline is a dietary essential for pigs and young calves. Calves fed on a synthetic choline-deficient diet from the second day of life develop an acute syndrome in about 7 days. There is marked weakness and inability to get up, labored or rapid breathing, and anorexia. Recovery follows treatment with choline. Older calves are not affected. On some rations, the addition of choline increases daily gain in feedlot steers, particularly during the early part of the feeding period.

Supplementation of 20 g/day of rumen-protected choline to dairy cows 14 days before parturition increased milk production during the first month of lactation and the concentration of choline in milk, but it did not affect fat or protein concentration in the milk or plasma levels of glucose, β-hydroxybutyrate, cholesterol, and non-esterified fatty acids (NEFAs). The NEFA concentrations at the time of parturition were lower in treated animals than in controls, indicating improved lipid metabolism. Choline also increased α-tocopherol plasma concentrations. There does not appear to be a difference in effect of rumen-protected and unprotected choline supplements to dairy cattle when energy-related metabolites are evaluated.<sup>1,2</sup>

In pigs, ataxia, fatty degeneration of the liver and a high mortality rate occur with severe deficiency. Enlarged and tender hocks have been observed in feeder pigs. For pigs, 1 kg/ton of food is considered to supply sufficient choline.

Congenital splayleg of piglets has been attributed to choline deficiency, but adding choline to the ration of the sows does not always prevent the condition.<sup>3</sup>

## REFERENCES

- Brusemeister F, et al. *Anim Res*. 2006;55:93.
- Toghdory A, et al. *J Anim Vet Adv*. 2009;8:2181.
- Papatsiros VG. *Am J Anim Vet Sci*. 2012;7:80.

## Multi-Organ Diseases Due to Toxicity

### SNAKEBITE

#### SYNOPSIS

**Etiology** Venom injected into victim by a bite with specially adapted fangs.

**Epidemiology** Isolated bites primarily during summer months. A rare clinical disease in large animals.

**Clinical pathology** Venom detectable in blood (coagulopathy), urine (hematuria, myoglobinuria, anuria, oliguria), body tissues (hemorrhage, ecchymosis, necrosis), and fluids generally.

**Lesions** Varies depending on snake; may be local swelling and tissue necrosis.

**Diagnosis confirmation** Based on detection of venom in body tissues or fluids.

**Treatment** Injection of type-specific antivenin (antivenom).

**Control** Difficult.

## ETIOLOGY

At least six toxic actions can result from snake venoms, and different snakes have varying combinations of toxins in their venoms (Table 21-11). The toxins include necrotizing, anticoagulant, and procoagulant fractions and neurotoxic, cardiotoxic, myotoxic, nephrotoxic, cytotoxic, and hemolytic, and hemorrhagic fractions.<sup>1</sup> Although there is often insufficient venom (composed of multiple toxins) injected to cause death in large animals, a serious secondary bacterial infection may occur in the local swelling and cause the subsequent death of the animal. Additionally, blood degradation products may be associated with coagulopathic insults resulting in secondary renal complications. The common venomous snakes include vipers, such as *Crotalus* spp. (rattlesnakes and other pit vipers of North America, Mexico, and Central and South America), the true vipers (e.g., *Vipera berus* [common European viper, the United Kingdom's only venomous snake]), and multiple other viper species, such as Africa's gaboon vipers (*Bitis* spp.) and Asia's Russell's vipers (*Daboia* spp.), and the elapid snakes, including coral snakes (*Micrurus* spp.) in the Americas, cobras (*Naja* spp.) and mambas (*Dendroaspis* spp.), and most of Australia's venomous snakes, including *Notechis scutatus* (tiger snake), *Oxyuranus* spp. (taipans), and *Pseudonaja (Demansia) textilis* (common brown snake).<sup>1-4</sup>

## EPIDEMIOLOGY

The incidence of snakebite is controlled by the geographic distribution of the snakes and their numbers. Asia, India, Africa, Central and South America, Australia, and the southern United States are areas in which snake populations are large. In general, the morbidity rate in farm animals is low, although a mortality rate from 9% to 25% has been recorded in horses<sup>5</sup> and 31% to 58% in New World camelids (llamas and alpacas).<sup>6,7</sup>

## Risk Factors

### Animal Risk Factors

Most snakebite incidents occur during the summer months, and bites are mainly near

**Table 21-11** Venomous snakes of importance: taxonomy, geographic range, and major venom effects (Prepared by Daniel E Keyler, Pharm. D., FAACT)

Family/genus	Common names	Geographic range	Chief venom effects
<b>Atractaspididae</b>			
<i>Atractaspis</i>	Burrowing asps	Africa	Vasoconstriction, myocardial
<b>Colubridae</b>			
<i>Dispholidus</i>	Boomslang	Africa	Coagulopathy, hemorrhage
<i>Philodryas</i>	Cobra-verde	C, S America	Coagulopathy, hemorrhage
<i>Rhabdophis</i>	Keelbacks	Asia	Coagulopathy, hemorrhage
<i>Thelotornis</i>	Twig snake	Africa	Coagulopathy, hemorrhage
<b>Elapidae</b>			
<i>Acanthophis</i>	Death adders	Australia	Paralysis
<i>Bungarus</i>	Kraits	SE Asia	Paralysis
<i>Dendroaspis</i>	Black/green mamba	Africa	Paralysis
<i>Hemachatus</i>	Rinkhals	Africa	Paralysis, local necrosis
<i>Hoplocephalus</i>	Broad-headed snakes	Australia	Coagulopathy
<i>Micropechis</i>	Small-eyed snake	New Guinea	Paralysis, anticoagulant, myolysis
<i>Micrurus</i>	Coral snakes	N, C, S America	Paralysis
<i>Naja</i>	Cobras/spitting cobra	Africa/Asia	Paralysis, corneal ulceration
<i>Notechis</i>	Tiger snakes	Australia	Paralysis, coagulopathy, myolysis
<i>Ophiophagus</i>	King cobra	Asia	Paralysis
<i>Oxyuranus</i>	Taipan	Australia	Paralysis, coagulopathy, myolysis
<i>Pseudechis</i>	Mulga/black snakes	Australia	Coagulopathy, myolysis
<i>Pseudonaja</i>	Brown snakes	Australia	Coagulopathy, paralysis
<i>Tropidechis</i>	Rough-scaled snake	Australia	Coagulopathy, paralysis, myolysis
<b>Hydrophiidae</b>			
<i>Astrotia</i>	Sea snakes	Indo-Pacific Oceans	Paralysis, myolysis
<i>Pelamis</i>		Pacific Oceans	
<i>Laticauda</i>		Indo-Pacific Oceans	
Many other genera			
<b>Viperidae:</b>			
<b><i>Crotalinae</i> (pit vipers)</b>			
<i>Agkistrodon</i>	Cantils, copperheads, Moccasins	N, C, S America N, C, S America	Coagulopathy, necrosis Coagulopathy, necrosis
<i>Bothrops</i>	Lanceheads	C, S America	Coagulopathy, necrosis
<i>Calloselasma</i>	Malayan pit viper	Asia	Coagulopathy, necrosis
<i>Crotalus</i>	North American rattlesnakes, tropical rattlesnake	N America C, S America	Coagulopathy, necrosis Paralysis, myolysis
<i>Hypnale</i>	Hump-nosed vipers	Asia	Local necrosis, renal
<i>Lachesis</i>	Bushmaster	C, S America	Coagulopathy, necrosis
<i>Sistrurus</i>	Massasauga, pygmy	N America	Hemorrhage, local necrosis
<i>Trimeresurus</i>	Green pit vipers	SE Asia	Coagulopathy, necrosis
<b>Viperinae (true vipers)</b>			
<i>Bitis</i>	Gaboon/puff adder	Africa	Cardiovascular, coagulopathy
<i>Causus</i>	Night adders	Africa	Local necrosis
<i>Cerastes</i>	Horned vipers	Africa/Asia	Coagulopathy, necrosis
<i>Daboia</i>	Russel's vipers	SE Asia	Coagulopathy, myolysis, renal
<i>Echis</i>	Carpet, saw-scaled	N Africa/Asia	Coagulopathy, necrosis
<i>Vipera</i>	adders, asps, European vipers	Eurasia	Cardiovascular, coagulopathy necrosis, paralysis

C = central; N = North; S = South; SE = Southeast.

the head because of the inquisitive behavior of the bitten animal.<sup>7</sup> Pigs are not highly susceptible but not, as generally believed, because of their extensive subcutaneous fat depots. Sheep may be bitten on the udder, but their long wool coat is generally effective as a protective mechanism on other parts of the body. Cows may be less represented because of their large size and the large venom dose required to cause death. Horses, however, appear to be much more susceptible to venom than any other species.<sup>8</sup>

## PATHOGENESIS

The effects of snakebite (envenomation) depend on the size and species of the snake, the quantity of venom injected, the route of venom delivery with the bite (e.g., subcutaneous, intramuscular, intravenous), the size of the bitten animal, and the location of the bite, particularly with reference to the thickness of the hair coat and the quantity of subcutaneous fat. As a general rule, the venom is injected by fangs, which leave a bite mark comprised of a row of small punctures with two large punctures outside them. An exception is the coral snake and other elapids, which typically chew to inoculate the venom. The bites may be visible on hairless and unpigmented skin but can only be seen on reflection of the skin at necropsy in many instances. Nonpoisonous snakes may bite animals, but the bite mark is typically (but not always) in the form of two rows of small punctures.

The toxins in venom include the following<sup>1,2</sup>:

- **Cardiotoxins**, causing coronary artery vasoconstriction/vasodilatation and direct myocardial effects, leading to hypotension and arrhythmias
- **Cytolins**, which are associated with tissue necrosis, including platelets, leading to intravascular coagulation and anticoagulation
- **Hemolysins/hemorrhagins**, causing blood cell lysis and degradation of blood components and increased permeability of vascular tissues, leading to fluid shifts
- **Myotoxins**, causing selective ion channel blockade, rhabdomyolysis, myoglobinemia, and myoglobinuria
- **Nephrotoxins**, causing direct nephrotic damage, acute tubular necrosis, renal cortical necrosis, and renal failure
- **Neurotoxins**, causing pre- and postsynaptic blockade and neurotransmitter destruction, with flaccid paralysis, pupillary dilation, and paralytic respiratory failure

The overall effect of a venomous bite by a snake depends on the mix of specific venom components and the dose delivered.<sup>4</sup> The actual dose delivered is highly variable, but also depends on the size of the snake and the period of time since the snake last expended



venom with a bite. Tiger snake venom contains neurotoxins and procoagulants.<sup>4</sup> Death adder venoms contain only neurotoxin; Australian brown snakes have procoagulant and some neurotoxin. Rattlesnake venom is associated with necrosis of arterioles and arteriolar thrombus formation, and in most species it contains an anticoagulant, causing a bleeding diathesis.<sup>2</sup> The Mojave rattlesnake *Crotalus scutulatus* and the neotropical and tropical rattlesnakes (*Crotalus durissus* spp.) are exceptions.

### CLINICAL FINDINGS

Bites by adder-type snakes (viperids) are associated with a local swelling and rapidly developing pain, which is usually sufficient to produce signs of excitement and anxiety. Bites on the head may be followed by swellings of sufficient size to cause dyspnea. If sufficient neurotoxin has been injected, a secondary stage of excitement occurs and is followed by marked dilation of the pupils, salivation, hyperesthesia, tetany, depression, recumbency, and terminal paralysis. In small animals, death may occur as a result of asphyxia during convulsions in the excitement stage of the disease. In animals that recover, there is usually local tissue sloughing at the site of the swelling.

Rattlesnake (*Crotalus* spp.) bites are reported primarily in North America, and affected animals include horses,<sup>5,9,10</sup> New World camelids,<sup>6,7</sup> cattle, and sheep. In horses, the most commonly reported signs are swelling around the bite site, which may be severe and result in respiratory distress, tissue necrosis, and evidence of a coagulopathy (spontaneous bleeding from eyes, ears, injection site, tracheotomy site).<sup>5,9</sup> Venom-associated cardiac abnormalities include tachycardia and arrhythmias, including atrial fibrillation, ventricular premature contractions, and second- and third-degree arterioventricular (AV) block.<sup>9,10</sup> Clinical signs in New World camelids include facial swelling, respiratory distress, tachypnea, hyperthermia, tachycardia, lethargy, and recumbency.<sup>6,7</sup> Rattlesnake bite in calves is associated with restlessness, teeth grinding, vomiting, hypersalivation, dyspnea, ataxia, and convulsions.

Bites by cobra-type snakes (elapids) may be associated with local swelling in animals that survive the effects of the neurotoxin.<sup>2,4</sup> They may develop significant localized tissue necrosis, and they frequently develop bacterial infection 3 to 4 days later. The major effects following bites of cobra-type snakes are excitement, with convulsions, respiratory depression, and death resulting from asphyxia. The signs appear quickly or may be delayed, and death occurs usually in up to 48 hours in horses. In calves, the effects of the neurotoxin are manifested by marked pupillary dilation, excitement, and incoordination, followed by paralysis.

Clinical signs in horses bitten by tiger snakes (*Notechis scutulatus*) in Australia

include anxiety, diffuse muscle tremors, tachycardia, tachypnea, and profuse sweating.<sup>4</sup> The gait is stiff and short. In another case, muscle tremors were obvious in the standing patient, disappeared when the animal became recumbent, and reappeared upon arising. Foals bitten by brown snakes (*Pseudonaja textilis*) in Australia show similar signs to those associated with tiger snake envenomation. Common signs include drowsiness, drooping of eyelids and lips, partial tongue paralysis, muscle tremors and weakness leading to recumbency, and, in some, pupillary dilation. Respiration becomes labored and abdominal in nature. Sweating and inability to suck, swallow, or whinny occur late in the course. Adults also show an inability to swallow, with salivation and accumulation of food in the mouth.

### CLINICAL PATHOLOGY

There are numerous clinicopathologic abnormalities associated with snake envenomation, with most of them dependent on the species and weight of animal affected, specific snake, and potency of venom.<sup>1</sup> Hematologic alterations include abnormalities in red and white blood cells and platelets. Venom-induced consumptive coagulopathies (VICCs) similar to DIC occur, in particular with venom from the Australian brown snakes (*Pseudonaja* spp.) and taipans (*Oxyuranus* spp.).<sup>1,11</sup> Increases in BUN and creatinine, creatine kinase, and liver enzymes occur, as do decreases in albumin, potassium, and calcium.<sup>1,4,5,7</sup> Horses with myocardial damage show elevations in cardiac troponin I (cTnI), which may be delayed for several days to weeks after envenomation.<sup>9,10</sup>

An ELISA for identification of venom in blood, urine, or other body tissue or fluid is available in Australia.<sup>4</sup> It is highly accurate, suitable for field or office use, and immediate, but it is expensive. It is limited to the snake species for which reagents are available.

### NECROPSY FINDINGS

Postmortem findings are specific to each snake. In general, local swellings at the site of the bite are a result of exudation of serous fluid and inflammatory reaction to venom components, which is often deeply blood-stained. Fang marks are usually visible on the undersurface of the reflected skin. A horse dying from rattlesnake envenomation showed ischemia of the heart, skeletal muscle, urinary bladder, and gastrointestinal tract.<sup>10</sup> Cardiac hypertrophy and myocardial necrosis involving both ventricular free walls and atria was present grossly, and myocytes in both ventricles and the atria were necrotic and degenerative on histopathologic examination.<sup>10</sup> New World camelids dying of rattlesnake envenomation showed severe and hemorrhagic facial swellings, congestion of the lungs and kidneys, ulcerations in the third compartment, and other

systemic manifestations.<sup>7</sup> Postmortem analysis of a cow presumed to have died from the bite of a snake in the Viperidae family showed petechial and ecchymotic hemorrhage to frank hemorrhage in the lung, liver, tracheal lumen, peritoneum, and epicardial and subendocardial surfaces. Pale linear streaks were present in the right ventricular myocardium.<sup>12</sup>

Diagnosis confirmation depends on a positive assay for venom in the patient's blood, urine, and tissues generally. Absolute identification of the snake by a knowledgeable herpetologist can also confirm the species of snake involved with envenomation. In acute cases death has usually occurred by the time the animal is seen. If the actual bite is observed, the diagnosis is made on the history.

### DIFFERENTIAL DIAGNOSIS

#### Differential diagnosis list:

Nervous syndrome:

- Organophosphorus/carbamate toxicosis
- Fluoroacetate toxicosis
- Tick paralysis

Local swelling:

- Anthrax in horses and pigs
- Black widow, redback or brown recluse spider bites
- Blackleg
- Insect stings (wasps, hornets, bees)
- Puncture/trauma wounds versus fang puncture marks
- Scorpion stings

### TREATMENT

In human medicine the application of a tourniquet proximal to a limb bite site has been replaced; for elapid envenomation a firm pressure immobilization bandage (PIB) is applied over the bite to restrict the distribution of the venom via the lymphatics and retain it in the site and prevent systemic effects. The use of PIB for crotalid or viperid envenomation is not recommended because the PIB holds the venom at the application site, and pit viper and viper venoms typically cause significant local tissue damage. As such, use of PIB in these instances may exacerbate local tissue damage. Excision of the bite site is not recommended for the bites of snakes (crotalids and viperids) that are associated with a serious local reaction because the procedure may worsen local tissue damage and enhance the distribution of venom from the bite-site region.

Emergency treatment should include early placement of an intravenous catheter, correction and maintenance of hydration, and establishment of a patent airway. In animals with severe facial or nasal swelling, a tracheotomy may be needed. Systemic treatment should include antivenin (antivenom), antibiotics, antiinflammatories, and antitoxin. Polyvalent antivenin containing antibodies against the venoms of all the

snake species in the geographic region can usually be obtained locally, often in highly purified form.<sup>4,7,8</sup> It is expensive to use but highly effective. Speed is essential, and the IV route is preferred. The dose rate varies widely depending on the degree of envenomation, with the size of the animal and clinical signs determining the dose. In horses and New World camelids this is typically 1 to 5 vials, but the dose may be higher depending on the venom and amount contained in the vial.<sup>5,7,8</sup> The use of antibiotics in human beings is controversial but should be administered to control the local infection at the site of the bite. The occurrence of clostridial infections after snakebite suggests the administration of antitoxins against tetanus and gas gangrene. A nonsteroidal antiinflammatory drug such as flunixin will provide pain relief and assist with local and systemic swelling.<sup>7</sup>

Many other pharmacologic treatments have been used in treating venomous snakebite, including antihistamines and corticosteroids. These drugs have been found to be valuable as a protection against possible anaphylaxis after treatment with antivenin, but in cases where local tissue damage is evident, they are without value and in many cases exert deleterious effects. Adrenaline or epinephrine has little or no value, and calcium salts do not significantly reduce mortality. The application of chemicals to the incised bite area is also of no value and may exacerbate tissue damage. Attention has been drawn to the need to appreciate the mode of action of one's local snake venoms before attempting a general program of treatment—what may be effective in one country may very well be lethal in another.

## CONTROL

Control is difficult because snakes occur in dry lots, paddocks, pastures, and fields where animals live. Vaccination against rattlesnake envenomation in horses is possible, but reported vaccine titers from the commercially available product are not as high as those that develop after natural rattlesnake envenomation.<sup>13</sup>

## FURTHER READING

- Angulo Y, Estrada R, Gutierrez JM. Clinical and laboratory alterations in horses during immunization with snake venoms for the production of polyvalent (*Crotalinae*) antivenom. *Toxicon*. 1997;35:81-90.
- Carmen M, Riet-Correa F. Snakebite in sheep. *Vet Hum Toxicol*. 1995;37:62-63.
- Dickinson CE, Traug-Dargatz JL, Dargatz DA, et al. Rattlesnake venom poisoning in horses: 32 cases (1973-1993). *J Am Vet Med Assoc*. 1996;206:1866-1871.
- Lavonas EJ. Antivenoms for snakebite: design, function and controversies. *Curr Pharmaceut Biotechnol*. 2012;13:1980-1986.
- White J. Snake venoms and coagulopathy. *Toxicon*. 2005;45:951-967.
- Yeruham I, Avidar Y. Lethality in a ram from the bite of a Palestine viper (*Vipera xanthina palestinae*). *Vet Hum Toxicol*. 2002;44:26-27.

## REFERENCES

- Goddard A, et al. *Vet Clin Path*. 2011;403:282.
- Panfoli I, et al. *Toxins (Basel)*. 2010;2:417.
- Tanaka GD, et al. *PLoS Negl Trop Dis*. 2010;4:e622. doi:10.1371/journal.pntd.0000622.
- Cullimore AM, et al. *Aust Vet J*. 2013;91:381.
- Fielding CL, et al. *J Am Vet Med Assoc*. 2011;238:631.
- Sonis JM, et al. *J Vet Int Med*. 2013;27:1238.
- Dykgraaf D, et al. *J Vet Int Med*. 2006;20:998.
- Chiacchio SB, et al. *J Venom Anim Toxins Trop Dis*. 2011;17:111.
- Gilliam LL, et al. *J Vet Int Med*. 2012;26:1457.
- Lawler JB, et al. *J Vet Int Med*. 2008;22:486.
- Isbister GK, et al. *Toxicon*. 2007;49:57.
- Banga HS, et al. *Toxicol Int*. 2009;16:69.
- Gilliam LL, et al. *Clin Vac Immunol*. 2013;20:732.

## BEE AND WASP STINGS (HYMENOPTERA)

Bees (*Apoidea*) and wasps, hornets, and yellow jackets (*Vespoidea*) are stinging insects found in the Hymenoptera family. Their venom is proteinaceous in nature.<sup>1</sup> Bees sting only once and die; wasps, hornets, and yellow jackets are capable of stinging multiple times.

Most single stings are self-limiting, but multiple stings may be associated with severe local swelling up to 6 cm in diameter, similar to those in angioedema. The lips, eyelids, tongue, and vulva are often swollen and painful. Pain may result in pronounced excitement, and in severe cases in horses there may be diarrhea, hemoglobinuria, jaundice, tachycardia, cardiac arrhythmia, rapid breathing, sweating, and prostration. Animals attacked about the head may show dyspnea because of severe local swelling. Horses often show mild to moderate colic. Anaphylaxis is rare and generally occurs within minutes of stinging.<sup>1</sup> In a few cases, the attack may be fatal and nonanaphylactic, usually occurring after a course of 4 to 12 hours.

Treatment depends on the location of the stings, but may include antihistamines, topical hydrocortisone or lidocaine cream or ointment, cool compresses, tracheotomy if swelling and asphyxia threaten, and early recognition and treatment of anaphylaxis. Necropsy lesions vary depending on the number of stings and location but may include hemorrhages and edema of all connective tissues and the bowel wall.

## FURTHER READING

- Australian Institute of Health and Welfare, Bradley C. *Venomous Bites and Stings in Australia to 2005*. Injury research and statistics series no. 40. Cat no. INJCAT 110. Adelaide: AIHW; 2008.
- Staempfli HR, et al. Acute fatal reaction to bee stings in a mare. *Eq Vet Edu*. 1993;5:250-252.

## REFERENCE

- Fitzgerald KT, et al. *Clin Tech Small Anim Pract*. 2006;21:194.

## RED FIRE ANT STINGS (SOLENOPSIS INVICTA)

The red fire ant (*Solenopsis invicta*) is present in most of the southern portion of the United States and many other countries. The venom is a nonproteinaceous alkaloid with a wide range of biocidal activities.<sup>1</sup> Fire ants are aggressive, and an individual attack usually results in a number of stings. Fire ants both bite and sting, but envenomation only occurs with the sting.<sup>2</sup> Stings occur in a circular pattern because the ant first bites the animal with its mandible and then rotates its head around the bite site.

Stings from the aggressive red fire ant have been associated with focal necrotic ulcers of the cornea and conjunctiva of newborn calves. Stings around the nostrils may cause swelling with open mouth breathing, inhalation of more ants, or suffocation. Weak calves, lambs, and deer fawns are most likely to be injured, as are older and weaker animals. In addition, adult animals may develop stress-related anorexia resulting in decreased weight gain or milk production.

Treatment depends on the sting site and severity of signs and may include antihistamines, cool compresses, corticosteroids, tracheotomy, and appropriate therapy for anaphylaxis.<sup>2</sup>

## FURTHER READING

- Austin GP. Investigations of cattle grazing behavior and effects of the red imported fire ant. PhD thesis. 2003 at: <<http://www.tdl.org>>; Accessed 14.01.13.
- Jemal A, Hugh-Jones M. A review of the red imported fire ant *Solenopsis invicta* and its impacts on plant, animal, and human health. *Prev Vet Med*. 1993;17:19-32.
- Joyce JR. Multifocal ulcerative keratoconjunctivitis as a result of stings by imported fire ants. *Vet Med*. 1983;78:107-108.

## REFERENCES

- Boronow KE, et al. *J Exp Zoo*. 2010;313:17.
- Fitzgerald KT, et al. *Clin Tech Small Anim Pract*. 2006;21:194.

## MOTHS

Insect-generated fiber (e.g., in the cocoons of *Molopo* moths) can be indigestible and, if eaten in large quantities, can be associated with ruminal impaction. The body scales of the brown-tail moth and its larvae have a nettling effect, causing skin irritation on contact and bronchial mucosal irritation on inhalation.

## SWEATING SICKNESS (TICK TOXICOSIS)

### SYNOPSIS

**Etiology** Unknown, associated with bites of *Hyalomma truncatum*.

Continued

**Epidemiology** Reported in Africa, India, and Sri Lanka affecting calves 2 to 6 months of age.

**Clinical findings** Fever, salivation, lacrimation, hyperemia of mucosae, epistaxis, extensive and severe dermatitis, necrosis of oral epithelium.

**Lesions** Dermatitis and necrotic stomatitis, disseminated intravascular coagulopathy.

**Treatment** Symptomatic and use of hyperimmune serum.

**Control** Tick control.

## ETIOLOGY

The cause of sweating sickness in cattle has not been identified, but it behaves as though it were an epitheliotropic or dermatrophic toxin produced by the salivary glands of certain strains of the hard tick *Hyalomma truncatum*. Both male and female ticks of the strains can produce the toxin, but not all strains of *H. truncatum* have the ability to do so.

## EPIDEMIOLOGY

Attempts to transmit the disease between animals by direct contact and by injections of tissue or blood are unsuccessful. The disease occurs in Central, East, and South Africa; Sri Lanka; and probably southern India. Younger animals up to 1.5 years of age are affected as a rule, but rare cases occur in adults. Sheep, pigs, and goats are susceptible, although the disease does not naturally occur in them, and a similar disease has been reported in a dog in Brazil infested with the soft tick *Ornithodoros brasiliensis*, popularly known as the mouro tick.<sup>1</sup>

Sweating sickness occurs at all times of the year but is most prevalent during the wet season when ticks are more plentiful. The morbidity rate varies with the size of the tick population but is usually 10% to 30%. The case-fatality rate is up to 30%.

## PATHOGENESIS

The clinical signs begin 4 to 7 days after the ticks attach, probably 3 days in experimental infestations. The effects are dose specific; if the ticks are removed very early, there is no clinical response, and the animal remains susceptible; with a longer exposure before the ticks are removed, the animal becomes immune but shows no clinical signs. With longer exposure of more than 5 days, the subject develops the full-blown clinical disease and may die. If it recovers, it has a solid and durable immunity. However, there is no passive immunity via colostrum.

## CLINICAL FINDINGS

There is a sudden onset of fever up to 41°C (106°F), anorexia, hyperemia of the mucosae, and hyperesthesia. The animal is lethargic, depressed, and dehydrated and has a serous then mucopurulent oculonasal discharge, an

arched back, and a rough coat. There is an extensive, moist dermatitis commencing in the axilla, groin, perineum, and the base of the ears, and it may extend to cover the entire body in bad cases. "Sweating" refers to this moist dermatitis. The hair is matted together by exudate, and moisture collects in the form of beads on the surface. The eyelids may be stuck together. Subsequently patches of the skin and hair are rubbed off or can be pulled off to leave raw, red areas of subcutaneous tissue exposed. The tips of the ears and tail may slough.

Affected calves seek shade, and their skin is very sensitive to touch. Later it becomes dry and hard, and cracks develop. Secondary bacterial infection and infestation with blowflies or screw-worm larvae are common sequelae. The oral mucosa is hyperemic at first and then becomes necrotic with the formation of ulcers and diphtheritic membranes. The calf salivates profusely, cannot eat or drink, and becomes emaciated and rapidly dehydrated. There are similar mucosal lesions in the vagina and nasal cavities, the latter causing dyspnea. The severity of the mucosal lesions appears to vary with different "strains" of the toxin. There may be abdominal pain and diarrhea in some calves.

The course may be as short as 2 days but is usually 4 or 5 days. In recovered animals the skin may heal and the hair may regrow, but there may be permanent, patchy alopecia, and the calves may remain stunted and unthrifty.

## CLINICAL PATHOLOGY

There is severe neutropenia and eosinopenia and a degenerative left shift;  $\alpha$ -globulin and beta-globulin levels are raised. Urinalysis indicates the existence of nephrosis, but serum creatinine levels are normal. Dermatologic examination fails to reveal the presence of any of the usual infectious causes of dermatitis.

## NECROPSY FINDINGS

The lesions are essentially those seen clinically. There is also evidence of severe toxemia, dehydration, emaciation, and hyperemia of all internal organs and disseminated intravascular coagulation. The necrosis of the oral epithelium extends into the esophagus and may reach the forestomachs.

## DIFFERENTIAL DIAGNOSIS

The combination of extensive dermatitis and mucosal necrosis is unusual. Mucosal disease and bovine malignant catarrh may bear some resemblance, and there could be difficulty in differentiation in areas where the tick *Hyalomma truncatum* occurs.

## TREATMENT

There is no specific treatment; efforts should be directed at relieving the severity of the dermatitis and mucosal loss. Nonsteroidal

antiinflammatory drugs (NSAIDs) and broad-spectrum antibiotic cover is a logical regimen. Hyperimmune serum, produced in sheep and cattle by infesting them with *Hyalomma truncatum* at 6-week intervals for 2 to 5 occasions, is an effective treatment in pigs, sheep, and, to a less extent, calves.

## CONTROL

Control is limited to control of the causative tick. No vaccine is available. Exposure to the strain of ticks for a period of about 72 hours confers a limited degree of immunity.

## FURTHER READING

- Bwangamoi O. Sweating sickness. In: Mugeru GM, ed. *Diseases of Cattle in Tropical Africa*. Nairobi: Kenya Literature Bureau; 1979:405.
- Gothe R. Tick toxicoses of cattle. In: Ristic M, McIntyre I, eds. *Diseases of Cattle in the Tropics*. Current Topics in Veterinary Medicine and Animal Science. Vol. 6. Boston: Martinus Nijhoff; 1981:587.

## REFERENCE

1. Reck J, et al. *Vet Clin Pathol*. 2011;40:356.

## 4-AMINOPYRIDINE TOXICOSIS

4-aminopyridine is marketed as an avicide or bird repellent to control the overpopulation of "pest birds" that might destroy crops or damage aircraft, monuments, and other areas. It is a highly toxic, restricted-use pesticide marketed under the tradename Avitrol. Currently, it is available as treated whole corn, treated corn pieces, and mixed grains in 0.5% and 1% concentrations.<sup>1</sup> Interestingly, in 2010 the U.S. Food and Drug Administration (FDA) granted medical approval for the use of 4-aminopyridine in humans with multiple sclerosis.<sup>2</sup>

Poisoning in large animals is rare, with an animal poison center reporting a single cow case in a 10-year retrospective study.<sup>2</sup> In horses, reported clinical signs occurred 6 to 8 hours after ingestion and included signs of fright, profuse sweating, severe convulsions, and fluttering of the third eyelid. Death occurred 2 hours after the onset of signs; the lethal dose was estimated at 2 to 3 mg/kg BW. In cattle, signs include anorexia, frequent passage of small amounts of feces, and tenesmus, with some animals also showing tremor, ataxia, and erratic behavior, especially walking backward, with some sudden deaths.

It is rapidly absorbed from the gastrointestinal tract, metabolized in the liver, and excreted in the urine. 4-aminopyridine blocks specific voltage-gated potassium ion channels and increases the release of acetylcholine at neuromuscular junctions and in the central nervous system.<sup>2,3</sup> In toxic amounts, agitation, hyperactivity, and seizures occur. Death is from cardiac or respiratory arrest.

Treatment is primarily supportive and symptomatic and involves managing the airway and controlling CNS signs with sedatives and/or anticonvulsants.<sup>2,3</sup>



## FURTHER READING

- Nicholson SS, Prejean CJ. Suspected 4-aminopyridine toxicosis in cattle. *J Am Vet Assoc.* 1981;178:1277.
- Ray AC, Dwyer JN, Fambro GW, et al. Clinical signs and chemical confirmation of 4-aminopyridine poisoning in horses. *Am J Vet Res.* 1978;39:329-331.
- Schafer EW, Brunton RB, Cunningham DJ, et al. A summary of the acute toxicity of 4-aminopyridine to birds and mammals. *Toxicol Appl Pharm.* 1973;26:532.

## REFERENCES

1. Avitrol. 2011 at: <<http://www.avitrol.com/avitrol-bird-control-label-and-msds.html>>; Accessed 17.01.14.
2. King AM, et al. *J Med Toxicol.* 2012;8:314.
3. McLean MK, et al. *J Med Toxicol.* 2013;9:418.

## CADMIUM TOXICOSIS

Cadmium is an environmental pollutant that may accumulate in plants and animals.<sup>1</sup> It contaminates the environment, especially the soil, when sewage sludge and rock phosphate are used as fertilizers. Other sources include industrial pollution from zinc smelters, mining wastes, coal combustion, and water from old zinc- or cadmium-sealed pipes.<sup>2</sup>

There is much interest in cadmium entering the human food chain via animals used as food. The chances of cadmium accumulating in lean meat are not very great because the levels of ingestion required to produce significant levels are so high that they would be associated with observable clinical illness. The kidney and liver accumulate cadmium far more readily than other tissues, and ingestion may be of concern.<sup>2-4</sup>

Accumulation in the kidneys is related to cadmium content in forage and soil ingested.<sup>5</sup> Horses may carry a higher body burden of cadmium than sheep, cattle, and pigs.<sup>6</sup> Concentrations of cadmium in kidneys obtained from animals in rural Croatia showed the highest levels in horses (0.1029–47.4 mg/kg), which exceeded the maximum European Union levels for cadmium in the kidney by 93%. In contrast, cattle exceeded the limit by 14% and sheep by 16%.<sup>6</sup> In Belgium, cattle kidney cadmium levels were much higher (75% cadmium from contaminated areas; 47% from rural areas); no equine kidneys were analyzed.<sup>7</sup>

Ingestion is the most common route of exposure in large animals, with absorption occurring in the intestinal tract. Once absorbed, cadmium is transported to the liver, where it induces and binds to metallothionein, forming an inert complex that decreases the toxic effects of cadmium on the liver.<sup>3,8</sup> The complex decreases biliary excretion of cadmium and increases retention of cadmium in cells, and it ultimately plays a role in the long half-life of cadmium in the body (10 to 25 years in human beings).<sup>2,3,8,9</sup>

Acute ingestion is rare in animals and in most cases result from accidental administrations of farm chemicals (e.g., a cadmium-containing fungicide). The target

organs in acute human ingestions are the lung, liver, kidney, and testes, with nephrotoxicity common.<sup>2,9</sup>

Chronic ingestion in animals is associated with accumulation in tissues such as liver, kidney, lung, bone, testes, intestinal tract, skin, and blood. Chronic poisoning in cattle is associated with inappetence, weakness, loss of weight, poor hoof keratinization, dry brittle horns, matting of the hair, keratosis, and peeling of the skin. At necropsy there is hyperkeratosis of forestomach epithelium and degenerative changes in most organs. In cattle and sheep, cadmium levels in the feed greater than 50 mg/kg DM are associated with toxicity and large accumulations of cadmium in the kidney and liver.<sup>3</sup> Experimental poisoning of sheep is associated with anemia, nephropathy, and bone demineralization at a dose rate of 2.5 mg/kg body weight per day. Abortion, congenital defects, and stillbirths are also potential toxic outcomes. In young pigs, levels in the feed of 50 mg/kg for 6 weeks reduce growth rate and are associated with an iron-responsive anemia. The most signs in horses are lameness and swollen joints with osteoporosis and nephrocalcinosis.

There is currently no accepted treatment.<sup>2</sup> Zinc and iron may play a protective role in liver and kidney accumulation.<sup>3</sup> Selenium in rats has had a protective effect on the liver and kidneys and may be beneficial in individual animals.<sup>10,11</sup> Chelating agents have been suggested in human beings, but there are no documented studies on which particular one is effective.<sup>3</sup>

## FURTHER READING

- Bianu E, Nica D. Chronic intoxication with cadmium in the horses at the Copsa Mica area. *Revista Romana de Medicina Veterinara.* 2004;14:99-106.
- Gunderson DE, Kowalczyk DF, Shoop CR, et al. Environmental zinc and cadmium pollution associated with generalized osteochondrosis, osteoporosis, and nephrocalcinosis in horses. *J Am Vet Med Assoc.* 1982;180:295-299.
- Johnson DE, Kienholz EW, Baxter JC, et al. Heavy metal retention in tissues of cattle fed high cadmium sewage sludge. *J Am Sci.* 1981;52:108-114.

## REFERENCES

1. Madejon P, et al. *Ecotoxicology.* 2009;18:417.
2. Bernhoft RA. *Sci World J.* 2013;doi:10.1155/2013/394652.
3. Reis LSLS, et al. *J Med Sci.* 2010;1:560.
4. Szkoda J, et al. *Pol J Environ Stud.* 2006;15:185.
5. Li J, et al. *Environ Geochem Health.* 2006;28:37.
6. Bilandzic N, et al. *Food Addit Contam B.* 2010;3:172.
7. Waegeneers N, et al. *Food Addit Contam.* 2009;26:326.
8. Klaassen CD, et al. *Tox Appl Pharmacol.* 2009;238:215.
9. Liu J, et al. *Tox Appl Pharmacol.* 2009;238:209.
10. Newairy AA, et al. *Toxicology.* 2007;242:23.
11. El-Sharaky AS, et al. *Toxicology.* 2007;235:185.

## CHROMIUM TOXICOSIS

Chromium is most commonly found in two oxidation states: hexavalent and trivalent.

Hexavalent chromium is a strong oxidizing agent that crosses biological membranes and is five times more toxic than trivalent chromium.<sup>1,2</sup> Toxicity from hexavalent chromium occurs primarily from inhalation or industrial contamination and trivalent chromium from ingestion or parenteral administration.

Chromium is absorbed in the gastrointestinal tract and transported in the blood to bone, spleen, liver, and kidney.<sup>1</sup> Excretion is primarily renal, with some biliary elimination.

The use of protein concentrates prepared from tannery waste as an animal feed is not recommended because of the material's high chromium content.<sup>3</sup> Trivalent chromium salts given orally to pigs at the rate of 0.5 to 1.5 and at 3 mg/kg BW are associated with transient diarrhea. With the higher dosage there is also tremor, dyspnea, and anorexia. Toxicity from hexavalent chromium in oil fields has been associated with death in cattle, and dermal absorption of a strong oxidizing solution of chromium has been associated with death in a dairy herd.

## FURTHER READING

- Page TG, Southern LL, Ward TL, et al. Effect of chromium picolinate on growth and serum and carcass traits of growing-finishing pigs. *J Anim Sci.* 1993;71:656-662.
- Talcott PA, Halderson GJ, Sathre P. Chromium poisoning in a group of dairy cows. In: *Proceedings of American Association of Veterinary Laboratory Diagnosticians.* Hershey, PA: 2005:45.
- Thompson LJ, Hall JO, Meerdink GL. Toxic effects of trace element excess. *Vet Clin North Am Food A.* 1991;7:233-306.

## REFERENCES

1. Pechova A, et al. *Vet Med-Czech.* 2007;52:1.
2. Bala A, et al. *Sci J Vet Adv.* 2012;1:47.
3. Oral R, et al. *Desalination.* 2007;211:48.

## COBALT TOXICOSIS

Cobalt is an essential component of vitamin B<sub>12</sub> (cobalamin).<sup>1,2</sup> Nonruminant animals are unable to synthesize vitamin B<sub>12</sub> and depend on a dietary source of cobalt; ruminants can synthesize it if enough cobalt is provided in the diet.<sup>1</sup> Poisoning from cobalt is unlikely to occur in domestic animals unless there are errors in feed mixing, contamination of feed or water supply, or deliberate overdosing.

Absorption appears to be age dependent, with higher absorption in younger animals. Iron deficiency, in nonruminants, is associated with a higher absorption of cobalt. Cobalt is excreted primarily in the urine, with a small amount of fecal excretion. Tissue concentrations are highest in the liver, followed by the kidney, pancreas, and heart.<sup>2</sup>

Poisoning with cobalt compounds is associated with anorexia, weight loss, rough hair coat, listlessness, and muscular incoordination. Toxic effects appear in calves at dose rates of about 40 to 55 mg of elemental cobalt per 50 kg BW per day. Sheep are much

less susceptible, ingesting 15 mg/kg BW of cobalt without apparent effect. Pigs tolerate up to 200 mg cobalt/kg of diet, but intakes of 400 and 600 mg/kg are associated with growth depression, anorexia, stiffness of the legs, incoordination, and muscle tremors. Supplementation of the diet with methionine, or with additional iron, manganese, and zinc, alleviate the toxic effects.

### FURTHER READING

- Andrews ED. Cobalt poisoning in sheep. *NZ Vet J.* 1965;13:101-103.
- Dickson J, Bond MP. Cobalt toxicity in cattle. *Aust Vet J.* 1974;50:236.
- Ely RE, Dunn KM, Huffman CF. Cobalt toxicity in calves resulting from high oral administration. *J Anim Sci.* 1948;7:239-246.

### REFERENCES

1. Herdt TH. *Vet Clin North Am Food A.* 2011;27:255.
2. Simonsen LO. *Sci Total Environ.* 2012;432:210.

## PRIMARY COPPER TOXICOSIS

### SYNOPSIS

**Etiology** Acute or chronic intake of copper.

**Epidemiology** Sheep most susceptible, horses least. Significant differences in breed susceptibility. Copper originates from copper-rich soils, industrial contamination of pasture, agricultural chemicals, copper preparations used pharmaceutically, feed, and other sources.

**Pathogenesis** Acute poisoning as a result of ingestion of a single large dose is associated with gastrointestinal tract mucosal necrosis and fatal shock. Acute injectable dosing or chronic oral intake is associated with hepatic necrosis and hemolytic anemia.

**Clinical pathology** Chronic oral poisoning: very high liver copper levels, low packed cell volume (PCV), hemoglobinemia, hemoglobinuria. Liver enzyme activity and blood copper levels may or may not be elevated depending on when they are taken.

#### Necropsy lesions

**Acute oral poisoning:** severe gastroenteritis, bluish-green discoloration of mucosa and ingesta.

**Chronic oral poisoning:** icterus, swollen liver, kidneys, spleen; high tissue levels of copper.

**Diagnostic confirmation** High copper levels in tissues.

**Treatment** Acute poisoning: supportive care; chronic poisoning: various dosages of sodium or ammonium molybdate in combination with thiosulfate; thiomolybdate; chelating agents (penicillamine, dimercaprol, calcium disodium EDTA).

**Control** Removal from source, prophylactic administration of molybdate.

### ETIOLOGY

Acute oral and injectable poisoning is associated with a single large dose of copper. Chronic oral poisonings are associated with the accumulation of small amounts of copper over a long period of time.<sup>1,2</sup> In these instances, the amount of copper may exceed that required by the animal or be related to deficiencies in minerals such as molybdenum and sulfur.<sup>2</sup>

### Causes of Acute Oral Poisoning

- Accidental administration of soluble copper salts
  - Old copper-containing anthelmintics
- Accidental ingestion of copper-containing substances
  - Copper sulfate foot baths, containers of copper algacides or fungicides

### Causes of Acute Injectable Poisoning

- Prophylactic injection of copper salts, especially soluble salts
- Copper (as the diethylamine oxyquinoline sulfonate) at recommended dose rates has been associated with death in sheep.

### Causes of Chronic Oral Poisoning

- Contamination of drinking water
- Contamination of plants with fungicidal sprays<sup>3</sup>
- Copper containing boluses, pastes, needles, or wires placed in the rumen/reticulum<sup>4</sup>
- Feeding seed grain treated with copper-containing antifungal agents
- Feeding mineral or salt licks or mixtures containing excessive amounts of copper
- Grazing pasture contaminated by smelter fumes<sup>5</sup> or by drippings from overhead power cables made of copper but corroded by the constituents of an industrially polluted area
- Grazing pasture growing on soils rich in copper
- Grazing pasture too soon after it has been top-dressed with the following:
  - Copper salts to correct a mineral deficiency in the soil
  - Poultry manure or dried chicken waste when the birds have been fed on a copper-rich diet<sup>6</sup>
  - Pig slurry or dried pig wastes when the pigs have been fed on a copper-enriched ration as a growth supplement<sup>7</sup>
- Mineral or salt mixes containing copper ingested by salt-hungry livestock
- Miscellaneous sources of copper causing poisoning—palm oil cake and lumber treated with arsenic, copper, and chromium
- Overfeeding of copper-enriched concentrate rations

### EPIDEMIOLOGY

#### Occurrence

Sporadic outbreaks of primary copper poisoning occur in many species and in many different countries. Toxicosis occurs far more often in ruminants, especially sheep, than in nonruminants. Poisoning in sheep is commonly reported in countries such as Australia, Brazil, New Zealand, South Africa, and the United States.<sup>1,8</sup> Cattle, buffalo, and goats are also affected, although reports are more sporadic.<sup>2,8-10</sup> The morbidity rate is often low, but the mortality rate is high.<sup>3</sup>

There is a great deal of published anecdotal evidence about the amount of copper fed to specific species that has been associated with illness or deaths but almost no evidence of MD<sub>50</sub> or LD<sub>50</sub>. The following toxic dose rates are provided as a rough guide.

#### Sheep

- Acute: Single oral doses of 9 to 20 mg copper/kg BW;<sup>2</sup> some references provide a range of 20 to 100 mg copper/kg BW.<sup>3</sup>
- Chronic: Daily intakes of 3.5 mg copper/kg BW, 25 ppm being the maximum tolerated concentration in the feed.<sup>3</sup> Even lower concentrations (15 ppm) may poison sheep if adequate molybdenum and sulfate are not present in the diet.

#### Calves (Preruminant)

Toxic doses are similar to those for sheep.<sup>2</sup>

#### Cattle

- Acute: 200 mg copper/kg BW<sup>2</sup> (up to 800 mg/kg BW)
- Chronic: varies considerably depending on the breed

#### Goats

No data are available.

#### Horses

- Acute: 125 mg copper solution/kg BW; signs did not occur when similar amount added to feed.<sup>2</sup>
- Chronic: Relatively resistant; 791 mg copper/kg BW × 6 months resulted in no signs, but a liver copper concentration greater than 3000 mg/kg DM.<sup>2</sup>

#### Swine

- Acute: No data but considered relatively resistant
- Chronic: 200 mg copper/kg BW stimulates growth in weanling pigs; 500 mg copper/kg BW resulted in reduced growth and death.<sup>2</sup>

None of these data on toxic intakes come with information on competing and contributory dietary factors such as sulfate, molybdenum, and zinc, and these are critical in determining the toxic effects of the copper intake.

## Risk Factors

### Animal Risk Factors

Many deaths attributable to copper poisoning are followed by deaths from general debility in sheep in poor condition. Dairy cows, especially those lactating at the time, fail to produce well, and special care is needed to bring them back to full production. Younger animals, especially calves, are more likely to be poisoned as a result of an increase in copper absorption.<sup>2</sup>

### Species Susceptibility

Ruminants, especially young ruminants, are more susceptible than nonruminants. Preruminant calves appear to mirror the susceptibility of sheep. Sheep are the most susceptible species, with some species tolerating as little as 9 mg/kg BW; they are different from other species in the way in which copper is handled. As ingestion increases, sheep are unable to increase the amount of biliary excretion, and copper accumulates in the liver. Goats tolerate higher amounts in their diets than sheep. Goats receiving 36 mg/kg DM for 88 days had higher liver concentrations of copper but no evidence of liver damage. Cattle will usually tolerate 100 ppm,<sup>1</sup> but lethal hemolysis has occurred in cattle fed a low-copper-level mineral supplement (38 mg/kg BW for lactating cows) for 2 years. Swine can tolerate and swine 250 ppm in their diets.<sup>2</sup> Horses are the least susceptible, with a tolerance to levels of 800 ppm in the diet.

### Breed Susceptibility

**Sheep.** Scottish Blackface sheep appeared to be the least susceptible, followed by the Finnish Landrace, with intermediate susceptibility when fed moderate to high amounts of copper.<sup>2</sup> Texel sired lambs followed by Suffolk lambs were the most susceptible.<sup>2</sup> North Ronaldsay sheep are reported to be the most copper sensitive of sheep and mammals in general.<sup>11,12</sup> These sheep normally subsist on seaweed that has a very low content of copper and molybdenum.<sup>12</sup> When the sheep are fed on terrestrial herbage containing normal levels of copper and molybdenum and high levels of zinc, they develop copper poisoning.

**Cattle.** Angus cattle are much more susceptible than Charolais and Simmental. Jerseys may be more sensitive than Holstein cows.<sup>2</sup>

### Environmental Factors

Both acute and chronic copper poisoning occur under field conditions. Acute poisoning usually occurs because of the accidental ingestion or administration of large quantities of soluble copper salts, whereas chronic poisoning occurs principally as a result of ingesting feed containing or contaminated by copper derived from the soil or by its application to the diet as an agricultural chemical or feed supplement.

The toxicity of copper ingested in this manner is governed not only by the absolute amount of copper but also by the interaction of a number of factors, including the amount of molybdenum and sulfate present in the diet, the presence or absence of specific plants in the diet, and the level of protein in the diet.<sup>1,2</sup> In fact, either copper deficiency or copper poisoning can occur on soils with apparently normal copper levels, with the syndrome depending on the particular conditioning factors present. High molybdenum and sulfate levels in the rumen lead to the microbiological synthesis of nonabsorbable thiomolybdates, and a high-sulfate diet also leads to lower retention of copper in tissues.

Other compounding factors exist. There is a competitive relationship between copper and zinc in the internal metabolism of ruminants, with a high level of zinc in the diet reducing the intake of copper. Reduction in rumen protozoa results in an increased susceptibility to copper, as does the use of ionophores such as monensin.<sup>2</sup> Sheep on a selenium-deficient diet and with low blood levels of glutathione peroxidase are more susceptible to chronic copper poisoning. Some sheep are conditioned by inheritance to have low blood glutathione levels in spite of a normal dietary intake of selenium. They also have low glutathione peroxidase blood levels and may be more susceptible for this reason.

## PATHOGENESIS

Toxicokinetics vary depending on the gastrointestinal tract. In nonruminant animals, including preruminant calves and lambs, absorption occurs primarily in the small intestine. Absorption in ruminant animals is low, primarily as a result of the relationship between molybdenum and sulfur in the rumen. In the intestinal mucosa, a portion is bound to metallothionein and eventually excreted in the feces. The remainder is bound to albumin and transcuprin in the blood and transported to the liver. Once in the liver, copper can be stored, incorporated into ceruloplasmin for use, or excreted in the bile.<sup>1,2</sup> Very little renal excretion occurs. The liver has the highest concentration of copper, followed by the kidney and brain.<sup>2,13,14</sup>

Acute exposure to soluble copper salts in high concentrations is associated with intense irritation of the gastrointestinal mucosa, blue-green discoloration of the feces and mucosa, and profound shock. Severe intravascular hemolysis occurs if the animal survives long enough. Free copper acts as a protein coagulant, binding to proteins and forming a reactive oxygen species.<sup>1,2</sup>

When excessive amounts of copper are injected the response is rapid, and animals begin to die the next day, with peak mortality about the third day after dosing.<sup>13</sup> Early deaths appear to be attributable to severe hepatic insufficiency and later deaths to renal tubular necrosis.

Chronic poisoning occurs when ingestion overwhelms biliary excretion. The frequent ingestion of small amounts produces no ill-effects while copper accumulates in the liver and to a less extent, the kidney. This is generally referred to as the “prehemolytic phase.”<sup>1,2</sup> When maximum hepatic levels are reached, often after periods of exposure as long as 6 months, copper is released from the liver into the bloodstream, and the animal dies of acute intravascular hemolysis. This phase is generally referred to as the “hemolytic phase.”<sup>1,2</sup> The production of superoxide radicals that damage erythrocyte membranes may be responsible for hemolysis. One of the dangers of cumulative copper poisoning is that the animal shows normal health until the hemolytic crisis, when it becomes acutely ill and dies very quickly. Death is ascribed to acute hemolytic anemia and hemoglobinuric nephrosis.

The liberation of the hepatic copper is not well understood, but the favored hypothesis is that the accumulation of copper ions in the liver cells is associated with the accumulation of electron-dense lysozymes in the hepatocytes and hepatic necrosis. Various stresses, including a fall in plane of nutrition, traveling, and lactation, are thought to precipitate the liberation.<sup>2,3</sup> Complex mechanisms relating to disorders of cell membranes; a marked change in hemoglobin composition, including the development of methemoglobinemia; and an increase in the oxidative status of the sheep are described as occurring during the critical stages.<sup>3</sup> Liver-specific enzymes may appear in the serum beginning a few days or weeks before the hemolytic stage. Severe hepatic necrosis occurs at the time of the hemolytic crisis.

## CLINICAL FINDINGS

### Acute Intoxication

Acute toxicosis from ingestion or injection of large amounts of copper salts is rare. Clinical signs present after ingestion include severe gastroenteritis accompanied by salivation, abdominal pain, dehydration, diarrhea, and vomiting in those species that are able to. The feces and vomitus are mucoid with a characteristic blue-green color. Shock with a fall in body temperature and an increase in heart rate is followed by collapse and death, usually within 24 hours.<sup>1,2</sup> If the animal survives for a longer period, dysentery and jaundice become apparent. Horses receiving an oral solution of copper sulfate (125 mg/kg BW) developed gastroenteritis, hemolysis, and liver and kidney damage, and they died within 2 weeks. Interestingly, horses receiving a similar amount in the feed did not develop any signs of poisoning.<sup>2</sup>

Poisoning associated with the injection of copper salts is manifested by anorexia, depression, and dehydration. Ascites, hydrothorax, hydropericardium, hemoglobinuria, and massive hemorrhages, tachypnea, head-pressing, opisthotonos, aimless wandering,



circling, and ataxia are reported in calves surviving for 3 or more days.<sup>1,13</sup> Lambs similarly poisoned die within 24 hours of injection.

### Chronic Intoxication

In ruminants, anorexia, thirst, hemoglobinuria, pallor, and jaundice appear suddenly. There is no disturbance of alimentary tract function.<sup>1-3,8</sup> Depression is profound, and the animal usually dies 24 to 48 hours after the appearance of signs. A herd of affected lactating dairy goats did not show hemolysis but rather anorexia, recumbency, and neurologic signs, whereas adult Boer goats developed hemolysis and hemoglobinuric nephrosis.<sup>9,10</sup> In pigs, signs of illness are uncommon, with most pigs being found dead without premonitory signs, although dullness, anorexia, poor weight gain, melena, weakness, pallor, hyperesthesia, and muscle tremor may be observed occasionally.

## CLINICAL PATHOLOGY

### Acute Intoxication

In acute intoxications, hepatic enzymes may not rise for a few days. Fecal examination may show large amounts (8000 to 10,000 mg/kg) of copper.

### Chronic Intoxication

Serum enzyme activity (aspartate aminotransferase [AST],  $\gamma$ -glutamyltransferase [GGT], sorbitol dehydrogenase [SDH]) may be increased just before the hemolytic episode. The hepatic enzymes GGT and AST were determined in one experimental study to be the best enzymes to assess copper load in sheep during the prehemolytic phase. GGT activity increases were evident 28 days before the hemolytic crisis, and AST activity increased from 14 days before onset of acute copper toxicosis. In one small study, GGT and AST were predictive indicators of hepatic accumulation in cattle, whereas only GGT was predictive in buffalo.<sup>15</sup>

Other laboratory abnormalities are consistent with hemolysis and renal damage. The packed cell volume decreases sharply with the onset of hemolysis. Hemoglobinemia and hemoglobinuria may be present, and elevations in blood urea nitrogen and creatinine indicate renal compromise.

Levels of copper in the liver are markedly increased in chronic copper poisoning. Liver biopsy is the best diagnostic technique and serves a most useful purpose in the detection of chronic copper poisoning because blood levels do not raise appreciably until the hemolytic crisis occurs before death.<sup>1,6</sup> Because of the greater concentration of copper in the caudate lobe compared with other parts of the liver, an autopsy specimen will give the most reliable results.

Blood levels of copper during the hemolytic crisis are usually of the order of 78 to 114  $\mu\text{mol/L}$  (4.9 to 7.2 ppm), compared with about 15.7  $\mu\text{mol/L}$  (1 ppm) in normal

animals. Normal liver levels of less than 5.5 mmol/kg dry matter (349 ppm) rise to above 15.7 mmol/kg (997 ppm) in the latter stages of chronic copper poisoning in sheep, to 95 mmol/kg in pigs, and to 30 mmol/kg in calves. In sheep, liver values greater than 7.85 mmol/kg and kidney values of greater than 1.25 to 1.57 mmol/kg dry matter are diagnostic. After a massive single dose, it is important to include kidney among specimens submitted for copper assay because levels may be high (more than 25 mg/kg dry matter), whereas liver copper levels have not yet risen. When comparing normal and toxic values, it should be remembered whether results are expressed as dry weight basis or wet weight basis. Assuming approximately 20% dry matter in tissue, a wet weight value of 1.5 ppm copper is actually 7.5 ppm on a dry weight basis, comparable to the toxic range reported previously for blood. Thus a commonly observed toxic value of 200 ppm copper in liver (wet weight basis) would be reported as 1000 ppm copper on a dry weight basis.

## NECROPSY FINDINGS

### Acute Intoxication

Acute copper poisoning via oral exposure is uncommon in ruminants, but gross changes include severe gastroenteritis with erosion and ulceration, particularly in the abomasum. Macroscopic changes in calves poisoned by injected solutions of copper salts include hepatomegaly with an enhanced zonal pattern and massive fluid accumulations in body cavities. Characteristic microscopic findings in such acute copper toxicoses include extensive periacinar hepatic necrosis and a variable amount of renal tubular nephrosis.

### Chronic Intoxication

In chronic copper poisoning, jaundice and hemoglobinuria are usually but not always present. The liver is swollen and yellow and may contain hemorrhagic foci. The spleen is enlarged, with a soft pulp; the kidneys are swollen and have a dark, gunmetal color. The hemolytic crisis typical of ovine copper toxicosis results in massive acute hepatocellular necrosis, which masks most of the chronic hepatic damage. These changes include hepatocellular vacuolation and degeneration, increased single-cell necrosis of hepatocytes, a variable amount of periportal fibrosis, and proliferation of cholangiolar cells. These chronic lesions are more easily identified in cattle suffering from copper poisoning. Granular casts are often present in the renal tubules, especially in affected sheep. The brain in affected sheep may have focal areas of gliosis in the cerebral cortex and white-matter areas.<sup>14</sup> Hemosiderin deposits are increased in the liver and spleen. Details of the critical copper levels of tissues are provided in the clinical pathology discussion.

Although the lesions described previously do occur in some outbreaks of the disease in pigs, they are not as pronounced as in ruminants, and they are often accompanied by pulmonary edema and by severe hemorrhage from ulcers in the pars esophagea or large intestine.

## Samples for Confirmation of Diagnosis

- **Toxicology**—5 mL blood; 50 g liver, kidney; 100 g stomach content; 500 g suspect feed (ASSAY [Cu])
- **Histology**—formalin-fixed liver, kidney, abomasum, spleen (light microscopy)

**Diagnostic confirmation** is by demonstration of high blood and liver levels of copper plus histologic evidence of liver damage. The history and the examination of feedstuffs and pastures are valuable aids in determining the cause.

## DIFFERENTIAL DIAGNOSIS

### Differential list:

#### Acute Intoxication:

The differential diagnosis list for acute copper poisoning includes other associations with gastroenteritis. Copper poisoning can usually be identified by the bluish-green color of the ingesta or feces.

#### Chronic Intoxication:

Acute hemolytic diseases that may be mistaken for chronic copper poisoning include the following:

- Babesiosis
- Bacillary hemoglobinuria
- Equine infectious anemia
- Leptospirosis
- Nitrate/nitrite poisoning
- Plant poisoning including allium and S-methylcysteine sulphoxide (SMCO) in rape, kale
- Postparturient hemoglobinuria
- Red maple (*Acer rubrum*) toxicosis (horses)

## TREATMENT

In acute poisoning, treatment is primarily symptomatic and supportive. Intravenous fluids, gastrointestinal protectants, and nonsteroidal antiinflammatory drugs may be used for dehydration, gastrointestinal pain, and shock. Blood transfusions may be indicated in individual animals with hemolysis and a rapidly falling packed cell volume.

Chelation may be useful in chronic toxicosis in small herds or individual animals. Common chelating agents used in the treatment of human copper toxicosis include penicillamine, dimercaprol, and calcium disodium EDTA.<sup>16</sup> Penicillamine has been used successfully in goats (50 mg/kg PO q24h  $\times$  7 days), but the cost may limit its use in herd situations.<sup>9</sup> Intravenous calcium disodium edetate (70 mg/kg BW  $\times$  2 days) has been used in calves.

There are a number of dosage recommendations for ammonium molybdate and sodium thiosulfate. For chronic copper poisoning, daily oral treatment of lambs with 100 mg ammonium molybdate and 1 g anhydrous sodium thiosulfate significantly reduced the copper content of tissues and appears to prevent deaths in lambs known to have toxic amounts of copper. In a herd of goats, 300 mg ammonium molybdate (300 mg PO q24h) and sodium thiosulfate (300 mg PO q24h) for 3 weeks has been used.<sup>9</sup> Ammonium tetrathiomolybdate (1.7 mg/kg IV or 3.4 mg/kg SQ every other day for 3 doses) or (2–15 mg/kg IV q24h × 3–6 days) has been recommended for use in food animals and sheep.<sup>17</sup> Different countries may have particular restrictions on the form of molybdenum approved for use, so locally available approved therapy should be determined.

### CONTROL

With chronic intoxication, the provision of additional molybdenum in the diet as described under the control of phyto-genous chronic copper poisoning should be effective as a preventive measure. Ferrous sulfide is effective, but difficulty is usually encountered in getting the animals to eat it. In pigs and sheep, the administration of iron and zinc reduces the risk of copper poisoning in diets supplemented by this element, and a diet high in calcium encourages the development of copper poisoning, probably by creating a secondary zinc deficiency. A lick that contains dicalcium phosphate, sulfur, and zinc sulfate has been used as a prophylactic.

### FURTHER READING

- Bidewell CA, David GP, Livesey CT. Copper toxicity in cattle. *Vet Rec.* 2000;14:399-400.
- Humphries WR, Mills CF, Greig A, et al. Use of ammonium tetrathiomolybdate in the treatment of copper poisoning in sheep. *Vet Rec.* 1986;119:596-598.
- Ishmael J, Gopinath C, Howell JM. Experimental chronic copper toxicity in sheep. Histological and histochemical changes during the development of the lesions in the liver. *Res Vet Sci.* 1971;12:358-366.
- Perrin DJ, Schiefer HB, Blakley BR. Chronic copper toxicity in a dairy herd. *Can Vet J.* 1990;31:629-632.
- Radostits O, et al. Primary copper poisoning. In: *Veterinary Medicine: A Textbook of the Disease of Cattle, Horses, Sheep, Goats and Pigs.* 10th ed. London: W.B. Saunders; 2007:1820.
- Smith JD, Jordan DR, Nelson ML. Tolerance of ponies to high levels of dietary copper. *J Anim Sci.* 1975;41:1645-1649.
- Solaiman SG, Maloney MA, Qureshi MA, et al. Effects of high copper supplements on performance, health, plasma copper and enzymes in goats. *Small Ruminant Res.* 2001;41:127-139.

### REFERENCES

- Reis LSL, et al. *J Med Med Sci.* 2010;1:560.
- National Research Council. Copper. In: *Mineral Tolerance of Animals.* 2nd rev ed. National Academies Press; 2005:134.
- Oruc HH, et al. *J Vet Diagn Invest.* 2009;21:540.
- Burke JM, et al. *J Anim Sci.* 2007;85:2753.

- Mozaffari AA, et al. *Turk J Vet Anim Sci.* 2009;33:113.
- Christodouloupoulos G, et al. *Aust Vet J.* 2007;85:451.
- Blanco-Penedo I, et al. *Environ Int.* 2006;32:901.
- Minervino AHH, et al. *Res Vet Sci.* 2009;87:473.
- Cornish J, et al. *J Am Vet Med Assoc.* 2007;231:586.
- Bozynski CC, et al. *J Vet Diagn Invest.* 2009;21:395.
- Simpson DM, et al. *BMC Vet Res.* 2006;2:36.
- Haywood S, et al. *J Comp Path.* 2008;139:252.
- Fazio LE, et al. *Pesq Vet Bras.* 2012;32:1.
- Giadinis ND, et al. *Turk J Vet Anim Sci.* 2009;33:363.
- Minervino AHH, et al. *J Vet Diagn Invest.* 2008;20:791.
- Franchitto N, et al. *Resuscitation.* 2008;78:92.
- Plumb DC. Ammonium molybdate/ammonium tetramolybdate. In: Plumb DC, ed. *Veterinary Drug Handbook.* 7th ed. Ames, IA: Wiley-Blackwell; 2011:56.

### TOXICOSIS FROM DRIED POULTRY WASTES

Feeding dried poultry wastes to ruminants provides them with a source of nitrogen and gets rid of the chicken farmer's disposal problem. However, deleterious effects include the following:

- Copper poisoning when the chickens are fed on diets supplemented with copper
- Estrogen poisoning when the chickens are fed on estrogen-supplemented diets
- An unidentified problem arises of hepatic necrosis, hypoalbuminemia, and ascites in lambs fed large amounts of poultry waste from hen batteries.
- Litter from broiler houses is associated with renal damage but not to the point of causing mortality.
- Botulism

### TOXICOSIS FROM DEFOLIANTS

Substances used to remove the leaves from plants to facilitate harvesting of seed may represent a toxic hazard if the residual stalks are fed to livestock or if the animals gain access to concentrated product.

- Monochloroacetate sodium (SMCA) is commonly used for this purpose. It is unlikely to cause poisoning unless very large quantities of the stalks are fed or if animals have access to the concentrated defoliants. Toxic signs in cattle include diarrhea, colic, muscular tremor, stiff gait, ataxia, and dyspnea. Terminally there may be convulsions, hyperexcitability, and aggressiveness. The course is short, with most animals dying within a few hours.
- Trialkyl phosphorothioates (Merphos and DEF), organophosphorus compounds used as a defoliant for cotton plants, produce typical signs of organophosphorus poisoning.
- Thidiazuron (TDZ), a cotton defoliant, appears to be nontoxic to animals, but it may enter the human food chain via goat's milk and chicken eggs.

### FURTHER READING

- Aldridge WN, Dinsdale D, Nemery B, et al. Some aspects of the toxicology of trimethyl and triethyl phosphorothioates. *Fund Appl Toxicol.* 1985;5:S47-S60.
- Hur JH, Wu SY, Casida JE. Oxidative chemistry and toxicology of S, S, S-tributyl phosphorotrithioate (DEF defoliant). *J Ag Food Chem.* 1992;40:1703-1709.
- Murthy BNS, Murch SJ, Saxena PK. Thidiazuron: a potent regulator of in vitro plant morphogenesis. *In Vitro Cell Develop Biol-Plant.* 1998;34:267-275.
- Quick MP, Manser PA, Stevens H, et al. Sodium monochloroacetate poisoning of cattle and sheep. *Vet Rec.* 1983;113:155-156.

### TOXICOSIS FROM FUNGICIDES

- Zinc ethylene dithiocarbamate (zineb) may be associated with thyroid hyperplasia and hypofunction, degeneration of myocardium and skeletal muscle, testicular weight reduction, and germ cell depletion.
- Thiram (tetramethyl thiuram sulfide) is a widely used agricultural fungicide that is associated with conjunctivitis, rhinitis, and bronchitis on local contact; it is thought to be associated with abortion in ewes on ingestion. It is a known teratogen, but no specific poisoning incidents have been recorded in large animals. In birds, ingestion of contaminated poultry feed caused soft eggshells, depressed growth, and leg abnormalities.<sup>1</sup>

### Fungistatic Agents

- Hexachlorobenzene (HCB) is widely known because of its indestructibility and capacity to pass from grain through cattle and into humans. Legislation against chlorinated hydrocarbons being found in the human food chain is very harsh, and hexachlorobenzene is a prime target for public health veterinarians. Its specific toxicity is not high, although experimental poisoning in pigs is associated with incoordination, paresis, and other disorders of the central nervous system.

### Grain Fumigants

- Grain treated by the fumigant dibromoethane is associated with mortality in sheep. The principal lesions are pulmonary edema, septal fibrosis, alveolar epithelialization, and pleural effusion. Death occurs 48 to 120 hours after exposure.
- Methyl bromide is used for stored grain and as a soil fumigant.

### FURTHER READING

- Guitart R, Mateo R, Gutierrez JM, et al. An outbreak of thiram poisoning on Spanish poultry farms. *Vet Hum Tox.* 1996;38:287-288.
- Palmer JS. Tolerance of sheep to the organic-zinc fungicide, Zineb. *J Am Vet Med Assoc.* 1963;143:994-995.

Robinson GR, Wagstaff DJ, Colaianne JJ, et al. Experimental hexachlorophene intoxication in young swine. *Am J Vet Res.* 1975;36:1615-1617.

## REFERENCE

1. Guitart R, et al. *Vet J.* 2010;183:249.

## TOXICOSIS FROM HERBICIDES

Over 200 different substances have been used as herbicides; some of them are historical and no longer manufactured. Herbicides vary widely in their composition, toxicity, associated toxicity, mechanism of action, and use. Associated toxicities include the following:

- Arsenicals herbicides may also cause other signs of arsenic poisoning.
- A hazard of the relatively safe organic compounds described here is their contamination by highly toxic ones as a result of faults in the manufacturing process (e.g., the dioxins that have been found to be significant contaminants of the 2,4,5-T chemical). Today, restrictions on registration and changes in the manufacturing process have drastically reduced contamination by dioxins.
- Sodium chlorate, in addition to other signs, causes methemoglobinemia.
- Some herbicides (e.g., glyphosate) increase the palatability of sprayed pasture more, creating their own toxicity hazard.
- The phenoxy acid herbicides (2,4-D, 2,4,5-T) can increase palatability of some plants after spraying and induce elevated nitrate concentration in plants for several days after spraying.

## BIPYRIDYL DERIVATIVES

Paraquat and diquat, the two common herbicides included in this classification, are poisonous by ingestion, inhalation, and dermal exposure. Paraquat is among the most toxic herbicides currently in use and is restricted in many developed countries; diquat is somewhat less toxic. Poisoning in large animals with a bipyridyl herbicide is unlikely to occur unless it is accidentally or maliciously administered. Cattle and sheep are more sensitive to bipyridyls than other species. The LD<sub>50</sub> of paraquat in cattle is 35 to 50 mg/kg BW; in sheep, the LD<sub>50</sub> is 8 to 10 mg/kg BW; and in pigs, 75 mg/kg BW. The LD<sub>50</sub> of diquat in cattle is 20 to 40 mg/kg BW.<sup>1</sup>

Paraquat accumulates in the lungs, affecting the type I and II alveolar cells and Clara cells and resulting in acute alveolitis and chronic pulmonary fibrosis in many species.<sup>2</sup> Paraquat is associated with fibrosing pneumonitis in pigs, but this does not develop in sheep or cattle with fatal doses. A dose rate of 100 mg/kg BW is uniformly fatal in pigs, with signs of vomiting, diarrhea, and dyspnea. Those animals that survive long

enough may develop acute renal failure. Other lesions include hepatic injury and mucosal damage.<sup>3</sup>

Diquat does not specifically affect the lungs, but rather the gastrointestinal tract, liver, and kidneys. Accidental poisoning of sheep as a result of contamination of pasture by diquat has been associated with widespread illness with signs of diarrhea and significant mortality. In cattle, accidental poisoning with diquat has been associated with fatal abomasitis and enteritis, hepatic and myocardial degeneration, and pulmonary emphysema.

## CARBAMATES, THIOCARBAMATES, DITHIOCARBAMATES

Herbicides in this group include, among others, asulam, barban, di-allate, tri-allate, and metham sodium. In general, these herbicides are safe when used in low concentrations. Repeated small doses are associated with marked alopecia.<sup>4</sup> Barban is toxic at doses of 25 mg/kg BW in cattle. Di-allate is toxic to ruminants, with anorexia, ataxia, and exhaustion reported as common signs.<sup>1</sup> The toxic dose of di-allate in cattle and sheep is 25 mg/kg BW for 5 days or 50 mg/kg BW for 3 days.<sup>1</sup> Tri-allate is associated with severe illness and sporadic death after single oral doses of 300 mg/kg BW in sheep and 800 mg/kg BW in pigs. Salivation, bradycardia, vomiting, muscular weakness, dyspnea, tremor, and convulsions are followed by death in 2 to 3 days. It is also toxic when continuously given in small amounts.

## DINITROPHENOL COMPOUNDS

Dinitrophenol (DNP) and Dinitro-orthocresol (DNOC) are the most common members of this group. Dinoseb, now rarely used, is a highly toxic DNP. Dinitrophenols are hazardous to all species; doses of 25 to 50 mg/kg BW are usually toxic, but much smaller doses produce toxicity when environmental temperatures are high. The toxic dose range in cattle is 2 to 50 mg/kg BW.<sup>1</sup>

Animals can be poisoned accidentally by inhalation, ingestion, or percutaneous absorption of these compounds, which have the effect of uncoupling oxidative phosphorylation and increasing the basal metabolic rate.<sup>5</sup> Poisoning is manifested by an acute onset of restlessness, sweating, deep and rapid respiration, hyperthermia, and collapse. In ruminants, but not in nonruminants, the metabolites of these compounds are associated with intravascular hemolysis, methemoglobinemia, and hypoproteinemia. Death may occur 24 to 48 hours later.

## INORGANIC HERBICIDES

Sodium chlorate, sodium borate or borax, ammonium sulfamate, and several arsenical products have historically been used as herbicides. For the most part they have been replaced by newer preparations. Sodium chlorate, although banned as an herbicide in

several countries,<sup>6</sup> has been studied in sheep, cattle, and pigs as means of decreasing the fecal shedding of *E. coli* and other gastrointestinal pathogens.<sup>7-10</sup>

## Sodium Chlorate

Animals seldom ingest sufficient sprayed plant material to produce clinical illness, and the principal danger is from accidental dosing or permitting salt-hungry cattle to have access to the chemical. The lethal oral dose is 2 to 2.5 g/kg BW for sheep, 0.5 g/kg for cattle, and 3.5 g/kg for dogs. Irritation of the alimentary tract is associated with diarrhea and deep, black erosions of the abomasal and duodenal mucosae. Hemoglobinuria, anemia, and methemoglobinemia result, and somnolence and dyspnea are characteristic. At necropsy, the blood, muscles, and viscera are very dark. No specific treatment is available. Sodium thiosulfate and methylene blue are used in treatment but have little effect; copious blood transfusions have been recommended.

## ORGANOPHOSPHORUS COMPOUNDS

Glyphosate and glufosinate, both organophosphorus compounds, are herbicides regularly used in many countries.<sup>11,12</sup> The acute oral toxicity is low; dermal, ophthalmic, and respiratory irritation can occur from exposure to wet product. Glufosinate is slightly more toxic than glyphosate, and the surfactant used in ammonium formulation has been implicated in human poisonings.<sup>1</sup>

## PHENOXY ACID DERIVATIVES

Substances found in this group are among the most extensively used herbicides, with 2,4-D (2,4-dichlorophenoxyacetic acid) and others commercially available since the mid-1940s. Common phenoxy acid derivatives include 2,4-D, 2,4-DB, 2,4,5-T, dalapon, 2,4-DP (dichloprop), MCPP (mecoprop), MCPA, and silvex. As a group, low doses are relatively safe; ingestion of higher doses results in gastrointestinal and nervous system signs.<sup>1</sup> Silvex, MCPA, 2,4-D, and 2,4,5-T are non-toxic in the concentrations used on crops and pasture, but dosing with 300 to 1000 mg/kg as a single dose is associated with deaths in 50% of cattle. They have also been tentatively linked with the high prevalence of small intestinal carcinomas in sheep.

Ingestion of 2,4-D at doses between 150 and 188 mg/kg BW is fatal to adult cows and at 10 mg/kg BW for sheep. Reversible toxic effects are produced with single doses in calves with doses of 200 mg/kg and in pigs with 100 mg/kg. Repeated administration of 50 mg/kg is toxic to pigs. In adult cows, signs include recumbency, ruminal stasis, salivation, and tachycardia. In calves, the signs are dysphagia, tympanites, anorexia, and muscular weakness; in pigs, additional signs include incoordination, vomiting, and transient diarrhea. Long-term administration to



pigs (500 ppm in the diet for 12 months) is associated with moderate degenerative changes in kidney and liver. Repeated dosing of sheep with silvex for about 30 days at 150 mg/kg BW causes death.

A commonly used mixture of 2,4-D, 2,4,5-T and a brushwood killer, monosodium methyl arsenate, is very toxic by mouth or after application to the skin; signs include anorexia, diarrhea, weight loss, and death in most cases.

### TRIAZINES/TRIAZOLES

Similar to phenoxy acid herbicides, triazine herbicides have been enjoyed widespread use for many years. Common herbicides include atrazine, cyanazine, propazine, prometon, simazine, and terbutryn. Atrazine and prometon appear to be nontoxic at usual levels of ingestion. Accidental poisoning of sheep with atrazine is associated with paralysis, exophthalmos, grinding of the teeth, diarrhea, dyspnea, and tachycardia, and that of cattle is associated with salivation, tenesmus, stiff gait, and weakness. Experimental dosing of heifers with large doses of atrazine is associated with fatalities, but animals treated with activated charcoal have survived. Continuous access to simazine is associated with tremor, tetany and paraplegia, and a prancing gait with the head held against the chest. Death occurs after 2 to 4 days, and mild to moderate myocardopathy is found at necropsy.

Simazine and aminonitrazole in combination have been associated with death in sheep and horses allowed access to pasture sprayed with the mixture. In sheep the signs are staggering, inappetence, and depression. In horses, colic is the prominent feature.

### UREAS/THIOUREAS

Diuron, isoproturon, linuron, and tebuthiuron are among the many herbicides found in this classification. With the exception of tebuthiuron, most of these herbicides are of low-order toxicity. The toxic dose of diuron in cattle is 100 mg/kg BW for 10 days, and in sheep it is 250 mg/kg BW or 100 mg/kg BW for 2 days.<sup>1</sup> The toxic dose of linuron in cattle is listed as 20 to 40 mg/kg BW.<sup>1</sup> Flumeturon toxicity in sheep results depression and drowsiness, dyspnea, salivation, mydriasis, teeth grinding, chewing movements, and incoordination.<sup>1</sup>

### OTHERS

#### Triclopyr

Triclopyr, a selective postemergence herbicide, is toxic to horses at five times the estimated maximum intake from herbage. It is associated with digestive and respiratory signs, ataxia, stiff gait, and occasional tremors.

#### Delrad

Delrad is an algicide historically used to control the growth of algae on ponds and

other water reservoirs. Cattle and sheep are unharmed by the ingestion of water containing 100 ppm of the compound. Dose rates of 250 g/kg BW in adult cattle, 150 mg/kg BW in calves, and 500 mg/kg BW sheep are associated with toxic effects.

### FURTHER READING

- Burgat V, Keck G, Guerre P, et al. Glyphosate toxicosis in domestic animals: a survey from the data of the Centre National d'Informations Toxicologiques Veterinaires (CNTV). *Vet Human Toxicol.* 1998;40:363-367.
- Conning DM, Fletcher K, Swan AAB. Paraquat and related bipyridyls. *Brit Med Bull.* 1969;25:245-249.
- Frank JF. The toxicity of sodium chlorate herbicides. *Can J Comp Med Vet Sci.* 1948;12:216-218.
- Mehmood OSA, Ahmed KE, Adam SE, et al. Toxicity of cotoran (fluometuron) in desert sheep. *Vet Hum Toxicol.* 1995;37:214-216.
- Osweller GD. Toxicology of triclopyr herbicide in the equine. In: *Proceedings American Association of Veterinary Laboratory Diagnosticians 25th Annual Meeting.* Reno, NV: 1983.
- Radostits O, et al. Herbicides. In: *Veterinary Medicine: A Textbook of the Disease of Cattle, Horses, Sheep, Goats and Pigs.* 10th ed. London: W.B. Saunders; 2007:1838.
- Rose MS, Lock EA, Smith LL, et al. Paraquat accumulation: tissue and species specificity. *Biochem Pharmacol.* 1976;25:419-423.
- Simon EW. Mechanisms of dinitrophenol toxicity. *Biol Rev.* 1953;28:453-478.

### REFERENCES

- Gupta PK. Toxicity of herbicides. In: Gupta RC, ed. *Veterinary Toxicology.* 2nd ed. London, UK: Elsevier; 2012:631.
- Dinis-Oliveira RJ, et al. *Crit Rev Toxicol.* 2008;38:13.
- Gawarammana IB, et al. *Br J Clin Pharmacol.* 2011;72:745.
- Hurt S, Ollinger J, Arce G, et al. Dialkylthiocarbamates (EBDCs). In: Krieger R, ed. *Haye's Handbook of Pesticide Toxicology.* Vol. 2. 3rd ed. San Diego, CA: Elsevier; 2010:1689.
- Miranda EJ, et al. *J Anal Toxicol.* 2006;30:219.
- Stuerzebecher A, et al. *Clin Toxicol.* 2012;50:52.
- Smith DJ, et al. *J Anim Sci.* 2013;91:5962.
- Smith DJ, et al. *J Anim Sci.* 2012;90:2026.
- Callaway TR, et al. *Ag Food Anal Bacteriol.* 2013;3:103.
- Cha CN, et al. *Acta Vet Hung.* 2012;60:93.
- Berny P, et al. *Vet J.* 2010;183:255.
- Duke SO, et al. *Pest Manag Sci.* 2008;64:319.

## HYDROCARBON TOXICOSIS

### ETIOLOGY

Crude oil coming directly from wells is usually repellent to animals, but they can consume lethal quantities if they are in salt-deficient and salt-hungry state. A characteristic of crude oil is that it is usually mixed with salty water, which is often left lying in ponds nearby. After extraction most crude oils are temporarily stored in installations where lead paint is available, and thus salt and lead poisoning commonly occur with oil poisoning. Of the natural crude oils, those with the highest content of sulfur ("sour crude") are most unpalatable and most toxic.

Petroleum distillates, including diesel oil, lamp oil, kerosene, and gasoline, are all poisonous to animals. Cattle will drink all of them and appear to have a positive liking for some products, especially used sump oil and liquid paraffin (mineral oil). Among the commercial oil products, those with the highest content of volatile and inflammable components, especially naphtha and petrol (gasoline) fractions, are the most toxic. Gasoline up to the level of 3 ppm in the drinking water does not appear to depress water intake or to interfere with growth performance of pigs.

The additives used with gasoline, especially lead, may also contribute to the poisoning. The introduction of lead-free gasoline has decreased this risk considerably.<sup>1</sup>

Other hydrocarbons or ingredients mixed with them are toxic as well. Toxic agents of all kinds can be encountered when reject sludge oil is available to animals. Chlorinated naphthalenes found in some older lubricants, greases, and oils can cause a severe hyperkeratosis in cattle similar to vitamin A deficiency. Methyl alcohol is used as antifreeze in gasoline engines for pumps working continuously on oilfields in cold regions. Accidental access to the pump enclosure may result in a poisoning incident.

Accurate dose levels are difficult to determine in field outbreaks. In experimental trials, crude oil at the rate of 37 mL/kg BW in a single dose or 123 mL/kg in 5 divided daily doses were poisonous to cattle. Kerosene at 20 mL/kg BW as a single dose and 62 mL/kg BW in 5 equal daily doses was poisonous. Tractor paraffin (kerosene) at a single dose rate of 13 mL/kg BW is associated with severe illness and at 21 mL/kg was fatal to cattle.

### EPIDEMIOLOGY

On farms access to tractor fuel (paraffin, gasoline, kerosene) is the most likely hazard. When highly chlorinated naphthalenes were used as lubricants, access to oil dumps could lead to clinical signs. Kerosene has an unwarranted reputation as a therapeutic agent for bloat and constipation, but it is unlikely to be given in amounts sufficient to be associated with more than slight illness, unless it is given repeatedly.

### PATHOGENESIS

The early signs are thought to be attributable to regurgitation of the oil; aspiration of the oil, causing pneumonia; and absorption of the volatile components through the pulmonary mucosa, causing toxemia. The later signs are thought to be associated with the direct effect of the oil on the alimentary tract.

Local application or ingestion of highly chlorinated naphthalenes to cattle produces hyperkeratosis characterized by thickening

and scaling of the skin, emaciation, and eventual death. The pathogenesis of the skin lesions is attributable to interference with the conversion of carotene to vitamin A, causing a syndrome similar to vitamin A deficiency. When poisoning results from accidental emission from industrial plants, there are additional signs as a result of ocular, nasal, and tracheobronchial irritation; infertility and abortion also occur.

Accidental ingestion of methyl alcohol by cattle is associated with vomiting, recumbency, death, and a high concentration of methyl alcohol in the ruminal contents.

## CLINICAL FINDINGS (OIL INGESTIONS)

### Natural Cases

When large volumes of crude oil are consumed, signs of toxemia and incoordination occur; regurgitation (vomiting) and bloat may or may not occur. In terminal stages mydriasis, tachycardia, hyperpnea, and hyperthermia are evident. Death is rapid. The animals smell of oil, oil is often present on the skin around the mouth and anus, and oil is found in the feces. The feces are usually oily, often soft to semifluid, and frequently black if the crude oil has been ingested. With kerosene the feces are often dry and firm in the later stages, and the regurgitus may be in the form of gelatin-like cuds, smelling strongly of kerosene. Oil persists in the alimentary tract for long periods and may be found in the cud and feces and at postmortem as long as 16 days after ingestion. Animals that survive the acute toxic syndrome eat poorly, lose weight, and die at variable periods from 16 to 36 days later. Recovered animals usually do so poorly after the incident that they are slaughtered after a history as long as 6 months.

### Experimental Cases

Early signs include incoordination, shivering, head-shaking, and mental confusion. Within 24 hours, anorexia, vomiting, and moderate to severe bloating occur. Experimental kerosene inhalation is associated with persistent severe intrapulmonary physiologic shunting, resulting in prolonged hypoxemia and acidemia and may account for the clinical disease in survivors.

## CLINICAL PATHOLOGY

There are no specific clinicopathologic findings, but hypoglycemia, acetonemia, and transient hypomagnesemia are all recorded.

## NECROPSY FINDINGS

In crude oil or kerosene poisoning aspiration pneumonia is recorded constantly in naturally occurring and experimentally produced cases. It is thought to be the result of vomiting and aspiration from the alimentary tract of already swallowed oil. In longstanding cases of bovine kerosene poisoning, the

lungs are colored gray-blue and are enlarged and firm, but there are no significant histopathologic changes, nor are there any in the kidney or liver. Oil is present in the alimentary tract, and there may be thickening and inflammation of the alimentary mucosa. Degenerative changes in liver and kidney are recorded in some cases.

## TREATMENT

No primary treatment is undertaken. Supportive treatment if the animal survives the initial acute phase should include an instillation of fresh rumen contents from a healthy animal.

## FURTHER READING

- Coppock RW, Mostrom MS, Khan AA, et al. Toxicology of oil field pollutants in cattle: a review. *Vet Hum Toxicol.* 1995;37:569-576.
- Gibson EA, Linzell JL. Diesel oil poisoning in cattle. *Vet Rec.* 1948;60:60.
- Sikes D, Bridges ME. Experimental production of hyperkeratosis ("X disease") of cattle with a chlorinated naphthalene. *Science.* 1962;116:506-507.

## REFERENCE

- Burren BG. *Aust Vet J.* 2010;88:240.

## IRON TOXICOSIS

Iron poisoning is uncommon in large animals, with sporadic case reports in cattle, goats, horses, and pigs.<sup>1</sup> The occurrence of a genetic iron storage disease is very rare but reported in Saler cattle. Young animals, such as piglets, absorb iron more efficiently than older ones. Toxicity can occur from excessive ingestion or parenteral administration of iron-containing supplements. Poisoning is most severe after intravenous administration followed by intramuscular or subcutaneous use and least with oral administration. Absorption is the rate-limiting factor for oral toxicosis, and intake must be high for systemic poisoning to occur. The toxicity associated with iron occurs from generation of free radicals and peroxidation of lipid membranes.<sup>1,2</sup> Oral toxicity results in damage to the gastric mucosa, whereas systemic toxicity results in accumulation and damage to the liver and other tissues such as the myocardium.

The extent of poisoning also varies with different iron-containing compounds and the presence of dietary substances.<sup>2-4</sup> The most toxic compounds are those that contain a high proportion of their iron in an ionic, and therefore readily absorbable, form. High dietary levels of vitamin E, selenium, or calcium may reduce or modulate iron toxicity; simultaneously low levels of vitamin E or selenium may predispose to toxicity.<sup>1,4</sup> Newborn piglets from vitamin-E-deficient sows showed signs of toxicity when injected with 100 mg or 200 mg iron dextran. In a recent study, day-old piglets with normal vitamin E and selenium levels receiving 100

mg iron dextran injections had normal PCV values and iron liver levels close to normal, whereas those treated with 150 mg and 200 mg had toxic levels of iron.<sup>4</sup>

## Neonatal Pigs

Neonatal pigs frequently receive oral or injected iron supplements after birth to prevent iron-deficiency anemia. Susceptibility in piglets is attributable to low fetal iron stores, insufficient iron concentration in sow's milk, large litter sizes, and rapid growth rate. Recent studies show that the duodenal transporters of iron are almost undetectable at birth, making oral absorption and toxicity less likely to occur.<sup>2</sup>

Two-day-old pigs are much more susceptible to the toxic effects of iron compounds than are 8-day-old pigs. A suggested reason for this age resistance is the older pigs' better renal functional ability to excrete iron. Another possible reason is the greater mobilization of calcium by older pigs in response to iron administration. This mobilization, or calciphylaxis, can be great enough to result in deposition of calcium in damaged tissues or to cause death. This effect appears to be precipitated by simultaneous or immediately preceding (within 24 hours) injection of vitamin D, but the injection is not essential to it. The progeny of vitamin-E-deficient sows are most susceptible; the muscle cell membranes are damaged, and extensive biochemical changes result, including a great increase in extracellular potassium levels causing cardiac arrest and sudden death.

Two different syndromes of poisoning occur. In peracute poisoning, death occurs within several minutes to an hour after injection of an iron salt. Vomiting or diarrhea may occur before death, or piglets may be found dead with no other signs. The mechanism of action, although similar to anaphylaxis, is unknown. In acute or subacute poisoning, death may not occur for 2 to 4 days and is accompanied by gastrointestinal necrosis (if ingested), with vomiting, abdominal pain, depression, and coma. There is an additional possible damaging effect of iron injection in young pigs, the development of asymmetric hindquarters. In this condition there is asymmetry, but the muscles are normal in composition and appear to have asymmetric blood supplies.

## Foals/Horses

Neonatal foals died soon after the oral administration of an oral supplement containing ferrous fumarate (16 mg/kg) or the iron compound alone. Naturally occurring and experimental cases pointed to acute hepatitis as the critical lesion and the iron compound as the cause. Depression, ataxia, recumbency, jaundice, nystagmus, and death occurred 1 to 5 days after administration. Foals were suspected of being more susceptible because of an age-related increase in

intestinal absorption and decreased iron-binding capacity. Postmortem lesions included hepatic cell necrosis with bile duct proliferation and periportal fibrosis.

Deaths have occurred in adult horses within a few minutes of intramuscular injection of iron compounds. Others have shown severe shock but recovered. Death, when it occurs, appears to be attributable to acute heart failure. Chronic iron poisoning may occur in horses receiving large amounts of iron-enriched supplements.<sup>5</sup>

### Cattle

Acute hepatitis and sudden deaths have occurred in 6- to 9-month-old bulls about 24 hours after injection of an organic iron preparation.

### FURTHER READING

- House JK, Smith BP, Mass J, et al. Hemochromatosis in Salers cattle. *J Vet Int Med.* 1994;8:105-111.
- Mullaney TP, Brown CM. Iron toxicity in neonatal foals. *Eq Vet J.* 1988;20:119-124.
- Pearson EG, Andreasen CB. Effect of oral administration of excessive iron in adult ponies. *J Am Vet Med Assoc.* 2001;218:400-404.
- Velasquez JL, Aranzazu D. An acute case of iron toxicity on newborn piglets from vitamin E/Se deficient sows. *Rev Col Cienc Pec.* 2004;17:60-62.

### REFERENCES

- Herdt TH. *Vet Clin North Am Food A.* 2011;27:255.
- Lipiński P, et al. *Am J Path.* 2010;177:1233.
- Svoboda M, et al. *Acta Vet Brno.* 2007;76:179.
- Ness A, et al. *Proc AASV Conf.* 2010:233.
- Mendel M, et al. *Med Weter.* 2006;1357.

## TOXICOSIS FROM FEED ADDITIVES

Many antibiotics, fungistats, vermicides, estrogens, arsenicals, urea, iodinated casein, and copper salts are added to prepared feed mixes to improve food utilization and hasten growth. Many of them are toxic if improperly used. Miscellaneous agents include amprolium, an antithiamine coccidiostat, which is associated with polyocephalomalacia in ruminants, and iodinated casein, which was used experimentally at one time to stimulate milk production in cows but is now associated with cardiac irregularity, dyspnea, restlessness, and diarrhea in hot weather. Toxic additives described elsewhere in this book are arsanilic acid and copper compounds.

### BRONOPOL

Bronopol (2-bromo-2-nitro-1,3-propanediol) is used as a laboratory preservative for milk (e.g., in milk samples used for butterfat estimation). This milk is usually fed to calves or pigs and may be toxic on occasional feedings. Affected calves salivate, are depressed, collapse, and die within 24 hours of feeding. Necropsy lesions include severe necrotizing abomasitis and local peritonitis on the serosal surface of the abomasum. The oral LD<sub>50</sub> values of bronopol in large animals

are not reported, but in male and female rats are 307 and 342 mg/kg body weight, respectively.<sup>1</sup>

### CARBADOX

Carbadox (mecadox, fortigro, getroxel), a member of the quinoxaline-di N oxide family, is used in pig feeds as a growth promotant and in the treatment of swine dysentery and other enteric diseases at the recommended rate of 50 mg/kg of feed/head per day. Toxic effects occur at rates of 150 mg/kg. Two chemically related compounds, cyadox and olaquinox, are also toxic, but carbadox is more harmful than olaquinox, and cyadox is safe in dosages up to 400 ppm. Affected pigs refuse the ration but will eat other rations, are gaunt and emaciated, pass hard fecal pellets, and drink urine, and they have a long and rough coat, pale skin, severe tachycardia, weak hind-quarters, and a swaying walk, followed by knocking of the hind fetlocks, posterior paralysis, and death in 8 to 9 days.<sup>2</sup> In the early stages the pigs screech frequently. Sows are agalactic and produce stillborn or weak, undersized piglets.

Necropsy lesions are diagnostic, with extensive damage to the zona glomerulosa of the adrenal gland accompanied by renal tubular necrosis. Both carbadox and olaquinox provided to pigs in the feed at 100 mg/kg for 6 weeks caused changes in the zona glomerulosa.<sup>2</sup> The resulting hypoaldosteronism is manifested by low serum sodium levels, elevated serum potassium (8 mmol/L), and elevated blood urea nitrogen levels. The condition is irreversible, and the outcome is severe disability or death.

### PLURONICS

These substances are administered to adult cattle in their feed as prevention against bloat. They are unpalatable and unlikely to be consumed in dangerous amounts unless they are well masked in feed. When they are fed accidentally to calves in their milk, they are associated with dyspnea, ruminal tympany, bellowing, protrusion of the tongue, nystagmus, opisthotonos, recumbency, and convulsions. Death after 24 hours is the usual outcome.

### TIN POISONING

Dibutyltin dilaurate (DBTD) is a coccidiostat fed to chickens in their feed. Errors in mixing may lead to cattle receiving toxic amounts in concentrates or pellets. Calves usually die acutely, with signs of tremors, convulsions, weakness, and diarrhea. Older animals usually suffer a chronic illness characterized by persistent diarrhea, severe weight loss, inappetence, polyuria, and depression, reminiscent of arsenic poisoning. Affected animals may not be suitable for human consumption because of the high content of tin in their tissues.

### FURTHER READING

- Baars AJ, van der Molen EJ, Spiereburg TJ, et al. Comparative toxicity of three quinoxaline-di-N-dioxide feed additives in young pigs. *Arch Tox.* 1988;S12:405-409.
- Naburs MJA, van der Molen EJ, de Graf GJ, et al. Clinical signs and performance of pigs treated with different doses of carbadox, cyadox, and olaquinox. *J Vet Med Assoc.* 1990;37:68-76.
- Shlosberg A, Eged MN. Mass poisoning in cattle, palm doves and mink caused by the coccidiostat dibutyltin dilaurate. *Vet Hum Toxicol.* 1979;21:1.
- Teague WR. Pluronic poisoning in a herd of dairy calves. *NZ Vet J.* 1986;34:104.

### REFERENCES

- Smith DJ, et al. *J Ag Food Chem.* 2013;61:763.
- Spilsbury MLA, et al. *Res J Biol Sci.* 2010;5:9.

## TOXICOSIS FROM MISCELLANEOUS FARM CHEMICALS

### FORMALIN

Formalin is used to preserve colostrum for calf feeding and in the preparation of formalin-treated grain. Milk containing too much formalin is associated with severe gastroenteritis and death in some calves that drink it. The clinical signs include salivation, abdominal pain, diarrhea, and recumbency.

### METHYL BROMIDE

Soil fumigants used to prepare fields for planting may be associated with toxicity hazards in animals grazing them or in feed harvested from them. Methyl bromide has been associated with poisoning in horses, cattle, and goats when used in this manner but should soon be historical in nature. Because of depletion of the ozone layer, the use of methyl bromide was phased out in the United States in 2001, in developed countries in 2005, and in developing countries by 2015.<sup>1</sup> Clinical signs in horses, cattle, and goats include ataxia, stumbling, and somnolence.

### POLYBROMINATED BIPHENYLS

Polybrominated biphenyls (PBBs; hexabromobiphenyl, octabromobiphenyl, and decabromobiphenyl) were produced commercially as flame retardants beginning in 1970. They are not especially poisonous, nor are they a greater risk to farm animals, because of degree of exposure, than many other industrial chemicals, but they found their way into the cattle food chain in reported incidents in the United States. In 1973 to 1974, PBBs were accidentally mixed into various animal feeds, and over 9 million people were exposed to contaminated animal products, including eggs, meat, milk, and cheese.<sup>2</sup> Subsequent to that, the production of PBBs in the United States was voluntarily discontinued. Most of the animal losses attributable to contamination with these compounds were a result of destruction of animals because they were



contaminated, and there was concern for adverse effects on humans who consumed them or their products. However, neither animals nor humans exposed to the PBBs showed any signs of illness at the time of exposure.

The excretion of these compounds occurs principally in feces and urine, but as much as 25% of ingested substance may be present in the milk. They are lipotropic and accumulate in fat depots and the liver. These compounds pass into the placenta and are found in fetuses but appear to be associated with no health problems in the offspring. Attempts to hasten excretion have not produced a satisfactory method. Grazing wool sheep on contaminated ground may be an option for utilization of contaminated land.

## CLINICAL SIGNS

### Cattle

Experimental dosing with 67 mg/kg BW daily for long periods is associated with poisoning, but levels of 10 mg/kg BW are not toxic. Clinical signs of illness are anorexia, diarrhea, lacrimation, salivation, emaciation, dehydration, depression, and abortion. Similar signs plus extensive cutaneous hyperkeratosis occur in natural cases. Necropsy lesions include mucoid enteritis, degenerative renal lesions in natural and experimental cases, hyperkeratosis in the glands, and epithelium of the eyelids.

### Pigs

Experimental poisoning in pigs causes no ill-effects in sows, but high concentrations of PBBs develop in the sow's milk, with death of some nursing pigs resulting.

## POLYBROMINATED DIPHENYL ETHERS

Compounds in the polybrominated diphenyl ethers (PBDEs) group (pentaBDE, octaBDE, and decaBDE) are similar to the PBBs in physical and chemical structure and are still produced commercially as flame retardants for in use in consumer products.<sup>2</sup> In many countries, the unrestricted production and disposal has resulted in environmental contamination of the water, soil, air, and marine animals.<sup>3</sup> Two of the compounds, pentaBDE and octaBDE, have been voluntarily phased out, restricted, or banned in many countries, including the United States and the European Union. Concentrations of PBDEs have been found in cow's and goat's milk, animal meats, fish, soil, and grass.<sup>3-9</sup>

## POLYCHLORINATED BIPHENYLS

Polychlorinated biphenyls (PCBs) have a number of industrial uses and are common environmental contaminants. They are hydrophobic and lipophilic, accumulate in body fat, have low rates of biotransformation and excretion, and persist in animal tissues for long periods. Concentrations of PCBs,

sometimes with seasonal variation, have been found in cow's milk in countries where no known PCB production occurs.<sup>6,8</sup> Belgium, in 1999, experienced PCB, dioxin, and dibenzofuran contamination of poultry products, resulting in a precipitous drop in egg production, decreased weight gain, and increased chick mortality.<sup>10</sup> At postmortem, degenerative changes were found in the skeletal and cardiac muscle.

The presence of PCBs in animal tissues is likely to cause rejection of meat from the human food chain. Recorded damage refers to unidentified reproductive inefficiency and reduction in efficiency of food conversion and possibly hepatic hypertrophy and gastric erosion, but in the same species a positive growth-stimulating effect has also been recorded. Experimental poisoning of gnotobiotic pigs has been associated with diarrhea, erythema of the nose and anus, distension of the abdomen, growth retardation, and, at doses of more than 25 mg/kg BW, coma and death.

## SODIUM FLUOROSILICATE

Sodium fluorosilicate is white, odorless, and tasteless powder previously used as a poison in baits for crickets, grasshoppers, and other pests. For the past 30 years it has largely been banned, restricted, or otherwise removed from the market in most countries. The preparation as a bran-based pellet made it attractive to all animal species, and poisoning has been recorded in cattle, sheep, and horses, usually because unused baits were not retrieved after baiting programs ended. In sheep, mild illness occurs after doses of 25 to 50 mg/kg BW and death after 200 mg/kg. Clinical signs include drowsiness, anorexia, constipation, ruminal stasis, teeth grinding, abdominal pain, and diarrhea.

## SUPERPHOSPHATE FERTILIZERS

Superphosphate fertilizer is the usual form in which phosphorus-rich fertilizers are applied to the soil and is therefore available to animals in most countries. It is made by a reaction that takes place when rock phosphate is treated by sulfuric acid, and the end product generally contains phosphorus, calcium, sulfur, and fluoride. The fertilizer is also used to prepare "superjuice," which in some countries is administered to cows as a phosphorus supplement.

Higher-than-normal intakes of the fertilizer either by dosing or by pasture application will cause poisoning, largely as a result of the fluoride present.<sup>10</sup> Calcium pyrophosphate, calcium orthophosphate, or calcium sulfate can also contribute to the toxicosis, causing proximal renal tubular nephrosis. It is not highly palatable, but sheep will eat it when it is in "pill" form (small and granular, resembling grain in texture and particle size). Clinical signs of poisoning include anorexia, thirst, diarrhea, weakness, ataxia, and death in about 48 hours. The LD<sub>50</sub>

of superphosphate for sheep is 100 to 300 mg/kg BW.

## FURTHER READING

- Clark RG, Hunter AC, Steward DJ. Deaths in cattle suggestive of subacute fluorine poisoning following ingestion of superphosphate. *NZ Vet J.* 1976;24:193-197.
- Kay K. Polybrominated biphenyls (PBB) environmental contamination in Michigan, 1973-1976. *Environ Res.* 1977;13:74-93.
- Noling JW, Becker JO. The challenge of research and extension to define and implement alternatives to methyl bromide. *J Nematol.* 1994;26:573-575.
- Pandey CK, Agawal A, Baronia A, et al. Toxicity of ingested formalin and its management. *Hum Exper Toxicol.* 2000;19:360-366.
- Tattersfield F, Gimingham C. Notes and correspondence-further experiments with sodium fluorosilicate as an insecticide. *Indus Eng Chem.* 1925;17:323.

## REFERENCES

1. Yamano Y, et al. *J Occup Health.* 2006;48:129.
2. EPA. 2012 technical fact sheet: polybrominated diphenyl ethers (PBDEs) and polybrominated biphenyls (PBBs). at: <[http://www.epa.gov/fedfac/pdf/technical\\_fact\\_sheet\\_pbde\\_pbb.pdf](http://www.epa.gov/fedfac/pdf/technical_fact_sheet_pbde_pbb.pdf)>; Accessed 24.02.14.
3. Fernandes AR, et al. *Food Addit Contam B.* 2009;2:86.
4. Kierkegaard A, et al. *Environ Sci Technol.* 2009;43:2602.
5. Kierkegaard A, et al. *Environ Sci Technol.* 2007;41:417.
6. Asante KA, et al. *Interdiscipl Stud Environ Chem.* 2010;191.
7. Ounnas F, et al. *Environ Sci Technol.* 2010;44:2682.
8. Grümping R, et al. *Organohalogen Compd.* 2006;68:2147.
9. Lake I, et al. *Chemosphere.* 2013;90:72.
10. Guitart R, et al. *Vet J.* 2010;183:249.

## TOXICOSIS FROM SEED DRESSINGS

Many poisoning incidents are caused by live-stock gaining access to seed that has been treated in some way. The more common ones are listed here, and each is dealt with under the heading of the toxic agent:

- Grain treated with arsenic used to poison birds
- Grain treated with highly toxic organophosphorus substances used to make baits for market garden pests
- Bran mixed with metaldehyde for use as a snail bait
- Grain to be used as seed that has been treated with a mercury-based fungistatic agent
- Corn treated with 4-aminopyridine for use as a bird repellent

Additional poisonous substances are grain fumigants and other fungistatic agents.

## TOXICOSIS FROM MISCELLANEOUS RODENTICIDES

### BROMETHALIN

Bromethalin is a highly toxic, single-dose, restricted-use rodenticide registered in the

United States but not several other countries, including New Zealand and Europe.<sup>1</sup> Poisoning in large animals is rare and primarily confined to ingestion of bait stations by young animals or accidental mixing in feed. The onset of action is slow, with signs appearing within 10 hours to a few days. Clinical signs are dose dependent and typically occur 1 to 2 days after ingestion.<sup>1,2</sup> Commonly reported signs in small animals are primarily related to the nervous system and include agitation or depression, hyperesthesia, seizures, coma, paresis, paralysis, and death.<sup>2,3</sup>

Bromethalin is a potent neurotoxin that is rapidly absorbed; widely distributed to the liver, fat, and the brain, where it crosses the blood-brain barrier; metabolized in the liver by N-demethylation; and excreted in the bile; it undergoes enterohepatic recirculation.<sup>3</sup> It acts by uncoupling mitochondrial oxidative phosphorylation in the central nervous system, decreasing the synthesis of ATP and the activity of N/K ATPase.<sup>1,2</sup> The end result is an increase in intracellular Na with loss of osmotic control, fluid within the myelin sheathes, increased pressure on nerve axons, increased cerebrospinal fluid pressure, and impairment of nerve conduction.<sup>1,3</sup> Convulsions, paralysis, and death occur.

There is no antidote, and treatment is symptomatic and supportive. Treatment should include therapy for cerebral edema and seizure control.<sup>3</sup> Judicious use of intravenous fluids is advised so cerebral edema does not become worse.

### CHOLECALCIFEROL (VITAMIN D<sub>3</sub>)

Cholecalciferol (vitamin D<sub>3</sub>) is an active ingredient in several rodenticides used worldwide.<sup>1</sup> It is effective when used alone or added to other baits such as coumatetralyl (an anticoagulant rodenticide).<sup>1</sup> Anecdotally, poisoning has occurred in calves that ingested individual baits or in farm animals secondary to mixing errors in their feed. Toxicity and clinical signs vary widely between species, and there are few data available for large animals. In dogs, clinical signs begin about 12 to 36 hours after a toxic ingestion and include vomiting, weakness, lethargy, melena, cardiac irregularities, seizures, and death.<sup>4</sup>

The mechanism of action is similar to other forms of vitamin D<sub>3</sub> poisoning in which cholecalciferol is first hydroxylated in the liver to 25-hydroxycholecalciferol and then modified in the kidney to form the biologically active 1,25-dihydroxycholecalciferol (calcitriol).<sup>1,4</sup> At toxic doses, calcitriol decreases calcium excretion by the kidneys and excessively increases intestinal calcium and phosphorus from the digestive tract, resulting in calcification of the cardiovascular system (vessels), lungs, kidneys, and stomach lining. Renal failure secondary to mineralization generally occurs simultaneously with the onset of clinical signs.<sup>4</sup>

Treatment is directed toward lowering the serum calcium concentrations, preventing

renal compromise, and treating seizures. Intravenous fluids at rates higher than maintenance should be used to increase urine production and promote excretion of calcium. Bisphosphonates are routinely used in small animal medicine to inhibit bone reabsorption and minimize hypercalcemia, but their cost may prohibit use in large animals.<sup>4,5</sup>

### RED SQUILL (SEA ONION)

Poisoning by red squill seldom occurs because the material is extremely unpalatable and when eaten is usually vomited. In all species large doses (100 to 500 mg/kg BW) must be administered to produce toxic effects. Young calves are most susceptible, and goats are least susceptible. Experimental poisoning is associated with convulsions, gastritis, and bradycardia.

### PHOSPHIDES

Zinc phosphide and, to a much lesser extent, aluminum phosphide are commonly used rodenticides; aluminum, calcium, and magnesium phosphides are used primarily as fumigants to protect grain during storage and transportation.<sup>6,7</sup> In large animals, toxicosis occurs primarily from mixing errors or accidental exposure to treated or stored grain. Poisoning is less likely to occur in ruminants because an acidic stomach pH is important for phosphide hydrolysis. Clinical signs occur in most species within 15 minutes to 4 hours of a toxic ingestion.<sup>6</sup> Vomiting and hematemesis (in those species that can vomit), abdominal distension, and abdominal pain occur first and are rapidly followed by tachycardia, tachypnea, agitation, ataxia, and abnormal neurologic behavior. Sixty-six horses accidentally received aluminum phosphide-contaminated grain; of these, 29 showed full body sweating, tachycardia, tachypnea, pyrexia, muscle tremors, seizures, and recumbency.<sup>7</sup> Hypoglycemia was present in all affected horses. The remaining 37 horses were treated aggressively and remained asymptomatic. Signs occurred 14 hours after ingestion of the contaminated grain; despite treatment, death occurred in 27 horses.<sup>7</sup>

The overall toxicity of phosphides is attributable to the generation of phosphine gas. In the stomach, zinc phosphides (or those of other metals) are hydrolyzed to form phosphine gas and zinc hydroxide.<sup>8</sup> Phosphine gas rapidly enters the blood and is widely distributed to the lungs, liver, kidney, and other organs.<sup>1,6,8</sup> Inhaled phosphine gas crosses the respiratory epithelium. The precise mechanism of toxicity from phosphine gas is unknown but was originally thought to be related to inhibition of cytochrome c oxidase.<sup>6</sup> More recent findings suggest that phosphine has an inhibitory effect on oxidative respiration and forms highly reactive free radicals.<sup>6,7</sup> The overall effect is a combination of local corrosive effects in the gastrointestinal tract and circu-

latory collapse. Death occurs from pulmonary edema or cardiac arrest.

There is no antidote, and treatment is symptomatic and supportive. Blood glucose concentrations should be monitored and treated appropriately. In asymptomatic cases, gastric lavage followed by activated charcoal or a di-tri-octahedral smectite has been used successfully.<sup>7</sup>

Necropsy lesions present in a horse ingesting zinc phosphide were congestion and hemorrhages in all organs; pulmonary edema; fatty degeneration of the liver; congestion of the lungs, kidney, and spleen; and hyperemia of the gastrointestinal mucosa. Common lesions in those horses dying from aluminum phosphide-contaminated grain included petechial and ecchymotic hemorrhages in the mesentery, epicardium, spleen, kidneys, lungs, skeletal muscle, and other tissues. Vascular congestion was a consistent finding, and pulmonary edema was present in 3/6 horses.<sup>7</sup>

### FURTHER READING

- Borron SW, Forrester MB, Brutlag AG, et al. Bromethalin (BR) vs. long-acting anticoagulant (LAAC) rodenticides: a 10-year comparison of exposures and toxicity. *Clin Toxicol*. 2013;61:627-628.
- Dorman DC. Toxicology of selected pesticides, drugs, and chemicals. Anticoagulant, cholecalciferol, and bromethalin-based rodenticides. *Vet Clin North Am Food A*. 1990;20:339-344.
- Drolet R, Laverly S, Braselton WE, et al. Zinc phosphide poisoning in a horse. *Equine Vet J*. 1996;28:161-162.
- Harrington DD, Page EH. Acute vitamin D<sub>3</sub> toxicosis in horses: case reports and experimental studies of the comparative toxicity of vitamins D<sub>2</sub> and D<sub>3</sub>. *J Am Vet Med Assoc*. 1983;182:1358-1360.
- Verbiscar AJ, Anthony J, Banigan F, et al. Scilliroside and other scilla compounds in red squill. *J Ag Food Chem*. 1986;34:973-979.

### REFERENCES

- Eason CT, et al. DOC Research and Development Series 312. 2009 Accessed at: <<http://www.doc.govt.nz/Documents/science-and-technical/drds312entire.pdf>>; Accessed 12.08.2016.
- Brutlag AG, et al. *Clin Toxicol*. 2013;51:711.
- Adams C, et al. Bromethalin. In: Osweiler GD, Hovda LR, Brutlag A, Lee J, eds. *Blackwell's Clinical Companion Small Animal Toxicology*. New York: Wiley-Blackwell; 2011:769.
- Adams C, et al. Cholecalciferol. In: Osweiler GD, Hovda LR, Brutlag A, Lee J, eds. *Blackwell's Clinical Companion Small Animal Toxicology*. New York: Wiley-Blackwell; 2011:775.
- Ulutas B, et al. *J Vet Emerg Crit Care*. 2006;16:141.
- Proudfoot AT. *Clin Toxicol*. 2009;47:89.
- Easterwood LE, et al. *J Am Vet Med Assoc*. 2010;236:446.
- Eason C, et al. *NZ J Ecol*. 2012;37.

### SULFUR TOXICOSIS

#### SYNOPSIS

**Etiology** Ingestion of sulfur-containing materials, generally feed and/or water;

*Continued*

inhalation of hydrogen sulfide or sulfur dioxide gas.

**Epidemiology** Sulfur toxicosis is a worldwide problem of ruminants; horses and pigs are rarely affected animals.

**Clinical pathology** Two distinct syndromes occur (acute and subacute). The acute form has a rapid-onset central nervous system (CNS) signs, and death is common; the subacute form has similar signs, but they develop over weeks, and recovery may occur.

**Lesions** Polioencephalomalacia in ruminants; osmotic diarrhea in monogastrics.

**Diagnostic confirmation** The diagnosis is generally made based on postmortem findings and the presence of sulfur in water or feed source. In some cases, hydrogen sulfide concentrations in rumen gas and the presence of sulfhemoglobin in serum may be helpful.

Polioencephalomalacia may not be present in acute cases.

**Treatment** Supportive care, including fluids and electrolytes; thiamine IV or IM.

**Control** Management of sulfur in feed and water; removal of animals near sulfur dioxide or hydrogen sulfide spills.

## ETIOLOGY

Sulfur exists in four different oxidative states: **sulfur (0), sulfide (-2), sulfite (+4), and sulfate (+6)** and all of them are present either naturally (sulfur) or in various biological products (sulfide, sulfite, sulfate). Absorption and metabolism of sulfur-containing compounds depends on the valence state.<sup>1</sup> Ruminants are more susceptible to toxicosis from dietary ingestion of elemental sulfur and sulfate compounds. Water, especially well water high in sulfates; feed products such as sulfate salt, mineral mixes (sulfur containing), protein sources high in sulfur, and dried distiller's grains; and inhaled gases such as eructated hydrogen sulfide gas and sulfur dioxide are all possible sources of sulfur toxicosis.<sup>2-4</sup> Another potential source is the use of elemental sulfur (flowers of sulfur) as an ectoparasiticide<sup>2</sup>

Sulfur and sulfates in the feed and drinking water play a significant role in the etiology of polioencephalomalacia. The feeding of 85 to 450 g per head to cattle has been fatal, as has 45 g of sulfur in feed pellets to ewes, and the minimum lethal dose of a sulfur-protein concentrate for sheep is estimated to be 10 g/kg BW. Continuous feeding of sulfur at the rate of 7 g per day can be fatal to adult sheep. Sulfur given to adult horses at a dose level of 1000 to 1500 mg/kg body weight has been associated with poisoning.

## EPIDEMIOLOGY

### Occurrence

Sulfur toxicosis occurs worldwide and has been reported in beef and dairy cattle, sheep,

goats, and horses.<sup>3,5</sup> It can occur as a single, isolated case or as an outbreak affecting many animals.

## Risk Factors

### Animal Risk Factors

Ruminants are the species most often affected by sulfur poisoning. Rumen microbes reduce sulfates and elemental sulfur to sulfides, which combine with hydrogen to make hydrogen sulfide.<sup>2,3</sup> Systemic absorption of hydrogen sulfide results in interference with cellular energy production and the onset of clinical signs.<sup>1,2</sup> The brain is most often affected because it has the highest energy demands. Inhaled hydrogen sulfide gas not only causes respiratory paralysis but can be absorbed and result in systemic effects.<sup>1</sup>

Horses, lacking a rumen, do not routinely absorb sulfur or sulfates, and they remain in the gastrointestinal tract and act as osmotic agents, pulling water into the intestinal lumen and causing severe, foul-smelling, black diarrhea.<sup>5</sup> Dehydration is severe, and the animals soon become recumbent and dyspneic, develop convulsions, and die after lapsing into a coma.

Pigs exposed to an environment containing 35 mg/kg of sulfur dioxide for long periods show increased salivation accompanied by clinical and histologic evidence of irritation of the conjunctiva and respiratory mucosa.

### Environmental Risk Factors

Animals housed over the slatted floors of a manure pits, exposed to industrial waste pits, or inhaling "sour gas" from crude-oil well explosions are at increased risk for developing respiratory tract irritation and signs of systemic sulfur poisoning.

### Transmission

- Ingestion of sulfur- or sulfate-containing products, either accidental or intentional
- Topical use of sulfur powder (flowers of sulfur) to control external parasites
- Inhalation of sulfur dioxide gas used in the preparation of ensilage or associated with industrial waste pits
- Inhalation of hydrogen sulfide gas from ruminant eructation or as a gas emanating from oil and natural gas wells or manure pits.

## PATHOGENESIS

In small doses the substance is relatively nontoxic, but excessive doses can be associated with fatal gastroenteritis and dehydration. Conversion of the sulfur to hydrogen sulfide by rumen microbes and the absorption of the gas across the rumen can result in the development of polioencephalomalacia in ruminants.<sup>2,6</sup> Hydrogen sulfide blocks ATP production and energy metabolism at a cellular level. Sulfides are potent oxidants, binding both glutathione peroxidase and superoxide dismutase.<sup>1</sup> The brain is most

often affected because of the high energy demands, relative lack of antioxidants, and high lipid concentrations. The amount of hydrogen sulfide produced in the rumen is pH dependent, with more produced as the rumen pH drops.<sup>3</sup> Other metabolism occurs in the rumen, primarily the incorporation of sulfur into amino acids; rumen bacteria can use these amino acids to produce hydrogen sulfide gas. Metabolism occurs in the liver, although much slower for the inhaled gases, and excretion is both renal and biliary.

## CLINICAL FINDINGS

### Ruminants

Two different clinical syndromes exist:<sup>1,2,6</sup>

1. **Acute:** Signs associated with this include central blindness, head pressing, opisthotonus, recumbency, seizures, coma, and death. Other signs include abdominal pain; severe, foul smelling diarrhea; colic; rumen stasis; and the odor of hydrogen sulfide gas. All species, including horses and pigs, are susceptible to this syndrome, which may be associated with the direct irritant effects of hydrogen sulfide and respiratory paralysis.<sup>2</sup> Clinical signs generally occur in 12 to 48 hours, and death is the normal outcome.<sup>6</sup>
2. **Subacute or chronic:** Signs associated with this form include cortical blindness, bruxism, weakness, ataxia, fine muscle tremors of the head, recumbency, and coma. Most signs are related to the development of polioencephalomalacia (cerebrocortical necrosis) and are associated with hydrogen gas production by ruminants. Often these signs do not occur for several weeks after an exposure, and recovery may be complicated by persistent neurologic deficits.<sup>6</sup>

## NECROPSY FINDINGS

The lungs are congested and edematous, the liver is pale, the kidneys are congested and black in color, there is severe gastroenteritis with peritoneal effusion, and petechial hemorrhages occur extensively in all organs and in musculature. Polioencephalomalacia may occur in a high proportion of cases.

## DIFFERENTIAL DIAGNOSIS

Water and feed analyses are helpful in making a diagnosis. Elevated hydrogen sulfide concentrations in the rumen and the presence of sulfhemoglobin in the systemic circulation may also be used.

### Monogastrics

- Carbohydrate overload
- Gastrointestinal parasites
- Infectious causes of diarrhea (*Salmonella*, *Clostridium perfringens*, *Neorickettsia risticii*)
- Nonsteroidal inflammatory toxicosis



- Organophosphorus/carbamate toxicosis
- Osmotic laxatives

#### Ruminants

- Amprolium administration
- Cyanobacteria (blue-green algae) toxicosis
- Lead toxicosis
- Listeria
- Rabies
- Sodium chloride (salt) poisoning/water deprivation
- Thiamine deficiency
- Thromboembolic meningoencephalitis

## TREATMENT

### TREATMENT

Thiamine (10 mg/kg slow IV, IM every 12h for 3 days) (R-2)

All sources of sulfur supplementation should be removed from the diet and environment. Treatment is primarily supportive with attention to fluid and electrolyte replacement. Glucose supplementation may be helpful.<sup>2</sup> Other adjunct therapies include a broad-spectrum antibiotic and corticosteroids.<sup>1,2</sup> Thiamine, even though polioencephalomalacia is not related to a thiamine deficiency, has been effective in several cases.<sup>1,2</sup>

## CONTROL

Management is the most effective way to prevent and control sulfur poisoning. Water sources and all dietary material should be tested to identify sources high in sulfur. Animals living close to oil wells and industrial waste pits should be monitored closely and moved if necessary.

## FURTHER READING

Dow C, Lawson GK, Todd JR. Sodium sulfate toxicity in pigs. *Vet Rec.* 1963;75:1052.  
Kandylis K. Toxicology of sulfur in ruminants: a review. *J Dairy Sci.* 1987;67:2179.

## REFERENCES

1. Enley S. *Vet Clin North Am Food A.* 2011;27:297.
2. Binta MG, et al. *J Pet Environ Biotechnol.* 2012;3:130.
3. Drenowski ME, et al. *J Vet Diagn Invest.* 2012;24:702.
4. Felix TL, et al. *J Anim Sci.* 2012;90:2710.
5. Burgess BA, et al. *Can Vet J.* 2010;51:277.
6. Fabiano JF, et al. *Braz J Vet Pathol.* 2010;3:70.

## VANADIUM TOXICOSIS

Vanadium is used extensively in industry and high amounts may occur in the air, soil, ash, and soot in areas surrounding smelters, burners, and other processing plants. Experimental and natural poisoning of adult cattle, calves, and sheep are recorded. Signs include anorexia, diarrhea, dehydration, oliguria, difficulty in standing, and incoordination. Postmortem findings include ruminal ulcers, hemorrhage in the gastrointestinal tract and surrounding the heart and kidney, and

congestion of the liver and lungs. Field cases are only likely to be encountered when industrial contamination of pasture occurs. Liver is considered the best tissue for assessing chronic vanadium toxicosis in cattle grazing vanadium-contaminated pastures.<sup>1</sup> Careful plowing of the pasture, especially when the vanadium is contained in a fertilizer such as basic slag, reduces the toxic risk.

## FURTHER READING

Frank A, Madej A, Galgan V, et al. Vanadium poisoning of cattle with basic slag. Concentrations in tissues from poisoned animals and from a reference, slaughter-house material. *Sci Total Environ.* 1996;181:73-92.  
Hansard SL, Ammerman CB, Henry PR, et al. Vanadium metabolism in sheep. I. Comparative and acute toxicity of vanadium compounds in sheep. *J Anim Sci.* 1982;55:344.  
McCrindle C, Mokantla E, Duncan N. Peracute vanadium toxicity in cattle grazing near vanadium mine. *J Environ Manage.* 2001;3:580-582.

## REFERENCE

1. Gummow B, et al. *J Environ Monitor.* 2006;8:445-455.

## TOXICOSIS FROM WOOD PRESERVATIVES

### Chromated Copper Arsenate

Chromated copper arsenate (CCA) is composed of chromium trioxide, copper oxide, and arsenic and was at one time the most widely used wood preservative in the United States. In 2003 the U.S. Environmental Protection Agency restricted CCA to industrial use because it poses an unreasonable human health risk. Several industrial uses remain, however, and it can still be used in animal production facilities, on utility poles, and in other cases.<sup>1</sup>

It is recorded that animals would need to eat at least 28 g of the treated wood daily for a month before a chronic poisoning occurred. Horses that crib or chew could eat more than that and could theoretically become poisoned. The risk to animals, however, is not ingested treated wood but ingestion of ashes left from burning treated lumber.<sup>1</sup> Burning concentrates arsenic in the ashes, and cattle, in particular, have been poisoned in this manner.

### Pentachlorophenol

Agricultural and residential use of pentachlorophenol (PCP; penta) in the United States was prohibited in 1986, but the treated lumber may still be found in older buildings, water and feed troughs, fence posts, and other animal areas. PCP is extremely toxic in humans by inhalation and ingestion and is irritating to the skin, respiratory tract, and mucous membranes.<sup>2</sup> Feeding pigs in PCP-treated wood troughs resulted in salivation and irritation to mucous membranes.<sup>1</sup> Inhalation of PCP by animals in an enclosed area caused death.<sup>1</sup> Acute signs include agitation, pyrexia, tachycardia, tachypnea, muscle tremors, seizures, and death.<sup>1,3</sup> Chronic

intoxication causes weight loss, fatty liver, and nephrosis. In high doses, PCP is embryotoxic and fetotoxic.<sup>3</sup>

Horses bedded on shavings from pentachlorophenol-treated wood, prepared wrongly by treating the rough lumber and then dressing it instead of applying the preservative to the dressed lumber, may have been poisoned by dioxin, a common contaminant in the preservative. Clinical signs include depression of appetite; severe weight loss; ventral and limb edema; hair loss; anemia; and a crusty, scaly dermatitis around the eyes, muzzle, axilla, and inguinal region, and on the neck. Exudation through cracks in the skin is a feature of the lesion. Lesions in liver biopsies include necrosis and severe vacuolar changes in the hepatocytes.

Pentachlorophenol is rapidly absorbed from the skin, lungs, and gastrointestinal tract; metabolized in the liver; and excreted primarily in the urine.<sup>2</sup> It acts to uncouple oxidative phosphorylation, increasing oxygen consumption and decreasing ATP production.<sup>1-3</sup> Acute fatal doses range from 27 to 350 mg/kg BW.<sup>1</sup>

There is no treatment other than removal from the source and supportive care. Intravenous fluids at doses higher than maintenance may be useful in promoting excretion.<sup>2</sup> Strict attention must be paid to the potential for milk and meat residues.

### Creosote (Coal Tar Creosote)

Creosote is produced as a by-product of high-temperature distillation of coal tar, and it contains hundreds of different compounds, including phenols, cresols, toluene, naphthols, and tar acids and bases.<sup>1,4</sup> Among these, phenol and phenolic compounds are among the most toxic. It is no longer registered in the United States for residential use but is used on utility poles, railroad ties, and other industrial lumbers. There are no human or animal studies clearly demonstrating the toxicokinetics of coal tar creosote.

Large animals are generally exposed to creosote by licking the material from treated lumber such as railroad ties or intentional topical misuse. A high mortality may be encountered in newborn pigs, and there may be a greater than normal incidence of stillbirths when sows are farrowed in treated crates. Weaned pigs may show depression, skin irritation, and, occasionally, death. Creosote applied as a treatment for ringworm has shown marked toxic effects in cattle. Fatal doses for coal tar creosote are 4 to 6 g/kg BW as a single dose or 0.5 g/kg BW daily.

Experimentally, a sheep dosed with 8000 mg/kg BW died in 4 days after dosing and a calf dosed with 4000 mg/kg BW survived but lost weight. There were no specific clinical signs in the sheep before death. At postmortem, excess fluid was present in the pleural cavity, and the urine was dark, with a tarry odor.<sup>4</sup>

Three sheep were dosed with varying amounts of creosote and monitored on a daily basis. A sheep receiving 500 mg/kg BW for 32 days showed no clinical signs; both other sheep, one receiving 1000 mg/kg/BW and the other receiving 2000 mg/kg BW, died at 8 and 16 days, respectively.<sup>4</sup> Clinical signs included rapid weight loss, anorexia, and weakness. Postmortem findings included excess peritoneal fluid, epicardial petechiation, inflammation of the colon and duodenal mucous membranes, and thyroid enlargement. A calf dosed with 500 mg/kg BW for 11 days lost weight, as did a second calf dosed with 1000 mg/kg BW for 11 days.<sup>4</sup> Weight loss in the second calf continued for 3 weeks after the dosing was discontinued.

There is no treatment other than removing the animals from the source, bathing with a degreasing shampoo if applied topically, and providing supportive care.

### FURTHER READING

- Hanlon G. Creosote poisoning of cattle. *Aust Vet J.* 1938;14:73.
- Harrison DL. The toxicity of wood preservatives to stock. *NZ Vet J.* 1959;7:89-98.
- Kerkvliet NI, Wagner SL, Schmotzer SL, et al. Dioxin intoxication from chronic exposure of horses to pentachlorophenol-contaminated wood shavings. *J Am Vet Med Assoc.* 1992;201:296-302.
- McConnell EE, Moore JA, Gupta BN, et al. The chronic toxicity of technical and analytical pentachlorophenol in cattle. *Toxicol Appl Pharmacol.* 1980;52:468-490.
- Radostits O, et al. Wood preservatives. In: *Veterinary Medicine: A Textbook of the Disease of Cattle, Horses, Sheep, Goats and Pigs.* 10th ed. London: W.B. Saunders; 2007:1840.
- Thatcher CD, Meldrum JB, Wikse SE, et al. Arsenic toxicosis and suspected chromium toxicosis in a herd of cattle. *J Am Vet Med Assoc.* 1983;187:179-182.

### REFERENCES

- Poppenga RH. *Vet Clin N Am Food A.* 2011;27:73.
- Pentachlorophenol. at: <<http://www.inchem.org/documents/pims/chemical/pim405.htm>>; Accessed 18.01.14.
- Oruc HH. *J Vet Diagn Investig.* 2009;17:349.
- Creosote. at: <<http://www.inchem.org/documents/cicads/cicads/cicad62.htm>>; Accessed 18.01.14.

## ZINC TOXICOSIS

### SYNOPSIS

**Etiology** Ingestion of excess amounts of zinc from a variety of sources.

**Epidemiology** Rare occurrence in large animals.

**Clinical pathology** Elevated serum and tissue levels of zinc.

### Clinical findings

- Pigs: lameness as a result of degenerative arthritis
- Cattle: lethargy and anorexia, diarrhea or constipation, reduced milk yield
- Horses: lameness, stiff gait, joint effusion

### Necropsy lesions

- Pigs: degenerative arthritis
- Cattle: degenerative lesions in all organs, especially pancreas

**Diagnostic confirmation** Elevated serum and tissue levels of zinc.

**Treatment** Find and remove source; supportive care.

**Control** Rinse galvanized pipes and utensils after each carriage of milk or milk products. Supplement diet with additional calcium.

### ETIOLOGY

Zinc is an essential element in most mammals, serving as a component in enzyme systems and structural and regulatory processes in the body. It plays a major role in the regulation of immune function, appetite, and growth.<sup>1</sup> It is found in feed supplements, medicines (zinc oxide), industry (steel and other alloys), wood preservatives, and a variety of other commercial and industrial products. Contamination of soil may lead to an increase in water and plants.<sup>2</sup> Zinc phosphide is a commonly used rodenticide, but it in cases of overdose, poisoning occurs from the generation of phosphine gas and not the amount of zinc ingested.<sup>3</sup>

Toxic doses are not well defined,<sup>4</sup> but drinking water containing 6 to 8 mg/kg of zinc is associated with constipation in cattle, and 200 g of zinc as lactate fed over a period of 2 months as a 0.1% solution is associated with arthritis in pigs. The maximum amount tolerated by pigs is 0.1% zinc (as zinc carbonate) in the diet. Experimental zinc poisoning in sheep and cattle is associated with reduced weight gains and feed efficiency when zinc is fed at the rate of 1 g/kg BW. At 1.5 to 1.7 g/kg BW there is reduced feed consumption in both species and depraved appetite in cattle.

### EPIDEMIOLOGY

#### Occurrence

Zinc poisoning in large animals is a rare occurrence and poorly documented. Case reports, when present, usually indicate the presence of another heavy metal.

Dietary levels of zinc associated with poisoning in different species have been summarized. Pigs develop abnormal articular cartilage at 500 ppm dietary zinc, whereas 2000 ppm zinc in the ration is associated with copper deficiency, anorexia, and subcutaneous hematoma. For horses, approximately 3600 ppm in the diet or 90 mg/kg body weight reduces growth rate. Sheep and cattle generally are adversely affected by 900 ppm zinc in their diet.

### Risk Factors

#### Animal Risk Factors

The accidental oral administration of large doses of zinc oxide may be associated with

hypocalcemia and a syndrome comparable to milk fever.

The addition of zinc to pig rations as a preventive against parakeratosis is unlikely to be associated with poisoning because of the unpalatability of rations containing excessive amounts.

Careless use of zinc sulfate as a prophylactic and treatment for the following should be avoided:

- Poisoning by fungi, especially *Pithomyces chartarum*
- Ovine foot rot
- Lupinosis—it is apparent that daily doses of 50 to 100 mg zinc/kg BW in these circumstances can be associated with severe abomasal lesions, pancreatic damage, and death in sheep, provided the material is administered with a drenching gun. The same dose administered by ruminal intubation is nontoxic, because the zinc triggers a closure of the reticular groove, resulting in its immediate deposition in the abomasum.

### Farm Risk Factors

Industry-related zinc dust settling on crops and pastures is a hazard; dose rates up to 45 mg/kg BW have no effect on cattle, 50 mg/kg is associated with anemia, and daily dose rates of 110 mg/kg BW are associated with deaths.

An outbreak of poisoning occurred in pigs fed buttermilk from a dairy factory. The buttermilk was piped to the pig pens each day through a long galvanized iron pipe. The buttermilk sat in pools in the pipe after each batch was run through; souring occurred, and the lactic acid produced was associated with the formation of zinc lactate, which was passed to the pigs in the next batch of buttermilk. The concentration of zinc in the milk (0.066%) was slightly higher than the minimum toxic strength (0.05%).

### Transmission

Common sources of zinc include:

- Zinc released from galvanized surfaces in the following circumstances:
  - When subjected to electrolysis when galvanized and copper pipes are joined
  - Galvanized bins flake zinc when used for storage of pig swill.
- Zinc chromate used as a paste in joining electrical cables
- Fumes from a nearby galvanizing factory
- Zinc, often associated with cadmium, is a common pollutant from industrial plants handling a variety of ores; nearby pasture may contain more than 500 mg/kg of zinc.
- Zinc-based paints, with a 50% to 55% zinc content when cattle lick freshly painted ironwork

- Zinc added to calf-grower rations as a nonspecific dietary supplement
- Accidental inclusion of zinc oxide in a prepared dairy cow ration

## PATHOGENESIS

Ingested zinc is absorbed primarily from the proximal small intestine, and approximately one-third of absorbed zinc is protein bound in the plasma. Phytic acid content of plant proteins interferes with absorption of zinc in monogastric diets. Other nutrients or elements that reduce zinc absorption include calcium, cadmium, and copper. Once absorbed, zinc accumulates rapidly in liver and pancreas, with slower accumulation in muscle and bone. Excretion is primarily in feces contributed from bile and from secretion via intestinal mucosa and bile.

The pathogenesis of zinc poisoning has not been determined, but it is likely that the arthritic lesions observed will be a result of faulty calcium absorption. The lesion in equines may be related to interactions of zinc and copper with interference in collagen metabolism. The development of anemia in some animals is poorly understood, but it may be a result of interactions of zinc, copper, and calcium.

## CLINICAL FINDINGS

### Acute Poisoning

#### Cattle

Large doses are associated with light-green-colored diarrhea and drastic reduction in milk yield. Severe cases show additional signs, including somnolence and paresis.

#### Pigs

Large doses are associated with decreased food intake, arthritis, hemorrhages in the axillae, gastritis, and enteritis. Death may occur within 21 days.

### Chronic Poisoning

#### Dairy Cattle

Dairy cattle show chronic constipation and a fall in milk yield. Other reported signs include inappetence, loss of condition, diarrhea with dehydration or subcutaneous edema, profound weakness, and jaundice.<sup>4</sup>

#### Pigs

Pigs fed buttermilk containing zinc show anorexia; lethargy; unthriftiness; rough coat; subcutaneous hematomas; stiffness; lameness, progressive weakness with enlargement of the joints, particularly the shoulder joint; and, finally, recumbency.

#### Horses

Chronic poisoning is associated with a nonspecific, degenerative arthritis, especially at the distal end of the tibia. The lesion is accompanied by an effusion into the joint capsule and the obvious enlargement of the hock joint. There may also be a generalized osteoporosis, lameness, and ill-thrift.

Affected foals may be reluctant to rise and have a joint effusion with a stiff gait.

Zinc fed experimentally to foals is associated with pharyngeal and laryngeal paralysis, stiffness, and lameness resulting from swelling of the epiphyses of long bones.

## CLINICAL PATHOLOGY

After experimental feeding, elevated levels of zinc are detectable in tissues, especially the liver, pancreas, and kidney, and liver (and serum) levels of copper are reduced. Serum zinc levels in affected cattle may be as high as 500 µg/mL, in contrast with the normal levels of about 140 µg/mL in normal cattle. Estimated as zinc protoporphyrin, the levels in poisoned donkeys and mules reach 900 to 1900 µg/mL. Fecal levels of zinc are likely to be elevated from an average of 220 mg/kg in normal animals to 8740 mg/kg in affected ones.

## NECROPSY FINDINGS

Severe, acute poisoning in sheep is associated with an abomasitis and duodenitis, in which the mucosa may appear green in color. In survivors, a severe, fibrosing pancreatitis may develop.

Acute poisoning in cattle has been accompanied by generalized pulmonary emphysema, a pale flabby myocardium, renal hemorrhages, and severe hepatic degeneration. Chronic poisoning in this species may result in lesions in many organs but the **most consistent damage** is in the pancreas. Atrophy of exocrine pancreatic acini with extensive interstitial fibrosis have also been described in piglets receiving a total parenteral nutrition diet.

In chronic zinc poisoning in pigs there is a nonspecific, degenerative arthritis affecting particularly the head of the humerus, with the articular cartilage being separated from the underlying osteoporotic bone. In foals, similar joint lesions and nephrosclerosis may be seen.

The hepatic zinc content in normal animals is high (30 to 150 mg/kg wet matter in calves) and may reach levels of 400 to 600 mg/kg wet matter after continued ingestion of zinc chromate paste without being accompanied by signs of zinc poisoning. In acute poisoning by zinc oxide in cattle, levels of 2000 mg/kg dry matter in the liver and 300 to 700 mg/kg dry matter in the kidney may be achieved; tissue copper levels in these animals may be reduced to 10 to 20 mg/kg. Tissue levels in calves dying of experimental zinc poisoning are much lower: 200 to 400 mg/kg.

## Samples for Confirmation of Diagnosis

- **Toxicology**—50 g liver, kidney; 500 g suspect feed or ingesta (ASSAY [Zn])
- **Histology**—formalin-fixed pancreas (light microscopy)

## Tissue Assay

The zinc Content of liver in normal animals is high (30 to 150 mg/kg wet matter in calves) and may reach levels of 400 to 600 mg/kg wet matter after continued ingestion of zinc chromate paste without being accompanied by signs of zinc poisoning. In acute poisoning by zinc oxide in cattle, levels of 2000 mg/kg dry matter in the liver and 300 to 700 mg/kg dry matter in the kidney may be achieved; tissue copper levels in these animals may be reduced to 10 to 20 mg/kg. Tissue levels in calves dying of experimental zinc poisoning are much lower at 200 to 400 mg/kg.

Diagnostic confirmation of zinc poisoning depends on identification of elevated levels of zinc in fluids or tissues.

## DIFFERENTIAL DIAGNOSIS

### Differential diagnosis list:

- Erysipelas
- Lead toxicosis
- Naphthalene toxicosis
- Osteochondrosis/degenerative joint disease
- Rickets limited in occurrence to young pigs

## TREATMENT

Removal of the source and supportive care are the most effective means of treatment. In foals, serum copper concentrations should be evaluated because copper may need to be added to the diet. Chelating agents, especially calcium disodium EDTA, have been used successfully in small animals and human beings.<sup>5</sup>

## CONTROL

Galvanized utensils and piping should be rinsed after each use in carrying milk. The addition of extra amounts of calcium to the diet of pigs is capable of preventing the toxic effects of zinc if the calcium supplementation is heavy and the zinc intake is not too high.

## FURTHER READING

- Abdel-Mageed AB, Oehme FW. A review of the biochemical roles, toxicity and interactions of zinc, copper and iron. *Vet Human Tox.* 1990;32:34-39.
- Allen JG, Maters HG, Peet RL, et al. Zinc toxicity in ruminants. *J Comp Path.* 1983;93:363-377.
- Radostits O, et al. Zinc poisoning. In: *Veterinary Medicine: A Textbook of the Disease of Cattle, Horses, Sheep, Goats and Pigs.* 10th ed. London: W.B. Saunders; 2007:1826.
- Wentink GH, Spierenburg TH, De Graaf G, et al. A case of chronic zinc poisoning in calves fed with zinc-contaminated roughage. *Vet Quart.* 1985;7:153-157.
- Willoughby RA, MacDonald E, McSherry BJ, et al. Lead and zinc poisoning and the interaction between Pb and Zn poisoning in the foal. *Can J Comp Med.* 1972;36:348-359.

## REFERENCES

1. Herdt TH, et al. *Vet Clin North Am -Food A.* 2011;27:255.
2. Rogowska KA, et al. *Bull Vet Inst Pulawy.* 2009;53:703.



3. Proudfoot AT. *Clin Tox.* 2009;47:89.
4. Reis LSL. *J Med Med Sci.* 2010;1:560-579.
5. Gurnee CM, et al. *J Am Vet Med Assoc.* 2007;230:1174.

## DITERPENOID ALKALOID TOXICOSIS

### SYNOPSIS

**Etiology** Toxic plants in *Aconitum* spp. (monkshood), *Delphinium* spp. (larkspur), and *Erythrophleum* spp. (Cooktown ironwood). Toxins include aconitine, MSAL-type alkaloids (methyllycaconitine [MLA], nudicauline [NUD], 14-deacetyl nudicauline [DAN], and MDL-type alkaloids (deltaline, 14-O-acetyl dictyocarpine [14-OAD]).

**Epidemiology** *Aconitum* spp. are present in North America and Europe. Toxic *Delphinium* spp. are rangeland plants found throughout the western United States. *Erythrophleum* spp. are trees in northern Australia, Asia, Africa. Poisoning is most often in cattle, but all species may be affected.

**Clinical pathology** Toxic alkaloids in blood, urine, or ingesta.

**Lesions** Nonspecific.

**Diagnostic confirmation** Toxic alkaloids in blood, urine, ingesta, tissues, or plant.

**Treatment** Physostigmine/neostigmine (*Delphinium* spp.). Supportive care.

**Control** Avoid all consumption of *Aconitum* spp. or *Erythrophleum* spp. plants. Graze cattle before or after "toxic window" for *Delphinium* spp.

### ETIOLOGY

Diterpenoid alkaloids occur in *Delphinium* spp. (larkspur), *Erythrophleum* spp., and *Aconitum* spp. and are associated with poisoning in grazing animals. Diterpenoid alkaloids in toxic larkspur are divided into three different groups: norditerpenoid alkaloids, C-20 diterpenoid alkaloids, and bis-diterpenoid alkaloids.<sup>1,2</sup> Of these, norditerpenoid alkaloids are the most toxic, and they are further divided into two primary groups: MSAL-type norditerpenoid alkaloids (important toxins include methyllycaconitine [MLA], nudicauline [NUD], 14-deacetyl nudicauline [DAN]) and MDL-type norditerpenoid alkaloids (important toxins include deltaline, 14-O-acetyl dictyocarpine [14-OAD]).<sup>2,3</sup> At least 18 different toxic alkaloids are produced by poisonous species of larkspur.<sup>4</sup> Methyllycaconitine and deltaline are present in many toxic larkspurs. MSAL type alkaloids are approximately 20 times as toxic as the MDL type,<sup>5</sup> but MDL types are more abundant and may potentiate the toxicity of MSAL-type alkaloids.<sup>4</sup> Plants in the *Erythrophleum* spp. contain a number of different toxic alkaloids;

among them are diterpene ester alkaloids. Aconitine is the toxin found in monkshood or wolfsbane (*Aconitum napellus*).<sup>6,7</sup>

There are over 100 species of these plants, but a full alkaloid content profile has been completed in only a few. Larkspur is often divided into low, tall, and plains larkspur based on their mature height and geographic distribution. The species known to contain toxic diterpenoid alkaloids and to be associated with disease in livestock are as follows:

- *Aconitum napellus* (monkshood, wolfsbane)
- *Delphinium andersonii* (low; Anderson's larkspur)
- *D. barbeyi* (tall; subalpine larkspur)
- *D. bicolor* (low; little larkspur)
- *D. geyeri* (plains; Geyer's larkspur)
- *D. glaucescens* (tall; smooth larkspur)
- *D. glaucum* (tall; sierra larkspur)
- *D. nuttallianum* (low; twolobe larkspur)
- *D. occidentale* tall; duncecap or subalpine larkspur)
- *Erythrophleum* spp., e.g. *E. chlorostachys* (Cooktown ironwood)

Some of the species assumed to contain the alkaloids because of their known association with the disease are as follows:

- *Delphinium ajacis*
- *D. consolida*
- *D. elatum*
- *D. hybridum*
- *D. nelsonii*
- *D. parryi*
- *D. ramosum*
- *D. robustum*
- *D. tricornis*
- *D. trollifolium*
- *D. virescens*

### EPIDEMIOLOGY

#### Occurrence

North America, especially the western United States, and Europe are the principal locations of *Delphinium* spp. and *Aconitum* spp. poisonings. Rangeland larkspurs (*Delphinium* spp.) are important pasture plants in North America, and many of them are associated with heavy losses (2% to 15%) in grazing livestock.<sup>4</sup> The incidence of poisoning varies widely with season and climate because of variations in the concentration and chemical composition of specific alkaloids in the specific larkspur plants. Plants in the *Erythrophleum* spp. are found in Africa, Asia, and northern Australia and have been associated with death in cattle and horses.<sup>8</sup> *Aconitum* spp. grow in the United States and Europe, but poisoning rarely occurs in large animals.

#### Risk Factors

##### Animal Risk Factors

All animal species are susceptible, but most cases are seen in cattle, less often in sheep, and rarely in horses. Sheep are 5 times less susceptible than cattle, and little is reported

about horses.<sup>9</sup> The rate of consumption and amount consumed are known risk factors for grazing cattle. The toxicity of tall larkspur is seasonal, being much more toxic early in the season and less so as it matures.<sup>3</sup> A "toxic window" has been established for grazing cattle that begins just before the flowering stage and ends with shattering of the pod.<sup>4</sup> During this time period, grazing cattle are at the highest risk for developing toxicosis.

### PATHOGENESIS

The principal action of diterpenoid alkaloids is neuromuscular paralysis secondary to blockade at the postsynaptic neuromuscular junction.<sup>3,4</sup> The toxins are competitive postsynaptic inhibitors of acetylcholine; MLA is a potent competitive blocker at nicotinic acetylcholine receptors (nAChRs) in the striated muscles and autonomic nervous system.<sup>3</sup> Interference with the other parts of the neuromuscular arc is also possible. Signs peak 18 to 24 hours after first ingestion, but the effects may be cumulative.<sup>10,11</sup> The signs in the herd disappear 6 to 7 days after the plant is withdrawn from the diet.<sup>10,11</sup>

Aconitine and other alkaloids present in *Aconitum* spp. are potent neurotoxins and cardiotoxins with actions on cell-membrane voltage-sensitive sodium channels.<sup>7</sup> Nerves, muscles, and myocardium are affected, becoming refractory to excitation. The alkaloids in *Erythrophleum chlorostachys* have a cardiac glycoside-like action.

### CLINICAL FINDINGS

Clinical signs in terminally poisoned cattle include tachycardia, muscle weakness, tremors, sternal recumbency leading to lateral recumbency, and death.<sup>3,4</sup> Other signs include constipation, bloating, and dyspnea.<sup>4</sup> Many animals are simply found dead. Those animals ingesting lower amounts may show dyspnea, an irregular heart rate, and collapse, but not death.

Diarrhea is reported in *Aconitum* spp. poisoning, possibly as a result of the presence of additional toxins. In large ingestions, rapid death from paralytic respiratory failure or ventricular arrhythmias may occur.<sup>7</sup> Aspiration of ruminal contents after regurgitation also causes some deaths. In the terminal stages, the pupils are dilated, and the pulse and respiration may be barely perceptible. Some animals are found dead without evidence of clinical signs.

*Erythrophleum chlorostachys* (ironwood) and *E. guineense* are both poisonous to all animal species. Clinical signs include anorexia, a staring expression, partial blindness, tremor, ataxia, contraction of abdominal muscle, increased heart sounds, mucosal pallor, and terminal dyspnea. Horses poisoned by *E. chlorostachys* have loud and often irregular heart sounds, dyspnea, and sporadic contraction of abdominal muscles, and they die rapidly.

## CLINICAL PATHOLOGY

There are no specific findings other than identification of toxic alkaloids in blood, urine, ingesta, and tissues.

## NECROPSY FINDINGS

There are no specific postmortem lesions. Aspiration pneumonia may be an incidental finding in some cases.

Diagnostic confirmation of larkspur poisoning depends on chemical identification of the causative alkaloids in the blood, urine, rumen contents, or plants. Normal and reverse-phase high-performance liquid chromatography (HPLC) has been used to successfully identify toxic alkaloids in several *Delphinium* spp.<sup>12</sup> Aconitine has been confirmed in urine and blood using liquid-chromatography tandem mass spectrometry (LC-MS/MS).<sup>13</sup>

### DIFFERENTIAL DIAGNOSIS

Differentiation from other plant poisonings causing incoordination, recumbency, and death in cattle on extensive grazing is usually based on botanical identifications.

#### Differential diagnosis list:

- *Clavibacter toxicus* (tunicaminyuracil poisoning)
- Lead poisoning
- Organophosphorus compounds.
- *Paspalum* spp., infested with *Claviceps paspali* (paspalitreum poisoning)
- *Phalaris* spp. (tyramine poisoning)

## TREATMENT

### TREATMENT AND CONTROL

Physostigmine (0.04–0.08 mg/kg BW IV, repeat prn) (R-2)

Neostigmine (0.02–0.04 mg/kg BW, IM or IV, repeat prn) (R-2)

Physostigmine and neostigmine have been used as effective antidotes for *Delphinium* spp. poisoning, but they may have limited practical value in a herd situation. Physostigmine, a cholinergic drug, given IV at 0.08 mg/kg BW, has been used successfully in experimental and field conditions;<sup>4</sup> alternate dosages in recumbent cattle include IV, SC, or IP administration at 0.04 to 0.08 mg/kg BW.<sup>14,15</sup> Intravenous neostigmine (0.04 mg/kg BW) has reversed clinical signs in cattle,<sup>14</sup> and IM administration at 0.02 mg/kg BW has used in cattle as a “rescue” drug.<sup>3,4</sup> Neostigmine may be more effective in reversing tachycardia and physostigmine in reversing muscle weakness.<sup>14</sup> The duration of action is less than 2 hours, and repeat doses will need to be administered.

No specific treatment has been identified for *Aconitum* spp. or *Erythrophleum* spp. poisoning. Treatment is supportive, with

particular attention paid to the cardiovascular and respiratory systems.

## CONTROL

Control of *Delphinium* spp. poisoning is only possible by careful management of pasture and preventing access to heavily infested areas. Prevention of grazing during the “toxic window” decreases toxicity, but the quality of the forage declines substantially.<sup>4</sup> Sheep are more resistant to the poisoning than cattle, but they are fond of the plant and may have to be restricted to areas where it does not occur.<sup>9</sup> Attempts to create and maintain a long-standing aversion to the plants to prevent ingestion of them and allow grazing of infested pastures have not always been successful.<sup>4,16</sup> Herbicides may be effective in reducing heavy growths of larkspur, but application timing is critical to success, and some herbicides may actually make plants more palatable.<sup>4</sup>

## FURTHER READING

- Griffin WJ, Phippard JH, Culvenor CJ, et al. Alkaloids of the leaves of *Erythrophleum chlorostachys*. *Phytochemistry*. 1971;10:2793-2797.
- Knight AP, Pfister JA. Larkspur poisoning in livestock: myths and misconceptions. *Rangelands*. 1997;19:10-13.
- McKenzie RA. Dealing with plant poisoning of livestock: the challenge in Queensland. *Aust Vet J*. 1991;68:41-44.
- Olsen JD. Tall larkspur poisoning in cattle and sheep. *J Am Vet Med Assoc*. 1978;173:762-765.
- Pfister JA, Panter KE, Manner GD, et al. Reversal of tall larkspur (*Delphinium barbeyi*) poisoning in cattle with physostigmine. *Vet Human Toxicol*. 1994;36:511-514.

## REFERENCES

1. Green BT, Welch JA, Pfister D, et al. The physiological effects and toxicokinetics of tall larkspur (*Delphinium barbeyi*) alkaloids in cattle. In: Riet-Correa F, Pfister J, Schild AL, Wierenga TL, eds. *Poisoning by Plants, Mycotoxins, and Other Toxins*. CAB International; 2011:557.
2. Green BT, et al. *J Appl Toxicol*. 2011;31:20.
3. Welch KD, Gardner DR, Panter KE, et al. Effect of MDL-type alkaloids on tall larkspur toxicosis. In: Riet-Correa F, Pfister J, Schild AL, Wierenga TL, eds. *Poisoning by Plants, Mycotoxins, and Other Toxins*. CAB International; 2011:540.
4. Green BT, et al. *Rangelands*. 2009;31:22.
5. Welch KD, et al. *J Anim Sci*. 2008;86:2761.
6. Pulella R, et al. *J Forensic Sci*. 2008;53:491.
7. Chan TK, Thomas YK. *Clin Tox*. 2009;47:279.
8. Burcham PC, et al. *Chem Res Toxicol*. 2008;21:967.
9. Pfister JA, et al. *Rangeland Ecol Manage*. 2010;63:262.
10. Green BT, et al. *Am J Vet Res*. 2012;73:1318.
11. Cook D, et al. *Am J Vet Res*. 2011;72:706.
12. Gardner DR, et al. *Phytochem Analysis*. 2009; 20:104.
13. Colombo ML, et al. *Nat Prod Comm*. 2009;4:1551.
14. Green BT. *Am J Vet Res*. 2009;70:539.
15. Plumb DC. Physostigmine salicylate. In: Plumb DC, ed. *Veterinary Drug Handbook*. 7th ed. Ames, IA: Wiley-Blackwell; 2011:822.
16. Pfister JA, Cheney CD, Gardner DR, et al. Conditioned flavor aversion and location avoidance in hamsters from toxic extract of tall larkspur (*Delphinium barbeyi*). In: Riet-Correa F, Pfister J,

Schild AL, Wierenga TL, eds. *Poisoning by Plants, Mycotoxins, and Other Toxins*. CAB International; 2011:637.

## ERGOT ALKALOID TOXICOSIS

Ergot alkaloids are mycotoxins produced by fungi found primarily in the *Claviceps* and *Neotyphodium* genus.<sup>1,2</sup> The presence of rich, fertile soil in addition to warm temperatures, elevated humidity, and high rainfall increase the production of ergot alkaloids. Many of the fungi occur naturally in plants and produce similar clinical syndromes, however, their presence in a feedstuff does not necessarily indicate toxicity. Rather, determination of the specific ergot alkaloid should be pursued.

Ergot alkaloids in the genus *Claviceps* produce external spores, infecting the flowers of grasses and cereal grains such as rye, barley, wheat, millet, and oats, and ultimately forming an ergot alkaloid packed sclerotium.<sup>2</sup> The sclerotia in cereal grains are generally large and easily visible; those in grass seeds often quite small and difficult to see. Several fungi in the *Neotyphodium*, *Balansia*, and *Epichloe* genera found in grasses produce ergot alkaloids.<sup>1</sup> These endophytic fungi do not sporulate and grow within plants in a variety of symbiotic relationships ranging from antagonistic (*Epichloe*) to mutualistic (*Neotyphodium*).<sup>1</sup>

The individual toxins, and the plants they parasitize, are only partially identified. A list of the fungi, the toxins they contain and the syndromes attributed to them is as follows:

- *Claviceps africana*<sup>3,4</sup>—sorghum ergot; contains dihydroergosine (DHES) and related alkaloids; agalactia, hyperthermia, decreased production
- *C. cinerea*—gait incoordination
- *C. cynodontis*<sup>5</sup>—paspalitreum B, ergonovine, ergine; muscle tremors
- *C. cyperi*—ergocryptine; hyperthermia and decreased milk production
- *C. fusiformis*—agalactia
- *C. paspali*<sup>6</sup>—paspalitreum A, paspalitreum B, paspalitreum C, paspalinine; gait incoordination, muscle tremors
- *C. purpurea*<sup>1,2</sup>—ergometrine, ergotamine, ergocornine, ergocristine ergosine, ergocryptine; peripheral gangrene, hyperthermia and decreased production, reproductive failure, rare nervous signs
- *C. sorghi*<sup>7</sup>—sorghum ergot
- *C. sorghicola*<sup>7</sup>—sorghum ergot
- *Balansia epichloe*—gait incoordination, peripheral gangrene
- *Neotyphodium* spp.<sup>1,2</sup>—ergonovine and lysergic acid amide; gait incoordination
- *Neotyphodium (Acremonium) coenophialum*<sup>1,2</sup>—ergopeptine alkaloids, ergovaline, ergotamine; hyperthermia, milk yield drop, peripheral gangrene

## ERGOTISM

Alkaloids produced by fungi in the *Claviceps* genus are generally referred to as ergots, and ergotism is loosely defined as the toxicity or physical manifestations that occur when a toxic amount of ergot is ingested.<sup>2</sup> *Claviceps purpurea*, with an ability to infect over 600 plants worldwide,<sup>1</sup> is often used to describe the clinical syndromes associated with ergotism.

### SYNOPSIS

**Etiology** Ingestion of large quantities of cereal grains or grasses containing ergots produced by *Claviceps purpurea*.

**Epidemiology** Warmth, high humidity, fertile soil; worldwide distribution in temperate climates.

**Clinical pathology** No specific abnormalities.

**Lesions** Gangrene of the extremities; hyperthermia in cattle; reproductive issues (abortion, poor mammary development, early neonatal deaths in mares and sows), poorly documented nervous syndrome.

**Diagnosis confirmation** Assay for specific ergot alkaloid in feed and/or body tissues.

**Treatment** Remove from source.

**Control** Avoid exposure or dilute feed with nontoxic material.

## ETIOLOGY

*Claviceps purpurea* is a fungus that under natural conditions infects rye and triticale and, less commonly, other cereals and many grasses, including the rye grasses, tall fescue grass, *Phleum pratense* (timothy, cocksfoot, Yorkshire fog), *Cynosurus cristatus* (crested dogstail, tall oat grasses, the brome grasses), *Brachiaria decumbens*, *Brachiaria humidicola*, and *Pennisetum typhoides* (bulrush millet). Ingestion of large quantities of seed heads infested with the fungal sclerotia is associated with ergotism in cattle, sheep, pigs, horses, dogs, and birds.

There is some evidence that corn smut may have pharmacologic activity similar to that of *C. purpurea*. *Claviceps cynocontis* infected *Cynodon dactylon* (Bermuda or couch grass, “kweek”) may be related to the tremor syndrome that occurs occasionally in cattle grazing this grass.<sup>5</sup>

## EPIDEMIOLOGY

*Claviceps purpurea* is widespread in distribution, but it is seldom ingested in large enough amounts during its toxic stage to be associated with poisoning. Poisoning is most likely to occur during or after a warm, wet season, which favors the growth of the fungus. Ergotism occurs commonly in cattle and usually in stall-fed animals feeding on heavily contaminated grain over

a considerable period of time. Other species are not usually exposed to the infected grain.

Ergot-infected pasture may be associated with the clinical syndrome, and the toxicity is preserved through the ensiling process. Cows may show early signs of lameness in as short a period as 10 days after going onto an infected pasture, but most animals do not become affected until 2 to 4 weeks after exposure. Peripheral gangrene occurs in the cooler months; hyperthermia in warmer weather.

## PATHOGENESIS

The ergots contain a number of alkaloids and amines with pharmacologic activity, and these vary in concentration with the maturity of the ergot. Clavine alkaloids, lysergic acid and lysergic acid derivatives (e.g., ergometrine or ergonovine), ergopeptine alkaloids (e.g., ergotamine, ergocornine), and lactam ergot alkaloids (e.g., ergocristamine) are the four main groups of naturally occurring ergot alkaloids.<sup>1,2</sup> Ergometrine, ergotamine, ergocornine, ergocristine, ergosine, and ergocryptine are the most common alkaloids produced by *Claviceps purpurea*.<sup>1,2</sup> Structurally, the ergot alkaloids are similar to serotonin, dopamine, norepinephrine, and epinephrine, and they are able to bind to biogenic amine receptors and elicit an effect.<sup>1</sup> The pharmacologically active compounds in the group stimulate (constrict) the smooth muscle of arterioles, intestines, and the uterus and decrease serum prolactin. The peptide alkaloids of ergot, particularly ergotamine, are associated with arteriolar spasm and capillary endothelial damage, with restriction of the circulation and gangrene of the extremities, when small amounts are ingested over long periods.

## CLINICAL FINDINGS

Four different clinical syndromes have been described. Classical ergotism is characterized by gangrene of the extremities, the hyperthermic syndrome results in elevated body temperatures and decreased production, and the reproductive syndrome presents with agalactia, lack of mammary gland development, low birth weight, and stillborn animals.<sup>1,9</sup> In spite of the known abortifacient action of *Claviceps purpurea*, abortion does not usually occur in poisoned animals. The fourth syndrome is a rare, ill-defined nervous form that may be associated with a single, acute ingestion of large amounts of sclerotia.

### Peripheral Gangrene (Classical Ergotism)

The extremities, particularly the lower part of the hindlimbs, tail, and ears, are affected. There is reddening, swelling, coldness, loss of hair or wool, and lack of sensation of the parts initially, followed by the development of a blue–black color and dryness of the skin.

Gangrene usually affects all local tissues, and after the lapse of some days, the affected part becomes obviously separated and may eventually slough. The lesions are not painful, but some lameness is evident even in the early stages, and the animal may remain recumbent most of the time. Severe diarrhea is often an accompanying sign. In sheep, gangrene of the limbs does not occur under experimental conditions, but there is ulceration and necrosis on the tongue and mucosa of the pharynx, rumen, abomasum, and small intestine.

The experimental feeding of ergots (1%–2% of ration) is associated with severe reduction in feed intake and growth rate in young pigs without producing overt signs of ergotism.

### Hyperthermia Form

Affected cows have temperatures of 41° to 42° C (105–107° F), dyspnea, and hypersalivation. Milk production and growth rate are depressed, and morbidity is about 100%. The syndrome occurs in hot weather conditions when affected animals seek water or shade, but exposure to sunlight under normal conditions of air temperature and humidity can be enough to be associated with clinical signs. Affected animals stressed by exercise in ambient temperatures over 30° C (86° F) commonly die. Long-term, low-level feeding of ergot to fattening beef cattle can result in reduced feed intake and weight gain, increased water intake and urination, failure to shed winter coat, and increased susceptibility to heat stress.

### Reproductive Form

The manifestation varies depending on the species. Although rare in cattle, a brief exposure to a heavily ergotized pasture caused abortion in late pregnant cows. It also occurs as a single outbreak of agalactia, lack of mammary gland development, abortions, prolonged gestations, and early foal deaths in mares fed oats containing *Lolium multiflorum* seeds heavily infested with *C. purpurea*. In sheep, the feeding of ergot reduces the chance of fetal survival, and thus relative infertility occurs, and feeding pregnant ewes on ergotized grain is not recommended.

In pigs, ergotism is manifested by lack of udder development and agalactia in sows, and the birth of small pigs that suffer a heavy neonatal mortality. Some of the piglets survive and subsequently suffer gangrene of the ear edges and tail tip. In sows, the chronic feeding of *C. purpurea* may not disturb existing pregnancies, but premature births, mummified fetuses, and low litter size are recorded. Levels up to 0.2% in the diet appear to be safe. A specific ergot, *Claviceps fusiformis*, which grows on *Pennisetum typhoides* (bulrush millet), is known to be associated with agalactia in sows in Zimbabwe. *Claviceps africana*, the ergot of



sorghum, has been associated with agalactia in sows and perinatal mortality of piglets in Australia.

## CLINICAL PATHOLOGY

There are no specific abnormalities. Samples of fungus-infested material, either animal tissues or feed, may be submitted for assay. High-performance liquid chromatography (HPLC) and liquid chromatography/mass spectrometry (LC/MS) techniques can be used to identify the presence of many ergot alkaloids.<sup>1,2,10</sup>

## NECROPSY FINDINGS

In cattle, gangrene of the extremities is the principal gross lesion. There may be evidence of congestion, arteriolar spasm, and capillary endothelial degeneration in the vicinity of the gross lesions and in the central nervous system. Ulceration and necrosis of the oral, pharyngeal, ruminal, and intestinal mucosae are recorded in sheep.

Diagnosis confirmation depends on a positive assay of ergot alkaloids in feed or tissues.

## DIFFERENTIAL DIAGNOSIS

### Differential diagnosis list:

- Classical ergotism
- Poisoning by *Neotyphodium coenophialum*
- Arterial thrombosis and embolism
- Trauma causing obstruction of circulation to the part
- Bacteremia (e.g., in salmonellosis)
- Hyperthermia/poor production
- Heat stroke
- Water deprivation

## TREATMENT

The infested grain should be withdrawn from the ration immediately. Further treatment is not usually attempted, although vasodilator drugs may have some beneficial effect.

## CONTROL

Heavily ergotized grain or pasture fields containing ergotized grasses should not be used for animal feeding. They may be grazed if they are first mowed with the mower blade set high to remove the seed heads. Feed should not contain more than 0.1% of ergot-infested heads. It is best not to feed ergot-infested feed to pregnant females.

## NEOTYPHODIUM (ACREMONIUM) SPP. TOXICOSIS

Infestation of the grasses *Achnatherum inebrians* (drunken horse grass) in China and *Stipa robusta* (sleepy grass) in North America by endophytes is associated with a syndrome of incoordination in horses and sheep grazing on the grass. Identification of the fungi is not complete but they contain ergonovine and lysergic acid amide. Low levels of

paxillene and lolitrem B (indo-terpenoids) are also present.

## FESCUE TOXICOSIS

### CLINICAL FINDINGS

Four clinical syndromes are associated with ingestion of *Neotyphodium (Acremonium) coenophialum*, an endophyte present in the tissues of the tall fescue grass *Lolium arundinaceum* (formerly *Festuca arundinacea*). The toxic hyphae are invisible without microscopy and produce no fruiting bodies. There is no visible effect on the growth of the grass, and spread of the endophyte is via infected seeds.<sup>1</sup> The fungus produces ergopeptide alkaloids, principally ergovaline, and many other pharmacologically active compounds, including peramine and ergine (lysergic acid amine). There is a great deal of variation in the toxicity of different varieties of the tall fescue grass: KY-31 is most toxic; Kenhy, Mo-96, and Kenmont are intermediate; and Fawn is least toxic.

Several clinical syndromes are associated with ingestion of pasture grass or hay made from infected tall fescue grass. In cattle and sheep, fescue summer toxicosis, fescue foot, and fat necrosis are reported; in mares, reproductive abnormalities occur most often.<sup>1</sup> All of these syndromes could theoretically occur on the same pasture, but summer toxicosis occurs only in the summer and fescue foot in the winter.

In Australia, horses grazing on a pasture seeded with novel Mediterranean (Max P or Max Q) fescue varieties known not produce ergovaline developed a fescue-associated edema syndrome.<sup>11</sup> Clinical signs included depression, inappetence, and dependent subcutaneous edema affecting the head, neck, chest, and abdomen. Analysis of the serum showed a low total protein, in particular a low albumin concentration.<sup>11</sup> Ruminants grazed on the same pasture were unaffected. It was proposed that *N*-acetyl norlooline, a pyrrolizidine alkaloid produced by the Max P endophyte, was responsible for the clinical signs.

### Fescue Summer Toxicosis (Summer Slump, Epidemic Hyperthermia)

Fescue summer toxicosis has caused significant economic losses in the US, New Zealand, and Australia dairy industries because of the high rate of use of tall fescue as a pasture grass. It is also the most common of the clinical syndromes associated with fescue toxicosis.<sup>1,12</sup>

The syndrome occurs in cattle at pasture in the summer and consists of a period of poor production manifested by a fall in milk production or a failure to grow adequately in fat cattle, both in the presence of what appears to be an optimum amount of nutritious pasture. The same poor weight gain is experienced by steers fed on fescue seed and in sheep. In cattle grazing at pasture the

depressing effect on production is made worse by environmental temperatures above 31°C (87°F). Affected cattle show hyperthermia with temperatures as high as 40.5°C (104.5°F), dyspnea, hypersalivation, inappetence, and rough coat, and they may compulsively seek out water or tree shade in which to stand. Hyperthermia may not recede until about 6 weeks after the cattle are moved from the pasture.

The mycotoxin responsible is ergovaline, an ergopeptide similar to, but more powerful than, ergotamine. The lowered milk yield is accompanied by low blood levels of prolactin, resulting in an indifferent prolactin surge when the premilking stimuli are applied. Prolactin levels may be significantly increased by the administration of metoclopramide, a dopamine antagonist, but side effects and cost may preclude use.

### Fescue Foot

Fescue foot occurs in cattle grazing pasture dominated by tall fescue, usually within 10 to 14 days of being turned onto the pasture during cold weather. Cattle permanently pastured on the field do not appear to be affected, and horses seem to be able to graze with impunity. The lesions and clinical signs include severe lameness followed in 2 or more weeks by gangrene and sloughing of the extremities, especially the digits and, to a lesser extent, the tail. The incidence in a herd may be as high as 10%. The lesions are associated with the vasoconstrictive agent ergovaline produced by *N. coenophialum*. In freezing temperatures, frostbite may be a complicating factor. New cases may continue to appear for up to 1 week after removal from the affected pasture. Broad-spectrum antibiotics may be useful early in the syndrome to prevent secondary infections.

There is a close similarity to the disease associated with the ingestion of *Claviceps purpurea*, and *Claviceps* ergot alkaloids are also present in fescue; thus identifying the specific cause of gangrene of the extremities may not be possible. Grass heads are commonly infested by *C. purpurea*, but the disease occurs in their absence.

### Fat Necrosis (Lipomatosis)

Abdominal fat stores in cattle are affected in the syndrome of fat necrosis. Clinical signs vary depending on the location of fat, but in general fat stores become hardened and necrotic. Dystocia may result if this occurs in the pelvic canal. Necrotic fat in the mesentery may cause an obstruction or bloat. Generally, the presence of fat necrosis is an incidental finding at postmortem.

### Reproductive Abnormalities in Mares

Pregnant mares grazing on pastures infected with *Neotyphodium (Acremonium) coenophialum* can experience a much higher incidence of dystocia, prolonged gestation,

low foal survival, small udder development, and poor milk yield compared with mares on unaffected pastures.<sup>8</sup> “Fescue” foals may be small and dysmature or large and overly mature. The delivery of an overly mature foal may result in dystocia or the birth of a “red bag” foal. This occurs when a prematurely detached chorioallantois enters the birth canal before the foal.<sup>8</sup> Prolongation of luteal function, an increase in cycles bred per pregnancy rate, and early embryonic death significantly reduce reproductive efficiency. Pregnant mares are most susceptible to toxicity after day 300 of gestation and should be removed from infected pasture before that time.

Domperidone, a D-2 dopamine antagonist, is an FDA-approved drug marketed for the prevention of fescue toxicosis in mares.<sup>8,13</sup> The drug is best used for those mares that cannot be removed from infected pasture. A dosage of 1.1 mg/kg BW/day is recommended, but it should be given no sooner than 15 days before the expected foaling date.<sup>13</sup> If the mare is agalactic after foaling, domperidone may be administered at the same dosage rate for an additional 5 days.<sup>13</sup>

### CONTROL

Planting endophyte-resistant varieties of tall fescue, rotating cattle through fescue and other grass and clover varieties, and diluting infected hay with nonfescue varieties are among the most effective means of control. Newer, novel endophyte-infected varieties of fescue should be planted with caution until complete information is available.<sup>11</sup> Ammonization of the affected hay will degrade ergovaline so it is safe to feed, but the procedure is expensive, labor intensive, and time consuming. Cattle on summer pastures with fescue-infected hay should have adequate shade and access to water; those on similar pasture in cooler weather should have shelter or windbreaks. If possible, mares should be removed from fescue-infected hay or pasture before 300 days of gestation; if this is not possible, domperidone should be administered as described previously.

### FURTHER READING

- Hemken RW, et al. Summer fescue toxicosis in lactating dairy cows and sheep fed experimental strains of ryegrass-tall fescue hybrids. *J Anim Sci.* 1979;49:641-646.
- Holliman A, et al. Ergotism in young cattle. *Vet Rec.* 1990;127:388.
- Hussein HS, et al. Toxicity, metabolism, and impact of mycotoxins on humans and animals. *Toxicology.* 2001;167:101-134.
- Naudé TW, et al. *Claviceps cyperi*, a new cause of severe ergotism in dairy cattle consuming maize silage and teff hay contaminated with ergotised *Cyperus esculentus* (nut sedge) on the Highveld of South Africa. *Onderstepoort J Vet Res.* 2005;72:23-28.
- Radostits O, et al. Poisoning by ergot alkaloids. In: *Veterinary Medicine: A Textbook of the Disease of Cattle, Horses, Sheep, Goats and Pigs.* 10th ed. London: W.B. Saunders; 2007:1901.

### REFERENCES

- Strickland JR, et al. *J Anim Sci.* 2011;89:603.
- Krska R, et al. *Food Addit Contam Part A.* 2008;25:722.
- Blaney BJ, et al. *Aust J Agri Res.* 2006;57:1023.
- Blaney BJ, et al. *Aust Vet J.* 2010;88:311.
- Uhlig S, et al. *J Agri Food Chem.* 2009;57:11112.
- Cawdell-Smith AJ, et al. *Aust Vet J.* 2010;88:393.
- Muthusubramanian V, et al. *Mycol Res.* 2006;110:452.
- Cross DL. Fescue toxicosis. In: McKinnon AO, Squires EL, Vaala WE, Varner DD, eds. *Equine Reproduction.* CAB; 2011:2418.
- Belsler-Ehrlich S, et al. *Toxicol Ind Health.* 2013;29:307.
- Schumann B, et al. *Mol Nutr Food Res.* 2009;53:931.
- Bourke CA, et al. *Aust Vet J.* 2009;87:492.
- Burke NC, et al. *J Anim Sci.* 2007;85:2932.
- Plumb DC. Domperidone. In: Plumb DC, ed. *Veterinary Drug Handbook.* 7th ed. Ames, IA: Wiley-Blackwell; 2011:351.

## FUMONISIN TOXICOSIS

### SYNOPSIS

**Etiology** Corn or corn products contaminated with fumonisins B<sub>1</sub> (FB<sub>1</sub>) and B<sub>2</sub> (FB<sub>2</sub>).

**Epidemiology** Sporadic occurrences worldwide in those countries where corn is grown. Equine leukoencephalomalacia (ELEM) and porcine pulmonary edema (PPE) are the two most widely recognized syndromes.

**Clinical pathology** Nonspecific increases in hepatic enzyme activities; increased serum or tissue concentrations of sphinganine (Sa) and sphingosine (So) and increase in Sa:So ratio.

**Lesions** ELEM: Fatal neurologic or hepatic syndrome; PPE: pulmonary edema, left-sided heart failure, hepatic syndrome.

**Diagnostic confirmation** Presence of FB<sub>1</sub> or FB<sub>2</sub> in corn or corn product.

**Treatment** None.

**Control** Remove animals from source, test corn or corn product; feed contaminated product to slaughter cattle.

### ETIOLOGY

Fumonisins B<sub>1</sub> and B<sub>2</sub> are mycotoxins produced by *Fusarium verticillioides* (synonym *F. moniliforme*, *Gibberella fujikuroi*) and *F. proliferatum* growing on moldy corn (maize) grain.<sup>1,2,3</sup> More than 25 fumonisins have been isolated and grouped (A, B, C, and P); however, the most important and well studied is fumonisin B<sub>1</sub> (FB<sub>1</sub>).<sup>4,5,6</sup> Fumonisins B<sub>2</sub> (FB<sub>2</sub>) and B<sub>3</sub> (FB<sub>3</sub>) occur in lower concentrations than FB<sub>1</sub> and don't appear to play an important role in the development of toxicity.<sup>4</sup> *Aspergillus niger* and other species of *Fusarium* also produce fumonisins;<sup>4,5</sup> there is some controversy as to whether *Alternaria alternata* f. sp. *lycopersici* produces fumonisins.<sup>5</sup>

### EPIDEMIOLOGY

Equine leukoencephalomalacia (ELEM) and porcine pulmonary edema (PPE) are the two most widely recognized syndromes associated with ingestion of FB<sub>1</sub> and FB<sub>2</sub> in corn.<sup>1,2,7</sup> Of the known toxic fumonisins, FB<sub>1</sub> is the most common cause of animal disease and is a known carcinogen in humans (esophagus) and rats (liver).<sup>4,5</sup>

### Occurrence

Outbreaks of ELEM and PPE associated with fumonisin-contaminated corn have occurred worldwide.<sup>4,8,9</sup> Historically, there have been reports of poisoning associated with FB<sub>1</sub>- and FB<sub>2</sub>-contaminated oats and New Zealand forage grass,<sup>3</sup> but the majority of problems occur with contaminated corn and corn products.<sup>1-3</sup>

### Risk Factors

#### Animal Risk Factors

Horses and pigs are much more susceptible to the poisoning than cattle and poultry.<sup>1,7,10</sup> The recommended concentration of fumonisins in animal feed varies depending on the species; both the U.S. FDA and the European Union Commission have published guidelines.<sup>1,7</sup> In the United States, the total fumonisins (FB<sub>1</sub>, FB<sub>2</sub>, and FB<sub>3</sub>) present in maize or maize by-product in formulated feed should not exceed 5 ppm for horses.<sup>1,7</sup> Fumonisins are not excreted in the milk of cows or sows ingesting the toxin, so nursing animals should not be at risk for development of toxicity.<sup>1</sup>

#### Environmental Risk Factors

The fungus is commonly found growing on moldy corn (maize) grain that has been affected by rain while on the stalk or stored wet. All forms of corn, including pelleted feeds, are susceptible to contamination, and visible mold may not necessarily be present on the corn. Infection by *F. verticillioides* may occur more often when a drought is followed by cool, damp weather during the pollination period.<sup>9</sup>

### PATHOGENESIS

The mechanism of action has not been clearly defined but may be related to interruption in sphingolipid metabolism.<sup>1,8</sup> The molecular structure of FB<sub>1</sub> and FB<sub>2</sub> is very close to that of sphinganine and sphingosine, sphingolipids found in lipid substances such as cellular membranes. Both FB<sub>1</sub> and FB<sub>2</sub> inhibit ceramide synthase (sphingosine and sphinganine *N*-acyl-transferase), effectively blocking sphingolipid metabolism and interfering with cellular differentiation, growth, communication, and transformation.<sup>1,9</sup> Serum and tissue concentrations of sphinganine and sphingosine increase and may be used as a biological marker of exposure to fumonisins.<sup>1</sup> An elevation in the serum, tissue, or urine ratio of sphinganine to sphingosine (Sa:So) may have promise as a biomarker.<sup>1,11</sup>

## EQUINE TOXICOSIS

### Equine Leukoencephalomalacia (Moldy Corn Disease)

The most common clinical entity is equine leukoencephalomalacia (ELEM), a disease of horses, mules, and donkeys associated with the ingestion of fumonisin-contaminated corn.<sup>4,9,12</sup> Of the known fumonisins, FB<sub>1</sub> and FB<sub>2</sub> are the most important, and FB<sub>1</sub> has been shown to be the specific cause of ELEM. Poisoning occurs in stored moldy corn, but it also occurs in horses fed commercial feeds, including pelleted feed; the disease incidence is usually in the form of an outbreak, with some of them being large-scale outbreaks.<sup>4,9,13</sup> Most feeds associated with ELEM contain a minimum of 15 to 22 ppm FB<sub>1</sub>, although risk is increased with ingestions of feeds containing 10 ppm FB<sub>1</sub>.<sup>4,8,13</sup>

### CLINICAL FINDINGS

Classically, the disease is described as either a neurotoxic or hepatotoxic syndrome, although it is likely a single syndrome with the spectrum of signs related more to the actual concentration of fumonisins present in the feed, prior exposure, individual susceptibility, and total amount ingested.<sup>13</sup> Cardiovascular dysfunction may play an important role in the development of ELEM.<sup>14</sup>

Clinical signs occur 14 to 21 days after introduction of contaminated feed; occasionally animals present with signs at 7 days and on rare occasions, not for 90 days.<sup>1</sup> Reported early neurologic signs (neurotoxic syndrome) include proprioceptive deficits and decreased tongue tone, followed by a wide variety of other signs.<sup>13</sup> Anorexia, hypersensitivity and agitation, sweating, muscle tremor and weakness, hypermetria, staggering, circling, inability to swallow, lower lip paralysis, protrusion of a flaccid tongue, apparent blindness, circling, head pressing, and dementia have all been reported.<sup>1,8,9,13</sup> Most animals die 4 to 24 hours after the onset of signs, although some horses are found dead without signs having been observed.<sup>19</sup> Hepatic signs (hepatotoxic syndrome) are edematous swelling of the lips, nose, supraorbital fossa, and lower limbs. Icterus, mucosal petechiae, and dyspnea are common signs. The time period from the onset of clinical signs to death is 5 to 10 days.<sup>1</sup>

### CLINICAL PATHOLOGY

Sphinganine and sphingosine concentrations and Sa:So ratio may be elevated. Serum chemistry analysis in horses with hepatic signs shows elevations in liver enzyme activities, including gamma-glutamyl transferase (GGT) and aspartate aminotransferase (AST).<sup>14</sup> Total bilirubin and bile acids may also be elevated. The cerebrospinal fluid in horses with ELEM often shows elevations in protein concentration.<sup>13</sup>

## NECROPSY FINDINGS

The classical lesion associated with ELEM is liquefaction necrosis of the white matter. There are macroscopic areas of softening, especially in the cerebrum, accompanied by hemorrhages in the white matter of the cerebral hemisphere and brown to yellow areas of discoloration. Histologically, there are swollen astrocytes or oligodendrites (previously referred to as clasmotodendritic astroglia) containing eosinophilic intracytoplasmic globules and eccentric hyperchromatic nuclei.<sup>8,9</sup> Grossly, the liver is firm and small with an increased lobular pattern. Hepatic periportal fibrosis and hepatocyte vacuolization or necrosis are present on histopathology.<sup>1,9,12</sup>

## SWINE TOXICOSIS

The lungs, liver, and heart are the primary target organs for FB<sub>1</sub> and FB<sub>2</sub> toxicosis in swine.<sup>14,10</sup> A reduction in cardiac and vascular efficiency is seen with chronic fumonisin intoxication. Alterations in immune function and intestinal colonization by pathogens may be present.<sup>2,14</sup> Fusaric acid, a mycotoxin also produced by *E. moniliforme*, is associated with depression and vomiting in pigs.

## PORCINE PULMONARY EDEMA

Ingestion of fumonisin-contaminated corn in levels as low as 16 ppm is associated with the development of fatal pulmonary edema (PPE).<sup>1,4,13</sup> Fumonisin B<sub>1</sub> blocks L-type calcium channels, resulting in left-sided heart failure and pulmonary edema.<sup>14</sup> Heart rate, contractility, and cardiac output are decreased, and pulmonary artery wedge pressure is increased.<sup>1</sup>

### Clinical Signs

Clinical signs occur 2 to 7 days after ingestion of feeds containing large concentrations of FB<sub>1</sub>.<sup>14</sup> There is an acute onset of respiratory distress characterized by a rapid respiratory rate, dyspnea, and open-mouth breathing. Decreased feed consumption, weakness, and cyanosis have been reported.<sup>13</sup> Death from pulmonary edema and hydrothorax occurs in a matter of hours following the onset of clinical signs.<sup>14</sup>

### Necropsy Findings

Grossly, the apical and cardiac lobes are firm and consolidated, with evidence of edema.<sup>15</sup> Alveolar edema, interstitial edema surrounding airways and vessels, and dilated lymphatics are present histologically.<sup>1,13</sup>

### Hepatos/Hepatic Effects

Hepatic toxicity precedes the development of PPE and occurs when ingested amounts are less than those associated with PPE or, less often, in chronic exposures without development of PPE.<sup>1,10</sup> Common clinical signs include anorexia, weight loss, and icterus. More chronic cases of the hepatosis

syndrome are accompanied by hyperkeratosis and parakeratosis of the distal esophageal mucosa.<sup>10</sup>

### Clinical Pathology

Elevations in liver enzyme activities (GGT, alkaline phosphatase [ALP], and AST) and increases in total bilirubin and bile acids occur as early as a day or so after exposure to fumonisins.<sup>12,15</sup> Experimentally, serum total protein and albumin were lower and AST and ALT activity higher in swine chronically fed diets containing more than 10 ppm FB<sub>1</sub>.<sup>2</sup>

### Necropsy Findings

The liver is large, yellow, and friable. Hepatic fibrosis and nodular hyperplasia are present in chronic cases.<sup>1</sup>

## RUMINANT TOXICOSIS

Ruminants are relatively resistant to the fumonisins, likely from minimal rumen absorption.<sup>1</sup> Beef calves fed 148 ppm fumonisins for 31 days developed only anorexia, but serum analysis showed evidence of hepatic damage.<sup>1,16</sup> Dairy cattle seem to be more susceptible compared with beef cattle. Lower milk production and decreased feed intake occurred when fed 100 ppm fumonisins for 7 days before and 70 days after parturition.<sup>10</sup> Lambs receiving high concentrations of fumonisins developed acute hepatic and renal toxicity and died.<sup>1,16</sup>

## DIAGNOSIS

The diagnosis depends on the species, clinical signs, and pathologic findings, but must include detection of the specific toxin (FB<sub>1</sub> or FB<sub>2</sub>) in the feed. The presence of *Fusarium* spp. in the feed does not confirm a diagnosis. High-performance liquid chromatography (HPLC) and enzyme-linked immunosorbent assay (ELISA) are available in many areas to assay corn and feed products for FB<sub>1</sub> and FB<sub>2</sub>.<sup>7</sup> Experimentally, liquid chromatography high-resolution mass spectrometry (LC-HRMS) has been used to identify hydrolyzed fumonisins in corn,<sup>17</sup> and a liquid chromatography-tandem mass spectrometry (LC-MS/MS) method has been developed and validated to identify FB<sub>1</sub> and FB<sub>2</sub> in swine liver.<sup>18</sup>

## TREATMENT

The onset of signs is so rapid that no specific treatment, other than supportive, has been effective. All suspect contaminated feed should be removed as soon as possible.

## CONTROL

Corn and corn-based products, including pellets, should be tested for the presence of FB<sub>1</sub> and FB<sub>2</sub> and compared with published guidelines for maximum tolerable levels for individual species.<sup>1</sup> Contaminated corn should be disposed of or diluted and fed to feeder cows.



## FURTHER READING

- Colvin BM, Cooley AJ, Beaver RW. Fumonisin toxicosis in swine: clinical and pathological findings. *J Vet Diagn Invest.* 1992;5:232-241.
- Edrington TS, Kamps-Holtzapfel CA, Harvey RB, et al. Acute hepatic and renal toxicity in lambs dosed with fumonisin containing culture material. *J Anim Sci.* 1995;73:508-515.
- Foreman JH, Constable PD, Waggoner AL, et al. Neurologic abnormalities and cerebrospinal fluid changes in horses administered fumonisin B<sub>1</sub> intravenously. *J Vet Int Med.* 2004;18:223-230.
- Radostits O, et al. Fumonisin. In: *Veterinary Medicine: A Textbook of the Disease of Cattle, Horses, Sheep, Goats and Pigs.* 10th ed. London: W.B. Saunders; 2007:1905.

## REFERENCES

- Voss KA, et al. *Anim Feed Sci Tech.* 2007;137:299.
- Gbore FA, et al. *J Central Eur Agric.* 2009;10:255.
- Norhasima WM, et al. *Am J Infect Dis.* 2009;5:273.
- Stockmann-Juvala H, et al. *Hum Exp Toxicol.* 2008;27:799.
- Frisvad JC, et al. *J Agric Food Chem.* 2007;55:9727.
- Mansson M, et al. *J Agric Food Chem.* 2010;58:949.
- Keller KM, et al. *Vet Res Commun.* 2007;31:1037.
- Giannitti F, et al. *Pesq Vet Bras.* 2011;31:407.
- Riet-Correa F, et al. *J Vet Diagn Invest.* 2013;25:692.
- Freitas BV, et al. *J Anim Prod Adv.* 2012;2:174.
- Kametler L, et al. *Acta Agraria Kaposvariensis.* 2006;10:285.
- dos Santos CEP, et al. *Acta Scientiae Veterinariae.* 2013;41:1119.
- Morgavy DP, et al. *Anim Feed Sci Tech.* 2007;137:201.
- Burel C, et al. *Toxins (Basel).* 2013;5:841.
- Fodor J, et al. *Food Addit Contam.* 2006;23:492.
- Mostrom MS, et al. *Vet Clin N Am Food A.* 2011;27:315.
- De Girolamo A, et al. *J Mass Spectrom.* 2014;49:297.
- Gazzotti T, et al. *Food Chem.* 2011;125:1379.

## GLUCOSINOLATE TOXICOSIS

### SYNOPSIS

**Etiology** Glucosinolates in *Brassica* spp. and related plants used as feed.

**Epidemiology** Outbreaks in grazing cattle or in cattle fed crop by-products, especially cake or meal made from residues of seed oil extraction.

**Clinical pathology** Assay of blood levels of glucosinolate or metabolic end products.

**Lesions** Nonspecific goiter, enteritis, pulmonary emphysema, and interstitial pneumonia.

**Diagnostic confirmation** Positive blood assay of glucosinolate.

**Treatment** Supportive care only.

**Control** Avoid toxic plants and meals.

## ETIOLOGY

Glucosinolates, sometimes referred to as “mustard oil glycosides” or “thioglucosides” are organic substances containing a sulfonated oxime group, combined with glucose

**Table 21-12** Plants causing glucosinolate poisoning

### Goitrogenic effect

Pasture and forage plants:

Rape (syn. canola)

*Brassica napus*

Kale, kohlrabi, chou moellier

*Brassica oleracea*

Cabbage, cauliflower, broccoli

Brussels sprouts, calabrese

Chinese cabbage

*Brassica chinensis*

Turnip rape, cole

*Brassica campestris*

Swede, rutabaga

*Brassica napobrassica*

Turnip

*Brassica rapa*

Radish

*Raphanus sativus*

Plant by-products:

Rapeseed oil cake

Weeds:

Turnip weed

*Rapistrum rugosum*

### Diarrhea, unpalatability, taint effects (caused by mustard oil glucosinolates)

Culinary plants:

Horse radish

*Armoracia rusticana*

Cress, mustard greens

*Lepidium, Nasturtium, Tropaeolum* spp.

Wild radish

*Raphanus raphanistrum*

White mustard

*Sinapis alba*

Black mustard

*Sinapis nigra*

Oriental mustard

*Brassica juncea*

Weeds:

Fanweed

*Thlaspi arvense*

Charlock

*Sinapis arvensis*

Wormseed or treacle mustard

*Erysimum cheiranthoides*

Note: The taxonomy of the *Brassica* spp. varies between countries.

in the form of glycosides. More than 120 compounds have been identified and characterized.<sup>1,2</sup> The metabolic by-products include isothiocyanates, nitriles, oxazolidinethiones, and carbinols. These plants also contain thioglucosidase (myrosinase), the enzyme needed to hydrolyze the glucosinolate to glucose and the toxic radical.<sup>1,2</sup>

A special group, mustard oil glucosinolates, occurs in the foliage of some plants and is concentrated in their seeds and the seeds of some others. Plant sources of glucosinolates are mostly from the family Brassicaceae (Cruciferae), as listed in Table 21-12.

## EPIDEMIOLOGY

### Occurrence

Outbreaks of glucosinolate poisoning are common wherever intensive animal husbandry is practiced, especially where plant wastes from the food industries are fed to livestock in feedlots.

### Risk Factors

#### Animal Risk Factors

Pigs are the most sensitive to glucosinolate poisoning followed by ruminants.<sup>2</sup> There is

one equine report of toxicity associated with rapeseed oil.

### Human Risk Factors

The toxic substances may be excreted in cows' milk, but the observed goitrogenic effect when the milk is fed may be attributable to the low iodine content of the milk.

Tainting of milk occurs in cows fed plants, more commonly plant seed by-products, containing glucosinolates. The odor and off-flavor are attributable to volatile thiocyanates and not to isothiocyanates. Treatment of the feed with caustic soda prevents the tainting.

### Plant Factors

Plants in several uncommon botanical families contain glucosinolates, but animal poisoning is largely limited to the agriculturally important members of the Brassicaceae (Cruciferae) family, all members of which contain these substances. The common fodder plants and commercial vegetables listed in Table 21-12 have all been associated with poisoning. Seed oil crops, such as seed rape and mustard seed, may be fed as roughage after

the seed has been harvested and represent a possible source of poison. Large quantities of seed also become available for animal feed, and because of the large quantity fed they may be associated with the enteric form of the disease. Glucosinolates are present in the vegetative parts of these plants but are in much higher concentration in the seeds. The glucosinolate concentration varies widely between species of plants (e.g. *Brassica napus* is much more goitrogenic than *B. campestris*), and even between cultivars of the same species at different times of the year and under different conditions of growth. Including the rapeseed in ensilage does not reduce its goitrogenicity. Plant stress, including drought and overcrowding of plants, and the feeding of high-3.sulfate diets are known to increase the concentration of the toxin, and small young leaves may contain as much as 5 times more glucosinolate than large, mature leaves. The high content of sulfate and glucosinolates in cabbage makes it a damaging feed. The most common and serious cases of poisoning occur in animals fed rapeseed or rapeseed meal. Diets containing as low as 3% of rapeseed meal may be associated with goiter and reduced weight gain in pigs. The meal is often fed in amounts up to 20% of the diet. An extensive plant-breeding program has produced varieties of seed rape that have very low concentrations of glucosinolate.

### PATHOGENESIS

Glucosinolate metabolites and the relative proportions of them produced by enzymatic breakdown of the glucosinolates depend largely on the composition of the glucosinolate present, but factors such as pH also have an effect. There are three groups of glucosinolates, each producing a particular metabolite:

- Glucosinolates producing principally isothiocyanates—some of these (e.g., allyl-isothiocyanate, 3-butenyl isothiocyanate) are the irritant components of mustard oils, contained in plant seeds, and are irritant to alimentary tract mucosa causing gastroenteritis, diarrhea, and dysentery. Others, present in the leaves of the plants, are hydrolyzed further to form thiocyanate ion.
- Glucosinolates producing principally thiocyanate ion—which, when taken in small amounts over long periods, is a goitrogen. It is likely to be associated with goiter only when the iodine status of the diet is low. This substance reduces iodine capture by the thyroid gland, and the condition can be alleviated by the administration of iodine.
- Thiones (e.g., 5-vinyloxazolidine-2-thione or goitrin), produced by the hydrolysis of glucosinolates present in the seeds of cruciferous plants, are more potent goitrogens than thiocyanate ion.

They interfere with the synthesis of thyroxin, and iodine is ineffective in the treatment of the poisoning. Clinically, the effects of low-level intakes of isothiocyanate and thiones include goiter and a related reduction of the growth rate in the young, and possibly an indirect, depressing effect on reproduction in adults. The reduction in growth rate may be attributable to the observed hypothyroidism, but there is, in addition, a reduction in palatability with diets containing high levels of glucosinolates. This effect is most noticeable in young pigs but may also be evident in high-producing cows.<sup>2</sup>

There is a positive correlation between cruciferous plants (*Brassica* spp.) and polioencephalomalacia in ruminants (e.g., in rape blindness), but the brain lesion is likely associated with the high sulfur content of the plant.<sup>3</sup> Mustard oil glucosinolates are associated with violent diarrhea, sometimes dysentery, and abdominal pain in animals eating large amounts of seeds.<sup>2</sup> No identifiable pathogenesis is advanced as being associated with acute pulmonary emphysema and interstitial pneumonia, or the ill-defined “digestive disturbance” seen in some outbreaks of poisoning with these plants.

### CLINICAL FINDINGS

#### Goiter

Enlargement of the thyroid may occur at any age, including the newborn of dams fed the plants during pregnancy. Deaths as a result of hypothyroidism, after a period of hypothermia, weakness, recumbency, and coma, are more likely in the latter age group. In older animals the accompanying syndrome will be weight loss or failure to gain weight.<sup>2</sup> In serious outbreaks the thyroid is enlarged by 50% in most lambs, with more than 10% showing gross enlargement. Affected flocks have longer-than-usual gestation periods, and lamb mortality is increased threefold because of the poor vigor of the lambs.

#### Enteritis

Abdominal pain, salivation, vomiting in some cases, diarrhea, dysentery, and a short course with a fatal outcome are common after animals have access to large amounts of reject seeds of these plants.

#### Acute Pulmonary Emphysema and Interstitial Pneumonia

The condition of acute pulmonary emphysema and interstitial pneumonia has been observed only in cattle. Affected animals show severe dyspnea, with stertorous rapid respiration, mouth breathing, and subcutaneous emphysema. The temperature may or may not be elevated. Affected animals may survive but often remain chronically affected and do poorly.

### Polioencephalomalacia (Rape Blindness)

Polioencephalomalacia, characterized by blindness, head pressing, aimless walking, ataxia, and recumbency, occurs in cattle, and rape blindness is manifested by the sudden appearance of blindness in cattle and sheep grazing these crops.<sup>3</sup> The eyes are normal on ophthalmoscopic examination; the pupils show some response to light and may or may not be dilated. Complete recovery usually occurs but may take several weeks.

### Other Unrelated Diseases

- Digestive disturbances in steers on rape are usually accompanied by anorexia, the passage of small amounts of feces, absence of ruminal sounds, and the presence of a solid, doughy mass in the rumen. Only a small quantity of sticky, black material is present on rectal examination.
- Photosensitization and bloat are also encountered in cattle grazing rape.

### CLINICAL PATHOLOGY

Assays of blood levels of glucosinolates and their metabolic products are available. The diet and the pastoral environment should be examined for the presence of the plants and plant by-products known to contain glucosinolates.

### NECROPSY FINDINGS

Goiter, enteritis, pulmonary emphysema, and interstitial pneumonia are nonspecific and dealt with at other points in the text. In *Thlaspi arvense* poisoning there may be massive edema of the forestomach walls.

Diagnostic confirmation is detection of glucosinolates in the blood of animals with access to relevant plants or feedstuffs made from them.

### DIFFERENTIAL DIAGNOSIS

#### Differential diagnosis list:

##### Goiter:

- Inherited goiter
- Low, continuous intake of cyanogenetic glucosides in, for example, pasture plants such as *Cynodon aethiopicus*, *C. nlemfuensis* (couch grasses), and *Trifolium repens* (white clover)
- Nutritional deficiency of iodine

##### Diarrhea with or without dysentery:

- Arsenic poisoning
- Infectious gastroenteritis
- Other poisonous plants in which the toxin has not been identified
- Salmonellosis

### TREATMENT

Treatment is symptomatic and supportive.

### CONTROL

Avoidance of losses can be best achieved by avoiding the use of the poisonous substance

or the grazing of the affected area. Some of the goiters can be relieved by the administration of iodine, and avoidance of high-sulfate diets reduces the level of glucosinolate production. Plant by-products containing glucosinolate derivatives can be treated with alkali solutions to destroy their toxicity.

### FURTHER READING

- Dixon PM, McGorum B. Oilseed rape and equine respiratory disease. *Vet Rec.* 1990;126:585.
- Mason RW, Lucas P. Acute poisoning in cattle after eating old non-viable seed of chou moellier (*Brassica oleracea* convar. *acephala*). *Aust Vet J.* 1983;60:272-273.
- Morton JM, Campbell PH. Disease signs reported in south-eastern Australian dairy cattle while grazing *Brassica* species. *Aust Vet J.* 1997;75:109-113.
- Radostits O, et al. Glucosinolate poisoning. In: *Veterinary Medicine: A Textbook of the Disease of Cattle, Horses, Sheep, Goats and Pigs*. 10th ed. London: W.B. Saunders; 2007:1866.
- Taljaard T. Cabbage poisoning in ruminants. *J South Afr Vet Med.* 1993;64:96-100.

### REFERENCES

- Halkier BA. *Ann Rev Plant Biol.* 2006;57:303.
- European Food Safety Authority. *EFSA J.* 2008;590:1.
- McKenzie RA, et al. *Aust Vet J.* 2009;87:27.

## MISCELLANEOUS MYCOTOXINS

### CYCLOPIAZONIC ACID

Cyclopiazonic acid (CPA), an indole-tetramic acid, is a secondary metabolite produced by several genera of *Aspergillus* and *Penicillium* growing on stored grain, including sunflower seeds.<sup>1</sup> It has been found in human and animal foods and food sources, including milk, eggs, and poultry.<sup>1,2</sup>

Toxicity associated with CPA is considered low, based on an LD<sub>50</sub> in rats of 30 to 70 mg/kg BW, and reports of animal poisonings are rare.<sup>1</sup> Ingestion of CPA-contaminated feed in sows is associated with feed refusal and conception problems in sows. Isolated from *A. flavus*, cyclopiazonic acid is associated with weakness, anorexia, loss of body weight, and diarrhea in pigs. Necropsy lesions include gastric ulceration and hemorrhages throughout the alimentary tract.

### PATULIN

Patulin, an important toxin in human medicine, is produced by *Aspergillus clavatus* and other fungi, including *Byssoschlamys nivea*, *Penicillium urticae*, *P. claviforme*, and *P. patulum*.<sup>3,4</sup> Toxicity is most commonly associated with rotting apples or apple juice, and poisoning may occur in pigs fed food waste containing rotten fruit.<sup>3</sup>

Cattle and sheep poisoned by patulin producing fungi develop brain hemorrhage, pulmonary edema, or liver and kidney damage with abomasal hemorrhage. When fed to piglets, it is associated with vomiting, salivation, anorexia, polypnea, weight loss, leukocytosis, and anemia. Patulin may be the toxin associated with neurologic problems in cattle ingesting malting by-products and

sprouted grains.<sup>4,6</sup> Affected cattle develop neuromuscular signs, including salivation, ataxia, hind limb weakness, muscle tremors, recumbency, and death.<sup>4-6</sup>

### STERIGMATOCYSTIN

Sterigmatocystin (STC) is a hepatotoxin and potential carcinogen in humans.<sup>7</sup> Carcinogenesis in farm animals is not reported. It has been isolated from *Aspergillus* spp., *Bipolaris* spp., *Penicillium luteum*, and other species of fungi.<sup>7,8</sup> It is a precursor of aflatoxin synthesis.<sup>7</sup> Contaminated foods include grains, soybeans, nuts, animal feeds, and silage.<sup>8</sup>

### FURTHER READING

- Lomax LG, Cole RJ, Dorner JW. The toxicity of cyclopiazonic acid in weaned pigs. *Vet Path.* 1984;21:418-424.
- Sabater-Vilar M, Maas RF, De Bosschere H, et al. Patulin produced by an *Aspergillus clavatus* isolated from feed containing malting residues associated with a lethal neurotoxicosis in cattle. *Mycopathologia.* 2004;158:419-426.

### REFERENCES

- Chang PK, et al. *Toxins (Basel).* 2009;1:74.
- Oliveira CA, et al. *Food Addit Contam.* 2006;23:196.
- Rosinska DM, et al. *J Liq Chromatogr R T.* 2009;32:500.
- Riet-Correa F, et al. *J Vet Diagn Invest.* 2013;25:692.
- Stec J, et al. *Bull Vet Inst Pulawy.* 2009;53:129.
- Mostrom M, et al. *Vet Clin N Am Food A.* 2011;27:315.
- Anninou N, et al. *Int J Environ Res Public Health.* 2014;11:1855.
- Versilovskis A, et al. *Mol Nutr Food Res.* 2010;54:136.

## MUSHROOM TOXICOSIS

Reports of poisoning associated with mushrooms in large animals are rare. Grazing animals may have access to poisonous mushrooms and develop clinical signs, but a specific mushroom is rarely identified, and diagnostic tests are often limited.

### AMATOXINS

Mushrooms in the genera *Amanita*, *Galerina*, and *Lepiota* contain amanitins (cyclopeptides) that are toxic to the gastrointestinal tract, kidney, and liver.<sup>1</sup> *Amanita phalloides* (dead cap) and *Amanita ocreata* (Western North American destroying angel), both found in the coastal western and southwestern United States and parts of Mexico, have been associated with poisonings in calves,<sup>1</sup> cattle,<sup>2</sup> dogs,<sup>3</sup> and human beings<sup>4-5</sup> and perhaps horses.<sup>1,4</sup> As a group, amatoxins include several amantins, amanin, amanullin, and proamanullin, but amanitins are the most commonly reported toxins. *A. phalloides* and *A. ocreata* contain high concentrations of  $\alpha$ -amanitin and  $\beta$ -amanitin.<sup>1</sup> Ingestions of small amounts have resulted in poisoning in humans and dogs; the toxic amount in large animals is unknown.

In monogastric animals, amanitins are absorbed in the gastrointestinal tract and transported to the liver, where they are taken

up by OATP1B3, an organic acid hepatic transporter.<sup>5</sup> Protein binding does not occur. Metabolism has not been recorded, and 80% to 90% of an ingested dose is eliminated in the urine and 7% in the bile.<sup>1</sup> Bioavailability, serum half-life, and plasma detection time vary with the species.<sup>1,2</sup> Similar information is not available for ruminants.

Clinical signs occur from inhibition of nuclear RNA polymerase II, which causes a decrease in messenger RNA and ultimately protein synthesis.<sup>1,2</sup> Hepatocytes, crypts cells, and those in the proximal convoluted tubules of the kidney are most commonly affected. Other cellular effects are at work as well.<sup>1,2</sup> The earliest signs identified in animals are gastrointestinal and include severe pain, vomiting, and bloody diarrhea.<sup>2</sup> These are followed by a latent period of hours to a few days and a final stage with acute necrotizing hepatic failure and renal failure.<sup>1,2</sup> Coagulation defects, hypoglycemia, elevations in liver enzymes, and encephalopathy may occur.

Several different modalities, including a liver transplant in humans, are used to treat toxicosis in humans and dogs, but large animals are generally found dead or die before treatment can be provided.

Postmortem examination shows a friable liver with diffuse centrilobular to panlobular necrosis.<sup>1</sup> Other organs, such as the kidney, and the gastrointestinal tract are also affected. Liquid chromatography/mass spectrometry is available in some laboratories to analyze serum, urine, liver, kidney, and gastric contents, including rumen, for amanitins.<sup>6</sup>

### RAMARIA FLAVO-BRUNNESCENS

The *Ramaria flavo-brunnescens* mushroom is found only in the eucalyptus woods of North America, Australia, China, Brazil, and Uruguay.<sup>7-9</sup> The toxin is unknown, but toxicity may be related to interference with sulfur-containing amino acids (cysteine) in keratinized structures.<sup>9</sup>

Clinical signs of "eucalyptus poisoning" have been recorded in sheep and cattle. Jersey calves experimentally poisoned with 20 mg/kg BW *R. flavo-brunnescens* mushrooms developed anorexia, hyperemia of the oral mucosa, and loosening of hair shafts at the tip of the tail.<sup>8</sup> Other recorded signs include salivation; lingual and esophageal ulcers; loss of hair, especially of the tail brush; recumbency; and pain in, and loss of, hooves.

### SCLERODERMA CITRINUM

*Scleroderma citrinum* (common earth ball) fed to a miniature Chinese pot-bellied pig has been associated with vomiting, depression, recumbency, and death.<sup>4</sup> The pupillary light reflex was lost, but the eye preservation reflex remained. Pain on abdominal palpation, hyperthermia, tachycardia, and mucoid feces passed with some straining were present; death occurred in about 5 hours. The toxin has not yet been identified.



## CORTINARIUS SPECIOCISSIMUS

*Cortinarius speciocissimus* has been associated with deaths in sheep in Norway with renal tubular necrosis and terminal uremia.

## INOCYBE AND CLITOCYBE SPP.

Muscarine, a mycotoxic alkaloid found in the macrofungi, is associated with excessive salivation, bradycardia, diarrhea, and vomiting. Atropine is an effective antidote.

## FURTHER READING

- Galey FD, et al. A case of *Scleroderma citrinum* poisoning in a miniature Chinese pot-bellied pig. *Vet Hum Toxicol*. 1990;32:329-330.
- Kommers GD, Santos MN. Experimental poisoning of cattle by the mushroom *Ramaria flavo-brunnescens* (Clavariaceae): a study of the morphology and pathogenesis of lesions in hooves, tail, horns and tongue. *Vet Hum Toxicol*. 1995;37:297-302.
- Radostits O, et al. Miscellaneous fungi. In: *Veterinary Medicine: A Textbook of the Disease of Cattle, Horses, Sheep, Goats and Pigs*. 10th ed. London: W.B. Saunders; 2007:1912.

## REFERENCES

1. Yee MM, et al. *J Vet Diagn Invest*. 2012;24:241.
2. Varga A, et al. *Vet Med Res Rep*. 2012;3:111.
3. Puschner B, et al. *J Vet Diagn Invest*. 2007;19:312.
4. Beug MW, et al. *McIlvainea*. 2006;16:47.
5. Letschert K, et al. *Toxicol Sci*. 2006;91:140.
6. Filigenzi MS, et al. *J Agric Food Chem*. 2007;55:2784.
7. Riss DR, et al. *Pesqui Vet Bras*. 2007;27:261.
8. Schons SV, et al. *Pesqui Vet Bras*. 2007;27:269.
9. Trost ME, et al. *Pesqui Vet Bras*. 2009;29:533.

## PHALARIS SPP. (CANARY GRASS) TOXICOSIS

### SYNOPSIS

**Etiology** Associated with the ingestion of the *Phalaris* spp. grasses containing dimethyltryptamine (causing an incoordination syndrome) or unknown substances (causing a sudden death/cardiac syndrome and a sudden death/polioencephalomalacia-like syndrome).

**Epidemiology** Outbreaks on lush, rapidly growing pasture; sheep most commonly affected.

**Clinical pathology** Isolation of tryptamines in plants and affected animals.

**Lesions** Green-gray discoloration of renal medulla, medulla oblongata, brainstem.

**Diagnostic confirmation** By detection of tryptamines in body fluids or cadaver.

**Treatment** None.

**Control** Limitation of access to causative plants.

## ETIOLOGY

Dimethyltryptamines associated with incoordination syndrome include the following:

- *Phalaris aquatica* (synonym *P. tuberosa*)
- *P. angusta*, timothy canary grass
- *P. arundinacea*, reed canary grass
- *P. caroliniana*, Maygrass, Southern canary grass
- *P. brachystachys*

- *P. canariensis*, annual canary grass, commercial canary grass
- *P. minor*, littleseed canary grass, wild canary grass
- *P. paradoxa*, hooded canary grass

The cause of acute death from cardiac arrest, originally ascribed to the methylated tryptamines, is unknown, but may be related phenylethylamines, other alkaloids (indoles/oxindoles), or other factors.<sup>1</sup> The cause of death associated with polioencephalomalacia, once thought to be related to thiamine analogs produced by the ruminal flora, is also unknown.<sup>1</sup>

## EPIDEMIOLOGY

### Occurrence

The disease has been recorded in many parts of Australia, New Zealand, South Africa, Spain, California, and South America where the phalaris grasses are in common use as pasture plants.<sup>1-3</sup> Heavy losses occur on individual farms as a result of sudden deaths, but careful management relieves the burden of the incoordination syndrome.

The individual tryptamine alkaloids associated with the disease vary significantly in their toxicity, and thus plants in a pasture can vary greatly in the danger they present. The concentration of tryptamines in the grass is increased by high environmental temperature and their growing in the shade, and toxicity is greatest when the plants are young and growing rapidly, especially after a break in a dry season. Provision of cobalt appears to stimulate the proliferation of microorganisms in the rumen that are capable of destroying the causative agent, but sheep affected with phalaris staggers do not usually show any signs of cobalt deficiency. Under some circumstances, plants with low tryptamine content will be associated with the syndrome.

### Risk Factors

#### Animal Factors

Sheep, followed by cattle, are most commonly affected, although alpacas have developed the incoordination syndrome and horses the sudden death/cardiac syndrome.<sup>1,4,5</sup>

Up to 30% of a flock may be affected when *P. aquatica* dominates the pasture or is preferentially grazed. On lightly stocked pastures the sudden death syndrome, with signs appearing within 4 hours but usually between 12 and 72 hours after going onto the pasture, is most likely to occur. Deaths are most common in hungry sheep in the early morning or in foggy or cloudy weather. This syndrome is also recorded in cattle on irrigated *Phalaris* spp. pasture in hot, humid weather.

The incoordination syndrome occurs in similar circumstances but in sheep that have protracted or repeated exposure. In this case clinical signs appear 2 to 3 weeks after sheep are put onto pasture showing new growth, usually in the autumn or early winter. Both

forms may occur in a single flock of sheep and also in feedlots. Sheep of all ages are affected, and mild cases may occur among cattle.

The variability in the numbers affected and the severity of the disability in sheep flocks from day to day appear to be attributable to the variation in the amount of toxin absorbed, possibly affected by the degree of detoxification of the tryptamines in the rumen. The reduction in severity of an outbreak associated with dietary supplementation with cobalt is thought to be effected in this way.

## PATHOGENESIS

Tryptamine alkaloids, structurally similar to serotonin, are present in the grass under certain conditions and are associated with the incoordination syndrome by a direct agonist action on serotonergic receptors in specific brain and spinal cord nuclei.<sup>1,4</sup> Clinical signs mimic those of the serotonin syndrome and include repetitive head movements tremors, rigidity, and hyperreactivity. The nervous disturbance appears to be functional in contrast to that associated with  $\beta$ -carbolines, which is accompanied by axonal degeneration and is an irreversible syndrome.

A characteristic of the disease is a greenish-gray discoloration of the brainstem, diencephalon, dorsal root ganglia, and kidneys.<sup>4</sup> The pigmentation is a result of the accumulation of indole-like pigments at the locations where the causative alkaloids act, but the pigments themselves do not have any effect on the signs.

## CLINICAL FINDINGS

The sudden cardiac death syndrome, the most rare of the three syndromes, is manifested by sudden collapse, especially when excited, a short period of respiratory distress with cyanosis, and then death or rapid recovery.<sup>1</sup> During the stage of collapse there is arrhythmic tachycardia followed by ventricular fibrillation and cardiac arrest. Consciousness is retained.

The sudden death polioencephalomalacia syndrome cases are rarely observed alive, but occur commonly after short periods of feed deprivation. This occurs most often in sheep, although cattle have been affected as well.

In the initial stages of the incoordination syndrome in sheep, signs appear only when the animals are disturbed. Hyperexcitability and generalized muscle tremor, including nodding and bobbing of the head, occur first. On moving, the limb movements are stiff, and the hocks are not bent, causing dragging of the hindfeet. Incoordination and swaying of the hindquarters follow. Some animals walk on their knees, others bound or hop, and others knuckle at the fetlocks; some show splaying of the digits. In the most severe cases collapse into lateral recumbency is accompanied by paddling movements of the legs and irregular involuntary

movements of the eyeballs. There is rapid respiration and irregular tachycardia. The sheep may die at this stage, but if left undisturbed they may recover and walk away apparently unaffected. If the sheep are left on the pasture, the condition worsens in individual cases, with the animal becoming recumbent and manifesting repeated convulsive episodes until death supervenes.

There is a great deal of variation from day to day in the number of sheep showing signs and in the severity of the signs observed. Even after sheep are removed from the pasture the clinical state may deteriorate, and although some appear to recover, clinical signs can usually be elicited by forcing them to exercise. Deaths are reported to continue for 1 week after removal of sheep from toxic pasture, and clinical signs of the nervous form of the disease may persist for as long as 2 months. The extraordinary situation is recorded where new cases continue to occur for as long as 12 weeks after sheep are moved onto pasture that contains no *Phalaris* spp.

In cattle, the signs may be restricted to stiffness of the hocks and dragging of the hind toes, but severe cases similar to the common syndrome in sheep also occur.<sup>3,4</sup> Additional, and more common, signs observed in some, but not all, cattle include an extraordinary incoordination of the tongue and lips in prehension; thus, the hungry animal, trying desperately to eat, can only prehend a few stalks of grass at a time.<sup>4</sup> The jaw movements are quite strong, but the tongue stabs and darts, and it lacks the sinuous curling movements normally present. There may also be an inability to put the muzzle to the ground, and thus prehension can only occur from a raised manger or hayrack. Affected cattle are often hyperexcitable and difficult to handle.

### CLINICAL PATHOLOGY

Laboratory tests on antemortem material can detect the presence of the causative tryptamines in plant material but are unlikely to be generally available.

### NECROPSY FINDINGS

Other than the characteristic green–gray pigmentation of tissues in the renal medulla, brainstem, midbrain, and dorsal root ganglia, gross lesions are absent. Degeneration of spinal cord tracts and of the ventral portion of the cerebellum has been observed in terminal cases of the incoordination syndrome, but is not a consistent finding. In the sudden death or cardiac syndrome sheep are usually found dead on their sides with their heads strongly dorsiflexed and legs rigidly extended. Some sheep have blood-stained nasal discharge, and many froth at the mouth. Abdominal visceral congestion and epicardial and duodenal hemorrhages are present and indicate acute heart failure. Polioencephalomalacia is characteristic of the sudden death–polioencephalomalacia syndrome.

The association between the nervous disease and the plants should suggest the diagnosis. The appearance of these signs only on exercise is significant, suggesting a functional rather than a physical lesion. Diagnostic confirmation rests on the identification of the causative tryptamines in the feed materials and the tissues and fluids on antemortem or postmortem examination.

### TREATMENT

Flocks of affected sheep should be removed immediately from the pasture. There is no specific antidotal treatment.

### CONTROL

No preventive measures are available against the sudden death syndrome, but the nervous form may be prevented by the oral administration of cobalt.<sup>1,4</sup> Affected pastures may be grazed if sheep are dosed with cobalt (at least 28 mg per week) at intervals of not more than 1 week, or if alternative grazing is provided in rotation. Dosing at too long intervals or with inadequate amounts may account for some failures in prevention. The parenteral administration of cobalt or vitamin B<sub>12</sub> is not effective. The additional cobalt can be provided by drenching the sheep individually or spreading it on the pasture mixed with fertilizer as described under cobalt deficiency. Unfortunately, the genetic selection of *P. aquatica* cultivars with low contents of methylated tryptamines favors a significant increase in toxic  $\beta$ -carbolines.

### FURTHER READING

- Bourke CA, Carrigan MJ, Dixon RJ. The pathogenesis of the nervous syndrome of *Phalaris aquatica* toxicity in sheep. *Aust Vet J*. 1990;67:356-358.
- Colegate SM, Anderton N, Edgar J, et al. Suspected blue canary grass (*Phalaris coerulescens*) poisoning of horses. *Aust Vet J*. 1999;77:538-547.
- Nicholson SS, Olcott BM, Usenik EA, et al. Delayed *phalaris* grass toxicosis in sheep and cattle. *J Am Vet Med Assoc*. 1989;195:345-346.

### REFERENCES

- Burrows GE, Tyril RJ. *Phalaris L. Toxic Plants of North America*. 2nd ed. Wiley-Blackwell; 2013:935.
- Finnie JW. *Aust Vet J*. 2011;89:247.
- Cantón G, et al. *Pesq Vet Bras*. 2010;30:63.
- Binder EM, et al. *J Vet Diagn Invest*. 2010;22:802.
- Sampaio N, et al. *Anim Prod Sci*. 2008;48:1099.

## TOXICOSIS FROM PLANT PHENOLS (GOSSYPOL AND TANNINS)

Two important groups of plant polyphenols (hydroxyl derivatives of benzene) are **gossypol** and the **tannins**.

### GOSSYPOL

#### ETIOLOGY

Gossypol is found primarily in oil glands (gossypol glands) of the seed but also in some other portions of the plant. It is present in variable amounts in cottonseed cake made

from the seeds of *Gossypium* spp. and hybrids (commercial cotton) and in the seeds and their hulls, and poisoning occurs primarily from ingestion of seed meal or other seed products. Seed meal usually contains 300 to 400 ppm but may contain as much as 18,000 ppm of free gossypol in a 17% protein ration.

### EPIDEMIOLOGY

Swine and preruminant animals are more susceptible to poisoning than mature ruminants. Levels of 200 to 300 ppm are toxic to swine, and preruminant calves' diets containing 100 to 200 mg/kg BW resulted in gossypol mortality. Horses appear to be resistant to gossypol toxicity, with no natural cases being on record.<sup>1</sup>

Most recorded outbreaks of gossypol poisoning refer to pigs. Cottonseed cake should not be fed to pigs at all, especially young pigs. Adults may tolerate up to 60 ppm gossypol in the feed, although other sources suggest 100 ppm may be safe.<sup>1</sup>

Animals with a functioning rumen are able to tolerate higher levels of free gossypol than preruminant animals. Goats are more susceptible than others, with daily intakes of 350 to 400 mg gossypol being fatal after 3 months. Calves die of heart failure if fed 800 to 1000 g cottonseed meal/day. Illness and mortality have also been produced by feeding gossypol to adult dairy cows. Adverse effects on spermatogenesis with an increase in sperm morphologic abnormalities occurs in bulls on low intakes and without clinical signs. Sheep are susceptible if the toxin is injected but appear to be unaffected when it is fed. In rams, feeding free gossypol in concentrations greater than 9 mg/kg BW resulted in reproductive toxicity.<sup>2</sup>

### PATHOGENESIS

Cottonseed oil is extracted at high temperatures, and during this process gossypol is released from the oil glands. Some binds to proteins and is considered nontoxic; the remainder is referred to as "free gossypol" and is the toxic form. In swine, free gossypol is absorbed from the gastrointestinal tract, conjugated in the liver, and excreted in the feces.<sup>1</sup> Little is excreted in the urine or milk. The mechanism of action is that of a reactive species, forming free radicals and damaging various tissues, especially the heart.<sup>1,2</sup> Other mechanisms are likely to work as well. Myocardial necrosis with congestive heart failure and hepatic changes are commonly associated with ingestion of toxic amounts of gossypol.<sup>1</sup>

### CLINICAL FINDINGS

Clinical signs are abrupt but don't usually appear until animals have been fed on rations containing cottonseed meal for 1 to 2 months. Pigs poisoned by gossypol are thin, are exercise intolerant, cough, and are severely dyspneic, with a "thumping" type of respiration.

Death from cardiac insufficiency occurs in a few days, often preceded by cyanosis and seizures. Feeding cottonseed meal to pregnant sows at the rate of 20% to 40% of the ration is associated with shortening of the gestation length, and in some cases 40% of piglets are born prematurely and die. Poisoned calves show anorexia, dyspnea, cough, brisket edema, ascites, distension of the jugular vein, and weakness; hematuria occurs occasionally, and death follows an illness of several days. Sublethal rates of ingestion are associated with stunting of growth and reduction of fertility in bulls. Feeding cottonseed meal to young bulls and rams is not recommended because of the risk of permanent damage to spermatogenic tissues, but the risk is considered to be negligible.

### CLINICAL PATHOLOGY

There are no specific clinical pathology tests that are specific for gossypol. In later stages, hepatic enzyme activities may be elevated; Thoracic radiographs may demonstrate the presence of fluid, which can be examined for protein content after collection via thoracocentesis.

### NECROPSY FINDINGS

There is generalized edema, including high-protein fluid in all the serous cavities, and hepatomegaly as a result of congestive heart failure, and histologically there is degeneration of the myocardium and skeletal musculature. Centrilobular necrosis in the liver is also a characteristic lesion, and the liver will contain as much as 42  $\mu\text{g/g}$  gossypol.

### CONTROL

Cottonseed cake may be fed with safety to adult cattle if the daily intake of meal is less than 2.5 to 3 kg/head per day, and it may be fed to pigs if it constitutes less than 9% of the ration.<sup>1</sup> Cooking of the cake or the addition of 1% calcium hydroxide or 0.1% ferrous sulfate to it are efficient methods of detoxification. In experimental trials the addition of iron in equal proportions to gossypol up to 600 mg/kg of the ration will protect pigs. Significant quantities of cations (particularly calcium and iron) in water supplies or rations appear to be protective. Providing calcium carbonate at a rate of 12 g/kg of whole cotton seed (WCS) for every 0.5% of free gossypol in the WCS prevents reproductive effects in cattle. Selenium (sodium selenite) supplementation in rams at 1 mg/ram per day has been used experimentally to counteract the adverse effects on semen characteristics.<sup>2</sup>

### TANNINS

Tannins include the condensed tannins (proanthocyanidins), which are insoluble and nontoxic, except that they may be associated with oral mucosal lesions, and the hydrolyzable tannins, which are soluble and

potentially toxic.<sup>3</sup> Pyrogallol, a degradation product of hydrolyzable tannins, is a gastrointestinal (GI) and renal toxin. Oaks (*Quercus* spp.) and yellow-wood tree (*Terminalia oblongata* ssp. *oblongata*) are important in this group. Miscellaneous other toxic plants in this group include the following:

- *Acacia melanoxylon*—black wattle
- *Acacia salicina*—black sally wattle
- *Clidemia hirtia*—harendong
- *Elephantorrhiza elephantina*—elephant's root; elan's bean
- *Stryphnodendron* spp.
- *Thilao glaucocarpa*—sipaubá, vaqueta
- *Ventilago viminalis*—supple jack

### OAK (QUERCUS SPP.)

The leaves and acorns of many varieties of oak trees can be browsed by animals and are associated with no illness when they form only a small part of the diet.<sup>3</sup> When ingested in large quantities, all *Quercus* spp. are associated with toxicity, including the following:

- *Q. agrifolia*—coast live oak
- *Q. garryana*—Oregon white oak
- *Q. havardii*—sand shin oak
- *Q. marilandica*—blackjack oak
- *Q. robur* (synonym *Q. pedunculata*)—European oak
- *Q. rubra*—Northern red oak
- *Q. velutina*—black oak

The toxic principles are hydrolyzable tannins and simple phenols in the leaves, especially the **young buds**, and **green acorns**. All species of animals are affected, with losses in sheep and cattle being reported most commonly and occasional cases occurring in horses.<sup>4-8</sup> Goats are thought to be capable of surviving much greater intakes of tannin than cattle because of greater concentrations of tannase enzymes in their ruminal mucosa.<sup>4</sup> Experimental administration of tannic acids to goats has produced anemia, but there is no record of the natural occurrence of the disease.

Oak toxicosis involves the gastrointestinal tract and kidneys.<sup>4-7</sup> Cattle and sheep tend to show both GI and renal disease, whereas horses are more likely to develop gastroenteritis and fewer renal issues. If little else is eaten, oak foliage and acorns ingested for 3 to 4 days may be associated with nephrosis, which is manifested by polyuria, ventral edema, abdominal pain, and constipation followed by the passage of feces containing mucus and blood. Blood urea nitrogen (BUN) and creatinine levels are elevated; serum electrolytes are altered (increased potassium, decreased sodium); urine specific gravity is low, and proteinuria, glucosuria, and hematuria may occur.<sup>4,6</sup> Hepatic enzymes, indicative of liver damage, may be elevated, depending on the animal and/or oak species. At necropsy in ruminants there is edema of the gastrointestinal wall and mesentery, a characteristic nephrosis, and hepatic damage. Ulcerations of the mucosa consistent with uremia may be present.

Survivors of an initial attack of nephrosis make compensatory weight gains and perform well in feedlot situations.

Extensive areas of oak-brush range in the United States can be utilized for cattle grazing, but this requires careful management if losses are to be avoided. The phenol content varies between species, and thus stands of *Q. alba* can be much less toxic than those of *Q. rubra* or *Q. velutina*. Calcium hydroxide (15% of the ration) is an effective preventive under experimental conditions.

### YELLOW-WOOD TREE (TERMINALIA OBLONGATA SPP.)

The foliage of the Yellow-Wood Tree contains a hepatotoxic tannin punicalagin and an unidentified nephrotoxin, and it is associated with losses in cattle. Acute poisoning of cattle is manifested by a sudden onset of hepatopathy, jaundice, and photosensitization, with some nephrosis and signs of abdominal pain and dehydration. Necropsy reveals a swollen congested liver, swollen gray-green kidneys, and gray-green pigmentation of the gastrointestinal mucosa, with multiple small hemorrhagic erosions of the abomasal mucosa. Chronic poisoning of cattle is dominated by severe nephrosis with pigment accumulation and fibrosis in the kidney cortex, polyuria, and wasting of the body. Yellow-wood poisoning of sheep is a nervous derangement, manifested by seizures if sheep are excited by handling, from which they recover spontaneously.

### FURTHER READING

- Danke RJ, Panciera RJ, Tillman AD. Gossypol toxicity studies with sheep. *J Anim Sci.* 1965;24:1199-1201.
- Duncan CS. Oak leaf poisoning in two horses. *Cornell Vet.* 1961;51:159-162.
- Garg SK, Makkar HP, Nagal KB, et al. Oak (*Quercus incana*) leaf poisoning in cattle. *Vet Hum Toxicol.* 1992;34:161-164.
- Kornegay ET, Clawson AJ, Smith FH, et al. Influence of protein source on toxicity of gossypol in swine rations. *J Anim Sci.* 1961;20:597-602.
- Legg J, Moule GR, Chester RD. The toxicity of yellow-wood (*Terminalia oblongata*) to cattle. *Queensland J Ag Sci.* 1945;2:199-208.
- Zelski RZ, Rothwell TJ, Moore RE, et al. Gossypol toxicity in preruminant calves. *Aust Vet J.* 1995;72:394-398.

### REFERENCES

1. Nicholson SS. Cottonseed toxicity. In: Gupta RC, ed. *Veterinary Toxicology*. Elsevier; 2012:1161.
2. El-Mokadem MY, et al. *J Anim Sci.* 2012;90:3274.
3. Mueller-Harvey I. *J Sci Food Agric.* 2006;86:2010.
4. Eroksuz Y, et al. *Revue Méd. Vét.* 2013;164:302.
5. Sadeghi-Nasab A, et al. *J Vet Res.* 2013;68:305.
6. Lorin B, et al. *Revue Méd Vét.* 2009;160:507.
7. Pérez V, et al. *Res Vet Sci.* 2011;91:269.
8. Hume T. *Vet Rec.* 2006;159:860.

### MISCELLANEOUS PLANT TOXICOSIS

#### AESCULIN

The glycoside aesculin (7-hydroxycoumarin-6-glucoside) occurs in *Aesculus* spp. plants,



including *A. californica*, *A. glabra*, *A. hippocastanum*, *A. octandra*, and *A. pavia* (buckeyes or horse chestnuts), with *A. pavia* being the most toxic.<sup>1</sup> Ingestion of the seeds and nuts is usually reported, but toxicity also occurs after eating bark and foliage.<sup>1</sup> In monogastric animals the glycoside is associated with gastroenteritis with vomiting, but its digestion in ruminants to a soluble aglycone results in the more common syndrome of depression, straddled posture, stiff and uncoordinated gait, tremor, easy falling, recumbency, and convulsions with opisthotonos. Signs are exacerbated by handling or harassment. No necropsy lesions are reported.

### ALCOHOL (COMPLEX PLANT)

Included in alcohol toxins are cicutoxin, occurring in *Cicuta* spp. (water hemlock); oenanthotoxin, isomeric with cicutoxin, in *Oenanthe* spp. (water hemlock dropwort); and tremetol in *Ageratina altissima* (formerly *Eupatorium rugosum* [white snakeroot]) and *Isocoma pluriflora* (rayless goldenrod).

Cicutoxin and oenanthotoxin are C17 conjugated polyacetylenes and act as  $\delta$ -aminobutyric acid antagonists in the CNS;<sup>2</sup> tremetol is composed of complex mixtures of alcohols and ketones that may act to impair the tricarboxylic acid cycle.<sup>3,4</sup>

- **Cicutoxin** poisoning in all species is characterized by early tremor, restlessness, and stumbling gait, followed by violent clonic convulsions with bellowing, opisthotonos, and frothing at the mouth.<sup>5</sup> Between convulsions there is ruminal tympany, dyspnea, profuse salivation, teeth grinding and chewing movements, frequent urination and defecation, tachycardia, hyperthermia, and pupillary dilation. Most affected animals die of respiratory failure after a course of a few minutes, but more usually several hours. Serum levels of muscle enzymes are elevated as a result of the muscle activity. Necropsy lesions are comprised of skeletal and cardiac myodegeneration. The characteristic roots may be found in the forestomachs, more commonly lodged in the esophageal groove than in the rumen proper. In experimentally produced cases, IV sodium pentobarbital administered at the onset of the first convulsion prevents further convulsions and the myodegeneration, but no practicable remedy is available for natural cases. Green seed heads and tubers are toxic.<sup>6</sup> Prevention depends on keeping animals away from the plant, including the roots, which may be exposed during excavation or after flooding
- **Oenanthotoxin** poisoning is associated with an identical syndrome, most commonly in cattle. The roots of the plant are the common source of the poison.

- **Tremetol** is associated with stiffness and incoordination of gait, severe tremor, salivation, depression, recumbency, and coma preceding death in ruminants. In goats, skeletal muscle degeneration and necrosis is extensive.<sup>3,7</sup> In horses, there is heavy sweating, regurgitation of food through the nostrils, and the passage of dark, hard feces; there may be congestive right-heart failure with electrocardiographic abnormalities and extensive myocardial damage.<sup>4</sup> Cardiac troponin I may be a useful diagnostic tool for horses suspected of tremetol toxicosis.<sup>4</sup> The alcohol is excreted in the milk of animals that ingest the plant and may be associated with clinical illness and even death in humans drinking the milk.<sup>7</sup> Liver damage and skeletal muscle and myocardial swelling and pallor are gross lesions at necropsy.

### ALIPHATIC ACETOGENIN (MONOGLYCERIDE)

The toxin responsible for poisoning by *Persea americana* (avocado, alligator pear) is a biologically active aliphatic acetogenin, persin, with the form of a monoglyceride. Only varieties of Guatemalan origin are toxic; Mexican varieties are not. All parts of the plants can be toxic. Horses, ruminants, and ostriches have been affected. In lactating females, poisoning produces sterile mastitis and agalactia, with necrosis of secretory epithelium of mammary glands. Horses are affected by a heart failure syndrome, usually nonfatal, with severe subcutaneous edematous swelling of the head and dyspnea. In some cases, there is ischemic necrosis of masseter and tongue muscles. Fatal cases have myocardial necrosis. Colic and diarrhea have been reported in foals. Poisoned ostriches have paresis of neck muscles, edema of the neck, pulmonary edema, and necrosis of cardiac muscle.

### AMINE TOXICITY

Tyramine (*N*-methyl-phenylethyl-amine) is found in *Acacia berlandieri* (guajillo) and two mistletoes, *Phoradendron villosum* and *Viscosum album*. Clinical signs in poisoning by the acacia include gait incoordination, limb weakness, and recumbency, all exacerbated by exercise or harassment, and all of which disappear if the patient is removed from contact with the plant. No signs are attributed to poisoning by mistletoe; in the only event recorded, the patient was found dead.

### AMINO ACID TOXICITY

The best-known toxic amino acids are as follows:

- Indospicine in *Indigofera hendecaphylla* (formerly *I. spicata*, creeping or trailing indigo)
- Indospicine in *Indigofera linnaei* (*I. dominii*, *I. enneaphylla*, Birdsville indigo)

- Canavanine in *Canavalia* spp., *Indigofera linnaei*
- Mimosine in *Leucaena leucocephala* (lead tree) and *Mimosa pudica* (sensitive plant)

### Indospicine/Canavanine

Poisoning by *Indigofera linnaei* has generally been ascribed to indospicine, an arginine analog, and, to a lesser extent, canavanine, also an arginine analog, but a nitrocompound may also be involved. The mechanism of action is an inhibition of nitrous oxide synthesis, decreased glutathione levels, and increased superoxides in hepatocytes.

Indospicine transmitted to dogs fed on meat from poisoned horses is associated with fatal liver damage in the dogs. *Canavalia* spp. and *I. hendecaphylla* in sheep and cattle are associated with a similar syndrome that includes anorexia, icterus, weakness, gait incoordination, and, less commonly, abortion. Horses show anorexia, depression, ataxia, and seizures.

### Mimosine

The nonprotein amino acid mimosine occurs in *Mimosa pudica* (sensitive plant) and *Leucaena leucocephala*, a leguminous fodder shrub.<sup>8,9</sup> Mimosine plus an enzyme in plant tissue produces 3,4-dihydropyridone (3,4-DHP), a potent goitrogen, which on mastication yields 2,3-DHP through the action of rumen flora. Mimosine, 3,4-DHP, and 2,3-DHP are all toxic.<sup>10</sup> Both plants are associated with alopecia, but *Leucaena* spp. is associated with the disease known as “jumbay” (Bahamas) or “lamtoro” (Indonesia). Some varieties of the tree contain more mimosine than others. Safe daily intakes of mimosine are 0.18 g/kg BW for cattle, 0.14 g/kg BW for sheep, and 0.18 g/kg BW for goats. There is a great deal of variation in the effects of poisoning with *L. leucocephala*, depending on the variety of the tree, the amount of other fodder available, and the selection of the feed by the animal.<sup>11</sup> Horses, sheep, cattle, and goats are all affected.

Cattle and goats in Indonesia, Hawaii, and the Virgin Islands, where the tree is indigenous, eat very large amounts of the plant without ill-effect. This immunity is attributable to the adaptation of ruminal microflora to degrade the mimosine, with the degree of degradation varying with the diet and being much greater on a concentrate diet than on a roughage one. A transfer of rumen contents from resistant to susceptible cattle is a successful preventive veterinary procedure. The bacterium capable of degrading the toxins is *Synergistes jonesii*.<sup>10,12</sup> In some areas, if ruminants are introduced to the plant gradually enough, the ruminal microflora may develop the capacity of metabolizing mimosine, and thus poisoning is not a problem. Animals in the areas of concern can be given a *Synergistes*

*jonesii* ruminal inoculum and successfully graze on leucaena pastures without issues.<sup>10</sup>

Loss of wool and hair is the most common sign. Other less frequent signs are anorexia, weakness, thyroid gland enlargement, gingival atrophy, lingual epithelial ulceration, infertility, and low birth weight. In experimental animals, hepatic injury is one of the most marked effects, but this is not recorded in field cases.

In horses the loss of hair is most marked in the mane and tail and around the hocks and knees. Ring formation in the hooves and emaciation also occur. In cattle and sheep, shedding of hair or wool occurs soon (7–14 days) after the first exposure to the plant, when very large amounts are fed. The alopecia is not necessarily general but is symmetric and includes the tail, ears, face, and sheath. Experimental feeding of large amounts of the plant to steers has been associated with hair loss, especially on the tail, pizzle, and escutcheon. Cattle fed on the plant for long periods develop other chronic syndromes, including incoordination, temporary blindness, and hyperactivity to the point of severely interfering with normal handling procedures. A secondary phase of poisoning is associated with the formation of DHP recorded in some countries, but not others. It is characterized by enlarged thyroid glands, poor breeding performance, and goitrous, weak calves. The goitrogenic effect is limited to ruminants, associated with 3,4-DHP, and unresponsive to iodine administration. A further complication, seen in goats on low-level feeding over a long period, is fibrous osteodystrophy of the mandible, causing salivation, slow eating, and weight loss. The long bones are normal.

In pigs, the feeding of diets containing up to 15% of dried *L. leucocephala* to pregnant gilts is associated with a high proportion of fetuses being resorbed and some having limb deformities. Feeding 1% ferrous sulfate in the diet reduces these effects.

Toxic effects are quickly reversible by removing animals from access to the plants, so the case-fatality rate is usually low. Taste aversion conditioning has been successful in an experimental setting and may be useful in reducing toxicity in those animals that must graze on leucaena pastures.<sup>13</sup> Supplementation of the diet of ruminants with iron, copper, and zinc is also claimed to reduce the toxic effects.

Animals grazing heavily on *L. leucocephala* may have low blood levels of thyroxine and are likely to have high blood and urine levels of DHPs.<sup>9,11</sup> Necropsy lesions are limited to alopecia, oral and esophageal ulcers, and thyroid enlargement.

### ARISTOLOCHINE

Aristolochine, an alkaloid, occurs in the following *Aristolochia* spp.:

- *A. bractea*
- *A. clematitis*—birthwort
- *A. densivena*
- *A. elegans*

In goats, poisoning takes the form of diarrhea, dyspnea, alopecia, and hindlimb weakness. In horses, signs include straining to urinate, passing small amounts of urine frequently, polyuria, and tachycardia.

### CREPENYNIC ACID

Necrosis of cardiac and skeletal muscle, manifested clinically by staggering and recumbency, or sudden death during exercise, is the significant lesion in poisoning of sheep by crepenynic acid, which is found in mature seed heads of *Ixiolaena brevicompta* (button weed).

### CYCAD GLYCOSIDES

All cycads that have been investigated contain one or more glycosides of methylazoxymethanol (MAM) and a neurotoxic amino acid ( $\beta$ -*N*-methylamino-L-alanine or BMAA). The two common glycosides are cycasin and macrozamin. These include species of the following:

- *Bowenia*
- *Cycas*
- *Dioon*
- *Encephalartos*
- *Lepidozamia*
- *Macrozamia*
- *Stangeria*
- *Zamia*

These robust cone-bearing plants grow in greatest numbers in poor soil in hot climates, and their young leaves and seeds are eaten eagerly by ruminants when other feed is short. Methylazoxymethanol glycosides are more concentrated in seeds than in leaves and roots.<sup>14</sup> The MAM glycosides are hydrolyzed in the rumen to aglycones and sugars. The MAM aglycone is the toxic portion, alkylating DNA and RNA and causing hepatotoxicosis with periacinal hepatocyte necrosis and damage to blood vessels leading to hepatic veno-occlusion. Long-term intake results in liver cirrhosis. The liver lesions result in anorexia, weight loss, jaundice, and photosensitization. In addition, acute poisoning is associated with hemorrhagic necrosis of the abomasum and small intestine in sheep and cattle, causing severe diarrhea. Sheep are more likely than cattle to consume seeds and develop hepato/gastrointestinal MAM poisoning.<sup>14,15</sup> Pigs and horses have been experimentally poisoned with seeds. MAM is mutagenic and carcinogenic in laboratory animals, but this effect has not been described under natural conditions.

The role  $\beta$ -*N*-methylamino-L-alanine (BMAA) plays in animal toxicosis has not been well established. It is a potent neurotoxin that concentrates in the roots of several *Cycas* spp. and may be associated with or produced by cyanobacteria.<sup>16,17</sup> It has

also been linked to the development of amyotrophic lateral sclerosis/parkinsonism dementia complex present in the Chamorro people in Guam.<sup>16</sup>

An unidentified neurotoxin in *Bowenia*, *Cycas*, *Macrozamia*, and *Zamia* produces posterior ataxia in cattle, a syndrome recognized in Australia, where it is called zamia staggers; some Japanese islands; and in the Caribbean region.<sup>18</sup> This is the most likely result of cattle consuming these plants under natural conditions; however, affected cattle often have some degree of chronic liver damage. This ataxia syndrome in sheep has been produced experimentally but is rare under natural conditions. Clinically, the condition is a proprioceptive defect affecting the hindlimbs causing an irregular, stiff overextension (“goose-stepping”) and knuckling over at the fetlocks. Atrophy of hindlimb muscles and posterior paralysis may follow. There are degenerative lesions of the fasciculus gracilis, dorsal spinocerebellar tracts, and corticospinal tracts of the spinal cord. Affected cattle do not recover.

### GRAYANOTOXINS

Grayanotoxins (synonyms acetylandromedol, andromedotoxins, rhodotoxins) are resinoid substances, members of the diterpenoid group of substances, and found in plants of the Ericaceae (heath), family including:

- *Agauria salifolia*
- *Clethra arborea*—heathers
- *Kalmia* spp.—mountain laurels
- *Ledum* spp.—labrador tea
- *Leucothoe* spp.—sierra laurel, hanahiri
- *Lyonia ligustrina*—staggerbush
- *Menziezia ferruginea*—mock azalea
- *Pieris* spp.—apanese pieris
- *Rhododendron* spp.—azaleas and rhododendrons

Grayanotoxins concentrate in the leaves but are found in all plant parts including the flowers and nectar. The toxins present in nectar are transferred to honey made from these plants and have been associated with poisoning in humans.<sup>19,20</sup> The toxins bind to voltage-dependent sodium channels, slowing their opening and closing, resulting in persistent activation and an increase in axon sodium ion permeability of almost 100-fold.<sup>19,21</sup> At higher doses, calcium channels may be affected as well.

The toxins are very poisonous, with deaths often occurring after plant clippings are thrown into pastures or fed individually by unsuspecting individuals.<sup>20,21</sup> The toxic dose of *Rhododendron* spp. in cattle is 0.2% of their body weight and for *Kalmia* spp. is 0.4% of body weight.<sup>19,21</sup> Cholinergic type signs begin 3 to 14 hours after the plant is eaten and include depression, salivation, projectile vomiting, bloat, repeated swallowing or belching, tenesmus, abdominal pain, and diarrhea.<sup>19-21</sup> Other signs include irregular respirations, blindness, weakness,

recumbency, convulsions, and cardiac arrhythmias (bradycardia, tachycardia, others). Diarrhea is rare. Aspiration pneumonia is a common sequela and is the only common gross necropsy finding.<sup>19,21</sup> Typically the acute signs last for about 24 hours, with 2 to 3 days required for resolution of the neurologic effects.<sup>19</sup>

### ISOQUINOLINE ALKALOIDS

**Berberine**, a pyridine alkaloid, a subgroup of the isoquinoline alkaloids, occurs in the following weeds:

- *Argemone mexicana*—Mexican prickly poppy
- *A. ochroleuca*
- *A. subfusiformis*
- *Berberis* spp.
- *Mahonia* spp.

The clinical syndrome in cattle and pigs includes weight loss, dyspnea, and subcutaneous edema. Diarrhea, abdominal pain, and recumbency are also recorded. At necropsy the principal lesion is cardiomyopathy accompanied by fluid in body cavities and pulmonary edema, and gastroenteritis in some cases. The toxic effect of *A. mexicana* seeds may be attributable to their total content of isoquinoline alkaloids rather than to their berberine content.

**Bulbocapnine** is an isoquinoline alkaloid found in *Corydalis flavula* (fitweed, fumatory) and *Dicentra spectabilis* (bleeding heart) and is associated with a transient syndrome of tremor, tetanic convulsions, frenzy and biting at surrounding objects, opisthotonos, drooling of saliva, and vomiting in grazing ruminants.

**Chelidonine**, a toxic isoquinoline alkaloid found in *Chelidonium majus* (greater celandine or celandine poppy), is associated with a syndrome of gait incoordination, dribbling urine, drooling saliva, and convulsions in cattle, especially if they are harassed.

**Corydaline** is an isoquinoline alkaloid found in *Corydalis caseana* (fitweed) and is associated with acute diarrhea, frenzy and excitement exacerbated by harassment, clonic convulsions, and a quick death in grazing animals. The same toxin in *Dicentra cucullaria* is associated with a similar syndrome, except that vomiting occurs and diarrhea does not. Gastroenteritis is present at necropsy.

### JUNIPERINE

An alkaloid, juniperine occurs in *Juniperus* spp. trees and is reputed to be associated with nephrosis, cystitis, and rumenitis when eaten. Signs include abdominal pain, diarrhea, proteinuria, elevation of blood urea nitrogen (BUN) levels, and abortion.

### RHOEADINE

Rhoeadine is an alkaloid found in the seed capsules of *Papaver rhoeas* (field poppy), and probably *P. nudicaule* and *P. somniferum*, and is associated with restlessness,

hypersensitivity, ataxia, ruminal stasis, dyspnea, and convulsions, but no significant necropsy lesions.

### SAPONIN POISONING

Saponins are naturally occurring glycosides with the physical properties of soaps; that is, they produce a stable froth in water. They have a bitter taste. They also lyse erythrocytes in vitro. There are two classes of saponins, those with a triterpene aglycone radical and those in which the nonsugar radical is a steroid.

#### Triterpene Saponins

In plants, almost all saponins are triterpene saponins. The compounds are concentrated in the rapidly growing shoots, the bark, and the roots, and they are thought to have an insect-repellent role in these sensitive areas of the plant. They are absorbed very slowly, if at all, from the alimentary tract, and it seems unlikely that they will exert any systemic effect unless there is preexisting damage to the intestinal mucosa.

Information regarding the toxicity of triterpene saponins for animals is scarce. The principal pathogenic effect is enteritis and gastroenteritis, manifested by diarrhea and dysentery. Other less common signs include abdominal pain, vomiting, and salivation. The following plants are known to have this effect:

- *Aleurites fordii*
- *Dialopsis africana*
- *Gutierrezia microcephala*
- *Hedera helix*
- *Jatropha curcas*
- *J. hyssopifolia*
- *Phytolacca americana*
- *Phytolacca dioica*—packalacca
- *Phytolacca dodecandra*
- *Saponaria officinalis*
- *Sesbania* spp.

*Bulnesia sarmientii* (Palo santo tree) seed pods and foliage contain an unspecified toxic saponin that is associated with convulsions, licking of forelimbs, geophagia, chewing movements, ruminal atony, bradycardia, and frequent urination and defecation. The bitter taste of saponins may result in a decrease in feed intake and a reduction in growth rate in monogastric animals.

#### Steroidal Saponins

Steroidal saponins are associated with Scandinavian (Norway) photosensitization disease (alveld or “elf fire”) and occasionally nephrosis in ruminants; they occur in the following plants:

- *Agave lecheguilla*
- *Agrostemma githago*
- *Brachiaria decumbens* grass
- *Kochia scoparia*—summer cypress
- *Narthecium ossifragum*—also associated with alveld
- *Panicum* spp. grasses
- *Panicum schinizzii*

- *Panicum miliaceum*—French millet
- *Panicum coloratum*—kleingrass
- *Panicum. dichotomiflorum*—smooth witch grass
- *Tribulus terrestris*.

Other *Panicum* spp. grasses that should now be on the suspicious list for this kind of poisoning are as follows:

- *P. decompositum*
- *P. effusum*
- *P. maximum*
- *P. queenslandicum*
- *P. whitei*

Birefringent crystals composed of the glucuronides of epismilagenin and episar-sasapogenin formed from an ingested saponin accumulate in the biliary system, blocking it and causing damage to it and surrounding hepatocytes. Jaundice, photosensitization, and hepatitis result. Blockage of the bile canaliculi and bile ducts and filling of hepatocytes, Kupffer, and renal tubules cells by acicular crystals are characteristic. Necrosis of the distal renal tubules, papillary muscles of the heart, and adrenal cortex are accompanying lesions. Other steroidal saponins are present in *Tribulus terrestris*, but they appear to be nonlithogenic.

### SESQUITERPENES

Sesquiterpenes are common plant poisons. Subgroups of them, described elsewhere in this chapter, are as follows:

- Furanoid sesquiterpenes
- Ipomeanols
- Ngaiones
- Sesquiterpene lactones
- Sporidesmin

Unspecified sesquiterpenes are also listed as being associated with other poisonings. For example, *Flourensia cernua* and *Vernonia* spp. are associated with heavy losses in South America and Africa as a result of hepatic necrosis in grazing ruminants. Affected animals show nonspecific signs of anorexia, ruminal atony, hypothermia, staggering gait, recumbency, and convulsions. Serum levels of liver enzymes are elevated, accompanying a massive liver necrosis.

### FURANOID SESQUITERPENES (FURANOSSESQUITERPENOID) POISONING

Furanosessquiterpenoids, including ngaione and myodesmone, are essential oils in the following plants:

- *Lasiospermum bipinnatum*—ganskweed
- *Myoporum* spp.—boobialla, Ellangowan poison bush, and others

Ingestion of these plants usually is associated with jaundice, photosensitization, ruminal stasis, constipation, tenesmus, and abdominal pain. Necropsy findings are limited to hepatic necrosis, jaundice, and photosensitive dermatitis. Ingestion of *L. bipinnatum* by lambs also is associated with the same hepatic insufficiency syndrome, but



the same plant from a different part of a farm may be associated with pulmonary and mediastinal emphysema and interstitial pneumonia reminiscent of the ipomeanols. The fungi *Ceratocystis* spp. is associated with the same problems as *L. bipinnatum*. The following are associated with acute hepatic injury and deaths in ruminants:

- *Myoporum laetum*—ngaio tree
- *Eremophila deserti* (= *M. deserti*)—Ellangowan poison bush
- *M. tetrandrum*—Australian boobialla

### Ipomeanol

Ipomeanols are produced in sweet potatoes in response to infection by the *Fusarium* fungi, *F. solani*, *F. oxysporum*, and *F. javanicum*, and *Ceratostomella fimbriata* and are associated with pulmonary emphysema and edema and interstitial pneumonia when fed to animals.<sup>22-24</sup> Ipomeanols are also suspected of being associated with the poisoning of *Perilla frutescens* (purple mint weed)<sup>25</sup> and *Zieria arborescens* (stinkwood tree). *P. frutescens* is toxic only after the plant has flowered and then loses its toxicity once it has been wilted by frost. Cases appear in calves 3 to 12 days after they begin eating the plant. Pulmonary edema develops because of damage to endothelial cells and young pneumocytes.

*Zieria arborescens*, a small tree in Tasmania and eastern Australia, is associated with interstitial pneumonia in cattle, and the disease is reproducible by feeding the foliage. Clinical signs appear as tachypnea, abdominal, grunting respiration with extension of the head, mouth breathing, and a nasal discharge. In severe cases the temperature and pulse are elevated. Most cases die after an illness of 1 to 21 days. Necropsy lesions include massive pulmonary edema and emphysema.

### Sesquiterpene Lactones

There are very many plant lactones suspected of being poisonous. Plant genera known to owe their toxicity to their content of sesquiterpene lactones include *Centaurea* spp. (especially *C. repens*, *C. solstitialis*), *Chrysanthemum* spp. (associated with contact dermatitis), *Geigeria* spp., *Helenium* spp., *Hymenoxys* spp., *Iphiona aucheri*, and *Parthenium hysterophorus* (parthenium weed).

### Vomiting Syndrome

*Geigeria*, *Helenium*, and *Hymenoxys* spp. poisonings in cattle are associated with a syndrome of regurgitation (spewing sickness, vermeersiekte), salivation, dysphagia, and coughing. An ELISA is available for the quantitative detection of the sesquiterpene lactone dihydrogriesenin in *Geigeria* spp. Contrast radiography of the esophagus and biopsy of skeletal and esophageal muscle are helpful in diagnosis. Dietary supplements used to prevent poisoning by sesquiterpene

lactones, including a soybean meal–sodium sulfate combination, are useful if thiol groups are added to the ration. Urea potentiates the poisoning.

### Encephalomalacia Syndrome

*Centaurea solstitialis* (yellow star thistle) and *C. repens* (Russian knapweed) poisoning in horses is associated with a well-known syndrome of severe depression, constant chewing movements, salivation, tongue flicking, dysphagia, intestinal bloat, paralysis, recumbency, and death.<sup>26</sup> Yawning and somnolence are evident, but the horse is easily aroused. Some horses show aimless, slow walking, and, in the early stages, transient circling. The gait is not grossly abnormal, with a slight stiffness in the walk being the only abnormality except for weakness in the terminal stages. A fixed facial expression is common, with the mouth being held half open or the lips drawn into a straight line. Wrinkling of the skin of the lips and muzzle and protrusion of the tongue are present in many cases. Signs fluctuate in severity for 2 to 3 days and then remain static until the animal dies or is destroyed. Nigropallidal encephalomalacia and fluid accumulations in body cavities are characteristic necropsy lesions. Areas of necrosis or softening are visible macroscopically in the brain, with lesions within the substantia nigra pars reticulata (sparing the dopaminergic cell bodies in the pars compacta) and in the rostral portion of the globus pallidus.<sup>26</sup>

The plants do not appear to be toxic to ruminants, rodents, or monkeys, and sheep do well on sole diets of the plants.

### SELENOCOMPOUNDS

Organic selenocompounds occur in two classes of plants that preferentially accumulate selenium: primary converter or indicator plants that grow only in soils with abnormally high selenium content and secondary converters that grow anywhere but accumulate selenium if it is available. Primary converters are more toxic, attaining levels of greater than 1000 and up to 10,000 ppm.<sup>27</sup> Secondary converters reach levels of about 1000 ppm.

Primary converters include the following:

- *Astragalus* spp.—milk vetch, poison vetch
- *A. bisulcatus*—two grooved milk vetch<sup>27</sup>
- *A. pattersonii*—Patterson's milk vetch
- *A. praelongus*—sinking milk vetch
- *A. pectinatus*—narrow leaf milk vetch
- *A. racemosus*—alkali milk vetch, creamy locoweed
- *Oenopsis condensata*—goldenweed
- *Stanleya pinnata*—prince's plume<sup>27</sup>
- *Xylorrhiza* spp.—woody aster

Secondary converters include the following:

- *Acacia cana*
- *Aster* spp.—woody aster

- *Astragalus* spp.
- *Atriplex canescens*—saltbush
- *Castilleja* spp.
- *Comandra pallidai*
- *Grindelia squarrosai*
- *Machaeranthera ramosa*
- *Morinda reticulata*
- *Neptunia amplexicaulis*
- *Penstemon* spp.
- *Sideranthus* spp.—ironweed

Clinical findings include the common acute form with signs of aimless wandering, circling, apparent blindness, head-pressing, dyspnea, lameness and recumbency, teeth grinding, and salivation. The chronic form is characterized by alopecia, weight loss, corinitis, hoof deformity, and hoof shedding in all species, including pigs. Assay of selenium in the feed is usually necessary to confirm the diagnosis. Daily intakes of more than 30 ppm are usual in the subacute form. In chronic cases the intake is usually below this level and has been maintained for some months.

Necropsy findings are nonspecific and include hepatic, myocardial, and renal injury and erosion of joint cartilage.

### STEROIDAL ALKALOIDS (SOLANUM SPP.)

*Solanum* spp. plants contain many poisonous glycosidic steroidal alkaloids, including solanidine, soladulcidine, solasodine, tomatidine, and others. The most well-known poisonous plants in the group include the following *Solanum* spp.:

- *S. bonariensis*<sup>28</sup>
- *S. dulcamara*—bitter nightshade, bittersweet
- *S. elaeagnifolium*—silver leaf nightshade, white horse nettle
- *S. esuriale*
- *S. fastigiatum*
- *S. kwebense*<sup>29</sup>
- *S. lycopersicum*—tomato
- *S. nigrum*—black nightshade
- *S. pseudocapsicum*—Jerusalem cherry
- *S. triflorum*—cut leaf nightshade<sup>30</sup>
- *S. tuberosum*—potato

The other important members of the genus are *S. malacoxylon* and *S. glaucophyllum*, with the principal association being enzootic calcinosis.<sup>31</sup> *Lycium halimifolium* is also listed as containing these alkaloids.

Acute poisoning with steroidal alkaloids, associated with large doses, appears in experimental animals as a syndrome of gastroenteritis, with diarrhea and necropsy lesions of mucosal necrosis in the stomach and intestines. Subacute poisoning with smaller doses, which are not associated with an enteric lesion but are absorbed, is associated with nervous signs of exercise-induced gait incoordination, easy falling, a straddled gait, nystagmus, and convulsions with opisthotonos, complemented in some cases by cardiac irregularity, hemolysis, and sometimes diarrhea. Records of necropsy lesions include

only occasional references to the presence of encephalomalacia and cerebellar agangliosis associated with the incoordination syndromes. *Solanum esuriale* has been suggested as being associated with humpy back, a common disease in sheep in Australia, but the association is unproven. After forced exercise, affected sheep show gait stiffness in the hindlimbs with shortness of steps. This is followed by an inability to keep walking and the adoption of a peculiar hump-backed stance. The disease occurs only in summer in fully woolled sheep. At necropsy, there is degeneration of spinal cord tracts. In the United States, *S. dimidiatum* is associated with a “crazy cow syndrome” of staggering and incoordination, with a selective loss of Purkinje cells from the cerebellum. A similar syndrome is associated with *S. kwebense* in South Africa (mad drunk disease),<sup>29</sup> one by *S. bonariense* (naranjillo) in cattle in Uruguay,<sup>28</sup> one by *S. cinereum* in goats in Australia, and one by *S. fastigiatum* var. *fastigiatum* in Brazil. The latter appears to be an acquired gangliosis. It is characterized by cytoplasmic membranous bodies in the Purkinje cells and a syndrome identical to that described previously for subacute poisoning with steroidal (*Solanum* spp.) alkaloids. After an attack lasting up to 60 seconds, the animal returns to normal. Affected animals do not recover but do not die unless by misadventure. The animals can be provoked to have an attack by raising their heads or by holding them in lateral recumbency and then letting go.<sup>28,29</sup> It is probable that these are not true “convulsive” diseases but cerebellar incoordination in which frantic efforts by a seriously ataxic animal give a superficial resemblance to convulsive episodes. It is also probable that the lesions in this disease are not associated with steroidal alkaloids but with perhaps with  $\beta$ -carbolines.

Potatoes are toxic only if they are green and sprouted, and the toxic alkaloid solanine is concentrated in those parts; potatoes must constitute more than 50% of the diet before toxicity occurs. Pigs are most commonly affected, but all species are susceptible. In pigs there is dullness, copious diarrhea, anorexia, hypothermia, and coma in the terminal stages. The mortality rate may be high. In horses, the signs include depression and prostration, but usually there are no signs of alimentary tract irritation. In cattle, dermatitis, comprised of vesicles and scabs on the legs, is a more common syndrome. At necropsy in all species there is a moderate hyperemia of the alimentary mucosa. Sprouted or diseased potatoes can be fed safely if they are boiled and the amount fed is restricted to less than 25% of the diet.

There are several anecdotal reports that tomatoes are toxic to horses and ruminants if they are fed green vines and foliage from tomato plants. This was not shown to be the case, at least in beef cattle; they did not

develop any clinical signs other than weight loss after being fed large amounts of tomato foliage for 42 days.

Some of these plants also contain specific teratogenic steroidal alkaloids that contain  $\alpha$ -piperidine moiety. The plants, in decreasing order of toxicity in terms of producing craniofacial deformities in laboratory animals, are as follows:

- *S. elaeagnifolium*
- *S. saccharoides*
- *S. dulcamara*
- *S. melongena*
- *S. tuberosum*

### VELLEIN

The toxin vellein, found in the plant *Velleia discophora*, is associated with hyposensitivity, dyspnea, tachycardia, and recumbency but no specific necropsy lesions.

### VERATRINE

The mixture of alkaloids found in *Veratrum californicum* is associated with a syndrome of salivation, dyspnea, vomiting, diarrhea, frequent urination, cardiac irregularity, and convulsions. The plant also contains the teratogen cyclophamide.

### ZIGADINE (ZIGADENINE)

The phytotoxin zigadine occurs in the plants *Zigadenus* spp. (death camas), especially the bulb, and is associated with a syndrome of salivation, vomiting, tremor, ataxia, and dyspnea. The toxin has been identified in the rumen of dead cattle by electron impact mass spectrometry, avoiding the necessity of identifying the plant botanically.

### FURTHER READING

- Buck WB, Dollahite JW, Alien TJ. *Solanum elaeagnifolium*, silver-leafed nightshade, poisoning in livestock. *J Am Vet Med Assoc.* 1960;137:348-351.
- Casteel SW, Johnson GC, Wagstaff DJ. *Aesculus glabra* intoxication in cattle. *Vet Hum Toxicol.* 1992;34:55-57.
- Hegarty MP, Kelly WR, McEwan D, et al. Hepatotoxicity to dogs of horse meat contaminated with indospicine. *Aust Vet J.* 1988;65:337-340.
- Hegarty MP, Schinckel PG. Reaction of sheep to the consumption of *Leucaena glauca* Benth and to its toxic principle mimosine. *Crop Past Sci.* 1964;15:153-167.
- Lopez TA, Cid MS, Bianchini ML. Biochemistry of hemlock (*Conium maculatum*) alkaloids and their acute and chronic toxicity in livestock. A review. *Toxicol.* 1999;37:841-865.
- Magnusson RA, Whittier WD, Veit HP, et al. Yellow buckeye (*Aesculus octandra* Marsh) toxicity in calves. *Bov Pract.* 1983;18:195-199.
- McKenzie RA, Brown OP. Avocado (*Persea americana*) poisoning of horses. *Aust Vet J.* 1991;68:77-78.
- Munday BL. *Zieria Arborescens* (stinkwood) intoxication in cattle. *Aust Vet J.* 1968;44:501-502.
- Olson CT, Keller WC, Gerken DF, et al. Suspected tremetol poisoning in horses. *J Am Vet Med Assoc.* 1984;185:1001-1003.
- Penrith ML, Van Vollenhoven E. Pulmonary and hepatic lesions associated with suspected ganskweek (*Lasioppermum bipinnatum*) poisoning in cattle. *J SA Vet Assoc.* 1994;65:122-124.

- Puschner B, Holstege DM, Lamberski N, et al. Grayanotoxin poisoning in three goats. *J Am Vet Med Assoc.* 2001;218:573-575.
- Radostits O, et al. Poisoning by miscellaneous phytotoxins. In: *Veterinary Medicine: A Textbook of the Disease of Cattle, Horses, Sheep, Goats and Pigs.* 10th ed. London: W.B. Saunders; 2007:1883.
- Shlosberg A, Bellaiche M, Hanji V, et al. The effect of feeding dried tomato vines to beef cattle. *Vet Hum Toxicol.* 1996;135-136.
- Storie GJ, McKenzie RA, Fraser IR. Suspected packalacca (*Phytolacca dioica*) poisoning of cattle and chickens. *Aust Vet J.* 1992;69:21-22.
- Walker KH, Thompson DR, Seaman JT. Suspected poisoning of sheep by *Ixiolaena Brevicompta*. *Aust Vet J.* 1980;56:64-66.
- Young S, Brown WW, Klinger B. Nigropallidal encephalomalacia in horses fed Russian knapweed (*Centaurea repens* L.). *Am J Vet Res.* 1970;31:1393-1404.

### REFERENCES

1. Campbell A. *Companion Anim.* 2008;13:86.
2. Schep LJ, et al. *Clin Tox.* 2009;47:270.
3. Davis T, et al. *Toxicol.* 2013;76:247.
4. Davis T, et al. *Toxicol.* 2013;73:88.
5. Takeda Y, et al. *J Japan Vet Med Assoc.* 2007;60:47.
6. Panter KE, Gardner DR, Holstege D, et al. A case of acute water hemlock (*Cicuta maculata*) poisoning and death in cattle after ingestion of green seed heads. In: Panter KE, Wierenga T, Pfister JA, eds. *Poisonous Plants: Global Research and Solutions.* CAB International; 2007:259-264.
7. Stegelmeier BL, et al. *J Vet Diag Invest.* 2010;22:570.
8. Hallak M, et al. *Apoptosis.* 2008;13:147.
9. Dalzell SA, et al. *Anim Prod Sci.* 2012;52:365.
10. Aung A. *J Ag Sci Tech A.* 2011;1:764.
11. Phaikaew C, et al. *Anim Prod Sci.* 2012;52:283.
12. Jones RJ, et al. *Anim Prod Sci.* 2009;49:643.
13. Gorniak SL, et al. *Appl Anim Behav.* 2008;111:396.
14. Ferguson D, et al. *J Vet Intern Med.* 2011;25:831.
15. Cunha BM, Franca TN, Pinto MSF, et al. Poisoning by *Cycas revoluta* in dogs in Brazil. In: Riet-Correa F, Pfister J, Schild AL, Wierenga TL, eds. *Poisoning by Plants, Mycotoxins, and Other Toxins.* CAB International; 2011:221.
16. Jonasson S, et al. *Plant Biotech.* 2008;25:227.
17. Krüger T, et al. *Endocyt Cell Res.* 2012;22:29.
18. Finnie JW, et al. *Aust Vet J.* 2011;89:247.
19. Jansen SA, et al. *Cardiovasc Tox.* 2012;12:208.
20. Cortinovis C, et al. *Vet J.* 2013;197:163.
21. Bischoff K, et al. *Vet Clin N Am Food A.* 2011;27:459.
22. Ling LJ, et al. *Clin Res Toxicol.* 2006;19:1320.
23. Parkinson OT, et al. *J Vet Pharm Ther.* 2012;35:402.
24. Mawhinney I, et al. *Vet Rec.* 2008;162:62.
25. Nicholson SS. *Vet Clin N Am Food A.* 2011;27:447.
26. Chang HT, et al. *Vet Path.* 2012;49:398.
27. Freeman JL, et al. *Plant Physiol.* 2006;142:124.
28. Verdes JM, et al. *J Vet Diag Invest.* 2006;18:299.
29. Van der Lugt JJ, et al. *Vet J.* 2010;185:225.
30. Stegelmeier BL, Lee ST, James LF, et al. Cutleaf nightshade (*Solanum triflorum* Nutt.) toxicity in horses and hamsters. In: Panter KE, Wierenga TL, Pfister JA, eds. *Poisonous Plants: Global Research and Solutions.* CAB International; 2007:296.
31. Fontana PA, et al. *Pesq Vet Bras.* 2009;29:266.

## TOXICOSIS FROM BREWER'S RESIDUES

Diseases associated with the feeding of by-products of brewing and distilling include the following:

- Carbohydrate engorgement in cattle fed wet brewer's grains
- Possibly spinal cord degeneration in adult cattle fed sorghum beer residues contaminated by *Aspergillus flavus* and containing aflatoxin
- Excess sulfur (>0.45% in the diet) from some methods of processing, which can lead to polioencephalomalacia

## TRICHOHECENE TOXICOSIS

Trichothecenes (TCT) are the largest group of mycotoxins and are among the most toxic.<sup>1,2</sup> They may produce toxic effects in the liver, kidney, gastrointestinal tract, central nervous system, immune system, or hematopoietic system or adversely affect productivity in many animals.<sup>3-5</sup> Trichothecenes exert these effects through several mechanisms, including inhibition of protein synthesis, inhibition of RNA and DNA synthesis, activation of cytokines, increased lipid peroxidation, dysfunction of mitochondria, and apoptosis.<sup>6,7</sup>

More than 180 TCT mycotoxins have been identified, all containing an epoxy group at the C12 to C13 portion of their chemical structure that is necessary for toxicity.<sup>7,8</sup> This epoxy group is necessary for toxicity.<sup>1,9</sup> They are divided into two different categories, the macrocyclic and the nonmacrocyclic trichothecenes, on the basis of their molecular structure. Chemically, they are divided into four types (A, B, C, D) based on substitutions at five different sites on the TCT molecule.<sup>1,2</sup> Type A contains T-2 toxin, HT-2 toxin, and 4,15-diacetoxyscirpenol (DAS); type B contains deoxynivalenol (DON) and nivalenol (NIV); type C contains crocacin and baccharin; and type D contains the macrocyclic mycotoxins such as verrucarins, roridin, and satratoxins.<sup>1,2,6</sup>

## MACROCYCLIC TRICHOHECENES

Trichothecene mycotoxins in this group include satratoxin, verrucarins, roridin and others.

The standard nomenclature for toxicity associated with this group of mycotoxins is retained, stachybotryotoxicosis and myrotheciotoxicosis.

## Stachybotryotoxicosis

Toxins in the fungus *Stachybotrys chartarum* (*S. atra*, *S. alternans*), which is associated with stachybotryotoxicosis, are the macrocyclic trichothecenes, satratoxins G and H, roridin E, and verrucarins J. These mycotoxins are found worldwide as contaminants of wet and decaying straw and hay.<sup>10,11</sup> Horses, cattle, sheep, and pigs may be affected, and the disease is characterized by fever, ruminal atony, diarrhea, dysentery, necrotic ulceration, hemorrhages of the nasal and oral mucosae causing epistaxis and purulent nasal discharge, and conjunctivitis causing lacrimation.<sup>3</sup> Drying and cracking of the skin are visible, especially peri-orbitally and on

the face. At necropsy there are hemorrhages into all tissues and under all serous membranes. An important abnormality is the depression of leukocyte formation, causing agranulocytosis and producing a disease not unlike that associated with bracken poisoning in cattle. Hemorrhages are visible in the mucosae; there is also hemorrhagic enteritis. In sheep, *Pasteurella haemolytica* can often be isolated from tissues. The infection is thought to occur as a result of the immunosuppression associated with the toxins. In horses, there is also a subacute or acute myositis. The disease resembles alimentary toxic aleukia (ATA), associated with the ingestion of toxin from *Fusarium poae* and *Fusarium sporotrichioides*, in humans.<sup>3</sup>

## Myrotheciotoxicosis

Roridin, a toxin in the fungus *Myrothecium roridum* and *Myrothecium verrucaria* growing on rye-grass and white clover plants in pasture, or on stored feeds, is associated with sudden death in sheep and cattle, with necropsy lesions of abomasitis, hepatitis, and pulmonary congestion and edema. Smaller intakes are associated with similar lesions, but over a course of 7 to 10 days. Very small doses administered over a 30-day period are associated with loss of weight but no deaths.

A bizarre involvement in what appears to be a plant poisoning is the role that *M. verrucaria* plays in *Baccharis* spp. poisoning. *Baccharis* spp., including *B. cordifolia*, *B. dracunculifolia*, *B. pteronioides* (synonym *B. ramulosa*), and *B. glomeruliflora*, are associated with tremor, stiff gait, and convulsions and some deaths in cattle and sheep. Roridin, a toxin produced by *Myrothecium* spp. growing in close apposition to the roots of the plants, is absorbed and, when eaten by animals, poisons them. In other plants roridin is lethal to the plant when present in very small amounts.

## NONMACROCYCLIC TRICHOHECENES

T-2 toxin and deoxynivalenol (DON) are well recognized TCT mycotoxins produced by several different genera of fungi, with many growing on cereal grains. Fungi producing these mycotoxins are not fully defined in terms of which toxins they produce, and many produce more than one. Accordingly, the syndromes described here, and attributed to specific fungi and toxins, are tentative. Any one or combination of them can be implicated in toxicity if they produce the specified toxin at the specified time. A partial list of well-known TCT producing fungi includes the following:

- *Cephalosporium* spp.
- *Fusarium acuinatum*
- *F. culmorum*
- *F. graminearum*
- *F. moniliforme*
- *F. nivale*
- *F. poae*

- *F. roseum*
- *F. semitectum*
- *F. sporotrichioides*
- *F. tricinctum*
- *Trichoderma* spp.
- *Trichothecium* spp.

## T-2 Toxin and HT-2 Toxin

A sesquiterpene compound, the T<sub>2</sub> toxin is produced by several different *Fusarium* species, including *F. acuinatum*, *F. poae*, and *F. sporotrichioides* growing in cereal grains.<sup>1</sup> Occasionally, in areas of uncommonly cool and wet weather, pastures used for animal grazing have been contaminated with *Fusarium* production of T-2 toxin, HT-2 toxin, and other mycotoxins.<sup>6</sup> Species, age, amount or dose of toxin ingested, and route of exposure are important determinants in the level of toxicity and production of signs.<sup>1</sup>

Reported signs associated with poisoning include feed refusal, vomiting, weight loss, diarrhea, rough hair coats, and abortion.<sup>1,6</sup> Historically, T-2 toxin has been associated with a hemorrhagic syndrome, but this has not been a consistent finding. Experimental administration of the purified toxin parenterally produced a range of signs including emesis, posterior paresis, lethargy, hunger, and frequent defecation of normal stools, whereas oral administration of the T-2 toxin or cultures containing it to piglets and calves was associated with hemorrhagic disease. Field evidence of the relationship between the ingestion of the fungus and the appearance of hemorrhagic disease is strong, but the identity of the specific toxic agent may be in doubt. Alternatively, other effects have been reported. Ingestion of T-2 toxin is associated with immunosuppression when fed to laboratory animals, sheep, and pigs. This leads to leukopenia, lymphopenia, and atrophy of lymph nodes, thymus, and spleen. Blood coagulability is reduced because of the toxic effects on platelets.

T-2 toxin fed to pigs is associated with necrotic contact lesions on the snout and commissures of the mouth and the prepuce. Topical application of T<sub>2</sub> toxin to pig skin is associated with initial swelling and purple discoloration, followed by separation and sloughing by day 14. It has also been cited as the probable cause of congenital skin defects about the head and tarsus of pigs. The toxin also is associated with reproductive inefficiency when given experimentally to pigs, causing small litters, repeat breeders, and abortion.

## Deoxynivalenol

Deoxynivalenol (synonym vomitoxin) is a sesquiterpene compound found in *Fusarium graminearum* (*roseum*), *F. culmorum*, and other species. It is a potent central emetic, to which pigs are very sensitive and ruminants more resistant.<sup>6,12</sup> The toxin may be associated with severe vomiting, acute diarrhea, dysentery, ataxia, mucosal hemorrhages, and



sudden death.<sup>6,12,13</sup> The most common field observation about the toxic effect of DON fed to pigs is that it is associated with absolute feed refusal or reduction in weight gain and feed intake.<sup>7</sup> Deoxynivalenol is minimally excreted in the milk and accumulation in swine tissues meant for human consumption is low.<sup>6,12</sup>

The only effective method of preventing losses as a result of deoxynivalenol is to dilute affected corn with uncontaminated feed to levels unlikely to result in toxicosis. Mixing the feed with bentonite, sweeteners, or sodium-calcium aluminosilicate is ineffective as a detoxification method, but rinsing and removing floating material is recommended.<sup>6</sup> Feed toxic to pigs may be utilized by diluting and feeding it to adult ruminants.

### Fusaritoxicosis Syndromes Without Specified Toxins

*F. graminearum* (*roseum*) produces toxins associated with emesis, refusal of feed, toxins lethal to pigs, and estrogenic substances causing infertility in pigs. *F. culmorum* also is associated with inappetence, scouring, ataxia, and a fall in milk yield when fed to cattle. The fungus *F. moniliforme* is associated with food refusal in cattle. Food refusal is also recorded with zearalenone. Ingestion of *Fusarium xylaroides* infected groundnut hay by cattle has resulted in anorexia, rumen atony, colic, tenesmus, and nasal and rectal hemorrhage.<sup>14</sup> Experimentally, when fed infected groundnut, calves developed diarrhea, weakness, ataxia, and conjunctival and cutaneous hemorrhage. Serum concentrations of urea nitrogen, creatinine, aspartate aminotransferase (AST), and alanine aminotransferase (ALT) were elevated. The toxin has not yet been identified.<sup>14</sup>

### FURTHER READING

- di Menna ME, Mortimer PH. Experimental myrotheciotoxicosis in sheep and calves. *NZ Vet J.* 1971;19:246-248.
- Friend DW, Trenholm HL, Hartin KE, et al. Toxicity of T-2 toxin and its interaction with deoxynivalenol when fed to young pigs. *Can J Anim Sci.* 1992;72:703-711.
- Friend DW, Trenholm HL, Elliot JL. Effect of feeding vomitoxin-contaminated wheat to pigs. *Can J Anim Sci.* 1982;62:1211-1222.
- Radostits O, et al. *Veterinary Medicine: A Textbook of the Disease of Cattle, Horses, Sheep, Goats and Pigs.* 10th ed. London: W.B. Saunders; 2007:1910.

- Trenholm HL, Thompson BK, Foster BC, et al. Effects of feeding diets containing *Fusarium* (naturally) contaminated wheat or pure deoxynivalenol (DON) in growing pigs. *Can J Anim Sci.* 1994;74:361-369.
- Vertinskii KL. Stachybotryotoxicosis in horses. *Veterinariya.* 1940;17:61-68.

### REFERENCES

- Li Y, et al. *J Agric Food Chem.* 2011;59:3441.
- Barthel J, et al. *Mycotoxin Res.* 2012;28:97.
- Paterson RM, Lima N. Toxicology of mycotoxins. In: Luch A, ed. *Molecular, Clinical and Environmental Toxicology, Clinical Toxicology.* Switzerland: Birkhäuser Basel; 2010:31-63.
- Pinton P, et al. *Curr Immunol Rev.* 2012;8:193.
- Caloni G, et al. *Toxicol.* 2009;54:337.
- Mostrom M, et al. *Vet Clin N Am Food A.* 2011;27:315.
- Pestka JJ. *Arch Toxicol.* 2010;84:663.
- Fink-Gremmels J. *Vet J.* 2008;176:84.
- Zain ME. *J Saudi Chem Soc.* 2011;15:129.
- Pieckova E, et al. *Ann Agric Environ Med.* 2006;13:259.
- Gottschalk C, et al. *Mycotoxin Res.* 2006;22:189.
- Pestka JJ. *Anim Feed Sci Tech.* 2007;137:283.
- Chaytor AC, et al. *J Anim Sci.* 2011;89:124.
- Tikare V, et al. *Indian J Anim Res.* 2011;45:180.

### TRITERPENE PLANT TOXICOSIS

Toxic triterpenes include the following:

- Cucurbitacins, tetracyclic triterpenes found in *Cucumis africanus* and *Cucumis myriocarpus*, *Stemodia kingii* and *Stemodia florulenta*, and *Ecballium elaterium*
- Lantadenes A and B, and triterpene acids found in *Lantana* spp.<sup>1</sup>
- Icterogenins A, B, and C in *Lippia* spp.
- Meliatoxins A, A<sub>1</sub>, B, and B<sub>1</sub>, tetranortriterpenes, found in *Melia azedarach* (chinaberry tree)<sup>2</sup>
- Colocynthin, a glucoside found in the fruit of the vine *Citrullus colocynthis* (synonym *Colocynthis vulgaris*).

Cucurbitacins are a group of tetracyclic triterpenes found in the fruits of the vines *C. africanus*, *C. melo* var. *agrestis* (Ulcardo melon), *C. myriocarpus* (prickly pad-dymelon), and *E. elaterium* (squirting cucumber). The ripe fruits are most toxic, and in cattle, sheep, and horses are associated with a syndrome of lethargy, dehydration, abdominal pain, diarrhea, dyspnea, and death in a matter of a few hours. Necropsy findings include edema and necrosis of the ruminal epithelium, intense congestion and

hemorrhage in the intestinal mucosa, pulmonary congestion and edema, and hepatopathy in some cases. Seeds of the plant are conspicuous in the ruminal contents.

Icterogenins and lantadenes are associated with liver damage and nephrosis, neither of which is specific, but the lantadenes cause damage to bile canaliculi, gallbladder paralysis, and intrahepatic cholestasis.<sup>3-5</sup> Jaundice, photosensitization, and ruminal stasis result.<sup>3,4</sup> *Lantana* spp. is a very pungent plant, and cattle will eat it only if other feed is scarce.<sup>6</sup> *Bos taurus* cattle at one time were felt to be more susceptible to lantadene poisoning than *Bos indicus* cattle, but that is no felt to be true.<sup>6</sup> Treatment with activated charcoal or bentonite is effective in decreasing absorption of the toxins.

Pigs are most commonly poisoned by meliatoxins, but cattle, sheep, and goats are also susceptible. Meliatoxin administered to pigs is associated with a syndrome of gastroenteritis manifested by diarrhea, melena, and vomiting, plus dyspnea as a result of pulmonary edema. The toxic dose in pigs is 0.5% of body weight. Pigs fed ground chinaberries at 5 g/kg BW developed mild diarrhea and rapidly recovered. Those fed 10 g/kg BW, 15 g/kg BW, and 20 g/kg BW developed muscle tremors, ataxia, incoordination, and recumbency 2 to 24 hours after dosing. Other observed signs included hypothermia and vocalization (moans, screams). Death occurred in the 20 g/kg BW group.<sup>2,7</sup>

### FURTHER READING

- Hare WR, Garland T, Barr AC. Chinaberry (*Melia azedarach*) poisoning in animals. In: Garland T, Barr AC, eds. *Toxic Plants and Other Natural Toxicants.* CAB International; 1998:514-516.
- McKenzie RA, Newman RD, Rayner AC, et al. Prickly paddy melon (*Cucumis myriocarpus*) poisoning of cattle. *Aust Vet J.* 1988;65:167-170.
- Pass MA. Current ideas on the pathophysiology and treatment of lantana poisoning of ruminants. *Aust Vet J.* 1986;6:169-171.

### REFERENCES

- Sharma OP. *CRC Cr Rev Toxicol.* 2007;37:313.
- Burrows GE, Tyril RJ. *Meliaceae Juss. Toxic Plants of North America.* 2nd ed. Wiley-Blackwell; 2013:825.
- Kumar N. *Indian Vet J.* 2009;86:725.
- Rivero R, et al. *Veterinaria (Montevideo).* 2011;47:29.
- Cooper RG. *Turk J Vet Anim Sci.* 2007;3:213.
- Burrows GE, Tyril RJ. Lantana. In: *Toxic Plants of North America.* 2nd ed. Wiley-Blackwell; 2013:1203.
- Méndez M, et al. *Pesq Vet Bras.* 2006;26:26.

# Conversion Tables

## CONVERSION FACTORS FOR OLD AND SI UNITS

	Old units	MULTIPLICATION FACTORS		SI units
		Old units to SI units	SI units to old units	
RBC	$\times 10^6/\text{mm}^3$	$10^6$	$10^{-6}$	$\times 10^{12}/\text{L}$
PCV	%	0.01	100	L/L
Hb	g/dL	None	None	g/dL
MCV	$\mu^3$	None	None	fL
MCH	$\mu\mu\text{g}$	None	None	pg
MCHC	%	None	None	g/dL
WBC	$\times 10^3/\text{mm}^3$	$10^6$	$10^{-6}$	$\times 10^9/\text{L}$
Platelets	$\times 10^3/\text{mm}^3$	$10^6$	$10^{-6}$	$\times 10^9/\text{L}$
<b>Total serum</b>				
Protein	g/dL	10	0.1	g/L
Albumin	g/dL	10	0.1	g/L
Bicarbonate	mEq/L	None	None	mmol/L
Bilirubin	mg/dL	17.1	0.0585	$\mu\text{mol}/\text{L}$
Calcium	mg/dL	0.25	4.008	mmol/L
Chloride	mEq/L	None	None	mmol/L
Cholesterol	mg/dL	0.0259	38.7	mmol/L
Copper	$\mu\text{g}/\text{dL}$	0.157	6.35	$\mu\text{mol}/\text{L}$
Cortisol	$\mu\text{g}/\text{dL}$	27.6	0.0362	nmol/L
Creatinine	mg/dL	88.4	0.0113	$\mu\text{mol}/\text{L}$
Globulin	g/dL	10	0.1	g/L
Glucose	mg/dL	0.0555	18.02	mmol/L
<b>Inorganic</b>				
phosphate	mg/dL	0.323	3.10	mmol/L
Iron	$\mu\text{g}/\text{dL}$	0.179	5.59	$\mu\text{mol}/\text{L}$
Lead	$\mu\text{g}/\text{dL}$	0.0483	20.7	$\mu\text{mol}/\text{L}$
Magnesium	mg/dL	0.411	2.43	mmol/L
Molybdenum	$\mu\text{g}/\text{dL}$	0.104	9.6	$\mu\text{mol}/\text{L}$
Potassium	mEq/L	None	None	mmol/L
Selenium	$\mu\text{g}/\text{dL}$	0.126	7.9	$\mu\text{mol}/\text{L}$
Sodium	mEq/L	None	None	mmol/L
Triglyceride	mg/dL	0.0113	88.5	mmol/L
Urea nitrogen	mg/dL	0.3570	2.8	mmol/L
Urea	mg/dL	0.1665	6.01	mmol/L
Zinc	$\mu\text{g}/\text{dL}$	0.15	6.54	$\mu\text{mol}/\text{L}$

## CONVERSIONS

To convert grams per 100 mL into grains per U.S. fluid ounce	–	multiply by 4.564
To convert grams per 100 mL into grains per Imperial fluid ounce	–	multiply by 4.385
To convert grams into ounces avoirdupois	–	multiply by 10 and divide by 283
To convert liters into U.S. pints	–	multiply by 2.114
To convert liters into Imperial pints	–	multiply by 88 and divide by 50
To convert kilograms into pounds	–	multiply by 1000 and divide by 454

## TEMPERATURE

Celsius (centigrade)	Fahrenheit
110°	230°
100	212
95	203
90	194
85	185
80	176
75	167
70	158
65	149
60	140
55	131
50	122
45	113
44	111.2
43	109.4
42	107.6
41	105.8
40.5	104.9
40	104.0
39.5	103.1
39	102.2
38.5	101.3
38	100.4
37.5	99.5
37	98.6
36.5	97.7
36	96.8
35.5	95.9
35	95
34	93.2
33	91.4
32	89.6
31	87.8
30	86
25	77
20	68
15	59
10	50
+5	41
0	32
–5	23
–10	14
–15	+5
–20	–4

To convert Fahrenheit into Celsius: subtract 32, multiply the remainder by 5, and divide the result by 9.

To convert Celsius into Fahrenheit: multiply by 9, divide by 5, and add 32.

**MASS**

<b>Metric</b>		<b>U.S./Imperial</b>	
1 kilogram (kg)	= 15,432 grains or 35.274 ounces or 2.2046 pounds	1 ton (2240 lb) 1 hundredweight (112 lb) (cwt)	= 1016 kilograms = 50.80 kilograms
1 gram (g)	= 15.432 grains	1 stone (14 lb) (st)	= 6.35 kilograms
1 milligram (mg)	= 0.015432 grains	1 pound (avoirdupois) (lb) 1 ounce (avoirdupois) (oz) 1 grain (gr)	= 453.59 grams = 28.35 grams = 64.799 milligrams

**CAPACITY**

<b>Metric</b>		<b>U.S. Liquid</b>		<b>Imperial</b>	
1 liter (L)	= 2.114 U.S. pints = 1.7598 Imperial pints	1 gallon (128 fl oz) (gall)	= 3.785 liters	1 gallon (160 fl oz) (gal)	= 4.546 liters
1 milliliter (mL)	= 16.23 U.S. minims = 16.894 Imperial minims	1 pint (pt)	= 473.17 milliliters	1 pint (pt)	= 568.25 milliliters
		1 fluid ounce (fl oz)	= 29.573 milliliters	1 fluid ounce (fl oz)	= 28.412 milliliters
		1 fluid dram (fl dr)	= 3.696 milliliters	1 fluid dram (fl dr)	= 3.5515 milliliters
		1 minim (min)	= 0.061610 milliliters	1 minim (min)	= 0.059192 milliliters

**LENGTH**

<b>Metric</b>		<b>US/Imperial</b>		<b>Pressure</b>	
1 kilometer (km)	= 0.621 miles	1 mile	= 1.609 kilometers	1 kilopascal (kPa)	= 10.197 cm H <sub>2</sub> O
1 meter (m)	= 39.370 inches	1 yard	= 0.914 meters	1 kilopascal (kPa)	= 7.50 mm Hg
1 decimeter (dm)	= 3.9370 inches	1 foot	= 30.48 centimeters	1 kilopascal (kPa)	= 0.145 pounds per square inch (PSI)
1 centimeter (cm)	= 0.39370 inch	1 inch	= 2.54 centimeters or 25.40 millimeters	1 atmosphere	= 760 mm Hg
1 millimeter (mm)	= 0.039370 inch			1 mm Hg	= 1.359 cm H <sub>2</sub> O = 0.133 kPa = 0.0193 PSI
1 micrometer (μm)	= 0.000039370 inch				



# Reference Laboratory Values

Reference values for some frequently measured variables in blood and serum are provided as a guide. Values of these variables from healthy animals vary depending on many factors, including age, breed, sex, diet, geographical habitat, and methods of sample collection and laboratory measurement. The values listed here are compiled from a variety of sources, including the clinical laboratories of the Western College of Veterinary Medicine at the University of Saskatchewan, the College of Veterinary Medicine at The Ohio State University, and Kaneko JJ. *Clinical biochemistry of domestic animals*, 5th ed. New York: Academic Press, 1997.

Tables of reference values for newborn foals and calves are provided elsewhere.

## HEMATOLOGY

	Cattle	Sheep	Goat	Swine	Horses
Hemoglobin (g/dL)	8.5–12.2	9.0–15.0	8.0–12.0	10.0–16.0	11.0–19.0
Hematocrit (packed cell volume) (%)	22–33	27–45	22–38	32–50	32–53
RBC ( $\times 10^6/\mu\text{L}$ )	5.1–7.6	9.0–15.0	8.0–18.0	5.0–8.0	6.8–12.9
MCV (fL)	38–50	28–40	16–25	50–68	37–59
MCH (pg)	14–18	8.0–12.0	5.2–8.0	17.0–21.0	12.3–19.7
MCHC (g/dL)	36–39	31.0–34.0	30.0–36.0	30.0–34.0	31.0–38.6
RDW (%)	15.5–19.7				
Thrombocytes (per $\mu\text{L}$ )	200,000–650,000	800,000–1,100,000	300,000–600,000	320,000–715,000	100,000–600,000
WBC (per/ $\mu\text{L}$ )	4900–12,000	4000–12,000	4000–13,000	11,000–22,000	5400–14,300
Neutrophils (mature) (per/ $\mu\text{L}$ )	1800–6300	700–6000	1000–7200	3100–10,500	2300–8500
Neutrophils (band cells) (per/ $\mu\text{L}$ )	Rare	Rare	Rare	0–880	0–100
Lymphocytes (per/ $\mu\text{L}$ )	1600–5600	2000–9000	2000–9000	4300–13 600	1500–7700
Monocytes (per/ $\mu\text{L}$ )	0–800	0–750	0–550	200–2200	0–1000
Eosinophils (per/ $\mu\text{L}$ )	0–900	0–1000	0–650	0–2400	0–1000
Fibrinogen (mg/dL)	200–700	100–500	100–400	100–500	200–400

## Hematology (International units, SI)

	Cattle	Sheep	Goat	Swine	Horses
Hemoglobin (g/L)	85–122	90–150	80–120	100–160	110–190
Hematocrit (packed cell volume) (L/L)	0.22–0.33	0.27–0.45	0.22–0.38	0.32–0.50	0.32–0.53
RBC ( $\times 10^{12}/\text{L}$ )	5.1–7.6	9.0–15.0	8.0–18.0	5.0–8.0	6.8–12.9
MCV (fL)	38–50	28–40	16–25	50–68	37–59
MCH (pg)	14–18	8.0–12.0	5.2–8.0	17.0–21.0	12.3–19.7
MCHC (g/L)	360–390	310–340	300–360	300–340	310–386
RDW (%)	15.5–19.7	18.0–24.6			
Thrombocytes ( $\times 10^9/\mu\text{L}$ )	200–650	800–1100	300–600	320–715	100–600
WBC ( $\times 10^9/\text{L}$ )	4.9–12.0	4.0–12.0	4.0–13.0	11.0–22.0	5.4–14.3
Neutrophils (mature) ( $\times 10^9/\text{L}$ )	1.8–6.3	0.7–6.0	1.2–7.2	3.1–10.5	2.3–8.5
Neutrophils (band cells) ( $\times 10^9/\text{L}$ )	Rare	Rare	1.0–7.2	0–0.9	0–0.1
Lymphocytes ( $\times 10^9/\text{L}$ )	1.6–5.6	2.0–9.0	2.0–9.0	4.3–13.6	1.5–7.7
Monocytes ( $\times 10^9/\text{L}$ )	0–0.8	0–0.8	0–0.6	0.2–2.2	0–1.0
Eosinophils ( $\times 10^9/\text{L}$ )	0–0.9	0–1.0	0–0.7	0–2.4	0–1.0
Fibrinogen (g/L)	2–7	1–5	1–4	1–5	2–4

## Serum constituents (U.S. units)

	Cattle	Sheep	Swine	Horses
<b>Electrolytes</b>				
Sodium (mEq/L)	132–152	145–152	140–150	132–146
Potassium (mEq/L)	3.9–5.8	3.9–5.4	4.7–7.1	3.0–5.0
Chloride (mEq/L)	95–110	95–103	94–103	98–110
Osmolality (mOsm/kg)	270–306	270–300		270–290
<b>Acid-base status</b>				
pH (venous)	7.35–7.50	7.32–7.50		7.32–7.46
PCO <sub>2</sub> (venous) (mm of Hg)	34–45	38–45		38–46
Bicarbonate (mEq/L)	20–30	21–28	18–27	23–32
Total carbon dioxide (mEq/L)	20–30	20–28	17–26	22–31
Anion gap (mEq/L)	14–26	12–24	10–25	10–25
<b>Minerals</b>				
Calcium, total (mg/dL)	9.7–12.4	11.5–13.0	7.1–11.6	11.2–13.6
Calcium, ionized (mg/dL)	4.0–5.2	4.0–4.8	3.5–5.8	5.6–6.8
Phosphorus (mg/dL)	5.6–6.5	5.0–7.3	5.3–9.6	3.1–5.6
Magnesium (mg/dL)	1.8–2.3	2.2–2.8	2.7–3.7	2.2–2.8
Iron (μg/dL)	57–162	166–222	56–190	91–199
Iron-binding capacity (μg/dL)	240–450		270–557	270–390
<b>Renal function</b>				
Urea nitrogen (mg/dL)	6.0–27	8.0–20	10–30	10–24
Creatinine (mg/dL)	1.0–2.0	1.2–1.9	1.0–2.7	0.9–1.9
<b>Liver function</b>				
Total bilirubin (mg/dL)	0.01–0.5	0.1–0.5	0–1.0	1.0–2.0
Direct (conjugated) bilirubin (mg/dL)	0.04–0.44	0–0.27	0–0.3	0–0.4
Bile acids (μg/mL)	<50	<10		4–8
<b>Metabolites</b>				
Ammonia (μg/dL)				13–108
Cholesterol (mg/dL)	65–220	52–76	54–120	46–180
Free fatty acids (mg/L)	<30	30–100		
Glucose (mg/dL)	45–75	50–80	85–150	75–115
<b>Ketones</b>				
Acetoacetate (mg/dL)	0–1.1	0.27–0.35		0.24–0.36
Acetone (mg/dL)	0.7–5.5	0–10		
β-Hydroxybutyrate (mg/dL)	5.9–13.9	4.7–6.7		0.55–0.80
Lactate (mg/dL)	5–20	9–12		10–16
Triglyceride (mg/dL)	0–14			9–44
<b>Hormones</b>				
Cortisol (μg/dL)	0.47–0.75	1.40–3.10	2.6–3.3	2–6
Thyroxine (T4) (μg/dL)	4.2–8.6			See Table 29.8
Triiodothyronine (T3) (ng/dL)				See Table 29.8
<b>Enzymes</b>				
Alanine aminotransferase (ALT) (units/L)	11–40	5–20	31–58	3–23
Alkaline phosphatase (units/L)	0–200	70–390	120–400	140–400
Aspartate aminotransferase (AST) (units/L)	78–132	60–280	32–84	220–600
Creatine kinase (units/L)	35–280			145–380
γ-Glutamyl transferase (units/L)	6.1–17.4	20–52	10–60	4–44
Isocitrate dehydrogenase (units/L)	9.4–21.9	0.5–8.0		
Lactate dehydrogenase (units/L)	692–1445	240–440	380–630	160–410
Sorbitol dehydrogenase (units/L)	4.3–15.3	5.8–28	1.0–5.8	1.9–5.8
<b>Protein</b>				
Total protein (g/dL)	5.7–8.1	6.0–7.9	4.5–7.5	6.0–7.7
Albumin (g/dL)	2.1–3.6	2.4–3.0	1.9–4.0	2.9–3.8

## Serum constituents (International units, SI)

	Cattle	Sheep	Swine	Horses
<b>Electrolytes</b>				
Sodium (mmol/L)	132–152	145–152	140–150	132–146
Potassium (mmol/L)	3.9–5.8	3.9–5.4	4.7–7.1	3.0–5.0
Chloride (mmol/L)	95–110	95–103	94–103	98–110
Osmolality (mmol/kg)	270–306	270–300		270–290
<b>Acid-base status</b>				
pH (venous)	7.35–7.50	7.32–7.50		7.32–7.46
PCO <sub>2</sub> (venous) (mm of Hg)	34–45	38–45		38–46
Bicarbonate (mEq/L)	20–30	21–28	18–27	23–32
Total carbon dioxide (mEq/L)	20–30	20–28	17–26	22–31
<b>Minerals</b>				
Calcium, total (mmol/L)	2.43–3.10	2.88–3.20	1.78–2.90	2.80–3.44
Calcium, ionized (mmol/L)	1.0–1.3	1.0–1.2	0.9–1.4	1.4–1.7
Phosphorus (mmol/L)	1.8–2.1	1.62–2.36	1.7–3.1	0.70–1.68
Magnesium (mmol/L)	0.74–1.10	0.90–1.26	1.1–1.5	0.9–1.2
Iron (μmol/L)	10–29	30–40	10–34	16–36
Iron-binding capacity (μmol/L)	42–80		48–100	45–73
<b>Renal function</b>				
Urea nitrogen (mmol/L)	2.0–9.6	3.0–7.1	3.0–8.5	3.5–8.6
Creatinine (μmol/L)	88–175	106–168	90–240	80–170
<b>Liver function</b>				
Total bilirubin (μmol/L)	0.17–8.55	1.71–8.55	0–17.1	17–35
Direct (conjugated) bilirubin (μmol/L)	0.7–7.54	0–4.61	0–5.1	0–6.8
Bile acids (μmol/L)	<120	<25		10–20
<b>Metabolites</b>				
Ammonia (μmol/L)				7.6–63.4
Cholesterol (mmol/L)	1.7–5.6	1.3–2.0	1.4–3.10	1.20–4.6
Glucose (mmol/L)	2.5–4.2	2.8–4.4	4.7–8.3	4.2–6.4
<b>Ketones</b>				
Acetoacetate (mmol/L)	0.0–0.11	0.026–0.034		0.023–0.035
Acetone (mmol/L)	0.1–1.0	0–1.7		
β-Hydroxybutyrate (mmol/L)	0.35–0.47	0.47–0.63		0.052–0.076
Lactate (mmol/L)	0.6–2.2	1.0–1.3		1.1–1.8
Triglyceride (mmol/L)	0–0.2			0.1–0.5
<b>Hormones</b>				
Cortisol (nmol/L)	13–21	39–86	72–91	55–165
Thyroxine (T4) (nmol/L)	54–110			See Table 29.8
Triiodothyronine (T3) (nmol/L)				See Table 29.8
<b>Enzymes</b>				
Alanine aminotransferase (ALT) (units/L)	11–40	5–20	31–58	3–23
Alkaline phosphatase (units/L)	0–200	70–390	120–400	140–400
Aspartate aminotransferase (AST) (units/L)	78–132	60–280	32–84	220–600
Creatine kinase (units/L)	35–280			145–380
γ-Glutamyl transferase (units/L)	6.1–17.4	20–52	10–60	4–44
Isocitrate dehydrogenase (units/L)		0.5–8.0		5–18
Lactate dehydrogenase (units/L)	692–1445	240–440	380–630	160–410
Sorbitol dehydrogenase (units/L)	4.3–15.3	5.8–28	1.0–5.8	1.9–5.8
<b>Protein</b>				
Total protein (g/L)	57–81	60–79	45–75	60–77
Albumin (g/L)	21–36	24–30	19–40	29–38



## 3

# Drug doses and intervals for horses and ruminants

Suggested drug doses and intervals for horses and ruminants are provided here. Dosages listed are general recommendations and might not be optimal or efficacious in all instances and might need to be adjusted depending on the disease and its severity; patient factors, including but not limited to age or diet; and because of regulatory considerations regarding milk and meat withholding times in animals intended as human food. The manufacturer's recommendations should be checked before administering any drug, and the effect on withholding time of varying from the manufacturer's recommendation regarding dosing should be considered. Local regulations regarding use of drugs in animals that could be used for human food should be consulted.

Doses are given in milligrams per kilogram body weight (mg/kg) unless otherwise stated (g = gram, IU = international units). Drugs given as total doses, such as intramammary preparations, are denoted by TD. Dosing interval is given in hours, unless otherwise stated, or unless given as a single dose (SD). The route of administration is indicated as follows: intravenous (IV), intramuscular (IM), oral (PO), subcutaneous (SC), intraarticular (IA), intramammary (IMM), intraperitoneal (IP), inhalation (IH), per rectum (PR), topically (TO), or subconjunctivally (IO). Drugs recommended not to be given to certain species are indicated by NR.

Drug	HORSES			RUMINANTS (CATTLE, SHEEP, GOATS)		
	Dose (mg/kg)	Interval (h)	Route	Dose (mg/kg)	Interval (h)	Route
Acepromazine maleate	0.044–0.088	SD	IM, IV, SC	0.01–0.02 0.03–0.1	SD SD	IV IM
Acetazolamide	2.2	6–12	PO			
Acetylcysteine	8 g, TD (for (retained meconium in foal)	SD	PR			
Acetylsalicylic acid (aspirin)	10–20	48	PO	50–100	12	PO
Acyclovir	10 20	12 8	IV as 1-h infusion (foal) PO (adult)			
Adrenaline; see Epinephrine						
Albendazole	25–50	SD-12	PO	10 7.5	SD SD	PO (cattle, goat) PO (sheep)
Albuterol	0.001–0.008	4–8	IH			
Altrenogest	0.044	24	PO			
Aluminum hydroxide	60	6–8	PO	15–60	SD, 8–24	PO
Amantadine hydrochloride	5	4	IV			
Amikacin sulfate	22 (foals) 10 (adults)	24 24	IV, IM IV, IM	NR		
Aminocaproic acid	40 10–20	SD 6	IV IV			
Amiodarone	Intravenous infusion of 5 mg/kg/h for 1 h, then 0.8 mg/kg/h for 23 h, then 1.9 mg/kg/h; for atrial fibrillation					
Aminopropazine fumarate	0.5	SD	IM, IV			
Amitraz	NR			Goats: 11 mL of 19.9% solution diluted in 7.5 liters		Topical
Ammonium chloride	60–520	24	PO	50–200	12–24	PO
Ammonium molybdate				50–200 TD	24	PO
Ammonium tetrathiomolybdate				1.7–3.4	48	IV; SC (3 treatments)
Amoxicillin sodium	11–50	6–8	IM, IV	22	12	SC
Amoxicillin/potassium clavulanate	15–25	6–8	IV			

Drug	HORSES			RUMINANTS (CATTLE, SHEEP, GOATS)		
	Dose (mg/kg)	Interval (h)	Route	Dose (mg/kg)	Interval (h)	Route
Amoxicillin trihydrate	6–22 NR	6–12	IM	11–22	12–24	SC
Amphotericin B	0.3–0.6	24–48	IV (dilute, slow)			
Ampicillin sodium	10–50	6–8	IM, IV	22	12	SC, IV
Ampicillin trihydrate	10–22 NR	6–8	IM, PO	4–22	12–24	IM, SC
Amprolium hydrochloride	NR			5–10 (calves), 15 (lambs), 50 (kids)	24	PO PO
Apramycin sulfate				20–40 (calves)	24	PO
Ascorbic acid (vitamin C)	30 1000–2000	12–24, SD 24	IV PO (red maple poisoning)	3 g TD (calves)	SD	SC
Aspirin (see Acetylsalicylic acid)						
Atipamezole	0.05–0.1	SD	IV	0.02–0.1	SD	IV
Atracurium besylate	0.15 then 0.06–0.2	SD or to effect	IV	0.5 then 0.2 to effect (sheep)	SD or to effect	IV
Atropine sulfate	0.001–0.003 (bronchodilation) 0.22 (organophosphate toxicity)	SD As needed	IV IV, IM, SC	0.06–0.12 (pre-anesthetic) 0.5 (organophosphate toxicity)	SD 4	IV, IM, SC IV, IM, SC
Aurothioglucose	1	7d	IM			
Azathioprine	2–5 loading dose then every 24 h		PO			
Azlocillin	25–75	6–12	IV			
Azithromycin	10	24 h for 5 days then q48 h	PO			
Bacampicillin sodium	20	12	PO			
BAL (British anti-Lewisite); see Dimercaprol.						
Baqueloprim/sulfadimidine				40–80	48	PO
Beclomethasone	0.001–0.003	12	IH			
Benzotropine mesylate	0.018	8	IV			
Betamethasone	0.02–0.1	24	IM, PO			
Bethanechol chloride	0.05–0.75	SD, 8	SC, IV	0.07	8	SC
Bismuth subsalicylate	0.5 mL/kg	4–6	PO	60–90 mL, TD (calves)	6–12	PO
Boldenone undecylenate	1.1	3 weeks	IM			
Bretylum	5–10	10 min until conversion	IV			
Bromhexine hydrochloride	0.1–0.25	24	IM, PO	0.2–0.5	24	IM, PO
Bromide, potassium	20–40	24	PO			
Bromocriptine mesylate	0.01	12	IM			
Buprenorphine hydrochloride	0.004–0.006	SD	IV			
Buscopan®; see Hyoscine						
Buserelin	0.04	SD	IM, IV, SC	0.02	SD	IM, IV, SC
Butorphanol tartrate	0.02–0.1	SD, 3–4	IV, IM	0.02–0.04	SD	IV, IM
Calcium EDTA	35	12	IV slow			
Calcium gluconate	150–250	SD	IV (slow, to effect)	150–250	SD	IV (slow, to effect), SC, IP
Cambendazole	20	SD	PO			
Carbenicillin sodium	50–100 6 g, TD	6–12 SD	IV Uterus			
Carprofen	0.7	24	IV	1.4 (cattle)	SD	IV, SC
Casein (iodinated)	0.01	24	PO			
Cefamandole	10–30	4–8	IV, IM			
Cefazolin sodium	25 (adults) 15–20 (foals)	6–8 8–12	IV, IM IV			

Continued

Drug	HORSES			RUMINANTS (CATTLE, SHEEP, GOATS)		
	Dose (mg/kg)	Interval (h)	Route	Dose (mg/kg)	Interval (h)	Route
Cefoperazone sodium	30–50	6–8	IV, IM	250 TD	SD	IMM
Cefotaxime sodium	20–30	6–8	IV			
Cefoxitin sodium	20	4–6	IV			
Cefpodoxime proxetil	10–12	8–12	PO (foals)			
Ceftiofur crystalline free acid	6.6 mg/kg IM, 2 doses given 4 days apart			6.6	SD	SC into posterior aspect of ear
				1.1–2.2	24	IM, SC (3–5 days)
Ceftiofur hydrochloride				125 mg TD	24	IMM
				500 mg TD (dry cow)	SD	IMM
Ceftiofur sodium	2.2–4.4	24	IV, IM	1.1–2.2	24	IM, IV
Ceftriaxone sodium	25–50	12	IV, IM			
Cefuroxime				250 mg TD	12	IMM
				40	12	IM (goats)
Cephacetrile sodium				250	SD	IMM
Cephalexin	25–33	6	PO			
Cephalothin sodium	10–30	6	IM, IV	55	6	SC
Cephapirin sodium	20–30	8–12	IM, IV	200 TD	12	IMM
	50	8–12	PO			
Cephapirin benzathine				300, TD	SD	IMM
Charcoal (activated)	750 g (adults)	8–12	PO	1–3 g	8–12	PO
Chloral hydrate	20–200	SD	IV			
	40–100	6–12	PO			
Chloramphenicol palmitate	25–50	6–8	PO	NR		
Chloramphenicol sodium succinate	20–60	6–8	IV, IM	NR		
Chlorpromazine hydrochloride	NR			0.22–1.0 (cattle)	SD	IM
				0.6–4.4 (sheep and goats)	SD	IM
Chlortetracycline				6–10	24	IM, IV
				10–20	24	PO
Chorionic gonadotropin (HCG)	1000–3000	SD	IM, IV, SC	2500–5000 IU, TD	SD	IV
	U, TD			(cattle)		
				10,000 IU, TD (cattle)	SD	IM
				250–1000 IU, TD	SD	IV, IM
Cimetidine hydrochloride	6.6	4–6	IV	8–16	8	IV
	18	8	PO	50–100	8	PO (calves)
Cisapride	0.1	8–12	IV	NR		
	0.5–1.0	8–12	PO			
Clarithromycin	7.5	12	PO (foals)			
Clenbuterol	0.0008–0.0032 (0.8–3.2 µg/kg)	12	PO			
	0.0008	12	IV			
Clioquinol	0.02	12–24	PO			
Cloprostenol sodium	0.1, TD	SD	IM	0.5, TD (cattle)	SD	IM
				0.06–0.13 TD (goats and sheep)	SD	IM
Closantel				10 (sheep)	SD	PO
Clorsulon				7	SD	PO
Cloxacillin, benzathine				500, TD	SD	IMM
Cloxacillin, sodium	10–30	6	IM, IV	200, TD	12	IMM
Colistin	2500 IU	6	IV (slow)			
Colony stimulating factor (granulocyte)	0.005	24	IV			
Cromolyn sodium	80–300, TD	24	IH			



Drug	HORSES			RUMINANTS (CATTLE, SHEEP, GOATS)		
	Dose (mg/kg)	Interval (h)	Route	Dose (mg/kg)	Interval (h)	Route
Cyclophosphamide	2.0	3 weeks	IV			
Cyproheptadine hydrochloride	0.25–1.2	12–24	PO			
Dalteparin sodium	50 U	12	SC			
Danofloxacin				8 6	SD 48	SC SC (only repeat once)
Dantrolene sodium	2 2–10	6 24	IV PO			
Decoquinat				0.5	24	PO
Dembrexine hydrochloride	0.3	12	PO			
Deferoxamine mesylate	10	SD	IM, IV	10	SD	IM, IV
Detomidine hydrochloride	0.005–0.08	SD, 2–4	IV, IM	0.002–0.02	SD	IV, IM
Dexamethasone	0.01–0.2 (anti-inflammatory) 0.5–2 (shock)	24 SD	IV, IM, PO IV, IM	20–30 TD (cattle, induction of parturition) 0.02–2 (cattle, anti-inflammatory dose) 5–20, TD (cattle, ketosis)	SD 24 SD, 24	IM IV, IM IM
Dexamethasone sodium phosphate; see Dexamethasone						
Dexamethasone 21-isonicotinate; see Dexamethasone						
Diazepam	0.05–0.4 0.5	SD SD	IV IM	0.4 (calves)	SD	IV
Dichlorvos	35	SD	PO			
Diclofenac of 1% cream	12.5 cm strip	12	TO			
Dicloxacillin sodium	10	6	IM			
Diethylcarbamazine hydrochloride				22	24	IM
Digoxin	0.002 0.01–0.02	12 12–24	IV PO	0.022 loading dose then 0.0034	 4	IV IV
Dihydrostreptomycin	11	12	IM, SC	11	12	IM, SC
Dimercaprol	5 then 3 then 1	SD 6 for 4 doses, then 6 for 8 doses	IM	3	4 for 2 days, then 6 for 1 day, then 12 for 10 days	IM
Dimethyl glycine	1–2	24	PO			
Dimethyl sulfoxide (DMSO)	0.5–2 100 g, TD	12–24 12–24	IV (as 10% solution, slowly), PO topical	NR		
Dimophebunine hydrochloride				1.0–1.5 g TD (cattle) 150–250, TD (sheep)	SD SD	IM IM
Dinoprost tromethamine	0.002–0.01	SD	IM	25 TD (cattle, estrus induction) 25 TD (cattle, abortifacient) 8 TD (ewe, estrus induction) 8 TD (doe, estrus induction 10–15 TD (ewe, abortifacient) 5–10 TD (doe, abortifacient)	10–12 days SD days 5 and 11 of cycle days 4 and 11 of cycle <60 days pregnancy entire pregnancy	IM IM IM IM IM

Continued

Drug	HORSES			RUMINANTS (CATTLE, SHEEP, GOATS)		
	Dose (mg/kg)	Interval (h)	Route	Dose (mg/kg)	Interval (h)	Route
Diocetyl sodium sulfosuccinate (DSS)	10–20	48 (limit 2 doses)	PO			
Diphenhydramine hydrochloride	0.5–1	6–8	IV, IM	0.5–1.0	6–8	IV, IM
Diprenorphine	0.03 (horses) 0.015 (donkeys)	SD	IV	0.03 (cattle) 0.015 (sheep)	SD	IV
Dipyrene	11–22	SD, 8	IV, IM	50	SD	IM, IV, SC
Dobutamine hydrochloride	1–10 µg/kg/min	Infusion	IV			
Docosate; see Diocetyl sodium sulfosuccinate						
Domperidone	0.2 1.1	SD, 12 24	IV PO			
Dopamine hydrochloride	1–10 µg/kg/min	Infusion	IV	2–10 µg/kg/min	Infusion	IV
Doramectin				0.2	SD	IM, SC
Doxapram hydrochloride	0.02–1	SD	IV	5–10	SD	IV
Doxycycline	10	12	PO (do not use IV)			
Doxylamine succinate	0.55	8	IM, SC, IV (slow)	0.5	12	PO, IM, SC
Edetate calcium disodium (EDTA)	75	24	IV (slow, dilute)	67	12	IV (slow)
Edrophonium chloride	0.1–0.5	SD	IV (slow)	0.5–1.0	SD	IV
Enrofloxacin	5 7.5	12 24	PO PO	7.5–12.5 2.5–5.0	SD 24	SC SC (3–5 days)
Ephedrine sulfate	0.7	12	PO			
Epinephrine (1 mg/mL)	0.01–0.02 mL/kg	SD	IM, SC	0.01–0.02 mL	SD	IM, SC
Epinephrine (1 mg/mL)	0.1–0.2 mL/kg	SD	IM, SC	0.1–0.2 mL	SD	IV
Eprinomectin				0.5 mg/kg 1	SD SD	Topical SC
Erythromycin base	0.1 (for ileus)	infusion per hour	IV	2.2–15	12–24	IM
Erythromycin estolate, ethylsuccinate	25–37.5	6–12	PO	300 TD 600 TD (dry cows)	12	IMM
Erythromycin				300 TD (lactating cows)	SD 12	IMM IMM
Estradiol (estrus induction)	5–10 TD	SD	IM	NR		
Estrone sulfate	0.04	12	IM			
Famotidine	1.9–2.8 0.2–0.4	8–12 8–12	PO IV			
Febantel	6	SD	PO	5–10	SD	PO
Fenbendazole	5 (adults) 10 (foals)	SD SD	PO PO	5	SD	PO
Fenoterol	2–4	6–12	IH			
Fenprostalene	0.001	SD	IM	0.002	SD	SC
Fentanyl (transdermal)	10, more commonly called "100 mcg/hr" patches per 400 kg					
Ferrous sulfate	10–20	24	PO	10–30	24	PO
Florfenicol				20 40	48 SD	IM (repeat once) IM
Fluconazole	4–5	24	PO			
Flumazenil	0.01–0.02	SD	IV (slow)			
Flumethasone	0.002–0.008	SD	IM, IV, IA			
Flunixin meglumine	0.25–1.1	6–24	IV, IM, PO	1.1–2.2	12–24	IV
Fluoroprednisolone acetate	0.01–0.04	SD	IM			

Drug	HORSES			RUMINANTS (CATTLE, SHEEP, GOATS)		
	Dose (mg/kg)	Interval (h)	Route	Dose (mg/kg)	Interval (h)	Route
Fluprostenol	0.55 µg	SD	IM			
Fluticasone	2–4 µg/kg	6–12	IH			
Folic acid	40–75 mg TD	SD	PO			
Folinic acid	50–100 TD	SD, 24	PO			
Follicle stimulating hormone	10–50TD	SD	IV, IM, SC	5TD	12	IM, SC
Framycetin sulfate				5 10 (calves)	12 24	IM PO
Frusemide; see Furosemide						
Furosemide	0.25–3	SD	IV, IM	0.5 or 1	12–24	IV, IM (adult cattle)
Gallamine triethiodide	1 then increments of 0.2	SD	IV	0.5 then 0.1 to effect (cattle) 0.4 (sheep)	SD SD	IV IV
Gamithromycin				6	SD	SC
Gentamicin sulfate	2.2 6.6	8 24	IV, IM IV, IM	NR		
Glauber's salts; see Sodium sulfate						
Glycerol				180 mL TD (cattle) 90 mL TD (sheep)	12 12	PO PO
Glycerol guaiacolate ether; see Guaifenesin	110	SD	IV			
Glycopyrrolate	0.001–0.01	SD, 12–24	IV, IM			
Glycopyrronium bromide; see Glycopyrrolate						
Gonadorelin				100 µg TD	SD	IM
Glycosaminoglycan, polysulfated	250 TD 1	SD, 7 days 5 days	1A IM			
Griseofulvin	5–10	24	PO	10–20	24	PO
Guaifenesin	110, give first one third to cause recumbency	SD	IV	66–130	SD	IV
Hemoglobin (bovine, polymerized)	10–30 mL/kg	SD	IV			
Heparin	25–125 IU/kg	6–12	SC, IV			
Hyaluronate sodium	10–50 mg TD	SD	IA			
Hydralazine	0.5–1.5	12	PO			
Hydrochlorothiazide	0.5	24	PO	0.25–0.5	12–24	IV, IM
Hydroxyethyl starch colloids (Hetastarch)	10 mL/kg	SD	IV slow			
Hydroxyzine	0.5–1.0	12	IM, PO			
hydrochloride or pamoate						
Hyoscine (butylbromide)	0.3	SD	IV (slow)			
Imipenem cilastatin sodium	15–20	4–6	IV			
Imidocarb dipropionate	2–4 4.4	SD 72	IM IM (total of 4 treatments)	1.2	SD	SC
Imipramine	0.55–1.5	8	IM, IV, PO			
Insulin, protamine zinc suspension	0.15 u	12	IM, SC	200 IU	TD	SC
Iodide sodium	20–40	24	IV, PO	66	SD	IM (repeat once at 7 days)
Iodochlorhydroxyquin	20	24	PO			

Continued



Drug	HORSES			RUMINANTS (CATTLE, SHEEP, GOATS)		
	Dose (mg/kg)	Interval (h)	Route	Dose (mg/kg)	Interval (h)	Route
Ipratropium	2–3 µg/kg (foal)	6–8	IH			
Iron cacodylate	2	SD	IV			
Isoflupredone acetate	5–20 mg TD	SD	IM	10–20 mg TD	SD	IM
Isoniazid	5–20	24	PO	11–25	24	PO
Isosuprine hydrochloride	0.4–1.2	8–12	PO			
Itraconazole	3–5	12–24	PO			
Ivermectin	0.2	SD	PO	0.2	SD	SC, PO
Kaolin pectate	2–4 mL/kg	8–12	PO	0.25–1 mL/kg	4	PO
Ketamine hydrochloride (after appropriate premedication)	1.1–2.2	SD	IV	2 4	SD SD	IV IM
Ketoconazole	5–30	12–24	PO			
Ketoprofen	2.2	24	IM, IV	2–4	24	IM, IV
Ketorolac tromethamine	0.5	SD	IV	0.3–0.7 (goats)	8	IM, IV, SC, PO
Lactulose	120–300	12	PO			
Lasalocid				1	24	PO
Levamisole	8–11	24	PO	5.5–11 3.3–8	SD SD	PO SC
Levothyroxine	0.02	24	PO			
Lidocaine	1.3 mg/kg as bolus then 0.05 mg/kg/ min	Infusion	IV			
Lincomycin hydrochloride	NR			5–10	12–24	IM
Loperamide	0.1–0.2	6	PO			
Lufenuron	5–20	24	PO			
Luprostiol	7.5 TD	SD	IM	7.5–15 TD (cattle)	SD	IM
Magnesium hydroxide	0.5 mL	8	PO	400–450 g, TD (cattle) 10–30 g, TD (sheep)	8–24 8–24	PO PO
Magnesium oxide				1000–2000	SD	PO
Magnesium sulfate	0.2–1.0 2.2–6 (for ventricular tachycardia)  50 mg/kg/h for 1 h then 25 mg/kg/h as CRI (for presumed neonatal hypoxic encephalopathy)	24 1 min	PO IV boluses every minute until conversion or total dose of 60 mg/kg	0.1 0.02	SD SD (with calcium gluconate)	SC IV (slow)
Mannitol	0.25–2.0 g/kg	SD	IV (slow)	1–3 g/kg	SD	IV
Marbofloxacin				2	24	IM, IV, SC
Mebendazole	8.8–20	SD	PO			
Meclofenamic acid	2.2	12–24	PO			
Meloxicam	0.6	24	IV, PO	0.5 0.5–1.0	SD 24–48	IV, SC PO
Meperidine	1–2 0.2–0.4	SD SD	IM IV (slow)	3–4	SD	IM, SC

Drug	HORSES			RUMINANTS (CATTLE, SHEEP, GOATS)		
	Dose (mg/kg)	Interval (h)	Route	Dose (mg/kg)	Interval (h)	Route
Methadone hydrochloride	0.05–0.2	SD	IV, IM			
Methicillin	25	4–6	IV			
Methionine-DL	20–50	24	PO	50	24	PO
Methocarbamol	5–55	6	IV	110	SD	IV
	40–60	24	PO			
Methylene blue	NR			4–15	SD, 6	IV
Methylprednisolone or methylprednisolone sodium succinate (shock)	0.5–1.0	24	PO			
	0.5–1.0	24	IV			
	10–20	SD	IV			
Methylprednisolone acetate	0.2	SD, as necessary	IM			
	0.1	SD	IV			
			IV			
Metoclopramide	0.02–0.25	6–8	IV	NR		
Metronidazole	15–25	8–12	IV, PO			
Mezlocillin	25–75	6	IV			
Midazolam hydrochloride	0.011–0.044	SD	IV			
Mineral oil	10 mL/kg (adults)	SD, 12	PO	8 mL/kg	SD	PO
Minocycline	3	12	PO			
Misoprostol	1–4 µg/kg	8–12	PO			
Monensin				1	24	PO
Morantel tartrate				8–10	SD	PO
Morphine sulfate	0.1–0.7	SD	IM, IV (slow)	1–10 mg TD (sheep and goats)	SD	IM
Moxalactam	50	8	IM, IV			
Moxidectin	0.4	SD	PO	0.2 (cattle) 0.5 (cattle) 0.2 (sheep) 0.2–0.5 (goat)	SD SD SD SD	SC, PO Topical PO PO, SC
Nafcillin	10	6	IM			
Naloxone	0.01–0.05	SD	IV			
Naproxen	5–10	12–24	PO			
Neomycin	2–6	6–12	PO	3–6	6–12	PO
	4.4	8–12	IV	88	8	SC
Neostigmine	0.004–0.02	SD, 6	SC	0.02	SD	SC
Netilmicin	2	8–12	IV, IM			
Netobimin				7.5	SD	PO
Niclosamide	100	SD	PO			
Nizatidine	6.6	8	PO			
Nitazoxanide	25 for days	24	PO			
	1–5, then 50 for days 6–28					
Nitrofurantoin	2.5–5	8	PO			
Nitroglycerin	15 TD	24	Topical over each digital artery			
Nitroxinil				10–15	SD	SC
Norepinephrine	0.1–1.5 µg/kg/min	SD	IM			
Novobiocin (dry cow)				400 TD 150 TD (lactating cow)	SD 24	IMM IMM
Nystatin	250,000–1,000,000	SD	IU			
Omeprazole	1–4	24	PO			
Oxacillin	25–50	8–12	IM, IV			

Continued

Drug	HORSES			RUMINANTS (CATTLE, SHEEP, GOATS)		
	Dose (mg/kg)	Interval (h)	Route	Dose (mg/kg)	Interval (h)	Route
Oxfendazole	10	SD	PO	4.5	SD	PO
Oxibendazole	10–15	SD	PO	10–20	SD	PO
Oxyclozanide				10–15	SD	PO
Oxymorphone	0.01–0.02	SD	IM, IV			
Oxytetracycline	6.6–10 10–20 (foals)	24 24	IV (slow) IV (slow)	5–20	12–24	IV, IM
Oxytocin	0.05–0.1 (induction of foaling) 0.01–0.02 (retained placenta)	SD 1–1.5	IM IM	0.05–0.1 (retained placenta) 0.025–0.05 (milk letdown)	1–1.5 SD	IM IV
Pancuronium	0.04–0.066	SD	IV	0.04 then 0.008 (cattle) 0.025 then 0.005 (sheep)	SD SD	IV IV
Pantoprazole	1.5	24	IV or PO			
Paromomycin	100	24	PO			
Penicillamine	3–4	6	PO	52	24	PO
Penicillin G, benzathine	10,000–40,000 IU	48–72	IM	44,000–66,000 IU/kg	48–72	IM, SC
Penicillin G, procaine	20,000–50,000 IU	12–24	IM	10,000–60,000 IU/kg	12–24	IM, SC
Penicillin G, sodium or potassium	10,000–50,000 IU	6–8	IV, IM			
Penicillin V, potassium	66,000–110,000	6–8	PO			
Pentazocine	0.33	SD	IV, IM, SC			
Pentobarbital	2–20 (to effect) 120–200 FOR EUTHANASIA	SD SD	IV IV	30 (to effect) 120–200 FOR EUTHANASIA	SD SD	IV IV
Pentobarbitone; see Pentobarbital						
Pentosan sulfate	250 mg (TD) 3 mg/kg	7 days 7 days	IA IM			
Pentoxifylline	10	12	PO			
Pergolide	0.002–0.004	24	PO			
Perphenazine	0.3–0.5	12	PO			
Pethidine; see Meperidine						
Phenobarbital	5–25 1–5	SD, 8 12	IV PO	10	24	PO
Phenothiazine	55	SD	PO			
Phenoxybenzamine hydrochloride	0.6 0.6–1.2	6–8 12	IV PO			
Phenylbutazone	2–4.4	12–24	PO, IV	4 10–20 (loading dose) then 5–10	24 24–48	IV PO
Phenylephrine	0.02–0.04 hydrochloride	SD	IV (over 10 min)			
Phenytoin sodium	5–10 then 1–5 (for seizures) 10–12 (for rhabdomyolysis) 10–22 (for arrhythmias)	SD 4–8 12 12	IV IV, IM, PO PO IV (slow), IM			
Physostigmine	0.1–0.6	SD	IM, IV			
Phytonadione (vitamin K <sub>1</sub> )	0.5–2.5	SD, 4–6	IV (slow)	0.5–2.5	SD, 8	IV (slow), IM
Piperazine	110–200	SD	PO			
Piperacillin	15–50	6–12	IV, IM			
Pirbuterol	0.001–0.002	12–24	IH			
Pirlimycin				50 TD	12–24	IMM
Pivampicillin sodium	20	12	PO			



Drug	HORSES			RUMINANTS (CATTLE, SHEEP, GOATS)		
	Dose (mg/kg)	Interval (h)	Route	Dose (mg/kg)	Interval (h)	Route
Poloxalene				110 mg/kg	24	PO
Polysulfated glycosaminoglycan	0.5	96	IM			
	0.25	96	IA			
Polymyxin B	6000	SD	IV	6000	SD	IV
Ponazuril	5	24	PO			
Potassium bromide	20–40	24	PO			
Potassium iodide	4–40	24	PO	1.5	24	IV
Potentiated sulfonamide; see Sulfonamide/trimethoprim						
Pralidoxime chloride	20–50	4–6	IV	25–50	SD, 6	IV (slow)
Praziquantel	1–2	SD	PO	10–15	SD	PO
Prednisolone	0.2–4.4	12–24	IM, PO	1–4	SD, 24	IV
Prednisolone sodium succinate	50–100 mg (adult)	SD	IV			
Primidone	10–20	6–12	PO			
Procainamide	0.5 to total dose of 4	10 min	IV			
Progesterone	0.3–0.6	24	IM			
Promazine	0.25–1	SD	IV			
	1–2	SD	PO			
Propafenone	0.5–1.0	SD	IV			
Propantheline bromide	0.014	SD	IV			
Propofol	2.4 (induction) 0.3 (maintenance)	Infusion	IV			
Propranolol	0.03–0.15	8	IV			
	0.4–0.8	8	PO			
Propylene glycol				110–225 mL TD (cattle)	24	PO
				110 mL TD (sheep)	24	PO
Protamine sulfate				0.2	SD	IV
Prostaglandin F2 $\alpha$	0.02	SD	IM			
Psyllium mucilloid	500	12–24	PO			
Pyrantel pamoate	6.6	SD	PO	25	SD	PO
Pyrantel tartrate	2.6	SD	PO			
Pyrilamine maleate	0.8–1.3	6–12	IV (slowly), IM, SC	0.55	SD	IV, IM
Pyrimethamine	1–2	24	PO			
Quinidine, gluconate	22	2–4	PO	50	Over 4 hours	IV
	0.5–2.2	10 min until conversion to sinus rhythm or suppression of arrhythmia	IV	210 loading dose then 180	6	PO
Ranitidine hydrochloride	6.6	6–12	PO	50 (calves)	8	PO
	1.5	6–12	IV			
Reserpine	0.002–0.008	24	PO			
Rifampin	5–10	12	PO			
Romifidine	0.04–0.12	SD	IV (slowly), IM			
Salmeterol	0.0005–0.001	6–12	IH			
Scopolamine hydrobromide	See Hyoscine					
Selenium	See text (pp. 15–105 to 15–110)					
Sodium acid phosphate				60 g in 300 mL water IV and SC every 24 h for adult cattle		

Continued

Drug	HORSES			RUMINANTS (CATTLE, SHEEP, GOATS)		
	Dose (mg/kg)	Interval (h)	Route	Dose (mg/kg)	Interval (h)	Route
Sodium chloride (hypertonic, 7.0%)	4 mL	SD	IV	4 mL	SD	IV
Sodium sulfate	1–2	SD, 24	PO	1–2	SD	PO
Sodium thiosulfate	30–40	SD	IV	660 (cyanide poisoning) 1 (copper poisoning)	SD 24	IV PO
Spectinomycin	20	8	IM	10–15	24	SC
Stanozolol	0.55	168	IM	2	SD	IM
Streptomycin	11	12	IM, SC	11	12	IM, SC
Succinylcholine chloride	0.09–0.11	Sd	IV			
Sucralfate	10–20	6–12	PO			
Sulfachloropyridazine				88–110 30–50 (calves)	12–24 8	IV PO
Sulfadimethoxine	55 then 28	24	IV	55–110 55 then 28	24 24	PO IV
Sulfadimidine				100–200 loading dose then 50–100	SD 24	IV
Sulfadoxine/trimethoprim	15	12–24	IM, IV (slow)	15	12–24	IM, SC, IV
Sulfamethoxyipyridazine				20	24	SC, IM, IV, IP
Sulfonamide/trimethoprim	15–30	12–24	PO, IV, IM	15–30 15–30 (pre-ruminant calves)	12–24 12–24	IM, IV PO
Suxamethonium chloride	0.1	SD	IV	0.02	SD	IV
Terbutaline sulfate	0.02–0.06 0.002	6–12 SD	PO IV			
Tetanus antitoxin	3 IU (tetanus prophylaxis) 100 IU (treatment of tetanus)	SD 72–120	IM, IV, SC IM, IV, SC			
Tetracycline; see oxytetracycline hydrochloride						
Theophylline	8–12	8–12	PO			
Thiabendazole	44	SD	PO	50–100	SD	PO
Thiamine hydrochloride (vitamin B <sub>1</sub> )	0.5–5	SD	IV, IM, PO	5–50	12	IV, IM
Thiamylal sodium	2–4	SD	IV (to effect)	4.4–8.8	SD	IV
Thiopental	6–12	SD	IV	8–16	SD	IV
Thiophanate				2.4–4.8 g, TD (cattle) 240–480 mg, TD (sheep)	SD SD	PO PO
Thyroxine L	0.01	24	PO			
Ticarcillin (with or without clavulanate)	50	6–8	IV, IM			
Tildipirosin				4	SD	SC
Tiletamine hydrochloride with zolazepam hydrochloride	1.6–2.2	SD	IV			
Tilmicosin				10	72	SC
Tobramycin	4 mg/kg every 24 hours IV, IM					
Tocopherol acetate (vitamin E)	10–15 IU	24	PO			
Tolazoline	4	SD	IV slowly			
Trenbolone acetate				140–200 TD	SD	SC
Triamcinolone acetonide	0.1–0.2 6–18 TD	SD SD	IM, SC IA	0.02–0.04	SD	IM
Trichlorphon	35–40	SD	PO			
Triclabendazole				12	8–10 weeks	PO

Drug	HORSES			RUMINANTS (CATTLE, SHEEP, GOATS)		
	Dose (mg/kg)	Interval (h)	Route	Dose (mg/kg)	Interval (h)	Route
Trilostane	0.4–1.0	24	PO			
Tripelennamine hydrochloride	1.1	6–12	IM	1.1	6–12	IV, IM
Tubocurarine chloride	0.3 then 0.05	SD	IV	0.06 then 0.01 (cattle) 0.04 then 0.01 (sheep)	SD, to effect  SD, to effect	IV  IV
Tulathromycin				2.5	SD	SC
Tylosin	NR			18	24	IM
Vancomycin	7.5	8	IV			
Verapamil	0.025–0.5	SD	IV (slow)			
Vecuronium bromide	0.1 then 0.02	SD, to effect	IV	0.04 then 0.01 (sheep)	SD to effect	IV
Vitamin B <sub>1</sub> ; see Thiamine				See text		
Vitamin C; see Ascorbic acid						
Vitamin E; see Tocopherol acetate						
Vitamin E micellated (water soluble)	6–10 IU	24	PO			
Vitamin K <sub>1</sub> ; see Phytonadione						
Warfarin sodium	0.02 then slowly increasing to effect	24	PO			
Xylazine hydrochloride	1.1 2.2	SD SD	IV IM	0.01–0.05 0.02–0.10	SD SD	IV IM
Yohimbine hydrochloride	0.05–0.2	SD	IV slowly, IM	0.125	SD	IV
Zeranol				36–72 TD	SD	SC

Sources: Bishop Y. The veterinary formulary, 6th ed. London: The Pharmaceutical Press, 2005; Plumb DC. Plumb's veterinary drug handbook, 8th ed., John Wiley & Sons, Inc. 2015; other sources.



## Drug doses and intervals for pigs

Suggested drug doses and intervals for pigs and concentrations of medicaments in feed are given here. Dosages listed are general recommendations and may not be optimal or efficacious in all instances and may need to be adjusted depending on the disease and its severity, patient factors such as age or diet, and because of regulatory considerations regarding milk and meat withholding times in food animals. The manufacturer's recommendations should be checked before administering any drug, and the effect on withholding time of varying from the manufacturer's recommendation regarding dosing should be considered. Local regulations regarding use of drugs in animals that may be used for human food should be consulted.

Doses are given in milligrams per kilogram body weight (mg/kg) unless otherwise stated (g = gram, IU = international units). Drugs given as total doses are denoted by TD. Dosing interval is given in hours, unless otherwise stated, or unless given as a single dose (SD). The route of administration is indicated as follows: intravenous (IV), intramuscular (IM), oral (PO), subcutaneous (SC), or intraperitoneal (IP). One ton = 1016 kg.

Drug	PIGS		
	Dose (mg/kg) or (Concentration in feed or water)	Interval (h)	Route
Acepromazine maleate	0.03–0.5	SD	IM, IV, SC
Acetazolamide	6–8	SD	IV, IM, PO
Acetylsalicylic acid (aspirin)	10	4	PO
Amoxicillin trihydrate	6.6–22	8–24	IM
	6.6–22	12–24	PO
Ampicillin sodium	6–8	8	IM, SC
Ampicillin trihydrate	4.4–22	8–24	IM
Amprolium hydrochloride	25–65	12–24	PO (3–4 days)
Apramycin sulfate	10–20 (150 g/ton)	24	PO
Arsanilate, sodium	(700 mg per 4 L drinking water for 7 days)		
Aspirin; see Acetylsalicylic acid			
Atropine sulfate	0.02–0.04	SD	IM
Azaperone	1–2	SD	IM
Bacitracin zinc	(10–50 g/ton)		
Bacitracin methylene disalicylate	(250 g/ton)		
Baquiloprim/sulfadimidine	10	24	IM
Bismuth subsalicylate	2–5 mL, TD (piglets)	6–12	PO (2 days)
Bromhexine hydrochloride	0.2–0.5	24	IM, PO
Calcium gluconate	150–250	SD	IV (slow, to effect), IM, SC, IP
Carbadox	(50 g/ton)		
Ceftiofur crystalline free acid	5	SD	IM (neck)
Ceftiofur hydrochloride	3–5	24	IM (3 days)
Ceftiofur sodium	3–5	24	IM (3 days)
Chlorpromazine hydrochloride	0.6–3.3	SD	IV
	1–4	SD	IM
Chlortetracycline	10–20 (50–100 g/ton)	24	PO
Cloprostenol sodium	0.18, TD	SD	IM
Dantrolene sodium	3.5	SD	IV
Dexamethasone	0.06 (1–10, TD)	SD, 24	IM
Dexamethasone sodium phosphate see Dexamethasone			
Dexamethasone 21-isonicotinate	0.02–0.1	SD, 96	IM
Diazepam	0.55–2.0	SD	IM
Dichlorvos	17 (334–500 g/ton)	SD	PO
Dimetridazole	10–25	24	PO

Drug	PIGS		
	Dose (mg/kg) or (Concentration in feed or water)	Interval (h)	Route
Dinoprost tromethamine	15 TD then 10 TD (estrus induction); 5–10 TD (abortifacient); 10–25 TD (induce parturition)	separate doses by 12 hours SD SD	IM IM IM
Dipyrene	50	SD	IM, IV, SC
Doramectin	0.3	SD	IM, SC
Doxapram hydrochloride	5–10	SD	IV
Doxylamine succinate	0.5	8	PO, IM, SC
Edrophonium chloride	0.5–1.0	SD	IV
Enrofloxacin	7.5–12.5	SD	IM, SC
Epinephrine			
1 mg/mL	0.01–0.02 mL/kg	SD	IM, SC
1 mg/mL	0.1–0.2 mL/kg	SD	IM, SC
Erythromycin estolate, ethylsuccinate	2.2–22	24	IM
Fenbendazole	5	SD	PO
	3 (10–80 g/ton)	24	PO
Ferrous sulfate	0.5–2	24	PO
Flunixin meglumine	2.2	SD	IM
Follicle stimulating hormone	1000–1500 IU TD	SD	IM
Gallamine triethiodide	4 then 0.8 to effect	SD	IV
Griseofulvin	20	24	PO
Guaifenesin	44–88	SD	IV
Hygromycin B	(12 g/ton)		
Iron dextran	100 mg, TD (piglet)	SD	IM
Ivermectin	0.3	SD	IM
Kaolin pectate	0.2 mL/kg	4	PO
Ketamine hydrochloride (after appropriate premedication)	11	SD	IM
Levamisole	8	SD	PO
Lincomycin hydrochloride	11	24	IM
	2–10 (40–200 g/ton)	24	PO
Luprostiol	7.5 TD	SD	IM
Mannitol	1–2 g/kg	SD	IV (slow)
Marbofloxacin	2 mg/kg	24	IM
Mineral oil	2–8 mL/kg	SD	PO
Morphine sulfate	0.2–0.9	SD	IM
Moxidectin	0.4	SD	SC, PO
Neomycin sulfate	7–12	12	PO
Neostigmine	0.06	SD	IM
Oxfendazole	3 mg/kg once orally	SD	PO
Oxibendazole	15	SD	PO
Oxymorphone	0.075 (with ketamine and xylazine)	SD	IV
Oxytetracycline	2–10 / 10–30	12–24 / 12–24	IM, SC / PO
Oxytocin	0.1–0.2 (agalactia) (2–10 IU)	3–4	IM
Penicillin G, benzathine	4.5 (11000–22000 IU/kg)	48–96	IM
Penicillin G, procaine	6–20 (6000–40000 IU/kg)	12–24	IM
Pentazocine	2.0	SD	IM
Pentobarbital	30 (to effect)	SD	IV

Continued

Drug	PIGS		
	Dose (mg/kg) or (Concentration in feed or water)	Interval (h)	Route
	120–200 (for euthanasia)	SD	IV
Pentobarbitone see pentobarbital			
Phenylbutazone	4	24	PO, IV
Phytomenadione (vitamin K <sub>1</sub> )	0.5–2.5	SD	IM, IV (slow)
Piperazine	110	SD	PO
Prednisolone sodium succinate	0.2–1.0	SD, 24	IV, IM
Pyrantel pamoate	22	SD	PO
	6.6 (pot-bellied pigs)	SD	PO
Pyrantel tartrate	22 (96 g/ton)	SD	PO
Pyrilamine maleate	0.5–1.0	SD	IM
Roxarsone	182 g/ton		
Sodium arsenilate see arsenilate, sodium			
Sodium chloride (hypertonic, 7.0%)	4 mL	SD	IV
Sodium sulfate	0.25–0.5	SD	PO
Spectinomycin HCl	11	12–24	PO
	6.6–22	24	IM
Streptomycin	13	12–24	IM
Sulfachloropyridazine	44–70	24	PO
Sulfadiazine/trimethoprim	48	24	PO
Sulfadoxine/trimethoprim	15	12–24	IM
Sulfonamide/trimethoprim	15–30	24	IM, PO
Suxamethonium chloride	2	SD	IV
Tetracycline hydrochloride	10–40	12/24	PO
Thiabendazole	50–75	SD	PO
Thiamine hydrochloride (vitamin B <sub>1</sub> )	5–10 mg/kg	SD	IV, IM, PO
Thiamylal sodium	6.6–11	SD	IV
Thiopental	5.5–11	SD	IV
Tiaprost	0.3–0.6 TD	SD	IM
Tiamulin	2–10 / 10–15 (35–200 g/ton)	24 / 24	PO / IM
Tildipirosin	4	SD	IM
Tilmicosin	10–20 (180–360 g/ton)	24	PO
Tripelennamine hydrochloride	1	8–12	IV, IM
Tubocurarine chloride	0.4 then 0.08	SD, to effect	IV
Tylosin	8.8 (40–100 g/ton)	12	IM, PO
Valnemulin	1.25–10	24 / 24	PO
Virginiamycin	(25–100 g/ton)		

Sources: Bishop Y. The veterinary formulary, 6th ed. London: The Pharmaceutical Press, 2005; Cowart RP, Casteel SW. An outline of swine diseases. A handbook, 2nd ed. Iowa State University Press, 2002; Plumb DC. Plumb's veterinary drug handbook, 8th ed., John Wiley & Sons, Inc. 2015; and other sources.



# Index

Page numbers followed by “f” indicate figures, “t” indicate tables, and “b” indicate boxes.

## A

- A. fumigatus*, 650  
A23187, porcine stress syndrome, 1527  
ABC Reflection Sovereign, 706  
Abdomen  
  clinical examination of, 13, 17–18  
  abdominal pain, detection of, 451–452  
  auscultation, 17–18  
  distended rumen lavage, 445–446  
  inspection and palpation, 446  
  laparoscopy, 454–455  
  left side, 446–448  
  rectal palpation, 449, 450f  
  right side, 448  
  silhouette, 237  
  palpation, 484  
  traumatic reticuloperitonitis, 482–490, 482b–483b  
  paracentesis of, 21  
  tactile percussion of, 18  
Abdominal distension, 182–183  
Abdominal fat necrosis, 215  
Abdominal fluid  
  gastric dilatation, horses, 241  
  newborns, 239  
Abdominal pain, 18, 177, 182  
  differential diagnosis of, 182b  
  relief of, 191  
Abdominal situs inversus, 751  
Abdominal surface ripples, 446  
Abdominal ultrasonography, 184  
Abdominocentesis  
  in cattle, 190  
  in equine colic, 231  
  in horses, 189–190  
  for peritoneal fluid, 186–190  
  for peritonitis, 218–219  
  uroolithiasis and, 1147  
Abducent nerve (cranial nerve VI), assessment of, 1169  
Aberdeen Angus  
  abdominal fat necrosis, 215  
  congenital osteopetrosis, 1534  
  familial convulsions and ataxia, 1336  
Aberrant pigment metabolism, photosensitization, 1550  
Aberrant right subclavian artery, 706  
Abiotrophies, 1186  
  cerebellar, 1328–1329  
  nervous system of, inherited, 1227  
Abnormal secretion, 1913  
Abnormality  
  defining, in examination of population, 30, 31f  
  of function present, key abnormality method and, 3  
Abomasal bloat (tympany), 522–523  
Abomasal dilatation, 456t, 513  
Abomasal emptying, rate of, 149  
Abomasal impaction  
  cattle, 515–517, 515b  
  differential diagnosis in, 516b–517b  
  grunting, 516  
  in lambs, 517–518  
  mineral oil for, 517  
  roughage, 515  
  sand and, 515  
  in sheep and goats, 517–518  
  surgery for, 517  
Abomasal luminal pressure, 501  
Abomasal phytozoars, 518  
Abomasal reflux, 501  
  metabolic alkalosis and, 493  
Abomasal reflux syndrome, 492  
Abomasal sounds, 506  
Abomasal trichobezoars, 518  
Abomasal ulcer  
  acute diffuse peritonitis and, 520  
  alkalinizing agents for, 522  
  in beef calves, 519–520  
  bluetongue, 2069–2076, 2069b–2070b  
  in bulls, 519  
  in calves, hand-fed, 519  
  cattle, 518–522, 518b  
  differential diagnosis in, 521b  
  cimetidine for, 522  
  coagulants for, 522  
  dairy cattle, 519  
  fecal examination for, 520  
  feedlot cattle, 519  
  hemogram for, 521  
  kaolin and pectin for, 522  
  magnesium hydroxide for, 522  
  melena and, 521  
  milk replacer for, 520  
  ranitidine for, 522  
  surgery for, 522  
  in veal calves, 519  
Abomasal volvulus (AV), 510–515  
  beef cattle, 510  
  in calves, 510  
  dairy cattle, 510  
  hemogram for, 512  
  hypokalemia and, 119  
  serum biochemistry for, 512  
  surgery for, 514  
  urinalysis for, 512  
Abomasitis, salmonellosis, 365  
Abomasocentesis, 507  
Abomasotomy, 518  
Abomasum  
  anatomy, 501  
  clinical examination of, 500–501  
  diseases of, 500–502  
  displacement. see Left-side displacement of the abomasum (LDA); Right-side displacement of the abomasum (RDA)  
  pathophysiology, 501  
Abortion  
  African swine fever, 2115  
  anaplasmosis, 771  
  bluetongue, 2071  
  border disease and, 1255  
  bovine herpesvirus-1 infection in, 954, 956  
  brucellosis, 1765, 1777t  
  *Campylobacter fetus*, 1777t  
  *Campylobacter jejuni*, 1777t  
  caprine herpesvirus-1 infection, 2086  
  causes of, in cattle, 1788t–1790t  
  cloned offspring, 1871  
  EHV-1 or BHV-1, 39  
  encephalomyocarditis virus disease, pigs, 696  
  endemic, neosporosis, 1817–1818  
  epizootic  
    bovine, 1769  
    neosporosis and, 1818  
  equine viral arteritis, 2089  
  ergotism, 2198  
  ewes, 1777t  
horses, 1762  
hyperthermia, 52–53  
inherited congenital achondroplasia with hydrocephalus, 1532  
leptospirosis and, 1120, 1122  
*Listeria ivanovii*, 1338  
listerial, 1338  
  in goats, 1338  
mycoses, 1788t–1790t  
myeloencephalopathy and, 1285  
ovine enzootic, 1786–1791, 1786b–1787b  
plants, 1827  
prevention of spread and, 1288  
rapid diagnosis of, 1288  
Rift Valley fever, 1777t  
*Salmonella dublin*, 1785  
*Salmonella typhimurium*, 1785  
salmonellosis and, 365  
sarcocystosis and, 2139  
sporadic, neosporosis and, 1818  
tick-borne fever, 1777t  
toxoplasmosis, 2142  
transplacental infection, 58  
Abscess, 76–77  
  discharge, in strangles, 1020  
  drainage of, 78  
  facial, in cattle and goats, 77  
  inguinal, 77  
  isolation of bacteria from, 78  
  liver, 632–635, 632b–633b  
  perirectal, 77  
  perivaginal, 77  
  pituitary, 77  
  pulmonary, 894–895, 895b  
  at tooth root, in llamas, alpacas, goats and sheep, 77  
  urachal, 77  
Absorption tests, 184–186, 211  
Accommodation, performance shortfalls in, 94  
Acetated Ringer's solution, 139  
Acetylpromazine, laminitis, horse and, 1402–1403  
*Achnatherum inebrians* (drunken horse grass), 2199  
*Acholeplasma laidlawii*, 1940  
*Acholeplasma oculi*, 1991  
*Acholeplasma* spp., 1794  
Achondroplasia, 1390  
Achromotrichia, 1553  
α1-Acid glycoprotein, 56  
Acid-base imbalances, 113, 123–130  
  naturally occurring, 130–137  
Acidemia, 113, 126–128  
  clinical findings in, 128  
  etiology of, 126–127, 127f  
  pathogenesis of, 127–128  
Acidifying agents, 459  
Acidosis, in dyspnea, 849  
Acne, contagious, of horses, 1576  
*Aconitum* spp., 2196  
“Acorn” calves, 1538  
Acquired equine polyneuropathy. see Scandinavian knuckling syndrome  
Acquired hemostatic defects, hemorrhage and, 721–722  
Acquired hydrocephalus, 1182, 1182b  
Acquired immunity, defects of, 744t  
*Acremonium lolii*, 966  
Acriflavine disk assay, for *Staphylococcus aureus* mastitis, 1934

- Actinobacillosis (wooden tongue), 532–534, 532b  
 differential diagnosis of, 533b  
 treatment of, 533–534, 534b
- Actinobacillus pleuropneumonia* (APP), 1055–1064
- Actinobacillus septicemia*, in piglets, 2056–2057
- Actinomyces hyovaginalis*, 1071
- Actinomycosis (lumpy jaw), 531–532, 531b, 531f  
 differential diagnosis, 532b  
 treatment, 532, 532b
- Acupuncture  
 for head-shaking, 1226  
 for heaves, 1011  
 for pain, 83
- Acute bacterial bronchopneumonia, 889
- Acute diffuse peritonitis, 69  
 milk fever and, 1681
- Acute hemorrhage, 733t–734t
- Acute hepatitis, of horses, 639–640  
 differential diagnosis, 640b
- Acute hypokalemia, in cattle, 1690–1693, 1690b  
 erythrocyte potassium concentration in, 1692  
 milk potassium concentration in, 1692  
 necropsy findings of, 1692  
 plasma potassium concentration in, 1691–1692  
 salivary potassium concentration in, 1692  
 skeletal muscle potassium content in, 1691  
 treatment of, 1692, 1693b  
 urine potassium concentration in, 1692
- Acute icteroaemia, 780
- Acute injectable poisoning, causes of, 2182
- Acute interstitial pneumonia, of cattle, 889
- Acute intoxication, 826
- Acute leptospirosis, associated with Pomona, 1121–1122
- Acute myocardialopathy, poisons associated with, 100
- Acute nutritional myopathy, 1379
- Acute oral poisoning, causes of, 2182
- Acute phase proteins (APPs), 1807–1808
- Acute phase response, 56–57, 60–61
- Acute pulmonary emphysema, glucosinolate toxicosis and, 2203
- Acute renal ischemia, 1112
- Acute respiratory distress syndrome (ARDS), 892
- Acute undifferentiated bovine respiratory disease, 55
- Acute undifferentiated diarrhea, of newborn farm animals, 373–377, 373t–374t, 376t
- Acute vesicular disease, differentiation of, 2064t
- Acute viral encephalomyelitis, 1290–1291
- Adactyly, 1537
- Adenohypophyseal hypoplasia, 1828–1829
- Adenoviruses  
 equine, 1029  
 porcine, 341
- Adjunctive therapy  
 for enzootic pneumonia of calves, 945  
 for septic arthritis synovitis, 1417
- Adrenocorticotrophic hormone (ACTH), 1727
- Aerobes, equine pleuropneumonia, 1047
- Aerosol infection, in enzootic pneumonia of calves, 940
- Aerosolization, of antimicrobials, 871
- Aesculin, 2207–2208
- Affective state framework, and stress, 86
- Aflatoxicosis, 649–650, 649b  
 differential diagnosis, 650b
- Aflatoxins (AFs), poisoning by, 649–650
- Africa  
 African swine fever in, 2111  
 anthrax in, 2011  
 rabies in, 1239
- African buffalo (*Syncerus caffer*), 2060
- African horse sickness (AHS), 2091–2097, 2091b–2092b  
 clinical findings, 2094–2095  
 clinical pathology, 2095  
 control, 2095–2096  
 differential diagnosis, 2095b  
 economic importance, 2094  
 epidemiology, 2092–2094  
 etiology, 2092
- necropsy findings, 2095  
 occurrence, 2092–2093  
 pathogenesis, 2094  
 prevention, 2095–2096  
 reduce exposure to biting midges in, 2096  
 risk factors, 2093–2094, 2094f  
 samples for confirmation of diagnosis, 2095  
 slaughter of sick or viremic animals, 2096  
 transmission of infection, 2093  
 treatment, 2095  
 zoonotic disease and, 2094
- African swine fever (ASF), 2110–2117, 2111b  
 clinical findings, 2115  
 clinical pathology, 2115  
 control, 2116–2117  
 differential diagnosis, 2116b  
 epidemiology, 2111–2114  
 etiology, 2111  
 geographic occurrence, 2111–2112  
 immune mechanisms, 2113–2114  
 methods of transmission, 2112–2113  
 morbidity and case fatality, 2112  
 necropsy findings, 2115–2116  
 pathogenesis, 2114–2115  
 recent disease outbreak, 2112  
 risk factors, 2113  
 species affected, 2112  
 treatment, 2116  
 wild boar and, 2008
- African trypanosomiasis, 2150–2156
- Agalactia, 1990  
 contagious, in goats, 924
- Agammaglobulinemia, 755
- Agar gel double diffusion test, 797
- Agar gel immunodiffusion (AGID) test, 838  
 in Johne's disease, 559, 569  
 in ovine progressive pneumonia, 976
- Agar gel precipitation test, for classical swine fever (hog cholera), 2104
- Age  
 caseous lymphadenitis, 763–764  
 in equine herpesvirus-1 and -4 infections, 1041  
 at infection, anaplasmosis risk factors and, 772  
 at manifestations, congenital cardiac defects and, 704  
 sheep, infectious footrot in, 1442
- Agglutination tests, for *Brucella abortus*, 1766
- Aggressive behavior, 1159
- Aging process, degenerative joint disease and, 1406
- Agnathia, 433  
 inherited, 1534
- $\alpha$ -2 agonists, 83, 234
- Agriostomum vryburgi*, 614
- Aimless wandering, 1159
- Aino virus  
 epidemiology of, 1511  
 source of infection of, 1512
- Airborne pollution, in mycoplasmal pneumonia, 1072
- Airway inflammation, heaves in, 1006
- Airway mucus, in pneumonia, 887
- Airway obstruction  
 in dyspnea, 849  
 in exercise-induced pulmonary hemorrhage, 998  
 heaves in, 1006  
 in hypoxic hypoxia, 846–847
- Airway secretions  
 examination of, in exercise-induced pulmonary hemorrhage, 1000–1001  
 in pneumonia, 887
- Akabane disease, 1511b, 1513b, 1514–1515
- Akabane virus, 1378
- Alanine aminotransferase, 628
- Albendazole  
 in *Fascioloides magna*, 645  
 in fasciolosis, 644  
 for parasitic gastroenteritis in ruminants, 607  
 poisoning of, 1211
- Albinism, 1553  
 inherited, 1643
- Albumin, 628  
 as acute phase protein, 56  
 cerebrospinal fluid in, 1177  
 in dairy-herd metabolic profile testing, 1670  
 glomerular filtrate in, 1096
- Alcohol (complex plant), 2208
- Alcohol ethoxylates, 478  
 detergents, 480–481
- Alfalfa, 475, 479–480
- Alfasure, 478, 480
- Algaecides, 103
- Algal bacteremia, 2158
- Algorithm method, for diagnosis, 2–3
- Alimentary ketosis, 1709–1710
- Alimentary sojourn, 1702
- Alimentary tract  
 abomasum, diseases of, 500–502  
 bacterial and viral, diseases of, 382–384  
 buccal cavity, diseases of, 192–194  
 diseases of, 436–621  
 distension, 177  
 dysfunction  
 principles of, 176–178  
 ruminant gastrointestinal, 441–445  
 esophagus, diseases of, 196–197  
 examination of, 183, 445–457  
 abdominocentesis for peritoneal fluid. see Abdominocentesis; Peritoneal fluid  
 absorption, tests of, 184–186  
 appetite, 445  
 cattle, 445–457  
 digestion, tests of, 184–186  
 endoscopy, 184  
 exploratory laparotomy (celiotomy), 184, 453–454  
 habitus, 445  
 history, 445  
 intestinal biopsy, 190  
 liver biopsy, 190  
 medical imaging, 183–184  
 nasogastric intubation, 183  
 systemic state, 445  
 functions of, 176  
 hemorrhage, 181–182  
 hypermotility, 177, 191  
 hypomotility, 177, 191–192  
 inherited atresia, 434–435  
 inherited defects, 434–435  
 lacerations, actinomycosis, 531  
 neoplasms, 431–432  
 of nonruminants, stomach and intestines, 203–215  
 omasum, diseases of, 457–459  
 parasitic diseases of, 397–401  
 plant toxins affecting, 427–429  
 reticulum, diseases of, 457–459  
 rumen, diseases of, 457–459  
 ruminants  
 anatomy and physiology, 436–441  
 forestomach, diseases of, 436  
 intestines, diseases of, 523–528  
 signs, viral diseases characterized by, 2058–2067  
 spiking activity, 176–177  
 stasis, peritonitis, 217  
 toxic and unknown diseases, 618–620  
 toxins affecting, 421  
 treatment, principles of, 190–192
- Aliphatic acetogenin (monoglyceride), 2208
- Alkalemia, 113, 128, 129f  
 etiology and pathogenesis of, 128, 129f  
 hypokalemia and, 119–120
- Alkaline phosphatase (ALP), 628  
 for equine colic, 230–231  
 serum, osteodystrophy and, 1390
- Alkalinizing agents  
 abomasal ulcer, 522  
 carbohydrate engorgement, 469–470  
 simple indigestion, 459
- Allergic rhinitis, familial, 874–875
- Allergy, 746–747
- Alleviation, of pulmonary microvascular damage, 882
- Allium* spp., 831

- Alloimmune hemolytic anemia, of newborn,  
740–744, 740b–741b  
differential diagnosis of, 743b
- Allotriophagia, 87–89
- Aloe vera gel, 285
- Alopecia, 1552–1553, 1553b
- Alpaca  
cerebellar abiotrophy in, 1334  
tooth root abscess in, 77
- Altered hemoglobin, in dyspnea, 849
- Alternaria alternata*, 797
- Aluminum hydroxide, 522
- Aluminum salts, fluoride toxicosis and, 1510
- Aluminum toxicosis, 1506
- Alveolar capillary membranes, exercise-induced  
pulmonary hemorrhage in, 998
- Alveolar hypoxia, 693
- Alveolar inspiratory pressure, increasing, in  
exercise-induced pulmonary hemorrhage,  
1002
- Alveolar macrophages, 916
- Alveoli, flooding of, with inflammatory cells, 849
- Alveolitis  
allergic, 966  
diffuse fibrosing, 967
- Alvsborg disease, 2164
- Amantadine, for equine influenza, 1035
- Amatoxins, 2204
- American Association of Swine Practitioners, 1073
- American Miniature horses, 879–880, 880f
- Amine toxicity, 2208
- Amino acid toxicity, 2208–2209
- Amino-acetonitrile derivatives, 1211
- Aminocaproic acid, 721  
for hemorrhagic shock, 76
- Aminocyclitols, 169–170
- Aminoglycosides, 169–170
- $\delta$ -Aminolevulinic acid dehydratase (D-ALAD), in lead  
poisoning, 1207
- Aminopropionitrile, 1506
- 4-Aminopyridine toxicosis, 2179–2180
- Amitraz toxicosis, 426
- Ammonia, 106, 627–628
- Ammoniated forage, feeds, 620
- Ammonium chloride, 1144  
for milk fever, 1688
- Ammonium sulfate, in sulfur-induced  
polioencephalomalacia, 1315
- Amniotic fluid  
examination, 1841  
inhaled, 1869
- Amoxicillin  
arthritis, 1415–1416  
small intestine *Escherichia coli* overgrowth,  
1891–1892
- Amphotericin, for *Aspergillus* spp., 1046
- Amplitude, 665
- Amprolium poisoning encephalopathy,  
1315
- Amputates, 1537
- Amyloidoses, 757–761, 759f, 760b  
decreased oncotic pressure and, 128
- Analgesia  
administration routes for, 83–84  
balanced (multimodal), for pain, 83  
for pain, 81  
preemptive, 80
- Analgesics  
for equine colic, 233t  
for laminitis of horse, 1402  
narcotic, for pain, 83  
for pain, 81
- Anaphylaxis, 746–747, 749b–750b, 753  
cattle, 750, 756f  
goats, 750  
horses, 750–751  
pigs, 750  
sheep, 750  
sudden death from, 101
- Anaplasma phagocytophilum*. *see* Equine  
granulocytic anaplasmosis
- Anaplasmosis, 769–775, 773b, 777b
- Anaplastic malignant melanomas, 1641
- Anasarca, 130, 1325
- Anatoxin-a, 102
- Anatoxins, 101
- Ancillary agents, for ketosis, 1715–1716
- Ancillary diagnostic testing, for recumbent adult  
horses, 2003
- Ancillary testing, for head-shaking, 1226
- Ancillary therapy  
for *Rhodococcus equi* pneumonia, 1018  
for strangles, 1024
- Andromedotoxin, alimentary tract and, 427
- Anemia, 728b, 749, 789  
correction of, 738  
dose-dependent, and chloramphenicol, 171  
dose-independent, and chloramphenicol,  
171  
in dyspnea, 849  
exercise intolerance, 99
- Anemic hypoxia, 732–734, 847
- Anesthetic agents, local, for pain, 81–82
- Anesthetics, local, for endotoxemia, 65
- Angioedema, 1555–1556, 1556b
- Angioneurotic edema, 1555–1556, 1556b
- Angiotensin-converting enzyme inhibitors, heart  
failure and, 661–662
- Anhidrosis, 44, 1561–1562
- Anhidrotic ectodermal dysplasia, 1644
- Animal data, clinical examination and, 6
- Animal welfare, and antimicrobial therapy,  
153
- Anion gap, and naturally occurring combined  
abnormalities of free water, electrolyte,  
acid-base balance, and oncotic pressure,  
135, 135f
- Anion-gap acidosis, 1883–1884
- Anionic salts, for milk fever, 1687–1688
- Ankylosing spondylitis, lameness in pigs and,  
1419–1420
- Ankylosis of coffin joint, 1539
- Anodontia, congenital hypotrichosis and, 1644
- Anophagia, 88
- Anophthalmos, 1331
- Anoplocephala perfoliata*, infestation, 257
- Anorectal lymphadenopathy, 751
- Anorexia  
definition of, 87  
granulomatous enteritis, of horses, 282  
peritonitis, 217
- Antacids, 522
- Anthelmintic programs, strategic, for lungworm,  
964–965
- Anthelmintic toxicosis, 1202
- Anthelmintics, 1351  
choice of, 607–608  
cobalt in, 819–820  
in *Fascioloides magna*, 645  
oral selenium and, 1476  
resistance, 608, 613
- Anthraquinone, alimentary tract and, 427
- Anthrax, 2011–2015, 2011b, 2014b  
in Africa, 2011  
in Asia, 2011  
in cattle, 104  
in Europe, 2011  
horses, 2013  
immunization, 2014–2015  
in Latin America, 2011  
lymphadenopathy and, 751  
pasteur vaccines and, 2014–2015  
pigs, 2013  
sheep, 2013
- Antibacterials  
for actinomycosis, 532  
for bovine footrot, 1434–1435
- Antibiotic oxytetracycline, 812
- Antibiotics  
banned, 157  
diarrhea  
cause of, 277  
chronic undifferentiated, 281–282  
in foals, 276  
enteritis, proximal, 257  
enterohemorrhagic *Escherichia coli* control, 542  
for equine colic, 234  
for equine influenza, 1035  
in footbaths, for bovine digital dermatitis, 1440  
growth promotion and, 156  
for heaves, 1011  
for infectious footrot in sheep, 1446–1447  
laminitis, horse and, 1403  
metaphylaxis with, 158  
rectal tear, 272  
for shock, 76
- Antibodies  
bovine virus diarrhea virus, 580  
for neonatal infection, 1876–1877
- Antibody index (AI), 1177
- Anticholinergic drugs  
enteritis, 213  
for respiratory tract disease, 872
- Anticoagulant citrate dextrose (ACD) solution, for  
hemorrhagic shock, 75
- Anticoagulants, 826b, 832–834  
for endotoxemia, 66  
for hemorrhagic shock, 75  
laminitis, horse and, 1403  
rodenticide toxicosis, 829b, 834–836  
differential diagnosis of, 829b  
treatment and prophylaxis, 832b
- Antidiarrheal drugs, enteritis, 213
- Antidiuretic hormone (ADH), 1096
- Antierysipelas serum, for erysipelas in swine,  
2055–2056
- Antifoaming agents, 478–479, 481
- Antifungal agents  
for *Aspergillus* spp., 1046  
for guttural pouch empyema, 986–987
- Antigen detection  
bovine viral diarrhea and, 586–587  
epizootic hemorrhagic disease and, 784  
in ovine progressive pneumonia, 976  
of pleuropneumoniae, in pigs, 1060  
in progressive atrophic rhinitis, 1051  
in swine influenza, 1082
- Antigen immunodiffusion test (AGID), in contagious  
bovine pleuropneumonia, 928
- Antigen variation, 2152  
of surface proteins, 2034–2035
- Antigenic drift, of equine influenza, 1030
- Antigenic shift, of equine influenza, 1030
- Antihistamines, in pulmonary edema, 882
- Antiinflammatory agents  
for acute undifferentiated bovine respiratory  
disease, 911b  
for heaves, 1009–1011  
for laminitis of horse, 1402  
for mastitis, 1927  
coliform, 1952  
for pneumonic pasteurellosis, 920  
for postpartum dysgalactia syndrome, 2000  
for respiratory tract disease, 870–871  
for septic arthritis synovitis, 1417
- Antimicrobial metaphylaxis, for pneumonic  
pasteurellosis, 923
- Antimicrobial prophylaxis, for *Mycoplasma*  
pneumonia, 1069
- Antimicrobial resistance  
campylobacteriosis, in pigs, 320–321  
*Escherichia coli*, 318  
salmonellosis, 297–298, 363
- Antimicrobial sensitivity  
in acute undifferentiated bovine respiratory  
disease, 909–910  
for pleuropneumoniae, of pigs, 1061



- Antimicrobial sensitivity (*Cont'd*)  
 in pneumonia, 890  
 for pneumonic pasteurellosis, 920
- Antimicrobials, **1109, 2000**  
 absorption of, 162  
 for acute undifferentiated bovine respiratory disease, 911*b*  
 administration of, 159–162  
   ease of, 165  
   intramuscular, 159–160  
   intraperitoneal, 160  
   intrathecal injections, **1179**  
   intratracheal, 162  
   intravenous, 159  
   local, 162  
   oral, 160–162  
   parenteral, 162  
   in peritoneal cavity, 220  
   subcutaneous, 160, 160*f*  
 aerosolization of, 891  
 antagonism, 164  
 approved, 169  
 bactericidal, 165–166, 165*f*  
 bacteriostatic, 165–166, 165*f*  
 for bovine footrot, **1434**  
 for bovine herpesvirus-1 infection, 957  
 for bovine mastitis, **1921**  
   coliform, **1951**  
   indication of, **1922–1923**  
   intramammary, **1925, 1951**  
   parenteral, **1925, 1950–1951**  
   prepartum, **1928**  
   resistance, *Staphylococcus aureus*, **1934**  
   selection of, **1923–1924**  
   *Staphylococcus aureus*, **1934**  
 for bovine respiratory syncytial virus, 951  
 broad spectrum, 164  
 for bronchitis, 879  
 classification of, 169–174  
 coccidiosis, 407  
 combinations of, 164–165  
 compliance of, testing for, 168  
 for contagious bovine pleuropneumonia, 930–931  
 cost of, 165  
 deterioration of, 166  
 diarrhea  
   acute, 279–280  
   in foals, 276  
 diffusion of, barriers to, 162  
 distribution of, 162–165  
 for dry cow, **1974–1976**  
 duration of treatment with, 164  
 for endotoxemia, 64  
 enteritis, 212  
 for environmental streptococci, **1957**  
 for enzootic pneumonia of calves, 945  
 for equine pleuropneumonia, 993–995  
 for erysipelas in swine, **2055**  
 excretion of, 163  
 extralabel dose of, 167, 167*b*  
 for fever, 55  
 for guttural pouch empyema, 985  
 inhalation of, 891  
 insensitivity to, 166  
 for intestinal obstruction, 528  
 intraarticular, for septic arthritis synovitis, **1416**  
 intramammary, infusion procedure for, **1925**  
 label dose of, 167  
 for laryngitis, 879  
 leptospirosis and, **1125, 1128**  
 for localized infections, 78  
 mass medication  
   enteritis, 212  
   swine dysentery, 333  
 for meningitis, **1193**  
 mode of action of, 164*b*  
 for *Mycoplasma bovis*, 937–938  
 for newborn, **1865, 1866t**  
 osteomyelitis and, **1394**
- parenteral  
 for bovine digital dermatitis, **1439**  
 for septic arthritis synovitis, **1415–1416**
- peritonitis, 220  
 pharmacokinetic principles for usage of, 163–164  
 for pleuritis, 898  
 for pleuropneumoniae, of pigs, 1061–1062  
 for pneumonia, 890–891  
 for pneumonic pasteurellosis, 919–920  
 porcine proliferative enteropathy, 326  
 for postpartum dysgalactia syndrome, **2000**  
 practical, 153–174  
 principles of, 154–156  
 prohibited, 166*b*  
 for puerperal metritis, 69  
 recommended dose, 158–159, 167  
 relative diffusion of, **1179, 1183t**  
 residue avoidance in, 167–169  
 residue testing for, 168  
 residue violations of  
   in beef cattle, 168  
   in milk, 168  
   in swine, 168–169  
 residues in milk, **1928–1929**  
 resistance, to enterohemorrhagic *Escherichia coli*, 538  
 resistance to, 153, 156–157  
   avoidance of, 157–158  
   mechanisms of, 156  
   three Ds approach to, 158  
   variable, 154  
 for respiratory tract disease, 871  
 reticuloperitonitis, traumatic, 489  
 salmonellosis, 303–304, 369–370  
 selection of, 153, 165–174  
 for *Streptococcus suis* infection, **2049–2050**  
 swine dysentery, 331–333  
 topical, for bovine digital dermatitis, **1438–1439**  
 toxicity of, 165  
 for tracheitis, 879  
 types of, 169  
 unfavorable response to, 166
- Antipyretics, for fever, 55–56  
 Antisecretory drugs, 213  
 Antiseptics, for puerperal metritis, 70  
 Antitoxin  
   for enterotoxemia, *Clostridium perfringens* type D associated, **1232**  
   tetanus, **1365**
- Antitussive drugs, for respiratory tract disease, 872
- Anuria, **1097**
- Aorta  
 coarctation of, 705  
 rupture of, 692–693
- Aortic aneurysm, inherited, 707  
 Aortic valve, insufficiency of, 687–688  
 Aphagia, 88  
 Aphthous fever, **2058–2067**  
 Aplasia cutis, **1643, 1645**  
 Apophysiolysis, lameness in pigs and, **1424**
- Appetite  
 decreased, and pain, 80  
 definition of, 87
- Apx toxins, in pleuropneumoniae, of pigs, 1057–1058, 1057*b*
- Aqueous humor antibody, **1124**
- Arab fading syndrome, **1645**
- Arabian breeding, inherited combined immunodeficiency in foals of, 807*t*
- Arachidonic acid metabolites, endotoxemia, 60  
 Arachnomelia, inherited, **1535–1536**
- Arcanobacterium pyogenes*, 1027
- ARDS. *see* Acute respiratory distress syndrome (ARDS)
- Area under the curve (AUC), 163  
 Aristolochine, **2209**
- Arrhythmias (dysrhythmias), 675, 675*t*  
 with normal heart rates or bradycardia, 679–680  
 with tachycardia, 680–685
- Arsenic toxicosis, 421–425, 421*b*, 424*b*
- Arterial blood gas analysis, 865–866, 866*t*  
 in bovine respiratory syncytial virus, 950
- Arterial blood pressure  
 in equine colic, 229  
 and naturally occurring combined abnormalities of  
   free water, electrolyte, acid-base balance, and oncotic pressure, 136
- Arterial blood-gas analysis, 737
- Arterial plasma ammonia concentration, **1175**
- Arterial thrombosis, 709–711, 709*b*  
 differential diagnosis of, 711*b*
- Arteritis, equine viral, **2087–2091, 2087*b***  
 animal risk factors, **2089**  
 clinical findings, **2089**  
 clinical pathology, **2089–2090, 2090t**  
 economic importance, **2089**  
 epidemiology, **2088–2089**  
 etiology, **2087–2088**  
 immunity, **2088**  
 necropsy findings, **2090**  
   samples for confirmation of diagnosis, **2090, 2090*b***  
 occurrence, **2088**  
 origin of infection and transmission, **2088**  
   horizontal transmission, **2088**  
   venereal transmission, **2088**  
 pathogenesis, **2089**  
 treatment and control, **2090–2091**
- Arthritis, 934, **1262–1263**  
 calves with experimentally induced infectious, **1412**  
 caprine arthritis encephalitis, **1256*b*–1257*b*, 1282–1283**  
 from erysipelas, **1455**  
 infectious, **1413**  
*Mycoplasma bovis*, 934–935  
*Mycoplasma bovis* polyarthritis, 932–939, 932*b*  
 septic, 937  
 septic arthritis synovitis, **1411–1418**  
 septic pedal, in cattle, **1417**
- Arthrocentesis  
 for musculoskeletal system disease, **1376**  
 for septic arthritis synovitis, **1414**
- Arthrodesis, for septic arthritis synovitis, **1417**
- Arthrogyposis  
 calves, Akabane disease and, **1513**  
 with dental dysplasia, **1538**  
 inherited, **1329, 1538–1539**  
 with multiple defects, **1538**  
 with palatoschisis, **1538**  
 in pigs, **1538–1539**  
 prolonged gestation with, **1829**  
 in sheep, **1538–1539**  
 simple, **1538**
- Arthropathy, fluoroquinolones and, 171
- Arthroscopic joint debridement, in *Mycoplasma bovis*, 937
- Arthroscopy  
 for degenerative joint disease, **1410**  
 for musculoskeletal system disease, **1376–1377**  
 for septic arthritis synovitis, **1414, 1416–1417**
- Arthrosis, lameness in pigs and, **1420**
- Arthrosonography, for septic arthritis synovitis, **1414**
- Arthrotomy, for septic arthritis synovitis, **1417**
- Artificial ankylosis, for septic arthritis synovitis, **1417**
- Artificial breeding techniques, 112
- Artificial feeding, of colostrum, **1849, 1852, 1855–1856**
- Artificial insemination  
 bovine immunodeficiency-like virus and, 786  
 bovine virus diarrhea virus, 583–584, 593  
   transmission, 579  
 enzootic bovine leukosis and, 833
- Aryepiglottic fold  
 axial deviation of, 989  
 entrapment, 988–989, 988*f*
- Arytenoid cartilages, mucosal lesions of, 988–989
- Arytenoid chondritis, 988
- Ascariasis, 409–411, 409*b*  
 cattle, 409–411  
 clinical findings, 410  
 clinical pathology, 410

- Ascariasis (*Cont'd*)  
 control, 411  
 diagnostic confirmation, 410  
 differential diagnosis, 410*b*  
 epidemiology, 410  
 etiology, 409  
 horses, 409–411  
 life cycle, 409  
 necropsy findings, 410  
 pathogenesis, 410  
 pigs, 409–411  
 treatment, 410–411, 410*b*–411*b*
- Ascaris lumbricoides*, 624  
*Ascaris suis*, in interstitial pneumonia, 966  
*Ascaris suum*, 409
- Ascending urinary tract infection, 1130
- Ascites, 660  
 edematous swellings in, 130
- Aseptic fevers, 54
- Ash hazards, volcanic eruptions, 109
- Asia  
 anthrax in, 2011  
 contagious bovine pleuropneumonia in, 926
- Aspartate aminotransferase (AST)  
 in fasciolosis, 643  
 left-side displacement of abomasum and, 503–504, 507  
 liver function test, 628  
 myopathy and, 1470–1471
- Aspergillosis  
 disseminated, 1045  
 pulmonary, 1045, 1046*f*  
 systemic, 1045
- Aspergillus flavus*, aflatoxicosis, 649  
*Aspergillus fumigatus*, in heaves, 1005–1006  
*Aspergillus* spp., 1045–1046, 1046*f*  
 aflatoxicosis, 649
- Aspergillus*-associated mycotoxins, 1202–1208
- Asphyxia, perinatal, 1851
- Aspiration pneumonia, 892–893  
 milk fever and, 1681
- Assessment, biosecurity and, 41
- Assisted traction during birth, femoral fractures and, 1389
- Astragalus*, in congenital defects, 1837
- Astroviruses  
 porcine, 342  
 in wild boar, 2008
- Asymmetric hindquarter syndrome, of pigs, 1529
- Ataxia, 1372  
 assessment of, 1171  
 in bovine spongiform encephalopathy, 1298  
 caused by proprioceptive defect, 1194  
 cerebellar, 1159  
 in encephalopathy, 1194  
 equine sensory. *see* Equine cervical vertebral stenotic myelopathy  
 familial, in cattle, 1333  
 inherited, of calves, 1333  
 inherited progressive, 1352–1353  
 median grade for, 1354*f*  
 in nervous system disease, 1161  
 spinal cord compression and, 1349  
 in spinal cord disease, 1162
- Ataxic animal, 1162
- Atelectasis, 849, 883, 883*f*
- Atlantooccipital cistern (cisterna magna), in cerebrospinal fluid collection, 1173
- Atlanto-occipital deformity, inherited, 1534
- Atopic rhinitis, bovine, 901–902
- Attractylolide, 1195
- Atrial contraction (“a” wave), 664
- Atrial fibrillation, 680–683  
 benign, in racehorses, 681  
 electrical cardioversion, 683  
 electrocardiography, 680–683  
 left-side displacement of abomasum and, 506  
 metabolic diseases and, 682  
 ruminants, 683
- Atrial jugular impulse, 679
- Atrial premature complexes, 680
- Atrioventricular block, 679–680
- Atrioventricular valves, left, 688
- Atrophic rhinitis  
 mycoplasmal pneumonia, 1071  
 progressive, 1047–1054, 1048*b*, 1052*b*
- Atropine  
 for gastrointestinal motility, 191  
 for heaves, 1011
- Attenuated vaccines, 2109–2110  
 anthrax, 2014  
 bluetongue, 2075–2076  
 bovine ephemeral fever, 2083  
 foot and mouth disease, 2065–2066  
 Japanese B encephalitis, 1817  
 Rift Valley fever, 2069
- Atypical interstitial pneumonia. *see* Interstitial pneumonia
- Aujesky’s disease, 1071  
*see also* Pseudorabies
- Aural flat warts, in horses, 1583, 1583*f*, 1640
- Aural plaques, in horses, 1583, 1583*f*, 1640
- Auricular vein, of cattle and calves, 146, 148*f*
- Auscultation  
 of abdomen, 17–18  
 clinical examination of, 14  
 in equine colic, 227  
 foals, 239  
 in equine pleuropneumonia, 992  
 of lungs, 17, 850, 889  
 murmurs in, 685  
 in respiratory system, examination of, 855  
 in *Rhodococcus equi*, 1015  
 of rumen, 446–448  
 sand colic, 266  
 of trachea, in heaves, 1007  
 ventricular septal defects, 704  
 volvulus, of large colon, 262
- Australia  
 bovine ulcerative mammillitis in, 1986  
 brucellosis in, 1773  
 contagious bovine pleuropneumonia in, 926  
 equine influenza in, 1033
- Austria, bovine virus diarrhoea virus eradication program, 598
- Autoimmune hemolytic anemia, 734
- Autoinfection larvae, bovine ostertagiosis, 605
- Autonomic nerve activity, cardiac reserve and, 658
- Autonomic nervous system  
 abnormalities of, 1163–1164  
 equine grass sickness, 1362
- Axial deviation of the aryepiglottic folds (ADAF), 983, 989
- Axonal degeneration, 990
- Axonopathy  
 central and peripheral, of Maine Anjou cattle, 1352–1353  
 inherited bovine degenerative, 1352  
 segmented, 1353–1354
- Azithromycin, for *Rhodococcus equi* pneumonia, 1016–1017
- Azotemia, 1097
- Azoturia. *see* Rhabdomyolysis

## B

- Baber’s fly traps, 1630
- Babesia bigemina*, 790*f*, 802
- Babesia bovis*, 801–802, 806
- Babesia caballi*, 808
- Babesia equi*, 798
- Babesia indicus*, 800
- Babesia* spp., 798  
 life cycle and development of, 797  
 methods of detection and identification of, 803
- Babesiosis, 816*b*, 822  
 acquired immune mechanisms of, 798  
 acute cases of, 800  
 clinical findings of, 800  
 clinical pathology of, 803  
 control of, 805  
 in species other than cattle, 809  
 culture of, 803  
 demonstration of presence of, 803  
 differential diagnosis of, 800*t*, 817*b*  
 economic importance of, 800–804  
 environmental factors of, 800  
 epidemiology of, 796  
 equine. *see* Equine babesiosis  
 equine piroplasmosis and, 796–797  
 etiology of, 795–796  
 geographic occurrence of, 796, 798*t*  
 in goats, 796, 806  
 host occurrence in, 796  
 immunity of, 798  
 susceptibility to infection and, 797  
 immunology of, 800  
 innate immune mechanisms of, 797–798  
 limitation of prevalence of, 805  
 natural endemic stability of, 809  
 necropsy findings of, 805  
 origin of infection and transmission of, 797  
 pathogen factors of, 800  
 pathogenesis of, 800–801  
 porcine, 796  
 risk factors of, 798  
 sheep, 796  
 supportive treatment of, 805  
 treatment of, 805  
 vector control of, 809  
 wildlife, 797  
 zoonotic importance of, 800
- Bacillary hemoglobinuria, 635–637, 635*b*  
 animal risk factors of, 635  
*C. haemolyticum*, 635  
 clinical findings, 636  
 clinical pathology, 636  
 control, 637  
 diagnosis, 636  
 differential diagnosis, 636*b*  
 environmental risk factors of, 635–636  
 epidemiology of, 635–636  
 etiology of, 635  
 necropsy findings, 636  
 occurrence, 635  
 pathogenesis, 636  
 risk factors of, 635–636  
 treatment of, 636, 637*b*  
 vaccination, 637
- Bacillus anthracis*, 2011
- Bacillus piliiformis*, 633
- Bacitracin, 173
- Bacitracin Zinc, 326
- Back pain, in horses, 1350
- Backflushing, milking units, 1970
- Back-muscle necrosis, porcine stress syndrome and, 1527
- BACTEC system, 569
- Bacteremia  
 definition of, 57  
 in neonatal infection, 1876  
 radiation and, 108  
 salmonellosis, 300, 365  
 in swine, 300
- Bacteria  
 bone access routes in osteomyelitis, 1391  
 enteritis and, 206*t*  
 in enzootic pneumonia of calves, 940, 943  
 in peritoneal fluid, 189
- Bacterial arteritis, 710
- Bacterial bronchopneumonia, acute, 889
- Bacterial colonization, equine pleuropneumonia, 992

- Bacterial culture  
 for acute undifferentiated bovine respiratory disease, 909–910  
 for *Brucella abortus*, 1766  
 for *Brucella melitensis*, 1783  
 for *Brucella suis*, 1780  
 for brucellosis associated with *Brucella ovis*, 1776  
 for colibacillosis, 1887  
 for localized infections, 78  
 for *Mycobacterium avium* subspecies paratuberculosis (MAP), 558, 568–569  
 for pneumonic pasteurellosis, 918  
 for salmonellosis, 301, 367
- Bacterial infection  
 endocarditis, 689  
 immune deficiency from, 755  
 in interstitial pneumonia, 966  
 myocardial disease, 690
- Bacterial multiplication, in equine pleuropneumonia, 992
- Bacterial myocarditis, 690
- Bacterial pseudomycosis, 1559
- Bacterial toxins, hemolytic jaundice and, 623
- Bactericidal antimicrobials, 165–166, 165f
- Bacteriologic culture, of bulk milk, 1981–1982
- Bacteriology  
 caseous lymphadenitis of, 766  
 of Glässer's disease, 1452–1453  
 porcine proliferative enteropathy, 325  
 swine dysentery, 331
- Bacteriostatic antimicrobials, 165–166, 165f
- Bacteriuria, 1103
- Bacteroides asaccharolyticus*, 1394
- Bacteroides fragilis*, 1394
- "Bagging" examination, 850
- Bairnsdale ulcer, 1574
- Balance, abnormalities of, 1170
- Balanced (multimodal) analgesia, 83
- Balanoposthitis, 1152, 1152b–1153b  
 differential diagnosis of, 1154b  
 treatment and prophylaxis of, 1154b
- Baldy calf syndrome, 1643, 1645
- Balling-gun-induced trauma, 196
- Ballottement, clinical examination of, 14
- Bang test, 1298
- Bang's disease, 1761–1774, 1761b  
 clinical findings of, 1765–1766  
 clinical pathology of, 1766–1768  
 control of, 1769–1774  
 eradication in, 1773–1774  
 guidelines in, 1769–1770  
 programs on a herd basis in, 1772  
 by vaccines, 1770–1772  
 diagnosis of, 1768  
 differential diagnosis of, 1769b  
 economic importance of, 1764  
 epidemiology of, 1761–1765  
 etiology of, 1761  
 immune mechanisms of, 1764  
 necropsy findings of, 1768  
 occurrence and prevalence of, 1761–1762  
 pathogenesis of, 1765  
 risk factors of, 1763–1764  
 transmission of, 1762–1763  
 treatment of, 1769  
 vaccination for, 1770–1772  
 cessation of, 1773–1774  
 zoonotic implications of, 1764–1765
- Barley smut (*Ustilago hordei*) fungus, 1828
- Barn fire, 110
- Barn itch, 1619–1621, 1620b
- Base-apex electrocardiograms, 676f–678f
- Base-apex lead system, 667, 667f, 668t
- Basidiobolus haptosporus*, 797
- Basioccipital bone, fracture of, 1190
- Basisphenoid bone, fracture of, 1190
- Batch farrowing, 1878
- Bayes theorem, 26
- B-cell lymphoma, 748
- Bedding  
 coliform mastitis in, 1945, 1953  
 for downer-cow syndrome, 1697  
 enterohemorrhagic *Escherichia coli* control, 542  
 stress induction, 84
- Bee and wasp stings (*Hymenoptera*), 2179
- Beef breeding herd  
 nutritional management of, 1749–1750  
 vaccination programs in, 960
- Beef calves, 1833  
 abomasal ulcer in, 519–521  
 administration of colostrum in, 1855  
 birth size of, 1833  
 dietary diarrhea, 214  
 in enzootic pneumonia of calves, 940  
 fetal disease in, 1833  
 mortality in, 1833  
 parturient disease in, 1833  
 postnatal disease in, 1833
- Beef cattle  
 abomasal displacement, 510  
 abomasal volvulus, 510  
 antimicrobial residue violations in, 168  
 biosecurity planning for, 37b  
 bovine virus diarrhea virus vaccination, 596  
 carbohydrate engorgement, 462  
 feed intake reduction manifestations, 88  
 Johne's disease, 563  
 neosporosis in, 1818  
 nutrient requirements of, 517  
 phosphorus requirements for, 1490  
 right-side displacement of abomasum, 510  
 salmonellosis, 361  
 salt-mineral mixture for, 1476–1477  
 tail-tip necrosis in, 1394–1395
- Beef cows, volume of colostrum ingested of, 1851
- Beef feedlots, nutritional advice for, 1750
- Behavior  
 abnormalities of, in encephalopathy, 1194–1195  
 in bovine spongiform encephalopathy, 1298  
 changes  
 in dehydration, 115  
 in nasal bots, 980  
 and stray voltage, 105  
 clinical examination of, 10  
 equine colic and, 226–227, 226t, 231  
 in nervous system examination, 1164  
 pain and, 78–80
- Belgium blue cattle, prolonged gestation with arthrogyposis, 1829
- Benign ovine theileriosis, 2145
- Benomyl, 652, 654
- "Bentleg", 1499–1500
- Benzimidazoles (BZDs), 1211  
 for parasitic gastroenteritis in ruminants, 607–608
- Benzylpenicillin, 162
- Berberine, 2210
- Berenil. see Diminazene
- Bergstrom muscle biopsy needles, 1381
- Bermudagrass stagers, 1202
- Besnoitiosis, 1607–1608, 1607b
- Beta irradiation, congenital defects and, 1837
- Beta-2-adrenergic agonists  
 for heaves, 1011  
 for pneumonia, 892  
 for respiratory tract disease, 871
- Betalactam antimicrobials, for respiratory tract disease, 871
- Bethanechol, for gastrointestinal motility, 192
- Bibersteinia traubalosi*, in enzootic pneumonia of calves, 940
- Bicarbonate system, acid-base balance, 123–124
- Big bale silage, 1338, 1366
- "Bighead" syndrome, 1389–1390
- Bigleg (sporadic lymphangitis), 781
- Bilateral laryngeal paralysis, 990
- Bile, regurgitation of, 289
- Bile acids, serum, 627, 629
- Bile duct carcinoma, 655
- Bile ducts, tumors of, 655
- Biliary atresia, 655
- Biliary disease, manifestations of, 623–625
- Biliary obstruction, 624
- Biliary peritonitis, 626
- Biliary system  
 concretions in, 655  
 diseases of, 655–656
- Bilirubin, 627  
 biliary obstruction and, 624  
 jaundice and, 623–624
- Bilirubin encephalopathy, 743
- Bioavailability, and intramuscular antimicrobials, 159–160
- Biochemical abnormalities  
 exercise intolerance and, 99  
 in recumbent adult horses, 2003–2006
- Biocontainment, leptospirosis and, 1126–1127
- Bioelectrical impedance analysis, 136
- Bioequivalence, 163–164
- Biofilm, in *Mycoplasma bovis*, 933
- Biofilm synthesis, 2035
- Biohazard, 36
- Biological functioning framework, and stress, 86
- Biomarkers, septicemia, 58
- Biopsy  
 equine grass sickness, 285  
 equine phycomycosis and, 797–798  
 lung, 867–868  
 in heaves, 1008  
*Mycobacterium avium* subspecies paratuberculosis (MAP), 569
- Biosecurity, 36–42  
 assessment and, 41  
 for bovine digital dermatitis, 1440  
 for bovine herpesvirus-1 infection, 958  
 bovine virus diarrhea virus, 592–593, 597  
*Brucella abortus* in, 1762–1763  
 cleaning and, 40–41  
 communication and, 41  
 concepts of, 36–37  
 controlling contact and  
 by visitors to operation, 39  
 by wildlife, neighboring livestock, and pets, 39  
 definition of, 36–37  
 development of biosecurity plan, 37–38  
 disease monitoring and, 41  
 diseases or agents for, 37b  
 disinfection and, 40–41, 40t  
 enzootic bovine leukosis, 840  
 for herd replacements, 1978  
 initial planning for, 37–38, 37b  
 Johne's disease, 561  
 leptospirosis and, 1126–1127  
 for *Mycoplasma bovis*, 938  
 online risk calculators and, 36t  
 online sources of information regarding, 36t  
 in ovine progressive pneumonia, 977  
 peste des petits ruminants (PPR), 575  
 porcine proliferative enteropathy, 326  
 porcine reproductive and respiratory syndrome in, 1812  
 practices to aid in maintaining, 38–41  
 record keeping and, 41  
 salmonellosis, in swine, 304  
 separating groups of animals based on risk and, 39–40  
 in *Streptococcus agalactiae* mastitis, 1939  
 swine dysentery, 333–334  
 testing and/or isolation of newly introduced animals and, 38  
 training and, 41
- Bioterrorism  
 anthrax as  
 major concern of, 2012  
 potential agent of, 2011  
*Brucella melitensis*, 1782  
*Coxiella burnetii*, 1792
- Biotin (vitamin H), deficiency, 1502–1503
- Biot's breathing, 1193
- Biotypes, in pleuropneumonias, of pigs, 1056
- Birch sawfly (*Arge pullata*), 654



- Birds  
 aquatic, influenza A virus in, 1079  
 enterohemorrhagic *Escherichia coli* transmission, 538
- Birdsville horse disease, 1200
- Birth weight  
 in colibacillosis, 1880  
 and summit metabolism, 46
- Birthcoat retention, inherited, 1645
- Bismuth subnitrate, internal teat sealants, 1976
- Bisolvon, 872
- Bison, Johne's disease, 568
- Bison (*Bison bison*), in *Brucella abortus* infection, 1762
- Biting flies, 2012
- Bivalent vaccines, mono- and, for infectious footrot in sheep, 1447
- Black disease, 637–638, 637b–638b
- Black flies, 1629–1630
- Black patch disease, 429–430
- Black pox, 1985
- Black soil blindness, 1203
- Black tongue, 784–785, 785b
- "Black-grain mycetomas", 797
- Black-hair-colored follicular dysplasia, 1645
- Blackleg, 1430–1432, 1430b, 1432b
- Bladder  
 diseases of, 1139  
 eversion of, 1140  
 paralysis of, 1139  
 rupture of (uroperitoneum), 1140
- Bladder rupture, test of, 1107
- Blight, 1650–1653
- Blind bronchoalveolar lavage, 862
- Blindness, 1163  
 black soil, 1203  
 vitamin A deficiency and, 1324
- Blink response, 1165
- Blister beetle poisoning, 430–431
- Bloat (ruminal tympany), 473–481, 473b  
 case fatality, 474–475  
 clinical findings, 476–477  
 clinical pathology, 477  
 control, 478–481  
 differential diagnosis, 477b–478b  
 economic importance, 476  
 epidemiology, 474–476  
 etiology, 473–474  
 first-aid emergency measures, 477–478  
 free-gas, 474  
 frothy, 473–474  
 morbidity, 474–475  
 necropsy findings, 477  
 pathogenesis, 476  
 risk factors, 475–476  
 treatment, 477–478, 481b–482b
- Blood  
 abnormalities, vitamin E deficiency and, 1467  
 diseases of, in dyspnea, 849  
 normal pH of, 134  
 selenium and, 1471  
 typing, for porcine stress syndrome, 1528  
 whole, 142
- Blood concentration, and naturally occurring combined abnormalities of free water, electrolyte, acid-base balance, and oncotic pressure, 134
- Blood culture, 1863  
 septicemia, 58
- Blood gas  
 analysis of, and naturally occurring combined abnormalities of free water, electrolyte, acid-base balance, and oncotic pressure, 133–134  
 in newborn, 1863
- Blood gas analysis  
 arterial, 865–866, 866t  
 venous, 866
- Blood glucose, and naturally occurring combined abnormalities of free water, electrolyte, acid-base balance, and oncotic pressure, 134–135
- Blood lactate concentration, in respiratory system, 867
- Blood lead, 1206–1207
- Blood L-lactate concentration, in bovine respiratory syncytial virus, 950
- Blood loss  
 decreased oncotic pressure and, 128  
 by hemorrhage, 813
- Blood samples, storage of, 133–134
- Blood smears, eperythrozoonosis of, 780
- Blood transfusion, 738–739  
 for hemorrhagic shock, 75  
 leptospirosis and, 1125
- Blood urea nitrogen (BUN), 628, 1137
- Blood vessel permeability, subcutaneous edema and, 1555
- Blow-fly strike, of sheep, 1611–1615, 1611b–1612b  
 clinical findings of, 1613, 1613f  
 clinical pathology and necropsy findings of, 1613  
 control of, 1614–1615  
 differential diagnosis of, 1613b  
 etiology of, 1612  
 fly population in, 1612  
 life cycle and epidemiology of, 1612–1613  
 pathogenesis of, 1613  
 prediction of risk periods in, 1614  
 prevention of, 1614–1615  
 reduction of fly numbers in, 1614  
 susceptibility of sheep in, 1612–1613  
 reducing, 1615  
 treatment of, 1613
- Bluetongue, 2069–2076, 2069b–2070b  
 clinical findings, 2073–2074  
 clinical pathology, 2074–2075  
 control, 2075–2076  
 economic importance, 2073  
 epidemiology, 2070–2073  
 etiology, 2070  
 experimental reproduction, 2073  
 host risk factors, 2072  
 method of transmission, 2070–2071  
 morbidity and case fatality, 2072–2073  
 necropsy findings, 2075, 2075b  
 occurrence, 2070  
 host, 2070  
 pathogen and vector risk factors, 2071–2072  
 pathogenesis, 2073  
 treatment, 2075  
 virus, in congenital defects, 1836
- Boars, semen shedding in, 2130–2131
- Bocavirus, porcine, 343
- Body condition, clinical examination of, 11
- Body condition score (BCS), 90–91  
 as indicator of fat-free mass and fat mass, 91, 91f–93f
- Body conformation, clinical examination of, 12
- Body mange, 1621–1622  
 differential diagnosis of, 1622b
- Body systems, combined effects on, of endotoxemia, 62–63
- Body temperature, 43–44
- Body weight, in vitamin A deficiency, 1323
- Body weight, loss of, and dehydration, 115
- Bolo disease, 1575
- Bone ash, phosphorus concentrations of, 1489
- Bone grafts, osteomyelitis, 1394
- Bone growth, in vitamin A deficiency, 1322
- Bone marrow, 735–736  
 inflammation of, osteomyelitis and, 1392
- Bone spavin, 1406
- Bones  
 bending of, 1390  
 congenital defects of, 1390  
 diseases of, 1388–1391  
 infection, classification of, 1392  
 inherited diseases of, 1530–1532, 1531t, 1533t
- Bony lesions, of vertebra, 1349
- Boophilus*, 799
- Borborygmi  
 absence, enteritis, 256  
 equine colic and, 227  
 sounds, 17
- Border disease, 1252b, 1282  
 clinical findings of, 1254  
 clinical pathology of, 1254–1255  
 conformation of, 1254  
 control of, 1256  
 differential diagnosis of, 1253b  
 economic importance of, 1253  
 enteric disease and, 1254  
 epidemiology of, 1252  
 etiology of, 1252  
 experimental reproduction of, 1253  
 host risk factors of, 1252  
 necropsy findings of, 1255  
 neurologic dysfunction of, 1254  
 occurrence of, 1252  
 pathogenesis of, 1253  
 reproductive performance of, 1254  
 samples for diagnostic confirmation of, 1255  
 in sheep, 579, 1253  
 transmission of, 1252  
 treatment for, 1255
- Border disease virus  
 in abortion, 1777t  
 in congenital defects, 1836
- Bordetella bronchiseptica*, 1047–1048, 1054  
 porcine reproductive and respiratory syndrome and, 1797–1798
- Bordetella parapertussis*, 972
- Bordetella* rhinitis, 1054–1055
- Borna disease, 1312–1314
- Born-after-the-ban, 1295–1296
- Boron toxicosis, 1201–1202
- Borrelia burgdorferi*, 1425
- Borreliosis, 1425–1428, 1425b  
 in cattle, 1425, 1427  
 clinical findings of, 1427  
 clinical pathology of, 1427  
 control of, 1428  
 differential diagnosis of, 1428b  
 epidemiology of, 1425–1427  
 etiology of, 1425  
 in horses, 1425–1427  
 immune mechanisms in, 1427  
 methods of transmission, 1426–1427  
 necropsy findings of, 1427–1428  
 pathogenesis of, 1427  
 in sheep, 1425, 1427  
 treatment for, 1428, 1428b  
 in wildlife, 1426  
 zoonotic implications and, 1426
- Botfly, 418–419
- Botryomycosis, 1559
- Bottle jaw, 624, 643
- Botulism, 1360–1363, 1367b  
 carrion-associated, 1366  
 clinical findings of, 1367  
 clinical pathology of, 1368  
 control of, 1370  
 differential diagnosis of, 1368b  
 epidemiology of, 1365  
 etiology of, 1365  
 experimental reproduction of, 1366  
 forage, 1366  
 importance of, 1367  
 necropsy findings of, 1368  
 occurrence of, 1365–1366  
 pathogenesis of, 1367  
 risk factors for, 1366  
 samples for diagnostic confirmation of, 1368  
 source of infection of, 1365–1366  
 toxicoinfectious, 1366  
 treatment for, 1368, 1368b  
 wound, 1366  
 zoonotic implications of, 1367

- Bovine atopic rhinitis, 901–902
- Bovine babesiosis  
epidemiology of, 796–797  
serology of, 804–805
- Bovine besnoitiosis, 1607
- Bovine coronavirus  
calf diarrhea, 386–387  
vaccine, 392  
winter dysentery, 387
- Bovine coronavirus (BCoV)  
calf diarrhea, 599  
respiratory tract infection, 600  
winter dysentery, 599–600
- Bovine coronavirus (BoCV), 906–907  
in enzootic pneumonia of calves, 939, 941
- Bovine digital dermatitis, 1435–1441, 1435b  
clinical findings of, 1436–1437, 1437f  
clinical pathology of, 1437–1438  
control of, 1440, 1440b–1441b  
differential diagnosis of, 1438b  
economic importance of, 1436  
epidemiology of, 1435–1436  
etiology of, 1435  
immune mechanisms of, 1436  
pathogenesis of, 1436  
risk factors of, 1436  
treatment for, 1438–1440, 1440b–1441b
- Bovine enzootic hematuria, 1151–1152, 1151b, 1152f  
differential diagnosis of, 1152b
- Bovine ephemeral fever (BEF), 2081–2084, 2081b–2082b  
animal risk factors of, 2082  
clinical findings of, 2083  
clinical pathology of, 2083  
control of, 2083  
economic importance of, 2082  
environmental risk factors of, 2082  
epidemiology of, 2082  
etiology of, 2082  
experimental reproduction of, 2082  
method of transmission of, 2082  
necropsy findings in, 2083  
occurrence of, 2082  
pathogenesis of, 2082–2083  
samples for confirmation of diagnosis, 2083, 2083b  
source of infection in, 2082  
treatment for, 2083
- Bovine factor XI deficiency, 843
- Bovine familial degenerative neuromuscular disease, 1515–1517
- Bovine farcy, 779–781
- Bovine footrot, 1432–1435, 1432b  
clinical findings of, 1433–1434  
clinical pathology of, 1434  
control of, 1434–1435, 1435b  
differential diagnosis of, 1434b  
economic importance of, 1433  
environmental risk factors of, 1433  
epidemiology of, 1433  
etiology of, 1433  
host risk factors of, 1433  
necropsy findings of, 1434  
occurrence of, 1433  
pathogenesis of, 1433  
transmission of, 1433  
treatment for, 1434, 1435b  
vaccination for, 1435
- Bovine hereditary dilated cardiomyopathy, 706–707
- Bovine herpes mammillitis. *see* Bovine ulcerative mammillitis
- Bovine herpesvirus-1 (BHV-1) infection, 906, 952–961, 952b  
clinical findings in, 955–956  
clinical pathology of, 956–957  
control of, 957–961  
differential diagnosis of, 957b  
epidemiology of, 952–954  
etiology of, 952  
necropsy findings in, 957  
pathogenesis of, 954–955  
risk factors for, 953  
treatment of, 957, 961b
- Bovine herpesvirus-2, 1986
- Bovine immunodeficiency-like virus (BIV), 785–794
- Bovine iritis, 1649–1650, 1649b
- Bovine ketosis, 1709–1711
- Bovine lentivirus-1, 786
- Bovine leptospiral vaccines, leptospirosis vaccination in, 1127–1128
- Bovine leukocyte adhesion deficiency (BLAD), 755
- Bovine lymphosarcoma. *see* Enzootic bovine leukosis (EBL)
- Bovine malignant catarrh, 2076–2080, 2076b
- Bovine mammary gland, *Mycoplasma bovis* in, 933
- Bovine Marfan syndrome, 707
- Bovine mastitis, 1904–1914, 1904b–1905b  
clinical  
abnormal cow in, 1914, 1914f  
abnormal gland in, 1913–1914  
antimicrobial therapy for, 1921  
clinical findings of, 1913  
detection of, 1914  
economic losses, 1912  
records for, 1980  
recurrence, 1980  
clinical findings of, 1913–1914  
control of, 1964–1985  
cost-effectiveness of, 1984–1985  
decreasing the infection rate in, 1965  
dynamics of infection, 1965, 1966f  
economic benefits of, 1964  
eradication in, 1964–1965  
incentives in, 1964  
legislative control in, 1965  
options in, 1964–1965  
penalties of, 1964  
principles, 1965–1966, 1966f  
requirements of, 1964  
udder health improvement, 1964  
voluntary program in, 1965  
diagnosis of, 1914–1921  
differential diagnosis of, 1920b  
drying off, permanently, 1929–1930  
duration of, 1913  
economic losses in, 1911–1912  
epidemiology of, 1906–1912  
etiology of, 1906  
genetic resistance to, 1909  
incidence of, 1907  
methods of transmission of, 1908  
miscellaneous causes of, 1961–1964  
necropsy findings of, 1920  
pathogenesis of, 1912–1913  
pathogens of, 1930  
antimicrobial indications for, 1922–1923  
colonizing ability, 1911  
common, 1960  
contagious, 1905–1908, 1930–1936  
distribution of, 1907–1908  
environmental, 1905–1906, 1908, 1943–1955  
intramammary, 1907  
opportunistic, 1905, 1907–1908, 1942–1943  
prevalence of, 1907  
production in, 1911–1912  
recurrent, 1913  
risk factors of, 1908–1909  
season of year and, 1908  
severity of, 1913  
source of infection in, 1908  
subclinical  
antimicrobial therapy for, 1921  
detection of, 1914  
economic losses, 1911–1912  
indirect tests for, 1917–1920  
treatment of, 1921–1930, 1930b  
adjunctive therapy for, 1927  
bacteriologic cure for, 1921  
clinical cure of, 1921  
frequency and duration of, 1924–1925
- lactating quarters, 1925–1927  
response to, 1927–1928  
route of administration in, 1923, 1923t  
supportive therapy for, 1927  
zoonotic potential of, 1912
- Bovine mastitis, in bovine herpesvirus-1 infection, 955
- Bovine neonatal pancytopenia (BNP), 724–725, 751b, 755–757  
clinical findings of, 757  
clinical pathology of, 757  
control of, 757–758  
differential diagnosis of, 757b  
epidemiology of, 756  
etiology of, 756  
necropsy findings of, 757–758  
pathogenesis of, 756–757  
samples for postmortem confirmation of diagnosis, 757  
treatment of, 757
- Bovine nodular thelitis, 1986
- Bovine norovirus, 387
- Bovine ocular squamous-cell carcinoma, 1655–1658, 1655b  
clinical findings of, 1657  
clinical pathology of, 1657  
control of, 1657–1658  
differential diagnosis of, 1657b  
economic importance of, 1656  
epidemiology of, 1655–1656  
etiology of, 1655  
pathogenesis of, 1656, 1656f  
risk factors of, 1655–1656  
treatment of, 1657, 1657b
- Bovine ostertagiosis, 605
- Bovine papular stomatitis (BPS), 601–603, 601b–602b  
differential diagnosis, 602b
- Bovine peritoneal fluid, 186–190, 187t
- Bovine pestivirus disease complex, 577–599
- Bovine petechial fever, 779
- Bovine pyelonephritis, 1129–1131, 1129b, 1130f–1131f  
differential diagnosis of, 1130b  
treatment and prophylaxis and, 1131b
- Bovine respiratory disease (BRD), 158
- Bovine respiratory syncytial virus (BRSV), 906, 946–952, 946b–947b  
in chronic enzootic pneumonia of sheep, 973  
clinical findings in, 949  
clinical pathology of, 949–950  
control of, 951  
differential diagnosis of, 950b–951b  
in enzootic pneumonia of calves, 939  
epidemiology of, 947–948  
etiology of, 947  
necropsy findings in, 950  
pathogenesis of, 948–949  
pneumonia  
in enzootic pneumonia of calves, 943, 943f  
experimental reproduction of, 949  
risk factors for, 947–948  
treatment of, 951, 951b
- Bovine respiratory tract, diseases of  
acute undifferentiated, 903–914, 911b  
associated with *Mycoplasma spp.*, 924–925  
bovine herpesvirus-1 infection in, 952–961, 952b, 957b, 961b  
bovine respiratory syncytial virus in, 946–952, 946b–947b, 950b–951b  
caudal vena caval thrombosis in, 902–903, 902f  
contagious bovine pleuropneumonia in, 925–932, 925b, 926t, 929b–930b  
cranial vena caval thrombosis in, 903, 903f  
differential diagnosis of, 904t–905t  
embolic pneumonia in, 902–903, 902f  
enzootic nasal granuloma in, 901–902  
enzootic pneumonia in, 939–946, 939b, 943f, 944b, 946b, 946f  
infectious bovine rhinotracheitis in, 952–961, 952b, 957b, 961b  
*Mycoplasma bovis* in, 932–939, 932b, 936b–938b

- Bovine respiratory tract, diseases of (*Cont'd*)  
 pneumonic pasteurellosis in, 914–924, 914b, 919b, 921b  
 tracheal stenosis in, 902–903
- Bovine rotavirus  
 serotypes, 385–386  
 viral diarrhea, in calves, 385–386  
 case fatality, 386  
 concurrent infections, 386  
 experimental studies, 392  
 immune mechanisms, 386  
 morbidity, 386  
 occurrence, 385–386  
 prevalence, 385–386  
 risk factors, 386  
 transmission, 386
- Bovine rotavirus-coronavirus vaccine, 392–393
- Bovine salmonellosis, 366
- Bovine spinal muscular atrophy, 1193
- Bovine spongiform encephalopathy, 1290b, 1293  
 age incidence in, 1295  
 clinical findings of, 1297  
 clinical pathology of, 1297  
 clinical signs of, 1297  
 detection of, 1297  
 differential diagnosis of, 1296b  
 economic importance of, 1296–1297  
 epidemiology of, 1293  
 etiology of, 1293  
 experimental reproduction of, 1296  
 geographic occurrence of, 1293  
 herd type and, 1294  
 necropsy findings of, 1297  
 occurrence of, 1293  
 in other countries, 1295–1296  
 passive surveillance of, 1297  
 pathogenesis of, 1297  
 samples for diagnostic confirmation of, 1298  
 sheep and, 1321  
 tissue infectivity in, 1296  
 transmission of, 1295  
 zoonotic implications of, 1297
- Bovine sterile eosinophilic folliculitis, 1554–1555  
 “Bovine teat skin summer sore”, 1988
- Bovine torovirus, 387
- Bovine tuberculosis (bTB), 2015–2023  
 clinical findings, 2018  
 clinical pathology, 2018–2021  
 culture, 2019  
 direct tests, 2018–2019  
 indirect tests, 2019–2021  
 interferon- $\gamma$  assay (IFN- $\gamma$ ), 2021  
 intradermal tuberculin test, 2019  
 lymphocyte proliferation test, 2021  
 microscopic examination, 2019  
 nucleic acid recognition methods, 2019  
 serologic tests, 2021  
 special aspects of sensitivity to tuberculin, 2019–2020  
 summary of testing procedures in cattle, 2020  
 tuberculin testing in other species, 2020–2021  
 control, 2022–2023  
 economic importance and, 2017  
 epidemiology, 2015–2017  
 etiology, 2015  
 methods of transmission, 2016  
 necropsy findings, 2021, 2021b–2022b  
 occurrence, 2015–2016  
 pathogenesis, 2017–2018  
 risk factors, 2016–2017  
 source of infection, 2016  
 synopsis, 2015b  
 treatment, 2022  
 zoonotic importance and, 2017
- Bovine ulcerative mammillitis, 1986b–1987b, 1987f
- Bovine viral diarrhea (BVD), 577–599, 577b  
 acute infections, diagnosis of, 577  
 antigen detection, 586–587  
 antigenic diversity, 580, 595  
 biocontainment, 592–594  
 case-fatality rates, 579  
 clinical findings, 584–586  
 clinical pathology, 586–588  
 combination vaccines, 595  
 congenital defects, 586, 589, 1836  
 congenital infection, 578  
 control and prevention, 592–598  
 cytopathic (CP), 578, 584  
 diagnosis, 589  
 differential diagnosis, 589b–592b  
 economic importance, 581, 597  
 embryonic period, infection during, 583  
 epidemiology, 578–581  
 eradication of, 597–598  
 etiology, 577–578  
 fetal infection, 579, 583–584  
 45 to 125 days’ gestation, 583–584  
 125 to 175 days’ gestation, 584  
 180 days’ gestation and term, 584  
 embryonic-early fetal period, 583  
 prevention, 596  
 genotypes, 577, 580, 595  
 goats, 578  
 herd  
 laboratory tests in, 587–588  
 monitoring, 592  
 screening, 588  
 testing, objectives of, 593f  
 immune mechanisms, 580–581  
 immunization programs, 593–594  
 schedules, 596–597  
 strategies, 596  
 isolation, 586  
 morbidity, 579  
 necropsy findings, 588–589  
 neonatal disease, 585–586  
 noncytopathic (NCP), 578, 580  
 occurrence, 578  
 pathogenesis, 581–584  
 peracute, 582, 585, 589  
 perinatal weak-calf syndrome and, 1868  
 persistent infection (PI), 578, 580  
 carriers, 588  
 clearance, 592  
 diagnosis, 588  
 elimination, 592, 594f–595f  
 identification, 592  
 prenatal diagnosis, 588  
 self-clearance, 592  
 serology, 587  
 unthrifty calves, 585  
 pigs, 578  
 prevalence, 578–579  
 prognosis, 592  
 reproductive failure, 585–586  
 risk factors, 580  
 sheep, 578  
 subclinical, 581–582, 584  
 transmission, 579–580  
 treatment, 592  
 type 1 (BVDV-I), 577  
 type 2 (BVDV-2), 577, 580, 582  
 vaccination, 596–597  
 vaccines, 594–595  
 adverse reactions, 595  
 booster, 596  
 combination, 595  
 commercially available, 596  
 cross-protective efficacy, 595  
 efficacy of, 595–596  
 failures, 597  
 fetal protection, 597  
 heifers, 596  
 immune response, 594  
 postnatal infections, 596  
 potency, 596  
 temperature-sensitive, 594–595
- Bovine virus diarrhea virus (BVDV), 391, 906
- Bovine-serum-based preparations, in colostrum supplements, 1855  
 “Bowie”, 1499–1500
- Box walking, 1224
- Brachial plexus injury, 1359f, 1362
- Brachycladium spiciferum*, 798
- Brachygnathia, 433, 1534–1535
- Brachyspira hamptonii*, 334
- Brachyspira hyodysenteriae*, swine dysentery, 327
- Brachyspira pilosicoli*, 327
- Brachyspiral colitis, 327
- Bracken fern (*Pteridium aquilinum*), poisoning, in thiamine deficiency, 1315
- Bracken ingestion, bright blindness caused by, 1655
- Bradsot, 544–545, 544b  
 differential diagnosis, 544b
- Bradycardia, 15, 676  
 heart failure etiology of, 663  
 sinus, 676  
 third-degree atrioventricular block, 679
- Brain  
 caprine arthritis encephalitis in, 1260  
 diffuse diseases of, 1178–1180  
 focal diseases of, 1187–1189  
 function of, in polioencephalomalacia, 1313  
 swelling, 1180  
 clinical findings of, 1181  
 clinical pathology of, 1181  
 differential diagnosis for, 1180b  
 necropsy findings in, 1181  
 pathogenesis of, 1181  
 treatment of, 1181  
 traumatic injury of, 1186  
 clinical findings of, 1188  
 clinical pathology of, 1188–1189  
 craniocerebral missile injury, 1188  
 diagnosis of, 1188  
 differential diagnosis of, 1189b  
 etiology of, 1187–1188  
 necropsy finding of, 1189–1191  
 pathogenesis of, 1188  
 treatment for, 1178–1179, 1190
- Brain abscess, 1190, 1191b
- Brain morphometry, computer-assisted MRI, for cerebellar abiotrophy, 1334–1336
- Brainstem, diseases of, 1329–1331
- Brainstem auditory evoked potentials, 1177–1178
- Branched-chain keto acid dehydrogenase deficiency, 1326–1327
- Brand cancer, 1641
- Brassica* spp., 837, 839b  
 iodine deficiency in, 1743
- Braunvieh- Brown Swiss calves, congenital myopathy of, 1378
- Braxy, 544–545, 544b  
 differential diagnosis, 544b
- Breath sounds, 850–852, 851t
- Breathing  
 abnormalities of, 848–849  
 work of, determining, 981
- Breda virus, 387
- Breed  
 anaplasmosis risk factors and, 771  
 caseous lymphadenitis, 764  
 differences in, and body temperature, 44  
 predisposition, lameness in pigs and, 1422  
 pregnancy toxemia and, 1724  
 sheep, infectious footrot in, 1442
- Breeding history, history taking of, 8
- Breeding stock, medication of, for *Mycoplasma pneumoniae*, 1070
- Breeze flies, 1626
- Brewer’s residues, toxicosis from, 2212–2213  
 “Bright blindness,” of sheep, 1655
- Brisket disease, bovine, 693
- Britain, in ovine pulmonary adenocarcinoma, 978
- Brix refractometry, in monitoring colostrum, 1854
- Broad-spectrum drugs, for lungworm, 964



- "Broken mouth", 194  
 Bromethalin, 2190–2191  
 Bromhexine, 872  
 Bromide toxicosis, 1201  
 Bromosulphophthalein (BSP) clearance test, 648  
 Bronchial angiogenesis, in exercise-induced pulmonary hemorrhage, 1002  
 Bronchial sounds, 851  
   see also Breath sounds  
 Bronchiectasis, in heaves, 1007–1008  
 Bronchitis, 878–879, 879b  
 Bronchoalveolar lavage (BAL)  
   in acute undifferentiated bovine respiratory disease, 909  
   fluid, 860  
   in tracheobronchial secretions, 861–862  
 Bronchoalveolar lavage fluid, in heaves, 1008–1009  
 Bronchoconstriction  
   in exercise-induced pulmonary hemorrhage, 1002  
   heaves in, 1006  
 Bronchodilators  
   for heaves, 1011  
   for pneumonia, 892  
   for respiratory tract disease, 871–872  
   smoke inhalation, 111  
 Bronchography, 857  
 Broncho-interstitial pneumonia, in foals, 889, 996  
 Bronchomucotropic agents, 872  
 Bronchopleural fistulae, in equine pleuropneumonia, 993  
 Bronchopneumonia, acute bacterial, 889  
 Bronopol, 2189  
*Brucella abortus*  
   in camelids, 1762  
   in cattle, 1762  
   in dogs, 1762  
   in horses, 1762  
   in pigs, 1762  
   strain 19 vaccine, 1770–1771  
   strain RB51 vaccine for, 1771–1772  
   in wildlife species, 1762  
*Brucella melitensis*, brucellosis. see Brucellosis  
*Brucella ovis*, brucellosis. see Brucellosis  
*Brucella suis*, brucellosis. see Brucellosis  
 Brucellosis  
   abortion in, 1765, 1777t  
   *Brucella abortus*, associated with. see Bang's disease  
   *Brucella melitensis*, associated with, 1781–1784, 1781b  
   clinical findings of, 1783  
   clinical pathology of, 1783  
   control of, 1783–1784  
   differential diagnosis of, 1783b  
   economic importance of, 1782  
   epidemiology of, 1781–1782  
   eradication of, 1784  
   etiology of, 1781  
   necropsy findings of, 1783  
   pathogenesis of, 1782–1783  
   risk factors of, 1782  
   source of infection of, 1782  
   transmission of, 1782  
   treatment of, 1783–1784  
   vaccination for, 1784  
   zoonotic importance of, 1782  
*Brucella ovis*, associated with, 1774–1778, 1774b  
   clinical findings of, 1775–1776  
   clinical pathology of, 1775–1776  
   control of, 1776–1778  
   differential diagnosis of, 1776b  
   economic importance of, 1775  
   epidemiology of, 1774–1775  
   eradication of, 1776  
   etiology of, 1774  
   experimental reproduction of, 1775  
   necropsy findings of, 1776  
   pathogenesis of, 1775  
   risk factors for, 1775  
   source of infection in, 1775  
   transmission of, 1775  
   treatment of, 1776  
   vaccination, killed, 1778–1781  
   zoonotic implications of, 1775  
*Brucella suis*, associated with, 1778–1781, 1778b  
   biovars, 1778  
   clinical findings of, 1780  
   clinical pathology of, 1780  
   control of, 1781  
   diagnosis of, 1780–1781  
   differential diagnosis of, 1781b  
   economic importance of, 1779  
   epidemiology of, 1778–1779  
   etiology of, 1778  
   necropsy findings of, 1780  
   pathogenesis of, 1779–1780  
   risk factors of, 1779  
   source of infection in, 1779  
   treatment of, 1781  
   vaccination for, 1781  
   zoonotic implications of, 1779  
   vaccination for, 1776–1778  
   in wild boar, 2008  
 Bubbling, 852  
 Bubo, 77  
 Buccal cavity, diseases of, 192–194  
 Buccal mucosa, abnormalities of, 19  
 Buccal mucosa, wounds, 531  
 "Buckskin"-colored follicular dysplasia, 1645  
 Buffalo  
   fasciolosis and, 644  
   lead poisoning in, 1205  
 Buffalo flies, 1628–1629  
 Buffalo gnats, 1629–1630  
 Buffalo pox, 1587–1588, 1587b  
   differential diagnosis of, 1588b  
 Bulbar necrosis, infectious, 1448–1449  
 Bulbocapnine, 2210  
 Bulk tank infection, 1339  
 Bulk tank milk, 1972  
   culture of, 1915  
   *Acholeplasma laidlawii* in, 1940  
   *Staphylococcus aureus* mastitis in, 1934  
   *Streptococcus agalactiae* mastitis in, 1938  
   somatic cell counts, 1914–1915, 1915t  
   record keeping for, 1981  
 Bulldog calves, 1534  
 Buller steer syndrome, 1760–1761, 1760b  
 Bullos stomatitis, 193  
 Bulls  
   abomasal ulcer in, 519  
   *Brucella abortus*, transmission of, 1763  
   femoral-tibial osteoarthritis of, 1408  
   spondylitis in, 1344  
   transportation stress and, 85  
   vaccination programs in, 960  
 Bungowannah virus, 2137  
 Bunostomosis, 613–615, 613b–614b  
   differential diagnosis, 614b  
   treatment, 614–615, 614b  
*Bunostomum phlebotomum*, 614  
*Bunostomum trigonocephalum*, 614  
 Bureau of Veterinary Drugs (Canada), 1969  
*Burkholderia mallei*, 1026  
*Burkholderia pseudomallei*, 2029  
 Burn injury, 110  
 Burros, strangles in, 1021  
 Bursattee, 813b, 814–817  
 Buruli ulcer, 1574  
 Bush flies, 1630  
 Bush foot. see Footrot, in pigs  
 Bushfire (grassfire) injury, 110–111, 110b, 111t  
 Buss disease, 1282  
 Butorphanol, 234
- 
- C**
- C. pseudotuberculosis* biovar *equi*, 1449  
 Cache valley virus disease, 1511b, 1514–1515  
   clinical findings of, 1513  
   clinical pathology of, 1513  
   in congenital defects, 1836  
   differential diagnosis of, 1513b  
   epidemiology of, 1511  
   necropsy findings of, 1513  
   pathogenesis of, 1512  
   risk factors of, 1512  
   source of infection of, 1512  
 Caddis flies (*Dicosmoecus gilvipes*), 382  
 Cadmium toxicosis, 2181  
 Calcification, arterial thromboembolism, 710  
 Calcinogenic glycoside poisoning, 1504–1505, 1504b–1505b  
 Calcinosi, of cattle, 1390  
 Calcium  
   absorption of, 1482–1483  
   deficiency, 1482–1485, 1483b  
   clinical findings of, 1484  
   clinical pathology of, 1484  
   control of, 1484–1485  
   differential diagnosis of, 1484b  
   epidemiology of, 1483–1484  
   etiology of, 1483  
   necropsy findings of, 1484  
   pathogenesis of, 1484  
   primary, 1484  
   secondary, 1484  
   treatment for, 1484  
 dietary  
   in milk fever, 1677  
   requirements of, 1486t  
 homeostasis, in milk fever, 1677  
 for intestinal absorption, in milk fever, 1686–1690  
 intravenous administration of, 122  
 in macromineral evaluation, 1670  
 metabolism of, 1482–1483, 1483f  
 oral administration of, 122  
 osteodystrophy and, 1388  
 serum  
   osteodystrophy and, 1390  
   vitamin D deficiency and, 1493  
   subcutaneous administration of, 122  
 Calcium borogluconate, 141  
   for hypocalcemia, 121–122  
 Calcium (Ca) borogluconate  
   intravenous, 1684  
   for lactation tetany, of mares, 1737  
   for milk fever, 1684  
 Calcium carbonate  
   crystalluria, 1103  
   iron deficiency and, 814  
 Calcium chloride, 1689  
 Calcium gluconate, 662  
   23%, 141  
   for hypocalcemia, 121–122  
 Calcium versenate, for lead poisoning, 1208–1209  
 Calcium:phosphorus ratio, vitamin D deficiency and, 1493  
 Calf Antibiotic and Sulfa Test (CAST), 168  
 Calf barns, for enzootic pneumonia of calves, 945  
 Calf enterotoxemia, 547  
 Caliciviruses, porcine, 341  
 Calicivirus-like (Norovirus) agent, 389  
 California Mastitis Test, 1918, 1918t  
   for coliform mastitis, 1949  
   for *Corynebacterium bovis*, 1940  
   *Staphylococcus aureus* mastitis and, 1934  
 Calves  
   abdomen, examination of, 455–456  
   abdominal distension in, 456, 456t  
   abdominocentesis for, 190  
   abomasal bloat (tympany) in, 522–523  
   abomasal volvulus, 510  
   acute heart failure and, 707  
   acute undifferentiated diarrhea, 373–377, 374t  
   aortoiliac thrombosis in, 711  
   arthrogryposis, Akabane disease and, 1513  
   auricular vein of, 146, 148f  
   birth, assisted traction and, 1389

## Calves (Cont'd)

bovine immunodeficiency-like virus and, 786  
 carbohydrate engorgement, 462  
 coccidiosis, 401  
 cold injury in, 51  
 colibacillosis in, 1879–1880, 1885–1886  
 congenital defects in, 1839  
 critical temperature in, 1846  
 cryptosporidiosis, 397  
 with diarrhea, 114–115, 143  
   decision tree for, 144f  
   feeding of milk to, 149  
   oral electrolyte solutions for, 149  
 dietary diarrhea, 214  
 digestive tract, examination of, 456  
 doddler, 1331  
 enterotoxemia in, associated with *Clostridium perfringens* type D, 1228, 1230  
 enzootic pneumonia of, 939–946, 939b, 944b, 946b, 946f  
 with experimentally induced infectious arthritis, 1412  
 femoral nerve paralysis in, 1362  
 glomerulonephritis and, 1111  
 hand-fed, abomasal ulcer in, 519  
 heart rates, fetal, 668  
 hemonchosis in, 611–612  
 hepatic enzyme profile of, 629  
 hydranencephaly, Akabane virus and, 1513  
 hypokalemia in, 119  
 hypomagnesemic tetany of, 1706–1707, 1706b–1707b  
 hypothermia in, 1846  
 indigestion from milk replacers, 460–461  
 inherited ataxia of, 1333  
 Johne's disease, 554–555  
 left-side displacement of abomasum (LDA) and, 502, 506  
 malnutrition, 90  
 management, 834–835  
 metabolic acidosis in, 128  
 neonatal, diarrhea of, 582  
 neonatal hypothermia in  
   prevention of, 50  
   risk factors for, 47  
   treatment for, 50  
 neonatal infection in, 1874–1875  
 in neonatal streptococcal infection, 1901–1902  
 newborn, systemic disease in, 956  
 oral fluid therapy in, 147–150  
 otitis media/interna in, 1335  
 parturition, induction of, 1758–1759  
 peritoneal fluid of, 190  
 plasma for, 142  
 portosystemic shunts in, 632  
 prevention of infection in, enzootic bovine leukosis, 840  
 primary copper toxicosis, 2182  
 prolonged gestation with fetal gigantism in, 1828–1829  
 pulmonary edema and, 707  
 radiographs of, 856–857  
 rickets in, 1495  
 septic arthritis synovitis and, 1411–1412  
 septicemia in, 57  
 serum biochemical values of, 1862t  
 sodium bicarbonate 8.4% for, 141  
 temperature, lower critical, 45, 46f  
 terminal colon, atresia, 433  
 transportation stress and, 85  
 unthriftiness (pine) of, 2169  
 vertebral osteomyelitis in, 1346–1347  
 viral diarrhea, 384–393  
   clinical findings, 389  
   differential diagnosis, 391  
   epidemiology, 385–388  
   oral vaccines, 392  
   pathogenesis, 388–389  
   water intoxication in, 116

## Calving

in control and prevention, of infectious diseases, 1877–1879  
 draft-free environment for, 50  
 hypomagnesemic tetany and, 1705  
 seasonal feeding changes and, 1671  
 Calving paralysis, 1362, 1694  
 Cambendazole, poisoning of, 1211  
 Camelids  
   idiopathic nasal/perioral hyperkeratotic dermatosis of, 1563–1564  
   New World, parenteral nutrition for, 151–152  
 Camels, peste des petits ruminants (PPR), 574  
 CAMP test, *Streptococcus agalactiae* mastitis, 1938  
*Campylobacter coli*, 320  
*Campylobacter* infection, antimicrobial sensitivity, 155–156  
*Campylobacter jejuni*, 320  
   mastitis and, 1962  
   water supply contamination, 540  
*Campylobacter lari*, 320  
*Campylobacter perfringens*, diarrhea, 275  
*Campylobacter* spp., wild boar, 2008  
*Campylobacteriosis*, in pigs, 320–322  
 Canada  
   bovine viral diarrhea infection in, 578  
   brucellosis in, 1774  
   ovine progressive pneumonia in, 974  
   ovine pulmonary adenocarcinoma in, 978  
   rabies in, 1239  
 Canadian horsepox, 1576, 1576b  
 Canary grass toxicosis, 2205–2206  
 Canavanine, 2208  
 Cancer-eye, 1640  
 Cannabinoids, affecting nervous system, 1195  
 Cannibalism, 88  
 Cantharidiasis, 430–431  
 Cantharidin toxicosis, 430–431, 430b–431b  
 Capillary damage, leptospirosis and, 1120  
 Capillary integrity, in exercise-induced pulmonary hemorrhage, 1003  
 Capillary permeability, increased, 129  
 Capillary refill time, equine colic and, 231–233, 238  
 Caprine adenocarcinoma virus, 969–970  
 Caprine arthritis encephalitis, 1256b–1257b, 1282–1283  
   clinical findings of, 1255f, 1260  
   clinical pathology of, 1261  
   control for, 1261  
   differential diagnosis of, 1258b  
   economic importance of, 1259–1260  
   epidemiology of, 1257  
   etiology of, 1257  
   experimental reproduction of, 1259–1262  
   geographic occurrence of, 1257–1258  
   host risk factors of, 1258  
   necropsy findings of, 1261  
   pathogenesis of, 1260–1261  
   perinatal transmission of, 1261  
   samples for diagnostic confirmation of, 1261  
   test and segregate/cull, 1261–1262  
   transmission of, 1258  
   vaccination and genetic selection in, 1261–1262  
 Caprine besnoitiosis, 1607  
 Caprine contagious ophthalmia, 1653–1654, 1653b  
 Caprine hepatic lipidosis, cobalt deficiency, 817  
 Caprine herpesvirus-1 infection, 2086–2087, 2086b  
   clinical pathology, 2086  
   clinical signs, 2086  
   economic importance, 2086  
   epidemiology, 2086  
   etiology, 2086  
   necropsy findings, 2086–2087, 2087b  
   occurrence, 2086  
   pathogenesis, 2086  
   transmission and experimental reproduction, 2086  
   treatment and control, 2087  
 Caprine idiopathic dermatitis, 1548

Caprine pleuropneumonia, contagious, 970–972, 970b, 971t, 972b  
 Caprine progressive spasticity, 1349  
 Caprine salmonellosis, 366  
 Capsaicin, for pain, 83  
 Capsules, in *Streptococcus suis* infection, 2047  
 Carbadox, 173, 2189  
   swine dysentery, 331–332  
 Carbamate insecticides, 1209, 1214b  
 Carbamazepine, for head-shaking, 1226  
 Carbamylcholine chloride, 458–459  
 Carbazochrome, 721  
 Carbendazim, 654  
 Carbicarb, 140  
 Carbohydrate engorgement  
   milk fever and, 1681  
   of ruminants, 461–472, 461b  
     accidental consumption, 461  
     beef breeding herds, 462  
     case-fatality rates, 462  
     clinical findings, 465–466, 466t  
     clinical pathology, 466–468  
     complications, 466  
     control, 470–472  
     dairy cattle herds, 462  
     differential diagnosis, 468b  
     epidemiology of, 461–463  
     etiology of, 461  
     feed, types of, 462–463  
     feedlot cattle, 461–462  
     lamb feedlots, 462  
     liquid-fed calves, 462  
     morbidity, 462  
     necropsy findings, 468  
     pathogenesis, 463–465  
     prevention, 470–472  
     severity, 465  
     speed of onset, 465  
     toxic amounts of feed, 462–463  
     treatment, 466t, 468–470, 472b  
 Carbohydrates  
   loss of, excessive, 93  
   metabolism of, endotoxemia and, 62  
 β-Carboline indoleamine alkaloid poisoning, 1196  
 Carbon dioxide retention, 848  
 Carboxyatractylolide, 1195  
 Carboxyhemoglobinemia, 745  
 Carboxyparquin, 1195  
 Carboy, intravenous fluids in, 147  
 Carcass(es)  
   condemnation for human consumption, caseous lymphadenitis, 765  
   contamination of, 360, 543  
   hemorrhage, coagulation defect, 722  
 Card agglutination test (CAT), 773  
 Cardiac area, clinical examination of, 16–17  
 Cardiac catheterization, 673–675, 674t  
 Cardiac contractility, acidemia and, 127–128  
 Cardiac dilatation (eccentric hypertrophy), 659  
 Cardiac dullness area, percussion of thorax to identify, 665  
 Cardiac dyspnea, 849  
 Cardiac enlargement, 659  
 Cardiac glycoside  
   cardiac enlargement and, 662  
   toxicosis, 697–699, 697b, 699b  
 Cardiac hypertrophy (concentric hypertrophy), 659  
 Cardiac index, 673  
 Cardiac insufficiency, cardiac reserve and, 658–659  
 Cardiac lesions, 837  
 Cardiac measurement, cardiac reserve and, 659  
 Cardiac neoplasia, 703  
 Cardiac output  
   anemic hypoxia and, 736  
   exercise and, 96  
 Cardiac reserve  
   autonomic nerve activity and, 658  
   cardiac insufficiency and, 658–659  
   heart rate and, 658

- Cardiac reserve (*Cont'd*)  
 measurement and, 659  
 mixed venous oxygen tension and, 658  
 stroke volume and, 658  
 valvular disease and, 686
- Cardiac signs, endocarditis, 689
- Cardiac tamponade, 692
- Cardiac troponin I, 661
- Cardiac troponin T (cTnT), 670
- Cardiomyopathy, 690–692, 690b  
 bovine hereditary dilated, 706–707  
 clinical findings of, 691  
 clinical pathology of, 691–692  
 congenital, 691  
 differential diagnosis of, 692b  
 etiology of, 690–691  
 necropsy findings of, 692  
 pathogenesis of, 691  
 treatment of, 692
- Cardiopulmonary function, endotoxemia and, 61
- Cardiotoxins, 2177
- Cardiovascular accidents, acute, 692–693
- Cardiovascular disease, in dyspnea, 849
- Cardiovascular dysfunction, causes of, 657b
- Cardiovascular system  
 arrhythmias (dysrhythmias), 675, 675t  
 blood vessel disease, 709–711  
 circulatory system inherited defects of, 706–707  
 congenital cardiac defects, 703–706, 703b  
 diseases of, 657–715  
   cardiac enlargement, 659  
   heart failure. *see* Heart failure  
   manifestations of, 659–662  
   principles of, 657–659  
 examination of, 663–665  
   angiocardigraphic examination, 673  
   arterial blood pressure measurement, 671  
   cardiac catheterization, 673–675, 674t  
   cardiac output, 673  
   echocardiography, 672–673  
   exercise tolerance, 666  
   heart rate, 664  
   jugular vein, 665  
   phonocardiography, 673  
   physical, 663–665  
   pulmonary artery blood pressure measurement, 671–672  
   radiographic examination, 673  
   heart disease, 690–692  
   vascular neoplasia and, 715
- Cardiovascular system, exercise intolerance, 99
- Caribbean, rabies in, 1239–1247
- Carotene, plasma, 1325
- Carotid artery aneurysm, rupture of, 99–100
- Carpal joints, arthritis in, 976
- Carprofen, for pain, 83
- Case, definition of, 30
- Case fatality  
 clinical examination and, 6  
 rate, of heaves, 1004
- Caseonecrotic bronchopneumonia, in *Mycoplasma bovis*, 936
- Caseous lymphadenitis, of sheep and goats, 765, 766b  
 clinical findings of, 763f, 766–767  
 clinical pathology of, 763f, 766  
 control of, 767  
 differential diagnosis of, 768b  
 economic importance of, 764  
 epidemiology of, 762  
 eradication, 768  
 etiology of, 762  
 necropsy findings of, 766–767  
 pathogenesis of, 766  
 prevention of, 768  
 samples for confirmation of diagnosis, 767  
 treatment of, 767  
 vaccination, 768  
 zoonotic implications of, 766–769
- Castanospermine poisoning, 1196
- Casts, urine, 1103
- Cat(s)  
 control, 2143  
 feces, 2140
- Cataracts, congenital, 1659
- Catarrhal stomatitis, 193
- Catecholamines, 691
- Cattle  
 abdomen  
   diseases of, 454t  
   silhouettes of the contour of, 446f  
 abdominal ultrasonography, 184  
 abdominocentesis, 190  
 abomasal impaction in, 515–517, 515b  
   differential diagnosis in, 516b–517b  
 abomasal ulcers of, 518–522, 518b  
   differential diagnosis in, 521b  
 acute hypokalemia in, 1690–1693, 1690b  
 alimentary tract examination, 445–457  
 anaphylaxis of, 750, 756f  
 auricular vein of, 146, 148f  
 differential diagnosis of diseases of, 590t–591t  
 diseases of, 1281t  
   differential diagnosis of, 1126t  
 endoscopic examination, of airways, 856  
 fasting, daily energy requirements of, 140t  
 fatty liver in, 1716–1722, 1717b  
 heart rate, resting, 676  
*Histophilus* septicemia of, 2033–2038, 2033b–2034b  
 inherited periodic spasticity of, 1347f, 1353  
 injection-site lesions in, 1387–1388  
 lead poisoning in, 1204, 1205f, 1206  
 listerial encephalitis/meningitis in, 1335f, 1338  
 musculoskeletal examination, ultrasonography, 1376  
*Mycoplasma bovis* in, 932–939, 932b, 936b–938b  
*Mycoplasma* spp. of  
   diseases of the respiratory tract associated with, 924–925  
   major pathogenic, 885t  
   nociception in, 81f  
   osseous sequestration in, 1392, 1392f–1393f  
   papillomatosis in, 1582, 1582f–1583f  
   periparturient period in, 1662–1667  
   phosphorus requirements for, 1489  
 rabies in, 1240  
 recumbent, 687  
 reproductive performance, selenium and vitamin E deficiency, 1465  
 rhinitis in, 874  
 ringworm in, 1601  
 rumen of, nasogastric intubation, 183  
 sarcocystosis, 2139  
 selenium subcutaneous injections for, 1475–1476  
 Senkobo disease of, 1570–1573  
 septic arthritis synovitis and, 1412  
 septic pedal arthritis in, 1417  
 septicemia in, 57  
 septicemic pasteurellosis of, 2040–2042  
 serum bile acid, 627  
 slow-release treatments in, 2175  
 spastic paresis of, 1348f, 1350f, 1351  
 starvation in, 90  
 steatitis in, 1726  
 thyroid enlargement in, 1744  
 toxoplasmosis, 2142  
 tracheal stenosis in, 879  
 tracheitis in, 878  
 transportation stress and, 85  
 ulcerative lymphangitis  
   clinical findings of, 761  
   epidemiology of, 760  
 vaccination, Johnes's disease, 563–564  
 vesicular stomatitis, 396  
 water medication in, 161  
 zinc toxicosis  
   acute poisoning, 2195  
   chronic poisoning, 2195
- Cattle Health Certification Standards (Checs), 598
- Cattle plague. *see* Rinderpest (RPV)
- Cauda equina syndrome, 1362
- Caudal compression, for head-shaking, 1226
- Caudal fold test (CFT), 2019
- Caudal skin fold, 2019
- Caudal vena cava syndrome, hepatic abscess with, 634
- Caudal vena caval thrombosis, 714
- Cauliflower saltwort (*Salsola tuberculatiformis*), 1827
- Caustic-treated grain, feeds, 620
- Cecal catheters, in horses, 146
- Cecal dilatation, in cattle, 524, 528–530, 530b
- Cecal distension, 228t, 258–259
- Cecal impaction, 258
- Cecal rupture, 258
- Cecal torsion, 258
- Cecal tympany, 258
- Cecocolic intussusception, 259
- Cecocolic intussusception, 259, 524
- Cecum, disease of, 257–259, 257b  
 clinical findings, 258–259  
 clinical pathology, 259  
 differential diagnosis, 259b  
 epidemiology, 258  
 etiology, 257–258  
 necropsy findings, 259  
 pathogenesis, 258  
 treatment, 259
- Cedist blocking enzyme-linked immunosorbent assay (ELISA), 587
- Cefquinome, for coliform mastitis, 1951
- Ceftiofur, for coliform mastitis, 1950–1951
- Ceftiofur crystalline-free acid sterile suspension (CCFA-SS), 920
- Celiotomy, 277, 453–454, 455t
- Cells, in urine, 1103
- Cellulitis  
 definition of, 77  
 traumatic, 77
- Centers for Disease Control and Prevention, enterohemorrhagic *Escherichia coli* infection, 539
- Central blindness, 1163
- Central cyanosis, in respiratory insufficiency, 853
- Central hypersensitivity, and pain, 80
- Central nervous system (CNS)  
 acidemia and, 128  
 associated masses of, 1218  
 associated tumors of, 1218  
 bacterial infection of, 1179  
 degenerative diseases of, 1184–1186  
   *see also* Encephalomalacia  
 depressants of, 1178  
 equine grass sickness, 285  
 injury response of, 1179  
 metastatic tumors of, 1221  
 in ovine progressive pneumonia, 975  
 palpation of bony encasement, 1172  
 stimulants of, 1178  
 stranglers in, 1021  
 tumors of, 1216, 1221b
- Central venous pressure, 73  
 measurement of, 665–666  
 and naturally occurring combined abnormalities of  
   free water, electrolyte, acid-base balance,  
   and oncotic pressure, 136
- Cephalosporins  
 toxicity of, 170–171
- Cephenemyia titillator*, 979
- Ceratopogonidae, 1631
- Cereal pastures, hypomagnesemic tetany and, 1701
- Cerebellar abiotrophy, 1328–1329
- Cerebellar atrophy, of lambs, 1331–1332
- Cerebellar disease  
 ataxia, 1159, 1161  
 hypoplasia, 1162
- Cerebellar hypoplasia, 1331  
 bovine virus diarrhoea virus, 586  
 in Churra lambs, 1332
- Cerebellum, diseases of, 1328
- Cerebral cortex, lesions of, blindness from, 1167



- Cerebral edema, 116–118, 1180  
 clinical findings of, 1181  
 clinical pathology of, 1181  
 cytotoxic, 1180  
 differential diagnosis for, 1180b  
 interstitial, 1181  
 laminar necrosis and, 1312  
 necropsy findings in, 1181  
 pathogenesis of, 1181  
 treatment of, 1181  
 vasogenic, 1180
- Cerebral hypoxia, 1179, 1179b
- Cerebrocortical necrosis, 1324–1325
- Cerebrospinal angiopathy, 312, 1265–1269
- Cerebrospinal fluid (CSF)  
 analysis of, 1174–1175  
 brain abscess and, 1191  
 collection of, 1158, 1172–1173  
 in encephalitis, 1184  
 examination of, 1172–1175  
 magnesium concentrations in, in hypomagnesemic tetany, 1703  
 in meningitis, 1193  
 in newborn, 1863  
 pH of, hypercapnia in, 848  
 in vitamin A deficiency, 1322, 1328
- Cerebrospinal nematodiasis, 1351
- Cerebrum, diseases of, 1252–1253  
 inherited, 1326
- Cervical abscesses, 2051
- Cervical adenitis, lymphadenopathy, 751
- Cervical esophagostomy alimentation, 202–203
- Cervical examination, equine colic and, 236–237
- Cervical skin fold, 2019
- Cervical vertebrae, osteomyelitis and, 1393
- Cervical vertebral instability. *see* Equine cervical vertebral stenotic myelopathy
- Cervicothoracic vertebral osteomyelitis, 1393
- Cesarean section, for pregnancy toxemia, 1725
- C-fibers, 79–80
- Chabertia, 617
- Chabertia ovina*, 617
- Chance nodes, 27
- Charm Farm and Disk Assays, 168
- Charm Inhibition Assay, 168
- Chediak-Higashi syndrome  
 thrombasthenia and, 726
- Chelidonine, 2210
- Chemical agents  
 gastritis, etiology of, 203  
 osteodystrophy and, 1388
- Chemical arthrodesis, for degenerative joint disease, 1411
- Chemical rinses, carcass decontamination, 543
- Chemotherapy, anaplasmosis and, 775–776
- Chewing, disturbances of, 1168t
- Cheyne-Stokes respiration, 12, 1193
- Chiasma, blindness from, 1179
- Chigger mites, 1618
- Chilled vaccine, 806–808
- Chiropractic manipulation, for head-shaking, 1226
- Chlamydiae*, wild boar, 2008
- Chlamydial disease, reproductive, 1786–1791
- Chlamydial infection in pig, 2057–2058
- Chlamydial polyarthritis, 1449
- Chlamydophila abortus*, in ovine enzootic abortion, 1786
- Chlamydophila pecorum*, in contagious ophthalmia, 1653
- Chlamydophila psittaci*, 1786
- Chlamydophila suis*, 1787
- Chloramphenicol, 171  
 analogs of, 171  
 mechanism of action, 171  
 toxicity of, 171
- Chlorellosis, protothecosis and, 2158
- Chlorhexidine, postmilking teat sanitization, 1969
- Chloride, 118  
 experimental restriction of, 2161–2162
- Chlortetracycline, porcine proliferative enteropathy, 326
- Choanal atresia, 433
- Choke, acute esophageal obstruction, 200–201
- Cholangiohepatitis, in horses, 655–656
- Cholangitis, 624
- Cholecalciferol (vitamin D<sub>3</sub>), 2191
- Cholecystocentesis, percutaneous ultrasound-guided, 626
- Cholelithiasis, 656
- Cholelithiasis, 624, 626, 655
- Cholestasis, 626
- Cholesteatoma, 1184
- Choline deficiency (Hypocholesterinosis), 2176
- Cholinesterase inactivation, in organophosphate poisoning, 1215
- Chondrodysplasia, inherited, 1535–1536
- Chondrodystrophy, 1390  
 congenital  
 manganese deficiency and, 1501  
 of unknown origin, 1538
- Chondroids, 984–985
- Chondroprotective agents, for degenerative joint disease, 1411
- Chordae tendineae rupture, 689
- Chorioptic mange, 1622–1623  
 differential diagnosis of, 1623b
- Chromated copper arsenate (CCA), 2193
- Chromium toxicosis, 2181
- Chromogenic assays, 723
- Chronic bronchopneumonia, in cattle, 889–890
- Chronic disease, in anemia, 730t, 731
- Chronic enzootic pneumonia, of sheep, 972–973, 972b
- Chronic equine eosinophilic dermatitis, 1548
- Chronic fluorosis, osteodystrophy of, 1390
- Chronic free-gas bloat, 2037
- Chronic interstitial fibrosis, 1114
- Chronic interstitial pneumonia  
 in foals, 996  
 in goats, 924
- Chronic leptospirosis, associated with *L. Pomona*, 1122
- Chronic nodular lung lesions, in glanders, 1026
- Chronic nonprogressive atypical pneumonia, 972–973, 972b
- Chronic oral poisoning, causes of, 2182
- Chronic pleuritis, 896
- Chronic pneumonia, *Mycoplasma bovis*, 934
- Chronic pneumonia and polyarthritis syndrome (CPPS), 932–933
- Chronic poisoning, 826
- Chronic renal ischemia, 1112
- Chronic wasting disease, 1321–1322
- Chrysomya bezziana*, 1615–1617, 1615b–1616b
- Chrysops* (deer fly), equine infectious anemia virus transmission, 789
- Chrysops* spp., 1626
- Cicutoxin, 2208
- Cimetidine, 251  
 for abomasal ulcer, 522
- Ciprofloxacin, diarrhea and, 277
- Circling, vestibular disease, 1162
- Circuit failure, 71, 658
- Circulatory disorders, encephalomalacia and, 1187–1189
- Circulatory failure, principles of, 657–659
- Circulatory hypoxia, 847
- Circulatory system, inherited defects of, 706–707
- Cirrhosis, 630–631
- Cisapride  
 equine colic, 234  
 equine grass sickness, 285  
 for gastrointestinal motility, 191
- Cisplatin, for sarcoid, 1586
- Cisterna magna, in cerebrospinal fluid collection, 1173
- Cistus salvifolius* ingestion, 1129
- Citrate, 1947
- Citrinin toxicosis, 1135
- Citrullinemia, 1838–1839  
 inherited, 1331
- Clara cells, 978
- Clarithromycin, for *Rhodococcus equi* pneumonia, 1016–1017
- “Clasp-knife release”, 1173
- Classical swine fever (hog cholera), 2098–2110, 2098b–2099b  
 Agar gel precipitation test, 2104  
 animal risk factors, 2100–2101  
 antigen-capture ELISA, 2104  
 attenuated vaccines, 2109–2110  
 chronic disease, 2103–2104  
 clinical findings, 2103–2104  
 clinical pathology, 2104–2105  
 control, 2107–2110  
 detection of antigen, 2106  
 detection of virus, 2104  
 diagnosis, 2103–2104, 2106–2107  
 differential diagnosis, 2107b  
 economic importance, 2101  
 epidemiology, 2099–2101  
 etiology, 2099  
 florescent antibody techniques, 2104  
 hematology, 2104  
 immune mechanisms, 2101  
 immunization methods, 2108–2110  
 inactivated vaccines, 2110  
 methods of transmission, 2100  
 morbidity and case fatality, 2100  
 necropsy findings, 2105–2106  
 nervous manifestations, 2103  
 occurrence, 2099–2100  
 versus other pestiviruses, 2104–2105  
 pathogen risk factors, 2101  
 pathogenesis, 2101–2103  
 PCR tests, 2104–2105  
 peracute and acute disease, 2103  
 reproductive failure, 2104  
 resistance of virus, 2101  
 risk factors, 2100–2101  
 samples  
   for confirmation of diagnosis, 2106  
   for laboratory, 2105  
 serology, 2105–2107  
 serum-virus vaccination, 2109  
 treatment, 2107  
 wild boar, 2008
- Claviceps*-associated mycotoxins, 1202
- Claw deformity, inherited, 1537
- Cleaning, biosecurity and, 40–41
- Cleft palate, 432–434, 1838
- Clenbuterol  
 for heaves, 1010  
 for pneumonia, 892
- Clenbuterol hydrochloride, for heaves, 1011
- Climate  
 fasciolosis, 642  
 hemonchosis, in ruminants, 611  
 history taking of, 8  
 hypomagnesemic tetany and, 1702  
 sheep, infectious footrot in, 1442  
 stress induction and, 84
- Clinical endometritis, 67
- Clinical examination, of individual animal, 5–22  
 abdomen, 13, 17–18  
 auscultation, 14  
 ballottement, 14  
 behavior, 10  
 body condition, 11  
 body conformation, 12  
 close physical examination of, 13–14  
 defecation, 11  
 diagnostic imaging for, 22  
 eating, 11  
 environment and, 8–10  
 examination of animal, 10–22  
 excitation states, 10–11

- Clinical examination, of individual animal (*Cont'd*)  
 external genitalia, 13  
 feet, 21  
 gait, 11  
 general inspection, 10–12  
 head, 12, 18  
 limbs, 13  
 mammary glands, 13, 21  
 musculoskeletal system, 21  
 neck, 12, 18  
 nervous system, 21  
 palpation, 13  
 particular distant examination, 12–13  
 percussion, 13–14  
 posture, 11  
 reproductive tract, 21  
 skin, 12, 21–22  
 succussion, 14  
 thorax, 12–13, 16–17  
 urinary system, 21  
 urination, 11  
 vital signs, 15–16  
 voice, 11
- Clinical lymphosarcoma, occurrence of, enzootic  
 bovine leukosis and, 833
- Clinical metritis, 67
- Clinical scoring systems, in enzootic pneumonia of  
 calves, 943
- Clinical surveillance, for contagious bovine  
 pleuropneumonia, 930
- Clinicopathological anemia, iron deficiency and, 813
- Clipboard test, 1298
- Clitocybe spp., 2205
- Clotfuzimine, 561
- Cloned offspring, diseases of, 1870–1871
- Clorsulon, 644, 1212
- Closantel  
 in fasciolosis, 644  
 for hemonchosis in ruminants, 612–613  
 for nasal bots, 980
- Close housing, in ovine pulmonary adenocarcinoma,  
 978
- Closed farming system, for bovine herpesvirus-1  
 infection, 958
- Clostridial enterotoxin, diarrhea and, 278–279
- Clostridial infection, localized, 77
- Clostridial myonecrosis. *see* Malignant edema
- Clostridiosis, in pigs, 308–311
- Clostridium*, myositis and, 1388
- Clostridium botulinum*  
 equine grass sickness, 283–284  
 tremor, 1161
- Clostridium difficile*  
 diarrhea, 275  
 enterocolitis associated with, 377–379
- Clostridium haemolyticum*, 635
- Clostridium novyi*  
 infection, 638–639  
 type B, black disease, 637  
 type D (*Clostridium haemolyticum*), 635
- Clostridium perfringens*  
 enteric disease, 545  
 mastitis and, 1962  
 myositis and, 1388  
 type B, enterotoxemia, 546–549, 546b  
 type C, enterotoxemia, 546–549, 546b  
 type E, enterotoxemia, 546–549, 546b
- Clostridium pseudotuberculosis*, localized infection,  
 77
- Clostridium sordellii*, 1428
- Clostridium tetani*, 1160
- Clotting factors, vitamin K-dependent, reduction of,  
 722
- Clover disease, phytoestrogen toxicosis, 1823
- Cluster dunking, 1970
- Coagulants, for abomasal ulcer, 522
- Coagulase-negative staphylococci (CNS), 1905
- Coagulation  
 defects, hemorrhage and, 721–722  
 diarrhea, acute, 278  
 equine colic and, 225–226
- Coagulopathies  
 arterial thromboembolism, 709  
 in exercise-induced pulmonary hemorrhage,  
 1002–1003  
 treatment of, 721–725
- Coal tar creosote, 2193–2194
- Coal tar pitch poisoning, 655–656
- Coast disease, of sheep, 815
- Coat-color dilution, 1644–1645
- Cobalt  
 in anthelmintics, 819–820  
 deficiency, 823, 825b  
 anemia, nonregenerative, 732  
 clinical findings of, 816–817  
 clinical pathology of, 816  
 in congenital defects, 1837  
 control of, 819  
 differential diagnosis of, 826b  
 epidemiology of, 814  
 etiology of, 814–817  
 experimental reproduction, 816  
 necropsy findings of, 817–818  
 occurrence of, 814–815  
 pathogenesis of, 816  
 primary, 816  
 risk factors of, 814–815  
 samples for confirmation of diagnosis, 818  
 status, biochemistry, 816  
 treatment of, 818–819  
 in ketosis, 1710  
 liver, 817  
 pasture top-dressing of, 819–820  
 serum concentration of, 817  
 status, biochemistry of, 816  
 supplementation of, 819–820  
 toxicity, 819–820
- Cobalt pellet, 819–820
- Cobalt toxicosis, 2181–2182
- Coccidioides immitis*, 2159
- Coccidioidomycosis, 2159, 2159b
- Coccidiosis, 391, 401–408, 401b  
 calves, 401  
 case fatality, 402  
 cattle, 402  
 clinical findings, 404–405  
 clinical pathology, 405  
 control, 406–408  
 diagnosis, 406  
 differential diagnosis, 406b  
 epidemiology, 401–403  
 etiology, 401  
 goats, 402  
 immune mechanisms, 403  
 life cycle, 403–404  
 morbidity, 402  
 multiinfections, 403  
 necropsy findings, 405–406  
 with nervous signs, 405  
 occurrence, 401  
 pathogenesis, 403–404  
 pigs, 402  
 prevalence, 401  
 risk factors, 402–403  
 sheep, 402  
 transmission, 402  
 treatment, 406  
 vaccines, 408
- Coccidiostats, 407
- Cochliomyia americana*, 1902
- Cochliomyia hominivorax*, 1615–1617,  
 1615b–1616b
- Cockle, 1562–1563
- Coenurosis, 1308b–1309b, 1323
- Coitus transmission, of dourine, 1820
- Colchicine, alimentary tract and, 428
- Cold cow syndrome, 2003
- Cold exposure  
 animal production in, 48  
 lethal limit, 45
- Cold injury (frostbite and chilblains), 50–51,  
 50b–51b
- Cold stress  
 management of, in sick foals, 50  
 in mortality in piglets, 1834  
 neonatal response to, 44–47
- Cold thermogenesis, 46
- Colibacillosis  
 enteric, 1883–1885  
 clinical findings of, 1885–1886, 1886t  
 diagnosis of, 1887, 1888t  
 necropsy findings of, 1887  
 treatment of, 1888
- enterotoxigenic, 1886–1887
- in newborn, 1879–1899, 1879b  
 analgesic and antiinflammatory therapy for,  
 1893  
 antimotility drugs for, 1893  
 clinical findings in, 1885–1887  
 clinical pathology of, 1887  
 diagnosis of, 1887  
 differential diagnosis of, 1888b  
 epidemiology of, 1879–1883  
 etiology of, 1879  
 immunoglobulin therapy for, 1893  
 morbidity in, 1880  
 mortality in, 1880  
 necropsy findings of, 1887  
 occurrence of, 1879–1880  
 pathogenesis of, 1883–1885  
 prevalence of infection in, 1879–1880  
 risk factors of, 1880–1883  
 transmission of, 1881  
 treatment of, 1888–1894, 1894b
- septicemic. *see* Coliform septicemia
- Colic  
 in foals, 237–240, 237b, 238t  
 clinical findings, 238–239  
 clinical pathology, 239  
 differential diagnosis, 239b, 240t  
 epidemiology, 238  
 necropsy findings, 239  
 pathophysiology, 238  
 prevention, 239  
 treatment, 239
- in horses, 220–236, 221b  
 acid-base, 231  
 acute, 221  
 case fatality rate, 223  
 chronic, 221  
 classification, 221, 222t–223t  
 clinical findings, 226–230  
 clinical pathology, 230–231  
 course of the disease, 229–230  
 differential diagnosis, 233b, 242t–243t  
 epidemiology, 221–225  
 etiology, 221  
 field, management of, 235  
 gastric ulcers and, 248–249  
 incidence, 223  
 infarctive, 221, 226  
 inflammatory, 221, 226  
 from ingestion of indigestible fiber, 427  
 mortality, 223  
 necropsy findings, 233  
 normal anatomy, 227  
 obstructive and strangulating, 221, 226  
 occurrence, 223  
 pathogenesis, 225–226  
 prevention, 235  
 prognosis, 232–233  
 protocol for evaluating a colic patient,  
 231–233  
 rectal examination, 227–228  
 rectal findings, 228t  
 recurrent, 221  
 risk factors, 223–224  
 simple obstructive, 226  
 spasmodic, 221  
 surgery, 232, 235  
 treatment, 233–236, 233t  
 trocization, 235  
 when to refer, 232–233

- Colic (*Cont'd*)  
 in postparturient mare, 236–237  
 in pregnant mare, 236–237  
 sand, 266–267  
 spasmodic, 221, 269  
 thromboembolic, 270
- Coliform gastroenteritis, of pigs, 315–320, 315b  
 case-fatality rate, 315–316  
 clinical findings, 317  
 clinical pathology, 317  
 control, 318–319  
 diagnosis, 317  
 differential diagnosis, 317b–318b  
 epidemiology, 315–316  
 etiology, 315  
 necropsy findings, 317  
 pathogenesis, 316–317  
 risk factors, 316  
 treatment, 318  
 vaccination, 319
- Coliform mastitis, 1943–1954  
 acute, 1681, 1948  
 case fatality of, 1945  
 chronic, 1949  
 clinical findings of, 1948–1949  
 clinical pathology of, 1949  
 control of, 1952–1954  
 diagnosis of, 1949  
 differential diagnosis of, 1950b  
 duration of infection of, 1944  
 endotoxin-induced, 1947–1948  
 epidemiology of, 1944–1947  
 etiology of, 1943–1944, 1944b  
 management of outbreaks, 1953  
 in mastitis, 1906  
 in mastitis-metritis-galactia, 1997  
 morbidity of, 1945  
 necropsy findings of, 1949  
 pathogenesis of, 1947–1948  
 peracute, 1681, 1948  
 prevalence of, 1944  
 risk factors of, 1945–1947  
 severity of, 1947  
 source of infection of, 1944–1945  
 subclinical, 1949  
 treatment of, 1950–1952, 1954b  
 vaccination for, 1954
- Coliform septicemia, 391, 1883  
 clinical findings of, 1885–1887  
 diagnosis of, 1887  
 necropsy findings in, 1887  
 treatment of, 1888–1894
- Colistin, for enterotoxigenic colibacillosis, 1892
- Colitis  
 diarrhea, acute, 277  
*Lawsonia*, 325  
 nonspecific, 334–335  
 right dorsal, 267–268  
 Colitis X, 277
- Collagenase solution, for puerperal metritis, 70
- Collagenolytic granuloma, 1559
- Colloid solutions, 142–143
- Colloids  
 hypovolemic shock, 74–75  
 maldistributive shock, 74–75
- Colobomata, typical, 1659
- Colon  
 displacement, 228  
 distension, 228, 228t  
 intussusception, 525–526
- Colostrum immunity, in bovine herpesvirus-1 infection, 954
- Colostrum  
 administration of, 1855–1856  
 antibody, *Clostridium perfringens* types B, C and E, 548–549  
 artificial feeding of, 1849  
 bacterial contamination of, 1850  
 banking for, 1854  
 benefits of, 1852  
 bovine virus diarrhea virus, 581  
 breed differences in, 1850  
 California Mastitis Test for, 1918t  
 caseous lymphadenitis effect, 767  
 concentration, determinants of, 1849b, 1850  
 cross-species, 1855  
 deprivation of, septicemia, 58  
 efficiency of absorption in, 1851–1852  
 esophageal feeder administration, 461  
 immunity and, in colibacillosis, 1880–1881  
 immunoglobulins in, 1848–1849, 1863  
 effects of, 1884  
 lactogenic immunity in, 1849  
 monitoring of, 1854  
 natural sucking of, 1849–1851  
 neonatal hypothermia prevention, 47  
 normal transfer of immunoglobulins in, 1848–1849  
 pasteurization of, 1850  
 pooling of, 1850  
 replacer, 1855  
 storage of, 1854  
 supplements, 392, 1855  
 in transfer of passive immunity, 1853–1854  
 transfer of selenium and vitamin E to, 1466–1467  
 viral diarrhea, 393  
 volume, ingestion of, 1850
- Coma, 1169
- Combination therapy, for coliform mastitis, 1952
- Combination vaccines, for bovine herpesvirus-1 infection, 959–960
- Combined immunodeficiency (CID), 755
- Communication, biosecurity and, 41
- Compartment syndrome, in downer-cow syndrome, 1695
- Compensation, of respiratory insufficiency, 847
- Competitive enzyme-linked immunosorbent assay (C-ELISA), 773  
 in contagious bovine pleuropneumonia, 929  
 peste des petits ruminants, 575
- Complement fixation test (CFT), 773, 804–805  
 for *Brucella abortus*, 1767  
 in contagious bovine pleuropneumonia, 928  
 for dourine, 1820  
 for Johne's disease, 559, 569  
 for ovine enzootic abortion, 1787  
 in pleuropneumoniae, of pigs, 1060
- Complement-fixing antibody, in equine herpesvirus-1 and -4 infections, 1041
- Complete blood count, for localized infections, 78
- Complete heart block, 679
- Complex vertebral malformation, in Holstein calves, 1536–1537
- Compression atelectasis, 883
- Compression stenosis, 524
- Compressive myelopathy, vertebral, 1349
- Compton metabolic profile test, 1667
- Compulsive walking, 1159
- Computed tomography (CT)  
 for musculoskeletal system disease, 1377  
 in nervous system examination, 1176  
 for newborn, 1860  
 in respiratory system, 857–858  
 for septic arthritis synovitis, 1414–1415  
 urinary system examination, 1108
- Computer-assisted diagnosis, 25–26
- Computer-assisted MRI brain morphometry, for cerebellar atrophy, 1334–1336
- Concentration-dependent killing, 166
- Concentric hypertrophy (cardiac hypertrophy), 659
- Conchal atrophy, in grading system, of progressive atrophic rhinitis, 1052
- Concussion, 1188
- Concussive laminitis, 1396
- Condition scoring, of sow, 2007
- Conditioning programs, for pneumonic pasteurellosis, 921–922
- Conduction disturbances, 675  
 electrocardiography and, 667–668  
 myocardial disease and, 691
- Conductive heat loss, 45
- Confinement  
 housing, effects of, 1087–1088  
 lameness in pigs and, 1422
- Confirmation, of strangles, 1022
- Conformation, 1376  
 of border disease, 1254
- Congenital absence, of skin, inherited, 1645
- Congenital achondroplasia, with hydrocephalus, 1534
- Congenital arthrogryposis, and hydranencephaly, 1511b, 1514–1515
- Congenital defects  
 of alimentary tract, 432–434  
 cardiac, 703–706, 703b  
 plants and, 1827  
 in respiratory tract, 1090  
 vitamin A deficiency and, 1324–1325
- Congenital dyserythropoiesis, 1643
- Congenital hydrocephalus, 1182, 1182b  
 inherited, 1329
- Congenital hyperostosis, inherited, 1537
- Congenital hyperplasia, of myofiber, 1510
- Congenital hypothyroidism, 1739–1742
- Congenital hypotrichosis, inherited, 1644
- Congenital ichthyosis, inherited, 1643, 1646
- Congenital infection, in enzootic bovine leukosis, 833
- Congenital inherited disease, 839
- Congenital joint laxity and dwarfism, 1538
- Congenital myasthenia gravis, 1515
- Congenital necrotizing encephalopathy, of lamb, 1227–1239
- Congenital nutritional muscular dystrophy, 1463
- Congenital osteopetrosis, 1534
- Congenital polycystic kidney disease, of lamb, 1138
- Congenital skin tumors, 1642–1643
- Congenital stationary night blindness (CSNB), 1659
- Congenital tremor  
 of pigs, 1355  
 syndromes of piglets, 1235t–1237t, 1248–1252, 1259t
- Congestive hepatitis, 631–632
- Conidiobolus coronatus*, 813b
- Conium, 1201
- Conium maculatum* (poison hemlock), 1837
- Conjunctiva  
 diseases of, 1540–1661  
 examination of, 18
- Conjunctivitis, 1648  
 bovine herpesvirus-1 infection in, 955–956  
 nonspecific, 1648
- Consciousness, abnormalities of, 1194–1195
- Conservative therapy, for puerperal metritis, 69
- Constipation, 180, 625, 1999
- Constrictive pericarditis, 707–708
- CONSULTANT program, 26
- Contagious acne, of horses, 1576  
 differential diagnosis of, 1576b
- Contagious agalactia, in goats, 924
- Contagious bovine pleuropneumonia (CBPP), 925–932, 925b  
 clinical findings in, 928  
 clinical pathology of, 928–929  
 control of, 930–932  
 differential diagnosis of, 929b  
 epidemiology of, 925–927  
 etiology of, 925, 926t  
 necropsy findings of, 929  
 pathogenesis of, 927–928  
 risk factors for, 927  
 status of, for countries or regions, 932  
 treatment of, 929–930, 930b
- Contagious caprine pleuropneumonia (CCPP), 970–972, 970b, 972b  
 in goats, 924



- Contagious conjunctivokeratitis, 1653b
- Contagious ecthyma, 1593–1596, 1593b  
 clinical findings of, 1594–1595  
 clinical pathology of, 1595  
 control of, 1596  
 differential diagnosis of, 1595b  
 economic importance of, 1594  
 epidemiology of, 1593–1594  
 etiology of, 1593  
 experimental reproduction of, 1593–1594  
 in goats, 1595  
 morbidity and case fatality of, 1593  
 necropsy findings of, 1595  
 occurrence of, 1593  
 pathogenesis of, 1594  
 risk factors of, 1594  
 in sheep, 1594–1595, 1594f–1595f  
 transmission of, 1593  
 treatment of, 1596  
 zoonotic implications of, 1594
- Contagious ovine digital dermatitis (CODD), 1444b
- Contagious pustular dermatitis, 1576, 1593–1596, 1593b  
 differential diagnosis of, 1576b
- Continuous-flow peritoneal dialysis, 1109, 1109f
- Contraction atelectasis, 883
- Control, of infection, 36–42
- Cotusion, traumatic brain injury, 1188
- Convulsions  
 clonic, 1160  
 in encephalopathy, 1194  
 extracranial, 1161  
 familial, in cattle, 1333  
 nervous system disease, 1160  
 vitamin A deficiency and, 1324–1325
- Coombs testing, 737–738
- Cooperative State-Federal Brucellosis Eradication Program, USA, 1771–1772
- Cooperia*, 603  
 resistance to, 603–604  
 see also Trichostrongylid worms
- Coordination, in nervous system examination, 1164–1165
- Copper  
 deficiency anemia, nonregenerative, 732  
 parenteral injections of, 2174–2175  
 supplementation, osteodystrophy, 1391
- Copper deficiency, 2163–2176, 2163b  
 animal factors, 2164–2165  
 clinical findings, 2168–2170  
 clinical pathology, 2170–2172, 2170t  
 in congenital defects, 1837  
 control, 2173–2175  
 copper supplementation, 2173–2174  
 copper toxicity, 2173  
 dietary requirements, 2173  
 genetic selection, 2175  
 parenteral injections of copper, 2174–2175  
 removal of sulfates, 2174  
 slow-release treatments, 2175  
 summary and guidelines, 2175  
 dietary factors, 2165–2166, 2166t  
 effects on tissues, 2166–2168  
 anemia, 2167  
 blood vessels, 2167  
 body weight, 2166–2167  
 bone, 2167  
 changes in gene expression, 2166  
 connective tissue, 2167  
 development of clinical signs, 2168  
 diarrhea, 2167  
 heart, 2167  
 immune system, 2167–2168  
 nervous tissue, 2167  
 pancreas, 2167  
 reproductive performance, 2167  
 wool, 2166  
 encephalomalacia and, 1190  
 epidemiology, 2164–2166  
 etiology, 2163–2164  
 geographic distribution, 2164  
 hepatic storage, 2168  
 laboratory diagnosis, 2171–2172  
 laboratory results, interpretation of, 2171  
 in lambs, 1390  
 molybdenum-sulfate relationship, 2168  
 necropsy findings, 2172  
 occurrence, 2164  
 osteodystrophy and, 1388  
 pathogenesis, 2166–2168  
 phases, 2168, 2169f  
 primary  
 etiology, 2163  
 general syndrome, cattle, 2169  
 risk factors, 2164–2166  
 samples for confirmation of diagnosis, 2172, 2172b–2173b  
 seasonal occurrence, 2164  
 secondary, etiology, 2163–2164, 2163t  
 treatment, 2173  
 utilization, 2168
- Copper oxide needles, for copper deficiency, 2175
- Copper poisoning  
 chronic, hepatogenous, 820  
 hepatogenous chronic, 823  
 phylogenous chronic, 820  
 secondary, 820  
 in sheep, 647
- Copper sulfate, 103  
 dietary supplementation, 2174  
 oral dosing, 2174  
 solution, for infectious footrot in sheep, 1446
- Coprophagia, 88
- Coprophagy, 169
- Cor pulmonale, 693  
 in pulmonary hypertension, 882
- Core lipopolysaccharide antigen vaccine, 1954
- Cork-screw claw, 1537
- Cornea  
 abnormalities of, 18  
 edema of, 2078–2079
- Corneal opacity, congenital, 1659
- Coronary arteries, anomalous origin, 705
- Coronary thrombosis infarction, 692
- Coronavirus, 389  
 equine, 384  
 porcine, 388
- Coronaviruses, 385
- Corpora amylacea, 1986
- Corridor disease, 2145
- Corriedales, black livers in, 625
- Corticosteroids  
 for bovine respiratory syncytial virus, 951  
 for ketosis, 1715  
 laminitis, horse and, 1397  
 for pneumonia, 892  
 for shock, 76
- Cortinarius speciocissimus*, 2205
- Cortisol  
 plasma, 78–79, 85  
 salivary, 85–86
- Corydaline, 2210
- Corynebacterium*, osteomyelitis and, 1393
- Corynebacterium bovis*, 1906, 1939–1940, 1940b
- Corynebacterium pseudotuberculosis*  
 caseous lymphadenitis, 764  
 lymphadenitis, caseous, 761  
 ulcerative lymphangitis, 763
- Corynebacterium suis*, 1132
- Corynetoxins, 1197, 1198b–1200b
- Cough reflex, in pneumonia, 888
- Cough suppressants, for heaves, 1011
- Coughing  
 in heaves, 1007  
 in mycoplasmal pneumonia, 1073  
 in ovine pulmonary adenocarcinoma, 978  
 in pneumonia, 889  
 in respiratory insufficiency, 853  
 winter dysentery, cattle, 600–601
- Coumestans, phytoestrogen toxicosis, 1822
- Counterimmunoelectrophoresis test, 390
- Cowdriosis, 2031–2033, 2031b
- Cow-lifting devices, 1697
- Cowpox, 1587–1588, 1587b  
 differential diagnosis of, 1588b
- Cows  
 contact voltage, 105  
 greasy heel of, 1554  
 heat tolerance in, 52  
 intravenous administration of fluids for, 146, 146f–147f  
 lowest behavioral perception, stray voltage, 105  
 nymphomania in, 1822  
 with puerperal metritis, identification of, 70  
 selection of, for metabolic profile testing, 1671–1673
- Cowside test, 1918  
 for antimicrobial residues in milk, 1929  
 for ketosis, 1712–1713  
 left-side displacement of abomasum and, 507
- Coxiella burnetii*, 1787
- Coxiellosis, 1792
- Coxofemoral joint, dislocation of, 1683
- Crackles, 852  
 in ovine pulmonary adenocarcinoma, 978
- Crackling sounds, in heaves, 1007
- Cranial mesenteric artery, aneurysm, 692–693
- Cranial nerve dysfunction, signs of, 986
- Cranial nerves (CN)  
 in nervous system examination, 1164–1165  
 vestibular disease in, 1161–1162
- Cranial neuritis, with guttural pouch mycosis, 1362
- Cranial thoracic masses, in equine pleuropneumonia, 993
- Cranial vena caval thrombosis, 903, 903f
- Craniovertebral missile injury, experimental traumatic, 1188
- Craniofacial deformity  
 inherited, 1535  
 prolonged gestation with, 1829
- Cranioschisis, inherited, 1534
- Cranioventral laparoscopy, 455
- Cranium bifidum, 1534
- C-reactive protein, 56
- Creatine kinase (CK)  
 blood levels of, porcine stress syndrome and, 1527–1528  
 in cerebrospinal fluid, 1177  
 myopathy, 1380  
 horse and, 1382  
 plasma, myopathy and, 1470
- Creatinine  
 concentration, 1104  
 equine colic, 231  
 and naturally occurring combined abnormalities of  
 free water, electrolyte, acid-base balance,  
 and oncotic pressure, 134  
 renal clearance of, 1105  
 renal insufficiency and, 1095–1096  
 serum and, 1862
- Creep feeding  
 coliform gastroenteritis, 315–316, 319  
 for pneumonic pasteurellosis, 921
- Creole cattle, chromosomal translocation in, 1828
- Creosote (Coal tar creosote), 2193–2194
- Crepenyic acid, 2209
- Crib-biting, 1224
- Crohn's disease, humans, 556, 567
- “Crooked-calf disease”, 1837
- Crop ears, 1661
- Crop maturity, bloat and, 475
- Cross-agglutination absorption test (CAAT), 1115–1116
- Crowding, stress induction, 84
- Crown-rump length, gestation and, 1835
- Crush syndrome, in downer-cow syndrome, 1695
- Crushing, in mortality in piglet, 1833
- Cryotherapy  
 laminitis, horse and, 1402  
 for sarcoid, 1587
- Cryptococcosis, 2160
- Cryptococcus* spp., equine pleuropneumonia, 991

- Cryptorchidism, 1829
- Cryptosporidia, wild boar, 2008
- Cryptosporidiosis, 391, 397–400, 397b  
calves, 397  
clinical findings, 399  
clinical pathology, 399  
control, 399–400  
diagnosis, 399  
differential diagnosis, 399b  
epidemiology, 397–398  
etiology, 397  
goats, 397  
necropsy findings, 399  
occurrence, 397  
pathogenesis, 398  
pigs, 397  
prevalence, 397  
risk factors, 397–398  
sheep, 397  
source of infection, 397  
supportive treatment, 400  
transmission, 397  
treatment, 400  
zoonotic implications, 398
- Crystalline preparations, 166
- Crystalloid solutions, 138–141, 138t  
hypertonic, 138–139, 145  
hypotonic, 138–139  
isotonic, 138–139  
number of charged components, 138  
polyionic, 143, 145
- Crystalluria, 1103
- CSF acidosis, 139
- Cud, stealing, 459
- “Cud-dropping”, 198
- Culard, 1516–1517
- Culicidae, 1631
- Culicoides brevitarsis*, Akabane disease and, 1512
- Culicoides* species, epizootic hemorrhagic disease and, 783
- Culling  
brucellosis associated with *Brucella ovis* and, 1776  
caseous lymphadenitis and, 767  
Johne’s disease and, 562  
in mastitis control program, 1978  
milk fever and, 1678  
*Mycoplasma mastitis*, 1942  
in neosporosis, 1819  
rate, history-taking of, 7  
somatic cell count in, 1983  
for *Staphylococcus aureus* mastitis, 1934–1935
- Culture  
in guttural pouch empyema, 986  
methods, in *Mycoplasma bovis*, 935  
of pleuropneumoniae, in pigs, 1059  
in progressive atrophic rhinitis, 1051
- Curled toe, 1537
- Curvularia geniculata*, 798
- Cushing’s syndrome, 1221
- Cutaneous actinobacillosis, 533
- Cutaneous angiomas, 1642
- Cutaneous asthenia, 1643
- Cutaneous cysts, 1558
- Cutaneous habronemosis, 1609
- Cutaneous lymphoma, 836f, 841–842
- Cutaneous lymphosarcoma, 748
- Cutaneous neoplasms, 1640–1641
- Cutaneous pain, 79
- Cutaneous stephanofilaria, 1611
- Cutaneous T-cell lymphoma, 843
- Cutaneous trunci reflex, 1174
- Cuttings, ingestion of, ruminal impaction and, 427
- Cyanide hydrocyanic acid, 832b, 834
- Cyanobacteria (blue-green algae) toxicosis, 100, 101b  
clinical findings in, 102  
clinical pathology of, 102  
control of, 103  
diagnosis of, 102–103  
differential diagnosis of, 103b  
epidemiology of, 101–102  
etiology of, 101  
freshwater toxins, various, 102  
ingestion of toxins, prevention of, 103  
necropsy findings, 102–103  
occurrence of, 101–102  
pathogenesis of, 102  
risk factors for, 102  
treatment of, 103
- Cyanogenic glycoside poisoning, 832b, 834  
animal risk factors of, 825–826  
clinical findings of, 826–829  
clinical pathology of, 826–827  
control of, 827  
cyanogenic risk factors of, 826  
diagnostic field tests of, 827  
differential diagnosis of, 832b  
environmental risk factors of, 826  
epidemiology of, 825  
etiology of, 825  
farm risk factors of, 826  
investigational treatments of, 827–828  
necropsy findings of, 827  
occurrence of, 825  
pathogenesis of, 826  
plant risk factors of, 826  
risk factors of, 825  
samples for confirmation of diagnosis, 827  
toxic variability of, 825  
treatment of, 827, 833b
- Cyanosis, in respiratory insufficiency, 853–854
- Cyathostomiasis  
diarrhea  
acute, 277–279  
chronic undifferentiated, 281  
larval, cecum, disease of, 257  
treatment, 281
- Cycad glycosides, 2209
- Cyclic octadepsipeptides (Emodepside), 1211
- Cyclooxygenase inhibitors, for shock, 76
- Cycloopia, 1535
- Cyclopiazonic acid (CPA), 2204
- Cyclops anomaly, 1535
- Cylindrospermopsin, 102
- Cynanchoside, affecting nervous system, 1195–1197
- Cynapine, 1200
- Cyproheptadine  
in equine pituitary pars intermedia dysfunction, 1730  
for head-shaking, 1226
- Cystitis, 1131–1132, 1132b, 1137, 1143–1144  
differential diagnosis of, 1133b, 1144b
- Cystocentesis, 1099
- Cystometry, urinary system examination, 1108
- Cytokines  
for mastitis, 1927  
in PRRS infection, 1801–1803, 1802t  
*Staphylococcus aureus* mastitis, 1935
- Cytolins, 2177
- Cytotoxic edema, 1180
- Cytotoxic necrotizing factor, 1882
- 
- D**
- 1,25-(OH)<sub>2</sub>D receptor protein, milk fever and, 1677
- Dactylomegaly, 1537
- Daft lamb disease 1, 1331–1332
- Daft lamb disease 2, 1331–1332
- Daily urine flow, variations in, 1097–1098
- Dairy calves  
administration of colostrum in, 1855–1856  
dehorning, stress, 85  
in enzootic pneumonia of calves, 940  
fetal disease in, 1832  
hand-fed, dietary diarrhea, 214  
hemonchosis in, 611  
lungworm in, 962  
management of, 1833  
mortality in, 1832  
postnatal disease in, 1832–1833
- Dairy cattle  
abomasal ulcer, 519  
abomasal volvulus, 510  
activity meters of, 1673  
biosecurity planning for, 37b  
body-condition scoring of, in fatty liver, 1722  
bovine herpesvirus-1 infection in, 955  
bovine respiratory syncytial virus in, 949  
bovine virus diarrhoea virus vaccination, 596–597  
carbohydrate engorgement, 462  
diet of, 470, 502–503  
with endotoxic shock, hypertonic saline solution for, 141  
feed intake reduction manifestations, 88  
hyperthermia management for, 53  
intravenous dextrose infusion for, 152  
Johne’s disease, 563  
lactational performance and health of, 1666  
lungworm in, 963  
milk production of, 1673  
phosphorus requirements for, 1489–1490  
reticuloperitonitis, traumatic, 483  
right-side displacement of abomasum and, 510  
rumination monitors of, 1673  
salmonellosis, 361  
selenium supplementation for, 1477  
transition period in, 1662–1664  
decrease nonesterified fatty acid (NEFA) supply during, 1722  
dry matter intake in, 1721  
energy balance in, 1721  
glucose demands during, 1722  
immunosuppression during, 1665  
metabolic adaptations during, 1721–1722  
record keeping during, 1667  
vaccination programs in, 960  
vitamin E supplementation for, 1477  
volume of colostrum ingested of, 1850–1851  
voluntary dry matter intake in, 1664–1665
- Dairy Herd Health and Productivity Service (DHHPs), 1667–1668
- Dairy Herd Improvement Association (DHIA), 1667
- Dairy herds  
biosecurity, in, 938  
bovine respiratory syncytial virus in, 947  
cold injury in, 51  
nutritional management in, 1748–1749
- Dairy-herd metabolic profile testing, 1668–1675
- Dallis grass staggers, 1202
- Dalteparin, 721
- Danish mix-ELISA (DME), 301–302
- Danofloxacin, for coliform mastitis, 1951
- Dantrolene sodium, 1381, 1386–1387, 1521
- Dapsone, 173
- Dark, firm, and dry (DFD) pork, 1527
- Darrow’s solution, 140
- Database method, for diagnosis, 4–5
- “3-Day sickness”, 2083
- Dead vaccines, 809
- Death by misadventure, volcanic eruptions, 109
- Decision analysis, 26–28
- Decision nodes, 27
- Decision tree, 27, 27f–28f
- Decomposing wood shavings, 1005
- Decompression  
in cerebral edema, 1182  
gastric, 183, 257  
of nervous system, 1178
- Decubitus ulcers, laminitis, horse and, 1400
- Deer  
copper deficiency, 2170  
epizootic hemorrhagic disease and, 785  
clinical findings, 784

- Deer (*Cont'd*)  
 farmed  
   bovine tuberculosis in, 2017  
   Johne's disease in, 553, 566  
   Johne's disease in, 553, 566  
   mycobacteriosis associated with MAC and with atypical mycobacteria, clinical and necropsy findings of, 2025
- Deer flies, 1626
- Defecation, 20–21  
 clinical examination of, 11  
 decreased frequency of, 180  
 in equine colic, 227  
 frequency increase. *see* Diarrhea  
 frequency of, 21
- Deficiency of UMP synthase (DUMPS), 1727
- Defoliants, 2185
- Deformity, 1372–1375  
 atlanto-occipital, inherited, 1534  
 facial, in enzootic nasal adenocarcinoma, 970  
 joints, 1375, 1388  
 muscle and tendon, 1372  
 skeleton, 1372–1375  
 of tongue, 193
- Degenerative axonopathy  
 inherited bovine, 1352  
 of tyrolean grey cattle, 1348–1349
- Degenerative coxofemoral arthropathy, 1406
- Degenerative diseases, hereditary, familial, and idiopathic, 1187
- Degenerative joint disease, 1406–1411  
 clinical findings of, 1408–1409, 1409f  
 control of, 1411  
 diagnosis of, 1409–1410  
 differential diagnosis of, 1410b  
 epidemiology of, 1406–1407  
 etiology of, 1406–1407  
 lameness in pigs and, 1418–1424  
 necropsy findings of, 1410  
 osteoarthritis and, 1499–1500, 1500f  
 pathogenesis of, 1407–1408  
 prevention of, 1411  
 treatment for, 1410–1411
- Degenerative lesions, 4
- Degenerative myopathy, 1378, 1683
- Dehorning, 85
- Dehydration, 113–116, 132  
 alimentary tract dysfunction, 177, 182  
 carbohydrate engorgement of ruminants, 465  
 clinical findings in, 114–115  
 clinical pathology of, 115  
 enteritis, 209–210  
 etiology of, 113, 114f  
 horses, 114–115  
 and hyperthermia, 52  
 hypertonic, 116, 117f, 134  
 hypotonic, 116, 117f, 134  
 isotonic, 116, 117f, 134  
 pathogenesis of, 113–114, 114f
- Delrad, 2187
- Delvotest P, 168
- Dembrexine, 872
- Demodectic mange, 1619, 1619b
- Demyelination, primary, 1185
- Dendritic cells, PPRSV and, 1799–1800
- Denmark, bovine virus diarrhoea virus eradication program, 598
- Dental alveoli, actinomycosis, 531
- Dental fluorosis, 194  
 fluoride toxicosis and, 1508
- Deoxyvalenol, 2213–2214
- Department of Agriculture (USDA), Pathogen Reduction Hazard Analysis of Critical Points System (HACCP) and, 543
- Depopulation  
 Bang's disease and, 1769  
 repopulation and, in porcine reproductive and respiratory syndrome, 1811, 1811f
- Depression, states of, 1159
- Dermal melanomatosis, 1641
- Dermatitis, 1546–1549, 1546b  
 caprine idiopathic, 1548  
 in cattle, 1547  
 clinical findings of, 1547–1549  
 clinical pathology of, 1549  
 diagnosis of, 1549  
 differential diagnosis of, 1549b  
 etiology of, 1546–1547  
 in goats, 1547  
 in horses, 1547  
 pathogenesis of, 1547  
 in pigs, 1547  
 plant poisoning and, 1637  
 in sheep, 1547  
 treatment of, 1549
- Dermatitis-nephropathy syndrome, 1110
- Dermatomycoses, 1600–1603
- Dermatophilosis, 1570–1573, 1570b  
 in cattle, 1571  
 clinical findings of, 1572  
 clinical pathology of, 1572  
 control of, 1573  
 differential diagnosis of, 1573b  
 economic importance of, 1572  
 environmental and management risk factors of, 1571  
 epidemiology of, 1570–1571  
 etiology of, 1570  
 experimental disease of, 1572  
 in horses, 1571  
 host risk factors of, 1571–1572  
 necropsy findings of, 1573  
 pathogen risk factor of, 1572  
 pathogenesis of, 1572  
 source of infection in, 1571  
 transmission of, 1571  
 treatment of, 1573
- Dermatosis, 1546–1549
- Dermatosis vegetans, 1643, 1647–1648  
 inherited, 1646
- Dermatoparaxia, 1643, 1646–1647
- Dermis, diseases of, 1543–1544
- Dermoid cysts, 1643  
 ocular, 1659, 1660f
- Deworming, colic and, prevention of, 239
- Dexamethasone  
 for decompression, 1179, 1182  
 for endotoxemia, 66  
 for granulomatous enteritis, of horses, 283  
 for heaves, 1009–1010
- Dexamethasone suppression test, 1728
- Dexamethasone-21-isonicotinate, for heaves, 1009–1010
- Dextran, preparations of, 142
- Dextrose  
 five percent, 139  
 fifty percent, 140  
 for ketosis, 1713
- Dhurrin poisoning, 827
- Diabetes insipidus, 1097, 1105
- Diabetes mellitus, 656  
 in cows, 656  
 glucosuria, 1102  
 in horses, 656  
 insulin-dependent, spontaneous, 584
- Diagnosis, making a, 1–28  
 arborization or algorithm method, 2–3  
 computer-assisted, 25–26  
 database method, 4–5  
 diagnostic methods, 2–5  
 hypothetico-deductive reasoning, 2  
 interpretation of laboratory data, 22–25  
 key abnormality method, 3–4, 3f  
 syndrome or pattern recognition, 2
- Dianthrono derivatives, plant poisoning by, 1637
- Diaphragm  
 diseases of, 895–896  
 diaphragmatic hernia in, 900–901, 901f  
 hemothorax in, 895–896, 896b  
 hydrothorax in, 895–896, 896b  
 pleuritis (pleurisy) in, 896–899, 898b, 899f  
 pneumothorax in, 899–900, 900b  
 perforation of, 896
- Diaphragmatic hernia, 496–499, 900–901, 901f  
 differential diagnosis of, 496b  
 strangulated, 254
- Diaphragmatic muscle dystrophy, 1378, 1380, 1515
- Diaphragmatic paralysis, 1362
- Diaporthe toxica*, 651
- Diarrhea, 131–132, 131f, 179–180, 204–213, 625  
 abnormal intestinal motility, 209  
 bunostomosis, 614  
 carbohydrate engorgement of ruminants, 465  
 dehydration, 177  
 dehydration and, 113–115, 143  
   dehydration tree for, 144f  
 exudative, 208  
 in horses, 150  
 hyponatremia and, 116  
 malabsorption syndromes, 180  
 mechanisms of, 208–209  
 new neonatal, 343  
 of newborn farm animals, acute undifferentiated, 373–377  
 oral electrolyte solutions for, 149  
 osmotic, 208  
 pathophysiology, 180  
 in pigs, 337–338  
 plants and, 429  
 porcine epidemic, 350–353  
 porcine intestinal spirochetosis, 335  
 secretory, 208–209  
 stomach fluke disease and, 618  
 viral, 384–393  
   *see also* Enteritis
- Diarrhea, horses, 220–236  
 acute, of adult horses, 276–280, 276b–277b  
   antibiotic administration, 277  
   clinical pathology, 278  
   clinical signs, 278  
   control, 280  
   diagnostic confirmation, 278–279  
   differential diagnosis, 279b  
   epidemiology, 277  
   etiology, 277  
   necropsy, 279  
   pathogenesis, 277–278  
   risk factors, 277  
   treatment, 279–280  
 acute, of suckling foals, 273–276  
   clinical pathology, 275  
   clinical signs, 275  
   control, 276  
   diagnostic confirmation, 275  
   epidemiology, 273–275  
   etiology, 273, 274t  
   lesions associated with, 275  
   pathogenesis, 275  
   risk factors, 273  
   treatment, 275–276  
 chronic undifferentiated, 280–282, 280b  
   clinical findings, 281  
   clinical pathology, 281  
   control, 282  
   differential diagnosis, 281b  
   etiology, 280  
   necropsy findings, 281  
   treatment, 281–282
- Diarrhetic calf  
 categorizing, into treatment groups, 1889  
 change in small intestinal bacterial flora in, 1889  
 hyperkalemia in, 1884  
 hypernatremia in, 1884  
 incidence of bacteremia, 1889–1890
- Diastolic failure, 660
- Diastolic murmurs, 686
- Diazepam, 1179
- Diclazuril, for equine protozoal myeloencephalitis, 1312
- Diclofenac, for pain, 83
- Dicoumarol poisoning, 826b, 832–834



- Dicrocoelium dendriticum*  
biliary obstruction, 624  
infection, 645
- Dictyocaulus armfieldi*, 1047
- Dictyocaulus filaria*, 980
- Dictyocaulus viviparus*, in cattle, 961, 980
- Diet  
buffers, carbohydrate engorgement prevention, 470–471  
calcium-to-phosphorus ratio in, 1686  
cobalt deficiency risk factors of, 816  
coliform gastroenteritis, of pigs, 316  
enteritis, 212  
enterohemorrhagic *Escherichia coli* control, 542  
equine colic, risk for, 224  
for equine hyperkalemic periodic paralysis, 1524  
frothy bloat and, 475  
gastric ulcers, 248  
for laminitis in ruminants and swine, 1405  
left-side displacement of abomasum risk, 502–503  
myopathic agents in, 1462  
polyunsaturated fatty acids in, 1462  
ration change, carbohydrate engorgement of ruminants, 461  
for recurrent exertional rhabdomyolysis, 1521  
swine dysentery, 333  
total mixed rations, carbohydrate engorgement prevention, 470
- Dietary cation-anion difference  
acid-base balance of dairy cows and, 1688  
calculating, 1687t  
milk fever and, 1678, 1686–1687
- Dietary diarrhea, 213–215  
clinical findings, 214–215  
clinical pathology, 215  
differential diagnosis, 215b  
etiology, 213–214  
necropsy findings, 215  
pathogenesis, 214  
treatment, 215
- Dietary medication, 161–162
- Diffusion impairment, in hypoxic hypoxia, 847
- Digestion, faulty, weight loss, 93–94
- Digestion tests, 184–186, 211
- Digestive function, alimentary tract dysfunction, 178
- Digestive tract lesions, 837
- Digital cooling, laminitis, horse and, 1402
- Digital dermatitis, bovine, 1435–1441, 1435b  
clinical findings of, 1436–1437, 1437f  
clinical pathology of, 1437–1438  
control of, 1440, 1440b–1441b  
differential diagnosis of, 1438b  
economic importance of, 1436  
epidemiology of, 1435–1436  
etiology of, 1435  
immune mechanisms of, 1436  
pathogenesis of, 1436  
pathology of, 1438  
risk factors of, 1436  
treatment for, 1438–1440, 1440b–1441b
- Digits, splayed, inherited, 1517–1518
- Digoxin, 662
- Dimethyl disulfide, 832
- Dimetridazole, 331–332
- Diminazene, 1821
- Diocetyl sodium sulfosuccinate, 234, 517
- Diphtheria, 534b
- Diplodia maydis*, 1197
- Dipping  
caseous lymphadenitis risk factor, 764  
malignant edema and, 1429  
tick-borne fever control, 778
- Dipyrrone, 234
- Direct test, for bovine tuberculosis, 2018–2019
- Directigen Flu A test, in equine influenza, 1035
- Discoid lupus erythematosus, 1548
- Discrete dermal melanomas, 1641
- Disease history, history taking of, 6–7
- Disease wastage, performance shortfalls and, 94
- Disinfection  
biosecurity and, 40–41, 40t  
swine dysentery, 333
- Disk susceptibility tests, 155
- Disopphenol, 612
- Disseminated aspergillosis, 1045
- Disseminated intravascular coagulation, 725–728  
clinical pathology of, 726–727  
clinical signs of, 726  
diagnostic confirmation of, 727  
diarrhea, acute, 280  
endotoxemia and, 61–62  
epidemiology of, 725–728  
etiology of, 725–728  
necropsy examination of, 727  
pathophysiology of, 726  
prevention, 280  
prognosis of, 725–726  
septicemia and, 58  
treatment for, 66, 280, 727
- Distal renal tubular acidosis (type I), 1114
- Disulfide plant toxicosis, 837, 839b  
differential diagnosis of, 840b
- Diterpenoid alkaloid toxicosis, 2196–2197, 2196b  
clinical findings, 2196  
clinical pathology, 2197  
control, 2197  
differential diagnosis, 2197b  
epidemiology, 2196  
etiology, 2196  
necropsy findings, 2197  
occurrence, 2196  
pathogenesis, 2196  
risk factors, 2196  
treatment, 2197, 2197b
- Diterpenoid (kaurene) glycosides, 1195
- Diuretics, 661
- Diverticulitis, of pigs, 291
- DNA probe, in *Mycoplasma bovis*, 935
- Dobutamine  
for endotoxemia, 65  
heart failure and, 662
- Doddler calves, 1331
- Dogs  
*Brucella abortus* infection in, 1762  
definitive host, of neosporosis, 1817–1818  
“Dog-sitting” posture, 1162
- Donkeys  
equine infectious anemia and, 794  
heat stress in, 53  
septicemia in, 57
- Doppellender, 1516–1517
- Doramectin  
bunostomosis, 614  
for parasitic gastroenteritis in ruminants, 607
- Double muscling, 1516–1517
- Double-outlet right ventricle, 705
- Doubling-muscling, in cattle, 1378
- Dourine, 1819–1821, 1819b  
clinical findings of, 1820  
clinical pathology of, 1820  
differential diagnosis of, 1821b  
epidemiology of, 1819–1820  
etiology of, 1819  
immune mechanism of, 1820  
incubation period of, 1820  
necropsy findings of, 1820–1821  
occurrence of, 1820  
pathogenesis of, 1820  
secondary stage of, 1820  
tertiary stage of, 1820  
transmission of, 1820  
treatment of, 1821, 1821b
- Downer-cow syndrome, 1173, 1693–1699, 1693b  
antiinflammatory therapy for, 1697  
assisted lifting for, 1697–1698  
bedding for, 1697  
clinical care for, 1697
- clinical examination of, 1696  
clinical findings in, 1695–1696  
clinical pathology of, 1696  
coliform mastitis and, 1947  
control of, 1698  
differential diagnosis of, 1696b–1697b  
disposition of, 1698  
epidemiology of, 1693–1694  
etiology of, 1693  
euthanasia for, 1698  
fluid and electrolyte therapy for, 1697  
handling of, 1698  
milk fever and, 1678, 1683, 1694  
myopathy and, 1378, 1380  
necropsy findings of, 1696  
occurrence of, 1693–1694  
pathogenesis of, 1694–1695  
risk factors of, 1694  
transportation of, 1698  
treatment of, 1697–1698, 1698b
- Doxapram, 870
- Doxycycline  
for *Mycoplasma pneumoniae*, 1068  
for pleuropneumoniae, of pigs, 1062
- Drechslera campanulata*, 654
- Drenching, of magnesium, for hypomagnesemic tetany, 1705
- Droping, of saliva, 178–179
- “Dropped pulse”, 665, 680
- Drowning, 893–894
- Dry coat, 1561–1562
- Dry cow  
antimicrobial therapy for, 1974–1976  
external teat sealants for, 1976  
internal teat sealants for, 1976  
intramammary devices for, 1976–1977  
intramammary infection  
epidemiology of, 1973–1974  
risk factors of, 1973  
types of pathogen, 1973  
management  
of environment for, 1977  
and therapy, in mastitis control program, 1973–1977  
metabolic profile testing of, 1672  
nutritional management of, 1977
- Dry cow therapy, 1928  
blanket, 1928  
for environmental streptococci, 1957  
lactation therapy and, 1928  
for mastitis, 1928  
in mastitis control program, 1973–1977  
selection of cow for, 1983  
selective, 1928  
for *Staphylococcus aureus* mastitis, 1935–1936
- Dry gangrene, 1557
- Drying off, method of, 1974
- Dummy foal, 1871–1874  
see also Equine neonatal maladjustment syndrome
- Dummy syndrome, 10  
hepatitis, 631  
plants causing, 649  
Dummy-calf syndrome, 1868
- Duodenal ileus, 525–527
- Duodenal ulceration, 245
- Duodenal-abomasal reflux, 501
- Duodenitis-proximal jejunitis, 255–257, 255b–256b, 257t
- Duodenum, stomach fluke disease in, 618
- Dust, 106  
caseous lymphadenitis risk factor, 764
- Dusty feed, 893
- Dwarfism, inherited, 1532–1534
- Dye dilution, cardiac output measurement, 673
- Dyschondroplasia, 1410
- Dysentery  
enteritis, acute, 210  
hemorrhagic enteritis, 449  
plants and, 429

- Dysmaturity, 1859–1860  
 Dysmetria, 1161, 1172  
 Dysmyelination, inherited spinal, 1350  
 Dysphagia  
   causes of, 178  
   in cranial nerve dysfunction, 986  
   esophageal obstruction, 200  
   plants and, 429  
 Dyspnea, 848  
   bloat and, 477  
   definition of, 846  
   diseases causing, in exercise tolerance, 849  
   expiratory, 848–849  
   inspiratory, 849, 878  
   in mycoplasmal pneumonia, 1073  
   in ovine progressive pneumonia, 973, 975  
   in pneumonia, 889  
 Dystocia, milk fever and, 1678  
 Dystrophy-like myopathy, in foal, 1378  
 Dysuria, 1098
- 
- E**
- E2 glycoprotein, 2109  
 Ear  
   cancer, 1640–1641  
   clinical examination of, 21–22  
   external, diseases of, 1540–1661  
 Ear mange, 1621–1622  
   differential diagnosis of, 1622b  
 Ear-chewing, in pigs, 1225  
 Ear-tip necrosis, 1661  
 East Coast fever (ECF), 2144–2148, 2145b  
   biosecurity concerns, 2146  
   clinical findings, 2146–2147  
   clinical pathology, 2147  
   control, 2147–2148  
   economic importance, 2146  
   environmental factors, 2146  
   epidemiology, 2145–2146  
   etiology, 2145  
   experimental reproduction, 2146  
   immune mechanisms, 2146  
   methods of transmission, 2145–2146  
   morbidity and case fatality, 2145  
   necropsy findings, 2147  
   occurrence, 2145  
   pathogenesis, 2146  
   risk factors, 2146  
   treatment, 2147, 2147b  
 Eastern encephalitis, of horses, 1269b, 1294–1300  
   animal risk factors of, 1274–1275  
   case fatality of, 1275  
   clinical findings of, 1276  
   clinical pathology of, 1276–1277  
   control of, 1277–1278  
   differential diagnosis of, 1271b  
   distribution of, 1273–1281  
   epidemiology of, 1272  
   etiology of, 1271–1272  
   morbidity of, 1275  
   necropsy findings of, 1277  
   pathogenesis of, 1276  
   protection from insects of, 1278  
   samples for diagnostic confirmation of, 1277  
   transmission of, 1266f  
   treatment for, 1277  
   vaccination of, 1278  
   viral ecology of, 1273–1274  
   zoonotic aspects of control, 1278–1279  
   zoonotic implications of, 1275–1276  
 Eating, clinical examination of, 11  
 Embolic drugs, for puerperal metritis, 70  
 Eccentric hypertrophy (cardiac dilatation), 659  
 Echocardiography, 672–673  
   Doppler, cardiac output measurement, 673  
   fetal, 672  
   pericarditis and, 709  
 Eclampsia, 1736–1737  
   in postpartum dysgalactia syndrome, 1996  
 Ecthyma, contagious, 1985  
 Ectopic heart, 704  
 Ectopic ureter, 1139  
 Edema, 880–882, 881b  
   cerebral. *see* Cerebral edema  
   colibacillosis and, 1886  
   in dourine, 1820  
   equine granulocytic anaplasmosis, 768  
   heart failure, right-sided chronic (congestive), 660  
   hepatitis and, 631  
   in horses, 130  
   liver disease and, 624  
   localized, 130  
   oncotic pressure and, 128–130  
   trauma at parturition and, 1843  
   trichostrongylid infection, 605  
   udder, 1985, 1989–1990, 1989f, 1989t  
 Edema disease, 312–315, 312b  
   clinical findings, 313–314  
   clinical pathology, 314  
   control, 314–315  
   differential diagnosis, 314b  
   epidemiology, 313  
   etiology, 312–313  
   necropsy findings, 314  
   pathogenesis, 313  
   treatment, 314  
 Edema factor (EF), 2012  
 Education, John's disease, 564  
 Effusive pericarditis, idiopathic, 708  
 Eggs, stomach fluke disease and, 618  
 EHEC. *see* Enterohemorrhagic *Escherichia coli* (EHEC)  
 Ehlers-Danlos syndrome, 1643  
*Ehrlichia (Cowdria) ruminantium*, 2031  
 Eicosanoids  
   endotoxemia, 60  
   in maldistributive shock, 72  
 Einthoven's triangle, 667–668  
 Eisenmenger complex, 705  
 Elaeophorosis (filarial dermatitis in sheep), 714–715, 715b  
 Elaphostrongylosis, 1345  
*Elaphostrongylus*, 1341–1345  
 Elastosis, 996  
 Electric fields, 106–107  
 Electrical cardioversion, atrial fibrillation, 683  
 Electrical transmission wires, 104  
 Electrocardiographic examination  
   equine grass sickness, 285  
   uroperitoneum in foals and, 1142  
 Electrocardiography (ECG), 666–670  
   atrial fibrillation, 680–683  
   atrial premature complex, 680  
   atrioventricular block and, 679–680  
   depolarization and, 666–668  
   endocarditis, 689  
   equipment of, 665  
   fetal, 668–669  
   heart rate variability, 669, 669f  
   lead systems, 667–668  
   pericarditis and, 708–709  
   repolarization, 666–668  
   second-degree atrioventricular block, 679  
   sinus arrhythmia and, 675  
   telemetry, 668  
   ventricular premature complexes, 680  
   ventricular tachycardia, 684  
 Electrocutation, sudden death by, 100, 103–105, 103b  
   clinical findings in, 104  
   clinical pathology of, 104  
   control of, 105  
   diagnosis of, 105  
   differential diagnosis of, 104b–105b  
   epidemiology, 104  
   etiology, 103–104  
   necropsy findings in, 104  
   pathogenesis of, 104  
   treatment of, 105  
 Electroencephalography  
   of brain abscess, 1191–1193  
   in nervous system examination, 1177  
 Electrolyte, serum  
   enteritis, 209  
   equine colic, 230  
 Electrolyte abnormalities  
   diarrhea, in foals, 276  
   exercise intolerance, 99  
 Electrolyte imbalances, 113, 116–123  
   enteritis, 209  
   naturally occurring, 130–137  
 Electrolyte paste, 150–151  
 Electrolyte status  
   diarrhea, acute, 279  
   dynamics of, 131–132  
 Electromyography  
   for equine hyperkalemic periodic paralysis, 1524  
   in nervous system examination, 1177  
 Electron microscopy  
   viral diarrhea, 389  
   winter dysentery, cattle, 601  
 Electroretinography, in nervous system examination, 1177  
 Elementary bodies, of *Chlamydomydia abortus*, 1786  
 “Elephant on a tub stance”, 285  
 Elephant skin disease, 1607–1608, 1607b  
 Elevated functional residual capacity, heaves in, 1007  
 Elk, 1762  
   *Brucella abortus*, 1762  
   strain RB51 vaccines, 1772  
 Ellis van Creveld syndrome, 1532–1534  
 Elso heel, 1348f, 1350f, 1351  
 Emaciation  
   liver disease and, 624  
   in ovine progressive pneumonia, 975  
 Embolic arteritis, 710  
 Embolic infarction, 691  
 Embolic nephritis, 1115, 1131  
 Embolic pneumonia, in cattle, 902–903  
 Embolism, 709–711, 709b  
   endocarditis, 689  
 Embryo technology, 833  
 Embryologic development, in vitamin A deficiency, 1322  
 Emphysema, pulmonary, 883–885  
 Enamel erosion, 194  
 Encephalitis, 1182  
   in bovine herpesvirus-1 infection, 954  
   in cattle, 1183  
   clinical findings of, 1184  
   clinical pathology of, 1184  
   differential diagnosis of, 1183b  
   entrance of viruses in, 1185  
   etiology of, 1182–1183  
   in goats, 1183–1184  
   in horses, 1184  
   leptospirosis, 1120  
   listerial, 1337–1339  
   necropsy findings of, 1184  
   in new world camelids, 1184–1186  
   pathogenesis of, 1184  
   in pigs, 1184  
   in sheep, 1183  
   West Nile, Kunjin, Murray Vallesy, 1265b, 1286–1293  
 Encephalomalacia, 1184–1186  
   clinical findings of, 1187  
   clinical pathology of, 1187  
   differential diagnosis of, 1186b  
   etiology of, 1186  
   focal symmetric, 1232b, 1262–1265  
   in horses, 1186  
   necropsy findings of, 1187  
   pathogenesis, 1186–1187  
   in pigs, 1186  
   in ruminants, 1186  
   treatment of, 1187  
 Encephalomalacia syndrome, 2211

- Encephalomyelitis  
 acute viral, 1290–1291  
 subacute viral, 1291  
 verminous, 1185  
 viral, in horses, 1286t
- Encephalomyocarditis virus disease, in pigs, 695–697  
 differential diagnosis of, 697b
- Encephalopathy, 1159  
 congenital, 1218–1219  
 inherited, 1218–1219  
 metabolic, 1191–1193  
 in pregnancy toxemia, in sheep, 1724  
 toxic, 1191–1193
- Endemic instability, 800  
 Endemic stability, 800
- Endocarditis, 688–690, 688b  
 in cattle, 688  
 clinical course of, 689  
 clinical findings of, 689  
 clinical pathology of, 689–690  
 differential diagnosis of, 690b  
 echocardiography and, 672  
 epidemiology of, 689  
 etiology of, 688–689  
 in horses, 688  
 necropsy findings of, 690  
 pathogenesis of, 689  
 in pigs, 688–689  
 relapse, 690  
 in sheep, 688–689  
 treatment of, 690  
 ventricular septal defects and, 704–705
- Endocrine diseases, 1662–1757
- Endocrinopathic laminitis, 1396
- Endogenous creatinine clearance, 1104
- Endogenous pyrogens, 54
- Endorphins, 80
- Endoscopic bronchoalveolar lavage, 862
- Endoscopic examination  
 of airways, 855–856  
 in guttural pouch empyema, 985  
 in guttural pouch tympany, 987  
 in heaves, 1007, 1008f  
 of paranasal sinuses, 856  
 in rhinitis, 875  
 of tracheal secretions, 861
- Endoscopy  
 alimentary tract, examination of, 184  
 equine colic, 239  
 esophageal obstruction, 202  
 rhinolaryngoscopy in, 1177  
 urinary system examination and, 1107
- Endothelial adhesion molecules, 60
- Endothelin (ET)-1, septic arthritis synovitis in horse and, 1413
- Endotoxemia, 59–67  
 biochemical mediators, 60–61  
 clinical findings, 63  
 clinical pathology, 63–64  
 control of, 66  
 definition of, 59  
 diarrhea, acute, 280  
 equine colic, 225, 234  
 etiology of, 59–60  
 hyperdynamic stage of, 72  
 laminitis, horse and, 1399  
 necropsy findings, 64  
 pathogenesis, 60–63  
 prophylaxis, 234, 280  
 reticulorumen motility, primary contraction influence, 439  
 in ruminal atony, 437  
 severe, 63  
 treatment for, 64–66, 280
- Endotoxins, 57–59, 2034  
 maldistributive shock and, 72  
 tolerance to, 63
- Energy  
 balance, in dairy-herd metabolic profile testing, 1668–1670, 1672, 1673t  
 deficiency of, 1753
- England, swine influenza in, 1078
- Enoxaparin, 721
- Enrofloxacin  
 for coliform mastitis, 1951  
 in pneumonic pasteurellosis, 920
- Enteric disease, with *Clostridium perfringens*, 545
- Enteritis, 204–213  
 acute, 210  
 cattle, 205t  
 chronic, 209–210  
 clinical findings, 210  
 clinical pathology, 210–211  
 control, 213  
 differential diagnosis, 211b  
 epidemiology, 204–208  
 etiology, 204–208  
 gastritis and, 210  
 glucosinolate toxicosis and, 2203  
 goats, 207t–208t  
 granulomatous, 282–283  
 horses, 206t, 282–283  
 listeriosis and, 1337, 1339–1340  
 location of lesion, 209  
 necropsy findings, 211  
 necrotic, 324  
 pathogenesis, 208–210  
 pharmacodynamics of drug, 210  
 pig, 206t–207t  
 proximal, 255–257  
 salmonellosis, 300, 365  
 sheep, 207t–208t  
 stomach fluke disease, 618  
 treatment, 212–213  
 yersiniosis, 337  
 see also Diarrhea
- Enterocolitis  
 associated with *Clostridium difficile*, 377–379, 377b, 379b  
*Clostridium perfringens* type A, 545  
 lymphocytic-plasmacytic, 283
- Enterohemorrhagic *Escherichia coli* (EHEC), 536–544  
 acid resistance, 538  
 antimicrobial resistance, 538  
 in cattle, 536–537  
 clinical pathology, 541  
 control, 541  
 ecology of, 541  
 economic importance, 540  
 epidemiology of, 536–540  
 etiology of, 536  
 experimental reproduction, 540–541  
 in goats, 537  
 immune mechanisms, 539  
 mechanisms, 538  
 occurrence, 536–537  
 outbreaks, 536  
 pathogenesis, 540–541  
 in pigs, 537  
 prevalence, 536–537  
 risk factors, 537–538  
 in sheep, 537  
 sources of organism, 538–539  
 transmission, 538–540  
 vaccination, 539, 542  
 virulence attributes, 538  
 zoonotic implications, 539–540
- Enteroliths, 264–266, 266f
- Enteropathy, 204–213
- Enterotoxemia, 312–315  
*Clostridium perfringens* type A, 545–546  
*Clostridium perfringens* type D, 1227b, 1259–1262  
 animal and management risk factors of, 1228–1229  
 clinical findings of, 1229  
 clinical pathology of, 1230  
 control of, 1231  
 differential diagnosis of, 1227b–1228b  
 epidemiology of, 1228  
 etiology of, 1227–1239  
 experimental reproduction, 1228–1230  
 necropsy findings of, 1230  
 occurrence of, 1228  
 pathogenesis of, 1229  
 samples for diagnostic confirmation of, 1230–1231  
 treatment for, 1231
- Clostridium perfringens* types B, C and E  
 associated, 546–549, 546b  
 antiserum, 548–549  
 clinical findings, 547–548  
 clinical pathology, 548  
 control, 548–549  
 differential diagnosis, 548b  
 epidemiology, 547  
 etiology, 546–547  
 goat, 546  
 necropsy findings, 548  
 outbreaks, 548–549  
 pathogenesis, 547  
 treatment, 548  
 vaccination, 548
- Enterotoxigenic colibacillosis, 391
- Enterotoxins, 59
- Entropion, 1659
- Environment  
 bacillary hemoglobinuria, 635–636  
 black disease, 637  
 bovine herpesvirus-1 infection, 953  
 bovine mastitis and, 1910–1911  
 bovine respiratory syncytial virus in, 947  
 bovine virus diarrhoea virus (BVDV), 580  
 chronic enzootic pneumonia, 973  
 cobalt deficiency risk factors of, 816  
 colibacillosis and, 1881  
 coliform mastitis and, 1945, 1953  
 congenital defects and, 1838  
 contamination of, and piggery, 169  
 control of, for respiratory tract disease, 873  
 enterohemorrhagic *Escherichia coli* in, 537–539, 542  
 enzootic pneumonia of calves, 940–941  
 equine grass sickness, 284  
 equine influenza, 1032  
 examination of, 8–10  
 gastric ulcers, 288  
 of heaves, 1004–1005  
 Johne's disease and, 555, 567  
 malnutrition and, 90  
 mastitis control program and, 1978–1980  
 for musculoskeletal system disease, 1377  
 in *Mycoplasma bovis*, 934  
 in *Mycoplasma pneumoniae*, 1065–1066  
 mycoplasmal pneumonia, 1072–1073  
 osteodystrophy and, 1389  
 ovine pulmonary adenocarcinoma, 978  
 pleuropneumoniae, of pigs, 1058  
 pneumonic pasteurellosis, 915  
 porcine intestinal spirochetosis, 336  
 porcine reproductive and respiratory syndrome and, 1797  
 salmonellosis, 361–362  
 sodium chloride poisoning, 829–832  
*Staphylococcus aureus* mastitis and, 1931–1932  
 stress and, 85–86  
 swine dysentery, 328  
 swine influenza, 1079  
 winter dysentery, cattle, 600
- Environmental pollutants, 106
- Environmental streptococci, 1906, 1955–1958, 1955b  
 clinical findings of, 1956  
 clinical pathology of, 1956–1957



- Environmental streptococci (*Cont'd*)  
 control of, 1957  
 differential diagnosis of, 1957b  
 economic importance of, 1956  
 epidemiology of, 1955–1956  
 etiology of, 1955  
 occurrence of, 1955–1956  
 pathogenesis of, 1956  
 prevalence of, 1955–1956  
 risk factors of, 1955–1956  
 source of infection in, 1955  
 treatment of, 1957, 1957b–1958b  
 vaccination of, 1957
- Enzootic ataxia, in lambs and goat kids, 2169–2170
- Enzootic bovine leukosis (EBL), 838, 841b  
 animal risk factors of, 833  
 antibodies of, 834  
 calf management of, 834–835  
 cardiac lesions, 837  
 clinical findings of, 835f, 836  
 clinical pathology of, 837  
 congenital infection, 833  
 diagnosis of presence of infection, 837  
 differential diagnosis of, 842b–843b  
 digestive tract lesions, 837  
 economic importance of, 835  
 enlargement of superficial lymph nodes, 836  
 environmental and management risk factors, 834  
 epidemiology of, 832  
 etiology of, 832  
 experimental transmission, 834  
 genetic resistance and susceptibility, 833  
 lesions and clinical disease of, 836  
 less common lesions, 837  
 methods of transmission of, 832–833  
 necropsy findings of, 839  
 nervous system involvement, 837  
 pathogen risk factors of, 834–835  
 pathogenesis of, 802f, 835–836  
 risk factors of, 833  
 samples for confirmation of diagnosis, 839  
 susceptibility to diseases, 834–836  
 trade restrictions of, 835–836  
 zoonotic implications of, 835
- Enzootic calcinosis, 1504–1505  
 of muscles, 1388
- Enzootic calf pneumonia (ECP), 914
- Enzootic nasal adenocarcinoma, 875, 970f
- Enzootic nasal granuloma (ENG), of cattle, 901–902
- Enzootic nutritional muscular dystrophy, 1378, 1460
- Enzootic pneumonia (EP), 1064, 2009, 2044b  
 of calves, 939–946, 939b  
 clinical findings in, 943, 943f  
 clinical pathology in, 943–944  
 control for, 945–946  
 differential diagnosis of, 944b  
 epidemiology of, 940–942  
 etiology of, 939–940  
 necropsy findings in, 944  
 pathogenesis of, 942–943  
 risk factors for, 940–942  
 treatment of, 945, 946b  
 chronic, of sheep, 972–973, 972b
- Enzootic posthitis, 1152, 1152b–1153b  
 differential diagnosis of, 1154b  
 treatment and prophylaxis of, 1154b
- Enzootic staphylococcosis, of lambs, 2039–2040, 2039b
- Enzyme-linked immunosorbent assay (ELISA), 2009  
 antibody capture, 1123–1124  
 in assessment of transfer of passive immunity, 1854  
 bovine virus diarrhoea virus and, 586–587  
 for *Brucella abortus*, 1767  
 for *Brucella ovis*, 1776  
 in equine herpesvirus-1 and -4 infection, 1041  
 in equine influenza, 1034  
 in fasciolosis, 643–644  
 indirect, 1123  
 John's disease and, 559–560, 569  
 leptospirosis and, 1123
- in lungworm, 963  
 in *Mycoplasma bovis*, 935  
 in *Mycoplasma pneumoniae*, 1066–1067  
 for neosporosis, 1819  
 for ovine enzootic abortion, 1787  
 in ovine progressive pneumonia, 976  
 in pleuropneumoniae, of pigs, 1060  
 of pseudorabies, 1248  
 salmonellosis and, 301–302, 368  
 in serum or milk, 838  
 for *Staphylococcus aureus* mastitis, 1934  
 in swine influenza, 1082  
 test, 805  
 viral diarrhoea, 390  
 winter dysentery, cattle, 601
- Enzymology, for musculoskeletal system disease, 1377
- Eosinophilia, 746
- Eosinophilic enteritis, 797  
 idiopathic focal, 283
- Eperythrozoon suis*, 782
- Eperythrozoonosis, 777–779, 783b
- Epidemic curves, temporal pattern and, 32
- Epidemic hyperthermia, 2199
- Epidemiologic investigations, for examination of herd or flock, 29
- Epidermal dysplasia, inherited, 1643, 1645
- Epidermis, diseases of, 1543–1544
- Epidermolysis bullosa, 1643, 1645–1646
- Epididymitis, 1765
- Epidural abscess, of spinal cord, 1348
- Epidural pressure, 1176
- Epiglottic conformation, 983
- Epiglottic entrapment, 988–989, 988f
- Epiglottic retroversion, during exercise, 988
- Epiglottitis, 988
- Epilepsy, 1225  
 inherited idiopathic, of cattle, 1331–1333
- Epinephrine, in pulmonary edema, 882
- Epiphysiolysis, lameness in pigs and, 1423–1424
- Epiphysitis, 1389
- Epiloic foramen  
 entrapment of, small intestine, 254  
 intestinal herniation through, 252
- Epistaxis, 877–878  
 causes of, in horses, 1001t  
 clinical examination of, 877  
 etiology of, 877  
 in exercise-induced pulmonary hemorrhage, 997, 999  
 in respiratory insufficiency, 854–855  
 treatment of, 877
- Epithelial tissues, in vitamin A deficiency, 1322
- Epitheliogenesis imperfecta, 1643, 1645
- Epizootic abortion, neosporosis and, 1818
- Epizootic bovine abortion, 1769
- Epizootic hemorrhagic disease, 784–785, 785b  
 clinical findings of, 784–785  
 clinical pathology of, 784  
 control of, 785, 839  
 differential diagnosis of, 792b  
 economic importance of, 783  
 epidemiology of, 782  
 eradication programs of, 839  
 etiology of, 782  
 host occurrence of, 782–783  
 host risk factors of, 783  
 limitation of spread of infection, 840–841  
 method of transmission of, 783  
 morbidity and case fatality and, 783  
 necropsy findings of, 785  
 occurrence of, 782–783  
 pathogenesis of, 783–784  
 reduction of infection through vector abatement, 785  
 sample for confirmation of diagnosis, 785  
 treatment of, 785, 839
- Epizootic hemorrhagic disease virus (EHDV), 785b
- Epizootic lymphangitis, 806b, 811–814  
 differential diagnosis of, 811b
- Eprinomectin  
 for lungworm, 964  
 for parasitic gastroenteritis in ruminants, 607
- Epsiprantel, 1212
- Epsom salts, 123, 459
- Equid besnoitiosis, 1607–1608
- Equid herpesvirus-1 myeloencephalopathy, 1283b, 1301–1302  
 clinical findings of, 1285  
 clinical pathology of, 1285  
 control of, 1287–1292  
 outbreaks of, 1287, 1297t  
 cycling of infection of, 1284  
 differential diagnosis of, 1285b  
 economic importance of, 1284  
 epidemiology of, 1284  
 etiology of, 1284  
 immunity to, 1284–1285  
 method of transmission of, 1284  
 necropsy findings of, 1285  
 occurrence of, 1284  
 pathogenesis of, 1284  
 prevention of infection in, 1287  
 rapid antemortem diagnosis of, 1277f  
 risk factors for, 1284  
 samples for diagnostic confirmation of, 1285  
 treatment for, 1286  
 vaccination for, 1287–1290
- Equine adenovirus infection, 1029
- Equine amnionitis and fetal loss (EAFL), 1827
- Equine atypical myopathy, 1378
- Equine aural plaque, 1548
- Equine babesiosis, 808, 820b–821b, 822–823  
 chemotherapy of, 811  
 clinical findings of, 810  
 clinical pathology of, 810  
 control of, 811  
 differential diagnosis of, 801t, 823b  
 epidemiology of, 809  
 etiology of, 809  
 geographic occurrence of, 809–810  
 host occurrence of, 809–810  
 immunology of, 810  
 impact of, 809  
 life cycle and transmission, 809  
 microscopic examination of, 810  
 movement of horses of, 809–810  
 necropsy findings of, 810  
 pathogenesis of, 810  
 serologic and DNA-based methods, 810  
 supportive treatment of, 811–814  
 treatment of, 811
- Equine B-cell lymphoma, 748
- Equine blastomycosis (epizootic lymphangitis), 806b, 811–814  
 differential diagnosis of, 811b
- Equine cauda equina syndrome, 1368–1369
- Equine cervical vertebral stenotic myelopathy, 1233t–1235t, 1351, 1360b  
 ancillary diagnostic tests for, 1359  
 clinical findings of, 1359  
 clinical pathology of, 1360–1363  
 differential diagnosis of, 1362b  
 epidemiology of, 1356–1357  
 etiology of, 1355–1356  
 necropsy findings of, 1360  
 neurologic examination for, 1359  
 occurrence of, 1358–1359  
 pathogenesis of, 1358–1359  
 radiographic examination for, 1354f, 1359  
 risk factors of, 1233t–1235t, 1358  
 treatment for, 1360
- Equine coital exanthema, 1794
- Equine coronavirus infection, 384
- Equine Cushing disease. See Equine pituitary pars intermedia dysfunction
- Equine degenerative myeloencephalopathy (EDM), 1162, 1239–1247  
 vitamin E deficiency and, 1468
- Equine dysautonomia. see Equine grass sickness
- Equine ehrlichial colitis. see Equine neorickettsiosis

- Equine encephalosis, 2097
- Equine eosinophilic granuloma, 1559
- Equine granulocytic anaplasmosis, 765–769, 768b
- Equine granulocytic ehrlichiosis. *see* Equine granulocytic anaplasmosis
- Equine grass sickness, 283–286, 283b, 1362
- acute cases, 285
  - case-fatality rate, 284
  - chronic cases, 285
  - clinical findings, 285
  - clinical pathology, 285
  - control, 286
  - diagnosis, 285
  - differential diagnosis, 285b–286b
  - epidemiology, 284
  - etiology, 283–284
  - farm or premise risk factors, 284
  - necropsy findings, 285
  - occurrence, 284
  - pathogenesis, 284–285
  - risk factors, 284
  - subacute cases, 285
  - transmission, 284
  - treatment, 286
- Equine hendra virus infection, 1043–1045
- Equine hepatic disease, 630
- Equine herpesvirus-1 and -4 infections, 1040–1042, 1040b
- clinical findings in, 1041
  - clinical pathology of, 1041–1042
  - control of, 1042
  - differential diagnosis of, 1042b
  - epidemiology of, 1040–1041
  - etiology of, 1040
  - necropsy findings in, 1042
  - pathogenesis of, 1041
  - risk factors, 1041
- Equine herpesvirus-3 (EHV-3), 1794
- Equine histoplasmosis (epizootic lymphangitis), 806b, 811–814
- differential diagnosis of, 811b
- Equine hyperkalemic periodic paralysis, 1523–1524, 1523b–1524b
- Equine hyperlipemia, 1737–1739, 1737b
- clinical findings of, 1738
  - clinical pathology of, 1738
  - control of, 1739
  - differential diagnosis of, 1739b
  - epidemiology of, 1737–1738
  - etiology of, 1737
  - necropsy findings of, 1738–1739
  - occurrence of, 1737
  - pathogenesis of, 1738
  - postmortem confirmation of diagnosis in, 1739
  - risk factors of, 1737–1738
  - treatment of, 1739
- Equine infectious anemia (EIA), 795–799, 795b
- animal risk factors of, 788
  - clinical findings of, 790
  - clinical pathology of, 786
  - control of, 791
  - diagnostic confirmation of, 790
  - differential diagnosis of, 798b
  - economic importance of, 788–789
  - epidemiology of, 788, 789f
  - eradication of, 794
  - etiology of, 787–788
  - immune reaction of, 789
  - infection persistence of, 789–791
  - insect vectors of, 788
  - methods of transmission of, 788
  - morbidity of, 789
  - necropsy findings of, 790–791
  - occurrence of, 788
  - pathogenesis of, 789
  - prevalence of, 789
  - relapse, 791
  - treatment of, 791
- virus, 749t
- epidemiology of, 788
- Equine influenza, 1029–1039, 1029b
- Australian outbreak of, 1033
  - clinical findings of, 1034
  - clinical pathology of, 1034–1035
  - control of, 1036–1038
  - differential diagnosis of, 1035b
  - epidemiology of, 1032–1033
  - etiology of, 1029–1032, 1031f
  - necropsy findings of, 1035
  - pathogenesis of, 1033–1034
  - risk factors for, 1032–1033
  - treatment of, 1035–1036
- Equine influenza A/H3N8, 1029
- Equine influenza A/H7N7, 1029
- Equine intestinal clostridiosis, 545
- Equine laryngeal hemiplegia, 1362
- Equine leukoencephalomalacia (ELEM), 1188, 2201
- Equine metabolic syndrome, 1731–1736, 1731b
- body-condition scoring in, 1732, 1733t, 1734f
  - clinical pathology of, 1735
  - clinical signs of, 1732–1735
  - diagnosis of, 1732–1735
  - dietary management for, 1735
  - differential diagnosis of, 1735b
  - dynamic testing in, 1734–1735
  - epidemiology of, 1731
  - etiology of, 1731
  - exercise for, 1735
  - medications for, 1735–1736
  - necropsy of, 1735
  - pathogenesis of, 1731–1732
  - treatment of, 1735–1736
- Equine molluscum contagiosum, 1596–1597
- Equine monocytic ehrlichiosis, 382–384
- Equine motor neuron disease, 1193–1194, 1351–1357
- diagnosis confirmation, 1472
  - vitamin E deficiency and, 1468
- Equine multinodular pulmonary fibrosis (EMPF), 1042–1043, 1043b
- Equine neonatal maladjustment syndrome, 1871–1874
- clinical pathology of, 1872
  - clinical signs of, 1872
  - control of, 1874
  - diagnostic confirmation of, 1872
  - differential diagnosis of, 1873b, 1873t
  - epidemiology of, 1872
  - etiology of, 1872
  - hypoxia in, 1872
  - necropsy findings of, 1873
  - pathogenesis of, 1872
  - treatment of, 1873–1874
- Equine neorickettsiosis, 277, 382–384, 382b
- case-fatality rates, 382
  - clinical findings, 382–383
  - clinical pathology, 383
  - control, 384
  - diagnosis, 383
  - differential diagnosis, 383b
  - epidemiology, 382
  - etiology, 382
  - laminitis and, 1397
  - necropsy findings, 383
  - occurrence, 382
  - pathogenesis, 382
  - risk factors, 382
  - transmission, 382
  - treatment, 383–384
- Equine neuraxonal dystrophy, 1239–1247
- Equine nodular necrobiosis, 1548
- Equine nutritional myopathy, selenium deficiency and, 1467–1468
- Equine ocular squamous-cell carcinoma, 1658
- Equine osteochondrosis, 1410
- Equine periodic ophthalmia, 1125
- Equine phycomycosis, 813b, 814–817
- Equine piroplasmiasis. *see* Equine babesiosis
- Equine pituitary pars intermedia dysfunction, 1727–1731
- clinical findings of, 1727–1728
  - clinical pathology of, 1728
  - control of, 1730
  - diagnostic confirmation of, 1728–1730, 1729t
  - differential diagnosis of, 1730b
  - epidemiology of, 1727
  - etiology of, 1727
  - necropsy findings of, 1730
  - pathogenesis of, 1727
  - treatment of, 1730
- Equine pleuropneumonia, 991–996
- clinical pathology of, 993
  - clinical signs of
    - acute, 992–993
    - chronic, 993
  - control of, 995–996
  - diagnostic confirmation of, 993
  - differential diagnosis of, 993b
  - epidemiology of, 991
  - etiology of, 991, 991b
  - necropsy findings of, 993
  - pathogenesis of, 991–992
  - risk factors for, 991
  - treatment of, 993–995, 994t
- Equine polysaccharide storage myopathy, 1378
- Equine protozoal myeloencephalitis, 1194, 1309b, 1323–1324
- clinical findings of, 1309
  - clinical pathology of, 1309
  - control of, 1309
  - differential diagnosis of, 1311b
  - epidemiology of, 1308–1309
  - etiology of, 1308
  - necropsy of, 1309
  - pathogenesis of, 1309
  - risk factors of, 1309
  - samples for diagnostic confirmation of, 1309
  - transmission of, 1309
  - treatment for, 1309
- Equine renal cortical tubular ectasia, 1139
- Equine rhinitis, 1039–1040
- Equine rhinitis A virus-1 (ERAV-1), 1039
- Equine rhinitis B virus (ERBV), 1039
- Equine rotavirus, 388
- vaccine, 393
- Equine salmonellosis, 366–367
- Equine sarcoidosis, 1559
- Equine seasonal allergic dermatitis, 1559–1560
- differential diagnosis of, 1560b
- Equine sensory ataxia. *see* Equine cervical vertebral stenotic myelopathy
- Equine staphylococcal pyoderma, 1548–1549
- Equine toxicosis, 2201
- Equine tropical lichen, 1548
- Equine viral arteritis, 2087–2091, 2087b
- animal risk factors, 2089
  - clinical findings, 2089
  - clinical pathology, 2089–2090, 2090t
  - economic importance, 2089
  - epidemiology, 2088–2089
  - etiology, 2087–2088
  - immunity, 2088
  - necropsy findings, 2090
  - samples for confirmation of diagnosis, 2090, 2090b
  - occurrence, 2088
  - origin of infection and transmission, 2088
  - horizontal transmission, 2088
  - venereal transmission, 2088
  - pathogenesis, 2089
  - treatment and control, 2090–2091
- Equine viral rhinopneumonitis, 1040–1042, 1040b, 1042b

- Eradication  
of bovine herpesvirus-1 infection, 960–961  
for erysipelas in swine, 2055  
leptospirosis and, 1127  
for *Mycoplasma pneumoniae*, 1068–1069  
for pleuropneumoniae, of pigs, 1062–1063  
in progressive atrophic rhinitis, 1053
- Ergonovine maleate, for hemorrhagic shock, 76
- Ergot alkaloid toxicosis, 2197–2200  
clinical findings, 2198–2199  
hyperthermia form, 2198  
peripheral gangrene, 2198  
reproductive form, 2198–2199
- clinical pathology, 2199  
control, 2199–2200  
differential diagnosis, 2199b  
epidemiology, 2198  
ergotism, 2198b  
etiology, 2198  
fescue toxicosis, 2199–2200  
clinical findings, 2199–2200  
summer, 2199  
necropsy findings, 2199  
*Neotyphodium (accremonium)* spp. toxicosis, 2199  
pathogenesis, 2198  
treatment, 2199
- Erosions  
gastric ulcers, 289  
mucosal disease, 584  
stomatitis, 193
- Eructation  
esophageal obstruction in free-gas bloat, 474  
failure of, 474  
reticulorumen motility, 440
- Erysipelas  
arthritis from, 1455  
in swine, 2051–2056, 2051b  
acute and subacute form, 2053  
animal risk factors, 2052–2053  
chronic form, 2054  
clinical findings, 2053–2054  
clinical pathology of, 2054  
control of, 2055–2056  
detection of organism, 2054  
diagnosis of, 2054–2055  
epidemiology of, 2052–2053  
etiology of, 2051–2052  
hematology, 2054  
hyperacute form, 2053  
methods of transmission, 2052  
morbidity and case fatality, 2052  
necropsy findings of, 2054  
occurrence of, 2052  
pathogenesis of, 2053  
prevalence of infection, 2052  
risk factors, 2052  
samples for confirmation of diagnosis, 2054–2055, 2055b  
serology, 2054  
treatment of, 2055  
zoonotic implications, 2053  
wild boar, 2008
- Erysipelothrix tonsillarum (ER), 2051
- Erythema multiforme, 752, 1548
- Erythrocyte(s)  
counts, 743  
decreased production, anemia from, 731  
in peritoneal fluid, 189
- Erythrocyte count, and radiation, 108
- Erythrocyte osmotic fragility, porcine stress syndrome and, 1528
- Erythrocyte potassium concentration, in acute hypokalemia, 1692
- Erythrocyte protoporphyrin, in lead poisoning, 1207
- Erythrocytosis, 745
- Erythromycin, 172  
for *Rhodococcus equi* pneumonia, 1016–1017
- Erythropoietin  
plasma concentration, 738–739  
serum concentration, anemia, 738–739
- Escherichia coli*, 311–315  
antibiotic resistance of, 156–157  
antimicrobial resistance of, 1890–1891  
antimicrobial sensitivity/susceptibility of, 155–156  
attaching and effacing, 311–312, 539–541  
blood, isolates, 1891  
cerebrospinal angiopathy, 312  
coliform gastroenteritis, 318  
cystitis and, 1132  
edema disease, 312–315  
enterohemorrhagic, 1879, 1882  
see also Enterohemorrhagic *Escherichia coli* (EHEC)  
enteropathogenic, 1879  
enterotoxigenic, 311, 1879, 1883  
fecal, isolates, 1890  
hepatic abscesses in goats and, 633  
in mastitis, 1905–1906, 1997  
necrotogenic, 1879, 1882  
in neonatal infection, 1876  
O157 in pigs, 312  
O157:H7, in pigs, 542  
pigs, weaned, 311–315  
pyelonephritis and, 1111  
verotoxin-producing, 311  
viral diarrhea and, 392  
virulence factors of, 1881–1883  
wild boar, 2008  
zoonotic implications of, 1883
- Esophageal groove  
actinomycosis, 531  
closure, reticulorumen motility, 440–441  
dysfunction, 491
- Esophageal lavage, 202
- Esophageal obstruction, 199–203, 893  
acute obstruction or choke, 200–201  
cattle, 200–201  
chronic, 201  
clinical findings, 200–201  
clinical pathology, 201  
complications, 201  
differential diagnosis, 201b–202b  
extraluminal, 199–200  
horse, 200–201  
intraluminal, 199  
manual removal, 202  
pathogenesis, 200  
treatment, 201–203
- Esophageal paralysis, 200
- Esophageal rupture, 198–199, 199b
- Esophageal strictures, 200
- Esophagitis, 198, 198b
- Esophagogastric lesions, 290b
- Esophagostomy, 202–203
- Esophagus  
diseases of, 196–197  
examination of, 445  
neoplasms, 431
- Esp protein, 539
- Estradiol cypionate, 773
- Estrogenic substances, poisoning in, 1821–1822
- Estrogenic subterranean clover, 1145
- Estrogenism, idiopathic female, 1821
- Ethmoidal hematomas, progressive, in equids, 876, 876f
- Ethyl pyruvate, for endotoxemia, 66
- Ethylene glycol toxicosis, 1136
- Ethylene-diamine dihydroiodide, 798
- Eubacterium suis*, 1132
- Europe  
African swine fever, 2111–2112  
anthrax, 2011  
bovine spongiform encephalopathy in, 1294–1295  
contagious bovine pleuropneumonia in, 926  
continental, bovine virus diarrhea virus eradication program, 598  
history of compulsory eradication programs in, epizootic hemorrhagic disease, 839  
ovine enzootic abortion in, 1786  
rabies in, 1238
- European blastomycosis, 2160
- Euthanasia, for downer-cow syndrome, 1698
- Ewes  
abortion in, 1777t  
body-condition score of, 1752  
phytoestrogen toxicosis in, 1823  
placental and fetal growth of, 1751  
volume of colostrum ingested of, 1851
- Excessive bleeding, in exercise-induced pulmonary hemorrhage, 1002–1003
- Excitation states, 1158–1159  
clinical examination of, 10–11
- Excitement, and stress induction, 85
- Exercise, 96–97  
cardiac irregularities following, 677  
diseases associated with, 97  
equine colic, risk for, 224  
intolerance of, in horses, 97–99  
lameness in pigs and, 1422  
recovery from, 96–97  
testing, in respiratory system, 868, 868f  
tolerance  
cardiac reserve determination, 659  
cardiovascular system examination, 666  
myocardial disease, 691  
unaccustomed, enzootic nutritional muscular dystrophy and, 1462
- Exercise-induced pulmonary hemorrhage (EIPH), of horses, 997–1003, 997b  
clinical findings in, 999–1003, 999f–1000f  
differential diagnosis of, 1001b, 1001t  
epidemiology of, 997–998  
etiology of, 997  
necropsy in, 1001  
pathogenesis of, 998–999  
treatment of, 1001–1003
- Exhaled breath condensate, collection and analysis of, 867
- Exhausted horse syndrome, 97
- Exhaustion, 97
- Exhaustion syndrome, 114
- Exogenous creatinine clearance, 1104
- Exogenous pyrogen, 54
- Exophthalmos, 834
- Exotoxins, 57–59
- Expected value, 27
- Expectorants, 872
- Experimental reproduction, posthitis and, 1153
- Experimental syndromes, thiamine deficiency and, 1315
- Experimental traumatic craniocerebral missile injury, 1188
- Experimental viral pneumonia, in enzootic pneumonia of calves, 943
- Expiratory dyspnea, 848–849
- Expiratory grunting, 852
- Exploratory laparotomy (celiotomy), 184, 453–454, 455t
- Exposure, previous, history taking of, 7
- Exposure pressure, in neonatal infection, 1875
- Extension subcutaneous abscess, 1558
- Extensive hepatic necrosis, 2069
- External genitalia, clinical examination of, 13
- External insulation, 45
- Extracranial convulsions, 1161
- Extralabel use  
of antimicrobials, 167, 167b  
of vancomycin, 174
- Extraneous sounds, 852
- Extrapulmonary manifestations, of *Rhodococcus equi*, 1015
- Extrapulmonary right-to-left shunting, in hypoxic hypoxia, 847
- Extrapylamidal tracts, 1163
- Extrasystoles (premature complexes), 680
- Extraurinary postrenal proteinuria, 1102
- Extremely low frequency magnetic field, 106–107
- Exudative diarrhea, 208
- Exudative epidermitis, 1576–1579  
See also Greasy pig disease



- Eye(s)  
 clinical examination of, 12, 18–19  
 degree of recession into orbit of, 114–115, 115f  
 diseases of, 1540–1661
- Eyeball  
 abnormal movements of, 18  
 size of, 18
- Eyeworm, 1655
- 
- F**
- Face fly, 1630
- Facial abscess, in cattle and goats, 77
- Facial deformity, in enzootic nasal adenocarcinoma, 970
- Facial eczema, 652–654, 652b  
 differential diagnosis, 653b
- Facial necrosis, 1054
- Facial nerve  
 assessment of, 1169  
 dysfunction, and cranial nerve dysfunction, 986
- Facial paralysis, 1170
- Facial pyemia, 1054
- Facial subcutaneous abscesses, 1558
- Factor VIII deficiency (hemophilia A), 723
- Factor XI deficiency, 723, 1838–1839
- Facultative anaerobes, equine pleuropneumonia, 1047
- Fagopyrin, plant poisoning by, 1637
- Failure of passive transfer (FPT), 1848
- Failure of transfer of passive immunity (FTPI), 57, 1849–1852
- Fainting, 1160
- Fainting goats, 1518–1519
- Falling disease, 100  
 in cattle, 2169
- Fallout, of radionuclides, 107
- “False blackleg”, 1431–1432
- FAMACHA system, 613
- Familial acantholysis, 1643, 1645
- Familial allergic rhinitis, 874–875
- Familial convulsions and ataxia  
 in cattles, 1333  
 cerebellar abiotrophy and, 1336
- Familial narcolepsy, 1327–1328
- Familial polycythemia, 840–841
- Familial undulatory nystagmus, 1660
- Famotidine, 251
- Fanconi’s syndrome, 1113
- Farm  
 pollution from, 106  
 pollution outside, 106
- Farm chemicals  
 congenital defects and, 1837  
 hepatitis, 630  
 miscellaneous, 2189–2190
- Farm visitors, enterohemorrhagic *Escherichia coli*, 540, 544
- Farmed deer, leptospirosis and, 1118
- Farmed red deer (*Cervus Elaphus*)  
 plasma and liver copper in, 2172  
 slow-release treatments in, 2175
- Farrowing hysteria, of sows, 1224
- Fasciola gigantica*, 642
- Fasciola hepatica*, 642  
 wild boar, 2008
- Fascioloides magna*, 645
- Fasciolosis (liver fluke disease), 641–643, 641b–642b  
 acute, 643  
 carriers, 642  
 cattle, 642–643  
 chronic, 643  
 clinical findings, 643  
 clinical pathology, 643  
 control, 644–645  
 diagnostic confirmation, 643–645  
 differential diagnosis, 644b
- epidemiology of, 642  
 etiology of, 642  
 goats, 642  
 host snails, 642  
 life cycle, of *Fasciola*, 642  
 necropsy findings, 643  
 pathogenesis, 642–643  
 sheep, 642–643  
 subacute, 643  
 treatment, 644, 644b  
 vaccination, 645
- Fast Antimicrobial Screen Test (FAST), 168
- Fat  
 bloat prevention, 480  
 dietary, gastric ulcers, 288
- Fat cow syndrome, 69, 651b, 1716–1722, 1717b
- Fat necrosis, 1726–1727, 2199  
 intestinal obstruction, 527
- Fatigue, in dyspnea, 849
- Fat-mobilization syndrome, 1716–1722, 1717b
- Fatty cirrhosis, 630–631
- Fatty liver  
 in cattle, 1716–1722, 1717b  
 clinical findings of, 1719  
 clinical pathology of, 1719–1720  
 control of, 1721–1722  
 differential diagnosis of, 1720b  
 epidemiology of, 1717–1718  
 fluid and electrolyte therapy for, 1720–1721  
 incidence of, 1717  
 necropsy findings of, 1720  
 occurrence of, 1717  
 outbreaks in, 1721  
 pathogenesis of, 1718–1719  
 risk factors of, 1717–1718  
 treatment of, 1720–1721, 1721b  
 cows, left-side displacement of abomasum and, 507
- Faulty wiring, 104
- Febantel, for parasitic gastroenteritis in ruminants, 607
- Febrile response, 54–55
- Fecal egg counts  
 bunostomosis, 614  
*Haemonchus*, 612  
 parasitic gastroenteritis, ruminants, 609  
 trichostrongylid worms, 606
- Fecal examination, 449–451  
 abomasal ulcer and, 520  
 amount, 449  
 color, 449–451  
 consistency, 451  
 diarrhea  
 acute, 278–279  
 chronic undifferentiated, 281  
 digestion, degree of, 451  
 enteritis, 210–211  
 enterohemorrhagic *Escherichia coli*, 541  
 fibrin, 451  
 intestinal obstruction, 527, 527f  
 mucus, 451  
*Mycobacterium avium* subspecies paratuberculosis (MAP), 558–559, 569  
 odor, 451
- Fecal lead, 1207
- Fecal softeners  
 equine colic, 234, 235t  
 large (ascending) colon, impaction, of horses, 264
- Fecaliths, 264–266, 266b
- Feces  
 absence of, 449, 451f  
 blood in, 182, 449–451  
 clinical examination of, 20–21  
 color of, 20–21  
 composition of, 21  
 consistency of, 20  
 equine colic, 227, 232  
 odor of, 21
- peritonitis, 217  
 protein loss in, 93  
 sand in, diarrhea, 281  
 scant, 180, 449, 451f, 512
- Feed  
 aflatoxins in, 649  
 ammoniated forage, 620  
 analysis, osteodystrophy and, 1390  
 aversion to, 88  
 caustic-treated grain, 620  
 changes, timing of blood tests and, 1671  
 chemically treated natural, 620–621  
 contamination, *Mycobacterium avium* subspecies paratuberculosis (MAP), 562–563  
 finely ground, gastric ulcers, 287–288  
 formalin-treated grain, 620  
 medication of, in pneumonic pasteurellosis, 920  
 newsprint, 620  
 pellets, gastric ulcers, 288  
 porcine intestinal spirochetosis, 336  
 restriction, edema disease, 314  
 salmonellosis and, 305  
 sewage sludge, 620  
 shortage in, 90  
 supplies  
 enterohemorrhagic *Escherichia coli* source, 539  
 environmental examination of, 9  
 withholding, gastric ulcers, 248
- Feeder pigs, source of, in *Mycoplasma pneumoniae*, 1070
- Feeding  
 methods, colibacillosis and, 1881  
 timing of blood tests and, 1671
- Feedlot bloat  
 case fatality, 475  
 clinical findings, 476–477  
 control, 481  
 epidemiology, 474  
 etiology, 473  
 morbidity, 475  
 treatment, 478  
 weather risk factors, 476
- Feedlot cattle  
 abomasal ulcer in, 519  
 bovine herpesvirus-1 infection in, 952, 955–956  
 bovine respiratory syncytial virus in, 947  
 bovine virus diarrhea virus, 582–583, 592, 596  
 carbohydrate engorgement, 461–462  
 hyperthermia management for, 53  
 interstitial pneumonia in, 967  
 liver abscess in, 634  
 otitis in, 2036  
 phosphorus requirements for, 1490  
 pneumonic pasteurellosis in, 917–918  
 primary vitamin A deficiency in, 1321  
 vaccination programs in, 960  
 winter dysentery, 601
- Feedlot playas, salmonellosis, 361
- Feedlot starter rations, carbohydrate engorgement prevention, 470
- Feedlots, cattle, salmonellosis, 361
- Feedstuff, contamination of, by antibiotics, 161
- Feet  
 clinical examination of, 21  
 foul in. see Bovine footrot
- Feline spongiform encephalopathy, 1295–1296
- Femoral fractures, 1389
- Fenbendazole  
 for lungworm, 964  
 for parasitic gastroenteritis in ruminants, 607  
 poisoning of, 1211
- Fentanyl, 83
- Fenugreek staggers, 1367–1368
- Fertility, in equine coital exanthema, 1794
- Fertilization, hypomagnesemic tetany and, 1701
- Fescue foot, 2199
- Fescue toxicosis, 2199–2200
- Fetal anasarca, 1555

- Fetal anoxia, [1844](#)  
 Fetal diseases, [1830](#)  
 Fetal echocardiography, [672](#)  
 Fetal electrocardiography, [668–669](#)  
 Fetal gigantism, prolonged gestation with, [1828–1829](#)  
 Fetal hypoxia, [1843–1844](#)  
 Fetal membrane retention, [67–68](#)  
 Fetal pleural fluid, in neosporosis, [1819](#)  
 Fetus  
   ballottement of, [14](#)  
   transfer of selenium and vitamin E to, [1466–1467](#)  
 Fever (pyrexia), [15](#), [43–50](#), [54–56](#)  
   aseptic, [54](#)  
   clinical findings in, [55](#)  
   clinical pathology of, [55](#)  
   encephalitis and, [1183b](#)  
   endogenous pyrogens in, [54](#)  
   etiology of, [54](#)  
   febrile response, [54–55](#)  
   lymphosarcoma, [748](#)  
   magnitude of, [55](#)  
   necropsy findings in, [55](#)  
   pathogenesis of, [54–55](#)  
   peritonitis, [217](#)  
   reticulopericarditis, traumatic, [497](#)  
   reticulorumen motility, primary contraction  
     influenza, [439](#)  
   septic, [54](#)  
   tick-borne fever and, [777](#)  
   treatment for, [55–56](#)  
   undifferentiated, [55](#)  
   of unknown origin, in horses, [55](#)  
 Fiber, dietary  
   gastric ulcers, [288](#)  
   left-side displacement of abomasum, [503](#), [509](#)  
 Fiber balls, luminal blockage, [525](#)  
 Fibrin degradation products, [727](#)  
 Fibrinogen, [56](#), [720–721](#)  
   deficiency, heritable, [723–724](#)  
   disseminated intravascular coagulation and, [727](#)  
 Fibrinogen, reticuloperitonitis, traumatic, [485](#)  
 Fibrinolysis  
   diarrhea, acute, [278](#)  
   equine colic, [225–226](#)  
 Fibrinolytic therapy  
   in equine pleuropneumonia, [995](#)  
   in exercise-induced pulmonary hemorrhage,  
     [1002–1003](#)  
   for pleuritis, [898–899](#)  
 Fibrinous pericarditis, [707–708](#)  
 Fibrinous polysynovitis, in *Mycoplasma bovis*,  
   [936](#)  
 Fibroelastosis, [705](#)  
 Fibrosis, kidney worm disease, [1135](#)  
 Fillies, [987](#)  
 Filtration system, for PPRSV, [1811–1814](#)  
 "Fingerprint lesions," *T. axei* infection, [606](#)  
 Finishers, lameness and, [1418–1419](#)  
 Finland, bovine virus diarrhea virus eradication  
   program, [598](#)  
 Finnish Landrace lambs, [1110–1111](#)  
 First-degree atrioventricular block, [679](#)  
 First-pass effect, [163](#)  
 Fish-scale diseases, [1646](#)  
 Fits. *see* Convulsions  
 Fixed-dose combinations, of antimicrobial drugs,  
   [164](#)  
 Flaccidity, [1173](#)  
 Flecainide, [682–683](#)  
 Fleece  
   border disease and, [1254](#)  
   loss of, caseous lymphadenitis, [765](#)  
   rot, in sheep, [1574–1575](#), [1574b](#)  
   wetness of, and hypothermia, [48](#)  
 Flesh fly, [1617–1618](#)  
 Flexor reflex, [1173](#)  
 Flexor spinal reflex, [1173–1174](#)  
 Flexural seborrhea, [1554](#)  
 Flocking instinct, and stress induction, [85](#)  
 Floor plan, environmental examination of, [10](#)  
 Flooring  
   environmental examination of, [10](#)  
   osteodystrophy and, [1389](#)  
   type, lameness in pigs and, [1422](#)  
 Florfenicol, [171](#)  
   for enterotoxic colibacillosis, [1892](#)  
   for *Mycoplasma pneumoniae*, [1068](#)  
 Florida horse leech<sup>(equine phycomycosis)</sup>, [813b](#),  
   [814–817](#)  
 Flow-volume loops, measurement of, [864](#)  
 Flu OIA (Biostar) assay, in equine influenza, [1035](#)  
 Fluid, intravenous administration, cecum, disease of,  
   [259](#)  
 Fluid and electrolyte replacements, [191](#)  
 Fluid and electrolyte therapy  
   carbohydrate engorgement, [469](#)  
   for coliform mastitis, [1952](#)  
   colloid solutions, [142–143](#)  
   electrolyte requirements in, calculation of, [137](#)  
   enteritis, [212–213](#), [213t](#)  
   equine colic, [234](#)  
   intestinal obstruction, [528](#)  
   intravenous catheters and complications in,  
     [146–147](#), [146f–147f](#)  
   in newborn piglets and lambs, [151](#)  
   oral, [147–151](#)  
     in calves and adult cattle, [147–150](#)  
     in horses, [150–151](#)  
   parenteral, [145](#)  
   peritonitis, [220](#)  
   practical administration of, [143–145](#), [144t](#)  
   principles of, [137–152](#), [137t](#)  
   quantity of fluids required, [145–147](#), [145t](#)  
   rate of administration, [145–146](#)  
   right-side displacement of abomasum, [514](#)  
   routes of administration, [145–147](#)  
   thrombophlebitis and, [146–147](#)  
   vagus indigestion, [495](#)  
 Fluid and electrolytes, urinary tract disease and,  
   [1108–1109](#)  
 Fluid exudate, accumulation of, peritonitis, [217](#)  
 Fluid line, [897](#)  
 Fluid status, dynamics of, [131–132](#)  
 Fluid therapy  
   aggressive, for endotoxemia, [64](#)  
   for anophagia, [88](#)  
   for cold injury, [51](#)  
   for hyperthermia, [53](#)  
   intravenous, for hypovolemic and maldistributive  
     shock, [74](#)  
   for newborns, [1865–1866](#)  
 Fluid thrill, [14](#)  
 Fluid-rushing sounds, enteritis, [210](#)  
 Fluids, myopathy, horse and, [1386](#)  
 Flukicides, fasciolosis, [644](#)  
 Flunixin meglumine, [65](#)  
   for coliform mastitis, [1951](#)  
   endotoxemia, [234](#), [280](#)  
   equine colic, [234](#)  
   for mastitis, [1926](#)  
   for pain, [82](#)  
   for permanently drying off, in bovine mastitis,  
     [1929–1930](#)  
 Fluorescent antibody test (FAT), in contagious bovine  
   pleuropneumonia, [928](#)  
 Fluoride toxicosis, [1506–1510](#), [1506b–1507b](#)  
   acute intoxication of, [1508](#)  
   chronic intoxication of, [1508](#)  
   clinical findings of, [1508–1509](#)  
   clinical pathology of, [1509](#)  
   control of, [1509–1510](#)  
   differential diagnosis of, [1509b](#)  
   epidemiology of, [1507–1508](#)  
   etiology of, [1507](#)  
   necropsy findings of, [1509](#)  
   pathogenesis of, [1508](#)  
   risk factors of, [1507–1508](#)  
   treatment for, [1509](#)  
 Fluorine poisoning  
   osteodystrophy and, [1388](#)  
   volcanic ash, [109](#)  
 Fluoroquinolones, [171](#)  
   for enterotoxic colibacillosis, [1892](#)  
   for *Mycoplasma pneumoniae*, [1068](#)  
 Flying foxes, in equine hendra virus infection, [1044](#)  
 Foal ataxia. *see* Equine cervical vertebral stenotic  
   myelopathy  
 Foal heat diarrhea, [273](#), [391](#)  
 Foals, [742](#)  
   administration of colostrum in, [1855](#)  
   antimicrobial treatment for, [1865](#), [1866t](#)  
   antimicrobials, septic arthritis synovitis and,  
     [1415–1416](#)  
   biliary atresia in, [655](#)  
   colic, [237–240](#), [237b](#), [238t](#), [239b](#), [240t](#)  
   congenital defects in, [1839](#)  
   congenital fixation of joints in, [1510–1511](#)  
   congenital hypothyroidism in, [1740](#)  
   congenital skin tumors in, [1643](#)  
   critical plasma IgG concentrations in, [1863–1864](#)  
   critical temperature in, [1846](#)  
   diarrhea  
   acute, [273–276](#)  
   *see also* Diarrhea, horses  
   dietary, [214](#)  
   viral, [384–393](#)  
   dysmaturity of, [1842–1843](#), [1859–1860](#)  
   dystocia, [1846](#)  
   endocrine abnormalities in, [1860](#)  
   enterotoxemia, [546–547](#)  
   equine rotavirus, [388](#)  
   examination protocol for, [1857f–1858f](#)  
   fetal disease in, [1834](#)  
   fluid therapy for, [1865–1866](#)  
   fractional clearance of electrolytes, [1108](#)  
   gastric ulcer in, [244–246](#)  
   *see also* Gastric ulcer, in foals  
   gestation in, [1859–1860](#)  
   goiter in, [1745](#)  
   heart rates, fetal, [668–669](#)  
   hematology in, [1861–1862](#), [1861t](#)  
   hemolytic enterotoxemia, [545–546](#)  
   hypoglycemia in, [1860](#)  
   hypothermia in, [1846](#)  
   hypoxia in, [1860](#)  
   iron toxicosis in, [2188–2189](#)  
   lactose digestion test, [185–186](#)  
   lethal white syndrome in, [434–435](#)  
   liver, radiography of, [626](#)  
   mortality in, [1834](#)  
   muscular dystrophy in, [1470](#)  
   neonatal hypothermia in  
   prevention of, [50](#)  
   risk factors for, [48](#)  
   treatment for, [50](#)  
   neonatal infection in, [1874–1875](#)  
   in neonatal streptococcal infection, [1901](#)  
   parenteral nutrition for, [151](#), [1865](#)  
   parturient disease in, [1834](#)  
   parturition, induction of, [1759](#)  
   peritoneal fluid, reference values, [189](#)  
   plasma for, [142](#)  
   portosystemic shunts in, [630](#), [632](#)  
   postnatal disease in, [1834](#)  
   prematurity of, [1842–1843](#), [1859–1860](#), [1859t](#)  
   radiographs of, [856–857](#)  
   rickets in, [1495](#)  
   sepsis score for, [1859](#), [1859t](#)  
   septic arthritis synovitis and, [1412](#)  
   in septic shock, [61](#)  
   coagulopathies in, [64](#)  
   septicemia in, [57](#), [1413](#), [1874](#)  
   *Salmonella abortusequi*, [1785–1786](#)  
   serum biochemical values of, [1862t](#)  
   stage of maturity of, [1859t](#)  
   terminal colon of, atresia in, [433](#)  
   transfusion of, [743](#)  
   uropertoneum in, [1140–1143](#)  
   xylose absorption test, [186](#)  
   Focal chronic interstitial nephritis, [1120](#)  
   Focal symmetric encephalomalacia, [1232b](#),  
   [1262–1265](#)

- Foliar dusting, and spraying, 1705
- Folic acid, 172  
deficiency, 734, 826–829
- Follicles, diseases of, 1552–1553
- Follicular mange, 1619, 1619b
- Folliculitis, 1554–1555  
differential diagnosis of, 1555b
- Fomite transfer, in equine influenza, 1032
- Fomites, transmission of, bovine virus diarrhea virus, 579
- Food and Drug Administration (FDA), 1969
- Food Animal Residue Avoidance Databank (FARAD), 167–168
- Food deprivation, hypomagnesemic tetany and, 1702
- Food intake  
decreased, 88  
disorders of, 87–88  
in enterotoxemia, *Clostridium perfringens* type D associated, 1231–1232
- Food products, antibiotic contamination of, 167
- Foot abscess, in sheep, 1448–1449
- Foot scald, 1443b
- Foot warts. *see* Digital dermatitis, bovine
- Foot-and-mouth disease, 2058–2067, 2058b  
biosecurity concerns, 2061  
clinical findings, 2062  
clinical pathology, 2062–2063, 2064t  
control, 2064–2067  
eradication, 2065  
vaccination, 2065–2067  
differential diagnosis, 2063b–2064b  
economic importance, 2061  
epidemiology, 2059–2061  
etiology, 2058–2059  
methods of transmission, 2059–2060  
morbidity and case-fatality rate, 2059  
necropsy findings, 2063  
occurrence, 2059  
pathogenesis, 2061–2062  
prevalence, 2059  
risk factors, 2060–2061  
environmental and pathogen, 2060–2061  
experimental reproduction, 2061  
host, 2060  
immune mechanism, 2061  
treatment, 2064, 2064b  
wild boar, 2009  
zoonotic implications, 2061
- Footbaths  
for bovine digital dermatitis, 1439–1440  
for bovine footrot, 1434  
for infectious footrot in sheep, 1445–1446
- Footrot  
benign, 1441, 1443  
bovine, 1432–1435, 1432b  
clinical findings of, 1433–1434  
clinical pathology of, 1434  
control of, 1434–1435, 1435b  
differential diagnosis of, 1434b  
economic importance of, 1433  
environmental risk factors of, 1433  
epidemiology of, 1433  
etiology of, 1433  
host risk factors of, 1433  
necropsy findings of, 1434  
occurrence of, 1433  
pathogenesis of, 1433  
transmission of, 1433  
treatment for, 1434, 1435b  
vaccination for, 1435  
in pigs, 1456–1458  
differential diagnosis of, 1457b  
in sheep, infectious, 1441–1448, 1441b  
clinical findings of, 1443–1444  
clinical pathology of, 1444  
control for, 1444–1447  
differential diagnosis of, 1444b  
economic importance of, 1442
- environmental risk factors of, 1442  
epidemiology of, 1441–1442  
eradication of, 1447–1448  
etiology of, 1441  
genetic selection and, 1447  
host risk factors of, 1442  
methods of transmission of, 1441  
necropsy findings of, 1444  
pathogenesis of, 1443  
scoring systems for, 1443  
source of infection of, 1441  
symptomless carriers for, 1443–1444  
treatment for, 1444–1447, 1446b  
vaccination for, 1447  
virulent, 1441, 1443
- Forages  
alternative temperate, 479  
choice of, 479  
frothy bloat and, 475
- Forced expiratory flow-volume curves, measurement of, 864–865
- Foreign body  
esophageal, surgical removal, 202  
gastric ulcers, 288  
pericardial sac penetration (traumatic pericarditis), 707–708  
pericardial sac penetration (traumatic reticulopericarditis), 497  
pharyngeal obstruction, 197  
rumen impaction, 459–460, 460f  
small-intestinal obstruction, 253–254
- Forelimbs, nervous system examination of, 1170–1171
- Foremilk, check of, for mastitis, 1967–1968
- Forest fires, 110
- Forestomach  
anatomy of, 436–441  
diseases of, 436  
distension of, 439  
hypomotility, 437, 439–440  
reticulorumen motility, 437–441
- Formalin, 2189  
coagulopathy treatment, 721  
for hemorrhagic shock, 76  
solution, for infectious footrot in sheep, 1446
- Formalin-treated grain, feeds, 620
- Formiminoglutamic acid, 817
- Fractional clearance, 1105
- Fractures  
femoral, 1389  
from lightning strike, 104  
ribs, trauma at parturition, 1843  
spontaneous, 1375  
osteodystrophy and, 1390
- France, winter dysentery, cattle, 599
- Francisella tularensis*, 2027
- Frank-Starling mechanism, 658
- Free-gas (secondary) bloat, 474, 476, 484
- Freemartinism, calves, 1760
- Free-water deficit, 1324–1325
- Frenzy, 10–11, 1159
- Friction sounds, pleuritic, 897
- Frog, support of, laminitis, horse and, 1403
- Froin's syndrome, 1176
- Frothy (primary) bloat, 473–476
- Frozen vaccine, 806
- Fruitbats, in equine hendra virus infection, 1044
- Fumes, inhalation of, in interstitial pneumonia, 966
- Fumonisin toxicosis, 2200–2201, 2200b
- Functional murmurs, 686–687
- Functional renal proteinuria, 1102
- Functional residual capacity, elevated, heaves in, 1007
- Functional systolic ejection murmurs, 687
- Fungal infection, in mastitis, 1906
- Fungal toxicosis, in congenital defects, 1837
- Fungal toxins, hemorrhagic disease, 723
- Fungi  
affecting nervous system, 1196, 1203  
causing hepatic damage, 654–655  
lacking, identified toxins, 1137  
poisoning, miscellaneous, 1137  
reproductive dysfunction and, 1827–1828
- Fungicides, 654, 2185–2186
- Fungistatic agents, 2185
- Furan toxicosis, 1087
- Furanoid sesquiterpenes poisoning, 2210–2211
- Furanoseterpenoid poisoning, 2210–2211
- Furocoumarin, plant poisoning by, 1637
- Furosemide, 1108
- Fusarotoxicosis syndromes, without specified toxins, 2214
- Fusarium*, in interstitial pneumonia, 966  
*Fusarium culmorum*, 1824  
*Fusarium graminearum*, 1824  
*Fusarium semitectum*, 966  
*Fusarium solani*, 966  
Fusarium toxin, splayleg syndrome and, 1529–1530  
*Fusobacterium necrophorum*, 943, 1054  
localized infection, 77  
mastitis and, 1962  
oral necrobacillosis, 534

## G

- Gabapentin, for pain, 83
- Gaigeria pachyscelis*, 614
- Gait, 1157  
abnormalities of, 1161, 1167t  
analysis of, 1376  
clinical examination of, 11  
deficit, 1172  
kinetic analysis of, 1178  
nervous system examination of, 1170
- Galactan, in contagious bovine pleuropneumonia, 927
- Galegine toxicoses, 1087
- Gallba bulimoides*, 642  
*Gallba bulimoides techella*, 642
- Gallbladder, tumors of, 655
- Gallium maltoate, in *Rhodococcus equi* pneumonia, 1018
- Gallop rhythm, 664
- Galloway calves, hepatic lipodystrophy in, 1727
- $\gamma$ -Aminobutyric acid analogs, for pain, 83
- Gamma-glutamyl transferase, left dorsal displacement, of large colon, 262
- Gangliosidosis, 1219, 1839
- Gangrene, 1557–1558, 1558b  
*Staphylococcus aureus* mastitis, 1933  
terminal dry, salmonellosis, 365
- Gas exchange, heaves in, 1006–1007
- Gas gangrene, 1557  
*see also* Malignant edema
- Gasoline, poisoning, 422
- Gasterophilus* spp. infestation, 418–419, 418b
- Gastric antacids, 251
- Gastric bacteria, gastric ulcers, 288
- Gastric center, control of primary contractions, 437–439
- Gastric decompression, 183, 257
- Gastric dilatation  
in horses, 240–243, 240b–241b  
in pigs, 287
- Gastric hemorrhage, gastric ulcers, 289
- Gastric impaction, in horses, 243
- Gastric lavage, 243
- Gastric lesions, grading system for, 249, 249b
- Gastric pH, gastric ulcer, 244, 246, 248
- Gastric reflux, 179  
gastric decompression, in horses, 183
- Gastric rupture, 100



- Gastric ulcer  
 in adult horses, 246–252, 247b  
 clinical findings, 249–250  
 clinical pathology, 250  
 control, 251  
 differential diagnosis, 250b  
 epidemiology, 247–248  
 etiology, 247  
 necropsy findings, 250  
 pathogenesis, 248–249  
 treatment, 246t, 250–251  
 in foals, 244–246, 244b  
 clinical findings, 245  
 clinical pathology, 245  
 control, 246  
 diagnostic confirmation, 245  
 differential diagnosis, 245b  
 epidemiology, 244  
 etiology, 244  
 necropsy findings, 245  
 pathogenesis, 244–245  
 treatment, 245–246, 246t  
 number/severity score, 249b  
 of swine, 287–290, 287b  
 clinical findings, 289  
 clinical pathology, 289  
 control, 290  
 differential diagnosis, 290b  
 epidemiology, 287–288  
 etiology, 287  
 necropsy findings, 289–290  
 pathogenesis, 288–289  
 severity and extent, 290b  
 treatment, 290
- Gastric volvulus, acute, 287
- Gastrin, 521, 606
- Gastritis, 203–204, 204b  
 parasitic, 417–418
- Gastrointestinal ulcer, prophylaxis for, 1866
- Gastroenteritis  
 listeriosis and, 1337  
 parasitic. *see* Parasitic gastroenteritis (PGE)  
 plants and, 429  
 radiation and, 108
- Gastrointestinal conditions, sudden death, 99–100
- Gastrointestinal disease/disorders  
 arrhythmia association, 681  
 hemorrhagic anemia, 728
- Gastrointestinal dysfunction in cattle, 442, 442t–444t
- Gastrointestinal motility, normal, 176–177
- Gastrointestinal stasis, edema disease, 313
- Gastrointestinal system, function of, and endotoxemia, 62
- Gastrointestinal tract, plants and, 429
- Gastrosocopy  
 gastric dilatation, 241  
 gastric ulcer  
 in adult horses, 249  
 in foals, 245
- Gastropillium suis*, gastric ulcers, 288
- Gaucher disease, type 2, 1219–1222
- Gelatins, 143
- General adaptation syndrome, 84
- General nursing care, for respiratory tract disease, 872
- Generalized cytomegalic inclusion-body disease, of swine, 1074–1075
- Generalized hyperkeratosis, 1544
- Genetic predisposition, lameness in pigs and, 1422
- Genetic selection  
 infectious footrot in sheep and, 1447  
 for ovine progressive pneumonia, 977  
 porcine stress syndrome and, 1528–1529
- Genetic testing  
 for hyena disease of cattle, 1504  
 for myopathy, horse, 1382
- Genital tract disease  
 dourine, 1819–1821  
 hemorrhagic anemia, 731  
*Mycoplasma*, 1793–1794
- Genome-wide association studies, 112
- Gentamicin, for coliform mastitis, 1951
- Geographic occurrence, caseous lymphadenitis and, 762
- Geographic region, anaplasmosis risk factors and, 772
- Germany, bovine virus diarrhea virus eradication program, 598
- Germinative epithelium, and radiation, 108
- Gestation  
 ages for viability in, 1831  
 prolonged, 1828–1829  
 arthrogryposis with, 1829  
 in cattle, 1828  
 craniofacial deformity with, 1829  
 fetal gigantism with, 1828–1829
- Gedah virus infection, 2097–2098
- GGT. *see*  $\gamma$ -Glutamyl transferase (GGT)
- Giardia duodenalis*, 408
- Giardiasis, 408–409, 408b
- Gingival sulcus, deepening of, 195
- Gingivitis, 192, 195  
*see also* Stomatitis
- Glanders, 1026–1028, 1026b  
 clinical findings in, 1027  
 clinical pathology of, 1027  
 control of, 1028  
 diagnostic confirmation of, 1027  
 differential diagnosis of, 1028b  
 epidemiology of, 1026  
 etiology of, 1026  
 necropsy findings in, 1027  
 pathogenesis of, 1027  
 treatment of, 1028
- Glanzmann's disease, 726
- Glass bolus, for copper deficiency, 2175
- Glässer's disease, 1450–1454, 1450b, 2044b  
 clinical findings of, 1452  
 clinical pathology of, 1452  
 control of, 1454  
 diagnosis of, 1453, 1453t  
 differential diagnosis of, 1453b  
 epidemiology of, 1450–1451  
 etiology of, 1450  
 necropsy findings of, 1452–1453  
 pathogenesis of, 1451–1452  
 treatment for, 1453–1454, 1454t
- Gliosis, 1184
- Globoid cell leukodystrophy, 1224
- Glomerular filtrate, 1095
- Glomerular filtration rate, 1096–1097, 1104
- Glomerular proteinuria, 1102–1103
- Glomerulonephritis, 1110–1111, 1131
- Glomerulopathy, 1111
- Glossal actinobacillosis, 533
- Glossitis, 192  
*see also* Stomatitis
- Glossopharyngeal nerve (cranial nerve IX), assessment of, 1169
- Glucagon  
 for fatty liver, 1721  
 for ketosis, 1709, 1714
- Glucocorticoids  
 for endotoxemia, 65–66  
 for fatty liver, 1721  
 for ketosis, 1714  
 for respiratory tract disease, 871  
 secondary immune system of, 758
- Glucose  
 for endotoxemia, 65  
 in fluid therapy, 140  
 ketosis and, 1712  
 metabolism, fatty liver and, 1721  
 in oral electrolyte solution, 149
- Glucose absorption test, 185
- Glucose cerebrospinal fluid concentration of, 1177
- Glucose-glycine electrolyte formulation, 391
- Glucosinolate toxicosis, 2202–2204, 2202b  
 clinical findings, 2203  
 clinical pathology, 2203
- control, 2203–2204  
 differential diagnosis, 2203b  
 epidemiology, 2202–2203  
 etiology, 2202, 2202t  
 necropsy findings, 2203  
 occurrence, 2202  
 pathogenesis, 2203  
 risk factors, 2202–2203  
 animal, 2202  
 human, 2202  
 plant, 2202–2203, 2202t  
 treatment, 2203
- Glucosuria, 1097
- Glutamate dehydrogenase (GDH)  
 in fasciolosis, 643  
 liver function tests, 628
- $\gamma$ -Glutamyl transferase (GGT)  
 equine colic, 230–231  
 liver function test, 628, 653
- $\gamma$ -glutamyl transpeptidase, in fasciolosis, 643
- Glutaraldehyde coagulation test, for transfer of passive immunity, 1853
- Glutathione peroxidases, 1460, 1471–1472, 1472t, 1475
- Glycerine, for ketosis, 1713–1714
- Glycerol, for ketosis, 1713–1714
- Glyceryl trinitrate, laminitis, horse and, 1403
- Glycine, in oral electrolyte solution, 149
- Glycogen branching enzyme deficiency, in horses, 1736
- Glycogen storage diseases, 1514
- Glycogenesis, generalized, 1514–1515
- Glycoprotein E (gE), in bovine herpesvirus-1 infection, 953
- Glycoprotein E2, bovine virus diarrhea virus, 580–581
- Glycopyrrolate, for heaves, 1011
- Goat kids, swayback and enzootic ataxia in, 2169–2170
- GoatMAP, 571–572
- Goatpox, 1591–1593, 1591b  
 differential diagnosis of, 1592b
- Goats  
 anaphylaxis of, 750  
 anaplasmosis and, clinical findings, 773  
 biosecurity planning for, 37b  
 bluetongue, 2072  
 border disease in, 1254  
 botulism in, 1368  
 caseous lymphadenitis and, 762  
 risk factors of, 764  
 coccidiosis, 402  
 congenital fixation of joints in, 1510  
 contagious agalactia in, 1994–1996  
 contagious ecthyma in, 1595  
 copper deficiency, 2170  
 cryptosporidiosis, 397  
 enterotoxemia, *Clostridium perfringens* type D associated, 1228, 1230  
 enzootic nasal adenocarcinoma of, 970f  
 facial abscess in, 77  
 hemorrhagic shock in, 71–72  
 infected by bovine tuberculosis, 2018  
 necropsy findings of, 2021  
 infectious footrot in, 1444  
 inherited goiter in, 1747  
 iodine deficiency in, 1744  
 leptospirosis and, 1117–1118, 1122  
 listerial abortion in, 1338  
 listerial encephalitis/meningitis in, 1335f, 1338  
 lungworm in, 980–981, 980b–981b  
 with *M. bovis*, 2017  
 mastitis of, 1993–1994  
 melioidosis, clinical findings, 2030  
 metabolic acidosis in, 128  
 methicillin-resistant *Staphylococcus aureus* in, 1567  
 mycobacteriosis associated with MAC and with atypical mycobacteria, clinical and necropsy findings of, 2025

- Goats (*Cont'd*)  
*Mycoplasma* spp. of  
 diseases of the respiratory tract associated with, 924  
 major pathogenic, 885t  
 myotonia of, 1518–1519  
 organophosphorus poisoning in, 1215  
 osteodystrophia fibrosa in, 1498  
 papillomatosis in, 1583  
 parenteral nutrition for, 151–152  
 pasteurellosis of, 2042–2043  
 pleuritis in, 896  
 pneumonia in, 886  
 primary copper toxicosis, 2182  
 pseudorabies in, 1248  
 psoroptic mange in, 1621  
 pulmonary and pleural neoplasms in, 1088–1089  
 rabies in, 1240  
 respiratory tract, diseases of, 969–970  
 rhinitis in, 874  
 septic arthritis synovitis and, 1412  
 squamous-cell carcinoma in, 1641  
 staphylococcal folliculitis in, 1555  
 systemic mycoplasmoses of, 971t  
 tick-borne fever and, 777  
 tooth root abscess in, 77  
 toxoplasmosis, 2142  
 water deprivation in, 114
- Goiter, 1743  
 congenital, 1744  
 glucosinolate toxicosis and, 2203
- Goldmann-Witmer coefficient (C-value), 1177
- Good-quality veal, iron deficiency and, 813
- Gossypol, 2207
- Gracilis muscle, myositis and, 1387
- Grain, gorge on, ruminants, 177
- Grain feeding  
 adaptation, 464, 471–472  
 left-side displacement of abomasum and, 503
- Grain fumigants, 2185
- Granular cell tumors, 1089, 1089f
- Granulocytopenic syndromes, 165
- Granulomas, granulomatous enteritis, 282
- Granulomatous dermatitis, 1579–1580
- Granulomatous enteritis, of horses, 282–283
- Granulomatous lesions, 1558–1559  
 actinomycosis, 532
- Grass disease. *see* Equine grass sickness
- Grass sickness. *see* Equine grass sickness
- Grass staggers, 1699–1706, 1699b
- Grass tetany, 1699–1706, 1699b
- Grassfire (bushfire) injury, 110–111
- Gravel, ingestion of, 515
- Grayanotoxins, 2209–2210
- Grazing  
 animals, vitamin D deficiency and, 1492  
 bloat control, 479–480  
 management, for interstitial pneumonia, 969
- Greasy heel, 1554
- Greasy pig disease, 1576–1579, 1577b  
 clinical findings of, 1577–1579  
 clinical pathology of, 1579  
 control of, 1579  
 diagnosis of, 1579  
 differential diagnosis of, 1578t, 1579b  
 epidemiology of, 1577  
 etiology of, 1576–1577  
 necropsy findings of, 1579  
 pathogenesis of, 1577  
 risk factors of, 1577  
 transmission of, 1577  
 treatment of, 1579
- Great arteries, complete transposition of, 705
- Great Britain  
 bovine spongiform encephalopathy in, 1288f, 1294  
 swine influenza in, 1078
- Green respiratory secretions, in pneumonia, 887
- Griseofulvin, for congenital defects, 1837
- Ground barley, gastric ulcers, 288
- Ground beef, *Escherichia coli* detection, 543
- Growers, lameness and, 1418–1419
- Growth inhibition test (GIT), in contagious bovine pleuropneumonia, 928
- Growth rate  
 of border disease, 1254  
 gastric ulcers, 289–290  
 lameness in pigs and, 1421
- Growth-plate defects, 1389
- Grunting  
 abdominal pain, 451  
 abomasal impaction, 516  
 alimentary tract disease in cattle, 445  
 causes of, 488f  
 elicit, 452  
 pain and, 80
- Guernsey cattle, chromosomal translocation in, 1828
- Gut edema, 312–315
- Gut tie, 524, 525f
- Guttural pouch empyema, 984–985, 984f, 985b
- Guttural pouch fluid, in respiratory secretions, 860
- Guttural pouch mycosis, 985–987, 986b  
*Aspergillus* spp. in, 1045  
 cranial neuritis with, 1362
- Guttural pouch tympany, 987
- Guttural pouches  
 diseases of, 984–985  
 strangles in, 1021
- 
- ## H
- H1N1 humanlike viruses, in pigs, 1076
- H1N1 virus, 1076
- H1N2 virus, 1077
- H<sub>2</sub> antagonist, 246
- H2N3 viruses, 1077
- H3N1 SIV, 1077
- H3N2 virus, 1077
- H5N1 influenza viruses, 1077
- H5N2 virus, 1077
- H6N6 virus, 1078
- H7N2 virus, 1078
- H9N2 SIVs, 1078
- H10N5 virus, 1078
- Habitus, alimentary tract examination, 445
- Haemaphysalis longicornis*, 777
- Haematobia* spp., 1628–1629
- Haematopota* spp., 1626
- Haemonchus*, 610
- Haemonchus contortus*, 610–611
- Haemonchus placei*, 611
- Haemophilus agni*, 2038
- Haemophilus pleuropneumoniae*, 1055
- Hair  
 fibers, abnormalities of, 1543  
 follicles, diseases of, 1552–1553
- Hair coat, palpation of, 21
- Hair-coat-color-linked follicle dysplasia, inherited, 1645
- Hairy foot warts. *see* Digital dermatitis, bovine
- Half-life (*t*<sub>1/2</sub>), 163
- Half-lives, 107
- Halicephalobus*, 1307–1308
- Halothane test, for porcine stress syndrome, 1527
- Hand-fed animals, history taking of, 7–8
- Haptoglobin, 56
- Hard bag, 976
- Hard udder, 976
- Hardwood forest fires, 110
- Harelip, 432–433
- Harvest mites, 1618
- Hay feeding, in heaves, 1005
- Hazard Analysis of Critical Points System (HACCP), 543
- Head  
 behavior and, 1164  
 clinical examination of, 12, 18  
 coordination of, 1164–1165  
 mental status and, 1164  
 position of, 1164–1165  
 posture, 1161
- Head fly, 1630
- Head trauma, 1178–1179
- Head-pressing, 1159
- Head-shaking, 1169  
 clinical findings of, 1226  
 clinical pathology of, 1226  
 control of, 1226  
 differential diagnosis of, 1226b  
 epidemiology of, 1225  
 etiology of, 1225  
 in horses, 1253–1256  
 necropsy findings of, 1226  
 pathogenesis of, 1225–1226  
 treatment of, 1226
- Heart  
 auscultation of, 16  
 disease associated with, 690–692  
 ectopic, 704  
 rhythm of, 16  
 rupture of, 692–693
- Heart failure, 657–658  
 acute, 662–663, 662b  
 chordae tendinae, 689  
 clinical findings of, 663  
 clinical pathology of, 663  
 differential diagnosis of, 663b  
 etiology of, 662–663  
 necropsy findings of, 663  
 pathogenesis of, 663  
 treatment of, 663
- cardiac reserve and compensatory mechanisms in, 658–659
- chronic (congestive), 659–662, 659b  
 clinical findings of, 660–661  
 clinical pathology of, 661  
 differential diagnosis of, 661b  
 etiology of, 659–660  
 left-sided, 660–661  
 necropsy findings of, 661  
 pathogenesis of, 660  
 right-sided, 660–661, 661f  
 treatment of, 661–662
- plants causing (unidentified toxins), 701
- poisons associated with, 100
- Heart rate  
 cardiac reserve and, 658  
 cardiovascular system examination, 664  
 decreased, 699  
 equine colic, 227, 232–233  
 fetal, 1841, 1841f  
 heaves in, 1007  
 intensity variation of, 664  
 resting, 676  
 cardiac reserve measurement, 659  
 cattle, 676  
 horses, 676  
 shock and, 73  
 variability, 669, 669f
- Heart sounds, 16, 663–664  
 abnormal, 16  
 first (S1), 663–664  
 fourth (S4), 664  
 intensity variation, 659  
 muffled, traumatic reticulopericarditis, 497–498  
 muffling of, 664  
 phonocardiography, 673  
 second (S2), 664  
 sequence of, 664  
 third (S3), 664
- Heart valves, rupture of, 693
- Heartwater, 781

- Heartwater/cowdriosis, 2031–2033, 2031b  
 clinical findings, 2032  
 clinical pathology, 2032  
 control, 2033  
 differential diagnosis, 2032b  
 economic importance, 2032  
 biosecurity concerns, 2032  
 epidemiology, 2031–2032  
 etiology, 2031  
 method of transmission, 2031  
 necropsy findings, 2032  
 occurrence, 2031  
 measures, 2031  
 pathogenesis, 2032  
 risk factors and immune mechanisms, 2031–2032  
 treatment, 2032–2033, 2032b–2033b
- Heat loss, 43–44  
 excessive, 44  
 and heat gain, balance between, 44  
 in lambs, 1845  
 neonatal control of, 45
- Heat production, 43  
 insufficient, 44  
 neonates, 45–47
- Heat stress  
 in immunoglobulin concentration in colostrum, 1850  
 in intrauterine growth retardation, 1840
- Heaves, 1003–1012, 1003b  
 clinical findings in, 1007–1008, 1008f  
 clinical pathology of, 1008–1009  
 diagnostic confirmation in, 1009  
 differential diagnosis of, 1009b  
 epidemiology of, 1004–1005  
 etiology of, 1003–1004  
 necropsy findings in, 1009  
 pasture-associated, 1012–1013  
 pathogenesis of, 1005–1007  
 risk factors for, 1004–1005, 1005f  
 special examinations for, 1008–1009  
 treatment of, 1009–1011, 1010t
- Heavy magnesium “bullets”, 1705
- Heel abscess, 1448–1449
- “Heel warts.” see Digital dermatitis, bovine
- Heifer calf herd replacements, dietary supplementation and, 813
- Heifers  
 bovine virus diarrhea virus vaccination, 596  
 intramammary infection of, 1907
- Helicobacter heilmannii*, gastric ulcers, 288
- Heliotropium europaeum*, copper poisoning and, 820
- Helminthosporium biseptatum*, 1828
- Helminthosporium ravenelii*, 654
- Helminthosporium spiciferum*, 798
- Hemagglutinating encephalomyelitis, porcine, 340–341
- Hemagglutination inhibition, in swine influenza, 1082
- Hemangioma, 715, 1642
- Hemangiosarcoma, 715, 1089, 1642
- Hematinics, 739–740
- Hematochezia, 210, 449
- Hematocrit  
 for dairy-herd metabolic profile testing, 1671  
 equine colic, 230, 232–233  
 hemorrhagic shock, 73, 75  
 radiation and, 108
- Hematogenous osteomyelitis, 1392
- Hematogenous spread, of brain abscess, 1190
- Hematogenous subcutaneous abscess, 1558
- Hematologic abnormalities  
 exercise intolerance, 99  
 in strangles, 1022
- Hematology  
 anaplasmosis and, 773  
 anemia and, 735  
 babesiosis and, 803  
 for bovine mastitis, 1920  
 of brain abscess, 1191  
 cobalt deficiency and, 817–818  
 for coliform mastitis, 1949  
 in dairy-herd metabolic profile testing, 1671  
 diarrhea, acute, 278  
 endotoxemia and, 63–64  
 enteritis and, 211  
 eperythrozoonosis of, 780  
 equine colic and, 230–231  
 hemorrhagic bowel syndrome and, 551  
 of lead toxicosis, 1206–1207  
 of meningitis, 1193  
 in newborn, 1861–1862, 1861t  
 peritonitis and, 218  
 in pneumonia, 890  
 in pneumonic pasteurellosis, 918–919  
 for postpartum dysgalactia syndrome, 1999  
 puerperal metritis in cattle and, 68
- Hematoma, 1557  
 differential diagnosis of, 1557b  
 infarction, 746–749  
 spleen, 746–749
- Hematophagous insect transmission, 771
- Hematopoietic cell density, reduced, 758
- Hematuria, 1100–1101
- Hemic murmurs, 686
- Hemlock, poison (*Conium maculatum*), 1837
- Hemochromatosis, 630, 844
- Hemoconcentration, 113–114
- Hemodialysis, 1109
- Hemoglobin  
 altered, in dyspnea, 849  
 decreased production, anemia from, 731  
 hemochrosis in ruminants, 611
- Hemoglobinopathies, 745
- Hemoglobinuria, 1101  
 water intoxication and, 115–116, 116f
- Hemogram  
 abomasal displacement/volvulus, 512  
 abomasal ulcer, 521  
 for encephalitis, 1185  
 in fatty liver, 1720  
 intestinal obstruction, 527  
 left-side displacement of abomasum and, 506–507  
 for localized infections, 78  
 in milk fever, 1681  
 reticulopericarditis, traumatic, 498  
 reticuloperitonitis, traumatic, 485  
 retroperitoneal abscess, 270–271  
 septicemia and, 58  
 vagus indigestion, 494
- Hemolymphatic system, 781–784  
 clinical pathology of, 782  
 clinical signs of, 782  
 control of, 782  
 diagnosis of, 782  
 diseases of, 716–844  
 plasma protein concentration abnormalities of, 716–718  
 spleen, diseases of, 751–752  
 thymus, diseases of, 751–752  
 white cell disorders of, 745–746  
 epidemiology of, 781  
 etiology of, 781  
*Mycoplasma suis*, 781–782  
 pathogenesis of, 782  
 pathology of, 782  
 treatment of, 782
- Hemolysins, 2177
- Hemolysis, 734–735  
 leptospirosis and, 1120
- Hemolytic anemia, 728–740  
 autoimmune, 729t–730t
- Hemolytic disease, *Clostridium perfringens* type A, 545–546
- Hemolytic jaundice, 623
- Hemolytic uremic-like syndrome, 1114
- Hemochrosis  
 in goats, 611  
 in ruminants, 610–613, 610b  
 breed, susceptibility with, 611  
 clinical findings, 611–612  
 clinical pathology, 612  
 control, 612–613  
 diagnostic confirmation, 612  
 differential diagnosis, 612b  
 epidemiology, 611  
 etiology, 610  
 natural resistance, 613  
 necropsy findings, 612  
 pathogenesis, 611  
 predisposing causes for, 611  
 self-cure phenomenon, 611  
 transmission, 610–611  
 treatment, 612, 612b  
 vaccination, 613  
 in sheep, 611
- Hemophilia, 842–844
- Hemophilia A, 722, 844
- Hemoptysis, 877–878  
 in respiratory insufficiency, 854–855
- Hemorrhage  
 alimentary tract, 181–182  
 diseases causing, 721  
 hemangiosarcoma and, 715  
 internal spontaneous, sudden death from, 99  
 panhypoproteinemia of, 717  
 peritonitis, 216  
 prevention of, in guttural pouch empyema, 986  
 pulmonary, 883, 883f
- Hemorrhagic anemia, 728–740
- Hemorrhagic bowel syndrome, in cattle, 549–552  
 clinical findings, 550–551  
 clinical pathology, 551  
 control, 551–552  
 differential diagnosis, 551b, 551f  
 epidemiology, 549  
 etiology, 549  
 necropsy findings, 551  
 pathogenesis, 549–550, 550f  
 treatment, 551
- Hemorrhagic diathesis, 625
- Hemorrhagic disease, 718–725  
 bovine virus diarrhea virus, 585  
 infection, 582
- Hemorrhagic enteritis, 449
- Hemorrhagic enterotoxemia, 391, 545–546
- Hemorrhagic septicemia (HS), 2040–2042
- Hemorrhagic shock, 71–76, 71b  
 cattle, 71–72  
 clinical findings in, 73  
 clinical pathology, 73–74  
 differential diagnosis of, 74b  
 etiology of, 71–72  
 horses, 72  
 necropsy findings, 74  
 pathogenesis of, 72  
 pigs, 72  
 treatment, 74–76
- Hemorrhagic syndrome, pigs, 722
- Hemorrhagins, 2177
- Hemostatic system, endotoxemia and, 61–62
- Hemothorax, 895–896, 896b
- Henderson-Hasselbalch equation, 124, 124f–125f, 135
- Heparin  
 coagulopathy treatment, 721  
 disseminated intravascular coagulation and, 728  
 equine colic, 234–235  
 for equine hyperlipemia, 1739  
 laminitis, horse and, 1403
- Hepatic abscess, 626, 632–635  
 in cattle, 626, 634  
 caudal vena cava syndrome, 634  
 in goats, 633  
 in horses, 626, 634  
 ultrasonography, 626
- Hepatic abscesses, carbohydrate engorgement, 463–464
- Hepatic biliary cystadenoma, 655
- Hepatic coma, 624
- Hepatic dysfunction, principles of, 622–623



- Hepatic encephalopathy, 624, 632, 647, 817, **1187**  
 in cattle, 624  
 in horses, 629
- Hepatic enzymes, serum profile, 628–629
- Hepatic fibrosarcoma, in goats, 655
- Hepatic fibrosis, 631–632
- Hepatic function, congenitally defective, **1550**
- Hepatic function tests, 627–628
- Hepatic injury  
 plants causing, 649–650  
 pyrrolizidine alkaloid toxicosis, 647
- Hepatic lipidosis, **1716–1722**, **1717b**  
 in goat, 816
- Hepatic lipodystrophy, in galloway calves, **1727**
- Hepatic necrosis, in pigs, 630
- Hepatitis, 622, 629–632  
 acute, 639–640  
 clinical findings, 631–632  
 clinical pathology, 632  
 congestive, 631  
 differential diagnosis, **632b**  
 epidemiology, 629–630  
 etiology, 629–630  
 infectious, 630, 637–638  
 infectious necrotic. *see* Black disease  
 necropsy findings, 632  
 nutritional, 630  
 parasitic, 630–631  
 pathogenesis, 630–631  
 postvaccinal, 639–640  
 serum, 631, 639–640  
 toxemia perfusion, 630  
 toxic, 630  
 toxipathic, 630–631  
 treatment, 632  
 trophopathic, 630–631
- Hepatitis E, 640–641  
 wild boar, **2009**
- Hepatoencephalopathy, 639
- Hepatogenous chronic copper poisoning, 823
- Hepatogenous photosensitization, **1550**
- Hepatopathy, congestive, 630
- Hepatitis, 622, 630
- Hepatitis dietetica  
 clinical findings of, **1470**  
 epidemiology of, **1464**  
 necropsy findings of, **1473**
- Herbicides, **2186–2187**  
 bipyridyl derivatives, **2186**  
 carbamates, **2186**  
 delrad, **2187**  
 dinitrophenol compounds, **2186**  
 dithiocarbamates, **2186**  
 inorganic, **2186**  
 sodium chlorate, **2186**  
 organophosphorus compounds, **2186**  
 phenoxy acid derivatives, **2186–2187**  
 poisoning, 422  
 thiocarbamates, **2186**  
 triazines/triazoles, **2187**  
 triclopyr, **2187**  
 ureas/thioureas, **2187**
- Herd, shortfalls in performance, 94
- Herd certification, in *Mycoplasma pneumoniae*, 1067
- Herd testing, **1668**
- Herding instinct, and stress induction, 85
- Hereditary equine regional dermal asthenia, **1643**, **1647**
- Hereditary hemimelia, **1537**
- Hereditary lissencephaly, **1332**
- Hereditary neuraxial edema, **1350**
- Hereditary peromelia, of Mohair goats, **1537**
- Hernia  
 diaphragmatic, 900–901, 901f  
 inguinal, 253–254  
 inherited umbilical, **1516**
- Hetastarch, 142–143
- Hexachlorophene, 618  
 poisoning of, **1212–1213**
- Hexokinase assay, 134–135
- High-frequency electromagnetic radiation, 106–107
- Hindlimbs  
 incoordination of, 313  
 nervous system examination of, **1171–1172**
- Hip dysplasia, inherited, **1539**
- Hip lifters, for downer-cow syndrome, **1697**
- Hirsutism, **1727–1728**
- Hirudin, 721–722
- Histamine, carbohydrate engorgement, 464
- Histamine type-2 (H<sub>2</sub>) receptor antagonists, 522
- Histiocytoma, **1642**
- Histology  
 caseous lymphadenitis of, 769  
 equine infectious anemia and, 793  
 of Glässer's disease, **1453**  
 hemochromatosis, 843  
 iron deficiency and, 817  
 porcine proliferative enteropathy, 325  
 of porcine reproductive and respiratory syndrome, **1810**  
 of Q fever, **1792**  
 swine dysentery, 331
- Histophilus ovis*, **2038**
- Histophilus* septicemia of cattle (*Histophilus somni* or *haemophilus somnus* disease complex), **2033–2038**, **2033b–2034b**  
 clinical findings, **2036–2037**  
 myocarditis, **2036–2037**  
 respiratory disease, **2036**  
 thrombotic meningoencephalitis (TME), **2036**  
 clinical pathology, **2037**  
 culture of organism, **2037**  
 hematology, **2037**  
 serology, **2037**  
 control, **2038**  
 metaphylactic antimicrobial therapy, **2038**  
 vaccination, **2038**  
 epidemiology, **2034–2035**  
 etiology, **2034**  
 immune mechanisms, **2035**  
 methods of transmission, **2035**  
 necropsy findings, **2037**  
 sample for confirmation of diagnosis, **2037**, **2037b**  
 occurrence of disease, **2034**  
 pathogenesis, **2035–2036**  
 prevalence of infection, **2034**  
 risk factors, **2034–2035**  
 animal, **2034**  
 pathogen, **2034–2035**  
 treatment, **2037–2038**, **2038b**
- Histophilus somni*  
 localized infection, 77  
 mastitis and, **1962**  
 septicemia, **2038–2039**, **2038b**  
 synovitis caused by, **1416**  
 thrombotic meningoencephalitis, **2038–2039**, **2038b**  
 vaccines, 913, 923
- Histoplasma capsulatum*, **2159–2160**
- Histoplasma capsulatum* var. *farciminosum*, 795
- Histoplasmosis, **2159–2160**
- History taking, of individual animal, 5–8  
 animal data, 6  
 case fatality, 6  
 climate, 8  
 culling rate, 7  
 disease history, 6–7  
 general management, 8  
 management history, 7–8  
 method, 5–6  
 morbidity, 6  
 nutrition, 7–8  
 population mortality rates, 6  
 present disease, 6  
 previous disease, 7  
 previous exposure, 7  
 prior treatment, 6
- prophylactic and control measures, 6  
 reproductive management and performance, 8  
 transit, 7
- Histotoxic anoxia, 847
- “Hobby farm malnutrition”, 92
- Hog cholera, **2098–2110**  
 virus, in congenital defects, **1836**
- Holodiastolic murmurs, 687–688
- Holosystolic murmurs, 687
- Holstein calves, complex vertebral malformation in, **1536–1537**
- Holstein Friesian calves, volume of colostrum ingested of, **1850–1851**
- Holstein-Friesian cattle  
 chromosomal translocation in, **1828**  
 factor XI deficiency, 723  
 rupture of abdominal artery aneurysm in, 711
- Homeothermy, 43, 48
- Homoanatoxin-a, 102
- “Honking” respiratory noise, 880
- Hookworm disease, 613–615
- Hooves, clinical examination of, 21–22
- Hormonal therapy, for ketosis, **1714**
- Hormones  
 defects, inagalactia, **1990**  
 reticulorumen motility, primary contraction influence, 439
- Horn cancer, **1640–1641**
- Horn flies, **1628–1629**
- Horn fly (*Hameotobia irritans*), *Staphylococcus aureus* mastitis, transmission of, **1931**
- Horner's syndrome, **1172**  
 in cranial nerve dysfunction, 986
- Horns, clinical examination of, 21–22
- Horse flies (*Tabanus fuscicostatus*), **1626**  
 enzootic bovine leukosis transmission, 834
- Horsepox, **1596–1597**
- Horses  
 abdominal ultrasonography, 184  
 abdominocentesis, 189–190  
 acute diarrhea in, 150  
 anaphylaxis of, 750–751  
 anthrax in, **2013**  
 antimicrobials, septic arthritis synovitis and, **1415–1416**  
 aortoiliac thrombosis in, 710–711  
 arterial blood pressure measurement, 671  
 ascariasis, 409–411  
 aural flat warts in, **1583**, **1583f**, **1640**  
 back pain in, **1350**  
 biosecurity planning for, **37b**  
 biotin and, **1503**  
 blood glucose levels, 185  
 borreliosis in, **1425–1427**  
 botulism in, **1368**  
 bovine tuberculosis in, **2017**  
 necropsy findings of, **2021**  
 bronchitis in, 878  
 cecal catheters in, 146  
 cerebellar abiotrophy in, **1334–1336**  
 cervical vertebrae in, **1344**  
 cholangiohepatitis in, 655–656  
 chronic pectoral and ventral midline abscess in, **1449–1450**  
 congenital cardiac defects and, 704  
 contagious acne of, **1576**  
 differential diagnosis of, **1576b**  
 copper deficiency, **2170**  
 dehydration in, 114–115  
 dermatitis in, **1547**  
 dermatophilosis in, **1571**  
 disease causing spinal ataxia in, **1356t**  
 diseases of, **1272t**  
 edema in, 130  
 endoscopic examination, of airways, 855–856  
 enterotoxemia in, *Clostridium perfringens* type D associated, **1228–1229**  
 exercise intolerance in, 97–99

## Horses (Cont'd)

- exercises-induced pulmonary hemorrhage of, 997–1003, 997b, 999f, 1001b
  - fever of unknown origin in, 55
  - gastric decompression, 183
  - granulomatous lesions in, 1559
  - grazing, atypical myopathy in, 1505–1506
  - greasy heel of, 1554
  - head-shaking in, 1253–1256
  - heart : weight ratio, 659
  - hemoglobinuria in, 631
  - hemoptysis in, 877
  - hemorrhagic shock, 72
  - hepatic abscesses in, 634
  - hepatic enzyme profile of, 629
  - hyperkalemic periodic paralysis, 111
  - hyperthermia in, 52–53
    - malignant, 1524–1525
  - with hyperthyroidism, 1740
  - hypertonic saline solution for, 141
  - hypoglycin A intoxication of, 1505–1506
  - hypokalemia, 120
  - infected by bovine tuberculosis, 2018
  - inguinal abscess in, 77
  - inherited congenital hydrocephalus in, 1329–1331
  - injection-site clostridial infections in, 1388
  - insect bite hypersensitivity in, 1559–1560
    - differential diagnosis of, 1560b
  - interstitial pneumonia in, 996–997
  - intramuscular injection reaction of, 159
  - iron toxicosis, 2188–2189
  - laminitis of, 1395–1404, 1395b, 1395f
  - laryngitis in, 878
  - lead poisoning in, 1205–1206
  - leptospirosis and, 1118–1119, 1122–1123
  - liver
    - biopsy, 626, 632
    - and kidney lead in, 1207
    - normal, 625
  - lungworm in, 1047, 1047b
  - lymphangitis in, 1557
  - melioidosis, clinical findings, 2030
  - methicillin-resistant *Staphylococcus aureus* in, 1568
  - mildly affected, myopathy and, 1386
  - muscular dystrophy in, 1470
  - mycobacteriosis associated with MAC and with atypical mycobacteria, clinical and necropsy findings of, 2025
  - Mycoplasma* spp. of
    - diseases of the respiratory tract associated with, 925
    - major pathogenic, 885t
  - myopathy of, 1381–1387
    - control of, 1386–1387
    - diagnosis of, 1382, 1386f
    - etiology of, 1382, 1383t–1385t
    - pathogenesis of, 1382
    - treatment for, 1382–1386
  - neuraxonal dystrophy of, 1349
  - neurotoxic mycotoxins in, 1186
  - oral fluid therapy in, 150–151
  - orally administered antimicrobial agents for, 161
  - organophosphorus poisoning in, 1215
  - osteochondrosis and, 1407–1408
  - osteodystrophia fibrosa in, 1388, 1498
  - otitis media/interna in, 1335
  - papillomatosis in, 1583–1584
  - parenteral nutrition for, 151
  - peritoneal fluid, 187t–188t
  - phosphorus deficiency in, 1487
  - plasma and liver copper in, 2172
  - pleuritis in, 896
  - pneumonia in, 886
  - polysaccharide storage myopathy of, 1522–1523
  - poor racing performance by, 97–99
  - poxvirus infections in, 1596–1597, 1597f, 1598t–1599t
  - primary copper toxicosis, 2182
  - primary vitamin A deficiency in, 1322
  - progressive ethmoidal hematoma in, 876, 876f
  - proliferative enteropathy, 379–381
  - pruritus in, 1543
  - psoroptic mange in, 1621
  - pulmonary and pleural neoplasms in, 1088
  - pulmonary emphysema in, 884
  - pulmonary lesions in, 877
  - rabies in, 1240–1241
  - respiratory tract of, viral infections of, 1028–1029
  - resting heart rate, 676
  - rhabdomyolysis, sporadic exertional, in, 1479–1481
  - rhinitis in, 874
  - ringworm in, 1601
  - SAA in, 56
  - salmonellosis, 357–373
  - selenium status in, 1471
  - selenium-responsive reproductive performance in, 1478
  - septic arthritis, prognosis for survival and athletic use in, 1417–1418
  - septic arthritis synovitis and, 1412–1413
  - septicemia in, 57
  - serum bile acids, 627
  - serum hepatitis in, 631
  - smoke inhalation in, 881
  - squamous-cell carcinoma in, 1583–1584, 1584f, 1640
  - starvation in, 89–90
  - steatitis in, 1726
  - strongylosis, 411–415
  - sudden death in, 100
  - summer sores in, 1608–1609, 1608b
  - synchronous diaphragmatic flutter in, 1013
  - thiamine deficiency in, 1319
  - thoracic radiographs of, 856–857, 857b, 857f
  - thoroughbred and standardbred, recurrent exertional rhabdomyolysis in, 1519–1522
  - thyroidectomy of, 1740
  - tick-borne fever and, 778
  - toxoplasmosis, 2142
  - tracheal collapse in, 879–880
  - tracheitis in, 878
  - transportation stress, 85
  - tuberculin testing in, 2020
  - tularemia, clinical findings, 2028
  - tying-up in, 1379
  - ulcerative lymphangitis
    - clinical findings of, 761–762
    - epidemiology of, 760
  - upper respiratory tract of
    - abnormalities of, 981–982
    - diseases of, differential diagnosis of, 1023t
  - Venezuelan viral encephalomyelitis of, 1300–1301
  - vertebral osteomyelitis in, 1347
  - vesicular stomatitis, 396
  - zearalenone toxicosis in, 1825
  - zinc toxicosis, chronic poisoning, 2194
- Hosepipe gut, 324
- “Hospital pasture”, 1878
- Host occurrence, caseous lymphadenitis and, 762
- Hot water rinse, carcass decontamination, 543
- Houseflies, porcine reproductive and respiratory syndrome, transmission of, 1799
- Housefly, 1630
- Housing
  - bovine digital dermatitis and, 1440
  - caseous lymphadenitis and, 764
  - colibacillosis and, 1881
  - coliform mastitis and, 1953
  - enterohemorrhagic *Escherichia coli* risk factor, 538
  - equine colic, risk for, 224
  - for equine influenza, 1033
  - facilities, for respiratory tract disease, 873
  - in heaves, 1005
  - in mastitis control program, 1979
  - in mortality in dairy calves, 1833
  - for musculoskeletal system disease, 1377
  - for newborns, 1878
  - performance shortfalls and, 94
  - for pneumonia, 892
  - in risk factors, of bovine mastitis, 1910–1911
  - stress induction and, 84
- HT-2 toxin, 2213
- Human H7N9 IV, 1078
- Humanlike H1N1 viruses, 1076
- Humans
  - Actinobacillus lignieresii* infection, 533
  - Anaplasma phagocytophilum*, 775–777
  - bovine papular stomatitis infection in, 602
  - Brucella melitensis* in, 1782
  - Brucella suis* infection in, 1779
  - brucellosis in, 1779
  - campylobacteriosis, in pigs, 321
  - Chlamydomphila abortus* infection in, 1786–1787
  - enterohemorrhagic *Escherichia coli* (EHEC) infections in, 536
  - Mycobacterium avium* subspecies paratuberculosis (MAP), 552
  - Q fever in, 1792
  - salmonellosis, 298, 363–364
  - yersiniosis, 337
- Hunger, 87, 89
- Hunting reaction, 45
- Hurdle technology, slaughter practices, 543
- Hutches, for enzootic pneumonia of calves, 945
- Hyaluronic acid
  - for degenerative joint disease, 1411
  - for septic arthritis synovitis, 1417
- Hydranencephaly
  - calves, Akabane virus and, 1513
  - inherited, 1329
- Hydration
  - clinical examination of, 16
  - diarrhea, acute, 279
  - status indicator of, 114–115, 115f
- Hydration therapy, 145
- Hydroallantois, 1871
- Hydrocarbon toxicosis, 2187–2188
- Hydrocephalus, 1181f, 1182–1184
- Hydrocyanic acid poisoning, minimum lethal dose, 827
- Hydrogen peroxide, in *Mycoplasma bovis*, 933
- Hydrogen sulfide, in polioencephalomalacia, 1313
- Hydronephrosis, 1098, 1114
- Hydropericardium, 130
  - enzootic bovine leukosis and, 837
- Hydrostatic pressure
  - increased, 129
  - subcutaneous edema and, 1555
- Hydrothorax, 130, 895–896, 896b
- Hydrotoea irritans*, 1630
- β-hydroxybutyrate
  - in energy balance, 1669
  - left-side displacement of abomasum and, 503–504, 507
- 25-hydroxycholecalciferol, 1689
- Hydroxyethyl starch, 142–143
  - solution, 723
- Hyena disease, of cattle, 1503–1504
- Hygiene
  - Brucella melitensis*, control of, 1783–1784
  - colibacillosis and, 1881
  - environmental examination of, 9
  - in equine herpesvirus-1 and -4 infections, 1042
  - Johne's disease control, 563
  - leptospirosis and, 1127
  - in mastitis control program, 1979
  - hygienic precautions, for equine influenza, 1038
- Hymenoptera*, 2179
- Hyoscine butylbromide, 234
- Hyper d-lactatemia, 132
- Hyperalgesia, peripheral, 79–80
- Hyperammonemia, 624, 1177
  - treatment of, 640
- Hyperbilirubinemia, 627
  - photosensitization and, 1646
- Hypercapnia, 846, 848
- Hypercoagulability, 728
- Hypercoagulable states, 725–728
  - clinical pathology of, 726–727
  - clinical signs of, 726
  - diagnostic confirmation of, 727
  - epidemiology of, 725–728

- Hypercoagulable states (*Cont'd*)  
 etiology of, 725–728  
 necropsy examination of, 727  
 pathophysiology of, 726  
 prognosis of, 725–726  
 treatment of, 727
- Hyperdynamic phase, 61
- Hyperelastosis cutis, 1643, 1646–1647
- Hyperemia, 1193
- Hyperesthesia, 1164, 1542
- Hyperesthetic leukotrichia, 1553
- Hyperfibrinogenemia, 718  
 in foals with sepsis, 1862  
 in strangles, 1022
- Hypergammaglobulinemia, lymphosarcoma, 748
- Hyperglobulinemia, 718
- Hyperglycemia  
 endotoxemia and, 62  
 equine metabolic syndrome and, 1733  
 parenteral nutrition and, 152
- Hyperhidrosis, inherited, 1647
- Hyperhydration, 872
- Hyperimmune serum  
 for endotoxemia, 66  
 peste des petits ruminants, 576
- Hyperinsulinemia  
 equine metabolic syndrome and, 1733  
 laminitis, horse and, 1397
- Hyperkalemia, 120–121, 134, 1143  
 in diarrhetic calf, 1884
- Hyperkalemic distal RTA (type IV), 1113
- Hyperkalemic periodic paralysis, 111, 121, 1378, 1380
- Hyperkeratosis, 1544  
 differential diagnosis of, 1544b  
 of swine, 287–290, 290b
- Hyperketonemia, 1708–1716, 1708b
- Hypermetria, 1162, 1171–1172
- Hypernatremia, 118, 118f  
 in diarrhetic calf, 1884
- Hyperorexia, definition of, 87
- Hyperparathyroidism, 1389–1390
- Hyperplasia, in *Mycoplasma pneumoniae*, 1066
- Hyperpnea, 846, 848
- Hyperproteinemia, 718  
 in strangles, 1022
- Hypersensitivity  
 central, 80  
 endotoxemia, 63  
 to molds, in interstitial pneumonia, 966
- Hypertension, 660, 671  
 pulmonary, 882–883
- Hyperthermia, 15, 43–54  
 clinical findings in, 52–53  
 clinical pathology of, 53  
 in congenital defects, 1837–1838  
 control for, 53  
 in dyspnea, 849  
 etiology of, 51–52  
 horses and, 52–53  
 malignant, 52, 1525–1529  
 clinical findings of, 1527  
 in horses, 1524–1525  
 necropsy findings in, 53  
 neurogenic, 52  
 other causes of, 52  
 pathogenesis of, 52  
 treatment of, 53
- Hyperthyroidism, 1739–1742
- Hypertonic crystalloid solutions, 138–141
- Hypertonic dehydration, 116, 117f, 134
- Hypertonic saline, 140, 145  
 hyperkalemia, 121  
 with or without Dextran 70, 140–141  
 water intoxication, 116
- Hypertonic saline solution  
 coliform mastitis and, 1952  
 for hemorrhagic shock, 76  
 for hypovolemic and maldistributive shock, 74
- Hypertonic sodium bicarbonate, 121, 145
- Hypertonic solutions, for endotoxemia, 64–65
- Hypertriglyceridemia  
 equine hyperlipemia and, 1738  
 parenteral nutrition and, 151
- Hypertrophic osteopathy, 1391
- Hyperventilation, stimulation of, in rebreathing examination, 850
- Hypervitaminosis A, treatment for, 1328
- Hypervolemia, red cell, 746
- Hyphomyces destruens*, 797
- Hypoadrenal corticalism, in premature foals, 1842–1843
- Hypoalbuminemia, 717  
 decreased oncotic pressure and, 128–129  
 fasciolosis with, 643  
 granulomatous enteritis, of horses, 282  
 in strangles, 1022  
 trichostrongylid infection, 605
- Hypobiosis, trichostrongylid worms, 603, 605
- Hypobiotinosis, 1502–1503
- Hypocalcemia, 121–122  
 diarrhea, acute, 279  
 experimental, 1679  
 hypomagnesemic tetany in, 1700  
 in lactation tetany, 1737  
 left-side displacement of abomasum and, 504  
 milk fever and, 1679  
 nonparturient, 1683  
 in sows, 1683  
 volcanic ash fallout, 109
- Hypocalcemic paresis, 1683
- Hypochloremia, 116, 118, 118f  
 diarrhea, acute, 279
- Hypocholinsis, 2176
- Hypochromic anemia, 976
- Hypocyanocobalaminosis, 823–825
- Hypoderma* spp. infestation, 1626–1628, 1626b–1627b
- Hypodermic needle reuse, bovine virus diarrhea virus transmission, 579
- Hypodynamic phase, 61
- Hypoesthesia, 1164
- Hypoferremia, 734  
 endotoxemia and, 62
- Hypofibrinogenemia, 717
- Hypofolicosis, 826–829
- Hypogammaglobulinemia, 717
- Hypoglossal nerve (cranial nerve XII), assessment of, 1169
- Hypoglycemia, 624  
 encephalomalacia and, 1187  
 endotoxemia and, 62  
 in newborn, 1860  
 postvaccinal hepatitis with, 640  
 pregnancy toxemia and, 1723
- Hypoglycemic coma, in prolonged gestation with fetal gigantism, 1828–1829
- Hypoglycin A intoxication, of horses, 1505–1506
- Hypokalemia, 119–120, 119f  
 acute, in cattle, 1690–1693, 1690b  
 alkalemia and, 119–120  
 defined, 119  
 horses, 120  
 severe  
 in downer-cow syndrome, 1694  
 in milk fever, 1681  
 treatment for, 120
- Hypomagnesemia  
 in cattle, volcanic eruptions, 109  
 chronic, 1703  
 concurrent, 1680  
 in downer-cow syndrome, 1694  
 herd diagnosis in, 1703–1704  
 in hypomagnesemic tetany, 1700  
 milk fever and, 1679, 1681  
 parturient paresis with, 1703  
 in sheep, 1702  
 winter, 1700
- Hypomagnesemic tetany, 1699–1706, 1699b  
 of calves, 1706–1707, 1706b–1707b  
 clinical findings of, 1702–1703  
 clinical pathology of, 1703–1704  
 combined calcium/magnesium therapy for, 1704  
 control of, 1704–1706  
 differential diagnosis of, 1704b  
 epidemiology of, 1700–1702  
 etiology of, 1699–1700  
 hypocalcemia in, 1700  
 magnesium for  
 supplements, 1704–1705  
 therapy, 1704  
 morbidity of, 1701  
 mortality of, 1701  
 necropsy findings of, 1704  
 pasture risk factors of, 1701  
 pathogenesis of, 1702  
 treatment of, 1704, 1706b
- Hypometria, 1172
- Hypomyelination, inherited, 1235t–1237t, 1248–1252, 1259t, 1355
- Hyponatremia, 116–118, 1143  
 diarrhea, acute, 279  
 etiology of, 117f  
 pathogenesis of, 117f
- Hyponiacinosis, 1325
- Hypopantothensinosis, 1326
- Hypophosphatemia, 122–123  
 in downer-cow syndrome, 1694  
 milk fever and, 1679, 1681
- Hypoplasia, cerebellar, 1331
- Hypoproteinemia, 716–718  
 exercise intolerance, 99  
 hemonchosis in ruminants, 611
- Hypoproteinemic (hypooncotic) edema, 1555
- Hypopyridoxinosis, 1325–1326
- Hyporiboflavinosis, 2176
- Hypothalamic-pituitary-adrenal axis  
 dysfunction of, and endotoxemia, 61  
 stress and, 84
- Hypothalamus, effect of pyrogens on, 54
- Hypothermia, 15, 44–50  
 clinical findings, 49  
 control of, 50  
 epidemiology of, 44–50  
 etiology of, 44  
 intravenous fluid administration and, 145–146  
 necropsy findings in, 49  
 neonatal, 44  
 clinical findings, 49  
 risk factors for, 47–48  
 pathogenesis of, 48–49  
 postshearing, in sheep, 48  
 secondary to other diseases, 49  
 treatment of, 49–50
- Hypothetico-deductive reasoning, for diagnosis, 2
- Hypothyroidism, 1739–1742
- Hypotonic crystalloid solutions, 138–139
- Hypotonic dehydration, 116, 117f, 134
- Hypotrichosis, 1552–1553
- Hypoventilation, in hypoxic hypoxia, 846–847
- Hypovitaminosis A, 2037b  
 see also Vitamin A, deficiency
- Hypovolemia  
 diarrhea, in foals, 275–276  
 equine colic, 225
- Hypovolemic shock, 71–76, 71b, 658  
 clinical findings, 73  
 clinical pathology, 73–74  
 differential diagnosis of, 74b  
 etiology of, 71  
 necropsy findings in, 74  
 pathogenesis of, 72  
 treatment for, 74–75
- Hypoxemia  
 definition of, 846  
 heaves in, 1006–1007



- Hypoxia, 846–847  
 anemic, 847  
 cerebral, [1179](#), [1179b](#)  
 circulatory, 847  
 consequences of, 847  
 definition of, 846  
 encephalomalacia and, [1187](#)  
 histotoxic, 847  
 hypoxic, 846–847  
 in newborn, [1860](#)  
 in pulmonary hypertension, 882  
 Hypoxic hypoxia, 846–847  
 Hypozincemia, endotoxemia and, 62
- 
- I**
- Iatrogenic deaths, 100  
 Iatrogenic transmission, 771  
   of enzootic bovine leukosis, 833  
 Ibaraki disease, 784–785  
 Ibaraki stain, 784  
 Iberian peninsula, bovine spongiform encephalopathy in, [1294–1295](#)  
 Iceland  
   ovine progressive pneumonia in, 974  
   in ovine pulmonary adenocarcinoma, 978–979  
 Ictus. *see* Convulsions  
 Idiopathic chronic inflammatory bowel diseases, of horses, 282  
 Idiopathic fibrosing dermatitis, [1548](#)  
 Idiopathic focal eosinophilic enteritis, 283  
 Idiopathic nasal/perioral hyperkeratotic dermatosis, of camels, [1563–1564](#)  
   differential diagnosis of, [1564b](#)  
   treatment of, [1564](#), [1564b](#)  
 "Idiopathic tetanus", [1363](#)  
 Iforesstine poisoning, [1137](#)  
 IgA  
   in bovine respiratory syncytial virus, 948  
   in swine influenza, 1083  
   winter dysentery, cattle, 600  
 IgG concentration, critical plasma, in foals, [1863–1864](#)  
 IgM  
   in bovine respiratory syncytial virus, 948  
   in indirect fluorescent antibody assay, for PRRS, [1809](#)  
   winter dysentery, cattle, 600  
 Ileal impaction, 253, 255  
 Ileitis  
   of pigs, 291  
   regional, enteritis, 209  
 Ileocecal intussusception, 253–254  
 Ileocecal valve impaction, 254  
 Ileocecolic intussusception, 524  
 Ileum, biopsy of, 559, 569  
 Ileus, 180–181  
   adynamic, 180  
   dynamic or mechanical, 180  
   equine colic, 225  
   etiology, 180–181  
   medications, 181t  
   paralytic, 180, 210, 216–217  
   pathogenesis, 180–181  
   postoperative, 62, 180  
   treatment, 181  
 Iliac artery thrombosis, myopathy and, [1380](#)  
 Ill-thrift, 90–94  
   weaner, 94–96  
 Imaging  
   alimentary tract, examination of, 183–184  
   of brain abscess, [1191](#)  
   equine colic, 239  
   of liver, 626  
   in nervous system examination, [1175–1176](#)  
   in newborn, [1860](#)  
   peritonitis, 218  
   in uroperitoneum, [1142](#)  
 Imidazothiazoles (Levamisole), 607, [1211](#)  
 Imidocarb (Imizol), 774, 805  
 Imiquimod, for sarcoid, [1586–1587](#)  
 Immune mechanisms  
   in bovine herpesvirus-1 infection, 953  
   in contagious bovine pleuropneumonia, 927  
   in leptospirosis, [1121](#)  
   in *Mycoplasma pneumoniae*, 1065  
   in pleuropneumoniae, of pigs, 1058  
   in vitamin A deficiency, [1322](#)  
 Immune response  
   acquired, bovine virus diarrhea virus, 580  
   in heaves, 1005–1006  
   Johne's disease, 557–558, 567–568  
   selenium deficiency and, [1466](#)  
 Immune responsiveness, in neonatal infection, [1875](#)  
 Immune system  
   diseases of, 716–844  
   in *Staphylococcus aureus* mastitis, [1933](#)  
   tick-borne fever, 775–777  
 Immune-deficiency disorders, 753–755  
 Immune-mediated anemia, 731  
 Immune-mediated (idiopathic) thrombocytopenia, 723–724  
 Immunity  
   in *Bordetella* rhinitis, 1055  
   in equine herpesvirus-1 and -4 infections, 1041  
   in equine influenza, 1033, 1036–1038  
   in neonatal infection, [1875](#)  
   in swine influenza, 1080  
 Immunity tests, in Johne's disease, 560, 570  
 Immunization  
   anthrax, [2014–2015](#)  
   for bovine respiratory syncytial virus, 951  
   for enzootic pneumonia of calves, 945–946, 946f  
   for erysipelas in swine, [2055](#)  
   for salmonellosis, in swine, 305–306  
 Immunoblotting test (IB), in contagious bovine pleuropneumonia, 929  
 ImmunoCardSTAT Rotavirus, 390  
 Immunochromatography, 390  
 Immunodiffusion and electron microscopy, viral diarrhea, 390  
 Immunofluorescence, viral diarrhea, 389–390  
 Immunofluorescence antibody test, 805  
 Immunofluorescence assay, for Q fever, [1792](#)  
 Immunofluorescent antibody test (IFAT), for porcine reproductive and respiratory syndrome, [1809](#)  
 Immunoglobulin status, septicemia, 58  
 Immunoglobulin-binding proteins, [2035](#)  
 Immunoglobulins  
   normal transfer of, [1848–1849](#)  
   parenteral, correction of failure of transfer of passive immunity, [1854](#)  
   serum concentration  
     lymphosarcoma, 748  
     in newborn, [1860–1861](#)  
 Immunohistochemistry (IHC)  
   bovine virus diarrhea virus, 586  
   detection of viral antigen by, [2128–2129](#)  
   in *Mycoplasma bovis*, 935  
 Immunologic tests, in contagious bovine pleuropneumonia, 928  
 Immunomodulators, for respiratory tract disease, 871  
 Immunoperoxidase monolayer assay (IPMA)  
   bovine virus diarrhea virus, 586  
   for porcine reproductive and respiratory syndrome, [1808](#)  
 Immunostimulating complexes (ISCOMs), bovine respiratory syncytial virus, 951  
 Immunosuppression, 755  
   bovine ketosis and, [1711](#)  
   bovine virus diarrhea virus, 582–583  
   in neoplasia, [1819](#)  
   during transition period, in dairy cows, [1665](#)  
 Immunotherapy  
   for sarcoid, [1587](#)  
   for shock, 76  
 Impaction, large intestine, in pigs, 291  
 Impedance, current flow, 105  
 Impetigo, [1545](#), [1545b](#)  
   udder of, [1988](#)  
 Impulse oscillometry, 864  
 Inactivated vaccines  
   for bovine herpesvirus-1 infection, 959  
   for bovine virus diarrhea virus, 580–581, 595  
   for swine influenza, 1083  
 Inanition, 89–90  
 Inappetence  
   definition of, 87  
   peritonitis, 217  
 Inbreeding, 111  
   degree of, 112  
 Inclusion bodies, tick-borne fever and, 778  
 Inclusion-body rhinitis, 1074–1075  
 Incontinence, urinary, [1139](#)  
 Incurable disease, [2070](#)  
 Indiana fever, 393–397  
 Indifference, in drug combination, 164  
 Indigestion of late pregnancy, in cattle, 491, 494  
 Indirect ELISA, in bovine respiratory syncytial virus, 950  
 Indirect enzyme-linked immunosorbent assay (I-ELISA), for porcine reproductive and respiratory syndrome, [1808–1809](#)  
 Indirect fluorescent antibody assay  
   for neoplasia, [1819](#)  
   for porcine reproductive and respiratory syndrome, [1809](#)  
 Indirect fluorescent antibody test (IFAT), 773  
   bovine immunodeficiency-like virus and, 787  
   in contagious bovine pleuropneumonia, 928  
 Indirect immunoperoxidase staining technique, bovine virus diarrhea virus, 586  
 Indolizidine alkaloid toxicosis, [1193](#)  
 Indoor environment, history taking of, individual animal, 9–10  
 Indospicine, [2208](#)  
 Indurative mastitis, 976  
 Industrial organophosphates, [1217](#)  
 Infantophagia, 88–89  
 Infarctive purpura hemorrhagica, 712  
 Infection(s)  
   age at, anaplasmosis risk factors and, 772  
   clinical examination for, 154  
   congenital defects and, [1836–1837](#)  
   gangrene from, [1558](#)  
   limitation of spread of, epizootic hemorrhagic disease, 840–841  
   localized, 76–78  
   bacterial causes of, 77  
   clinical findings in, 77–78  
   clinical pathology of, 78  
   endotoxemia, 63  
   etiology of, 76–77  
   necropsy findings in, 78  
   pathogenesis of, 77  
   portal of entry in, 77  
   treatment for, 78  
   lowered resistance to, 753–755  
   of nervous system, elimination and control, [1178](#)  
   prevalence of  
   bovine immunodeficiency-like virus and, 786  
   enzootic bovine leukosis and, 832  
   removal of foci of, and endotoxemia, 64  
   risk factors, caseous lymphadenitis and, 763  
   source of  
   caseous lymphadenitis and, 762  
   in enzootic bovine leukosis, 833  
   stress-related susceptibility, 86  
   taking samples for diagnosis of, 154–155  
   thrombocytopenia and, 723–724  
   transmission, caseous lymphadenitis and, 762–763  
 Infection control, 36–42  
 Infectious agents  
   diseases associated with, sudden death from, 101  
   gastritis, etiology of, 203  
 Infectious arthritis, [1413](#)  
 Infectious bacterial, [2011–2015](#)  
   *Actinobacillus* septicemia in piglets, [2056–2057](#)  
   anthrax, [2011–2015](#)

- Infectious bacterial (*Cont'd*)
- bovine tuberculosis, 2015–2023
  - chlamydial infection in pig, 2057–2058
  - erysipelas in swine, 2051–2056
  - heartwater or cowdriosis, 2031–2033, 2031b
  - Histophilus* septicemia of cattle (*Histophilus somni* or *haemophilus somnus* disease complex), 2033–2038, 2033b–2034b
  - Klebsiella pneumoniae* septicemia, 2057
  - mastitis, 2043
  - melioidosis, 2029–2031, 2029b
  - mycobacteriosis, associated with *Mycobacterium avium* intracellulare complex and with atypical mycobacteria, 2024–2025, 2024b
  - pasteurellosis
    - of sheep and goats, 2042–2043
    - of swine, 2043–2045
  - pneumonic pasteurellosis, 2043–2045
    - affecting wildlife, 2043
  - septicemia and thrombotic meningoencephalitis in sheep associated with *Histophilus somni*, 2038–2039, 2038b
  - septicemic pasteurellosis, 2043–2045
    - of cattle (Hemorrhagic septicemia), 2040–2042
    - of suckling lambs, 2042–2043
  - streptococcal lymphadenitis of swine, 2051
  - Streptococcus suis* infection of young pigs, 2045–2051, 2045b
  - tick pyemia of lambs (enzootic staphylococcosis of lambs), 2039–2040, 2039b
  - tuberculosis associated with *Mycobacterium tuberculosis*, 2023–2024
  - tularemia, 2027–2029, 2027b
  - yersiniosis, 2025–2027
- Infectious bovine keratoconjunctivitis, 1650–1653, 1650b
- ancillary therapy for, 1652
  - clinical findings of, 1651, 1651f
  - clinical pathology of, 1651
  - control of, 1652–1653
  - differential diagnosis of, 1651b–1652b
  - economic importance of, 1651
  - environmental risk factors of, 1650
  - epidemiology of, 1650–1651
  - etiology of, 1650
  - immune mechanisms in, 1650–1651
  - parenteral therapy for, 1652
  - source of infection in, 1650
  - subconjunctival therapy for, 1652
  - topical therapy for, 1652
  - transmission of, 1650
  - treatment of, 1652, 1652b
  - vaccination for, 1653
- Infectious bovine pododermatitis. *see* Bovine footrot
- Infectious bovine rhinotracheitis (IBR), 903, 952–961, 952b, 957b, 961b
- ocular form of, 956
  - vaccine for, 912
- Infectious diseases, 1425–1428
- bacterial, 536–544
    - resistance to, selenium and vitamin E deficiency and, 1465–1467
    - viral and parasitic, 572–573
  - Infectious equine anemia, 626
  - Infectious fungal, 2158–2159
    - coccidioidomycosis, 2159
    - cryptococcosis, 2160
    - histoplasmosis, 2159–2160
    - North American blastomycosis, 2160–2161
    - paracoccidioidomycosis (paracoccidioides infection), 2159
    - protothecosis and chlorellosis, 2158
    - Rhodotorula* spp. infection, 2159
  - Infectious hepatitis, 630, 637–638
  - Infectious polyarthritis. *see* Glässer's disease
  - Infectious protozoal, 2137–2140
    - sarcocystosis, 2137–2140
    - theileriosis, 2144–2145
    - toxoplasmosis, 2140–2144
    - tropical theileriosis, 2148–2150
  - Infertility, in zearalenone, 1824
  - Infertility and milk drop syndrome, 1121–1122
  - Inflammatory bowel disease
    - chronic, 621
    - idiopathic chronic, 282
  - Inflammatory lesions, 4
  - Inflammatory mediators, in maldistributive shock, 72
  - Inflammatory response, in bovine mastitis, 1922
  - Influenza A virus, 1076, 1079
  - Inguinal abscess, in horses, 77
  - Inguinal hernia, 253–254, 1829
  - Inguinal ring, palpation of, 20
  - Inhalation, of antimicrobials, 871
  - Inheritance, performance shortfalls in, 94
  - Inherited ataxia, of calves, 1333
  - Inherited bleeding disorders, 842
  - Inherited bovine degenerative axonopathy, 1352
  - Inherited cerebellar defects, 1331–1332
  - Inherited citrullinemia, 1331
  - Inherited congenital hydrocephalus, 1329
  - Inherited congenital posterior paralysis, 1352–1357
  - Inherited congenital spasms, of cattles, 1333
  - Inherited cystic renal dysplasia, 1138
  - Inherited defects, of alimentary tract, 434–435
  - Inherited disease
    - control of, 112
    - diagnosis of, 111–112
  - Inherited erythrocytic protoporphyria, 844
  - Inherited eye defects, 1658–1660
  - Inherited hypomyelinogenesis, 1355
  - Inherited idiopathic epilepsy, of cattle, 1331–1333
  - Inherited multifocal symmetric encephalopathy, 1330–1331
  - Inherited myopathies, 1378
  - Inherited neonatal spasticity, 1331–1337
  - Inherited parakeratosis, 1643
  - Inherited periodic spasticity, of cattle, 1347f, 1353
  - Inherited progressive degenerative myeloencephalopathy, 1352
  - Inherited spinal dysraphism, 1351
  - Inherited spinal muscular atrophy, 1354–1355
  - Inherited spontaneous lower motor neuron diseases, 1350
- Inhibition enzyme immunoassay, in pleuropneumoniae, of pigs, 1060
- Injection injuries, to peripheral nerves, 1362
- Injection site reactions, in strangles, 1025
- Injection-site lesions, in cattle, 1387–1388
- Innate immune system, bovine virus diarrhea virus, 580
- Innate immunity, deficiencies of, 756
- Inocybe* spp., 2205
- Inorganic phosphate, fractional clearance of, 1105
- Inotropic agents, for endotoxemia, 65
- Insect baits, poisoning, 422
- Insect bite hypersensitivity, in horses, 1559–1560
  - differential diagnosis of, 1560b
- Insect repellent, equine infectious anemia and, 794
- Insects
  - as mode of transmission, in enzootic bovine leukosis, 833
  - porcine reproductive and respiratory syndrome, transmission of, 1799
- Inspection, history taking of, individual animal, 10–12
- Inspiration, prolongation of, 12
- Inspiratory dyspnea, 849, 878
- Insulation
  - external, 45
  - tissue, 45
- Insulin
  - for endotoxemia, 65
  - for fatty liver, 1721
  - in ketosis, 1709, 1714
  - resistance
    - in equine hyperlipemia, 1738
    - in equine metabolic syndrome, 1731
- Insulin resistance, left-side displacement of abomasum and, 505
- Insulin-dependent diabetes mellitus, spontaneous, 584
- Integrated animal health and production management program, in examining population, 29, 34–35
- Integrated therapy, for heaves, 1011
- Interdigital dermatitis, 1548
- bovine footrot and, 1434
- Interdigital necrobacillosis. *see* Bovine footrot
- Interdigital phlegmon. *see* Bovine footrot
- Interferon, for respiratory tract disease, 871
- Interferon- $\gamma$  assay (IFN- $\gamma$ )
  - for bovine tuberculosis, 2021
  - for Johne's disease, 557, 560
- Interferons, in PRRSV infection, 1802
- Interleukin-1 (IL-1), as pyrogen, 54
- Interleukin-10 (IL-10), porcine reproductive and respiratory syndrome and, 1800
- Interleukin-12 (IL-12), 1796
- Interleukins, endotoxemia, 60
- Intermittent dorsal displacement, of soft palate, 982–984, 982f–983f, 983b
- Intermittent thoracic drainage, in equine pleuropneumonia, 995
- Intermittent-flow peritoneal dialysis, 1108–1109
- Internal abdominal abscess, 270–271
- International trade, restrictions in, 2073
- Interspecies transmission, in enzootic bovine leukosis, 833
- Interstitial cells of Cajal, 285
- Interstitial edema, 1181
- Interstitial inflammation, in exercise-induced pulmonary hemorrhage, 1002
- Interstitial nephritis, 1114, 1131
  - differential diagnosis of, 1115b
  - leptospirosis and, 1120
- Interstitial pneumonia
  - in adult horses, 996–997
  - of cattle, 889, 965–969, 965b
    - clinical findings of, 967–968
    - clinical pathology of, 968
    - control of, 969
    - differential diagnosis of, 968b
    - epidemiology of, 966–967
    - etiology of, 965–966
    - necropsy findings of, 968–969
    - pathogenesis of, 967
    - treatment of, 969, 969b
  - chronic, in foals, 996
  - glucosinolate toxicosis and, 2203
  - ovine progressive pneumonia in, 975
  - porcine reproductive and respiratory syndrome, 1809–1810
  - viral, 889
- Interstitial space, increased fluid passage into, 130
- Intervention strategies, for examination of population, 34, 34b
- Intestinal absorption, 208
- Intestinal accidents, 523–524
- Intestinal aganglionosis, 435
- Intestinal amphistomosis, 617–618
- Intestinal biopsy, 190, 281
- Intestinal clostridiosis, in pigs, 308–311
  - clinical signs, 309–310
  - control, 311
  - differential diagnosis, 310
  - epidemiology, 308–309
  - etiology, 308
  - histology, 311
  - laboratory diagnosis, 310–311
  - pathogenesis, 309
  - pathology, 310
  - treatment, 311
- Intestinal fibrinous casts, 451
- "Intestinal hurry", 209
- Intestinal hyperammonemia, 286
- Intestinal hypermotility, 213

- Intestinal hypersensitivity, 316  
 Intestinal infection, in *Rhodococcus equi*, 1015  
 Intestinal lubricants, equine colic, 234, 235t  
 Intestinal lymphosarcoma, 747  
 Intestinal motility, enteritis, 209–210  
 Intestinal mucosal injury, 209  
 Intestinal obstruction  
   in cattle, 523–528, 523b  
     clinical findings, 526–527, 526f  
     clinical pathology, 527  
     differential diagnosis, 528b  
     epidemiology, 523–525  
     etiology, 523–525  
     functional, 525  
     intestinal accidents, 523–524  
     luminal blockages, 524–525  
     necropsy findings, 527  
     pathogenesis, 525–526  
     treatment, 527–528  
   clinical findings, 290  
   etiology, 290  
   functional, peritonitis, 216–217  
   in horses, 252  
   in pigs, 290  
   see also ileus; Large intestine, obstruction; Small intestine, obstruction  
 Intestinal reflux, 290  
 Intestinal sounds  
   in enteritis, 210  
   in equine colic, 231–232  
   of horse, 17  
 Intestinal tympany  
   abdominal distension, 182–183  
   in horses, 269, 269b  
   in pigs, 291  
 Intestinal wall  
   infarction of, 180  
   ischemia of, 225  
 Intestines  
   atresia, congenital, 433–434  
   diseases of  
     nonruminants, 203–215  
     ruminants, 523–528  
   distention of, 447t  
   endotoxins in, 60  
   neoplasms, 432  
 Intimin, 542  
 Intoxication  
   encephalomalacia and, 1187–1189  
   vitamin D, 1494  
 Intraabdominal abscesses, 271  
   in *Rhodococcus equi*, 1015  
 Intraabdominal drain, peritonitis, 220  
 Intraabdominal masses, equine colic, 228t  
 Intracranial hemorrhage, trauma at parturition and, 1843  
 Intracranial lesion, cerebral hypoxia secondary to, 1179  
 Intracranial pressure, 1176  
   increase in, 1180  
     in decompression, 1178  
     in hydrocephalus, 1182  
   measurement of, 1178  
 Intradermal testing, in heaves, 1009  
 Intradermal tuberculin test, for bovine tuberculosis, 2019  
 Intraluminal hemorrhage, acute, 210  
 Intramammary antimicrobial agents, for coliform mastitis, 1951  
 Intramammary infections  
   in risk factors, of bovine mastitis, 1909  
   sensitivities and specificities for diagnosing, 1915t  
 Intramuscular injection  
   of antimicrobials, 159–160  
   reaction, of horses, 159  
 Intramuscular vaccine, for bovine herpesvirus-1 infection, 958  
 Intranasal vaccine  
   for bovine herpesvirus-1 infection, 958  
   for strangles, 1025  
 Intrapartum death, 1843  
 Intrapartum hypoxemia, 1843  
 Intraperitoneal injection, of antimicrobials, 160  
 Intrastadial transmission, hematophagous insect, 771  
 Intrathoracic abscesses, in equine pleuropneumonia, 993  
 Intratracheal antimicrobials, 162  
 Intrauterine growth retardation, 1840  
 Intrauterine medication, for puerperal metritis, 69–70  
 Intravenous catheters, and complications, 146–147  
 Intravenous fluids  
   administration of, adverse reactions to, 145  
   in carbo, 147  
   and hypothermic animals, 145–146  
   types of, 137–143  
 Intravenous injection, of antimicrobials, 159  
 Intussusception, 524  
 Inulin clearance, 1104  
 Involuntary movements, 1159–1160, 1166t  
 Involuntary spastic contraction, of large muscle masses, 1194  
 Involuntary spastic paresis, 1160  
 Iodides, actinobacillosis (wooden tongue), 533  
 Iodine deficiency, 831, 1742–1747, 1742b–1743b  
   clinical findings of, 1744–1745, 1745f  
   clinical pathology of, 1745–1746, 1746f  
   in congenital defects, 1837  
   control of, 1746–1747  
   differential diagnosis of, 1746b  
   epidemiology of, 1743–1744  
   etiology of, 1743  
   necropsy findings of, 1746  
   occurrence of, 1743  
   pathogenesis of, 1744  
   risk factors of, 1743–1744  
   treatment of, 1746  
 Iodine formulations, for teat dip, 1969  
 Iodine toxicosis, 1640  
 Iodochlorhydroxyquin, 281–282  
 Iodophor, 1985–1986, 1988  
 Ionizing radiation, 107  
 Ionophore (carboxylic) toxicosis, 701–703, 701b  
   in cattle, 702  
   clinical pathology of, 702–703  
   clinical signs of, 702  
   control of, 703  
   differential diagnosis of, 703b  
   epidemiology of, 701–702  
   etiology of, 701  
   in horses, 702  
   necropsy findings of, 703  
   pathogenesis of, 702  
   in sheep, 702  
   in swine, 702  
   treatment of, 703  
 Ionophores, 161–162  
   bloat, 481  
   carbohydrate engorgement prevention, 470–472  
   coccidiosis, 407  
   for ketosis, 1715  
 Iotatorquevirus, 2134–2135  
 Ipomeanol, 2211  
   toxicosis, 1087  
 Ipratropium bromide, for heaves, 1011  
 Iris, absence of, 1659  
 Iritis, bovine, 1649–1650, 1649b  
 Iron, in acute phase response, 56  
 Iron deficiency, 811–812, 824b–825b  
   anemia, nonregenerative, 732  
   clinical findings of, 811–812  
   clinical pathology of, 812  
   control of, 812–813  
   dietary supplementation, 812–813  
   differential diagnosis of, 825b  
   epidemiology of, 811  
   etiology of, 811  
   hemonchosis in ruminants, 611  
   intramuscular injection of iron preparation, 812–813  
   necropsy findings of, 812  
   oral dosing, 813–814  
   pathogenesis of, 811  
   samples for confirmation of diagnosis, 812  
   treatment of, 812  
 Iron toxicosis, 2188–2189  
 Irradiation, carcass decontamination, 544  
 Irritant diterpenoids, alimentary tract and, 428  
 Irritant oils, alimentary tract and, 428  
 Irritation, 1158  
 Ischemia  
   myasthenia and, 1377  
   myopathy and, 1378–1380  
 Ischemic muscle necrosis, 1683  
 Ischemic nephrosis, 1112, 1112b  
 Isoflavones, phytoestrogen toxicosis, 1822  
 Isoflupredone, for heaves, 1009–1010  
 Isoimmune thrombocytopenia, 725, 743  
 Isolated farrowing, for *Mycoplasma pneumoniae*, 1069  
 Isolation, for ovine enzootic abortion, 1787  
 Isoniazid  
   actinobacillosis (wooden tongue), 534  
   Johnes disease, 561  
 Isoquinoline alkaloids, 2210  
 Isothermal loopmediated amplification (LAMP), in contagious bovine pleuropneumonia, 928  
 Isotonic crystalloid solutions, 138–140  
   for hypovolemic and maldistributive shock, 74  
 Isotonic dehydration, 116, 117f, 134  
 Isotonic electrolyte solution, for heaves, 1011  
 Isotonic saline, 139  
 Isotonic sodium bicarbonate, 139  
 Isoxsuprine, laminitis, horse and, 1402–1403  
 Itchmites, 1618–1619  
 Itraconazole, 794  
 Ivermectin  
   in fasciolosis, 644  
   for hemonchosis in ruminants, 612  
   for nasal bots, 980  
   for parasitic gastroenteritis in ruminants, 607–608  
*Ixodes*, ecology of, 768–769  
*Ixodes pacificus*, 768, 777  
*Ixodes persulcatus*, 768, 777  
*Ixodes ricinus*  
   *Anaplasma phagocytophila* vector, 768, 776  
   bovine babesiosis transmission and, 799  
*Ixodes scapularis*, 768, 777  
*Ixodes* ticks, borreliosis and, 1426
- 
- ## J
- Jaagsiekte sheep retrovirus (JSRV), 978  
 Jaffe reaction, 1104  
 January disease, 2145  
 Japan, bovine spongiform encephalopathy in, 1295  
 Japanese B encephalitis, 1817, 2136–2137  
 Japanese B encephalitis virus, in congenital defects, 1837  
 Japanese encephalitis, 1293–1294  
   clinical pathology of, 1270  
   clinical signs of, 1270  
   control of, 1271  
   differential diagnosis of, 1271  
   epidemiology of, 1270  
   etiology of, 1263f, 1270  
   necropsy findings of, 1270–1271  
   samples for diagnostic confirmation of, 1271  
   transmission of, 1263f  
   treatment for, 1271  
   zoonosis and, 1271  
 Japanese theileriosis, 2144  
 Jaundice, 623–624, 623f  
   clinical findings, 624  
   clinical pathology, 624  
   extrahepatic biliary obstruction and, 624  
   hemolytic, 623  
   hepatic, 623–624  
   with hepatic cell degeneration, 624



Jaundice (*Cont'd*)  
 hepatitis and, 631  
 hepatocellular, 623–624  
 neonatal, 623  
 posthepatic, 624  
 prehepatic, 623  
 toxemic, 647

Jaundiced foal agglutination test (JFA), 745

Jaw  
 deformity of, 434  
 malapposition, inherited, 1534–1535  
 inherited defects of, 434

Jejunal hemorrhage syndrome. *see* Hemorrhagic bowel syndrome, in cattle

Jejunitis, duodenitis-proximal, 255–257, 255b, 257t

Jejunojejunal intussusception, 524, 524f

Jembrana disease, 2080–2081, 2081b

John's absorbed enzyme-linked immunosorbent assay (ELISA), 560

John's disease  
 accreditation program, 571–572  
 advanced clinical, 558  
 bison, 568  
 “borderline forms”, 568  
 case fatality, 552  
 cattle, 552–565, 552b  
 clinical, 558, 568  
 clinical findings, 558, 568  
 clinical pathology, 558–561, 568–570  
 control, 562, 570–572  
 countrywide basis, 563, 571–572  
 flock basis, 571  
 herd testing/classification, 564  
 decreased oncotic pressure and, 128  
 deer, 566, 570  
 diagnosis, 558–560  
 differential diagnosis, 561b, 570b  
 economic importance, 555–556  
 epidemiology, 552–557, 565–567  
 etiology, 552, 565  
 exotic species, 552–553  
 goats, 565–572, 565b  
 herd characteristics of, 554  
 herds, certify, 564  
 incubation period, 553, 558  
 leptomatous extreme, 568  
 lesions, development of, 568  
 morbidity, 552, 565–566  
 necropsy findings, 561, 570  
 outbreaks, 552–553, 566  
 pathogenesis, 557–558, 567–568  
 prepurchase testing, 561  
 prevalence, 553, 566  
 determination of herd status, 562  
 rabbits, 570  
 risk factors, 554–555, 566–567  
 sheep, 565–572, 565b  
 silent, 558  
 stages of, 558, 567  
 subclinical, 555, 558, 567–568  
 transmission, 553, 566  
 treatment, 561–562, 562b, 570  
 tuberculoid extreme, 568  
 vaccination, 563–564, 571  
 wildlife, 552–553  
 zoonotic implications, 556–557, 567

John's Disease Market Assurance Program, 571–572

Johnin tests, 560, 570

Joint fluid  
 analysis of, 1414  
 culture of, 1414  
 degenerative joint disease and, 1409–1410, 1409t  
 septic arthritis synovitis and, 1414  
 serology of, 1414

Joints  
 caprine arthritis encephalitis in, 1260  
 defects of, 1375, 1388  
 diseases of, 1406–1411

fixation of, 1510–1511  
 hypermobility of, 1514, 1539  
 inherited diseases of, 1538–1539  
 lavage of, 1416, 1417f

Jowl abscesses, 2051

Juglone, 1506

Jugular blood pressure, and naturally occurring combined abnormalities of free water, electrolyte, acid-base balance, and oncotic pressure, 136

Jugular vein  
 catheterization of, and thrombophlebitis, 146  
 examination of, 665  
 thrombophlebitis, 714

Jugular venous pressure, measurement of, 665

Junctional premature complexes, 680

Juniperine, 2210

Juvenile Arabian leukoderma, 1553

## K

Kaolin and pectin  
 for abomasal ulcer, 522  
 mixtures, enteritis, 213

Kappatotorquevirus, 2134–2135

Kata. *see* Peste des petits ruminants (PPR)

Ked infestations, 1623–1624

Keratin plug, 1973

Keratoconjunctivitis, 1648  
 listeriosis and, 1338–1341

Keratomycosis, in *Aspergillus* spp., 1045–1046

Kernicterus, 743

Ketone  
 formation of, 1709  
 ketosis and, 1712

Ketonuria, 1101–1102  
 puerperal metritis, 69

Ketoprofen, 1112–1113  
 for coliform mastitis, 1952  
 for endotoxemia, 65  
 equine colic, 234  
 for mastitis, 1927  
 for pain, 82

Ketosis  
 alimentary, 1709–1710  
 body-condition score and, 1710  
 bovine, 1709–1711  
 in cattle, 1708–1716, 1708b  
 clinical chemistry of, 1713  
 clinical findings of, 1711–1712  
 clinical pathology of, 1712–1713, 1712t  
 control of, 1714–1716  
 differential diagnosis of, 1713b  
 economic significance of, 1710  
 energy balance in, 1708  
 energy supplements for, 1715–1716  
 epidemiology of, 1710  
 etiology of, 1708–1709  
 hematology of, 1713  
 hepatic insufficiency in, 1708–1709  
 herd monitoring for, 1716  
 hormonal therapy for, 1714  
 left-side displacement of abomasum and, 502–504, 506, 508–509  
 milk fever and, 1678, 1681  
 necropsy findings of, 1713  
 nervous form of, 1711, 1711f  
 nutritional deficiency and, 1710  
 occurrence of, 1710  
 pathogenesis of, 1710–1711  
 primary, 1709  
 prophylaxis for, 1714b  
 replacement therapy for, 1713–1714  
 risk factors of, 1710  
 secondary, 1709  
 starvation, 1710  
 subclinical, 1669, 1708–1716, 1708b

treatment of, 1713–1714, 1714b  
 wasting form of, 1711

Key abnormality method, for diagnosis, 3–4, 3f

Kidney(s)  
 cortex, selenium and, 1471  
 diseases of, 1110–1111  
 function of, 1095  
 lead in, 1207  
 morphological abnormality of, 1098  
 rectal examination palpation of, 20

Kidney worm disease, in pigs, 1134–1135, 1134b  
 differential diagnosis of, 1135b

Kids  
 rotavirus, 387  
 viral diarrhea, 384–393

Killed vaccines  
 anaplasmosis and, 774  
 for ovine enzootic abortion, 1787  
 for porcine reproductive and respiratory syndrome, 1813

Killed-virus vaccines, 2069

Kinetic gait analysis, 1178

Kirby-Bauer method, 909–910

Kirby-Bauer technique, 155

*Klebsiella pneumoniae*  
 in mastitis-metritis-agalactia, 1997  
 septicemia, 2057

Knopvelsiekte, 1589–1591

Knuckling, of flexed foot, 1171

Kobuviruses, porcine, 342

Kunjin virus, encephalitis of, 1265b, 1286–1293  
 animal risk factors for, 1267  
 case fatality of, 1267–1268  
 clinical findings of, 1268  
 clinical pathology of, 1268  
 control of, 1269–1270  
 differential diagnosis of, 1268b  
 distribution of, 1267  
 epidemiology of, 1267  
 etiology of, 1266–1267  
 identification of, 1268  
 morbidity of, 1267–1268  
 necropsy findings of, 1268  
 pathogenesis of, 1268  
 samples for diagnostic confirmation of, 1269–1272  
 serologic tests for, 1268  
 transmission of, 1267  
 treatment for, 1269  
 viral ecology of, 1267  
 zoonotic implications of, 1267–1268

Kussmaul breathing, 127–128

## L

Label dose, in antimicrobials, 159

Laboratory data  
 indications for, 22–23  
 interpretation of, 22–25  
 properties of, 23–25, 24t  
 likelihood ratio and, 24  
 positive and negative predictive value, 24–25, 25f  
 sensitivity and, 24  
 specificity and, 24  
 utility for, 23  
 reference range and, 23–24  
 problems with, 24

Laboratory test  
 in examination of population, 33–34  
 in liver disease, 626–629

Laceration, traumatic brain injury, 1188

β-lactam antibiotics, 170–171

Lactase deficiency  
 diarrhea, 178  
 lactose digestion test, 186

- Lactate, 737  
 equine colic, 231  
 plasma, and shock, 73
- Lactate dehydrogenase (LDH)  
 in cerebrospinal fluid, 1177  
 liver function test, 628  
 myopathy and, 1380
- Lactated Ringer's solution, 139
- Lactating cow therapy, for *Staphylococcus aureus* mastitis, 1935
- Lactation  
 age and stage of, 1694  
 diseases of, 1665  
 feeding management in, 472  
 of magnesium, in hypomagnesemic tetany, 1699  
 number, in perinatal mortality, 1832  
 precocious, 1843  
 sow, feeding during, 2007  
 stage of  
   in bovine mastitis, 1908, 1922  
   in coliform mastitis, 1946–1947  
   in mastitis control program, 1980  
 therapy, dry cow therapy and, 1928  
 treatment during, 1983
- Lactation tetany, 1699–1706, 1699b  
 acute, 1702  
 of cows, 1700  
 of ewes, 1700  
 of mares, 1736–1737  
 occurrence of, 1700–1701  
 risk factors for, 1700–1701  
 subacute, 1702
- Lactical-secretion-based-preparations, 1855
- Lactic acidosis  
 experimental, 464  
 ruminal atony, 437  
 systemic, carbohydrate engorgement, 463  
 vaccination against, 472
- Lactoferrin, 1947
- Lactogenesis, endotoxemia and, 62
- Lactogenic immunity, 1849, 1849t
- Lactose, intolerance, viral diarrhea and, 388
- Lactose digestion test, 185–186
- Lairage, gastric ulcers, 288
- Lambing  
 in control and prevention, of infectious diseases, 1877  
 draft-free environment for, 50  
 management at, 1832
- Lambs  
 abomasal bloat (tympany) in, 522–523  
 abomasal impaction in, 517–518  
 administration of colostrum in, 1856  
 arthritis in  
   erysipelas and, 1455  
 benign folliculitis of, 1555  
 birth weight of, 47, 1831  
 border disease in, 579  
 “bowie” or “bentleg” in, 1499–1500  
 cerebellar atrophy of, 1331–1332  
 coccidiosis, 404–405  
 colibacillosis in, 1883, 1886  
 congenital necrotizing encephalopathy of, 1227–1239  
 congenital polycystic kidney disease of, 1138  
 critical temperature in, 1845  
 diarrhea, viral, 384–393  
 dysentery, 546–547  
 enterotoxemia in, associated with *Clostridium perfringens* type D, 1229–1230  
 feedlots, carbohydrate engorgement, 462  
 fetal disease in, 1831  
 fluid and electrolyte therapy in, 151  
 glomerulonephritis and, 1110–1111  
 goiter in, 1744  
 hypothermia in, 44, 1844–1845, 1845f  
 neonatal, risk factors for, 47–48  
   pathogenesis of, 49  
   prevention of, 50  
   treatment of, 49–50  
 infectious diseases in, 1832
- iron deficiency of, 814
- lead poisoning in, 1390
- lethal white syndrome in, 434–435
- liver rupture in, 625
- losses, 1751–1752
- lungworm in, 980–981
- metabolic acidosis in, 128
- mortality rates in, 1831
- neonatal infection in, 1874–1875
- in neonatal streptococcal infection, 1902
- osteoporosis from copper deficiency, 1390
- otitis media/interna in, 1330f, 1335
- ovine progressive pneumonia in, 974
- ovine pulmonary adenocarcinoma in, 978
- parasitic gastroenteritis, 606
- parturient disease in, 1831
- parturition, induction of, 1759
- postnatal diseases in, 1831
- rickets in, 1495
- rotavirus, 387
- septic arthritis synovitis and, 1412
- septicemia, 57
- star-gazing, 1332
- with *Streptococcus dysgalactiae* polyarthritis, 1412
- subcapsular liver rupture in, 1470
- suckling, septicemic pasteurellosis of, 2042–2043
- swayback and enzootic ataxia in, 2169–2170
- temperature, lower critical, 45, 46f
- thiamine deficiency in, 1319
- thrombocytopenia and, 725
- tick pyemia of, 2039–2040, 2039b
- Lameness, 1179, 1372  
 accompanied by foot lesions in sheep, differential diagnosis of, 1445t  
 bovine footrot and, 1433  
 in degenerative joint disease, 1418–1424  
 exercise intolerance, 99  
 painful aspects of, 1375–1376  
 in pigs, 1418–1424, 1420b  
   clinical findings of, 1423–1424  
   clinical pathology of, 1424  
   control of, 1424  
   differential diagnosis of, 1424b  
   economic importance of, 1422  
   epidemiology of, 1421–1422  
   etiology of, 1421  
   necropsy findings of, 1424  
   occurrence of, 1421–1422  
   pathogenesis of, 1422–1423  
   risk factors of, 1421–1422  
   postdipping, erysipelas and, 1455
- Laminitis  
 chronic, carbohydrate engorgement of ruminants, 466  
 in equine pituitary pars intermedia dysfunction, 1728  
 of horses, 1395–1404, 1395b, 1395f  
   acute disease, 1400  
   chronic, 1403  
   clinical findings of, 1399–1401  
   clinical pathology of, 1401  
   clinical signs in, 1400  
   control of, 1403–1404  
   differential diagnosis of, 1401b  
   epidemiology of, 1396–1398  
   etiology of, 1396  
   importance of, 1397–1398  
   mechanical support, 1403  
   necropsy findings of, 1401  
   occurrence of, 1396–1397  
   pathogenesis of, 1398–1399  
   phases of, 1399  
   prognosis of, 1400–1401  
   promotion of healing, 1403  
   recumbency, 1400  
   risk factors for, 1397  
   severe disease in, 1400  
   treatment for, 1401–1403, 1403b  
 ruminal acidosis and, 464  
 in ruminants and swine, 1404–1406, 1404b
- clinical findings of, 1405
- clinical pathology of, 1405
- control of, 1405
- differential diagnosis of, 1405b
- epidemiology of, 1404–1405
- etiology of, 1404
- importance of, 1405
- necropsy findings of, 1405
- occurrence of, 1404
- pathogenesis of, 1405
- risk factors of, 1404–1405
- treatment for, 1405
- toxic, 1396
- Laparoscopy  
 abdomen examination, 454–455  
 alimentary tract, examination of, 184
- Large (ascending) colon  
 displacement, 259–262, 259b  
   clinical findings, 261–262  
   clinical pathology, 262  
   differential diagnosis, 262b  
   epidemiology, 260  
   etiology, 259–260  
   left dorsal, 260f, 261, 263f  
   necropsy findings, 262  
   pathogenesis, 260–261  
   right dorsal, 261–262, 261f  
   treatment, 262
- impaction, of horses, 263–264, 263b–264b
- volvulus, 259–262, 259b  
   clinical findings, 261–262  
   clinical pathology, 262  
   differential diagnosis, 262b  
   epidemiology, 260  
   etiology, 259–260  
   necropsy findings, 262  
   pathogenesis, 260–261, 261f  
   treatment, 262
- Large intestine  
 impaction of, in pigs, 291  
 obstruction of, abdominal distension, 183  
 obstructive lesions, equine colic, 226
- Large offspring syndrome, 1871
- Larvae  
*Haemonchus contortus*, 610–611  
*Oesophagostomum*, 615  
*Stephanurus dentatus*, 1134  
 trichostrongylid worms, 604
- Laryngeal adductory reflex, 1173–1174
- Laryngeal hemiplegia, 981  
 in cranial nerve dysfunction, 986
- Laryngeal hemiplegia, equine, 1362
- Laryngeal necrobacillosis, 534–536, 534b  
 differential diagnosis, 535b  
 treatment, 535b–536b
- Laryngeal neuropathy, recurrent, 989–991, 990b
- Laryngeal obstruction, 990
- Laryngitis, 878–879, 879b
- Laryngoplasty, prosthetic, for recurrent laryngeal neuropathy, 990–991
- Laryngotracheal injury, traumatic, 879
- Laryngotracheitis, traumatic, 879–880, 880f
- Larynx, examination of, 878
- Laser ablation, equine phycomyces, 798
- Lateral compartment, of guttural pouch, 984
- Lateral flow assay (LFA), 773
- Lateral-flow immunoassay, for assessment of transfer of passive immunity, 1853
- Latex agglutination test (LAT), 804  
 for assessment of transfer of passive immunity, 1853  
 diarrhea, acute, 278–279  
*Streptococcus agalactiae* mastitis, 1938  
 viral diarrhea, 390
- Latin America  
 anthrax, 2011  
 rabies in, 1239–1247
- Lavage fluid, examination of, in exercise-induced pulmonary hemorrhage, 1000–1001
- Lavender foal syndrome, 1247–1248, 1647

- Law of Laplace, 659  
*Lawsonia intracellularis*  
 antibiotics and, 157  
 diarrhea, 275  
 enteritis, 381f  
 porcine proliferative enteropathy, 322  
 Laxatives, vagus indigestion, 495  
 LDA. see Left-side displacement of the abomasum (LDA)  
 Lead  
 left-side displacement of abomasum and, 503  
 poisoning, osteodystrophy and, 1388, 1390  
 toxicosis, 1199–1201, 1202b  
 clinical findings of, 1206  
 clinical pathology of, 1206  
 control of, 1208  
 differential diagnosis, 1207b  
 environmental risk factors of, 1205  
 epidemiology of, 1203  
 etiology of, 1203  
 farm or premise risk factors of, 1205  
 human and public health risk factors of, 1205–1206  
 occurrence of, 1203  
 pathogenesis of, 1206  
 risk factors of, 1203–1204  
 samples for diagnostic confirmation of, 1207  
 transmission of, 1205  
 treatment for, 1207–1208, 1207b  
 Lead-pipe rigidity, 1173  
 Lectins, alimentary tract and, 428  
 LEE. see Locus for enterocyte effacement (LEE)  
 Left-side displacement of the abomasum (LDA), 502–510, 502b  
 acute, 506  
 “atypical,” exploratory laparotomy (celiotomy), 453  
 case fatality, 502  
 clinical findings, 506  
 clinical pathology, 506–507  
 control, 509  
 course of, 506  
 differential diagnosis, 507b  
 economic importance, 504–505  
 epidemiology, 502–505  
 etiology, 502  
 “floaters”, 505  
 genetic predisposition, 504, 509  
 hypokalemia, 119  
 lactational incidence rate, 502  
 metabolic predictors of, 504  
 necropsy findings, 507  
 pathogenesis, 505–506  
 risk factors, 502–504  
 surgical techniques, 508  
 treatment, 508–509, 509b–510b  
 Leg buckling, 132  
 Leg disorders, 1418  
 Leg mange, 1622–1623  
 differential diagnosis of, 1623b  
 Leg weakness, 1418  
 “Lelystad virus”, 1795  
 Lens dystrophy, 1659  
 Lepromatous extreme, Johne’s disease, 568  
*Leptospira*, in mastitis, 1906  
*Leptospira interrogans*, leptospirosis and, 1116  
*Leptospira* spp., wild boar, 2009  
 Leptospirosis, 1115–1129, 1115b  
 acute form, 1120  
 associated with *L. Hardjo*, 1122  
 in cattle, 1117–1118  
 clinical findings of, 1121–1123  
 clinical pathology of, 1123–1124  
 control of, 1126–1128  
 culture of urine, 1124  
 demonstration or culture of organism, 1124  
 differential diagnosis of, 1125b  
 economic importance of, 1119  
 epidemiology of, 1116–1117  
 etiology of, 1115–1116  
 in farmed deer, 1118  
 forms of, 1120t  
 general considerations of, 1122  
 in goats, 1117–1118, 1122  
 in horses, 1118–1119, 1122–1123  
 methods of transmission of, 1119–1120  
 necropsy findings of, 1124–1125  
 occurrence and prevalence of infection, 1117  
 pathogenesis of, 1120–1121  
 in pigs, 1118, 1122  
 portal of entry of organism, 1120  
 risk factors of, 1116–1117  
 samples for confirmation of diagnosis, 1125  
 serologic and related tests, 1123–1124  
 in sheep, 1117–1118, 1122  
 treatment of, 1125, 1126b  
 zoonotic implications of, 1118  
 Leptospiuria, 1119  
 Lesion  
 of skin, 1541–1542, 1542t  
 specific cause of, 4  
 within system or organ affected, location of, 4  
 type of, 4  
 Letdown, failure of, 1990–1991, 1991t  
 Lethal factor (LF), 2012  
 Lethal white foal syndrome, 1553  
 Lethal white syndrome, 435, 1643–1644  
*Leucaena leucocephala*, 1837  
 Leukemia, 746  
 Leukocytes, and endotoxemia, 61  
 Leukocytosis, 746  
 in equine pleuropneumonia, 993  
 ovine progressive pneumonia in, 976  
 Leukoderma, 1553  
 inherited, 1645  
 Leukoencephalomalacia, 1186–1187  
 Leukopenia, 743  
 in coliform mastitis, 1947  
 endotoxemia, 61  
 Leukoproliferative disease, 746  
 Leukosis, sporadic bovine, 838–839, 843b  
 Leukotoxin  
 bovine footrot and, 1433  
 of *M. haemolytica*, 917  
 Leukotoxin extract vaccine, for pneumonic pasteurellosis, 922  
 Leukotrichia, 1553  
 Leukotriene, for heaves, 1011  
 Levamisole  
 kidney worm disease, 1135  
 for parasitic gastroenteritis in ruminants, 607  
 Levothyroxine, for thyroid function, disorders of, 1742  
 Licking syndrome, 1543  
 L-iditol dehydrogenase (sorbitol dehydrogenase), 628  
 Lidocaine  
 for endotoxemia, 65  
 equine colic, 234  
 laminitis, horse and, 1402  
 ventricular tachycardia and, 684  
 Life cycle, kidney worm disease in pigs and, 1134  
 Lifting, assisted, 1697–1698  
 Lighting, examination of, 10  
 Lightning strike, sudden death by, 100, 103–105, 103b  
 clinical findings in, 104  
 clinical pathology of, 104  
 control of, 105  
 diagnosis of, 105  
 differential diagnosis of, 104b–105b  
 epidemiology, 104  
 etiology, 103–104  
 necropsy findings in, 104  
 pathogenesis of, 104  
 treatment of, 105  
 Likelihood ratio, laboratory data and, 24  
 Limb muscles, acute myositis of, 1387, 1387f  
 Limbs, clinical examination of, 13  
 Limulus amoebocyte lysate (LAL) assay, 64  
 Linamarin poisoning, 827  
 Lincomycin  
 diarrhea and, 277  
 porcine proliferative enteropathy, 326  
 swine dysentery, 331–332  
 Lincosamides, 171–172  
 Linear dodecyl benzene sulfonic acid products, 1969  
 Linear hyperkeratosis, 1548  
 Linseed meal/cake  
 cyanogenic glycoside poisoning, 827  
 iodine deficiency and, 1744  
 Lipid mobilization  
 in fatty liver, 1721  
 genetics of, in fatty liver, 1718  
 Lipid pneumonia, 893  
 Lipofuscin, deposition of, in sheep liver, 625  
 Lipoma, 527, 1641–1642  
 pedunculated, in horses, 253  
 Lipomatosis, 215, 2199  
 Lipooligosaccharides (LOS), 2034  
 Lipopolysaccharide (LPS), 1116  
 of *M. haemolytica*, 917  
 Lipopolysaccharide binding protein (LBP), 56, 60  
 Lissencephaly, hereditary, 1332  
*Listeria ivanovii*, abortion caused by, 1338  
*Listeria meningoencephalitis*, 2037b  
*Listeria monocytogenes*, mastitis and, 1962  
 Listerial keratoconjunctivitis, 1649–1650, 1649b  
 differential diagnosis of, 1649b  
 treatment of, 1649b  
 Listeriosis, 1331–1337, 1341b  
 clinical findings of, 1337–1339  
 clinical pathology of, 1339  
 control of, 1342  
 differential diagnosis of, 1341b–1342b  
 epidemiology of, 1336  
 etiology of, 1336  
 experimental reproduction in, 1336  
 host of, 1336  
 necropsy findings of, 1339–1340  
 occurrence of, 1336  
 pathogenesis of, 1336–1337  
 risk factors of, 1336  
 samples for diagnostic confirmation of, 1340  
 septicemic, 1338  
 source of infection in, 1336  
 transmission of, 1336  
 treatment for, 1341, 1344b  
 zoonotic implications of, 1336  
 Litter size, mortality in lambs, 1831  
 Live Animal Swab Test (LAST), 168  
 Live attenuated vaccines, 2069  
 Live vaccines  
 anaplasmosis and, 774  
 babesiosis of, 806  
 hazards and precautions of, 808  
 modified, for swine influenza, 1083–1084  
 for ovine enzootic abortion, 1791  
 problems with, 776  
 use of, 806–808  
 Liver  
 diseases of, 622–656  
 in cattle, 631  
 diffuse, 622, 629–632  
 examination, 625–629  
 biopsy. see Liver biopsy  
 medical imaging, 626  
 palpation, 625–626  
 percussion, 625–626  
 radiography, 626  
 ultrasonography, 626, 627f  
*Fascioloides magna* infection, 645  
 fasciolosis (liver fluke disease), 641–643, 641b–642b  
 focal, 622, 655–656  
 hepatic dysfunction, 622–623  
 in horse, 631



- Liver (*Cont'd*)  
 introduction, 622  
 laboratory tests, 626–629  
 liver failure and, 631  
 manifestations of, 623–625  
   abdominal pain, 625  
   alteration in size of liver, 625  
   black livers of sheep, 625  
   constipation, 625  
   diarrhea, 625  
   displacement of liver, 625  
   edema, 624  
   emaciation, 624  
   hemorrhagic diathesis, 625  
   hepatic encephalopathy, 624  
   jaundice, 623–624, 623f  
   photosensitization, 625  
   rupture of liver, 625  
 nervous signs, 631  
 with phytotoxins, 645–648  
 portal circulation, 623  
 primary, 622  
 secondary, 622  
 systemic involvement, 639–640  
 telangiectasis, 635  
 treatment in, 629–632  
 trematodes, associated with, 641–645  
 enlargement of, traumatic reticulopericarditis, 498  
 lead in, 1207  
 postvaccinal hepatitis, 639–640  
 rupture of, trauma at parturition and, 1843  
 selenium and, 1471  
 ultrasonography of, 1720
- Liver abscess, 632–635, 632b–633b  
 clinical findings, 634  
 clinical pathology, 634  
 control, 635  
 diagnosis, 634  
 differential diagnosis, 634b  
 epidemiology of, 633–634  
 etiology of, 633  
 farm animals, risk factors in, 633–634  
 feed management, 635  
 grain-fed cattle, risk factors in, 633  
 necropsy findings, 634  
 occurrence, 633  
 pathogen risk factors, 633  
 pathogenesis, 634  
 prophylactic antimicrobial therapy, 635  
 treatment, 634, 634b–635b  
 vaccination, 635  
 young lambs, 635  
 see also Hepatic abscess
- Liver atrophy  
 acute, 630  
 in horses, 625
- Liver biopsy, 626  
 alimentary tract, examination of, 190  
 of horses, 626, 632  
 technique, 626
- Liver cobalt, 817
- Liver failure, 743  
 liver disease and, 631
- Liver fluke disease. see Fasciolosis (liver fluke disease)
- Liver function tests, for puerperal metritis, 69
- Liver tumors, 655
- Livestock  
 movement, role of, 2069  
 neighboring, controlling contact by, 39  
 at pasture, history taking of, 7
- Llamas  
 eperythrozoonosis and, 785  
 tooth root abscess in, 77
- Lobeline, 1200
- Local analgesia, laminitis, horse and, 1402
- Local antimicrobials, 162
- Local hyperkeratosis, 1544
- Local spread, of brain abscess, 1190
- Locus for enterocyte effacement (LEE),  
 enterohemorrhagic *Escherichia coli*, 540
- Lolium perenne*, 966
- Long bones, angular deformities of joints of, 1388
- Longus capitis muscle, rupture of, 987, 987f
- Lophyrotoma interrupta*, 654
- Lophyrtomin toxicosis, 654–655
- Lotaustralin poisoning, 827
- Lotusin poisoning, 827
- Louping-ill. see Ovine encephalomyelitis
- Louping-ill virus, 777
- Louse infestations, 1623–1625, 1624b  
 chewing lice in, 1624–1625  
 clinical findings and diagnosis of, 1624–1625  
 etiology of, 1624  
 life cycle and epidemiology of, 1624  
 sucking lice in, 1624  
 treatment and control of, 1625
- Low inspired oxygen tension, in hypoxic hypoxia, 847
- Low milk fat syndrome, 1990
- Low serum iron concentration, iron deficiency and, 813
- Lower motor neuron, lesion of, 1163
- Lower motor neuron disease  
 inherited, 1193  
 inherited spontaneous, 1350
- Lower respiratory tract  
 pneumonic pasteurellosis in, colonization of, 916  
 small particles into, in pneumonia, 888
- Low-milk-fat syndrome, 1754
- Lumbosacral cistern, in cerebrospinal fluid collection, 1173, 1173t
- Luminal blockages, 524–525
- Lumpy jaw (actinomycosis), 531–532, 531b  
 differential diagnosis, 532b  
 treatment, 532b
- Lumpy skin disease, 1589–1591, 1589b  
 differential diagnosis of, 1591b
- Lumpy wool, of sheep, 1570–1573
- Lung, rupture of, in pneumothorax, 899
- Lung biopsy, 867–868  
 in heaves, 1008
- Lung parenchyma, diseases of, 880–882  
 acute respiratory distress syndrome in, 892  
 aspiration pneumonia in, 892–893  
 atelectasis in, 883, 883f  
 drowning in, 893–894  
 edema in, 880–882, 881b  
 pneumonia in, 885–892, 885t, 887f, 890b–891b  
 pulmonary abscess in, 894–895, 895b  
 pulmonary congestion in, 880–882, 881b  
 pulmonary emphysema in, 883–885, 884f, 885b  
 pulmonary hemorrhage in, 883, 883f  
 pulmonary hypertension in, 882–883
- Lung sounds, abnormal, heaves in, 1007
- Lungworm  
 in cattle, 961–965, 961b, 963b–964b  
 in goats, 980–981, 980b–981b  
 in horses, 1047, 1047b  
 in pigs, 1086–1087, 1086b  
 in sheep, 980–981, 980b–981b
- Lupinus angustifolius*, 652
- Lycorine, alimentary tract and, 428
- Lyme disease. see Borreliosis
- Lymnaea columella*, 642
- Lymnaea tomentosa*, 642
- Lymnaea truncatula*, 642
- Lymnaeid mud snails, 642
- Lymph node, 735t  
 abscess and, 77, 760–761  
 enzootic bovine leukosis, 836  
 ovine progressive pneumonia in, 976
- Lymphadenitis, 749–751  
 wild boar, 2009
- Lymphadenopathy, 749–751  
 malignant catarrhal fever, 2078  
 retropharyngeal, 989, 989f  
 in strangles, 1021
- Lymphangitis, 1556–1557  
 epizootic, 806b, 811–814  
 differential diagnosis of, 811b
- Lymphatic flow, obstruction to, 129
- Lymphocyte proliferation test, for bovine  
 tuberculosis, 2021
- Lymphocytic-plasmacytic enterocolitis, 283
- Lymphocytopenia, tick-borne fever and, 777
- Lymphocytosis, 786
- Lymphomas, 1223
- Lymphomatosis, 1642  
 metastatic lesions of, 655
- Lymphopenia, 746, 753  
 endotoxemia, 61
- Lymphoproliferative disease, 746–749
- Lymphosarcoma, 735t, 745–746, 1089  
 diagnosis of, 839  
 juvenile or calf, 841
- Lysosomal storage diseases, inherited, 1221, 1224b, 1839

## M

- M. hyosynoviae*, 1455
- M proteins, in strangles, 1020
- Maceration, of skin, 1562
- “Machinery murmur”, 705
- Macracanthorhynchus hirudinaceus*, 419, 419b
- Macrocytic lactone anthelmintics (MLs), for parasitic  
 gastroenteritis in ruminants, 607
- Macrocytic lactone compounds, for *Hypoderma*  
 spp. infestation, 1628
- Macrocytic lactones, 1211–1212  
 toxicosis, 1202–1208, 1212b–1213b
- Macrolides, 172
- Macromineral evaluation, in dairy-herd metabolic  
 profile testing, 1670–1671
- Macrophage damage, PRRSV infection and, 1801
- Macrophages, equine infectious anemia virus, 796
- Madura foot, 797
- Maduromycosis, 795–799
- Maedi-visna virus (MVV), 974
- Magnesium, 1145  
 dietary, milk fever and, 1677  
 in hypomagnesemic tetany  
 dietary intake of, 1699  
 factors influencing, 1699–1700  
 in pastures and tetany hazard, 1700  
 renal excretion of, 1699  
 reserves, 1699  
 in macromineral evaluation, 1671
- Magnesium alloy bullets, 1707
- Magnesium deficiency, 2162
- Magnesium homeostasis, 1699  
 in calf, 1706
- Magnesium hydroxide  
 for abomasal ulcer, 522  
 for carbohydrate engorgement, 469–470  
 for simple indigestion, 459
- Magnesium sulfate  
 for equine colic, 234  
 for lead poisoning, 1208  
 ventricular tachycardia and, 684
- Magnetic fields, 106–107
- Magnetic resonance imaging (MRI)  
 for musculoskeletal system disease, 1377  
 in nervous system examination, 1176  
 for newborns, 1860  
 of respiratory system, 857  
 for septic arthritis synovitis, 1414–1415
- Main drain virus encephalitis, 1311–1312
- Maintenance therapy, 145
- Mal de caderas, 2156–2158
- Mal secco, 283–286  
 see also Equine grass sickness
- Malabsorption  
 diarrhea, 180  
 granulomatous enteritis, of horses, 282  
 viral diarrhea and, 388  
 see also Enteritis
- Maladie du coit. see Dourine
- Malassezia* spp. dermatitis, 1603–1604
- Maldistributive shock, 71–76, 71b, 658  
 clinical findings, 73  
 clinical pathology, 73–74

- Maldistributive shock (*Cont'd*)  
 differential diagnosis of, 74b  
 etiology of, 72  
 necropsy findings in, 74  
 treatment for, 74–75
- Male castrates, phytoestrogen toxicosis in, 1823
- Male estrogenism, 1822
- Malignant catarrh, in pigs, 2080
- Malignant catarrhal fever (MCF), 2076–2080, 2076b  
 animal risk factors, 2078  
 clinical findings, 2078–2079  
 clinical pathology, 2079  
 control, 2080  
 economic importance, 2078  
 environment risk factors, 2077  
 epidemiology, 2077–2078  
 etiology, 2076–2077  
 experimental reproduction, 2077  
 head-and-eye form, 2078–2079, 2078f  
 methods of transmission, 2077  
 alcelaphine MCF, 2077  
 sheep-associated MCF, 2077  
 mild form, 2079  
 necropsy findings, 2079  
 samples for confirmation of diagnosis, 2079, 2079b  
 occurrence and prevalence, 2077  
 alcelaphine MCF, 2077  
 sheep-associated MCF, 2077  
 pathogenesis, 2078  
 peracute and alimentary tract forms, 2078–2079  
 pigs, 2079  
 treatment, 2079–2080
- Malignant edema, 1428–1430, 1428b–1430b
- Malignant head catarrh, 2076–2080, 2076b
- Malignant hyperthermia, 52
- Malignant lymphoma, congenital, 1903
- Mallein test, 796  
 in glanders, 1027
- Malnutrition, 89–90  
 in cattle, sheep and horses, 90  
 in congenital defects, 1837  
 controlled, 90  
 of dam, during late gestation, 47  
 definition of, 87
- Mammary gland  
 biopsy of, 1920  
 bovine, *Mycoplasma bovis* in, 933  
 clinical examination of, 13, 21  
 diseases of, 1904–2001  
 hematoma of, 1988–1989  
 immunologic function of, in bovine mastitis, 1909–1910  
 infrared thermography of, 1920  
 ovine progressive pneumonia in, 976  
 resistance mechanism within, 1973–1974  
 selenium and vitamin E deficiency and, 1465  
 ultrasonography of, 1920
- Mammary hypoplasia, 1996
- Management  
 of bovine mastitis, 1910–1911  
 of colibacillosis, 1881  
 in mastitis control program, 1979  
 of porcine reproductive and respiratory syndrome, 1797  
 for postpartum dysgalactia syndrome and, 1998  
 of *Staphylococcus aureus* mastitis, 1931–1932
- Management practices  
 bovine virus diarrhea virus, 580  
 in enterohemorrhagic *Escherichia coli*, 538, 542  
 history taking, individual animals, 7–8  
 Johne's disease and, 554–555, 564  
 sheep, infectious footrot in, 1442
- Management risk factors  
 porcine intestinal spirochetosis, 336  
 salmonellosis, 361–362
- Mandible, developmental deficiency of, 433
- Mandibular prognathism, 1535
- Manganese, in congenital defects, 1837
- Manganese deficiency, 1500–1502  
 clinical findings of, 1501  
 clinical pathology of, 1501  
 control of, 1501–1502  
 epidemiology of, 1500–1501  
 etiology of, 1500  
 necropsy findings of, 1501  
 pathogenesis of, 1501  
 treatment for, 1501–1502
- Mania, 10–11, 1158–1159
- Mannheimia haemolytica*, 1960, 1960b  
 in acute undifferentiated bovine respiratory disease, 906  
 antimicrobial sensitivity in, 920  
 in bovine herpesvirus-1 infection, 955  
 bovine virus diarrhea virus and, 582  
 capsular polysaccharides and, 916  
 in chronic enzootic pneumonia, 972  
 in enzootic pneumonia of calves, 939  
 fimbriae, 916–917  
 leukotoxin in, 917  
 lipopolysaccharide in, 917  
 passive immunity to, 922  
 in pneumonic pasteurellosis, 914  
 synergism in, 917  
 vaccine for, 913  
 adverse reaction of, 923  
 efficacy of, evaluation of, 922–923  
 virulence factors of, 916
- Mannitol, 1108  
 for decompression, 1179, 1182
- Mannosidosis, 1221, 1839  
 $\alpha$ -Mannosidosis, 1222  
 $\beta$ -Mannosidosis, 1222–1223
- Manure  
 enterohemorrhagic *Escherichia coli* source, 539  
 Johne's disease and, 555
- Manure gas poisoning, 1087–1088
- MAP. see *Mycobacterium avium* subspecies paratuberculosis (MAP)
- Maple syrup urine disease (MSUD), 1326–1327, 1838–1839
- March flies, 1626
- Mare, pregnant, equine colic, 236–237
- Mare reproductive loss syndrome, 1825–1827, 1825b  
 clinical findings of, 1826  
 clinical pathology of, 1826–1827  
 control of, 1827  
 differential diagnosis of, 1827b  
 epidemiology of, 1825–1826  
 etiology of, 1825  
 necropsy findings of, 1827  
 occurrence of, 1826  
 pathogenesis of, 1826  
 risk factors of, 1826  
 treatment of, 1827
- Mares  
 dourine in, 1820  
 mastitis of, 1996  
 reproductive abnormalities in, 2199–2200
- Marfan syndrome, 692
- Marie's disease, 1391
- Marker vaccines, for bovine herpesvirus-1 infection, 959
- Market cattle testing, brucellosis, 1773
- Mass medication  
 for acute undifferentiated bovine respiratory disease, 911–912  
 for pleuropneumoniae, of pigs, 1062  
 for pneumonia, 891  
 for pneumonic pasteurellosis, 923  
 for progressive atrophic rhinitis, 1053
- Masseter myonecrosis, 1479
- Mast cell tumors, 1642
- Mastication abnormalities, 11, 178
- Mastitis, 2043  
 acute, 69  
 antimicrobials and, 154  
 in immunoglobulin concentration in colostrum, 1850–1851  
 listeriosis and, 1337–1339  
 milk fever and, 1678  
 peracute, 69  
 tuberculous, 2018  
 vitamin E deficiency and, 1467
- Mastitis control programs, 1966–1967  
 appropriate therapy of mastitis during lactation, 1977  
 culling chronically infected cows, 1977–1978  
 dry cow management and therapy, 1973–1977  
 maintenance of an appropriate environment, 1978–1980  
 milking methods for, 1967–1970  
 monitoring udder health status, 1980–1984  
 periodic review of the udder health management program, 1984  
 proper installation, function, and maintenance of milking equipment, 1970–1973  
 proper milking methods in, 1967–1970  
 record keeping in, 1980  
 requirements, 1964  
 setting goals, 1984  
 ten-point mastitis control program, 1967–1984  
 udder hygiene in, 1967–1970
- Mastitis-metritis-agalactia (MMA), 1996  
 endotoxemia and, 62  
 see also Postpartum dysgalactia syndrome
- Maternal antibody, bovine virus diarrhea virus, 581
- Maternal deficiency, primary vitamin A deficiency in, 1321
- Maternal nutrition  
 caloric undernutrition, 1840, 1847  
 newborn and, 1846–1847
- Maternal obstetric paralysis, 1683
- Matrix metalloproteinases (MMPs), laminitis, horse and, 1399
- Maxilla swelling, actinomycosis, 531
- Maximum permissible concentration, radioactivity in meat, 107–108
- Maximum plasma concentration ( $C_{max}$ ), 163
- McRebel system, 1812
- McSherry's balanced electrolyte solution, 140
- MD. see Mucosal disease (MD)
- Mean corpuscular hemoglobin, 730t
- Meat  
 consumer education on handling and cooking, 544  
 radiation and, 107–108
- Meat inspection service and surveillance, enterohemorrhagic *Escherichia coli* control, 543
- Meat-and-bone meal, ingestion of, 1295
- Meat-producing animals, intramuscular injection avoidance of, 159
- Mechanical ventilation, 1866  
 for respiratory tract disease, 870
- Mechanoreheat nociceptors, 79–80
- Meconium impaction, 238–239
- Meconium staining, for fetal hypoxia, 1844
- Medial compartment, of guttural pouch, 984
- Median ataxia grade, 1354f
- Mediastinum, *Aspergillus* spp. in, 1045
- Medicago*, phytoestrogen toxicosis, 1822
- Medical imaging, in pneumonia, 889–890
- Mediterranean Coast fever, 2144, 2148–2150
- Megaesophagus, 200
- Melanocytic nevi, 1641
- Melanoma  
 congenital, 1903  
 cutaneous, 1641  
 inherited, 1647  
 malignant, 1223
- "Melanosis," in sheep liver, 625
- Melanotropes, 1727
- Melena  
 abomasal ulcer and, 521  
 abomasum, hemorrhage into, 449

- Melena (*Cont'd*)  
 alimentary tract examination, 445  
 alimentary tract hemorrhage, 181–182  
 enteritis, acute, 210
- Melengestrol acetate (MGA), in interstitial pneumonia, 966
- Melioidosis, 2029–2031, 2029b  
 clinical findings, 2030  
 goats, 2030  
 horses, 2030  
 pigs, 2030  
 sheep, 2030  
 clinical pathology, 2030  
 control, 2031  
 diagnostic confirmation, 2030, 2030b  
 epidemiology, 2029–2030  
 etiology, 2029  
 experimental production, 2030  
 necropsy, 2030  
 occurrence, 2029–2030  
 pathogenesis, 2030  
 risk factors, 2030  
 pathogen, 2030  
 source and methods of transmission, 2030  
 treatment, 2031  
 zoonotic implications of, 2030
- Melophagus ovinus*, 1623–1624
- Meloxicam  
 for degenerative joint disease, 1410  
 for pain, 82–83  
 for pneumonia, 891–892
- Membrane-bound receptor (mCD14), endotoxemia, 60
- Menace reflex, 1165, 1170  
 examination of, 1170  
 in polioencephalomalacia, 1315  
 vitamin A deficiency and, 1331
- Menace reflex, blindness test, 19
- Menangle, 1816–1817, 2136  
 clinical signs, 2136  
 control, 2136  
 diagnosis, 2136  
 differential diagnosis, 2136  
 epidemiology, 2136  
 etiology, 2136  
 pathology, 2136  
 treatment, 2136
- Meninges, diseases of, 1189
- Meningitis, 1192  
 in cattle, 1192  
 clinical findings in, 1193  
 clinical pathology of, 1193  
 differential diagnosis of, 1192b–1193b  
 etiology of, 1192  
 in horses, 1192  
 listeriosis and, 1337–1338  
 necropsy findings of, 1193  
 in neonatal streptococcal infection, 1901  
 pathogenesis of, 1192  
 in pigs, 1192  
 in sheep, 1192  
 treatment for, 1193  
 in young animals, 1192
- Meningoencephalitis, bovine virus diarrhea virus, 582
- Mental state/mentation, 1157  
 abnormalities of, 1165t  
 altered, 1158–1159  
 in nervous system examination, 1164, 1165f
- Mercury toxicosis, 1201, 1208b–1209b
- Merino breed, of sheep, brucellosis associated with *Brucella ovis*, 1775
- Merino sheep, Johne's disease, 566
- Mesenteric lymph node, biopsy of, 569
- Mesenteric rents, 253
- Mesenteric root volvulus, 524, 527
- Mesothelial cells, peritoneal fluid, 189
- Mesothelioma, 432
- Metabolic acidosis, 124, 132  
 diarrhea, acute, 279  
 enteritis, 209
- equine colic, 231  
 hyperkalemia, 120–121  
 right-side displacement of abomasum and, 511  
 syndrome of, 128
- Metabolic alkalosis, 124  
 hypochloremic hypokalemic, 118, 120, 134, 145  
 hypokalemia and, 119  
 right-side displacement of abomasum and, 511  
 vagus indigestion, 493
- Metabolic deficiencies, 2161–2163  
 choline deficiency, 2176  
 copper deficiency, 2163–2176  
 magnesium deficiency, 2162  
 riboflavin deficiency, 2176  
 sodium and/or chloride deficiency, 2161–2162
- Metabolic diseases, 1662–1757  
 atrial fibrillation and, 682  
 breed susceptibility in, 1666  
 encephalomalacia and, 1187–1189  
 incidence of, 1664f  
 management practices in, 1666  
 myasthenia and, 1377  
 occurrence and incidence of, 1666  
 periparturient period in, 1662–1667  
 salient features of, 1663t  
 stress and, 86–87  
 transition period, in dairy cows, 1662–1664
- Metabolic profile testing, 1667–1675  
 background information in, 1673  
 biological and statistical basis for herd testing in, 1668  
 body condition score in, 1673–1675, 1674f, 1675t  
 dairy-herd, 1668–1675  
 interpretation of results of, 1673  
 optimum values of, 1672t  
 usefulness of, 1667–1668  
 written advice for, 1673
- Metabolic rate, exercise and, 96
- Metabolism  
 dehydration and, 114  
 faulty, and weight loss, 93–94
- Metacercariae  
*Dicrocoelium dendriticum*, 645  
*Fasciola*, 642, 644  
*Fascioloides magna*, 645
- Metaphylactic antimicrobial therapy, for undifferentiated bovine respiratory disease, 2038
- Metaphylaxis, for acute undifferentiated bovine respiratory disease, 911b
- Metastatic infection, in strangles, 1021
- Metazoan agents, gastritis, etiology of, 203
- Meteorologic influences, in colibacillosis, 1881
- Meteorological factors, in mycoplasmal pneumonia, 1072
- Metformin, for equine metabolic syndrome, 1736
- Methallibure, 1837
- Methemoglobinemia, 737–738  
 anemia and, 734–735, 736f, 745
- Methemoglobinemia, in respiratory insufficiency, 853
- Methicillin-resistant *Staphylococcus aureus*, 1564–1569  
 animal, 1565  
 butchers and, 1565  
 in cattle, 1567  
 control of, 1569  
 diagnosis of, 1569  
 epidemiology of, 1565–1566  
 etiology of, 1565  
 in horses, 1568  
 human public health and, 1564  
 pathogenesis of, 1569  
 pathology of, 1569  
 pig farmers and, 1565  
 in pigs, 1566–1567  
 risk factors of, 1566–1569  
 in sheep and goats, 1567  
 in small animals, 1567–1568  
 in veal calves, 1567  
 veterinarians and, 1564–1565
- Methionine, laminitis, horse and, 1403
- 4-Methoxypropylidone plant toxicosis, 701
- Methyl bromide, 2189
- Methylene blue, 831
- 3-Methylindole  
 production, for interstitial pneumonia, 969  
 toxicosis, 1087
- Methylmalonic acid (MMA), 817
- S-methylmethionine sulfonium chloride, 290
- Methylxanthines, for respiratory tract disease, 872
- Metoclopramide  
 contraindications for, 191  
 dose rate, 191  
 for gastrointestinal motility, 191  
 indications for, 191  
 simple indigestion, 459
- Metritis  
*Brucella suis*, 1780  
 milk fever and, 1678
- Metronidazole, 173, 281–282
- Miconazole, 798
- Microagglutination test (MAT), 1123
- Microangiopathy, 709
- Microcystins, 101
- Microfilariae, of onchocerciasis, 1610
- Microflora, antibiotic effects on, 156
- Micrognathia, 433
- Microneutralization ELISA, in bovine respiratory syncytial virus, 950
- Microphthalmia, 1659
- Microphthalmos, 1331
- Micropolyspora faeni*, 966
- Microscopic agglutination test, *Brachyspira hyodysenteriae*, 330
- Microscopic lesions, of bovine neonatal pancytopenia, 758–759
- Microscopy, viral diarrhea, 389
- Microtiter techniques, 155
- Micturition abnormalities, 1098
- Midges  
 African horse sickness, transmission of infection, 2093  
 biting, 1560, 1631
- Midstream voiding, urine sampling, 1099
- Migrating myoelectric complex, 176–177
- Miliary nodules, 1027
- Miliary tuberculosis, 2021
- Milk  
 abnormalities, in mastitis, 1915  
 antimicrobial residues in, 1928–1929  
*Brucella melitensis* and, 1782  
 bulk-tank, myopathy and, 1471  
 calcium concentration of, 1841  
 contamination, *Mycobacterium avium* subspecies paratuberculosis (MAP), 553, 555–556  
 continuous feeding of, to diarrheic calves, 149  
*Coxiella burnetii* and, 1792  
 culture, *Mycobacterium avium* subspecies paratuberculosis (MAP), 559  
 culture of, 1915–1917  
 bacteriologic, 1982  
 coliform mastitis in, 1947, 1949  
 in monitoring udder health, 1982–1984  
*Staphylococcus aureus* mastitis in, 1933–1934  
 digestion, dietary diarrhea, 214  
 discoloration of, in bovine mastitis, 1913  
 electrical conductivity of, 1917  
 electrolyte concentration of, in mastitis, 1904  
 endotoxin test, in coliform mastitis, 1948–1949, 1949f  
 examination of, in postpartum dysgalactia syndrome, 1999  
 ketone, left-side displacement of abomasum and, 507  
 lead in, 1206–1207  
 listeriosis in, 1339  
 overfeeding, dietary diarrhea, 214  
 pasteurization, *Mycobacterium avium* subspecies paratuberculosis (MAP) survival, 555  
 potassium in, 120



- Milk (*Cont'd*)  
 production  
   in bovine mastitis, 1909–1911  
   bulk tank milk somatic cell count, 1915t  
   at dry off, 1974  
   Johne's disease, subclinical, 555  
   left-side displacement of abomasum and, 503  
   milk fever and, 1678  
   radiation and, 107–108  
   regurgitation, persistence of right aortic arch, 706  
   residue violations in, 168, 168b  
   *Salmonella*, 360  
   selenium and, 1471  
   starvation, 89  
   stress and, 87  
   testing, for ketosis, 1712  
   transfer of selenium and vitamin E to, 1466–1467  
   unpasteurized consumption of, 544  
   withholding period for, 167  
   withholding times and, 1928–1929
- Milk allergy, 1991
- Milk claw, 1971–1972
- Milk drop syndrome, 1990
- Milk ejection reflex, failure of, 1996
- Milk fever, 121, 1675–1690, 1675b  
 body-condition score of, 1677  
 case fatality of, 1676  
 in cattle, 1675–1676, 1679  
 clinical care procedures of, 1685  
 clinical findings of, 1679–1680, 1680f  
 clinical pathology of, 1680–1681  
 complication of, 1694  
 control of, 1685b, 1686–1690  
 dietary and environmental risk factors of, 1677–1678  
 differential diagnosis of, 1681–1685, 1682t  
 economic importance of, 1678  
 epidemiology of, 1675–1678  
 etiology of, 1675  
 general management of, 1685  
 in goats, 1676, 1680  
 morbidity of, 1676  
 necropsy findings of, 1681  
 pathogenesis of, 1679  
 relapses, 1678  
 risk factors of, 1676–1677  
 in sheep, 1676, 1680  
 standard treatment of, 1684  
 treatment of, 1683–1684, 1685b
- Milk impacts, 1971
- Milk line sampling, 1915
- Milk pipeline, 1972
- Milk potassium concentration, in acute hypokalemia, 1692
- Milk replacer  
 abomasal bloat (tympany), 522–523  
 abomasal ulcer and, 520  
 dietary diarrhea, 213–214  
 indigestion in calves, 460–461  
 for newborns, 1878–1879
- Milk ring test, 1767
- Milk transport system, 1971
- Milk urea nitrogen (MUN), 1670
- Milk yield acceleration, 1662, 1664f
- Milkers' nodule, 1588–1589
- Milking equipment  
 bulk milk tank and, 1972  
 evaluation of, 1972–1973  
 installation of, 1970–1973  
 maintenance of, 1972–1973  
 milk claw in, 1971–1972  
 milk pipeline in, 1972  
 milk transport system in, 1971  
 pulsation system for, 1971  
 udder health and, 1972  
 vacuum system for, 1970–1971
- Milking machine  
 liner slips and, 1968  
 stripping, liner slip and, 1968
- Milking methods, in mastitis control program, 1967–1970
- Milking practices  
 characteristic, in risk factor, of bovine mastitis, 1908  
 establish milking order and, 1970  
 in risk factor, of bovine mastitis, 1911  
 schedule for, 1967  
 segregation program in, 1970  
 udder, premilking, 1967
- Milking system  
 components of, 1970  
 function and objectives of, 1970
- Milking unit  
 attachment of, 1968  
 backflushing of, 1970  
 cluster dunking and, 1970  
 removing of, 1968
- Mimosine, 2208–2209
- Mine spills, 106
- Mineral nutrients, deficiencies of, 1754–1757  
 in developing countries, 1755  
 diagnostic strategies for, 1754–1755  
 economic importance of, 1754  
 laboratory diagnosis of, 1756–1757, 1756f  
 prevalence of, 1754  
 trace-element deficiency in, pathophysiology of, 1755–1756, 1755t
- Mineral oil  
 abomasal impaction, 517  
 bloat, 480  
 equine colic, 234  
 sand colic, 267
- Minerals, metabolism of, and endotoxemia, 62
- Minimal disease herds, for *Mycoplasma pneumoniae*, 1069
- Minimal inhibitory concentration (MIC), of  
 antimicrobial agents, 153, 155, 165
- Minimal-disease pigs, *Mycoplasma pneumoniae* in, 1069
- Miracidia, 642
- Miscellaneous mycotoxins, 2204
- Miscellaneous plant toxicosis, 2207–2212
- Mismothering, in lambs, 1845
- Mite infestations, 1618
- Mitral valve, 663–664
- Mixed venous oxygen tension, cardiac reserve and, 658
- Moaning, and pain, 80
- Mobitz type 1 second-degree atrioventricular block, 679
- Modified bovine collagens, 143
- Modified live-virus (MLV) vaccines  
 for bovine herpesvirus-1 infection, 958  
 for bovine respiratory syncytial virus, 951  
 for bovine virus diarrhea virus, 594–595  
 for porcine reproductive and respiratory syndrome, 1813  
 for swine influenza, 1083–1084
- Mohair goats, hereditary peromelia of, 1537
- Molar teeth, displaced, inherited, 1534
- Moldy corn disease, 2201
- Molluscicide toxicosis, 1213–1214
- Molluscum contagiosum, 1548
- Molybdenosis, 425–426
- Molybdenum  
 copper interaction, 2168  
 excess, soil characteristics of, 2166  
 sulfate interaction, 2168  
 toxicosis, 425–426, 425b–426b
- Monensin, 1664  
 bloat, 481  
 controlled-release capsules  
   bloat, 481  
   left-side displacement of abomasum prevention, 509  
 for fatty liver, 1722  
 Johne's disease, 561–562  
 for ketosis, 1715
- liquid formulation of, 481  
 swine dysentery, 331–332
- Monopantel, 1211
- Monitoring, disease, biosecurity and, 41
- Monoclonal antibody 15C5, 586
- Monoclonal antigen-capture ELISA (ACE) test, bovine  
 virus diarrhea virus, 586–587
- Monofluoroacetate plant toxicosis, 700
- Monoglyceride, 2208
- Monosodium phosphate, 123
- Monosporium apiospermum*, 798
- "Moose sickness," cobalt deficiency and, 816
- Morantel, 1212
- Morantel citrate monohydrate, 607
- Morbidity  
 history taking of, 6  
 neonatal, selenium and, 1467
- Morbillivirus, 572
- Morel's disease, 768b
- Morphine, intraarticular, for degenerative joint  
 disease, 1410–1411
- Mortality, neonatal, selenium and, 1467
- Mortellaro's disease. see Digital dermatitis, bovine
- Mortierella wolfii*, 633
- Mosquitoes, 789, 1625–1626, 1631
- Mothering  
 effect, colostral immunoglobulin and, 1852  
 poor  
   in lambs, 1845  
   in neonatal mortality, 1832, 1847–1848, 1848t
- Moths, 2179
- Motor evoked potentials, 1178
- Motor neuron diseases, 1193
- Motor system, 1162
- Mount St. Helens, 109
- Mountain sickness (brisket disease), 693–695, 693b, 695t  
 differential diagnosis of, 694b
- Mouth  
 clinical examination of, 19–20  
 inherited defects of, 434
- Mouth munge, 1563–1564
- Movement  
 abnormality, 1372  
 peritonitis, 217  
 trauma caused by, degenerative joint disease and, 1406
- Moxidectin  
 for bunostomosis, 614  
 for hemonchosis in ruminants, 612  
 for oesophagostomosis, 616  
 for parasitic gastroenteritis in ruminants, 607–608
- Mucokinetic agents, for respiratory tract disease, 872
- Mucolytics  
 for heaves, 1011  
 for respiratory tract disease, 872
- Mucopolysaccharidosis type IIIB, bovine, 1222–1223
- Mucormycosis, 817–822
- Mucosal disease (MD), 577–599  
 acute, 584–585, 588  
 chronic, 585, 589  
 death, 579, 584  
 differential diagnosis, 589b–592b  
 necropsy findings, 588–589  
 pathogenesis of, 584
- Mucosal lesions, of arytenoid cartilages, 988–989
- Mucous membranes  
 alimentary tract examination, 445  
 equine colic, 227, 231  
 foals, 238
- Mucus, heaves in, 1006
- Muellerius capillaris*, 980
- Mulberry heart disease  
 clinical findings of, 1470  
 epidemiology of, 1463–1464  
 necropsy findings of, 1473

- Mule deer (*Odocoileus hemionus*), epizootic hemorrhagic disease and, 783
- Mule operation, caseous lymphadenitis and, 767
- Mules, septicemia in, 57
- Mulga trees (*Acacia aneura*), 625
- Multifocal symmetric encephalopathy, inherited, 1330–1331
- Multi-organ diseases, 2002–2214
- Multiple ankyloses, inherited, 1539
- Multiple exostosis, inherited, 1537–1538
- Multiple myeloma, 745–746
- Multiple organ defects, 434
- Multiple organ dysfunction syndrome, 57
- Multiple tendon contracture, inherited, 1538–1539
- Multiplex PCR test, in *Rhodococcus equi* pneumonia, 1016
- Multivalent vaccines  
for bovine herpesvirus-1 infection, 959–960  
for infectious footrot in sheep, 1447
- Mummification, 583–584
- Murmurs, 685–688, 685b  
acquired, 685  
cattle, 685  
clinical findings of, 686–688  
clinical pathology of, 688  
congenital, 685  
continuous, 686  
patent ductus arteriosus, 705  
diastolic, 686  
differential diagnosis of, 688b  
epidemiology of, 685  
etiology of, 685  
examination of, 686–687  
functional (innocent), 687  
functional systolic ejection, 687  
generation of, 685–686  
holodiastolic, 687–688  
holosystolic, 687  
horses, 685  
interpretation, 686  
necropsy findings of, 688  
pansystolic, 687  
pigs, 685  
point of maximum intensity, 687  
presystolic, 687  
systolic, 686  
treatment of, 688  
without valvular disease, 686
- Murray Valley encephalitis, 1265b, 1286–1293  
animal risk factors for, 1267  
case fatality of, 1267–1268  
clinical findings of, 1268  
clinical pathology of, 1268  
control of, 1269–1270  
differential diagnosis of, 1268b  
distribution of, 1267  
epidemiology of, 1267  
etiology of, 1266–1267  
identification of, 1268  
morbidity of, 1267–1268  
necropsy findings of, 1268  
pathogenesis of, 1268  
samples for diagnostic confirmation of, 1269–1272  
serologic tests for, 1268  
transmission of, 1267  
treatment for, 1269  
viral ecology of, 1267  
zoonotic implications of, 1267–1268
- Murrina, 2156–2158
- Musca autumnalis*, 1630
- Musca domestica*, 1630
- Musca vetustissima*, 1630
- Muscle enzymes, myopathy and, 1379
- Muscle fiber, myopathy and, 1379
- Muscle glycogen phosphorylase deficiency, 1515
- Muscle infarction, in strangles, 1021–1022
- Muscle relaxants, myopathy, horse and, 1386
- Muscle-derived serum enzymes, 1380  
myopathy, horse and, 1382
- Muscles  
biopsy of  
for musculoskeletal system disease, 1377  
myopathy and, 1381  
of polysaccharide storage myopathy in horses, 1522  
damage to, intravenous antimicrobials and, 159  
defects of, 1372  
diseases of, 1377–1381  
inherited diseases of, 1514–1515  
skeletal  
and potassium, 120  
weakness of, 1510  
tone, decreased, 1173
- Muscular atrophy, inherited spinal, 1354–1355
- Muscular dystonia type 1, congenital, 1518
- Muscular dystrophy  
congenital, 1470  
control of, 1476–1477  
enzootic  
acute, 1469  
subacute, 1469–1470, 1469f  
progressive, inherited, 1517  
subclinical nutritional, 1470
- Muscular hypertrophy, idiopathic, 254
- Muscular tremors, 132
- Musculoskeletal diseases, in dyspnea, 849
- Musculoskeletal (somatic) pain, 79
- Musculoskeletal pain, relief of, 1376
- Musculoskeletal system  
abnormal movement, 1372  
abnormal posture, 1372  
clinical examination of, 21  
congenital/inherited diseases and, 1510–1514  
differential diagnosis of diseases of, 1373t–1375t  
diseases characterized by involvement of, 1503–1504  
diseases of, 1371–1539  
bones, 1388–1391  
joints, 1406–1411  
muscles, 1377–1381  
examination of, 1376–1377  
exercise intolerance, 99  
infectious diseases and, 1425–1428  
lameness. see Lameness  
nutritional diseases and, 1458–1479  
obvious absence or deformity of specific parts of, 1510  
principal manifestations of, 1372–1376  
spontaneous fractures in, 1375
- Mushroom toxicosis, 2204–2205
- Mutagen attenuated vaccines, 2069
- Mutant prevention concentration (MPC), 158
- Mutations, and radiation, 108
- Muzzle, diseases of, 192
- Myasthenia, 1377
- Myasthenia gravis, 1362
- Mycobacteriosis, 2024–2025, 2024b
- Mycobacterium avium* intracellulare complex (MAC),  
and with atypical mycobacteria,  
mycobacteriosis associated with,  
2024–2025
- Mycobacterium avium* subspecies paratuberculosis (MAP)  
chemotherapeutic agent resistance, 570  
dormancy, in environment, 555  
fetal infection, 566  
Johne's disease, 552  
molecular studies of, 565  
risk factors, 554–555  
strains, 552  
survival, 555  
thermal resistance, 555  
vaccines, 563
- Mycobacterium bovis*, wild boar, 2009
- Mycobacterium phlei*, localized infection, 77
- Mycobacterium* spp.  
granulomatous enteritis, of horses, 282  
mastitis and, 1962
- Mycobacterium tuberculosis*, 2023–2024
- Mycobacterium tuberculosis* complex (MTC), 2015
- Mycobacterium ulcerans* infection, 1574
- Mycoplasma*  
diseases of the respiratory tract associated with, 924–925  
in enzootic pneumonia of calves, 939, 941–943
- Mycoplasma agalactiae*  
in contagious agalactia, in sheep, 1994  
disease associated with, 1793
- Mycoplasma agalactiae* var. *bovis*, 1793
- Mycoplasma arthritis*, 933
- Mycoplasma bovigenitalium*, 1793–1794
- Mycoplasma bovis*  
in cattle, 924–925  
in enzootic pneumonia of calves, 939  
infection, 2037b  
synergism, 917
- Mycoplasma bovis* pneumonia, 932–939, 932b  
clinical findings of, 934–935  
clinical pathology of, 935–936  
control of, 938  
differential diagnosis of, 936b–937b  
epidemiology of, 932–934  
necropsy findings in, 936  
pathogenesis of, 934  
risk factors for, 933–934  
treatment of, 937, 937b–938b
- Mycoplasma bovis* polyarthritis, 932–939, 932b  
clinical findings of, 934–935  
clinical pathology of, 935–936  
control of, 938  
differential diagnosis of, 936b–937b  
epidemiology of, 932–934  
necropsy findings in, 936  
pathogenesis of, 934  
risk factors for, 933–934  
treatment of, 937, 937b–938b
- Mycoplasma californicum*, 933
- Mycoplasma capricolum* subsp. *capricolum*,  
contagious agalactia, in sheep, 1994
- Mycoplasma conjunctivae*, in contagious ophthalmia, 1653
- Mycoplasma dispar*  
in cattle, 925  
in enzootic pneumonia of calves, 942
- Mycoplasma felis*, in horses, 924–925
- Mycoplasma hyopneumoniae*, 1055, 1071  
porcine reproductive and respiratory syndrome and, 1798  
wild boar, 2009
- Mycoplasma mastitis*, 1940–1942  
clinical findings of, 1941  
clinical pathology of, 1941  
control of, 1942  
diagnosis of, 1941  
differential diagnosis of, 1942b  
economic importance of, 1941  
epidemiology of, 1940–1941  
etiology of, 1940, 1940b  
necropsy findings of, 1941–1942  
pathogenesis of, 1941  
prevalence of, 1940  
risk factors of, 1941  
source of infection in, 1940–1941  
transmission of, 1941  
treatment of, 1942, 1942b
- Mycoplasma mycoides* subsp. *mycoides* small colony (MmmSC), in contagious bovine pleuropneumonia, 925, 927
- Mycoplasma ovipneumoniae*  
in chronic enzootic pneumonia of sheep, 972  
in sheep, 924
- Mycoplasma pneumoniae*, 1064–1071  
clinical findings in, 1066  
clinical pathology of, 1066–1067  
control of, 1068–1070  
diagnosis of, 1067–1068  
epidemiology of, 1064–1066  
etiology of, 1064  
necropsy findings in, 1067  
treatment of, 1068

- Mycoplasma* spp.  
diseases of eyes associated with, 1654–1655  
in diseases of the genital tract, 1793–1794  
in interstitial pneumonia, 966  
*Mycoplasma suis*, 781–782  
*Mycoplasma suis*, 781–782  
Mycoplasmal hyosynoviae, in pigs, 1455–1456  
Mycoplasmal pneumonia, of pigs, 1071–1074  
clinical signs of, 1073  
control of, 1074  
epidemiology of, 1071–1073  
etiology of, 1071  
monitoring of, 1074  
pathology of, 1073  
treatment of, 1073–1074  
Mycoplasma lung, in *Mycoplasma pneumoniae*, 1068  
Mycoplasmosis, 63  
Mycosis fungoides, 748  
Mycotic dermatitis cutaneous streptotrichosis, 1570–1573  
Mycotic nasal granuloma, 902  
Mycotic rhinitis, 875  
Mycotic stomatitis, 193  
Mycotoxicosis, in interstitial pneumonia, 966  
Mycotoxins  
miscellaneous, 2204  
poisoning by, 649–650  
Myelitis, 1193  
Myeloencephalopathy, 1285  
control of outbreaks of, 1287–1288  
inherited progressive degenerative, 1352  
Myelography, 1178, 1354f, 1360  
Myelomalacia, 1189–1191  
Myelophthitic anemia, 731–732  
Myeloproliferative diseases, 744  
Myocardial disease, 690–692, 690b  
clinical findings of, 691  
clinical pathology of, 691–692  
congenital, 691  
differential diagnosis of, 692b  
etiology of, 690–691  
heart failure, chronic (congestive), 659  
necropsy findings of, 692  
pathogenesis of, 691  
premature complexes, 680  
treatment of, 692  
Myocardial injury, biomarkers of, 670–671  
Myocarditis  
acute focal, 1695  
attributable to *H. somni*, 2037b  
bacterial, 690  
bovine virus diarrhea virus and, 589  
*Histophilus* septicemia of cattle, clinical findings, 2036–2037  
parasitic, 690–691  
viral, 690  
Myoclonus, 1160  
inherited congenital, 1350  
Myofiber, congenital hyperplasia of, 1510  
Myofiber hyperplasia, 1516–1517, 1516f  
Myoglobinuria, 1101  
in grazing horses, 1505–1506  
myopathy and, 1378, 1381  
horse and, 1382  
nephrosis and, 1378  
Myopathic agents, enzootic nutritional muscular dystrophy and, 1462  
Myopathy, 1377–1381  
acute nutritional, 1379  
atypical, in grazing horses, 1505–1506  
clinical findings of, 1379–1380  
clinical pathology of, 1470–1473  
control for, 1381  
degenerative, 1378, 1683  
diagnosis of, 1380–1381  
differential diagnosis of, 1381b  
epidemiology of, 1377–1378  
etiology of, 1377–1378  
of horses, 1381–1387  
inherited, 1378  
necropsy findings of, 1381  
pathogenesis of, 1378–1379  
plant poisonings and, 1506  
primary, 1378–1379  
secondary, 1379–1380  
treatment for, 1381  
Myositis, 1387–1388  
Myositis ossificans, 1387  
Myotonia, of goats, 1518–1519, 1518b  
clinical findings of, 1519  
clinical pathology of, 1519  
economic importance of, 1519  
epidemiology of, 1518–1519  
necropsy findings of, 1519  
pathogenesis of, 1519  
Myotonia congenita, myotonic dystrophy and, 1519  
Myotonic dystrophy, myotonia congenita and, 1519  
Myotoxins, 2177  
Myrotheciotoxicosis, 2213
- 
- N**
- N-acetyl- $\beta$ -D-glucosaminidase (NAGase), 1917  
Nagana, 2150–2156, 2150b  
biosecurity concerns, 2153  
clinical findings, 2153–2154  
clinical pathology, 2154  
control, 2155–2156  
differential diagnosis, 2155b  
economic importance, 2152–2153  
epidemiology, 2151–2153  
etiology, 2150–2151  
experimental reproduction, 2152  
immune mechanisms, 2152  
methods of transmission, 2151–2152  
carrier state, 2152  
cyclical, 2151  
noncyclical, 2151–2152  
morbidity and case fatality, 2151  
necropsy findings, 2154–2155  
gross pathology, 2154  
specimens for pathology, 2155  
occurrence, 2151  
pathogenesis, 2153  
prevalence, 2151  
risk factors, 2152  
environmental, 2152  
host, 2152  
pathogen, 2152  
treatment, 2155, 2155b  
zoonotic implications, 2153  
NAGase test, 1918–1919, 1919f  
Nairobi sheep disease (NSD), 2084  
Naloxone, 191  
Narcolepsy (catalepsy)  
familial, 1327–1328  
nervous system disease, 1160  
Narcotic analgesics  
laminitis, horse and, 1402  
for pain, 83  
Nasal adenocarcinoma, enzootic, 875, 970f  
Nasal bots, 979–980, 979b  
Nasal cavities, obstruction of, 875–877  
clinical findings in, 876–877  
enzootic nasal adenocarcinoma, 875  
neoplasms, 875–876  
progressive ethmoidal hematomas, in equids, 876, 876f  
treatment of, 877  
Nasal discharge  
in guttural pouch empyema, 985  
in heaves, 1007  
in respiratory insufficiency, 854  
in strangles, 1020  
Nasal form, of glanders, 1027  
Nasal granuloma  
enzootic, of cattle, 901–902  
mycotic, 902  
Nasal insufflation, 869, 870t  
Nasal lavage, in respiratory secretions, 859  
Nasal passages, *Aspergillus* spp. in, 1045  
Nasal reflux, esophageal obstruction, 200  
Nasal swabs  
in acute undifferentiated bovine respiratory disease, 908–909  
in respiratory secretions, 859  
Nasogastric intubation  
abdominal examination of, 18  
alimentary tract, examination of, 183  
equine colic, 228–229, 232, 239  
esophageal obstruction, 201  
gastric dilatation, 241  
in horses, 241  
gastric (gastroduodenal) ulcer, 245  
Nasolacrimal duct fistulae, 1659  
Nasopharyngeal swabs  
in acute undifferentiated bovine respiratory disease, 908–909  
in bovine respiratory syncytial virus, 950  
in respiratory secretions, 859  
National Academy of Sciences, 543  
National Advisory Committee on Microbiological Criteria for Foods, 543  
National Committee on Clinical Laboratory Standards/Veterinary Antimicrobial Susceptibility Testing Subcommittee (NCCLS/VASTS), 910  
National Institute for Research in Dairying (NIRD), 1964  
National Scrapie Flocks Scheme, 1309  
Natural exposure, for bovine herpesvirus-1 infection, 957–960  
Natural living framework, and stress, 86  
Naturally occurring combined abnormalities of free water, electrolyte, acid-base balance, and oncotic pressure, 130–137  
clinical findings in, 132  
clinical pathology of, 132–136, 133t  
history of, 132  
nature of disease, 132  
Navel (umbilical) bleeding, in piglet, 723  
Navel ill, 1900–1901  
Neck  
clinical examination of, 12, 18, 20  
nervous system examination of, 1170–1171  
posture, 1161  
Necrobacillosis, 632–635  
Necrosis  
back-muscle, porcine stress syndrome and, 1527  
gangrene and, 1557–1558  
Necrotic bronchopneumonia, suppurative, in strangles, 1021  
Necrotic dermatitis, 761  
Necrotic enteritis, 324  
of pigs  
clinical findings, 547–548  
*Clostridium perfringens* types B and C, 547  
endemic, 547  
etiology, 546  
outbreaks, 547  
peracute, 547  
risk factors, 547  
Necrotic stomatitis, 534, 534b  
Necrotizing glomerulonephritis, 1110  
Necrotizing vasculitis, 721  
Negative predictive value (NPV)  
biosecurity and, 38  
laboratory data and, 24–25, 25f  
Nematodiosis, cerebrospinal, 1351  
*Nematodirus*, 604  
age resistance, 603–604  
control of, 609  
eggs of, 603  
see also Trichostrongylid worms



- Neonatal animals, dietary diarrhea, 213  
 Neonatal deaths, investigation of, 1835  
 Neonatal diarrhea syndrome, 343  
 Neonatal foal disease, 1123  
 Neonatal infection, 1874–1877, 1874b  
   clinical findings of, 1876  
   clinical pathology of, 1876  
   control of, 1877  
   differential diagnosis of, 1876b  
   epidemiology of, 1875–1876  
   etiology of, 1874–1875  
   pathogenesis of, 1876  
   risk factors of, 1875–1876  
   sources of infection in, 1875  
   streptococcal, 1901–1903  
   transmission of, 1875  
   treatment of, 1876–1877  
 Neonatal isoerythrolysis isoimmune hemolytic anemia, 740–744, 740b–741b  
   differential diagnosis of, 743b  
 Neonatal jaundice, 623  
 Neonatal neoplasia, congenital, 1903  
 Neonatal septicemia, 1285  
 Neonatal tetanus, 1363  
 Neonatal viremia, 1285  
 Neonates  
   hypothermia, 44  
     clinical findings, 49  
     risk factors for, 47–48  
     treatment for, 49–50  
   septicemia, 57–58  
   streptococcal infections of, 1901–1903, 1901b  
     clinical findings of, 1902  
     clinical pathology of, 1902  
     control of, 1903  
     diagnosis of, 1902  
     differential diagnosis of, 1902b–1903b  
     economic importance of, 1902  
     epidemiology of, 1901–1902  
     etiology of, 1901  
     necropsy findings of, 1902  
     pathogenesis of, 1902  
     source of infection in, 1902  
     treatment of, 1903  
     zoonotic implications of, 1902  
   sudden death of, 101  
   thermoregulation in, 44–48  
 Neoplasms  
   alimentary tract, 431–432  
   myopathy and, 1378  
 Neoplastic diseases, of respiratory tract, 1088–1090  
 Neoplastic tissue, ovine pulmonary adenocarcinoma in, 979  
*Neospora caninum*, 1817–1818  
 Neosporosis, 1817–1819, 1817b  
   bovine viral diarrhea virus in, 1818  
   clinical findings of, 1818–1819  
   clinical pathology of, 1819  
   congenital infection in, 1818  
   control of, 1819  
   differential diagnosis of, 1819b  
   economic importance of, 1818  
   epidemiology of, 1818  
   etiology of, 1817–1818  
   experimental studies for, 1818  
   in horses, 1818–1819  
   necropsy findings of, 1819  
   occurrence of, 1818  
   pathogenesis of, 1818  
   risk factors of, 1818  
   transmission of, 1818  
   treatment of, 1819  
 Neostigmine, 192, 458–459  
*Neotyphodium*-associated mycotoxins, 1202–1204  
 Nephritis, interstitial, 1114  
 Nephroblastoma, 1137  
 Nephrogenic diabetes insipidus, 1114  
 Nephrosis, 1111–1112, 1131, 1137  
 Nephrotic syndrome, 1110  
 Nephrotoxicity, of aminoglycosides, 169  
 Nephrotoxins, 2177  
 Nerve conduction studies, 1178  
 Nerve sheath tumors, peripheral, 1370  
 Nervous dysfunction, 1157–1158  
   excitation (irritation) signs, 1158  
   inhibition release signs, 1158  
   modes of, 1158  
   nervous shock, 1158  
   paresis/paralysis, 1158, 1162  
 Nervous ketosis, 1711, 1711f  
 Nervous shock, 104, 1158  
 Nervous signs  
   in liver disease, 631  
   malignant catarrhal fever, 2078  
 Nervous system  
   abiotrophies of, inherited, 1227  
   clinical examination of, 21  
   diseases of, 1155–1370  
     altered mentation, 1158–1159  
     altered sensation, 1162–1163  
     associated with prions, 1320–1321  
     autonomic nervous system abnormality, 1163–1164  
     clinical manifestations of, 1158–1164  
     in dyspnea, 849  
     etiology of, 1179  
     exercise intolerance, 99  
     gait abnormality, 1161  
     involuntary movements, 1159–1160  
     meninges in, 1189  
     mental state, 1157  
     paresis/paralysis, 1158, 1162  
     pathophysiologic mechanisms of, 1178  
     posture abnormality, 1160–1161  
     posture and gait, 1157  
     sensory perceptivity, 1157  
     treatment of, 1178  
   endotoxemia effects, 63  
   enzootic bovine leukosis, 837  
   examination of, 1164–1175  
     anus, 1172  
     brainstem auditory evoked potentials, 1177–1178  
     cranial nerves in, 1164–1165  
     electroencephalography, 1177  
     electromyography, 1177  
     electroretinography, 1177  
     endoscopy (rhinolaryngoscopy), 1177  
     epidemiology, 1164  
     forelimb, 1170–1171  
     gait, 1170  
     head, 1164–1169  
     history, 1164  
     with imaging techniques, 1175–1176  
     intracranial pressure measurement in, 1178  
     kinetic gait analysis in, 1178  
     neck, 1170–1171  
     neurologic, 1164  
     ophthalmoscopy, 1177  
     palpation of bony encasement, 1172  
     posture, 1170  
     serum biochemical analysis in, 1175  
     signalment, 1164  
     tail, 1172  
     fungi affecting, 1196  
     nematodes affecting, 1322  
     plants affecting, 1195  
     vitamin A deficiency and, 1324–1325  
 Net acid excretion, 1100, 1101f  
 Netherlands, Johne's disease control in, 564  
 Netobimin, for parasitic gastroenteritis in ruminants, 607  
 Neuraxial edema, hereditary, 1350  
 Neuraxonal dystrophy, 1193  
   of horses, 1349  
   of sheep, 1353–1354  
 Neuroanatomical location of lesions, 1158  
 Neurodegeneration, inherited, 1350–1351  
 Neurofibromatosis, 1642  
 Neurogenic dyspnea, 849  
 Neurogenic hyperthermia, 52  
 Neurogenic muscular atrophy  
   clinical findings of, 1380  
   etiology of, 1378  
   paresis/paralysis, 1162  
   pathogenesis of, 1379  
 Neurogenic quinolizidine alkaloid poisoning (*Lupinus* spp.), 1194–1195  
 Neurologic dysfunction, of border disease, 1254  
 Neurologic examination, 21  
 Neuromas, 1223  
 Neuronal ceroid lipofuscinosis, 1227  
 Neuronal degeneration, 989–990  
 Neuronal satellitosis, 1185  
 Neuronophagia, 1185  
 Neurons, extrapontine and pontine, demyelination of, 116–118  
 Neuroses, 1224  
 Neurotoxic mycotoxins, in encephalomalacia, 1186  
 Neurotoxicity, organophosphorus-induced delayed, 1215  
 Neurotoxins, 2177  
 Neutralizing antibodies  
   bovine virus diarrhea virus, 580–581  
   equine infectious anemia virus of, 790  
 Neutropenia, 746  
   in coliform mastitis, 1947  
   endotoxemia, 61  
   tick-borne fever and, 777  
 Neutrophils  
   coliform mastitis and, 1946–1947  
   heaves in, 1006  
   intestinal mucosal injury, 209  
   radiation and, 108  
   selenium deficiency and, 1466  
   tick-borne fever and, 777  
 Nevus, 1643  
 New World camelids (NWCs), 1834–1835, 2017  
   bluetongue, 2072  
   encephalitis in, 1184–1186  
   fetal disease in, 1834  
   with *M. bovis*, 2018  
   mortality in, 1834  
   parturient disease in, 1834  
   postnatal disease in, 1834–1835  
   rickets in, 1495  
   tuberculin testing in, 2020–2021  
 New Zealand, brucellosis in, 1773  
 Newborns  
   critically ill, 1856–1867  
     clinical examination of, 1856–1860, 1857f–1858f  
     clinical pathology of, 1860–1863  
     complications of, 1866  
     imaging for, 1860  
     prognosis of, 1866–1867, 1867t  
     treatment of, 1863–1866  
   hypothermia in, 1844–1846  
   lactose digestion test, 185  
   maternal transfer to, selenium deficiency and, 1474  
   resistance of, increasing, 1878–1879  
 Newly introduced animals, testing and/or isolation of, 38  
 Newsprint, feeds, 620  
 Niacin, for ketosis, 1716  
 “Nibbling” reaction, 1164  
*Nicoletella semolina*, 996  
 Nicotiana, 1200  
*Nicotiana glauca*, 1837  
*Nicotiana tabacum*, 1837  
 Nicotine, poisoning of, 1213  
 Nicotinic acid deficiency, 1325  
 Nidus formation, 1144  
 Niemann-Pick disease, 1224–1227  
 Nigerian equine encephalitis, 1288  
 Night blindness (nyctalopia), 1166  
   in vitamin A deficiency, 1323  
 Night vision, vitamin A deficiency and, 1322  
 Night-blindness, testing for, 19  
 Nipah, 2135–2136  
 Nitazoxanide, for equine protozoal myeloencephalitis, 1312

- Nitrate, poisoning, 834b, 837  
 animal risk factors and, 828  
 cattle, 828  
 clinical findings of, 829  
 clinical pathology of, 829  
 control of, 830  
 environmental factors of, 829  
 etiology of, 827–828  
 minimum lethal dose, 829  
 necropsy findings of, 829  
 pathogenesis of, 829  
 pigs, 829  
 ration dilution, 830  
 sheep, 828  
 toxic levels of, 830  
 treatment of, 830, 838b
- Nitrite, poisoning, 834b, 837  
 animal risk factors and, 828  
 cattle, 828  
 clinical findings of, 829  
 clinical pathology of, 829  
 control of, 830  
 differential diagnosis of, 836b  
 environmental factors of, 829  
 epidemiology of, 828  
 etiology of, 827–828  
 minimum lethal dose, 829  
 necropsy findings of, 829  
 pathogenesis of, 829  
 pigs, 829  
 ration dilution, 830  
 risk factors of, 828  
 samples for confirmation of diagnosis, 829–832  
 sheep, 828  
 toxic levels of, 830  
 treatment of, 830, 838b
- Nitrocompound plant toxicosis (milk vetch), 1195, 1196b–1197b
- Nitrofurans, 173
- Nitrogen dilution test, 864–865
- Nitroxylin  
 for bunostomosis, 614  
 in fasciolosis, 644
- N-methyl-D-aspartate receptor antagonists, for pain, 83
- Nocardia* sp., mastitis and, 1960–1961, 1961b
- Nociception, 79  
 in cattle, 81f
- Nodularins, 102
- Nodules, oesophagostomosis, 615–616
- Noise pollution, 106
- Nonambulatory cows  
 disposition of, 1698  
 with nonprogressive neurologic findings, 1693–1699, 1693b
- Nonesterified fatty acids, 1668–1669  
 in energy balance, 1669f  
 fatty liver and, 1718, 1722
- Nonesterified fatty acids (NEFA), left-side displacement of abomasum and, 504
- Non-feed-borne transmission, of bovine spongiform encephalopathy, 1295
- “Nonparasitic scouring syndrome”, 605
- Nonpastured cattle, interstitial pneumonia in, 968
- Nonprogressive atrophic rhinitis, 1047–1048
- Nonprotein nitrogen (NPN) toxicosis, 618b  
 differential diagnosis, 619b–620b  
 treatment, 620, 620b
- Nonregenerative anemia, 731
- Nonshivering thermogenesis, 43, 45–46
- Nonspecific colitis, 334–335
- Nonsteroidal antiinflammatory drugs (NSAIDs)  
 for acute undifferentiated bovine respiratory disease, 911  
 for bovine respiratory syncytial virus, 951  
 for bronchitis, 879  
 for degenerative joint disease, 1410–1411  
 for endotoxemia, 65  
 for equine colic, 234  
 for equine pleuropneumonia, 995  
 for gastric ulcer in foals, 246  
 for guttural pouch empyema, 985  
 for intestinal obstruction, 528  
 for laryngitis, 879  
 for listeriosis, 1342  
 for mastitis, 1927  
 coliform, 1952  
 for pain, 82–83  
 for peritonitis, 220  
 for pneumonia, 891–892  
 for puerperal metritis, 70  
 for respiratory tract disease, 871  
 toxic nephrosis from, 1112  
 for tracheitis, 879
- Nonsweating syndrome, 1561–1562
- Nonulcerative keratouveitis, 1123
- Nonviable hypotrichosis, 1644
- Nonvolatile buffer ion acidosis, 126
- Norepinephrine, for endotoxemia, 65
- Normovolemic anemia, 728, 742
- Norovirus, 389  
 bovine, 387  
 porcine, 342
- North America, bovine spongiform encephalopathy in, 1295–1297
- North American blastomycosis, 2160–2161, 2161f
- North Country Cheviot lambs, liver rupture in, 625
- Northern Ireland, bovine spongiform encephalopathy in, 1294–1300
- Norway, bovine virus diarrhoea virus eradication program, 598
- Nostrils, clinical examination of, 19
- Novel porcine parvoviruses, 2137
- Novel porcine viruses, 2135–2136  
 Bungowannah virus, 2137  
 Japanese B encephalitis, 2136–2137  
 menangle, 2136  
 Nipah, 2135–2136  
 novel porcine parvoviruses, 2137  
 porcine parvovirus, 2137  
 porcine retroviruses, 2136  
 Reston virus, 2137  
 Tioman virus, 2136
- Novobiocin, 174
- Nuclear factor κB (NF-κB), 60
- Nuclear imaging, in respiratory system, 858
- Nuclear scintigraphy  
 for musculoskeletal system disease, 1377  
 for septic arthritis synovitis, 1414
- Nucleic acid  
 epizootic hemorrhagic disease and, 784  
 recognition  
 in contagious bovine pleuropneumonia, 928  
 methods, for bovine tuberculosis, 2019
- “Nursery pasture”, 1878
- Nursing beef calves, bovine respiratory syncytial virus in, 947
- Nursing behavior, in postpartum dysgalactia syndrome and, 1998
- Nursing care, for newborns, 1863
- Nutrients, addition to water of, prevention of, 103
- Nutrition  
 alimentary tract dysfunction, 183  
 coliform mastitis and, 1953  
 degenerative joint disease and, 1406  
 edema disease, 313  
 and feeding methods, colibacillosis and, 1881  
 hemonchosis in ruminants, 611  
 history taking of, 7–8  
 lameness in pigs and, 1421  
 osteodystrophy and, 1388  
 performance shortfalls in, 94
- Nutritional deficiencies, 823, 1747–1753  
 abnormal absorption in, 1748  
 abnormal requirement of, 1748  
 abnormal utilization of ingested nutrients in, 1748
- anemia, nonregenerative, 731  
 congenital defects and, 1837  
 evidence of  
 associated with disease, 1748  
 based on cure or prevention by correction of, 1748–1752  
 as cause of disease, 1747–1748  
 immunosuppression of, 758  
 intrauterine growth retardation in, 1840  
 levels of nutritional service in, 1749  
 maternal, 1846–1847  
 myocardial disease/cardiomyopathy etiology, 691  
 nutritional advice for  
 beef feedlots, 1750  
 for sheep flocks, 1751–1752  
 for swine-herds, 1750–1751  
 nutritional management in, 1748–1749  
 nutritional status of, 1748  
 stress induction and, 85  
 sudden death by, 100
- Nutritional diseases, 1458–1479  
 encephalomalacia and, 1187
- Nutritional (trophopathic) hepatitis, 630–631
- Nutritional history  
 for musculoskeletal system disease, 1377  
 osteodystrophy and, 1390
- Nutritional management, in mastitis control program, 1979
- Nutritional muscular dystrophy  
 enzootic, 1378  
 necropsy findings of, 1473  
 pathogenesis of, 1468  
 treatment for, 1473–1474
- Nutritional service, in nutritional deficiencies, 1749
- Nutritional status  
 anaplasmosis risk factors and, 771–772  
 disorders of, 87–88  
 in risk factors, of bovine mastitis, 1908–1909
- Nutritional support  
 diarrhea, chronic undifferentiated, 282  
 in newborn, 1864–1865
- Nyctalopia, testing for, 19
- Nymphomania, in cows, 1822
- Nystagmus, 1162  
 inherited, 1660

## O

- Oak (*Quercus* spp.), 2207
- Obesity, equine metabolic syndrome and, 1731
- Obligate anaerobes, equine pleuropneumonia, 991
- Obstacle test, for blindness, 19
- Obstruction  
 atelectasis, 883  
 esophageal, 893
- Obstructive shock, 71–76, 71b  
 clinical findings, 73  
 clinical pathology, 73–74  
 differential diagnosis of, 74b  
 etiology of, 72  
 necropsy findings in, 74  
 pathogenesis of, 72–73  
 treatment for, 74–76
- Occult forms, leptospirosis, 1120–1121
- Occupation time, examination of, 9
- Ochratoxin poisoning, 649
- Ochratoxins (ochratoxicosis), 1136–1137, 1136b  
 differential diagnosis of, 1137b
- Ocular abnormalities, in vitamin A deficiency, 1317f, 1322–1323
- Ocular dermoids, 1659
- Ocular lesions, thrombotic meningencephalitis, 2036
- Ocular movements, testing of, 1170
- Ocular squamous-cell carcinoma, 1640
- Odema (opacity), of cornea, 2078–2079

- Oenanthotoxin, 2208
- Oesophagostomiasis, 615–617, 615b  
 clinical findings, 616  
 clinical pathology, 616  
 control, 616–617  
 diagnostic confirmation, 616  
 differential diagnosis, 616b  
 epidemiology, 615  
 etiology, 615  
 necropsy findings, 616  
 pathogenesis, 615–616  
 pigs, 615–616  
 sheep, 616  
 treatment, 616, 616b
- Oesophagostomum*, 615
- Oesophagostomum asperum*, 615
- Oesophagostomum columbianum*, 615
- Oesophagostomum dentatum*, 615
- Oesophagostomum quadrispinulatum*, 615
- Oesophagostomum radiatum*, 615
- Oesophagostomum venulosum*, 615
- Oestrus ovis*, 979–980
- Offspring segregation, of pseudorabies, 1249–1250
- Oil field pollutants, 106
- Oils, bloat prevention, 480
- Olfactory mucosa, neoplasms of, 875
- Olfactory nerve (cranial nerve I), assessment of, 1165–1169
- Oliguria, 1097–1098
- Omasum, 437  
 diseases of, 457–459  
 impaction of, 499–500, 499f, 515–517
- Omental bursitis, 270–271, 522
- Omentopexy, 508
- Omeprazole, 245, 246f, 250–251
- Omphalitis, 1900–1901
- Omphaloarteritis, 1901
- Omphalophlebitis, 1901
- Onchocerciasis, 1609–1610  
 treatment of, 1610b
- Oncolytic agents, lymphosarcoma, 750
- Oncotic pressure  
 decreased, 113  
 edema and, 128–130  
 clinical findings in, 130  
 clinical pathology of, 130  
 differential diagnosis of, 130b  
 etiology of, 128–130  
 necropsy findings in, 130  
 pathogenesis of, 129–130  
 treatment of, 130  
 plasma, decreased, 128–129
- Ondiri disease, 779
- Online Mendelian Inheritance in Animals (OMIA), 112
- Open-mouth breathing, 849
- Ophthalmoscopy, in nervous system examination, 1177
- Opiates, 213, 234
- Opioids, for degenerative joint disease, 1410–1411
- Opisthotonus, posture of, 1159
- Optic nerve (cranial nerve II)  
 assessment of, 1165  
 diseases of, blindness from, 1179
- Oral administration, of antimicrobials, 160–162
- Oral cavity, examination of, 445
- Oral electrolyte solution  
 alkalinizing agent in, 149  
 glucose in, 149  
 glycine in, 149  
 for horses, 150  
 osmolality of, 148–149  
 propionate in, 149  
 for ruminants, 150  
 sodium concentration of, 149
- Oral fluids, in swine influenza, 1082
- Oral necrobacillosis, 534–536, 534b  
 differential diagnosis, 535b  
 treatment, 535b–536b
- Oral neoplasms, 431
- Oral sugar test, for equine metabolic syndrome, 1735
- Orbit, diseases of, blindness from, 1178
- Orbiviruses, porcine, 342
- Orchitis  
 actinomycosis, 531  
*Brucella abortus* infection, 1765  
*Brucella suis* in, 1780
- Orf, 1593–1596, 1593b  
 peste des petits ruminants and, 575
- Orf virus (ORFV), 602
- Organic arsenical, swine dysentery, 332
- Organochlorine insecticides, 1210, 1216b–1218b
- Organophosphate  
 anthelmintics, 612  
 in congenital defects, 1837  
 poisoning, 882
- Organophosphorus compounds, poisoning from, 1209, 1214b  
 clinical findings of, 1215  
 control of, 1217  
 differential diagnosis of, 1215b–1216b  
 epidemiology of, 1214  
 etiology of, 1214  
 industrial organophosphates in, 1217  
 necropsy findings of, 1216  
 pathogenesis of, 1215  
 risk factors of, 1214–1215  
 transmission of, 1215  
 treatment of, 1216b
- Oriental cockroach (*Blatta orientalis*) nymphs, 553
- Oriental theileriosis, 2144
- Ornithine carbamoyl transferase (OCT), liver function test, 628
- Oryctolagus cuniculus* (wild rabbit), Johne's disease, 553
- Oscillometric sphygmomanometry, 671
- Oscillometry, impulse, 864
- Osmolal gap, 136
- Osmolality, 138  
 of oral electrolyte solution, 148–149
- Osmolarity, 138
- Osmotic diarrhea, 208
- Osseous sequestration, in cattle, 1392, 1392f–1393f
- Osseus metaplasia, 291
- Osteitis, salmonellosis, 365
- Osteoarthritis, degenerative joint disease and, 1499–1500
- Osteoarthropathy, 1406–1411  
 primary, 1407
- Osteochondrosis, 1406–1411  
 etiology and epidemiology and, 1406–1407  
 leg weakness in pigs and, 1420, 1422  
 pathogenesis of, 1408
- Osteodystrophia fibrosa, 1388–1390  
 clinical findings of, 1498  
 clinical pathology of, 1498  
 control of, 1499  
 differential diagnosis of, 1499b  
 epidemiology of, 1498  
 etiology of, 1497–1498  
 necropsy findings of, 1498  
 pathogenesis of, 1498  
 phosphorus ratio and, 1482  
 treatment for, 1499
- Osteodystrophy, 1388–1391  
 of chronic fluorosis, 1390  
 clinical findings of, 1390  
 diagnosis of, 1390  
 differential diagnosis of, 1391b  
 etiology of, 1388–1389  
 necropsy findings of, 1390–1391  
 pathogenesis of, 1389–1390  
 treatment for, 1391
- Osteofluorosis, fluoride toxicosis and, 1508–1509
- Osteogenesis imperfecta, inherited, 1532
- Osteomalacia, 1496–1497, 1496b  
 clinical findings of, 1497  
 clinical pathology of, 1497  
 control of, 1497  
 differential diagnosis of, 1497b  
 epidemiology of, 1497  
 etiology of, 1497
- necropsy findings of, 1497  
 pathogenesis of, 1389, 1497  
 treatment for, 1497  
 vitamin D deficiency and, 1482
- Osteomyelitis, 1391–1394  
 clinical findings of, 1393  
 diagnosis of, 1393  
 differential diagnosis of, 1394b  
 etiology of, 1391–1392  
 hematogenous, 1392  
 necropsy findings of, 1393  
 pathogenesis of, 1391–1392  
 pyelogrammatous, jawbones, 531  
 treatment for, 1394
- Osteopetrosis, congenital, 1534
- Osteophagia, 88
- Osteoporosis, 589, 1390  
 phosphorus ratio and, 1482
- Osteosarcomas, osteodystrophy and, 1389
- Ostertagia*, 603, 605  
 see also Trichostrongylid worms
- Ostertagiosis, bovine, 605
- Otitis, in feedlot cattle, 2036
- Otitis externa, 1660–1661
- Otitis media/interna, 1334, 1339b  
*Mycoplasma bovis*, 933–937
- Ototoxicity, of aminoglycosides, 169
- Outdoor environment, history taking of, individual animal, 8–9
- Outer membrane proteins (OMPs), 1116
- Outflow abnormality, scant feces, 180
- Ovarian dysfunction, bovine virus diarrhea virus, 583
- Overactive stretch reflex, 1350f, 1354
- Overcrowding, 9  
 swine dysentery, 328
- “Overeating disease”, 1230
- Overfeeding, in fatty liver, 1718
- Overhydration, acute, 115
- Overmilking, avoidance of, 1968
- Overnourishing, in intrauterine growth retardation, 1840, 1847
- Overwintering, 2071
- Ovine atopic dermatitis, 1548
- Ovine contagious ophthalmia, 1653–1654, 1653b
- Ovine encephalomyelitis, 1259b, 1283–1286  
 clinical findings of, 1265–1268  
 clinical pathology of, 1265  
 control of, 1265  
 differential diagnosis of, 1262b  
 epidemiology of, 1262–1265  
 etiology of, 1262  
 geographic occurrence of, 1264  
 host and environmental risk factors for, 1264  
 host occurrence of, 1264  
 necropsy findings of, 1265–1267  
 nontick transmission of, 1264  
 occurrence of, 1262–1264  
 pathogenesis of, 1265  
 samples for diagnostic confirmation of, 1265  
 transmission of, 1264  
 treatment for, 1265–1266  
 zoonotic implications of, 1264–1265
- Ovine enzootic abortion, 1786–1791, 1786b–1787b
- Ovine heritable arthrogryposis multiplex congenita, 1539
- Ovine humpyback, 1518
- Ovine interdigital dermatitis, 1443b
- Ovine Johne's Disease Control and Evaluation Program, 571–572
- Ovine “kangaroo” gait, 1367–1368
- Ovine ketosis, in pregnancy toxemia, 1724
- Ovine lentiviruses, 974
- Ovine nasal adenocarcinoma virus (ENT-1), 969–970
- Ovine postdipping necrotic dermatitis, 1548
- Ovine progressive pneumonia, 973–977, 973b–974b  
 clinical findings of, 975–976  
 clinical pathology of, 976  
 control of, 976–977  
 differential diagnosis of, 976b  
 epidemiology of, 974–975



Ovine progressive pneumonia (*Cont'd*)  
 etiology of, 974  
 necropsy findings in, 976  
 pathogenesis of, 975  
 treatment of, 976

Ovine pulmonary adenocarcinoma, 977–979, 977b, 979b, 1089

Ovine skin cancer, 1641

Ovine white liver disease, 816

Oxalate, toxic nephrosis from, 1113

Oxfendazole  
 for lungworm, 964  
 for parasitic gastroenteritis in ruminants, 607

Oxidative damage, anemia and, 734–735, 736f

Oxime, in organophosphate poisoning, 1217

Oximetry, anemia and, 737

Oxyclozanide, 618, 644

Oxygen delivery, 735–736, 865  
 system, transtracheal, 869

Oxygen saturation, 865

Oxygen tension  
 low inspired, in hypoxic hypoxia, 847  
 measurement of, 865

Oxygen therapy, for respiratory tract disease, 869–870, 870t

Oxygen toxicity, 869–870

Oxytetracycline  
 for acute undifferentiated bovine respiratory disease, 912  
 for anaplasmosis, 774  
 for borreliosis, 1428  
 for bovine digital dermatitis, 1438–1439  
 for brucellosis associated with *Brucella ovis*, 1776  
 for coliform mastitis, 1951  
 for osteodystrophy, 1391  
 for pleuropneumoniae, of pigs, 1062

Oxytocin  
 for coliform mastitis, 1951  
 for postpartum dysgalactia syndrome, 2000  
 for puerperal metritis, 70

*Oxytropis* spp., 1837

*Oxyuris equi*, 415–416, 415b

## P

*P. purpurogenum*, 654

*P. rubrum*, 654

P26, equine infectious anemia, 788

Pachyderma, 1544–1545  
 differential diagnosis of, 1545b  
 treatment of, 1545

Packed cell volume (PCV)  
 for dairy-herd metabolic profile testing, 1671  
 equine colic, 232  
 naturally occurring combined abnormalities of free water, electrolyte, acid-base balance, and oncotic pressure, 132  
 peritoneal fluid, 189

Pain, 78–84  
 assessment of, 78–79  
 attitude towards, advances in, 79  
 behavioral responses to, 80  
 central hypersensitivity, 80  
 clinical findings in, 80–81  
 cutaneous or superficial, 79  
 definition of, 78  
 duration and periodicity of, 81  
 in dyspnea, 849  
 elicitation of, by veterinarian, 80  
 equine colic, 225  
 etiology of, 79  
 measurement of, difficulties in, 278  
 musculoskeletal (somatic), 79  
 pathogenesis of, 79–80  
 physiologic responses to, 80  
 preemptive analgesia and, 80  
 problem of, 78–79

reticulorumen motility, primary contraction  
 influence, 439  
 stress induction, 84  
 treatment for, 81–84  
 visceral, 79

Pain receptors, 79

Palatal dysfunction, 982–984

Palatitis, 192  
 see also Stomatitis

Pale, soft, and exudative (PSE) pork, 1527–1528

Palmar digital artery pulse, laminitis, horse and, 1400

Palpation  
 of abdomen, 484  
 of bladder, 20  
 in clinical examination, 13  
 of hair coat, 21  
 of inguinal ring, 20  
 of kidney, 20  
 of liver, 625–626  
 of lung, 17  
 in nervous system examination, 1172  
 of pharynx, 196  
 of rumen, 437, 446  
 of spleen, 20  
 of testicles, 1775  
 through abdominal wall, 17–18  
 of tongue, 533

Palpebral eye-preservation reflex, in polioencephalomalacia, 1315

Pancreas, diseases of, 656

Pancreatic adenocarcinoma, 656

Pancreatic adenoma, 656

Pancreatitis, 656

Pancytopenia, 746

Pandy test, 1177

*Pangonia* spp., 1626

Panhypoproteinemia, 718

Panhyproteinemia, 717

Panniculitis, 1557, 1726–1727

Panniculus reflex, 1164

Pansystolic murmur, 687

Pantothenic acid deficiency, 1326

Papilloma, 1640

Papillomatosis, 1580–1585, 1580b  
 in cattle, 1582, 1582f–1583f  
 clinical findings of, 1582–1584  
 clinical pathology of, 1584  
 control of, 1585  
 differential diagnosis of, 1584b  
 economic importance of, 1582  
 epidemiology of, 1581–1582  
 etiology of, 1580–1581  
 experimental production of, 1582  
 in goats, 1583  
 in horses, 1583–1584  
 pathogenesis of, 1582  
 treatment of, 1584–1585  
 vaccination for, 1584–1585

Papillomatous digital dermatitis of cattle. see Bovine digital dermatitis

Papillomavirus infection, 1580–1585

Para-amino-benzoic acid (PABA), 172

Parachute left atrioventricular valve, 706

Paracoccidiosis infection, 2159

Paradoxical aciduria, 119

Paradoxical vestibular syndrome, 1162

*Parafilaria bovicola*, 722–723

Parafilariosis, 1610–1611, 1610b

Paraganglioma, 1736

Parainfluenza-3 paramyxovirus, in enzootic pneumonia of calves, 939

Parainfluenza-3 virus, 1029  
 in chronic enzootic pneumonia of sheep, 972–973  
 in enzootic pneumonia of calves, 941–942

Parakeratosis, 1544, 1634–1637, 1634b  
 clinical findings of, 1635–1636  
 clinical pathology of, 1636

control of, 1637  
 differential diagnosis of, 1544b–1545b, 1636b  
 etiology of, 1634–1635  
 in goats, 1636  
 infertility in ewes and, 1636  
 inherited, 1643  
 necropsy findings in, 1636  
 pathogenesis of, 1635  
 in pigs, 1634  
 ruminal, 472–482, 473f  
 in ruminants, 1634–1635  
 in sheep, 1636  
 treatment of, 1544, 1636–1637

Paralysis, 1158  
 bladder, 1139  
 calving, 1362  
 degree of, 1163  
 diaphragmatic, 1362  
 in encephalopathy, 1194  
 of femoral nerve, in calves, 1362  
 hyperkalemic periodic, 121  
 inherited congenital posterior, 1352–1357  
 nervous system disease, 1162  
 tick, 1363–1367, 1367t  
 vitamin A deficiency and, 1324–1325

Paralytic ileus, 180, 216–217

Paralytic respiratory failure, 848

Paranasal sinus fluid, in respiratory secretions, 859–860

Paranasal sinuses  
*Aspergillus* spp. in, 1045  
 endoscopy of, 856

Parapoxvirus (PPV), 602

*Parascaris equorum*, 409

Parasite refugia, 608–609

Parasites  
 attenuation of, 806  
 enteritis and, 206t  
 wild boar, 2009

Parasitic arteritis, 709–710

Parasitic diseases, of alimentary tract, 397–401

Parasitic gastritis, in pigs, 417–418, 417b–418b

Parasitic gastroenteritis (PGE)  
 cattle, 606–607  
 goats, 605, 607  
 in ruminants, 603–610, 603b  
 anthelmintic, choice of, 607–608  
 anthelmintic reliance reduction, 610  
 anthelmintic resistance, 608  
 clinical findings, 606  
 clinical pathology, 606  
 contamination, sources of, 604–605  
 control, 608–610  
 diagnostic confirmation, 606–607  
 differential diagnosis, 607b  
 disease, outbreaks of, 605  
 epidemiology, 603–605  
 etiology, 603  
 necropsy findings, 606  
 pathogenesis, 605–606  
 “resilience”, 604  
 sheep, 606–607  
 transmission, 604  
 treatment, 607, 607b

Parasitic hepatitis, 630–631

Parasitic infestation, in interstitial pneumonia, 966

Parasitic myocarditis, 690–691

Parasitism, hemorrhagic anemia and, 728

Parasitoses, weight loss from, 93

Parasympatholytic drugs, for respiratory tract disease, 872

Parasympathomimetic drugs, 191

Parasympathomimetics, 458–459

Paratuberculosis. see Johne’s disease

Paratyphoid. see Salmonellosis

Parbendazole, poisoning of, 1211

Parenchymatous enzymuria, 1103

- Parenteral antimicrobials, 162  
for coliform mastitis, 1950–1951
- Parenteral calcium, supplementation, for milk fever, 1689–1690
- Parenteral fluid therapy, 145
- Parenteral nutrition, 151–152  
colic in foals, 239  
in newborn, 1865
- Parenteral vitamin D<sub>3</sub>, for milk fever, 1689
- Paresis, 1158  
assessment of, 1171  
degree of, 1163  
in encephalopathy, 1194  
hypocalcemic, 1683  
involuntary spastic, 1160  
nervous system disease, 1162  
of sciatic nerve, 1359f, 1362  
spastic, of cattles, 1348f, 1350f, 1351
- Paresthesia, 1542
- Parity, pregnancy toxemia and, 1724
- Parotitis, 195
- Paroxysmal tachycardia, 683–684
- Paroxysmic respiratory distress syndrome (PRDS), 948
- Parquin, 1195
- Partial heart block, 679
- Partial hypotrichosis, 1644
- Partial milking, for milk fever, 1690
- Parturient diseases, 1830
- Parturient injury, 1843
- Parturient paresis, 1675–1690, 1675b
- Parturition, 1665  
*Brucella abortus*, transmission of, 1762  
cecal rupture, 258  
induction of, 517, 1758–1759, 1759b–1760b  
prolonged gestation with fetal gigantism, 1828  
trauma at, 1843
- Parturition syndrome, 67
- Parvovirus, 385, 389
- Paspalum staggers, 1202
- Passive immunity  
assessment of transfer of, 1853–1854  
decline of, 1852  
failure of transfer of, 1848–1856  
avoidance of, 1854–1856  
colibacillosis and, 1880  
correction of, 1854, 1863–1864  
to *Mannheimia haemolytica*, 922  
transfer failure of, 744t
- Pasteur vaccines, anthrax and, 2014–2015
- Pasteurella multocida*, 2043  
*Actinobacillus pleuropneumonia* and, 1057  
in enzootic pneumonia of calves, 939, 942  
in pneumonic pasteurellosis, 914  
in progressive atrophic rhinitis, 1047–1048
- Pasteurella* vaccines  
for acute undifferentiated bovine respiratory disease, 913  
for pneumonic pasteurellosis, 922
- Pasteurellosis, of sheep and goats, 2042–2043
- Pasture  
abrasive, actinobacillosis (wooden tongue), 533  
environmental examination of, 9  
equine grass sickness, 284  
management of, 1705  
sheep, infectious footrot in, 1442  
top dressing, 1705  
cobalt of, 819–820  
sodium selenate in, 1476
- Pasture bloat  
case fatality, 474–475  
clinical findings, 476–477  
control, 478–481  
epidemiology, 474  
etiology, 473  
genetic control of, 481  
morbidity, 474–475
- Pasture-associated heaves, 1012–1013
- Pastured cattle, interstitial pneumonia in, 967–968
- Patchy atelectasis, 883
- Patellar reflex, 1174
- Patellar subluxation, inherited, 1539
- Patent ductus arteriosus, 705
- Patent foramen ovale, 704–705
- Patent urachus, 1098, 1140
- Path models, for examination of population, 32
- Pathologic surveillance, for contagious bovine pleuropneumonia, 930
- Pattern recognition, for diagnosis, 2
- Patulin, 2204
- Patulin poisoning, 649
- Peat scours (“Teart”), in cattle, 2169
- Pediculosis, 1624–1625, 1624b
- Pedunculated lipomas, 215, 253
- Pellets, magnesium-rich, for hypomagnesemic tetany, 1705
- Pelvic limbs, injuries to  
in downer-cow syndrome, 1694  
at parturition, 1683
- Pelvis  
fracture of, 99–100  
injuries to, at parturition, 1683  
size of, trauma at parturition and, 1843
- Pemphigus, 1549
- Pemphigus foliaceus, 1549
- Pendular nystagmus, 1171, 1660
- Penetrating wound, 77
- Penicillin G, for guttural pouch empyema, 985
- Penicillins, 170–171  
categories of, 170t  
for listeriosis, 1341  
mechanism of action of, 170  
for neonatal streptococcal infection, 1903  
of strangles, 1022  
toxicity and clinical considerations for, 170–171
- Penicillium citrinum*, 649
- Penicillium roqueforti*, 1827–1828
- Penicillium*-associated mycotoxins, 1203
- Pentachlorophenol, 2193
- Pentastarch, 143
- Pentoxifylline  
for endotoxemia, 66, 234, 280  
for heaves, 1011
- Pepsinogen, 606
- Peracute intoxication, 826
- Peramivir, in equine influenza, 1035
- Percussion  
clinical examination of, 13–14  
equine colic, 227  
in equine pleuropneumonia, 992  
of liver, 625–626  
of lung, 17  
respiratory system, examination of, 855  
through abdominal wall, 17–18
- Percutaneous transtracheal aspiration, in tracheobronchial secretions, 861
- Percutaneous ultrasound-guided cholecystocentesis, 626
- Perennial ryegrass staggers, 1202–1204
- Performance, shortfalls in, 94
- Pergidin toxicosis, 654–655
- Pericardial friction rub, reticulopericarditis, 497–498
- Pericardial friction sound, pericarditis, 708
- Pericardiocentesis, 498
- Pericarditis, 707–709, 707b  
in cattle, 708  
clinical findings of, 708  
clinical pathology of, 708–709  
constrictive, 707–708  
differential diagnosis of, 709b  
etiology of, 707–708  
fibrinous, 707–708  
in goats, 708  
in horses, 708  
idiopathic effusive, 708  
necropsy findings of, 709  
pathogenesis of, 708  
in pigs, 708  
prognosis of, 709  
in sheep, 708  
in treatment of, 709
- Pericardium, diseases of, 707–709
- Periconia* spp., 654
- Perilla frutescens*, 966
- Perinatal diseases, 1830–1803  
classification of, 1830–1831  
cloned offspring, diseases of, 1870–1871  
congenital defects in, 1835–1840, 1835b–1836b  
clinical findings of, 1839  
clinical pathology of, 1839  
differential diagnosis of, 1839b  
epidemiology of, 1838  
etiology of, 1836–1838  
necropsy findings of, 1839  
pathogenesis of, 1838–1839  
fetal diseases in, 1830  
general epidemiology of, 1831–1835  
parturient diseases in, 1830  
physical and environmental causes of, 1840–1842  
postnatal diseases in, 1830–1831
- Perinatal fatality, sarcocystosis and, 2139
- Perinatal weak-calf syndrome, 1867–1870, 1867b  
control of, 1870  
differential diagnosis of, 1870b  
epidemiology of, 1868–1869  
etiology of, 1868–1869  
historical aspects of, 1867–1868  
necropsy findings of, 1869–1870  
prevention of, 1870  
treatment of, 1870
- Perinatology, 1841
- Perineal reflex, 1175
- Perineum, urine scalding, 1098
- Perinodal myocardial fibrosis, 677
- Periodic ophthalmia, leptospirosis, 1121–1123
- Periodontal disease, 194–195  
sheep, 194–195
- Periosteum, proliferation of the, 1391
- Periparturient egg rise (PPER)  
elimination of, parasitic gastroenteritis, 609  
*Oesophagostomum*, 615  
trichostrongylid worms, 604
- Peripheral blindness, 1163
- Peripheral circulatory failure, in dyspnea, 849
- Peripheral cyanosis, in respiratory insufficiency, 853–854
- Peripheral hyperalgesia, 79–80
- Peripheral nerve sheath tumors, 1370
- Peripheral nerves, 1178  
injection injuries to, 1362
- Peripheral nervous system, diseases of, 1357–1358
- Peripheral neuropathy, glomerulopathy and, 1111
- Peripheral nociceptors, 79–80
- Peripheral tissues, cold injury in, 51
- Perirectal abscess, 77
- Peristalsis  
abnormality, diarrhea, 179–180  
enteritis, 210  
equine grass sickness, 285  
failure, 180
- Peritoneal effusion, reticuloperitonitis and, 487
- Peritoneal fluid, 186–190  
analysis  
cecal impaction, 259  
characteristics, 186  
diarrhea, chronic undifferentiated, 281  
equine colic, 231  
equine grass sickness, 285  
large colon, displacement of, 262  
peritonitis, 218–219  
reticuloperitonitis, traumatic, 485–486  
bovine, 187t  
properties of, 187t, 189  
reference values, 189  
vagus indigestion, 494
- Peritoneal lavage, 220
- Peritoneal leiomyomatosis, disseminated, 432
- Peritoneum  
adhesions, 217  
diseases of, 215–220  
tumors of, 432
- Peritonitis, 215–220  
abdominocentesis, 189  
acute, 217–218

- Peritonitis (*Cont'd*)  
 acute diffuse, 69  
   abomasal ulcer and, 520  
 acute local, 520  
 case-fatality rate, 219  
 cattle, 215–216  
 chronic, 218, 270–271  
 chronic hypoalbuminemia and, 722  
 clinical findings, 217–218  
 clinical pathology, 218–219  
 colitis, right dorsal, 267–268  
 diagnosis, 219  
 differential diagnosis, 220*b*  
 etiology, 215–216  
 goats, 216  
 horses, 216  
 necropsy findings, 219  
 pathogenesis, 216–217  
 peracute diffuse, 218  
 prognosis, 219  
 septic, 219  
 sheep, 216  
 subacute, 217–218  
 treatment, 220
- Perivaginal abscess, 77
- Perivasular cuffing, 1184
- Perivasular reactions, intravenous antimicrobials and, 159
- “Permanent clover disease,” phytoestrogen toxicosis, 1823
- Pernicious anemia, 820
- Perreya flavipes*, 654
- Persistence of the right aortic arch, 706, 706*f*
- Persistent dorsal displacement, of soft palate, 984
- Persistent lymphocytosis (PL), 833, 841  
 diagnosis of, 838–839
- Persistent pulmonary hypertension of the neonate (PPHN), 693
- Persistent truncus arteriosus, 705
- Persistent (pervious) urachus, 1098
- Peruvian horse sickness virus, 1302
- Peste des petits ruminants (PPR), 573–577, 573*b*  
 acute forms, 575  
 biosecurity concerns, 575  
 case-fatality rate, 574  
 clinical findings, 575  
 clinical pathology, 575  
 control, 576–577  
 differential diagnosis, 576*b*  
 economic importance, 575  
 epidemiology, 574–575  
 etiology, 574  
 experimental reproduction, 575  
 immune mechanisms, 575  
 necropsy findings, 575–576  
 occurrence, 574  
 pathogenesis, 575  
 risk factors, 575  
 sample collection, 575  
 subacute forms, 575  
 transmission, 574–575  
 treatment, 576, 576*b*  
 zoonotic implication, 575
- Peste des petits ruminants virus (PPRV), 574–575
- Pestiviruses, 577
- Petrous temporal bone, fracture of, 1189–1190
- Pets, controlling contact by, 39
- Peyer's patches, 567
- PGE. see Parasitic gastroenteritis (PGE)
- pH  
 analysis of, and naturally occurring combined abnormalities of free water, electrolyte, acid-base balance, and oncotic pressure, 133–134  
 normal blood, 134  
 in urine, 1100, 1101*f*
- Phalanges, inherited, reduced, 1537
- Phalanx, third, laminitis, horse and, 1400
- Phalaris aquatica*, 1311
- Phalaris* spp. toxicosis, 2205–2206, 2205*b*
- Pharyngeal lymphoid hyperplasia, 196
- Pharyngeal obstruction, 197, 197*b*
- Pharyngeal paralysis, 197–198, 198*b*
- “Pharyngeal phlegmon”, 196
- Pharyngitis, 196–197, 197*b*, 878
- Pharynx  
 clinical examination of, 19–20  
 diseases of, 196–197  
 neoplasms, 431  
 palpation, 196
- Phaseolus vulgaris*, 966
- Phenolsulfonphthalein, plasma clearance and, 1104
- Phenothiazine, poisoning of, 1213
- Phenylbutazone  
 for degenerative joint disease, 1410  
 for disorders of thyroid function, 1740–1741  
 for endotoxemia, 65, 234, 280  
 for laminitis, of horse, 1402  
 for mastitis, 1927  
 for pain, 82  
 for retropharyngeal lymphadenopathy, 989  
 toxicity, venous thrombosis and, 714
- Phenylephrine, 262, 285
- Phenytion  
 myopathy, horse and, 1386–1387  
 rhabdomyolysis  
   in horses and, 1481  
   recurrent exertional for, 1521
- Phenytoin sodium, 684
- Pheochromocytoma, 1736
- Phlebitis, 714
- Phlegmon, 77, 1393  
 definition of, 77
- Phomopsins toxicosis (lupinosis), 650–652, 650*b*–651*b*  
 differential diagnosis, 651*b*
- Phonocardiography, 673
- Phosphate, retention, renal insufficiency, 1096–1097
- Phosphides, 2191
- Phospholipase A<sub>2</sub>, endotoxemia, 60
- Phosphorus  
 absorption of, 1482–1483  
 deficiency, 1482, 1485–1491, 1485*b*  
   cattle, 1485–1487  
   clinical findings of, 1488  
   clinical pathology of, 1488–1489  
   control of, 1489–1491, 1489*b*  
   differential diagnosis of, 1489*b*  
   epidemiology of, 1485–1487  
   etiology of, 1485  
   horses, 1487  
   necropsy findings of, 1489  
   pathogenesis of, 1487–1488  
   pigs, 1487  
   secondary, 1487  
   sheep, 1487  
   treatment for, 1489, 1489*b*  
 dietary  
   content of, 1489  
   milk fever and, 1678  
   requirements of, 1486*t*, 1489–1491  
 in macromineral evaluation, 1671  
 metabolism of, 1482–1483, 1483*f*  
 osteodystrophy and, 1388  
 serum  
   osteodystrophy and, 1390  
   phosphorus deficiency, 1488–1489  
   vitamin D deficiency and, 1493  
   supplementation, 1491
- Phosphorus deficiency, *Trichostrongylus colubriformis*, 605
- Phosphorus toxicosis, 421
- Photoperiod, lactation and, 1666
- Photosensitive thelitis, 1986
- Photosensitization, 1549–1552, 1549*b*  
 clinical findings of, 1551  
 clinical pathology of, 1551  
 differential diagnosis of, 1551*b*–1552*b*
- etiology and epidemiology of, 1549–1551
- hepatitis and, 631
- hepatogenous, 1550
- hyperbilirubinemia and, 1646
- in liver disease, 625
- necropsy findings in, 1551–1552
- pathogenesis of, 1551
- plant poisoning and, 1637–1638
- plants causing, 649
- primary, 1550
- as result of aberrant pigment metabolism, 1550
- treatment of, 1552
- of uncertain etiology, 1551
- Photosensitizing substances, 1550
- Phylloerythrin, 1550
- Physical effort, excessive, stress induction, 84
- Physical examination  
 of abomasum, 500  
 in exercise-induced pulmonary hemorrhage, 999, 999*f*  
 for musculoskeletal system disease, 1376
- Physical therapy, for septic arthritis synovitis, 1417
- Physiological arrhythmias, 676–679
- Phystitis, osteodystrophy and, 1388–1389
- Phytobezoars  
 abomasal, 518  
 luminal blockages, 525
- Phytoestrogen toxicosis, 1822–1824, 1822*b*  
 clinical findings of, 1823  
 clinical pathology of, 1823  
 control of, 1824  
 differential diagnosis of, 1824*b*  
 epidemiology of, 1822–1823  
 etiology of, 1822  
 in fungi, 1822  
 necropsy findings of, 1823–1824  
 occurrence of, 1822  
 pathogenesis of, 1823  
 in plants, 1822  
 risk factors of, 1822–1823  
 treatment of, 1824
- Phylogenous chronic copper poisoning, 823
- PI-3 V vaccine, 913
- Pica, 88–89  
 consequences, 89  
 definition of, 87  
 gastric ulcers, 288  
 significance of, 89  
 types of, 88
- Picornaviruses, porcine, 342
- Pietrain creeper pigs, 1529
- Pigeon fever, 1449–1450
- Piglets  
*Actinobacillus* septicemia in, 2056–2057  
 acute undifferentiated diarrhea, 373–377  
 administration of colostrum in, 1856  
 coccidiosis, 405  
 colibacillosis in, 1880, 1886–1887  
 congenital defects in, 1839  
 congenital fixation of joints in, 1511  
 congenital tremor syndromes of, 1248–1252  
 critical temperature of, 1846  
 diarrhea  
   dietary, 214  
   viral, 384–393  
 enteritis in, *Clostridium perfringens* type A, 545  
 fetal disease in, 1833  
 fluid and electrolyte therapy in, 151  
 hypothermia in, 1846  
 management of, 1834  
 mortality in, 1833  
 navel (umbilical) bleeding in, 723  
 necrosis of the skin of, 1985  
 neonatal hypothermia in  
   prevention of, 50  
   risk factors for, 48  
   treatment for, 50  
 in neonatal streptococcal infection, 1902



Piglets (*Cont'd*)

- parturient disease in, 1833–1834
- parturition, induction of, 1759
- porcine coronavirus, 388
- porcine reproductive and respiratory syndrome, 1800
- porcine rotavirus, 387–388
- postnatal disease in, 1834
- postpartum dysgalactia syndrome and, 2000
- septic arthritis synovitis and, 1412
- septicemia in, 57
- streptococcal arthritis and, 1416
- streptococcal infection in, 1901
- teeth clipping of, 1848
- vaccination of, 2131
- viable weight of, 1833

## Pigs

- age-related changes in, 1418–1420
- anaphylaxis of, 750–751
- anthrax in, 2013
- ascariasis, 409–411
- asymmetric hindquarter syndrome of, 1529
- biotin and, 1503
- botulism in, 1368
- bronchitis in, 878
- cerebellar abiotrophy in, 1334
- changes in behavior of, stray voltage, 105
- chlamydial infection in, 2057–2058
- coccidiosis, 402
- congenital cardiac defects and, 704
- congenital progressive ataxia and spastic paresis, 1350
- congenital skin tumors in, 1643
- congenital tremor of, 1355
- control of tuberculosis in, 2023
- copper deficiency, 2170
- cryptosporidiosis, 397
- electrocution of, 104
- eperythrozoonosis and serology, 781–784
  - source of transmission, 779
- granulomatous lesions in, 1559
- hemorrhagic shock, 72
- infected by bovine tuberculosis, 2018
  - necropsy findings of, 2021
- inherited congenital hydrocephalus in, 1329–1331
- inherited deficiency in, 1747
- inherited dermatosis vegetans in, 1646
- injections for, selenium, 1475–1476
- iodine deficiency in, 1744
- kidney worm disease in, 1134–1135, 1134b
- lameness in, 1418–1424
- laryngitis in, 878
- lead poisoning in, 1206
- leptospirosis and, 1118, 1122
- listeriosis in, 1340
- lungworm in, 1086–1087, 1086b
  - with *M. bovis*, 2017
- major pathogenic *Mycoplasma* spp. of, 885t
- malignant catarrh in, 2080
- malignant catarrhal fever, 2079
- melioidosis, clinical findings, 2030
- methicillin-resistant *Staphylococcus aureus* in, 1566–1567
- muscular dystrophy in, 1470
- mycobacteriosis associated with MAC and with atypical mycobacteria, clinical and necropsy findings of, 2025
- mycoplasmal hyosynoviae in, 1455–1456
- neonatal, iron toxicosis, 2188
- neonatal infection in, 1874
- newborn
  - splayleg syndrome in, 1529–1530
  - splaylegs of, 1378
- organophosphorus poisoning in, 1215
- osteochondrosis and, 1409
- osteodystrophia fibrosa in, 1388, 1498
- osteomalacia in, 1497
- otitis media/interna in, 1335–1336
- parasitic gastritis in, 417–418
- phosphorus deficiency in, 1487

- phosphorus requirements for, 1491
- pleuritis in, 896
- pleuropneumonia of, with *Actinobacillus pleuropneumoniae*, 1055–1064
- pneumonia in, 886
- primary vitamin A deficiency in, 1322
- pruritus in, 1543
- pseudorabies in, 1248
- rabies in, 1241
- reactivity to voltage levels, 105
- reproductive performance, selenium and vitamin E deficiency, 1465
- respiratory tract of, diseases of, 1047–1054
  - rhinitis in, 874
- ricketts in, 1495
- selenium and vitamin E deficiency and, 1472–1473
- selenium supplementation in, 1475
- selenium-responsive reproductive performance in, 1477–1478
- septic arthritis synovitis and, 1412
- septicemia in, 57
- Streptococcus suis* infection, 2045–2051, 2045b
- thiamine deficiency in, 1319
- thick forelimbs of, 1537
- thorny-headed worm in, 419
- tracheitis in, 878
- transfer of selenium and vitamin E in, 1467
- tuberculin testing in, 2020
- tularemia, clinical findings, 2028
- ulcerative dermatitis of, 1579–1580
- vesicular stomatitis, 396
- vitamin E-selenium deficiency in, 1470
- water medication of, 161
- zinc toxicosis
  - acute poisoning, 2195
  - chronic poisoning, 2195

*Pilobolus*, 962

## Pinching, 1174

## “Pine,” lamb dysentery, 547

## Pinkeye, 1650–1653

## Pinworm, 415–416, 415b

## Pioglitazone, for equine metabolic syndrome, 1736

## Piperazine, poisoning of, 1211–1212

## Piperidine alkaloid plant toxicosis, 1195–1197

*Pithomyces chartarum*, 652, 654

## Pithomycotoxicosis, 652–654, 652b

- in cattle and sheep, 653f
- differential diagnosis of, 653b
- distribution of, 653f

## Pithyosis hyphomycosis destruens (equine

- phycomycosis), 813b, 814–817
- differential diagnosis of, 814b

## Pituitary abscess, 77

## Pituitary abscess syndrome, 1191, 1191b

## Pituitary gland

- abscesses of, 1191
- adenoma of the pars intermedia of, 1221
- hypophysis of, 1221

## Pituitary pars intermedia dysfunction, equine, 1727–1731

- clinical findings of, 1727–1728
- clinical pathology of, 1728
- control of, 1730
- diagnostic confirmation of, 1728–1730, 1729t
- differential diagnosis of, 1730b
- epidemiology of, 1727
- etiology of, 1727
- necropsy findings of, 1730
- pathogenesis of, 1727
- treatment of, 1730

## Pityriasis, 1543–1544

## Pityriasis rosea, 1544, 1648

- differential diagnosis of, 1648b
- treatment of, 1648

## Pizzle rot, 1152, 1152b–1153b

- differential diagnosis of, 1154b
- treatment and prophylaxis of, 1154b

## Placenta

- abnormalities, in cloned offspring, 1871
- in ovine enzootic abortion, 1787

- premature-like signs, in foals, 1843
- retained fetal, selenium and vitamin E deficiency and, 1465
- retention of, 68

## Placental cotyledons, 1787

## Placentitis

- brucellosis associated with *Brucella ovis*, 1775
- precocious lactation and, 1843

## Plant phenols (gossypol and tannins), 2207

## Plant poisoning, 1506

- caused by toxins, 1137
- in interstitial pneumonia, 966
- miscellaneous, 1137
- from unidentified toxins, 1137
- volcanic ash fallout, 109

## Plant toxicosis, miscellaneous, 2207–2212

## Plants

- abortion and, 1827
- affecting nervous system, 1195, 1203
- awns or spines, stomatitis, 192
- causing pulmonary disease, 1088
- containing hepatotoxins, 1550
- containing steroidal saponins, 1550
- materials, causing physical damage, 427
- poisoning
  - associated with known toxins, 1637
  - associated with unidentified toxins, 1637–1638
- selenium in, 1461
- toxins, affecting the alimentary tract, 427–429
- unidentified toxins, affecting the gastrointestinal tract, 429

## Plaque

- in dourine, 1820
- peste des petits ruminants, 575

## Plasma, 142, 1864

- decreased oncotic pressure in, 128–129
- hyperimmune, 142
- in neonatal infection, 1877
- pH, 124

## transfusion, hypofibrinemia and, 719

## transfusion of, in newborn, 1864

Plasma  $\delta$ -aminolevulinic acid, in lead poisoning, 1207Plasma fibrinogen concentration, in *Rhodococcus equi* pneumonia, 1016

## Plasma glucose, and naturally occurring combined abnormalities of free water, electrolyte, acid-base balance, and oncotic pressure, 134–135

## Plasma L-Lactate concentration

- and anion gap, 135
- and naturally occurring combined abnormalities of free water, electrolyte, acid-base balance, and oncotic pressure, 134

## Plasma oncotic pressure, 882

## Plasma potassium concentration, in acute

- hypokalemia, 1691–1692

## Plasma protein, naturally occurring combined abnormalities of free water, electrolyte, acid-base balance, and oncotic pressure and, 132

## Plasma transfusion, for endotoxemia, 66

## Plasmacytoma, 745–746

## Plasmid-determined antimicrobial resistance, 156–157

## Plasmids, 156

## Platelet(s)

- count, 721
  - disseminated intravascular coagulation and, 728
- disorders of, 723–725
  - and endotoxemia, 61
  - equine infectious anemia of, 790
  - in excessive bleeding, of exercise-induced pulmonary hemorrhage, 1003
- function, 721
  - thrombocytopenia of, 723–724
- Platelet count, and radiation, 108

## Pleural cavity

- diseases of, 895–896
  - diaphragmatic hernia in, 900–901, 901f
  - hemothorax in, 895–896, 896b

- Pleural cavity (*Cont'd*)  
 hydrothorax in, 895–896, 896b  
 pleuritis (pleurisy) in, 896–899, 898b, 899f  
 pneumothorax in, 899–900, 900b  
 drainage and lavage of, for pleuritis, 898, 899f
- Pleural effusion  
 hemangiosarcoma and, 715  
 pleuritis, 897
- Pleural fluid, in equine pleuropneumonia, 993
- Pleural lavage  
 in equine pleuropneumonia, 995  
 in pleuritis, 898, 899f
- Pleural neoplasms, 1088–1089, 1089f
- Pleural pain, pleuritis and, 897
- Pleural pressure changes, measurement of, 864  
 in heaves, 1007–1008
- Pleurisy, 896–899
- Pleuritic friction sounds, 852, 897
- Pleuritis, 896–899  
 associated with *H. somni*, 2037b  
 chronic, hypoalbuminemia and, 722  
 clinical findings in, 897–898  
 clinical pathology of, 898  
 differential diagnosis of, 898b  
 etiology of, 896  
 necropsy findings in, 898  
 pathogenesis of, 896–897  
 pneumonia and, 889  
 traumatic reticuloperitonitis and, 484  
 treatment of, 898–899, 899f
- Pleurocentesis  
 in pleuritis, 898  
 in tracheobronchial secretions, 862–864
- Pleurodynia, pleuritis and, 897
- Pleuropneumonia  
 associated with *A. pleuropneumoniae*, 2044b  
 contagious caprine, 970–972, 970b, 972b  
 of pigs, associated with *Actinobacillus pleuropneumoniae*, 1055–1064  
 clinical findings in, 1059  
 clinical pathology of, 1059–1060  
 control of, 1062–1063  
 diagnosis of, 1060–1061, 1061b  
 epidemiology of, 1055–1058, 1057b  
 etiology of, 1055  
 necropsy findings in, 1060  
 pathogenesis of, 1058–1059  
 treatment of, 1061–1062
- Pleuropulmonary fibrosis, 996
- Pleuroscopy  
 in airways, 856  
 in pleuritis, 897–898
- Plumbism, 1199–1201
- Plunge dipping, caseous lymphadenitis risk factor, 765
- Pluronic, 2189
- Pneumocystis carinii*, 996
- Pneumocystis jiroveci* pneumonia, 891
- Pneumocytes, in ovine pulmonary adenocarcinoma, 978
- Pneumonia, 885–892  
 aspiration, 892–893  
 associated with *H. somni*, 2037b  
 chronic obstructive, 693  
 clinical findings in, 889–890  
 clinical pathology of, 890  
 development of, 888–889  
 differential diagnosis of, 890b–891b  
 epidemiology of, 886–887  
 etiology of, 885–886, 885t  
 housing for, 892  
 in lambs, 1832  
 lipid, 893  
 in mortality in beef calves, 1833  
 necropsy findings in, 890  
 ovine progressive, 973–977, 973b–974b, 976b  
 pathogenesis of, 887–889, 887f  
 predisposition to, bovine herpesvirus-1 infection in, 955  
 traumatic reticuloperitonitis and, 484  
 treatment of, 890–892
- Pneumonic pasteurellosis, 907, 2043–2045  
 affecting wildlife, 2043  
 in cattle, 914–924  
 clinical findings of, 917–918  
 clinical pathology of, 918–919  
 control of, 921–923  
 differential diagnosis of, 919b  
 epidemiology of, 914–916  
 etiology of, 914  
 experimental, 917  
 necropsy findings of, 919  
 pathogenesis of, 916–917  
 risk factors, 915–916  
 treatment of, 919–921, 921b
- clinical findings, 2044  
 control, 2044–2045  
 diagnosis, 2044, 2044b  
 epidemiology, 2043–2044  
 etiology, 2043  
 necropsy findings, 2044  
 in ovine pulmonary adenocarcinoma, 979  
 pathogenesis, 2044  
 treatment, 2044
- Pneumoperitoneum, 182
- Pneumothorax, 899–900, 900b
- Podophyllin poisoning, alimentary tract and, 428
- Point source epidemic curve, 32
- Point-of-care clinical analyzing systems, 134  
 for blood L-lactate concentration, 134
- Poisoning  
 aflatoxins, 649–650  
 blindness from, 1179  
 in cattle, 877  
 in dyspnea, 849  
 in estrogen substances, 1821–1822  
 hemolytic jaundice and, 623  
 mycotoxins, 649–650  
 myelomalacia and, 1193  
 stomatitis, 192–193  
 sudden death by, 100  
 thrombocytopenia, 724
- Poisonous plants, in congenital defects, 1837
- Poisons, potent, access to, 100–101
- Polioencephalomalacia (PEM), 1187, 1311b, 1324–1325, 2037b  
 case fatality of, 1310  
 cattles in, 1306f, 1312  
 clinical findings of, 1312  
 clinical pathology in, 1312  
 control of, 1314  
 definition of, 1186  
 differential diagnosis of, 1312b  
 epidemiology of, 1310  
 etiology of, 1310  
 glucosinolate toxicosis and, 2203  
 menace reflex and, 1170  
 morbidity of, 1310  
 necropsy findings of, 1313  
 occurrence of, 1310  
 outbreak management for, 1313  
 pathogenesis of, 1311  
 risk factors of, 1310–1311  
 sheep in, 1307f, 1312  
 sulfate toxicity in, 1315  
 sulfur-induced, 1311  
 treatment for, 1312b, 1313
- Pollakiuria, 1097–1098
- Poloxalene, 480
- Polyacrylamide Gel Electrophoresis, 390
- Polyarthritis  
 infectious. see Glässer's disease  
 salmonellosis, 365
- Polyarthritis syndrome, *Mycoplasma bovis*, 934
- Polybrominated biphenyls, 106, 2189–2190
- Polybrominated diphenyl ethers, 2190
- Polychlorinated biphenyls, 2190
- Polycystic kidneys, 1138
- Polycythemia, familial, 840–841
- Polydactylism, 1537
- Polydipsia, 1137  
 psychogenic, 1105
- Polymerase chain reaction (PCR), 2019  
 borreliosis and, 1428  
 in bovine papular stomatitis, 602  
 in bovine respiratory syncytial virus, 950  
 in bovine virus diarrhoea virus, 564, 592  
*Brachyspira hyodysenteriae* and, 330  
 in contagious bovine pleuropneumonia, 928  
 detection by  
 of *Brucella abortus*, 1766  
 for dourine, 1820  
 in porcine reproductive and respiratory syndrome, 1808
- eperythrozoonosis of, 780
- Johne's disease, 564
- for *Mycobacterium avium* subspecies paratuberculosis (MAP), 559, 568–569
- in *Mycoplasma bovis*, 935
- in *Mycoplasma pneumoniae*, 1068
- in pleuropneumoniae, of pigs, 1060
- for porcine stress syndrome, 1528
- in *Rhodococcus equi* pneumonia, 1016
- in strangles, 1022  
 test, enzootic bovine leukosis and, 838
- Polymethylmethacrylate beads, antimicrobial-impregnated, 1416
- Polymicrobial infections, equine pleuropneumonia, 991
- Polymyxin, 234, 280
- Polymyxin B, 66
- Polymyxins, 174
- Polyneuritis equi, 1362, 1368–1369
- Polyneuropathy, acquired equine. see Scandinavian knuckling syndrome
- Polyphagia, 88
- Polypnea, 848  
 definition of, 846  
 in pneumonia, 889
- Polysaccharide storage myopathy, 1380  
 of horses, 1522–1523  
 clinical findings of, 1522  
 clinical pathology of, 1523  
 control of, 1523  
 diagnostic confirmation of, 1523  
 differential diagnosis of, 1523b  
 epidemiology of, 1522  
 etiology of, 1522  
 necropsy findings of, 1523  
 pathogenesis of, 1522  
 treatment for, 1523
- Polysulfated glycosaminoglycan, for degenerative joint disease, 1411
- Polyunsaturated fatty acids, enzootic nutritional muscular dystrophy and, 1462
- Polyuria, 1097, 1137  
 acidemia and, 128
- Ponazuril, for equine protozoal myeloencephalitis, 1312
- Population, examination of, 29–35  
 abnormality, defining, 30, 31f  
 approach to, 29–30, 30b  
 epidemiologic investigations for, 29  
 etiologic group, defining, 32  
 intervention strategies for, 34, 34b  
 laboratory testing in, 33–34  
 methods for, 29  
 numerical assessment of performance, 34  
 pattern of occurrence and risk factors, defining, 30–32, 31f  
 response trials, 34, 34b  
 role of integrated animal health and production management program in, 34–35  
 sample size for, 34  
 sampling strategy for, 33  
 selection of animals, 33

- Population, examination of (*Cont'd*)  
 specific etiology, defining, 32  
 steps for, 30–32, 31f  
 techniques in, 32–34
- Population density, history taking of, individual animal, 9
- Population factors, in mycoplasmal pneumonia, 1072
- Population mortality rates, history taking of, 6
- Porcine adenoviruses, 341
- Porcine arthritis. *see* Glässer's disease
- Porcine astroviruses, 342
- Porcine babesiosis, 796
- Porcine bocavirus, 343
- Porcine brucellosis, 1780
- Porcine caliciviruses, 341
- Porcine circovirus type 2, wild boar, 2009
- Porcine circovirus-associated disease, 2117–2134  
 antibody, 2128  
 detection of viral antigen by immunohistochemistry, 2128–2129  
 diagnosis in boars, 2128  
 oral fluids, 2129  
 virus detection, 2128  
 clinical pathology, 2128–2129  
 clinical signs, 2127–2128  
 control, 2129–2132  
 cytokine studies, 2124  
 diagnosis, 2128  
 embryo infectivity, 2118  
 epidemiology, 2119–2123  
 etiology, 2117–2118  
 genome studies, 2118  
 genotypes, 2118–2119  
 histopathology, 2126–2127  
 host-virus interactions, 2124  
 immunity, 2124–2125  
 interferons, 2124  
 pathogenesis, 2123–2124  
 pathology, 2125–2127  
 porcine dermatitis and nephropathy syndrome, 2126–2127  
 replication, 2118  
 transcription, 2118  
 ultrastructural changes, 2127  
 vaccines, 2129–2130  
 effects, 2130  
 experimental, 2131–2132  
 maternally derived antibodies, 2131  
 piglet vaccination, 2131  
 semen shedding in boars, 2130–2131  
 sow compared with piglet vaccination, 2130  
 sow vaccination, 2130  
 vectored, 2132  
 virus import, 2118  
 wild boar, 2119  
 breeding, 2121  
 concurrent infections, 2121–2123  
 environmental survival, 2119–2120  
 horizontal transmission, 2120  
 occurrence, 2121  
 prevalence, 2119  
 risk factors, 2121  
 transmission, 2120–2121  
 vertical transmission, 2120–2121
- Porcine colitoxicosis, 63
- Porcine colonic spirochetosis, 335–337  
 clinical findings, 336  
 control, 337  
 etiology, 335–336  
*see also* Porcine intestinal spirochetosis
- Porcine congenital splayleg, 1529–1530
- Porcine coronavirus, 388
- Porcine cytomegalic virus, 1074–1075
- Porcine dense deposit disease, 1110
- Porcine dermatitis and nephropathy syndrome (PDNS), 1548, 2126–2127
- Porcine epidemic diarrhea, 350–353, 391  
 clinical signs, 352  
 control, 353  
 diagnosis, 352–353
- epidemiology, 351  
 etiology, 350–351  
 immunity, 352  
 occurrence, 351  
 pathogenesis, 351–352  
 pathology, 352  
 treatment, 353
- Porcine failure to thrive, 96
- Porcine hemagglutinating encephalomyelitis, 340–341
- Porcine idiopathic chronic recurrent dermatitis, 1548
- Porcine intestinal adenomatosis (PIA), 322
- Porcine intestinal spirochetosis, 335–337  
 clinical findings, 336  
 control, 337  
 etiology, 335–336  
 immunology, 336  
 laboratory diagnosis, 336–337  
 pathogenesis, 336  
 pathology, 336  
 treatment, 337  
 vaccination, 337
- Porcine kobuviruses, 342
- Porcine necrotic ear syndrome, 1548
- Porcine necrotizing pneumonia (PNP), 1804
- Porcine norovirus, 342
- Porcine orbiviruses, 342
- Porcine parvovirus (PPV), 2137  
 wild boar, 2010
- Porcine picobirnaviruses, 342
- Porcine polyserositis. *see* Glässer's disease
- Porcine proliferative enteritis complex, 322
- Porcine proliferative enteropathy, 322–327, 322b  
 case fatality, 322–323  
 clinical findings, 324  
 clinical pathology, 324  
 control, 326–327  
 diagnosis, 325  
 differential diagnosis, 325b–326b  
 epidemiology, 322–323  
 eradication, 326  
 etiology, 322  
*Lawsonia intracellularis*, 322  
 morbidity, 322–323  
 necropsy findings, 324–325  
 pathogenesis, 323–324  
 risk factors, 323  
 transmission, 323  
 treatment, 326–327  
 vaccines, 326–327
- Porcine pulmonary edema, 2201
- Porcine reproductive and respiratory syndrome (PRRS), 1794–1816, 1794b–1795b  
 aerosol spread of, 1799  
 airborne spread of, 1799  
 clinical findings of, 1806–1807  
 clinical pathology of, 1807–1809  
 colostral antibodies in, 1805  
 concurrent infection in, 1806  
 congenital infection of, 1799  
 control of, 1810–1811  
 secondary infection in, 1812  
 cytokines and, 1801–1803, 1802t  
 detection of virus in, 1808  
 differential diagnosis of, 1810b  
 in endemic herds, 1796–1797  
 epidemiology of, 1796–1799  
 etiology of, 1795–1796  
 experimental infections with, 1796  
 filtration system for, 1811–1814  
 general effects of, in immune system, 1801  
 herd diagnosis for, 1809  
 herd profile, 1809  
 immunology in, 1804–1805  
 isolation of virus in, 1808  
 maternal immunity in, 1805  
 morbidity in, 1797  
 mortality in, 1797  
 necropsy findings of, 1809–1810  
 occurrence of, 1796
- pathogenesis of, 1799–1800  
 prevalence of, 1796–1797  
 protective immunity in, 1805  
 receptors of, 1800  
 replication of, 1800–1803  
 reproductive failure in, 1806–1807  
 respiratory disease and, 1807  
 risk factors of, 1797–1798  
 secondary bacterial infection in, 1806  
 strain variations of, 1804  
 transmission of, 1798  
 treatment of, 1810  
 vaccine for, 1812–1814  
 virus entry of, 1800  
 wild boar, 2010
- Porcine reproductive and respiratory syndrome virus (PRRSV), 1795
- Porcine respiratory coronavirus, 1085–1086
- Porcine respiratory disease complex (PRDC), 1795  
 mycoplasmal pneumonia and, 1071–1074  
 in swine influenza, 1079
- Porcine retroviruses, 2136
- Porcine rotaviruses, 338–340  
 clinical signs, 339  
 control, 340  
 diagnosis, 339  
 differential diagnosis, 339b–340b  
 epidemiology, 338–339  
 etiology, 338  
 immunity, 339  
 pathogenesis, 339  
 pathology, 339  
 serotypes, 338  
 transmission, 338  
 treatment, 340  
 vaccines, 393  
 viral diarrhea, 387–388
- Porcine salmonellosis, 300–301
- Porcine sapelovirus, wild boar, 2010
- Porcine sapoviruses, 341
- Porcine somatotropin, gastric ulcers, 288
- Porcine spirochetal colitis, 327
- Porcine stress syndrome, 1525–1529, 1525b  
 clinical findings of, 1527  
 clinical pathology of, 1527–1528  
 control of, 1528–1529  
 differential diagnosis of, 1528b  
 economic importance of, 1526  
 epidemiology of, 1525–1526  
 etiology of, 1525  
 myopathy and, 1378  
 necropsy findings of, 1528  
 occurrence of, 1525  
 pathogenesis of, 1526–1527  
 prevalence of, 1525  
 risk factors of, 1525–1526  
 treatment for, 1528
- Porcine torovirus, 342
- Porphyrias, 842–844
- Portal circulation, liver disease, 623
- Portosystemic shunts, 632
- Portosystemic vascular anomaly, 630–631
- Positive predictive value (PPV)  
 biosecurity and, 38  
 laboratory data and, 24–25, 25f
- Postanesthetic myositis, 1379
- Postantibiotic effect, 165–166
- Postmilking teat germicide, 1968–1970
- Postnatal diseases, 1830–1831
- Postnatal infection, 1875
- Postpartum dysgalactia syndrome, 1996–2001  
 case fatality in, 1997  
 clinical findings of, 1998–1999  
 clinical pathology of, 1999  
 control of, 2000–2001  
 diagnosis of, 1999  
 differential diagnosis of, 2000b  
 epidemiology of, 1997  
 etiology of, 1996–1997



- Postpartum dysgalactia syndrome (*Cont'd*)  
 morbidity of, 1997  
 necropsy findings of, 1999  
 pathogenesis of, 1998  
 risk factors of, 1997–1998  
 treatment of, 2000
- Postparturient hemoglobinuria, 623
- Posttrace dilatation, in horses, 241
- Postrenal proteinuria, 1102
- Postrenal uremia, 1096
- Postshearing hypothermia, in sheep, 48
- Posture, 1157  
 abnormalities of, 1160–1161, 1166t–1167t, 1372  
 clinical examination of, 11  
 equine colic, 227  
 laminitis  
   horse and, 1400  
   ruminants and swine and, 1405  
 nervous system examination of, 1170  
 peritonitis, 217
- Postvaccinal (serum) hepatitis, 639–640  
 differential diagnosis, 640b
- Postweaning diarrhea, 1886–1887  
 see also Coliform gastroenteritis
- Postweaning multisystemic wasting syndrome (PMWS), 2117
- Potassium  
 administration of, 120  
   oral, 120  
 deficiency, 734  
 dietary, milk fever and, 1677  
 low diet, for equine hyperkalemic periodic paralysis, 1524  
 in macromineral evaluation, 1671  
 measurement of, 120  
 serum, digoxin administration of, 662  
 solutions containing, 143
- Potassium deficiency, 1370
- Potassium iodate, for iodine deficiency, 1746
- Potassium iodide  
 actinobacillosis (wooden tongue), 533  
 equine phycocystosis, 794  
 sporotrichosis and, 798
- Potomac horse fever, 1397  
 see also Equine neorickettsiosis
- Povidone iodine solution, 1929–1930
- Powassan virus, 1302–1310
- Poxvirus infections, in horses, 1596–1597, 1597f, 1598t–1599t
- PPR. see Peste des petits ruminants (PPR)
- Prairie fire, 110
- Praziquantel, 1212
- Precocious lactation, 1843
- Precolostral serum, in congenital defects, 1839
- Preconditioning programs, for pneumonic pasteurellosis, 921
- Precordial thrill, 686
- Predation, 1832
- Predictive value, positive and negative, laboratory data and, 24–25, 25f
- Prednisolone, for heaves, 1009–1010
- Preemptive analgesia, 80
- Pregnancy  
 cow, bovine mastitis and, 1922–1923  
 failure, endotoxemia and, 62  
 feeding during, 2007  
 left-side displacement of abomasum and, 503  
 pregnancy toxemia and, 1724  
 Q fever in, 1791  
 rectal palpation of, 1837
- Pregnancy toxemia  
 in cattle, 1716–1722, 1717b  
 in sheep, 1722–1726, 1722b–1723b  
 clinical findings of, 1724  
 clinical pathology of, 1724  
 control of, 1725–1726  
 differential diagnosis of, 1725b  
 economic significance of, 1724  
 epidemiology of, 1723–1724
- etiology of, 1723  
 experimental production of, 1723–1724  
 fat-ewe, 1723  
 necropsy findings of, 1724–1725  
 occurrence of, 1723  
 oral therapy for, 1725  
 parenteral therapy for, 1725  
 pathogenesis of, 1724  
 prevention of, 1725  
 primary, 1723  
 risk factors of, 1724  
 secondary, 1723  
 starvation, 1723  
 stress-induced, 1723  
 treatment of, 1725, 1725b
- Preharvest beef safety production programs, 541
- Prehension  
 abnormalities of, 11, 178  
 disturbances of, 1168t
- Prekallikrein deficiency, 723, 843
- Premature complexes, 680
- Prematurity, 1841, 1859–1860  
 hematology and, 1862  
 serum biochemistry and, 1863
- Premilking teat disinfection, 1968
- Premunity, tick-borne fever and, 777
- Prenatal infection, 1875
- Prepartum nutrition, left-side displacement of abomasum and, 502–503, 509
- Prepuce, diseases of, 1152–1154
- Prerenal azotemia, 1099–1100
- Prerenal uremia, 1098
- Pressure damage, in downer-cow syndrome, 1695
- Pressure load, chronic heart failure, 660
- Presystolic murmur, 687
- Primary cobalt deficiency, 816
- Primary copper deficiency  
 etiology, 2163  
 general syndrome  
   cattle, 2169  
   sheep, 2169
- Primary copper toxicosis, 2182–2185, 2182b  
 breed susceptibility, 2183  
 clinical findings, 2183–2184  
 clinical pathology, 2184  
 control, 2185  
 differential diagnosis, 2184b  
 epidemiology, 2182–2183  
 etiology, 2182  
 necropsy findings, 2184  
 occurrence, 2182  
 pathogenesis, 2183  
 risk factors, 2183  
 samples for confirmation of diagnosis, 2184  
 species susceptibility, 2183  
 treatment, 2184–2185
- Primary immune deficiencies, 755–757
- Primary pityriasis, 1543–1544
- Primary pulmonary congestion, 880
- Probatocephaly, inherited, 1534–1535
- Probenzimidazole, 607  
 poisoning of, 1211
- Probiotics, 1894  
 enterohemorrhagic *Escherichia coli* control, 542
- Problem-oriented method, for diagnosis, 4
- Problem-oriented veterinary medical record system, 4–5
- Procaine penicillin, for borreliosis, 1428
- Procaine penicillin G, 1939
- Production, effects of stray voltage on, 105–106
- Production diseases, 1662
- Production ketosis, 1709
- Productivity indexes, for examination of population, 34
- Progesterone, plasma, 1841
- Prognosis, 26–28
- Progressive ethmoidal hematomas, in equids, 876, 876f
- Progressive muscular dystrophy, inherited, 1517
- Prolactin, release of, 1997
- Proliferative and necrotizing pneumonia (PNP), 1073
- Proliferative dermatitis, 1575–1576  
 differential diagnosis of, 1576b
- Proliferative enteropathy  
 in horses, 379–381, 381b, 381f  
 pathogenesis, 323  
 porcine, 322–327
- Proliferative exudative pneumonia, 972–973, 972b
- Proliferative hemorrhagic enteropathy (PHE), 322
- Prolonged gestation, plants and, 1827
- Promotility agents  
 enteritis, proximal, 257  
 equine colic, 234, 235t  
 large (ascending) colon, impaction, of horses, 264
- Proopiomelanocortin, 1727
- Propagative epidemic curve, 32
- Prophylaxis, history taking of, 6–7
- Propionate, 1708  
 in oral electrolyte solution, 149
- Propionic acid, 817, 1715
- Proportional dwarfs, 1534
- Propylene glycol  
 for fatty liver, 1721  
 for ketosis, 1713–1714  
 toxicosis, 427
- Prosencephaly, inherited, 1329–1330
- Prostacyclin, endotoxemia, 60
- Prostaglandins, and fever, 54
- Prosthetic laryngoplasty, for recurrent laryngeal neuropathy, 990–991
- Protectants, 213, 251
- Protective antigen (PA), 2012
- Protein  
 in dairy-herd metabolic profile testing, 1670, 1672–1673  
 deficiency of, 1753–1754  
   differential diagnosis of, 1754b  
 feces, loss in, 93  
 high-protein diet, in hemonchosis, 611  
 loss of, excessive, 93  
 metabolism of, endotoxemia and, 62  
 plasma  
   equine colic, 230, 232  
   reticuloperitonitis, traumatic, 485  
   serum total, in assessment of transfer of passive immunity, 1853
- Protein-energy malnutrition, 758, 1753
- Protein-losing enteropathy  
 enteritis, 209  
 panhypoproteinemia and, 717  
 radioactive isotopes, 186
- Proteins, in *Streptococcus suis* infection, 2047
- Proteinuria, 1102–1103  
 weight-loss from, 93
- Protexin Hoof-Care, 1439
- Prothrombin formation, deficiency in, 625
- Prothrombin time, 720  
 disseminated intravascular coagulation and, 728
- Protoanemonin poisoning, alimentary tract and, 428
- Prototheca wickerhamii*, 2158
- Protothecosis, and chlorellosis, 2158
- Prototype *Parapoxvirus ovis* (Orf virus), 602
- Protozoa, preservation of live, 803
- Protozoan, hemolytic jaundice and, 623
- Provirus, 786
- Proximal enteritis, 255–257
- Proximal jejunitis, 255–257, 255b–256b, 257t
- Proximal renal tubular acidosis (type II), 1114
- Pruritis, 1542–1543
- Prussic acid, 832b, 834
- Pseudoalbuminism, 1643–1644
- Pseudoallescheria boydii*, 797
- Pseudocowpox, 1588–1589, 1588b, 1986  
 differential diagnosis of, 1589b
- Pseudocowpox virus (PCPV), 602

Pseudoglanders (epizootic lymphangitis), 806b, 811–814  
 differential diagnosis of, 811b  
*Pseudomonas aeruginosa*, mastitis and, 1960, 1960b  
 Pseudomyotonia, of cattle, 1517–1518, 1517b  
 Pseudorabies, 1248b, 1272–1282  
 case fatality of, 1245–1247  
 clinical findings of, 1248  
 clinical pathology of, 1248  
 control of, 1249  
 detection of, 1248–1252  
 differential diagnosis of, 1248b  
 economic importance of, 1248  
 epidemiology of, 1245  
 etiology of, 1245  
 immune mechanisms of, 1248  
 morbidity of, 1245–1247  
 necropsy findings of, 1248–1249  
 offspring segregation of, 1249–1250  
 pathogenesis of, 1248  
 prevalence determination of, 1249  
 risk factors of, 1246  
 samples for diagnostic confirmation of, 1249  
 strategies available for, 1249  
 transmission of, 1247–1248  
 vaccines and vaccination for, 1250  
 wild boar, 2008  
 Pseudorabies virus, 1837  
 Pseudothrombocytopenia, 721, 724  
*Psorergates bos*, 1618–1619  
*Psorergates ovis*, 1618–1619  
 Psoroptic mange, 1621–1622  
 differential diagnosis of, 1622b  
 Psychogenic polydipsia, 1105  
 Psychoses, 1224  
 Psychosomatic disease, stress-related, 86  
 Psyllium mucilloid, 267  
 Puerperal metritis, in cattle, 67–70  
 clinical findings in, 68  
 clinical pathology of, 68–69  
 epidemiology of, 67–68  
 etiology of, 67  
 necropsy findings, 69  
 pathogenesis of, 68  
 treatment for, 69–70  
 ancillary, 70  
 and prophylaxis, 70b  
 Puff disease, 1561–1562  
 Pulmonary abscess, 894–895, 895b  
 Pulmonary artery blood pressure measurement, 671–672  
 Pulmonary aspergillosis, 1045, 1046f  
 Pulmonary blood flow, cardiac catheterization, 674  
 Pulmonary capillary pressure, 882  
 reducing, in exercise-induced pulmonary hemorrhage, 1002  
 Pulmonary congestion, 880–882  
 Pulmonary defense mechanisms, in pneumonia, 887–888, 887f  
 Pulmonary edema, plants causing, 1088  
 Pulmonary edema, 880–881  
 heart failure, left-sided chronic (congestive), 660  
 Pulmonary embolism, 710  
 Pulmonary emphysema, 883–885, 884f, 885b  
 Pulmonary form, of glanders, 1027  
 Pulmonary function tests, 864–865  
 Pulmonary hemorrhage, 854, 883, 883f  
 exercise-induced, 997–1003, 997b, 999f, 1001b  
 leptospirosis, 1121  
 Pulmonary hypertension, 882–883  
 Pulmonary lesions, in horses, 877  
 Pulmonary neoplasms, 1088–1089, 1089f  
 Pulmonary valve, 688  
 Pulsation system, 1971  
 Pulse  
 amplitude  
 clinical examination of, 15  
 equine colic, 231–232  
 arterial, examination of, 664–665

cardiac reserve determination, 659  
 clinical examination of, 15  
 left atrioventricular valve insufficiency, 687  
 rate, 664–665  
 clinical examination of, 15, 15t  
 equine colic, 231–232  
 rhythm, 665  
 clinical examination of, 15  
 in shock, 73  
 Pulse oximetry, in respiratory system, 866–867  
 Pump failure, 71  
 Pupillary light reflex, 1164–1165, 1170  
 Purgatives, 191  
 Purified protein derivate (PPD), bovine tuberculin, 2019  
 Purpura hemorrhagica, 711–713, 711b–712b, 721  
 differential diagnosis of, 713b  
 in strangles, 1025  
 Pus, bacterial influence on, 77  
 Pustular psoriaform dermatitis, 1544, 1648  
 Pyelogrammatous osteomyelitis, 531  
 Pyelonephritis, 1111, 1131–1132, 1132b  
 bovine, 1129–1131, 1129b, 1130f–1131f  
 cattle and, 1098  
 differential diagnosis of, 1111b, 1133b  
 Pyloric achalasia, 491  
 Pyloric obstruction, 494  
 Pyramidal tracts, 1162  
 Pyrantel, 1212  
 Pyrexia, 15  
 Pyridoxine (vitamin B<sub>6</sub>) deficiency, 734, 1325–1326  
 Pyrogens  
 effect of, on hypothalamus, 54  
 endogenous, 54  
 exogenous, 54  
 Pyrrolizidine alkaloid (PA) poisoning, in sheep, 624, 646  
 Pyrrolizidine alkaloid (PA) toxicosis, 645–648, 645b–646b  
 animal risk factors, 646  
 cattle, 647  
 clinical findings, 647–648  
 clinical pathology, 648  
 control, 648  
 differential diagnosis, 648b  
 environmental risk factors, 646–647  
 epidemiology of, 646–647  
 etiology of, 646  
 horses, 647–648  
 human risk factors, 647  
 necropsy findings, 648  
 occurrence, 646  
 pathogenesis, 647  
 pigs, 648  
 plant factors, 646–647  
 risk factors, 646–647  
 secondary photosensitization, 647  
 transmission, 647  
 treatment, 648  
 Pyrrolizidine poisoning, 624  
*Pythium insidiosum*, 797  
 Pyuria, 1103

## Q

“Q” fever, 1791–1793, 1791b  
 clinical findings of, 1792  
 clinical pathology of, 1792  
 control of, 1793  
 differential diagnosis of, 1793b  
 epidemiology of, 1791–1792  
 etiology of, 1791  
 necropsy findings of, 1792  
 risk factors of, 1792  
 source of infection of, 1791–1792  
 transmission of, 1791–1792  
 zoonotic implication of, 1792

Quarantine  
 for Bang's disease, 1769  
 bovine virus diarrhea virus, 592  
 for equine influenza, 1038  
 Quarter horse, acute nutritional myopathy and, 1379  
 Quaternary ammonium compounds, 1969  
 Queckenstedt's test, 1176  
*Quercus* spp., 2207  
 Quietness, and stress induction, 85  
 Quinapyramine sulfate, 1821  
 Quinidine, 682  
 Quinidine gluconate, 682  
 Quinidine sulfate, 684  
 oral, 682

## R

Rabbits, Johne's disease in, 570  
 Rabies, 1239b, 1269–1272  
 animal vectors for, 1239  
 clinical findings of, 1240–1241  
 clinical pathology of, 1241  
 control of, 1243  
 differential diagnosis of, 1244b  
 economic importance of, 1240  
 epidemiology of, 1238  
 etiology of, 1238  
 furious in, 1243  
 intraspecific transmission of, 1241  
 latent infection of, 1239–1240  
 necropsy findings of, 1241–1242  
 paralytic form in, 1243  
 pathogenesis of, 1240  
 postexposure vaccination for, 1243–1244  
 preexposure vaccination for, 1243  
 prevention of exposure to, 1243  
 quarantine and biosecurity, 1244  
 samples for diagnostic confirmation of, 1242  
 seasonal spread of, 1239  
 transmission methods of, 1239–1242  
 treatment for, 1243  
 vaccination of wildlife for, 1244–1247  
 vaccines for, 1244  
 virus variant distribution of, 1239  
 zoonotic implications of, 1239–1240  
 Racehorses  
 anemia, 734  
 benign atrial fibrillation, 681  
 gastric ulcers in, 247–248  
 poor performance, 97–99  
 vaccines for, in equine influenza, 1037–1038  
 Radial immunodiffusion, in assessment of transfer of passive immunity, 1853  
 Radial nerve, traumatic damage to, 1359f, 1362  
 Radiation injury, 107–109, 107b  
 acute syndrome, 108  
 case fatality, 107  
 chronic exposure, 108  
 clinical findings in, 108  
 clinical pathology of, 108  
 control of, 108–109  
 diagnosis of, samples for confirmation of, 108  
 differential diagnosis of, 108b  
 epidemiology of, 107–108  
 etiology of, 107  
 incidence of, 107  
 nature of radiation in, 107  
 necropsy findings in, 108  
 pathogenesis, 108  
 risk factors for, 107  
 subacute syndrome, 108  
 zoonotic implications, 107–108  
 Radiation therapy, for sarcoid, 1587  
 Radioactive isotopes, protein-losing enteropathy, 186  
 Radiographic examination  
 in caudal vena caval thrombosis, 902  
 in equine pleuropneumonia, 992  
 in exercise-induced pulmonary hemorrhage, 1000

- Radiographic examination (*Cont'd*)  
 in guttural pouch empyema, 985–986  
 in heaves, 1007  
 in nasal discharge, 854  
 in progressive atrophic rhinitis, 1051  
 in respiratory system, 856–857, 857b, 857f  
 in *Rhodococcus equi*, 1015  
 uroperitoneum in foals and, 1142
- Radiography  
 abdomen examination, 452–453  
 abdominal, 183–184  
 cardiovascular system examination, 673  
 caudal abdominal obstruction, 254  
 for degenerative joint disease, 1405, 1410, 1500  
 enterolith, 265, 266f  
 for equine cervical vertebral stenotic myelopathy, 1354f, 1359  
 equine colic, 229, 239  
 esophageal, 183  
 gastric dilatation, in horses, 241  
 gastric ulcers, 245  
 for laminitis  
   horse and, 1400, 1400f–1401f  
   in ruminants and swine, 1405  
 of liver, 626  
 monitoring of lesions in, lameness in pigs and, 1423  
 for musculoskeletal system disease, 1376  
 in nervous system examination, 1175–1176  
 for osteodystrophy, 1390  
 for osteomyelitis, 1393  
 pericarditis and, 709  
 reticulum, 486  
 for rickets, 1496  
 sand colic, 266, 267f  
 for septic arthritis synovitis, 1414  
 for urachitis, 1901  
 urinary system examination, 1107–1108  
 urolithiasis and, 1148
- Radioimmunoassay, 838–839
- Radioimmunoprecipitation assay, 838
- Radionuclides, 107
- Radiosensitivity, 107
- Rafoxanide, 614
- Ramaria flavo-brunnescens*, 2204
- Ranitidine  
 for abomasal ulcer, 522  
 gastric ulcers, 245, 246t, 251
- Rat-tail syndrome, 602, 1644–1645
- Rattling sounds, 852
- RDA. see Right-side displacement of the abomasum (RDA)
- Rebreathing (“bagging”) examination, 850
- Receptors, of porcine reproductive and respiratory syndrome virus, 1800
- Reciprocal translocation, 1828
- Recombinant bovine somatotropin, 1665  
 in bovine mastitis, risk factor of, 1910  
 in mastitis control program, 1979
- Recombinant human erythropoietin, 736
- Recommended dose, of antimicrobial therapy, 154
- Record keeping, biosecurity and, 41
- Rectal biopsy, 190  
 diarrhea, chronic undifferentiated, 281  
 granulomatous enteritis, of horses, 282
- Rectal examination, 20–21  
 aortoiliac thrombosis, 710  
 cecal dilatation/ceocolic volvulus, 529, 530f  
 diarrhea, acute, 278  
 enteritis, proximal, 256  
 enteroliths and fecaliths, 265  
 equine colic  
   foals, 239  
   postparturient mare, 236–237  
 equine grass sickness, 284–285  
 gastric dilatation, in horses, 241  
 large (ascending) colon, impaction, of horses, 264  
 left dorsal displacement, of large colon, 261  
 left-side displacement of abomasum and, 506  
 peritonitis, 218  
 rectal tear, 272–273  
 reticuloperitonitis, traumatic, 485  
 retroperitoneal abscess, 270  
 right dorsal displacement, of large colon, 261–262  
 small colon obstruction, 268  
 urinary system examination, 1130  
 vagus indigestion, 493  
 volvulus, of large colon, 262
- Rectal pack, 272
- Rectal palpation, 449  
 abdomen, of cattle, 449, 450f  
 of enzootic bovine leukosis, 833  
 of pregnancy, 1837  
 sand colic, 266
- “Rectal paralysis,” luminal blockage, 525
- Rectal prolapse, 291, 434  
 in pigs, 291–292  
 postparturient mare, equine colic, 236–237  
 small colon obstruction, 268
- Rectal stricture, 292
- Rectal tears, 271–273  
 classification, 271–272  
 clinical pathology, 272  
 clinical signs, 271–272  
 epidemiology, 271  
 etiology, 271  
 iatrogenic rupture, 271  
 pathogenesis, 271  
 prevention, 273  
 prognosis, 272  
 risk factors, 271  
 spontaneous or noniatrogenic rupture, 271
- Rectovaginal constriction, inherited, 434
- Recumbency  
 duration of, 1694  
 experimental sternal, 1695  
 horses  
   complications and prevention, 2006  
   diagnosis and care, 2003–2006, 2004f–2005t  
   epidemiology, 2003  
   examination, 2003–2006  
   history, 2003  
   management and care, 2006  
   myopathy and, 1386  
   physical examination, 2003–2006  
 laminitis, horse and, 1400  
 prolonged, 1694–1695
- Recumbent animal, 1173–1174
- Recurrent airway obstruction, 1003–1012, 1003b, 1005f, 1008f, 1009b
- Recurrent laryngeal neuropathy, 989–991, 990b
- Recurrent uveitis, leptospirosis, 1121
- Red cell aplasia, 731–734
- Red cell function, abnormal, 744–745
- Red clover (*Trifolium pratense*), poisoning in, 1822
- Red deer, farmed  
 selenium and, 1472  
 selenium subcutaneous injections for, 1475–1476
- Red fire ant stings (*Solenopsis invicta*), 2179
- Red foot disease, of sheep, 1646
- Red maple leaf (*Acer rubrum*) toxicosis, 837–838
- Red squill (sea onion), 2191
- Red urine, caused by pigmented substance from plant, 1137
- Red water disease. see Bacillary hemoglobinuria
- Reduction, of progressive atrophic rhinitis, 1053
- Redworm infestation, 411–415
- Reference range  
 laboratory data and, 23–24  
 problems with, 24
- Reflux  
 enteritis, proximal, 256  
 equine colic, 228–229, 232
- Regional ileitis, 209, 324
- Regional limb perfusion, septic arthritis synovitis and, 1416
- Regurgitation, 179
- Reindeer, bovine papular stomatitis, 602
- Reinfection, of herds, for *Mycoplasma pneumoniae*, 1069
- Reinfection syndrome, in lungworm, 963
- Relative adrenal insufficiency, and endotoxemia, 61
- Renal abscess, 1115
- Renal adenocarcinoma, 1138
- Renal azotemia, 1099
- Renal biopsy, 1107
- Renal carcinoma, 1137
- Renal clearance studies, 1105
- Renal crystalluria, and sulfonamides, 172
- Renal dysplasia, 1138–1139
- Renal failure, 1096–1097  
 acute, 1098  
 chronic, 1098  
 and endotoxemia, 63
- Renal function tests, 1099  
 summary of, 1106, 1106t
- Renal hypoplasia, 1137–1138
- Renal injury, detection of, 1099
- Renal insufficiency  
 causes of, 1096  
 pathogenesis of, 1096–1097  
 principles of, 1095–1097  
 renal failure and, 1096–1097
- Renal ischemia, 1096  
 acute, 1112  
 chronic, 1112
- Renal neoplasms, 1137
- Renal perfusion, decreased, hypovolemic shock, 72
- Renal toxicity, of aminoglycosides, 169–170
- Renal tubular acidosis (RTA), 1113–1114
- Renin-angiotensin-aldosterone system, 670–671  
 activation of, and endotoxemia, 61
- Renosplenic entrapment, 261, 263f
- Reovirus, 1029
- Reproduction, endotoxemia and, 62
- Reproductive efficiency, vitamin A deficiency and, 1323
- Reproductive failure, in bovine herpesvirus-1 infection, 955
- Reproductive history, clinical examination of, 8
- Reproductive performance  
 biotin deficiency, 836  
 of border disease, 1254
- Reproductive system  
 congenital and inherited diseases primarily affecting, 1828  
 diseases primarily affecting, 1758–1760  
 toxic agents primarily affecting, 1821–1822
- Reproductive tract  
 clinical examination of, 21  
 ultrasonography of, 22
- Republic of Ireland, bovine spongiform encephalopathy in, 1294–1300
- Resistance, general, selenium deficiency and, 1466
- Respiration, type of, 13
- Respiration depth, clinical examination of, 13
- Respiration rate, clinical examination of, 12
- Respiration rhythm, type of, 12
- Respiratory acidosis, 124
- Respiratory alkalosis, 124
- Respiratory center, in dyspnea, 849
- Respiratory disease  
 bovine virus diarrhea virus, 585  
 equid herpesvirus-1 myeloencephalopathy and, 1285  
*Histophilus* septicemia of cattle, clinical findings, 2036  
 volcanic ash, 109
- Respiratory failure, 848  
 definition of, 846
- Respiratory gas transport, 869
- Respiratory insufficiency  
 abnormal posture in, 849–850  
 breath sounds, normal and abnormal, 850–852  
 breathing, rate, depth, and ease of, abnormalities in, 848–849



- Respiratory insufficiency (*Cont'd*)  
 carbon dioxide retention in, 848  
 compensatory mechanisms of, 847–848  
 coughing in, 853  
 cyanosis in, 853–854  
 definitions of, 846  
 epistaxis in, 854–855  
 hemoptysis in, 854–855  
 hypoxia in, 846–847  
 nasal discharge in, 854  
 principal manifestations of, 848–855  
 principles of, 846–848  
 respiratory failure and, 848  
 respiratory noises and, 852  
 thoracic pain in, 855
- Respiratory mucociliary clearance, in pneumonia, 887–888
- Respiratory mucus, secretion of, in pneumonia, 887
- Respiratory muscles, paralysis of, in dyspnea, 849
- Respiratory noises, clinical examination of, 13
- Respiratory rate  
 equine colic, 227, 231  
 heaves in, 1007  
 and hyperthermia, 53
- Respiratory secretions  
 laboratory evaluation of, 859–864  
 in pneumonia, 890
- Respiratory sound spectrum analysis, 868
- Respiratory stimulants, 870
- Respiratory support, for newborn, 1866
- Respiratory system  
 diseases of, 845–1090  
 bovine, 901–902  
 caprine, 969–970  
 congenital, 1090  
 control of, 872–873  
 diagnosis of, 872  
 in diaphragm, 895–896  
 equine, 981–982  
 inherited, 1090  
 in lung parenchyma, 880–882  
 lungworm infestation in, 961–965  
 neoplastic, 1088–1090  
 ovine, 969–970  
 in pleural cavity, 895–896  
 swine, 1047–1054  
 treatment of, 868–872  
 in upper respiratory tract, 874–875
- exercise intolerance and, 98
- special examination of, 855–868  
 arterial blood gas analysis in, 865–866, 866f  
 auscultation in, 855  
 blood lactate concentration in, 867  
 computed tomography in, 857–858  
 endoscopic examination, of airways, 855–856  
 exercise testing, 868, 868f  
 exhaled breath condensate, collection and analysis of, 867  
 lung biopsy in, 867–868  
 magnetic resonance imaging in, 857  
 paranasal sinuses, endoscopy of, 856  
 percussion in, 855  
 pleuroscopy in, 856  
 pulse oximetry in, 866–867  
 radiography in, 856–857, 857b, 857f  
 respiratory secretions, laboratory evaluation of, 859–864  
 respiratory sound spectrum analysis, 868  
 scintigraphy in, 858  
 ultrasonography in, 858–859  
 venous blood gas analysis, 866  
 toxicoses, 1087
- Respiratory tract disease, in dyspnea, 849
- Response trials, for examination of population, 34, 34b
- Rest, laminitis, horse and, 1403
- Restlessness, 10
- Reston virus, 2137
- Reticular abscesses, 484–487, 487f, 490
- Reticular adhesions, 491
- Reticular magnet, 488, 490
- Reticulated leukotrichia, 1553
- Reticulitis, iatrogenic, 485
- Reticulocytosis, 739
- Reticulohepatitis, traumatic, 499–500
- Reticulopericarditis, traumatic, 497–499, 497b, 497f–498f  
 differential diagnosis, 498b–499b  
 treatment, 499, 499b
- Reticuloperitonitis, traumatic, 482–490, 482b–483b  
 acute  
 diffuse, 485, 488  
 local, 483–484  
 chronic local, 484–485  
 clinical findings, 484–485  
 clinical pathology, 485–486  
 complications of, 491  
 differential diagnosis, 488b–489b  
 digesta passage disturbances, 492  
 economic importance, 483  
 epidemiology, 483  
 etiology, 482–483  
 exploratory laparotomy (celiotomy), 454  
 laparoscopy, 488  
 metal detection, 487  
 necropsy findings, 488  
 pathogenesis, 483–484  
 prevention, 490  
 radiography, 486–487  
 risk factors, 483  
 sequelae, 482, 482f  
 treatment, 489–490, 490b  
 ultrasonography, 486–487, 487f
- Reticulorumen  
 anatomy of, 437  
 hypomotility, 437  
 ingesta, layers of, 491  
 left-side displacement of abomasum and, 506  
 motility, 437–441, 446  
 eructation, of gas, 440  
 esophageal groove closure, 440–441  
 primary contraction cycle, 437  
 rumination, 440, 441f  
 secondary cycle contraction, 440, 447  
 outflow abnormality, vagus indigestion, 491  
 retention time, 492
- Reticulosplenitis, traumatic, 499–500
- Reticulum, 437  
 biphasic contractions of, 437  
 diseases of, 457–459  
 foreign body penetration. *see* Reticuloperitonitis, traumatic  
 radiography, 486  
 ultrasonography, 486–487
- Retina, diseases of, blindness from, 1179
- Retinol, plasma, 1325
- Retropitoneal abscess, 270–271
- Retropharyngeal lymph nodes, swelling of, in strangles, 1021
- Retropharyngeal lymphadenopathy, 989, 989f
- Return-over-feed index (ROF), 1667
- Rev. 1 vaccine, 1784
- Reverse passive hemagglutination, 390
- Reverse transcription polymerase chain reaction (RT-PCR)  
 in bovine virus diarrhea virus, 587  
 in equine influenza, 1034–1035  
 in peste des petits ruminants, 575  
 in porcine reproductive and respiratory syndrome, 1808  
 in winter dysentery, cattle, 601
- Rewarming, of hypothermic calves, 1846
- Rhabditid dermatitis, 1609
- Rhabdomyolysis  
 exertional, 1379–1380  
 clinical findings of, 1379–1380  
 etiology of, 1378  
 muscle-derived serum enzymes and, 1380  
 or postexercise, 1378  
 pathogenesis of, 1379  
 treatment of, 1381
- recurrent exertional, in thoroughbred and standardbred horses, 1519–1522  
 clinical findings of, 1520  
 clinical pathology of, 1520–1521  
 control of, 1521  
 diagnostic confirmation of, 1521  
 differential diagnosis of, 1521b  
 epidemiology of, 1520  
 etiology of, 1519–1520  
 necropsy findings of, 1521  
 pathogenesis of, 1520  
 treatment for, 1521, 1521b
- sporadic exertional, in horses, 1479–1481  
 clinical findings of, 1480  
 clinical pathology of, 1480–1481  
 control of, 1481  
 diagnostic confirmation of, 1481  
 differential diagnosis of, 1481b  
 epidemiology of, 1480  
 etiology of, 1479–1480  
 necropsy findings of, 1481  
 pathogenesis of, 1480  
 treatment for, 1481
- in strangles, 1021–1022
- Rhabdomyosarcoma, 704, 1223
- Rhinitis, 874–875, 875b  
*Bordetella*, 1054–1055  
 bovine herpesvirus-1 infection in, 955–956  
 equine, 1039–1040  
 equine grass sickness, 284–285  
 familial allergic, 874–875  
 inclusion-body, 1074–1075  
 mycotic, 875  
 in nasal bots, 980  
 progressive atrophic, 1047–1054, 1048b, 1052b
- Rhinoestrus* spp., 979
- Rhinolaryngoscopy, 855–856, 1177
- Rhinospordium seeberi*, 1046–1047
- Rhinospordiosis, 1046–1047, 1046f
- Rhodococcus equi*  
 diarrhea, 275  
 localized infection, 77
- Rhodococcus equi* pneumonia, of foals, 1013–1019, 1013b  
 clinical findings in, 1015  
 clinical pathology of, 1016  
 control of, 1018  
 diagnostic confirmation in, 1016  
 differential diagnosis of, 1016b, 1017t  
 epidemiology of, 1014  
 etiology of, 1013–1014  
 extrapulmonary manifestations of, 1015, 1015t  
 necropsy findings in, 1016  
 pathogenesis of, 1014–1015  
 prognosis of, 1015–1016  
 treatment of, 1016–1018, 1018f
- Rhodotorula* spp. infection, 2159
- Rhoeadine, 2210
- Riboflavin deficiency, 2176
- Rickets, 1494–1496, 1494b  
 clinical findings of, 1495  
 clinical pathology of, 1495–1496  
 control of, 1496  
 differential diagnosis of, 1496b  
 epidemiology of, 1495  
 etiology of, 1495  
 inherited, 1537–1538  
 necropsy findings of, 1496  
 pathogenesis of, 1389, 1495  
 treatment for, 1496  
 vitamin D deficiency and, 1482
- Rifampin, 174  
 Johne's disease, 561  
 for *Rhodococcus equi* pneumonia, 1017–1018
- Rift Valley fever, 2067–2069, 2067b  
 clinical findings, 2068–2069  
 clinical pathology, 2069  
 control, 2069

- Rift Valley fever (*Cont'd*)  
 economic importance, 2068  
 epidemiology, 2067–2068  
 etiology, 2067  
 experimental reproduction, 2068  
 method of transmission, 2068  
 necropsy findings, 2069  
   samples for confirmation of diagnosis, 2069, 2069b  
 occurrence, 2067  
 pathogenesis, 2068  
 risk factors, 2067–2068  
   animal, 2067–2068  
   environmental, 2068  
 source of infection, 2068  
 treatment, 2069  
 vaccines, 2069  
 zoonotic implications, 2068
- Rift Valley fever virus, 1836
- Right ventricle, double-outlet, 705
- Right-side displacement of the abomasum (RDA), 510–515, 510b  
 clinical findings, 512  
 clinical pathology, 512–513  
 control, 514  
 differential diagnosis, 513b–514b  
 epidemiology, 510–511  
 etiology, 510  
 hypokalemia, 119  
 necropsy findings, 513  
 pathogenesis, 511–512  
 postsurgical complication in, 493  
 prognostic indicators, 513  
 risk factors, 510–511  
 surgical correction, 514  
 treatment, 514
- Rima glottidis, obstruction of, 983, 983f
- Rimantidine, for equine influenza, 1035
- Rinderpest (RPV), 572–573
- Ringer's solution, 139
- Ringworm, 1600–1603, 1600b  
 in cattle, 1601  
 clinical findings of, 1601–1602  
 clinical pathology of, 1602  
 control of, 1603  
 differential diagnosis of, 1602b  
 epidemiology of, 1600–1601  
 etiology of, 1600  
 in horses, 1601  
 pathogenesis of, 1601  
 in pigs, 1601–1602  
 risk factors of, 1600–1601  
 in sheep, 1601  
 treatment of, 1602–1603, 1603b  
 vaccination for, 1603  
 zoonotic considerations and economic importance of, 1601
- Risk group analysis, computation for, 30
- Roaring, 852  
 "Robber" ewes, 1848
- Robertsonian translocation (ROB), 1828
- Rodenticides, miscellaneous, 2190–2191
- Roll-and-toggle-pin suture, 508
- Romulea rosea*, 1827–1828
- Rose bengal test, for *Brucella abortus*, 1766
- Ross river virus, 1458
- Rotavirus  
 bovine, 385–386  
 coliform gastroenteritis, 316  
 diarrhea, 275–276  
 equine, 388  
 porcine, 338–340, 339b–340b, 387–388  
 viral diarrhea, 385  
   concurrent infection, 388  
   kids, 387  
   lambs, 387  
   pathogenesis, 388–389
- Rotazyme test, 390
- Rotenone toxicosis, 1209–1210
- Roughage  
 abomasal impaction, 515  
   feeding, 1315  
   simple indigestion, 457
- RPV. *see* Rinderpest (RPV)
- Ruapehu, 109
- Rubratoxin toxicosis, 654
- Rumen, 436–437  
 atony, 437, 438t, 474, 493–494  
 auscultation of, of cattle and sheep, 17  
 collapse, 446  
 diseases of, 457–459  
 distention of  
   decompression, 183  
   differential diagnosis in, 447t  
   vagus indigestion, 493  
 examination, 448–449, 465  
 flora, 192  
 hypermotility, vagus indigestion, 493  
 impaction, with indigestible foreign bodies, 459–460  
 lavage  
   carbohydrate engorgement, 469  
   distended rumen, 445–446  
   vagus indigestion, 495, 495f  
 microflora  
   changes in, 463  
   reconstitution of, simple indigestion, 459  
 neoplasms, 431–432  
 overload. *see* Carbohydrate engorgement, of ruminants  
 palpation, 437, 446  
 sodium:potassium ratio in, 1699–1700  
 volatile fatty acids  
   carbohydrate engorgement, 463  
   reticulorumen motility, primary contraction influence, 439
- Rumen fluid/juice  
 abomasum, flow into, 501  
 analysis of, 448–449  
 chloride concentration of, 449, 494  
 color, 183, 448  
 consistency of, 183, 448  
 examination of, 448–449  
 frothy bloat, 473  
 microscopic examination of, 448–449  
 odor, 183  
 pH, 183, 448  
   carbohydrate engorgement, 466–467  
   correction of, 192  
   diet changed, 465  
   simple indigestion, 459
- Rumen transfaunation, 509
- Rumenatorics, 458
- Rumenitis, 442–445  
 chemical, carbohydrate engorgement, 463  
 mycotic, carbohydrate engorgement, 463, 465
- Rumenocentesis, 467
- Rumenotomy  
 carbohydrate engorgement, 468–469, 469f  
 emergency, 477  
 for lead poisoning, 1208  
 reticuloperitonitis, traumatic, 489–490  
 vagus indigestion, 496
- Ruminal drinkers, 460–461
- Ruminal impaction, in cattle, 427
- Ruminal lactic acidosis. *see* Carbohydrate engorgement, of ruminants
- Ruminal parakeratosis, 472–482, 473f
- Ruminal protozoa, carbohydrate engorgement, 467
- Ruminal tympany. *see* Bloat (ruminal tympany)
- Ruminant toxicosis, 2201–2202
- Ruminants  
 atrial fibrillation, treatment of, 683  
 carbohydrate engorgement. *see* Carbohydrate engorgement, of ruminants  
 enterohemorrhagic *Escherichia coli* reservoirs, 538  
 hypothermia, neonatal, 44  
 laminitis in, 1404–1406  
 lymphoma/lymphosarcoma, 747  
 neurotoxic mycotoxins in, 1186  
 oral electrolyte solution for, 150  
 osteomalacia in, 1497  
 primary vitamin A deficiency in, 1321  
 salmonellosis, 357–373  
 sulfur toxicosis, 2192  
 transit recumbency of, 1707–1708  
 zearalenone toxicosis in, 1825
- Rumination, 440, 441f  
 absence, traumatic reticuloperitonitis, 484  
 appetite and, 445  
 reduction, in causes, 440
- Runt, 1840
- Rupture, blood vessels and, 709–711, 709b
- Ryegrass, annual, staggers, 1197, 1198b–1200b
- Ryegrass pastures, 652

## S

- Sabin-Feldman dye test, 2142
- Sabulous urolithiasis, 1139
- Sacrocaudalis dorsalis muscle, 1472
- Sadism, 100
- Salicylanilides/substituted phenols, 1212
- Salicylates, for pain, 83
- Saline-dextran solution, hypertonic, 142
- Saliva, excessive, 19
- Salivary abomasum disease, 621
- Salivary cortisol, stress, 85–86
- Salivary ducts, atresia, 433
- Salivary glands, parotid, diseases of, 195–196, 196b
- Salivary potassium concentration, in acute hypokalemia, 1692
- Salivation  
 excessive, 178–179  
   actinobacillosis (wooden tongue), 533  
   frothy bloat role, 474  
   promote, in bloat, 478
- Salmonella*  
 osteomyelitis and, 1393  
 serovar Typhimurium DT104, 299  
 vaccinology, 305–306, 372
- Salmonella abortusequi*, 1785–1786
- Salmonella abortusovis*, 1784–1785
- Salmonella bongori*, 357
- Salmonella choleraesuis*  
 in pigs, 295  
 porcine reproductive and respiratory syndrome and, 1806
- Salmonella dublin*  
 abortion, 1785  
 osteomyelitis and, 1393
- Salmonella enterica*  
 in horses, 357  
 in pigs, 293  
 serovar Abortusequi, 1785  
 serovar Abortusovis, 1784
- Salmonella ruiro*, 1785
- Salmonella* serotypes, wild boar, 2010
- Salmonella typhimurium*  
 abortion, 1785  
 rectal stricture, 292  
 vaccination for, 1785
- Salmonellosis  
 abomasitis, 365  
 abortion, 365  
 bacteremia, 300, 365  
 cattle  
   occurrence, 358–359  
   prevalence, 358  
 chronic, 281  
 diarrhea, acute, 278–279  
 economic importance, 299, 364  
 enteritis, 300, 365  
 gangrene, terminal dry, 365

- Salmonellosis (*Cont'd*)  
 genetic resistance, 295, 360–361  
 in horses and ruminants, 357–373, 357b  
 carrier state, 360  
 case fatality, 359  
 clinical findings, 366–367  
 clinical pathology, 367–368  
 control, 370–372  
 differential diagnosis, 368b–369b  
 epidemiology, 358–364  
 etiology, 357–358  
 immune mechanisms, 361  
 morbidity, 359  
 necropsy findings, 368  
 occurrence, 358–359  
 pathogenesis, 364–365  
 risk factors, 360–361  
 transmission, 359–360  
 treatment, 369–370, 370b  
 infection, 299–300, 364  
 osteitis, 365  
 polyarthritis, 365  
 portal of infection, 360  
 septicemia, 300, 365  
 sheep  
 occurrence, 359  
 prevalence, 358  
 in swine, 292–308, 292b–293b  
 clinical findings, 300–301  
 clinical pathology, 301–302  
 control, 304–307  
 diagnosis, 303  
 differential diagnosis, 303b  
 epidemiology, 293–299  
 etiology, 293  
 necropsy findings, 302–303  
 pathogenesis, 299–300  
 risk factors, 295–298  
 transmission, 294–295, 294t  
 treatment, 303–304  
 zoonotic implications, 298–299, 363–364  
*Salsola tuberculatiflora* (cauliflower saltwort), 1827
- Salt  
 deficiency, diagnosis, 2162  
 supplementation of, to dairy cows, 2161
- Salt blocks, 1705
- Samore, 2150–2156
- Sampling, in examination of population, 33–34
- Sand, abomasal impaction, 515
- Sand colic, 266–267, 267f
- Saponin poisoning, 2210
- Sapoviruses, porcine, 341
- Sarcocystosis, 2137–2140, 2137b–2138b  
 clinical findings, 2139  
 clinical pathology, 2139  
 control, 2140  
 economic importance, 2139  
 epidemiology, 2138–2139  
 etiology, 2138, 2138t  
 necropsy findings, 2139  
 samples for confirmation of diagnosis, 2139, 2139b  
 occurrence, 2138  
 pathogenesis, 2139  
 risk factors, 2138–2139  
 cats, 2138  
 climate, 2138  
 farm dogs, 2138  
 species of *Sarcocystis*, 2138  
 stocking density, 2139  
 source of infection, 2138  
 treatment, 2139–2140
- Sarcoid, 1585–1587, 1585b, 1640  
 clinical findings of, 1586  
 clinical pathology of, 1586  
 differential diagnosis of, 1586b  
 epidemiology of, 1585–1586  
 experimental reproduction of, 1585  
 pathogenesis of, 1586  
 risk factors of, 1585–1586  
 transmission of, 1585  
 treatment of, 1586–1587
- Sarcoptic mange, 1619–1621, 1620b
- Sarcosporidiosis, 2137–2140
- Sawfly larvae toxicosis, 654–655
- Sawhorse posture, 1361f–1362f, 1363
- Saxitoxins, 102
- Scabby mouth, 1593–1596, 1593b
- Scabby ulcer, 1152, 1152b–1153b  
 differential diagnosis of, 1154b  
 treatment and prophylaxis of, 1154b
- Scandinavian countries, bovine virus diarrhoea virus  
 eradication, 598
- Scandinavian knuckling syndrome, 1369–1370
- Scant feces, 180
- Scedosporium prolificans*, 797
- Schiff-Sherrington syndrome, 1163
- Schmallenberg virus, 1511b, 1514–1515  
 clinical findings of, 1513  
 clinical pathology of, 1513  
 control of, 1513–1514  
 differential diagnosis of, 1513b  
 epidemiology of, 1511  
 necropsy findings of, 1513  
 pathogenesis of, 1512–1513  
 risk factors of, 1512  
 source of infection of, 1512  
 treatment for, 1513–1514
- Schwannomas, 1223
- Schwartzman reaction, 63
- Sciatic nerve, paresis of, 1359f, 1362
- Scintigraphic detection, colitis, right dorsal, 267
- Scintigraphy, in respiratory system, 858
- Scleroderma citrinum*, 2204
- Sclerosis, head-shaking and, 1226
- Scoliosis, head, 1838
- Scours, 1833
- Scrapie, 1299b, 1321  
 advanced cases of, 1299f, 1305  
 clinical findings of, 1305  
 clinical pathology of, 1305–1306  
 control of, 1306–1307  
 differential diagnosis of, 1302b  
 early signs of, 1305  
 economic importance of, 1303  
 epidemiology of, 1301–1302  
 etiology of, 1300  
 experimental reproduction for, 1303–1305  
 genetics of, 1302–1303, 1327t  
 geographic occurrence of, 1301  
 host occurrence of, 1301  
 incubation of, 1305  
 necropsy findings of, 1305–1306  
 pathogen risk factors for, 1303  
 pathogenesis of, 1304–1305  
 risk factors for, 1302–1303  
 transmission of, 1302
- Scrapie Flock Certification, 1309
- Screwworm, 1615–1617, 1615b–1616b  
 differential diagnosis of, 1617b  
 treatment of, 1617b
- Screwworm, myositis and, 1387
- Screwworm fly (*Cochliomyia americana*), 1902
- Scrotal mange, 1622–1623  
 differential diagnosis of, 1623b
- Scrotum, cold injury to, 51
- Sea onion, 2191
- Season  
 hypomagnesemic tetany and, 1701  
 sheep, infectious footrot in, 1442
- Seasonal allergic dermatitis, in sheep, 1560–1561, 1561f
- Seasonal pasture myopathy, 1378
- Seborrhea, 1554  
 differential diagnosis of, 1554b
- Second syndrome, otitis media/interna in, 1336–1337
- Secondary bacterial pneumonia, mycoplasmal pneumonia, 1071
- Secondary copper deficiency  
 etiology, 2163–2164  
 general syndrome, cattle, 2169
- Secondary copper poisoning, 820
- Secondary immune deficiencies, 755–756
- Secondary osteoarthritis, 1407–1408
- Secondary pityriasis, 1544
- Secondary pulmonary congestion, 880
- Second-degree atrioventricular block, 679
- Secretory diarrhoea, 208–209
- Sedation  
 esophageal obstruction, 201–202  
 mild, myopathy, horse and, 1386
- Sedimentation and decanting technique, 618
- Seed dressings, 2190
- Segmentation, abnormality of, diarrhoea, 179–180
- Segmented axonopathy, 1353–1354
- Segregated rearing, for ovine progressive pneumonia, 977
- Seizures. see Convulsions
- Selenium  
 biological functions of, 1459–1460  
 coliform mastitis and, 1946  
 deficiency, 1458–1478, 1459b  
 clinical findings of, 1469–1470  
 control of, 1474–1478  
 differential diagnosis of, 1473b–1474b  
 epidemiology of, 1460–1468  
 etiology of, 1459–1460  
 necropsy findings of, 1473  
 pathogenesis of, 1468–1469  
 reproductive performance and, 1464–1465  
 treatment for, 1474  
 volcanic eruptions, 109  
 dietary requirement of, 1475  
 dosage of, 1475–1476  
 gastric ulcers, 290  
 intraruminal pellets, 1478  
 level in blood and body tissues deficient of, 1472t  
 in milk supplies, 1475  
 myopathy and, 1377–1378, 1381  
 horse and, 1382  
 oral, 1476  
 in plants, 1461  
 reference range of, 1472t  
 responsive reproductive performance and growth for, 1477–1478  
 responsiveness of, 1478  
 soil in, 1461  
 status, 1471  
 subclinical insufficiency, 1464, 1468–1469  
 toxicity of, 1474–1475, 1478  
 transfer to fetus, colostrum, and milk, 1466–1467
- Selenium toxicosis, 1638–1640, 1638b  
 acute, 1639  
 chronic, 1639  
 clinical findings of, 1639  
 clinical pathology of, 1638–1639  
 control of, 1639  
 differential diagnosis of, 1639b  
 epidemiology of, 1638  
 etiology of, 1638  
 necropsy findings of, 1639  
 pathogenesis of, 1638–1639  
 risk factors of, 1638  
 treatment of, 1639
- Selenium-responsive disorders, 1464
- Selenocompounds, 2211
- Semen, 833  
*Brucella abortus*, transmission of, 1763  
 examination of, brucellosis associated with  
*Brucella ovis*, 1776  
 ovine progressive pneumonia in, 974  
 in Q fever, transmission of, 1792
- Senkobo disease, of cattle, 1570–1573
- Sensation  
 altered, 1162–1163  
 skin, 1174
- Sensible grazing management, for lungworm, 964



- Sensitivity  
laboratory data and, 24  
test of, 1164
- Sensory nerve action potentials, 1178
- Sensory nerve fibers, 79
- Sensory perceptivity, 1157
- Separation, of groups of animals based on risk, 39–40
- Sepsis  
definition of, 57  
in neonates, 1856–1859  
severe, 57
- Sepsis score, 58, 1859, 1859t, 1876, 1877t
- Sepsis-related laminitis, 1396
- Septic arthritis, treatment of, 937
- Septic arthritis synovitis, 1411–1418  
clinical findings of, 1413–1414, 1413f  
control of, 1418  
diagnosis of, 1414–1415  
differential diagnosis of, 1415b  
epidemiology of, 1411–1412  
etiology of, 1411–1412  
necropsy findings of, 1415  
pathogenesis of, 1412–1413  
treatment for, 1415–1418
- Septic fevers, 54
- Septic pedal arthritis, in cattle, 1417
- Septic peritonitis, 219
- Septic shock, 57, 59–67  
clinical findings, 63  
horse in, 61  
treatment for, 64–66
- Septic shock, fluid therapy, in newborn, 1865
- Septicemia, 57–59  
associated with *Histophilus somni*, 2038–2039, 2038b  
clinical findings, 2039  
clinical pathology of, 2039  
epidemiology of, 2038–2039  
etiology of, 2038  
necropsy findings of, 2039  
pathogenesis of, 2039  
samples for confirmation of diagnosis, 2039, 2039b  
treatment and control of, 2039
- cattle, 57  
clinical findings in, 58  
clinical pathology, 58–59  
definition of, 57  
donkeys, 57  
due to *Brucella abortus*, 1771  
epidemiology of, 57  
etiology of, 57  
foals with, 1413  
hemorrhagic, 2040–2042  
horses, 57  
intravenous antimicrobials and, 159  
*Klebsiella pneumoniae*, 2057  
leptospirosis and, 1120  
mules, 57  
necropsy findings in, 58–59  
neonatal, 57–58  
in neonatal infection, 1876  
pathogenesis of, 57–58  
peritonitis, 216  
pigs, 57  
*Salmonella abortusequi* with, 1785–1786  
salmonellosis, 300, 365  
in swine, 300  
secondary, 57  
sheep of, 57  
treatment of, 59  
vasculitis and, 721
- Septicemic listeriosis, 1337–1338
- Septicemic pasteurellosis, of cattle (hemorrhagic septicemia), 2040–2045  
clinical findings, 2041  
clinical pathology, 2041  
culture and detection of bacteria, 2041  
serology, 2041
- control, 2041–2042  
antimicrobial metaphylaxis, 2041–2042  
vaccines, 2042
- differential diagnosis, 2041b
- epidemiology, 2040–2041
- etiology, 2040
- necropsy findings, 2041
- occurrence, 2040
- pathogenesis, 2041
- risk factors, 2040  
animal, 2040  
environmental, 2040  
pathogen, 2040  
samples for confirmation of diagnosis, 2045  
transmission, 2040–2041  
treatment, 2041, 2041b
- Serologic surveillance, for contagious bovine pleuropneumonia, 930–931
- Serologic tests  
in bovine herpesvirus-1 infection, 956–957  
bovine immunodeficiency-like virus and, 787  
in bovine respiratory syncytial virus, 950  
in contagious bovine pleuropneumonia, 928–929  
in enzootic pneumonia of calves, 944  
epizootic hemorrhagic disease and, 785  
in equine herpesvirus-1 and -4 infections, 1041  
in equine influenza, 1034–1035  
in *Mycoplasma bovis*, 935  
in *Mycoplasma pneumoniae*, 1066–1067  
in ovine progressive pneumonia, 976  
in pleuropneumoniae, of pigs, 1060  
in progressive atrophic rhinitis, 1051  
in *Rhodococcus equi* pneumonia, 1016  
in swine influenza, 1082
- Serology  
anaplasmosis and, 773–775  
babesiosis and, 804  
of borreliosis, 1427  
of bovine digital dermatitis, 1438  
for bovine ulcerative mammillitis, 1987  
bovine viral diarrhea, 587  
*Brachyspira hyodysenteriae*, 330  
for *Brucella abortus*, 1766–1767  
for brucellosis associated  
with *Brucella melitensis*, 1783  
with *Brucella ovis*, 1776  
with *Brucella suis*, 1780  
of encephalitis, 1184  
eperythrozoonosis of, 780  
equine infectious anemia and, 796  
of Glässer's disease, 1453  
in Johne's disease, 559–560, 569–570  
porcine proliferative enteropathy, 325  
for porcine reproductive and respiratory syndrome, 1808–1809  
of pseudorabies, 1248  
salmonellosis, 301–302, 368  
septicemia, 58  
for teschovirus infections, 1291  
viral diarrhea, 390  
winter dysentery, cattle, 601
- Seropositivity, high rates of, 2077
- Serotype, of pleuropneumoniae, in pigs, 1056–1057, 1059–1060
- Serovars, leptospirosis and, 1116
- Serpulina pilosicoli*, 335
- Serratia* spp., mastitis and, 1963
- Serum  
assessment test on, 1853–1854  
tests of, 1103–1106  
urea nitrogen, 1104
- Serum agglutination test, for *Brucella abortus*, 1766
- Serum amyloid A (SAA) protein, 56  
in horses, 56
- Serum biochemical profiles, limitations of, 24
- Serum biochemistry  
abomasal displacement/volvulus, 512  
anemia and, 737  
for bovine mastitis, 1920  
carbohydrate engorgement, 467  
for coliform mastitis, 1949  
colitis, right dorsal, 267–268  
diarrhea, acute, 278  
endotoxemia, 64  
enteritis, 211  
equine colic, 230–231  
of fatty liver, 1719–1720  
hemorrhagic bowel syndrome, 551  
intestinal obstruction, 527  
Johne's disease, 570  
left-side displacement of abomasum and, 507  
for musculoskeletal system disease, 1377  
in newborns, 1862–1863, 1862t  
in pneumonic pasteurellosis, 918–919  
for postpartum dysgalactia syndrome, 1999  
uroolithiasis and, 1147  
vagus indigestion, 494
- Serum electrolyte imbalance, in downer-cow syndrome, 1694
- Serum electrolytes, and naturally occurring combined abnormalities of free water, electrolyte, acid-base balance, and oncotic pressure, 134
- Serum  $\gamma$ -glutamyltransferase activity, for assessment of transfer of passive immunity, 1853
- Serum (postvaccinal) hepatitis, 631, 639–640
- Serum methylmalonic acid, 817–822
- Serum muscle enzyme activity, 1681
- Serum neutralization test (SNT), 785  
for porcine reproductive and respiratory syndrome, 1809  
of pseudorabies, 1248
- Serum neutralizing (SN) antibodies, bovine virus diarrhea virus, 581–582, 587
- Serum total protein, for assessment of transfer of passive immunity, 1853
- Sesquiterpene lactones, 2211
- Sesquiterpenes, 2210
- Setaria*, 1345–1346
- Severe pericardial tamponade, and obstructive shock, 72–73
- Severely affected horses, myopathy and, 1386
- Sewage sludge, feeds, 620
- Sex, sheep, infectious footrot in, 1442
- Shade, and hyperthermia, 53
- Shaker calf syndrome, 1350–1351
- Shamonda virus, 1511
- Shearing  
caseous lymphadenitis risk factor, 764  
hypothermia and, 48–49  
winter, lamb birth weight and, 47
- Sheat rot, 1152, 1152b–1153b  
differential diagnosis of, 1154b  
treatment and prophylaxis of, 1154b
- Sheep  
abomasal impaction in, 517–518  
anaphylaxis of, 750  
anaplasmosis and, clinical findings, 773  
anthrax in, 2013  
babesiosis of, 802  
treatment, 805–806  
biosecurity planning for, 37b  
biotin and, 1503  
blow-fly strike of, 1611–1615, 1611b–1612b  
bluetongue, 2072  
border disease in, 1253  
borreliosis in, 1425, 1427  
botulism in, 1368  
bronchitis in, 878  
caseous lymphadenitis and, 762  
risk factors of, 763–764  
cerebellar atrophy in, 1334  
chondrodysplasia in, 1535  
chronic enzootic pneumonia in, 972–973, 972b

- Sheep (*Cont'd*)  
 coccidiosis, 402  
 congenital cardiac defects and, 704  
 congenital fixation of joints in, 1510  
 contagious agalactia in, 1994–1996, 1994b  
 contagious ecthyma in, 1594–1595, 1594f–1595f  
 copper deficiency, 2169–2170  
 cryptosporidiosis, 397  
 dwarfism in, 1532  
 ELISA and, 805  
 enterotoxemia, *Clostridium perfringens* type D associated, 1228–1230  
 enzootic nasal adenocarcinoma of, 970f  
 eperythrozoonosis and serology, 780  
 source of transmission, 779  
 erysipelas in, 1455  
 fate of, burned by pasture fire, 110–111  
 fleece rot in, 1574–1575  
 foot abscess in, 1448–1449  
 granulomatous lesions in, 1559  
 hemorrhagic shock in, 71–72  
 infected by bovine tuberculosis, 2018  
 necropsy findings of, 2021  
 infectious footrot in, 1441–1448, 1441b  
 clinical findings of, 1443–1444  
 clinical pathology of, 1444  
 control for, 1444–1447  
 differential diagnosis of, 1444b  
 economic importance of, 1442  
 environmental risk factors of, 1442  
 epidemiology of, 1441–1442  
 eradication of, 1447–1448  
 etiology of, 1441  
 genetic selection and, 1447  
 host risk factors of, 1442  
 methods of transmission of, 1441  
 necropsy findings of, 1444  
 pathogenesis of, 1443  
 scoring systems for, 1443  
 source of infection of, 1441  
 symptomless carriers for, 1443–1444  
 treatment for, 1444–1447, 1446b  
 vaccination for, 1447  
 inherited congenital hydrocephalus in, 1329–1331  
 inherited goiter in, 1747  
 interstitial pneumonia in, 967  
 intestinal obstruction in, 528–530  
 intraruminal selenium pellets for, 1478  
 iodine deficiency in, 1744, 1745f  
 laryngitis in, 878  
 lead poisoning in, 1204–1206  
 leptospirosis and, 1117–1118, 1122  
 listerial abortion in, 1338  
 listerial encephalitis/meningitis in, 1337–1338  
 lumpy wool of, 1570–1573  
 lungworm in, 980–981, 980b–981b  
 lymphosarcoma, outbreaks of, 837  
 with *M. bovis*, 2017  
 mastitis of, 1991–1993, 1993b  
 differential diagnosis of, 1993b  
 maternal nutrition in, 1847  
 melioidosis, clinical findings, 2030  
 methicillin-resistant *Staphylococcus aureus* in, 1567  
 mycobacteriosis associated with MAC and with atypical mycobacteria, clinical and necropsy findings of, 2025  
*Mycoplasma* spp. of  
 diseases of the respiratory tract associated with, 924  
 major pathogenic, 885t  
 neuraxonal dystrophy of, 1353–1354  
 nonprotein nitrogen toxicosis in, 619  
 nutritional advice for, 1751–1752  
 organophosphorus poisoning in, 1215  
 osteogenesis imperfecta in, 1532  
 parenteral nutrition for, 151–152  
 pasteurellosis of, 2042–2043  
 periparturient period in, 1662–1667  
 phosphorus deficiency in, 1487  
 plasma and liver copper in, 2171–2172  
 pleuritis in, 896  
 pneumonia in, 886  
 posthitis and, 1153  
 postshearing hypothermia in, 48  
 primary copper toxicosis, 2182  
 pruritus in, 1543  
 pseudorabies in, 1248  
 psoroptic mange in, 1621  
 pulmonary and pleural neoplasms in, 1088  
 rabies in, 1240  
 red foot disease of, 1646  
 reproductive performance, selenium and vitamin E deficiency, 1465  
 respiratory tract, diseases of, 969–970  
 rhinitis in, 874  
 salmonellosis, 358  
 salt-mineral mixture for, 1476–1477  
 sarcocystosis, 2139  
 seasonal allergic dermatitis in, 1560–1561, 1561f  
 selenium subcutaneous injections for, 1475–1476  
 selenium-responsive reproductive performance in, 1477  
 septic arthritis synovitis and, 1412  
 septicemia and thrombotic meningoencephalitis in, associated with *Histophilus somni*, 2038–2039, 2038b  
 septicemia in, 57  
 shorn, hypothermia in, 49  
 slow-release treatments in, 2175  
 starvation in, 90  
 strawberry footrot of, 1575–1576  
 systemic mycoplasmoses of, 971t  
 temperature, upper critical, 52  
 tick-borne fever and, 777–778  
 tooth root abscess in, 77  
 toxoplasmosis, 2142  
 tracheitis in, 878  
 transportation, stress, 85  
 tuberculin testing in, 2020  
 tularemia, clinical findings, 2028  
 ulcerative dermatosis of, 1596  
 Sheep ked (*Melophagus ovinus*), 1623–1624  
 Sheep scab, 1621–1622  
 differential diagnosis of, 1622b  
 SheepMAP, 571–572  
 Sheepox, 1591–1593, 1591b  
 differential diagnosis of, 1592b  
 Sheepshead, 1534–1535  
 Shiga toxin (Stx) genes, 540  
 Shipping fever, 158, 939  
 Shivering thermogenesis, 43, 45–46  
 Shock  
 alimentary tract dysfunction, 177, 182  
 enteritis, 210  
 equine colic, 225  
 hypovolemic, 658  
 from lightning strike, 104  
 maldistributive, 658  
 milk fever and, 1681–1682  
 monitoring in, 73  
 peritonitis, 216  
 septic, 57, 59  
 Short chain fatty acids, gastric ulcers, 288  
 Short-term mechanical ventilation, 870  
 Show horses, vaccines for, in equine influenza, 1037–1038  
 Shower dipping, caseous lymphadenitis risk factor, 765  
 Shunting, in hypoxic hypoxia, 846  
 Shunts  
 cardiac catheterization of, 674–675  
 congenital anatomic defects producing, 659  
 congenital cardiac defects and, 704  
 Sideroleukocytes, equine infectious anemia, 792  
 Siggaard-Andersen's empirical equation, 125  
 Sign-time relationship, 1169  
 Silage, listeriosis and, 1336  
 Silage eye, 1649–1650, 1649b  
 Silicosis, 109  
 “Silver dollar spots”, 1820  
 Simple indigestion, 457–459, 457b  
 clinical findings, 457–458  
 clinical pathology, 458  
 differential diagnosis, 458b  
 etiology, 457  
 pathogenesis, 457  
 spontaneous recovery, 458  
 treatment, 458–459, 459b  
 Simuliidae, 1629–1630  
 Single intradermal comparative test (SICT), 2019  
 Single intradermal test (SIT), 2019  
 Sinks, laminitis, horse and, 1400  
 Sinoatrial block, 679  
 Sinus arrhythmia, 679  
 Sinus bradycardia, 676  
 Sinus tachycardia, 675–676  
 Sinusitis, in nasal bots, 980  
 Siphonage, repeated, 202  
 Skeletal muscle potassium content, in acute hypokalemia, 1691  
 Skeleton, defects of, 1372–1375  
 Skin  
 biopsy, bovine virus diarrhea virus, 586–587  
 burned, 110  
 burns of, 111  
 changes in, in vitamin A deficiency, 1323  
 clinical examination of, 12, 21–22  
 congenital absence of, 1645  
 diseases of, 1540–1661  
 abnormal coloration of, 1542  
 abnormalities of  
 skin glands, 1543  
 wool and hair fibers, 1543  
 clinical signs and special examination of, 1541  
 dermis, diseases of, 1543–1544  
 epidermis, diseases of, 1543–1544  
 granulomatous lesions of, 1558–1559  
 infectious diseases in, 1564–1570  
 inherited, 1644  
 lesions in, 1541–1542  
 miscellaneous plants in, 1637–1638  
 primary/secondary lesions of, 1541  
 principles of treatment of, 1543  
 pruritus in, 1542–1543  
 subcutis, diseases of, 1555–1559  
 form, of glands, 1027  
 pricking of, from cutaneous trunci reflex, 1174  
 sensation, 1174  
 tenting, equine colic, 232  
 wrinkling of, 114  
 Skin tuberculosis, 1573–1574  
 differential diagnosis of, 1574b  
 Skunk cabbage (*Lysichiton americanus*), prolonged gestation and, 1827  
 Skunks, rabies in, 1240  
 Slaframine toxicosis, 429–430, 429b–430b  
 Slap test, 1173–1174  
 Slaughter  
 enterohemorrhagic *Escherichia coli*  
 control, 543–544  
 prevalence, 537  
 equine histoplasmosis, 796  
 “Sleeper syndrome”, 2036  
 Slick hair gene, and hyperthermia, 52  
 Slide agglutination test, *Brachyspira hyodysenteriae*, 330  
 Slobbers, 429–430  
 Slurry, 307  
 Slurry applications, 106  
 Slurry pits, 106  
 Small colon  
 impaction, 268–269, 268b  
 obstruction, 268–269  
 Small intestine  
 biopsy, granulomatous enteritis, 282  
 distension, equine colic, 227–228, 228t  
 epiploic foramen entrapment, 254  
 equine grass sickness, 285  
 hemorrhage, 181–182  
 incarceration, 526

- Small intestine (*Cont'd*)  
 intussusception, 525–526  
 exploratory laparotomy (celiotomy), 453  
 intussusception, obstruction, 253–254  
 obstruction  
 abdominal distension, 183  
 exploratory laparotomy (celiotomy), 453  
 in horses, 252–255, 252b  
 acute, 253  
 caudal abdominal, 254  
 clinical findings, 253–254  
 clinical pathology, 254–255  
 differential diagnosis, 255b  
 epidemiology, 252–253  
 etiology, 252  
 functional obstruction, 252, 254  
 with infarction, 252  
 necropsy findings, 255  
 pathogenesis, 253  
 subacute, 253  
 treatment, 255  
 without infarction, 252  
 obstructive lesions, equine colic, 226  
 viral diarrhea, 390  
 volvulus, 254, 523–526
- Small ruminants, epizootic hemorrhagic disease and, 783
- Smelter emissions, 106
- Smithburn strain, 2069
- Smoke inhalation, in horses, 881
- Smooth tongue (epitheliogenesis imperfecta linguae bovis), 434
- Snake venom, coagulation defect of, 722
- Snakebite, 2176–2179, 2176b  
 clinical findings, 2178  
 clinical pathology, 2178  
 control, 2179  
 differential diagnosis, 2178b  
 epidemiology, 2176–2177  
 etiology, 2176, 2177t  
 necropsy findings, 2178  
 pathogenesis, 2177–2178  
 risk factors, 2176–2177  
 animal, 2176–2177  
 treatment, 2178–2179
- Sneezing, 852  
 in mycoplasmal pneumonia, 1073  
 in nasal bots, 979–980  
 in porcine cytomegalic virus, 1075
- Snoring, 852
- Snorter dwarfs, 1532–1534
- Snorting, 852
- Snout-rubbing, in pigs, 1225
- Snuffing, 852
- SOAP acronym, 4
- Sodium  
 and/or chloride deficiency, 2161–2162  
 fractional clearance of, 1105  
 hypernatremia, 118  
 hyponatremia, 116  
 in macromineral evaluation, 1671  
 in oral electrolyte solution, 149
- Sodium bicarbonate  
 5%, 141  
 8.4%, 141  
 carbohydrate engorgement, 469  
 diarrhea, acute, 279  
 for horses, 150  
 hypertonic, for endotoxemia, 65  
 isotonic, 139  
 myopathy and, 1381  
 horse, 1386–1387  
 oral administration of, 150  
 rhabdomyolysis and  
 in horses, 1481  
 recurrent exertional for, 1521
- Sodium chlorate supplementation,  
 enterohemorrhagic *Escherichia coli* control,  
 542
- Sodium chloride, 138, 1145  
 7.2%, 140  
 toxicosis of, 1325, 1331b  
 clinical findings of, 1318  
 clinical pathology of, 1318  
 control of, 1319  
 differential diagnosis of, 1331b  
 epidemiology of, 1317  
 etiology of, 1317  
 necropsy findings of, 1318  
 occurrence of, 1317  
 pathogenesis of, 1318  
 risk factors of, 1317–1318  
 samples for diagnostic confirmation of, 1318  
 treatment for, 1319
- Sodium citrate, for hemorrhagic shock, 75
- Sodium cromoglycate, for heaves, 1011
- Sodium dilution principle, 136
- Sodium fluoroacetate (compound 1080) toxicosis,  
 1210–1212
- Sodium fluorosilicate, 2190
- Sodium hypochlorite, 1969
- Sodium iodide, 533, 796
- Sodium lactate, hypertonic solutions of, 141
- Sodium nitrite, cyanogenic glycoside poisoning, 829
- Sodium pentosan polysulfate, 721
- Sodium phosphate, monobasic monophosphate  
 form of, 122–123
- Sodium selenate, 1476–1477
- Sodium sulfanilate, plasma clearance and, 1104
- Sodium sulfate, equine colic, 234
- Sodium sulfite precipitation test, for assessment of  
 transfer of passive immunity, 1853
- Soft palate  
 conformation, 983  
 dorsal displacement of, 982–984  
 intermittent, during exercise, 982–984, 983b,  
 983f  
 persistent, 984  
 ulceration, stomatitis, 193–194
- Softwood forest fires, 110
- Soil  
*Clostridium haemolyticum*, 635  
 enterohemorrhagic *Escherichia coli* source, 539  
 John's disease and, 555  
 selenium in, 1461  
 type  
 clinical examination of, 8–9  
 and radiation, 107
- Solanum* spp., 2211–2212
- Solenopsis invicta*, 2179
- Soluble CD14 receptors (sCD14), 60
- Solutes, precipitation of, 1144–1145
- Somatic cell count  
 bulk tank milk, 1914–1915, 1915t, 1981  
 of composite or quarter samples, 1917–1918,  
 1917f, 1918t  
 herd average of, 1981  
 of individual cow, 1982–1983  
 in mastitis, 1904, 1909  
 bovine, risk factors of, 1908  
 coliform, 1945, 1949  
*Corynebacterium bovis*, 1940  
*Staphylococcus aureus*, 1934  
*Streptococcus agalactiae*, 1938  
 problem solving using, 1983  
 threshold and, 1982
- Somatic-cell nuclear transfer, in cloning, 1870
- Somatosensory evoked potentials, 1178
- Somatotropin, 1709
- Sonic bang, aircraft, 106
- "Sonorensis Line", 2072
- Sorbital dehydrogenase (SDH), 628
- Soremouth, 393–397, 1593–1596, 1593b
- Sorghum cystitis-ataxia syndrome, 827
- Sound spectrum analysis, respiratory, 868
- South Africa, African horse sickness, occurrence of,  
 2092–2093
- South America, rabies in, 1239–1247
- Sow vaccination, 2130
- Sows  
 dietary supplementation and, 813  
 gastric volvulus, acute, 287  
 volume of colostrum ingested of, 1851
- Soybean by-products, 1744
- Soybean products, dietary diarrhea, 213
- Space-occupying lesions, 4
- Spasmodic colic, 221, 269, 269b
- Spasmolytics  
 for equine colic, 233t  
 for increased motility, 191
- Spasms, inherited congenital, of cattles, 1333
- Spastic paresis, involuntary, 1160
- Spasticity  
 caprine progressive, 1349  
 inherited neonatal, 1331–1337  
 upper motor neuron lesion, 1163
- Spatial Examination, of disease problem, 32
- Species susceptibility, leptospirosis and, 1116
- Specific gravity, 1100
- Specific pathogen-free pigs, *Mycoplasma pneumonia*  
 in, 1069
- Specificity, laboratory data and, 24
- Spectinomycin, 170
- Spectroscopy, infrared, for degenerative joint  
 disease, 1409–1410
- Spheroids, 1193
- Sphingomyelinase deficiency, 1222–1223
- Spider lamb syndrome, 1535, 1536f
- Spinal accessory nerve (cranial nerve XI), assessment  
 of, 1169
- Spinal cord  
 compression of, 1339–1341  
 clinical findings of, 1349  
 clinical pathology of, 1349  
 differential diagnosis of, 1355b  
 etiology of, 1347–1348  
 necropsy findings of, 1349–1350  
 pathogenesis of, 1349  
 treatment of, 1350
- diseases of, 1337–1339  
 inherited, 1346–1347  
 local ischemia of, 1343  
 traumatic injury of, 1342–1343  
 clinical findings of, 1344  
 clinical pathology of, 1344–1345  
 differential diagnosis of, 1351b–1352b  
 etiology of, 1342  
 by parasitic invasion, 1343  
 pathogenesis of, 1343–1344  
 by physical trauma, 1342–1343  
 treatment for, 1346  
 tumors of, 1339f, 1348
- Spinal cord disease, 1161–1162
- Spinal dysraphism, inherited, 1351
- Spinal muscular atrophy, bovine, 1193
- Spinal myelitis, listeriosis and, 1337, 1339
- Spinal reflexes, of thoracic limbs, 1171
- Spinal stenosis, congenital, 1538
- Spiral colon, testing of, 390
- Spirochetal colitis, 335–337
- Splayed digits, inherited, 1517–1518
- Splayleg syndrome, in newborn pigs, 1529–1530
- Splaylegs, of newborn pigs, 1378
- Spleen  
 congenital anomalies of, 752–753  
 diseases of, 751–752  
 displaced, equine colic, 228t  
 infarction of, 746–749  
 neoplasms of, 751  
 rectal examination palpation of, 20  
 rupture of, 751
- Splenectomy, 751
- Splenic abscess, 746–749
- Splenic hematoma, 746–749
- Splenomegaly, 746–749, 777
- Spondylitis, osteodystrophy and, 1389
- Spondylosis, in bulls, 1344



- Spongiotic vesicular dermatitis, 1548
- Spontaneous fractures, 1375, 1390
- Sporadic abortion, neosporosis and, 1818
- Sporadic bovine encephalomyelitis (SBE), 1251b, 1282
- Sporadic bovine leukosis, 838–839, 843b
  - clinical findings of, 841–842
  - clinical pathology of, 842
  - differential diagnosis of, 844b
  - differentiation between enzootic and, 838
  - epidemiology of, 840–841
  - etiology of, 840
  - necropsy findings of, 842
  - pathogenesis of, 841
  - samples for confirmation of diagnosis, 842
- Sporadic lymphangitis, 781
- Sporidesmin toxicity, 652–654, 652b
  - differential diagnosis, 653b
- Sporidesmium bakeri* (*Pithomyces chartarum*), 652
- Sporothrix beurmanii*, 794
- Sporothrix equi*, 794
- Sporothrix schenckii*, 794
- Sporotrichosis, 799–811
  - differential diagnosis of, 799b–800b
- Sporotrichum schenckii*, 794
- Spotted leukotrichia, 1553
- Sputolosin, 872
- Squamous cell carcinoma
  - esophagus, 431
  - mouth, 431
  - pharynx, 431
  - stomach, 431
- Squamous-cell carcinoma
  - bovine ocular, 1655–1658, 1655b
  - cutaneous, 1640–1641
  - in horses, 1583–1584, 1584f, 1640
- St. Helens, Mount, 109
- Stable fly (*Stomoxys calcitrans*), 1625–1626
- Stable footrot, 1434
- Stachybotryotoxicosis, 2213
- Staining, for localized infections, 78
- Stall rest, heart failure and, 662
- Stall-fed animals, history taking of, 7–8
- Stallions, 2088
  - dourine in, 1820
- Stalls, confinement to, gastric ulcers and, 248
- Standardbred horses, granulomatous enteritis, 282
- Staphylococcus*
  - coagulase-negative, in mastitis, 1906
  - localized infection, 77
- Staphylococcus aureus* mastitis
  - acute, 1933
  - bulk tank milk somatic cell count and, 1914, 1930–1936, 1930b–1931b
  - chronic, 1933
  - clinical findings of, 1933, 1943
  - clinical pathology of, 1933–1934, 1943
  - coagulase-negative, 1942–1943
  - coagulase-positive, 1931
  - control of, 1936
  - culture of bulk tank milk and, 1915
  - cure rates of, 1921
  - diagnosis of, 1934
  - differential diagnosis of, 1934b
  - economic importance of, 1932
  - epidemiology of, 1931–1932, 1942–1943
  - etiology of, 1931, 1942
  - genotype of strains of, 1932
  - method of transmission of, 1931
  - necropsy findings of, 1934
  - pathogenesis of, 1932–1933
  - peracute, 1933
  - prevalence of, 1931
  - risk factors of, 1931
  - source of infection in, 1931
  - treatment of, 1934–1936, 1936b, 1943, 1943b
  - vaccination for, 1936
  - virulence of, 1932
  - zoonotic implications of, 1932
- Staphylococcus chromogenes*, 1942
- Staphylococcus epidermidis*, mastitis, 1942
- Staphylococcus hyicus*, mastitis and, 1942
- Starch absorption test, 281
- Starch digestion test, 185
- Star-gazing lambs, 1332
- Starvation, 89
  - in mortality in piglets, 1833
  - secondary, dental disease, 195
- Starvation ketosis, 1710
- Status spongiosus, 624
- Steam pasteurization, carcass decontamination, 543
- Steam vacuum, carcass decontamination, 543
- Steatitis, 1726–1727
  - generalized
    - necropsy findings of, 1473
    - vitamin E deficiency and, 1468
- Stenosis
  - anterior functional (achalasia), 492
  - compression, 524
  - posterior functional (achalasia), 492
  - vagus indigestion, 492
  - vagus nerve injury/dysfunction, 491
- Stephanofilariasis, 1611
  - treatment of, 1611b
- Stephanurosis, 1134
- Stephanurus dentatus*, 1134–1135
- Stepwise resistant mutants, 159
- Stereotypy, 1224
- Sterigmatocystin, 2204
  - poisoning, 649
- Sterne vaccine, 2011
  - anthrax and, 2015
- Steroidal alkaloids (*Solanum* spp.), 2211–2212
- Steroidal saponins, 2210
  - plants containing, 1550
- Steroids
  - anabolic, for ketosis, 1714
  - inducing, degenerative joint disease, 1406
  - intraarticular, for degenerative joint disease, 1411
- Stertor, 852
- Stevens-Johnson syndrome, 752
- Stewart Range syndrome, 1197, 1198b–1200b
- Stick test, 1298
- Stillbirth, 1867–1870
  - congenital defects and, 1839
  - in lambs, 1831
  - in pigs, 1833–1834
  - in porcine reproductive and respiratory syndrome, 1807
- Stock, segregation of, in fasciolosis, 644
- Stocking rate examination, 9
- Stomach
  - diseases of, nonruminants, 203–215
  - equine grass sickness, 285
  - hemorrhage, 181–182
  - neoplasms, 431–432
  - tube, bloat, 478
- Stomach fluke disease, 617–618, 617b
  - differential diagnosis, 618b
  - treatment, 618, 618b
- Stomatitis, 192–194
  - bullous, 193
  - catarrhal, 193
  - clinical findings, 193–194
  - clinical pathology, 194
  - differential diagnosis, 194b
  - etiology, 192–193
  - mycotic, 193
  - necropsy findings, 194
  - necrotic, 534, 534b
  - pathogenesis, 193
  - treatment, 194
  - vesicular. *see* Vesicular stomatitis
- Stomoxys calcitrans*, 1625–1626
  - enzootic bovine leukosis transmission, 834
  - equine infectious anemia virus transmission, 789
- Strabismus, with exophthalmos, 1658, 1659f
- Strangles, 1019–1026, 1019b
  - clinical findings of, 1021–1022
  - clinical pathology of, 1022
  - control of, 1024–1026
  - diagnostic confirmation in, 1022
  - differential diagnosis of, 1022b, 1023t
  - epidemiology of, 1020
  - etiology of, 1020
  - hepatic abscesses and, 633
  - necropsy findings in, 1022
  - pathogenesis of, 1020–1021
  - transmission of, 1020
    - prevention of, 1024, 1025t
    - treatment of, 1022–1024
    - venous thrombi, 714
- Strangulation, intestinal, 524
- Stranguria, 1098
- Strategic anthelmintic programs, for lungworm, 964–965
- Strawberry footrot, of sheep, 1575–1576
  - differential diagnosis of, 1576b
- Stray voltage, 105–106, 105b–106b
- Streaked hairlessness, 1644
- Streptococcal arthritis, piglets and, 1416
- Streptococcal lymphadenitis, of swine, 2051
- Streptococcus*, localized infection, 77
- Streptococcus agalactiae* mastitis, bovine, 1937–1939, 1937b
  - bulk tank milk somatic cell counts and, 1914
  - clinical findings of, 1938
  - clinical pathology of, 1938
  - control of, 1939
  - in culture of bulk tank milk, 1915
  - cure rate of, 1921
  - differential diagnosis of, 1938b
  - economic importance of, 1937
  - epidemiology of, 1937
  - etiology of, 1937
  - intramammary antimicrobial therapy for, 1925
  - necropsy findings of, 1938
  - pathogenesis of, 1937–1938
  - prevalence of, 1937
  - risk factors in, 1937
  - source of infection in, 1937
  - transmission of, 1937
  - treatment of, 1938–1939, 1939b
  - vaccination for, 1939
- Streptococcus bovis*, 463
- Streptococcus dysgalactiae*
  - in bulk tank milk, 1915
  - lamb arthritis and, 1449
  - in mastitis, 1906
  - in neonatal streptococcal infection, 1901
  - polyarthritis, lambs with, 1412
- Streptococcus equi*, in neonatal streptococcal infection, 1901
- Streptococcus suis* infection
  - adhesion, 2047
  - clinical findings, 2048
  - clinical pathology, 2048–2049
    - culture or detection of organism, 2048–2049
    - serology, 2049
  - control, 2050
    - environment and management, 2050
    - mass medication of feed, 2050
    - vaccination, 2050
  - diagnosis, 2049, 2049b
  - epidemiology, 2045–2048
  - etiology, 2045, 2045t
  - hemolysin, 2047
  - methods of transmission, 2046
  - morbidity and case fatality, 2046
  - necropsy findings, 2049
  - occurrence, 2046
  - other properties, 2047
  - pathogenesis, 2048
  - prevalence of infection, 2046
  - risk factors, 2046–2047
    - animal, 2046–2047
    - environmental and management, 2047
    - pathogen, 2047
  - samples for confirmation of diagnosis, 2049
  - treatment, 2049–2050
  - of young pigs, 2045–2051, 2045b
  - zoonotic implications, 2047–2048

- Streptococcus uberis*, in mastitis, 1906  
*Streptococcus zooepidemicus*  
infection, 1019, 1033–1034  
in neonatal streptococcal infection, 1901  
Streptomycin  
actinobacillosis (wooden tongue), 534  
John's disease, 561  
Stress, 84–87  
animal welfare, 86  
causes of, 84–85  
clinical pathology, 85–86  
coliform gastroenteritis, 319  
diarrhea, acute, 277  
economic performance of, 87  
gastric ulcer in foals, 244  
management of, 87  
metabolic disease and, 86–87  
pathogenesis of, 85  
sources of, 85  
syndromes, 86–87  
Stressors, 84  
management of, for porcine stress syndrome, 1529  
Stridor, 852  
history taking of, individual animal, 13  
String sampling, 1915  
Stringhalt, 1346  
Strip cup, in bovine mastitis, 1913  
Strip grazing, bloat control, 479  
Stripping of the affected quarter, coliform mastitis, 1951–1952  
Stroke volume, cardiac reserve and, 658  
Stroma-free Hb, 142  
Strong ion acidosis, 126  
Strong ion approach, to acid-base imbalance, 125, 125f–126f, 139  
Strong ion gap (SIG), and naturally occurring combined abnormalities of free water, electrolyte, acid-base balance, and oncotic pressure, 135–136, 136f  
Strongyloides (threadworm), 416, 416b  
*Strongyloides papillosus*, 416  
*Strongyloides ransomi*, 416  
*Strongyloides westeri*, 416  
Strongylosis, 411–415, 411b–412b  
clinical findings, 413  
clinical pathology, 413  
diagnostic confirmation, 414  
differential diagnosis, 414b  
epidemiology, 412  
etiology, 412  
in horses, 411–415  
life cycle, 412  
necropsy findings, 413–414  
pathogenesis, 412–413  
treatment, 414, 414b  
*Strongylus vulgaris*, 709–710  
Struck, 547  
Strychnine, 1216  
Stypanrol, 1195  
Subacute forms, leptospirosis, 1120–1121  
Subacute leptospirosis, associated with *L. Pomona*, 1122  
Subacute ruminal acidosis (SARA), 461–472  
dairy cattle, 464–466, 471–472  
clinical findings, 466  
pathogenesis, 464  
prevention, 471  
Subclinical hypocuprosis, in cattle, 2169  
Subclinical iron-deficiency anemia, iron deficiency and, 813  
Subcutaneous abscess, 1558  
Subcutaneous edema, 1555  
differential diagnosis of, 1555b  
pleuritis and, 897  
Subcutaneous emphysema, 1556  
differential diagnosis of, 1556b  
Subcutaneous injection, of antimicrobials, 160, 160f  
Subcutaneous tissue, aspirate of, urolithiasis and, 1147  
Subcutis, diseases of, 1555–1559  
Subepiglottic cysts, 988  
Submaxillary region, clinical examination of, 20  
Subterranean clover (*Trifolium subterraneum*) poisoning, 821, 1823  
Subunit vaccines  
for bovine herpesvirus-1 infection, 959  
for pleuropneumoniae, of pigs, 1063  
for viral diarrhea, 393  
Subvalvular aortic stenosis, 706  
Succussion, clinical examination of, 14  
Sucking  
behavior, postpartum dysgalactia syndrome and, 1998  
drive, hypothermia, neonatal, 48  
loss of, in hypothermic lambs, 1845  
natural  
in administration of colostrum, 1855  
colostral immunoglobulin, 1849  
weak, colostral immunoglobulin and, 1851  
Sucralfate, 251  
Sucrose absorption test, 186  
Sudden death, 99–101  
bacillary hemoglobinuria, 636  
black disease, 637  
coliform gastroenteritis, 315  
groups of animal, 100–101  
in horses, 100  
investigation of, procedure for, 101  
myocardial disease, 691  
plants causing, without cardiomyopathy, 103  
reticuloperitonitis, traumatic, 485  
single animal, 99–100  
Suffocation, volcanic eruptions, 109  
Suffolk lambs, osteochondrosis and, 1406  
Suliyin, in *Streptococcus suis* infection, 2047  
Sulfadiazine, 277  
Sulfamethylphenazole, 778  
Sulfate  
removal of, 2174  
toxicity, in polioencephalomalacia, 1315  
Sulfonamides, 172  
actinobacillosis (wooden tongue), 534  
mechanism of action of, 172  
precautions and contraindications for, 172  
residues of, 169  
toxicity and clinical considerations of, 172  
use of, by ruminants, 160–161  
Sulfur  
environmental, selenium and, 1461  
excess dietary, in polioencephalomalacia, 1310–1311  
Sulfur toxicosis, 2191–2193, 2191b–2192b  
clinical findings, 2192  
control, 2193  
differential diagnosis, 2192b–2193b  
epidemiology, 2192  
etiology, 2192  
necropsy findings, 2192  
occurrence, 2192  
pathogenesis, 2192  
risk factors, 2192  
transmission, 2192  
treatment, 2193, 2193b  
Sulfur-induced polioencephalomalacia  
clinical pathology of, 1312–1313  
pathogenesis of, 1311–1312  
risk factors for, 1311  
treatment of, 1313–1314  
Sumicidin, poisoning of, 1214  
Summer infertility, 52–53  
Summer pneumonia, 972–973, 972b  
Summer slump, 2199  
“Summer snuffles,” of cattle, 874  
Summer sores, in horses, 1608–1609, 1608b  
differential diagnosis of, 1609b  
treatment of, 1609b  
Summit metabolism, cold thermogenesis, 46  
Superficial burns, 104  
Superficial pain, 79  
Superinfection  
oral antimicrobial-induced, 160  
and penicillin, 170  
Superphosphate fertilizers, 2190  
Supporting limb laminitis, in horses, 1397  
Supportive therapy  
antimicrobials and, 166  
for equine influenza, 1035–1036  
for equine pleuropneumonia, 995  
for mastitis, 1927  
for myopathy, 1381  
for pain, 84  
for pneumonia, 892  
Supportive treatment  
in bacillary hemoglobinuria, 636  
diarrhea, chronic undifferentiated, 282  
Suppurative foci, in *Rhodococcus equi*, 1015  
Suppurative necrotic bronchopneumonia, in strangles, 1021  
Suramin, 1821  
Surfactant  
bloat and, 478  
in ovine pulmonary adenocarcinoma, 978  
for respiratory tract disease, 872  
Surgery  
abomasal impaction, 517  
abomasal ulcer, 522  
abomasal volvulus, 514  
cecal dilatation/ cecocolic volvulus, 530  
equine colic, 232, 235, 239  
intestinal obstruction, 527–528  
left-side displacement of abomasum, 508  
for omphalophlebitis, 1901  
for respiratory tract disease, 872  
small-intestinal obstruction, 255  
Surgical debridement, actinomycosis, 532  
Surgical drainage  
for bovine footrot, 1434  
for septic arthritis synovitis, 1417  
Surgical therapy, for degenerative joint disease, 1411  
Surgical treatment  
enteritis, proximal, 257  
large (ascending) colon, impaction, of horses, 264  
Surra, 2156–2158, 2156b–2157b  
biosecurity concerns, 2157  
clinical findings, 2157  
clinical pathology, 2157–2158  
control, 2158  
differential diagnosis, 2158b  
economic importance, 2157  
epidemiology, 2157  
etiology, 2157  
immune mechanisms, 2157  
method of transmission, 2157  
morbidity and case fatality, 2157  
necropsy findings, 2158  
occurrence, 2157  
pathogenesis, 2157  
treatment, 2158, 2158b  
zoonotic implications, 2157  
Susceptibility tests, antimicrobial, 155–156  
flaws and limitations of, 156  
methods for, 155  
purpose of, 155  
rationale for, 155–156  
vs. empirical therapy, pros and cons of, 156b  
Swab Test on Premises (STOP), 168  
Swainsonine poisoning, 1193b, 1195b, 1196  
Swallowing  
abnormalities of, 11, 178  
disturbances of, 1168f  
Swamp cancer (equine phycomycosis), 813b, 814–817  
Swathing, bloat control, 479  
Sway reaction, 1172, 1174

Swayback, in lambs and goat kids, 2169–2170

Sweating

- dehydration and, 113
- equine colic and, 227
- exercise and, 96

Sweating sickness, 2179–2180, 2179b–2180b

- clinical findings, 2180
- clinical pathology, 2180
- control, 2180
- differential diagnosis, 2180b
- epidemiology, 2180
- etiology, 2180
- necropsy findings, 2180
- pathogenesis, 2180
- treatment, 2180

Sweden, winter dysentery, cattle, 599

Sweet clover poisoning, 826b, 832–834

- differential diagnosis, 826b
- treatment and prophylaxis, 828b

“Swelled head”, 1429

Swine

- biosecurity planning for, 37b
- erysipelas in, 2051–2056
- laminitis in, 1404–1406
- leptospirosis vaccination in, 1128
- noninfectious intestinal disease of, 290–291
- primary copper toxicosis, 2182
- residue violations in, 168–169
- salmonellosis, 292–308
- sarcocystosis, 2139
- streptococcal lymphadenitis of, 2051
- urinary disease in, 1131–1132
- zearalenone toxicosis in, 1824–1825

Swine dysentery, 327–334, 327b

- antibiotic therapy for, 332t
- antimicrobials, 331–332
- biosecurity, 333–334
- case-fatality rate, 329
- clinical findings, 329–330
- clinical pathology, 330
- control, 333–334
- diagnosis, 331
- differential diagnosis, 331b
- drug-augmented, 333
- drug-delayed, 332
- drug-diminished, 332
- epidemiology, 328–329
- etiology, 327–328, 327t
- immunity, 329–330
- morbidity, 329
- necropsy findings, 330–331
- pathogenesis, 329
- risk factors, 328–329, 328t
- transmission, 329
- treatment, 331–333
- vaccines, 334

Swine estrogenism, 1822

Swine influenza, 1075–1085

- clinical findings in, 1081
- clinical pathology of, 1082
- concurrent infections in, 1081
- control of, 1083
- differential diagnosis of, 1083b
- epidemiology of, 1078
- etiology of, 1076
- inactivated vaccines for, 1083
- modified live vaccines for, 1083–1084
- necropsy findings in, 1082–1083
- pathogenesis of, 1080–1081
- risk factors for, 1079
- seasonality in, 1078–1080
- treatment of, 1083
- vaccination for, 1083
- wild boar, 2010
- zoonotic implications in, 1080

Swine toxicosis, 2201

Swine vesicular disease, 353–355, 353b

- clinical findings, 355
- clinical pathology, 355
- control, 355, 355b
- epidemiology, 354

- etiology, 354
- necropsy findings, 355
- pathogenesis, 354
- treatment, 355

Swine-herds, nutritional advice for, 1750–1751

Swinepox, 1597–1600, 1597b

- differential diagnosis of, 1600b

Sympathoadrenal medullary system, 84–87

Synchronous diaphragmatic flutter, in horses, 1013

Syncope, 1159

Syndactylism, 1537

Syndrome recognition, for diagnosis, 2

Synergism, 164

Synovial fluid

- interpretation, for musculoskeletal system disease, 1376
- in newborns, 1863
- septic arthritis synovitis in horse and, 1413

Synovitis

- Brucella abortus* infection, 1765
- Histophilus somni* and, 1416
- thrombotic meningoencephalitis, 2036

System, determination of, key abnormality method and, 3–4

Systematic reviews, 26

Systemic AA amyloidosis, 760

Systemic antimicrobial administration, in guttural pouch empyema, 985

Systemic aspergillosis, 1045

Systemic blood flow, cardiac catheterization, 674

Systemic diseases, 2002–2214

- in newborn calves, 956

Systemic inflammatory response syndrome (SIRS), 57

Systemic lupus erythematosus (SLE), 1548

Systemic states, 43–112

- in diseases causing dyspnea, at exercise tolerance
- disturbances of appetite, 87–88
- food intake, 87–88
- nutritional status, 87–88

Systolic failure, 660

Systolic murmurs, 686

## T

T-2 toxin, 2213

Tabanid fly, 834

Tabanids, insect transmission and, 771

*Tabanus* spp., 1626

Tachyarrhythmia, heart failure etiology of, 662–663

Tachycardia, 15, 132

- bloat and, 477
- equine grass sickness, 284–285
- paroxysmal, 683–684
- sinus, 675–676
- ventricular, 684

Tachypnea, 848

- definition of, 846
- in fetal hypoxia, 1843–1844

Tachyzoites, *Neospora caninum*, 1819

Tail

- abscessation and cellulitis on, 77
- cold injury to, 51
- nervous system examination, 1172

Tail deformity, 1538

Tail jack, pain distraction, 80

Tail mange, 1622–1623

- differential diagnosis of, 1623b

Tail-biting, in pigs, 1225, 1256–1259

Taillessness, inherited, 1538

Tail-tip necrosis, in beef cattle, 1394–1395

- control for, 1395
- risk factors for, 1394
- treatment for, 1395

Talfan disease, 1291

Tamm-Horsfall protein, 1102

Tannins, 2207

Tapeworm infestations, 419–420

- adult tapeworm, 420–421, 420b
- larval, 419–420
- life cycle, 420
- treatment, 420–421, 420b–421b

Tay-Sachs disease, 1222

T-cell lymphoma, 748

Teat-end lesion, 1985

Teats

- abnormalities of, 1985–1986
- burn injury to, 110
- congenital defects of, 1991
- disinfection, dry cow, 1976
- external sealants, 1969, 1976
- frostbites of, 1985
- internal sealants for, 1976
- lesions of, 1985–1988
- liner disinfection of, 1970
- morphology of, in risk factor, of bovine mastitis, 1908
- papillomatosis of, 1986, 1991
- photosensitization of, 1986
- physical condition of, in risk factor, of bovine mastitis, 1908
- postmilking barrier teat dips, 1953
- premilking, disinfection of, 1953, 1968
- supernumerary, 1991
- traumatic injuries to, 1985

Teeth

- clinical examination of, 19
- congenital defects, 194
- diseases of, 194–195
- eruption of, rickets and, 1495
- grinding of, and pain, 80
- molar, inherited displaced, 1534
- premature wear and loss, 194

Telemetry, 668

Temperature, 132

- body, 43–44
- clinical examination of, 15, 15t
- equine colic, 231
- lower critical, 45, 46f
- upper critical, 52

Temperature-sensitive BHV-1 modified live vaccine, 958

Temporal pattern, of distribution of disease, 32

Tendon, defects of, 1372

Tenesmus, 182

- cattle, 182
- horses, 182
- pigs, 182
- puerperal metritis, 68
- relief of, 192

Tenotomy, laminitis, horse and, 1403

Teratogenic pathogen, 1835

Teratogens, 112

Terbutaline, for heaves, 1011

Terminal colon, atresia, 433–434

Terminal dry gangrene, salmonellosis, 365

Terminal ileal hypertrophy, 254

*Terminalia oblongata* spp., 2207

Teschen disease, 1290–1291

Teschovirus infections, 1287b, 1314–1320

- clinical findings of, 1290
- clinical pathology of, 1291
- control of, 1292
- differential diagnosis of, 1290b
- epidemiology of, 1289
- etiology of, 1289
- immunity for, 1292
- necropsy findings of, 1292
- pathogen risk factors for, 1290
- pathogenesis of, 1290
- risk factors for, 1289
- samples for diagnostic confirmation of, 1292
- serotypes, 1288–1289
- transmission of, 1289

“Test and cull” strategy

- bovine virus diarrhea virus, 597
- in ovine progressive pneumonia, 977
- program, components of, 597–598



- Testicles, palpation of, brucellosis, 1775
- Tetanus, 1358–1360, 1362b–1363b
- active immunity for, 1365
  - animal risk factors of, 1363
  - antitoxin, 1365
  - case-fatality rate of, 1362
  - clinical findings of, 1361f–1362f, 1363
  - clinical pathology of, 1363
  - control of, 1364–1365
  - differential diagnosis of, 1363b
  - epidemiology of, 1362
  - etiology of, 1362
  - importance of, 1363
  - necropsy findings of, 1363
  - occurrence of, 1362
  - passive immunity for, 1365
  - pathogenesis of, 1363
  - samples for diagnostic confirmation of, 1363
  - source of infection of, 1362–1363
  - toxoid, 1364
  - transmission of, 1363
  - treatment for, 1364, 1366b
- Tetanus antitoxin, 631
- Tetanus-associated bloat, 440
- Tetany, nervous system disease, 1159–1160
- Tetrachlorethylene, poisoning of, 1213
- Tetracyclines, 172–173
- anaplasmosis and, 774
  - diarrhea and, 277
  - mechanism of action of, 173
  - for *Mycoplasma pneumoniae*, 1068
  - for puerperal metritis, 69–70
  - tick-borne fever and, 778
  - toxicity of, 173
- Tetrahydropyrimidines, 607, 1212
- Tetralogy of Fallot, 705
- Tetrastarch, 143
- Texel sheep, inherited chondrodysplasia in, 1535
- Theileria annulata*, 2148
- Theilerioses, 2144–2145, 2144t
- Theiler's disease (postvaccinal/serum hepatitis), 631, 639–640
- Thelaziasis, 1655
- Thelitis, 1986
- Theophylline, 872
- for heaves, 1011
- Therapeutic decision making, 26–28
- Thermal nociceptors, 79–80
- Thermomodulation, cardiac output measurement, 673
- Thermogenesis, cold-induced, 45
- Thermography, infrared, for musculoskeletal system disease, 1377
- Thermoneutral zone, 45
- Thermoregulation
- endotoxemia and, 62
  - mechanisms for, 45
  - in neonates, 44–48
- Thiabendazole, 654
- poisoning of, 1211
- Thiaminases, 1311
- toxicosis of, 1314b–1315b, 1319b, 1325
- Thiamine
- deficiency, 1315
  - clinical findings of, 1315–1316
  - clinical pathology of, 1315
  - control of, 1316
  - differential diagnosis of, 1314b
  - encephalomalacia and, 1190
  - etiology of, 1315–1320
  - experimental syndromes and, 1315
  - necropsy findings of, 1315–1316
  - treatment for, 1316
  - supplementation of, 1314
- Thiamine hydrochloride
- for lead poisoning, 1208
  - for polioencephalomalacia, 1313
- Thiamine inadequacy polioencephalomalacia
- clinical pathology of, 1312
  - etiology of, 1310
  - pathogenesis of, 1311
  - risk factors of, 1311
- Thiamphenicol, 171
- Thick forelimbs, of pigs, 1537
- Thin ewe syndrome, 766, 975
- Thin sow syndrome, 2006–2007
- clinical findings, 2007
  - control, 2007
  - epidemiology, 2007
  - etiology, 2006
  - Oesophagostomum*, 615
  - synopsis, 2006b
  - thirst, 89
- Thiophanate methyl, 654
- Thiosulfate, urine concentration of, in polioencephalomalacia, 1317
- Thirst, 87–88
- degree of, 115
  - hyperthermia and, 52–53
- Thoracic drainage, in equine pleuropneumonia, 995
- Thoracic limbs, spinal reflexes of, 1171
- Thoracic pain, in respiratory insufficiency, 855
- Thoracic radiographs, of horses, 856–857, 857b, 857f
- Thoracic wall, trauma to, in pneumothorax, 899
- Thoracocentesis
- in pleuritis, 898
  - in pneumonia, 890
  - in tracheobronchial secretions, 862–864
- Thoracotomy
- in equine pleuropneumonia, 995
  - in pleuritis, 898
- Thorax
- auscultation of, traumatic pericarditis, 497–498
  - clinical examination of, 12–13, 16–17
- Thorny-headed worm, in pigs, 419
- Thoroughbred horses, exercise-induced pulmonary hemorrhage in, 998
- Threadworm, 416
- Thrombasthenia, 724
- Thrombin time, 720
- Thrombocytopenia, 723–724, 789
- bovine virus diarrhea virus, 585, 589
  - infection, 582
  - decreased platelet production, 724
  - endotoxemia, 61
  - equine granulocytic anaplasmosis of, 768–769
  - horses, 725–726
  - immune-mediated (idiopathic), 723–724
  - increased platelet destruction, 723–724
  - isoimmune, 725
  - tick-borne fever and, 777
- Thrombocytosis, 724–725
- Thromboelastography (TEG), 720f, 721
- Thromboembolic colic, 270, 270b
- Thrombopathia, inherited, 843
- Thrombophlebitis, 713–714
- and fluid therapy, 146–147
- Thrombosis, 728
- arterial, 709–711, 709b
  - differential diagnosis of, 711b
- Thrombotic meningoencephalitis (TME)
- Histophilus* septicemia of cattle, clinical findings, 2036
  - Histophilus somni* associated, 2037b
- Thromboxane A<sub>2</sub>, endotoxemia, 60
- Thymic lymphosarcoma, 836f, 841, 1223
- Thymoma, 1089
- Thymus, 753
- diseases of, 751–752
  - function of, 753
- Thyroid, damage to, and radiation, 108
- Thyroid adenoma, 1739–1742
- Thyroid function, disorders of, 1739–1742
- clinical findings of, 1740
  - clinical pathology of, 1740–1742
  - control of, 1742
  - epidemiology of, 1740
  - etiology of, 1739–1740
  - necropsy findings of, 1742
  - treatment of, 1742
- Thyroid hormone assays, 1740–1742, 1741t
- Thyroid-stimulating hormone, 1740, 1741t
- Thyroxine, for disorders of thyroid function, 1742
- Tiamulin
- porcine proliferative enteropathy, 326
  - swine dysentery, 331–332
- Tick
- babesiosis vectors, 808
  - bacterial, viral and rickettsial disease transmitted by, 1632, 1632t
  - causing direct losses, 1632
  - infestations, 1631–1634, 1631b
    - acaricidal agents of, 1632–1633
    - eradication of, 1634
    - macrocyclic lactones for, 1633
    - multiple-host ticks in, 1631t
    - organophosphates for, 1633
    - pasture management for, 1633–1634
    - pyrethroids for, 1633
    - single-host ticks in, 1631t
    - treatment and control of, 1632–1634
    - use of resistant cattle for, 1633
    - vaccination for, 1634  - ovine encephalomyelitis, transmission of, 1264
  - transmit protozoan diseases, 754t, 795
- Tick paralysis, 1363–1367, 1367t
- Tick pyemia, 777
- of lambs, 2039–2040, 2039b
  - clinical and necropsy findings, 2040
  - epidemiology, 2039
  - etiology, 2039
  - pathogenesis, 2039
  - treatment and control, 2040
- Tick toxicosis, 2179–2180
- Tick-borne fever, 775–777, 777b
- cattle, 777
  - clinical findings of, 777–778
  - clinical pathology of, 778
  - congenital infection of, 777
  - control of, 778
  - differential diagnosis of, 777b
  - epidemiology of, 776
  - etiology of, 776
  - experimental reproduction of, 777
  - goats, 777
  - intercurrent disease of, 777
  - necropsy findings of, 778
  - occurrence of, 776
  - pathogen risk factors of, 777
  - pathogenesis of, 777
  - sheep of, 777–778
  - source of infection and transmission, 776–777
  - treatment of, 778, 781b
  - zoonotic implications of, 777–779
- Tics, nervous system disease, 1159
- “Tiger stripe” pattern, large intestine mucosa, 588
- Tilmicosin
- for Glässer's disease, 1454
  - for *Mycoplasma pneumoniae*, 1068
  - for pleuropneumonias, of pigs, 1062
  - for progressive atrophic rhinitis, 1052
- Time to peak plasma concentration ( $T_{max}$ ), 163
- Tin poisoning, 2189
- Tingle voltage, 105
- Tioman virus, 2136
- Tissue, insulation of, 45
- Tissue hypoxia, anemia and, 745
- Tissue necrosis, extensive, 727
- Tissue peroxidation, selenium and, 1460
- Tissue plasminogen activator, 722
- Tissue thromboplastin, 727
- T-lymphocytes, bovine virus diarrhea virus, 580
- Tobacco plants, in congenital defects, 1837

- Toe abscess, 1449
- Toll-like receptor-4 (TLR-4), endotoxemia, 60
- Toll-like receptors, PRRSV infection and, 1801
- Tongue  
clinical examination of, 19  
deformity, stomatitis, 193  
laceration, stomatitis, 193  
palpation of, actinobacillosis, 533
- Tongue aplasia, 434
- Topography, clinical examination of, 8–9
- Toroviruses, 385  
porcine, 342
- Torque teno virus, 2134–2135  
clinical signs, 2135  
diagnosis, 2135  
epidemiology, 2135  
etiology, 2134–2135
- Torticollis, congenital, 1838
- Torulosis, 2160
- Total body water, and naturally occurring combined abnormalities of free water, electrolyte, acid-base balance, and oncotic pressure, 136
- Total CO<sub>2</sub>, 132–133
- Total leukocyte count, and radiation, 108
- Total serum protein, naturally occurring combined abnormalities of free water, electrolyte, acid-base balance, and oncotic pressure and, 132
- Toxalbumins, alimentary tract and, 428
- Toxemia, 59–67  
acute, 63  
chronic, 63  
definition of, 59  
diarrhea, acute, 280  
etiology of, 59–60  
milk fever and, 1681–1682  
necropsy findings in, 64  
pathogenesis, 60–63  
peracute endogenous, 100  
peritonitis, 216–217  
in recently calved cow, 67–71  
treatment in, 64–66
- “Toxemic jaundice” complex, 820
- Toxemic septic metritis, milk fever and, 1681
- Toxic agents, myopathy and, 1378
- Toxic chemicals, volcanic eruptions, 109
- Toxic gases, inhalation of, in interstitial pneumonia, 966
- Toxic nephrosis, 1112–1113  
differential diagnosis of, 1113b
- Toxic reactions, and intravenous antimicrobials, 159
- Toxic shock, 63
- Toxic-infectious diseases, encephalomalacia and, 1187
- Toxicity, 2176–2179  
4-aminopyridine toxicosis, 2179–2180  
bee and wasp stings, 2179  
cadmium toxicosis, 2181  
chromium toxicosis, 2181  
cobalt toxicosis, 2181–2182  
defoliants, 2185  
degenerative joint disease and, 1406  
diterpenoid alkaloid toxicosis, 2196–2197  
equine toxicosis, 2201  
Ergot alkaloid toxicosis, 2197–2200  
fumonisin toxicosis, 2200–2201  
fungicides, 2185–2186  
glucosinolate toxicosis, 2202–2204  
herbicides, 2186–2187  
hydrocarbon toxicosis, 2187–2188  
iron toxicosis, 2188–2189  
miscellaneous farm chemicals, 2189–2190  
miscellaneous mycotoxins, 2204  
miscellaneous plant toxicosis, 2207–2212  
miscellaneous rodenticides, 2190–2191  
moths, 2179  
mushroom toxicosis, 2204–2205  
*Phalaris* spp. toxicosis, 2205–2206  
plant phenols, 2207  
porcine pulmonary edema, 2201  
primary copper toxicosis, 2182–2185  
red fire ant stings, 2179  
ruminant toxicosis, 2201–2202  
seed dressings, 2190  
snakebite, 2176–2179  
sulfur toxicosis, 2191–2193  
sweating sickness, 2179–2180  
swine toxicosis, 2201  
toxicosis from  
Brewer's residues, 2212–2213  
dried poultry wastes, 2185  
feed additives, 2189  
trichothecene toxicosis, 2213–2214  
triterpene plant toxicosis, 2214  
vanadium toxicosis, 2193  
wood preservatives, 2193–2194  
zinc toxicosis, 2194–2196
- Toxicology, iron deficiency and, 812
- Toxicosis  
from Brewer's residues, 2212–2213  
from dried poultry wastes, 2185  
from feed additives, 2189
- Toxins, 1112–1113  
affecting the alimentary tract, 421  
antigenic, 59  
binding, acute diarrhea, 280  
fungal, 723  
immune deficiency from, 758  
metabolic, 59–60  
myasthenia and, 1377  
plant poisonings and, 1137, 1506
- Toxocara vitulorum*, 409
- Toxoplasma*, wild boar, 2010
- Toxoplasma gondii*, 2140
- Toxoplasmosis, 2140–2144, 2140b  
cat control, 2143  
prophylaxis, 2143  
reduction of zoonotic risk from food and water, 2143  
serologic monitoring, 2143  
vaccination, 2143  
clinical findings, 2142  
clinical pathology, 2142  
abortion, 2142  
control, 2143  
economic importance, 2141  
epidemiology, 2140–2141  
etiology, 2140  
experimental studies, 2141  
cattle, 2141  
horses, 2141  
pigs, 2141  
ruminants, 2141  
sheep, 2141  
necropsy findings, 2142–2143  
abortion, 2142–2143  
samples for diagnostic testing, 2143, 2143b  
occurrence, 2140  
pathogenesis, 2141–2142  
pregnant sheep and goats, 2142  
risk factors, 2141  
environmental and management, 2141  
pathogen, 2141  
source of infection, 2140–2141  
cat feces, 2140  
other, 2140–2141  
treatment, 2143  
zoonotic implications, 2141
- Trabecular bone, abnormal modeling of, 1389
- Trace elements  
deficiency in, weaner ill-thrift, 94  
in intrauterine growth retardation, 1840
- Trachea, actinomycosis, 531
- Tracheal aspirates, 860–861  
in equine pleuropneumonia, 993
- Tracheal collapse, 879–880, 880f
- Tracheal compression, 879–880, 880f
- Tracheal secretions, endoscopic sampling of, 861
- Tracheal stenosis  
in cattle, 879  
of feedlot cattle, 902–903
- Tracheitis, 878–879, 879b  
bovine herpesvirus-1 infection in, 955–956
- Tracheobronchial secretions, 860–864  
assessment of results in, 861  
bronchoalveolar lavage in, 860–862  
endoscopic sampling of, 861  
laboratory assessment of, 862, 863t  
percutaneous transtracheal aspiration in, 861  
thoracocentesis (pleurocentesis), 862–864  
tracheal aspirates in, 860–861
- Tracheobronchoscopy, 855–856  
in exercise-induced pulmonary hemorrhage, 999–1000, 1000f
- Tracheolaryngostomy, 879
- Tracheostomy, for respiratory tract disease, 872
- Trade restrictions, enzootic bovine leukosis, 835–836
- Traditional approach, to examining population, 29
- Training, biosecurity and, 41
- Trampling, in mortality in piglets, 1834
- Tranexamic acid, 721
- Transcranial magnetic stimulation, 1178
- Transfaunation, chronic, 282
- Transferrin-binding proteins, 2035
- Transfusion triggers, 738–740
- Transient voltage, 105
- Transit, history taking of, individual animal, 7
- Transit recumbency, of ruminants, 1707–1708
- Transit tetany, 1736–1737
- Transmissible gastroenteritis, in pigs, 391
- Transmissible serositis, 1282
- Transmissible spongiform encephalopathies (TSEs), 1293, 1320t
- Transplacental transmission, 771
- Transport  
death, porcine stress syndrome and, 1527  
stress, selenium and vitamin E deficiency and, 1465
- Transportation  
salmonellosis and, 372  
stress  
induction of, 84–85  
management of, 86
- Transstadial transmission, hematophagous insect, 771
- Transtracheal aspiration  
percutaneous, in tracheobronchial secretions, 861  
in *Rhodococcus equi* pneumonia, 1016
- Transtracheal oxygen delivery system, 869
- Transtracheal wash (TTW), in acute undifferentiated bovine respiratory disease, 909
- Trauma  
biomechanical, degenerative joint disease and, 1406  
in dyspnea, 849  
endocarditis and, 689  
injury, bovine footrot and, 1434  
laminitis, horse and, 1397  
myositis and, 1387  
osteomyelitis secondary to, 1392  
rupture of liver and, 625  
in subcutaneous abscess, 1558  
sudden death from, 100
- Traumatic cellulitis, 77
- Traumatic injury, hemorrhagic shock, 71
- Traumatic laryngotracheitis, 879–880, 880f
- Traumatic pericarditis, 708
- Traumatic pharyngitis, 196
- Trematodes, associated with, hepatic diseases, 641–645
- Tremetol, 2208
- Tremor  
in encephalopathy, 1194  
nervous system disease, 1159
- Tremorgenic mycotoxins, 1201
- Triamcinolone, for heaves, 1009–1010
- Trichinella*, wild boar, 2010
- Trichlorfon, in congenital defects, 1837

- Trichobezoars  
 abomasal, 518  
 luminal blockage, 525
- Trichophyton verrucosum* infection, 731
- Trichostrongylid worms, 603  
 abomasal infection, 605  
 eggs, 604  
 intestinal infections, 605  
 life cycle of, 603  
 resistance, 603–604  
 transmission, 604  
 type I disease, 605  
 type II disease, 605
- Trichostrongylosis, 605
- Trichostrongylus*, 603–605
- Trichostrongylus axei*, 606
- Trichostrongylus colubriformis*, 605
- Trichothece toxicosis, 2213–2214
- Trichuris* (whipworm), 416–417, 416b
- Triclabendazole, 644
- Triclopyr, 2187
- Tricuspid valve, 663–664, 687
- Trifolium*, phytoestrogen toxicosis, 1822
- Trifolium pratense* (red clover), poisoning in, 1822
- Trifolium repens* (white clover), poisoning in, 1822, 1828
- Trifolium subterraneum*, 821
- Trigeminal ganglion, bovine herpesvirus-1 infection in, 954
- Trigeminal nerve (cranial nerve V), assessment of, 1169
- Trimethoprim, 277, 778
- Trimethoprim-sulfadiazine  
 for coliform mastitis, 1951  
 for progressive atrophic rhinitis, 1052  
 for *Rhodococcus equi* pneumonia, 1016–1017
- Triple-reassortant H1N1 virus, 1076
- Trisodium citrate, clotting assays and, 720–721
- Triterpene plant toxicosis, 2214
- Triterpene saponins, 2210
- Trocar and cannula, 478, 485–486
- Trocarization, 235, 477
- Trochlear nerve (cranial nerve IV), assessment of, 1169
- Tromethamine, 139–140
- Tropane alkaloids, 1195–1196
- Trophopathic (nutritional) hepatitis, 630–631
- Tropical theileriosis, 2144, 2148–2150, 2148b  
 biosecurity concerns, 2148  
 clinical findings, 2149  
 clinical pathology, 2149  
 control, 2149  
 differential diagnosis, 2149b  
 economic importance, 2148  
 epidemiology, 2148  
 etiology, 2148  
 necropsy findings, 2149  
 occurrence and methods of transmission, 2148  
 pathogenesis, 2148–2149  
 risk factors and immune mechanisms, 2148  
 treatment, 2149, 2149b
- Trueperella pyogenes*, 943, 1958–1960, 1958b  
 clinical findings of, 1959  
 clinical pathology of, 1959  
 control of, 1959  
 differential diagnosis of, 1959b  
 economic importance of, 1959  
 epidemiology of, 1958–1959  
 etiology of, 1958  
 necropsy findings of, 1959  
 occurrence of, 1958  
 pathogenesis of, 1959  
 prevalence of, 1958  
 risk factors of, 1958–1959  
 source of infection, 1958  
 transmission of, 1958  
 treatment of, 1959, 1959b
- Trunk, nervous system examination of, 1171–1172
- Trypanosoma equiperdum*, 1819
- Trypanosoma evansi*, 2157
- Trypanosomoses, 2150–2156, 2150t
- Trypanotolerance, 2152
- D,L-tryptophan, in interstitial pneumonia, 965
- Tsetse fly disease, 2150–2156
- Tube susceptibility tests, 155
- Tuberculin, special aspects of sensitivity to, 2019–2020
- Tuberculin test, intradermal, for bovine tuberculosis, 2019
- Tuberculoïd extreme, Johne's disease, 568
- Tuberculosis  
 associated with *Mycobacterium tuberculosis*, 2023–2024  
 bovine, 2015–2023  
 miliary, 2021
- Tubular enzyuria, 1103
- Tubular proteinuria, 1102–1103
- Tularemia, 2027–2029, 2027b  
 clinical findings, 2028  
 horses, 2028  
 pigs, 2028  
 sheep, 2028  
 clinical pathology, 2028–2029  
 control, 2029  
 epidemiology, 2028  
 etiology, 2027–2028  
 necropsy findings, 2029  
 sample for confirmation of diagnosis, 2029, 2029b  
 occurrence, 2028  
 pathogenesis, 2028  
 risk factors, 2028  
 animal, 2028  
 pathogen, 2028  
 transmission, 2028  
 treatment, 2029, 2029b  
 zoonotic implications, 2028
- Tulathromycin, for *Mycoplasma pneumoniae*, 1068
- Tumor necrosis factor- $\alpha$  (TNF- $\alpha$ ), 54  
 in bovine respiratory syncytial virus, 949  
 endotoxemia, 60–61
- Tumorous calcinosis, 1559
- Tumors  
 myocardial disease/cardiomyopathy etiology, 691  
 osteodystrophy and, 1389
- Tunicamyluracils, 1197, 1198b–1200b
- Tutin, 1196
- Twin calf, perinatal mortality of, 1832
- Twin lamb disease, 1722–1726, 1722b–1723b
- Tying-up, 1378–1379  
 see also Rhabdomyolysis
- Tylosin  
 porcine proliferative enteropathy, 326  
 for progressive atrophic rhinitis, 1052
- Tympanocentesis, 1337
- Type IA $\delta$  fibers, 79–80
- Type IIA $\delta$  fibers, 79–80
- Tyrolean grey cattle, degenerative axonopathy of, 1348–1349
- Tyzer's disease, 633
- U**
- Uasin gishu, 1596–1597
- Udder  
 actinomycosis, 531  
 base of, cold injury to, 51  
 caprine arthritis encephalitis in, 1260–1261  
 cleft dermatitis, 1988, 1988f  
 congenital defects of, 1991  
 edema, 1989–1990, 1989f, 1989t  
 fibrosarcoma in, 1991  
 hard, 976  
 health status of  
 in bovine mastitis, 1922, 1984  
 milking equipment and, 1972
- monitoring, 1966, 1980–1984  
 productivity and profitability and, 1984  
 setting goals for, 1984  
 strategies for dry cow, 1974–1977
- hygiene of  
 in bovine mastitis, 1908, 1909f  
 and milking methods, 1967–1970
- hygiene score of, 1967
- impetigo, 1988
- morphology of, in risk factors, of bovine mastitis, 1908
- neoplasms of, 1991
- rupture of the suspensory ligaments of, 1990
- Ulcerative dermatitis, 761, 1579–1580
- Ulcerative dermatosis, of sheep, 1596
- Ulcerative lesions, stomatitis, 193
- Ulcerative lymphangitis, of horses and cattle, 761–765, 761b  
 clinical findings of, 761  
 clinical pathology of, 761  
 control of, 761  
 differential diagnosis, 764b  
 epidemiology of, 760  
 etiology of, 760  
 pathogenesis of, 761–764  
 treatment of, 761
- Ulcers  
 abomasal. see Abomasal ulcer
- Bairnsdale, 1574
- bluetongue, 2069–2076, 2069b–2070b
- Buruli, 1574
- equine coital exanthema and, 1794
- gastric  
 in adult horses, 246–252, 247b  
 in foals, 244–246, 244b  
 number/severity score, 249b  
 of swine, 287–290, 287b
- gastroduodenal, prophylaxis for, 1866
- orf, 1593–1596, 1593b
- scabby, 1152, 1152b–1153b
- in upper respiratory tract, 1027
- Ultrasonography, 22  
 abdominal, 184  
 of abomasum, 500–501, 500f–501f  
 aortoiliac thrombosis, 710–711  
 benefits of, 22  
 for bovine mastitis, 1920  
 caudal abdominal obstruction, 254  
 in caudal vena caval thrombosis, 902, 902f  
 cecum, examination of, 529–530  
 colitis, right dorsal, 267  
 equine colic, 229, 229f, 230t, 237, 239  
 in equine pleuropneumonia, 992–993  
 of fatty liver, 1720  
 for fetus, 1841, 1842f  
 gastric dilatation, in horses, 241  
 left dorsal displacement, of large colon, 261  
 left-side displacement of abomasum, 506  
 limitations of, 22  
 of liver, 626, 627f  
 of mammary gland, 1920  
 for musculoskeletal system disease, 1376  
 in nervous system examination, 1176  
 for newborn, 1860  
 for omphalophlebitis, 1901  
 in pleuritis, 897  
 in respiratory system, 858–859  
 reticuloperitonitis, traumatic, 486–487, 487f  
 reticulum, 487, 487f  
 in *Rhodococcus equi*, 1015  
 pneumonia, 1017–1018  
 of rumen contents, 452f  
 for septic arthritis synovitis, 1414  
 urinary system examination and, 1106–1107, 1106f
- uroolithiasis and, 1147–1148
- uroperitoneum in foals and, 1142
- volvulus, of large colon, 262



- Ultraviolet irradiation, vitamin D deficiency and, 1491–1492
- Umbilical bleeding, 722, 726
- Umbilical hernia, inherited, 1516
- Umbilical structures, examination of, 1860
- Undernutrition, definition of, 87
- Undifferentiated bovine respiratory disease, acute, 903–914
  - clinical case definition of, 907
  - clinical pathology of, 908–910
  - control of, 911–913
  - definition of the problem, 903–904
  - diagnosis of, 907–908
  - epidemiology of, 907
  - etiology of, 904–907
  - necropsy findings in, 910
  - risk factors for, 907
    - management of, 912
    - treatment of, 910–911, 911b
- Unilateral rhinitis, EHV-3 and, 1794
- United Kingdom
  - bovine immunodeficiency-like virus in, 786
  - bovine ulcerative mammillitis in, 1986
  - bovine virus diarrhea virus eradication program in, 598
  - ovine enzootic abortion in, 1786
  - ovine progressive pneumonia in, 974
  - ovine pulmonary adenocarcinoma in, 979
- United States of America
  - bovine ulcerative mammillitis in, 1986
  - bovine virus diarrhea virus eradication program in, 598
  - brucellosis in, 1773
  - contagious bovine pleuropneumonia in, 926
  - John's disease control in, 564
  - ovine progressive pneumonia in, 974
  - ovine pulmonary adenocarcinoma in, 978
  - rabies in, 1238–1239
  - swine influenza in, 1078
- Upper motor neuron lesion, 1163
- Upper respiratory tract
  - abnormalities of, in horses, 981–982, 982t
  - diseases of, 874–875
    - bronchitis in, 878–879, 879b
    - differential diagnosis of, in horses, 1023t
    - epistaxis in, 877–878
    - equine herpesvirus-1 and -4 infections in, 1040
    - hemoptysis in, 877–878
    - in horses, 1794
    - laryngitis in, 878–879, 879b
    - nasal cavities, obstruction of, 875–877
    - pharyngitis in, 878
    - rhinitis in, 874–875, 875b
    - tracheal collapse in, 879–880, 880f
    - tracheal compression in, 879–880, 880f
    - tracheitis in, 878–879, 879b
    - traumatic laryngotracheitis in, 879–880, 880f
  - large particles in, 888
  - pneumonic pasteurellosis in, colonization of, 916
- Urachal abscess, 77
- Urachitis, in newborn, 1901
- Urachus
  - patent, 1098, 1140
  - persistent, 1098
- Urea, 619
  - and naturally occurring combined abnormalities of
    - free water, electrolyte, acid-base balance, and oncotic pressure, 134
    - renal insufficiency and, 1096–1097
    - serum, 1104
    - tolerance, 619
- Urea nitrogen
  - in equine colic, 231
  - in protein evaluation, 1670
- Urea toxicosis, 618b
- Ureaplasma diversum*, 1793
- Uremia, 1098, 1137
  - causes of, 1096
- Uremic encephalopathy, 1098
- Ureters
  - diseases of, 1139
  - ectopic, 1139
  - morphological abnormality of, 1098
- Urethra
  - abnormality, palpable, 1098
  - diseases of, 1139
- Urethral atresia, 1151
- Urethral defects, 1151
- Urethral obstruction
  - estrogen substances and, 1822
  - in ruminants, 1144
- Urethral pressure profile, urinary system
  - examination, 1108
- Urethral tears, in stallions and geldings, 1151
- Urinalysis, 1099
  - in abomasal displacement/volvulus, 512
  - ketones and, 507
  - of newborn, 1863
  - uroolithiasis and, 1147
- Urinary bladder neoplasms, 1151
- Urinary burn, 1098
- Urinary lead, 1206–1207
- Urinary postrenal proteinuria, 1102
- Urinary system
  - clinical examination of, 21
  - diseases of, 1095–1154
  - examination of, 1099–1108
- Urinary tract, disease of
  - abdominal pain, 1098
  - clinical features of, 1097–1098
  - principles of treatment of, 1108–1110
  - in swine, 1131–1132
- Urination
  - clinical examination of, 11
  - difficult, 1098
  - painful, 1098
- Urine
  - abnormal constituents of, 1097
  - blood in, 1101
  - collection of sample, 1099–1100, 1099f
  - culture of, 1124
  - diagnostic examination techniques of, 1106–1108
  - dribbling, 1098
  - enzymuria, 1103
  - evaluation of, in dairy-herd metabolic profile testing, 1671
  - flow, daily, variations in, 1097–1098
  - glucosuria, 1102
  - left-side displacement of abomasum and, 507
  - leukocytes in, 1103
  - pH, carbohydrate engorgement, 467
  - pH of, 1144
  - red-brown discoloration of, 1101
  - samples, tests of, 1100–1103
  - tests, 1104–1106
    - for ketosis, 1712–1713
  - Urine dipstick protein test, 1177
  - Urine magnesium concentrations, in
    - hypomagnesemic tetany, 1703
  - Urine osmolality to serum osmolality ratio, 1104
  - Urine potassium concentration, in acute hypokalemia, 1692
  - Urine thiosulfate concentration, in polioencephalomalacia, 1317
- Urobilinogen, jaundice and, 623–624
- Urolithiasis
  - in horses, 1150–1151
  - in ruminants, 1144–1150
    - clinical findings of, 1146–1147
    - clinical pathology of, 1147–1148
    - composition of calculi, 1145
    - differential diagnosis of, 1148b
    - epidemiology of, 1144–1146
    - etiology of, 1144
    - factors favoring concretion, 1145
    - miscellaneous factors in development of, 1145
    - necropsy findings of, 1148
    - obstruction of urethra by calculus, 1146–1147, 1146f
    - obstructive, risk factors for, 1145
  - occurrence in, 1146
  - pathogenesis of, 1146
  - prevention of, 1149–1150
  - rupture of urethra or bladder, 1146f–1147f, 1147
  - treatment of, 1148–1149
- Uroperitoneum
  - in foals, 1140–1143
    - clinical pathology of, 1142
    - clinical signs of, 1141–1142
    - differential diagnosis of, 1142b
    - epidemiology of, 1141
    - etiology of, 1140–1141
    - necropsy findings of, 1142
    - pathophysiology of, 1141
    - prevention and control of, 1143
    - treatment of, 1142–1143
  - rupture of bladder, 1140
  - test of, 1107
- Urticaria, 1545–1546
  - differential diagnosis of, 1546b
  - treatment of, 1546b
- U.S. Department of Agriculture (USDA)-Animal and Plant Health Inspection Service (APHIS), 1773
- U.S. Voluntary John's Disease Herd Status Program, 562
- USDA Genetics-Based Flock Cleanup and Monitoring Plan, 1309
- Ustilago hordei* (barley smut) fungus, 1828
- Uterine discharge, *Brucella abortus*, transmission of, 1763
- Uterine fluid, analysis of, 68–69
- Uterus, enlargement of, 447t
- Uveitis, 1649–1650, 1649b
  - listeriosis and, 1338–1341
- 
- ## V
- Vaccination
  - African horse sickness, 2096
  - Akabane disease, 1513
  - anaplasmosis and, 775–776
  - babesiosis of, 805–806
  - bacillary hemoglobinuria, 637
  - black disease, 638
  - for blackleg, 1432
  - bluetongue, 2075–2076
  - bovine digital dermatitis, 1440
  - bovine footrot, 1435
  - caseous lymphadenitis, 775–776
  - coccidiosis, 408
  - coliform gastroenteritis, 319
  - enterohemorrhagic *Escherichia coli* (EHEC), 539, 542
  - enterotoxemia
    - Clostridium perfringens* associated, 548
    - Clostridium perfringens* type D associated, 1232
  - environmental streptococci, 1957
  - enzootic bovine leukosis, 840
  - epizootic hemorrhagic disease and, 785–794
  - equid herpesvirus-1 myeloencephalopathy, 1287–1290
  - erysipelas in swine, 2056
  - fasciolosis (liver fluke disease), 645
  - foot-and-mouth disease, 2065–2067
  - for Glässer's disease, 1454
  - hemonchosis, 613
  - Histophilus* septicemia, 2038
  - in increasing specific resistance of the newborn, 1897
  - infectious footrot in sheep, 1447
  - John's disease, 563–564, 571
  - laminitis, ruminants and swine and, 1405
  - leptospirosis and, 1127–1128
  - porcine intestinal spirochetosis, 337
  - porcine proliferative enteropathy, 326–327
  - of pregnant dam, 392

- Vaccination (*Cont'd*)  
 rabies, [1244](#)  
 serum-virus, [2109](#)  
 for *Streptococcus agalactiae* mastitis, [1939](#)  
*Streptococcus suis* infection, [2050](#)  
 with subunit vaccines, 809  
 swine dysentery, 334  
 Venezuelan viral encephalomyelitis, [1284](#), [1297t](#)  
 viral diarrhea, 391–393  
 West Nile encephalitis, [1271](#)  
 Western encephalitis, [1278](#)  
 winter dysentery, of cattle, 601
- Vaccines  
 for acute undifferentiated bovine respiratory disease, 911b, 912–913  
 for African swine fever (ASF), [2117](#)  
 attenuated, [2109–2110](#)  
 for Bang's disease, [1770–1772](#)  
 for *Bordetella* rhinitis, 1055  
 for bovine herpesvirus-1 infection, 958–960  
 for bovine respiratory syncytial virus, 951  
 for brucellosis, [1776–1778](#), [1784](#)  
 for contagious bovine pleuropneumonia, 931  
 contaminated, with bovine viral diarrhea virus, 580  
 for enzootic pneumonia of calves, 945–946, [946f](#)  
 for equine hendra virus infection, 1045  
 for equine herpesvirus-1 and -4 infections, 1042  
 for equine influenza, 1036–1037  
 inactivated, [2110](#)  
 killed-virus, [2069](#)  
 live attenuated, [2069](#)  
 for lungworm, 964  
 for *Mannheimia haemolytica*, 922–923  
 mutagen attenuated, [2069](#)  
 for *Mycobacterium avium* subspecies paratuberculosis (MAP), 563  
 for *Mycoplasma bovis*, 938  
 for *Mycoplasma* mastitis, [1942](#)  
 for *Mycoplasma* pneumonia, 1070  
 for ovine enzootic abortion, [1787–1791](#)  
 for ovine progressive pneumonia, 977  
 for peste des petits ruminants, 576  
 for pleuropneumoniae, of pigs, 1063  
 for pneumonic pasteurellosis, 922–923  
 for porcine reproductive and respiratory syndrome, [1812–1814](#)  
 for progressive atrophic rhinitis, 1053–1054  
 for Q fever, [1793](#)  
 for respiratory tract disease, 873  
 for Rift Valley fever, [2069](#)  
 for septicemic pasteurellosis of cattle, [2042](#)  
 for strangles, 1024–1026  
 for swine influenza, 1083
- Vacuum regulator, [1971](#)  
 Vacuum reserve tank, [1970–1971](#)  
 Vaginal discharge, in postpartum dysgalactia syndrome, [1999](#)  
 Vaginal examination, postparturient mare, 237  
 Vaginal fluid, analysis of, 68–69  
 Vagus indigestion, 490–496, [490b–491b](#)  
 clinical findings in, 493–494, [493f](#)  
 clinical pathology, 494  
 differential diagnosis, [494b–495b](#)  
 epidemiology of, 491  
 etiology of, 491  
 necropsy findings, 494  
 pathogenesis of, 491–493  
 prevention, 496  
 reticulorumen contractions in, 446, 448  
 treatment, [495–496](#), [496b](#)
- Vagus nerve, 437, 440, 491  
 assessment of, [1169](#)
- Valve lesions, murmurs and, 685–686  
 Valve predilection, endocarditis, 689  
 Valvular abnormalities, 706  
 Valvular defects, echocardiography and, 672
- Valvular disease, 685–688, [685b](#)  
 acquired, 685  
 cattle, 685  
 clinical findings of, 686–688  
 clinical pathology of, 688  
 congenital, 685  
 differential diagnosis of, [688b](#)  
 effects of, 686  
 epidemiology of, 685  
 etiology of, 685  
 examination of, 686–687  
 heart failure, chronic (congestive), 659  
 horses, 685  
 insufficiency of, 687  
 necropsy findings of, 688  
 pathogenesis of, 685–686  
 pigs, 685  
 stenosis of aortic valve, 688  
 treatment of, 688
- Vanadium toxicosis, [2193](#)  
 Vancomycin, 174  
 Vancomycin-resistant enterococci (VRE), 157  
 Vanilloids, for pain, 83  
 Vap A, in *Rhodococcus equi* pneumonia, 1013–1014  
 Variable surface proteins (VSPs), in *Mycoplasma bovis*, 933
- Vascular obstruction, gangrene from, [1558](#)
- Vasculitis  
 bovine virus diarrhea virus infection, 584  
 hemorrhage and, 721  
 necrotizing, 721  
 panhyproteinemia and, 717  
 septicemic diseases, 721  
 treatment of, 721–723  
 viremic diseases, 721
- Vasoconstriction, laminitis, horse and, [1399](#)  
 Vasoconstrictive agents, 710  
 Vasoconstrictors, for shock, 76  
 Vasodilation, phasic, 45  
 Vasodilators, for shock, 76  
 Vasodilatory drugs, laminitis, horse and, [1402–1403](#)  
 Vasogenic edema, [1180](#)  
 Vasopressors, for endotoxemia, 65  
 Veal calf hemorrhagic enteritis, [1886](#)
- Veal calves  
 abomasal ulcer in, 519  
 bovine virus diarrhea virus vaccination, 597  
 dietary supplementation and, 813  
 methicillin-resistant *Staphylococcus aureus* in, [1567](#)
- Vector abatement, reduction of infection through, [2075](#)  
 Vector control, [2069](#)  
 Vector-based systems, 668  
 Vellein, [2212](#)  
 Venereal transmission, of *C. renale*, [1129](#)  
 Venezuelan viral encephalomyelitis, of horses, [1272b–1273b](#), [1300–1301](#)  
 animal risk factors of, [1280](#)  
 clinical findings of, [1281](#)  
 clinical pathology of, [1281](#)  
 control of, [1283](#)  
 differential diagnosis of, [1278b](#)  
 distribution of, [1280](#)  
 epidemiology of, [1269f](#), [1279–1280](#)  
 necropsy findings of, [1281](#)  
 pathogenesis of, [1280–1281](#)  
 protection from insects in, [1284](#)  
 samples for diagnostic confirmation of, [1282](#)  
 treatment for, [1283–1285](#)  
 vaccination of, [1284](#), [1297t](#)  
 viral ecology of, [1280](#)  
 zoonotic implications of, [1280](#)
- Venoms, 691  
 Venous blood gas analysis, 737, 866  
 Venous blood oxygen tension (P<sub>o2</sub>), and shock, 73  
 Venous congestion, 660  
 Venous thrombosis, 713–714
- Ventilation  
 environmental examination of, 9–10  
 for heaves, 1011  
 Ventilation-perfusion, in hypoxic hypoxia, 847  
 Ventricular fibrillation, 684–685  
 Ventricular premature complexes, 680  
 Ventricular septal defect, 704–705  
 inherited, 707  
 Ventricular tachycardia, 684  
 Veratrine, [2212](#)  
 Verminous aneurysm, 270  
 Verminous encephalomyelitis, [1185](#)  
 Verminous mesenteric arteritis, 270  
 Verrucose dermatitis, bovine footrot and, [1434](#)  
 Vertebral and spinal dysplasia, tail deformity and, [1538](#)  
 Vertebral body abscesses (osteomyelitis), [1344](#)  
 Vertebral exostoses, osteodystrophy and, [1389](#)  
 Vertebral fracture, trauma at parturition and, [1843](#)  
 Vertebral osteochondrosis, osteodystrophy and, [1389](#)  
 Vertebral subluxation, [1349](#)  
 Vertical transmission, of bovine spongiform encephalopathy, [1295](#)
- Vesicles, stomatitis, 193  
 Vesicular exanthema, of swine, 356–357, [356b–357b](#)  
 Vesicular sounds, 851  
 see also Breath sounds
- Vesicular stomatitis, 393–397, [393b](#)  
 cattle, 396  
 clinical findings, 396  
 clinical pathology, 396  
 control, 396  
 differential diagnosis, [396b](#)  
 economic importance, 395  
 epidemiology, 394–395  
 etiology, 393–394  
 experimental reproduction, 395  
 horses, 396  
 immune mechanisms, 396  
 necropsy findings, 396  
 occurrence, 394  
 pathogenesis, 395–396  
 pigs, 396  
 risk factors, 395  
 transmission, 394–395  
 treatment, 396
- Vestibular disease, [1160–1161](#)  
 brainstem and, [1329–1331](#)  
 causes of, [1161](#)
- Vestibulocochlear nerve (cranial nerve VIII), assessment of, [1169](#)
- Veterinarian-client-patient relationship, 167b  
 Viable hypotrichosis, [1644](#)  
 Villous epithelial cells, replacement of, 209  
 Viral arteritis, 710  
 Viral diarrhea, 384–393, [384b–385b](#)  
 clinical findings, 389  
 clinical pathology, 389–390  
 control, 391–393  
 detection of virus, 389–390  
 differential diagnosis, [391b](#)  
 epidemiology, 385–388  
 etiology, 385  
 immune mechanism, 385  
 necropsy findings, 390  
 occurrence, 385  
 pathogenesis, 388–389  
 transmission, 385  
 treatment, 391  
 vaccination, 391–393
- Viral diseases  
 characterized by alimentary tract signs, [2058–2067](#)  
 African horse sickness, [2091–2097](#)  
 African swine fever, [2110–2117](#)  
 bluetongue, [2069–2076](#)  
 bovine ephemeral fever, [2081–2084](#)

Viral diseases (*Cont'd*)

- Caprine herpesvirus-1 infection, 2086–2087
- classical swine fever, 2098–2110
- equine encephalosis, 2097
- equine viral arteritis, 2087–2091
- foot-and-mouth disease, 2058–2067
- Getah virus infection, 2097–2098
- Jembrana disease, 2080–2081
- malignant catarrh in pigs, 2080
- malignant catarrhal fever, 2076–2080, 2076b
- Nairobi sheep disease, 2084
- porcine circovirus-associated disease, 2117–2134
- Rift Valley fever, 2067–2069
- torque teno virus, 2134–2135
- Wesselsbron disease, 2084–2086, 2084b
- hemolytic jaundice and, 623
- immune deficiency from, 755
- myocarditis, 690
- Viral evolution, of equine influenza, 1030–1032
- Viral infections
  - in congenital defects, 1836–1837
  - in interstitial pneumonia, 966
  - in intrauterine growth retardation, 1840
  - in pneumonia, 888
  - of respiratory tract, in horses, 1028–1029
- Viral multiplication, 789
- Viral popular dermatitis, 1596–1597
- Viral teratogenesis, 1838
- Viral vaccines
  - for acute undifferentiated bovine respiratory disease, 913
  - for pneumonic pasteurellosis, 923
- Viral-bacterial synergism, in acute undifferentiated bovine respiratory disease, 906
- Viremia, 57–59, 1278
  - clinical findings in, 58
  - clinical pathology, 58–59
  - definition of, 57
  - epidemiology of, 57
  - etiology of, 57
  - necropsy findings, 58–59
  - neonatal, 1285
  - pathogenesis of, 57–58
  - porcine reproductive and respiratory syndrome in, 1805
  - treatment of, 59
- Virginiamycin, 174
- Virology
  - equine infectious anemia, 796
  - of porcine reproductive and respiratory syndrome, 1810
- Virulent strains, of *Rhodococcus equi*, 1014–1015
- Virus entry, of porcine reproductive and respiratory syndromevirus, 1800
- Virus isolation
  - in bovine herpesvirus-1 infection, 956
  - in bovine respiratory syncytial virus, 950
  - epizootic hemorrhagic disease and, 784
  - Rift Valley fever, 2069
- Virus neutralization test (VNT), peste des petits ruminants, 575
- Viruses
  - detection of, 838
  - diarrhea, in foals, 275
  - enteritis and, 206t
  - in enzootic pneumonia of calves, 942
  - new, 342–343
- Virus-neutralization (VN) test, in bovine respiratory syncytial virus, 950
- Visceral pain, 79, 177
  - in horses, 221t
  - see also Abdominal pain
- Vision tests, 19
- Visitors, to operation, controlling contact by, 39
- Visna, 1253b, 1256b, 1282
- Visual system, abnormalities of, 1168t
- Vital signs, clinical examination of, 15–16
- Vitamin A
  - daily dietary allowances of, 1352t
  - deficiency, 1325, 1336b

- clinical findings of, 1322–1323
- clinical pathology of, 1325
- in congenital defects, 1837
- control of, 1328
- differential diagnosis of, 1337b
- encephalomalacia and, 1190
- epidemiology of, 1320
- etiology of, 1320
- maternal, 1321
- necropsy findings of, 1328
- night vision and, 1322
- ocular abnormalities and, 1322
- pathogenesis of, 1322
- primary, 1320
- reproductive efficiency and, 1323
- samples for diagnostic confirmation of, 1328
- secondary, 1322
- treatment for, 1328
- dietary requirement of, 1329
- hepatic, 1328
- oral, 1329
- parenteral injection of, 1329
- plasma, 1325
- supplementation method for, 1329
- Vitamin B<sub>6</sub> (pyridoxine) deficiency, 734, 1325–1326
- Vitamin B<sub>12</sub>
  - concentrations, 817
  - deficiency, 823–825
  - injections, 820
  - microencapsulated in lactide/glycolide copolymers, 819–820
  - status, biochemistry determination, 816
- Vitamin D
  - deficiency, 1482, 1491–1494, 1491b
  - clinical findings of, 1493
  - clinical pathology of, 1493
  - in congenital defects, 1837
  - control of, 1493–1494
  - differential diagnosis of, 1493b
  - epidemiology of, 1491–1492
  - etiology of, 1491
  - necropsy findings of, 1493
  - pathogenesis of, 1492–1493
  - treatment for, 1493
  - dietary, 1492
    - requirements of, 1486t
  - injection of, 1493–1494
  - intoxication, 1494
  - maternal status and, 1492–1493
  - osteodystrophy and, 1388, 1391
  - plasma, 1493
  - supplementation of
    - daily intake, 1493
    - for milk fever, 1689
- Vitamin D<sub>3</sub> (cholecalciferol), 2191
- Vitamin E
  - biological functions of, 1459–1460
  - deficiency, 1458–1478, 1459b
  - clinical findings of, 1469–1470
  - in congenital defects, 1837
  - control of, 1474–1478
  - differential diagnosis of, 1473b–1474b
  - epidemiology of, 1462
  - etiology of, 1459–1460
  - necropsy findings of, 1473
  - pathogenesis of, 1468–1469
  - reproductive performance and, 1464–1465
  - treatment for, 1473
  - gastric ulcers, 290
  - for metabolic diseases, 1665
  - myopathy and, 1377–1378, 1381
  - in horse, 1382
  - status, 1472
    - coliform mastitis and, 1946
    - transfer to fetus, colostrum, and milk, 1467
- Vitamin E-selenium deficiency syndrome, 1463–1464, 1469–1470
- Vitamin K, deficiency, 825–826
- Vitamin K<sub>1</sub>, dicoumarin derivative poisoning, 824
- Vitiligo, 1553–1554

- Vitreous humor, hypomagnesemic tetany in, 1703, 1703f
- Vitroantibiotic sensitivity testing, in *Rhodococcus equi* pneumonia, 1016–1017
- Voice, clinical examination of, 11
- Volcanic ash, 109
- Volcanic eruptions, 109–110
  - ash hazards in, 109
  - long-term effects of, 109
  - physical properties of, 109
  - toxic chemicals from, 109
  - blast and gas damage in, 109
- Volume depletion, 113–114
- Volume load, heart failure, 660
- Volume of distribution (V), 163
- Voluntary John's Disease Control Program (VJDCP), 564
- Volvulus
  - in cattle, 523–524
  - small intestine, 254
  - sudden death in, 100
- Vomiting, 179
  - equine colic, 227
  - gastric dilatation, in horses, 241
  - gastritis, 203
  - plants and, 429
  - projectile, 179
  - true, 179
- Vomiting and wasting disease, in pigs, 340
- Vomiting syndrome, 2211
- Vomitous, blood in, 182
- von Willebrand disease, 722–723
- von Willebrand's factor, 722–723
- VSV Indiana (VSV-IND), 393–394
- VSV New Jersey (VSV-NJ), 393–394
- Vulvar squamous-cell carcinoma, 1640
- Vulvovaginal area, diseases of, 1152–1154
- Vulvovaginitis, 1152, 1152b–1153b
  - differential diagnosis of, 1154b
  - treatment and prophylaxis of, 1154b

## W

- Waddlia* spp., 1787
- Wanderers. see Equine neonatal maladjustment syndrome
- Wandering pacemaker, 679
- Warble flies, 1626–1628, 1626b–1627b
- Warfarin, 721
- Warts, 1580–1585
- Washout period, and antimicrobials, 167–168
- Waste disposal, environmental examination of, 9
- Water
  - deprivation of, 87–88
    - adaptation to, 113
  - environmental examination of, 9
  - for hyperthermia, 53
  - immersion of hypothermic lambs in, 50
  - with magnesium, for hypomagnesemic tetany, 1705
  - mass medication with, 161
  - medication of, for pneumonic pasteurellosis, 920
  - nitrate-nitrite poisoning, 831
- Water contamination
  - Campylobacter jejuni*, 540
  - enterohemorrhagic *Escherichia coli* source, 539
  - Mycobacterium avium* subspecies paratuberculosis (MAP), 562–563
- Water deprivation test, 1104–1105
- Water flotation tanks, 1697–1698
- Water intoxication, 113, 115–116, 115b
  - clinical findings in, 116, 116f
  - clinical pathology of, 116
  - control of, 116
  - differential diagnosis of, 116b
  - epidemiology of, 116
  - etiology of, 115
  - postmortem findings in, 116
  - treatment of, 116



- Water medication  
in cattle, 161  
in pigs, 161
- Water vapor treatment, for exercise-induced pulmonary hemorrhage, 1002
- Water-hammer pulse, 688
- Watery mouth of lambs, 1899–1900, 1899b  
differential diagnosis of, 1900b
- Weak-calf syndrome, 1477
- Weakness, 1162, 1372  
assessment of, 1171  
of skeletal muscles, 1510
- Weaned beef calves, bovine respiratory syncytial virus in, 947, 949
- “Weaner ill-thrift”, 606
- Weaner sheep, unthriftiness in, 94–96, 94b–95b
- Weaning  
dietary diarrhea, 214  
procedures, for pneumonic pasteurellosis, 921  
stress associated with, 319
- Weather  
frothy bloat and, 475–476  
left-side displacement of abomasum and, 503  
malnutrition, 90
- Weaver syndrome, 1352
- Weaving, 1224
- Wedeloides, 1195
- Wedge pads, laminitis, horse and, 1403
- Weed (sporadic lymphangitis), 781
- Weed method, for diagnosis, 4
- Weight  
milk fever and, 1678  
osteodystrophy and, 1389
- Weight, loss of, 90–94  
carbohydrate loss, excessive, 93  
faulty digestion, absorption, or metabolism, 93–94  
granulomatous enteritis, 282  
nutritional causes, 92  
protein loss, excessive, 93
- Weight bearing laminitis, 1396
- Wesselsbron disease (WBD), 2084–2086  
clinical findings, 2085  
clinical pathology, 2085  
control, 2086  
economic importance, 2085  
epidemiology, 2085  
etiology, 2085  
necropsy findings, 2085  
samples for confirmation of diagnosis, 2085, 2085b  
occurrence, 2085  
pathogenesis, 2085  
risk factors, 2085  
animal, 2085  
environmental, 2085  
source of infection and method of transmission, 2085  
treatment, 2086  
zoonotic implications, 2085
- Wesselsbron virus, 1836–1837
- West Nile encephalitis, 1265b, 1286–1293  
animal risk factors for, 1267  
case fatality of, 1267–1268  
clinical findings of, 1268  
clinical pathology of, 1268  
control of, 1269–1270  
differential diagnosis of, 1268b  
distribution of, 1267  
epidemiology of, 1267  
etiology of, 1266–1267  
identification of, 1268  
morbidity of, 1267–1268  
necropsy findings of, 1268  
pathogenesis of, 1268  
samples for diagnostic confirmation of, 1269–1272  
serologic tests for, 1268  
transmission of, 1267
- treatment for, 1269  
viral ecology of, 1267  
zoonotic implications of, 1267–1268
- Western encephalitis, of horses, 1269b, 1294–1300  
animal risk factors of, 1274–1275  
case fatality of, 1275  
clinical findings of, 1276  
clinical pathology of, 1276–1277  
control of, 1277–1278  
differential diagnosis of, 1271b  
distribution of, 1273–1281  
epidemiology of, 1272  
etiology of, 1271–1272  
morbidity of, 1275  
necropsy findings of, 1277  
pathogenesis of, 1276  
protection from insects of, 1278  
samples for diagnostic confirmation of, 1277  
transmission of, 1266f  
treatment for, 1277  
vaccination of, 1278  
viral ecology of, 1273–1274  
zoonotic aspects of control, 1278–1279  
zoonotic implications of, 1275–1276
- Wet gangrene, 1557
- Wetness, of skin, 1562
- Wheat (cereal) pasture poisoning, 1699–1706, 1699b
- Wheelbarrow test, in ovine pulmonary adenocarcinoma, 978
- Wheezes, 852
- Wheezing, in heaves, 1007
- Whipworm, 416–417
- White blood cells (WBC)  
concentrations, in *Rhodococcus equi* pneumonia, 1016  
disorders of, 745–746  
function abnormality, 746  
in peritoneal fluid, 189
- White clover (*Trifolium repens*), poisoning in, 1822, 1828
- White liver disease, 630
- White-tailed deer, epizootic hemorrhagic disease and, 784
- Whole blood, 142
- Wild bird H1N1 viruses, 1076
- Wild boar, 2007–2011  
African swine fever, 2008  
astroviruses, 2008  
Aujeszky's disease, 2008  
brucellosis, 2008  
*Campylobacter* spp., 2008  
*Chlamydiae*, 2008  
classical swine fever, 2008  
control, 2010  
cryptosporidia, 2008  
disease in general, 2007  
erysipelas, 2008  
*Escherichia coli*, 2008  
*Fasciola hepatica*, 2008  
foot-and-mouth disease, 2009  
hepatitis E, 2009  
*Leptospira* spp., 2009  
lymphadenitis, 2009  
*Mycobacterium bovis*, 2009  
*Mycoplasma hyopneumoniae*, 2009  
parasites, 2009  
porcine circovirus type 2, 2009  
porcine circovirus-associated disease, 2119  
porcine parvovirus, 2010  
porcine reproductive and respiratory syndrome, 2010  
porcine sapelovirus, 2010  
risk factors, 2007  
*Salmonella* serotypes, 2010  
swine influenza, 2010  
toxoplasma, 2010  
*Trichinella*, 2010
- Wild rabbit (*Oryctolagus cuniculus*), Johne's disease, 553
- Wild ruminants  
bluetongue, 2072  
bovine coronavirus (BCoV), 599  
epizootic hemorrhagic disease and, 783  
morbidity and case fatality and, 783
- Wildlife  
borreliosis in, 1426  
bovine herpesvirus-1 infection in, 952  
*Brucella* vaccines, 1772  
controlling contact by, 39  
enterohemorrhagic *Escherichia coli* in, 537  
Johne's disease, 552–553  
ovine progressive pneumonia in, 974  
as source of infection, 1119–1120
- Wildlife babesiosis, 797, 802–803
- Wilting, bloat control, 479
- Wind chill factors, 48
- Wind farms, 106–107
- Wind up, 80
- Windsucking, 1224
- Winter dysentery, of cattle, 599–601, 599b  
case-fatality rates, 599–600  
clinical findings, 600–601  
clinical pathology, 601  
control, 601  
differential diagnosis, 601b  
epidemiology, 599–600  
etiology, 599  
experimental reproduction, 600  
morbidity, 599–600  
necropsy findings, 601  
occurrence, 599  
pathogenesis, 600  
prevalence, 599  
risk factors, 600  
transmission, 600  
treatment, 601  
vaccination, 601  
virus, detection of, 601
- Winter hypomagnesemia, 1700
- Withdrawal  
periods, in antimicrobials, 153, 167–168  
reflex, absence of, 1164
- Withers, pinching of, 452
- Wobbler. see Equine cervical vertebral stenotic myelopathy
- Wohlfahrtia magnifica*, 1617–1618
- Wohlfahrtiosis, 1617–1618
- Wood preservatives, 2193–2194
- Wooden tongue. see Actinobacillosis (wooden tongue)
- Wool  
abnormalities of, 1543, 1552–1553  
caseous lymphadenitis effect, 766  
eating, 1563  
loss, 1563  
shedding of, fasciolosis and, 643
- Wool slip, 1563
- “Woolsorter's disease”, 2011
- World Organization for Animal Health (OIE), in contagious bovine pleuropneumonia, 932
- Worm nodule disease, 1609–1610
- “Wormkill” program, 613
- Wright's stain, 189

---

**X**

- Xanthium* spp., 1197
- Xanthosis, myopathy and, 1378
- Xerophthalmia, in vitamin A deficiency, 1323
- Xylazine, 1176  
for gastrointestinal motility, 191  
for pain, 83
- Xylose absorption test, 186

## Y

Yaks, 2060  
 Yawning, 11  
 Yellow lamb disease, 545–546  
 Yellow respiratory secretions, in pneumonia, 887  
 Yellow-wood tree (*Terminalia oblongata* spp.), 2207  
*Yersinia enterocolitica*, 337, 1766  
   occurrence, 2026  
   zoonotic implications, 2026  
*Yersinia pseudotuberculosis*  
   occurrence, 2025–2026  
   zoonotic implications, 2026  
 Yersiniosis, 2025–2027  
   clinical findings, 2026–2027  
   clinical pathology, 2027  
   epidemiology, 2025–2026  
   etiology, 2025–2027  
   necropsy findings, 2027  
     samples for confirmation of diagnosis, 2027, 2027b  
   occurrence, 2025–2026  
   pathogenesis, 2026  
   in pigs, 337  
   treatment and control, 2027  
   zoonotic implications, 2026  
 Yew (*Taxus* spp.) toxicosis, 699–700, 699b  
   differential diagnosis of, 700b  
 Young adult congestive heart failure, 707

## Z

*Zamia*, poisoning, 1193  
 Zearalenone toxicosis, 1824–1825, 1824b–1825b  
 Zebra, African horse sickness, transmission of infection, 2093  
 “Zebra stripes,” peste des petits ruminants, 575–576  
 Ziehl-Neelsen stained smears of feces, *Mycobacterium avium* subspecies paratuberculosis (MAP), 569  
 Zigadenine, 2212  
 Zigadine, 2212  
 Zinc, for sporidesmin poisoning, 654  
 Zinc deficiency, 1634–1637, 1634b  
   clinical findings of, 1635–1636  
   clinical pathology of, 1636  
   control of, 1637  
   differential diagnosis of, 1636b  
   etiology of, 1634–1635  
   in goats, 1636  
   infertility in ewes and, 1636  
   necropsy findings in, 1636  
   pathogenesis of, 1635  
   in pigs, 1634  
   in ruminants, 1634–1635  
   in sheep, 1636  
   treatment of, 1636–1637  
 Zinc oxide, coliform gastroenteritis, 318

Zinc sulfate solution, for infectious footrot in sheep, 1446  
 Zinc sulfate turbidity test, for assessment of transfer of passive immunity, 1853  
 Zinc toxicosis, 2194–2196, 2194b  
   clinical findings, 2195  
   clinical pathology, 2195  
   control, 2195  
   differential diagnosis, 2195b  
   epidemiology, 2194–2195  
   etiology, 2194  
   necropsy findings, 2195  
   occurrence, 2194  
   pathogenesis, 2195  
   risk factors, 2194  
   samples for confirmation of diagnosis, 2195  
   tissue assay, 2195  
   transmission, 2194–2195  
   treatment, 2195  
*Zona pellucida*, bovine virus diarrhea virus, 583  
 Zoo animals, bovine tuberculosis in, 2017  
 Zoo felids, 1295–1296  
 Zoonotic implications, borreliosis and, 1426

# How to Use This Book

We would like you to get the most out of this book. To do that, you should follow the directions provided in this section. And if you keep doing this every time you use the book, you will develop a proper diagnostic routine of going from:

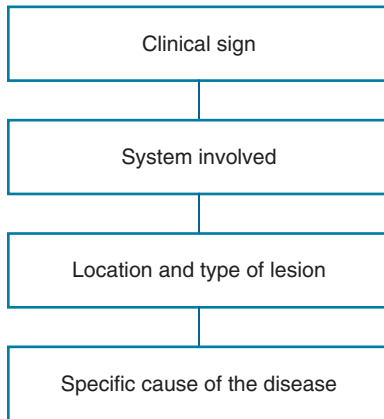

... and become what we wish for every one of you: a thinking clinician.

## FOR EXAMPLE

A yearling bull has a sudden onset of dyspnea, fever, anorexia, abnormal lung sounds, and nasal discharge.

**Step 1** The bull's problem is dyspnea. Go to the index and find the principal entry for dyspnea.

**Step 2** The discussion on dyspnea will lead you to respiratory tract dyspnea and cardiac dyspnea.

**Step 3** Via the index, consult these and decide that the system involved is the respiratory system and that the lungs are the location of the lesion in the system.

**Step 4** Proceed to diseases of the lungs and decide on the basis of the clinical and other findings that the nature of the lesion is inflammatory and is pneumonia.

**Step 5** Proceed to pneumonia, and consult the list of pneumonias that occur in cattle. Consult each of them via the index and decide that pneumonic pasteurellosis is the probable specific cause.

**Step 6** Proceed to the section on pneumonic pasteurellosis and determine the appropriate treatment for the bull and the chances of saving it.

**Step 7** Don't forget to turn to the end of the section on pneumonic pasteurellosis and remind yourself of what to do to protect the rest of the herd from sharing the illness.

## Guidelines for Selection and Submission of Necropsy Specimens for Confirmation of Diagnosis

In this edition we continue with the subheading *Samples for Confirmation of Diagnosis* to serve as a rough guideline for the collection of samples at necropsy. Several points must be emphasized with regard

to this section. First and foremost, **collection of these samples is not advocated as a substitute for a thorough necropsy examination.** Furthermore, the samples listed are selected to confirm the diagnosis, but a conscientious diagnostician should also collect samples that can be used to rule out other disease processes. Even the best of practitioners can make an incorrect tentative diagnosis, but it is an even more humbling experience if there are no samples available to pursue alternate diagnoses. Also, recall that some diseases may be the result of several different etiologic factors (e.g., neonatal diarrhea of calves), and the veterinarian who samples to confirm one of these factors but does not attempt to investigate others has not provided a good service to the client.

A huge variety of veterinary diagnostic tests have been developed, but each veterinary diagnostic laboratory (VDL) offers only a selected panel, chosen after consideration of a number of factors. Such factors may include cost, demand, reliability, sensitivity and specificity, and the availability of appropriate technology at the lab. The array of diagnostic tests is constantly improving, and it is beyond the scope of this text to list all the tests available for a given disease or to recommend one test method to the exclusion of others. Under the *Samples for Confirmation of Diagnosis* sections, we have merely listed some of the more common tests offered. Advances in molecular biology are providing exciting avenues for disease diagnosis, but many of these tests have limited availability in VDLs at present. For optimal efficiency in the confirmation of a diagnosis at necropsy, the practitioner must contact the VDL to determine what tests are offered and to obtain the preferred protocol for sample collection and submission to that particular laboratory. Most VDLs publish user guidelines, which include the tests available and the samples required. The guidelines listed here are broad, and individual VDLs may have very specific requirements for sample handling.

Several general statements can be made with regard to the submission of samples to VDLs:

- The samples should be accompanied by a clearly written and concise clinical history, including the signalment of the animal and feeding and management information. Failure to provide this information deprives the owner of the full value of the expertise available from the laboratory staff.
- If a potentially zoonotic disease is suspected, this should be clearly indicated in a prominent location on the submission form.
- All specimens should be placed in an appropriate sealed, leak-proof container and clearly labeled with a waterproof marker to indicate the tissue/fluid collected, the animal sampled, and the owner's name. At some VDLs, pooling of tissues within a single bag or container is permitted for specific tests (such as virus isolation), but in general, all fresh samples should be placed in separate containers. When packaging samples for shipment, recognize that condensation from ice packs and frozen tissues will damage any loose paper within the package; the submission sheet should be placed within a plastic bag for protection or taped to the outside of the shipping container.
- Samples for histopathology can be pooled within the same container of 10% neutral-buffered formalin. An optimal tissue sample of a gross lesion should include the interface between normal and abnormal tissue. For proper fixation, tissue fragments should not be more than 0.5 cm in width, and the ratio of tissue to formalin solution should be 1:10. If necessary, large tissues such as brain can be fixed in a larger container and then transferred to a smaller one containing only a minimal quantity of formalin for shipping to the laboratory. To speed fixation and avoid artifactual changes, formalin containers should not be in direct contact with frozen materials during shipment.



- In the *Samples for Confirmation of Diagnosis* sections, the tests are listed under various discipline categories (bacteriology, virology, etc.). The appropriate sample(s) is noted, followed by the types of test that might be applied to these samples. The following is a list of these different tests, including any abbreviation used in this section of the text. A brief discussion of how the samples collected for each test should be handled is also provided. Again, it must be emphasized that this is by no means a complete listing of diagnostic tests available, and different VDLs often have differing sample handling procedures.
  - **Aerobic culture** = (CULT). These samples should generally be kept chilled during shipment. If a transit time of greater than 24 hours is anticipated the samples should be frozen, then packaged appropriately so that they are still frozen upon arrival at the VDL. Various bacterial species cannot be recovered using routine culture techniques, and most of these are highlighted in the text by the phrase “special culture requirements.”
  - **Agar gel immunodiffusion** = (AGID). A type of serologic test. Chilled or frozen serum may be submitted.
  - **Anaerobic culture** = (ANAEROBIC CULT). Confirmation of the diagnosis requires that any swabs be transported in special transport media and that the VDL attempts to grow bacteria from the samples under anaerobic culture conditions. Transport requirements are as for (CULT) (aerobic culture) specimens.
  - **Analytical assay** = (ASSAY). This refers to a broad range of tests in which a substance is quantitatively measured. The substance to be assayed is listed in brackets, e.g. (ASSAY [Ca]) denotes a test for calcium levels. The method used to perform the assay is not listed, but in general, frozen samples may be submitted for most of these analytical assays.
  - **Bioassay** = (BIOASSAY). This typically refers to tests in which the sample material is administered to an animal under experimental conditions. Preserved material is inappropriate, and some bioassays cannot be performed using samples that have been frozen. The VDL performing the test should be contacted for instructions prior to sample collection
  - **Complement fixation** = (CF). A serologic test. Ship chilled or frozen serum.
  - **Cytology** = (CYTO). Air-dried impression smears are usually adequate. Keep dry during transport.
  - **Direct smear** = (SMEAR). The type of test is usually given in brackets (e.g., [Gram]). Air-dried smears are usually adequate but must be kept dry during shipment.
  - **Enzyme-linked immunosorbent assay** = (ELISA). Chilled or frozen samples are usually acceptable. There are many variants of ELISA (e.g., antigen-capture, kinetic, indirect, direct, etc.), and the specific type used is not specified in this portion of the text.
  - **Electron microscopic examination** = (EM). Appropriate sample collection and handling varies with the specimen being examined. Most of the diagnostic specimens submitted to VDLs for EM are fecal samples, and these do not require any special preservative.
- **Fecal floatation** = (FECAL). Sample can be fresh, chilled, or frozen.
- **Fluorescent antibody test** = (FAT). This may refer to either a direct or indirect method of antigen detection. Generally, cryostat sections are utilized, and therefore the tissue received by the laboratory should still be frozen upon arrival to provide the best results. Freeze/thaw cycles should be avoided. If impression smears are being shipped, they should be kept dry.
- **Fungal culture** = (FCULT). Special media is required. Transport as per (CULT) specimens.
- **Immunohistochemical testing** = (IHC). Many of these tests can be performed on formalin-fixed material, but in some instances frozen tissues must be delivered to the laboratory. In such instances the test is listed under a heading distinct from histology (e.g., virology, bacteriology, etc.).
- **Indirect hemagglutination** = (IHA). A serologic test. Ship chilled or frozen serum.
- **In-situ hybridization** = (IN-SITU HYBRID). Samples should be shipped chilled, although some test methods can use formalin-fixed material. These tests utilize nucleic acid probes that bind with complementary nucleic acid sequences in the specimen. Although not widely used in routine diagnostics at present, these methods may gain more prominence as their use is refined,
- **Virus isolation** = (ISO). Samples should be kept chilled during shipment or maintained in a frozen state if prolonged transit times are anticipated,
- **Latex agglutination** = (LATEX AGGLUTINATION). Fresh, chilled, or frozen samples are acceptable.
- **Light microscopic examination** = (LM). Formalin-fixed tissues are preferred. The shipment of fresh tissues to the VDL permits more tissue autolysis prior to fixation, resulting in less useful specimens. If Bouin's fixative is available, it is the preferred preservative for eye globes.
- **Microagglutination test** = (MAT). A type of serologic test. Ship chilled or frozen serum.
- **Mycoplasma culture** = (MCULT). These types of organism have specific growth requirements that are usually not met by standard bacteriologic culture techniques. Transport as per (CULT) specimens. Culture swabs cannot be submitted in media containing charcoal or glycerol.
- **Polymerase chain reaction** = (PCR). Tissues should be frozen and maintained in that state until arrival at the VDL. Swabs and fluids submitted for PCR testing should be chilled but not frozen. These tests are capable of detecting minute quantities of nucleic acid, so if multiple animals are tested, the samples should be “clean” to avoid false positives through cross-contamination (i.e., blood/tissue from one animal contaminating the sample from another)
- **Serum urea nitrogen** = (SUN). A useful test to determine degree of renal compromise. Sample can be shipped chilled or frozen.
- **Virus neutralization** = (VN). A serologic test. Ship chilled or frozen serum.